

TL213 NRG TENDL-2015, AKONING

Principal cross sections

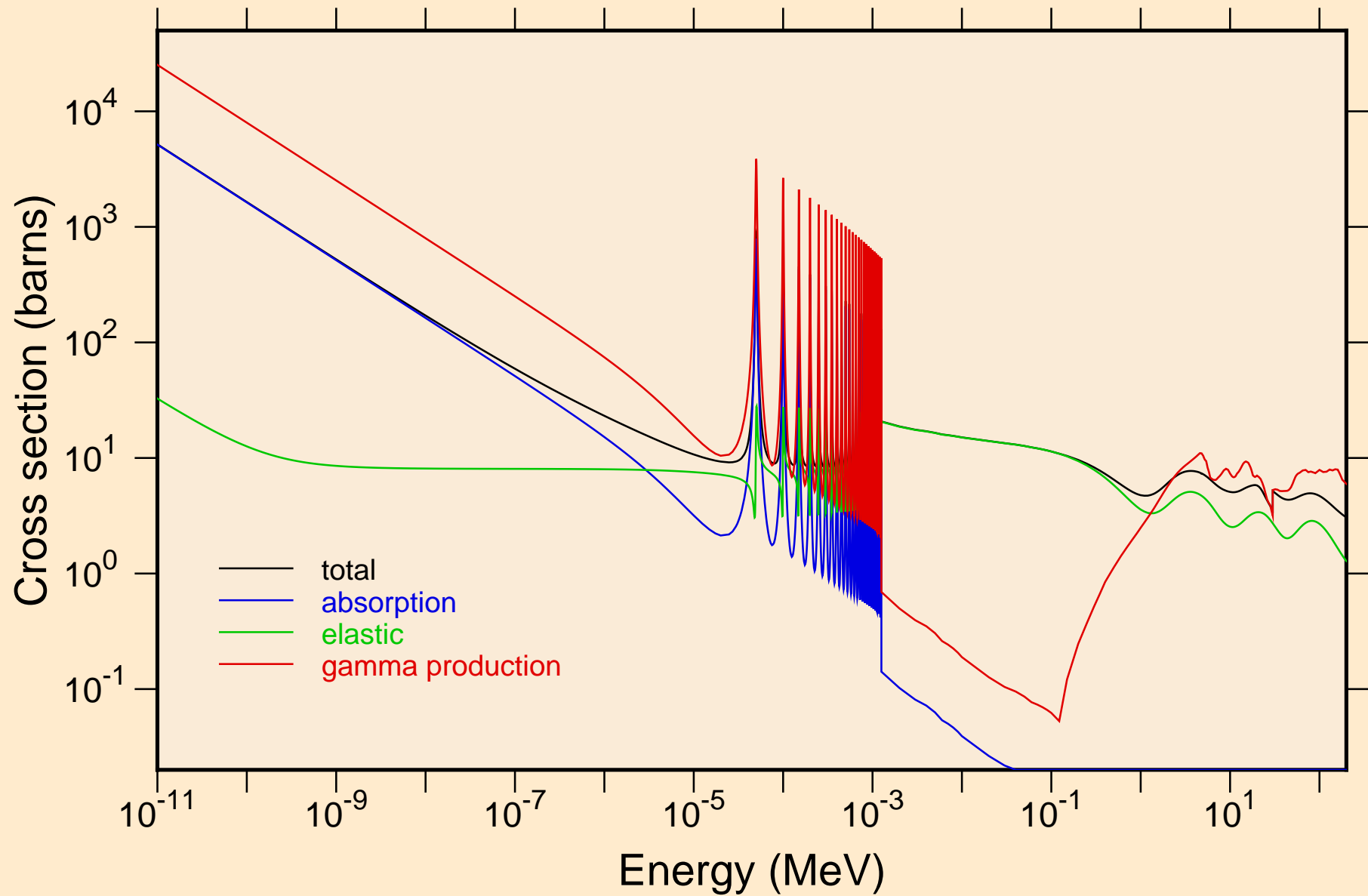

TL213 NRG TENDL-2015, AKONING
resonance total cross section

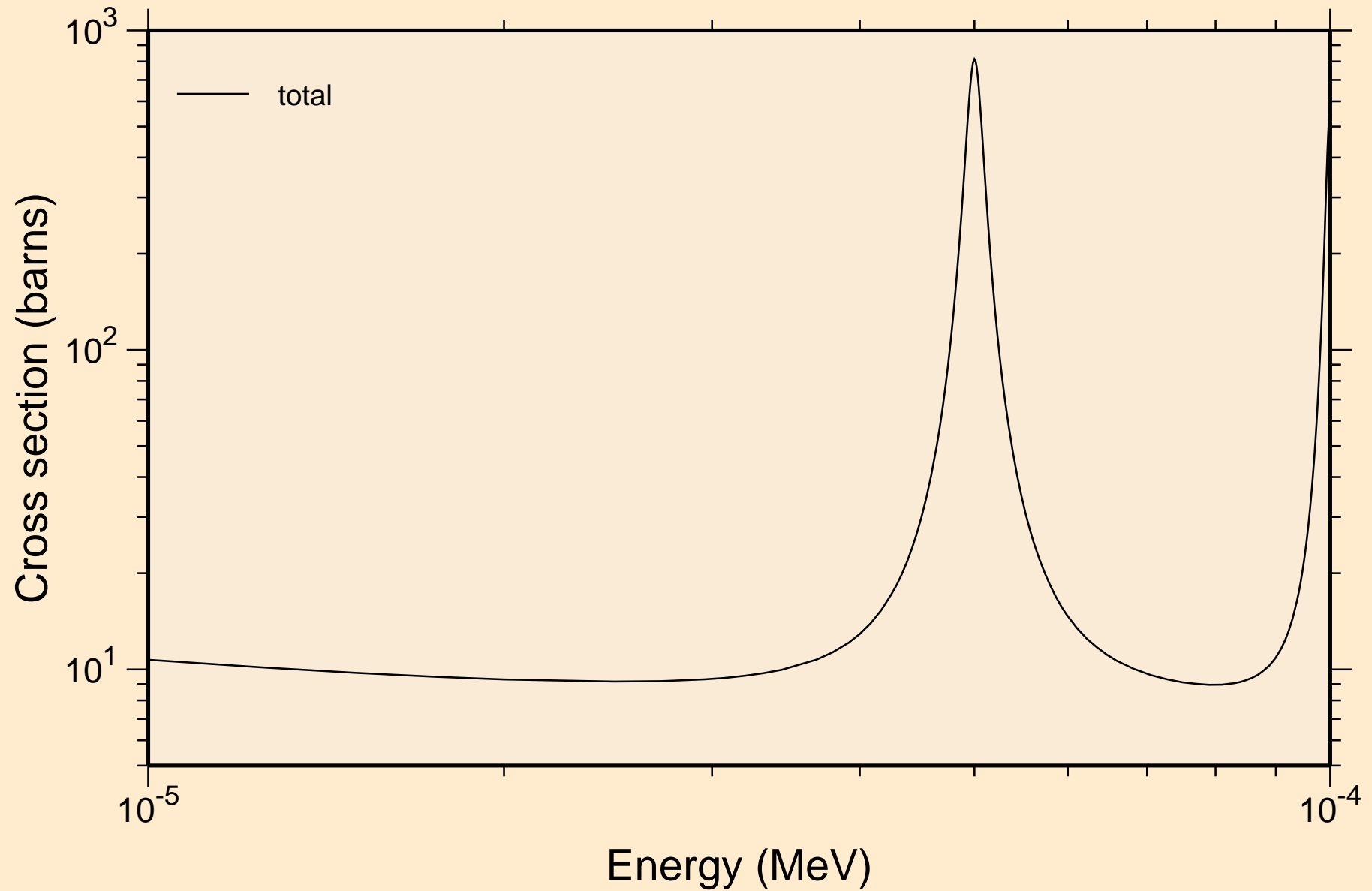

TL213 NRG TENDL-2015, AKONING
resonance total cross section

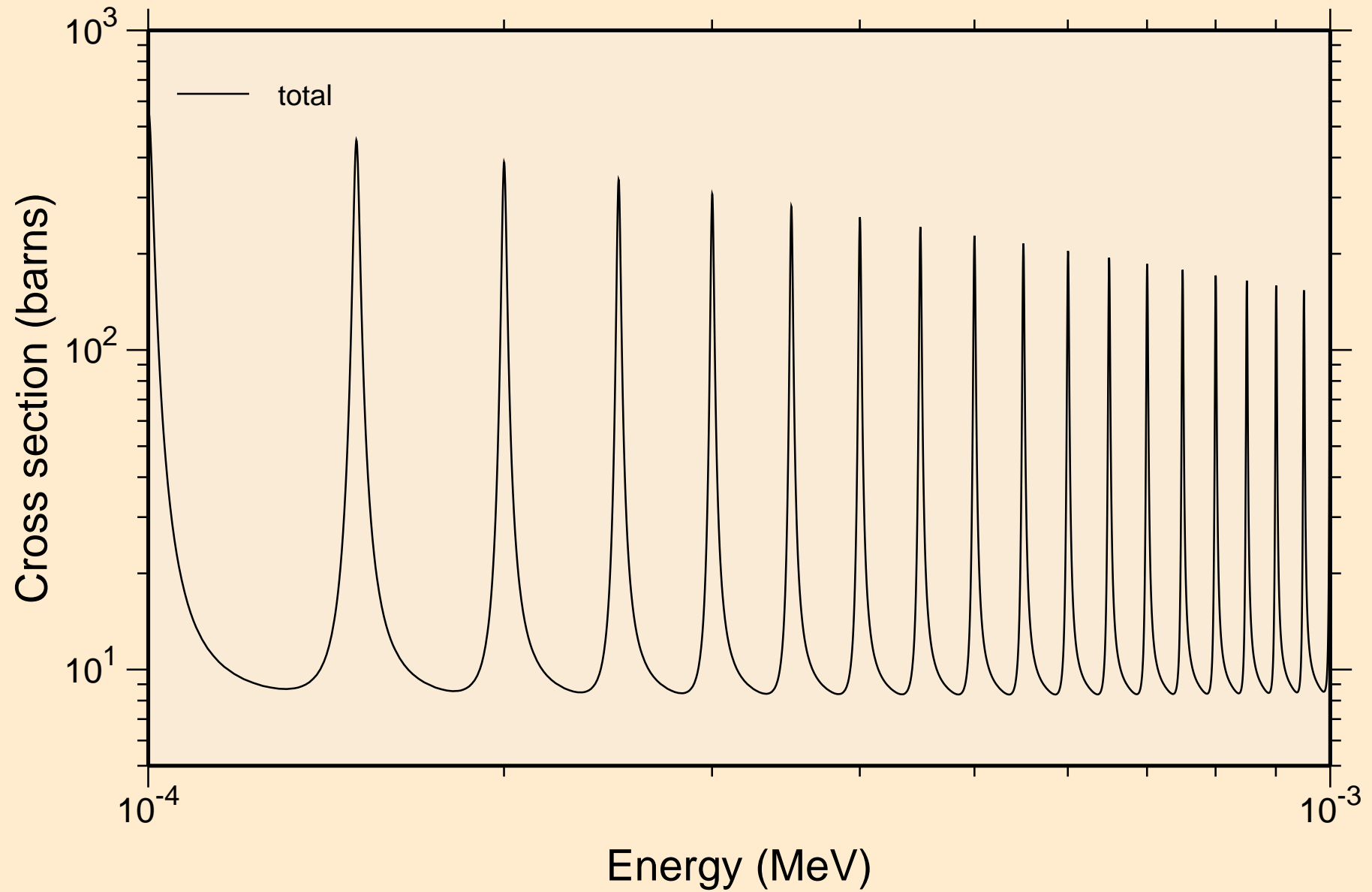

TL213 NRG TENDL-2015, AKONING
resonance total cross section

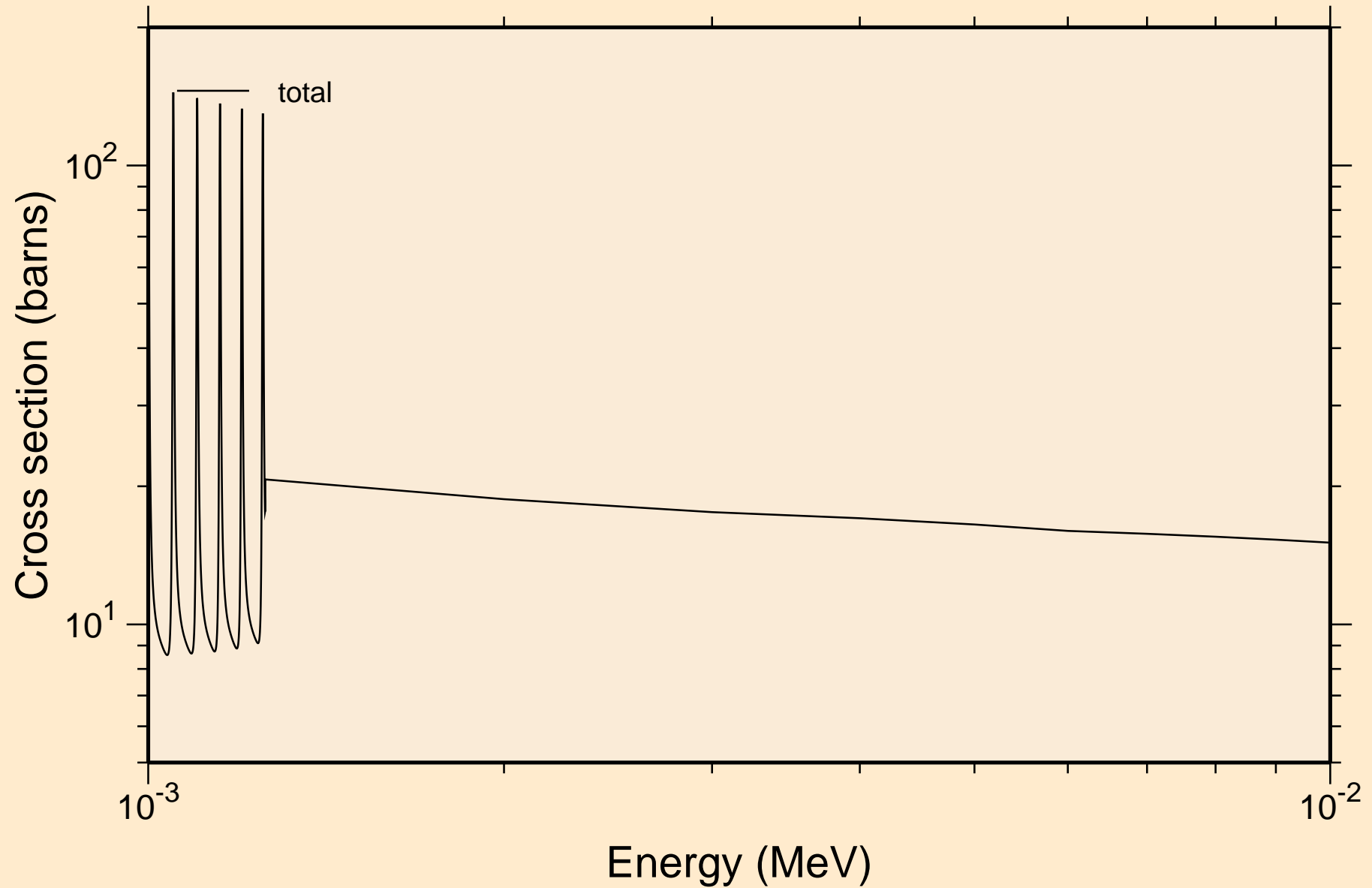

TL213 NRG TENDL-2015, AKONING
resonance total cross section

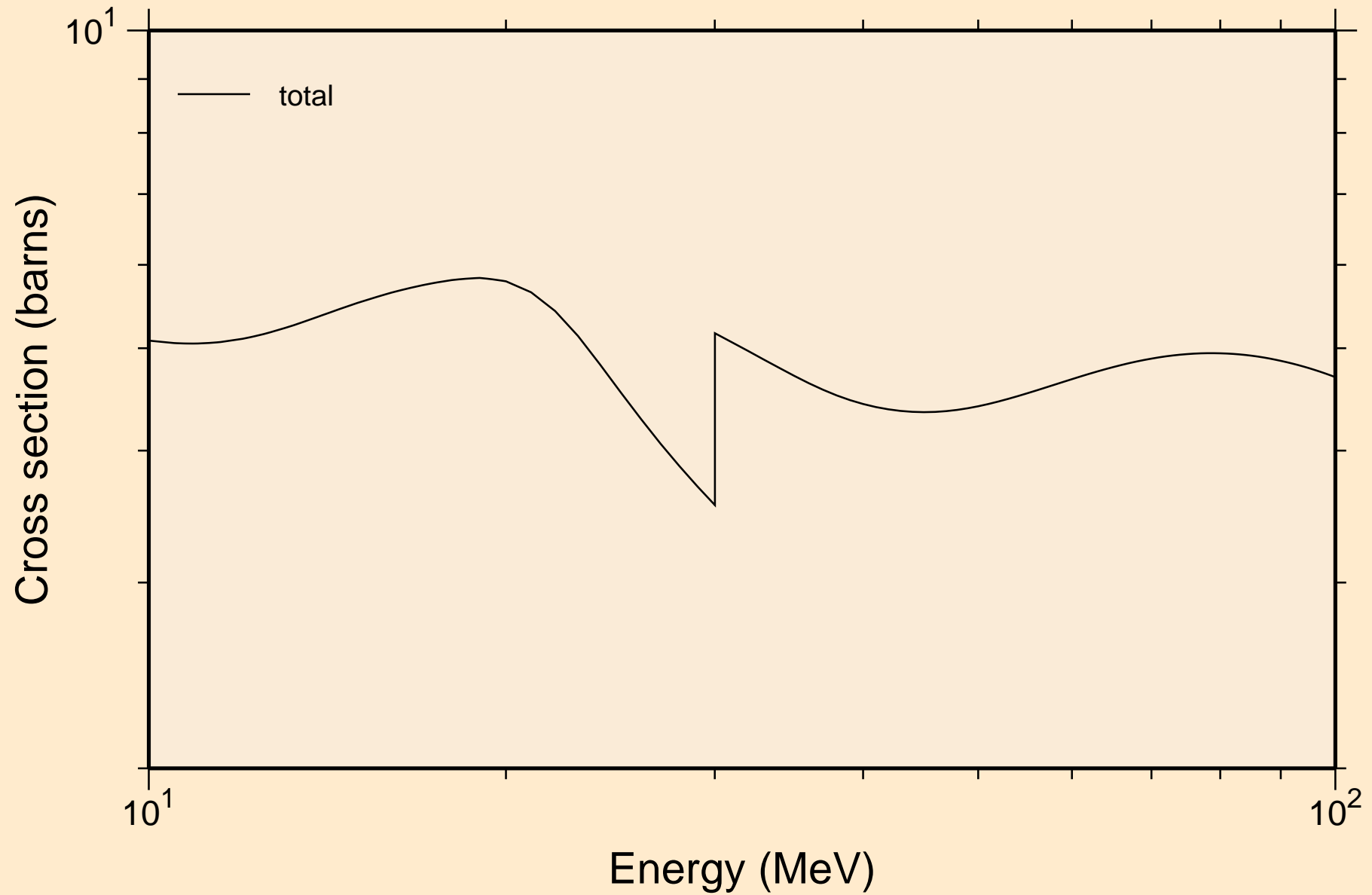

TL213 NRG TENDL-2015, AKONING
resonance absorption cross sections

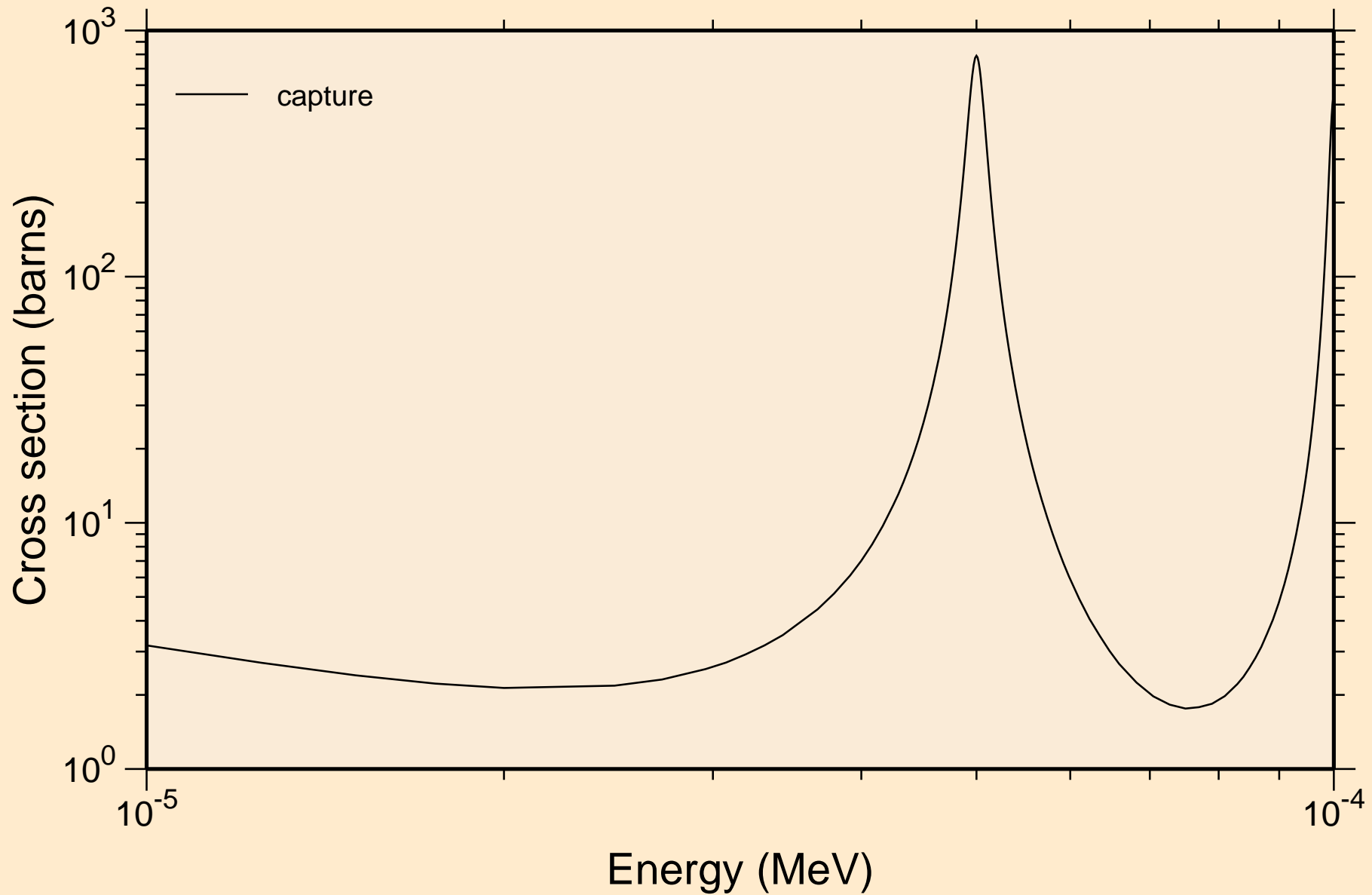

TL213 NRG TENDL-2015, AKONING resonance absorption cross sections

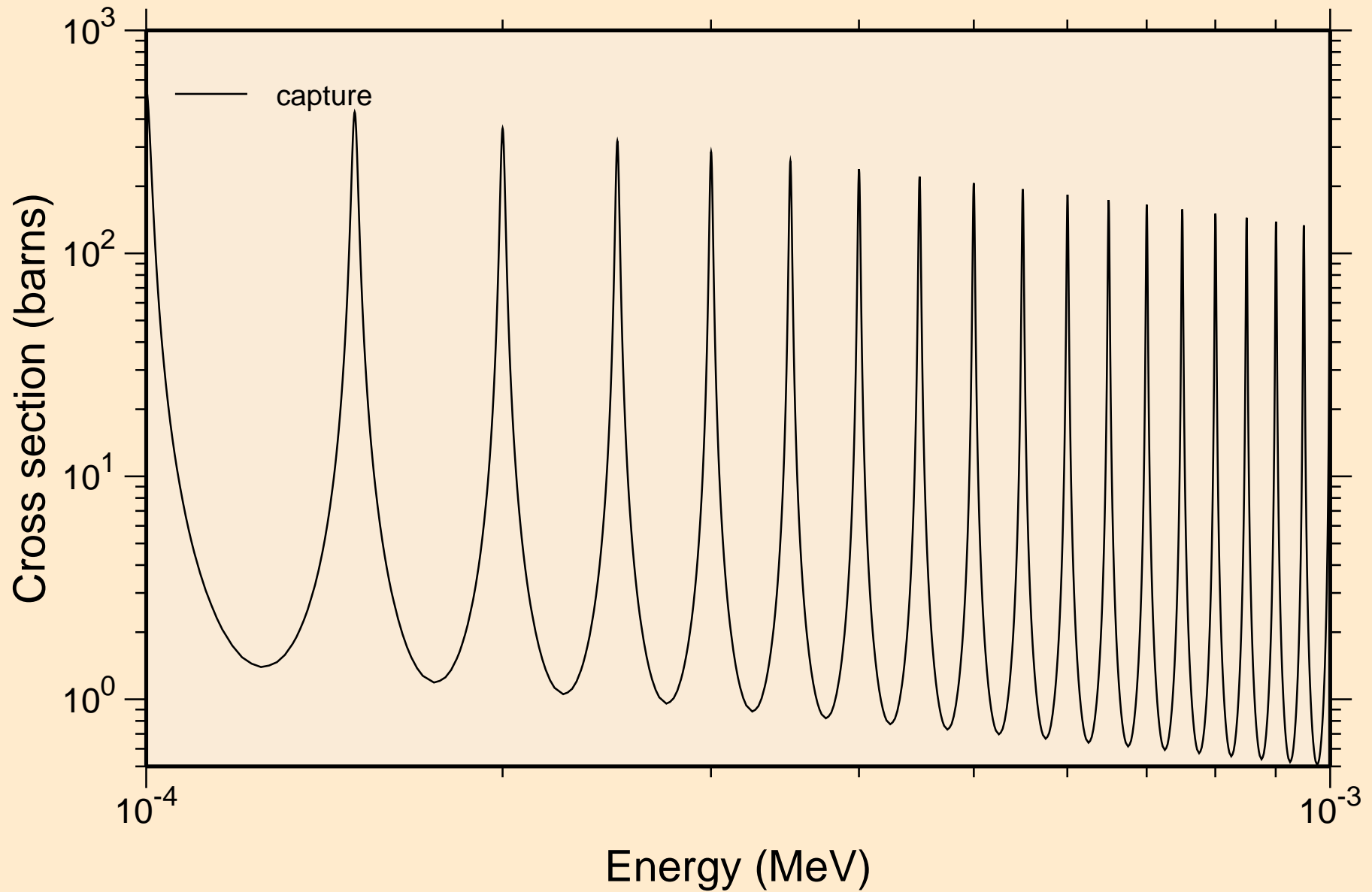

TL213 NRG TENDL-2015, AKONING
resonance absorption cross sections

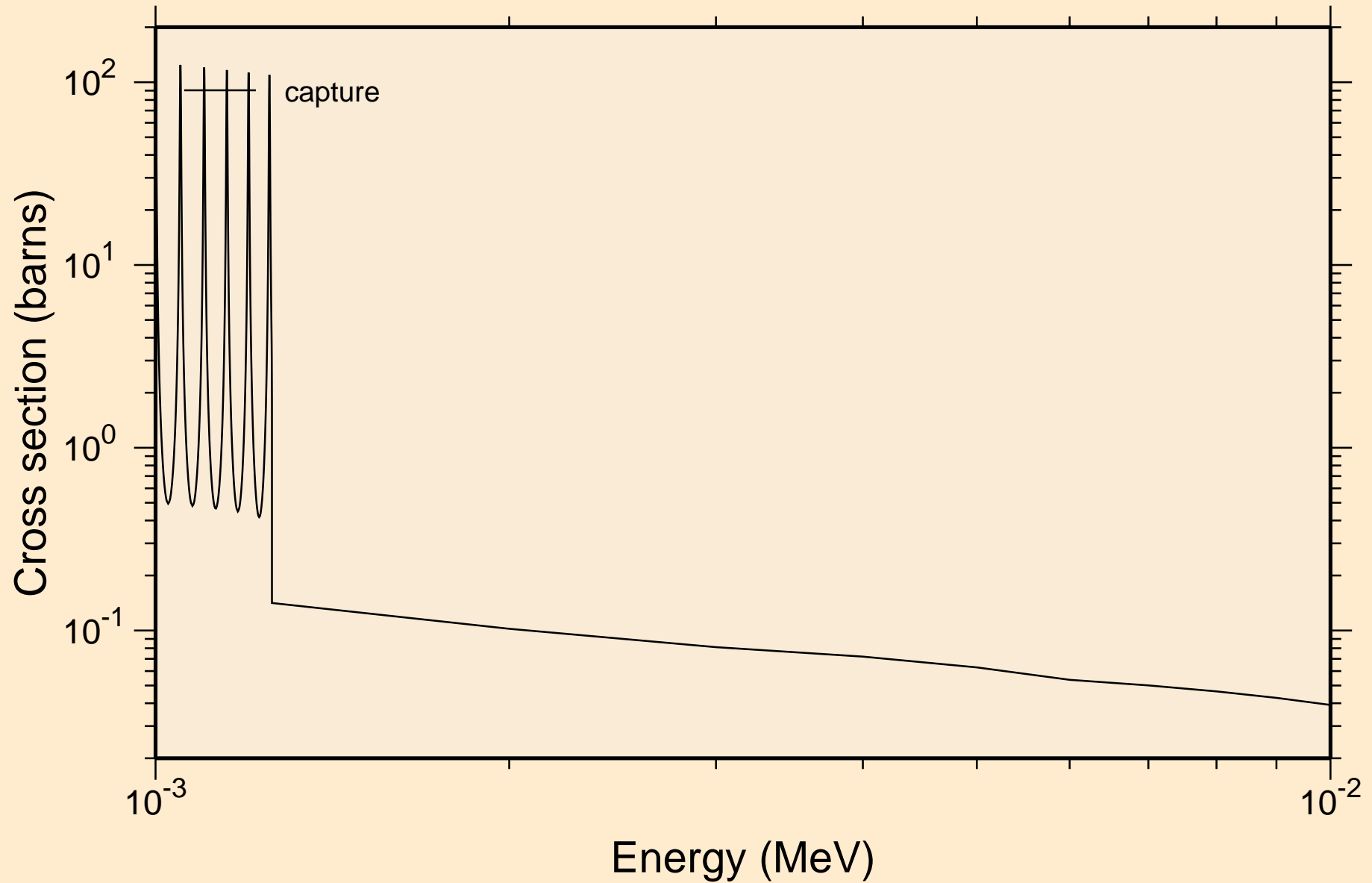

TL213 NRG TENDL-2015, AKONING
resonance absorption cross sections

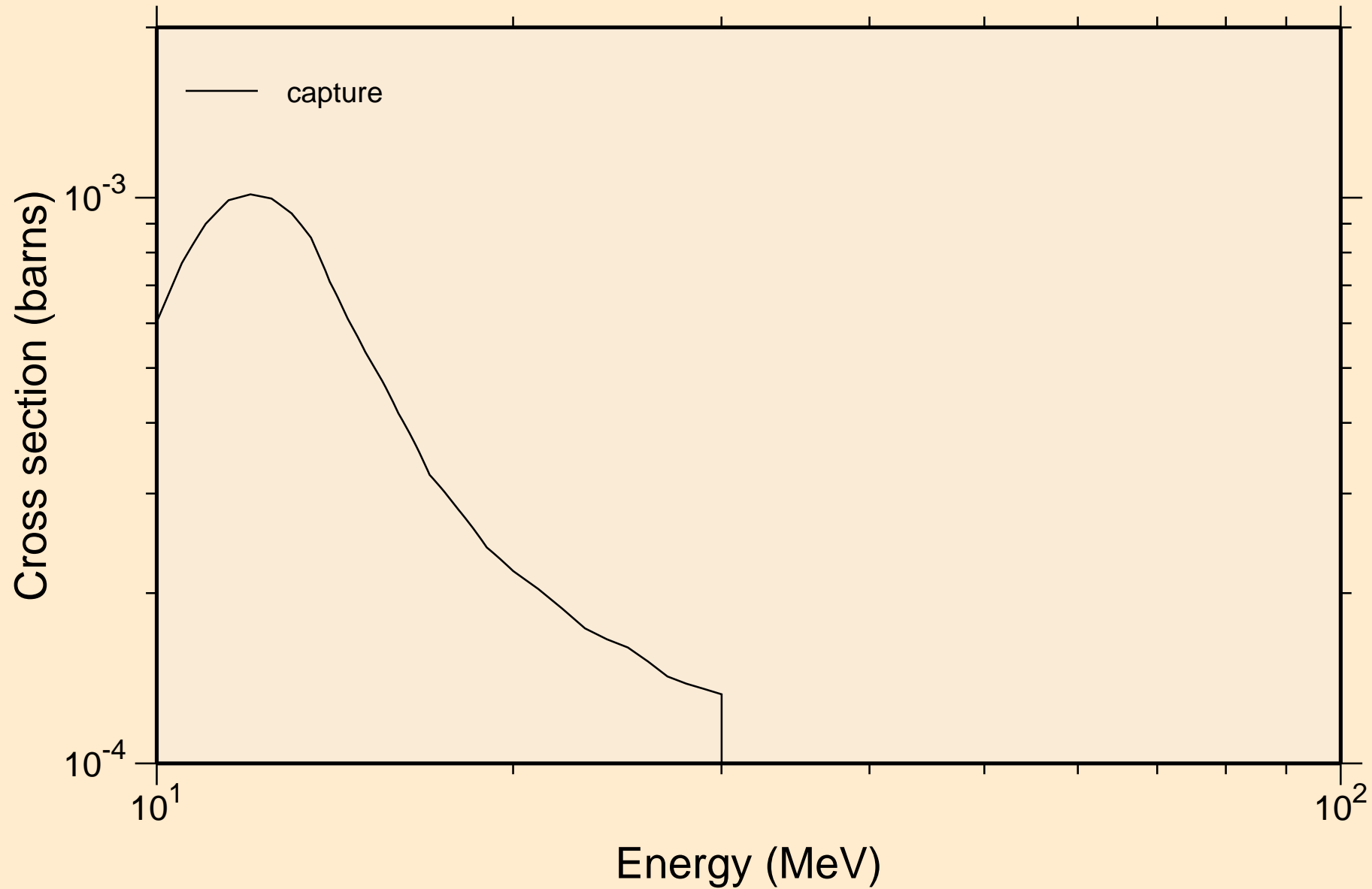

TL213 NRG TENDL-2015, AKONING
Non-threshold reactions

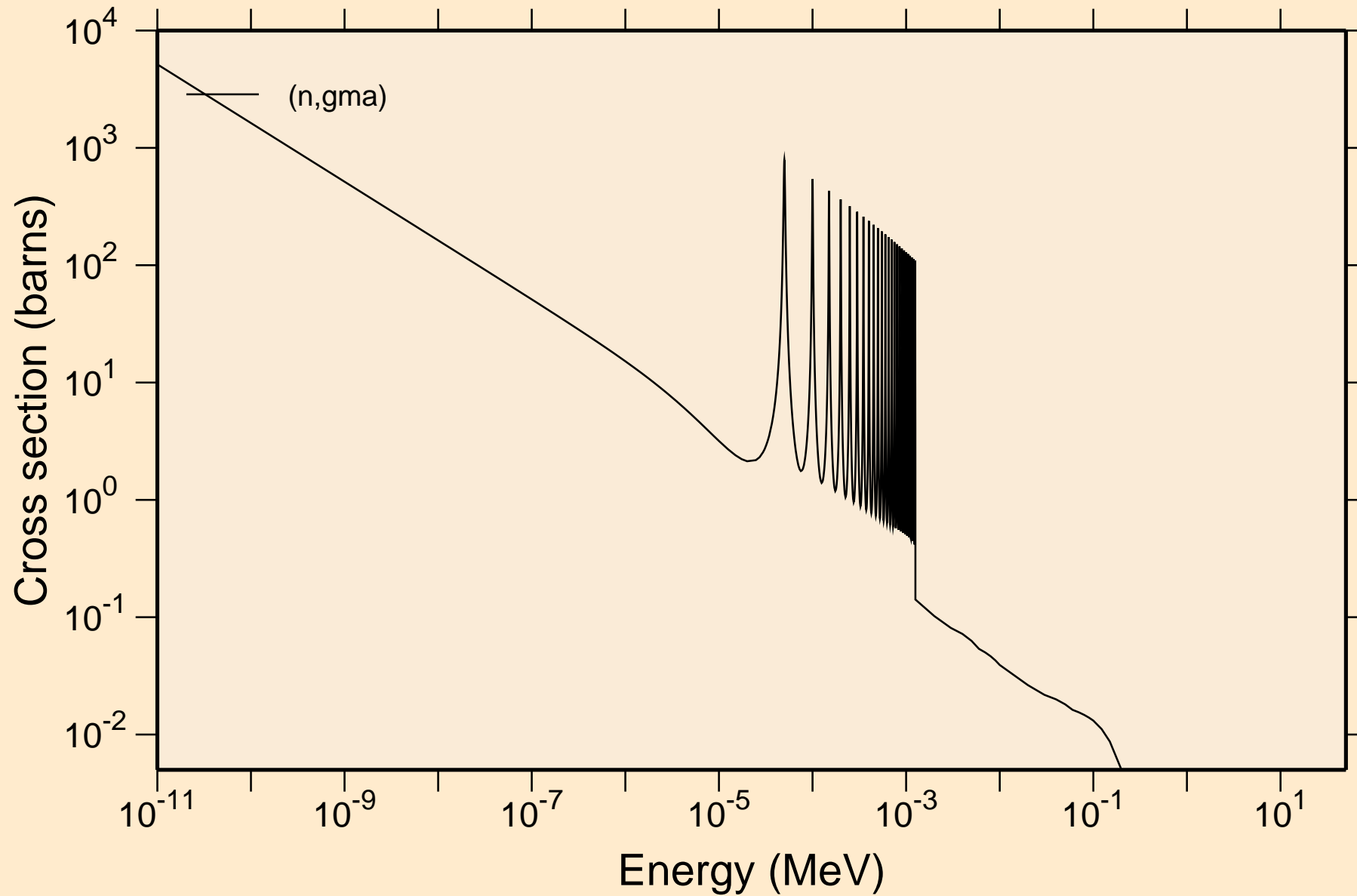

TL213 NRG TENDL-2015, AKONING

Principal cross sections

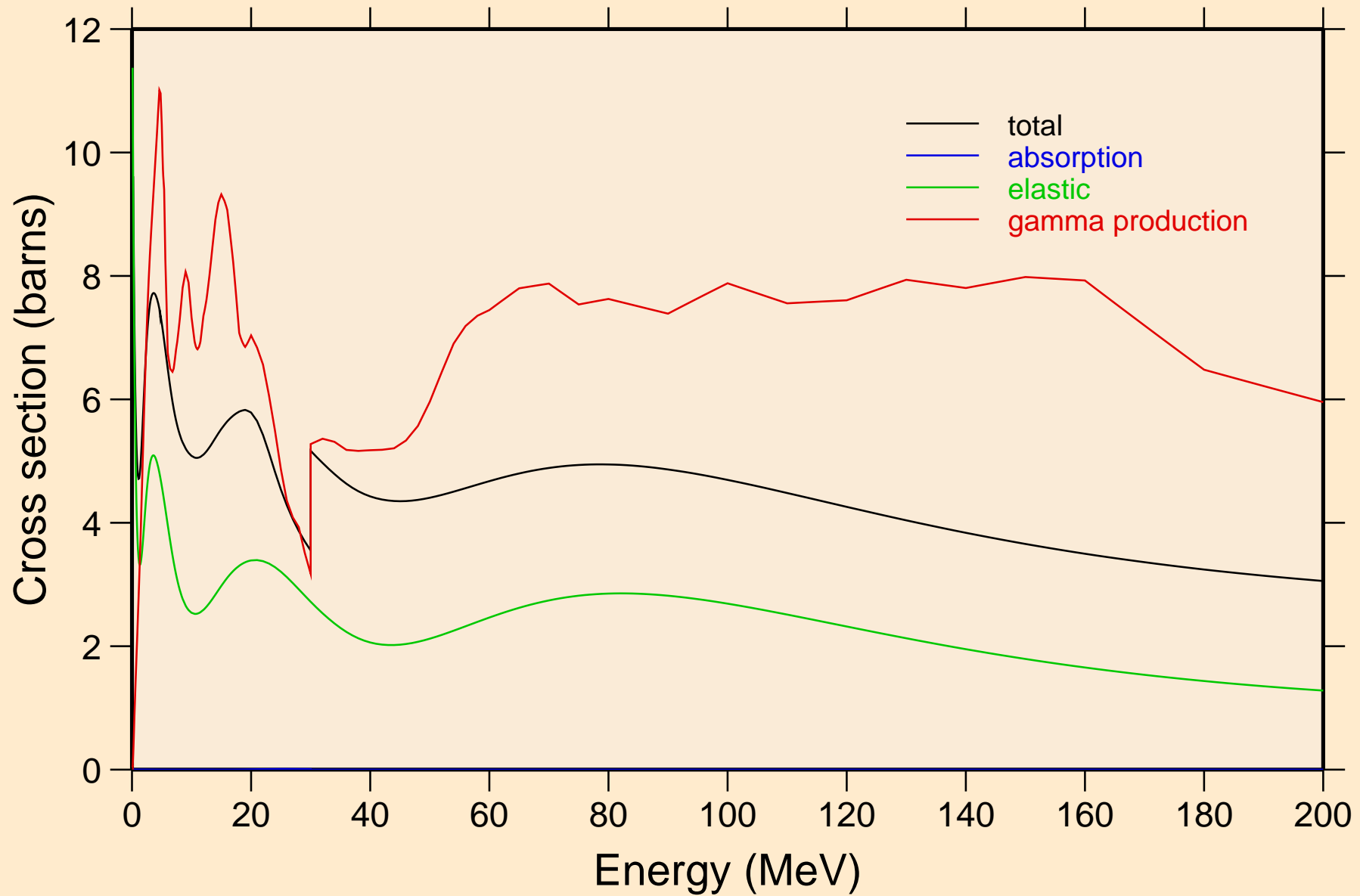

TL213 NRG TENDL-2015, AKONING
Non-threshold reactions

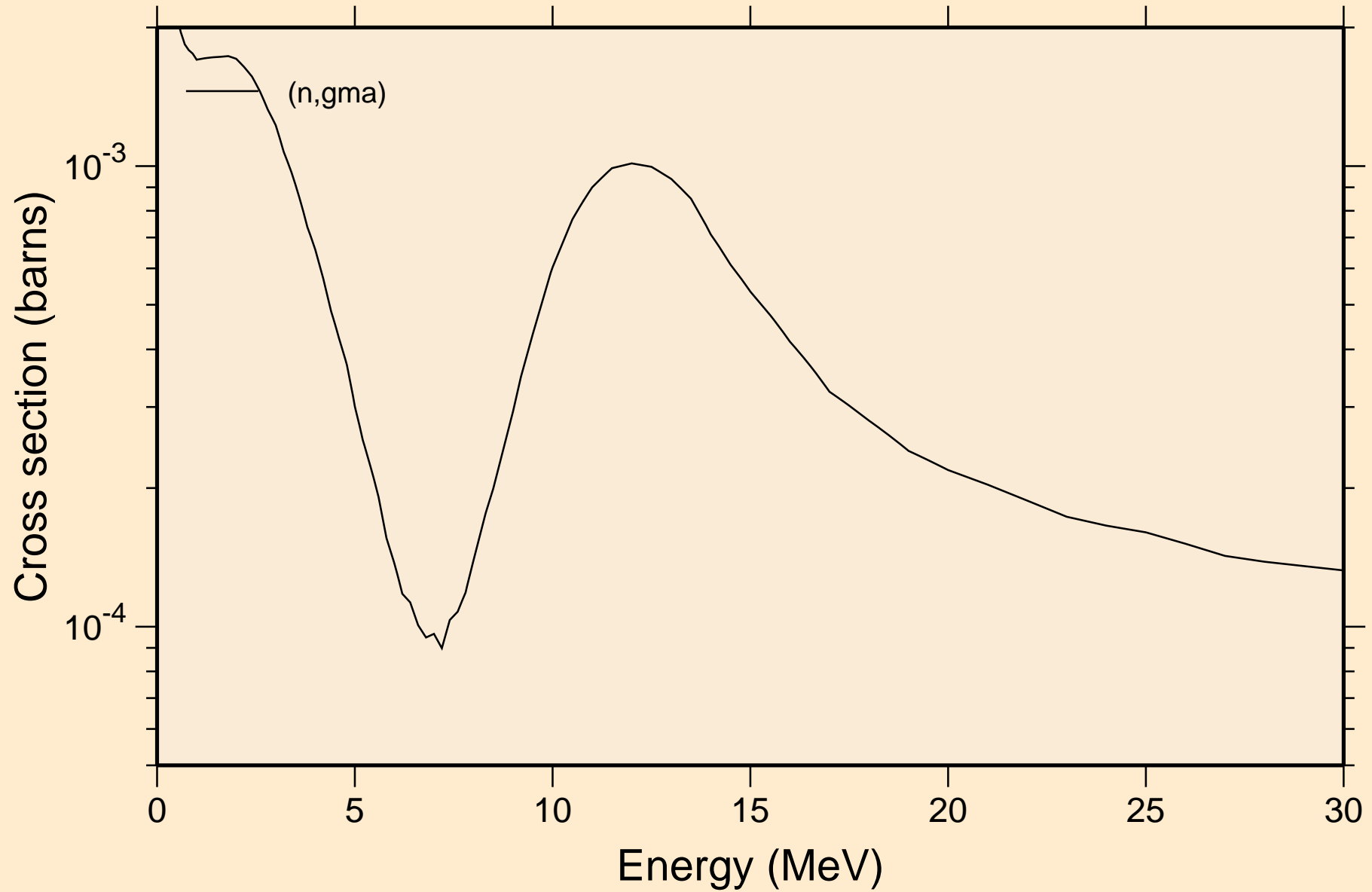

TL213 NRG TENDL-2015, AKONING
Inelastic levels

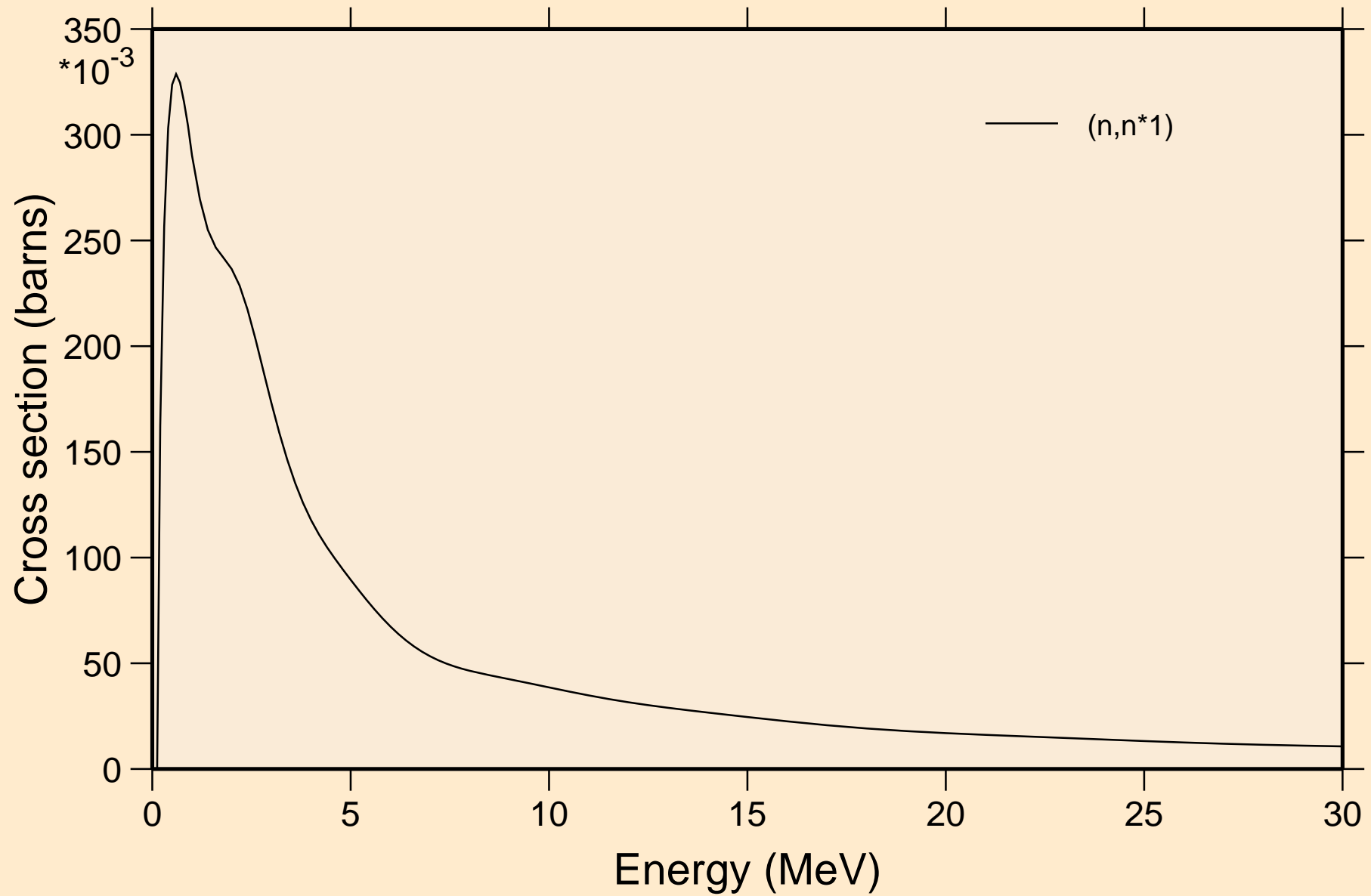

TL213 NRG TENDL-2015, AKONING

Threshold reactions

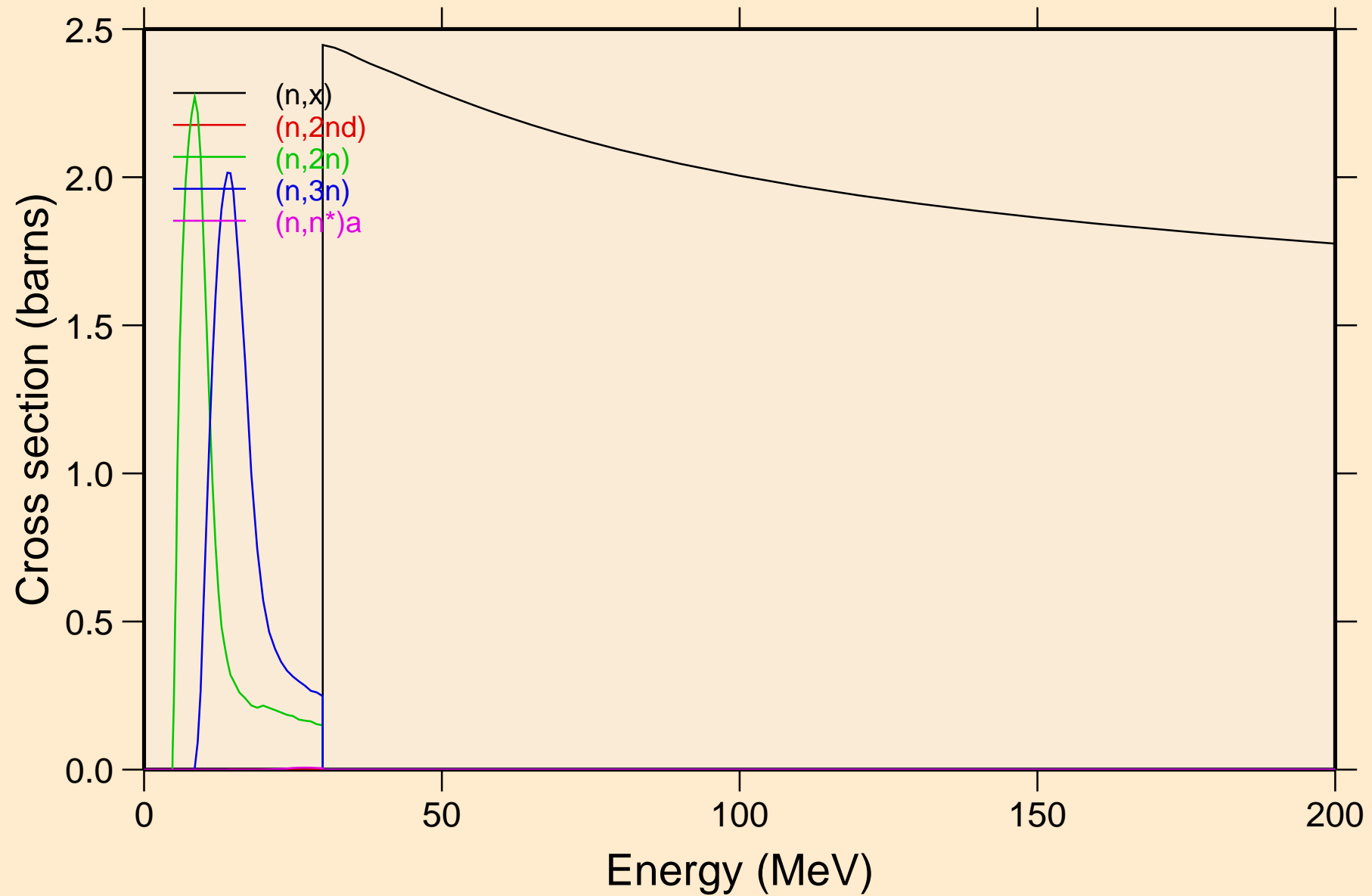

TL213 NRG TENDL-2015, AKONING

Threshold reactions

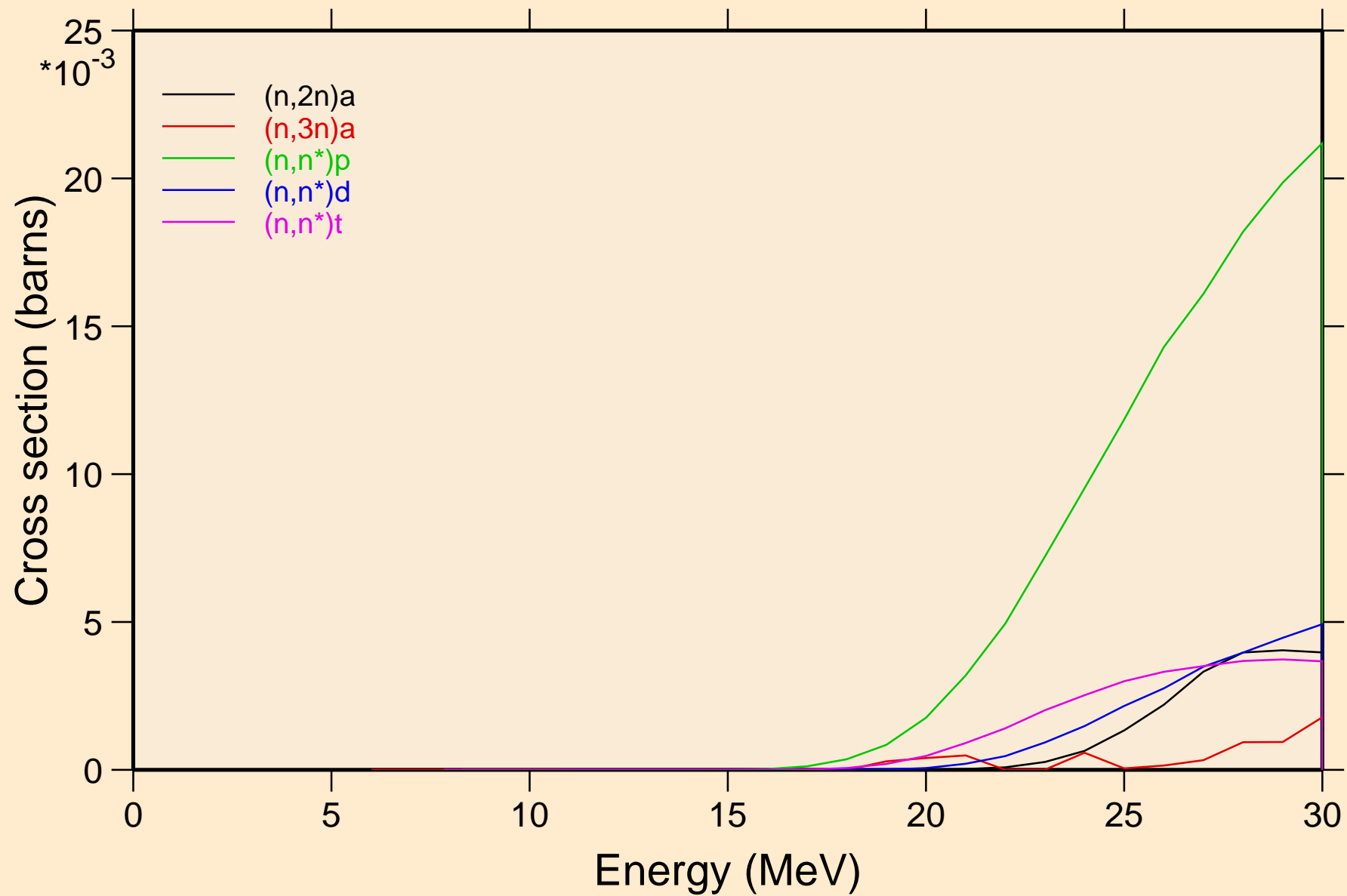

TL213 NRG TENDL-2015, AKONING

Threshold reactions

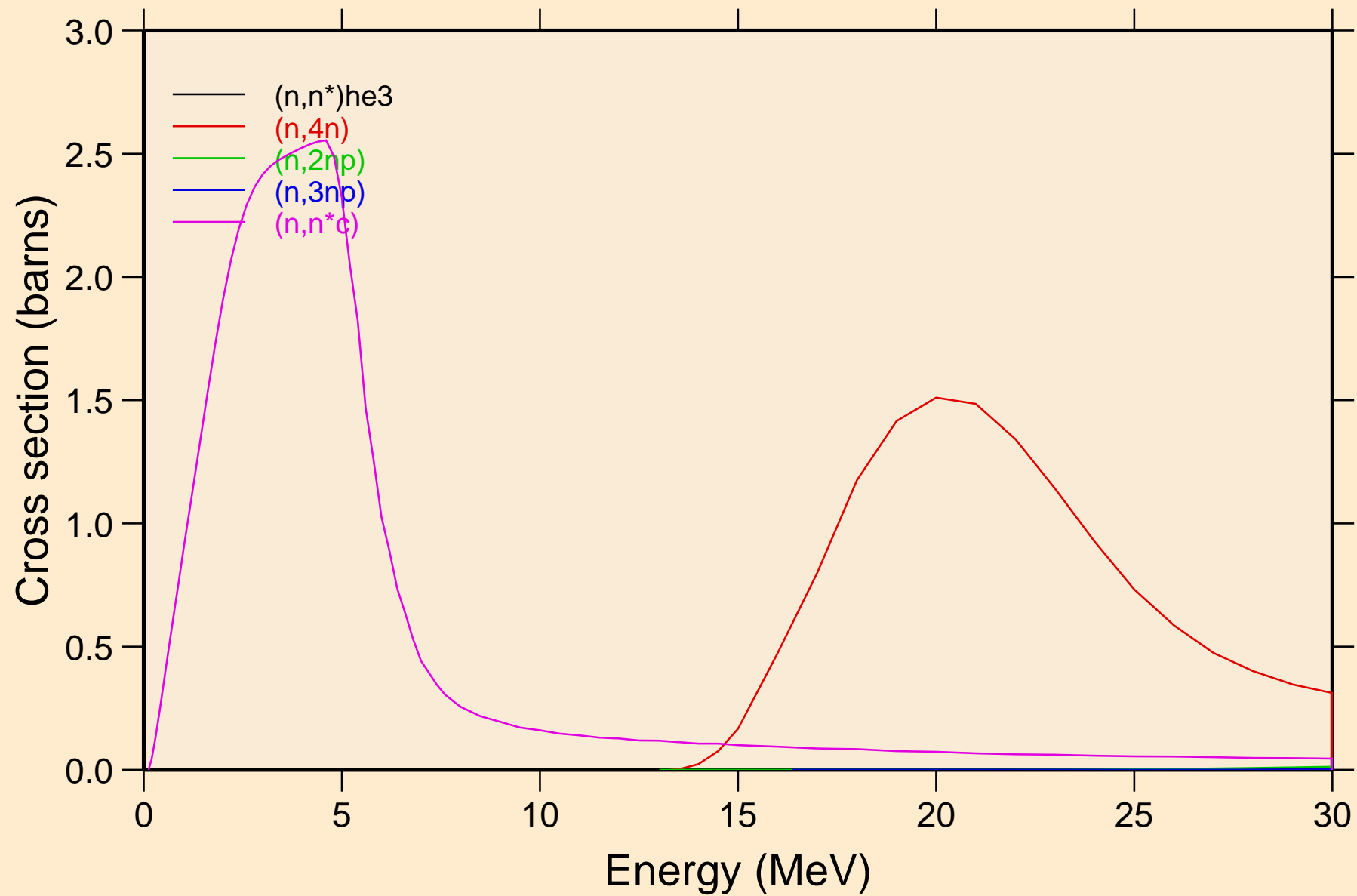

TL213 NRG TENDL-2015, AKONING

Threshold reactions

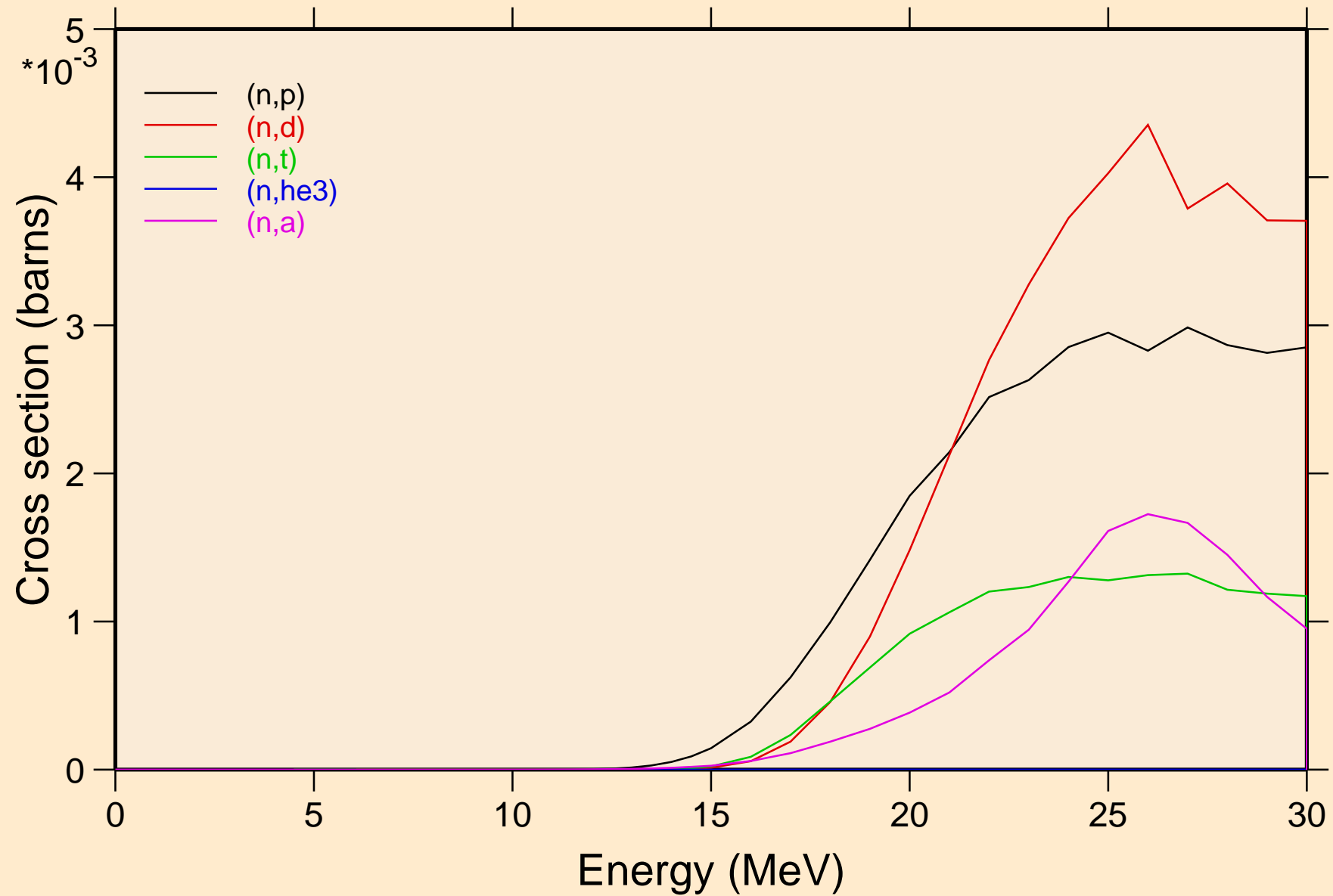

TL213 NRG TENDL-2015, AKONING
angular distribution for elastic

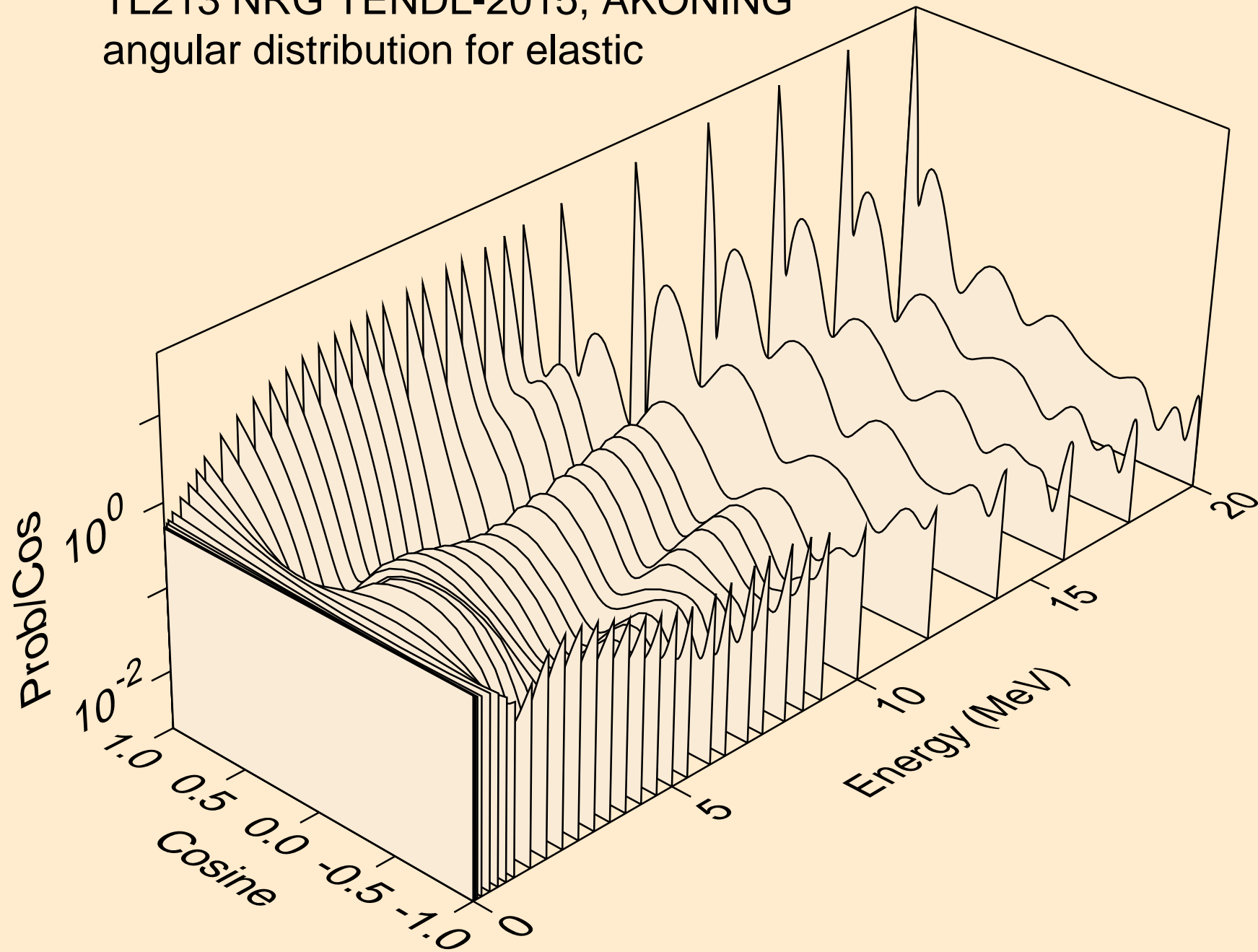

TL213 NRG TENDL-2015, AKONING
angular distribution for elastic

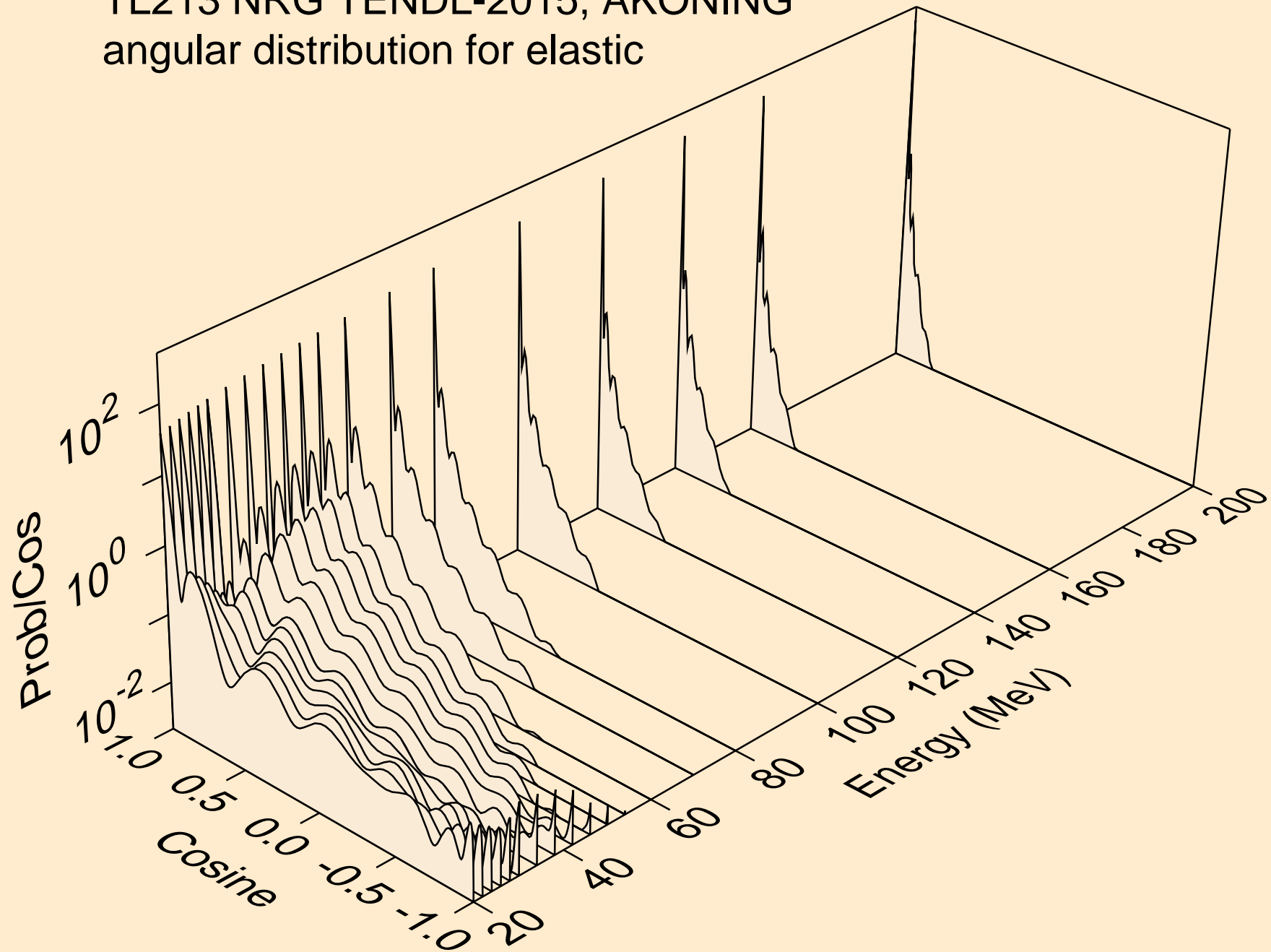

TL213 NRG TENDL-2015, AKONING
angular distribution for (n,n*1)

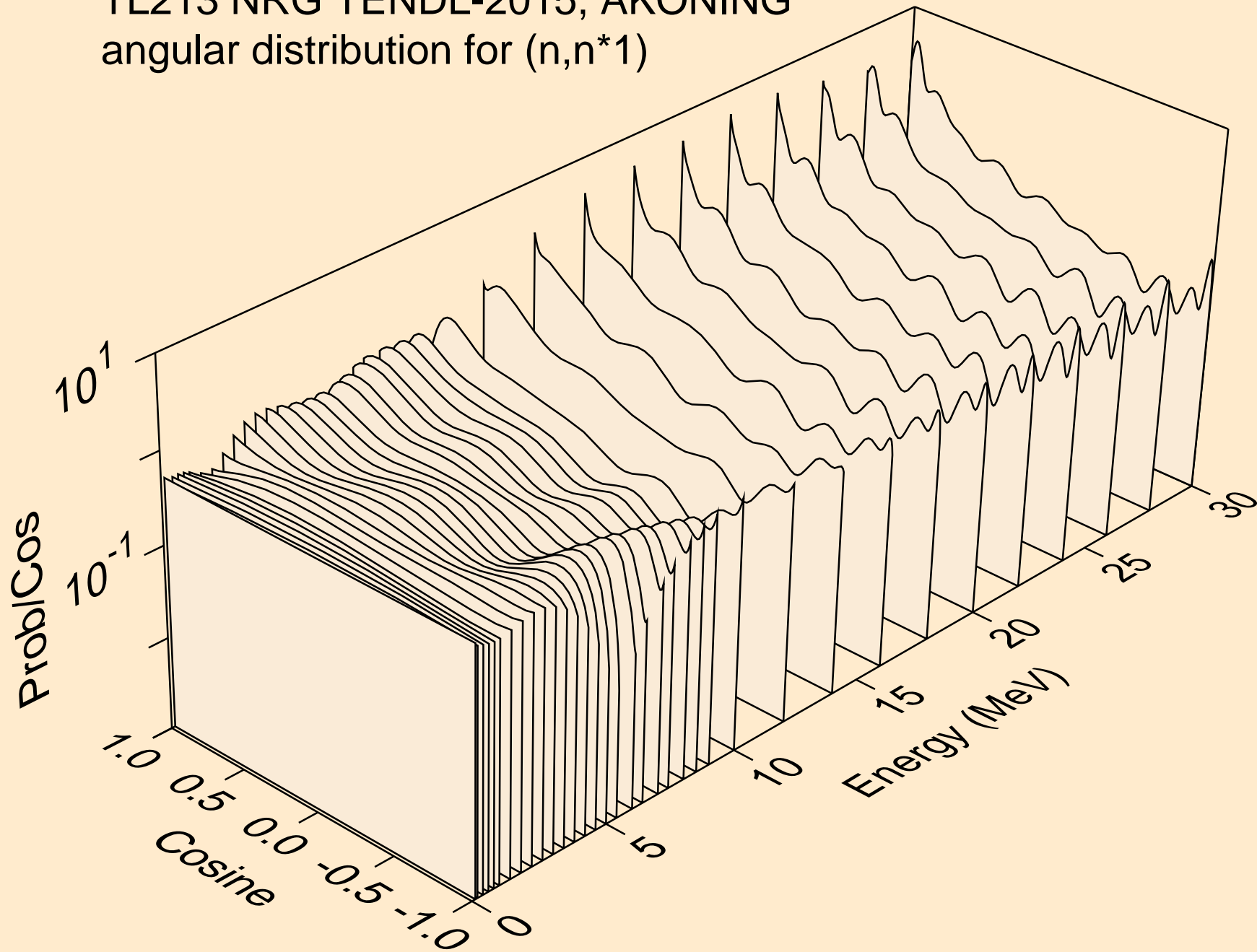

TL213 NRG TENDL-2015, AKONING
Neutron emission for (n,x)

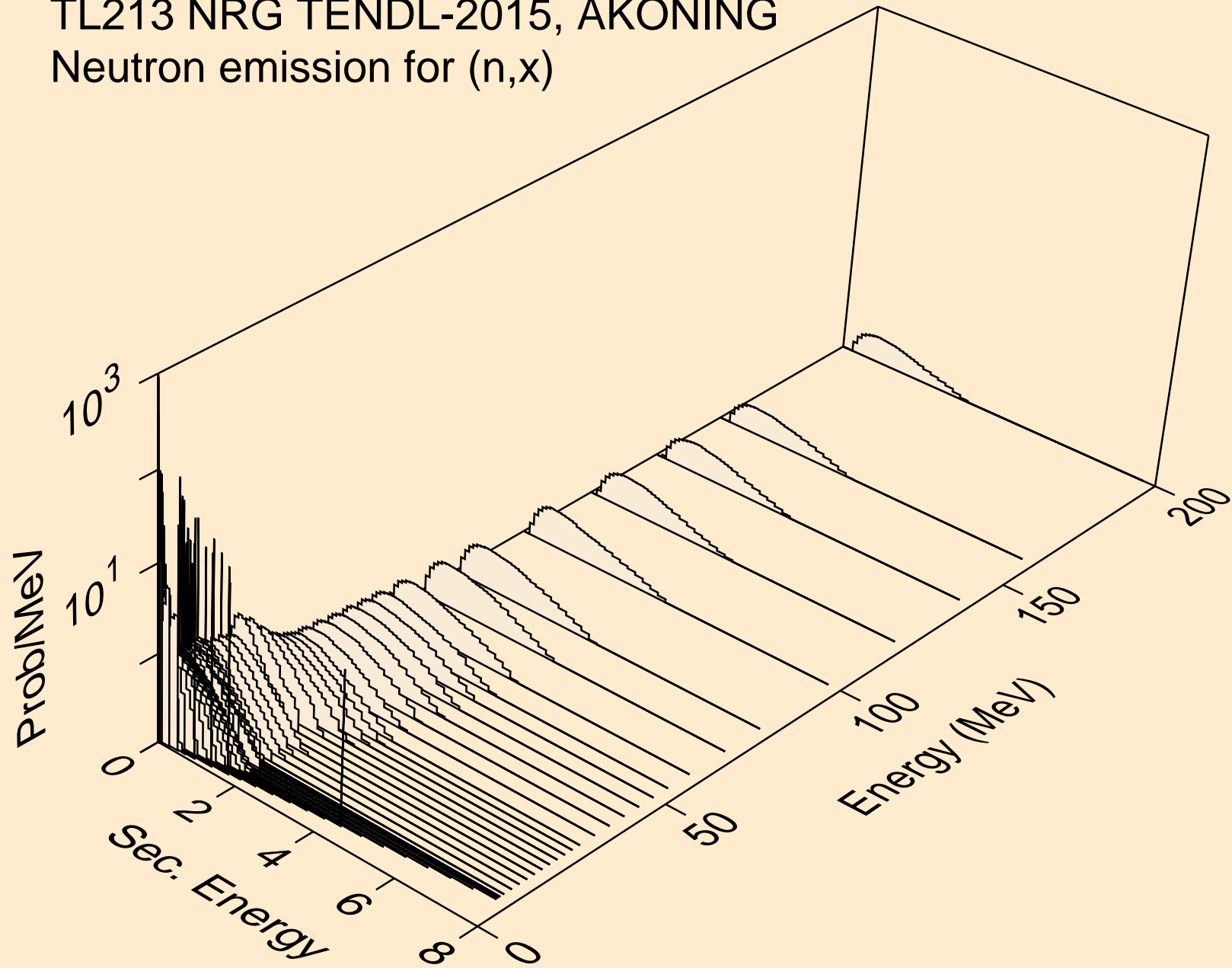

TL213 NRG TENDL-2015, AKONING
Neutron emission for (n,2nd)

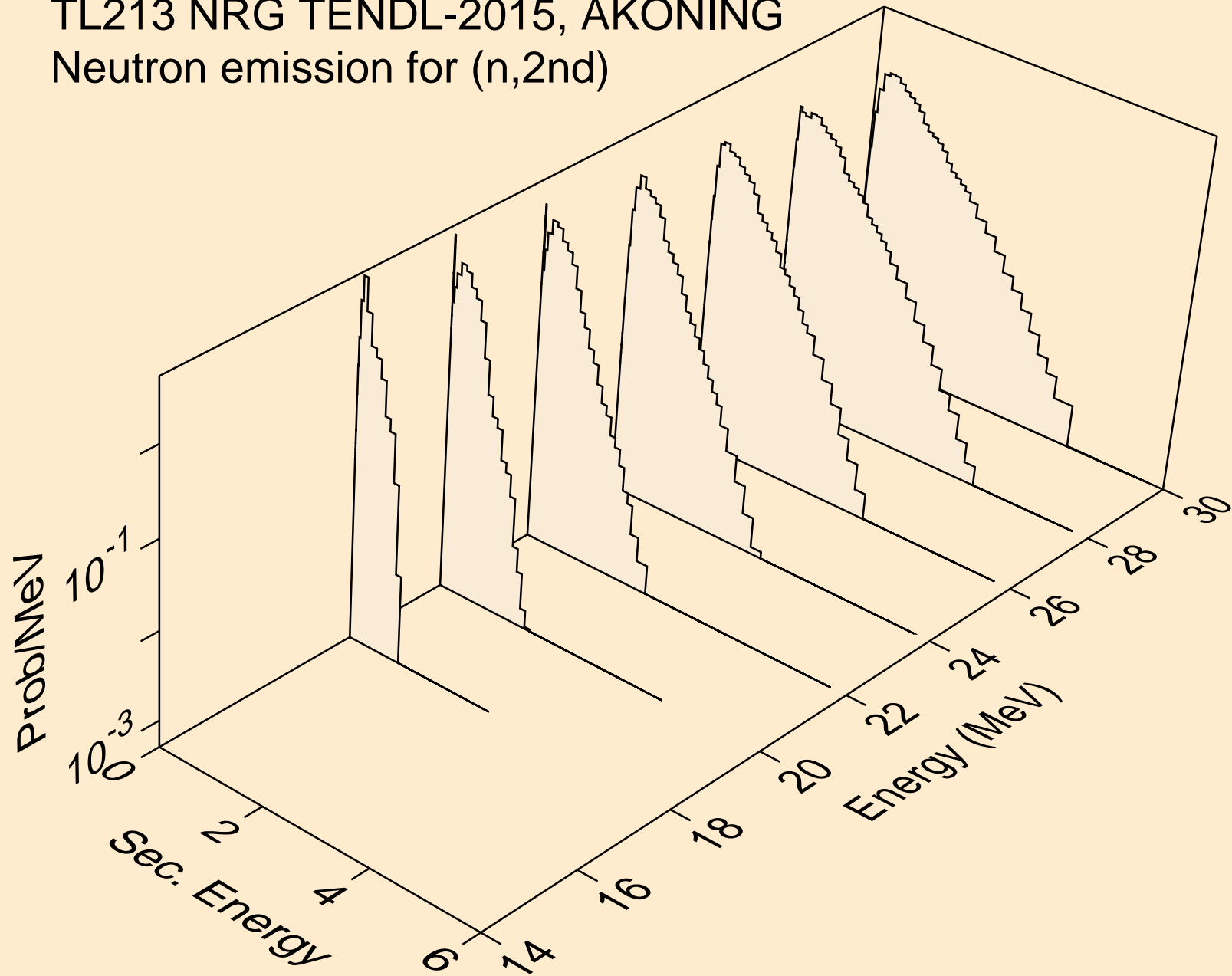

TL213 NRG TENDL-2015, AKONING
Neutron emission for (n,2n)

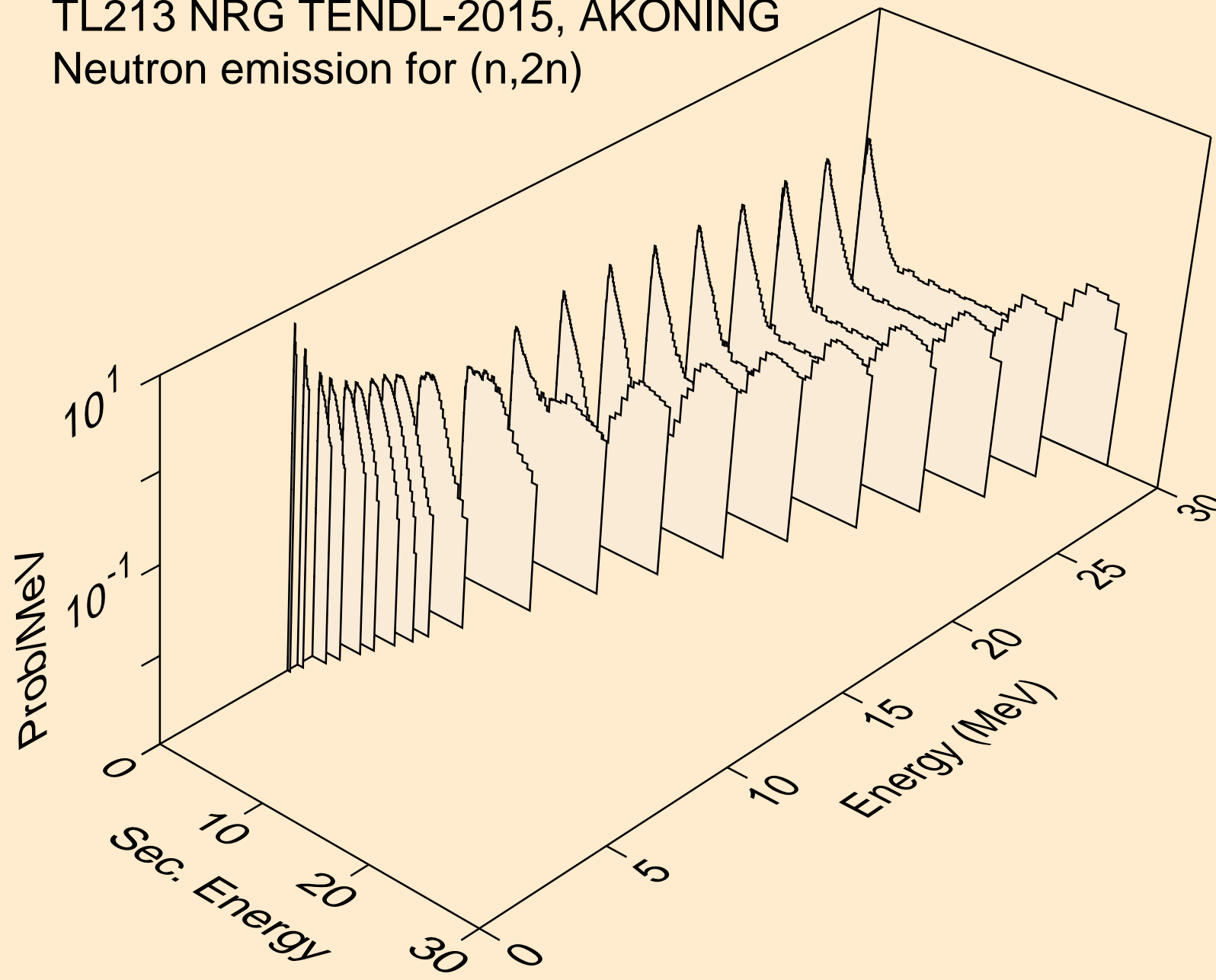

TL213 NRG TENDL-2015, AKONING
Neutron emission for (n,3n)

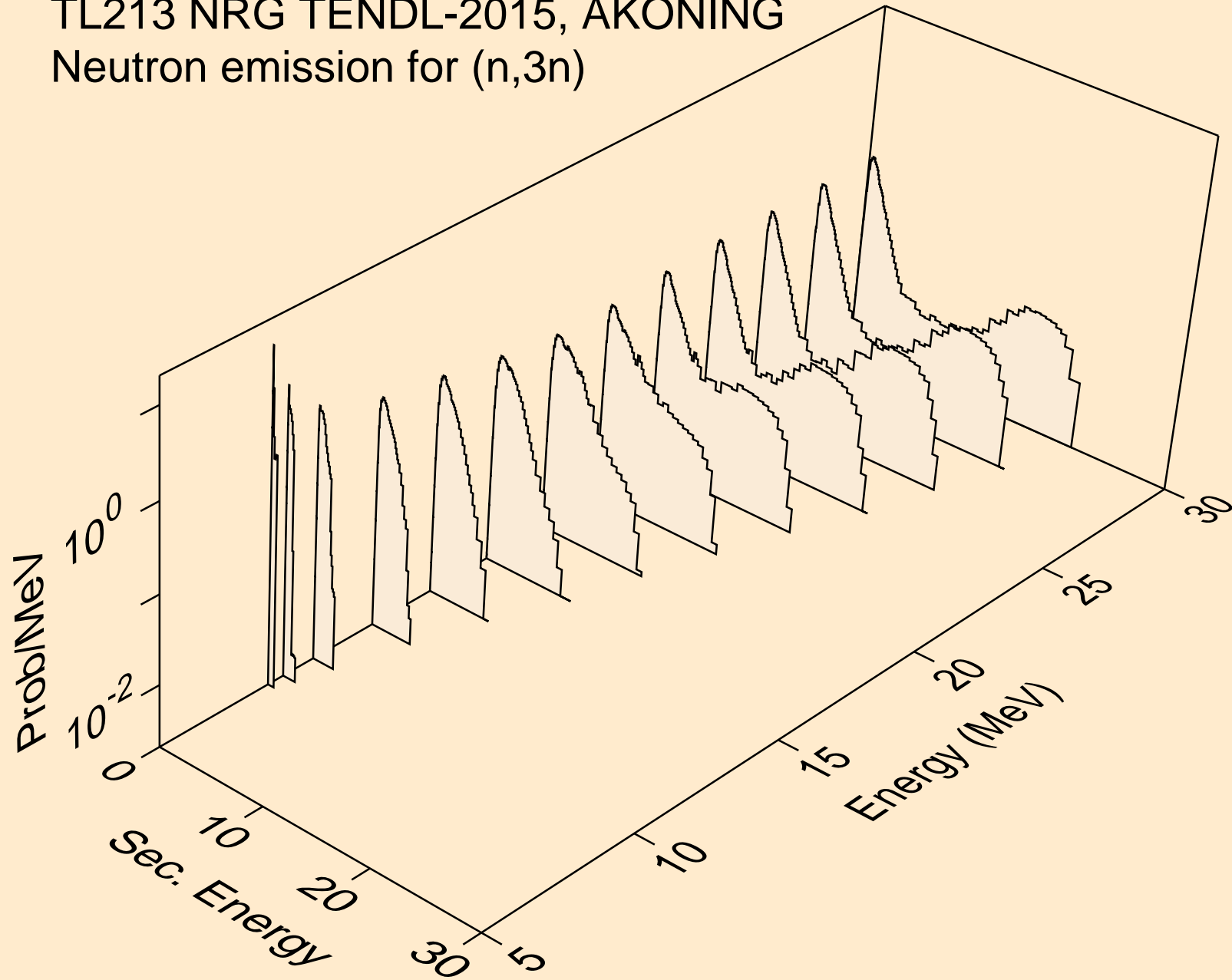

TL213 NRG TENDL-2015, AKONING
Neutron emission for (n,n*)a

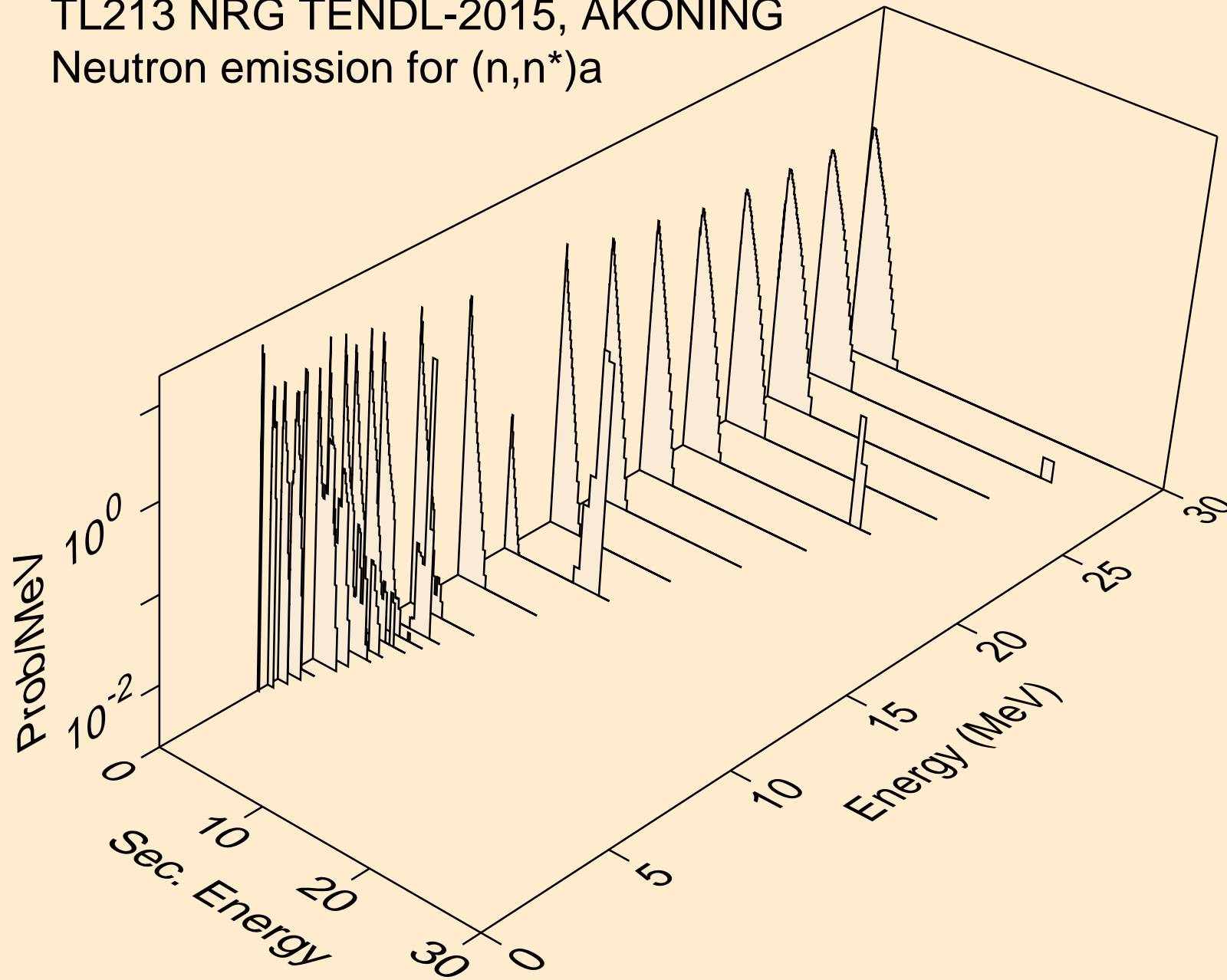

TL213 NRG TENDL-2015, AKONING
Neutron emission for (n,2n)a

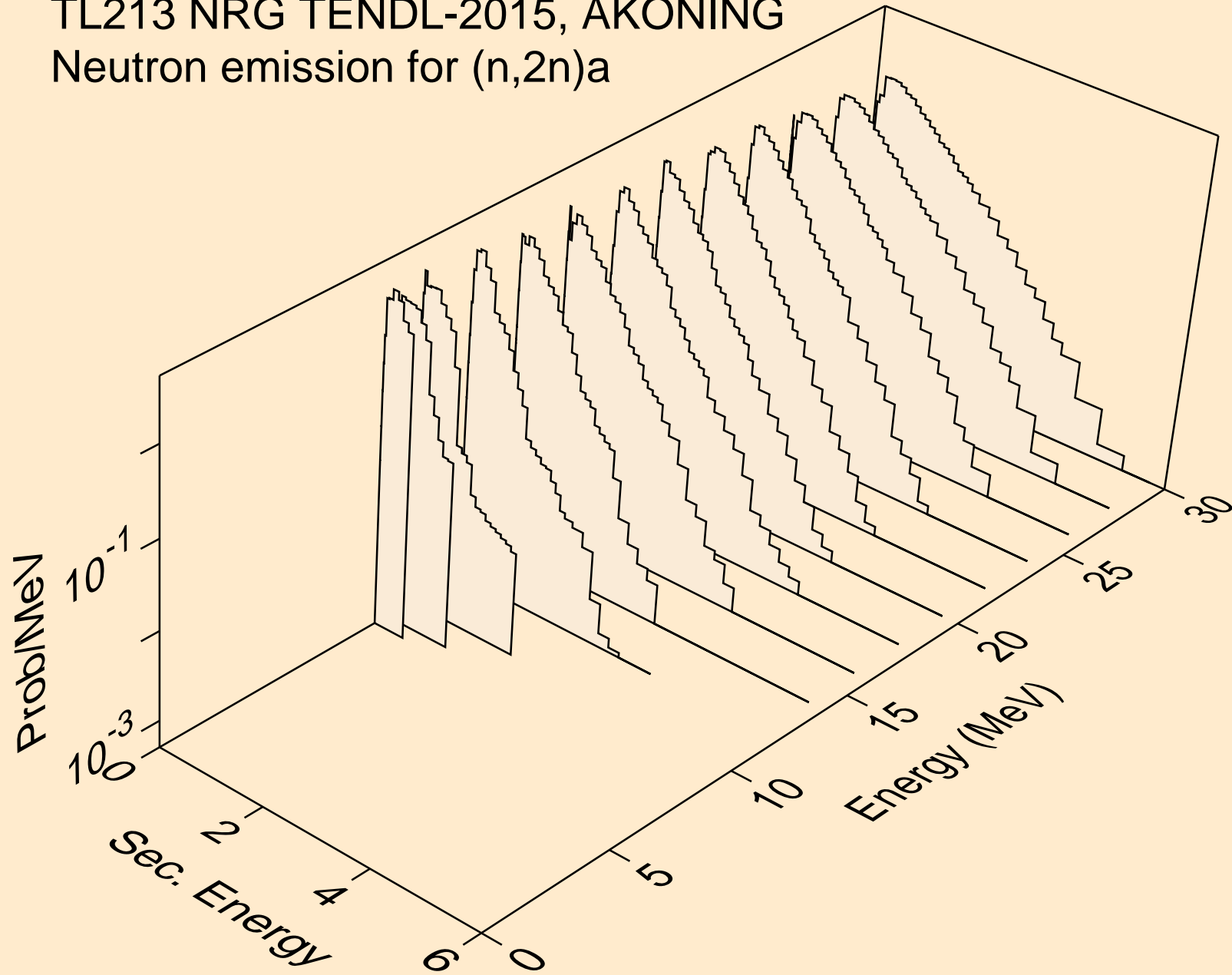

TL213 NRG TENDL-2015, AKONING
Neutron emission for (n,3n)a

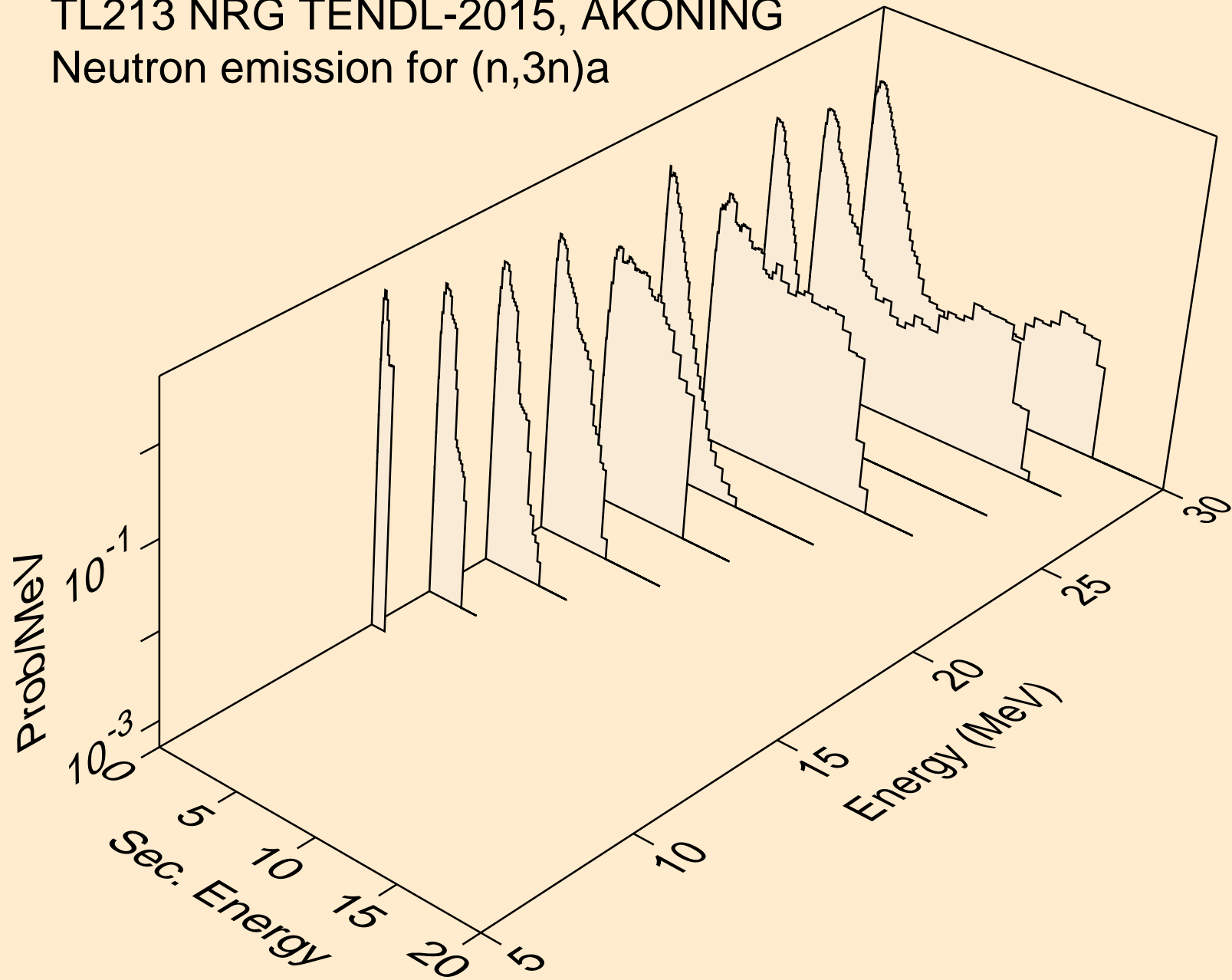

TL213 NRG TENDL-2015, AKONING
Neutron emission for (n,n*)p

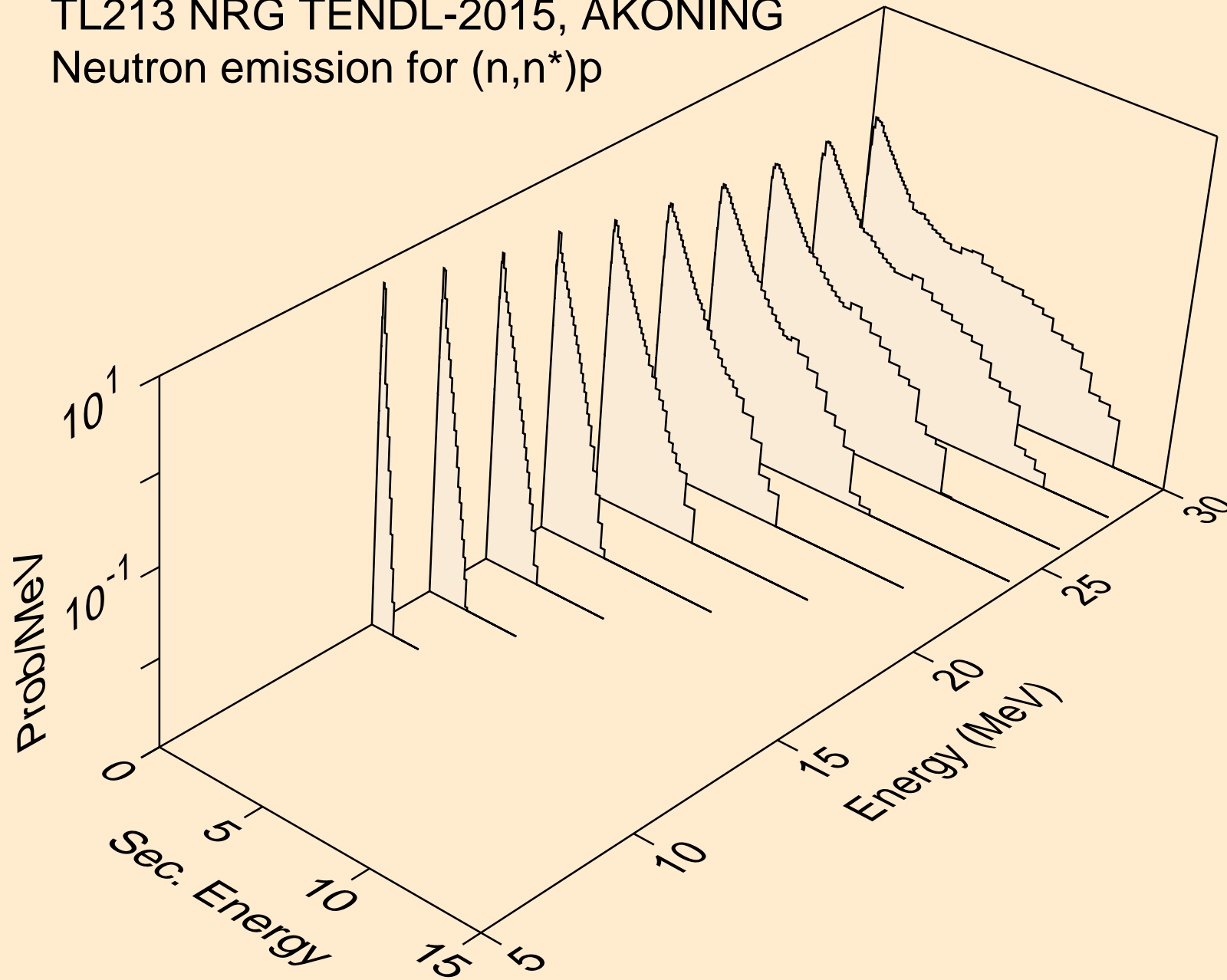

TL213 NRG TENDL-2015, AKONING
Neutron emission for (n,n*)d

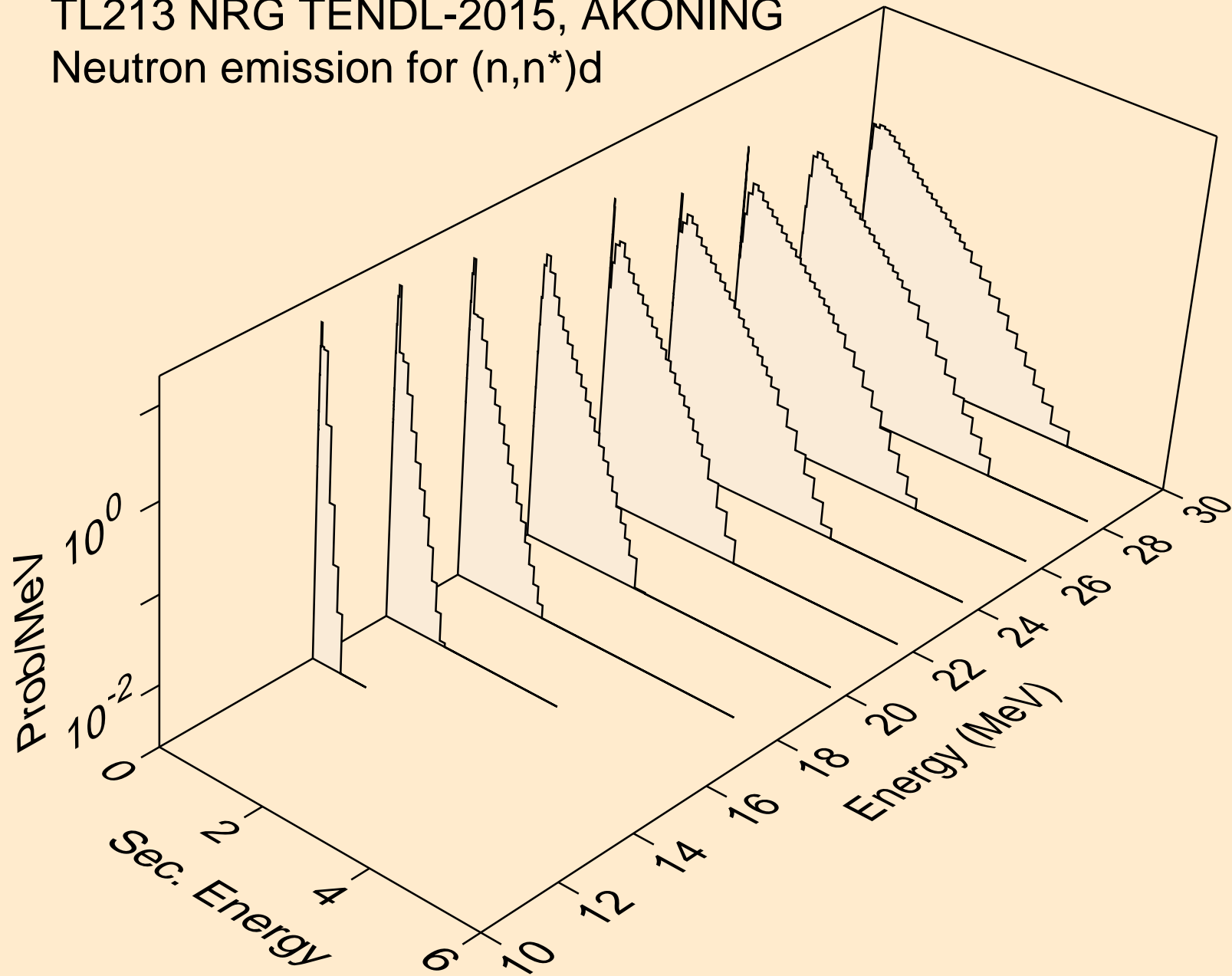

TL213 NRG TENDL-2015, AKONING
Neutron emission for (n,n*)t

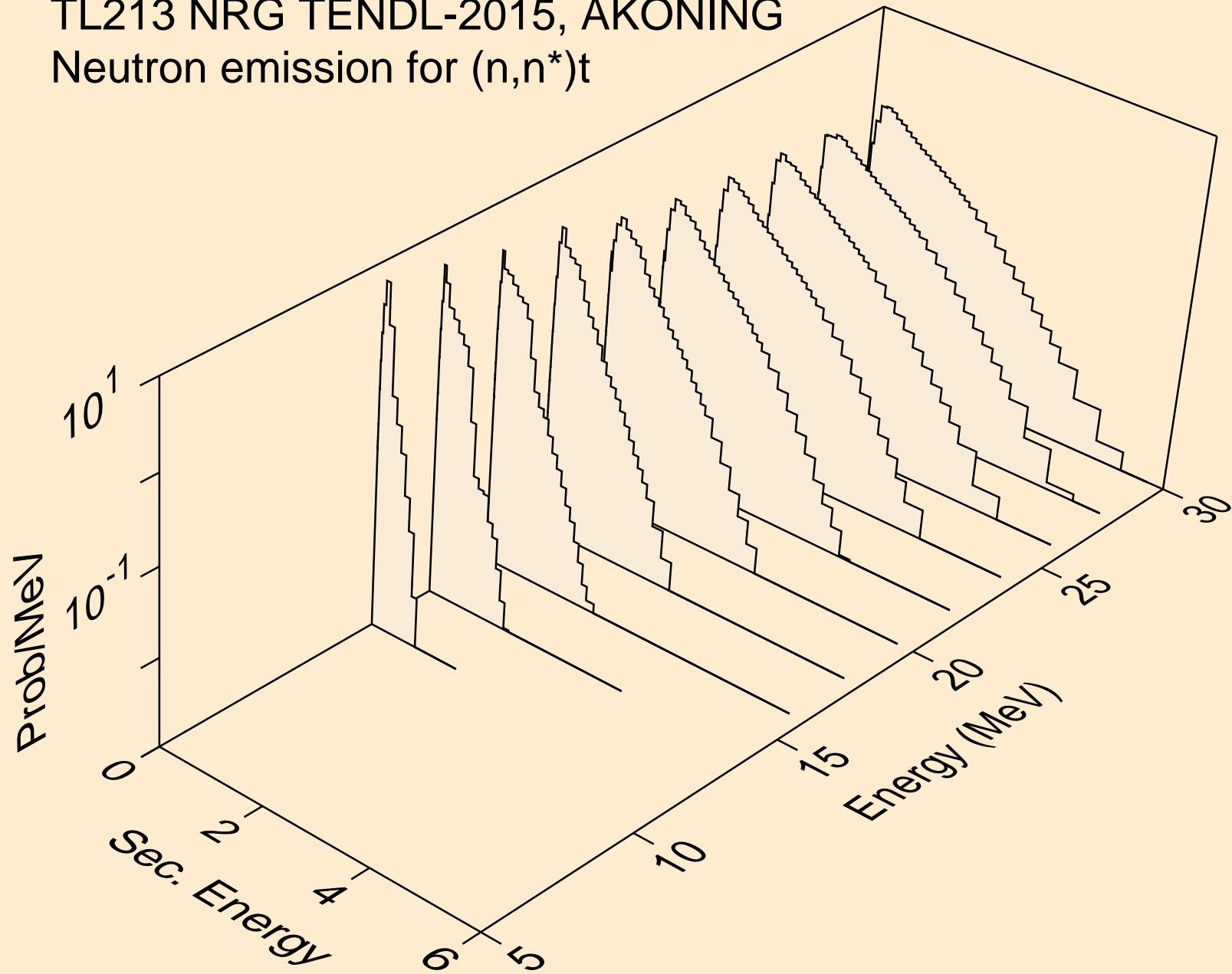

TL213 NRG TENDL-2015, AKONING
Neutron emission for (n,n*)he3

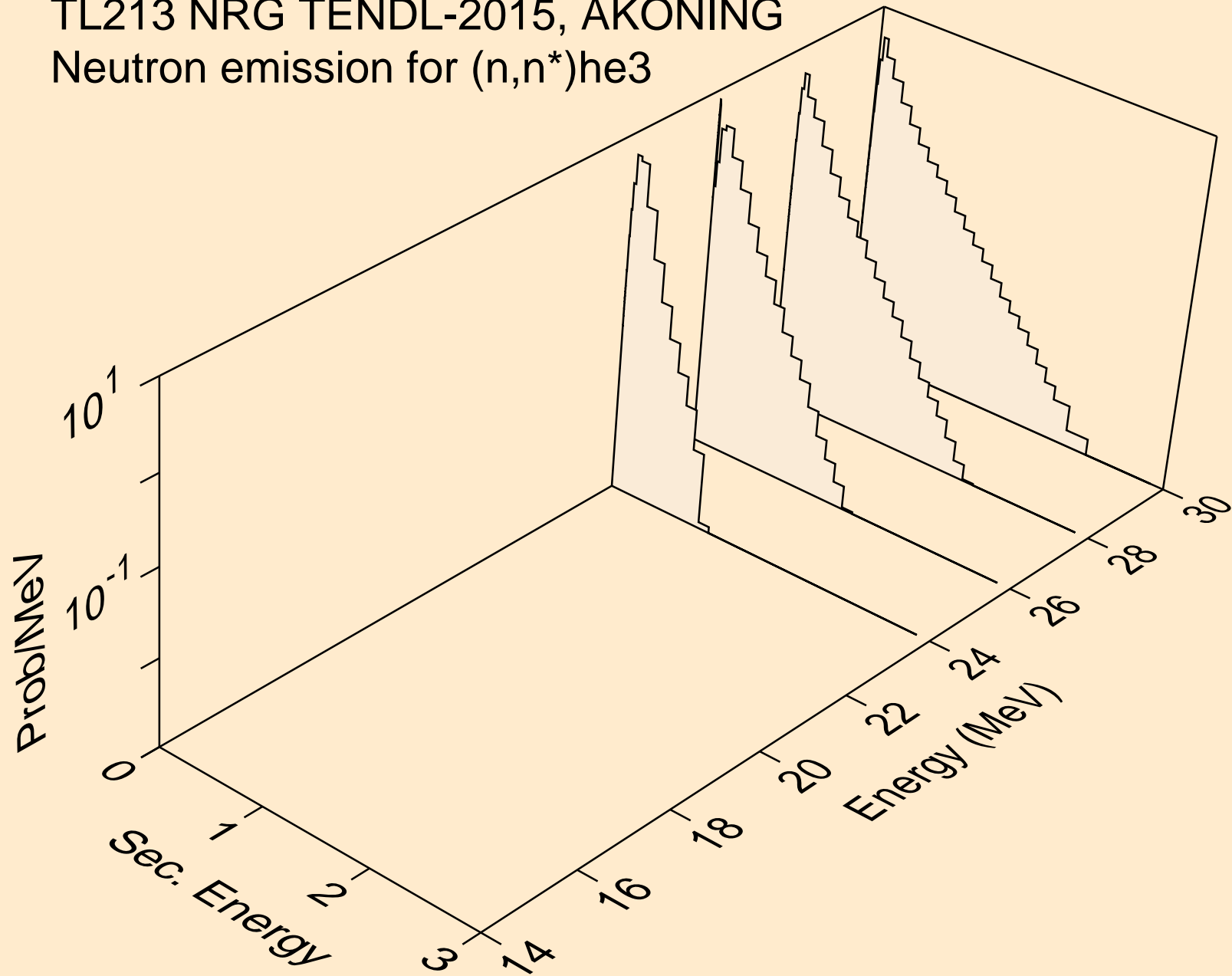

TL213 NRG TENDL-2015, AKONING
Neutron emission for (n,4n)

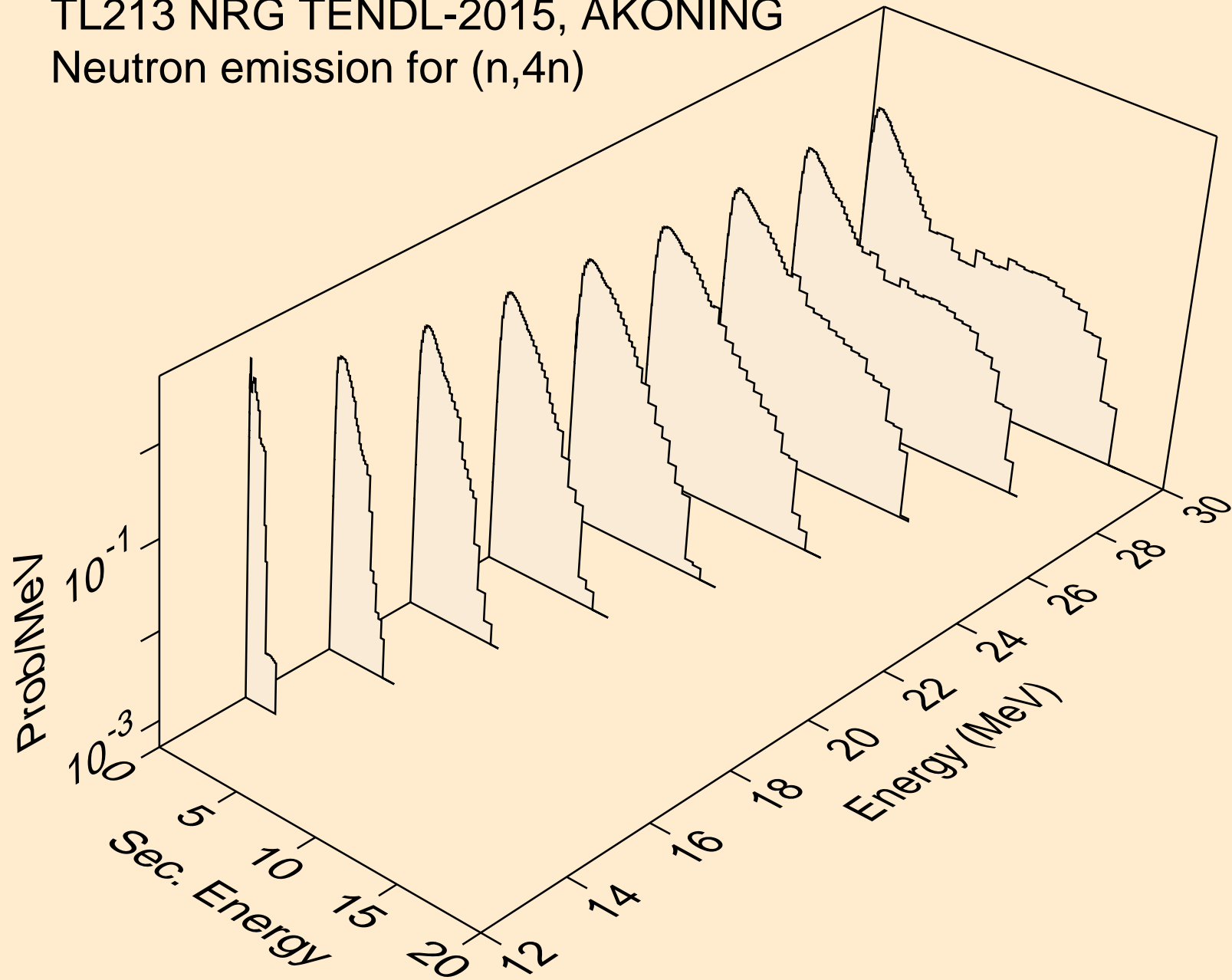

TL213 NRG TENDL-2015, AKONING
Neutron emission for (n,2np)

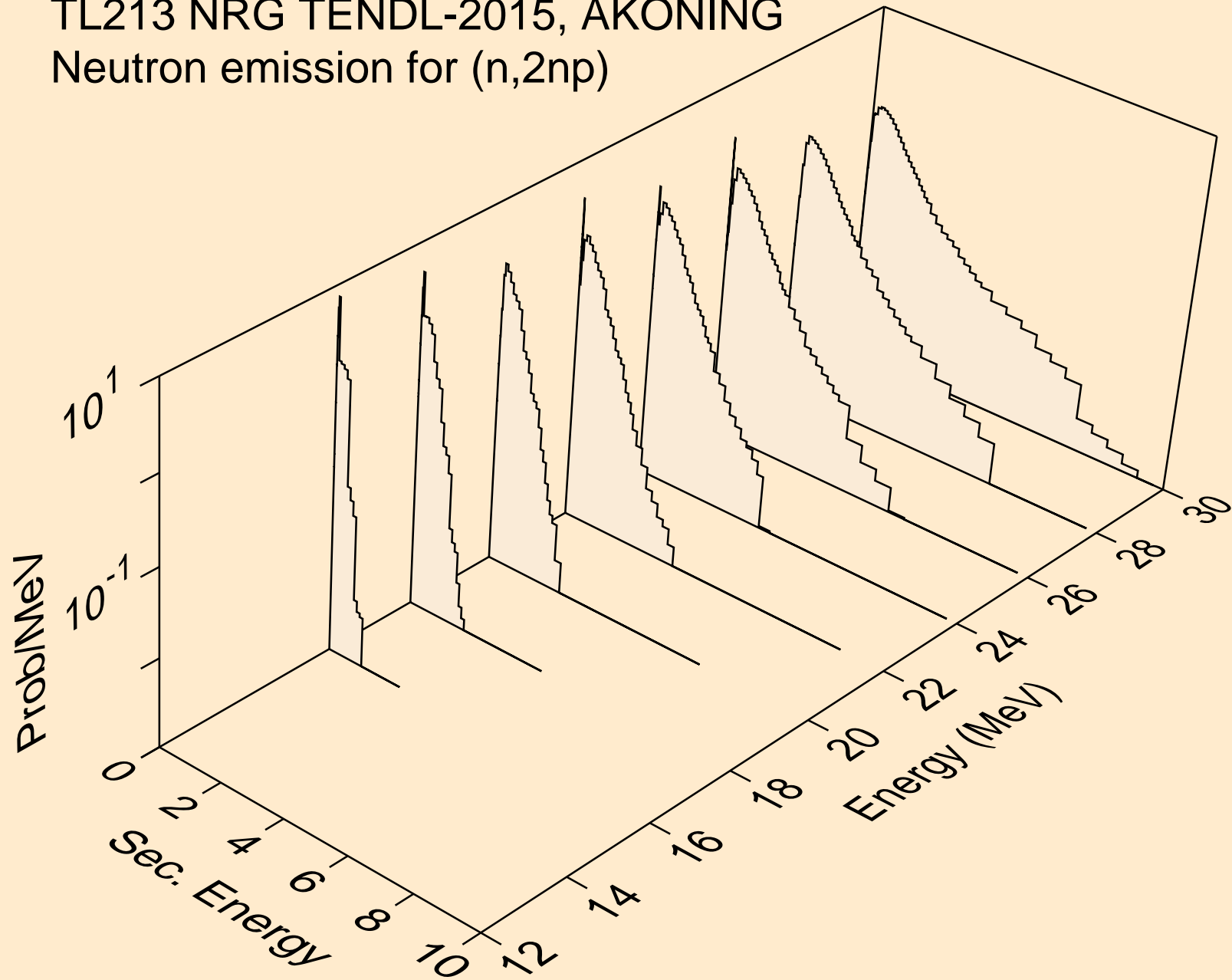

TL213 NRG TENDL-2015, AKONING
Neutron emission for (n,3np)

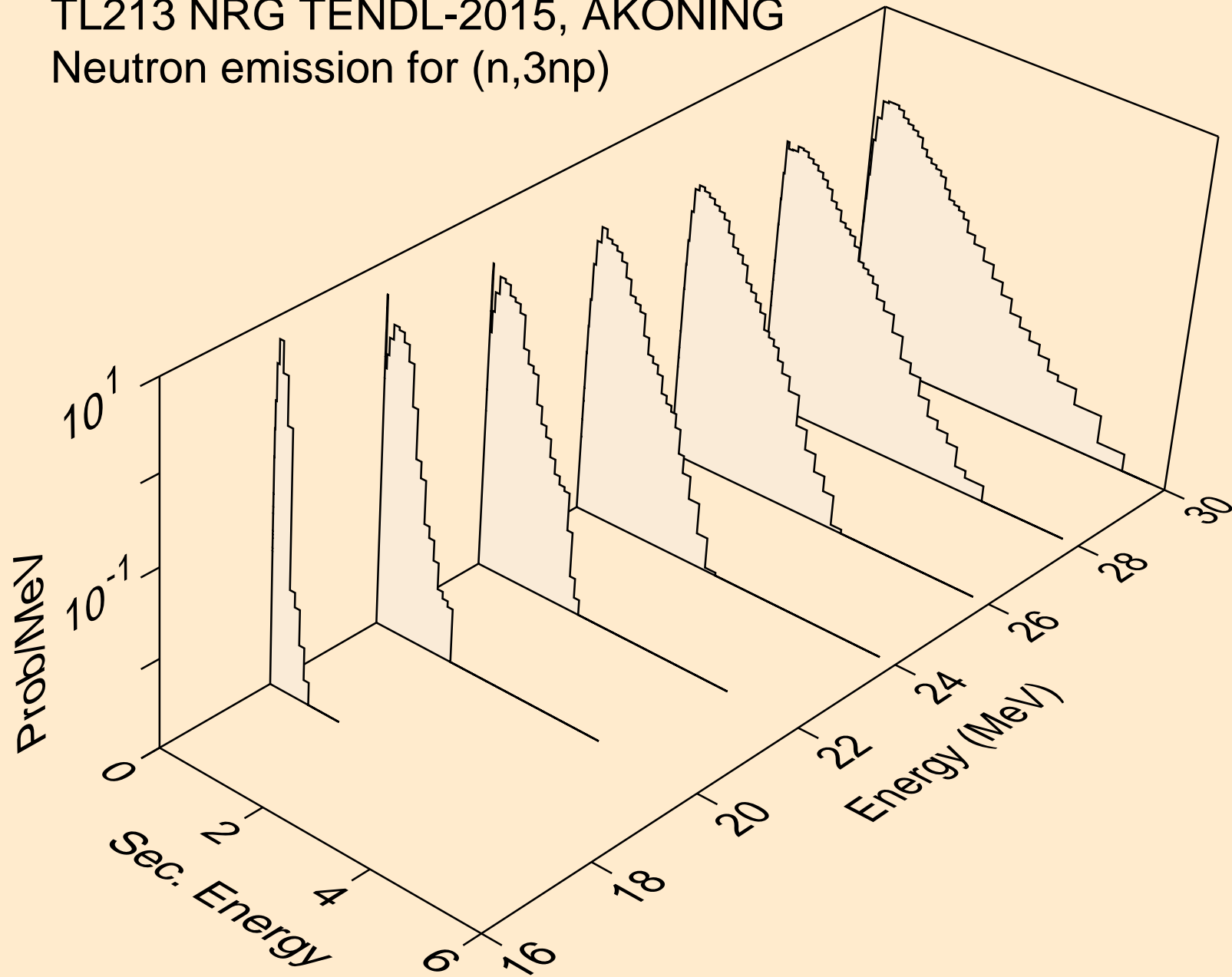

TL213 NRG TENDL-2015, AKONING
Neutron emission for (n,n*c)

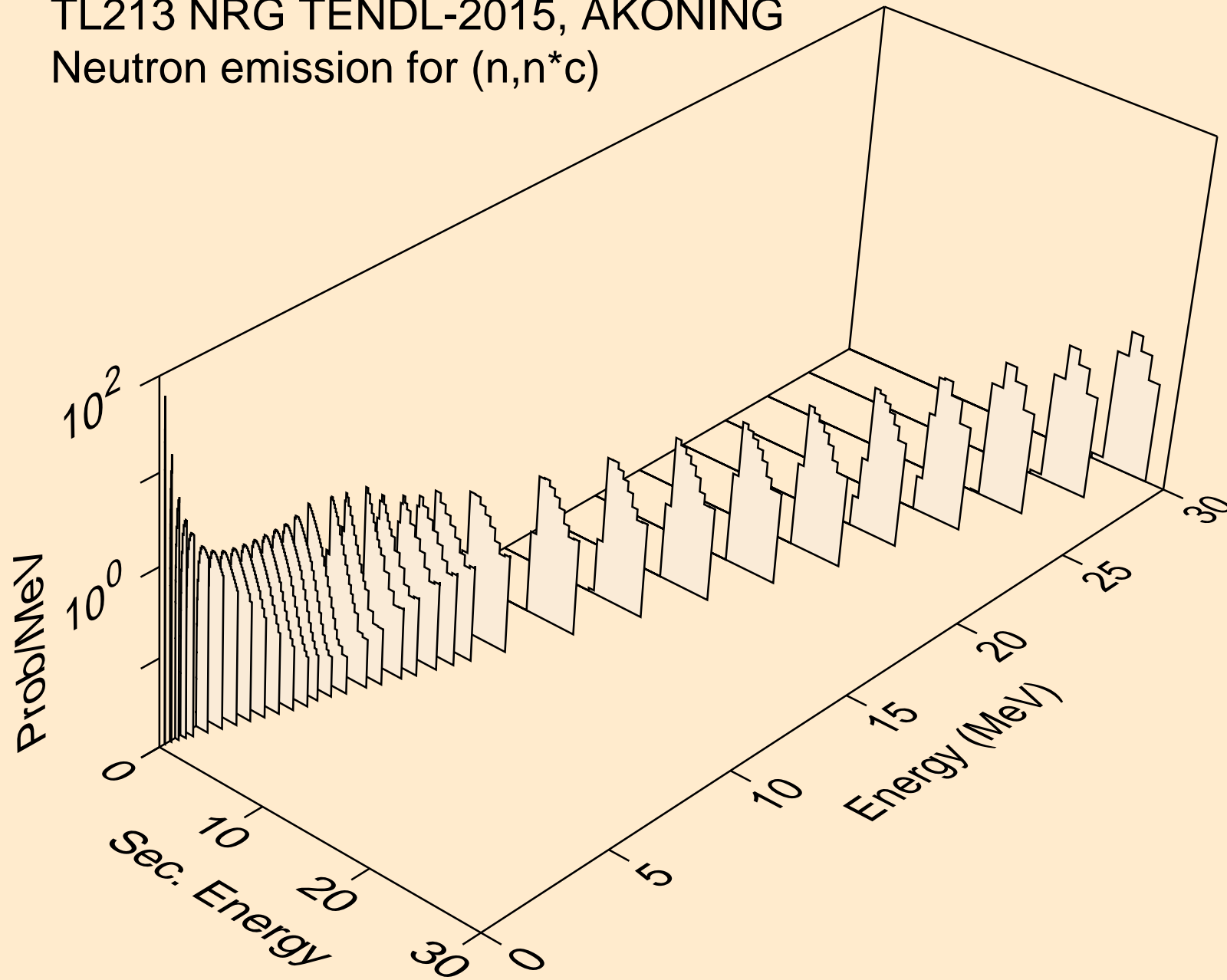

TL213 NRG TENDL-2015, AKONING
Photon emission for (n,x)

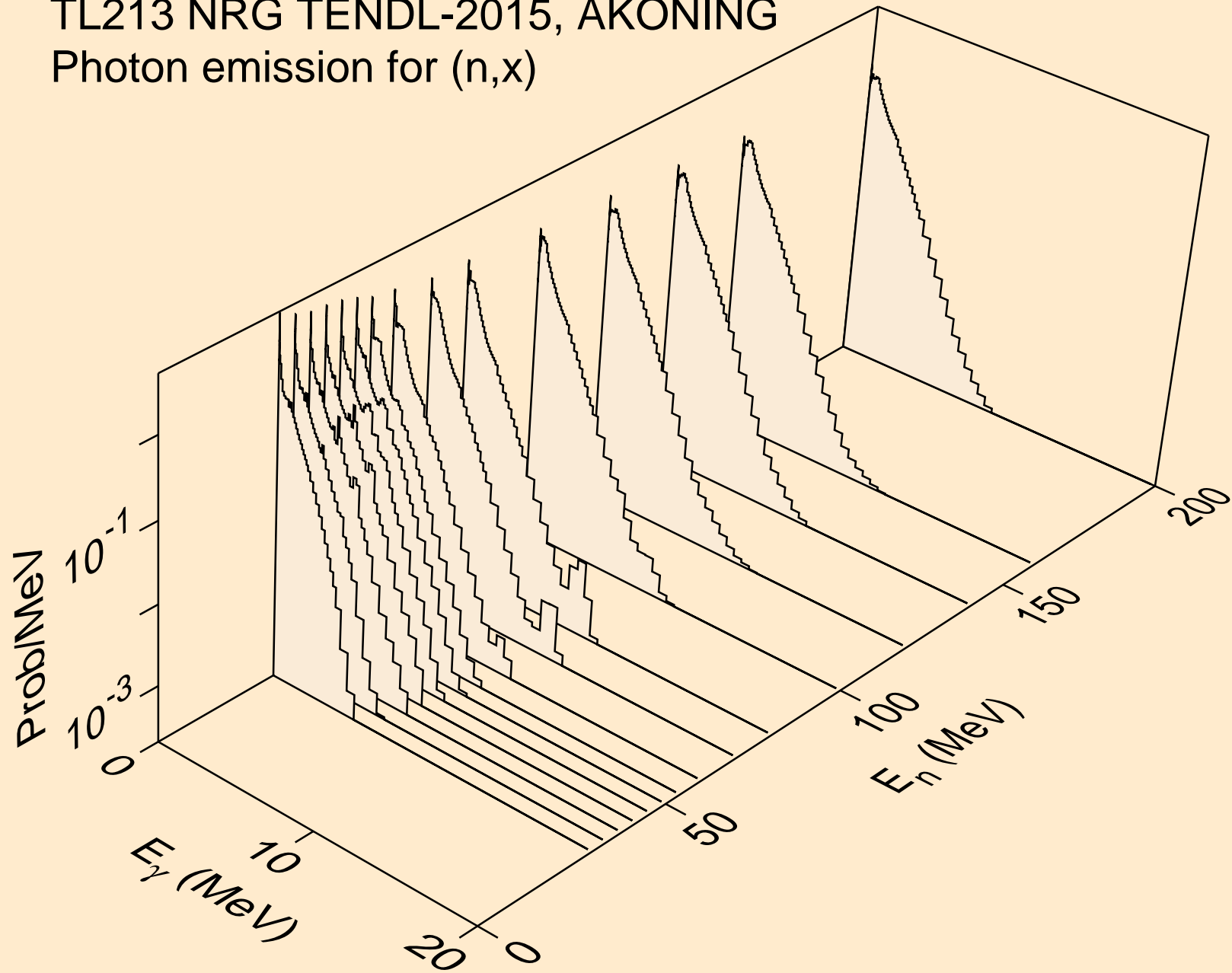

TL213 NRG TENDL-2015, AKONING
Photon emission for (n,2nd)

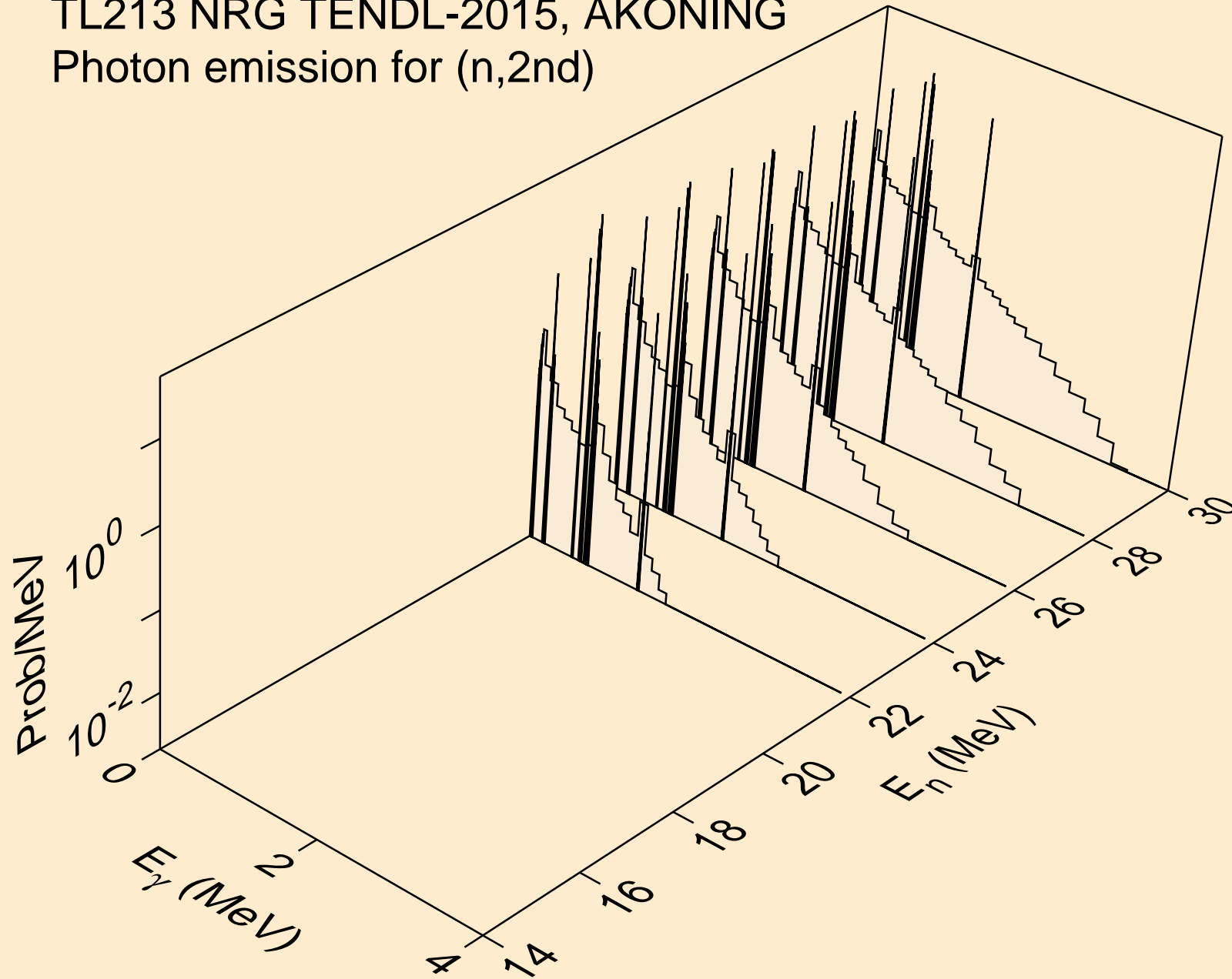

TL213 NRG TENDL-2015, AKONING
Photon emission for (n,2n)

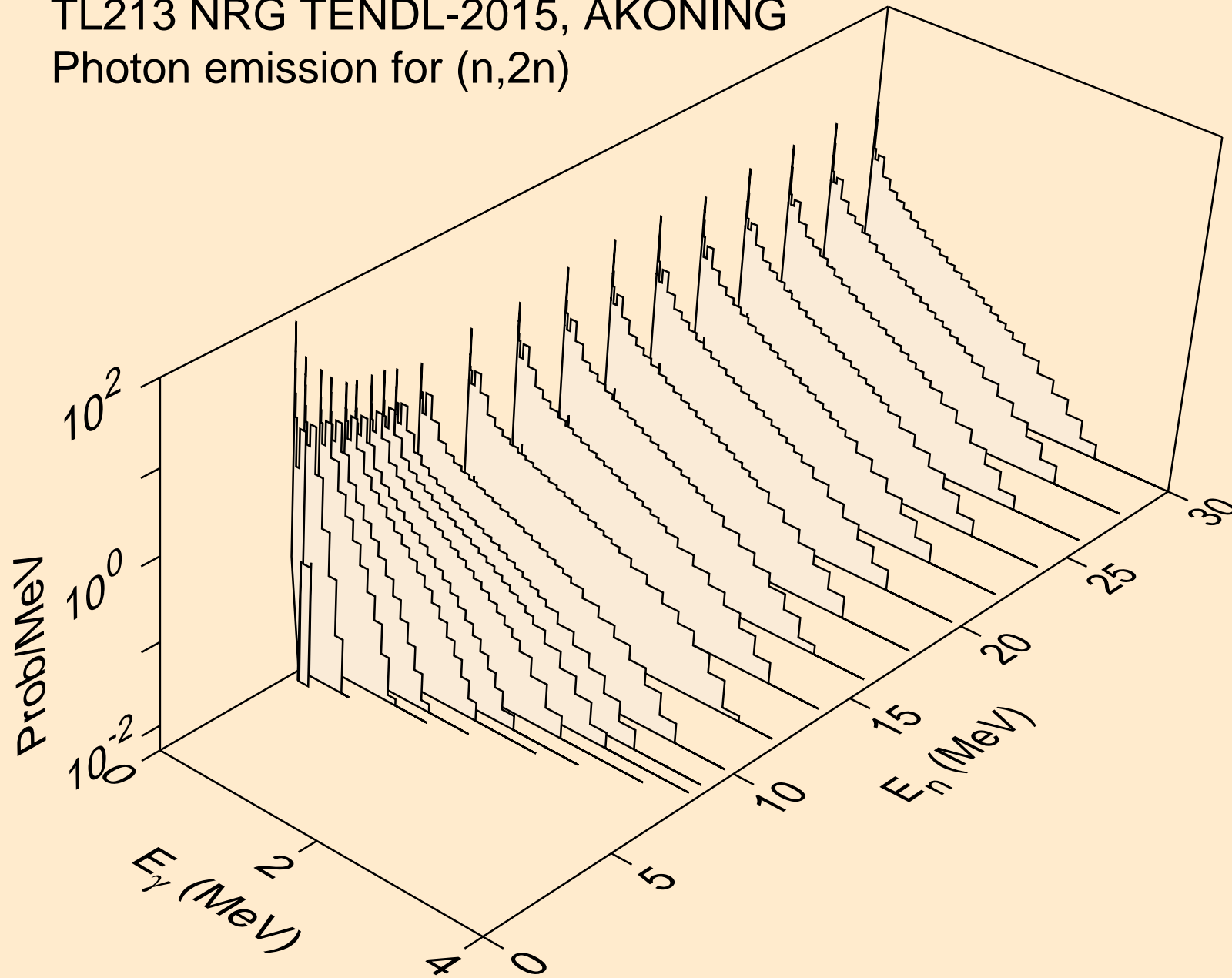

TL213 NRG TENDL-2015, AKONING
Photon emission for (n,3n)

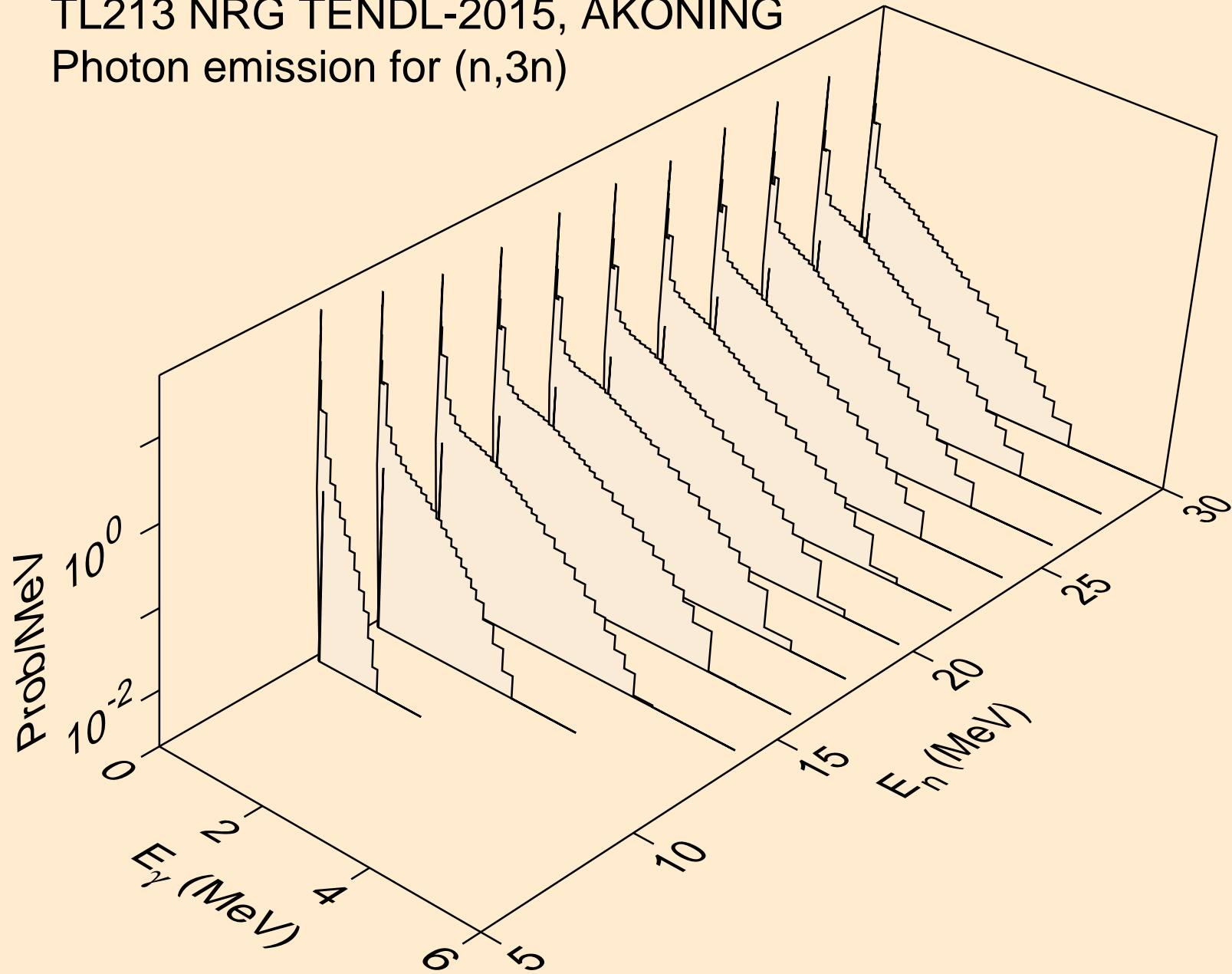

TL213 NRG TENDL-2015, AKONING
Photon emission for (n,n*)a

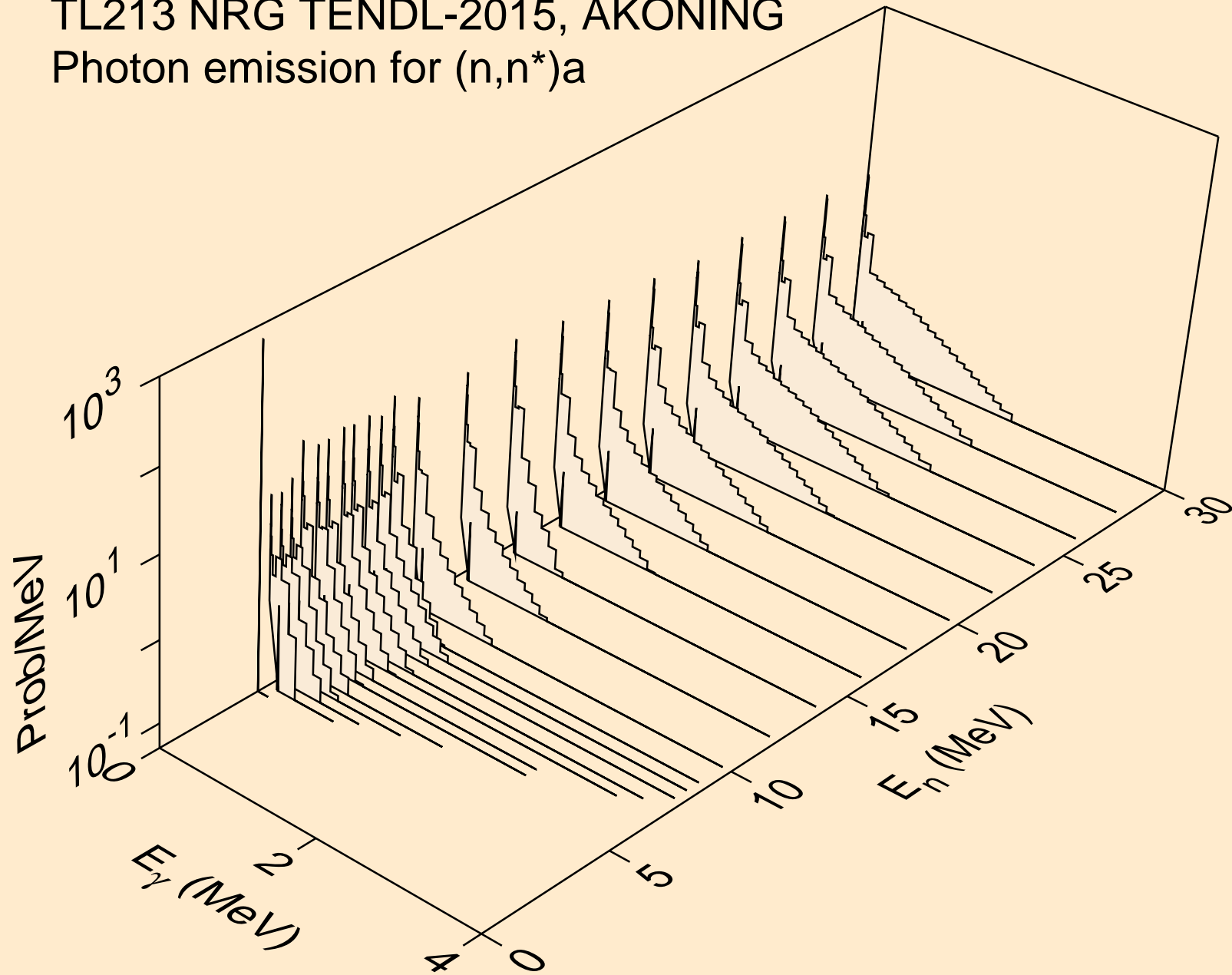

TL213 NRG TENDL-2015, AKONING
Photon emission for (n,2n)a

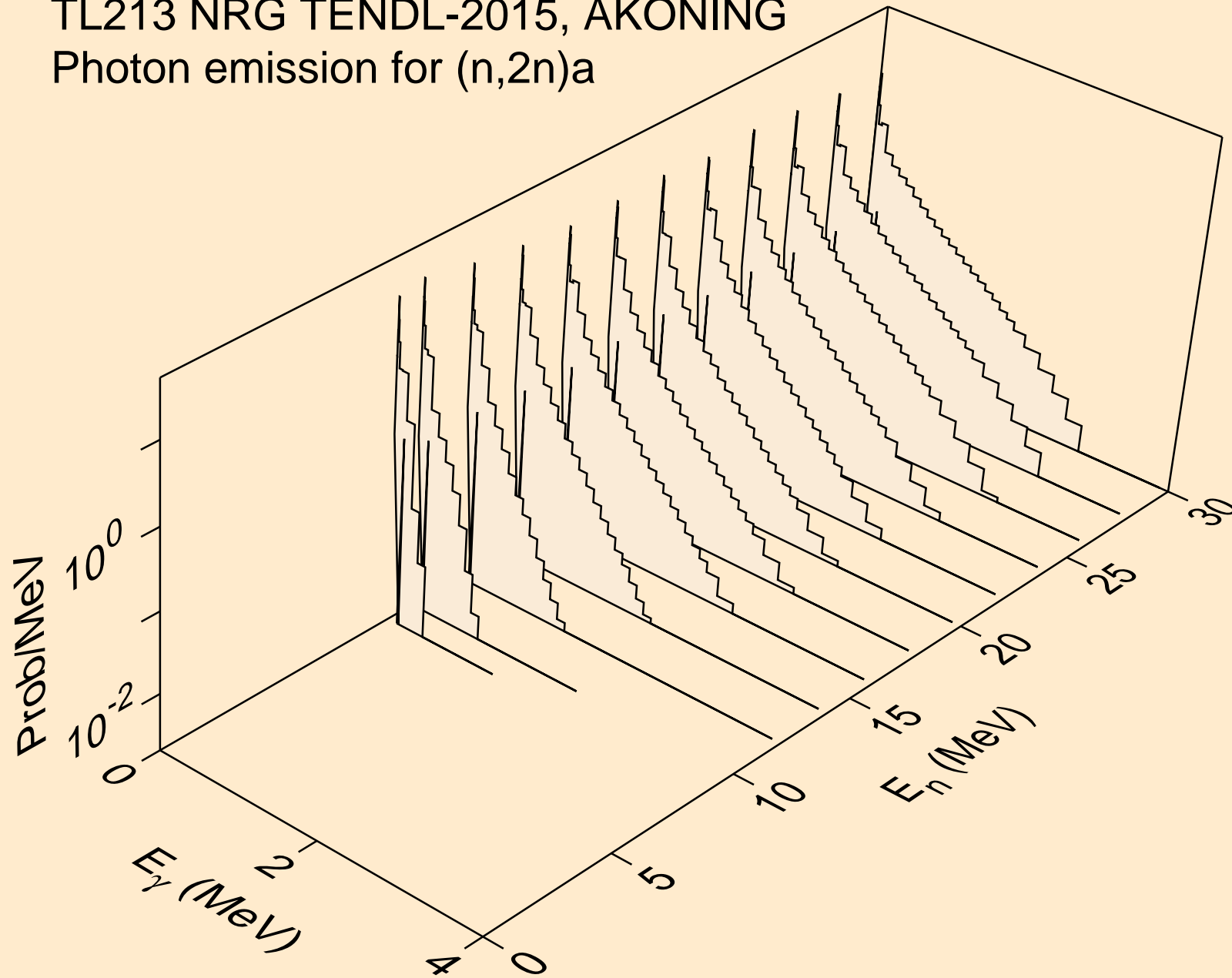

TL213 NRG TENDL-2015, AKONING
Photon emission for (n,3n)a

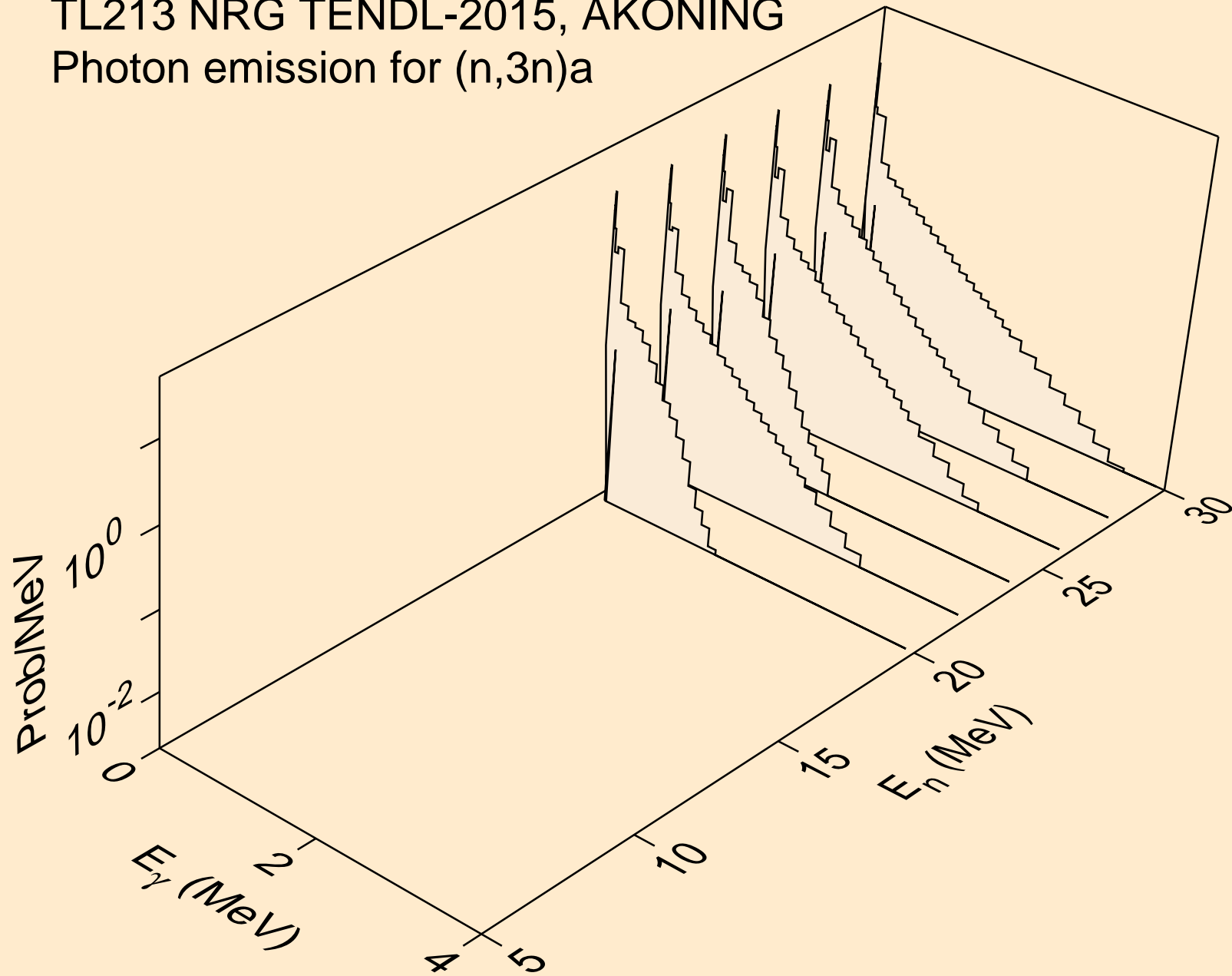

TL213 NRG TENDL-2015, AKONING
Photon emission for (n,n*)p

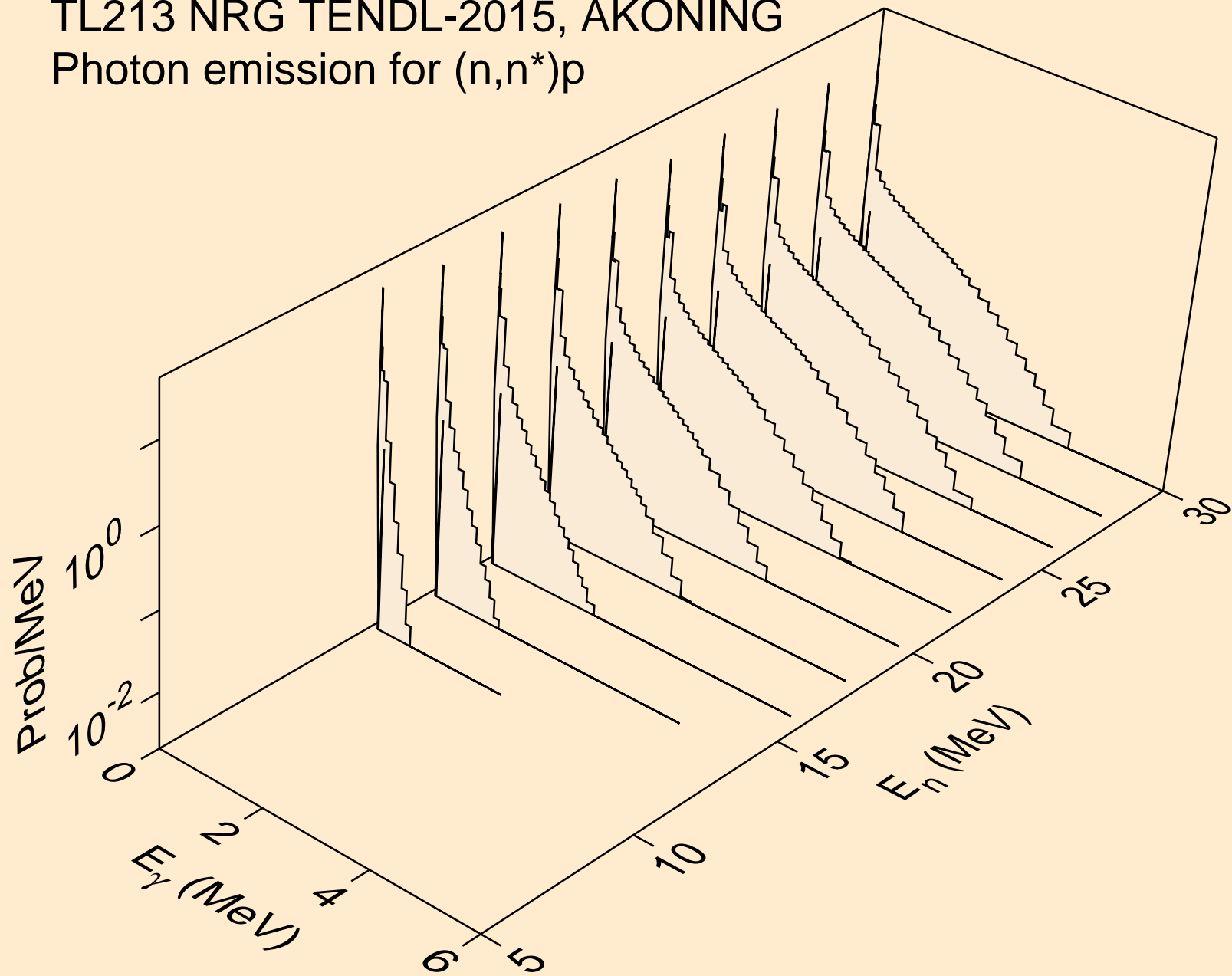

TL213 NRG TENDL-2015, AKONING
Photon emission for (n,n*)d

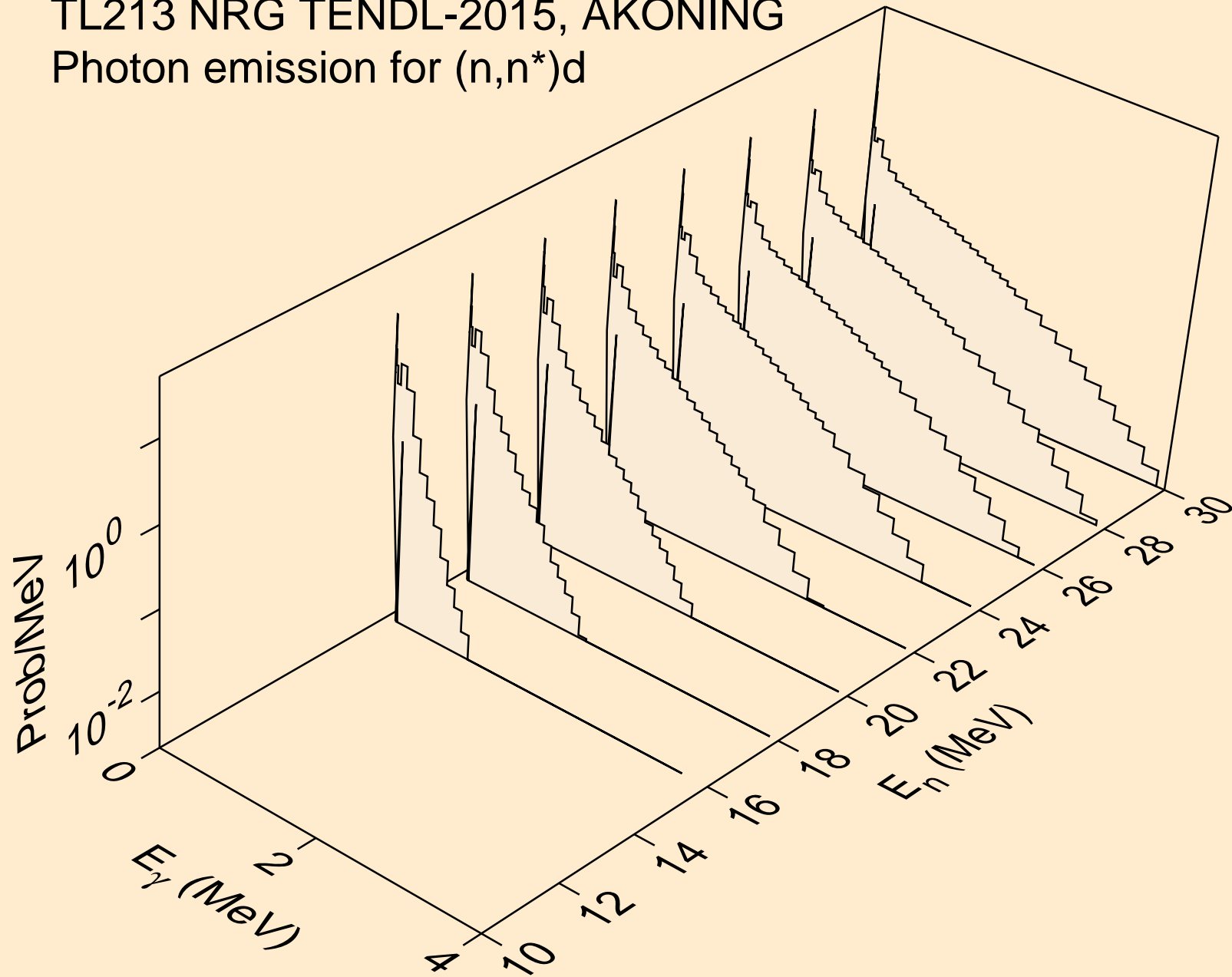

TL213 NRG TENDL-2015, AKONING
Photon emission for (n,n*)t

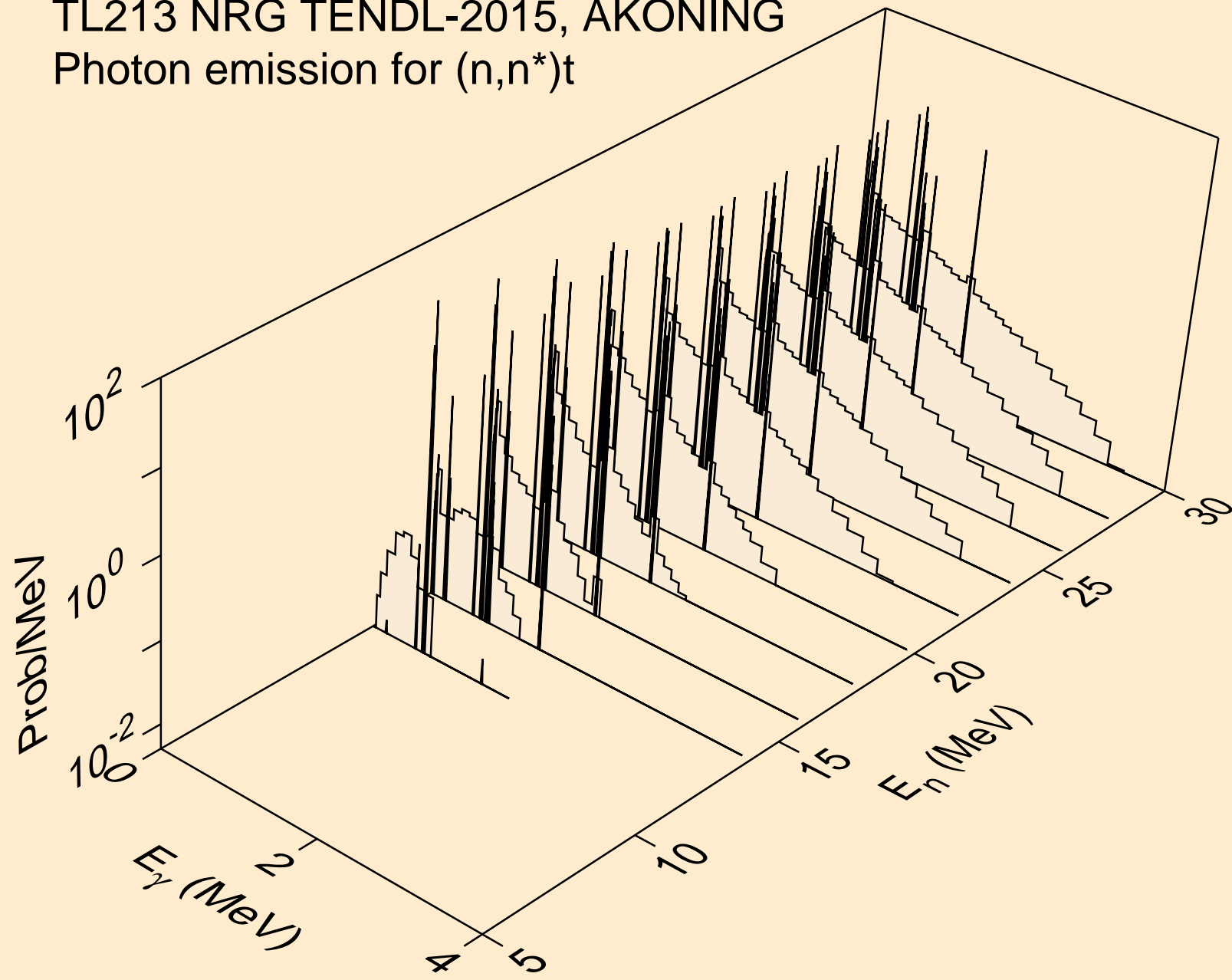

TL213 NRG TENDL-2015, AKONING
Photon emission for (n,n*)he3

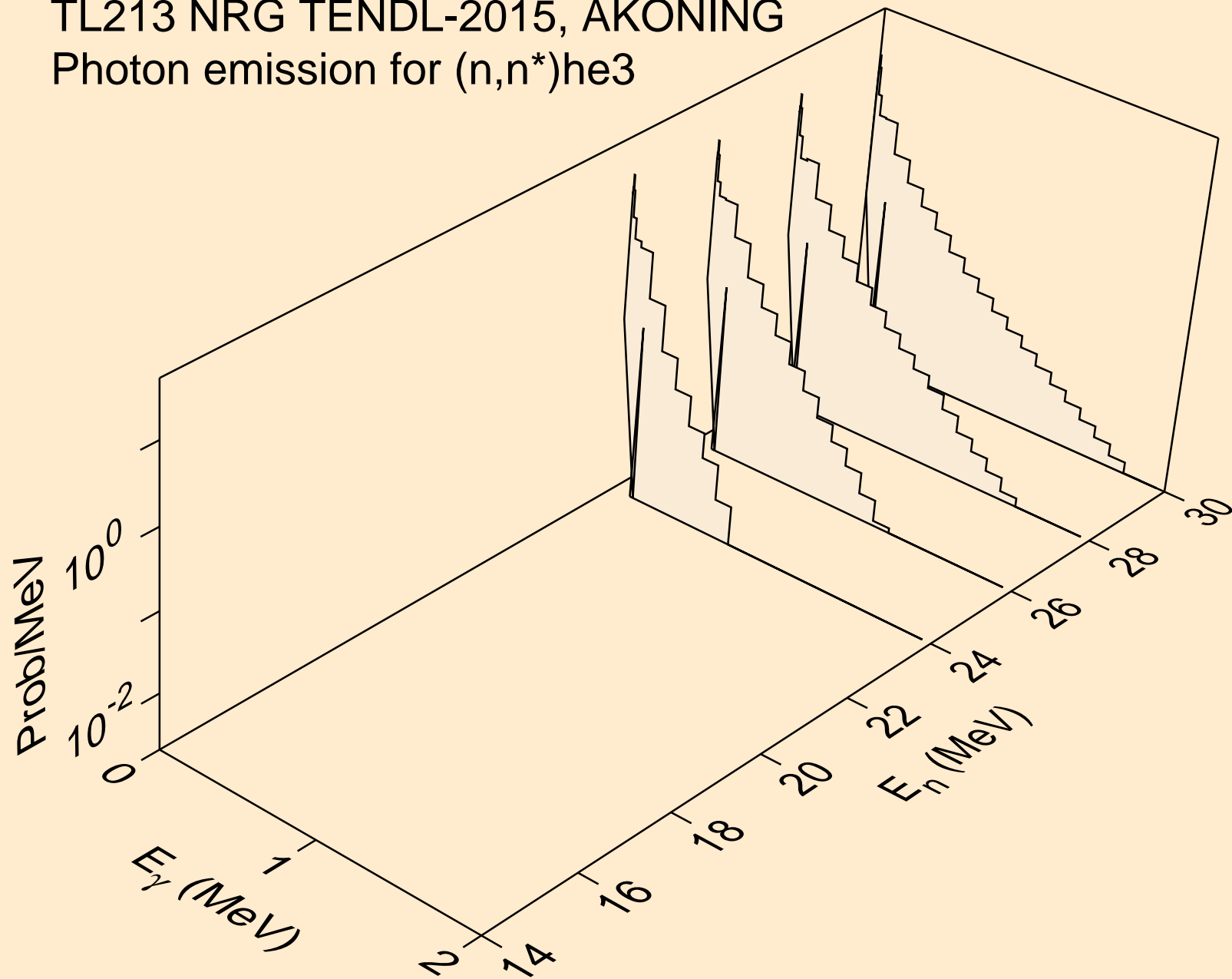

TL213 NRG TENDL-2015, AKONING
Photon emission for (n,4n)

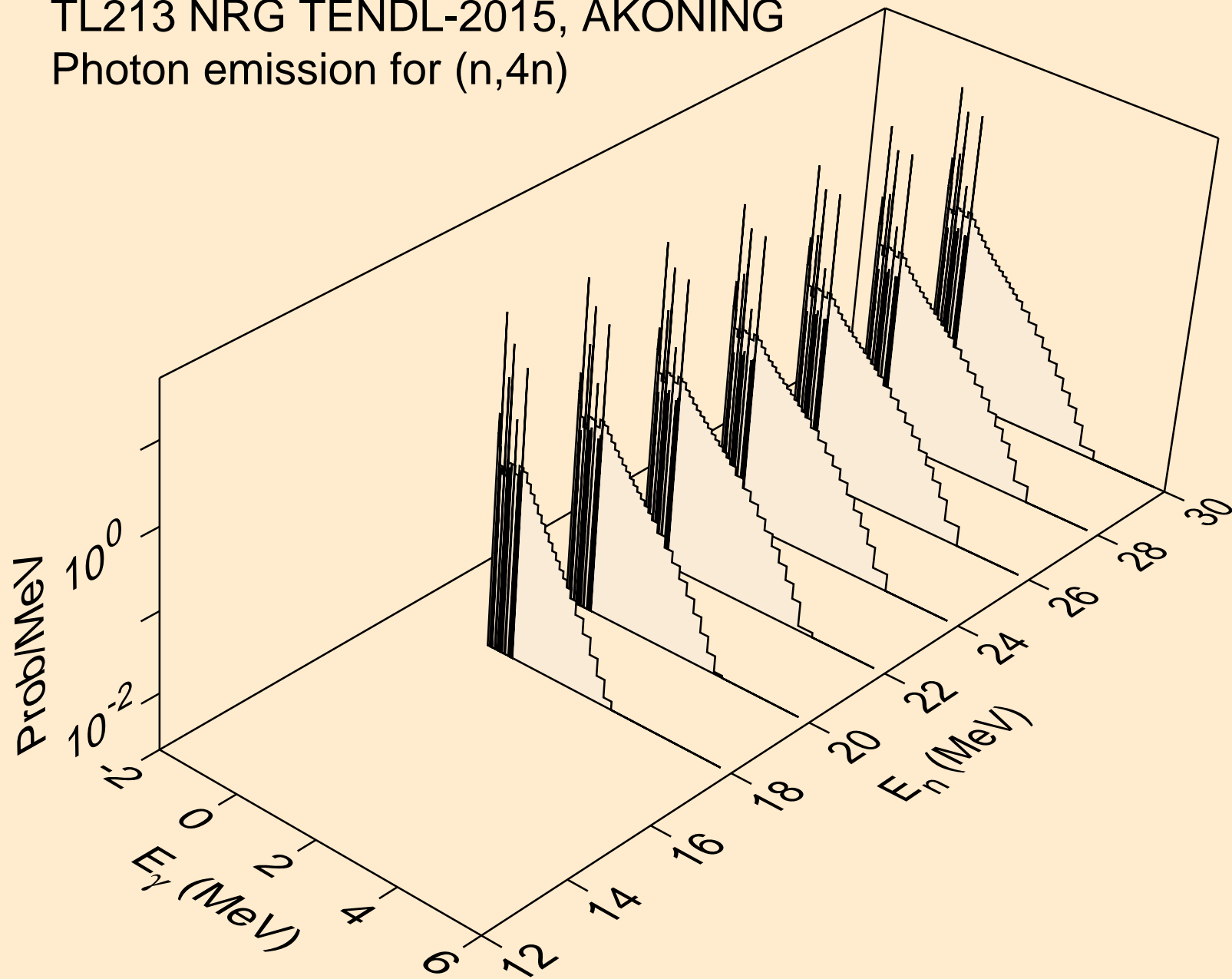

TL213 NRG TENDL-2015, AKONING
Photon emission for (n,2np)

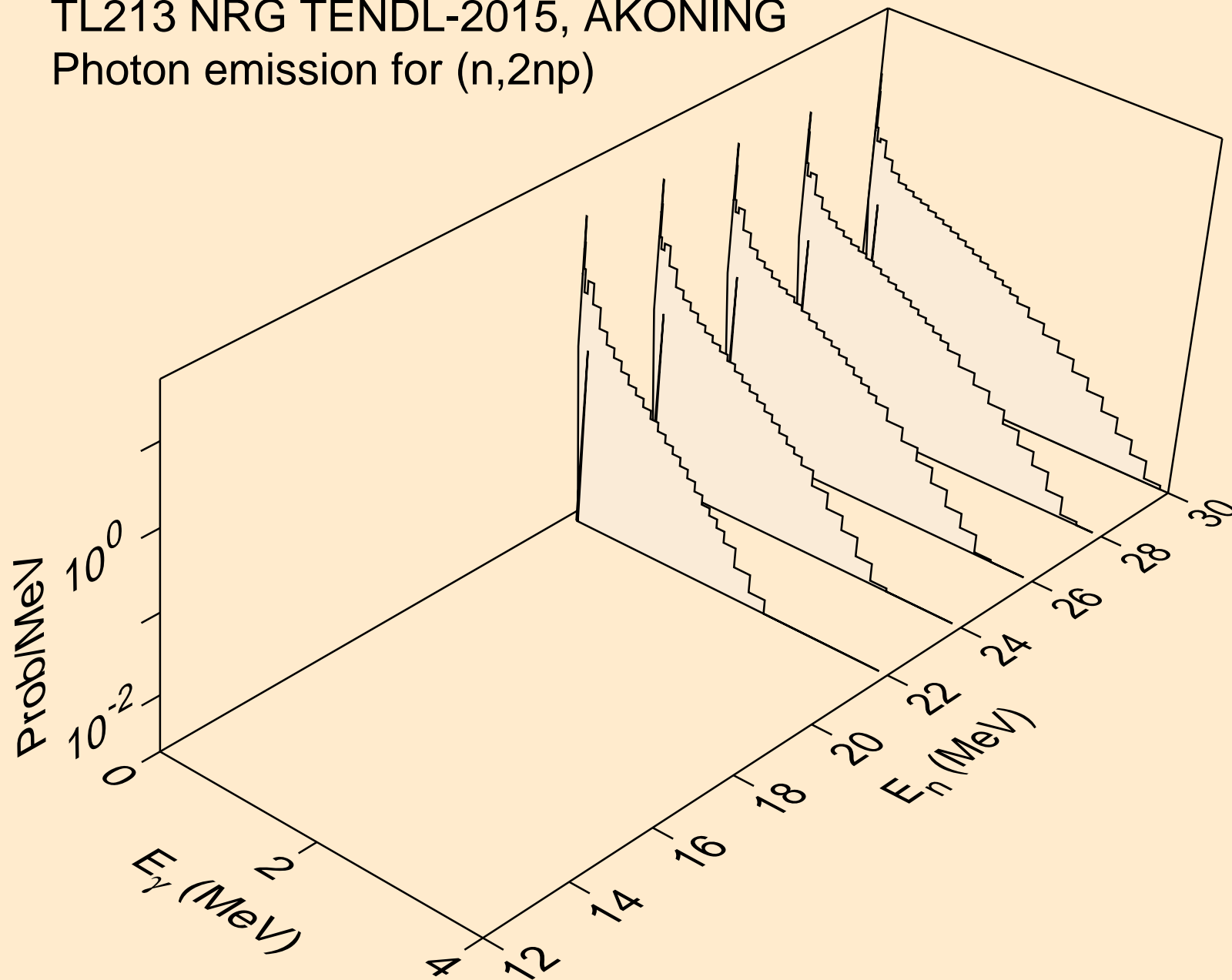

TL213 NRG TENDL-2015, AKONING
Photon emission for (n,3np)

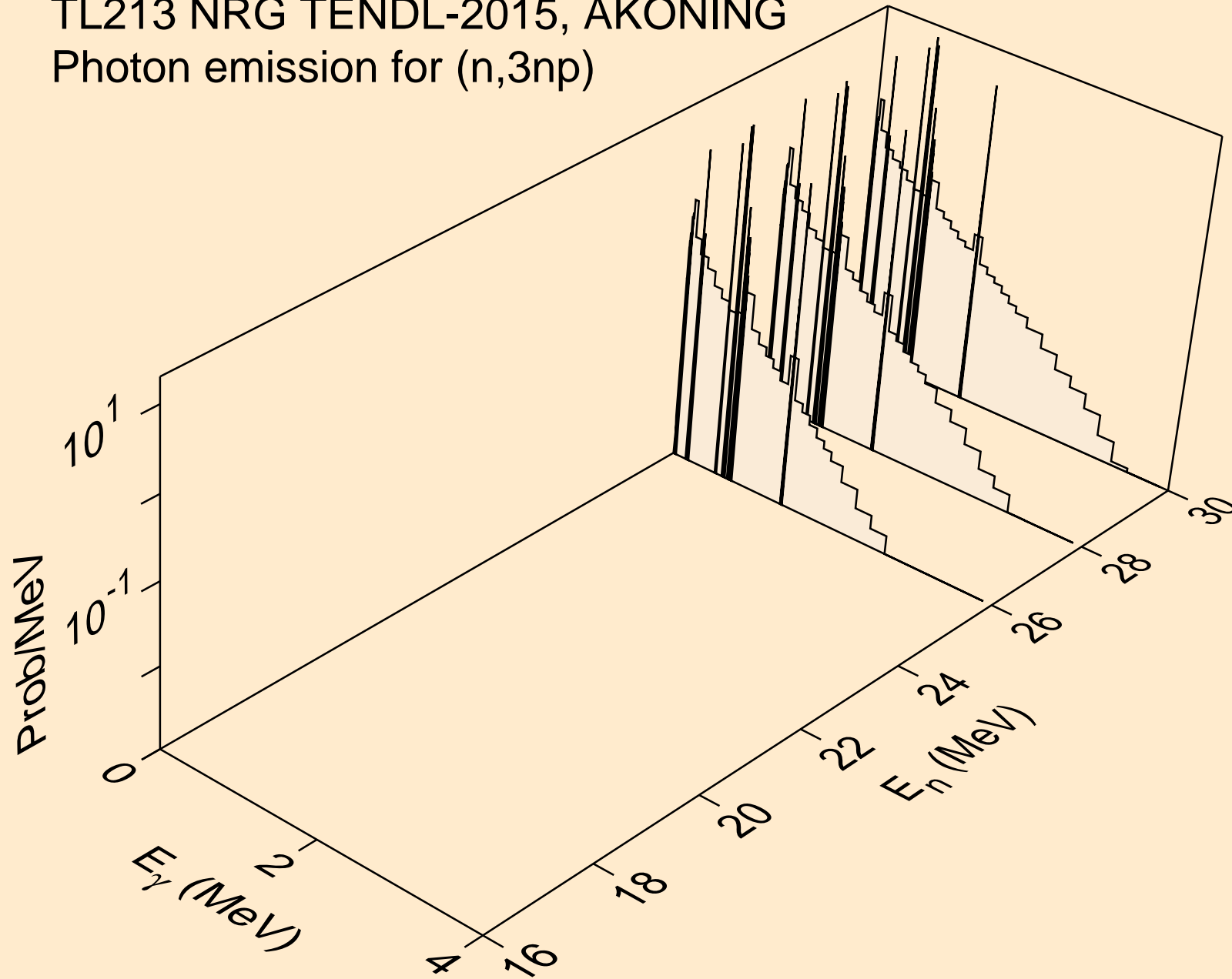

TL213 NRG TENDL-2015, AKONING
Photon emission for (n,n*c)

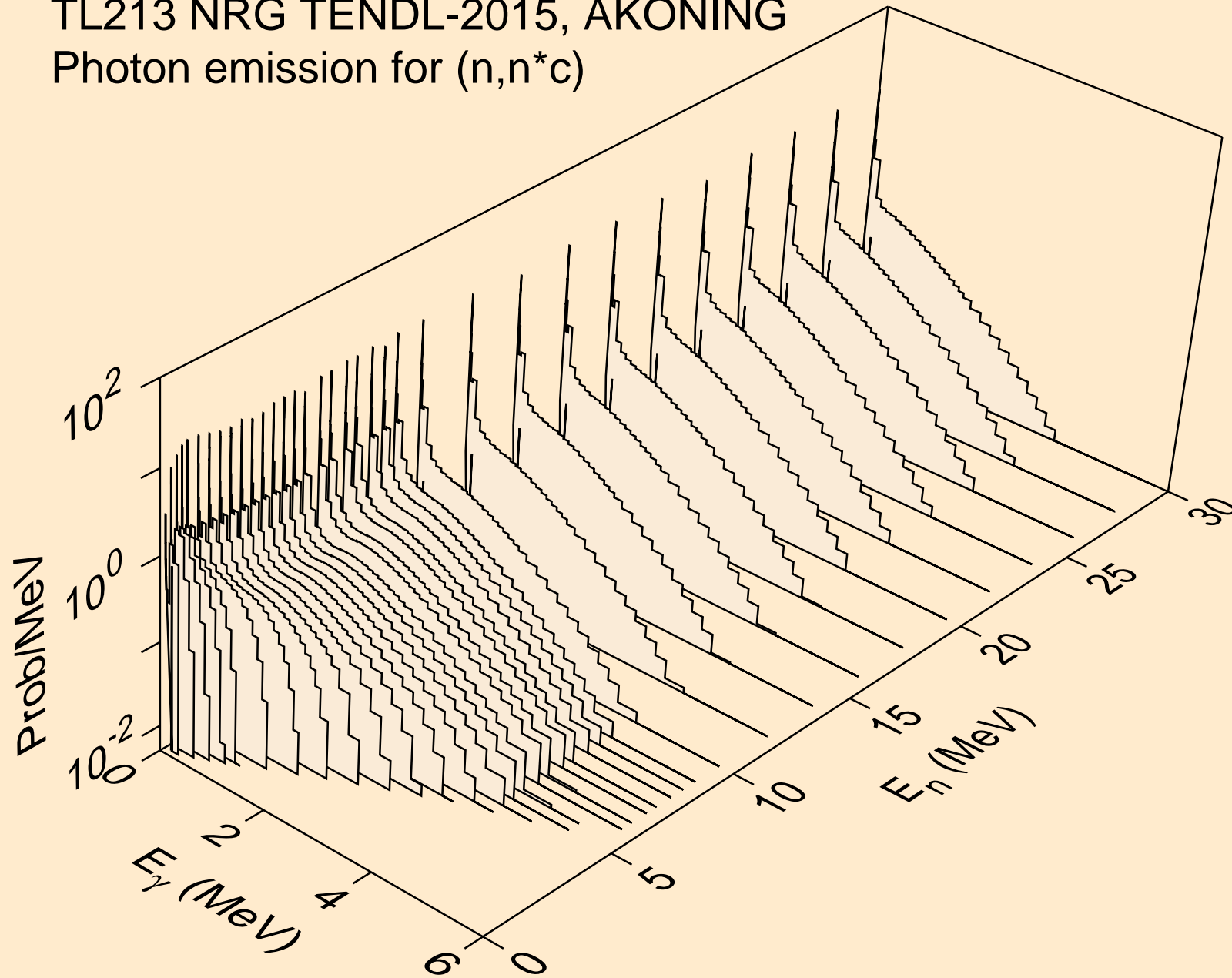

TL213 NRG TENDL-2015, AKONING
Photon emission for (n,gma)

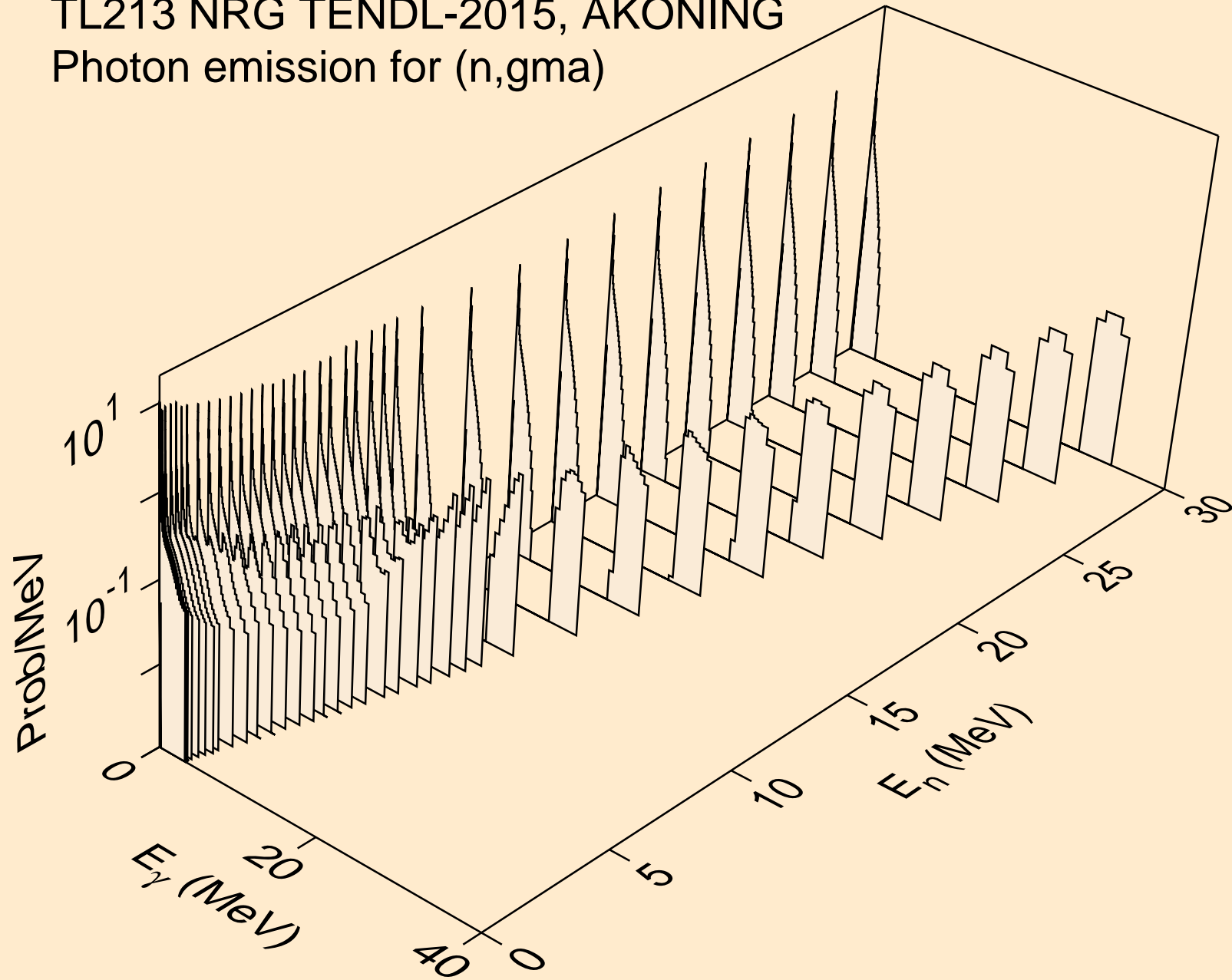

TL213 NRG TENDL-2015, AKONING
Photon emission for (n,p)

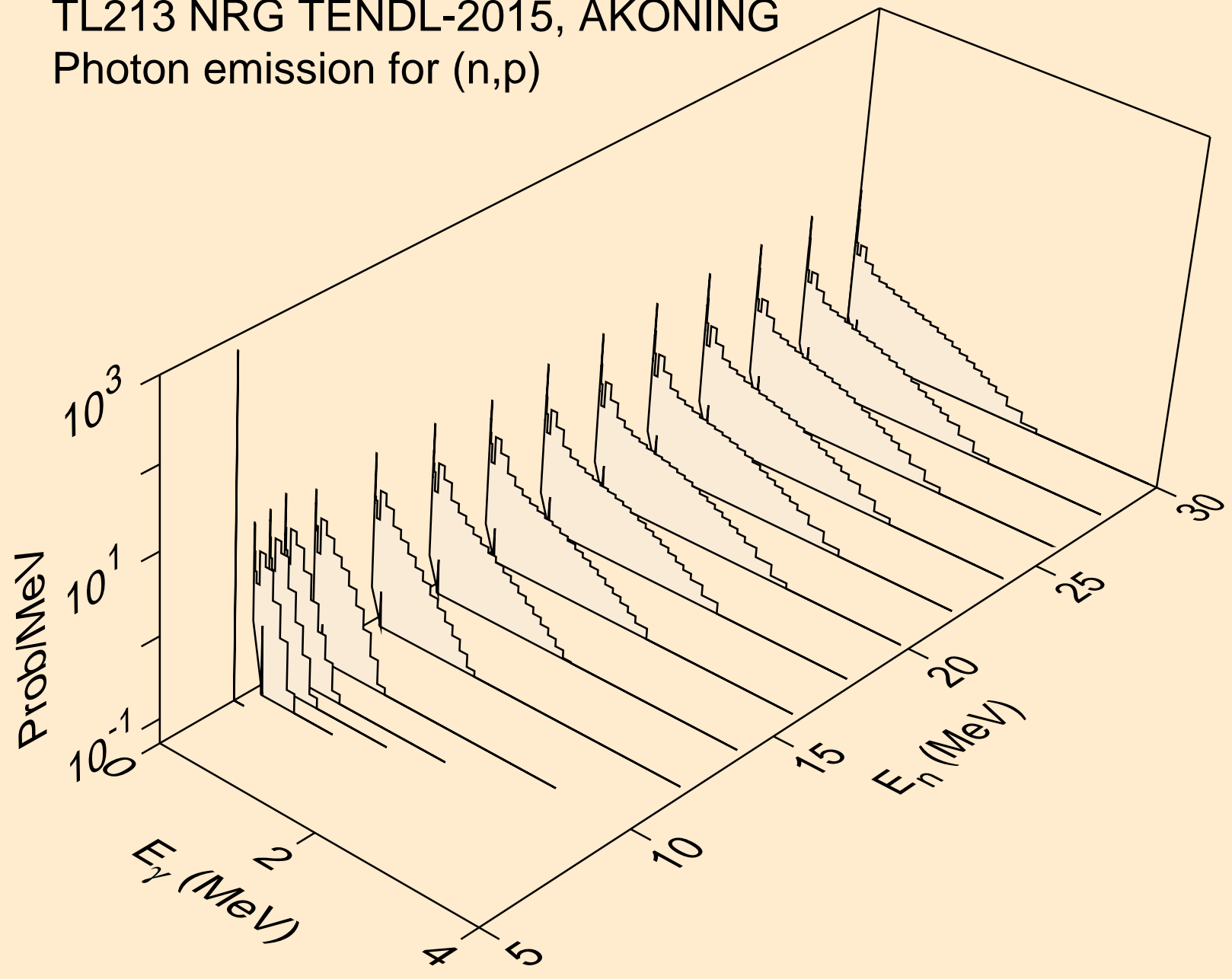

TL213 NRG TENDL-2015, AKONING
Photon emission for (n,d)

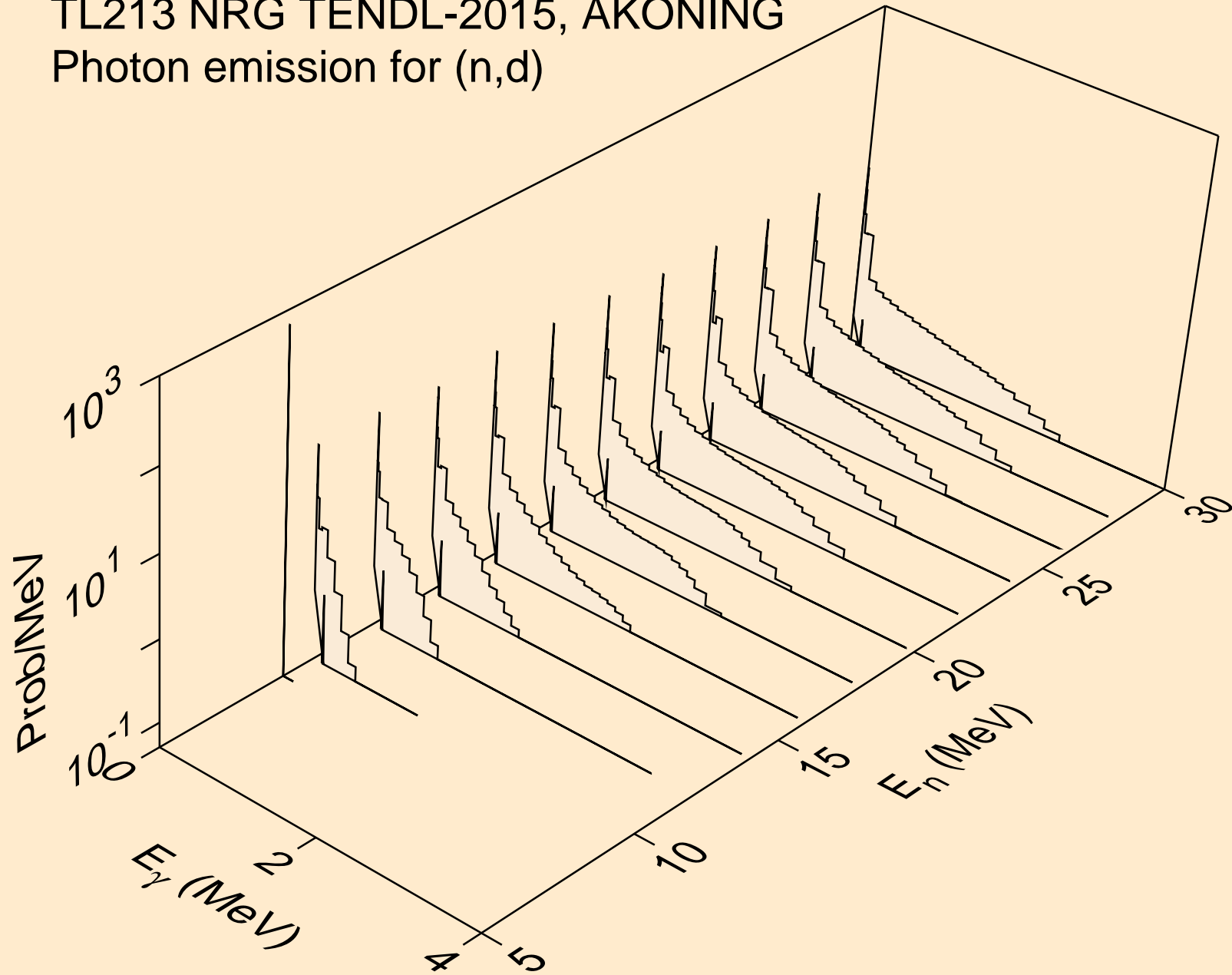

TL213 NRG TENDL-2015, AKONING
Photon emission for (n,t)

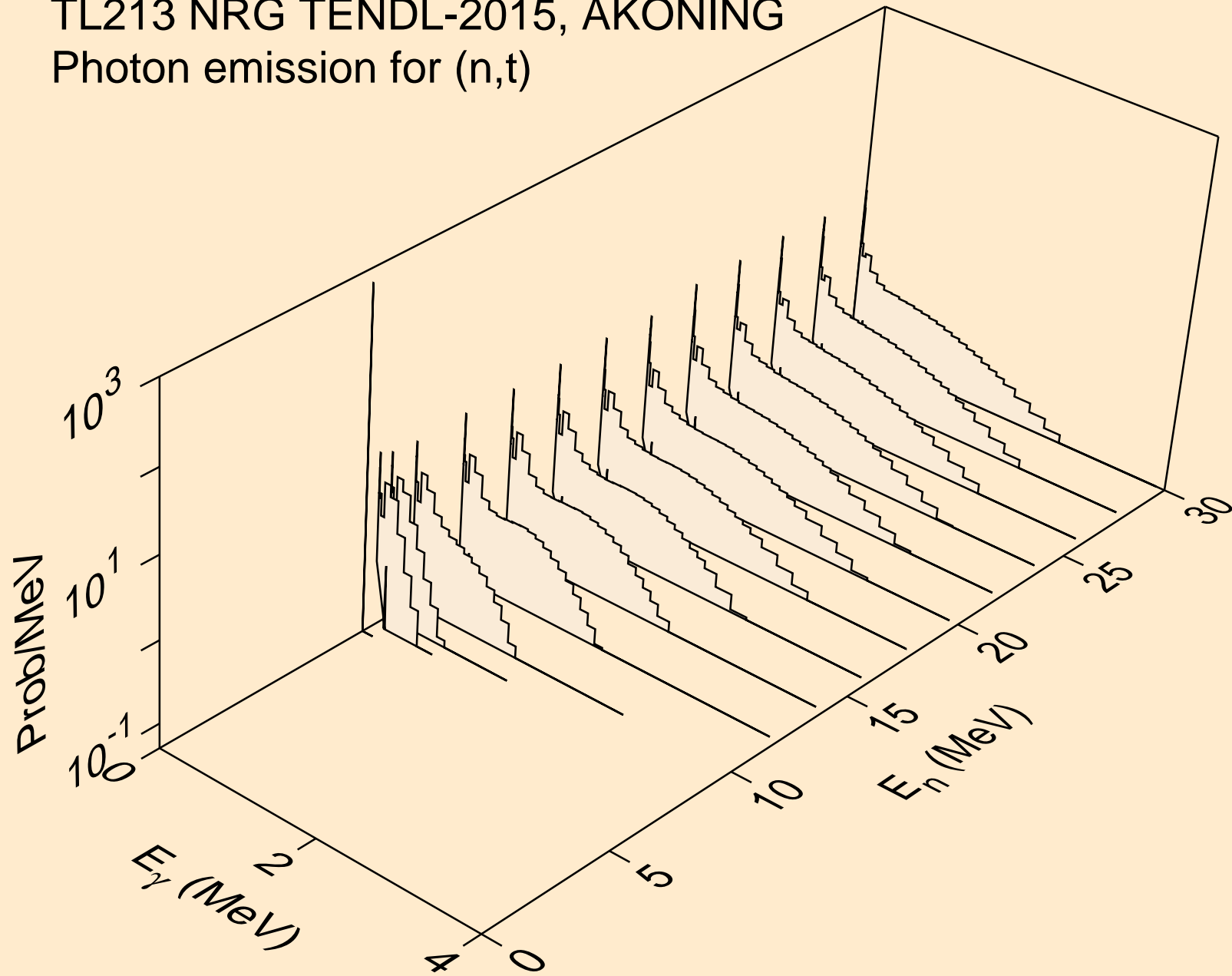

TL213 NRG TENDL-2015, AKONING
Photon emission for (n,he3)

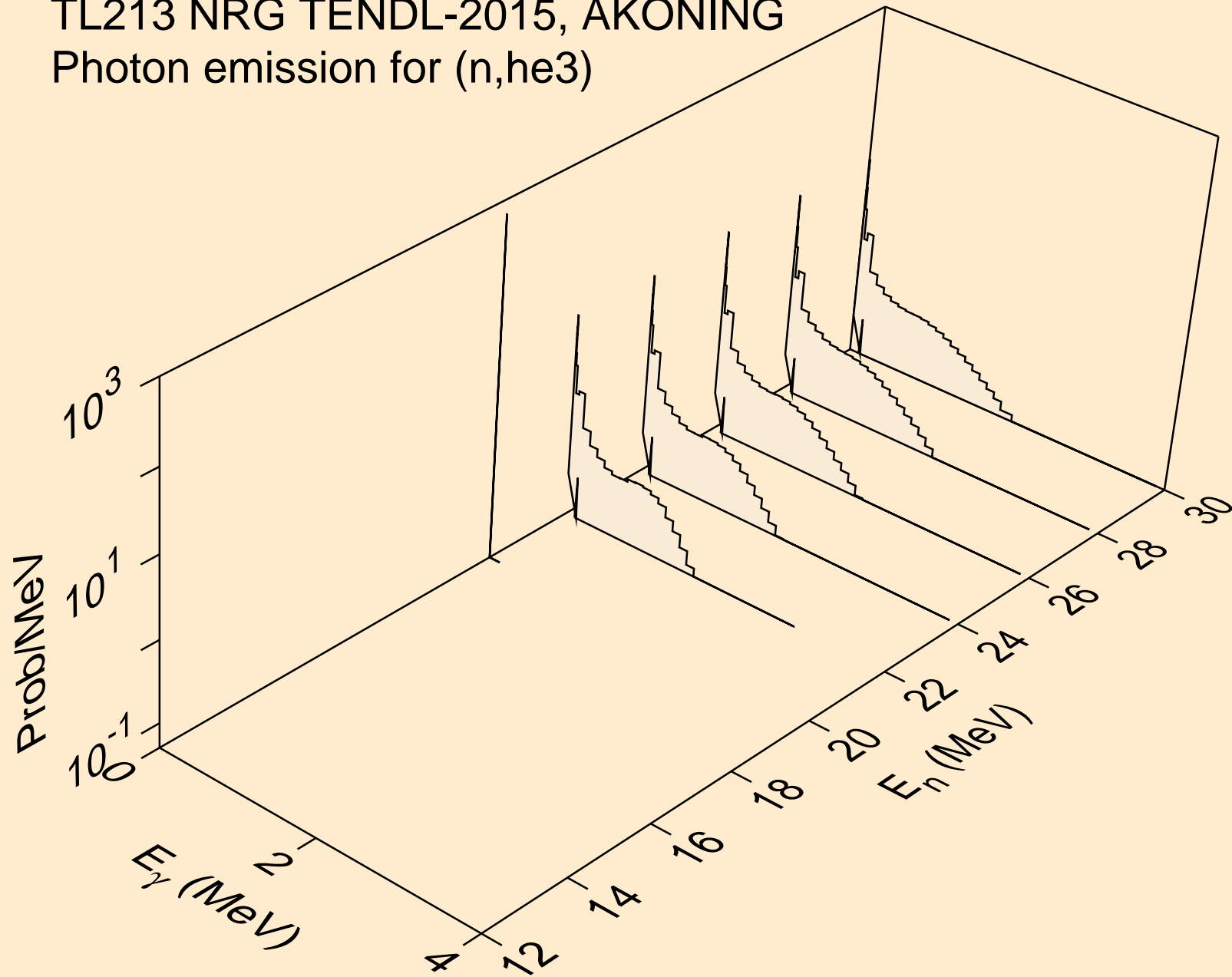

TL213 NRG TENDL-2015, AKONING
Photon emission for (n,a)

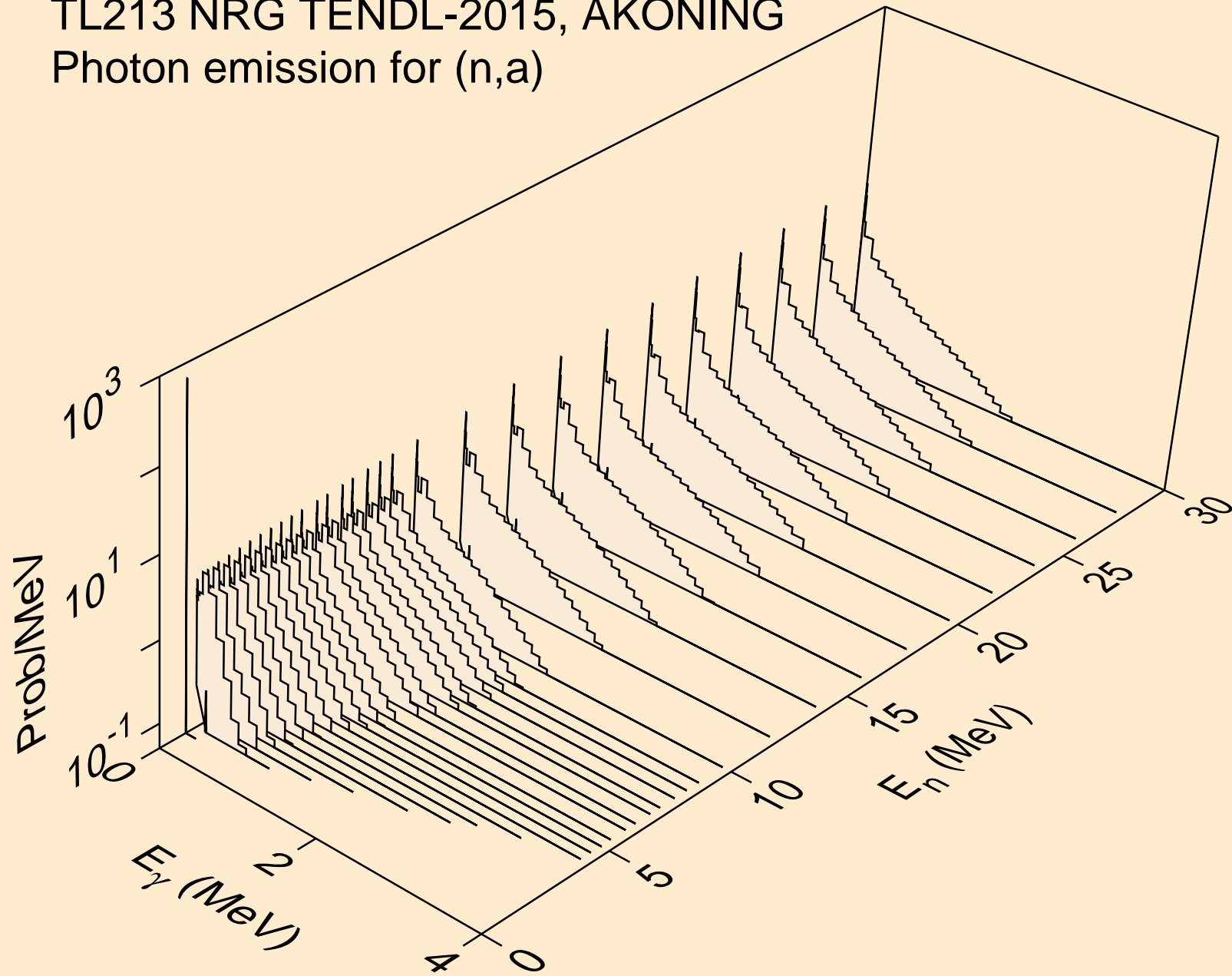

TL213 NRG TENDL-2015, AKONING
thermal capture photon spectrum

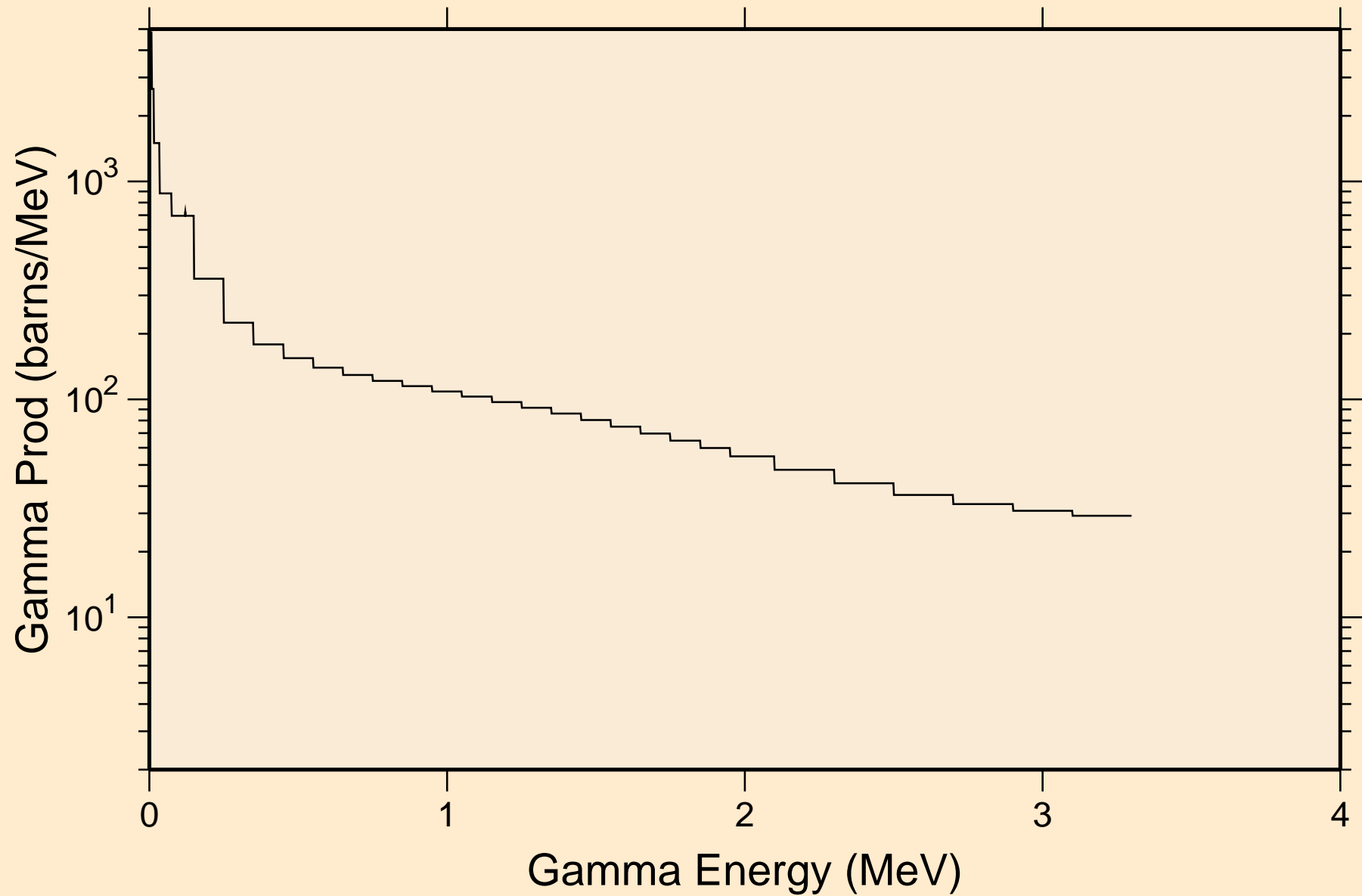

TL213 NRG TENDL-2015, AKONING
14 MeV photon spectrum

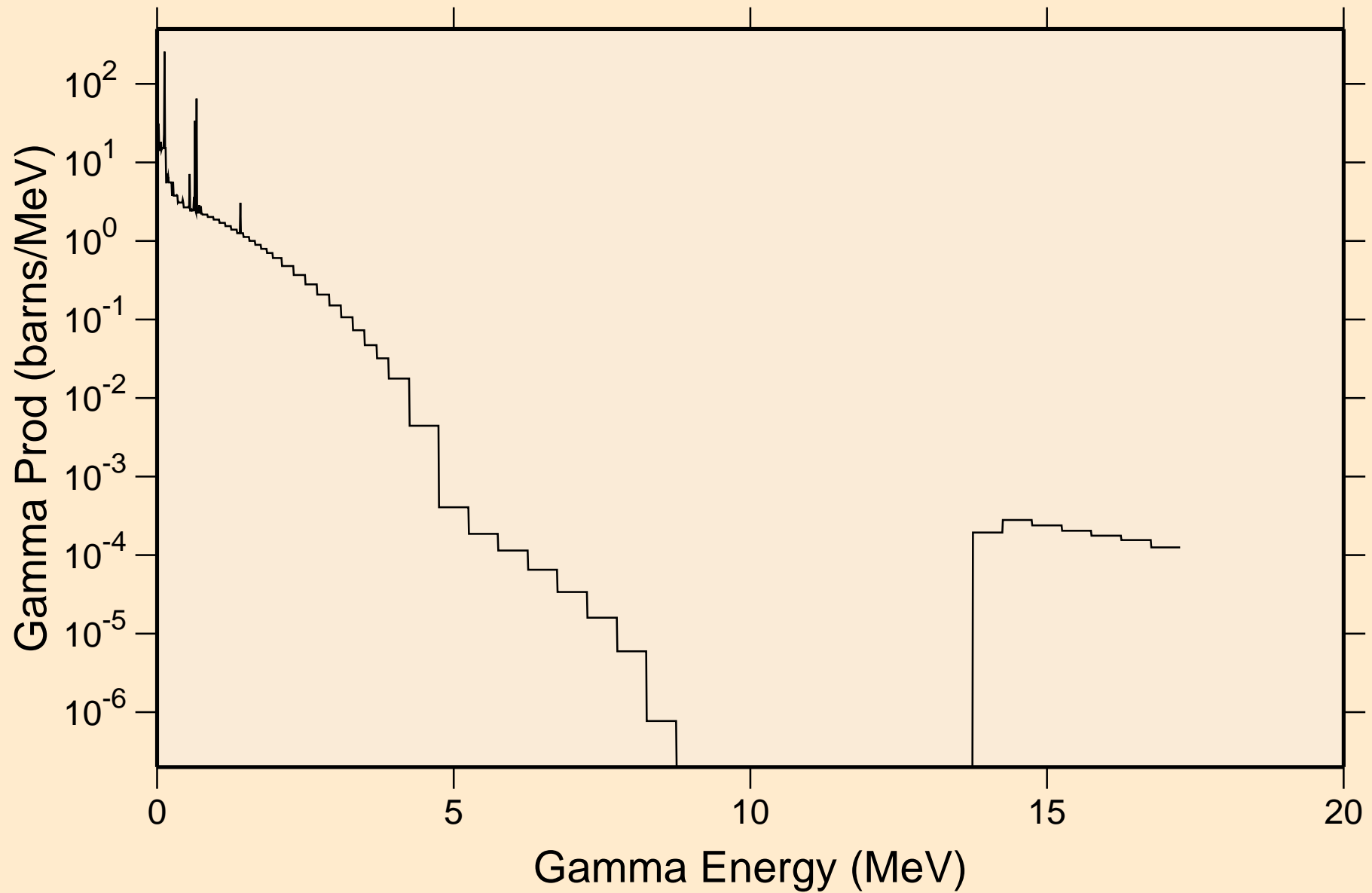

TL213 NRG TENDL-2015, AKONING

Particle heating contributions

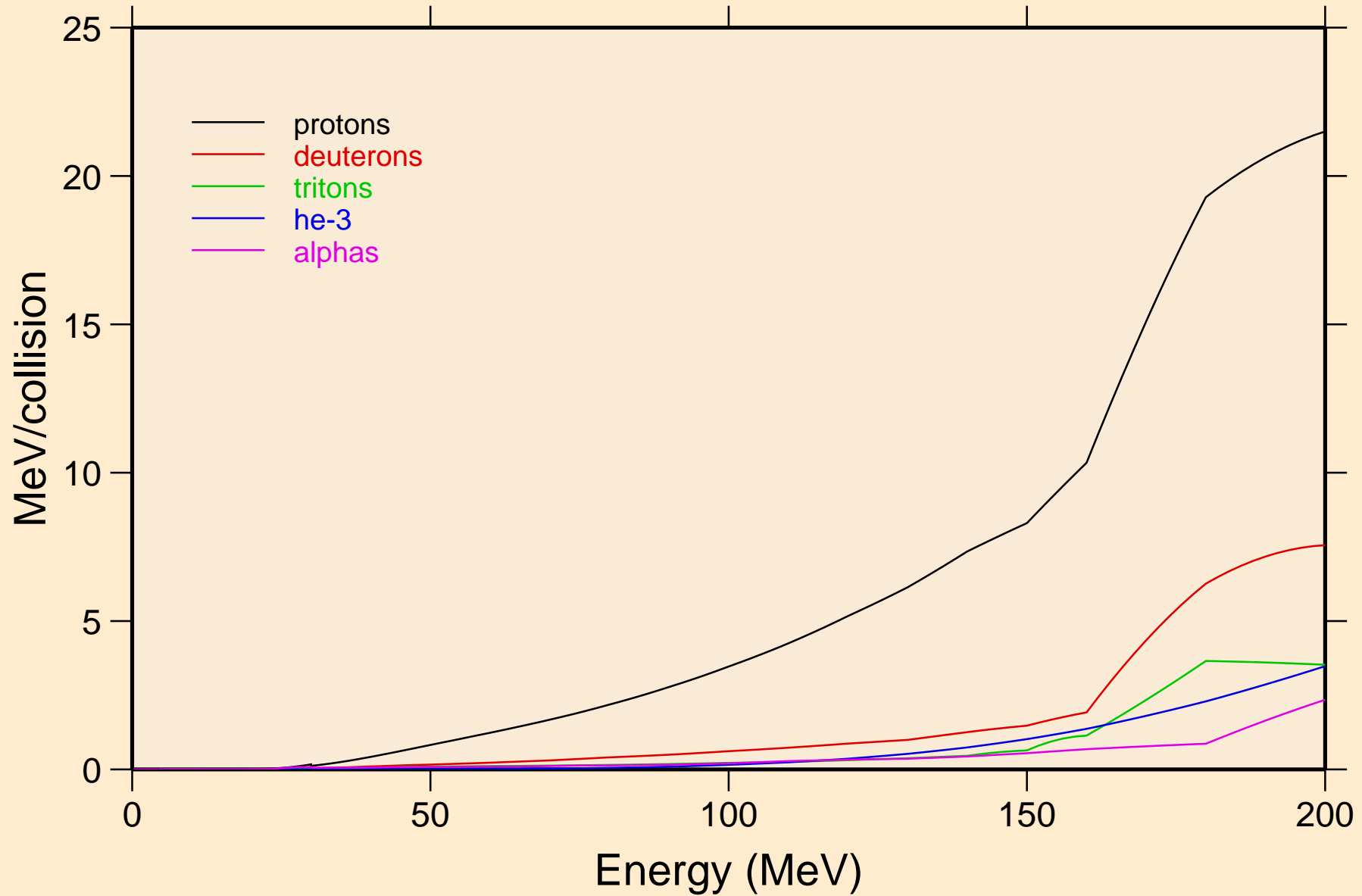

TL213 NRG TENDL-2015, AKONING

Recoil Heating

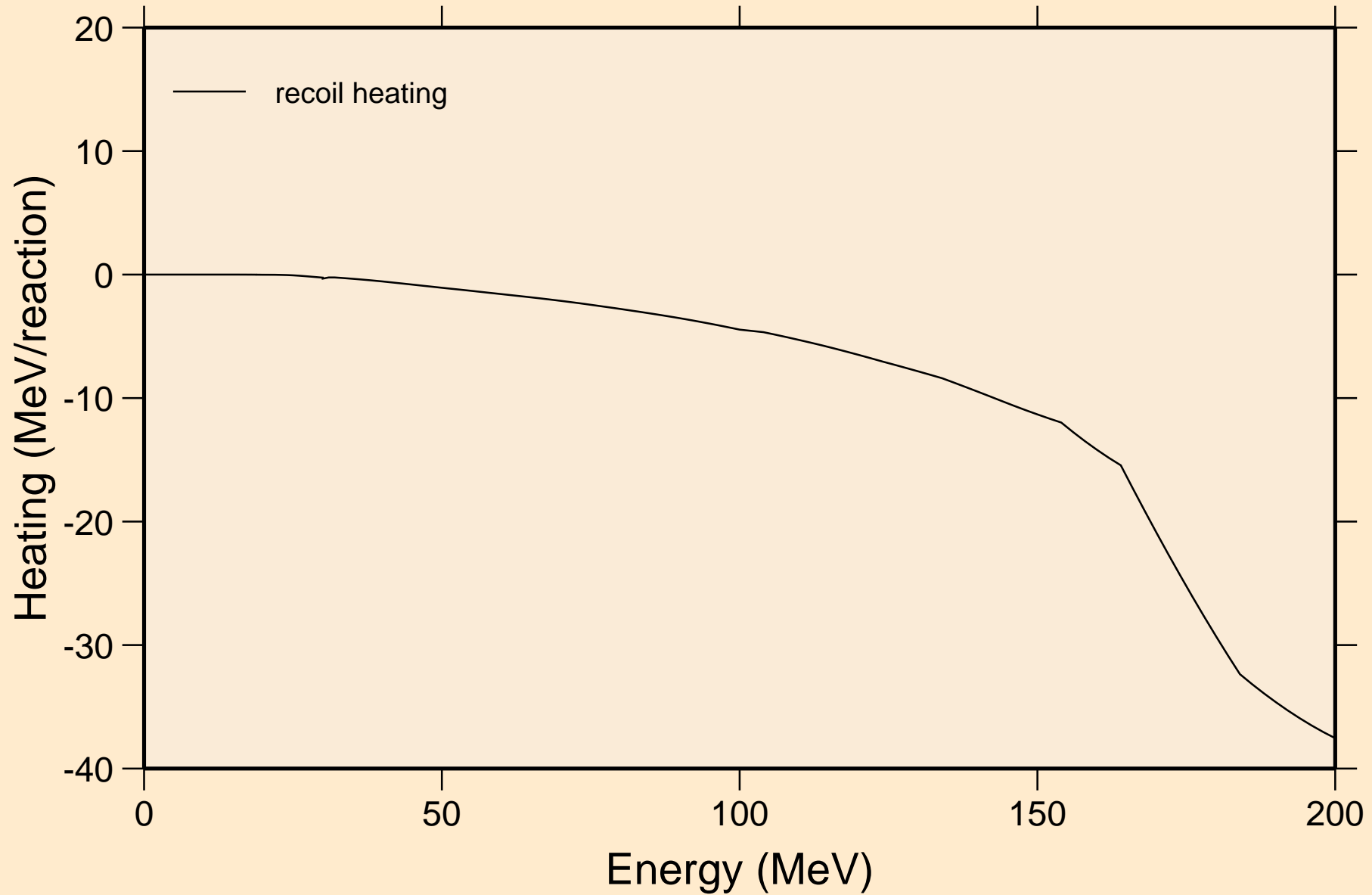

TL213 NRG TENDL-2015, AKONING

Particle production cross sections

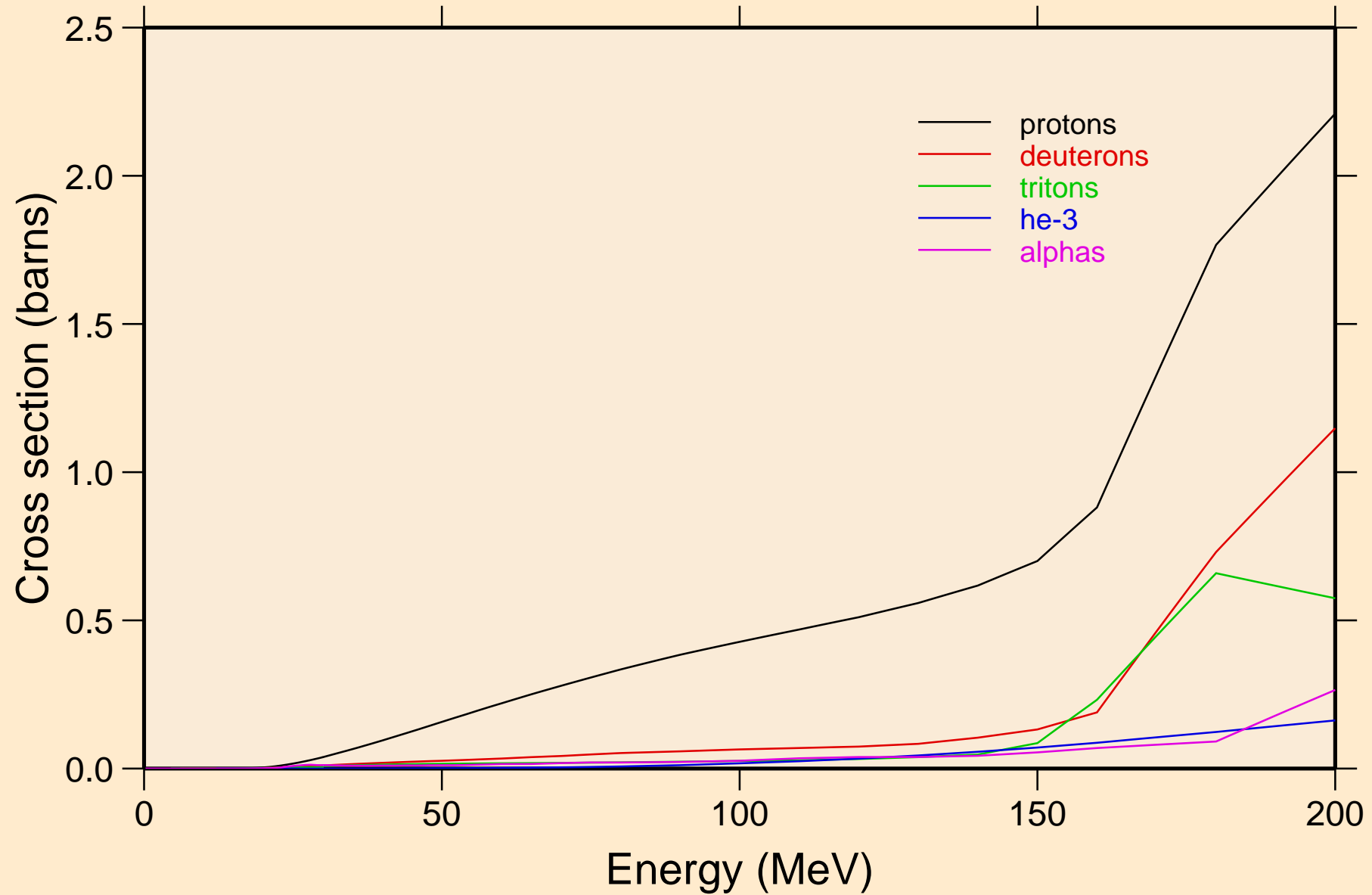

TL213 NRG TENDL-2015, AKONING
protons from (n,x)

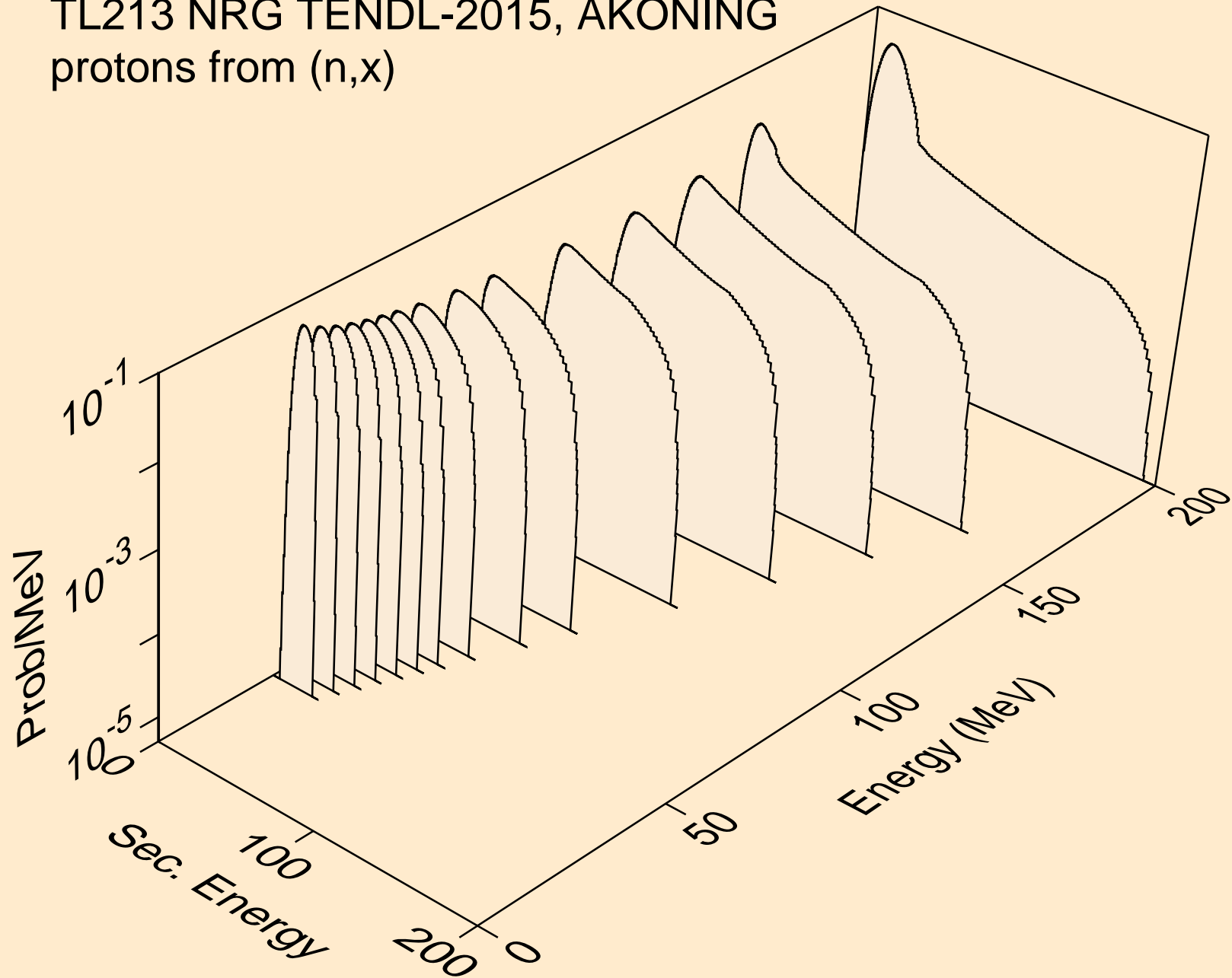

TL213 NRG TENDL-2015, AKONING
protons from (n,n*)p

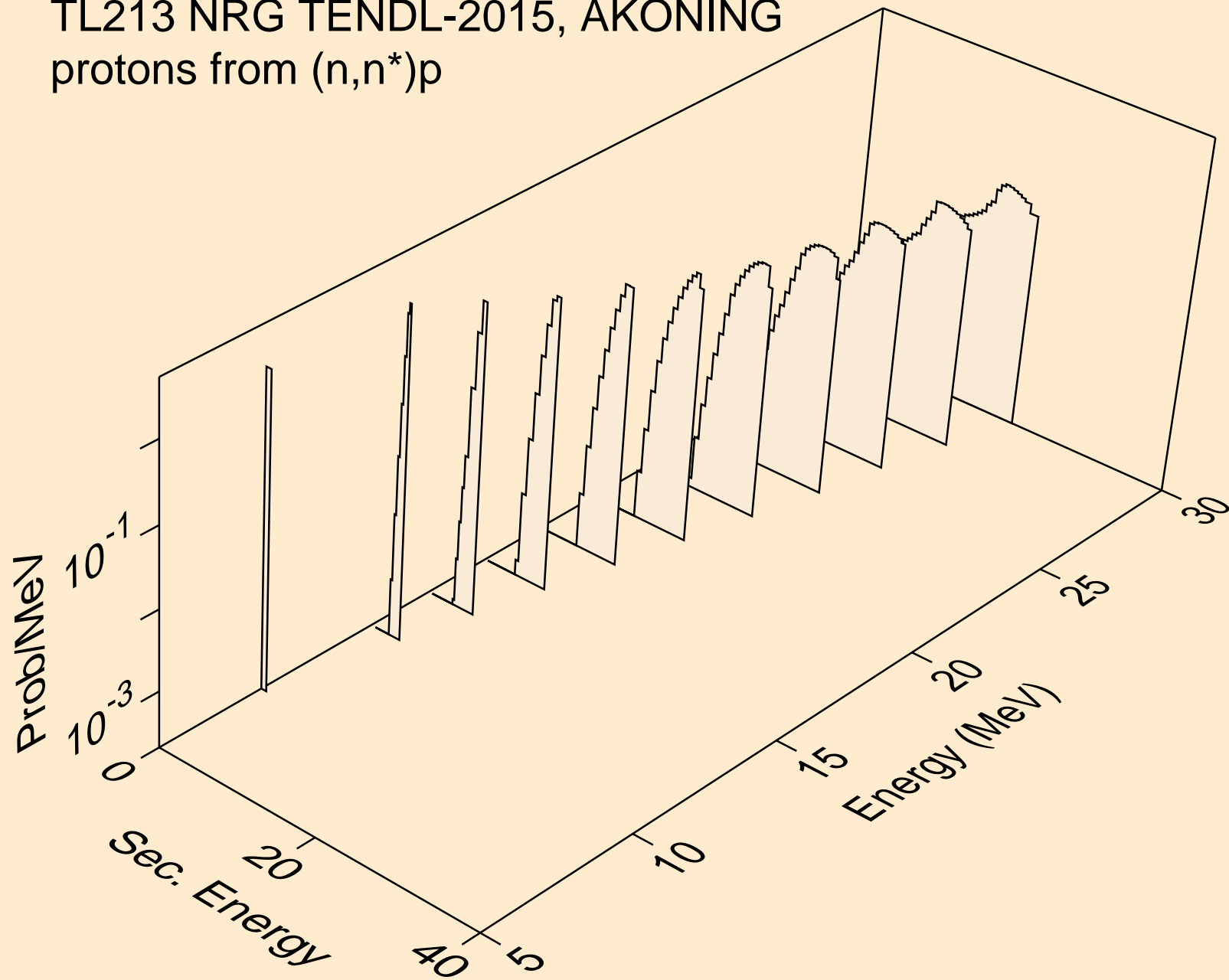

TL213 NRG TENDL-2015, AKONING
protons from (n,2np)

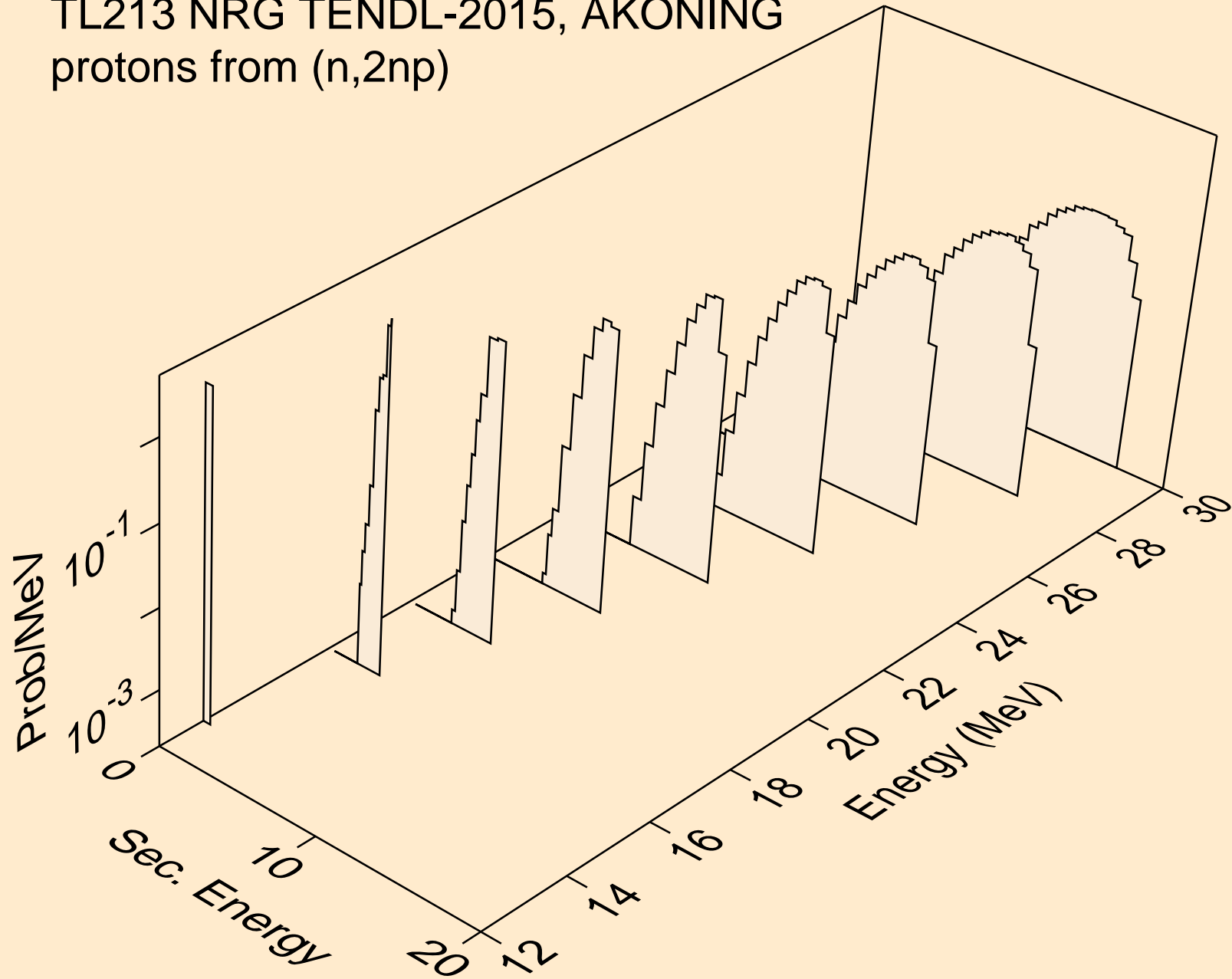

TL213 NRG TENDL-2015, AKONING
protons from (n,3np)

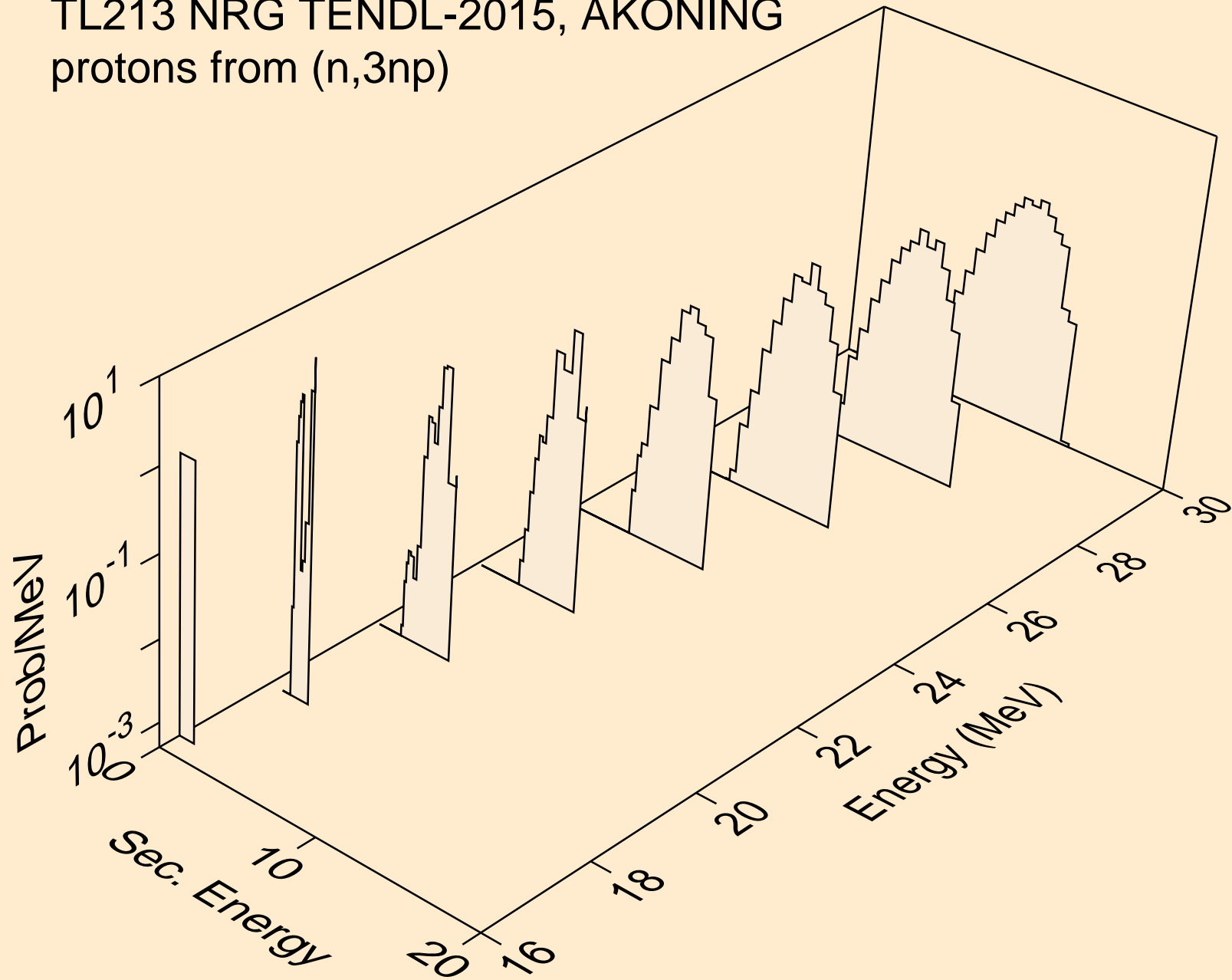

TL213 NRG TENDL-2015, AKONING
protons from (n,p)

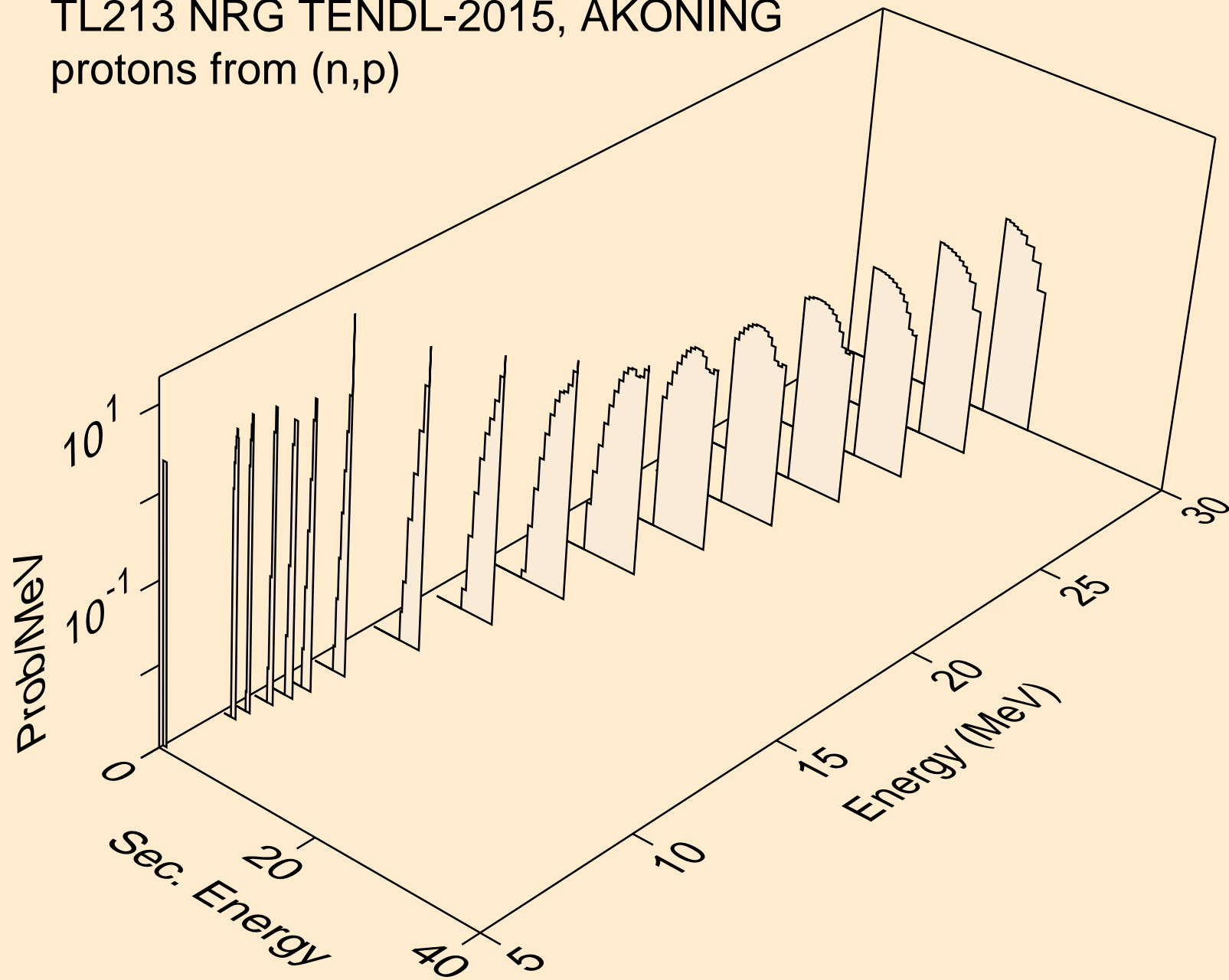

TL213 NRG TENDL-2015, AKONING
deuterons from (n,x)

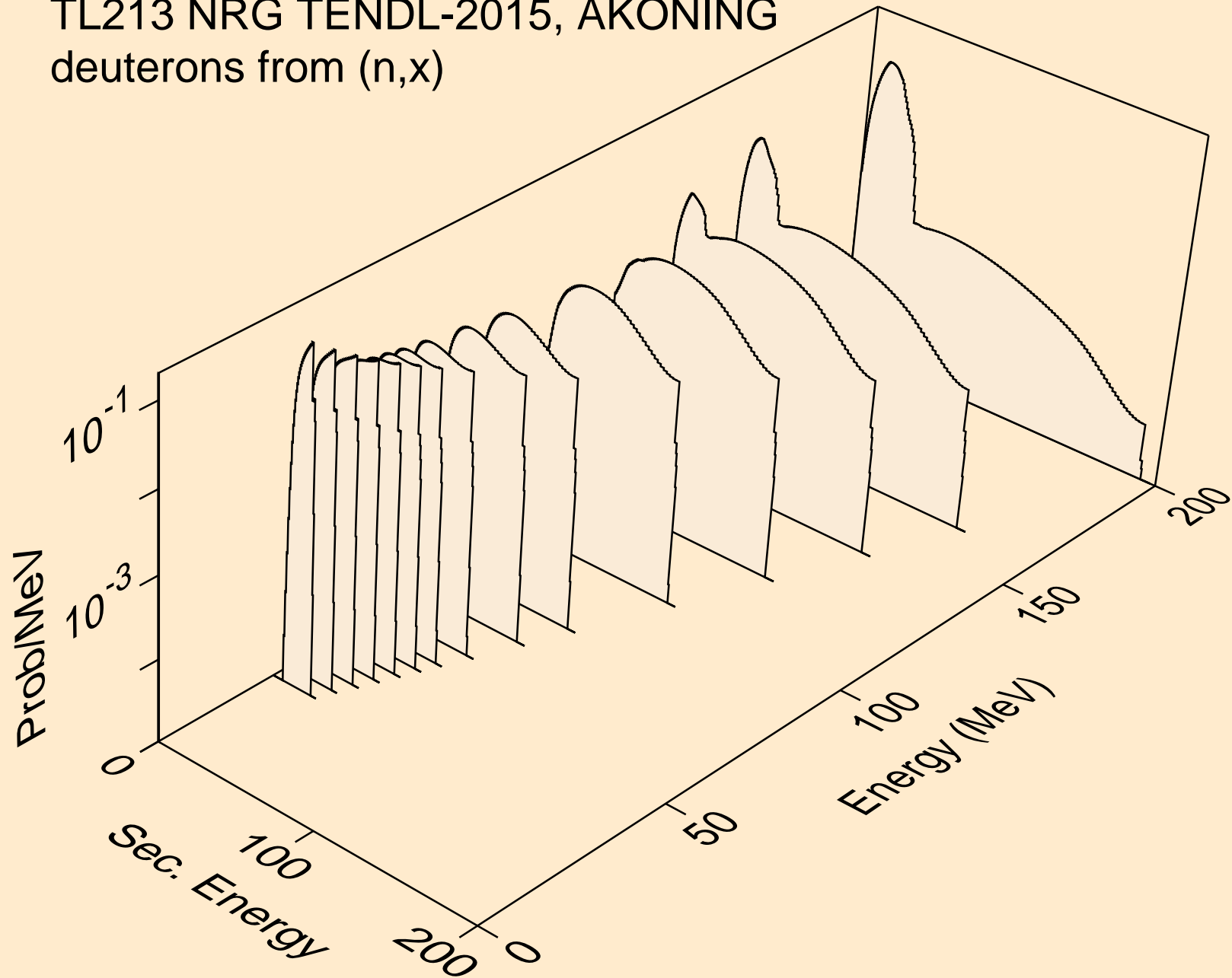

TL213 NRG TENDL-2015, AKONING
deuterons from (n,2nd)

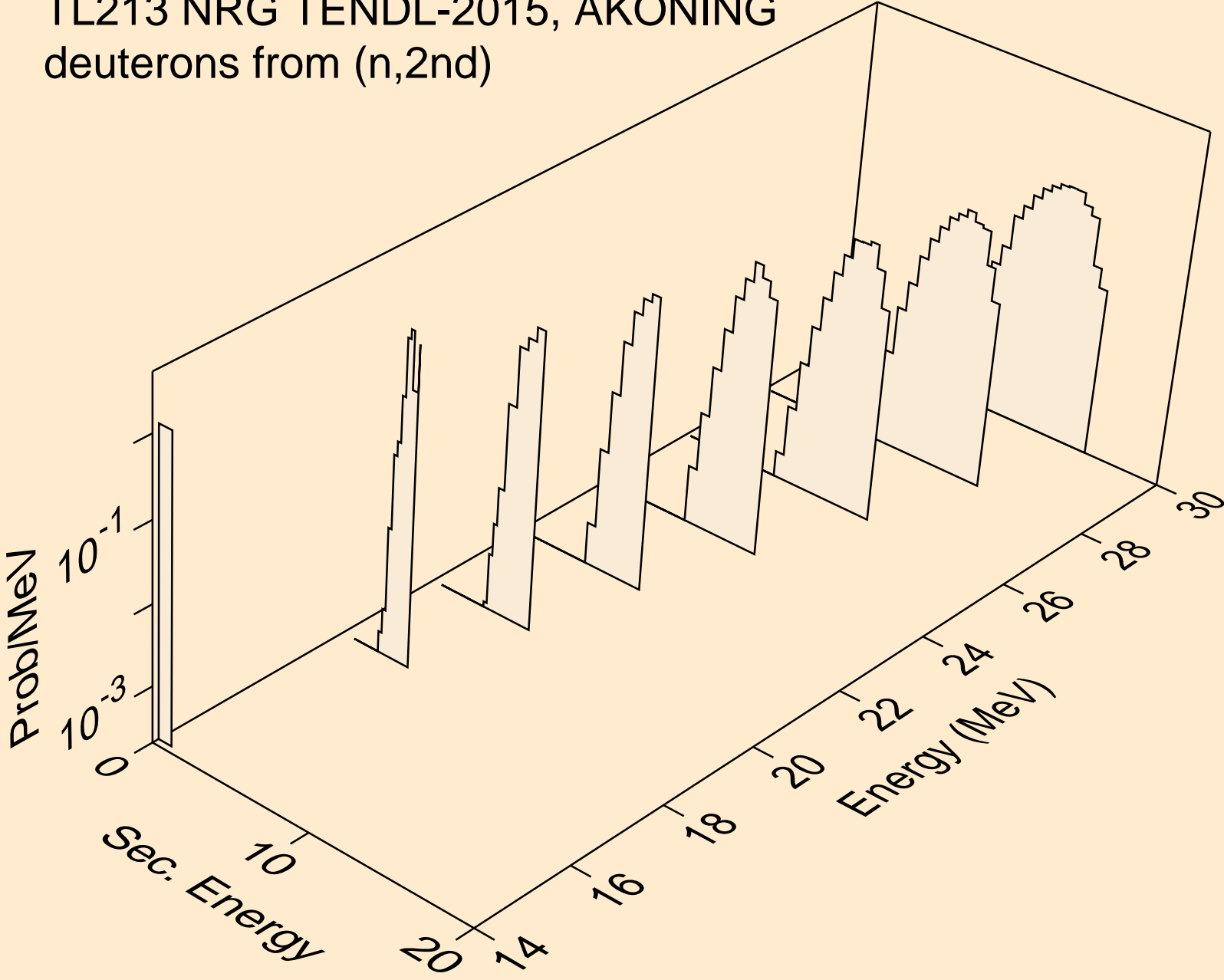

TL213 NRG TENDL-2015, AKONING
deuterons from (n,n*)d

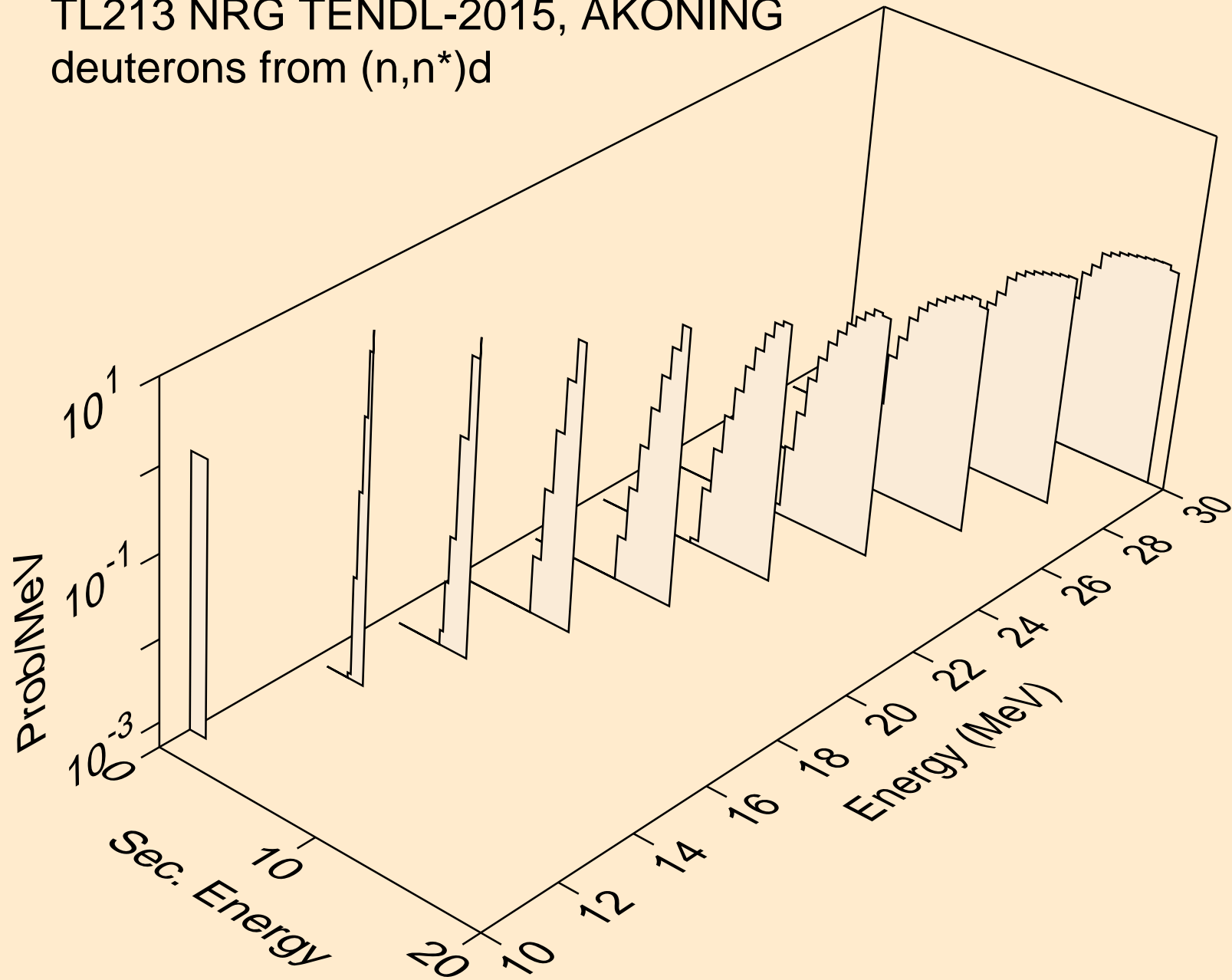

TL213 NRG TENDL-2015, AKONING
deuterons from (n,d)

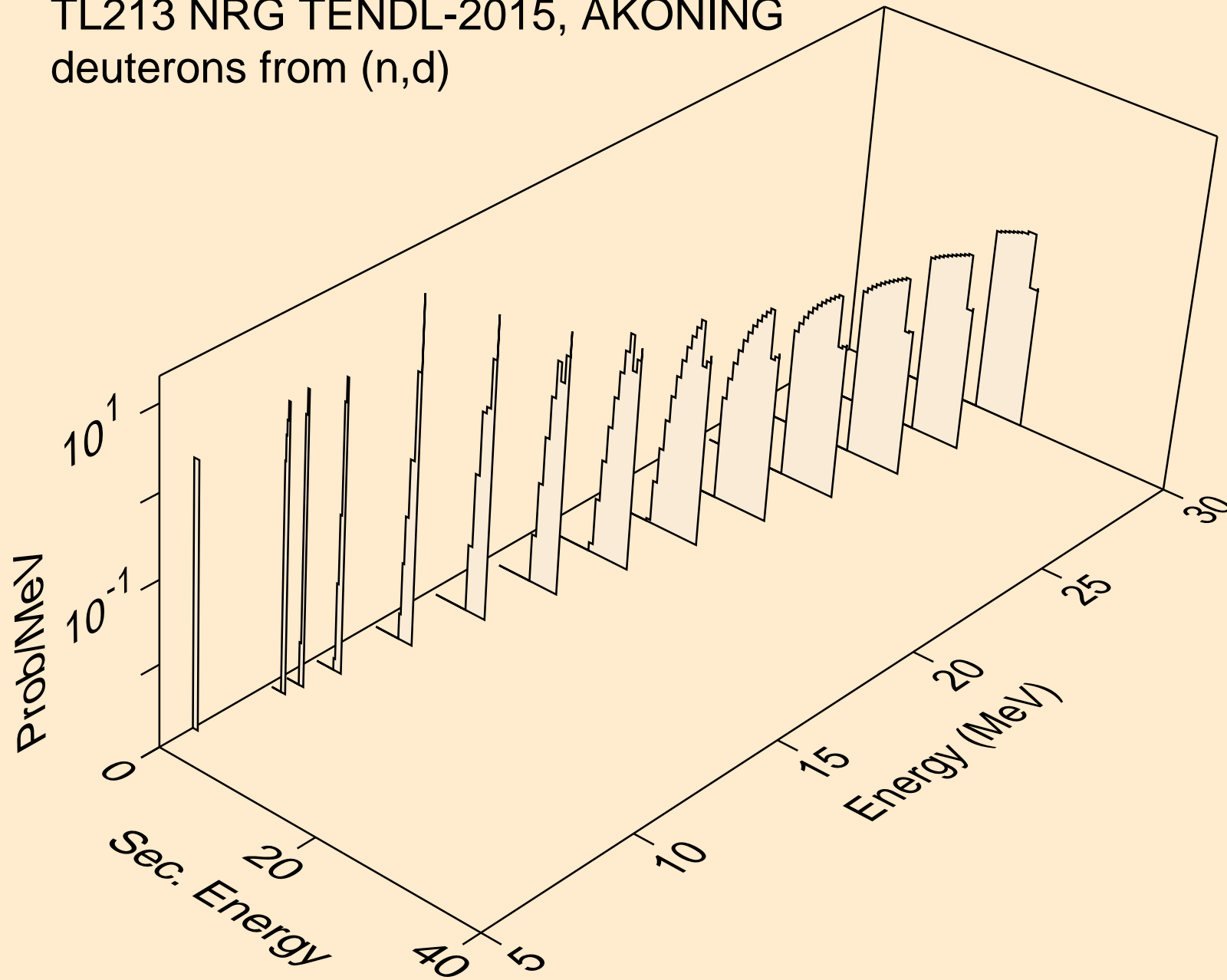

TL213 NRG TENDL-2015, AKONING
tritons from (n,x)

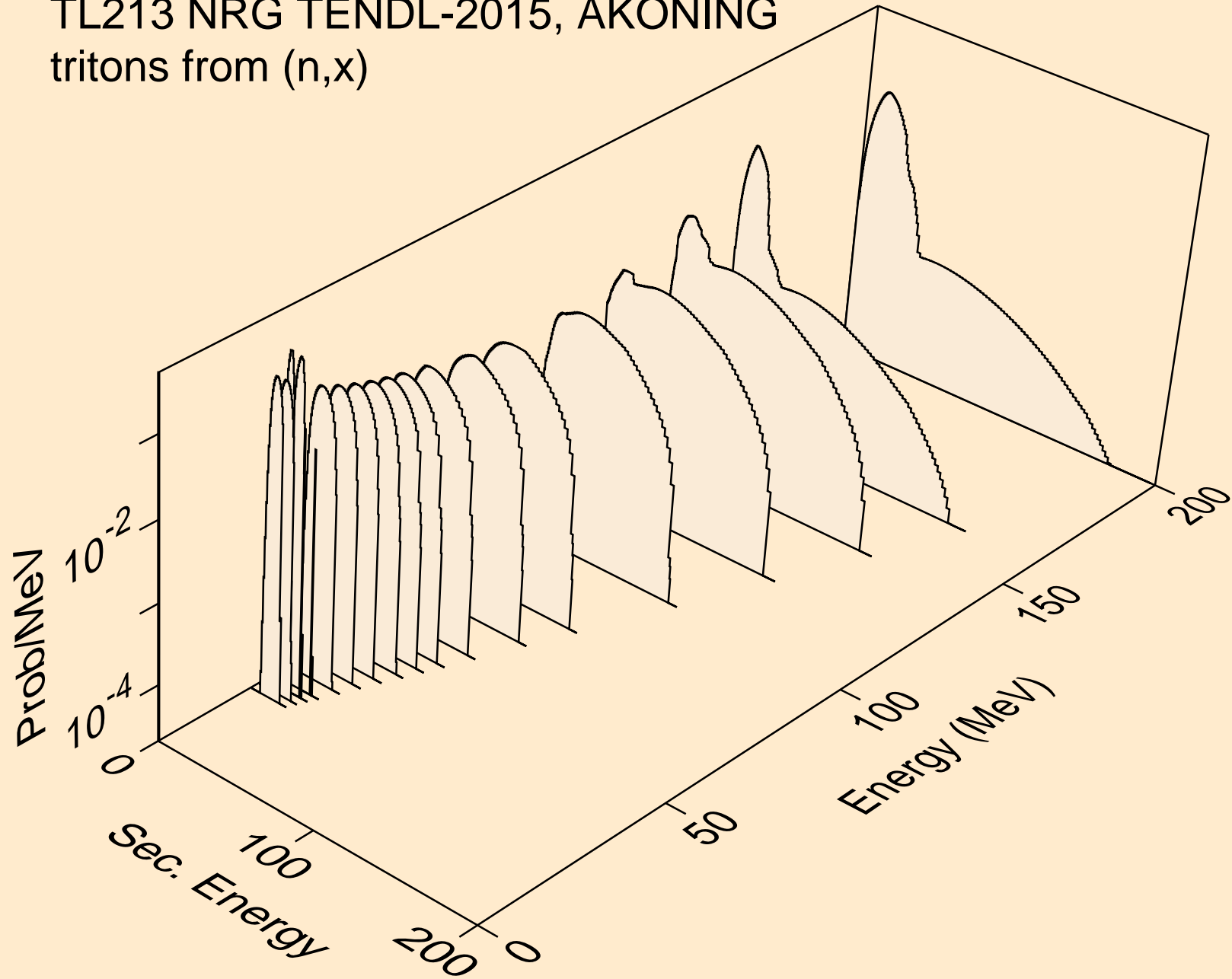

TL213 NRG TENDL-2015, AKONING
tritons from (n,n*)t

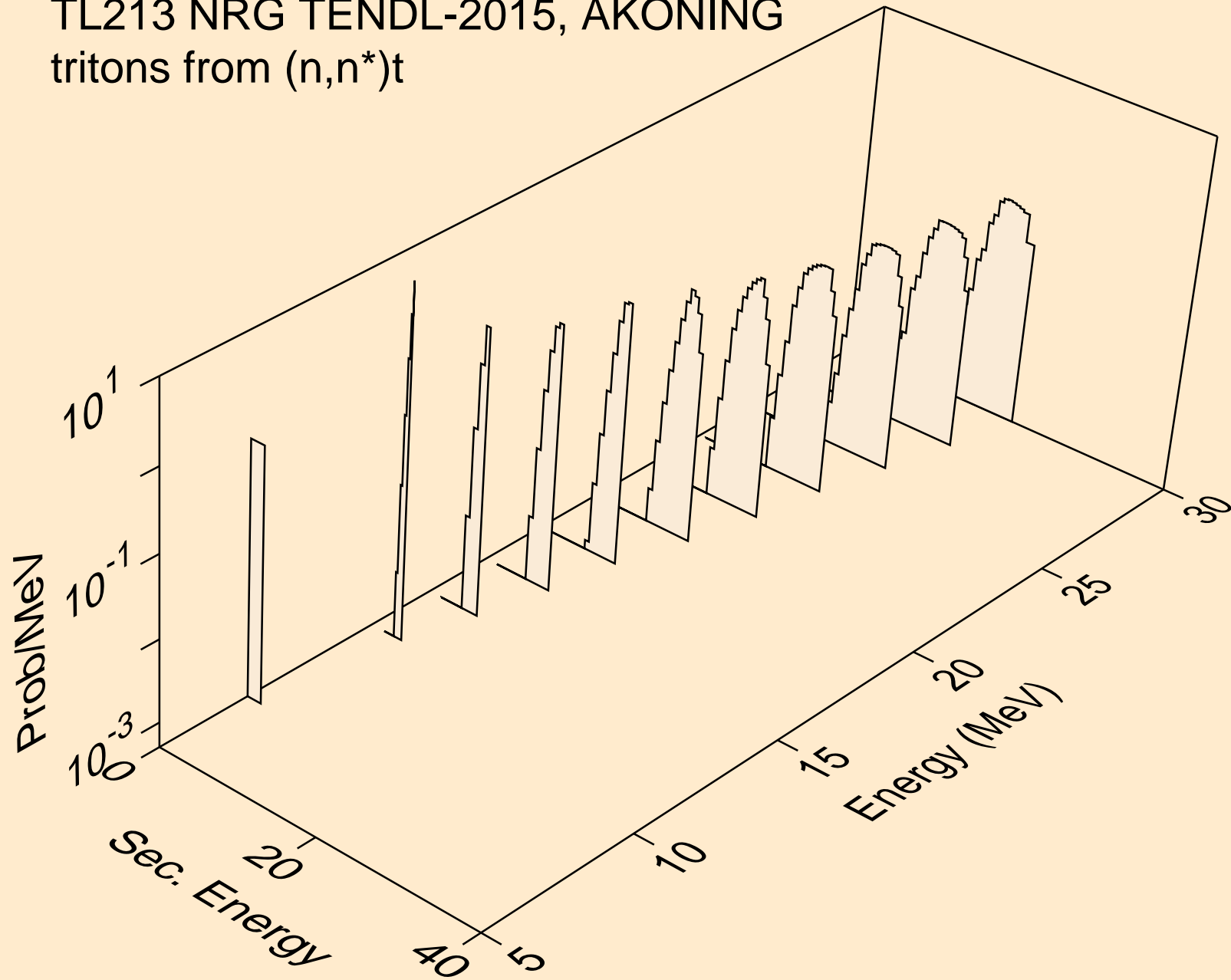

TL213 NRG TENDL-2015, AKONING
tritons from (n,t)

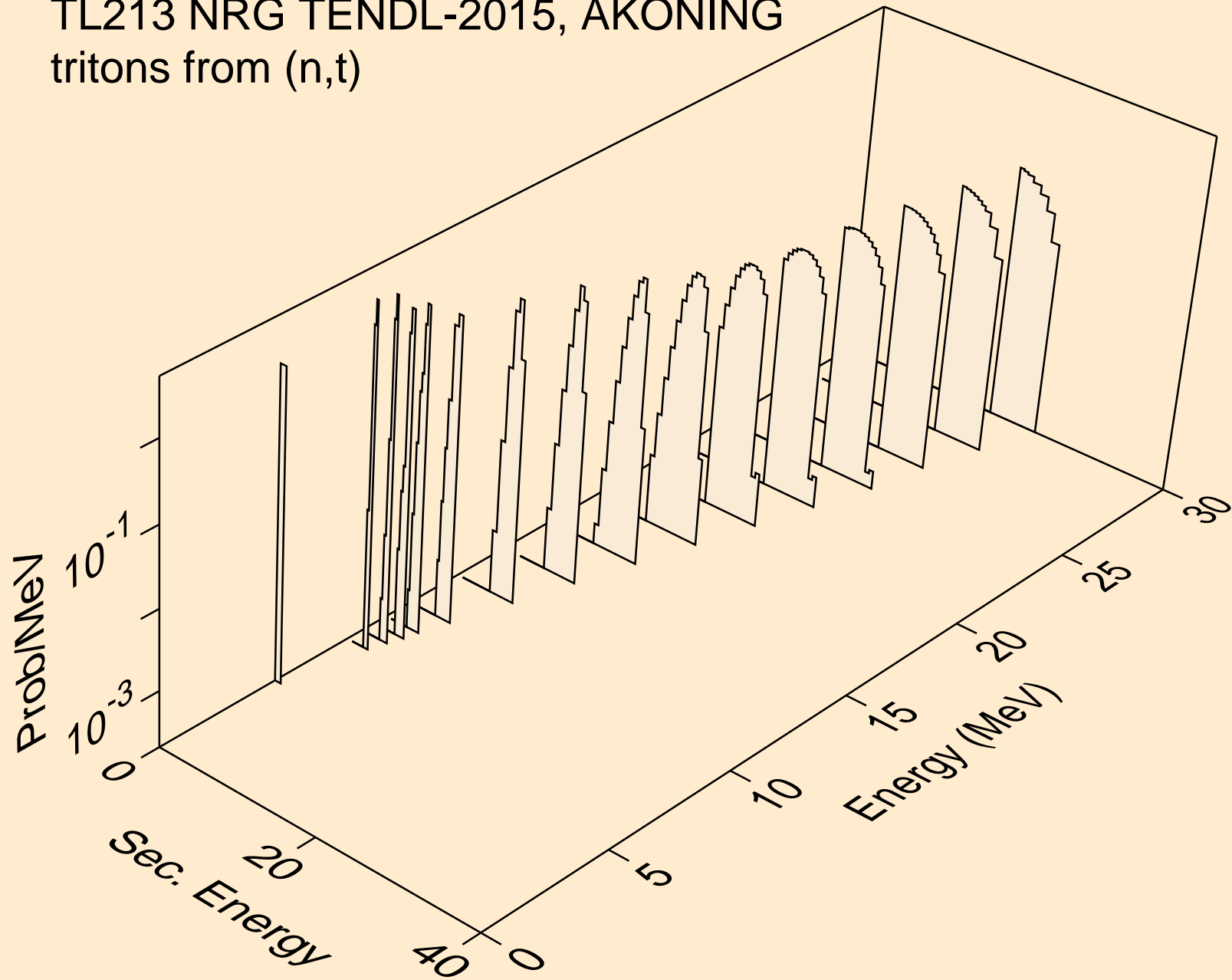

TL213 NRG TENDL-2015, AKONING
he3s from (n,x)

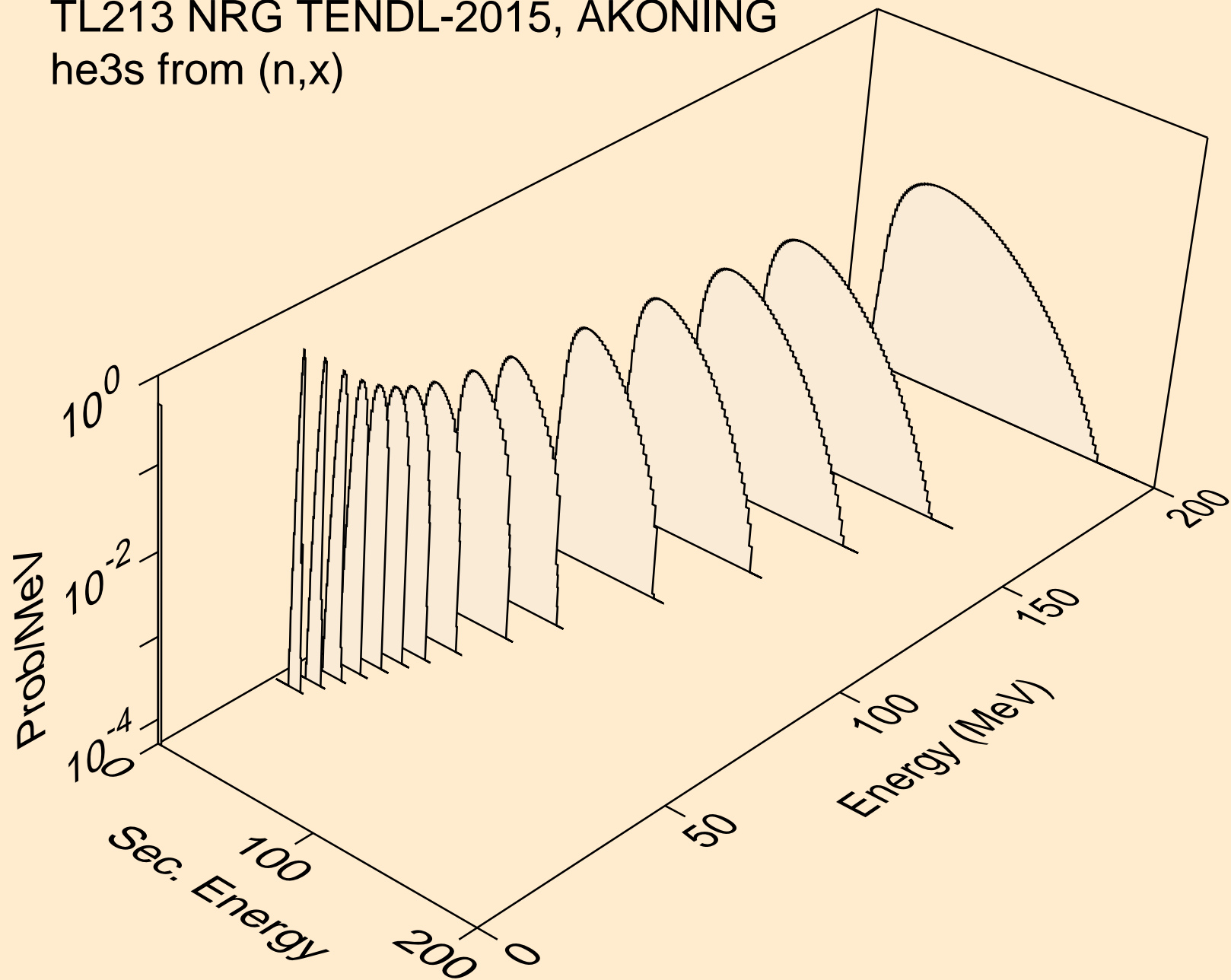

TL213 NRG TENDL-2015, AKONING
he3s from (n,n*)he3

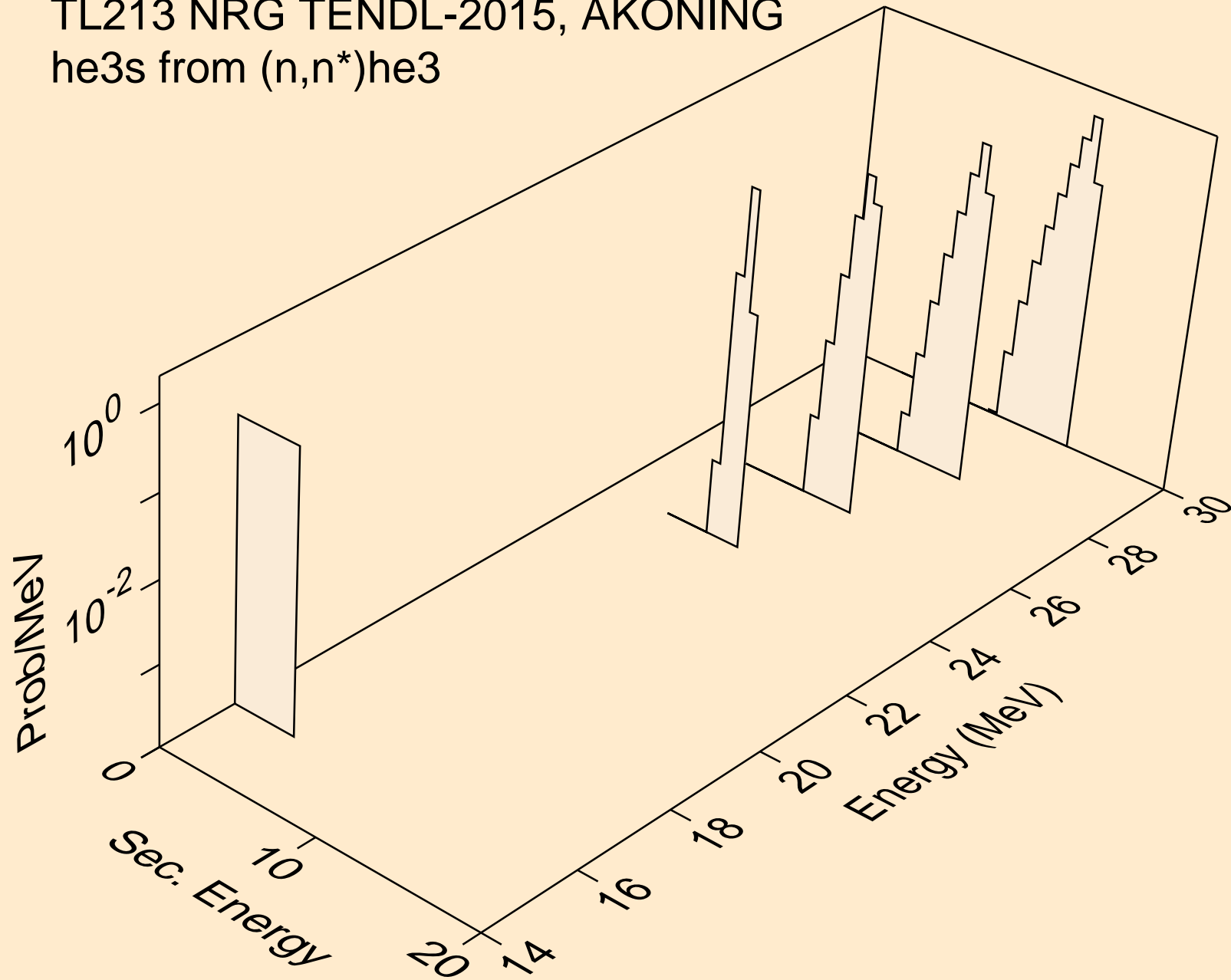

TL213 NRG TENDL-2015, AKONING
he3s from (n,he3)

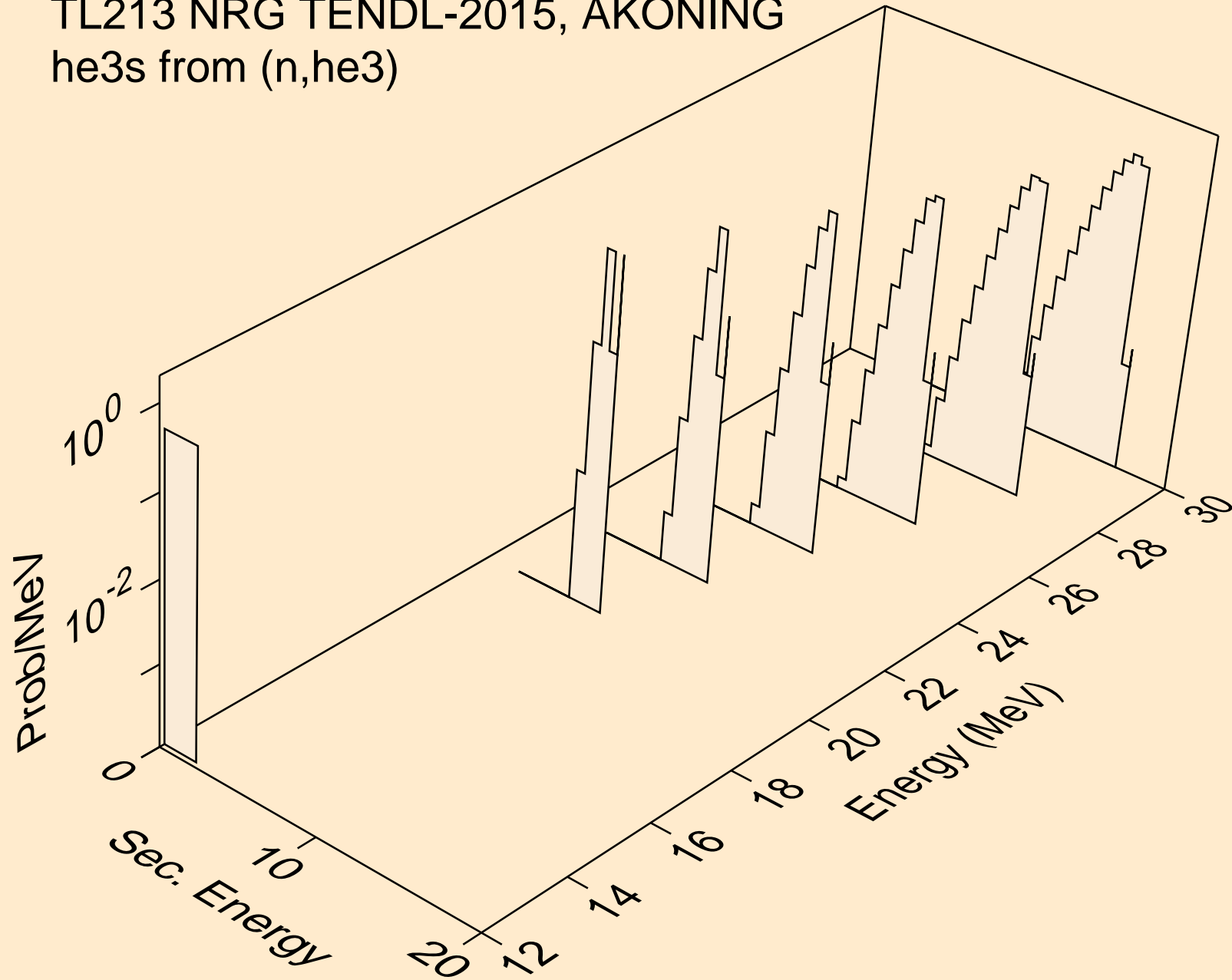

TL213 NRG TENDL-2015, AKONING
alphas from (n,x)

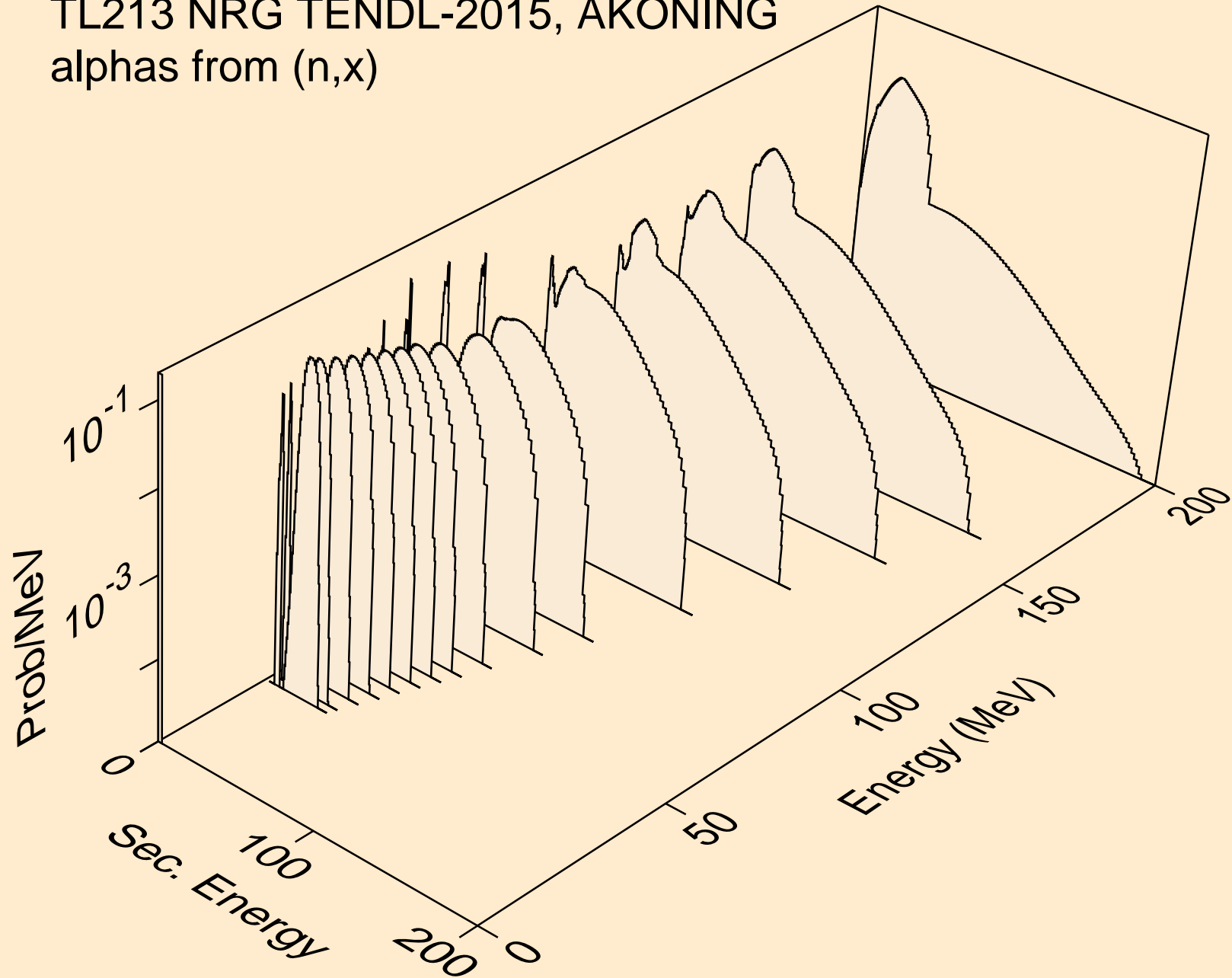

TL213 NRG TENDL-2015, AKONING
alphas from (n,n*)a

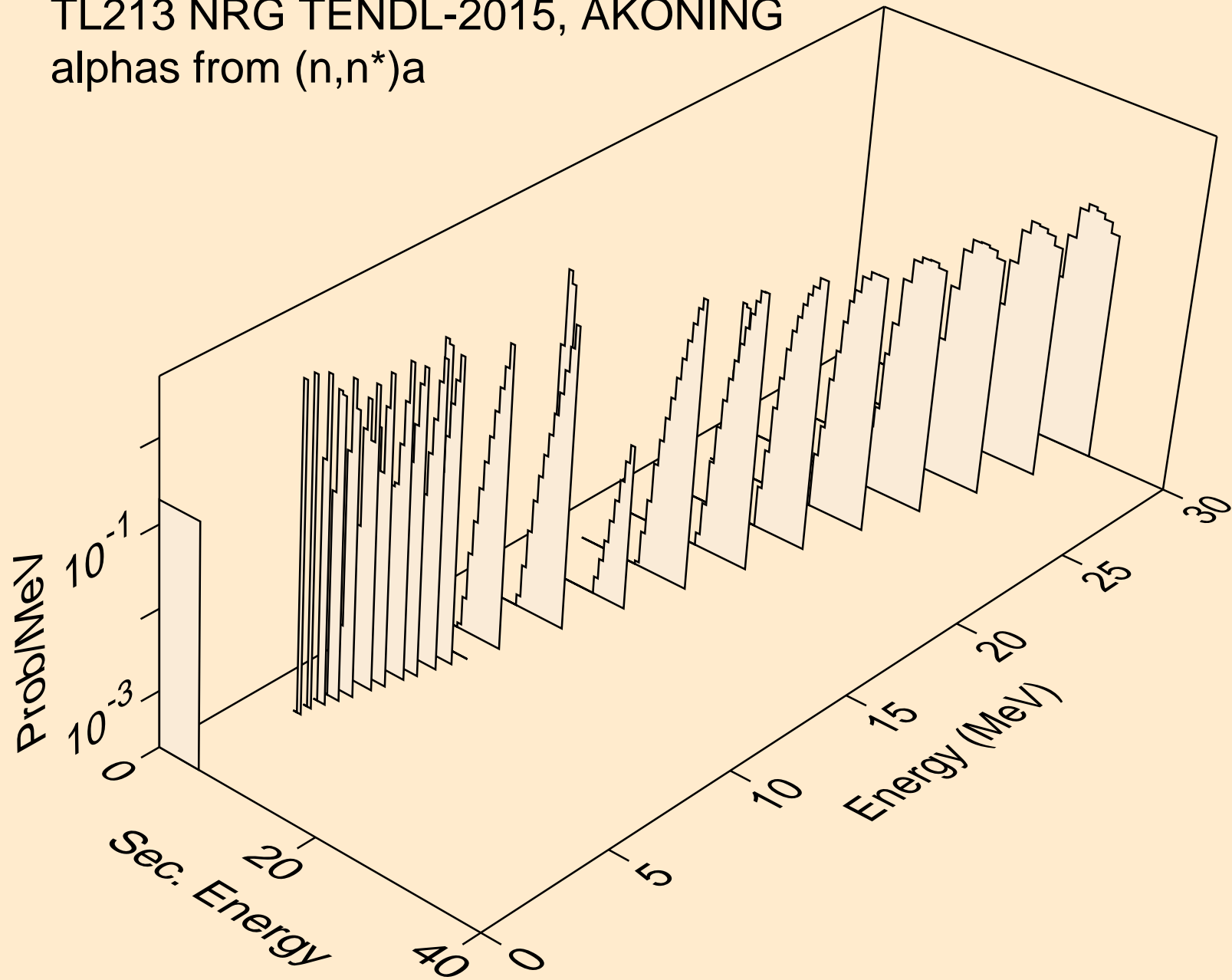

TL213 NRG TENDL-2015, AKONING
alphas from (n,2n)a

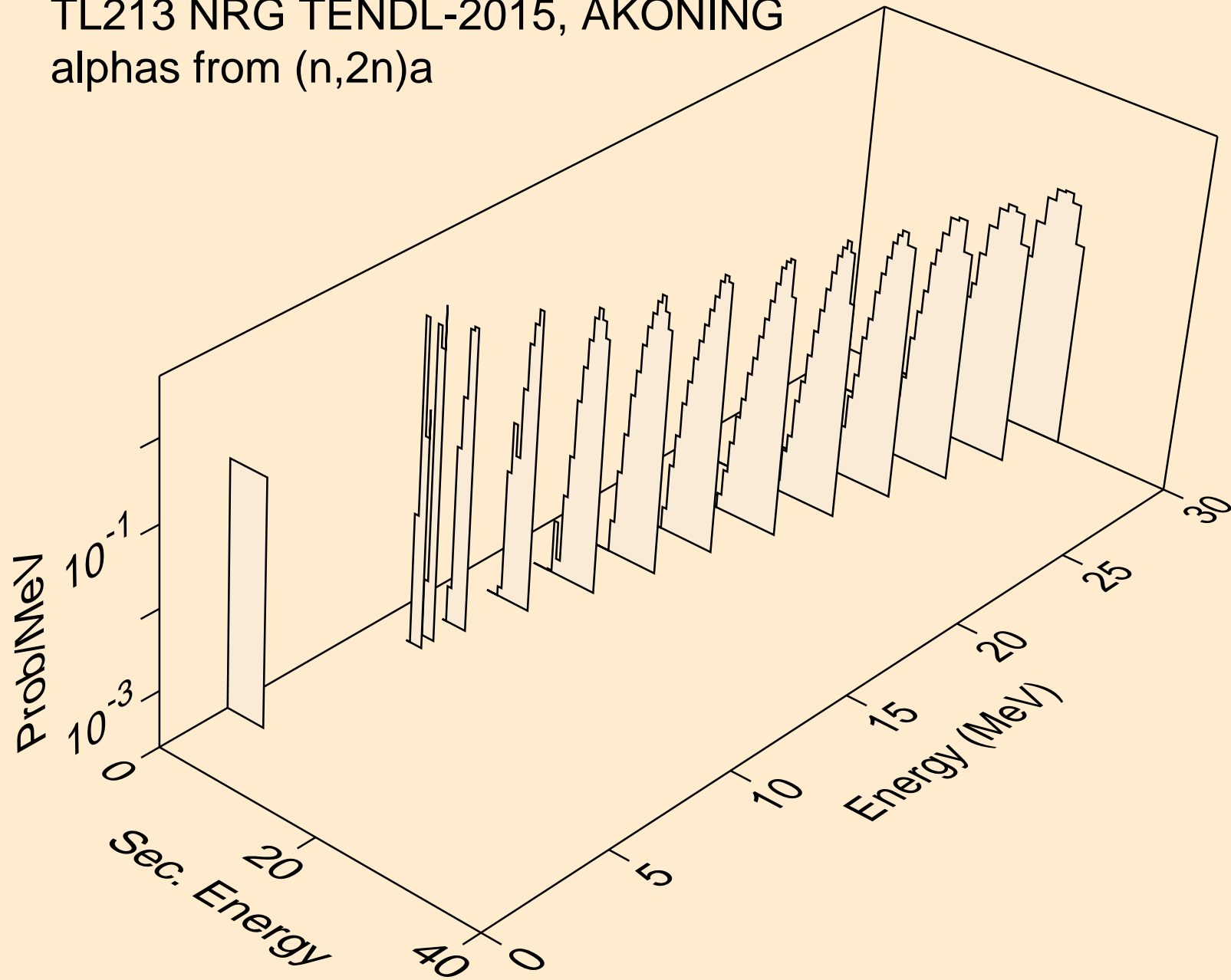

TL213 NRG TENDL-2015, AKONING
alphas from (n,3n)a

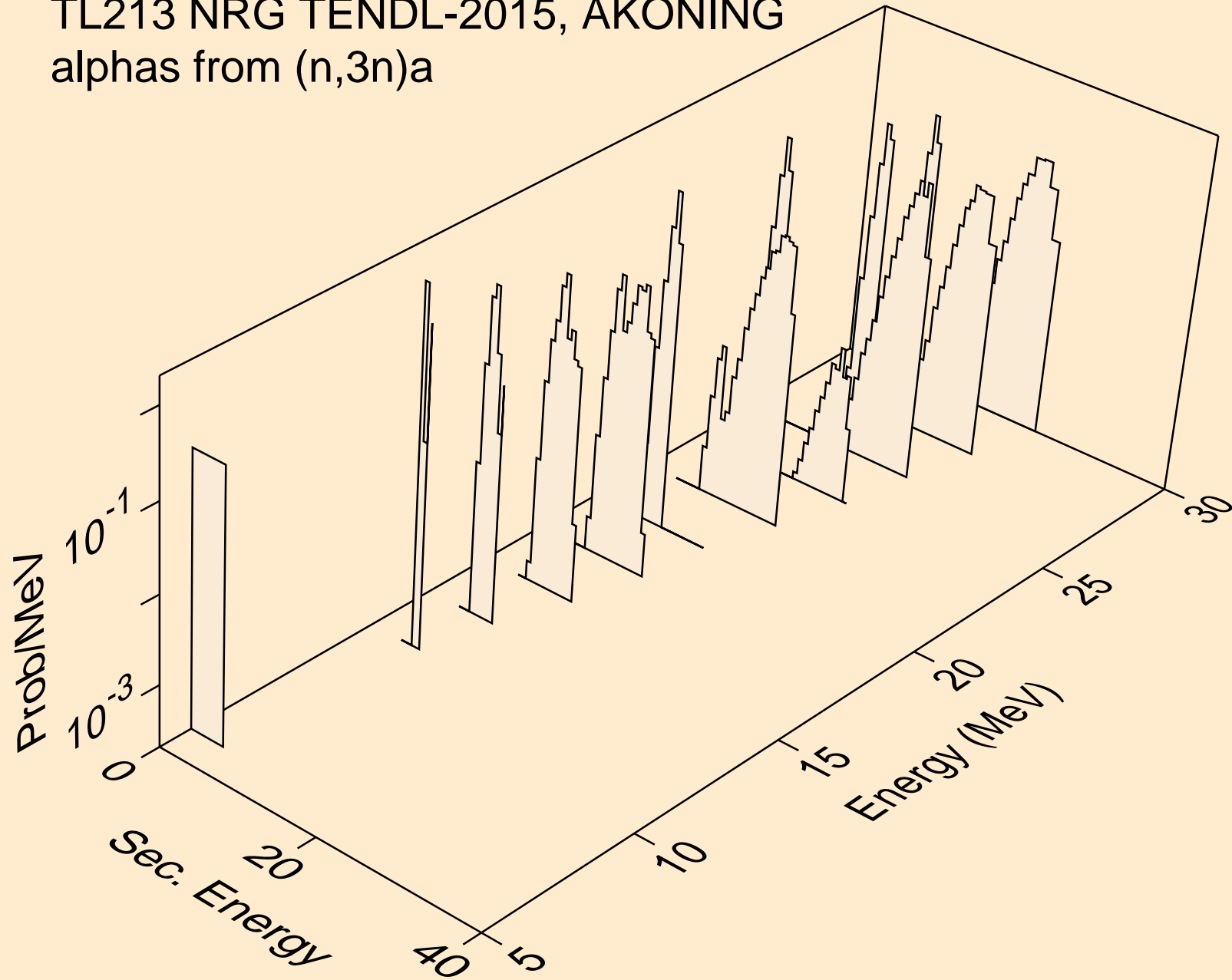

TL213 NRG TENDL-2015, AKONING
alphas from (n,a)

