

TL214 NRG TENDL-2015, AKONING

Principal cross sections

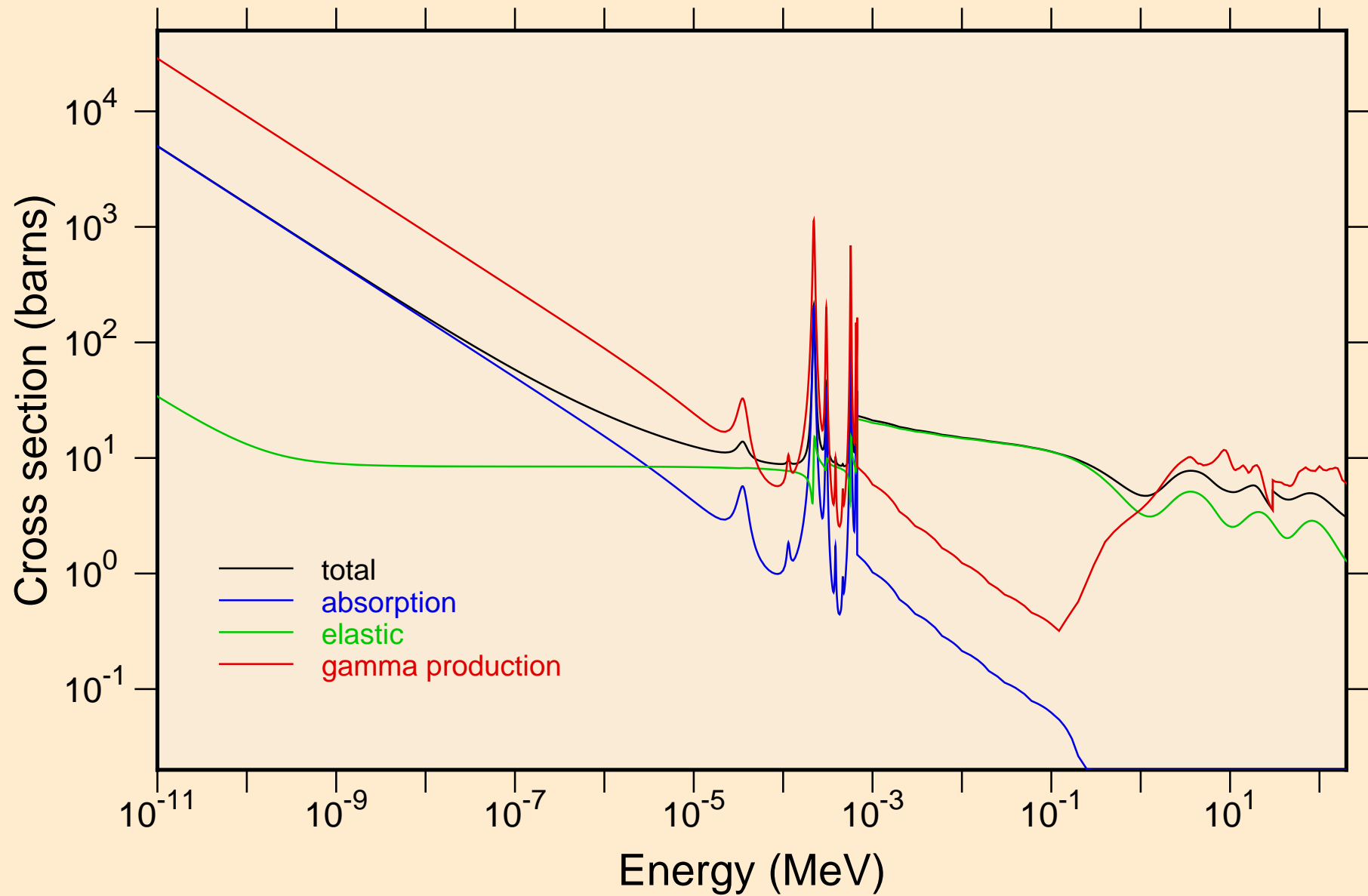

TL214 NRG TENDL-2015, AKONING
Non-threshold reactions

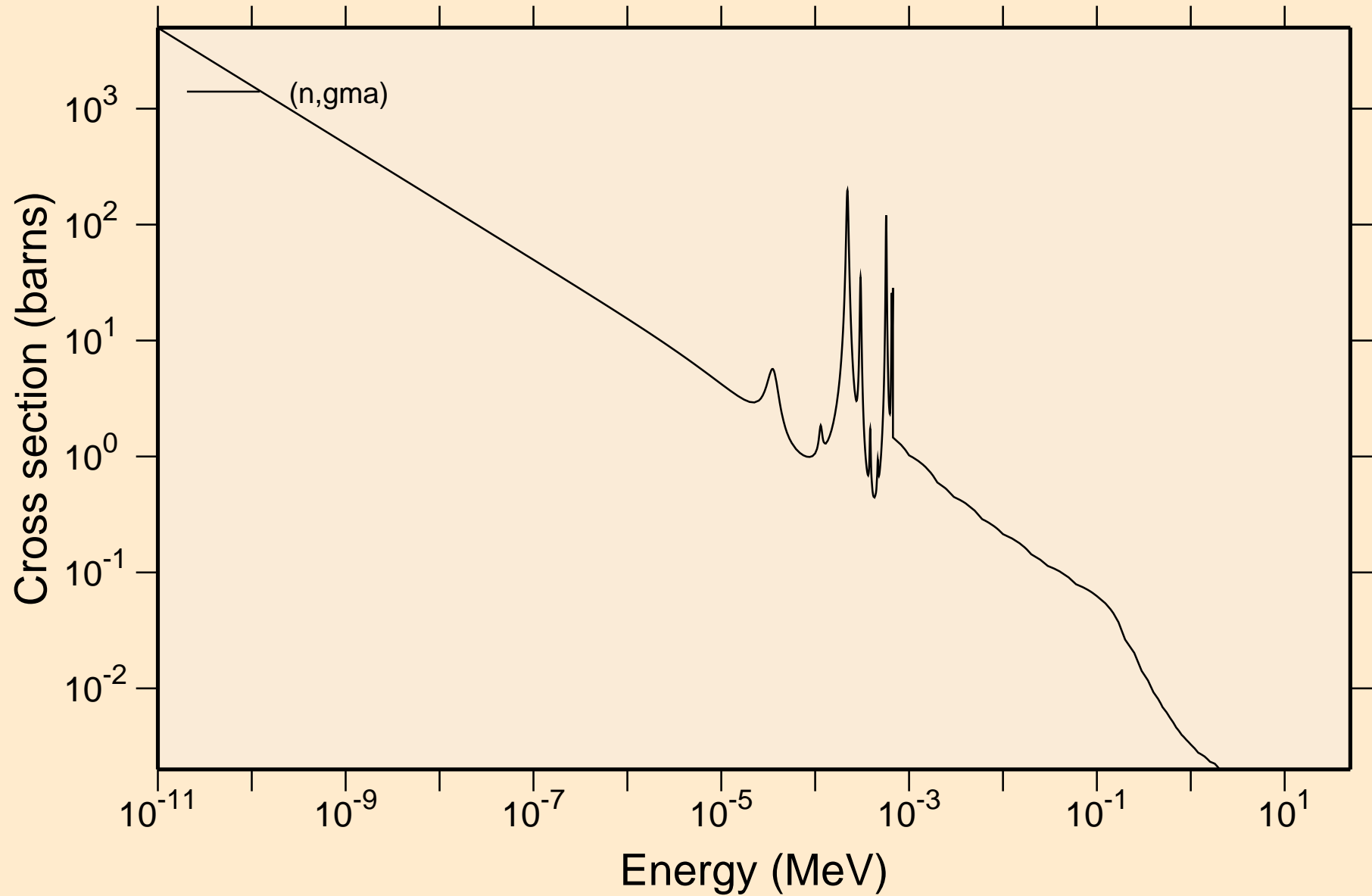

TL214 NRG TENDL-2015, AKONING

Principal cross sections

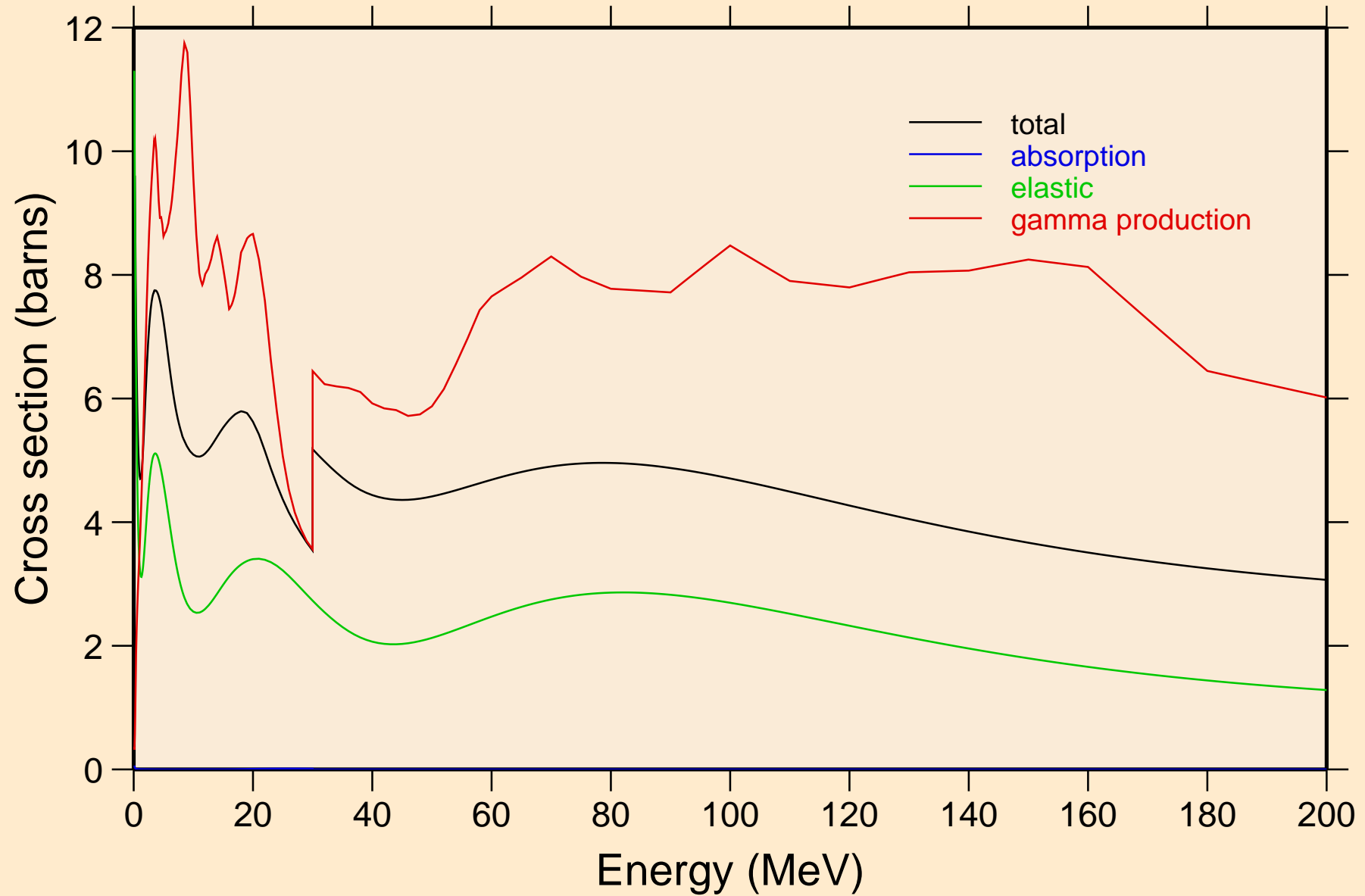

TL214 NRG TENDL-2015, AKONING
Non-threshold reactions

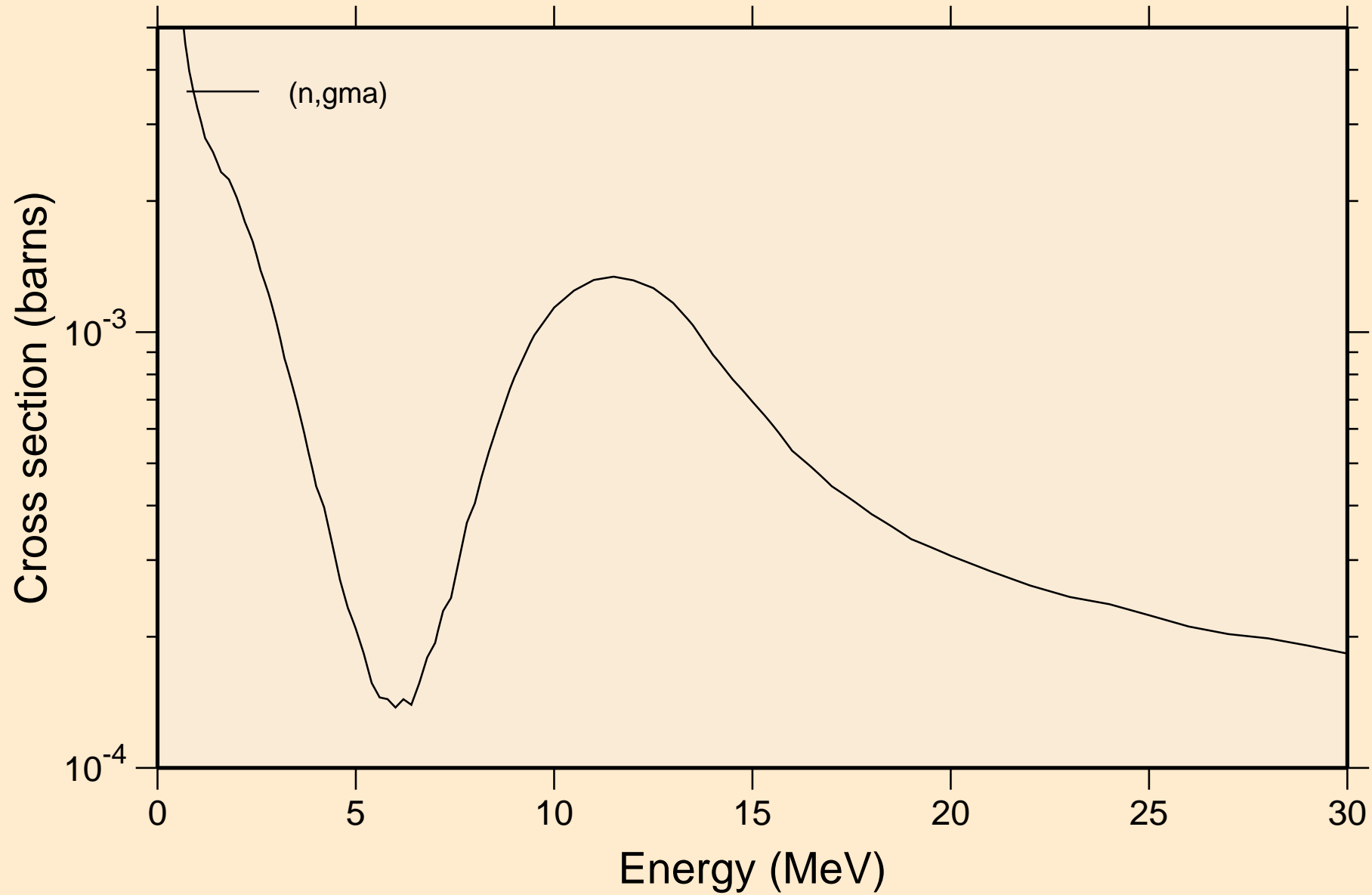

TL214 NRG TENDL-2015, AKONING
Inelastic levels

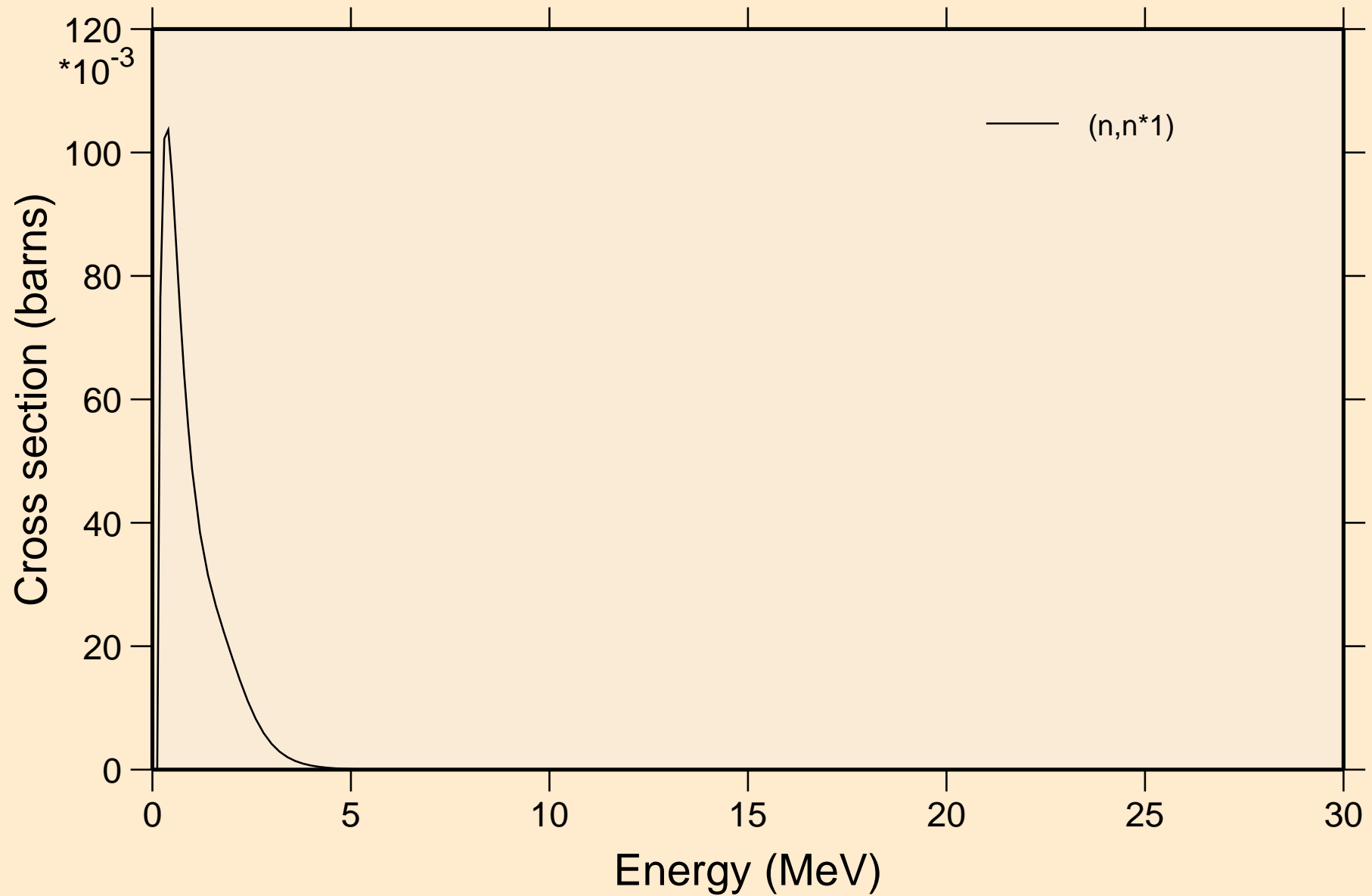

TL214 NRG TENDL-2015, AKONING

Threshold reactions

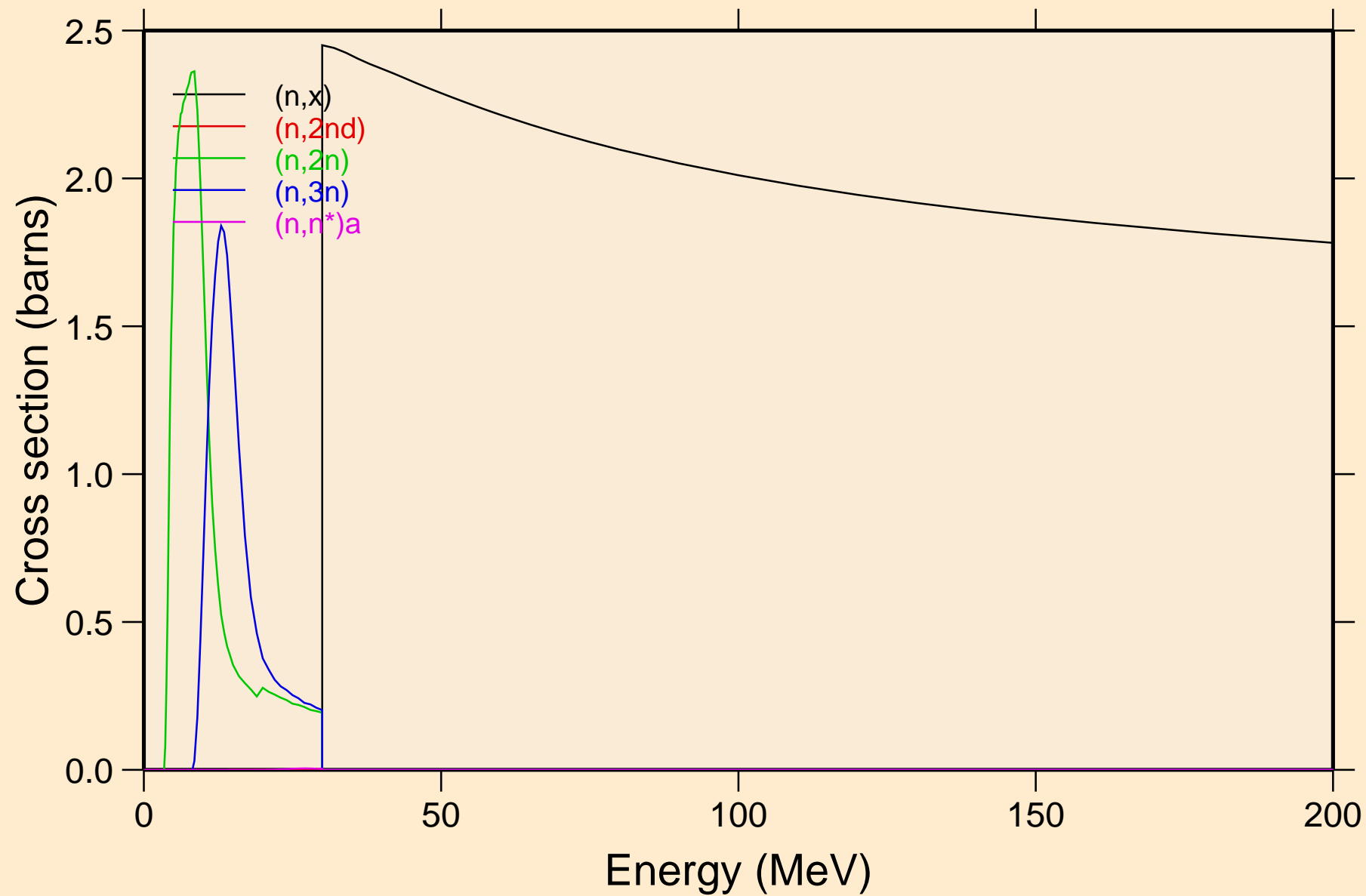

TL214 NRG TENDL-2015, AKONING

Threshold reactions

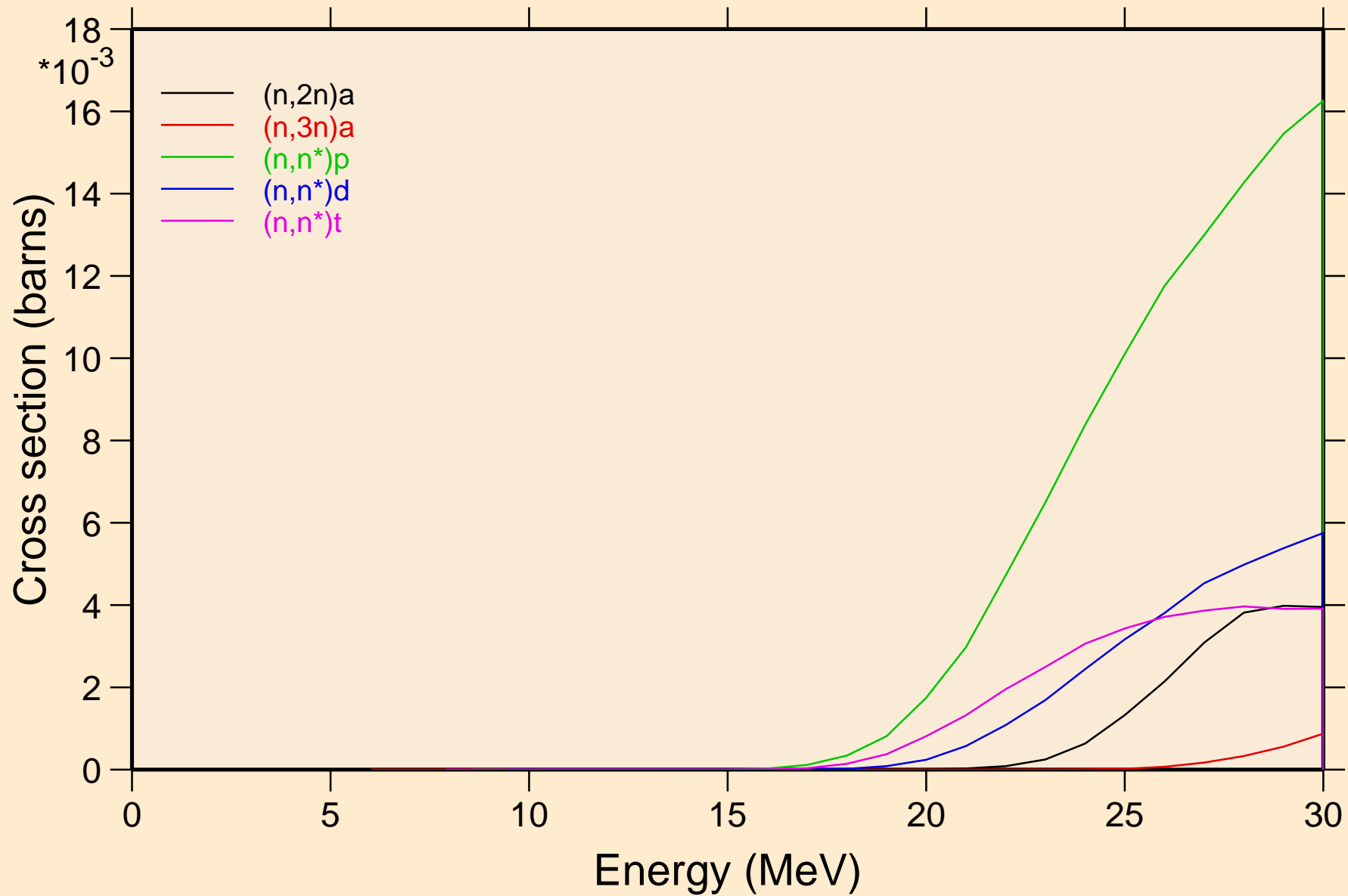

TL214 NRG TENDL-2015, AKONING

Threshold reactions

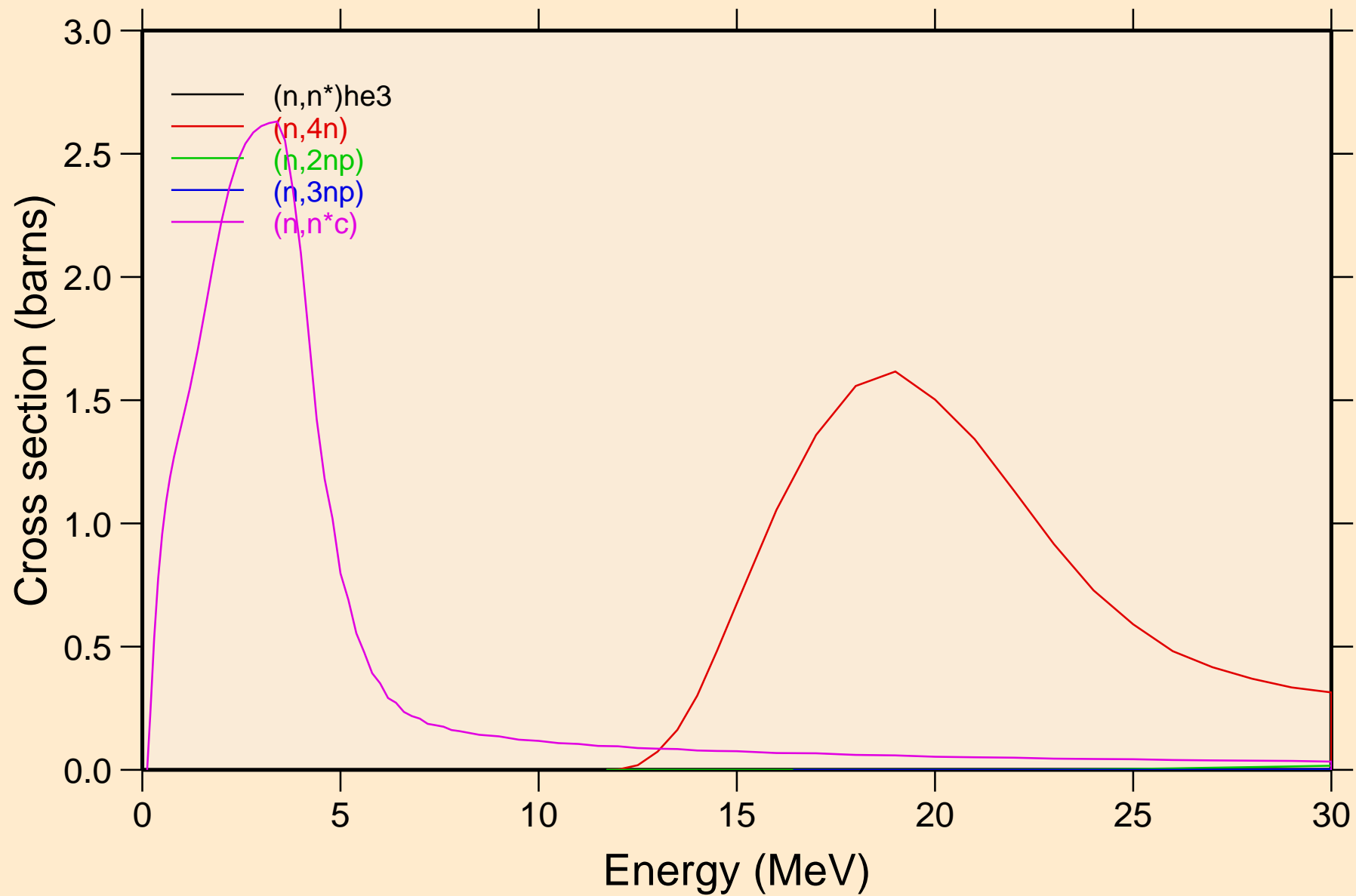

TL214 NRG TENDL-2015, AKONING

Threshold reactions

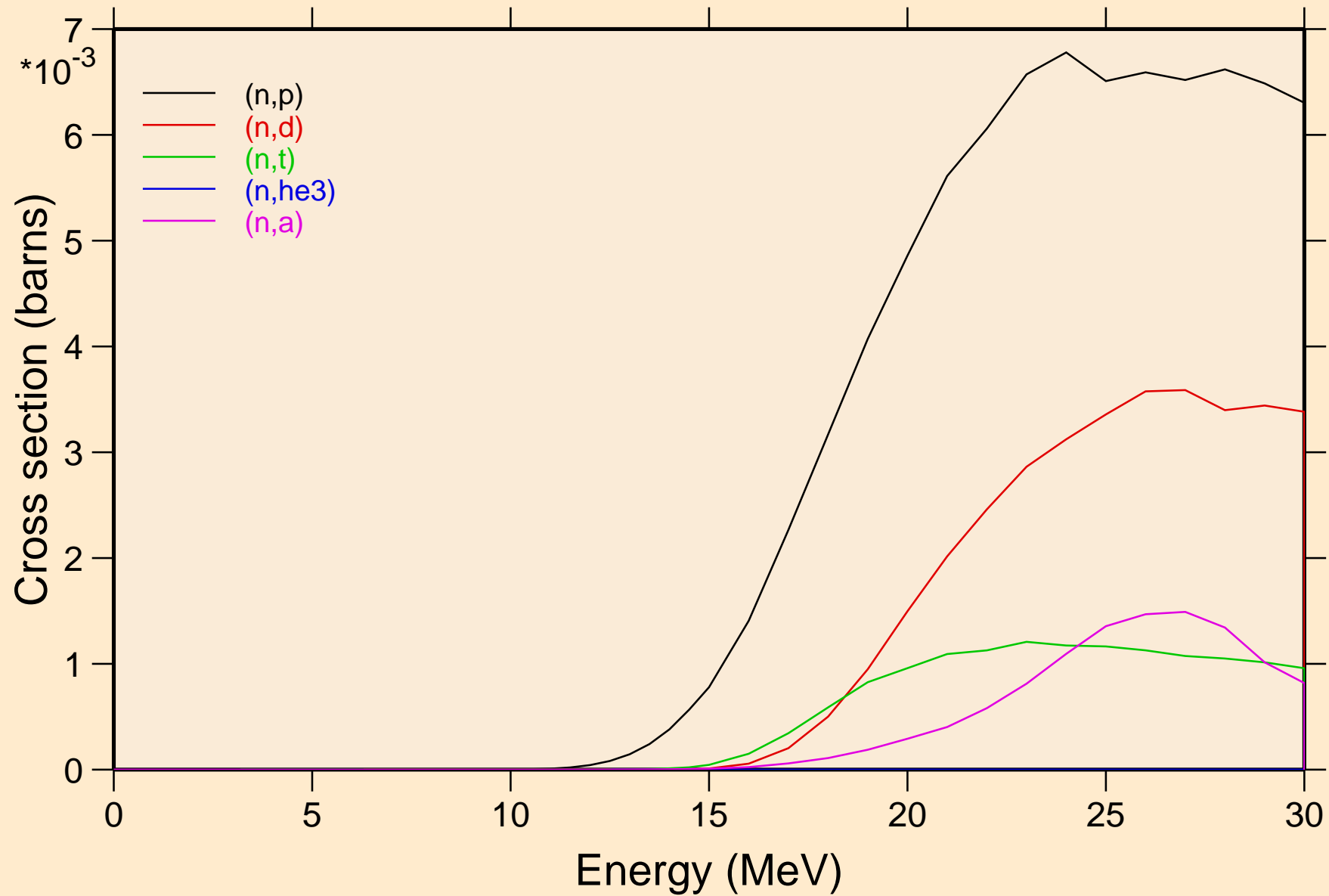

TL214 NRG TENDL-2015, AKONING
angular distribution for elastic

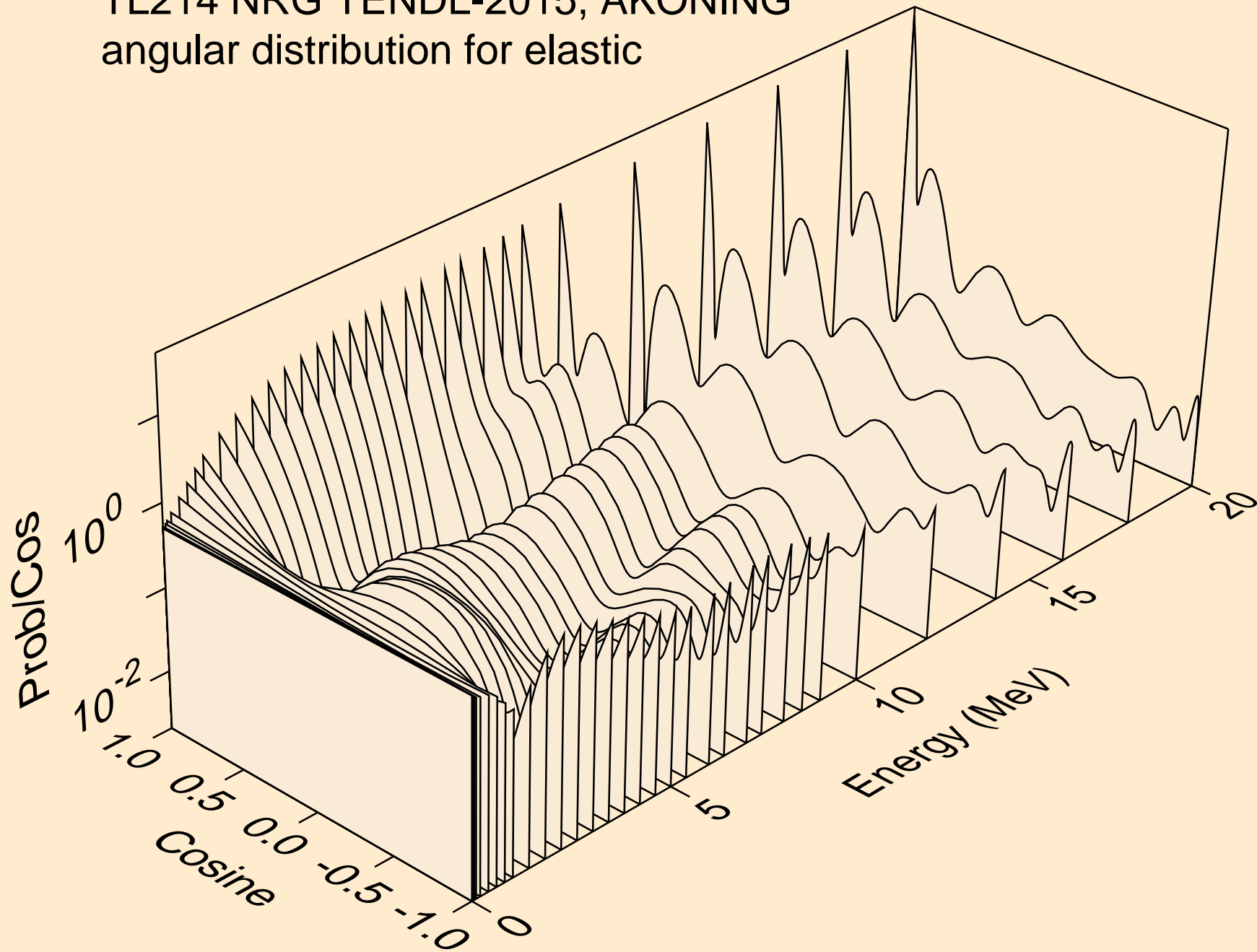

TL214 NRG TENDL-2015, AKONING
angular distribution for elastic

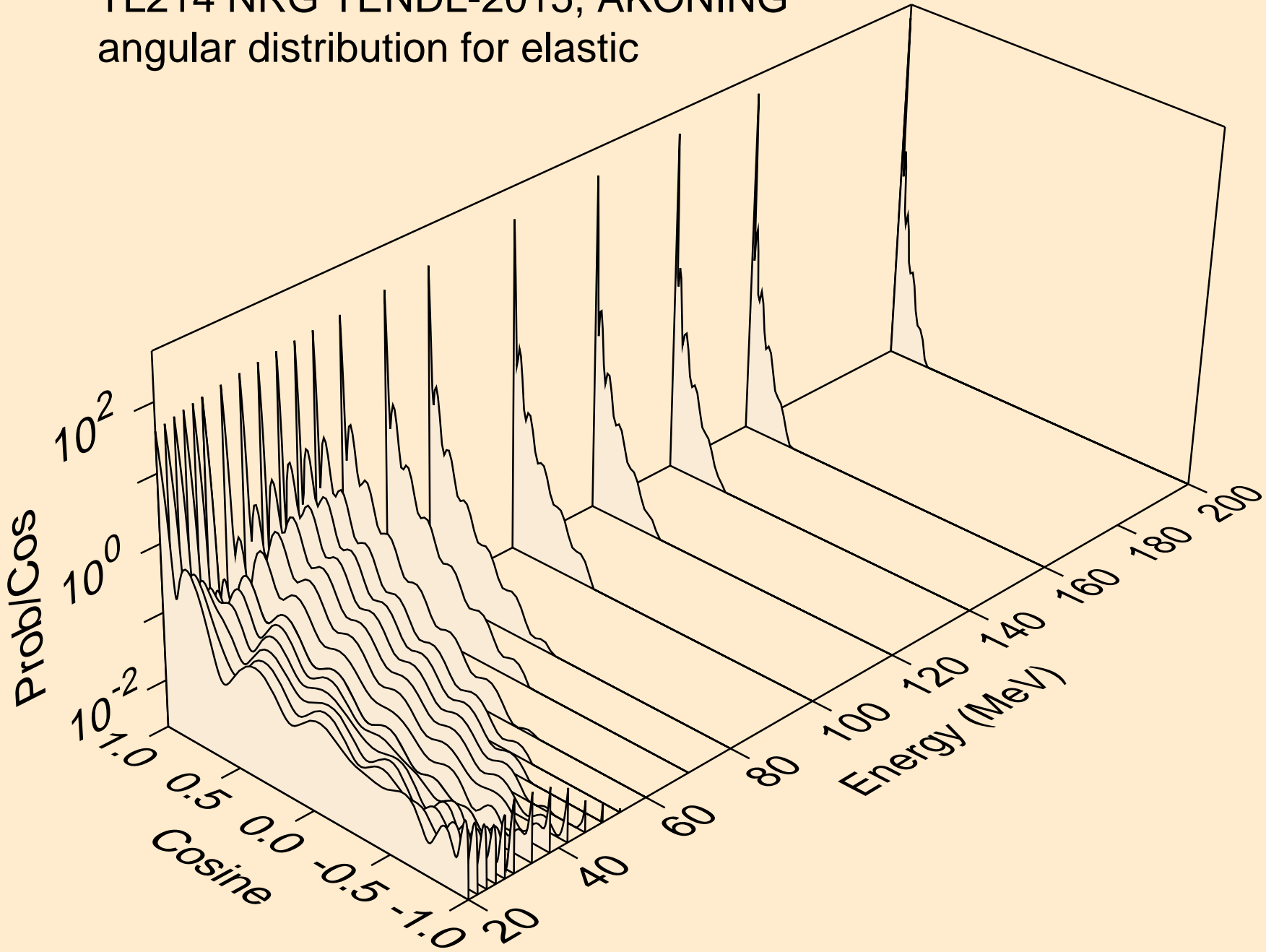

TL214 NRG TENDL-2015, AKONING
angular distribution for (n,n*1)

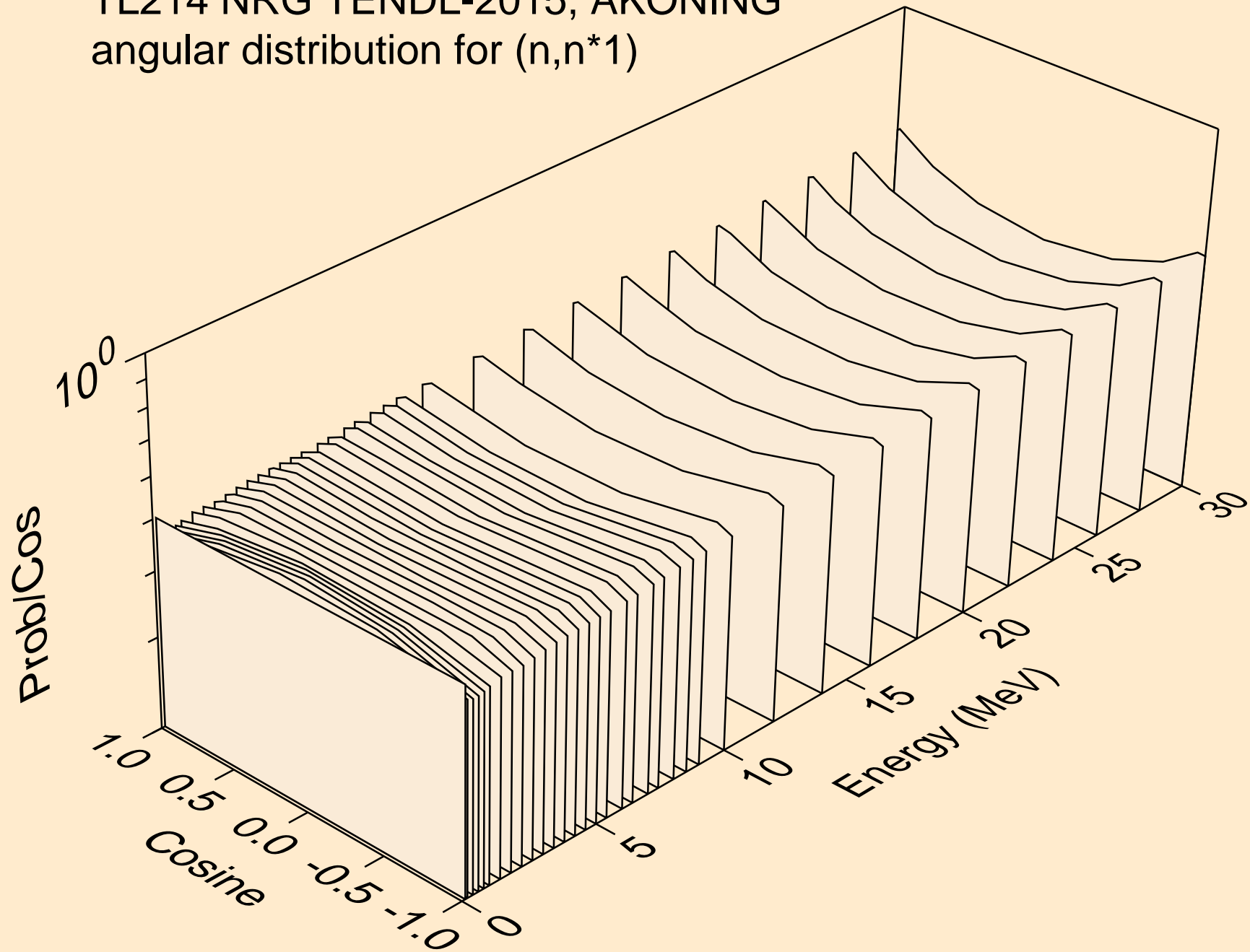

TL214 NRG TENDL-2015, AKONING
Neutron emission for (n,x)

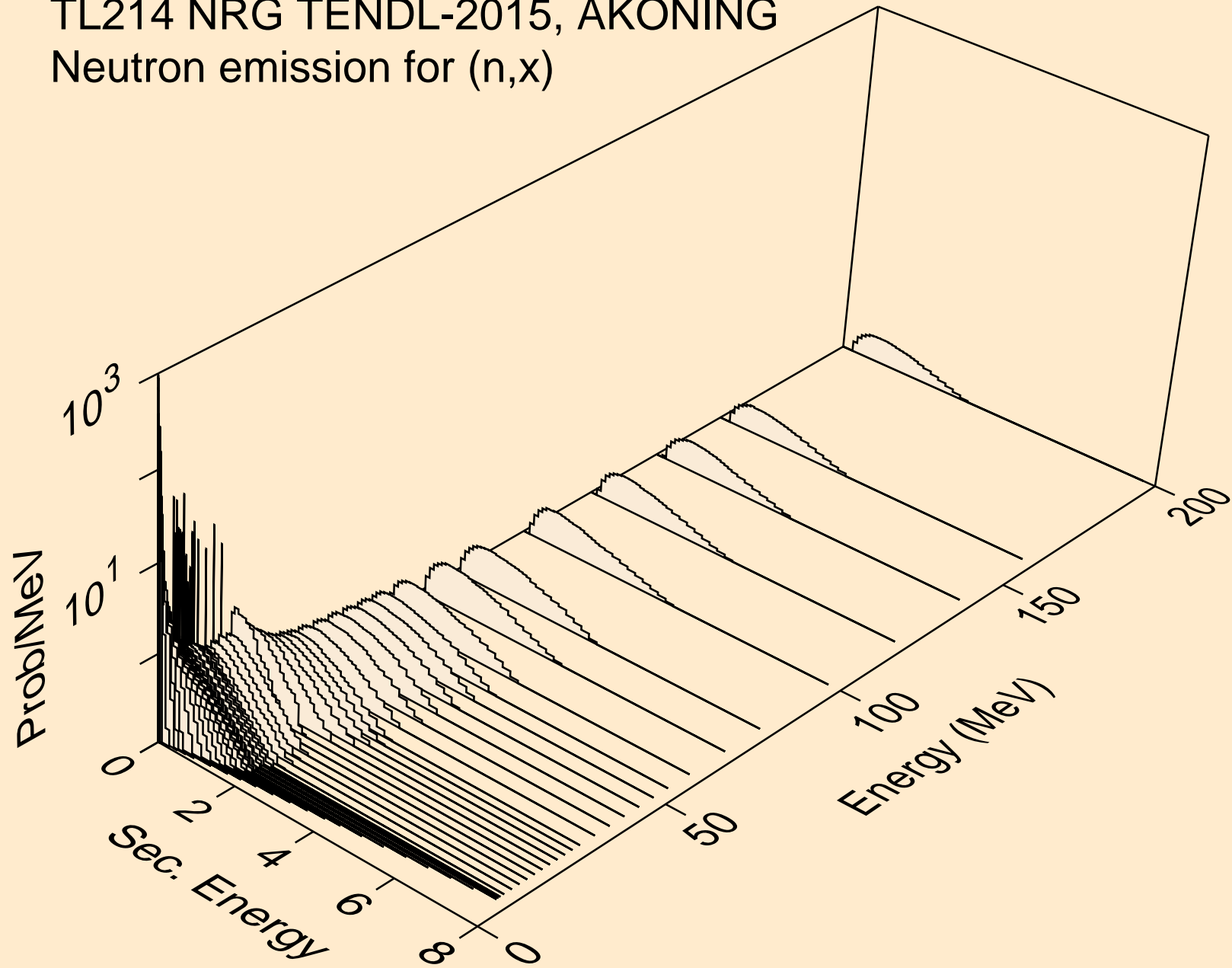

TL214 NRG TENDL-2015, AKONING
Neutron emission for (n,2nd)

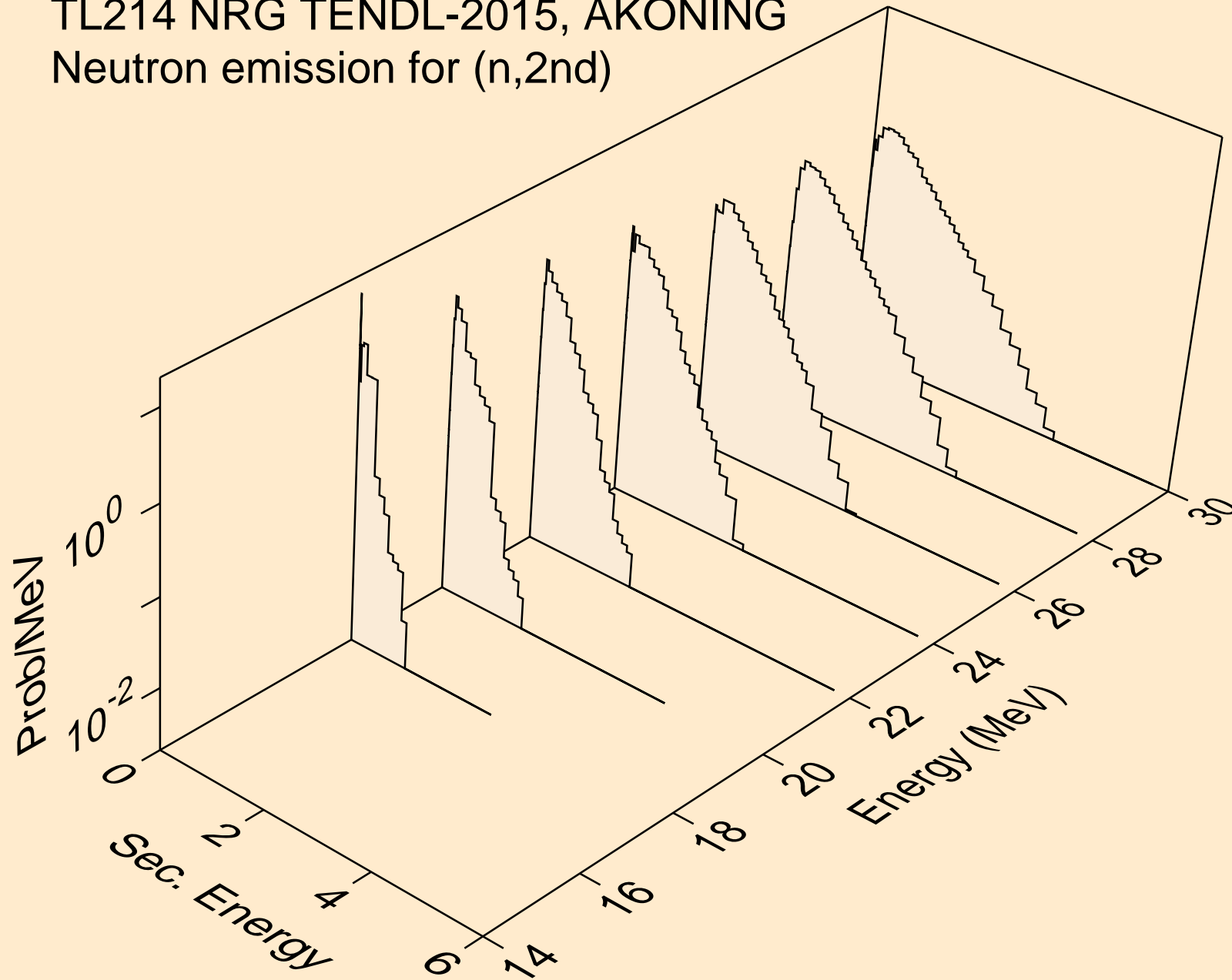

TL214 NRG TENDL-2015, AKONING
Neutron emission for (n,2n)

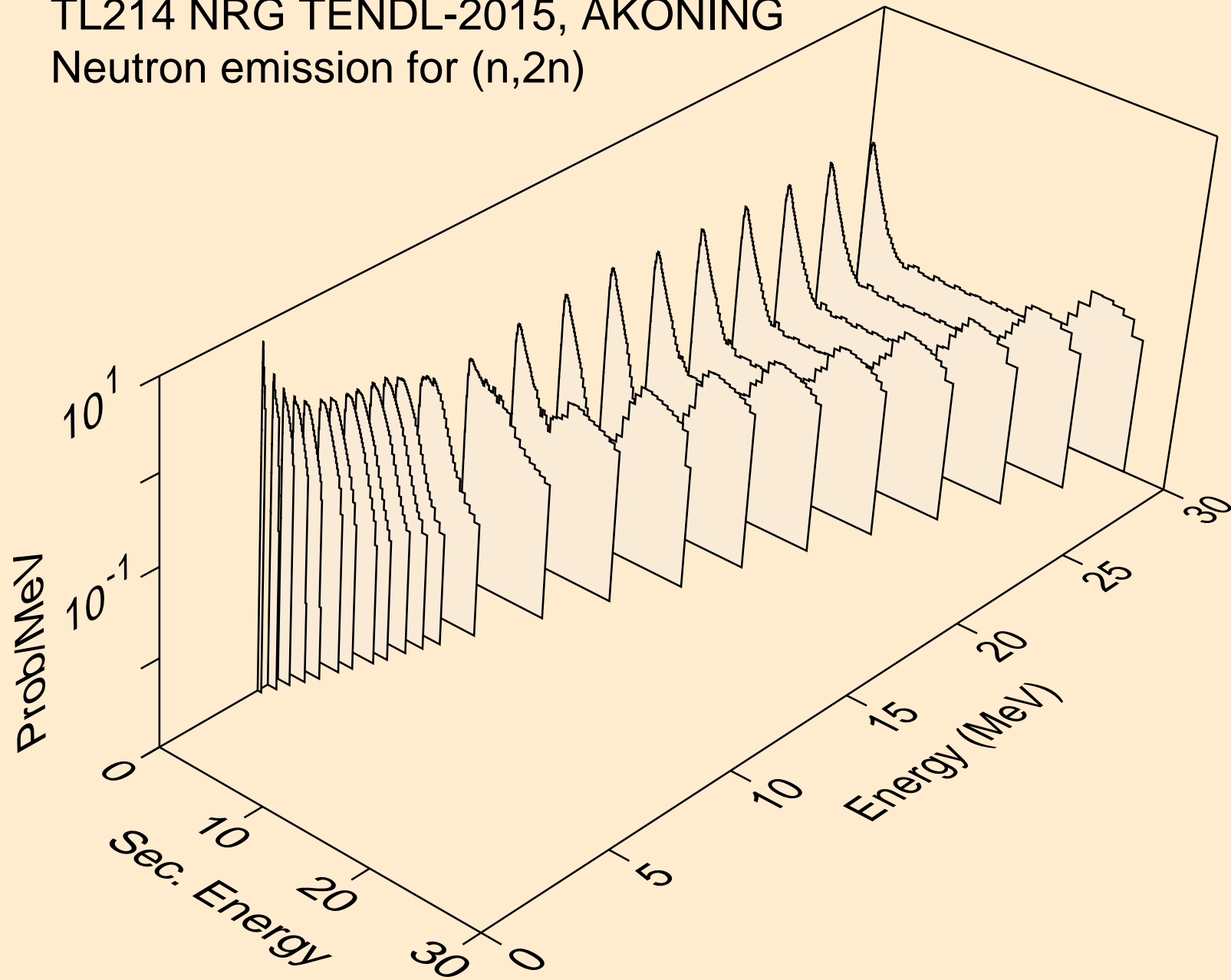

TL214 NRG TENDL-2015, AKONING
Neutron emission for (n,3n)

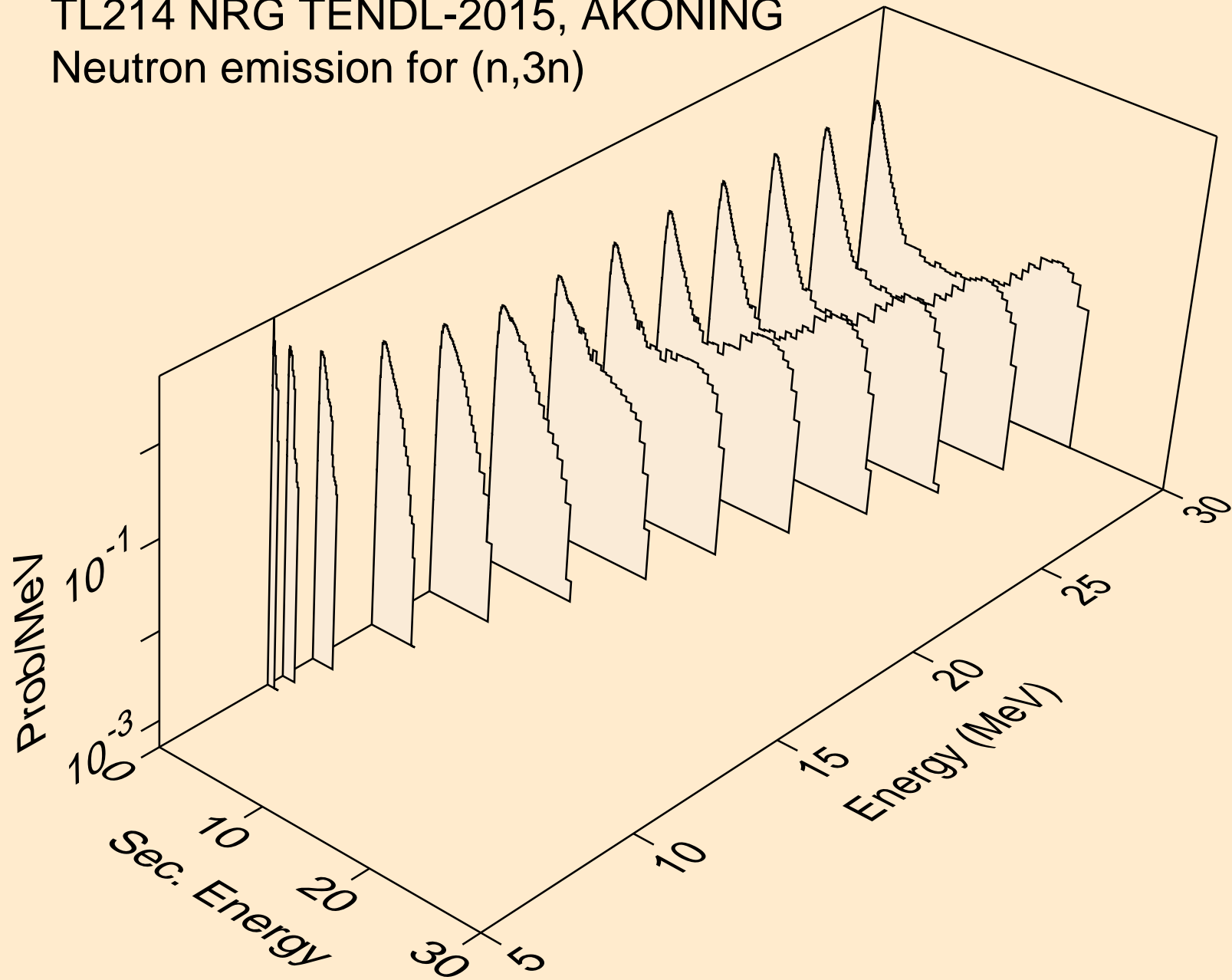

TL214 NRG TENDL-2015, AKONING
Neutron emission for (n,n*)a

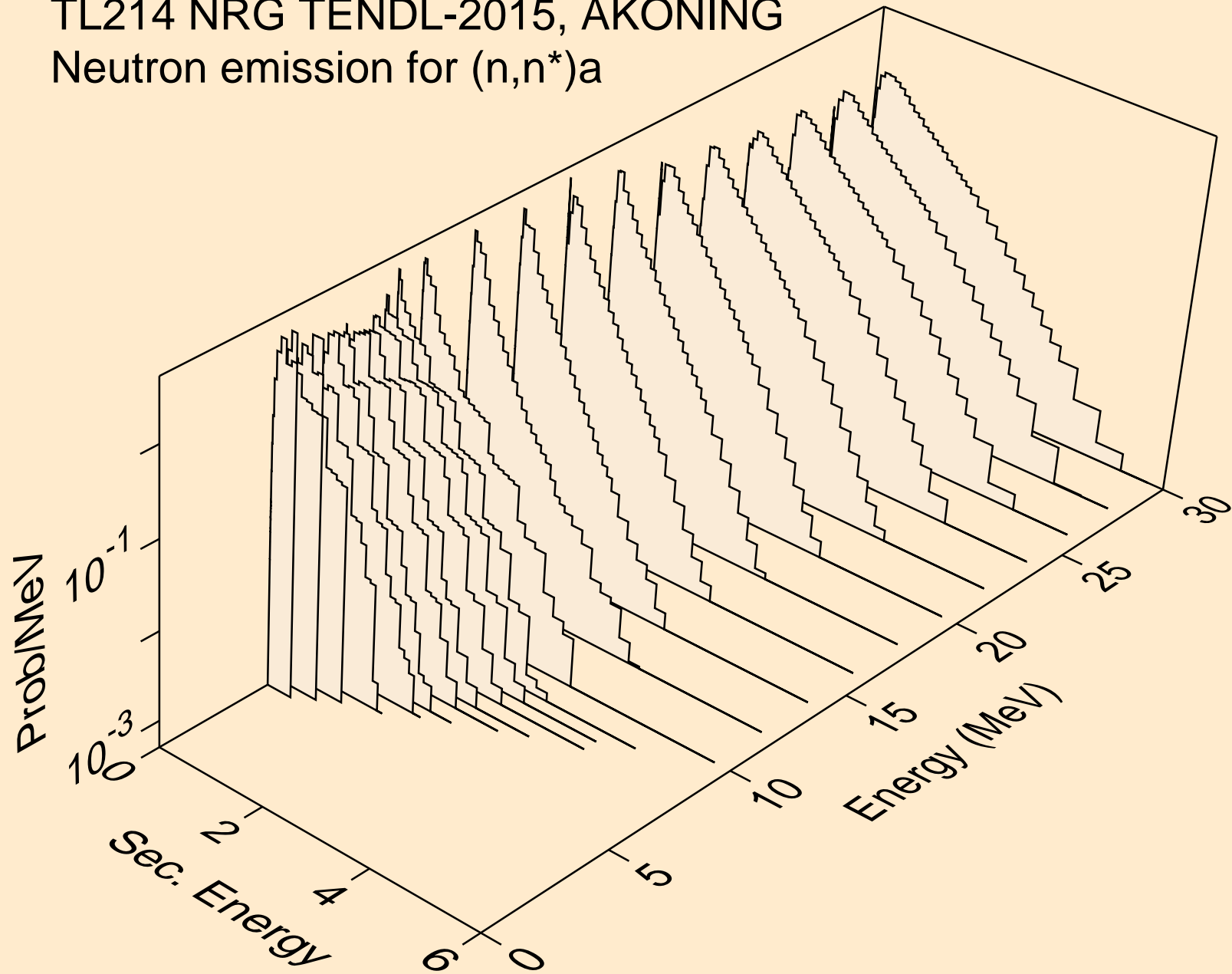

TL214 NRG TENDL-2015, AKONING
Neutron emission for (n,2n)a

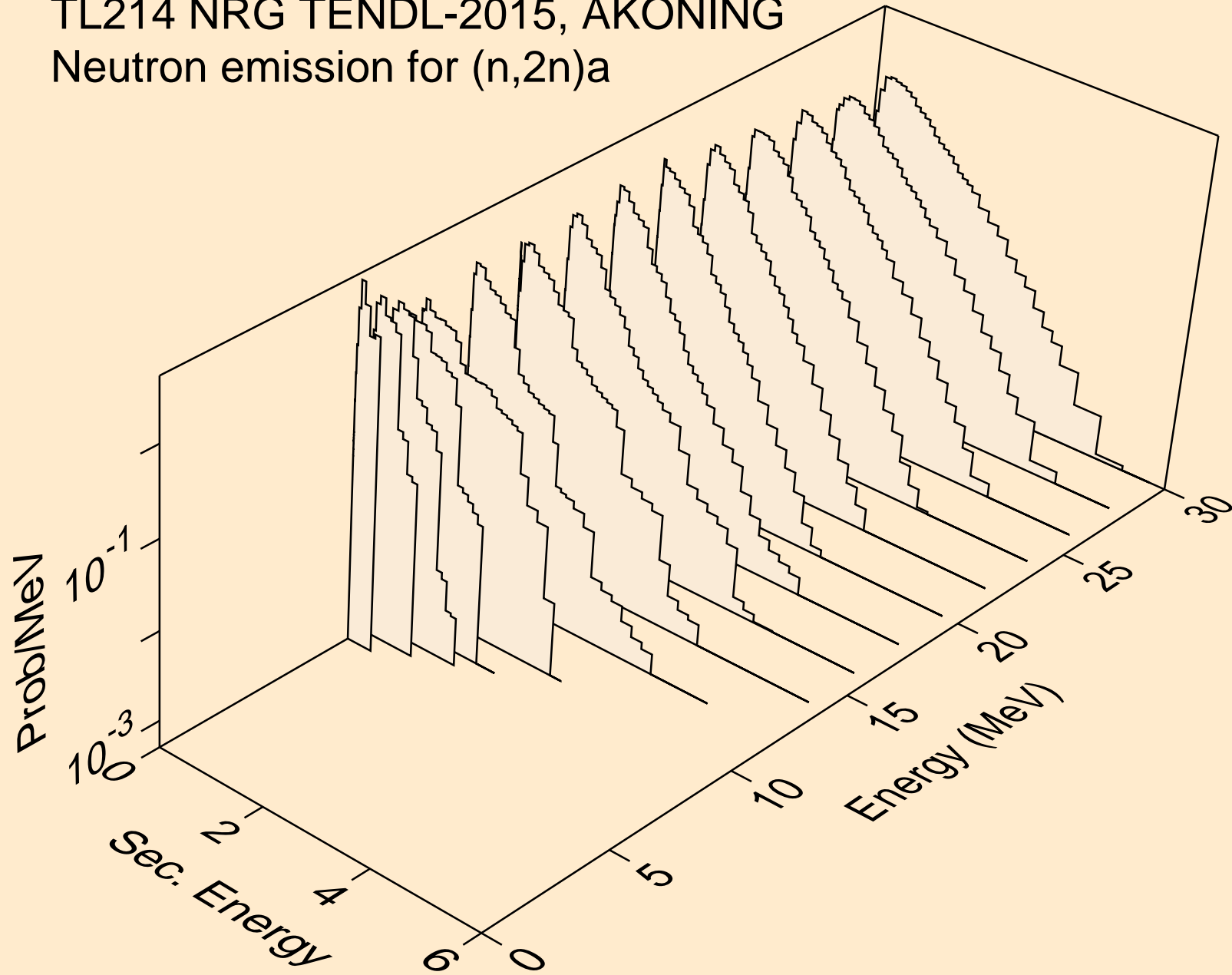

TL214 NRG TENDL-2015, AKONING
Neutron emission for (n,3n)_a

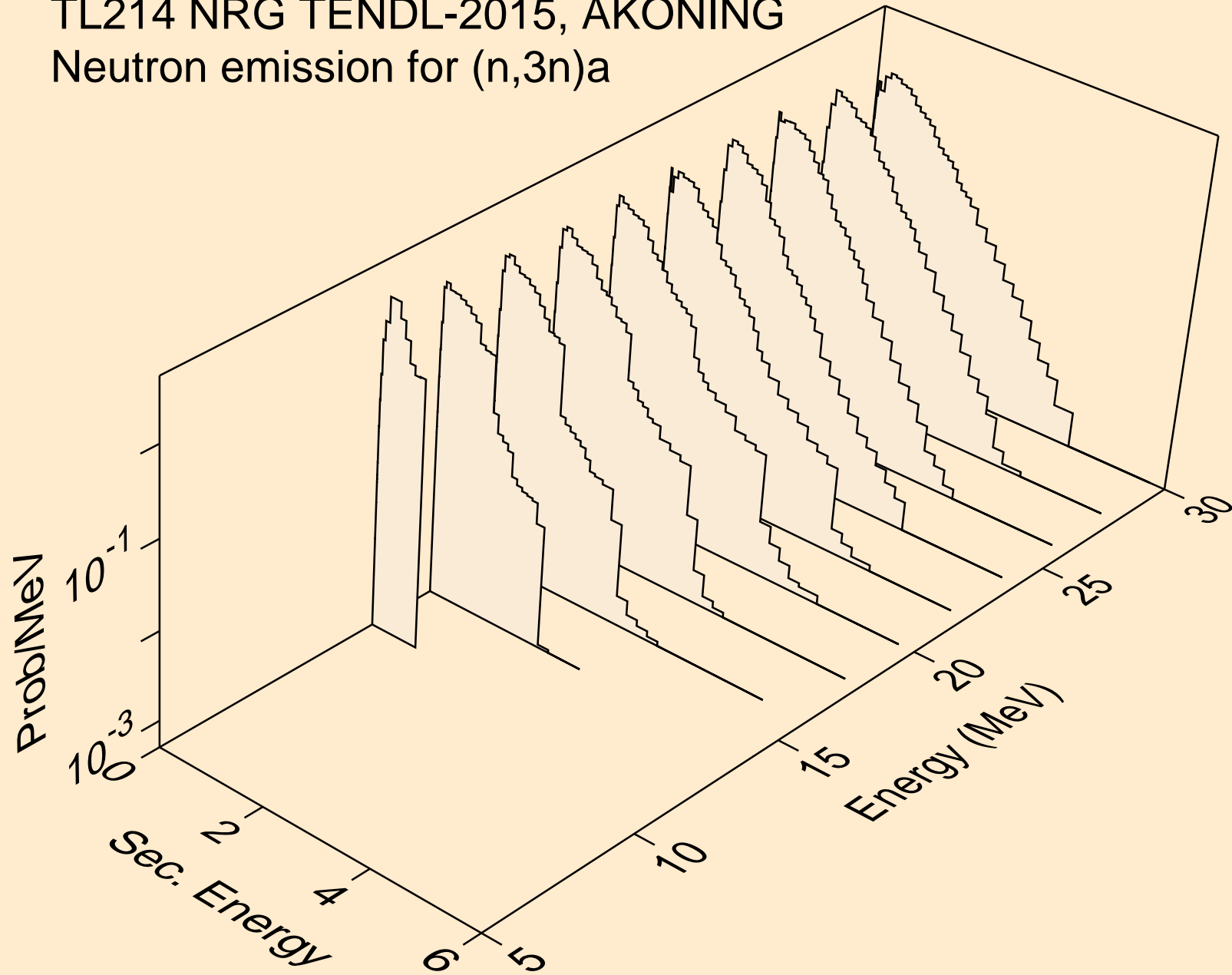

TL214 NRG TENDL-2015, AKONING
Neutron emission for (n,n*)p

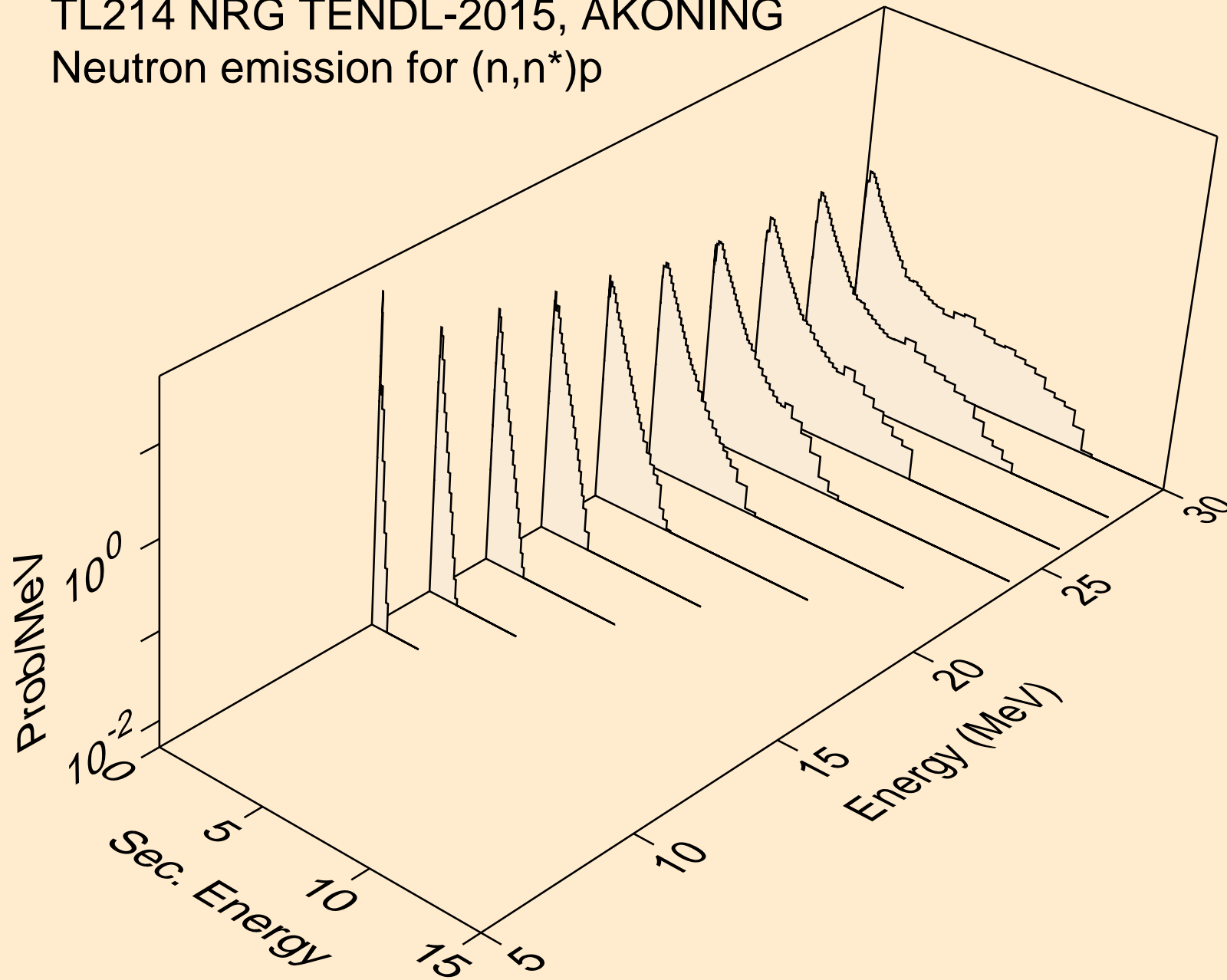

TL214 NRG TENDL-2015, AKONING
Neutron emission for (n,n*)d

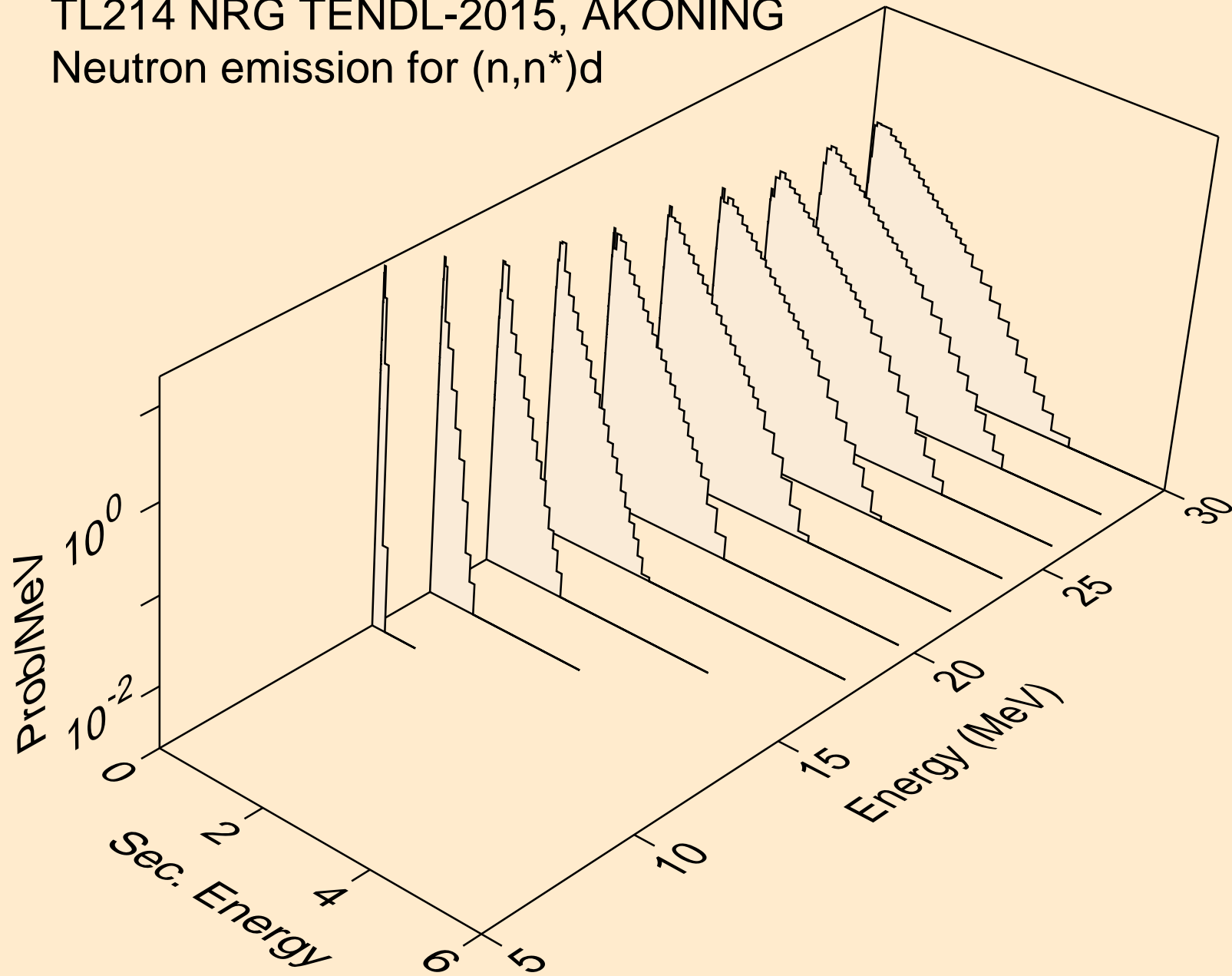

TL214 NRG TENDL-2015, AKONING
Neutron emission for (n,n*)t

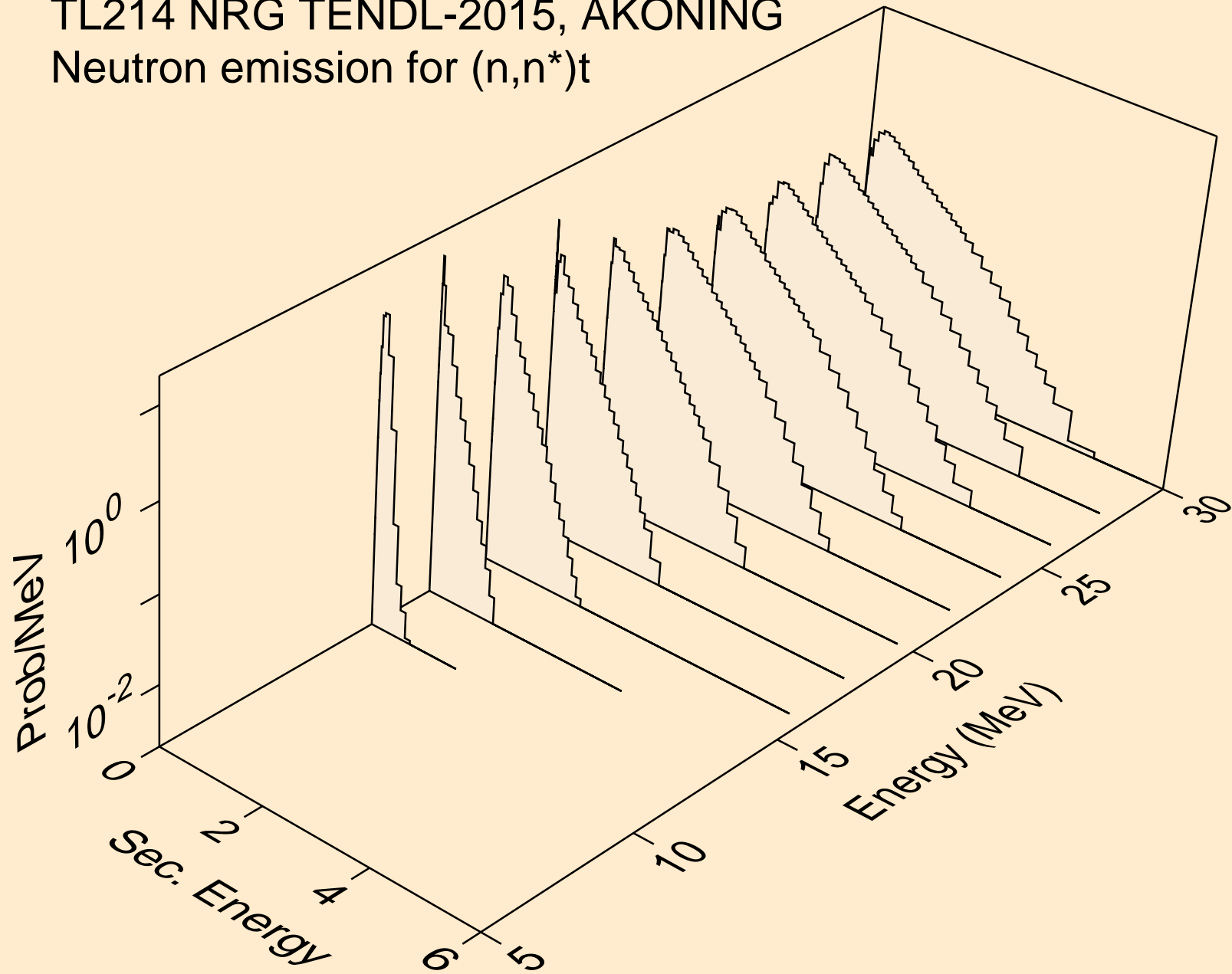

TL214 NRG TENDL-2015, AKONING
Neutron emission for (n,n*)he3

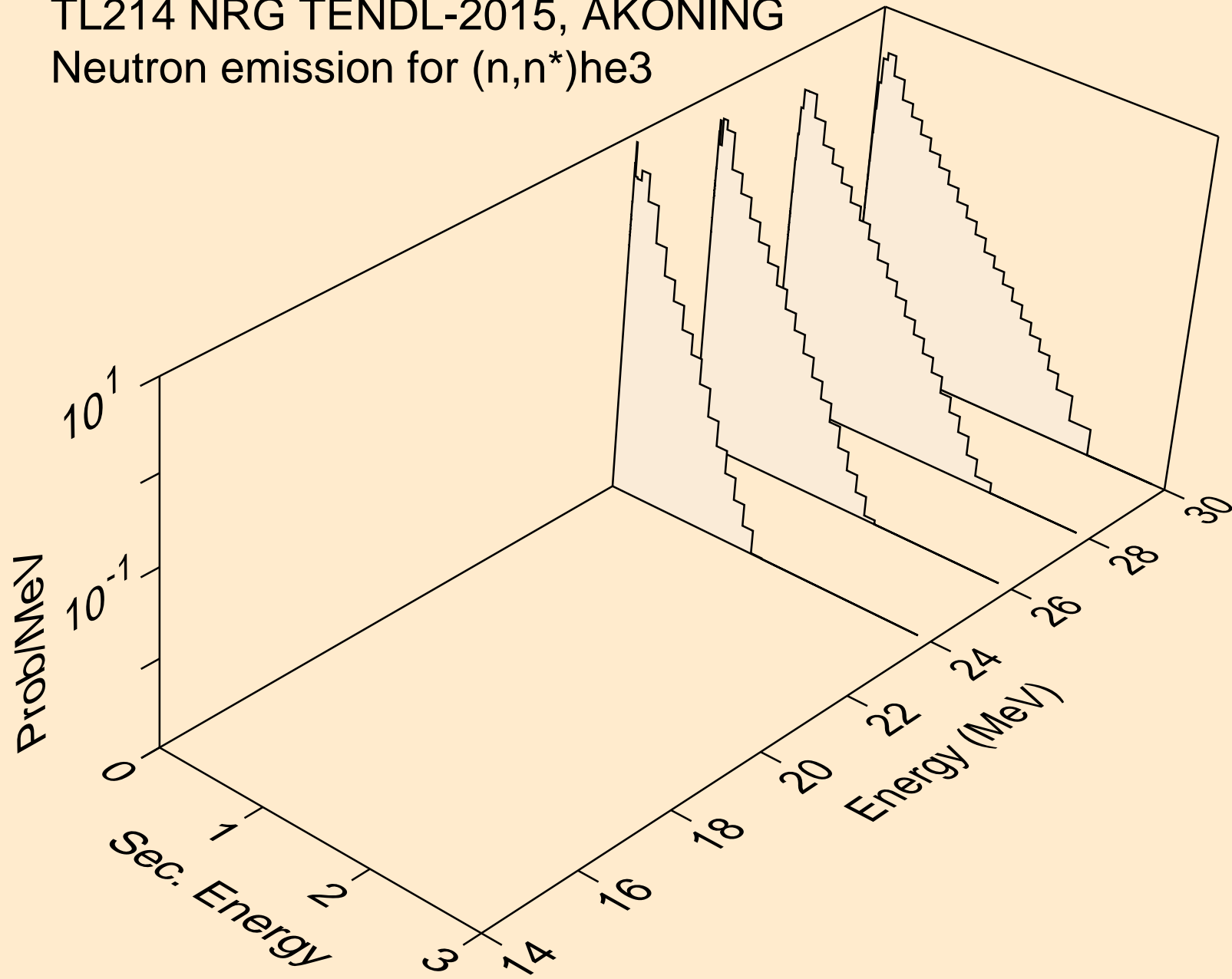

TL214 NRG TENDL-2015, AKONING
Neutron emission for (n,4n)

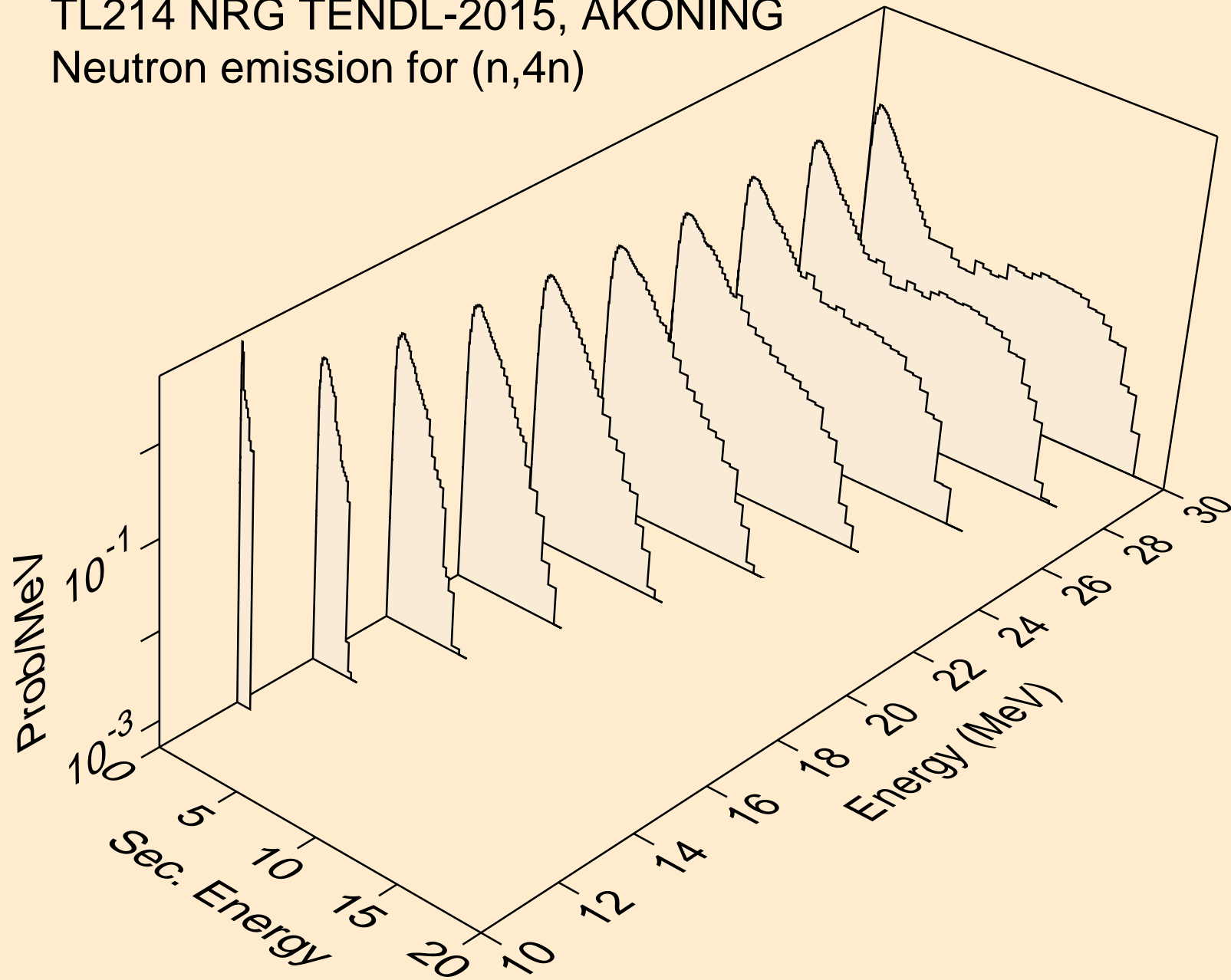

TL214 NRG TENDL-2015, AKONING
Neutron emission for (n,2np)

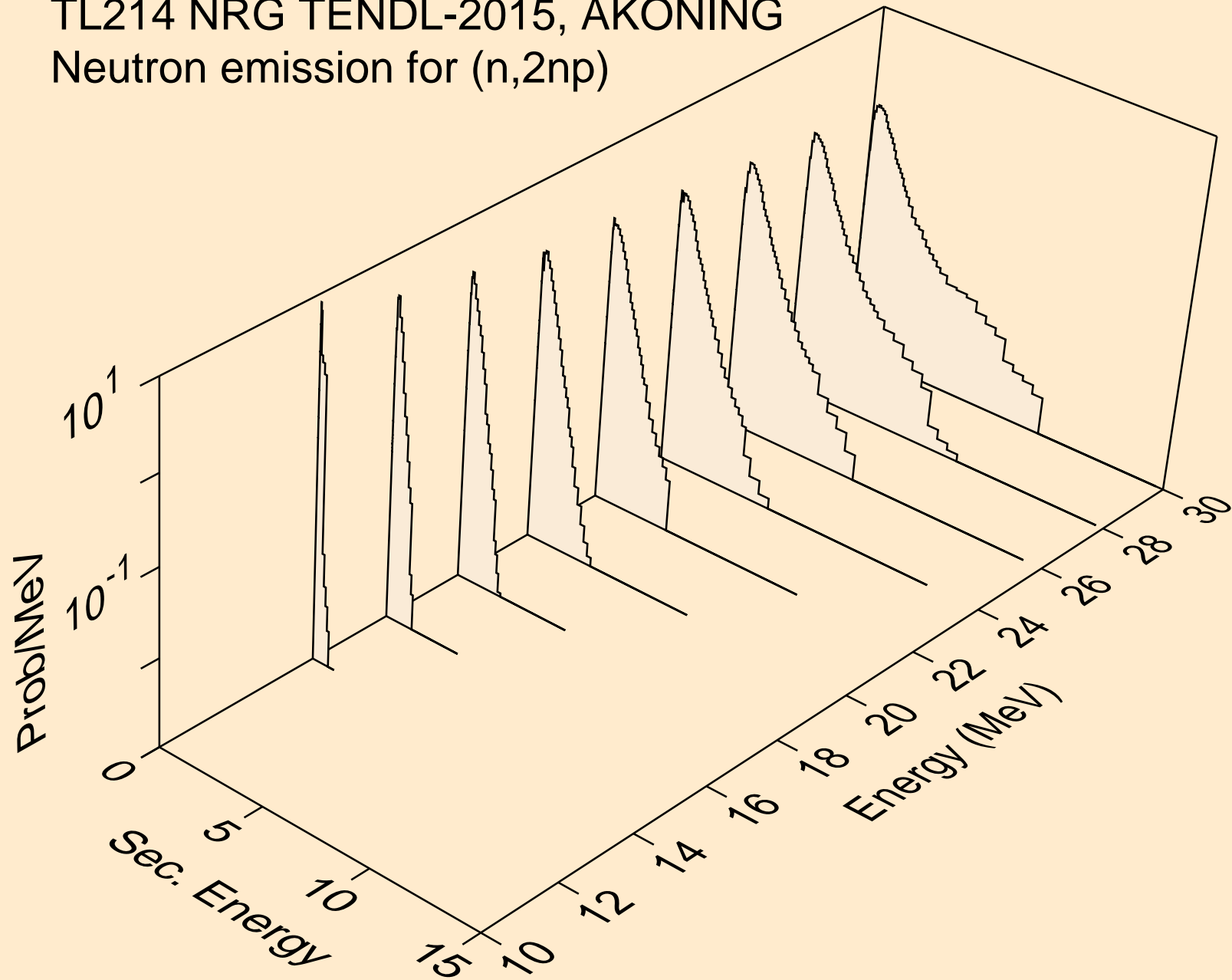

TL214 NRG TENDL-2015, AKONING
Neutron emission for (n,3np)

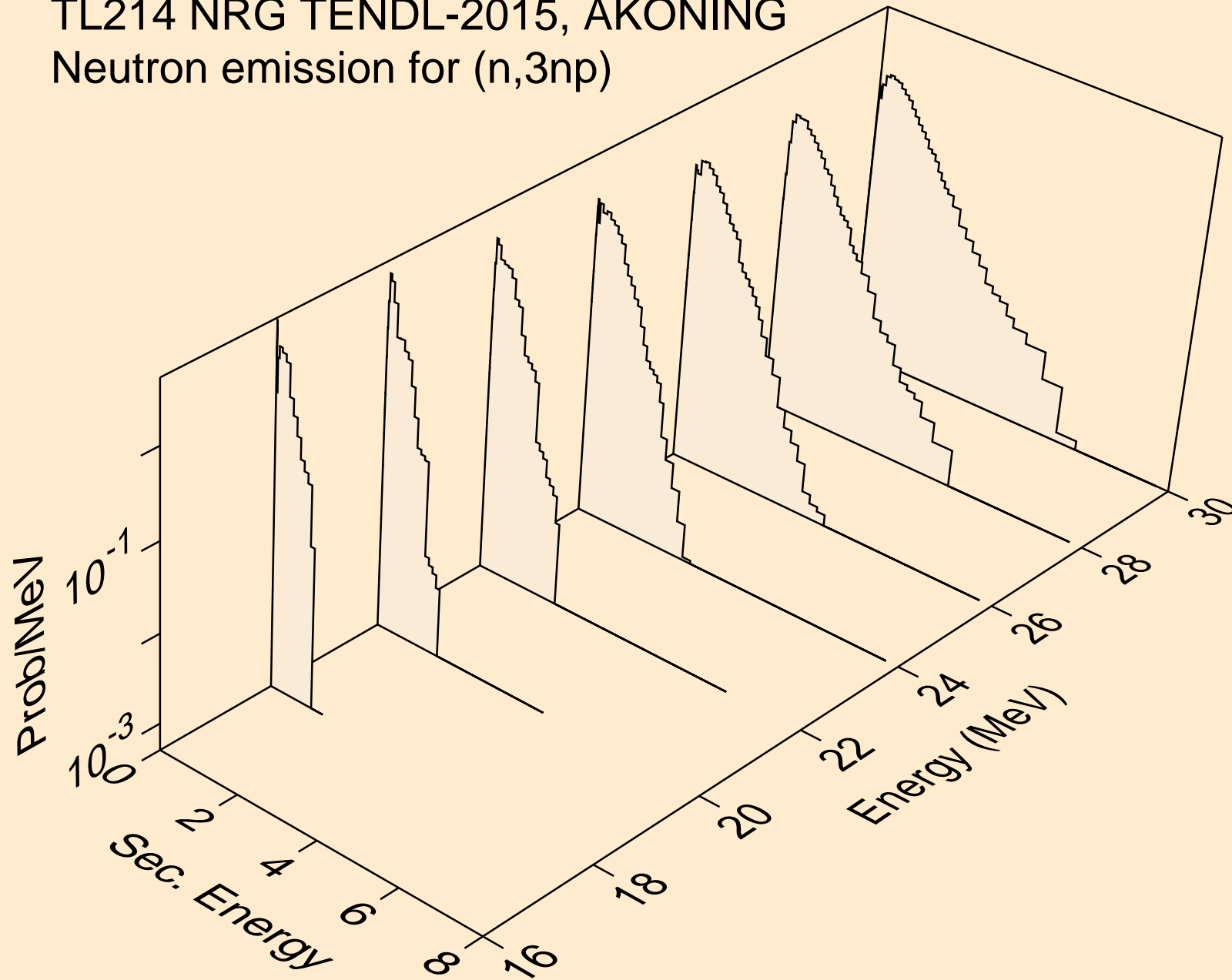

TL214 NRG TENDL-2015, AKONING
Neutron emission for (n,n*c)

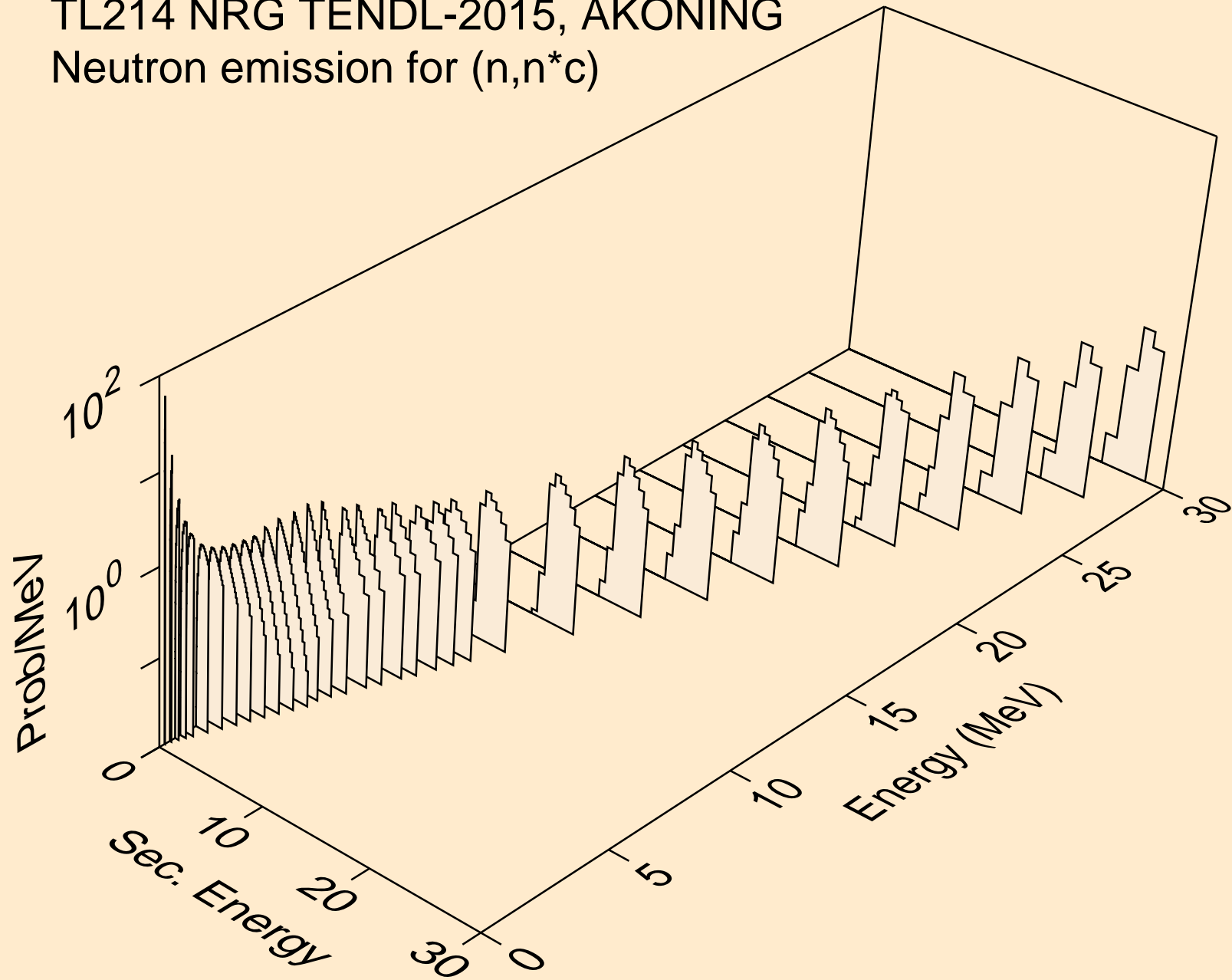

TL214 NRG TENDL-2015, AKONING
Photon emission for (n,x)

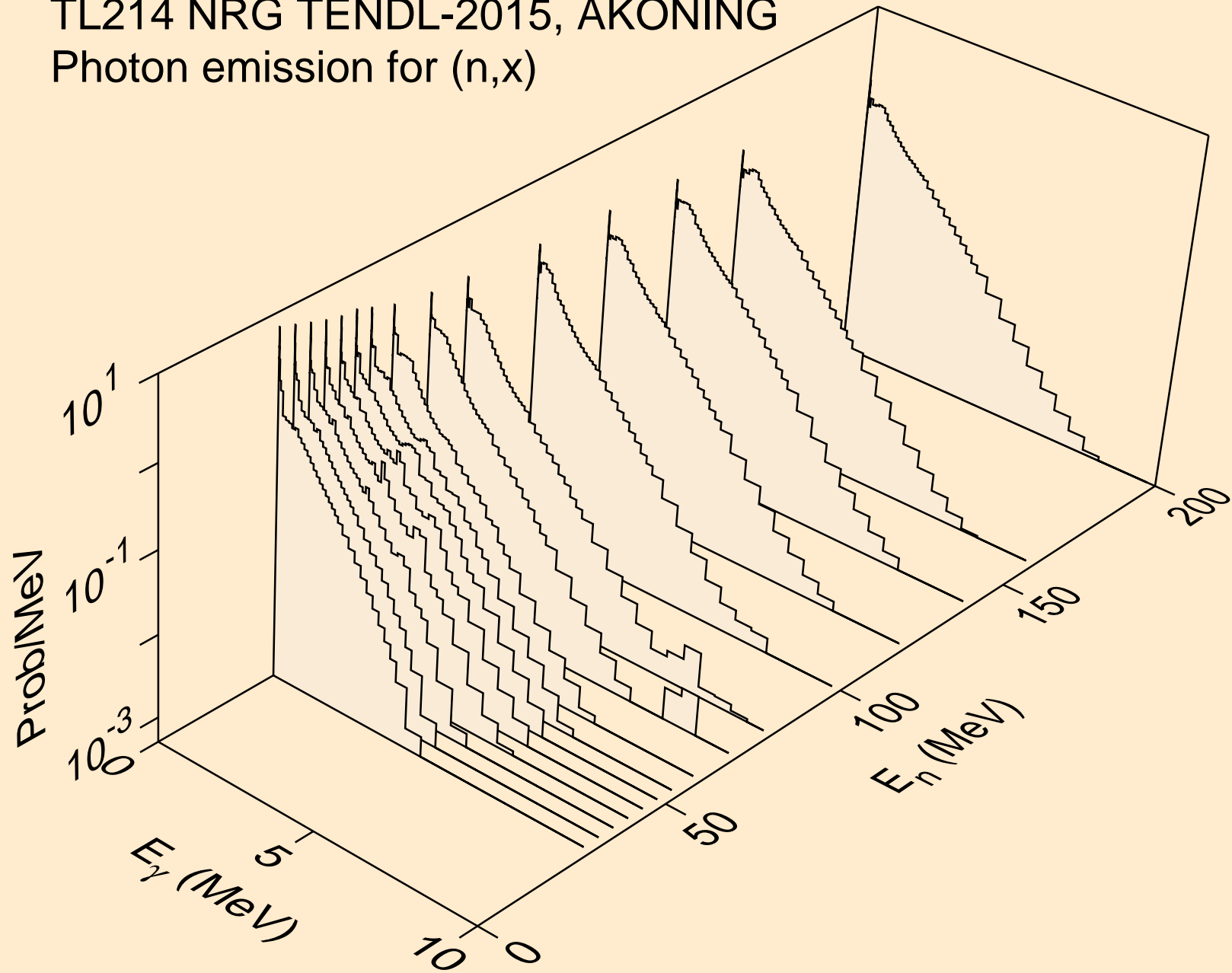

TL214 NRG TENDL-2015, AKONING
Photon emission for (n,2nd)

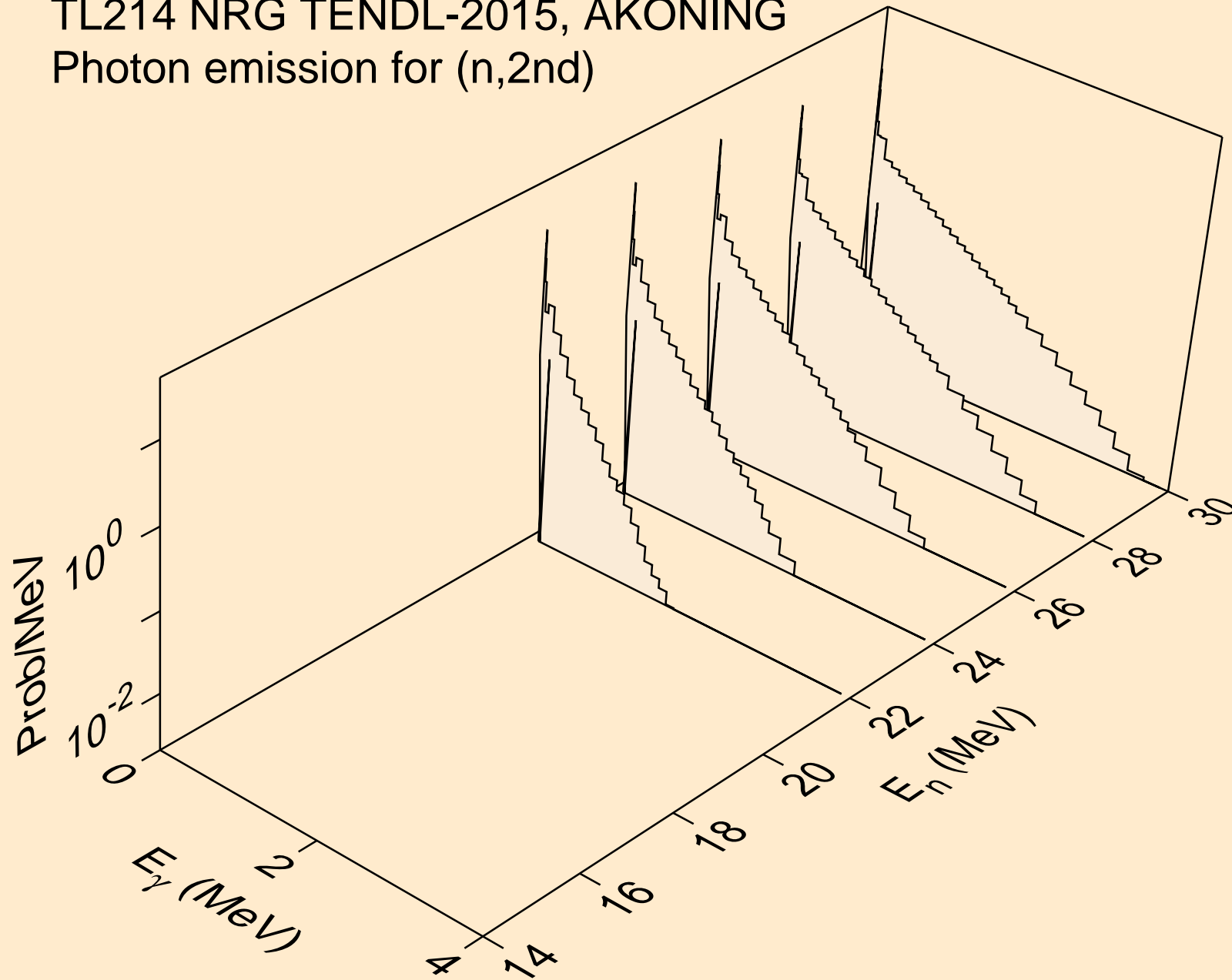

TL214 NRG TENDL-2015, AKONING
Photon emission for (n,2n)

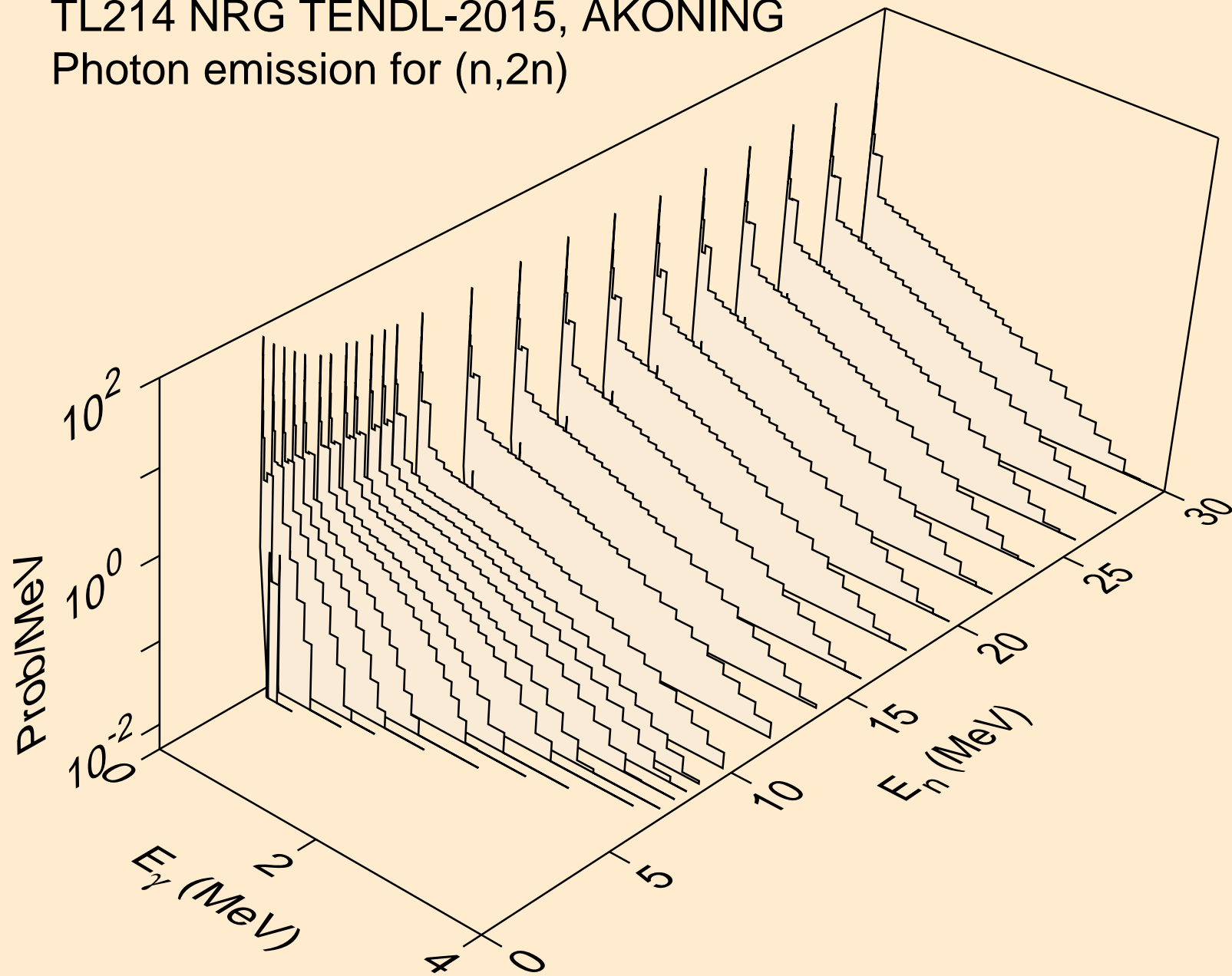

TL214 NRG TENDL-2015, AKONING
Photon emission for (n,3n)

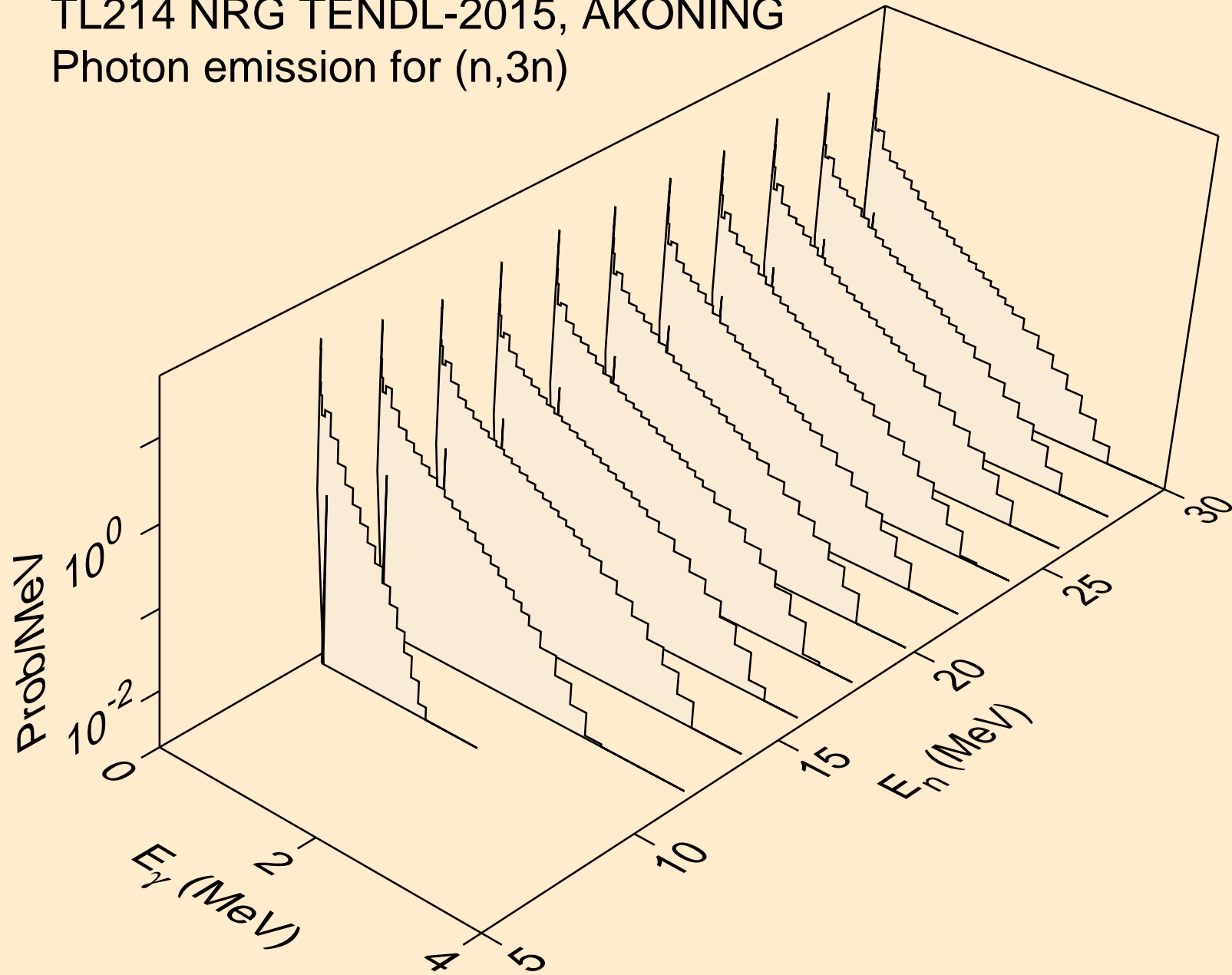

TL214 NRG TENDL-2015, AKONING
Photon emission for (n,n*)a

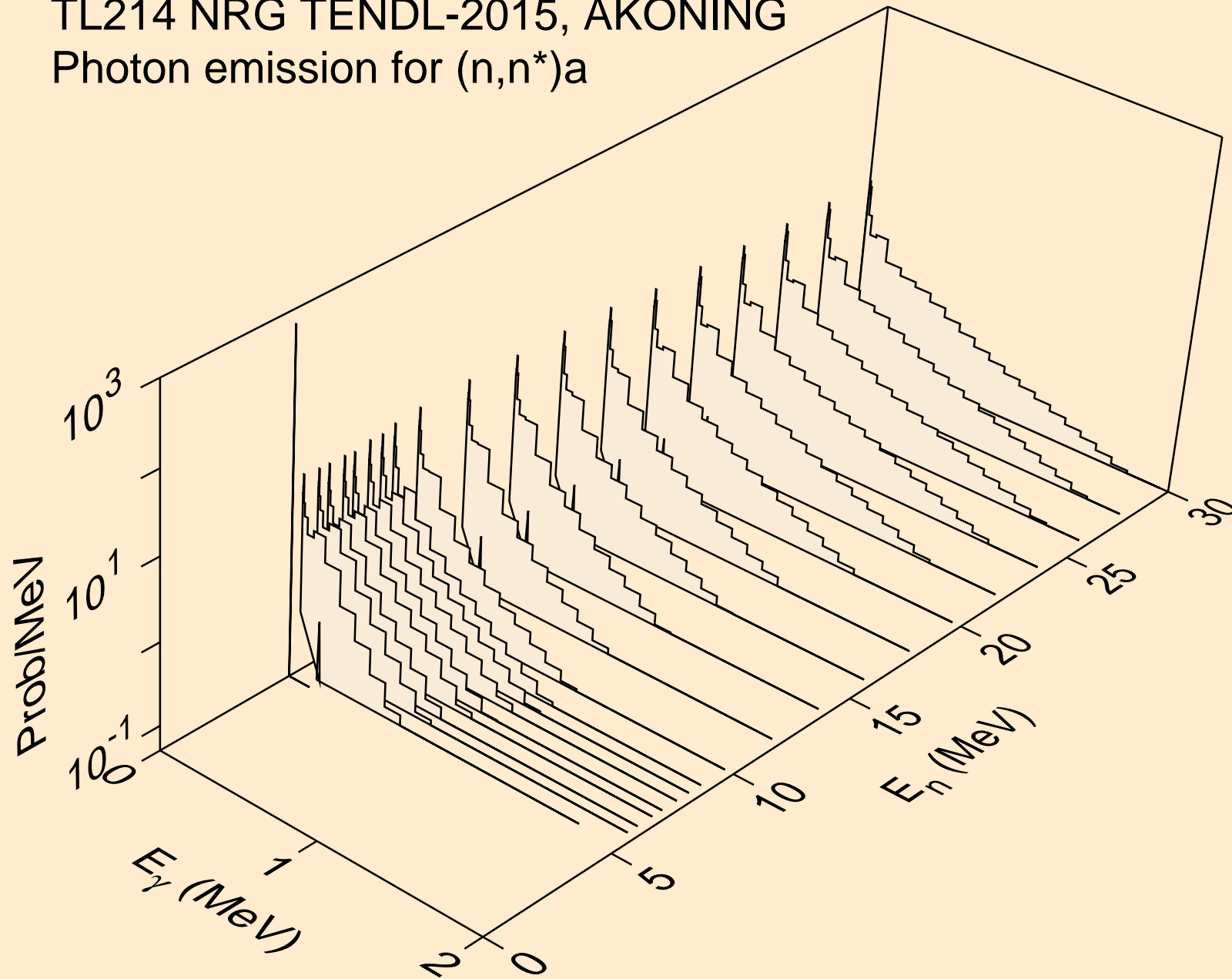

TL214 NRG TENDL-2015, AKONING
Photon emission for (n,2n)a

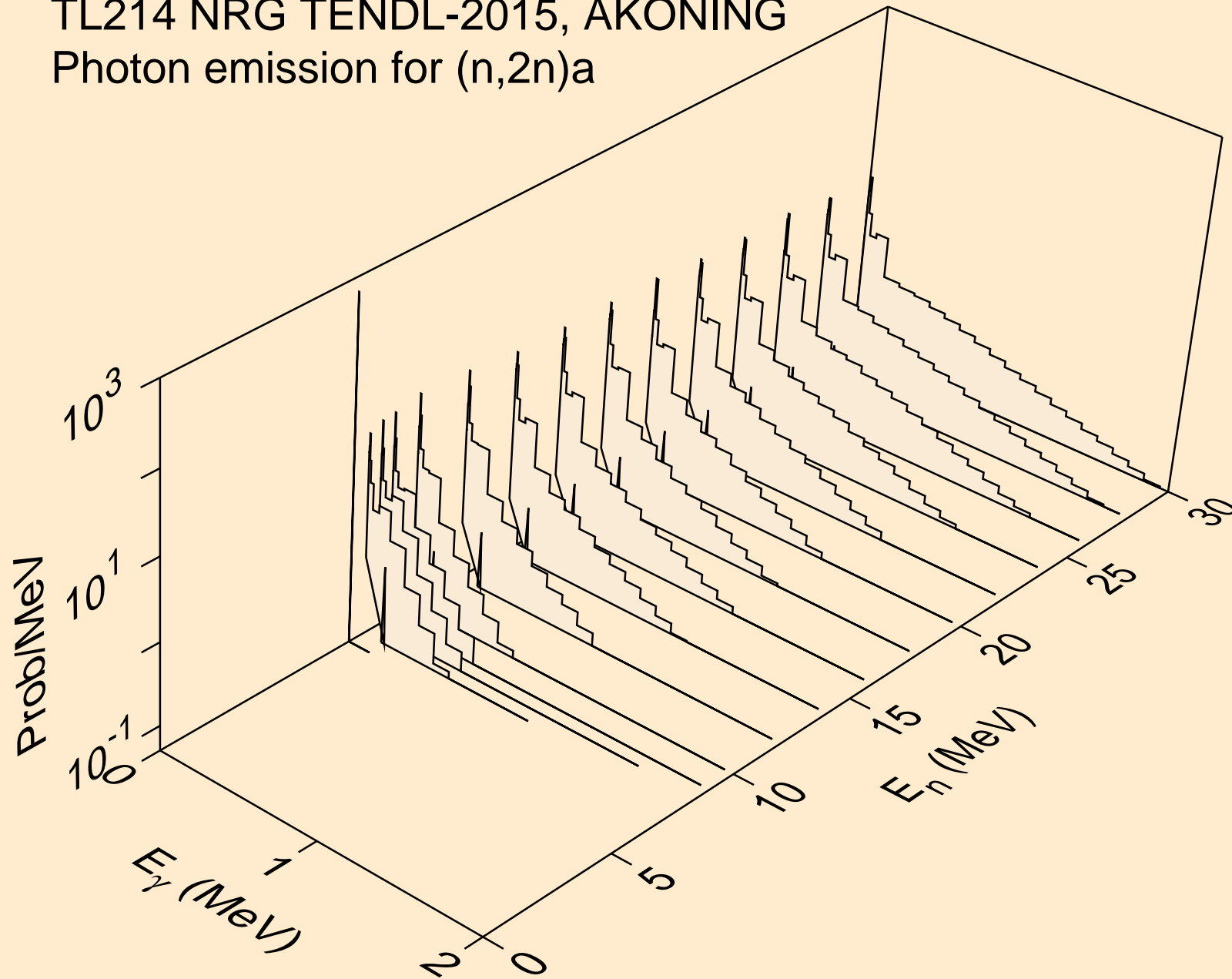

TL214 NRG TENDL-2015, AKONING
Photon emission for (n,3n)a

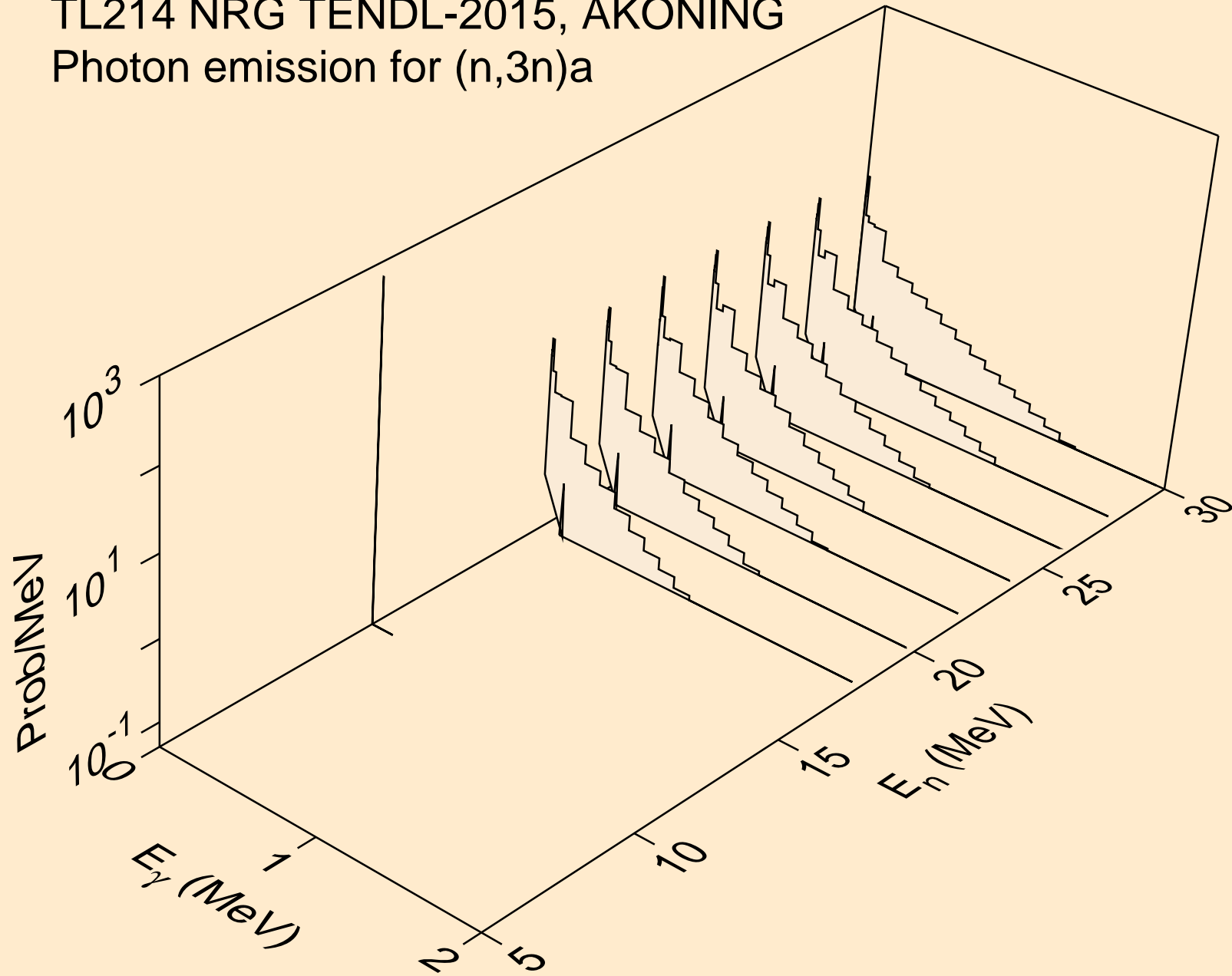

TL214 NRG TENDL-2015, AKONING
Photon emission for (n,n*)p

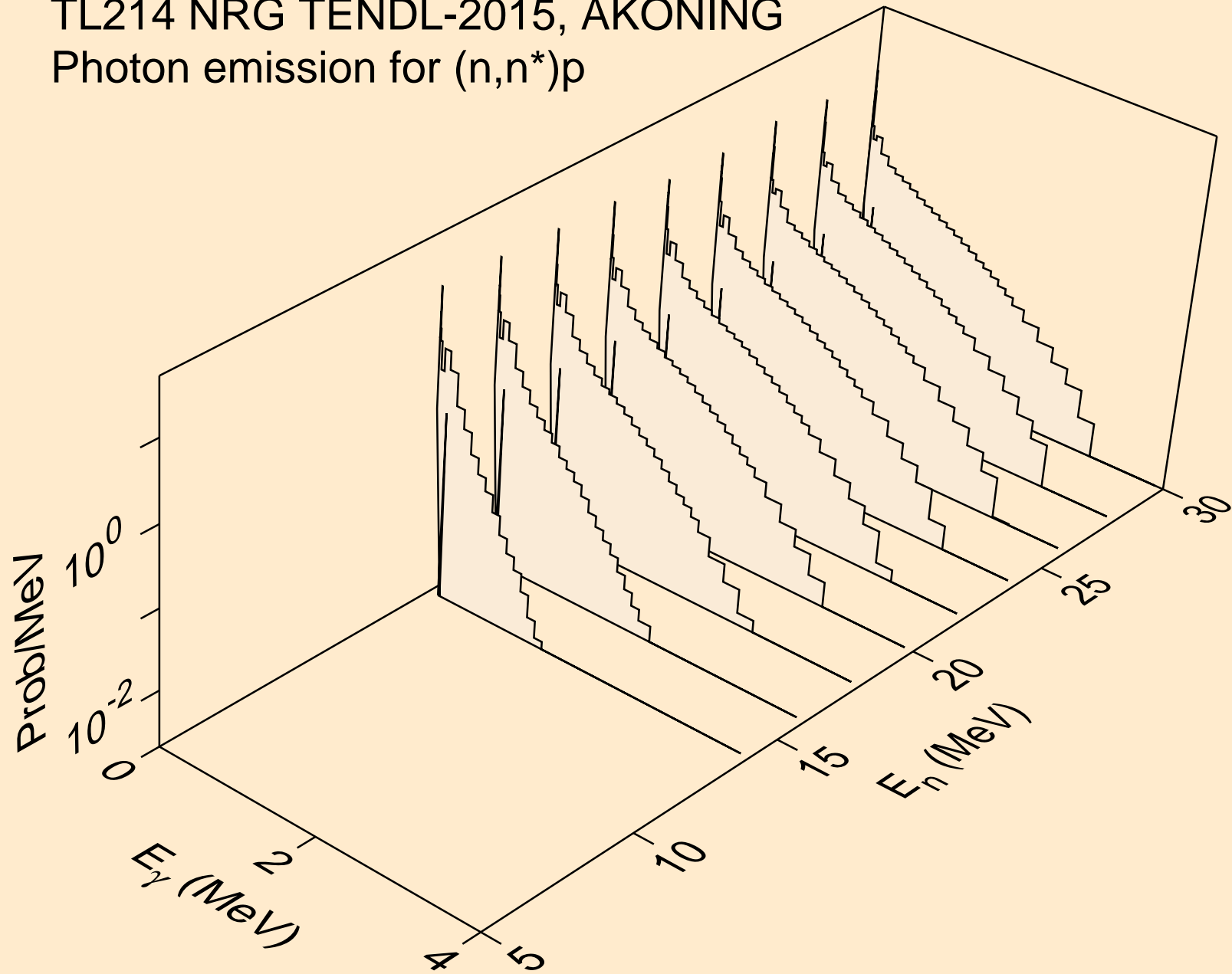

TL214 NRG TENDL-2015, AKONING
Photon emission for (n,n*)d

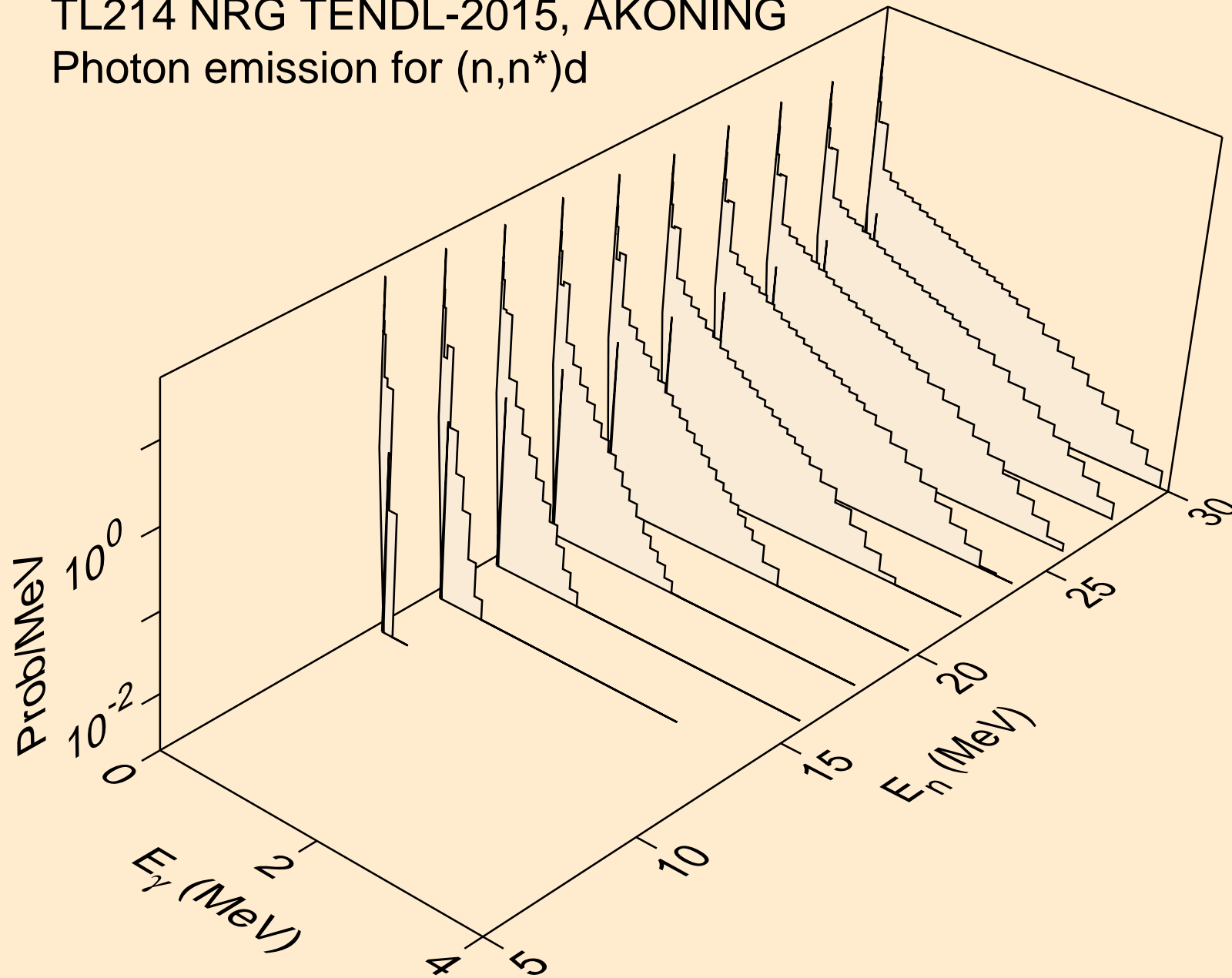

TL214 NRG TENDL-2015, AKONING
Photon emission for (n,n*)t

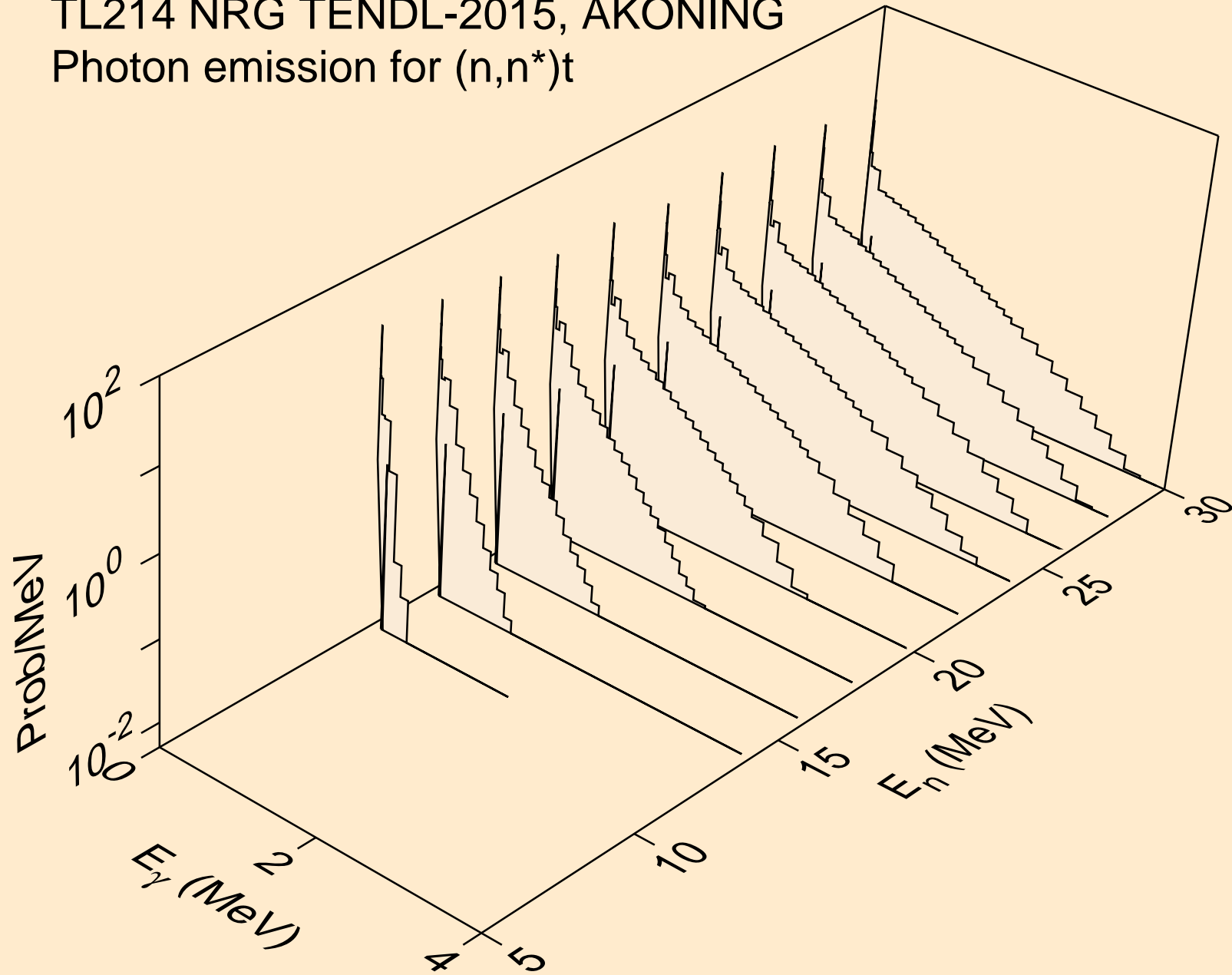

TL214 NRG TENDL-2015, AKONING
Photon emission for (n,n*)he3

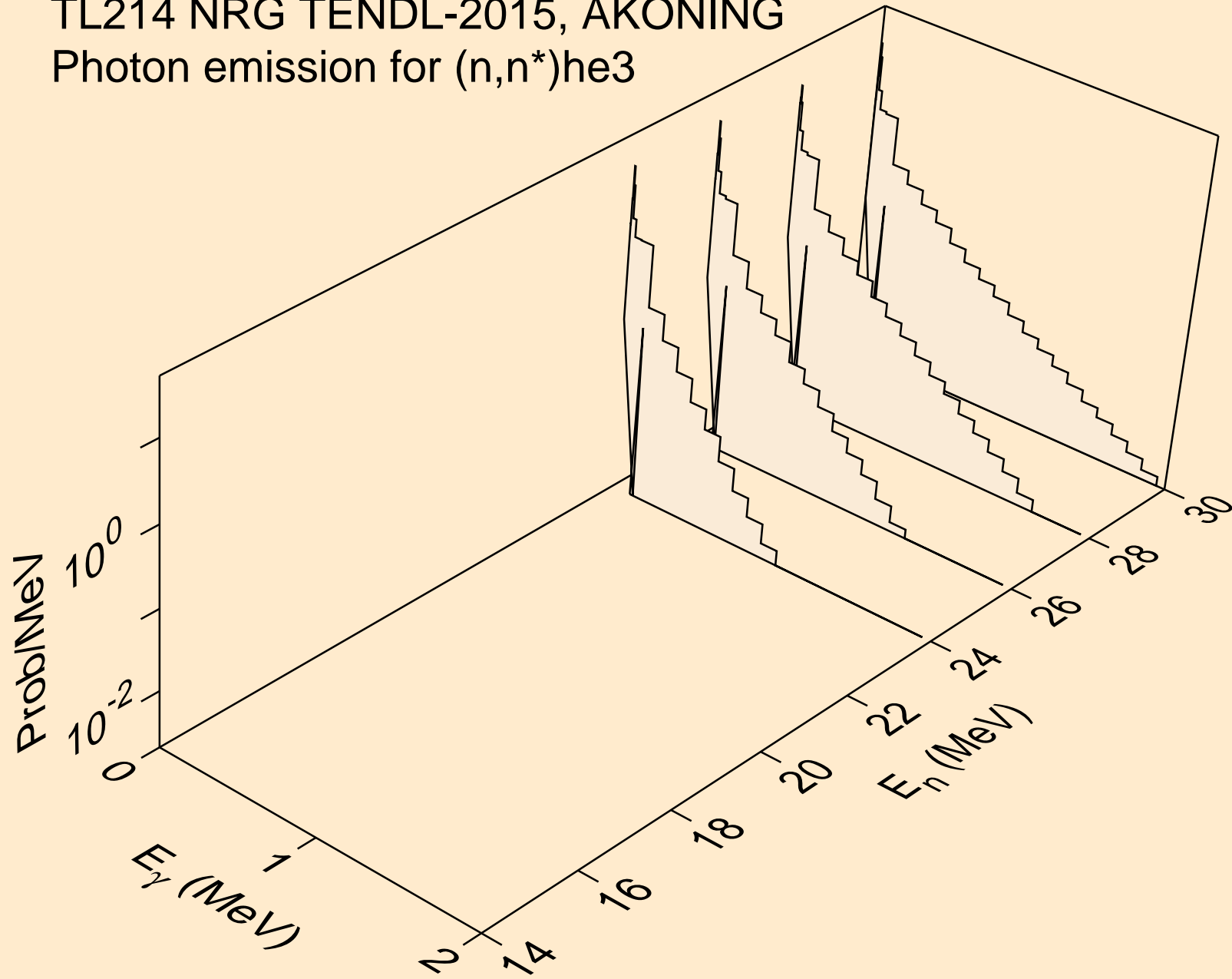

TL214 NRG TENDL-2015, AKONING
Photon emission for (n,4n)

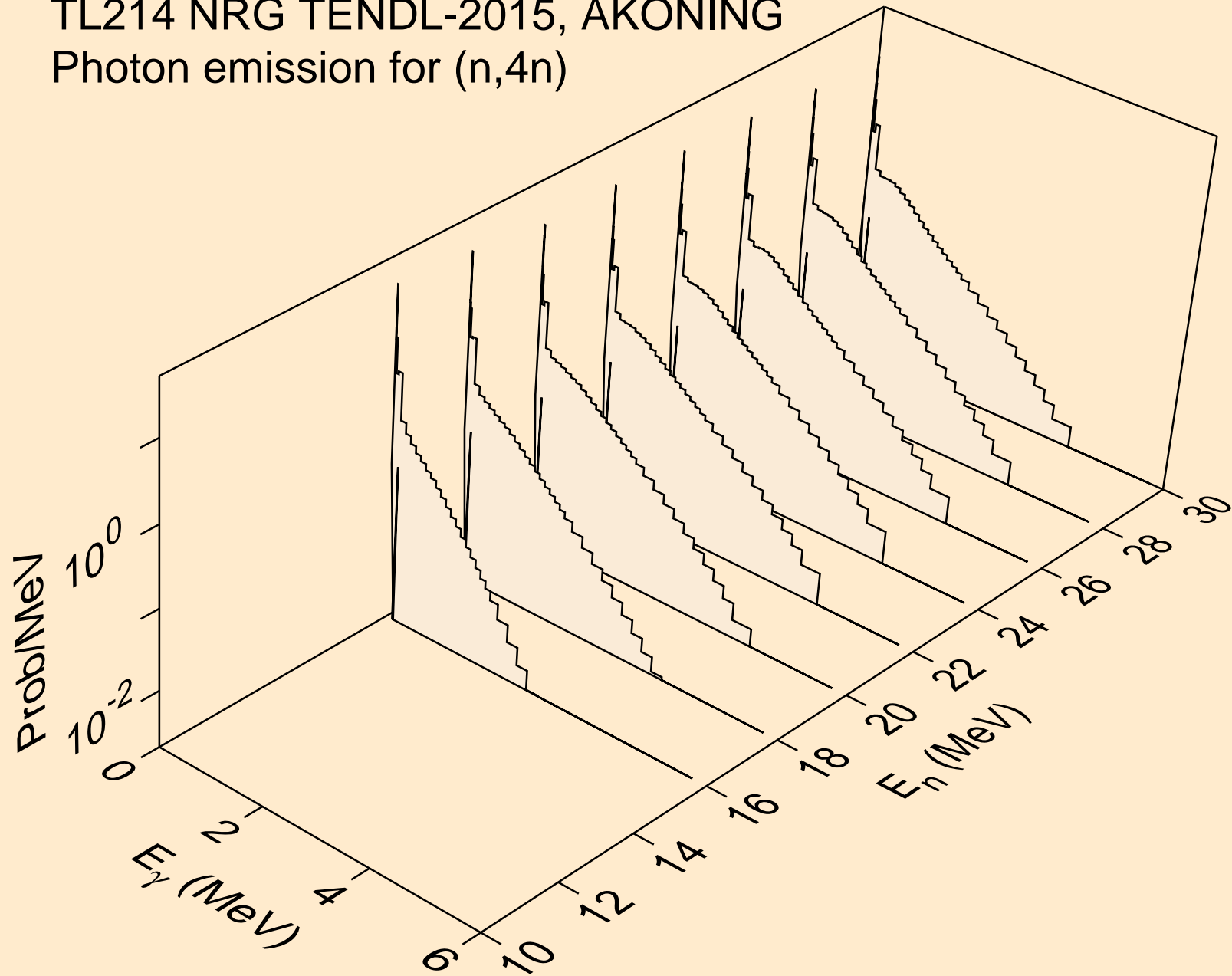

TL214 NRG TENDL-2015, AKONING
Photon emission for (n,2np)

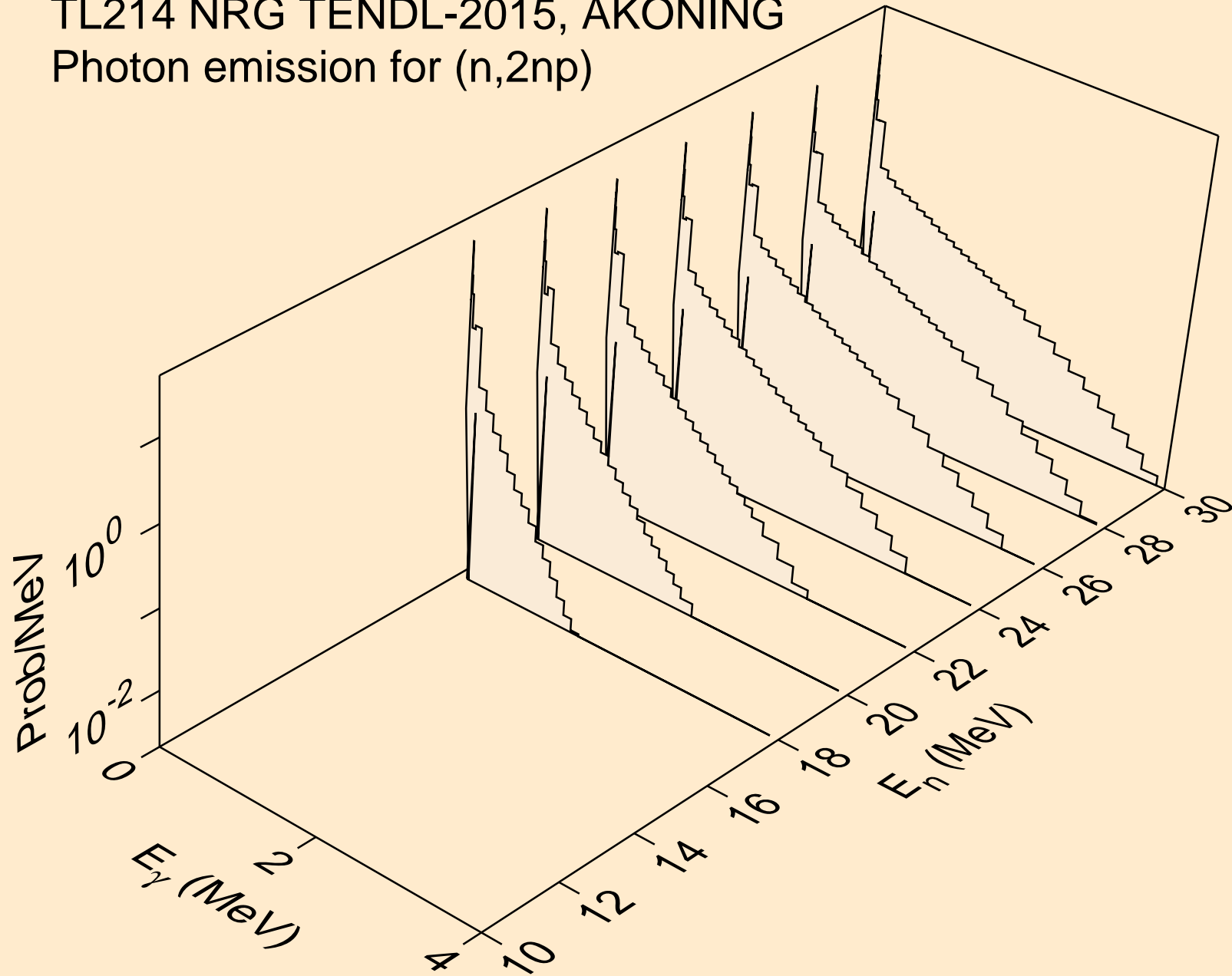

TL214 NRG TENDL-2015, AKONING
Photon emission for (n,3np)

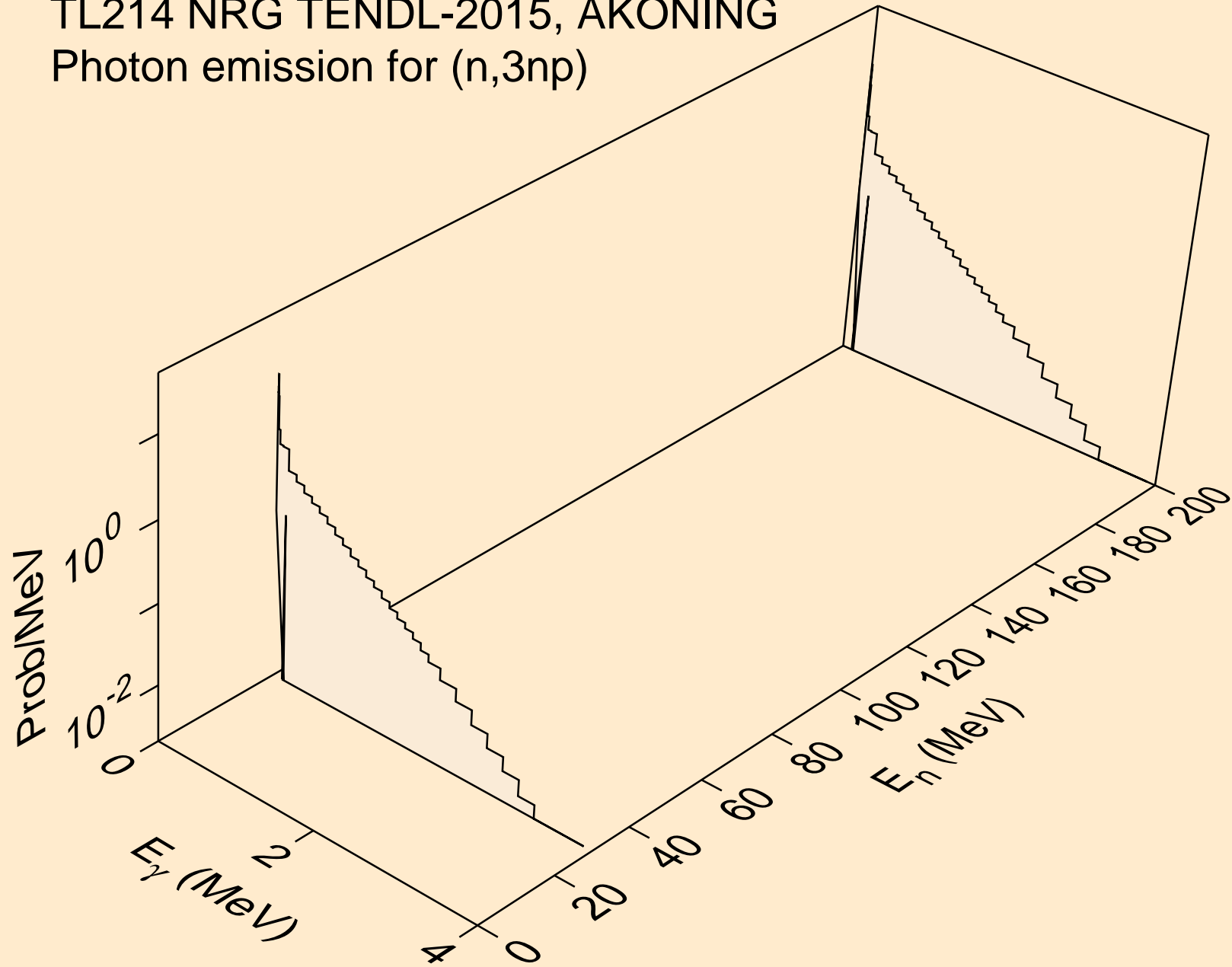

TL214 NRG TENDL-2015, AKONING
Photon emission for (n,n*c)

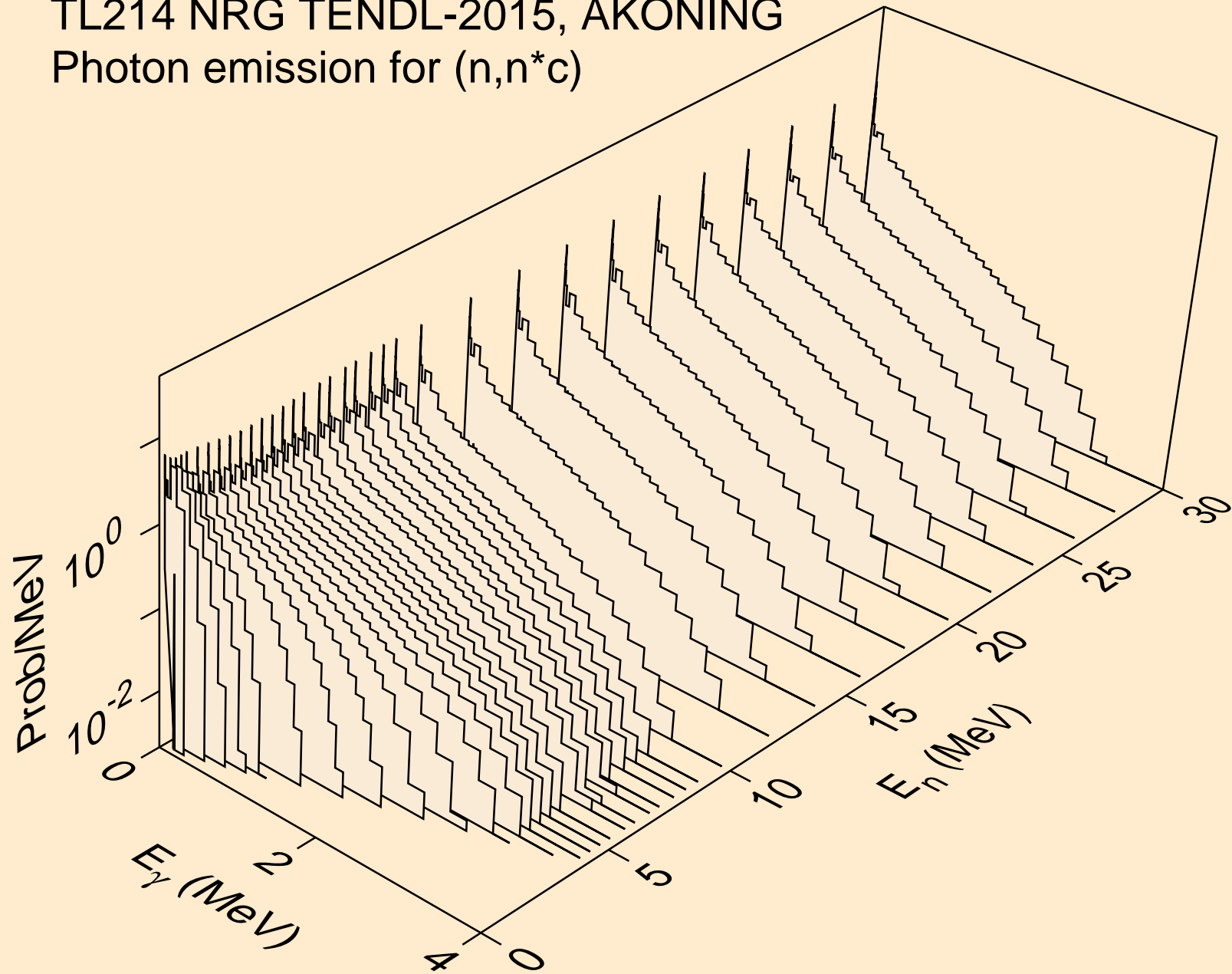

TL214 NRG TENDL-2015, AKONING
Photon emission for (n,gma)

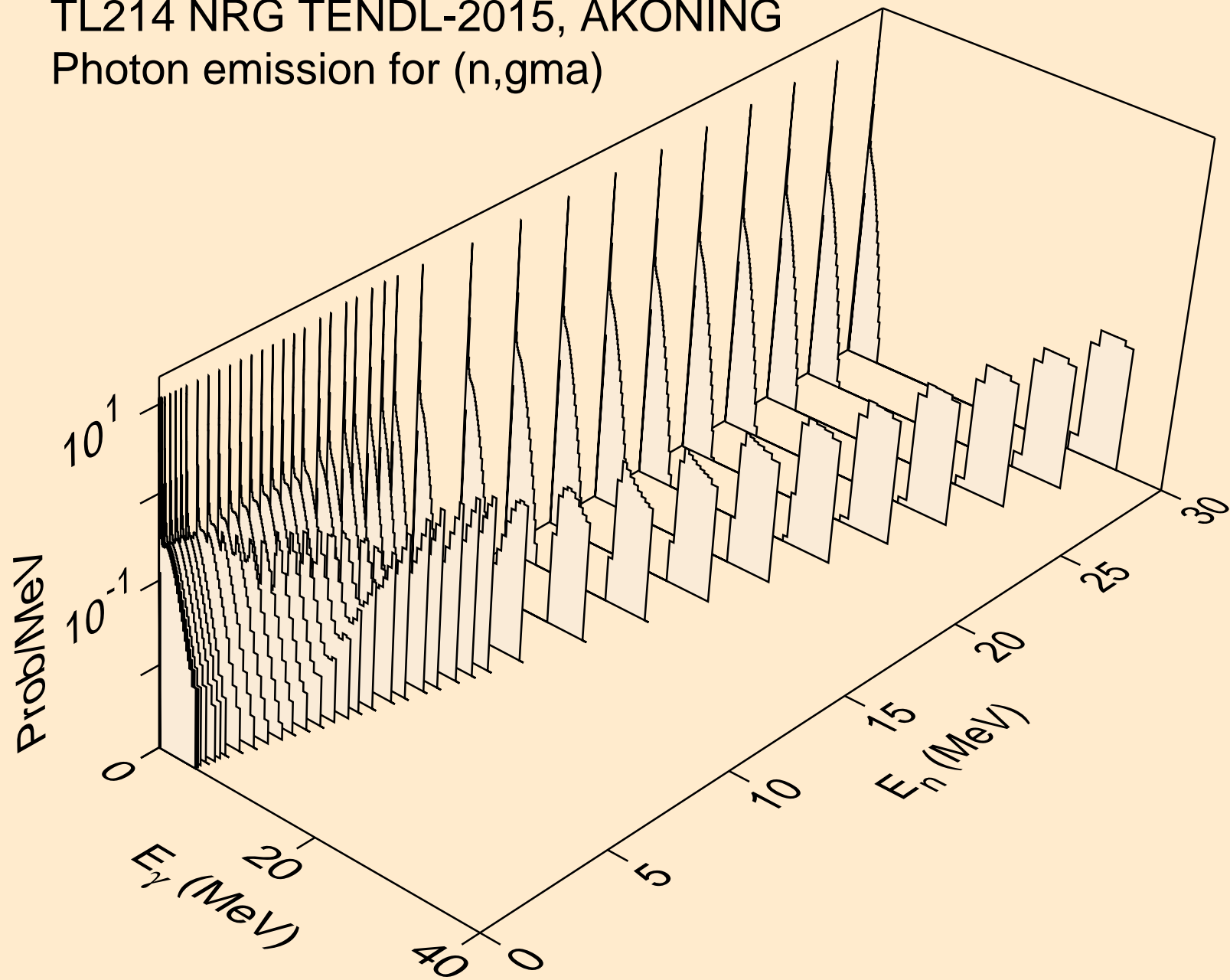

TL214 NRG TENDL-2015, AKONING
Photon emission for (n,p)

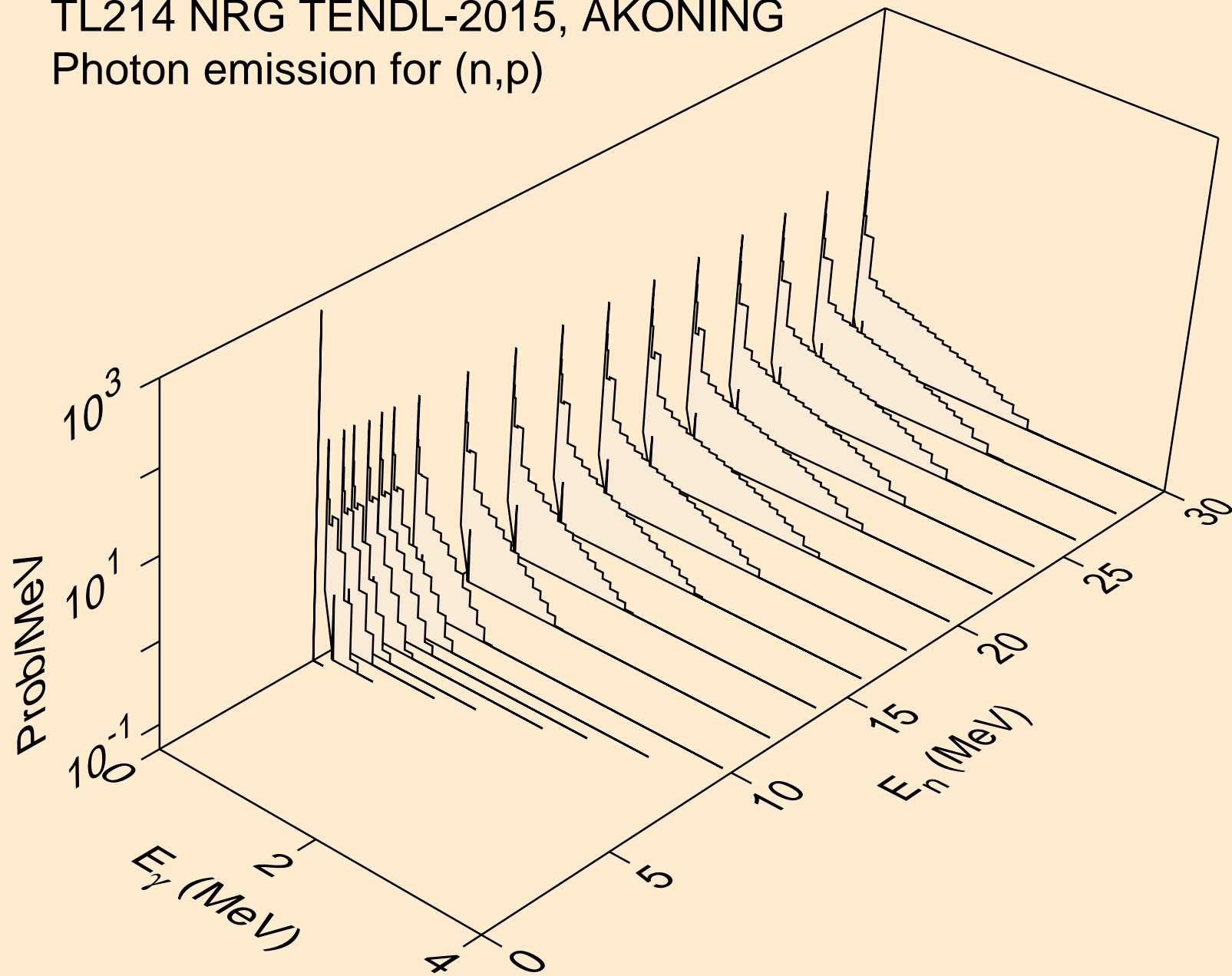

TL214 NRG TENDL-2015, AKONING
Photon emission for (n,d)

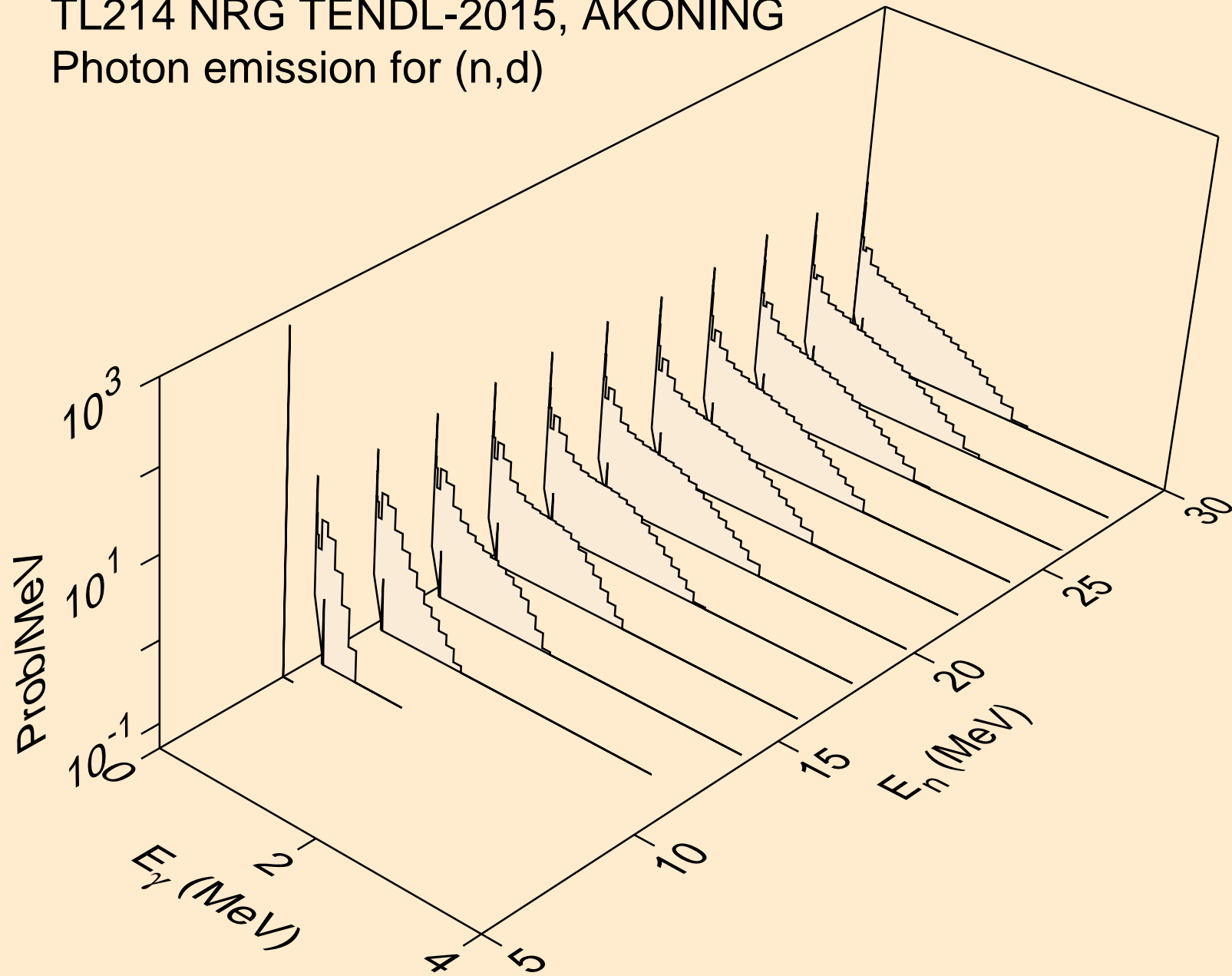

TL214 NRG TENDL-2015, AKONING
Photon emission for (n,t)

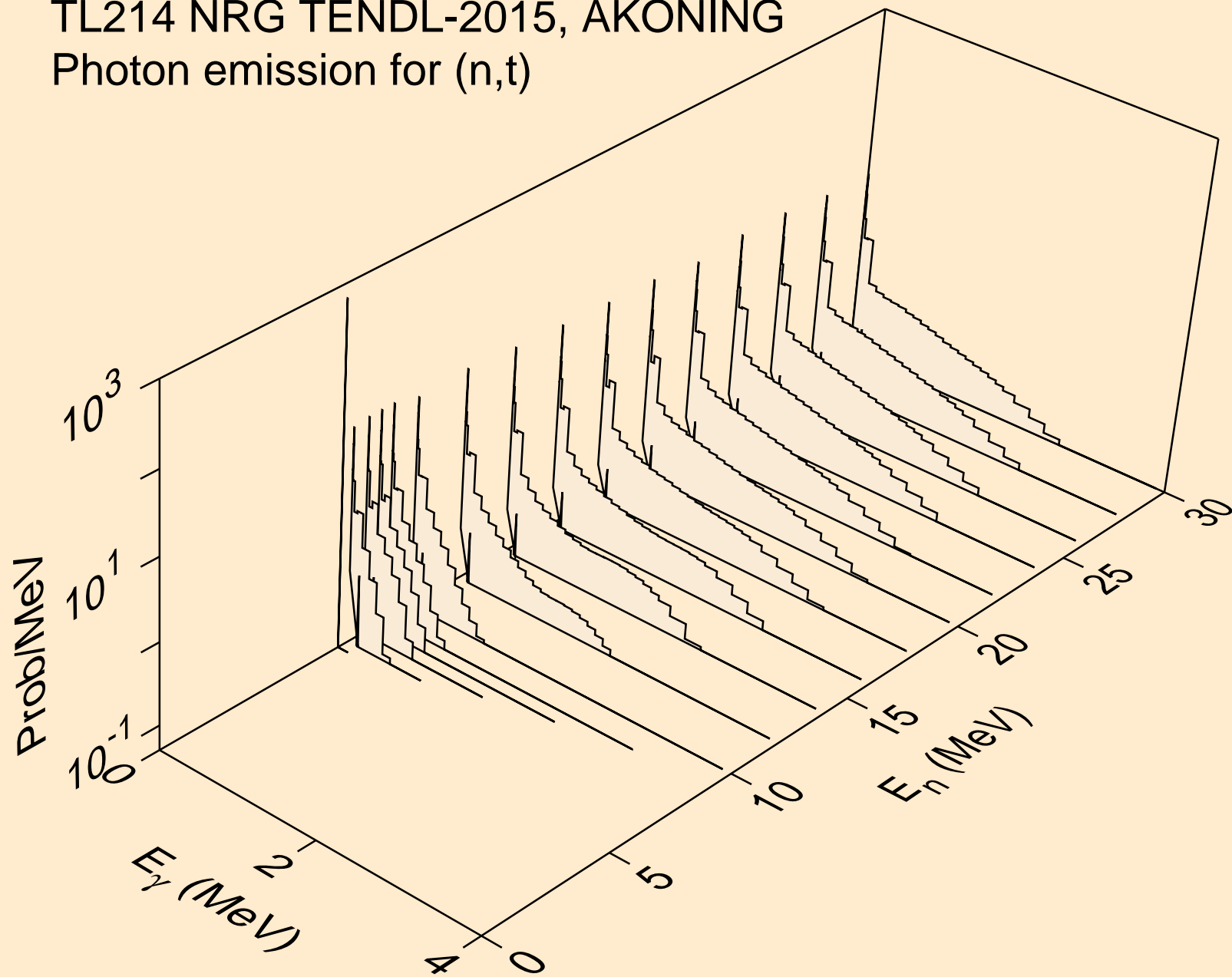

TL214 NRG TENDL-2015, AKONING
Photon emission for (n,he3)

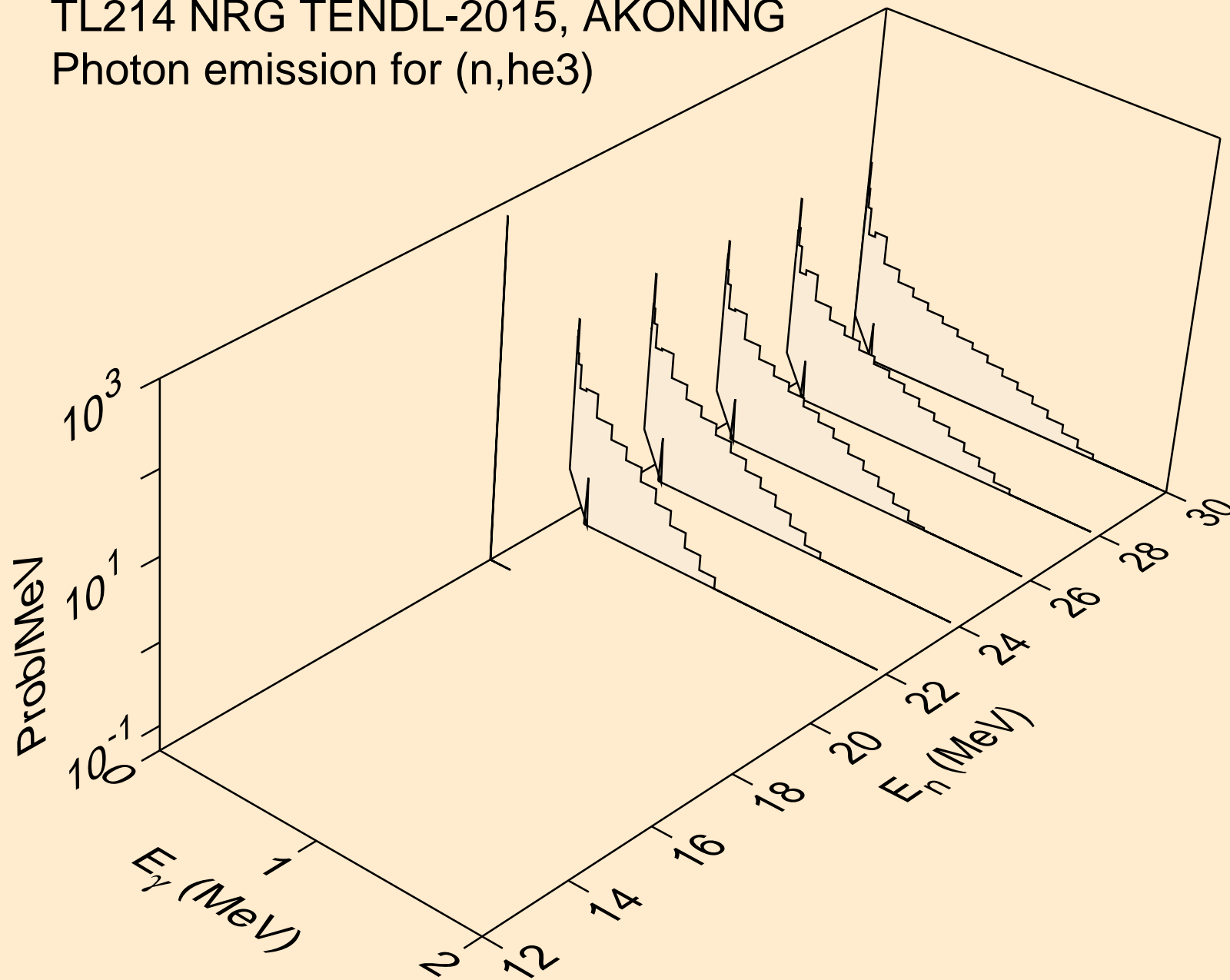

TL214 NRG TENDL-2015, AKONING
Photon emission for (n,a)

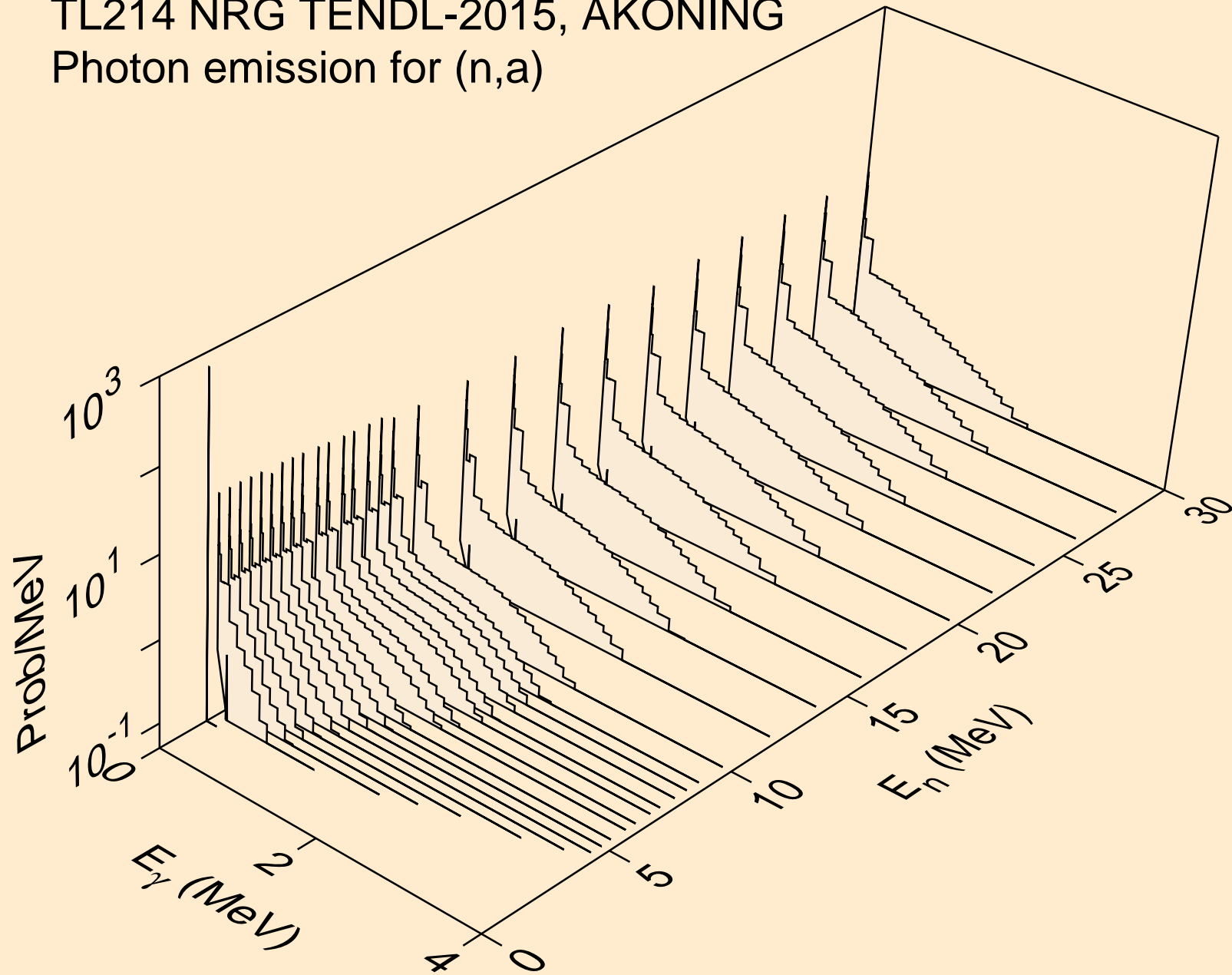

TL214 NRG TENDL-2015, AKONING
thermal capture photon spectrum

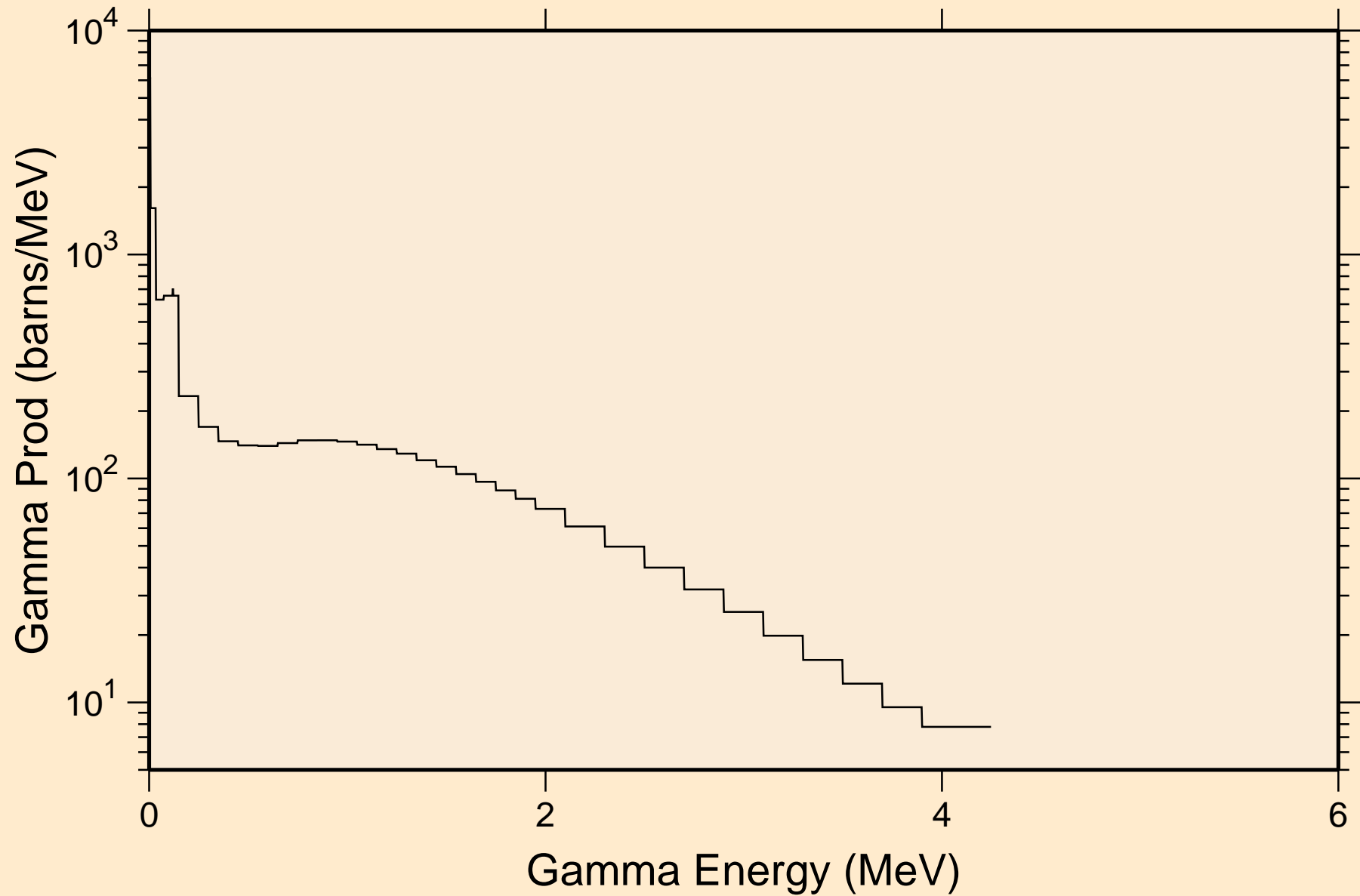

TL214 NRG TENDL-2015, AKONING
14 MeV photon spectrum

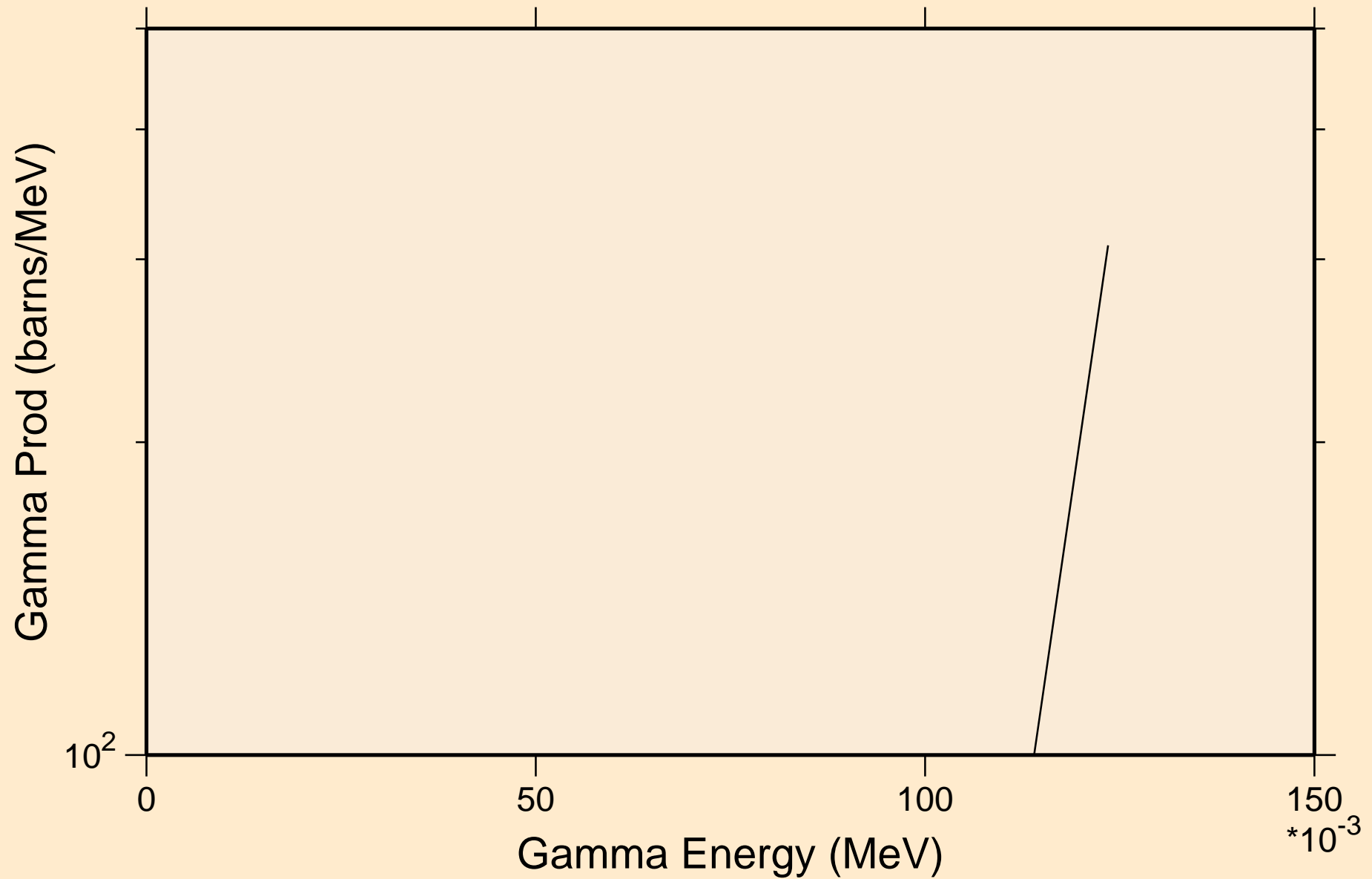

TL214 NRG TENDL-2015, AKONING

Particle heating contributions

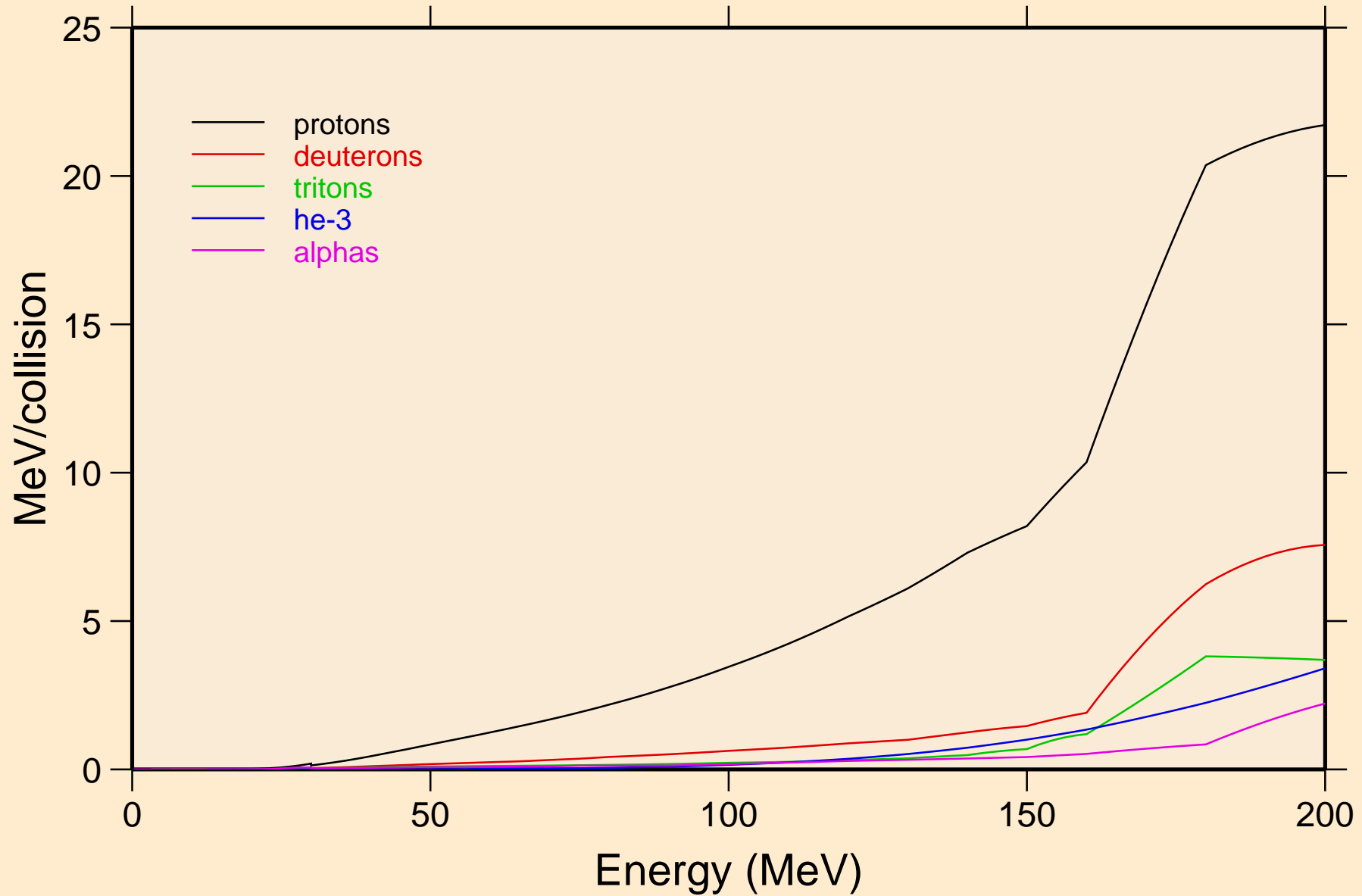

TL214 NRG TENDL-2015, AKONING

Recoil Heating

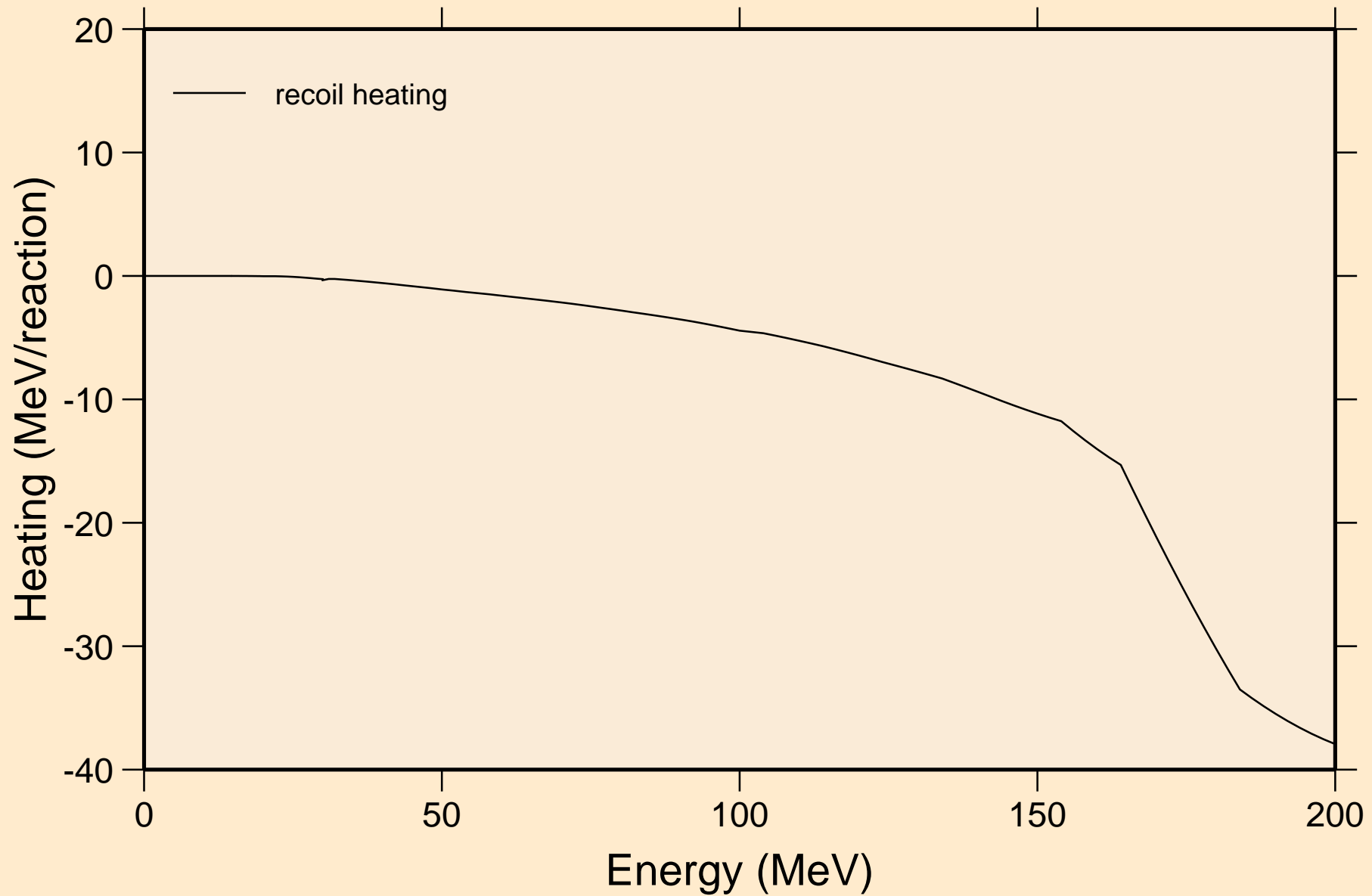

TL214 NRG TENDL-2015, AKONING

Particle production cross sections

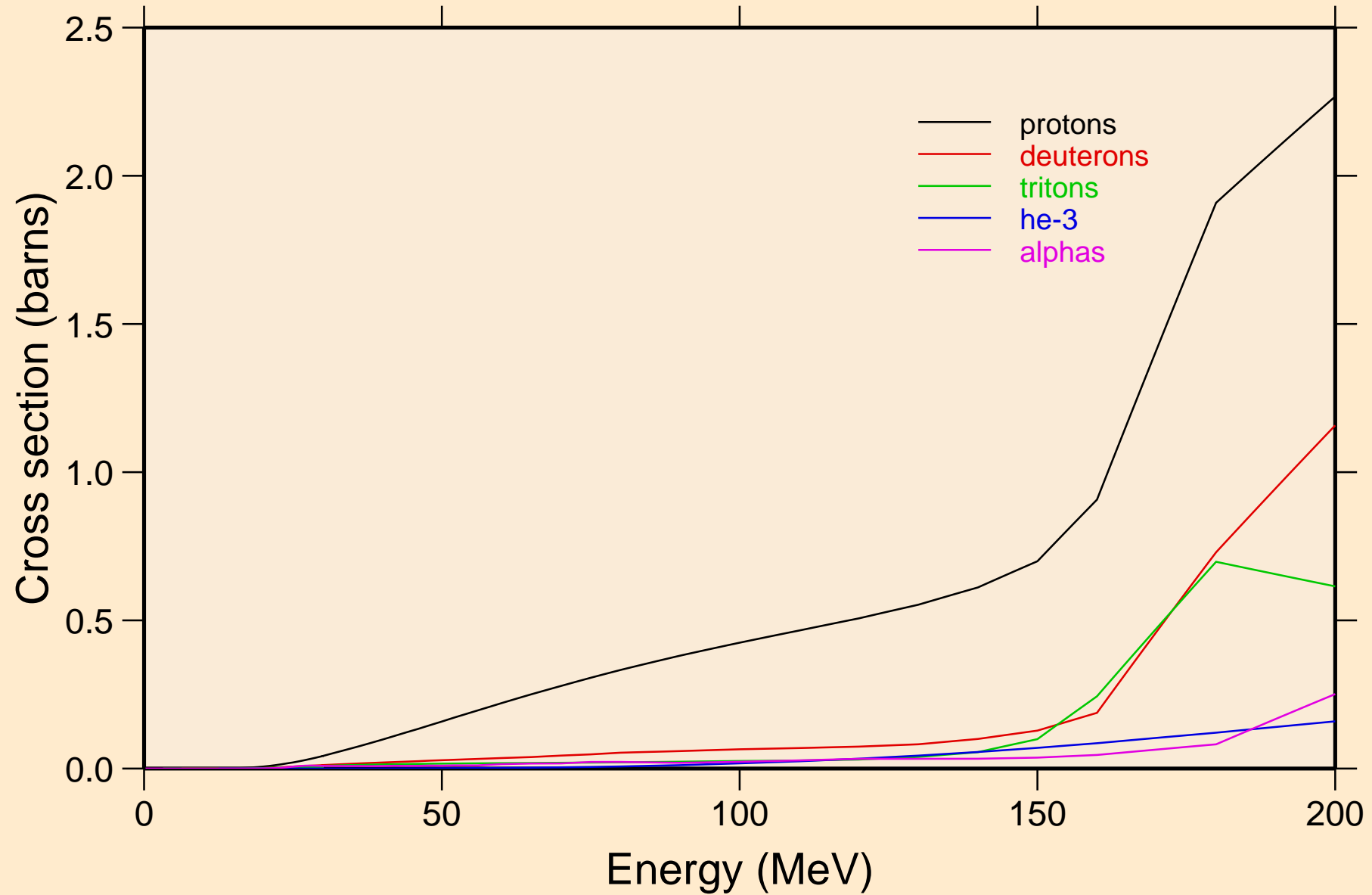

TL214 NRG TENDL-2015, AKONING
protons from (n,x)

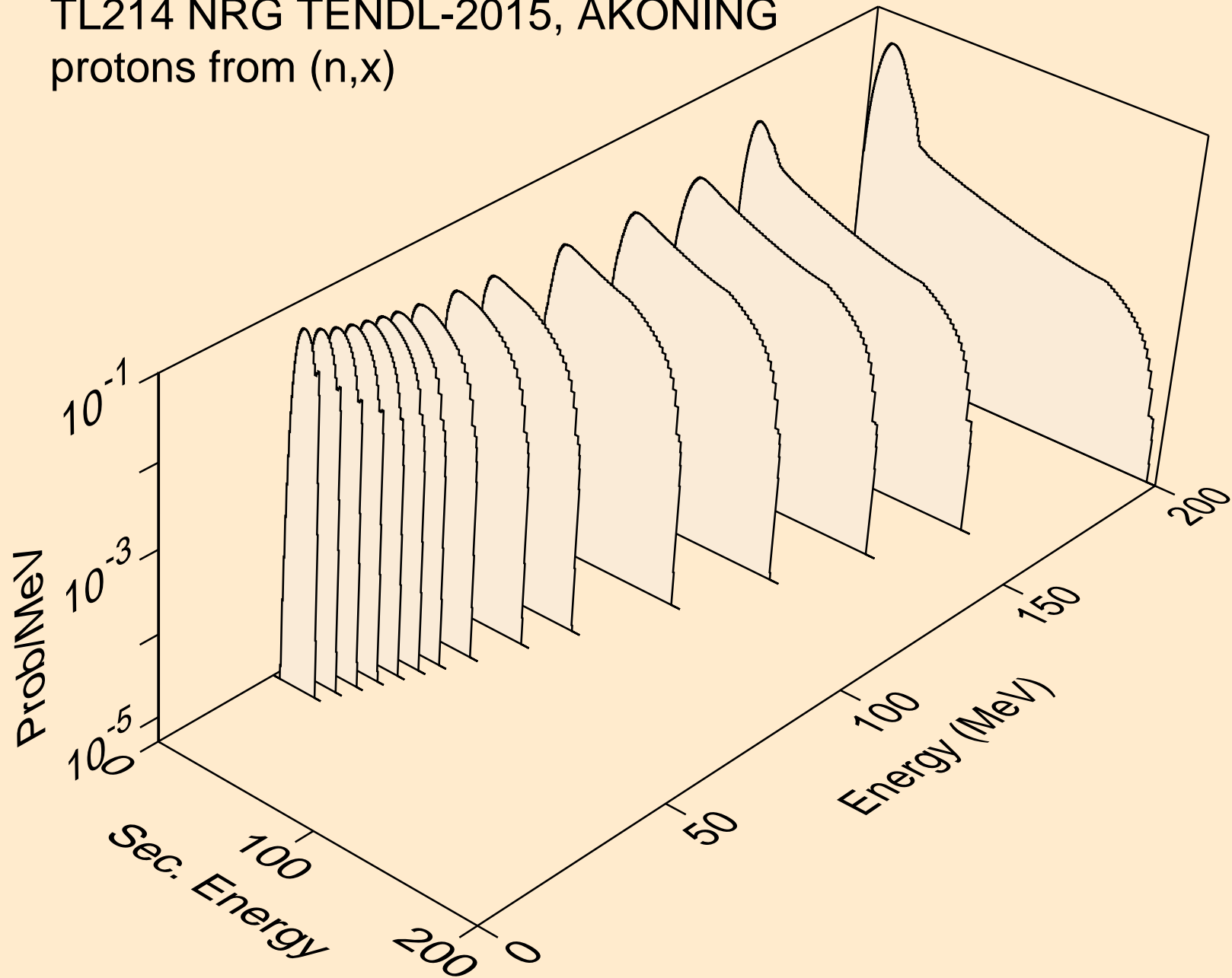

TL214 NRG TENDL-2015, AKONING
protons from (n,n*)p

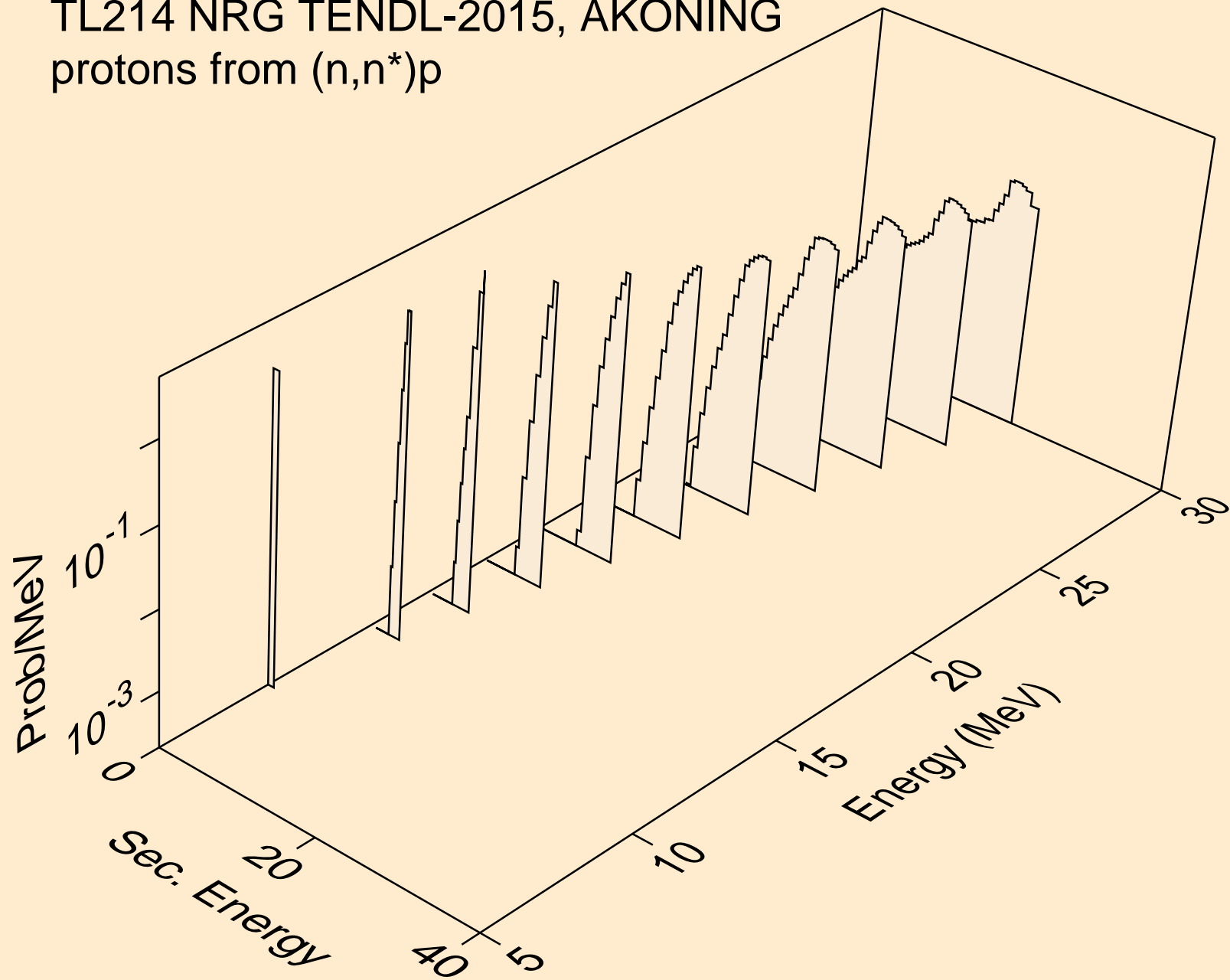

TL214 NRG TENDL-2015, AKONING
protons from (n,2np)

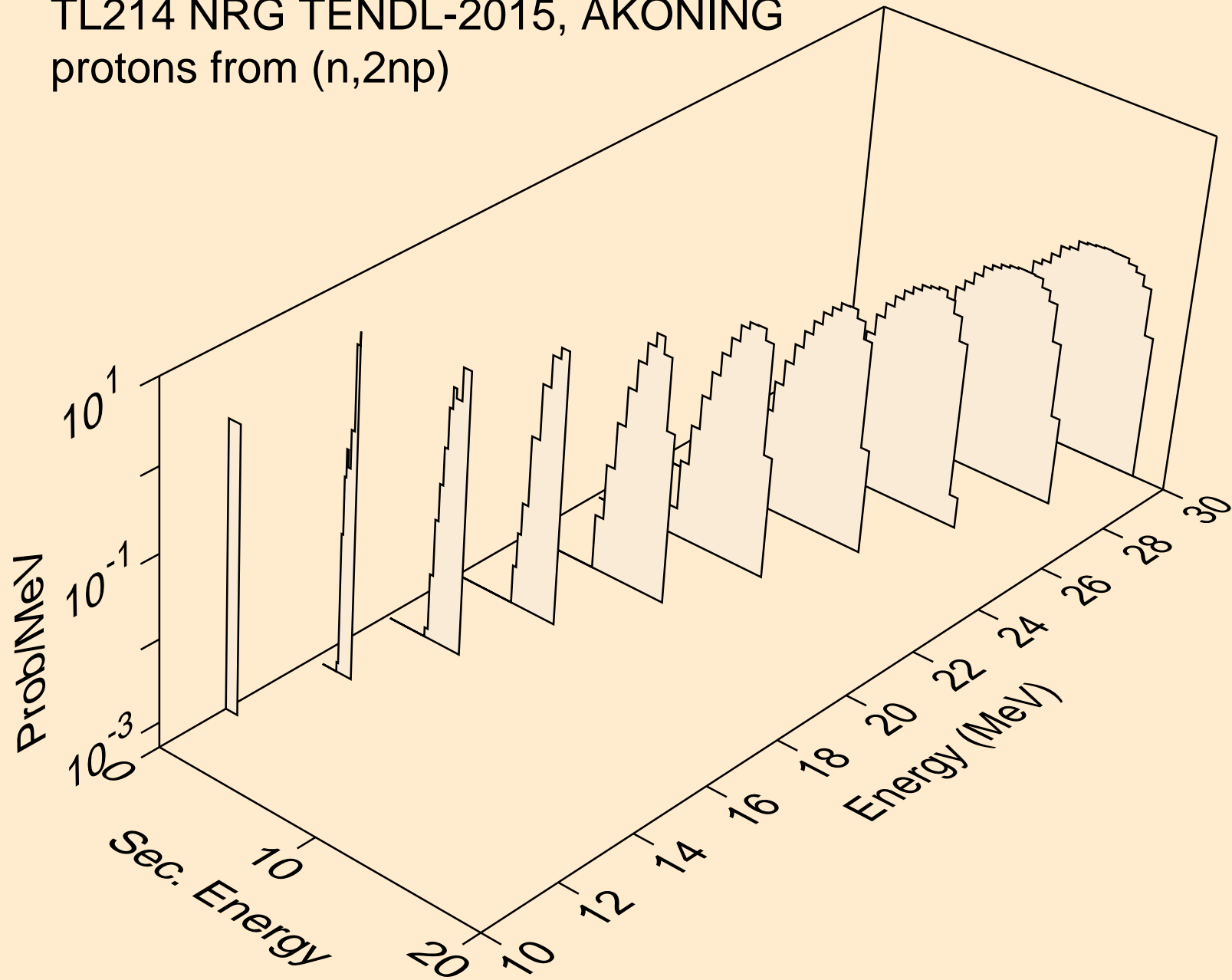

TL214 NRG TENDL-2015, AKONING
protons from (n,3np)

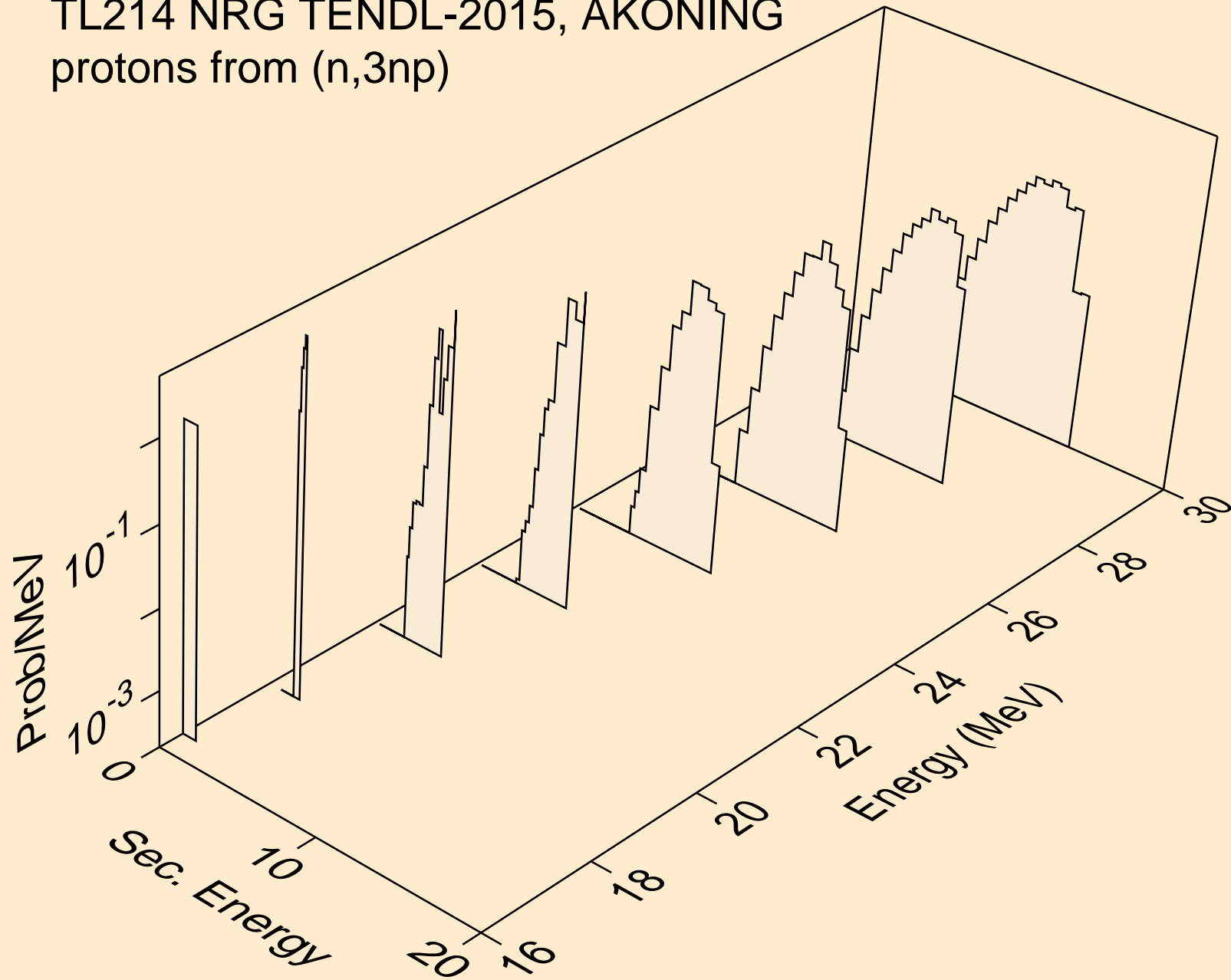

TL214 NRG TENDL-2015, AKONING
protons from (n,p)

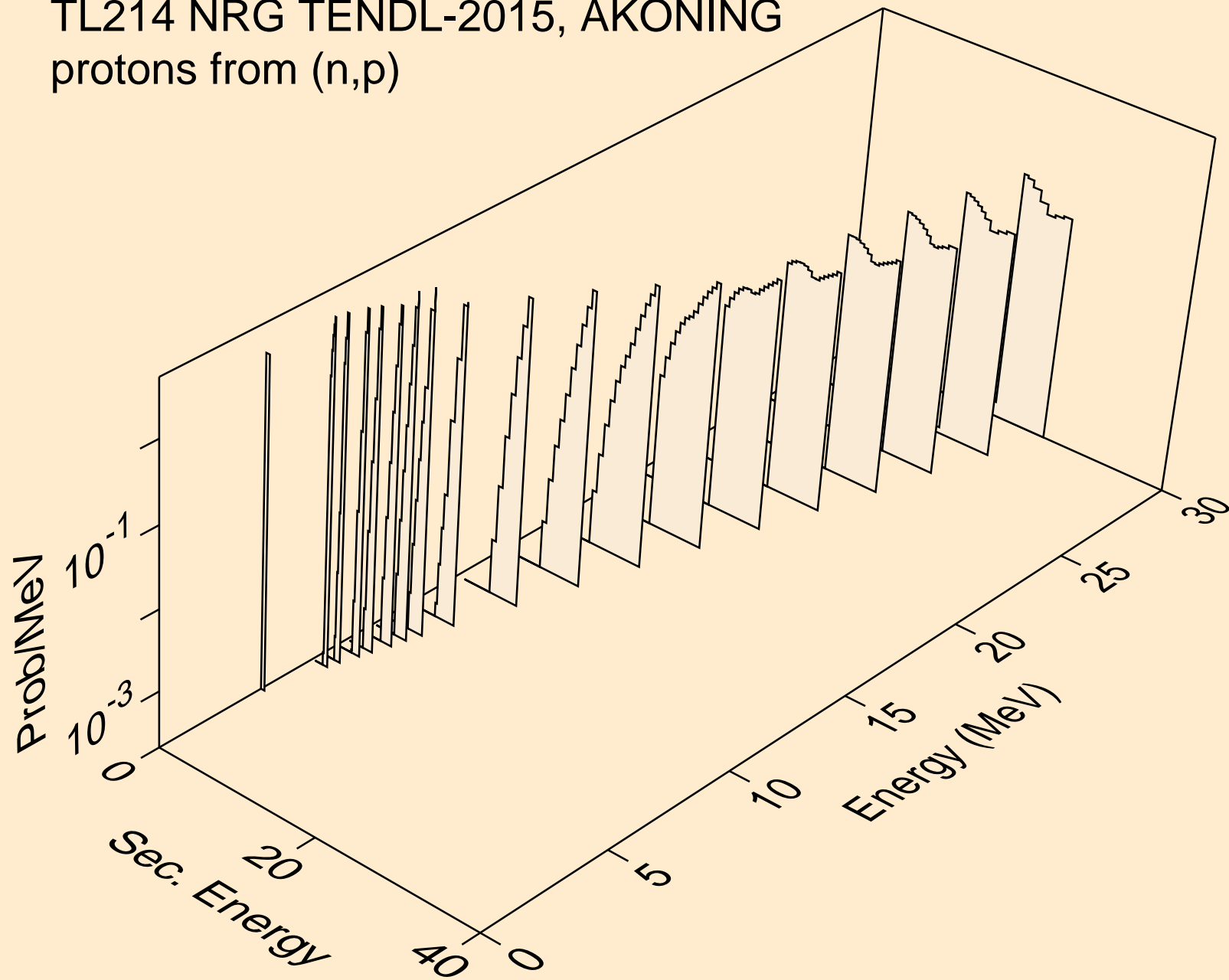

TL214 NRG TENDL-2015, AKONING
deuterons from (n,x)

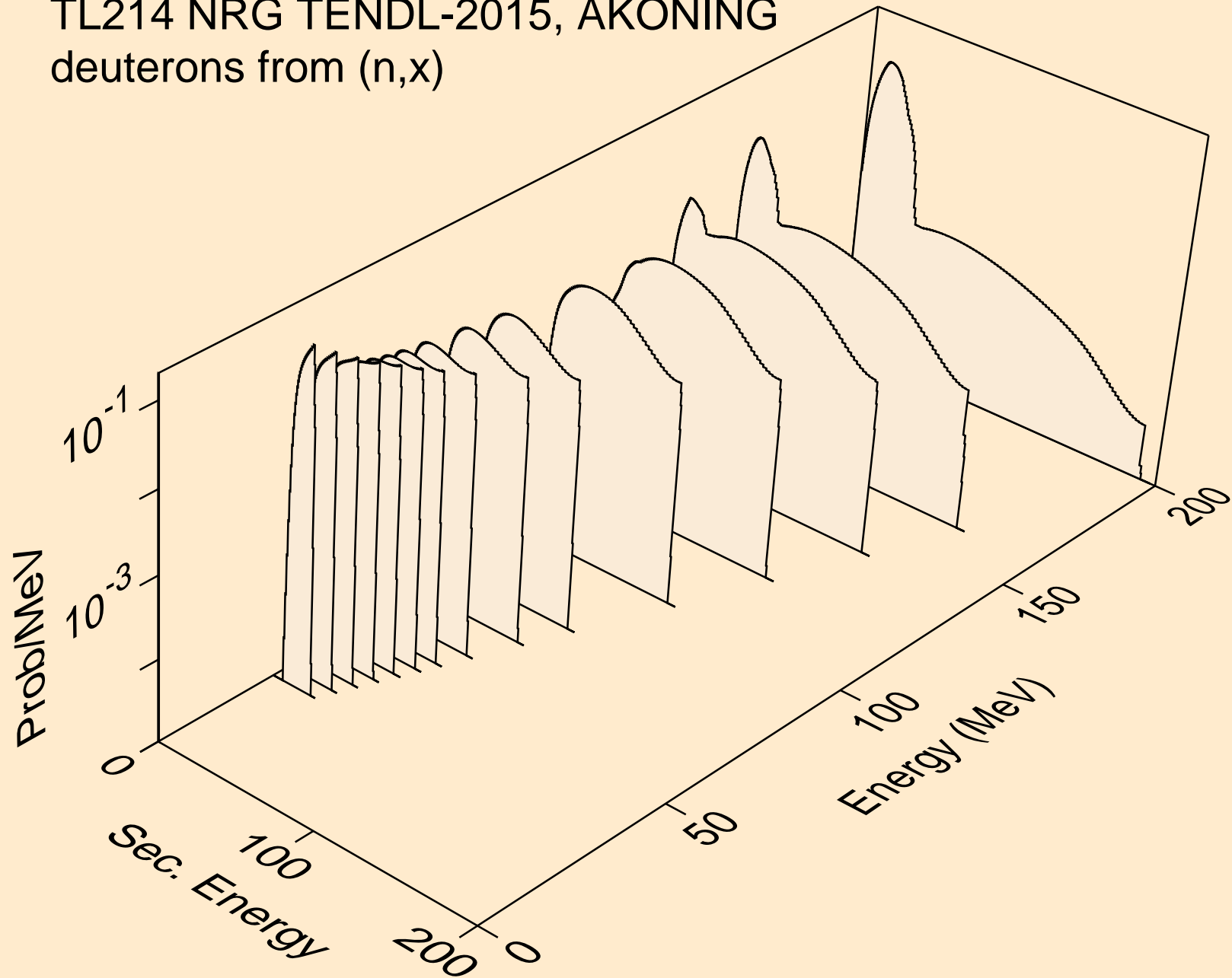

TL214 NRG TENDL-2015, AKONING
deuterons from (n,2nd)

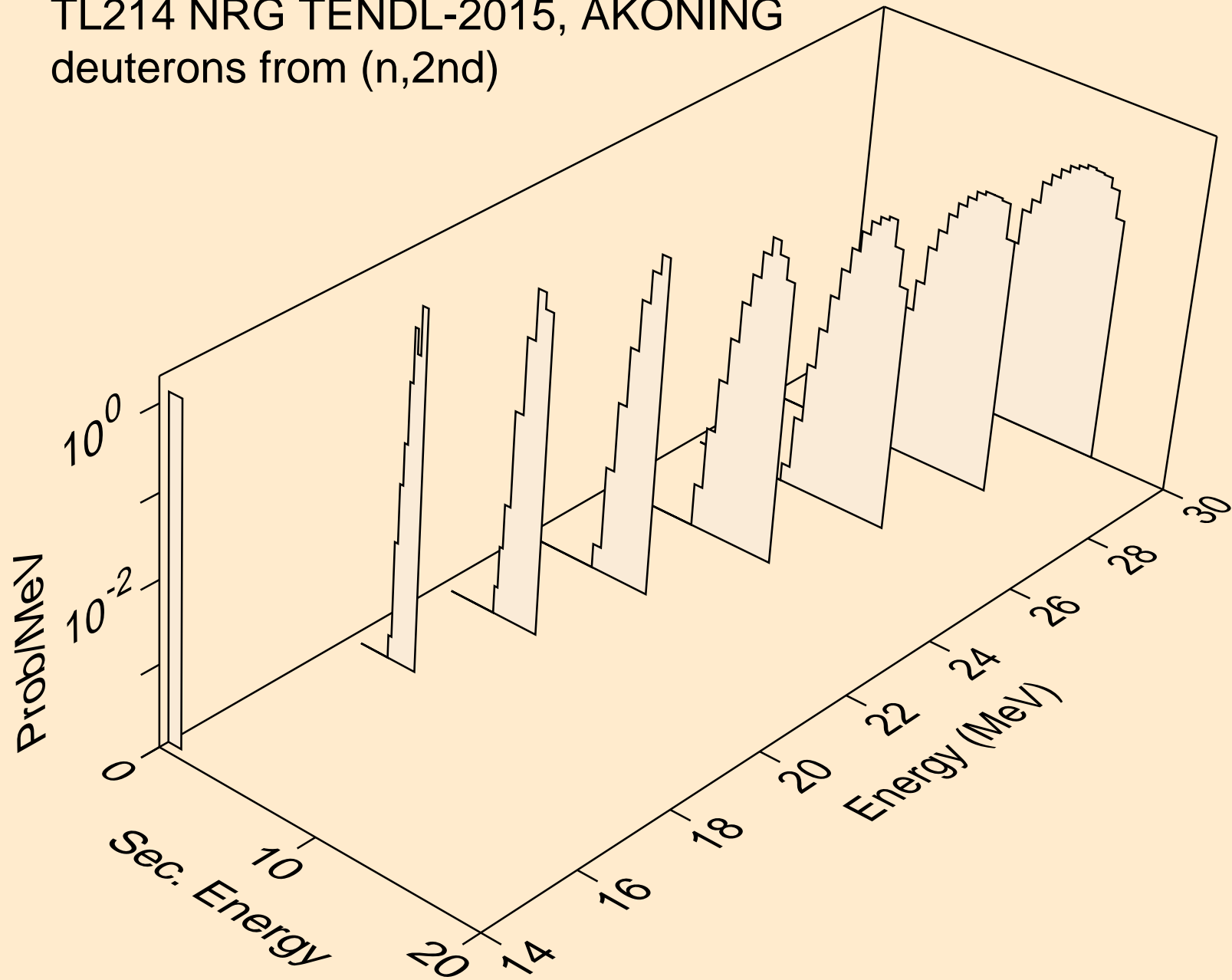

TL214 NRG TENDL-2015, AKONING
deuterons from (n,n*)d

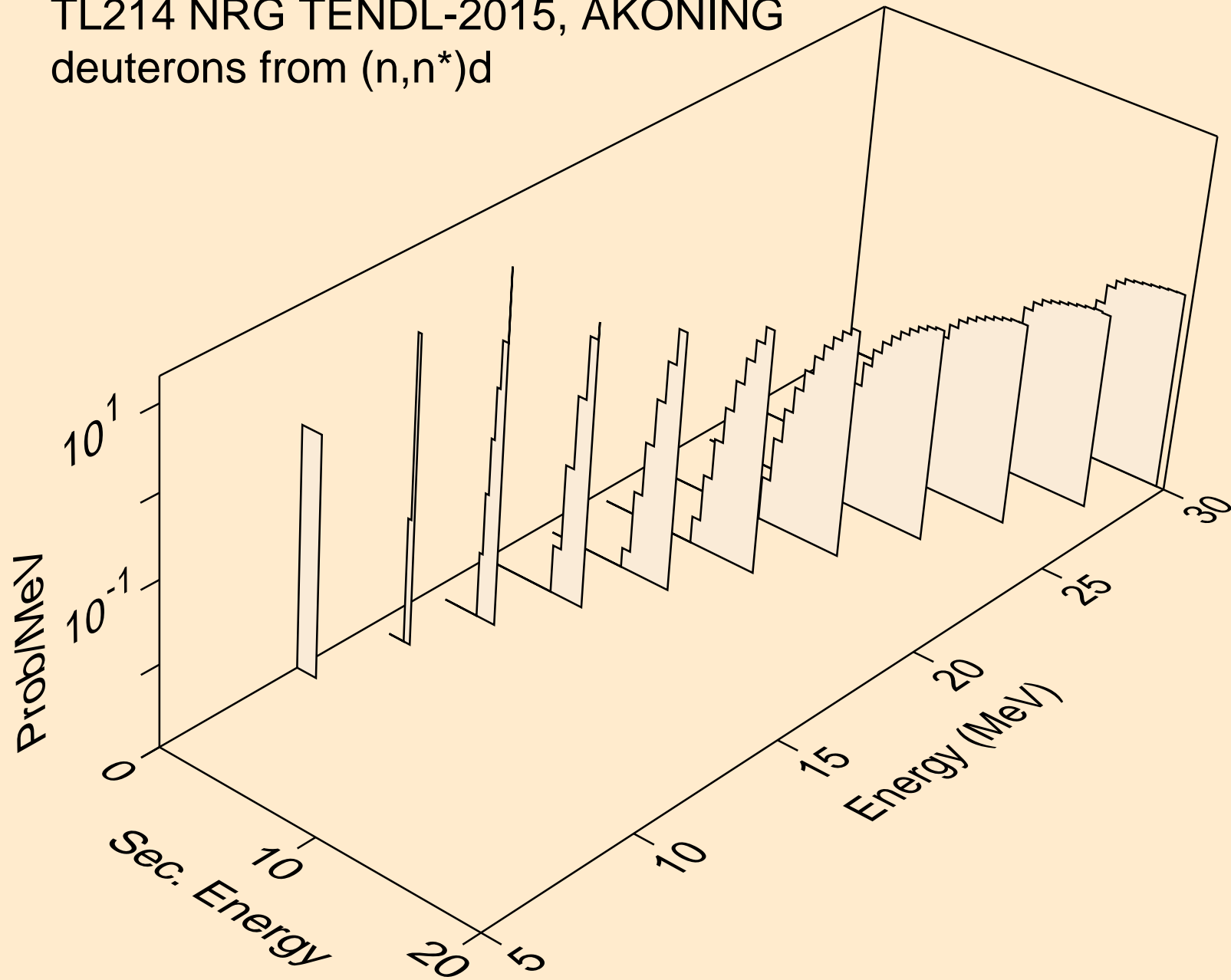

TL214 NRG TENDL-2015, AKONING
deuterons from (n,d)

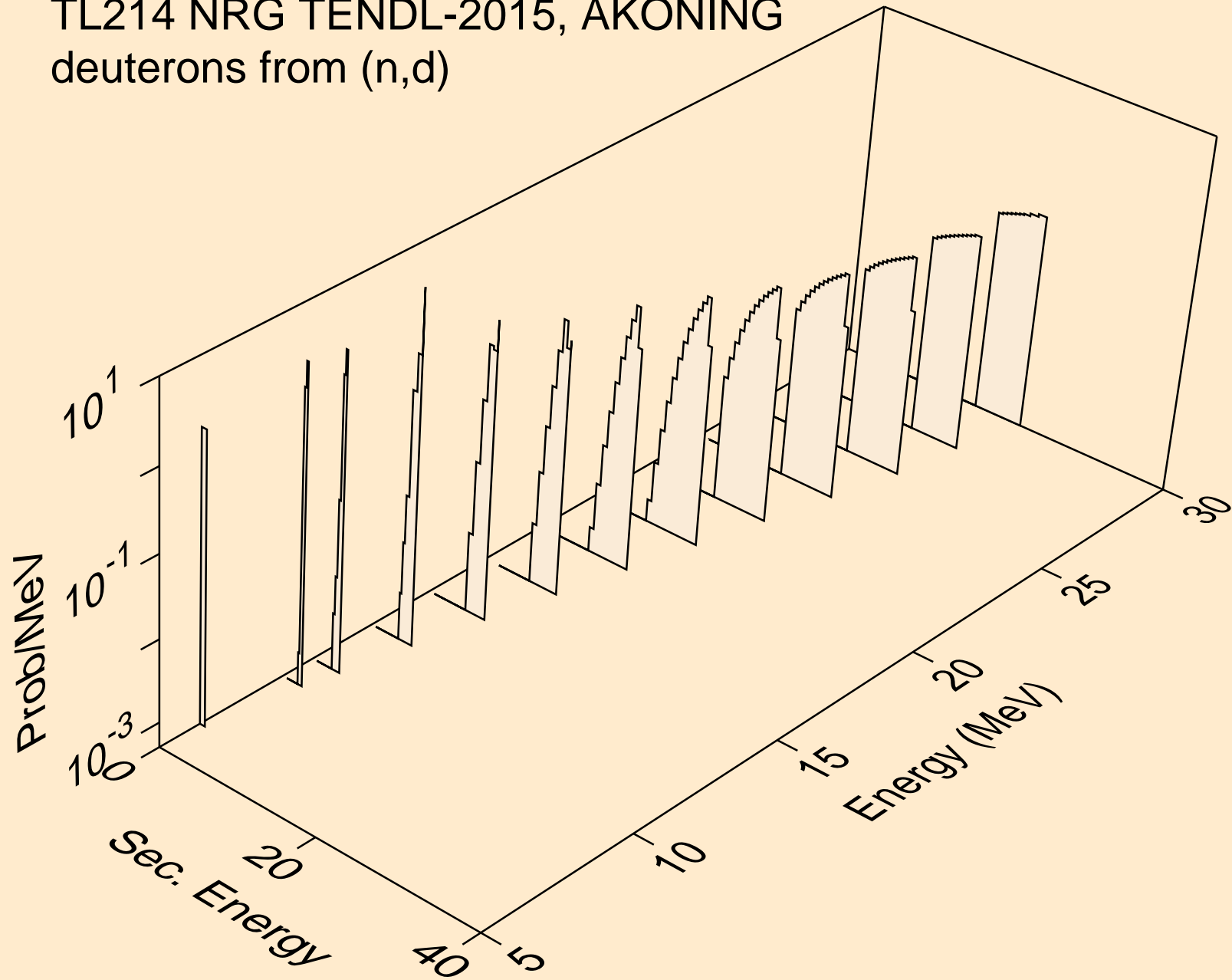

TL214 NRG TENDL-2015, AKONING
tritons from (n,x)

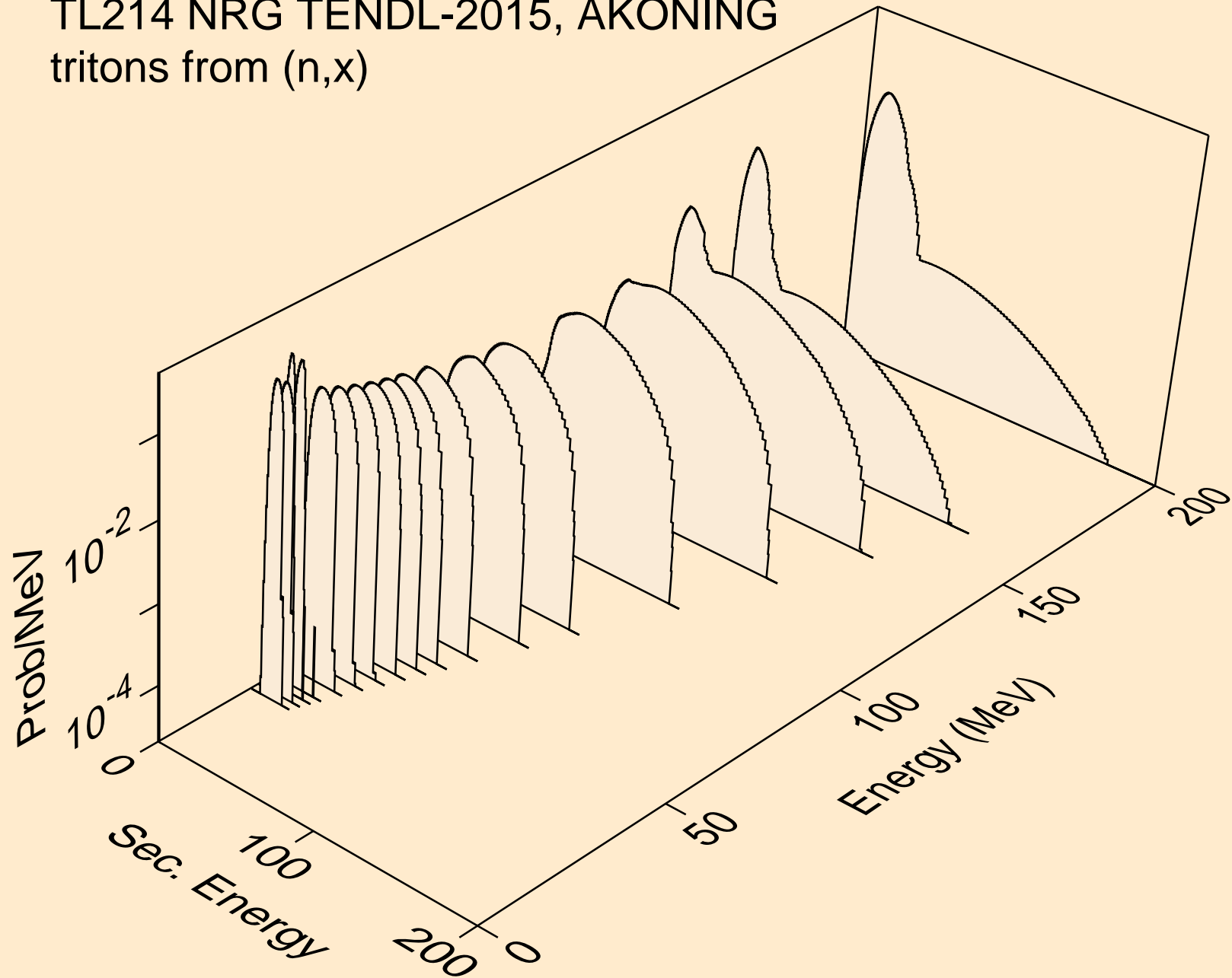

TL214 NRG TENDL-2015, AKONING
tritons from (n,n*)t

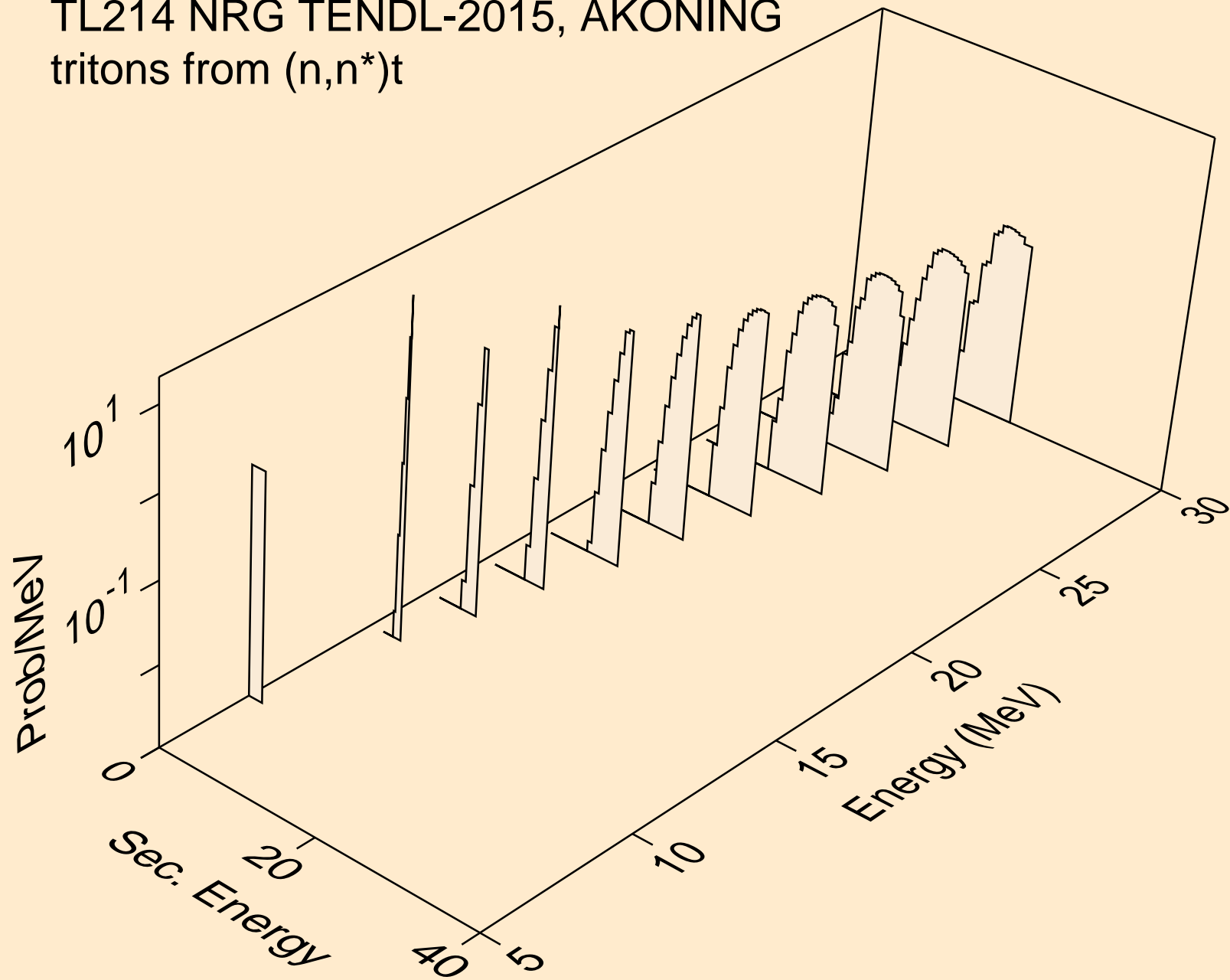

TL214 NRG TENDL-2015, AKONING
tritons from (n,t)

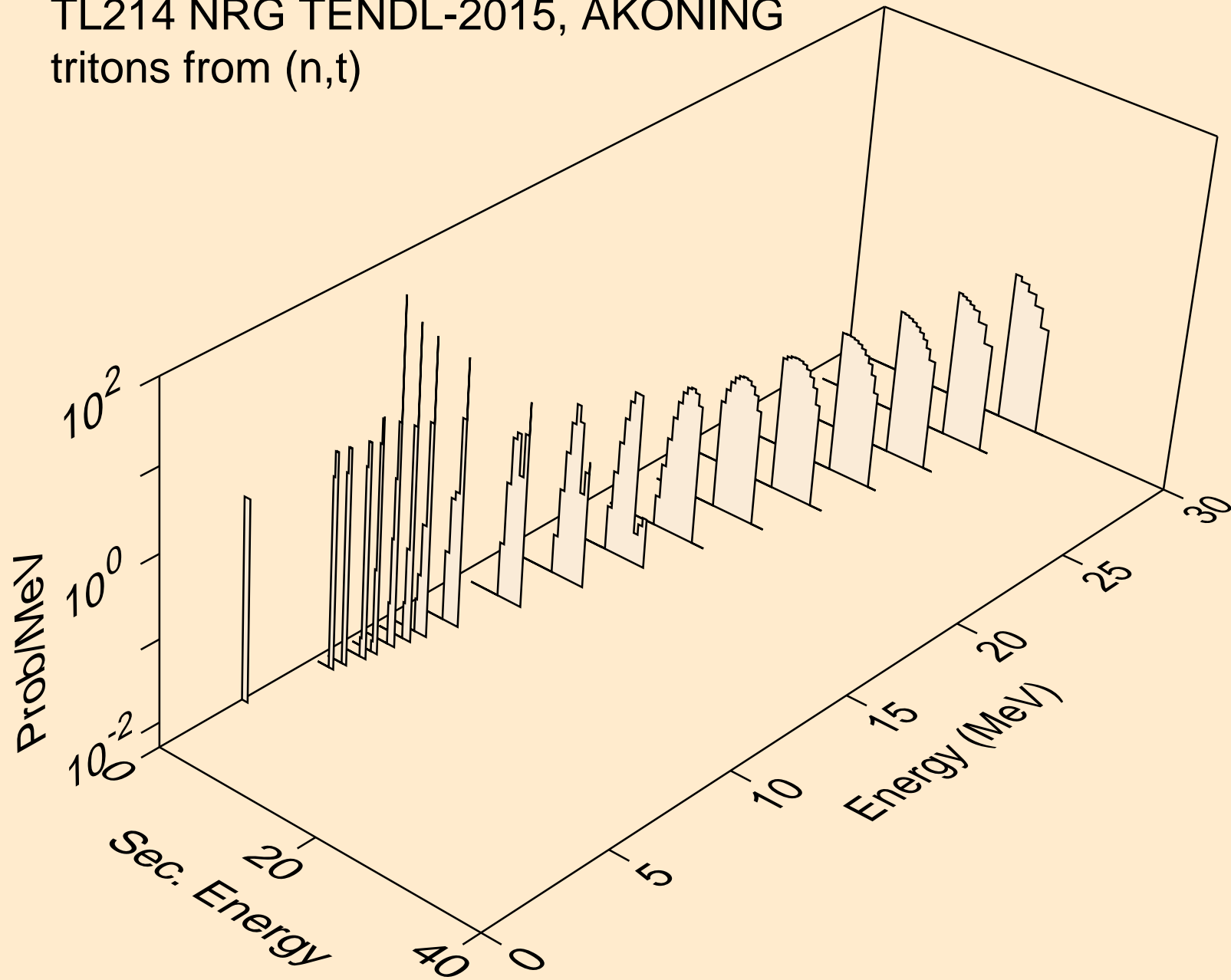

TL214 NRG TENDL-2015, AKONING
he3s from (n,x)

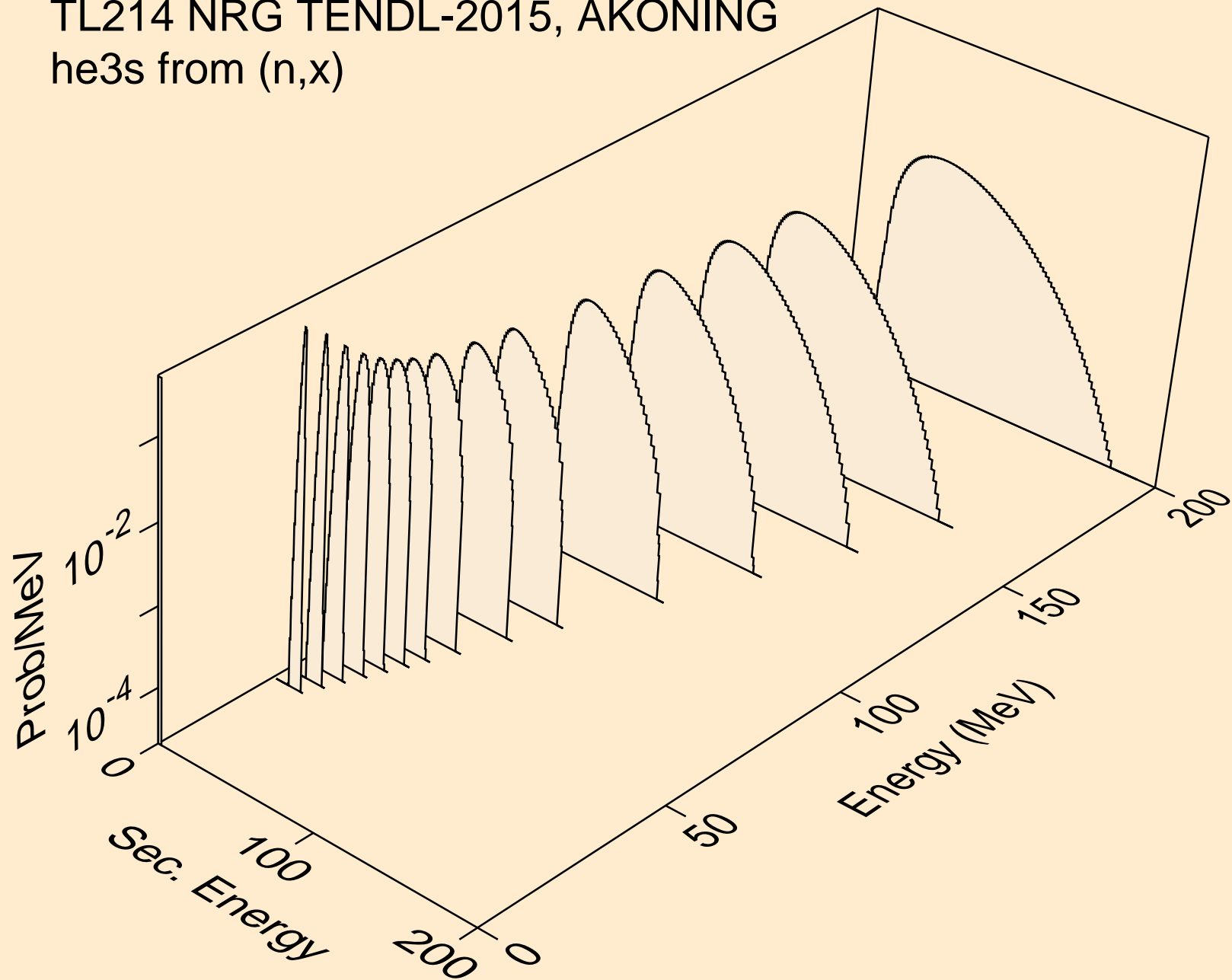

TL214 NRG TENDL-2015, AKONING
he3s from (n,n*)he3

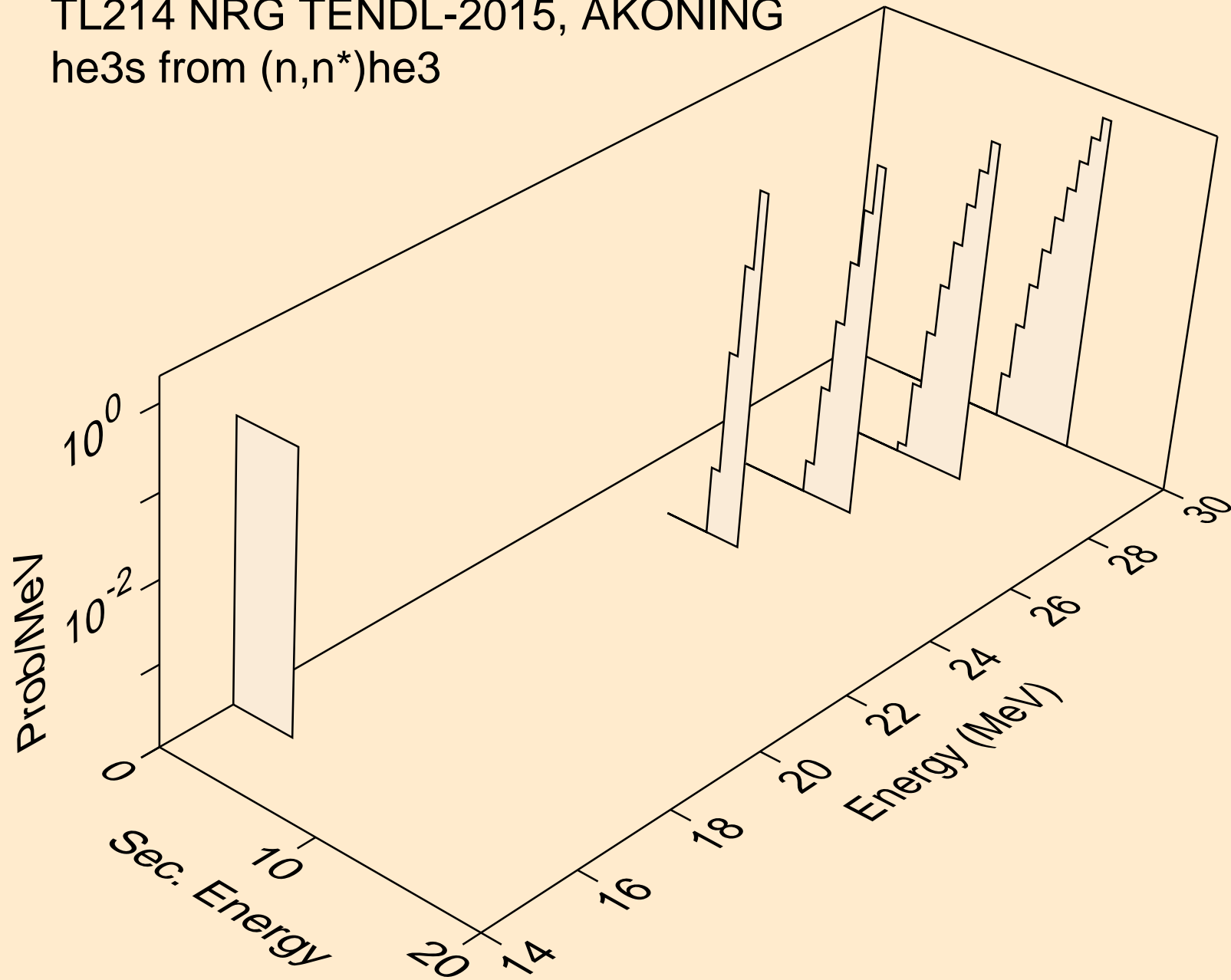

TL214 NRG TENDL-2015, AKONING
he3s from (n,he3)

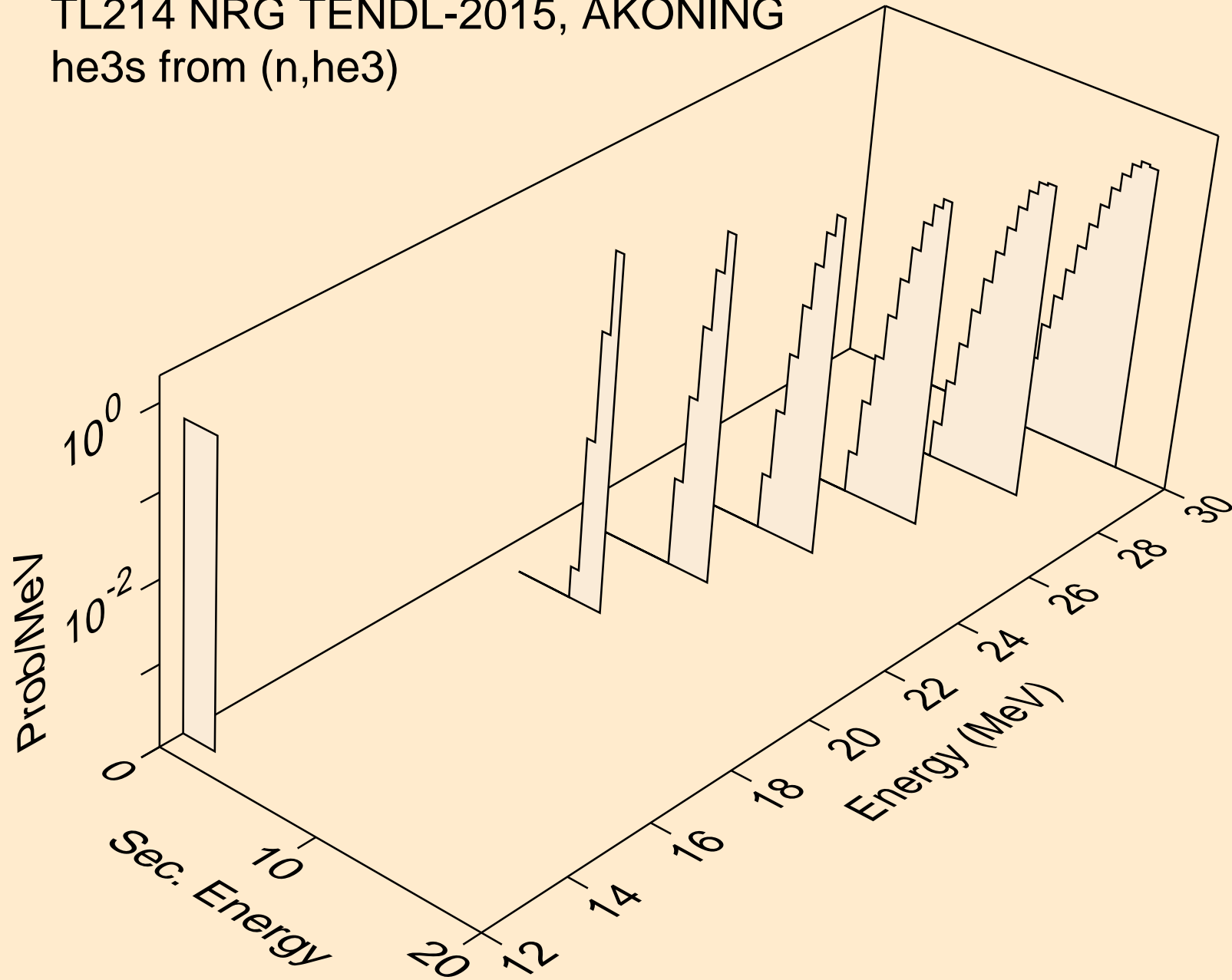

TL214 NRG TENDL-2015, AKONING
alphas from (n,x)

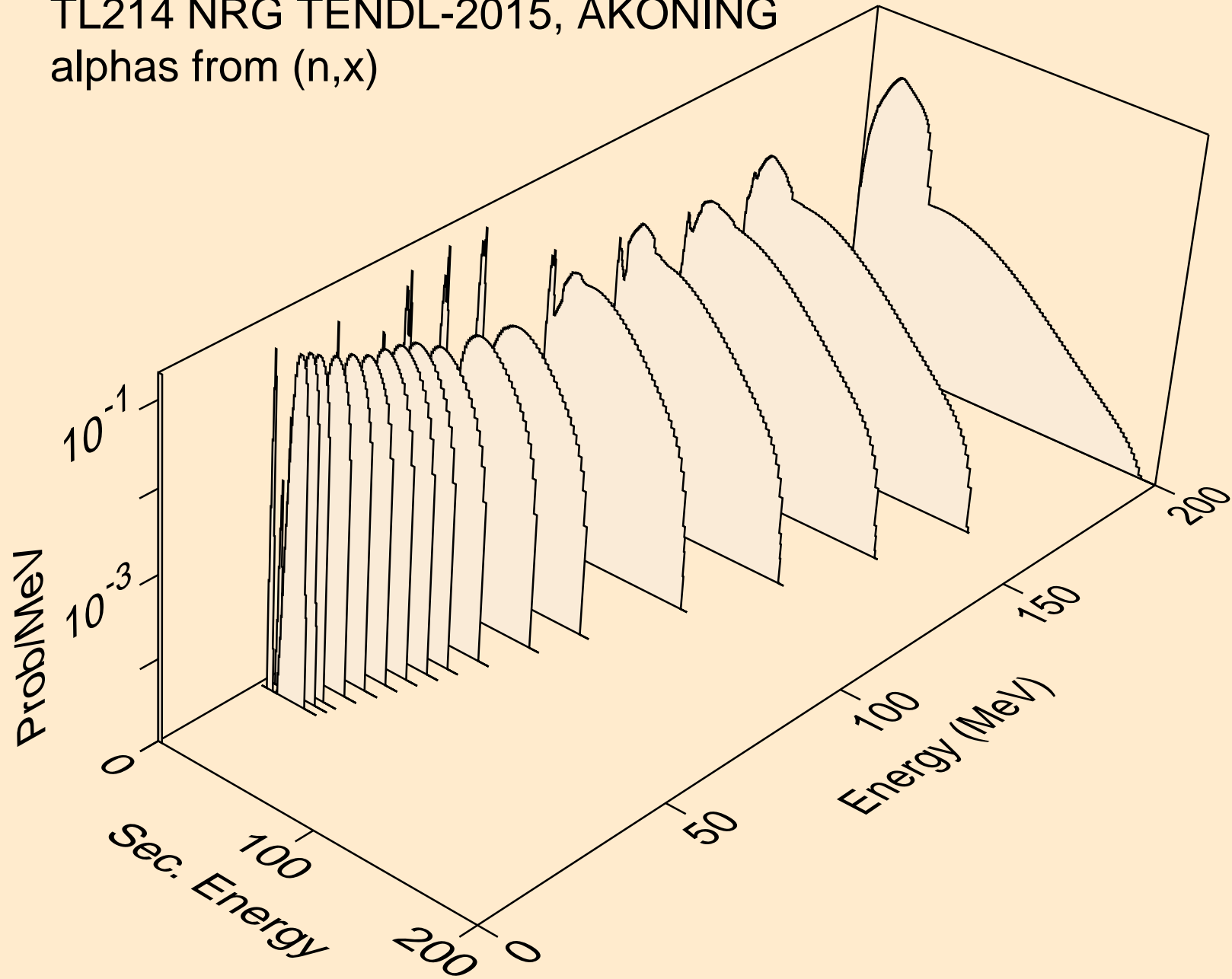

TL214 NRG TENDL-2015, AKONING
alphas from (n,n*)a

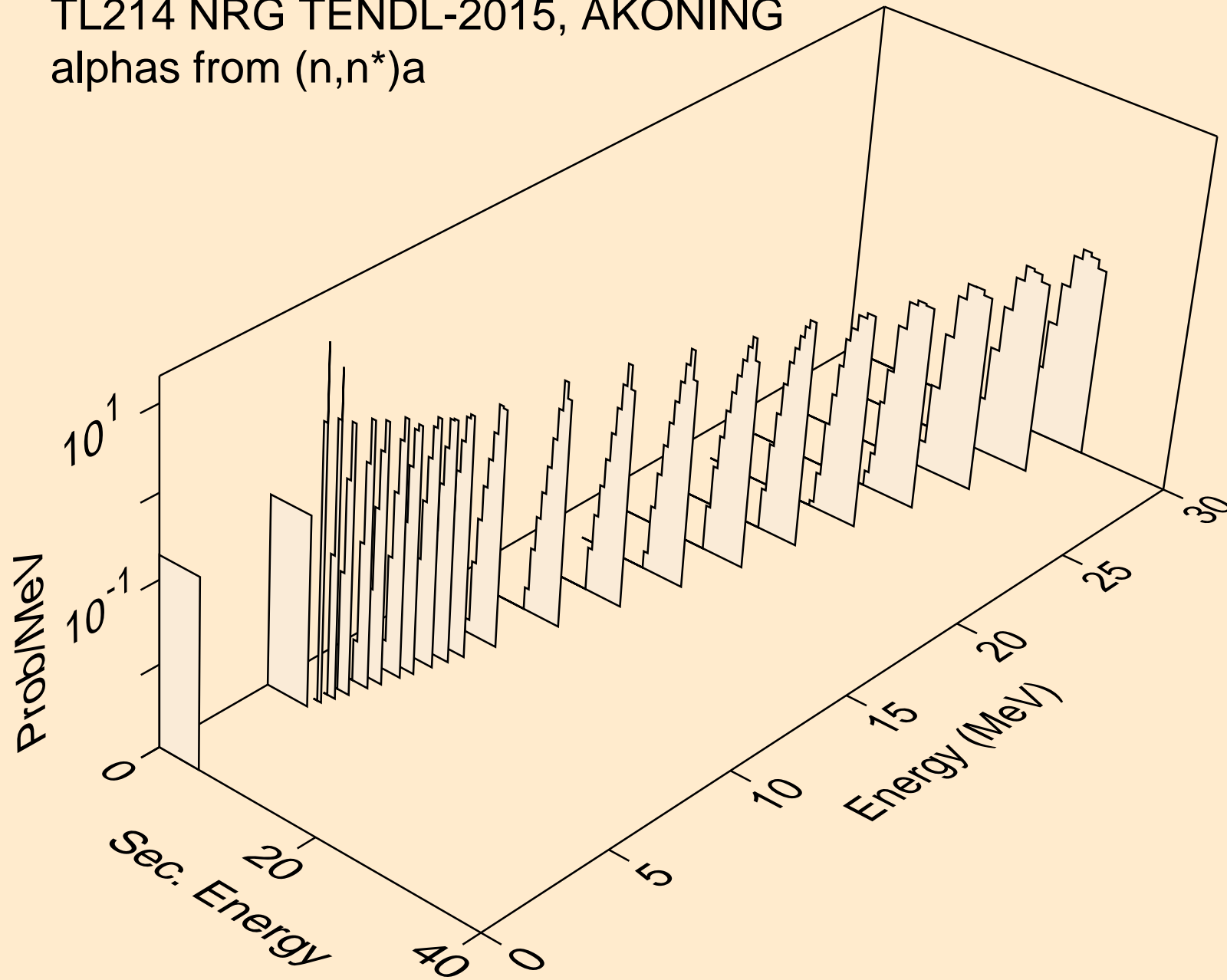

TL214 NRG TENDL-2015, AKONING
alphas from (n,2n)a

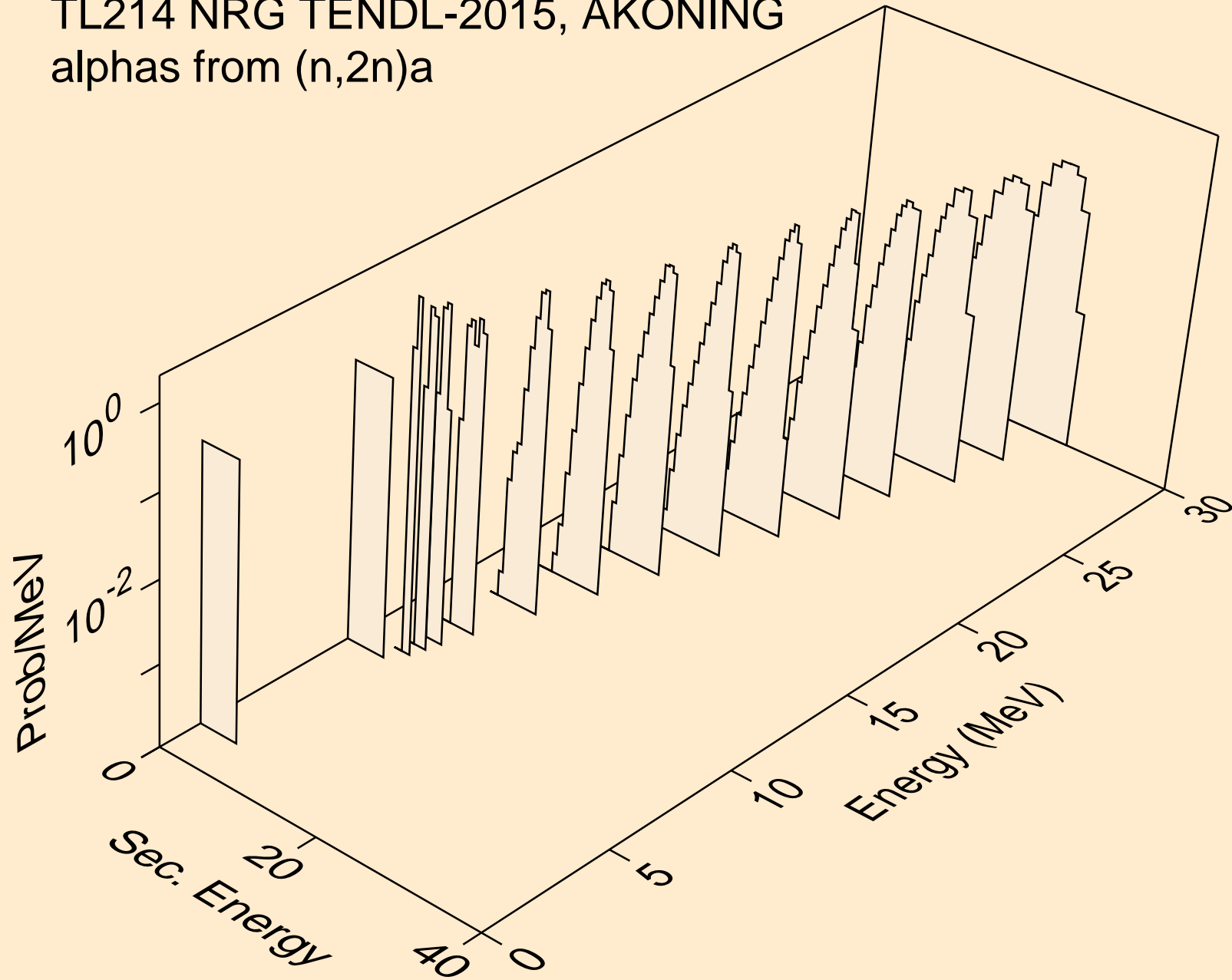

TL214 NRG TENDL-2015, AKONING
alphas from (n,3n)a

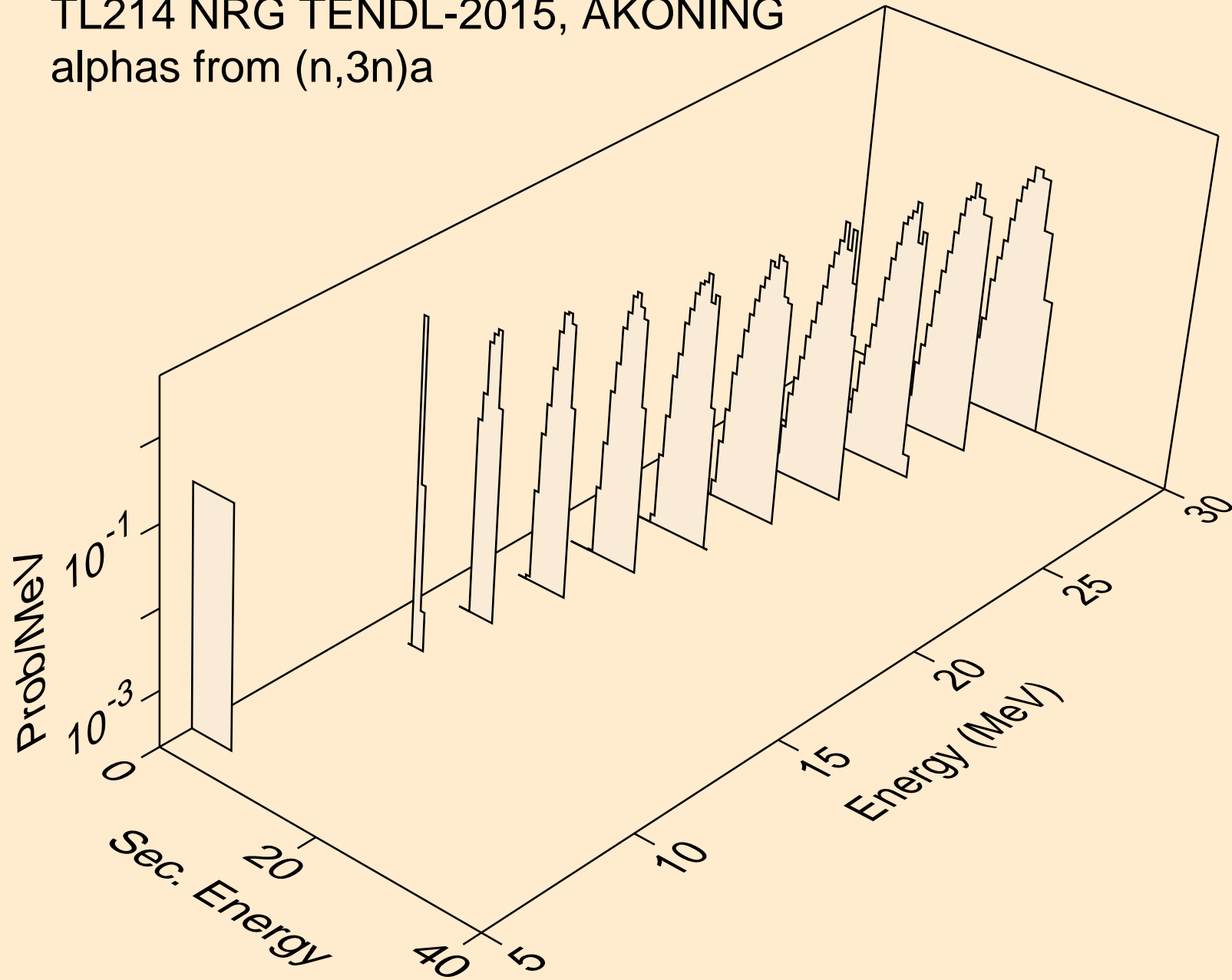

TL214 NRG TENDL-2015, AKONING
alphas from (n,a)

