

Program EVALPLOT
(Version 2015-2)

by

Dermott E. Cullen
(Present Contact Information)

Dermott E. Cullen
1466 Hudson Way
Livermore, CA 94550
U.S.A.

Tele: 925-443-1911

E.Mail:redcullen1@comcast.net
Web:home.comcast.net/~redcullen1

Press Mouse Button to Start

MAT 6934

Major

293 Kelvin Cross Sections

69-Tm-172

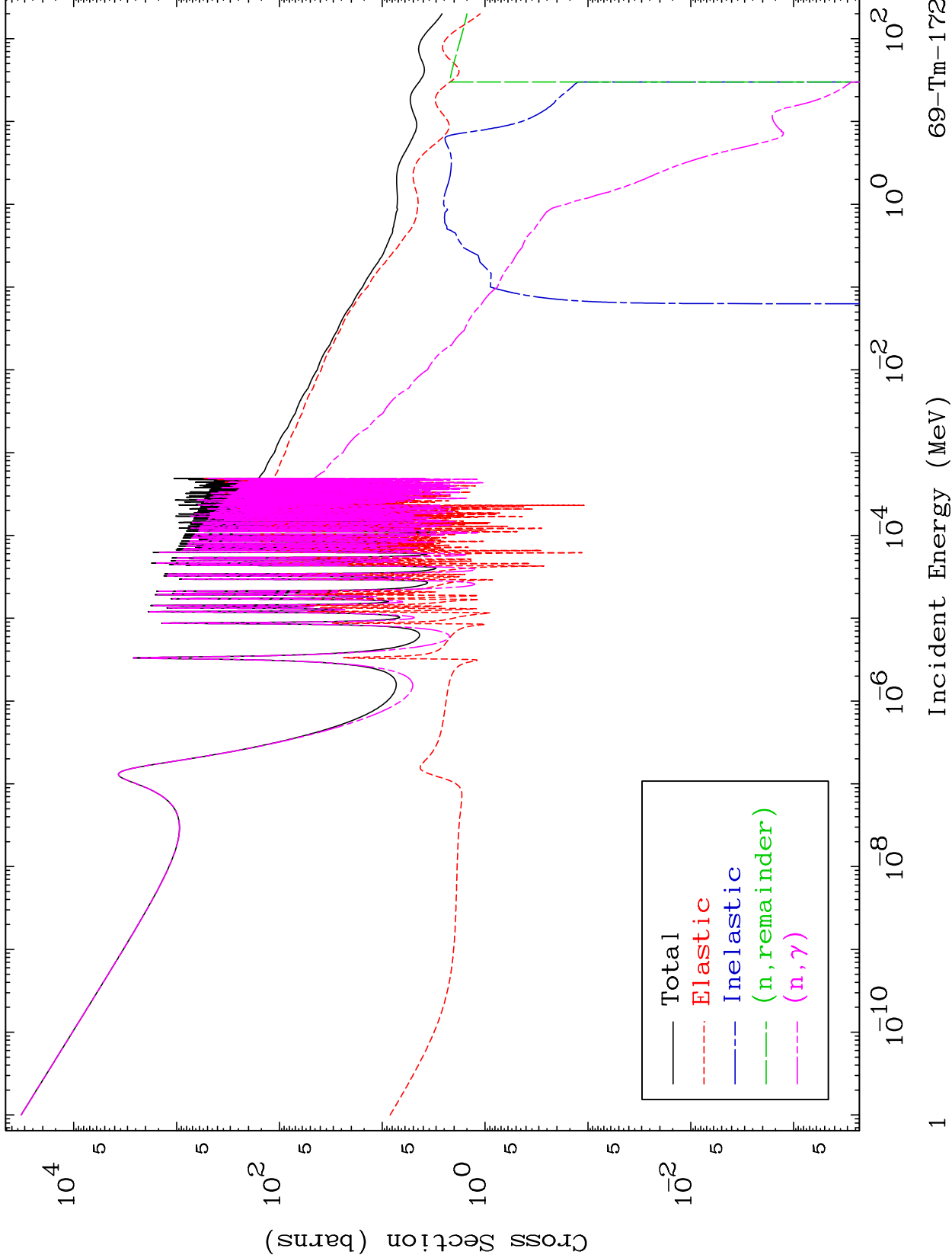

MAT 6934

Neutron Production
293 Kelvin Cross Sections

69-Tm-172

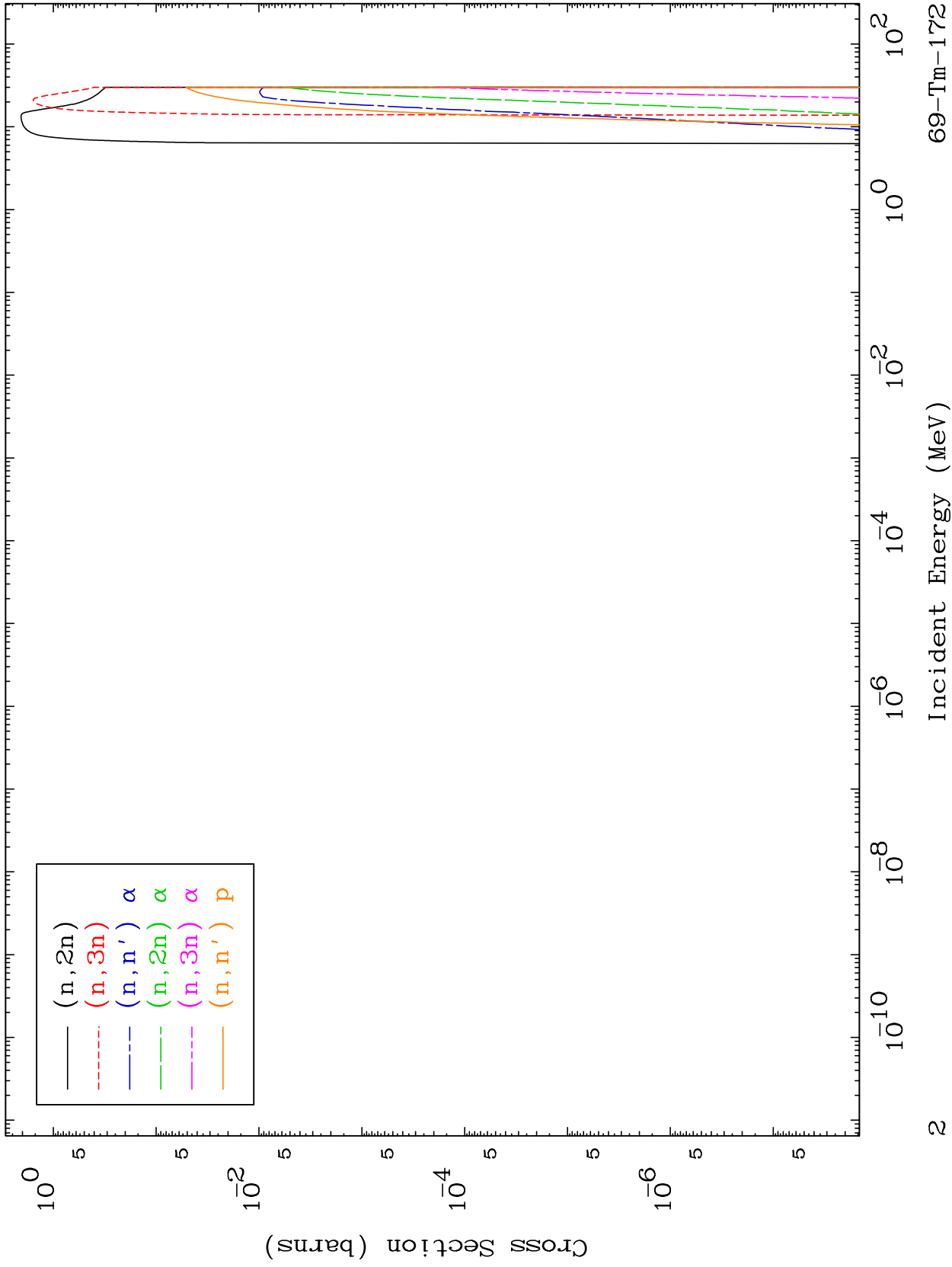

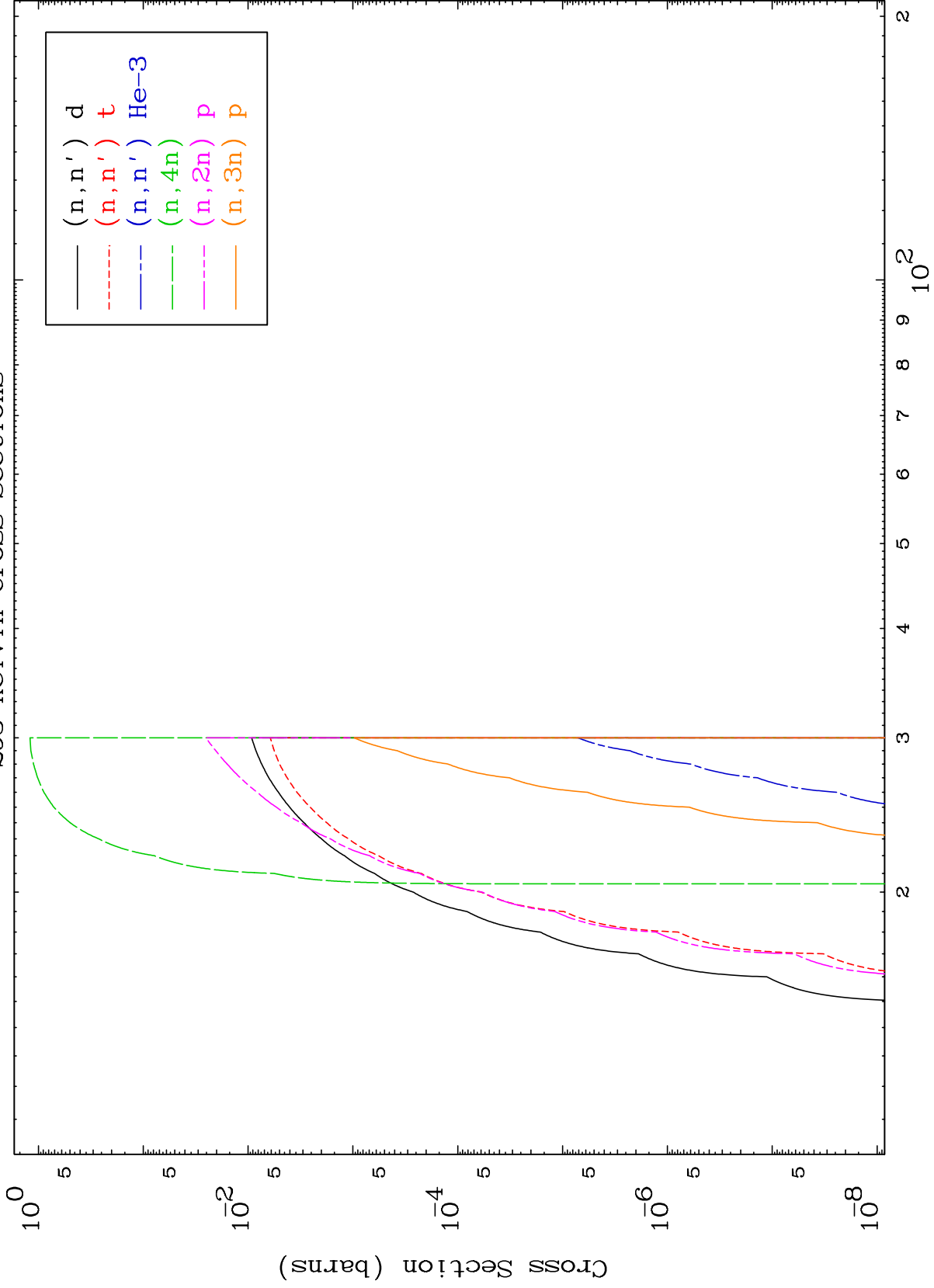

MAT 6934

Charged Particle
293 Kelvin Cross Sections

69-Tm-172

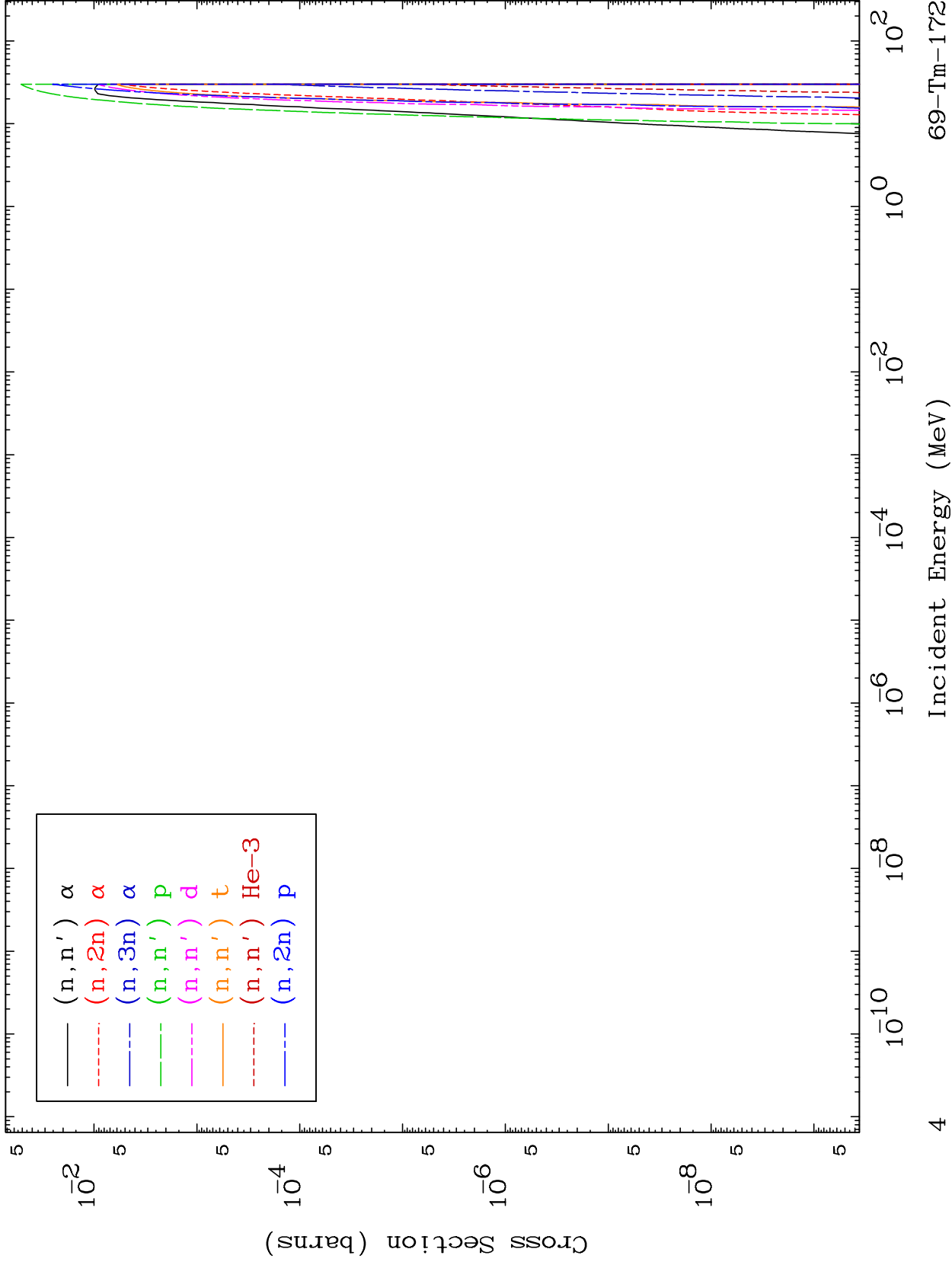

MAT 6934

Charged Particle
293 Kelvin Cross Sections

69-Tm-172

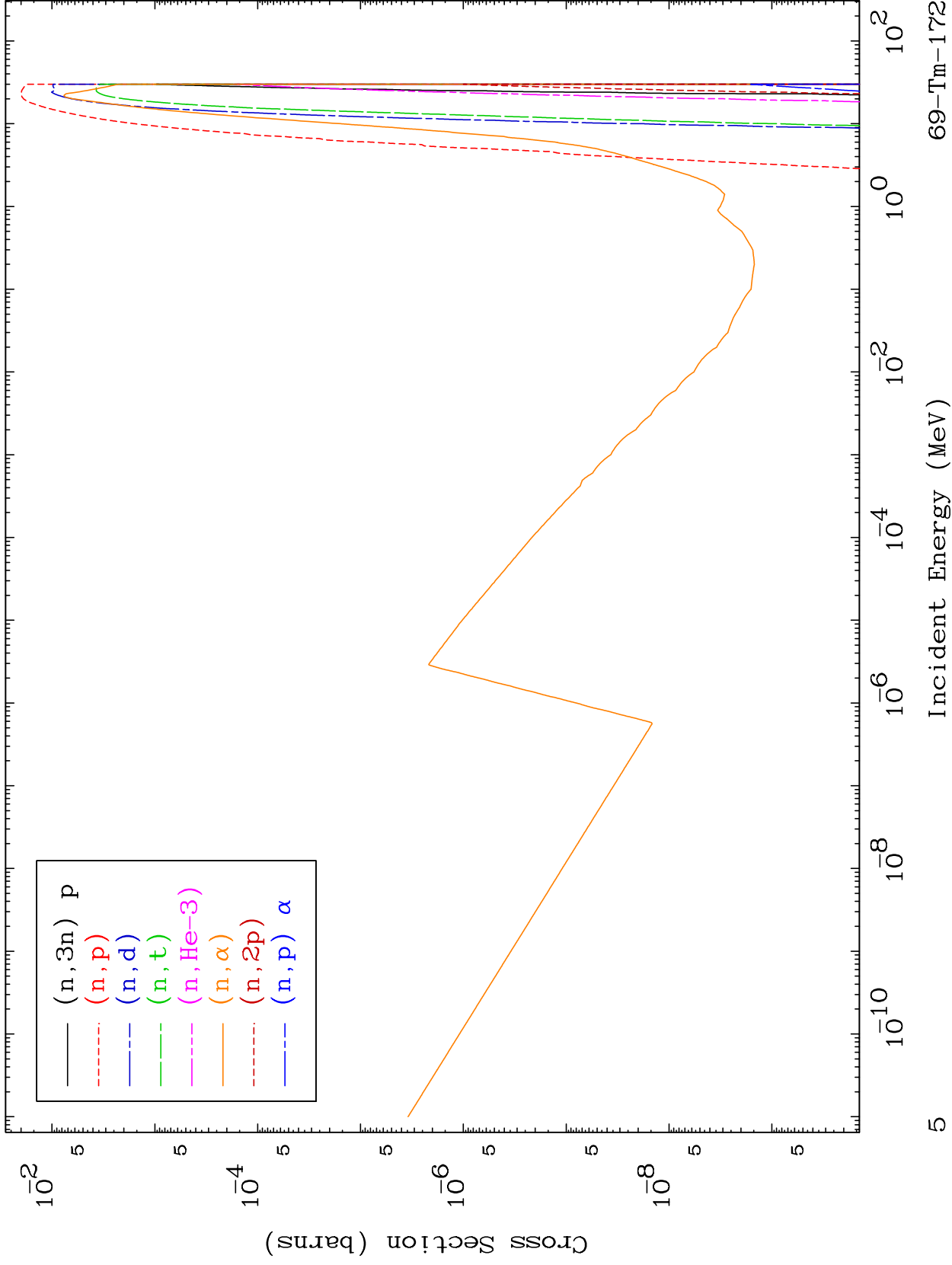

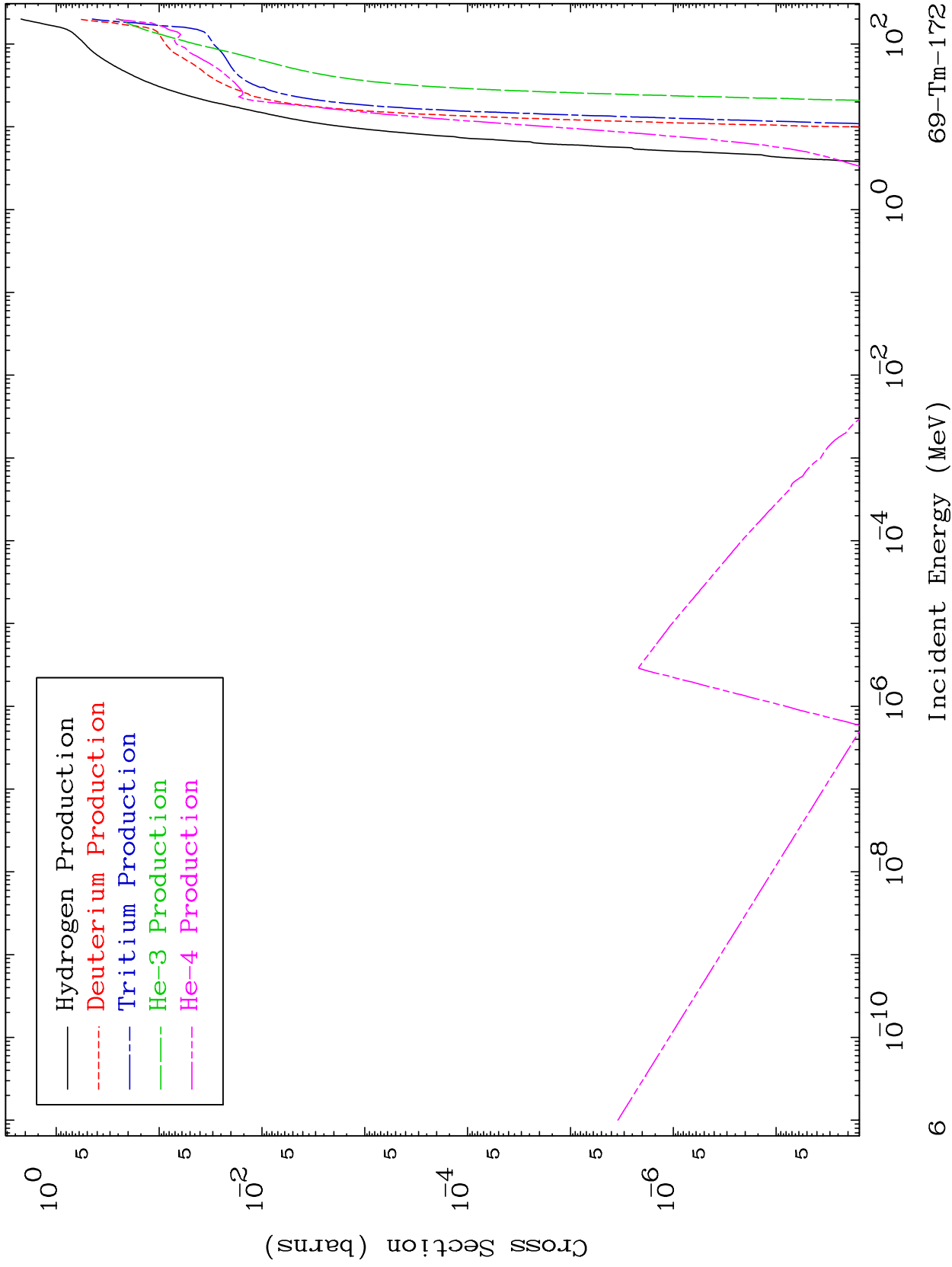

MAT 6934

(n,n') Level

69-Tm-172

293 Kelvin Cross Sections

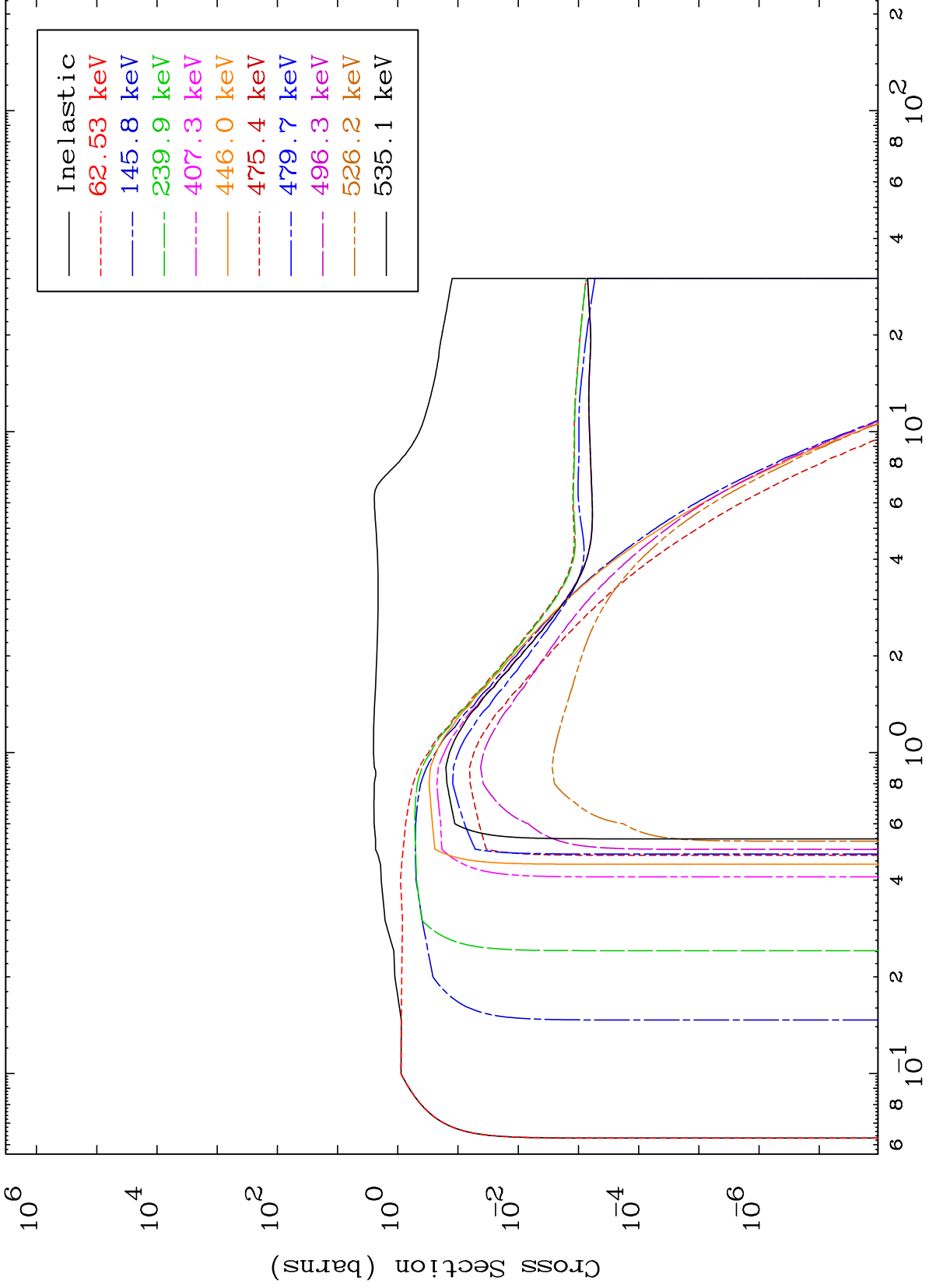

MAT 6934

(n,n') Level
293 Kelvin Cross Sections

69-Tm-172

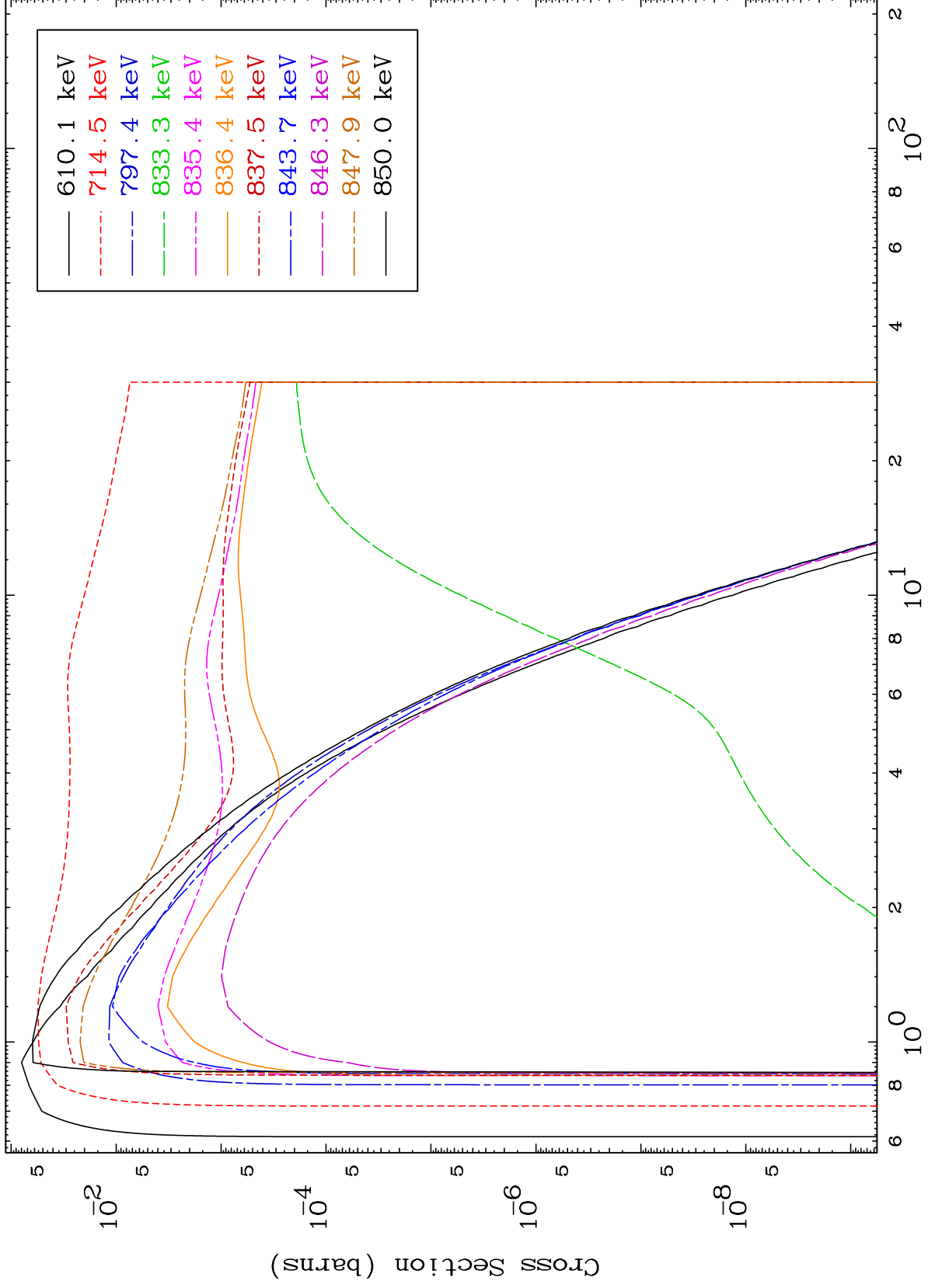

Incident Energy (MeV)

69-Tm-172

8

MAT 6934

(n,n') Level
293 Kelvin Cross Sections

69-Tm-172

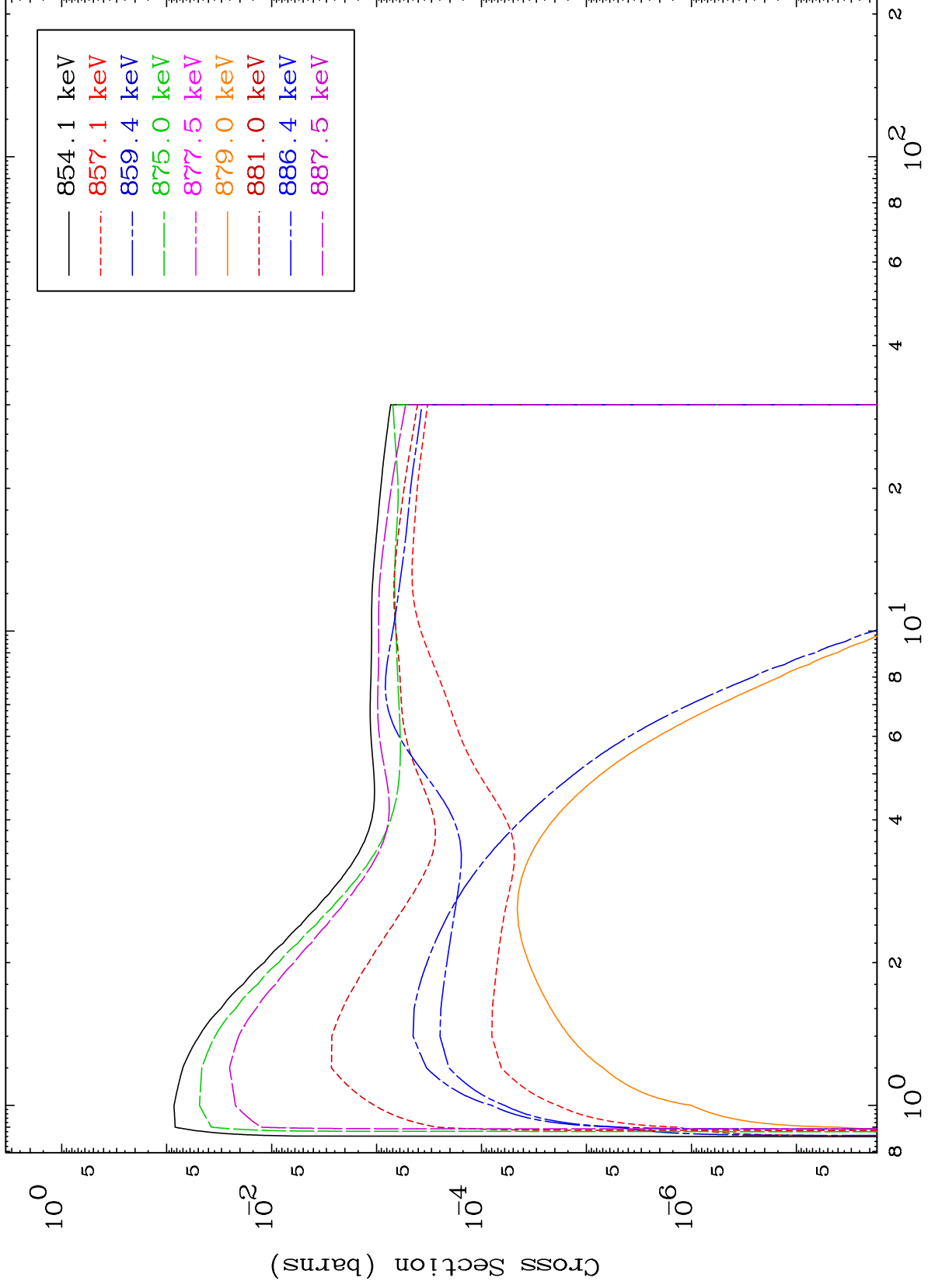

69-Tm-172

Incident Energy (MeV)

9

MAT 6934

(n,p) Levels
293 Kelvin Cross Sections

69-Tm-172

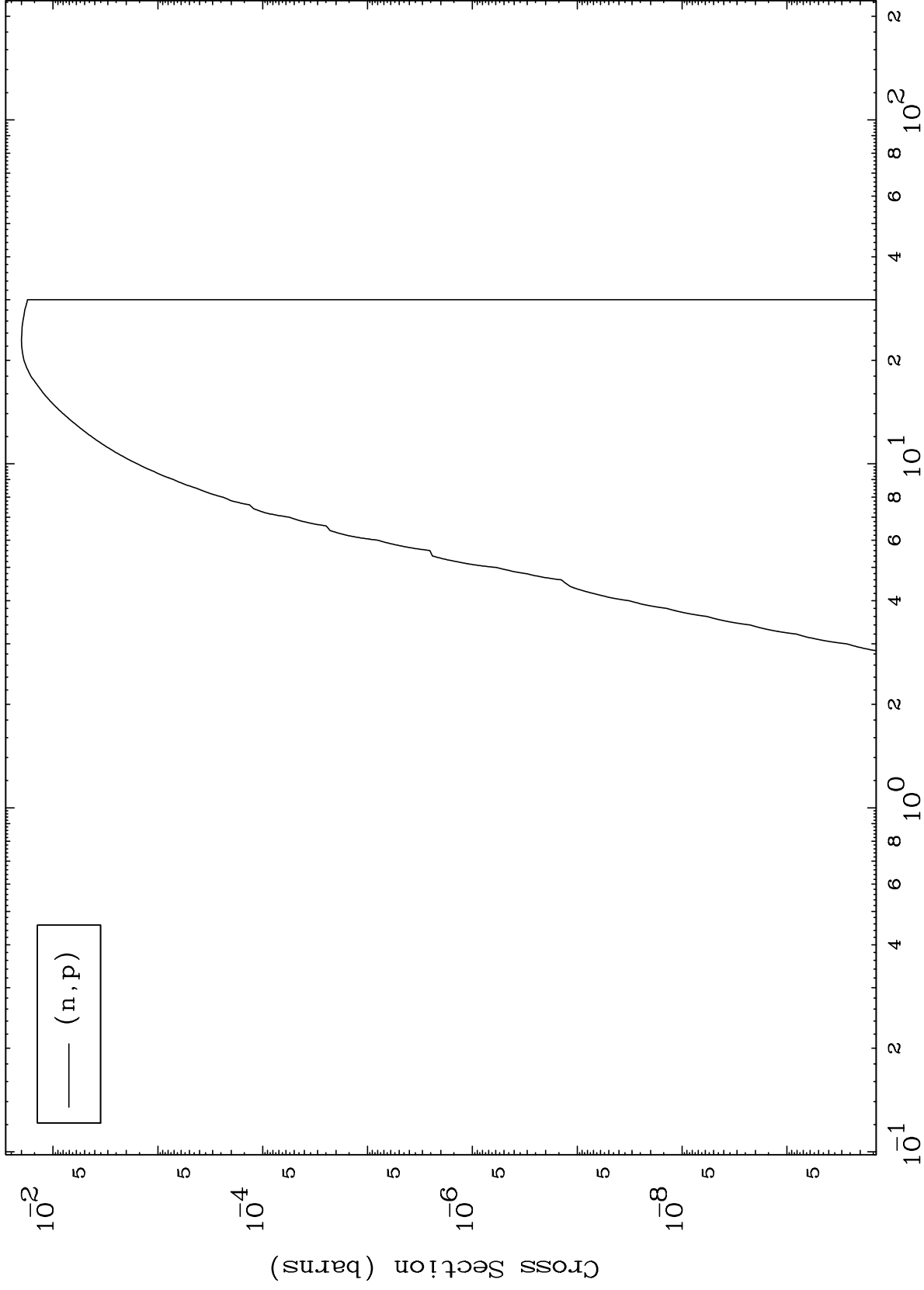

Incident Energy (MeV)

69-Tm-172

MAT 6934

(n,d) Levels
293 Kelvin Cross Sections

69-Tm-172

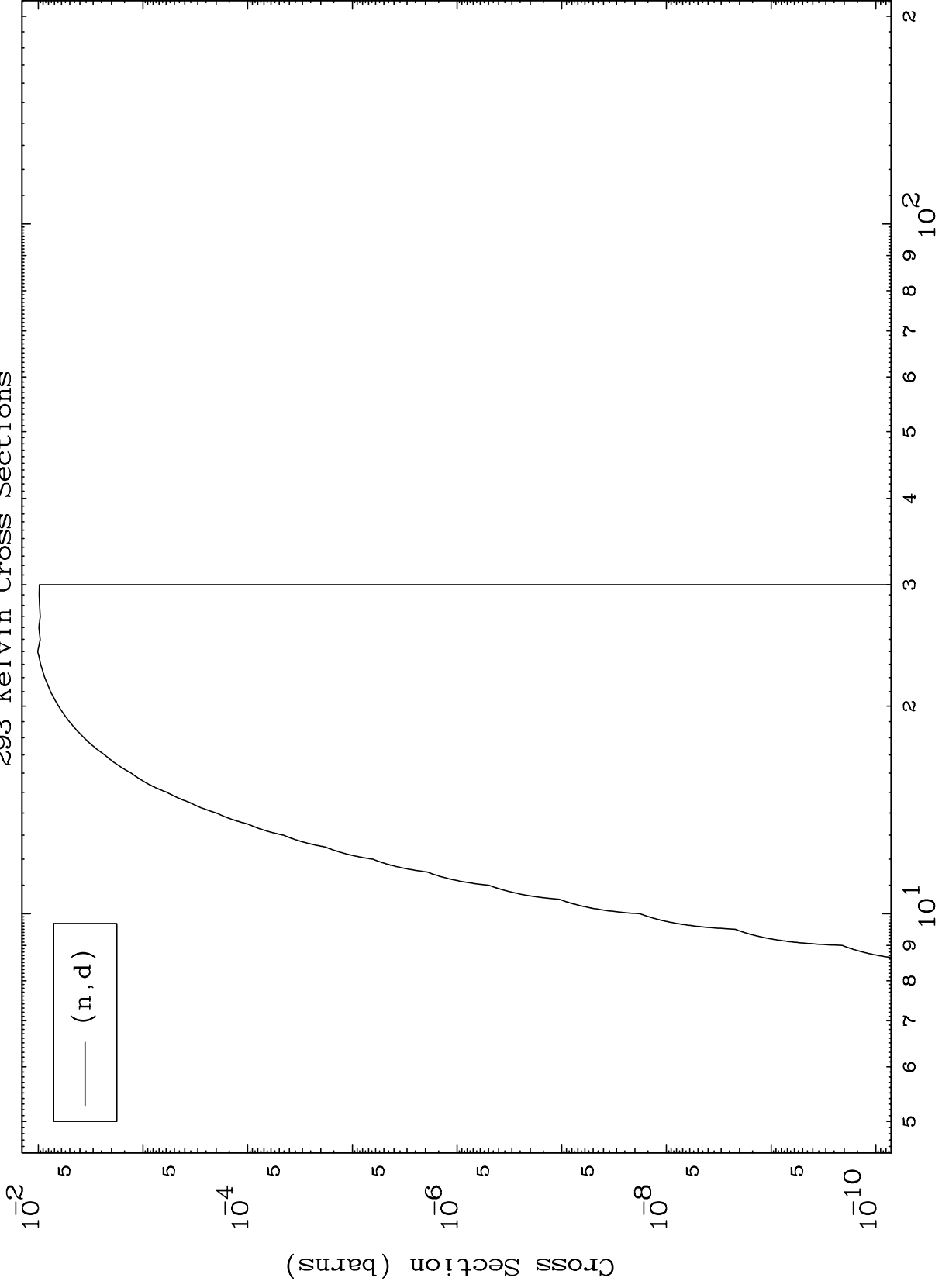

MAT 6934

(n,t) Levels
293 Kelvin Cross Sections

69-Tm-172

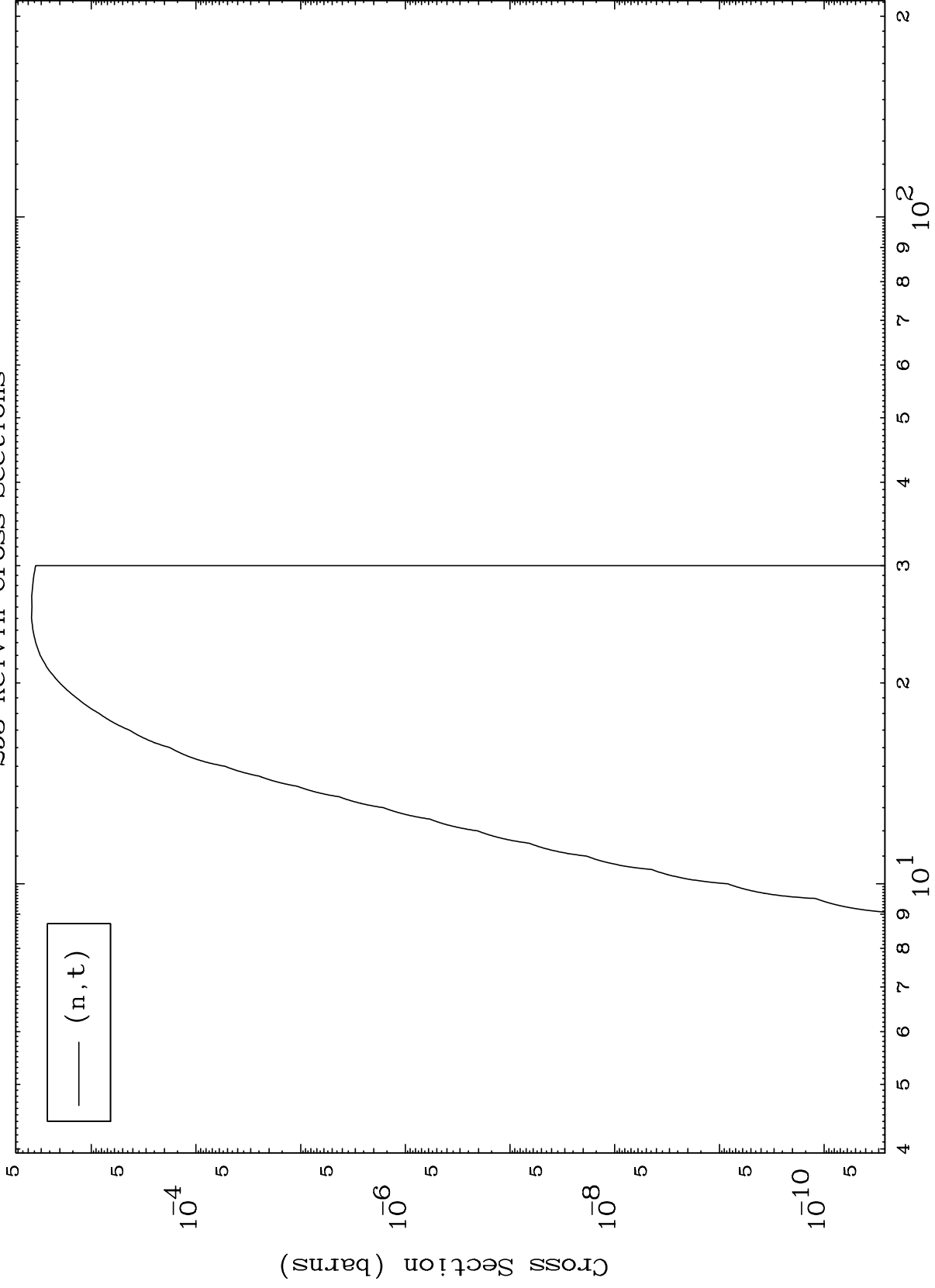

12

Incident Energy (MeV)

69-Tm-172

MAT 6934

(n,He3) Levels
293 Kelvin Cross Sections

69-Tm-172

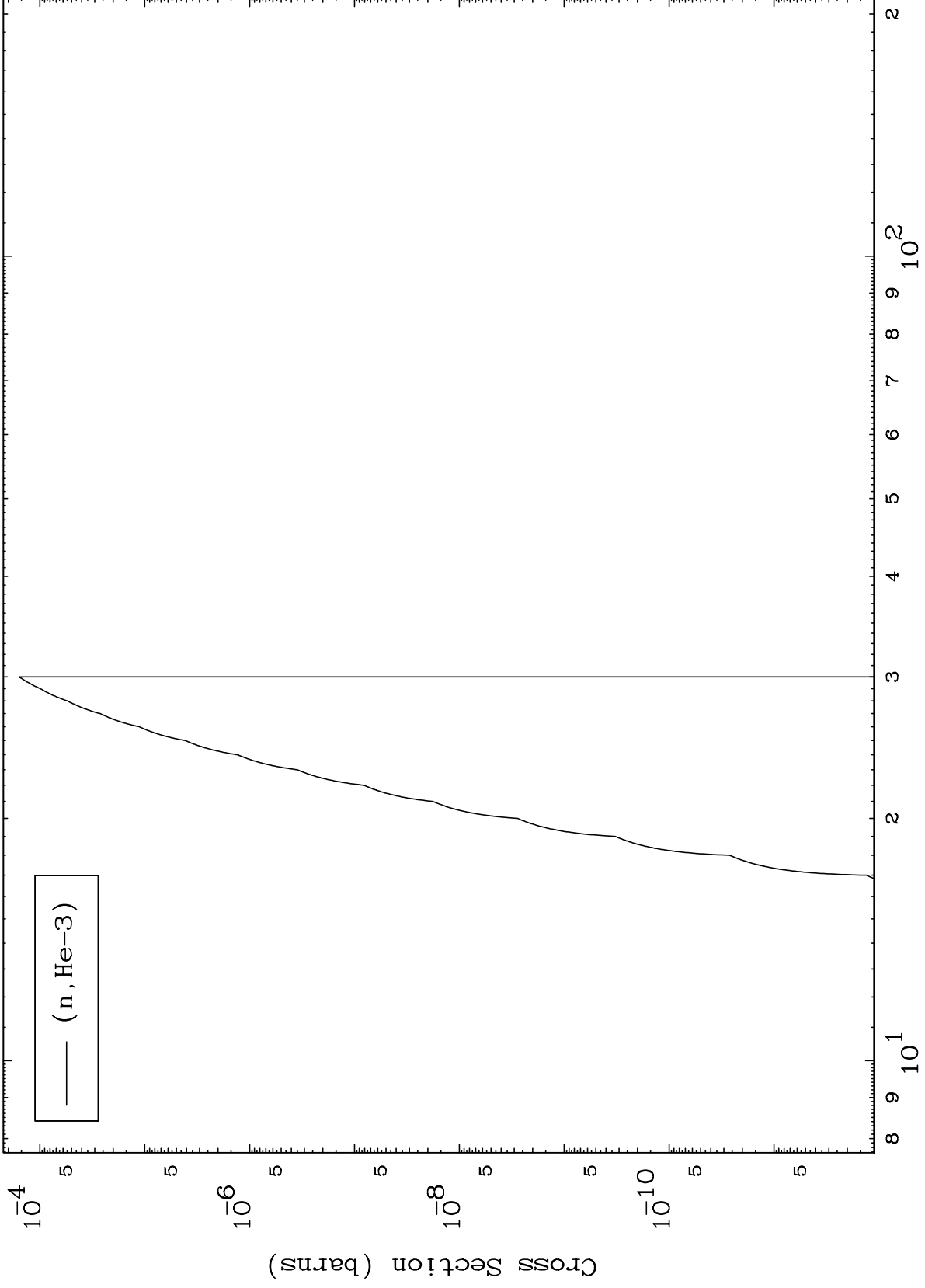

13

Incident Energy (MeV)

69-Tm-172

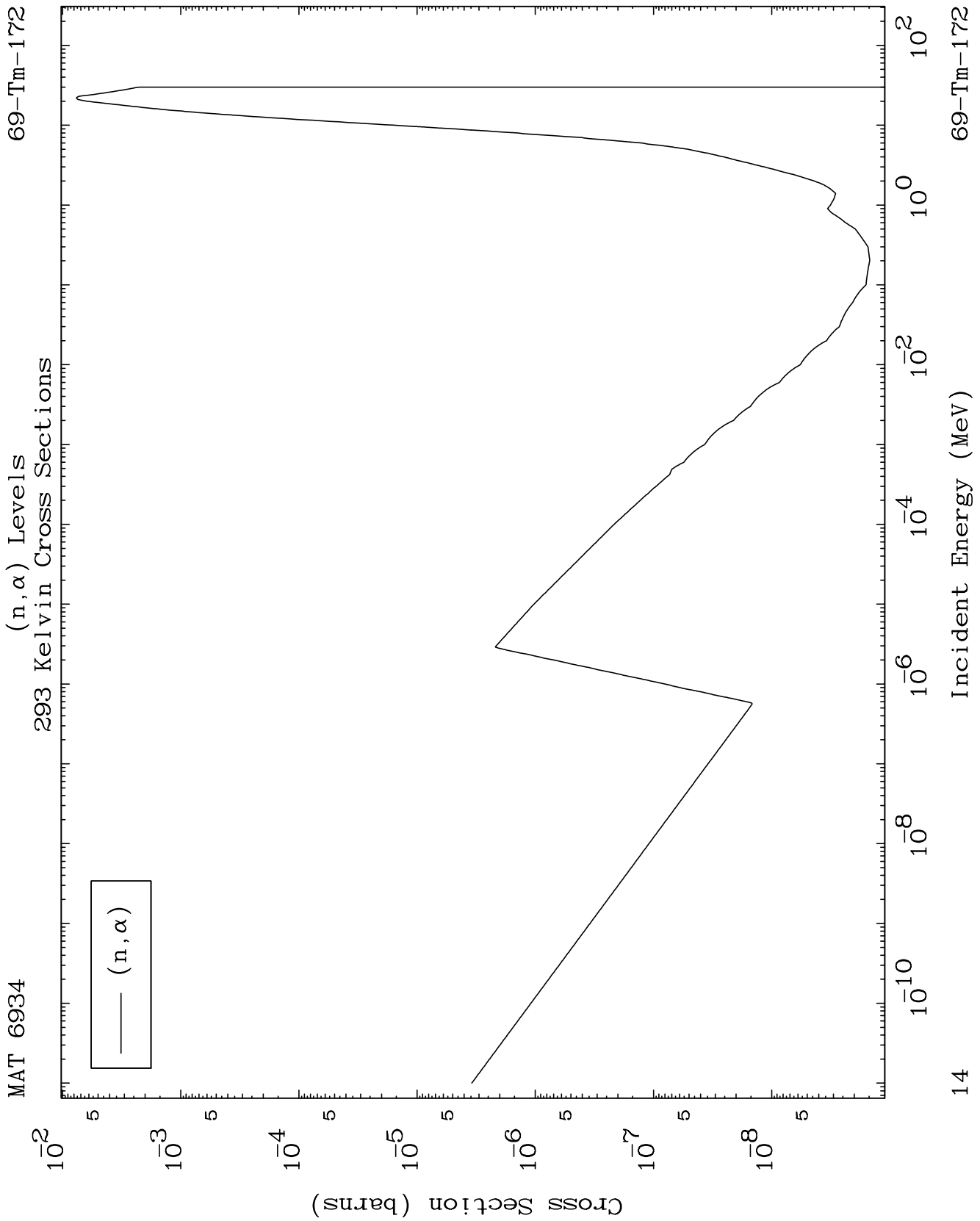

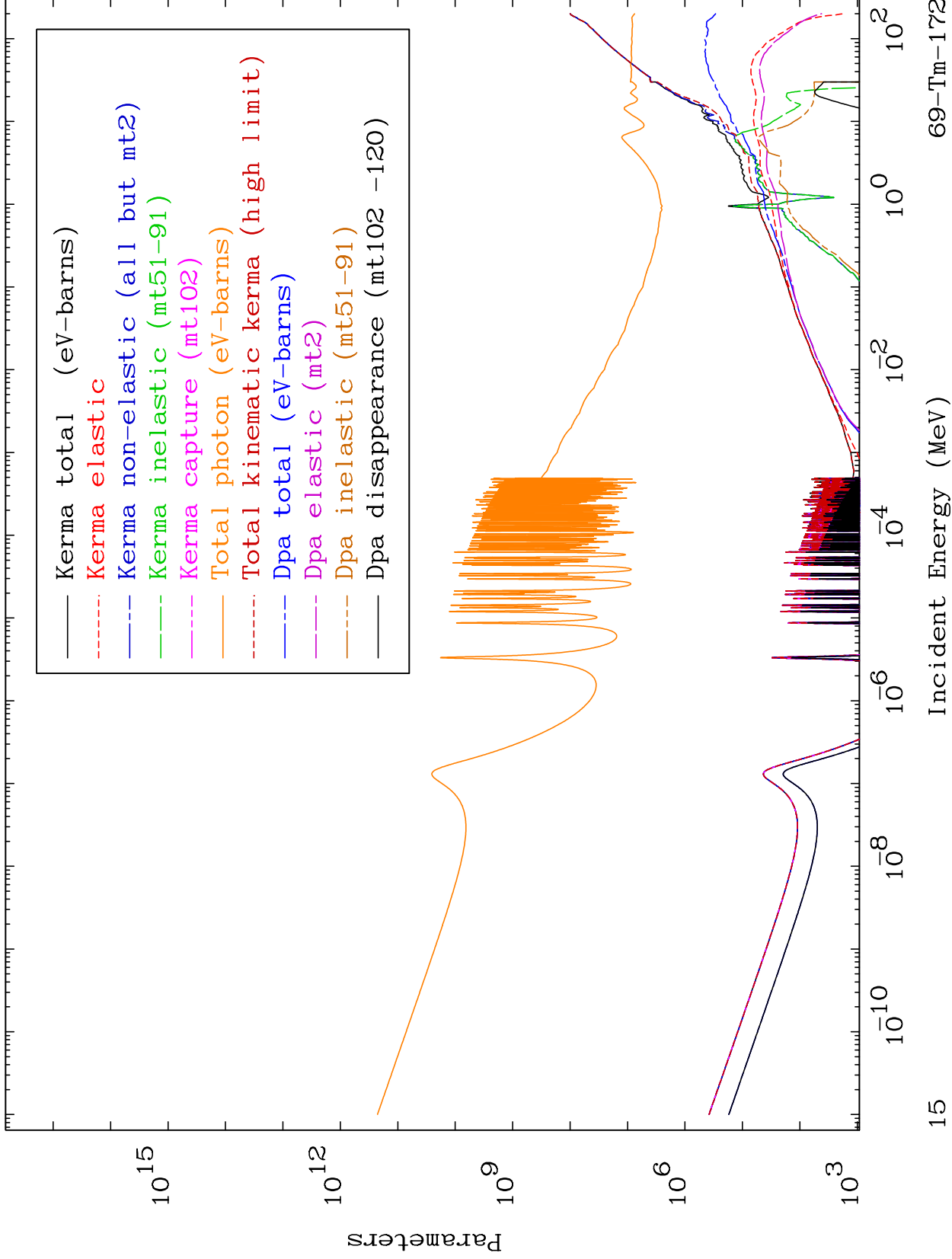

MAT 6934

Elastic Legendre Coefficients

69-Tm-172

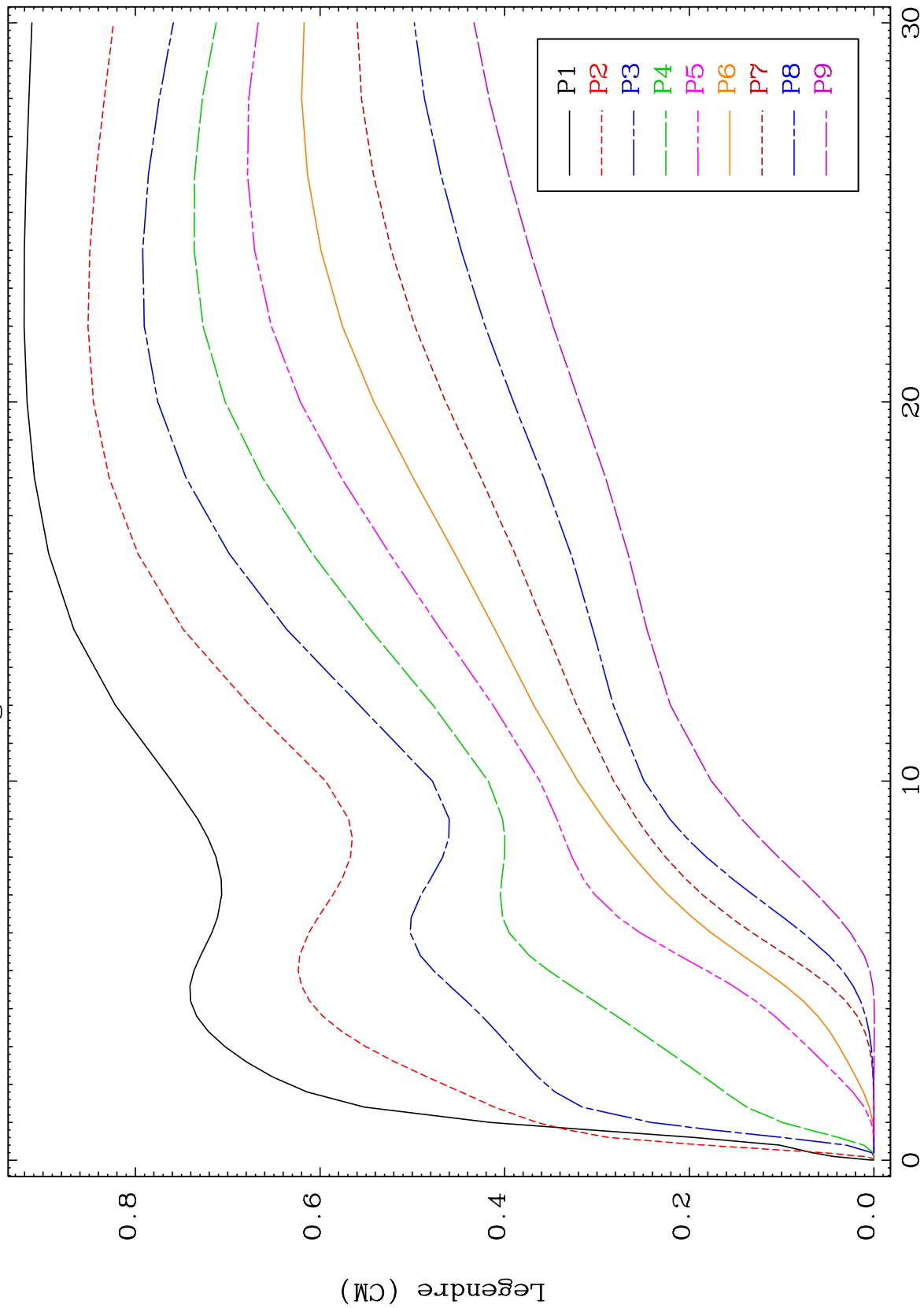

16

Incident Energy (MeV)

69-Tm-172

MAT 6934

Elastic Legendre Coefficients

69-Tm-172

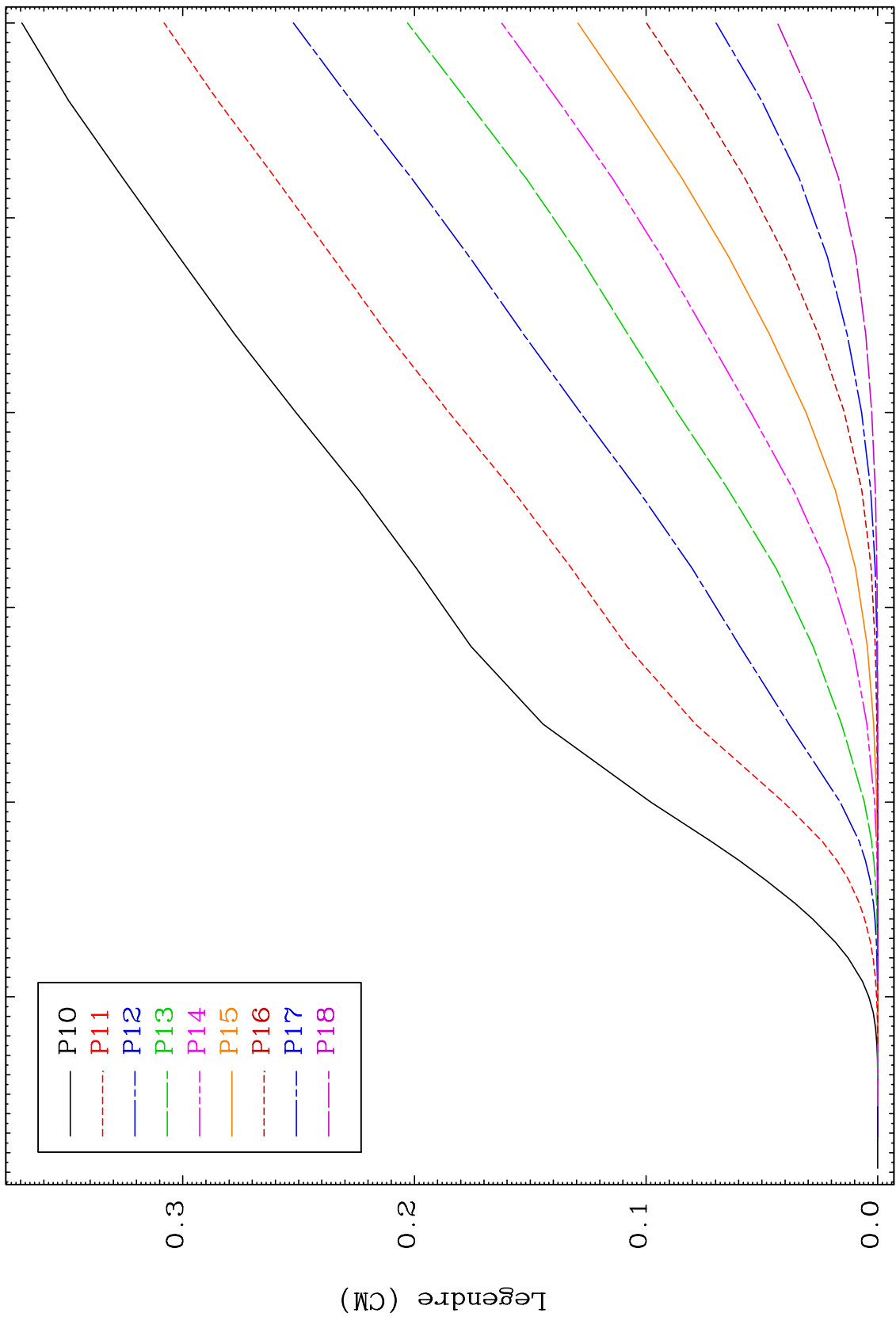

17

Incident Energy (MeV)

69-Tm-172

MAT 6934

Elastic Legendre Coefficients

69-Tm-172

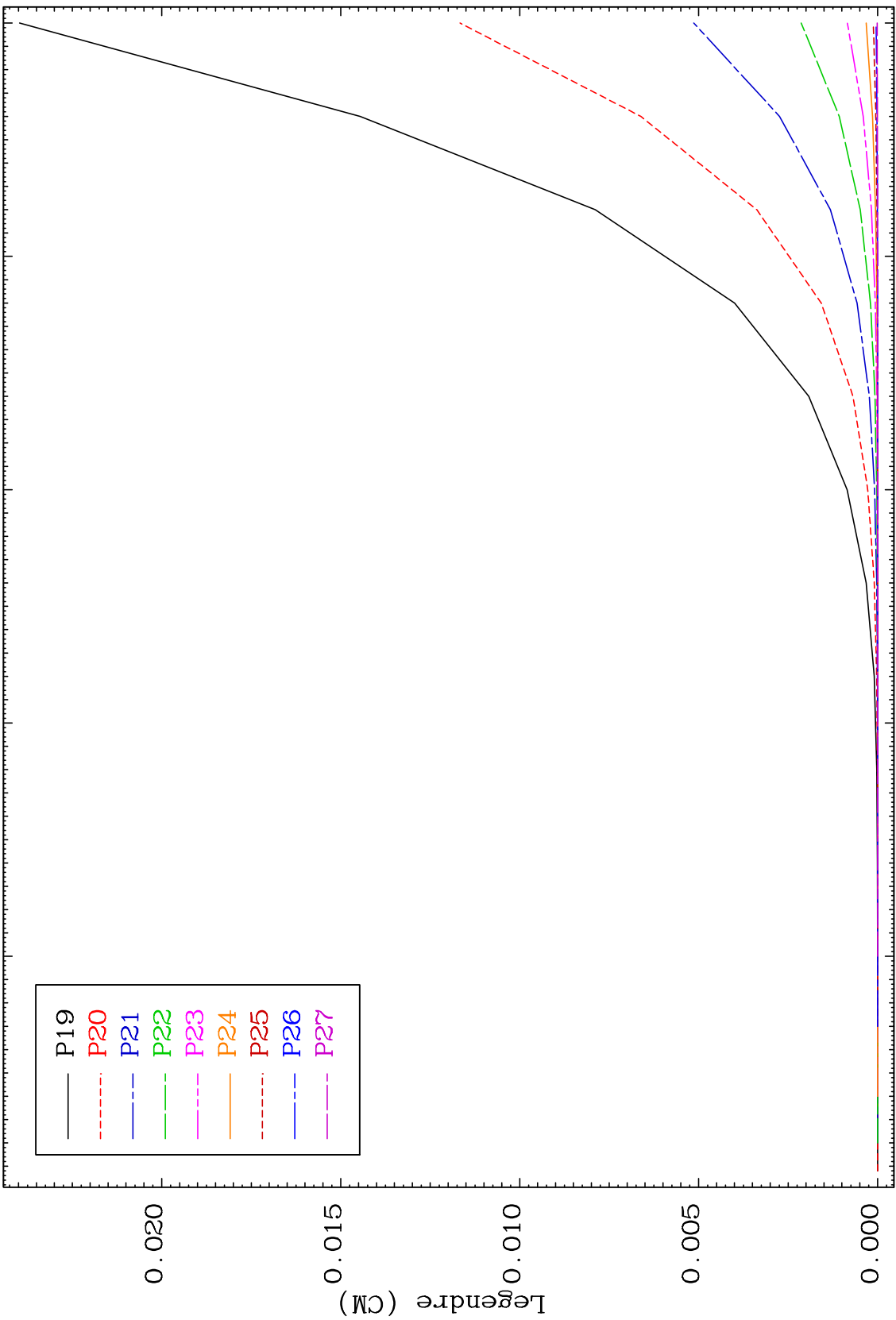

18

Incident Energy (MeV)

69-Tm-172

MAT 6934

Elastic
Legendre Coefficients

69-Tm-172

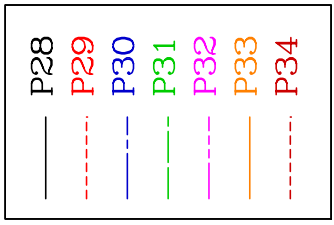
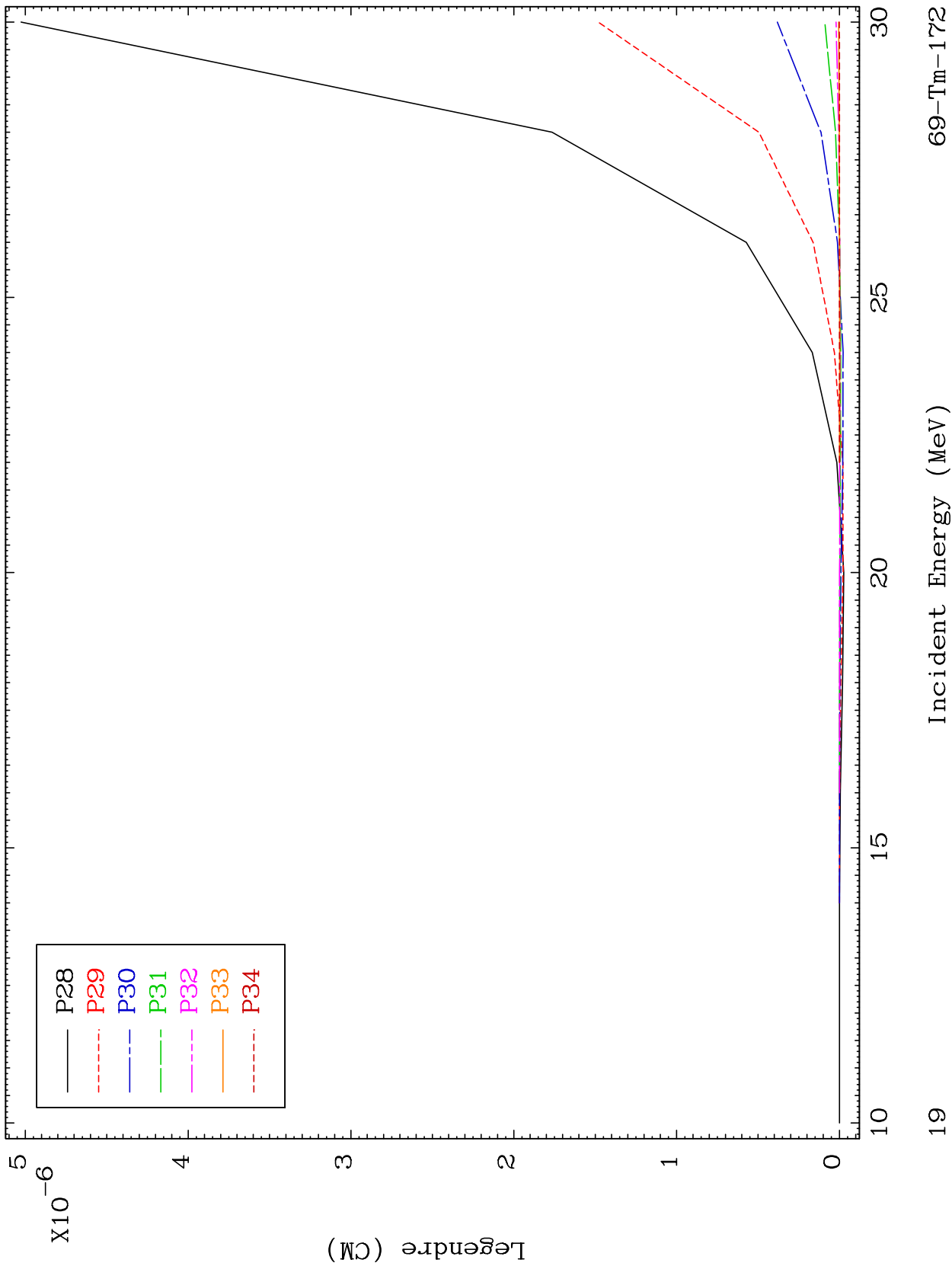

MAT 6934

62.53 keV (n,n') Level
Legendre Coefficients

69-Tm-172

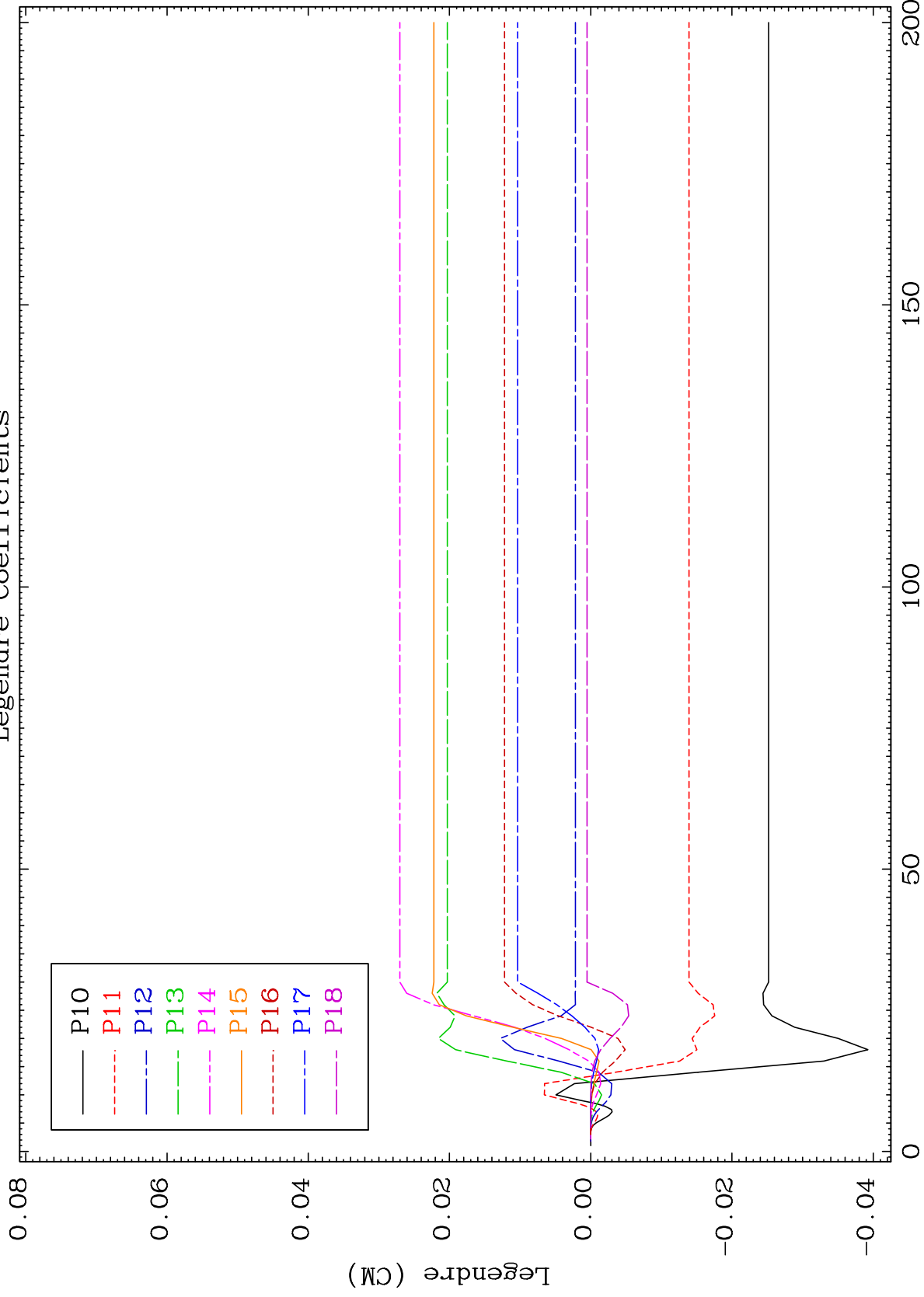

MAT 6934

62.53 keV (n,n') Level
Legendre Coefficients

69-Tm-172

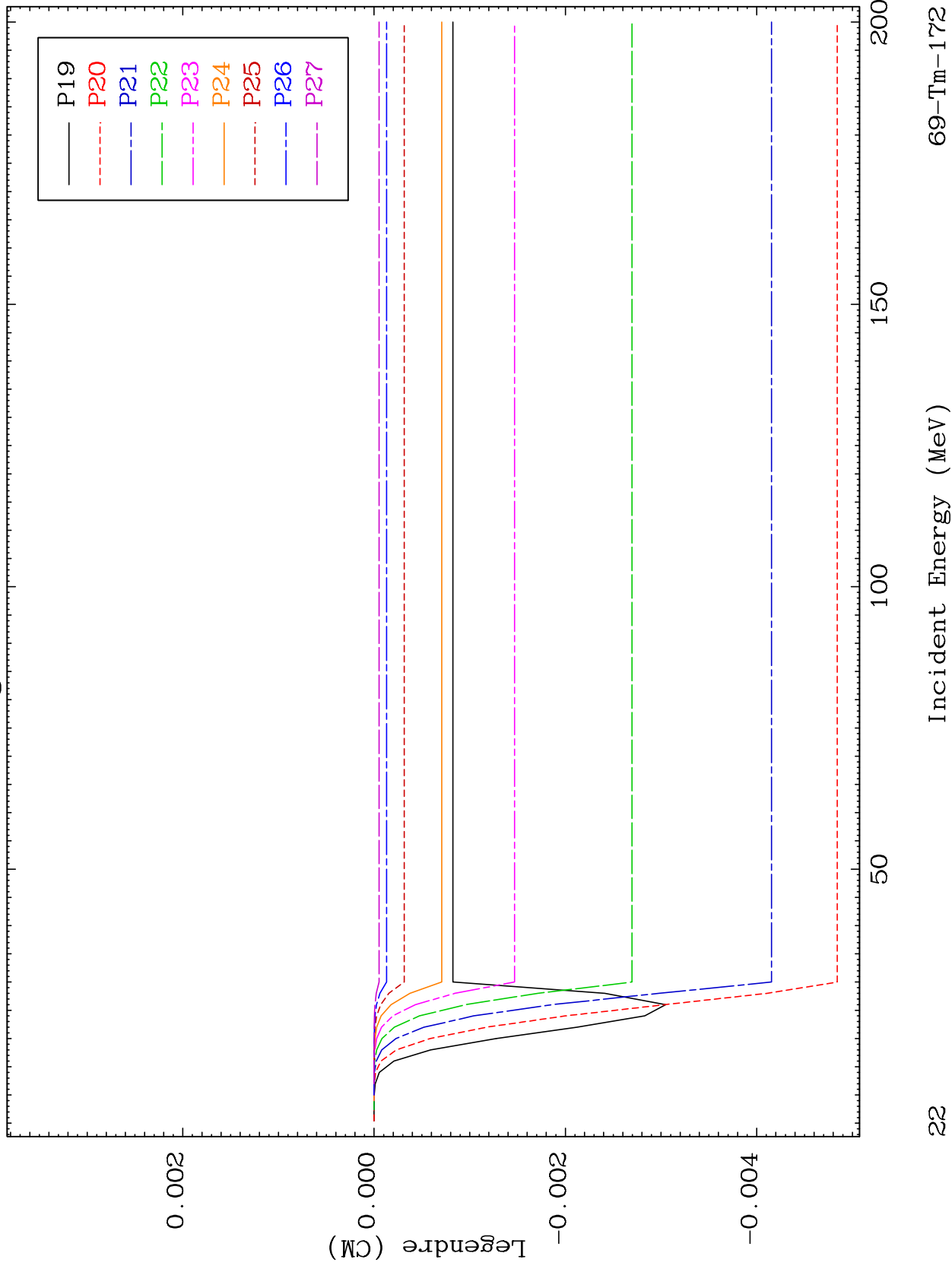

22

Incident Energy (MeV)

69-Tm-172

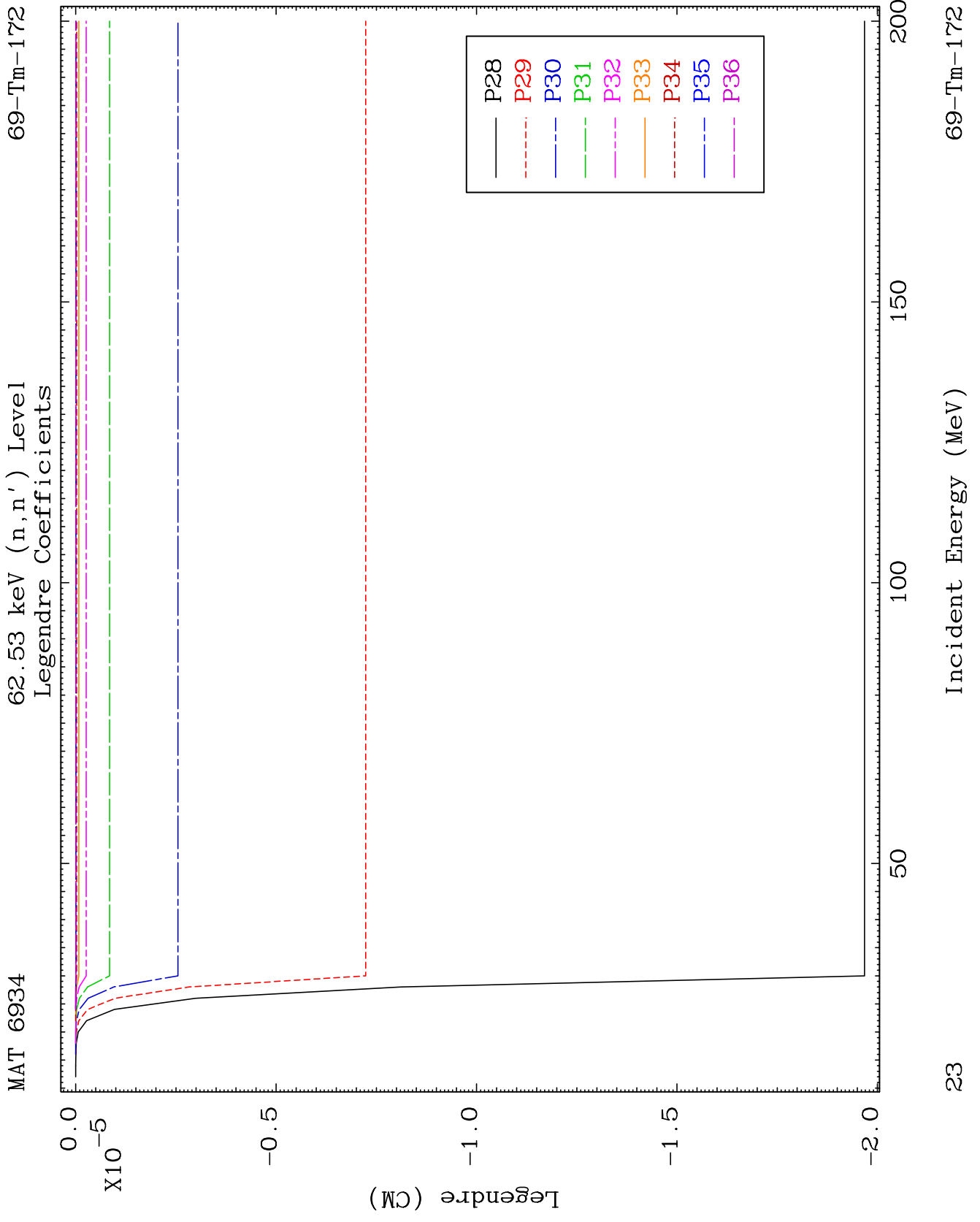

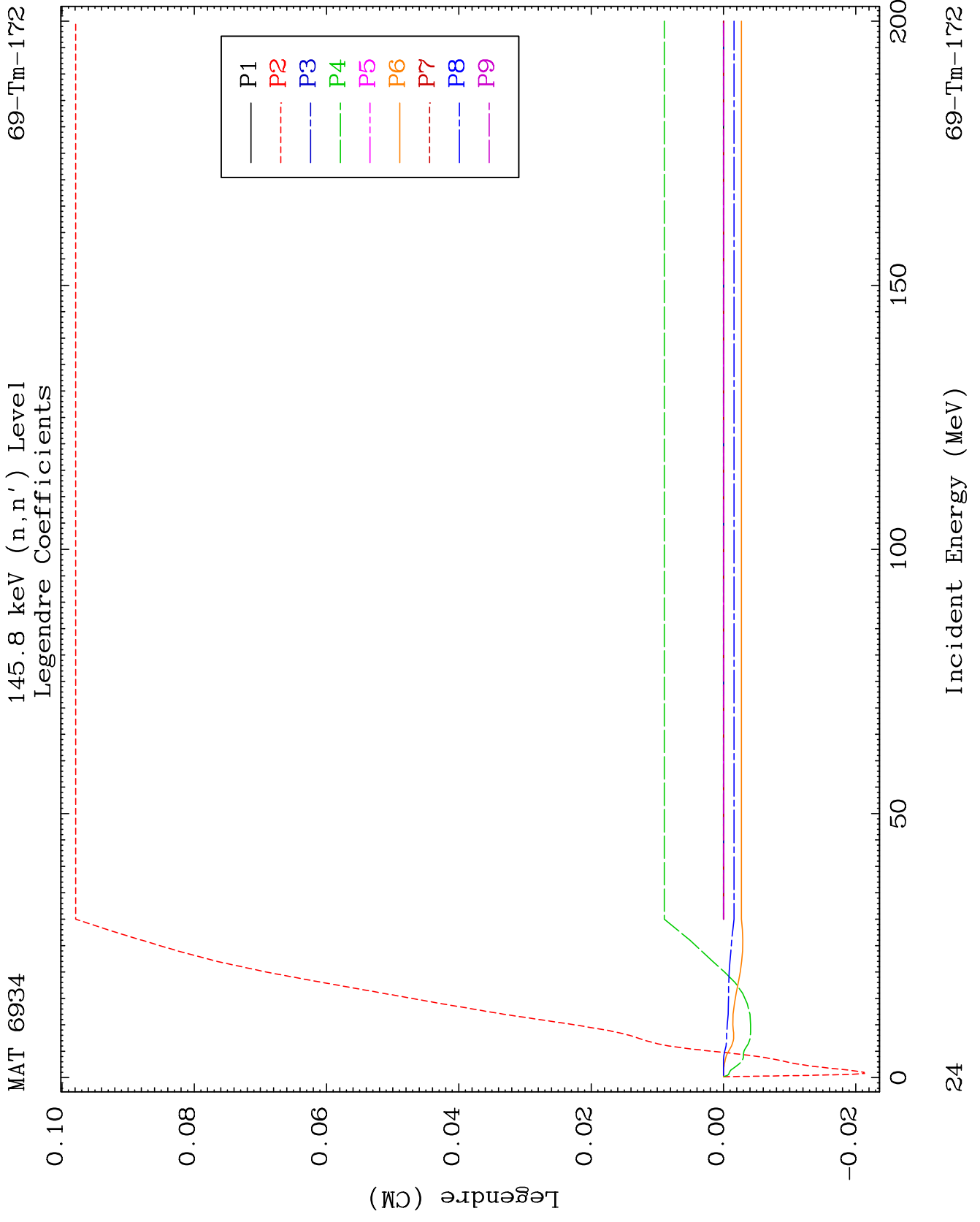

MAT 6934

145.8 keV (n,n') Level
Legendre Coefficients

69-Tm-172

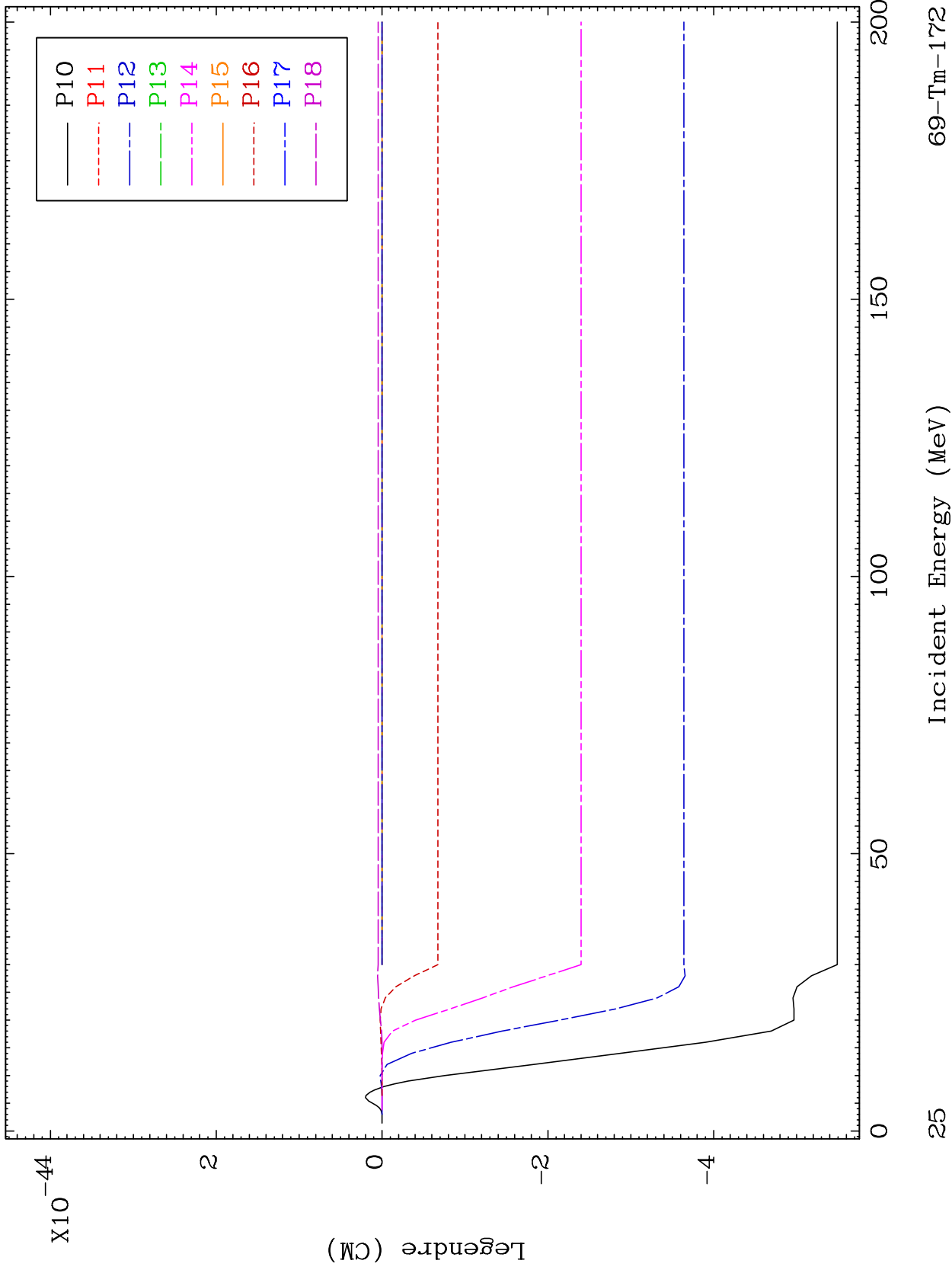

69-Tm-172

Incident Energy (MeV)

25

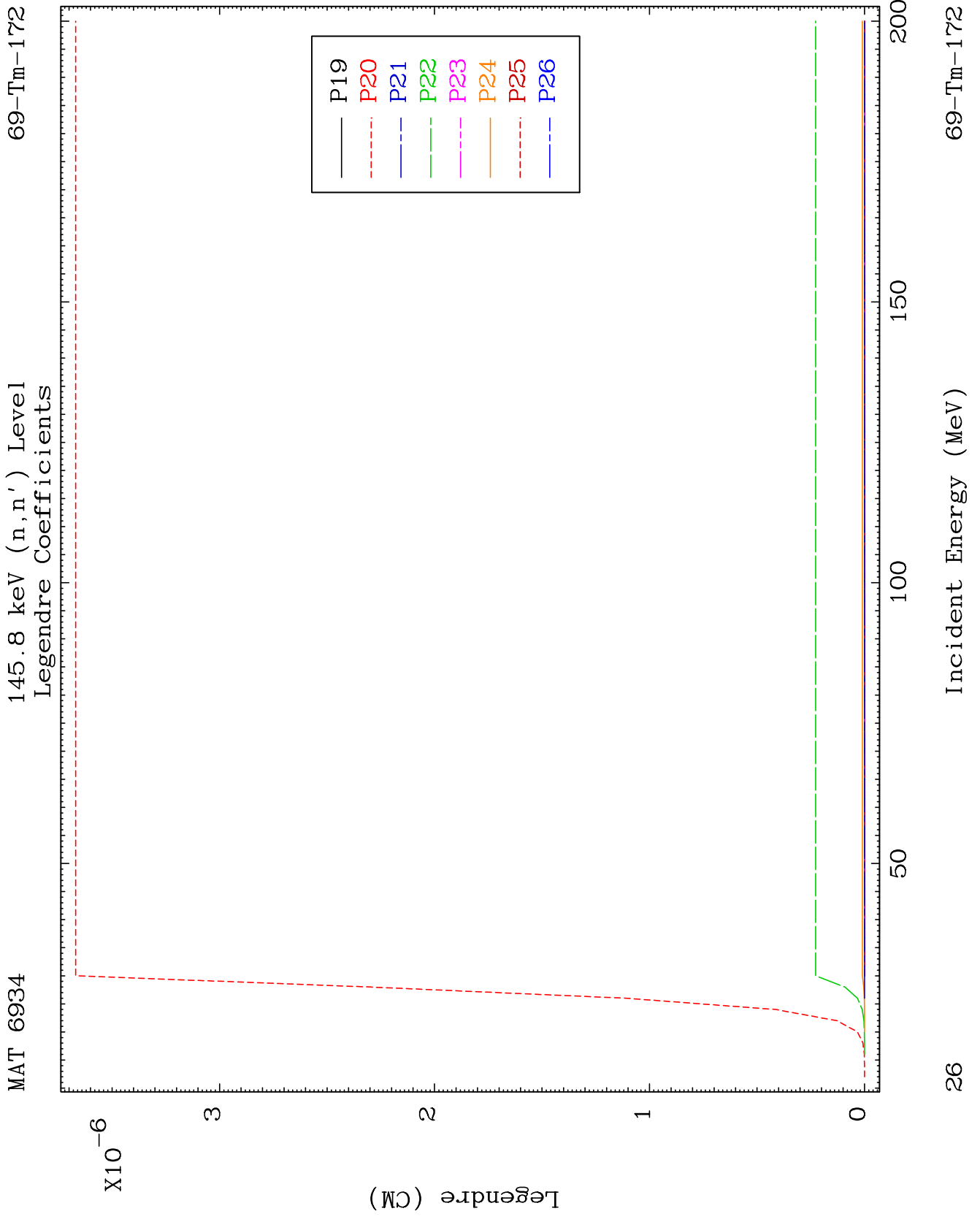

MAT 6934

239.9 keV (n,n') Level
Legendre Coefficients

69-Tm-172

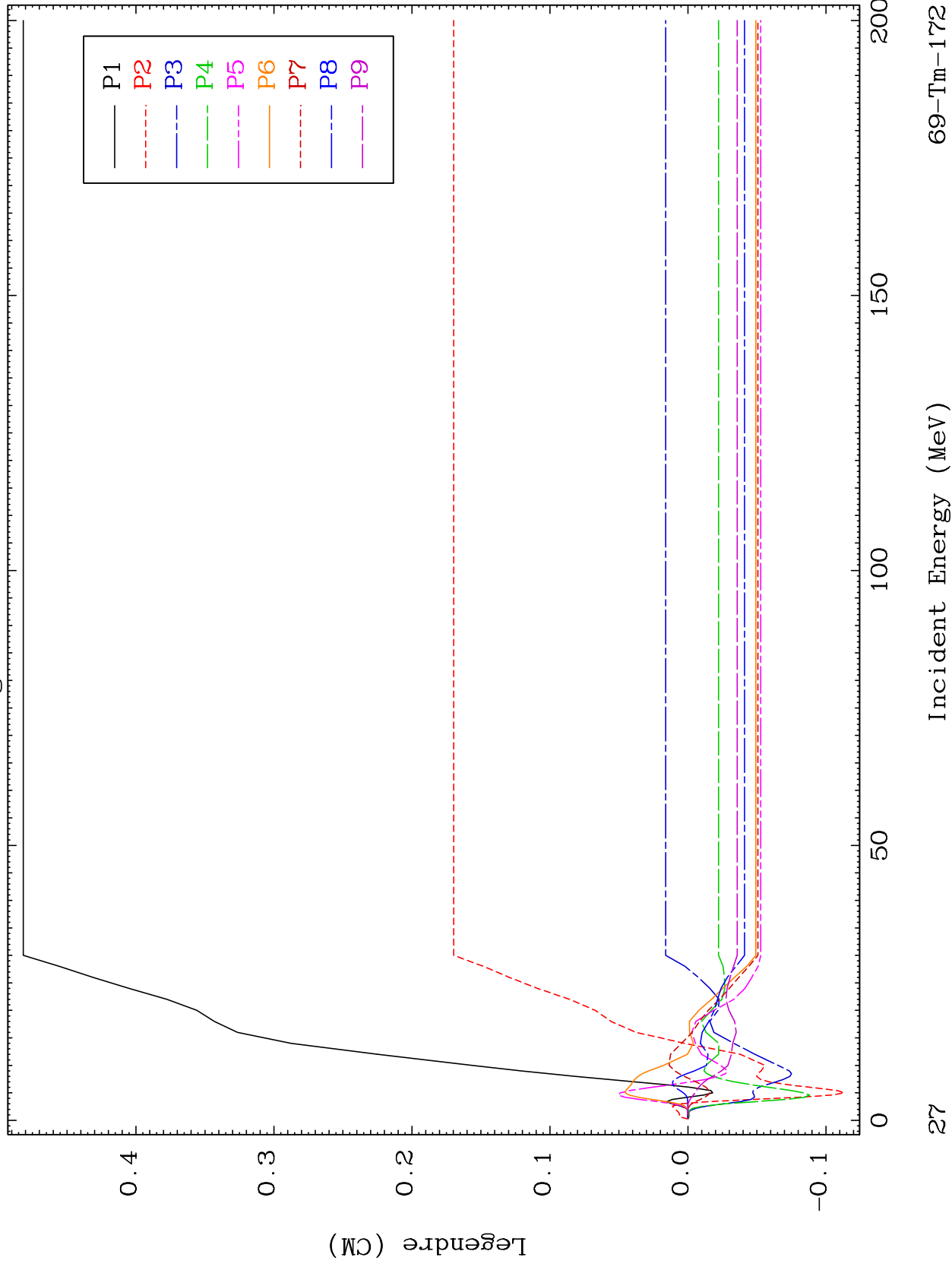

27

Incident Energy (MeV)

69-Tm-172

MAT 6934

239.9 keV (n,n') Level
Legendre Coefficients

69-Tm-172

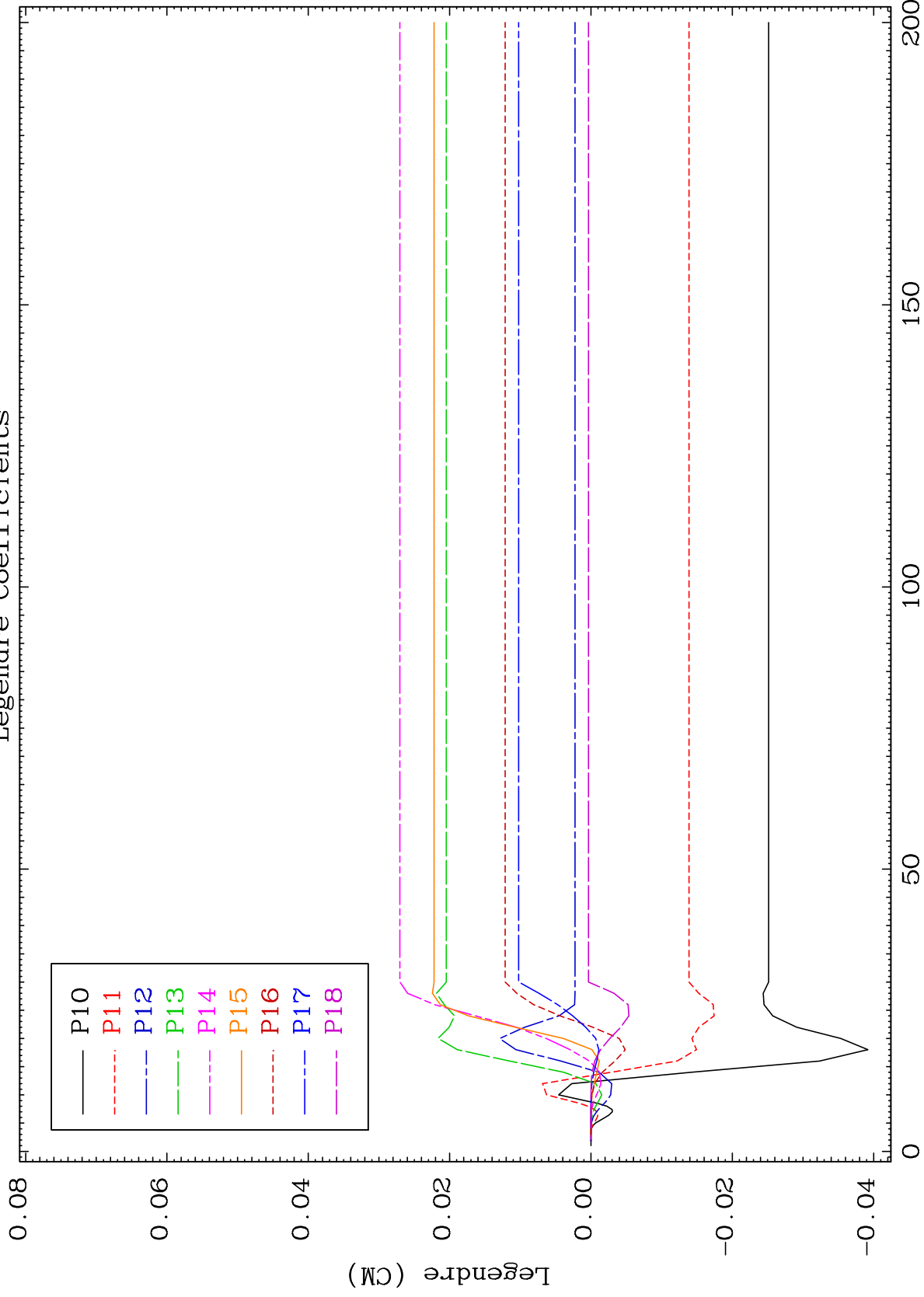

28

Incident Energy (MeV)

69-Tm-172

MAT 6934

239.9 keV (n,n') Level
Legendre Coefficients

69-Tm-172

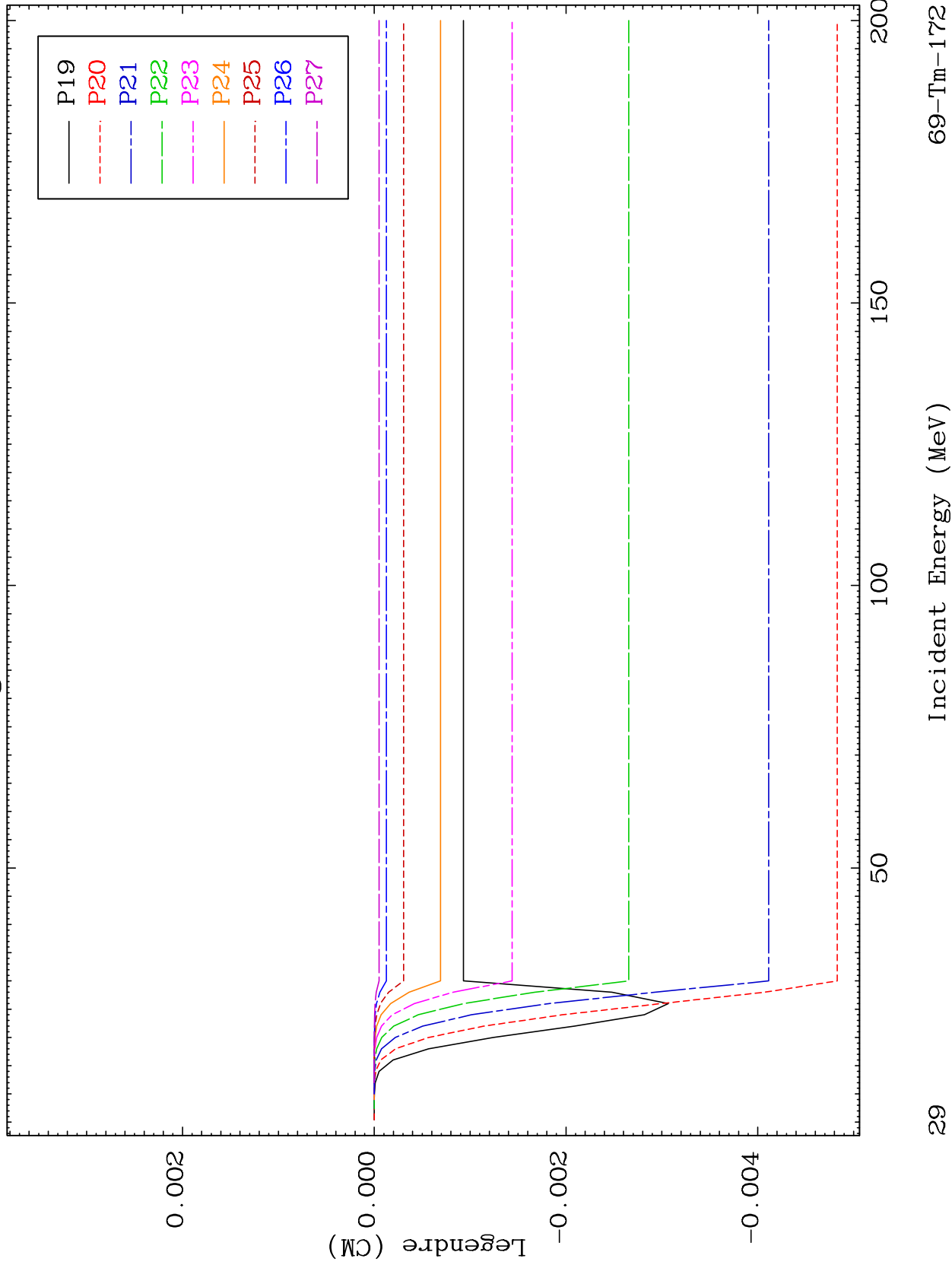

29

Incident Energy (MeV)

69-Tm-172

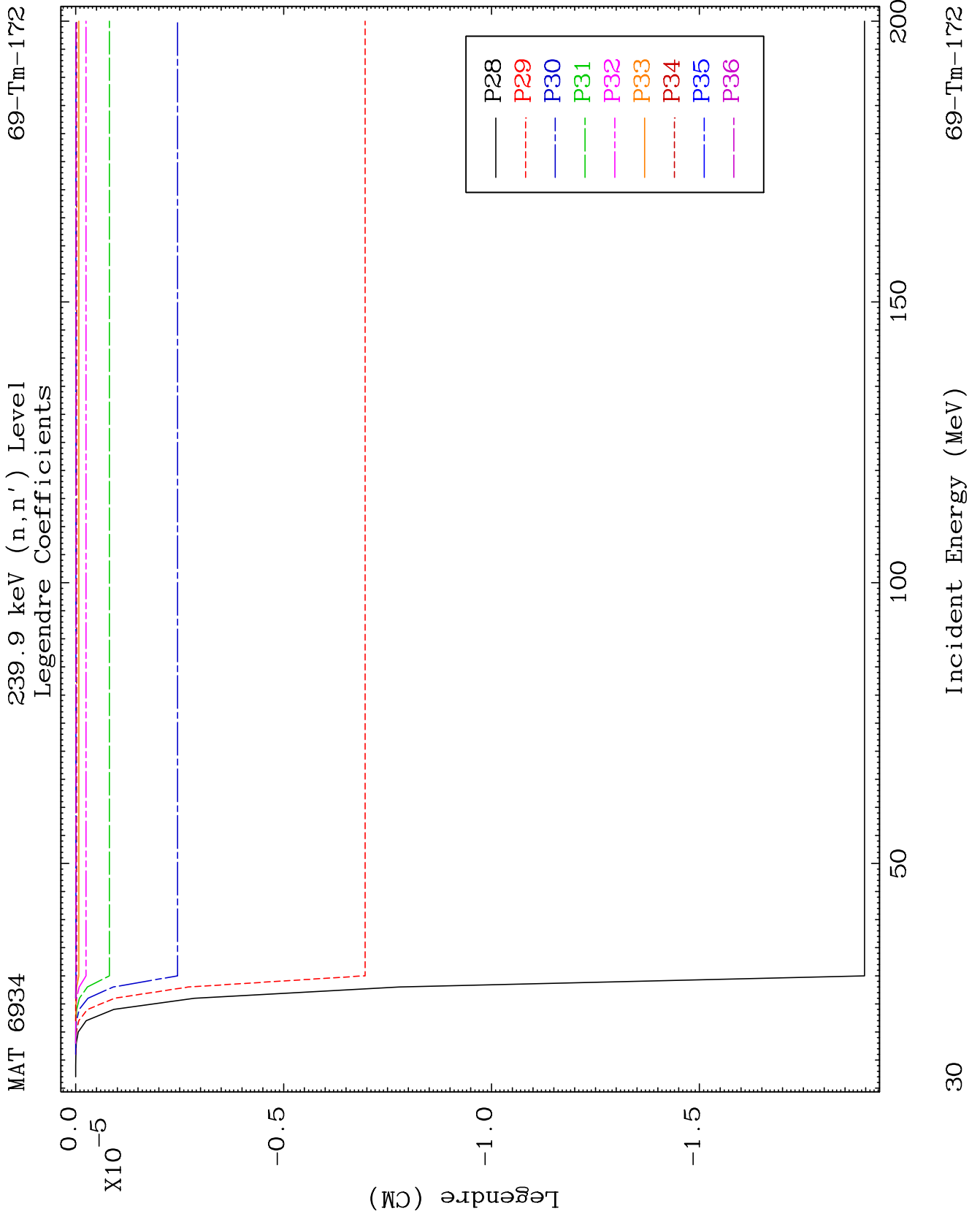

MAT 6934

407.3 keV (n,n') Level
Legendre Coefficients

69-Tm-172

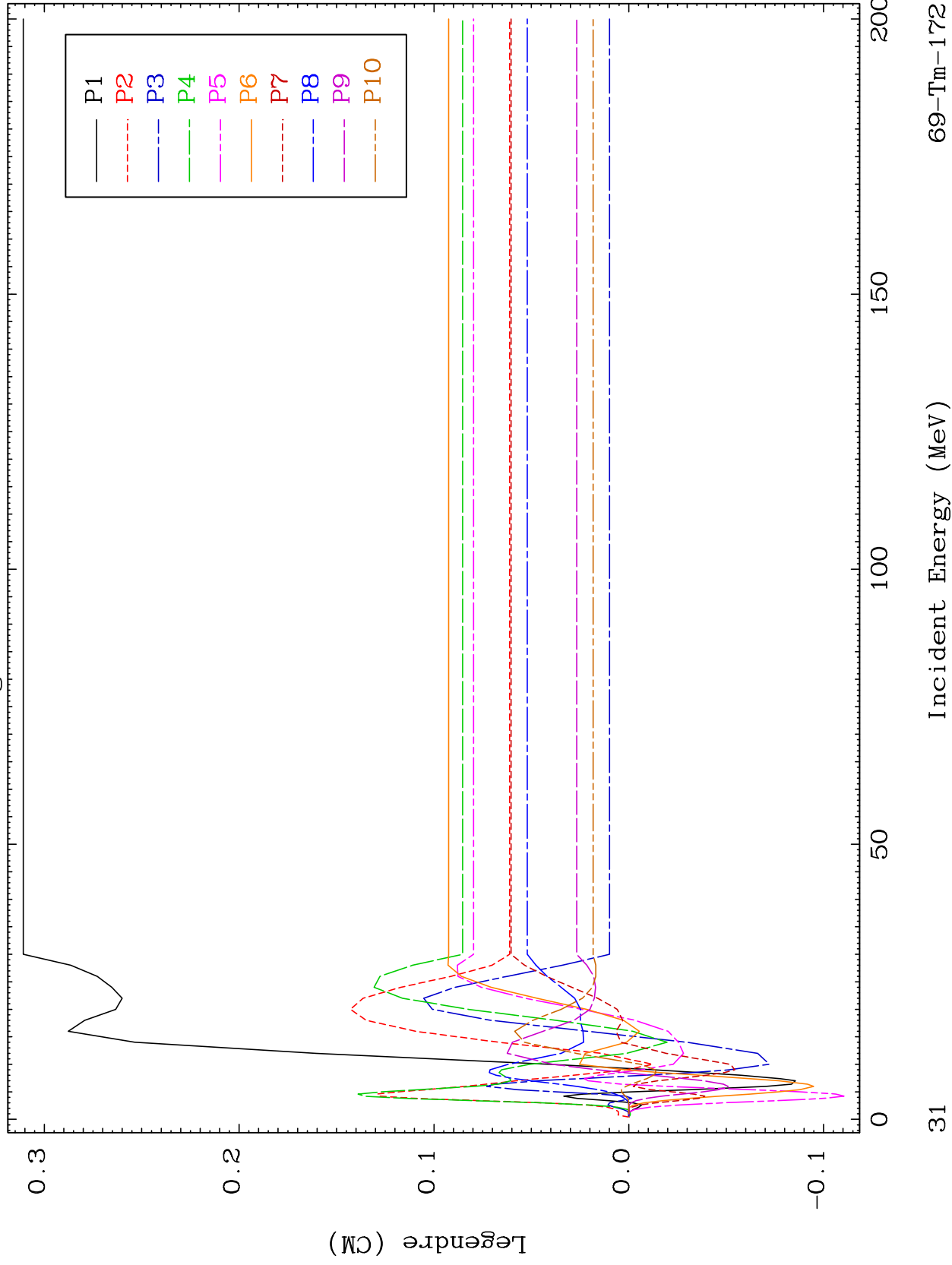

MAT 6934

407.3 keV (n,n') Level
Legendre Coefficients

69-Tm-172

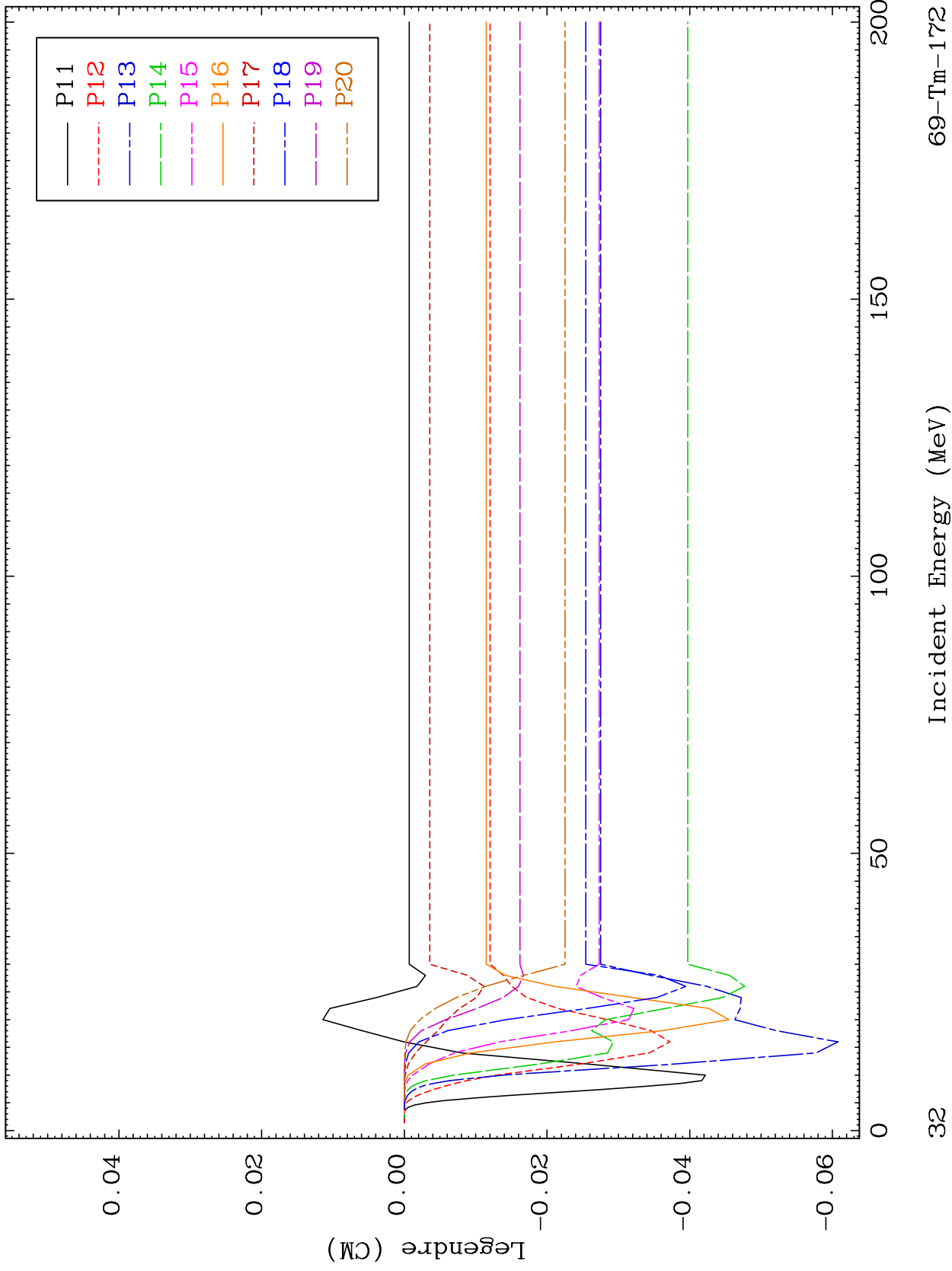

32

Incident Energy (MeV)

69-Tm-172

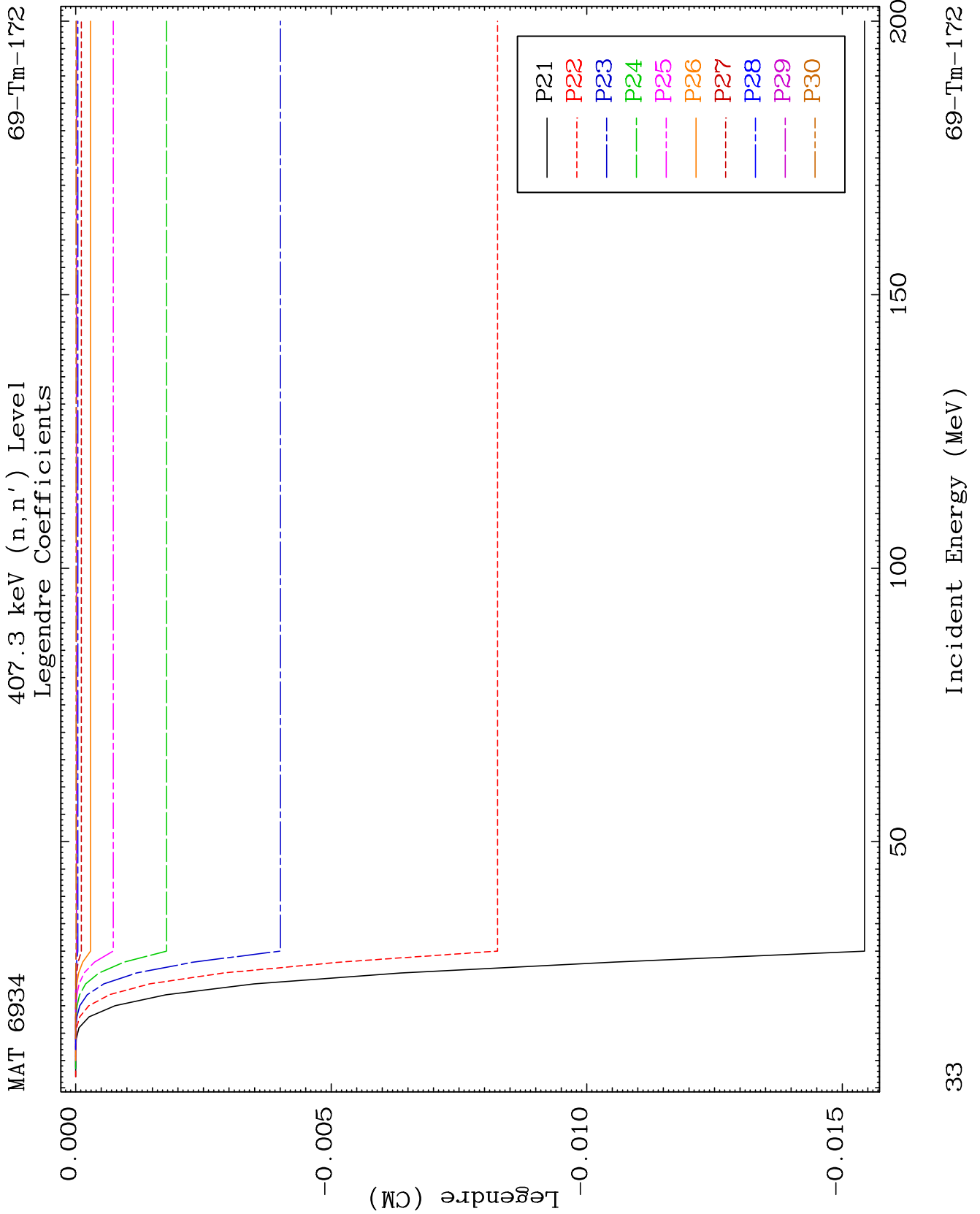

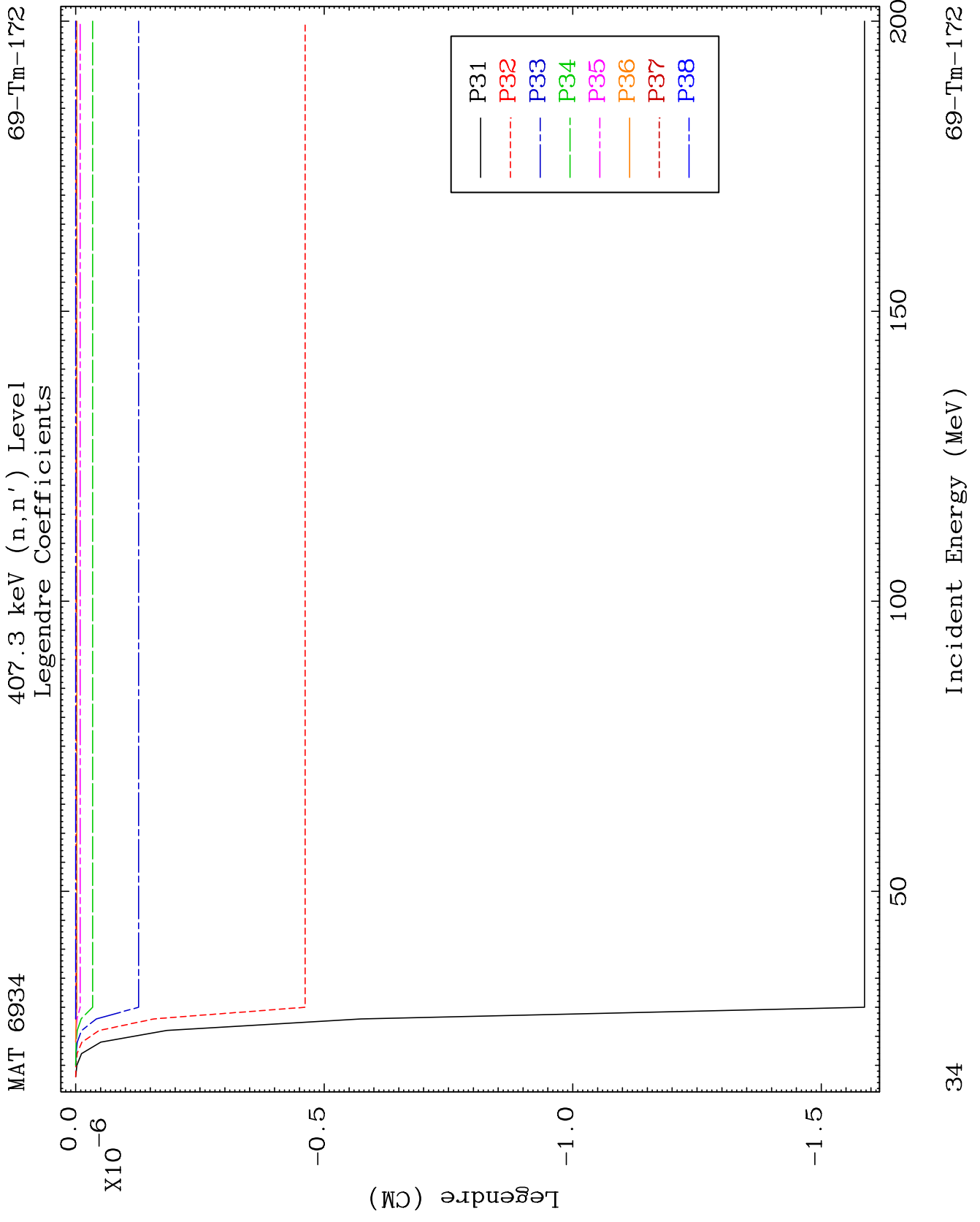

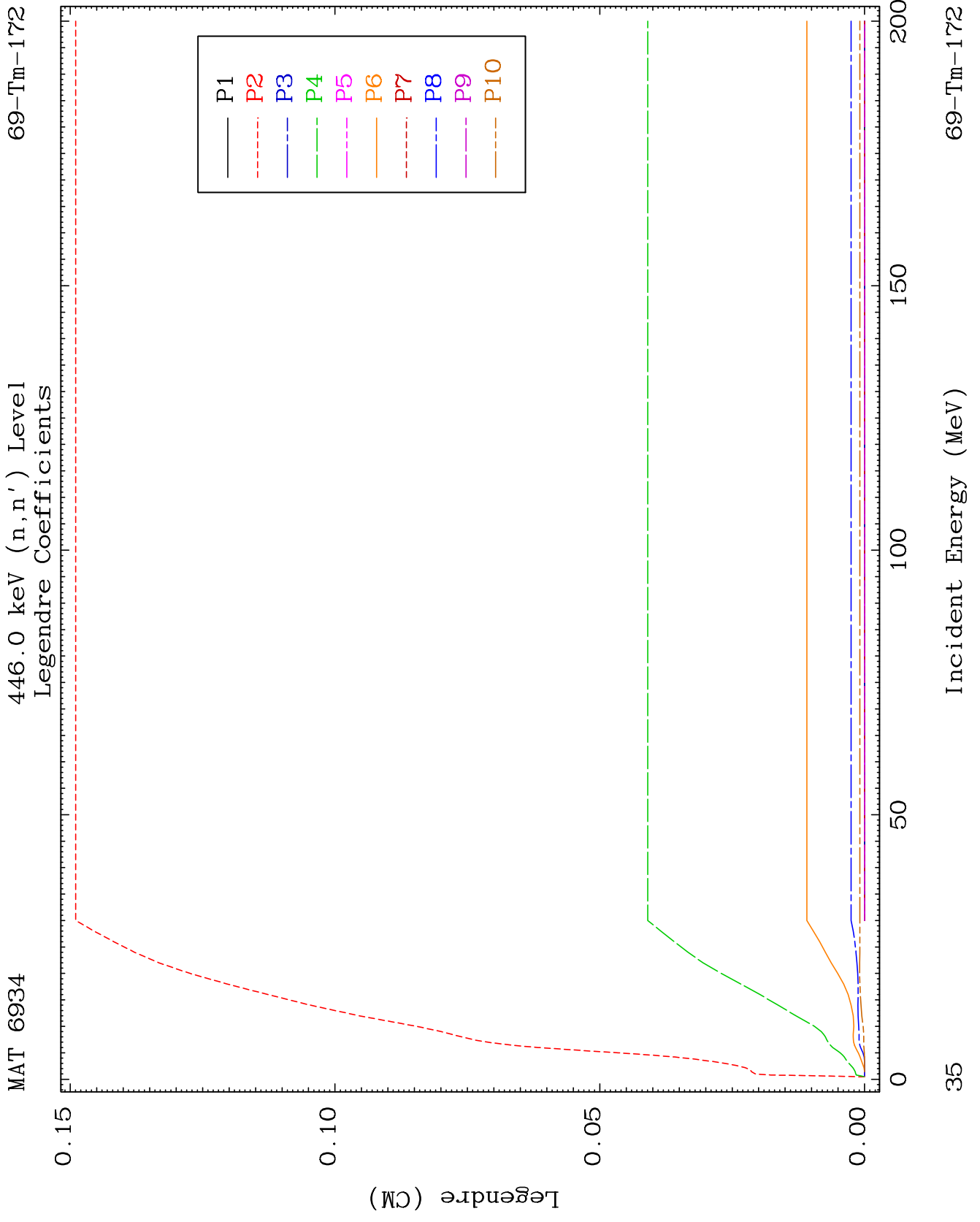

MAT 6934

446.0 keV (n,n') Level
Legendre Coefficients

69-Tm-172

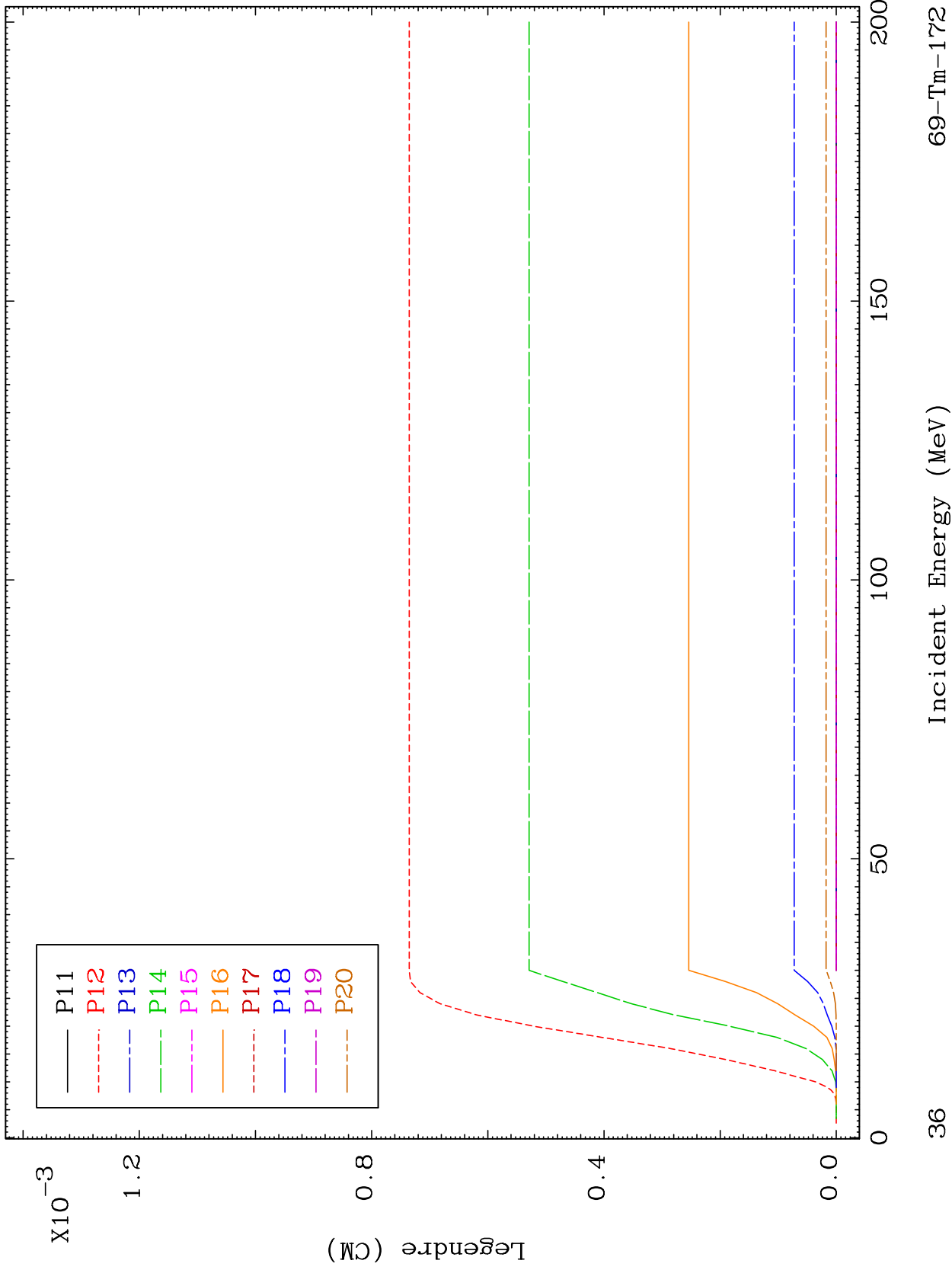

36

Incident Energy (MeV)

69-Tm-172

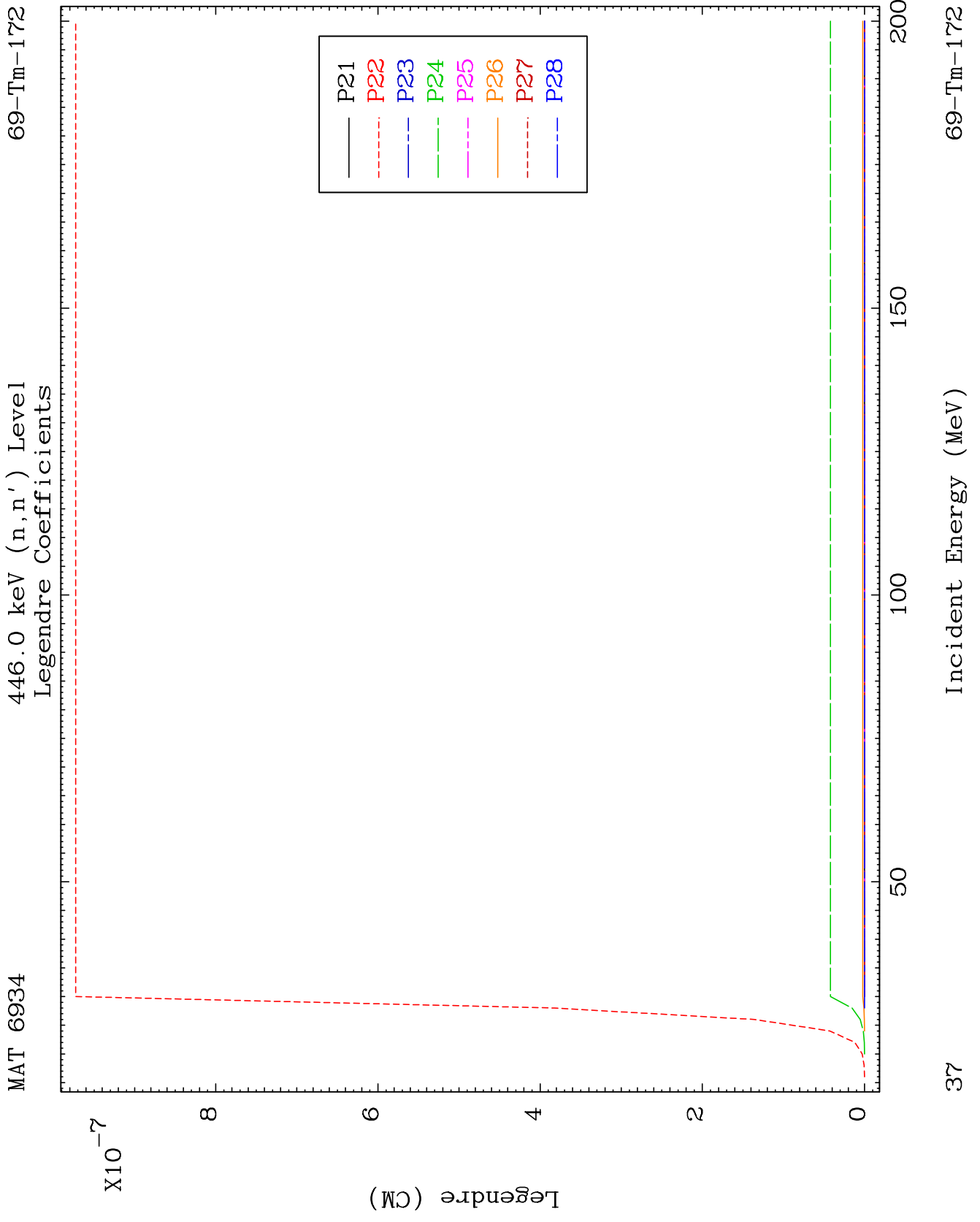

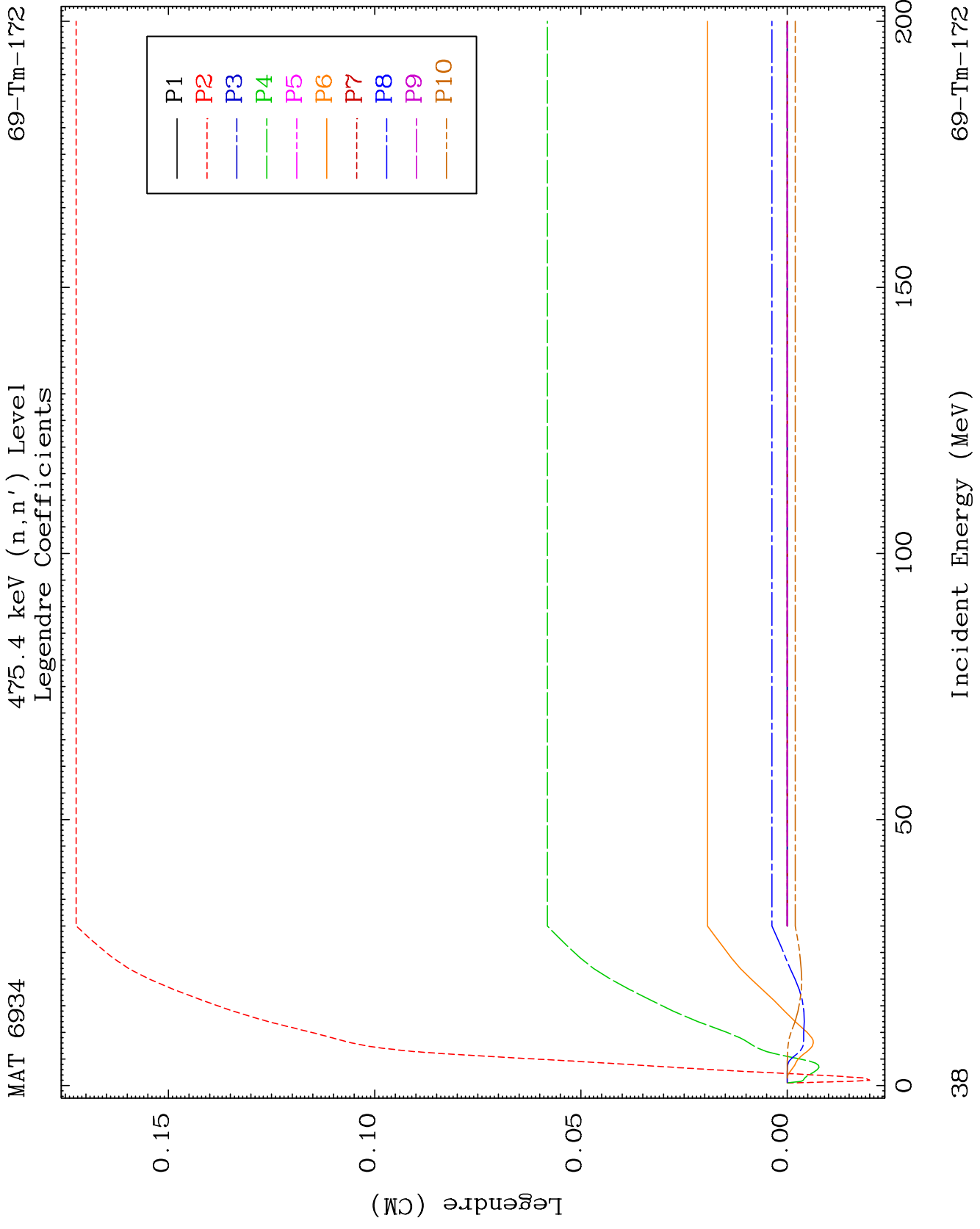

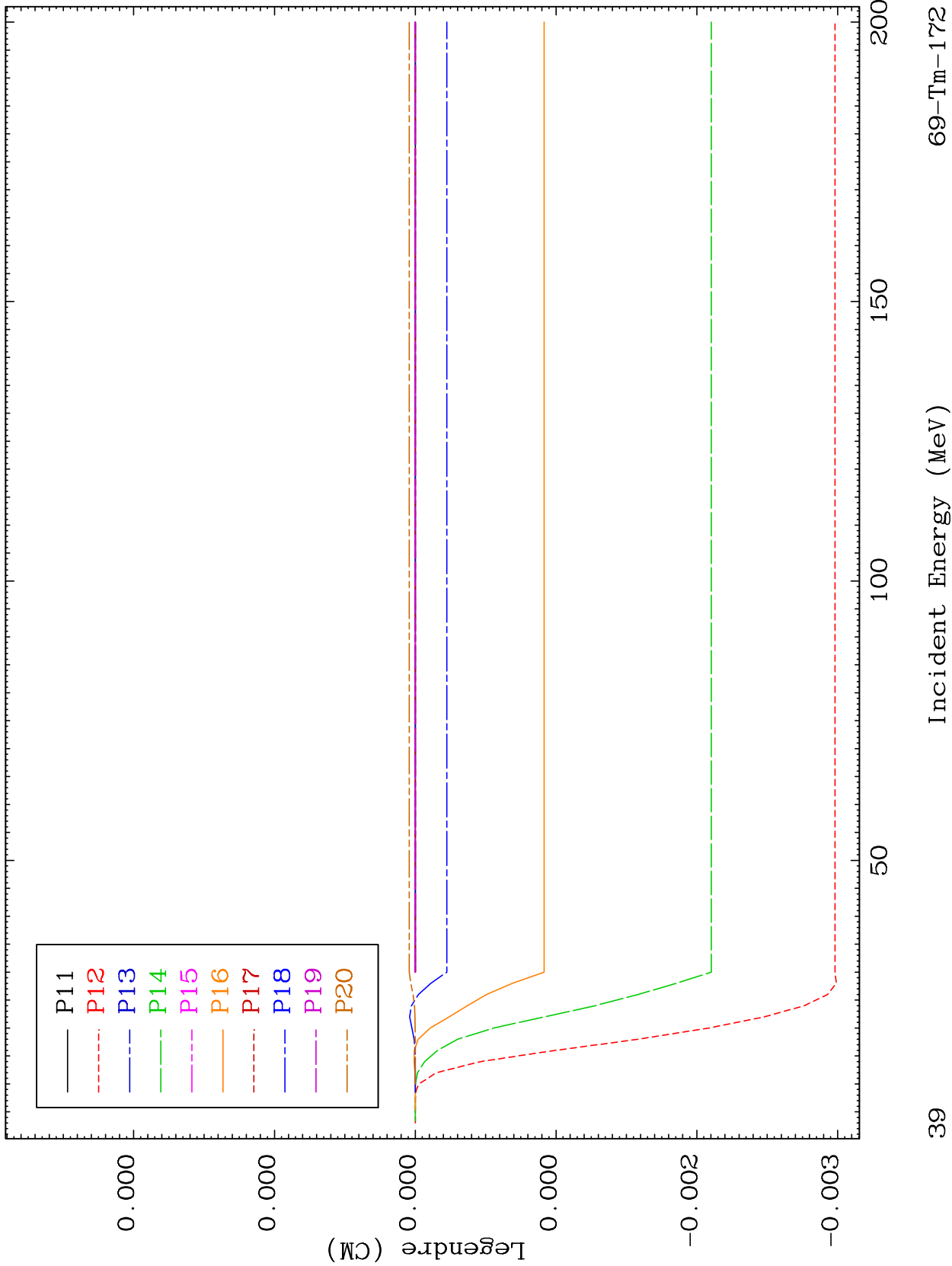

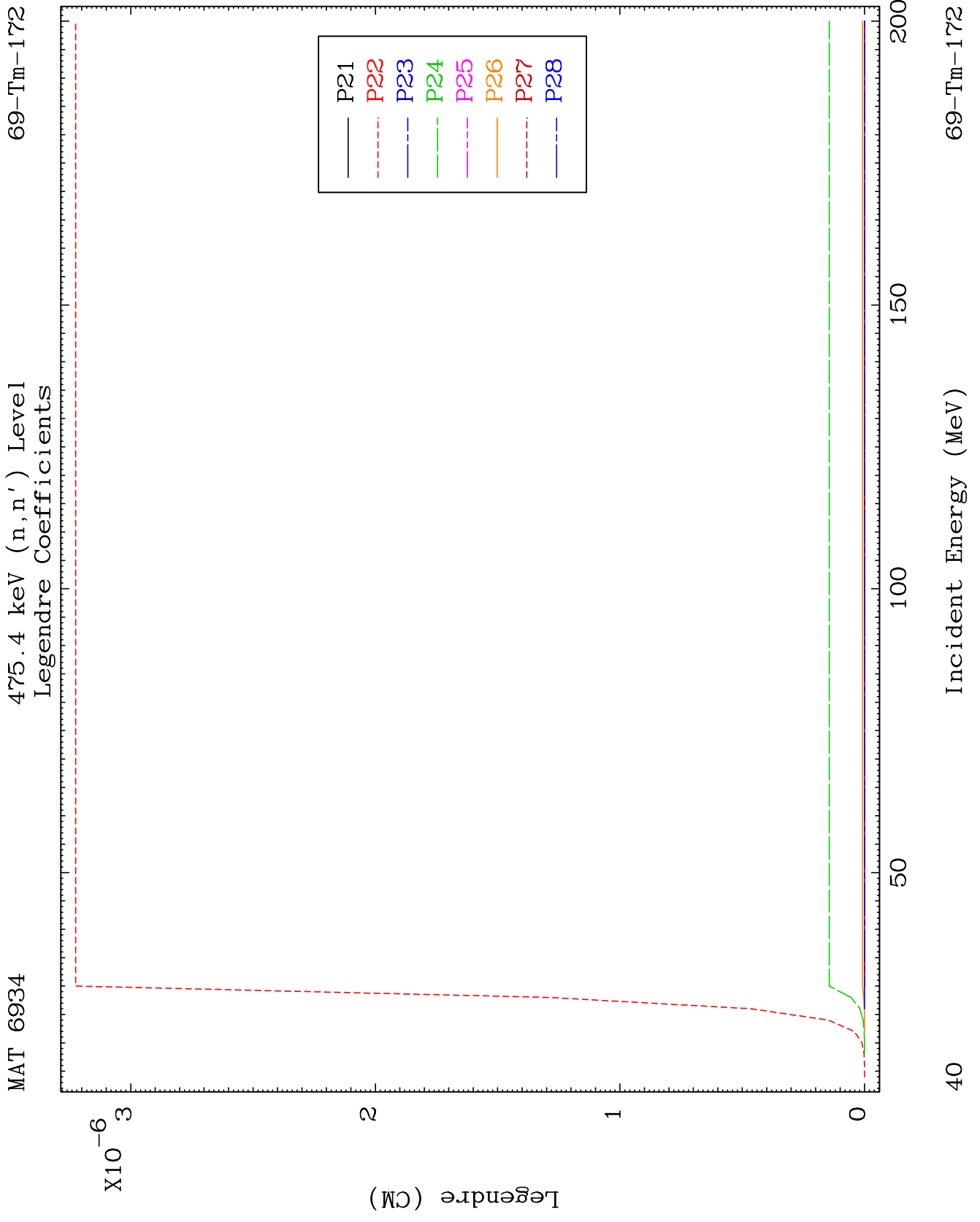

MAT 6934

479.7 keV (n,n') Level
Legendre Coefficients

69-Tm-172

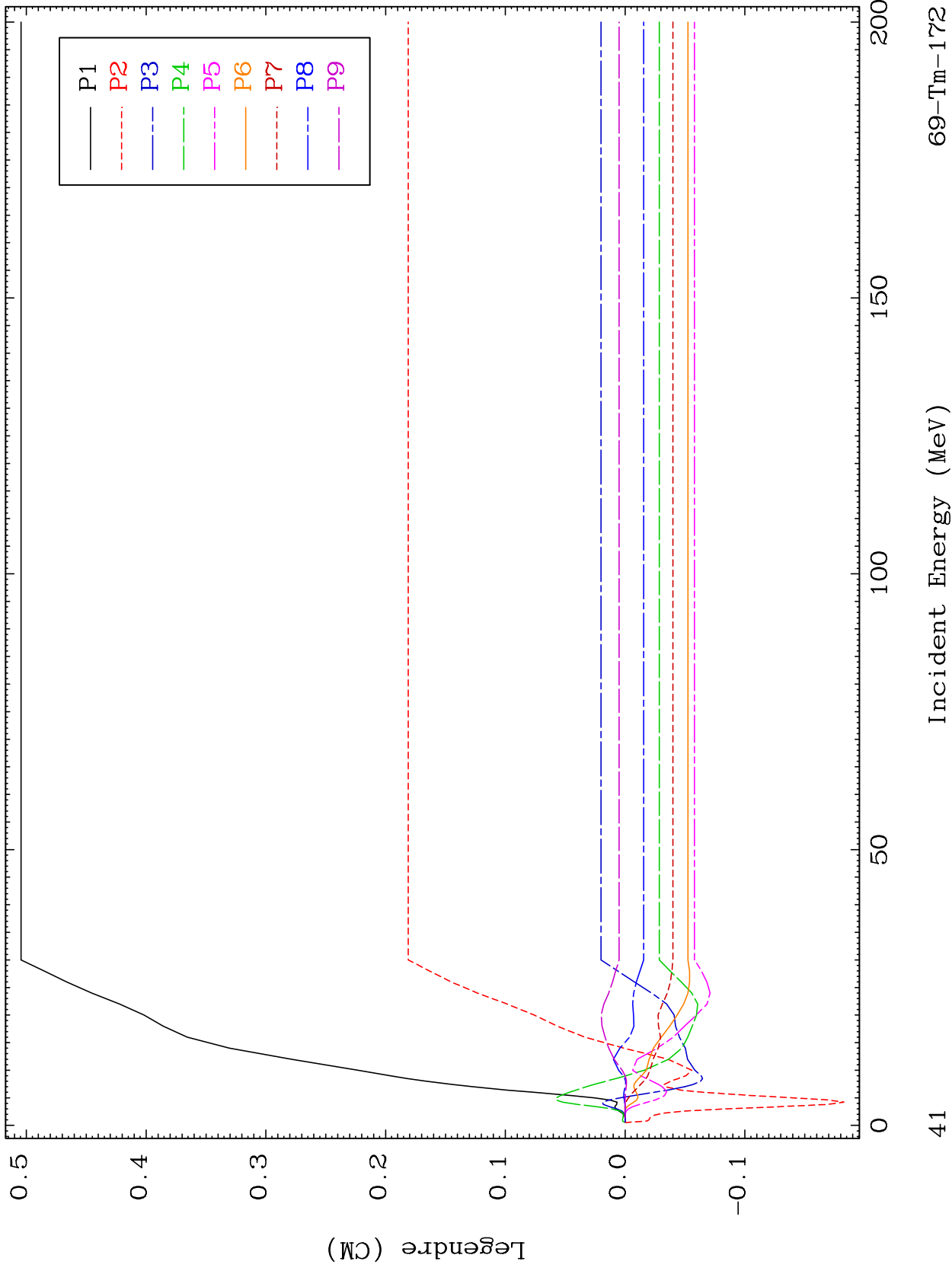

41

Incident Energy (MeV)

69-Tm-172

MAT 6934

479.7 keV (n,n') Level
Legendre Coefficients

69-Tm-172

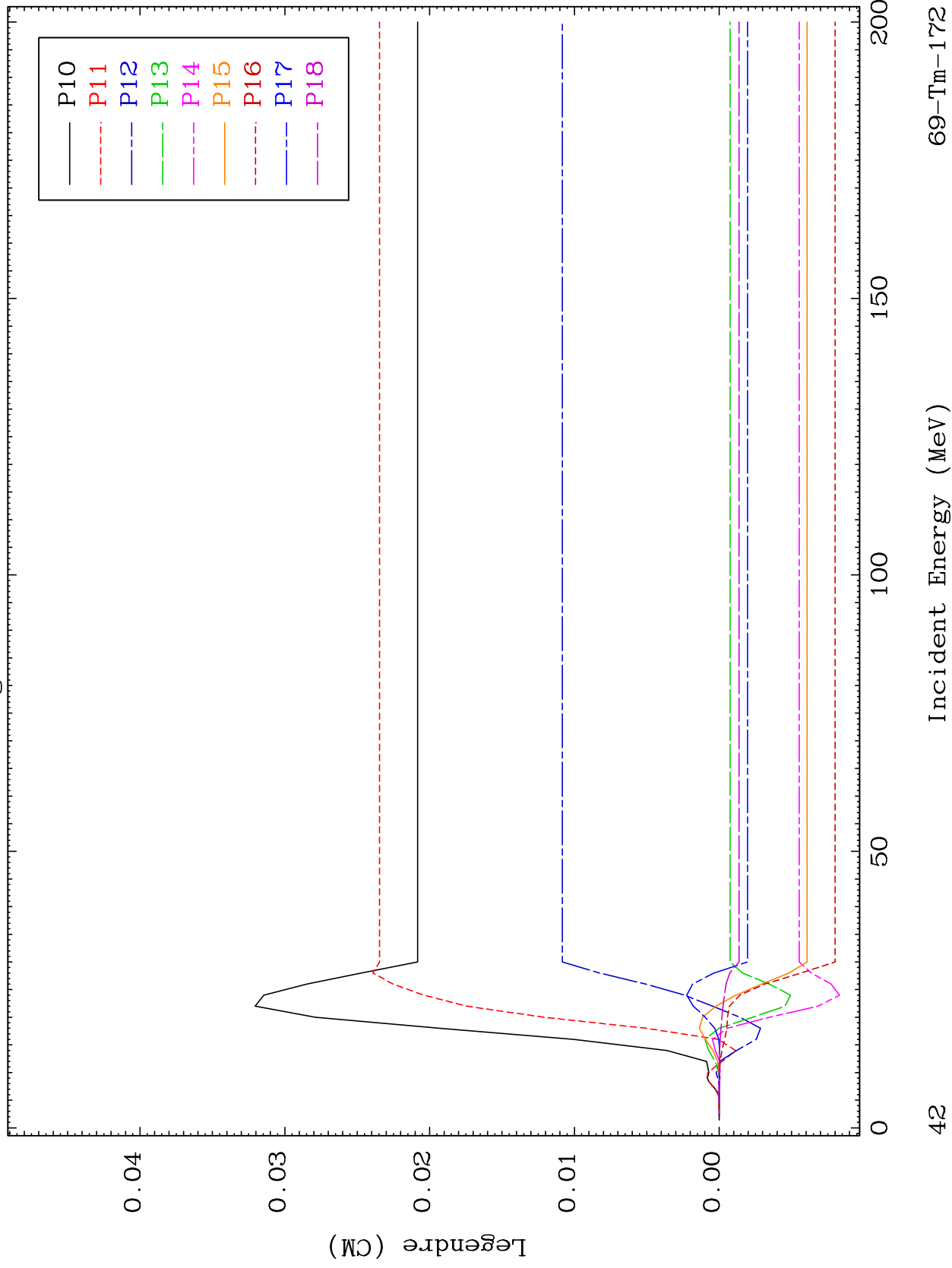

69-Tm-172

Incident Energy (MeV)

42

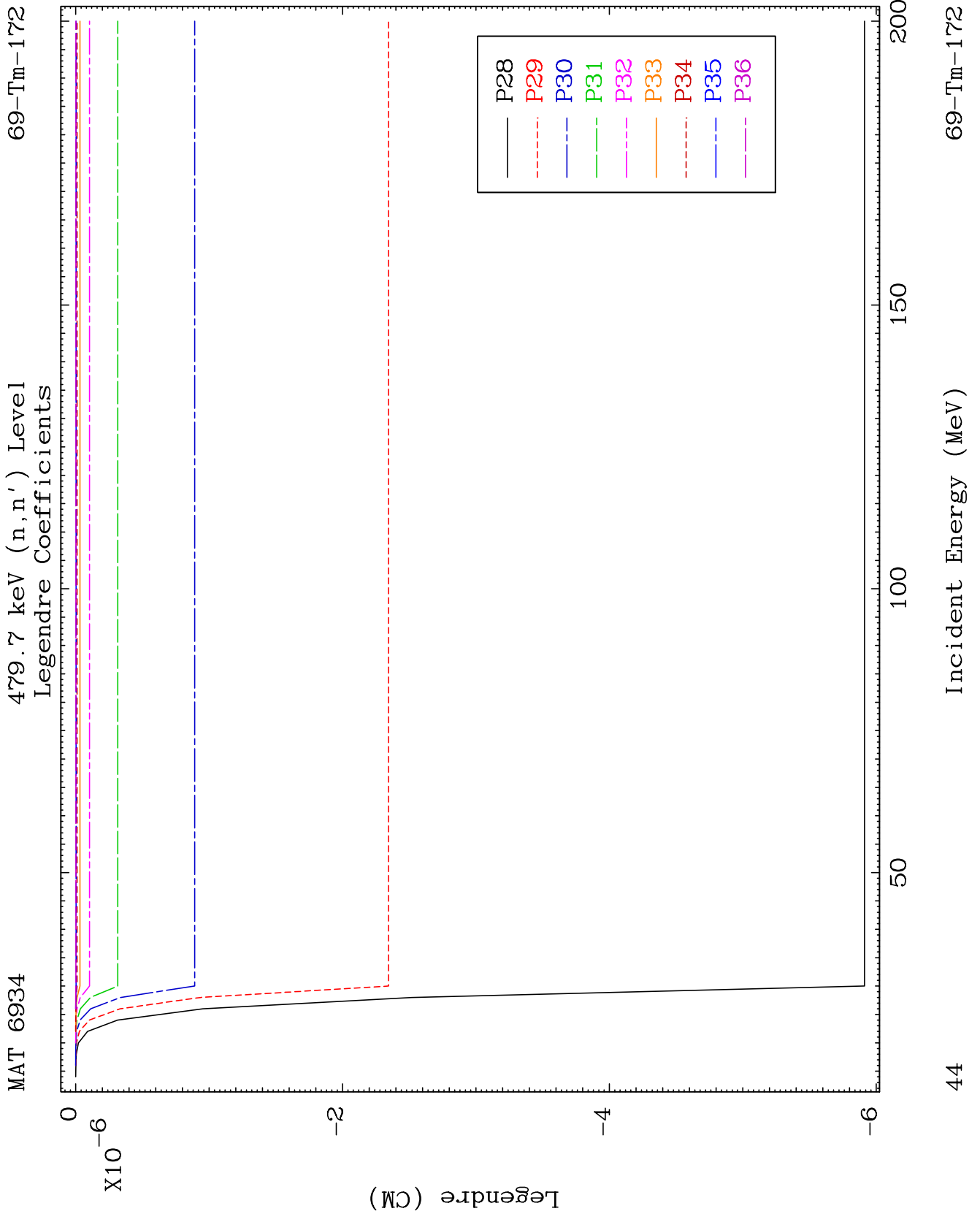

MAT 6934

496.3 keV (n,n') Level
Legendre Coefficients

69-Tm-172

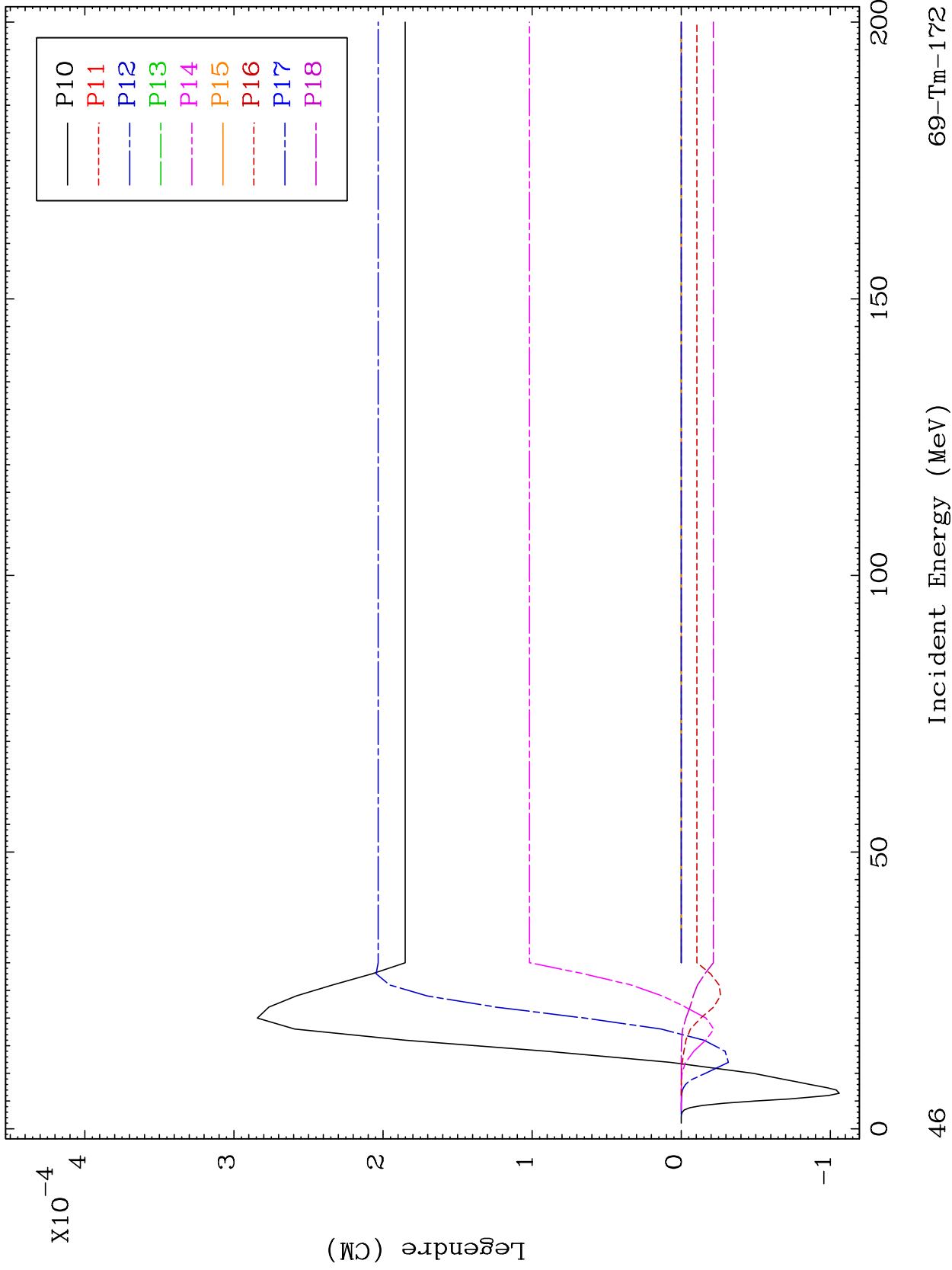

46

Incident Energy (MeV)

69-Tm-172

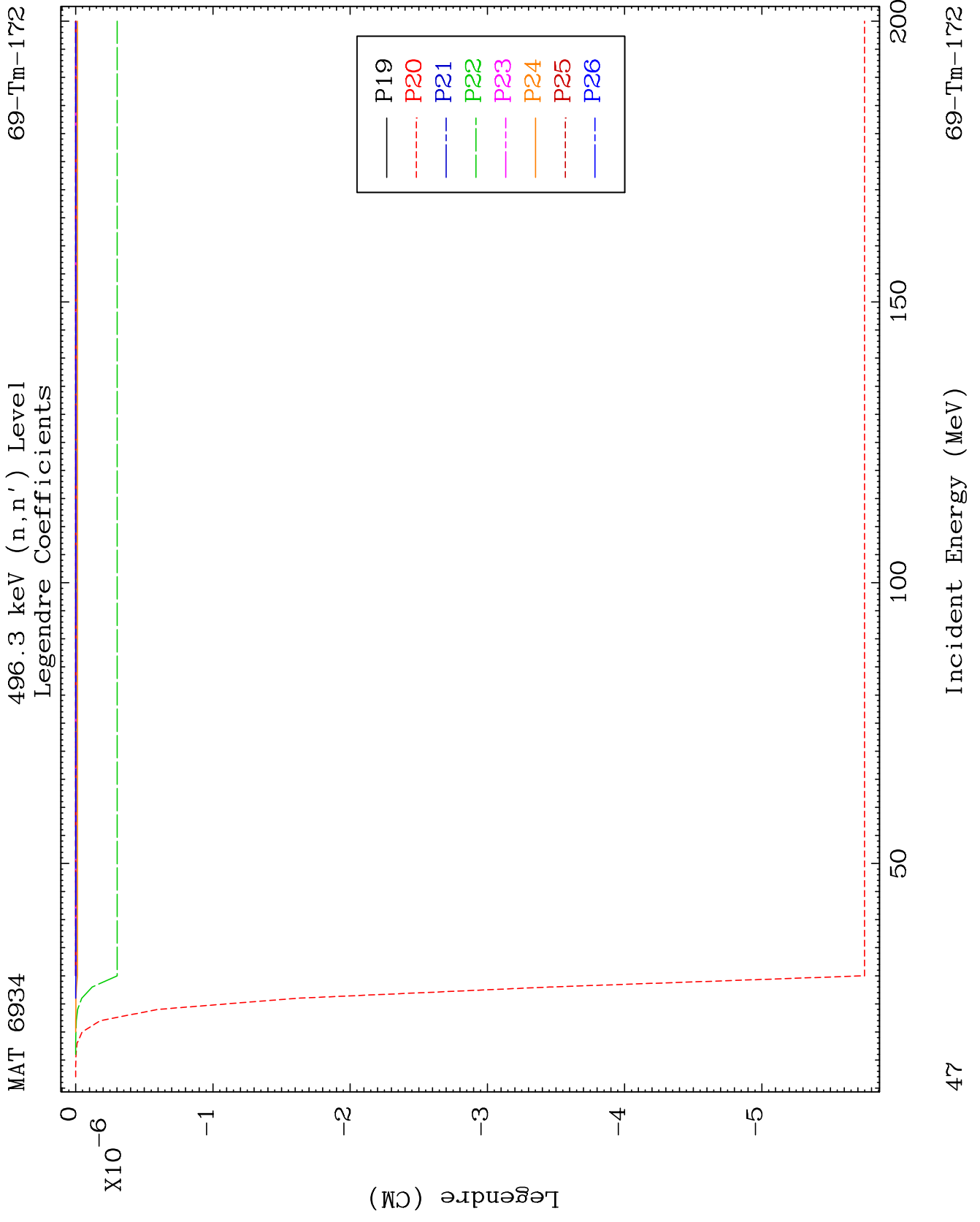

MAT 6934

526.2 keV (n,n') Level
Legendre Coefficients

69-Tm-172

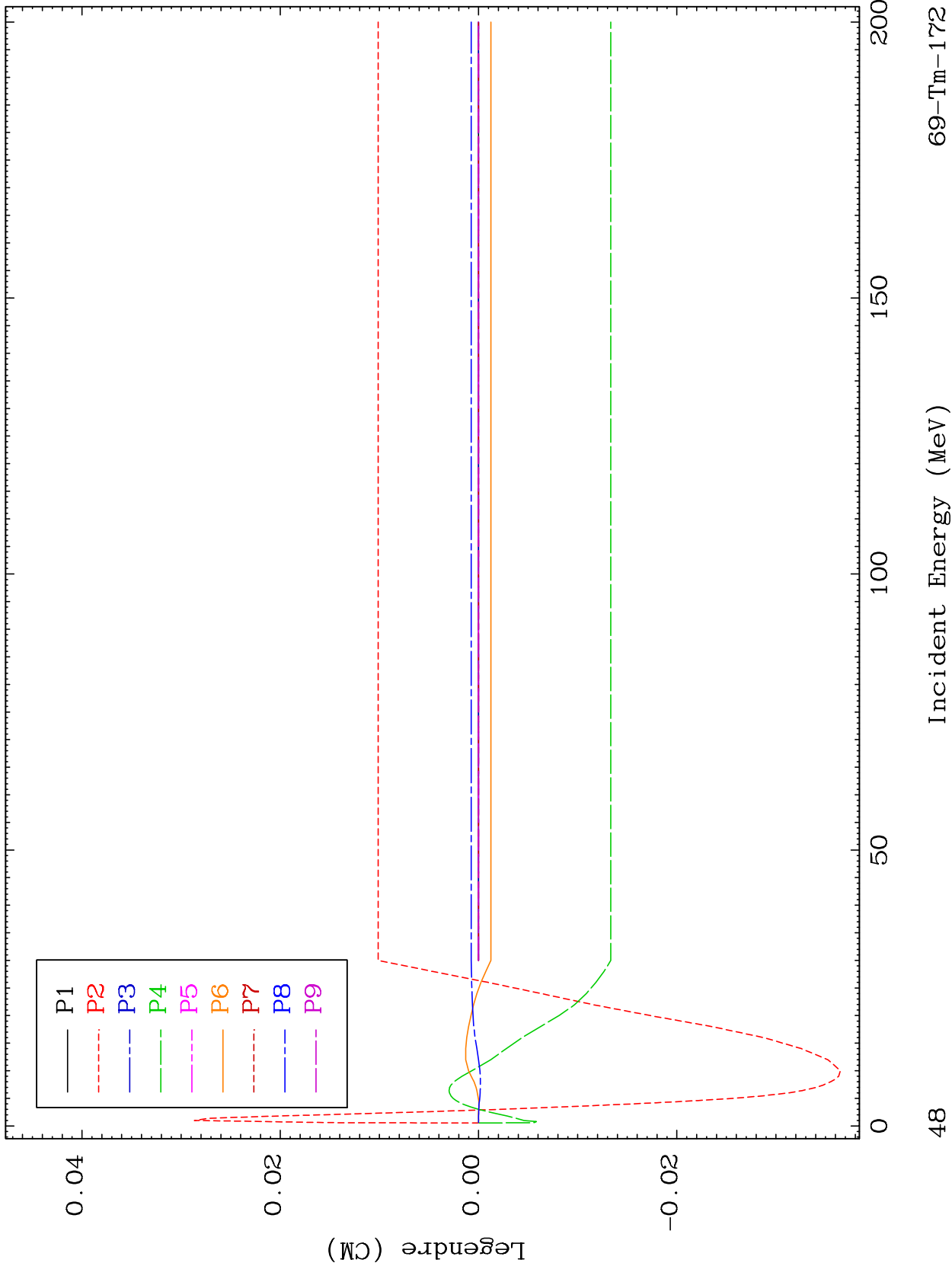

69-Tm-172

Incident Energy (MeV)

48

MAT 6934

526.2 keV (n,n') Level
Legendre Coefficients

69-Tm-172

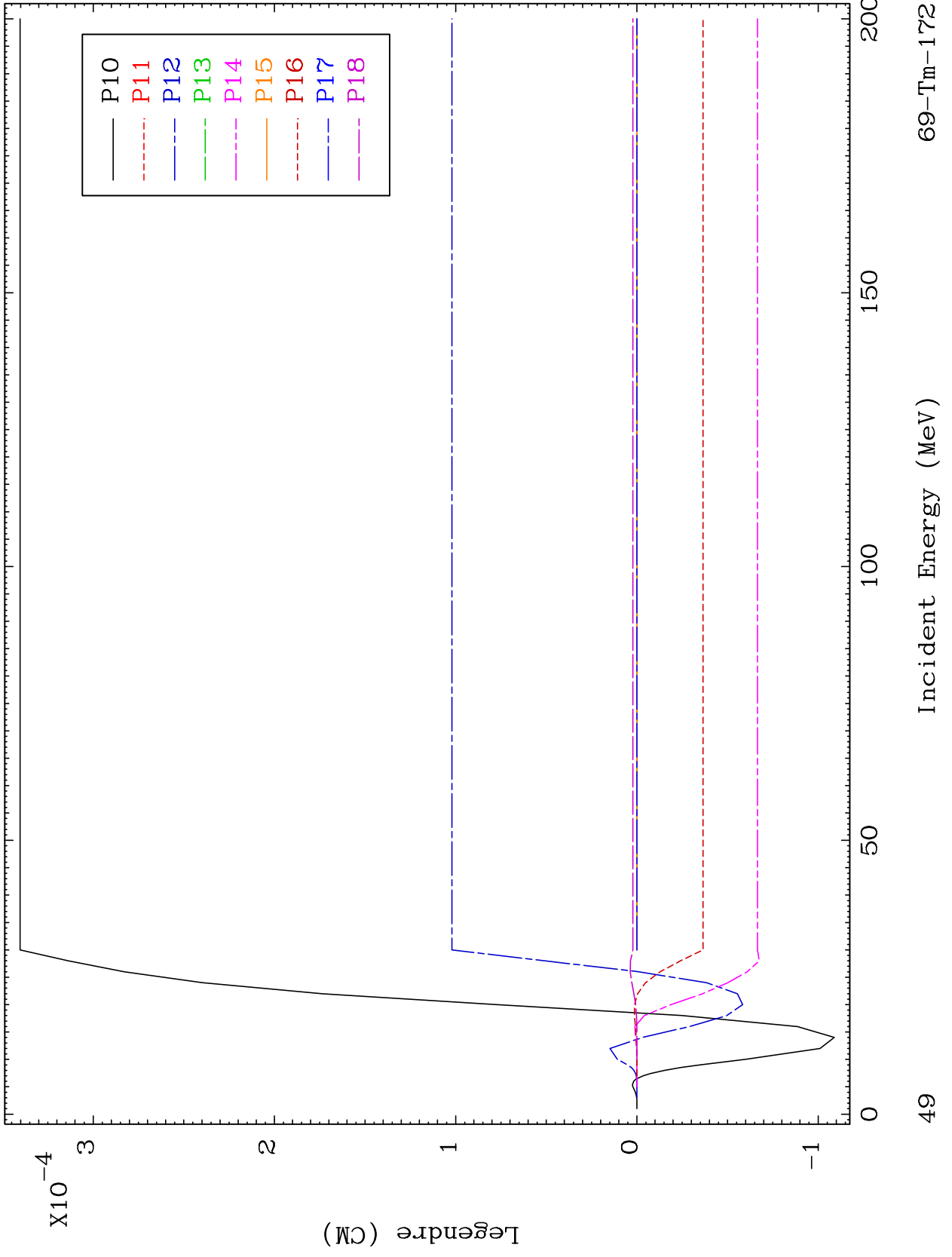

69-Tm-172

Incident Energy (MeV)

49

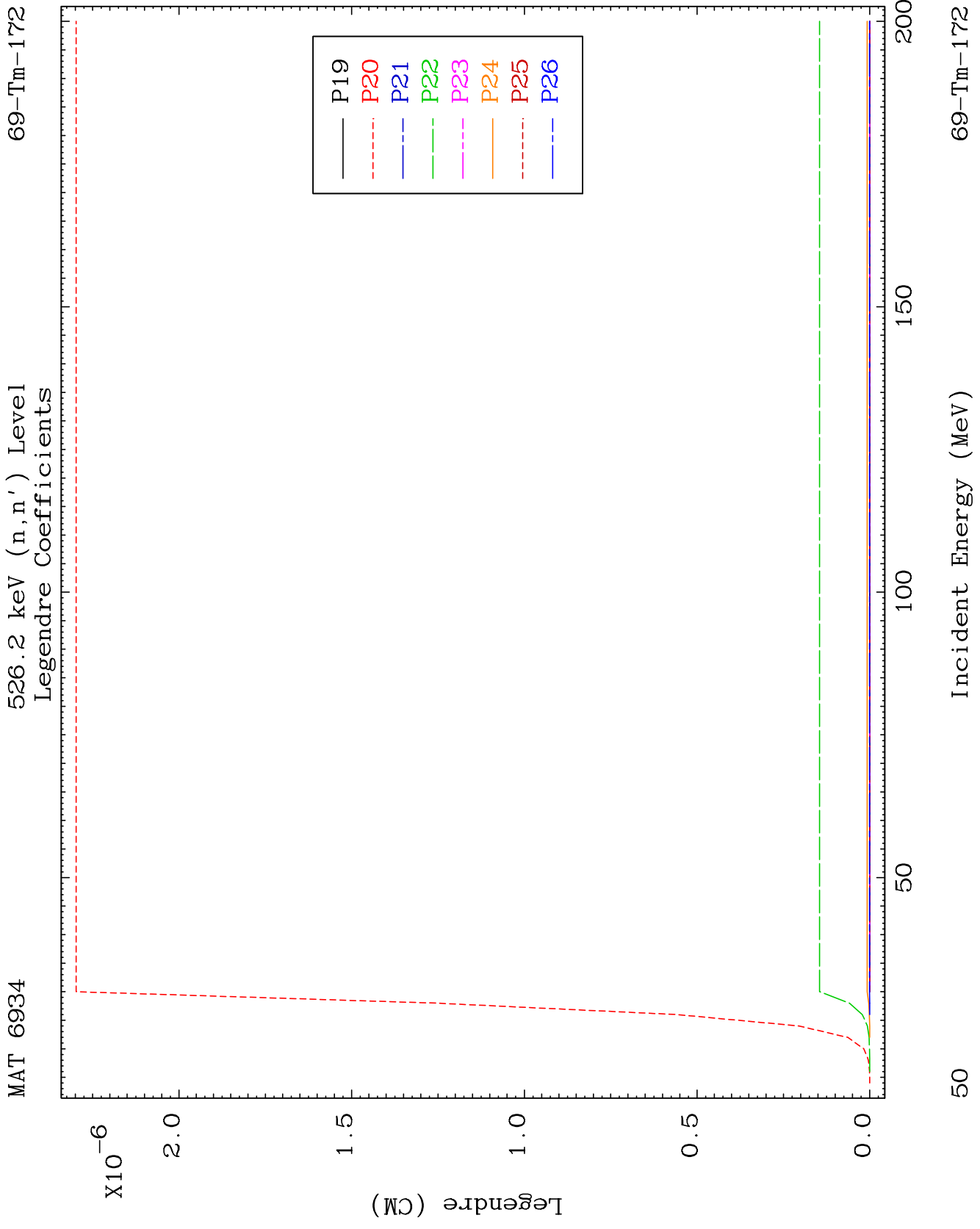

MAT 6934

535.1 keV (n,n') Level
Legendre Coefficients

69-Tm-172

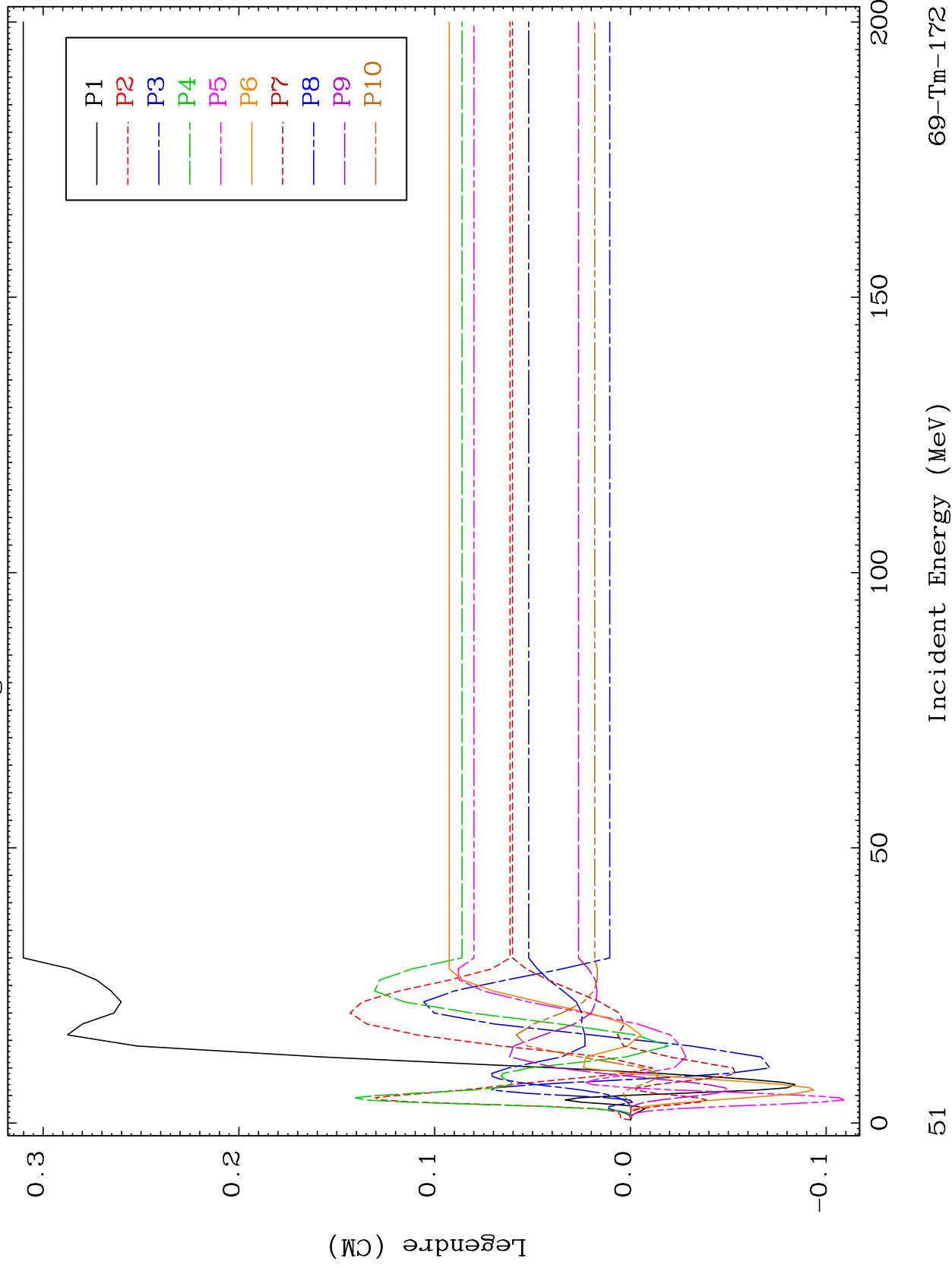

69-Tm-172

Incident Energy (MeV)

51

MAT 6934

535.1 keV (n,n') Level
Legendre Coefficients

69-Tm-172

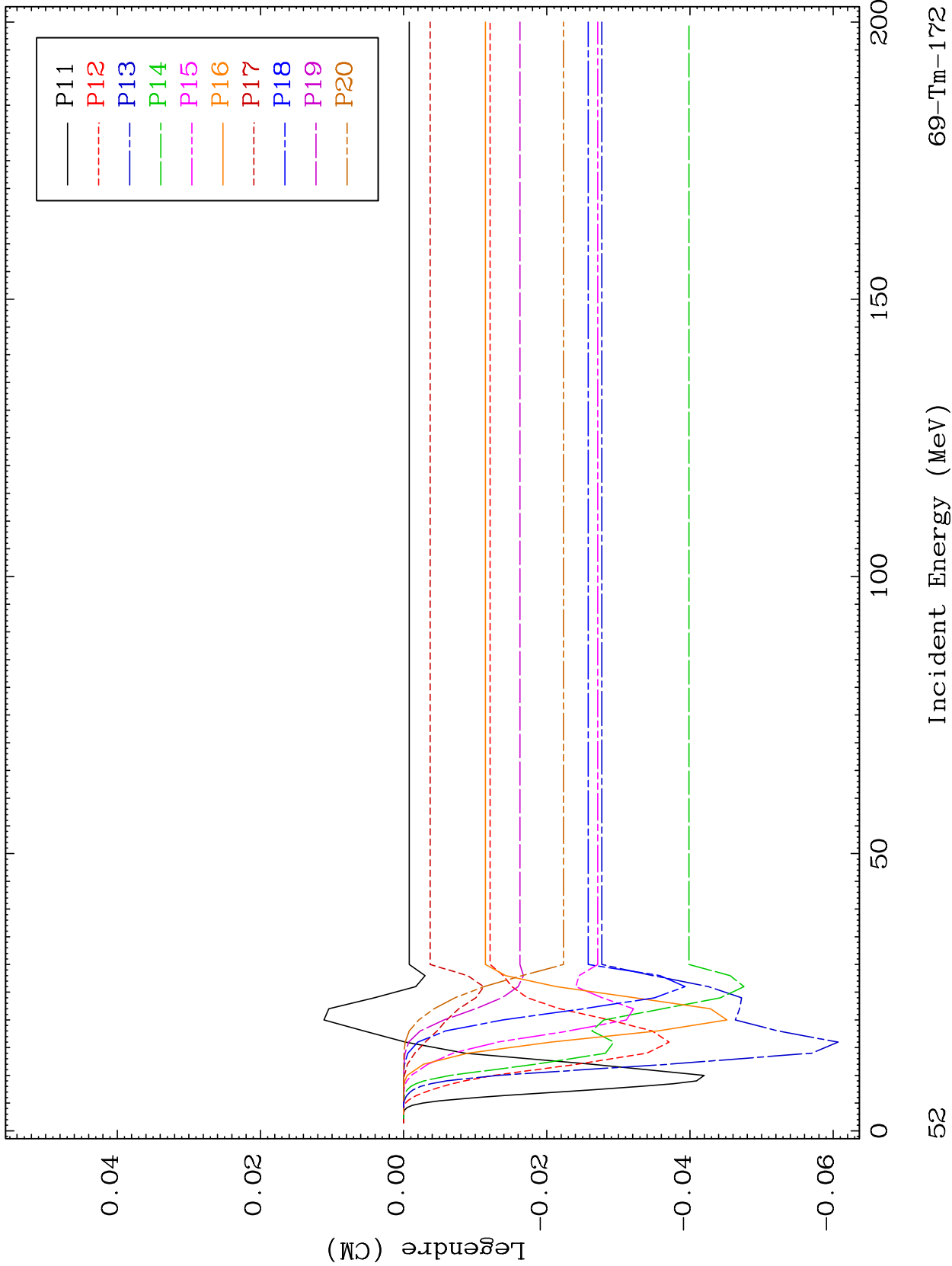

69-Tm-172

Incident Energy (MeV)

52

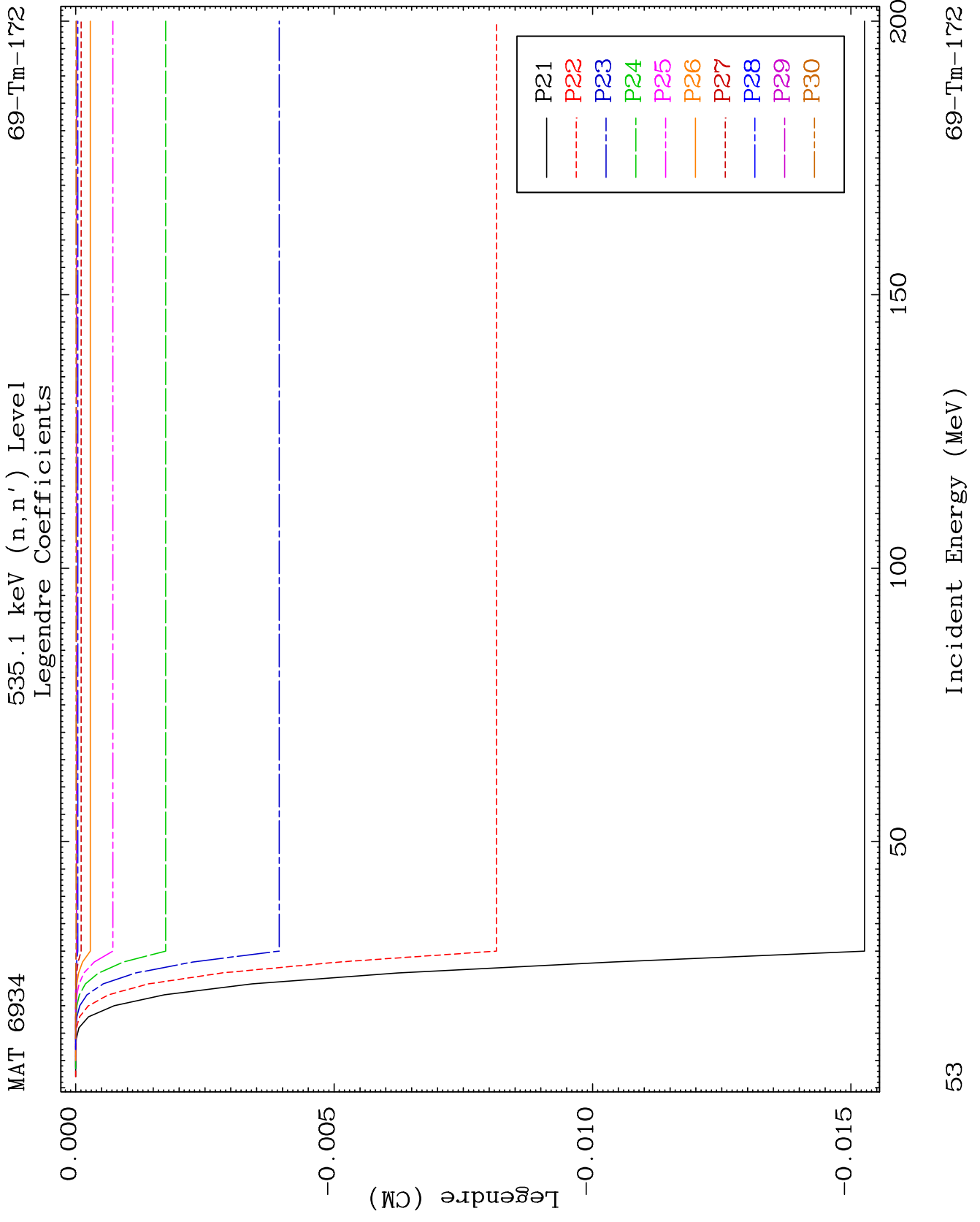

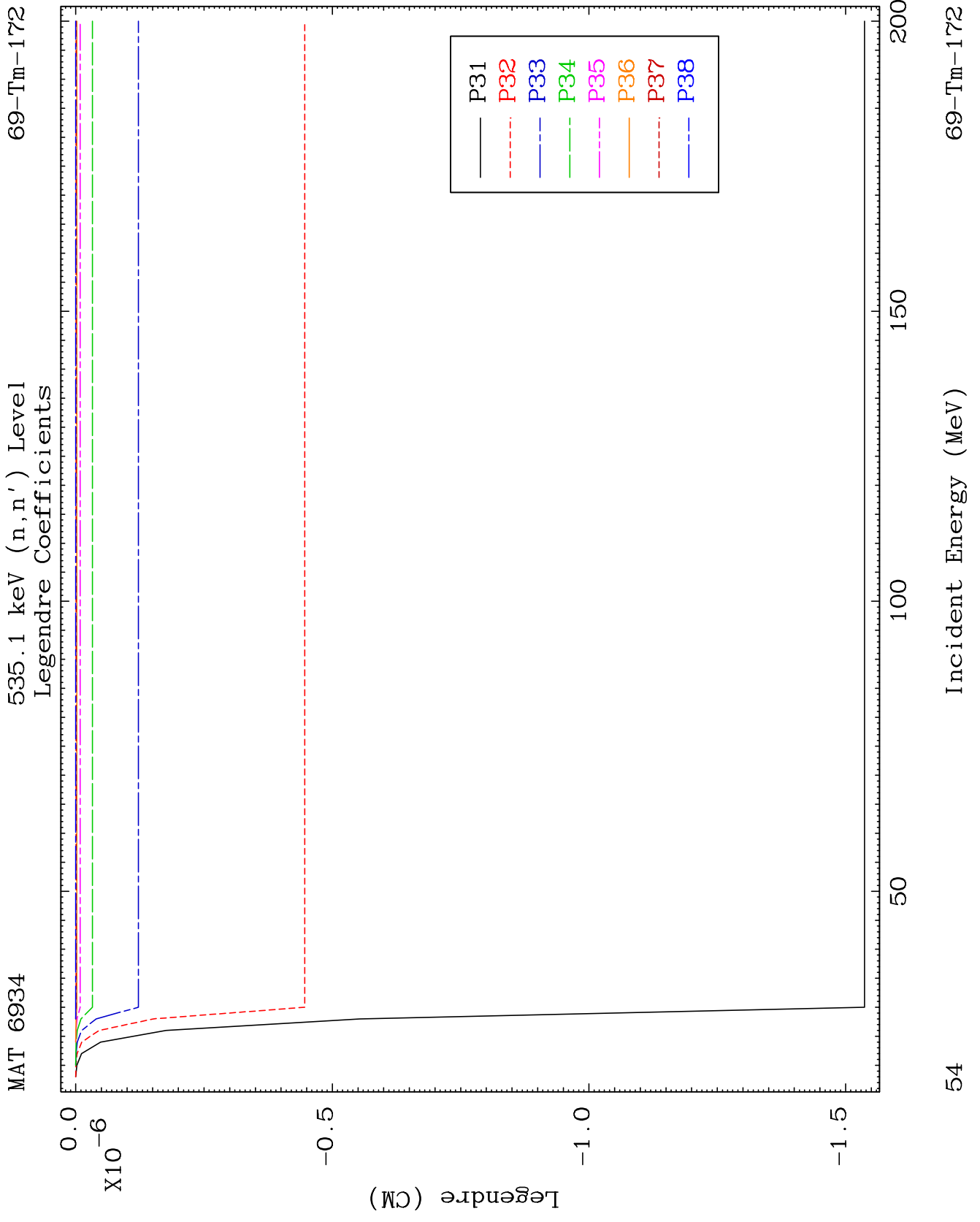

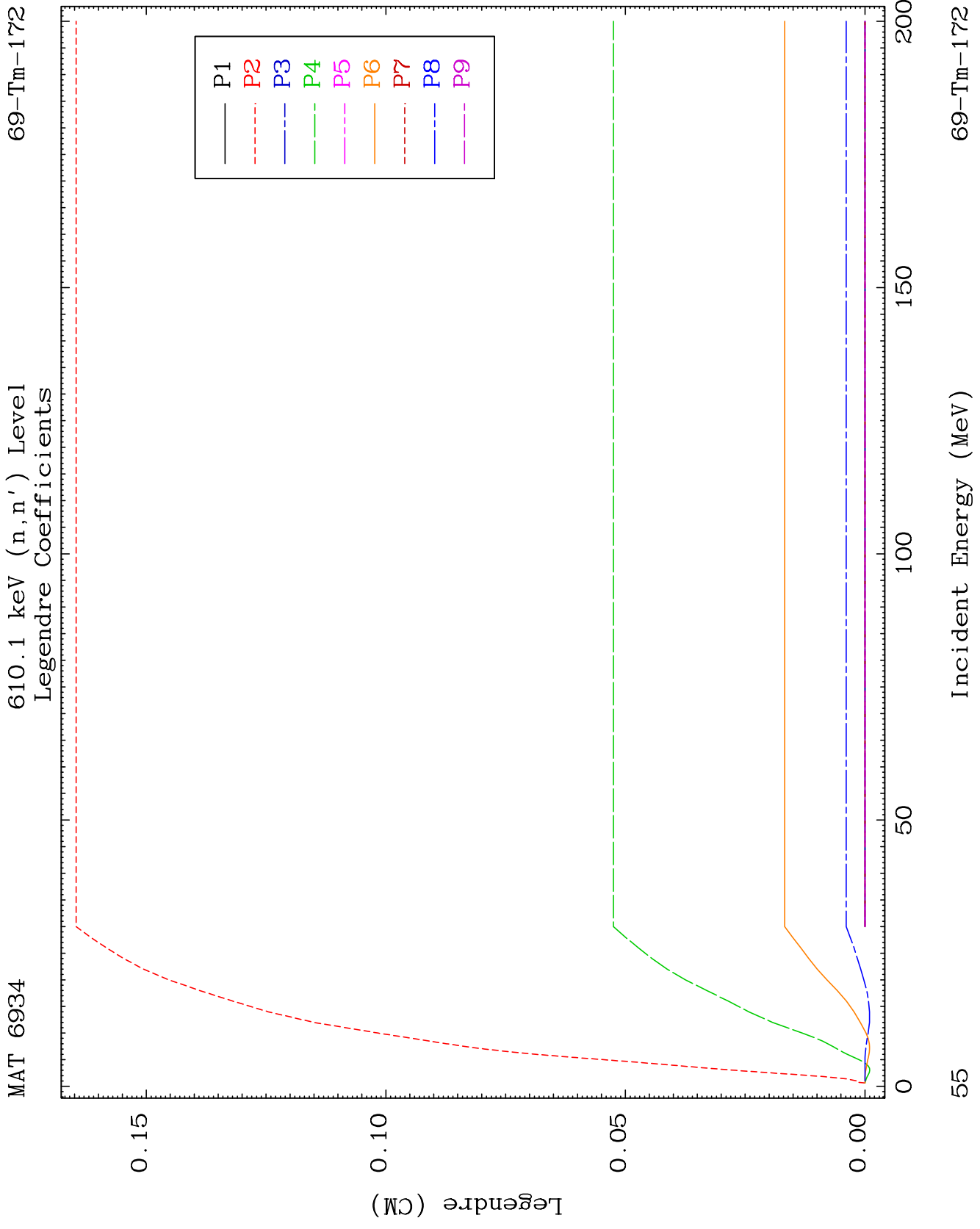

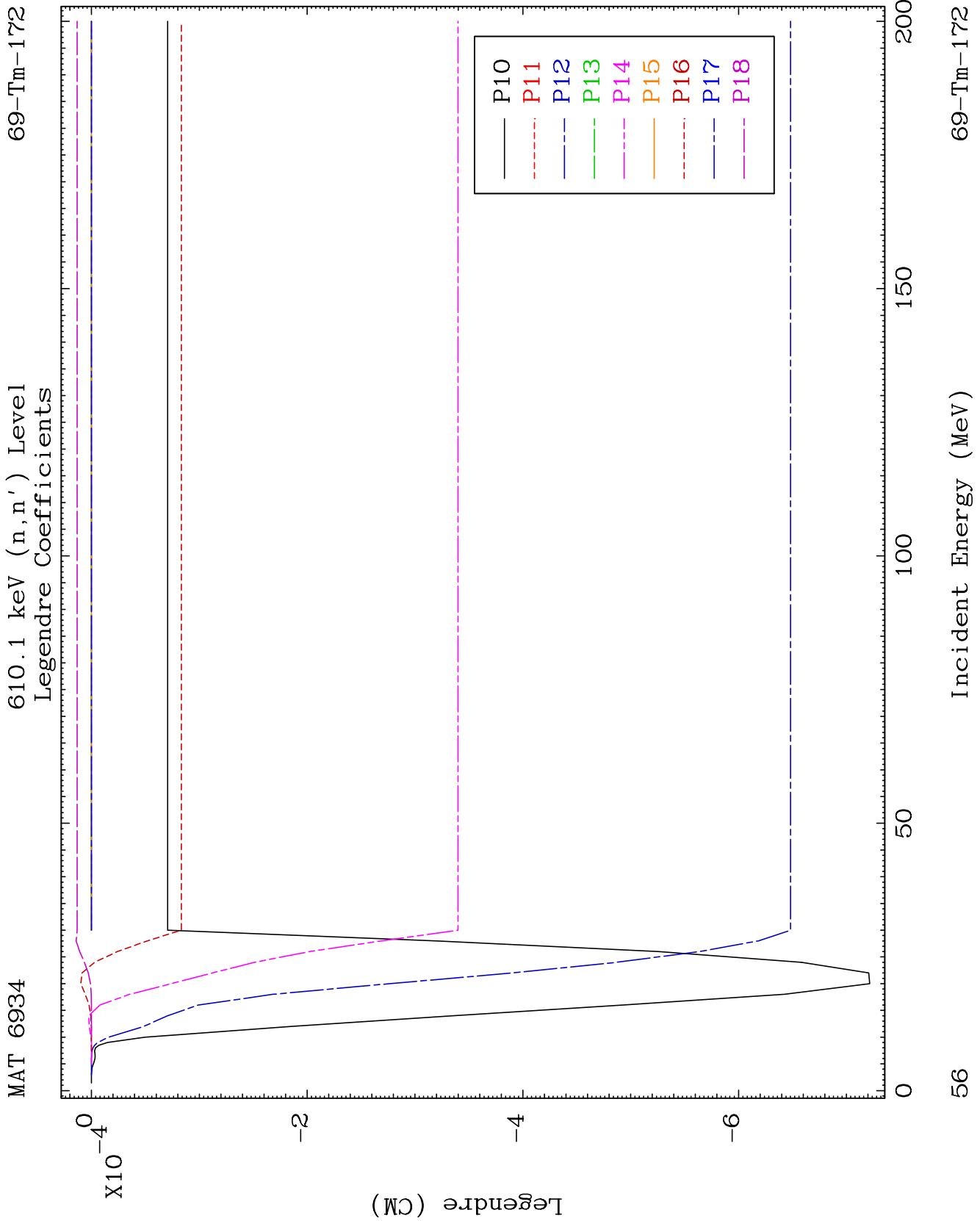

MAT 6934

714.5 keV (n,n') Level
Legendre Coefficients

69-Tm-172

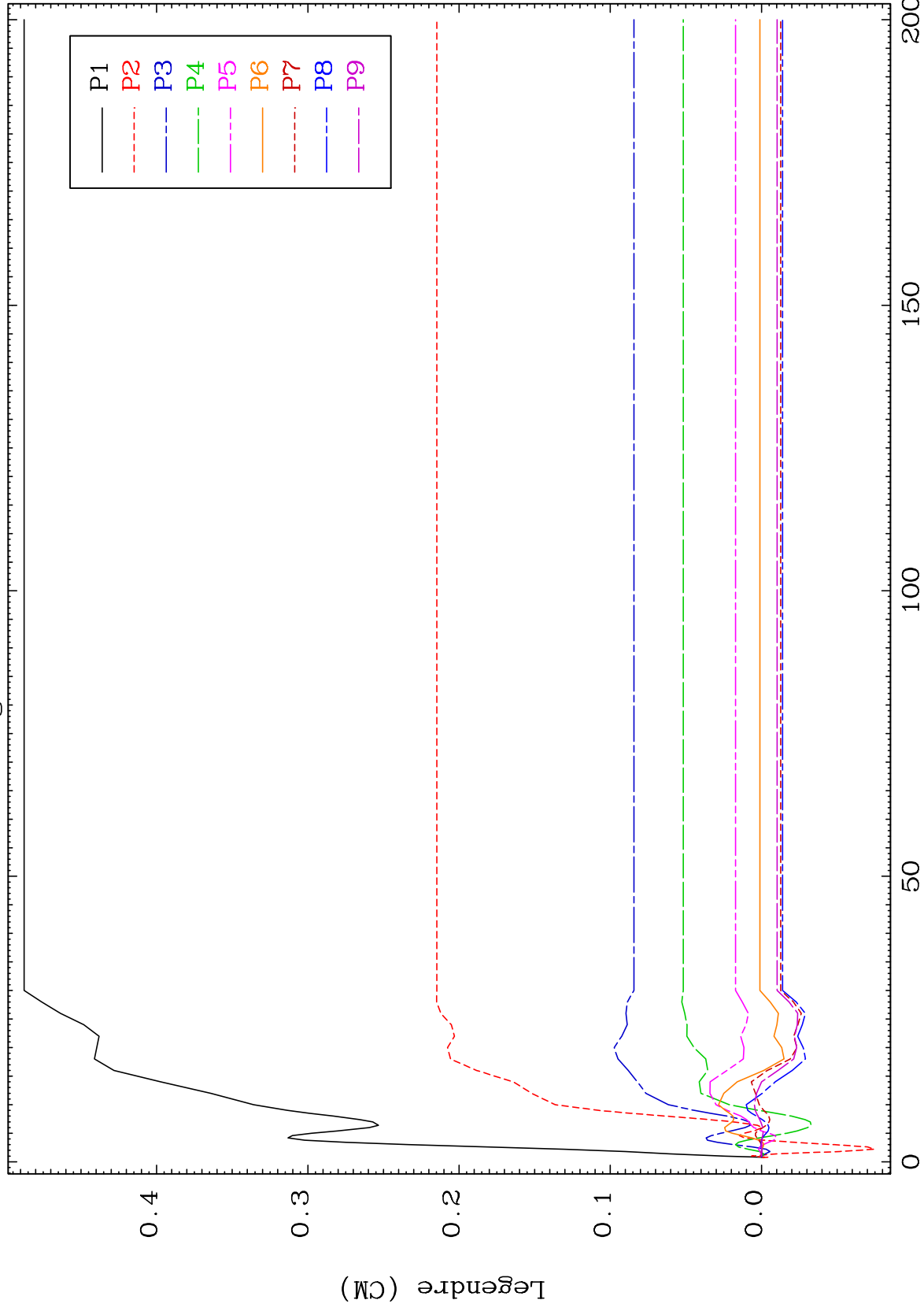

58

Incident Energy (MeV)

69-Tm-172

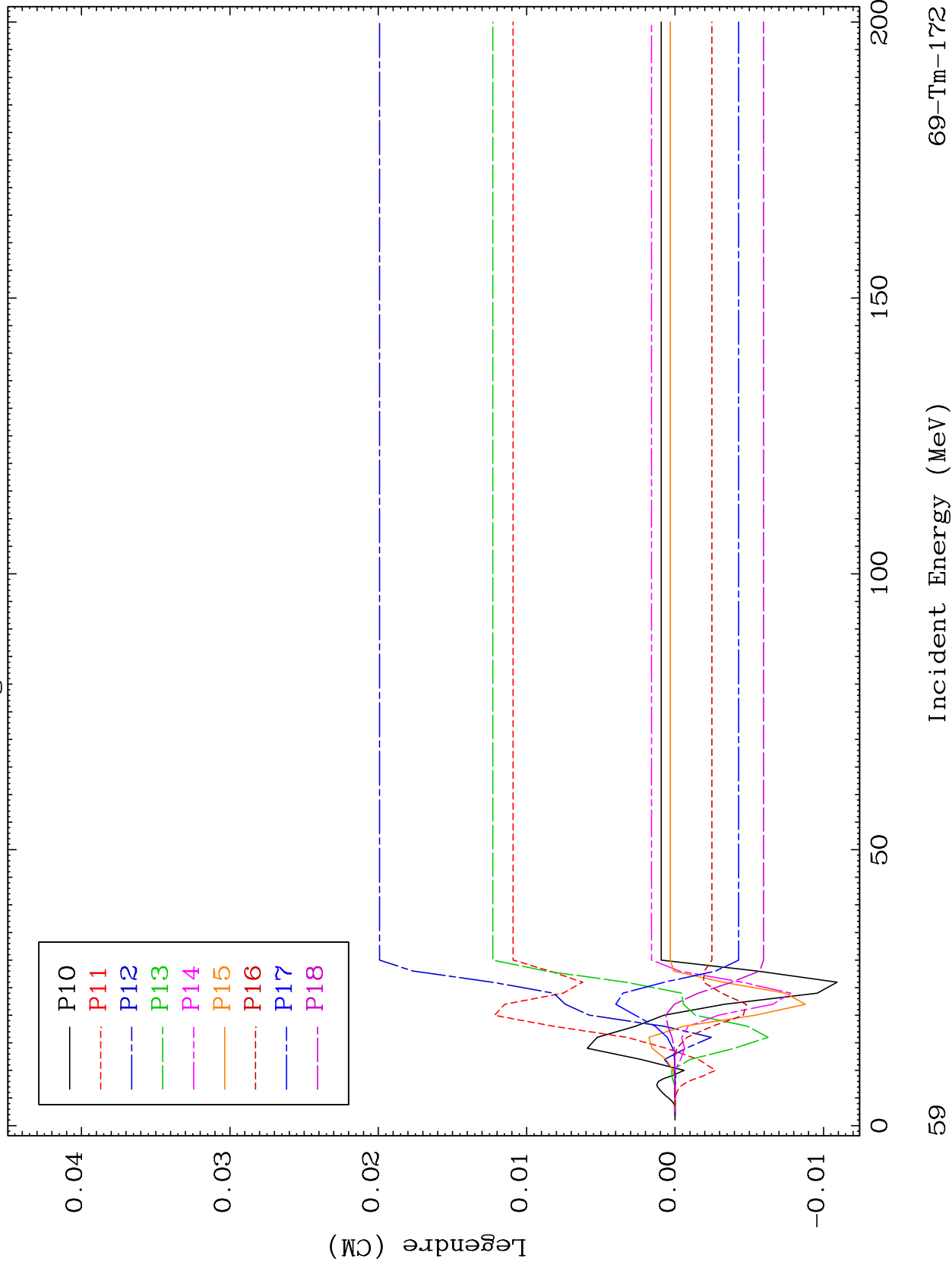

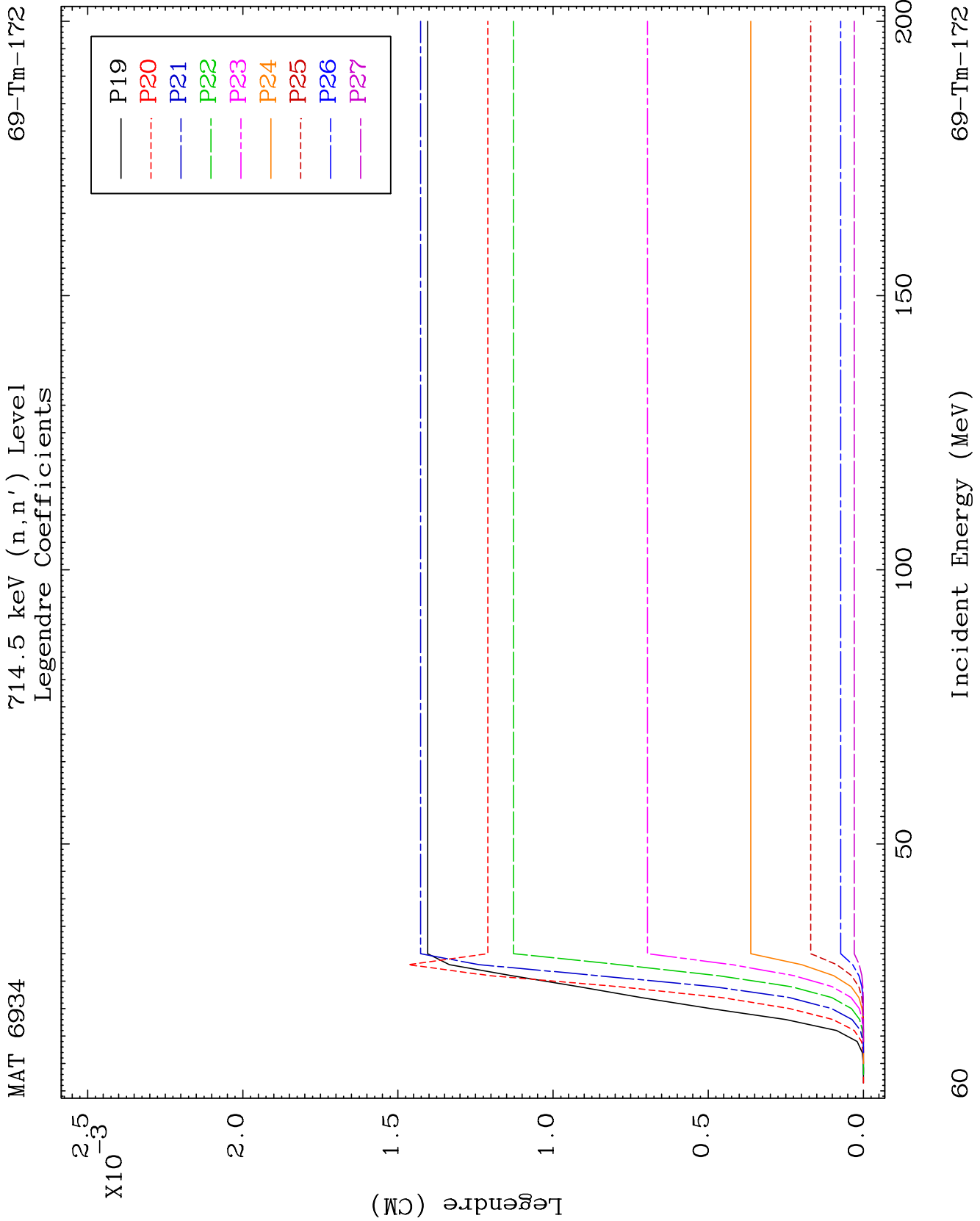

MAT 6934

714.5 keV (n, n') Level
Legendre Coefficients

69-Tm-172

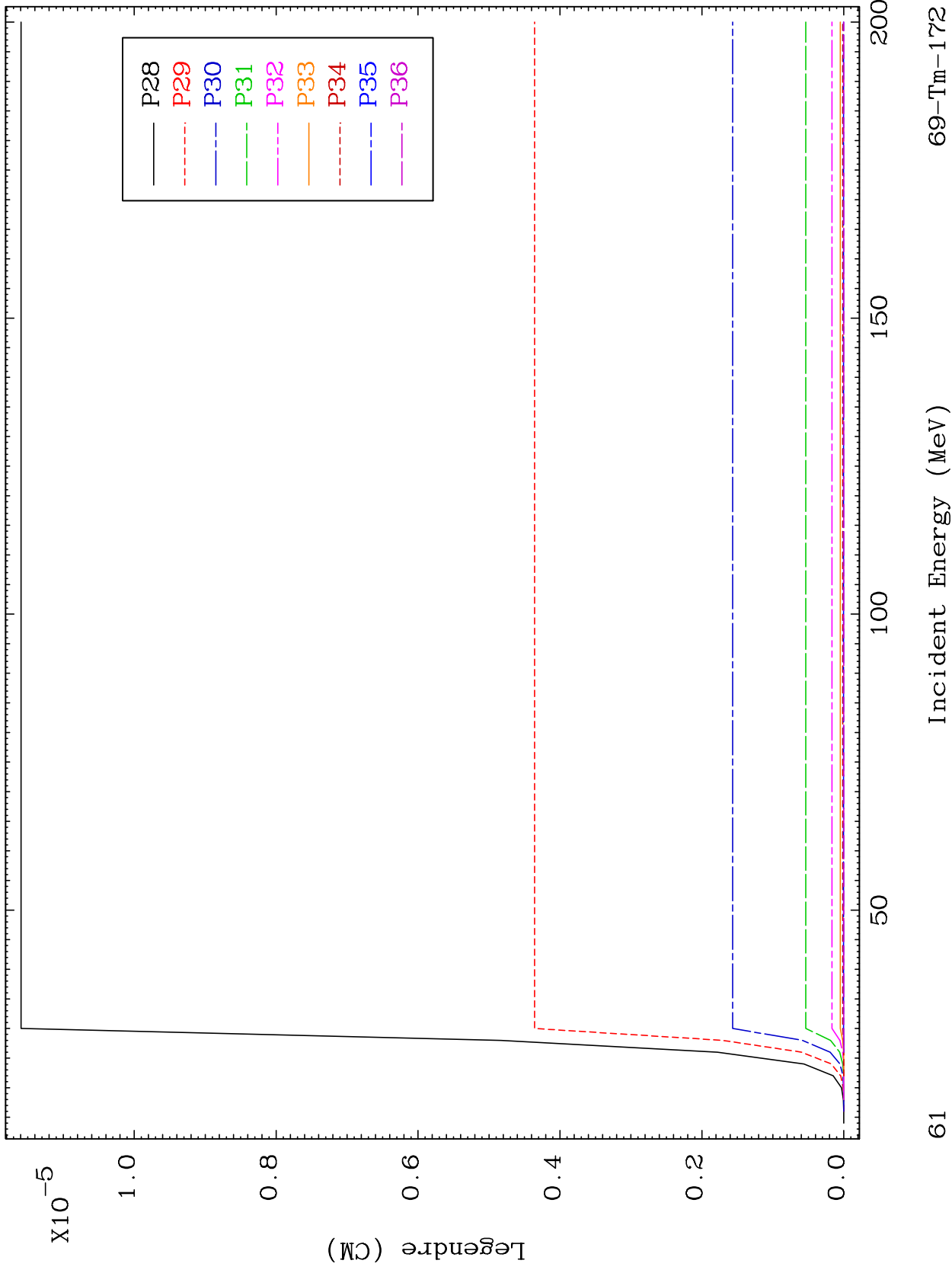

MAT 6934

797.4 keV (n,n') Level
Legendre Coefficients

69-Tm-172

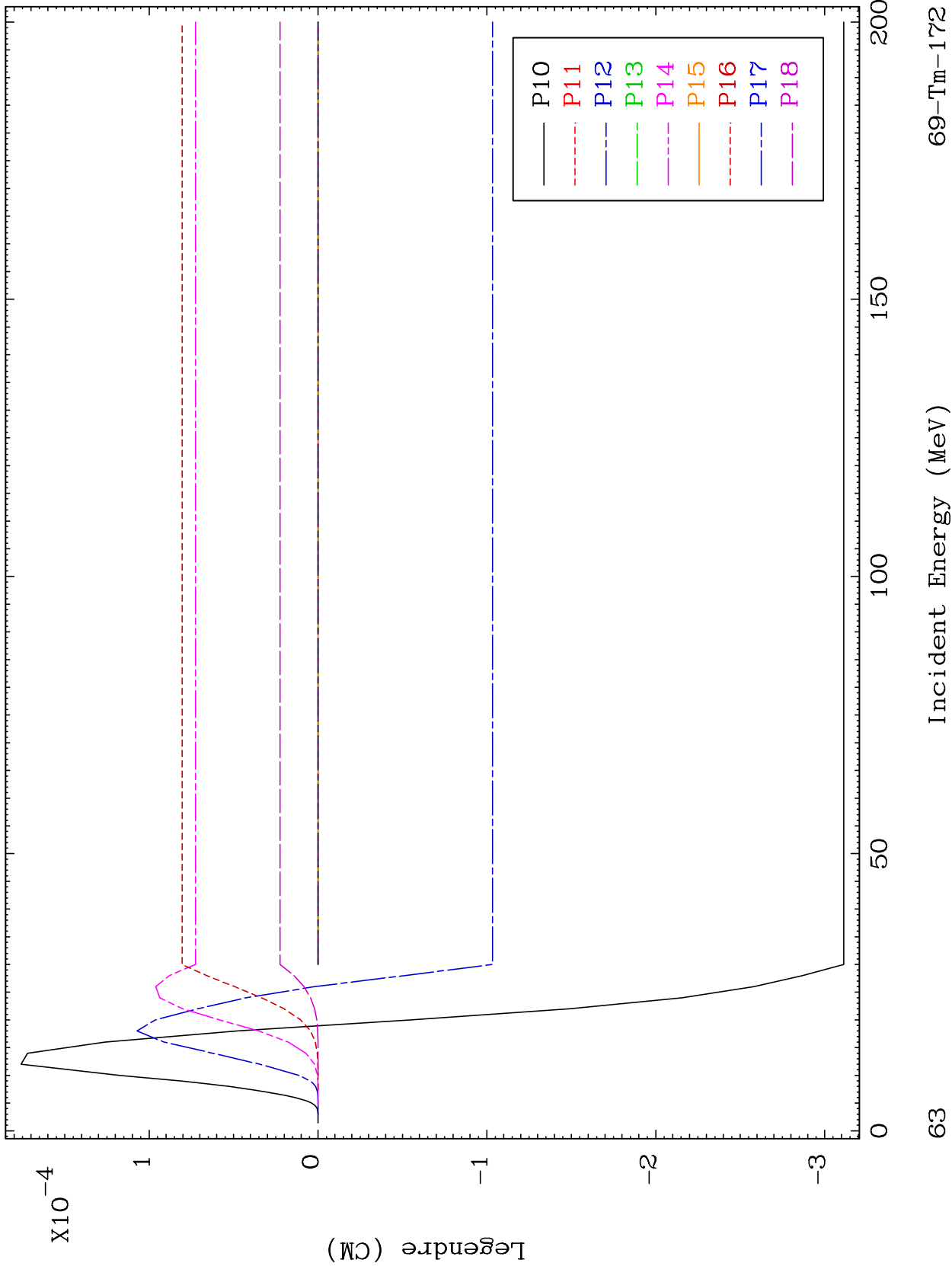

63

Incident Energy (MeV)

69-Tm-172

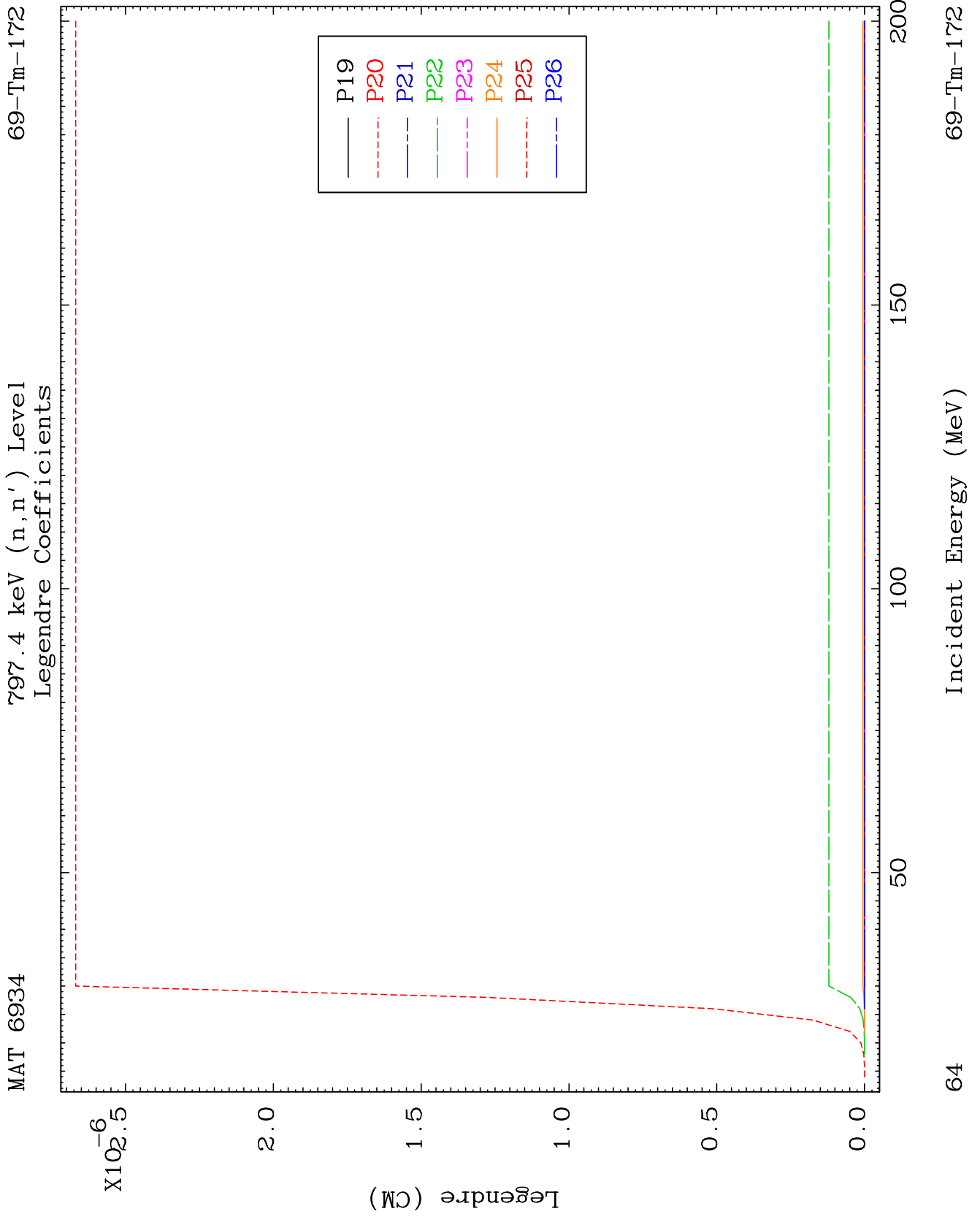

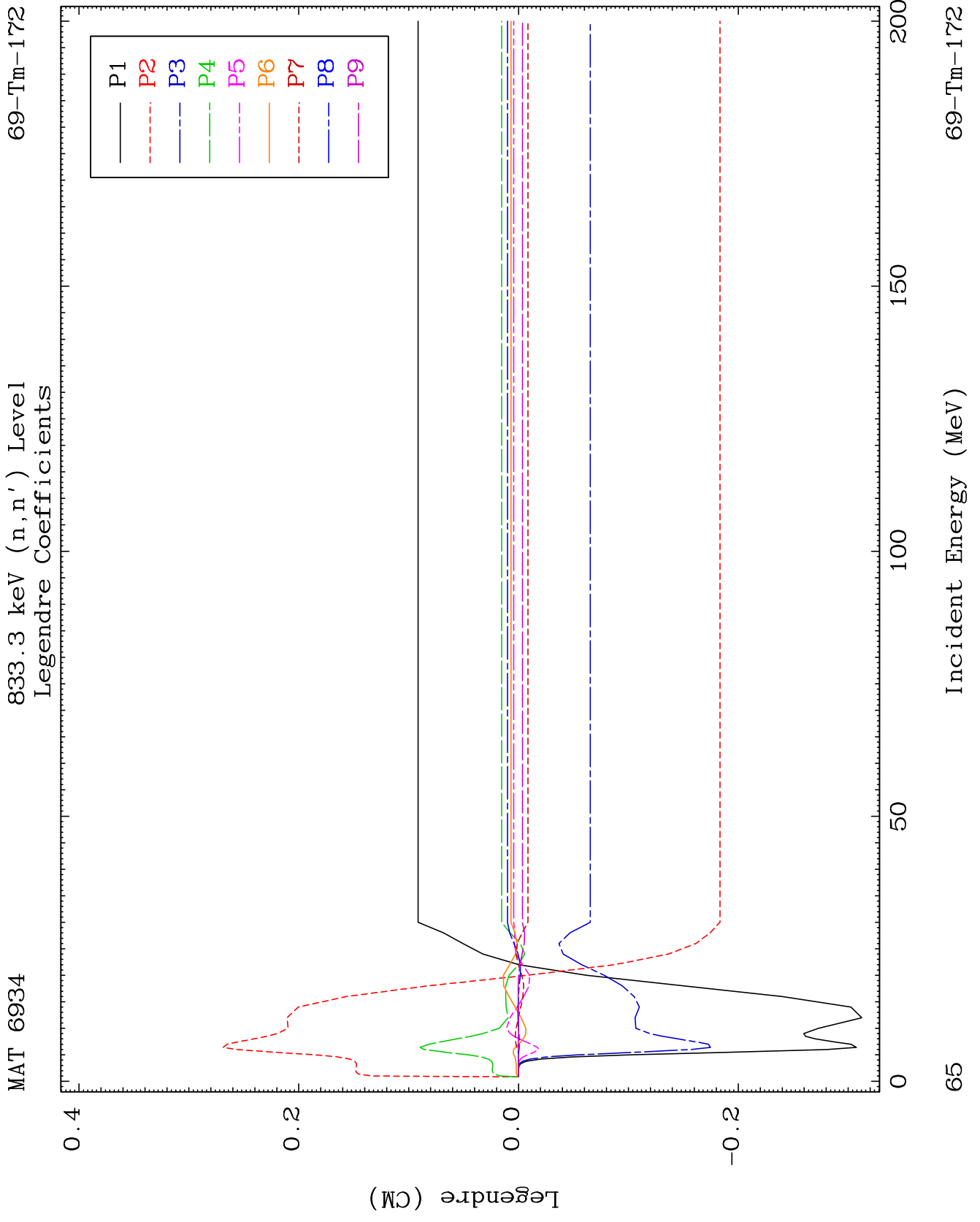

MAT 6934

833.3 keV (n,n') Level
Legendre Coefficients

69-Tm-172

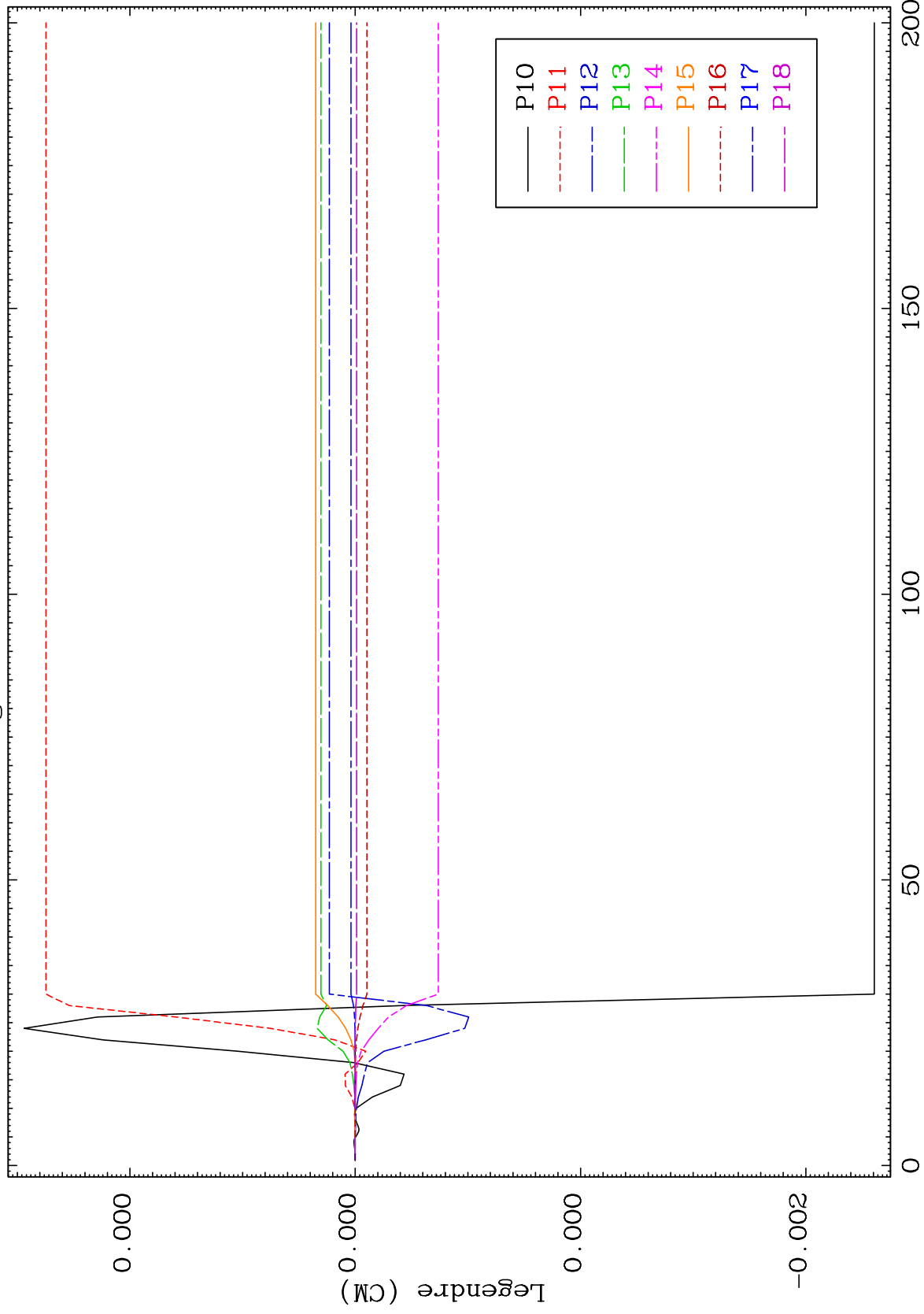

66

Incident Energy (MeV)

69-Tm-172

MAT 6934

833.3 keV (n,n') Level
Legendre Coefficients

69-Tm-172

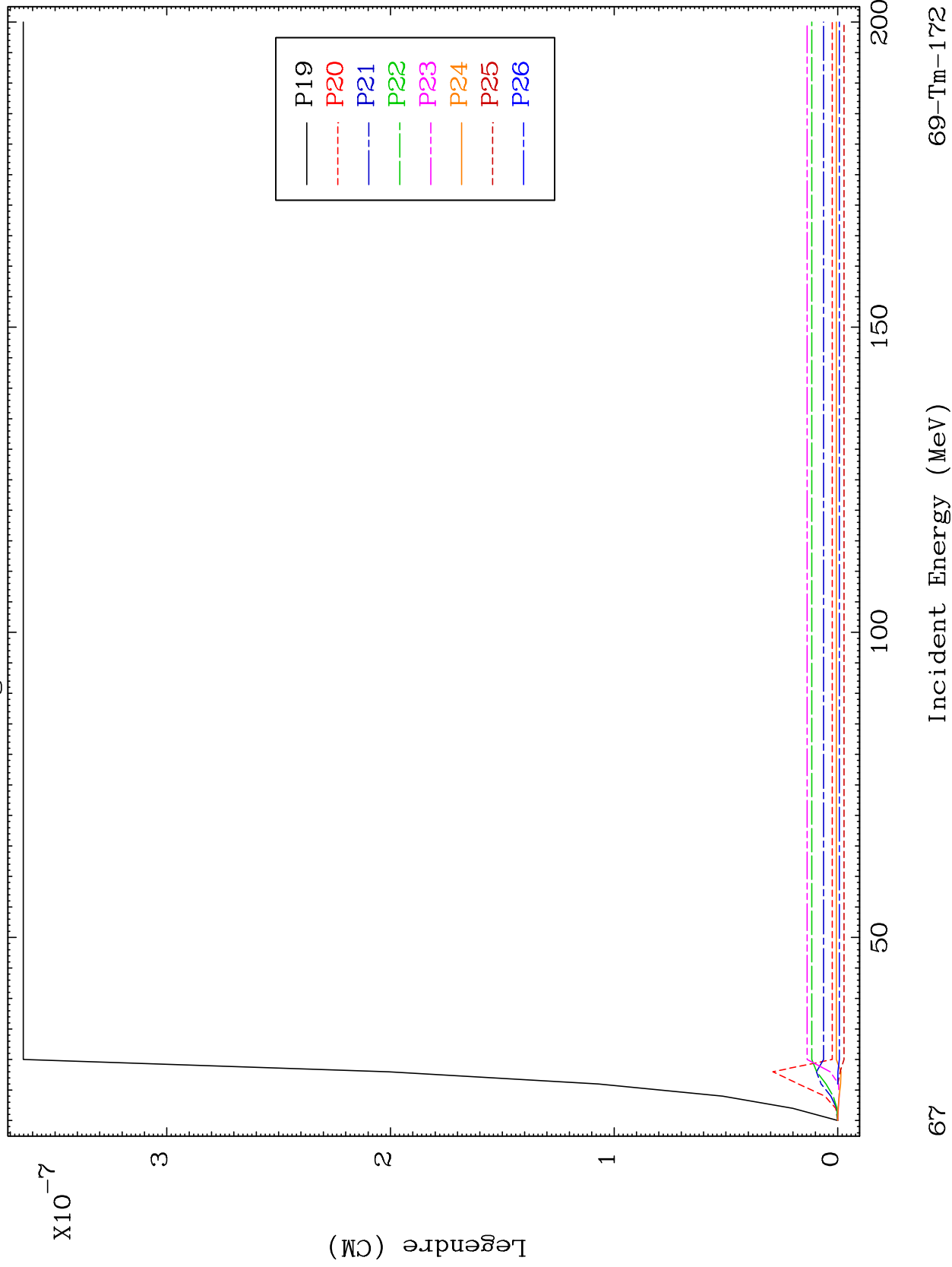

67

Incident Energy (MeV)

69-Tm-172

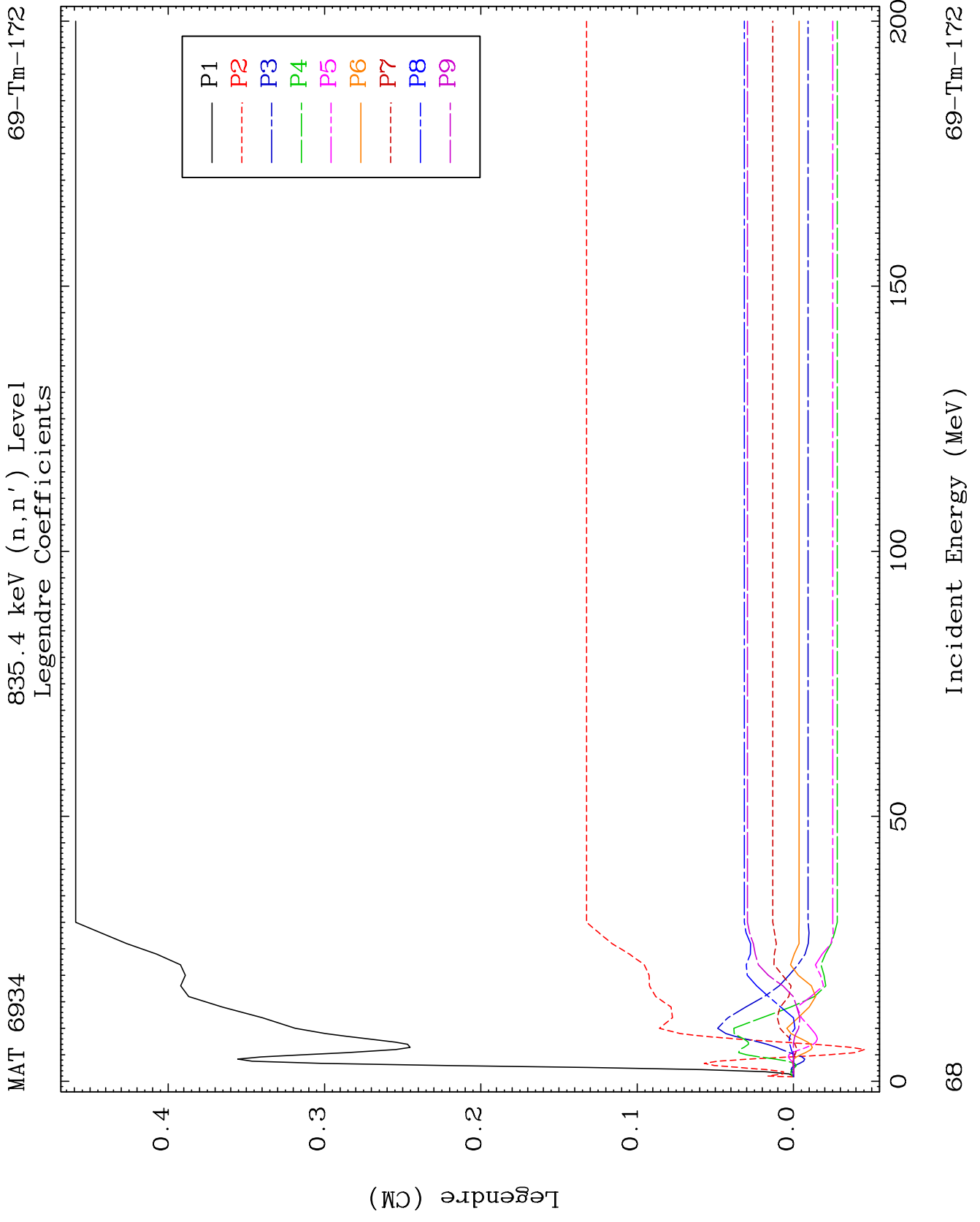

MAT 6934

835.4 keV (n,n') Level
Legendre Coefficients

69-Tm-172

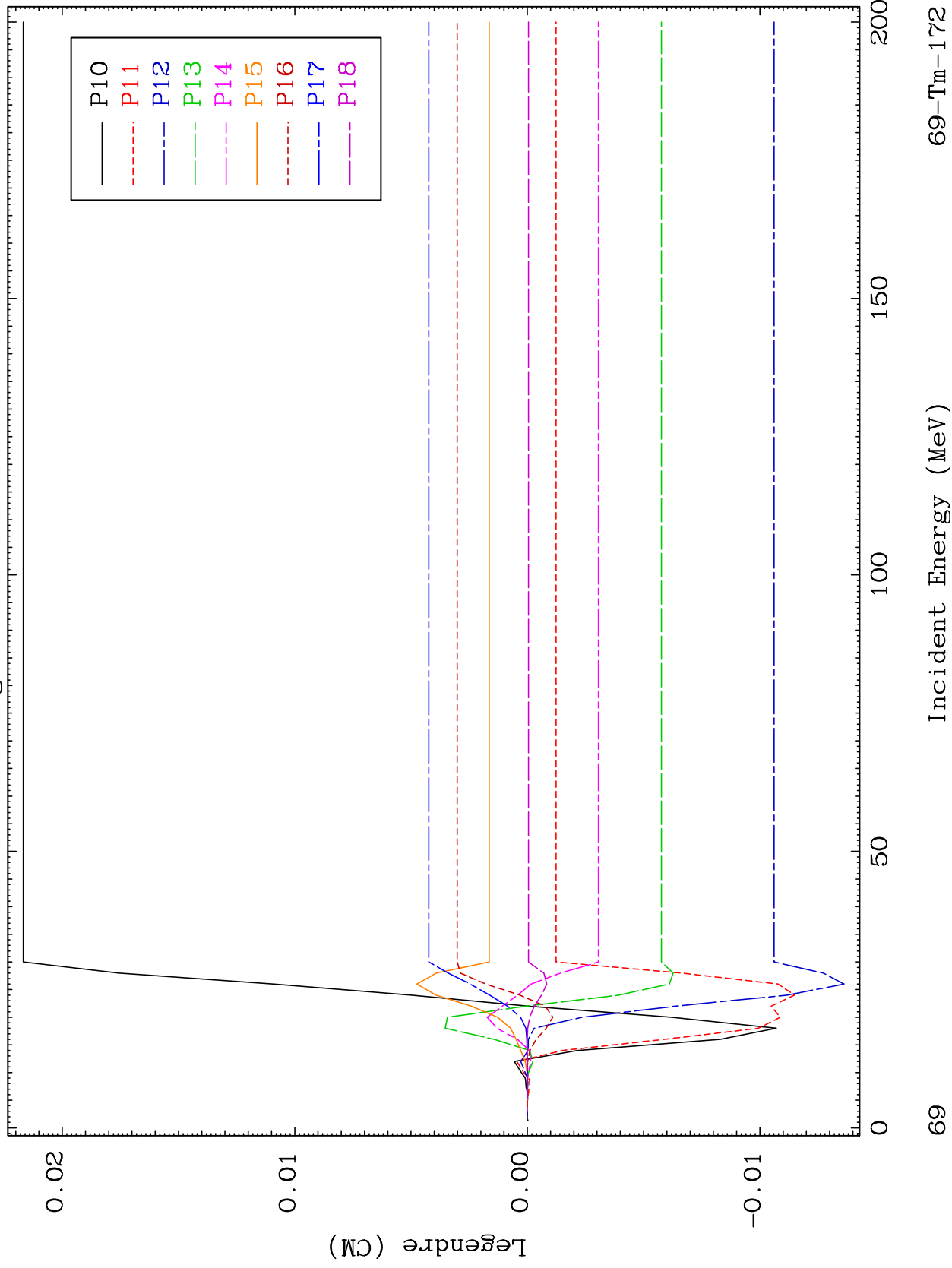

69-Tm-172

Incident Energy (MeV)

69

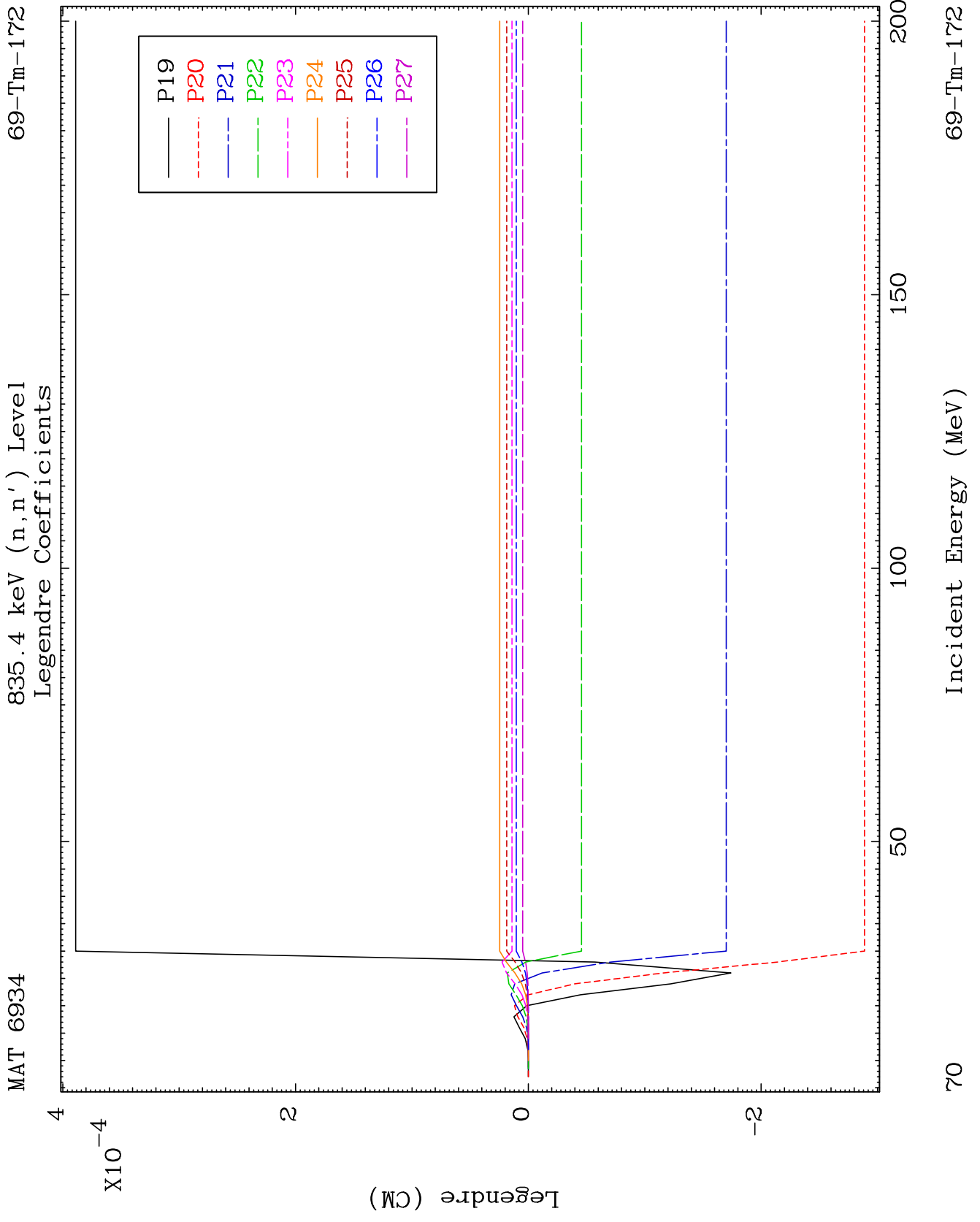

MAT 6934

835.4 keV (n,n') Level
Legendre Coefficients

69-Tm-172

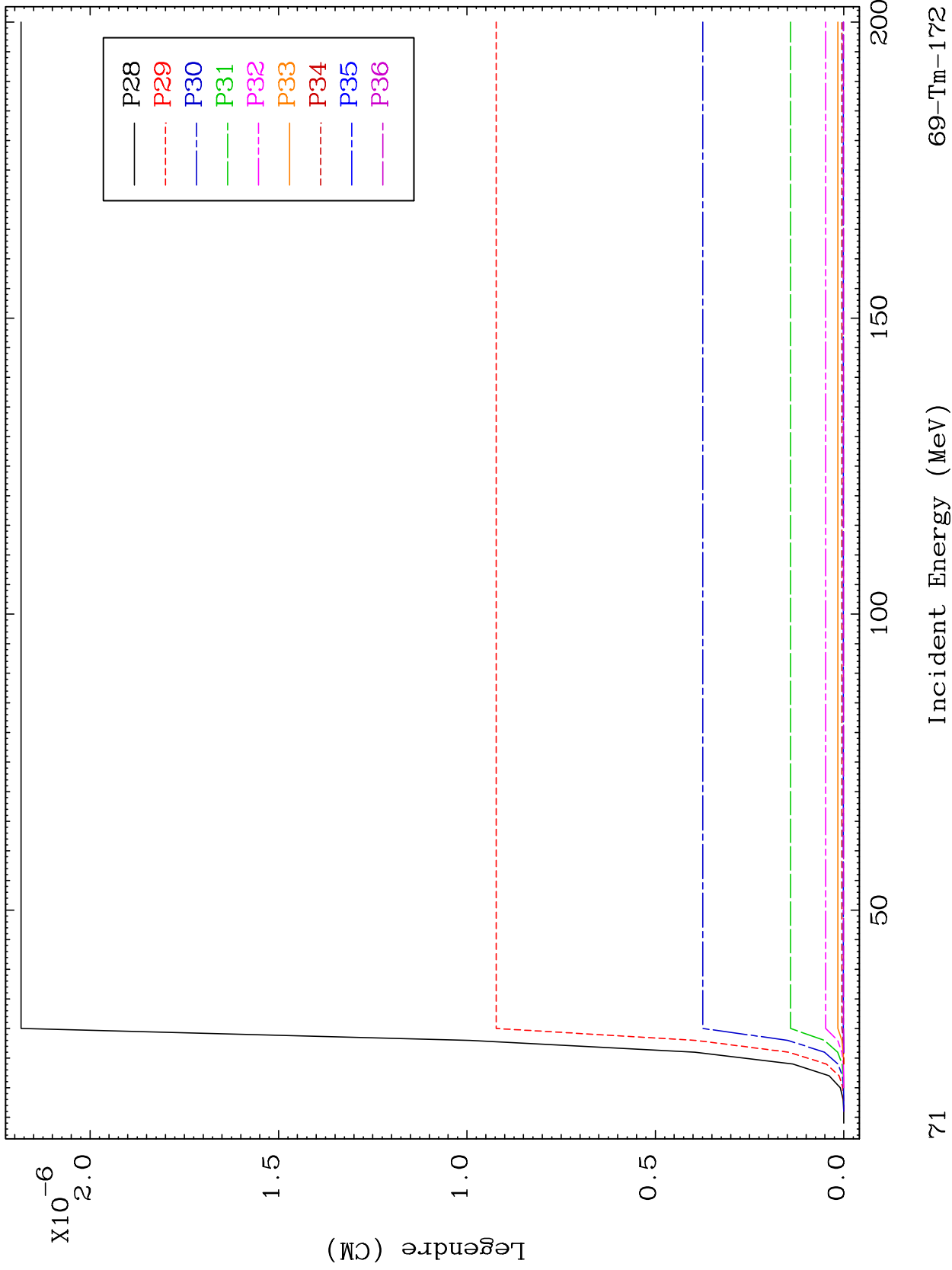

MAT 6934

836.4 keV (n,n') Level
Legendre Coefficients

69-Tm-172

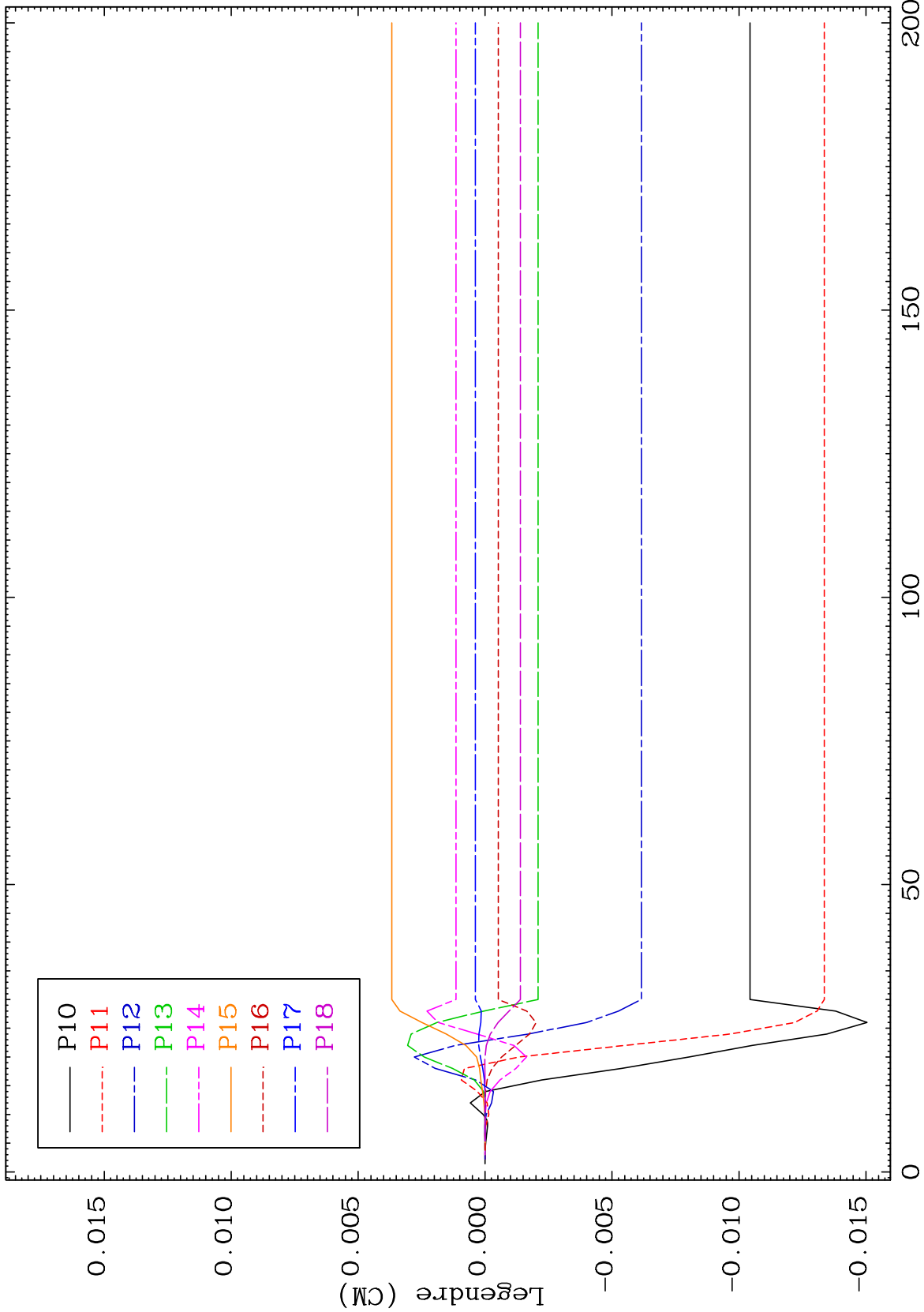

73

Incident Energy (MeV)

69-Tm-172

MAT 6934

836.4 keV (n,n') Level
Legendre Coefficients

69-Tm-172

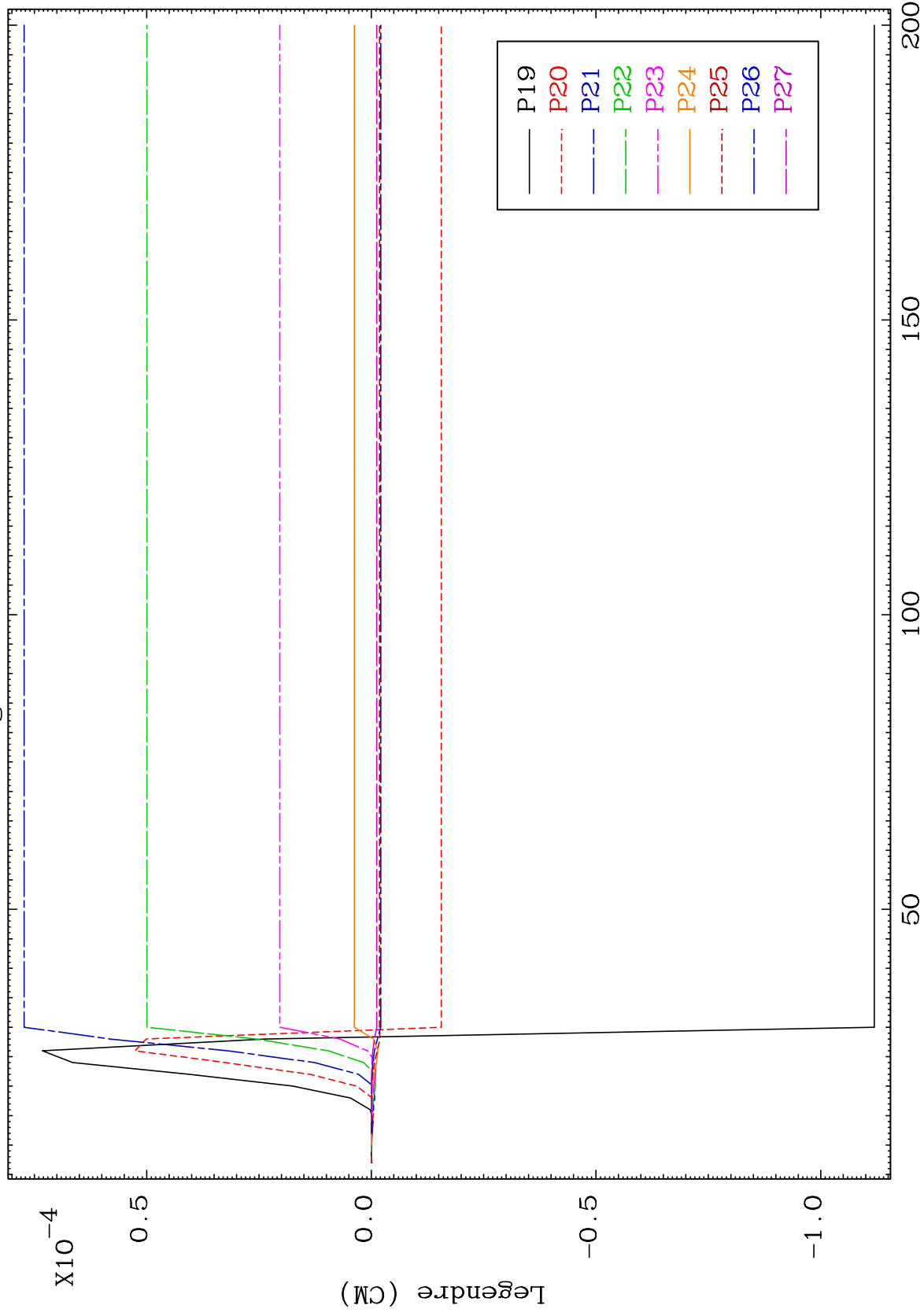

74

Incident Energy (MeV)

69-Tm-172

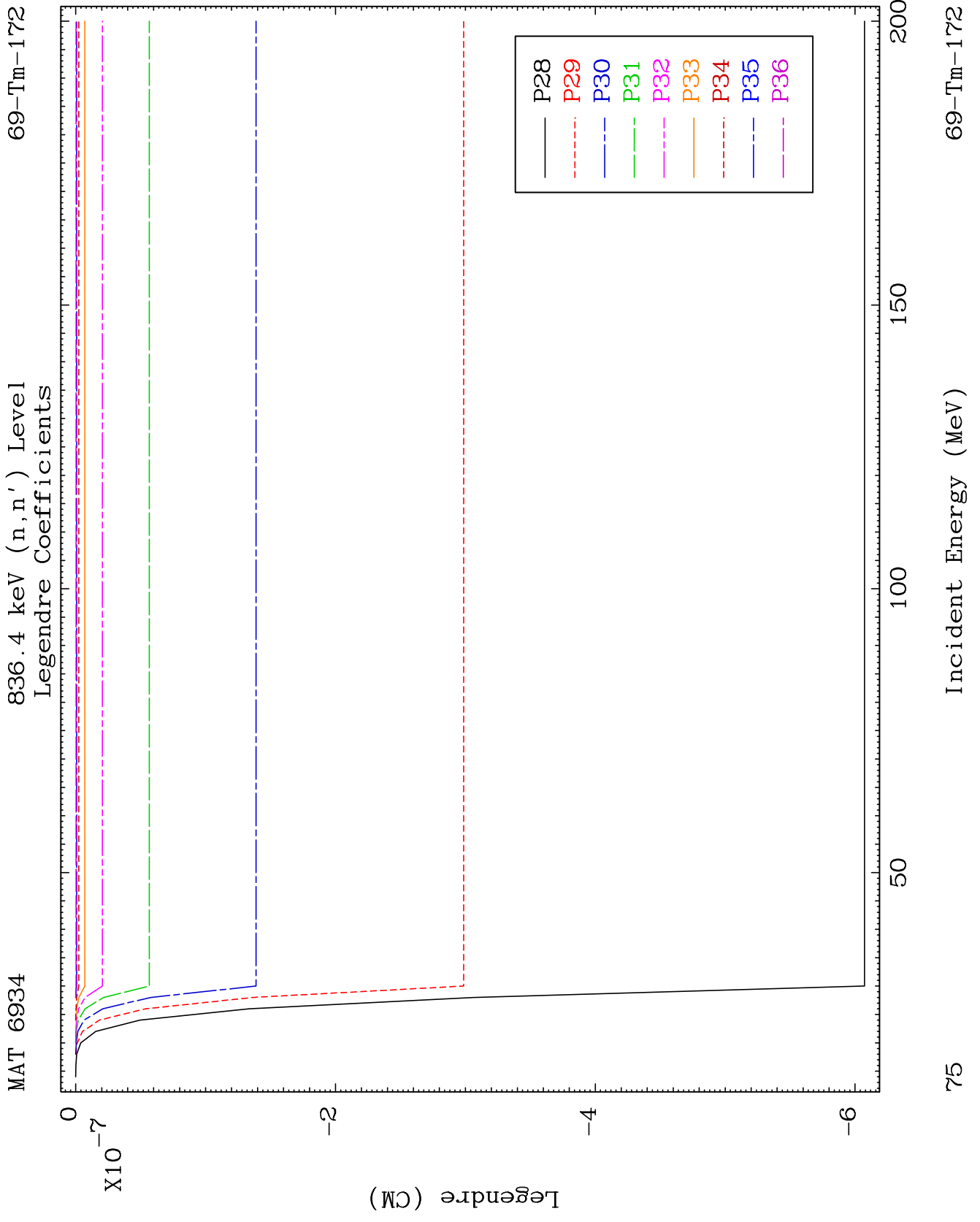

MAT 6934

837.5 keV (n,n') Level
Legendre Coefficients

69-Tm-172

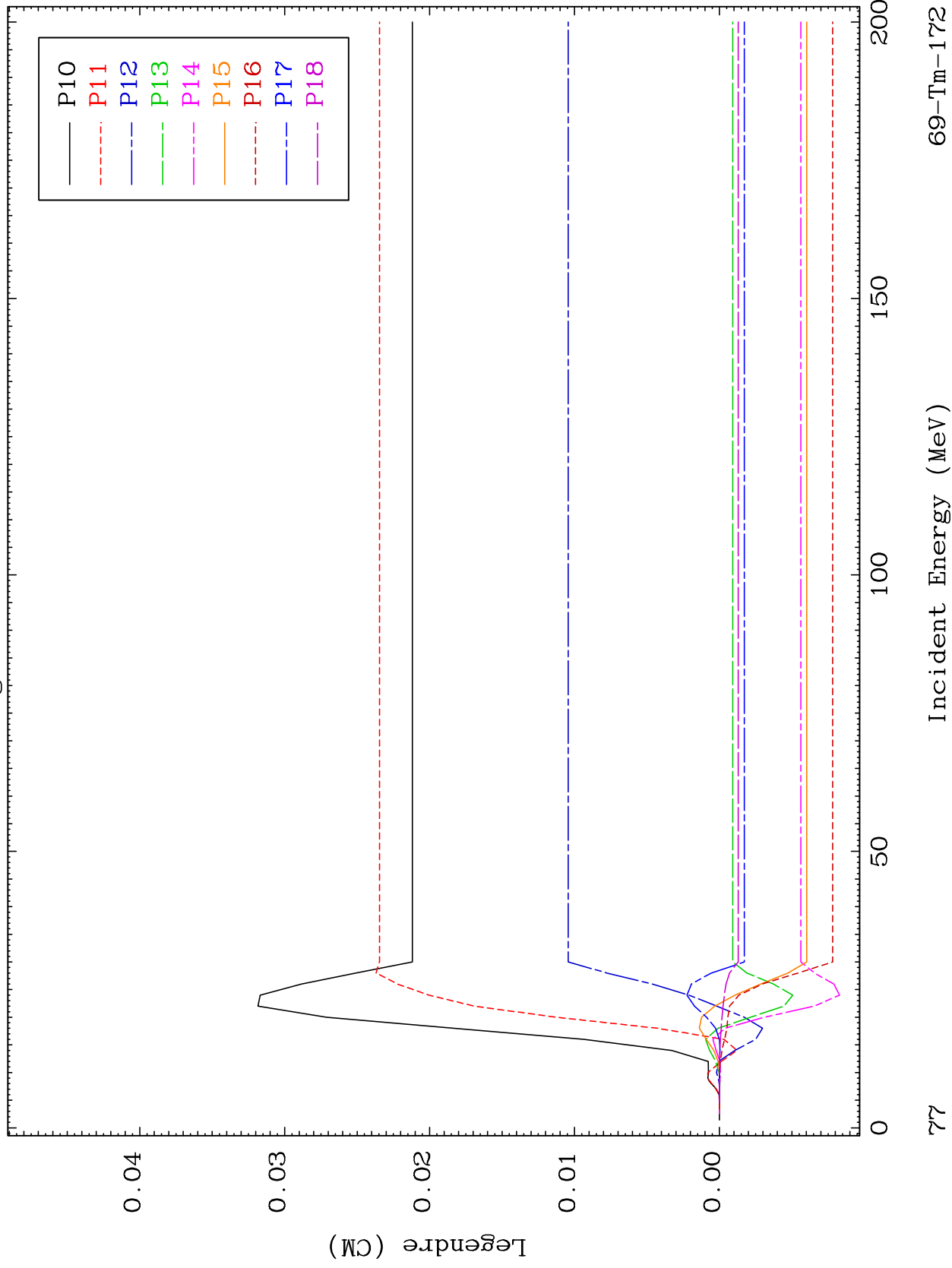

77

Incident Energy (MeV)

69-Tm-172

MAT 6934

837.5 keV (n,n') Level
Legendre Coefficients

69-Tm-172

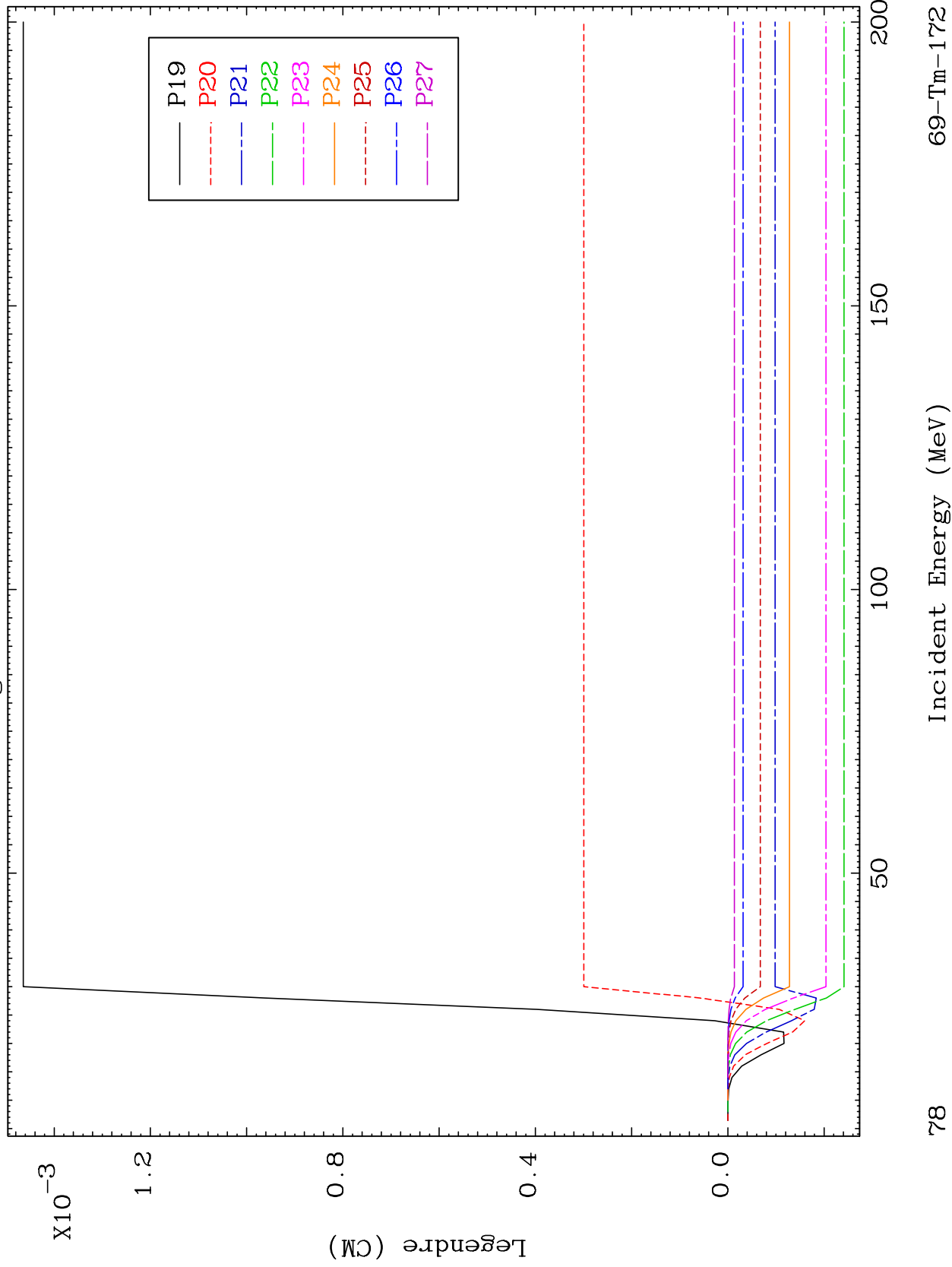

78

Incident Energy (MeV)

69-Tm-172

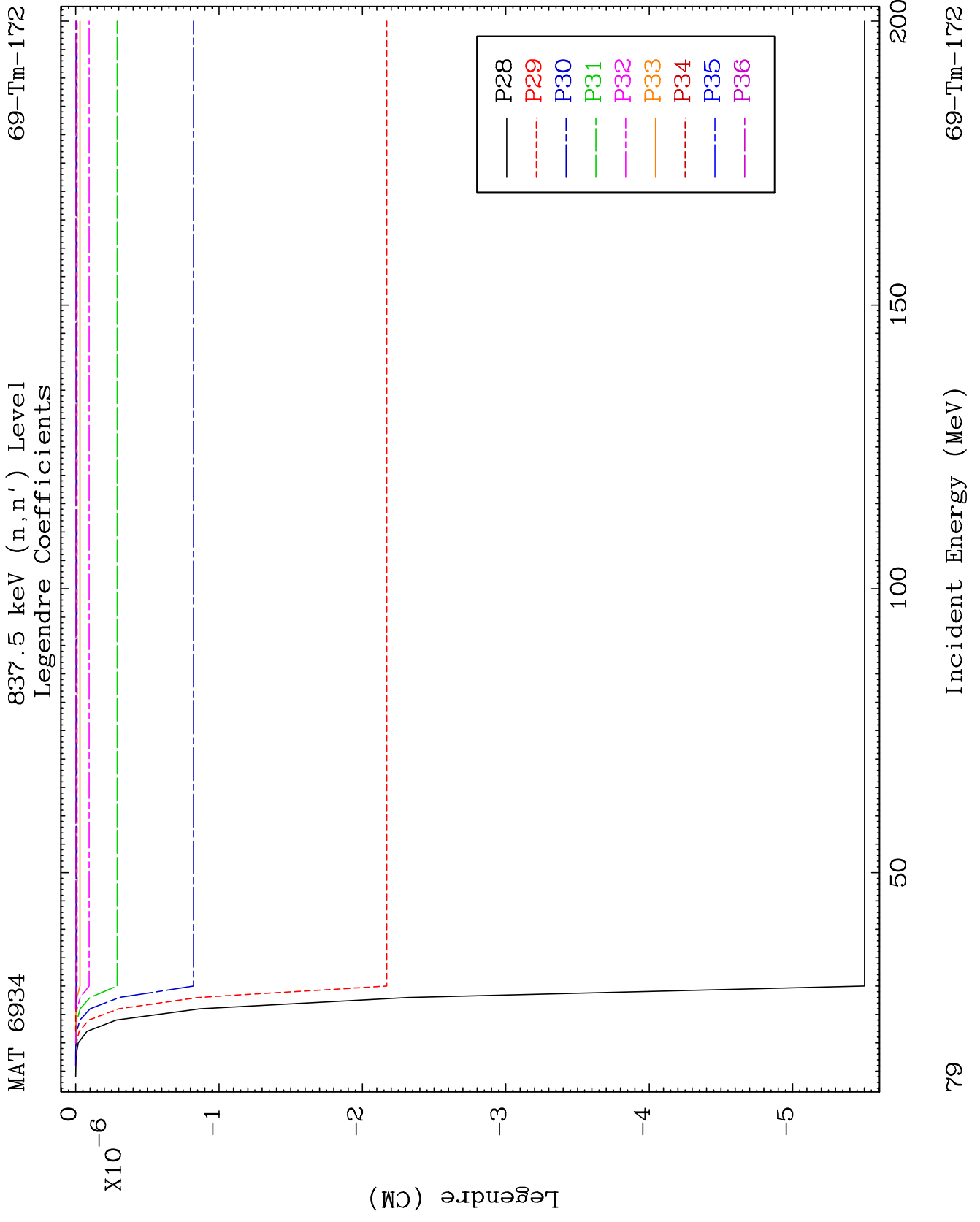

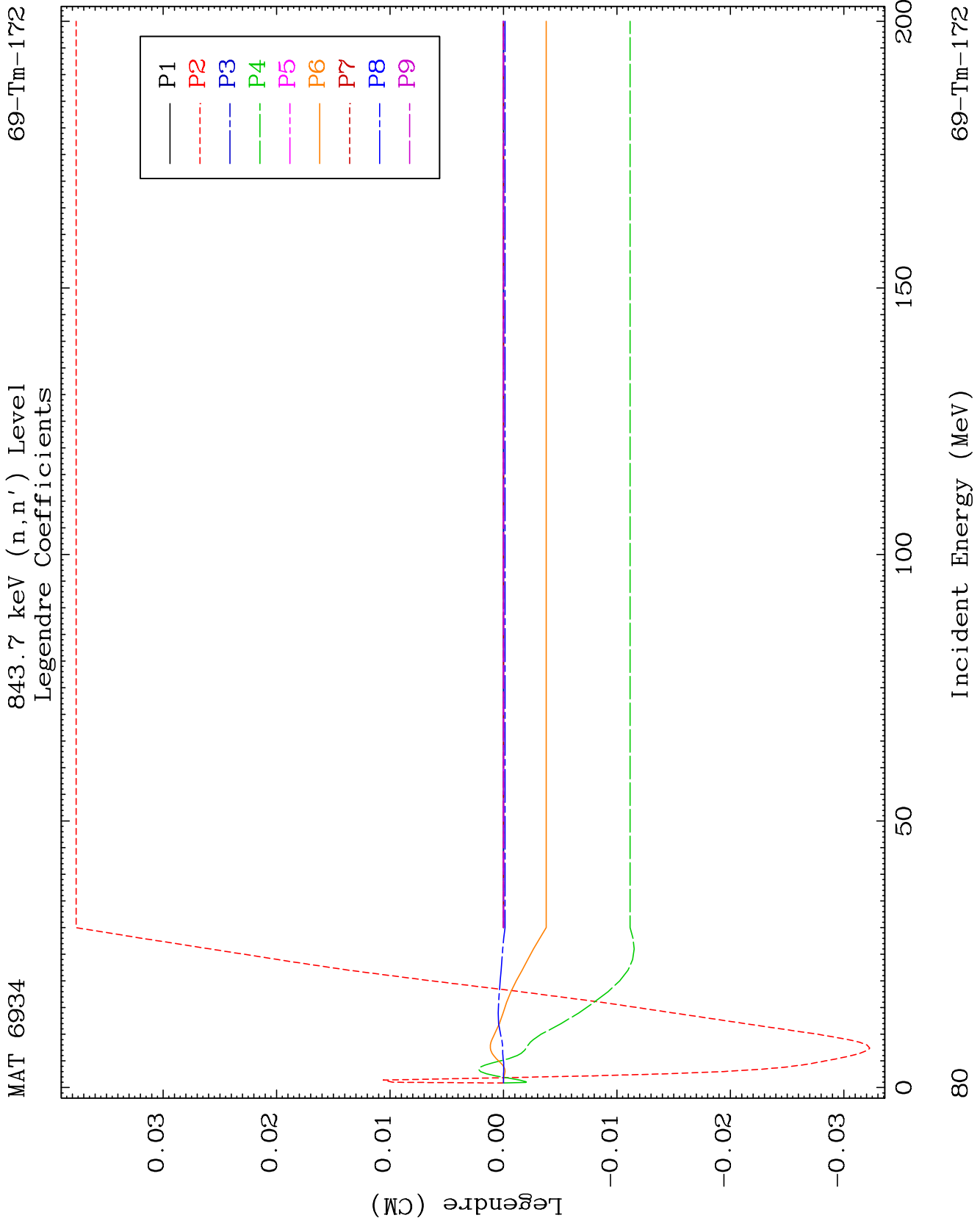

MAT 6934

843.7 keV (n,n') Level
Legendre Coefficients

69-Tm-172

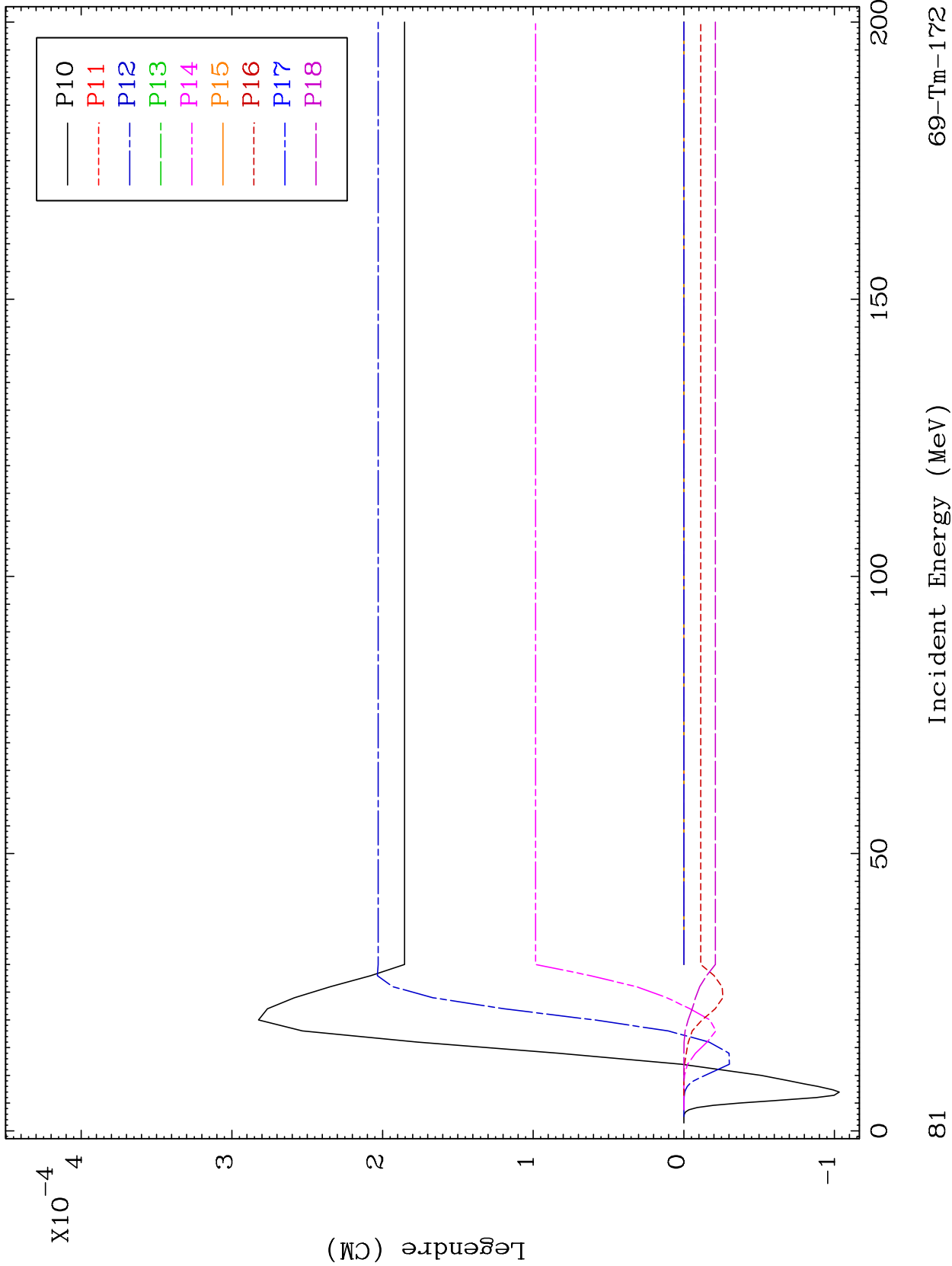

81

Incident Energy (MeV)

69-Tm-172

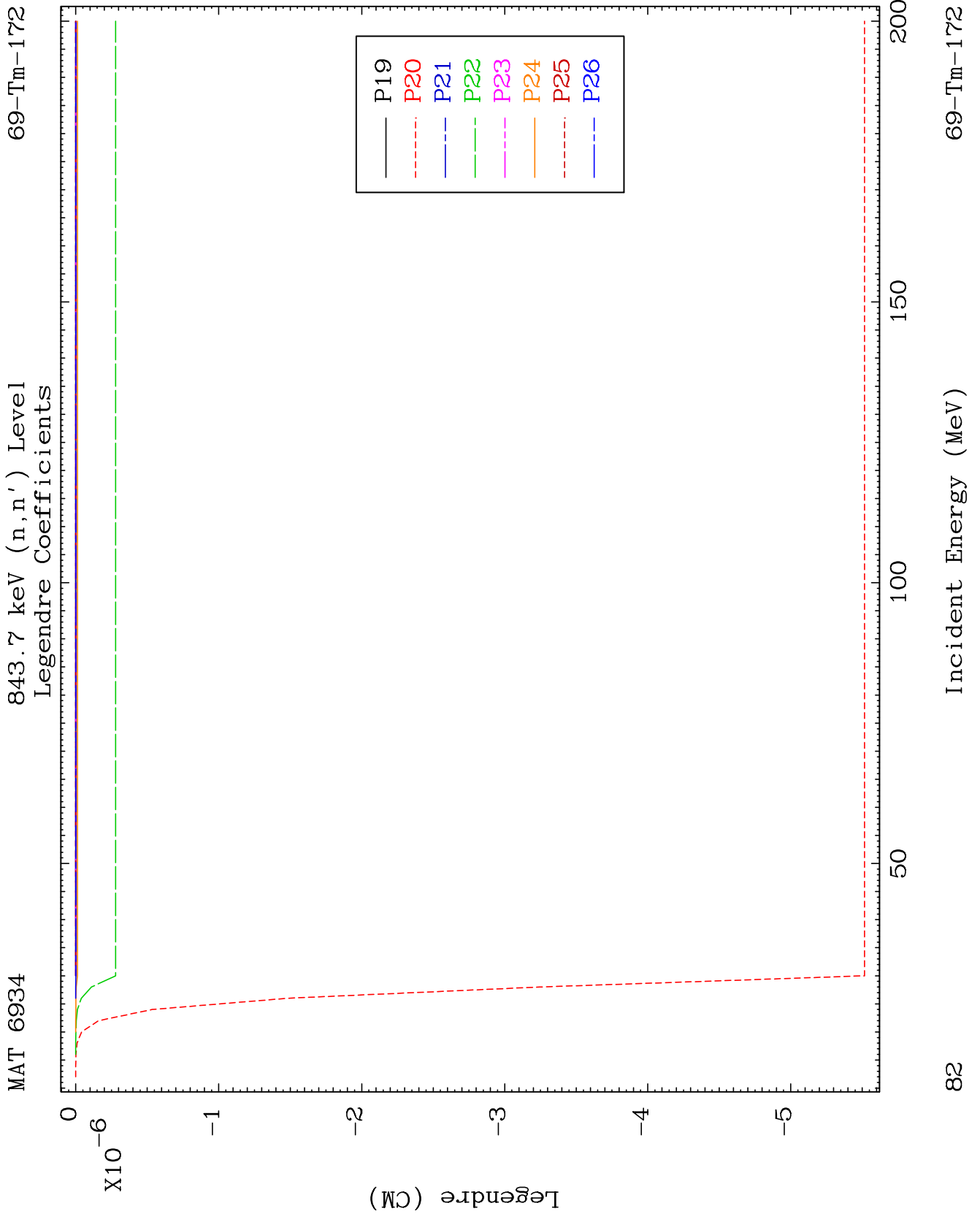

MAT 6934

846.3 keV (n,n') Level
Legendre Coefficients

69-Tm-172

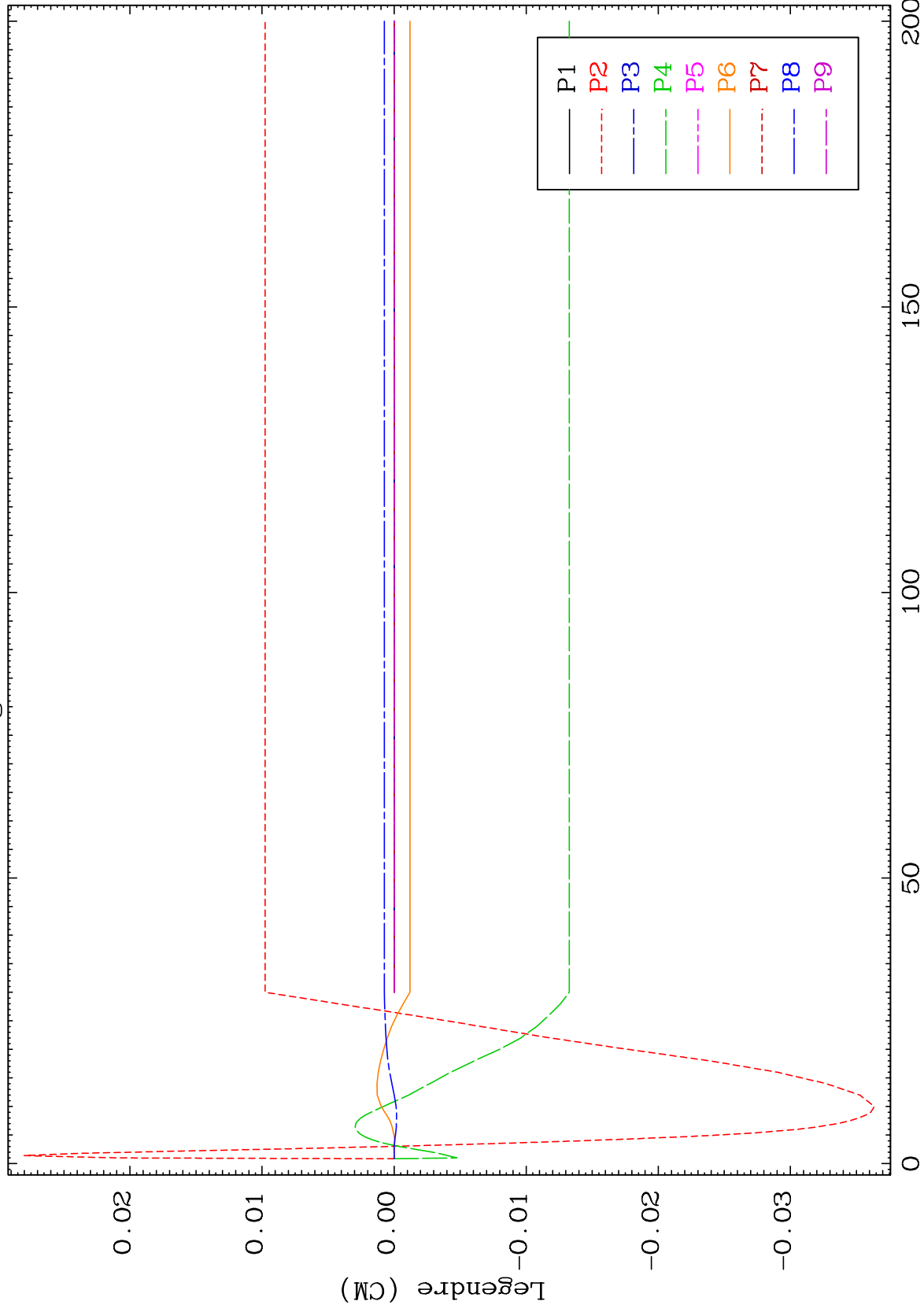

83

Incident Energy (MeV)

69-Tm-172

MAT 6934

846.3 keV (n,n') Level
Legendre Coefficients

69-Tm-172

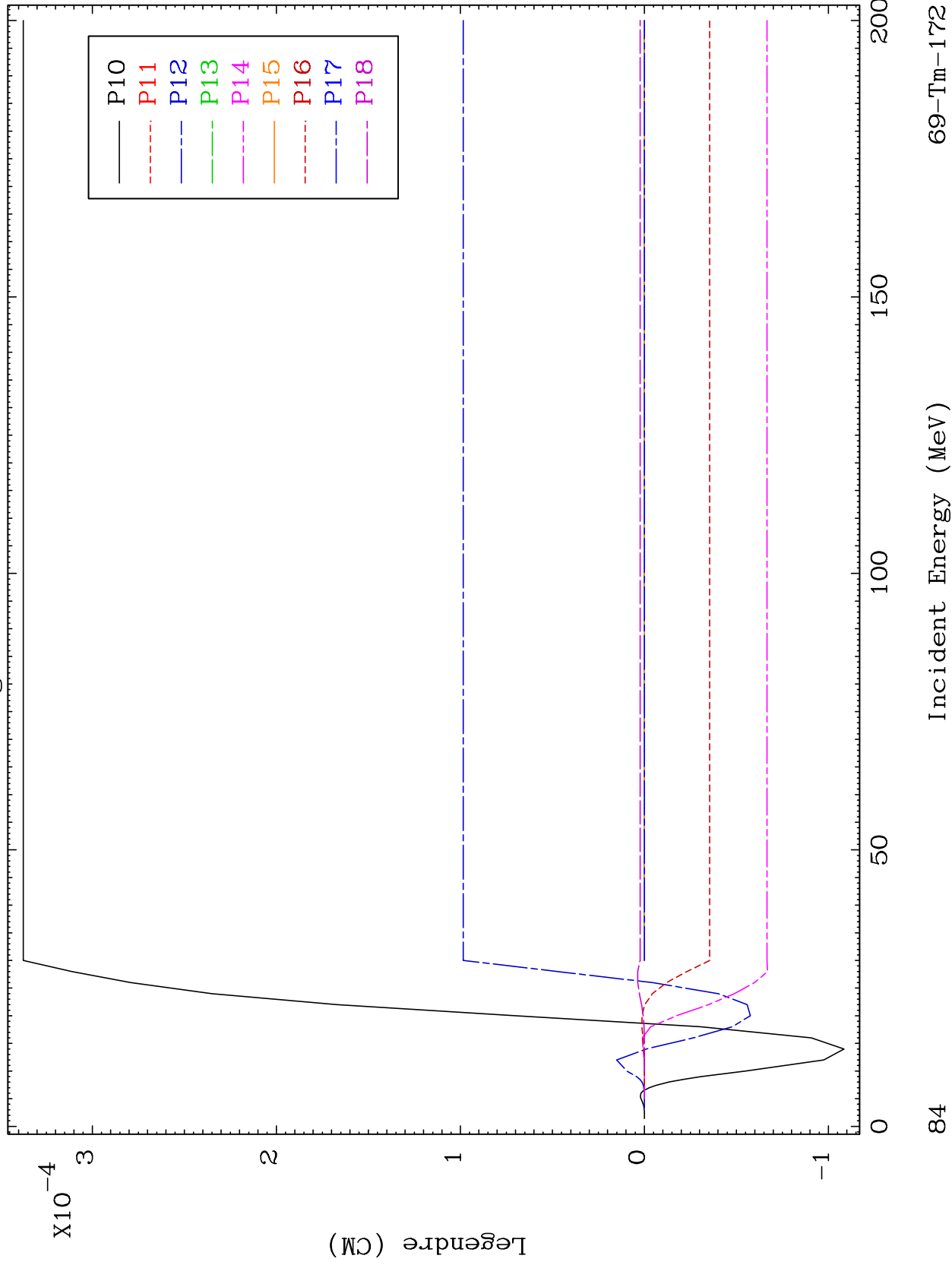

69-Tm-172

Incident Energy (MeV)

84

MAT 6934

847.9 keV (n,n') Level
Legendre Coefficients

69-Tm-172

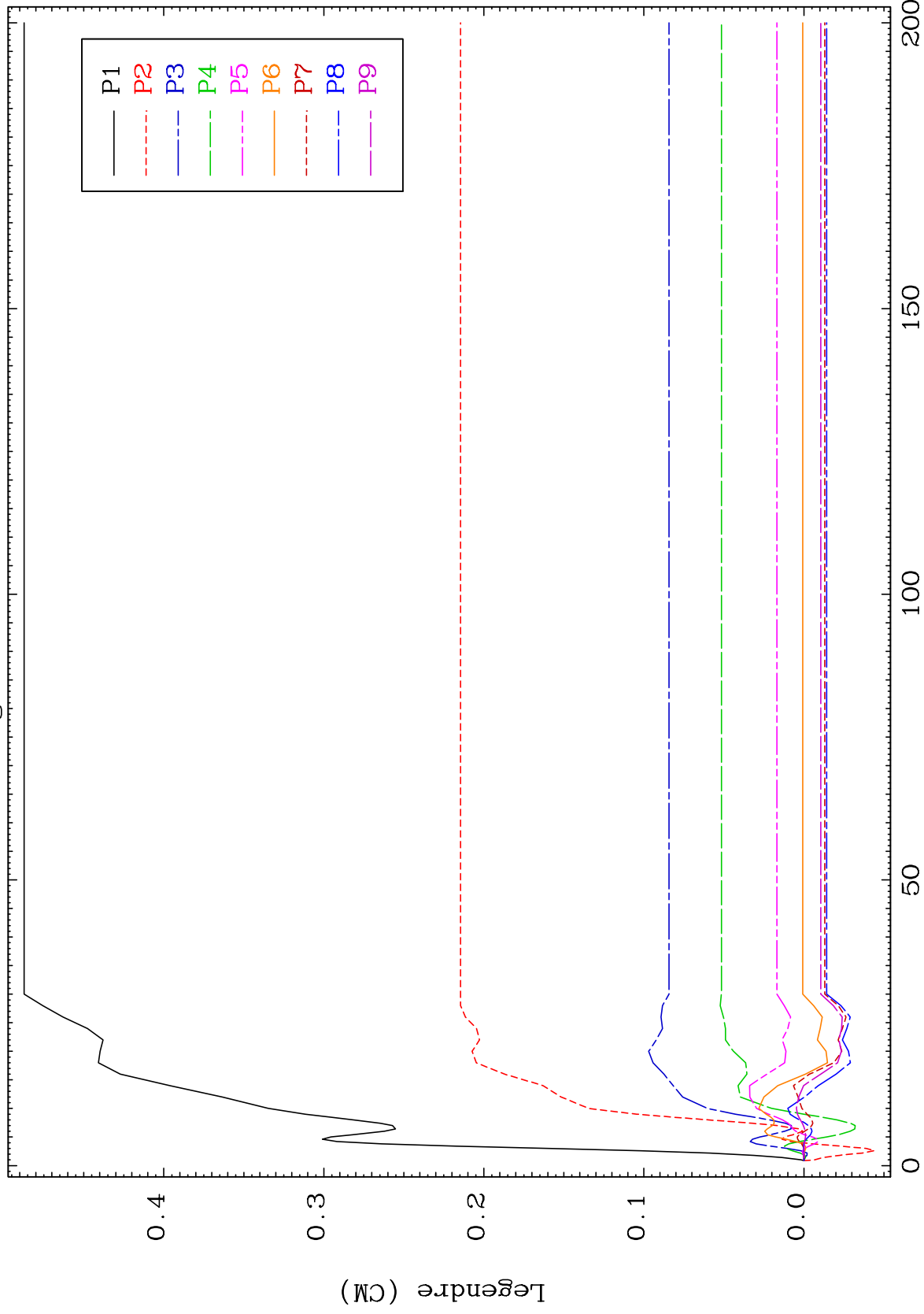

86

Incident Energy (MeV)

69-Tm-172

MAT 6934

847.9 keV (n,n') Level
Legendre Coefficients

69-Tm-172

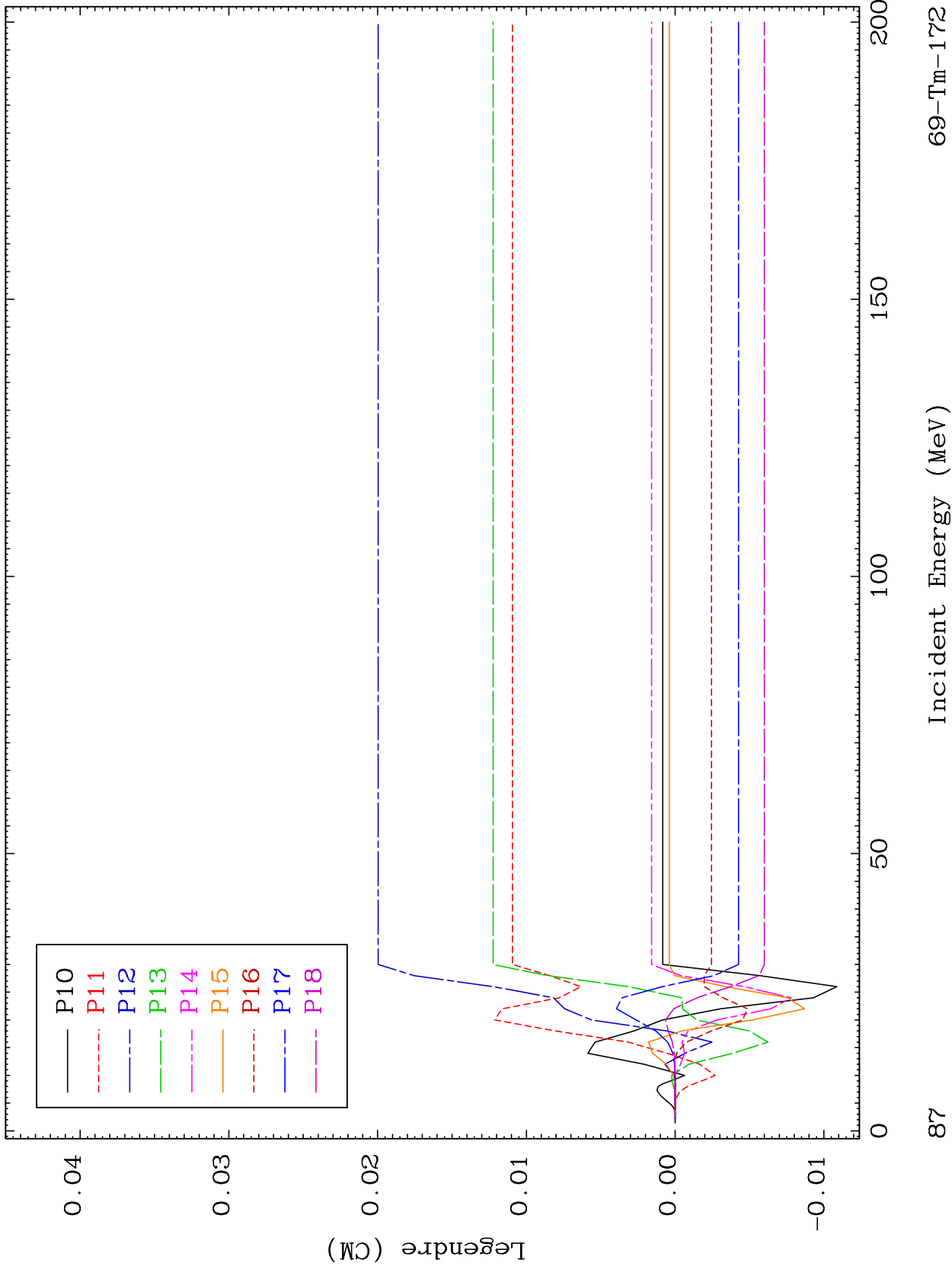

87

MAT 6934

847.9 keV (n,n') Level
Legendre Coefficients

69-Tm-172

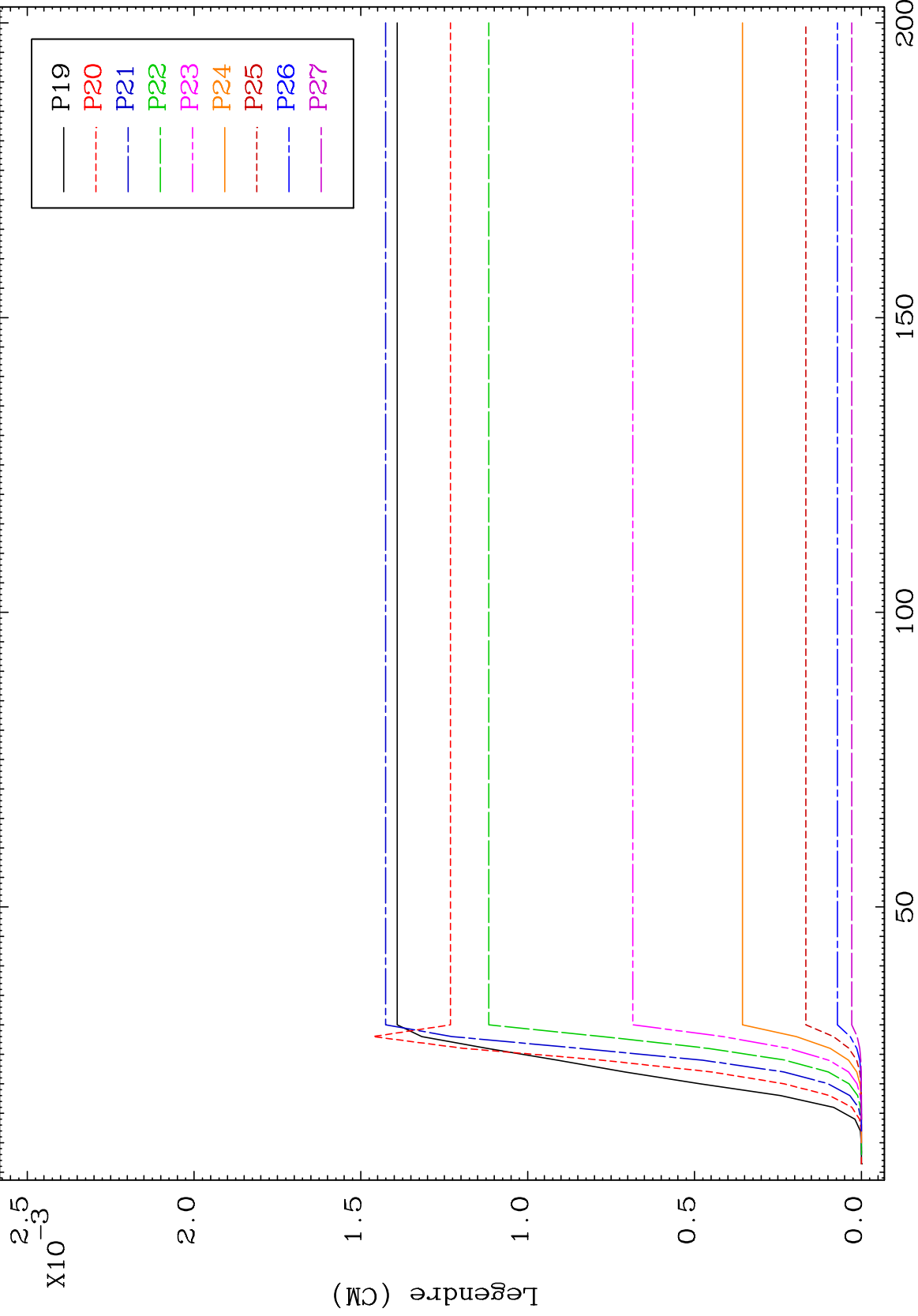

88

Incident Energy (MeV)

69-Tm-172

MAT 6934

847.9 keV (n,n') Level
Legendre Coefficients

69-Tm-172

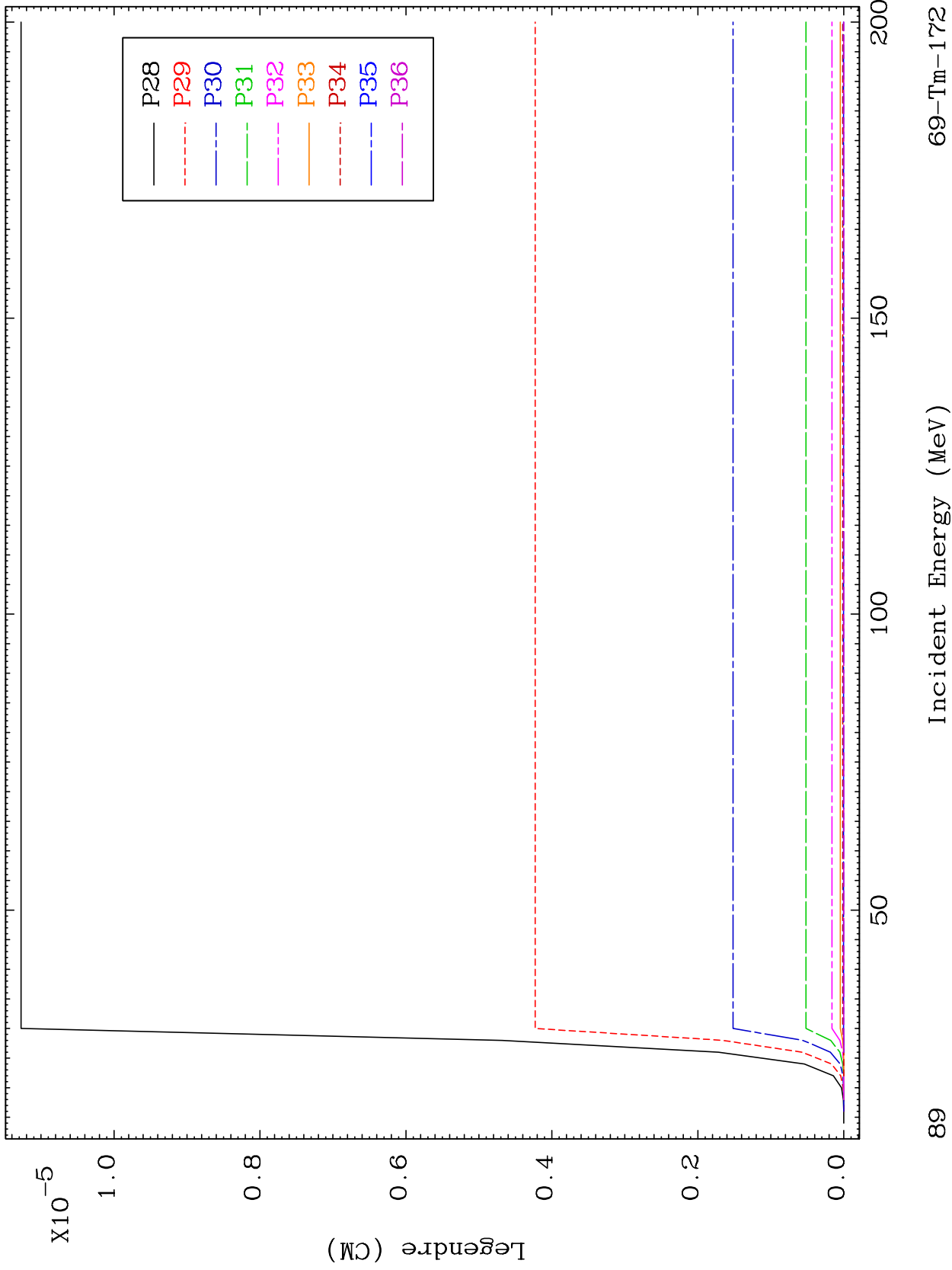

89

Incident Energy (MeV)

69-Tm-172

MAT 6934

850.0 keV (n,n') Level
Legendre Coefficients

69-Tm-172

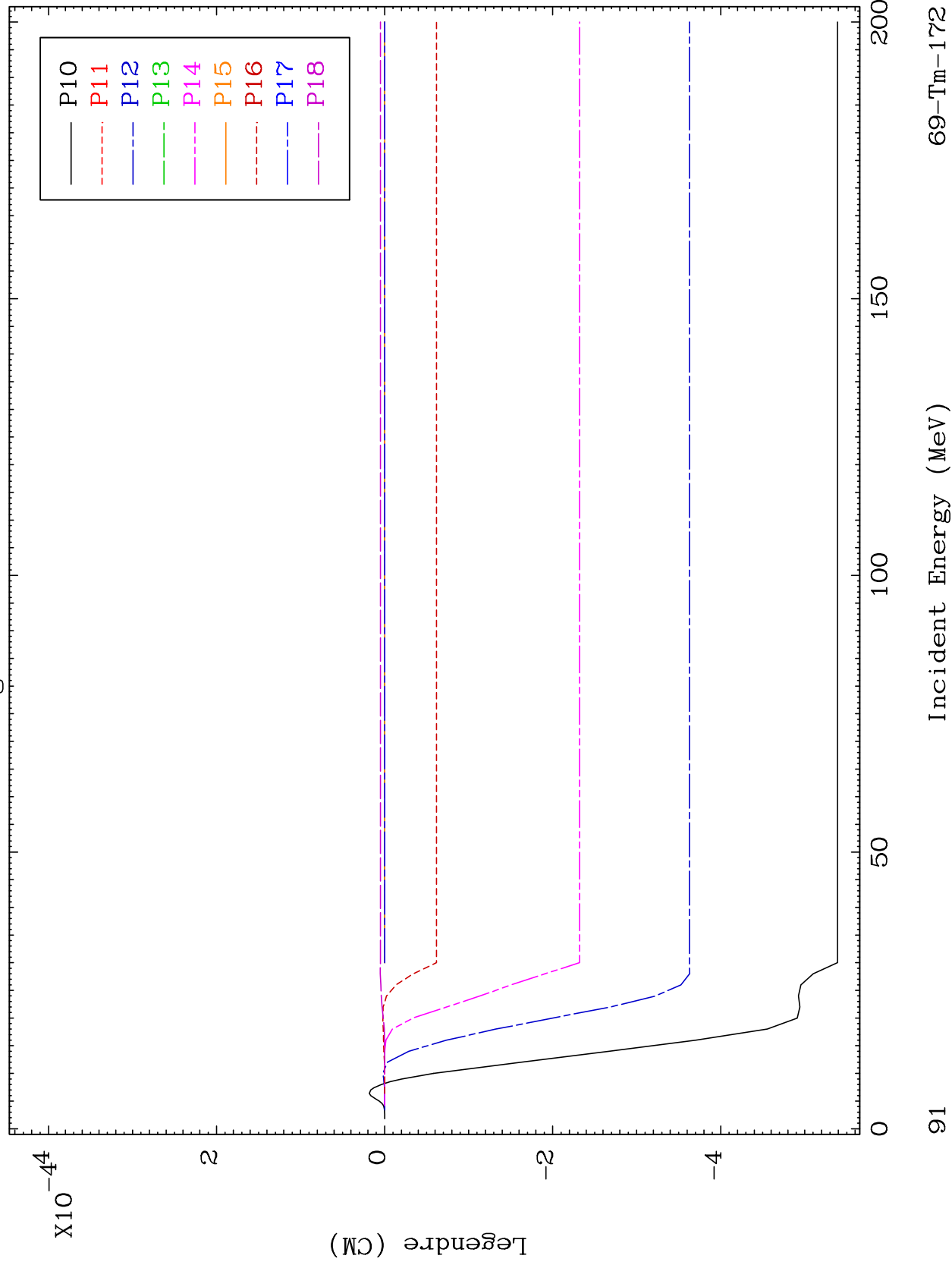

91

Incident Energy (MeV)

69-Tm-172

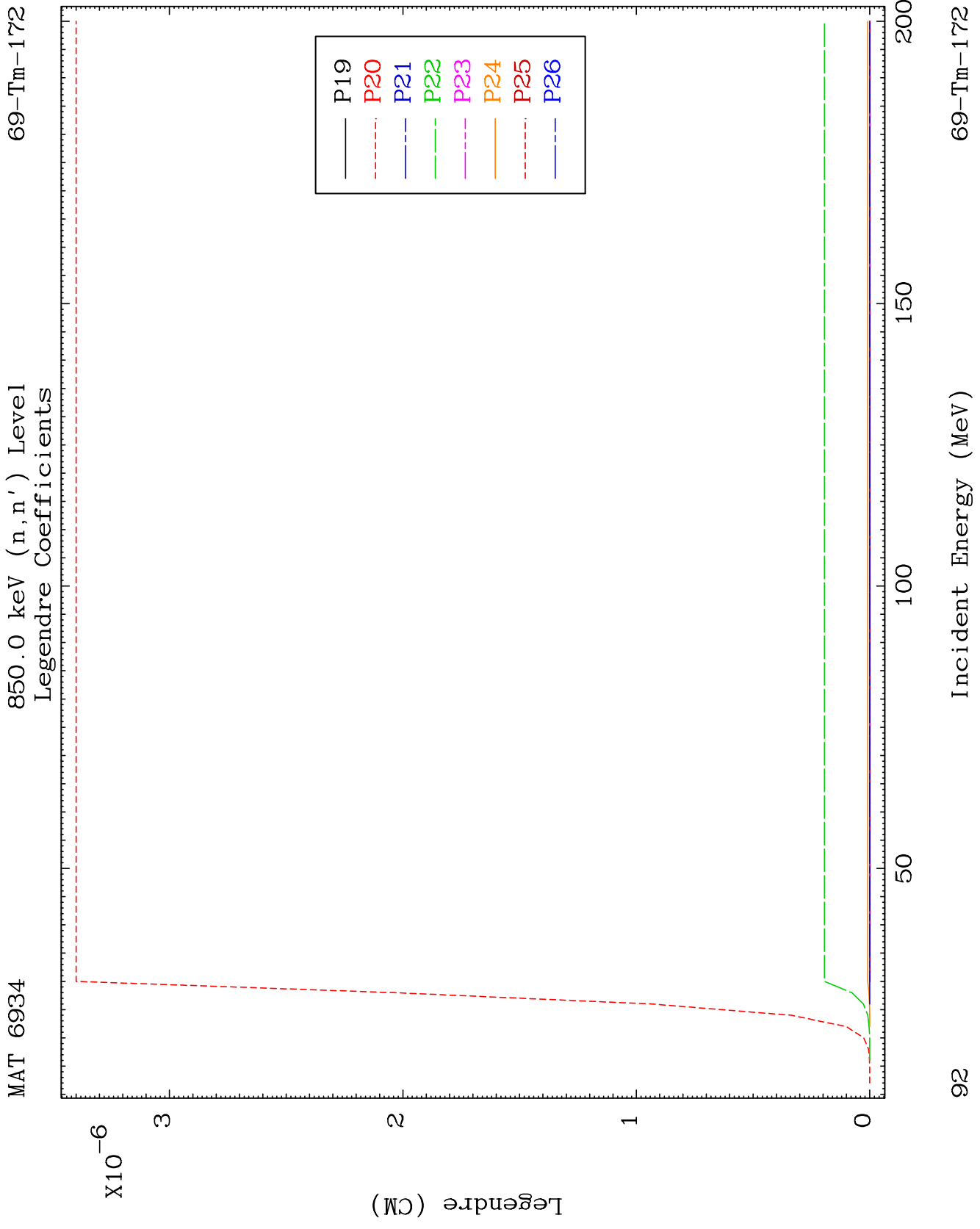

MAT 6934

854.1 keV (n,n') Level
Legendre Coefficients

69-Tm-172

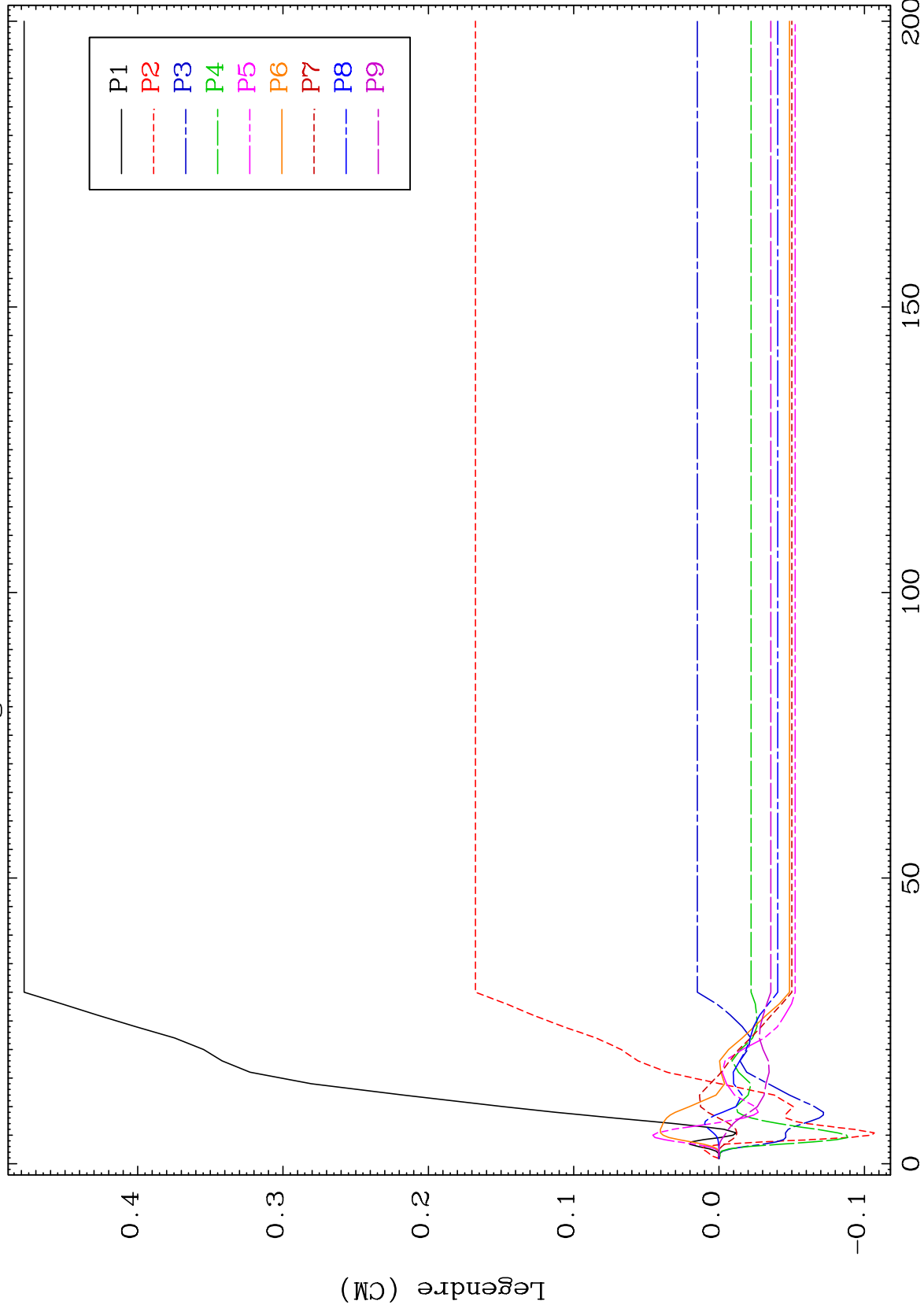

93

Incident Energy (MeV)

69-Tm-172

MAT 6934

854.1 keV (n,n') Level
Legendre Coefficients

69-Tm-172

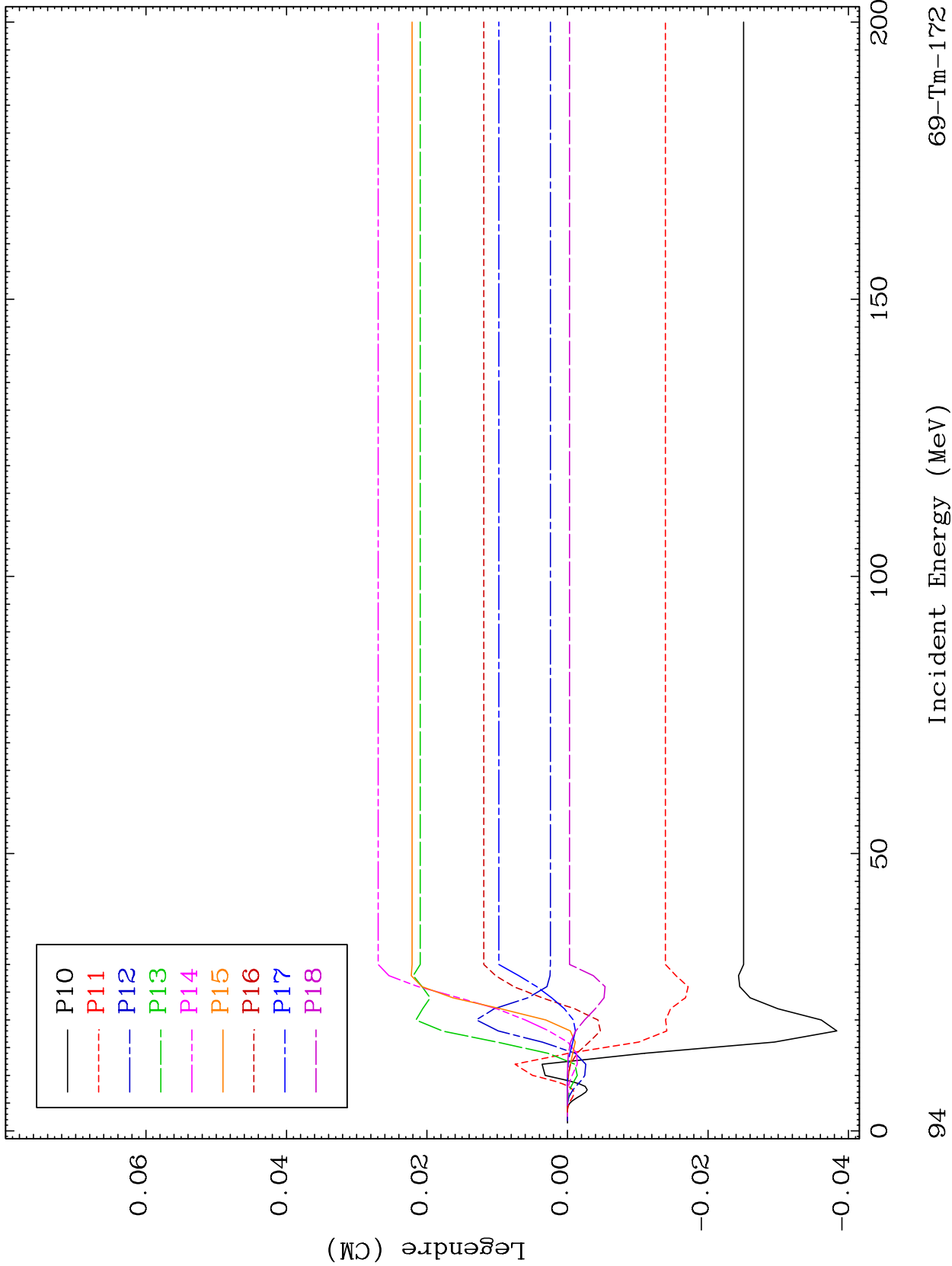

94

Incident Energy (MeV)

69-Tm-172

MAT 6934

854.1 keV (n,n') Level
Legendre Coefficients

69-Tm-172

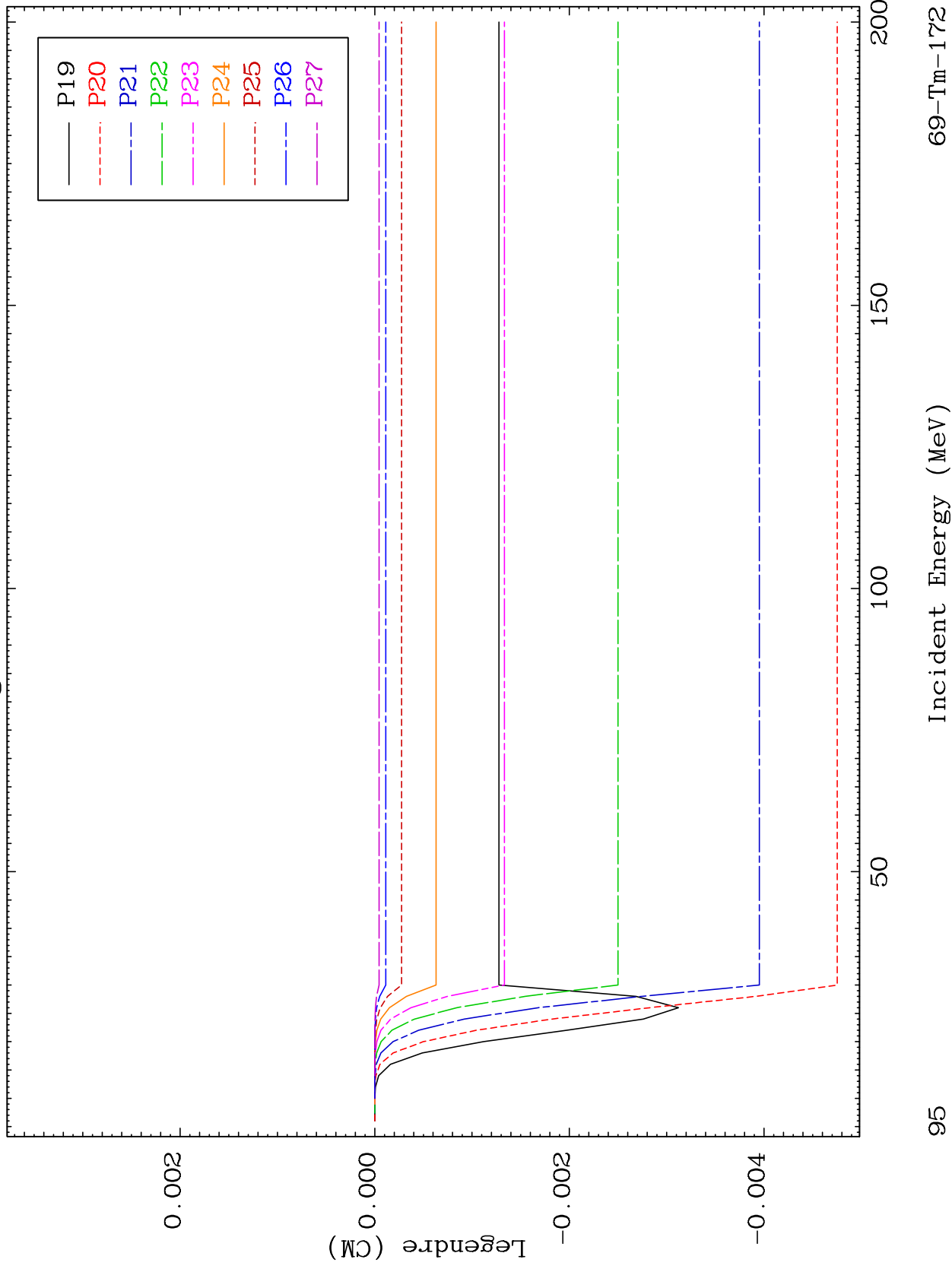

95

Incident Energy (MeV)

69-Tm-172

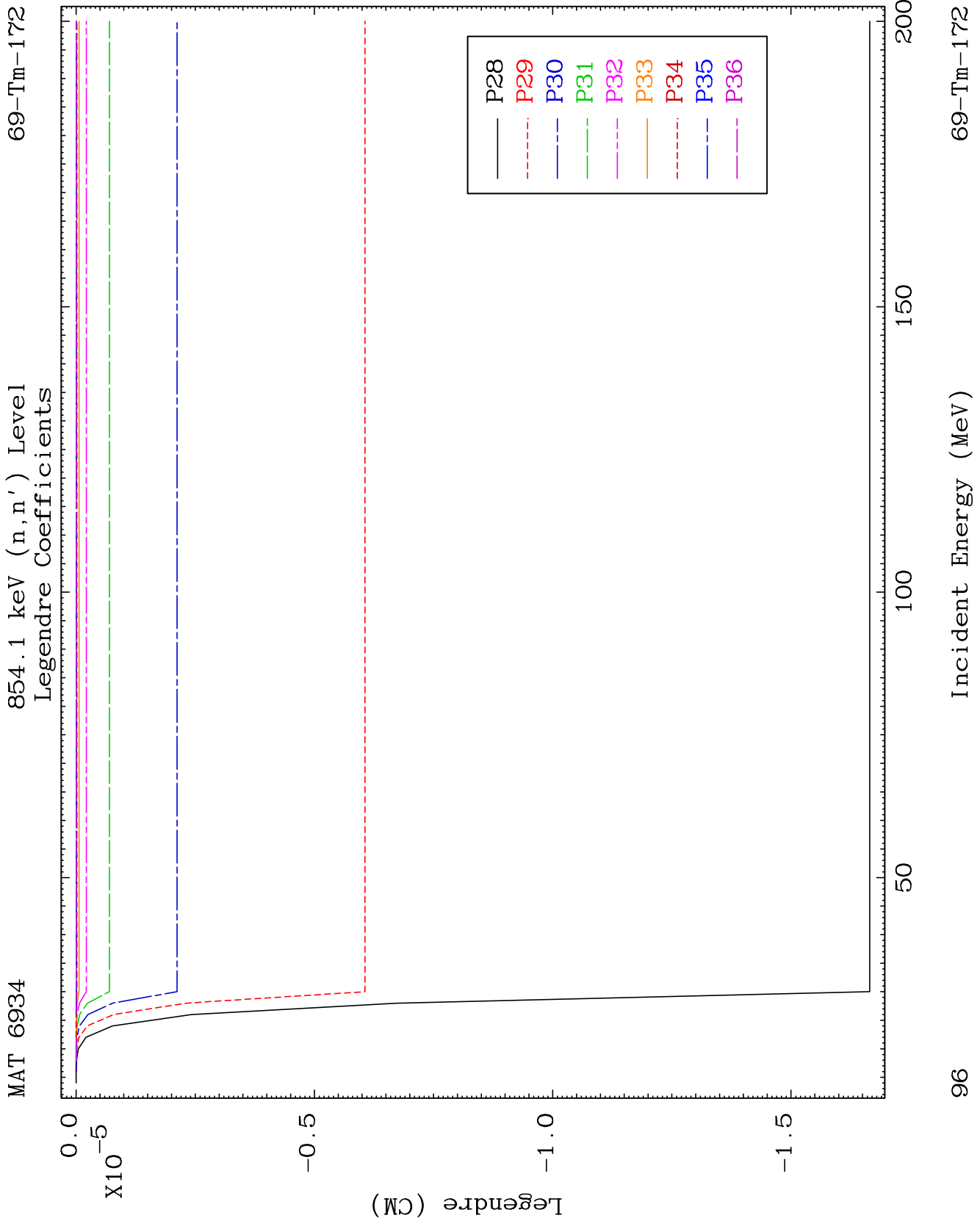

MAT 6934

857.1 keV (n,n') Level
Legendre Coefficients

69-Tm-172

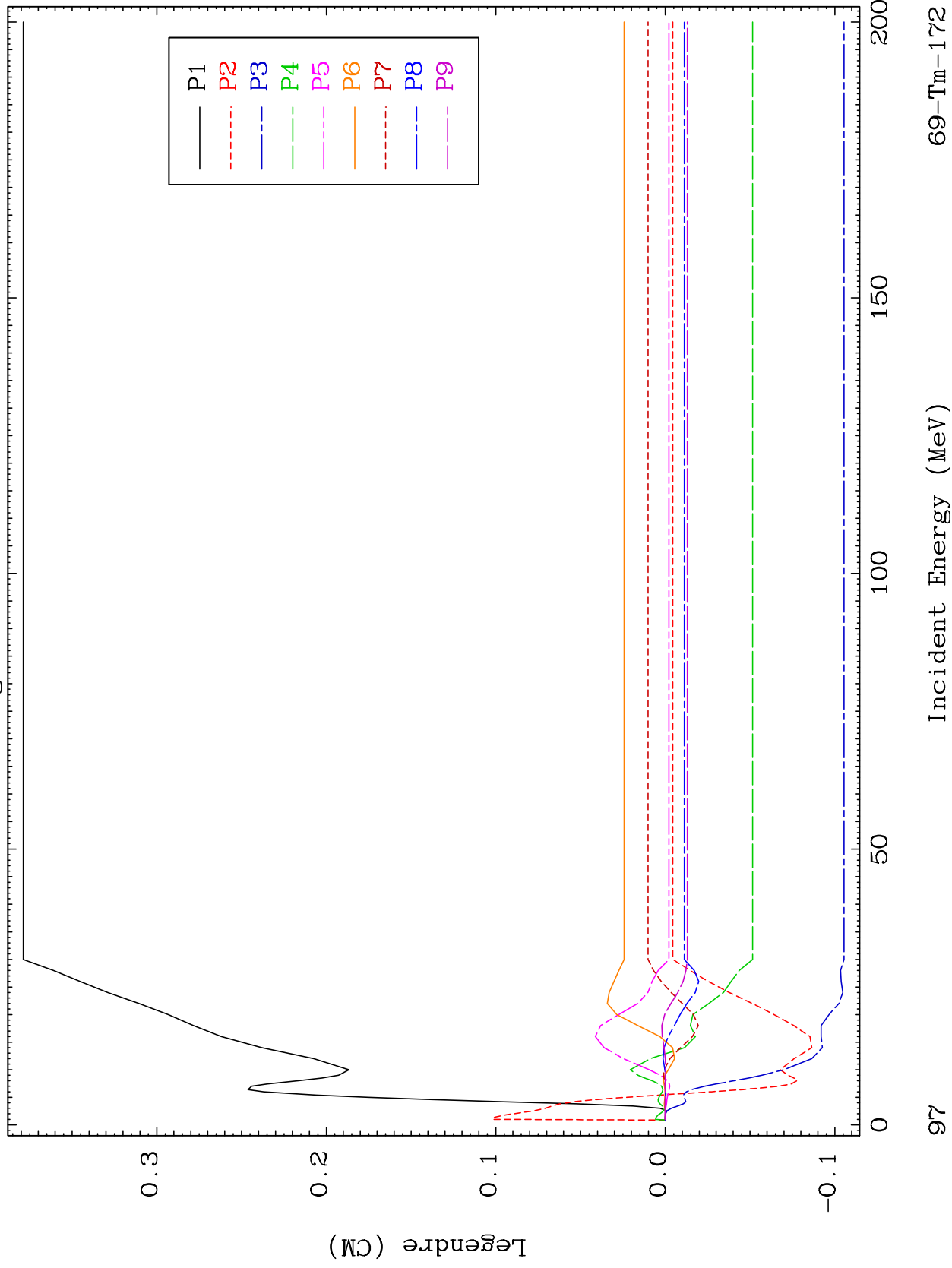

MAT 6934

857.1 keV (n,n') Level
Legendre Coefficients

69-Tm-172

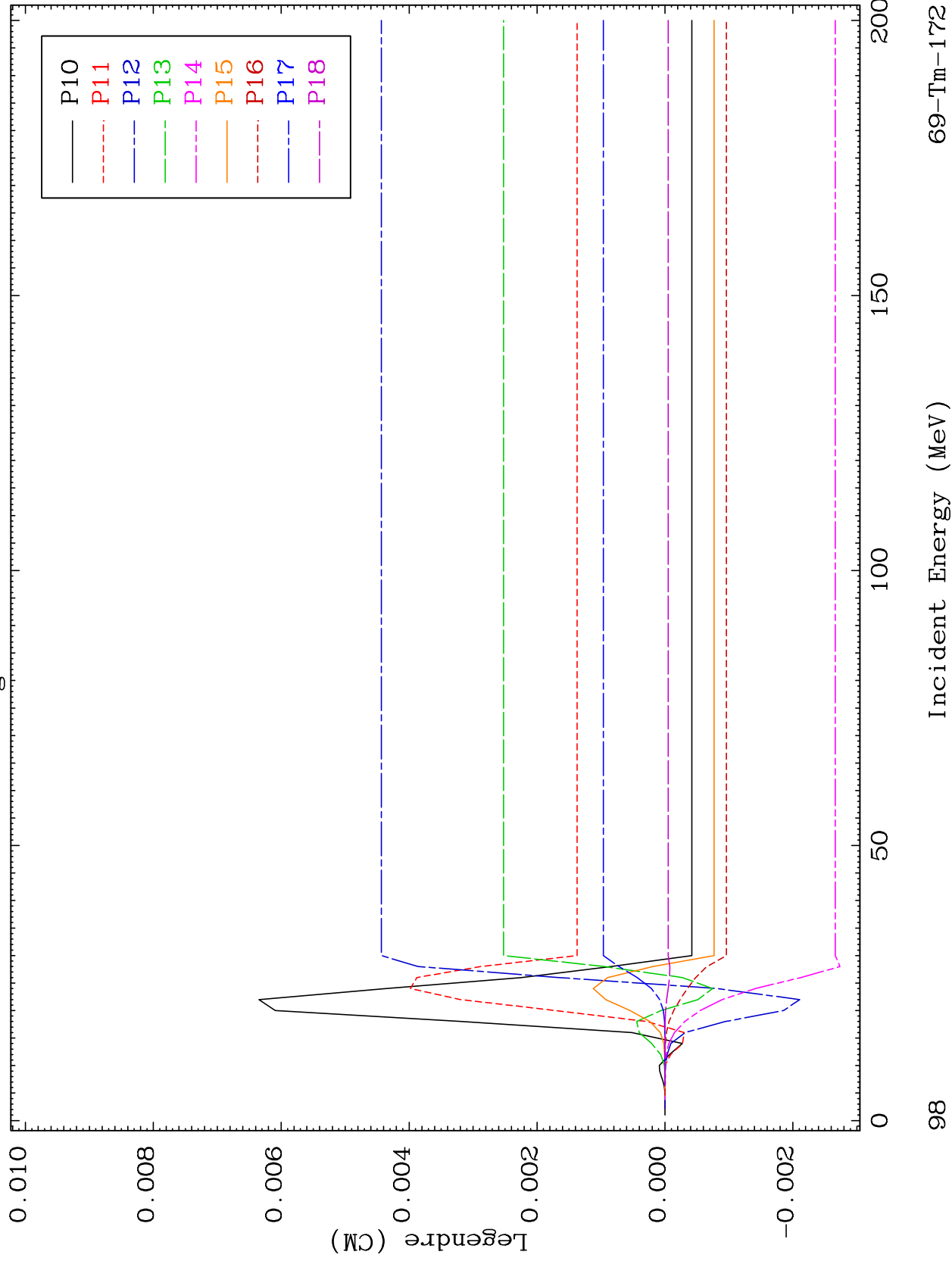

69-Tm-172

Incident Energy (MeV)

98

MAT 6934

857.1 keV (n,n') Level
Legendre Coefficients

69-Tm-172

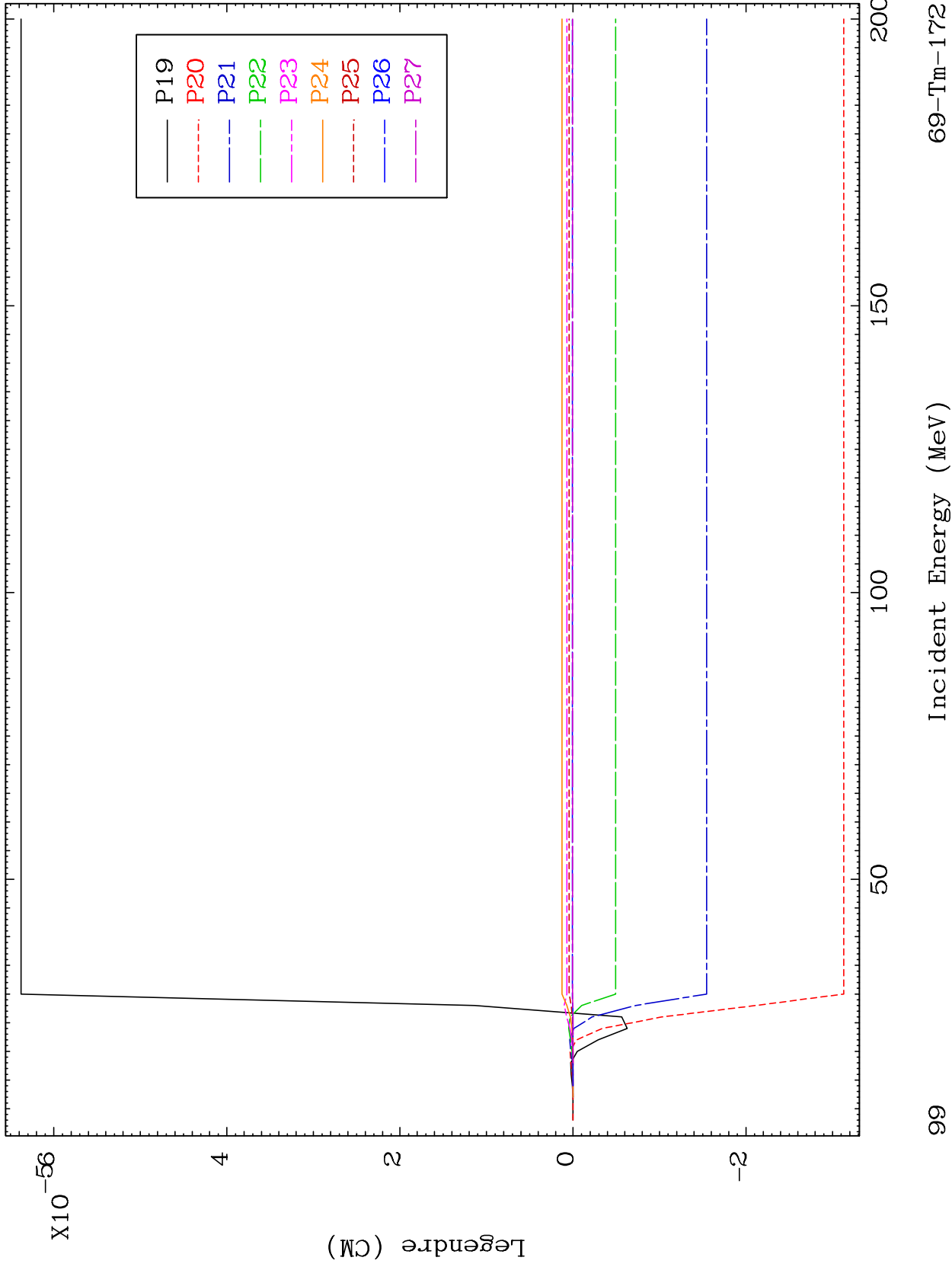

MAT 6934

857.1 keV (n,n') Level
Legendre Coefficients

69-Tm-172

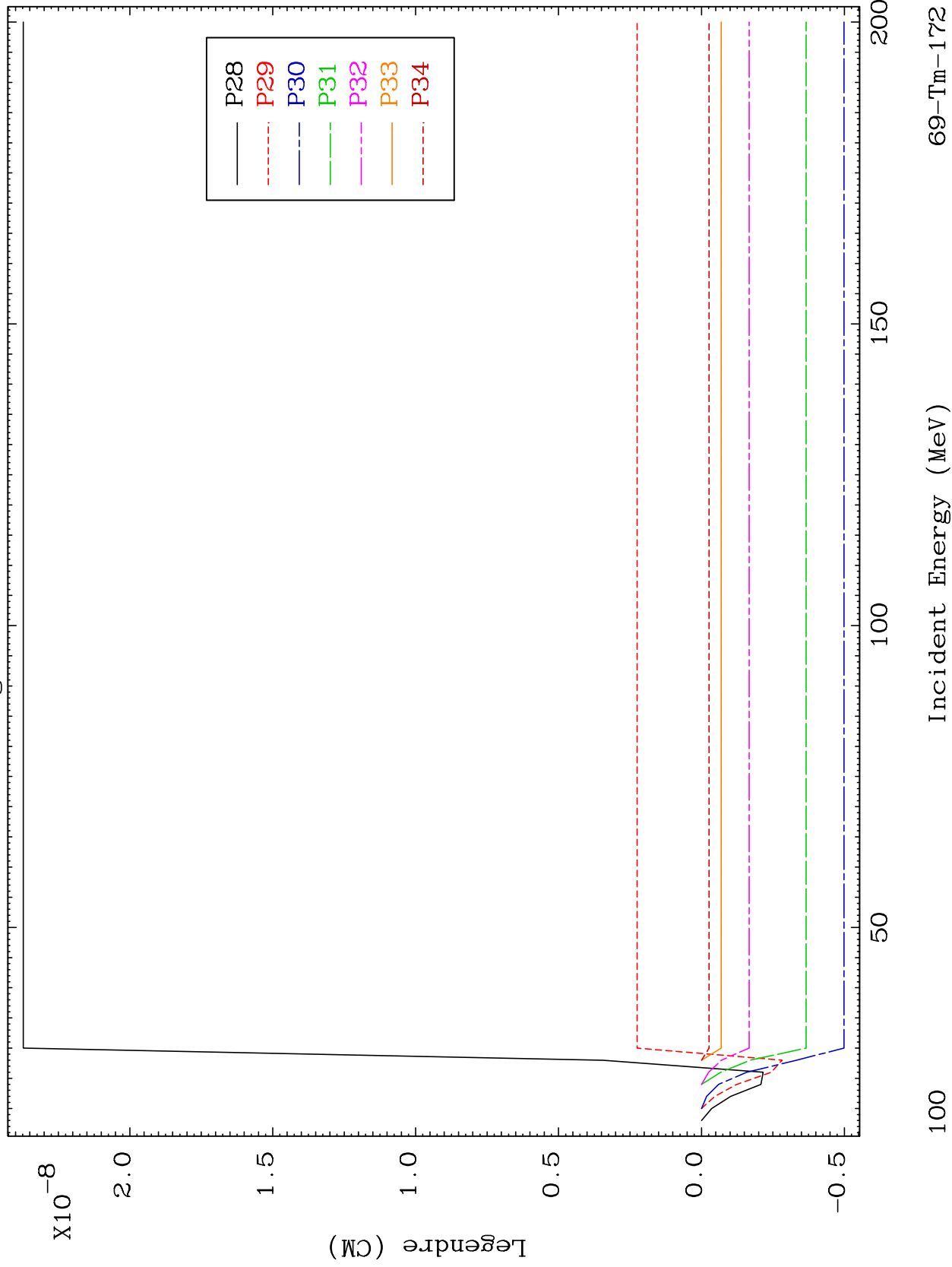

MAT 6934

859.4 keV (n,n') Level
Legendre Coefficients

69-Tm-172

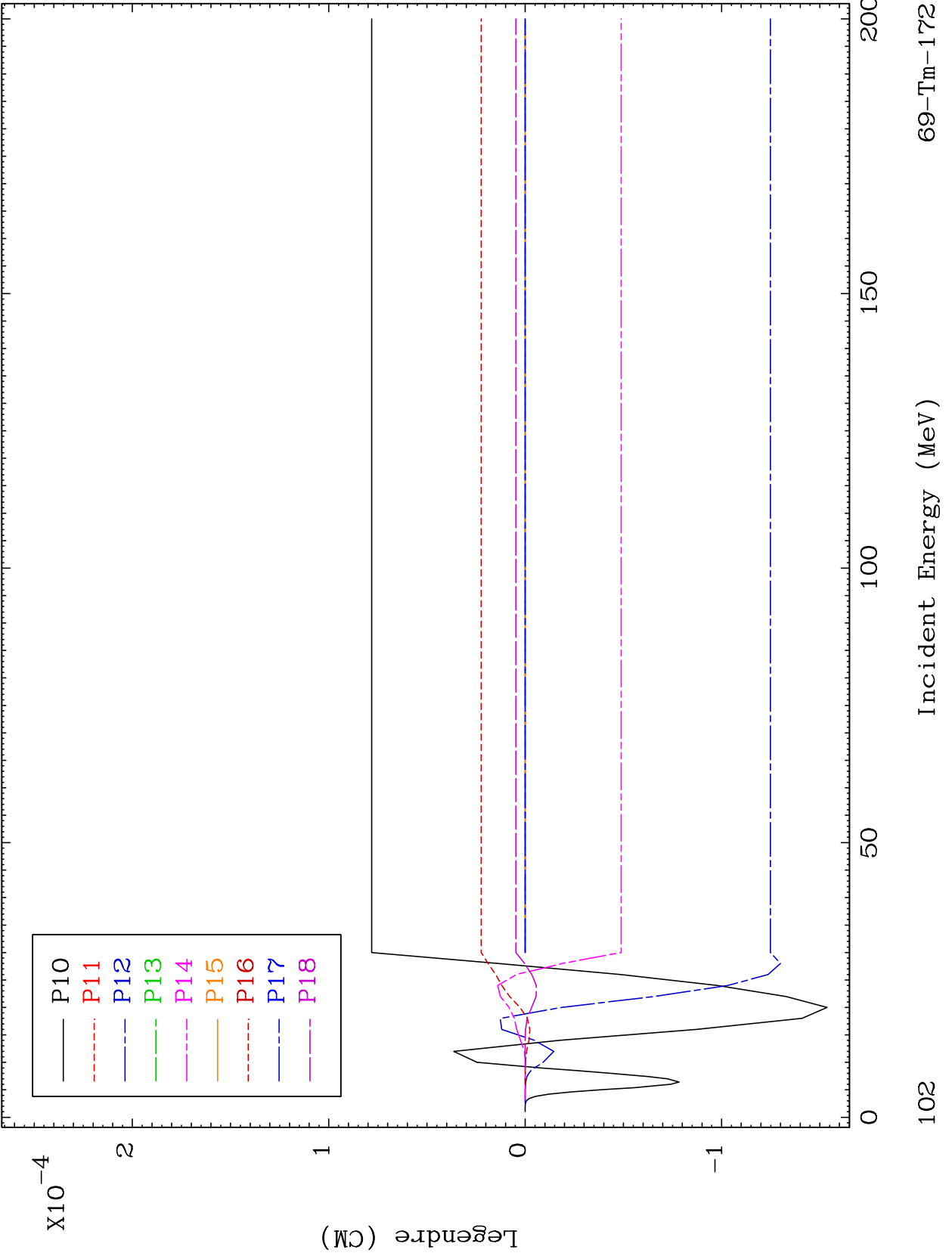

102

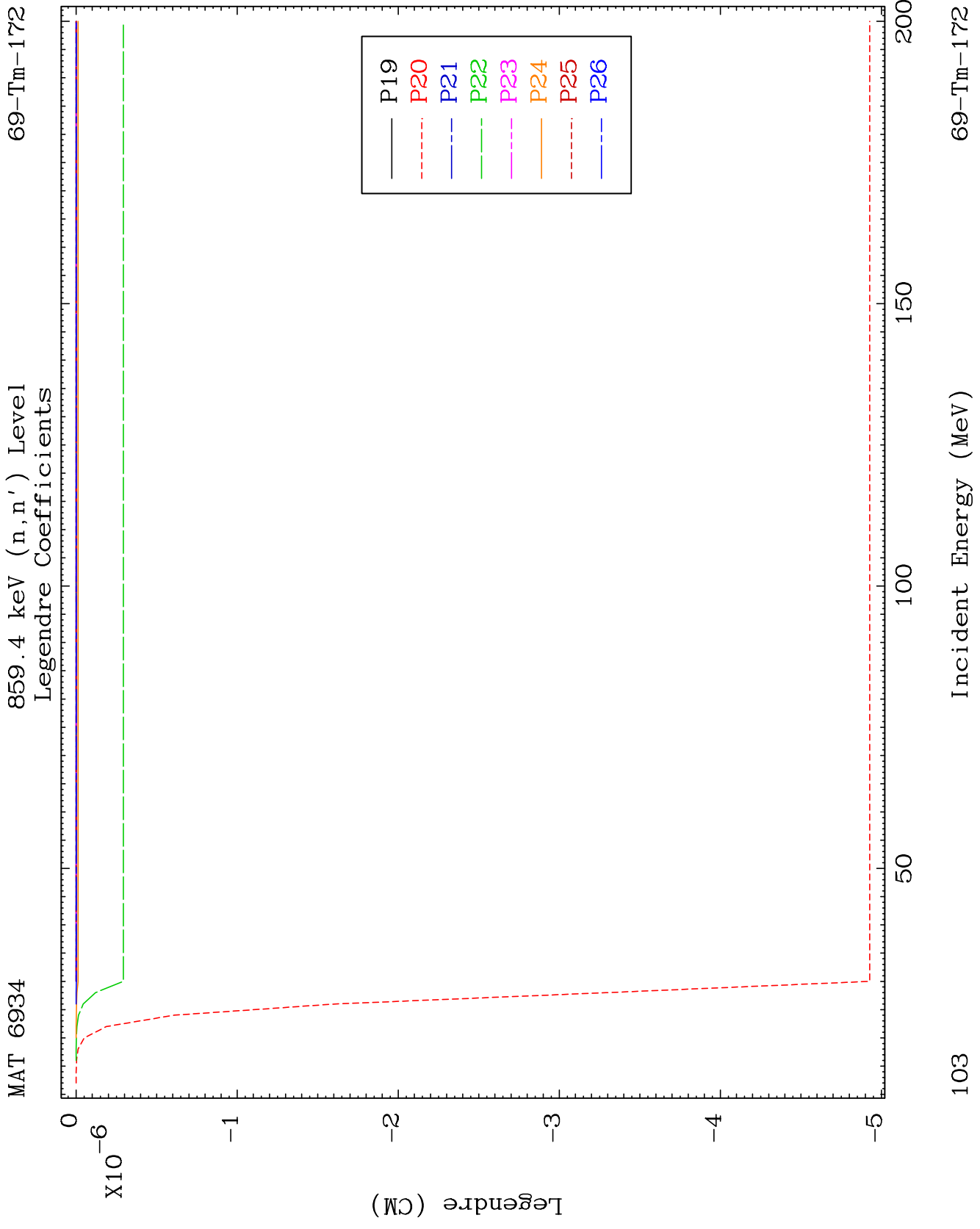

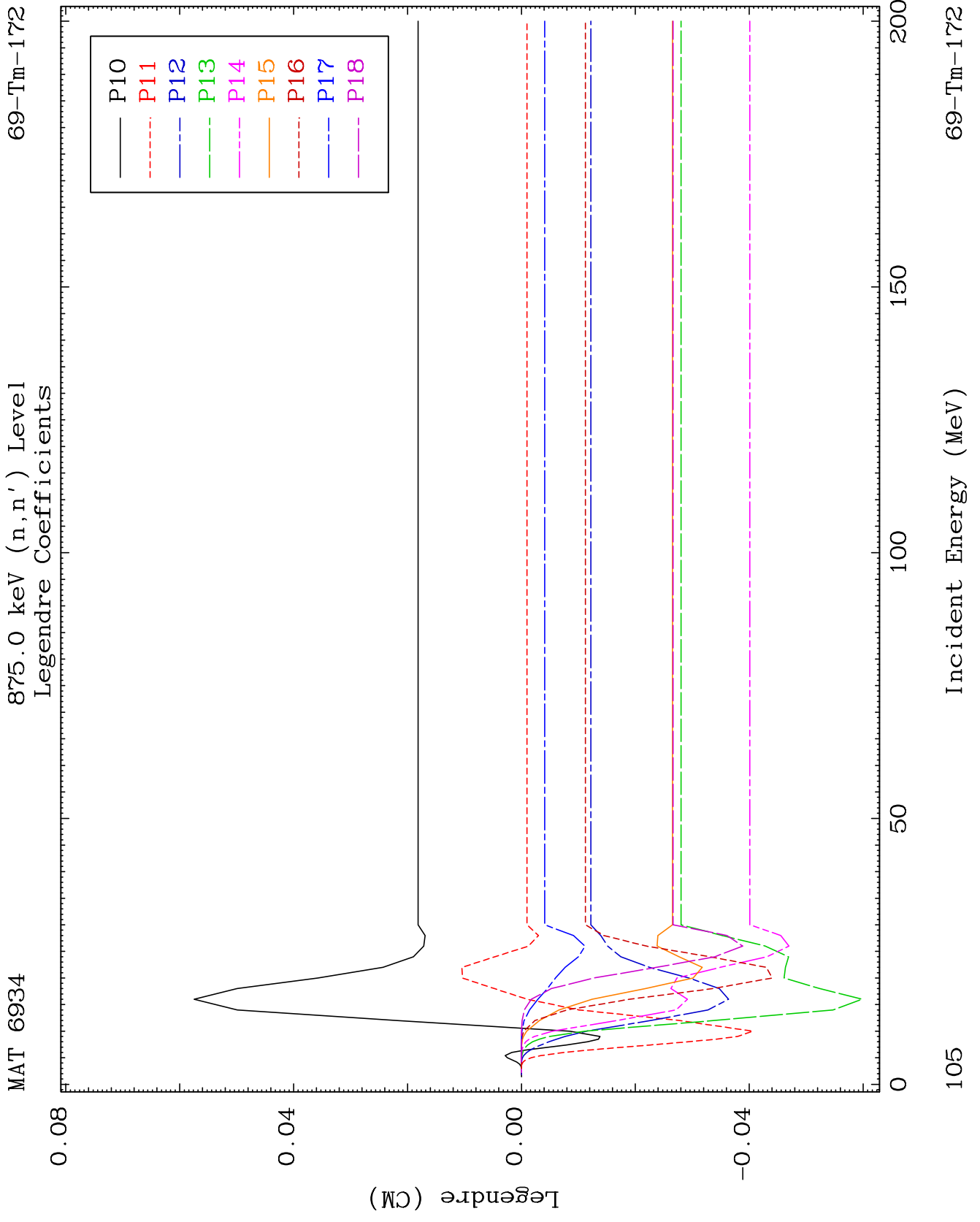

MAT 6934

875.0 keV (n,n') Level
Legendre Coefficients

69-Tm-172

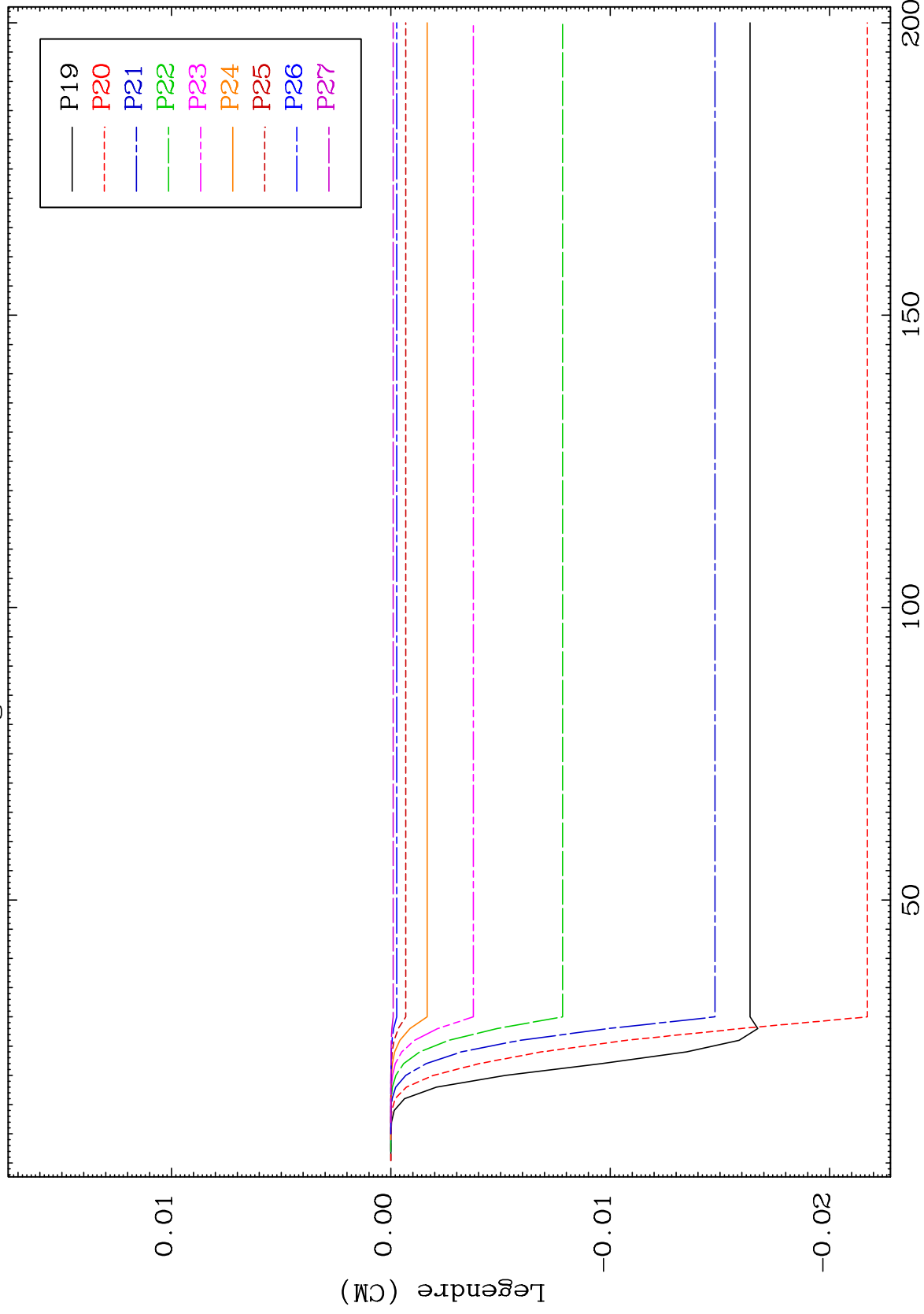

106

Incident Energy (MeV)

69-Tm-172

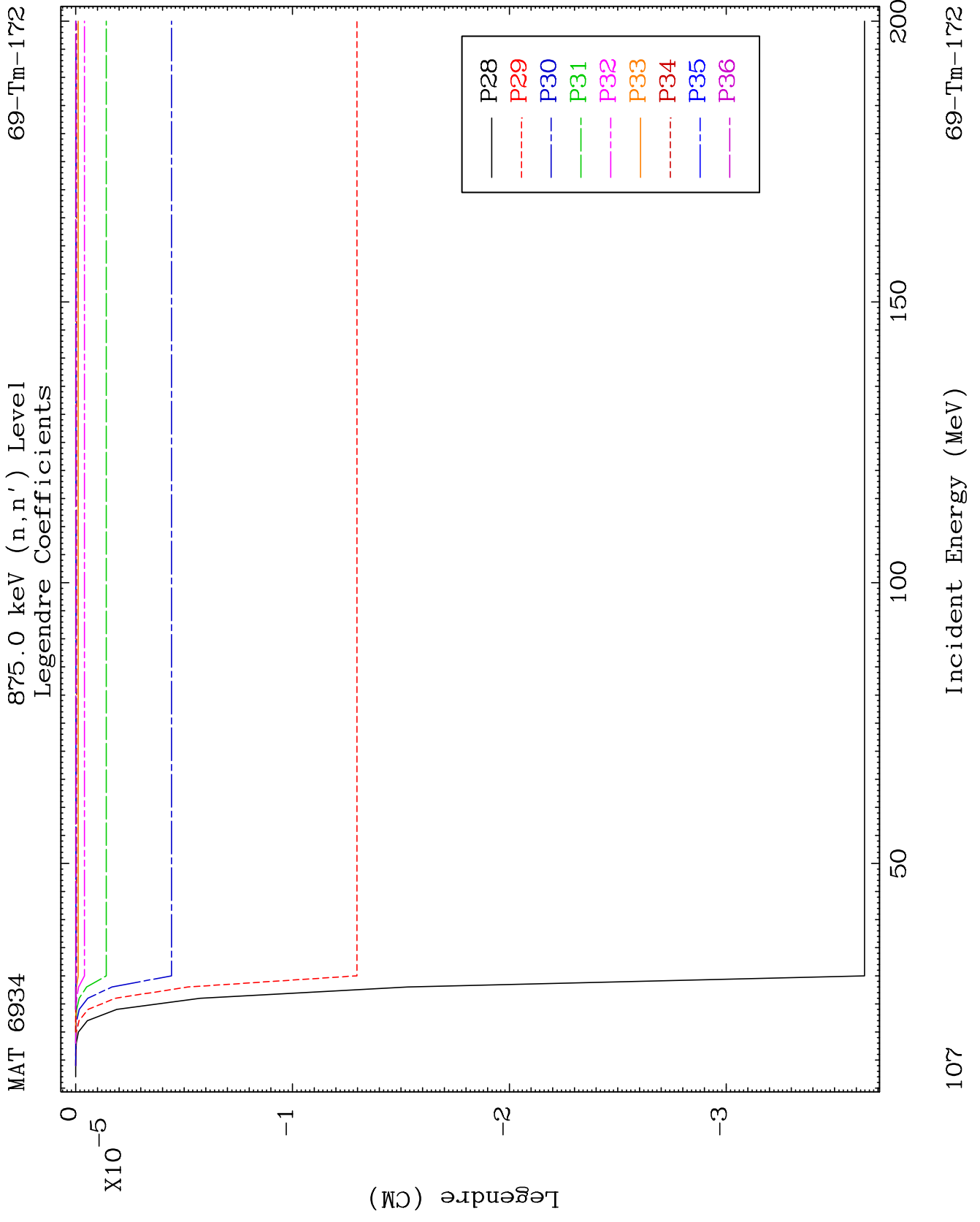

MAT 6934

877.5 keV (n,n') Level
Legendre Coefficients

69-Tm-172

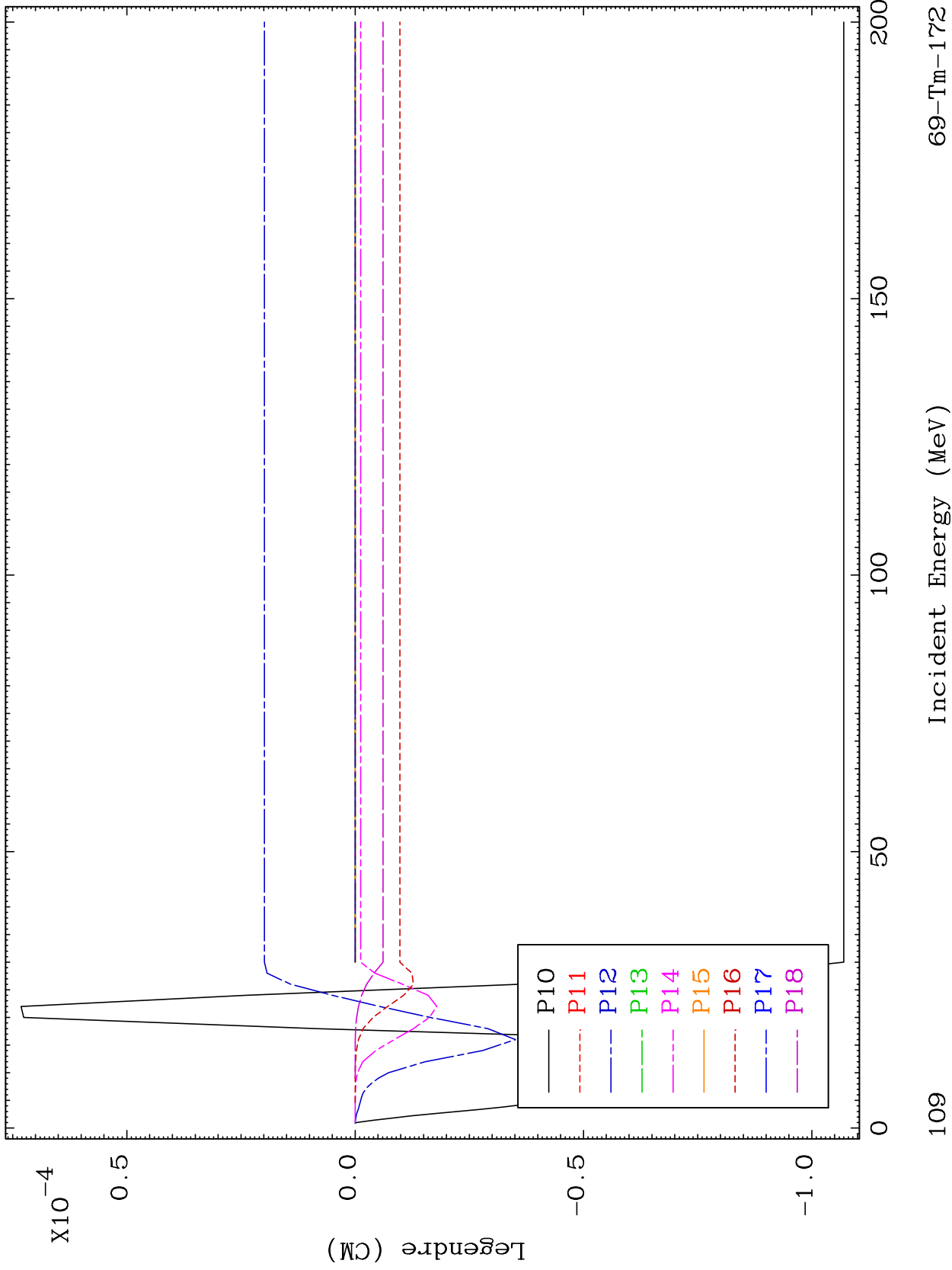

109

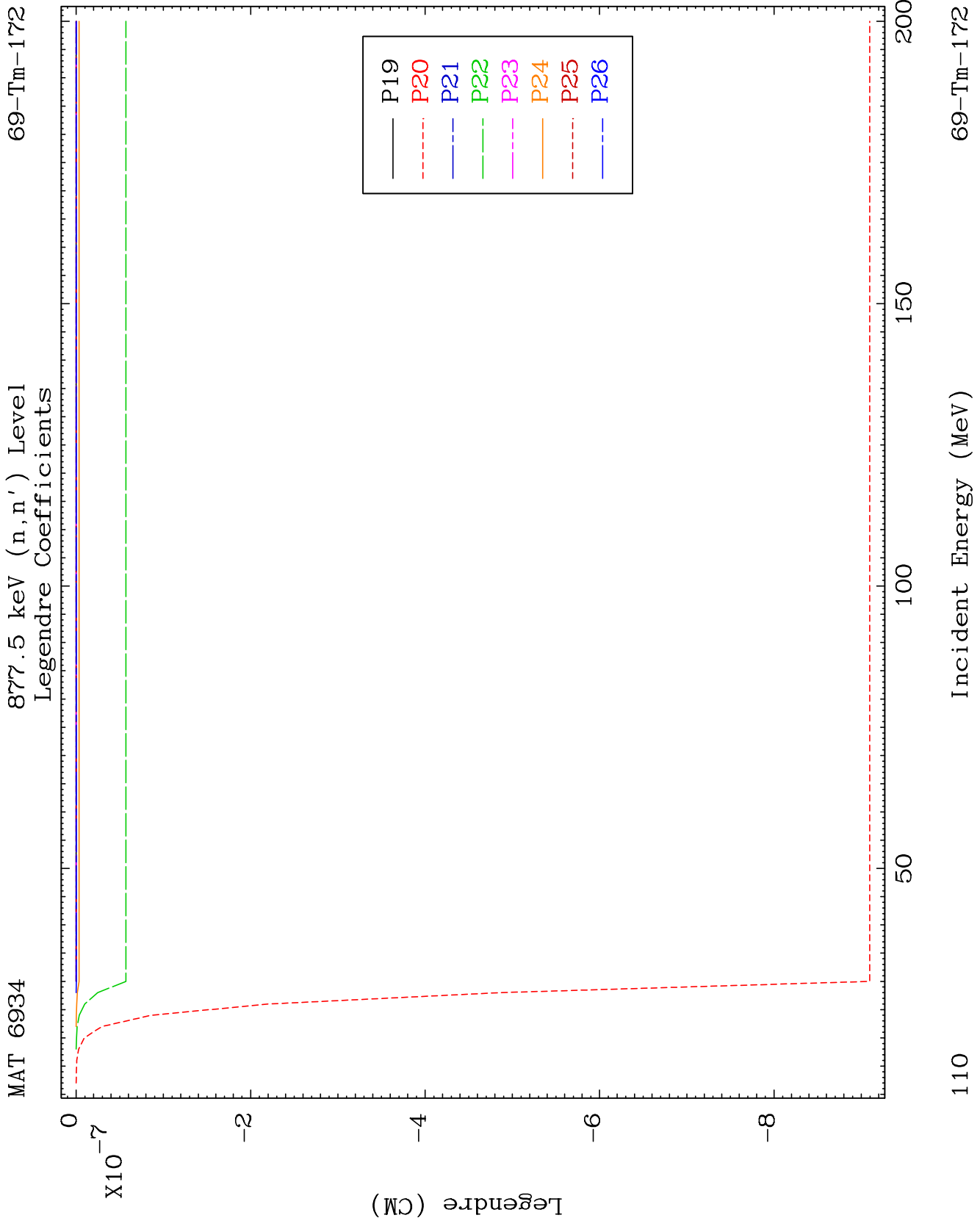

MAT 6934

879.0 keV (n,n') Level
Legendre Coefficients

69-Tm-172

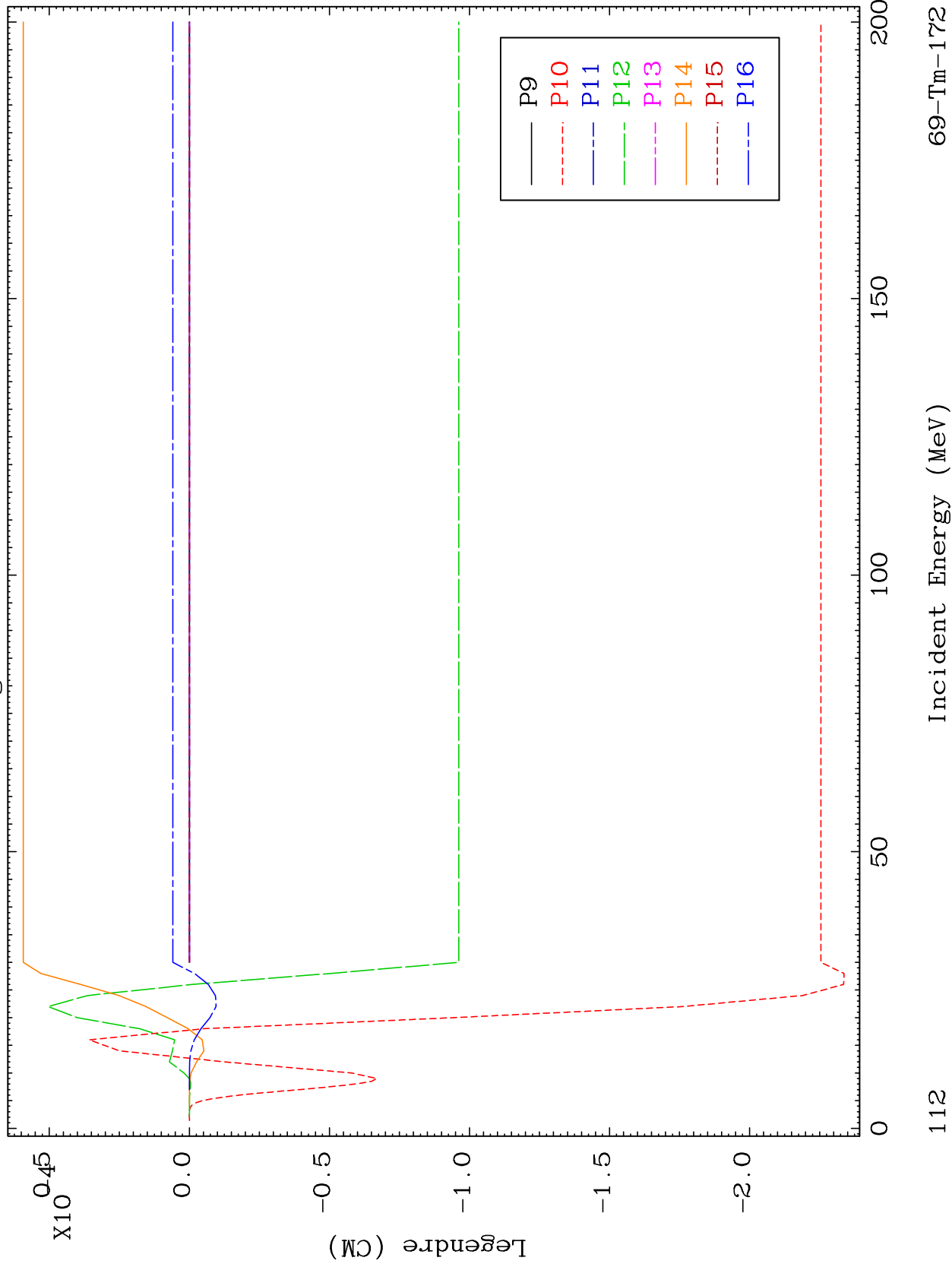

112

Incident Energy (MeV)

69-Tm-172

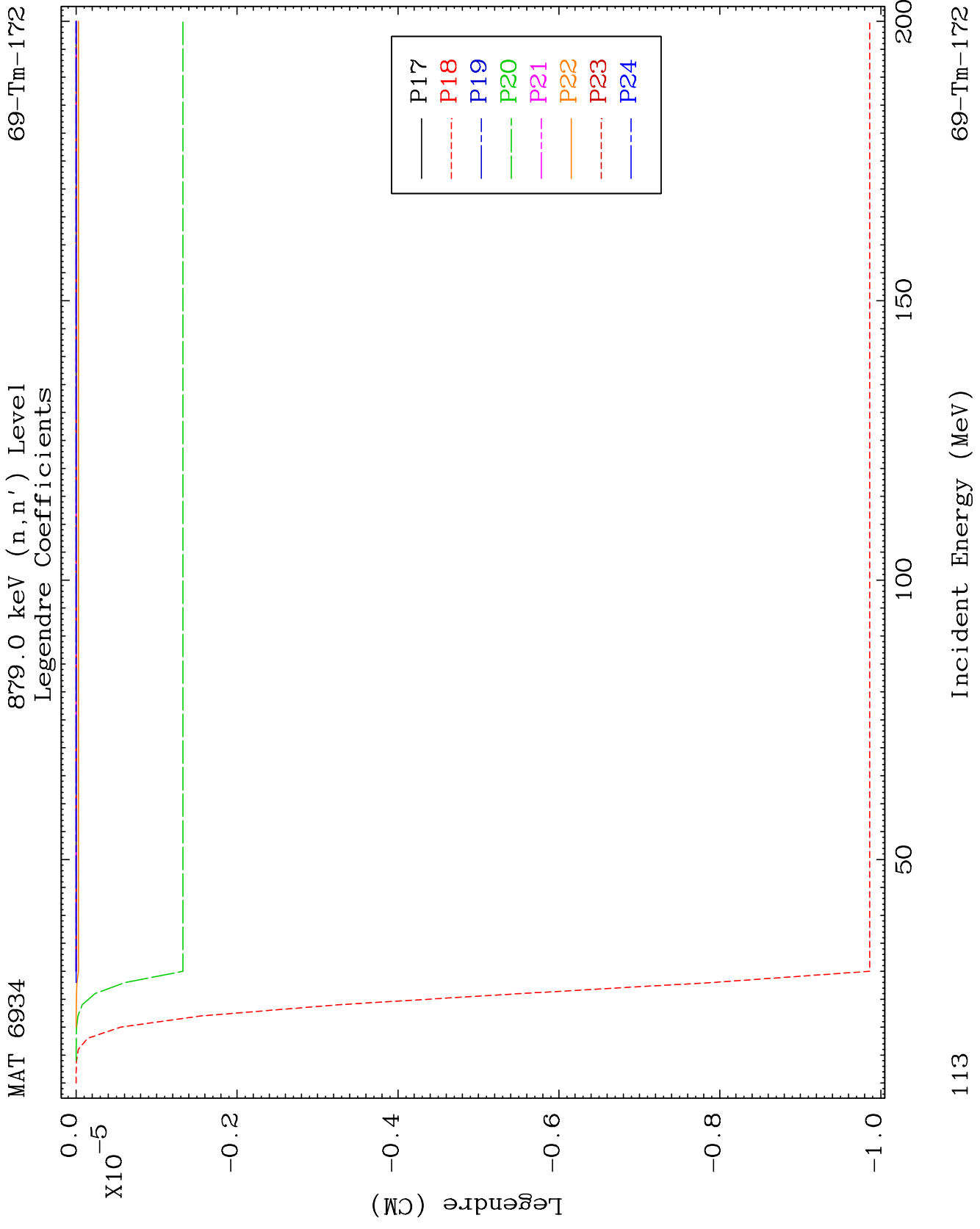

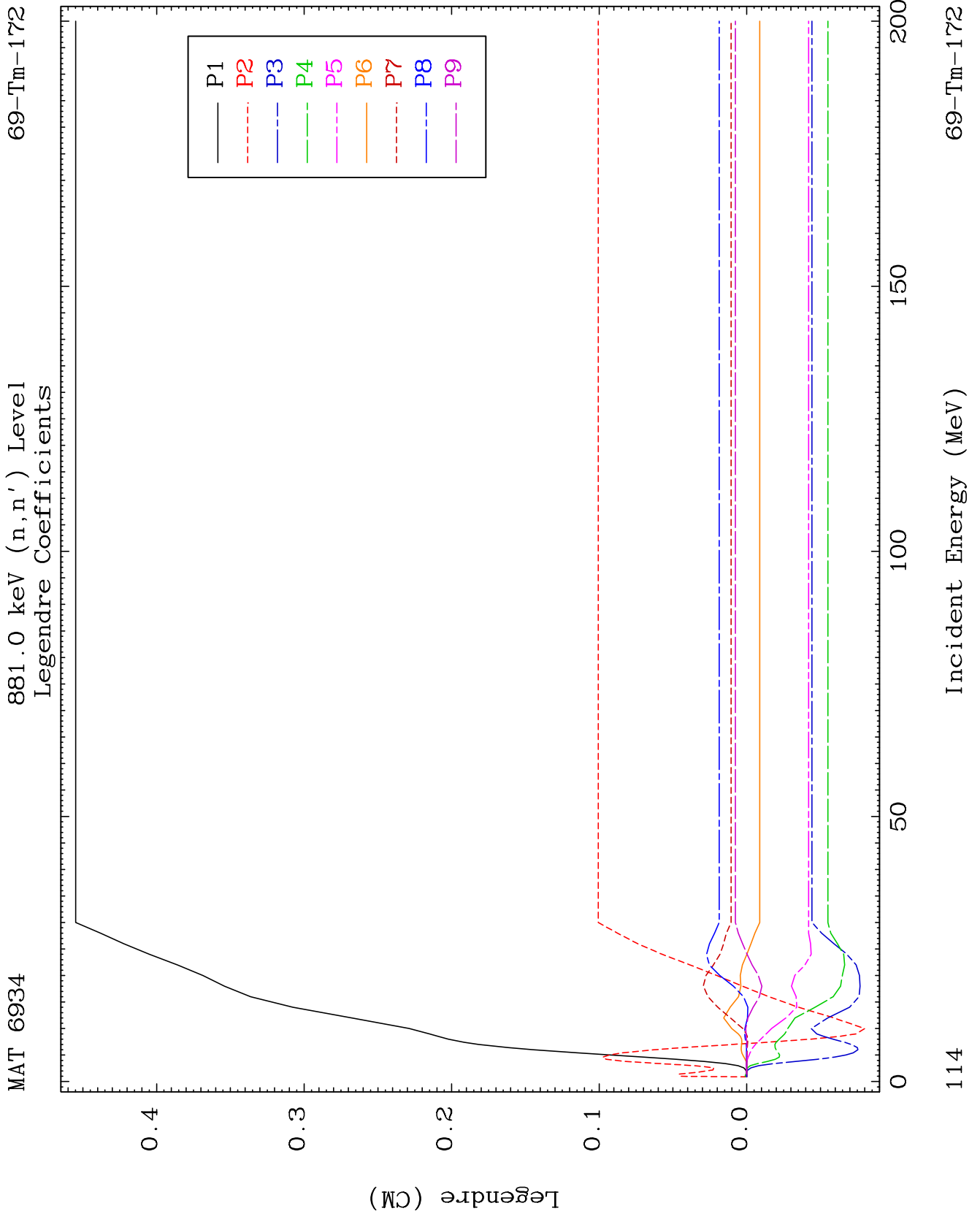

MAT 6934

881.0 keV (n,n') Level
Legendre Coefficients

69-Tm-172

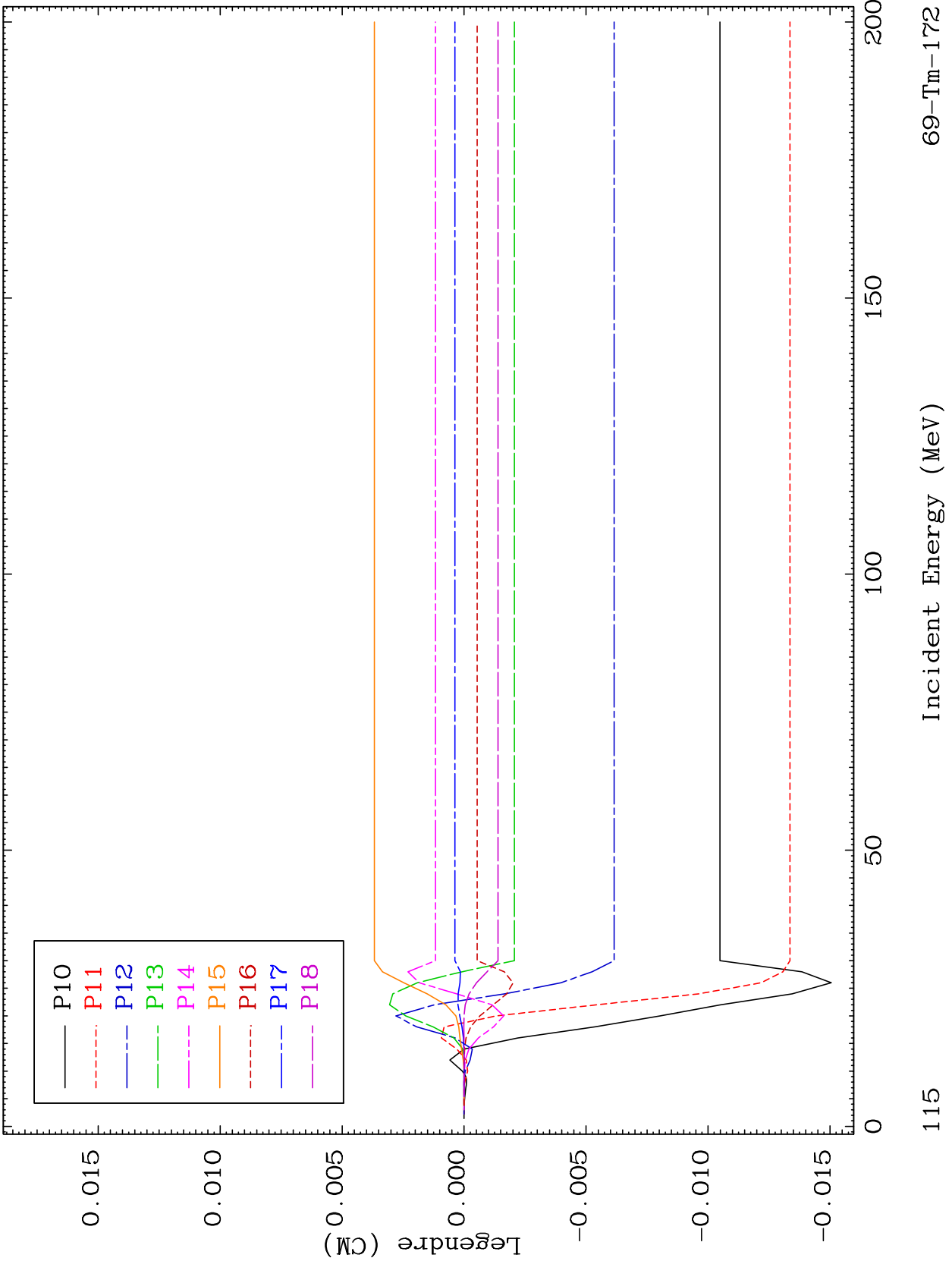

69-Tm-172

Incident Energy (MeV)

115

MAT 6934

881.0 keV (n,n') Level
Legendre Coefficients

69-Tm-172

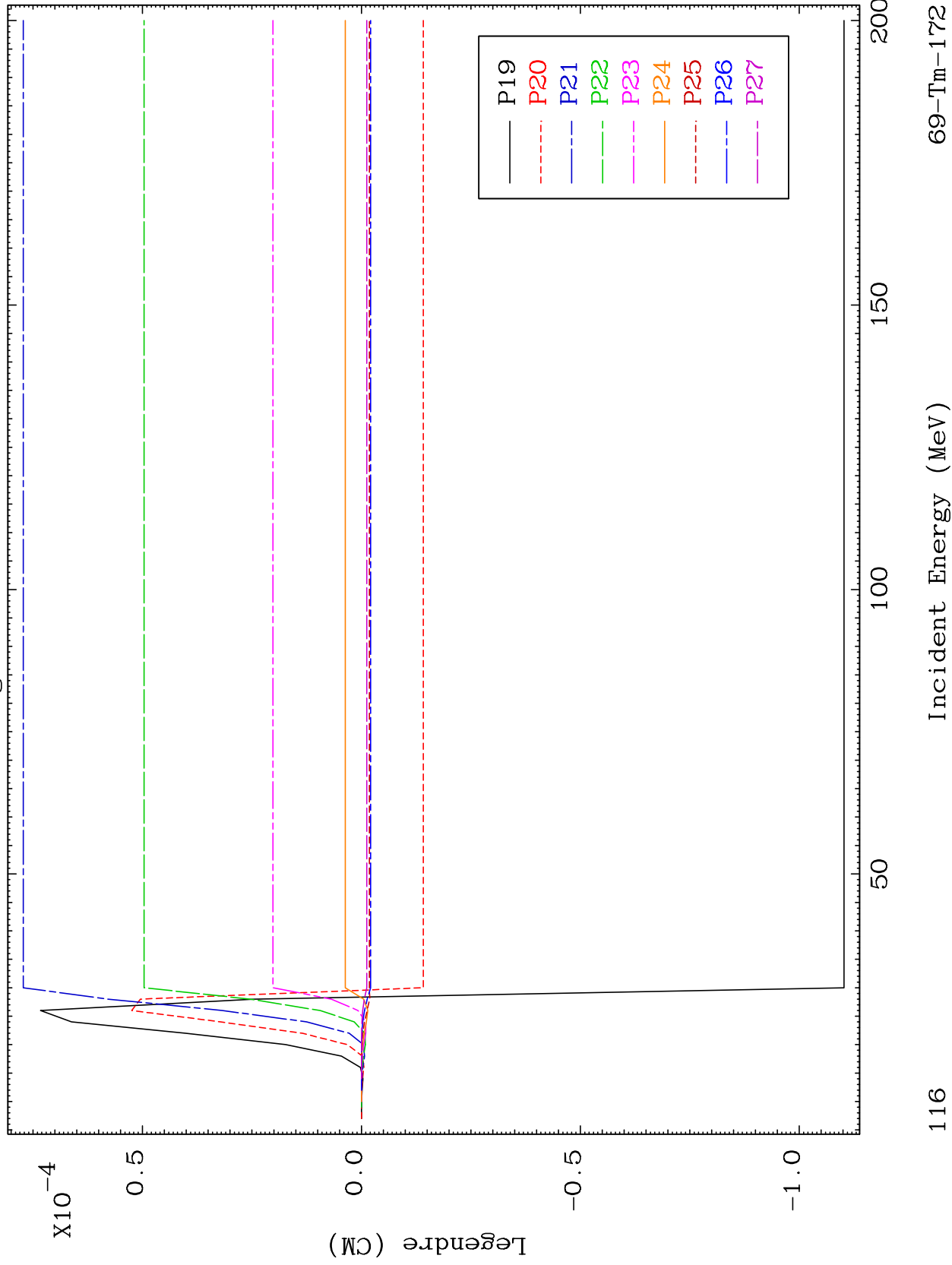

116

Incident Energy (MeV)

69-Tm-172

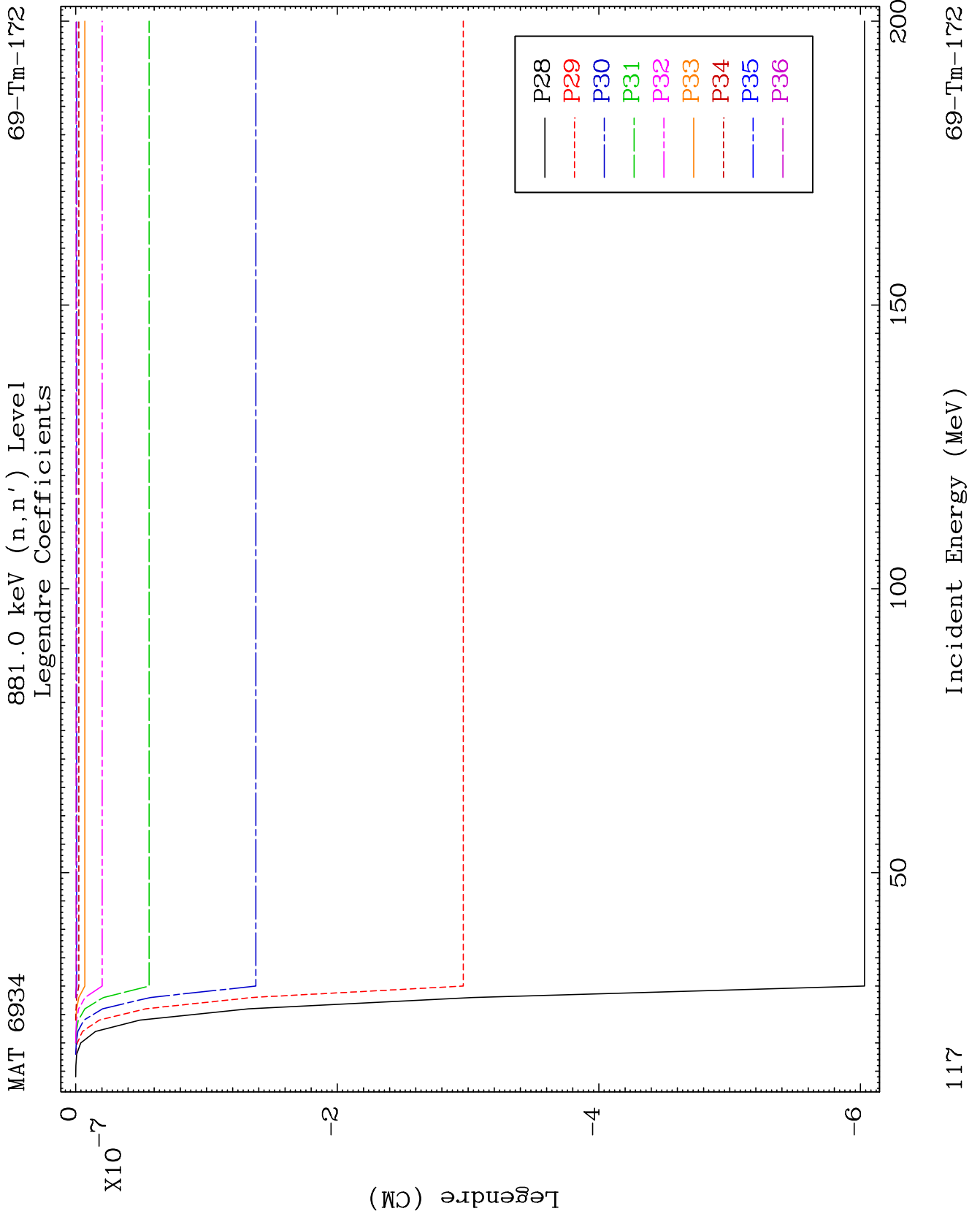

MAT 6934

886.4 keV (n,n') Level
Legendre Coefficients

69-Tm-172

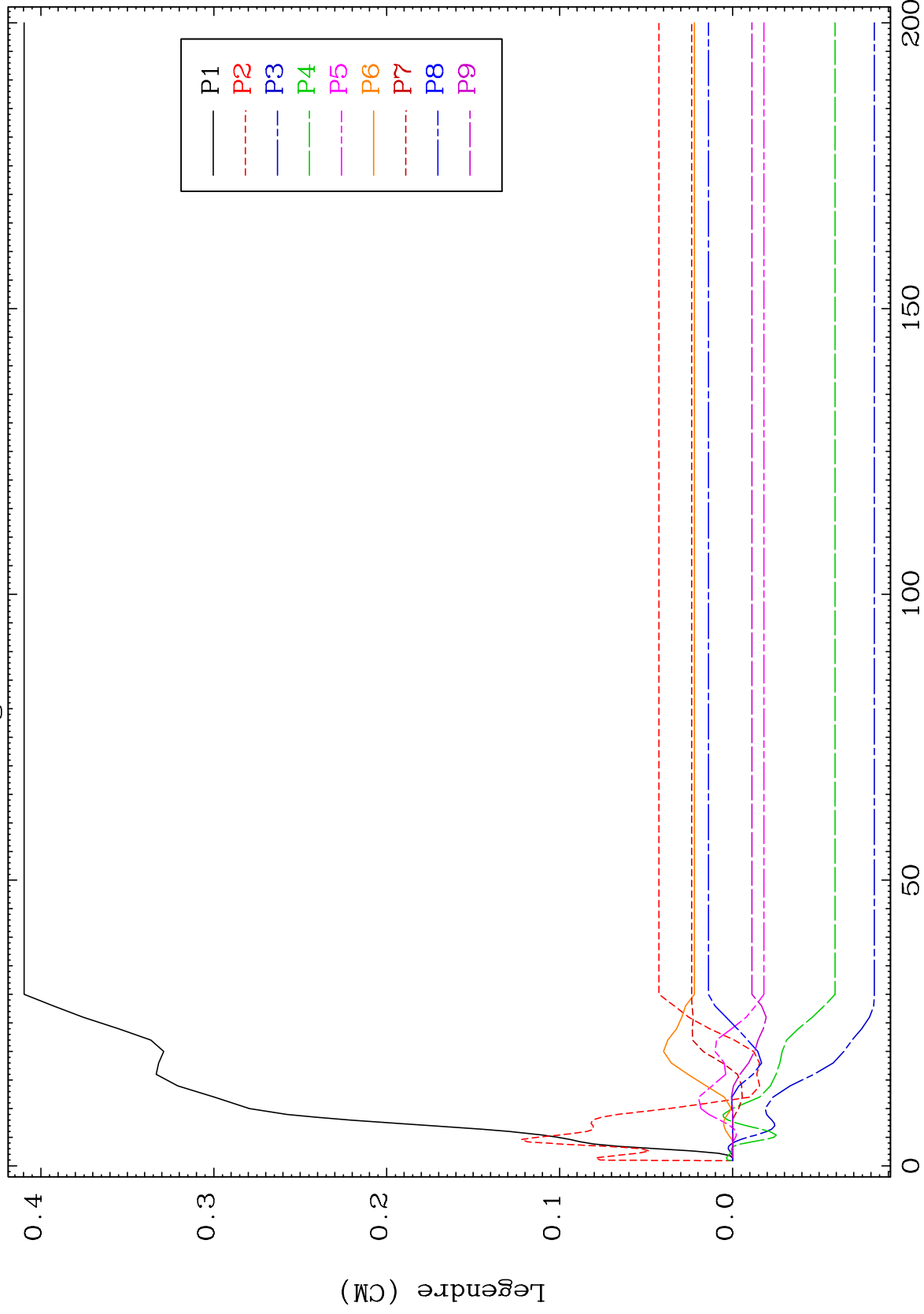

118

Incident Energy (MeV)

69-Tm-172

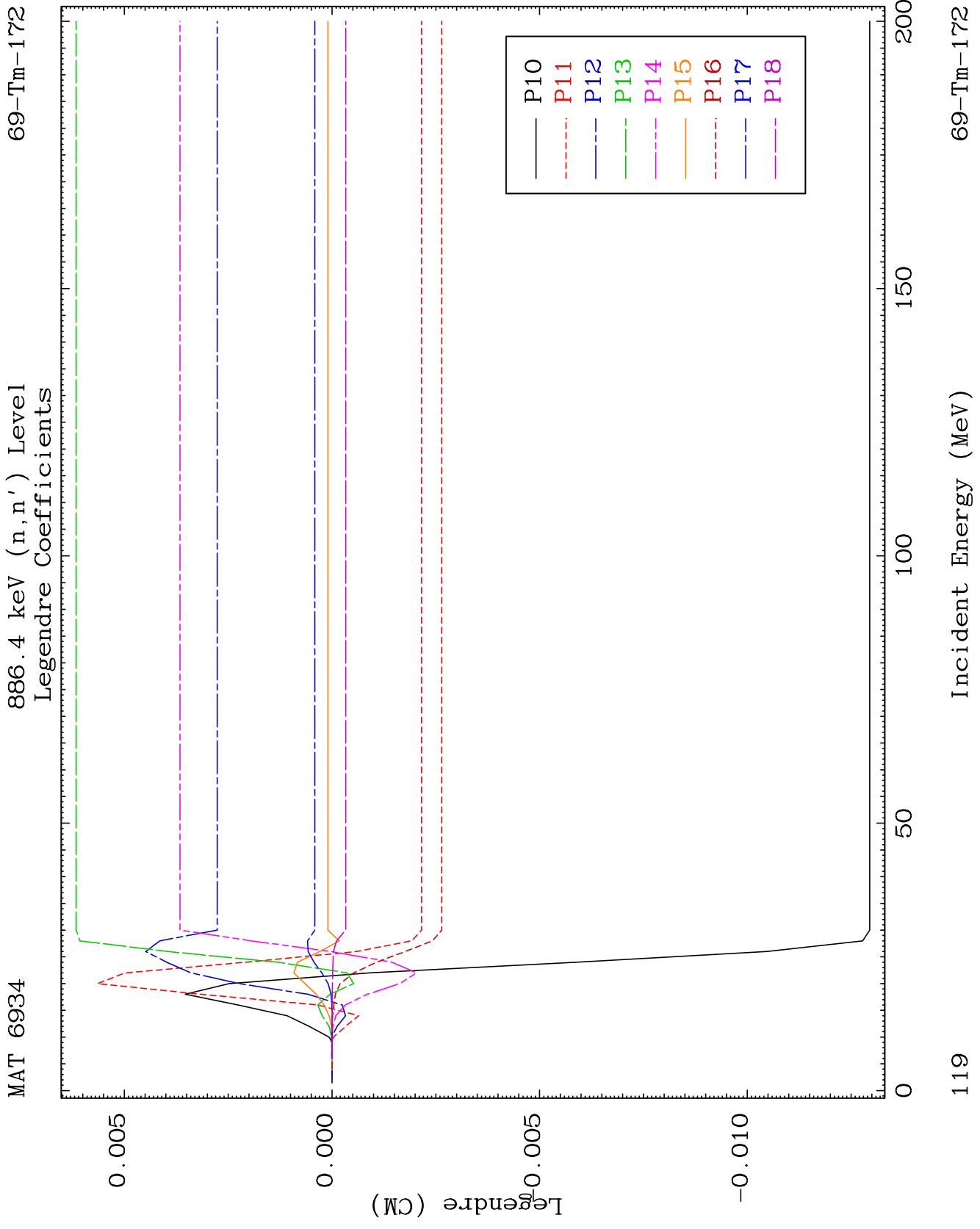

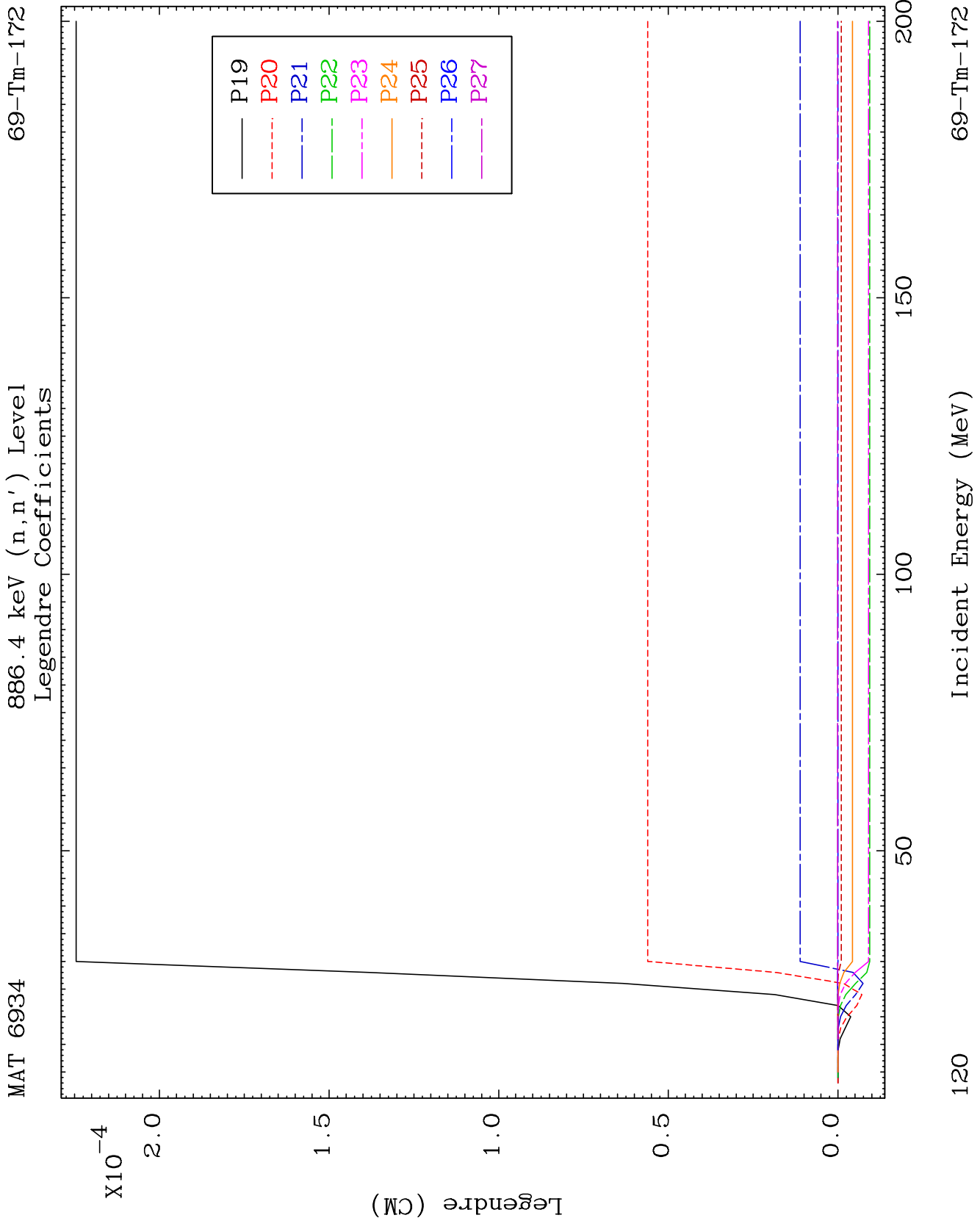

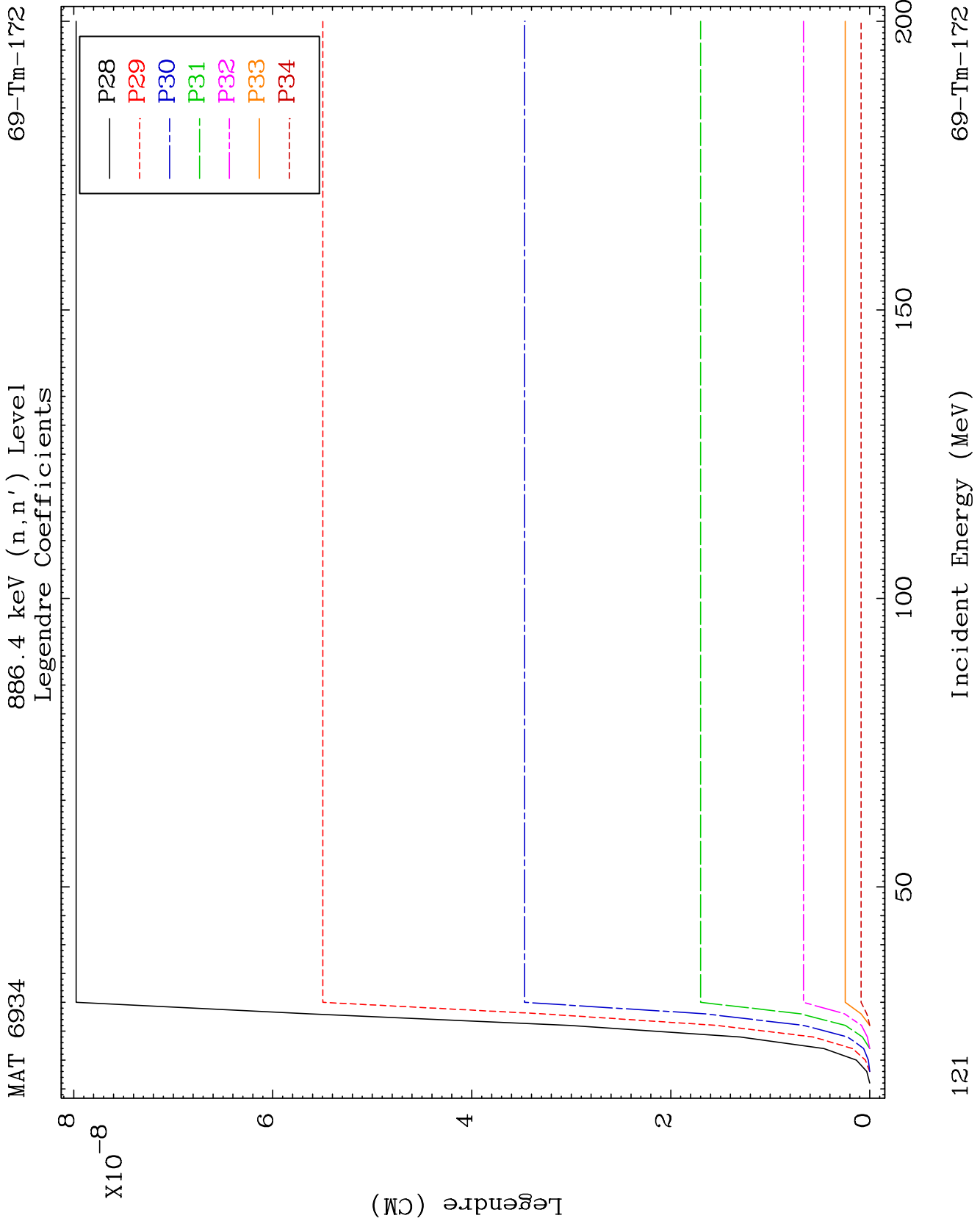

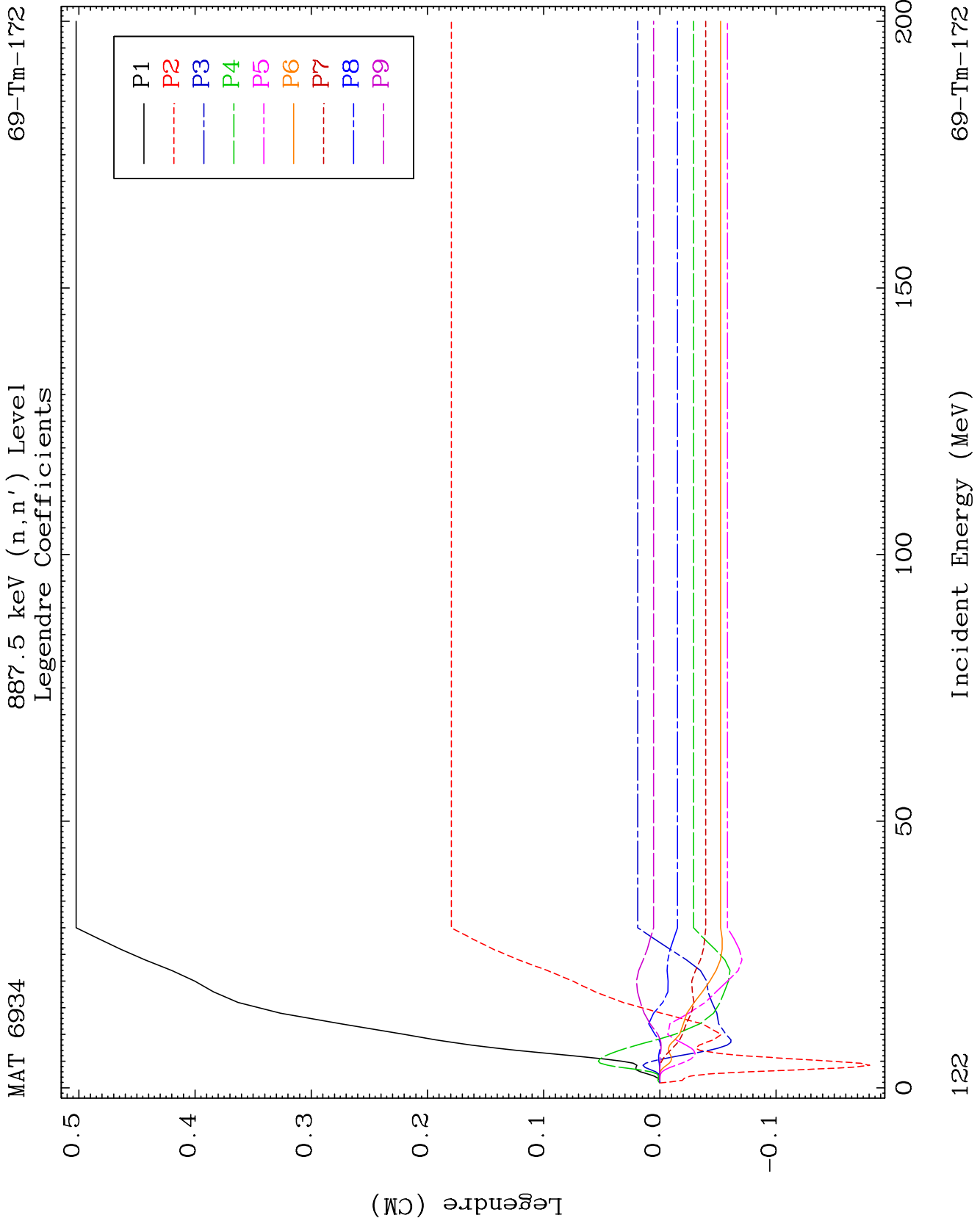

MAT 6934

887.5 keV (n,n') Level
Legendre Coefficients

69-Tm-172

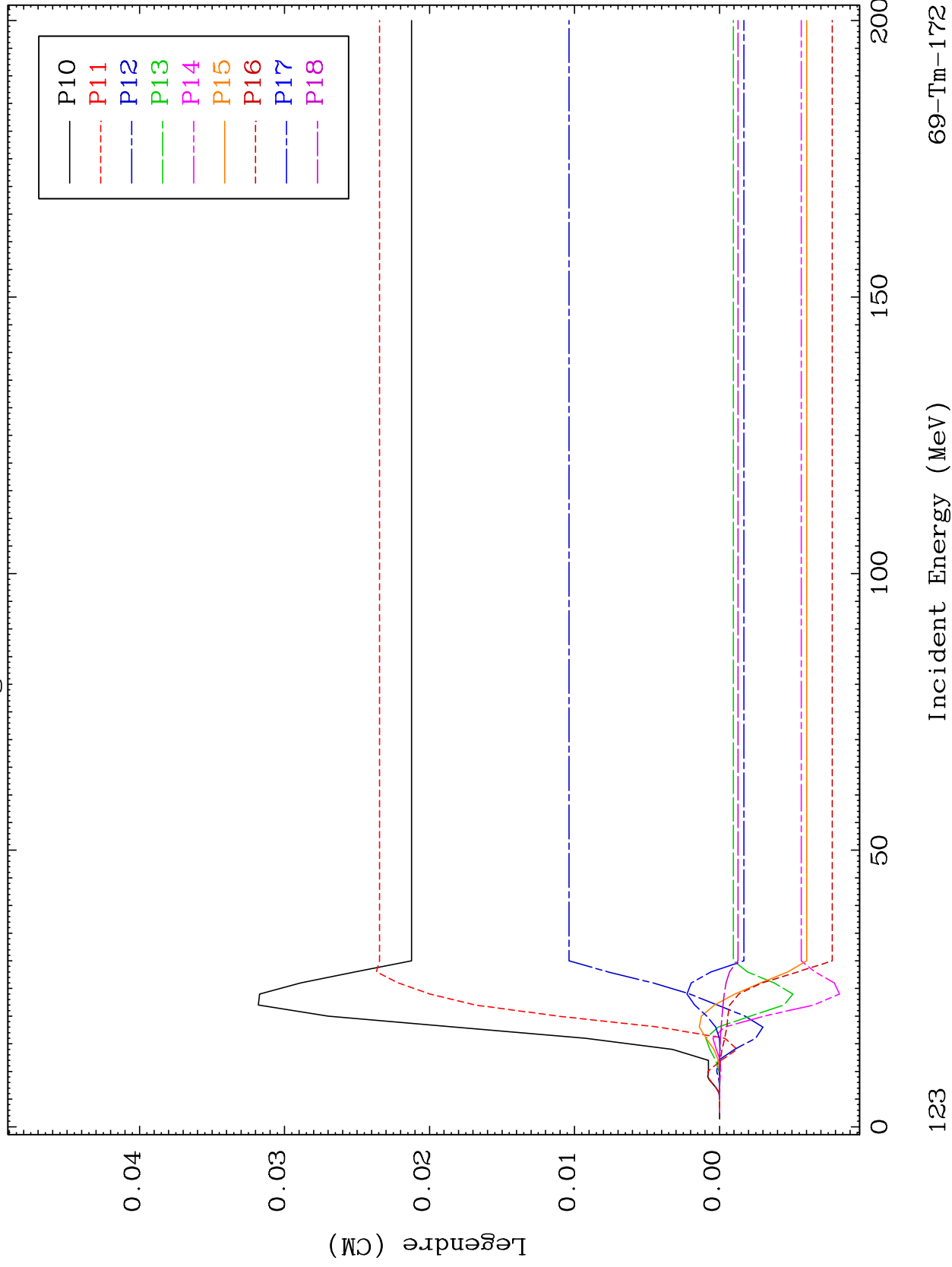

123

Incident Energy (MeV)

69-Tm-172

MAT 6934

887.5 keV (n,n') Level
Legendre Coefficients

69-Tm-172

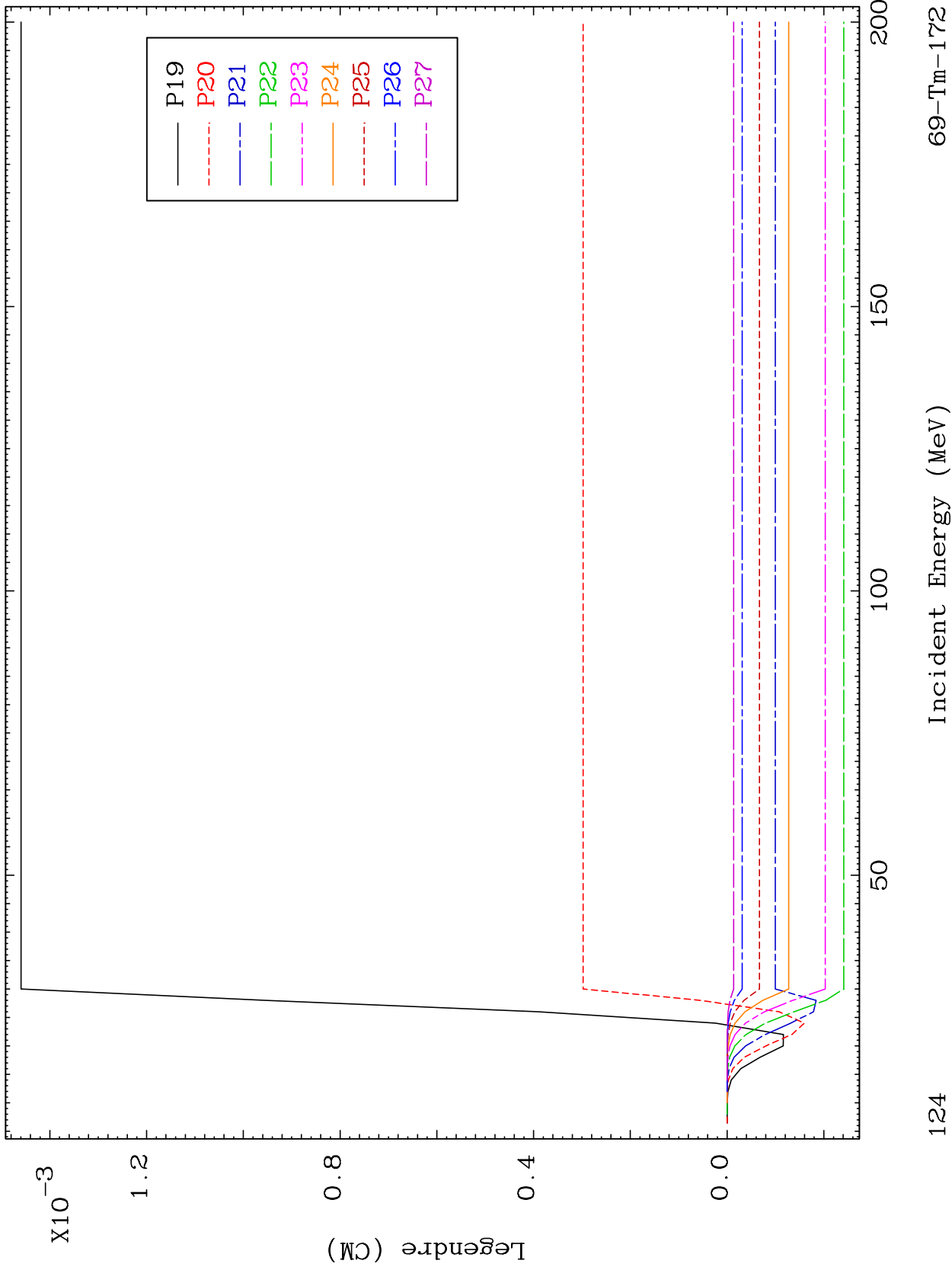

124

Incident Energy (MeV)

69-Tm-172

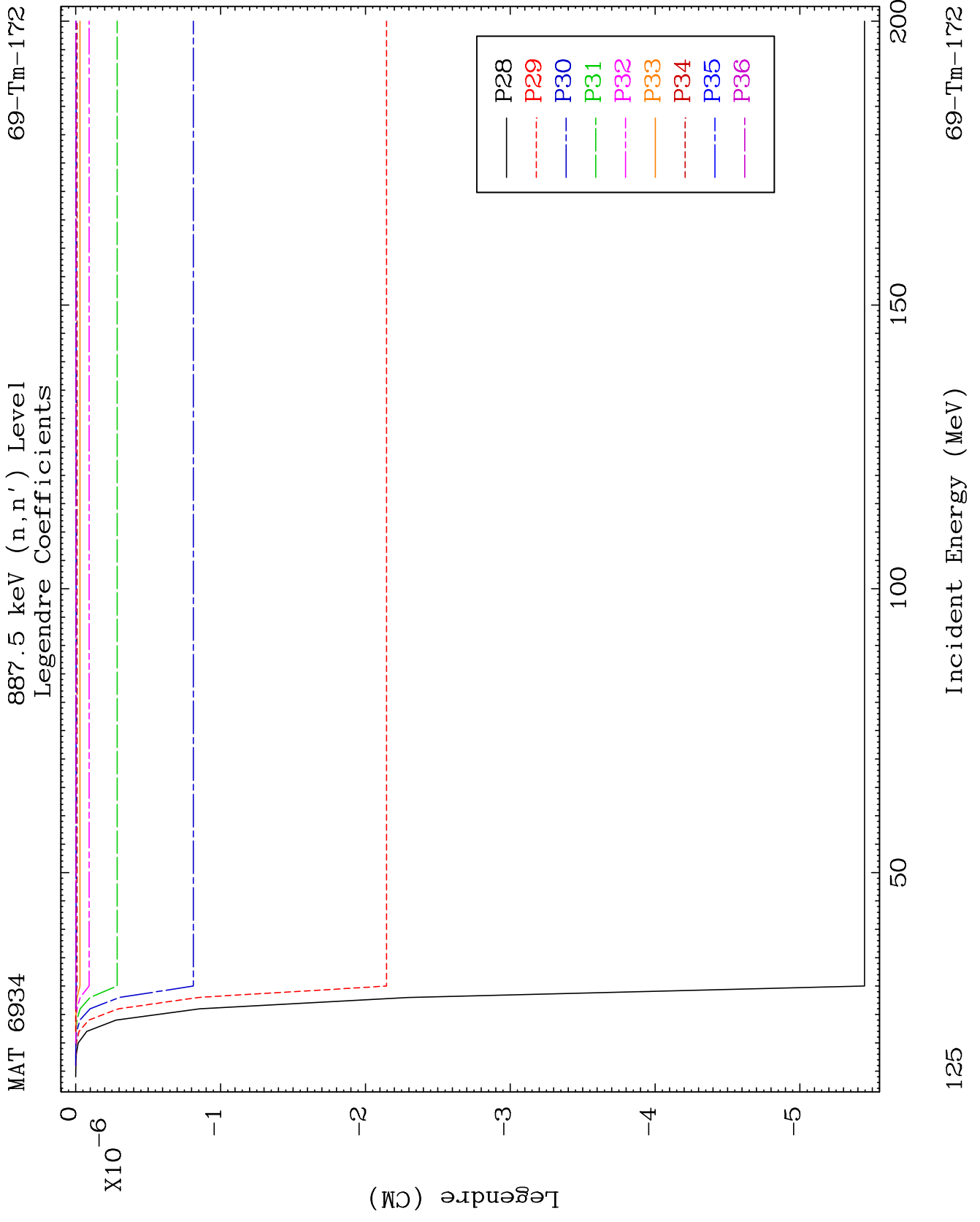

MAT 6934

$(n, n') \alpha$

69-Tm-172

Radionuclide Production Cross Section

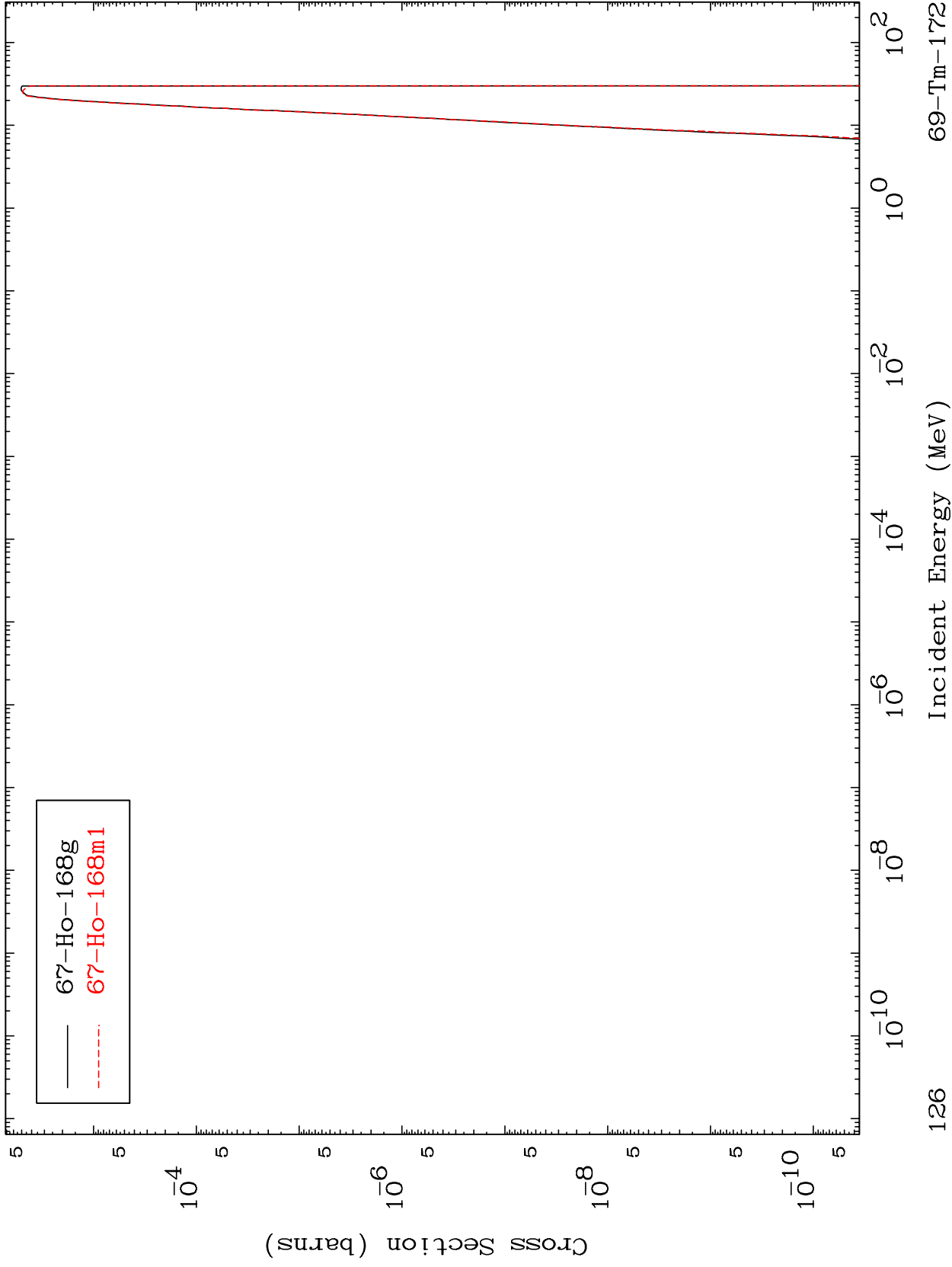

MAT 6934

(n,3n) α

69-Tm-172

Radionuclide Production Cross Section

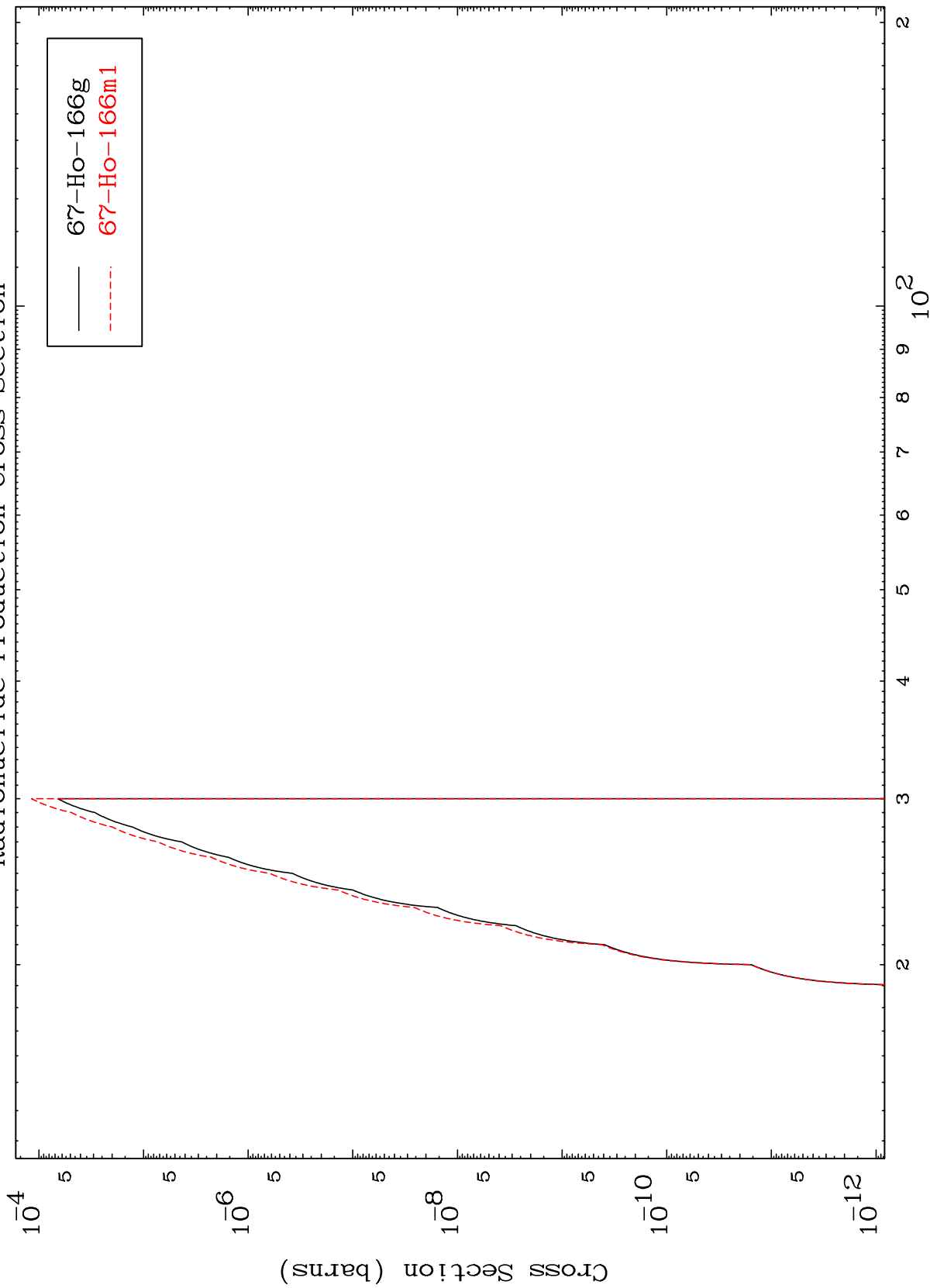

67-Ho-166g
67-Ho-166m1

127

Incident Energy (MeV)

69-Tm-172

Radionuclide Production Cross Section

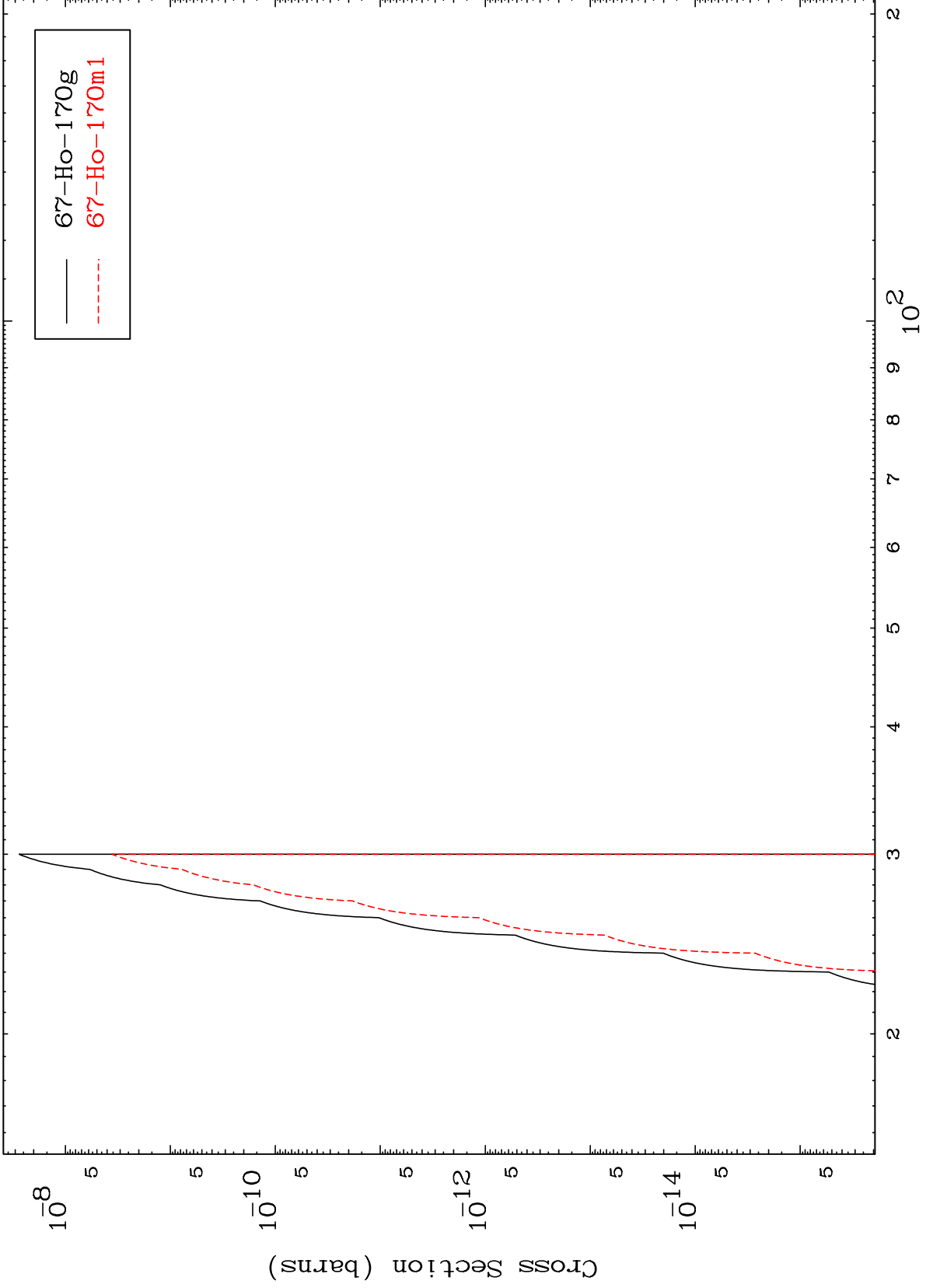

MAT 6934

(n,He-3)

69-Tm-172

Radionuclide Production Cross Section

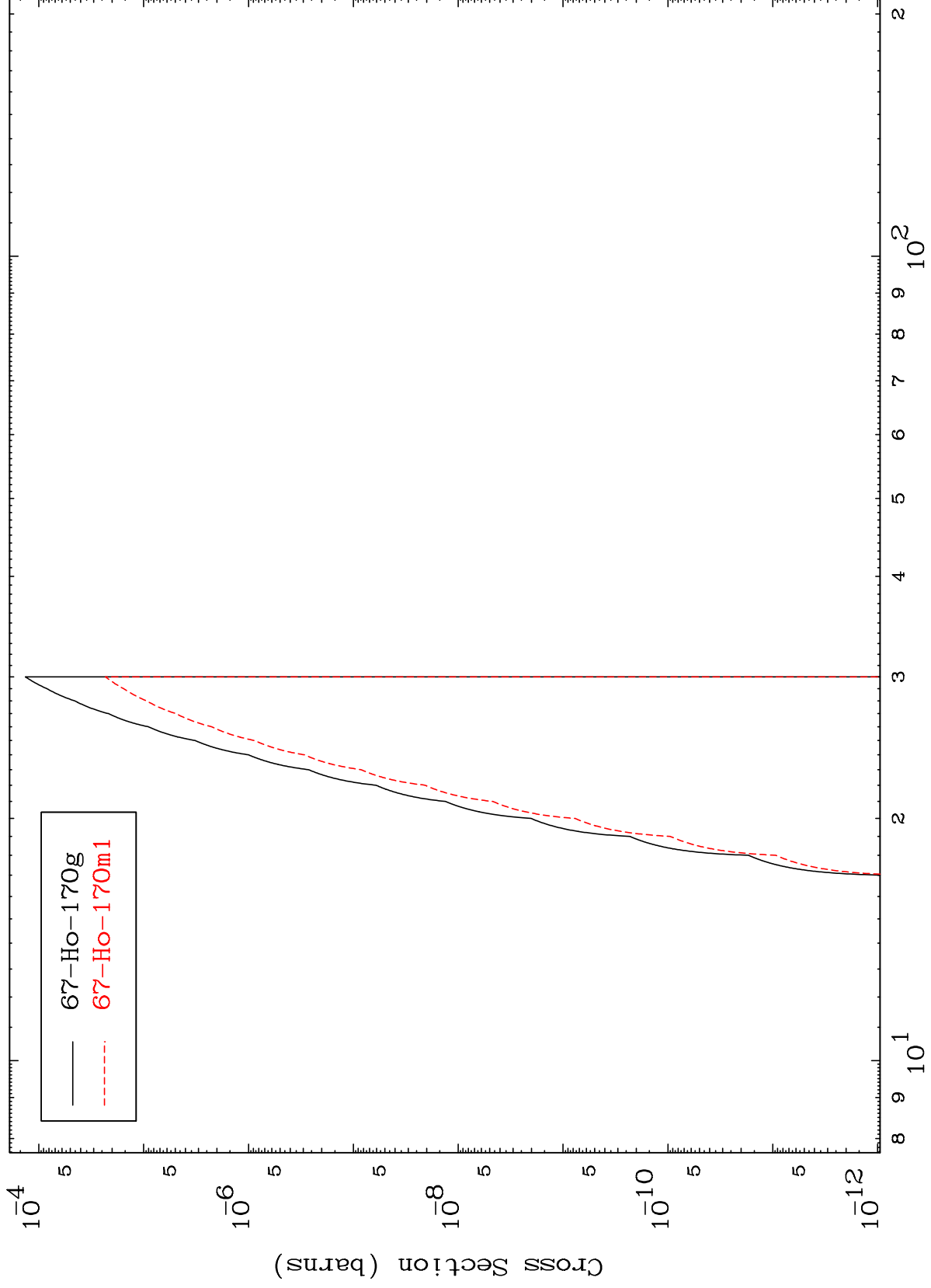

129

Incident Energy (MeV)

69-Tm-172