

Program EVALPLOT
(Version 2015-2)

by

Dermott E. Cullen
(Present Contact Information)

Dermott E. Cullen
1466 Hudson Way
Livermore, CA 94550
U.S.A.

Tele: 925-443-1911

E.Mail:redcullen1@comcast.net
Web:home.comcast.net/~redcullen1

Press Mouse Button to Start

MAT 6937

Major

293 Kelvin Cross Sections

69-Tm-173

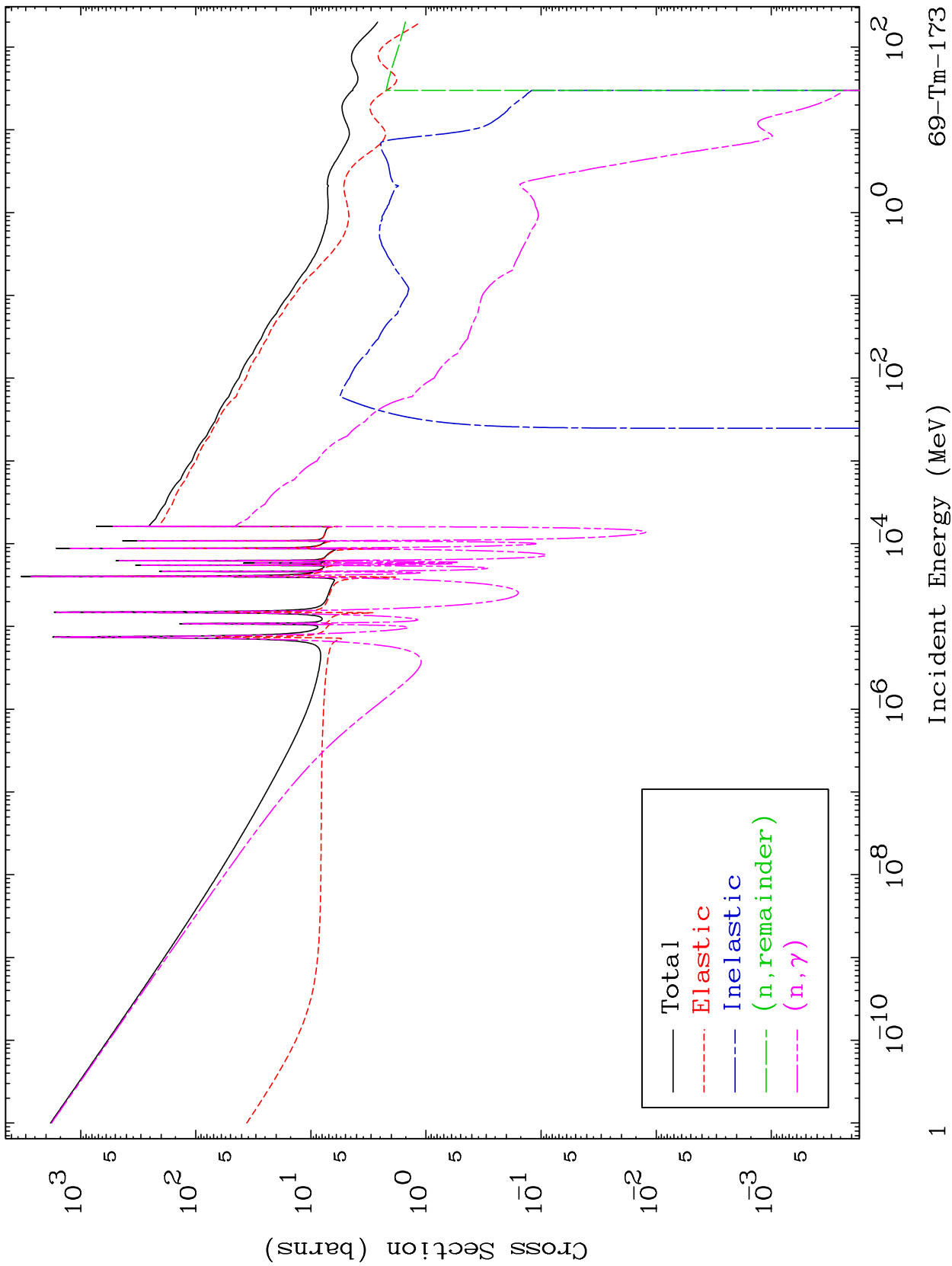

MAT 6937

Neutron Production
293 Kelvin Cross Sections

69-Tm-173

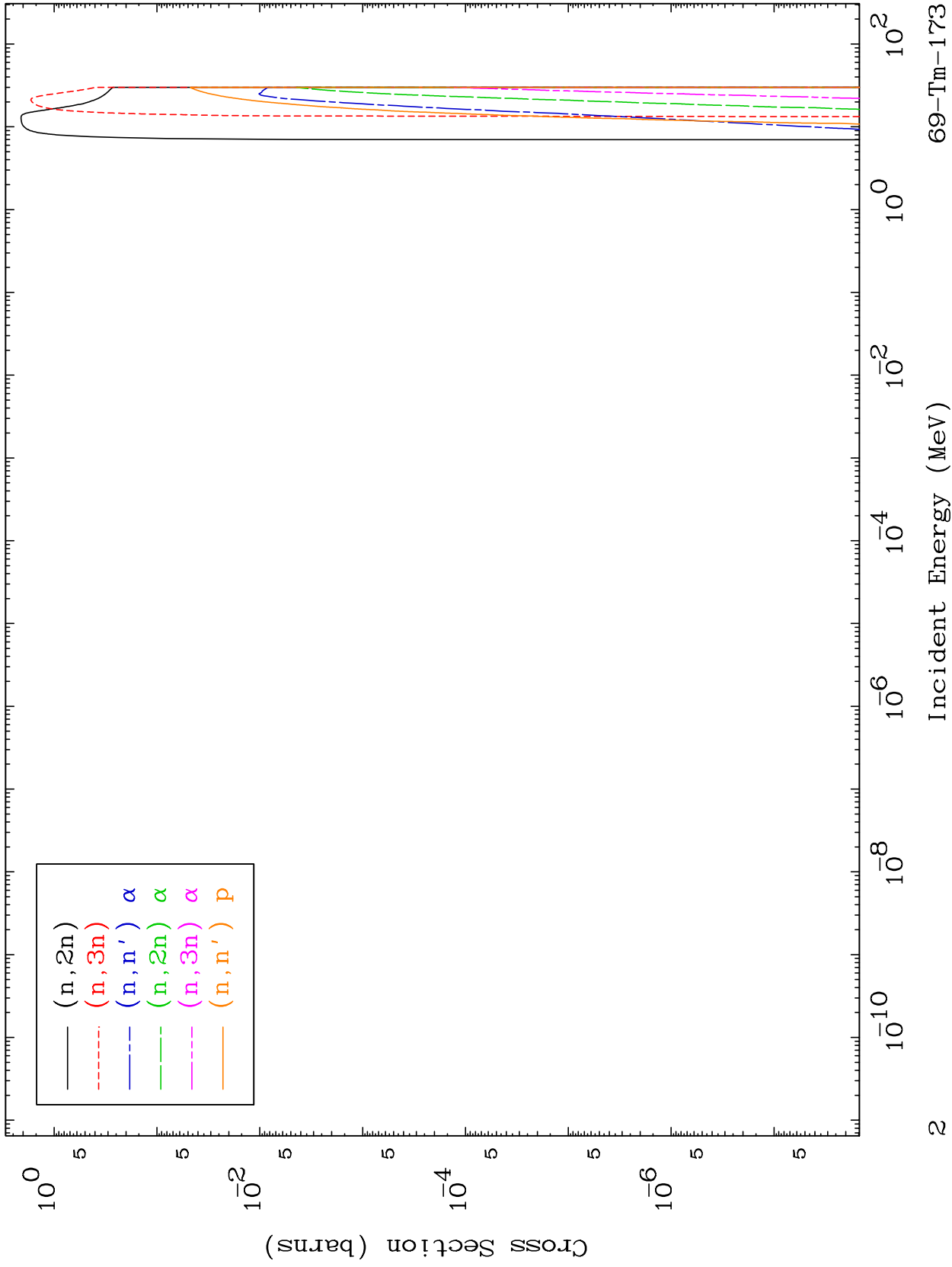

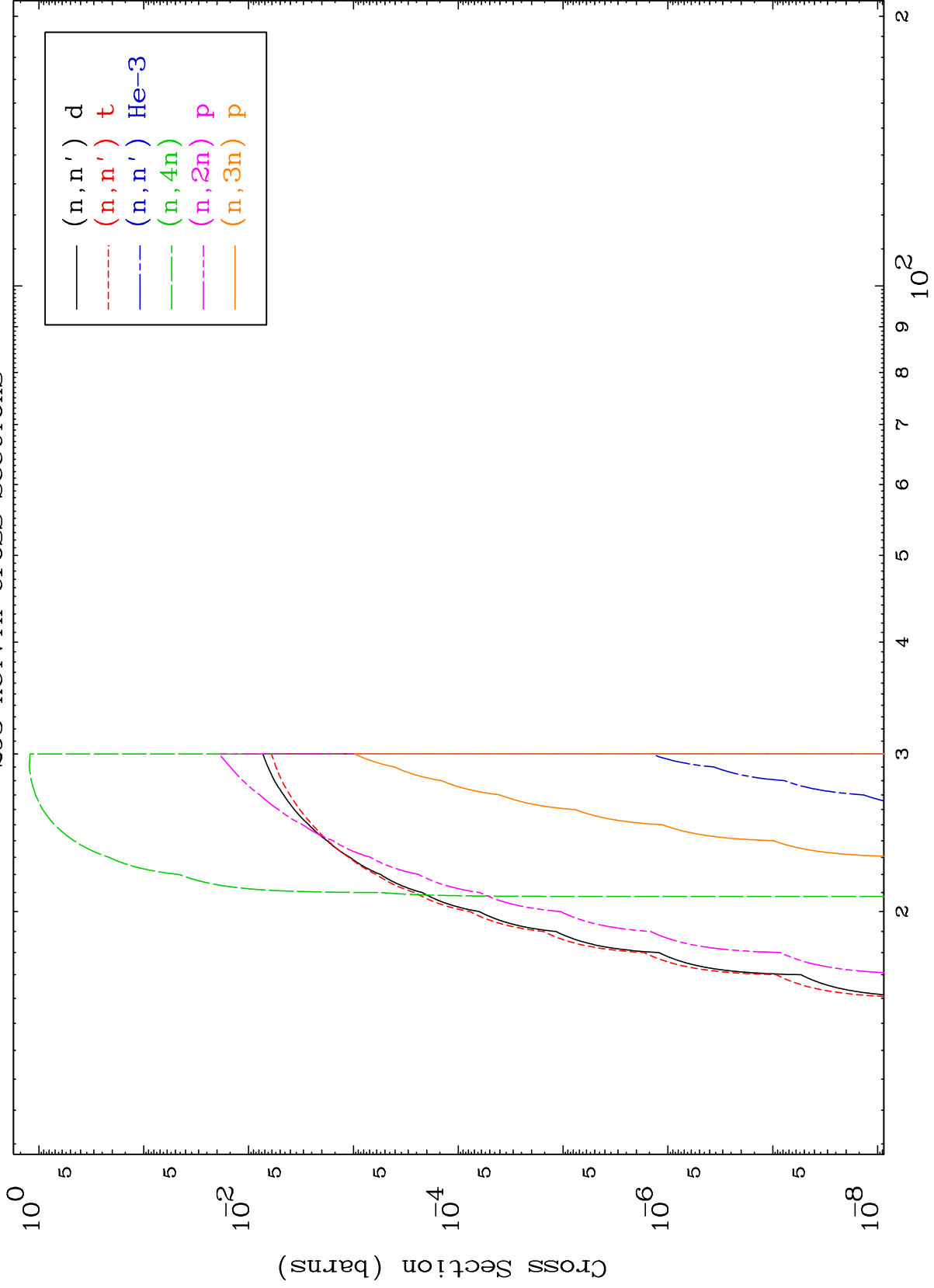

MAT 6937

Charged Particle
293 Kelvin Cross Sections

69-Tm-173

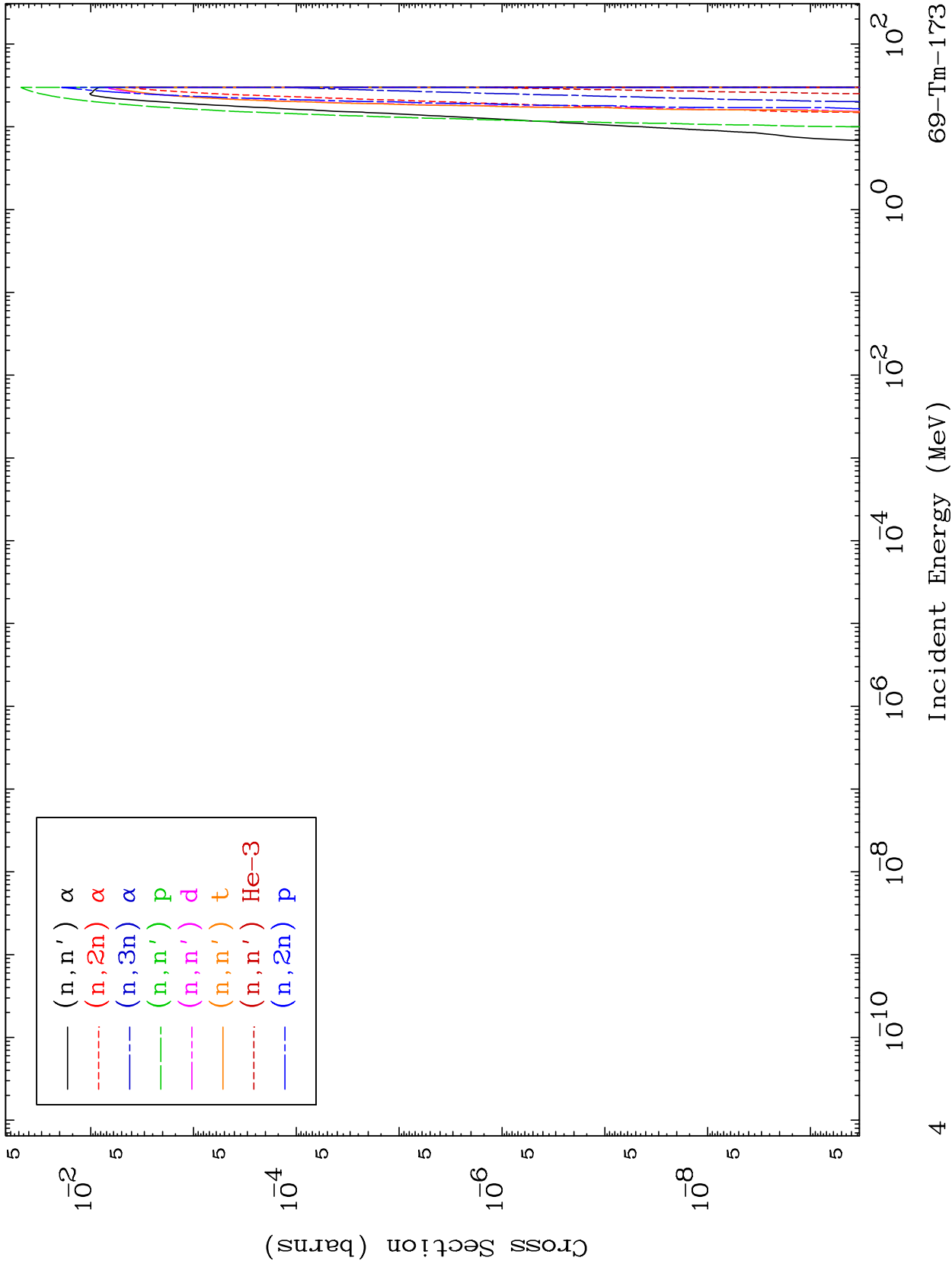

MAT 6937

Charged Particle
293 Kelvin Cross Sections

69-Tm-173

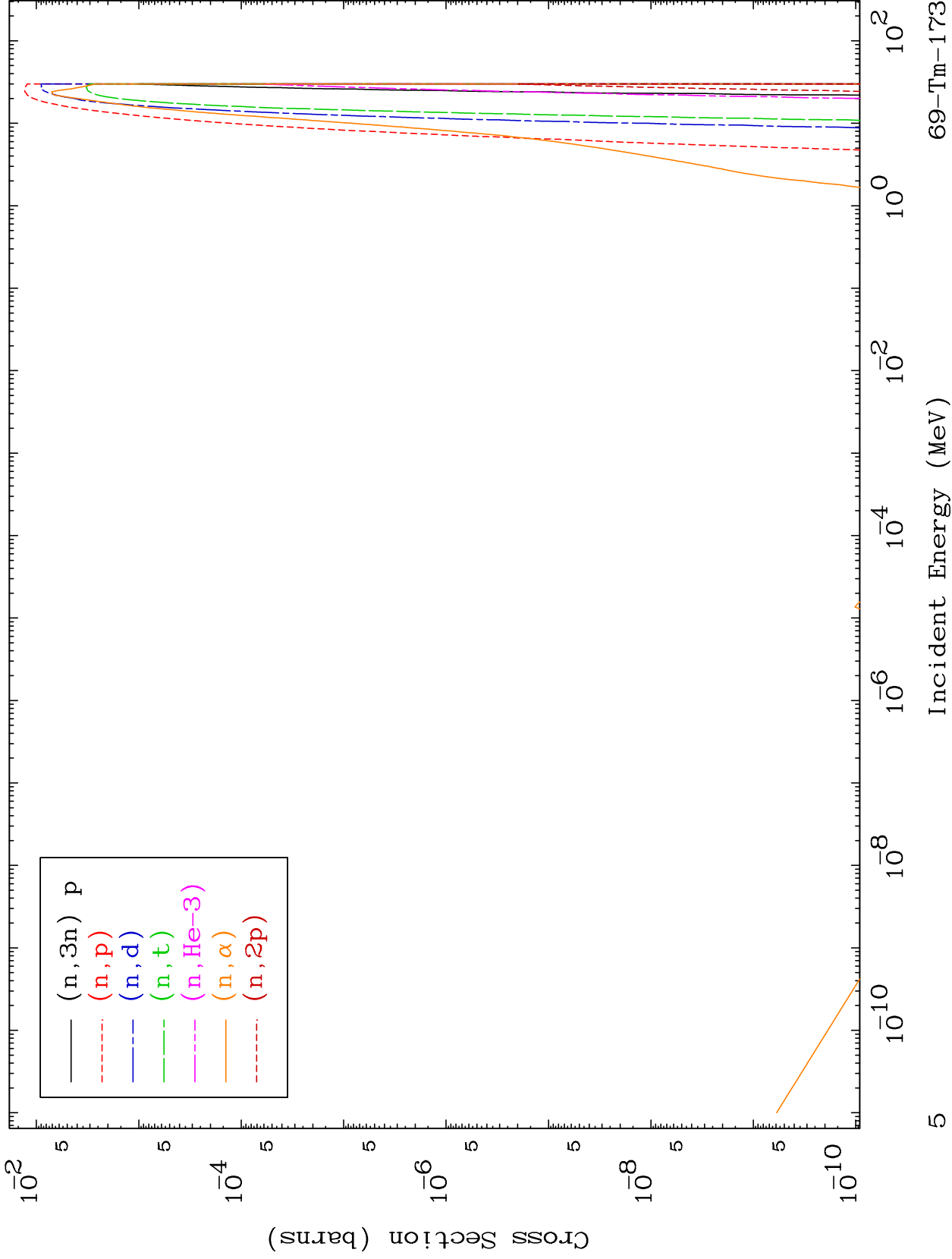

MAT 6937

Particle Production
293 Kelvin Cross Sections

69-Tm-173

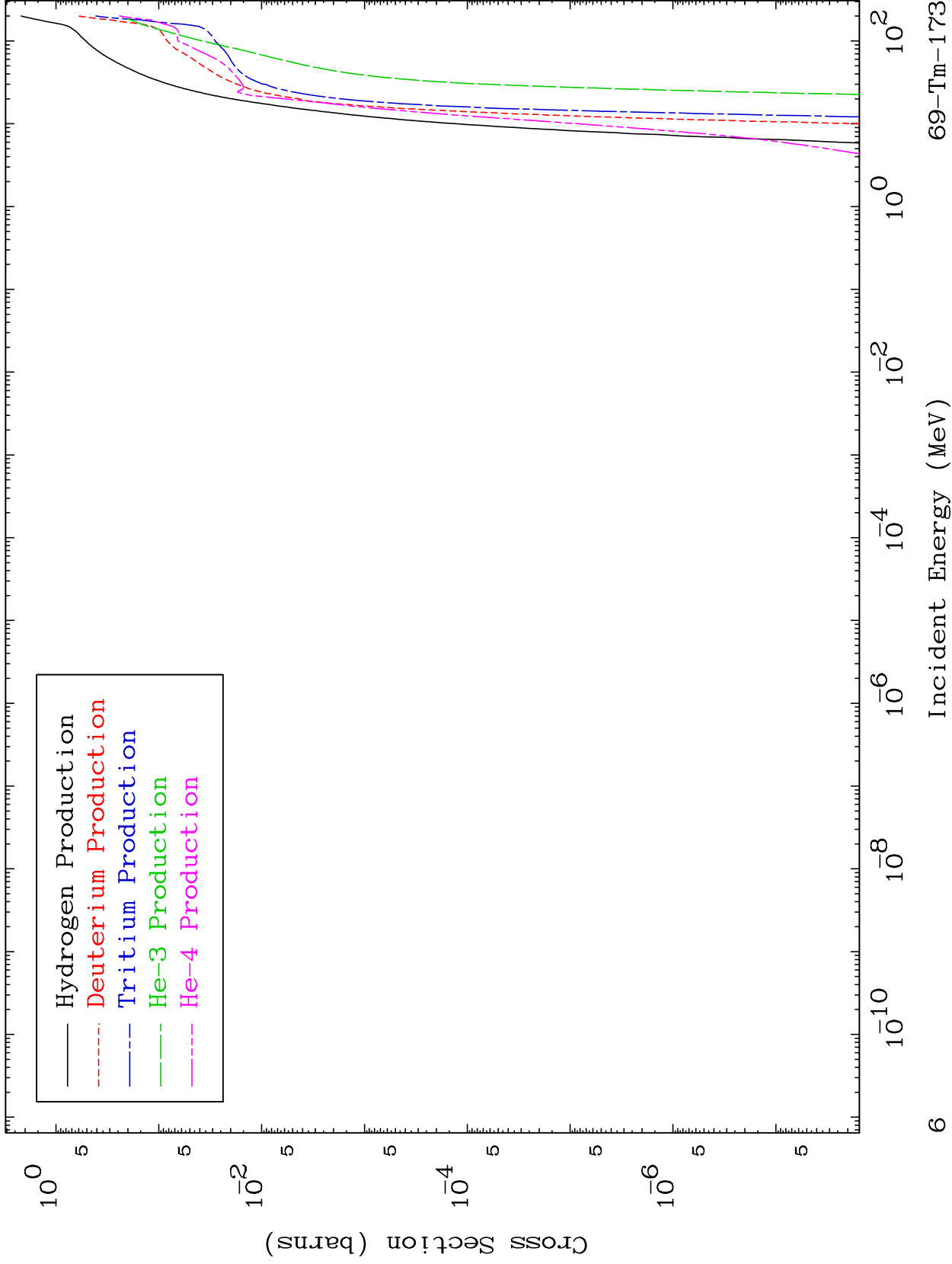

MAT 6937

(n,n') Level
293 Kelvin Cross Sections

69-Tm-173

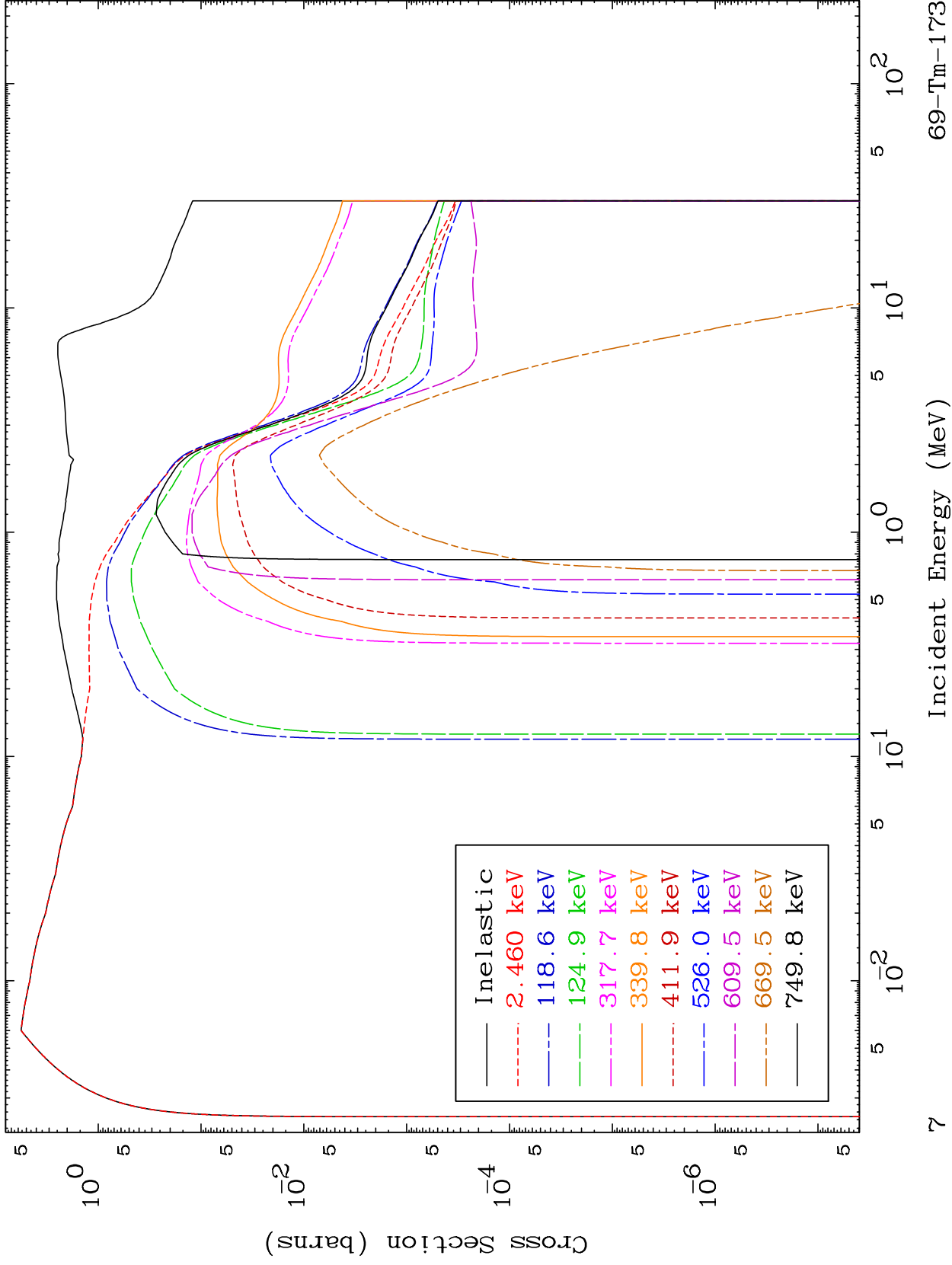

MAT 6937

(n,n') Level
293 Kelvin Cross Sections

69-Tm-173

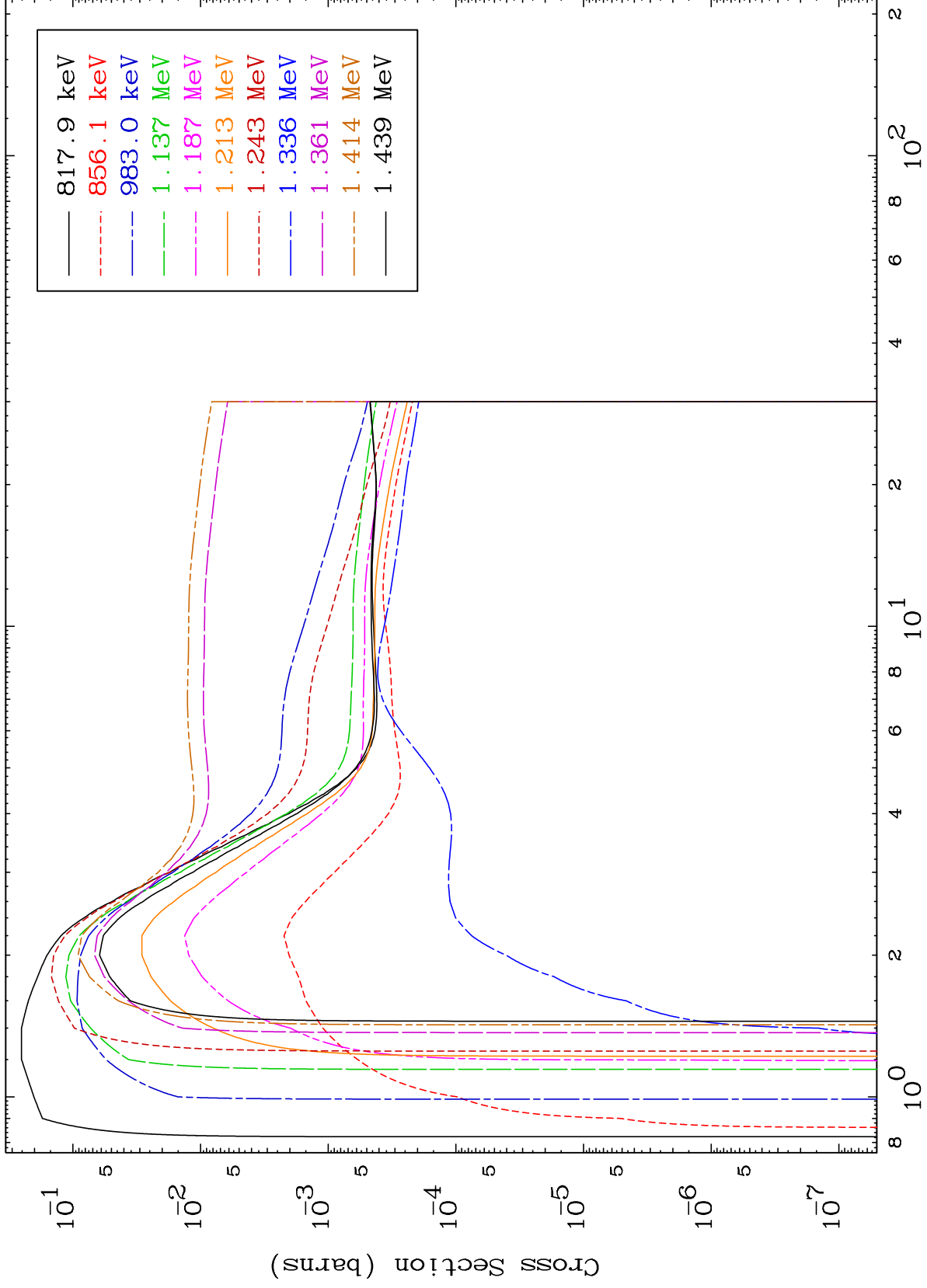

Incident Energy (MeV)

69-Tm-173

MAT 6937

(n,n') Level

69-Tm-173

293 Kelvin Cross Sections

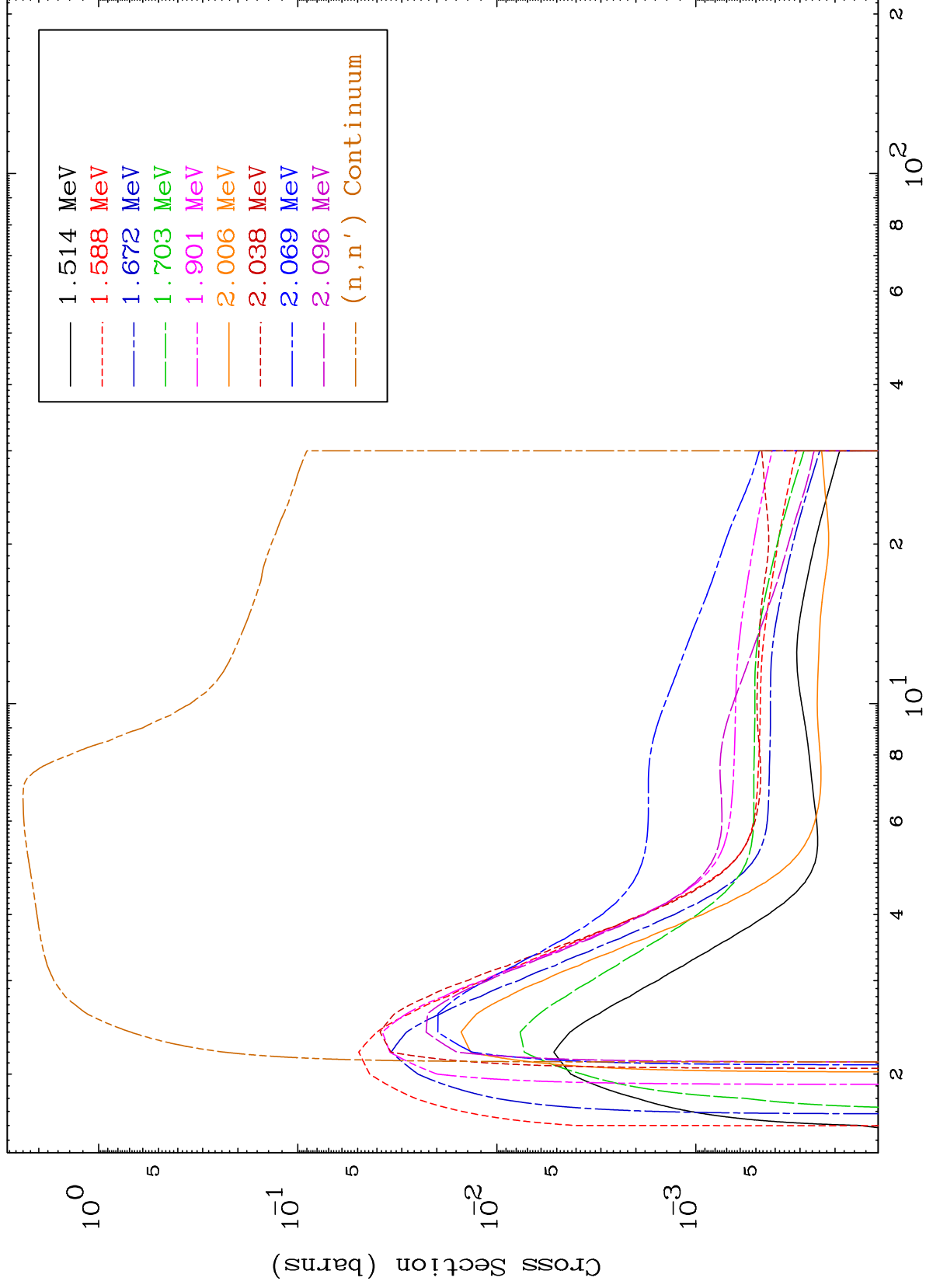

9

Incident Energy (MeV)

69-Tm-173

MAT 6937

(n,p) Levels
293 Kelvin Cross Sections

69-Tm-173

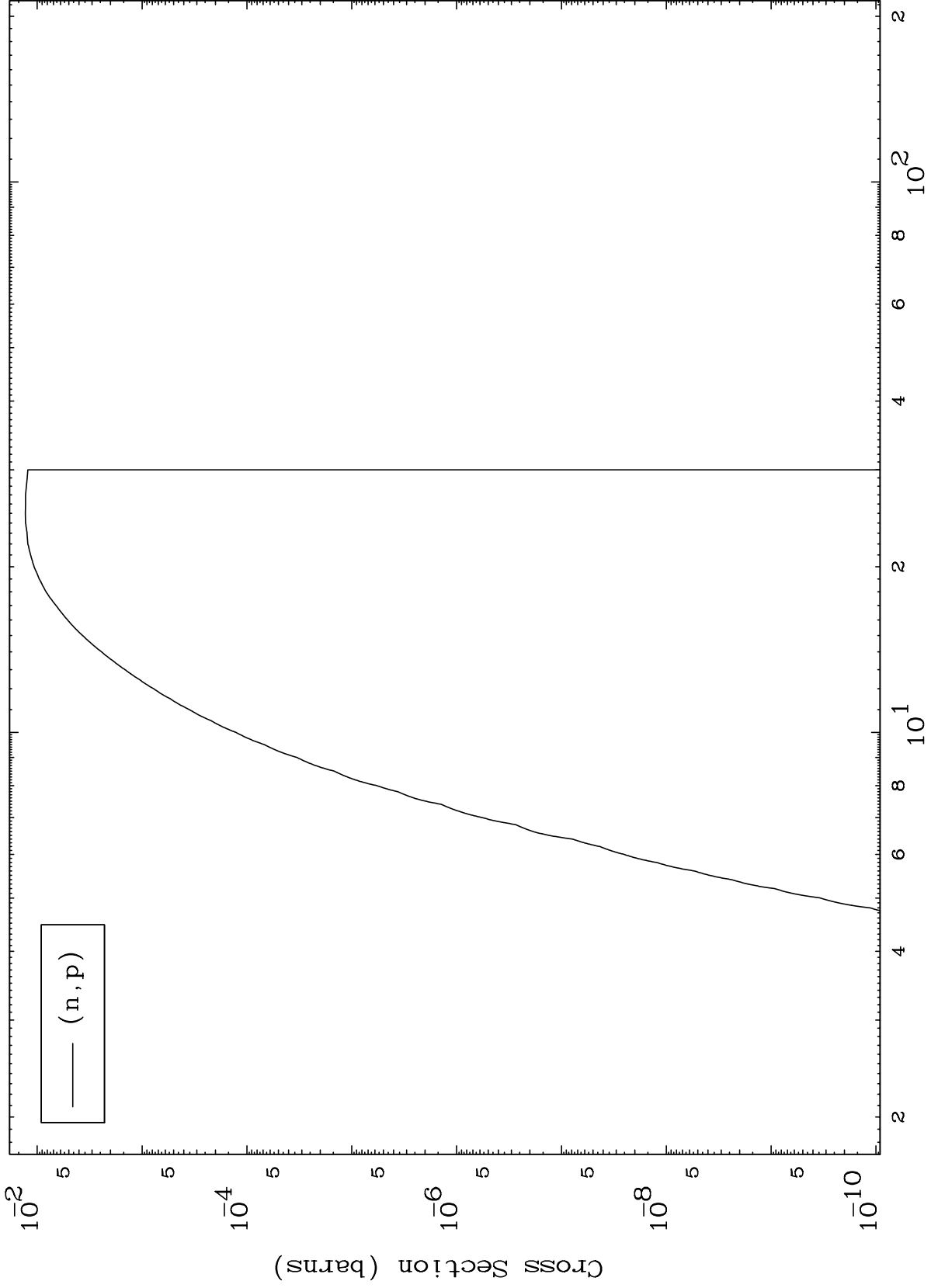

10

Incident Energy (MeV)

69-Tm-173

MAT 6937

(n,d) Levels
293 Kelvin Cross Sections

69-Tm-173

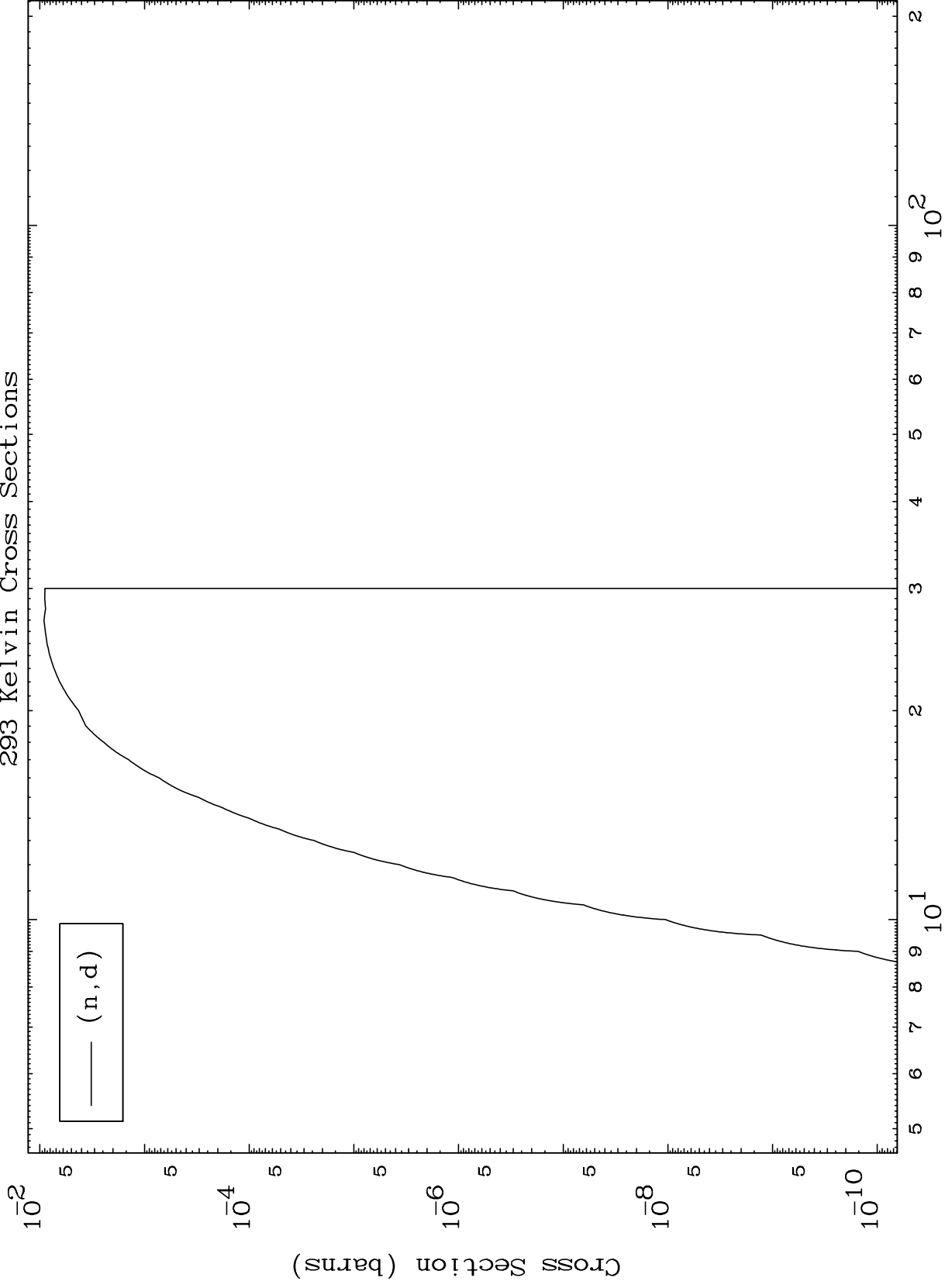

11

Incident Energy (MeV)

69-Tm-173

MAT 6937

(n,t) Levels
293 Kelvin Cross Sections

69-Tm-173

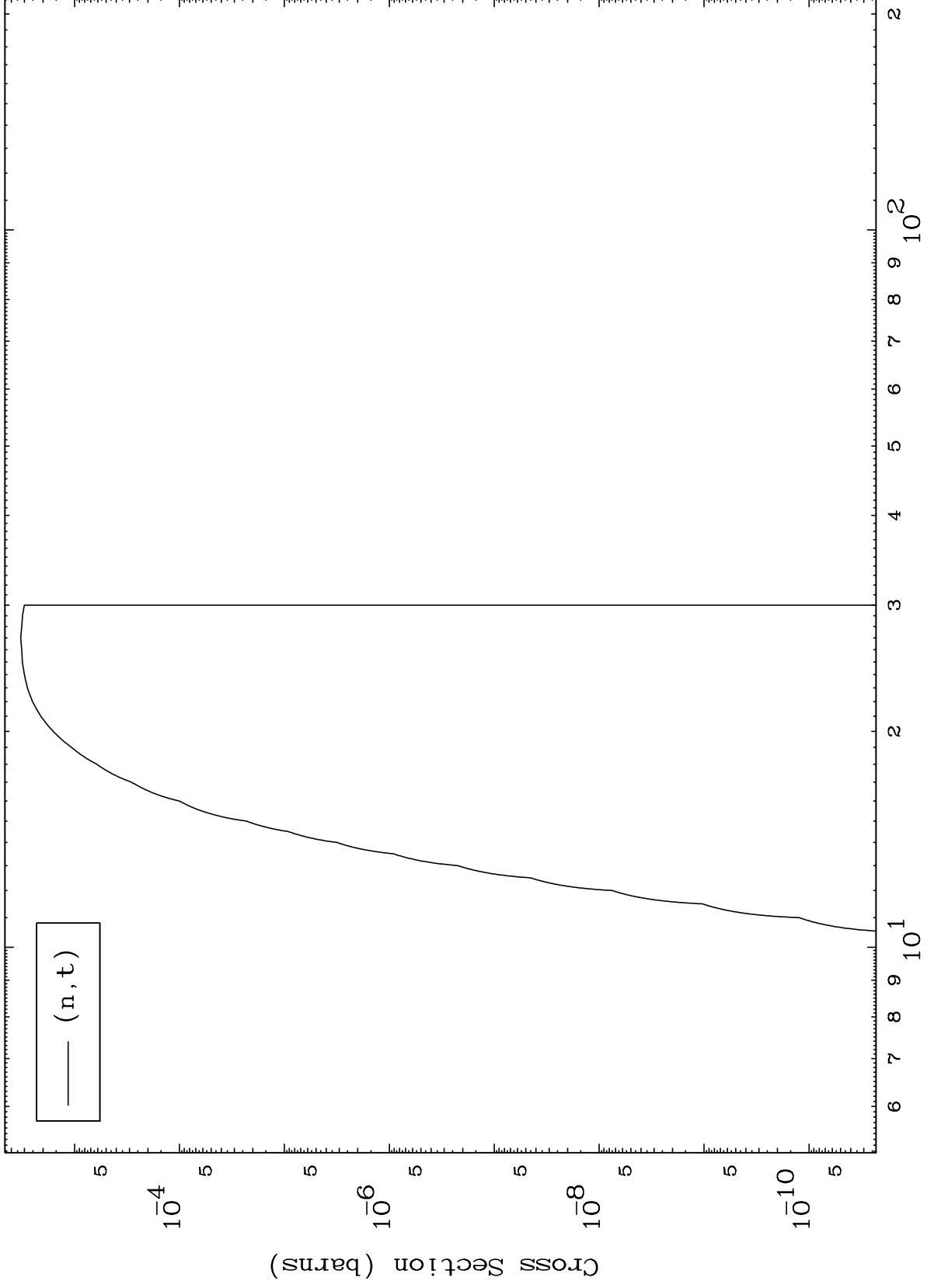

12

Incident Energy (MeV)

69-Tm-173

MAT 6937

(n,He3) Levels
293 Kelvin Cross Sections

69-Tm-173

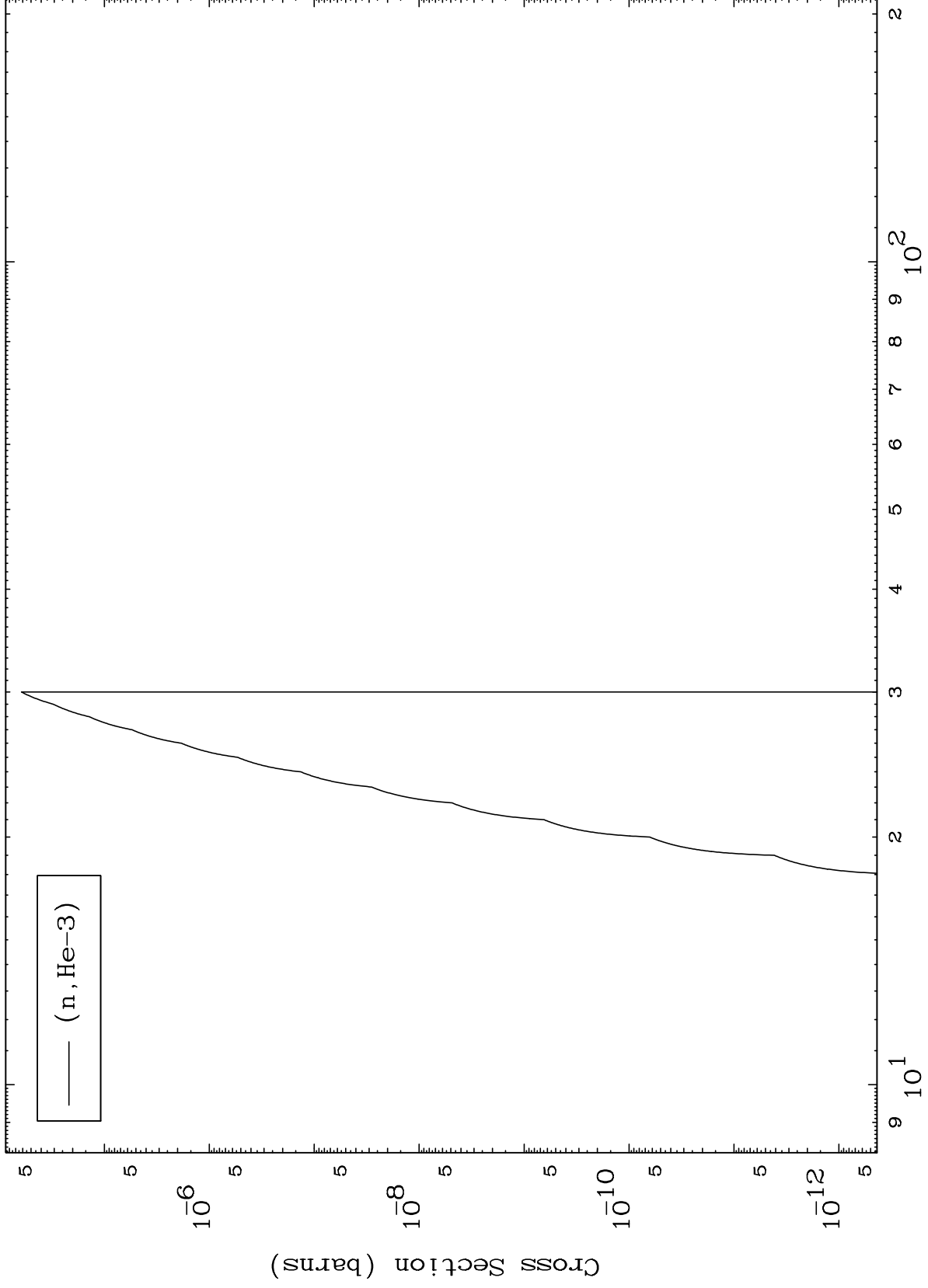

13

Incident Energy (MeV)

69-Tm-173

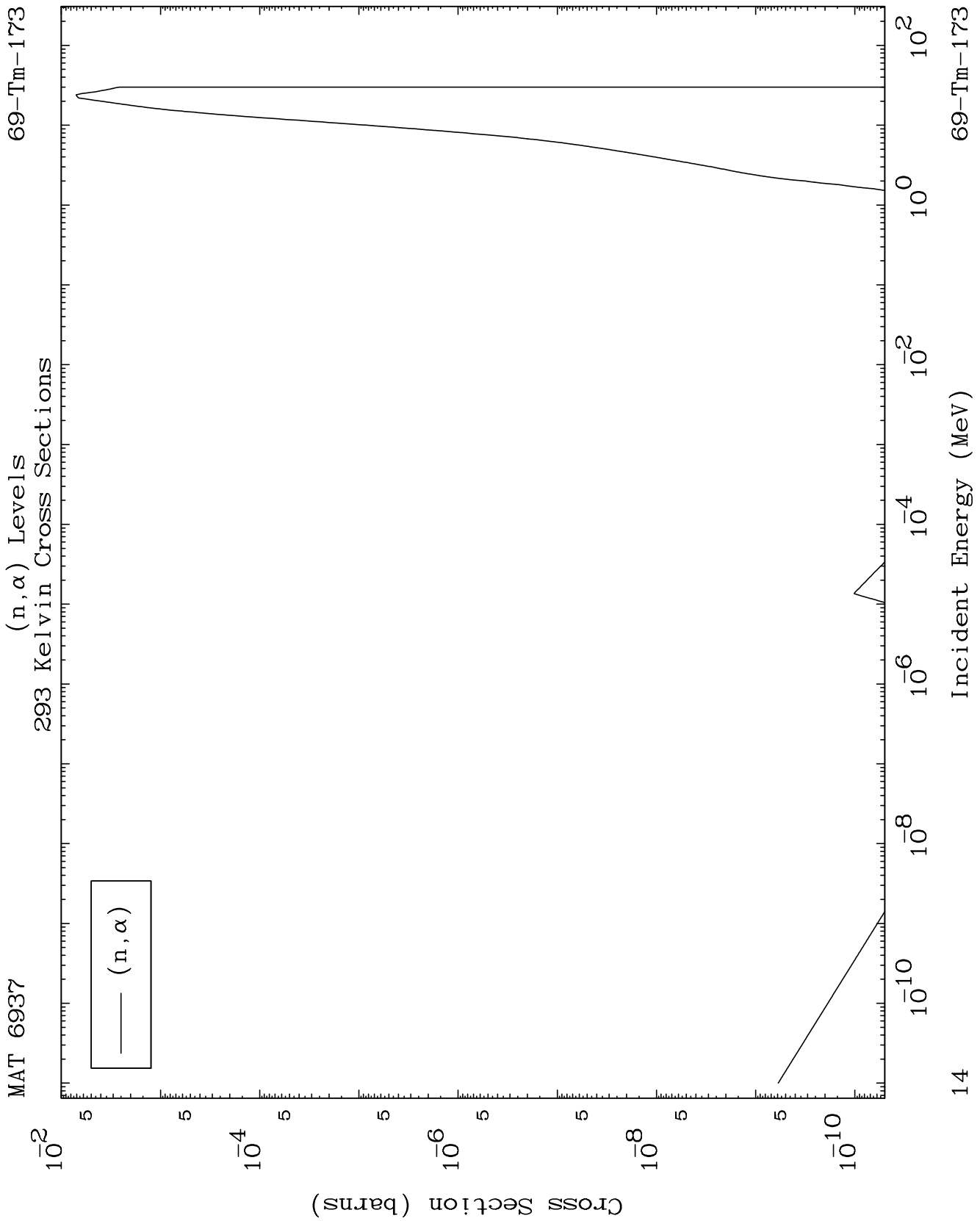

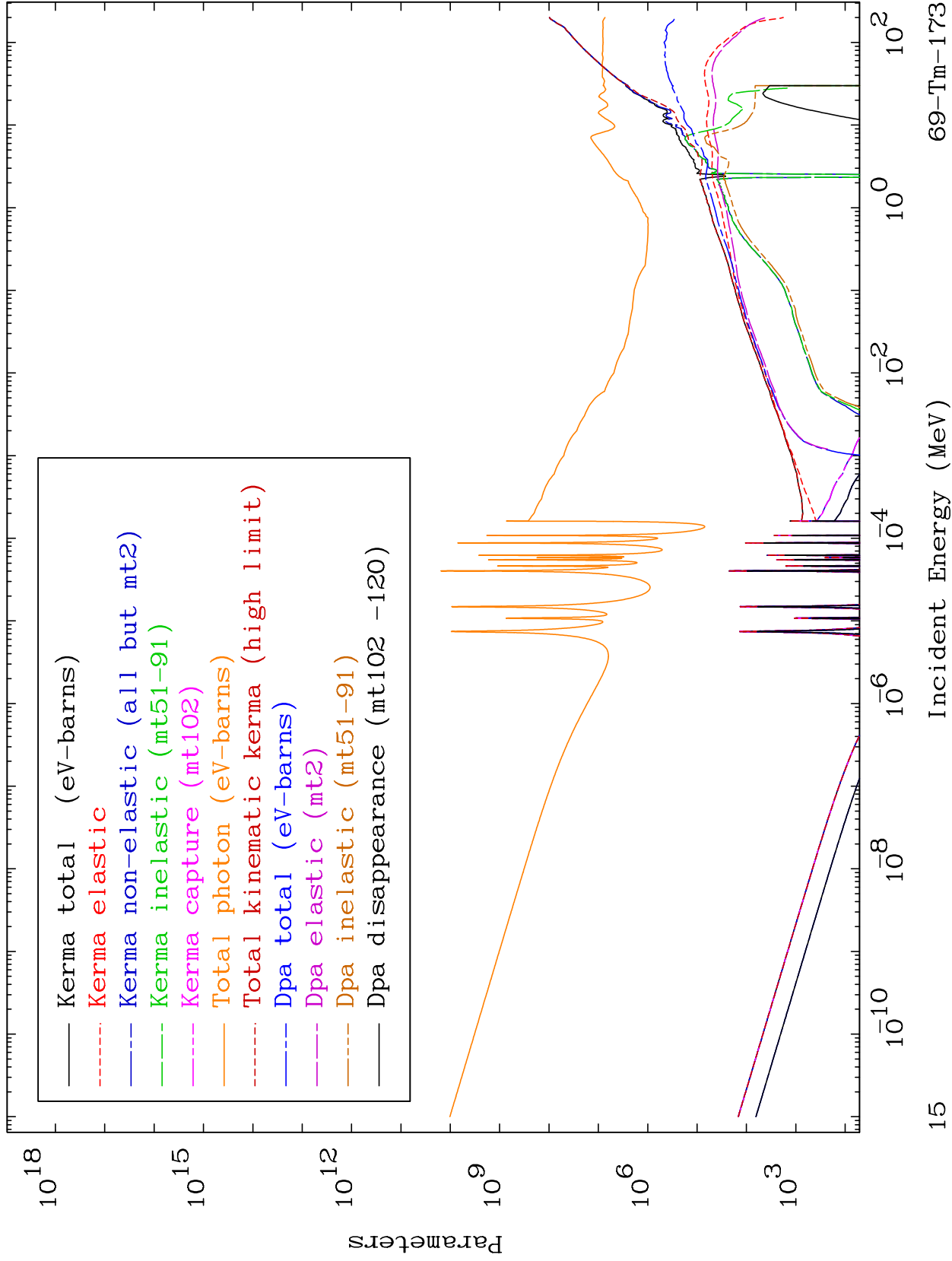

MAT 6937

Elastic Legendre Coefficients

69-Tm-173

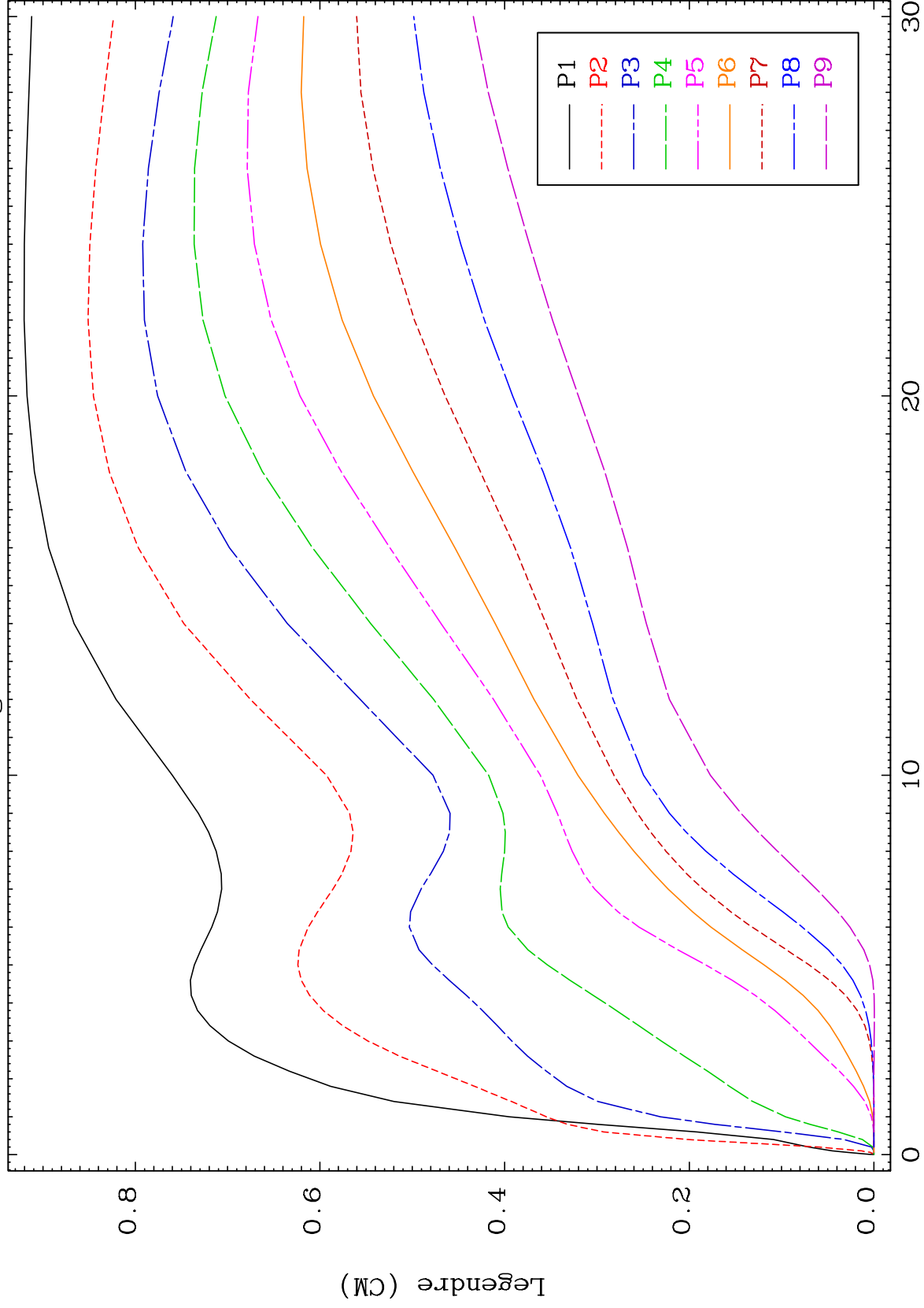

16

Incident Energy (MeV)

69-Tm-173

MAT 6937

Elastic Legendre Coefficients

69-Tm-173

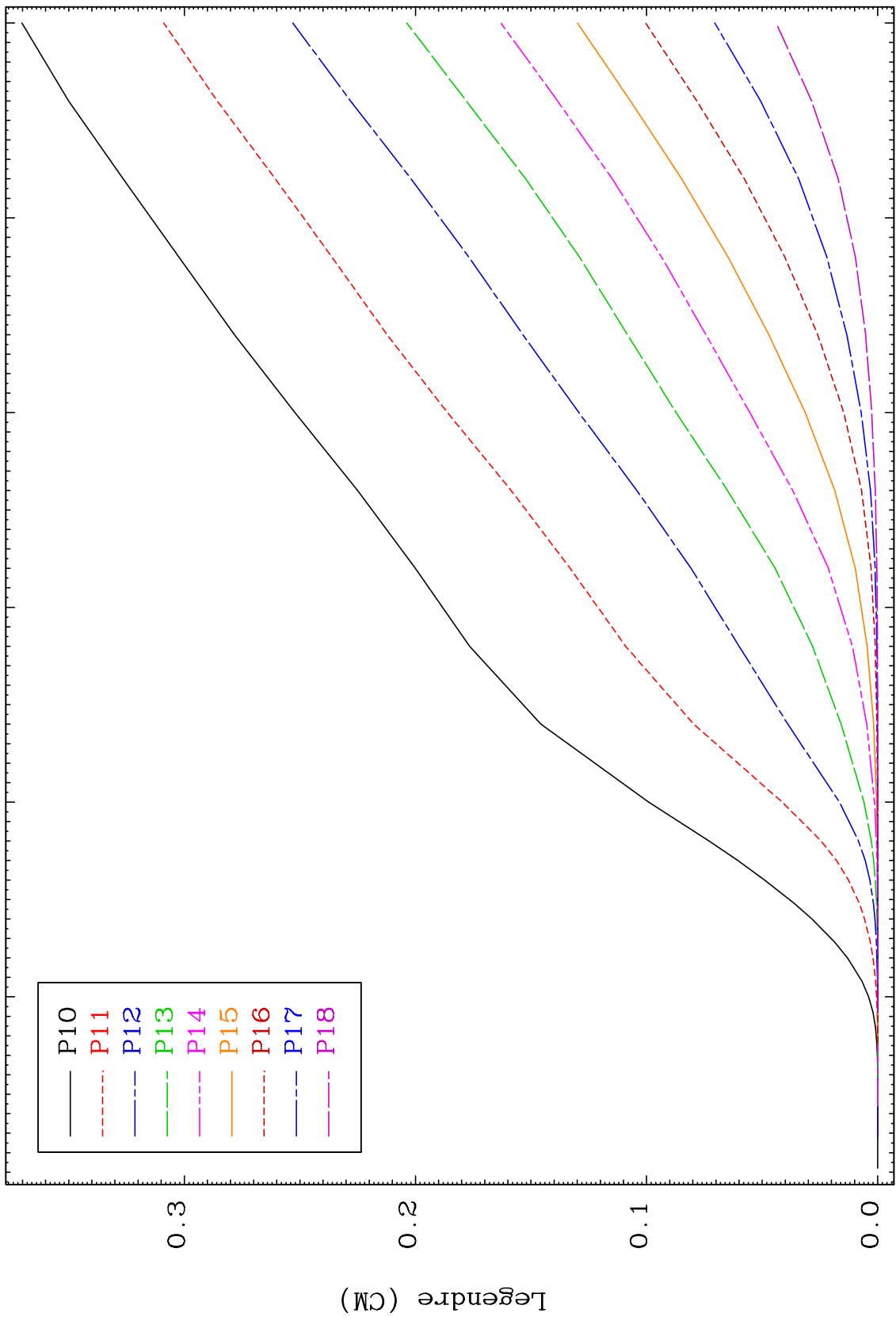

17

Incident Energy (MeV)

69-Tm-173

MAT 6937

Elastic Legendre Coefficients

69-Tm-173

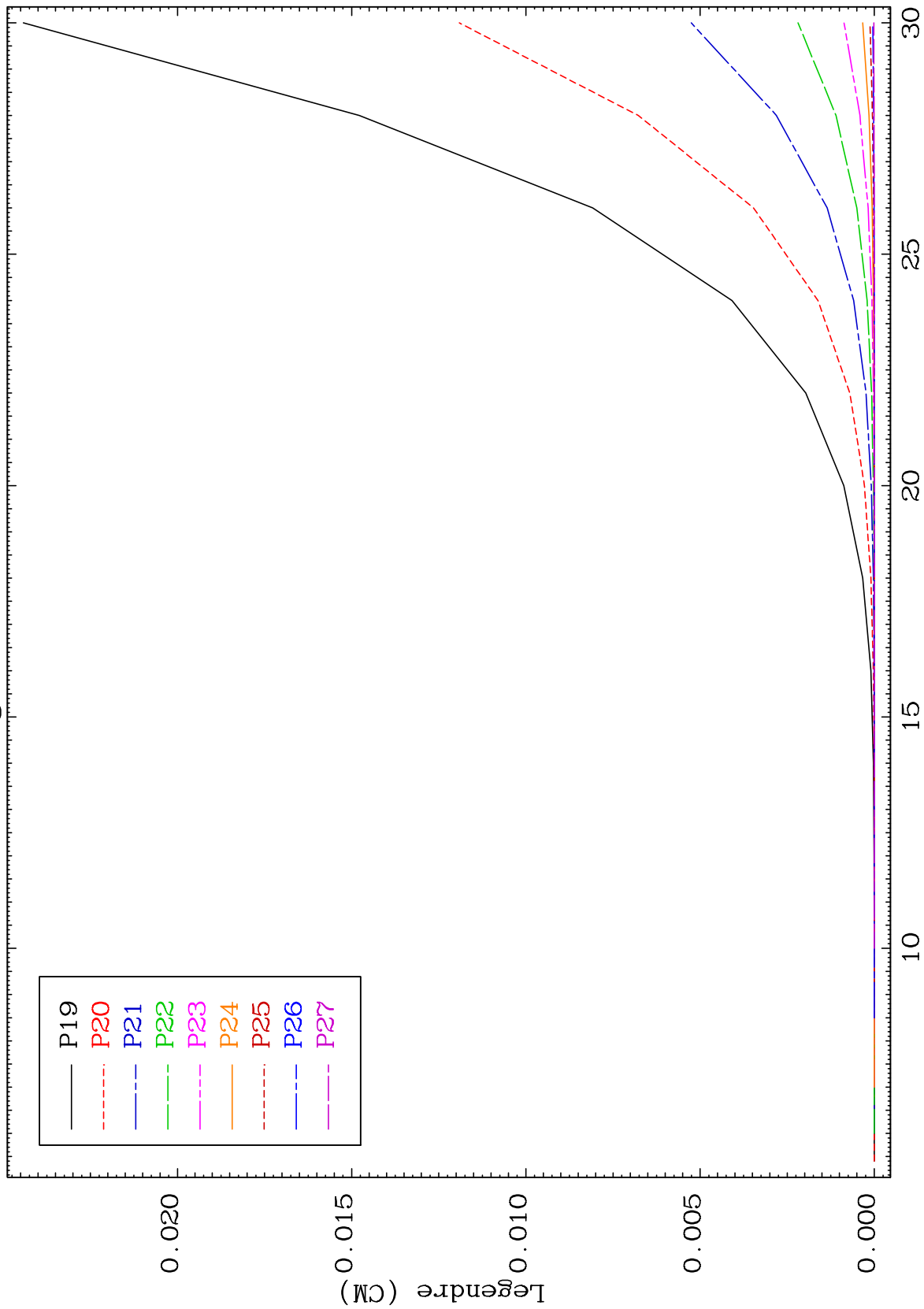

18

Incident Energy (MeV)

69-Tm-173

MAT 6937

Elastic Legendre Coefficients

69-Tm-173

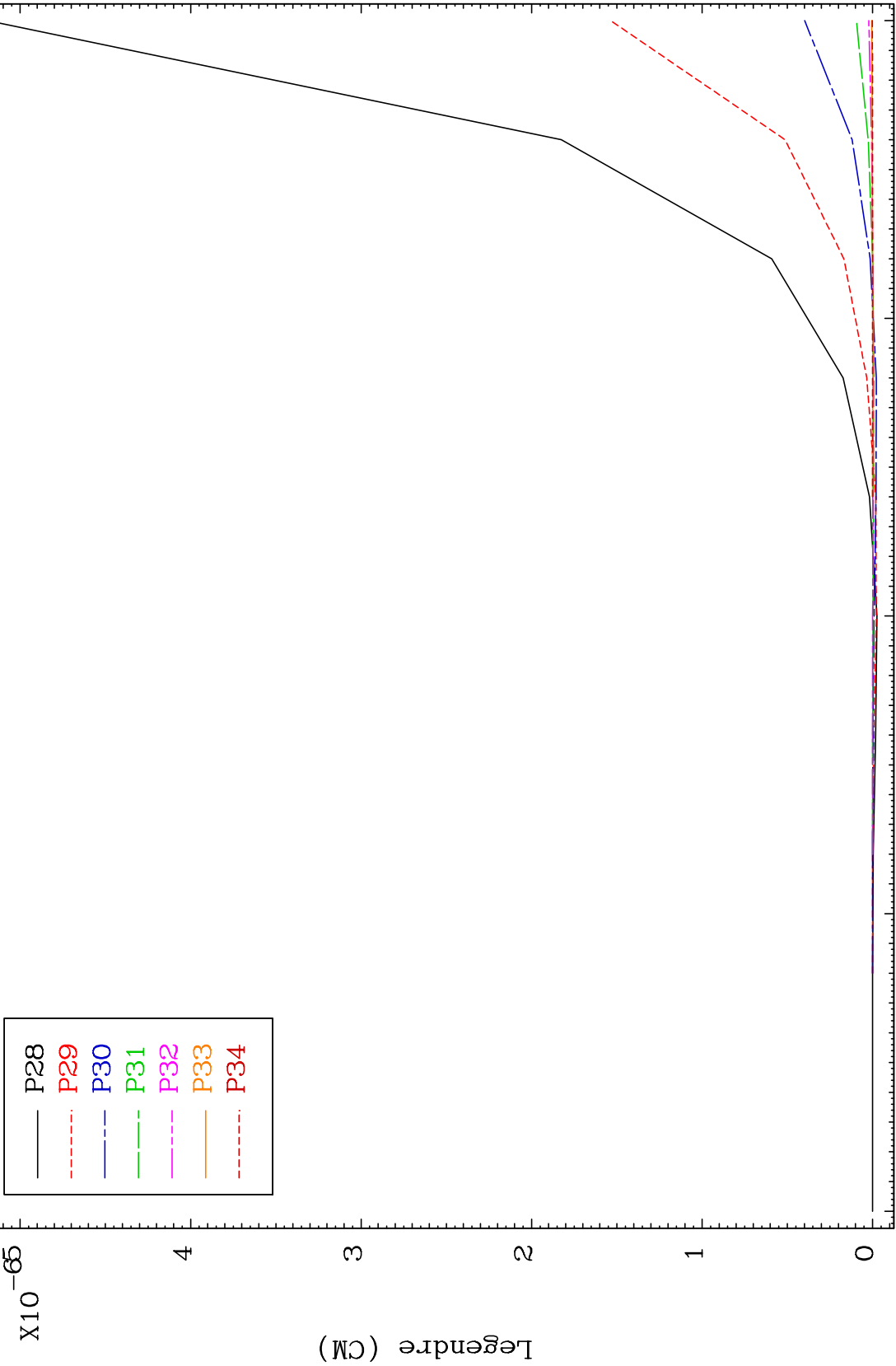
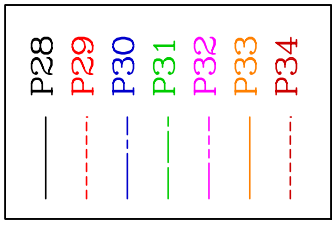

10

15

20

25

30

Incident Energy (MeV)

69-Tm-173

MAT 6937

2.460 keV (n,n') Level
Legendre Coefficients

69-Tm-173

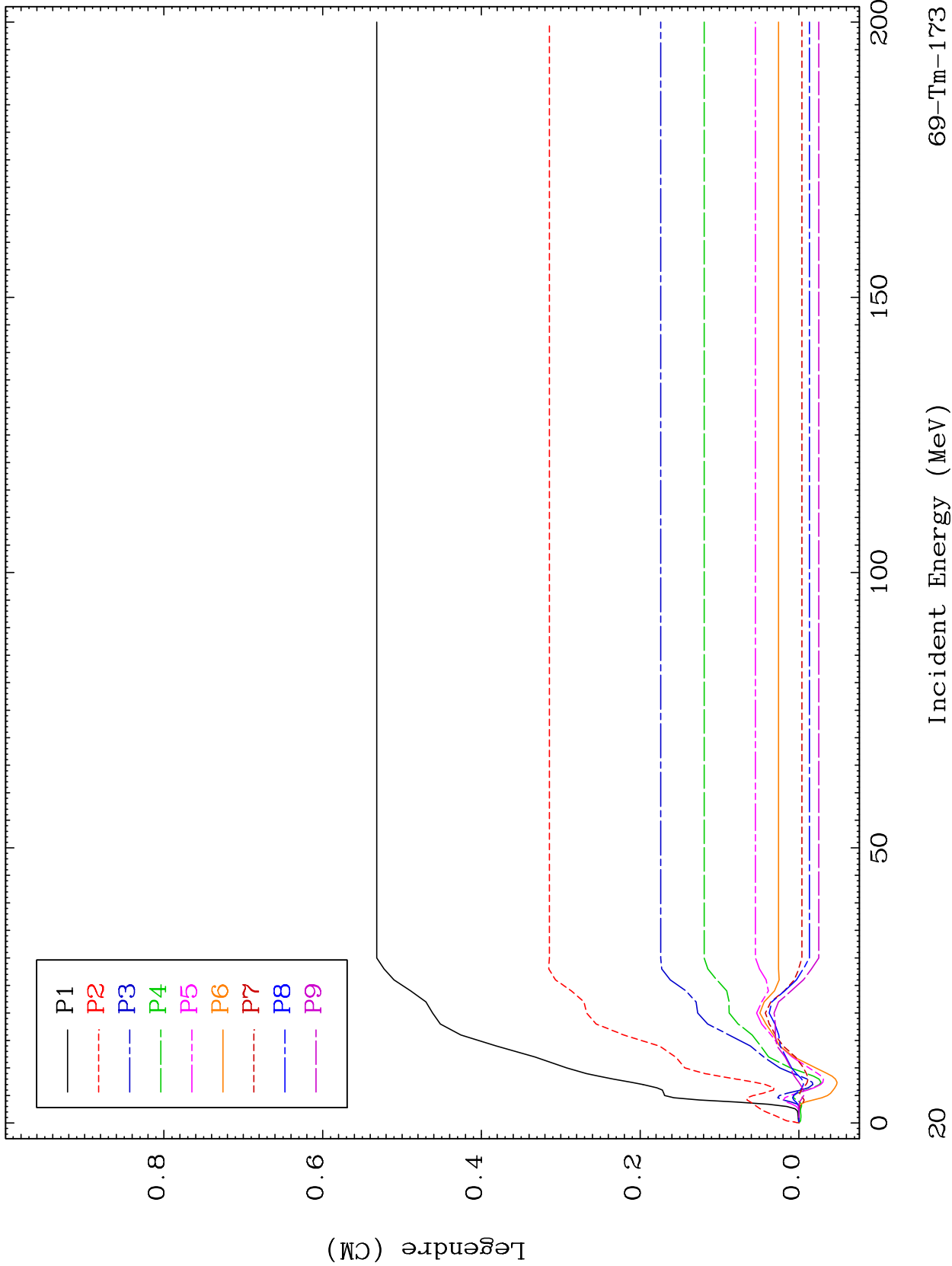

69-Tm-173

Incident Energy (MeV)

0

MAT 6937

2.460 keV (n,n') Level
Legendre Coefficients

69-Tm-173

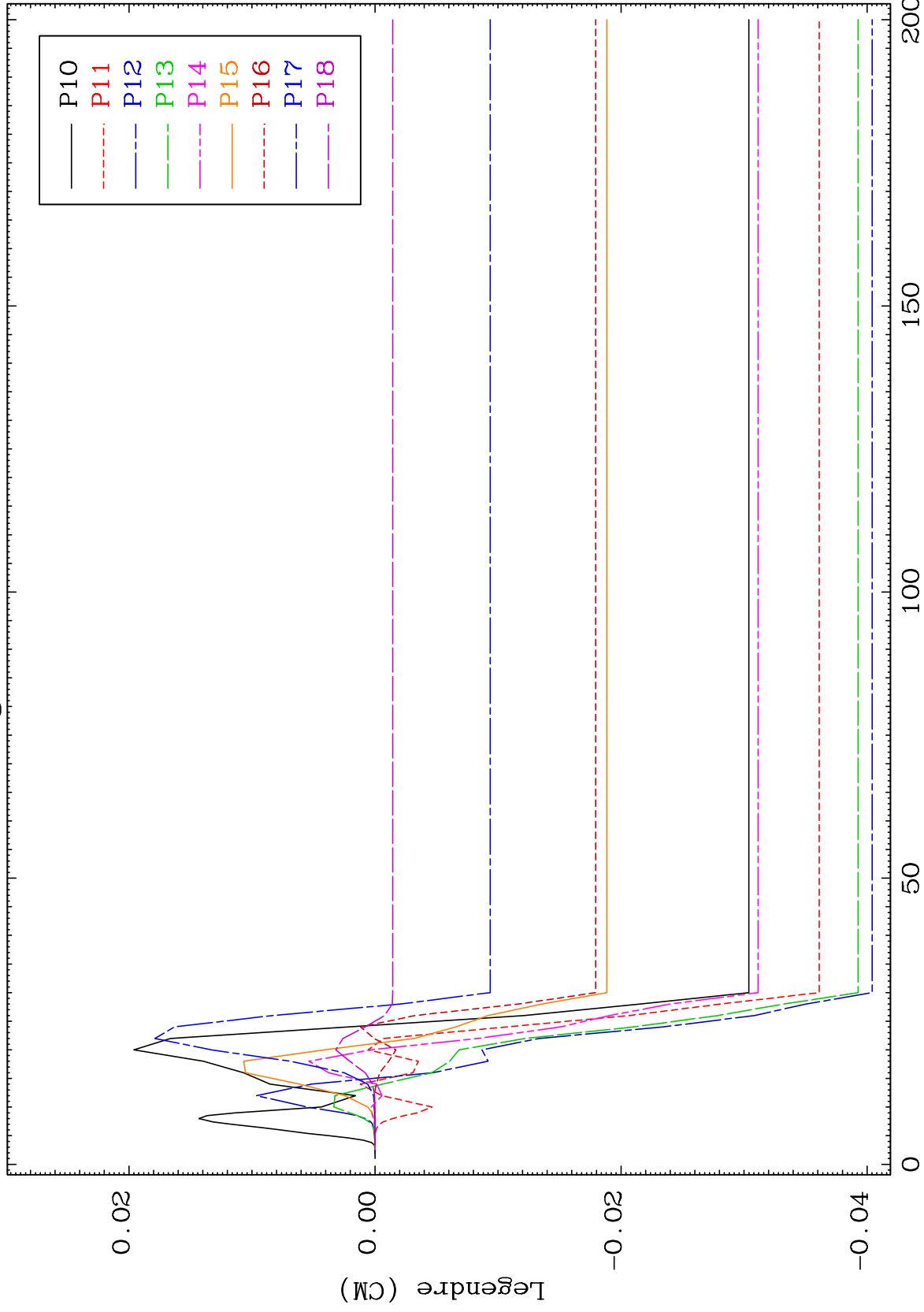

21

Incident Energy (MeV)

69-Tm-173

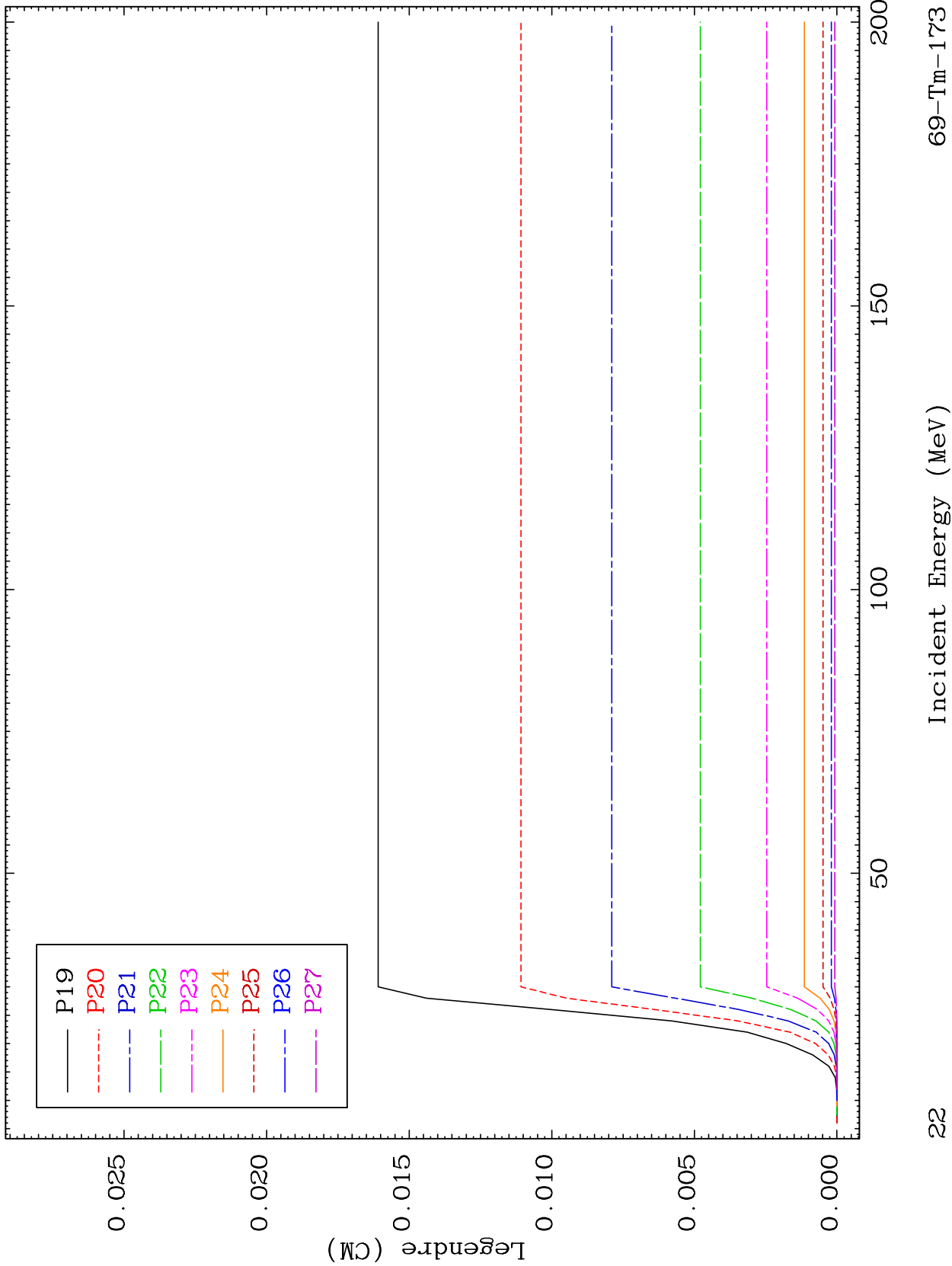

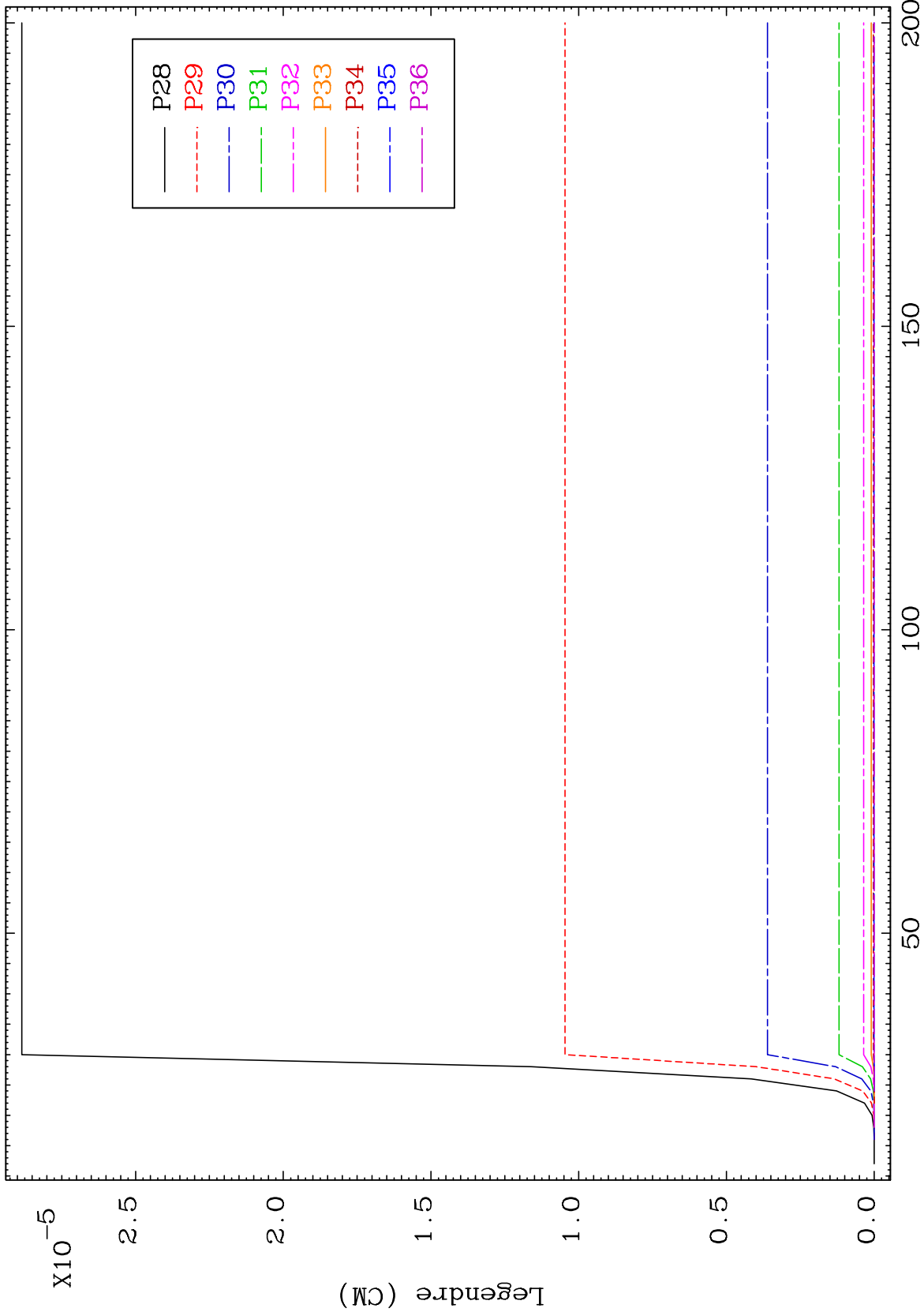

MAT 6937

118.6 keV (n,n') Level
Legendre Coefficients

69-Tm-173

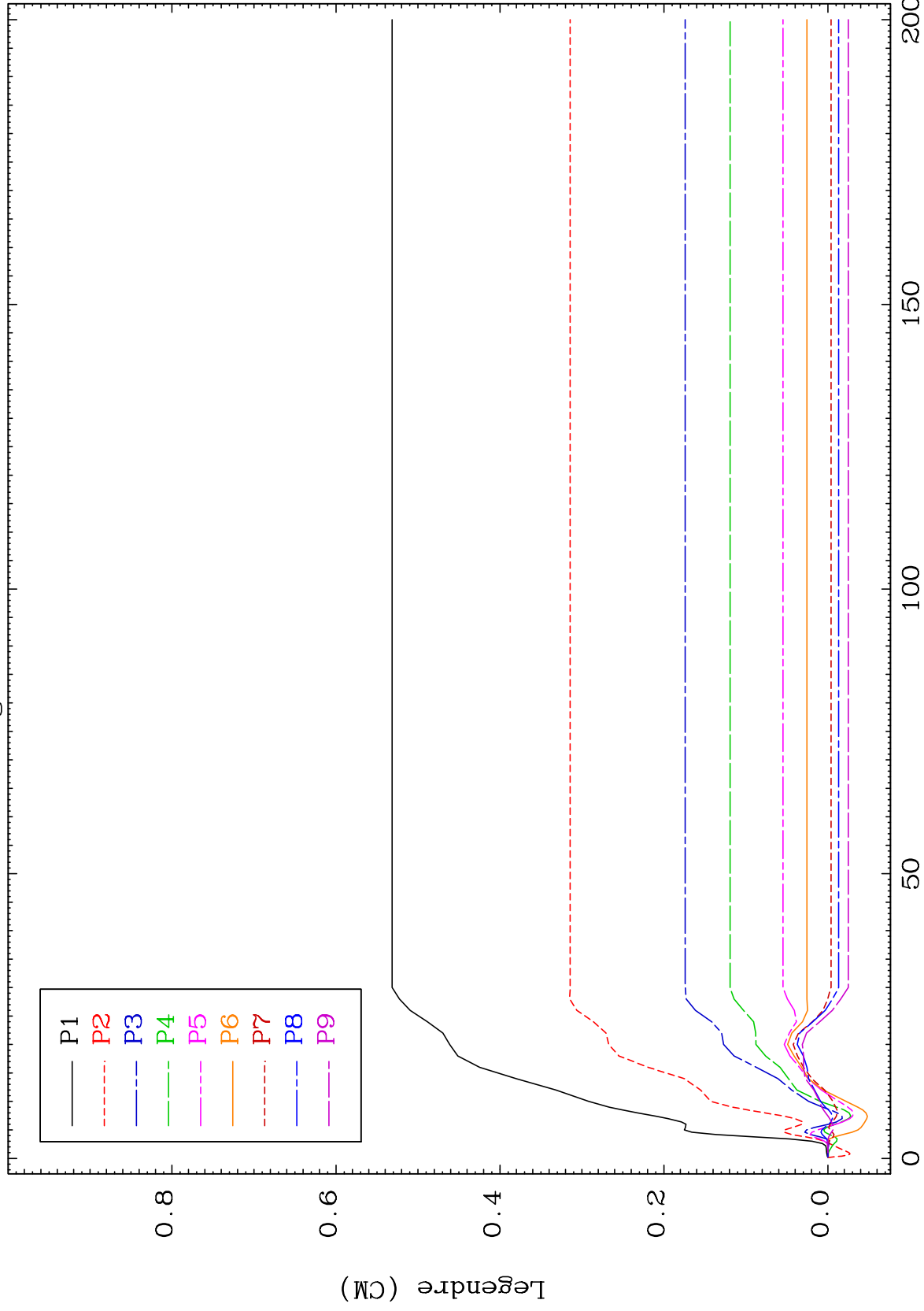

24

Incident Energy (MeV)

69-Tm-173

MAT 6937

118.6 keV (n,n') Level
Legendre Coefficients

69-Tm-173

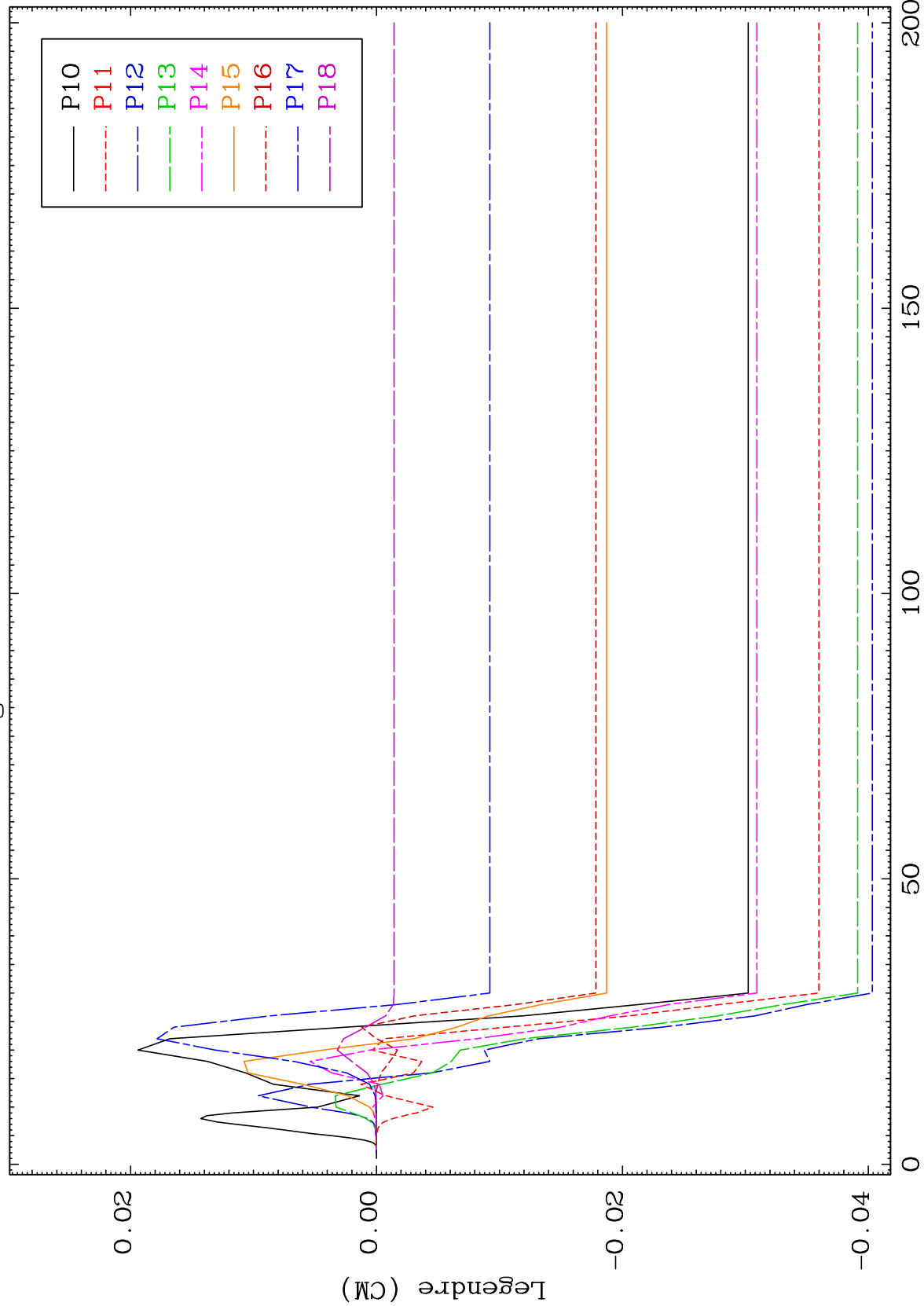

25

Incident Energy (MeV)

69-Tm-173

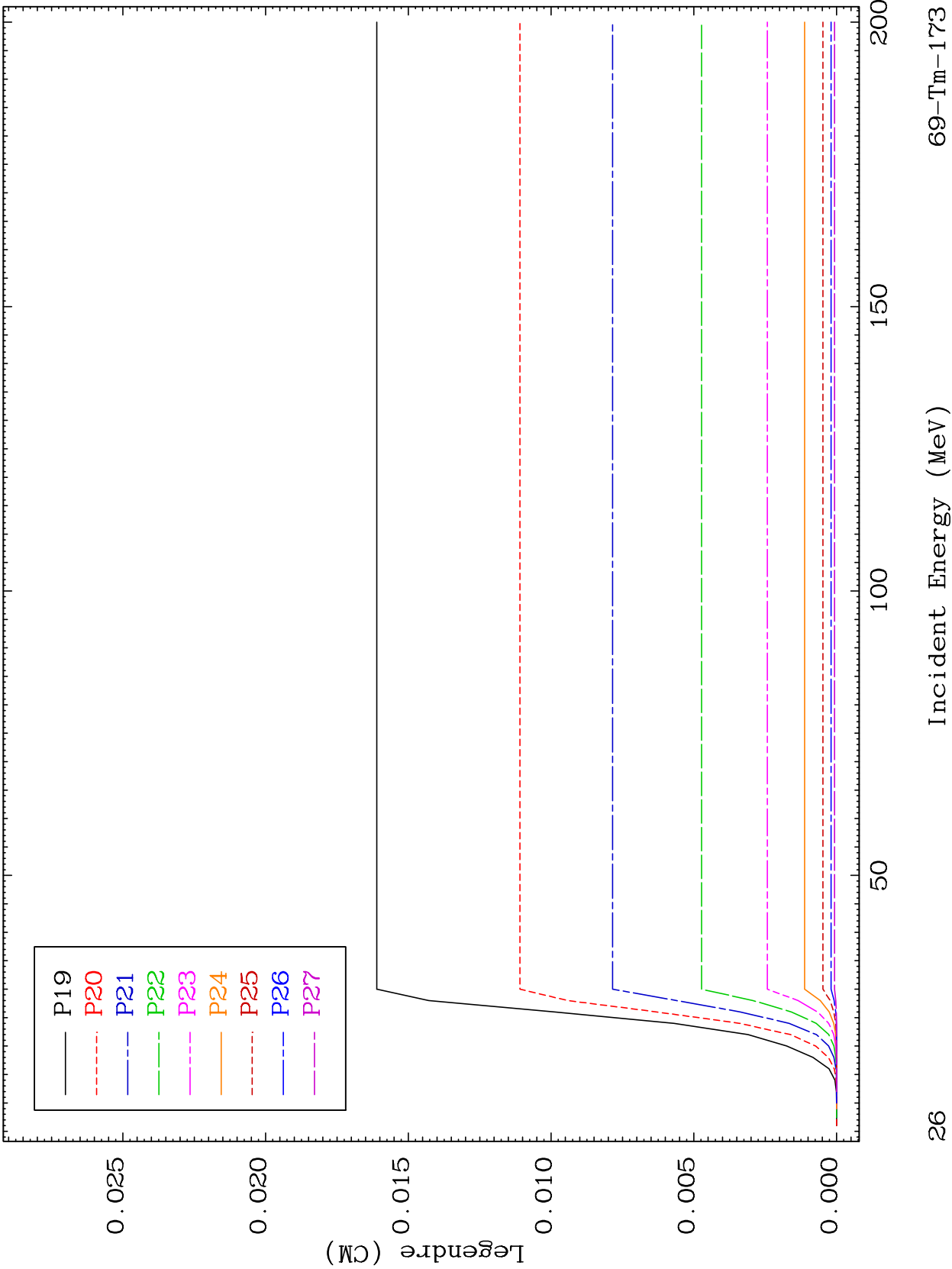

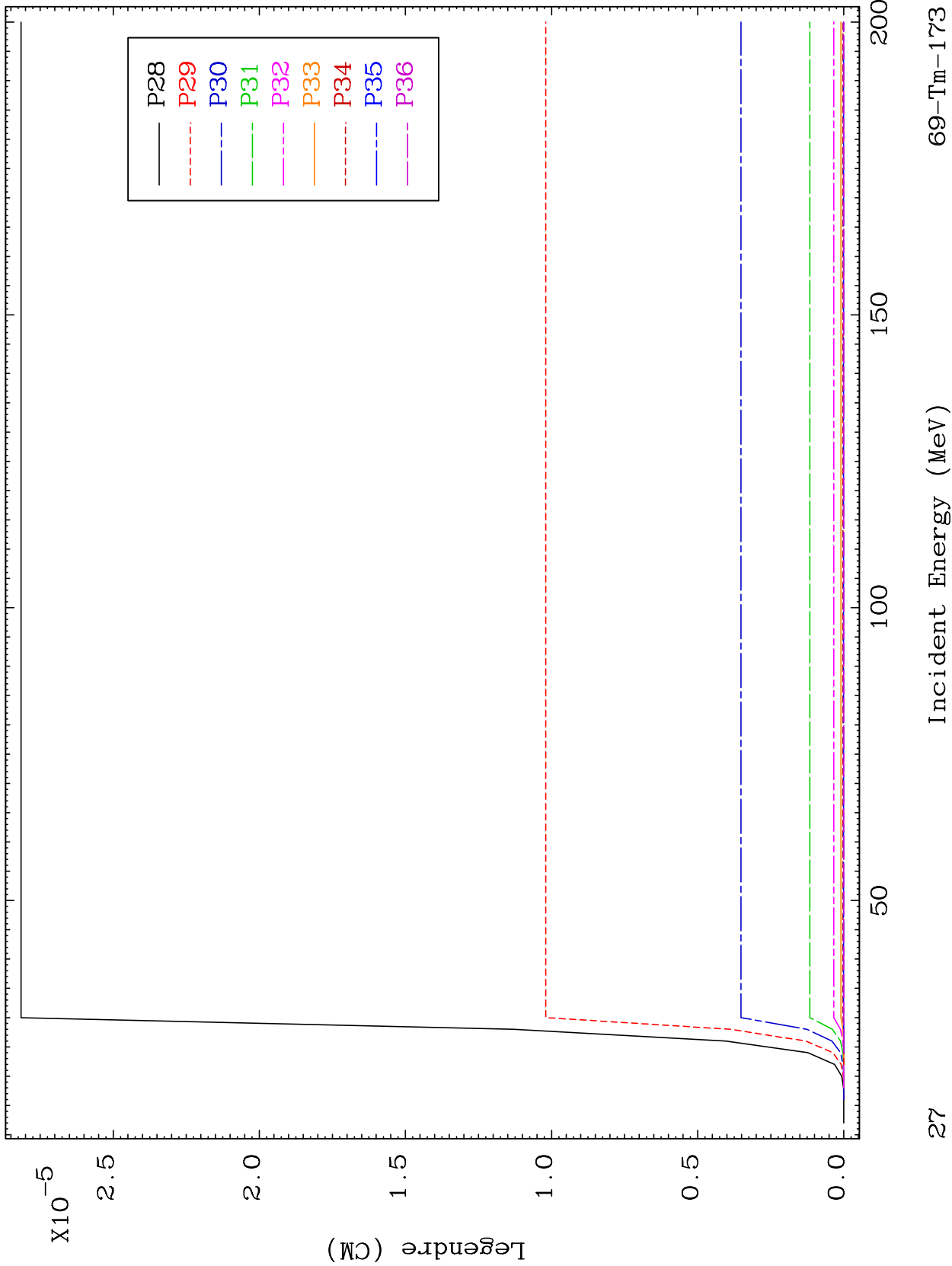

MAT 6937

124.9 keV (n,n') Level
Legendre Coefficients

69-Tm-173

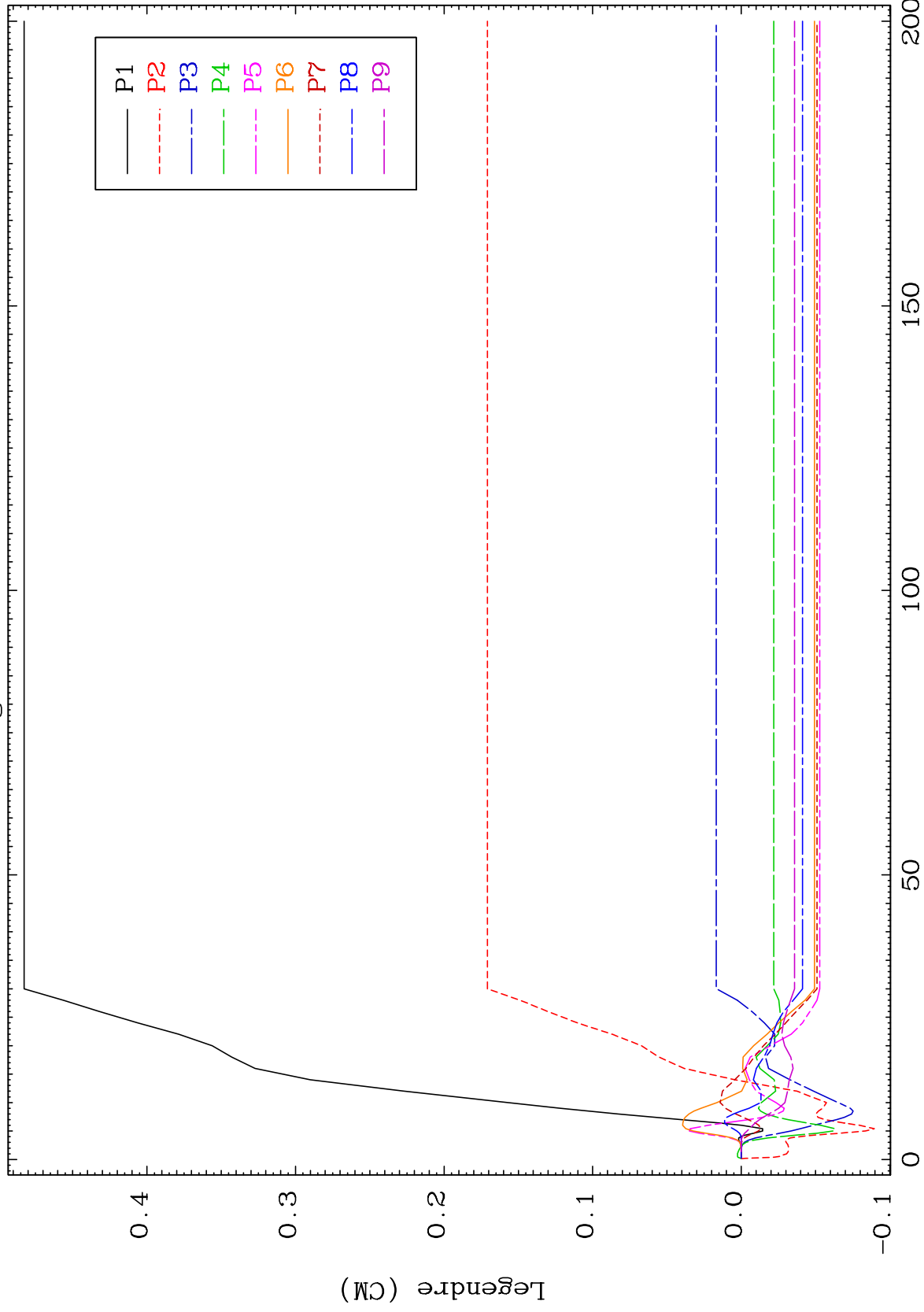

69-Tm-173

Incident Energy (MeV)

28

MAT 6937

124.9 keV (n,n') Level
Legendre Coefficients

69-Tm-173

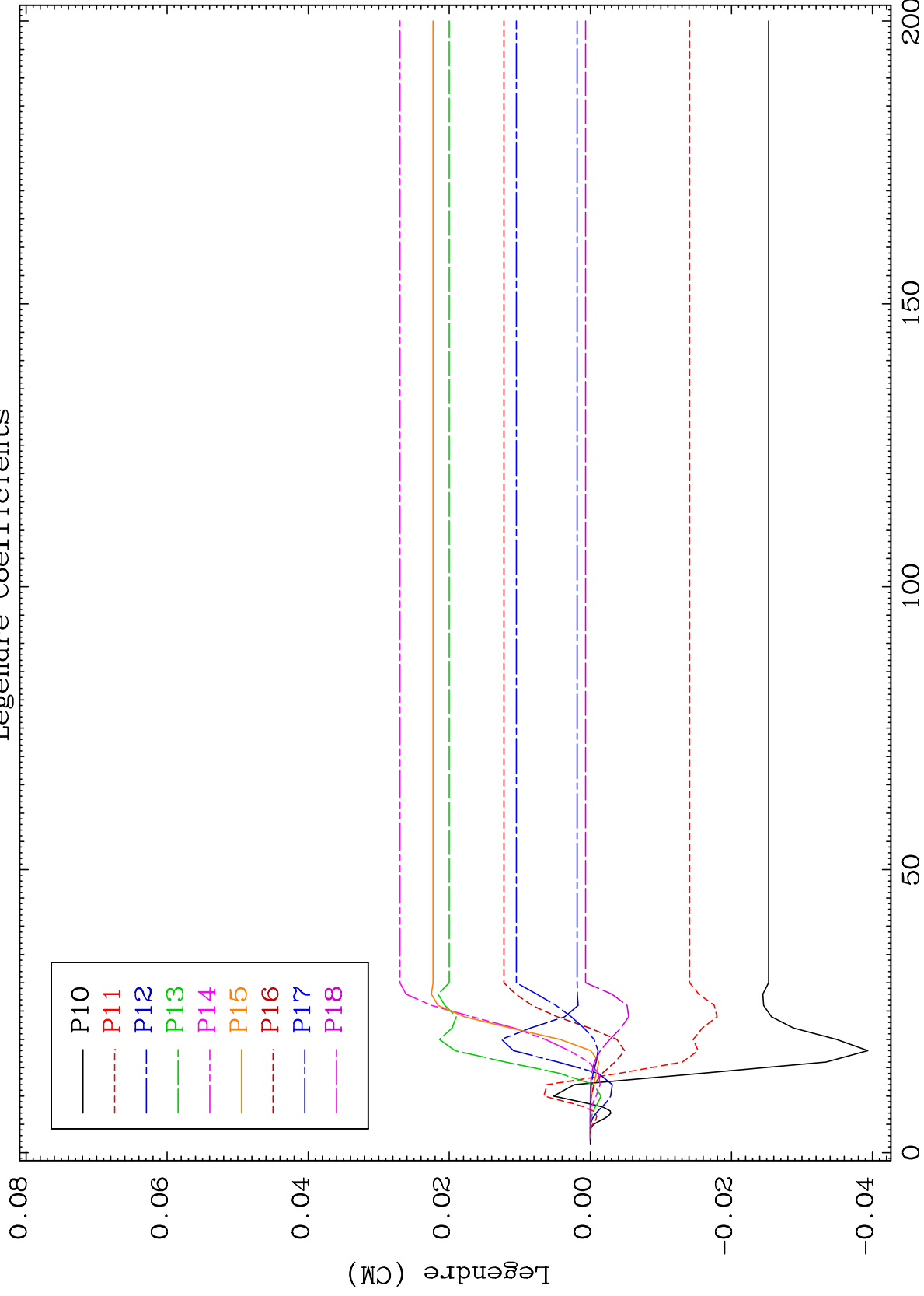

29

Incident Energy (MeV)

69-Tm-173

MAT 6937

124.9 keV (n,n') Level
Legendre Coefficients

69-Tm-173

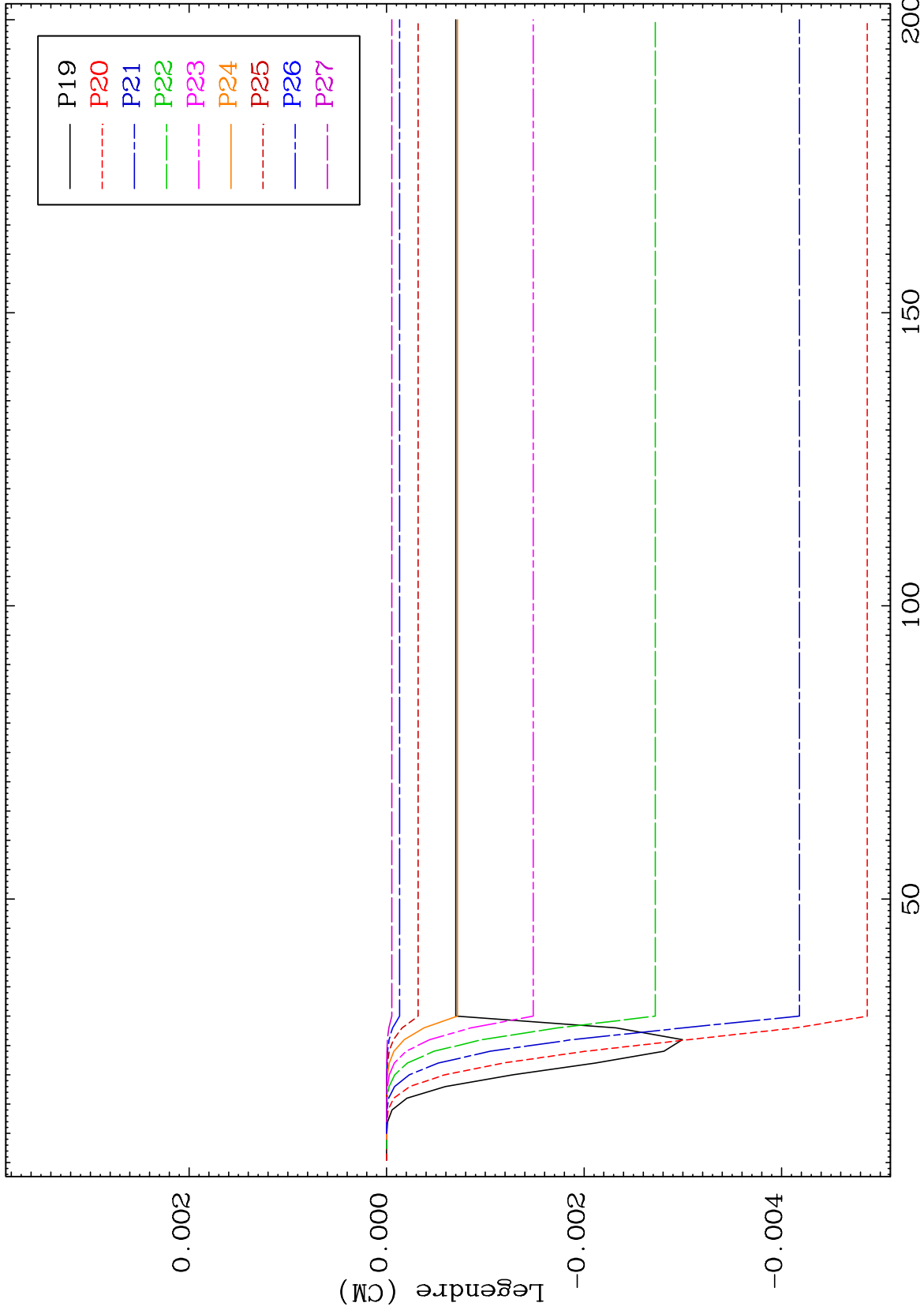

30

Incident Energy (MeV)

69-Tm-173

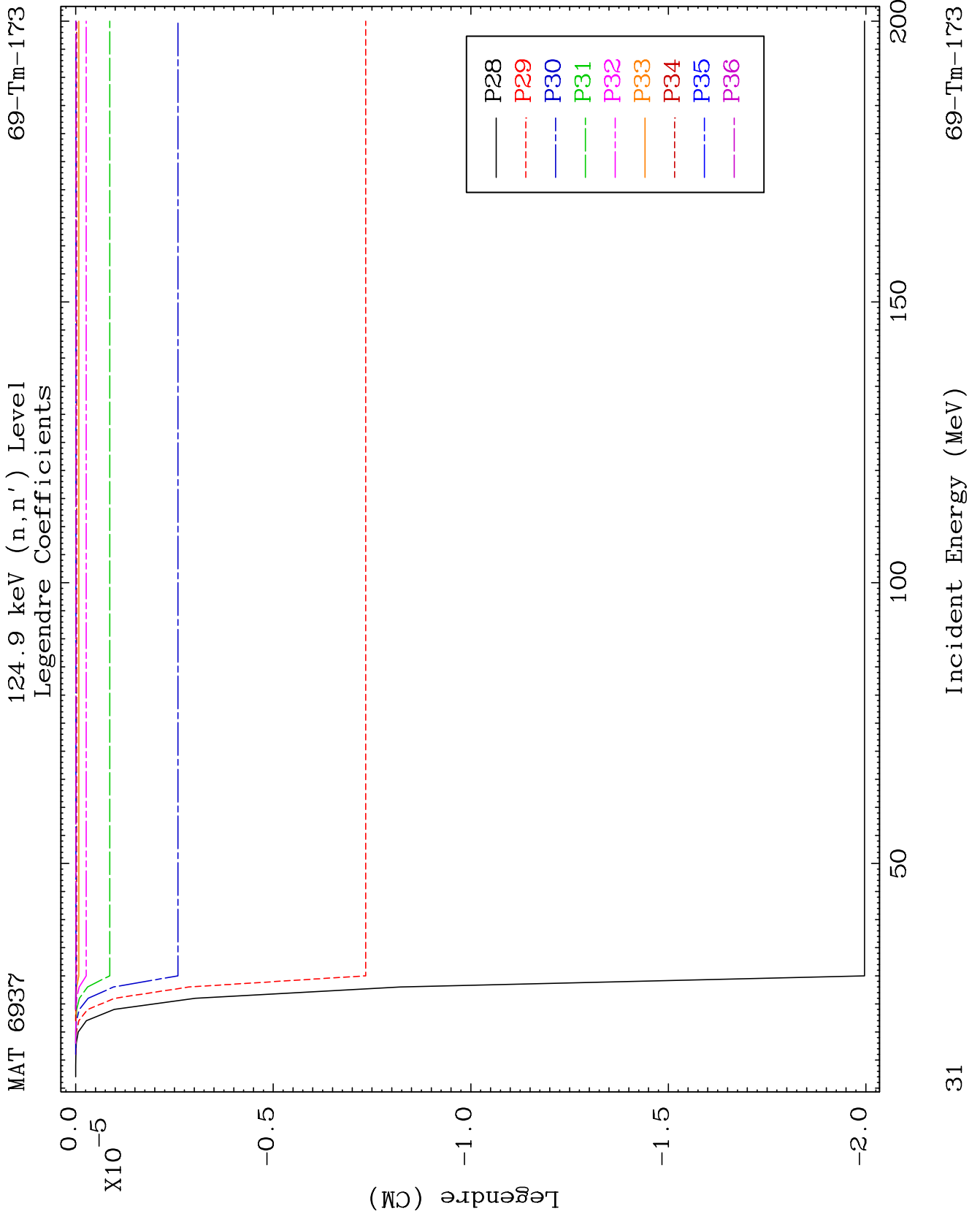

MAT 6937

317.7 keV (n,n') Level
Legendre Coefficients

69-Tm-173

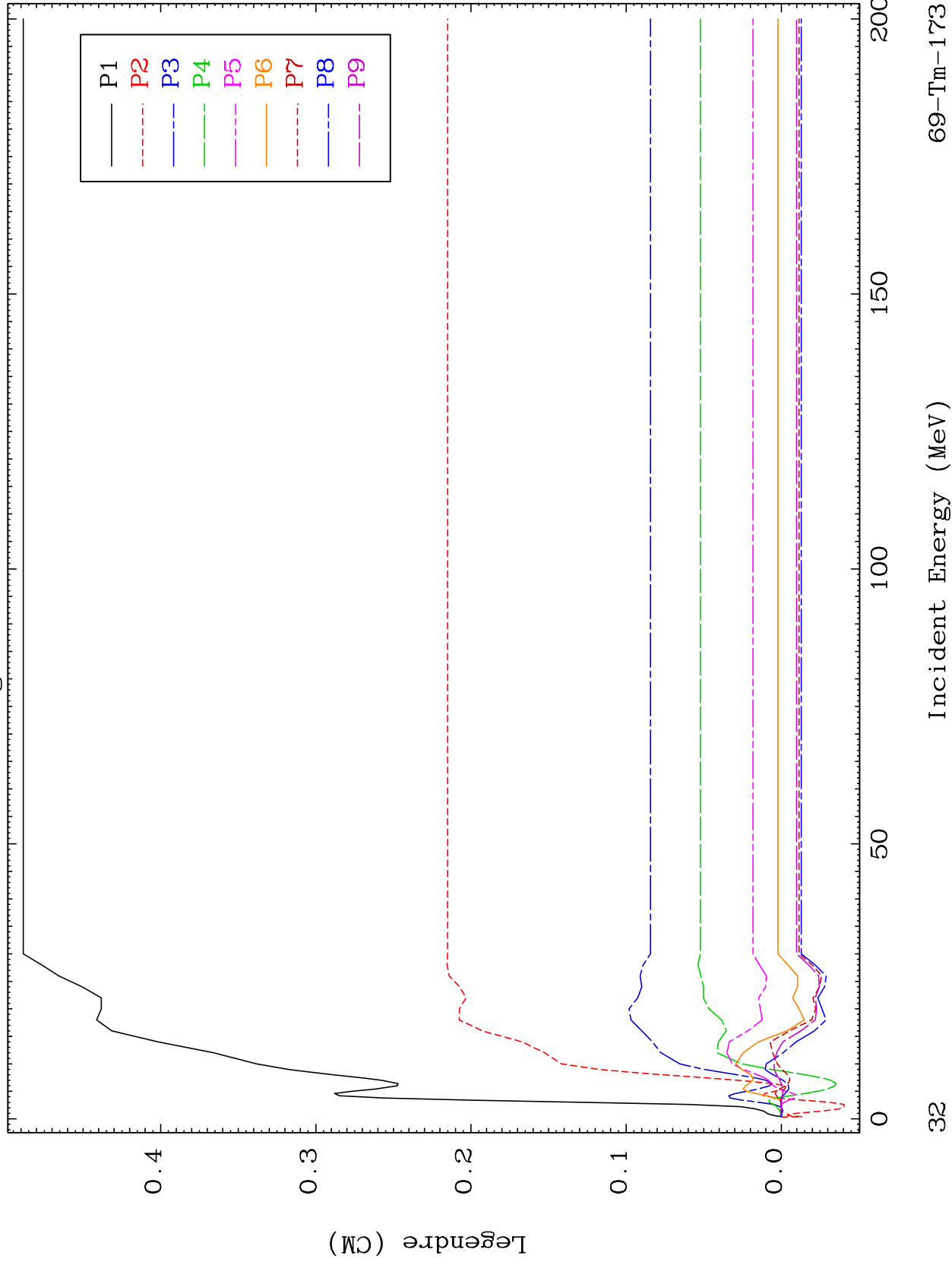

69-Tm-173

Incident Energy (MeV)

32

MAT 6937

317.7 keV (n, n') Level
Legendre Coefficients

69-Tm-173

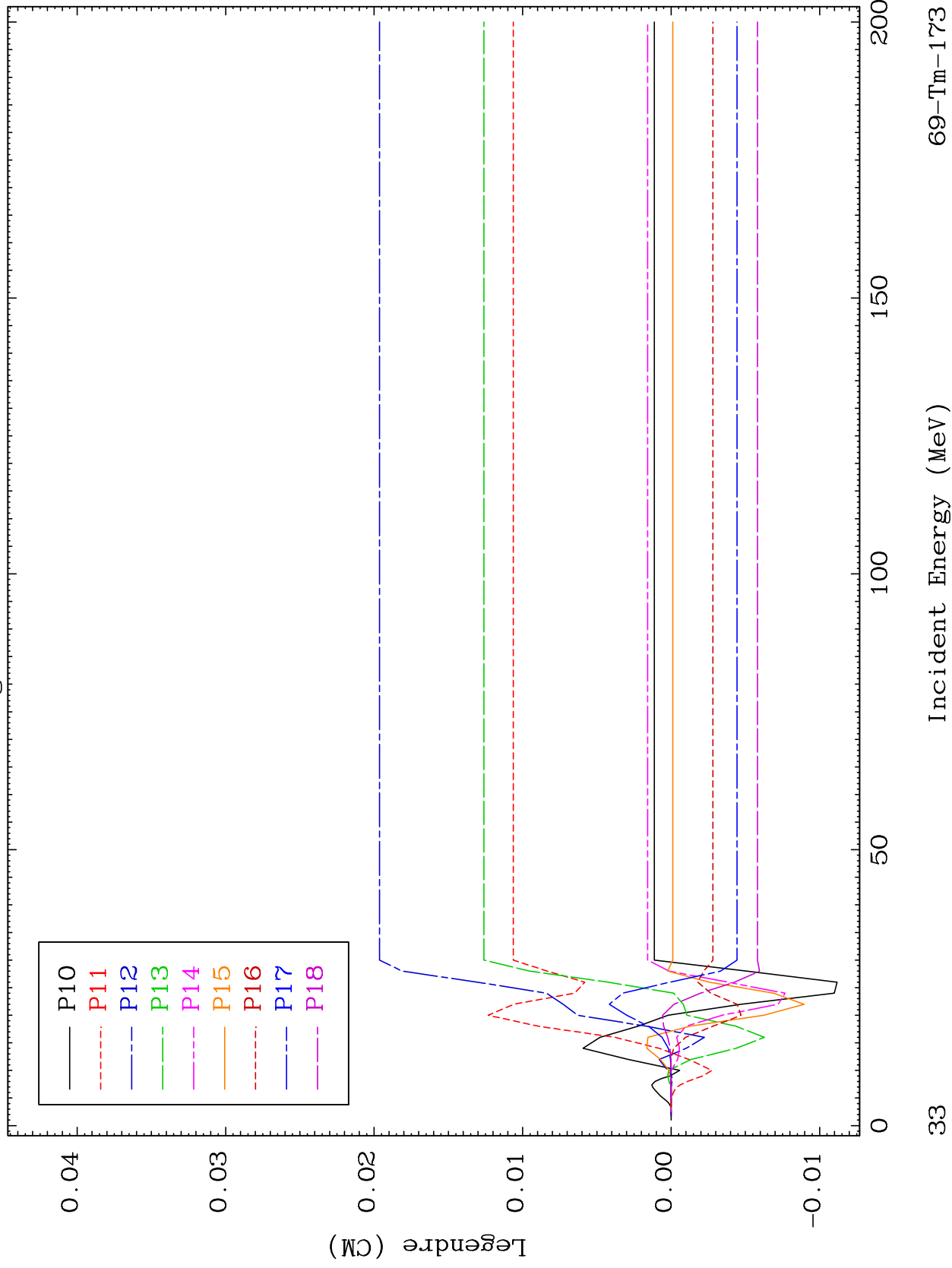

33

Incident Energy (MeV)

69-Tm-173

MAT 6937

317.7 keV (n,n') Level
Legendre Coefficients

69-Tm-173

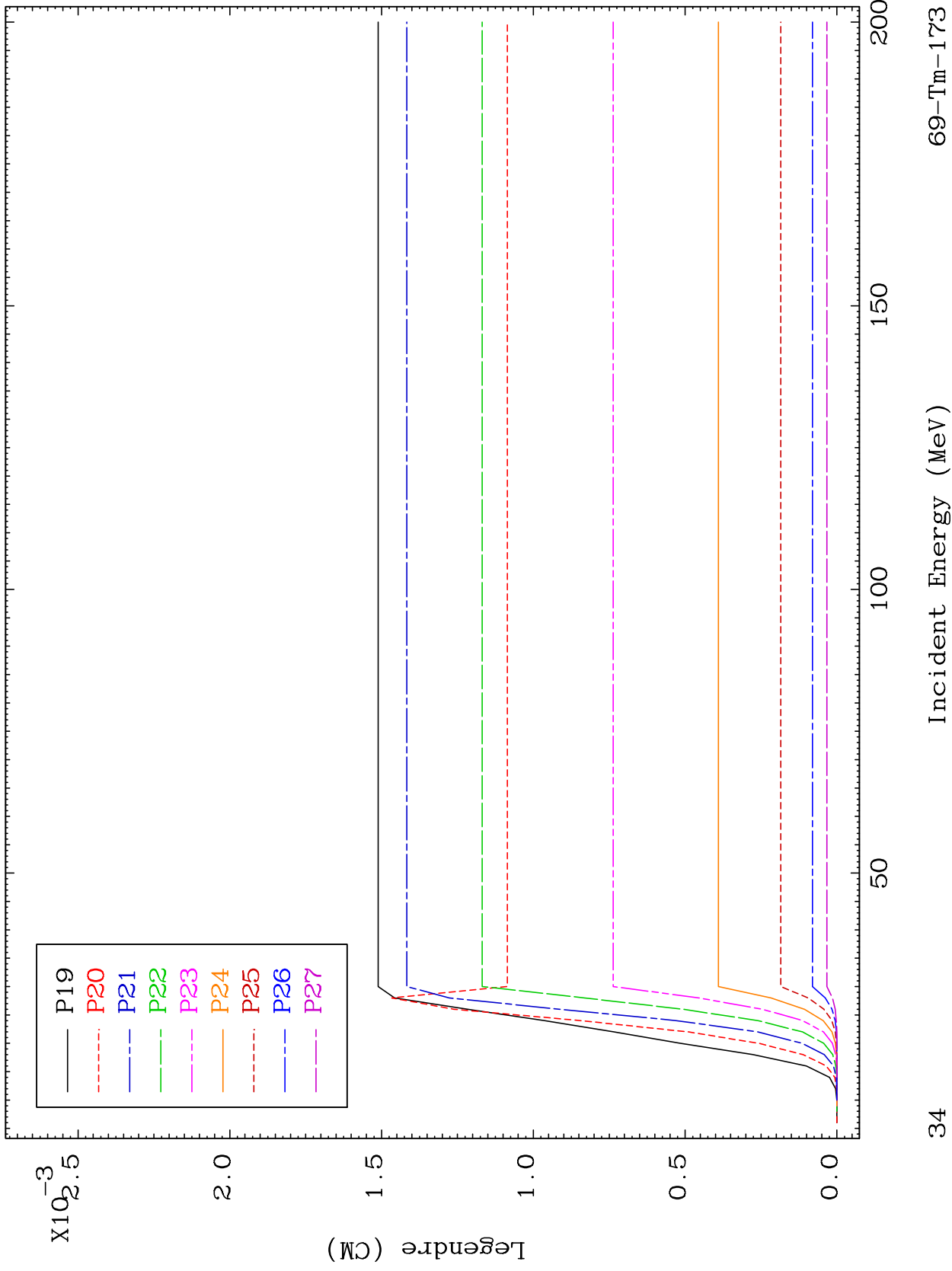

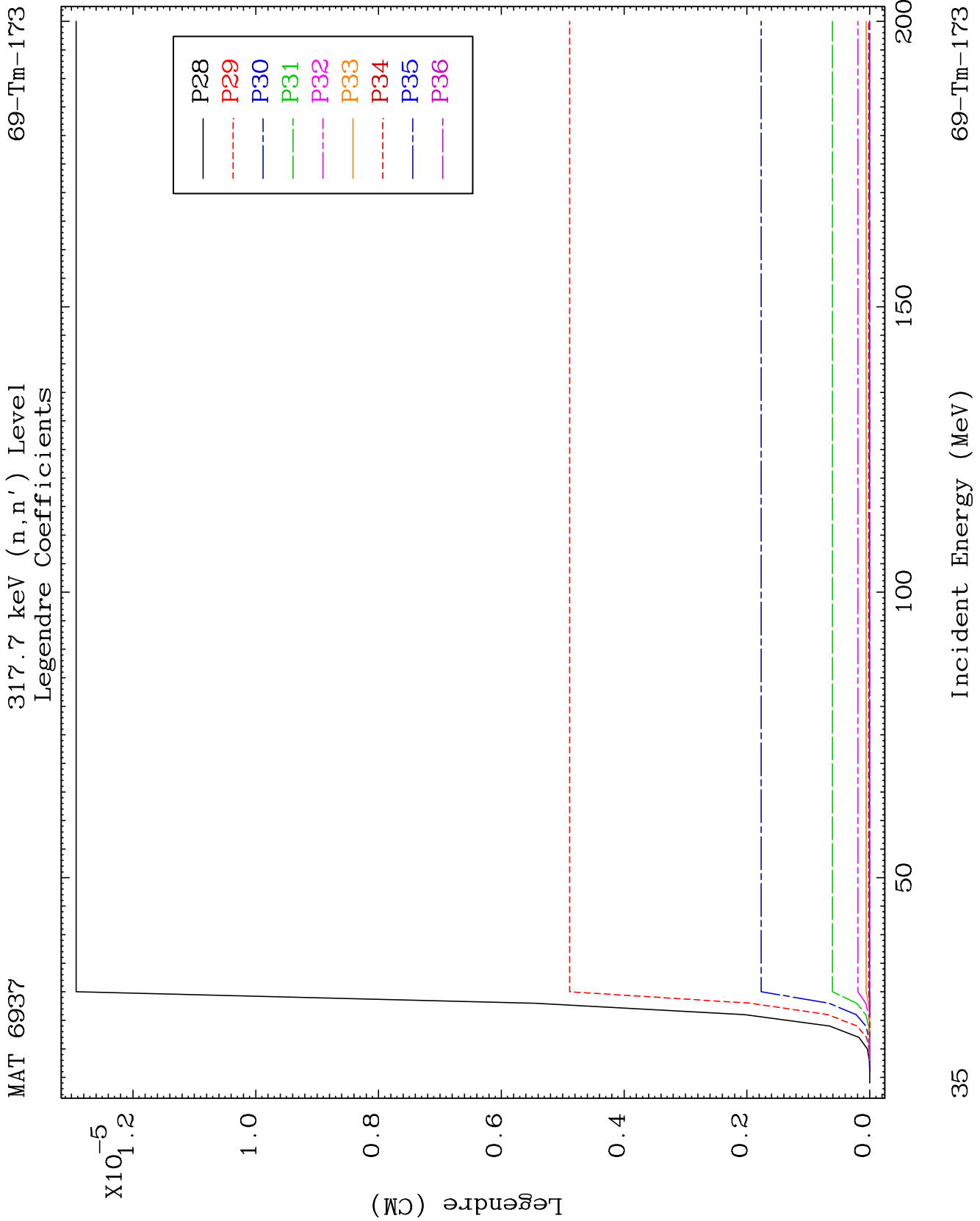

MAT 6937

339.8 keV (n,n') Level
Legendre Coefficients

69-Tm-173

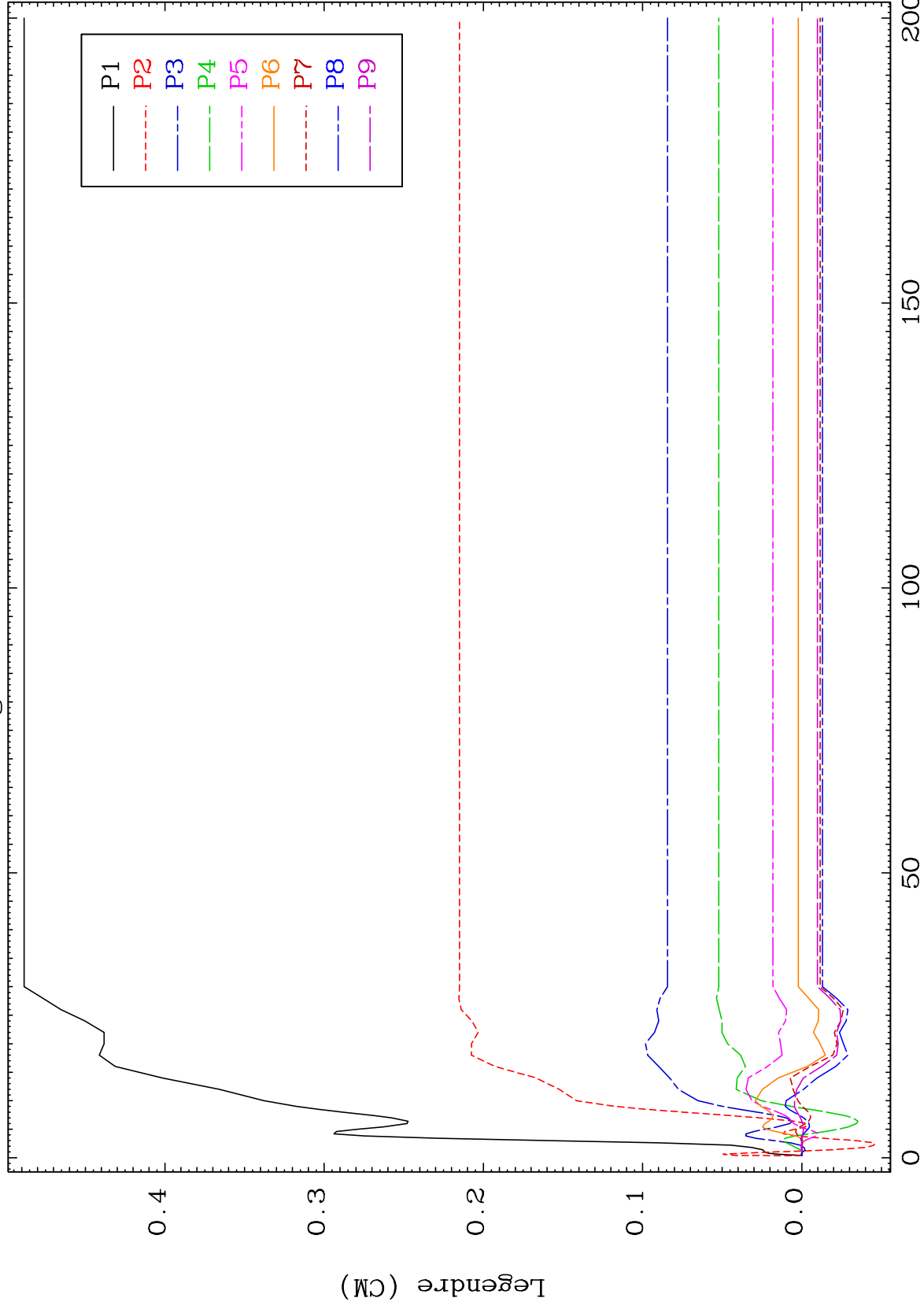

36

Incident Energy (MeV)

69-Tm-173

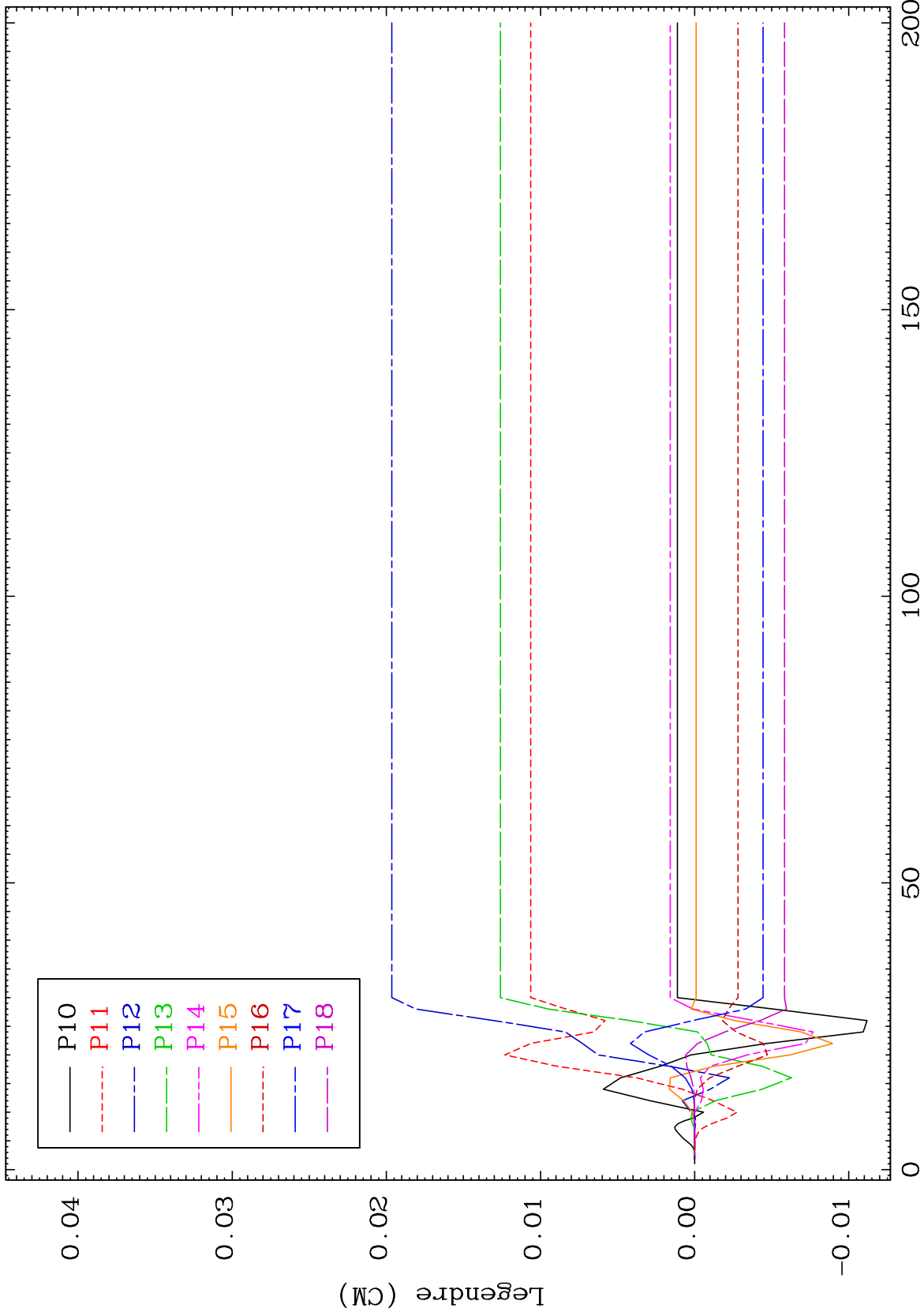

MAT 6937

339.8 keV (n,n') Level
Legendre Coefficients

69-Tm-173

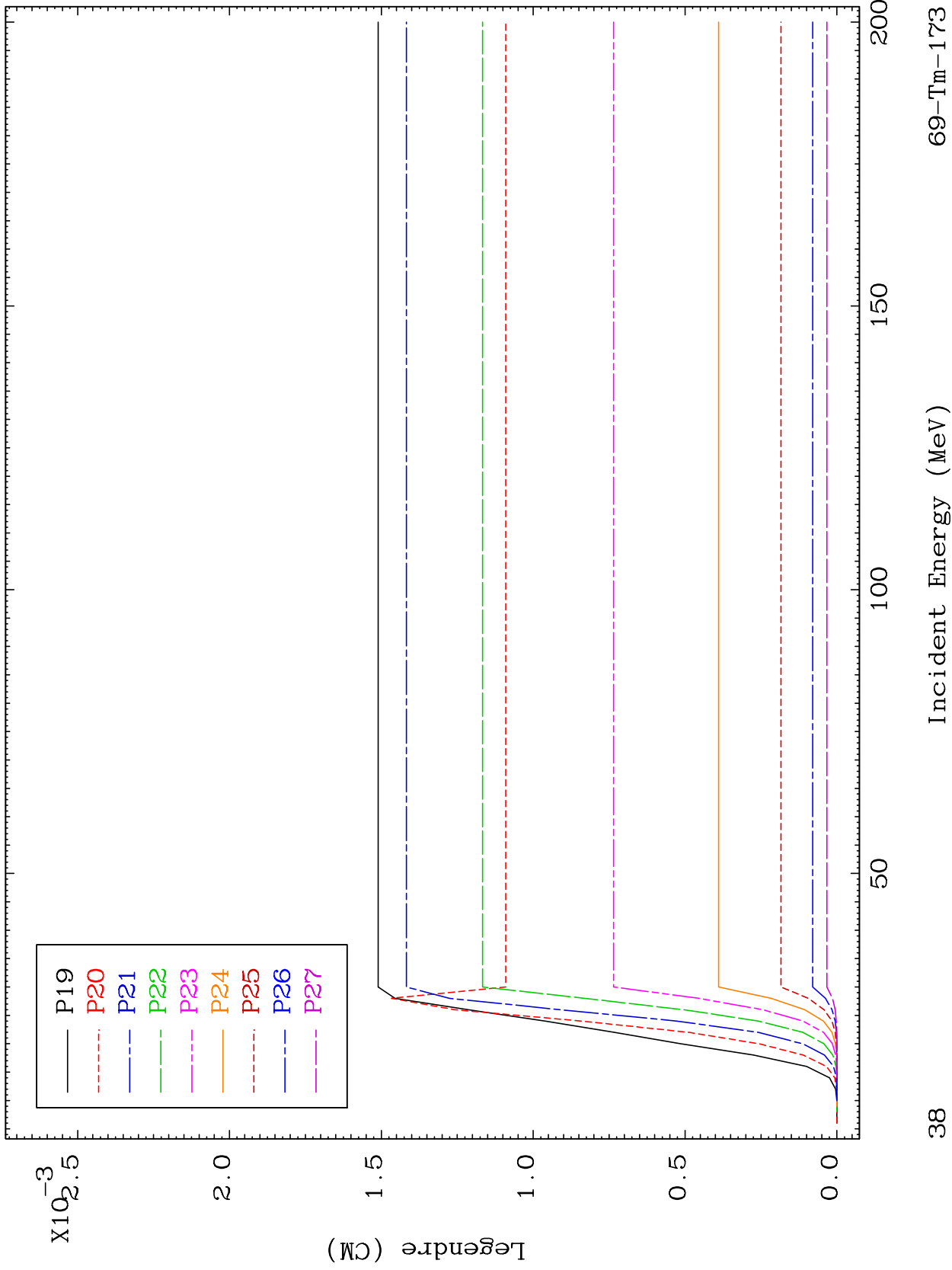

38

Incident Energy (MeV)

69-Tm-173

MAT 6937

339.8 keV (n,n') Level
Legendre Coefficients

69-Tm-173

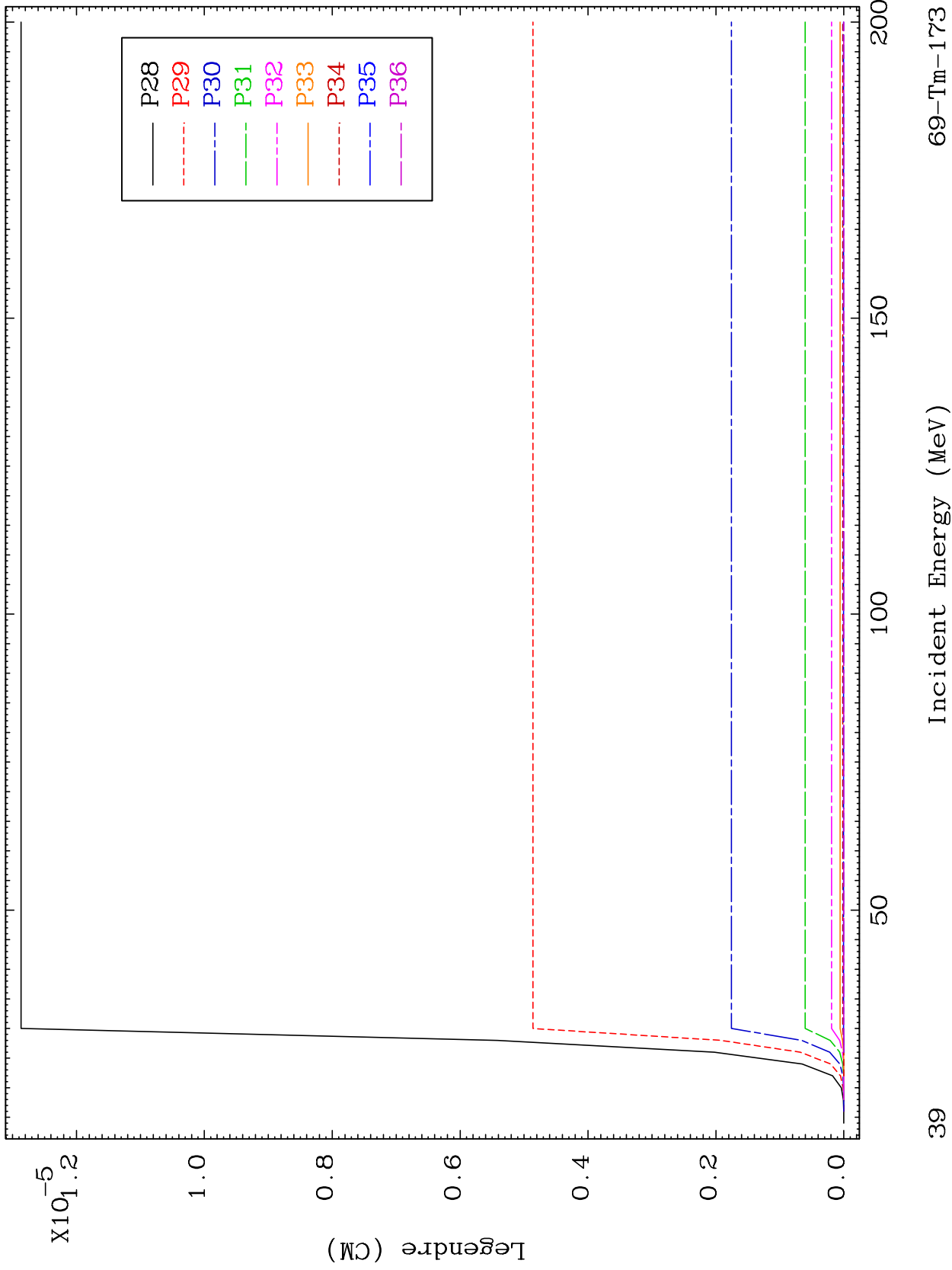

39

Incident Energy (MeV)

69-Tm-173

MAT 6937

411.9 keV (n,n') Level
Legendre Coefficients

69-Tm-173

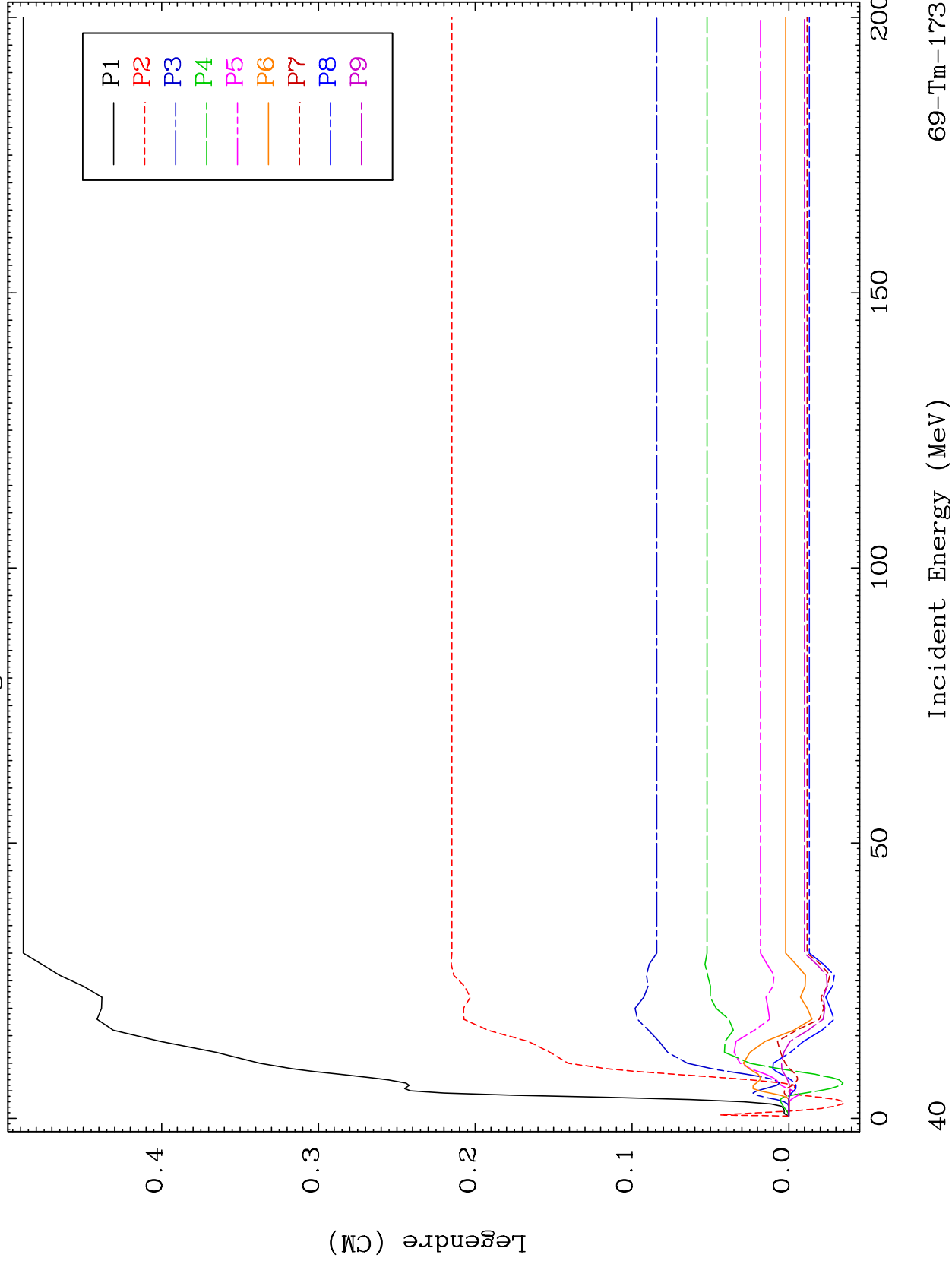

69-Tm-173

Incident Energy (MeV)

40

MAT 6937

411.9 keV (n,n') Level
Legendre Coefficients

69-Tm-173

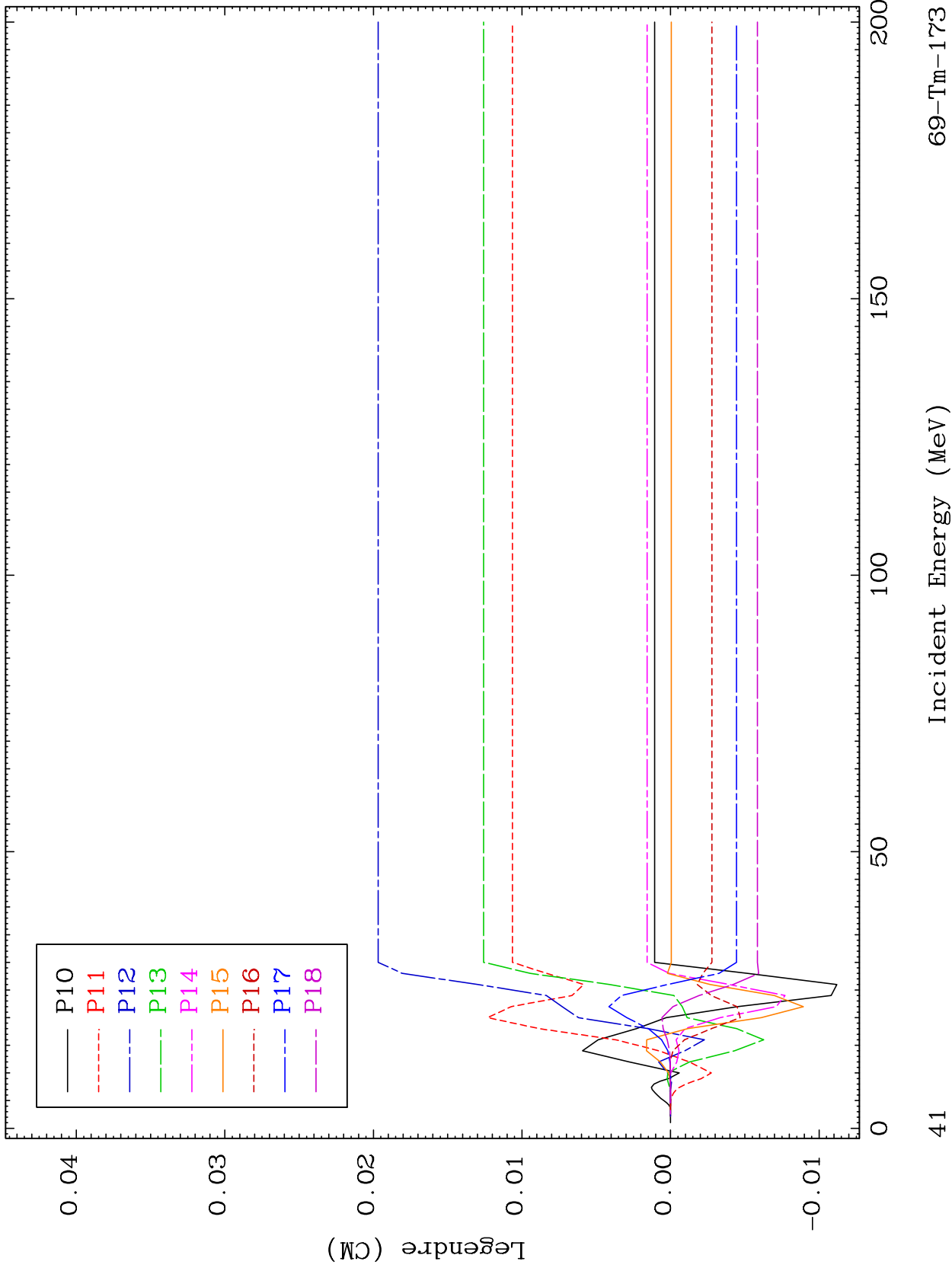

41

Incident Energy (MeV)

69-Tm-173

MAT 6937

411.9 keV (n,n') Level
Legendre Coefficients

69-Tm-173

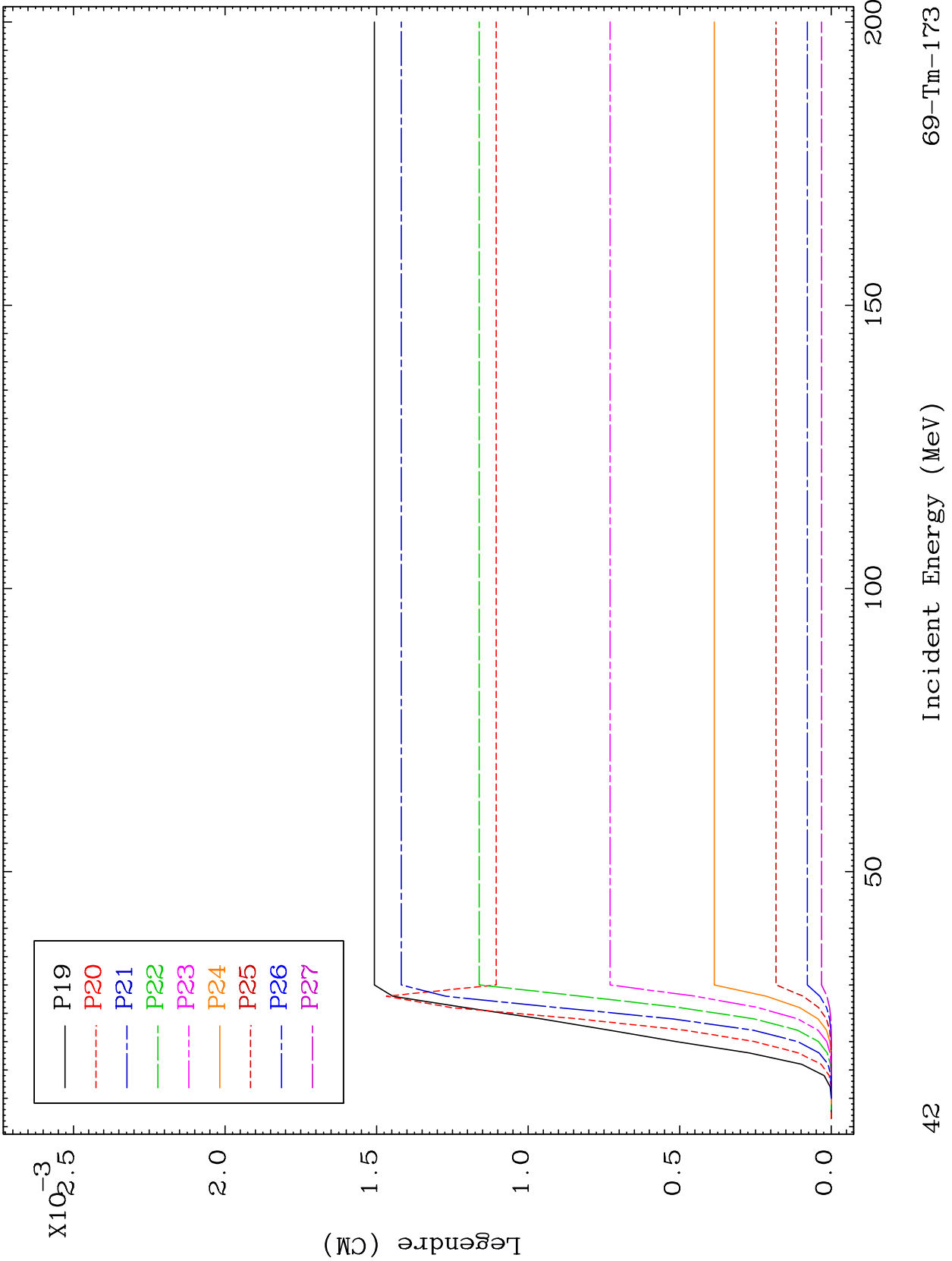

MAT 6937

411.9 keV (n,n') Level
Legendre Coefficients

69-Tm-173

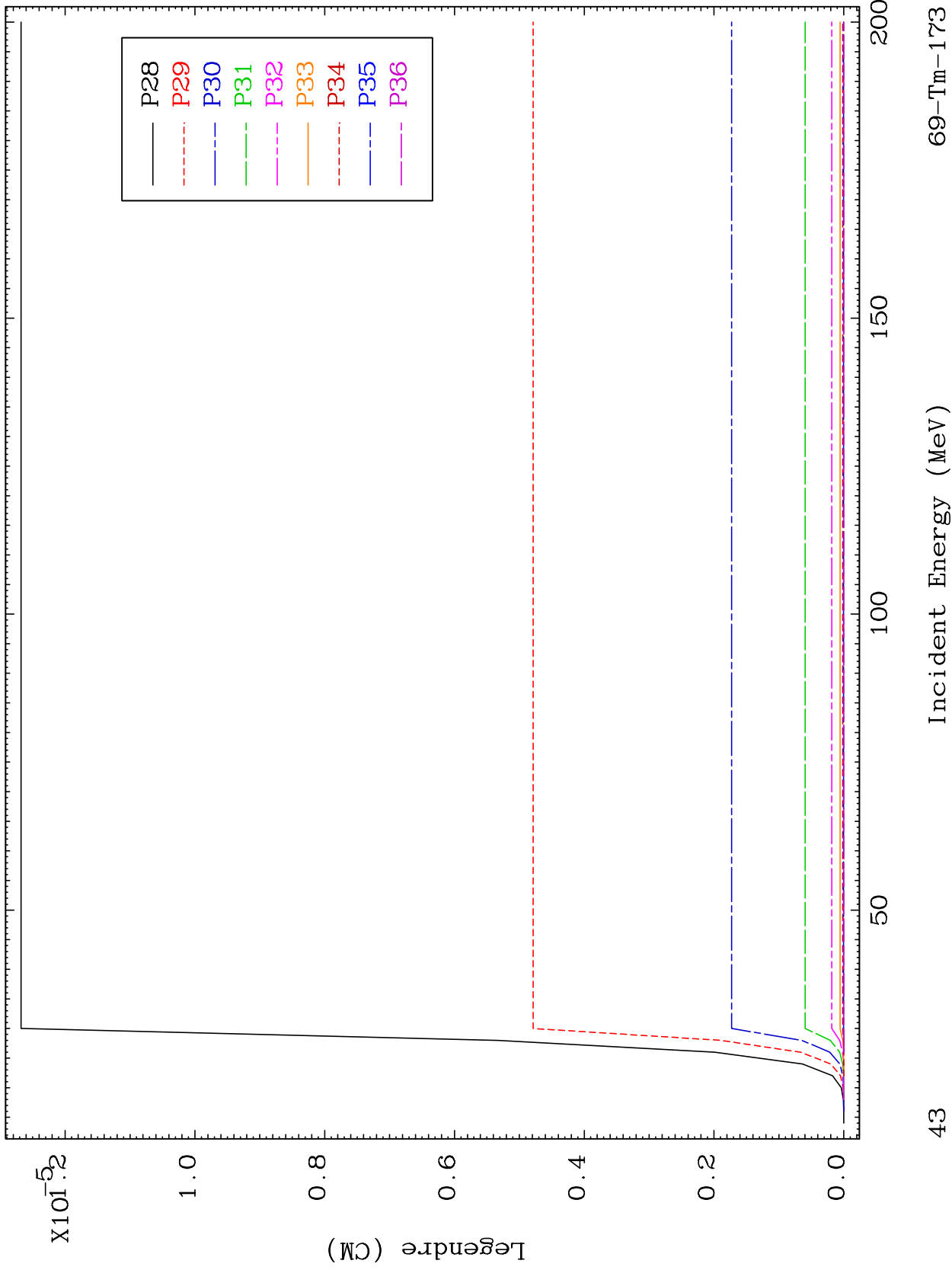

43

Incident Energy (MeV)

69-Tm-173

MAT 6937

526.0 keV (n,n') Level
Legendre Coefficients

69-Tm-173

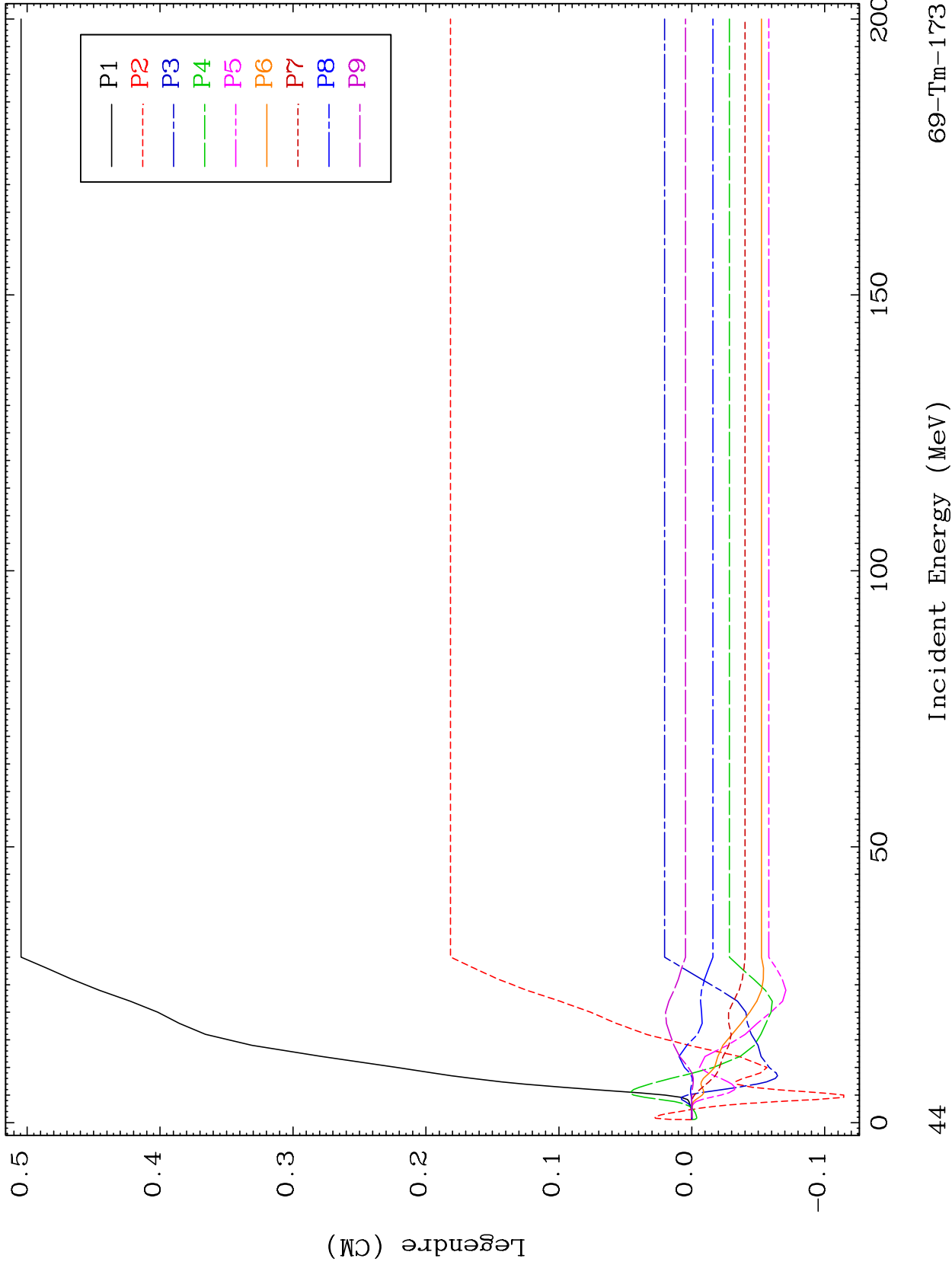

69-Tm-173

Incident Energy (MeV)

44

MAT 6937

526.0 keV (n,n') Level
Legendre Coefficients

69-Tm-173

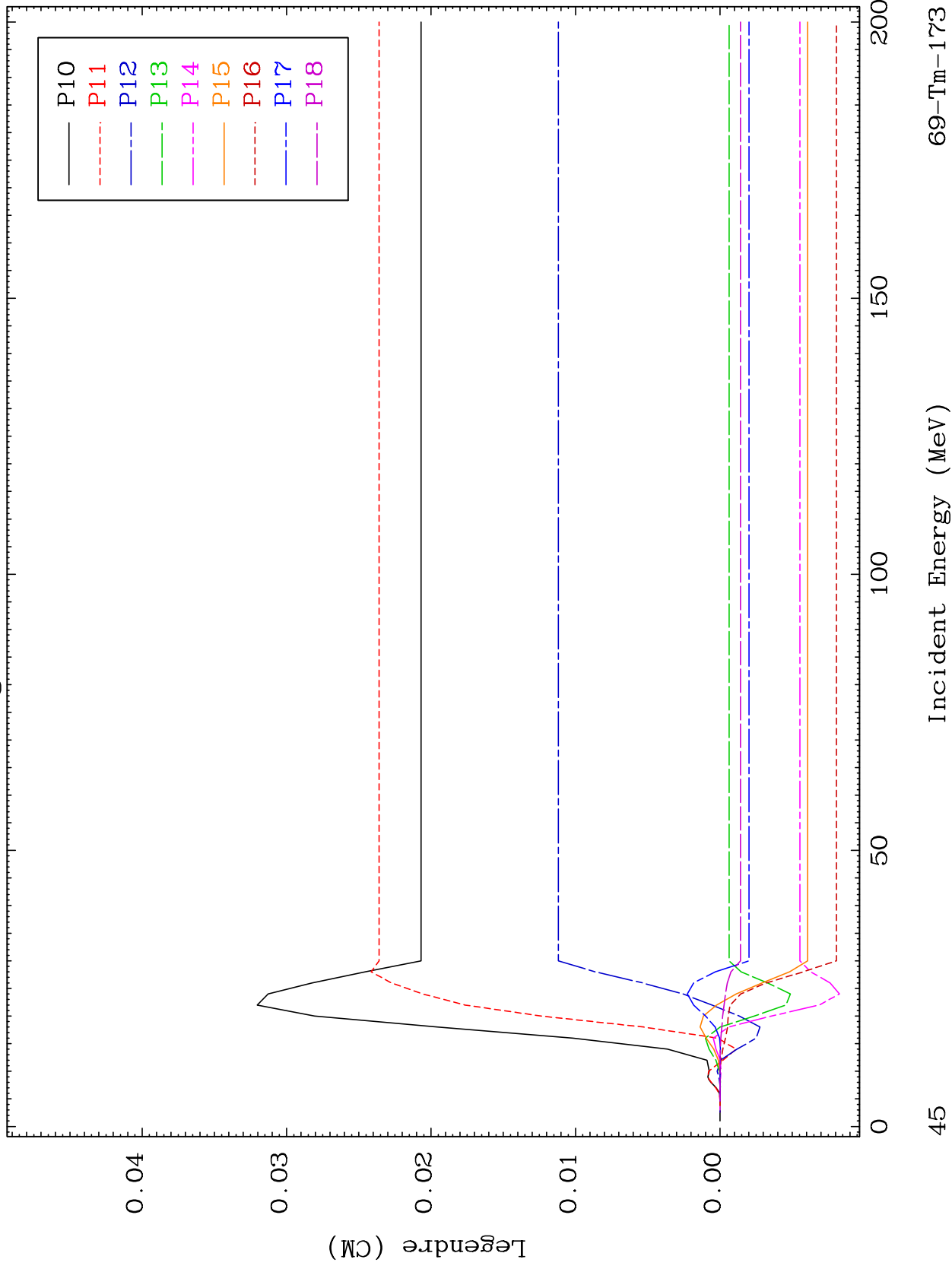

69-Tm-173

Incident Energy (MeV)

45

MAT 6937

526.0 keV (n,n') Level
Legendre Coefficients

69-Tm-173

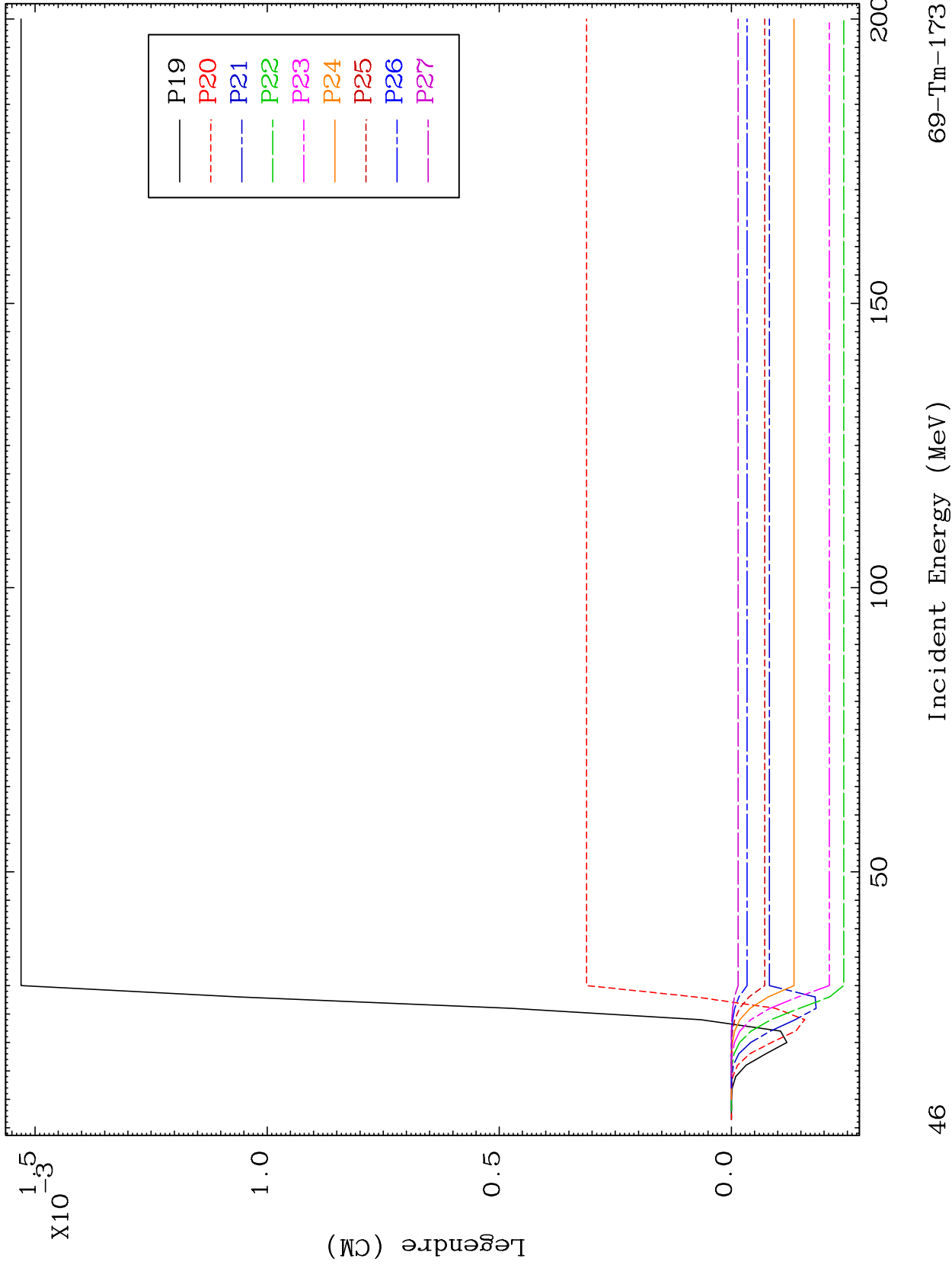

46

Incident Energy (MeV)

69-Tm-173

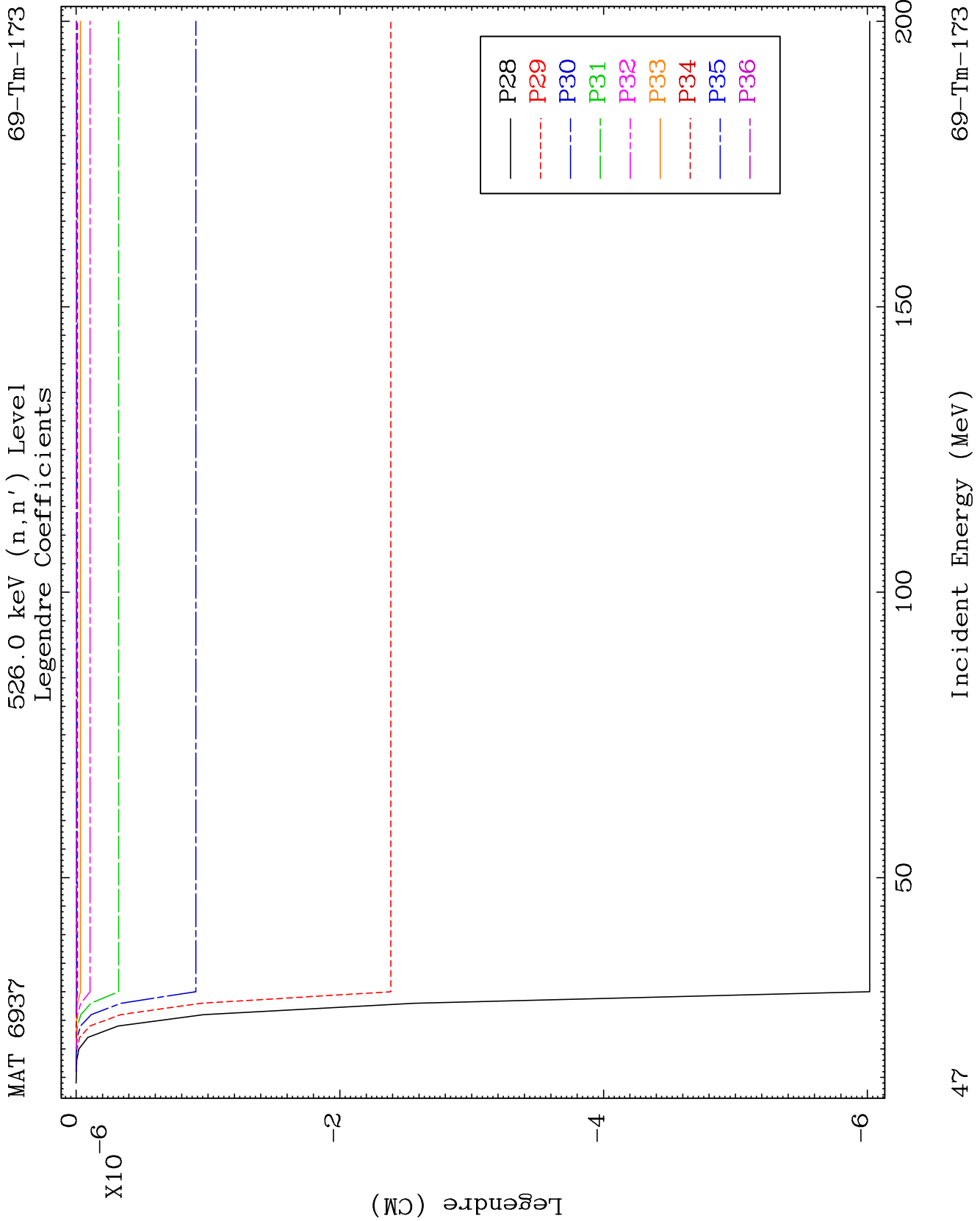

MAT 6937

609.5 keV (n,n') Level
Legendre Coefficients

69-Tm-173

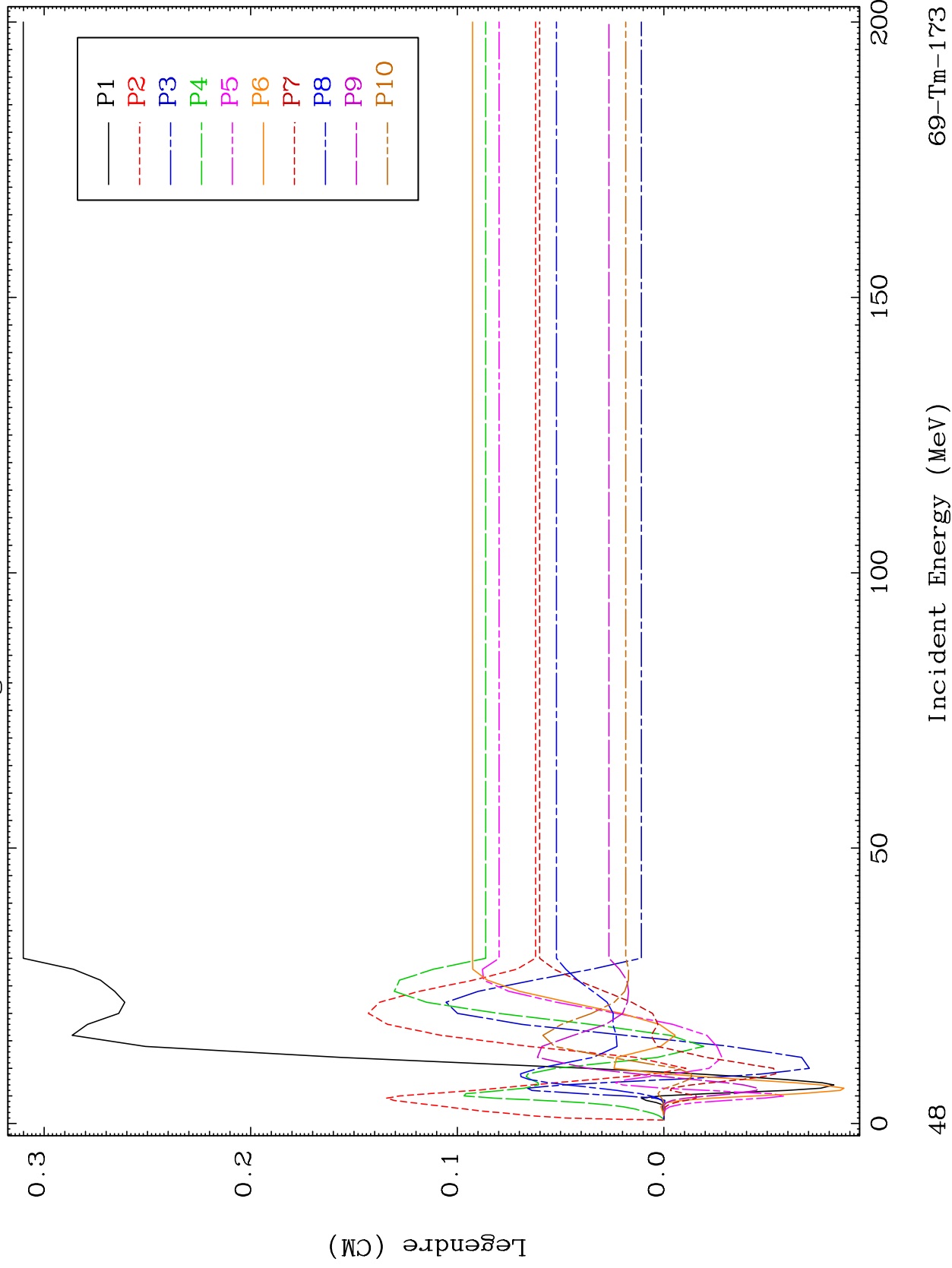

69-Tm-173

Incident Energy (MeV)

48

MAT 6937

609.5 keV (n,n') Level
Legendre Coefficients

69-Tm-173

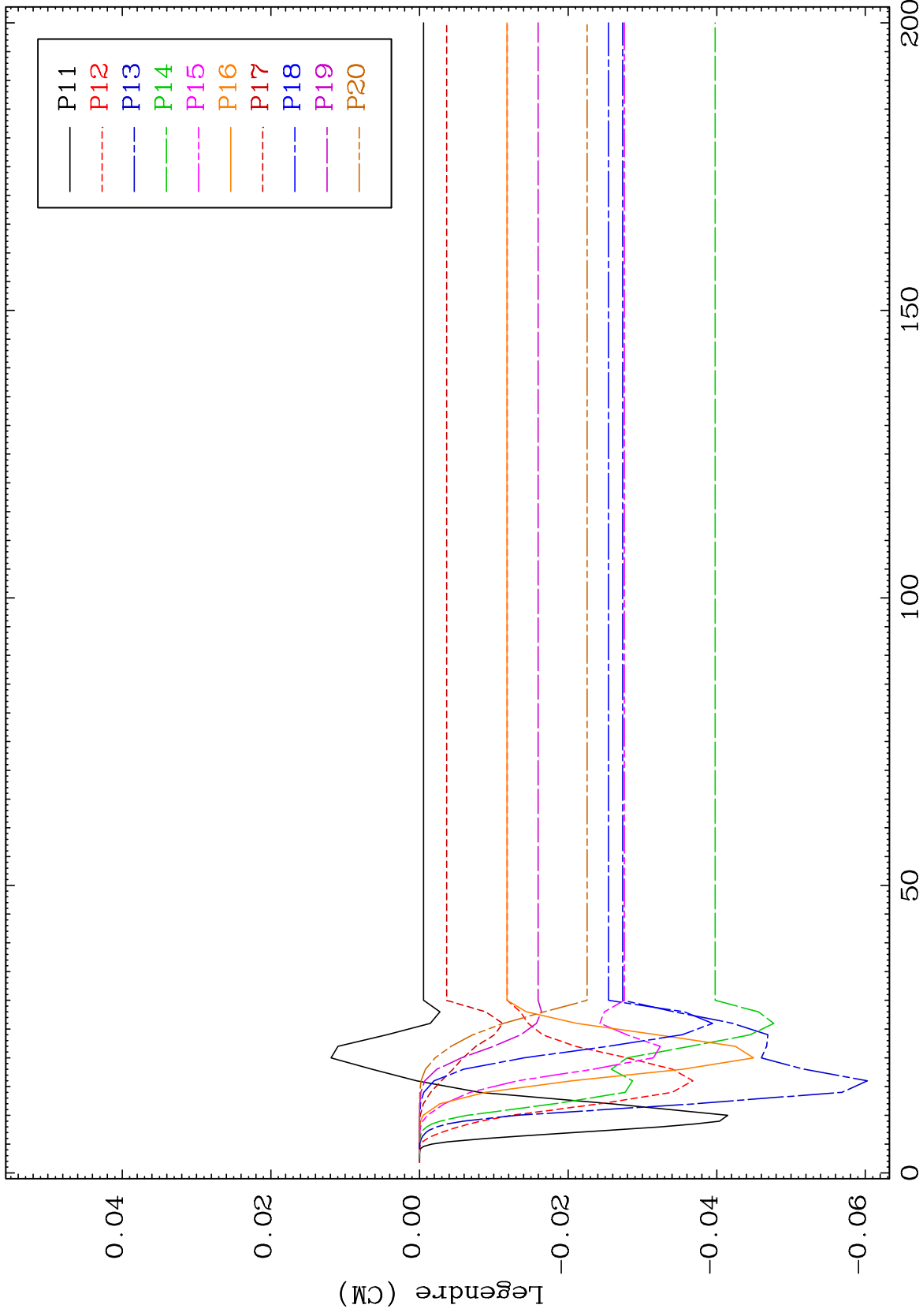

49

Incident Energy (MeV)

69-Tm-173

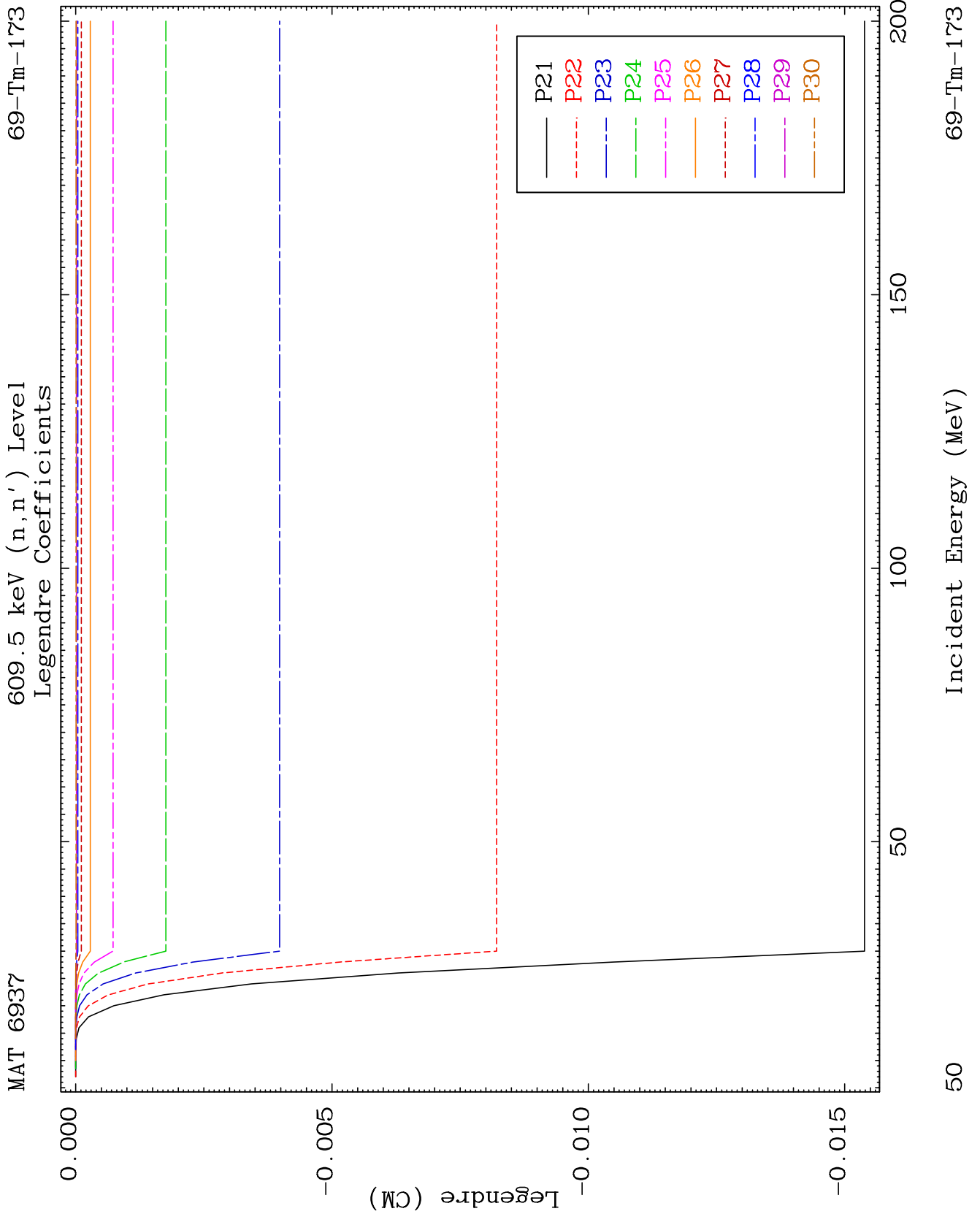

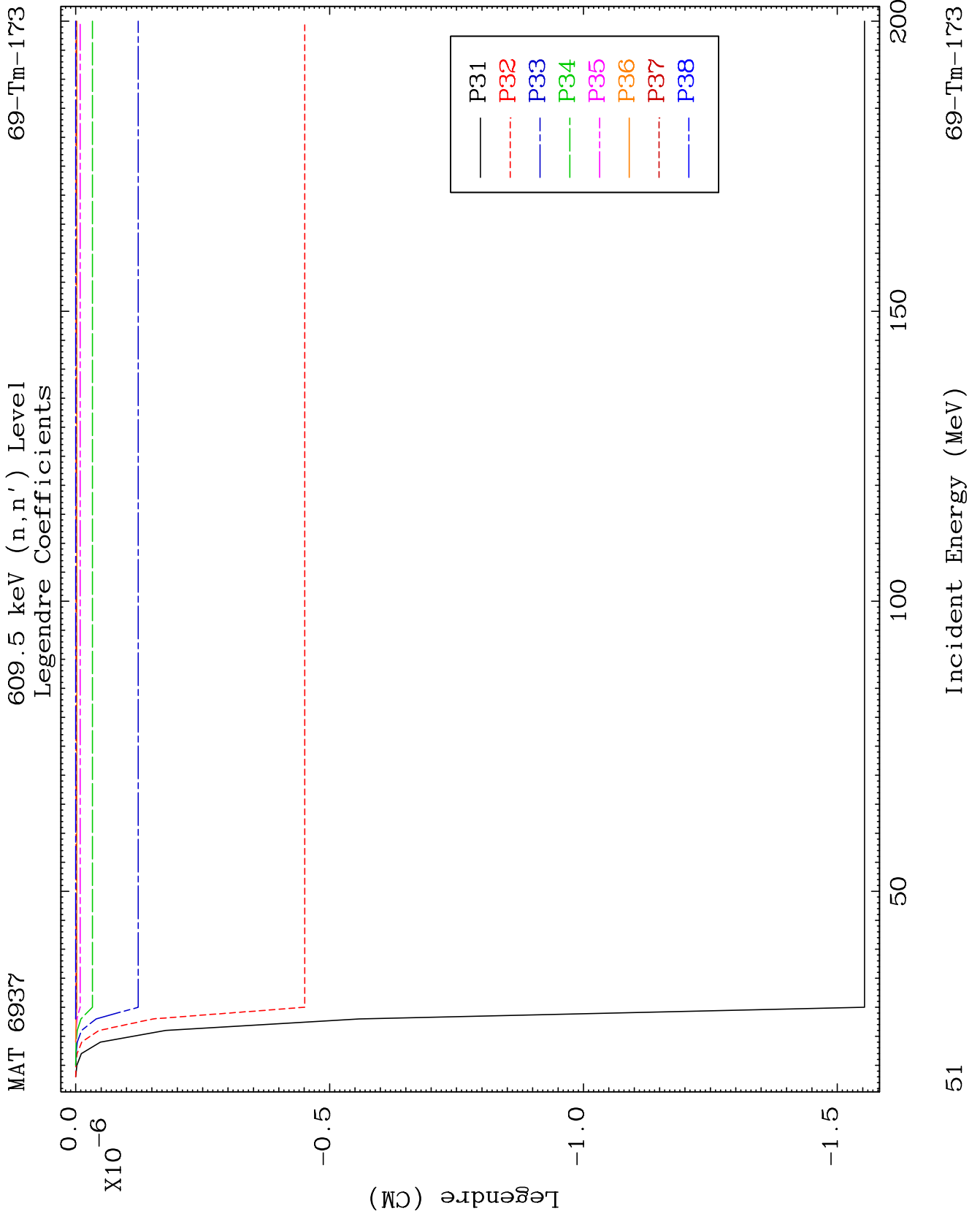

MAT 6937

669.5 keV (n,n') Level
Legendre Coefficients

69-Tm-173

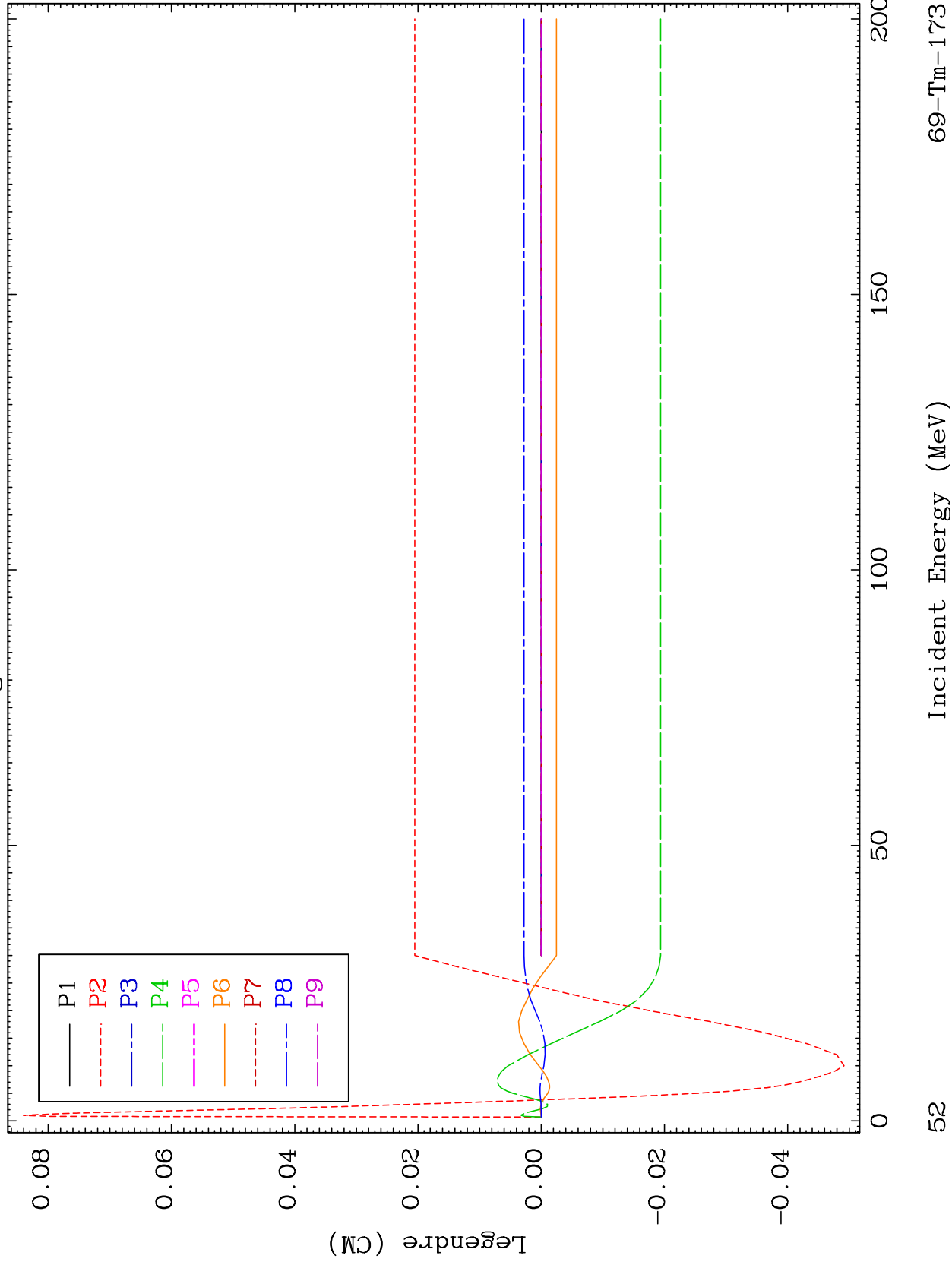

69-Tm-173

Incident Energy (MeV)

52

MAT 6937

669.5 keV (n,n') Level
Legendre Coefficients

69-Tm-173

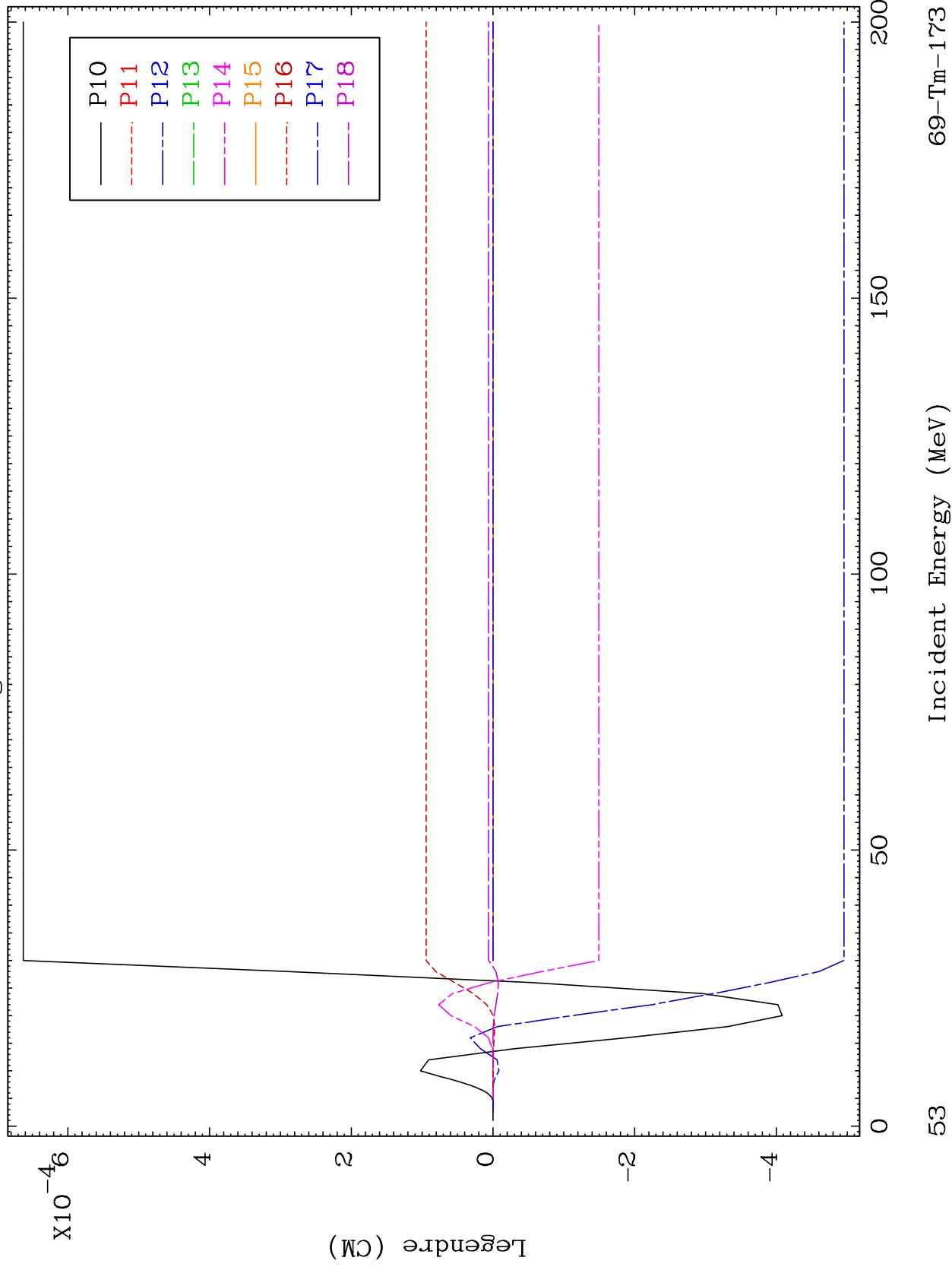

69-Tm-173

Incident Energy (MeV)

53

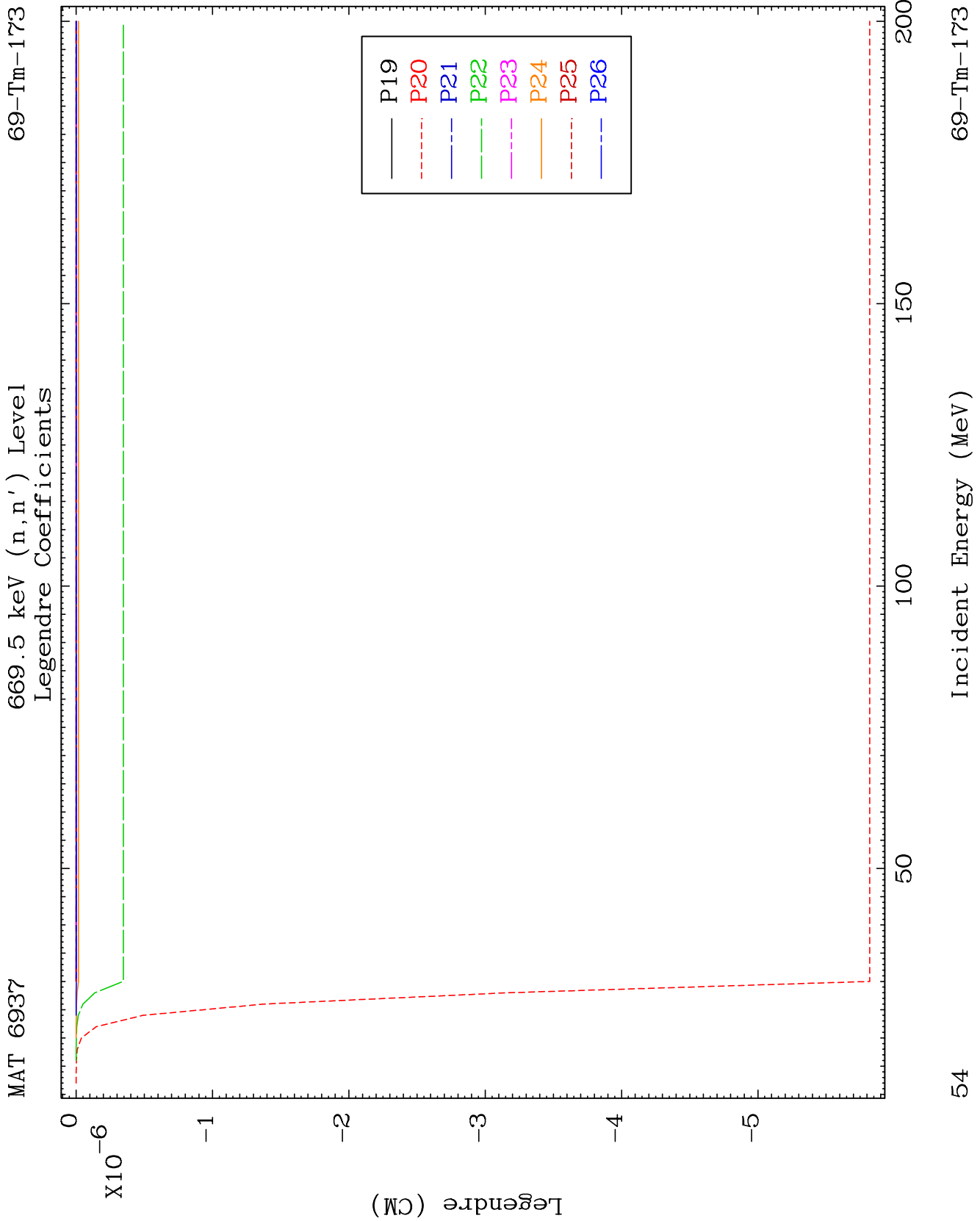

MAT 6937

749.8 keV (n, n') Level
Legendre Coefficients

69-Tm-173

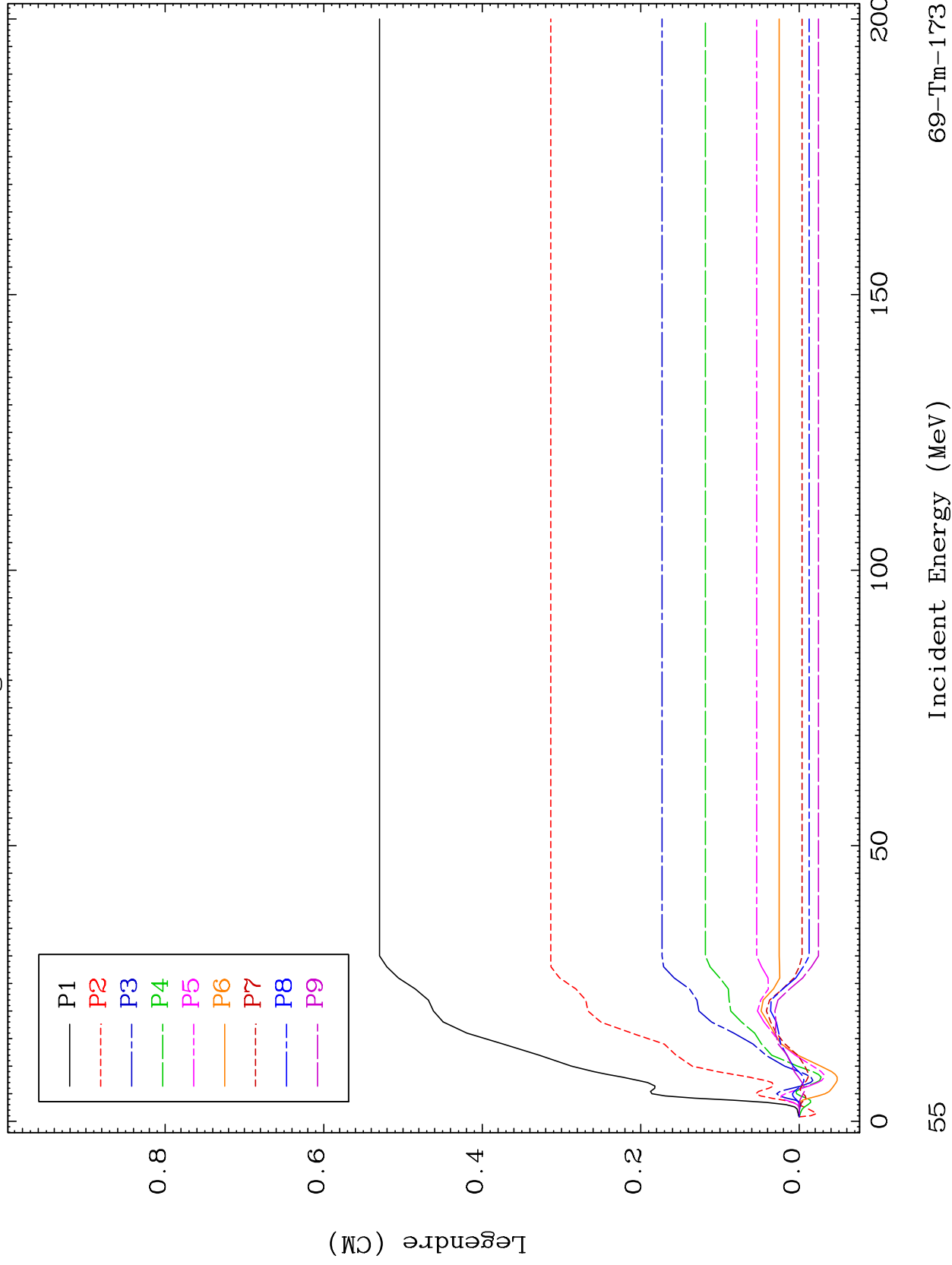

69-Tm-173

Incident Energy (MeV)

55

MAT 6937

749.8 keV (n,n') Level
Legendre Coefficients

69-Tm-173

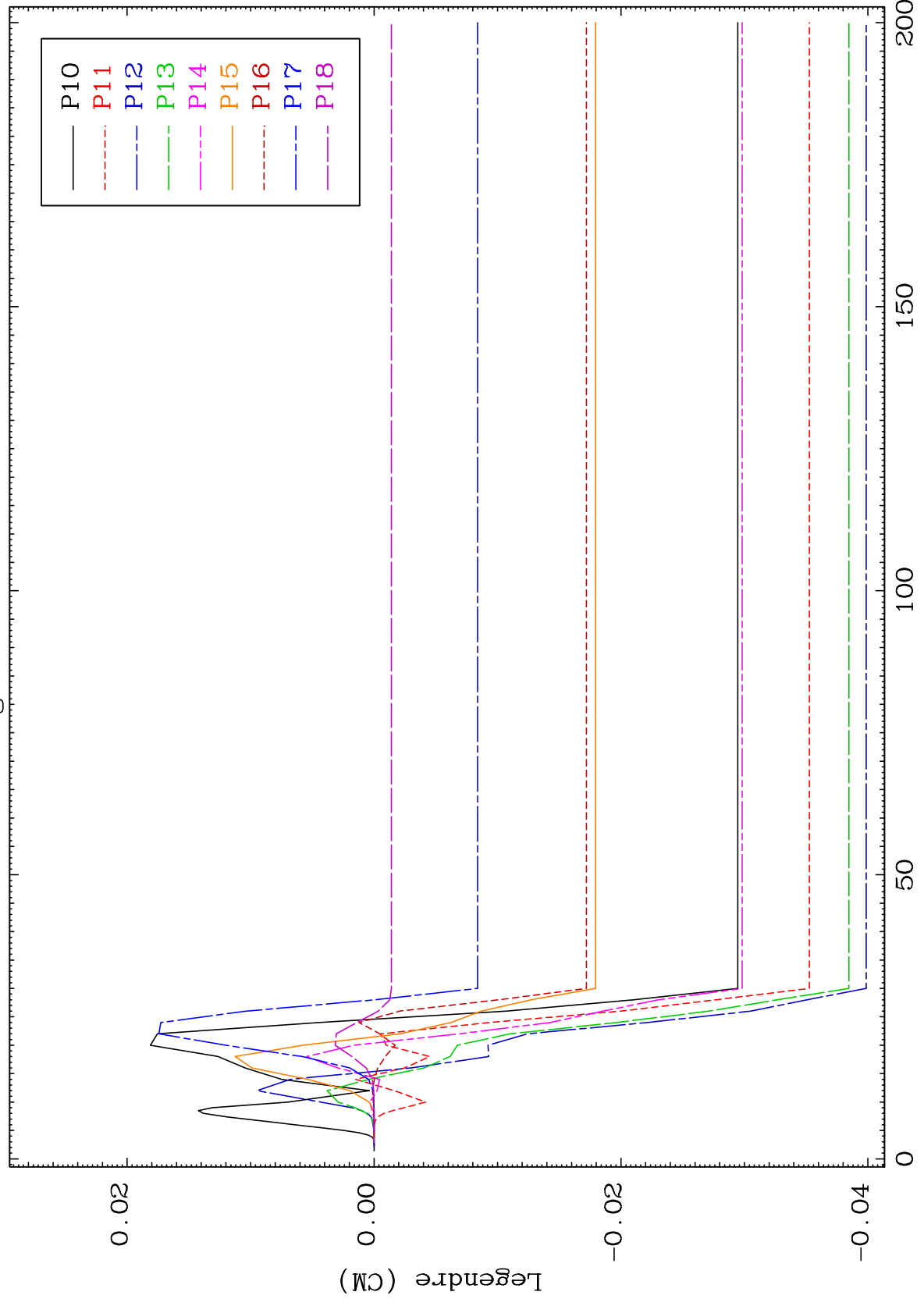

56

Incident Energy (MeV)

69-Tm-173

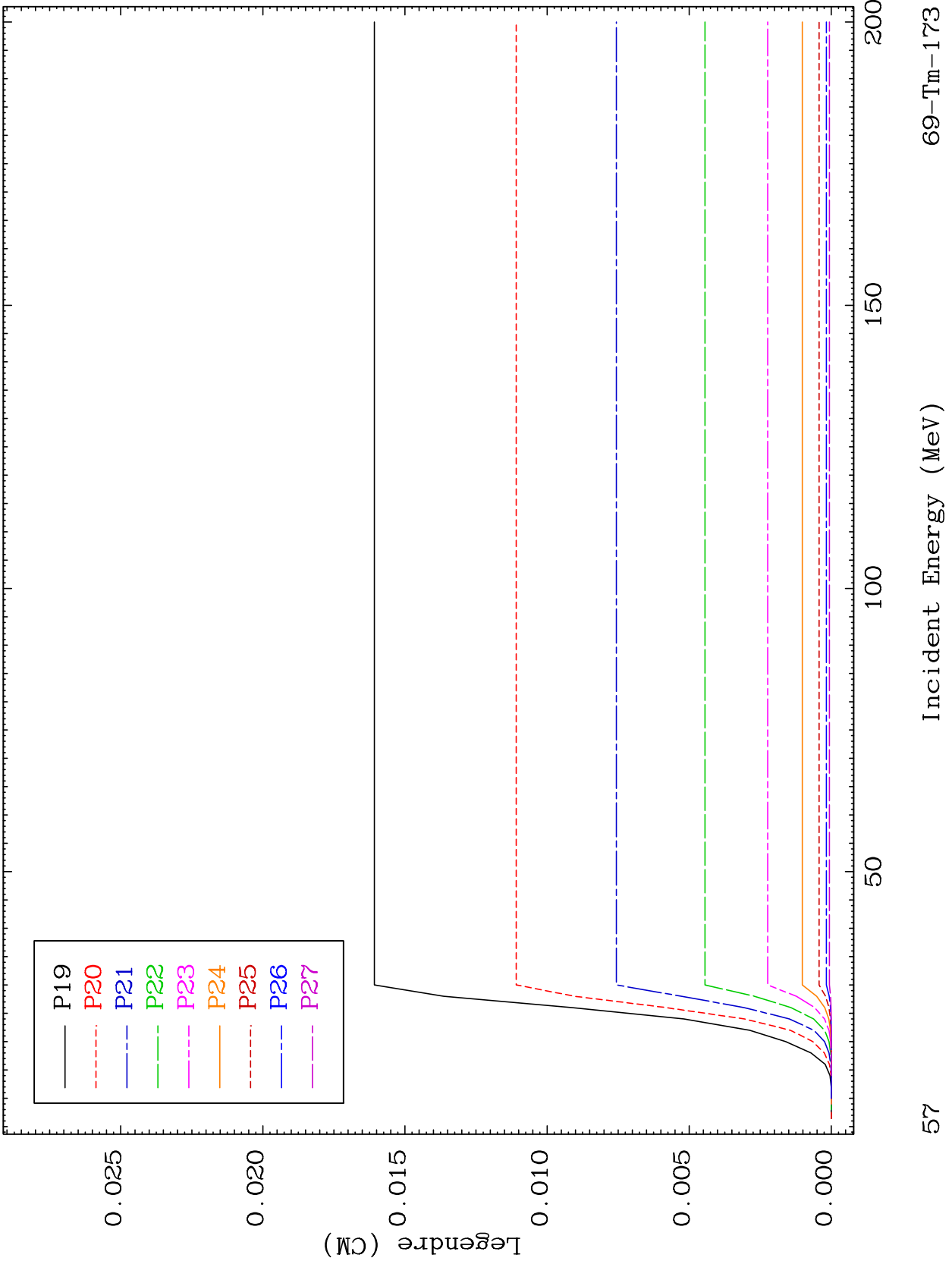

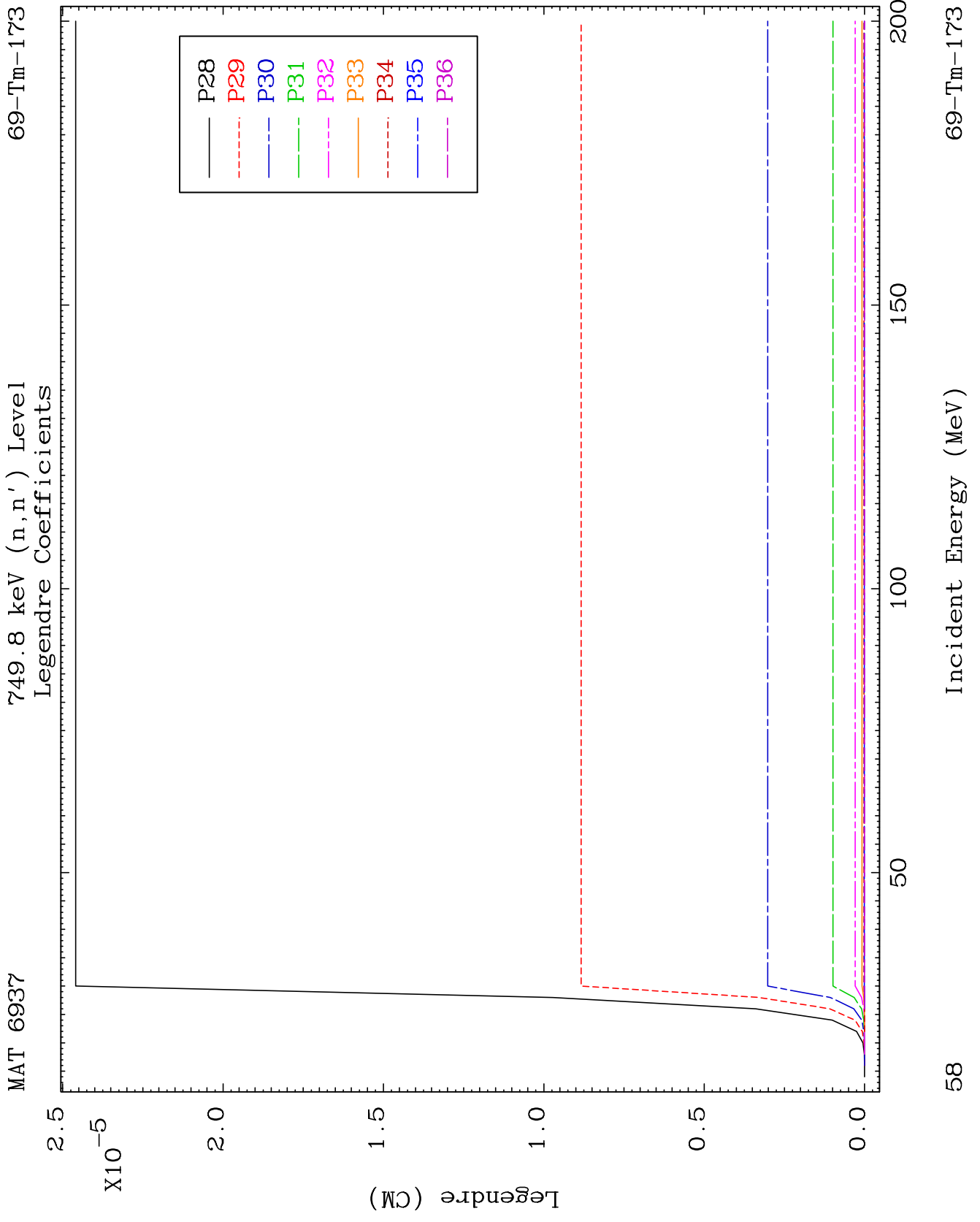

MAT 6937

817.9 keV (n,n') Level
Legendre Coefficients

69-Tm-173

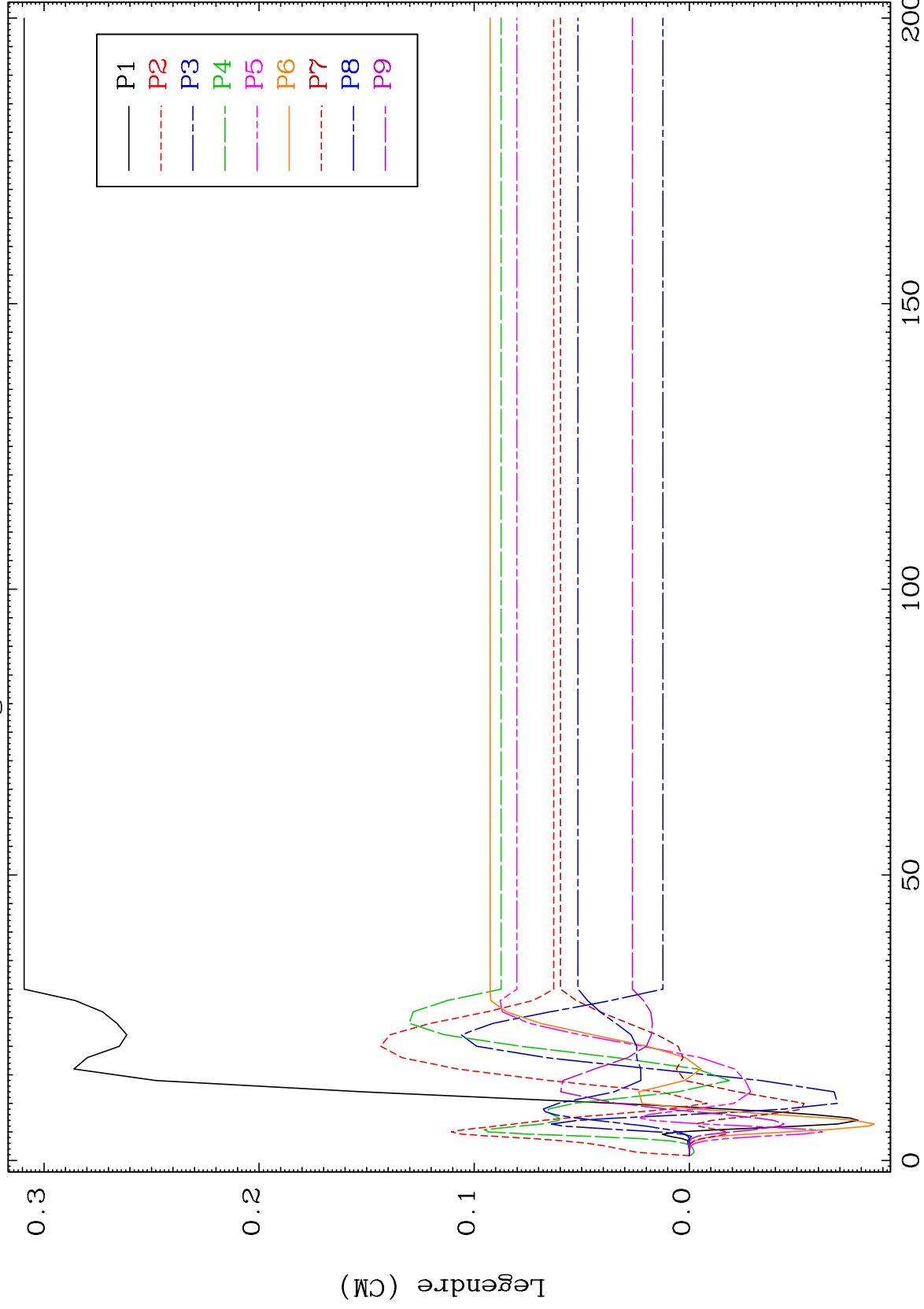

69-Tm-173

Incident Energy (MeV)

59

MAT 6937

817.9 keV (n,n') Level
Legendre Coefficients

69-Tm-173

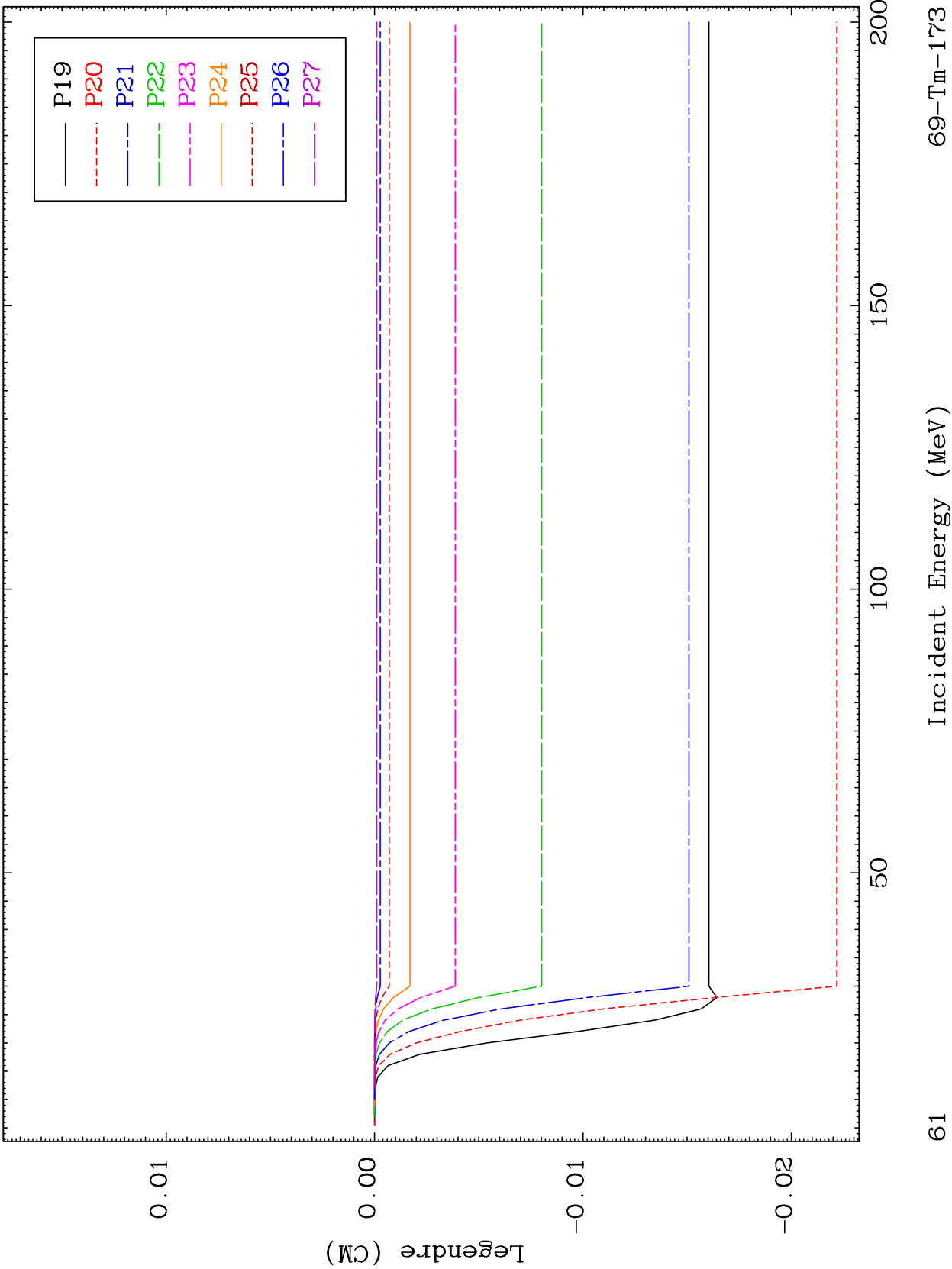

61

Incident Energy (MeV)

69-Tm-173

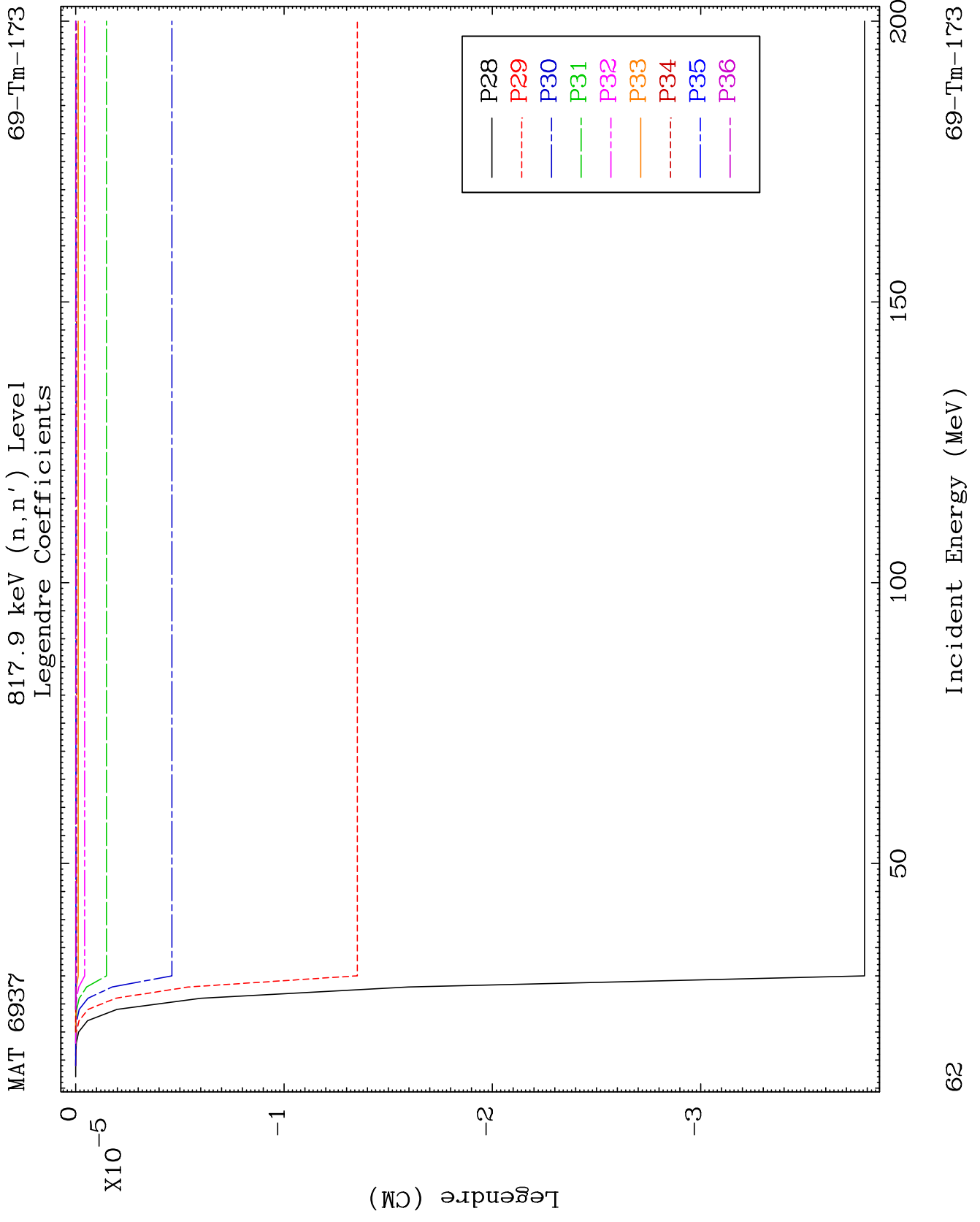

MAT 6937

856.1 keV (n,n') Level
Legendre Coefficients

69-Tm-173

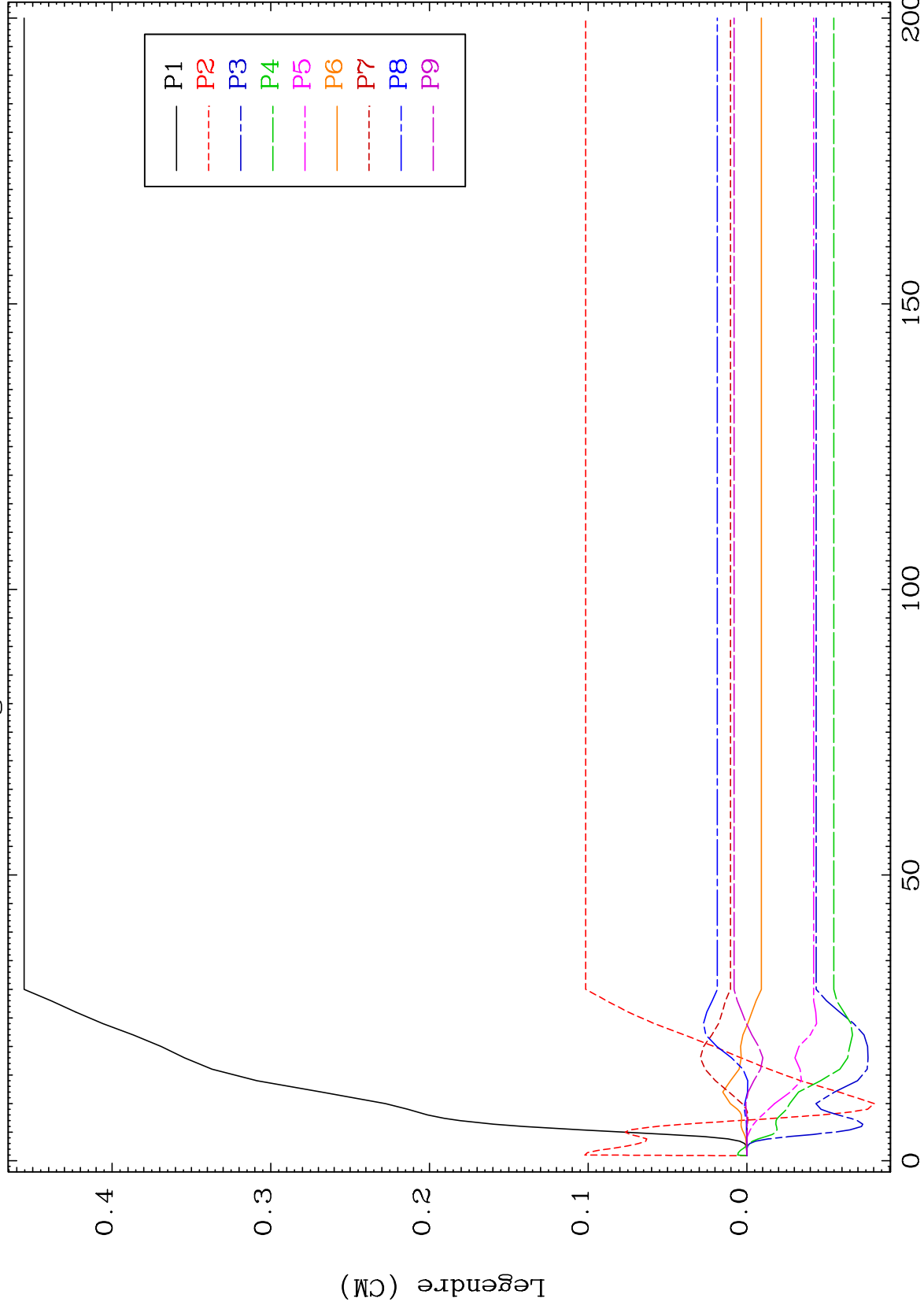

63

Incident Energy (MeV)

69-Tm-173

MAT 6937

856.1 keV (n,n') Level
Legendre Coefficients

69-Tm-173

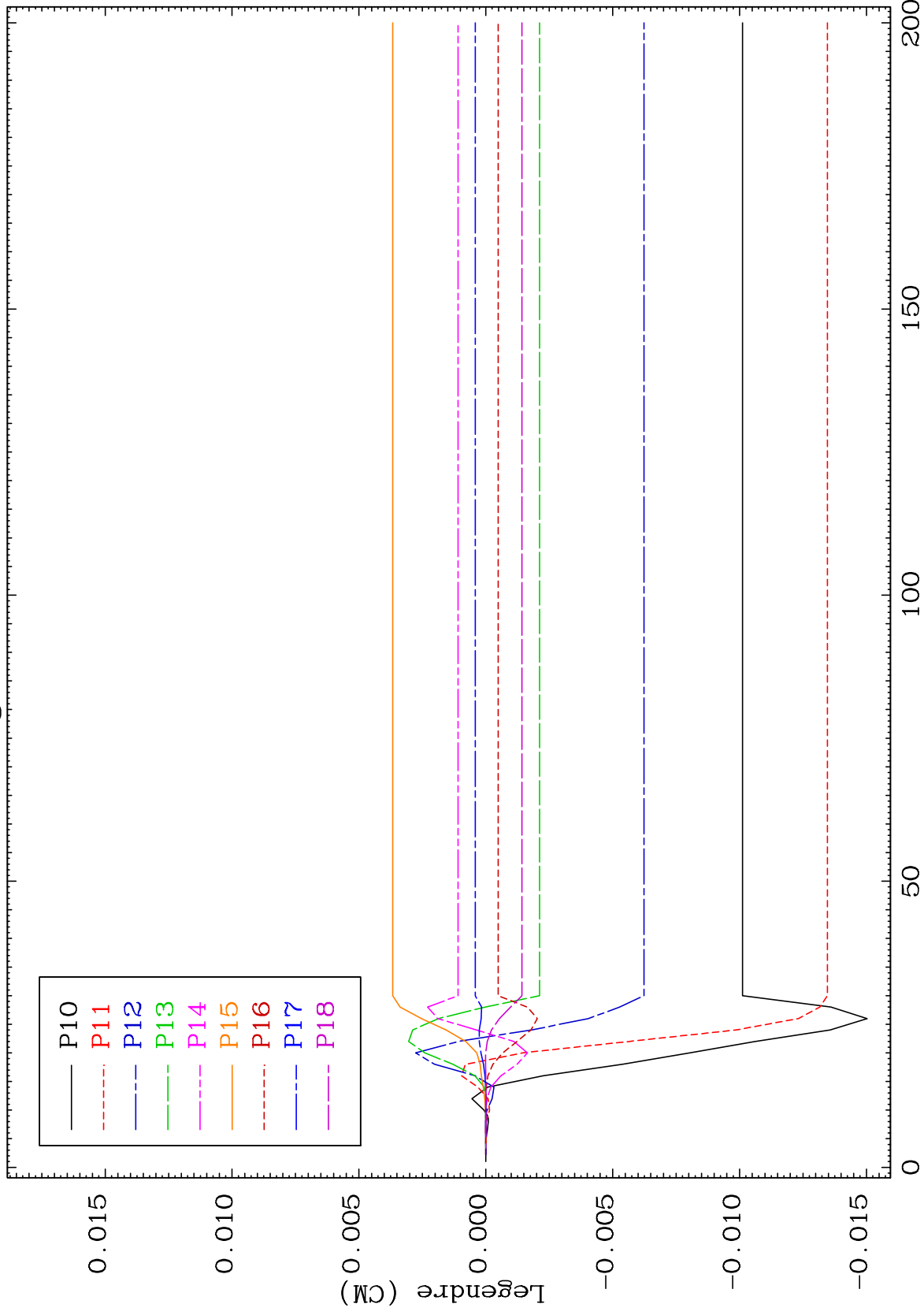

64

Incident Energy (MeV)

69-Tm-173

MAT 6937

856.1 keV (n,n') Level
Legendre Coefficients

69-Tm-173

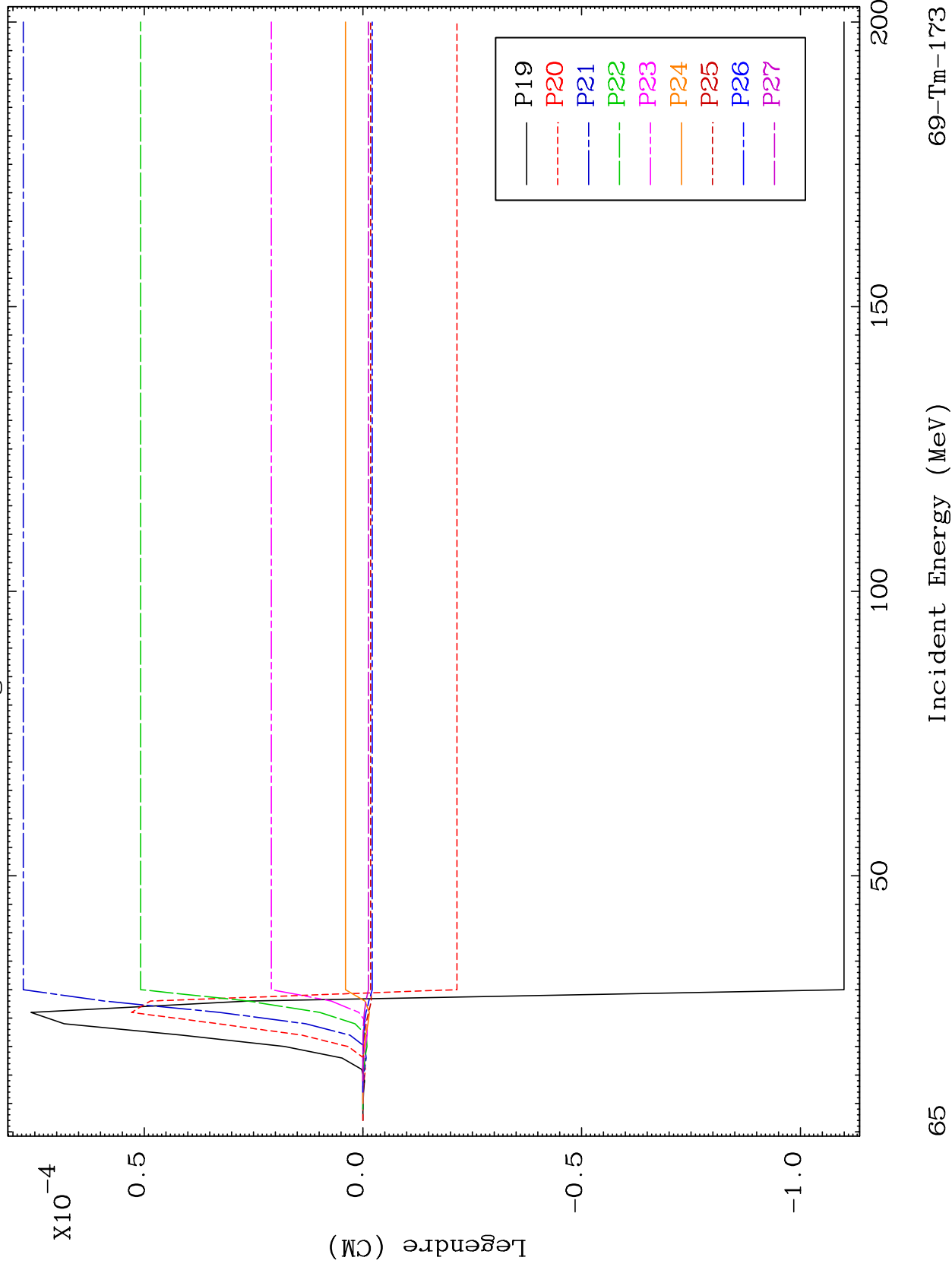

65

Incident Energy (MeV)

69-Tm-173

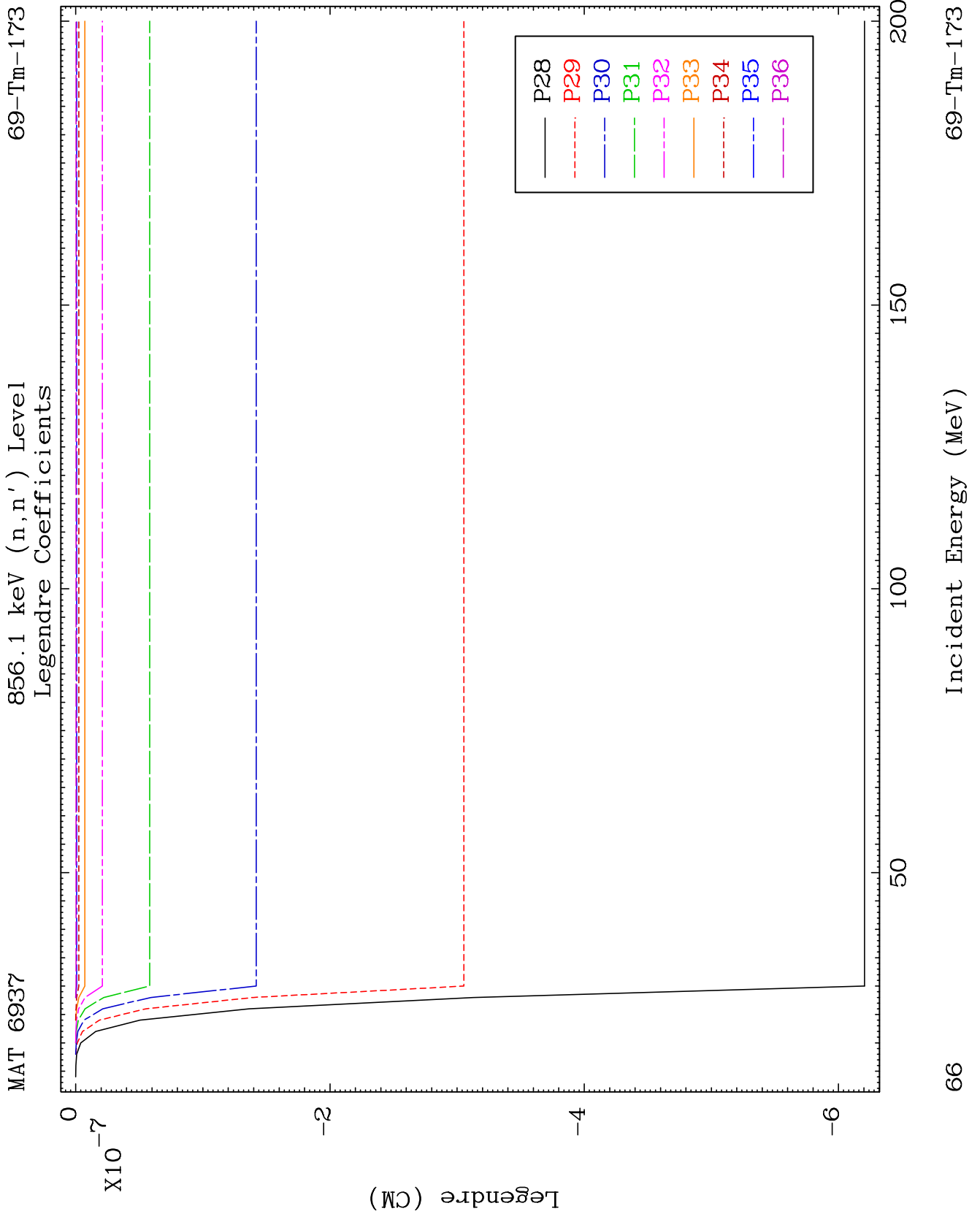

MAT 6937

983.0 keV (n,n') Level
Legendre Coefficients

69-Tm-173

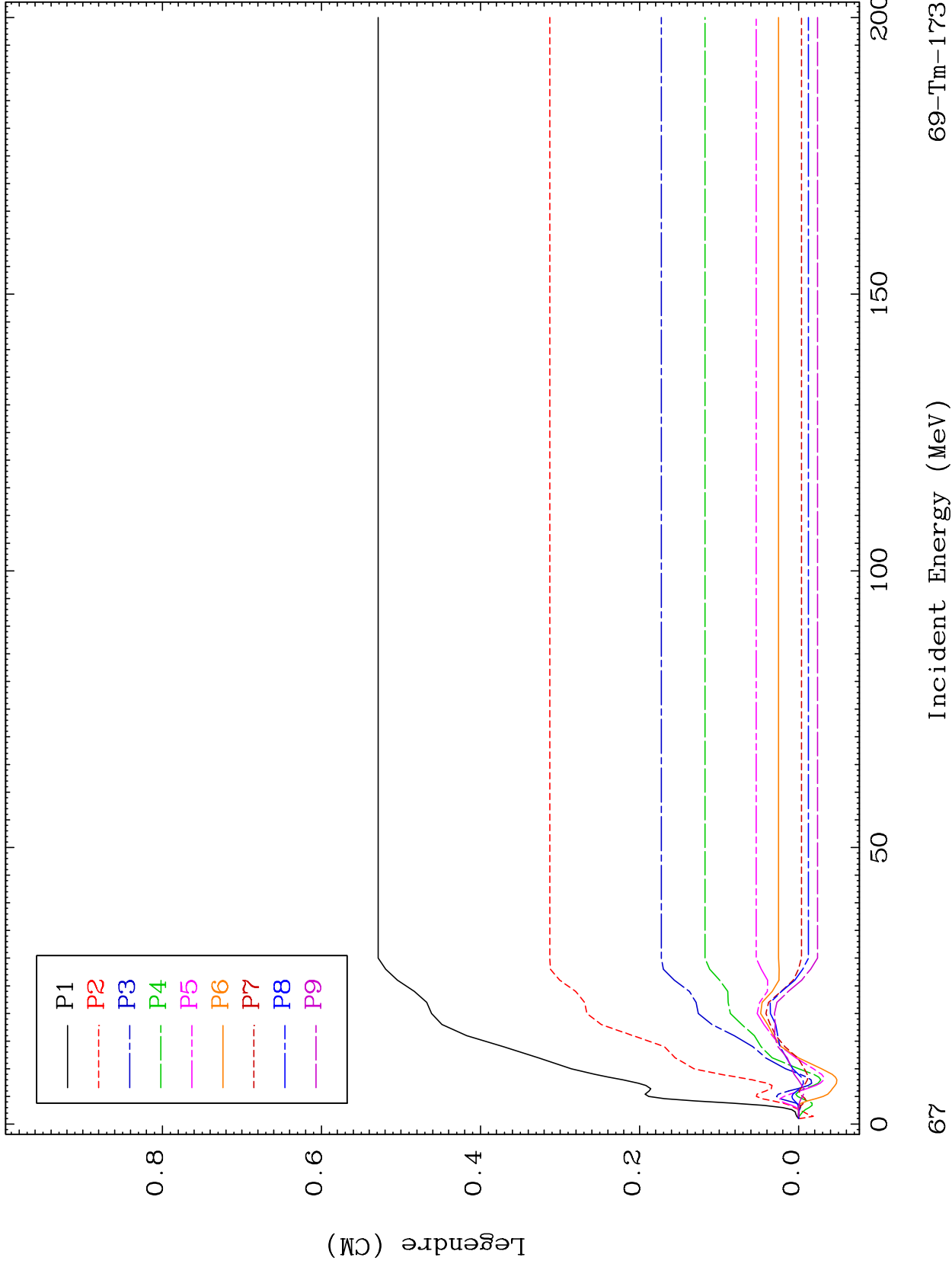

69-Tm-173

Incident Energy (MeV)

67

MAT 6937

983.0 keV (n,n') Level
Legendre Coefficients

69-Tm-173

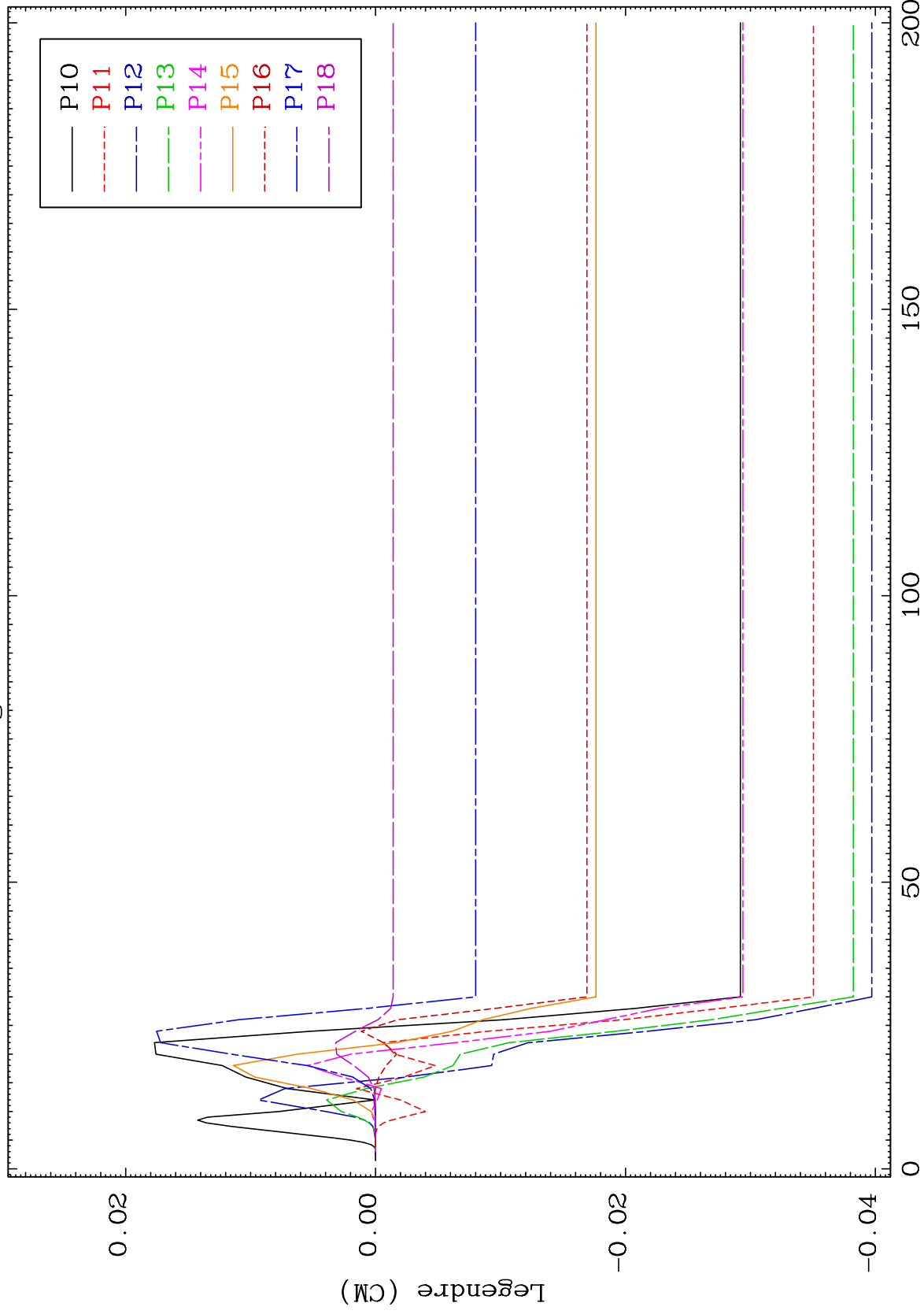

68

Incident Energy (MeV)

69-Tm-173

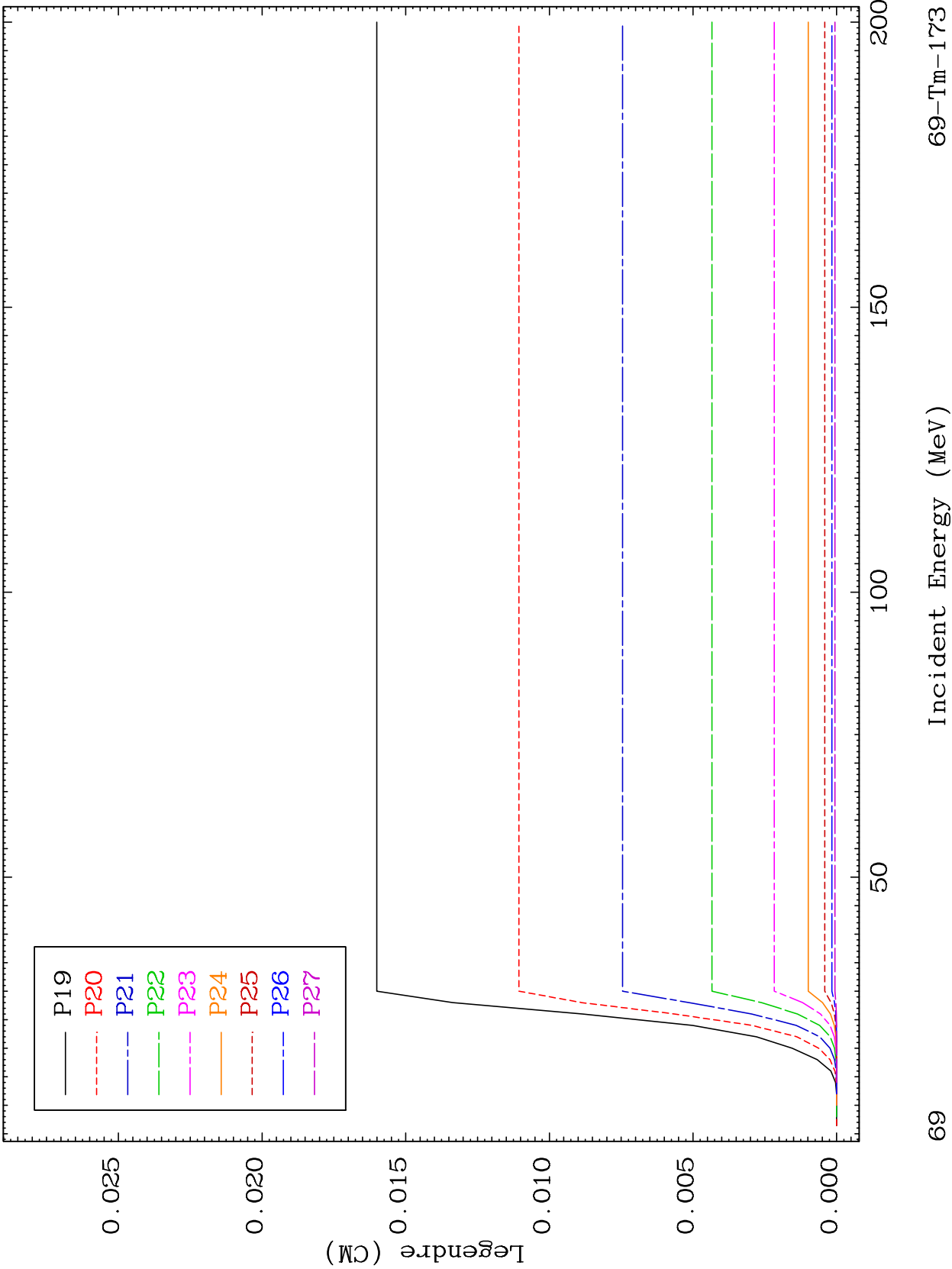

MAT 6937

983.0 keV (n,n') Level
Legendre Coefficients

69-Tm-173

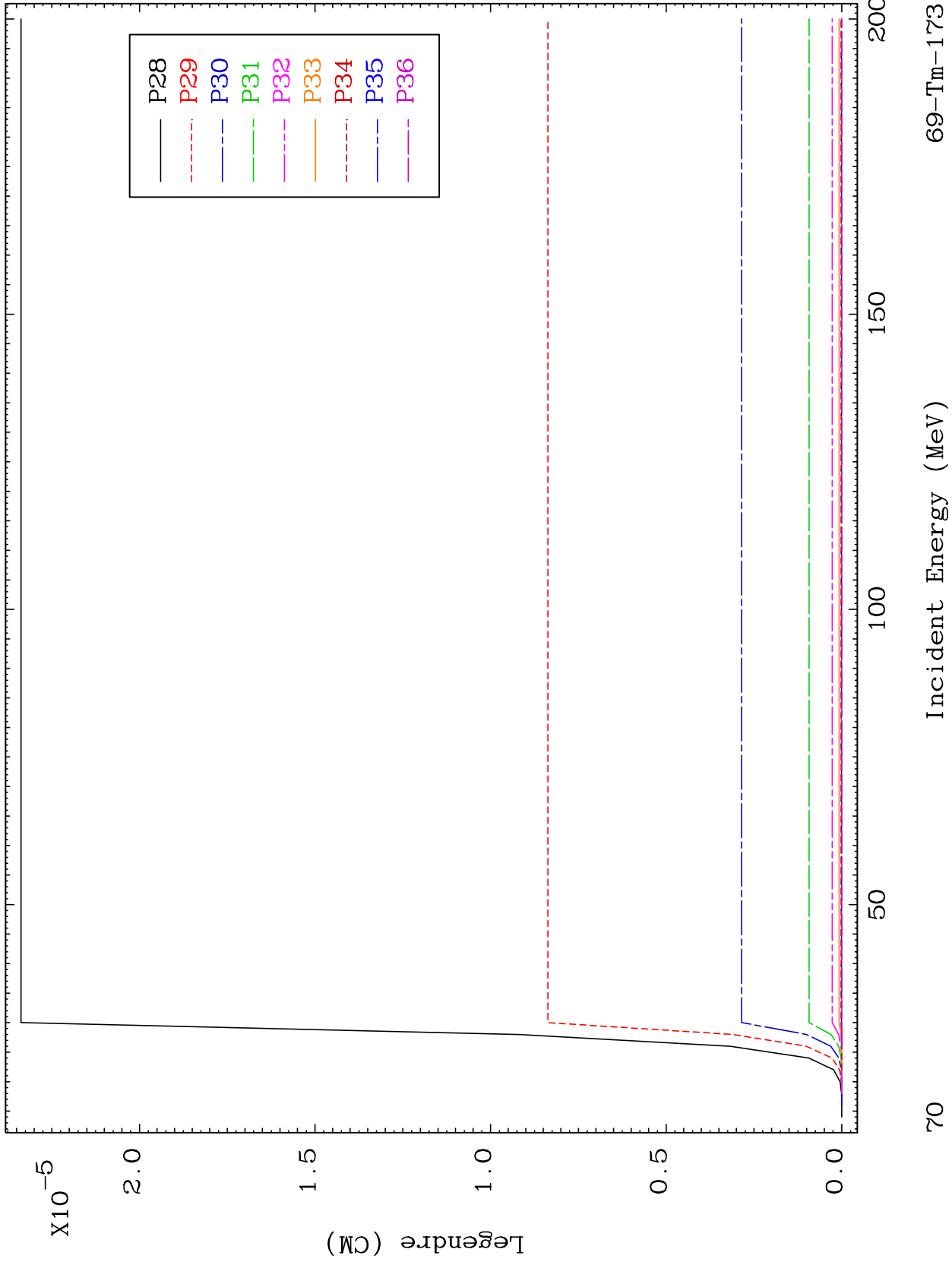

70

Incident Energy (MeV)

69-Tm-173

MAT 6937

1.137 MeV (n,n') Level
Legendre Coefficients

69-Tm-173

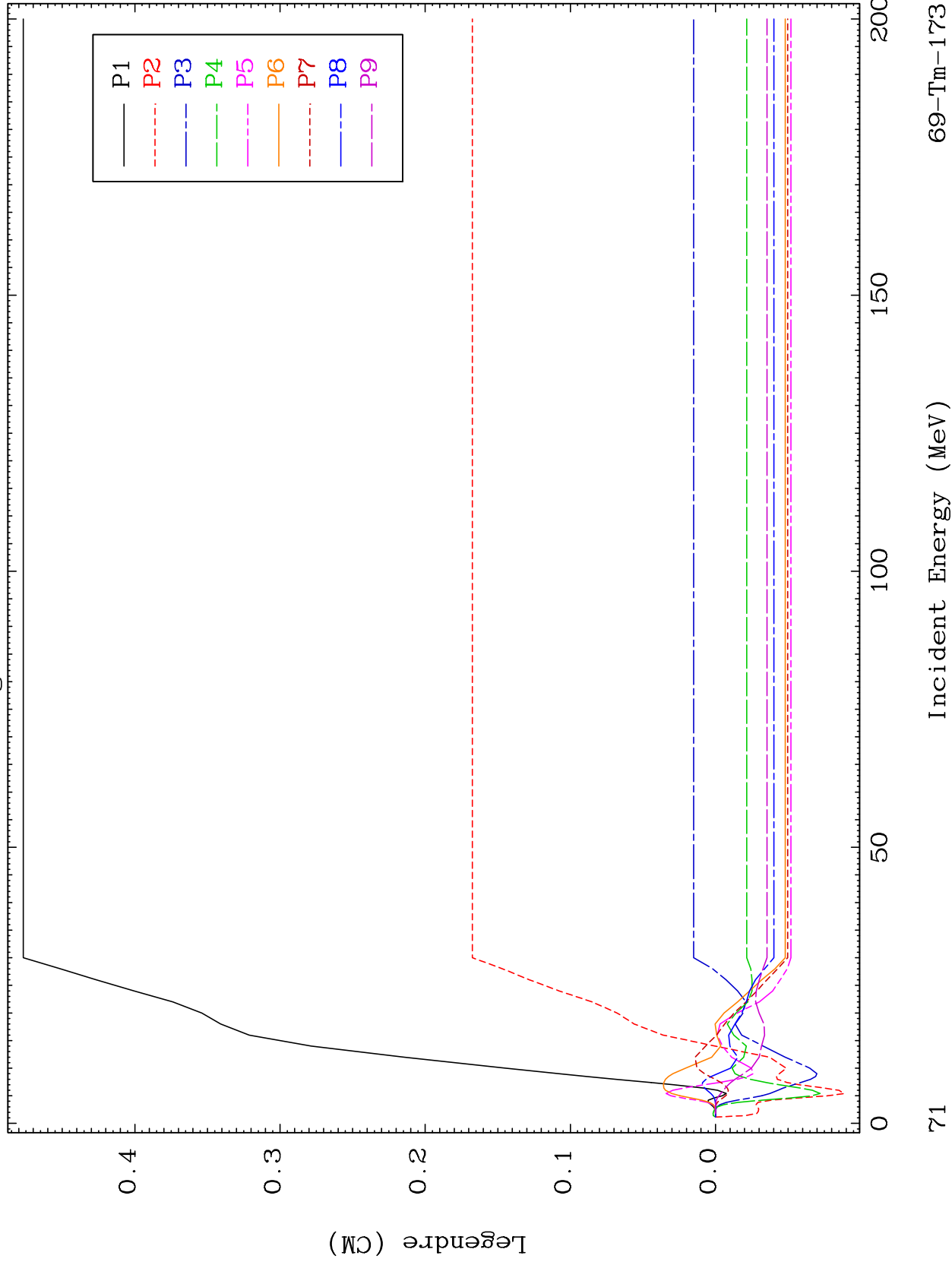

69-Tm-173

Incident Energy (MeV)

71

MAT 6937

1.137 MeV (n,n') Level
Legendre Coefficients

69-Tm-173

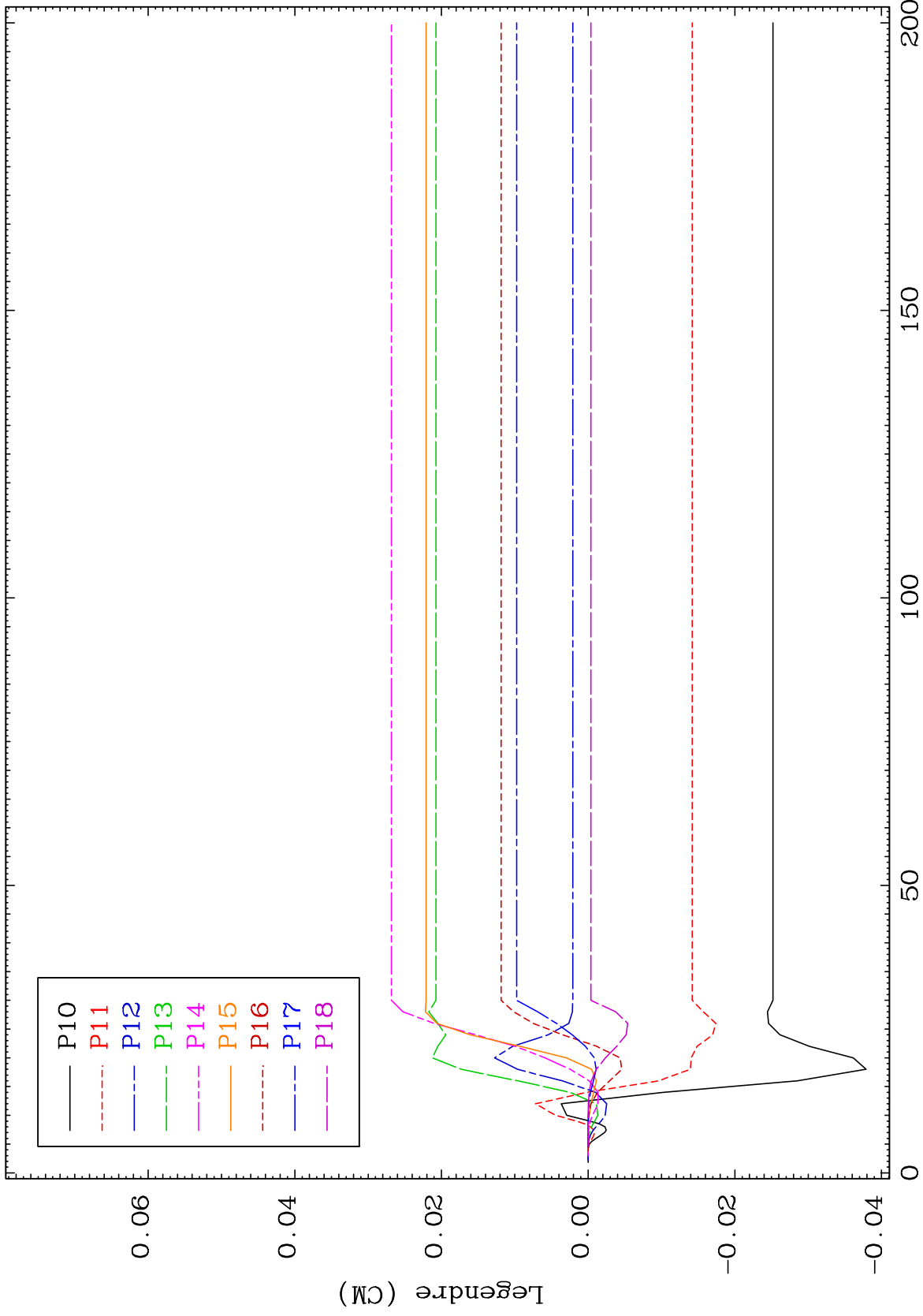

72

Incident Energy (MeV)

69-Tm-173

MAT 6937

1.137 MeV (n,n') Level
Legendre Coefficients

69-Tm-173

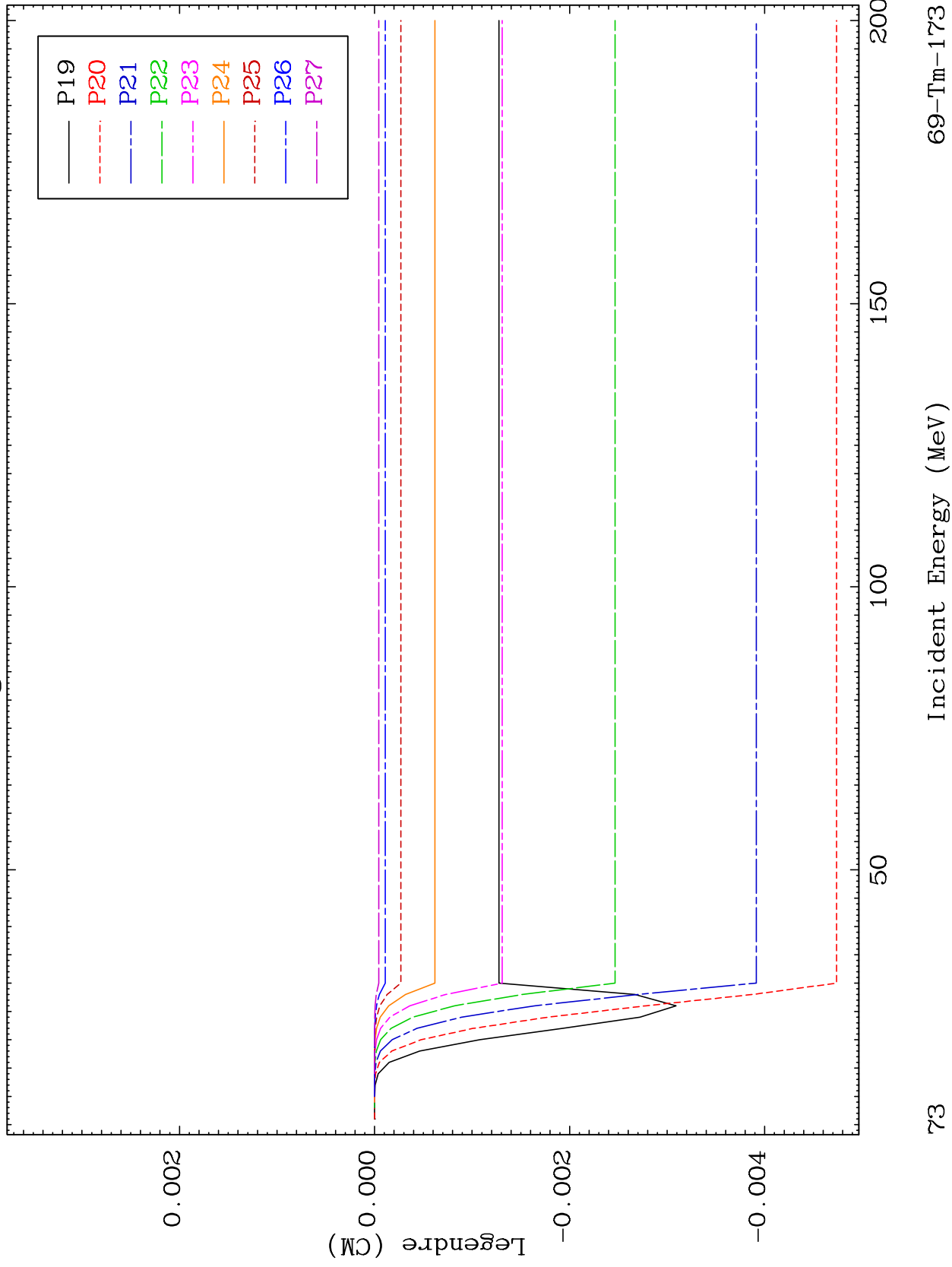

73

Incident Energy (MeV)

69-Tm-173

MAT 6937

1.187 MeV (n,n') Level
Legendre Coefficients

69-Tm-173

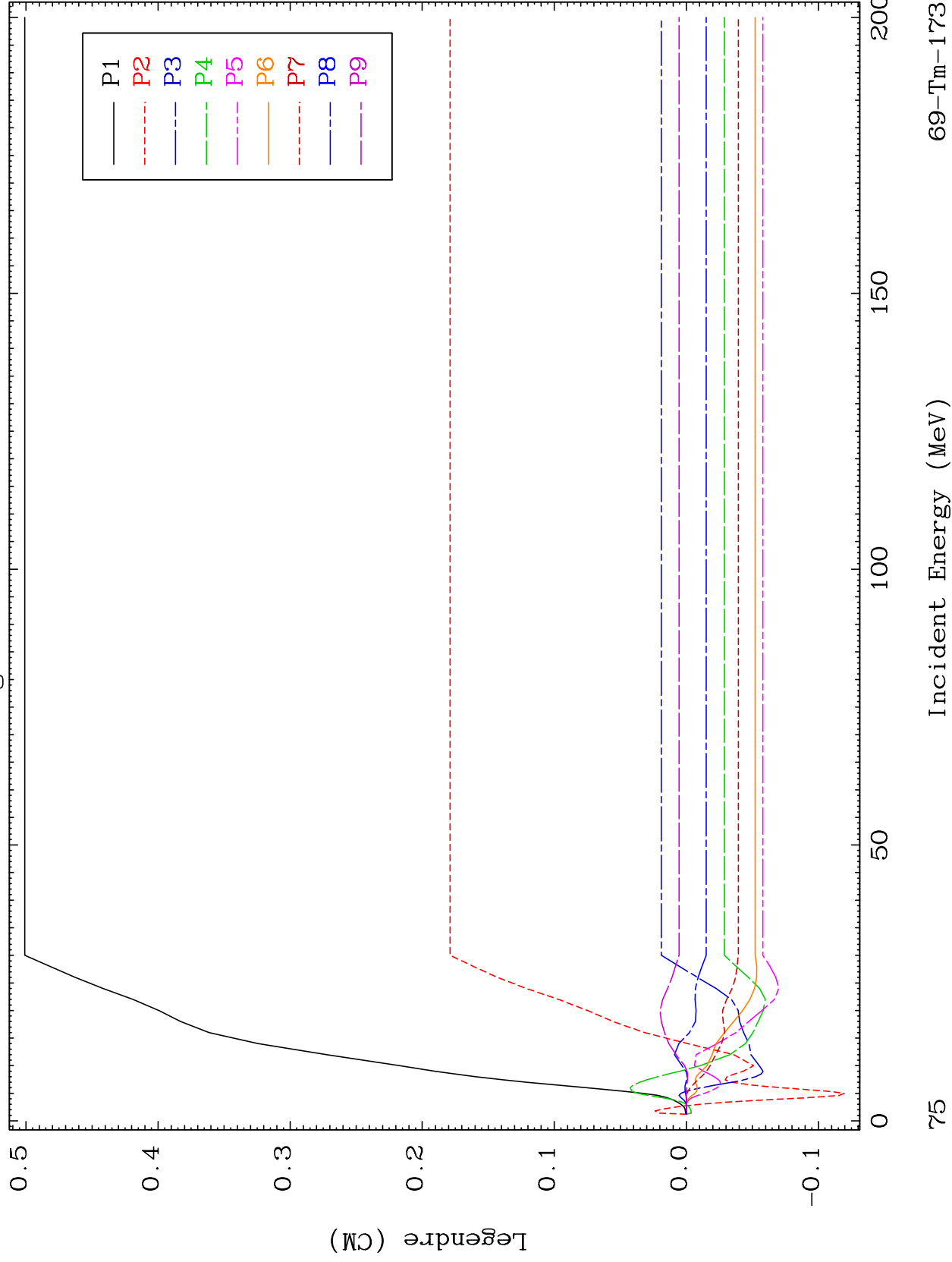

69-Tm-173

Incident Energy (MeV)

75

MAT 6937

1.187 MeV (n,n') Level
Legendre Coefficients

69-Tm-173

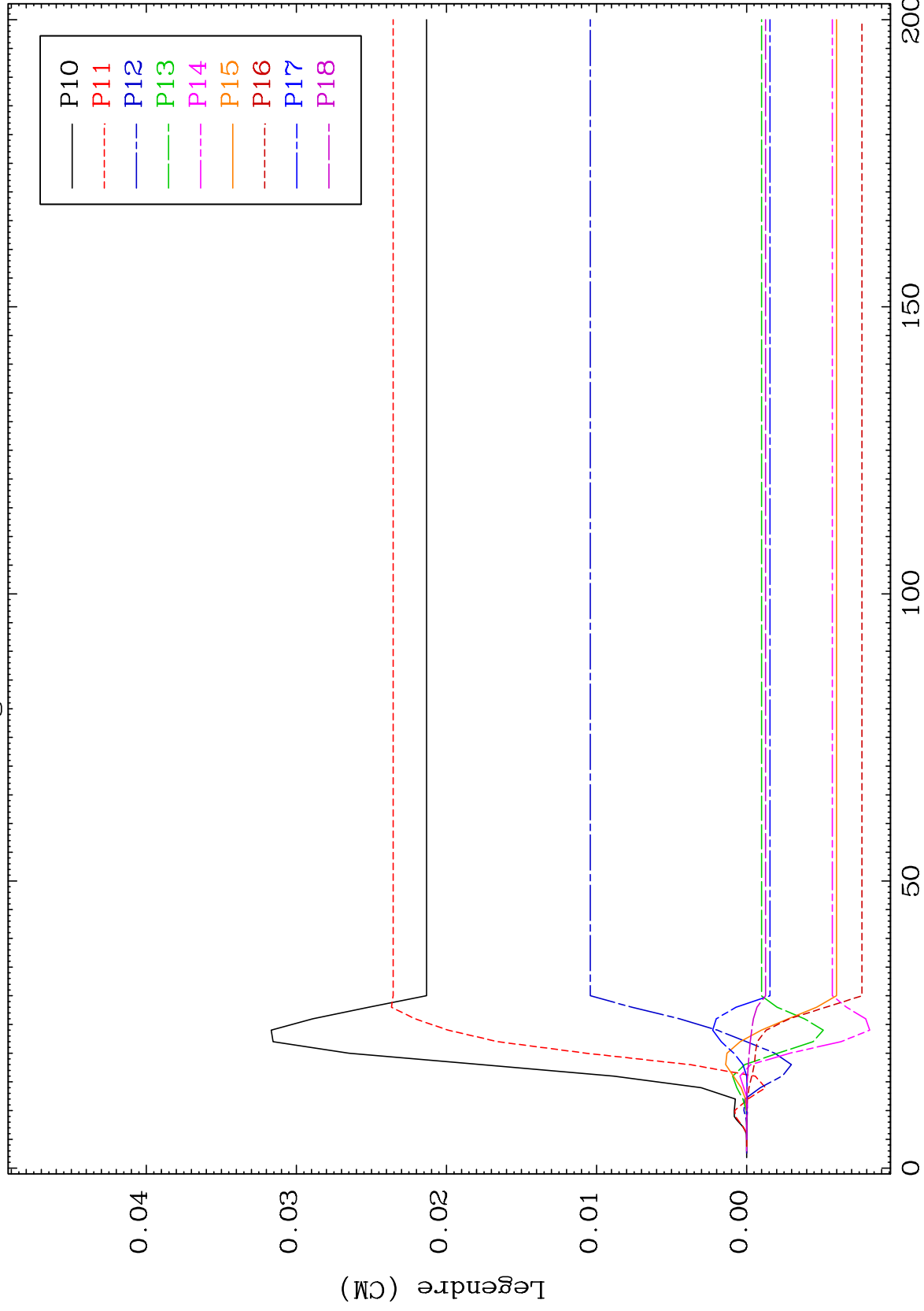

76

Incident Energy (MeV)

69-Tm-173

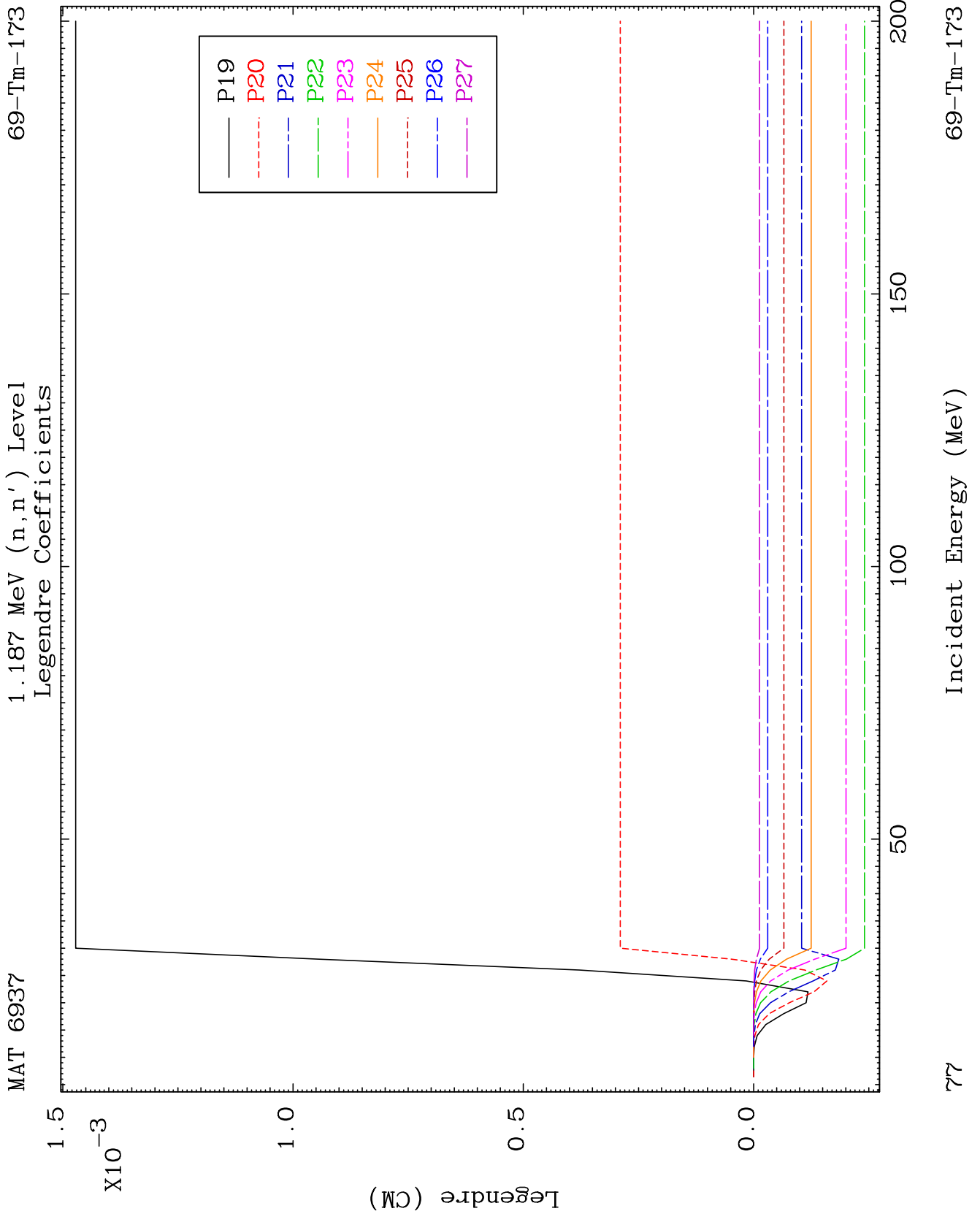

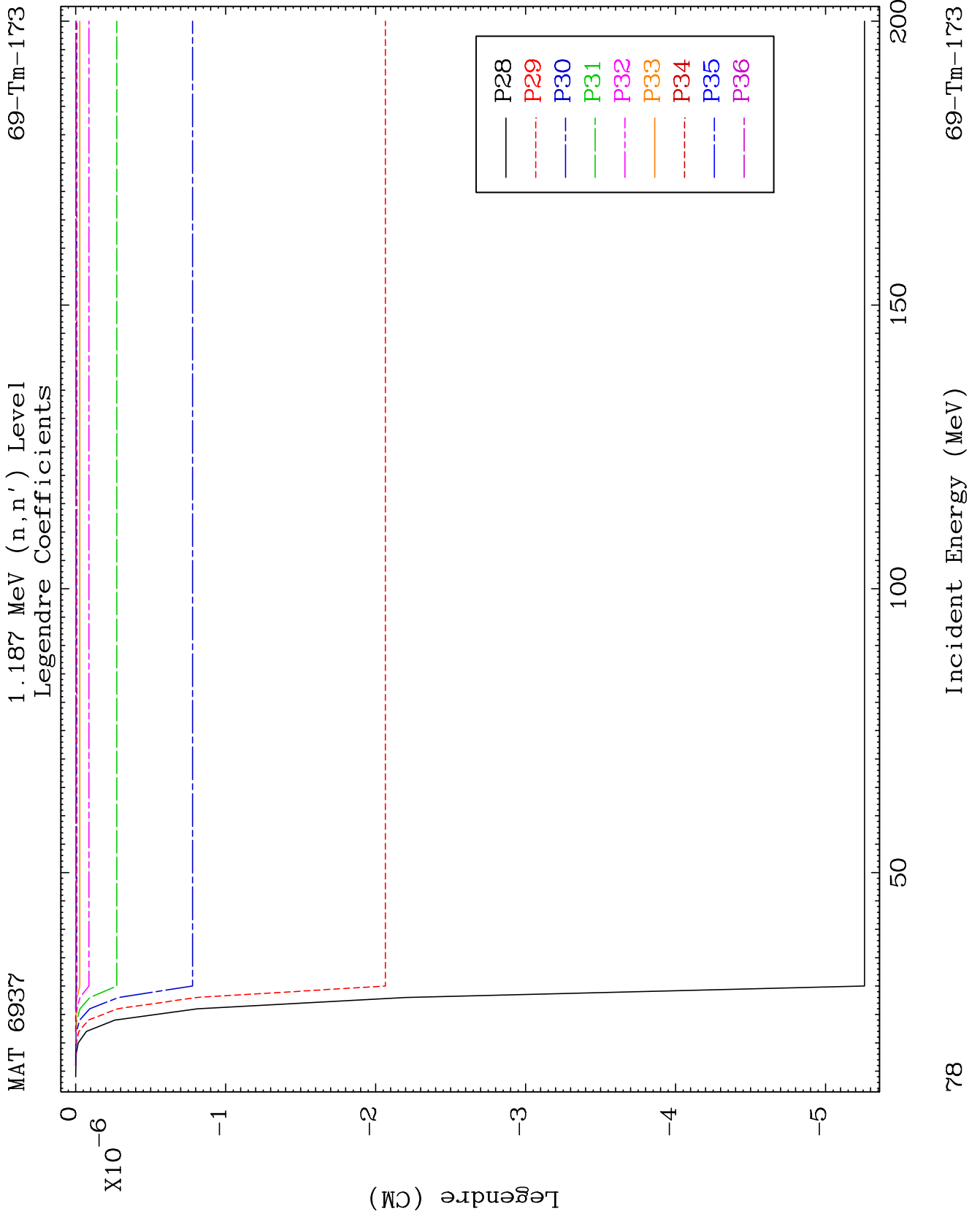

MAT 6937

1.213 MeV (n,n') Level
Legendre Coefficients

69-Tm-173

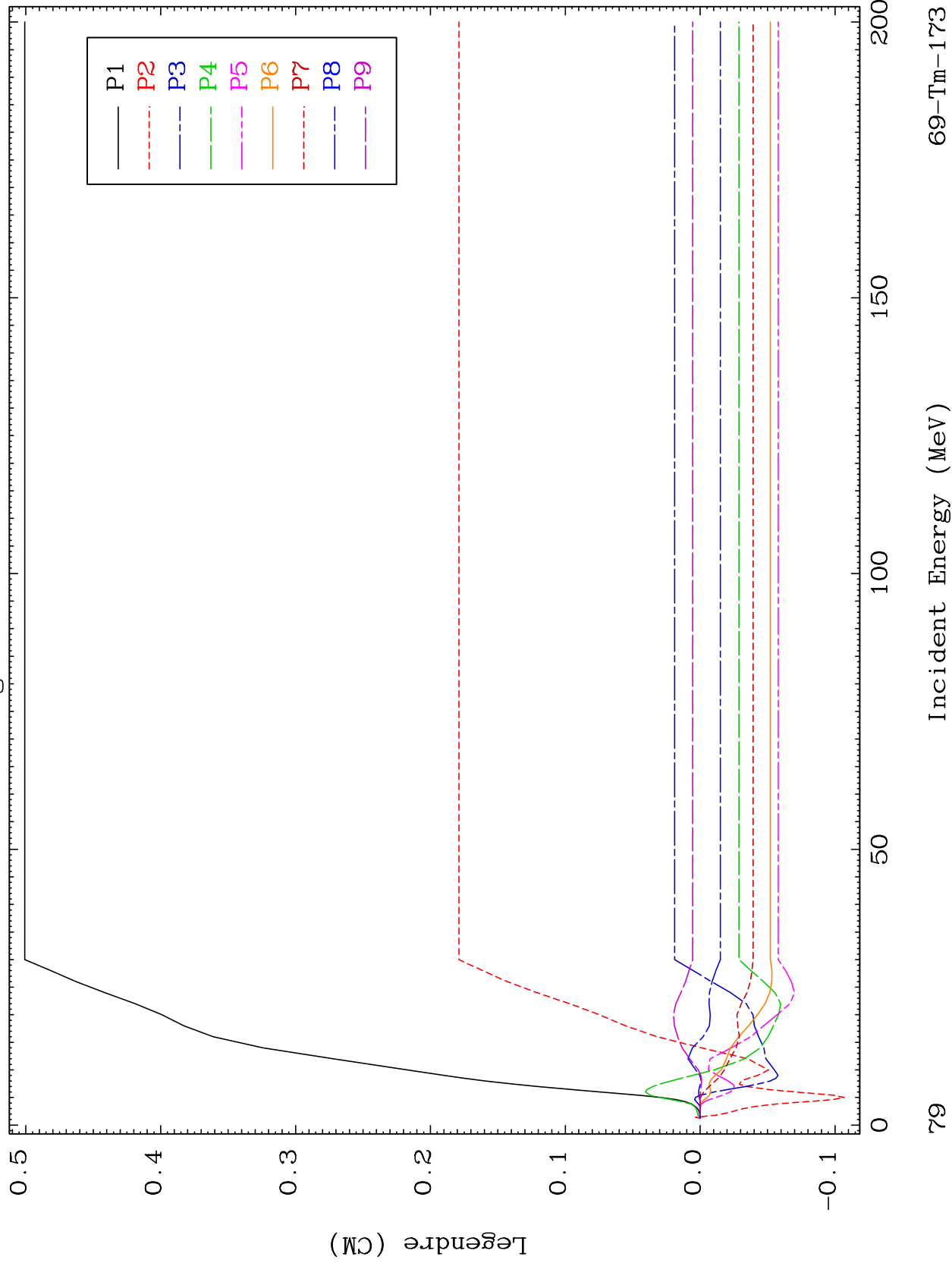

79

Incident Energy (MeV)

69-Tm-173

MAT 6937

1.213 MeV (n,n') Level
Legendre Coefficients

69-Tm-173

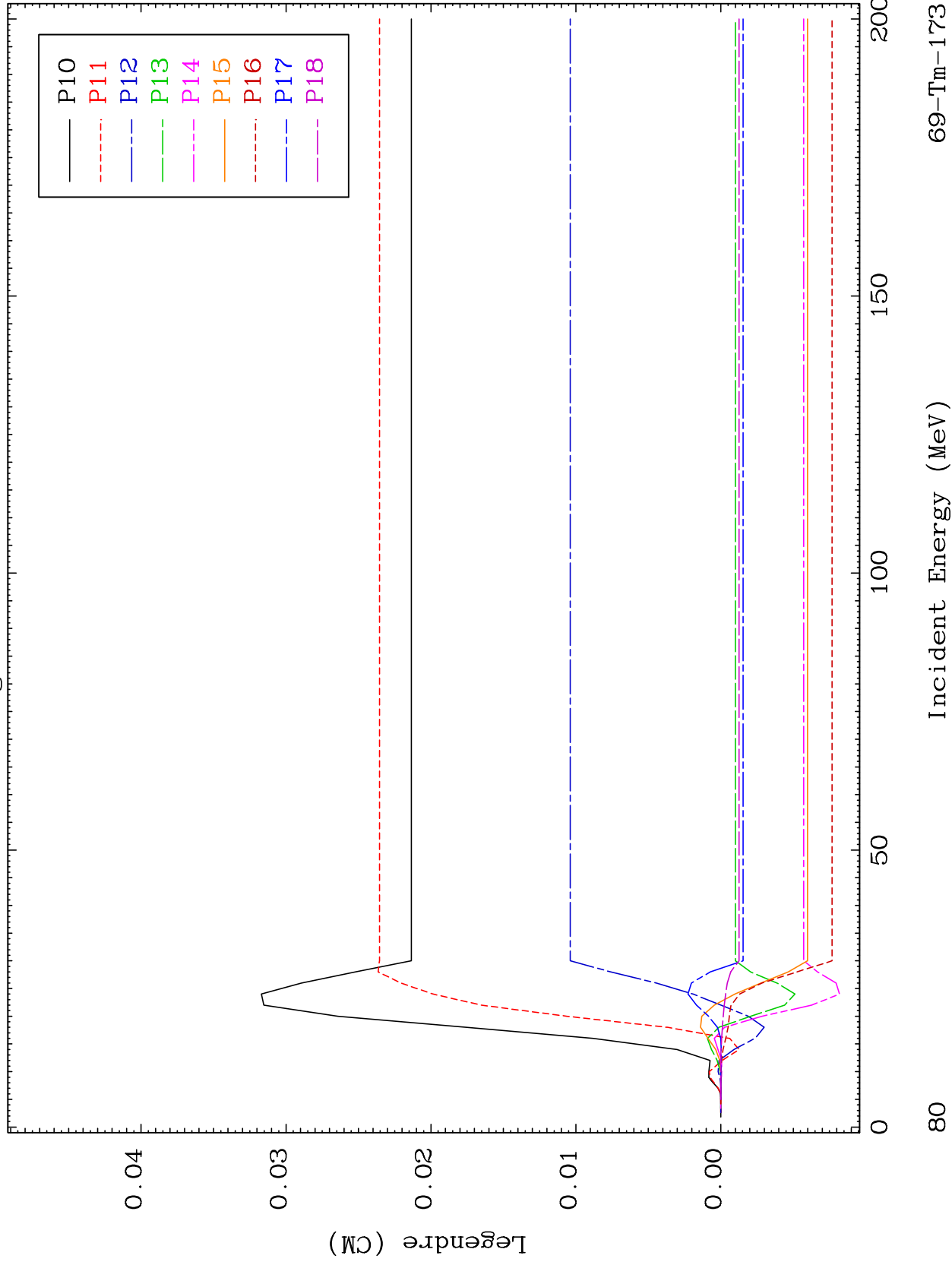

69-Tm-173

Incident Energy (MeV)

80

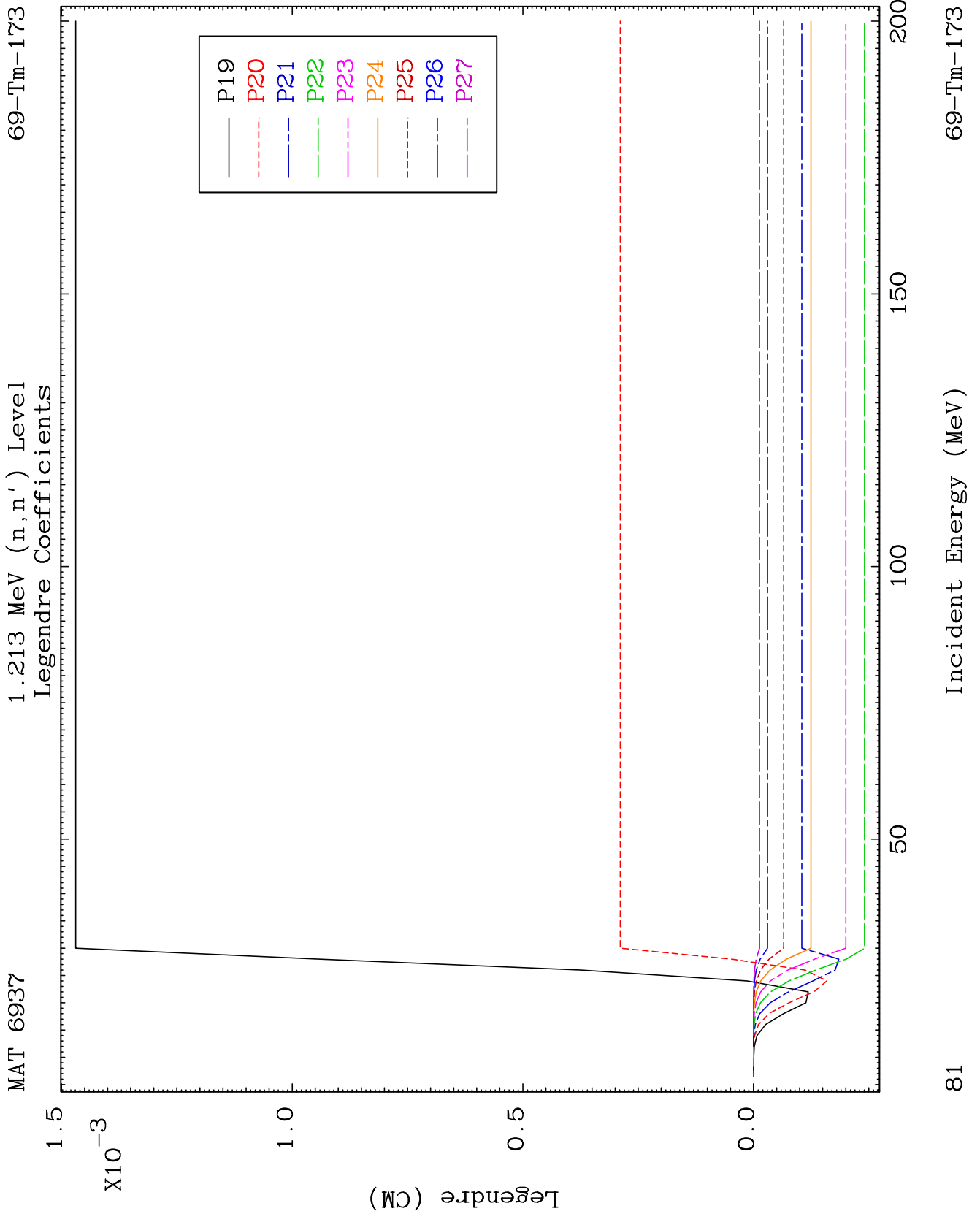

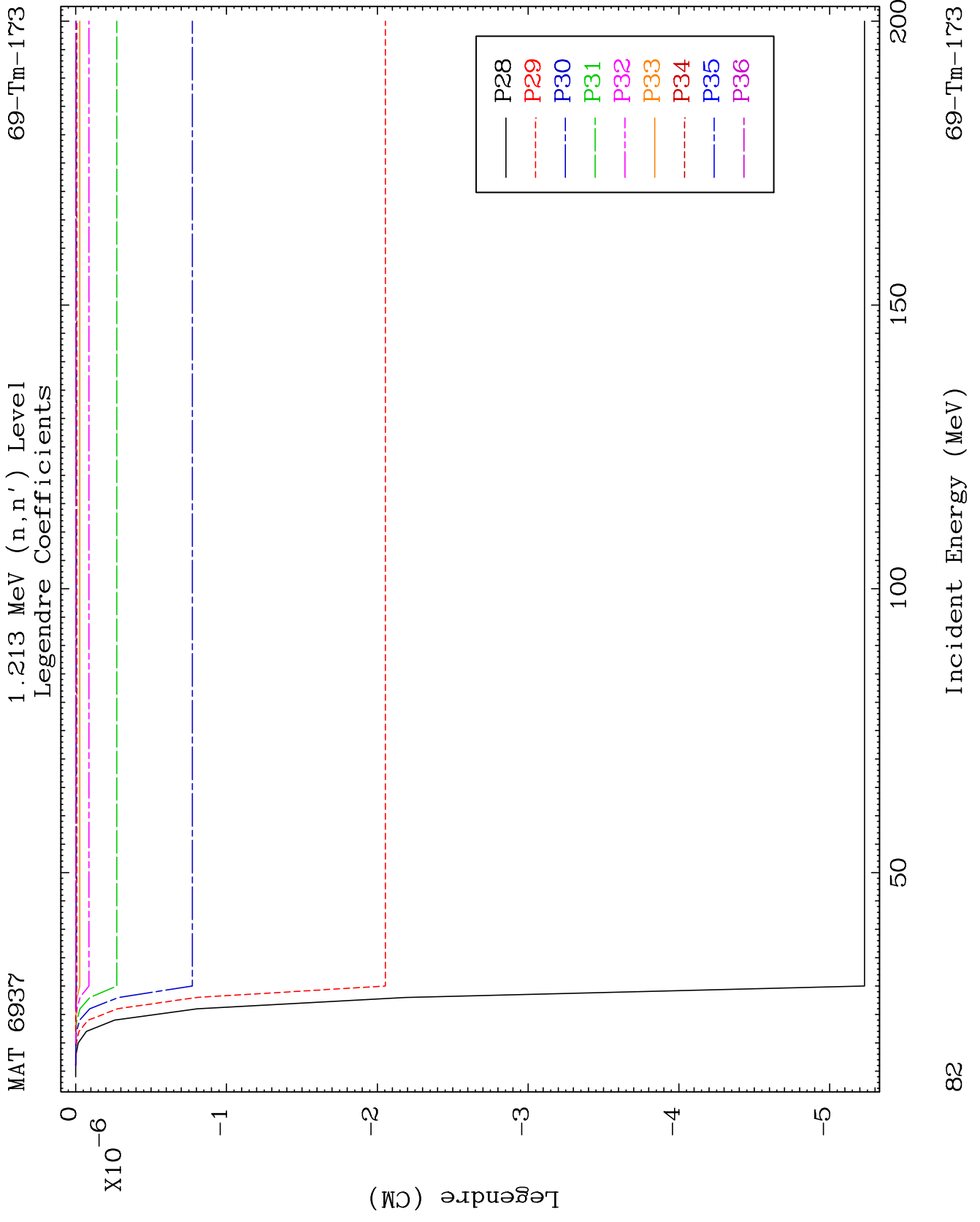

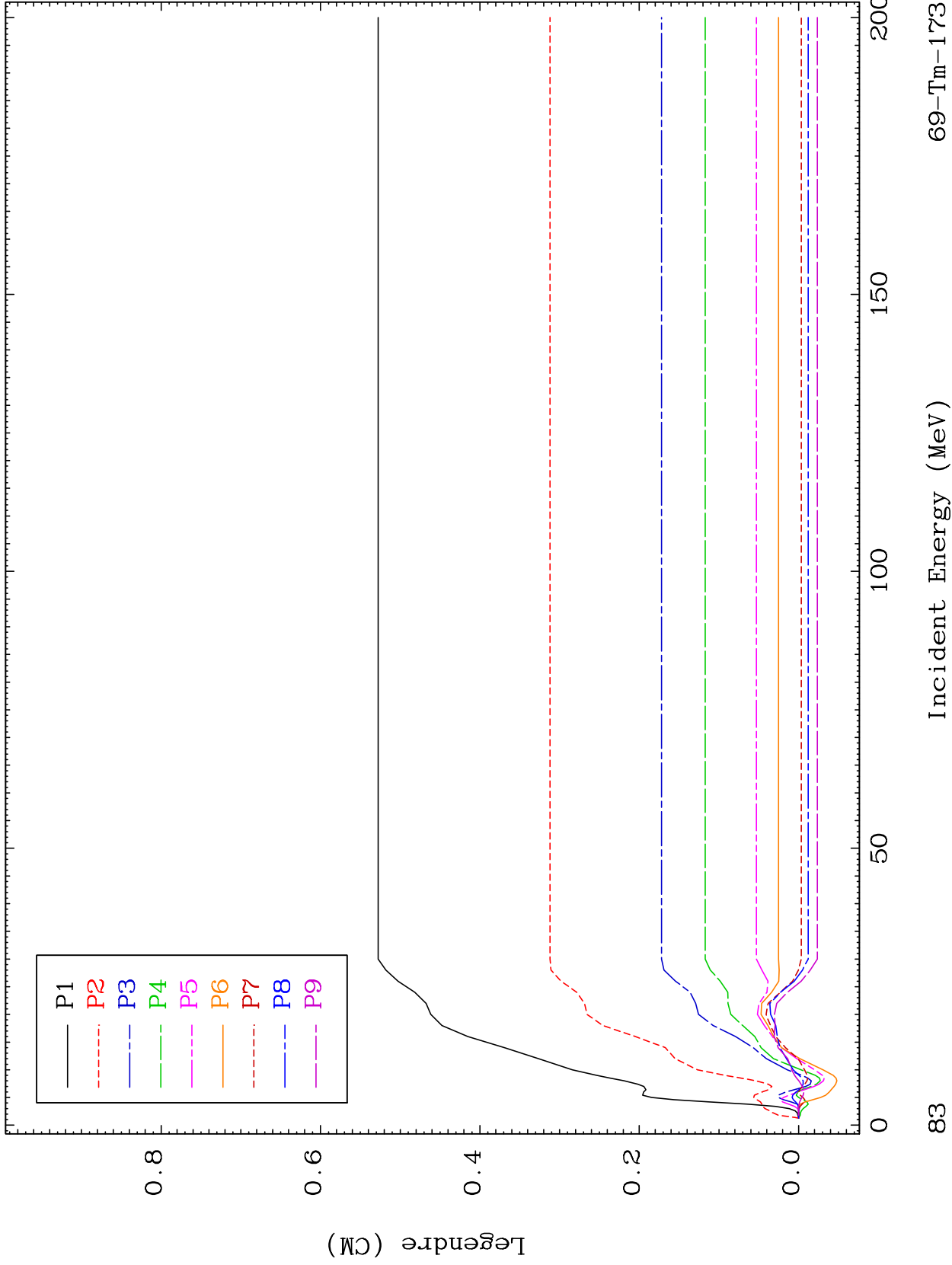

MAT 6937

1.243 MeV (n,n') Level
Legendre Coefficients

69-Tm-173

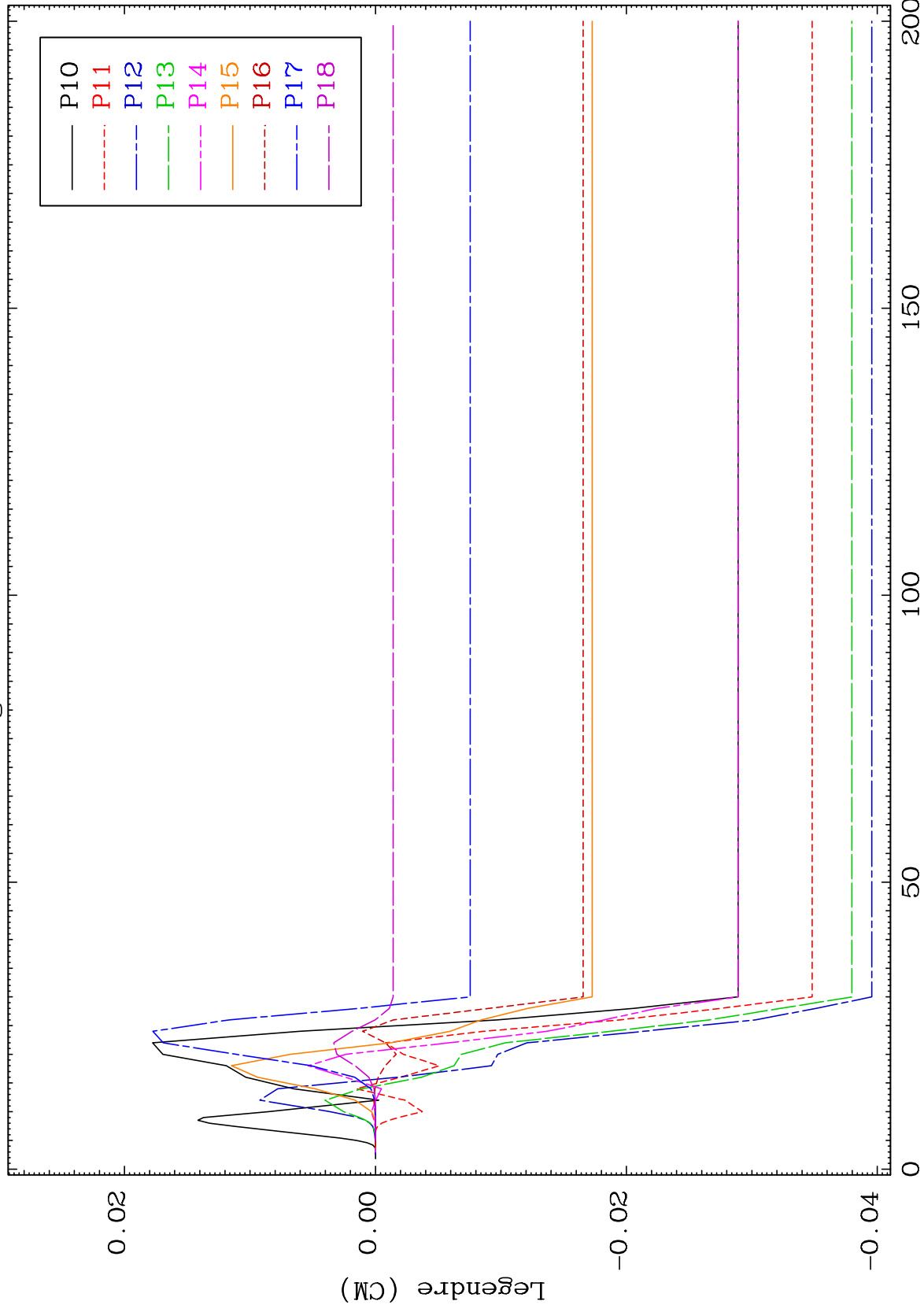

84

Incident Energy (MeV)

69-Tm-173

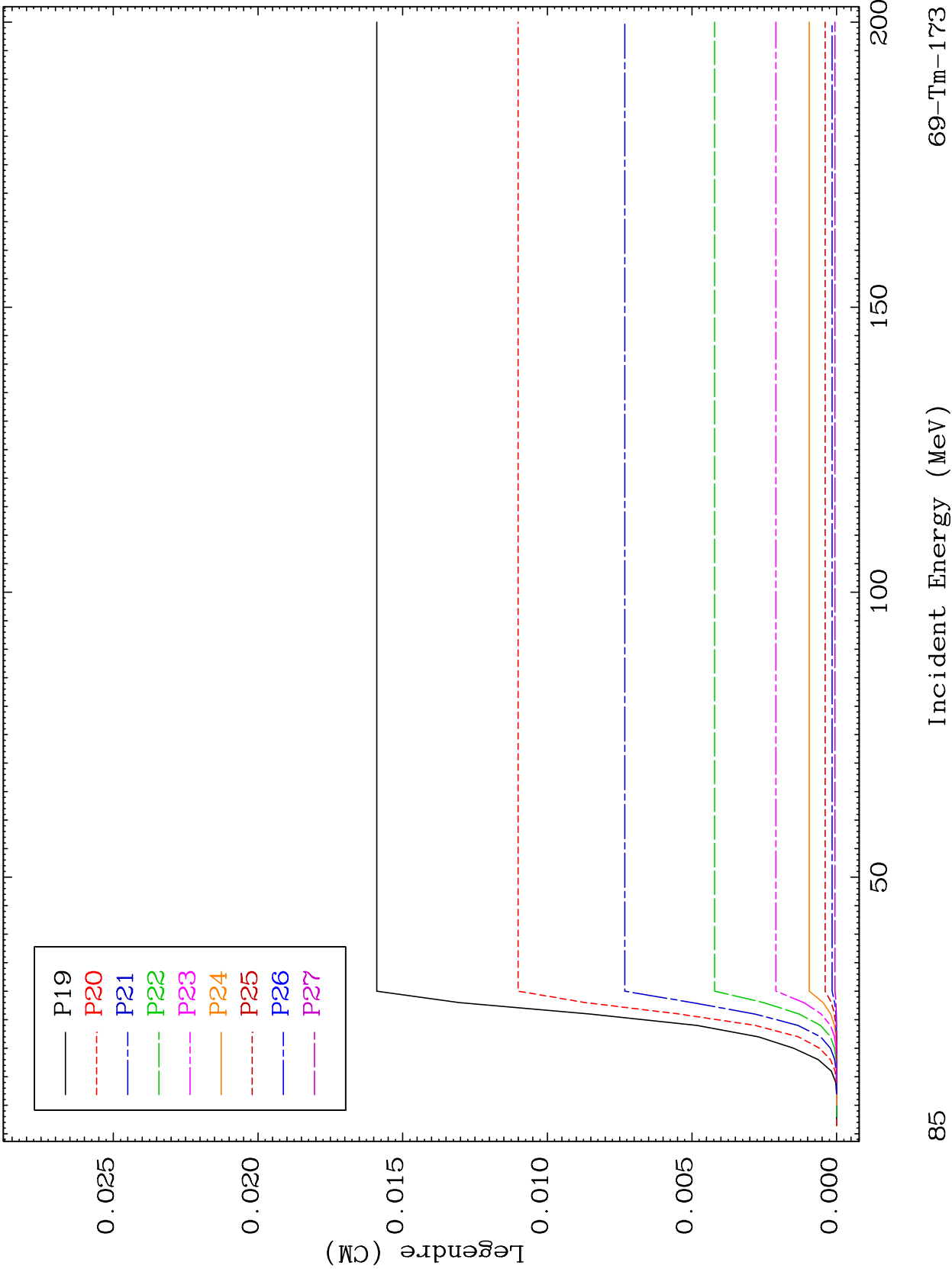

MAT 6937

1.243 MeV (n,n') Level
Legendre Coefficients

69-Tm-173

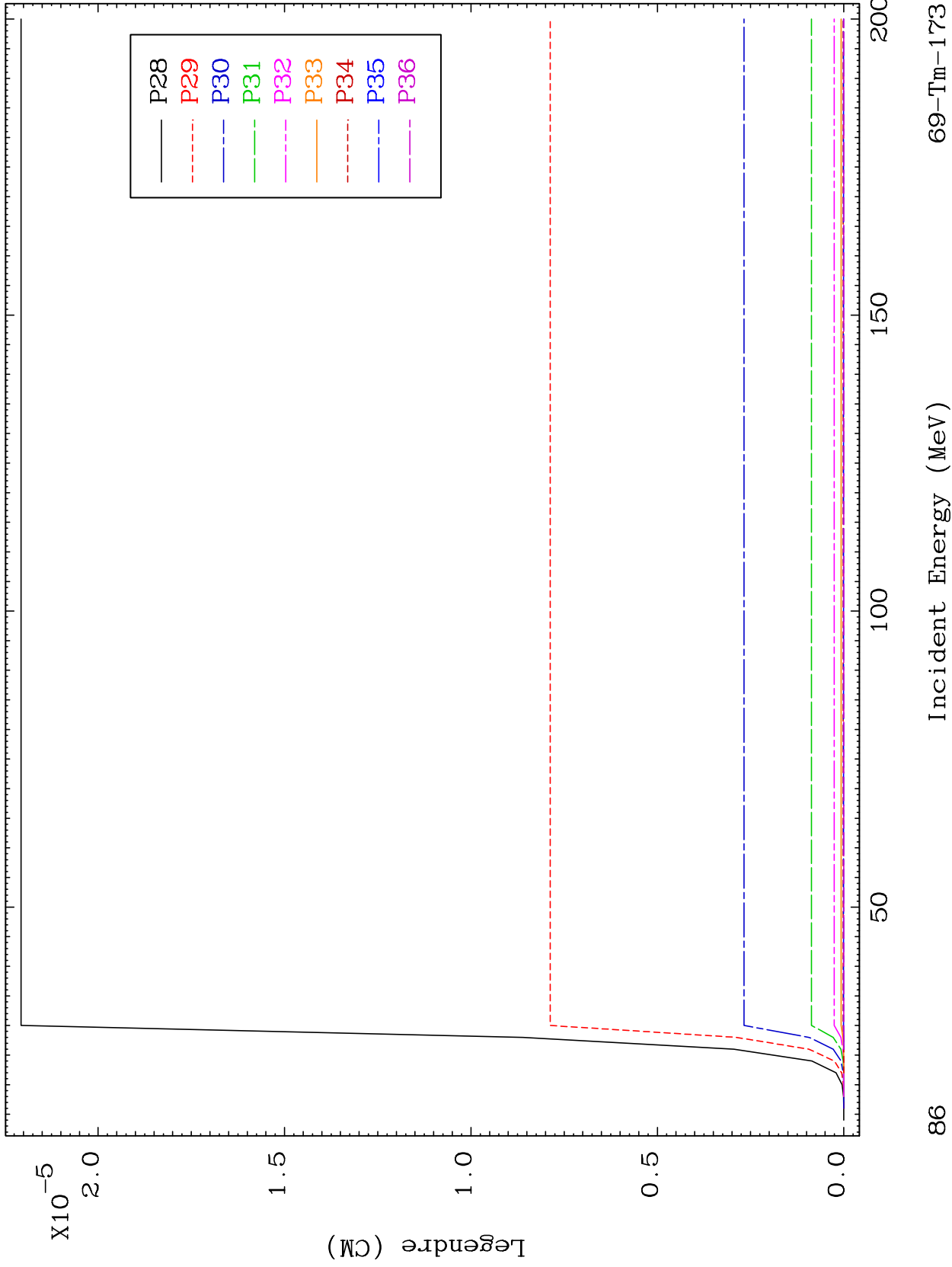

86

69-Tm-173

MAT 6937

1.336 MeV (n,n') Level
Legendre Coefficients

69-Tm-173

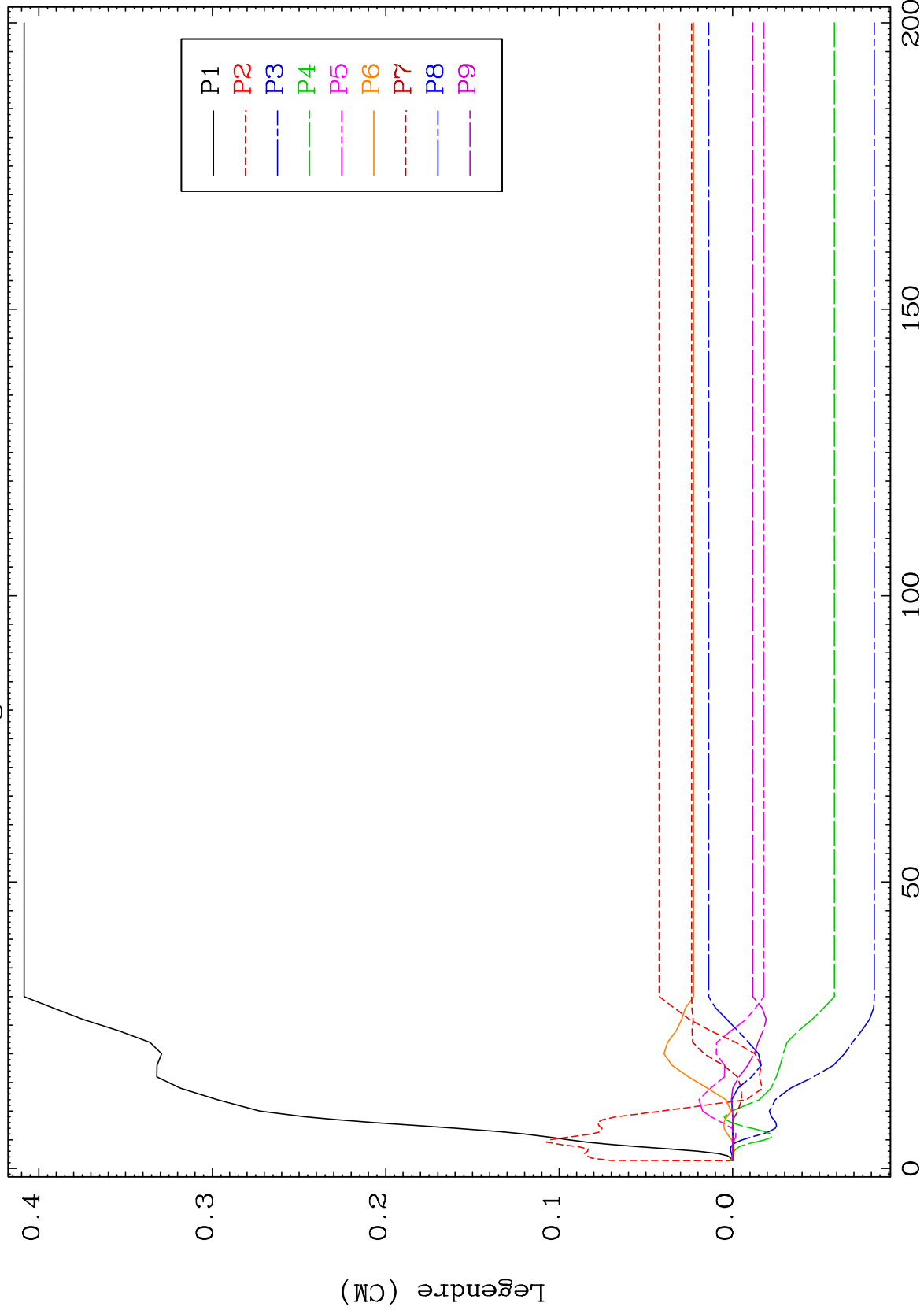

87

Incident Energy (MeV)

69-Tm-173

MAT 6937

1.336 MeV (n,n') Level
Legendre Coefficients

69-Tm-173

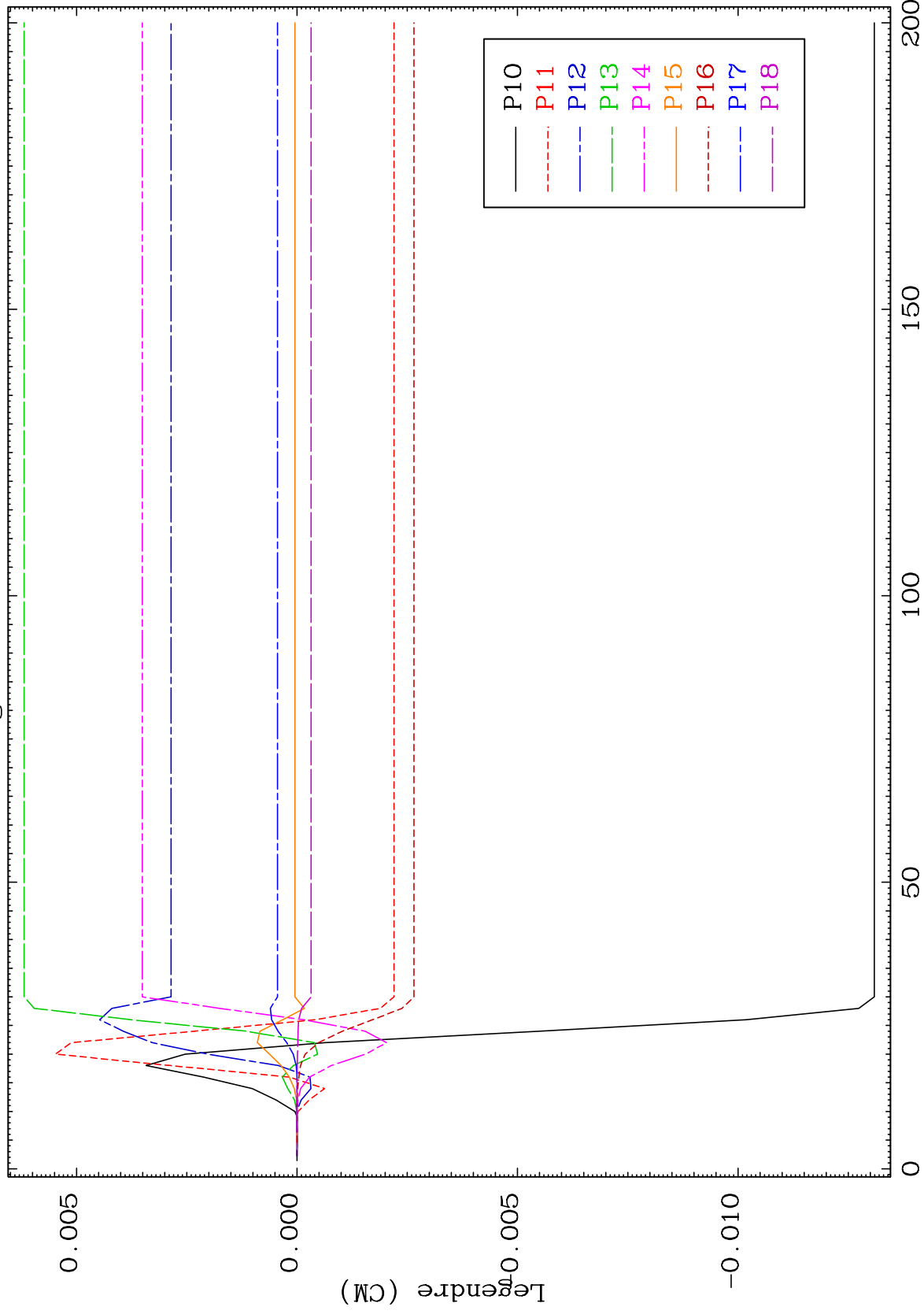

88

Incident Energy (MeV)

69-Tm-173

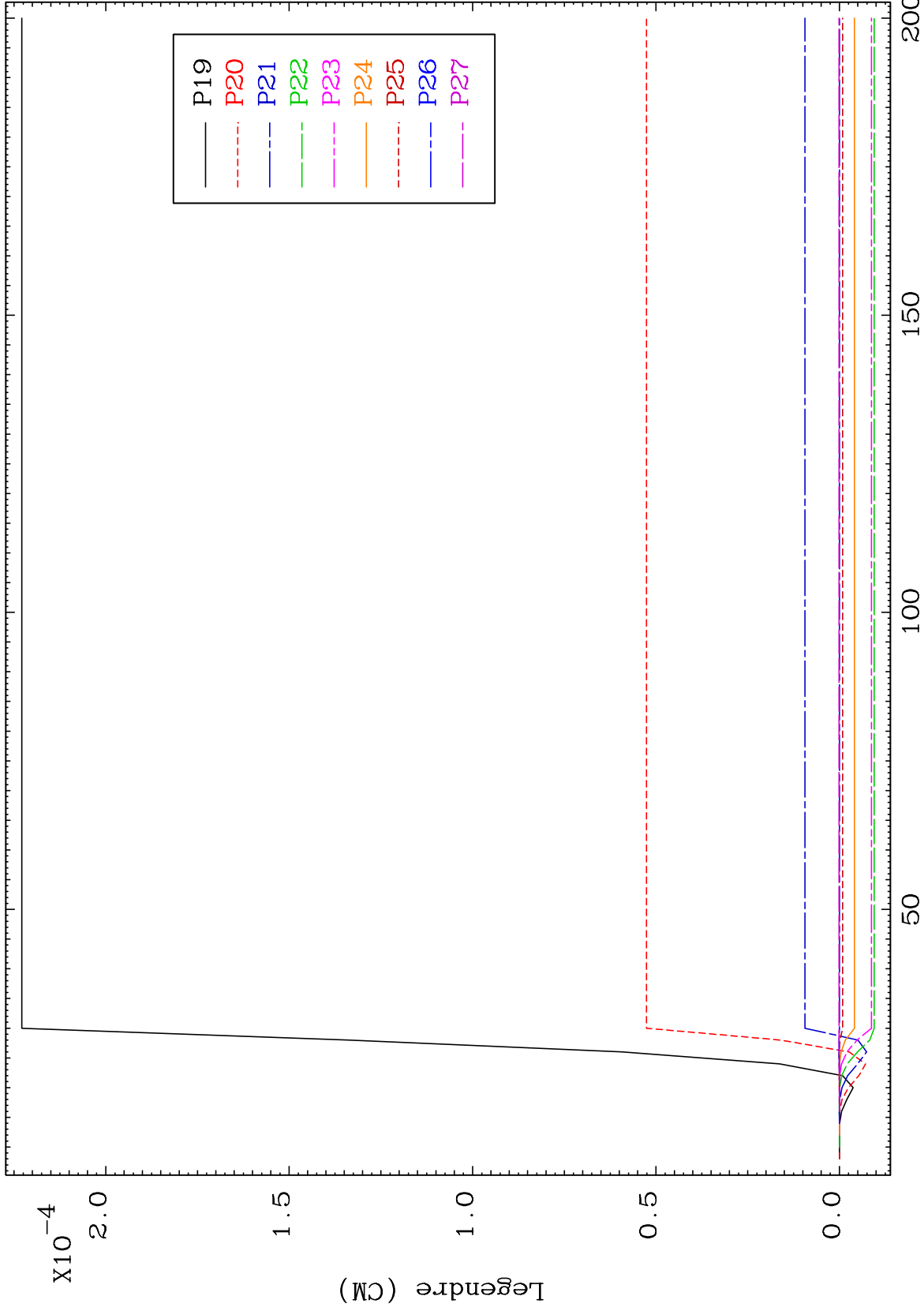

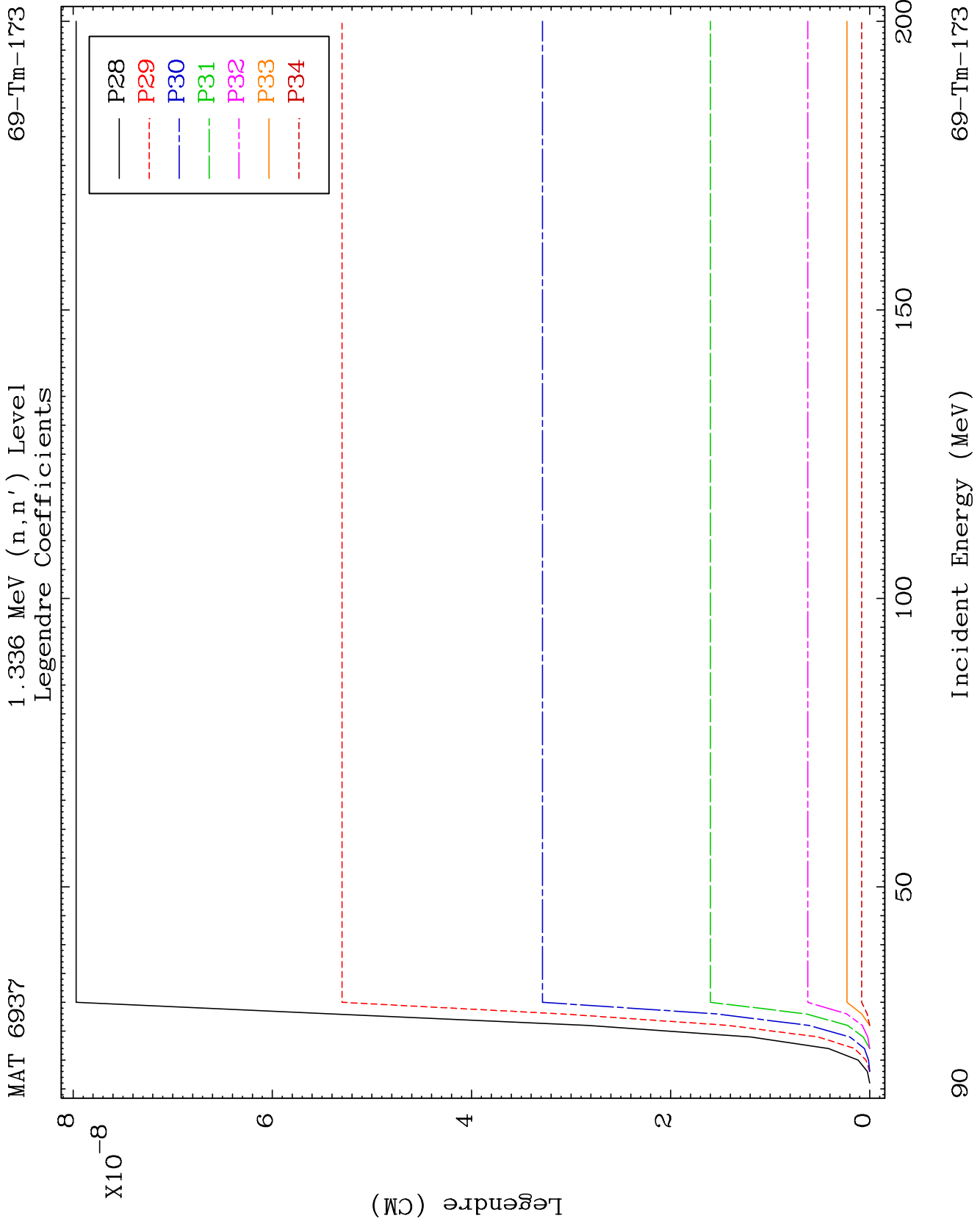

MAT 6937

1.361 MeV (n,n') Level
Legendre Coefficients

69-Tm-173

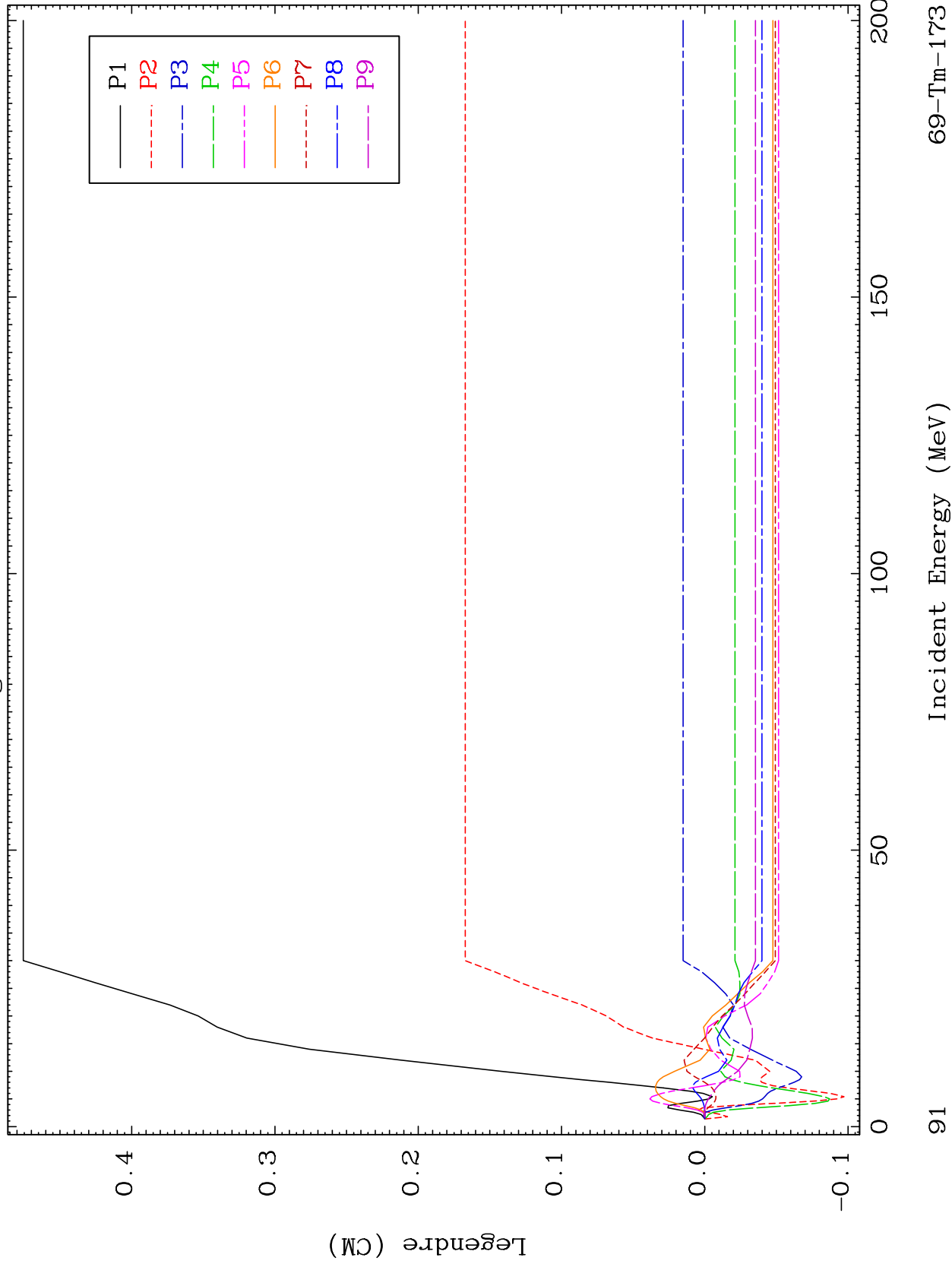

69-Tm-173

Incident Energy (MeV)

91

MAT 6937

1.361 MeV (n,n') Level
Legendre Coefficients

69-Tm-173

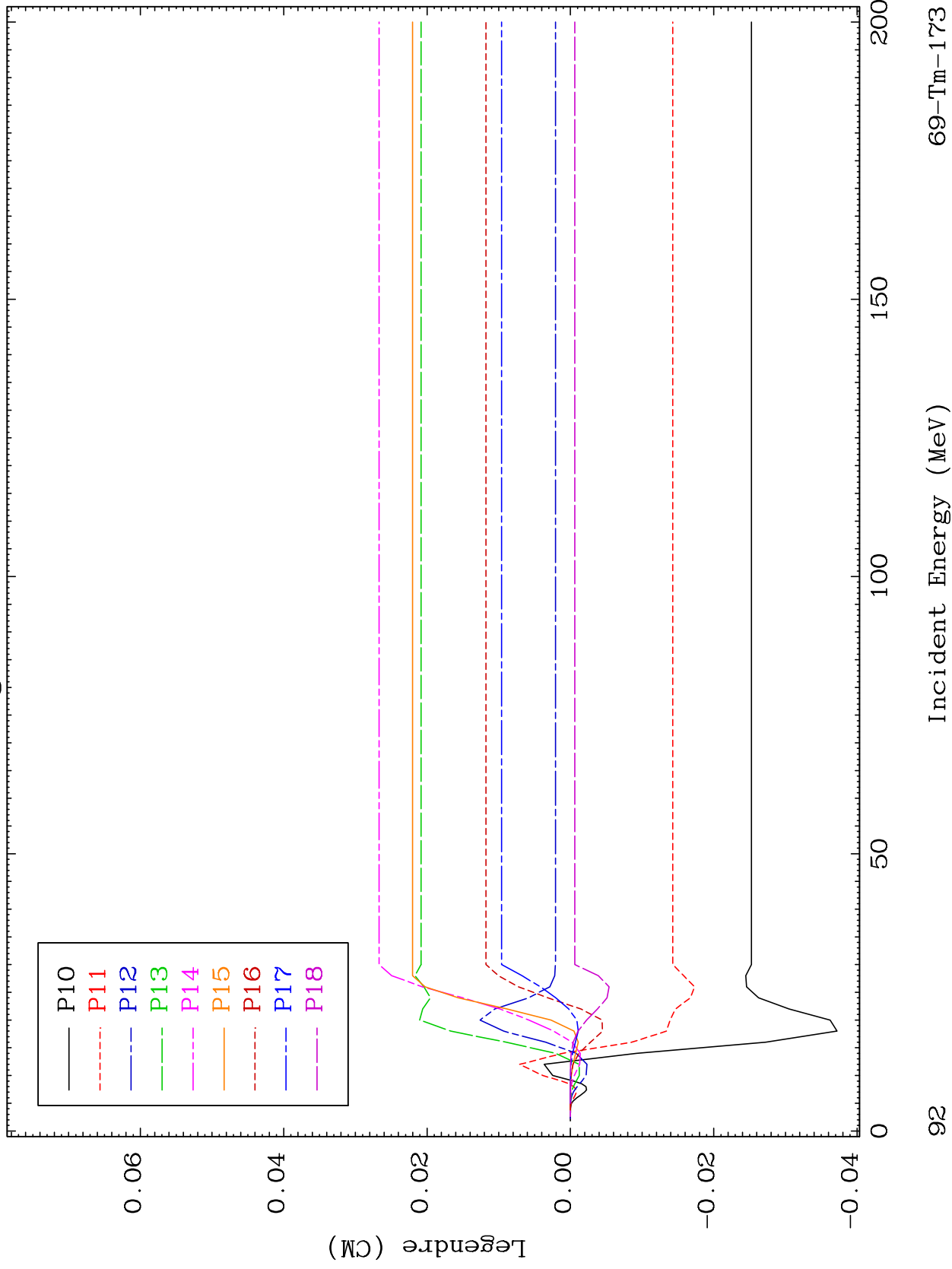

69-Tm-173

Incident Energy (MeV)

92

MAT 6937

1.361 MeV (n,n') Level
Legendre Coefficients

69-Tm-173

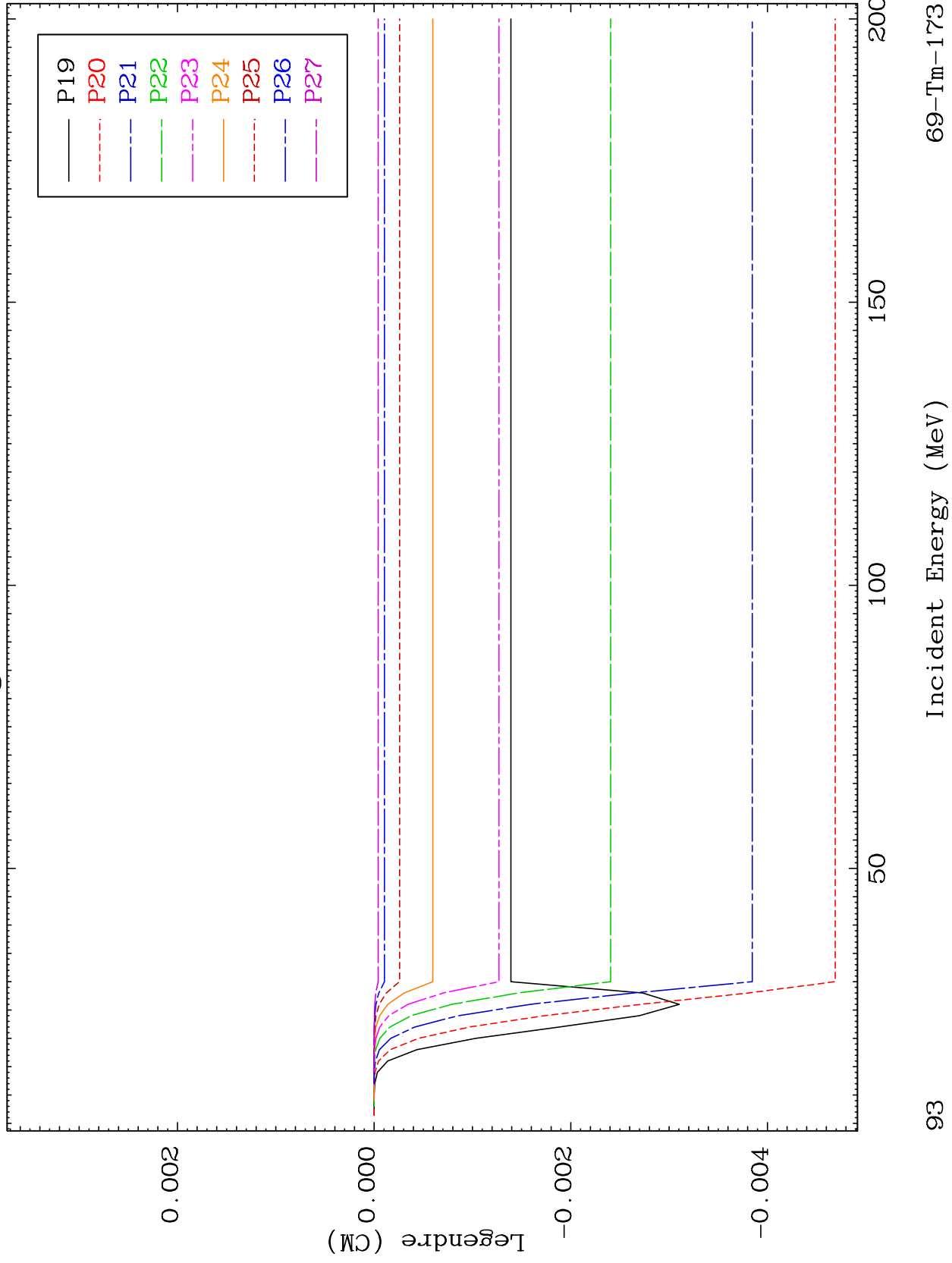

93

Incident Energy (MeV)

69-Tm-173

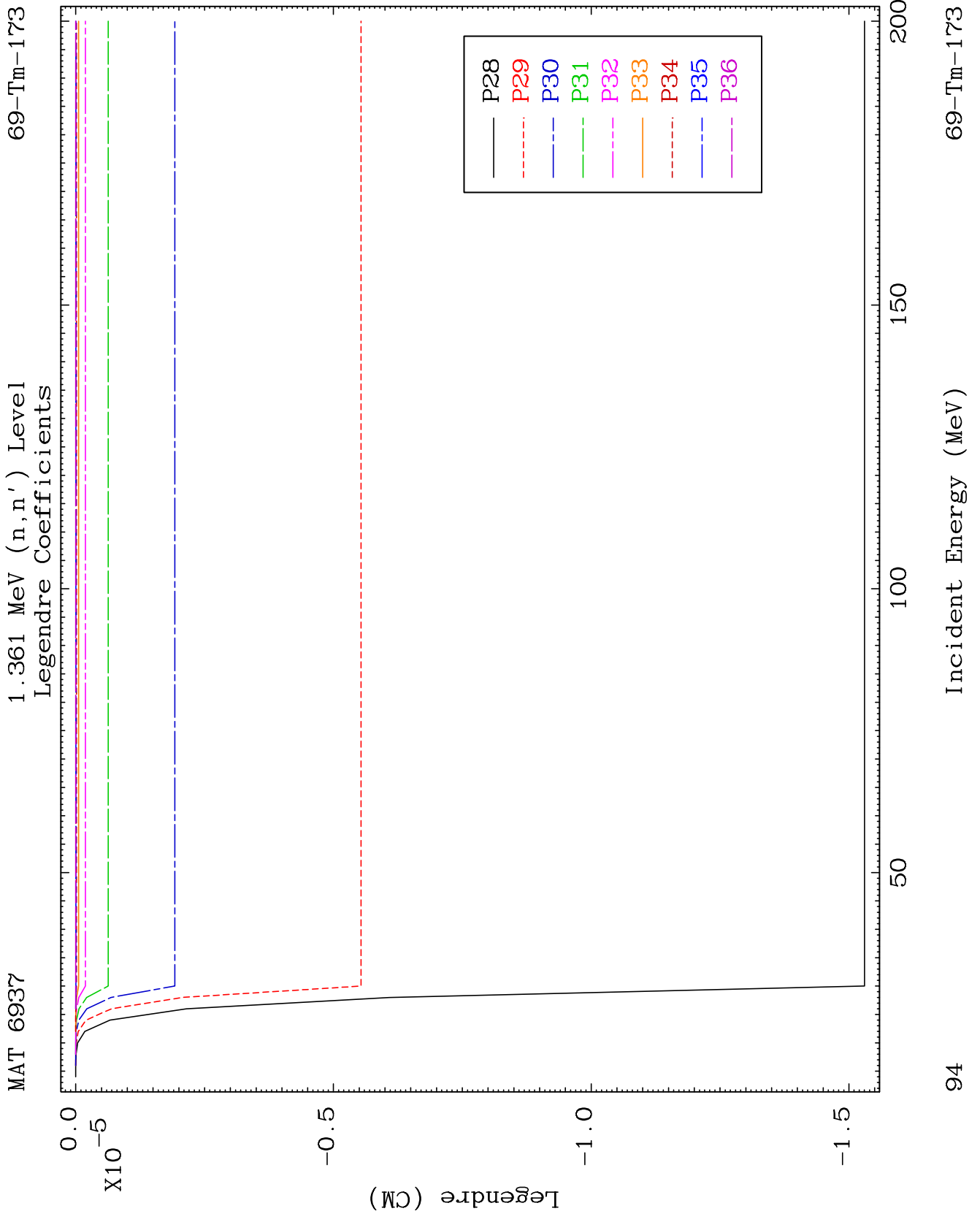

MAT 6937

1.414 MeV (n,n') Level
Legendre Coefficients

69-Tm-173

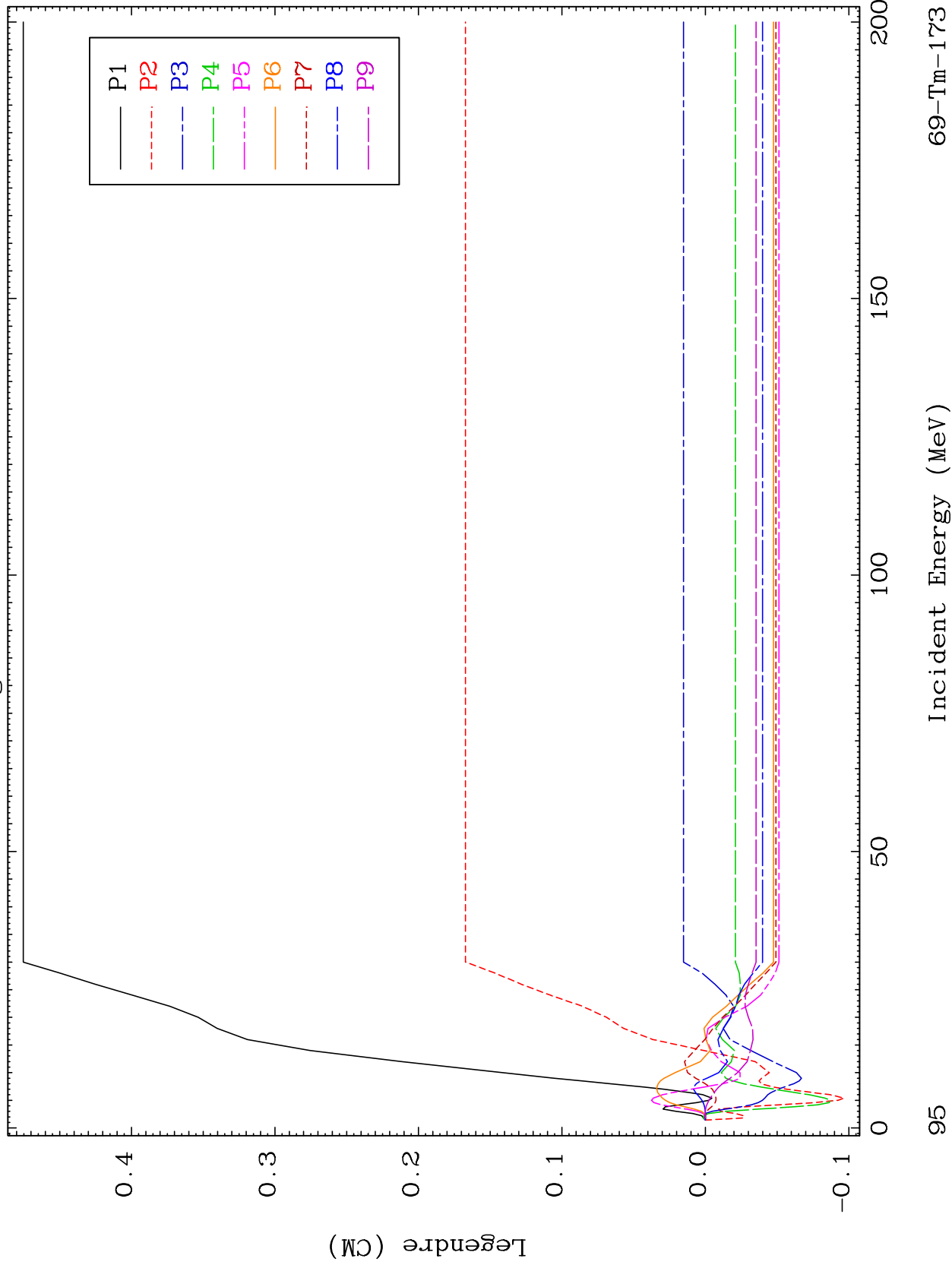

69-Tm-173

Incident Energy (MeV)

95

MAT 6937

1.414 MeV (n,n') Level
Legendre Coefficients

69-Tm-173

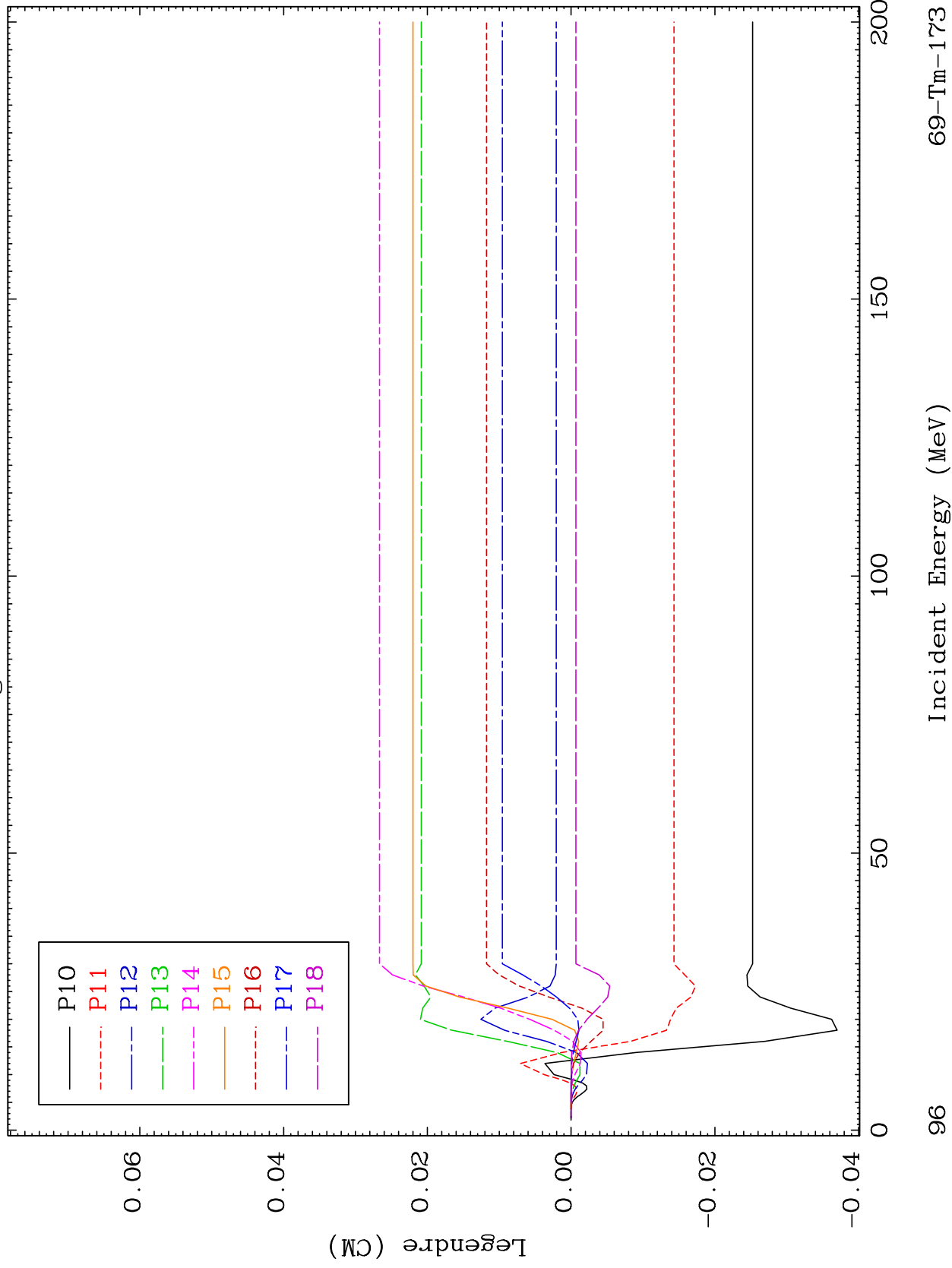

69-Tm-173

Incident Energy (MeV)

96

MAT 6937

1.414 MeV (n,n') Level
Legendre Coefficients

69-Tm-173

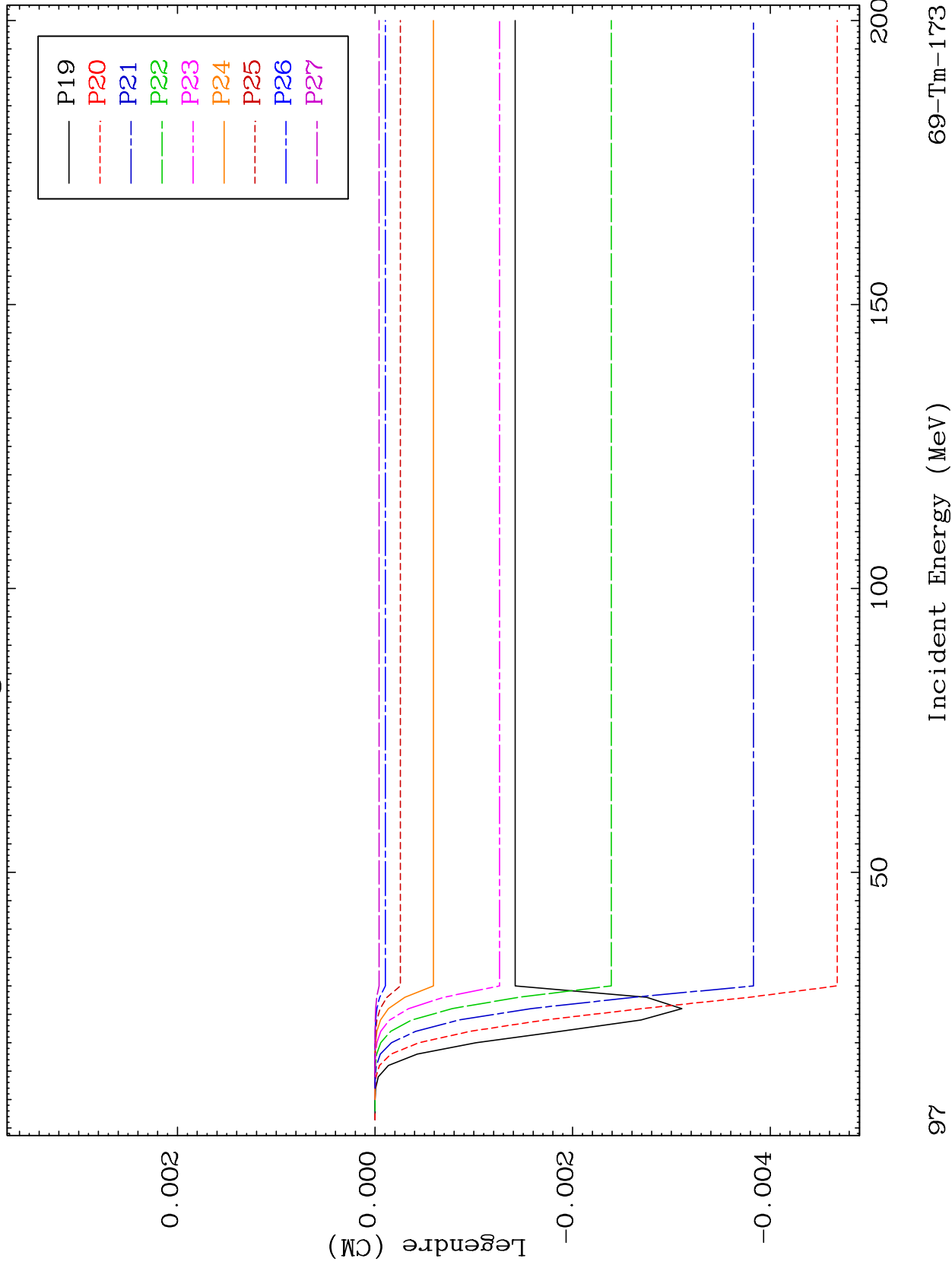

97

Incident Energy (MeV)

69-Tm-173

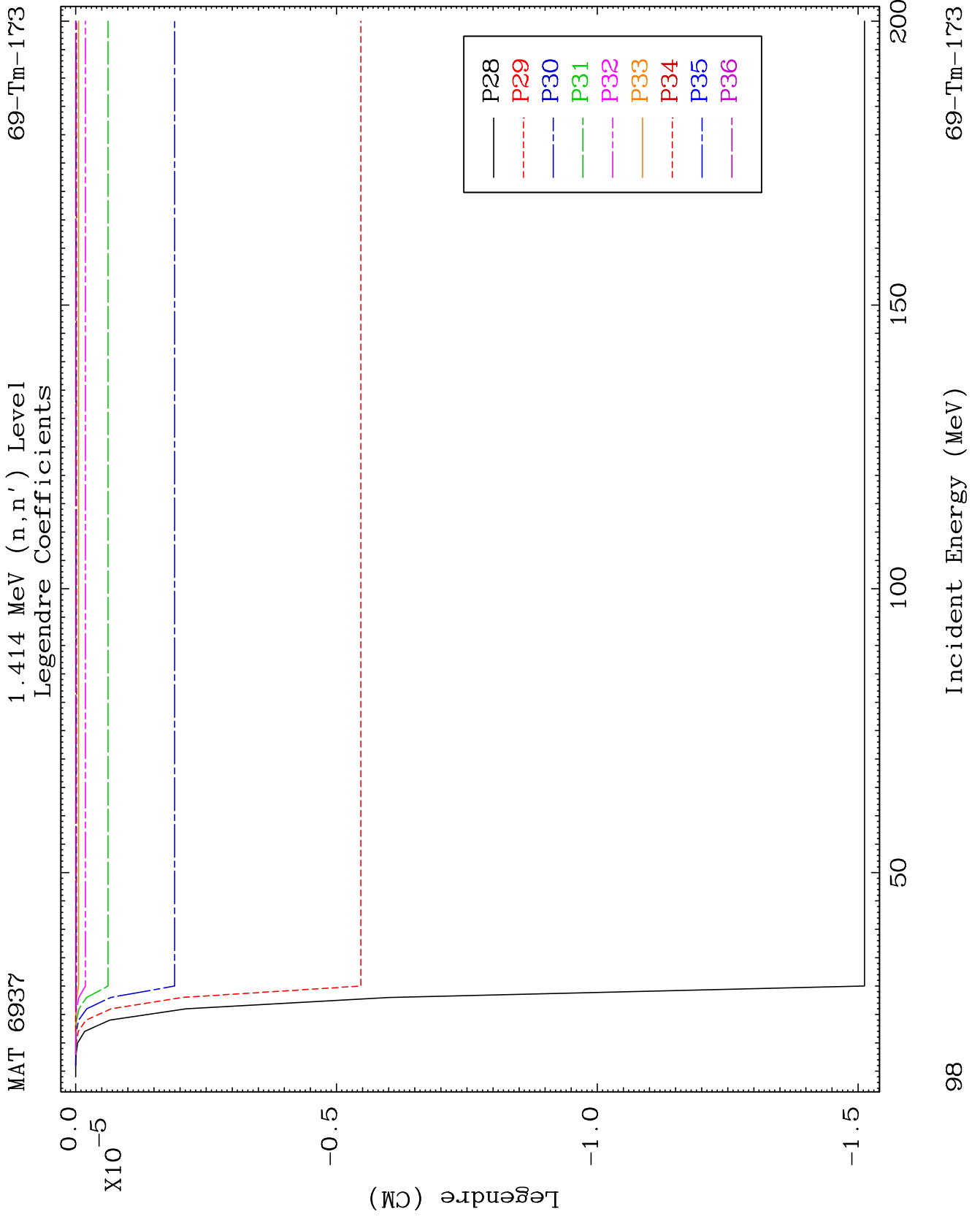

MAT 6937

1.439 MeV (n,n') Level
Legendre Coefficients

69-Tm-173

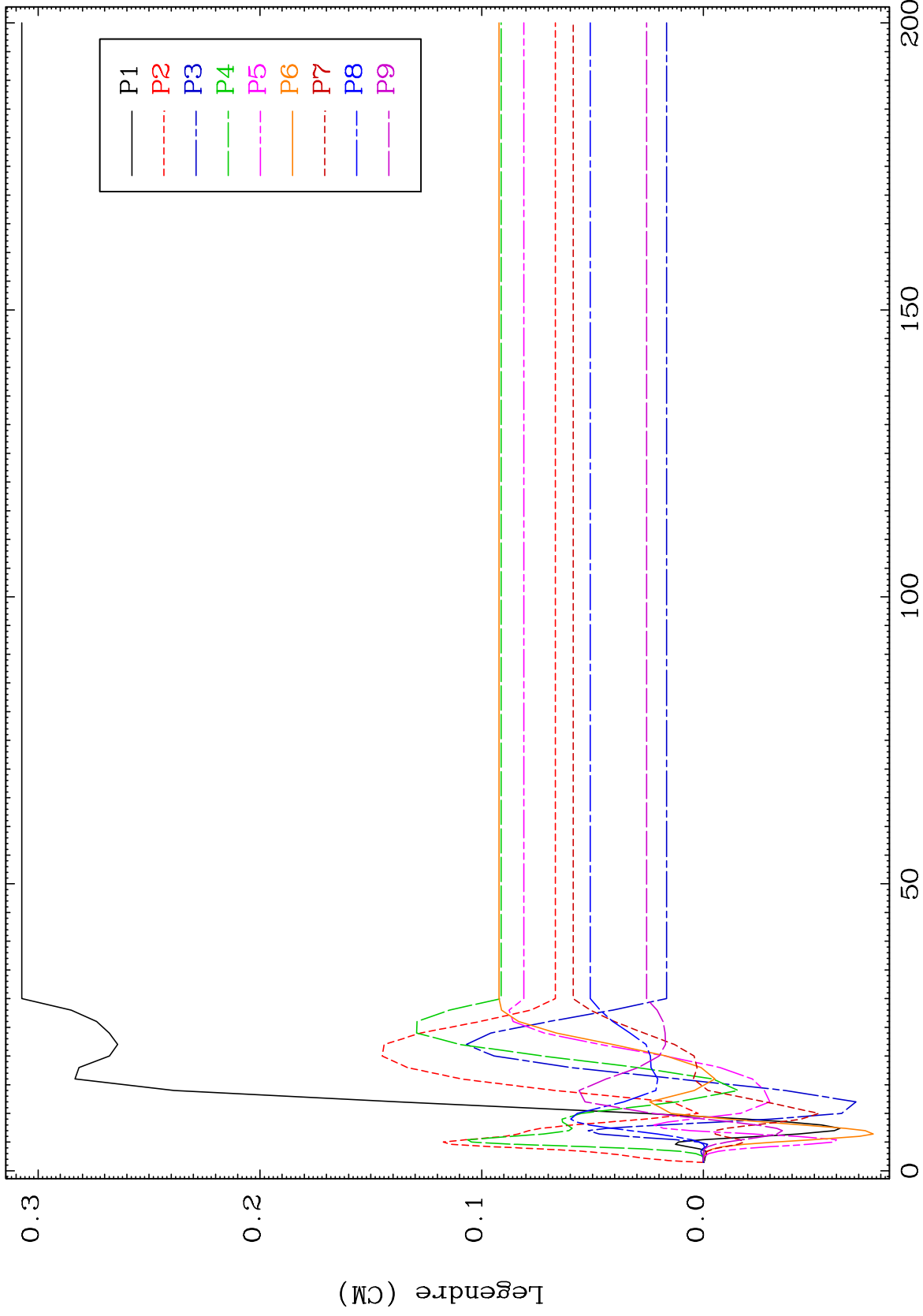

99

Incident Energy (MeV)

69-Tm-173

MAT 6937

1.439 MeV (n,n') Level
Legendre Coefficients

69-Tm-173

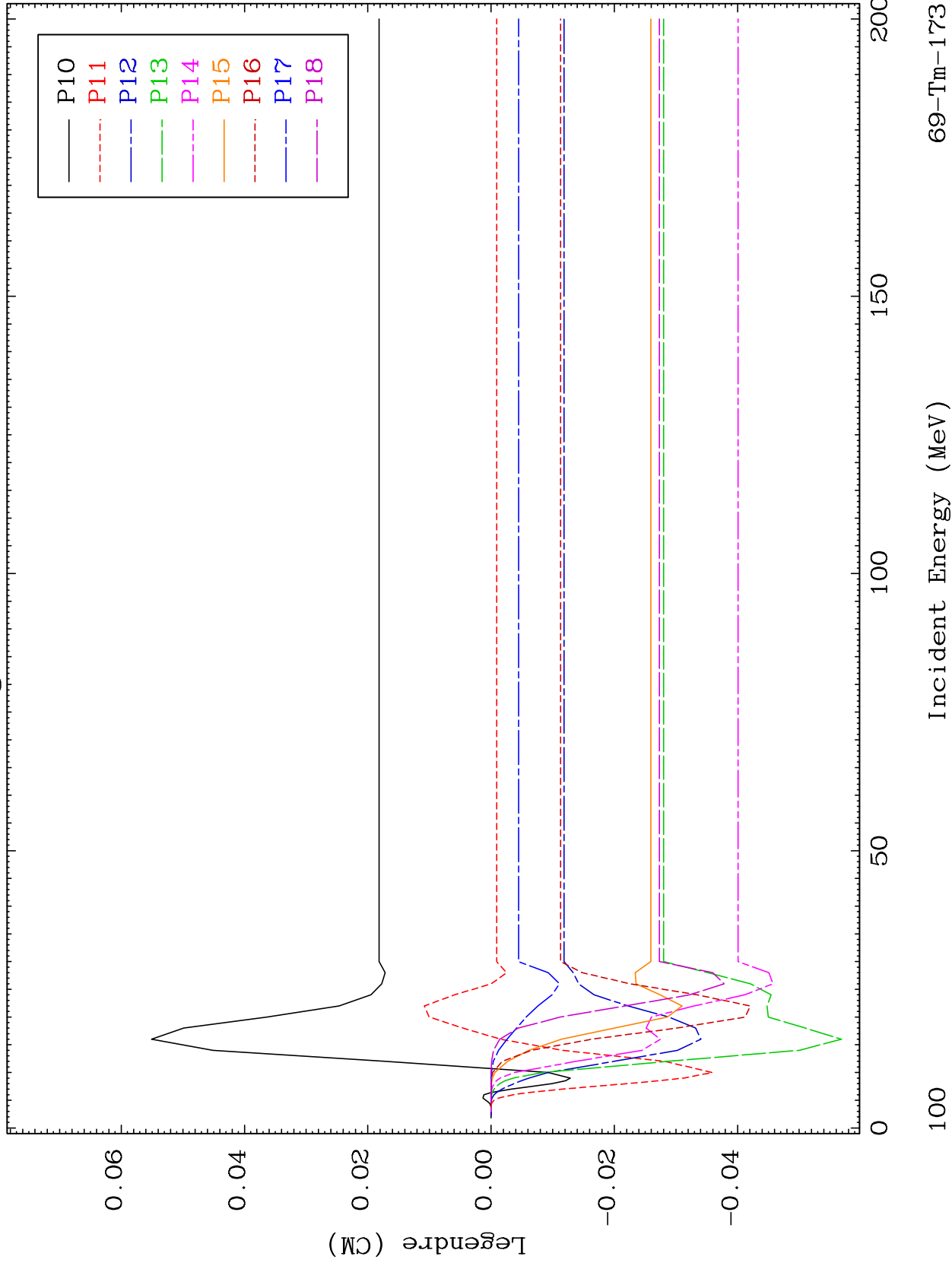

69-Tm-173

Incident Energy (MeV)

MAT 6937

1.439 MeV (n,n') Level
Legendre Coefficients

69-Tm-173

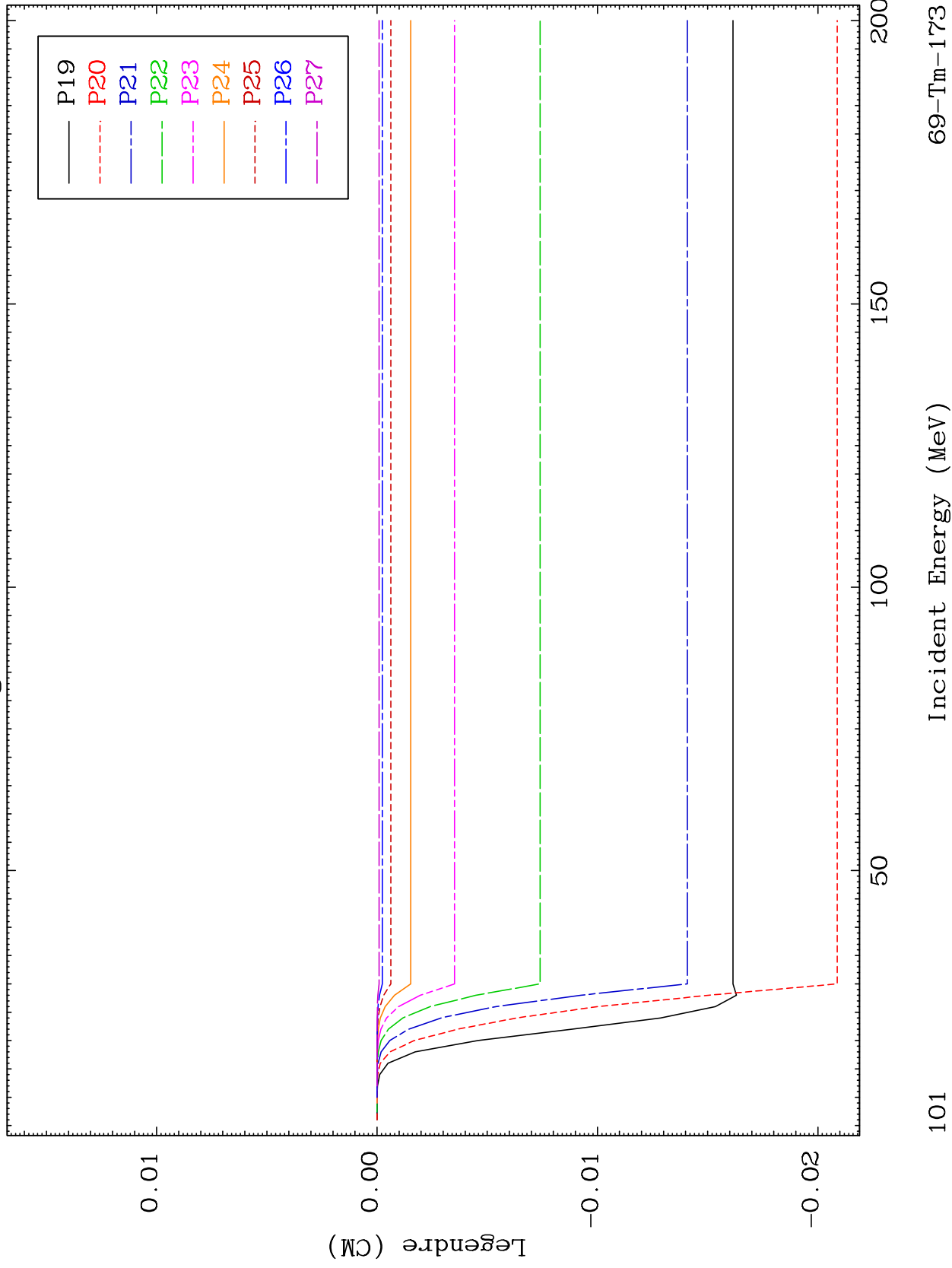

101

Incident Energy (MeV)

69-Tm-173

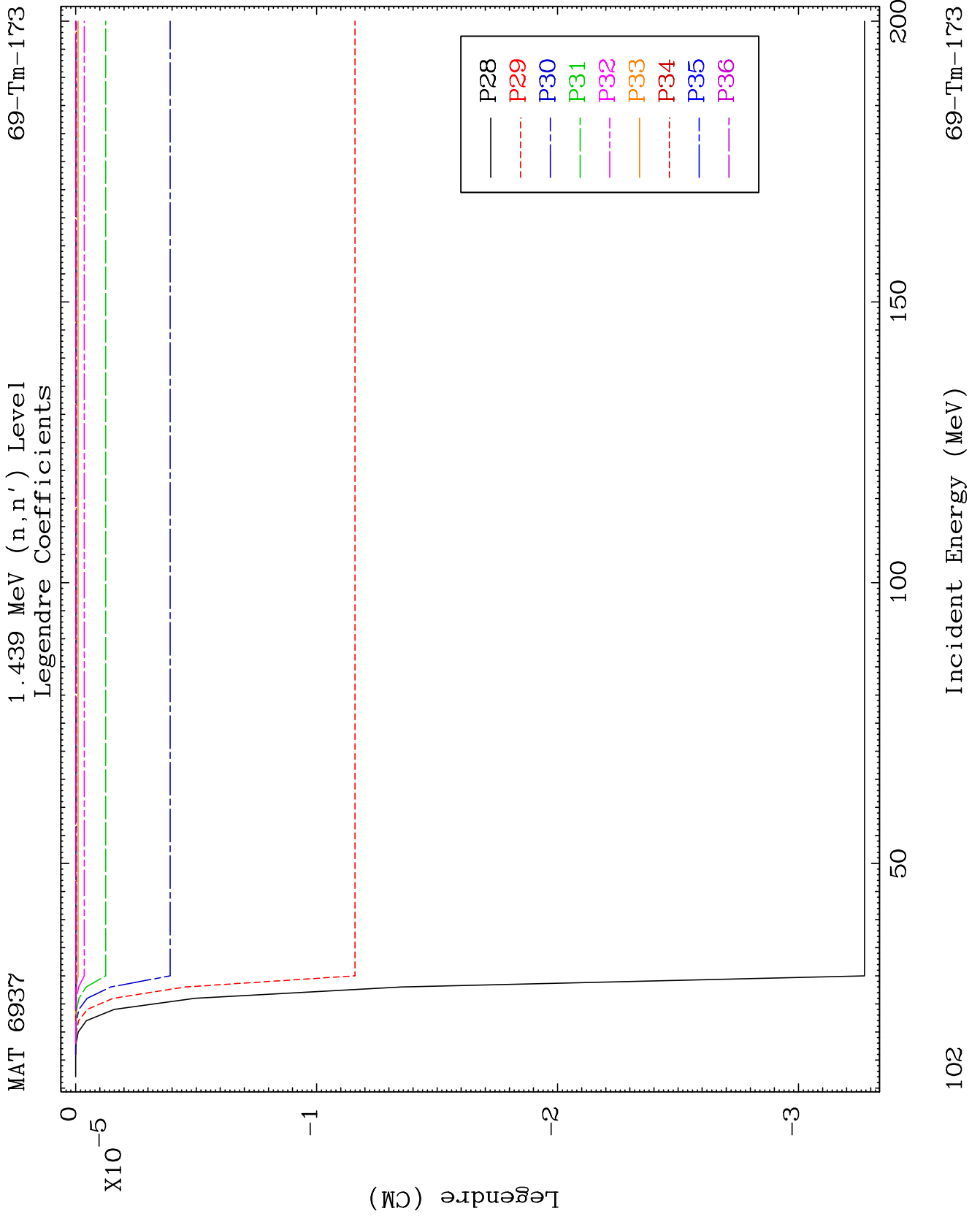

MAT 6937

1.514 MeV (n,n') Level
Legendre Coefficients

69-Tm-173

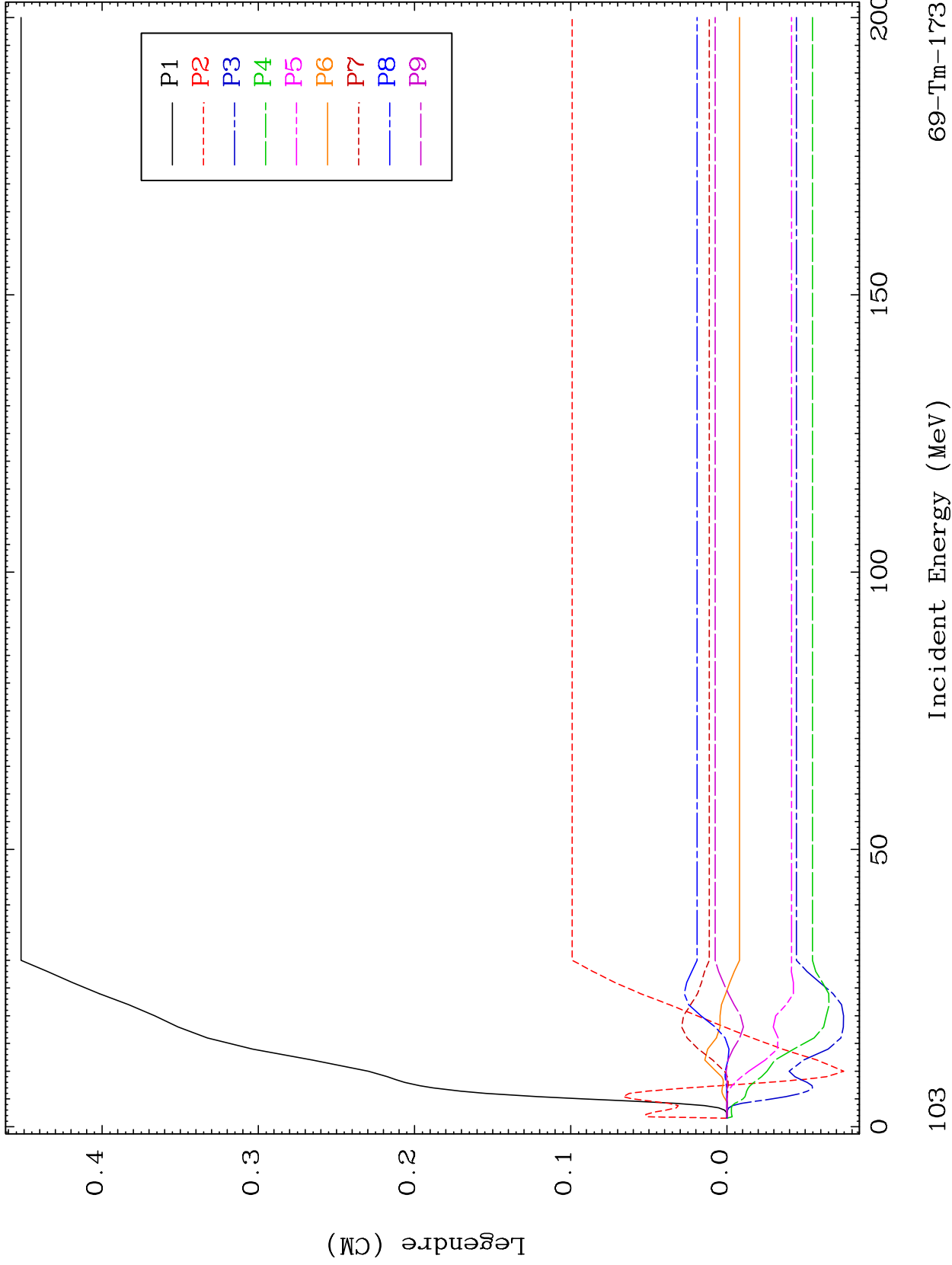

103

Incident Energy (MeV)

69-Tm-173

MAT 6937

1.514 MeV (n,n') Level
Legendre Coefficients

69-Tm-173

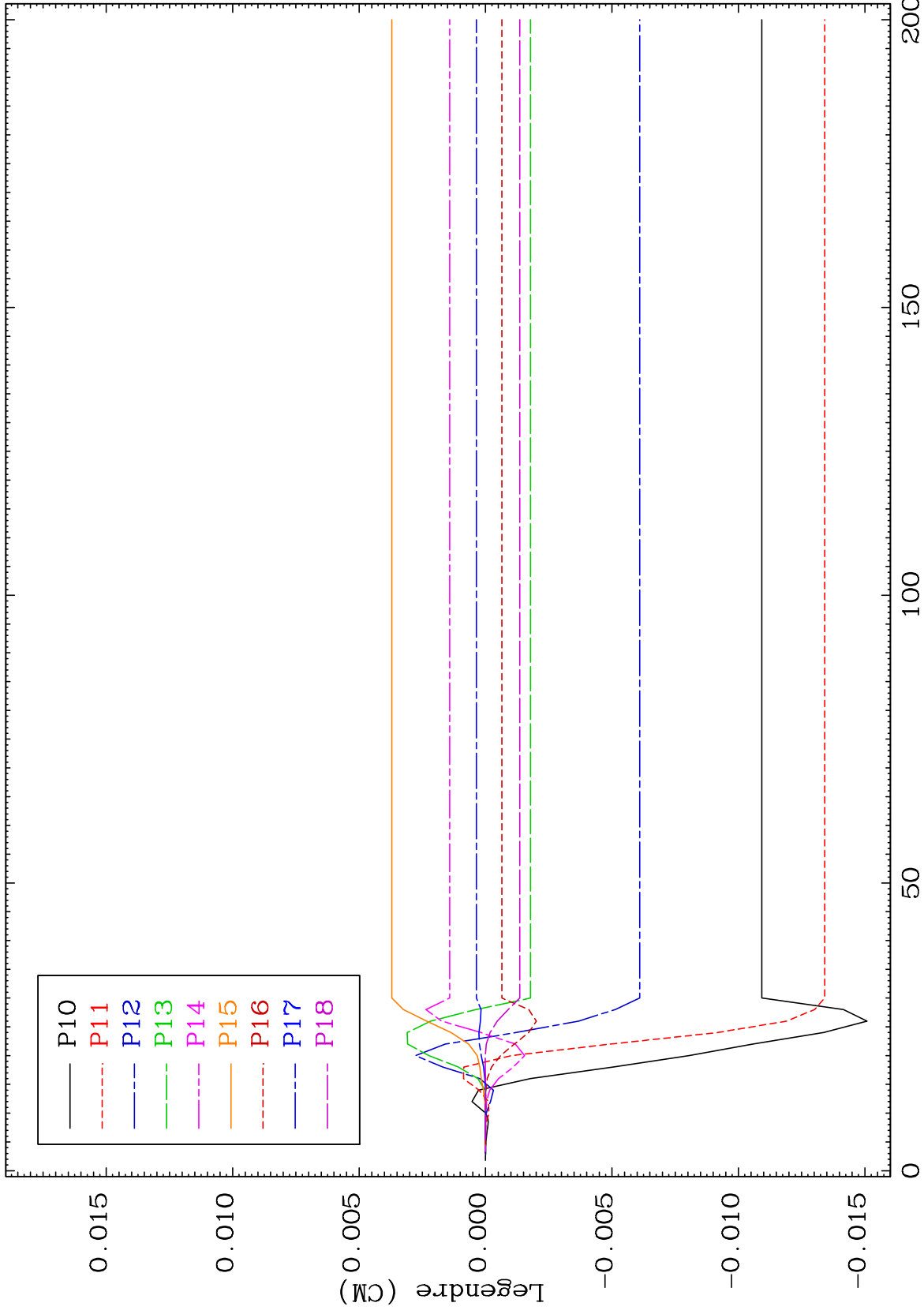

104

Incident Energy (MeV)

69-Tm-173

MAT 6937

1.514 MeV (n,n') Level
Legendre Coefficients

69-Tm-173

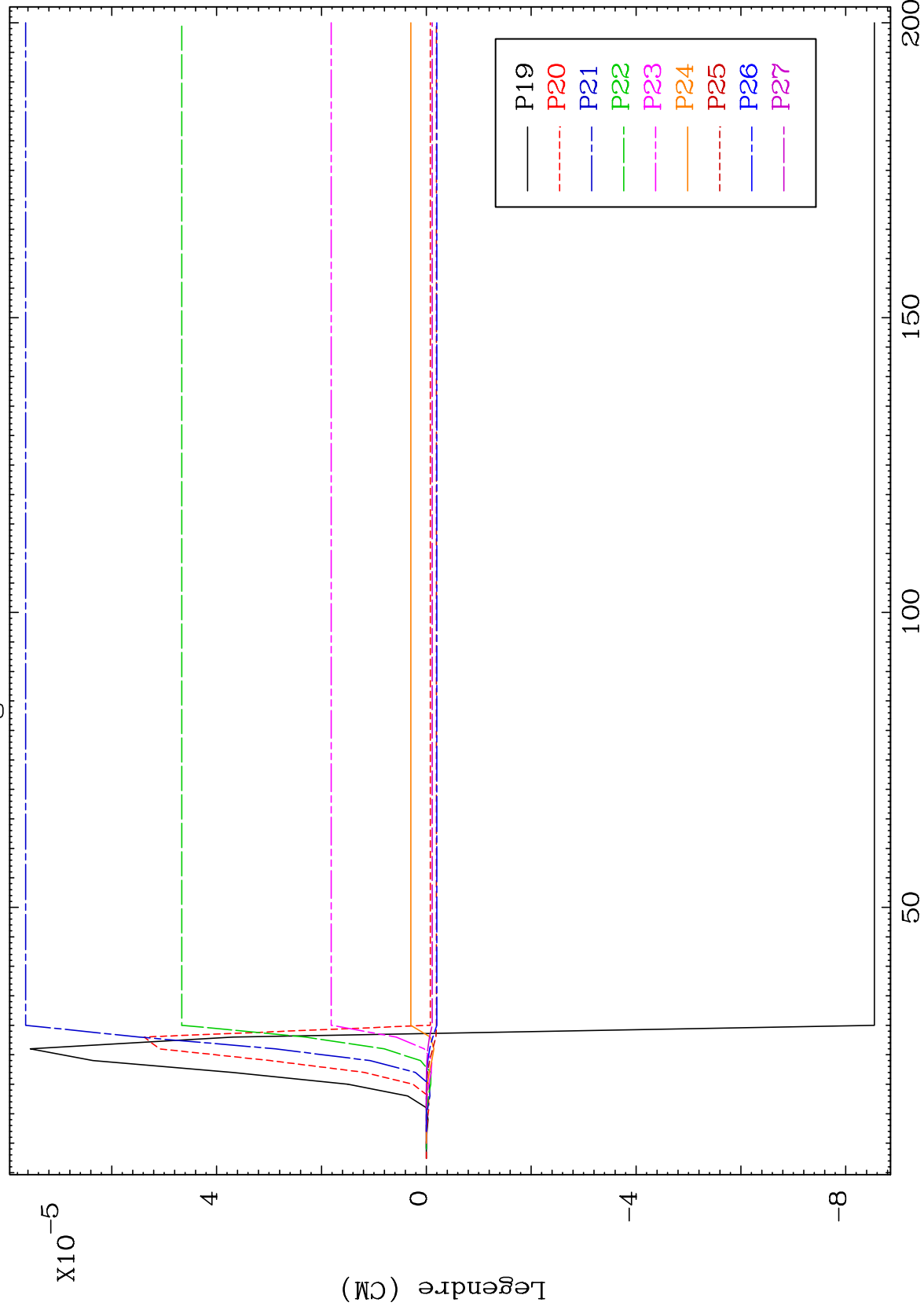

105

Incident Energy (MeV)

69-Tm-173

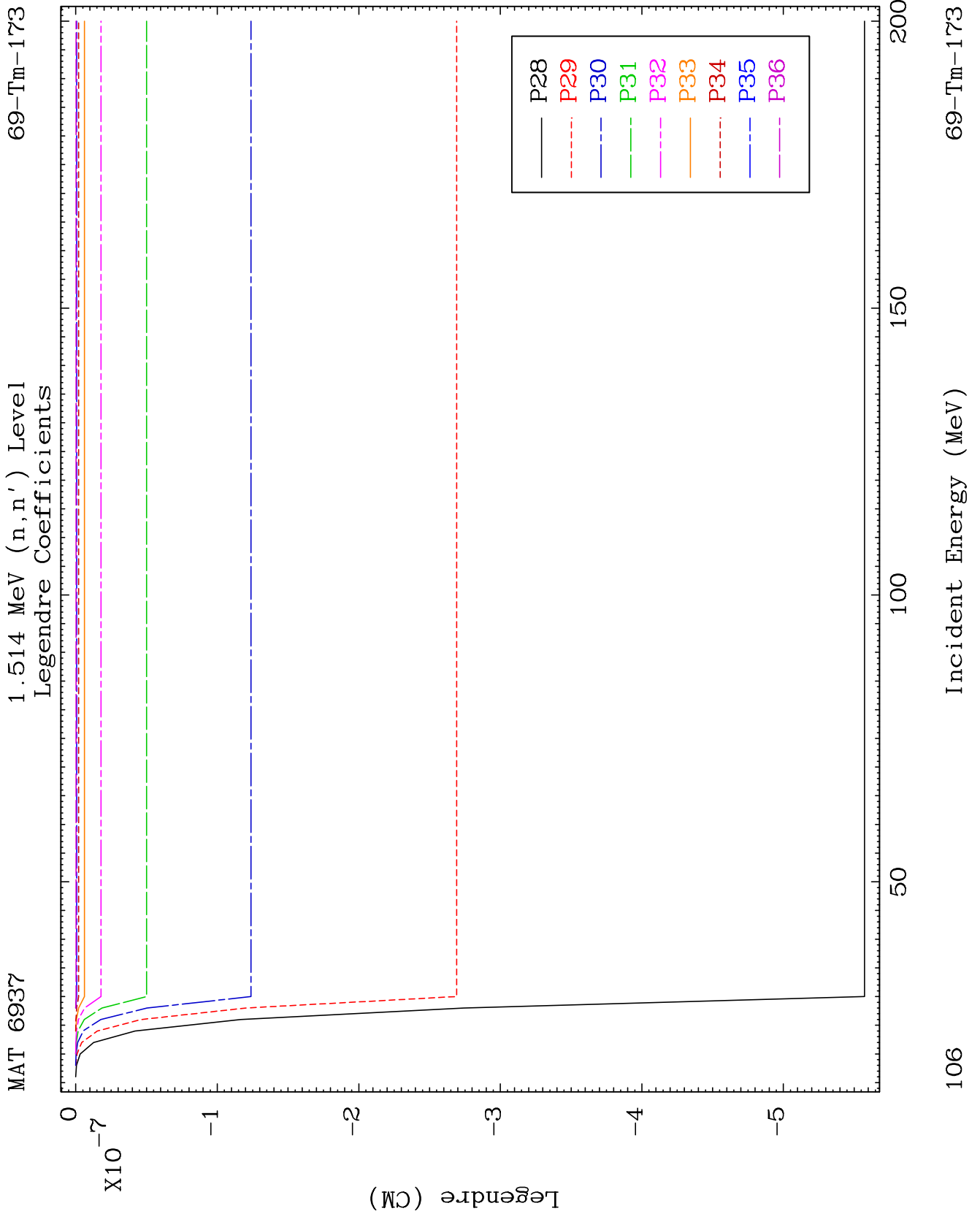

MAT 6937

1.588 MeV (n,n') Level
Legendre Coefficients

69-Tm-173

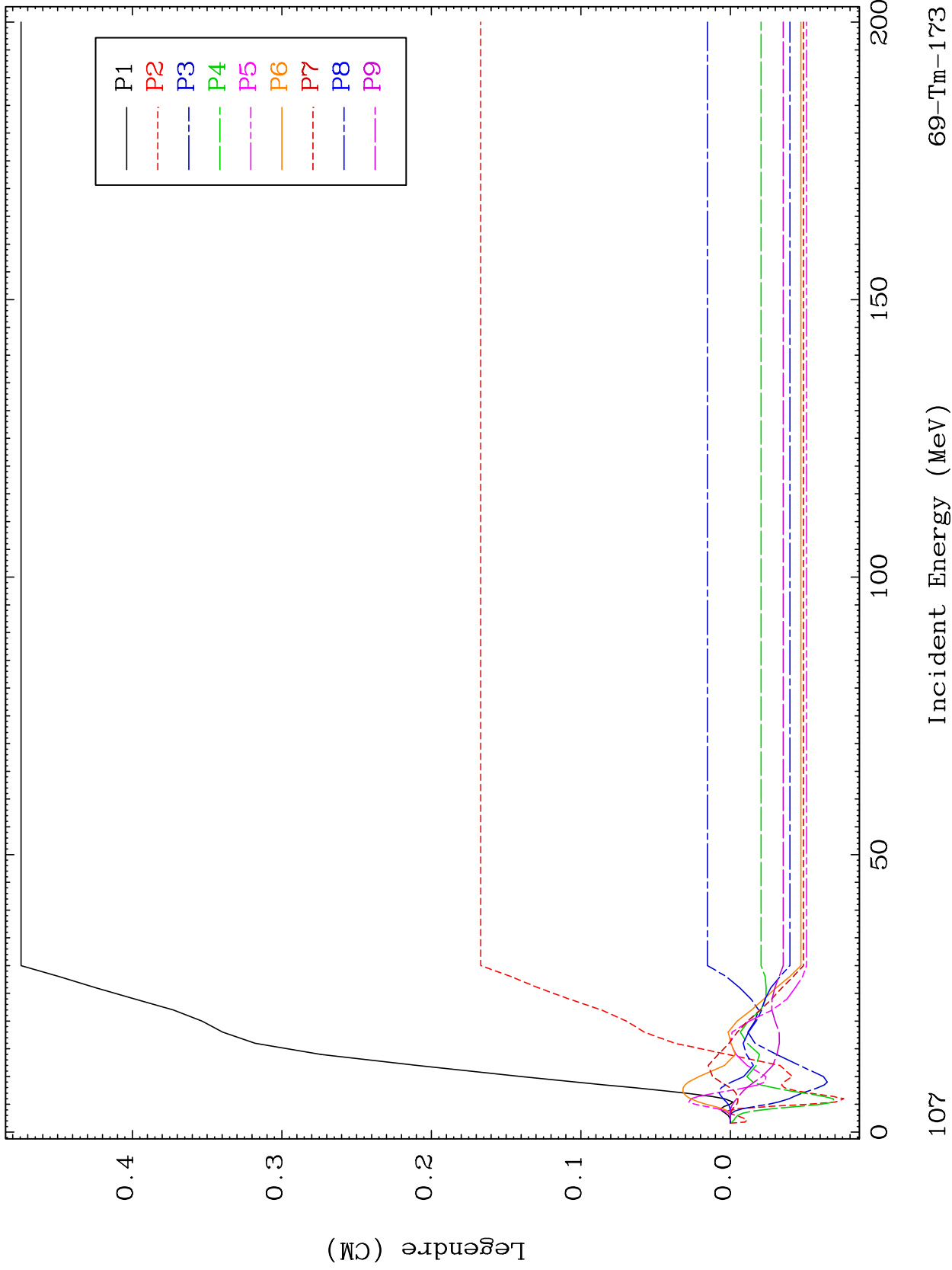

69-Tm-173

Incident Energy (MeV)

107

MAT 6937

1.588 MeV (n,n') Level
Legendre Coefficients

69-Tm-173

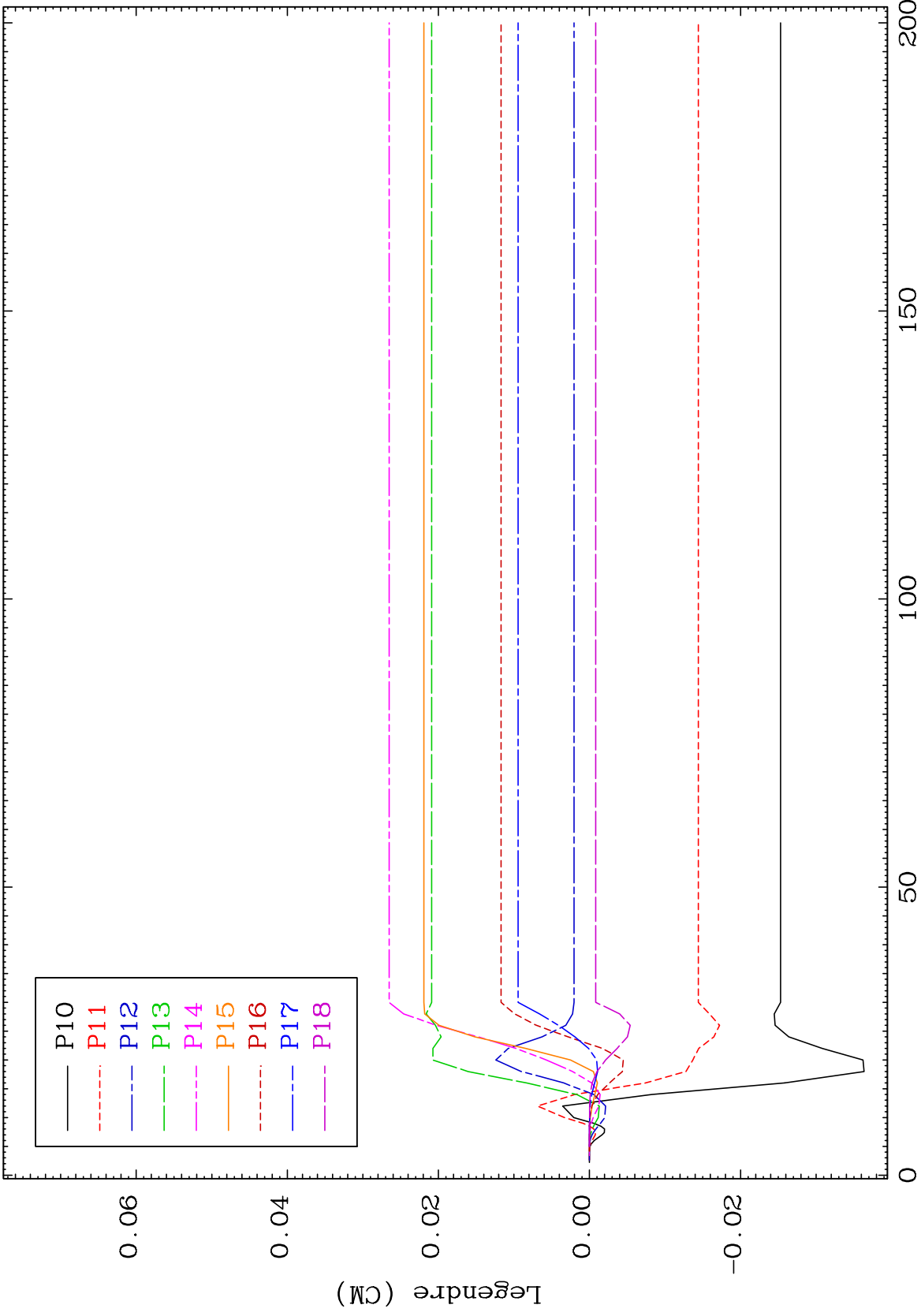

108

Incident Energy (MeV)

69-Tm-173

MAT 6937

1.588 MeV (n,n') Level
Legendre Coefficients

69-Tm-173

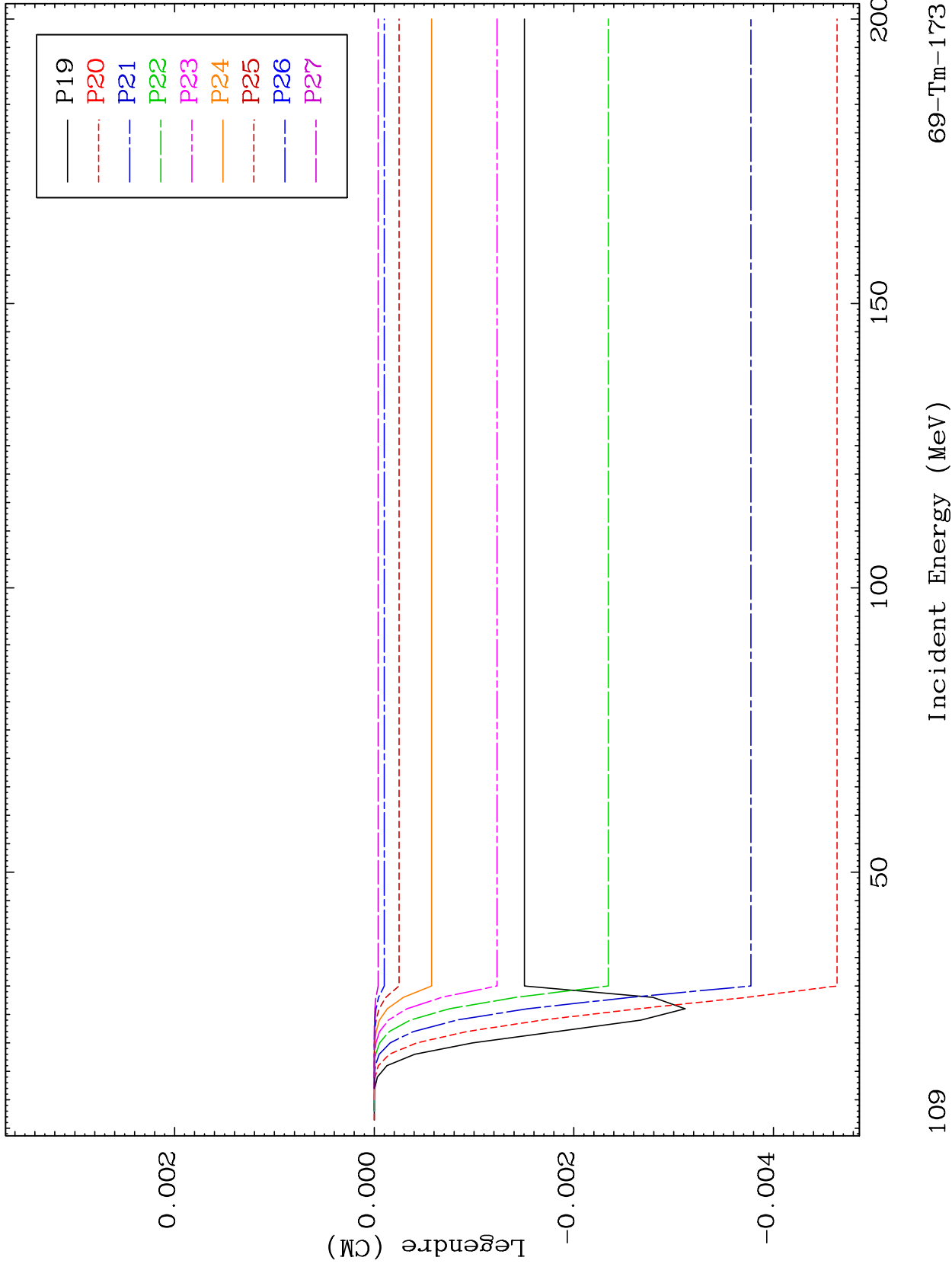

109

Incident Energy (MeV)

69-Tm-173

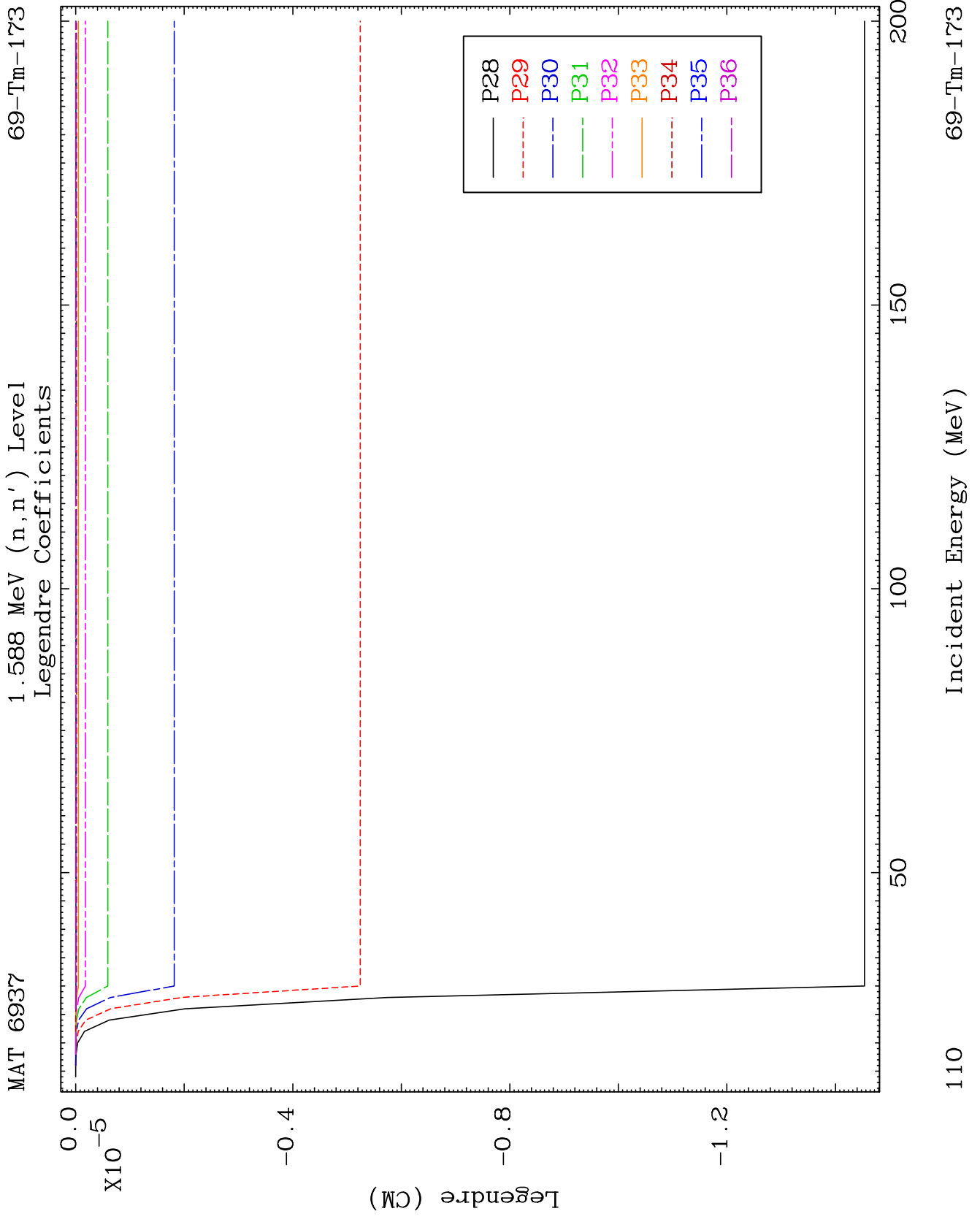

MAT 6937

1.672 MeV (n,n') Level
Legendre Coefficients

69-Tm-173

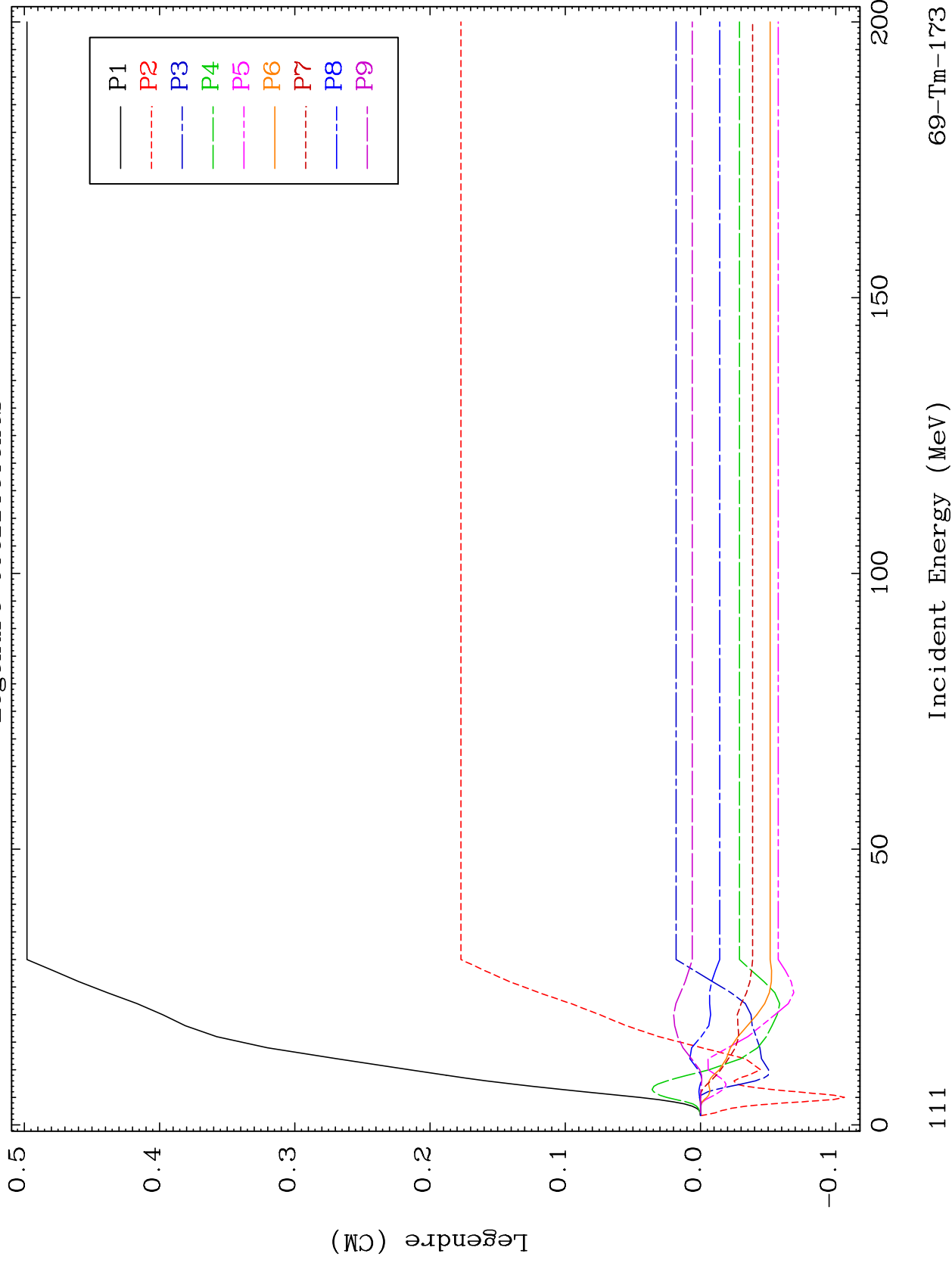

69-Tm-173

Incident Energy (MeV)

111

MAT 6937

1.672 MeV (n,n') Level
Legendre Coefficients

69-Tm-173

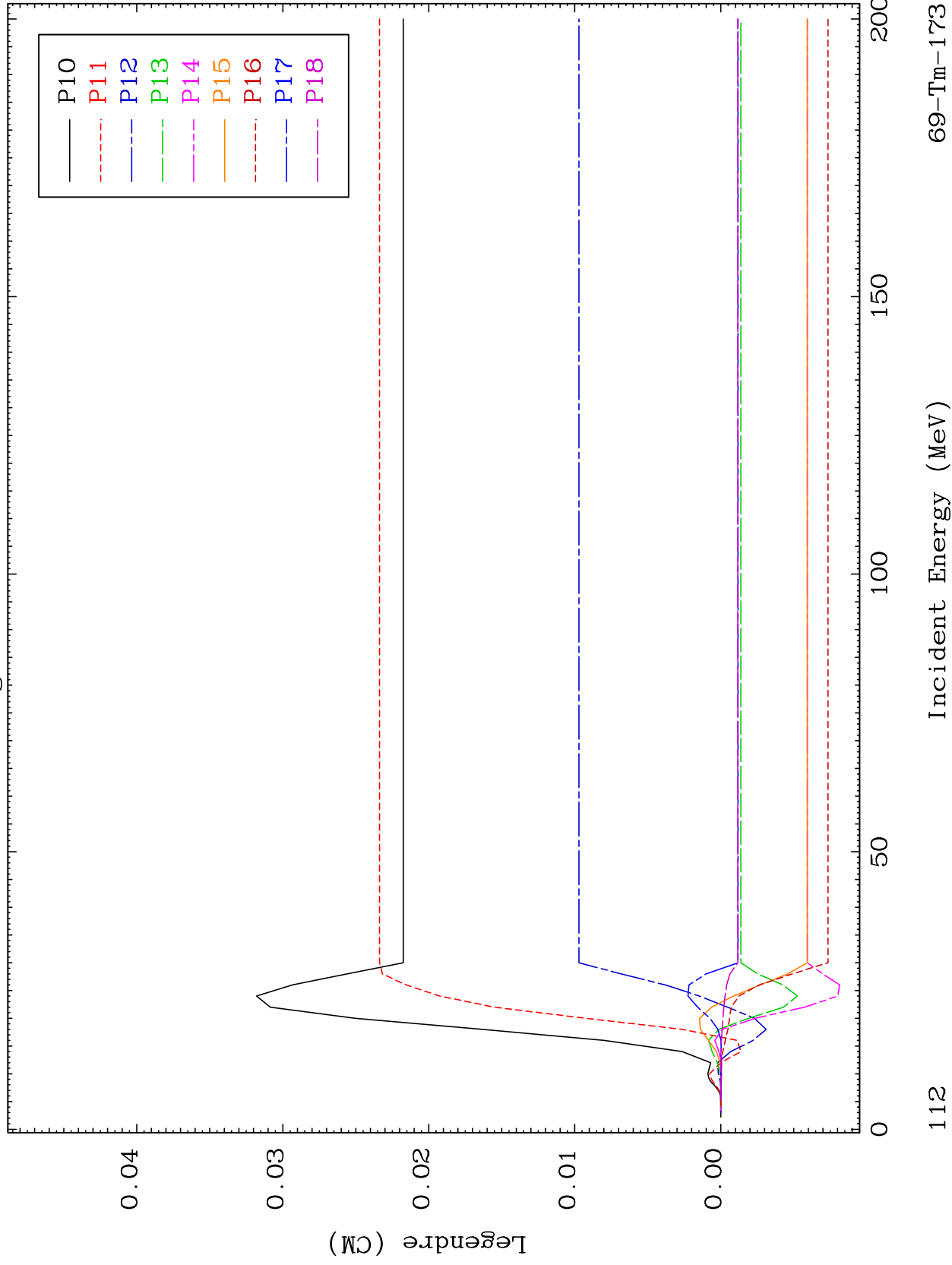

69-Tm-173

Incident Energy (MeV)

112

MAT 6937

1.672 MeV (n,n') Level
Legendre Coefficients

69-Tm-173

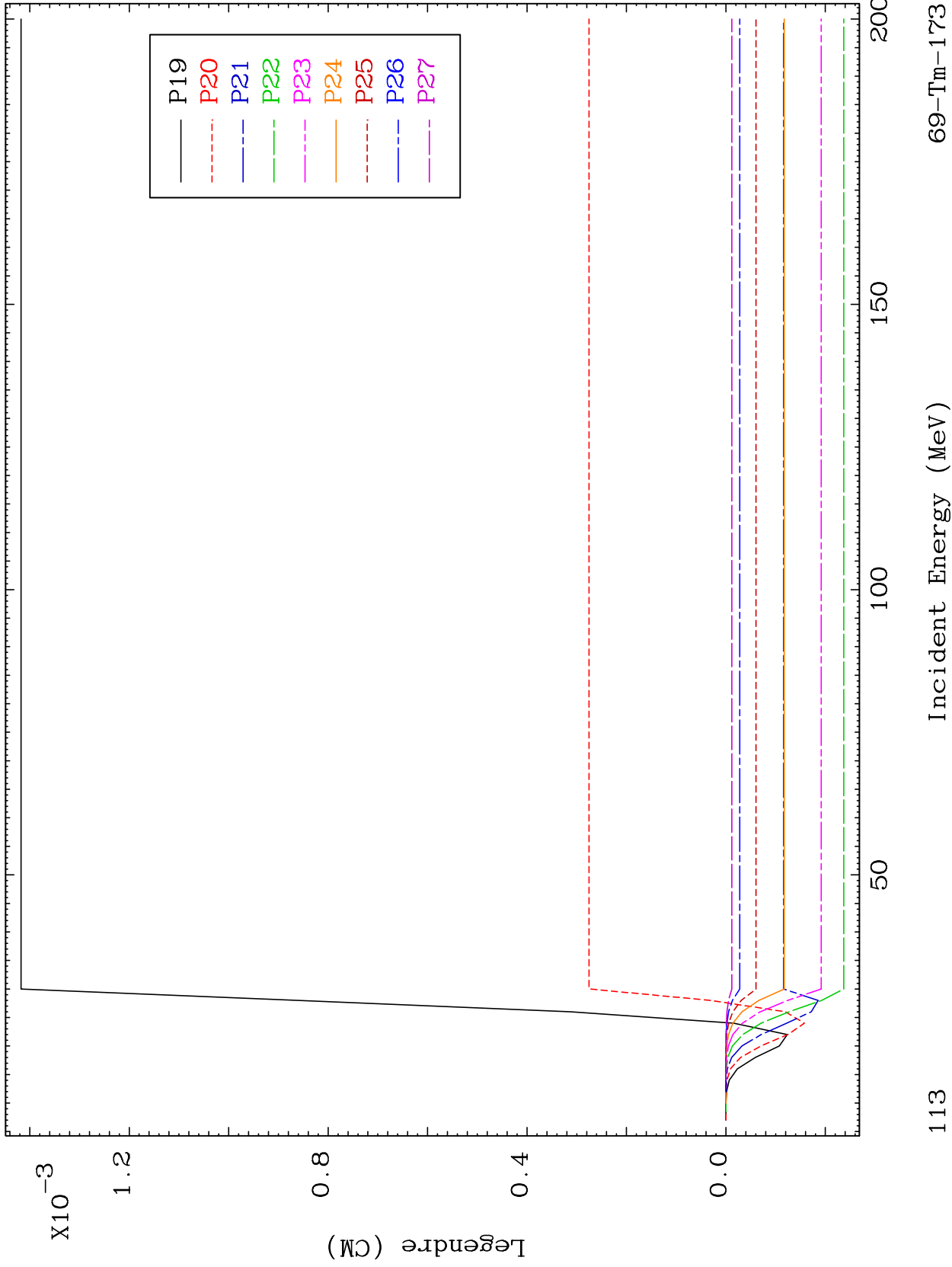

113

Incident Energy (MeV)

69-Tm-173

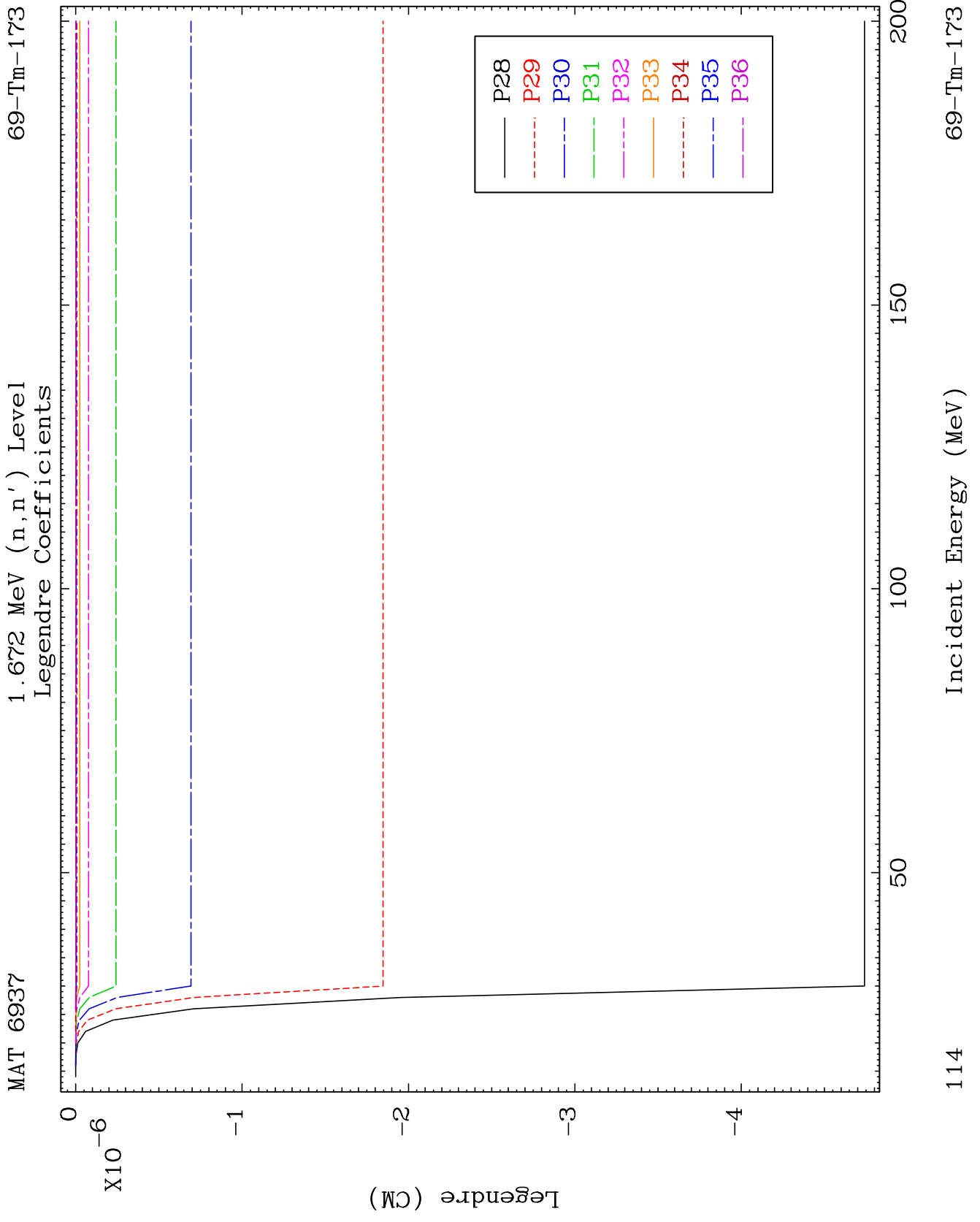

MAT 6937

1.703 MeV (n,n') Level
Legendre Coefficients

69-Tm-173

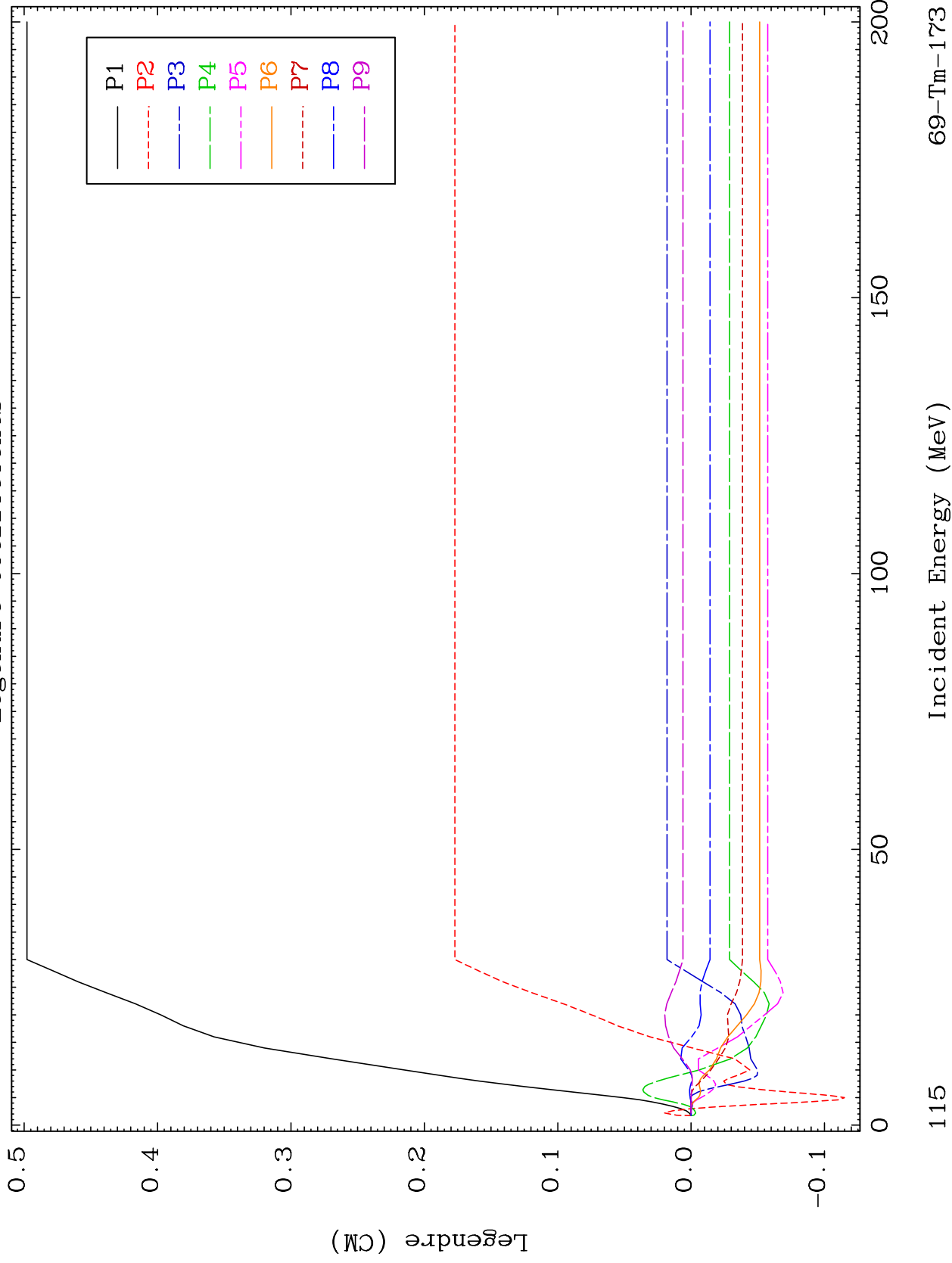

69-Tm-173

Incident Energy (MeV)

115

MAT 6937

1.703 MeV (n,n') Level
Legendre Coefficients

69-Tm-173

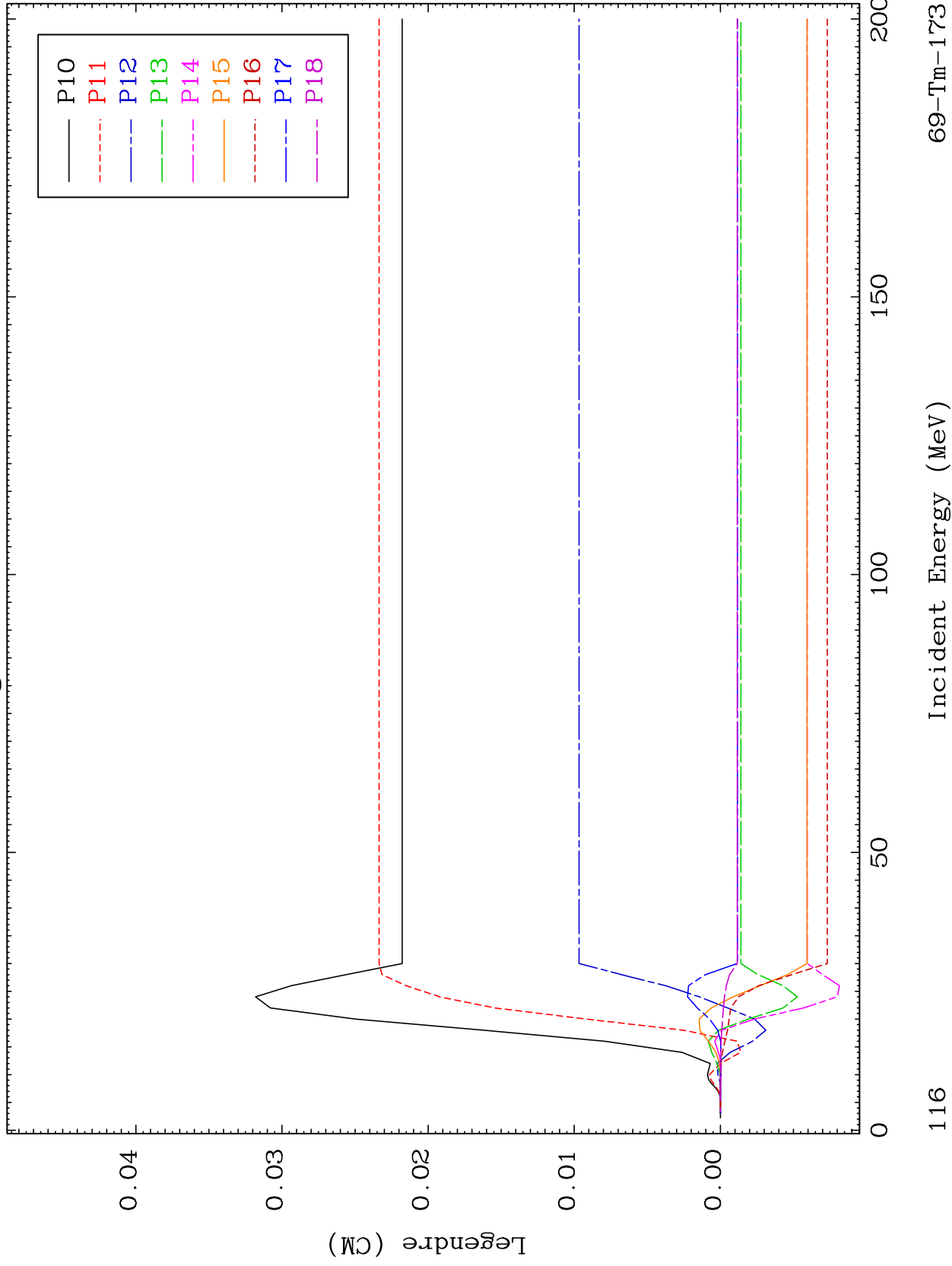

116

Incident Energy (MeV)

69-Tm-173

MAT 6937

1.703 MeV (n,n') Level
Legendre Coefficients

69-Tm-173

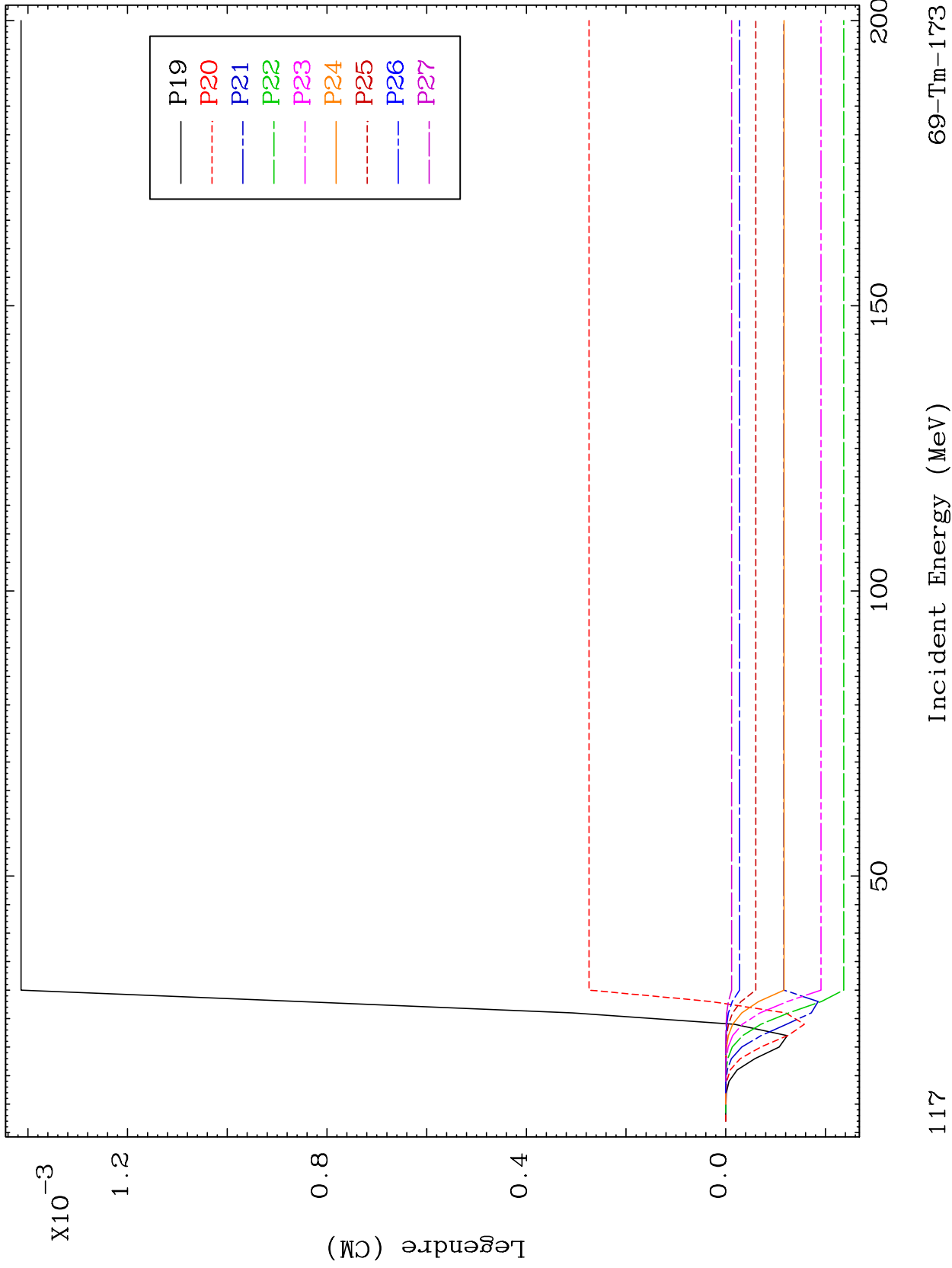

117

Incident Energy (MeV)

69-Tm-173

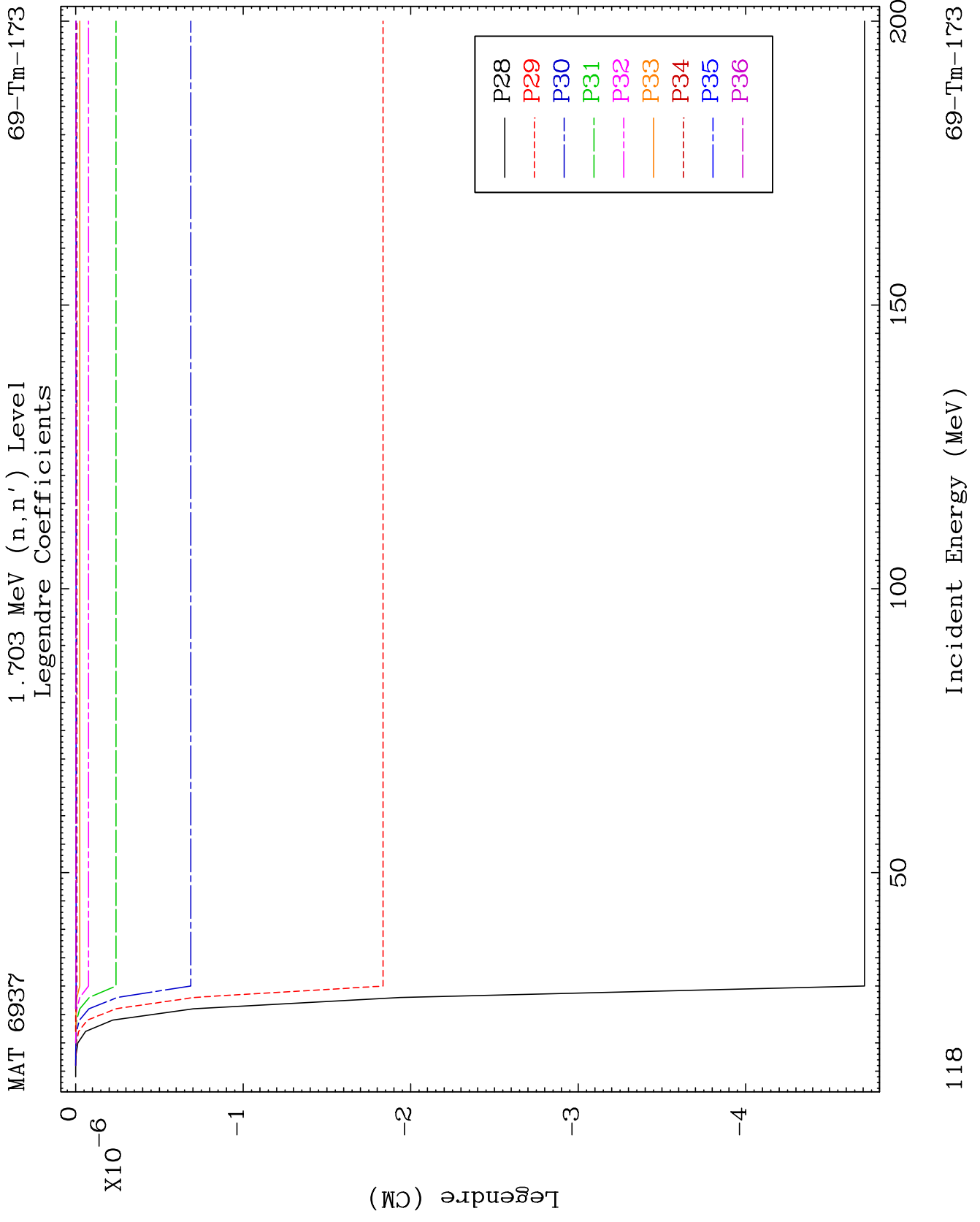

MAT 6937

1.901 MeV (n,n') Level
Legendre Coefficients

69-Tm-173

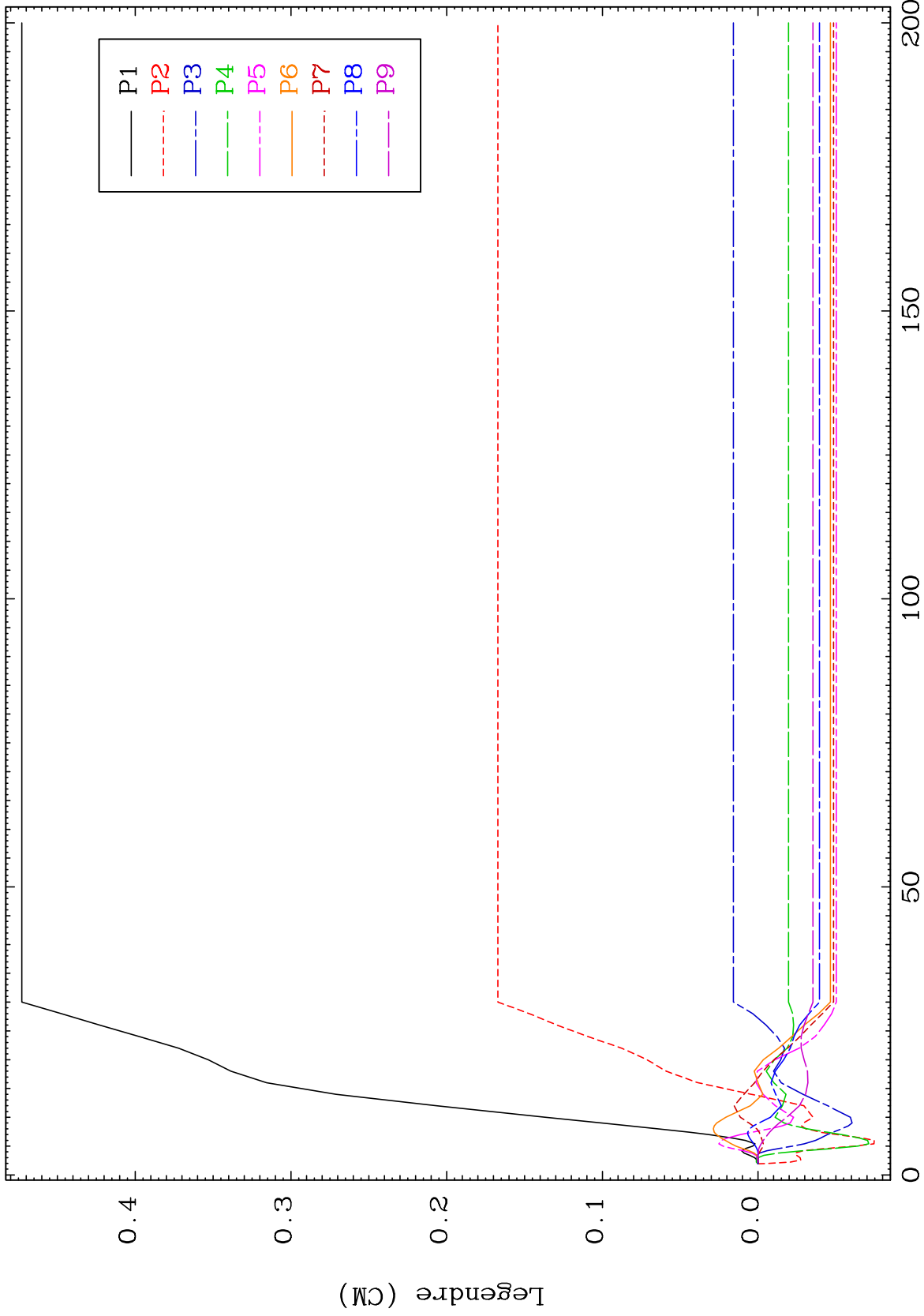

69-Tm-173

Incident Energy (MeV)

119

MAT 6937

1.901 MeV (n,n') Level
Legendre Coefficients

69-Tm-173

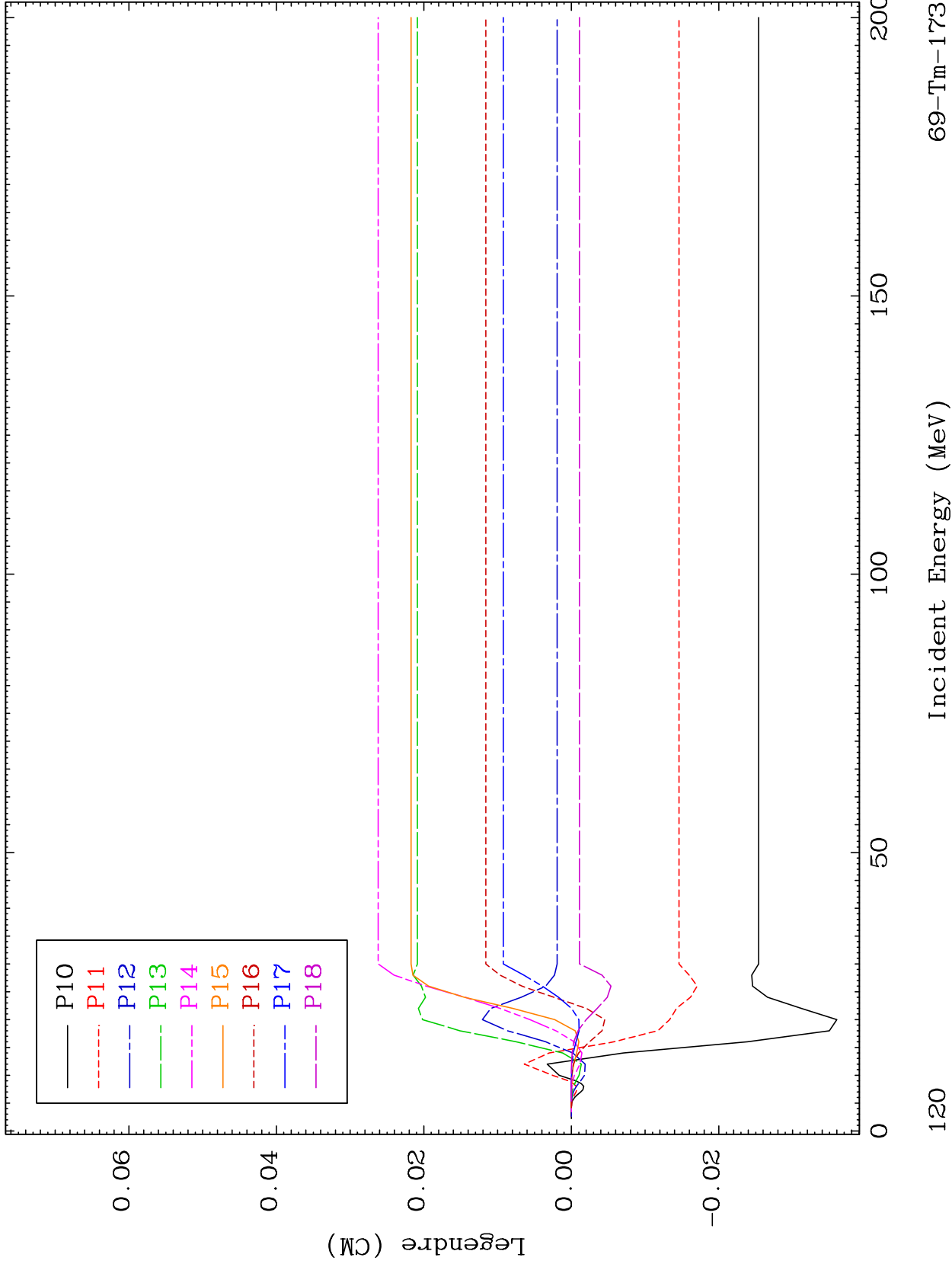

69-Tm-173

Incident Energy (MeV)

120

MAT 6937

1.901 MeV (n,n') Level
Legendre Coefficients

69-Tm-173

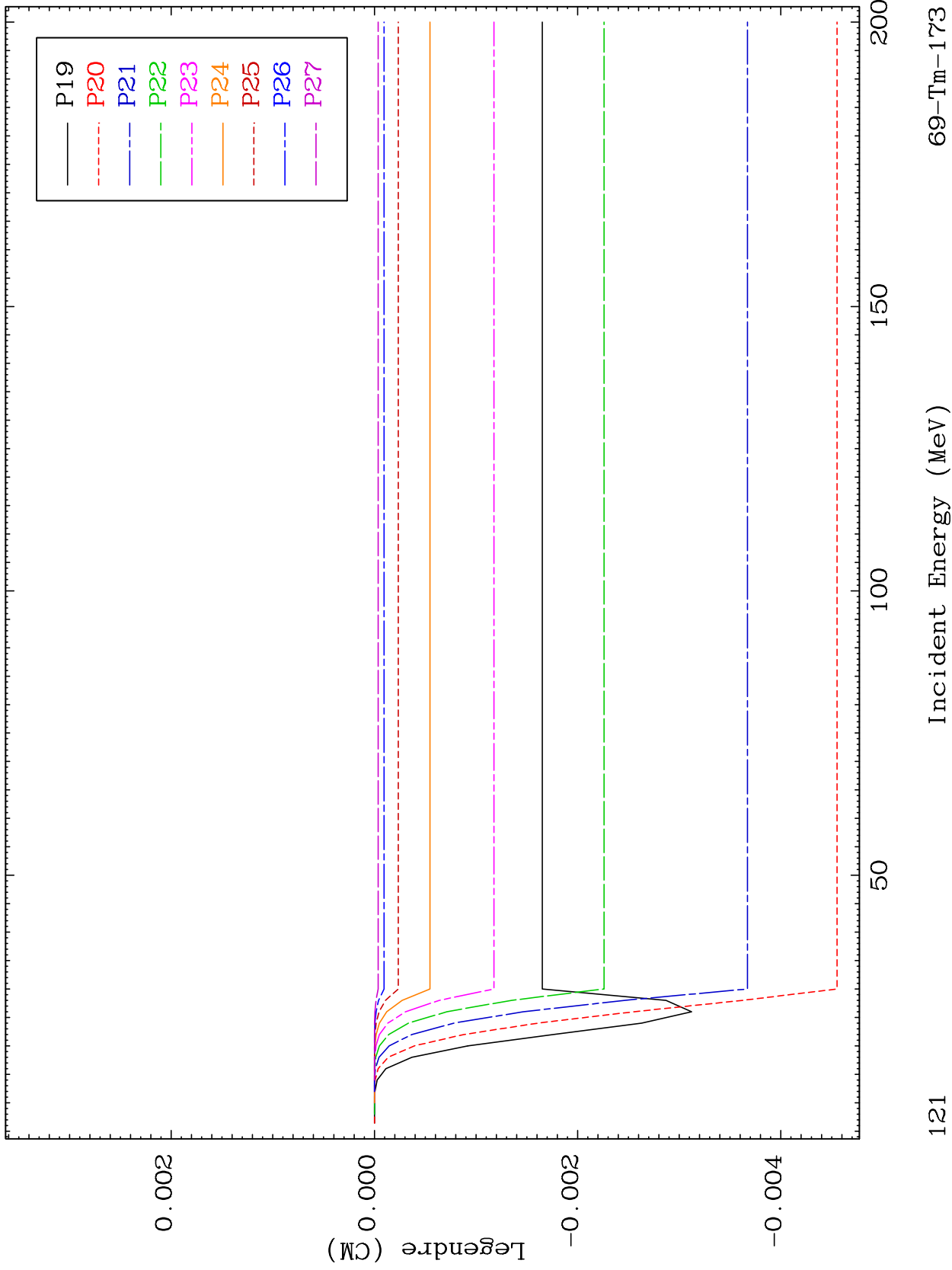

121

Incident Energy (MeV)

69-Tm-173

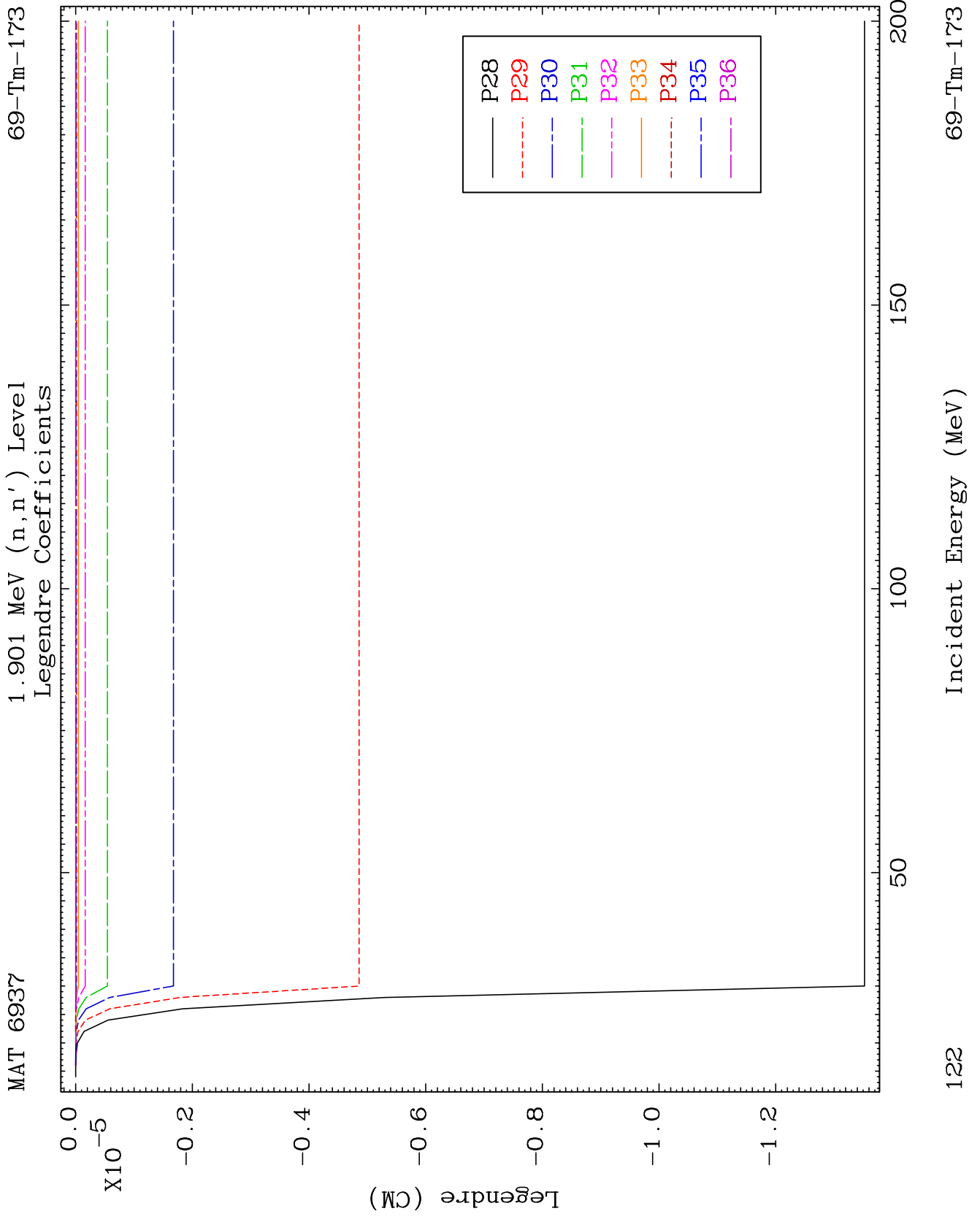

MAT 6937

2.006 MeV (n,n') Level
Legendre Coefficients

69-Tm-173

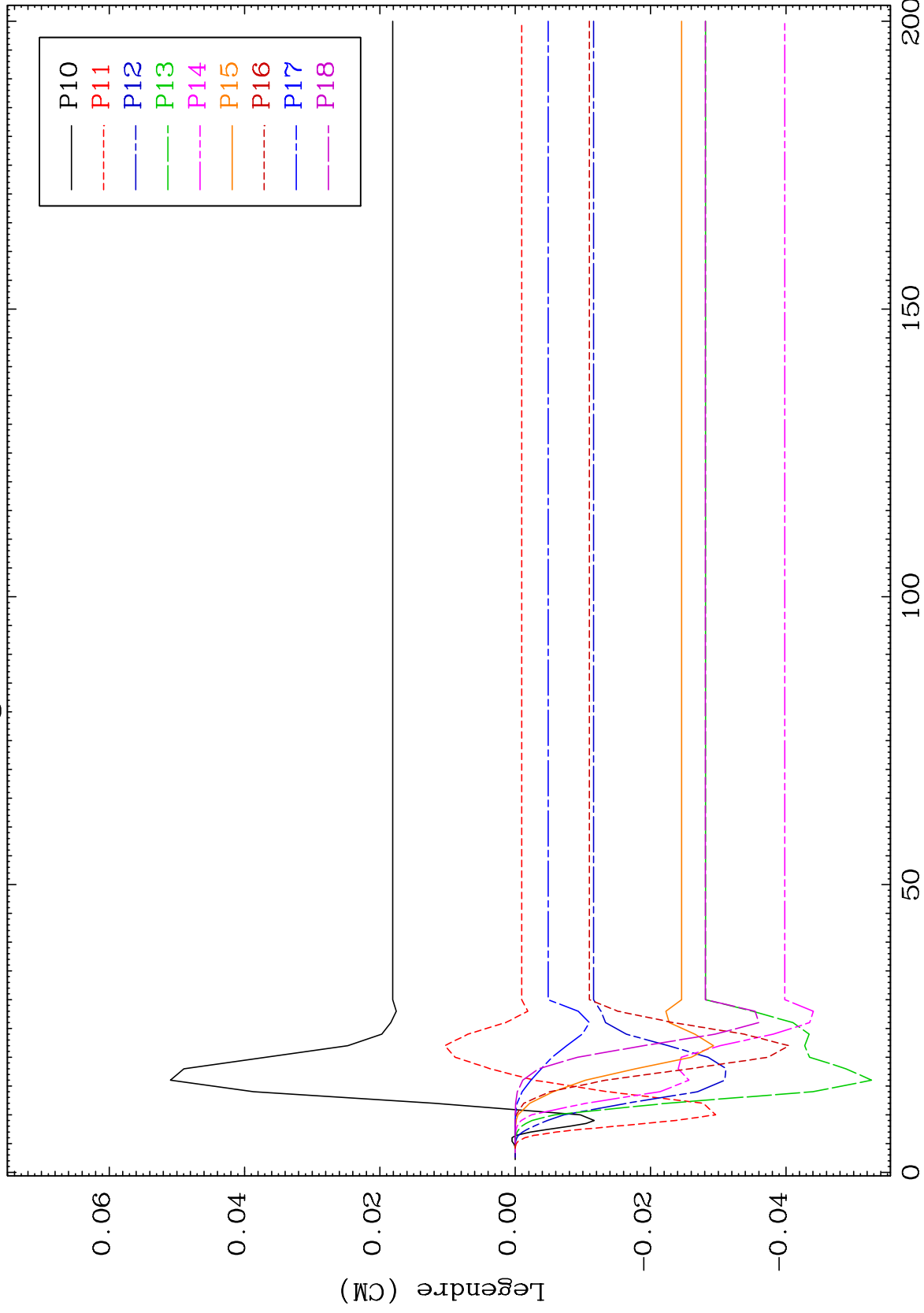

124

Incident Energy (MeV)

69-Tm-173

MAT 6937

2.006 MeV (n,n') Level
Legendre Coefficients

69-Tm-173

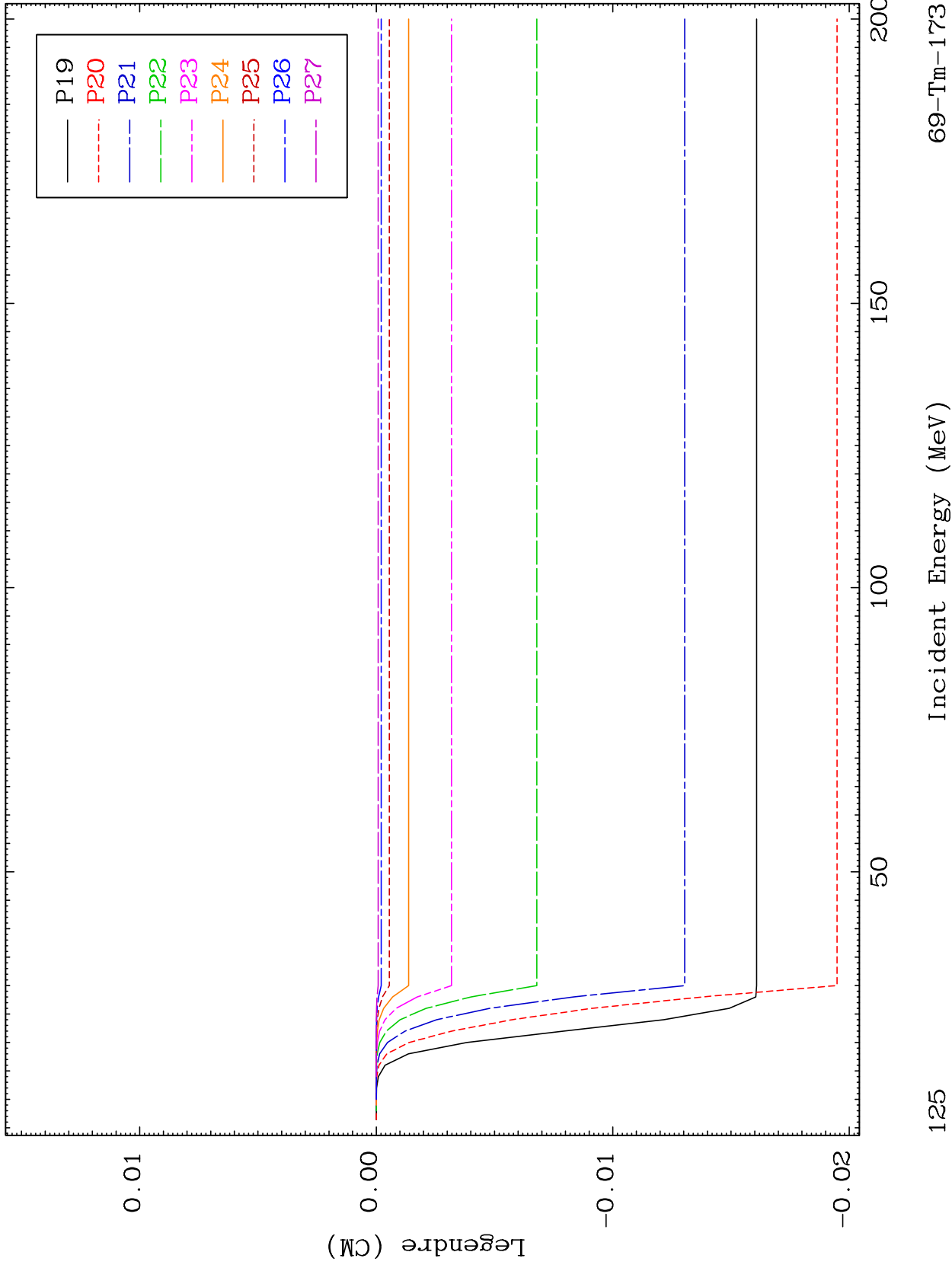

125

Incident Energy (MeV)

69-Tm-173

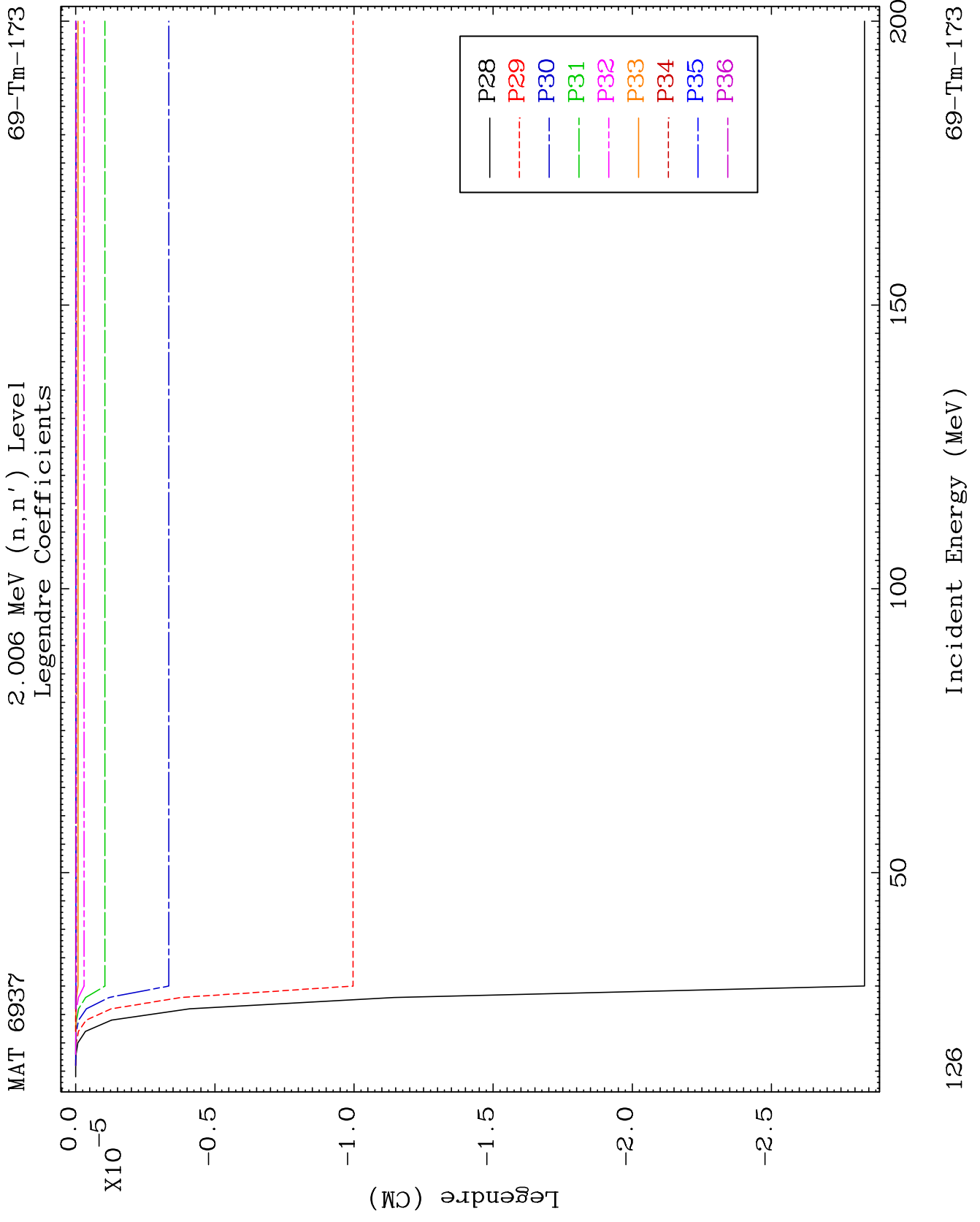

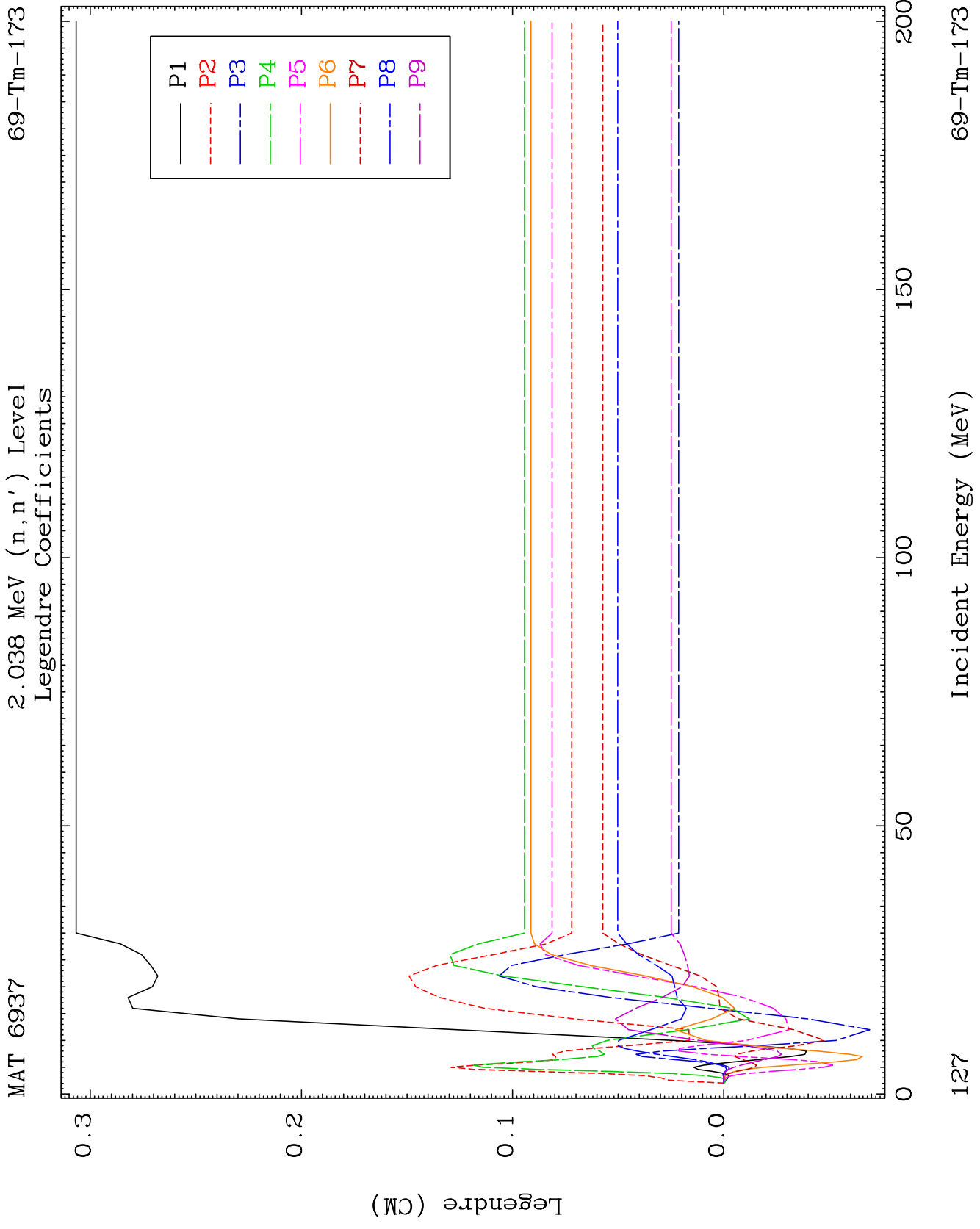

MAT 6937

2.038 MeV (n,n') Level
Legendre Coefficients

69-Tm-173

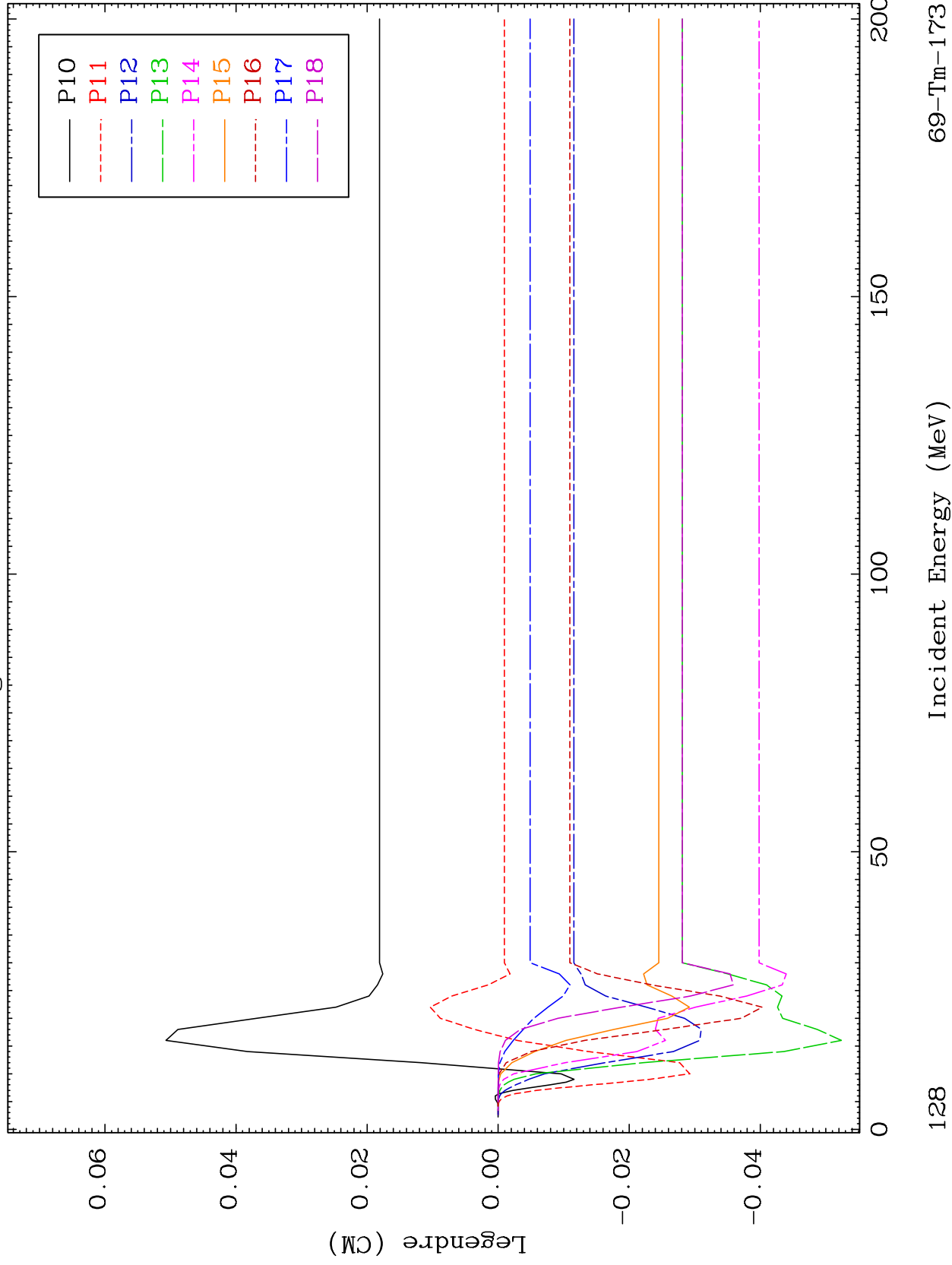

69-Tm-173

Incident Energy (MeV)

128

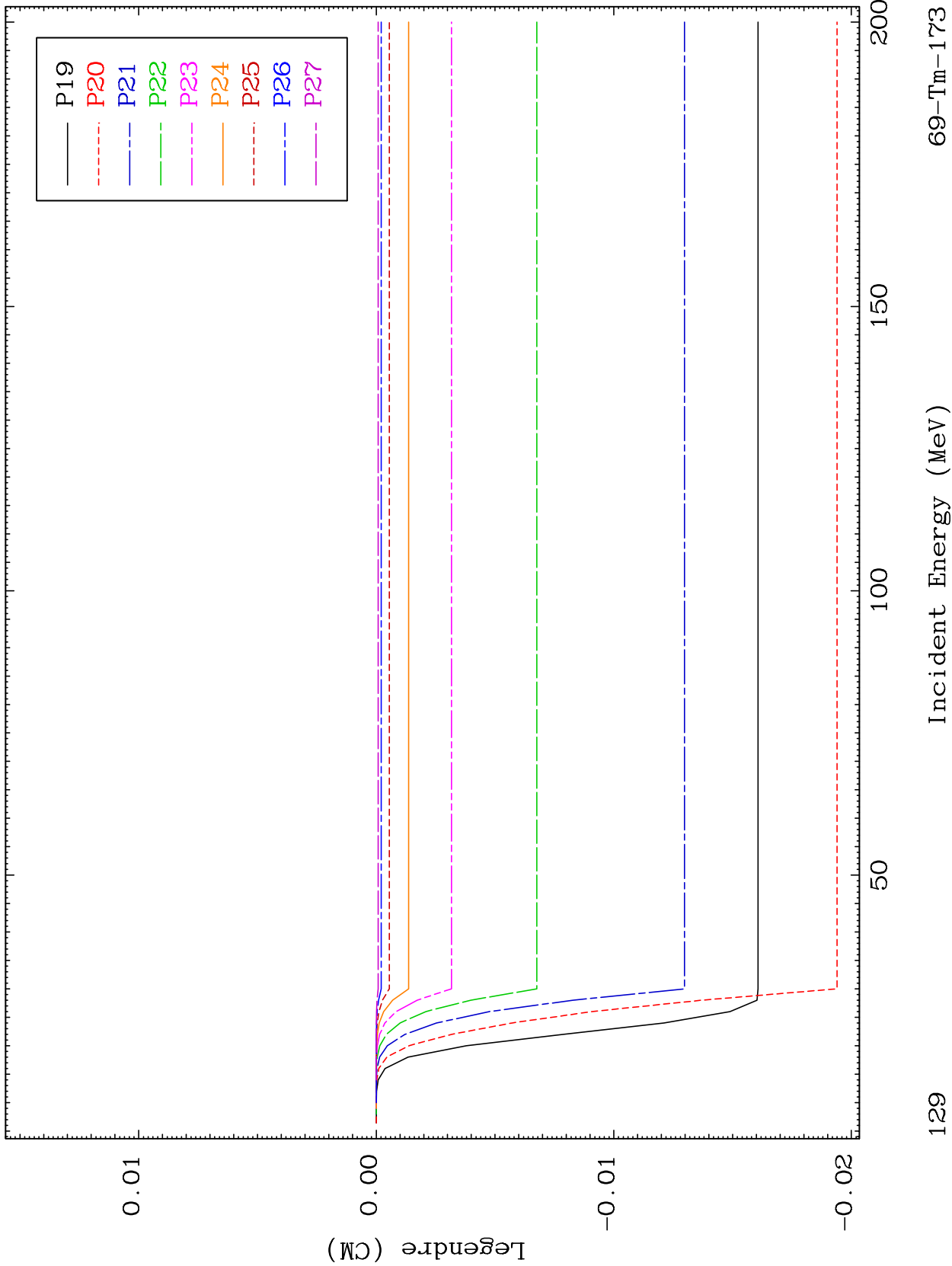

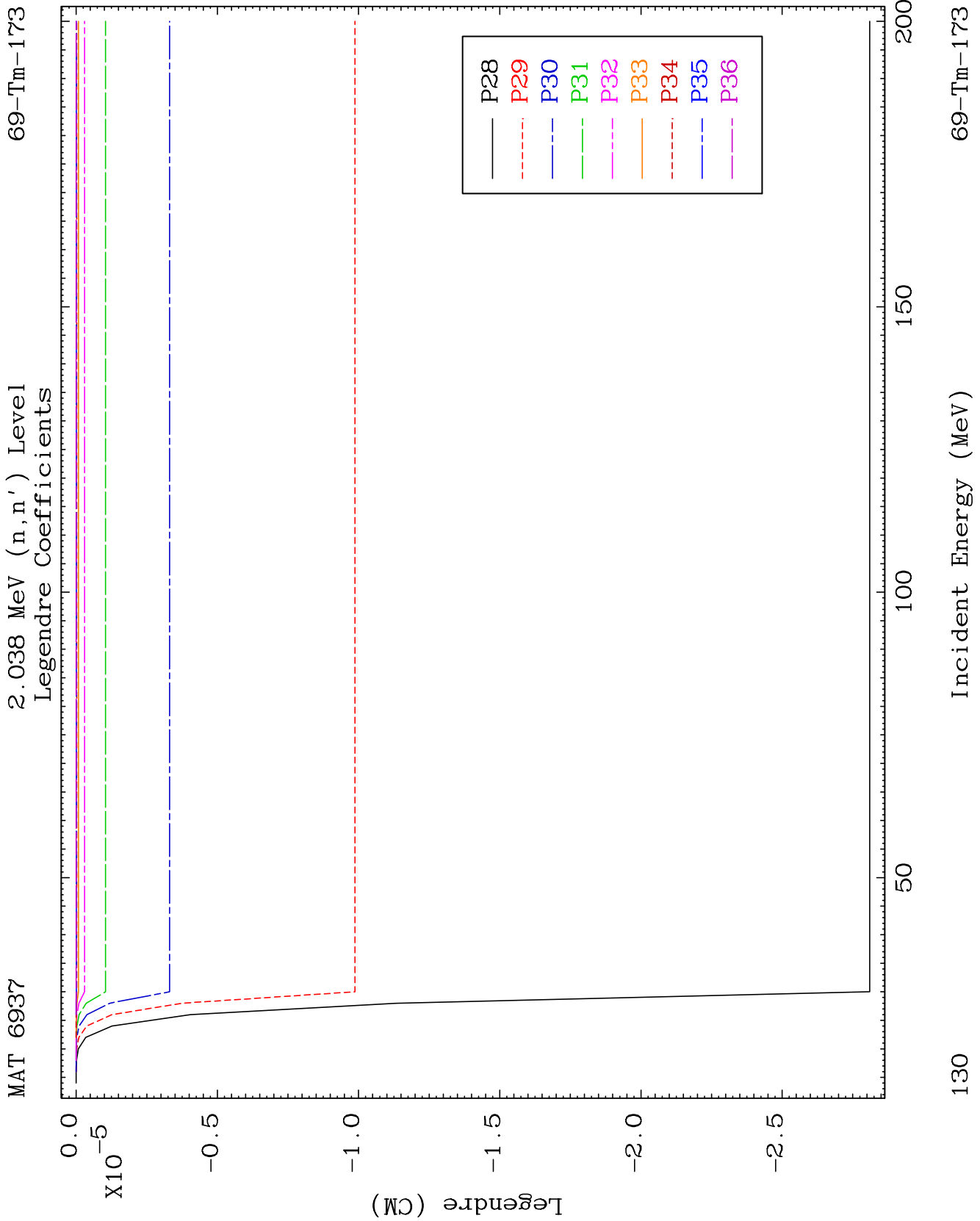

MAT 6937

2.069 MeV (n,n') Level
Legendre Coefficients

69-Tm-173

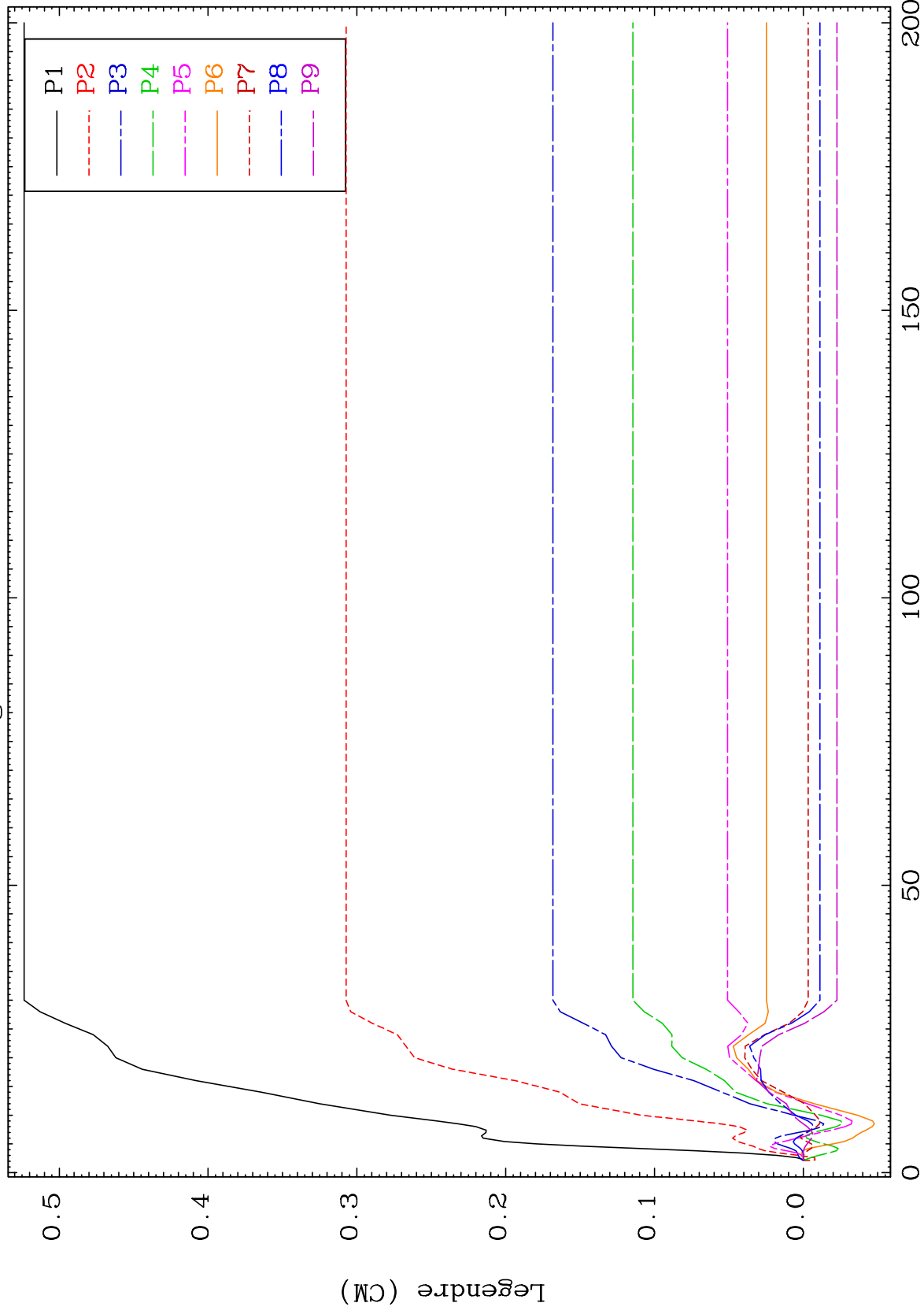

131

Incident Energy (MeV)

69-Tm-173

MAT 6937

2.069 MeV (n,n') Level
Legendre Coefficients

69-Tm-173

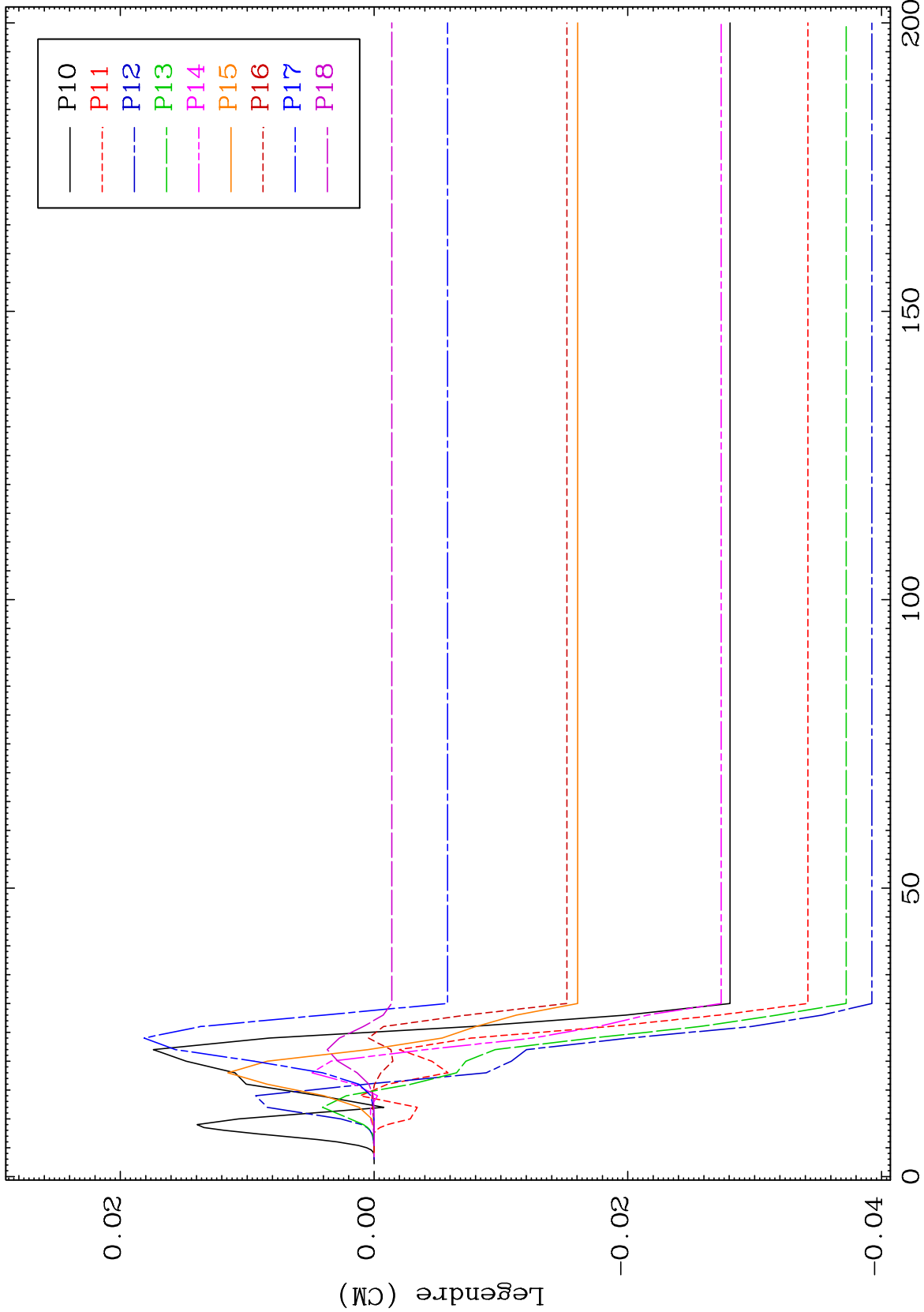

132

Incident Energy (MeV)

69-Tm-173

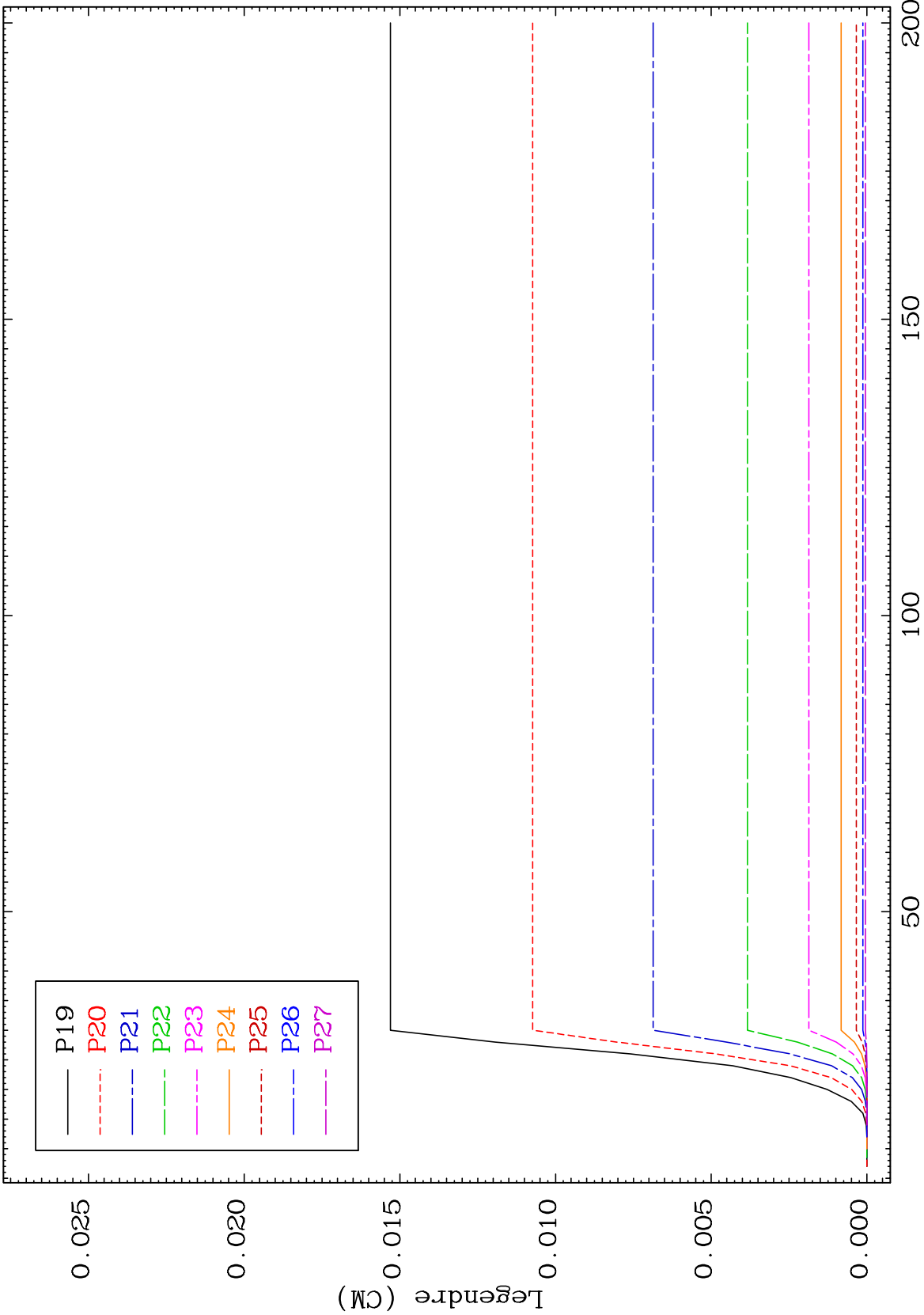

MAT 6937

2.069 MeV (n,n') Level
Legendre Coefficients

69-Tm-173

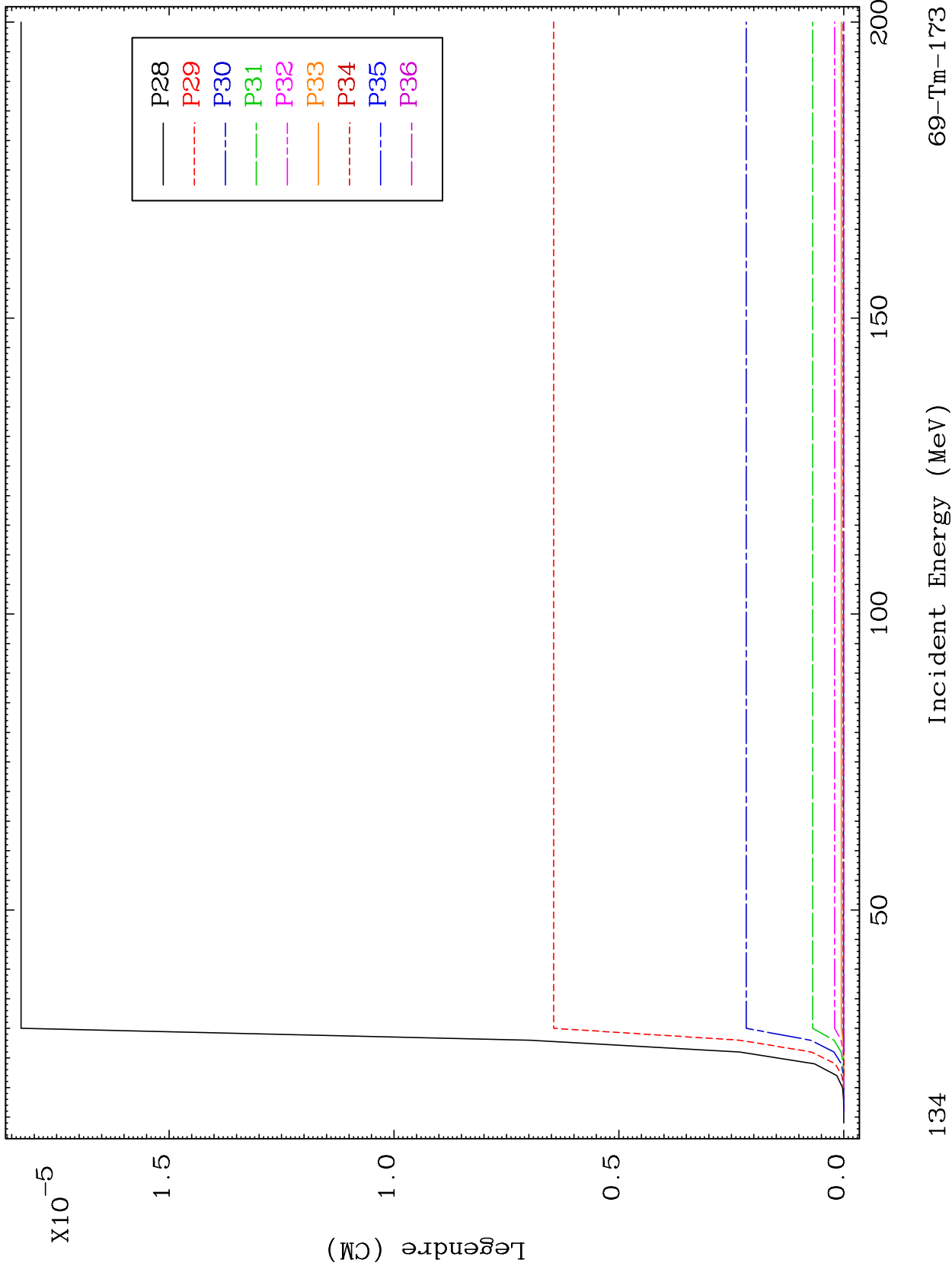

134

69-Tm-173

MAT 6937

2.096 MeV (n,n') Level
Legendre Coefficients

69-Tm-173

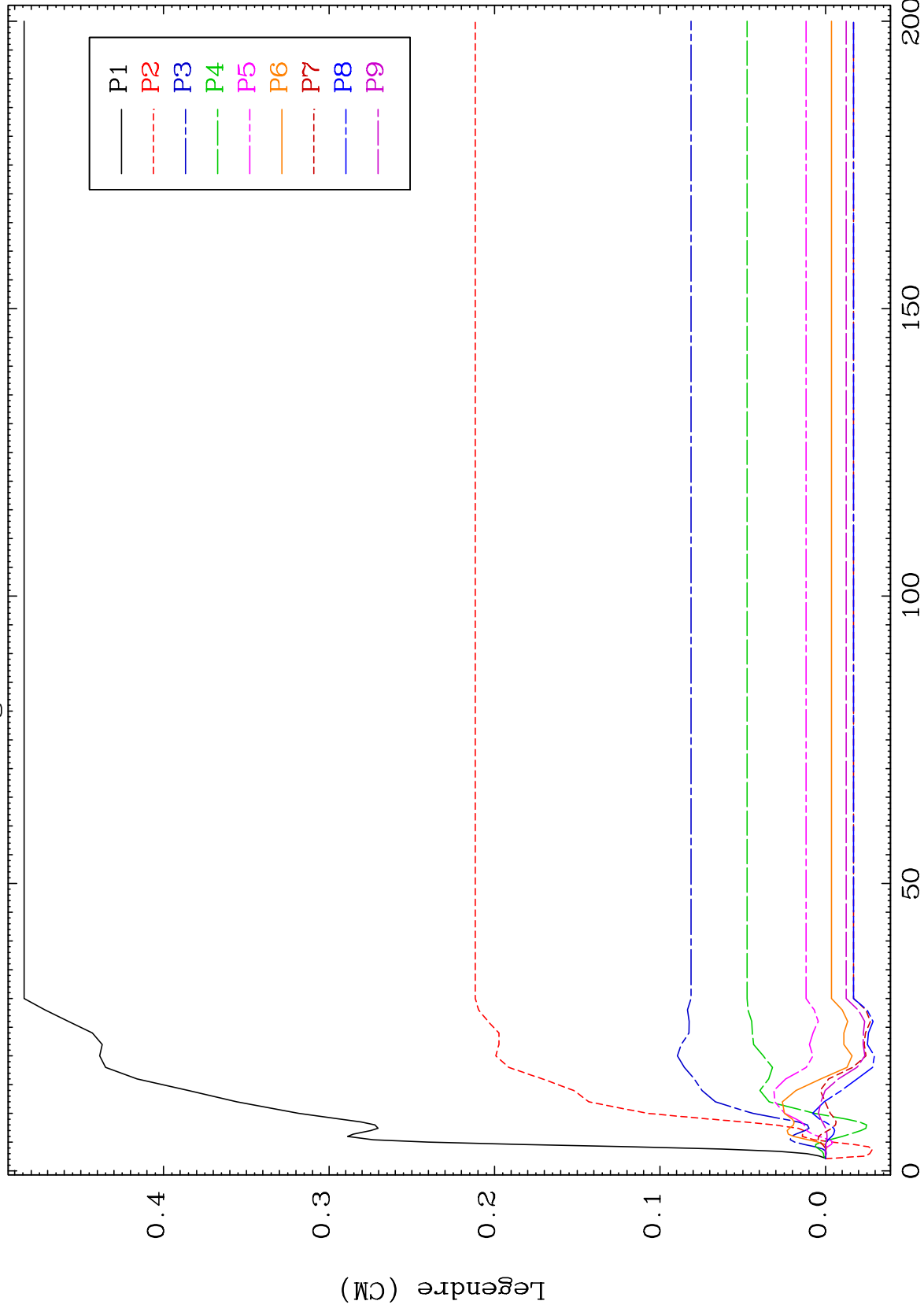

69-Tm-173

Incident Energy (MeV)

135

MAT 6937

2.096 MeV (n,n') Level
Legendre Coefficients

69-Tm-173

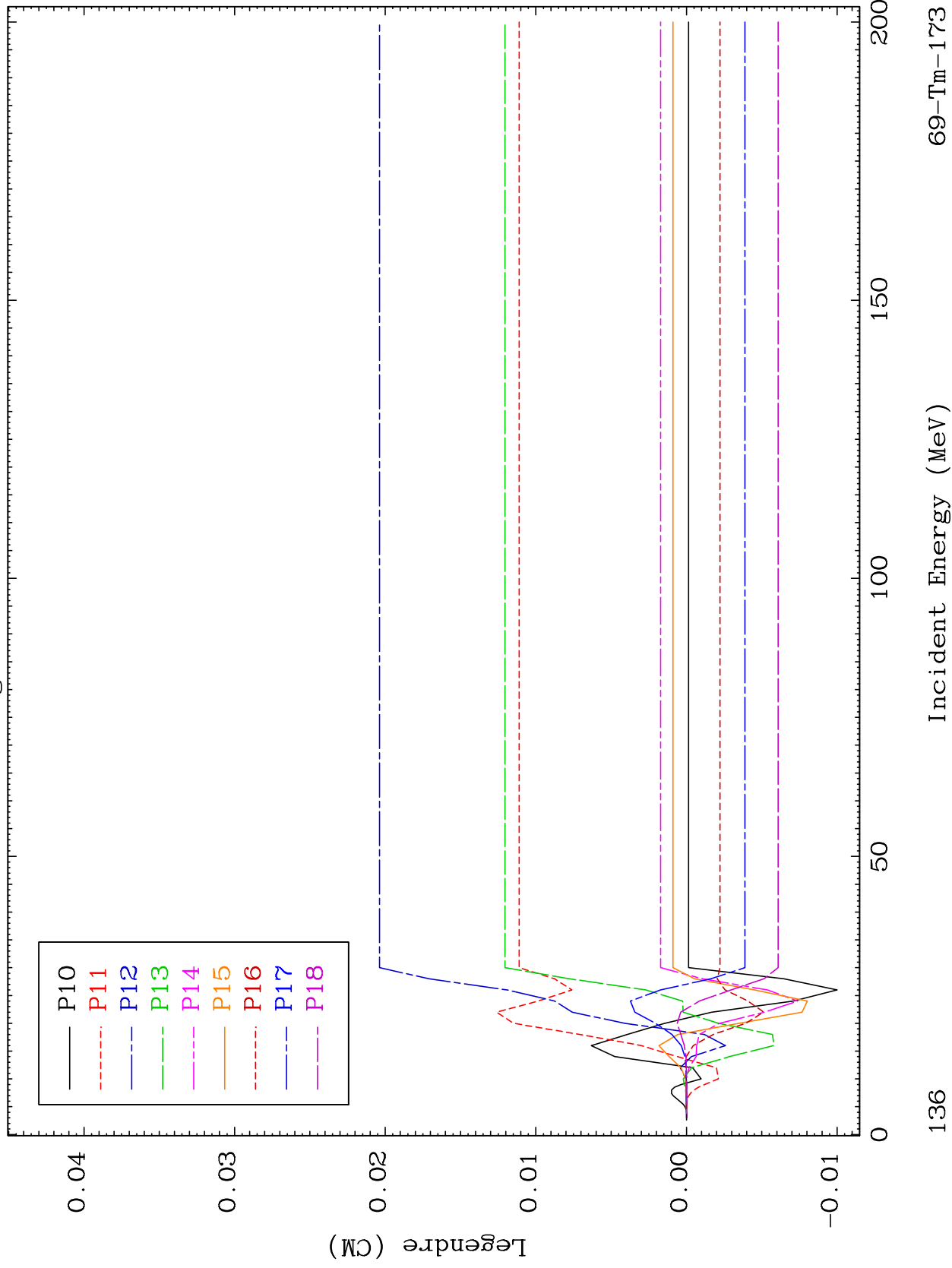

136

Incident Energy (MeV)

69-Tm-173

MAT 6937

2.096 MeV (n,n') Level
Legendre Coefficients

69-Tm-173

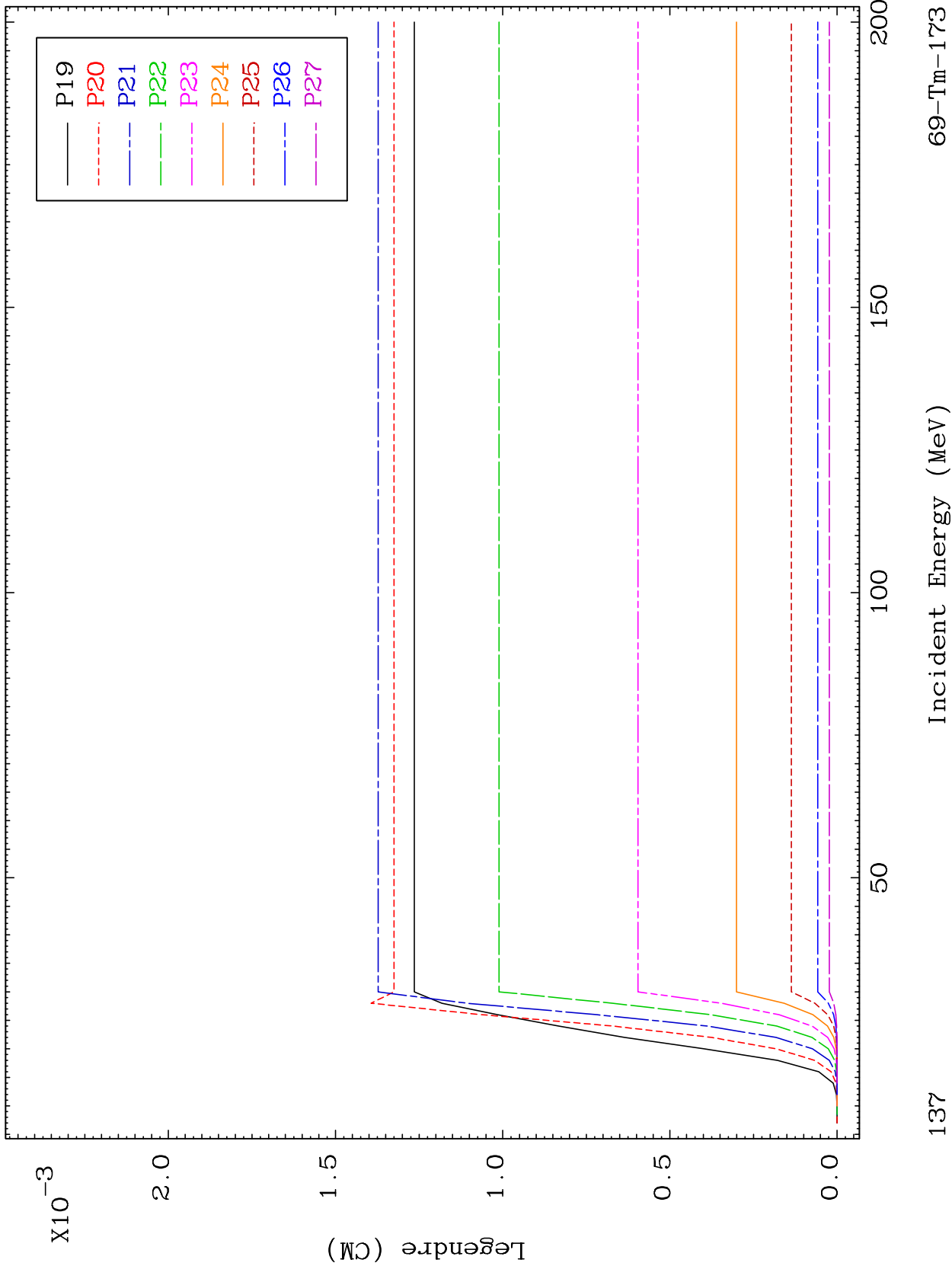

137

Incident Energy (MeV)

69-Tm-173

MAT 6937

2.096 MeV (n,n') Level
Legendre Coefficients

69-Tm-173

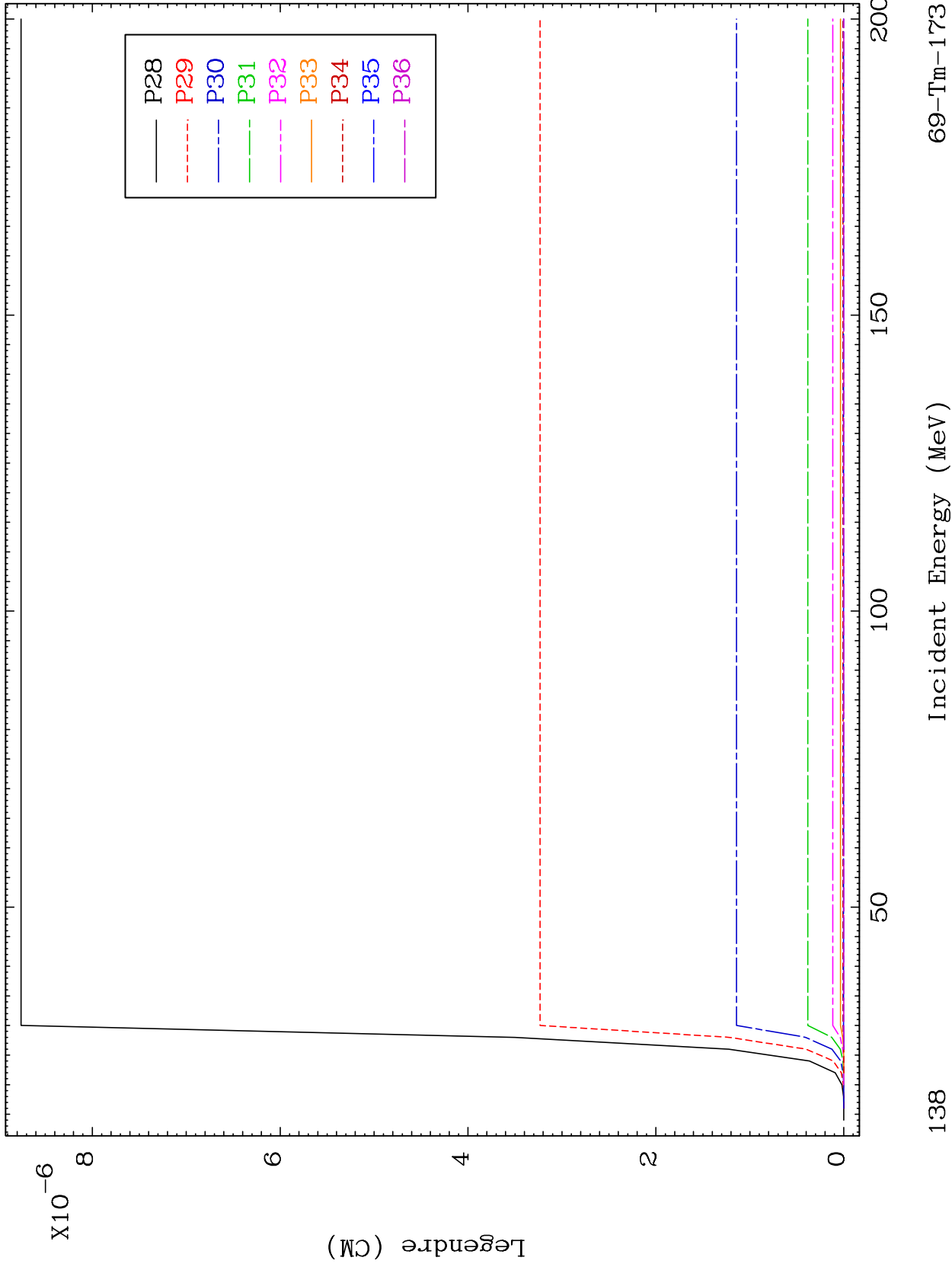

138

Incident Energy (MeV)

69-Tm-173

MAT 6937

$(n,2n) \alpha$

69-Tm-173

Radionuclide Production Cross Section

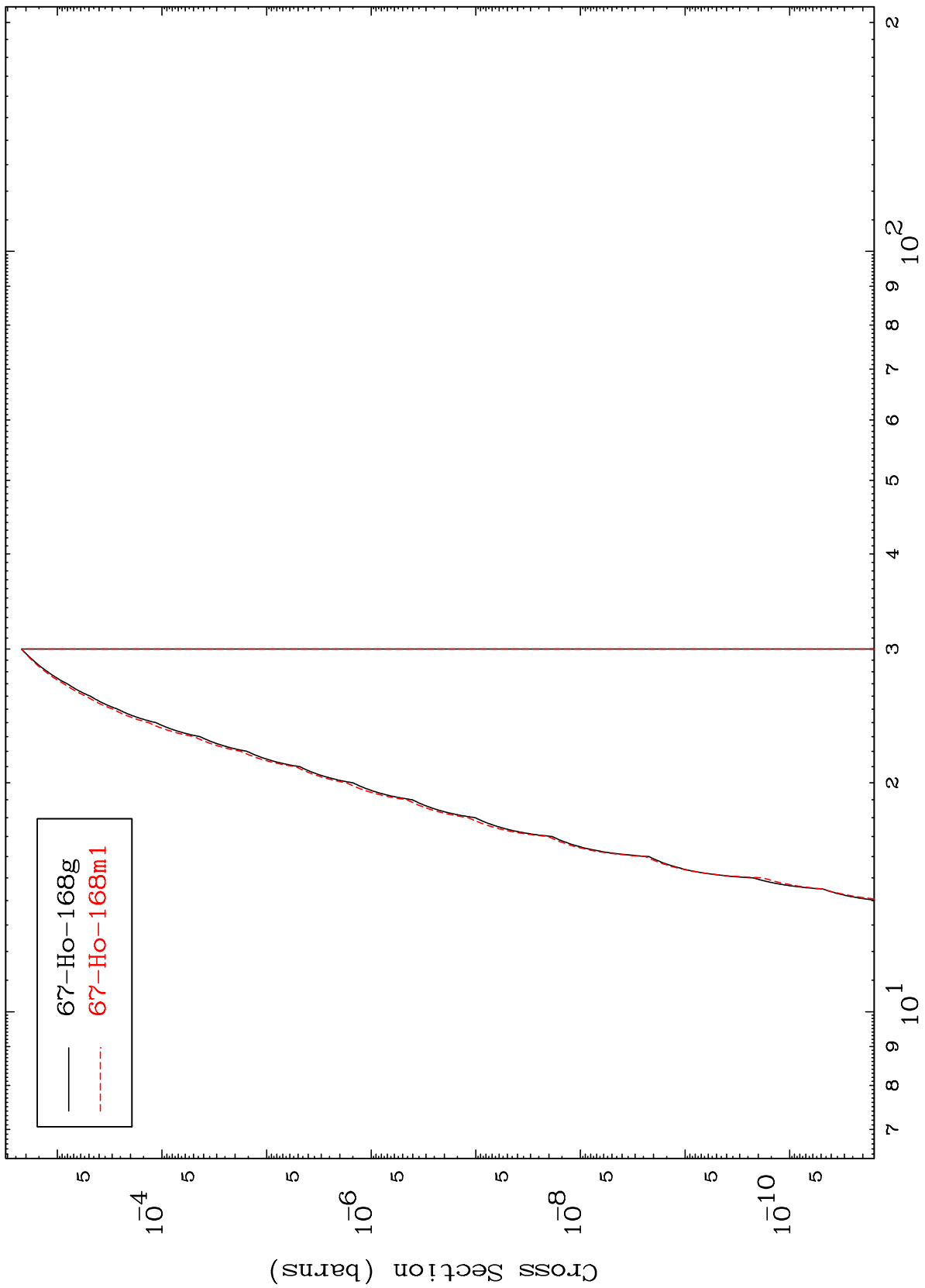

139

Incident Energy (MeV)

69-Tm-173

MAT 6937

(n,n') He-3

69-Tm-173

Radionuclide Production Cross Section

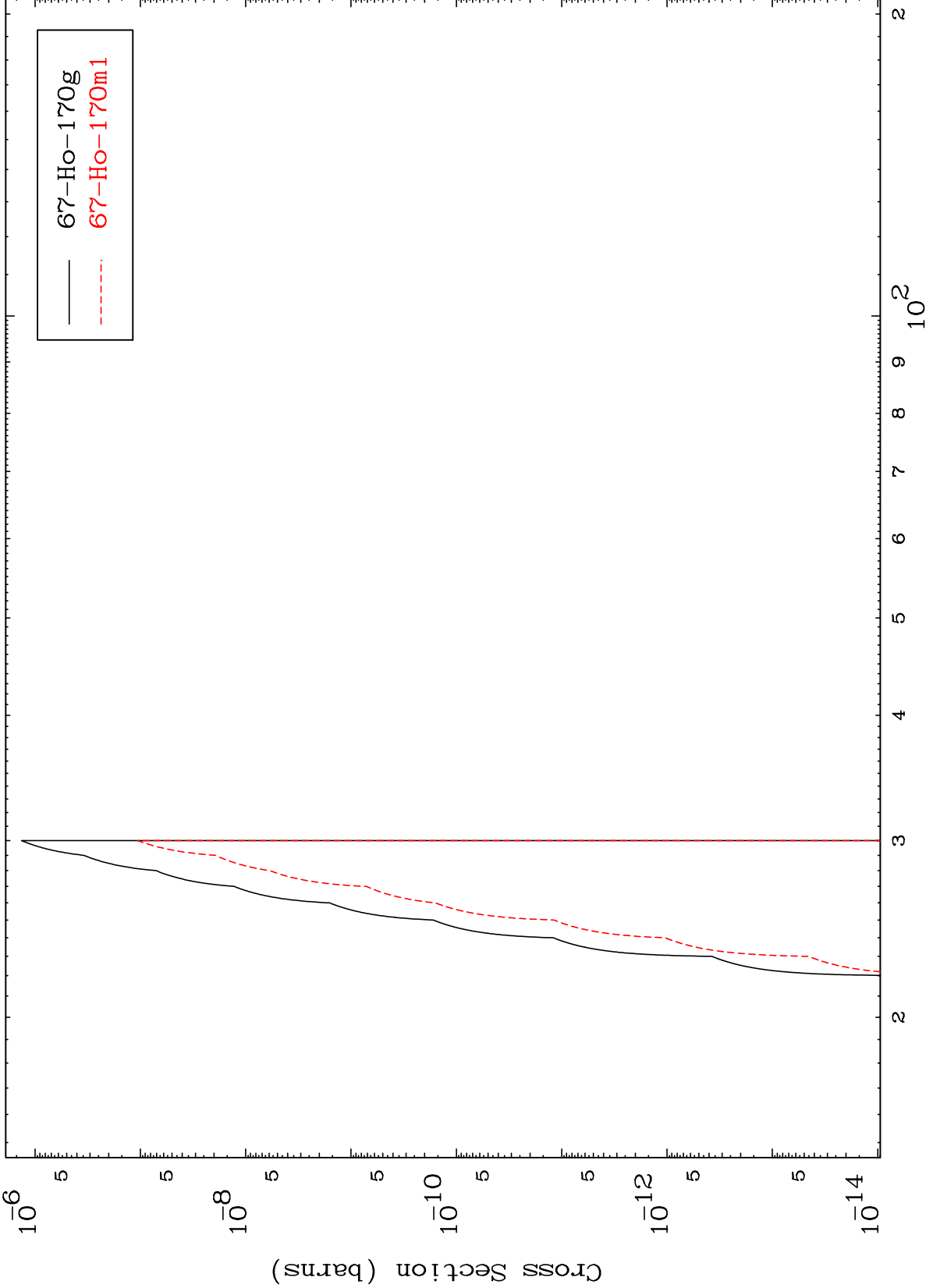

140

Incident Energy (MeV)

69-Tm-173

MAT 6937

(n, α)

69-Tm-173

Radionuclide Production Cross Section

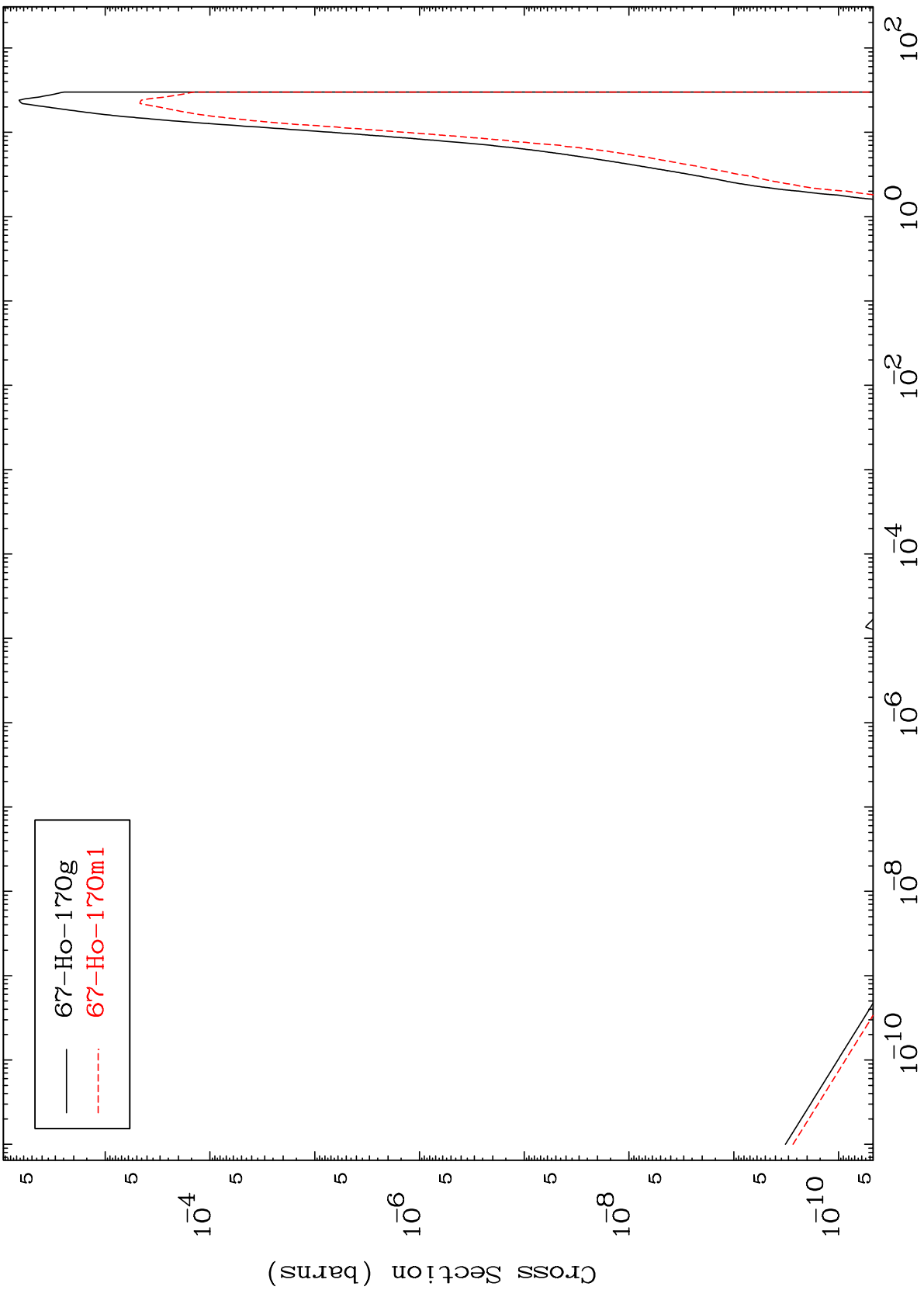

67-Ho-170g
67-Ho-170m1

Incident Energy (MeV)

69-Tm-173

141