

# TM178 NRG TENDL-2015, AKONING

## Principal cross sections

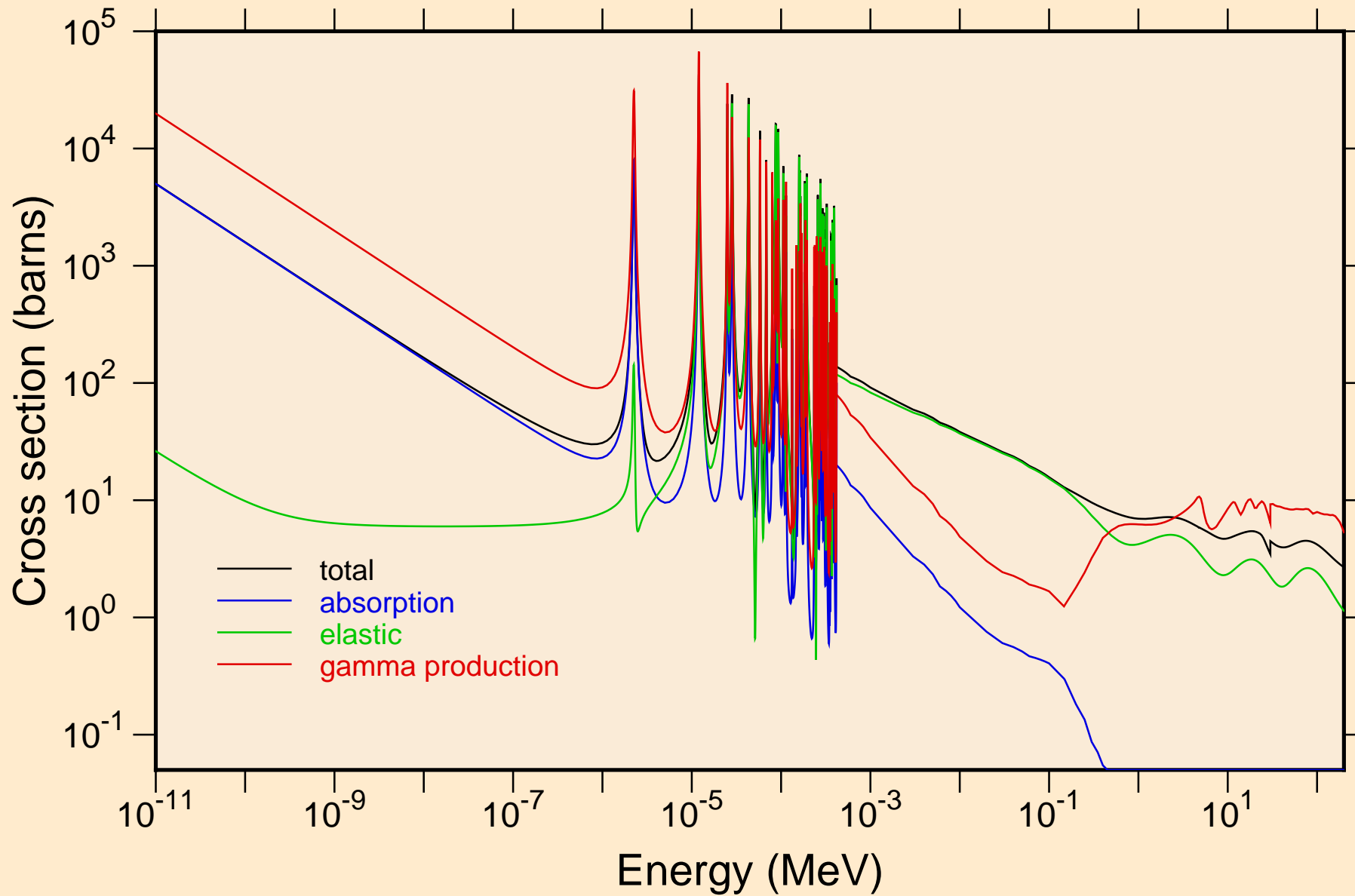

TM178 NRG TENDL-2015, AKONING  
resonance total cross section

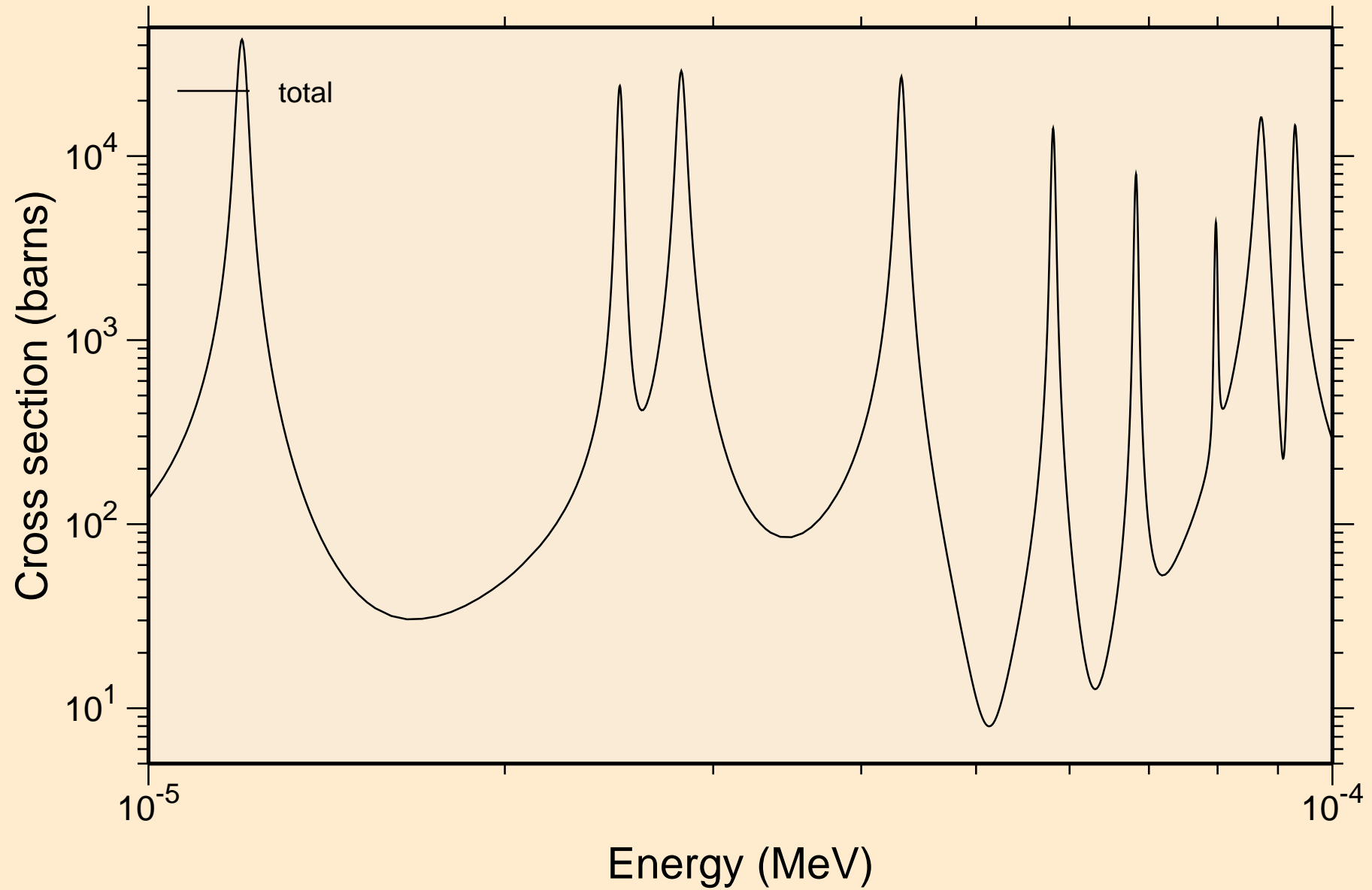

TM178 NRG TENDL-2015, AKONING  
resonance total cross section

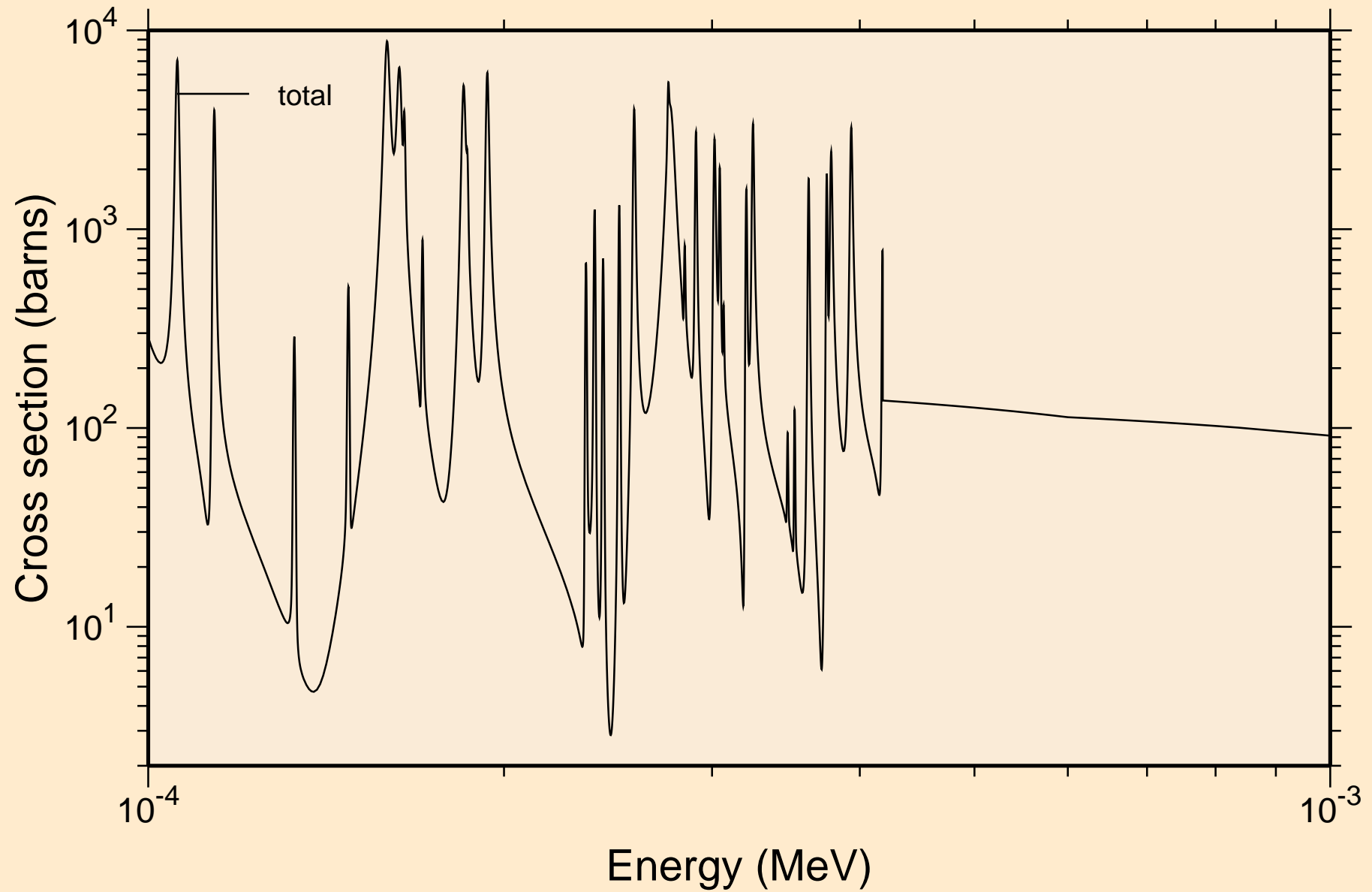

TM178 NRG TENDL-2015, AKONING  
resonance total cross section

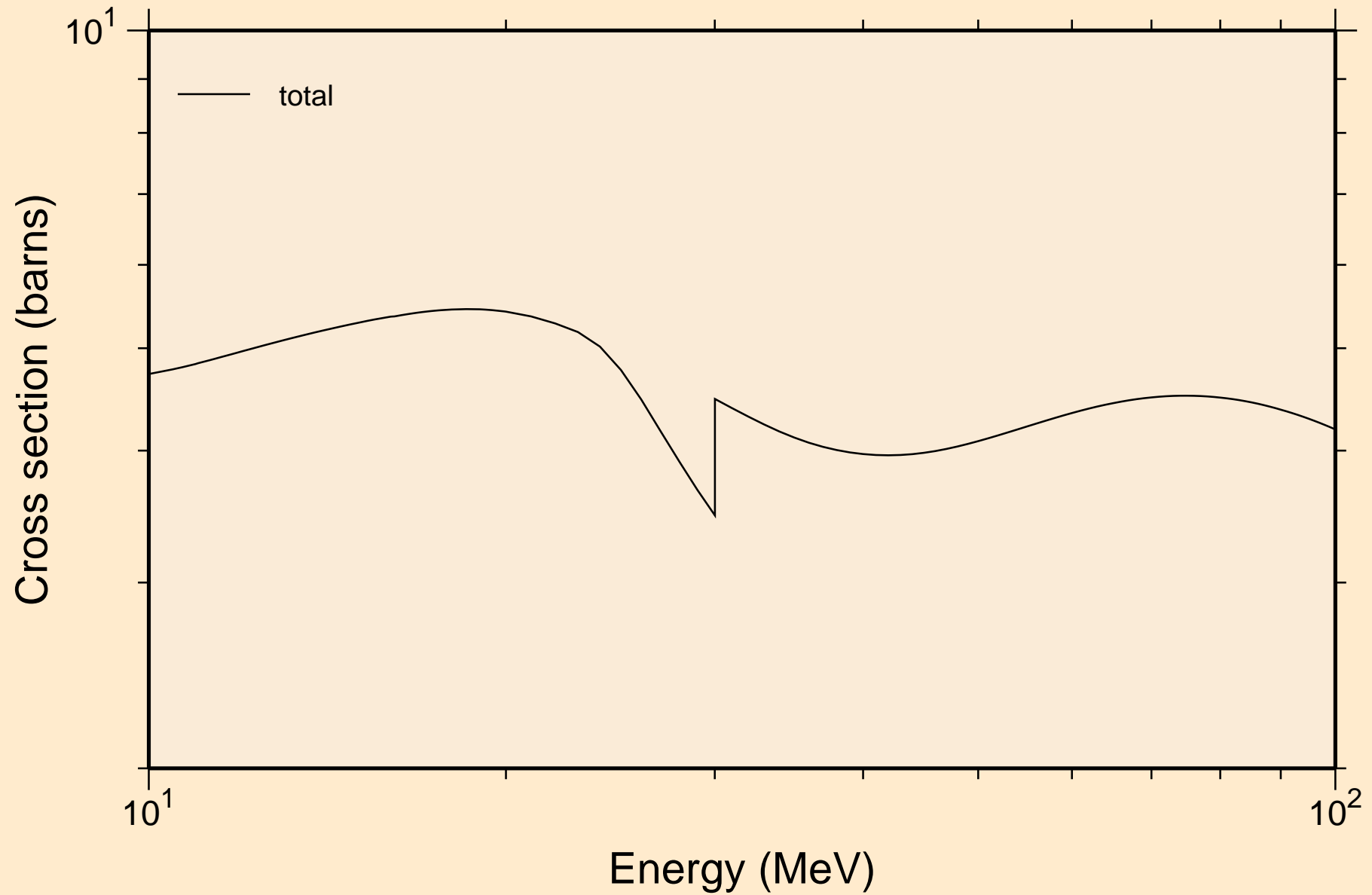

TM178 NRG TENDL-2015, AKONING  
resonance absorption cross sections

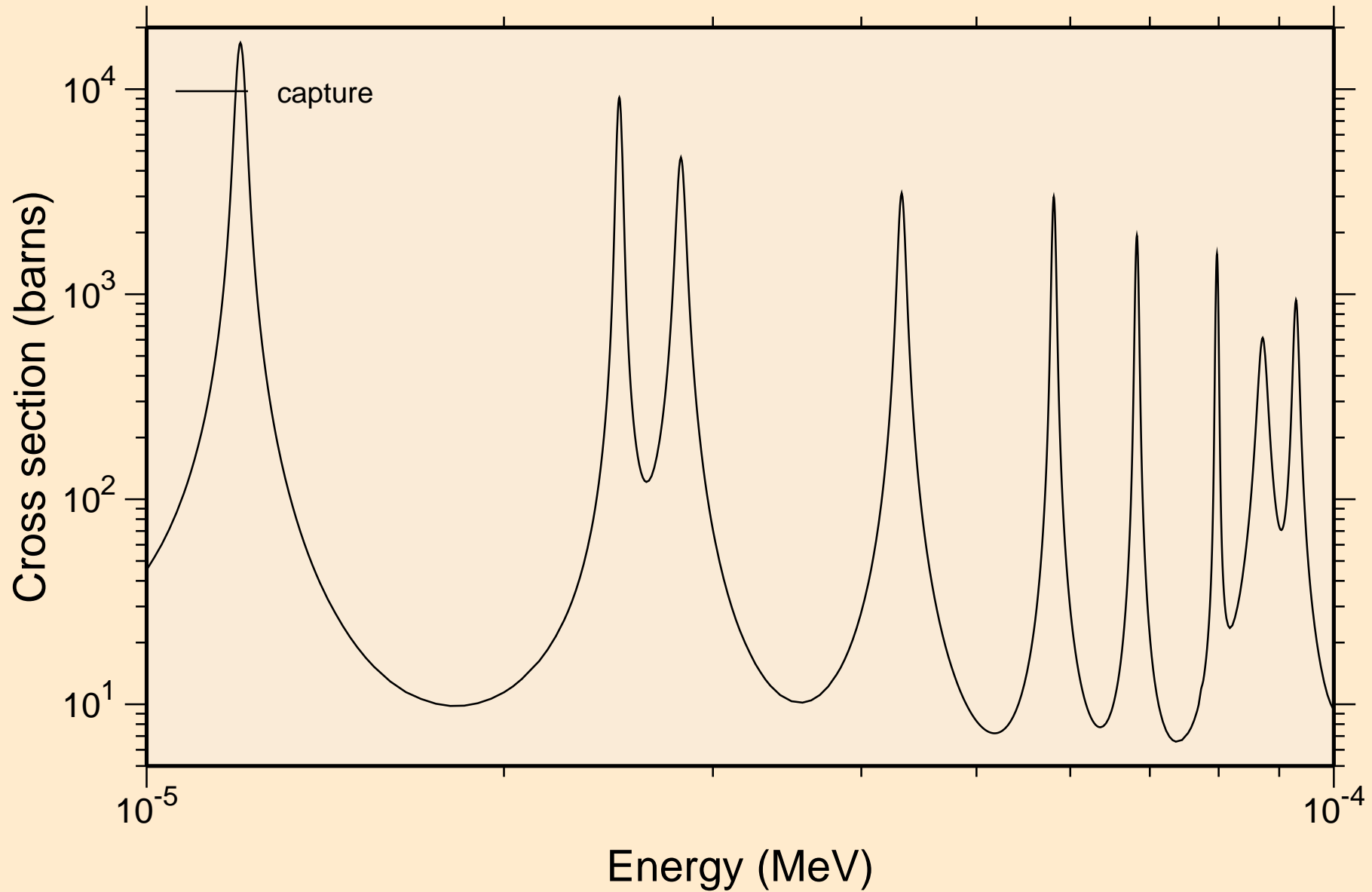

TM178 NRG TENDL-2015, AKONING  
resonance absorption cross sections

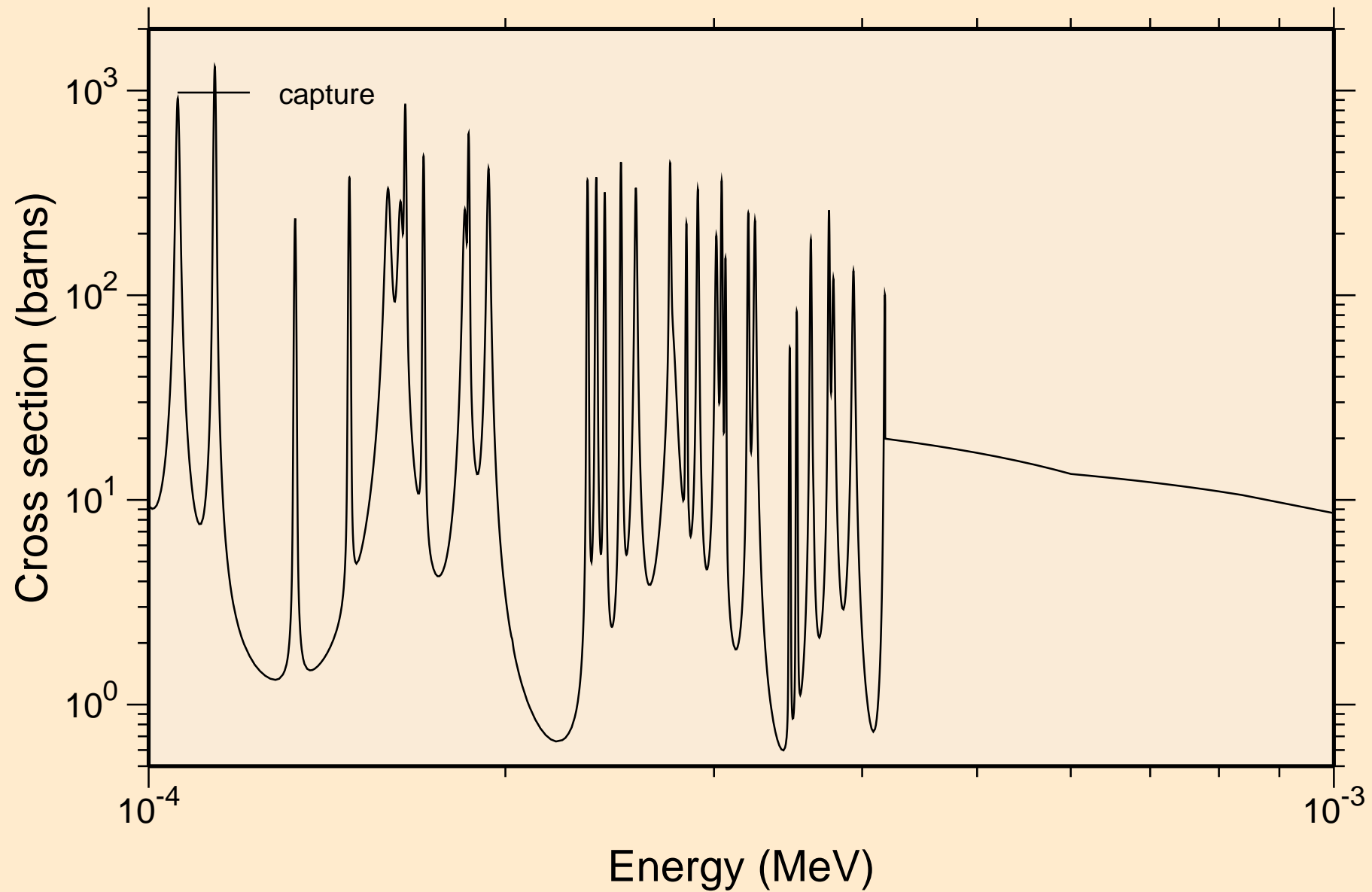

TM178 NRG TENDL-2015, AKONING  
resonance absorption cross sections

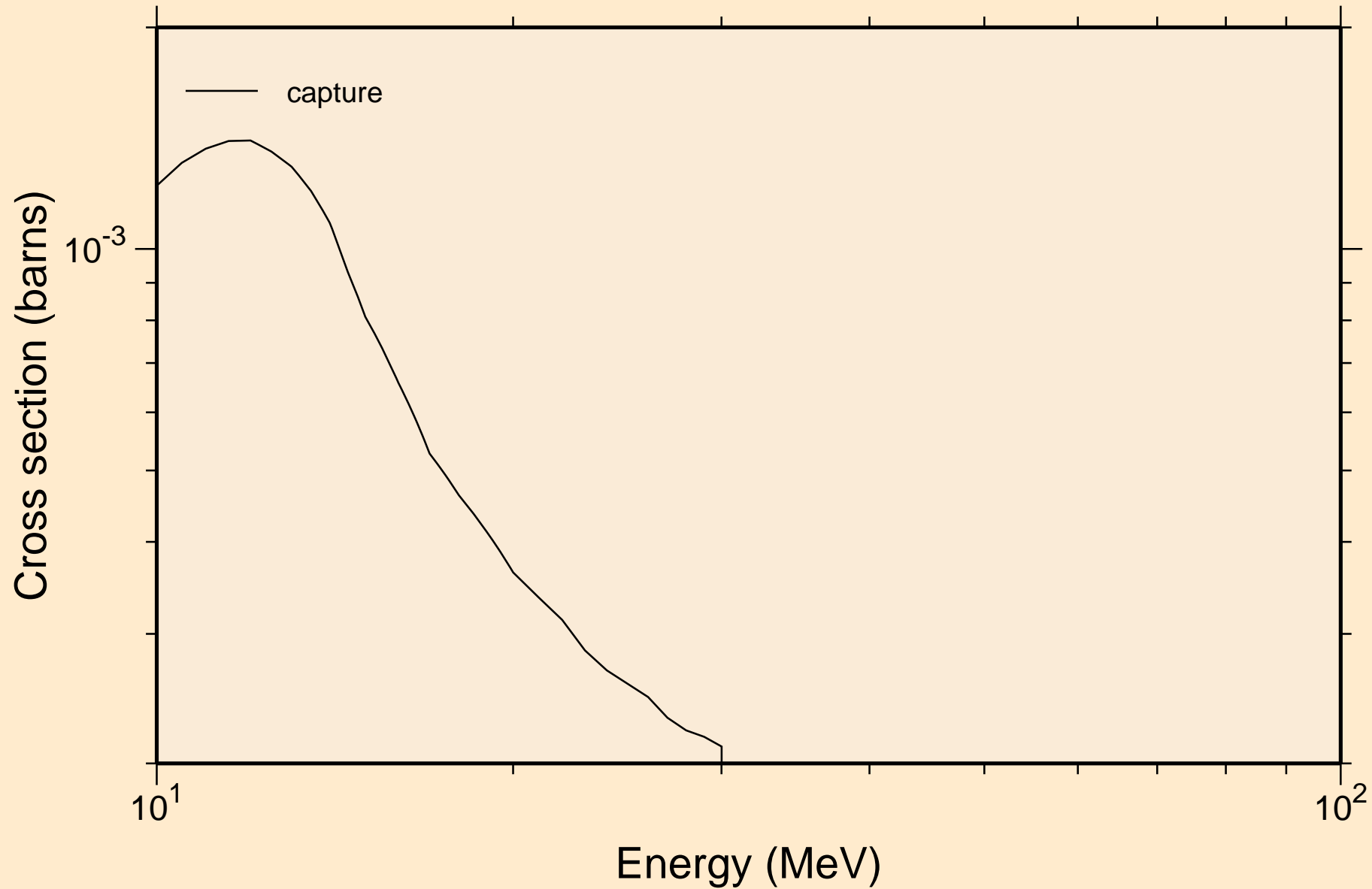

# TM178 NRG TENDL-2015, AKONING

## Non-threshold reactions

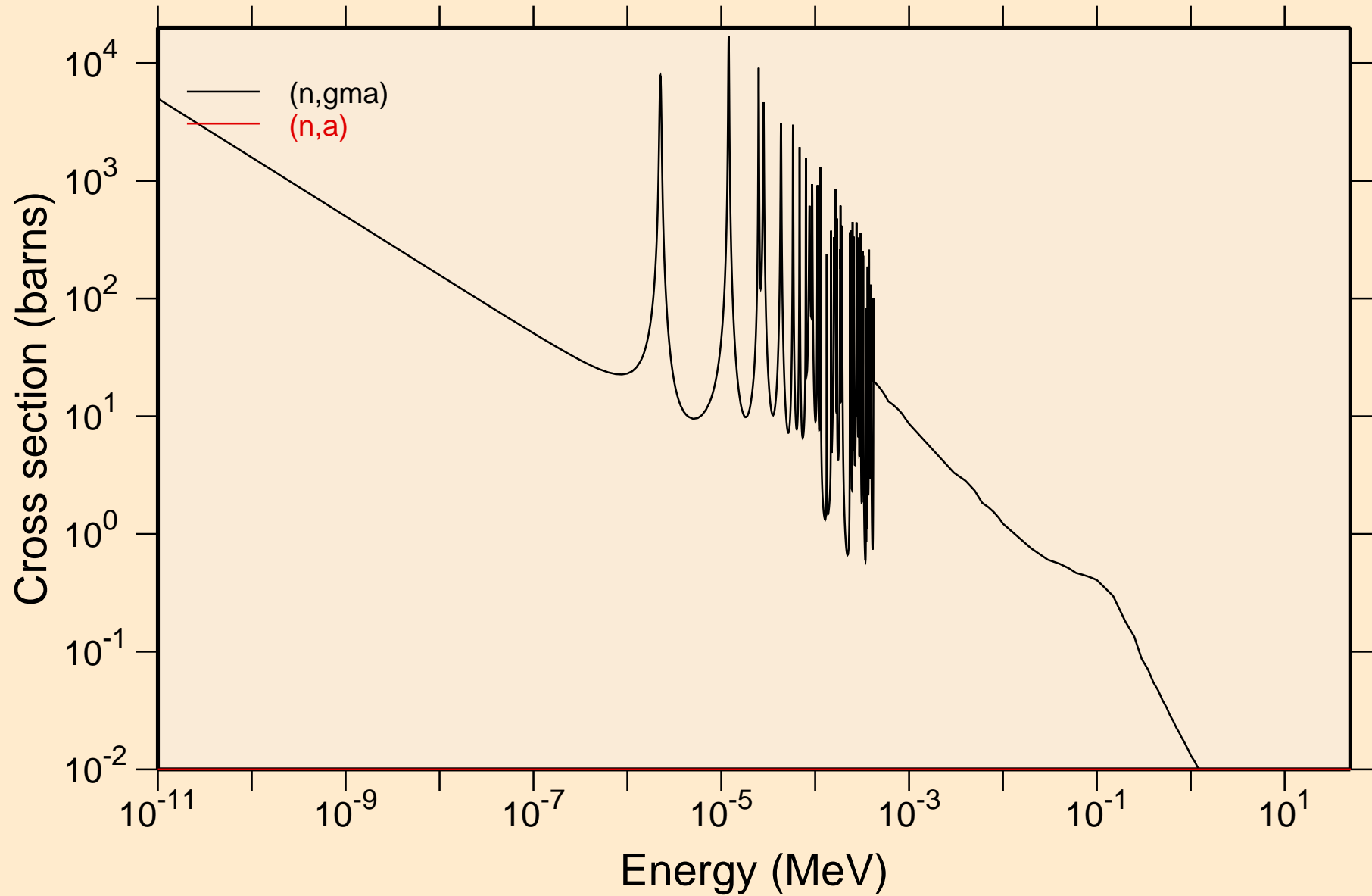



# TM178 NRG TENDL-2015, AKONING

## Principal cross sections

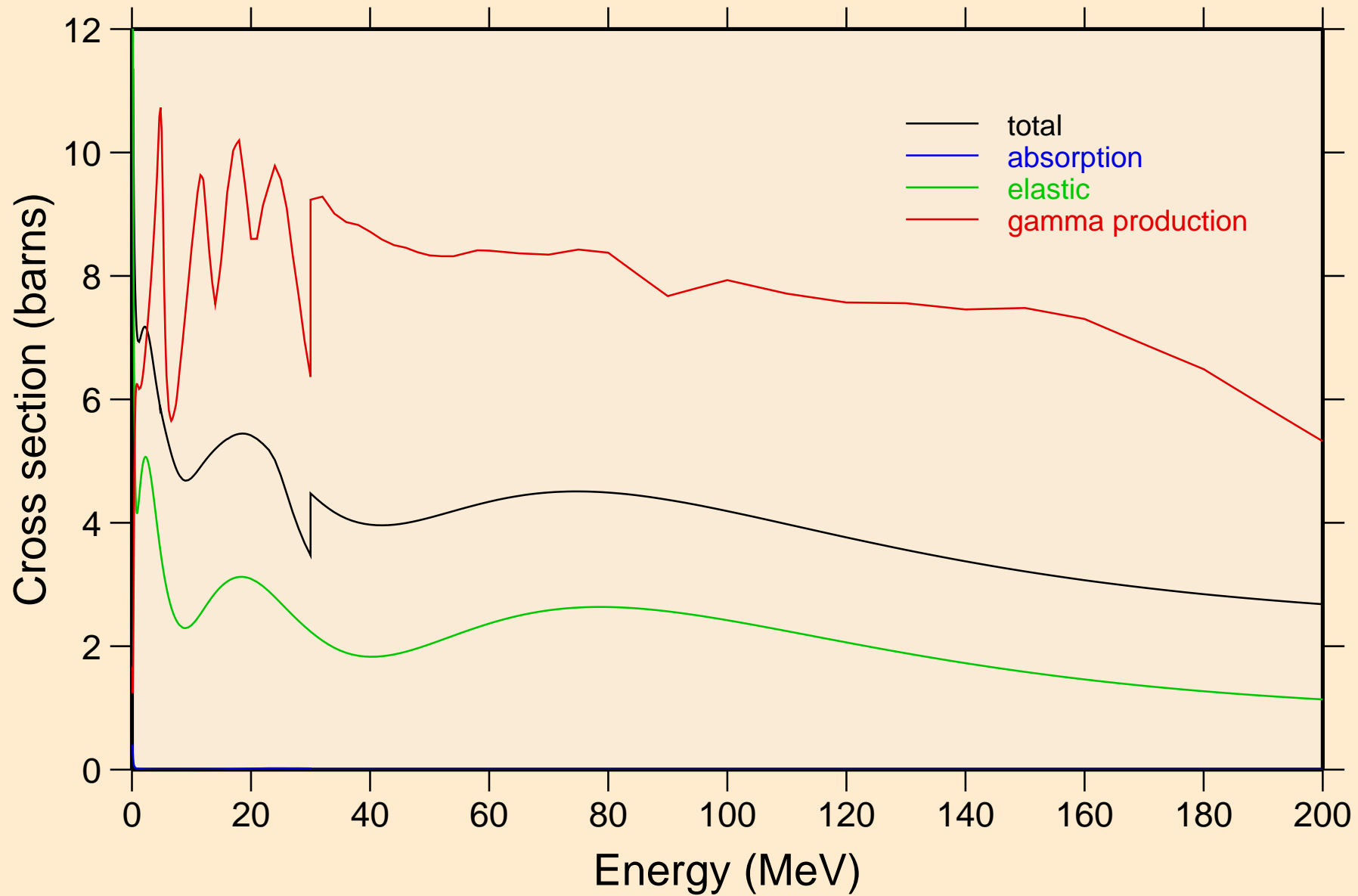

# TM178 NRG TENDL-2015, AKONING

## Non-threshold reactions

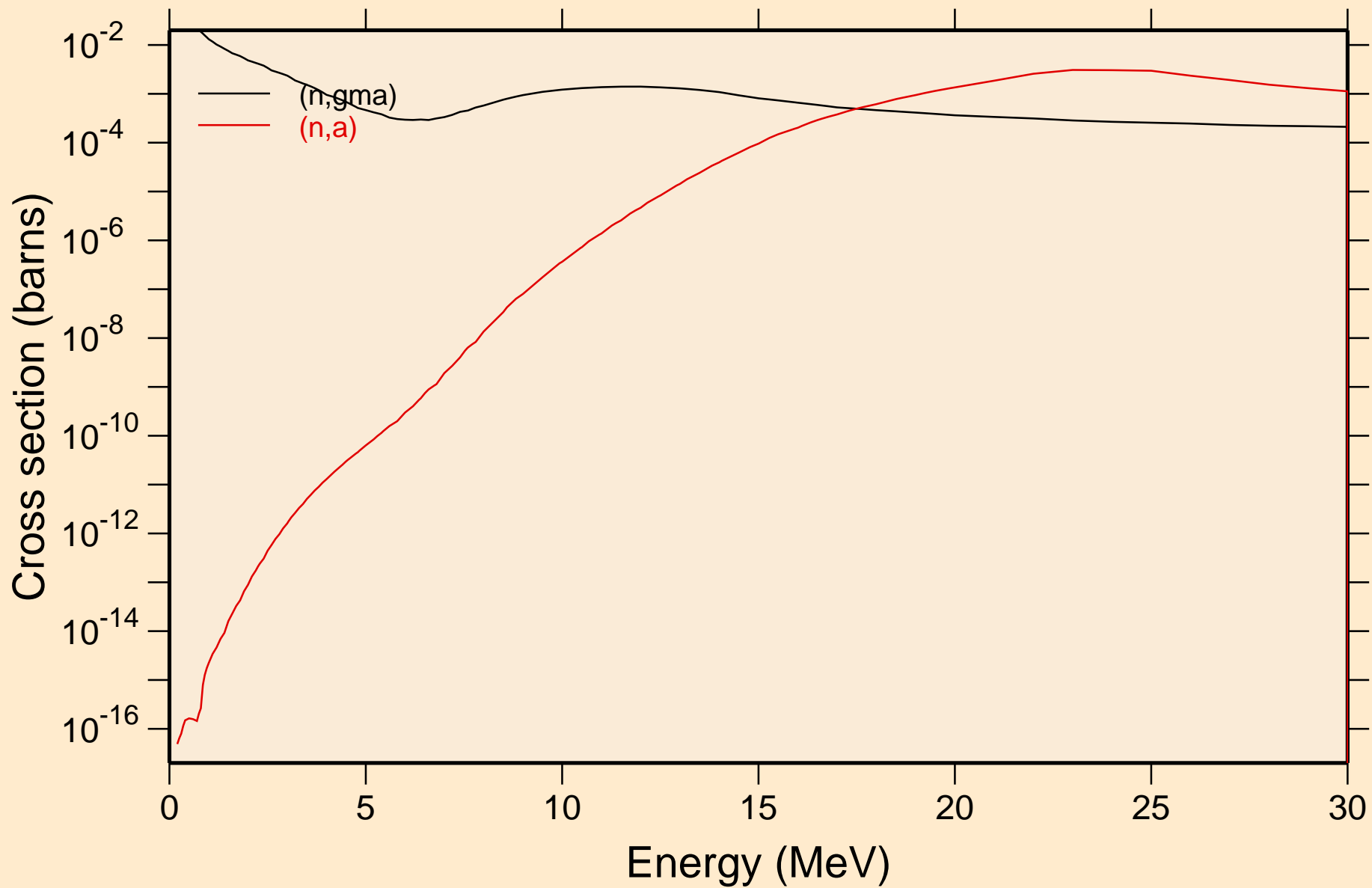

# TM178 NRG TENDL-2015, AKONING

## Inelastic levels

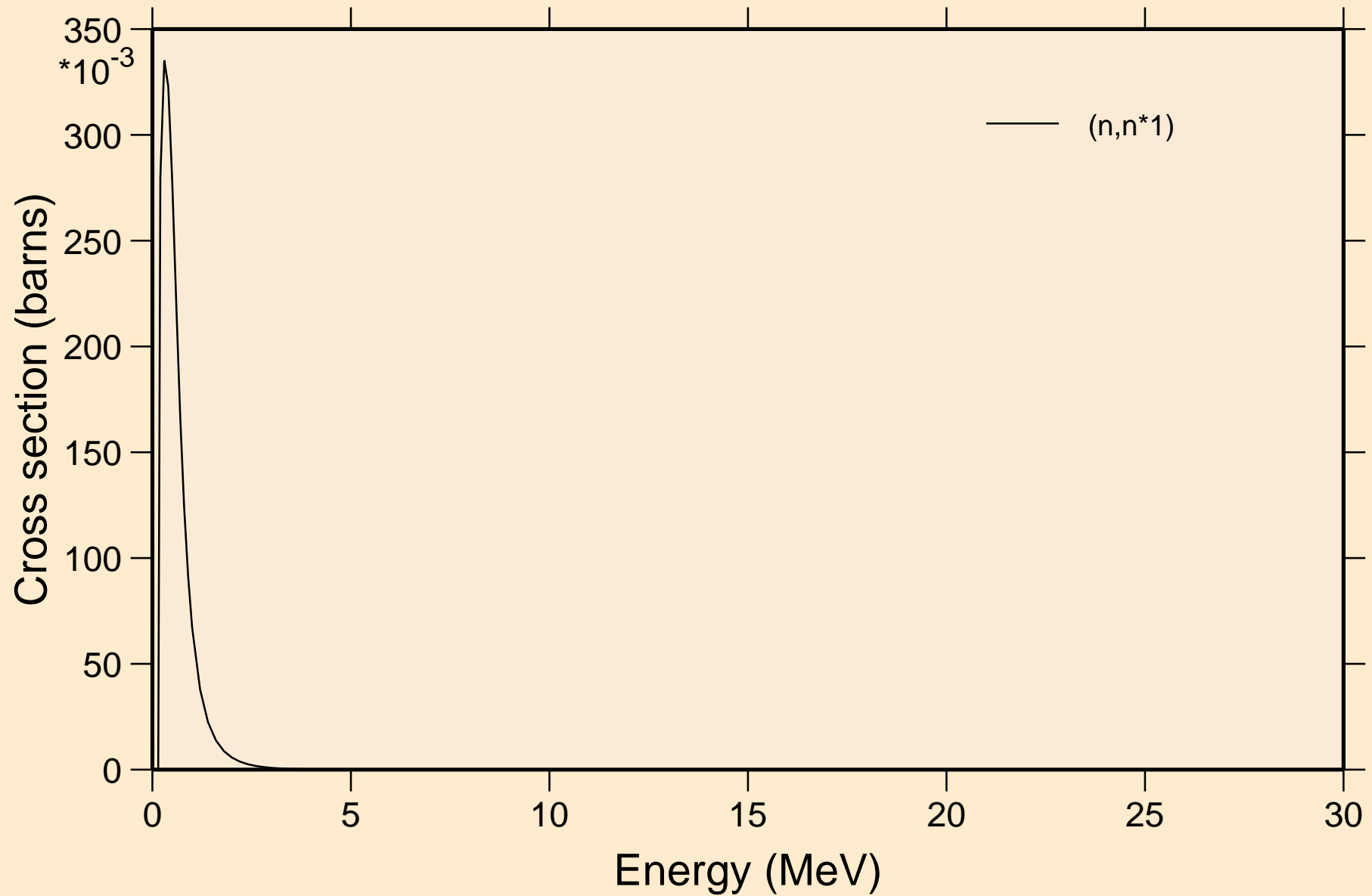

# TM178 NRG TENDL-2015, AKONING

## Threshold reactions

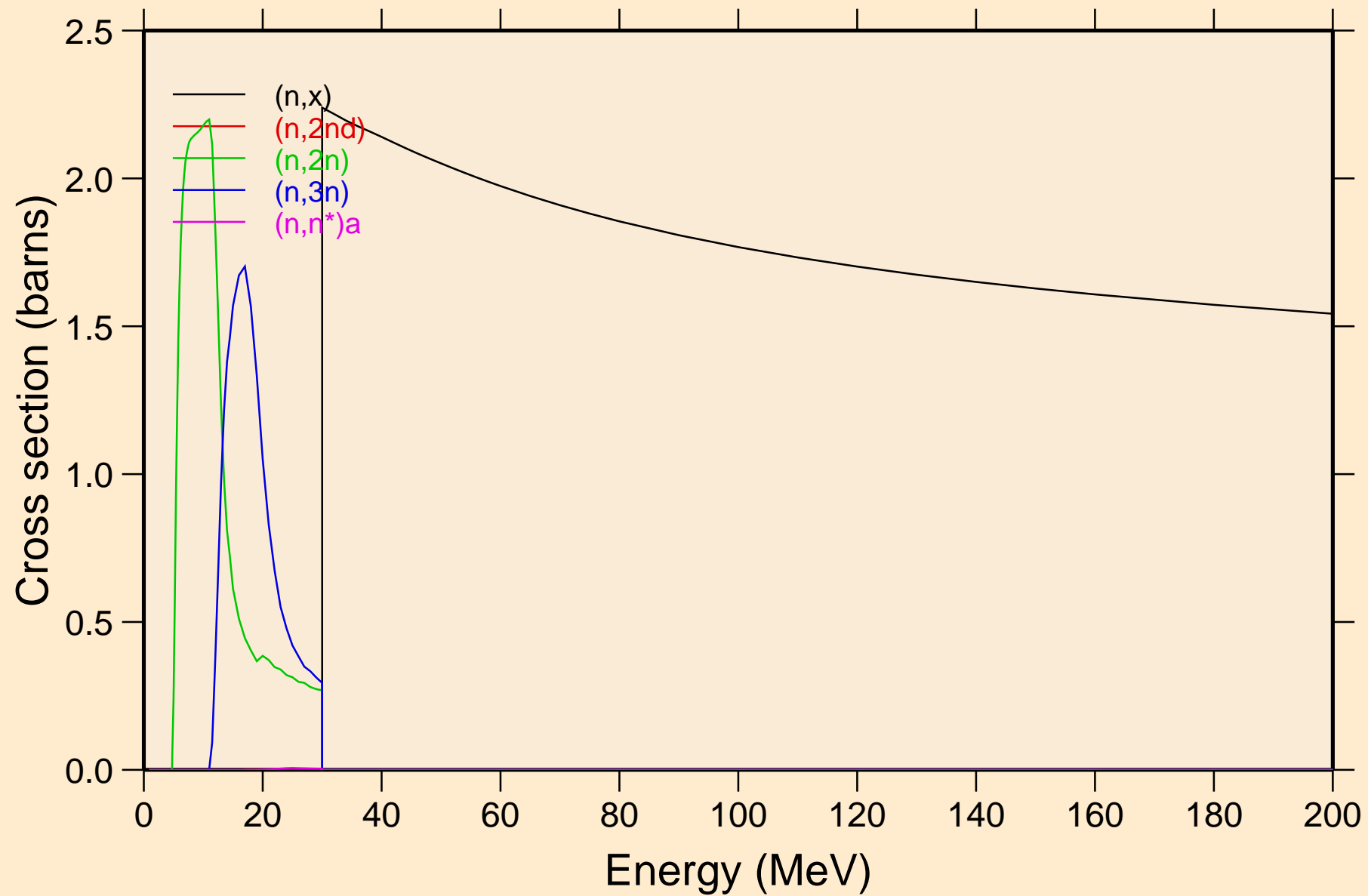

# TM178 NRG TENDL-2015, AKONING

## Threshold reactions

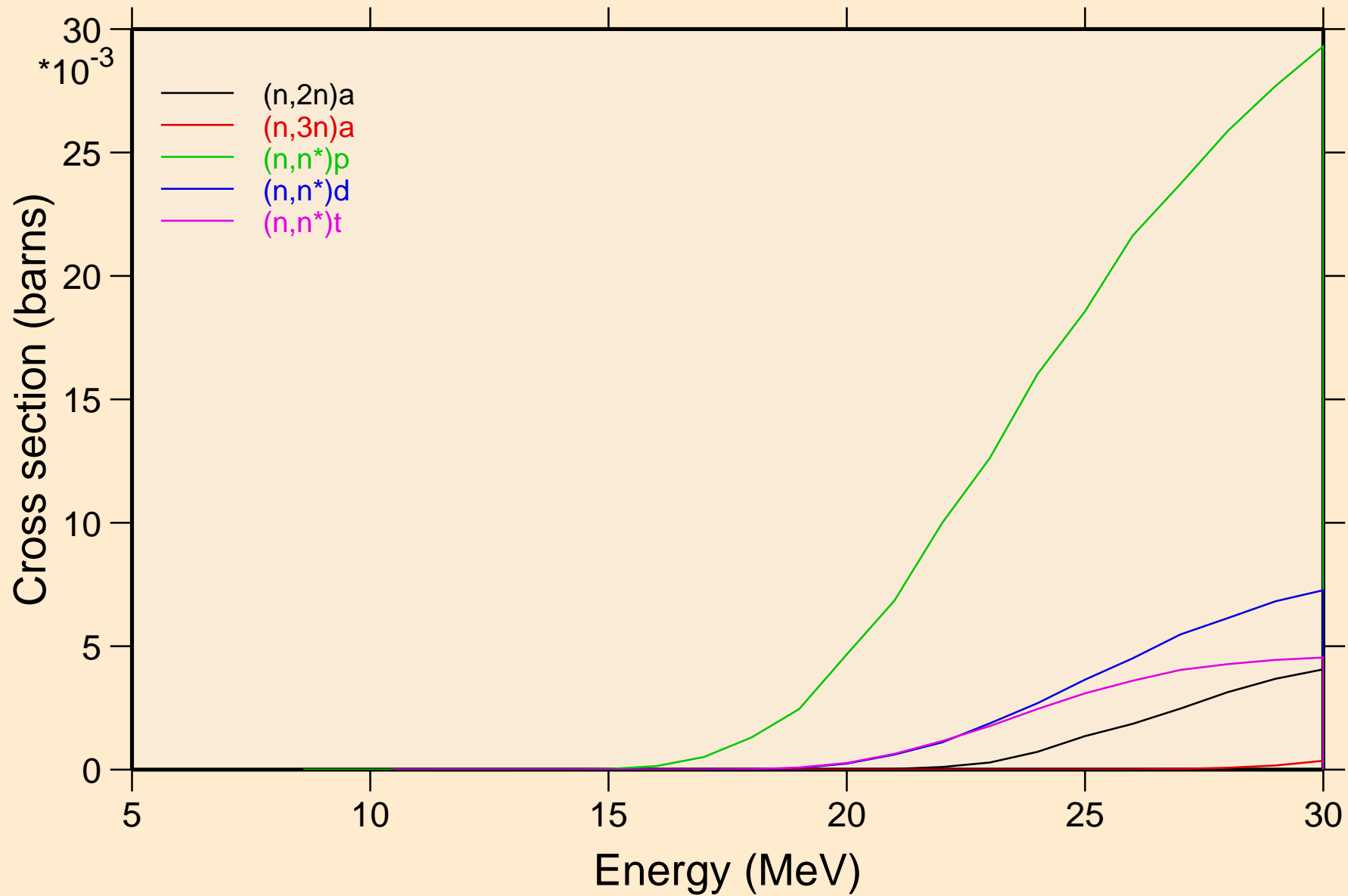

# TM178 NRG TENDL-2015, AKONING

## Threshold reactions

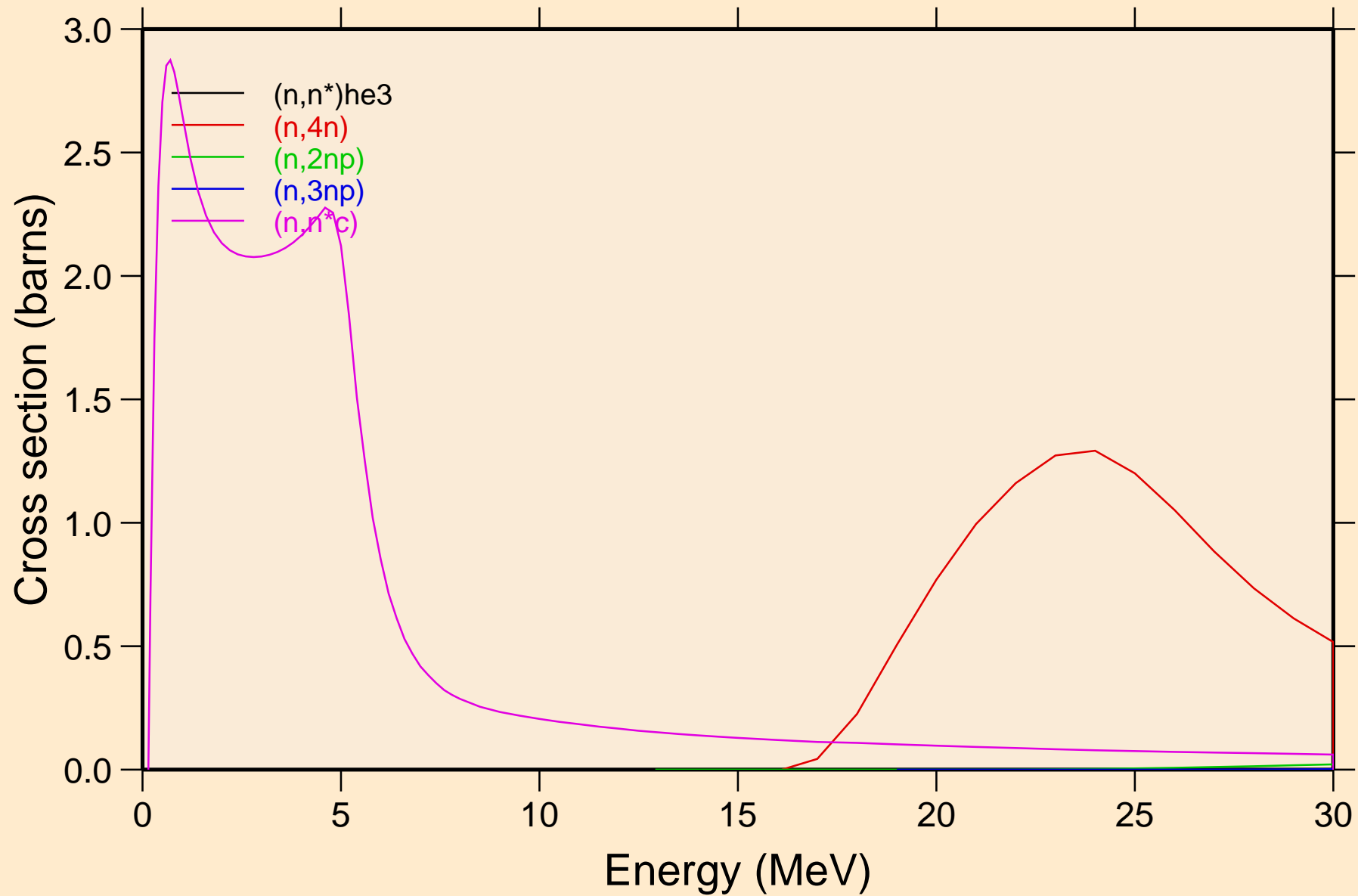

# TM178 NRG TENDL-2015, AKONING

## Threshold reactions

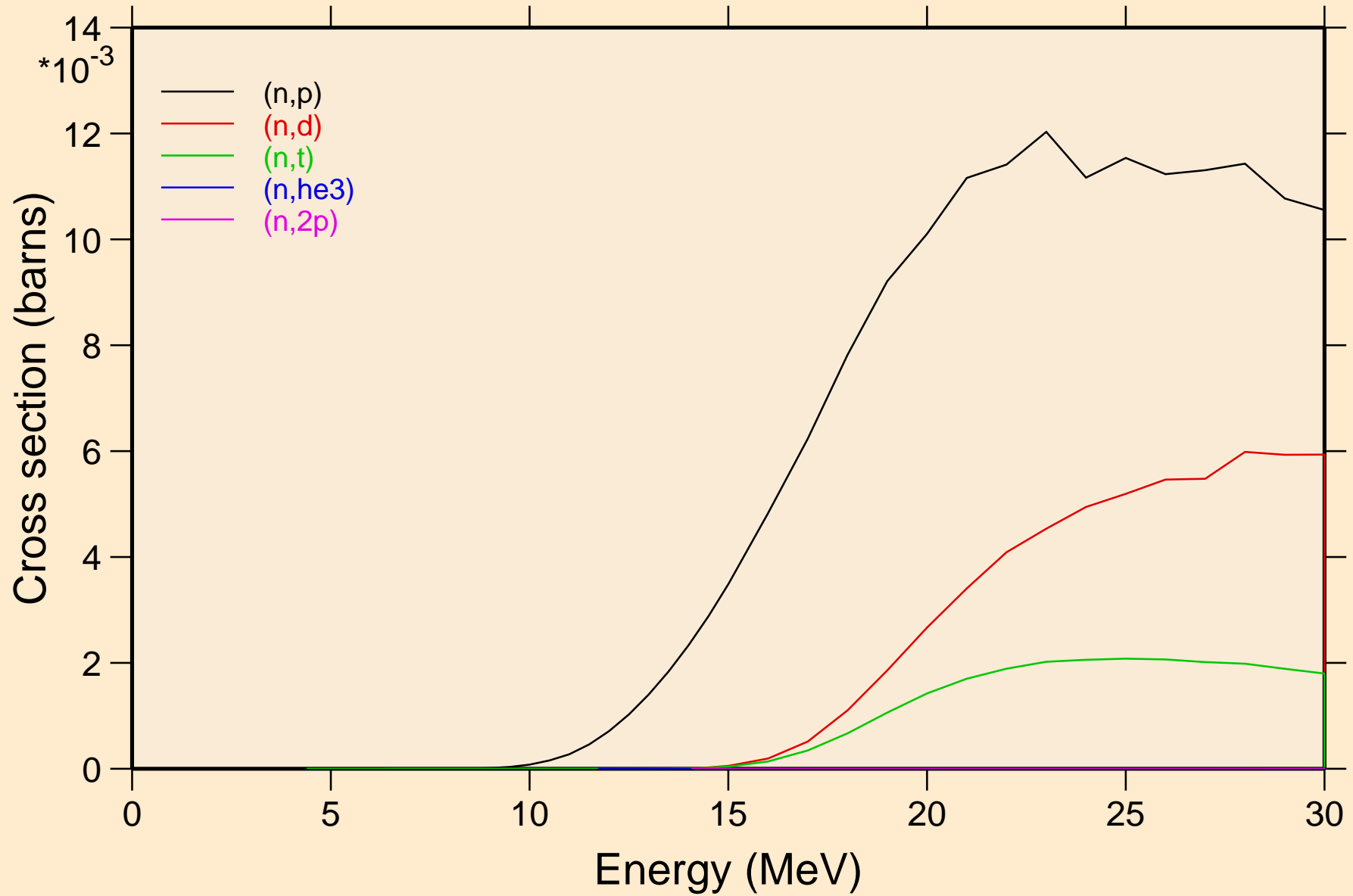

TM178 NRG TENDL-2015, AKONING  
angular distribution for elastic

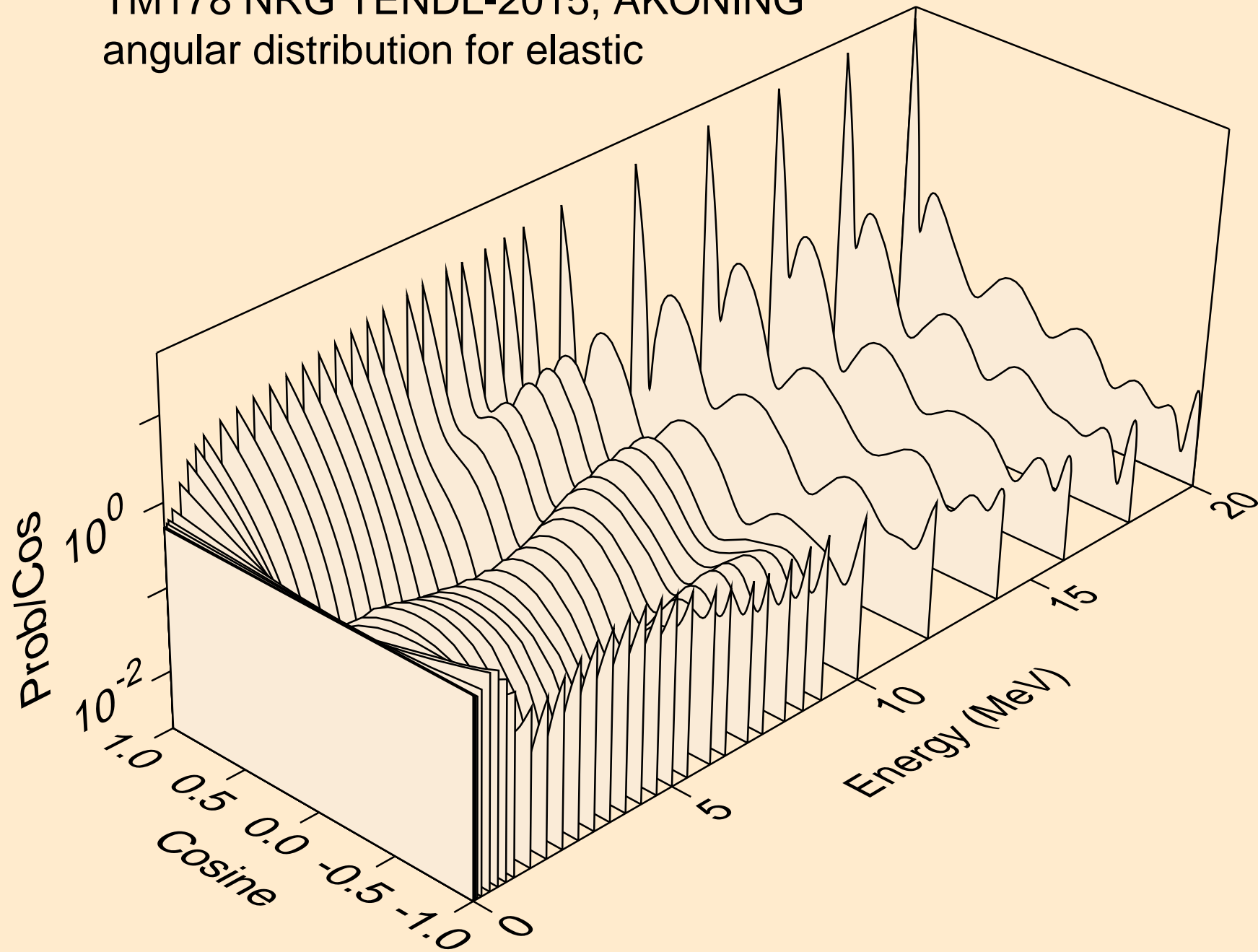



TM178 NRG TENDL-2015, AKONING  
angular distribution for elastic

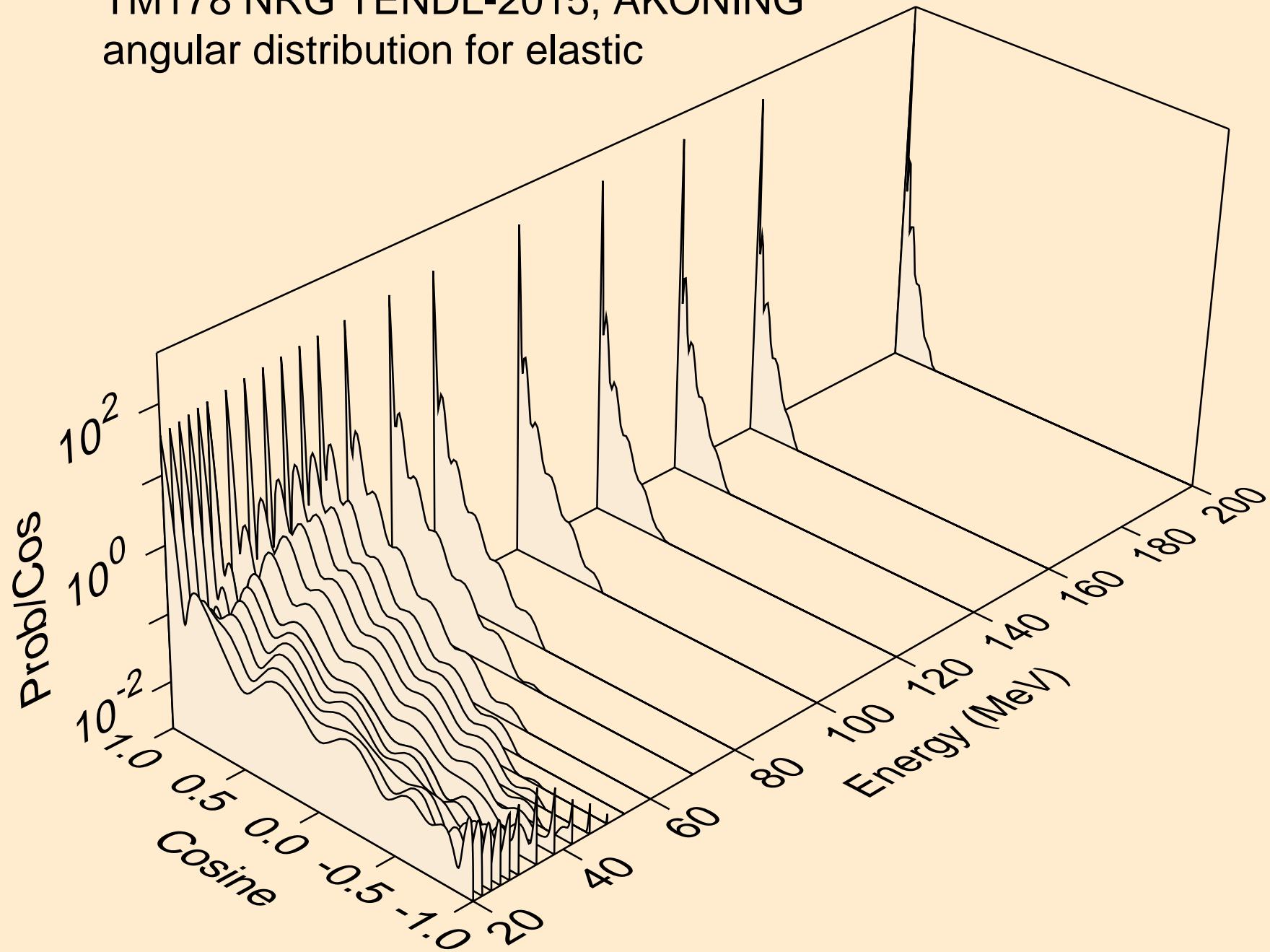

TM178 NRG TENDL-2015, AKONING  
angular distribution for (n,n\*1)

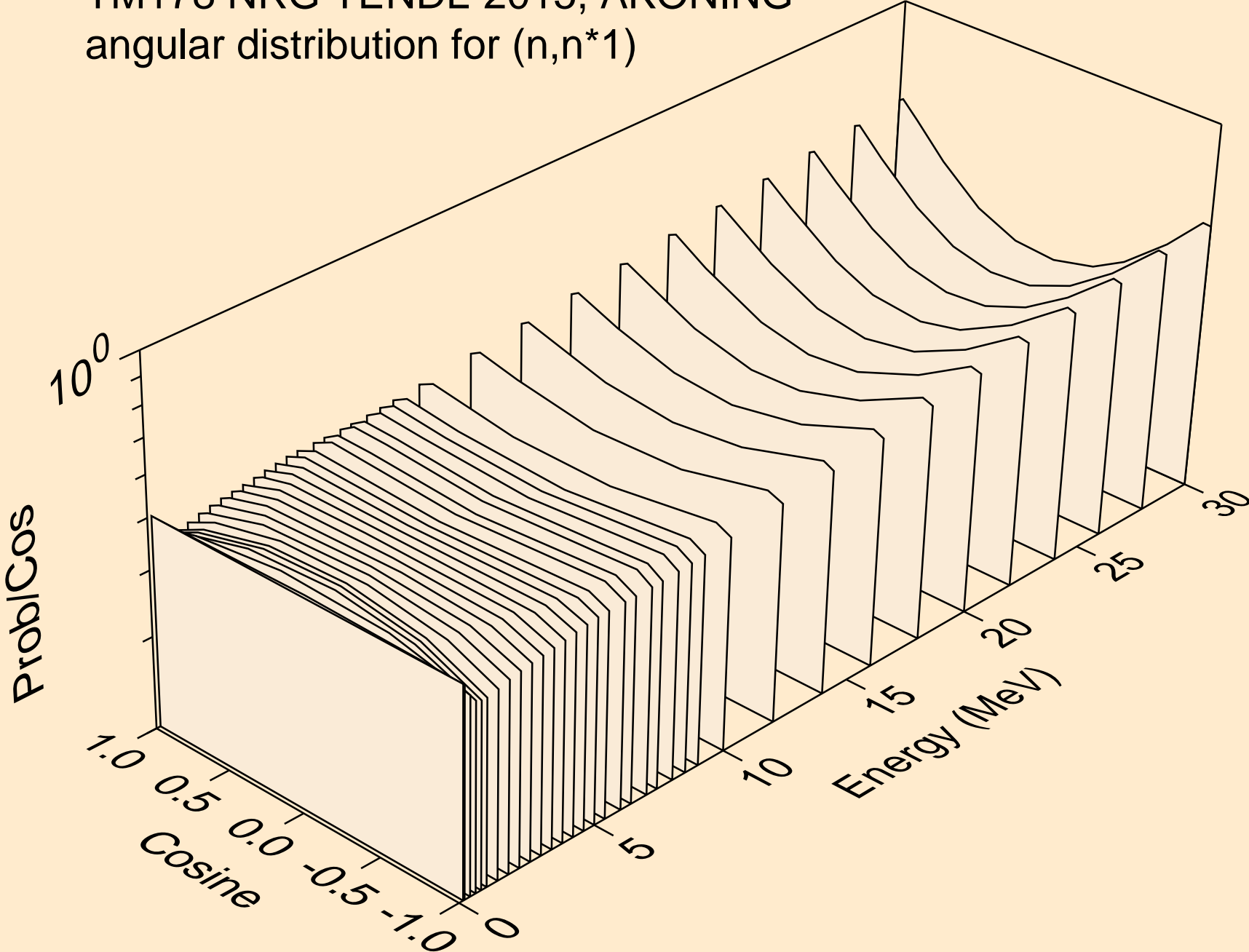

TM178 NRG TENDL-2015, AKONING  
Neutron emission for (n,x)

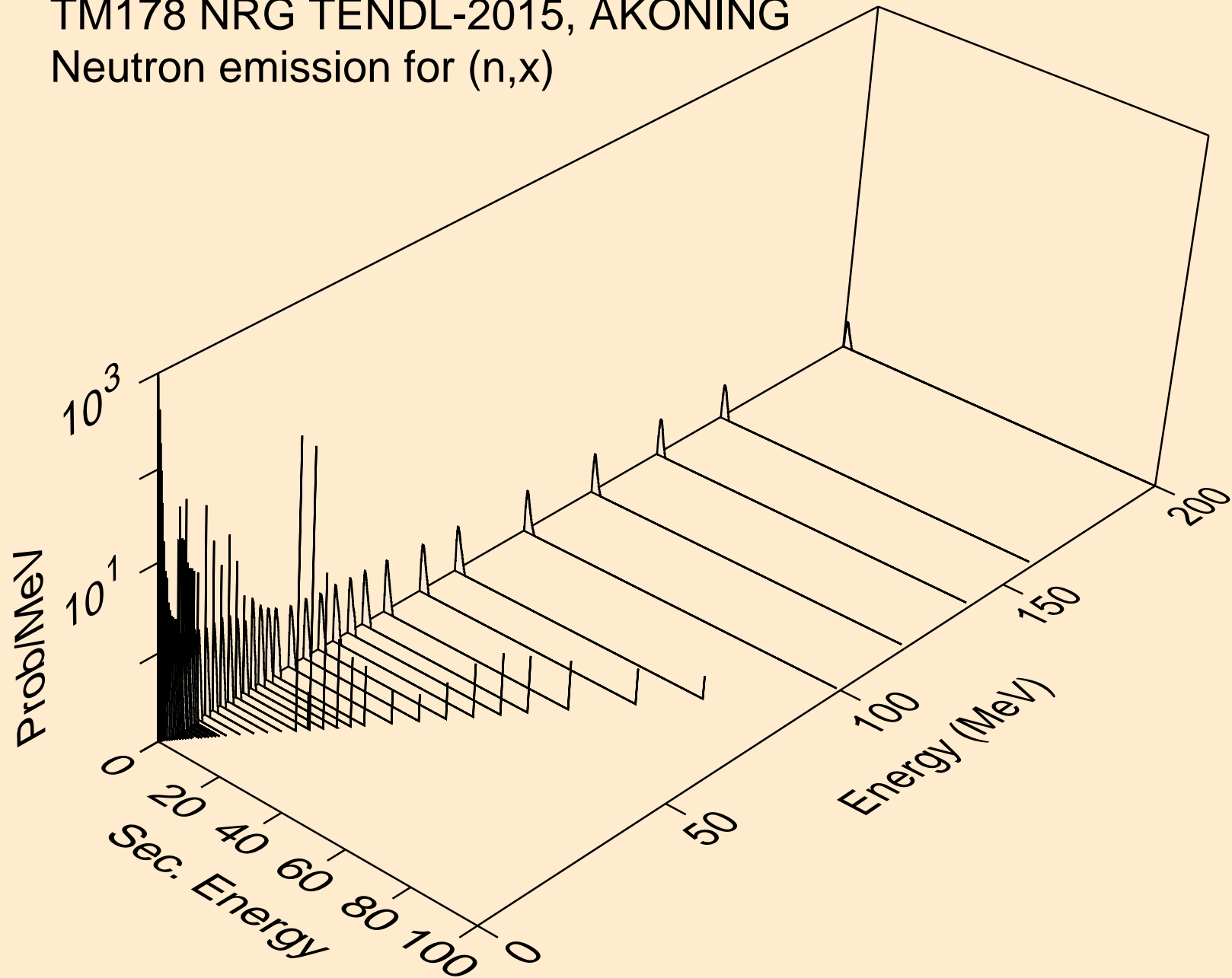

TM178 NRG TENDL-2015, AKONING  
Neutron emission for (n,2nd)

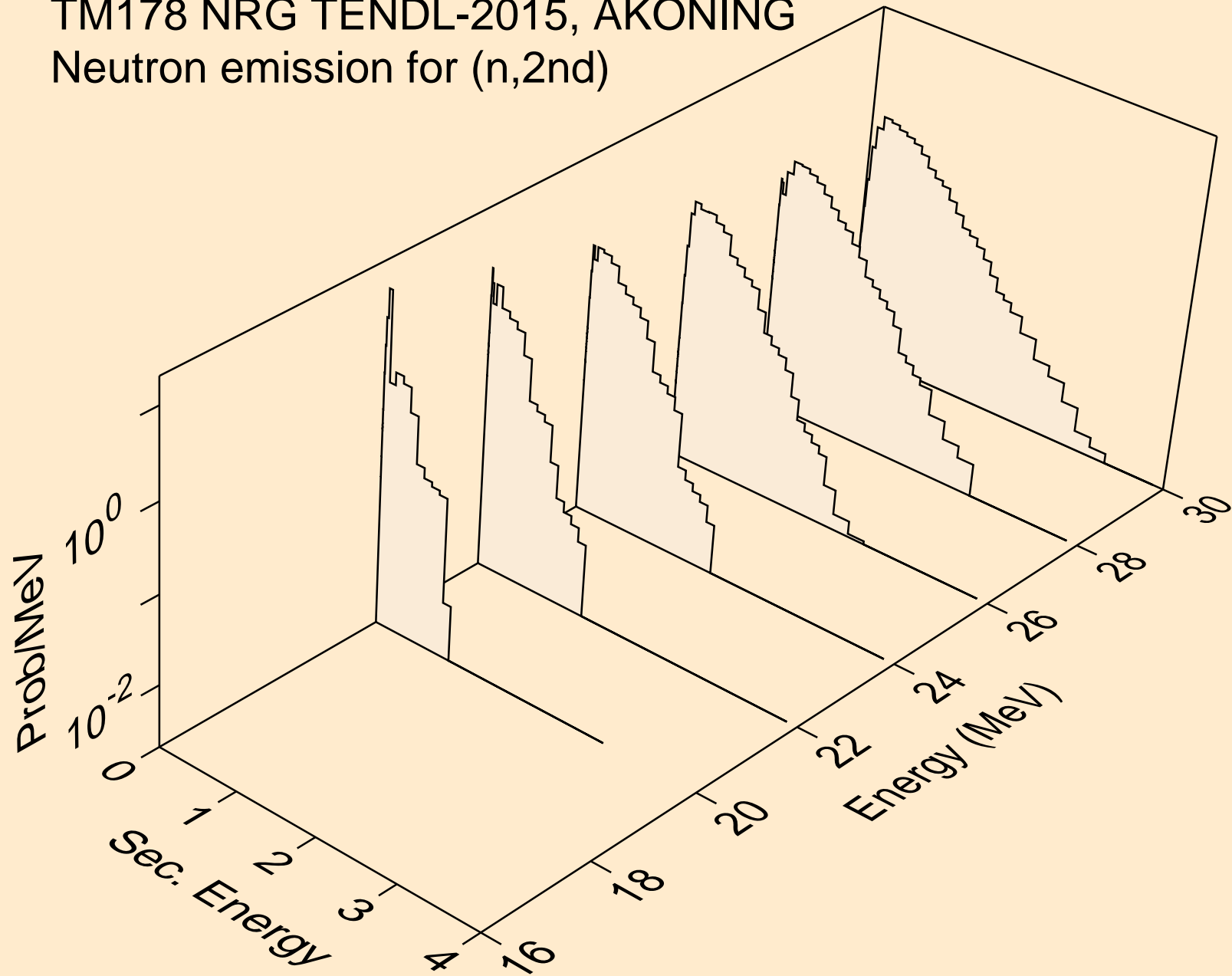

TM178 NRG TENDL-2015, AKONING  
Neutron emission for (n,2n)

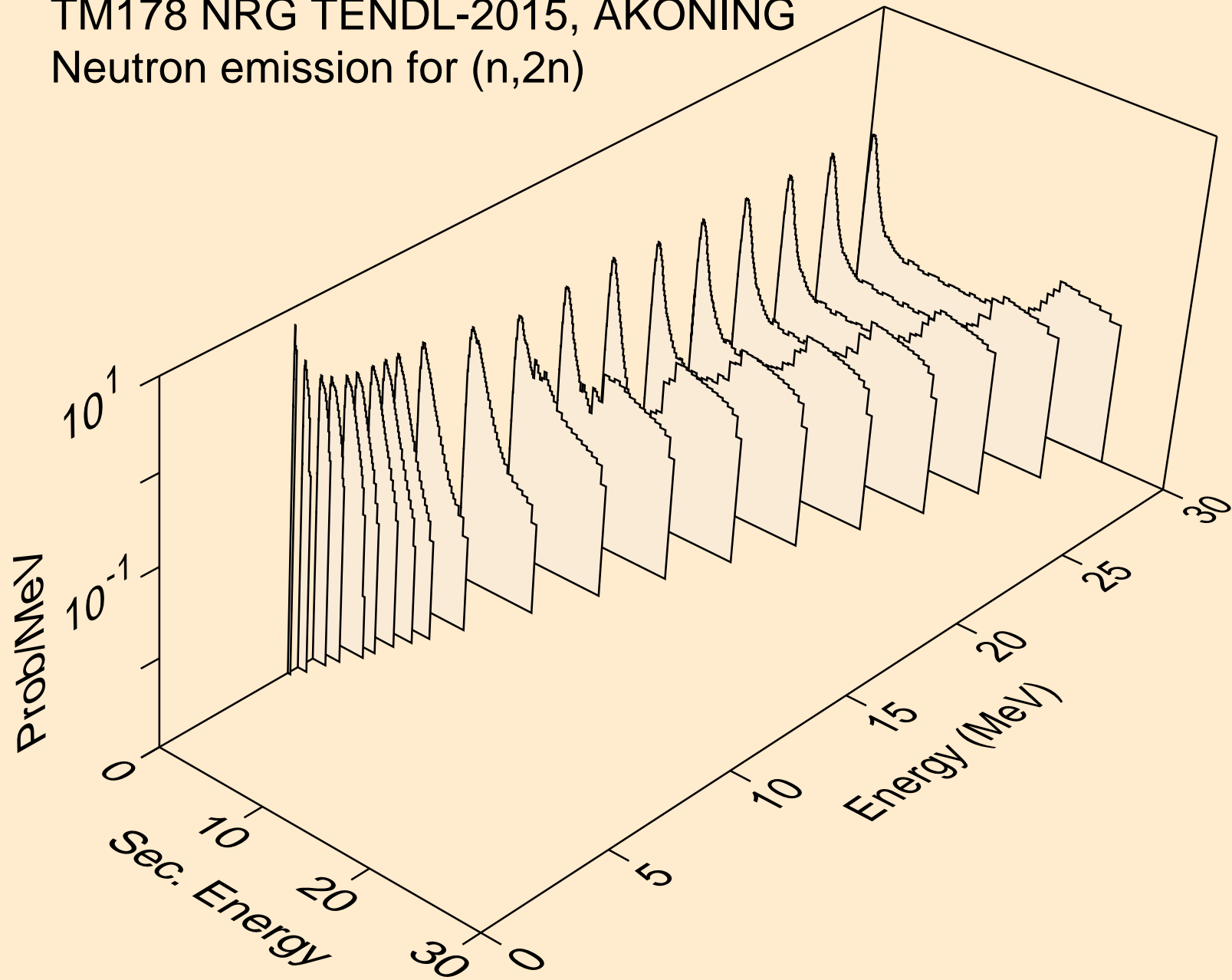

TM178 NRG TENDL-2015, AKONING  
Neutron emission for (n,3n)

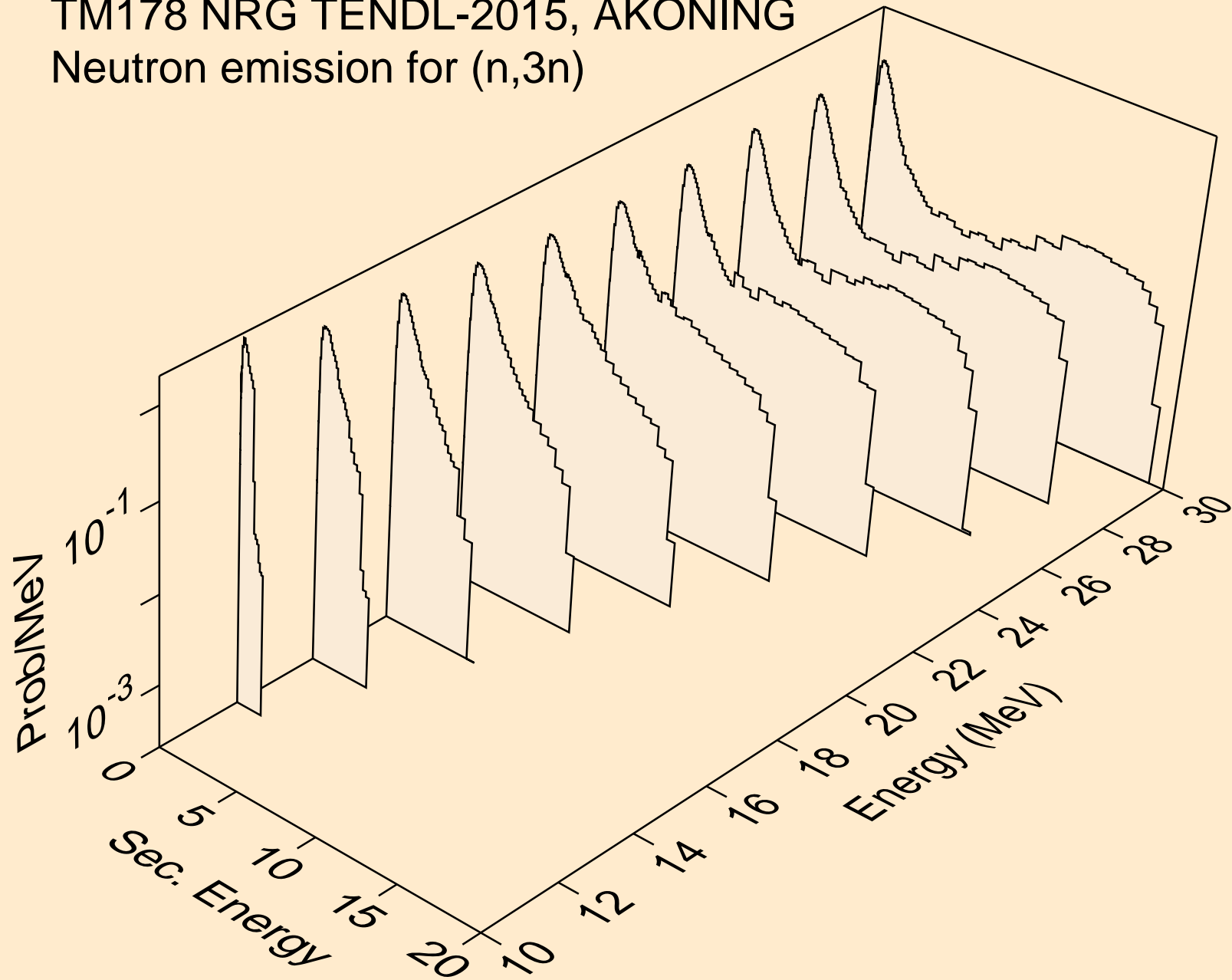

TM178 NRG TENDL-2015, AKONING  
Neutron emission for (n,n\*)a

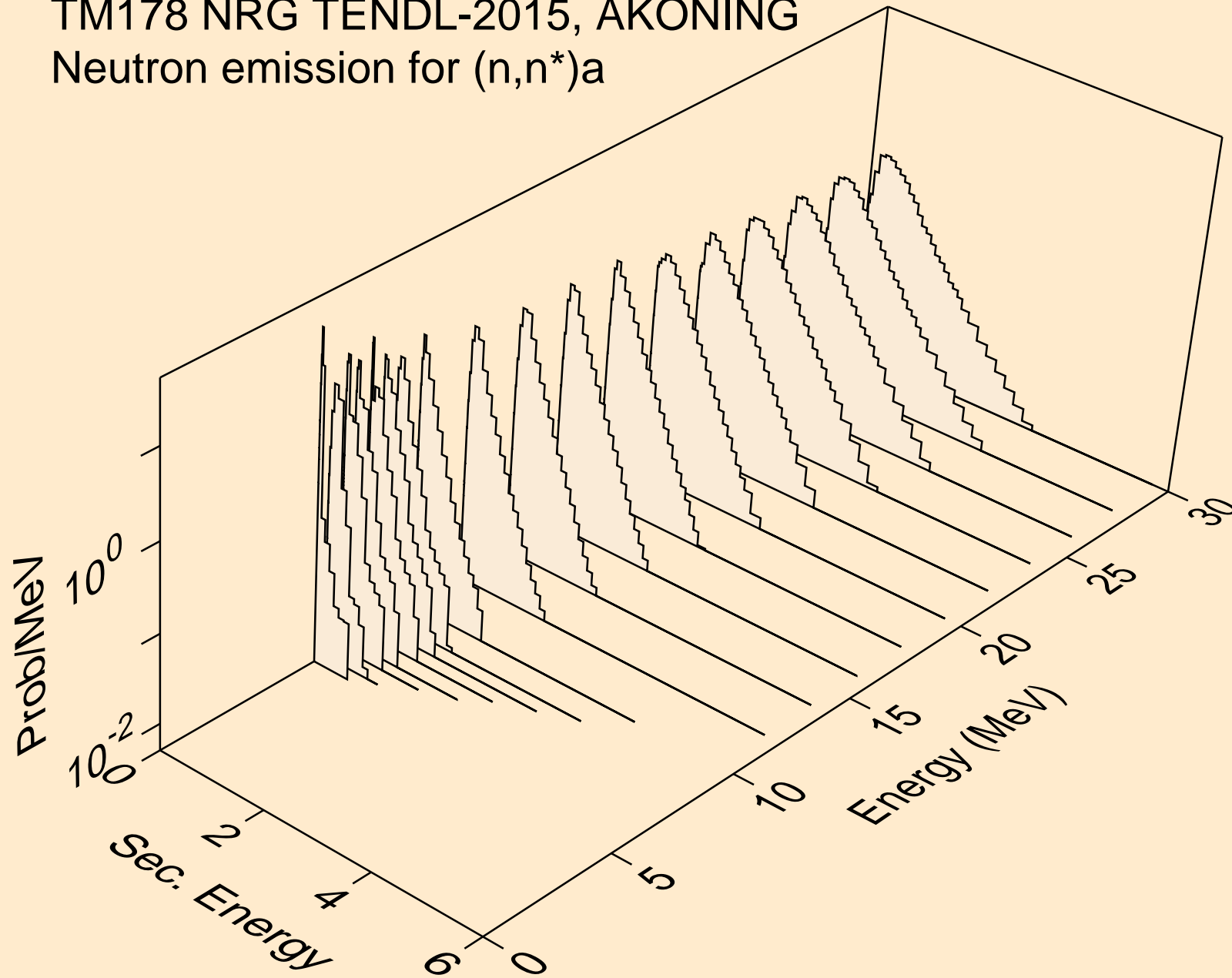

TM178 NRG TENDL-2015, AKONING  
Neutron emission for (n,2n)a

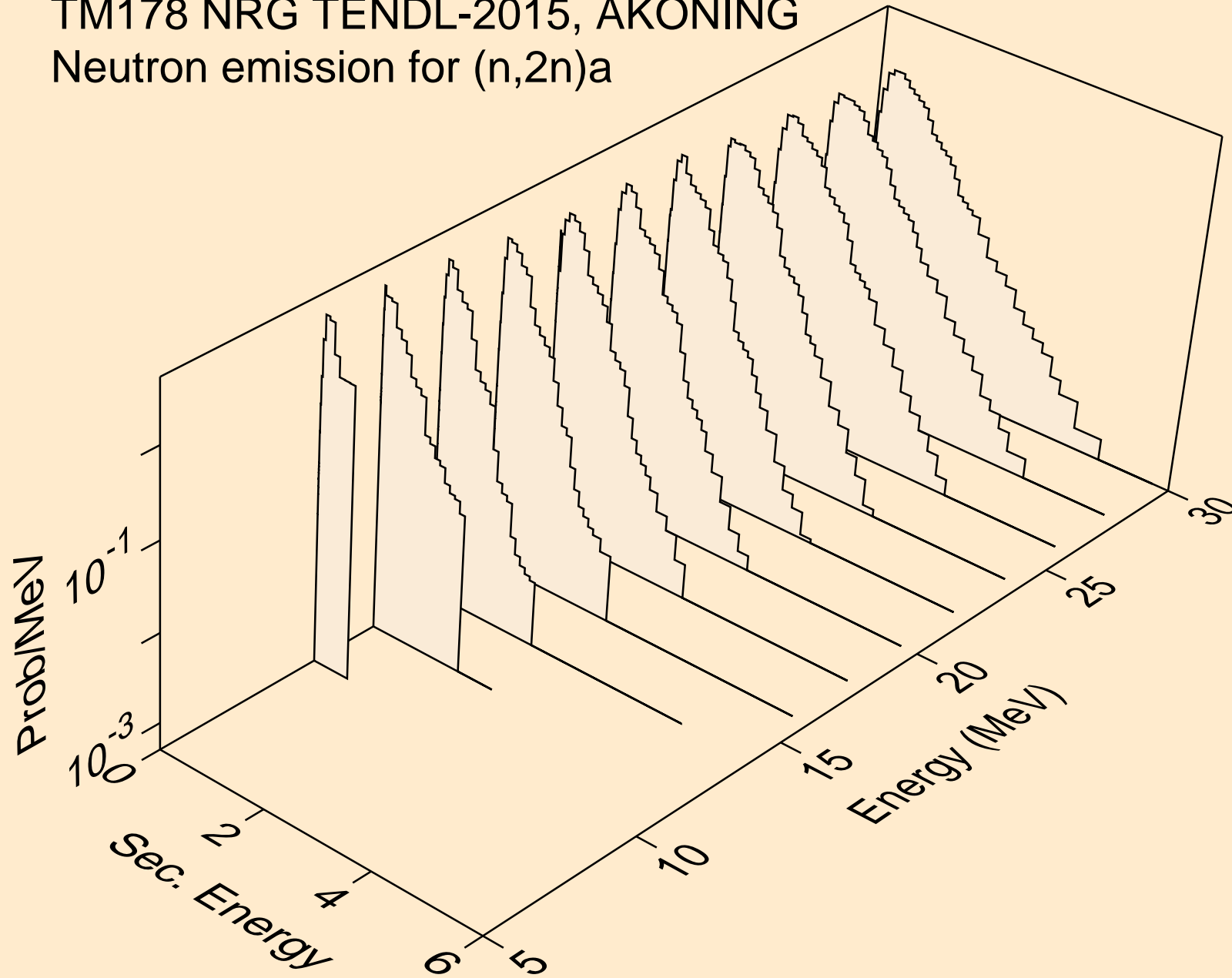



TM178 NRG TENDL-2015, AKONING  
Neutron emission for (n,3n)a

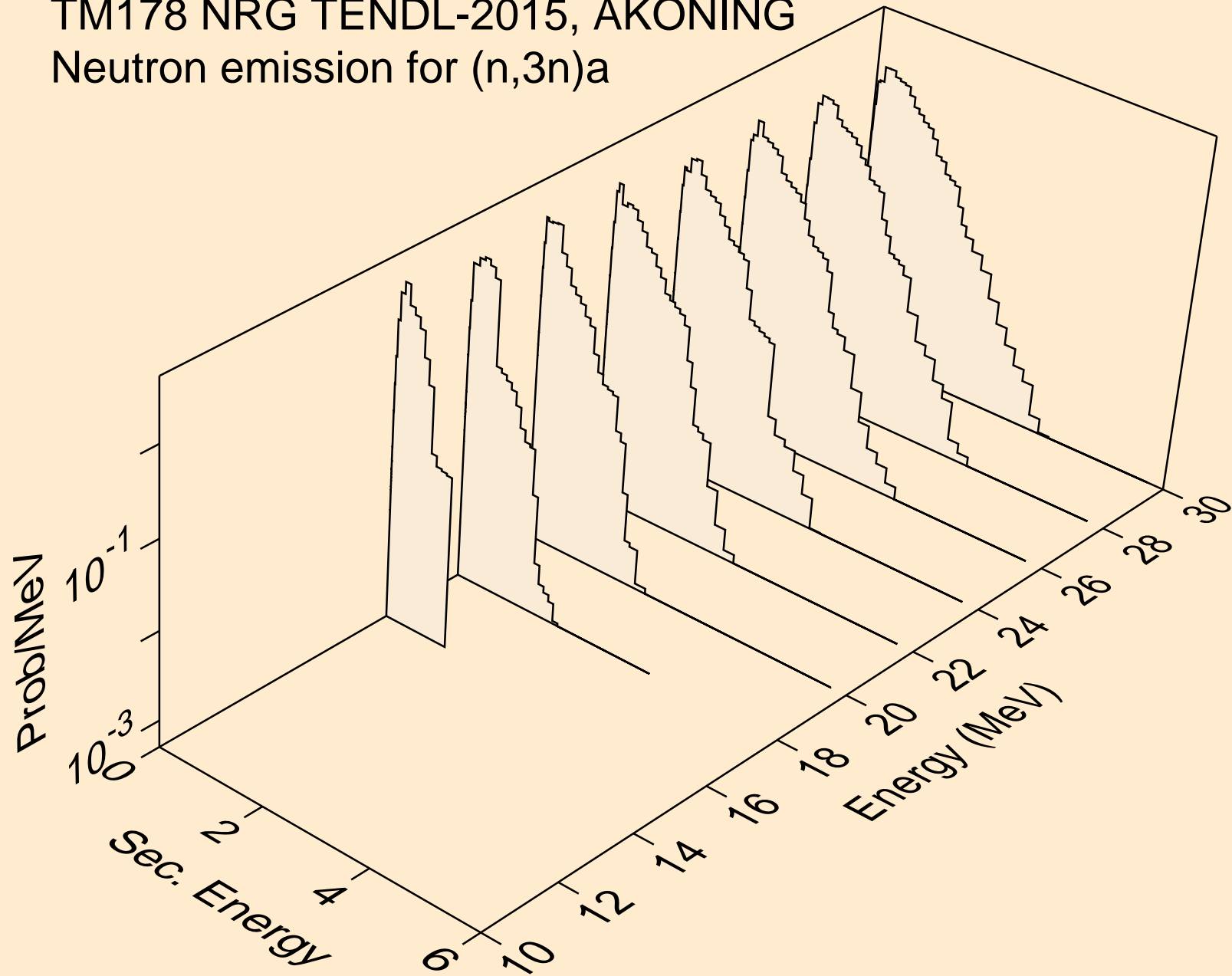

TM178 NRG TENDL-2015, AKONING  
Neutron emission for (n,n\*)p

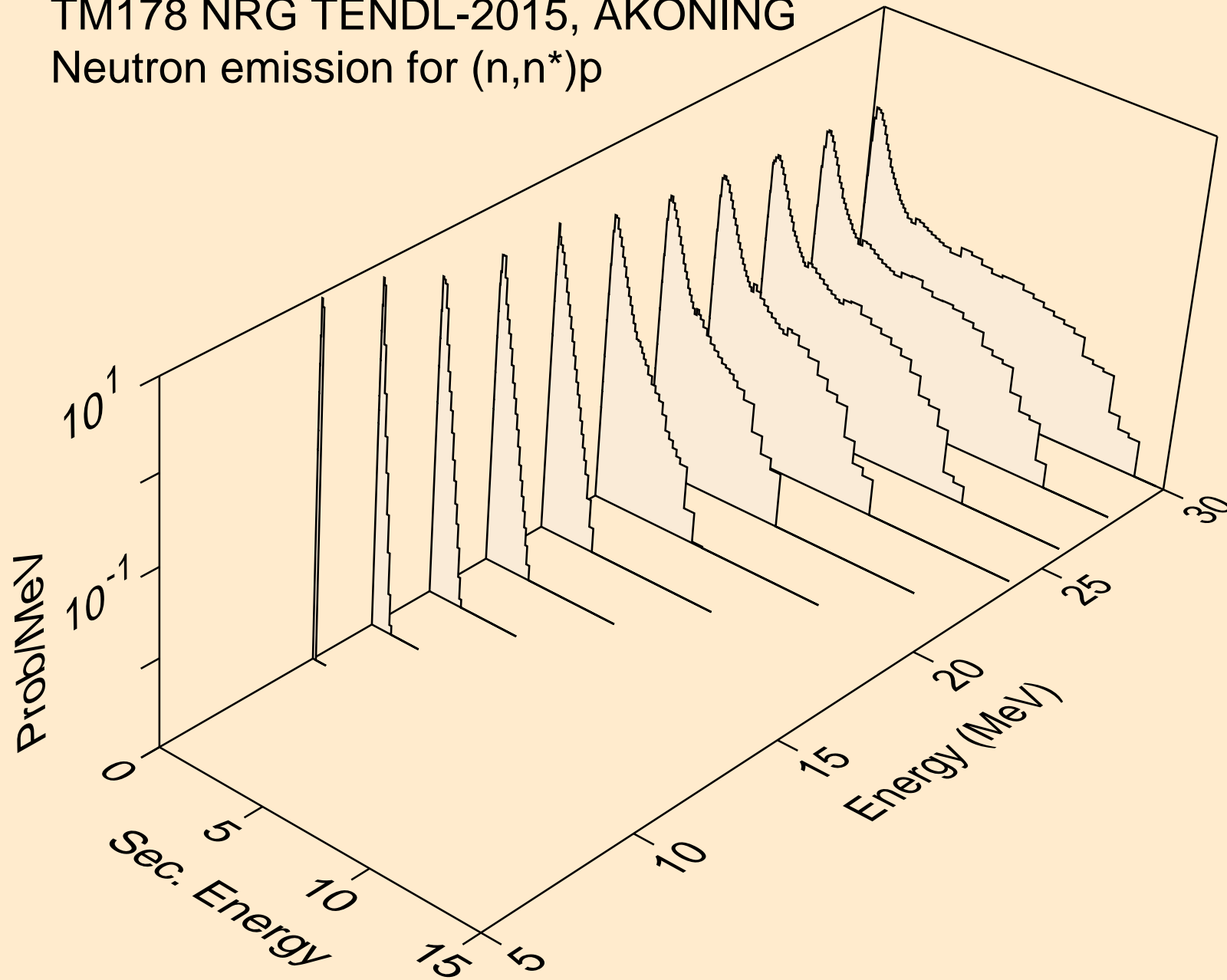

TM178 NRG TENDL-2015, AKONING  
Neutron emission for (n,n\*)d

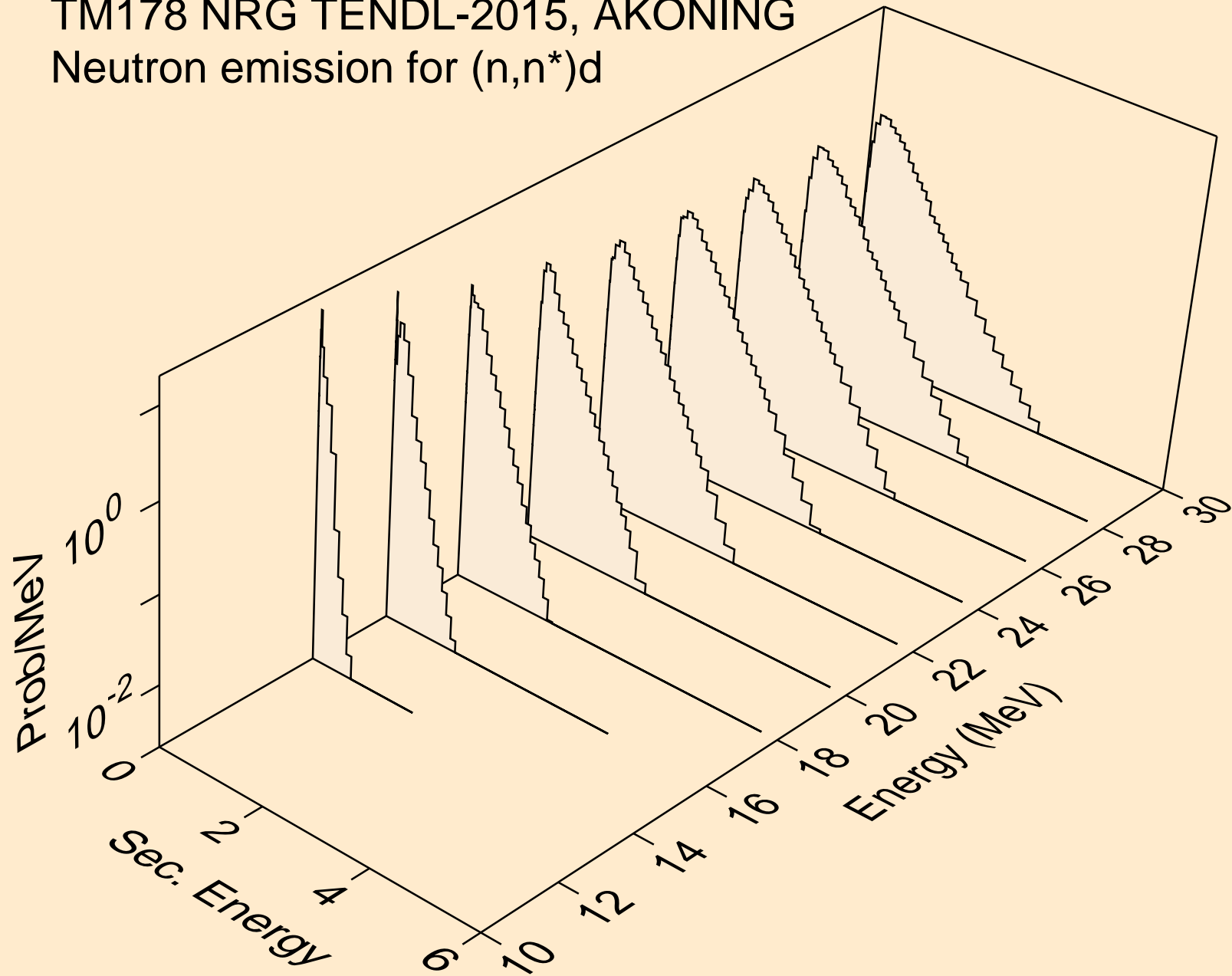

TM178 NRG TENDL-2015, AKONING  
Neutron emission for (n,n\*)t

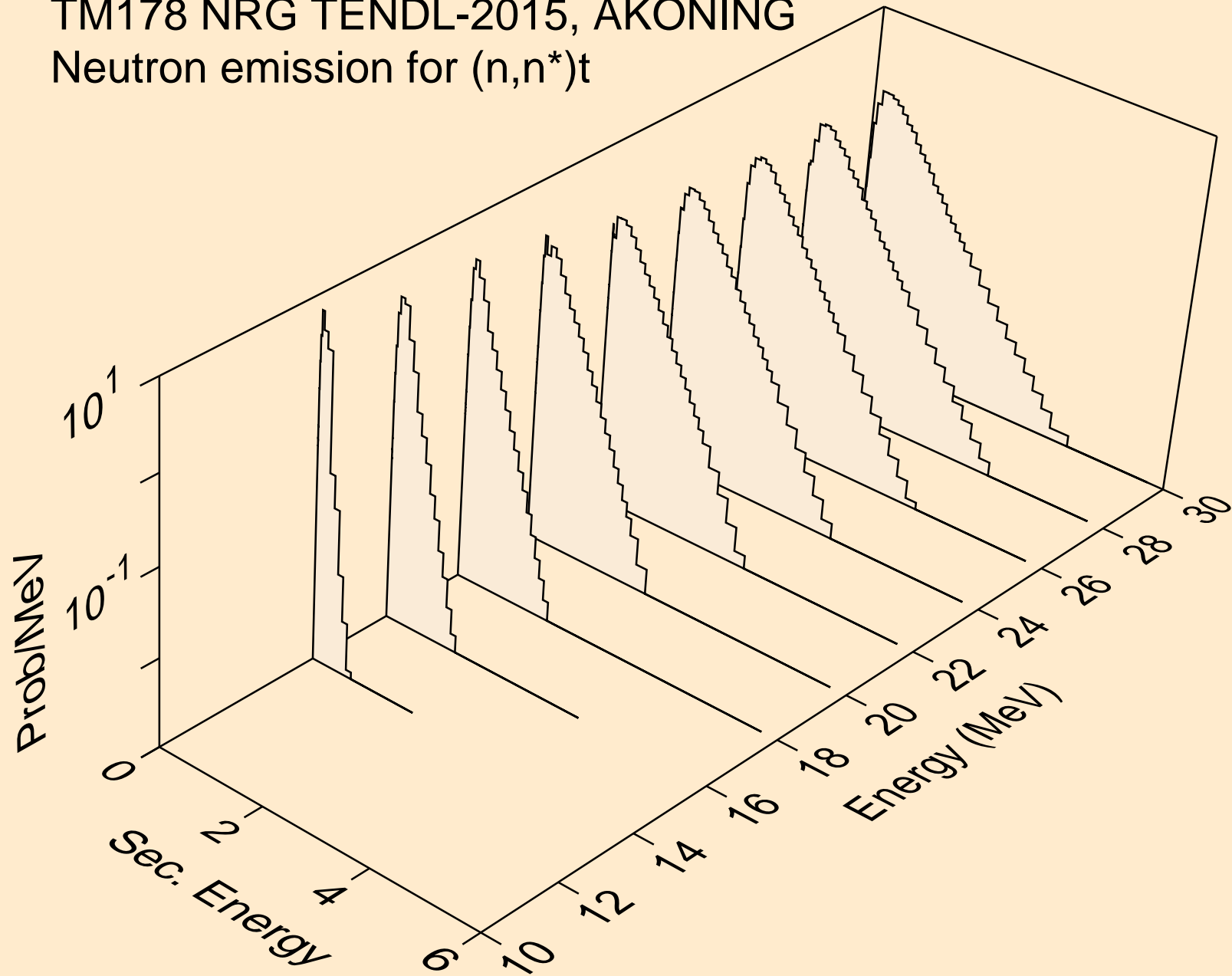

TM178 NRG TENDL-2015, AKONING  
Neutron emission for (n,n\*)he3

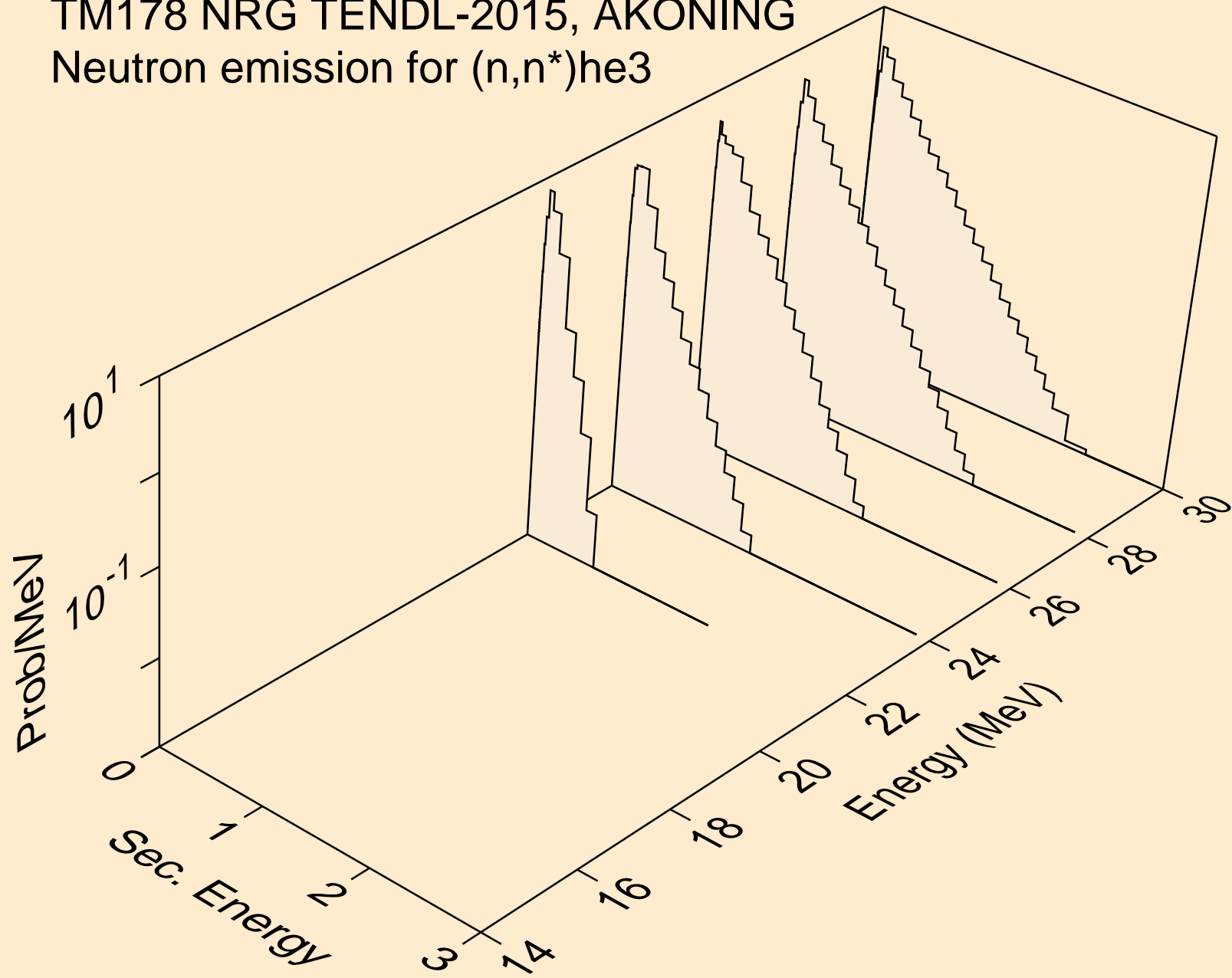

TM178 NRG TENDL-2015, AKONING  
Neutron emission for (n,4n)

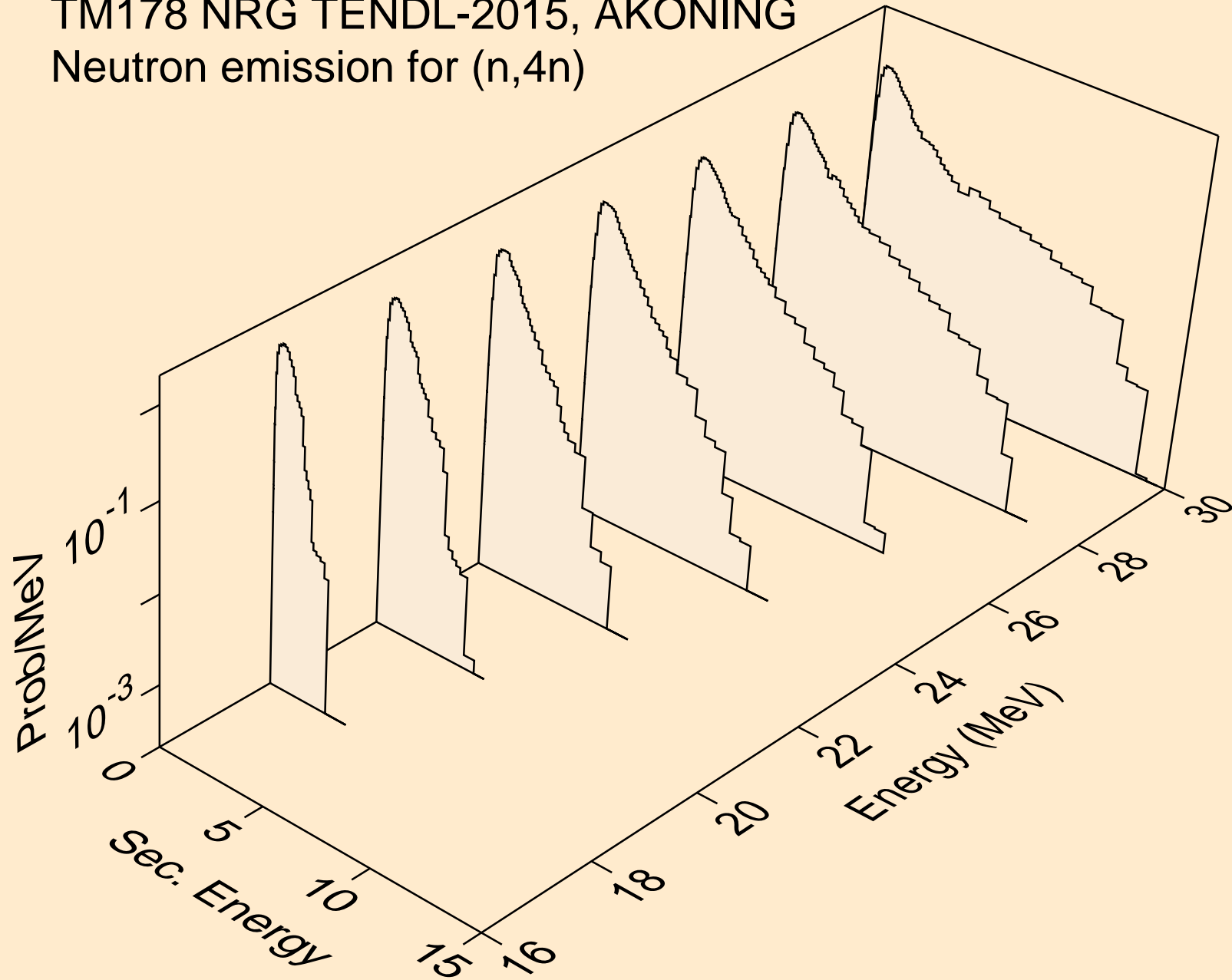

TM178 NRG TENDL-2015, AKONING  
Neutron emission for (n,2np)

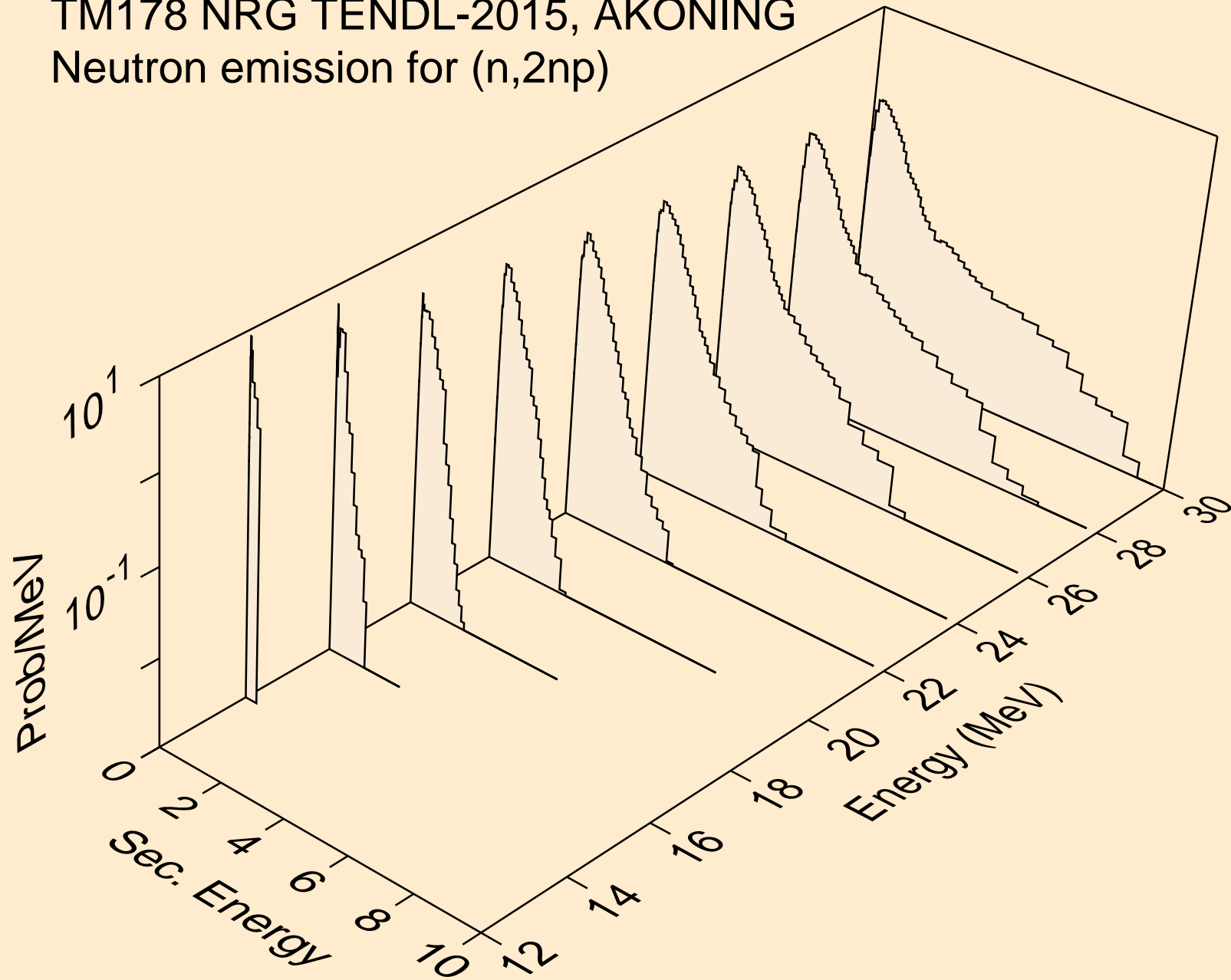

TM178 NRG TENDL-2015, AKONING  
Neutron emission for (n,3np)

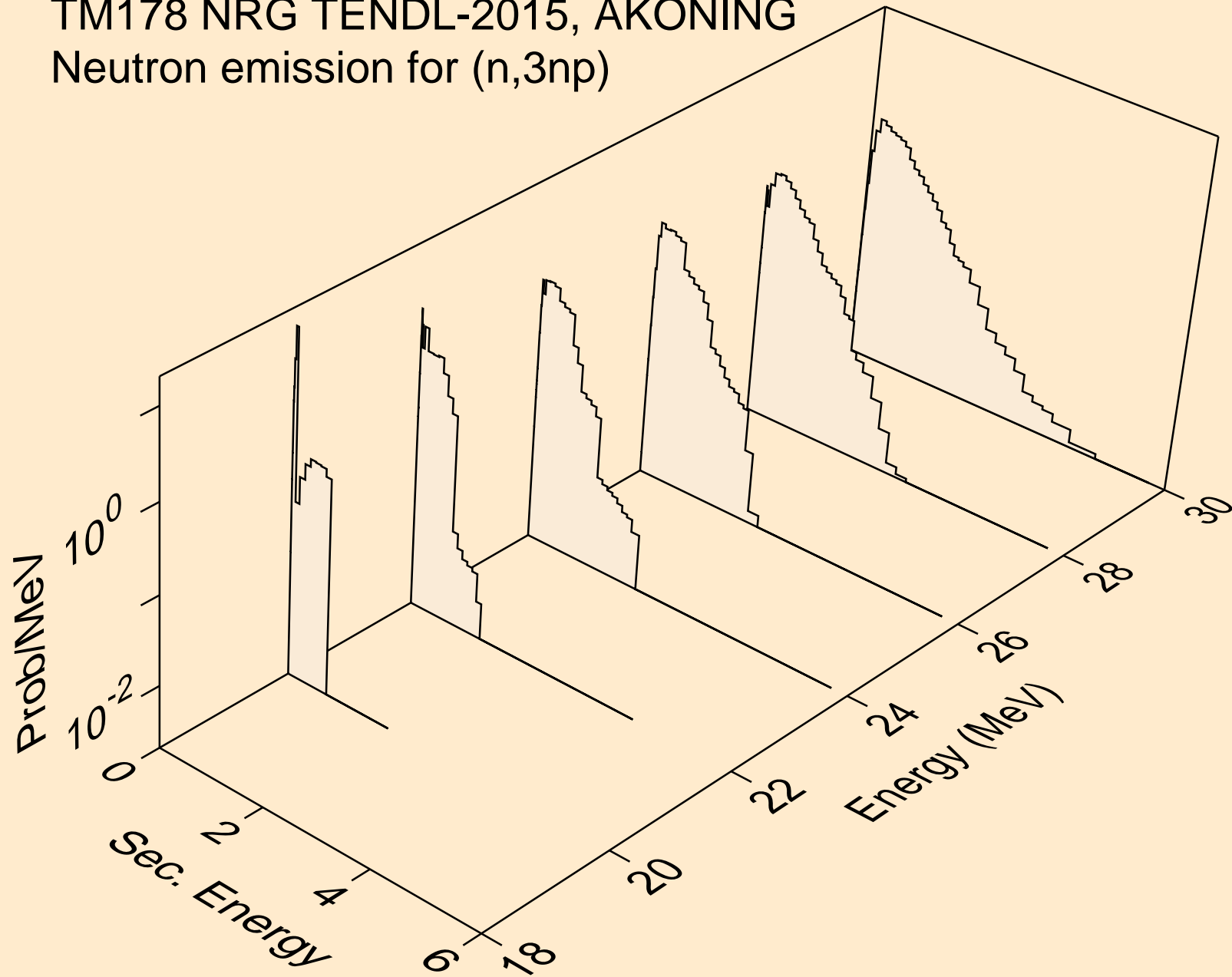



TM178 NRG TENDL-2015, AKONING  
Neutron emission for (n,n\*c)

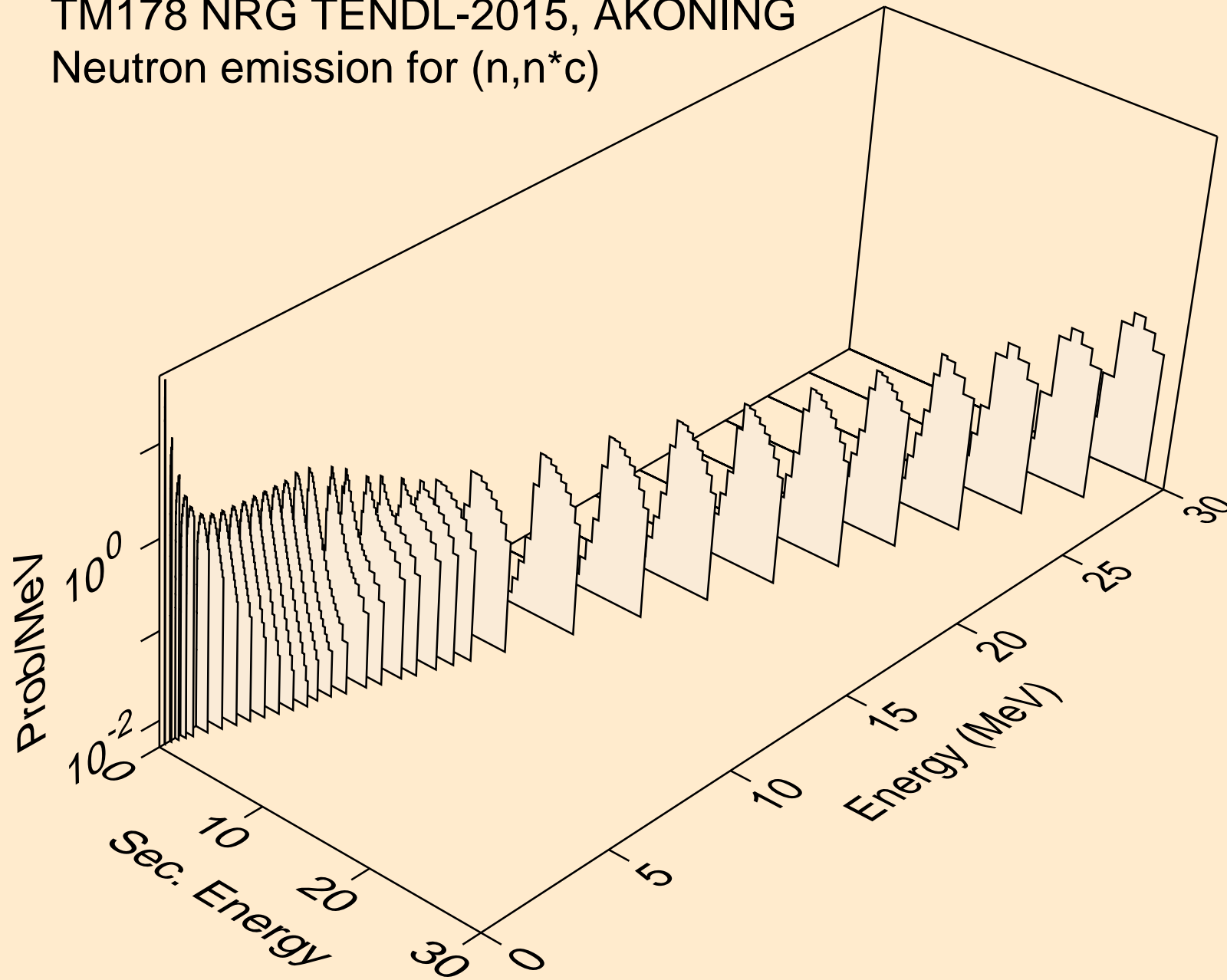

TM178 NRG TENDL-2015, AKONING  
Photon emission for (n,x)

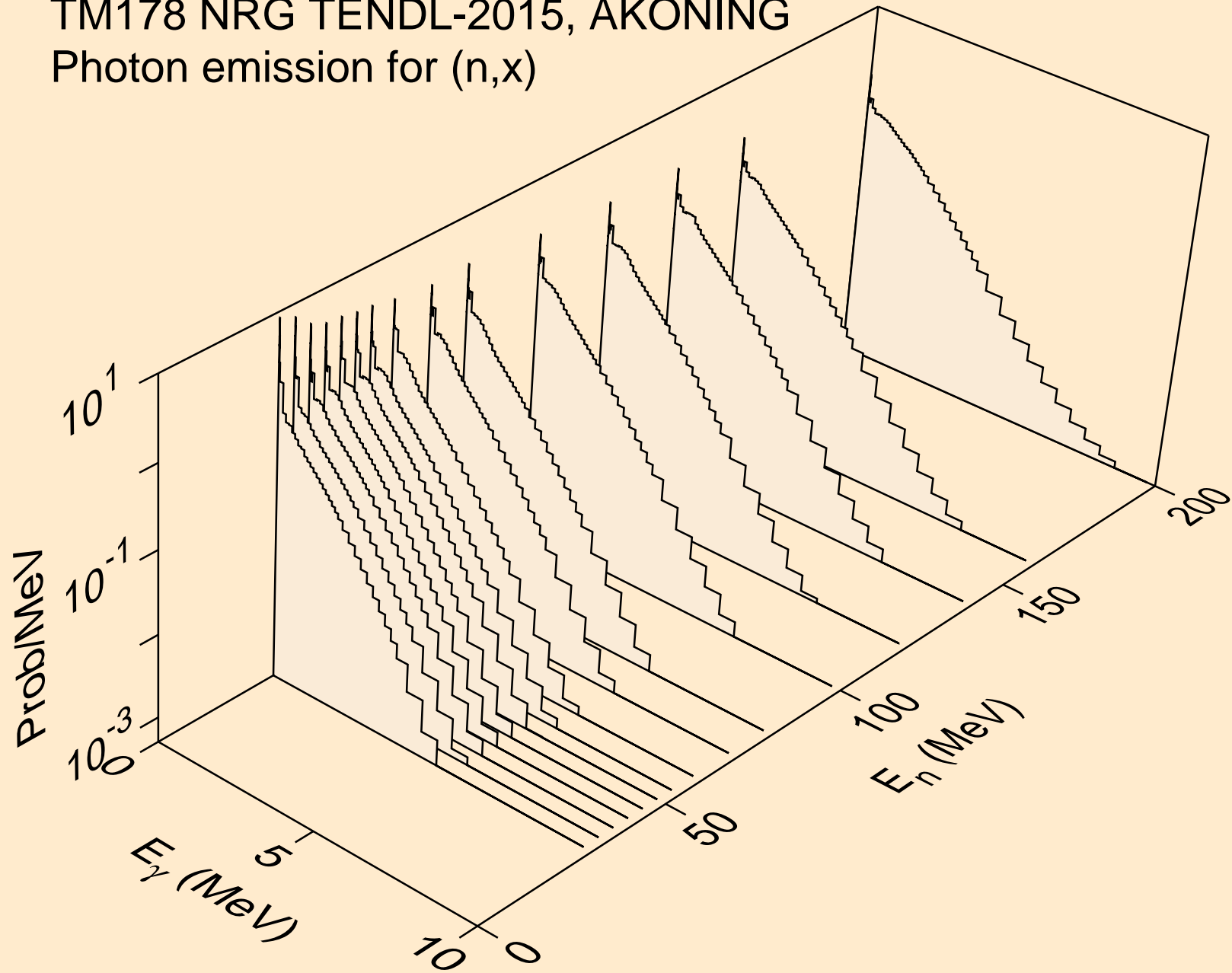

TM178 NRG TENDL-2015, AKONING  
Photon emission for (n,2nd)

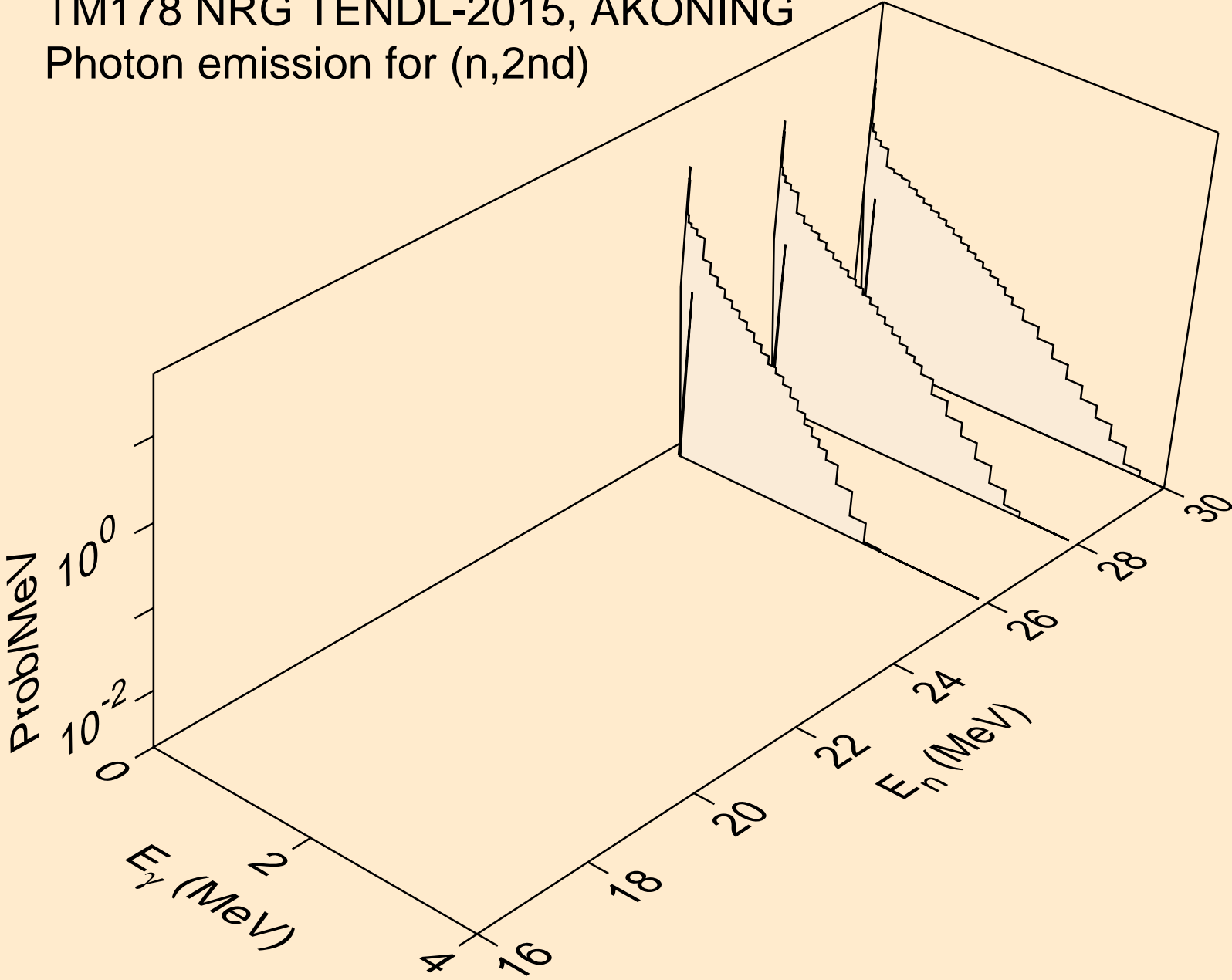

TM178 NRG TENDL-2015, AKONING  
Photon emission for (n,2n)

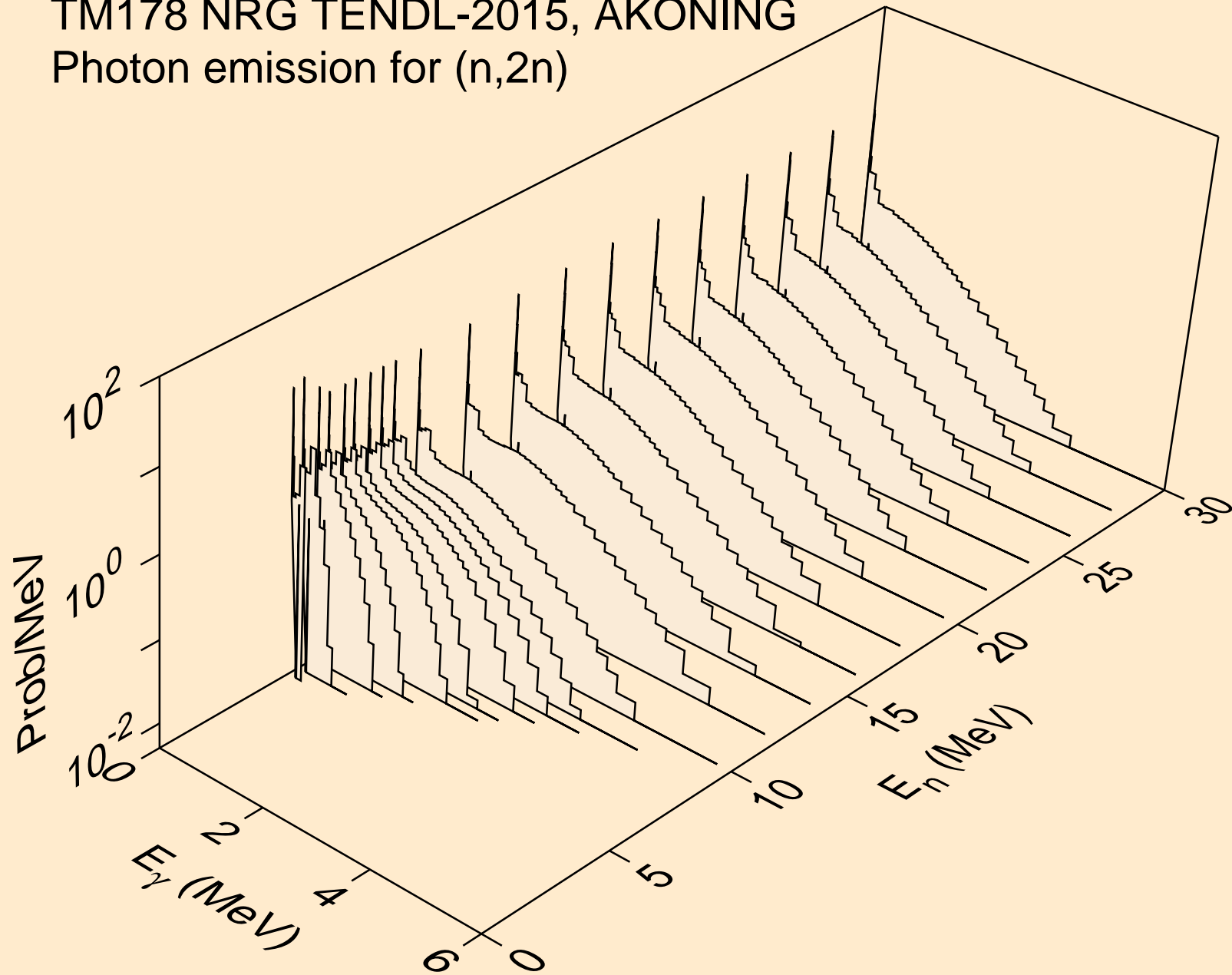

TM178 NRG TENDL-2015, AKONING  
Photon emission for (n,3n)

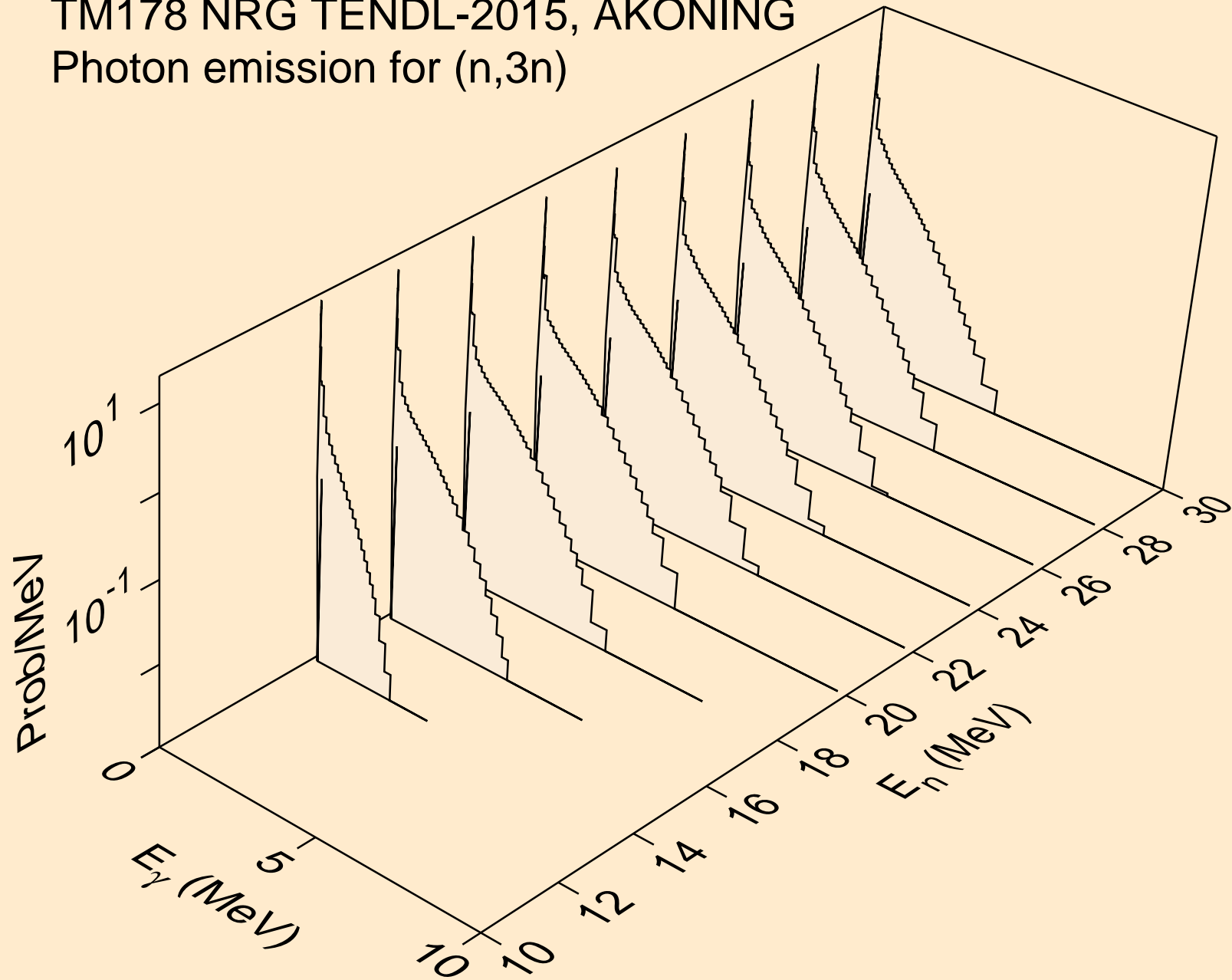

TM178 NRG TENDL-2015, AKONING  
Photon emission for (n,n\*)a

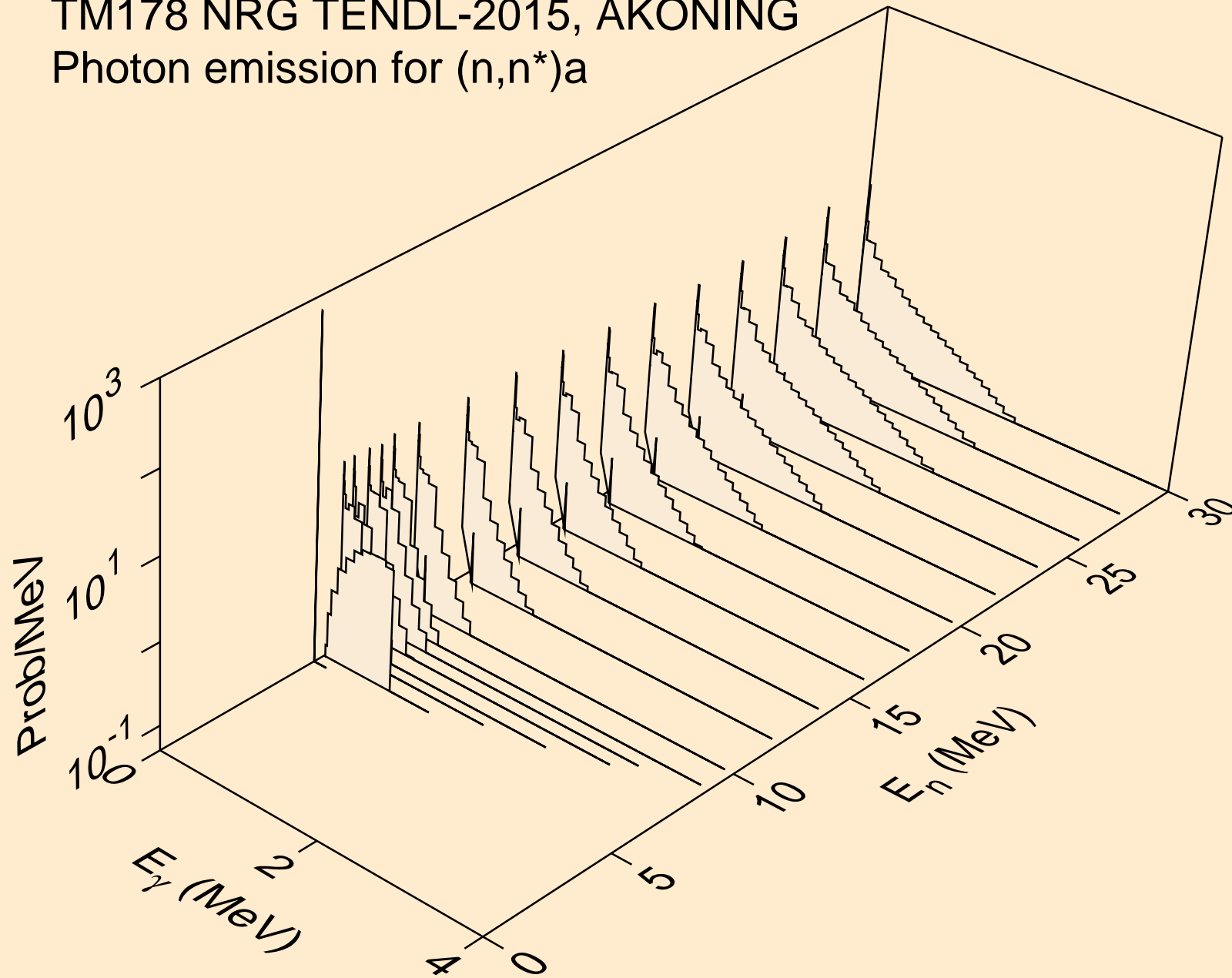

TM178 NRG TENDL-2015, AKONING  
Photon emission for (n,2n)a

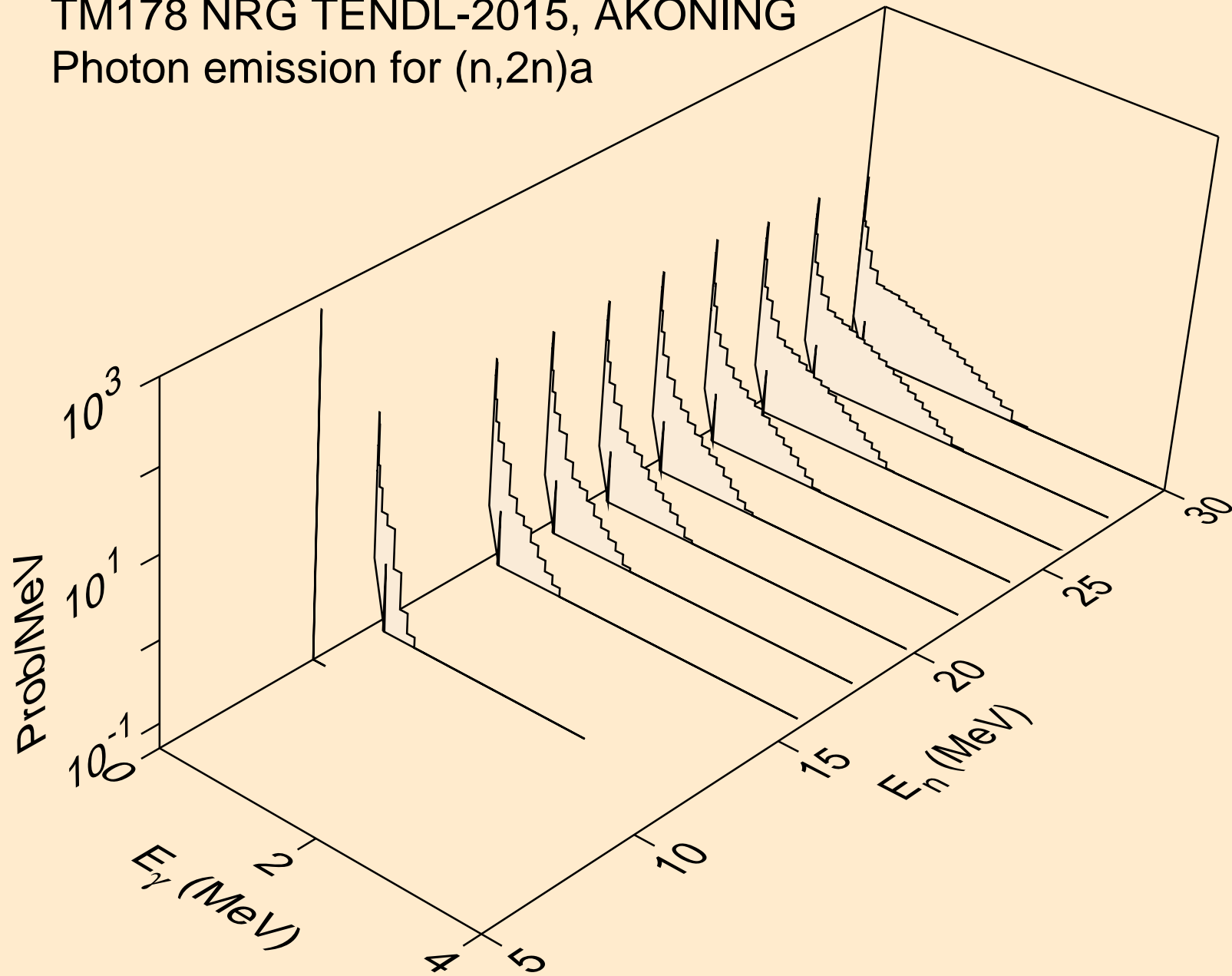

TM178 NRG TENDL-2015, AKONING  
Photon emission for (n,3n)a

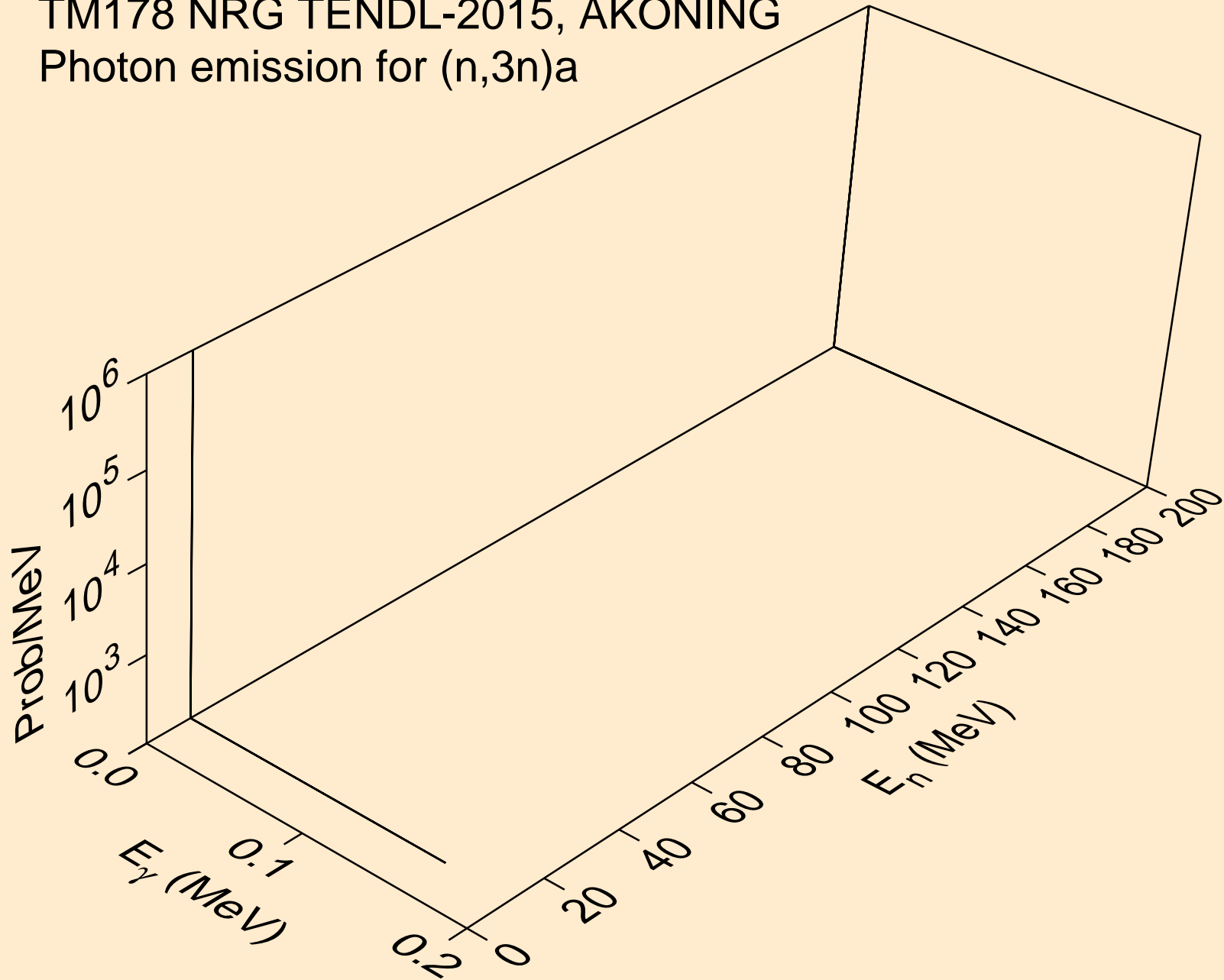



TM178 NRG TENDL-2015, AKONING  
Photon emission for (n,n\*)p

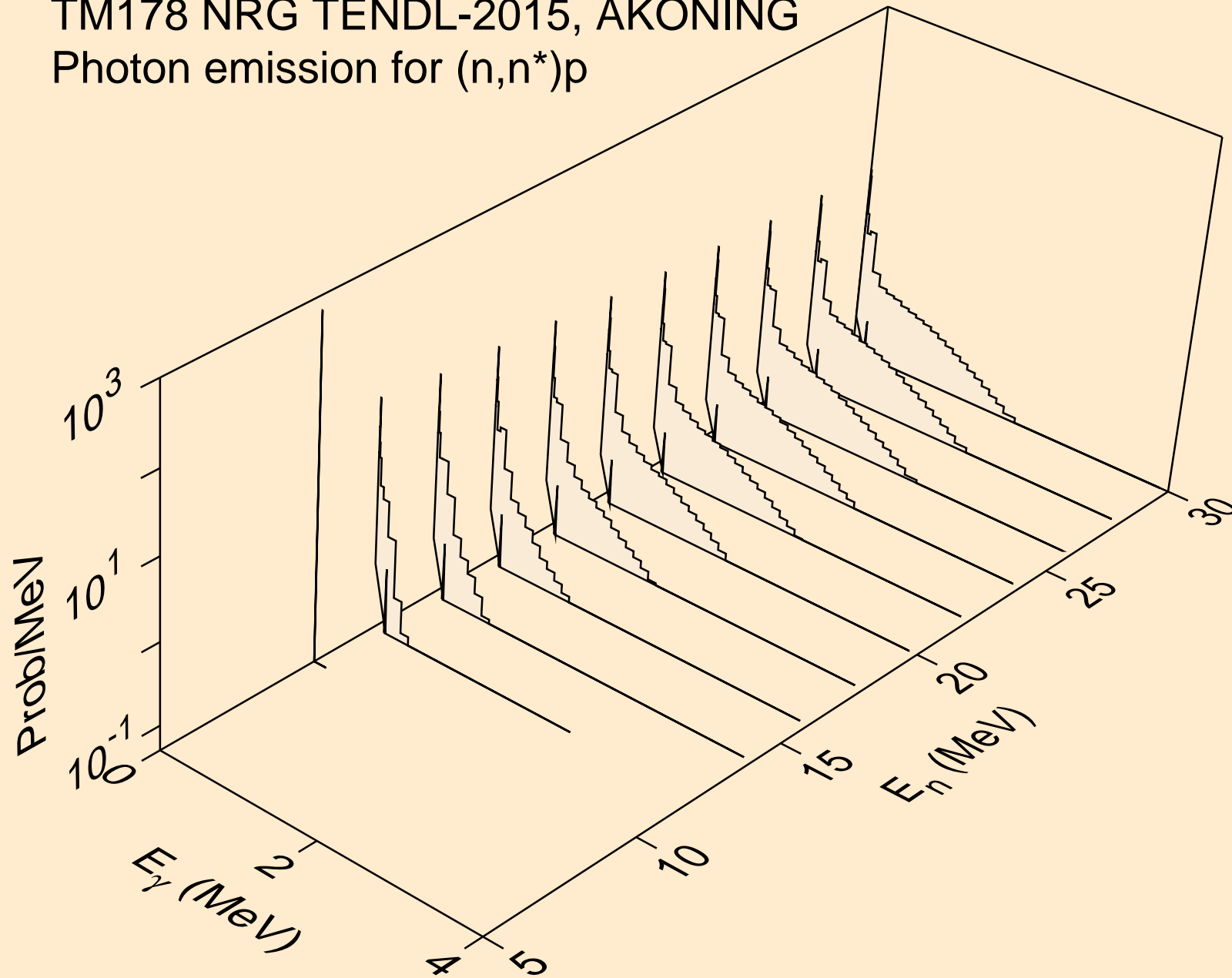

TM178 NRG TENDL-2015, AKONING  
Photon emission for (n,n\*)d

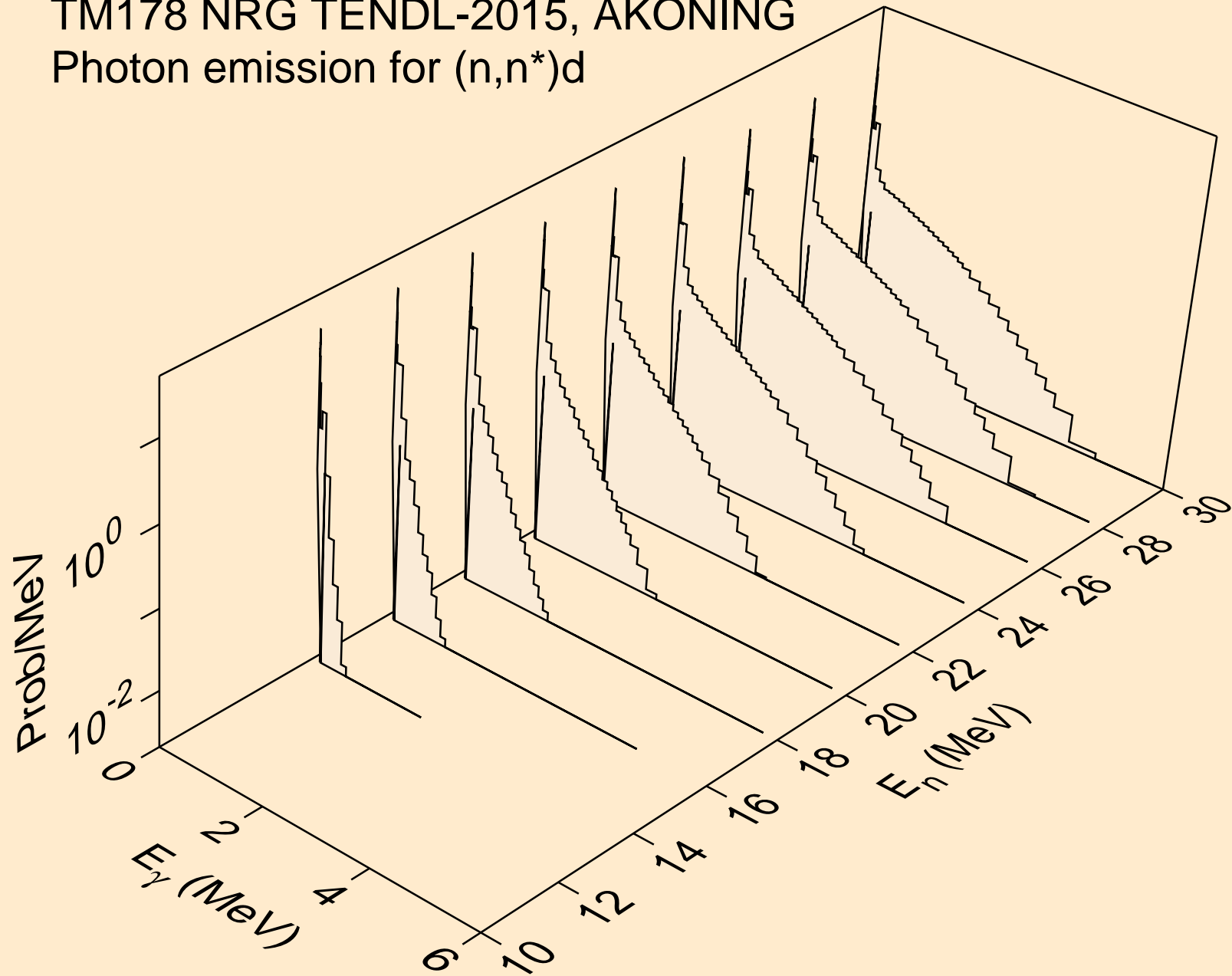

TM178 NRG TENDL-2015, AKONING  
Photon emission for (n,n\*)t

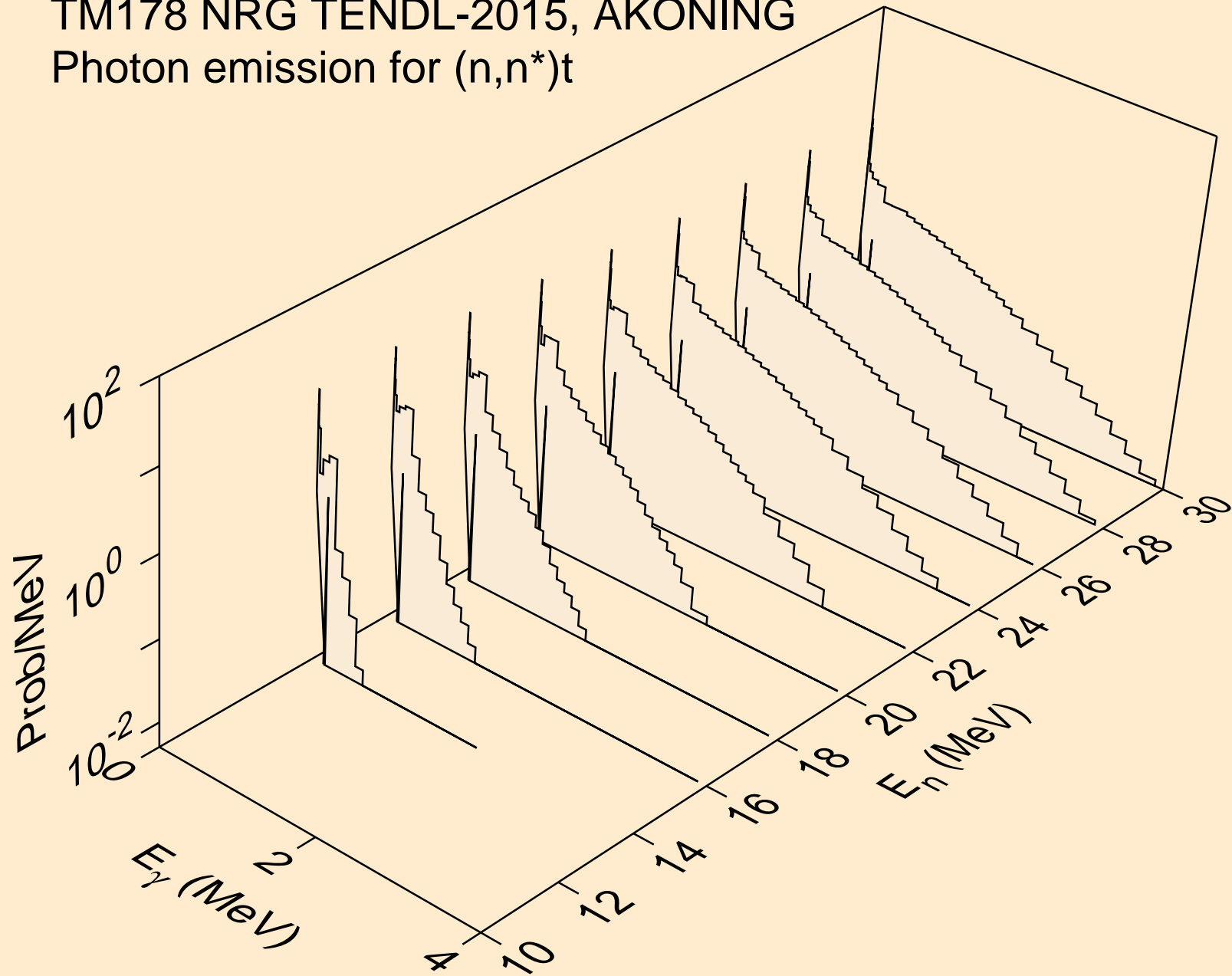

TM178 NRG TENDL-2015, AKONING  
Photon emission for (n,n\*)he3

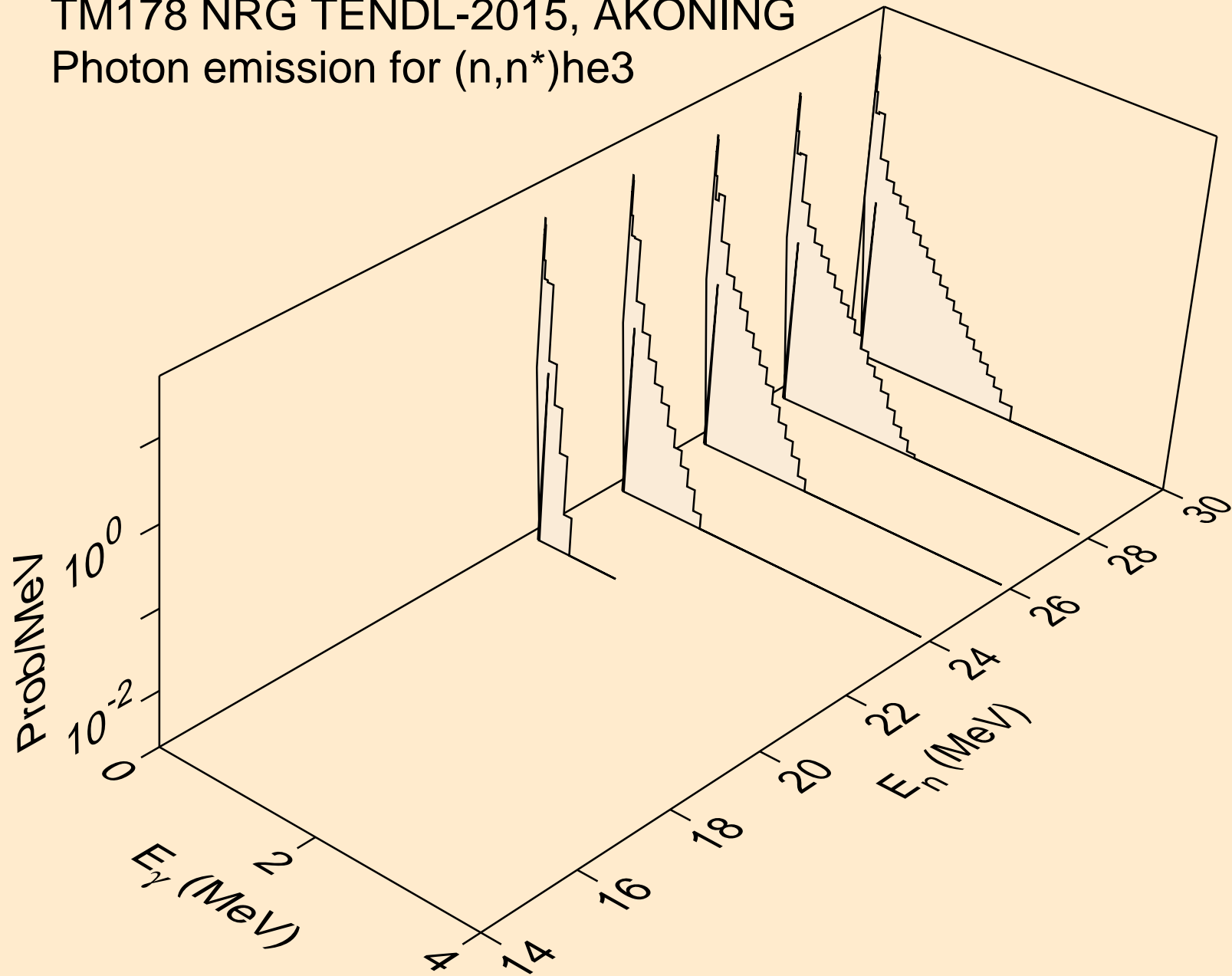

TM178 NRG TENDL-2015, AKONING  
Photon emission for (n,4n)

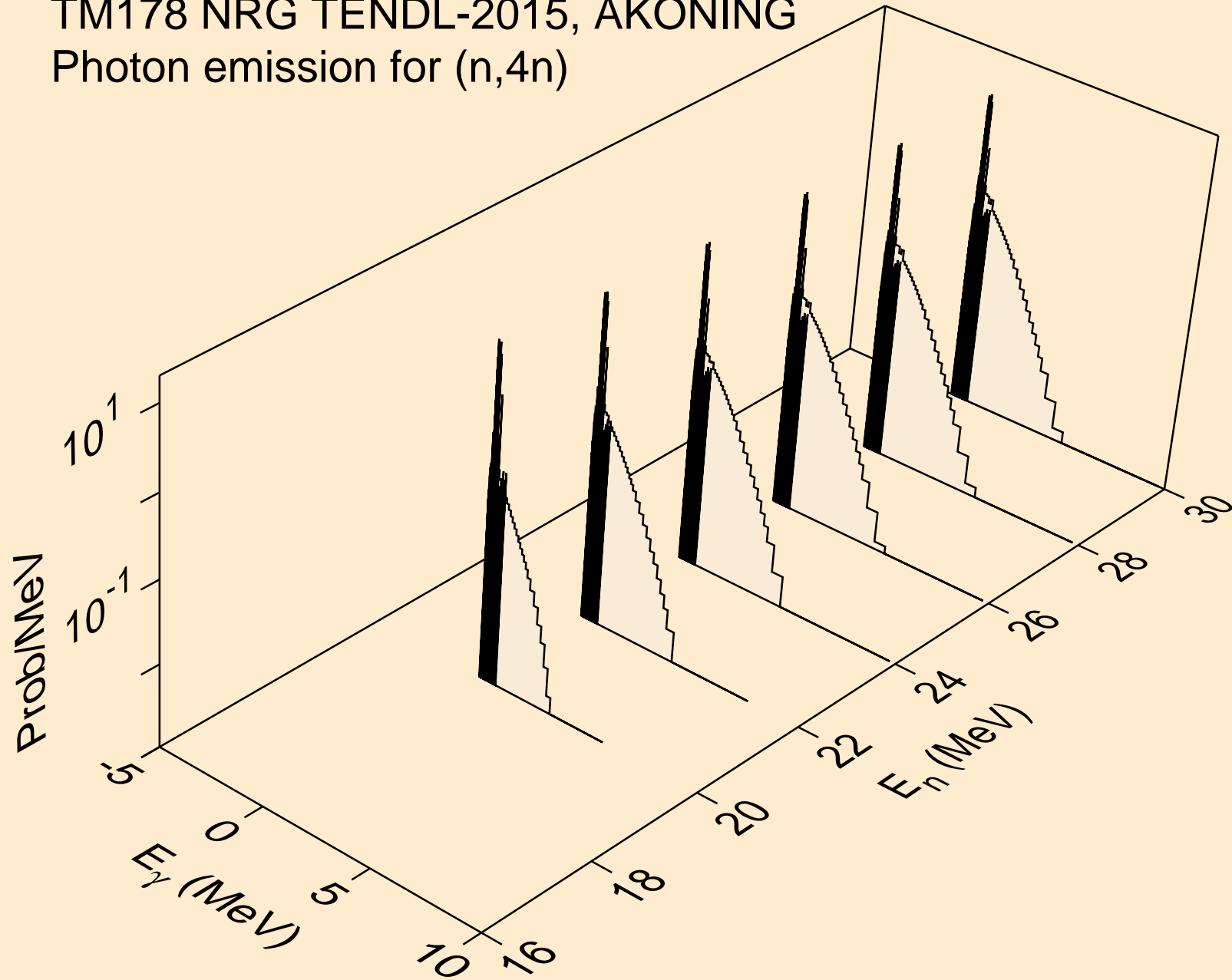

TM178 NRG TENDL-2015, AKONING  
Photon emission for (n,2np)

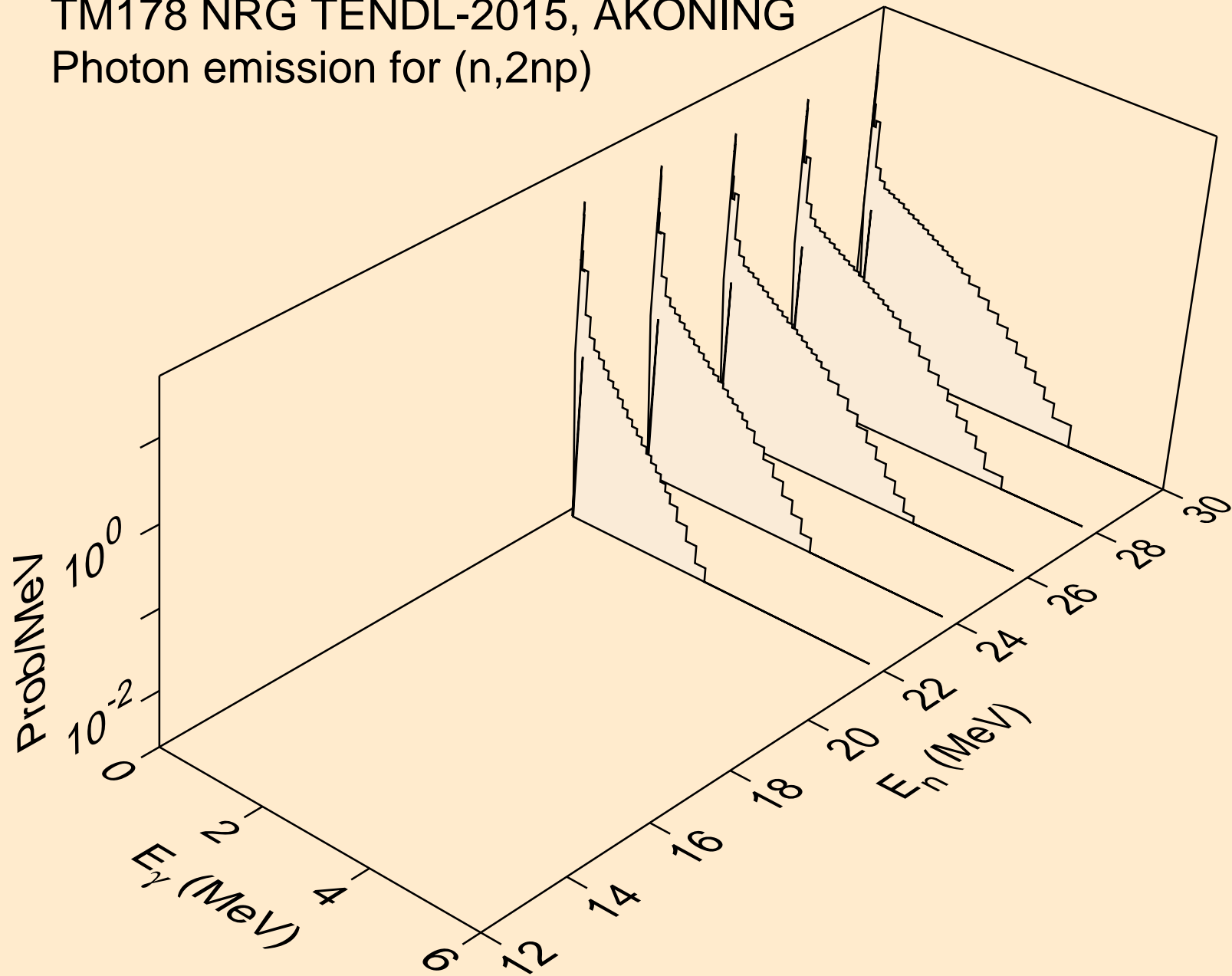

TM178 NRG TENDL-2015, AKONING  
Photon emission for (n,3np)

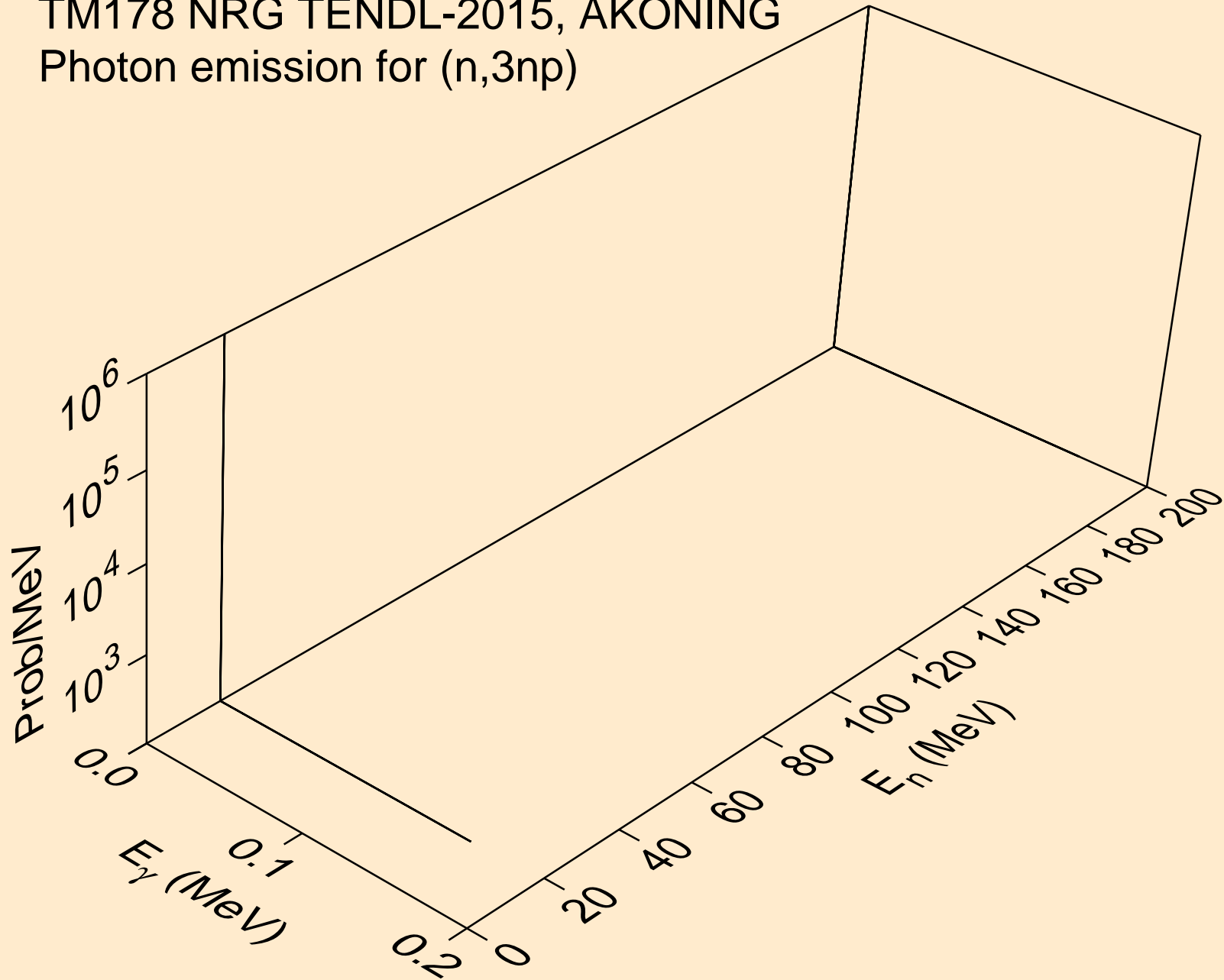

TM178 NRG TENDL-2015, AKONING  
Photon emission for (n,n\*c)

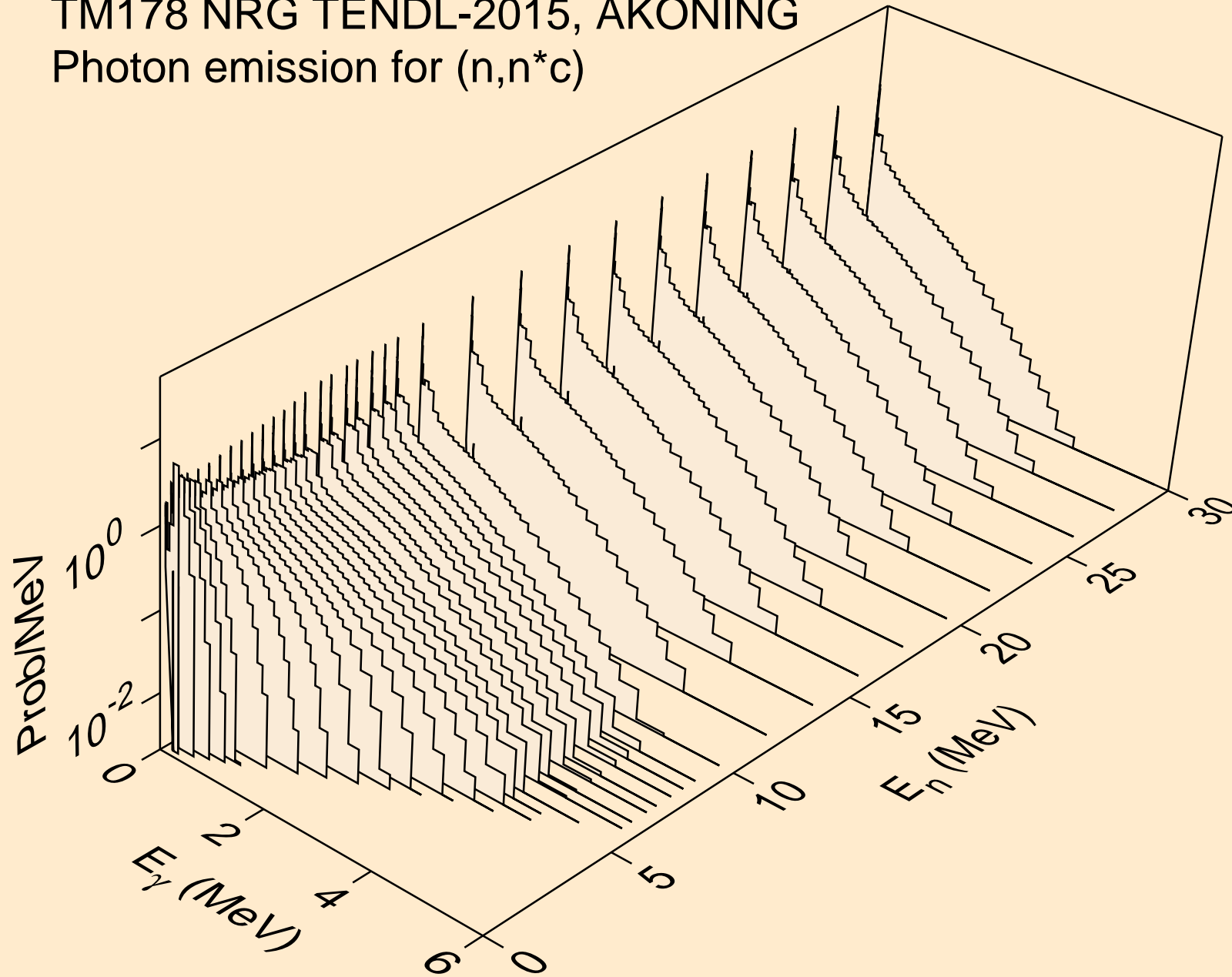



TM178 NRG TENDL-2015, AKONING  
Photon emission for (n,gma)

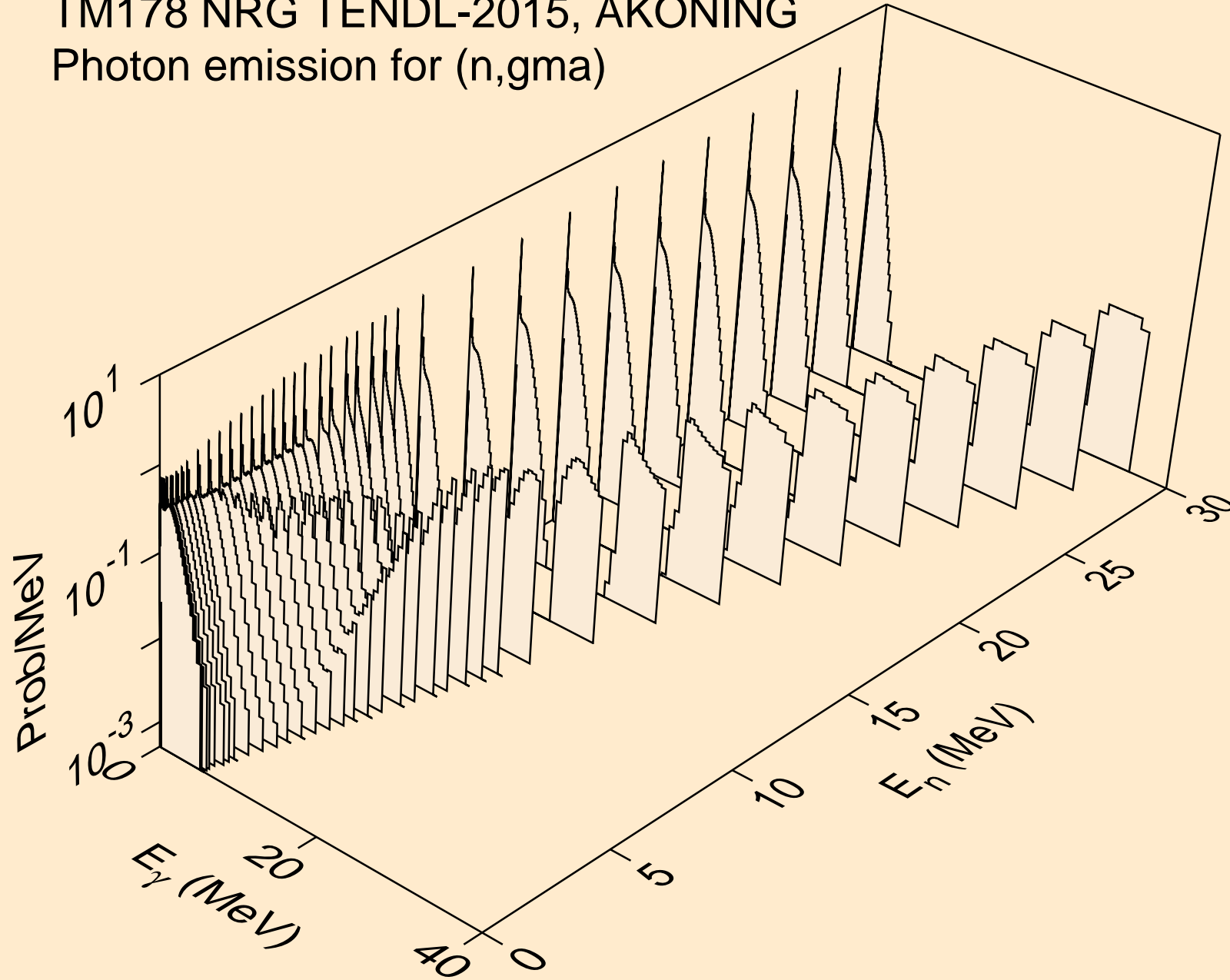

TM178 NRG TENDL-2015, AKONING  
Photon emission for (n,p)

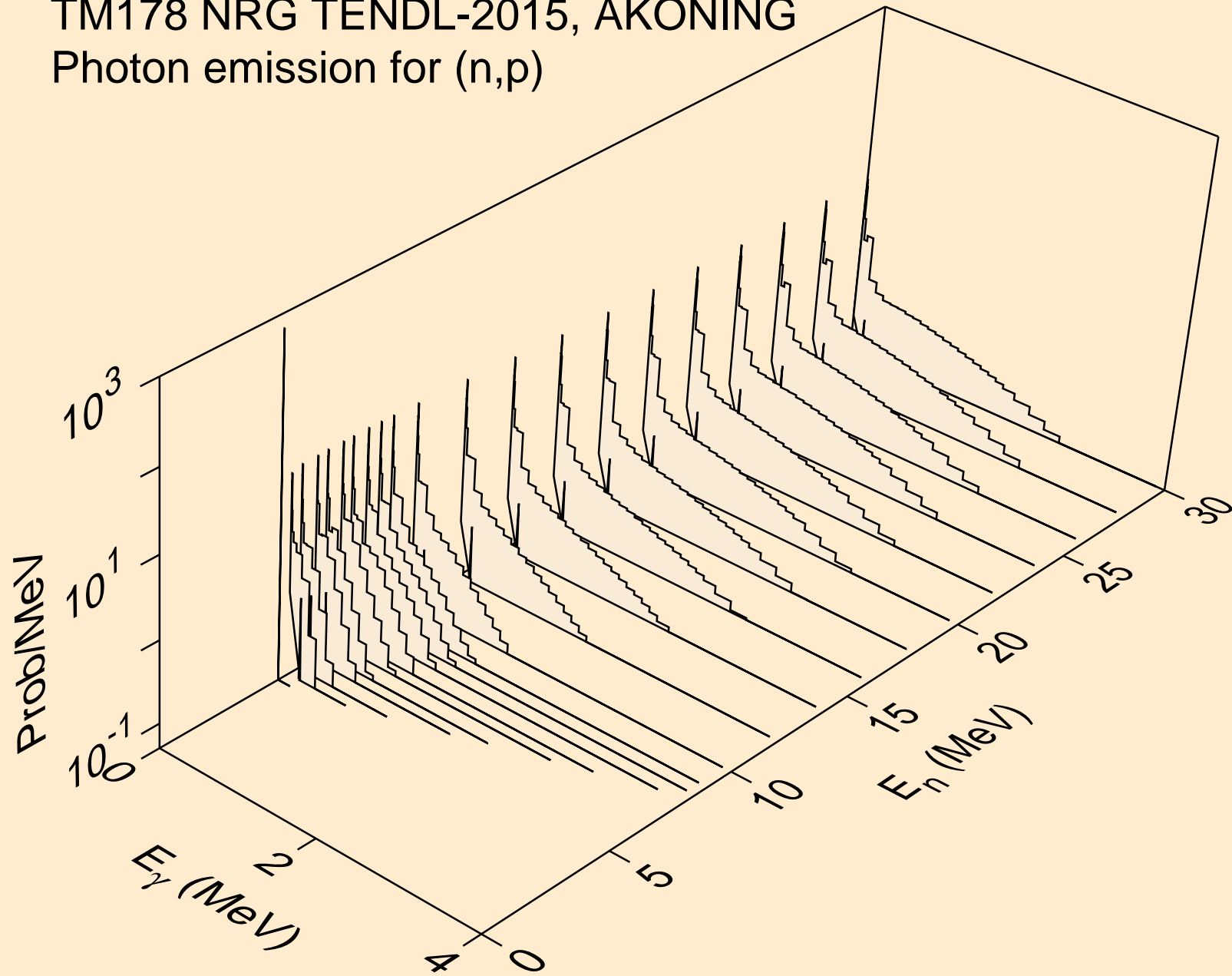

TM178 NRG TENDL-2015, AKONING  
Photon emission for (n,d)

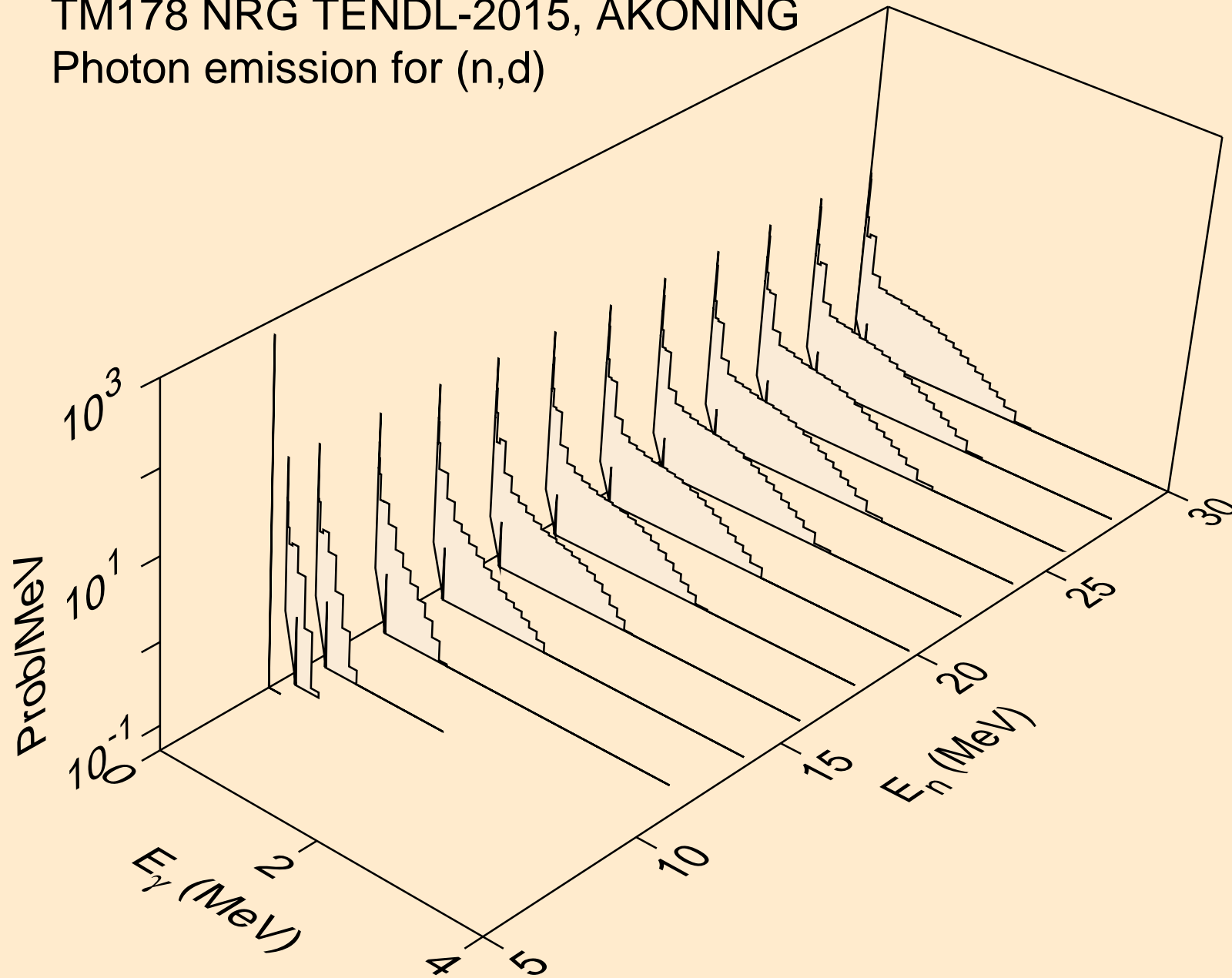

TM178 NRG TENDL-2015, AKONING  
Photon emission for (n,t)

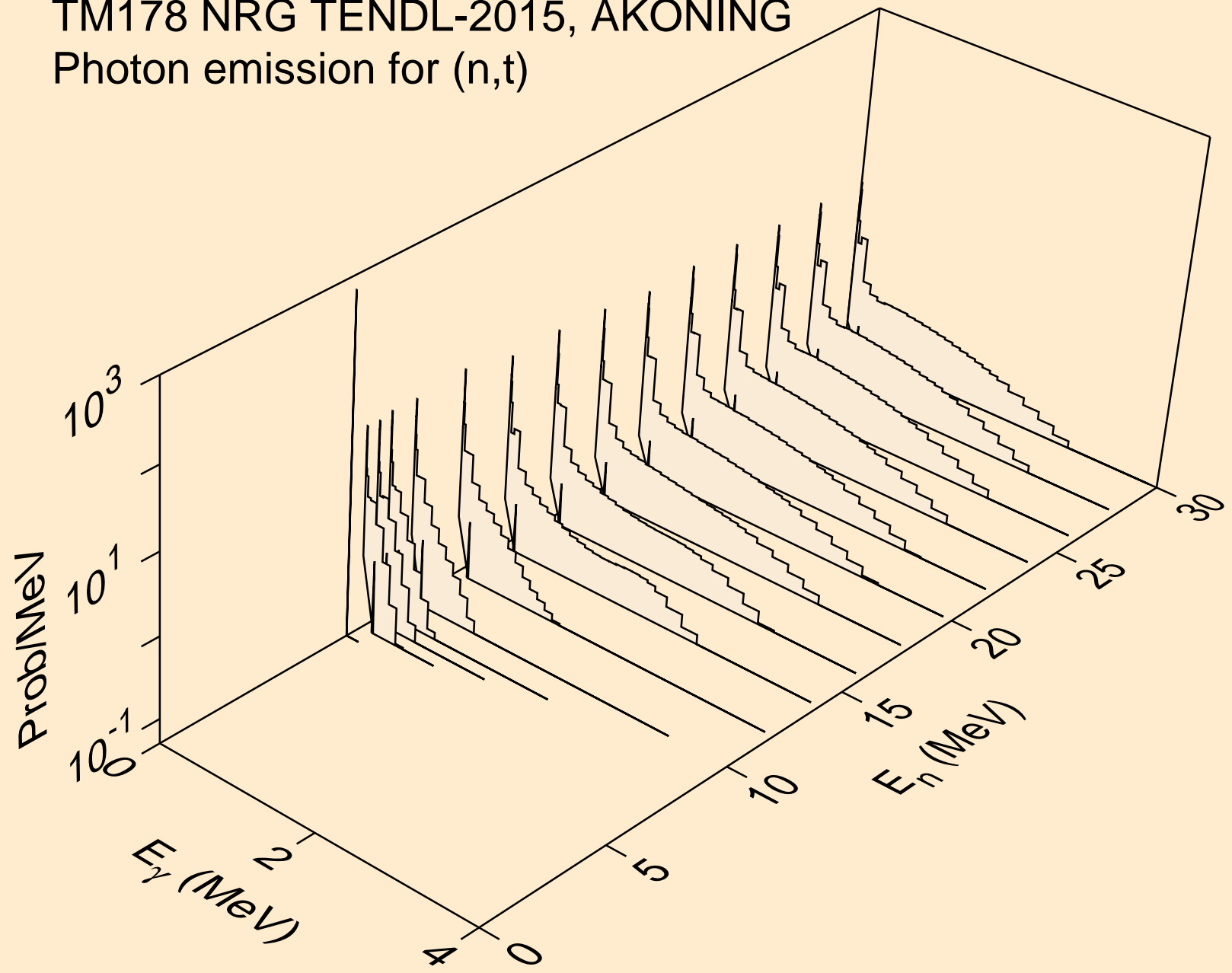

TM178 NRG TENDL-2015, AKONING  
Photon emission for (n,he3)

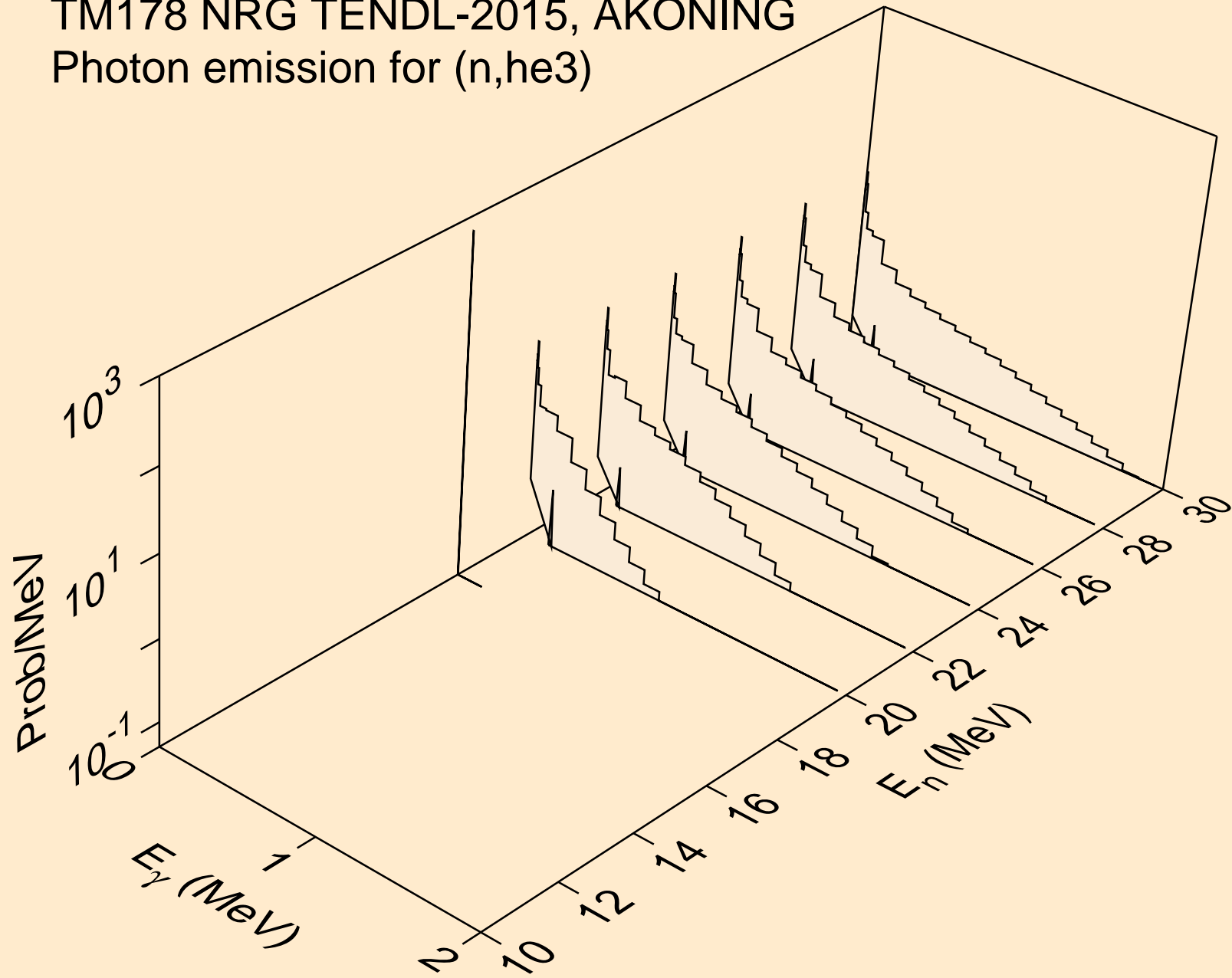

TM178 NRG TENDL-2015, AKONING  
Photon emission for (n,a)

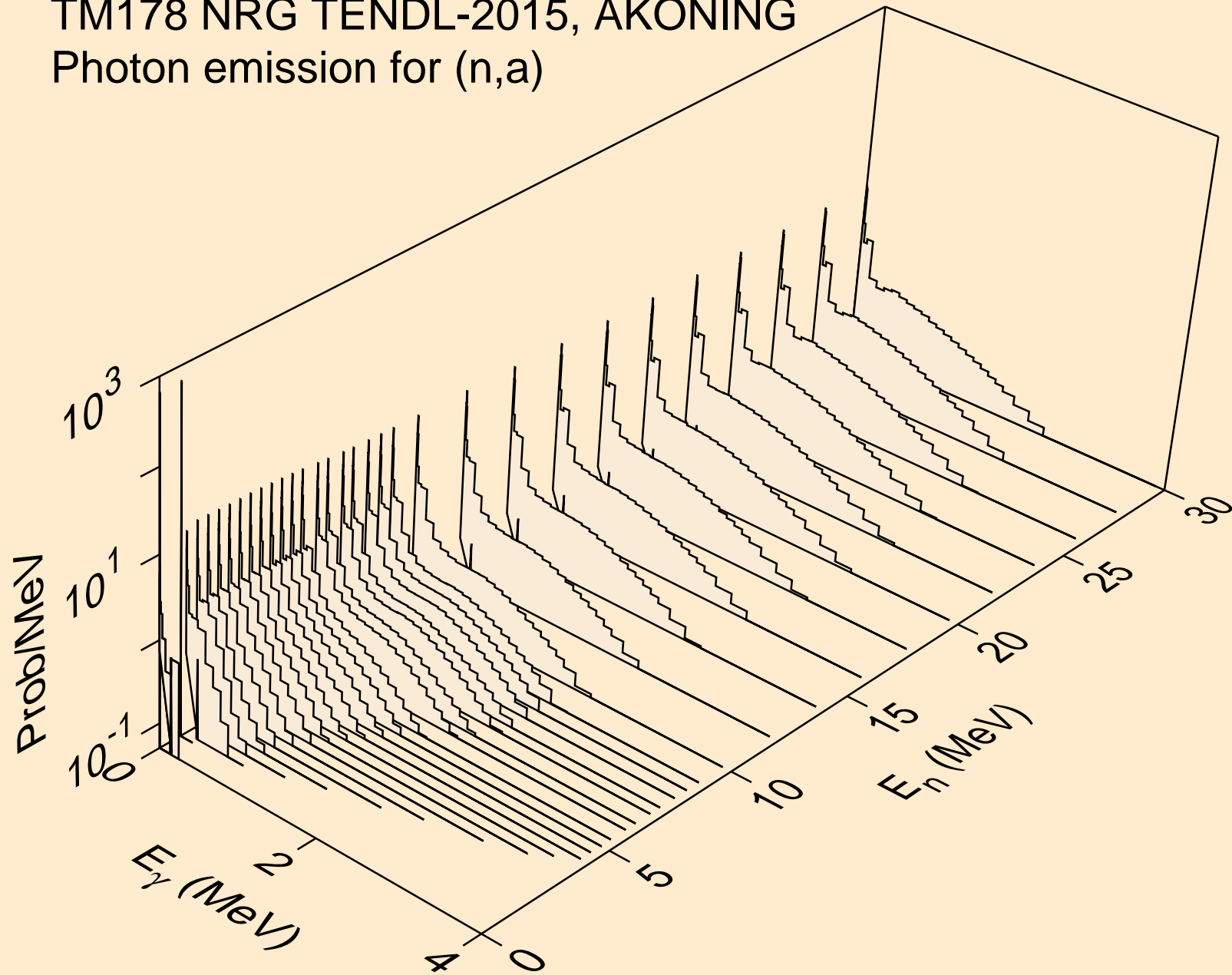

TM178 NRG TENDL-2015, AKONING  
Photon emission for (n,2p)

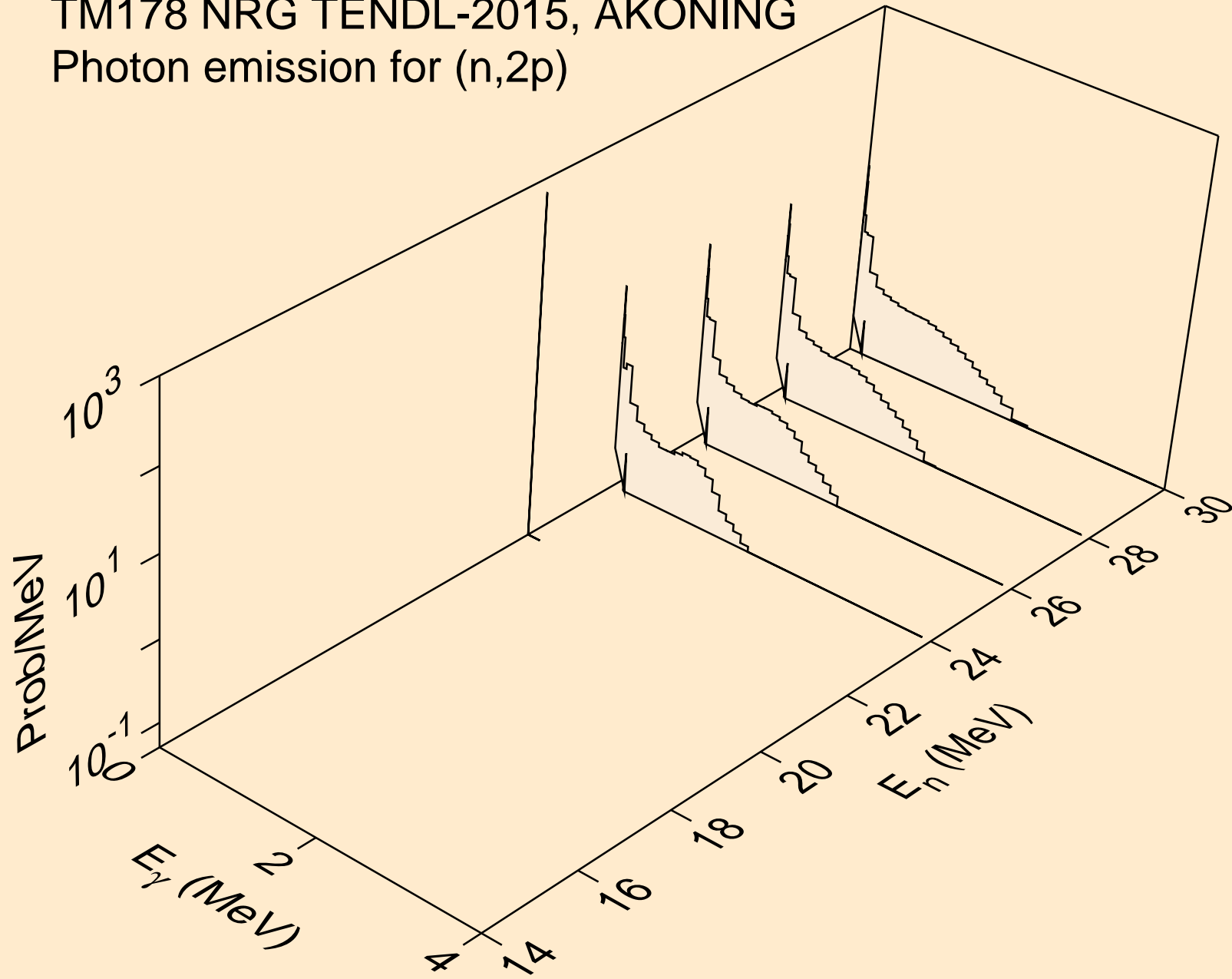

TM178 NRG TENDL-2015, AKONING  
thermal capture photon spectrum

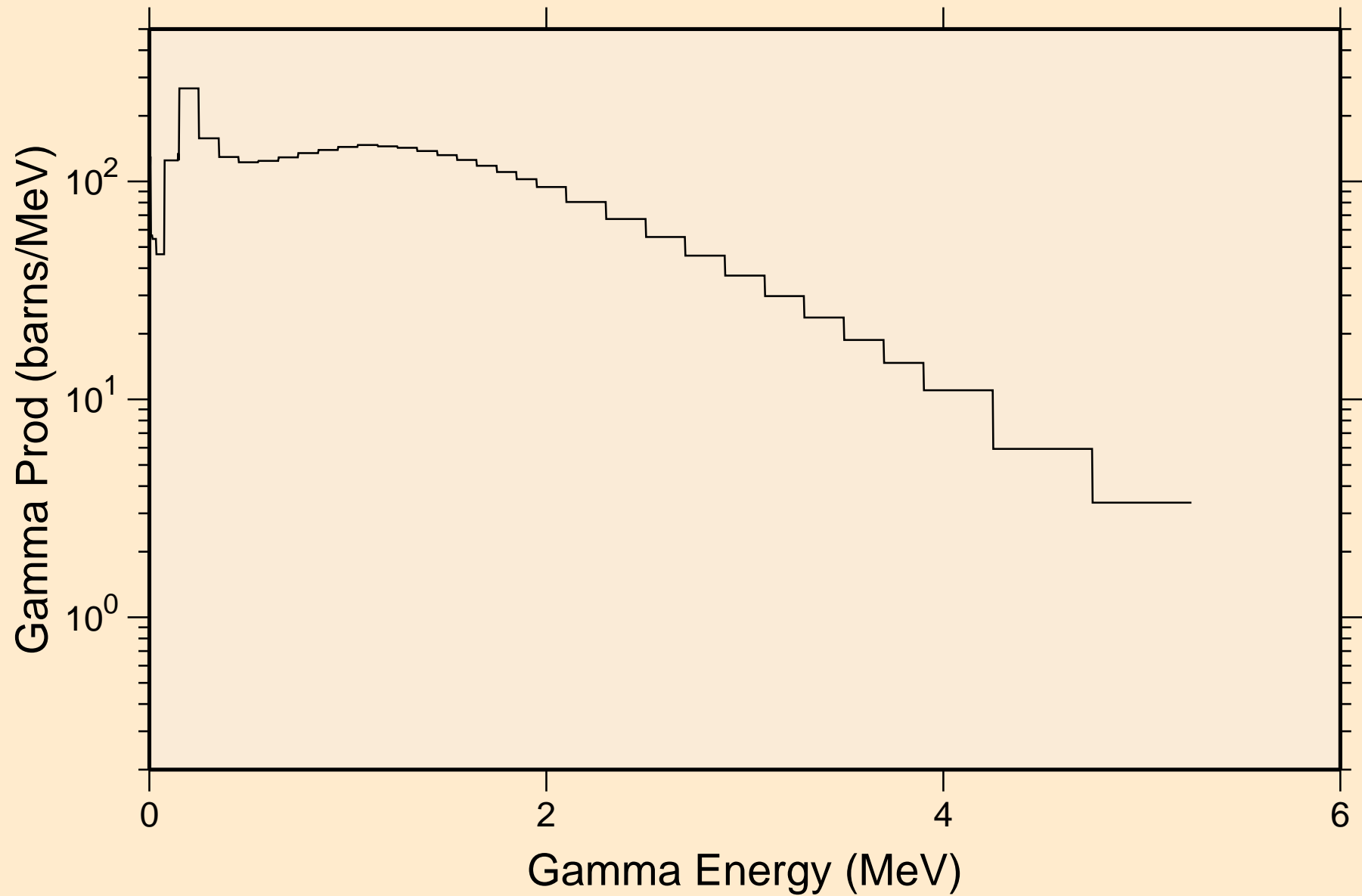



TM178 NRG TENDL-2015, AKONING  
14 MeV photon spectrum

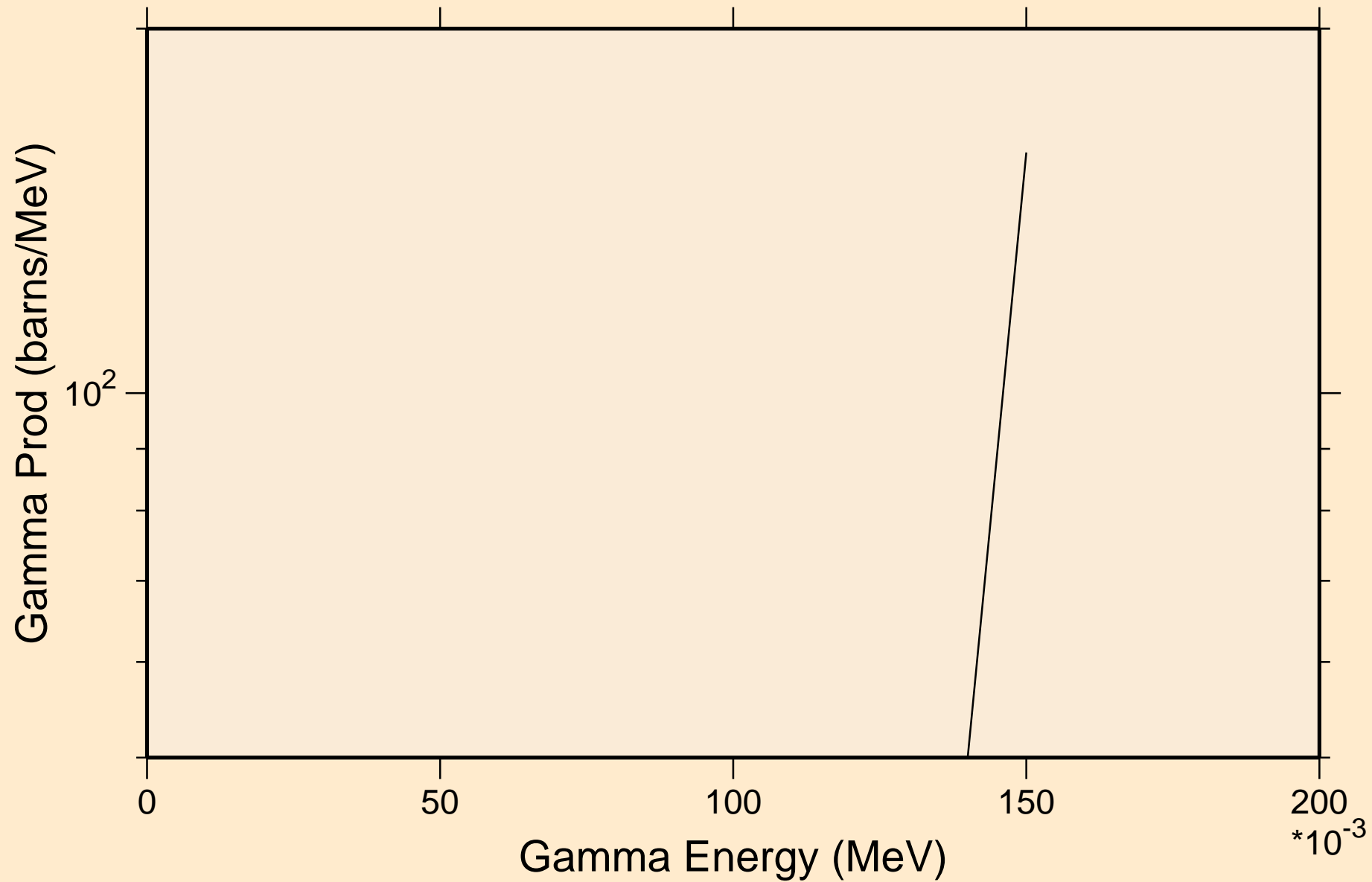

# TM178 NRG TENDL-2015, AKONING

## Particle heating contributions

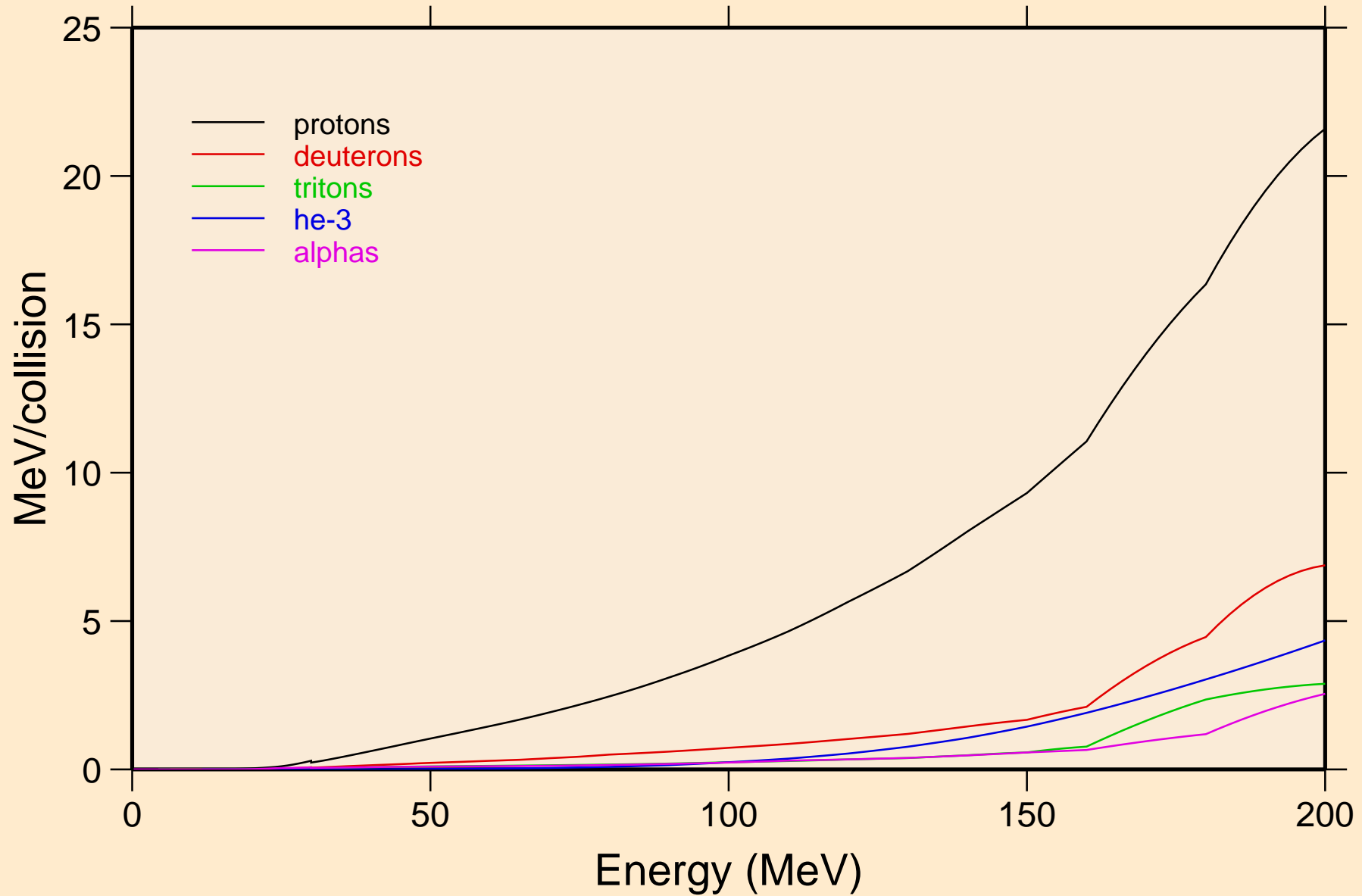

# TM178 NRG TENDL-2015, AKONING

## Recoil Heating

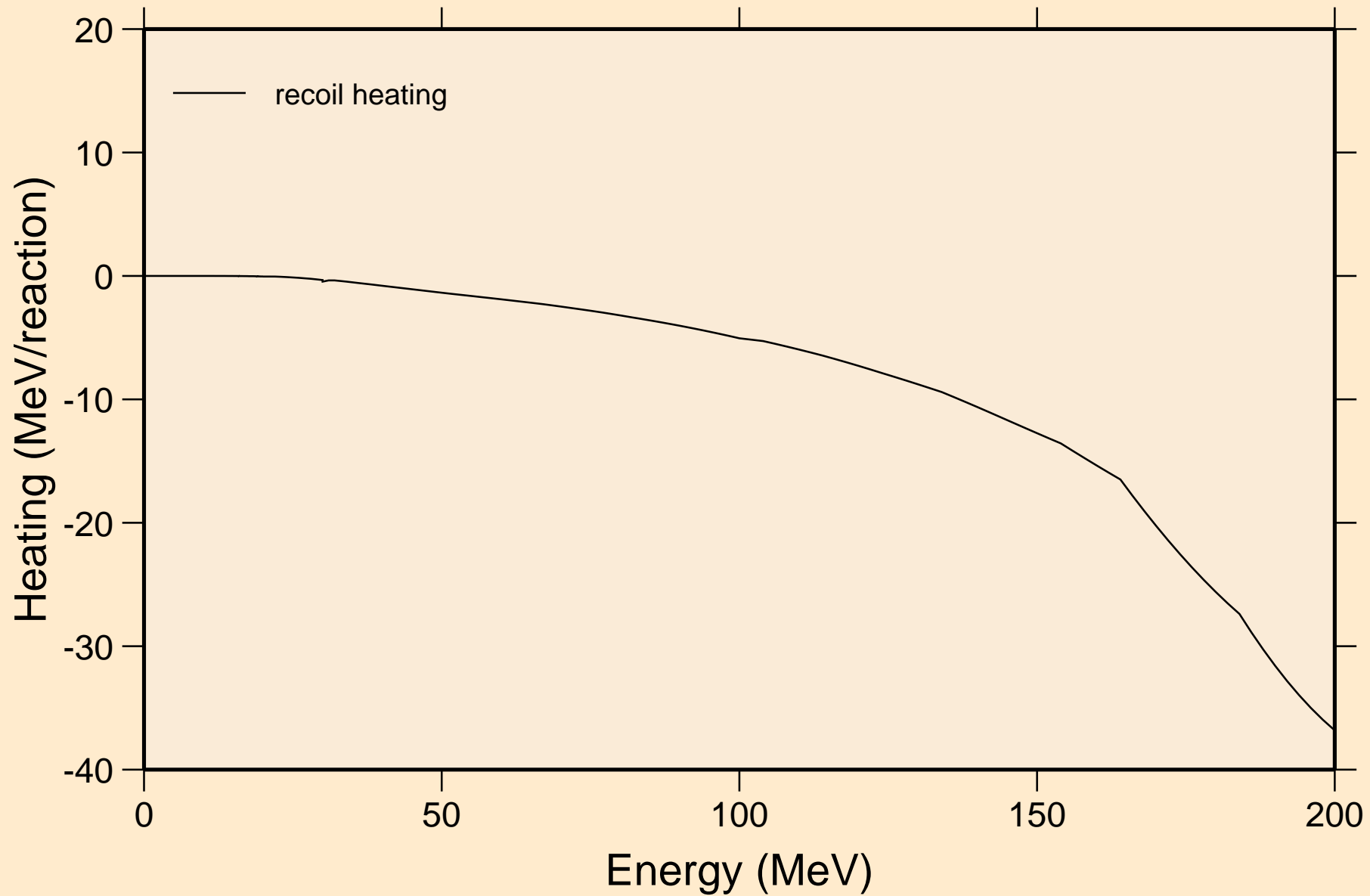

# TM178 NRG TENDL-2015, AKONING

## Particle production cross sections

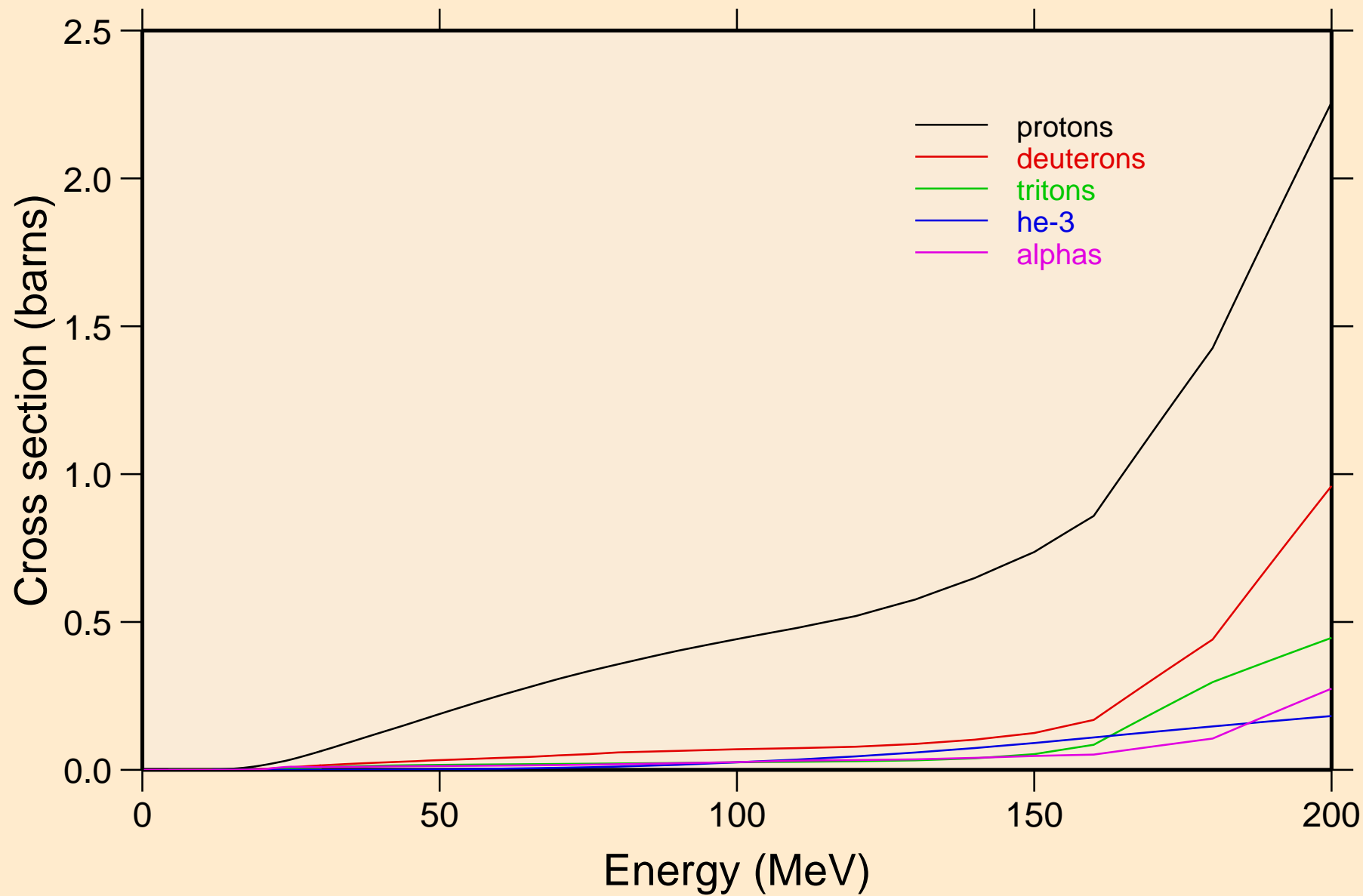

TM178 NRG TENDL-2015, AKONING  
protons from (n,x)

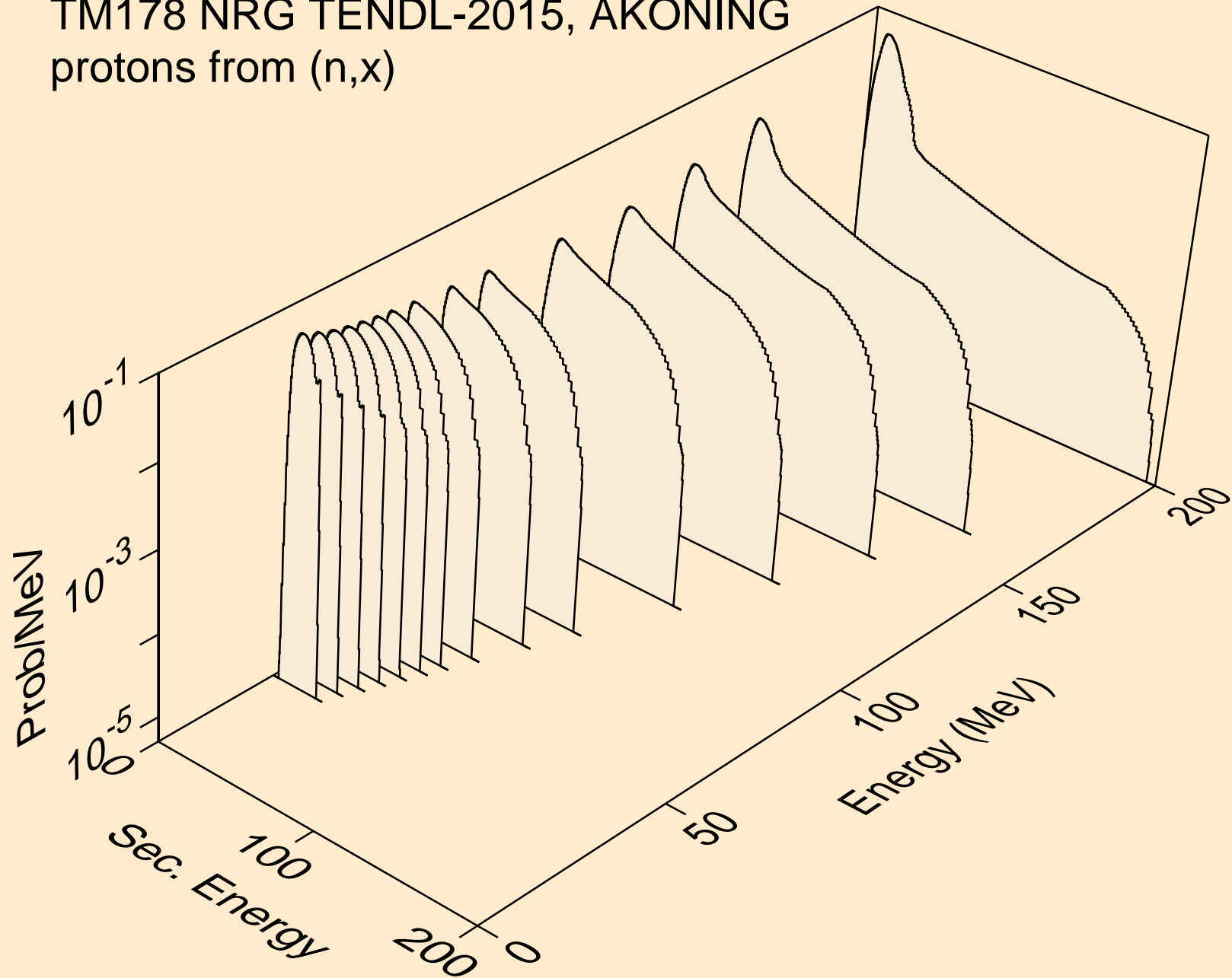

TM178 NRG TENDL-2015, AKONING  
protons from (n,n\*)p

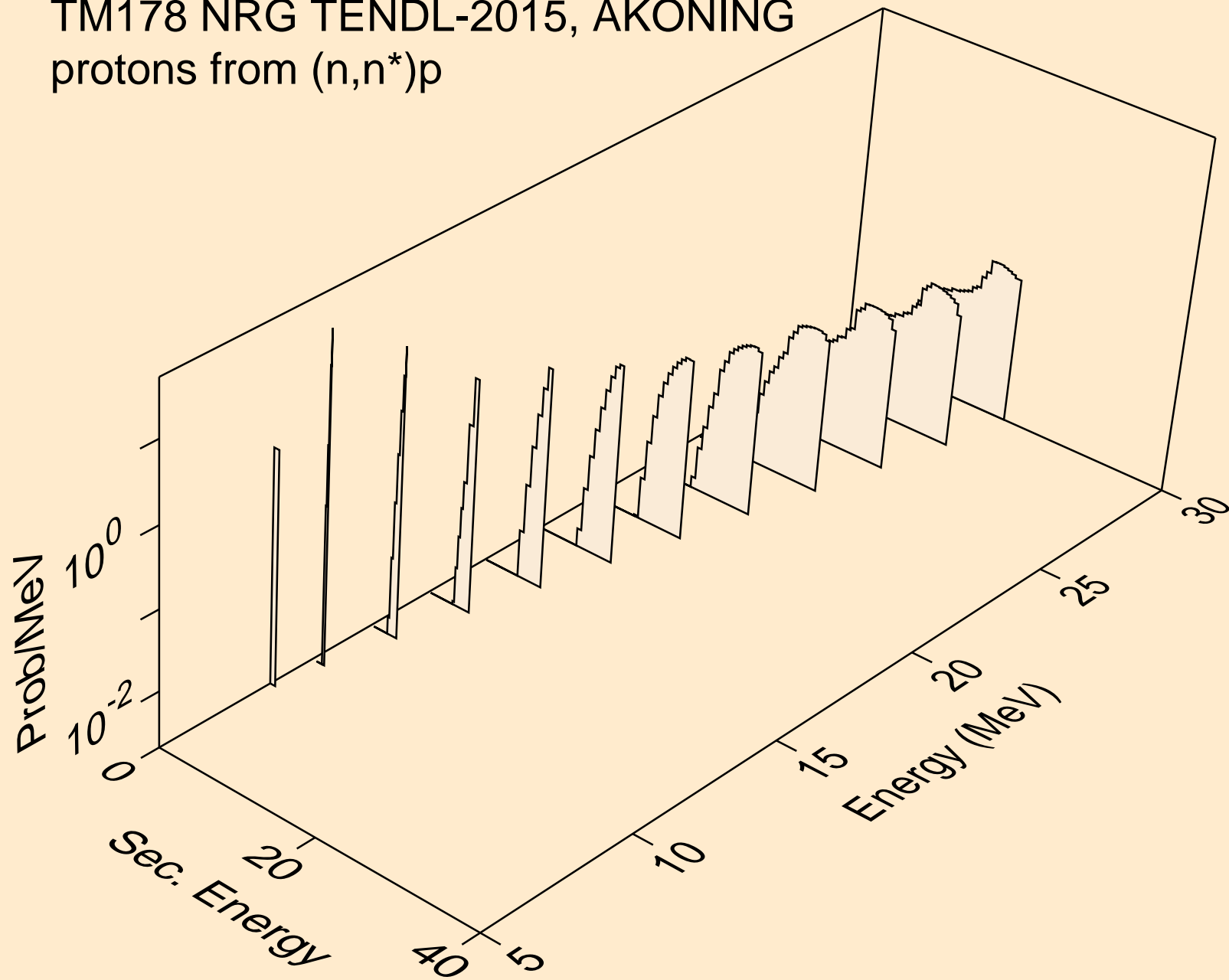

TM178 NRG TENDL-2015, AKONING  
protons from (n,2np)

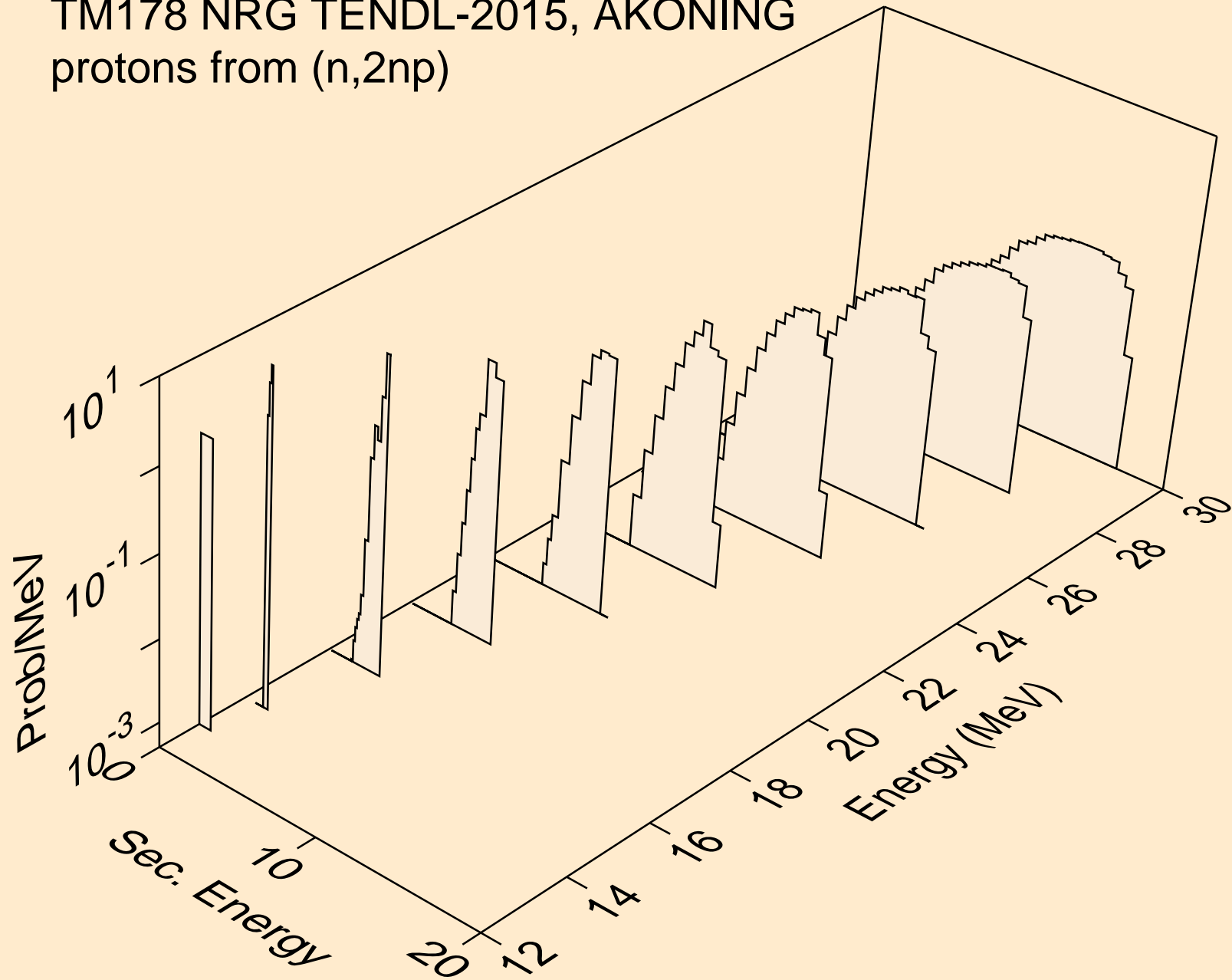

TM178 NRG TENDL-2015, AKONING  
protons from (n,3np)

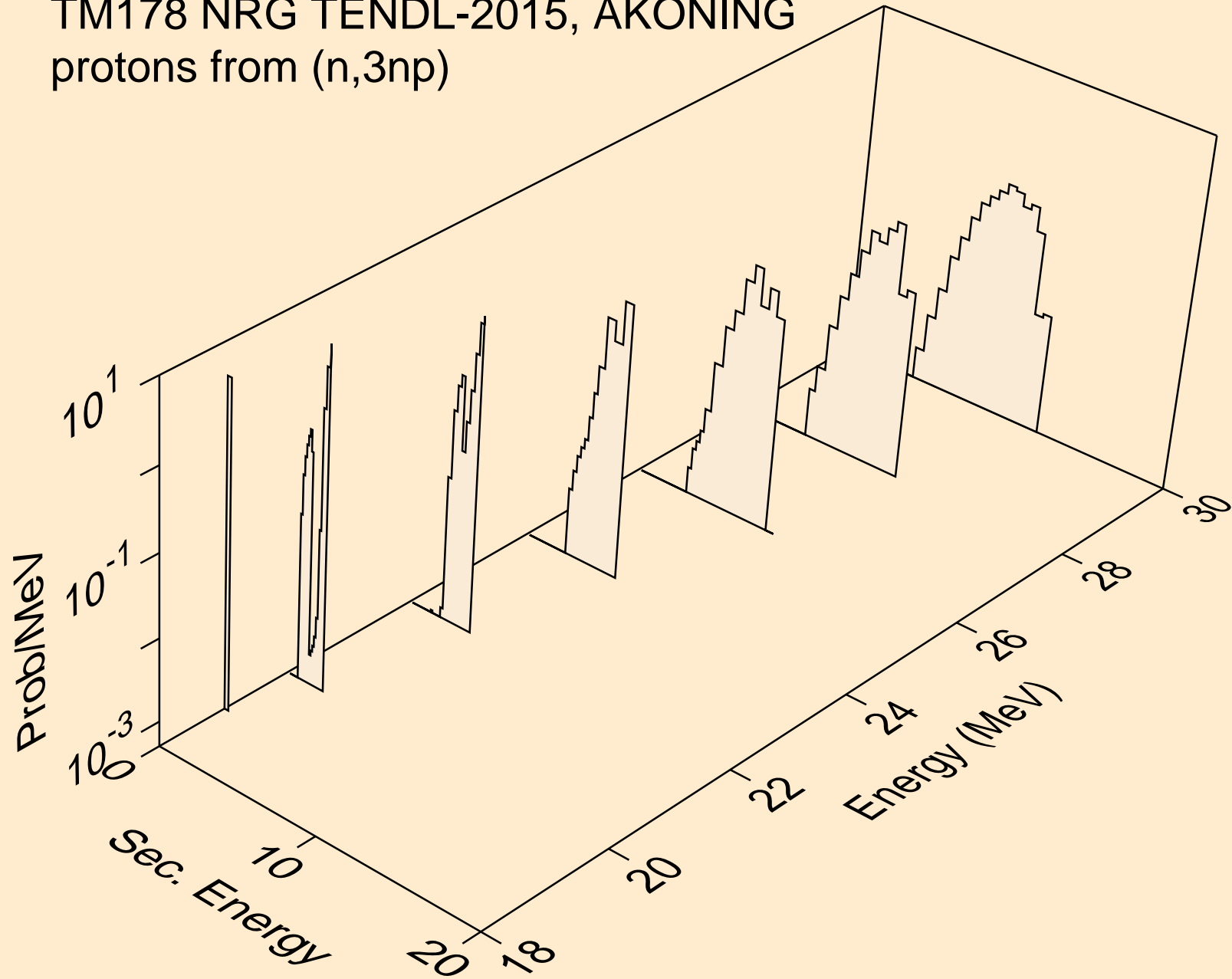



TM178 NRG TENDL-2015, AKONING  
protons from (n,p)

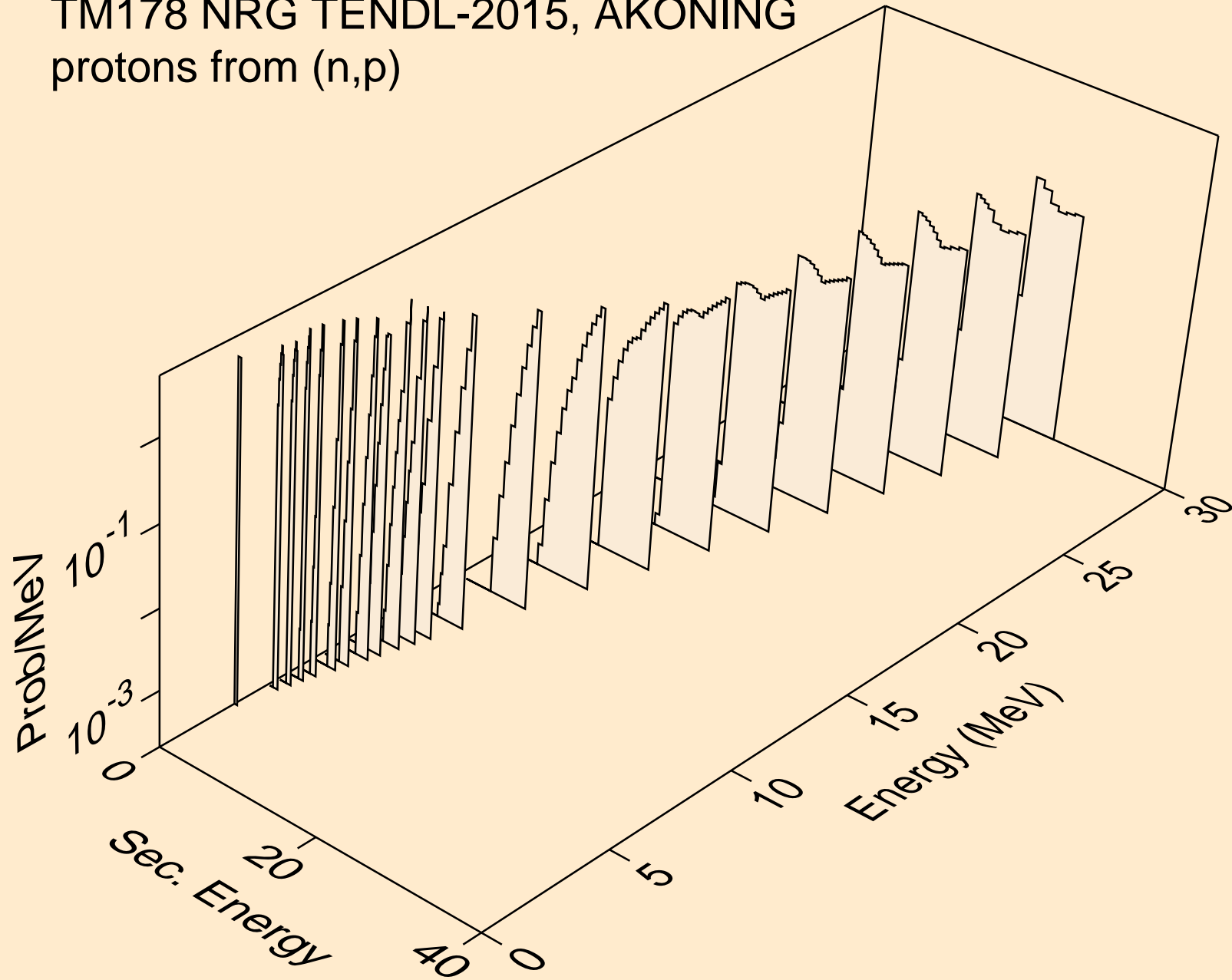

TM178 NRG TENDL-2015, AKONING  
protons from (n,2p)

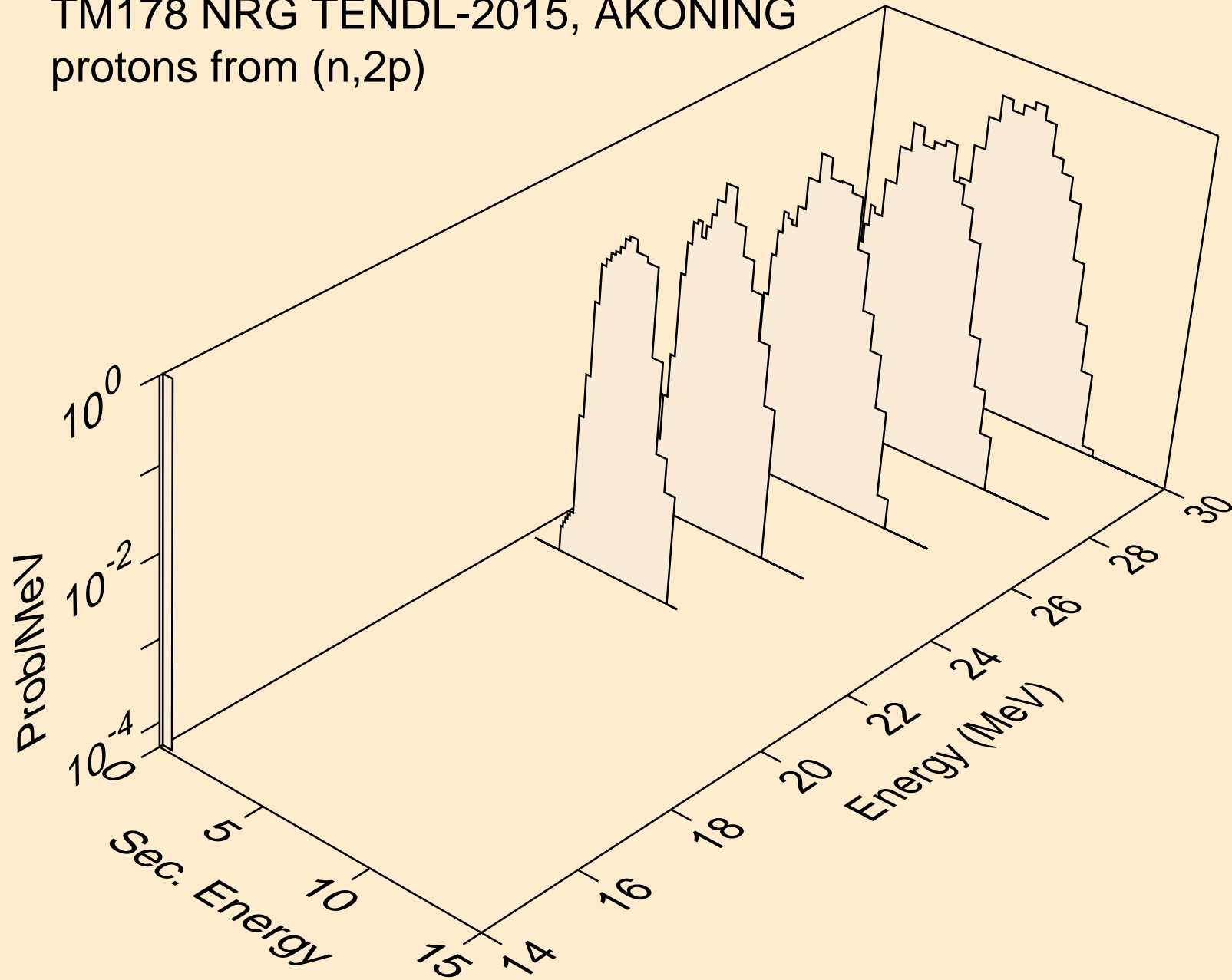

TM178 NRG TENDL-2015, AKONING  
deuterons from (n,x)

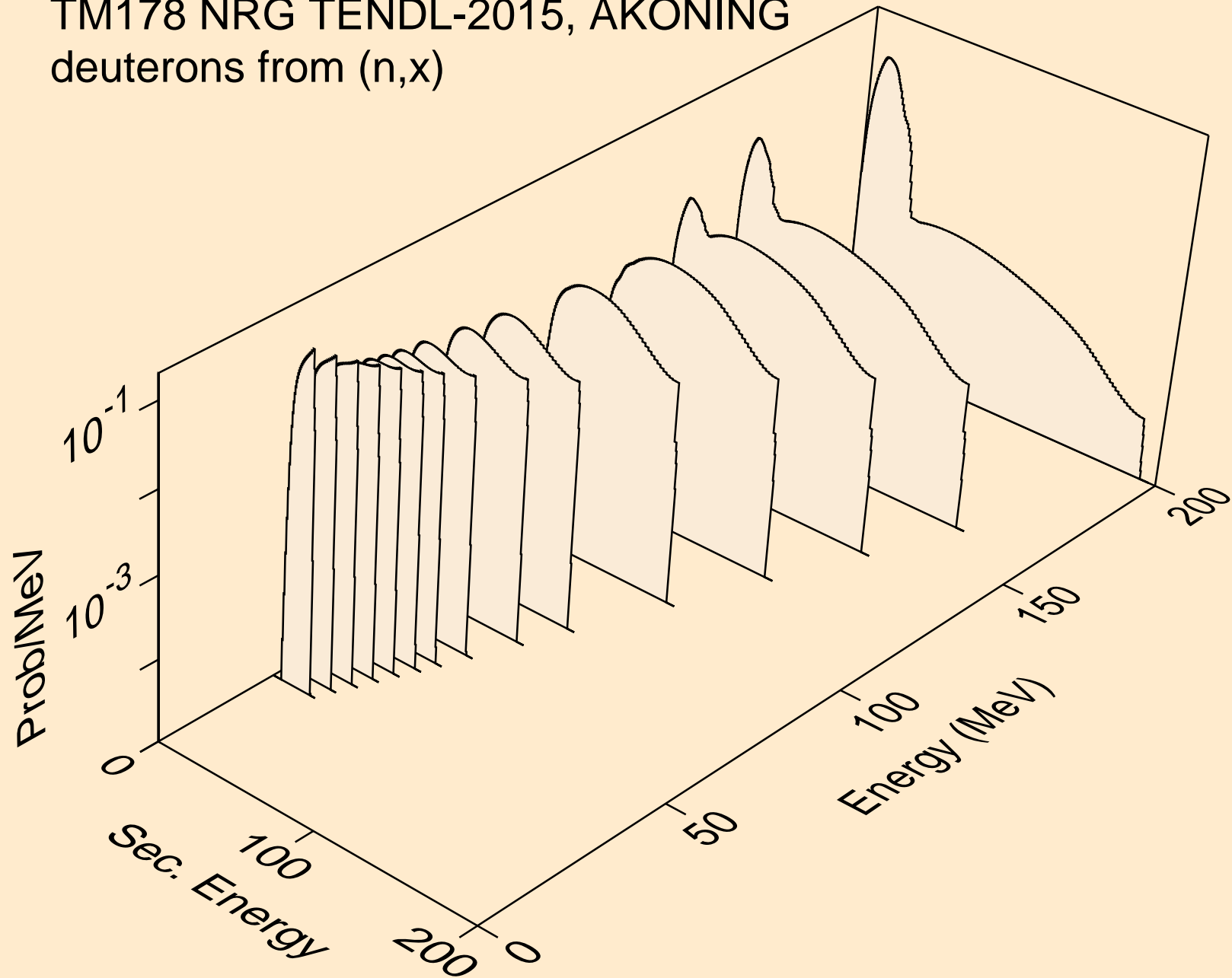

TM178 NRG TENDL-2015, AKONING  
deuterons from (n,2nd)

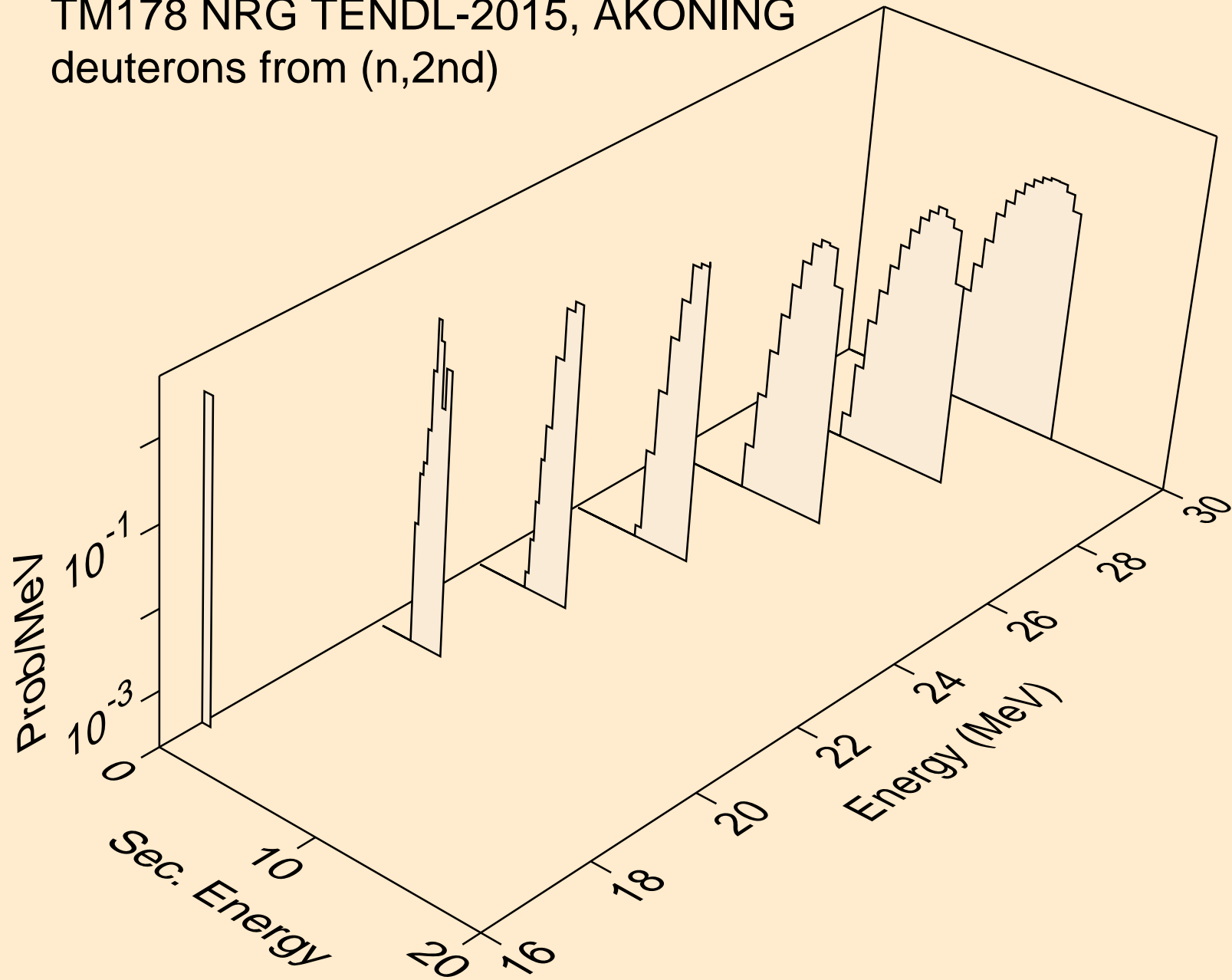

TM178 NRG TENDL-2015, AKONING  
deuterons from (n,n\*)d

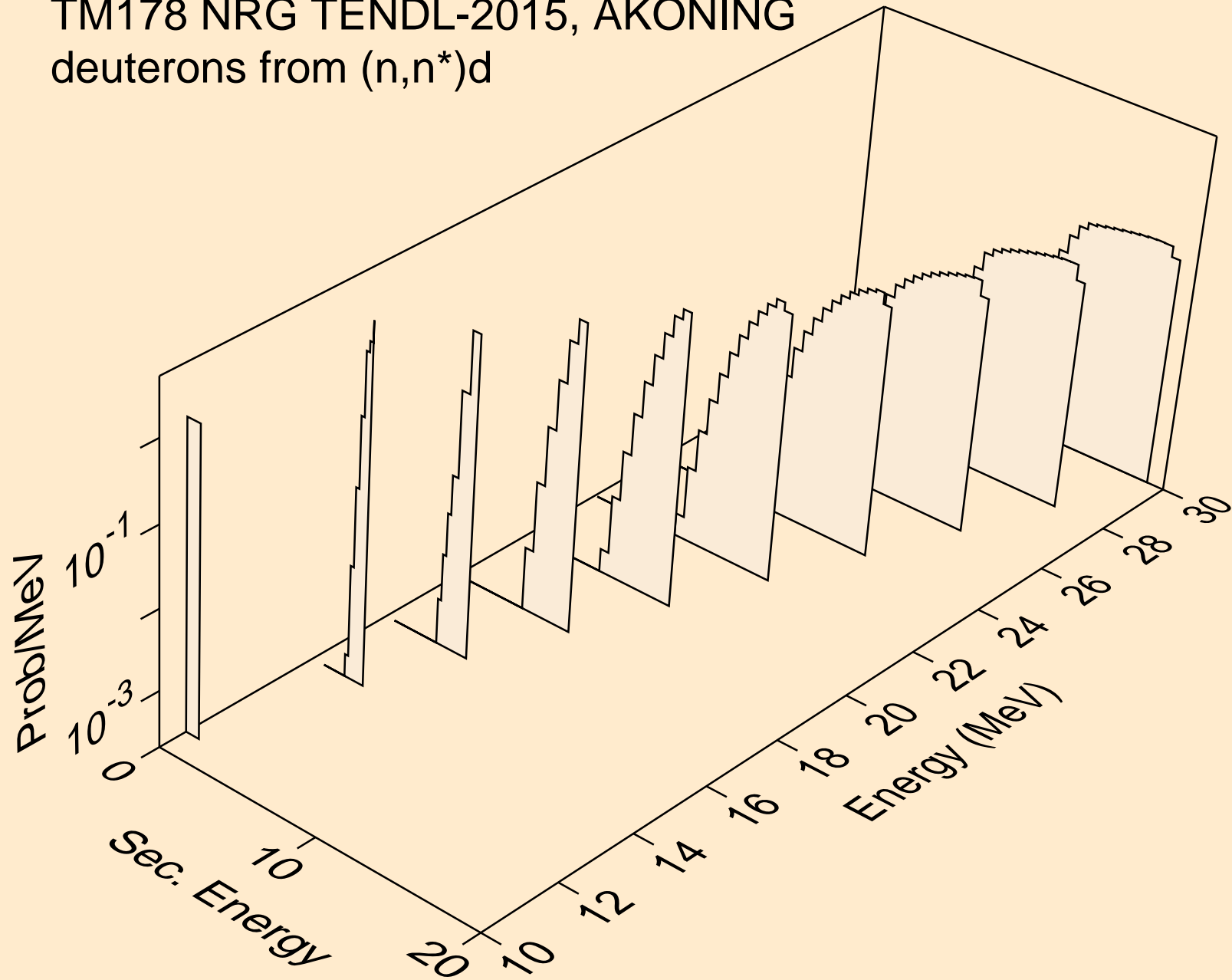

TM178 NRG TENDL-2015, AKONING  
deuterons from (n,d)

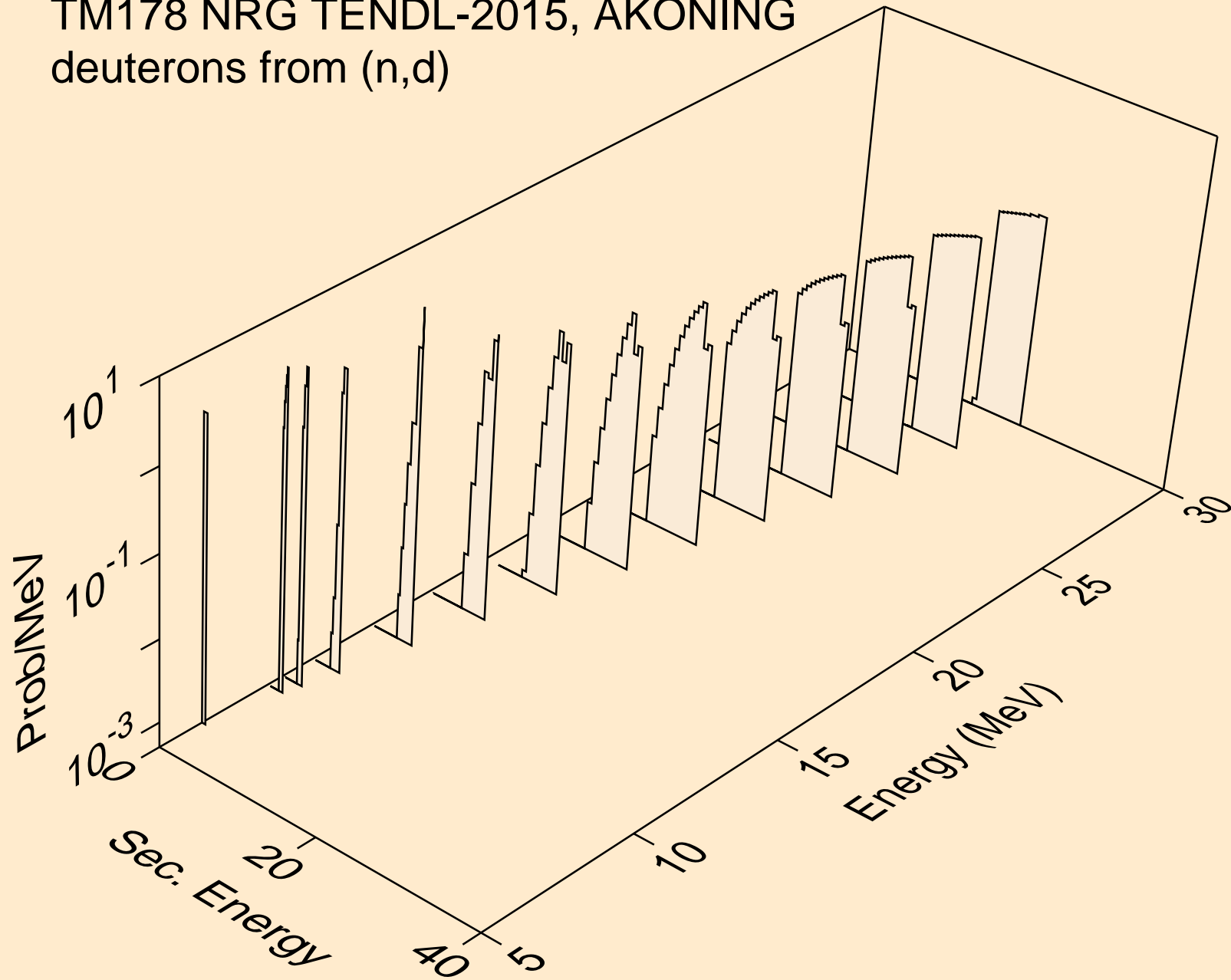

TM178 NRG TENDL-2015, AKONING  
tritons from (n,x)

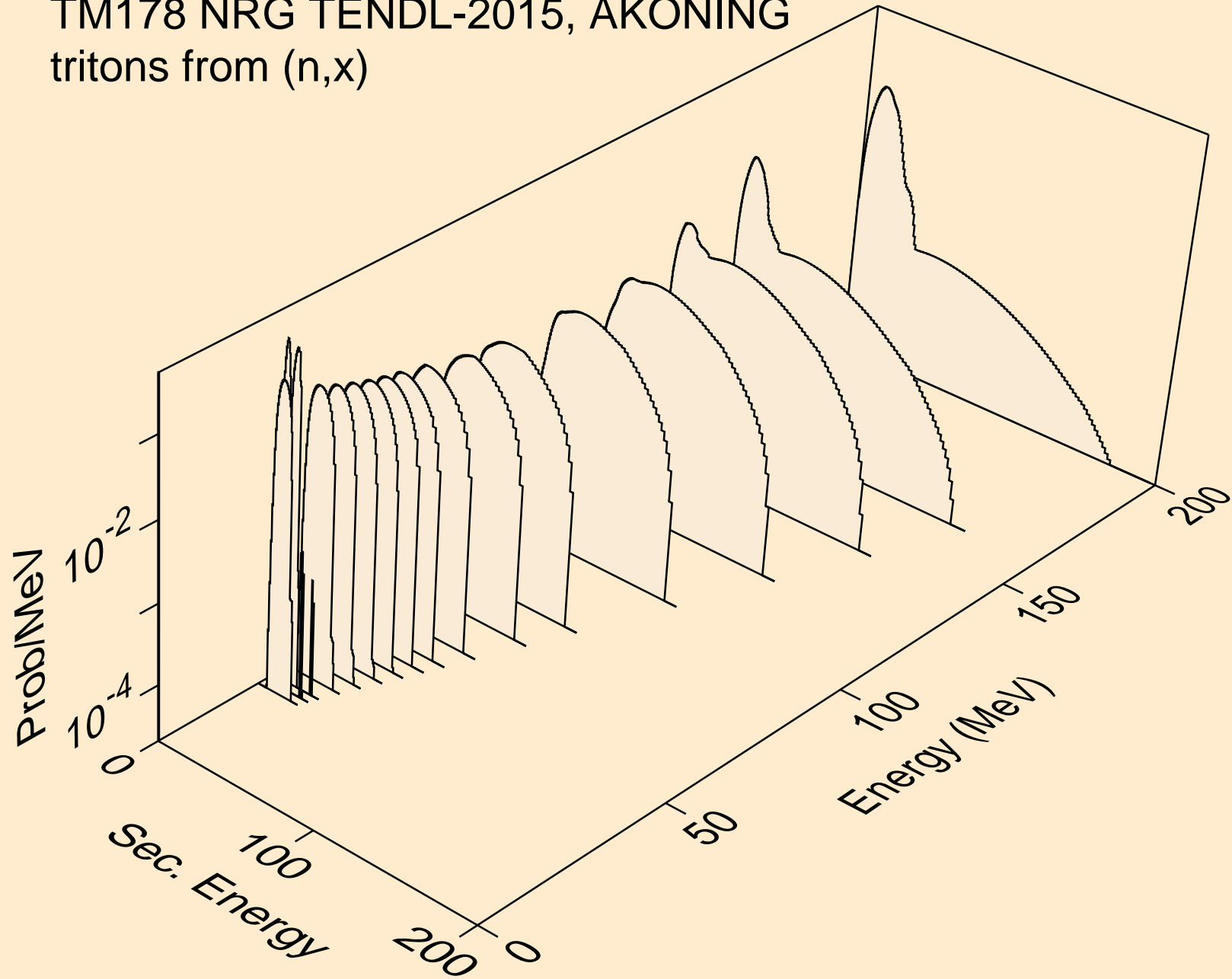

TM178 NRG TENDL-2015, AKONING  
tritons from (n,n\*)t

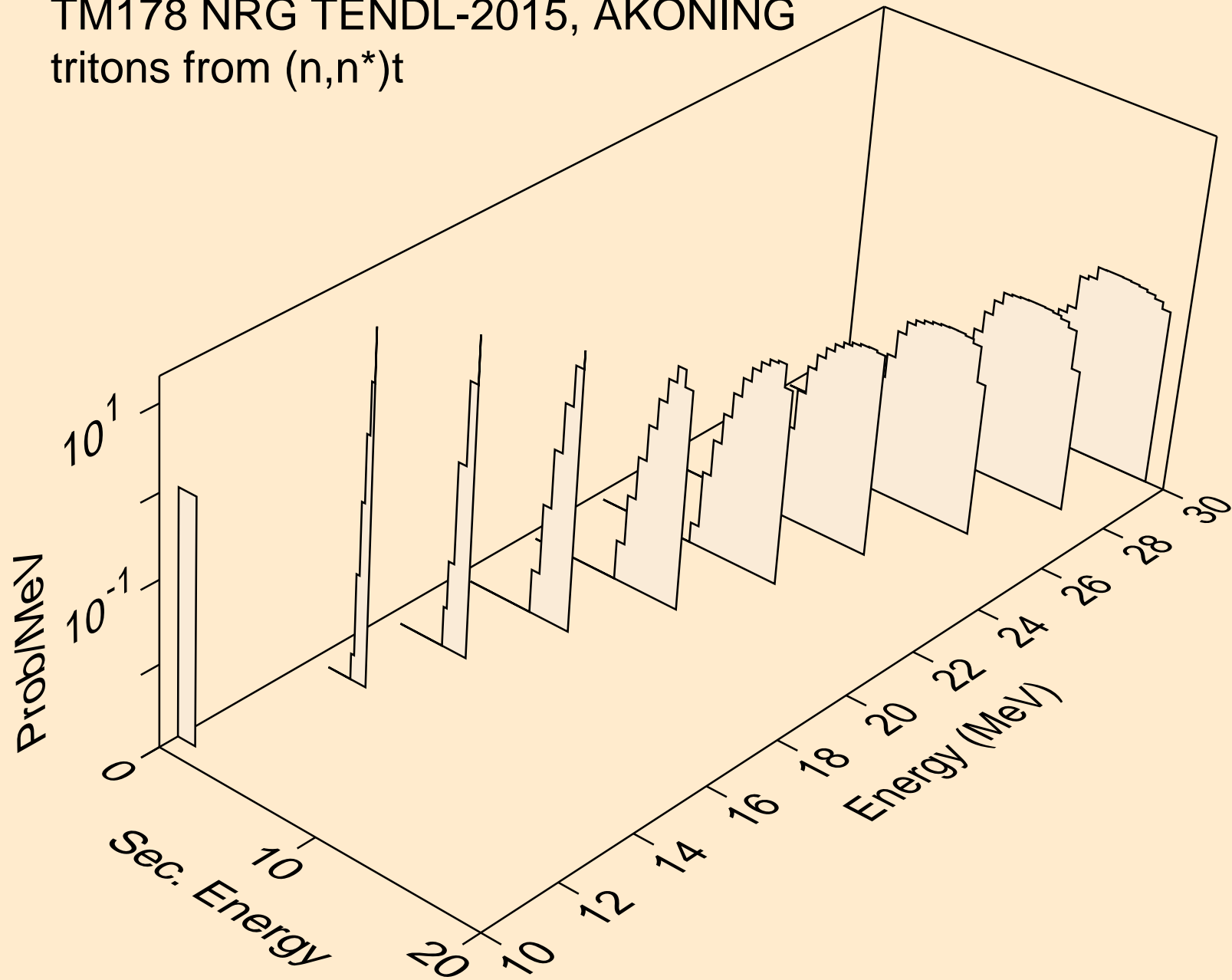



TM178 NRG TENDL-2015, AKONING  
tritons from (n,t)

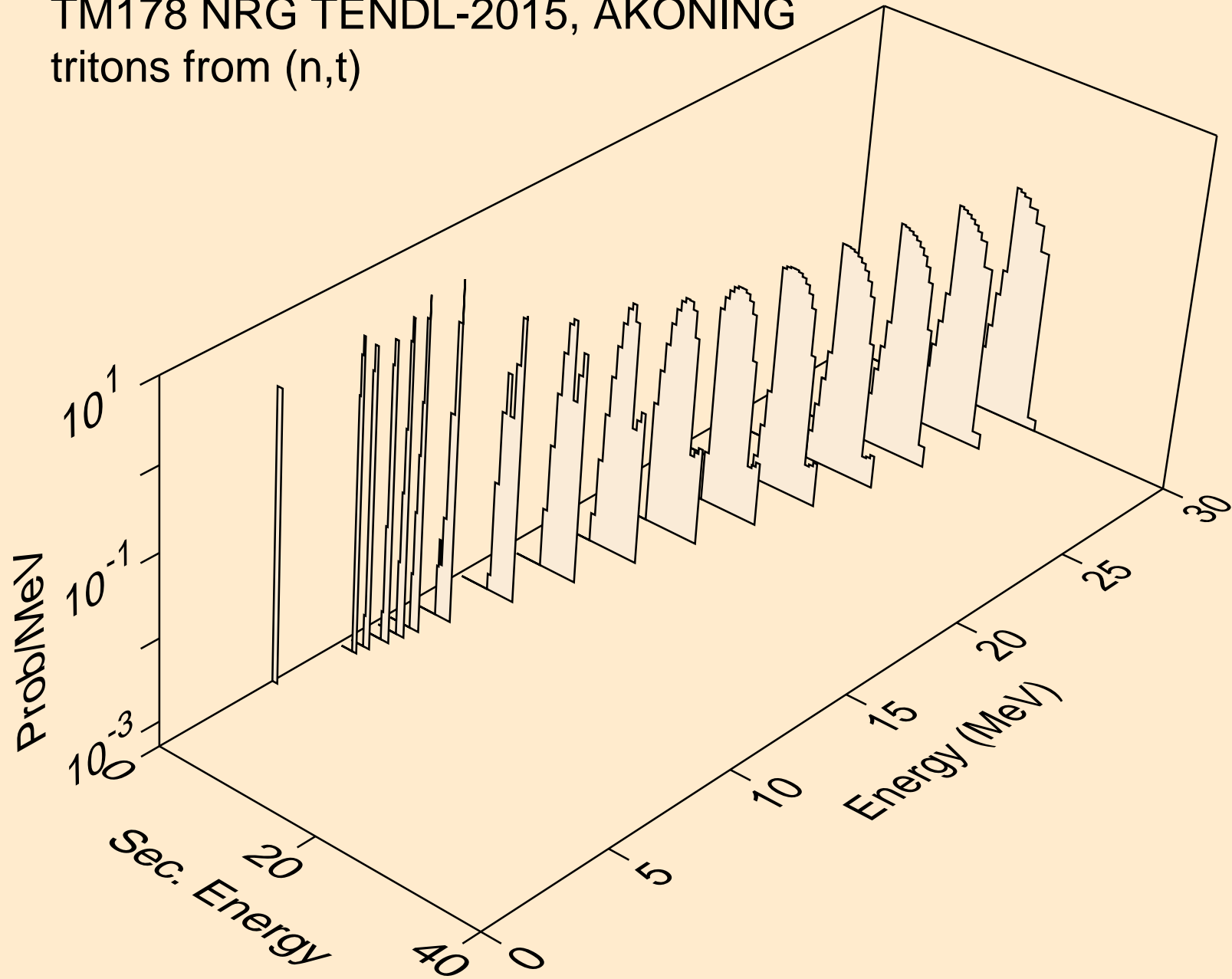

TM178 NRG TENDL-2015, AKONING  
he3s from (n,x)

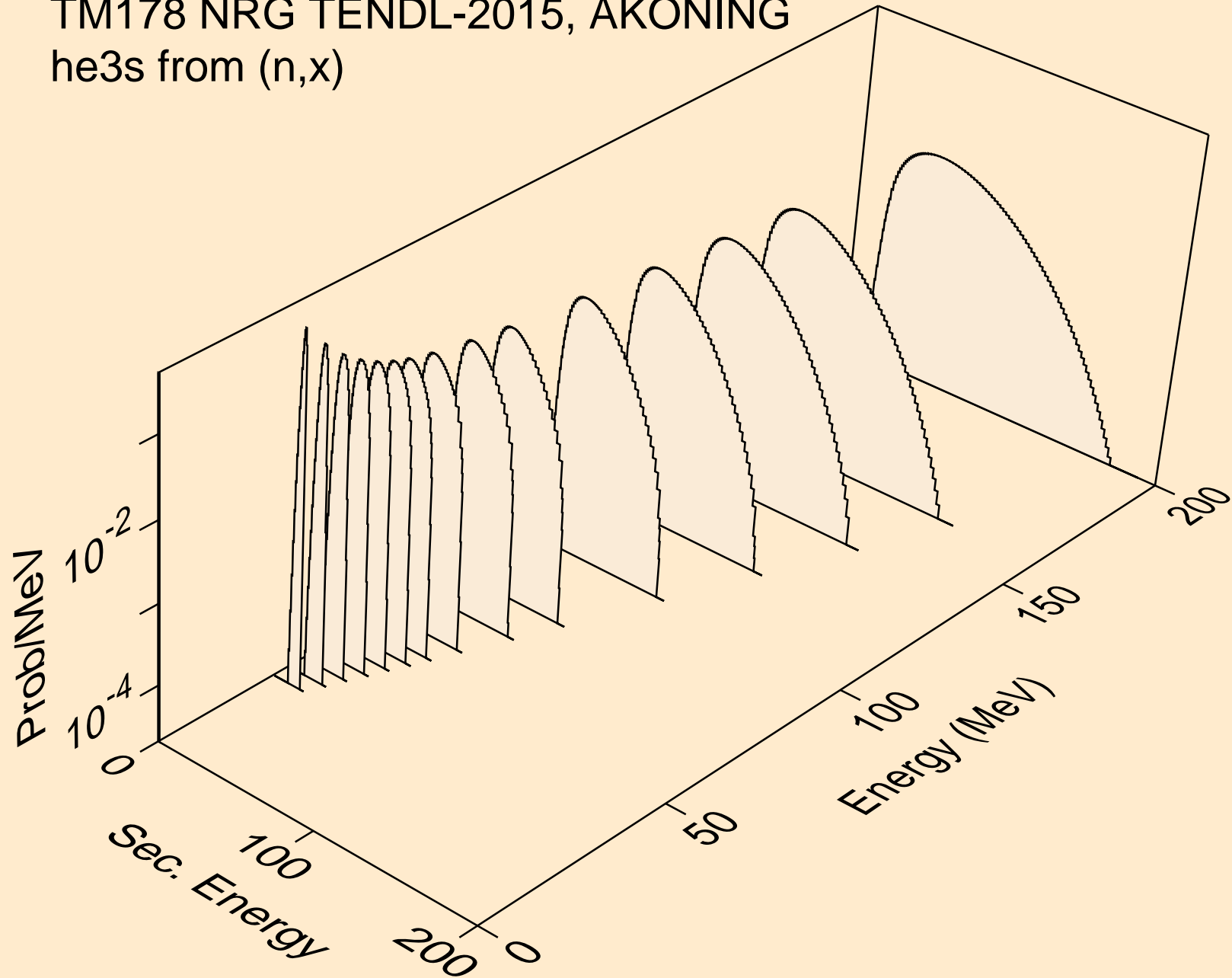

TM178 NRG TENDL-2015, AKONING  
he3s from (n,n\*)he3

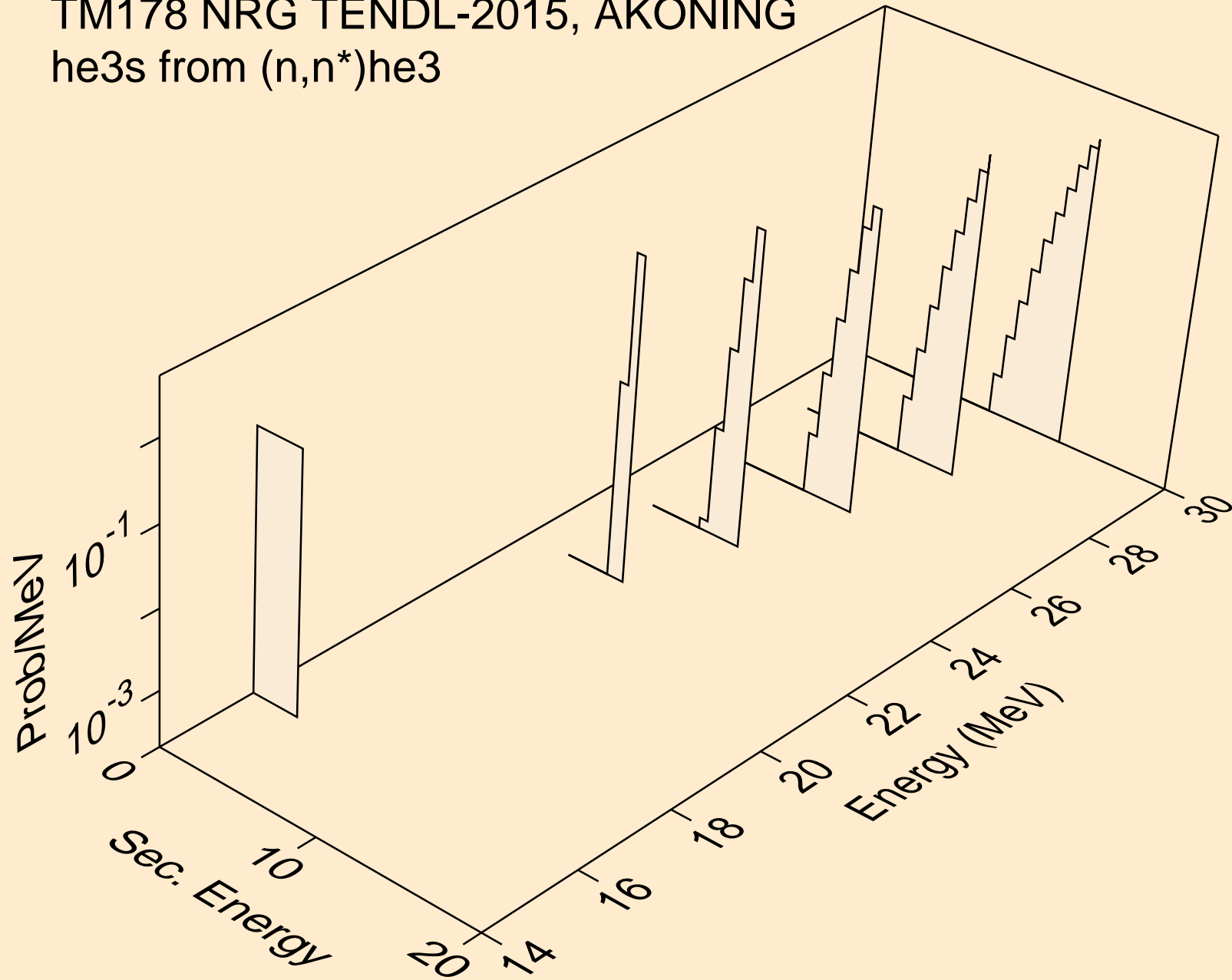

TM178 NRG TENDL-2015, AKONING  
he3s from (n,he3)

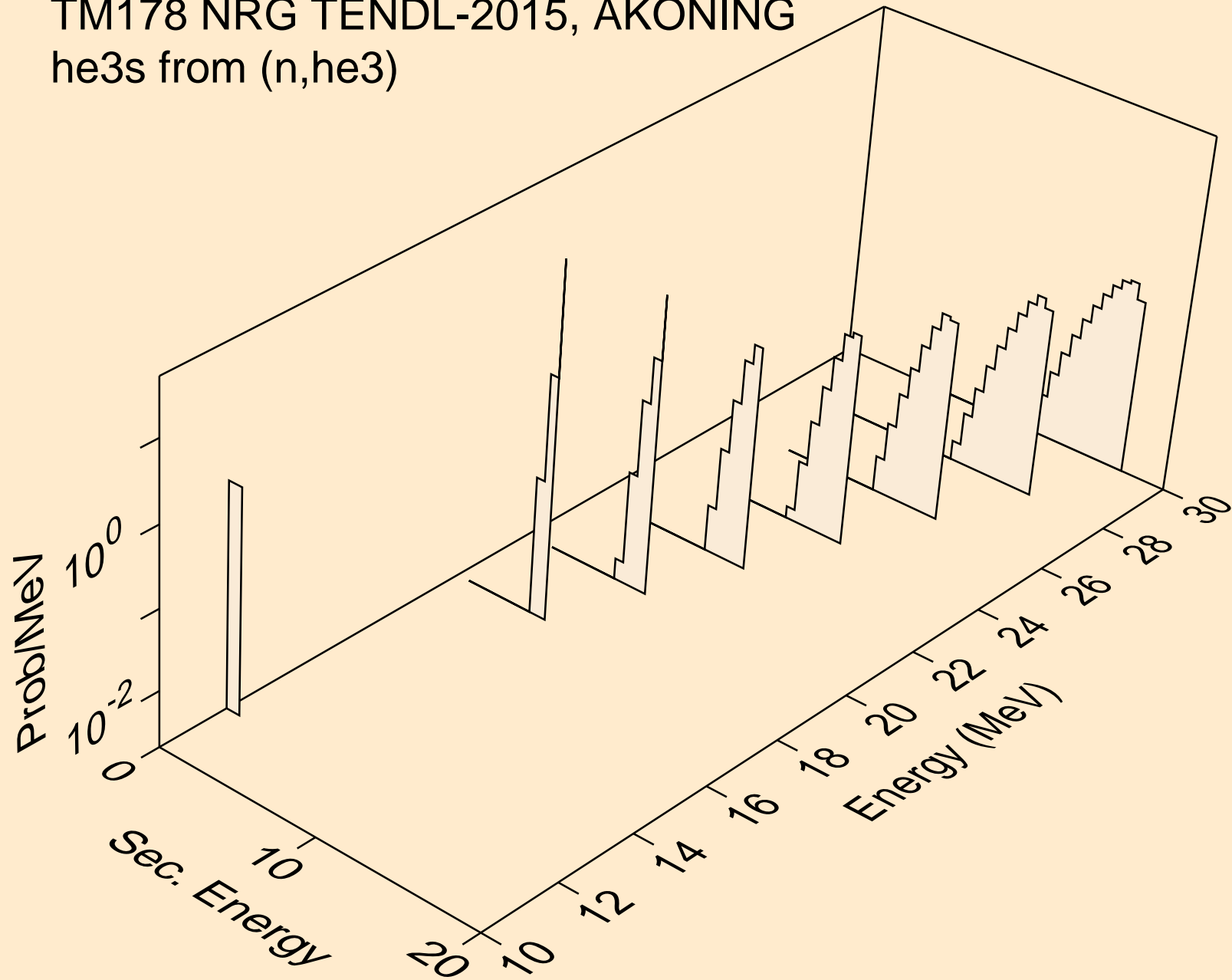

TM178 NRG TENDL-2015, AKONING  
alphas from (n,x)

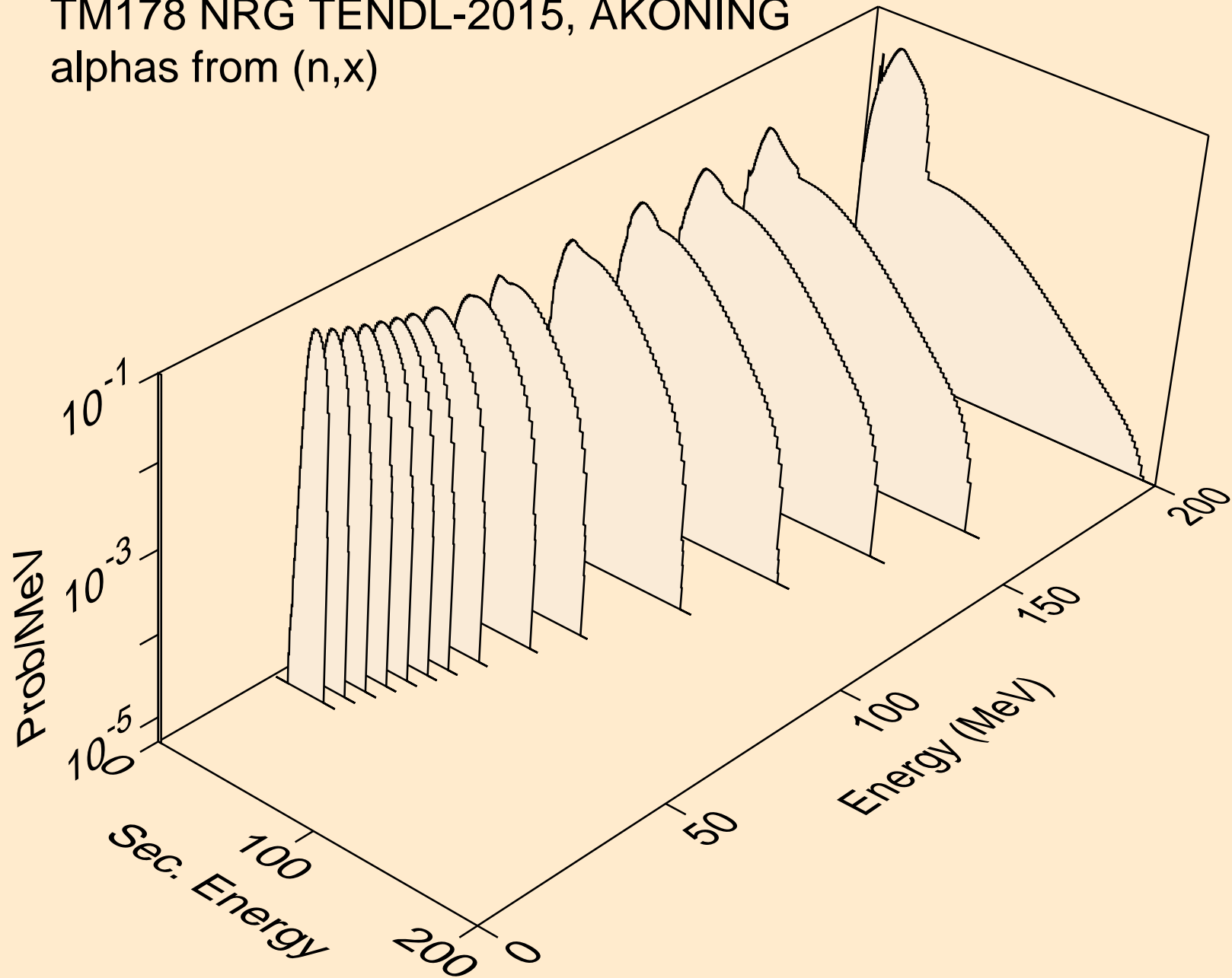

TM178 NRG TENDL-2015, AKONING  
alphas from (n,n\*)a

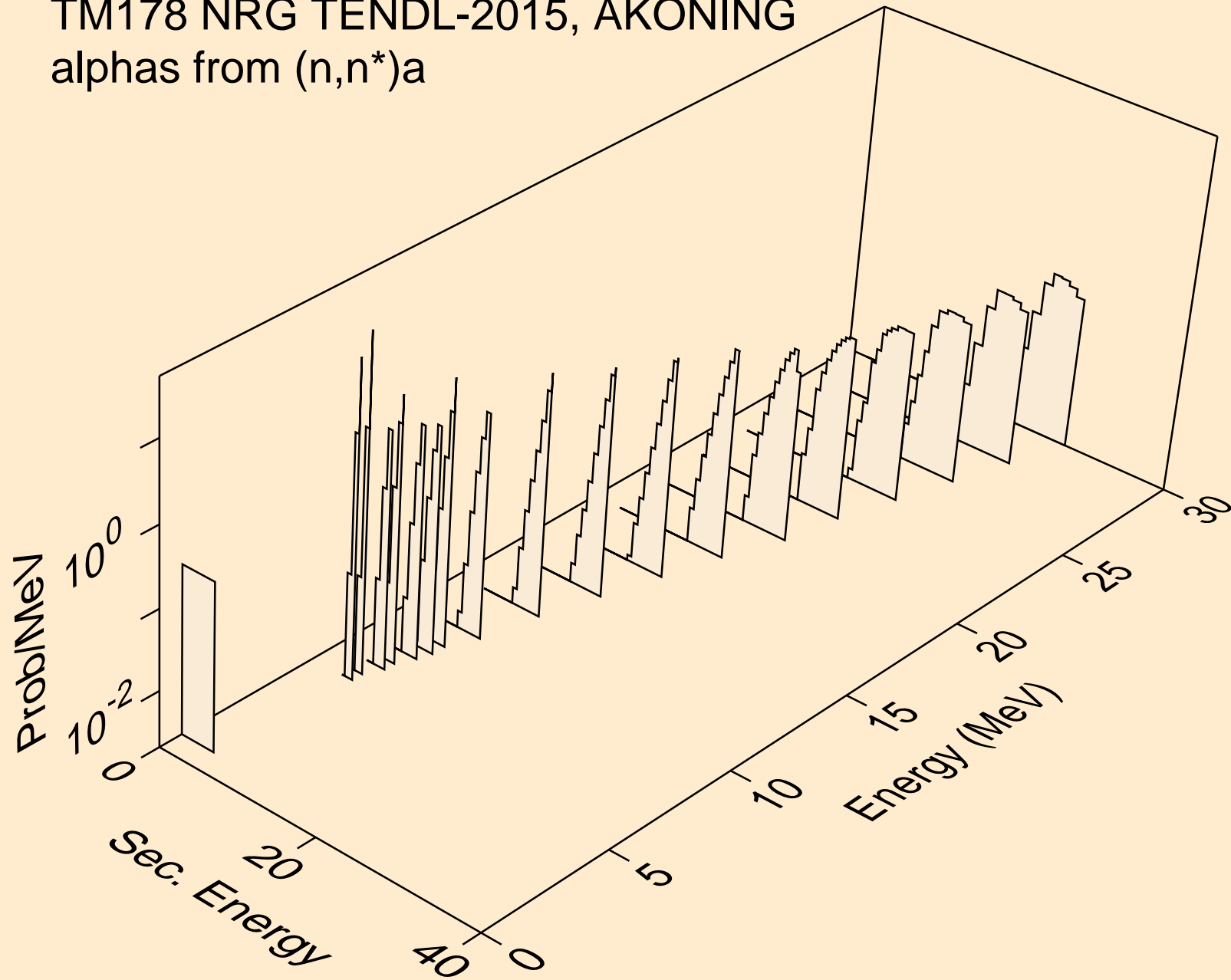

TM178 NRG TENDL-2015, AKONING  
alphas from (n,2n)a

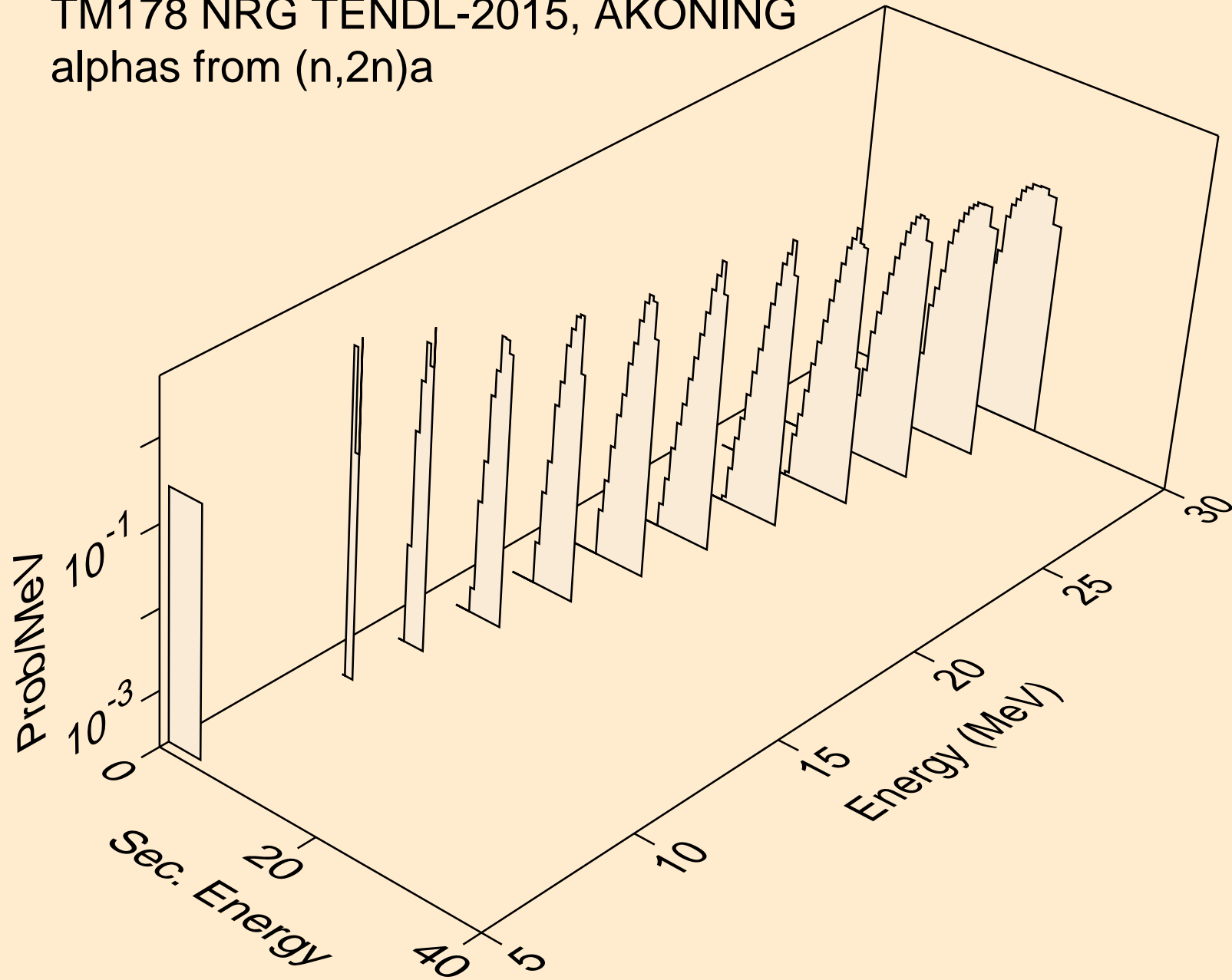

TM178 NRG TENDL-2015, AKONING  
alphas from (n,3n)a

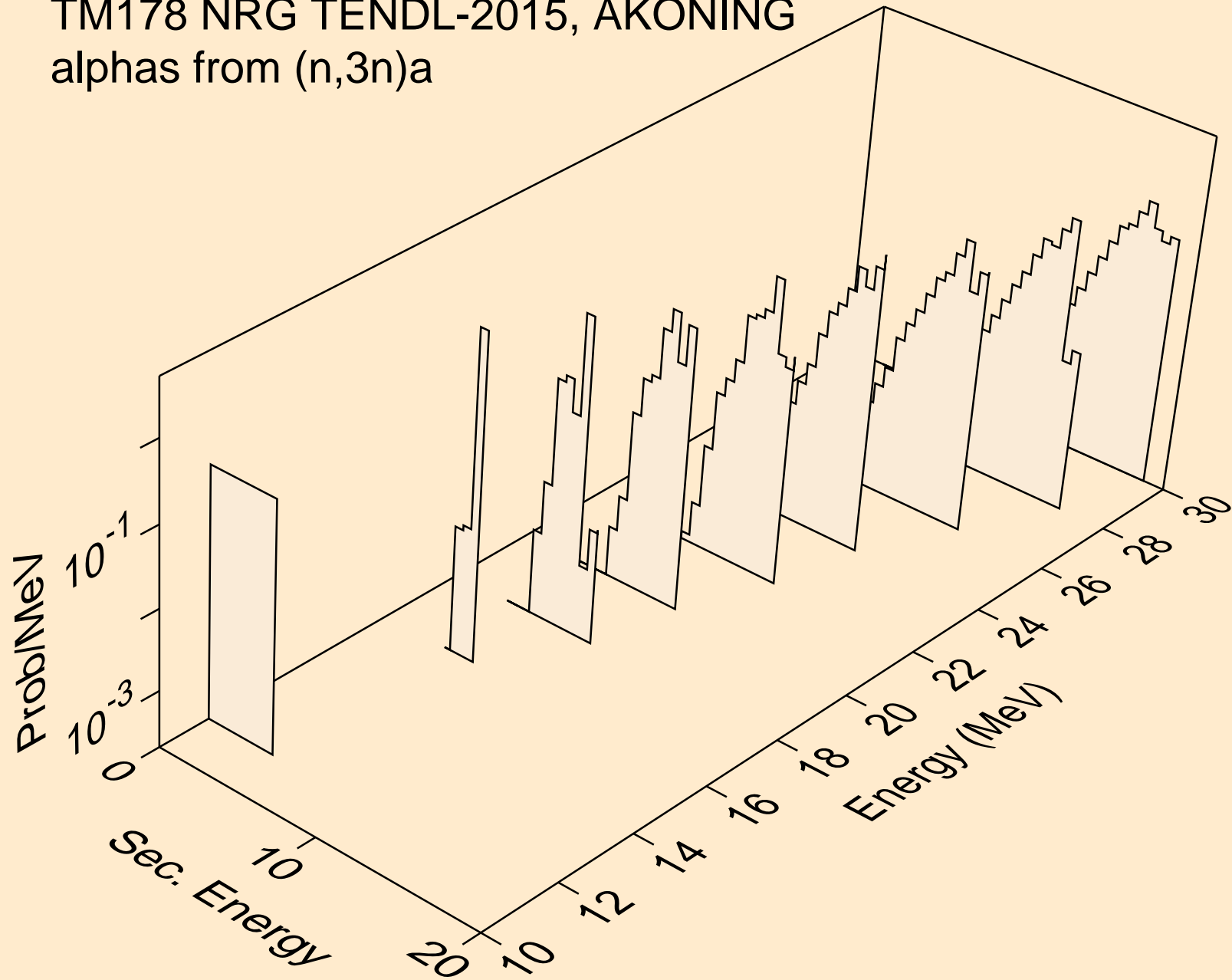



TM178 NRG TENDL-2015, AKONING  
alphas from (n,a)

