

U227 NRG TENDL-2015, AKONING

Principal cross sections

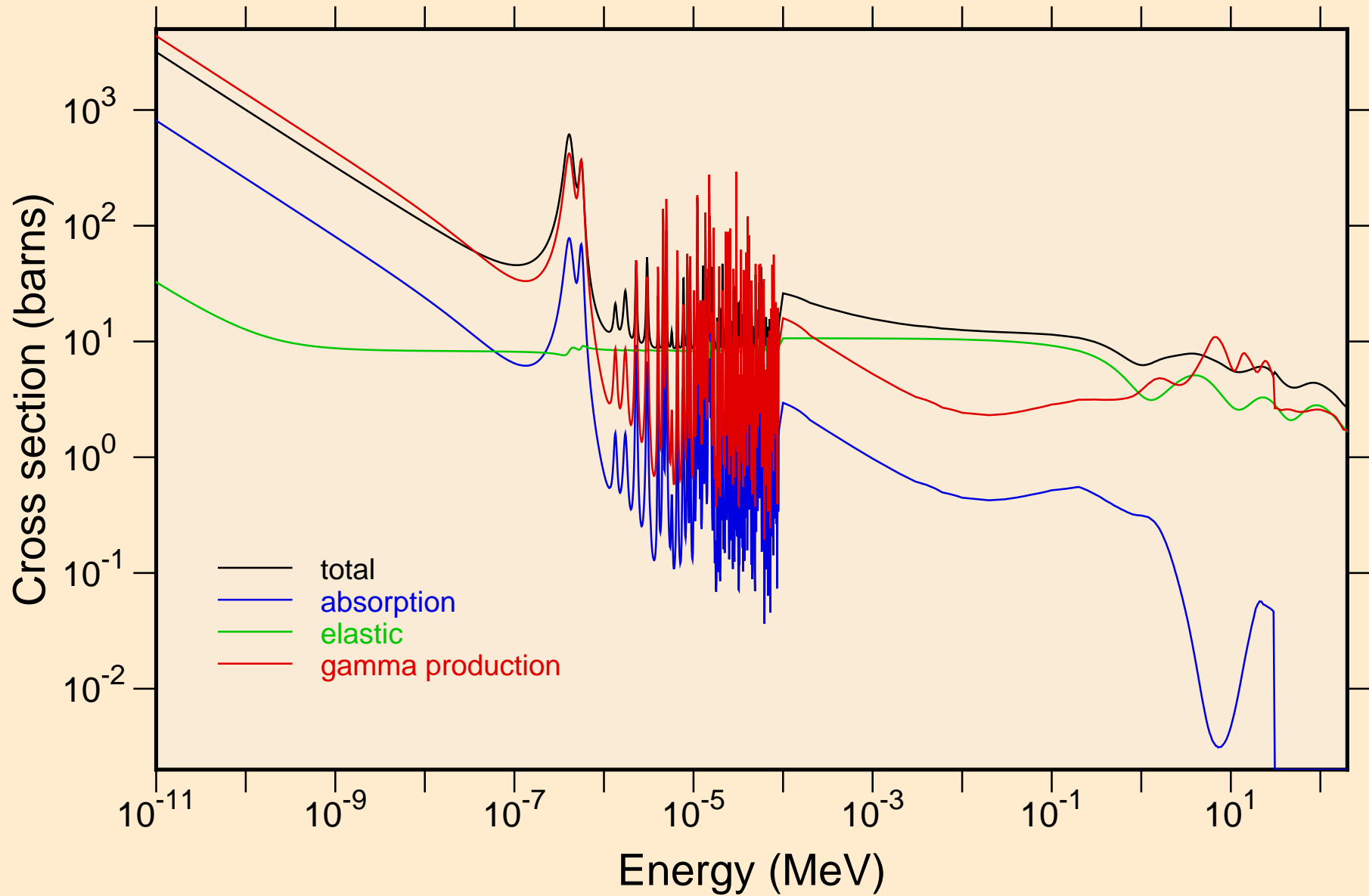

U227 NRG TENDL-2015, AKONING
resonance total cross section

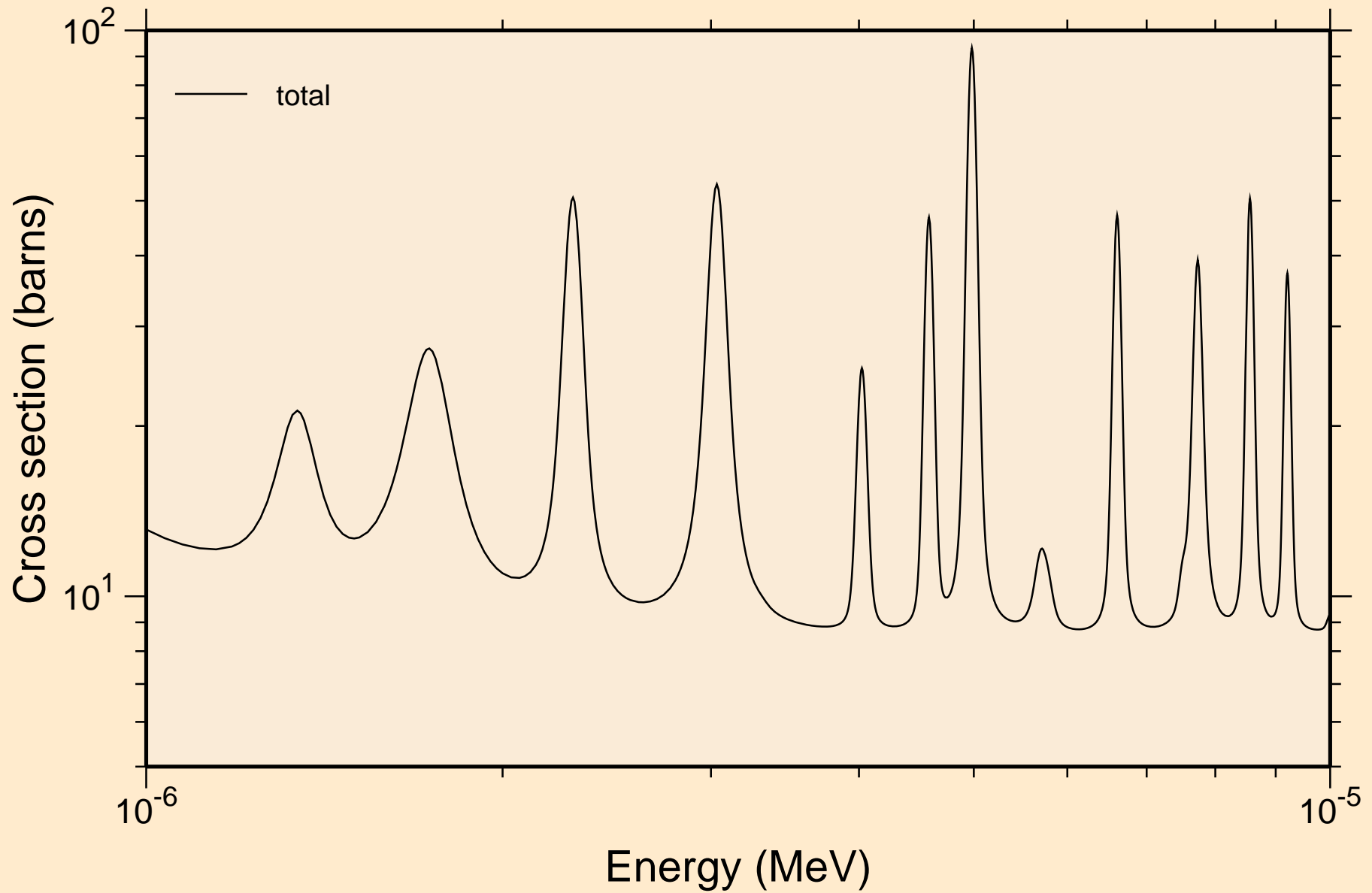

U227 NRG TENDL-2015, AKONING
resonance total cross section

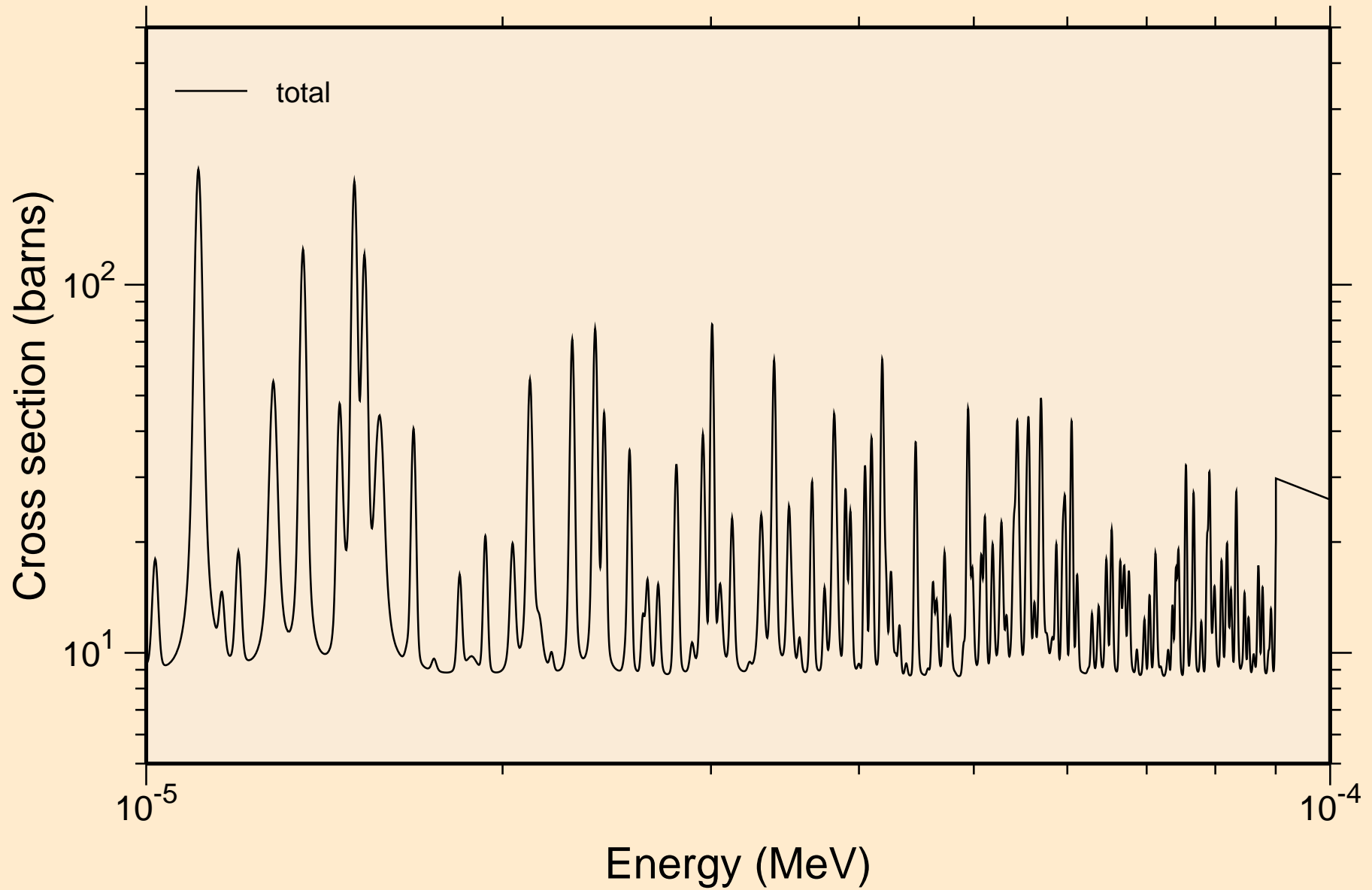

U227 NRG TENDL-2015, AKONING
resonance total cross section

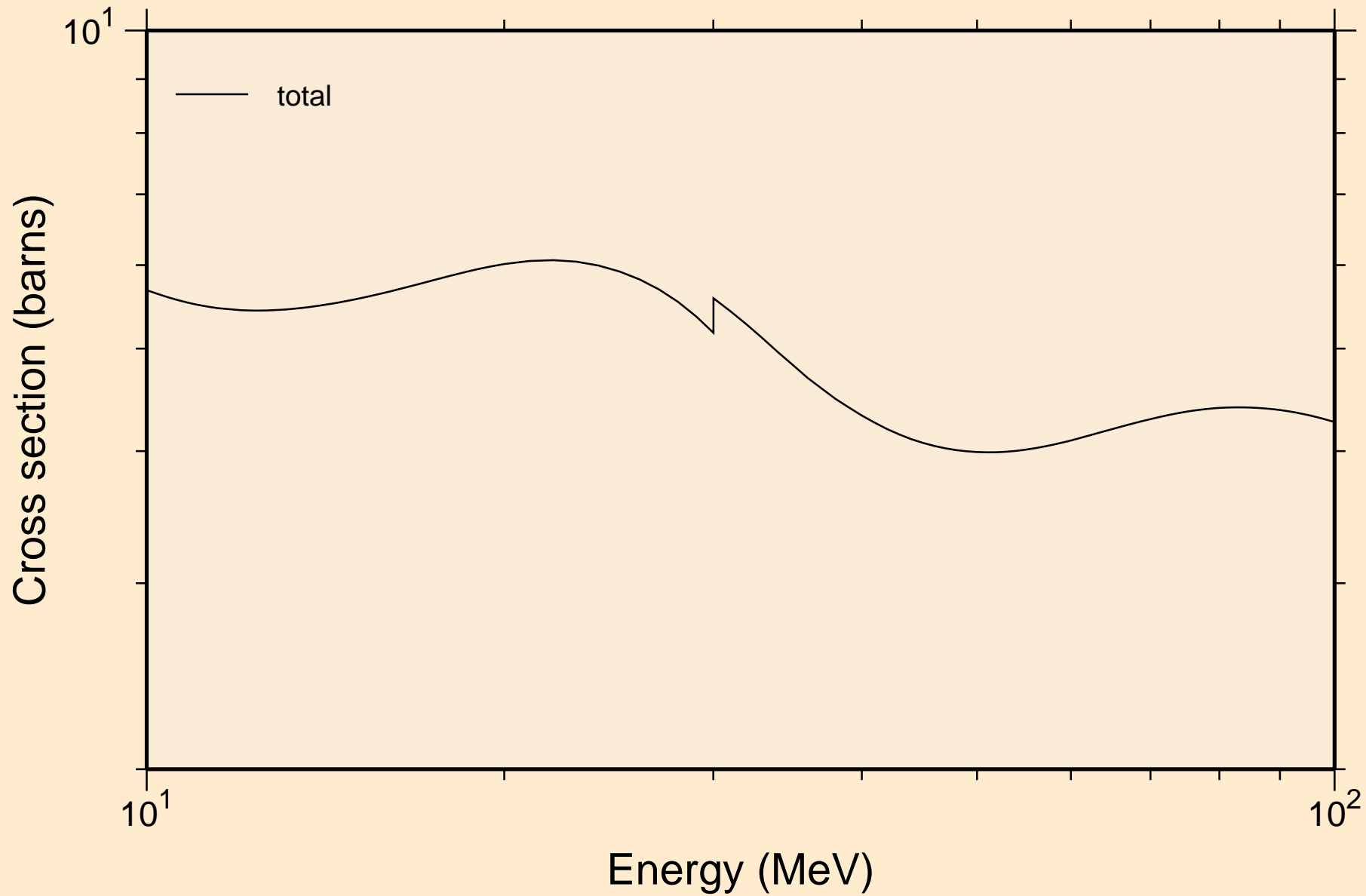

U227 NRG TENDL-2015, AKONING
resonance absorption cross sections

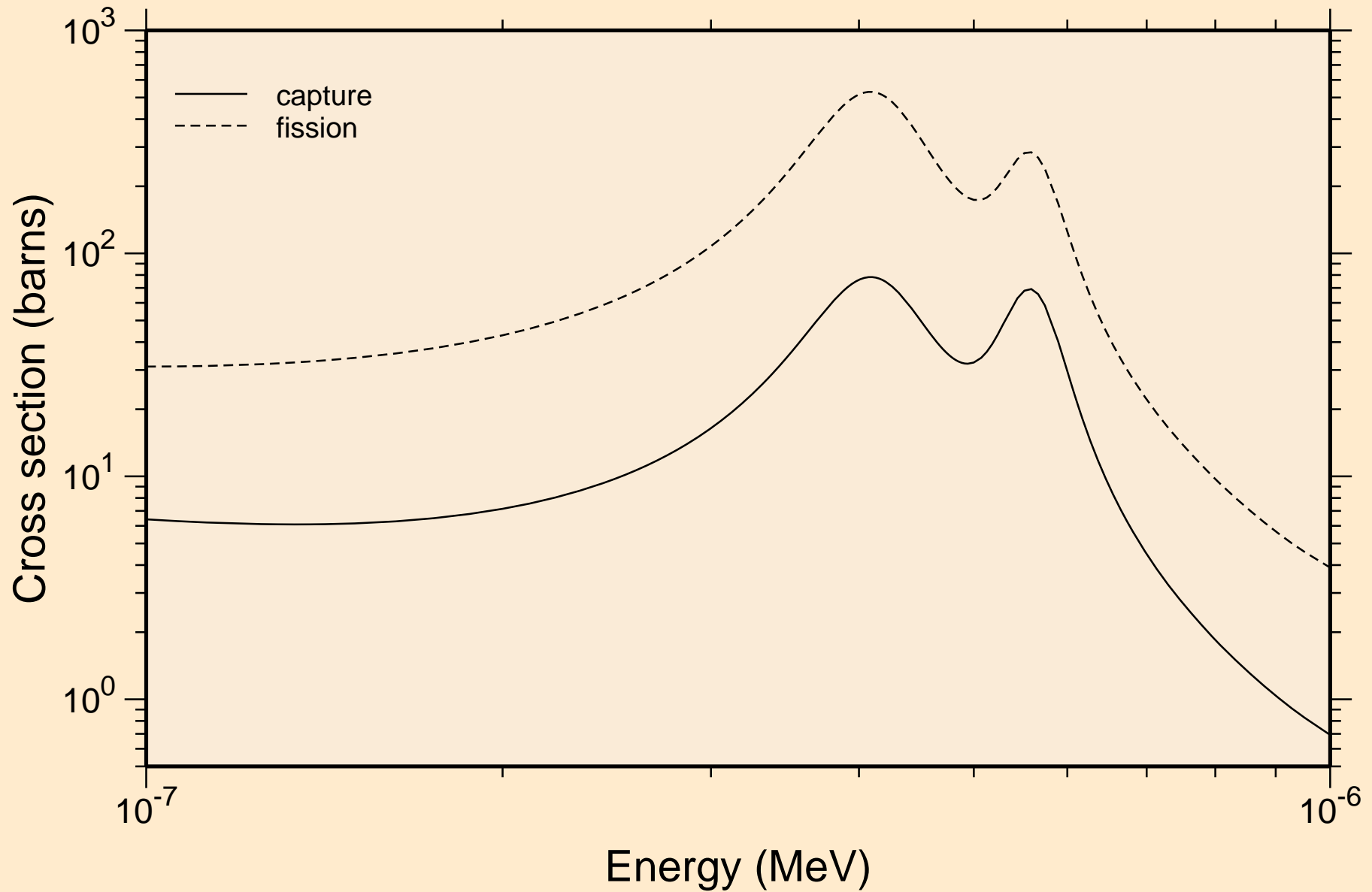

U227 NRG TENDL-2015, AKONING resonance absorption cross sections

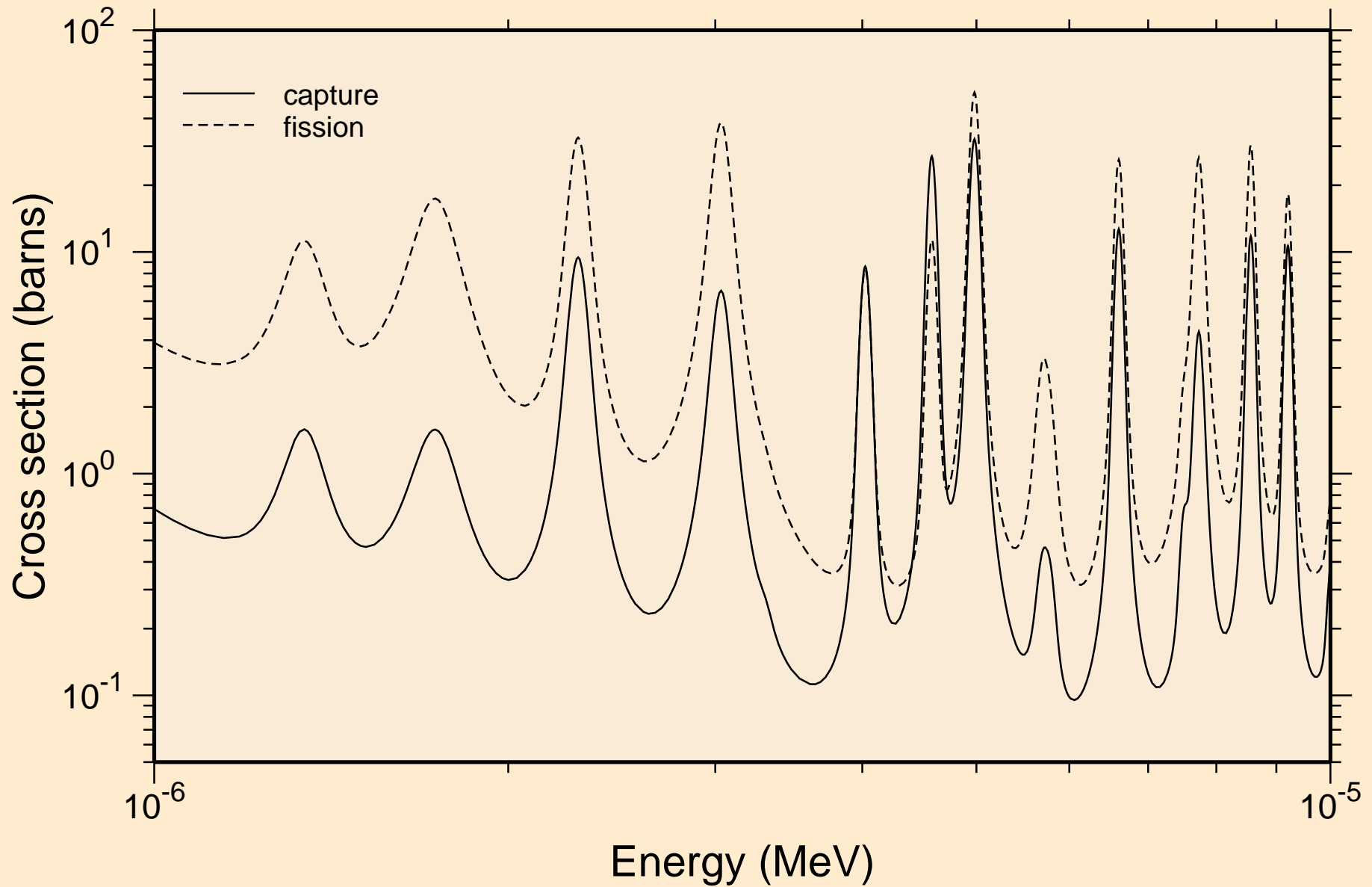

U227 NRG TENDL-2015, AKONING
resonance absorption cross sections

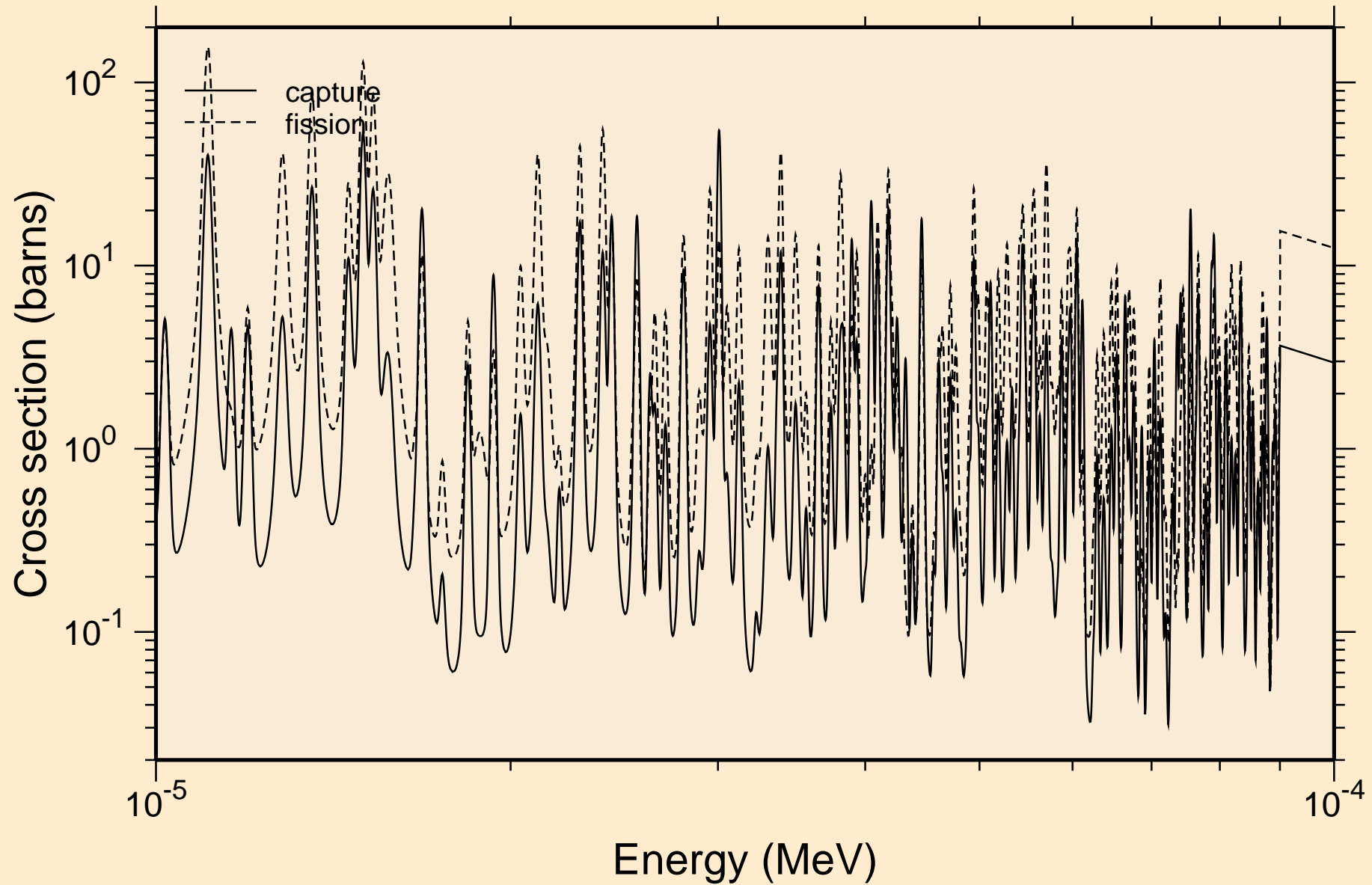

U227 NRG TENDL-2015, AKONING
resonance absorption cross sections

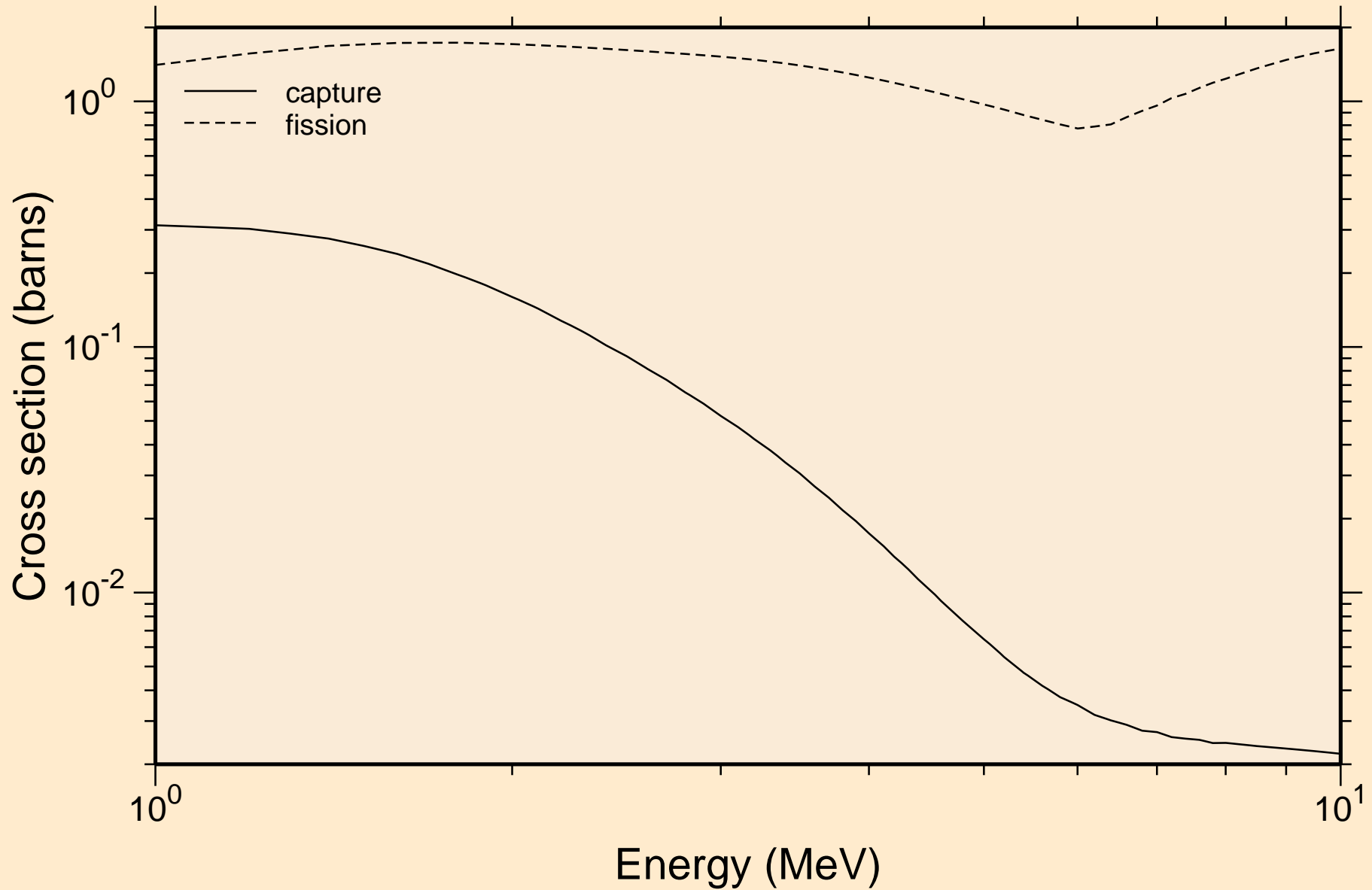

U227 NRG TENDL-2015, AKONING

Non-threshold reactions

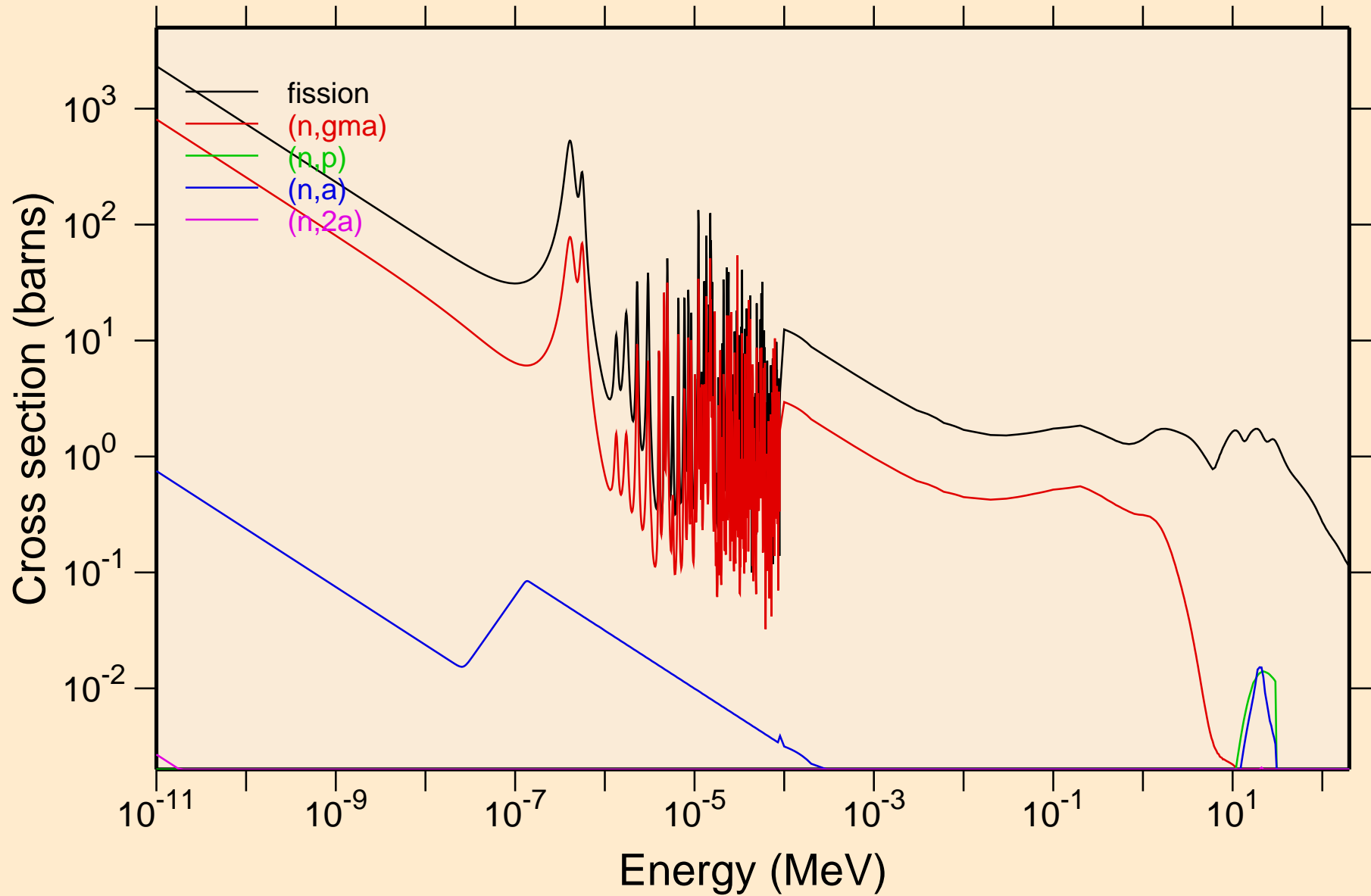

U227 NRG TENDL-2015, AKONING

Non-threshold reactions

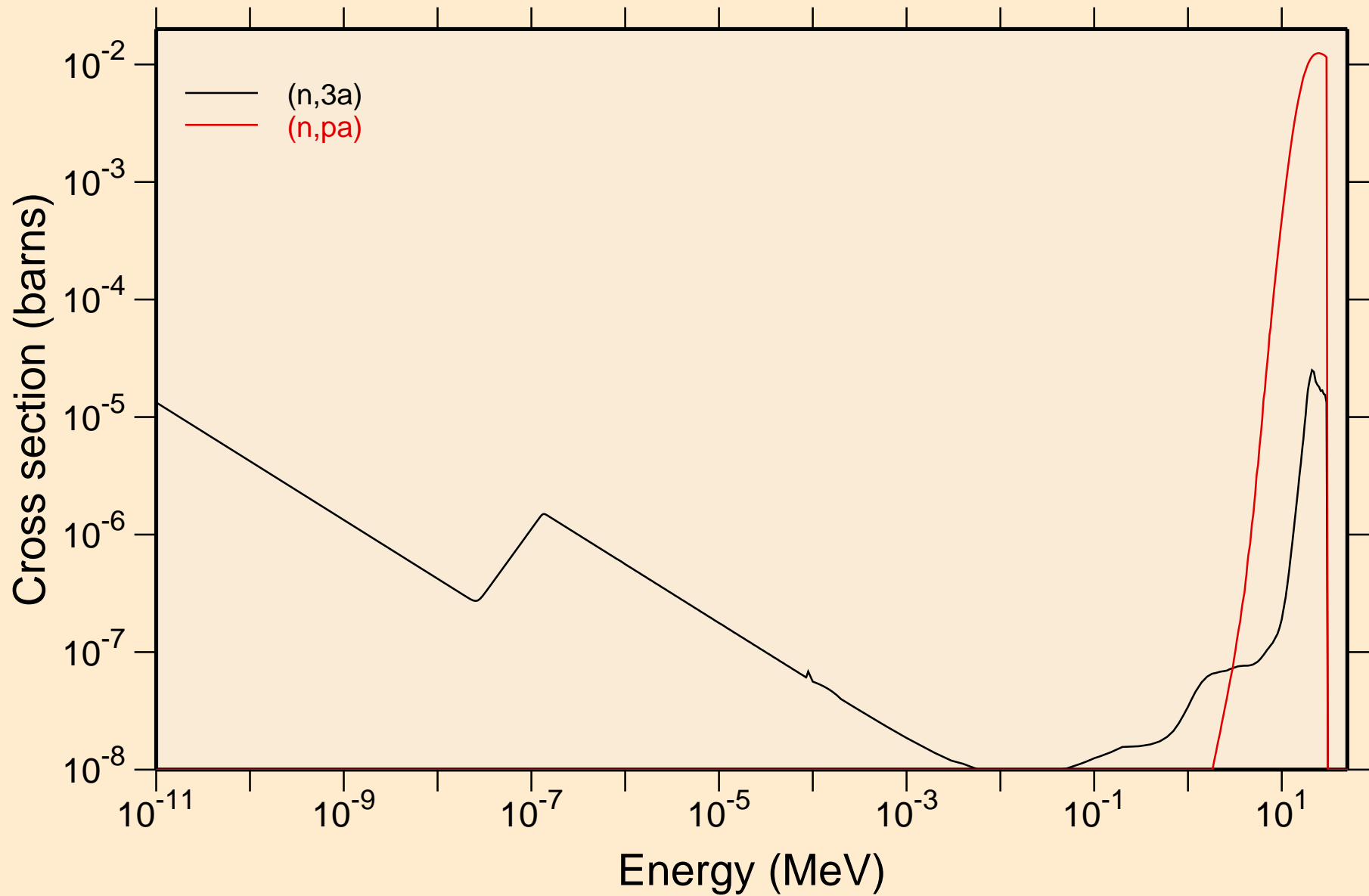

U227 NRG TENDL-2015, AKONING

Principal cross sections

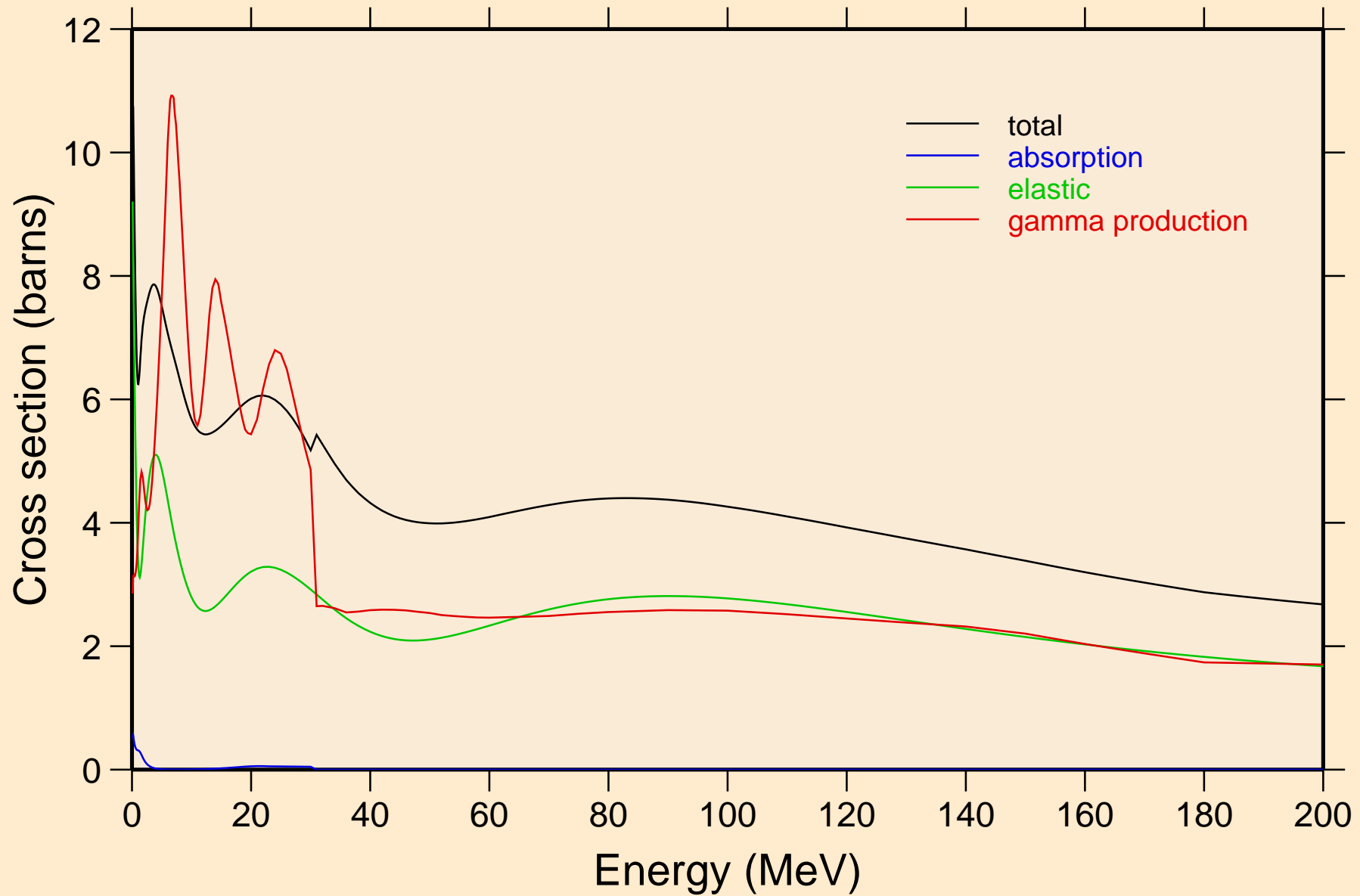

U227 NRG TENDL-2015, AKONING

Non-threshold reactions

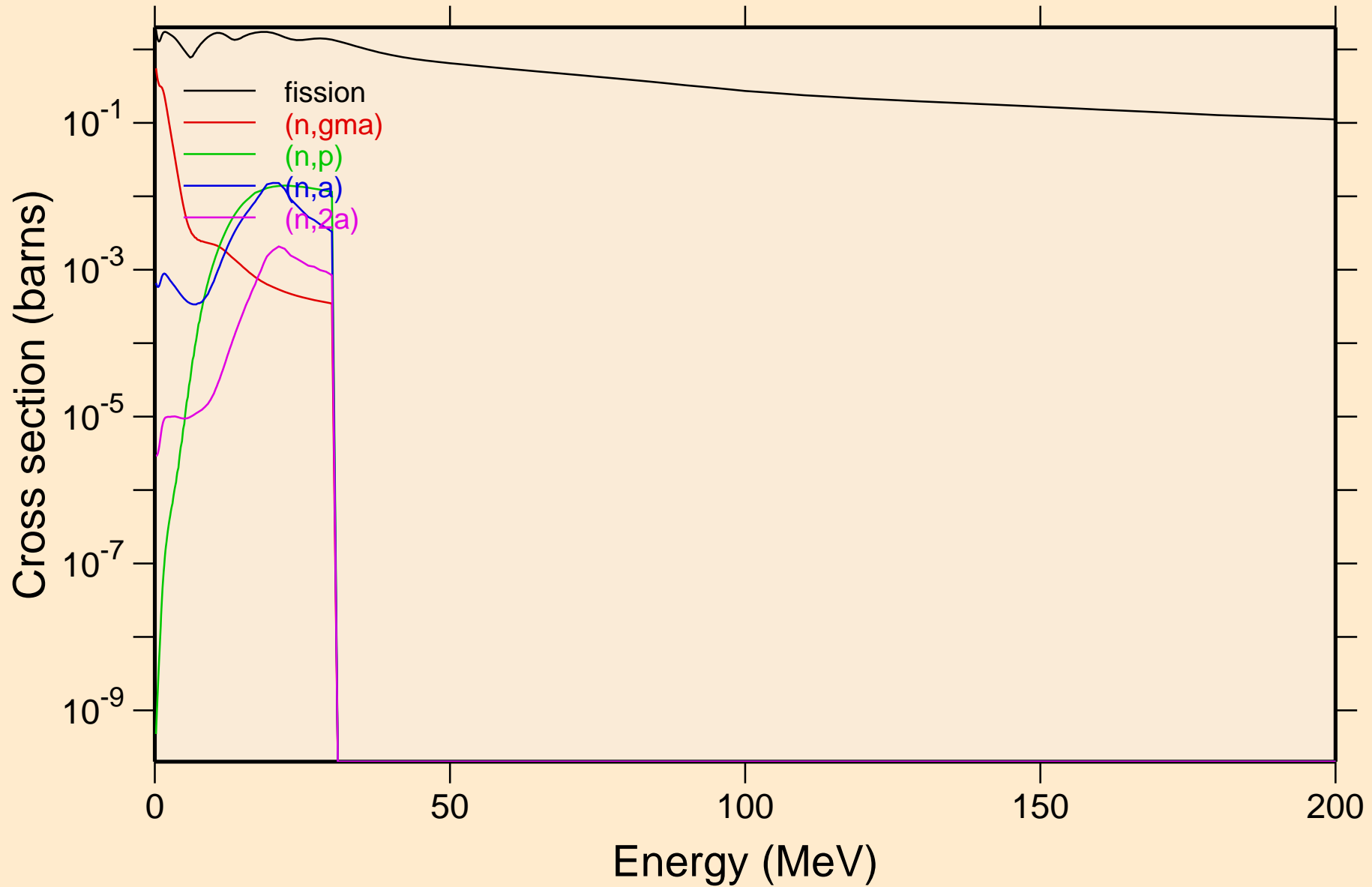

U227 NRG TENDL-2015, AKONING
Non-threshold reactions

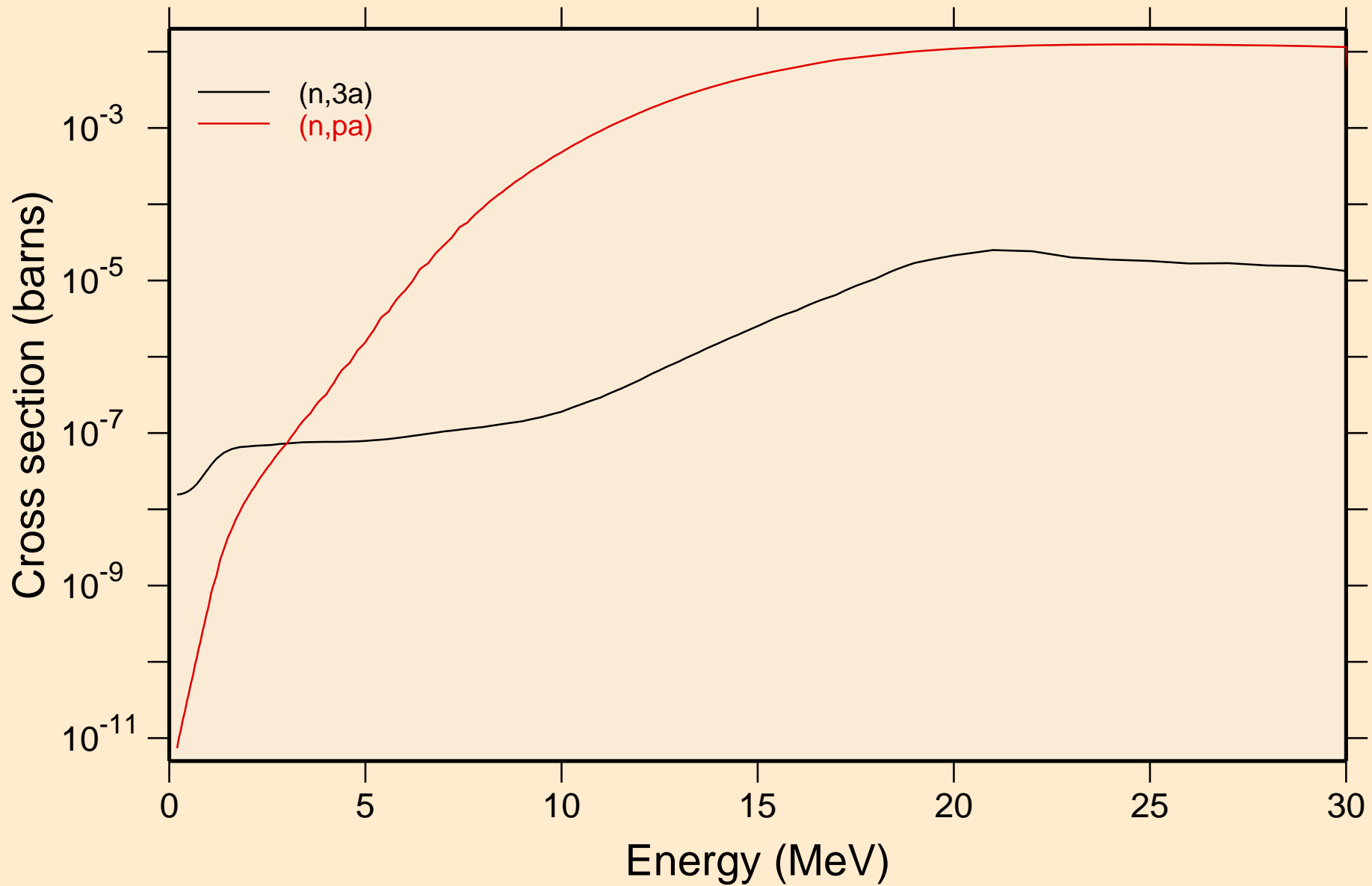

U227 NRG TENDL-2015, AKONING
Inelastic levels

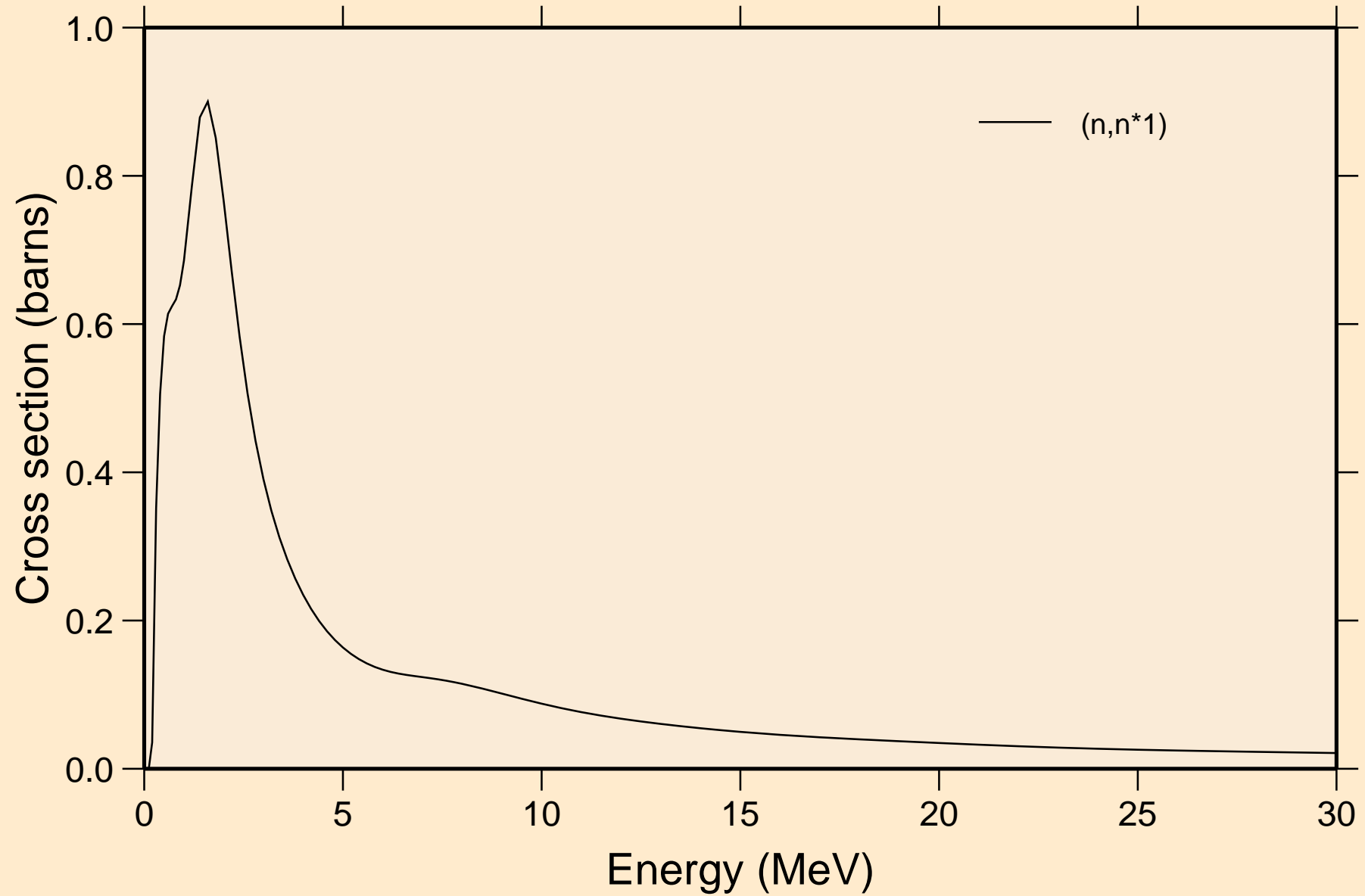

U227 NRG TENDL-2015, AKONING

Threshold reactions

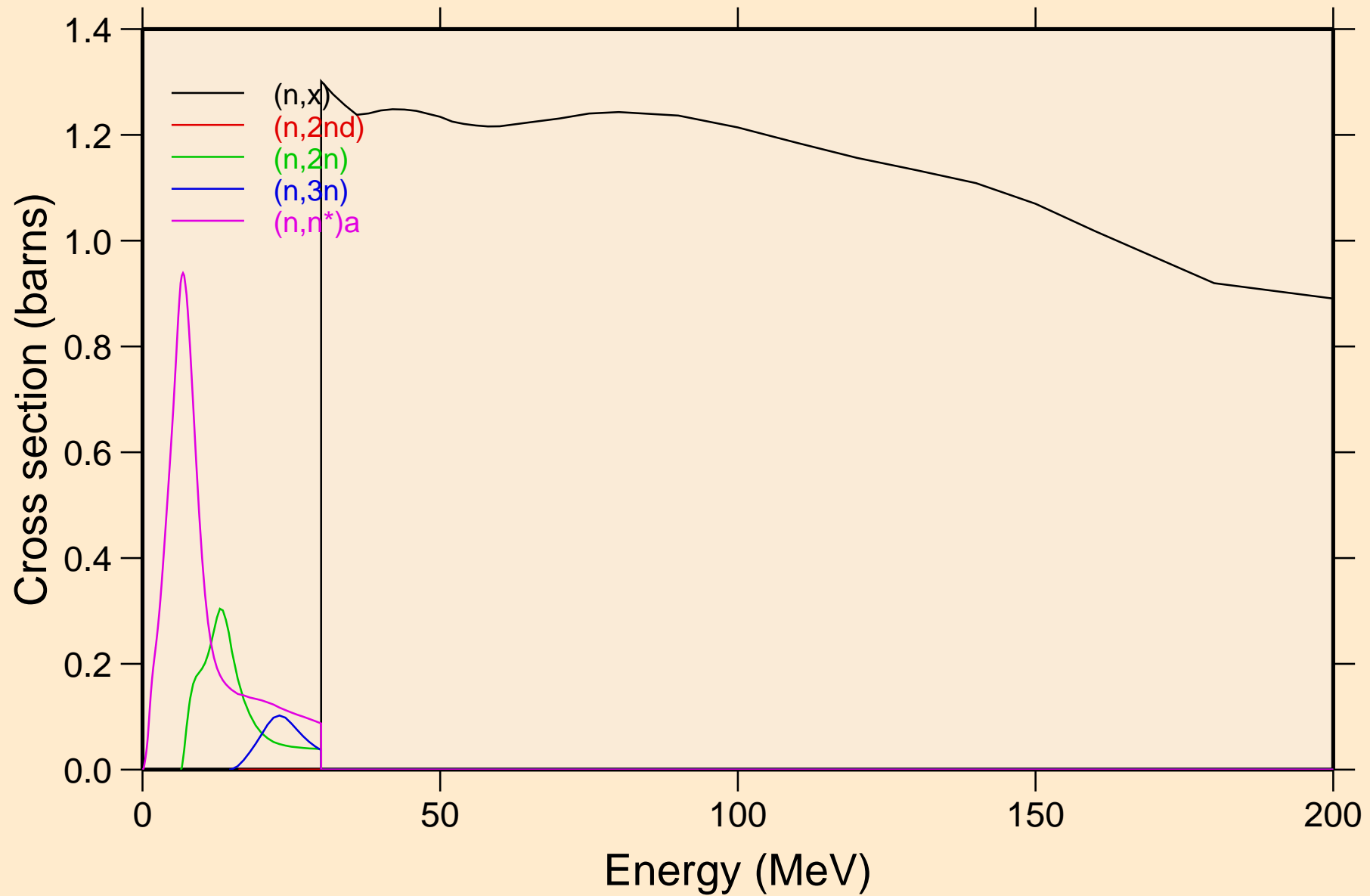

U227 NRG TENDL-2015, AKONING

Threshold reactions

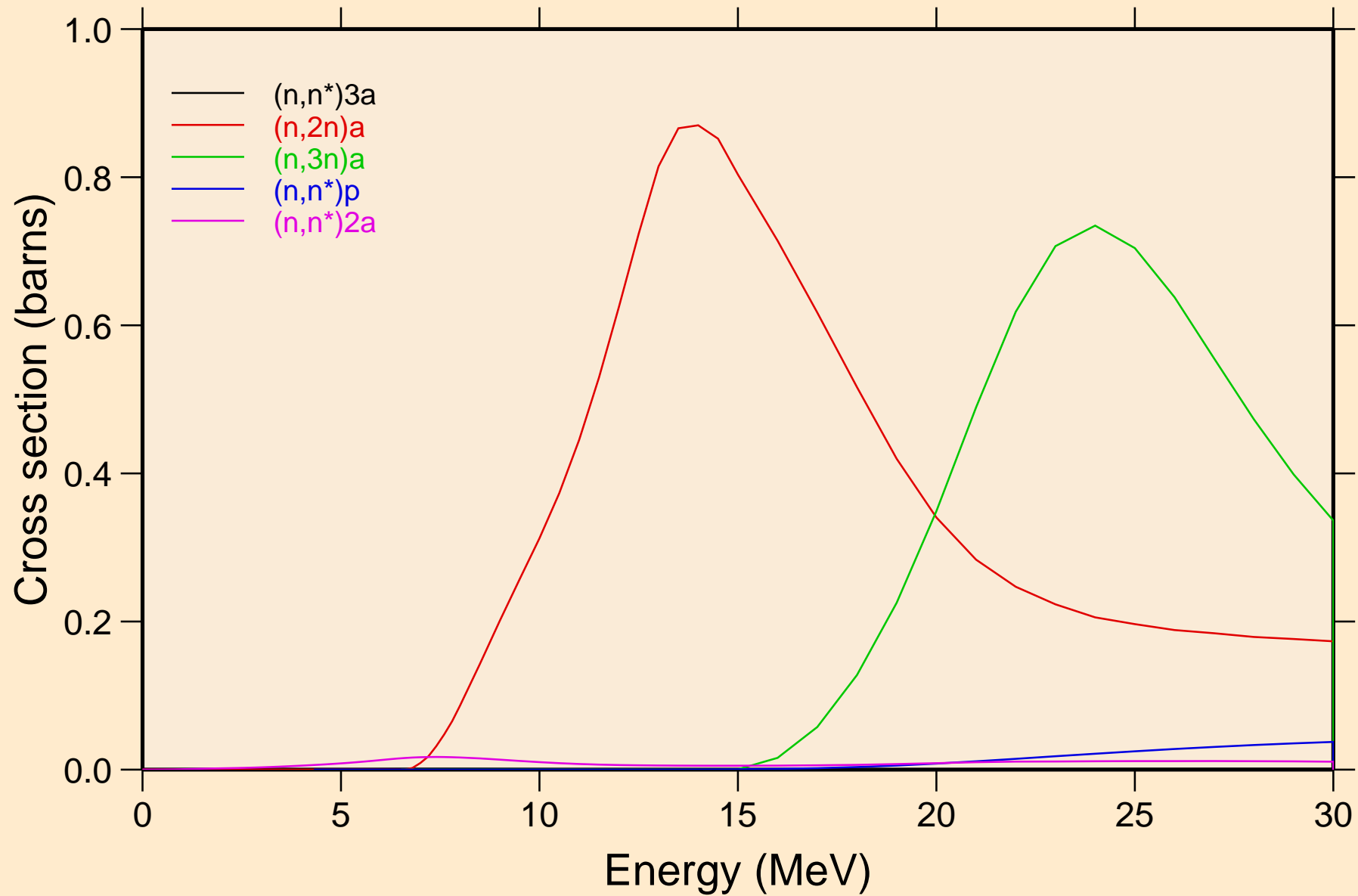

U227 NRG TENDL-2015, AKONING

Threshold reactions

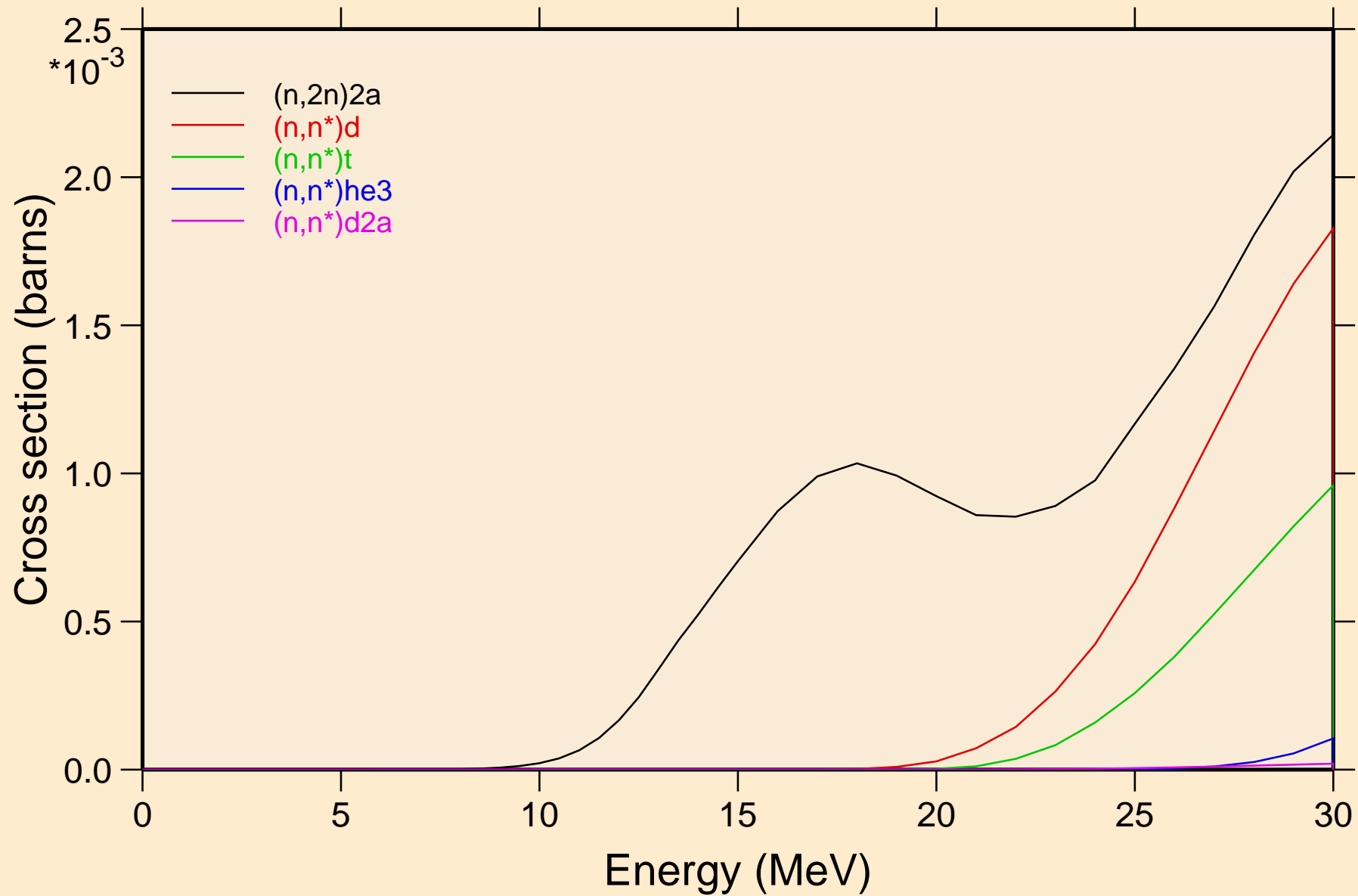

U227 NRG TENDL-2015, AKONING

Threshold reactions

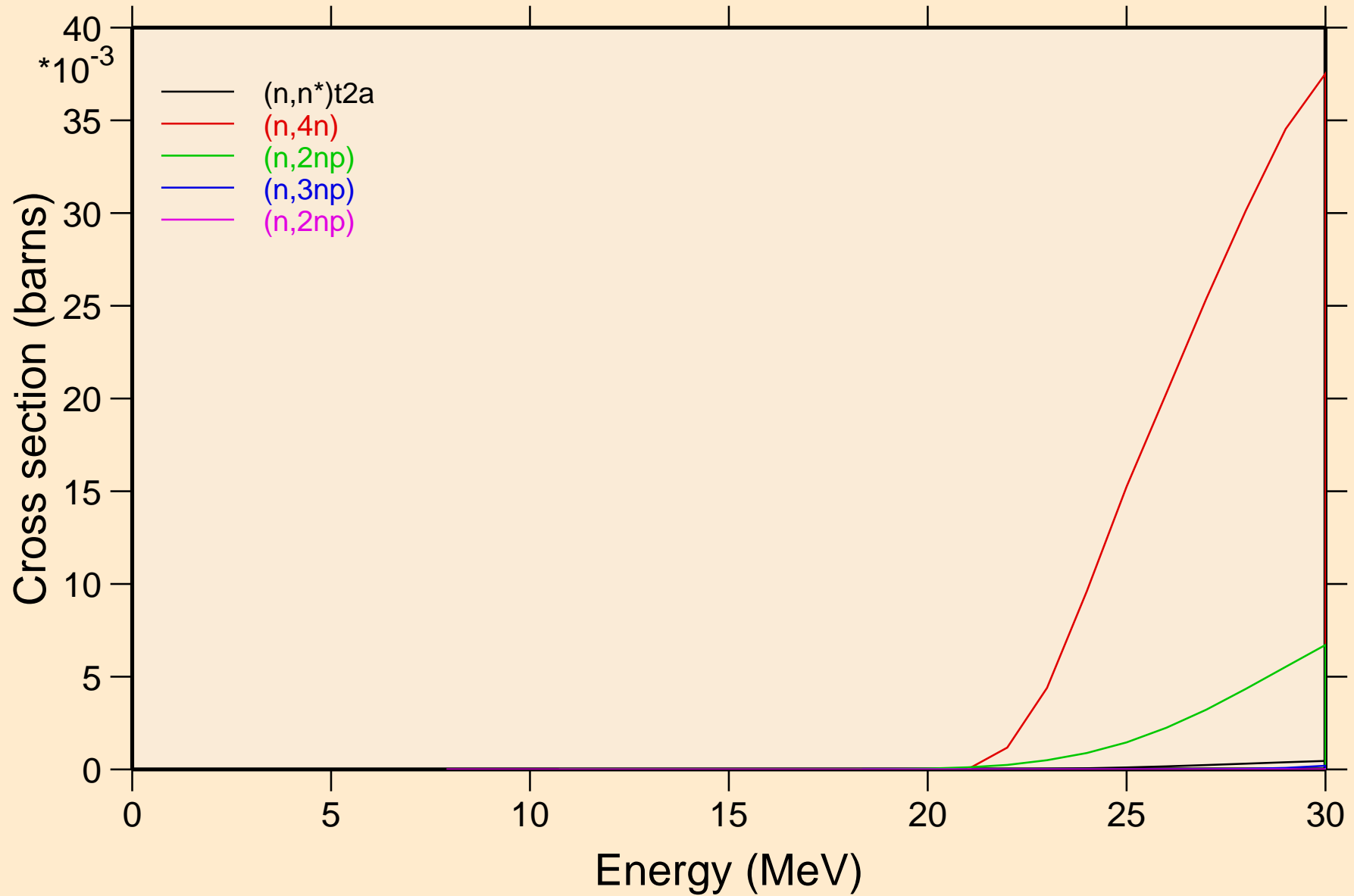

U227 NRG TENDL-2015, AKONING

Threshold reactions

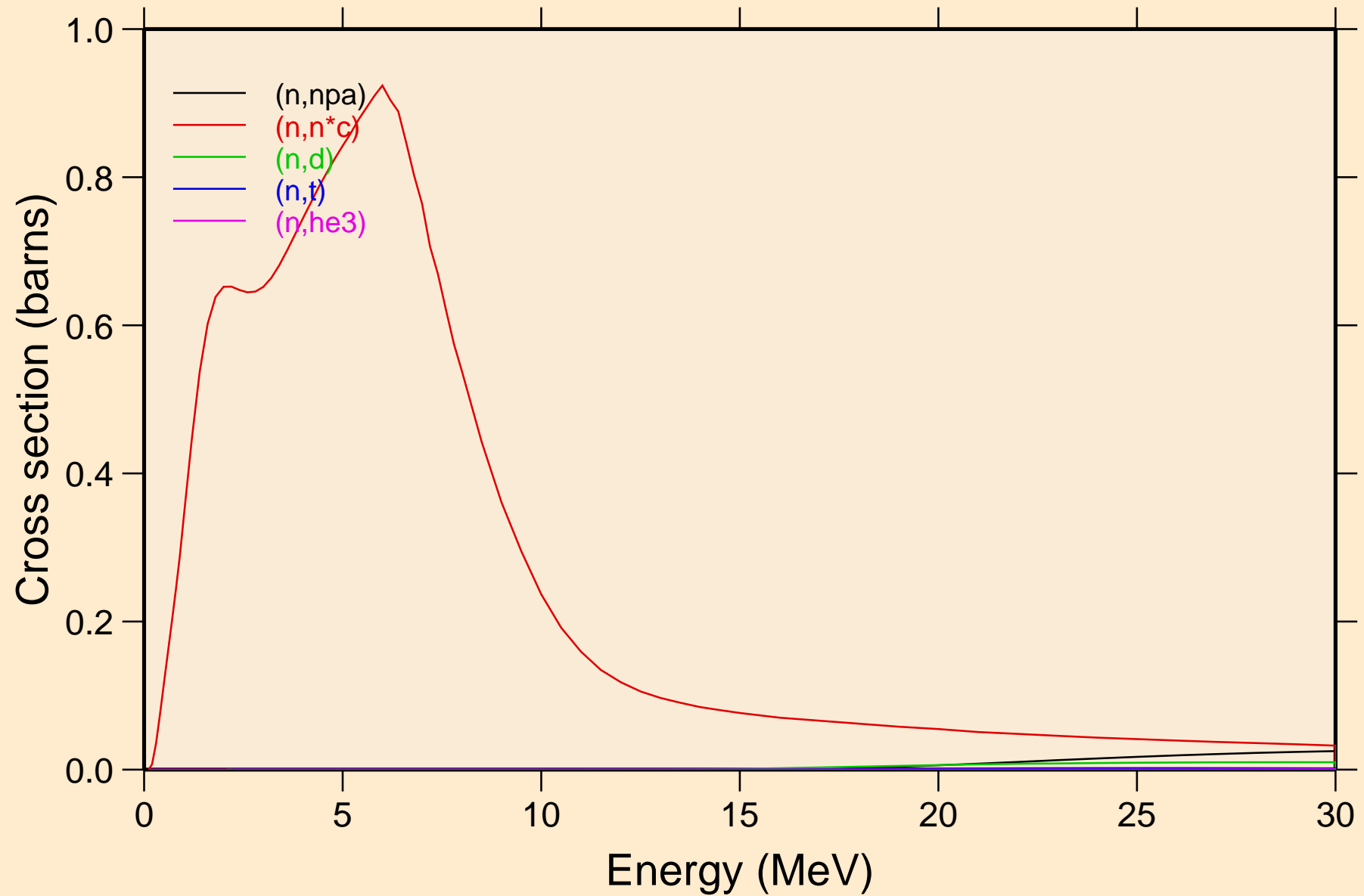

U227 NRG TENDL-2015, AKONING

Threshold reactions

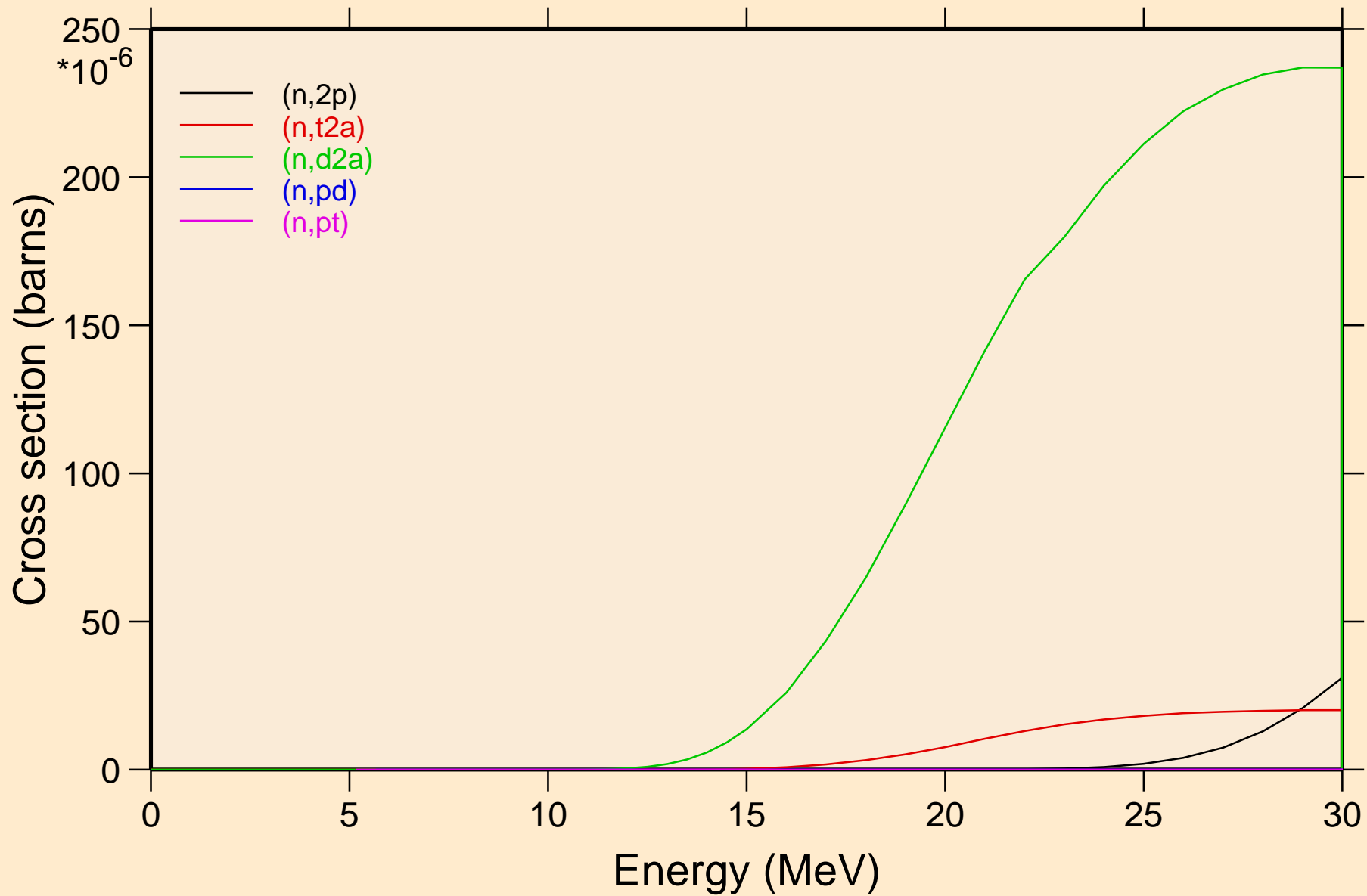

U227 NRG TENDL-2015, AKONING

Threshold reactions

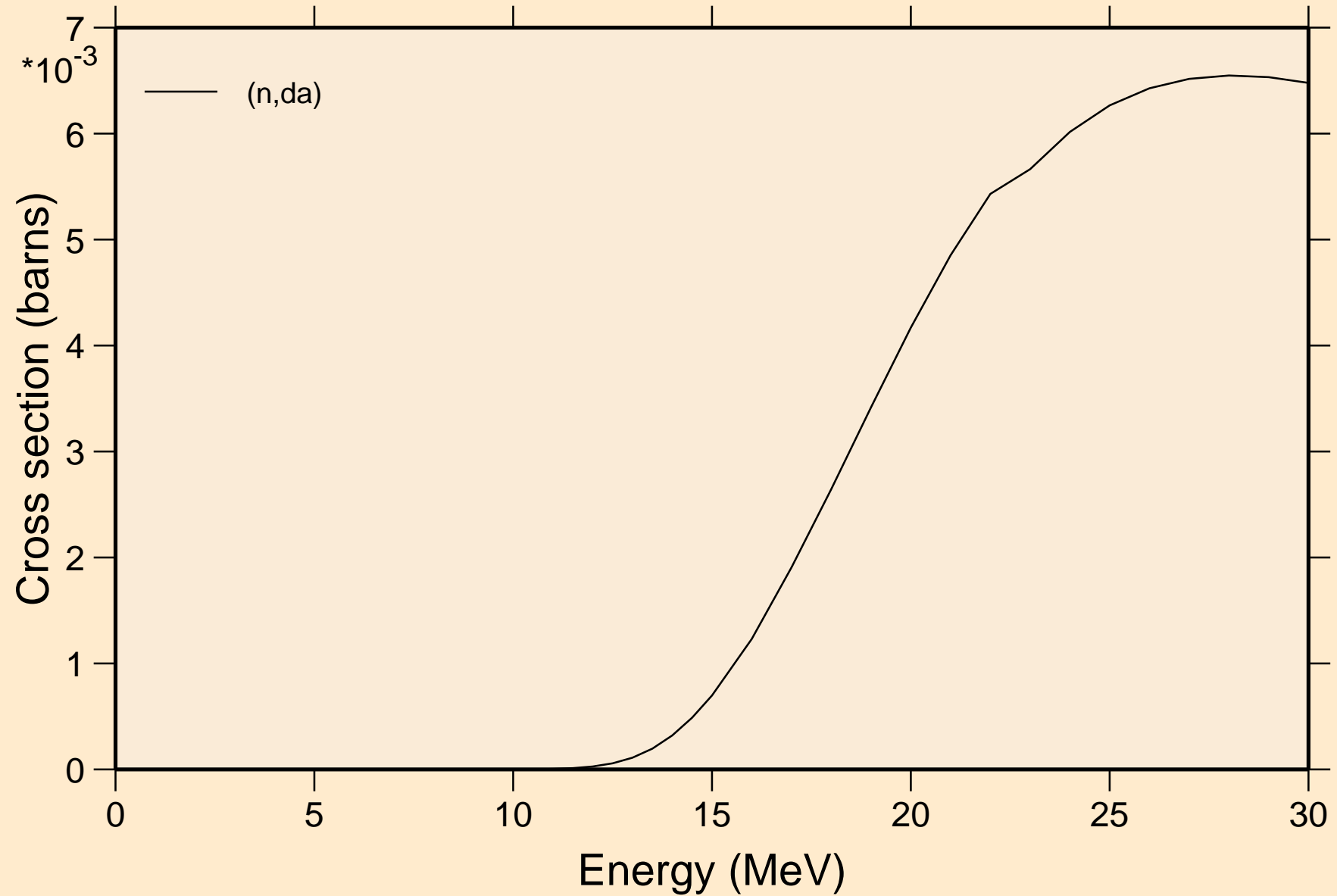

U227 NRG TENDL-2015, AKONING
angular distribution for elastic

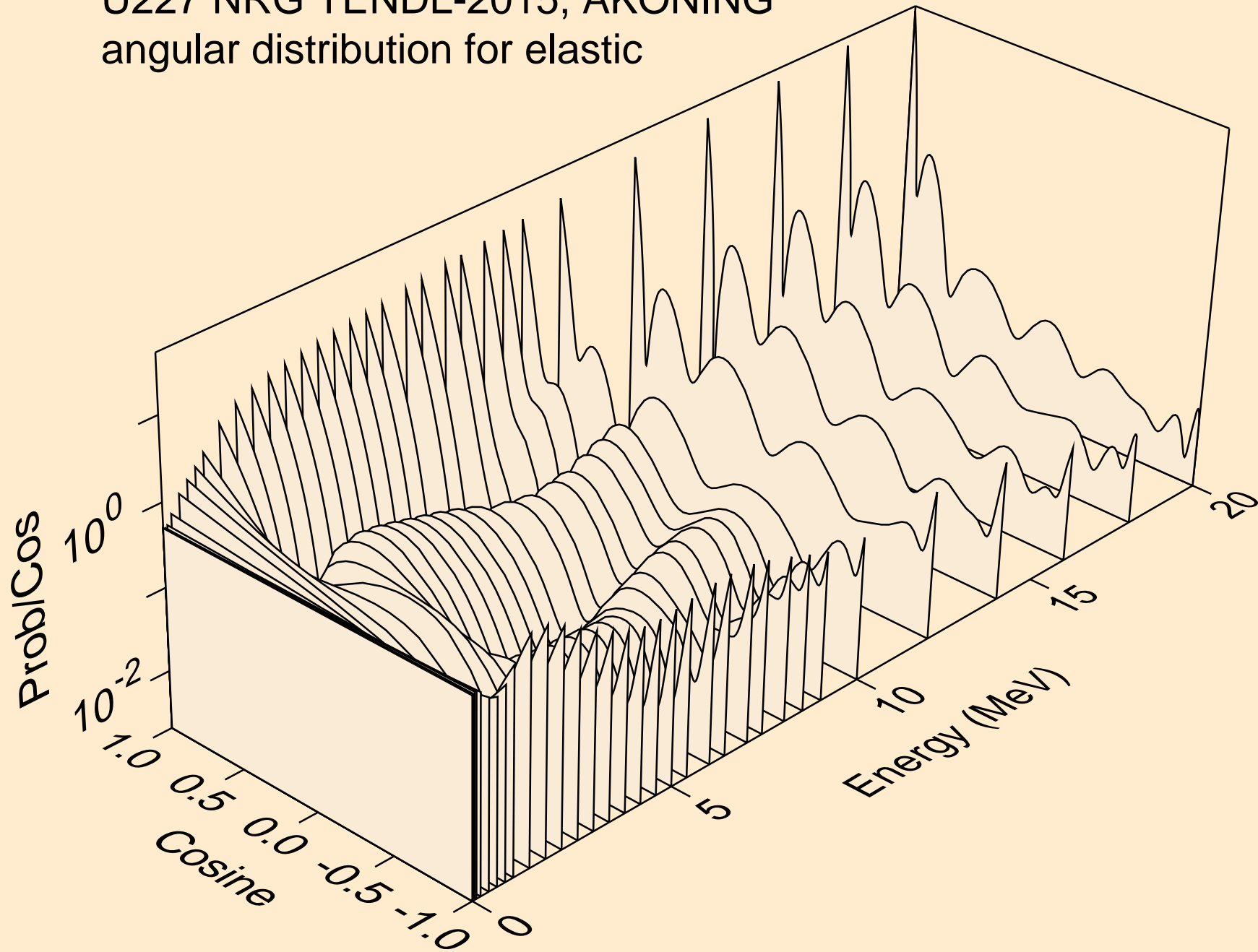

U227 NRG TENDL-2015, AKONING
angular distribution for elastic

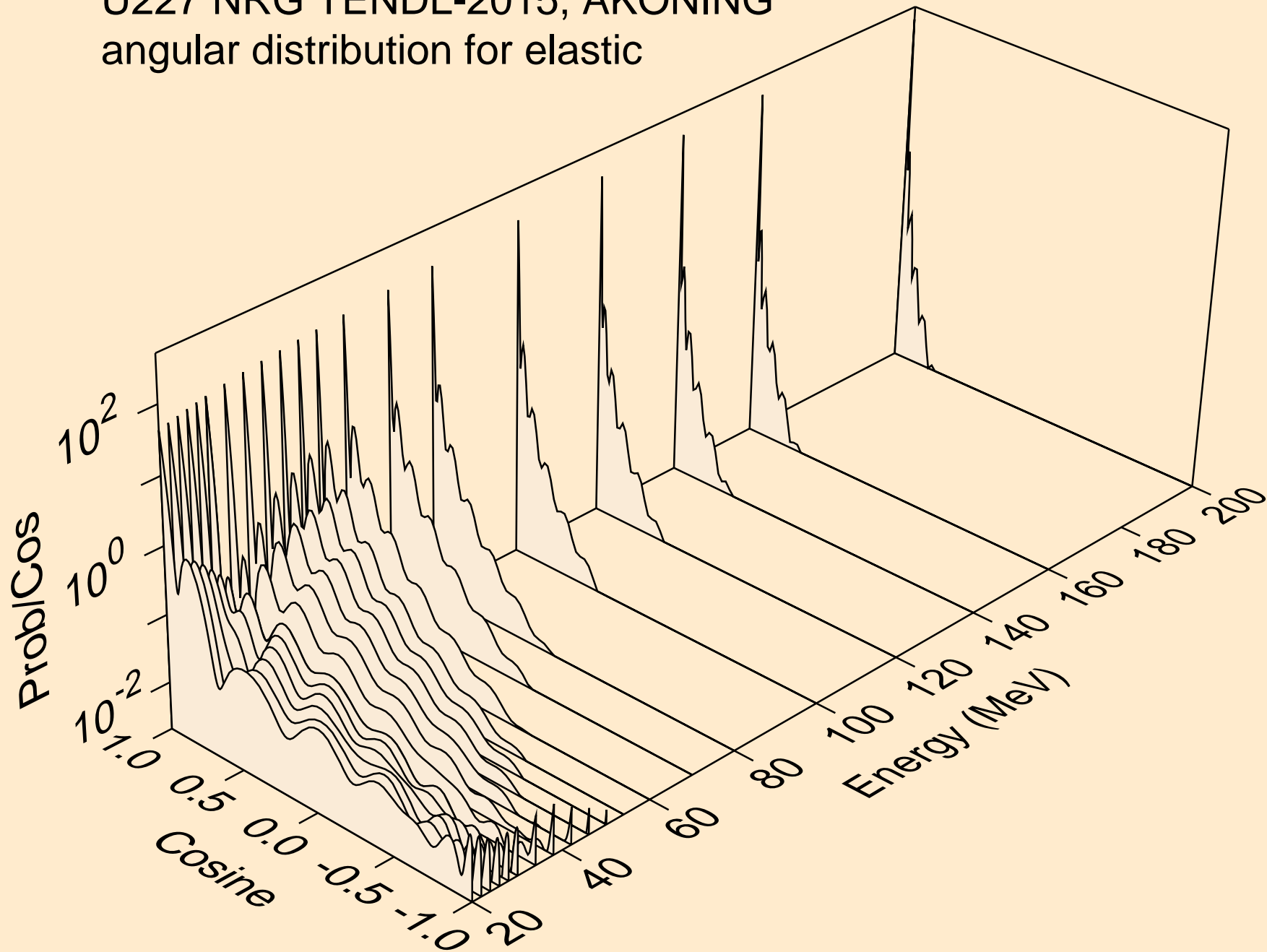

U227 NRG TENDL-2015, AKONING
angular distribution for (n,n*1)

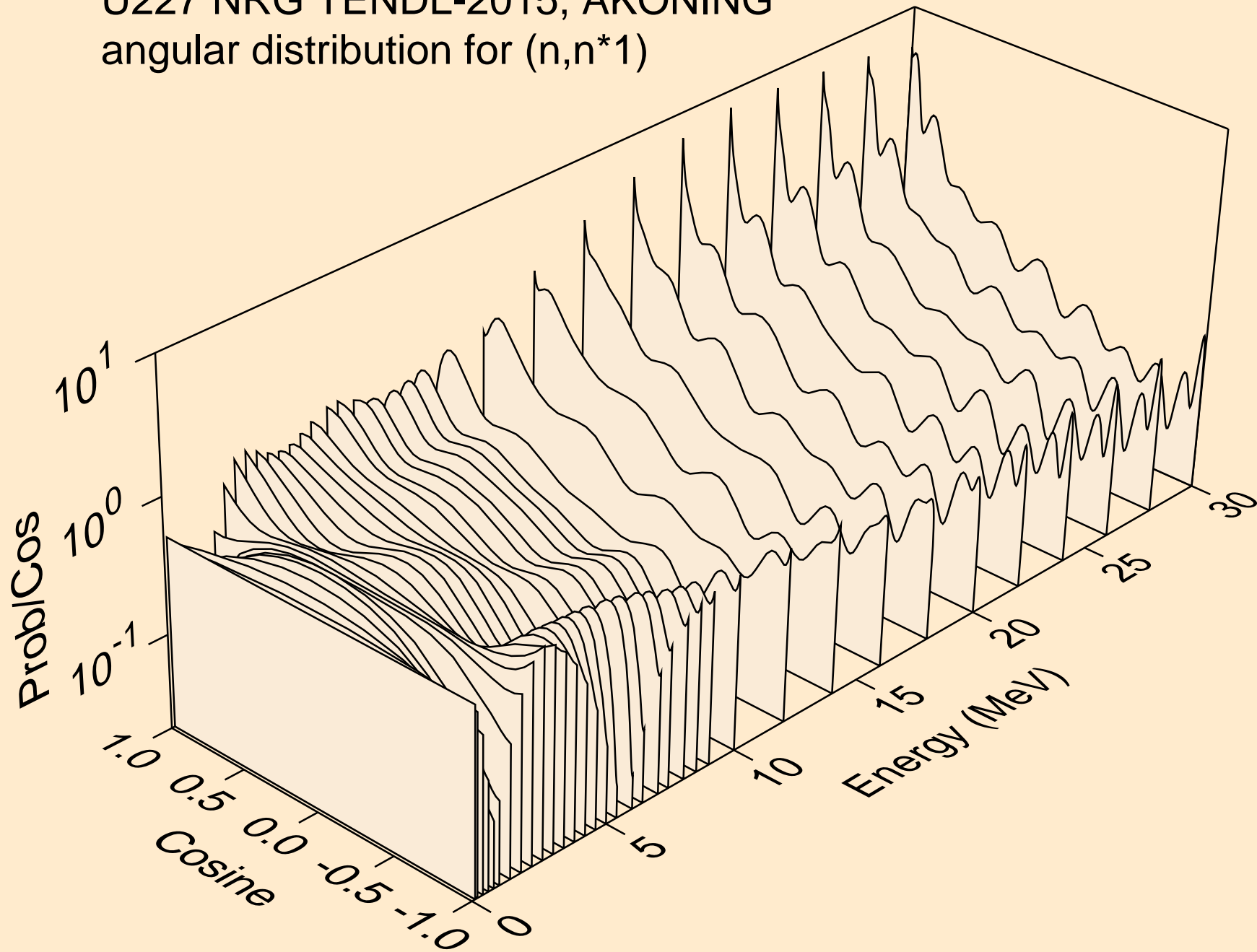

U227 NRG TENDL-2015, AKONING

Total fission nubar

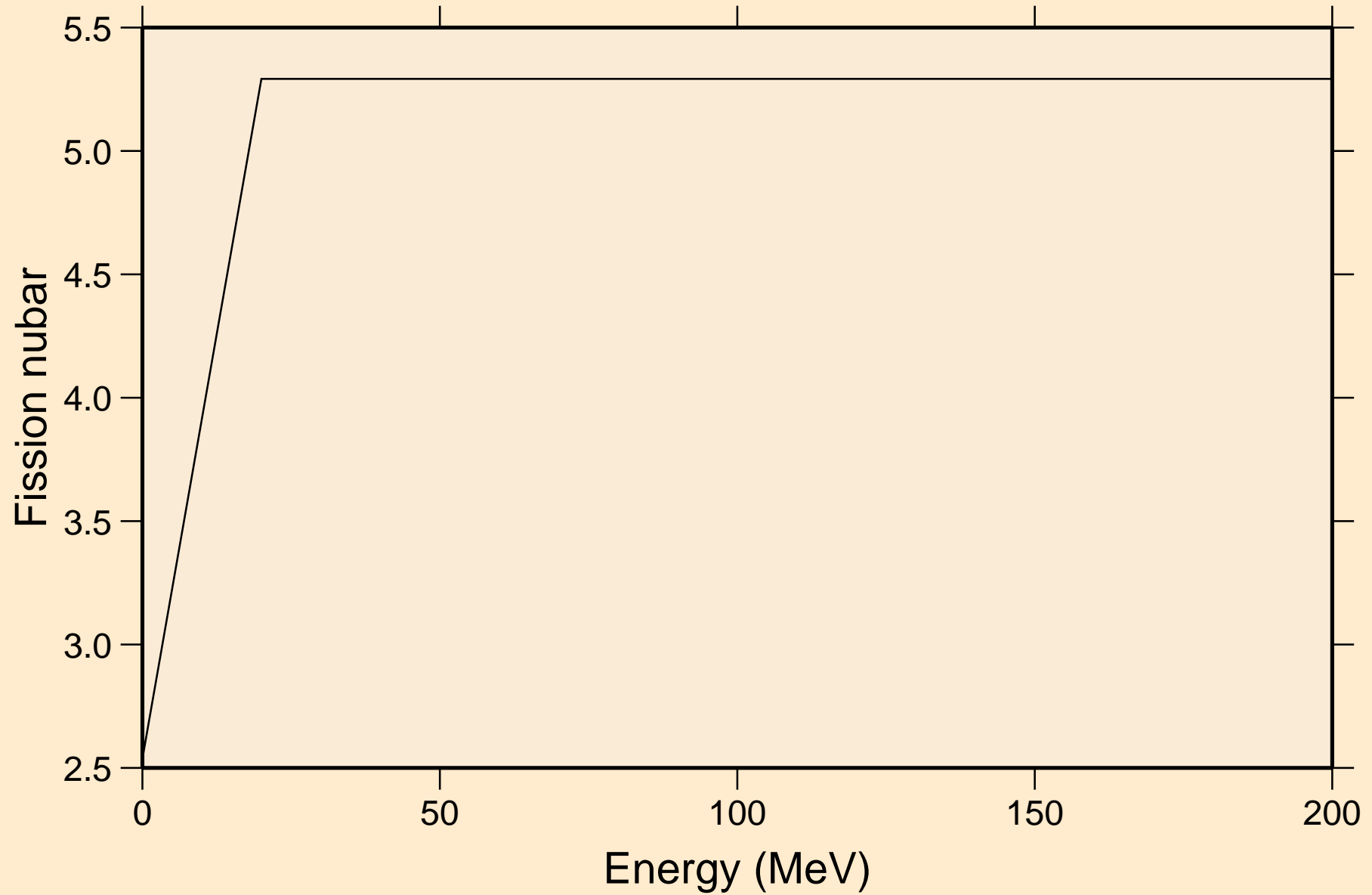

U227 NRG TENDL-2015, AKONING
Neutron emission for (n,x)

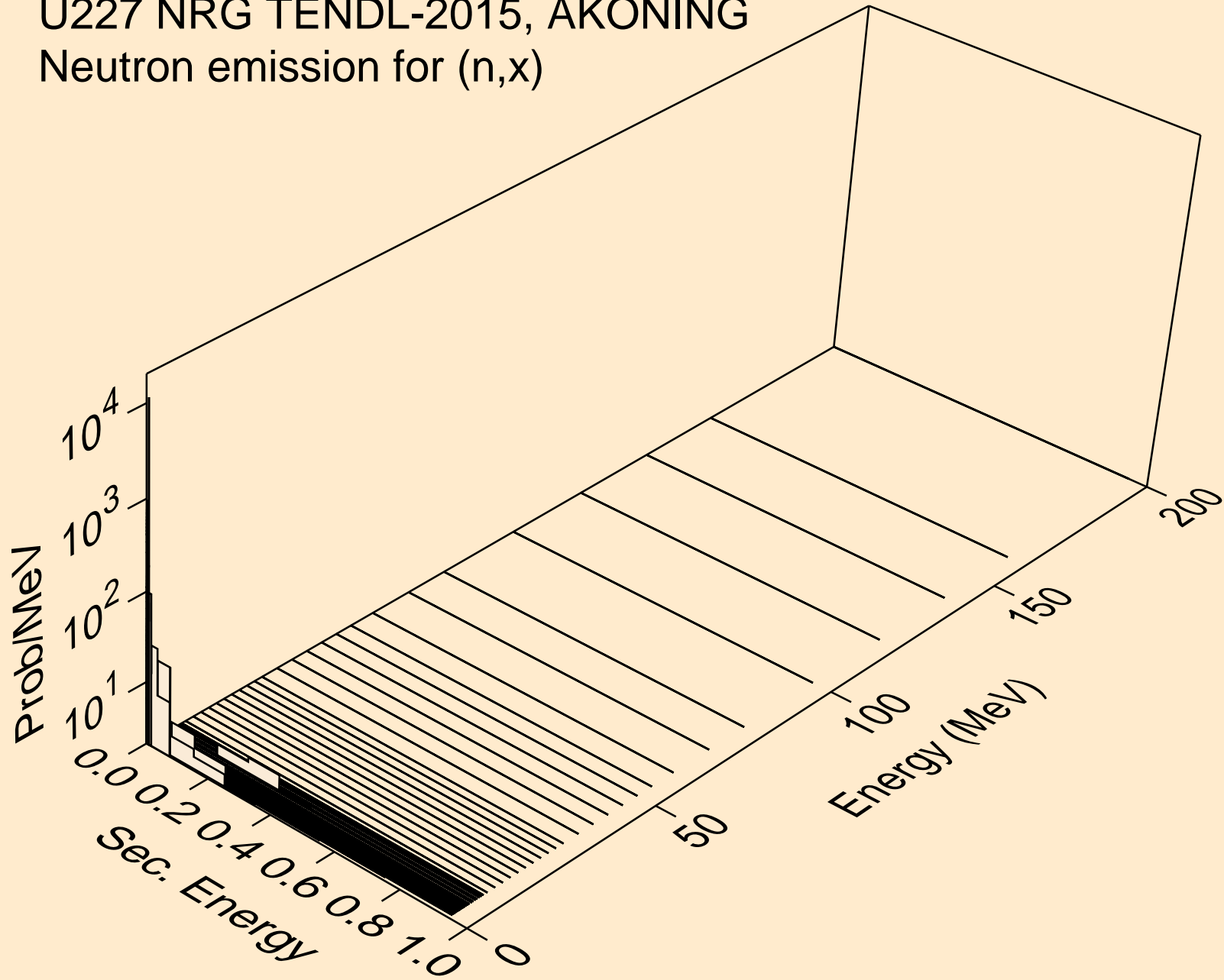

U227 NRG TENDL-2015, AKONING
Neutron emission for (n,2nd)

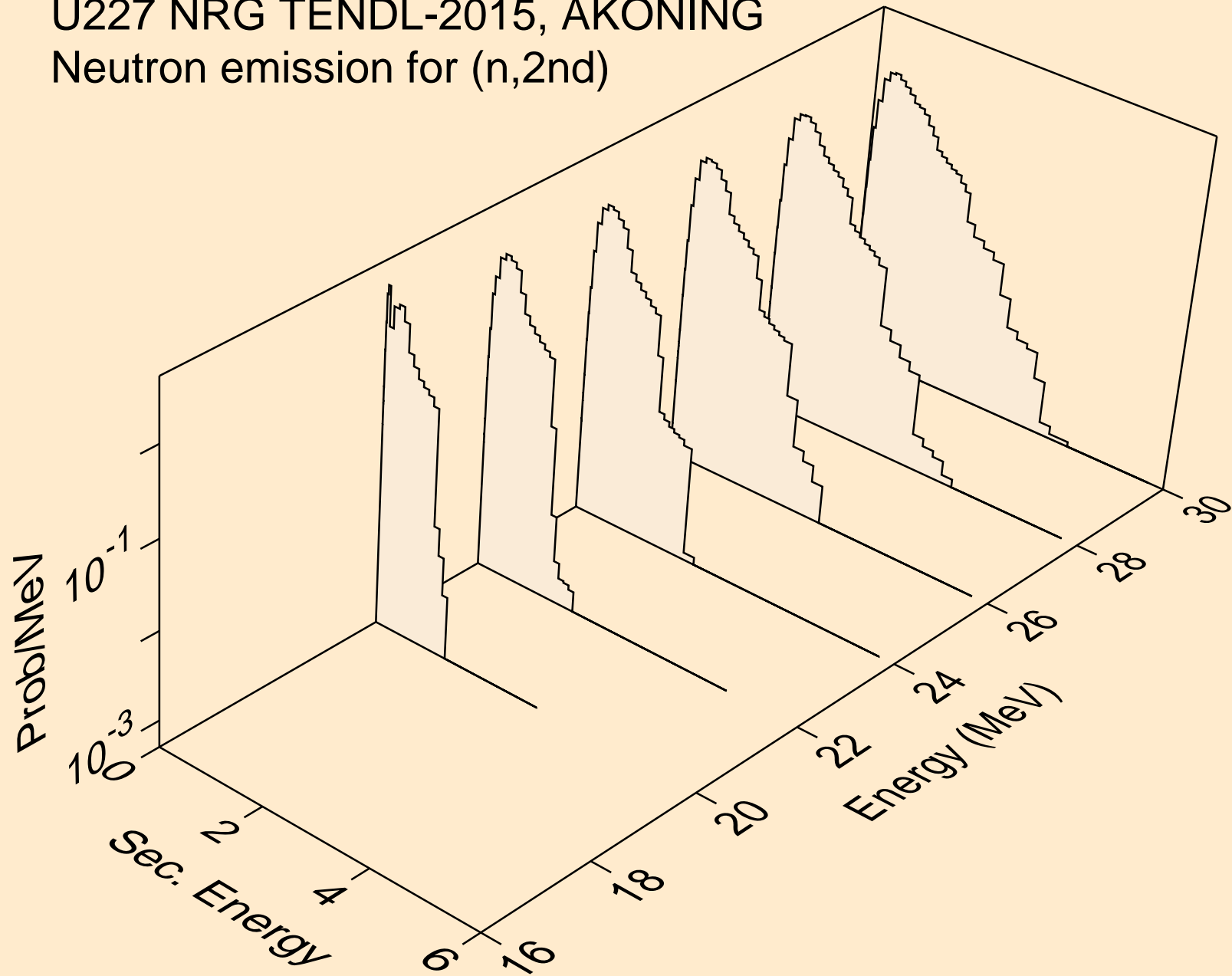

U227 NRG TENDL-2015, AKONING
Neutron emission for (n,2n)

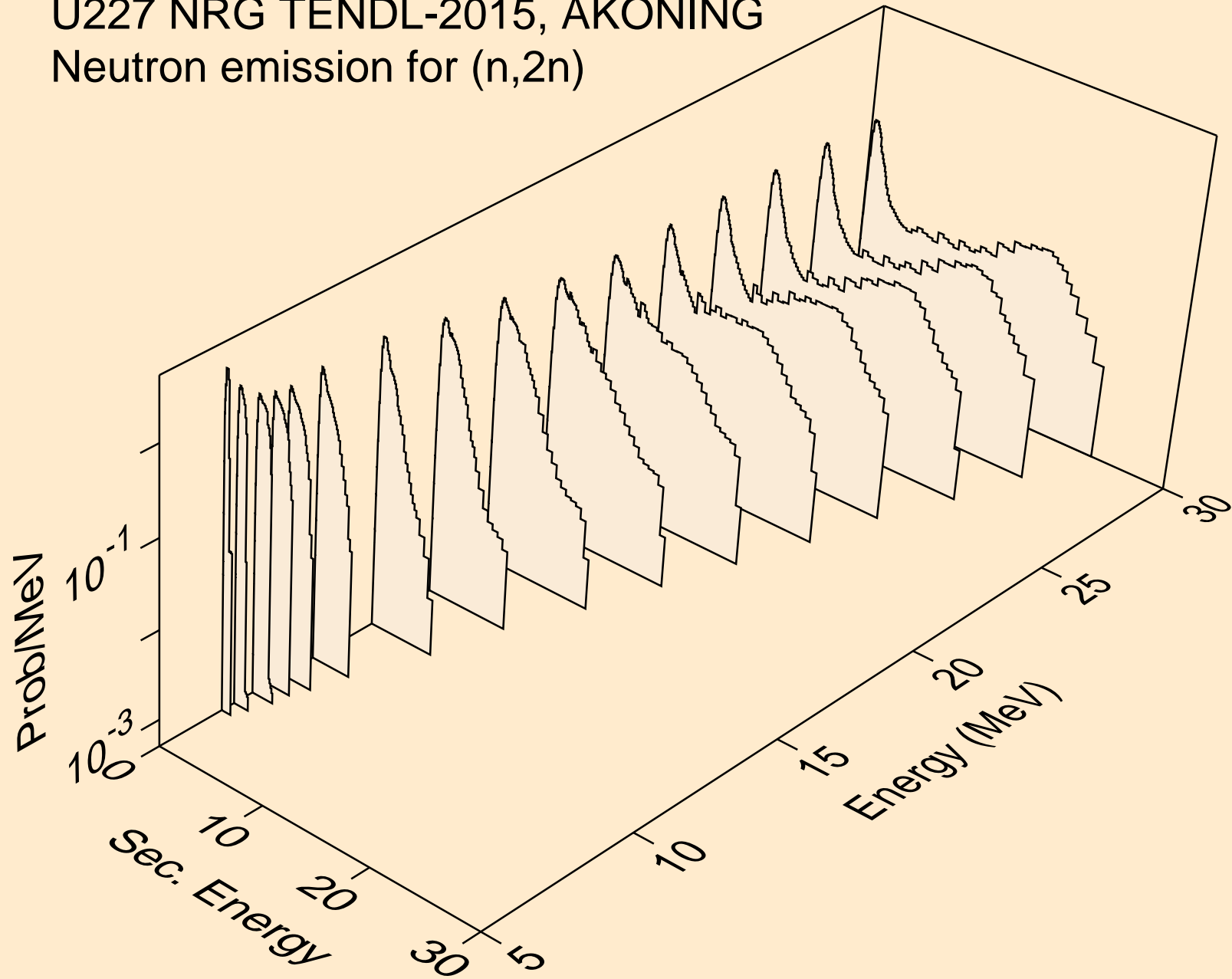

U227 NRG TENDL-2015, AKONING
Neutron emission for (n,3n)

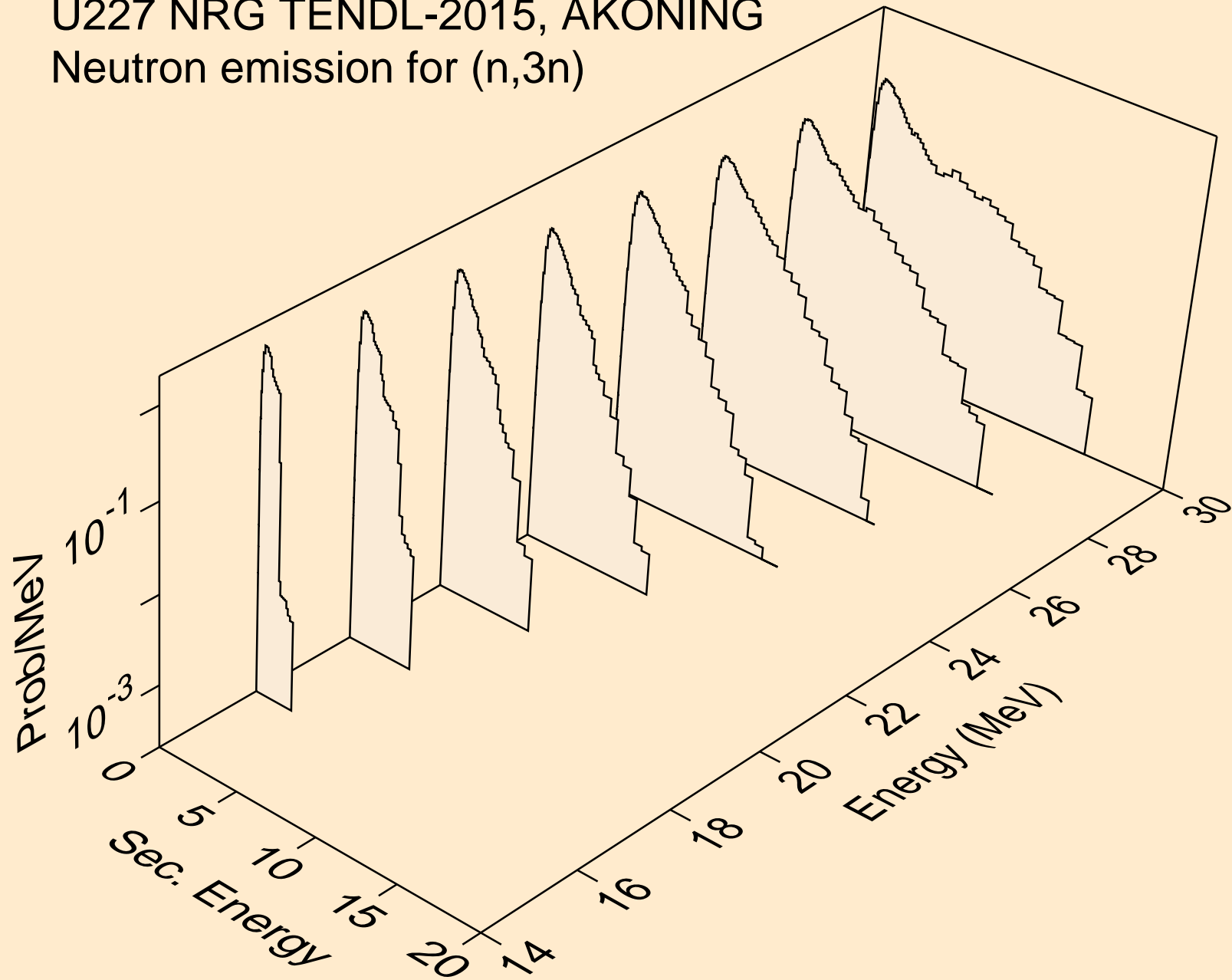

U227 NRG TENDL-2015, AKONING
Neutron emission for fission

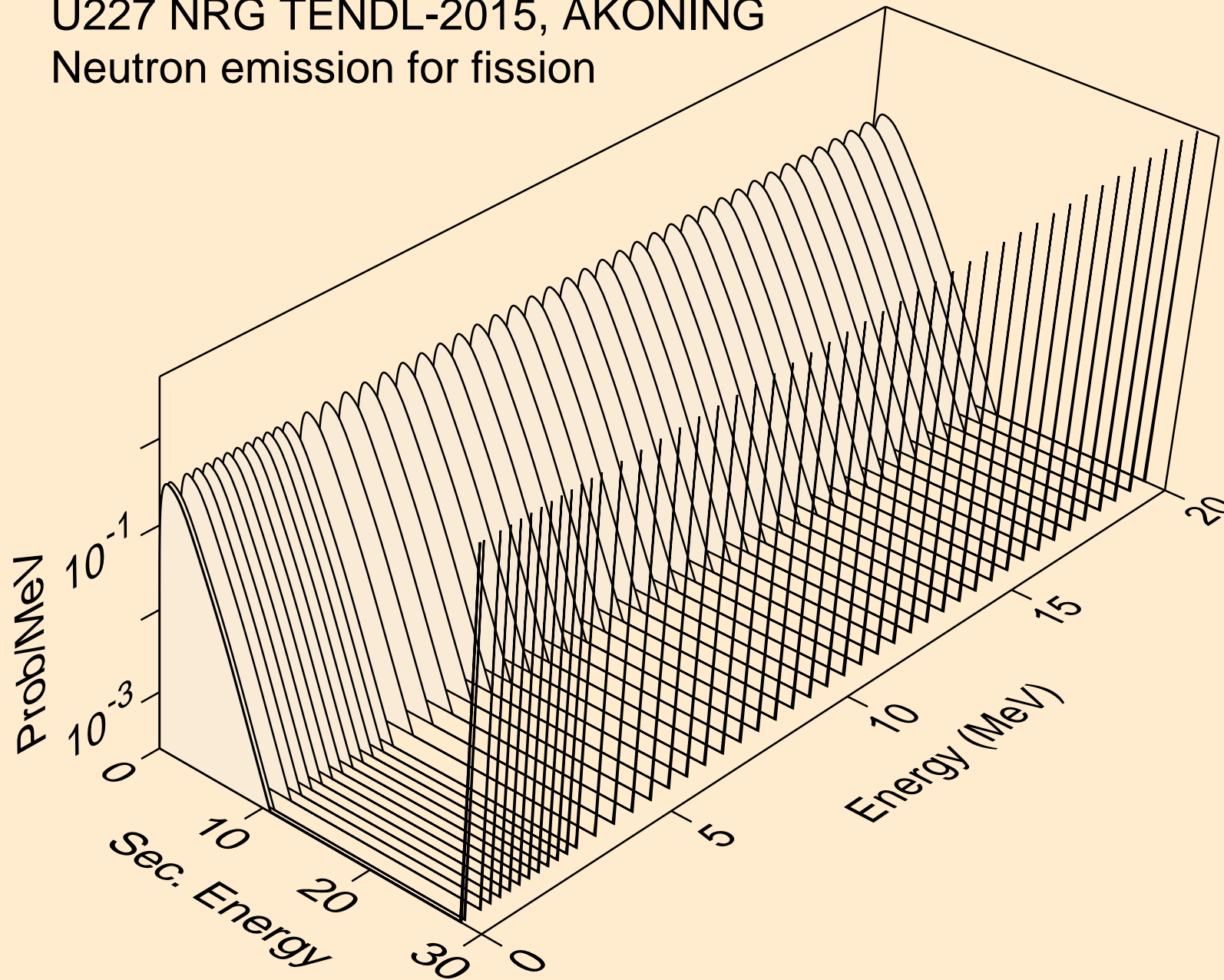

U227 NRG TENDL-2015, AKONING
Neutron emission for (n,n*)a

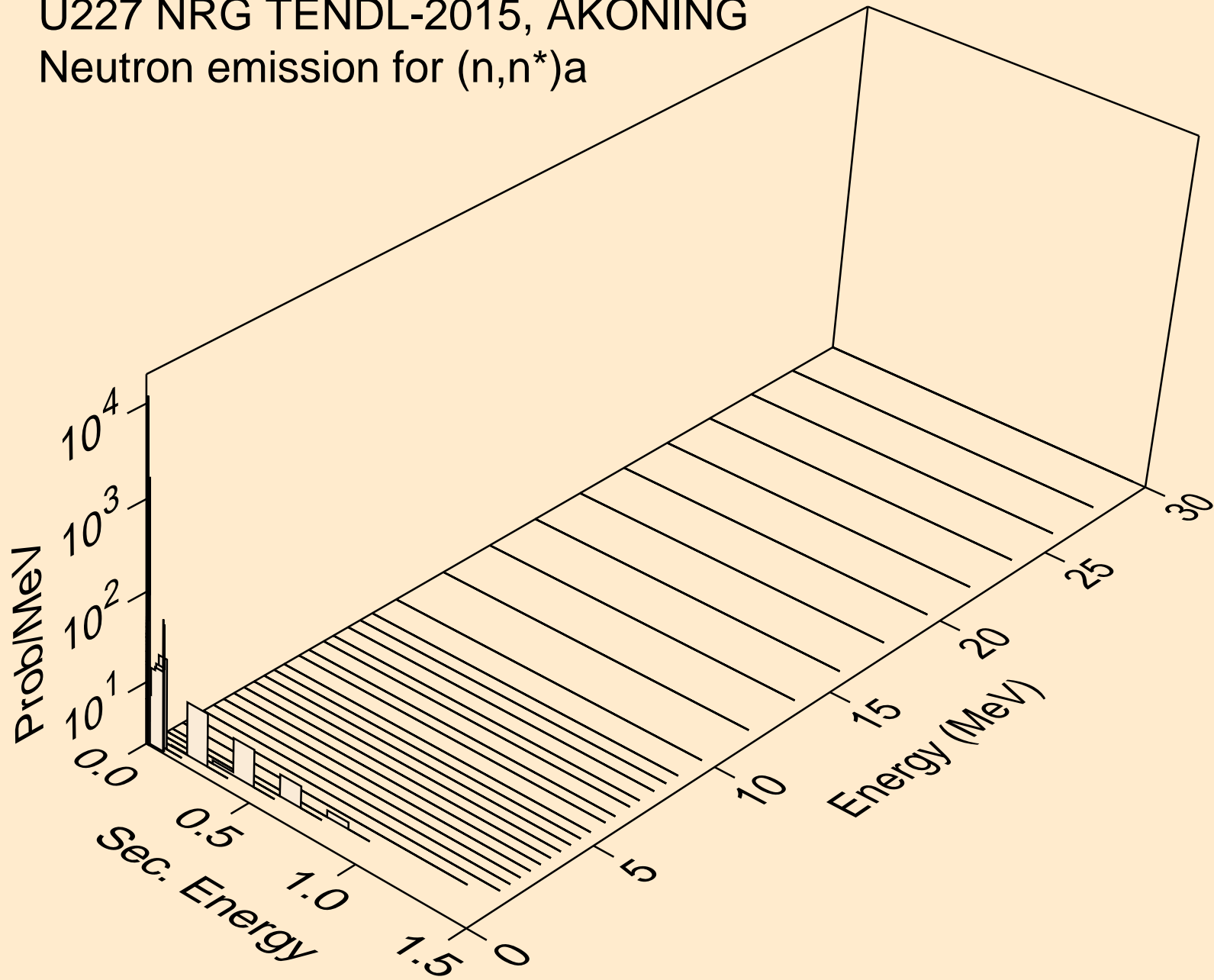

U227 NRG TENDL-2015, AKONING
Neutron emission for (n,n*)3a

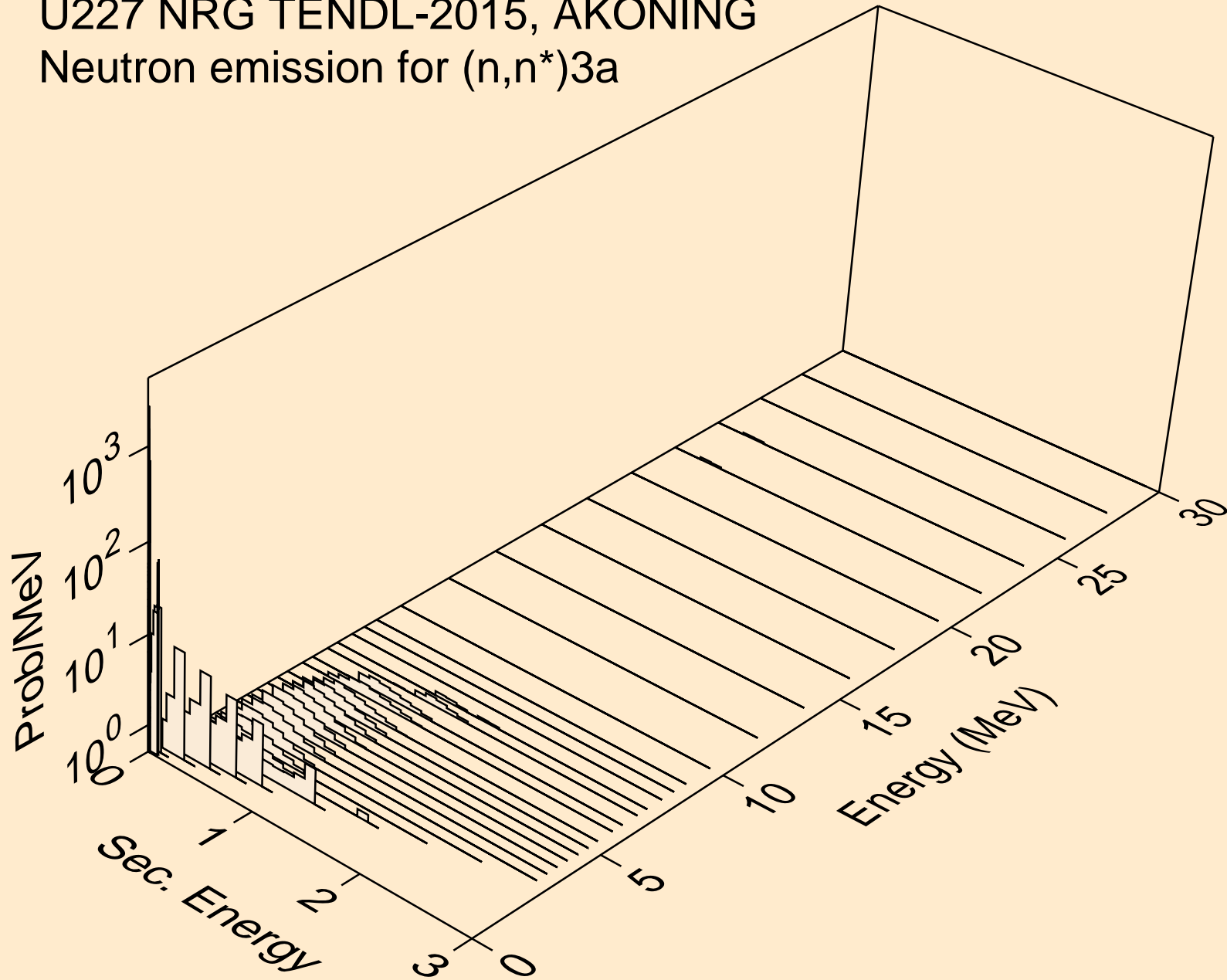

U227 NRG TENDL-2015, AKONING
Neutron emission for (n,2n)a

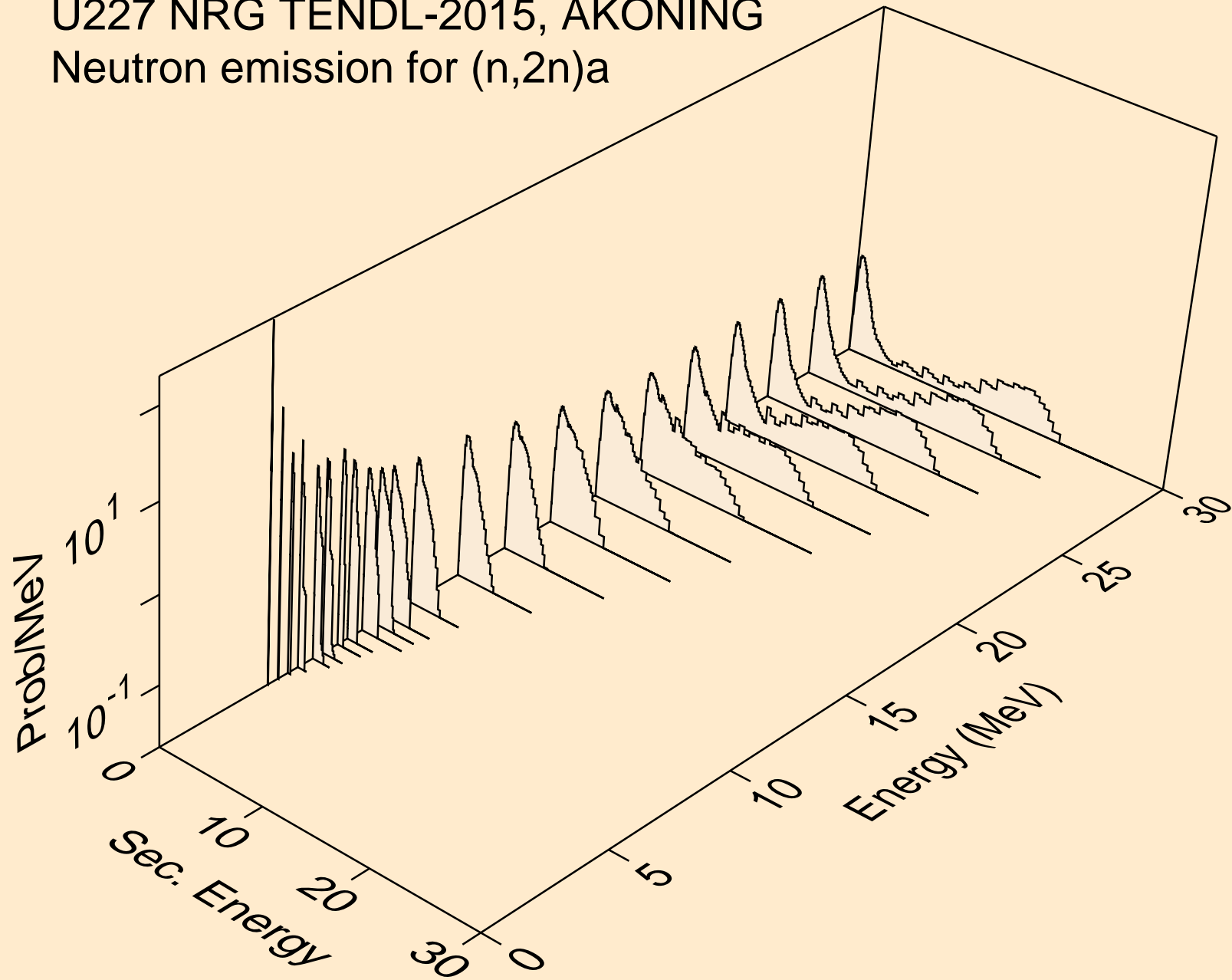

U227 NRG TENDL-2015, AKONING
Neutron emission for (n,3n)a

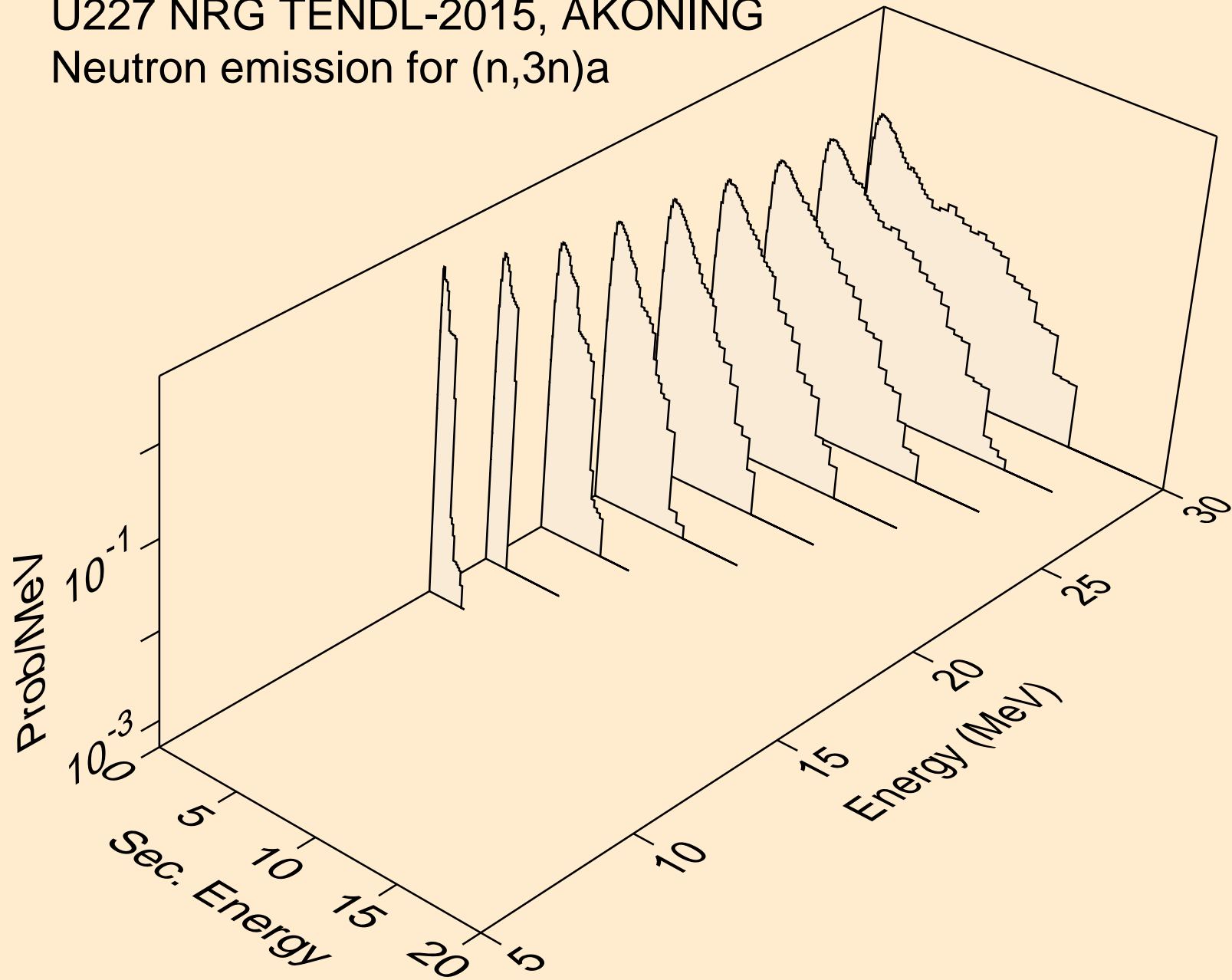

U227 NRG TENDL-2015, AKONING
Neutron emission for (n,n*)p

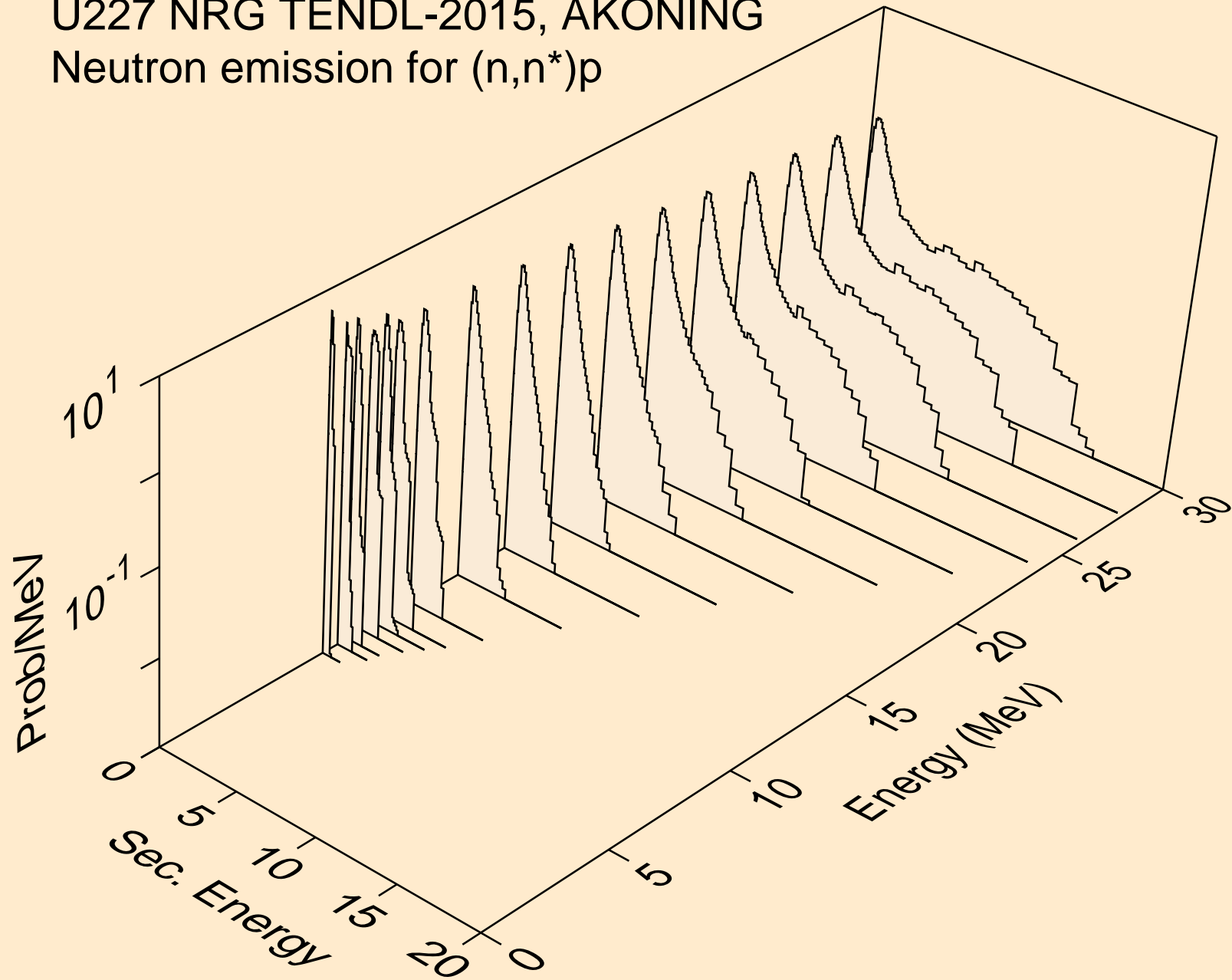

U227 NRG TENDL-2015, AKONING
Neutron emission for (n,n*)2a

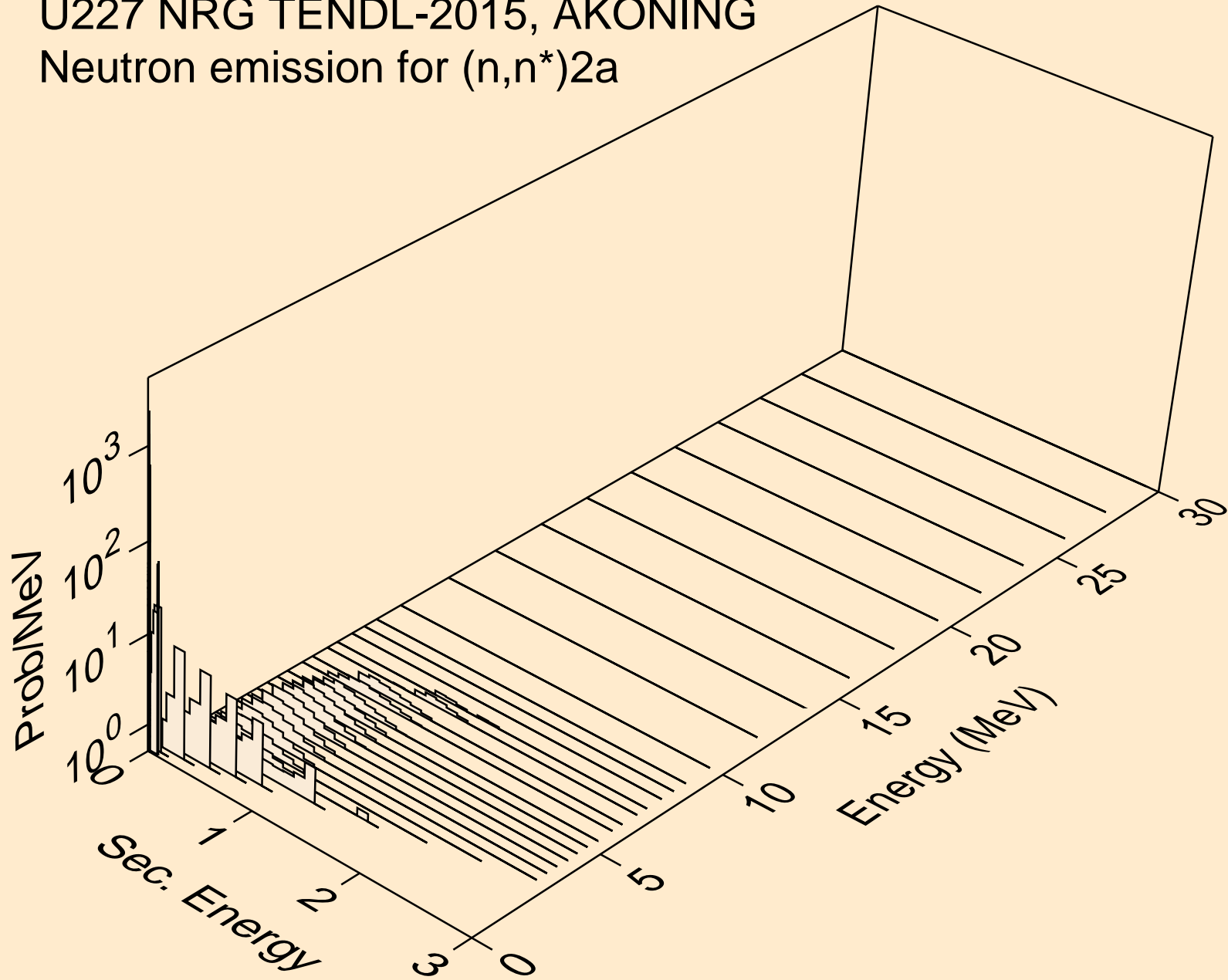

U227 NRG TENDL-2015, AKONING
Neutron emission for (n,2n)2a

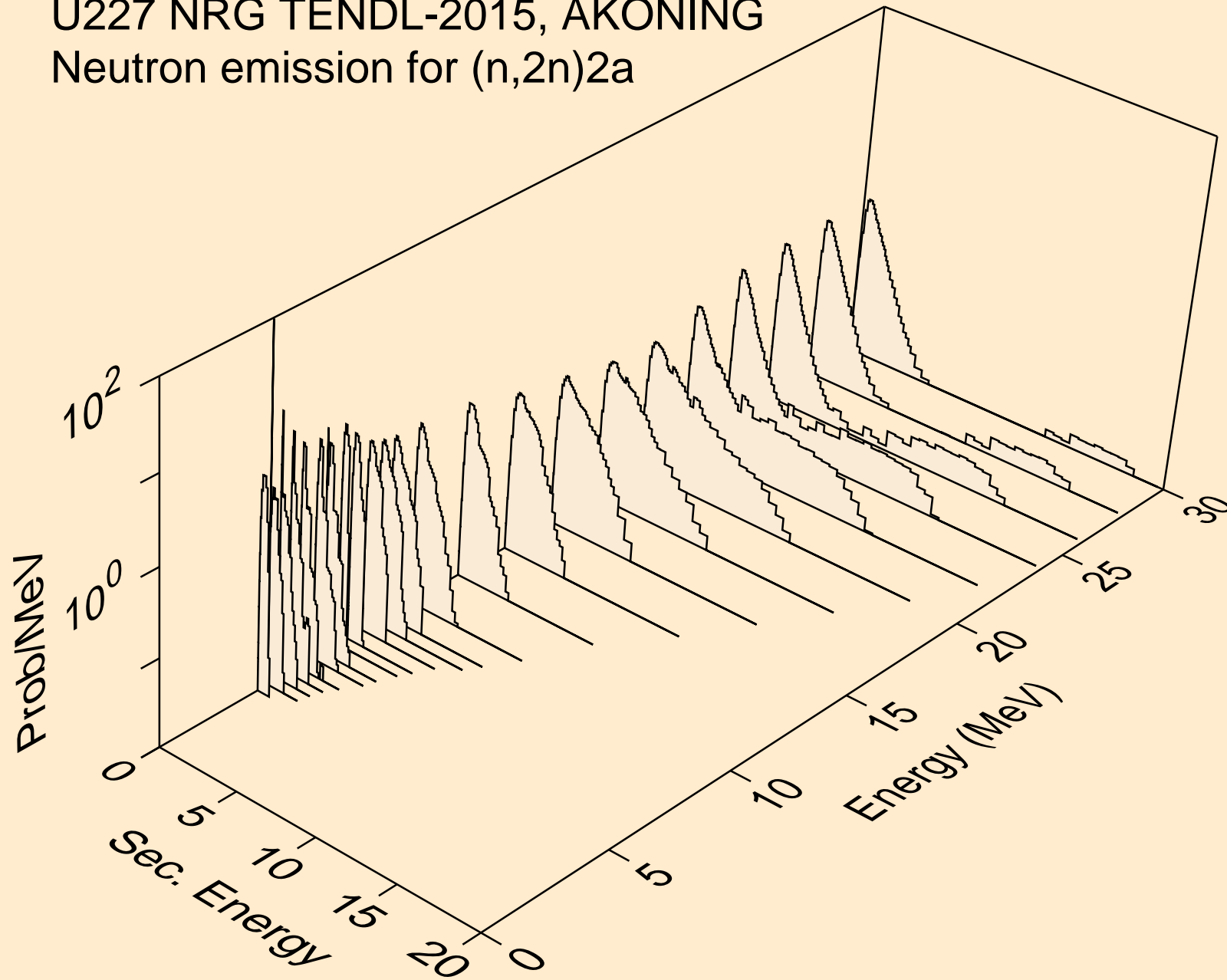

U227 NRG TENDL-2015, AKONING
Neutron emission for (n,n*)d

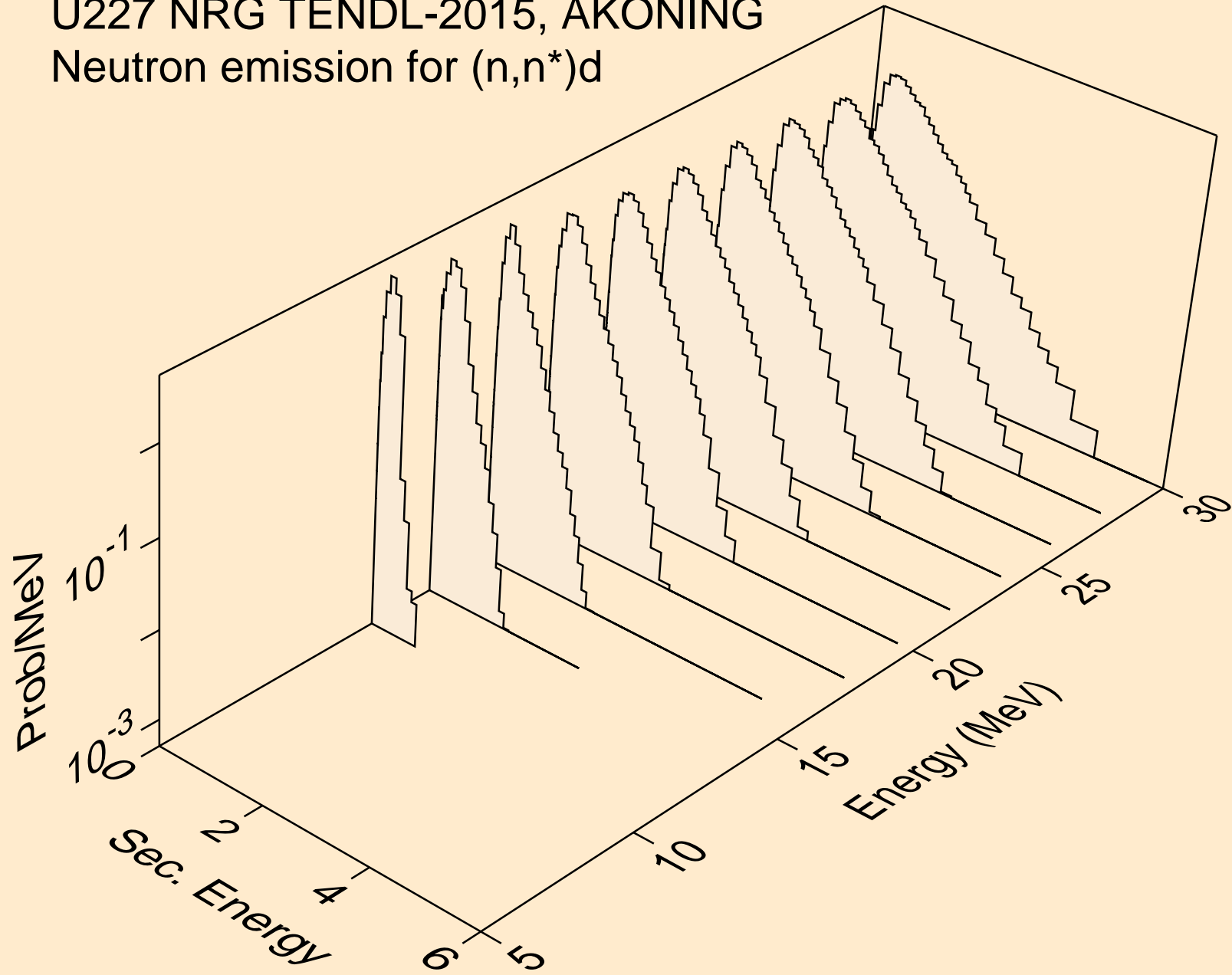

U227 NRG TENDL-2015, AKONING
Neutron emission for (n,n*)t

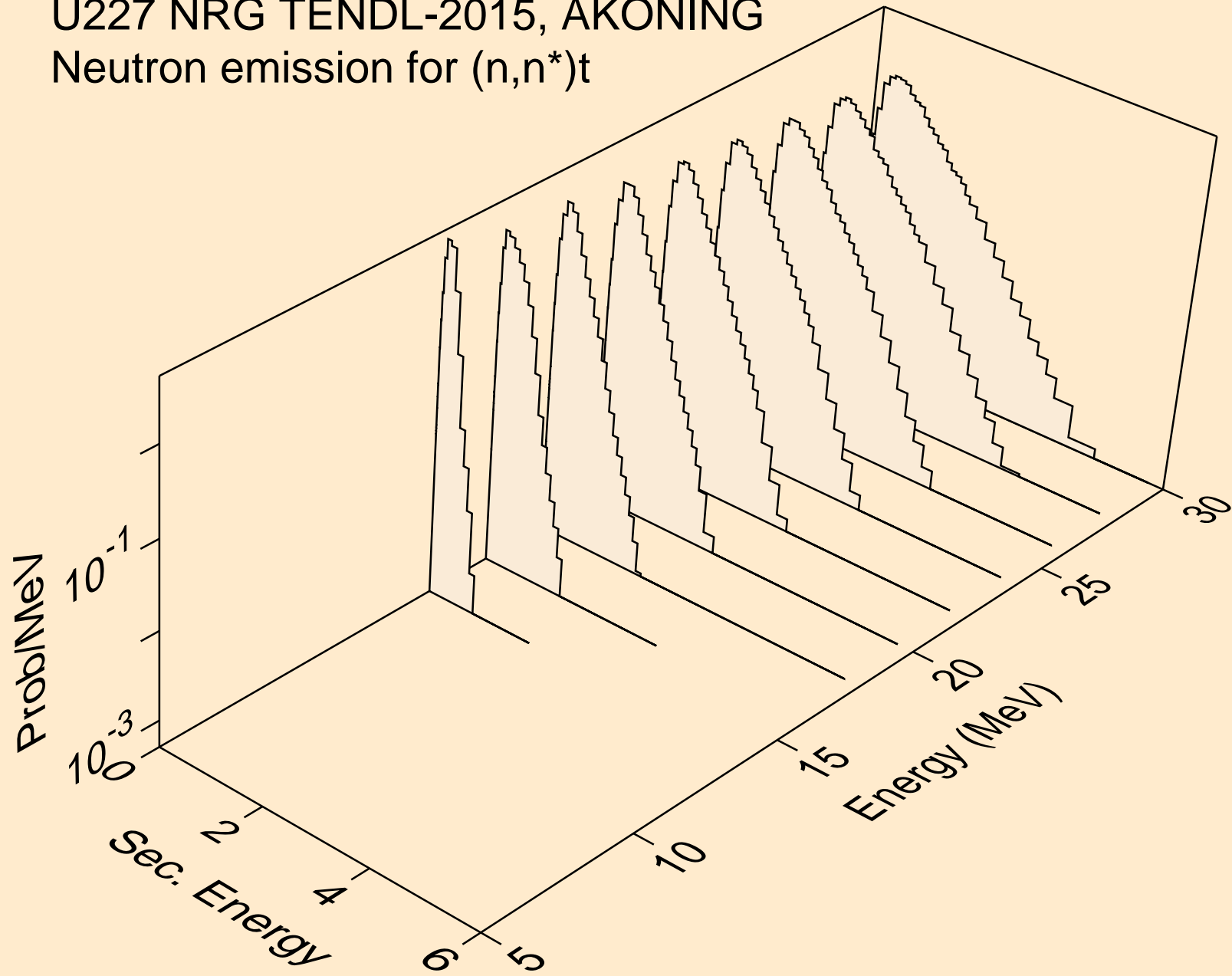

U227 NRG TENDL-2015, AKONING
Neutron emission for (n,n*)he3

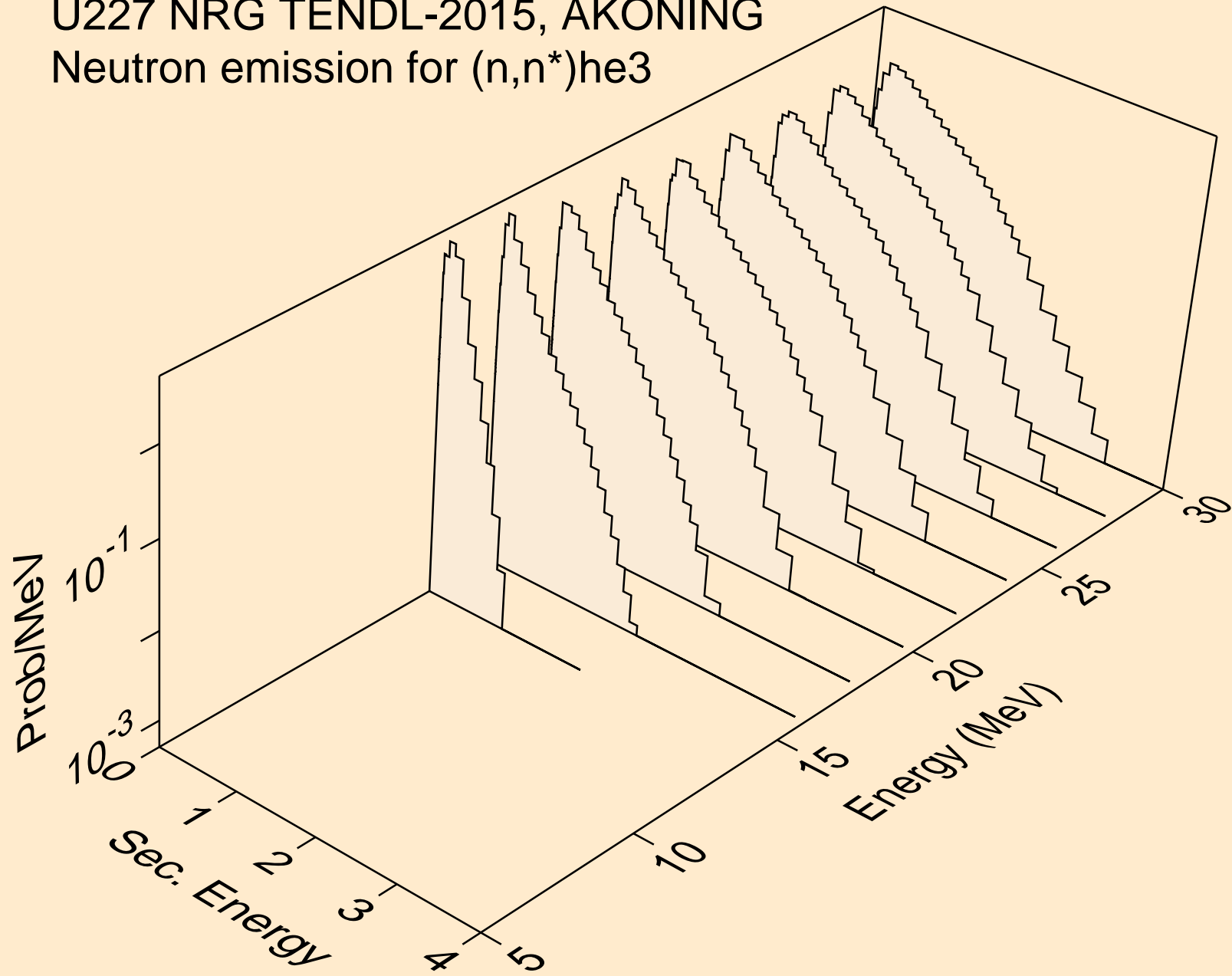

U227 NRG TENDL-2015, AKONING
Neutron emission for (n,n*)d2a

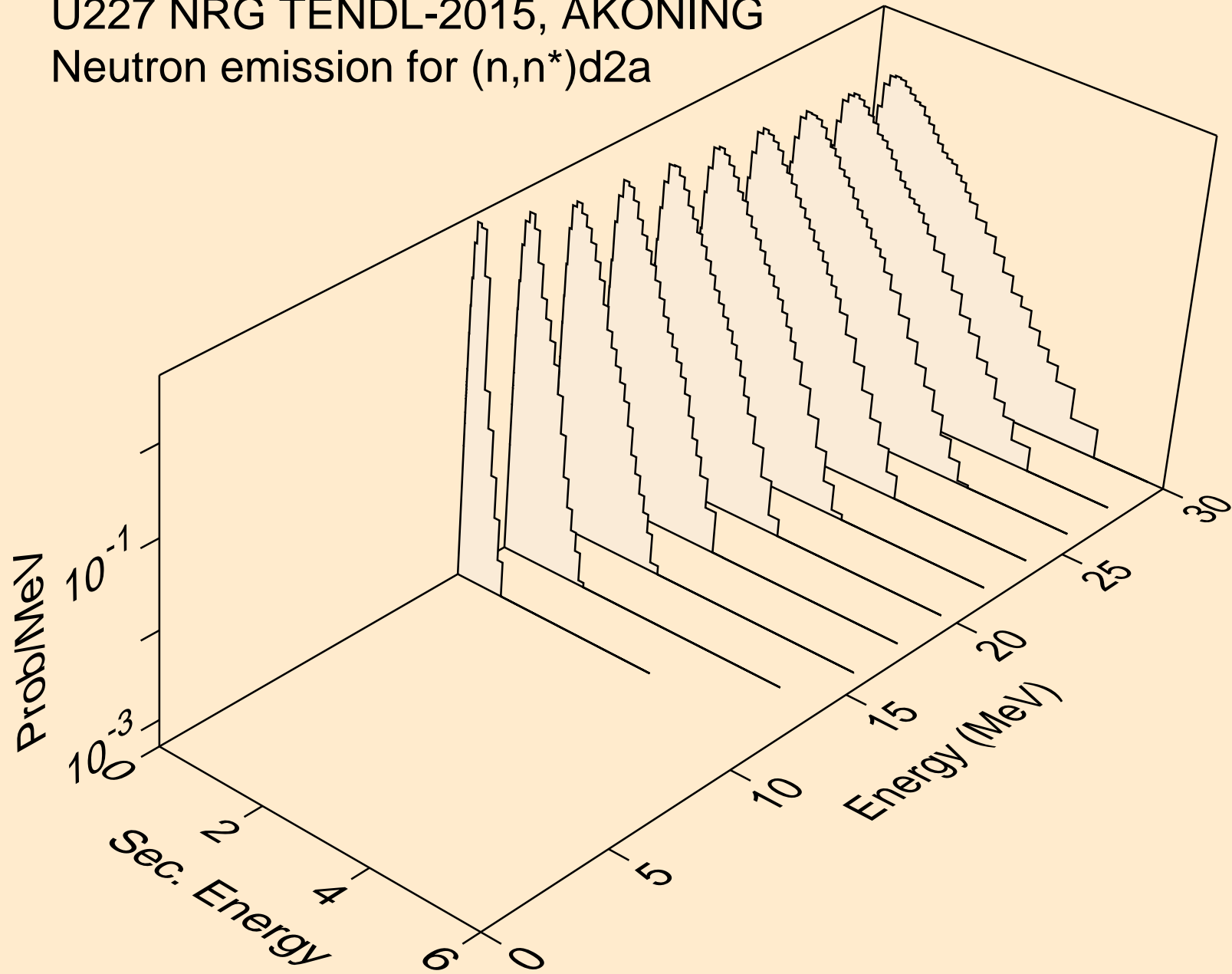

U227 NRG TENDL-2015, AKONING
Neutron emission for (n,n*)t2a

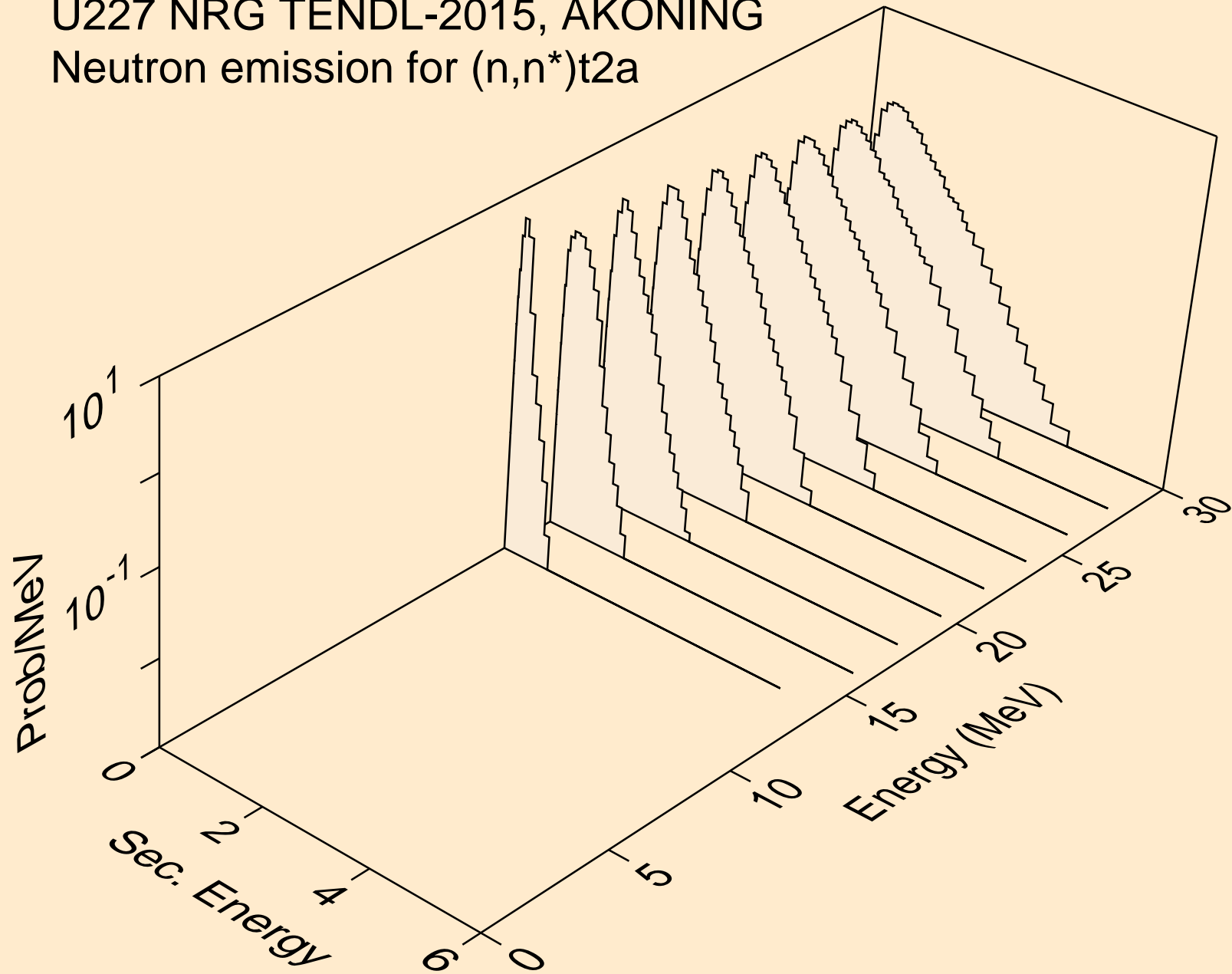

U227 NRG TENDL-2015, AKONING
Neutron emission for (n,4n)

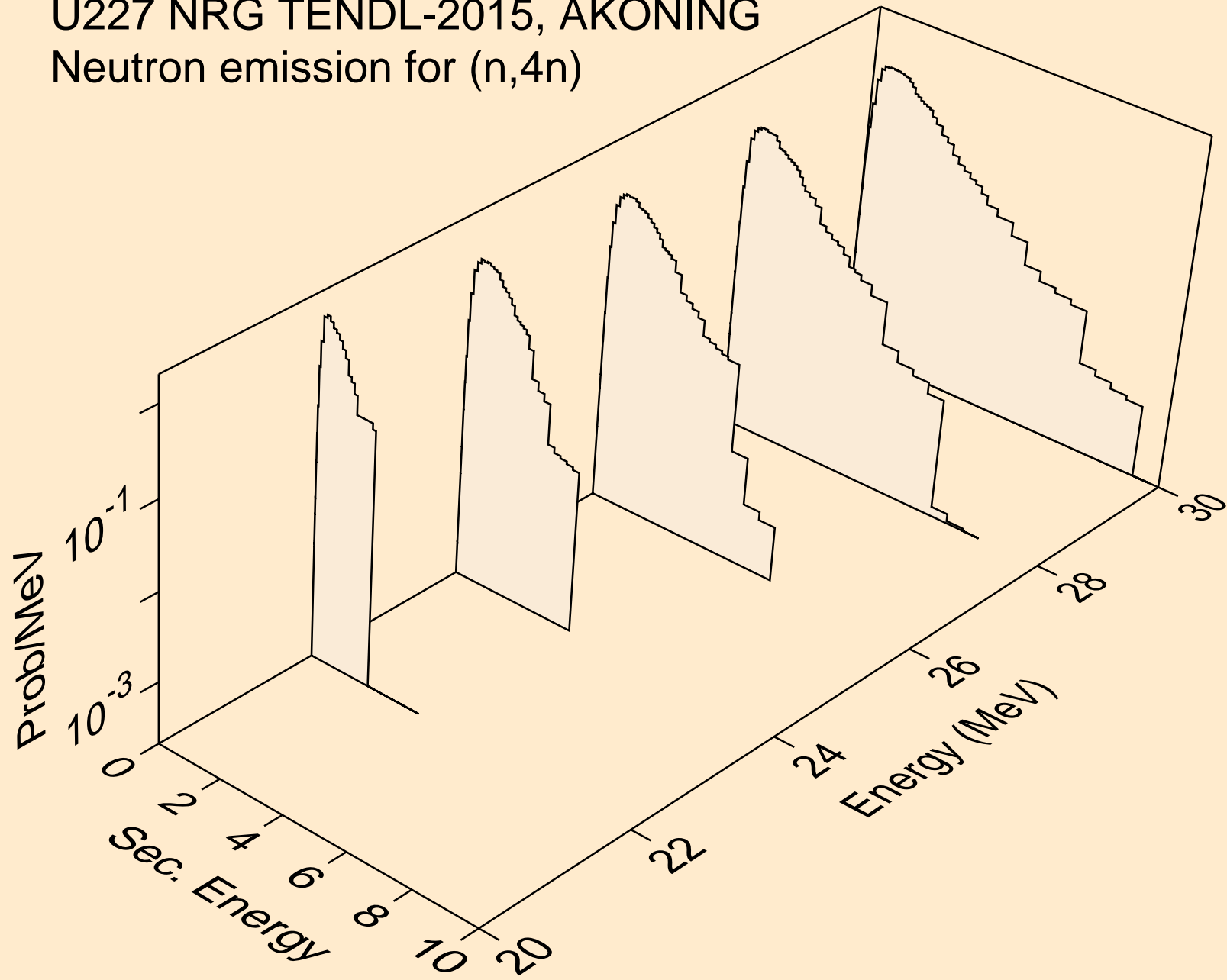

U227 NRG TENDL-2015, AKONING
Neutron emission for (n,2np)

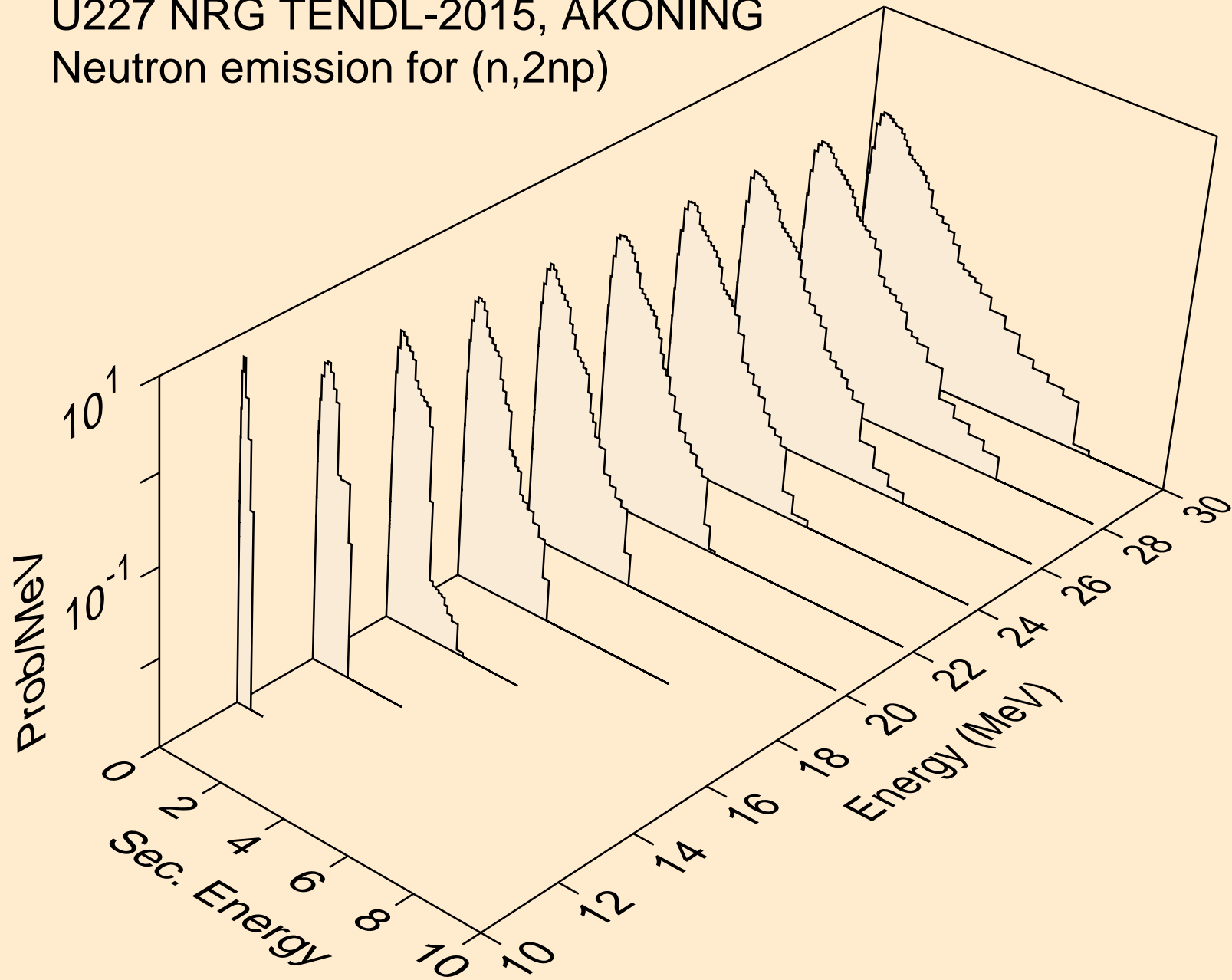

U227 NRG TENDL-2015, AKONING
Neutron emission for (n,3np)

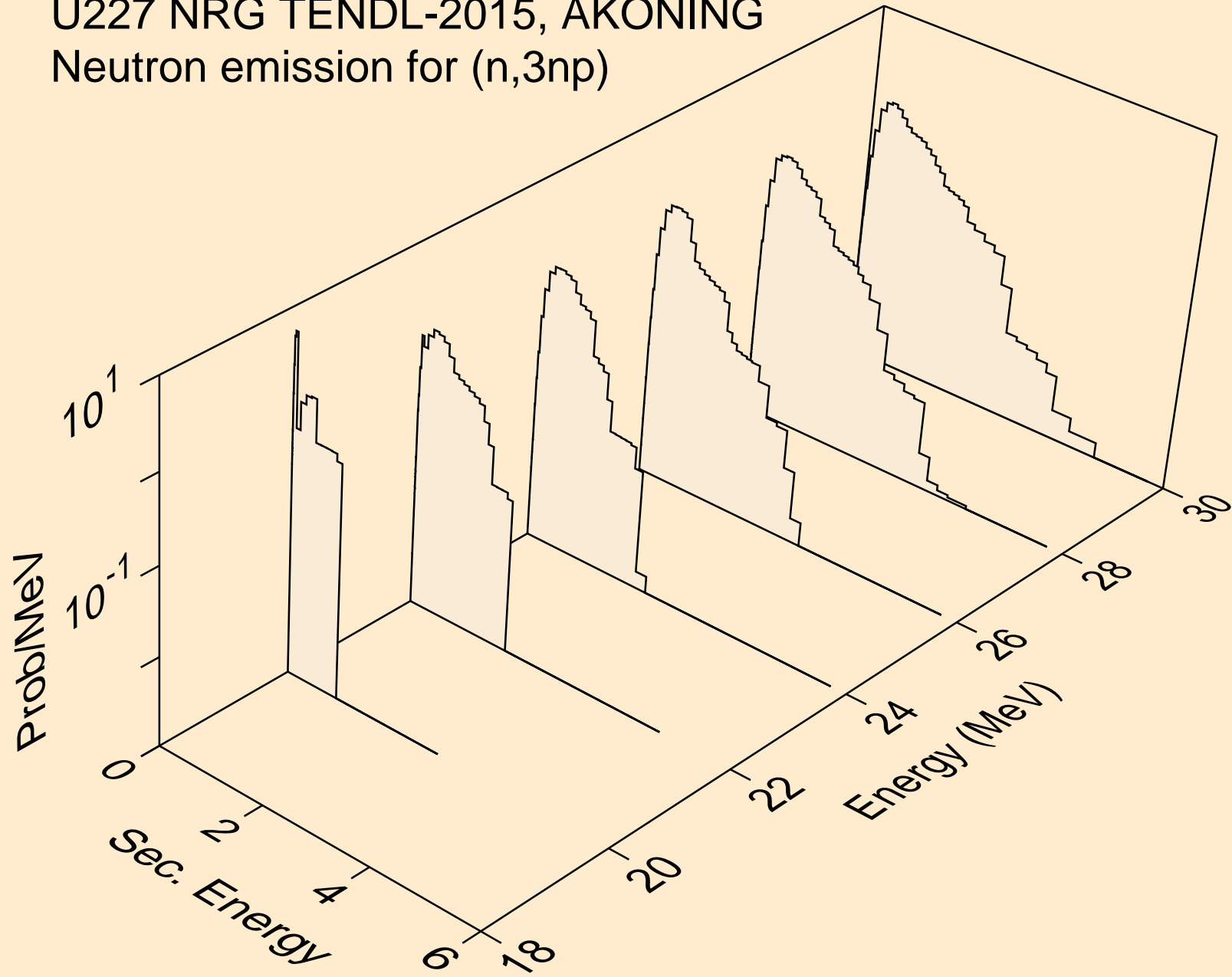

U227 NRG TENDL-2015, AKONING
Neutron emission for (n,2np)

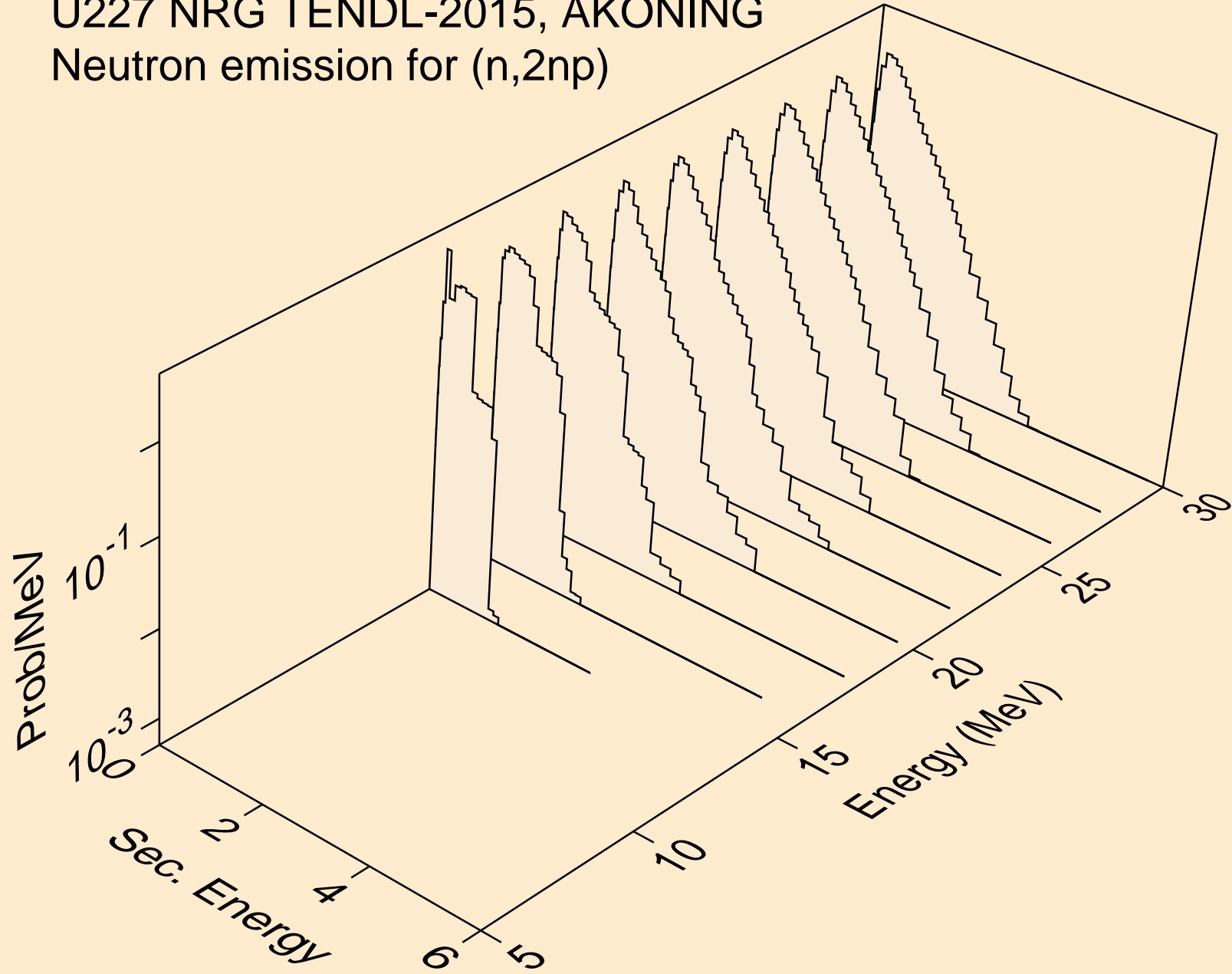

U227 NRG TENDL-2015, AKONING
Neutron emission for (n,npa)

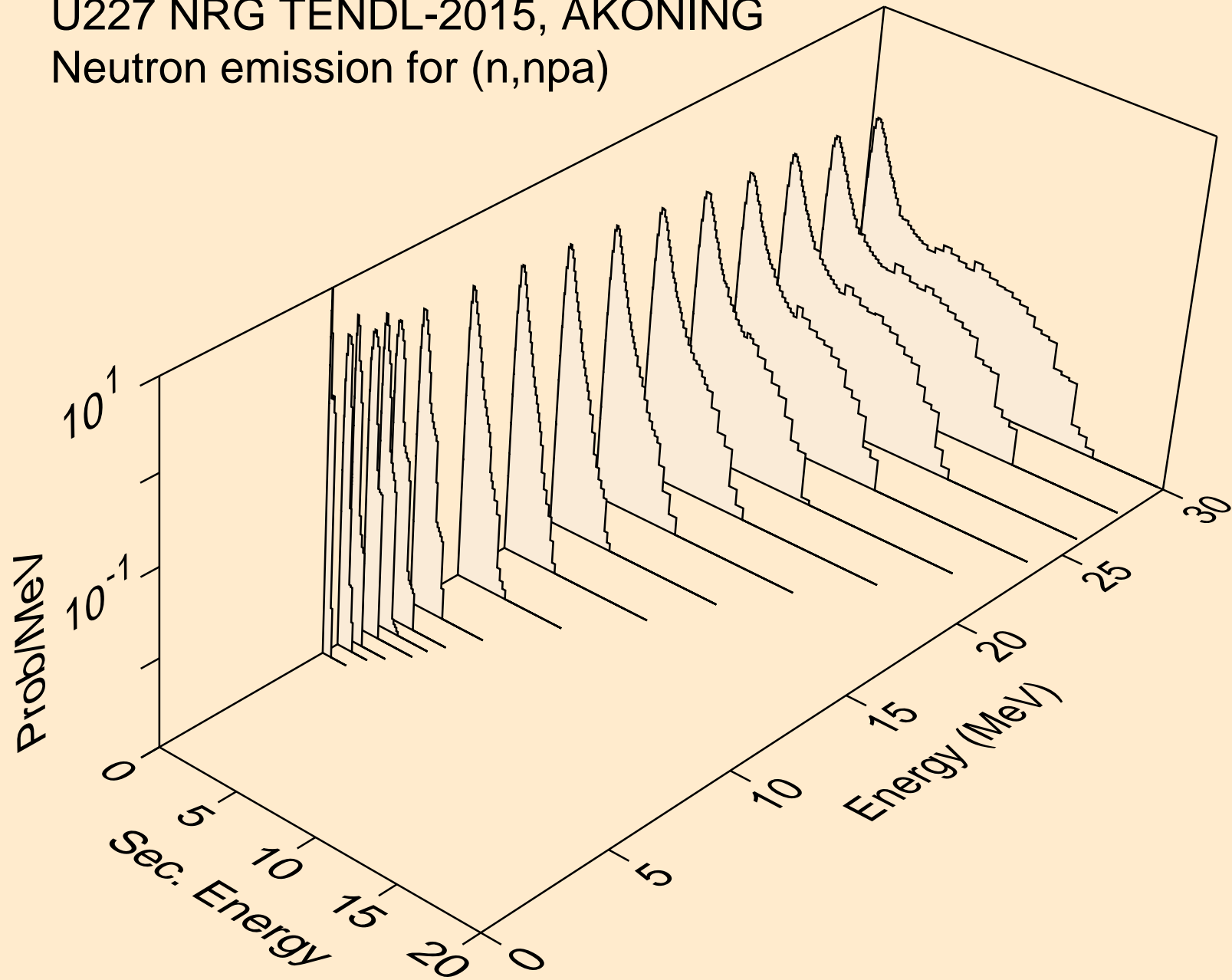

U227 NRG TENDL-2015, AKONING
Neutron emission for (n,n*c)

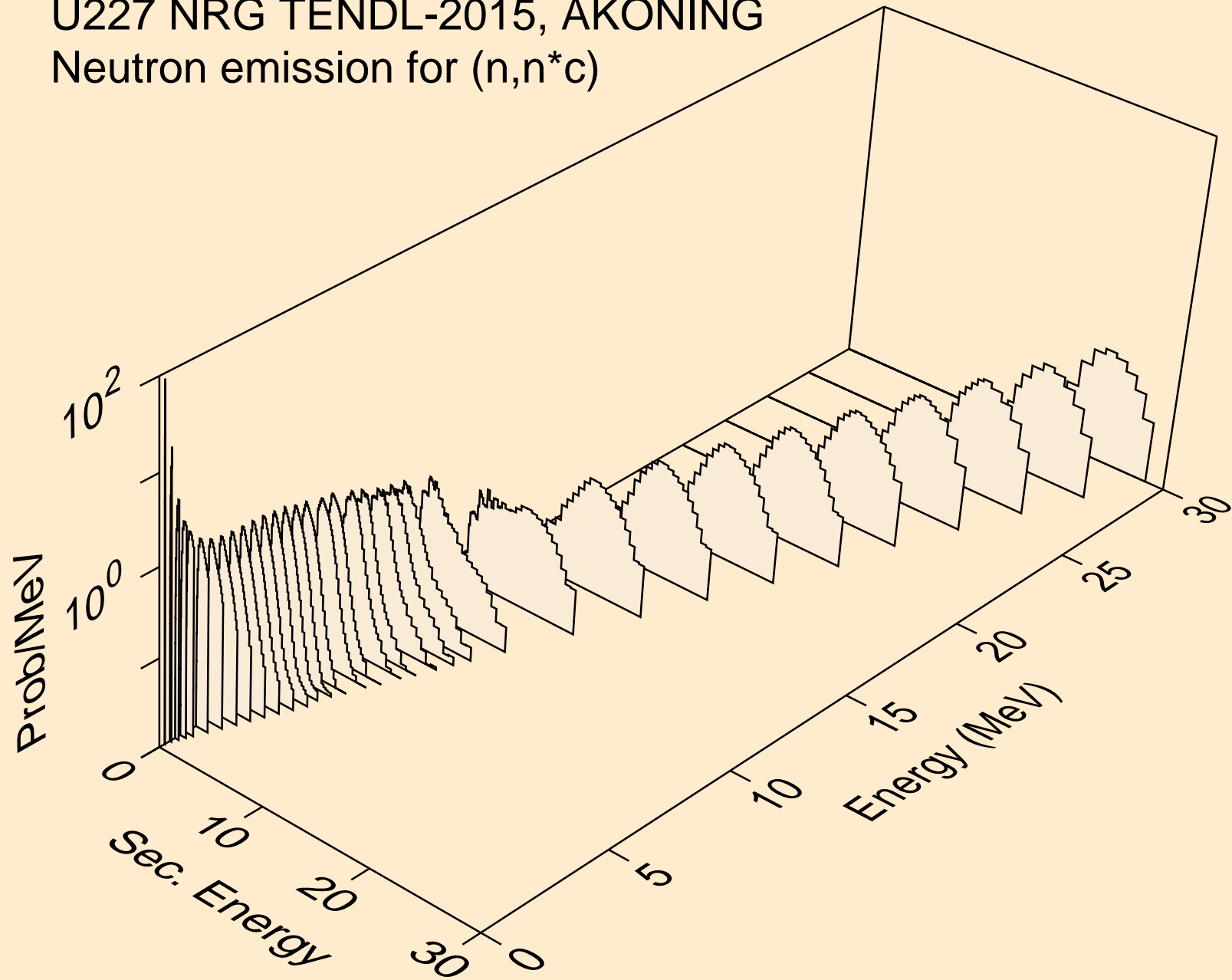

U227 NRG TENDL-2015, AKONING

Delayed nubar

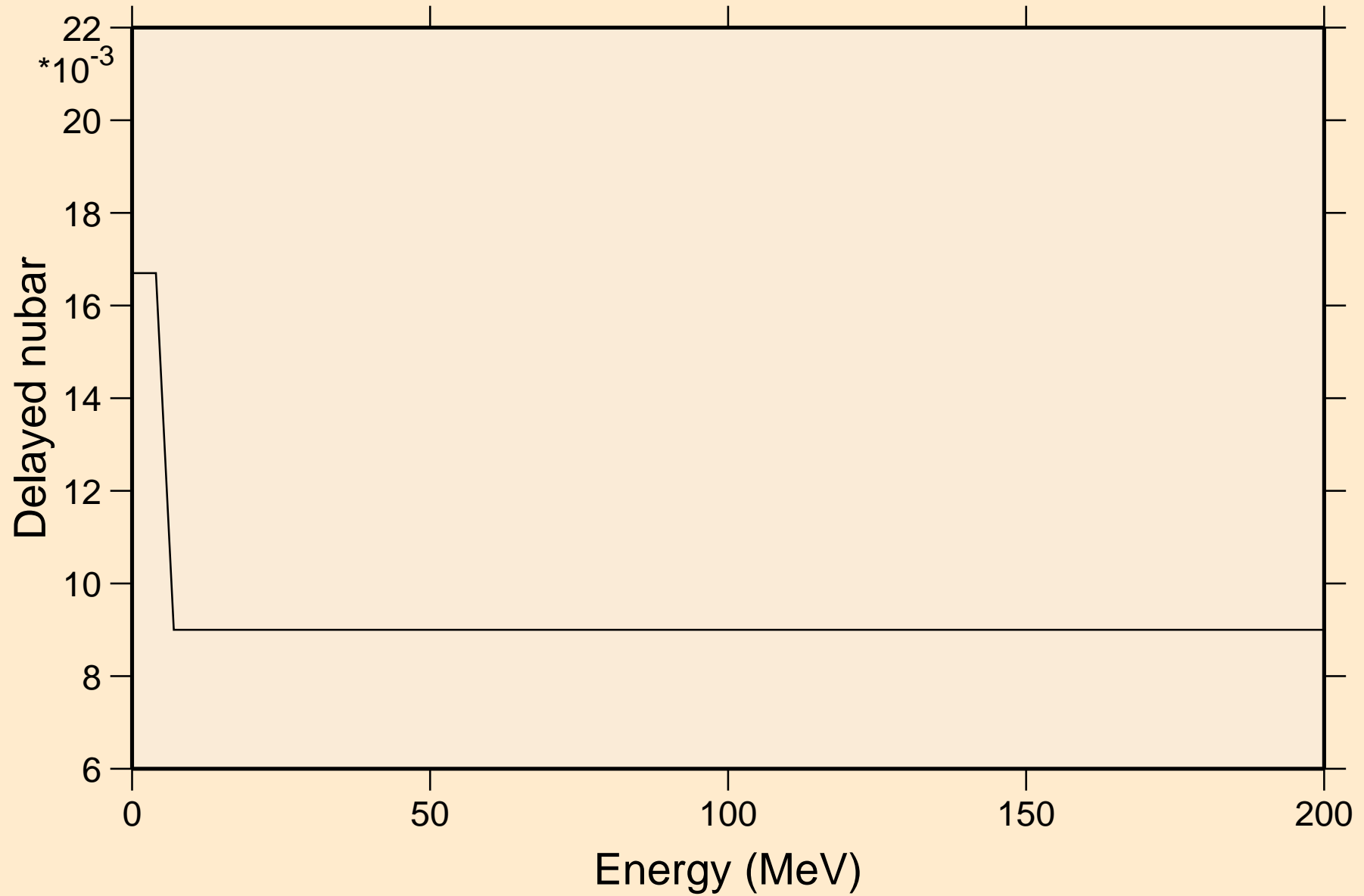

U227 NRG TENDL-2015, AKONING

Delayed neutron spectra

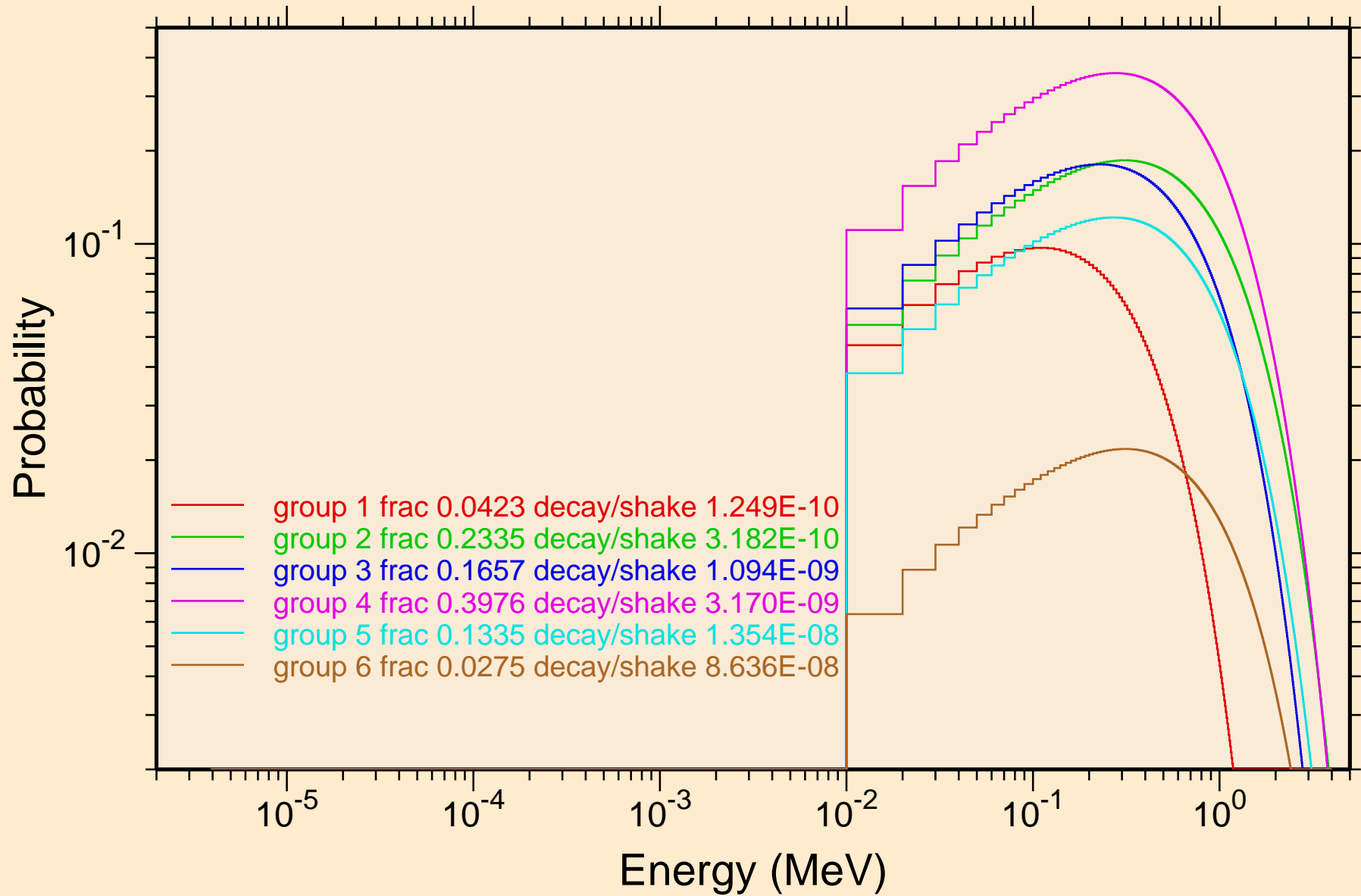

U227 NRG TENDL-2015, AKONING
Photon emission for (n,x)

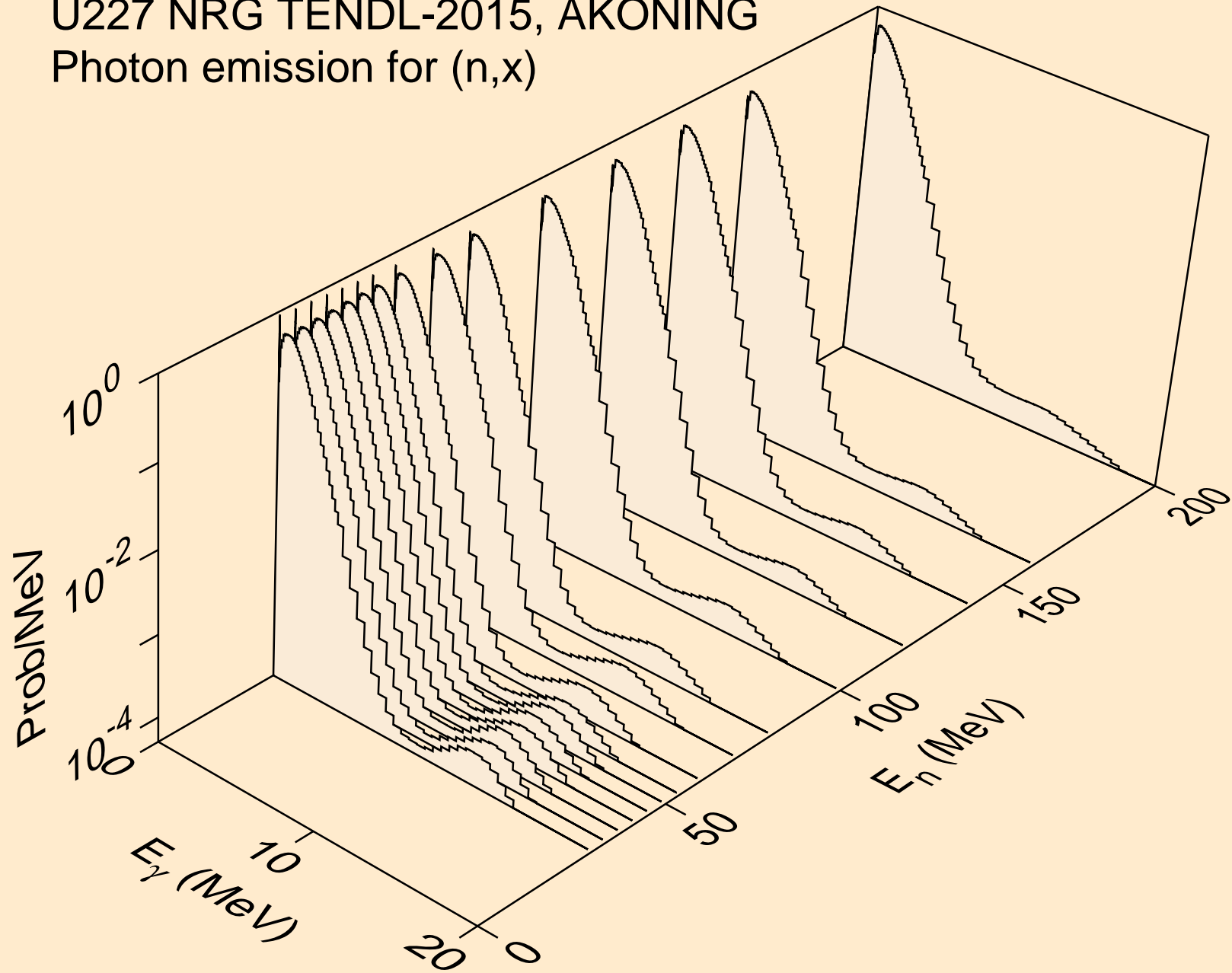

U227 NRG TENDL-2015, AKONING
Photon emission for (n,2nd)

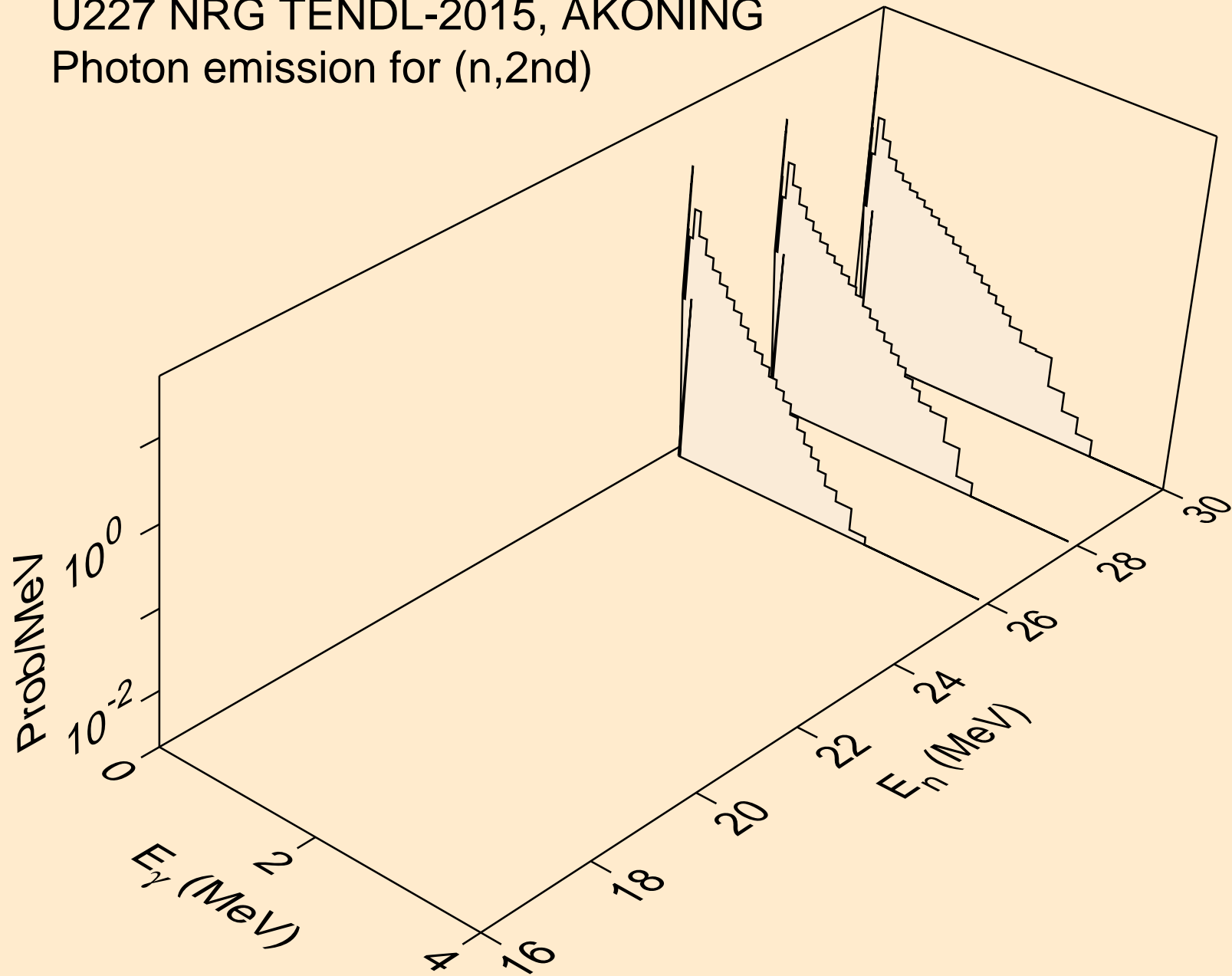

U227 NRG TENDL-2015, AKONING
Photon emission for (n,2n)

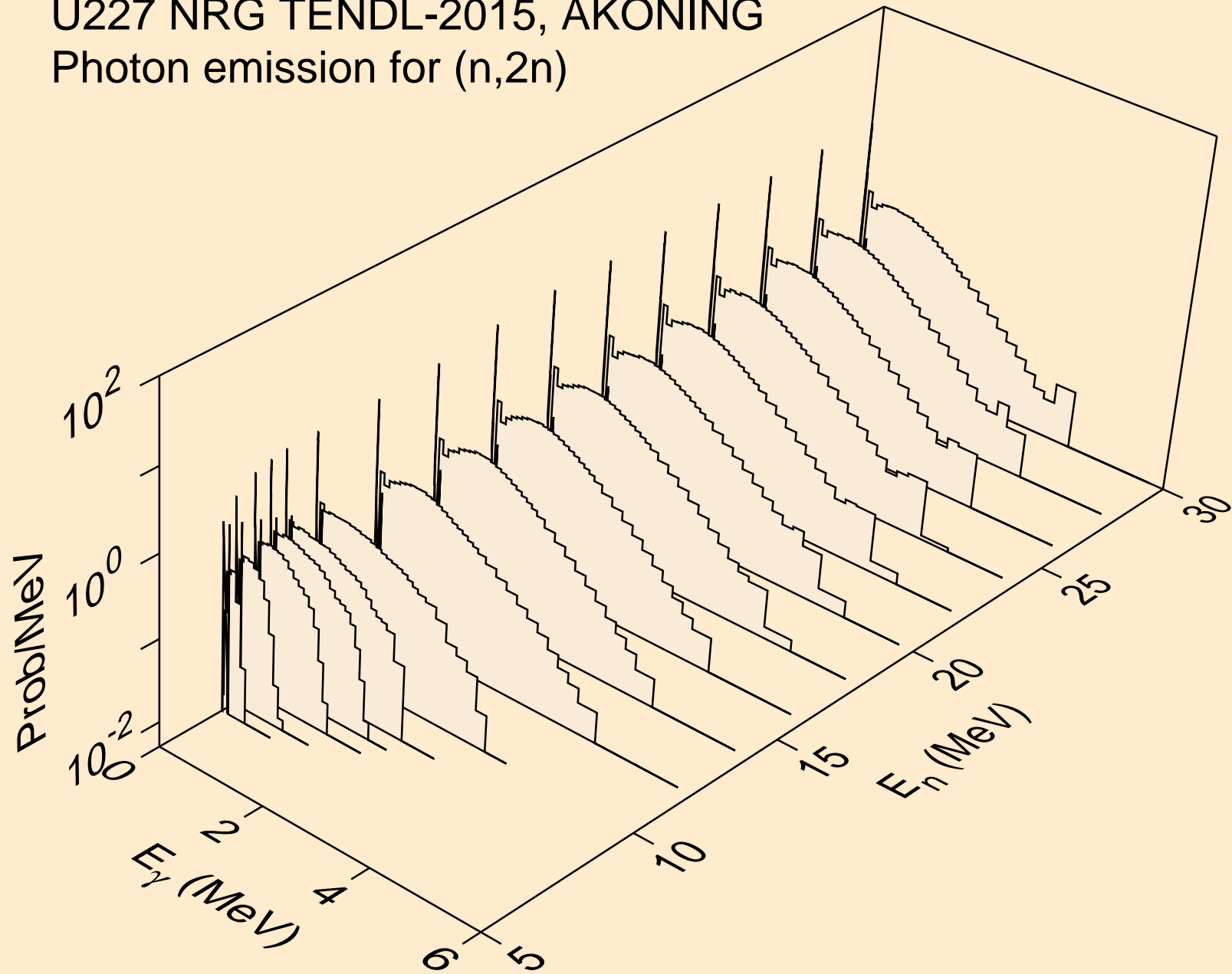

U227 NRG TENDL-2015, AKONING
Photon emission for (n,3n)

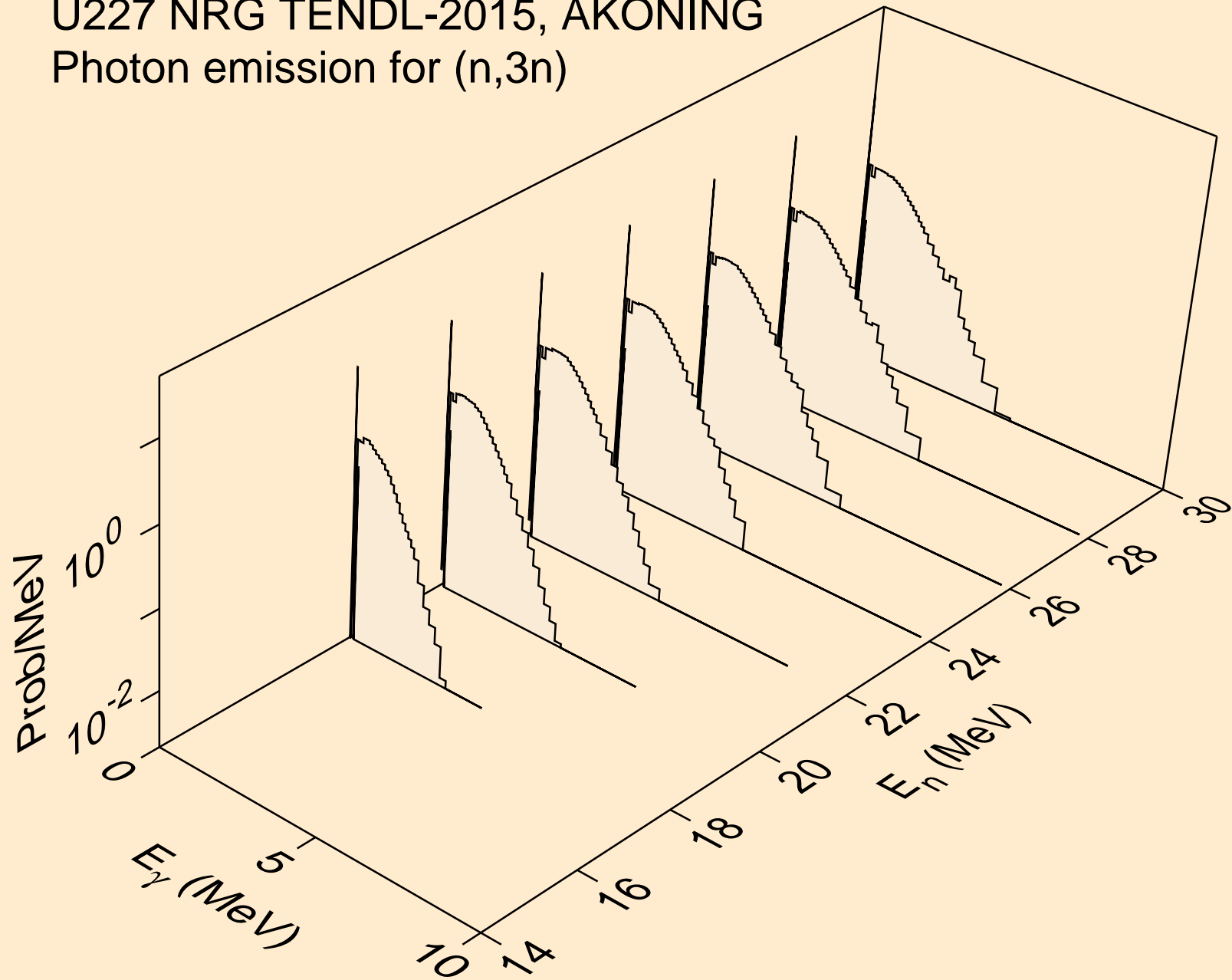

U227 NRG TENDL-2015, AKONING
Photon emission for (n,n*)a

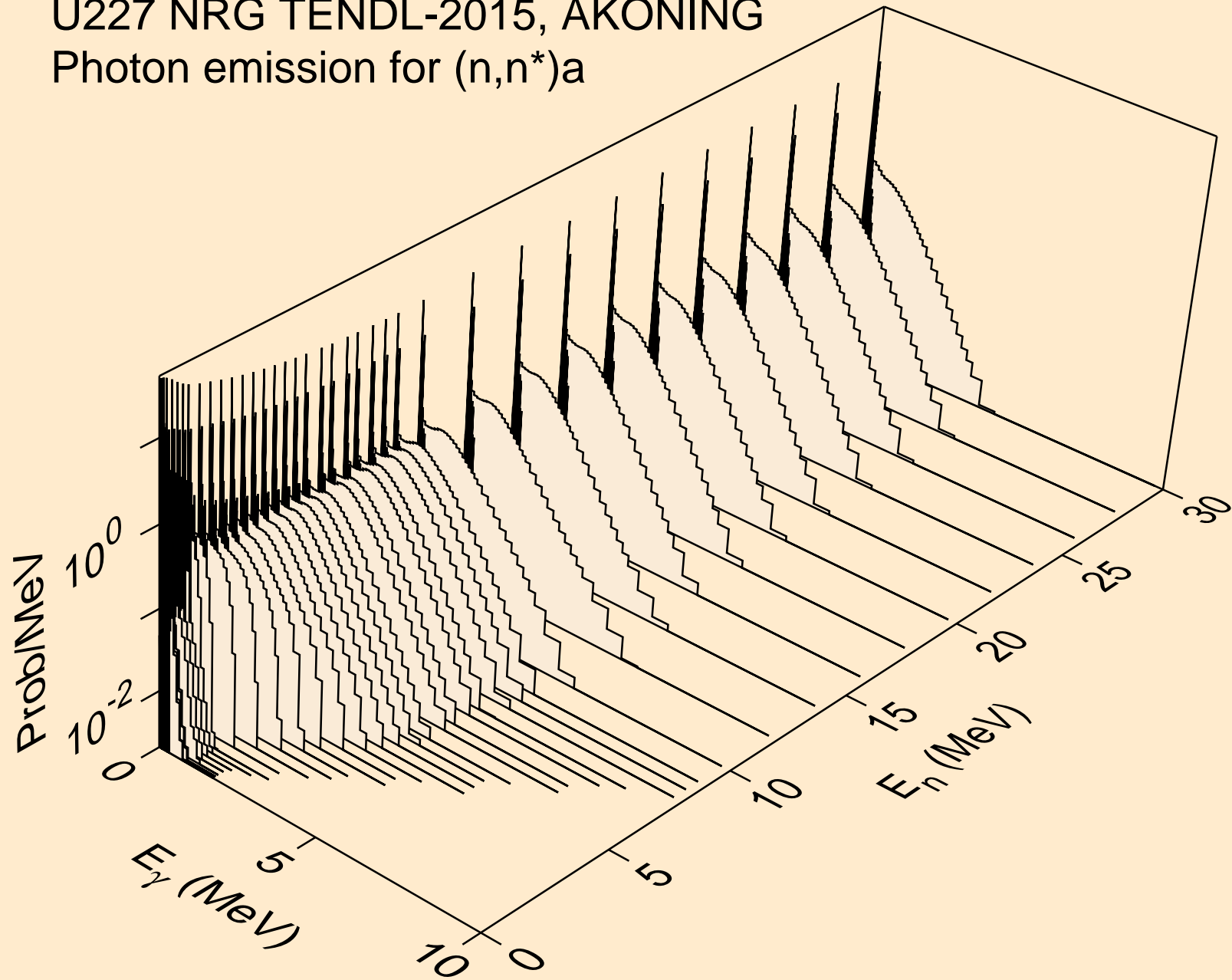

U227 NRG TENDL-2015, AKONING
Photon emission for (n,n*)3a

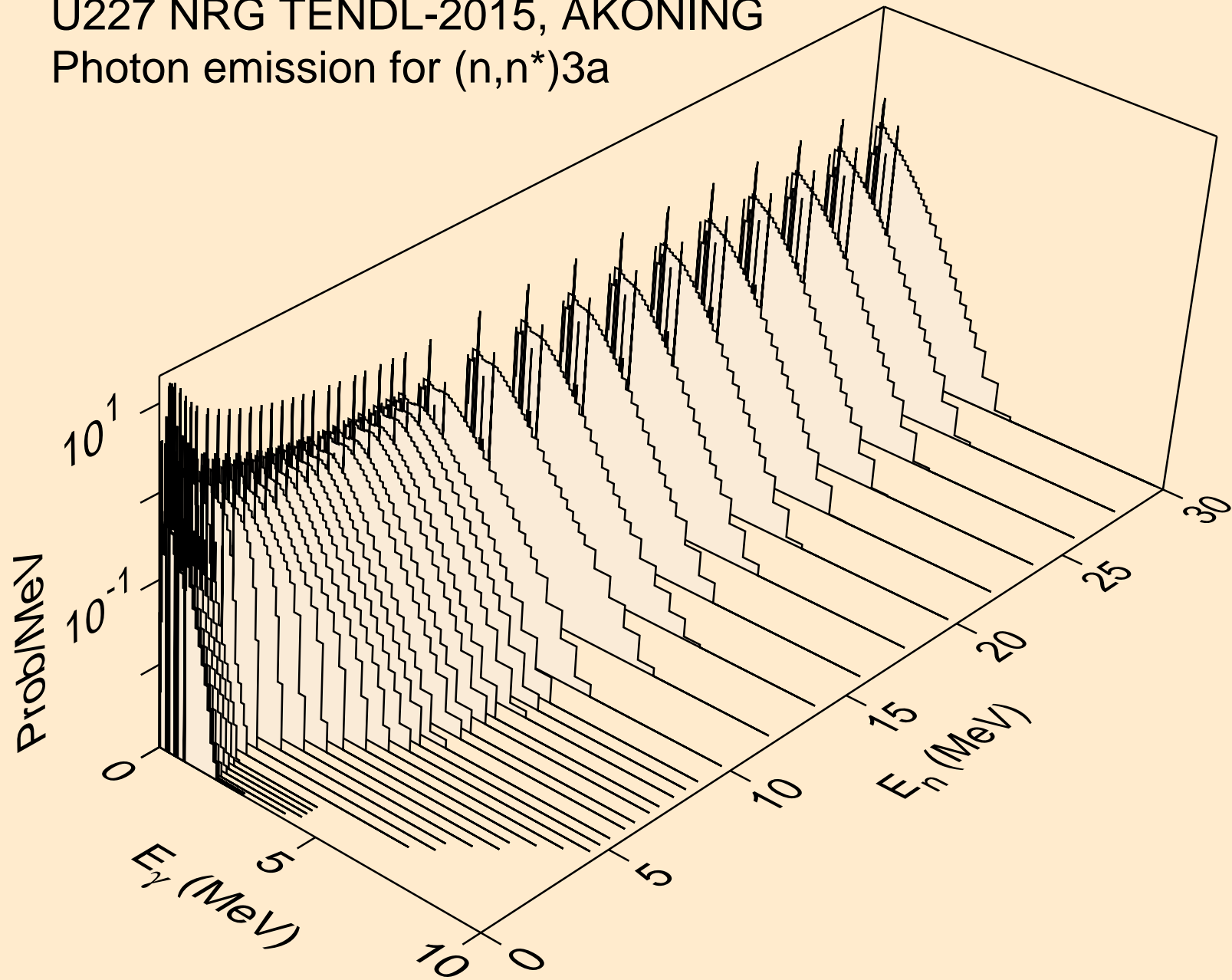

U227 NRG TENDL-2015, AKONING
Photon emission for (n,2n)a

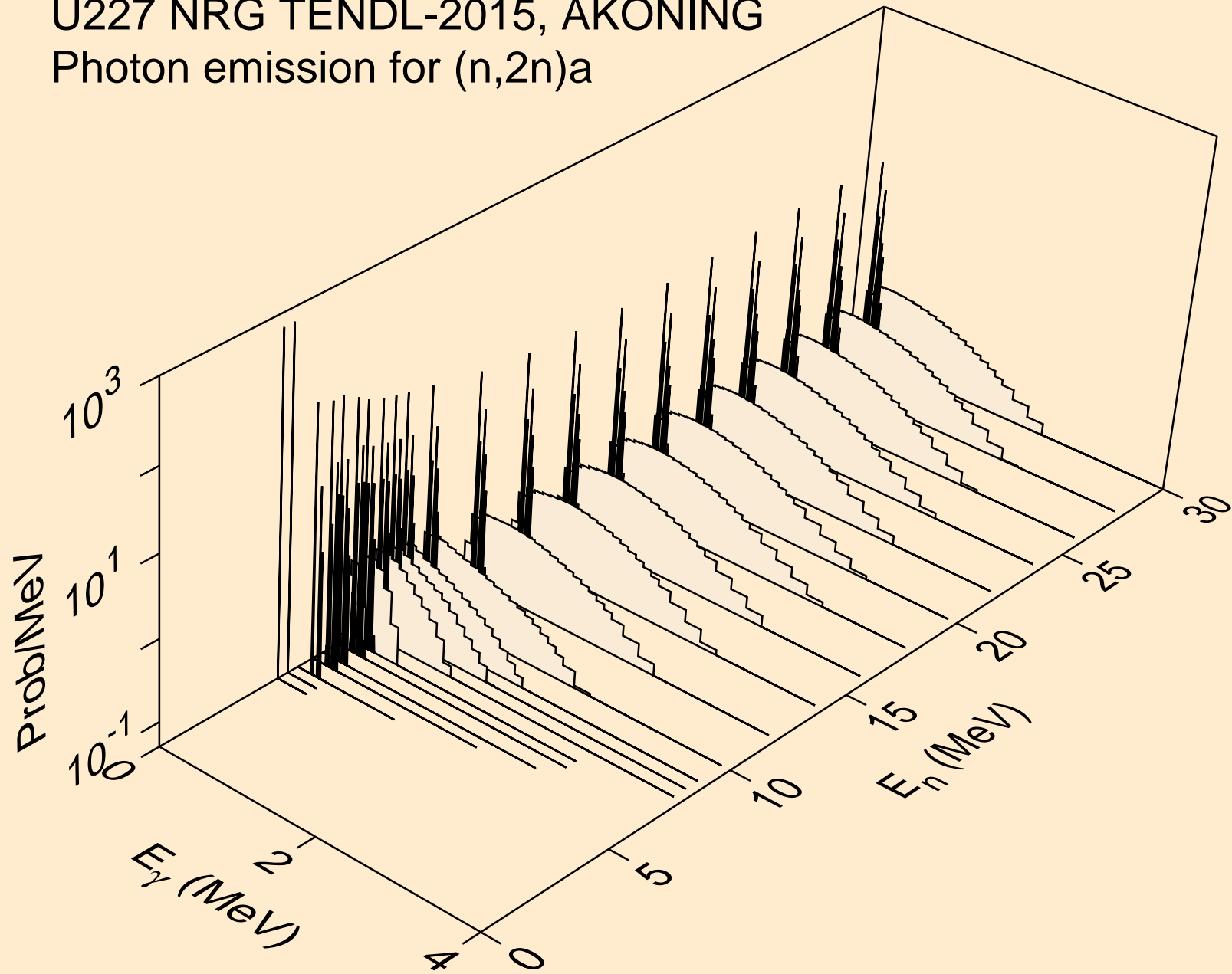

U227 NRG TENDL-2015, AKONING
Photon emission for (n,3n)a

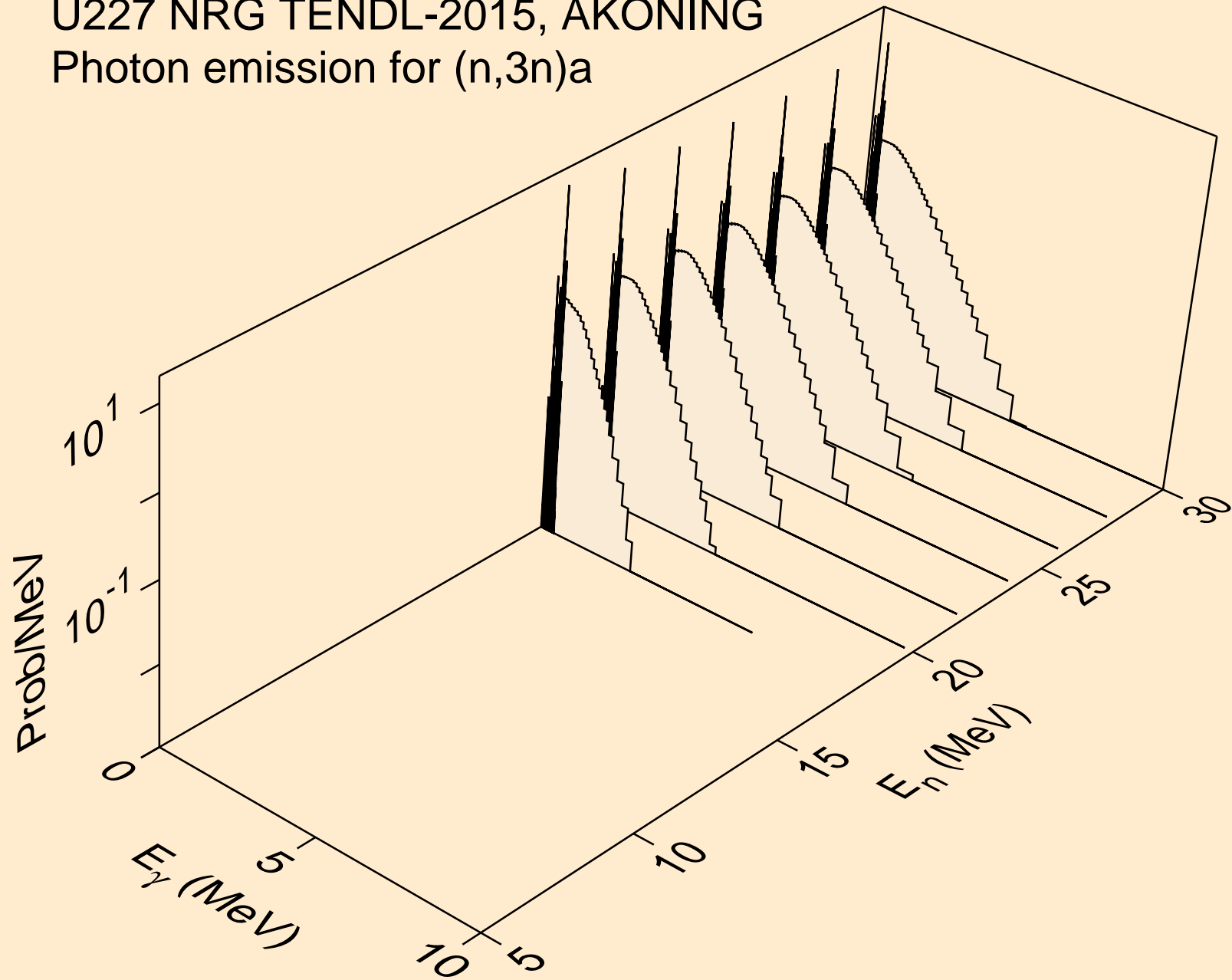

U227 NRG TENDL-2015, AKONING
Photon emission for (n,n*)p

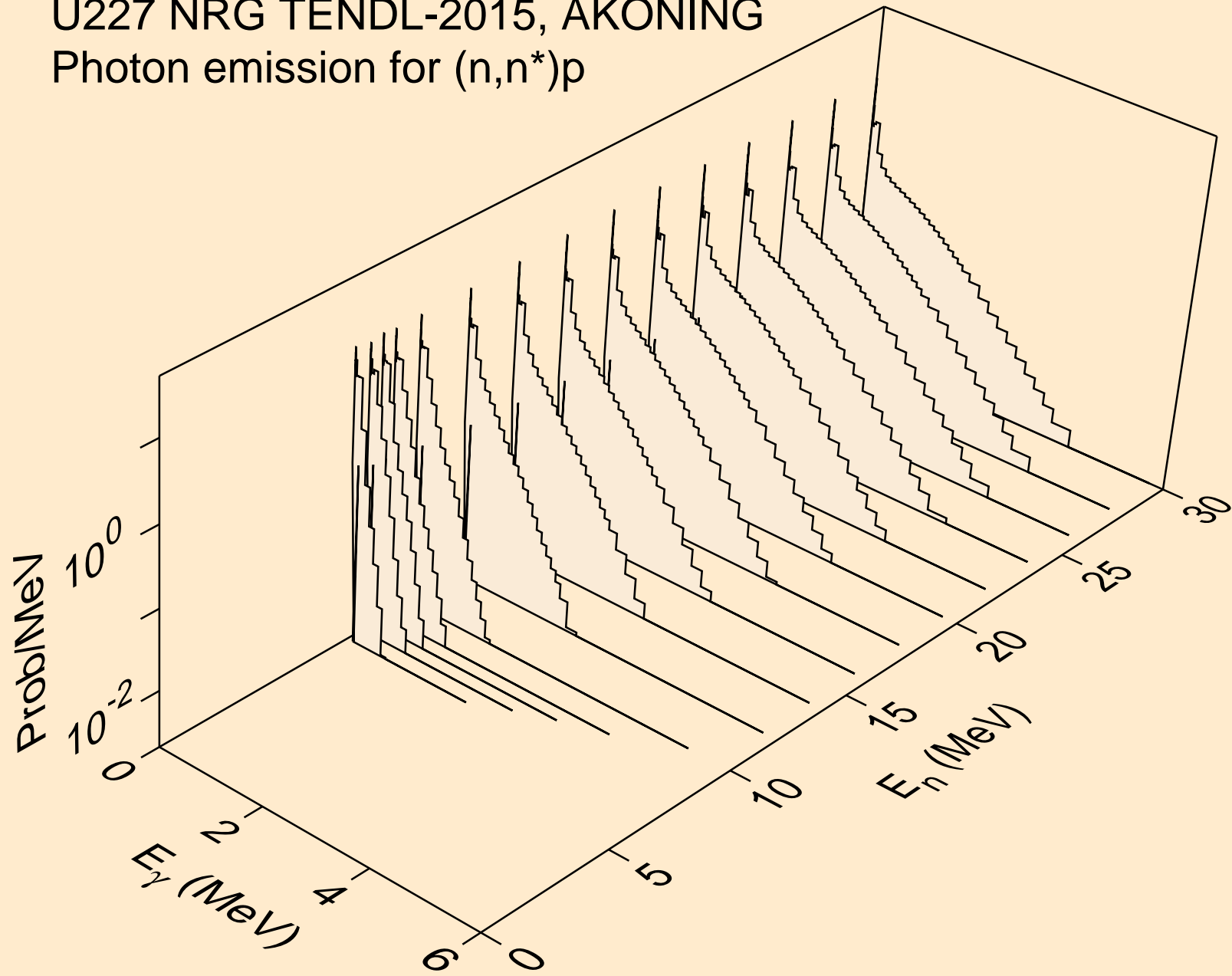

U227 NRG TENDL-2015, AKONING
Photon emission for (n,n*)2a

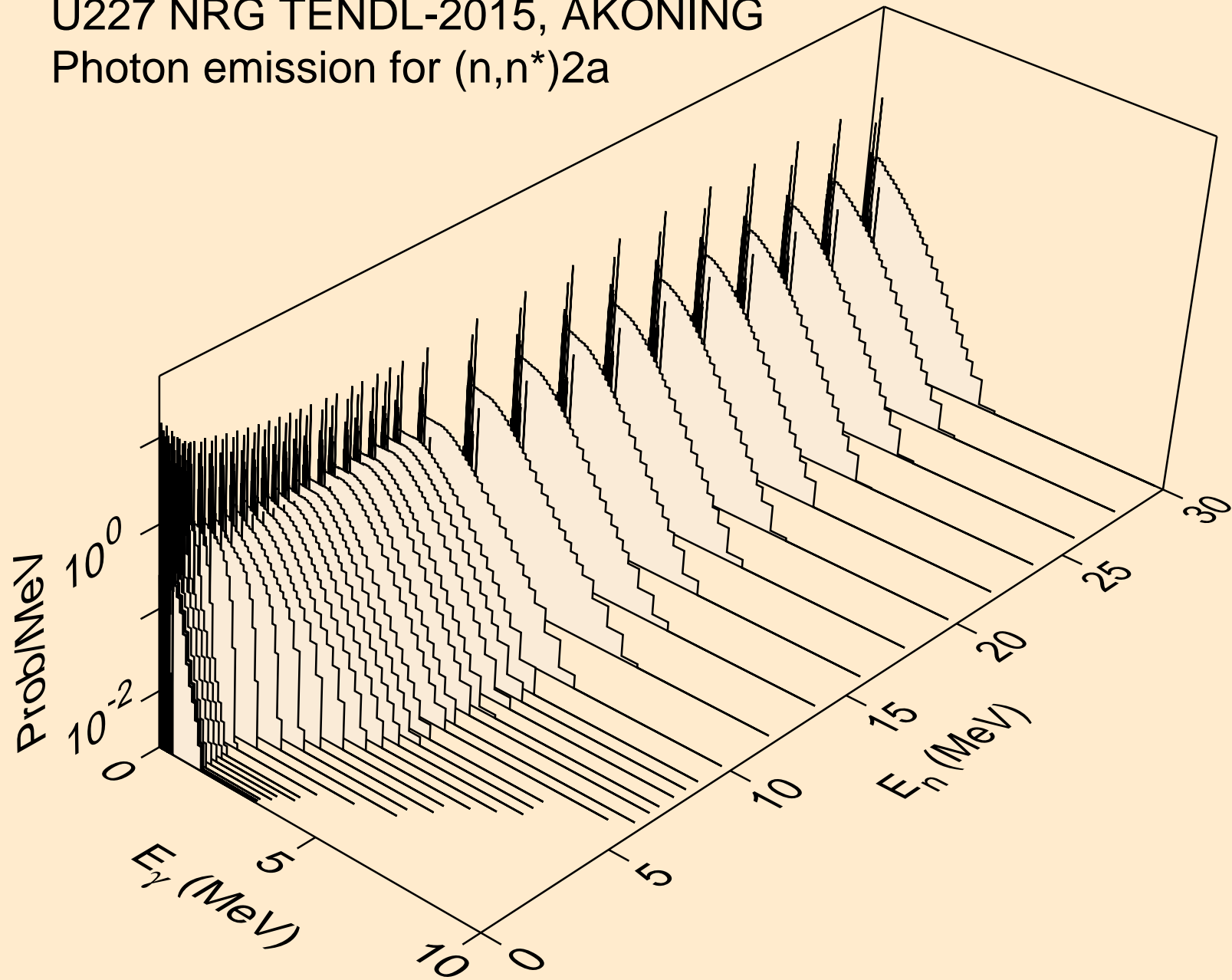

U227 NRG TENDL-2015, AKONING
Photon emission for (n,2n)2a

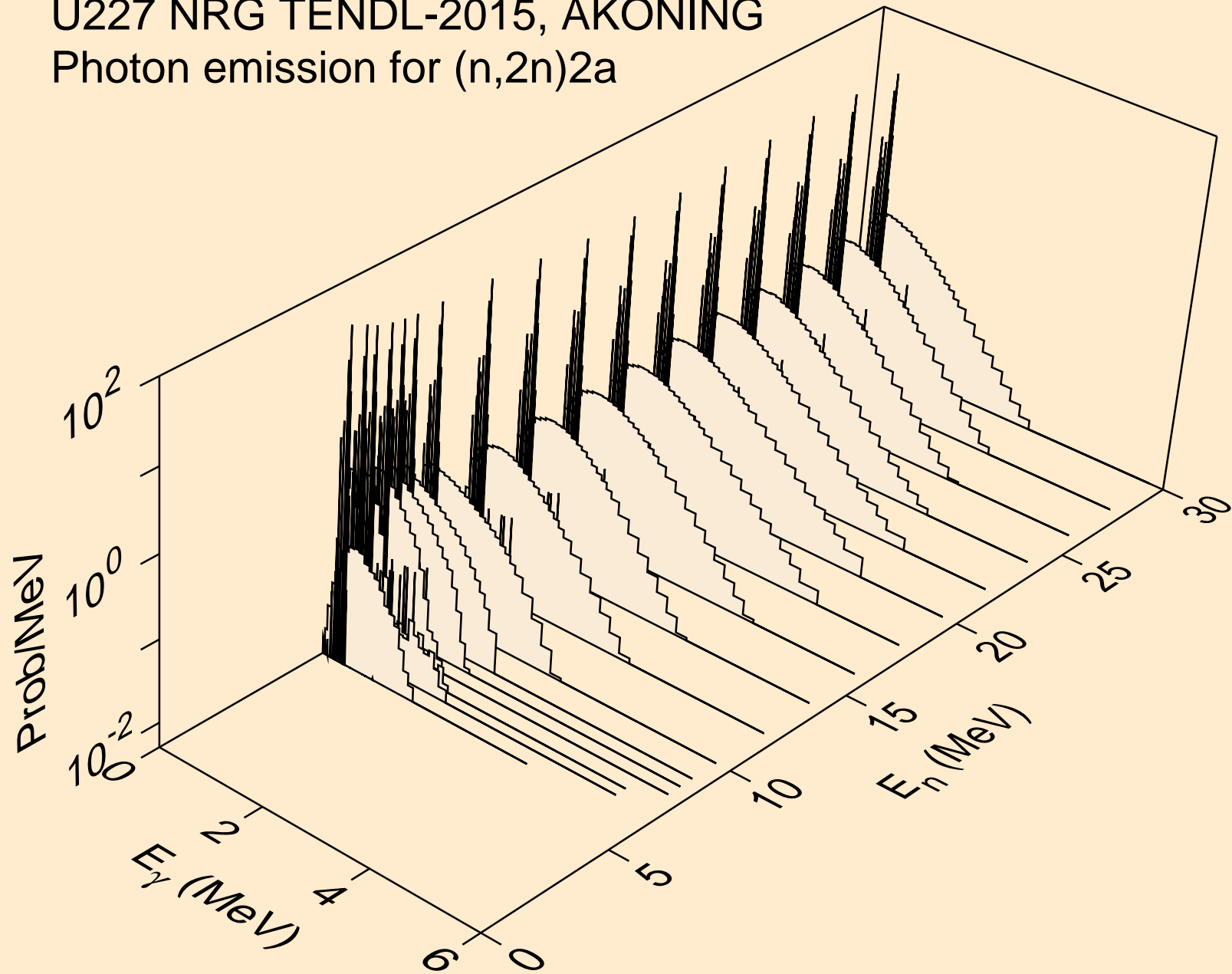

U227 NRG TENDL-2015, AKONING
Photon emission for (n,n*)d

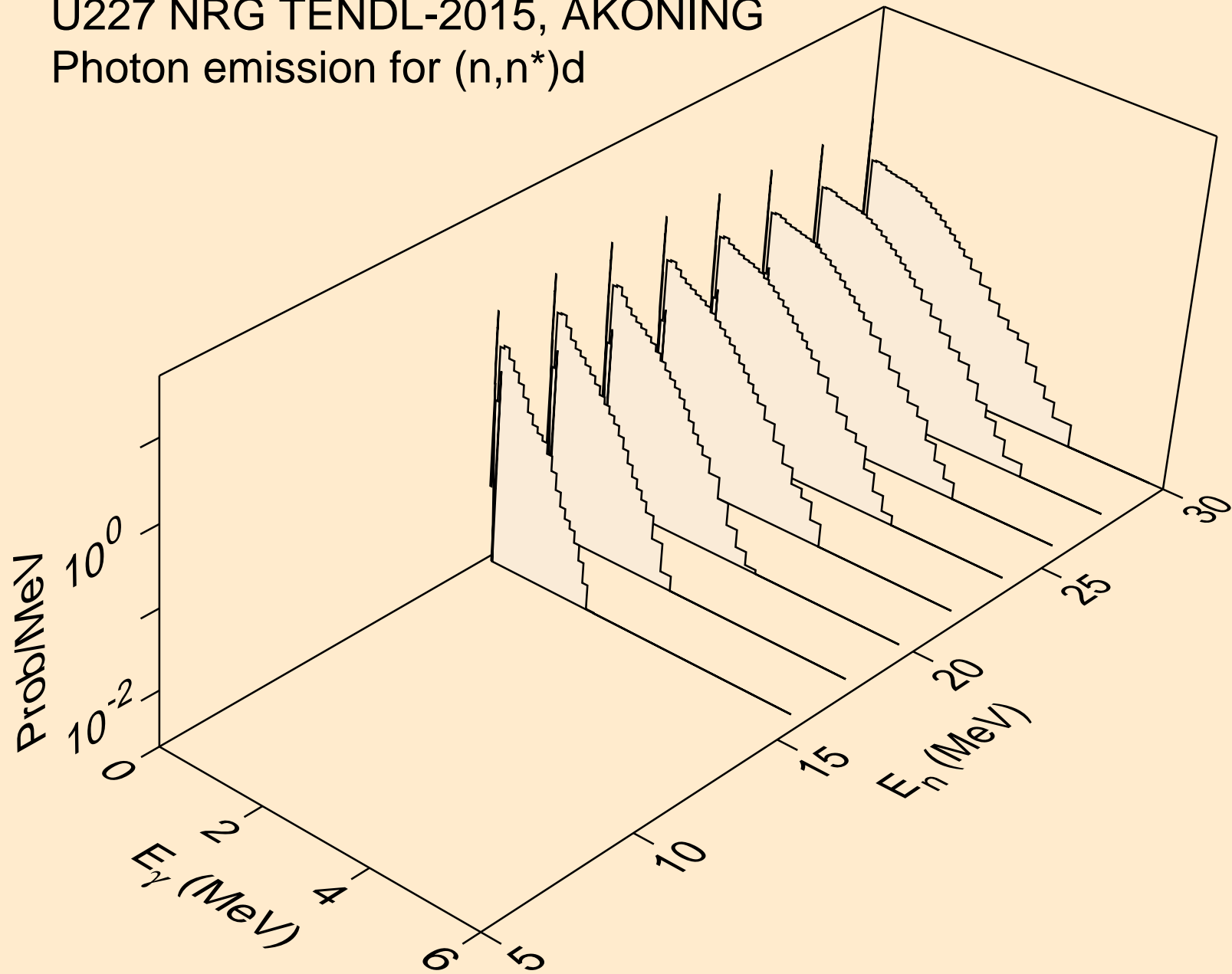

U227 NRG TENDL-2015, AKONING
Photon emission for (n,n*)t

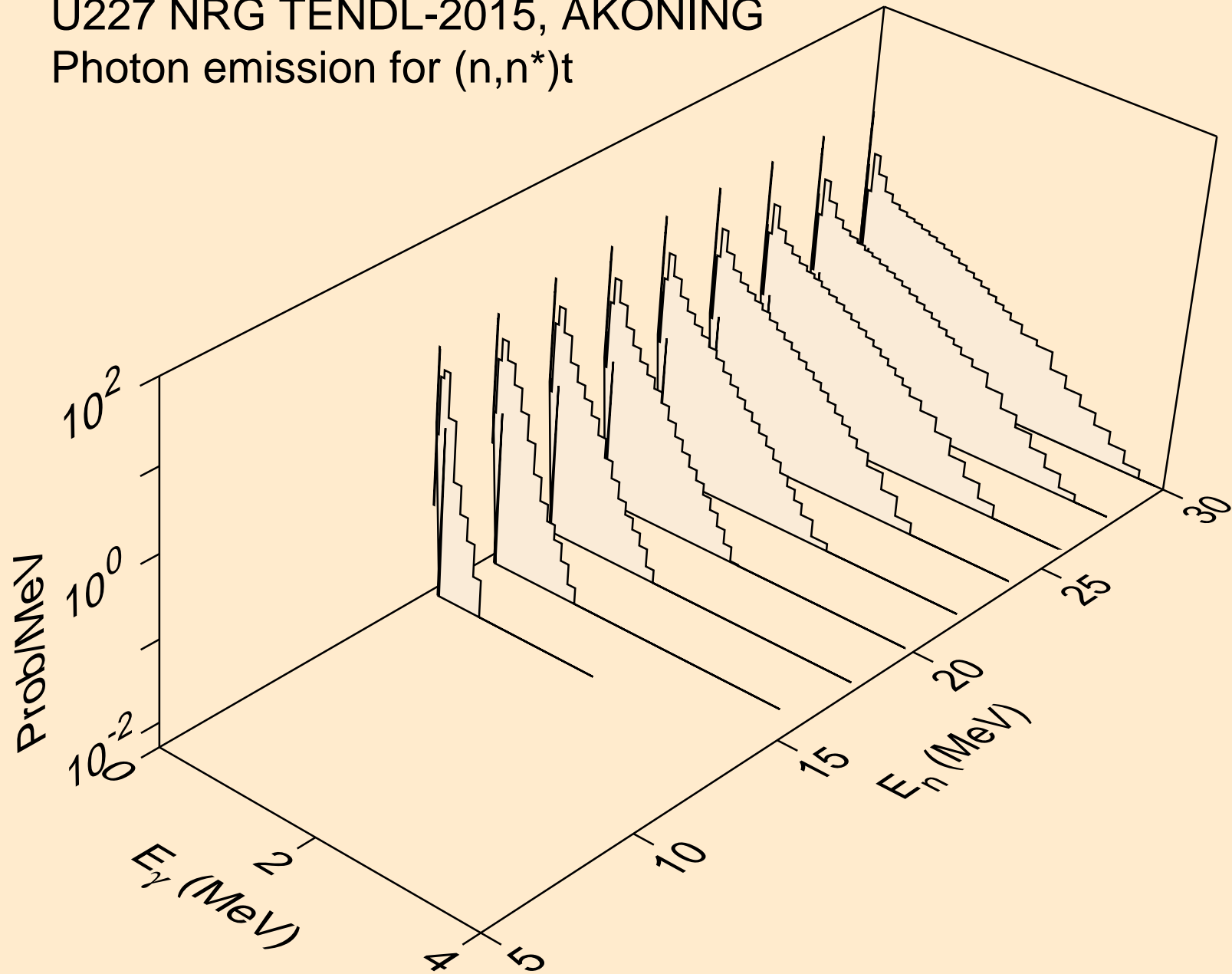

U227 NRG TENDL-2015, AKONING
Photon emission for (n,n*)he3

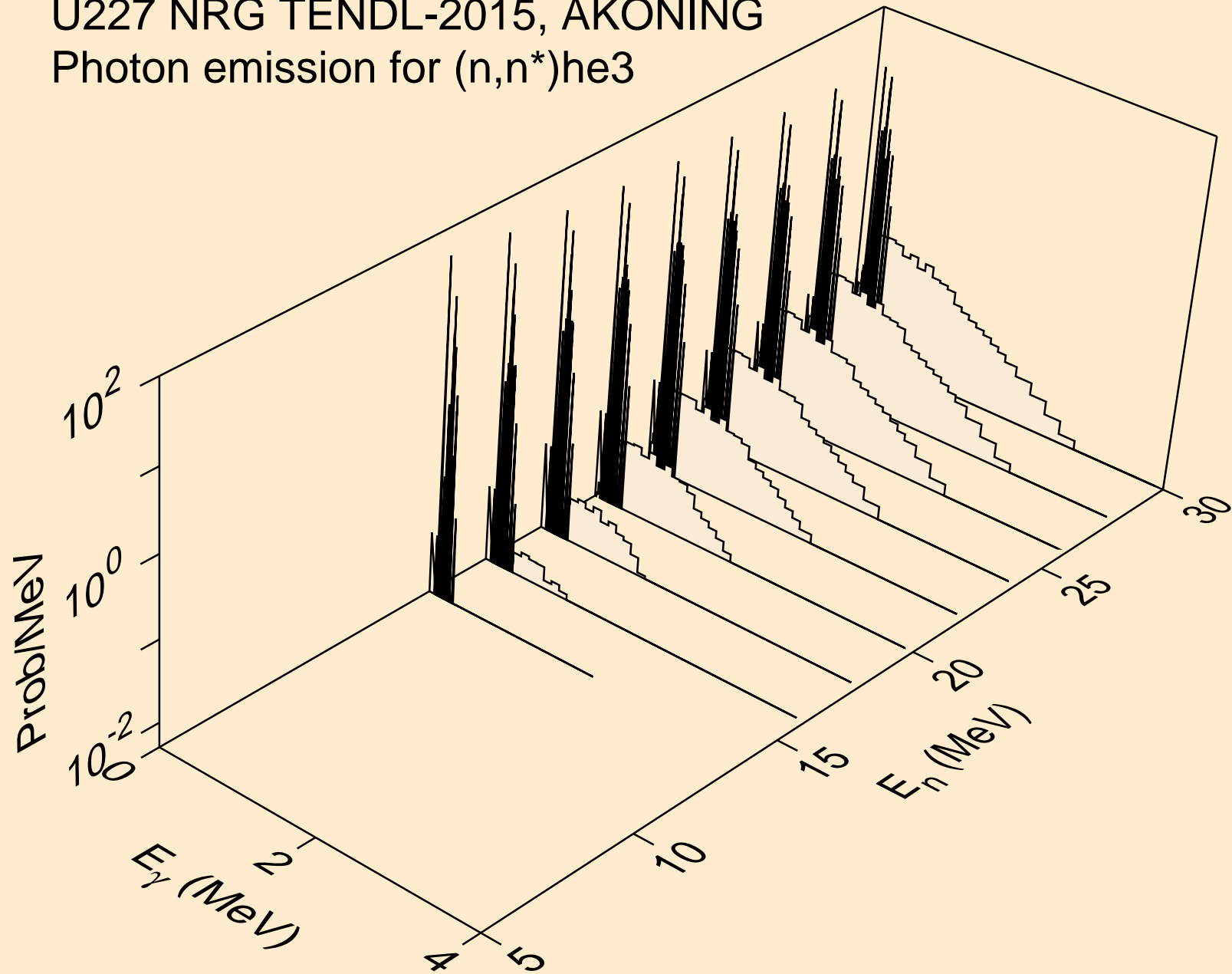

U227 NRG TENDL-2015, AKONING
Photon emission for (n,n*)d2a

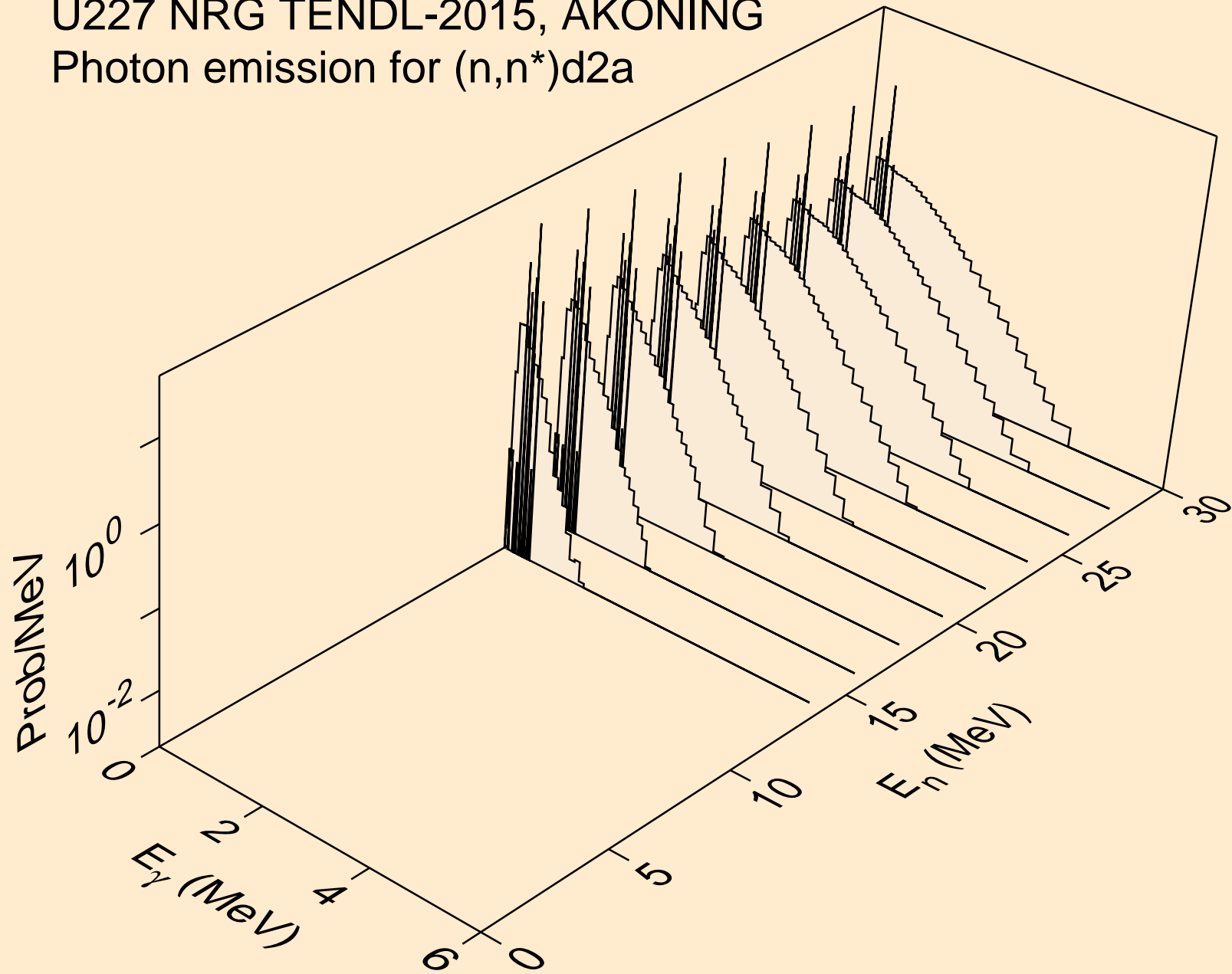

U227 NRG TENDL-2015, AKONING
Photon emission for (n,n*)t2a

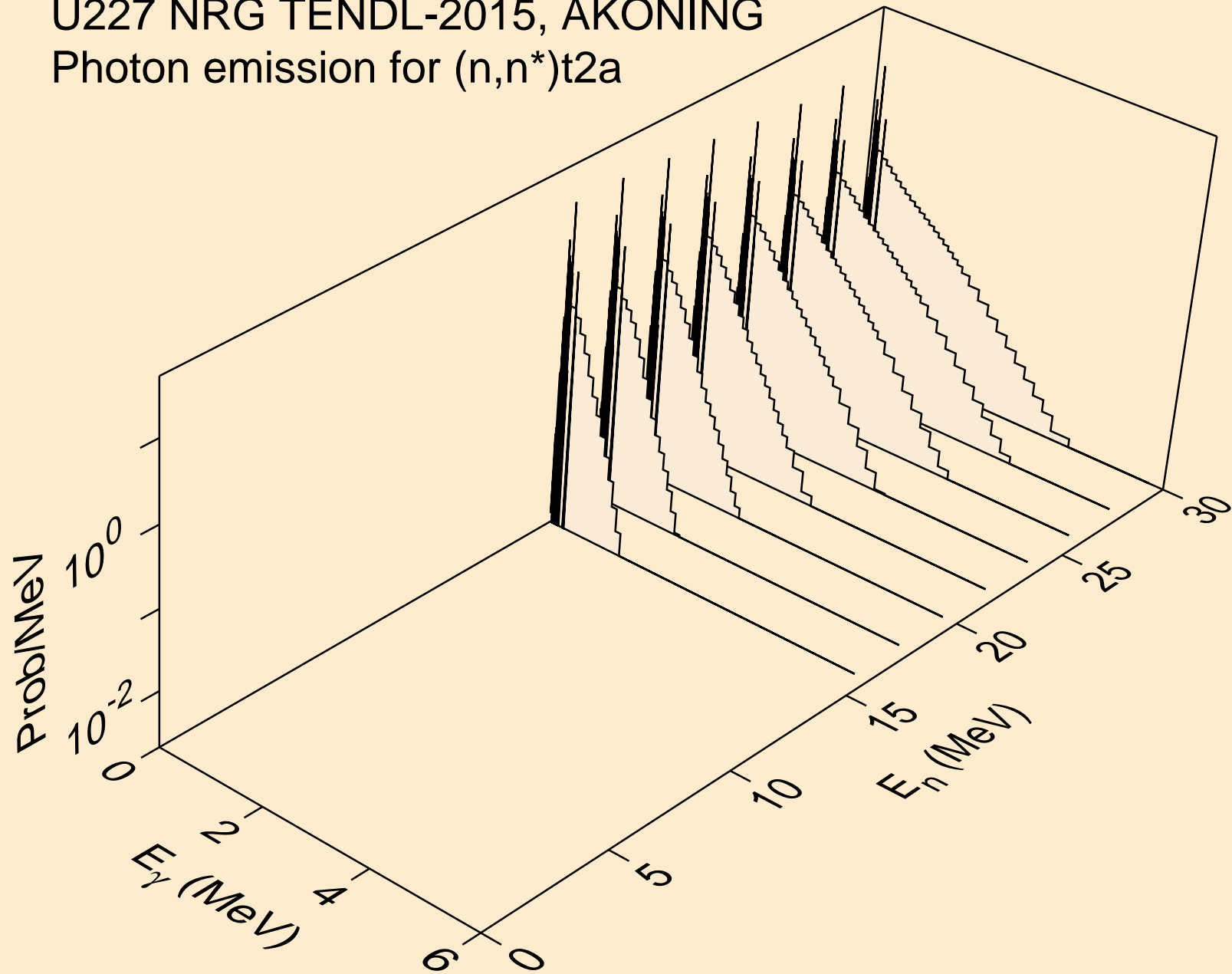

U227 NRG TENDL-2015, AKONING
Photon emission for (n,4n)

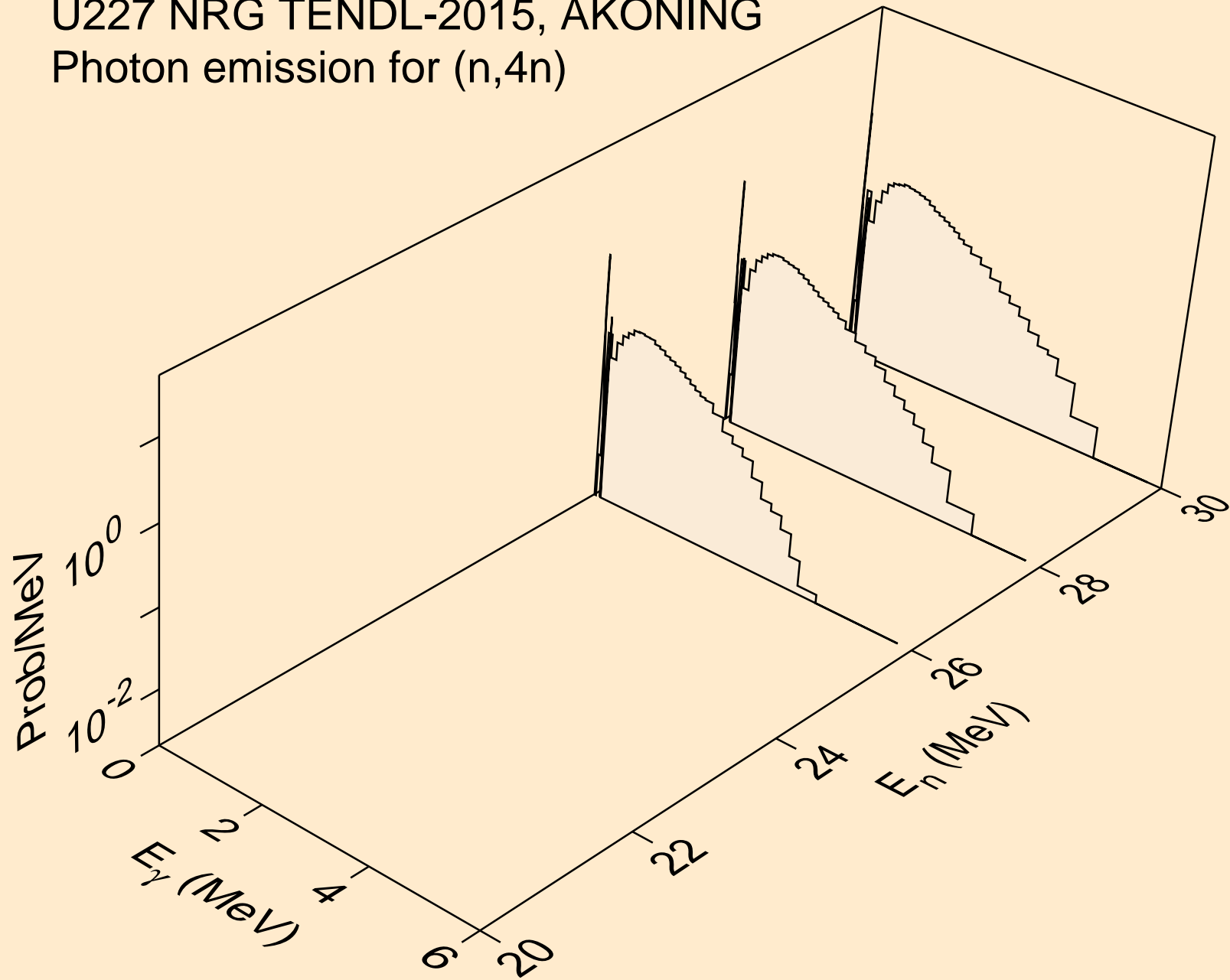

U227 NRG TENDL-2015, AKONING
Photon emission for (n,2np)

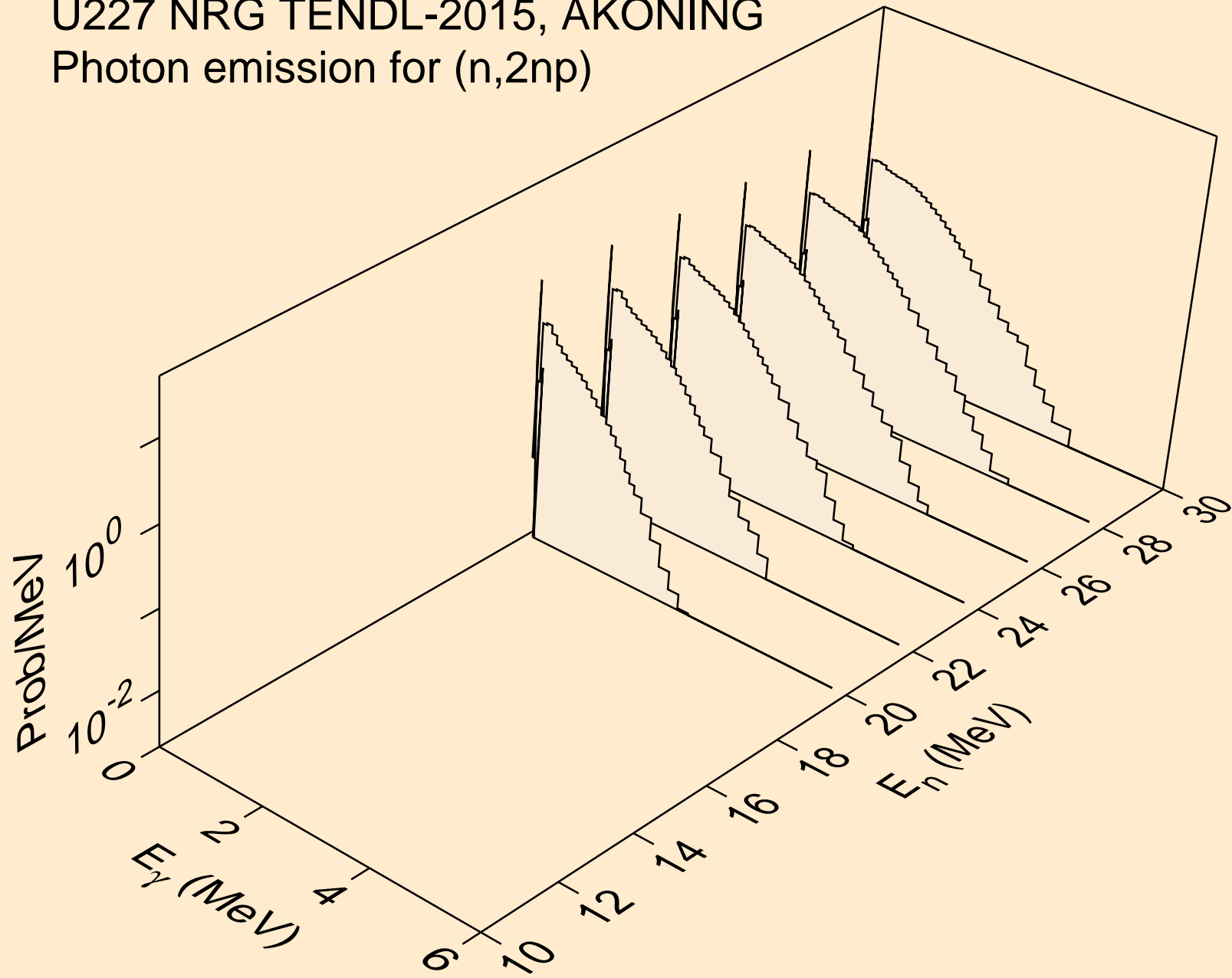

U227 NRG TENDL-2015, AKONING
Photon emission for (n,3np)

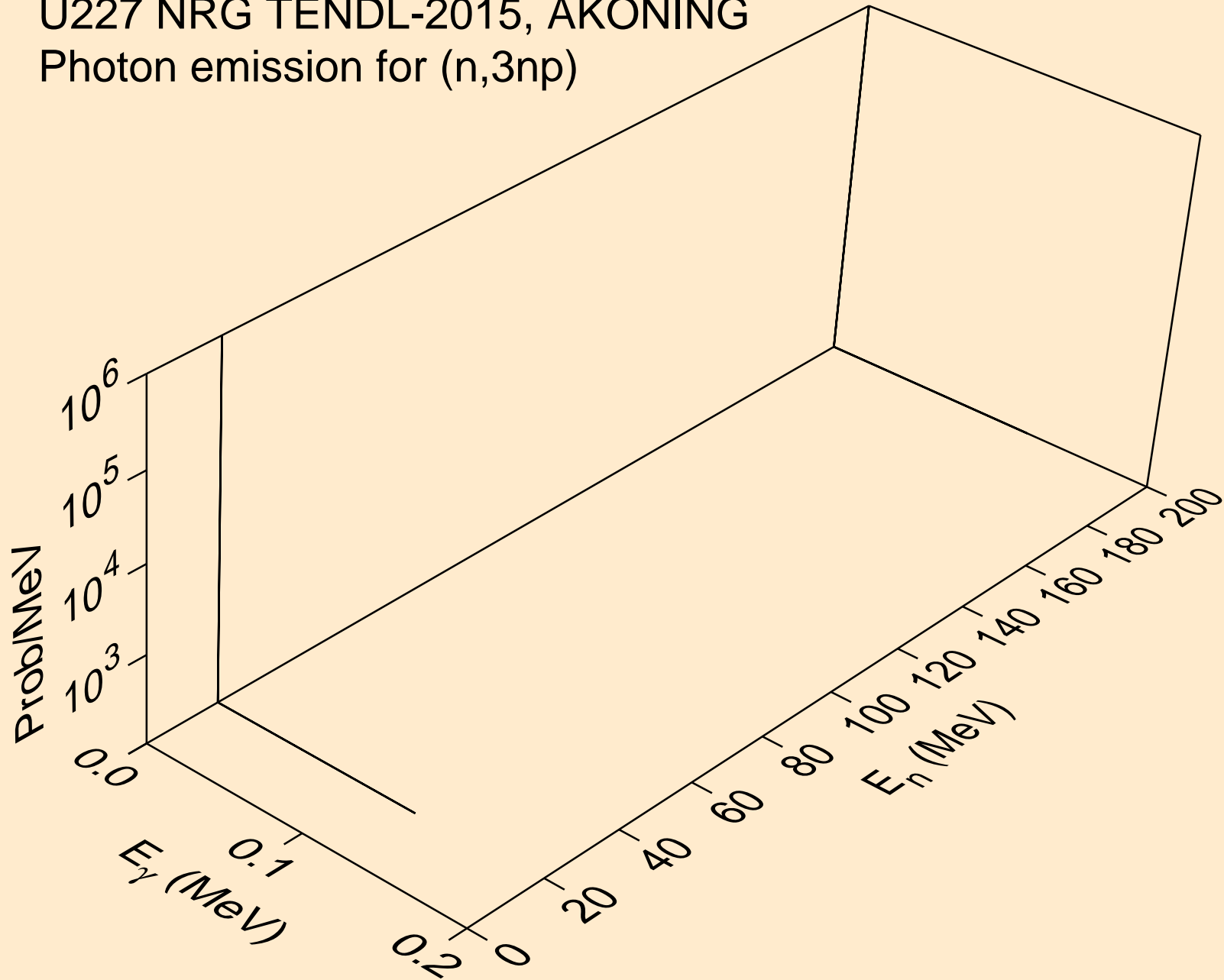

U227 NRG TENDL-2015, AKONING
Photon emission for (n,2np)

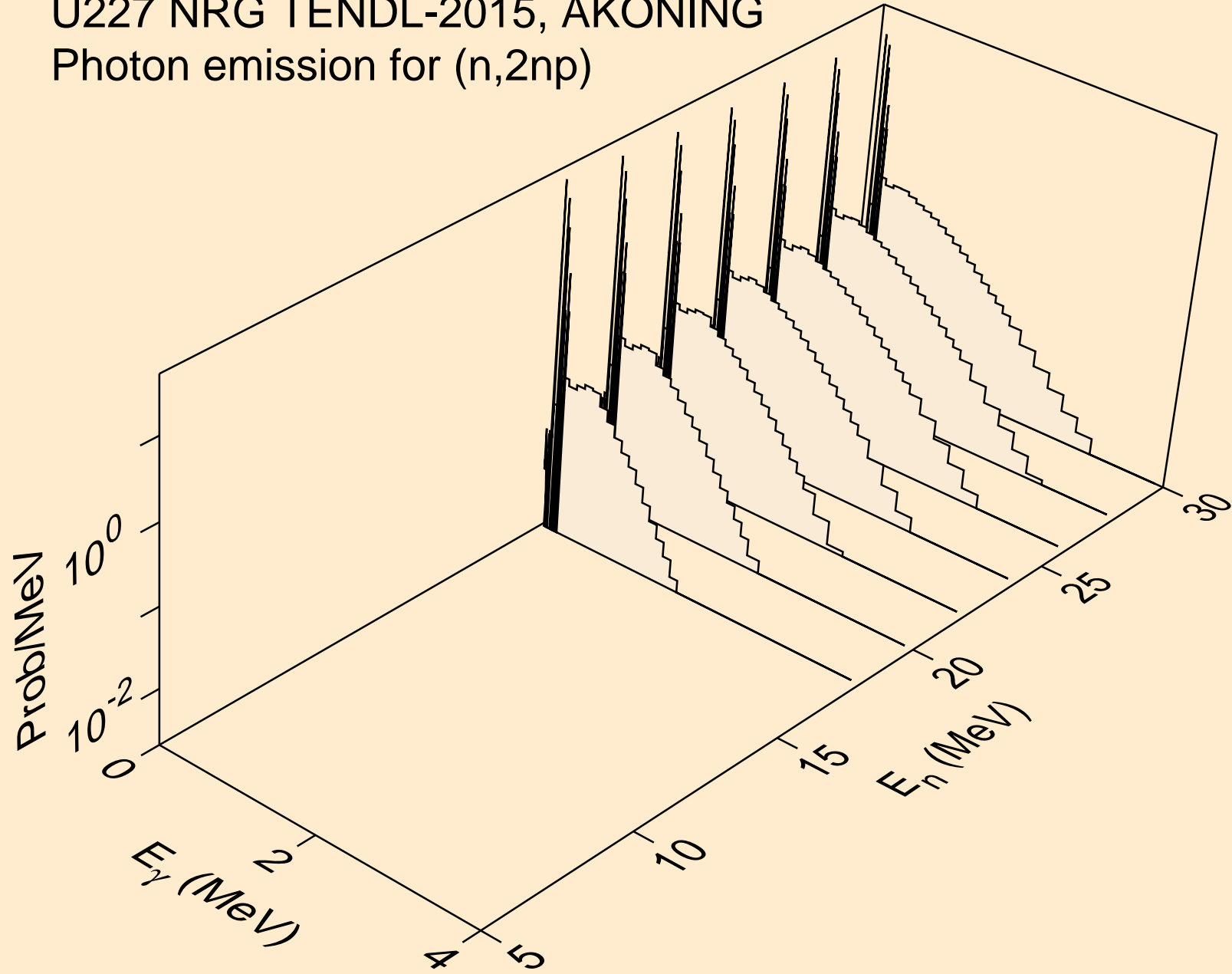

U227 NRG TENDL-2015, AKONING
Photon emission for (n,npa)

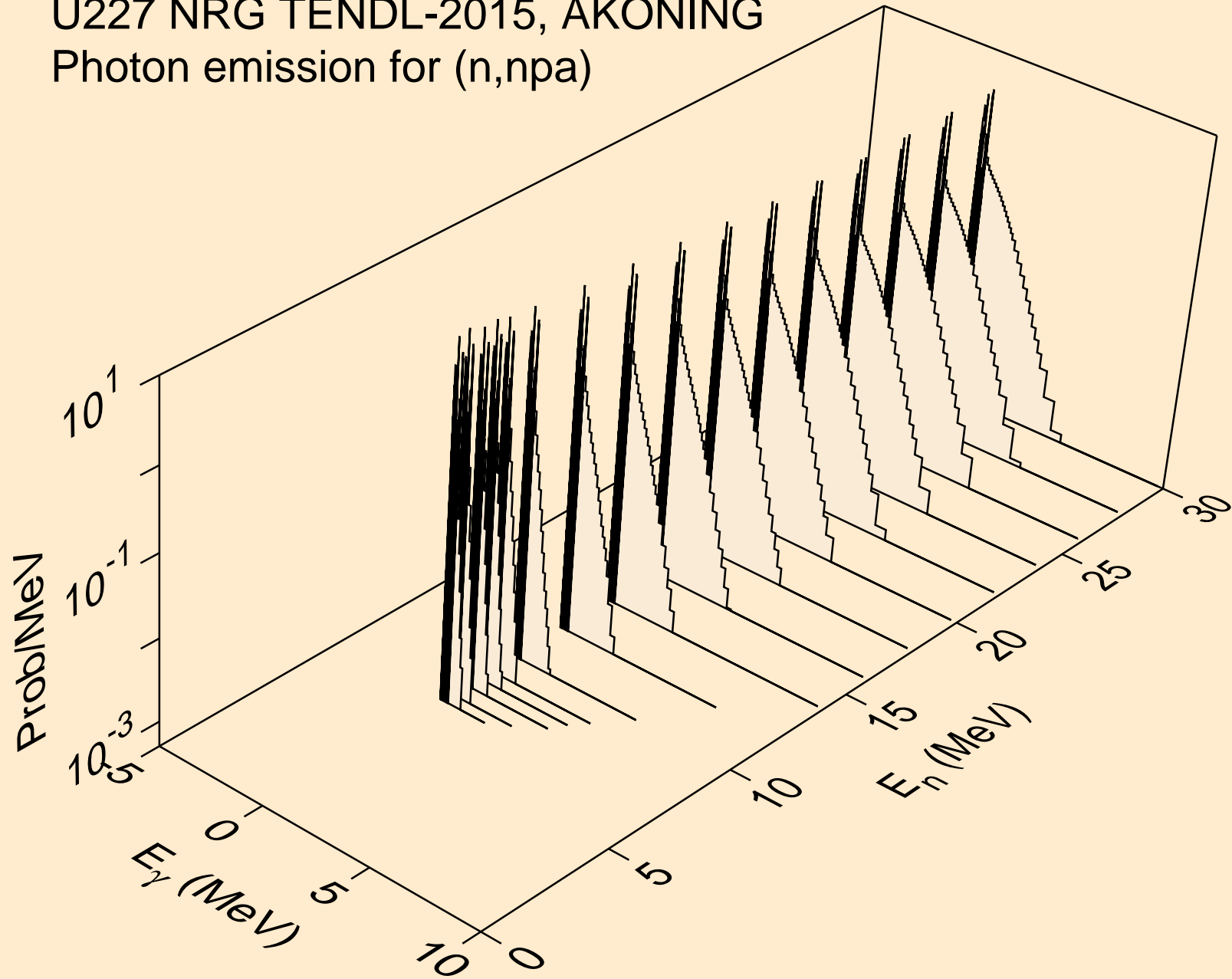

U227 NRG TENDL-2015, AKONING
Photon emission for (n,n*c)

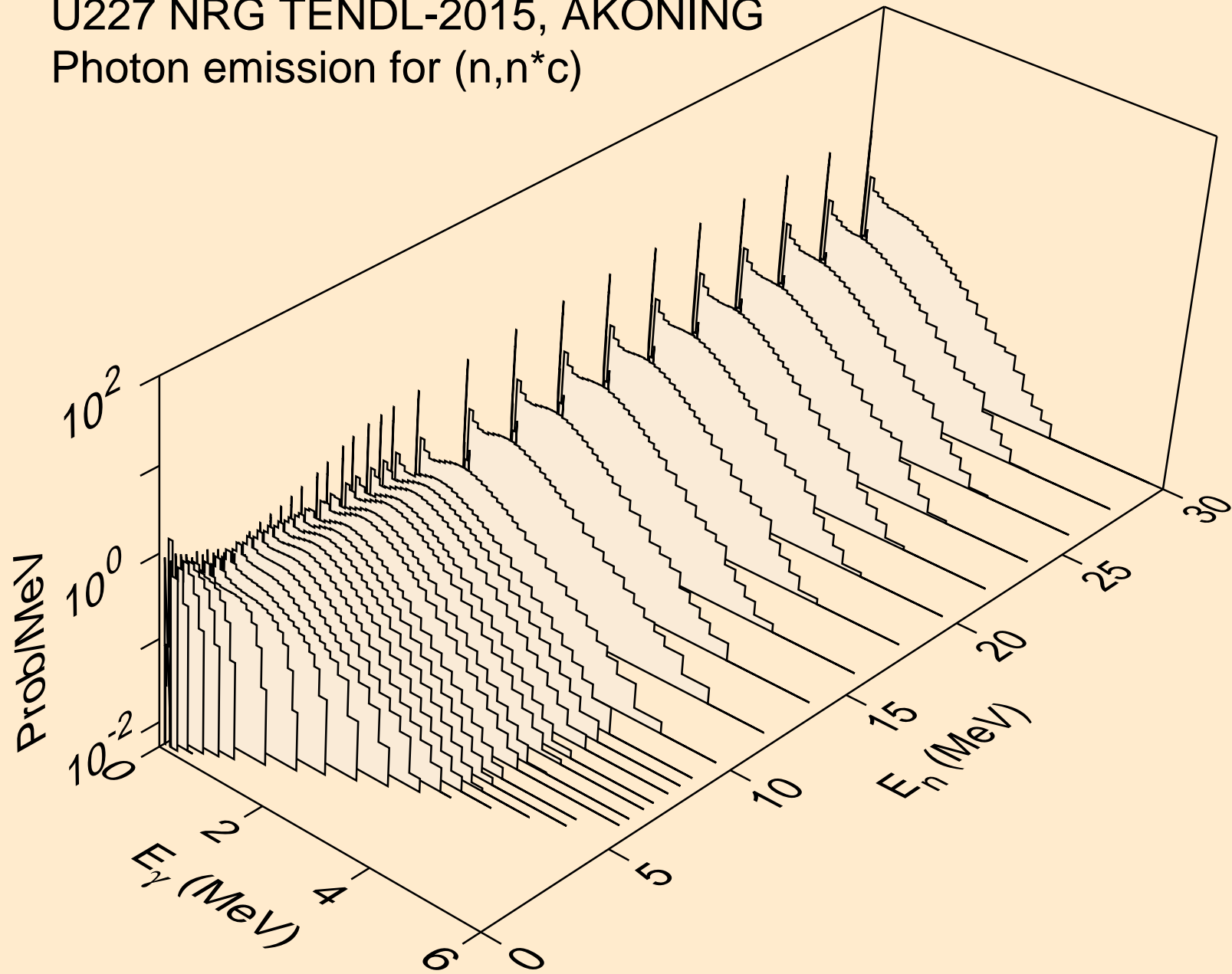

U227 NRG TENDL-2015, AKONING
Photon emission for (n,gma)

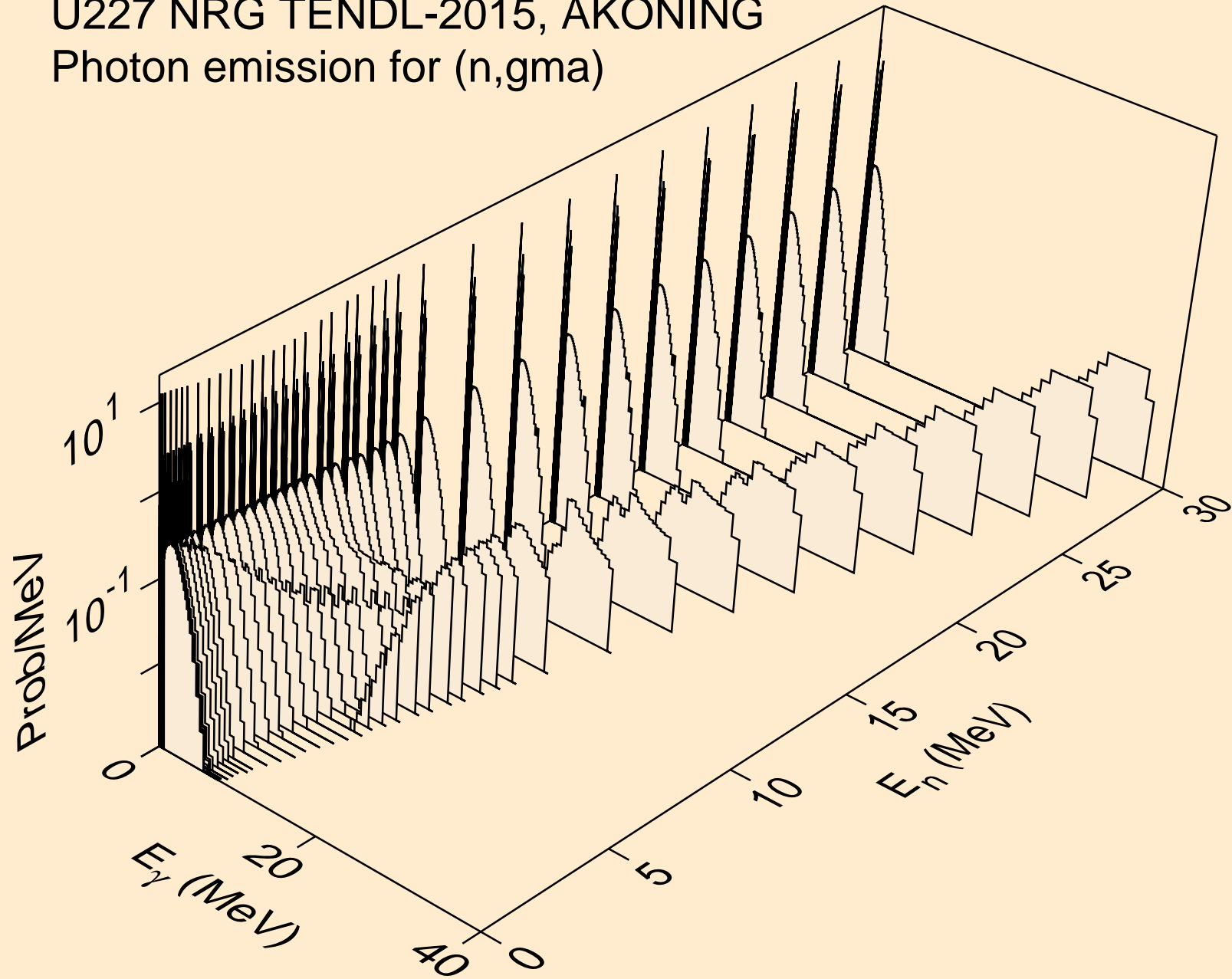

U227 NRG TENDL-2015, AKONING
Photon emission for (n,p)

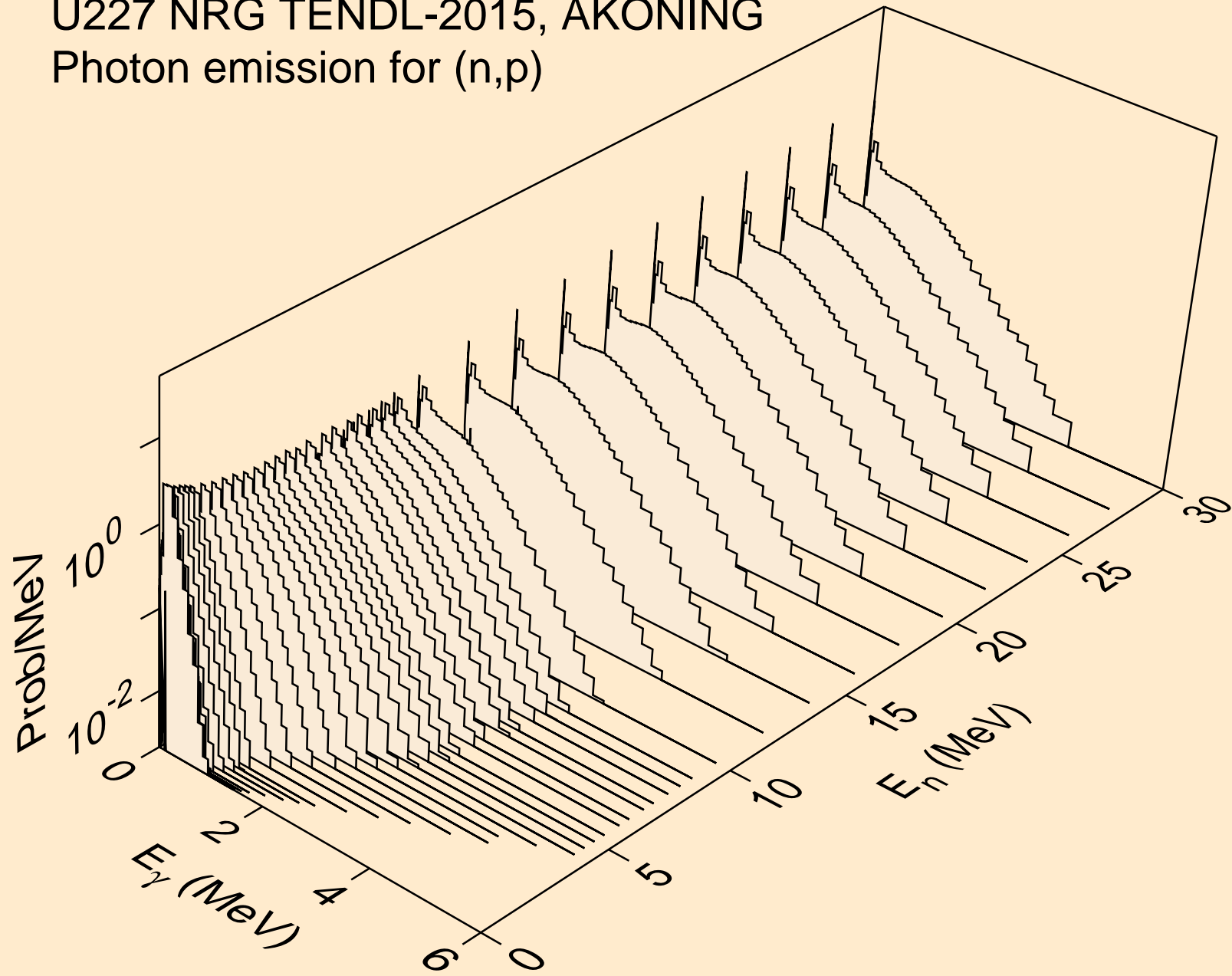

U227 NRG TENDL-2015, AKONING
Photon emission for (n,d)

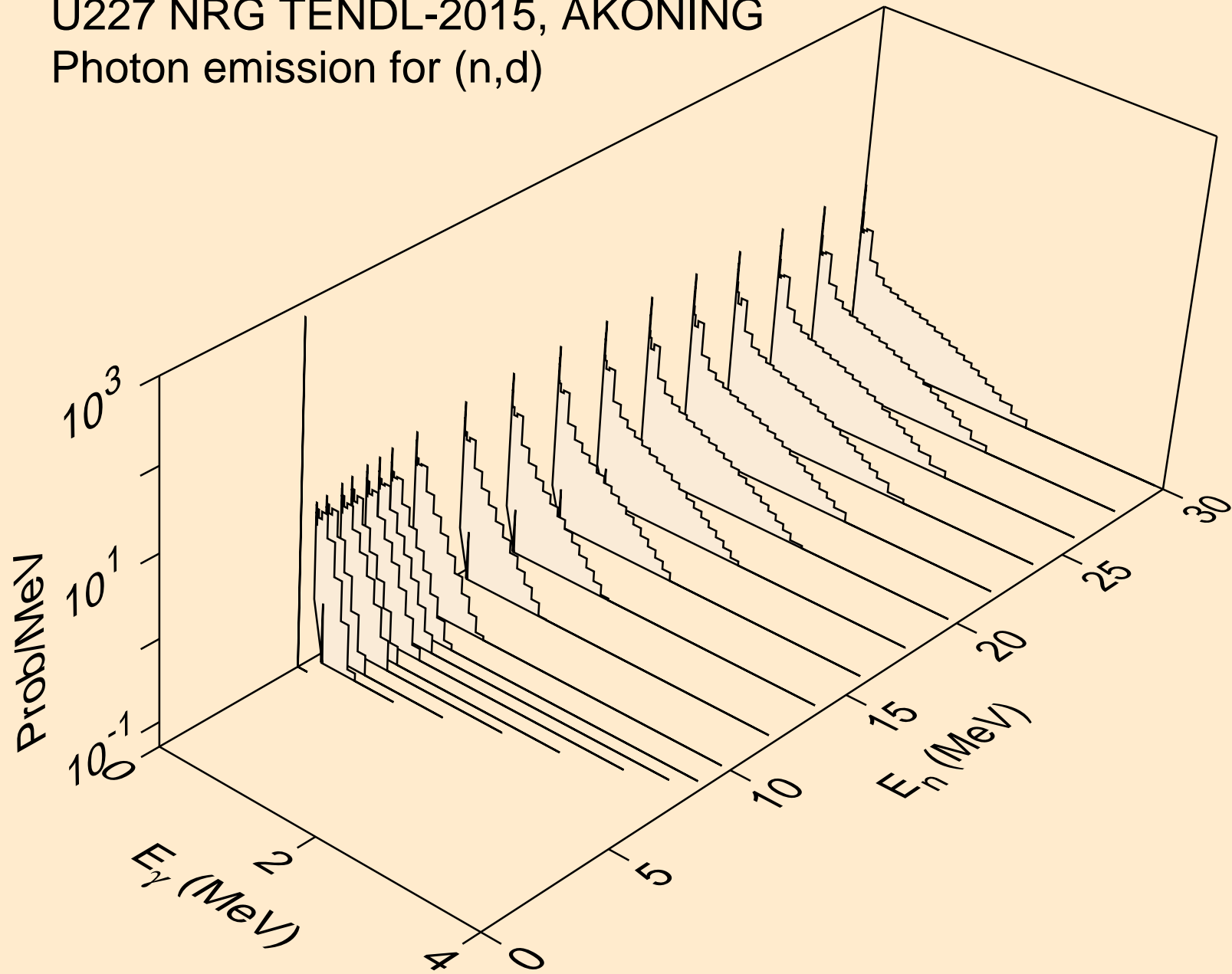

U227 NRG TENDL-2015, AKONING
Photon emission for (n,t)

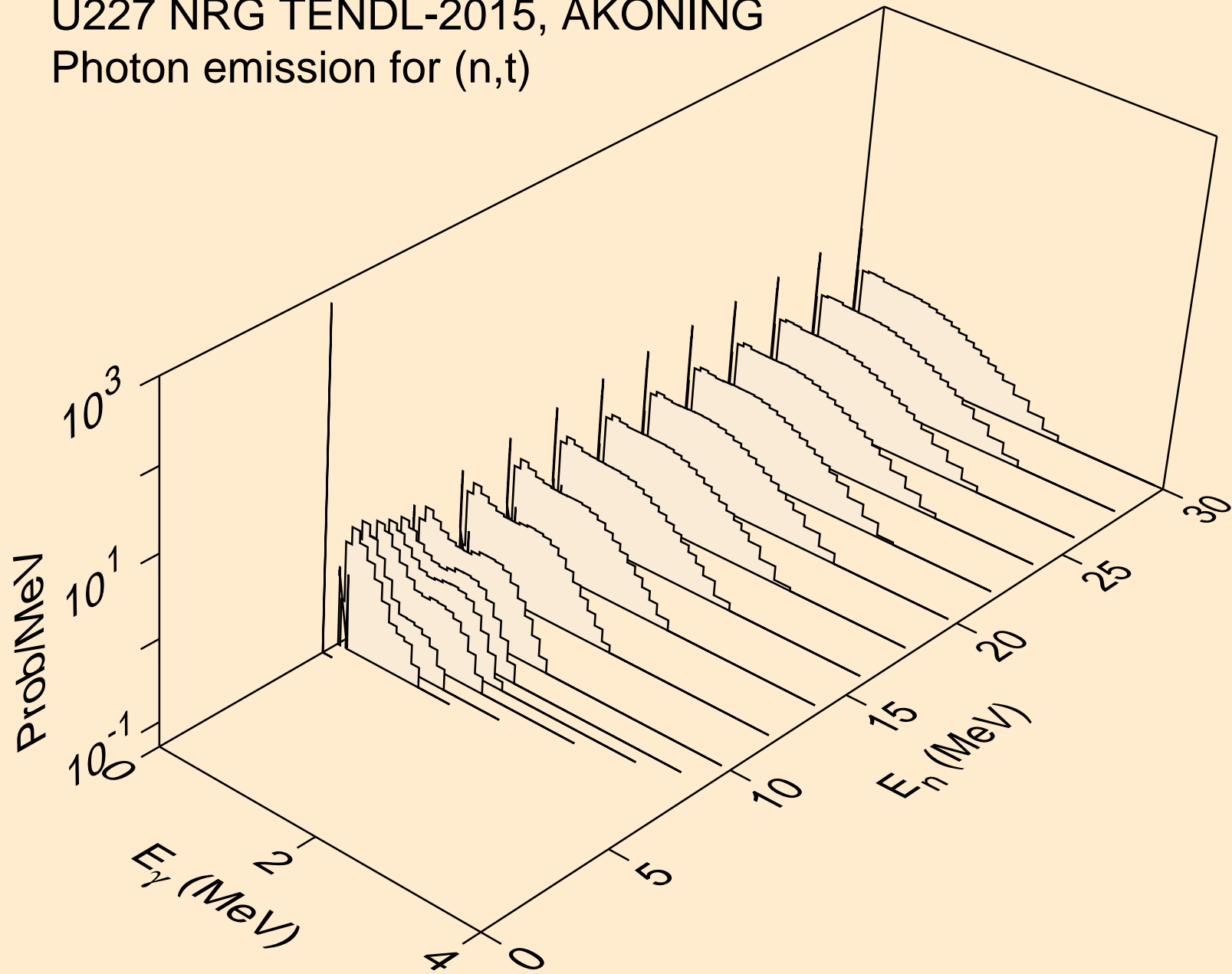

U227 NRG TENDL-2015, AKONING
Photon emission for (n,he3)

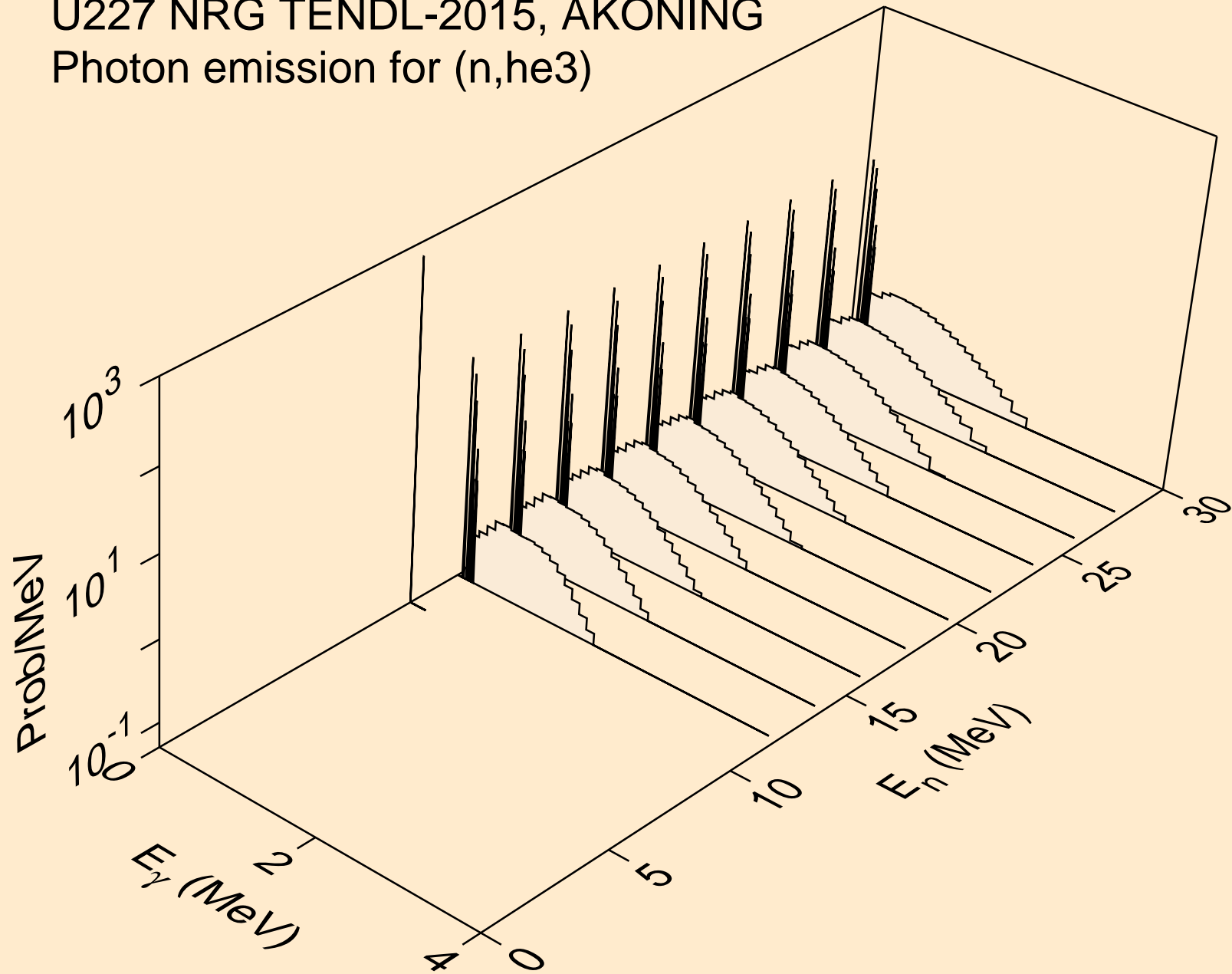

U227 NRG TENDL-2015, AKONING
Photon emission for (n,a)

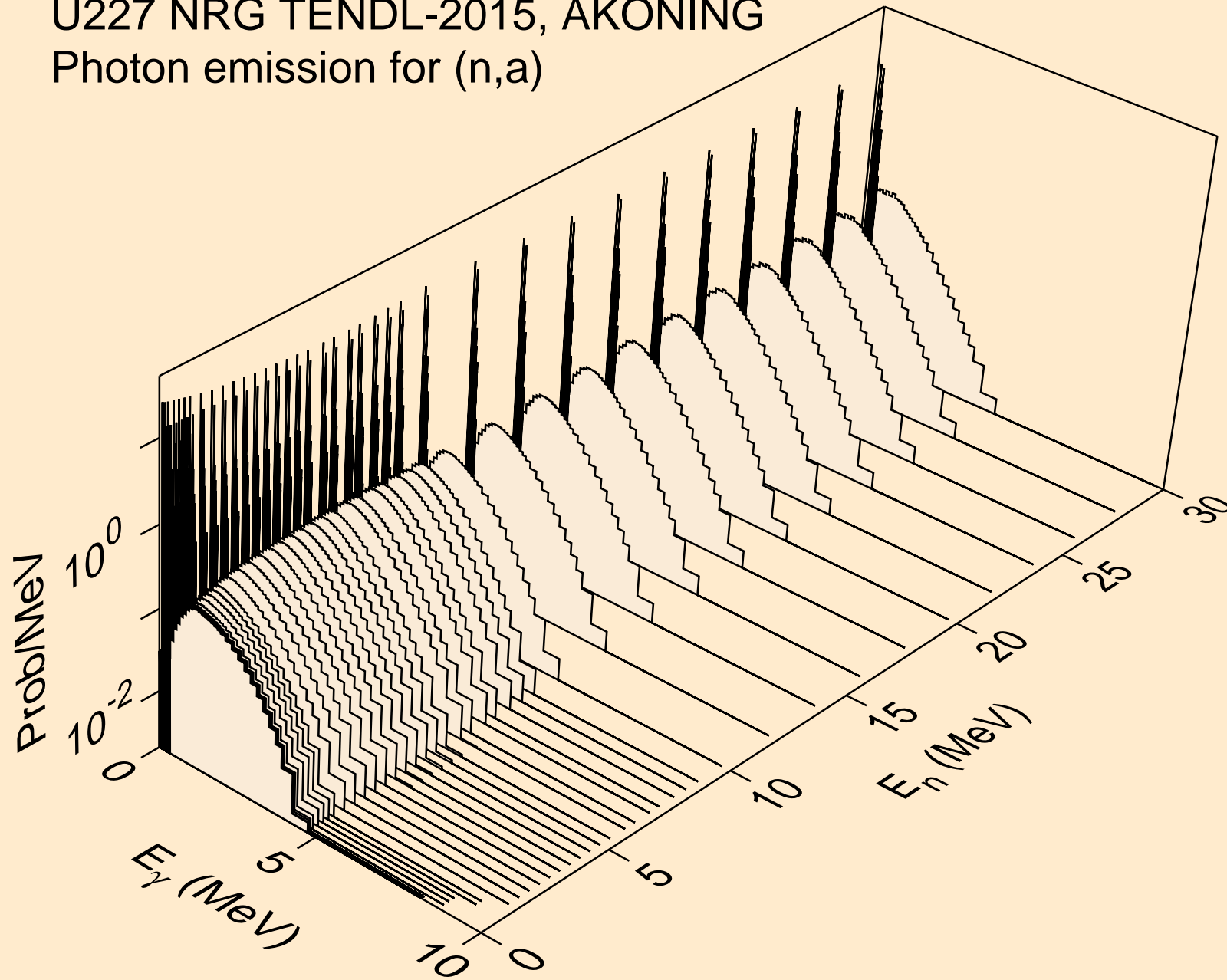

U227 NRG TENDL-2015, AKONING
Photon emission for (n,2a)

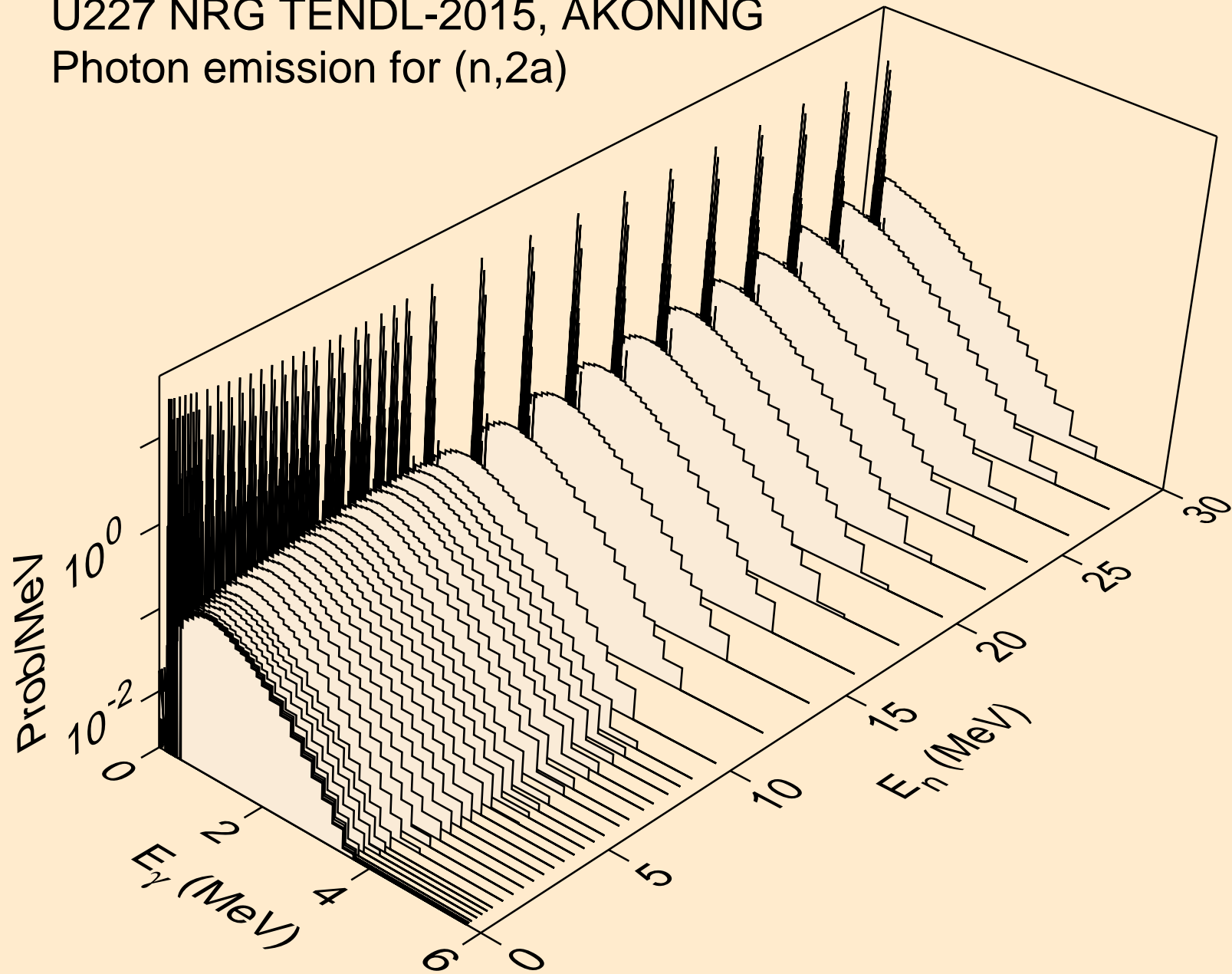

U227 NRG TENDL-2015, AKONING
Photon emission for (n,3a)

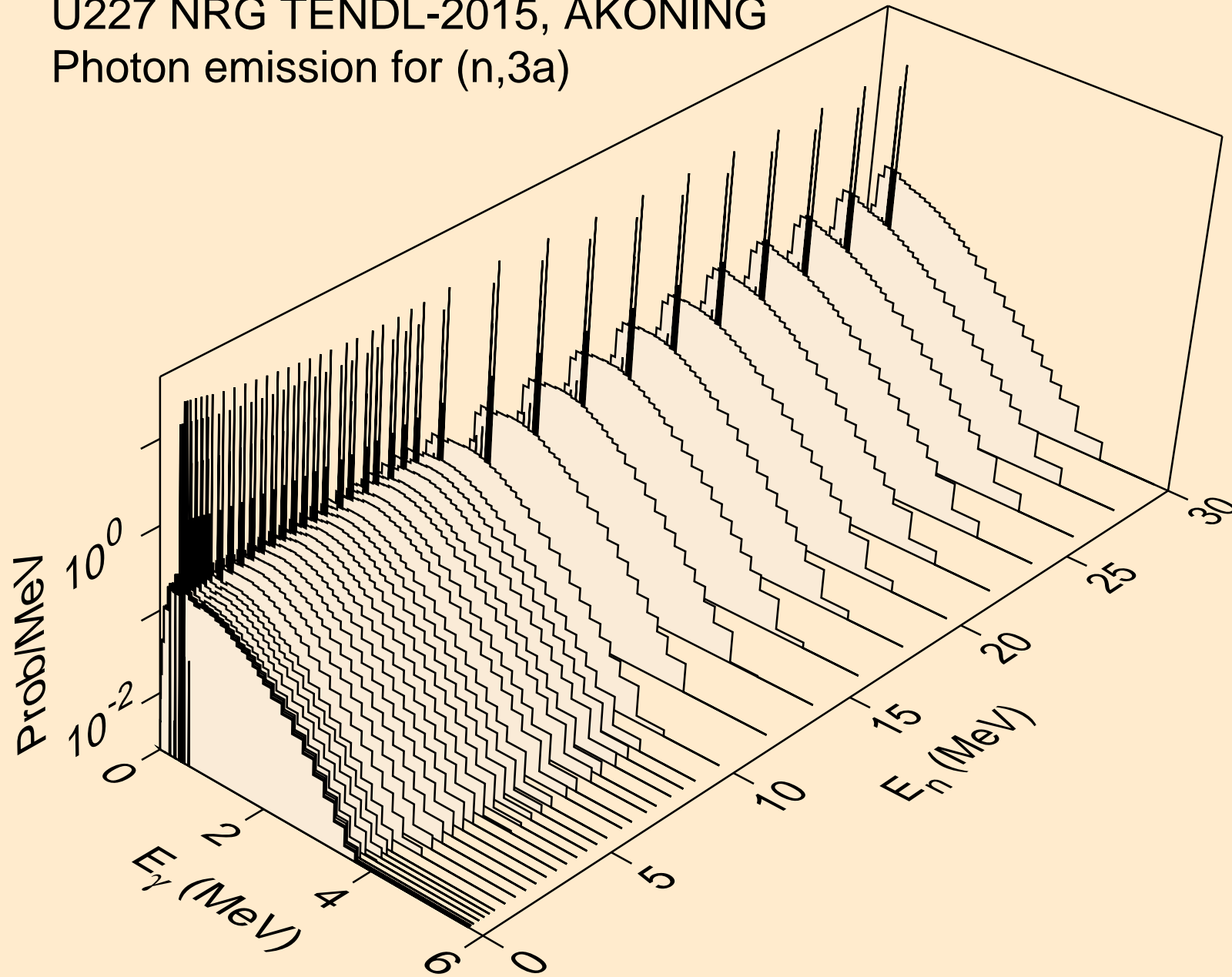

U227 NRG TENDL-2015, AKONING
Photon emission for (n,2p)

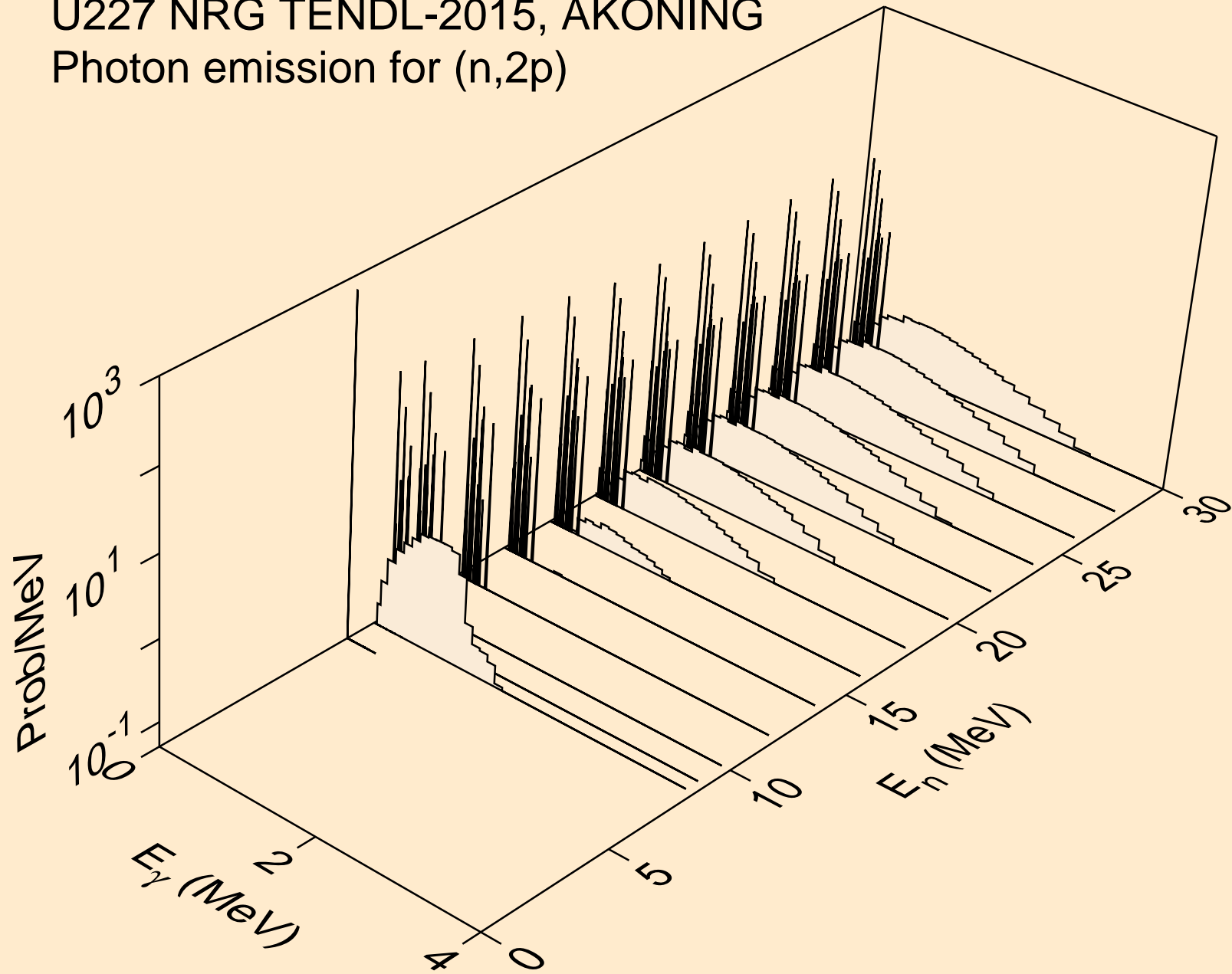

U227 NRG TENDL-2015, AKONING
Photon emission for (n,pa)

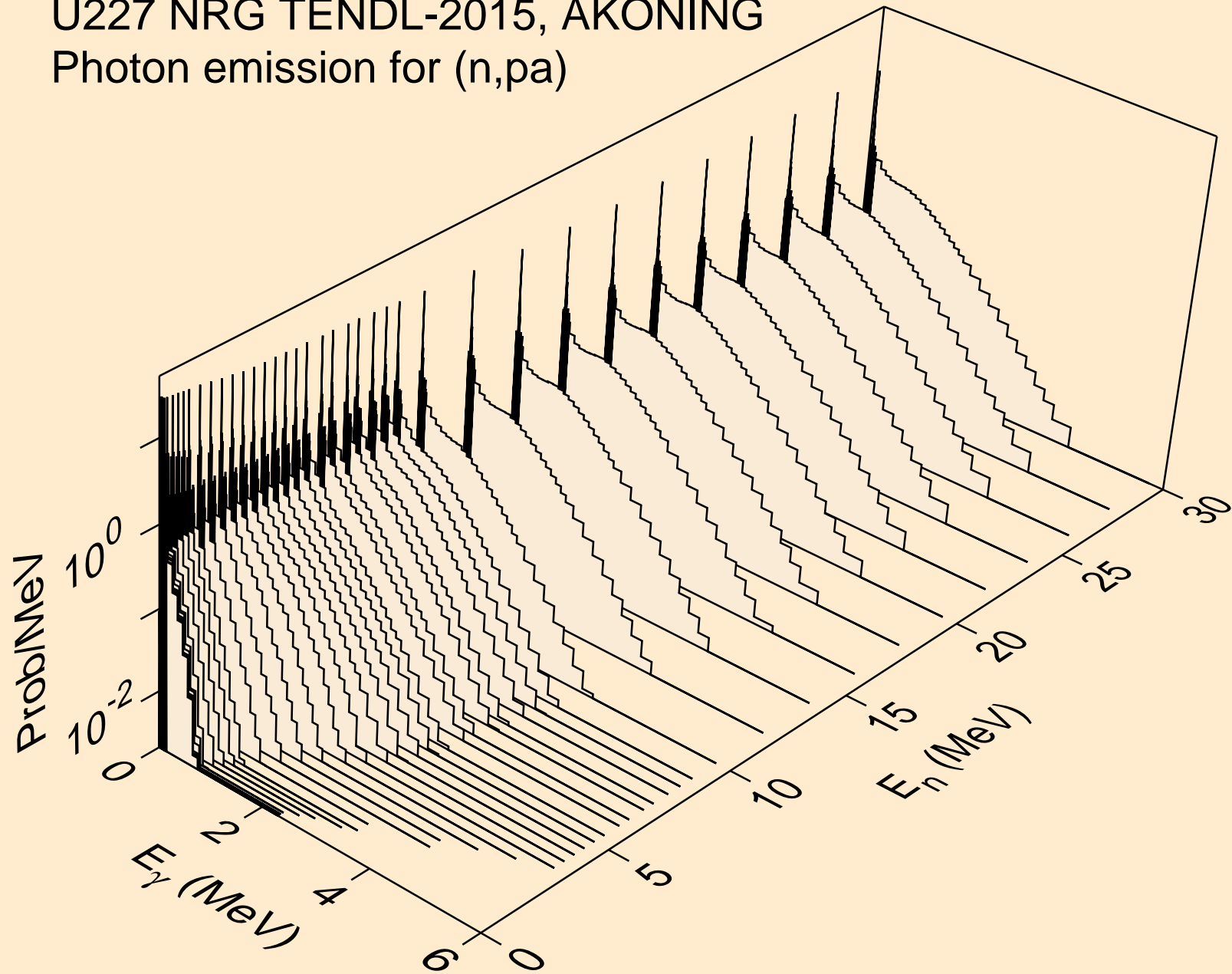

U227 NRG TENDL-2015, AKONING
Photon emission for (n,t2a)

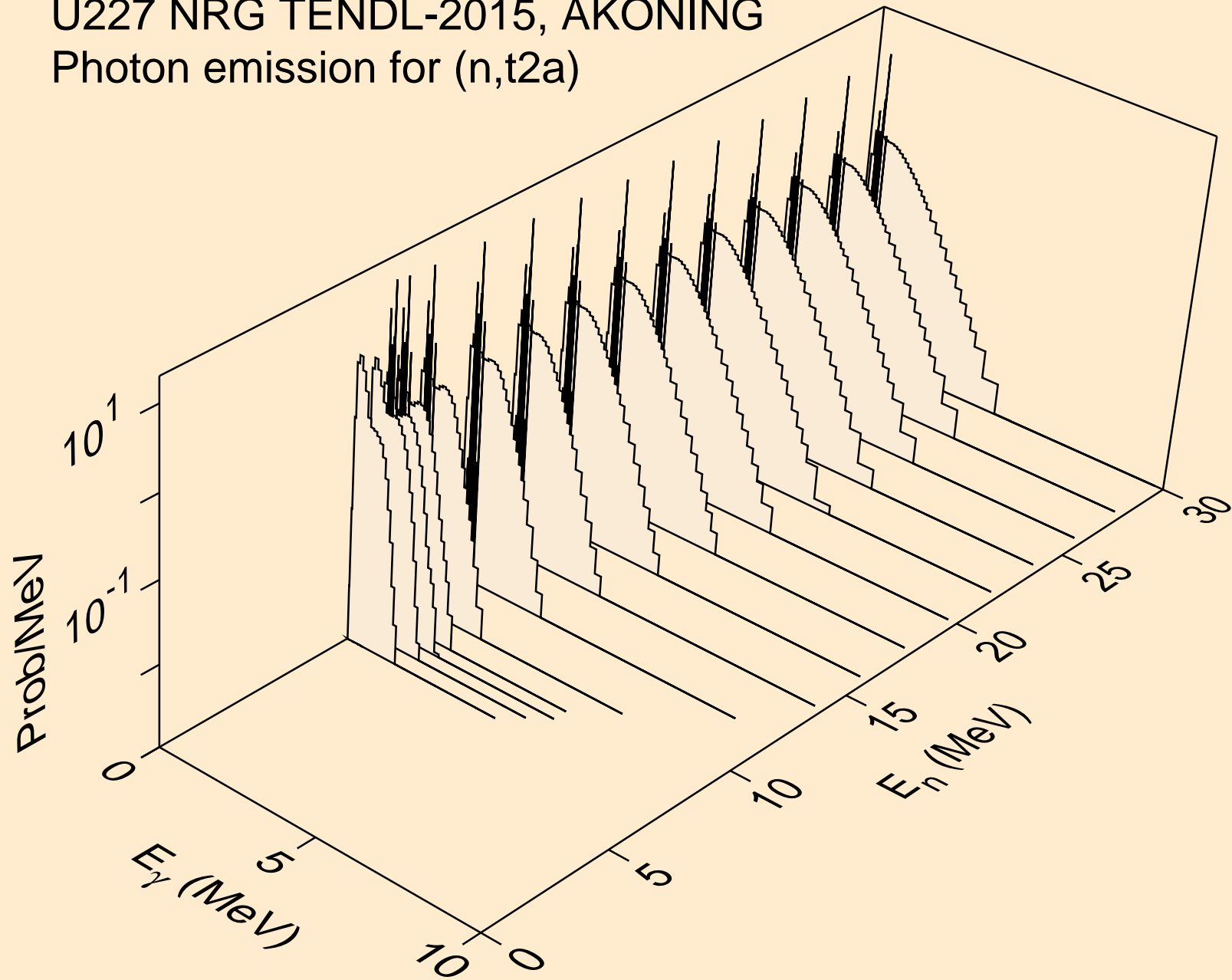

U227 NRG TENDL-2015, AKONING
Photon emission for (n,d2a)

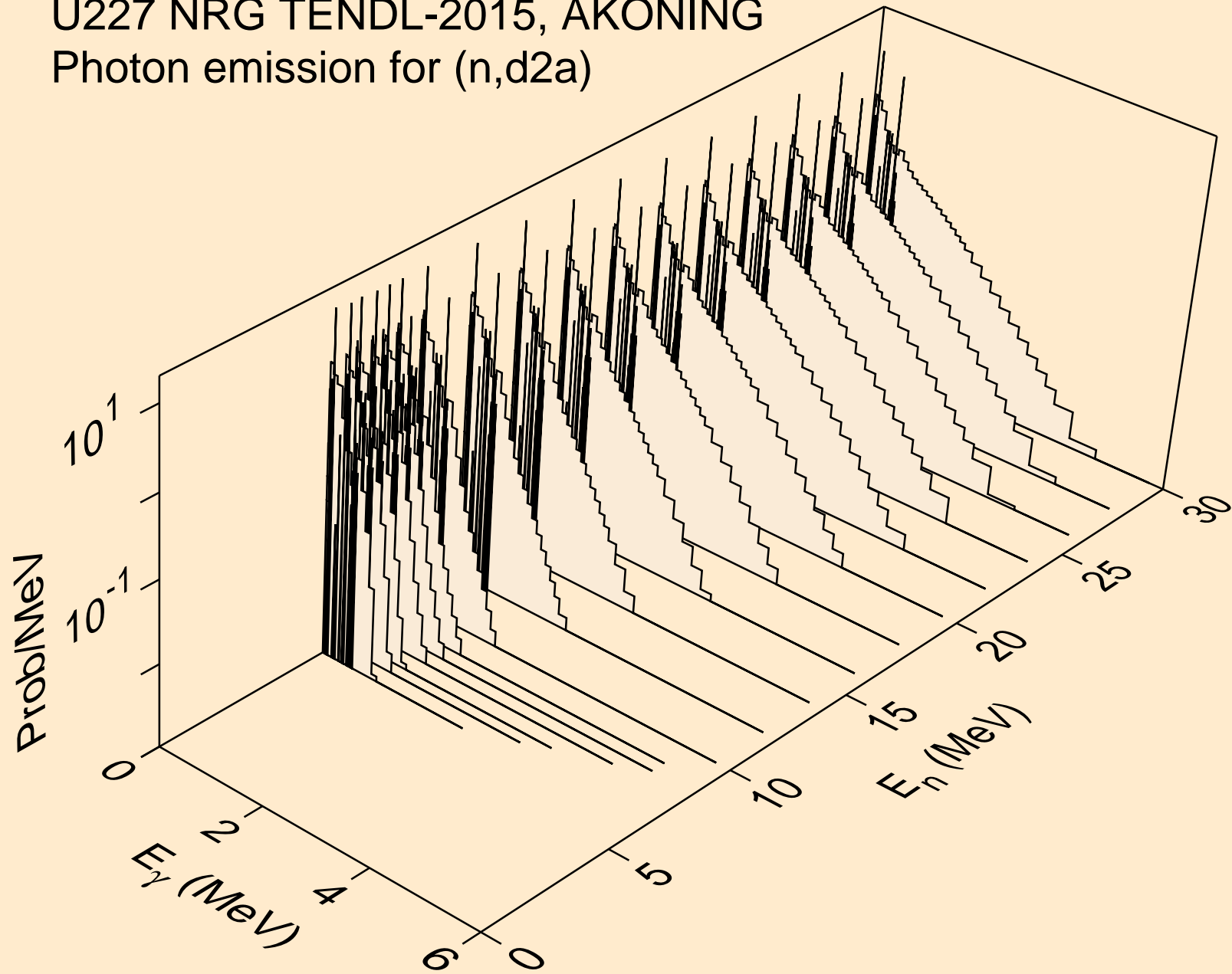

U227 NRG TENDL-2015, AKONING
Photon emission for (n,pd)

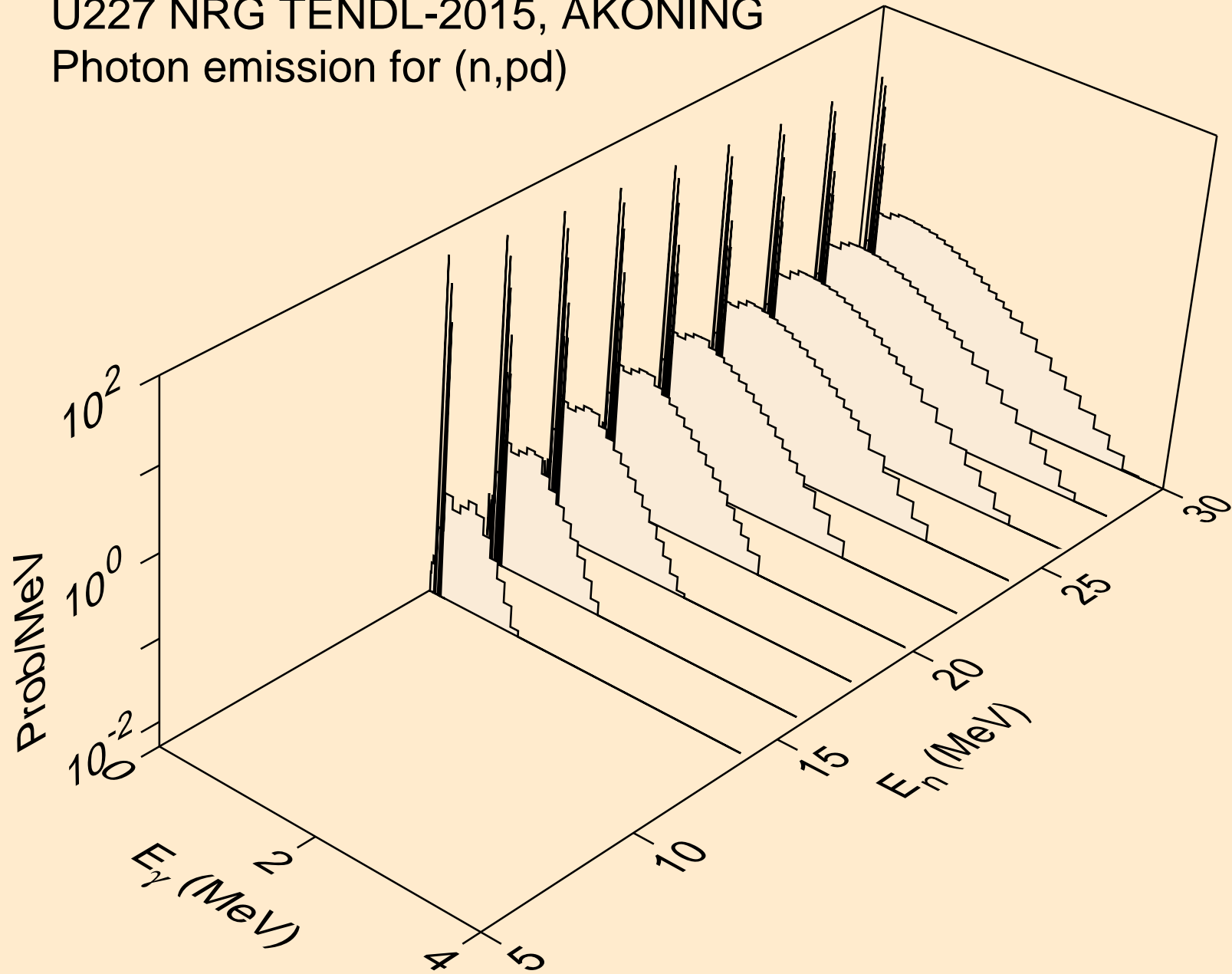

U227 NRG TENDL-2015, AKONING
Photon emission for (n,pt)

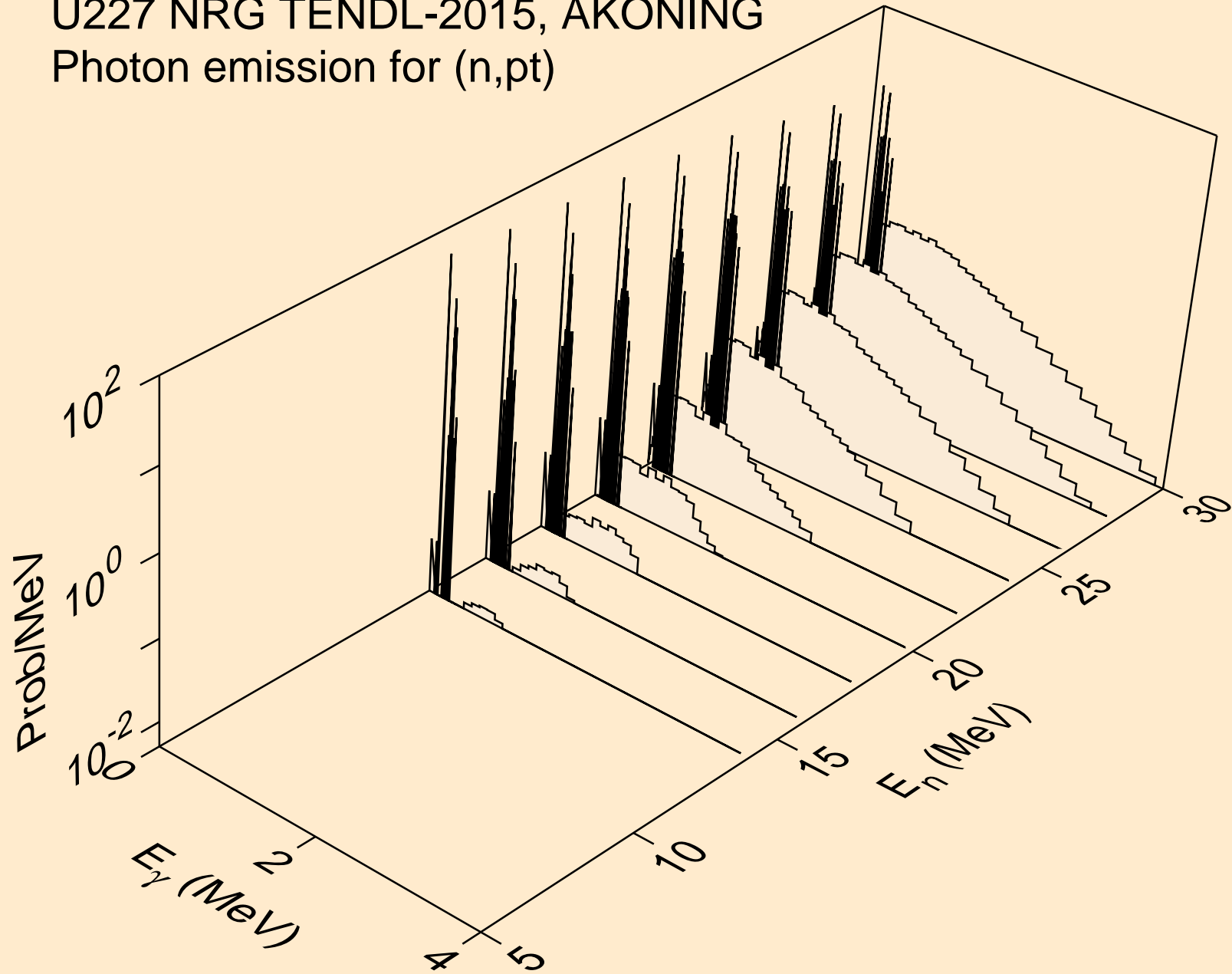

U227 NRG TENDL-2015, AKONING
Photon emission for (n,da)

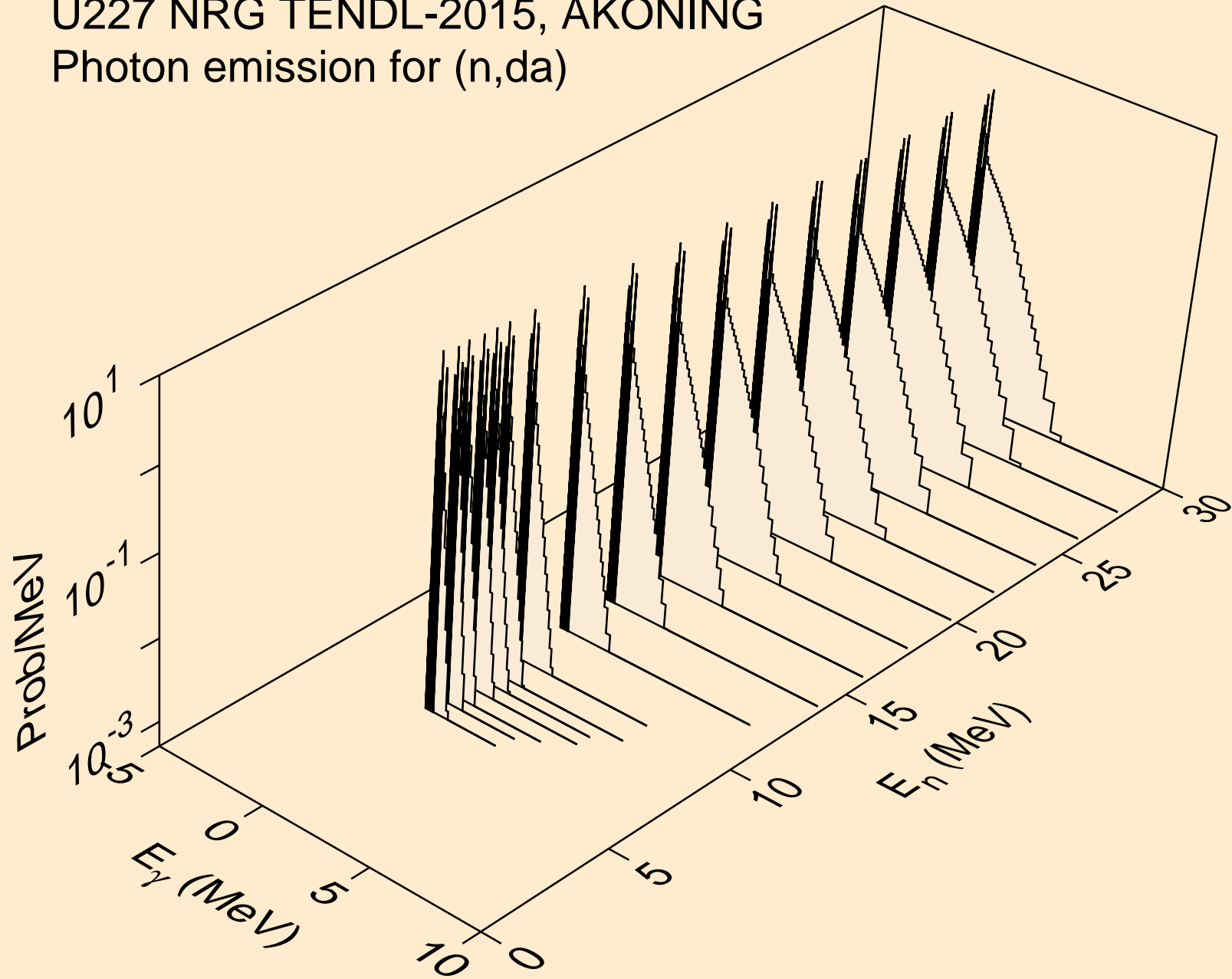

U227 NRG TENDL-2015, AKONING
thermal capture photon spectrum

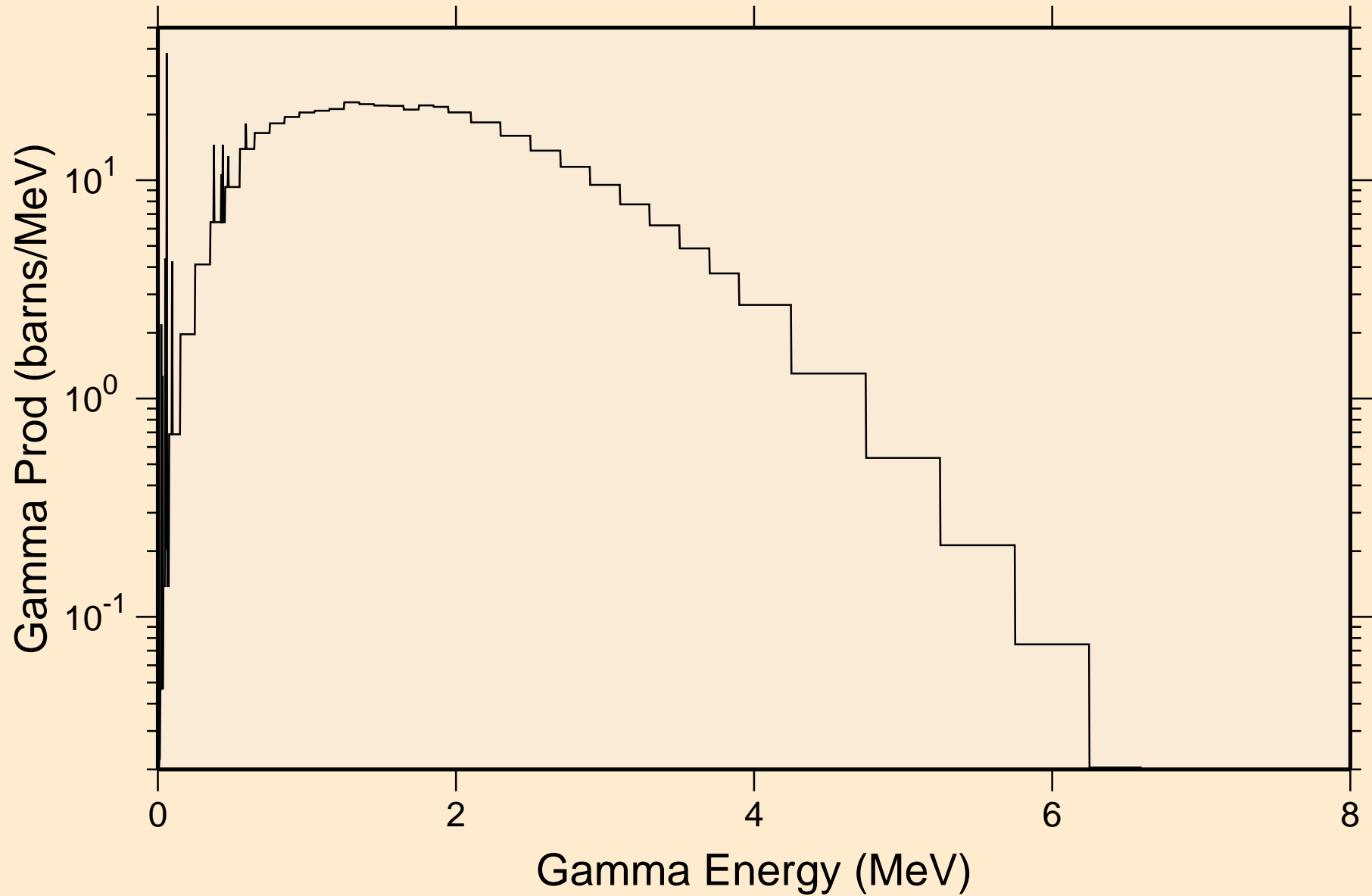

U227 NRG TENDL-2015, AKONING
14 MeV photon spectrum

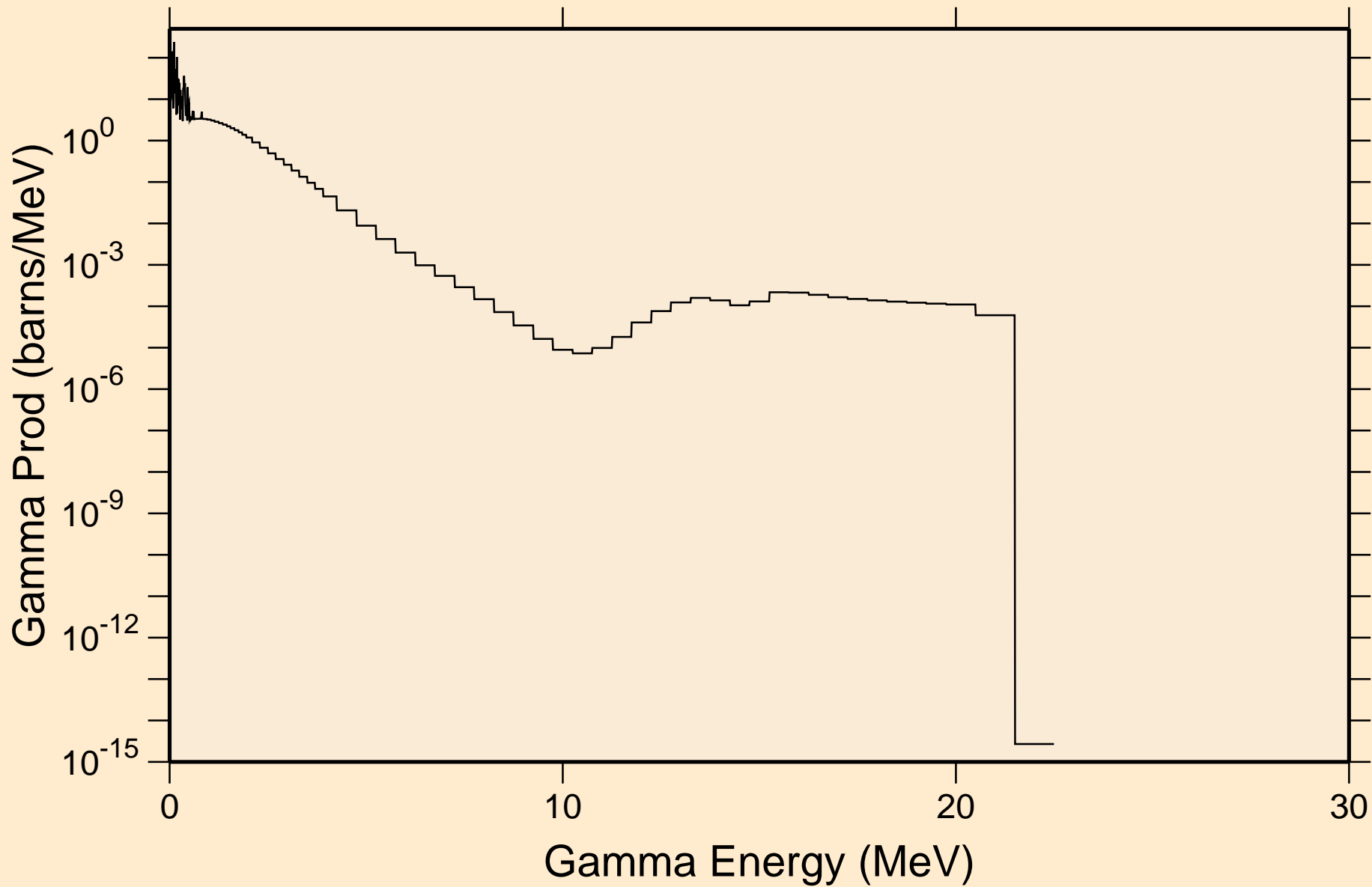

U227 NRG TENDL-2015, AKONING

Particle heating contributions

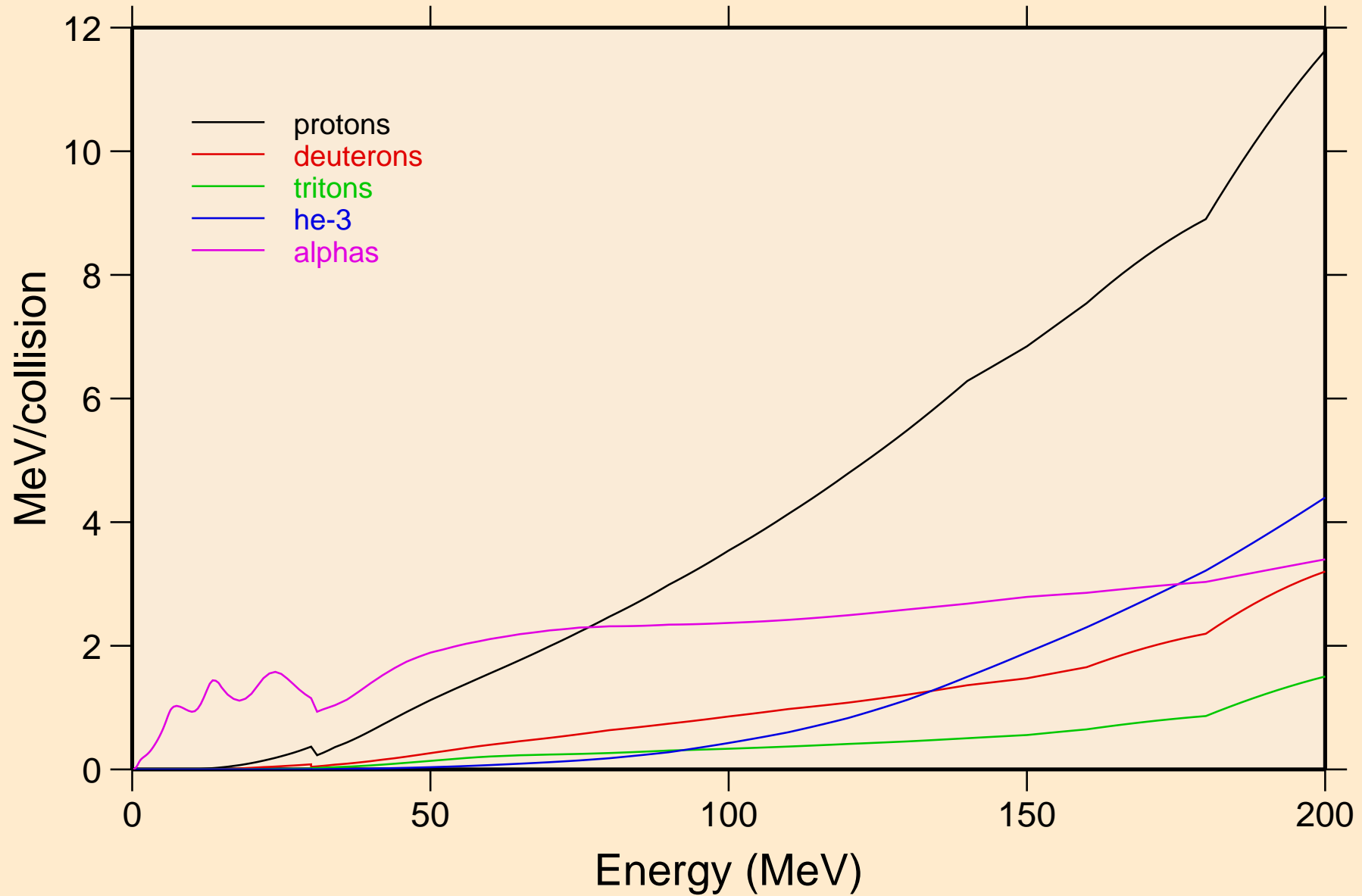

U227 NRG TENDL-2015, AKONING

Recoil Heating

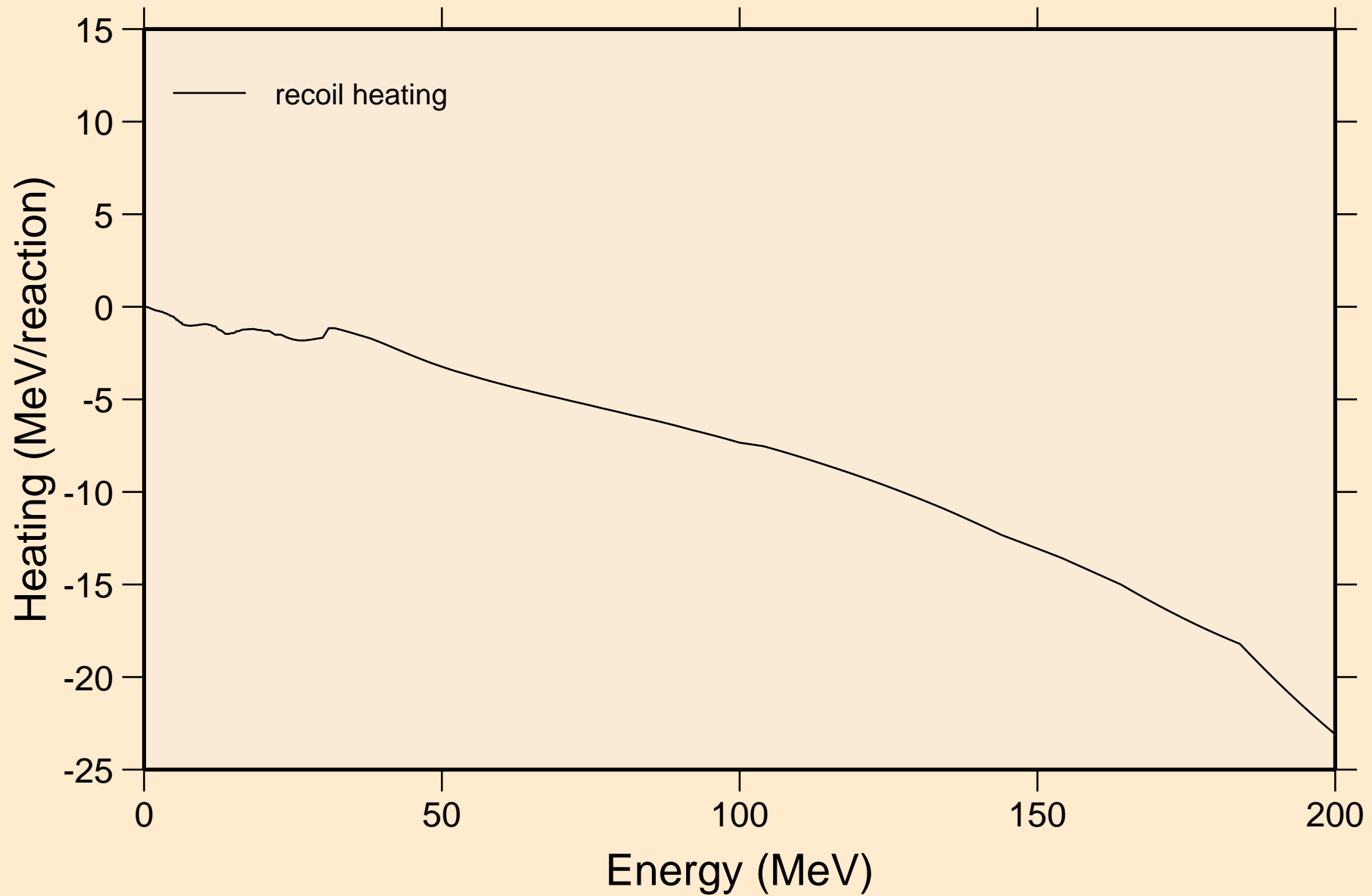

U227 NRG TENDL-2015, AKONING

Particle production cross sections

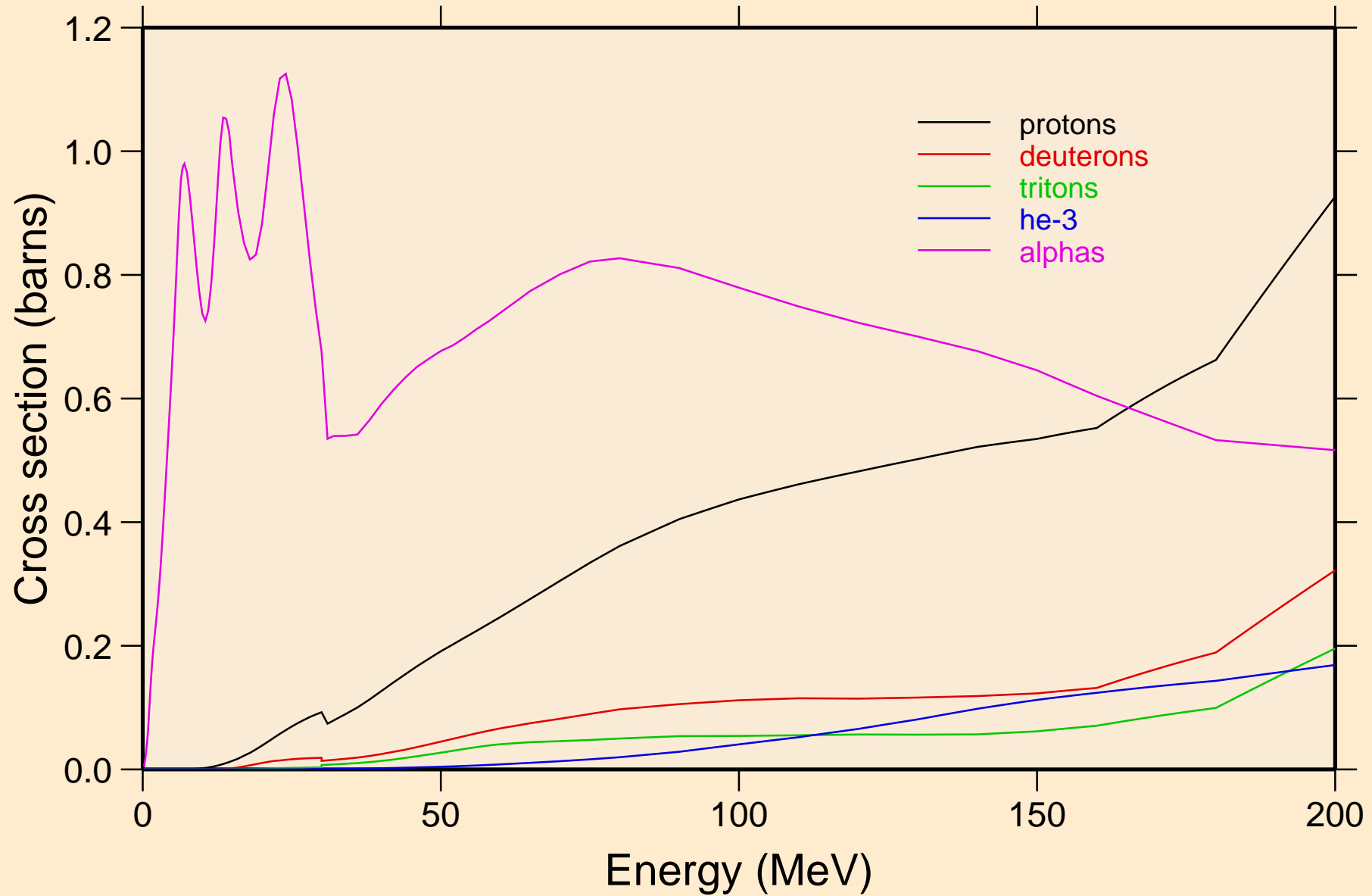

U227 NRG TENDL-2015, AKONING
protons from (n,x)

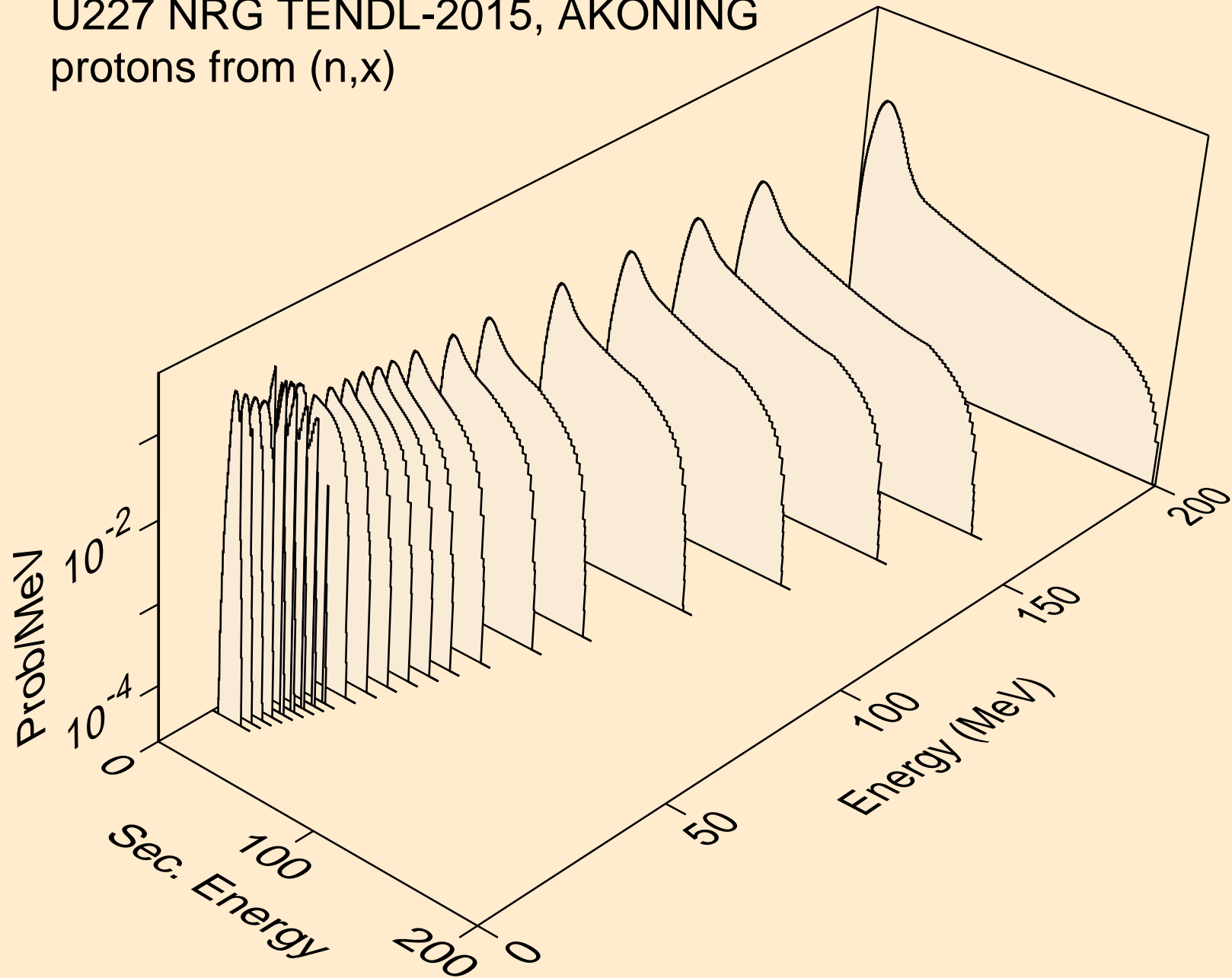

U227 NRG TENDL-2015, AKONING
protons from (n,n*)p

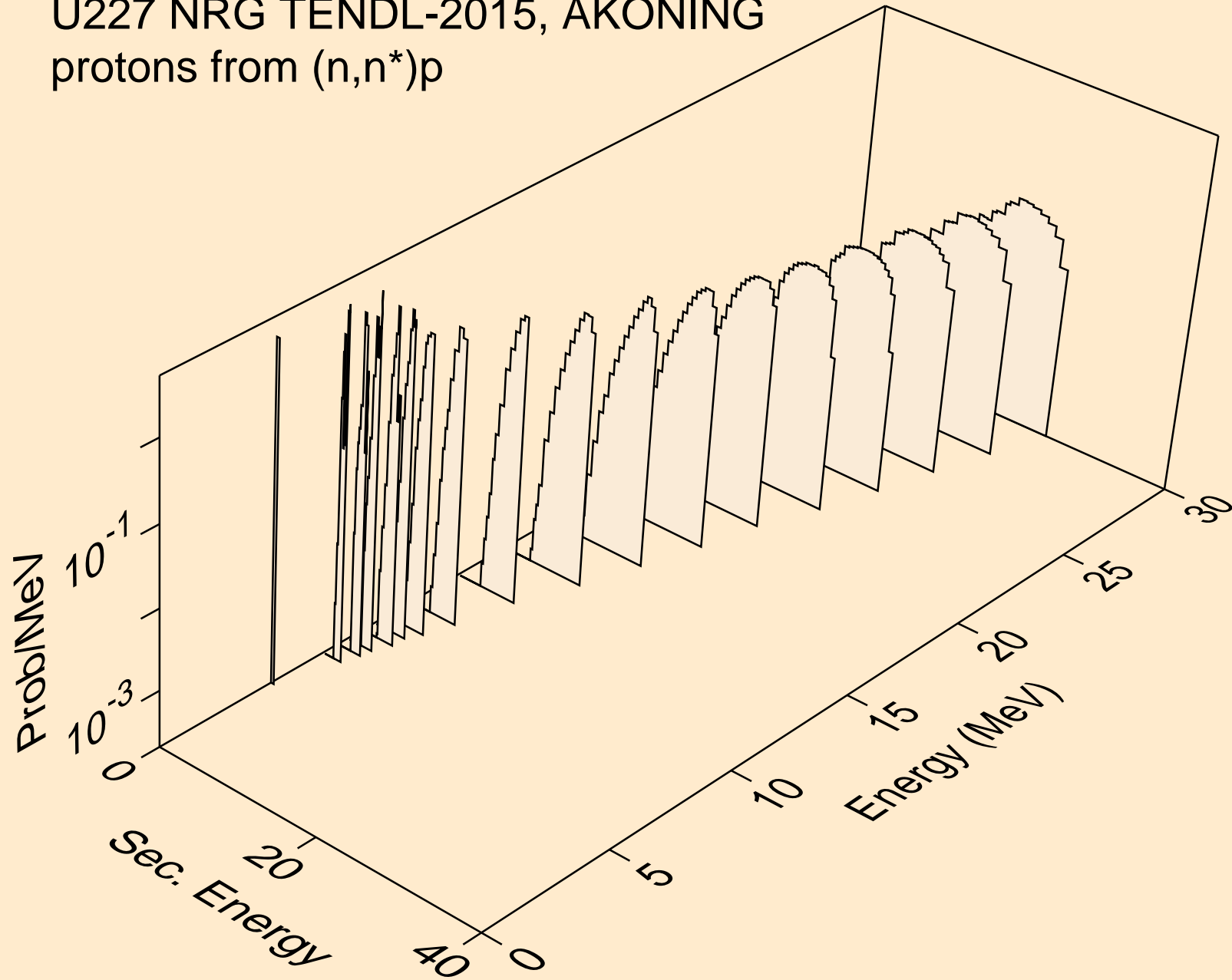

U227 NRG TENDL-2015, AKONING
protons from (n,2np)

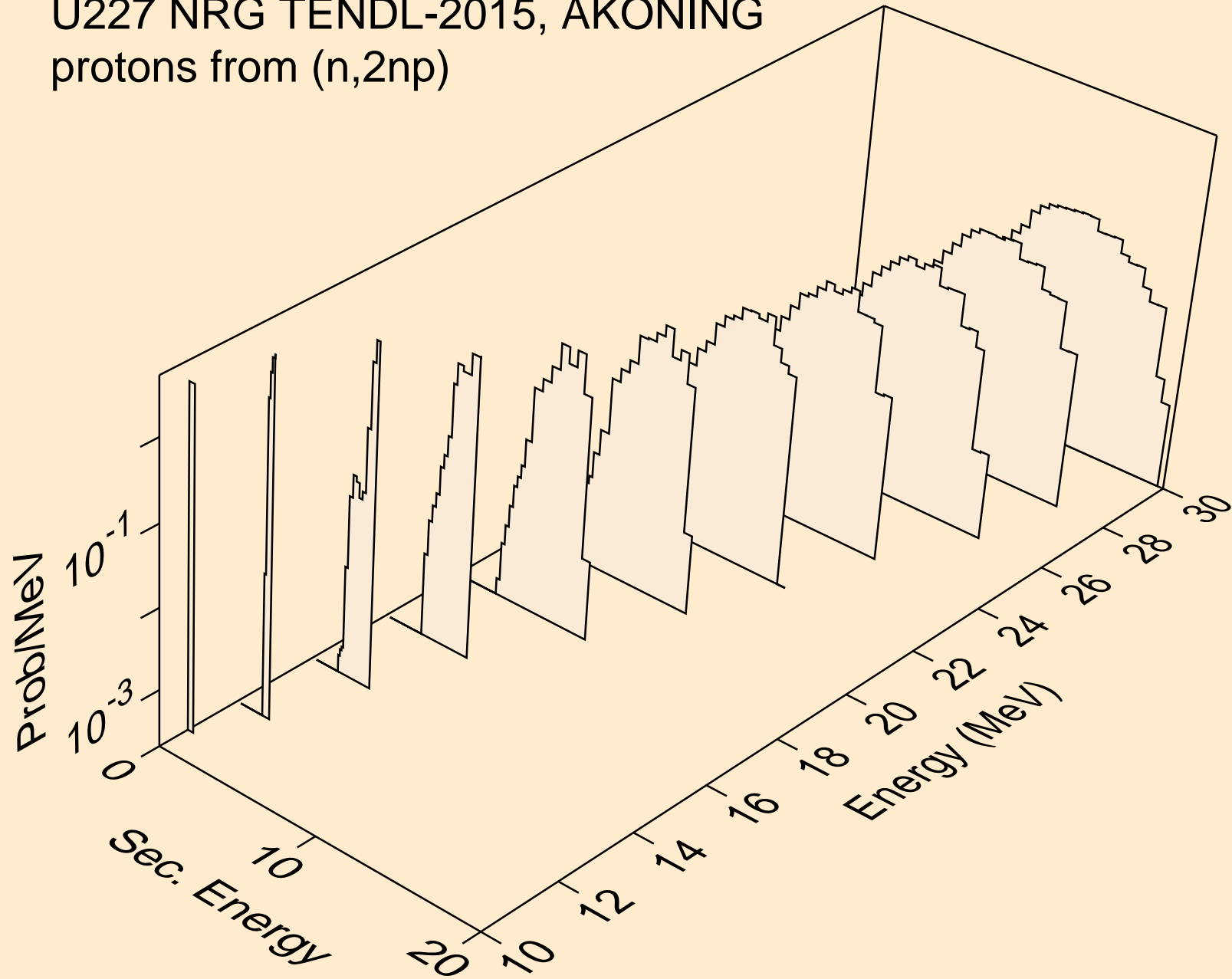

U227 NRG TENDL-2015, AKONING
protons from (n,3np)

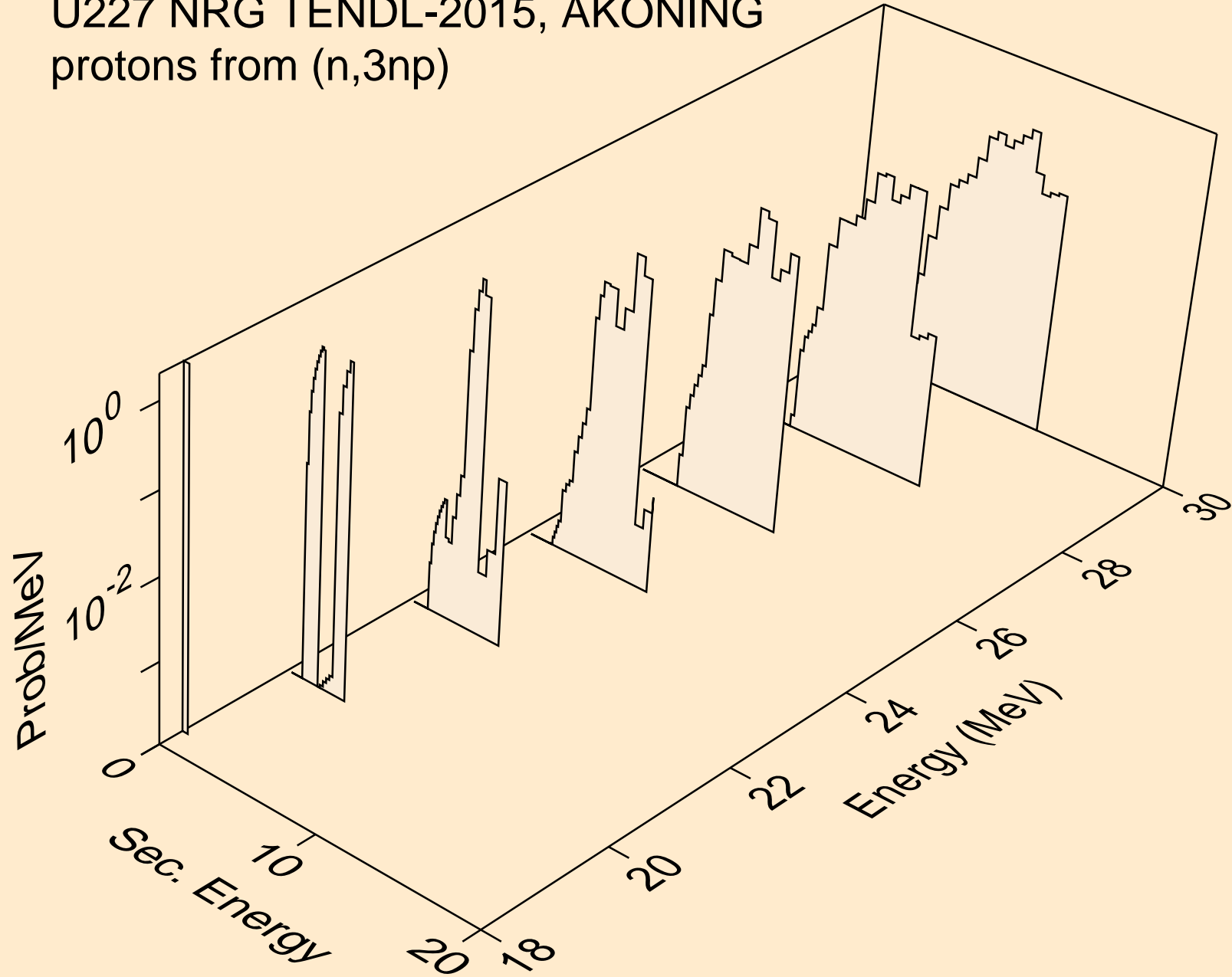

U227 NRG TENDL-2015, AKONING
protons from (n,2np)

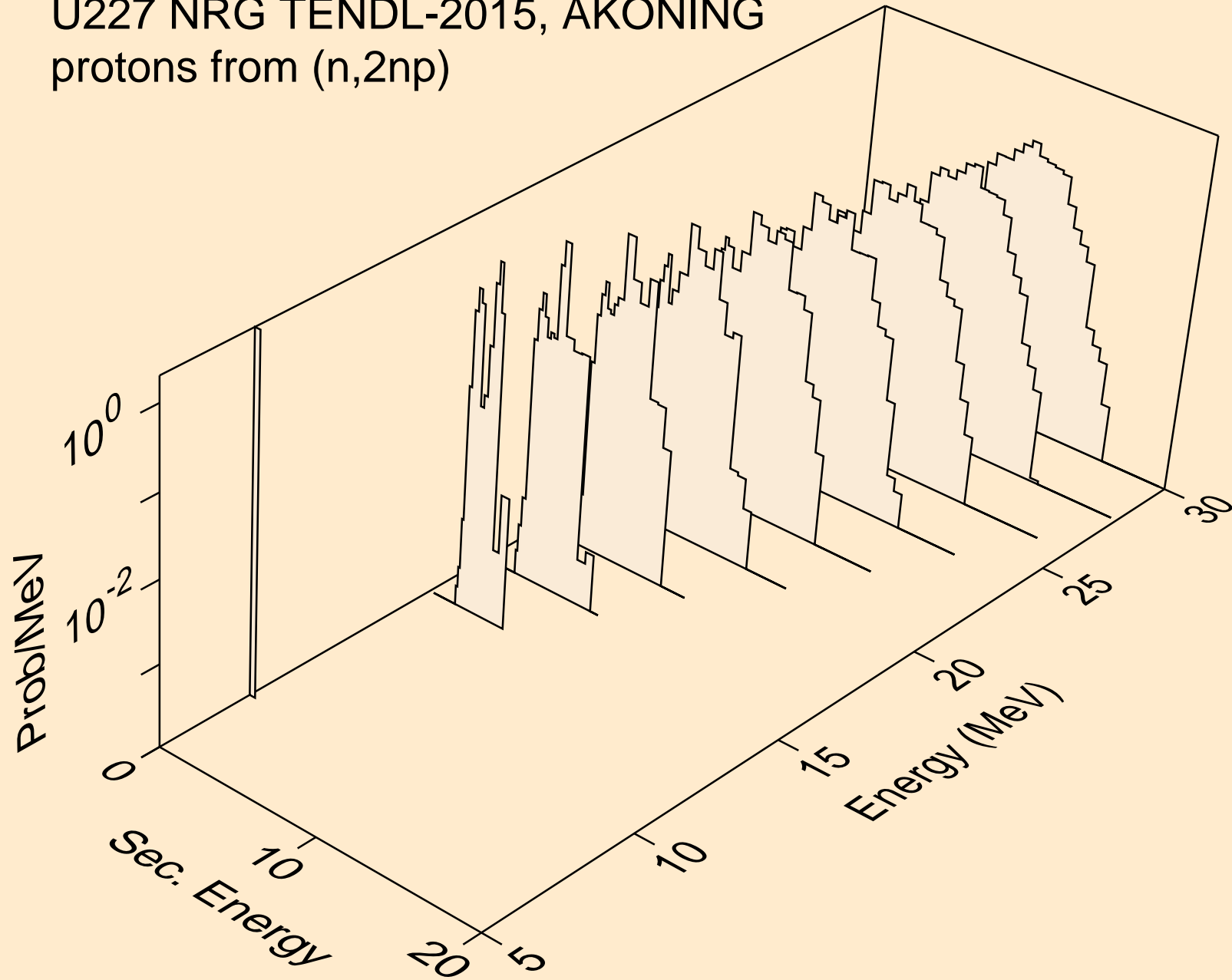

U227 NRG TENDL-2015, AKONING
protons from (n,npa)

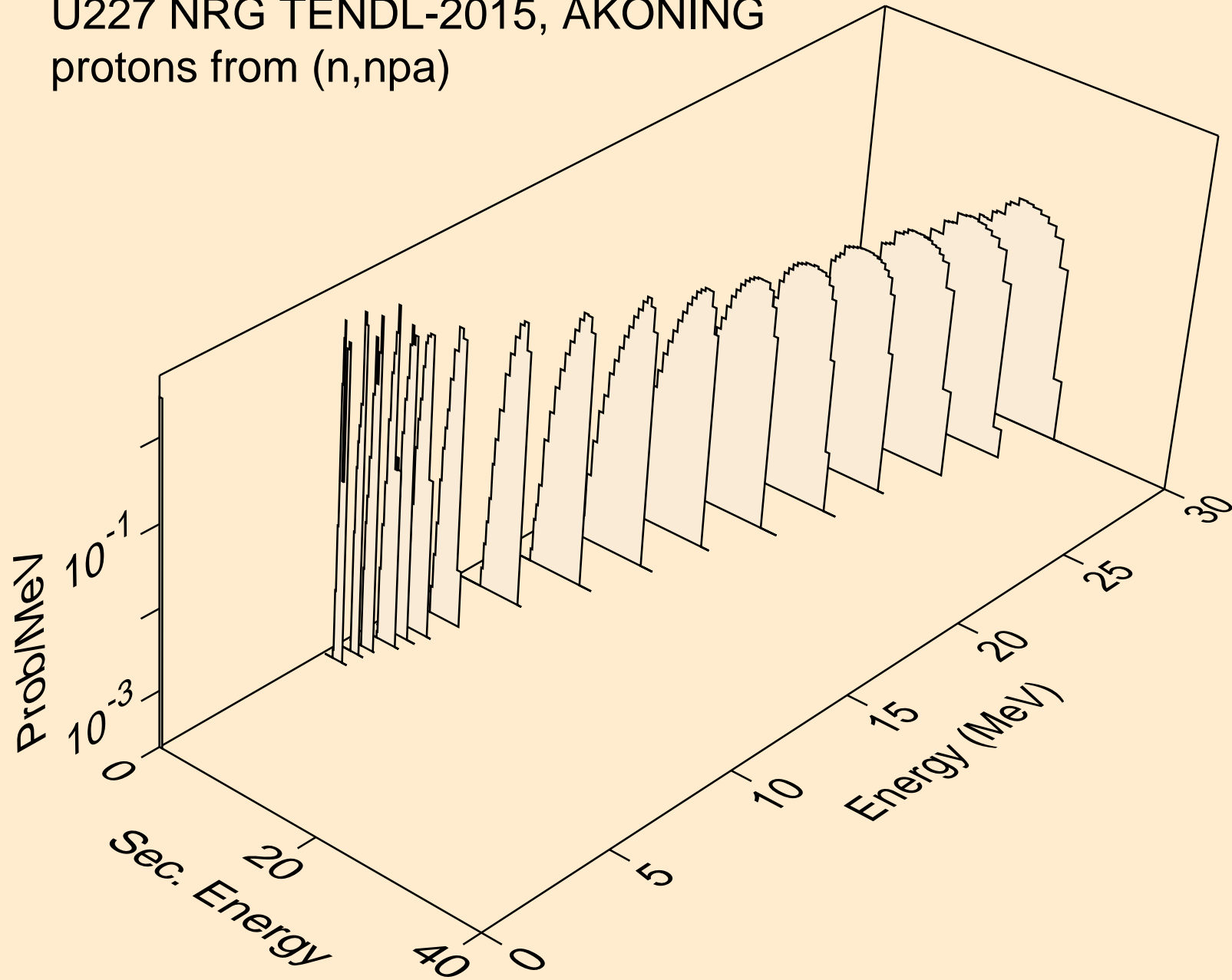

U227 NRG TENDL-2015, AKONING
protons from (n,p)

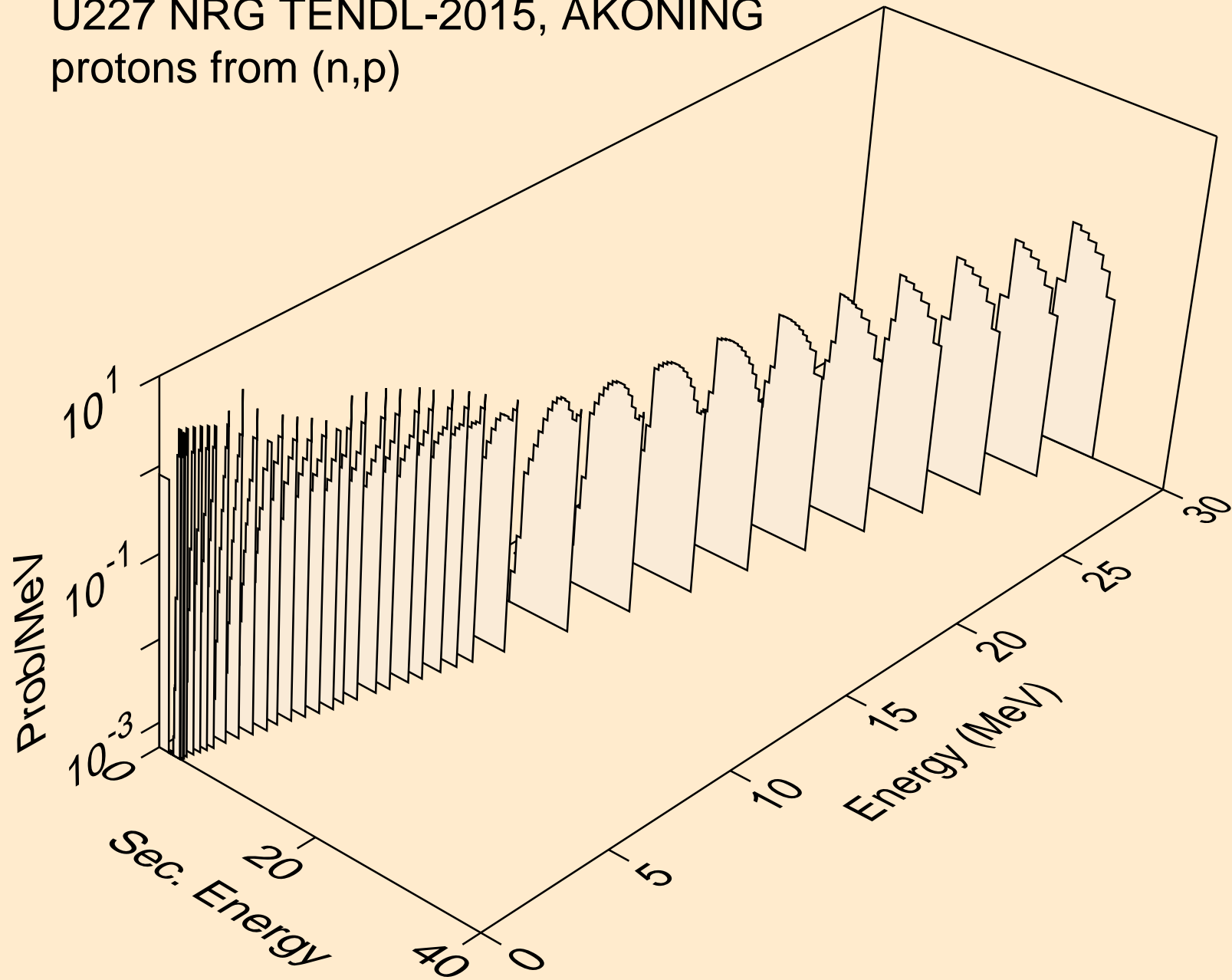

U227 NRG TENDL-2015, AKONING
protons from (n,2p)

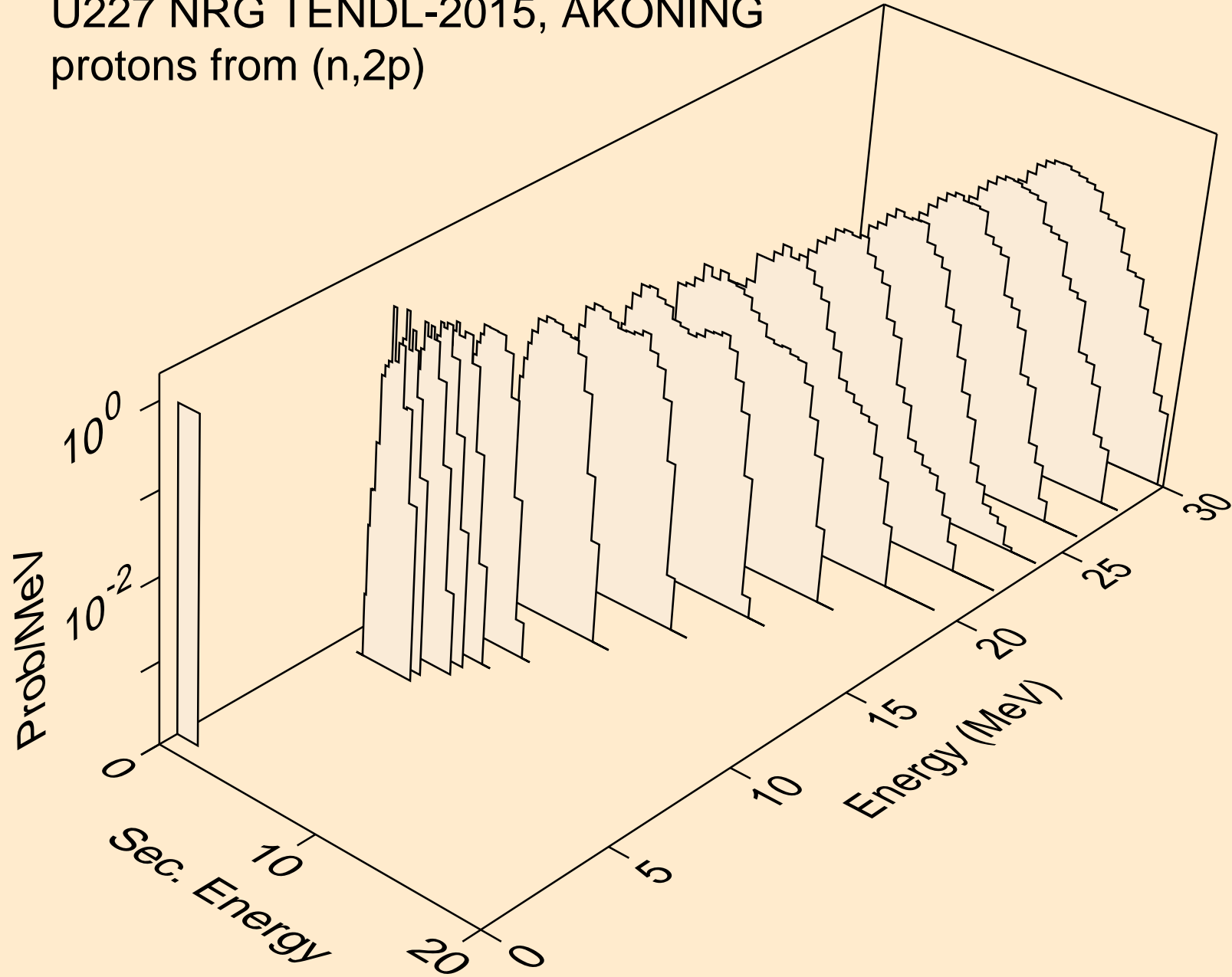

U227 NRG TENDL-2015, AKONING
protons from (n,pa)

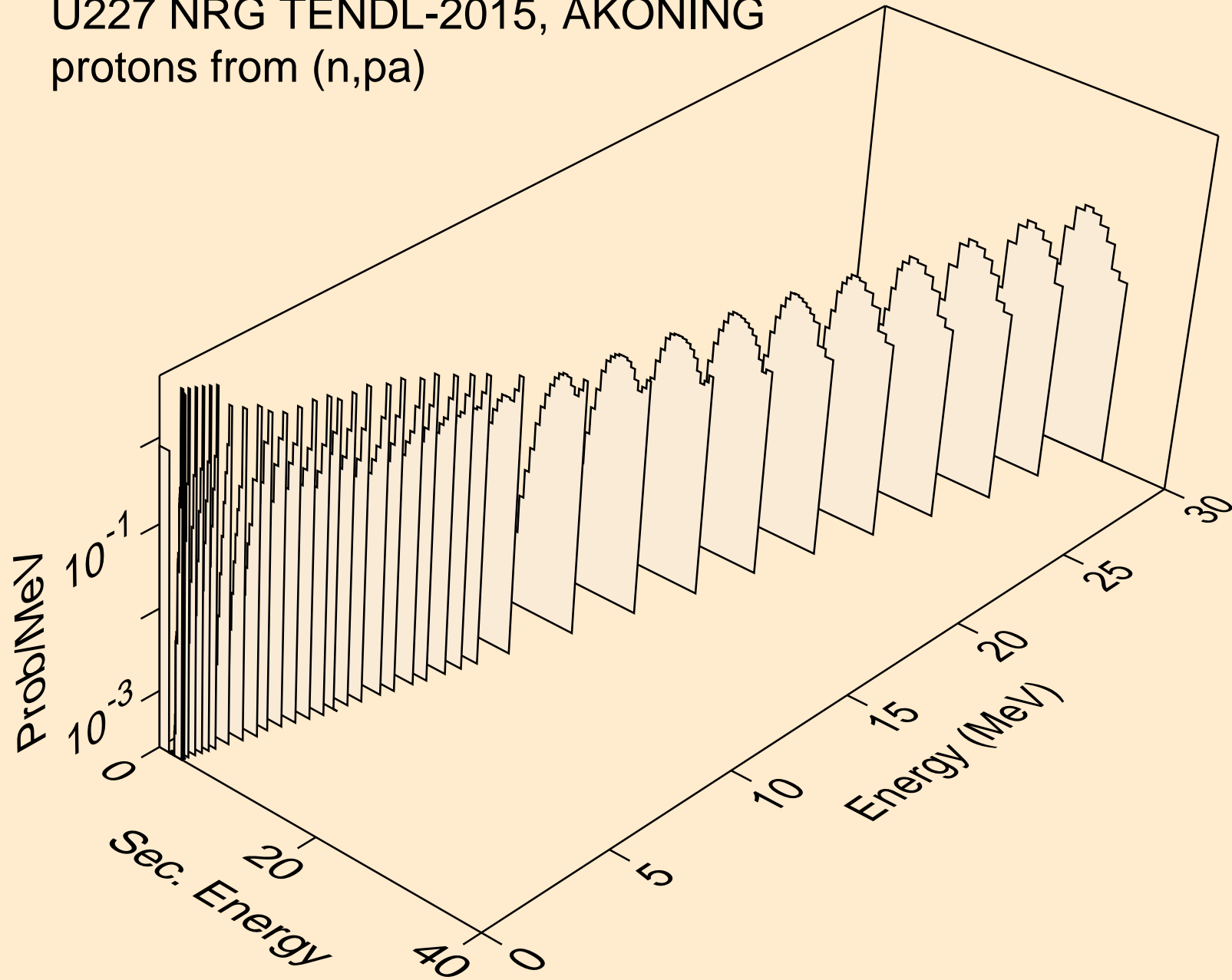

U227 NRG TENDL-2015, AKONING
protons from (n,pd)

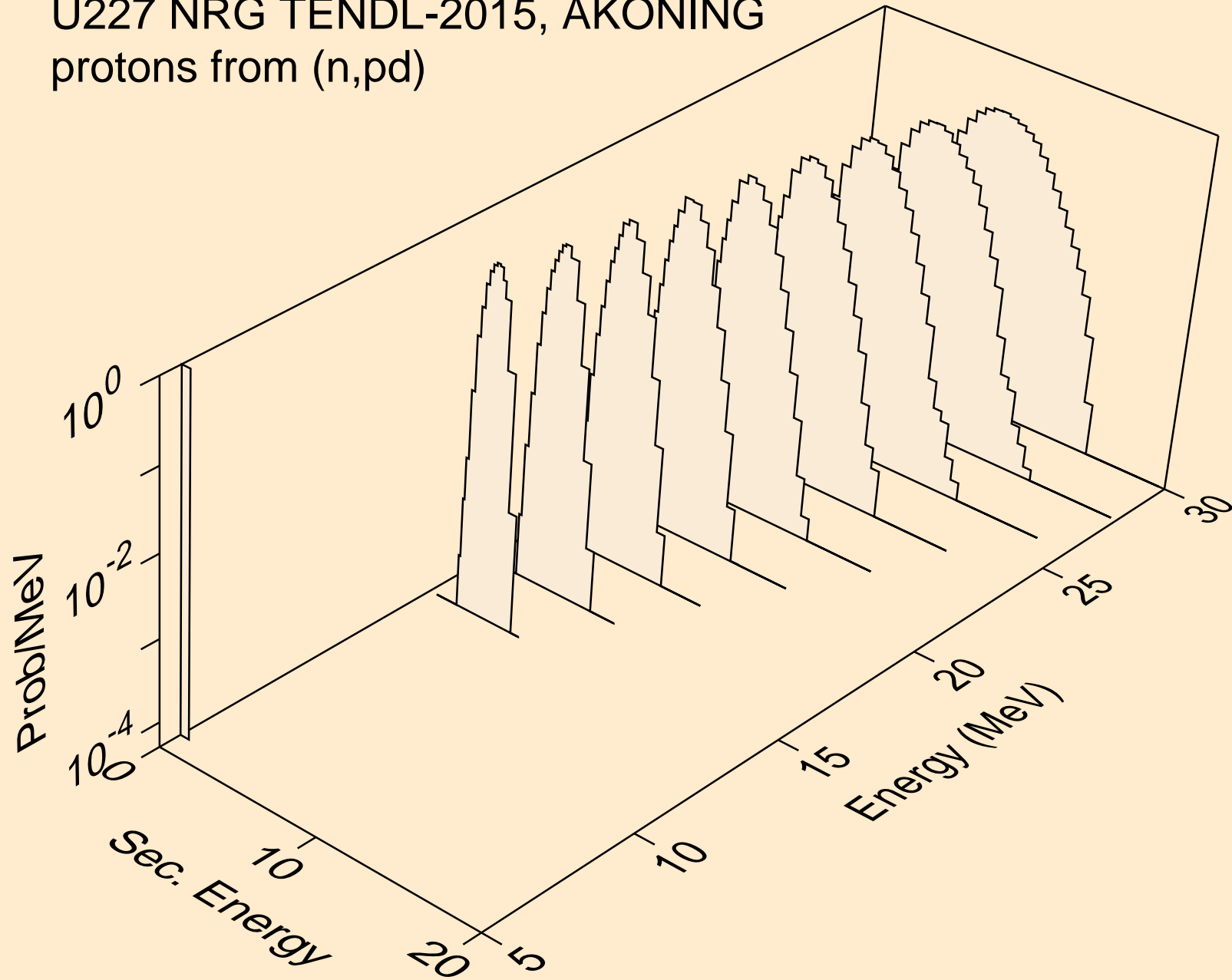

U227 NRG TENDL-2015, AKONING
protons from (n,pt)

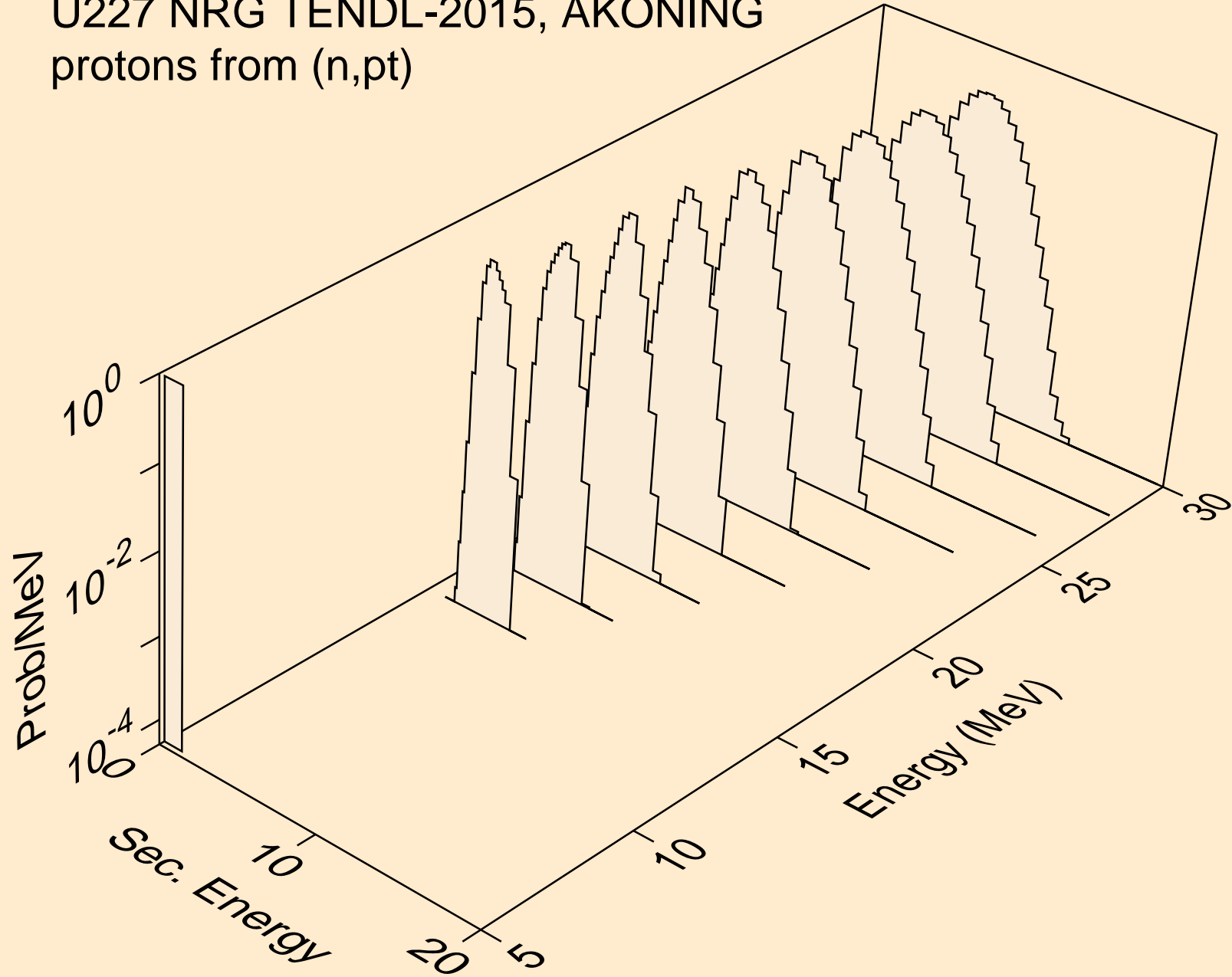

U227 NRG TENDL-2015, AKONING
deuterons from (n,x)

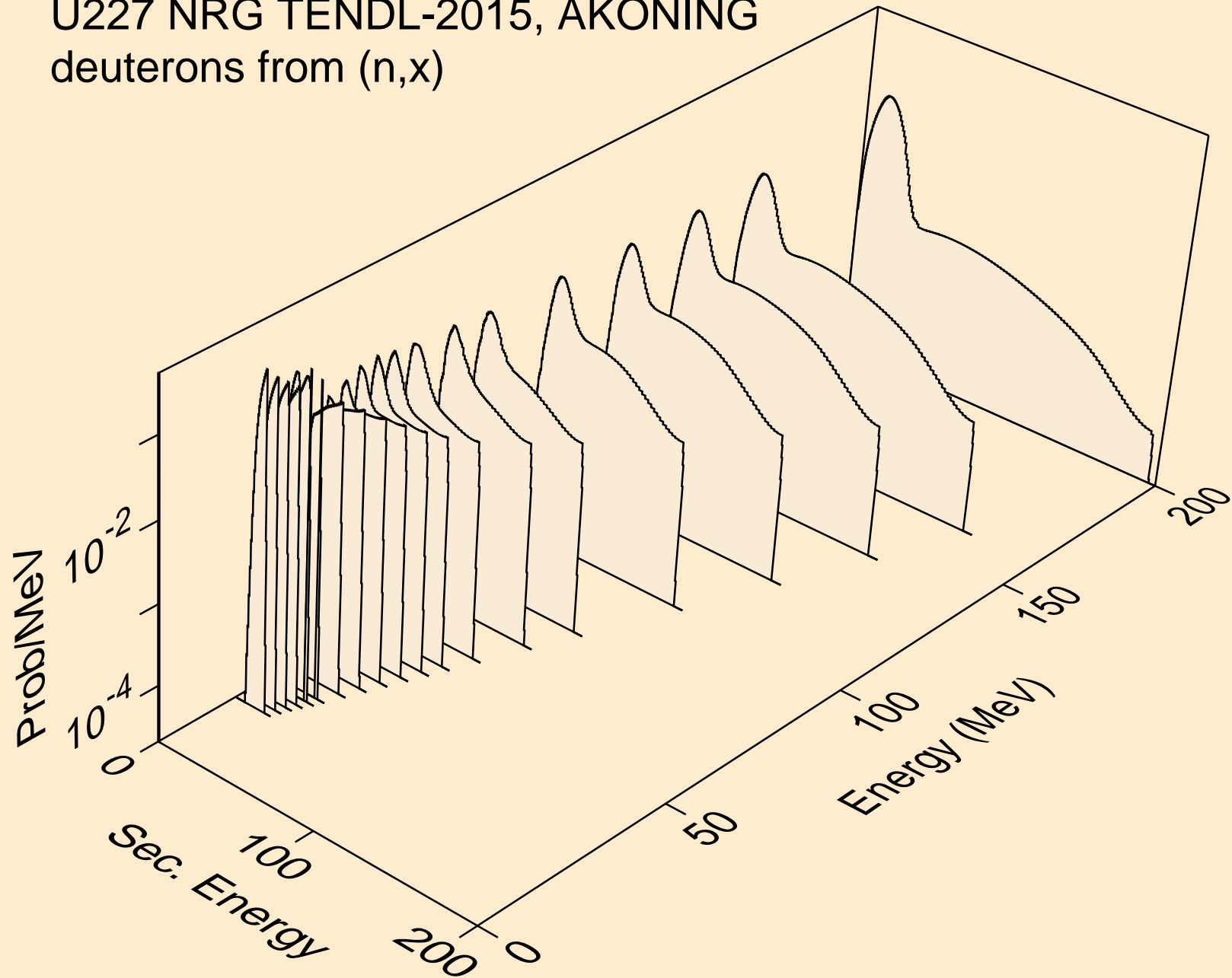

U227 NRG TENDL-2015, AKONING
deuterons from (n,2nd)

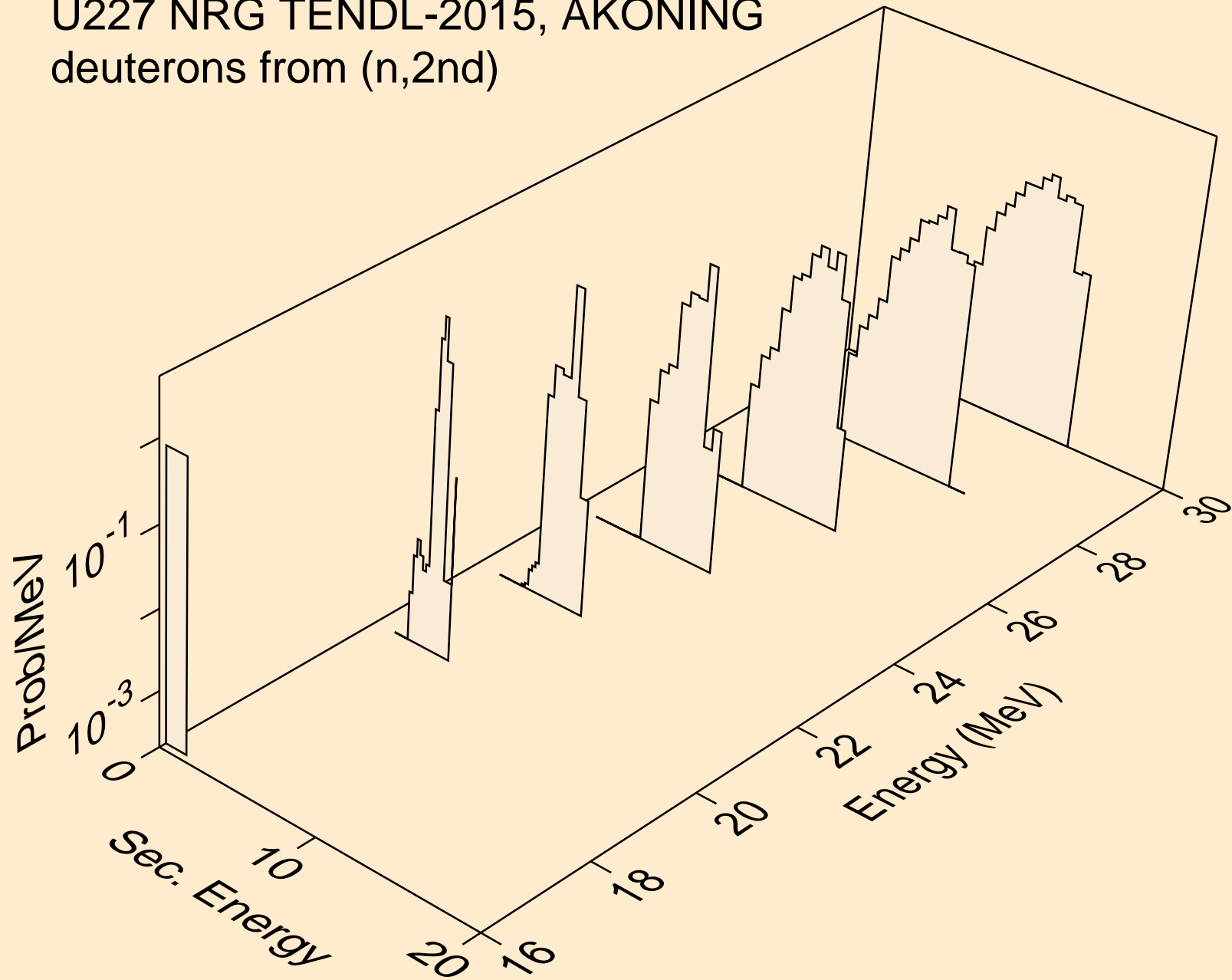

U227 NRG TENDL-2015, AKONING
deuterons from (n,n*)d

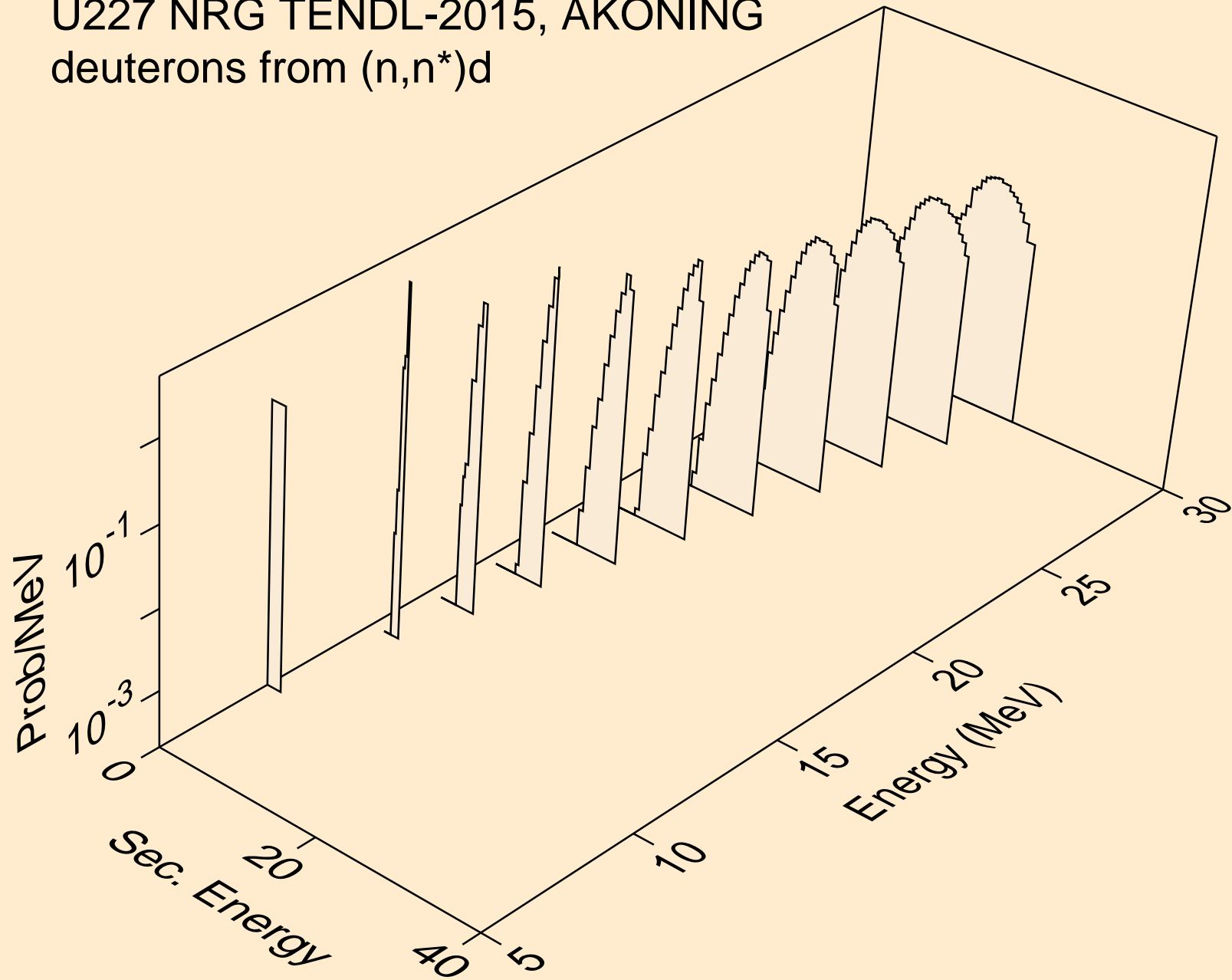

U227 NRG TENDL-2015, AKONING
deuterons from (n,n*)d2a

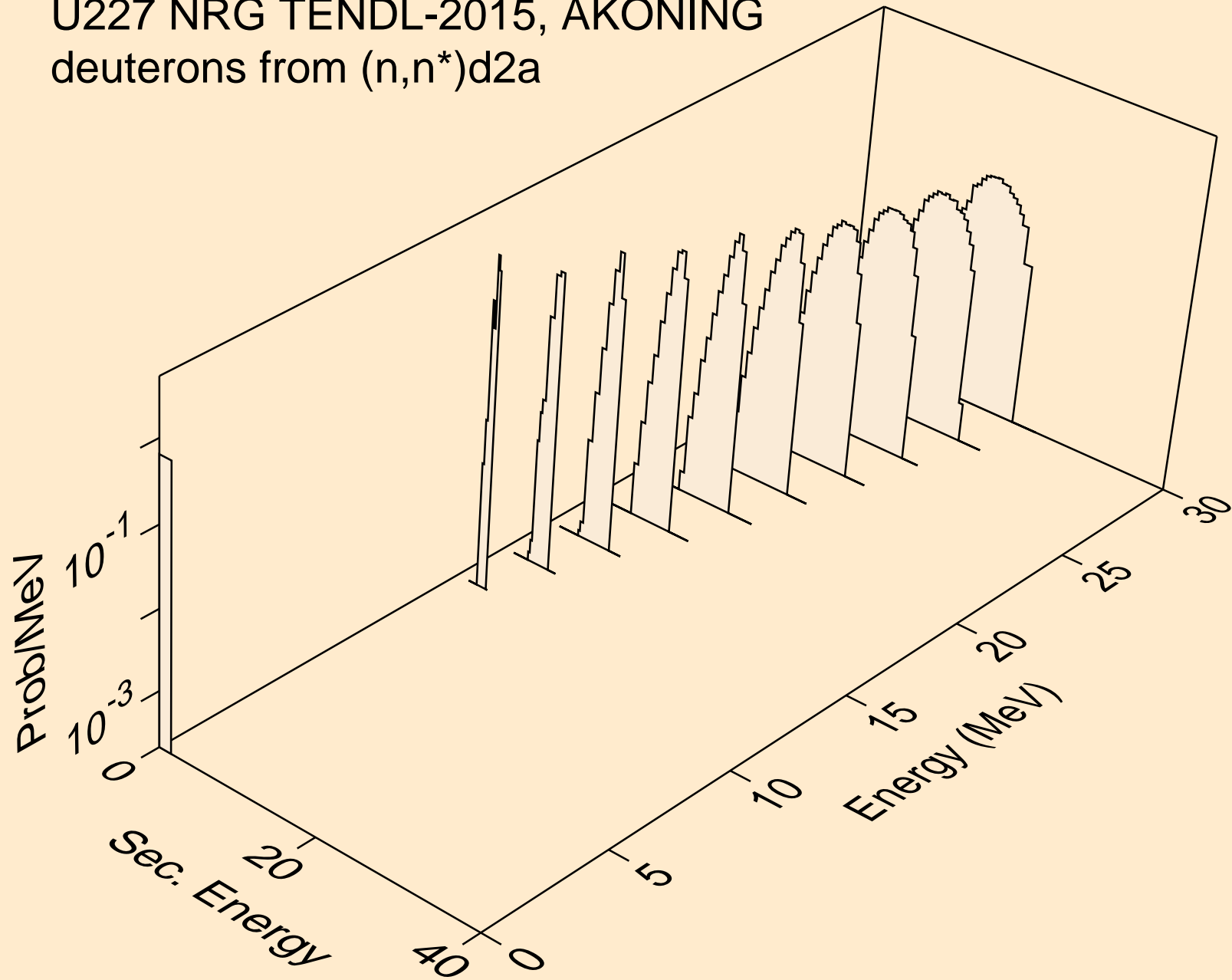

U227 NRG TENDL-2015, AKONING
deuterons from (n,d)

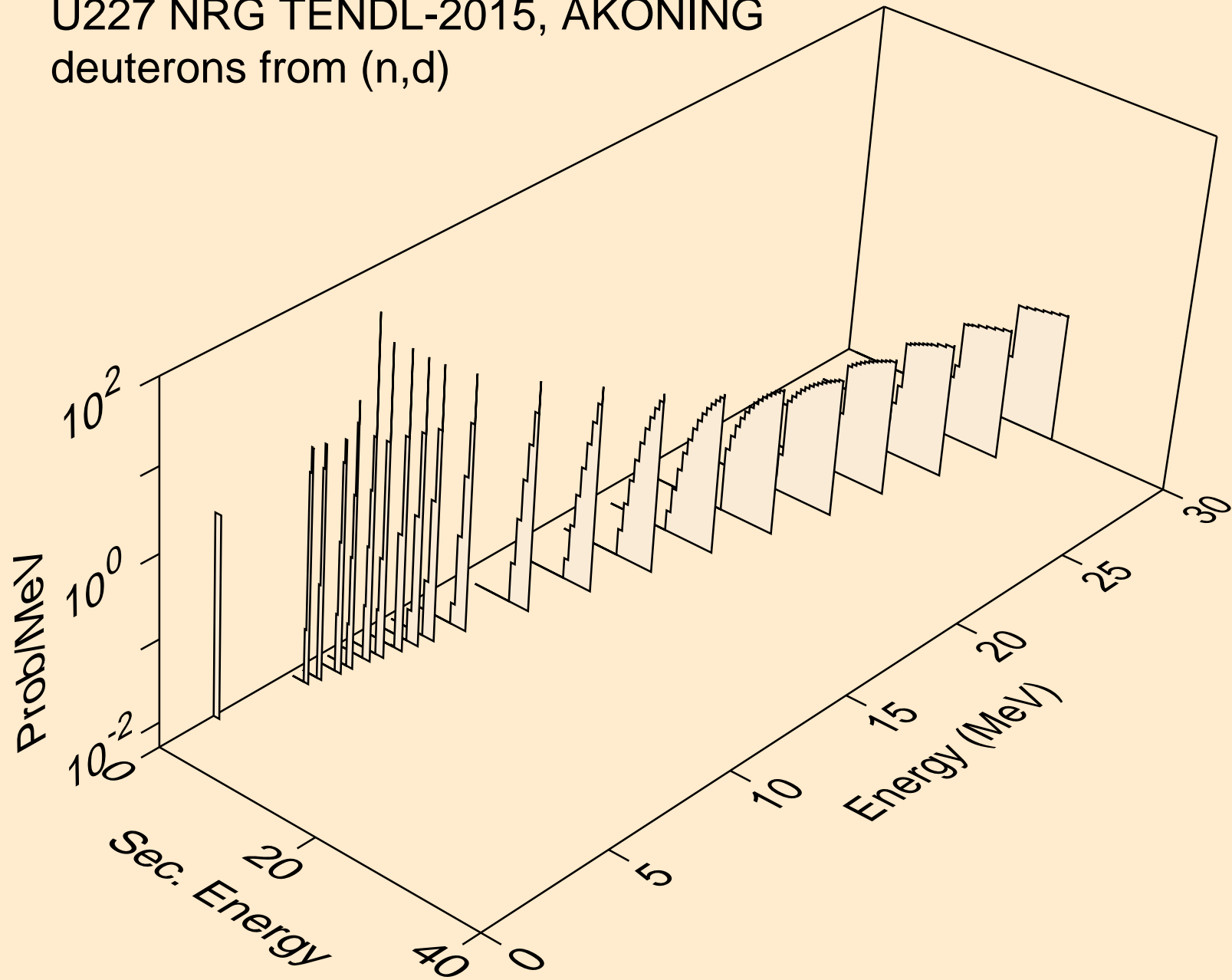

U227 NRG TENDL-2015, AKONING
deuterons from (n,d2a)

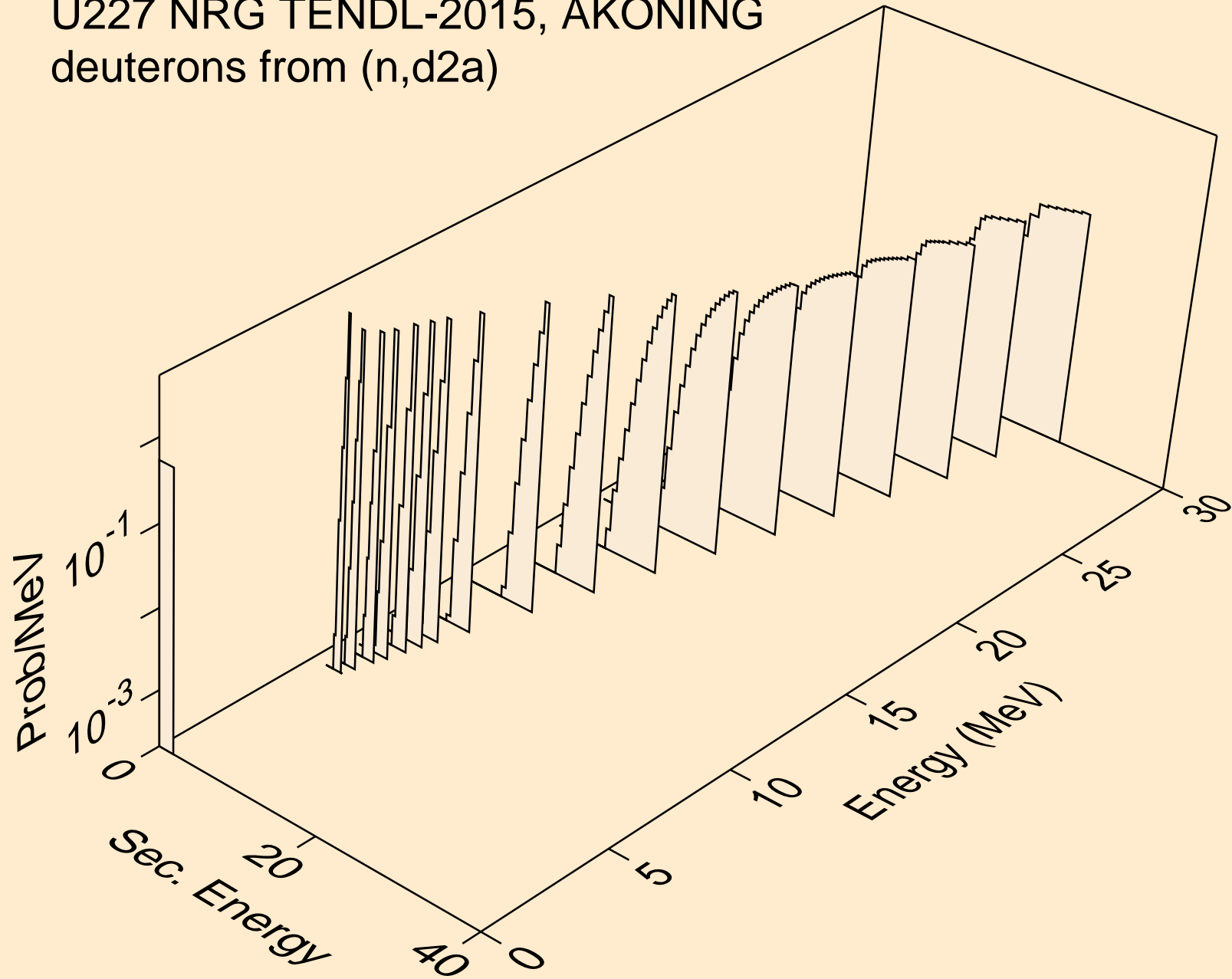

U227 NRG TENDL-2015, AKONING
deuterons from (n,pd)

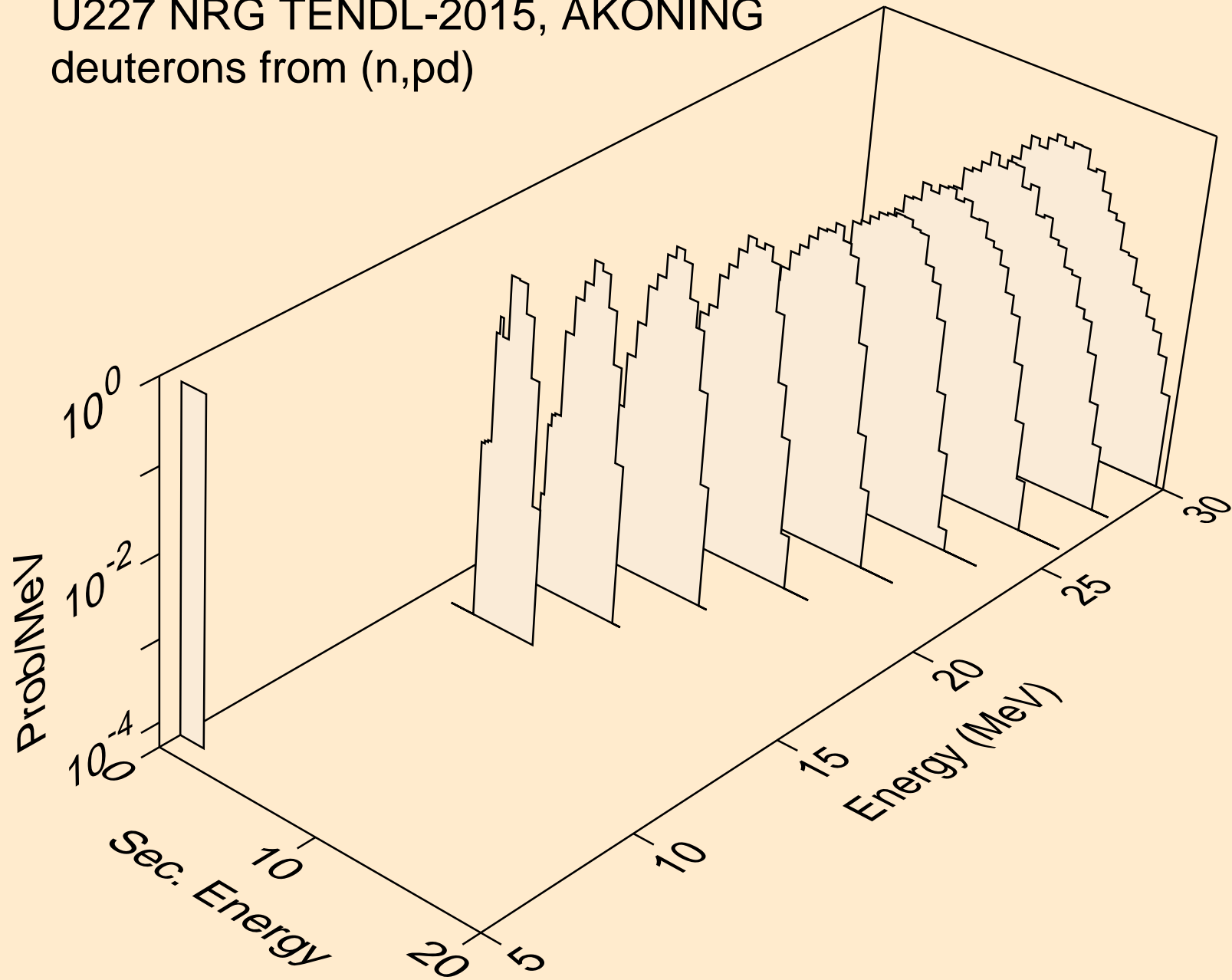

U227 NRG TENDL-2015, AKONING
deuterons from (n,da)

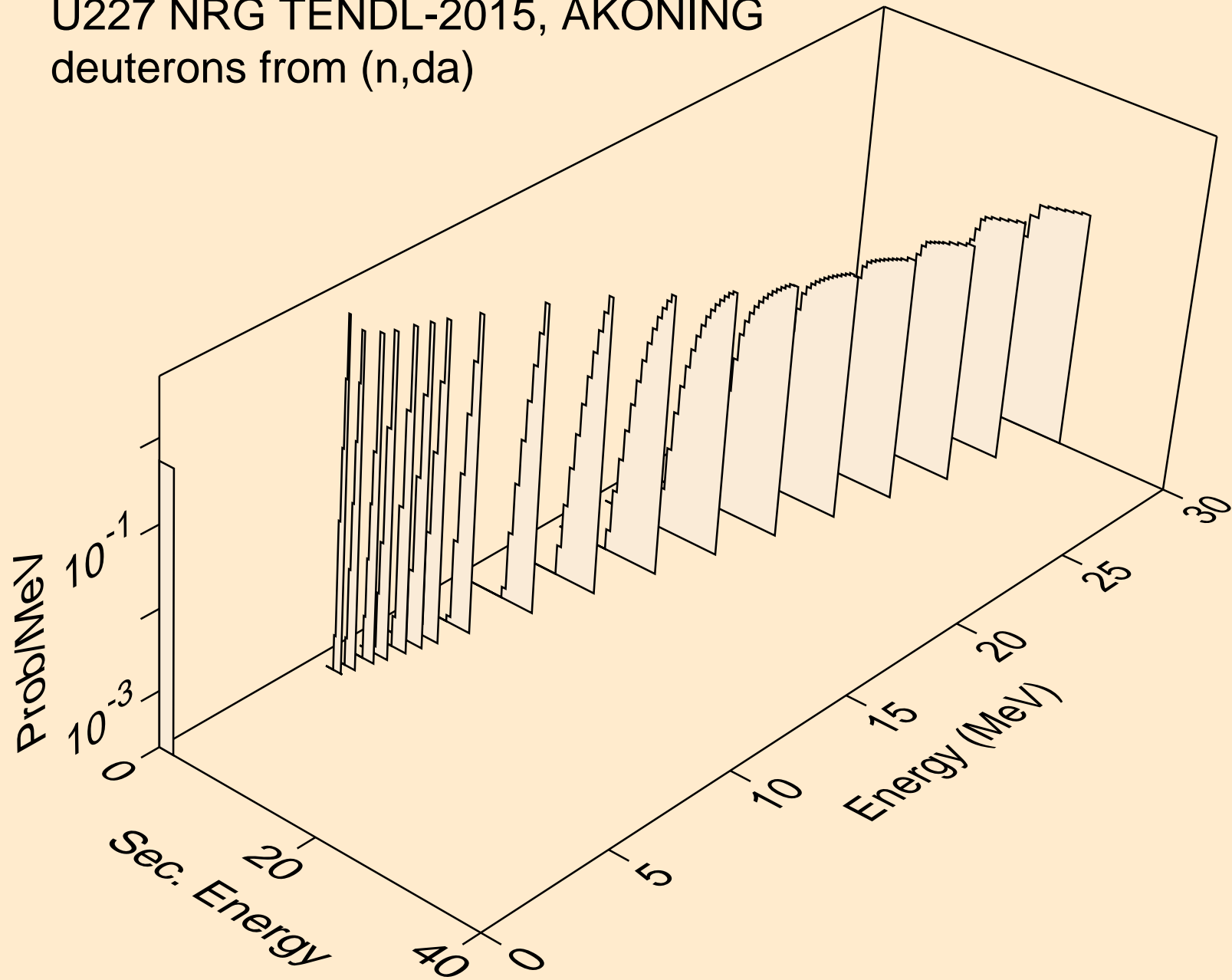

U227 NRG TENDL-2015, AKONING
tritons from (n,x)

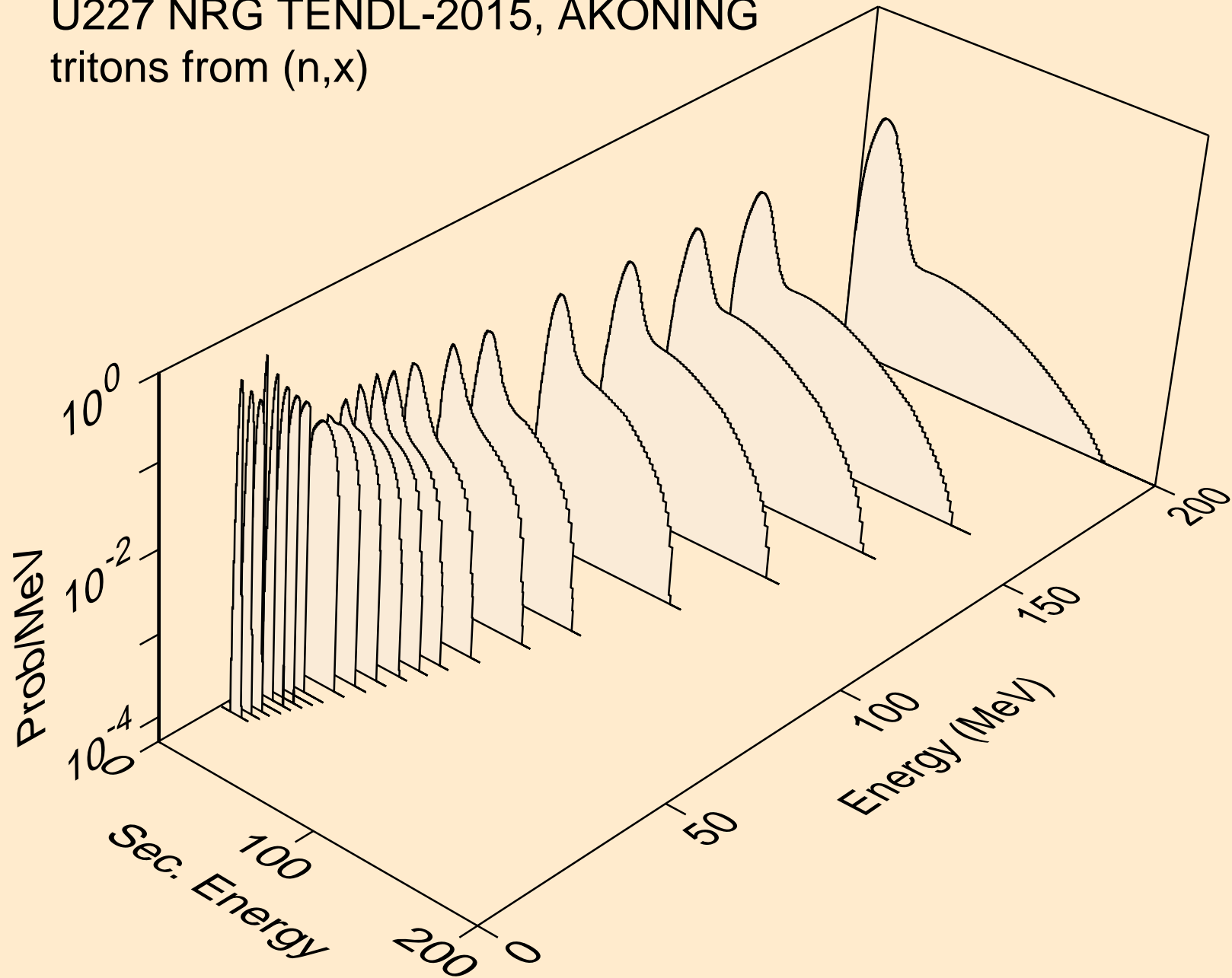

U227 NRG TENDL-2015, AKONING
tritons from (n,n*)t

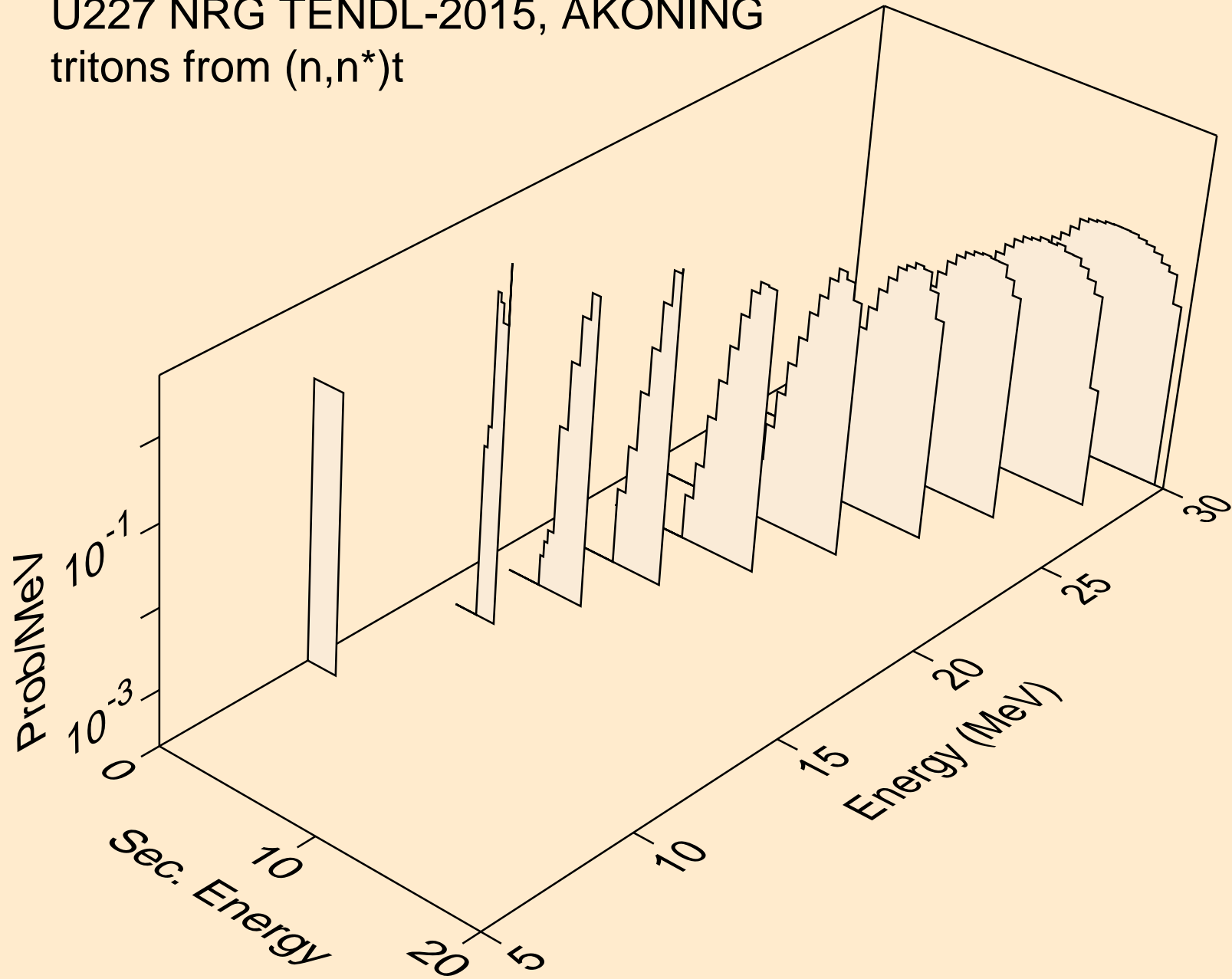

U227 NRG TENDL-2015, AKONING
tritons from (n,n*)t2a

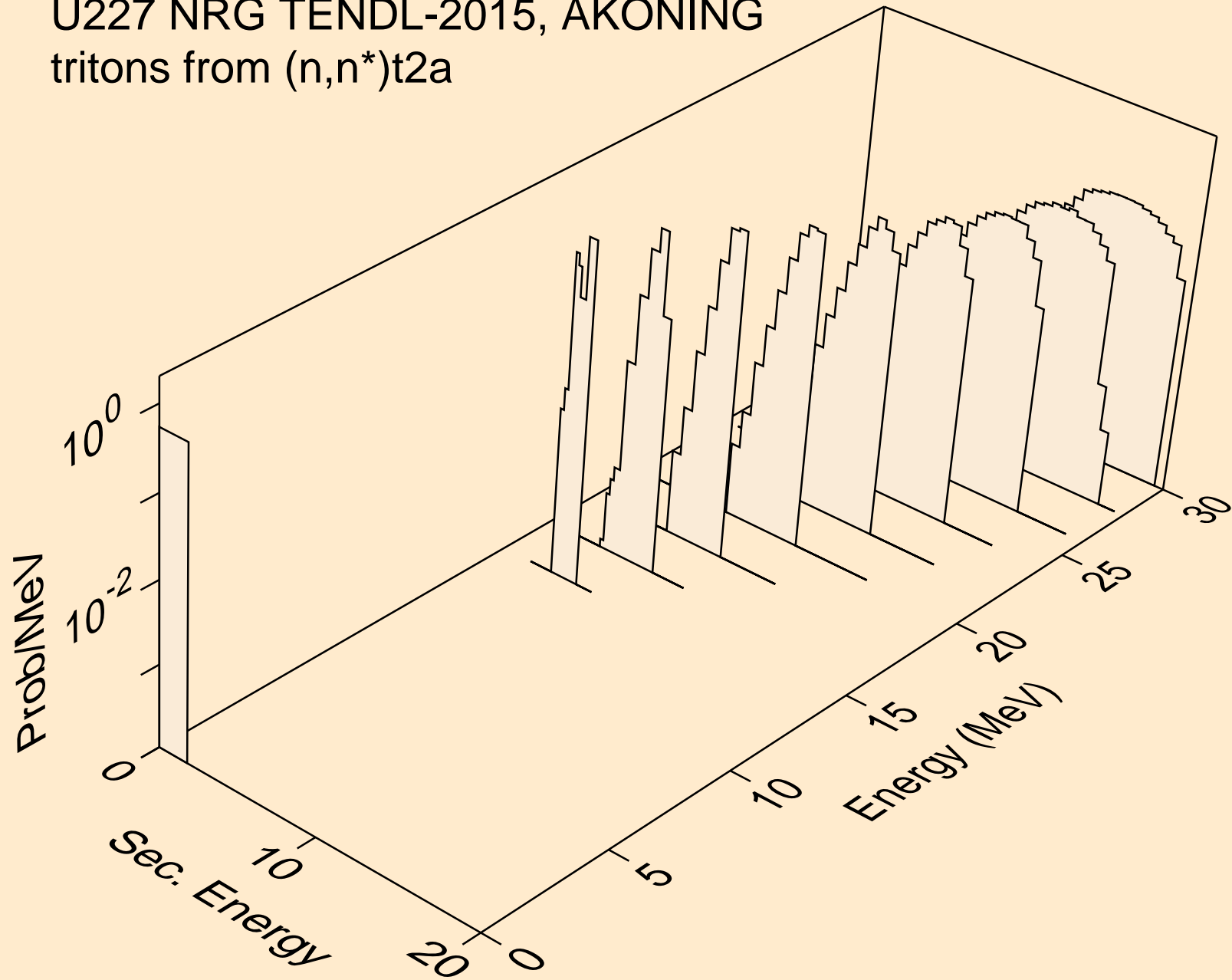

U227 NRG TENDL-2015, AKONING
tritons from (n,t)

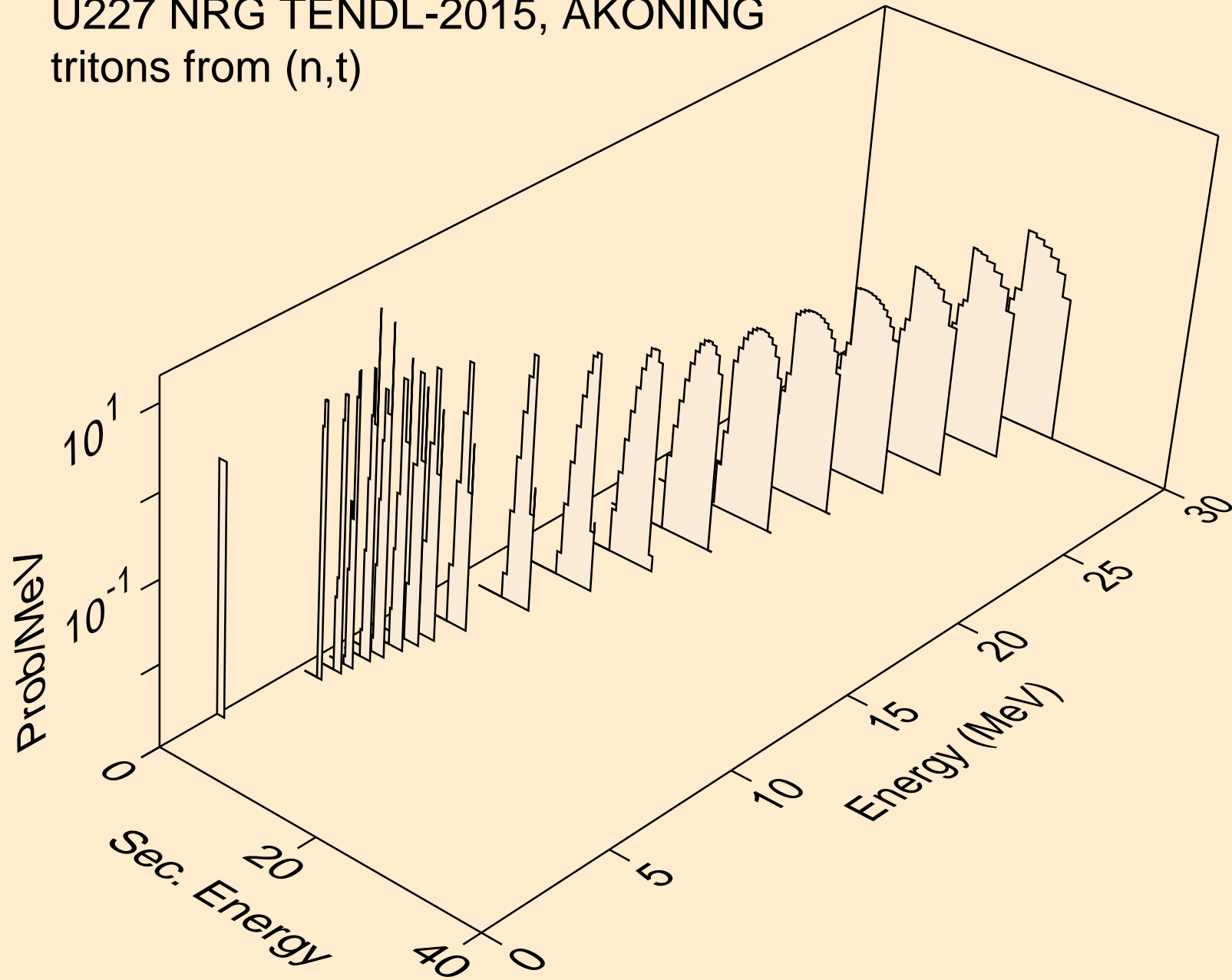

U227 NRG TENDL-2015, AKONING
tritons from (n,t2a)

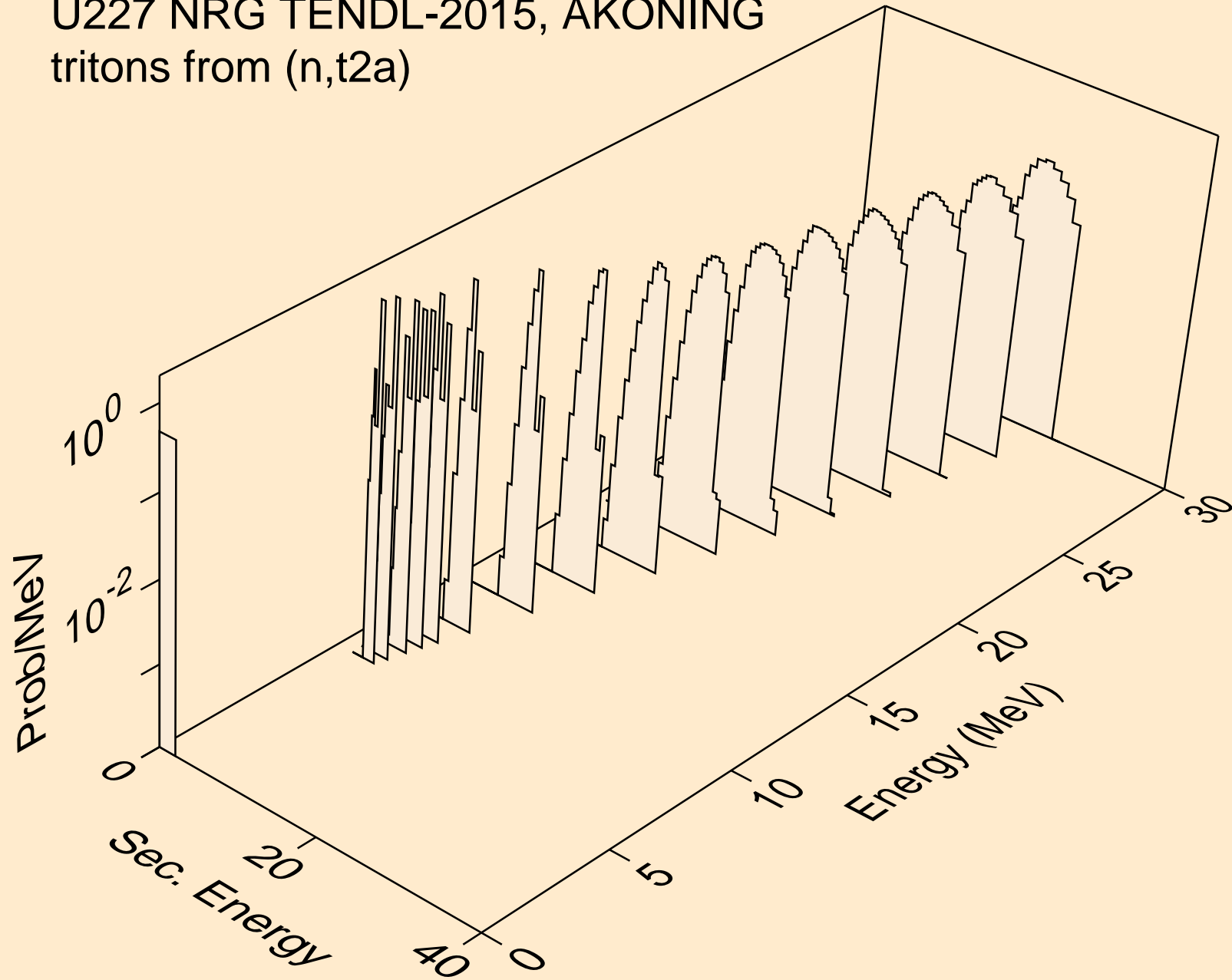

U227 NRG TENDL-2015, AKONING
tritons from (n,pt)

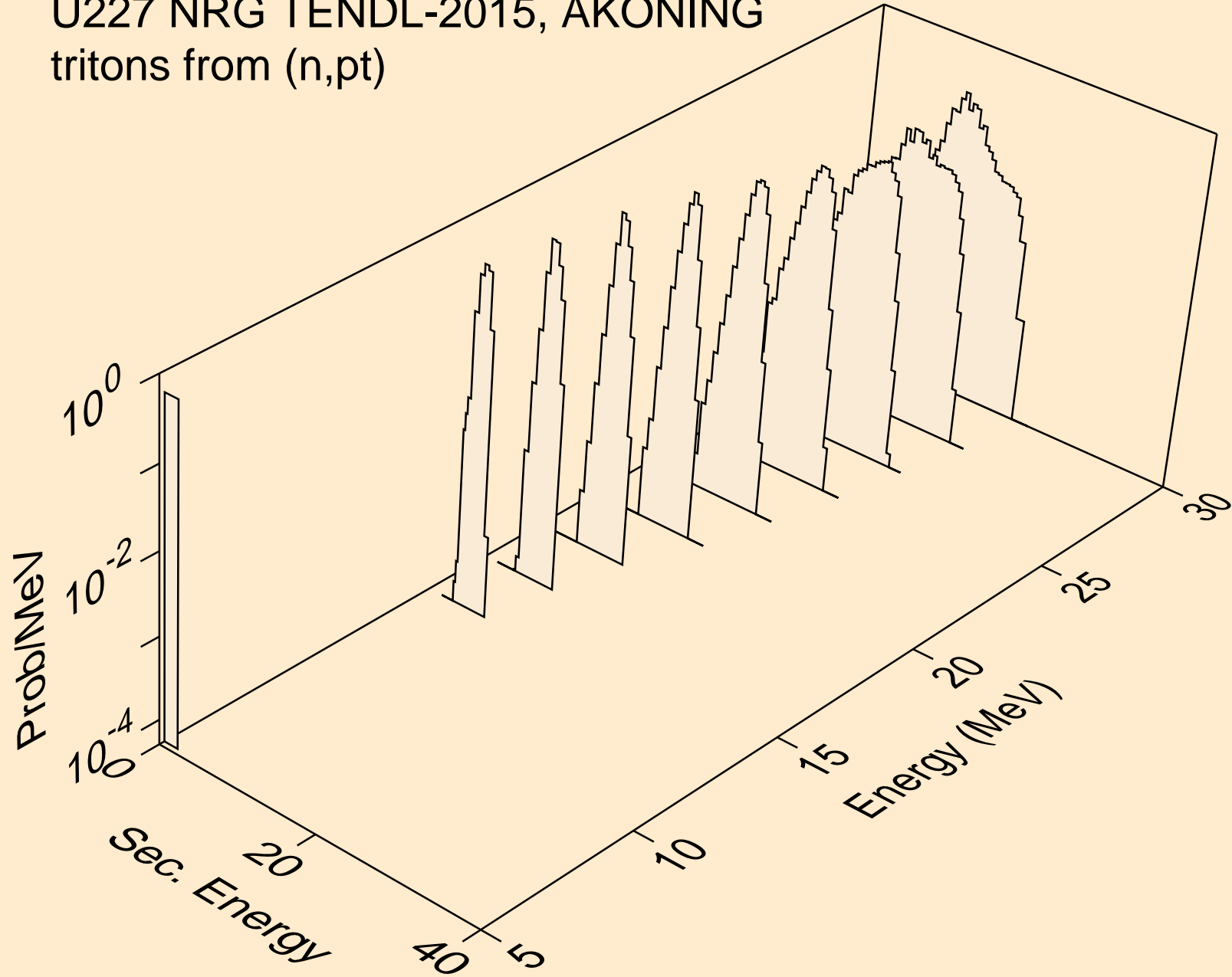

U227 NRG TENDL-2015, AKONING
he3s from (n,x)

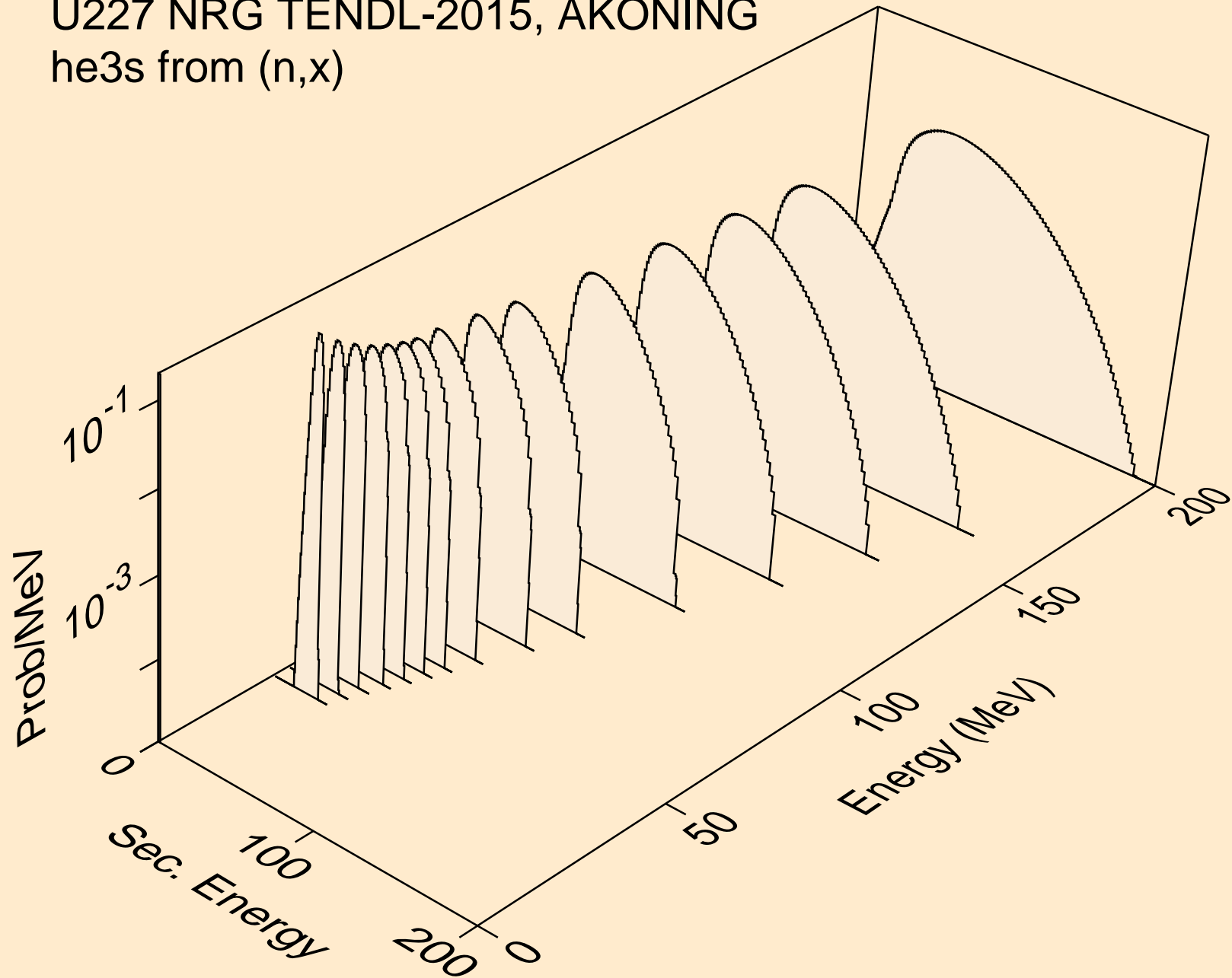

U227 NRG TENDL-2015, AKONING
he3s from (n,n*)he3

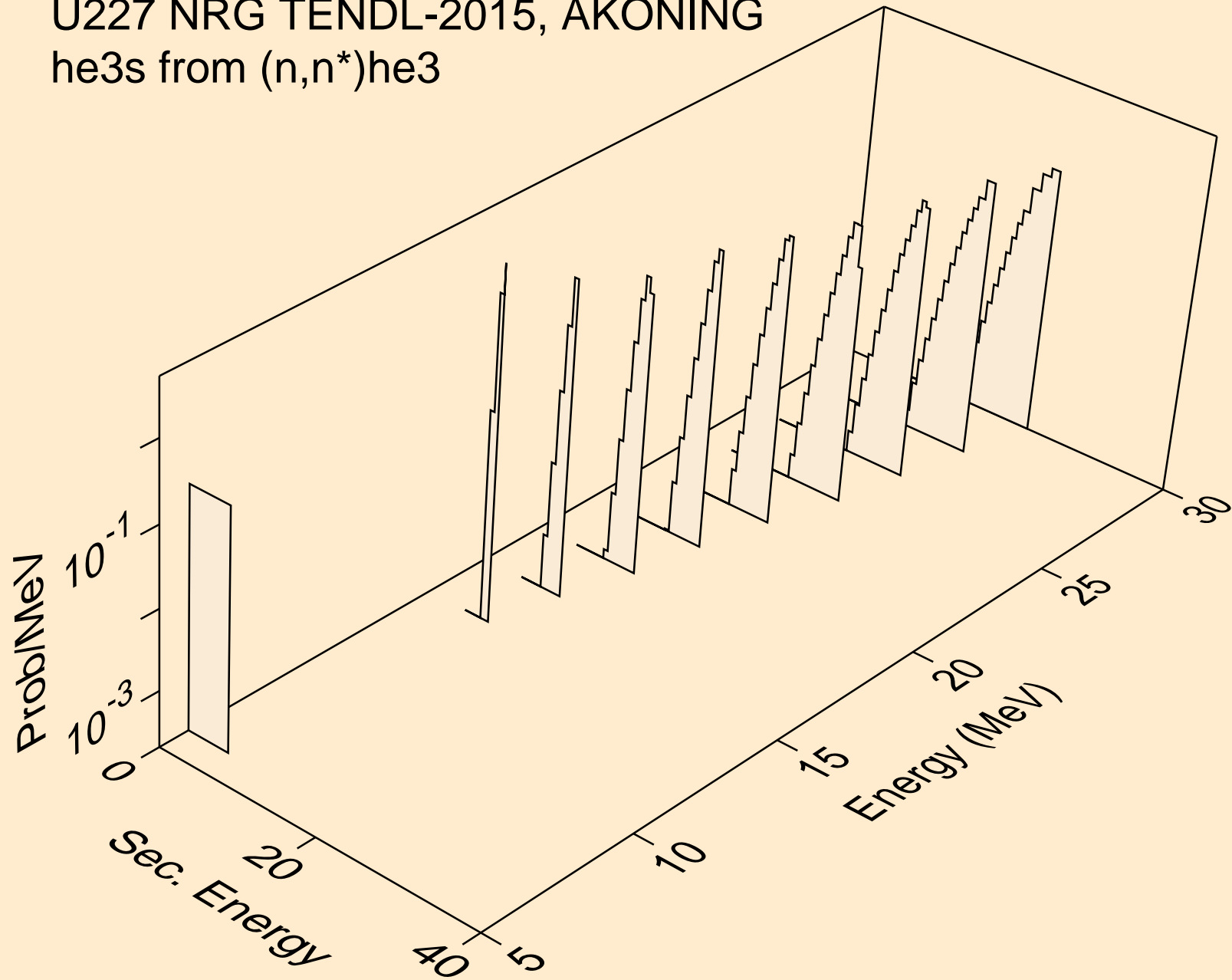

U227 NRG TENDL-2015, AKONING
he3s from (n,he3)

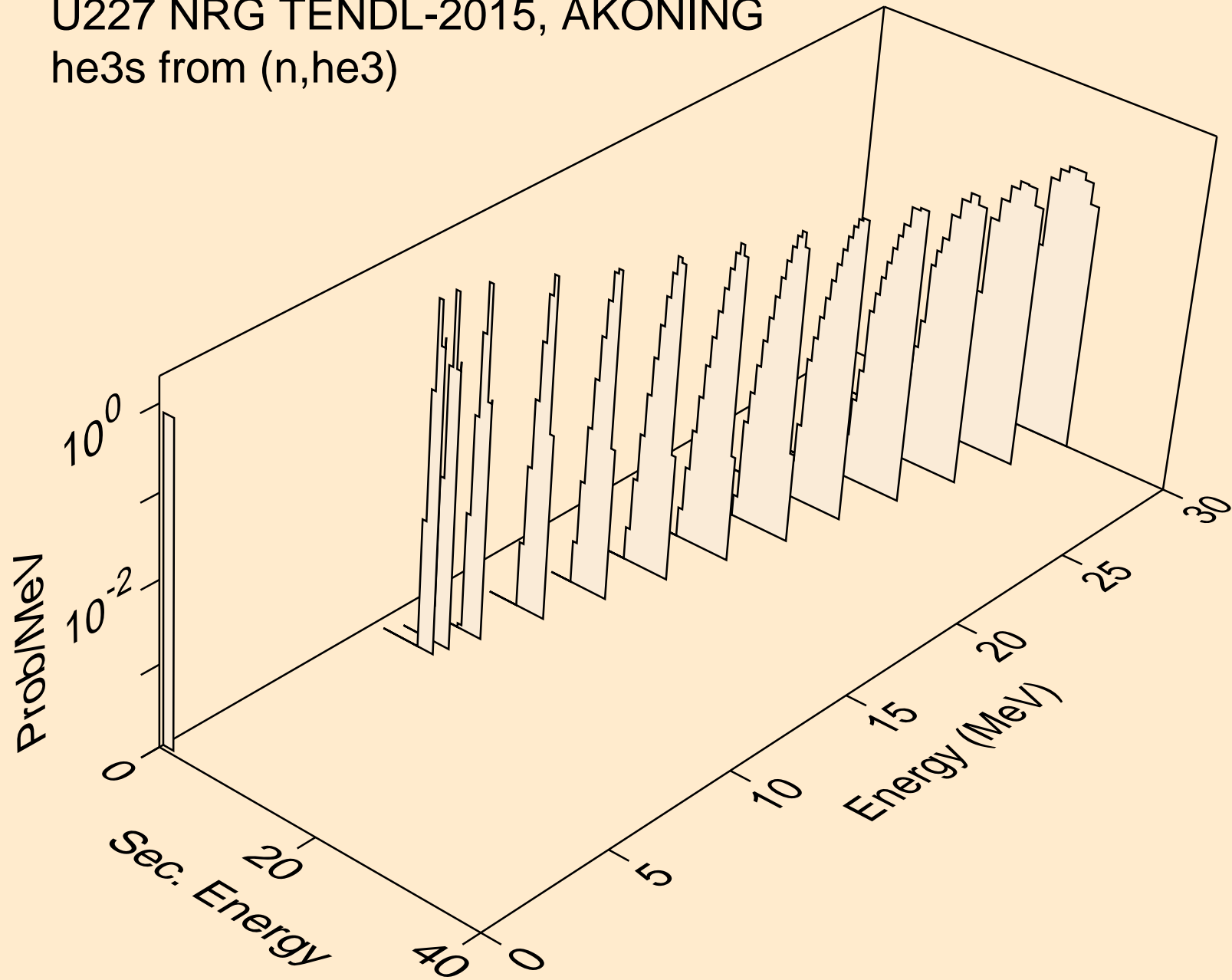

U227 NRG TENDL-2015, AKONING
alphas from (n,x)

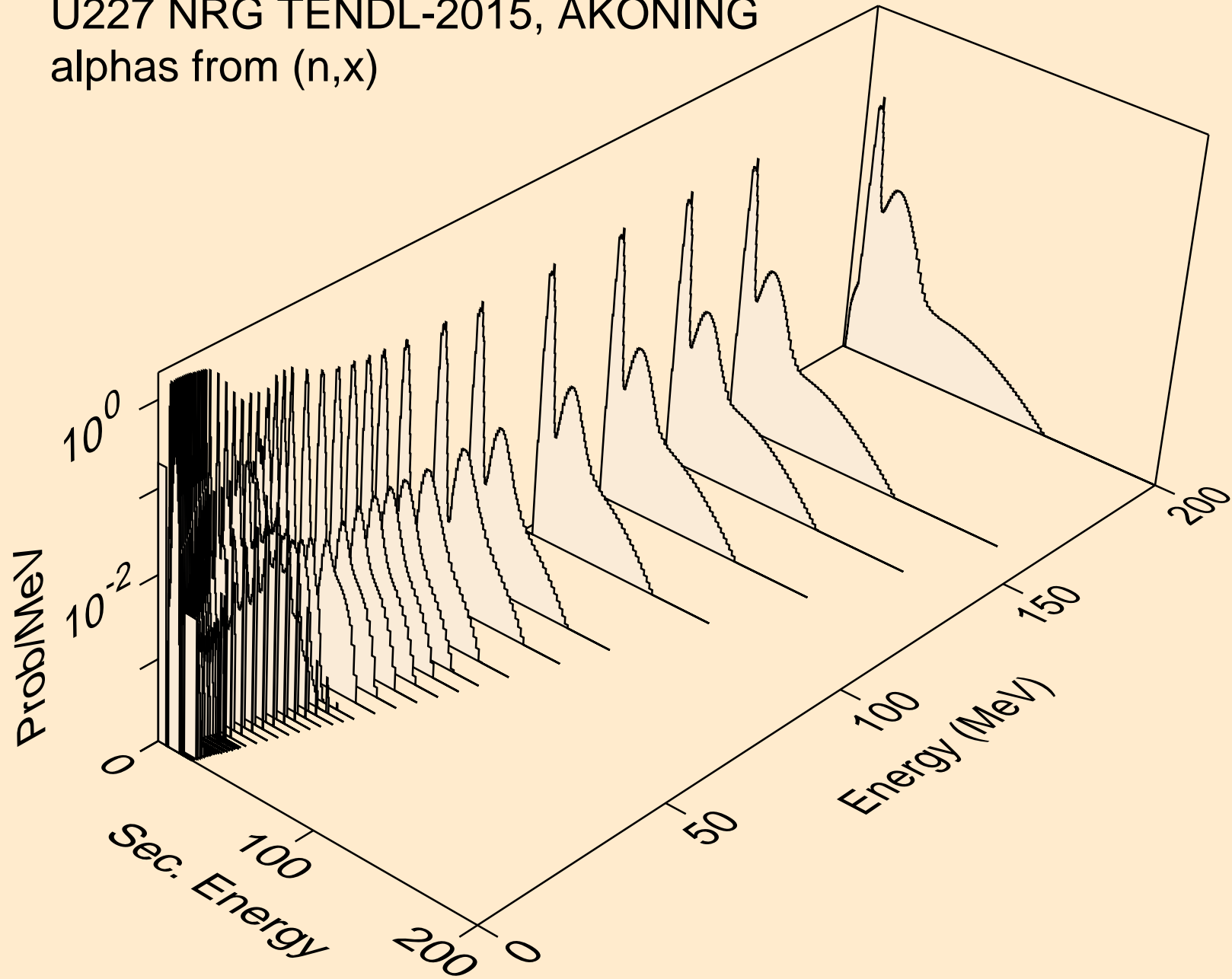

U227 NRG TENDL-2015, AKONING
alphas from (n,n*)a

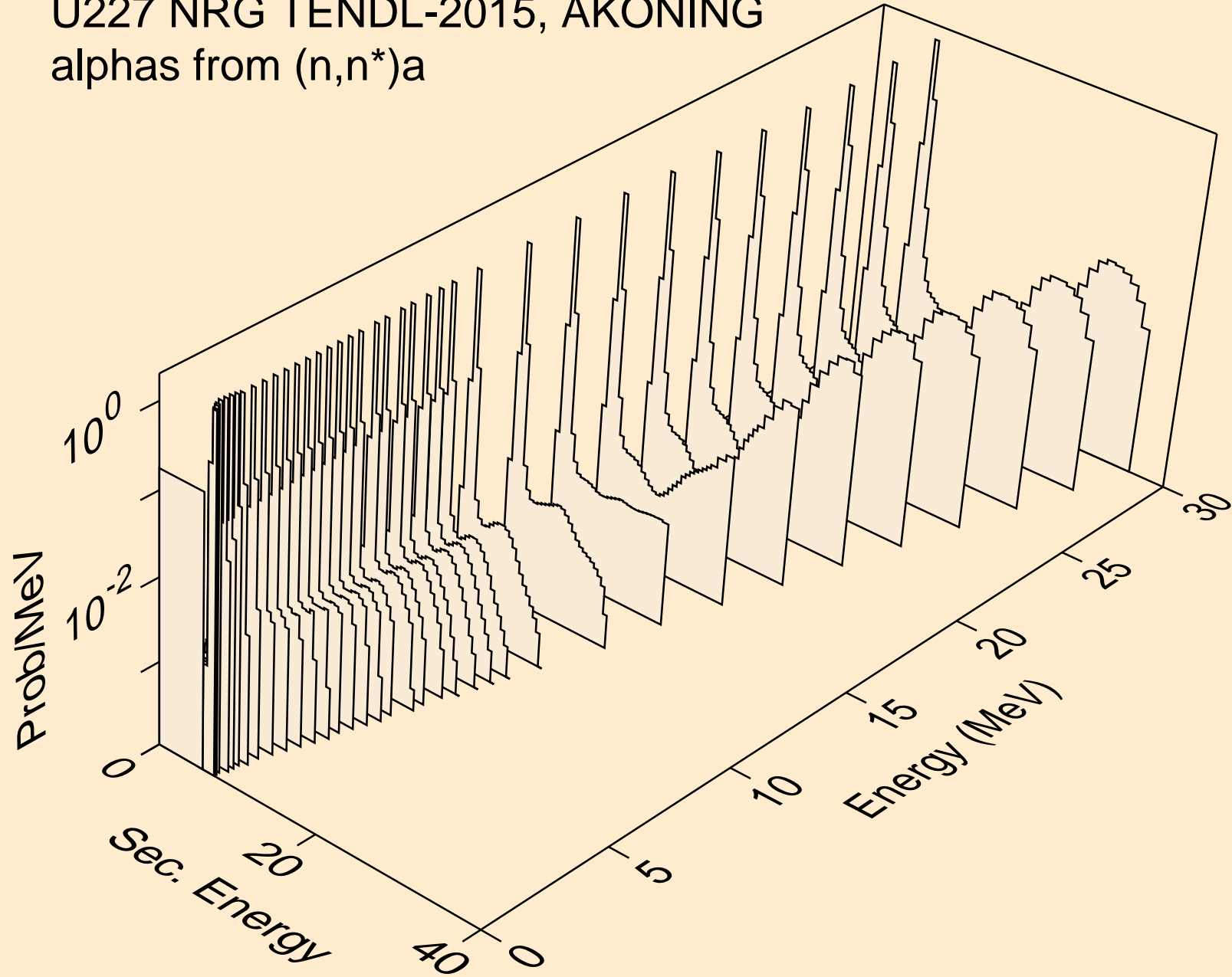

U227 NRG TENDL-2015, AKONING
alphas from (n,n*)3a

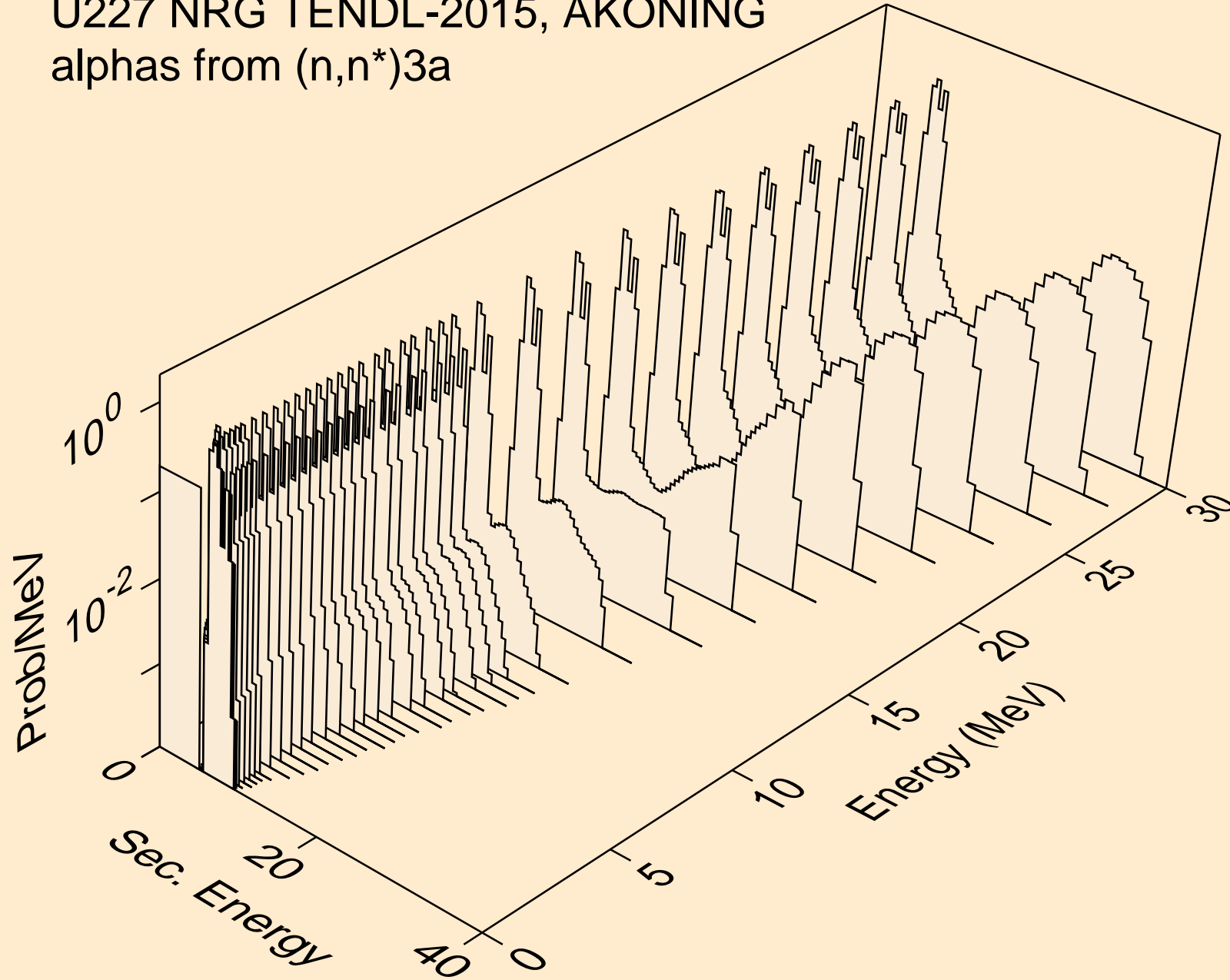

U227 NRG TENDL-2015, AKONING
alphas from (n,2n)a

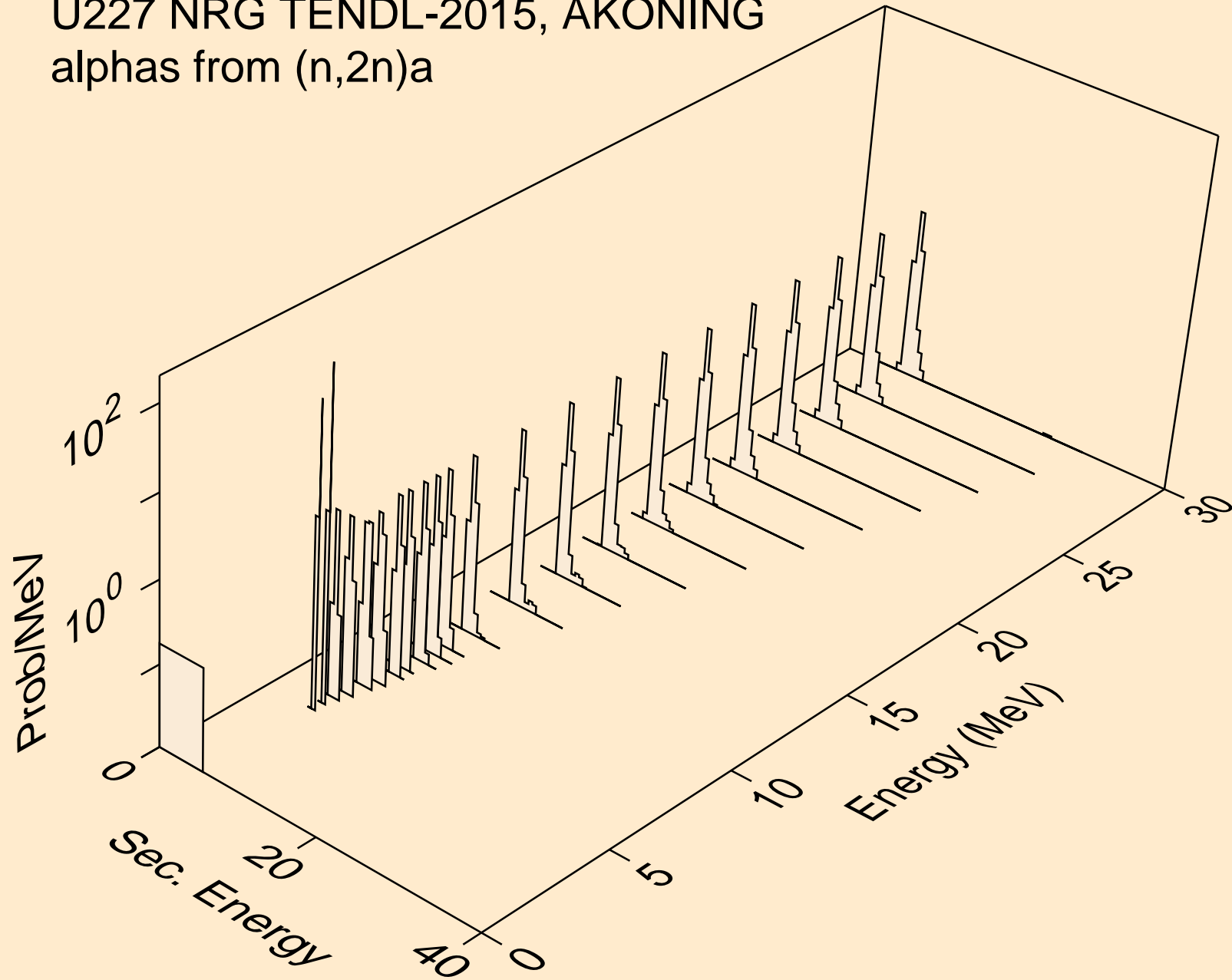

U227 NRG TENDL-2015, AKONING
alphas from (n,3n)a

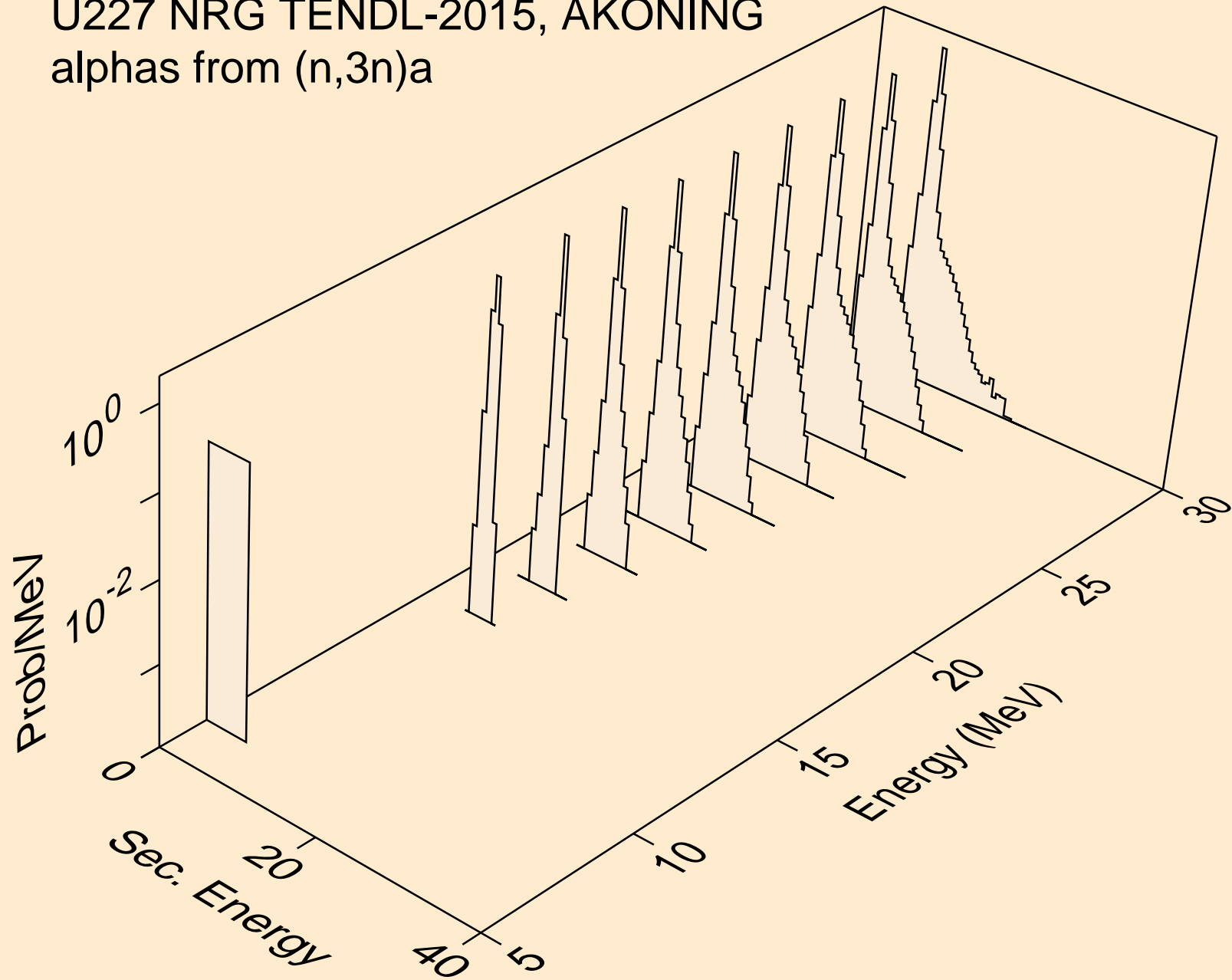

U227 NRG TENDL-2015, AKONING
alphas from (n,n*)2a

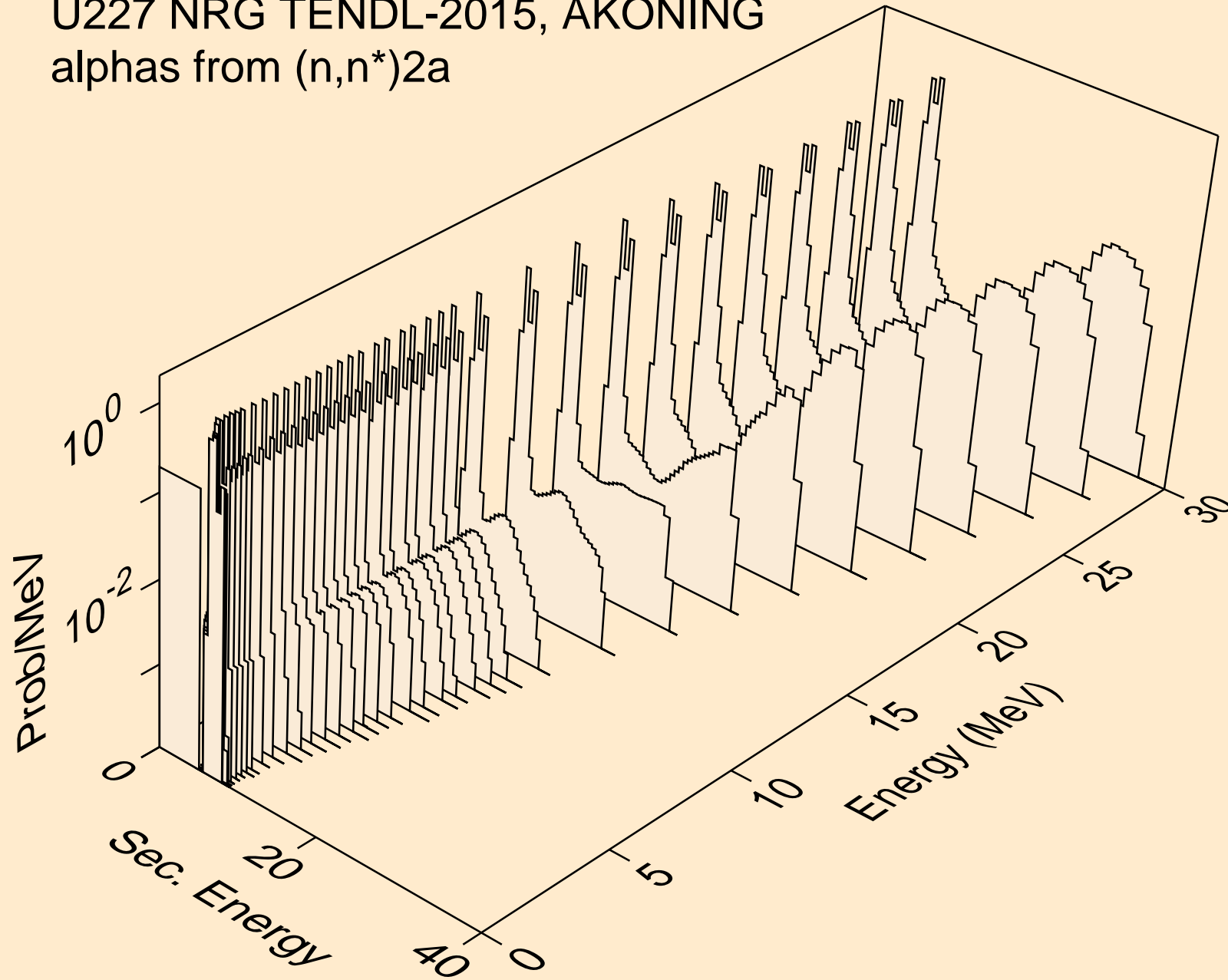

U227 NRG TENDL-2015, AKONING
alphas from (n,2n)2a

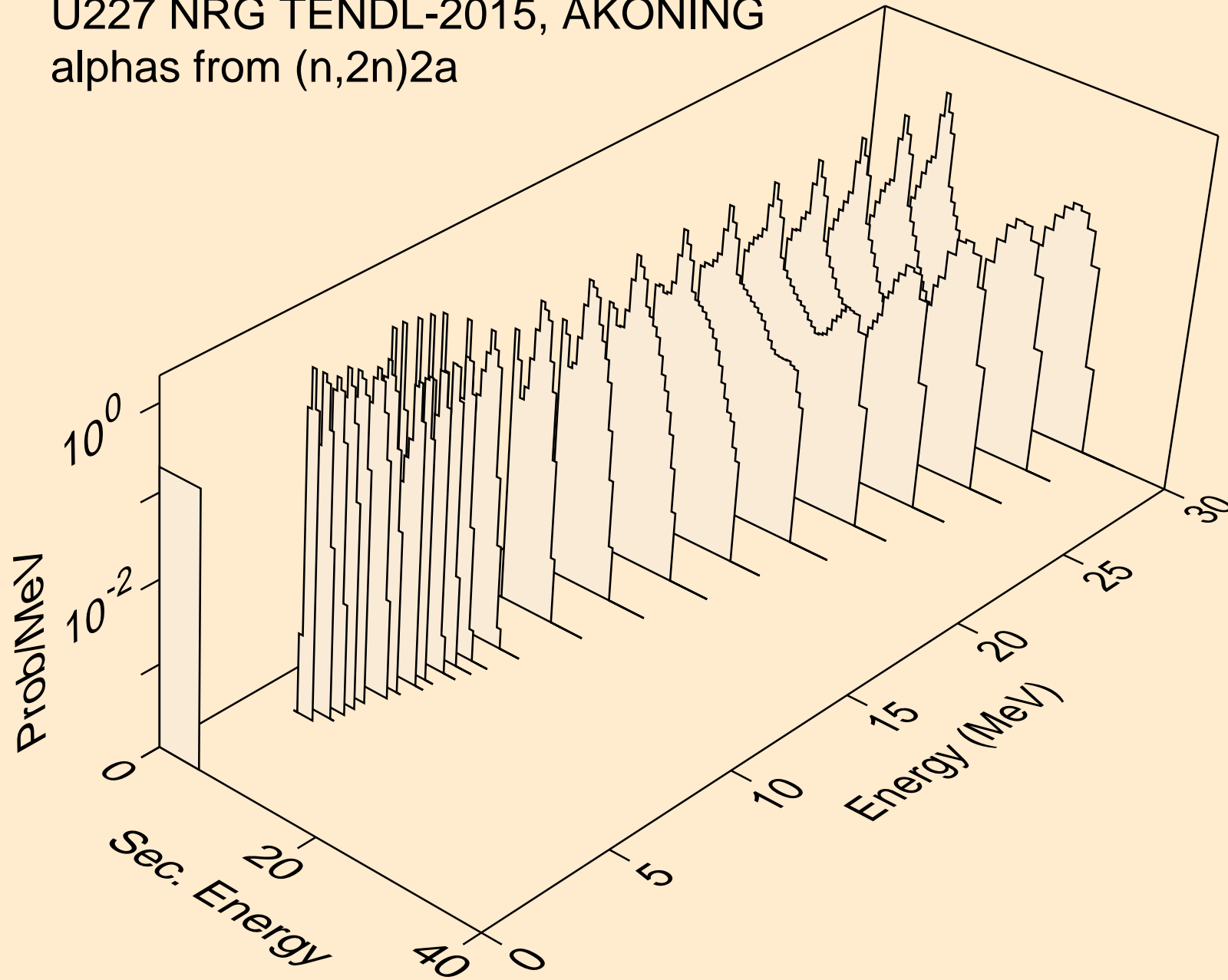

U227 NRG TENDL-2015, AKONING
alphas from (n,n*)d2a

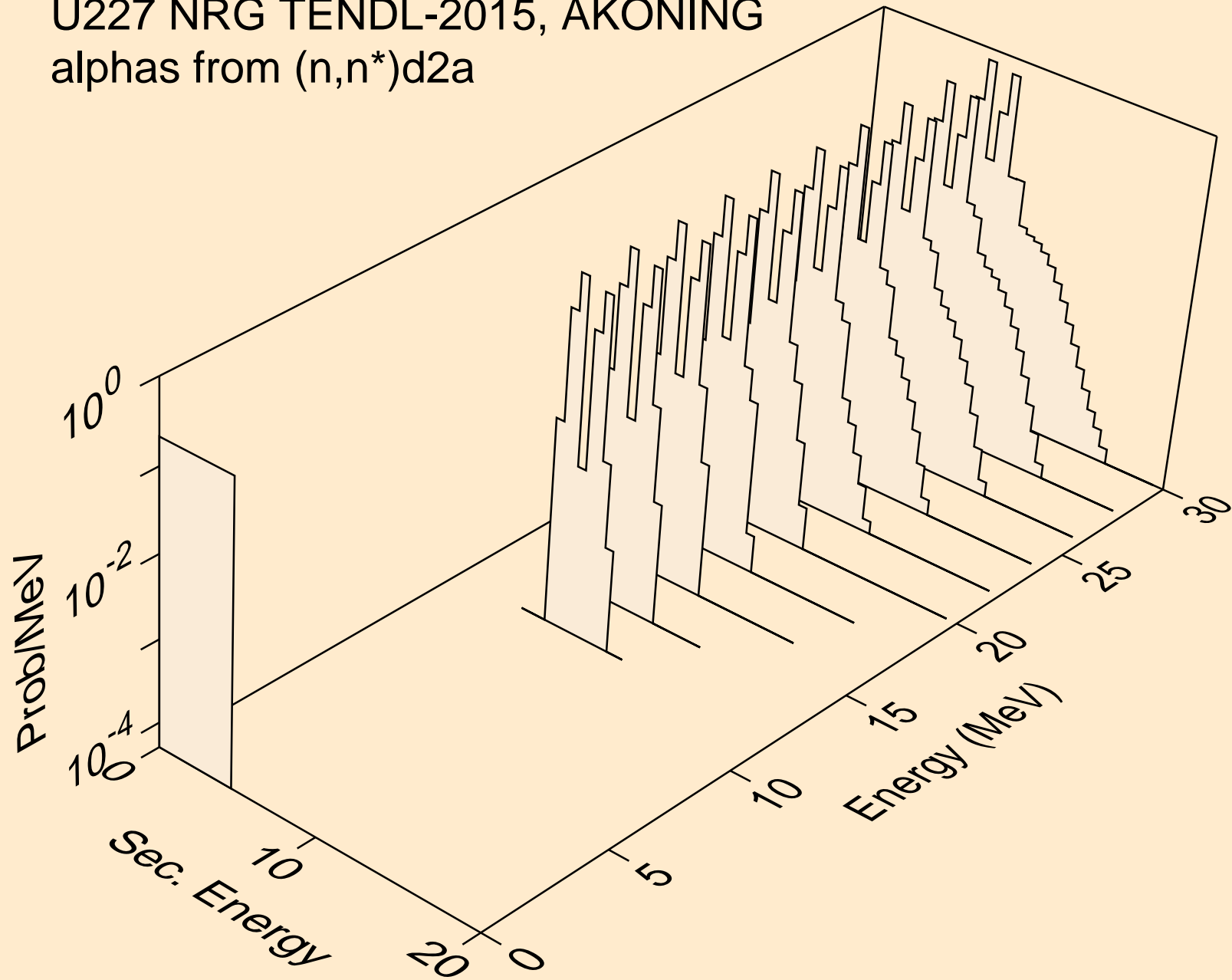

U227 NRG TENDL-2015, AKONING
alphas from (n,n*)t2a

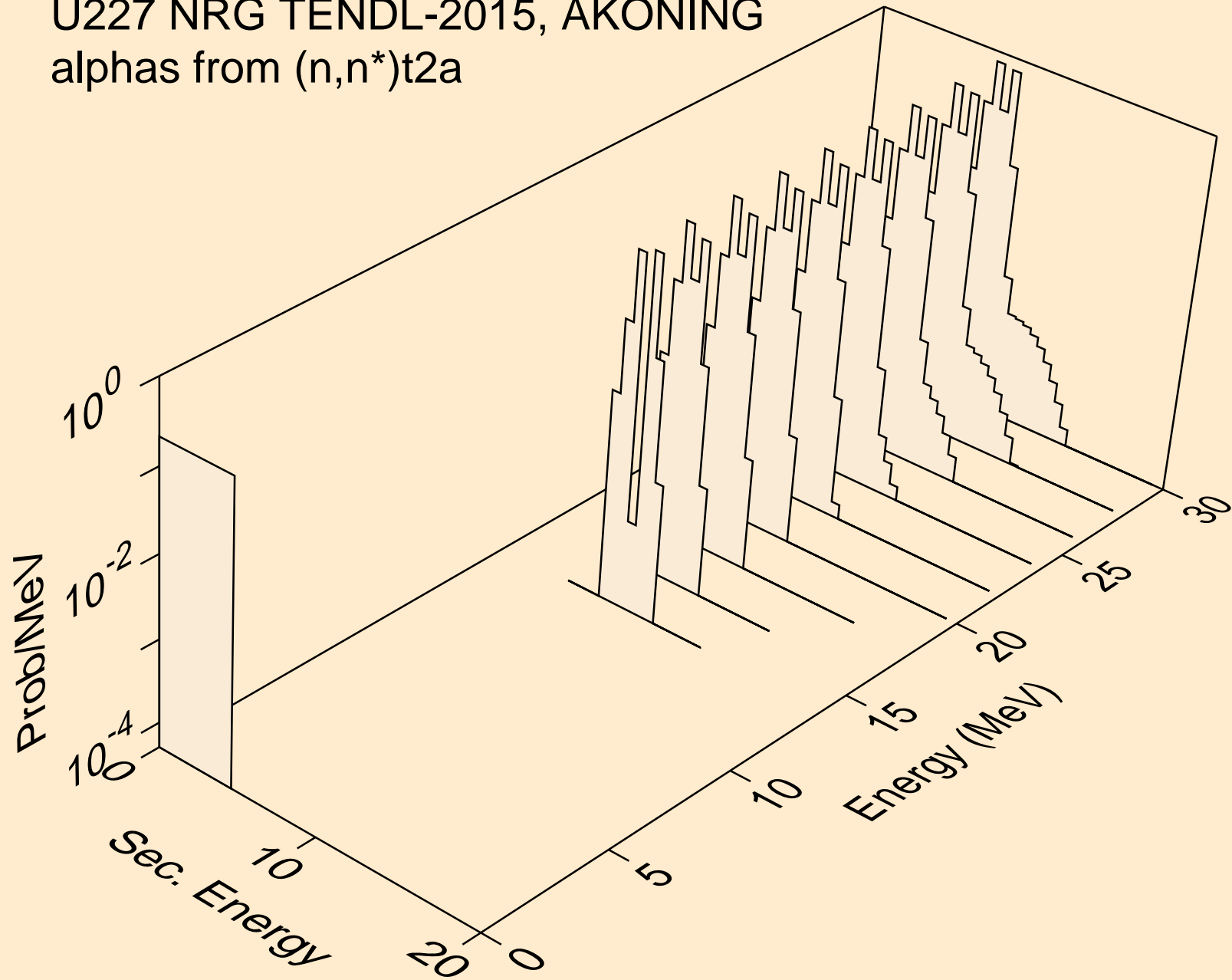

U227 NRG TENDL-2015, AKONING
alphas from (n,npa)

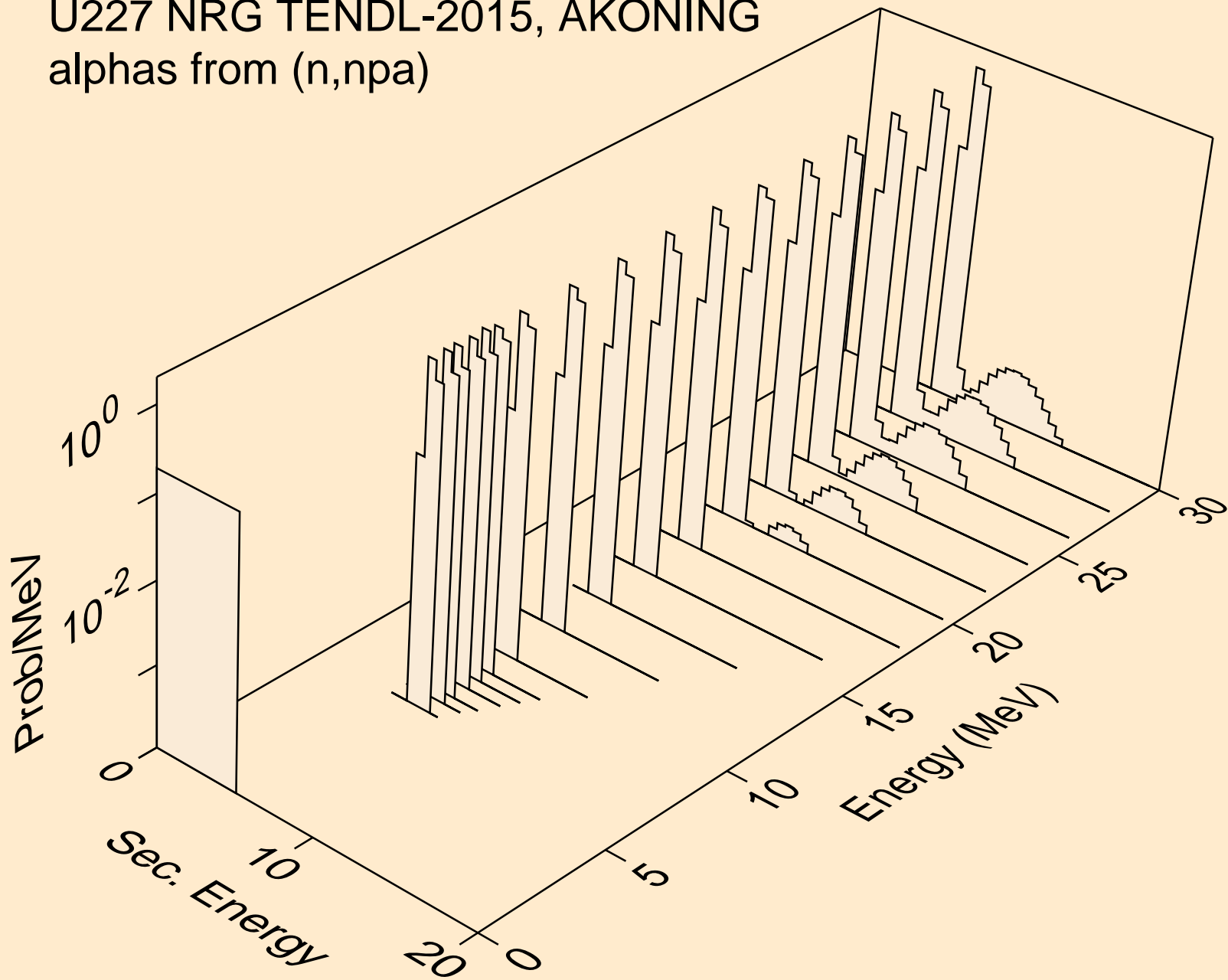

U227 NRG TENDL-2015, AKONING
alphas from (n,a)

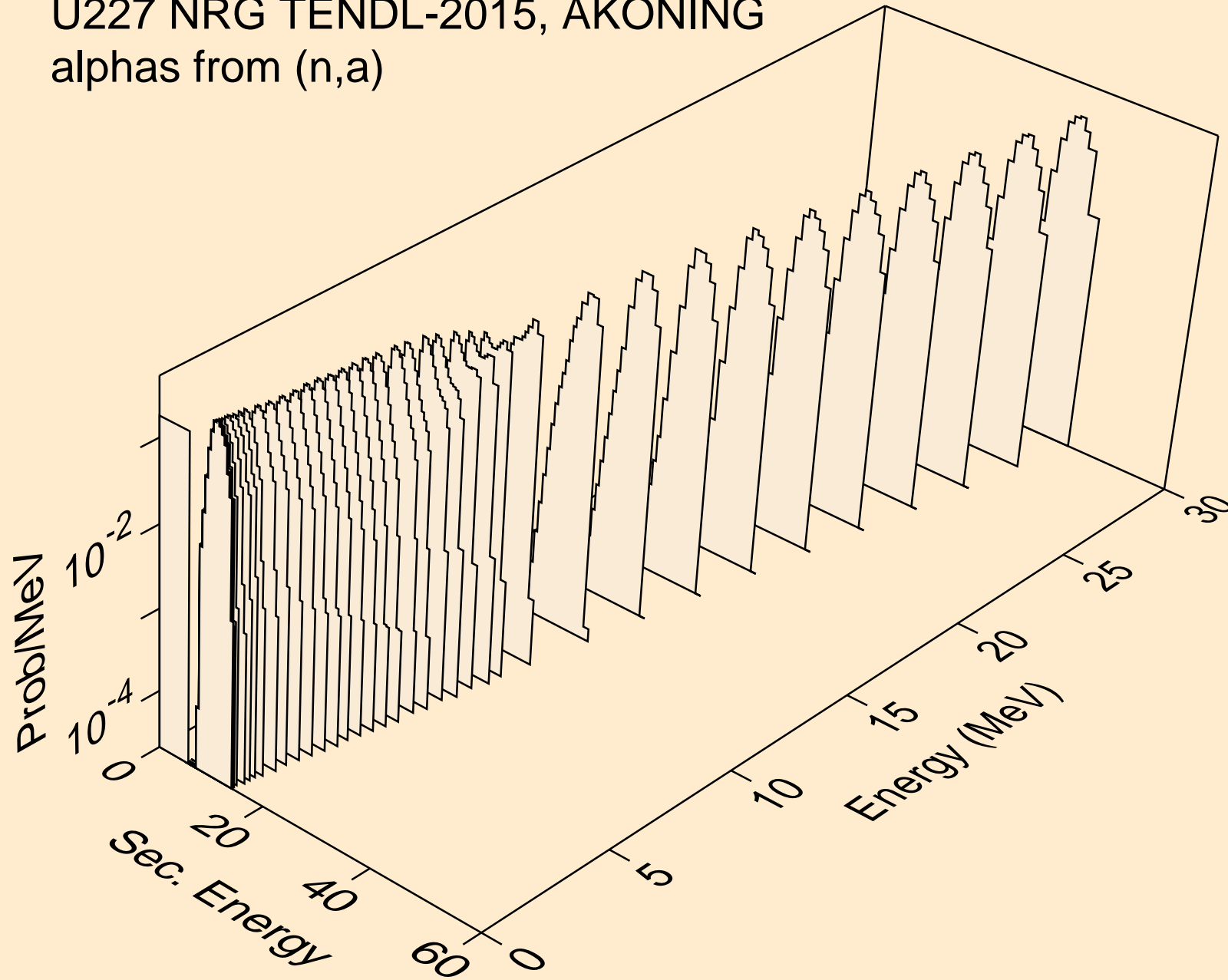

U227 NRG TENDL-2015, AKONING
alphas from (n,2a)

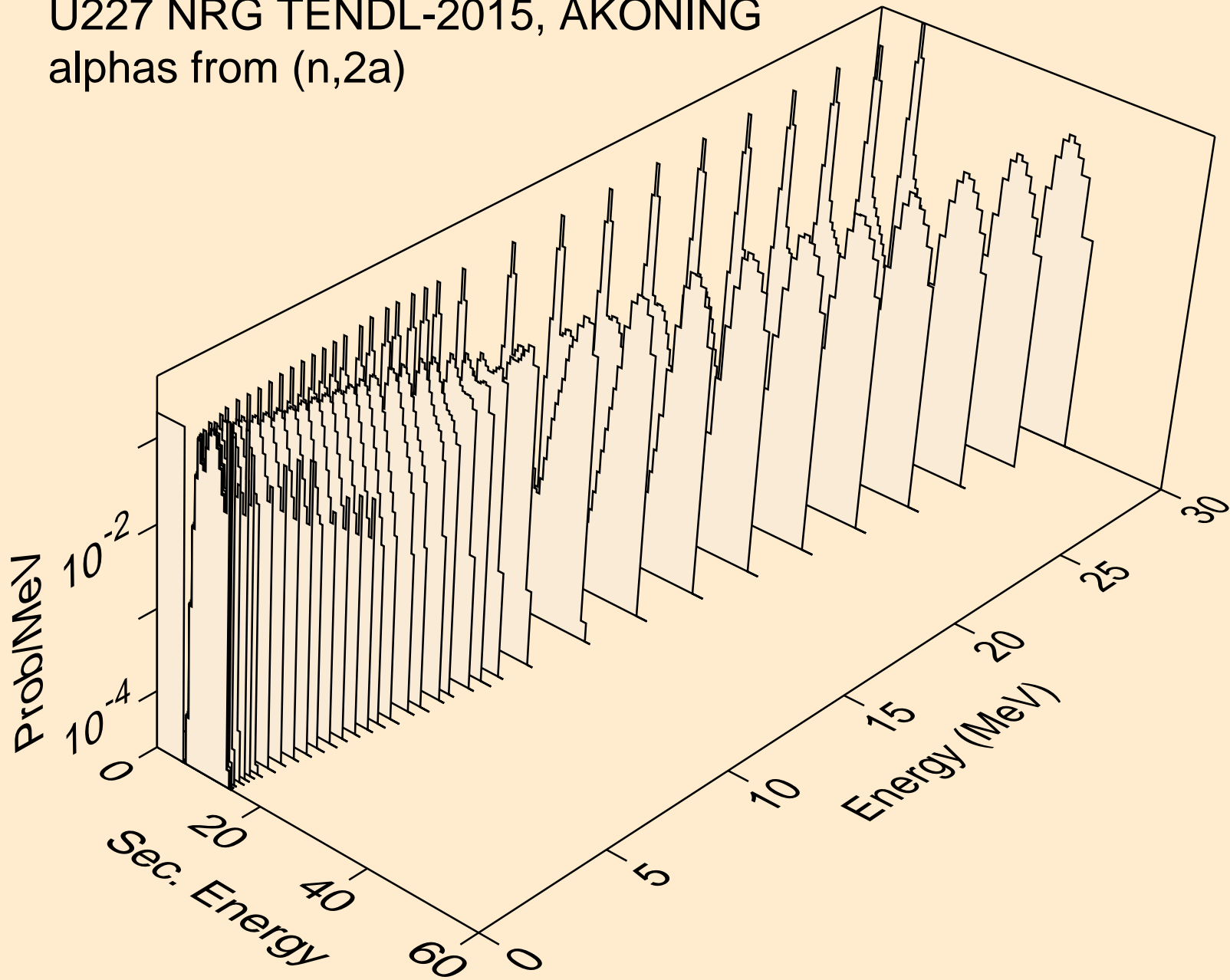

U227 NRG TENDL-2015, AKONING
alphas from (n,3a)

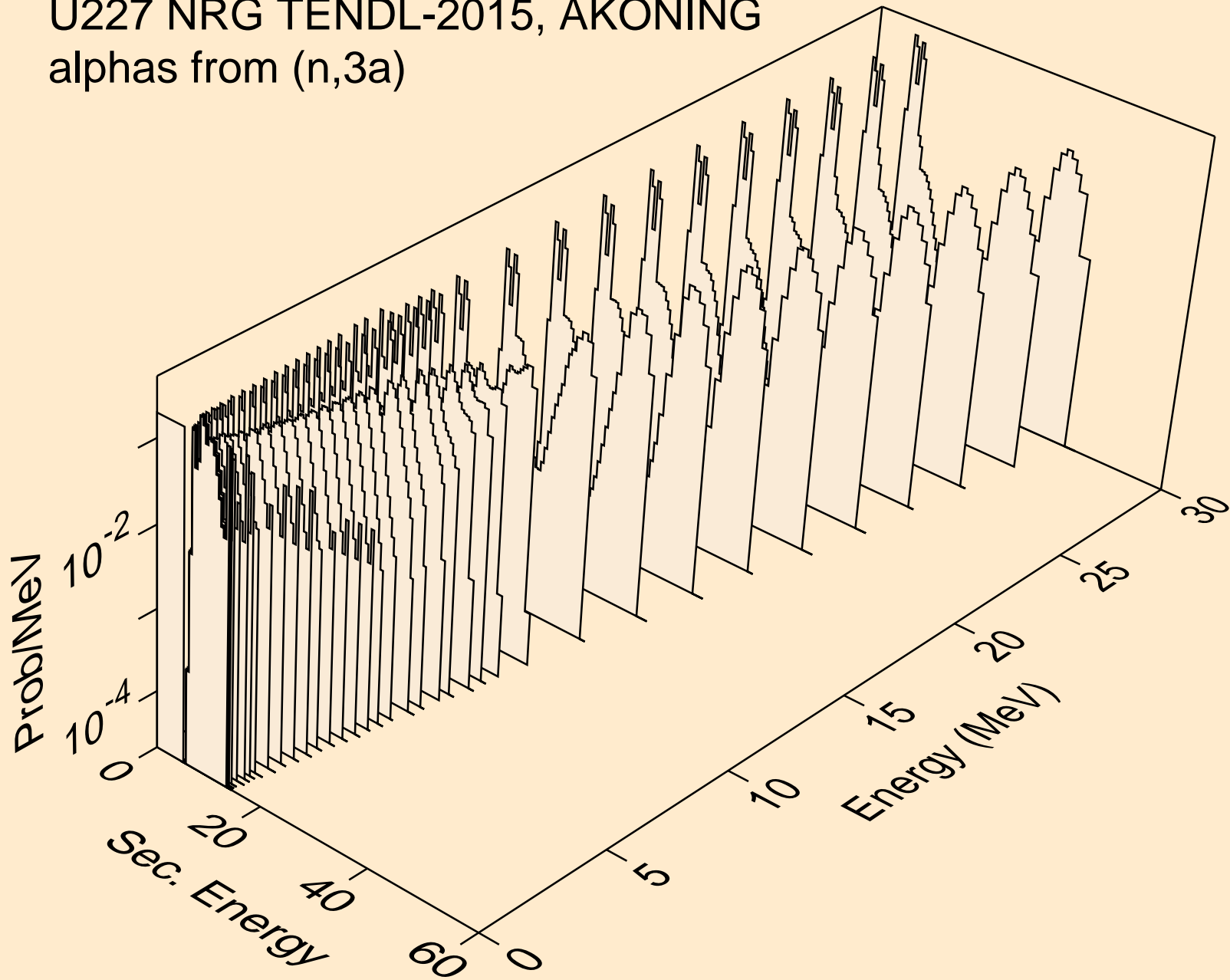

U227 NRG TENDL-2015, AKONING
alphas from (n,pa)

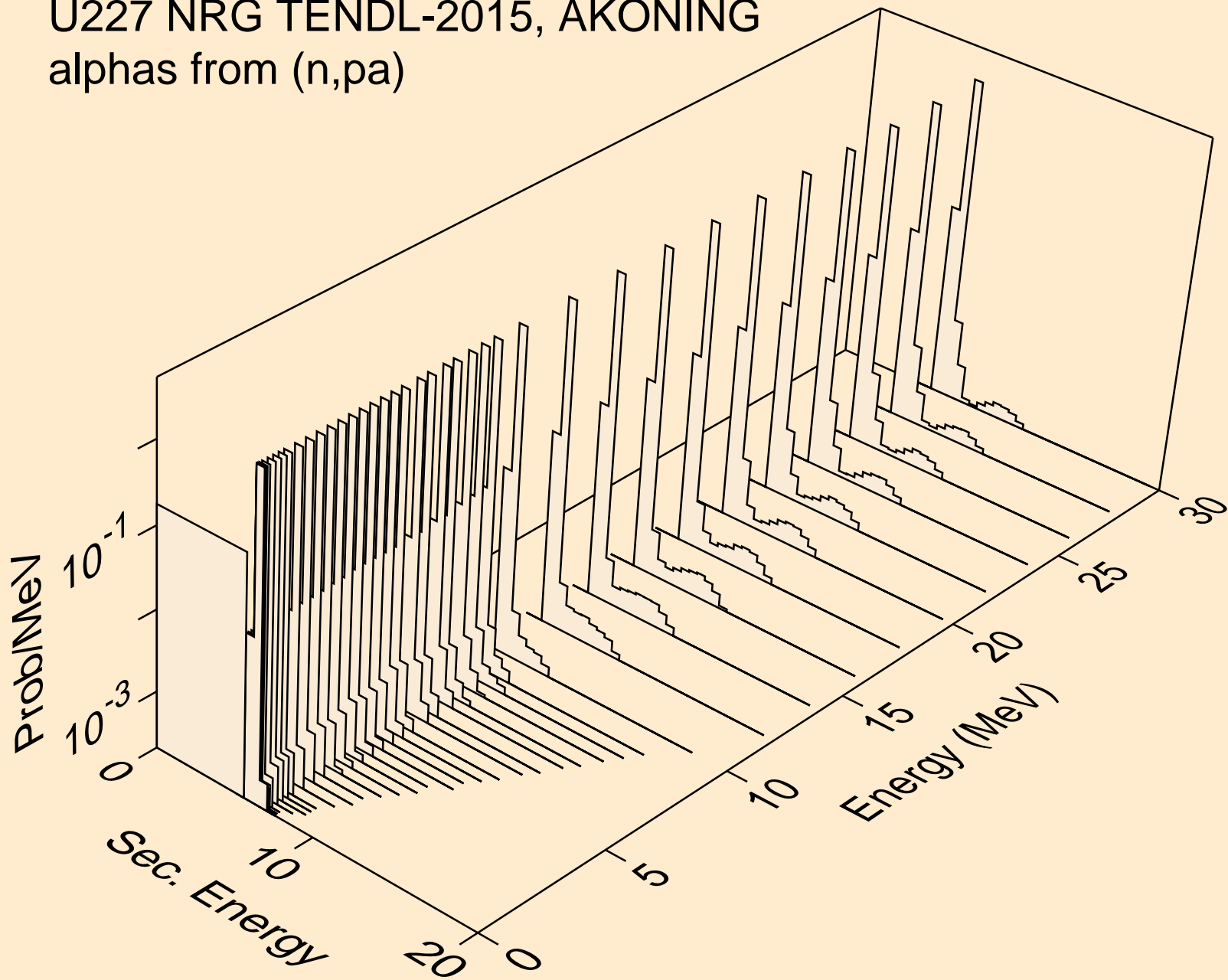

U227 NRG TENDL-2015, AKONING
alphas from (n,t2a)

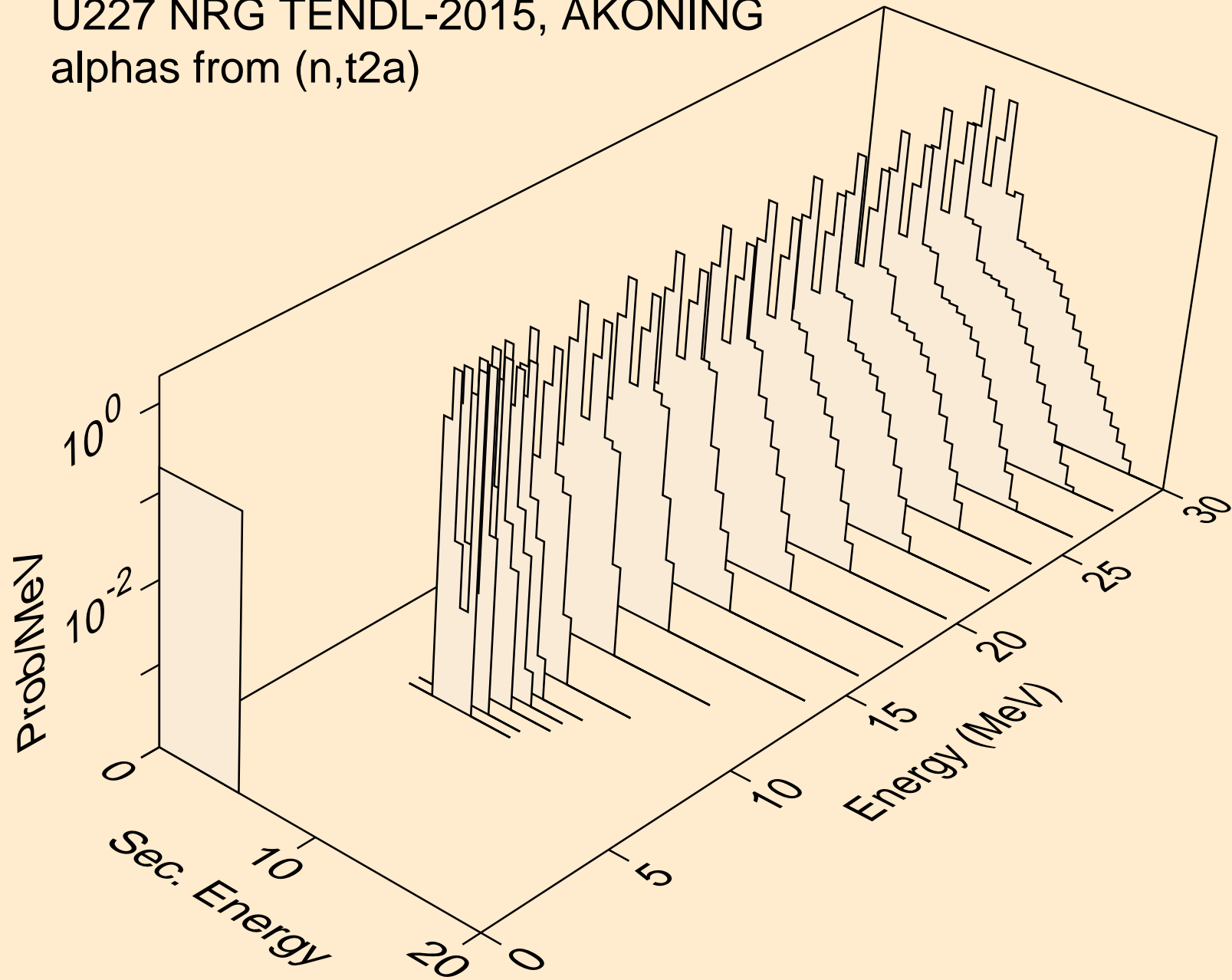

U227 NRG TENDL-2015, AKONING
alphas from (n,d2a)

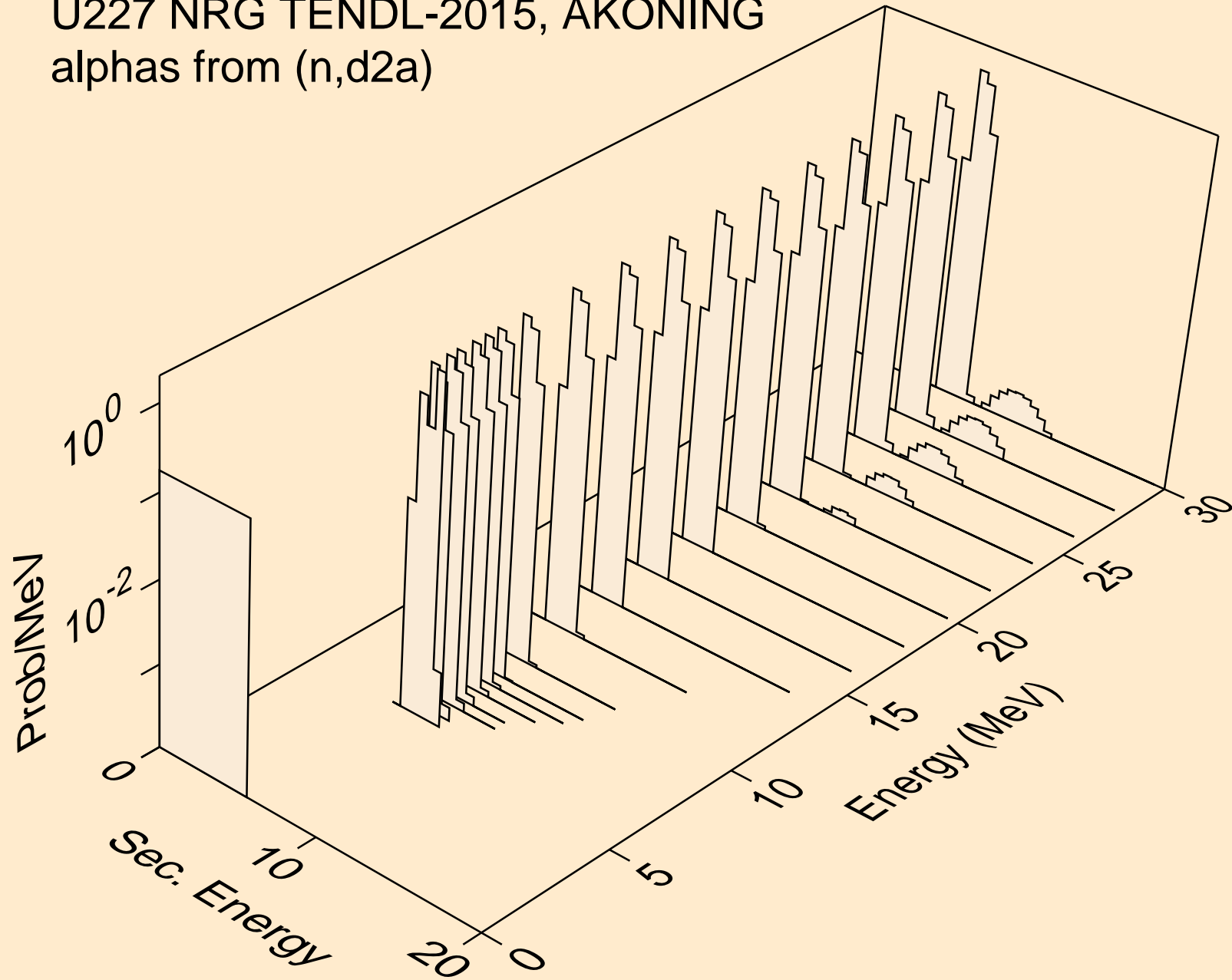

U227 NRG TENDL-2015, AKONING
alphas from (n,da)

