

U228 NRG TENDL-2015, AKONING

Principal cross sections

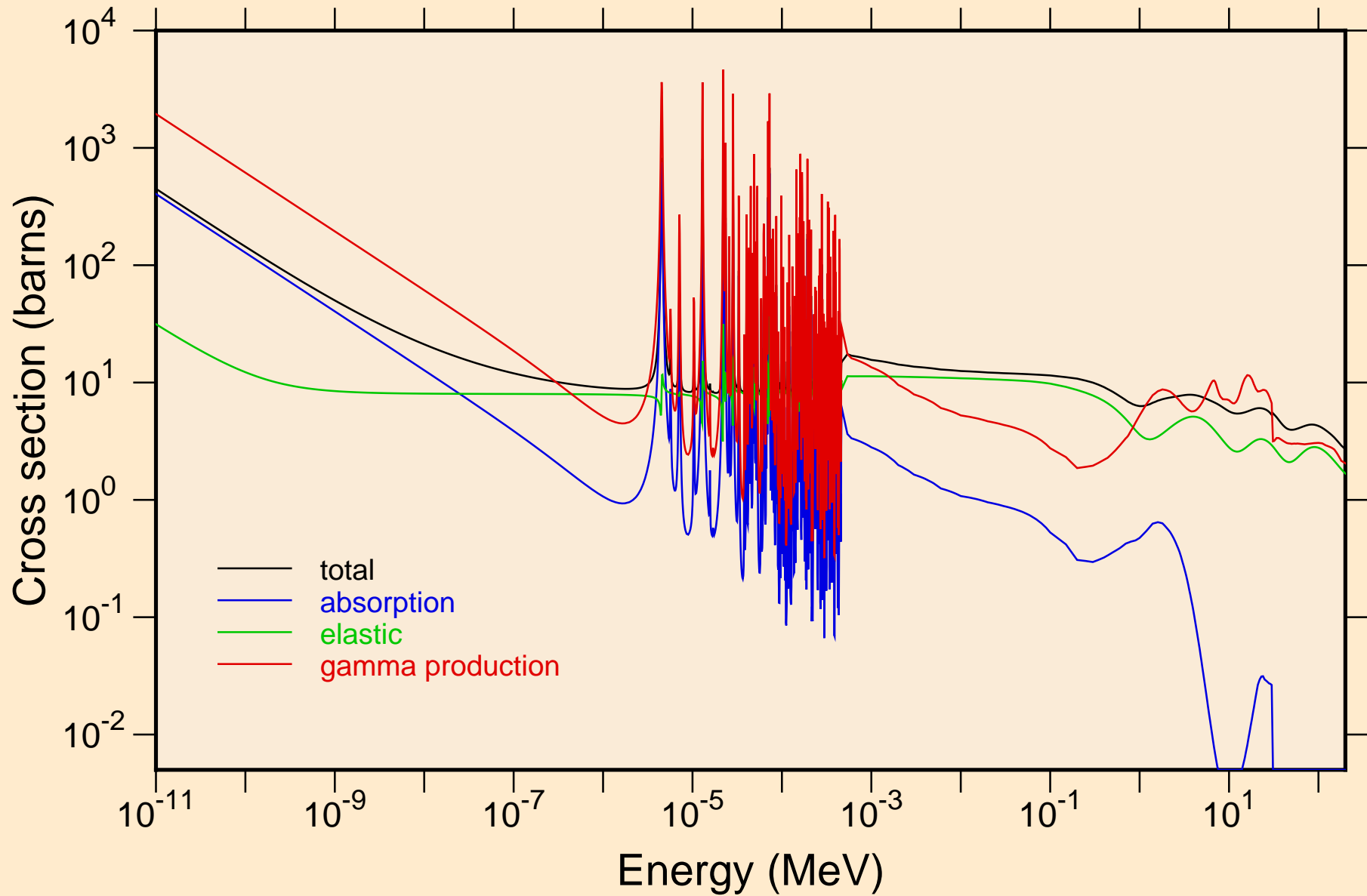

U228 NRG TENDL-2015, AKONING
resonance total cross section

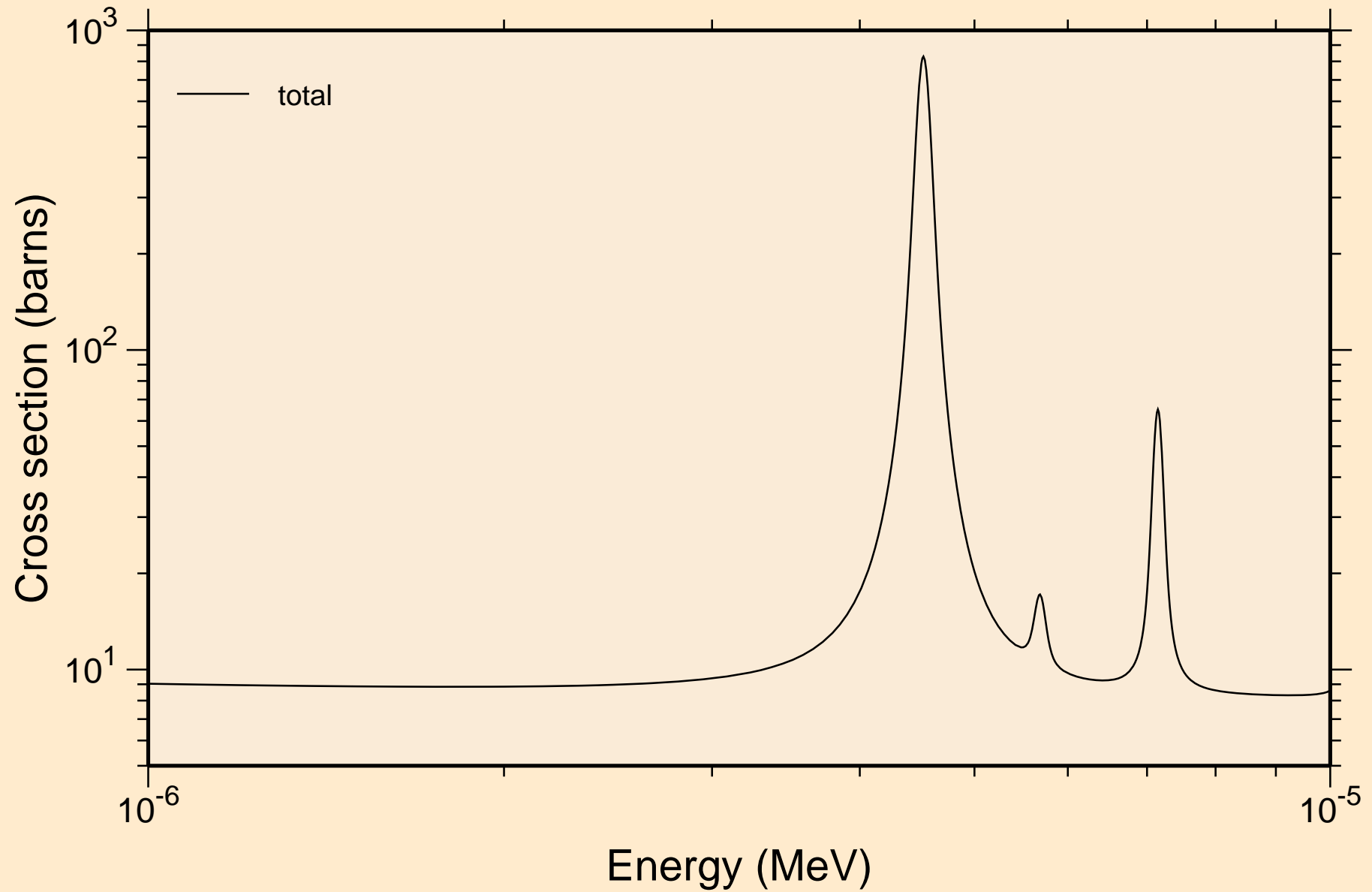

U228 NRG TENDL-2015, AKONING
resonance total cross section

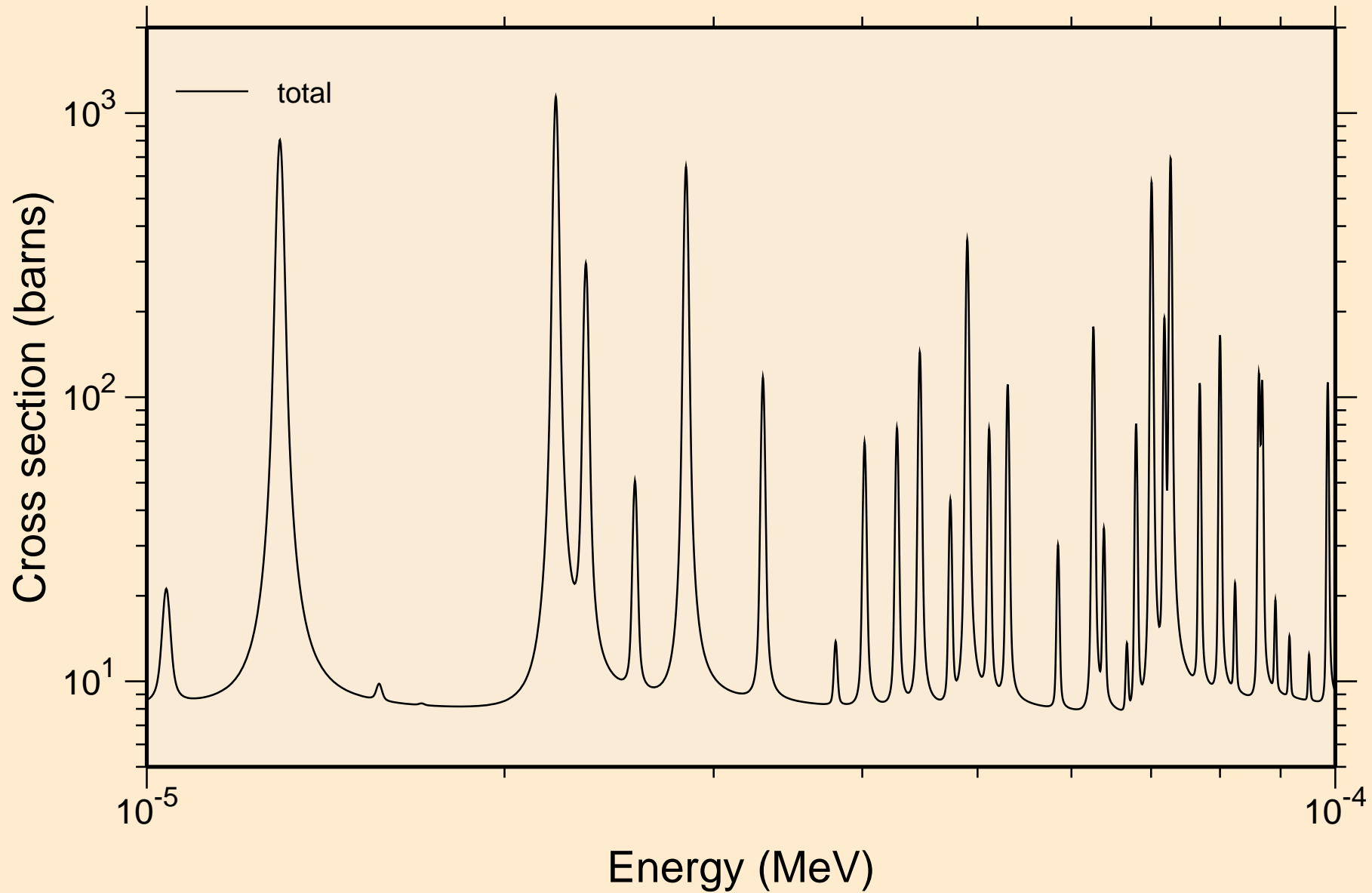

U228 NRG TENDL-2015, AKONING
resonance total cross section

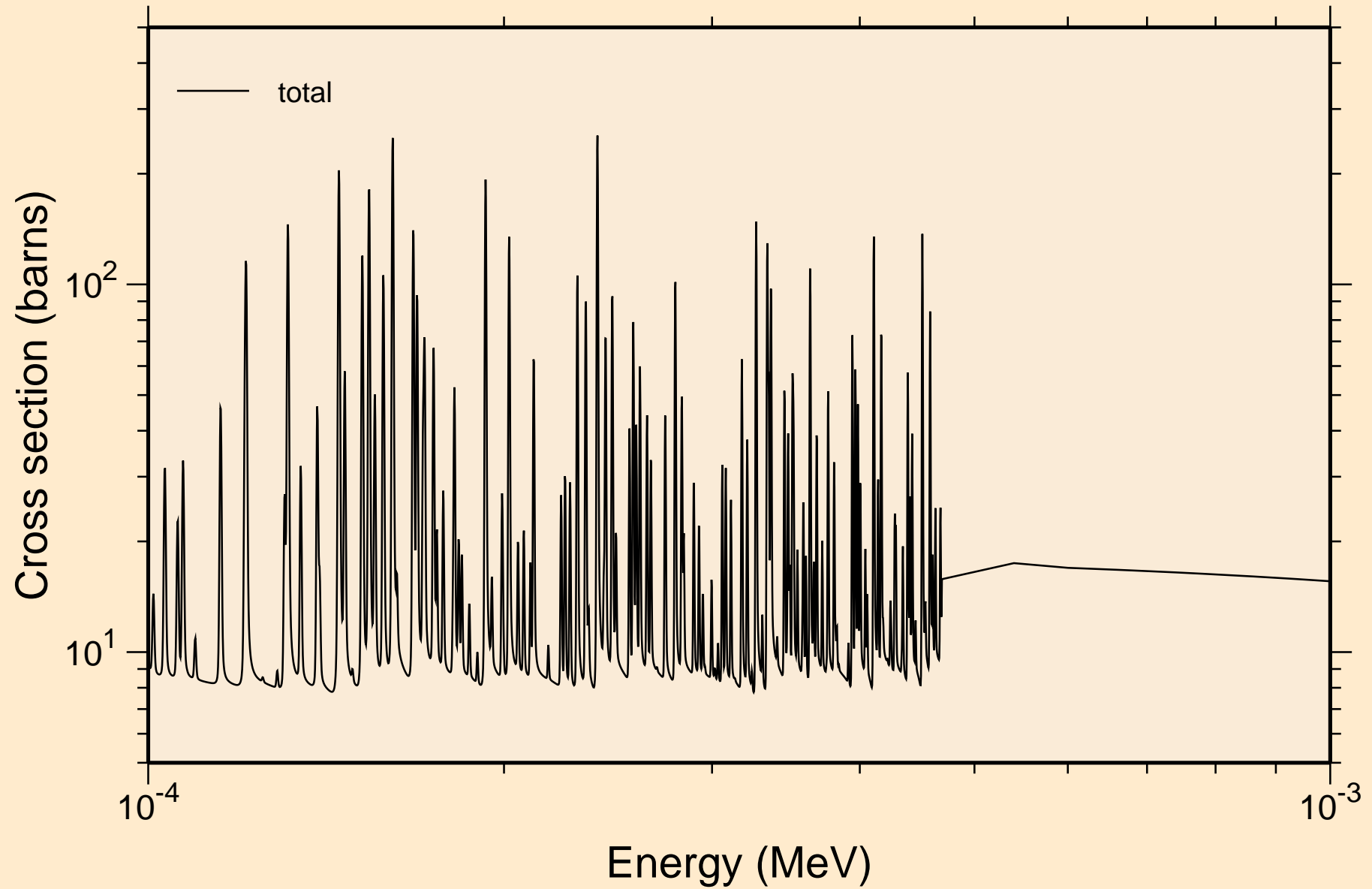

U228 NRG TENDL-2015, AKONING
resonance total cross section

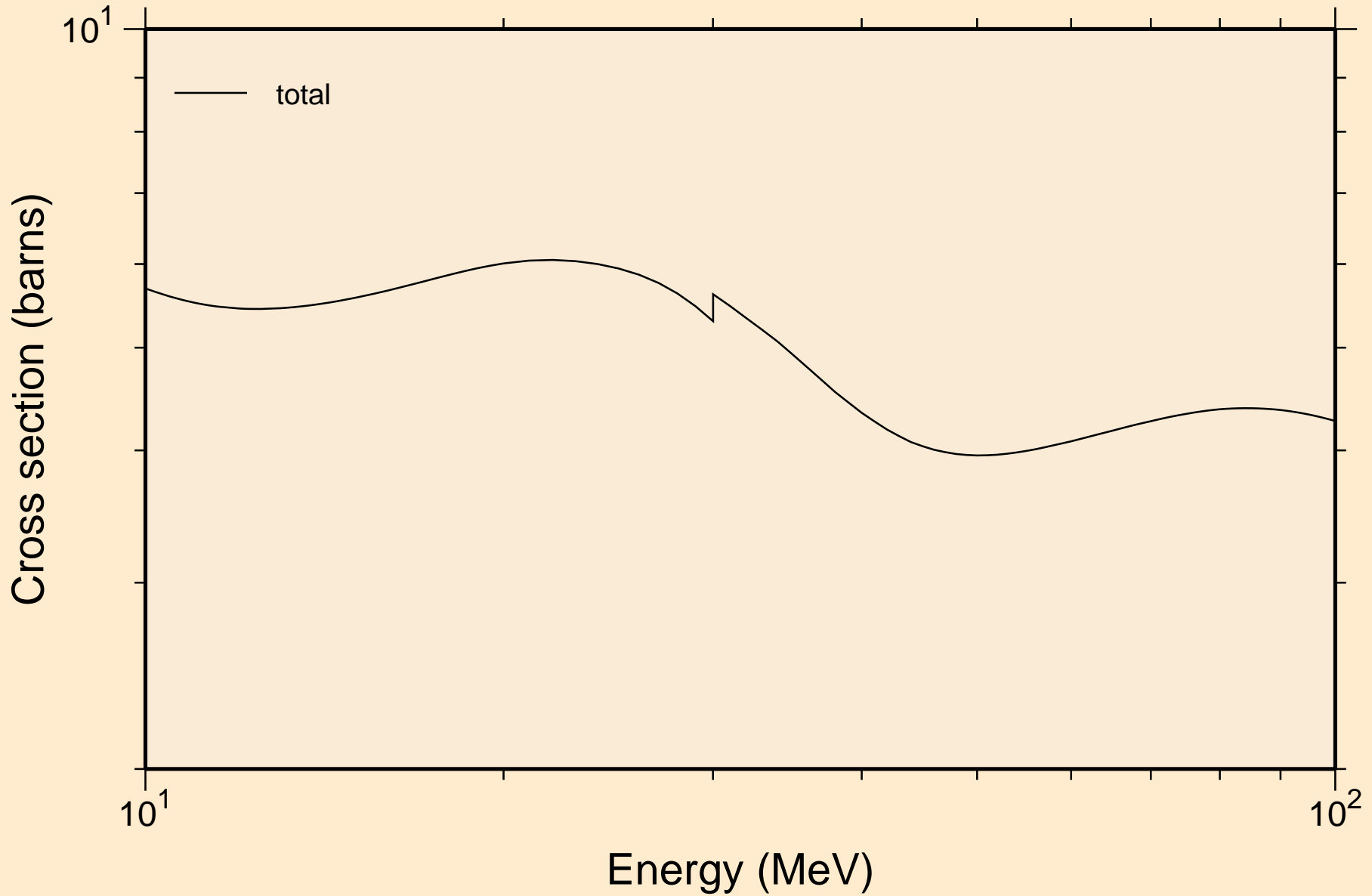

U228 NRG TENDL-2015, AKONING resonance absorption cross sections

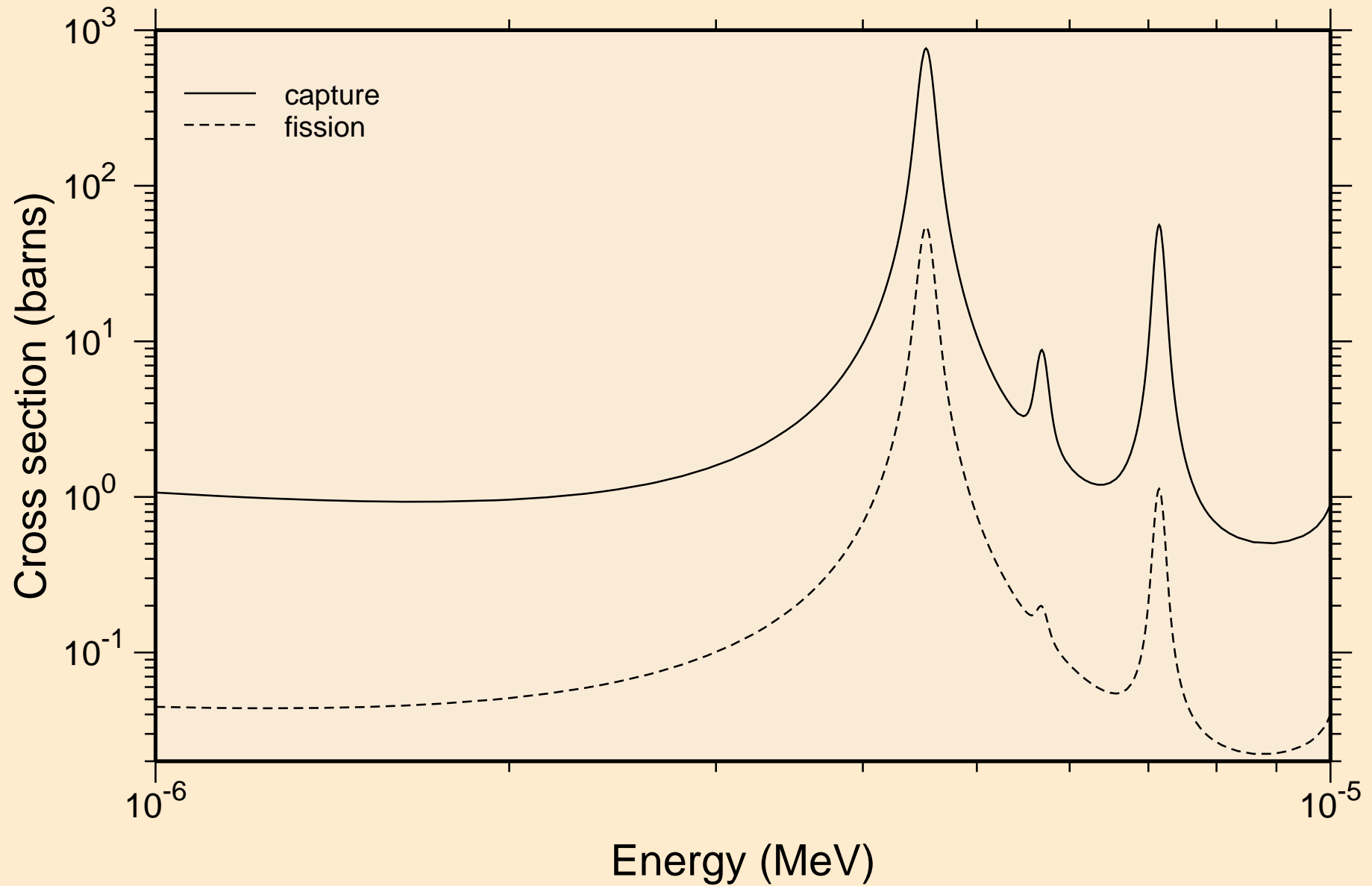

U228 NRG TENDL-2015, AKONING resonance absorption cross sections

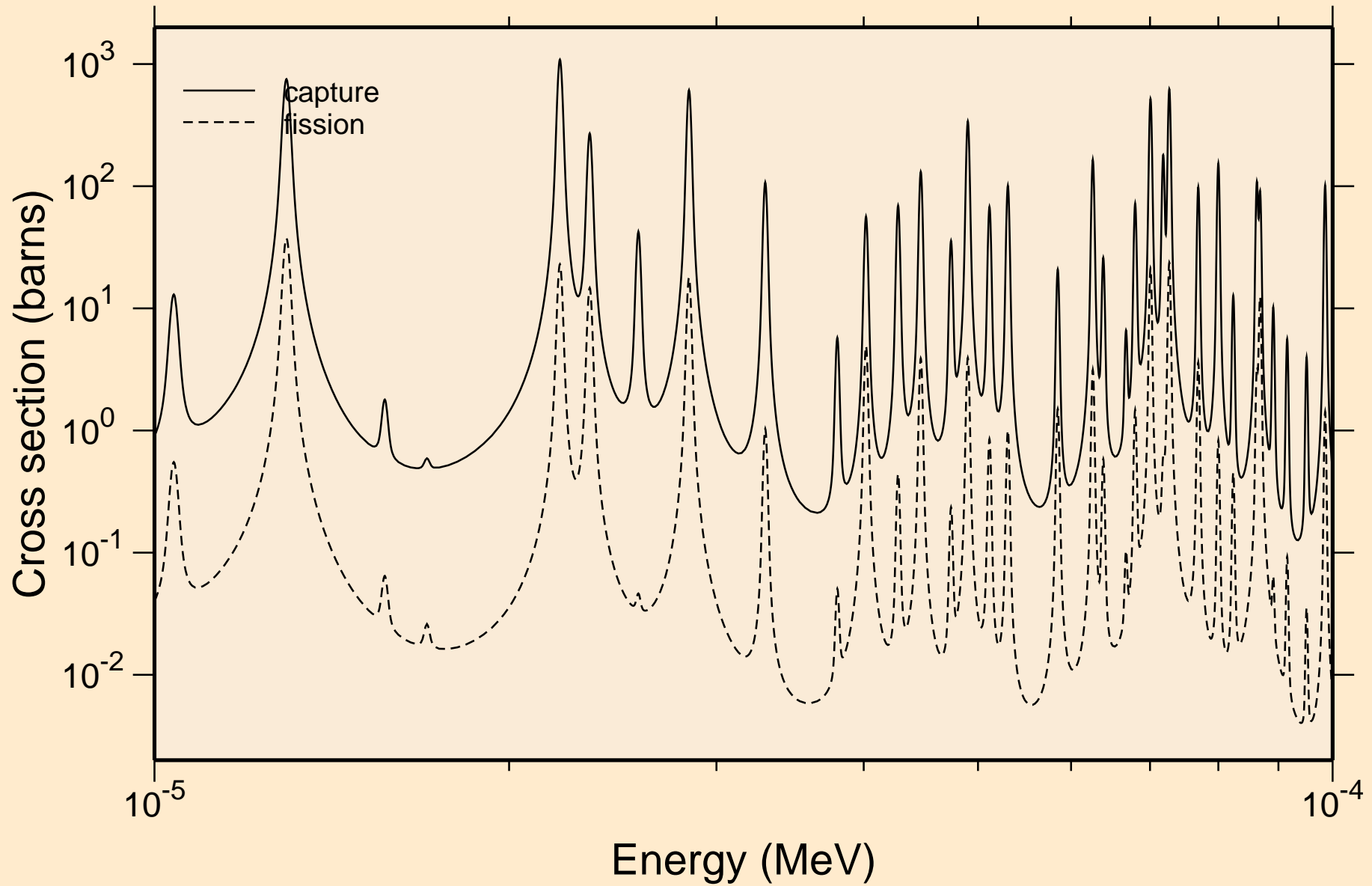

U228 NRG TENDL-2015, AKONING resonance absorption cross sections

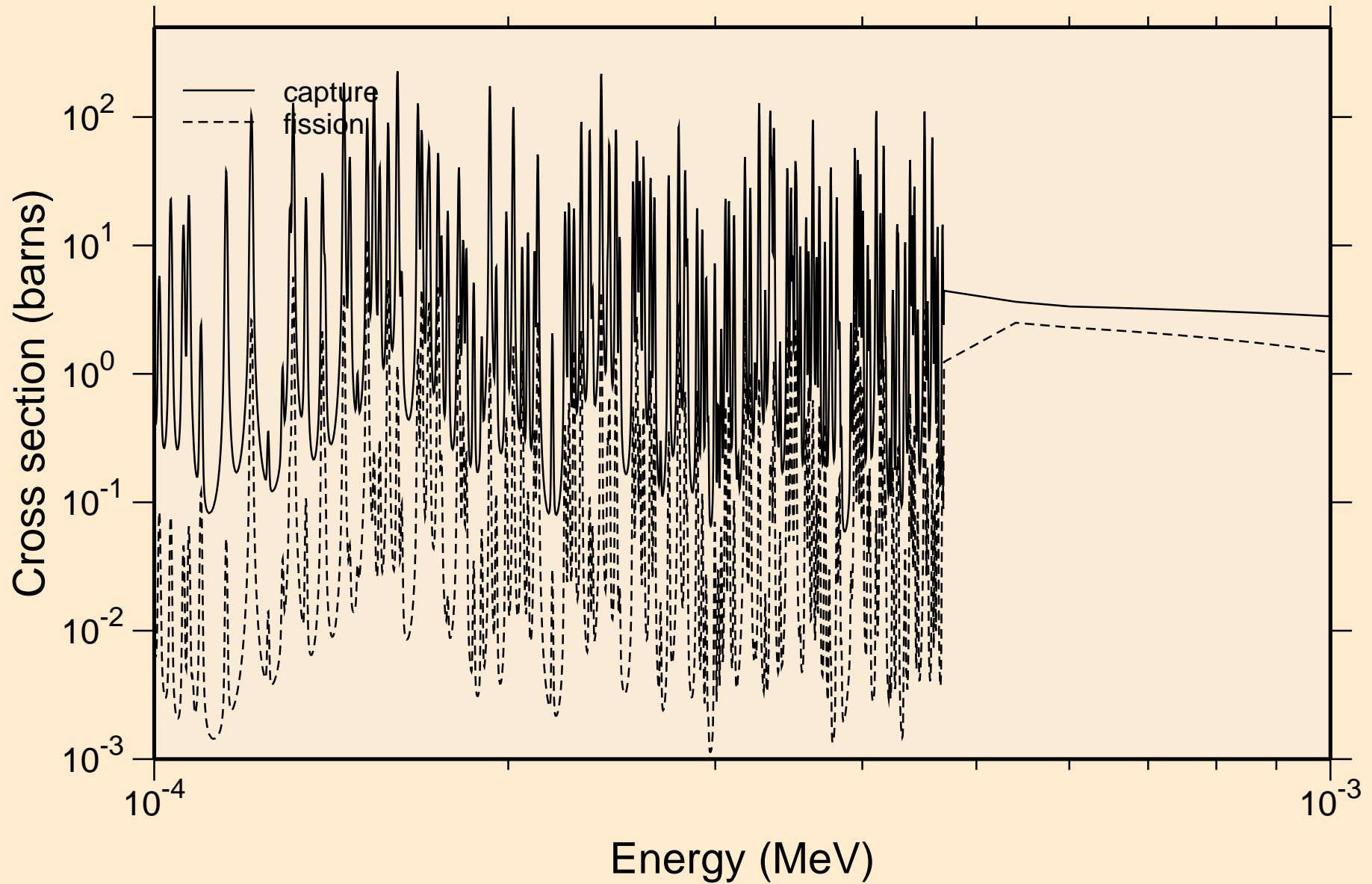

U228 NRG TENDL-2015, AKONING
resonance absorption cross sections

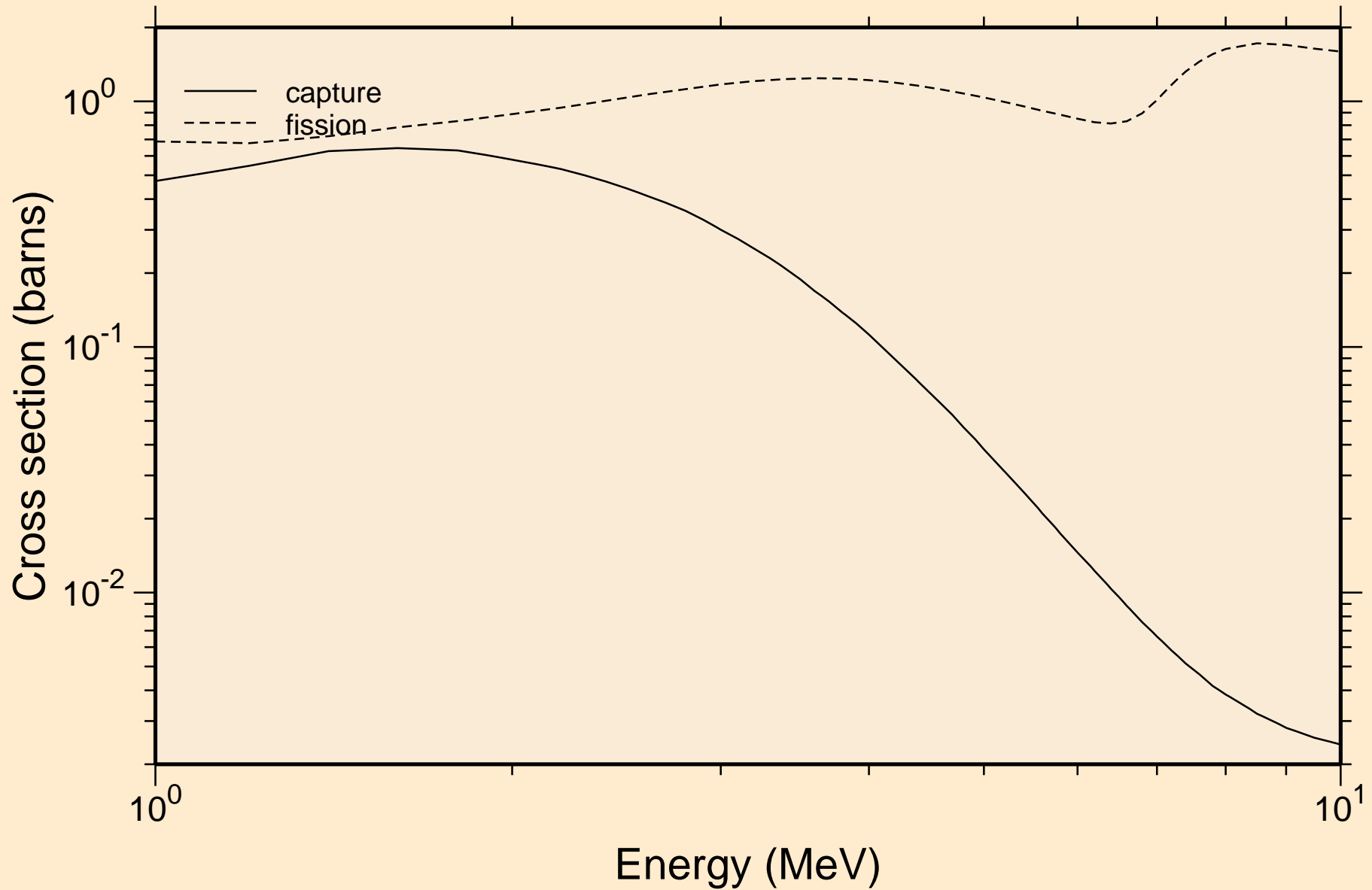

U228 NRG TENDL-2015, AKONING

Non-threshold reactions

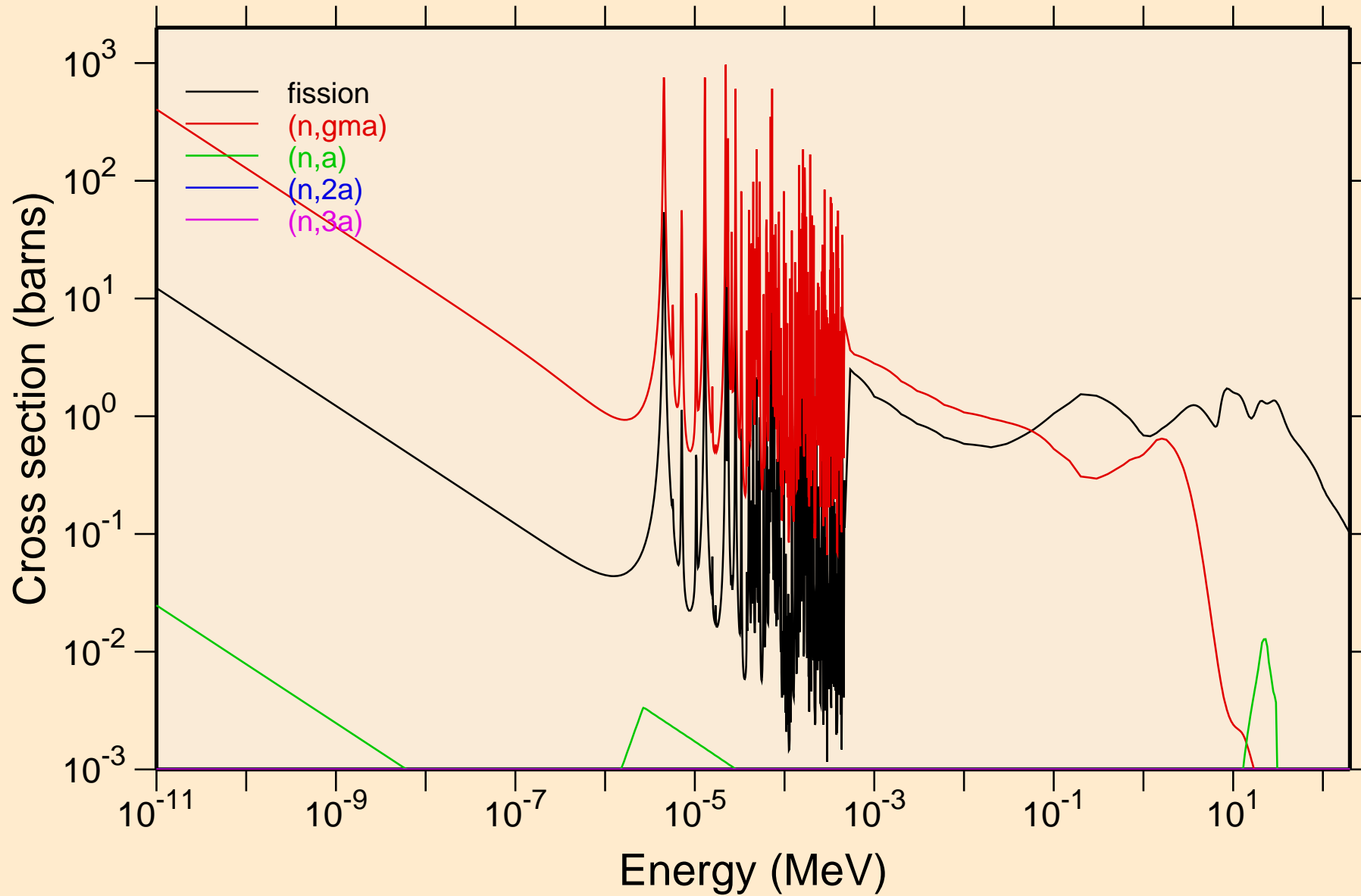

U228 NRG TENDL-2015, AKONING

Principal cross sections

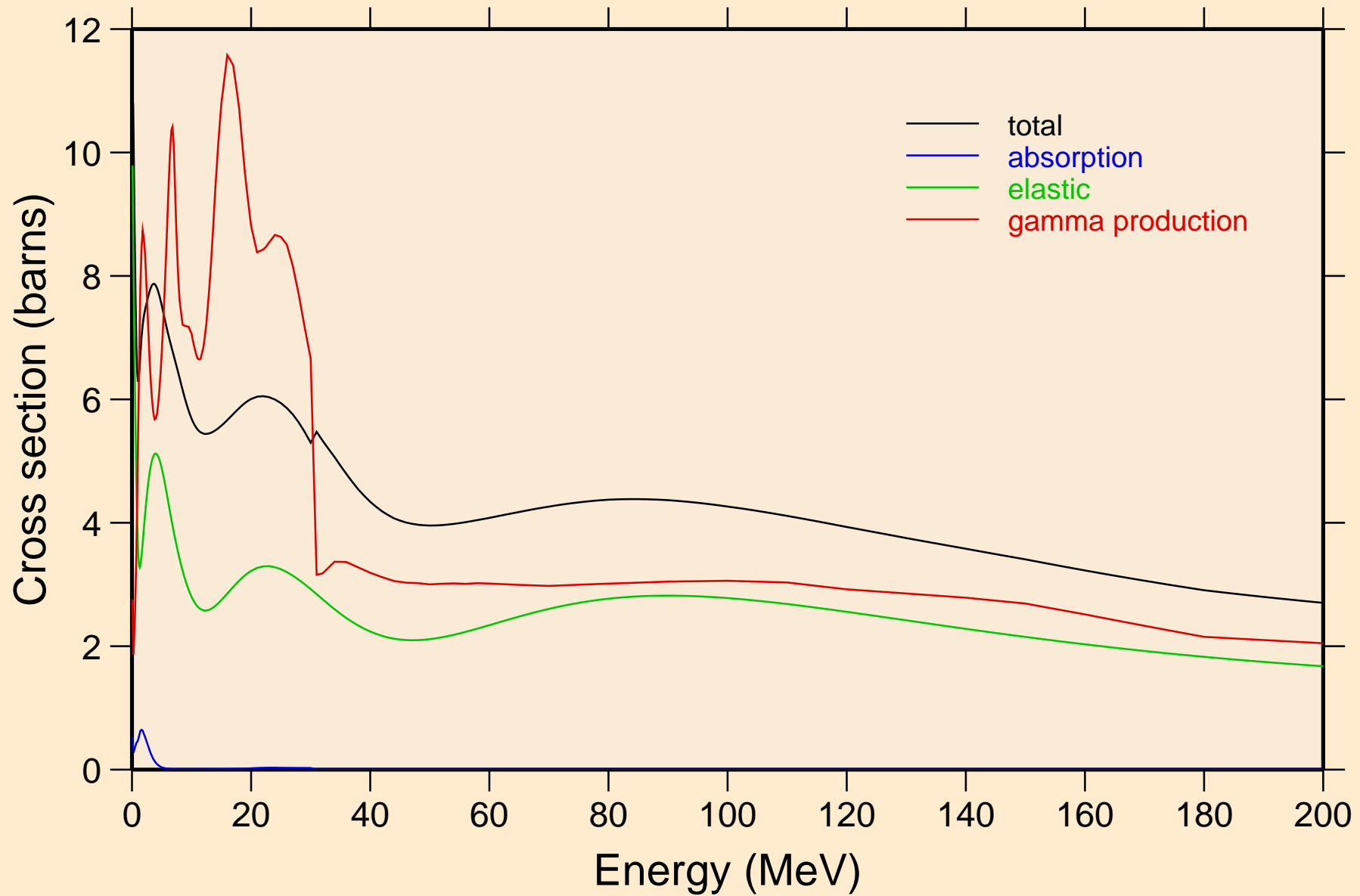

U228 NRG TENDL-2015, AKONING

Non-threshold reactions

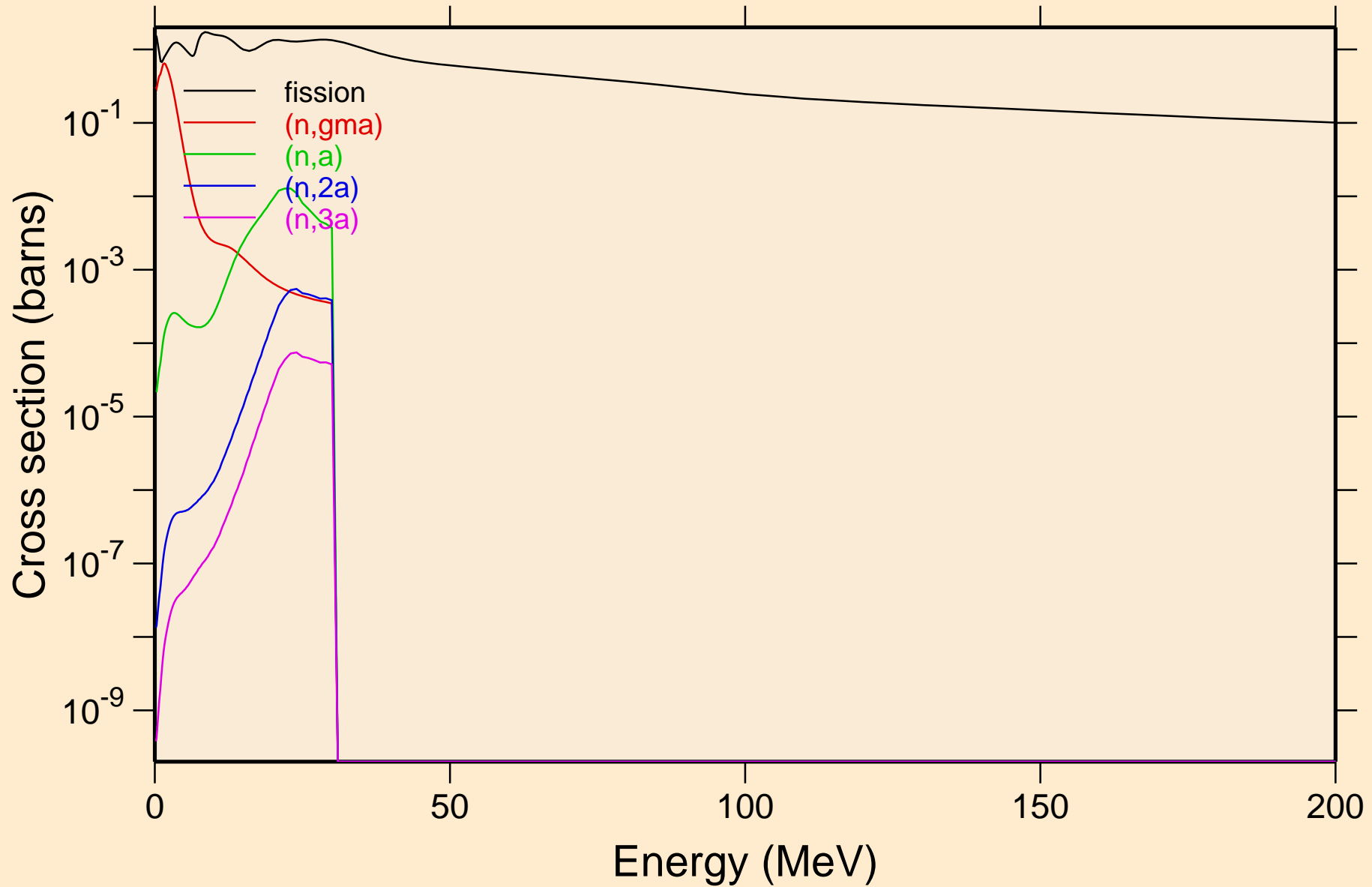

U228 NRG TENDL-2015, AKONING

Inelastic levels

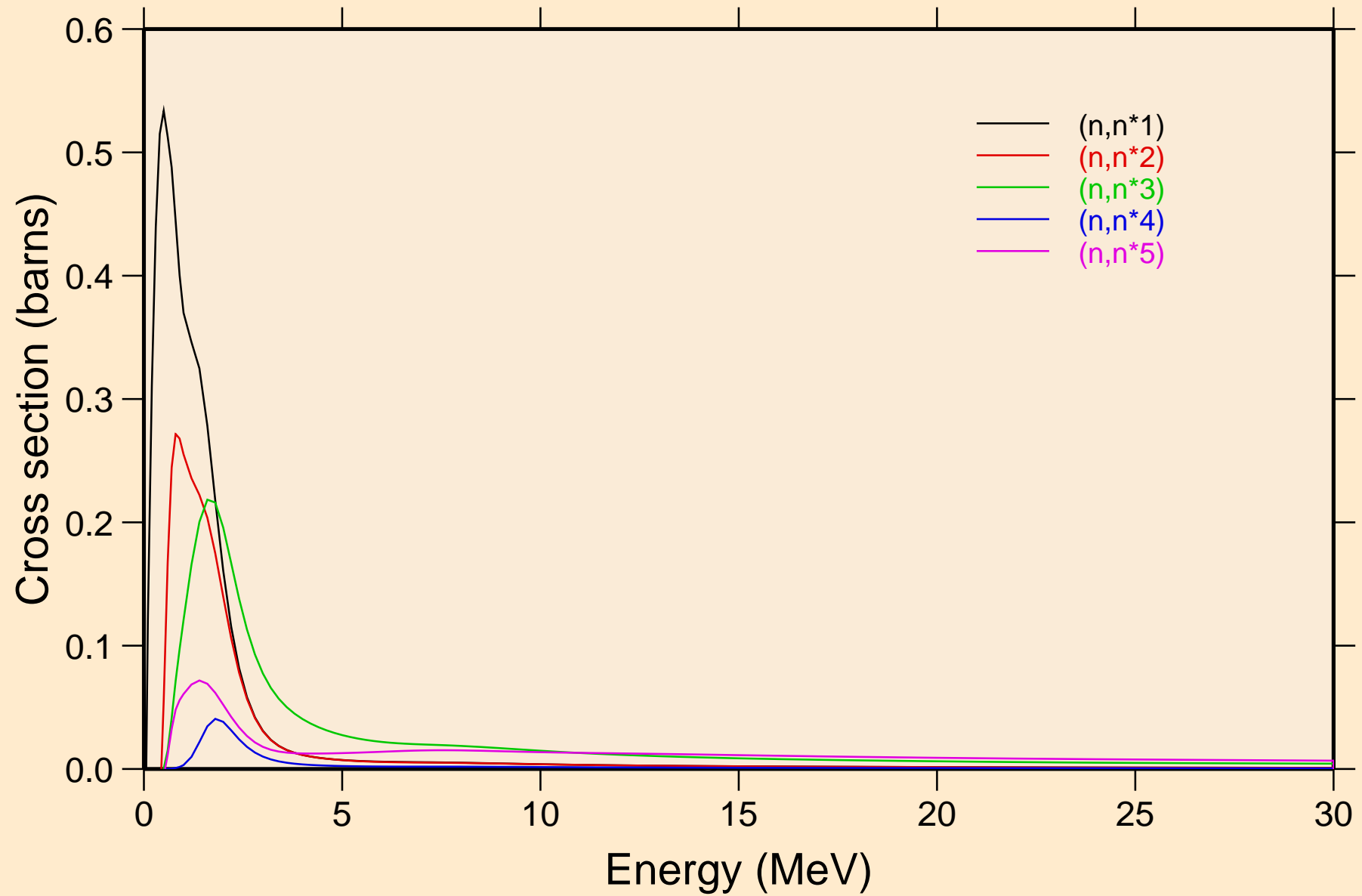

U228 NRG TENDL-2015, AKONING

Inelastic levels

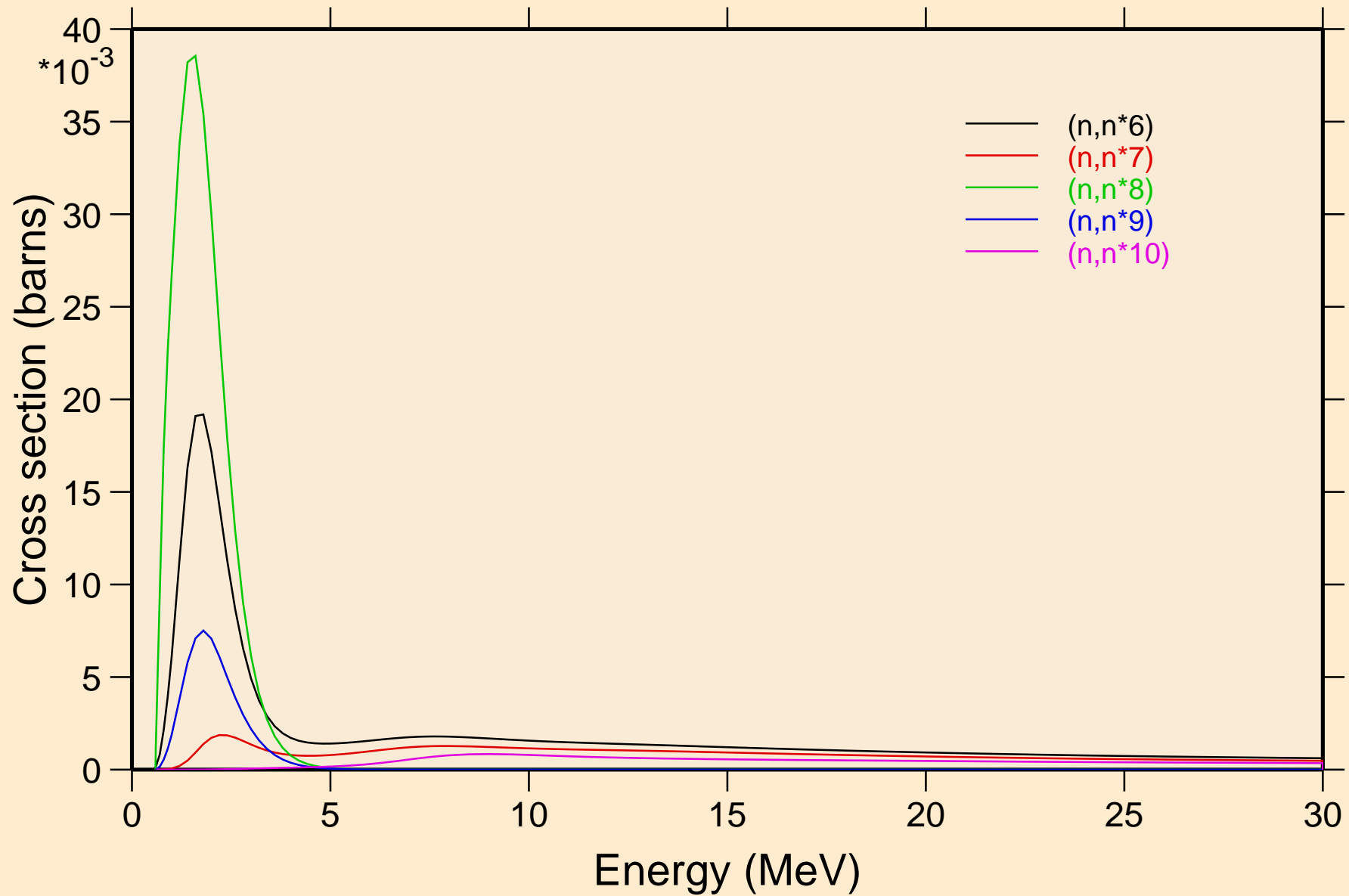

U228 NRG TENDL-2015, AKONING

Inelastic levels

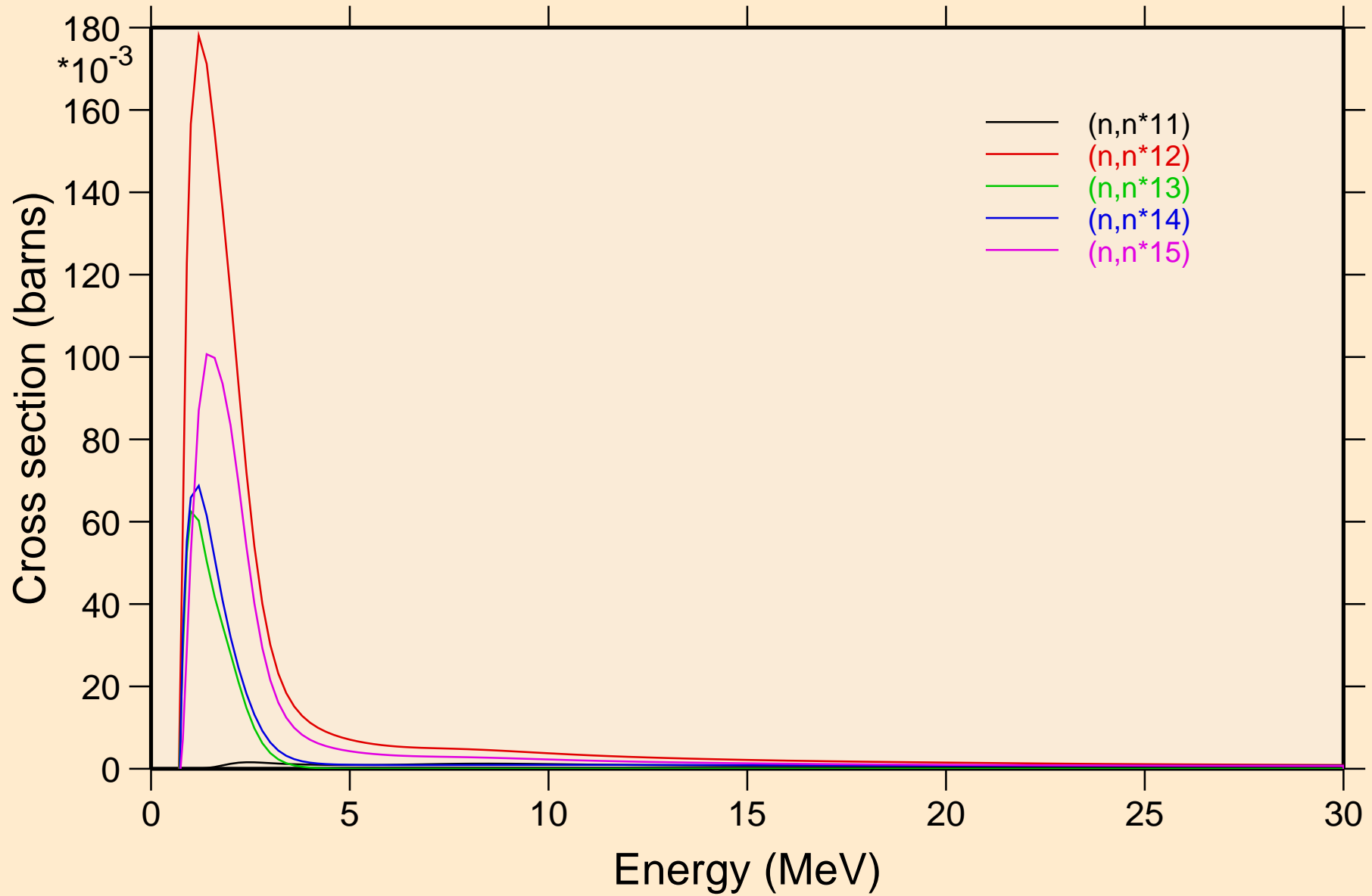

U228 NRG TENDL-2015, AKONING

Inelastic levels

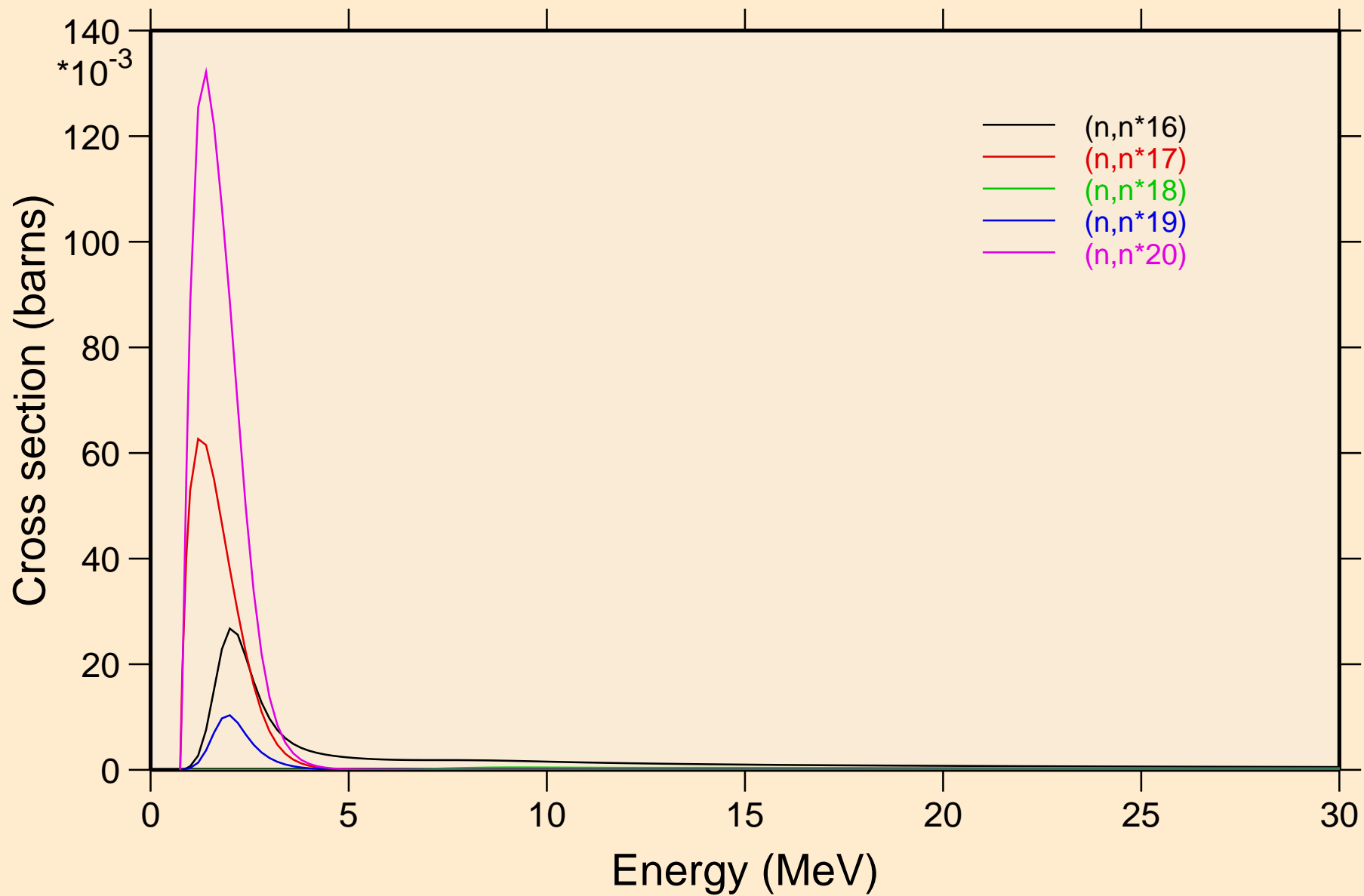

U228 NRG TENDL-2015, AKONING

Inelastic levels

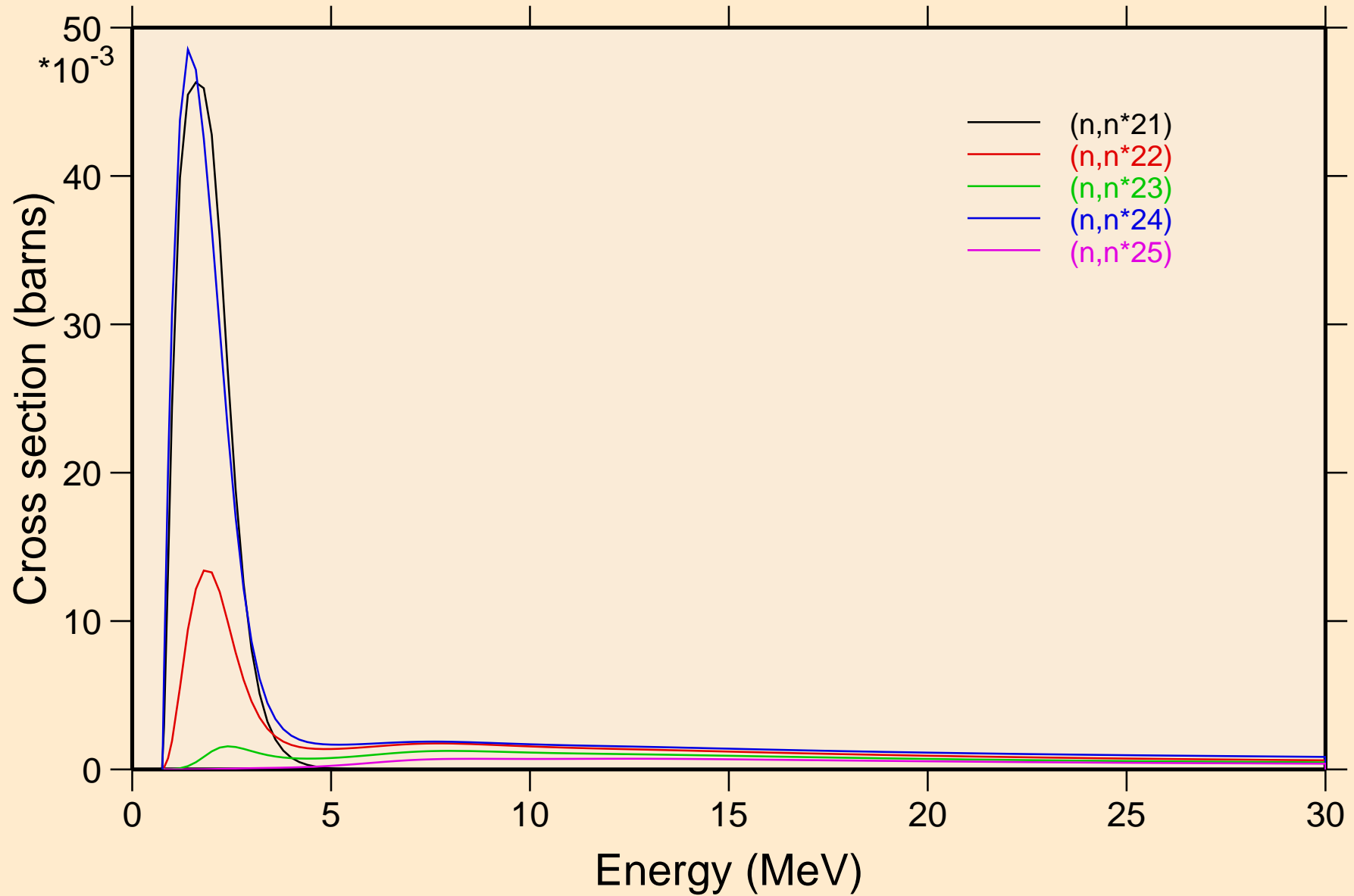

U228 NRG TENDL-2015, AKONING

Inelastic levels

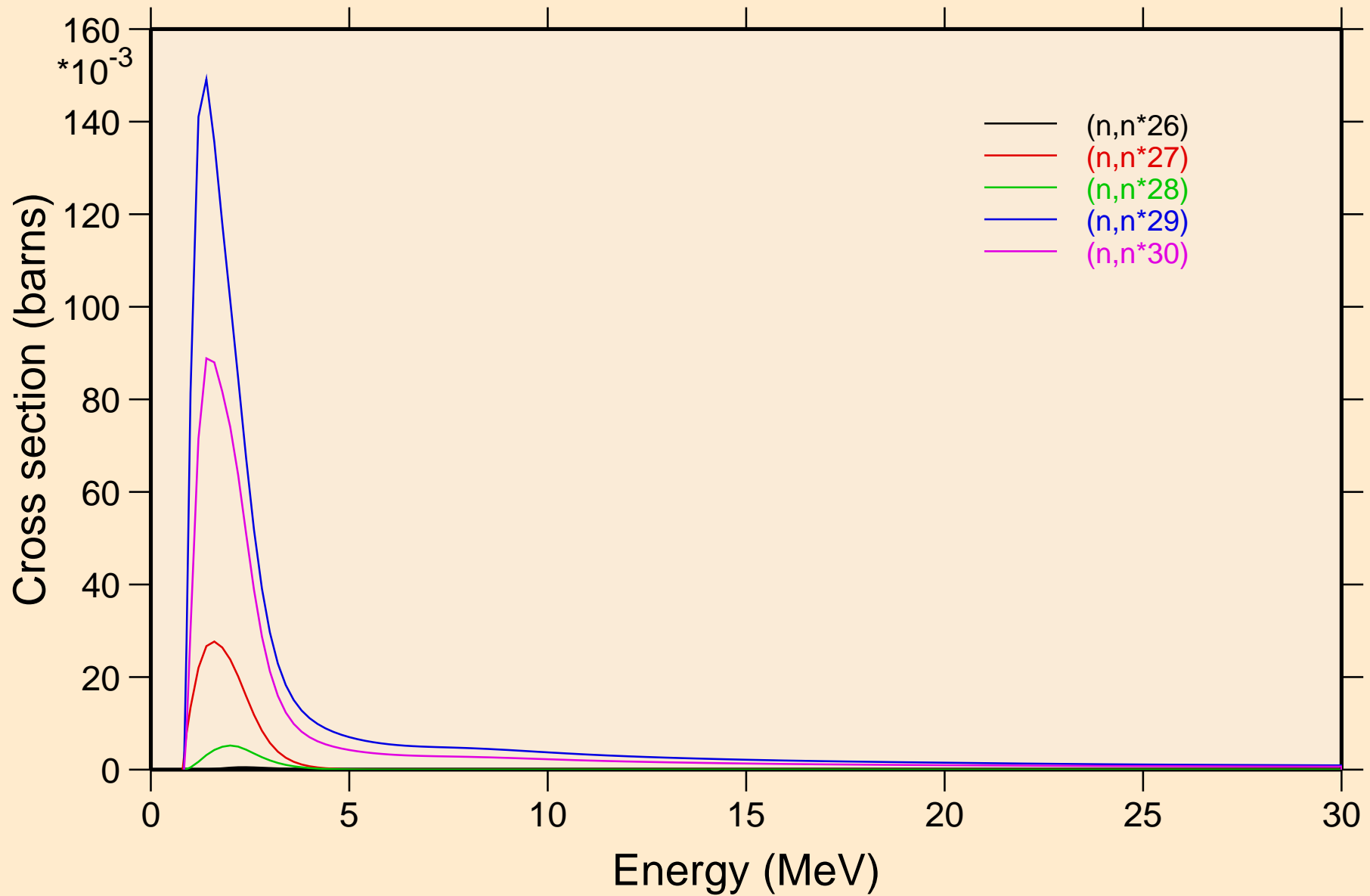

U228 NRG TENDL-2015, AKONING

Threshold reactions

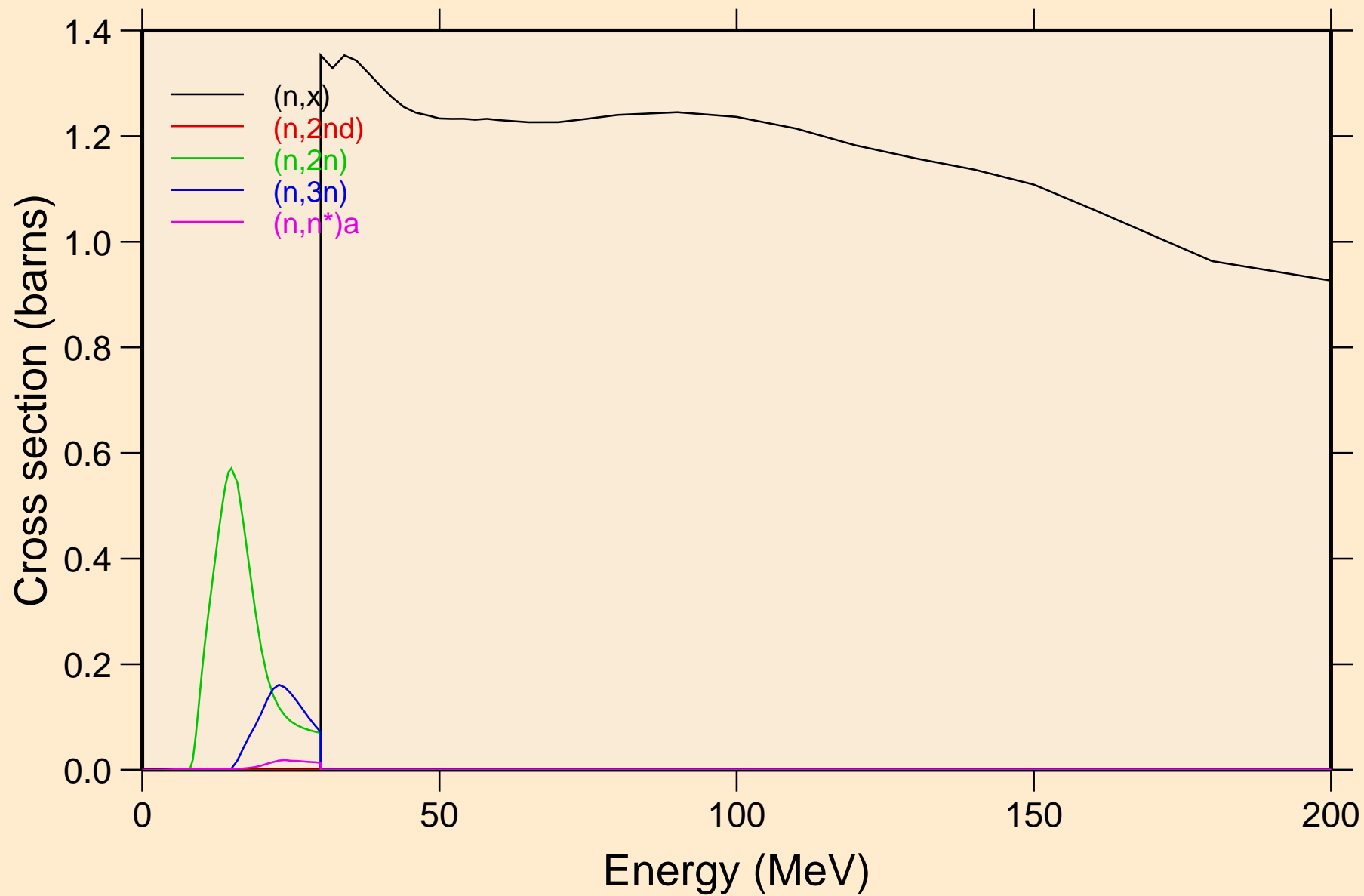

U228 NRG TENDL-2015, AKONING

Threshold reactions

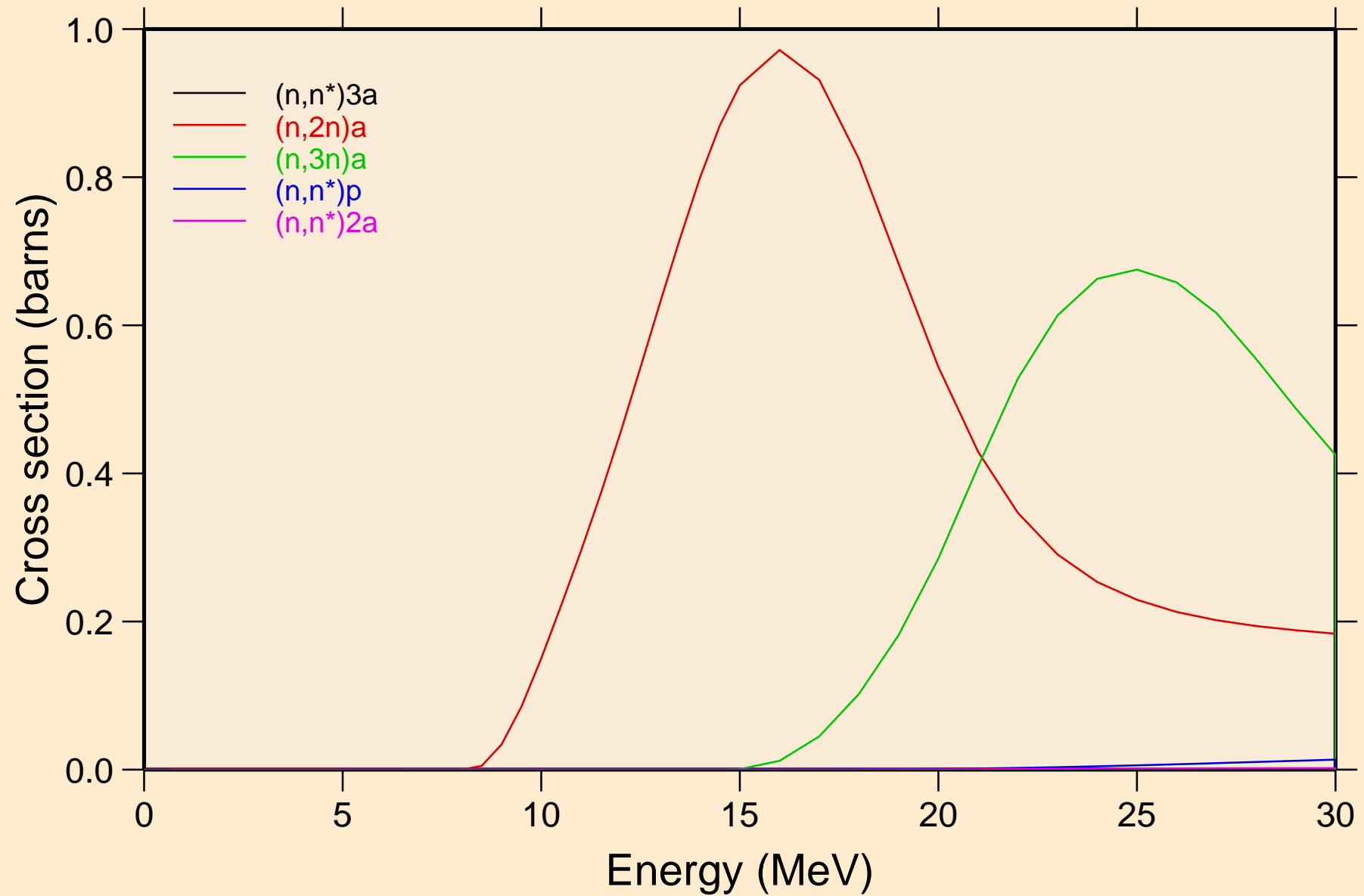

U228 NRG TENDL-2015, AKONING

Threshold reactions

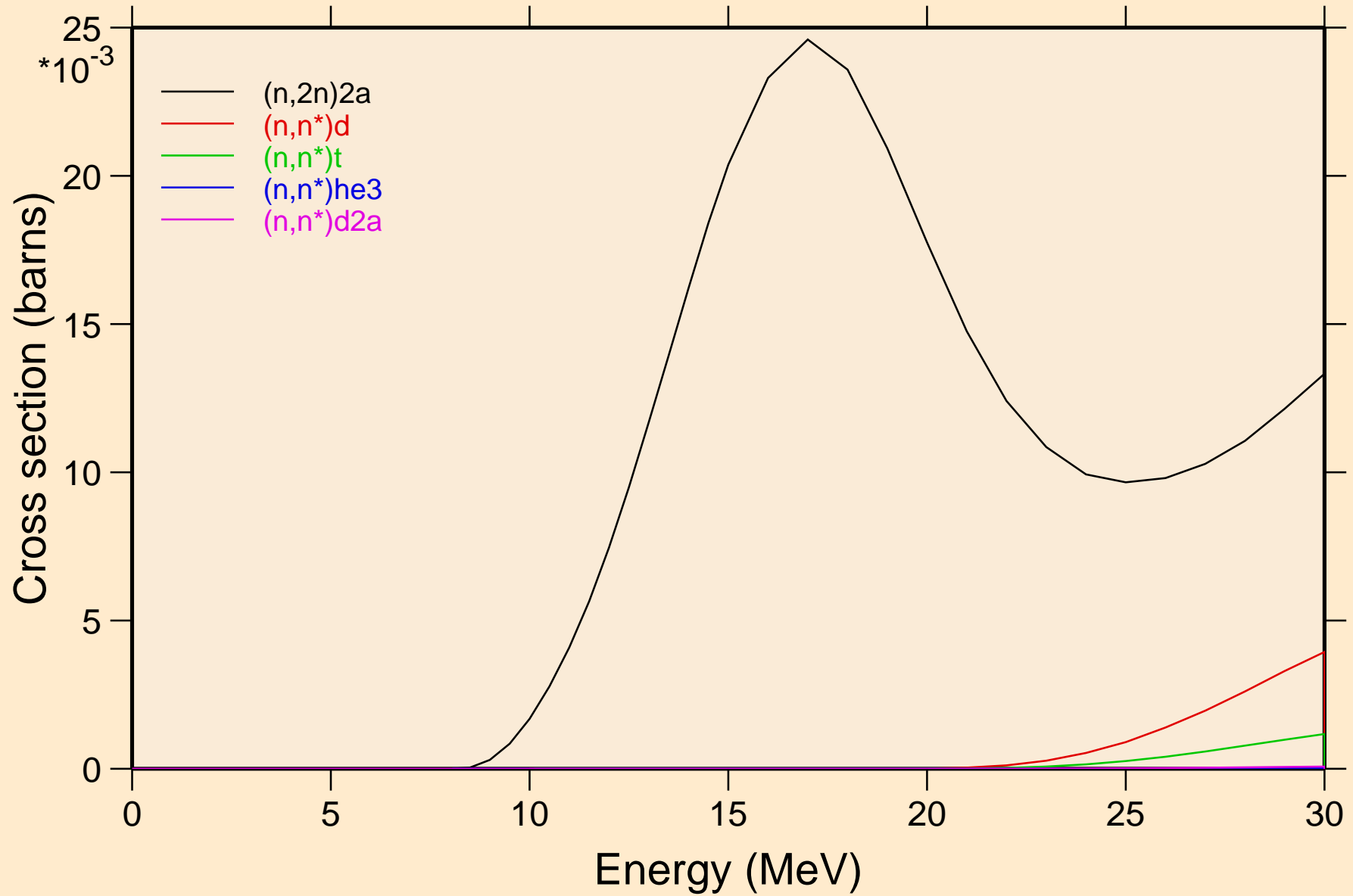

U228 NRG TENDL-2015, AKONING

Threshold reactions

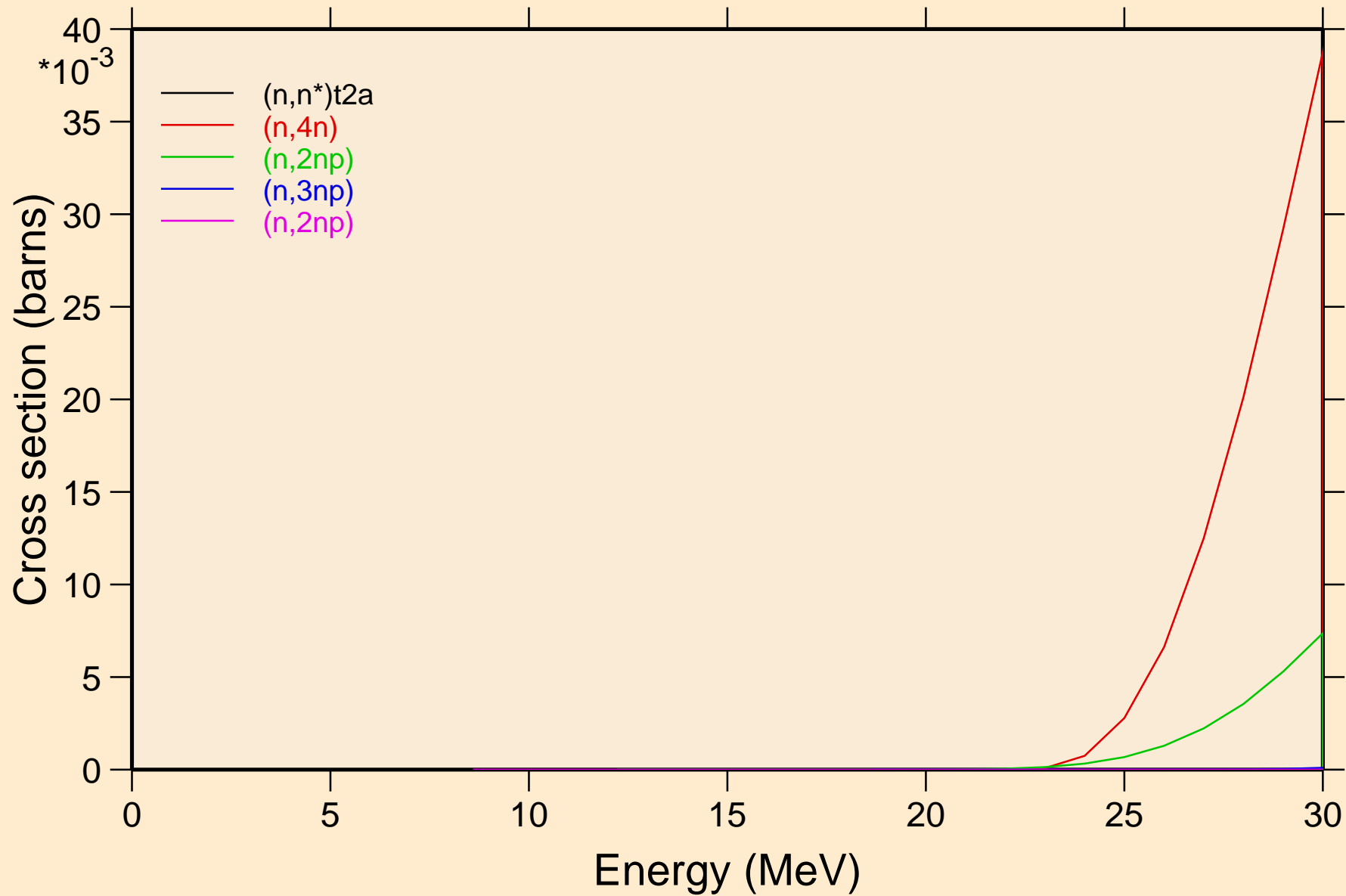

U228 NRG TENDL-2015, AKONING

Threshold reactions

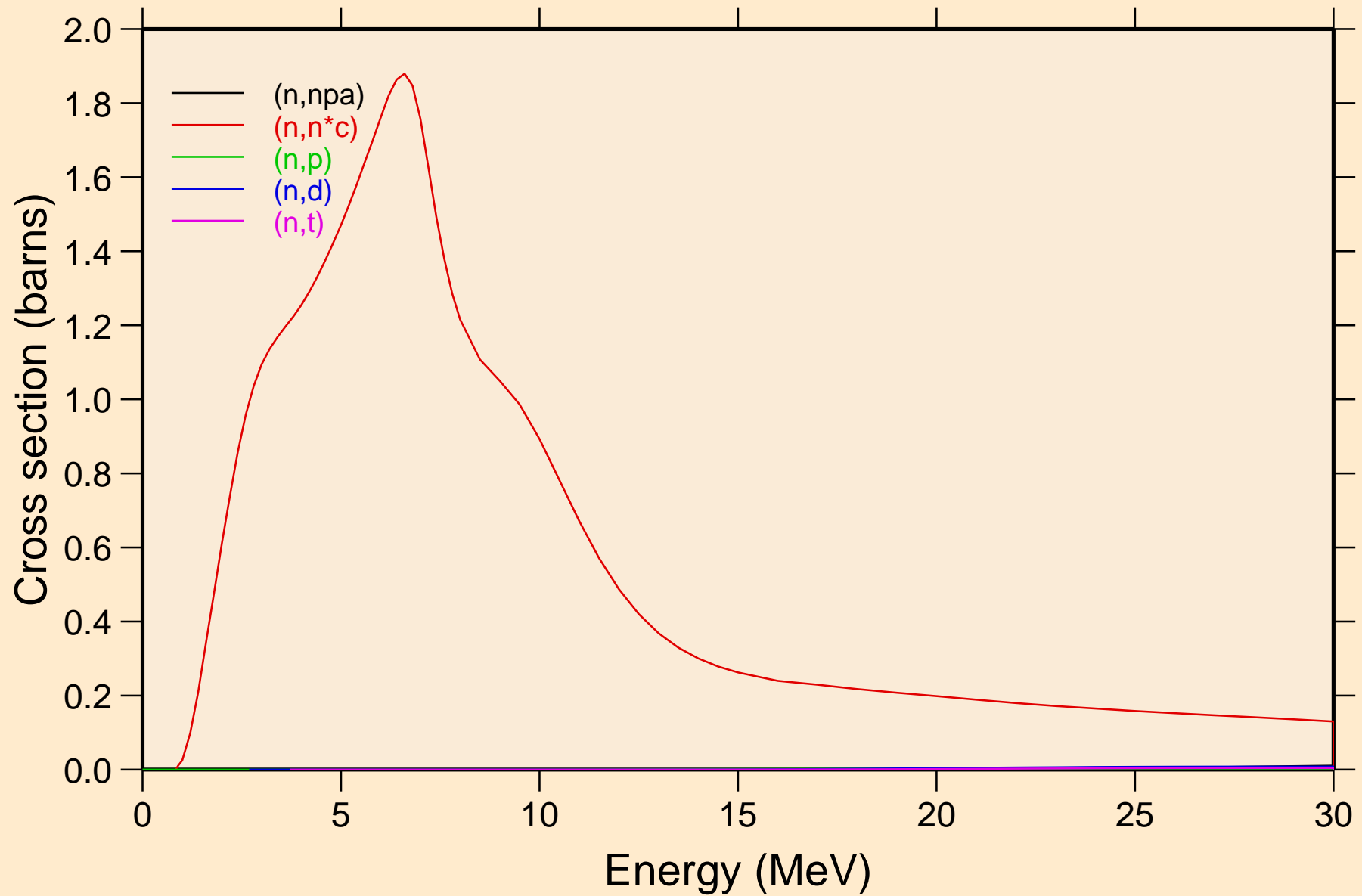

U228 NRG TENDL-2015, AKONING

Threshold reactions

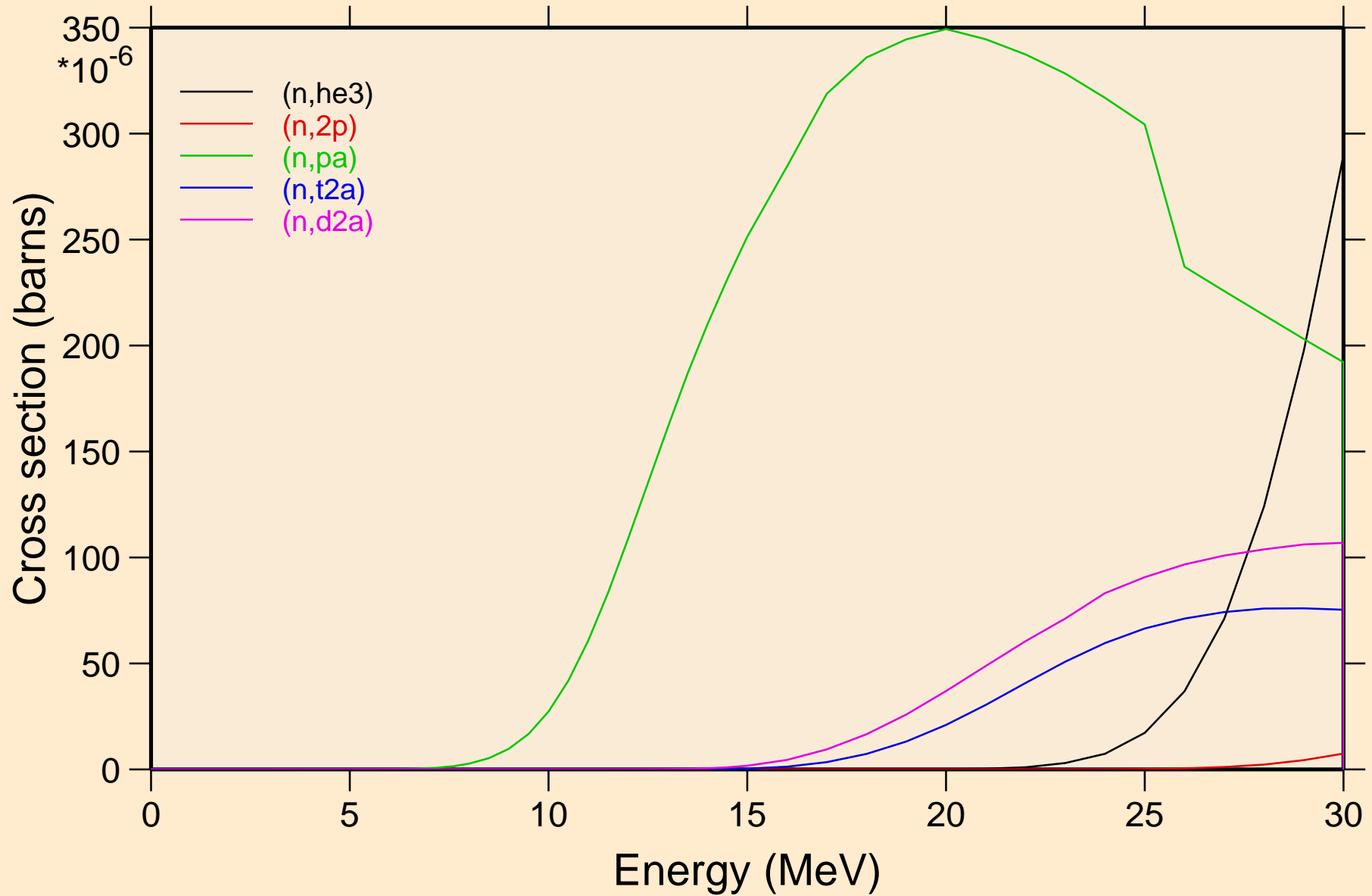

U228 NRG TENDL-2015, AKONING

Threshold reactions

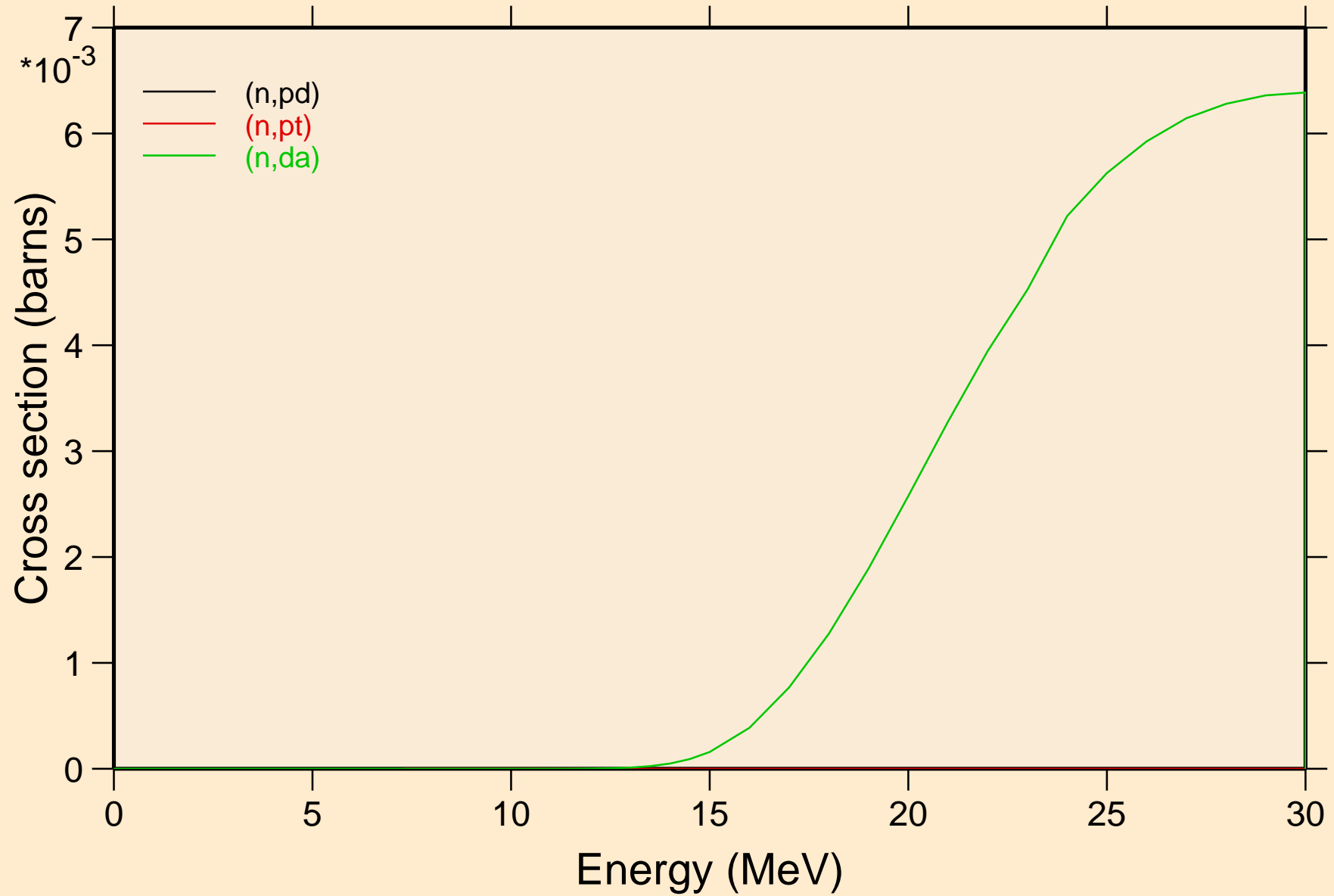

U228 NRG TENDL-2015, AKONING
angular distribution for elastic

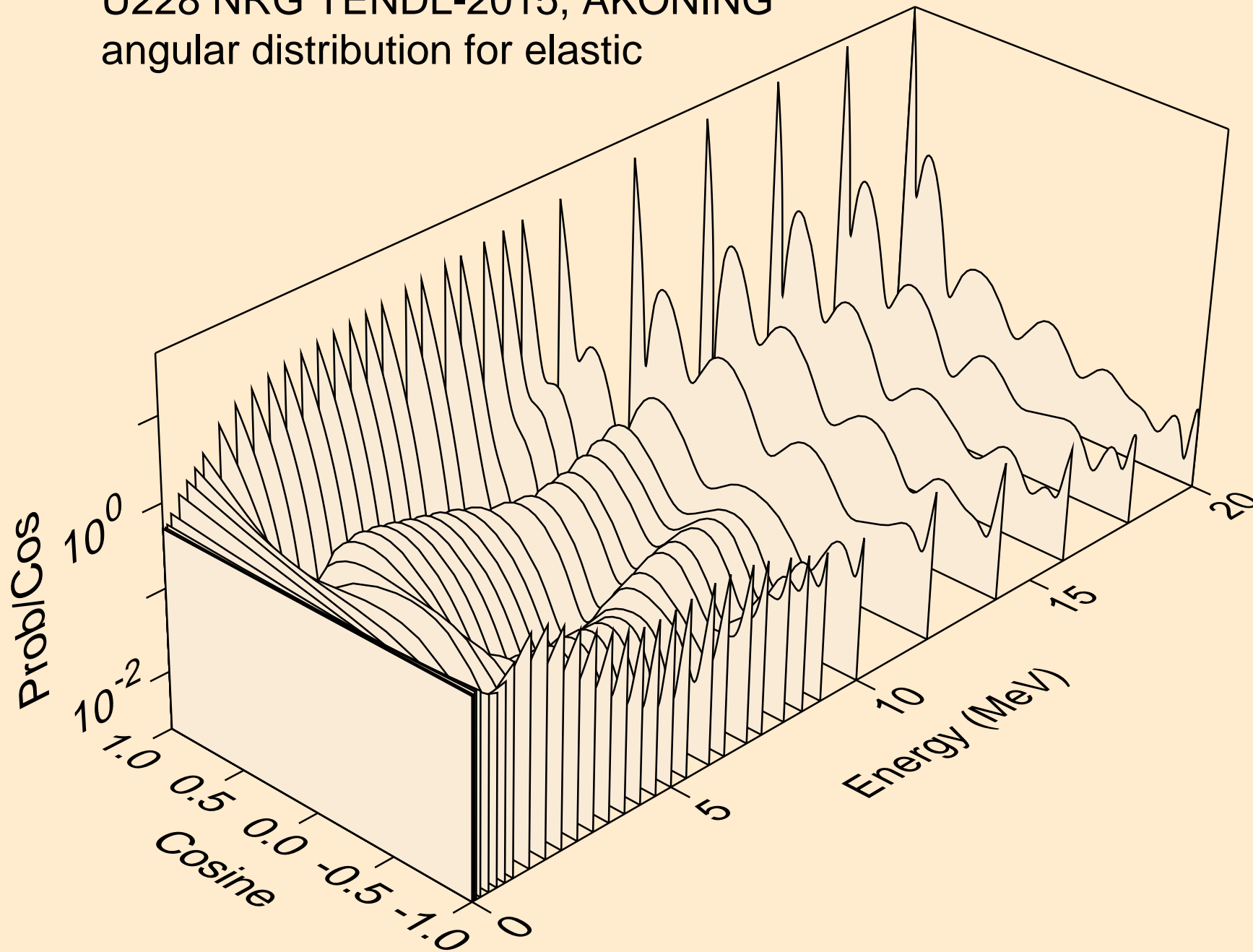

U228 NRG TENDL-2015, AKONING
angular distribution for elastic

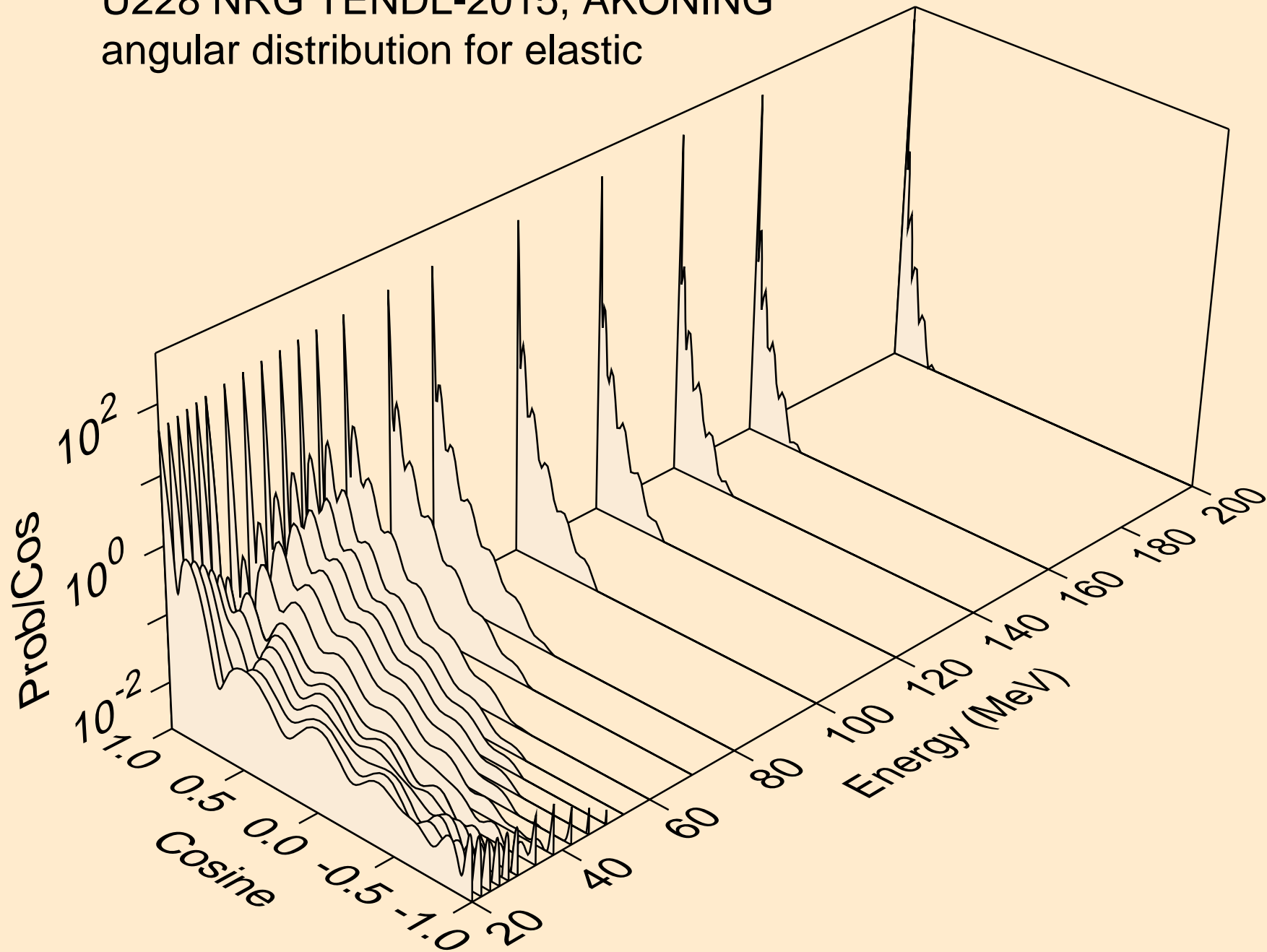

U228 NRG TENDL-2015, AKONING
angular distribution for (n,n*1)

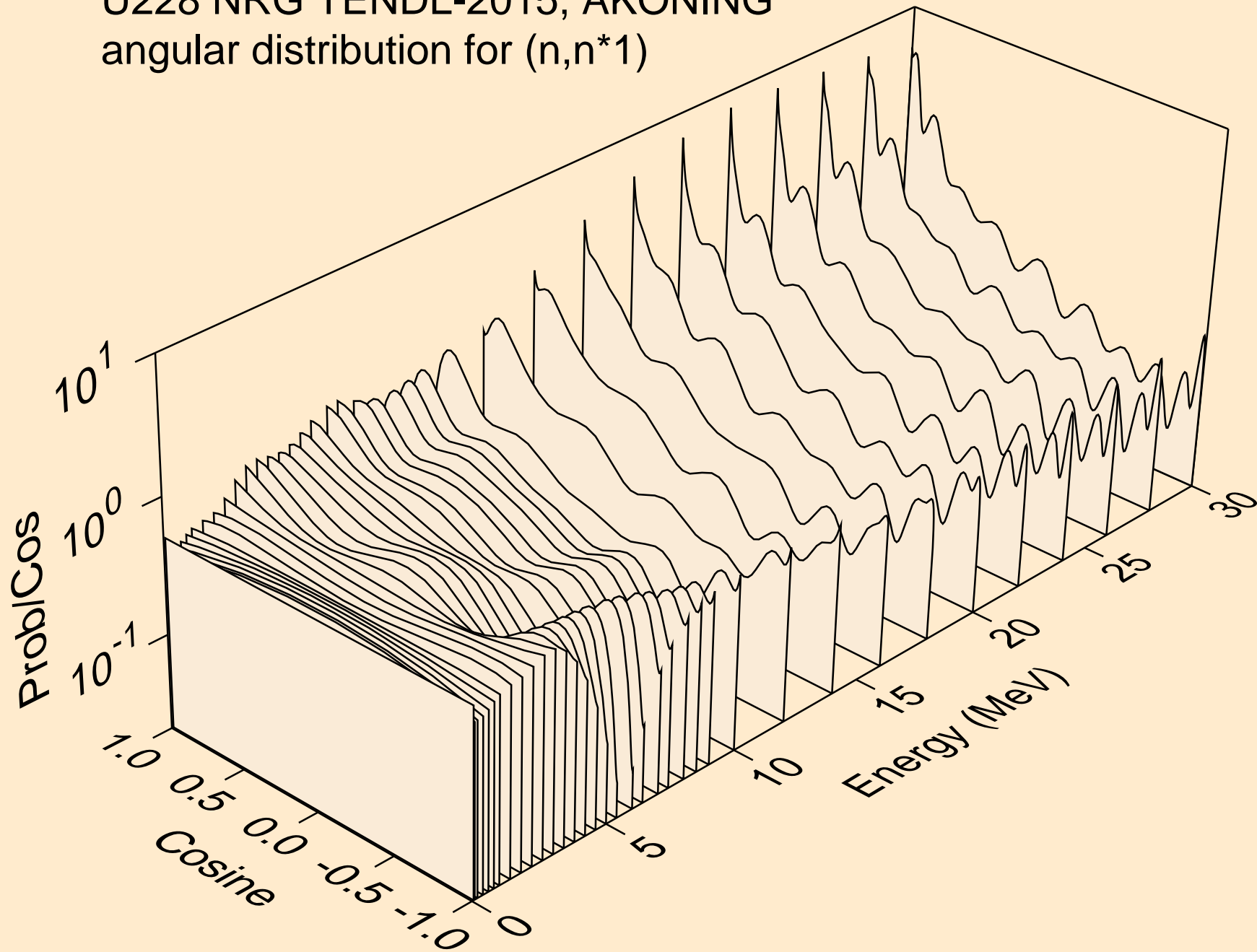

U228 NRG TENDL-2015, AKONING
angular distribution for (n,n*2)

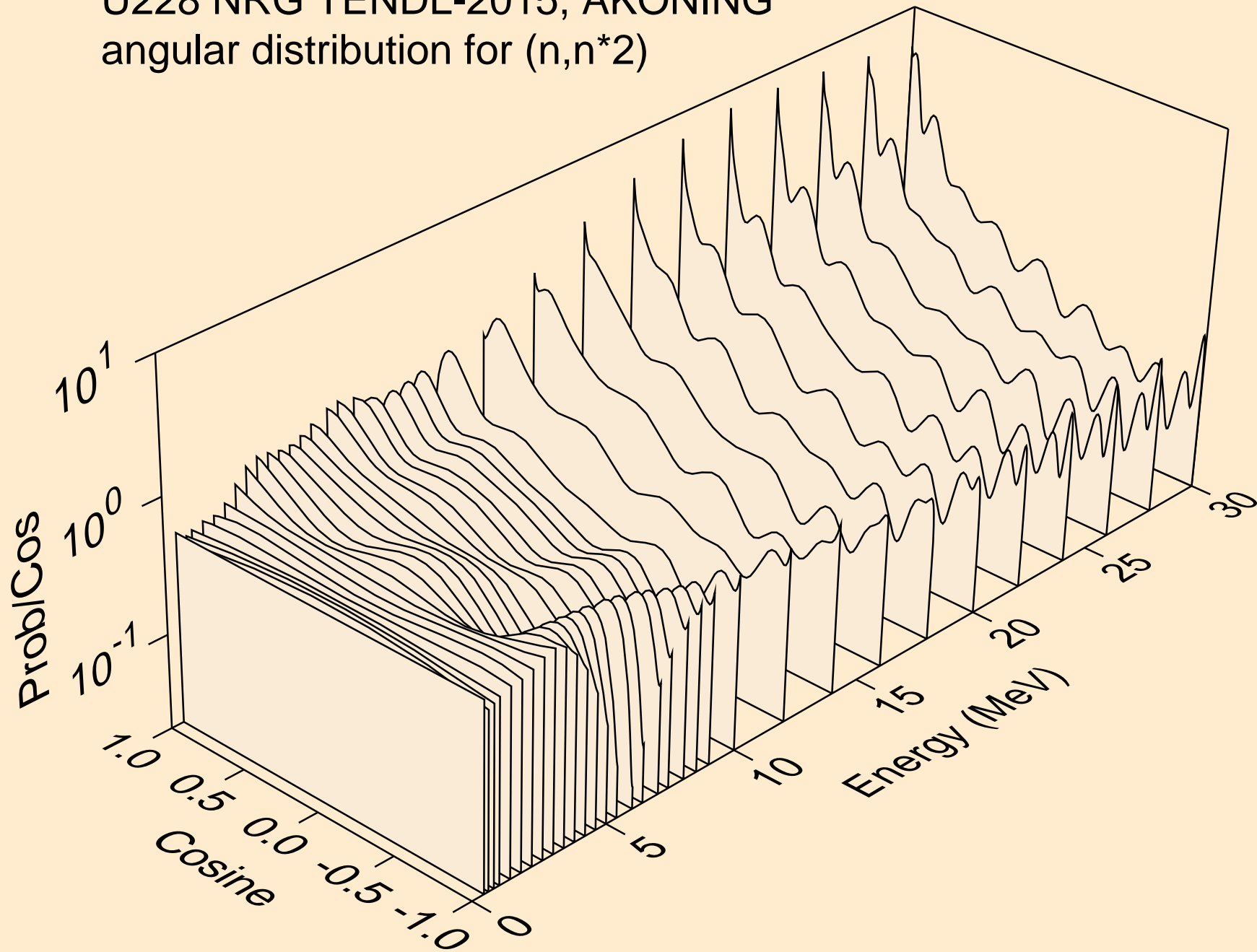

U228 NRG TENDL-2015, AKONING
angular distribution for (n,n*3)

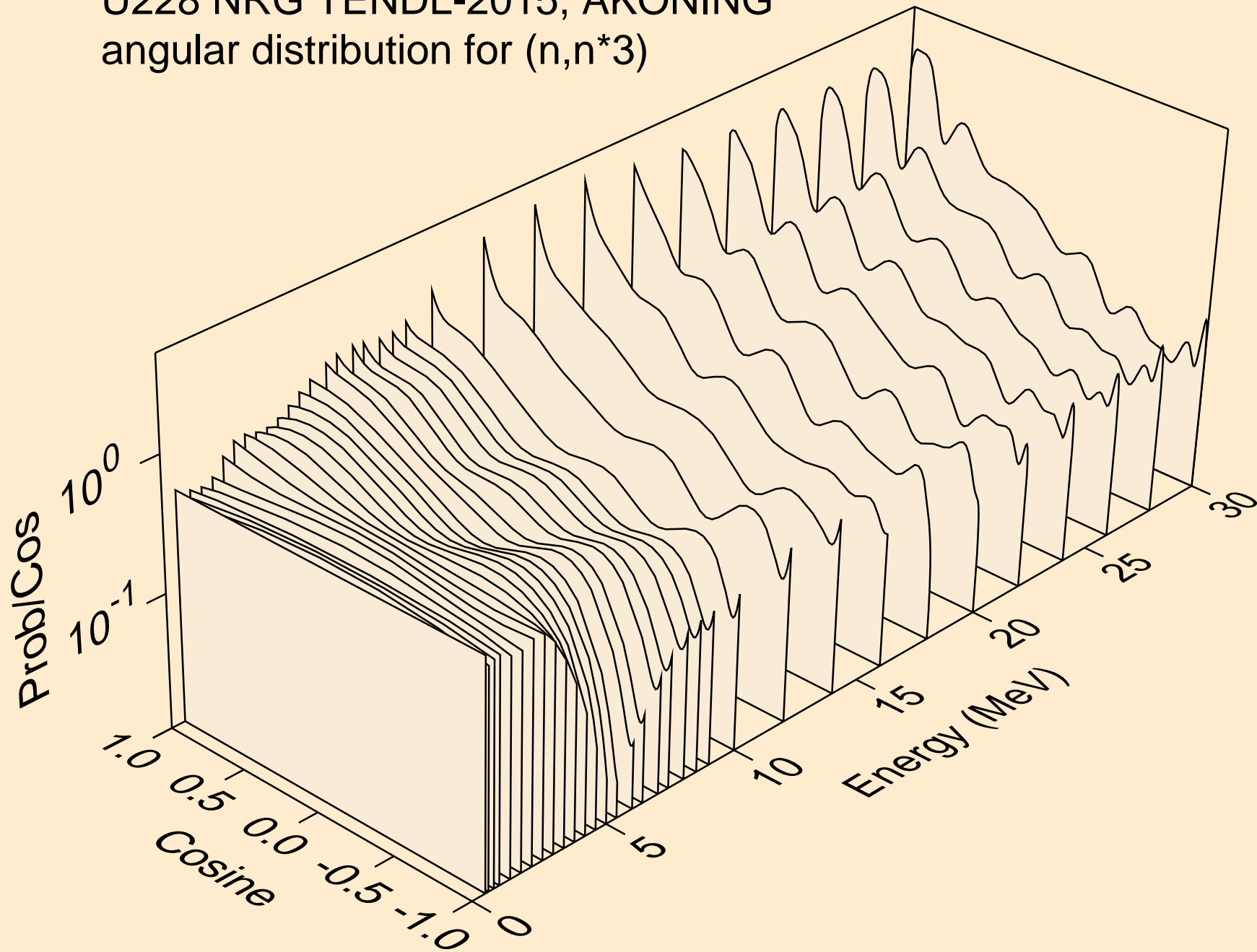

U228 NRG TENDL-2015, AKONING
angular distribution for (n,n*4)

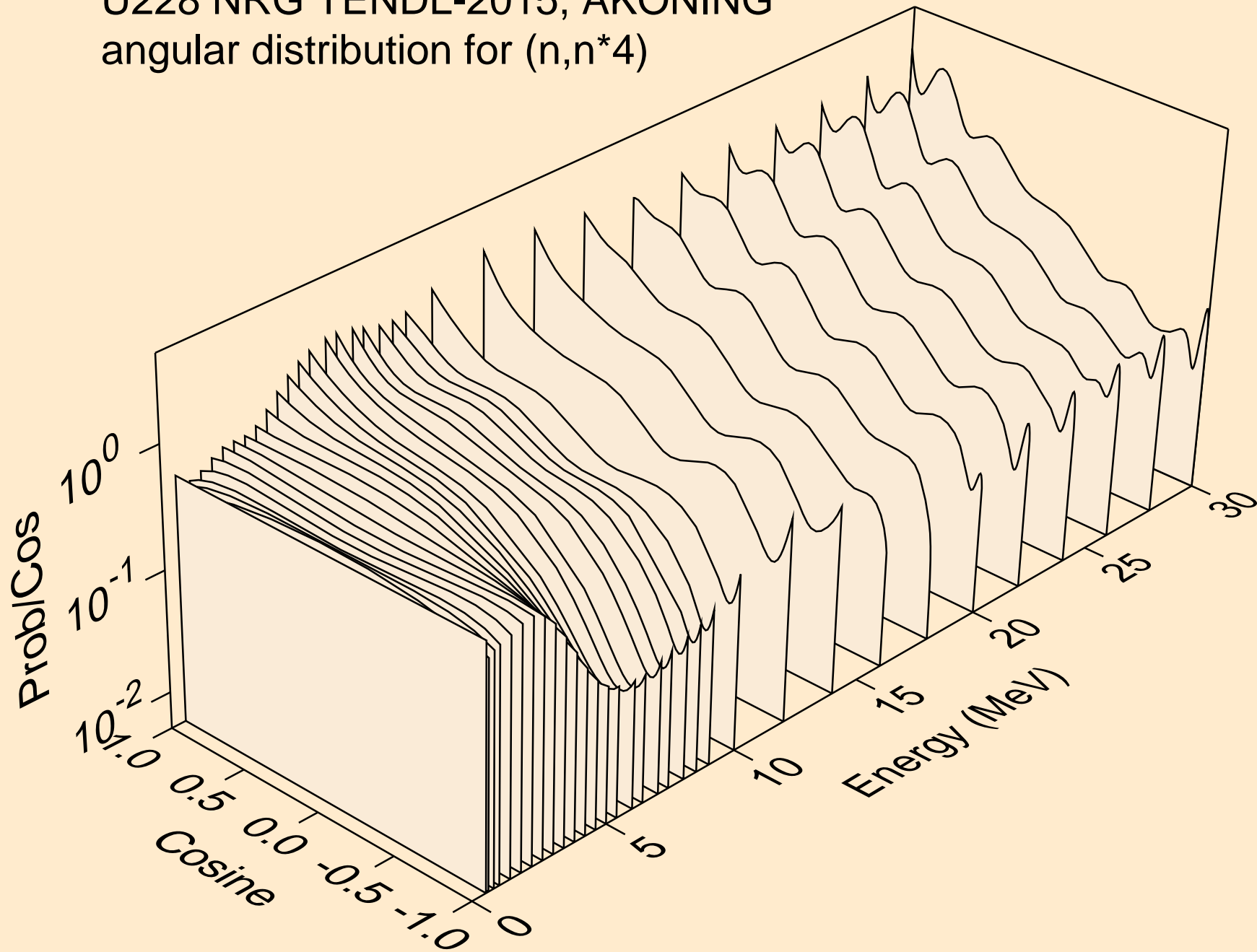

U228 NRG TENDL-2015, AKONING
angular distribution for (n,n*5)

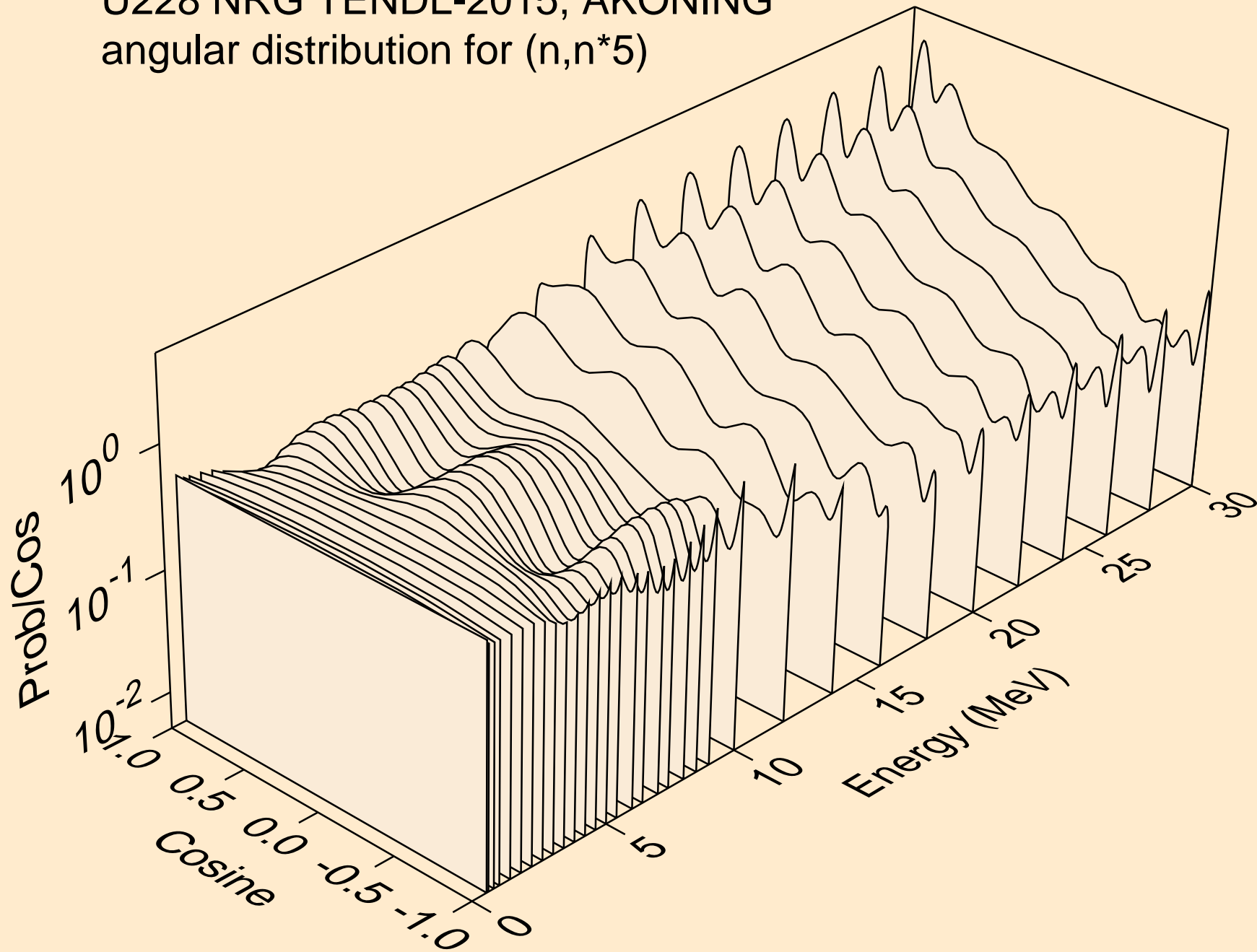

U228 NRG TENDL-2015, AKONING
angular distribution for (n,n*6)

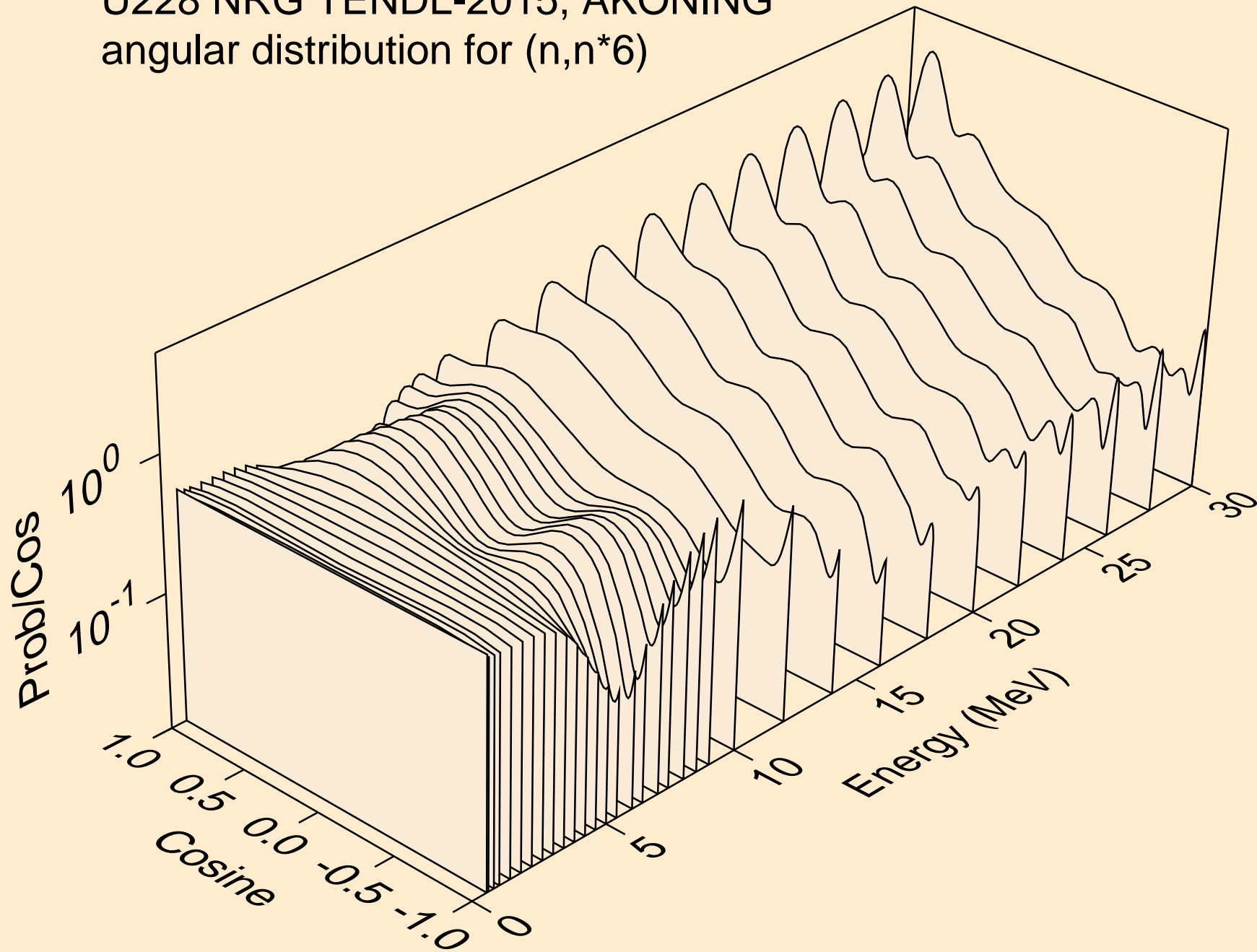

U228 NRG TENDL-2015, AKONING
angular distribution for (n,n*7)

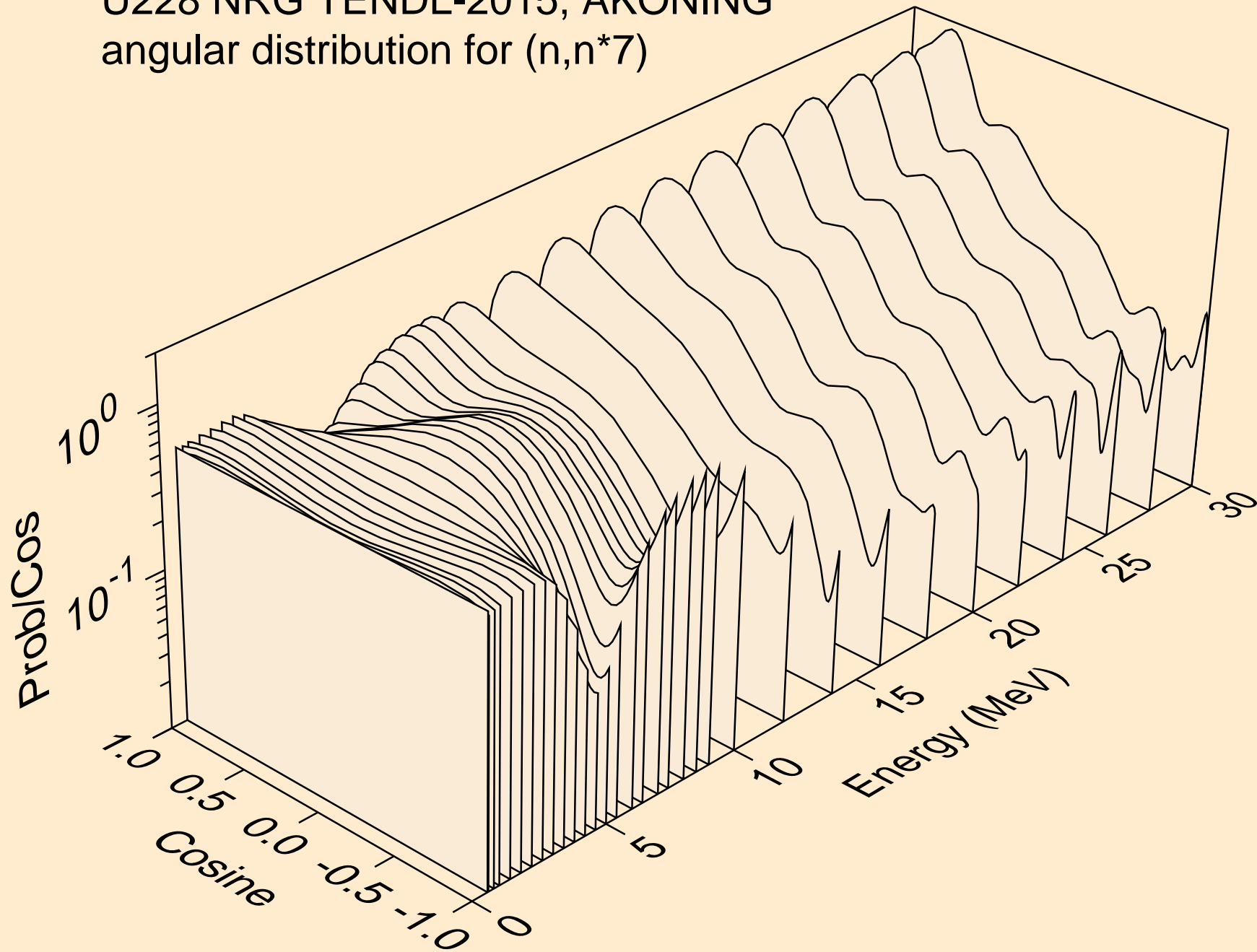

U228 NRG TENDL-2015, AKONING
angular distribution for (n,n*8)

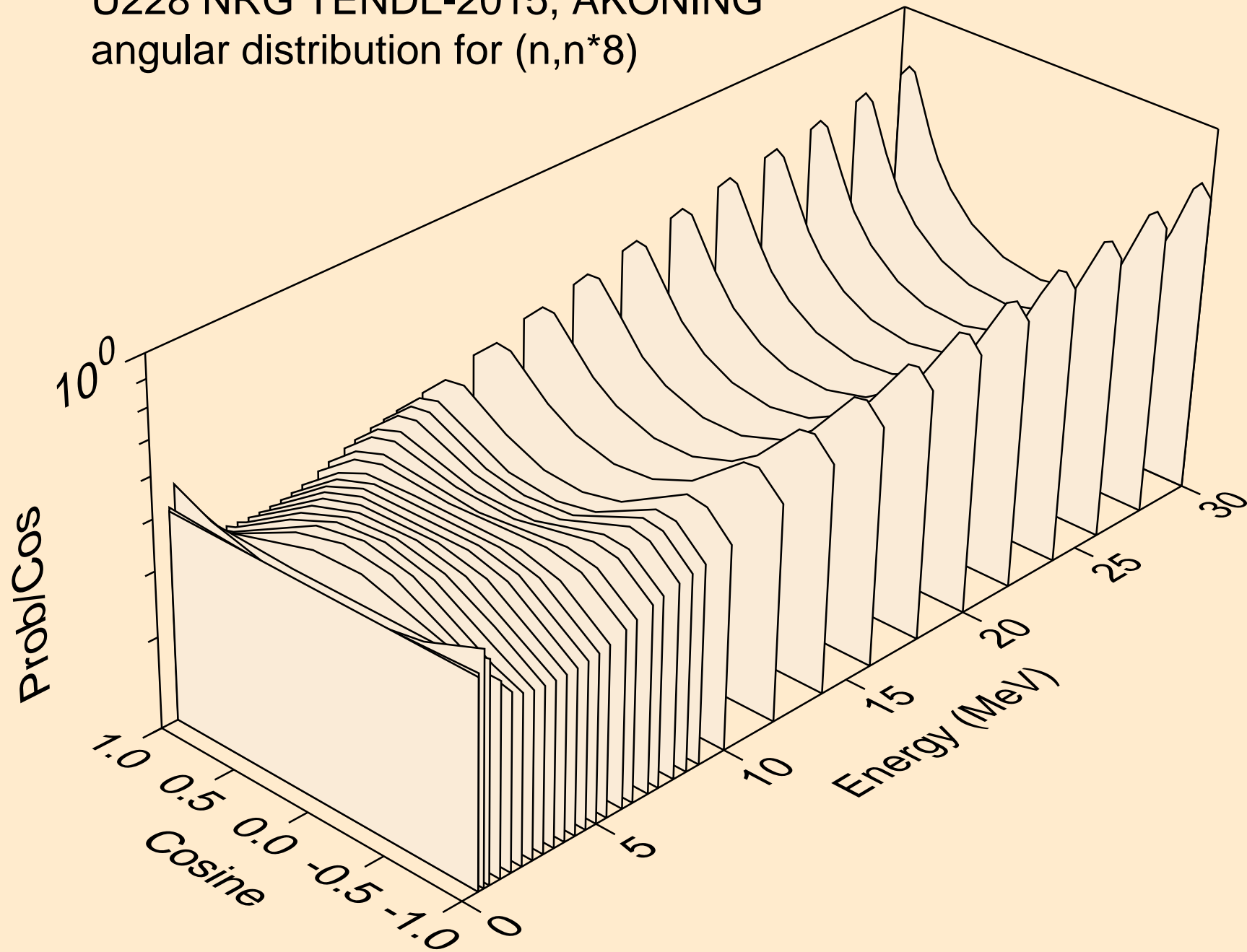

U228 NRG TENDL-2015, AKONING
angular distribution for (n,n*9)

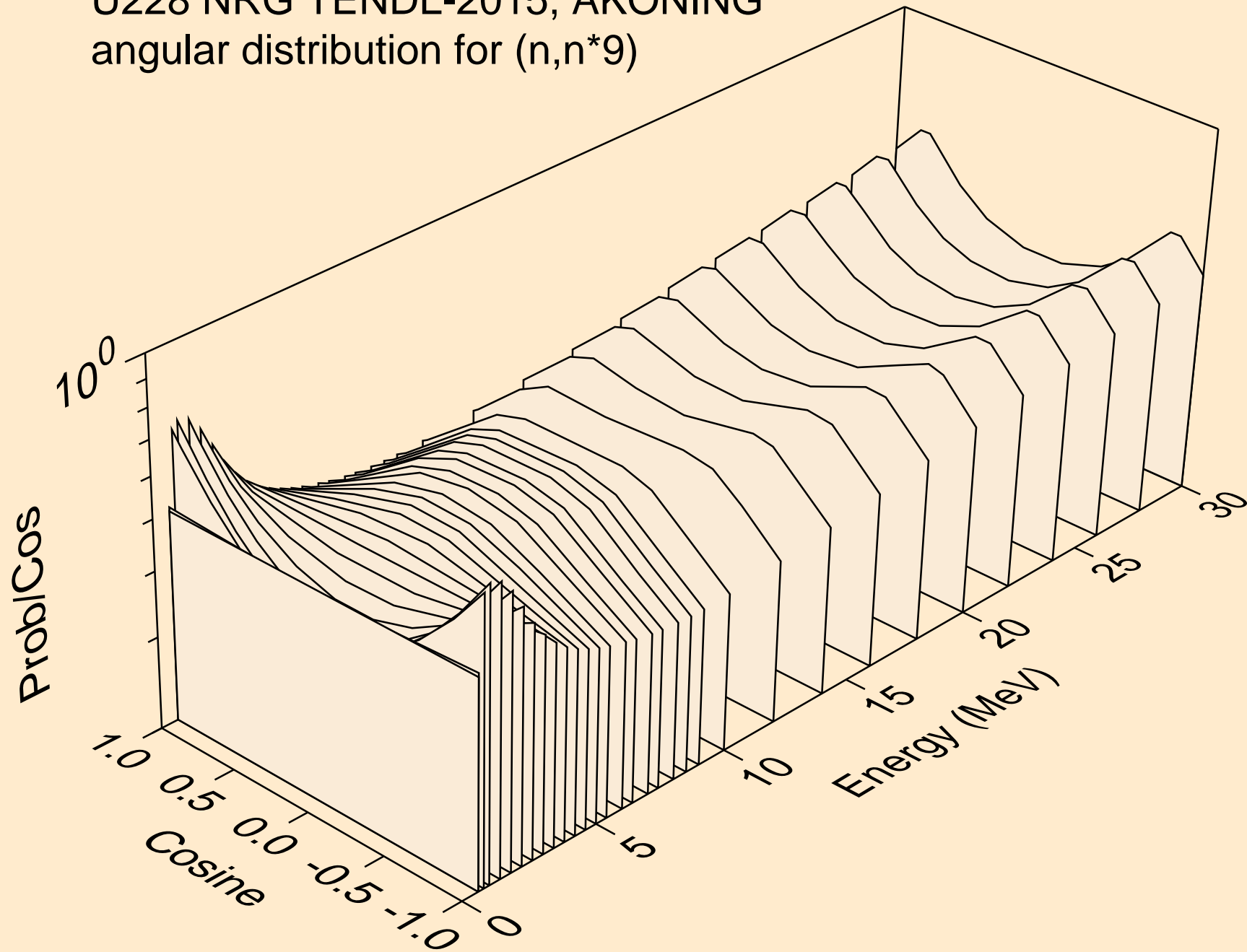

U228 NRG TENDL-2015, AKONING
angular distribution for (n,n*10)

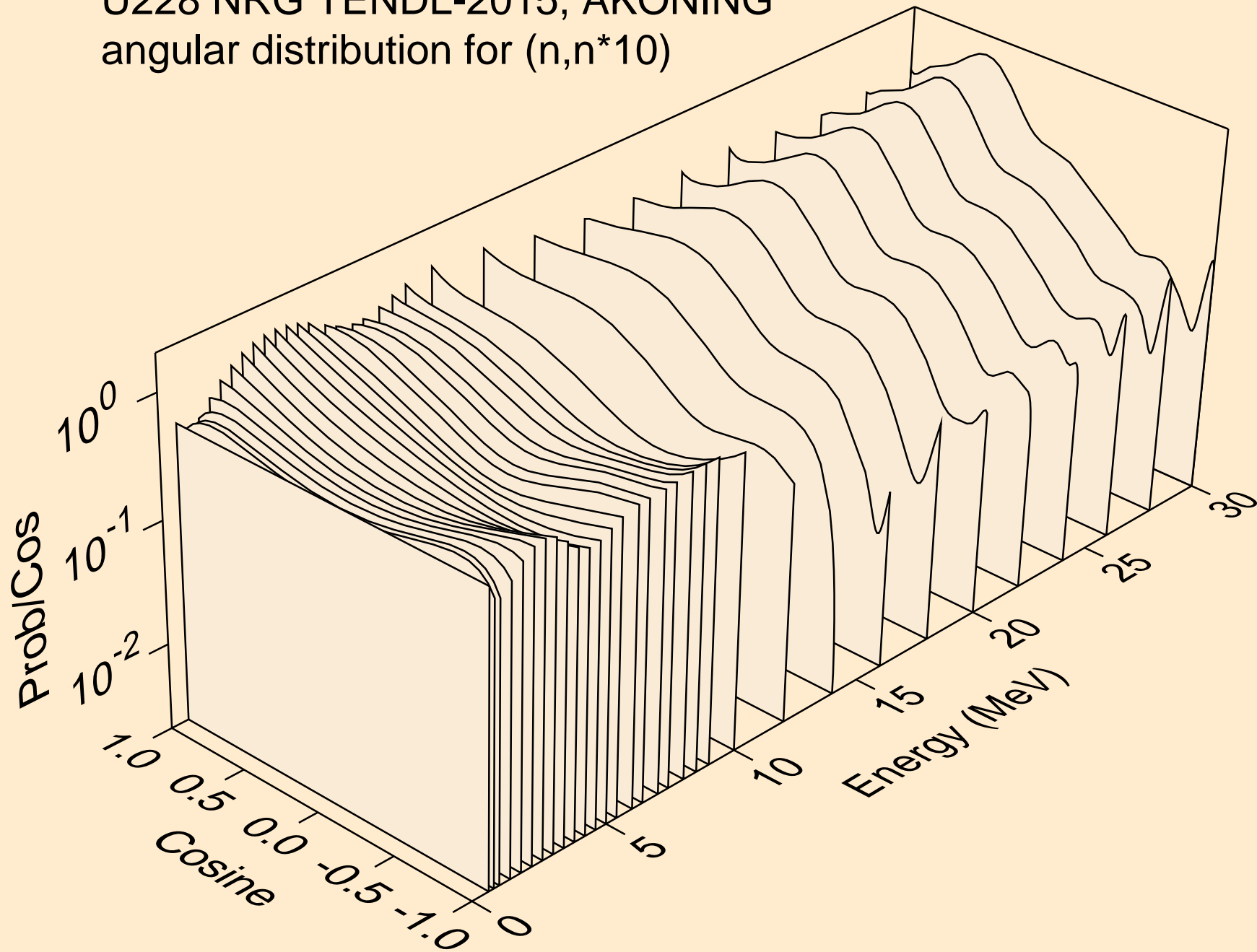

U228 NRG TENDL-2015, AKONING
angular distribution for (n,n*11)

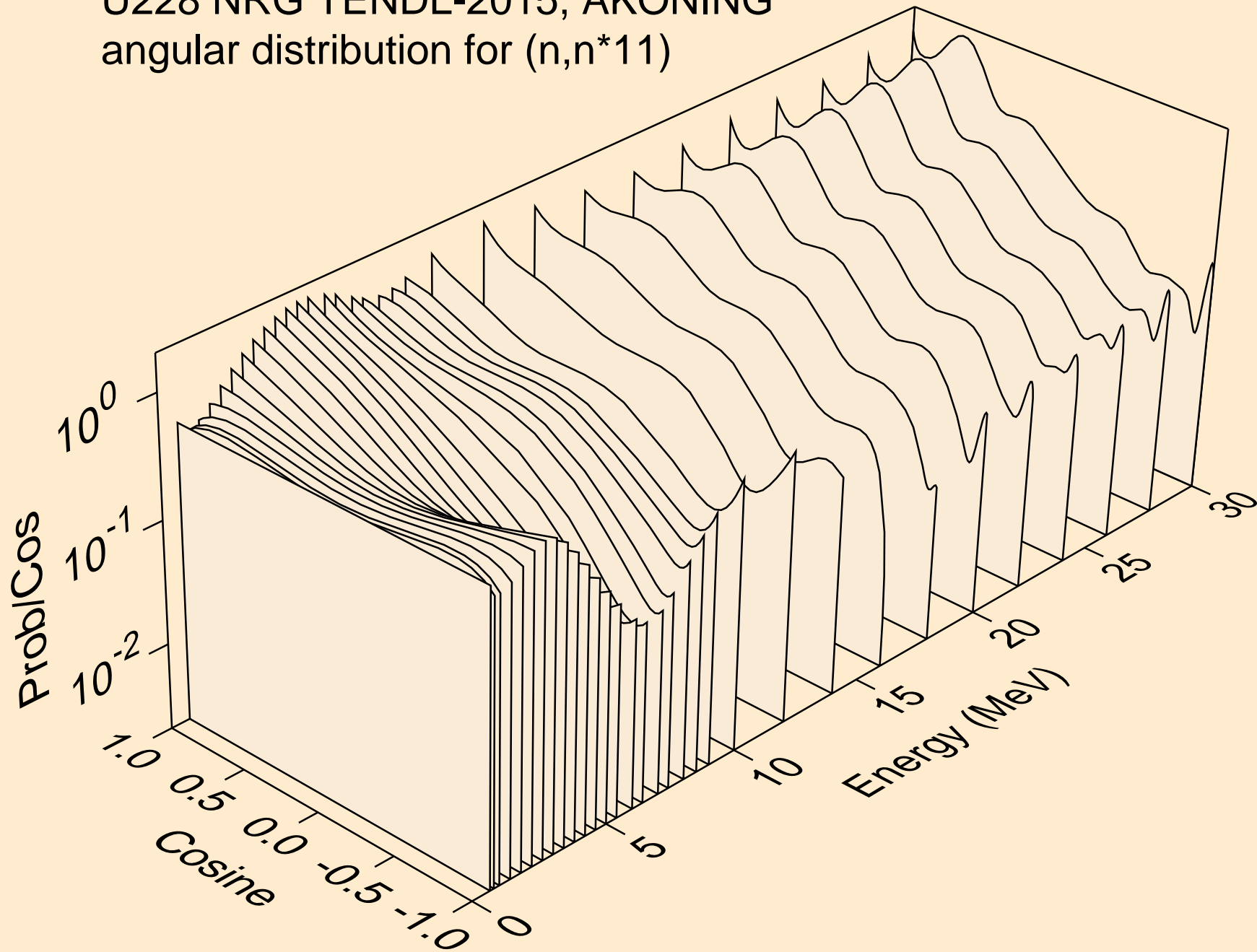

U228 NRG TENDL-2015, AKONING
angular distribution for (n,n*12)

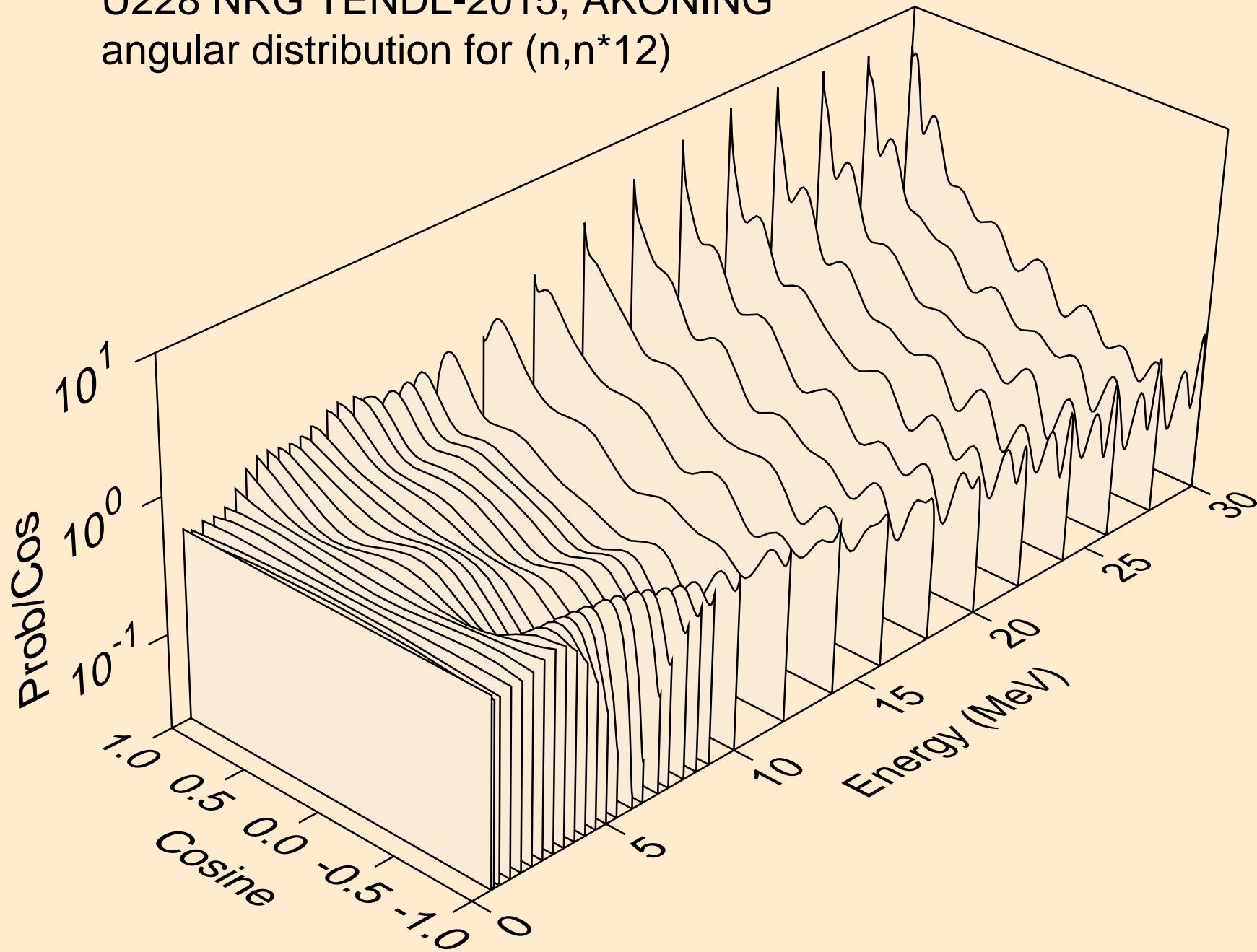

U228 NRG TENDL-2015, AKONING
angular distribution for (n,n*13)

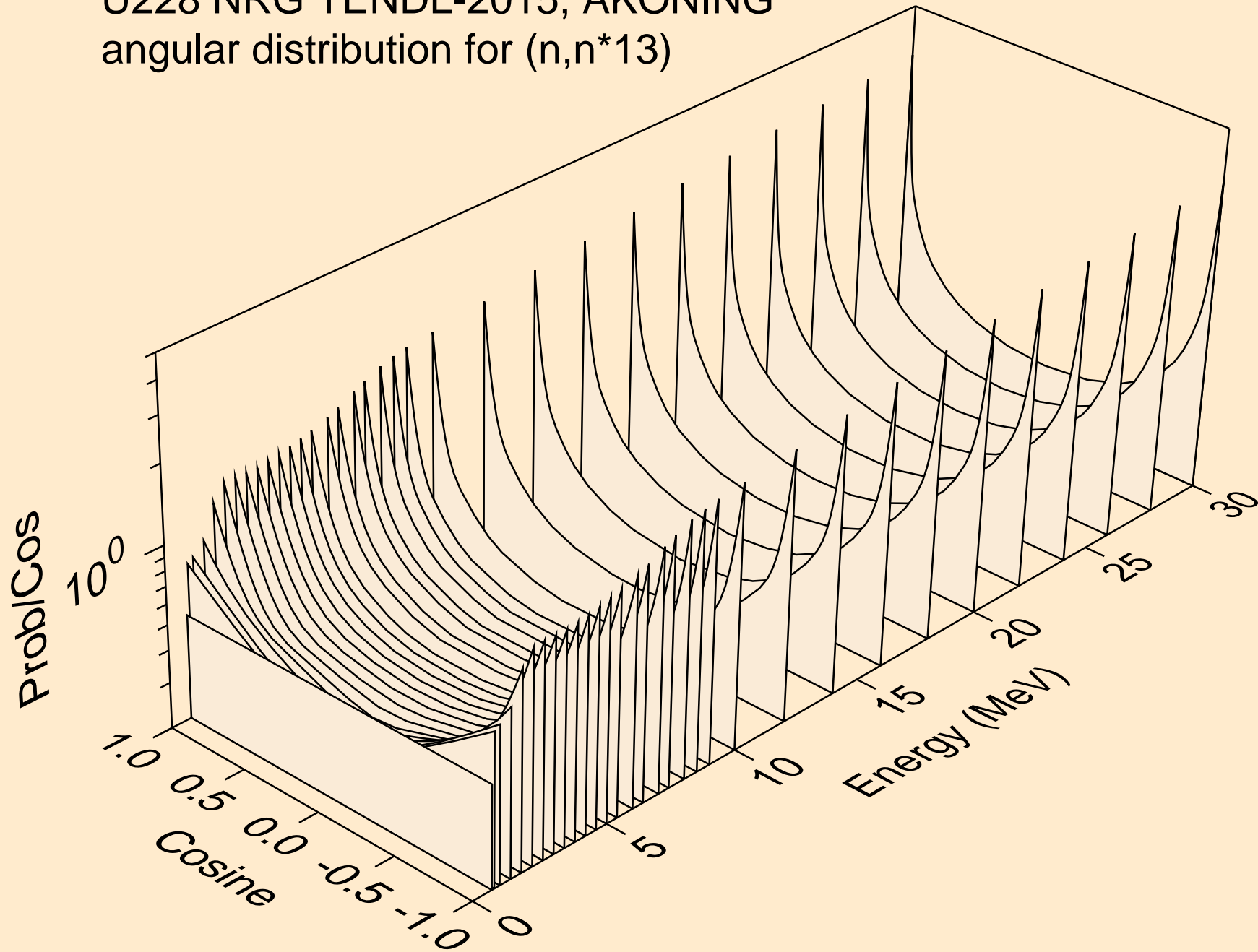

U228 NRG TENDL-2015, AKONING
angular distribution for (n,n*14)

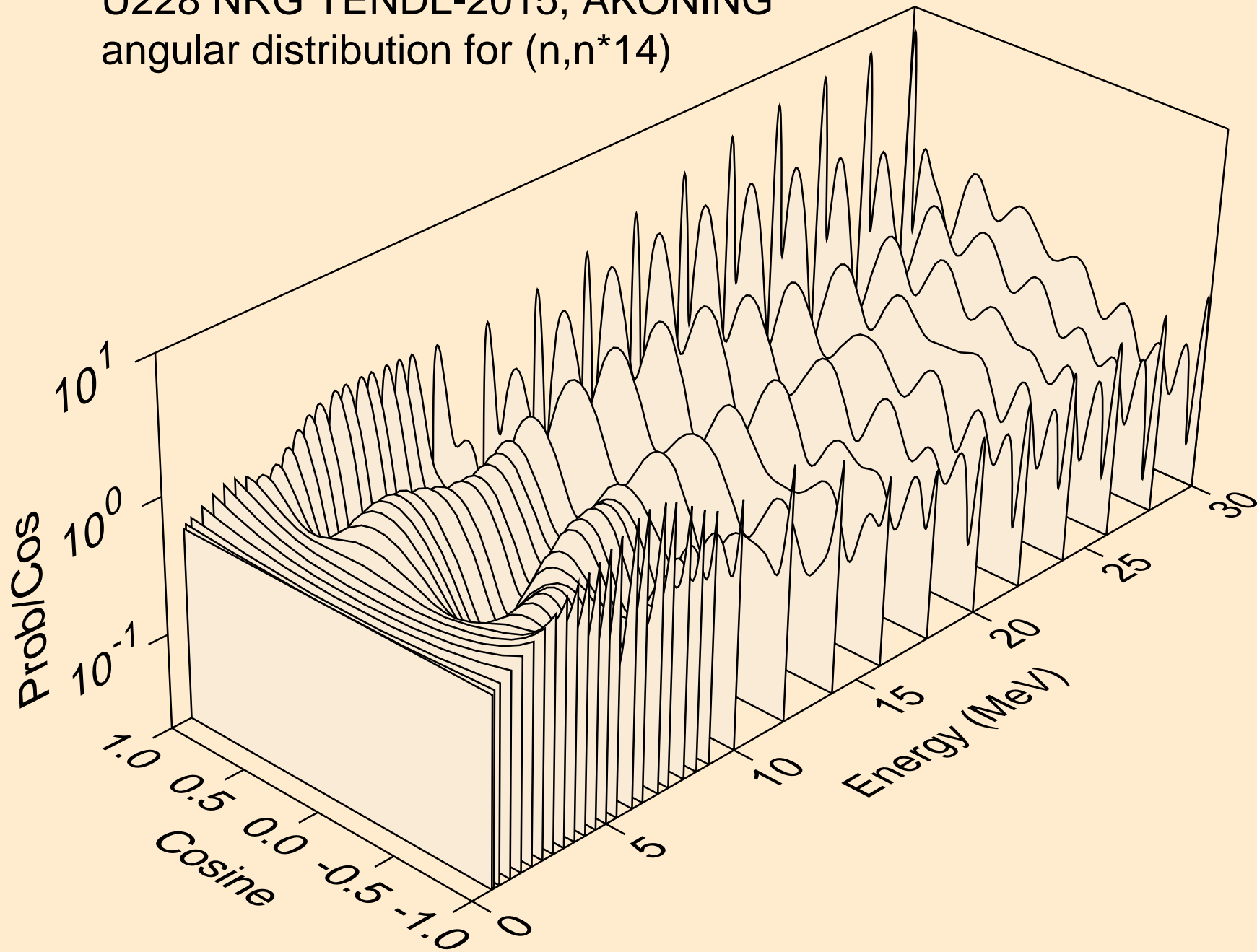

U228 NRG TENDL-2015, AKONING
angular distribution for (n,n*15)

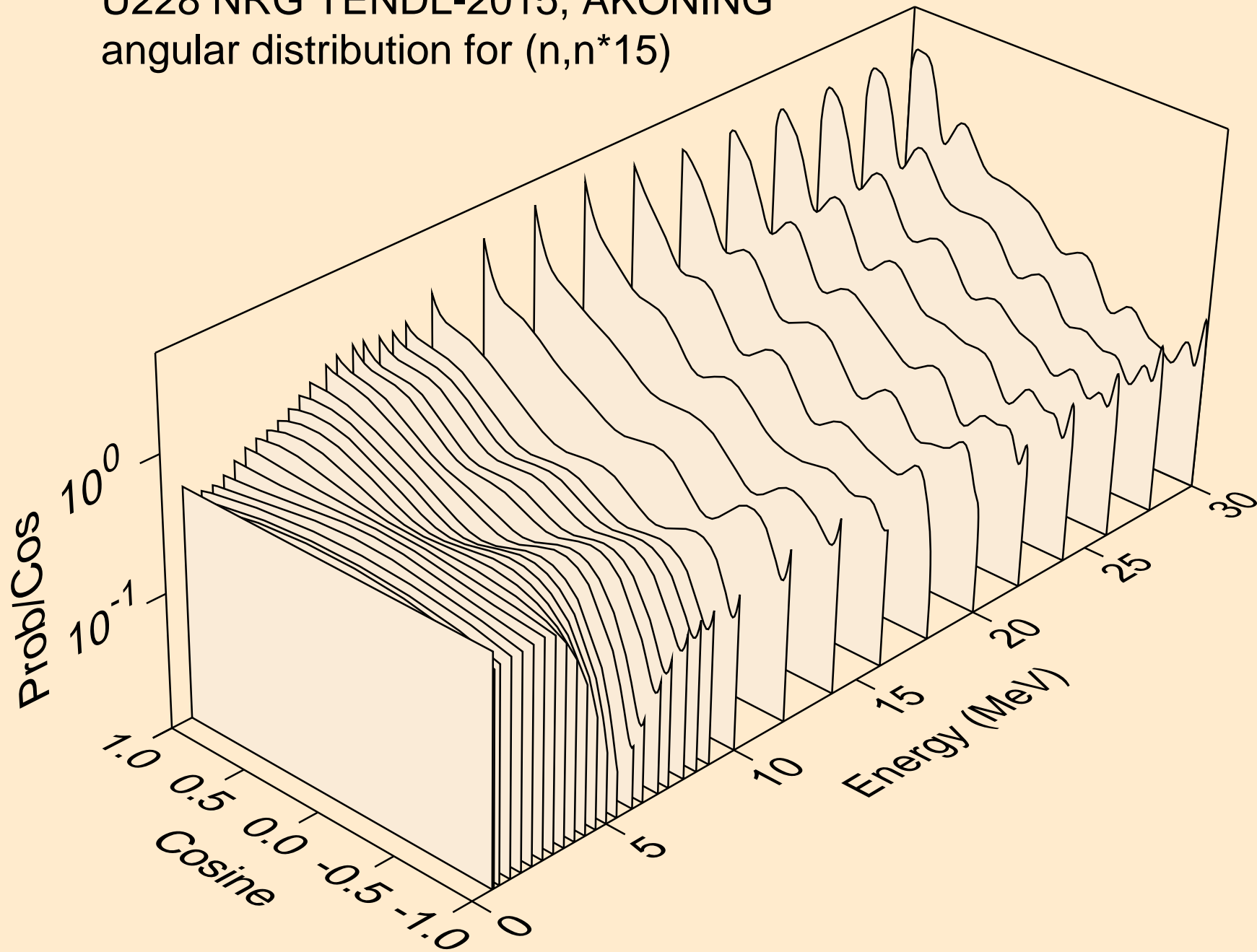

U228 NRG TENDL-2015, AKONING
angular distribution for (n,n*16)

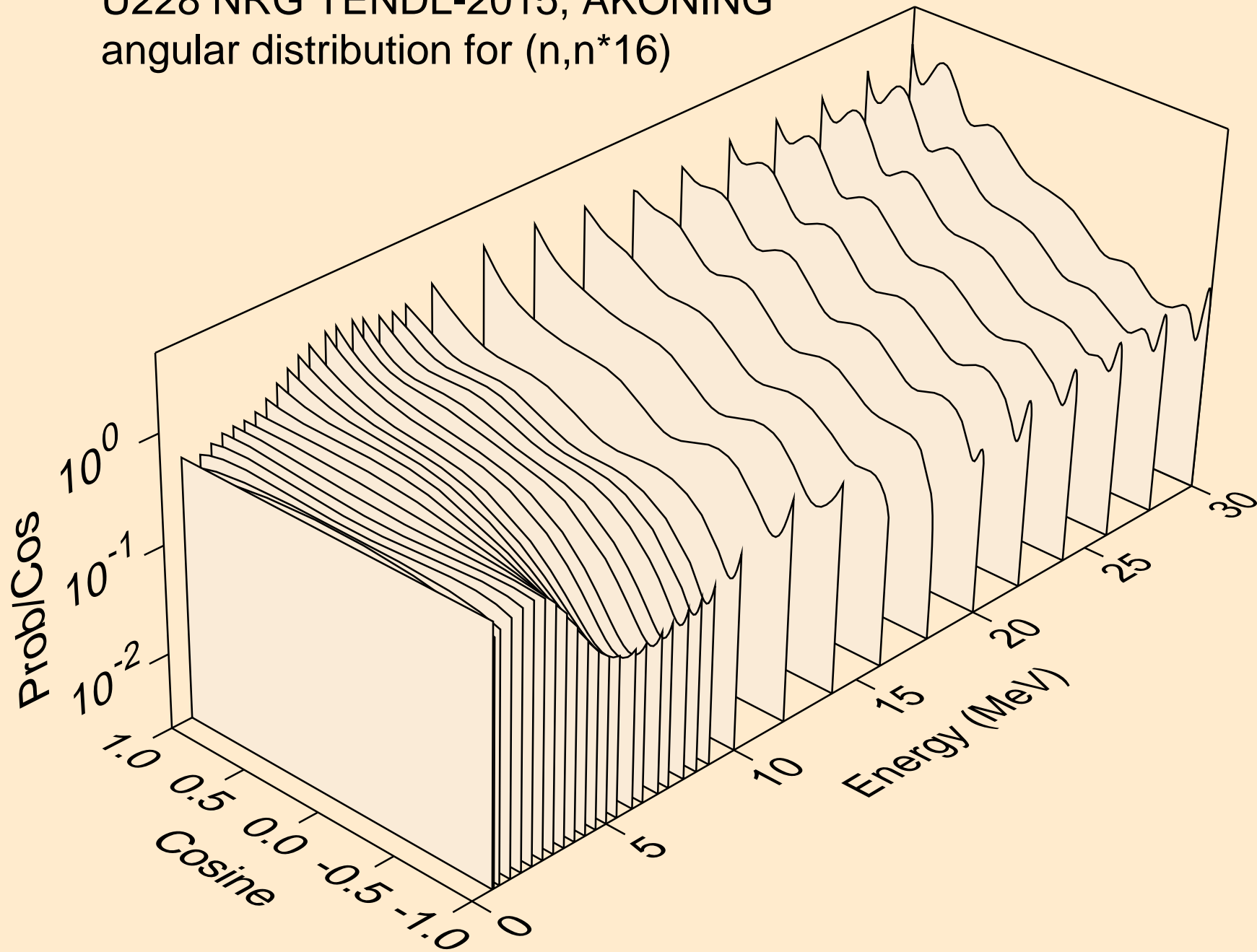

U228 NRG TENDL-2015, AKONING
angular distribution for (n,n*17)

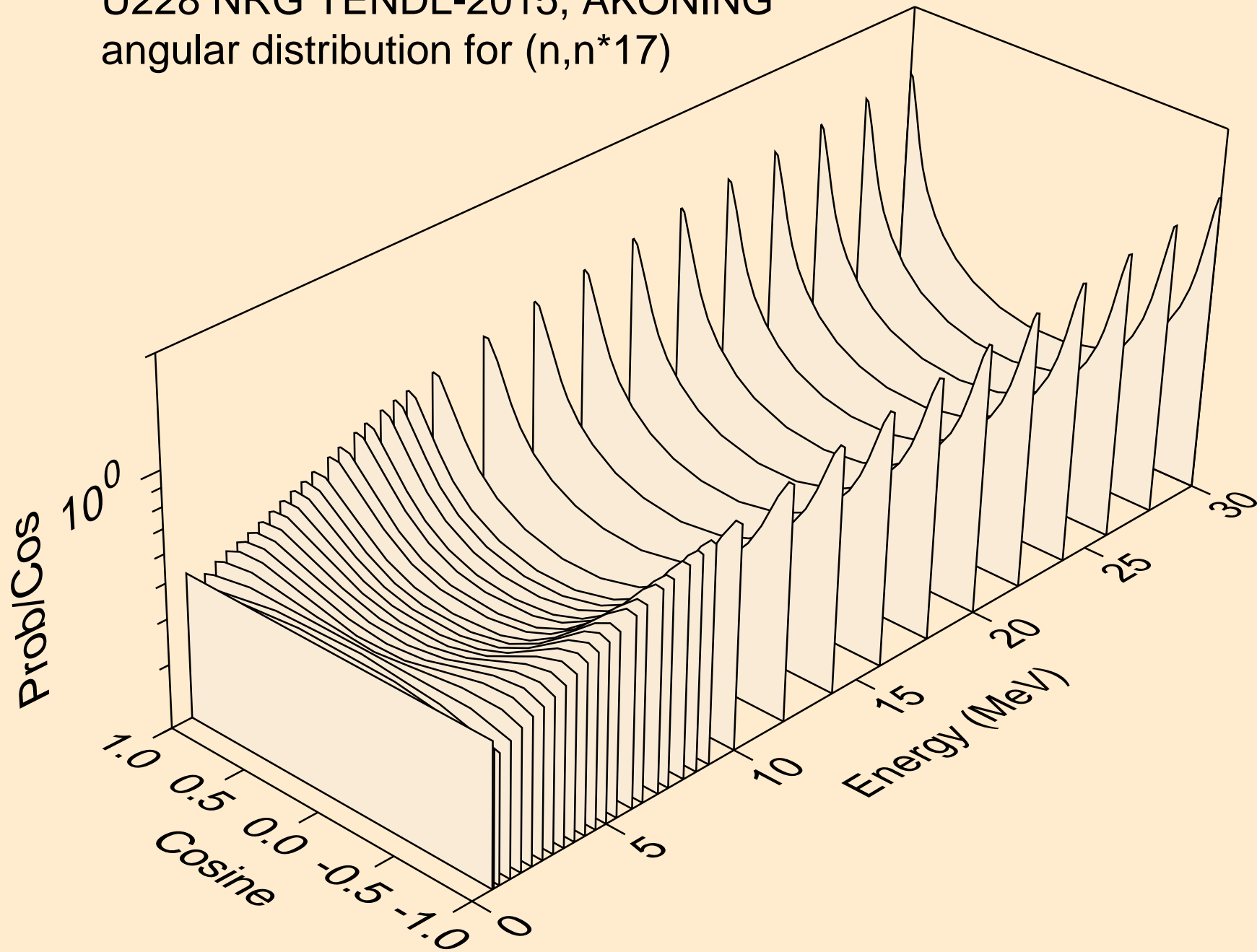

U228 NRG TENDL-2015, AKONING
angular distribution for (n,n*18)

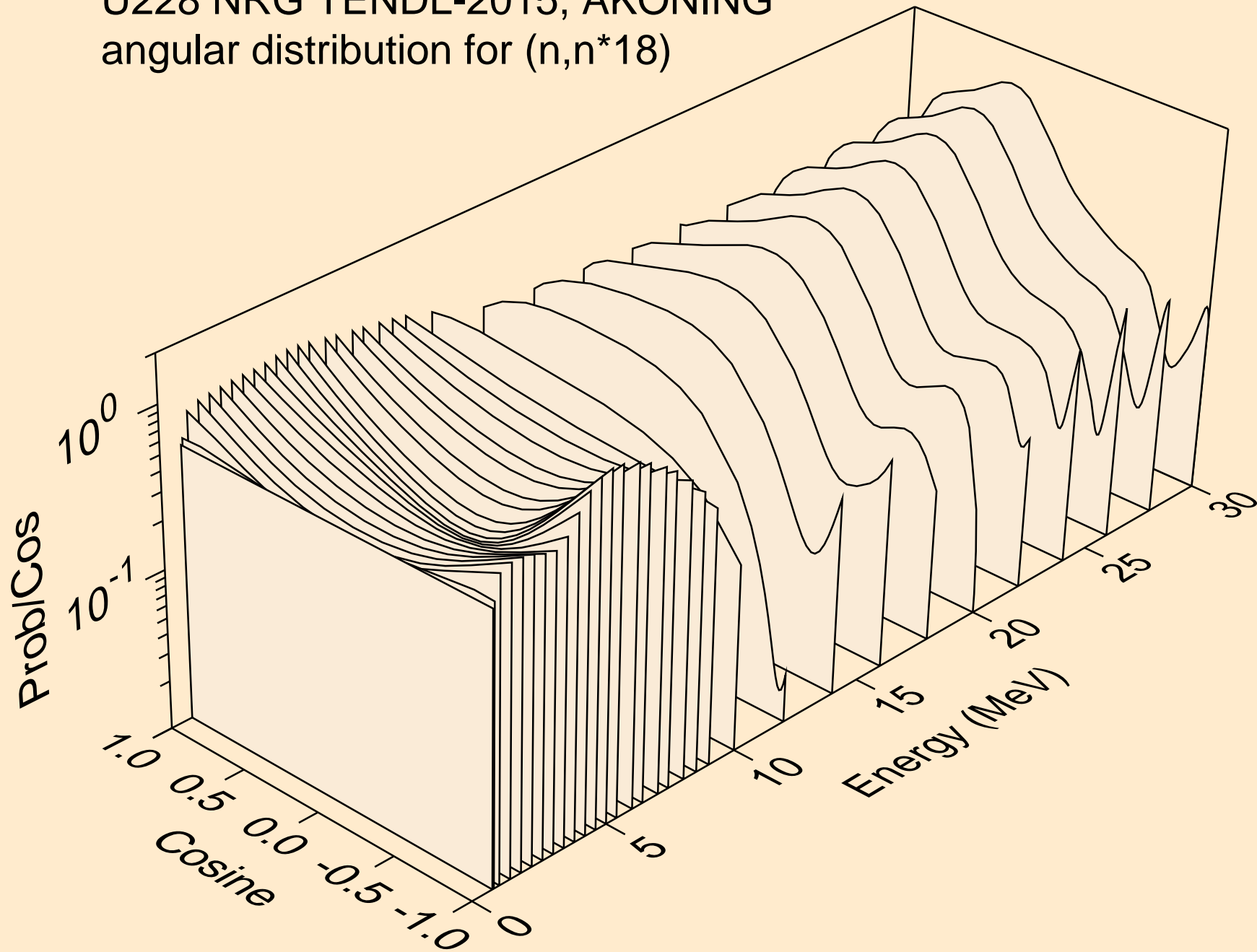

U228 NRG TENDL-2015, AKONING
angular distribution for (n,n*19)

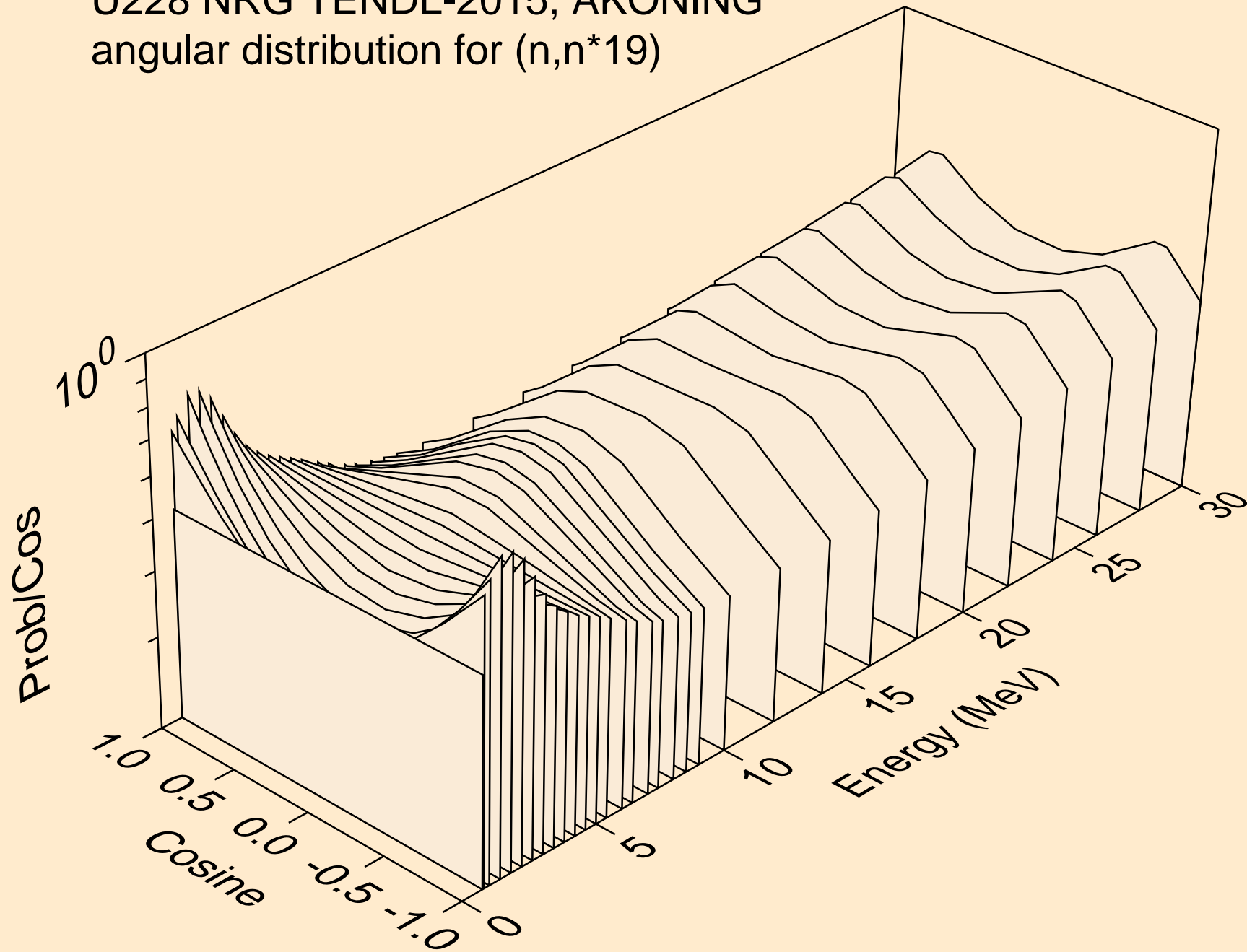

U228 NRG TENDL-2015, AKONING
angular distribution for (n,n*20)

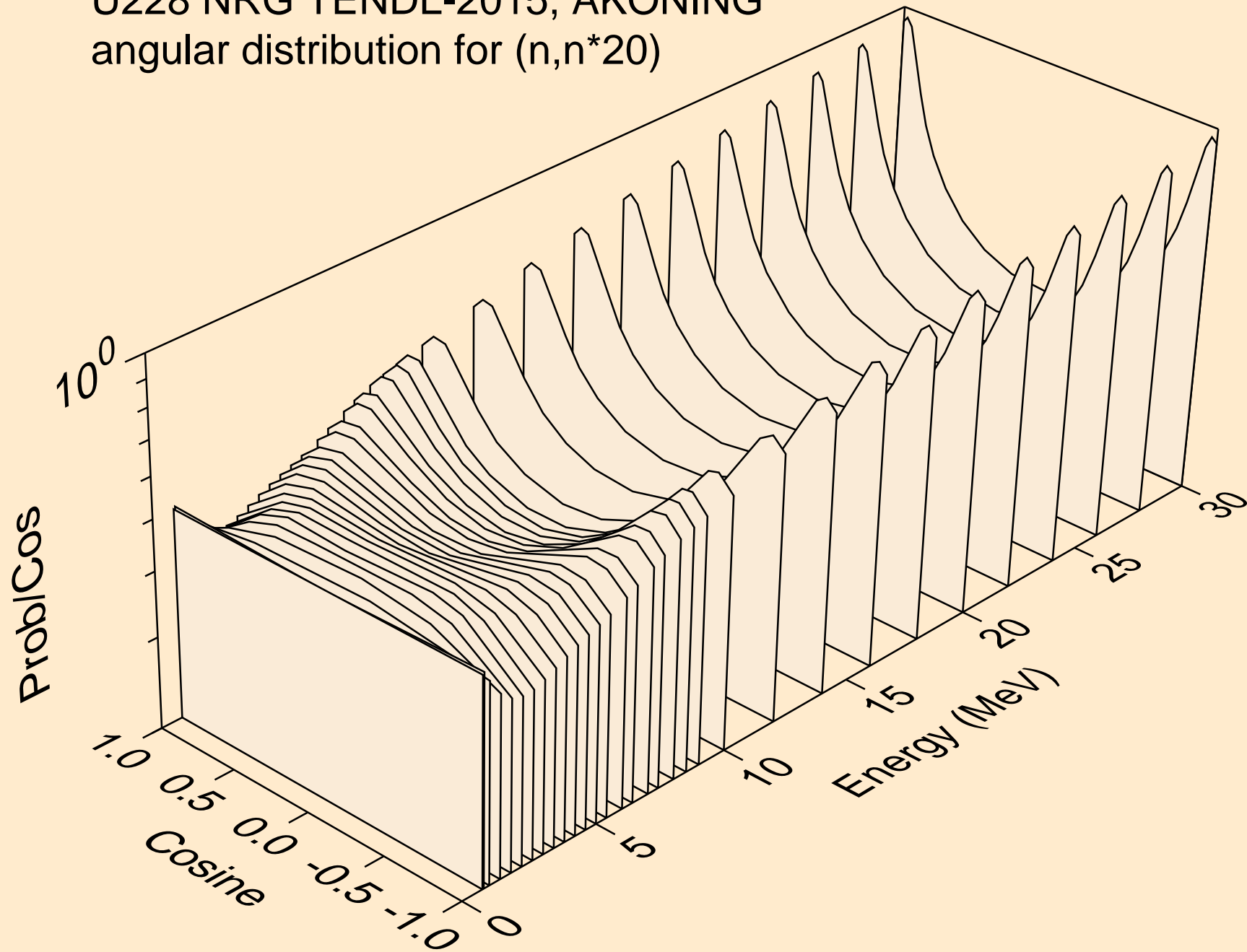

U228 NRG TENDL-2015, AKONING
angular distribution for (n,n*21)

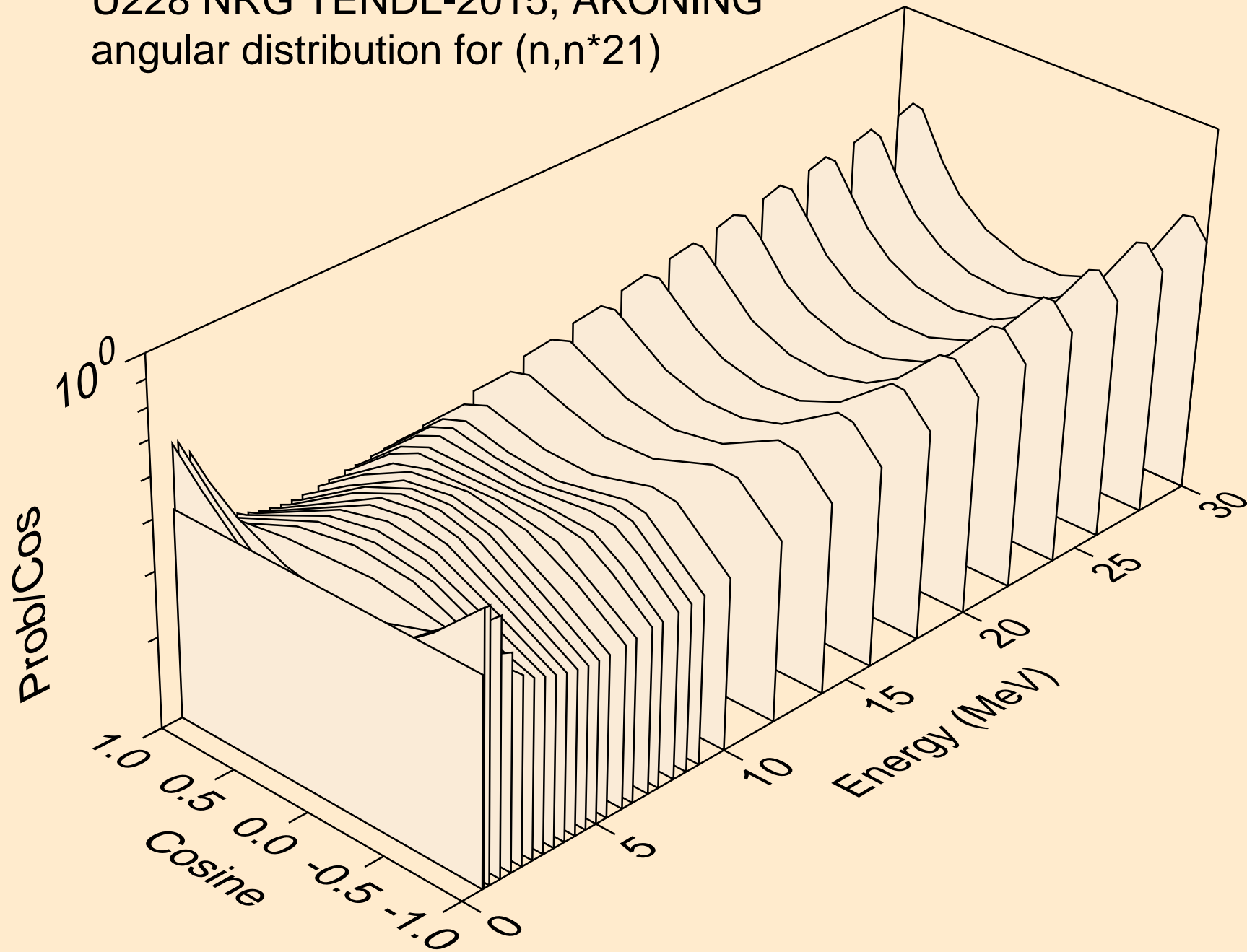

U228 NRG TENDL-2015, AKONING
angular distribution for (n,n*22)

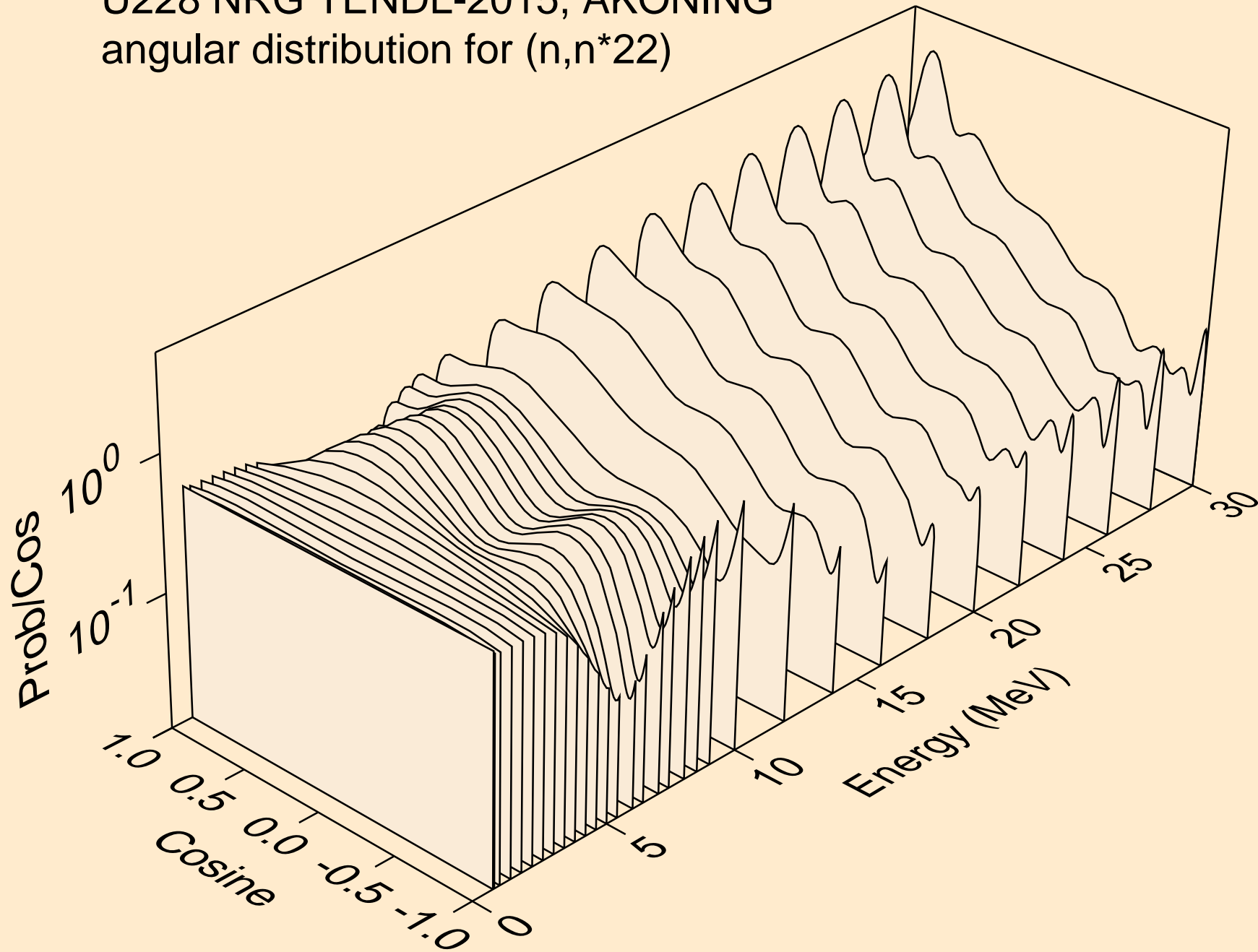

U228 NRG TENDL-2015, AKONING
angular distribution for (n,n*23)

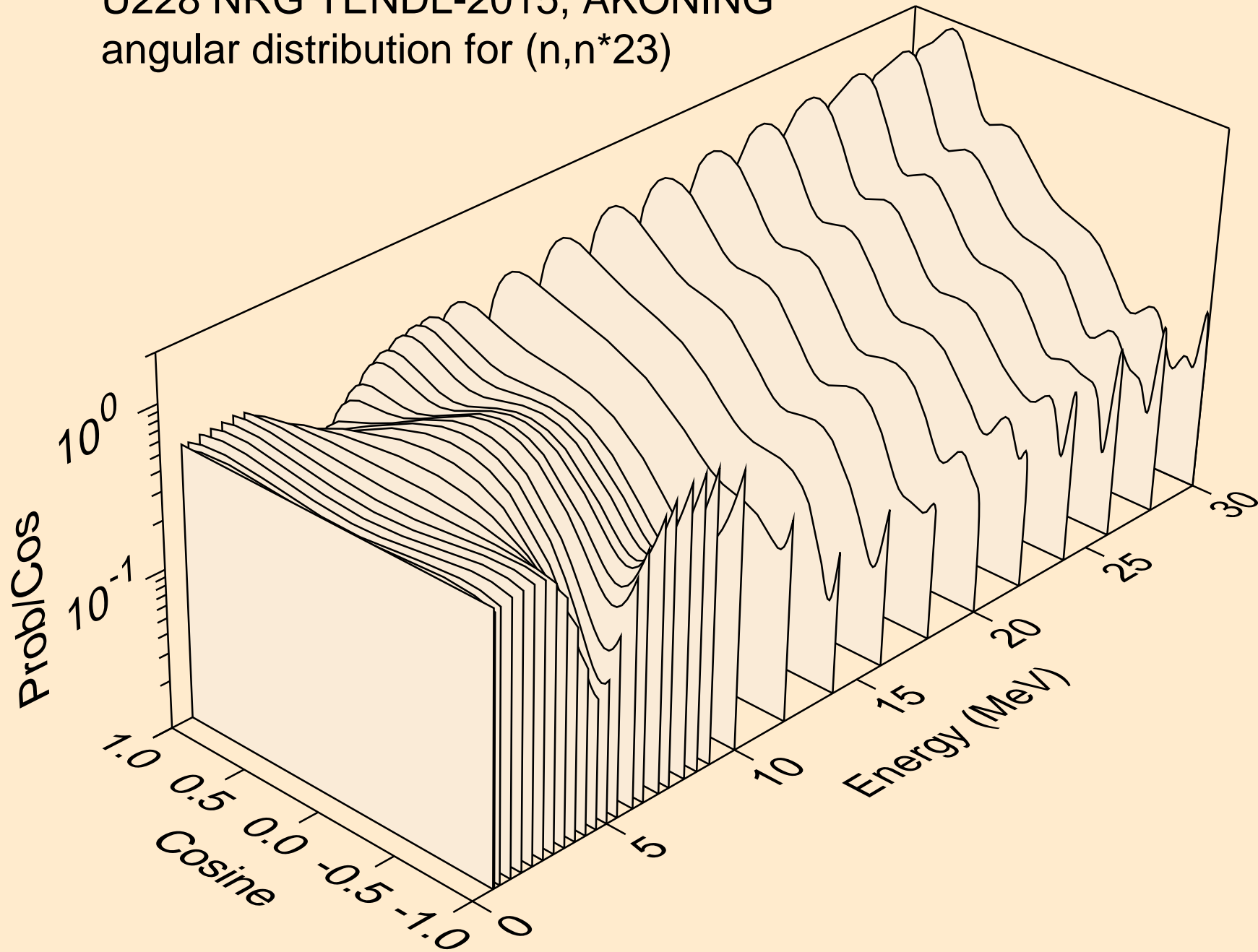

U228 NRG TENDL-2015, AKONING
angular distribution for (n,n*24)

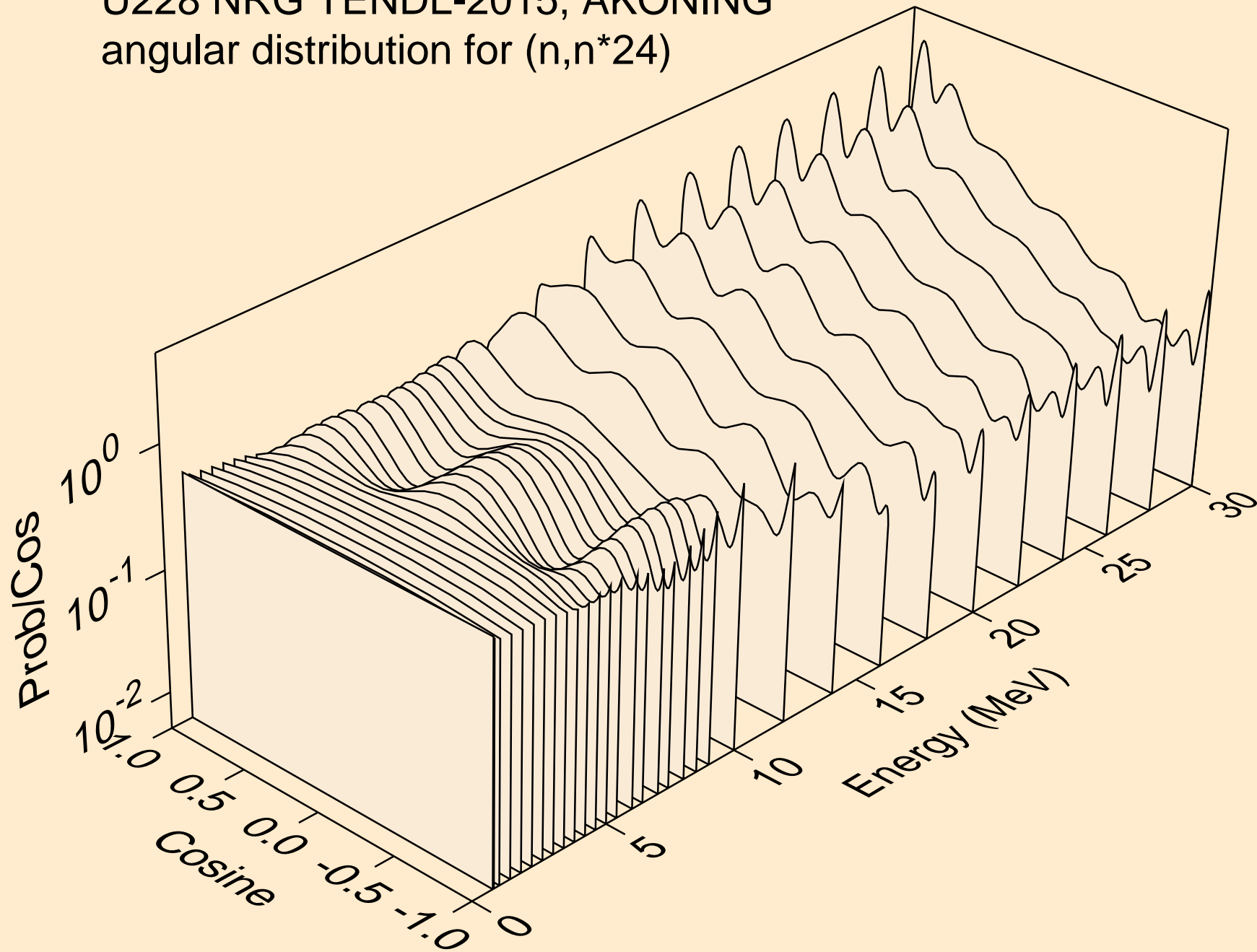

U228 NRG TENDL-2015, AKONING
angular distribution for (n,n*25)

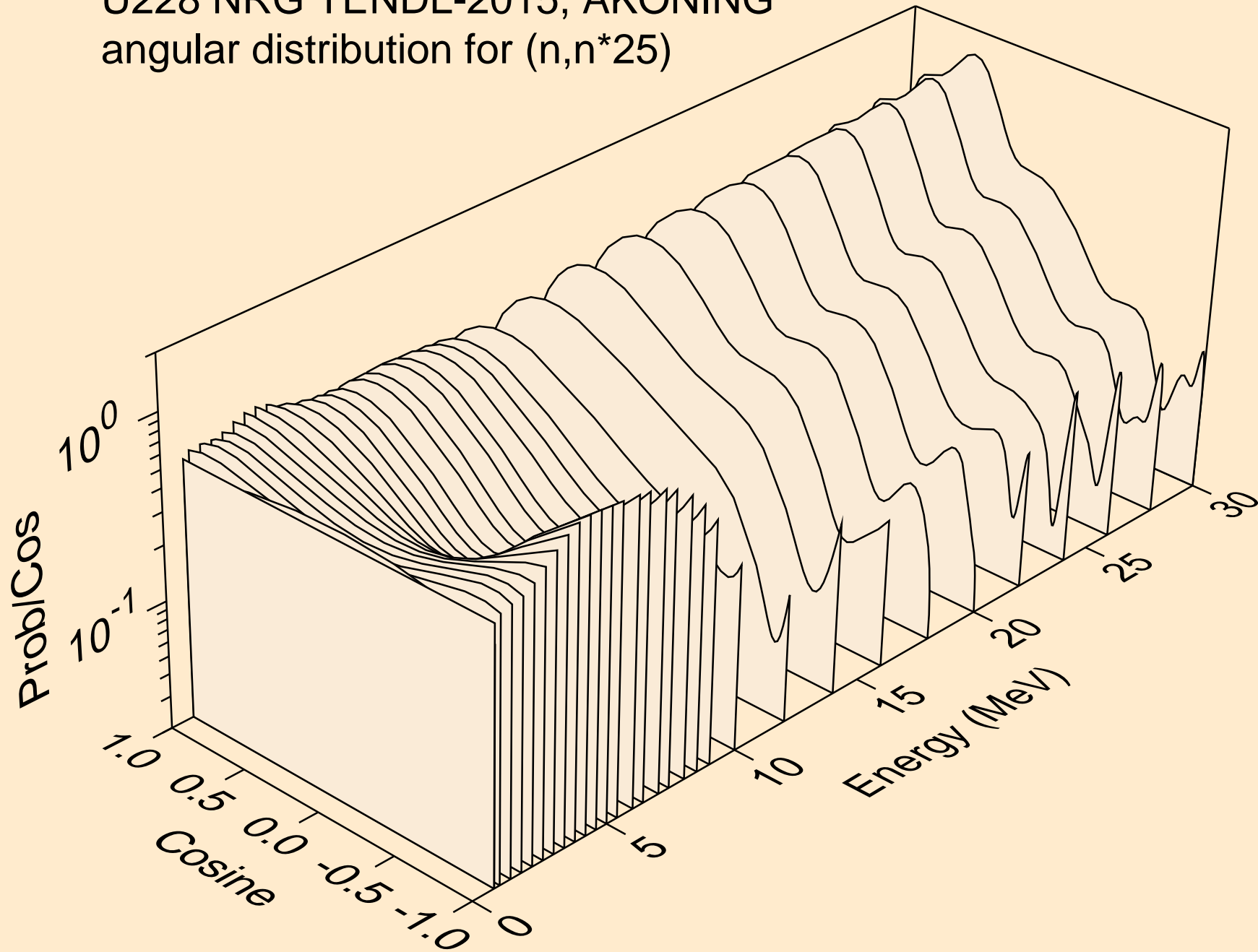

U228 NRG TENDL-2015, AKONING
angular distribution for (n,n*26)

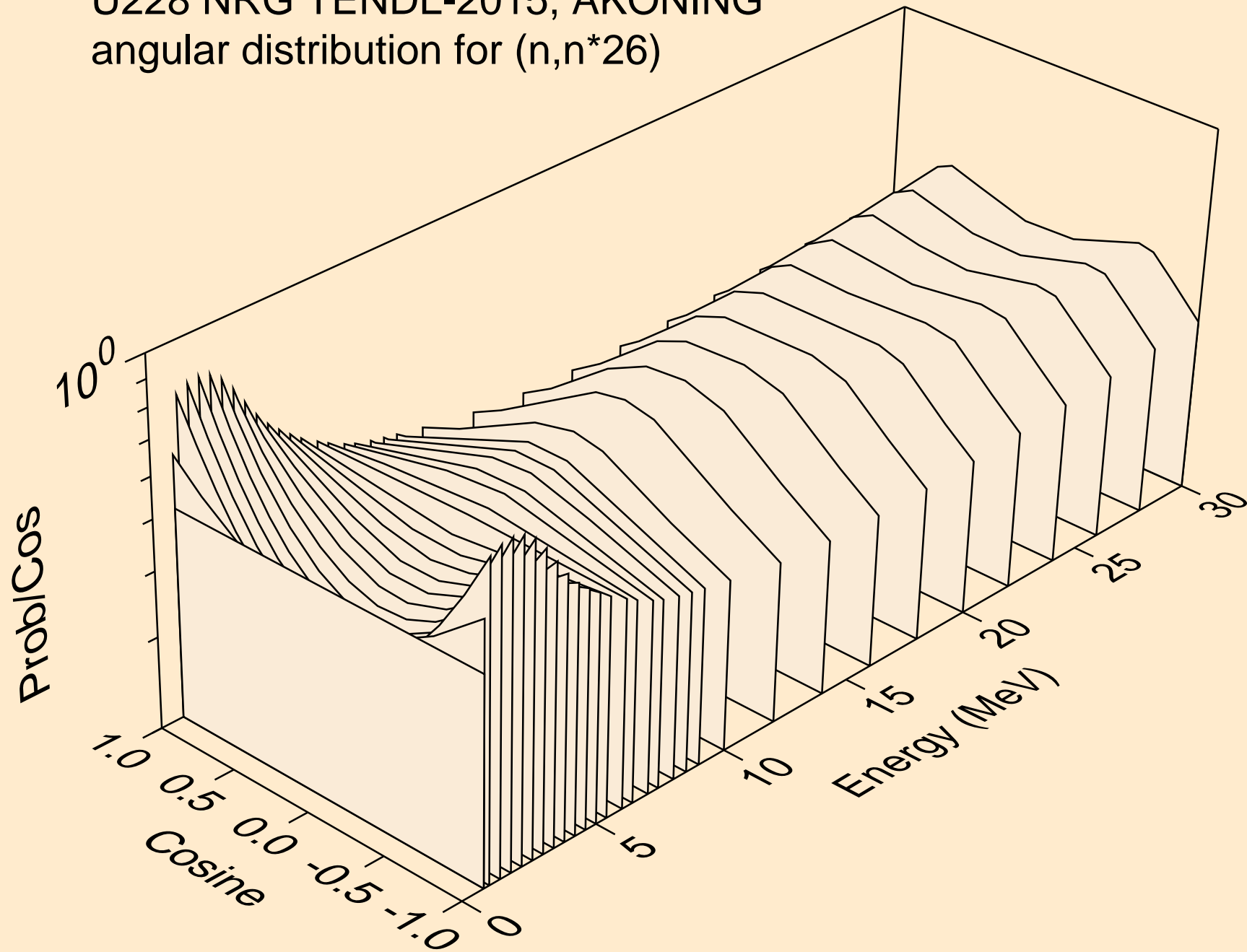

U228 NRG TENDL-2015, AKONING
angular distribution for (n,n*27)

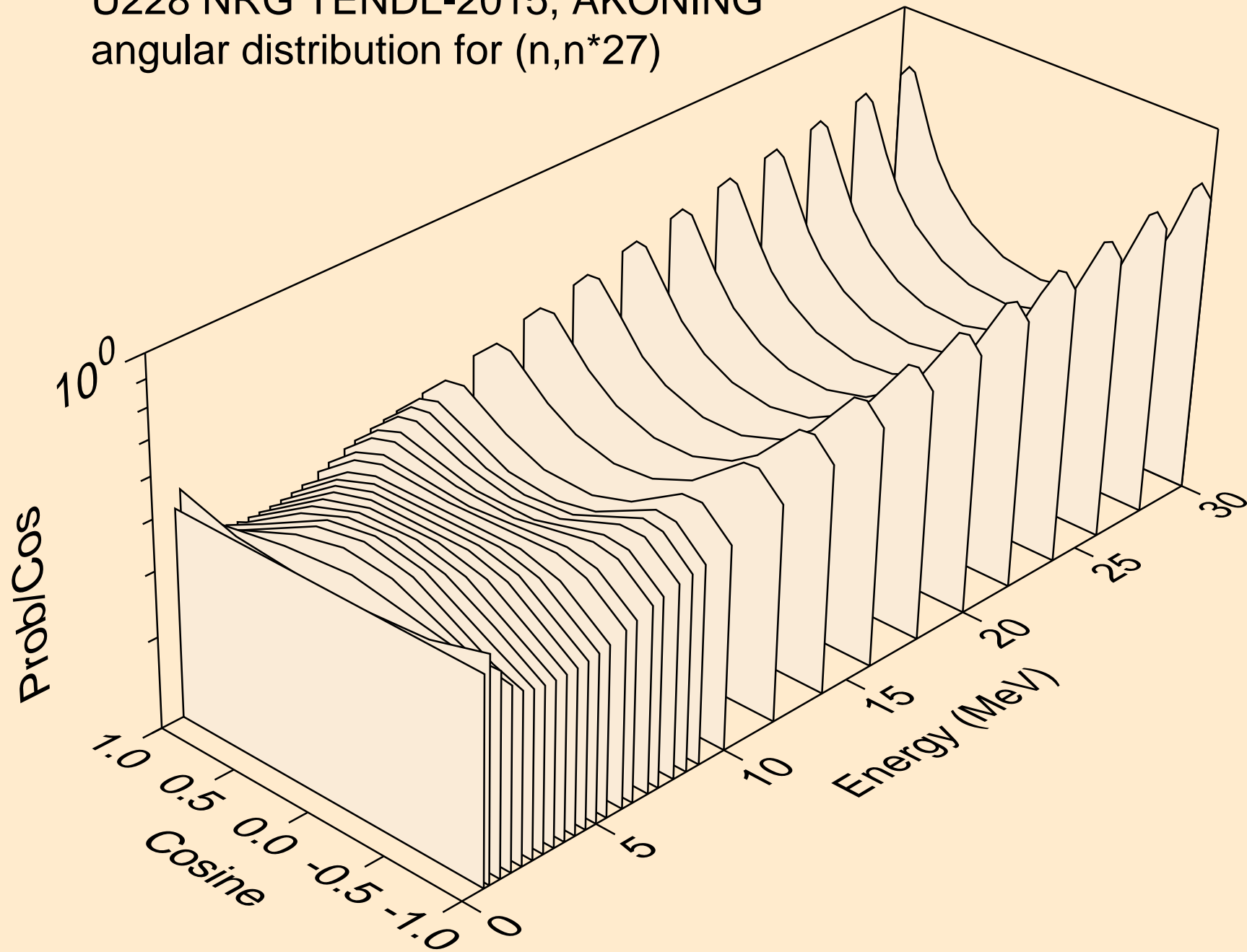

U228 NRG TENDL-2015, AKONING
angular distribution for (n,n*28)

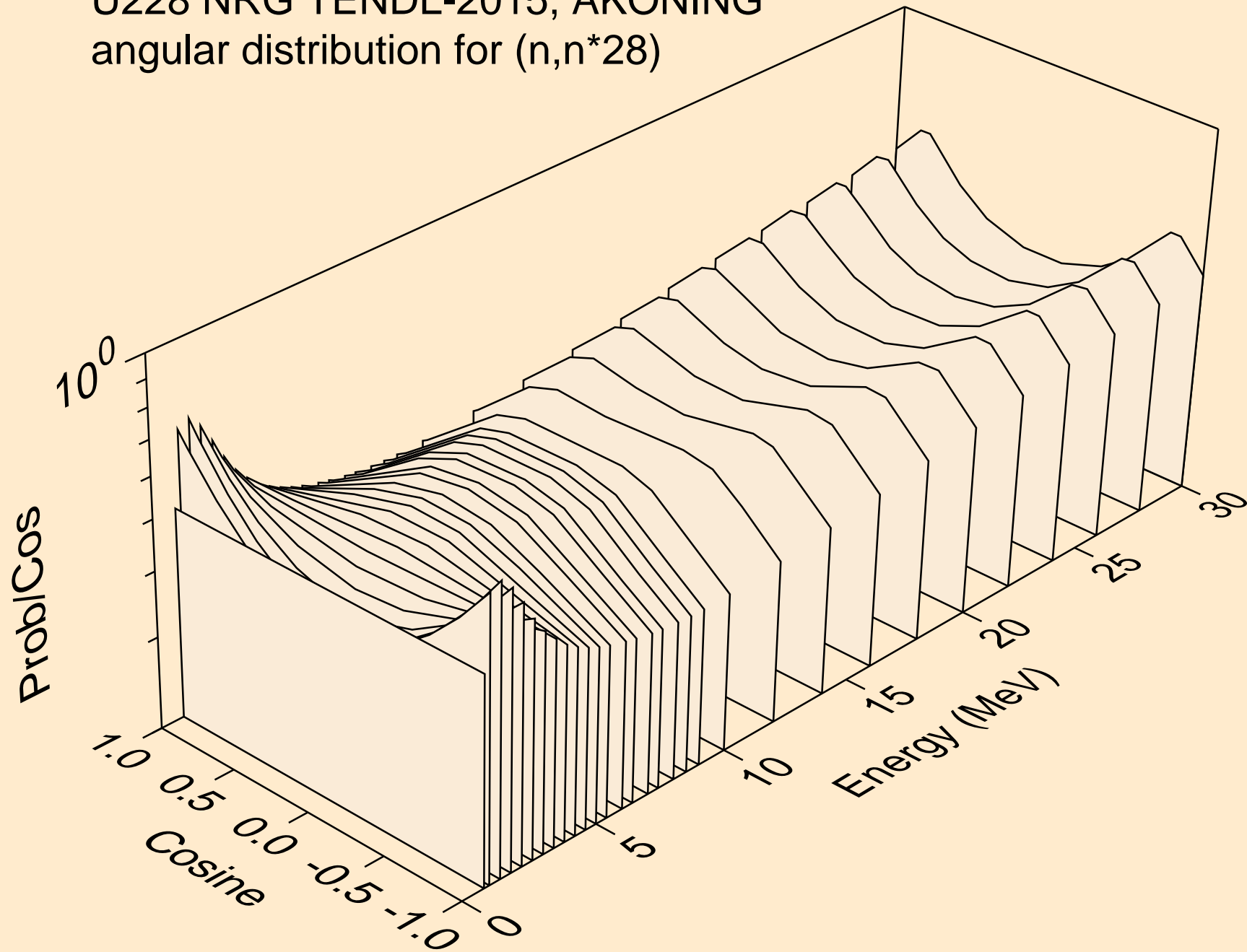

U228 NRG TENDL-2015, AKONING
angular distribution for (n,n*29)

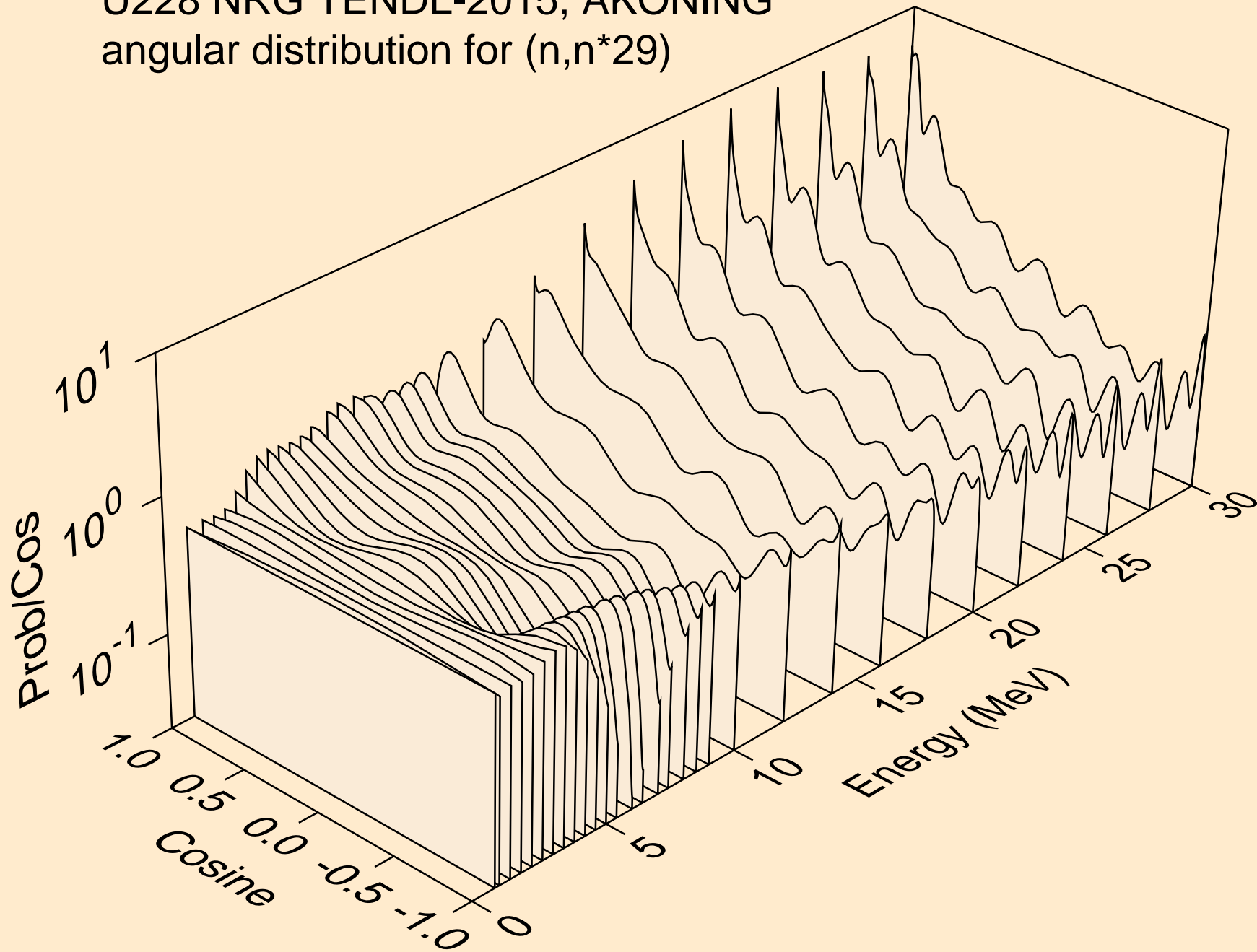

U228 NRG TENDL-2015, AKONING
angular distribution for (n,n*30)

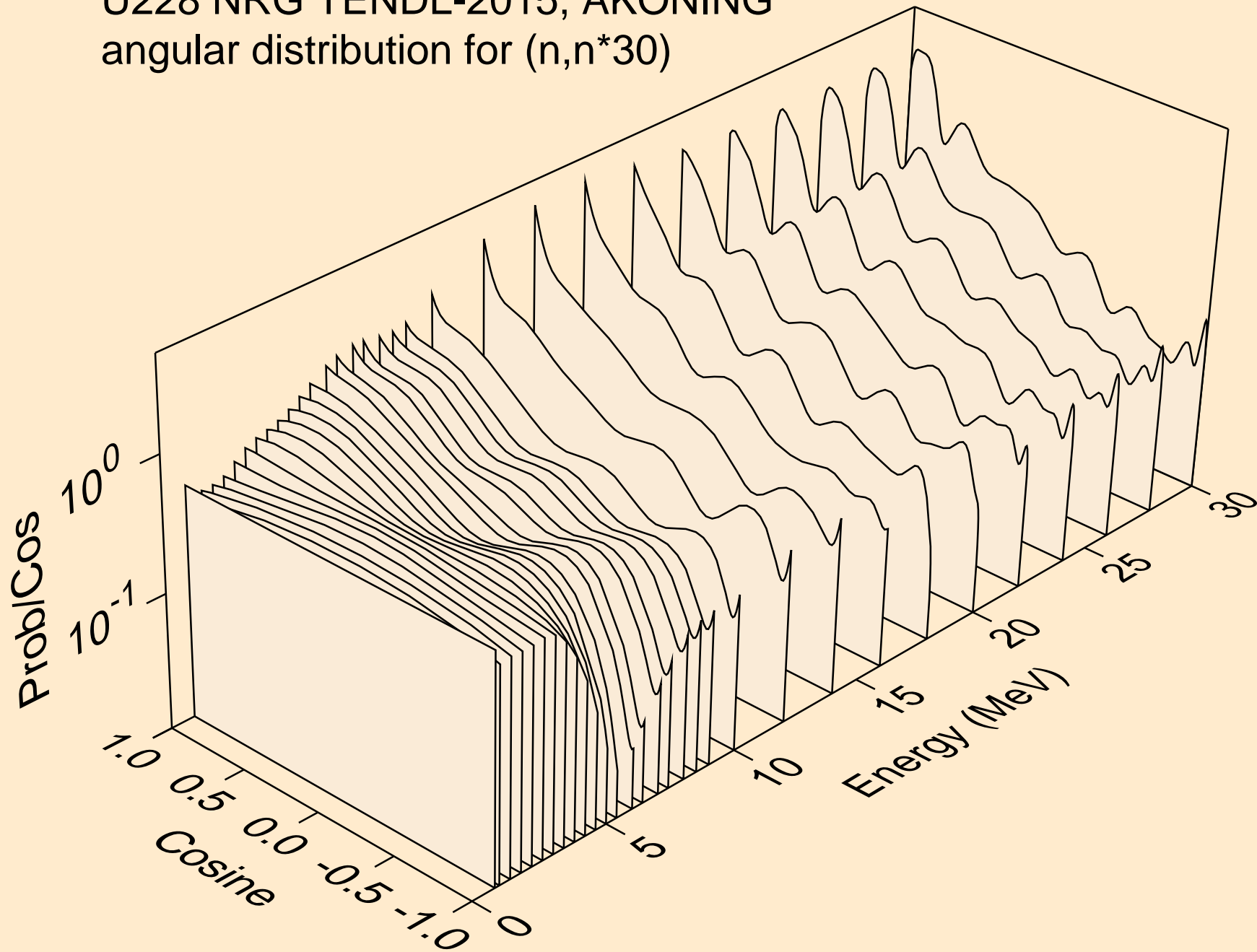

U228 NRG TENDL-2015, AKONING

Total fission nubar

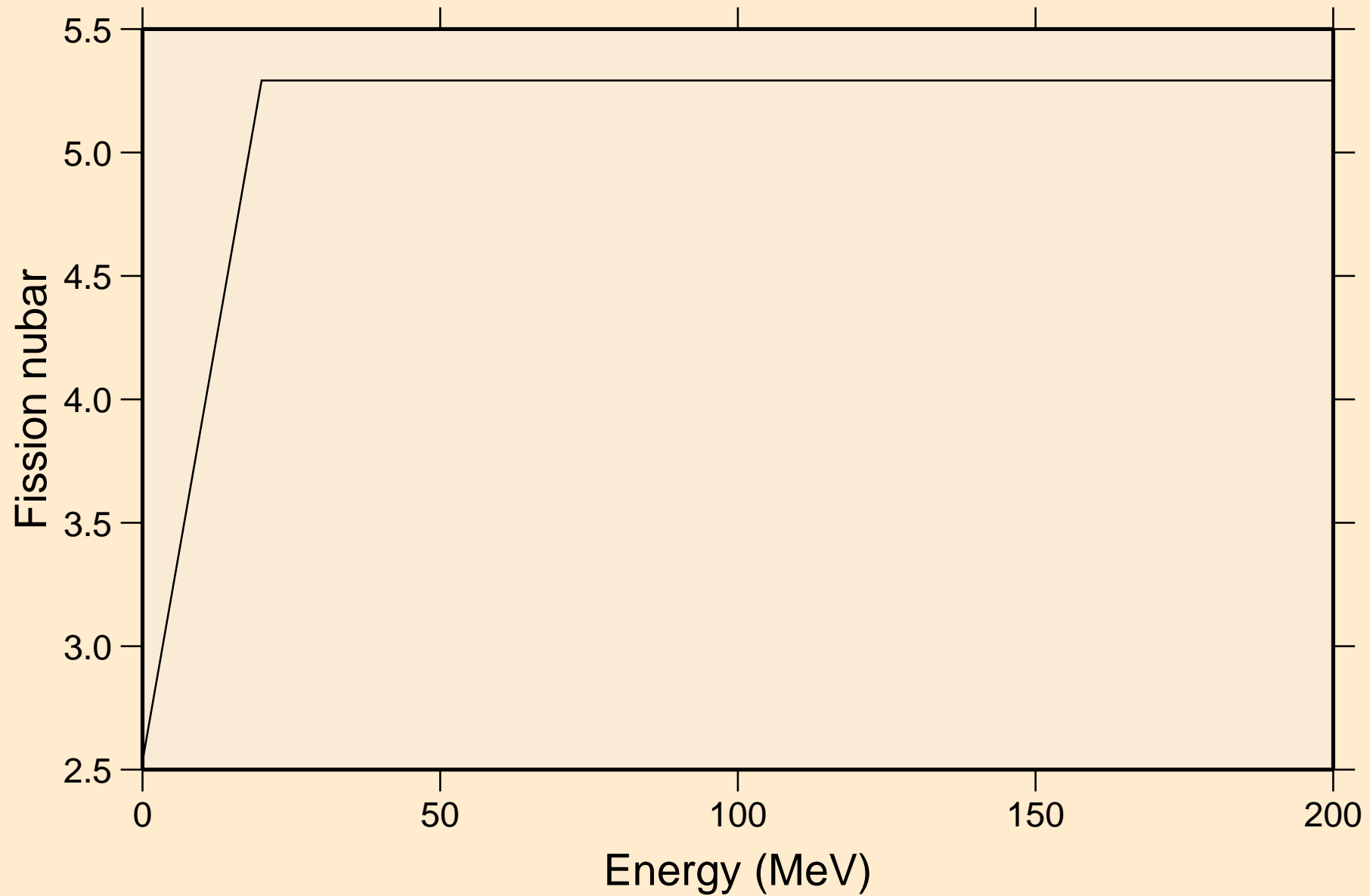

U228 NRG TENDL-2015, AKONING
Neutron emission for (n,x)

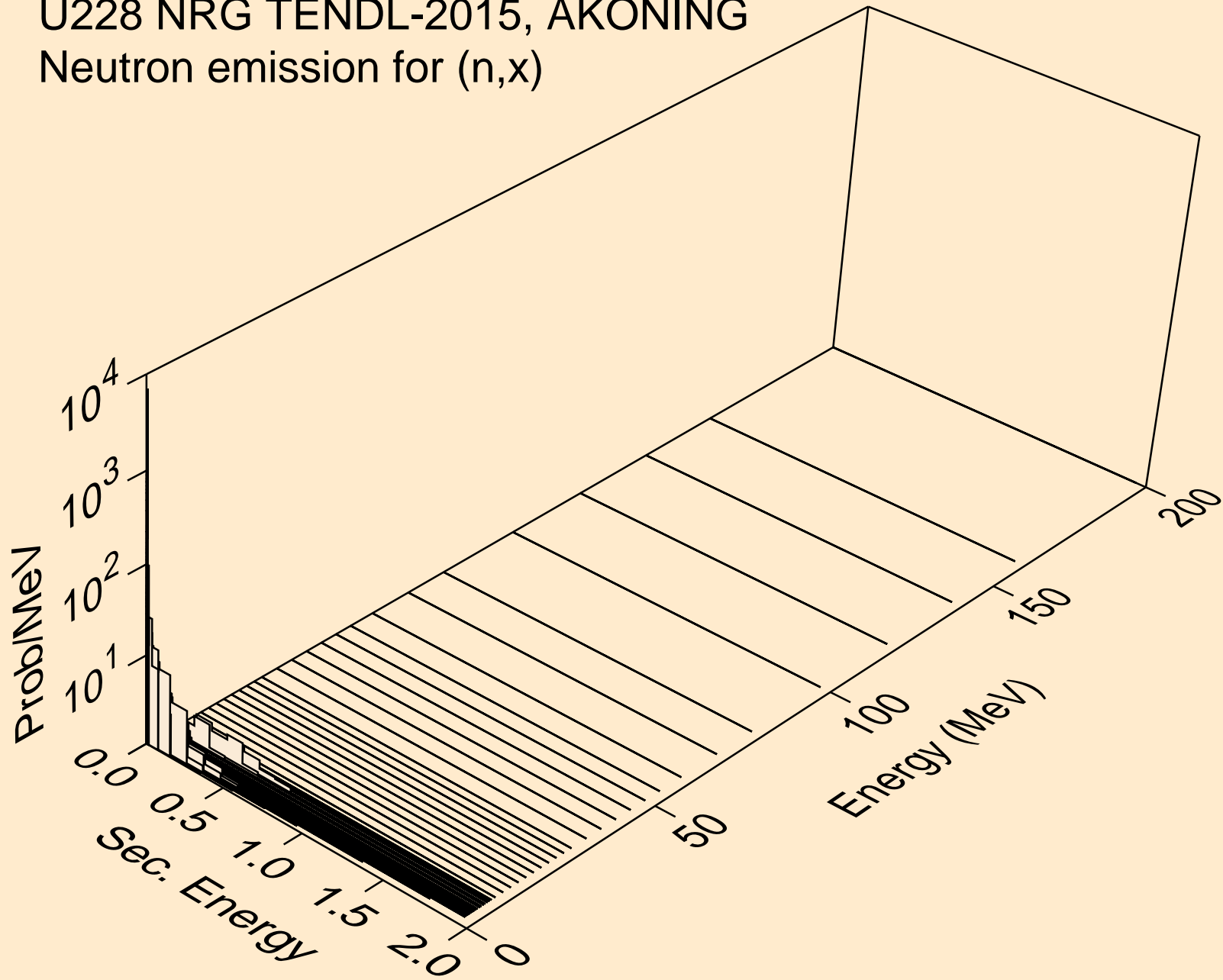

U228 NRG TENDL-2015, AKONING
Neutron emission for (n,2nd)

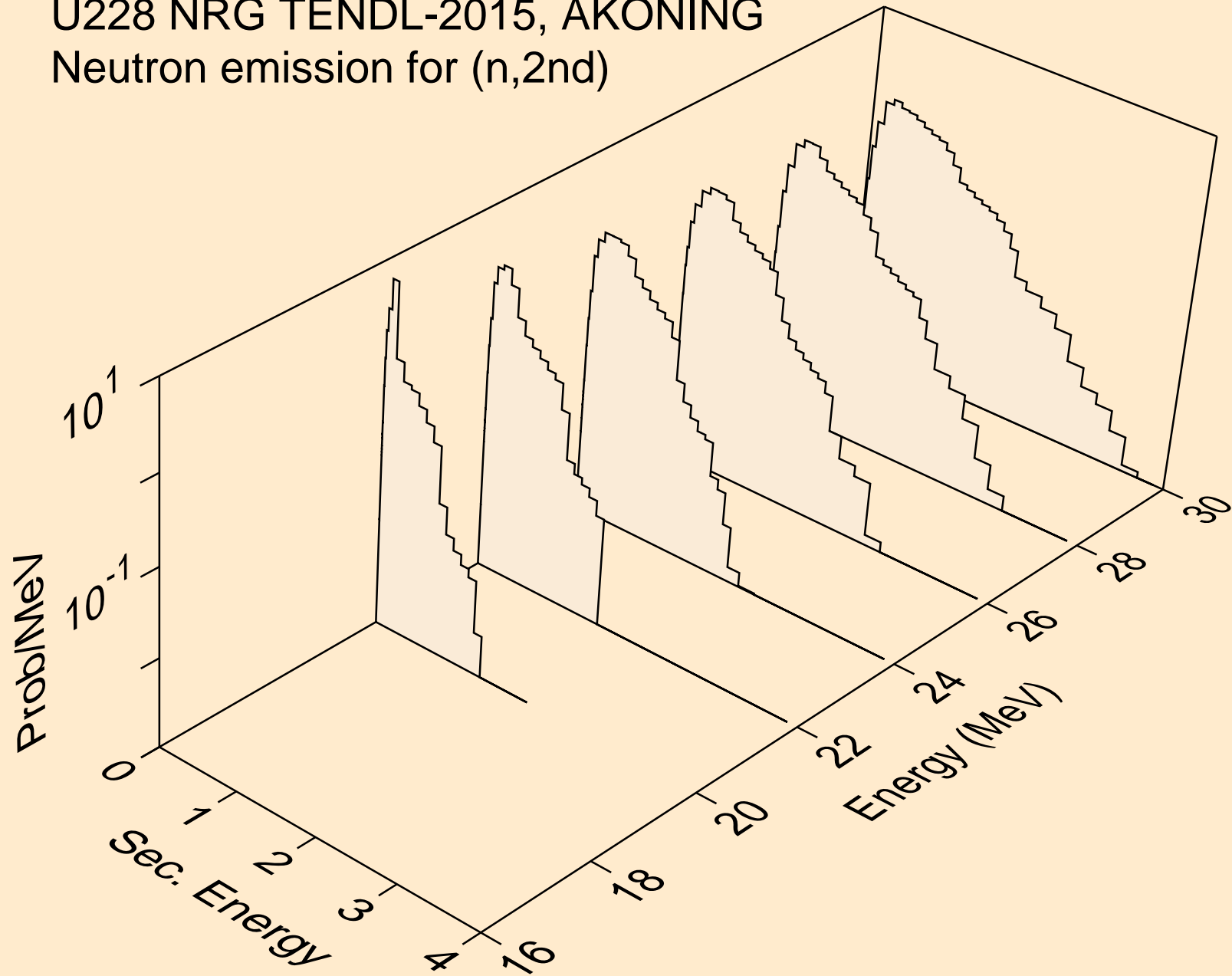

U228 NRG TENDL-2015, AKONING
Neutron emission for (n,2n)

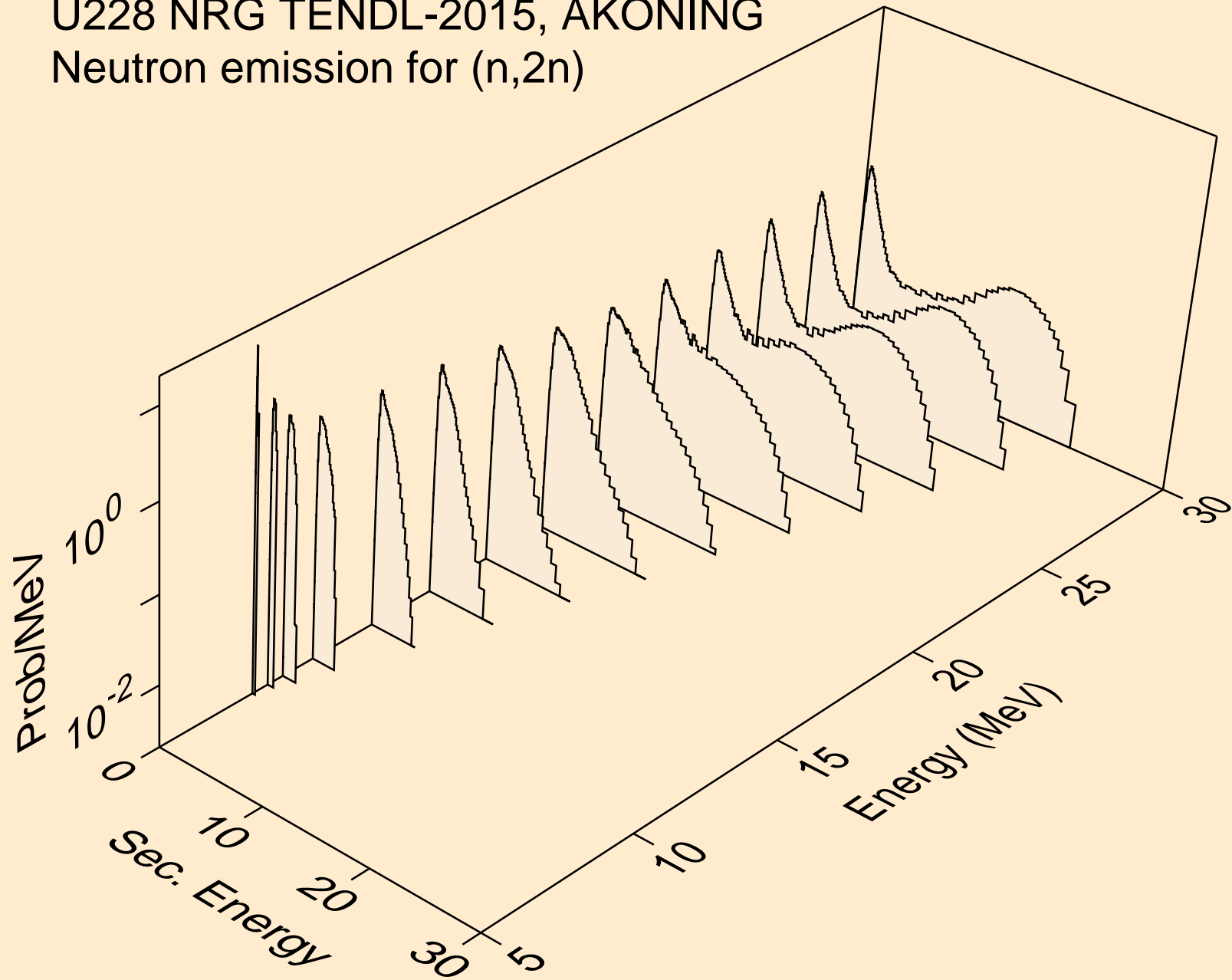

U228 NRG TENDL-2015, AKONING
Neutron emission for (n,3n)

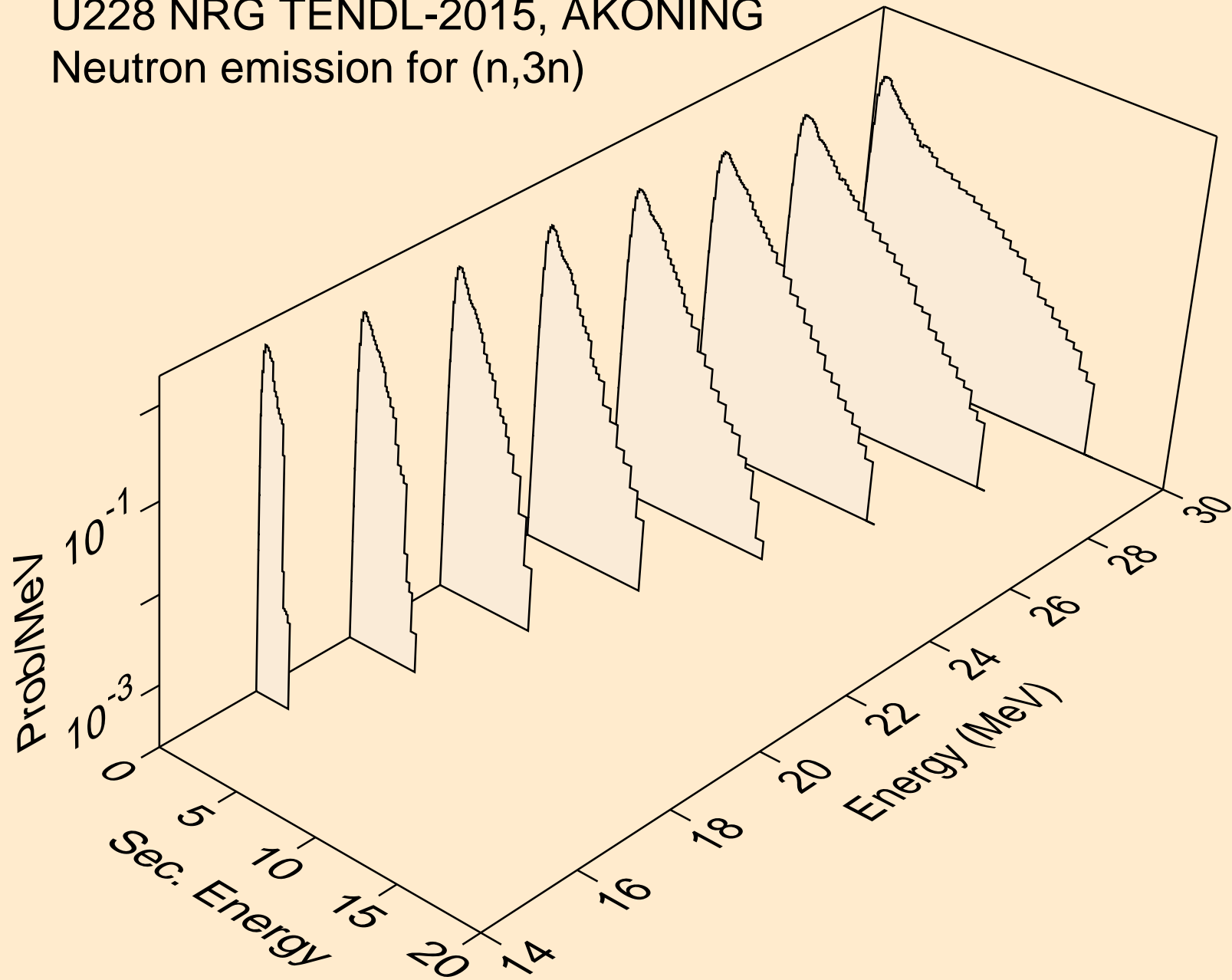

U228 NRG TENDL-2015, AKONING
Neutron emission for fission

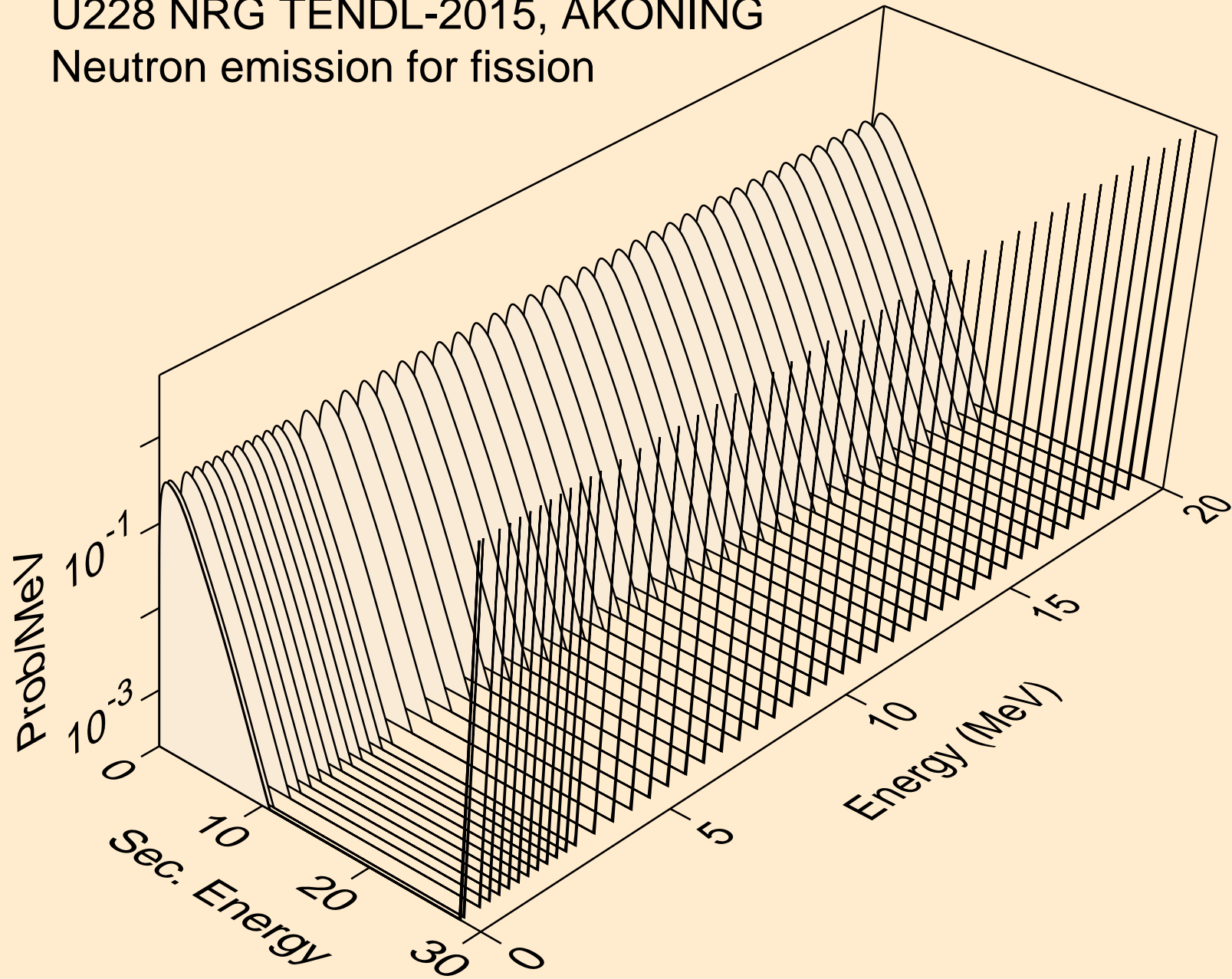

U228 NRG TENDL-2015, AKONING
Neutron emission for (n,n*)a

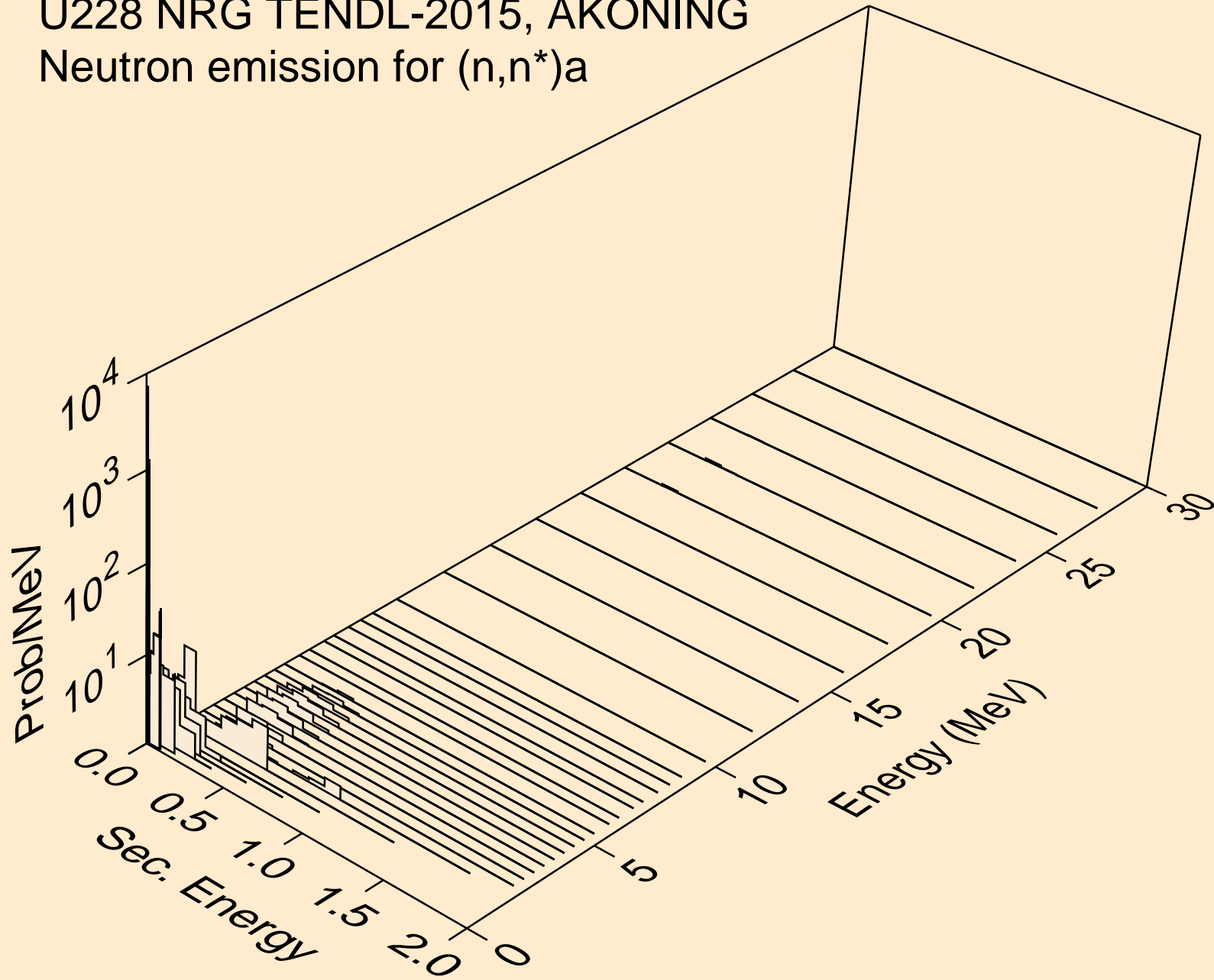

U228 NRG TENDL-2015, AKONING
Neutron emission for (n,n*)3a

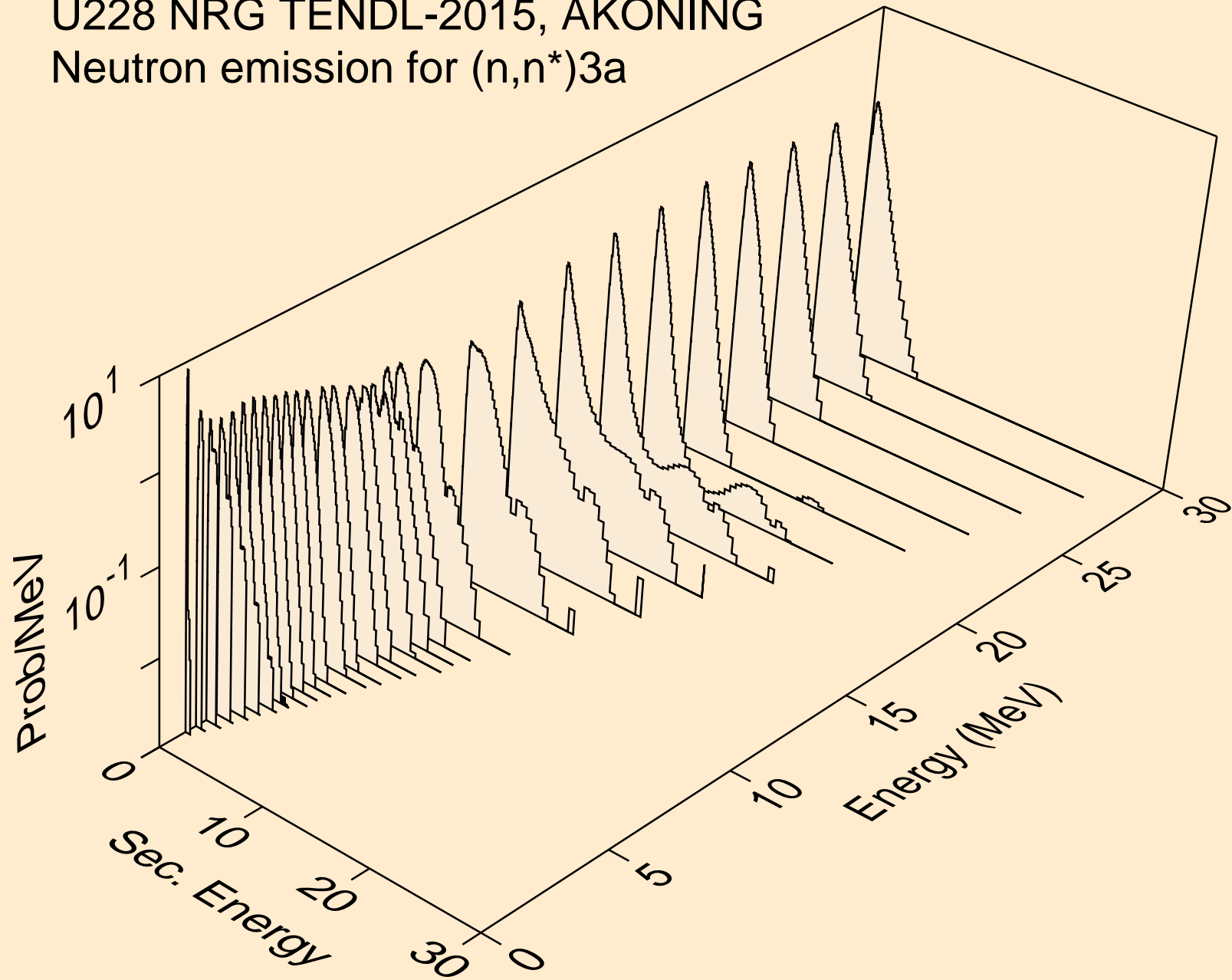

U228 NRG TENDL-2015, AKONING
Neutron emission for (n,2n)a

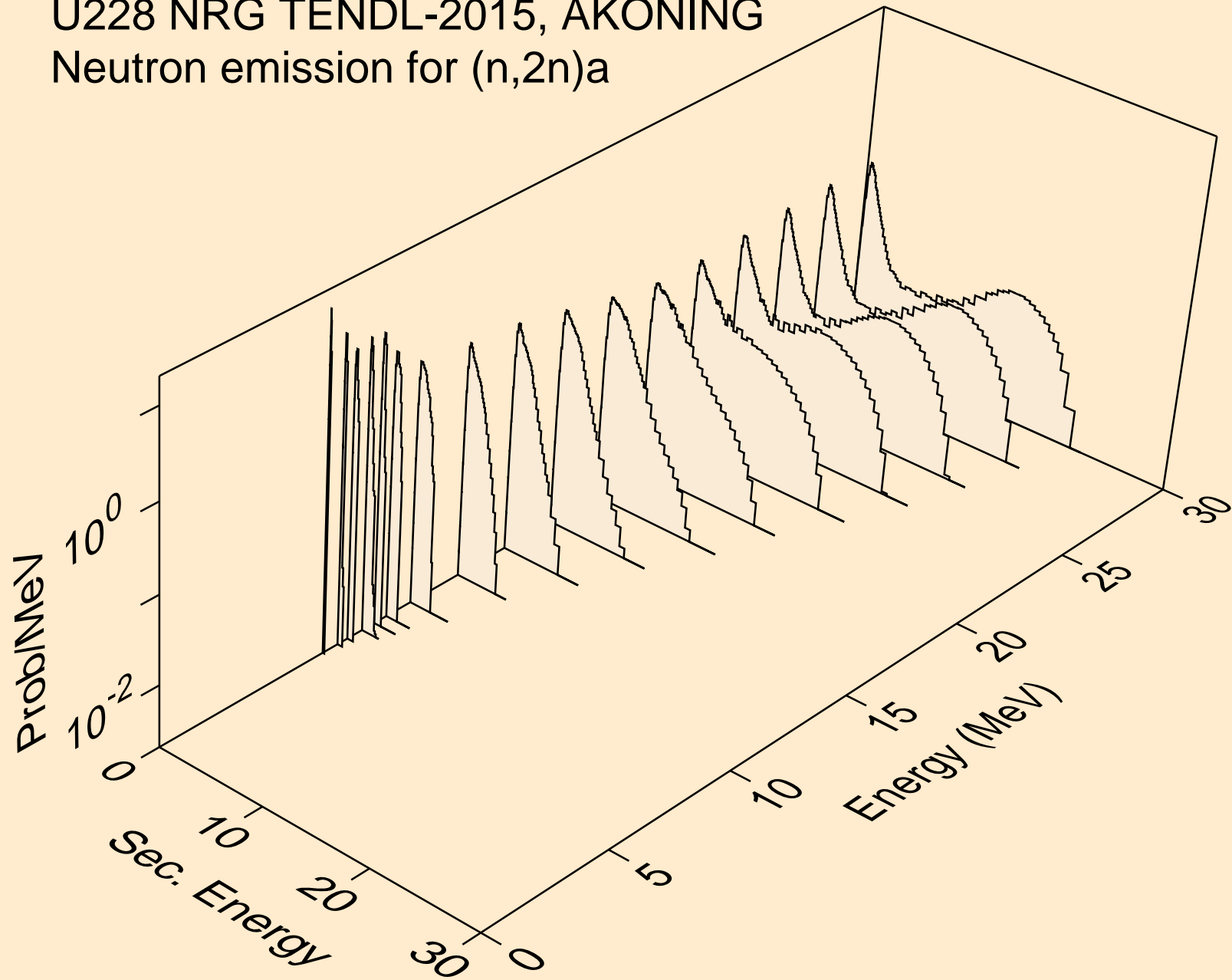

U228 NRG TENDL-2015, AKONING
Neutron emission for (n,3n)a

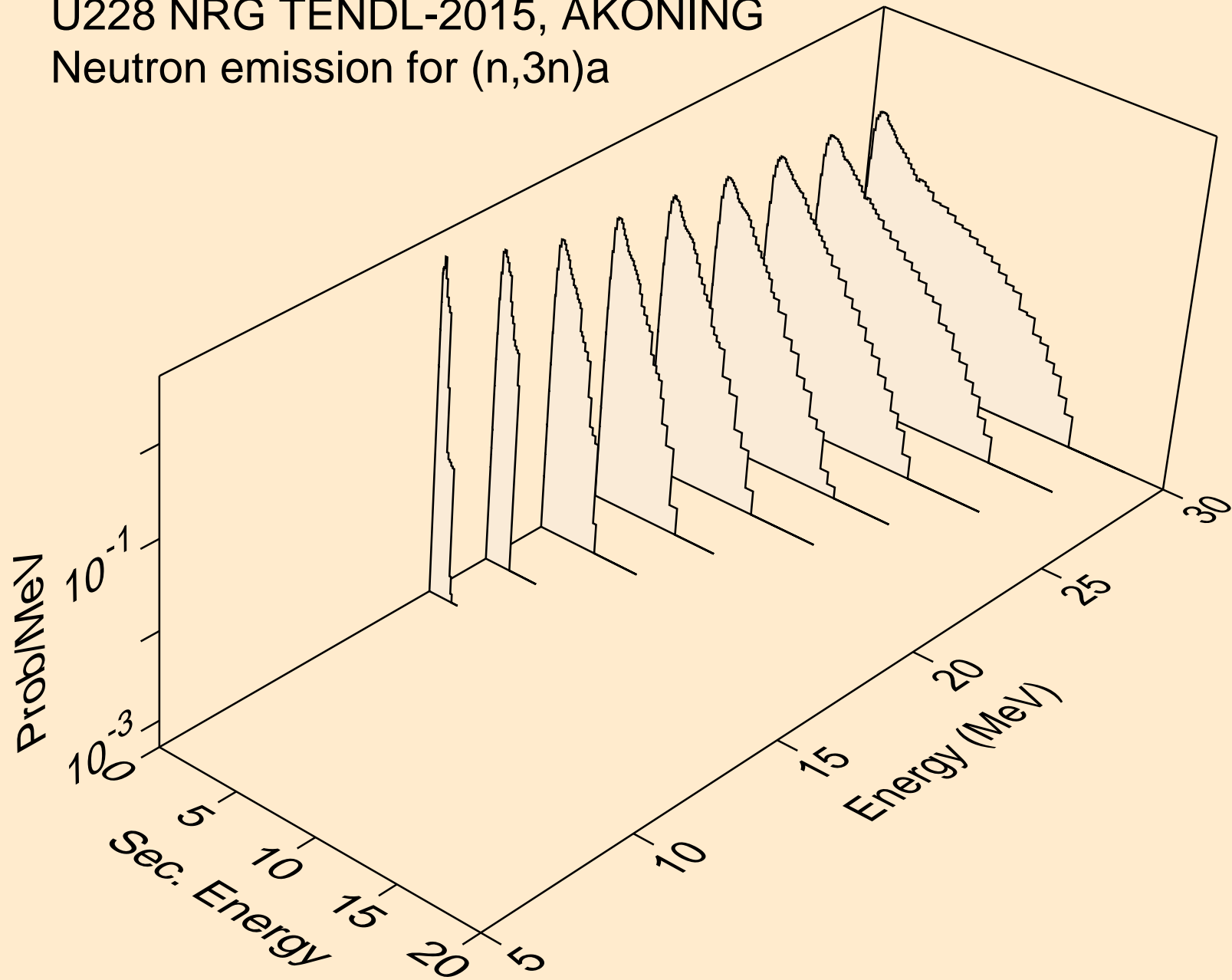

U228 NRG TENDL-2015, AKONING
Neutron emission for (n,n*)p

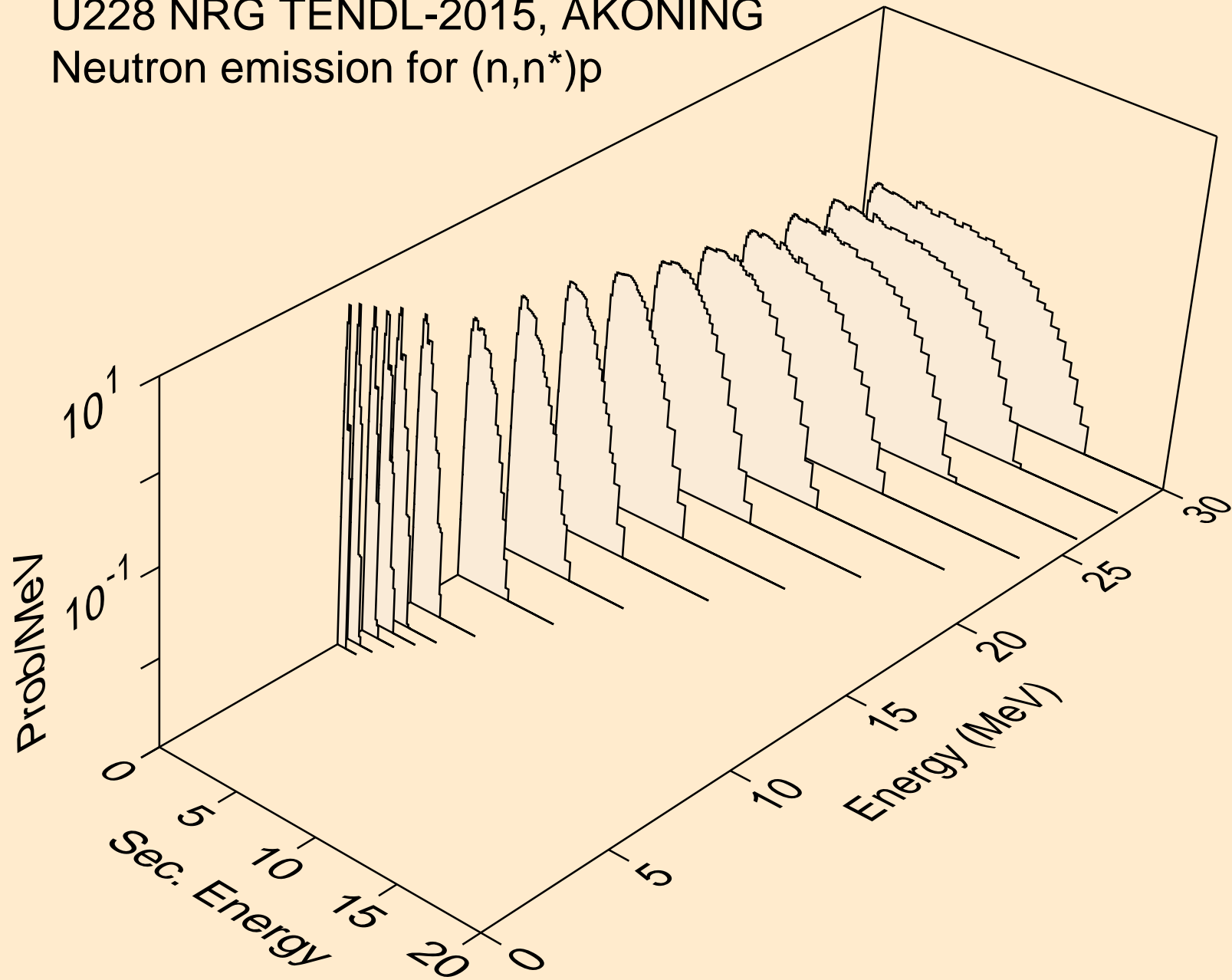

U228 NRG TENDL-2015, AKONING
Neutron emission for (n,n*)2a

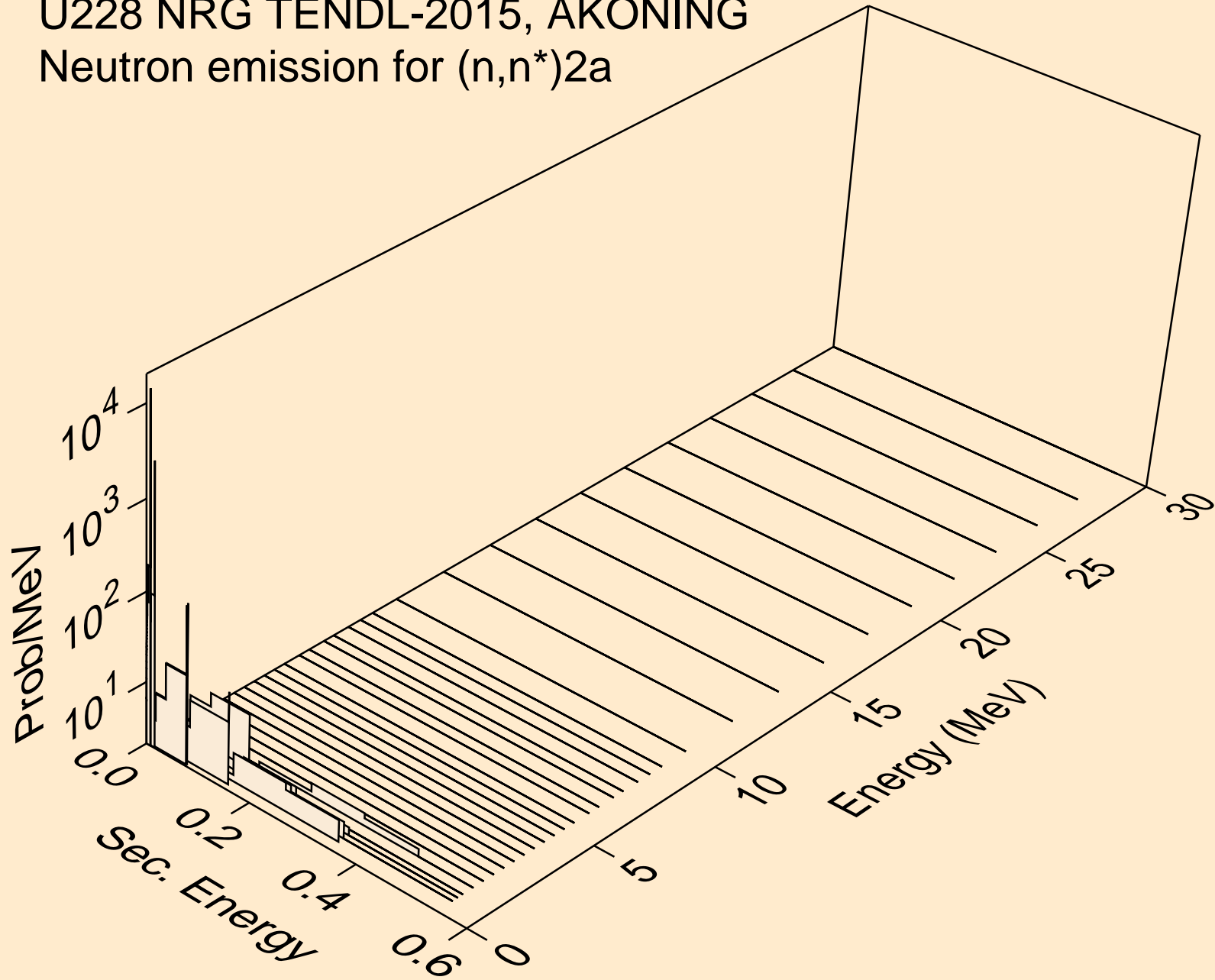

U228 NRG TENDL-2015, AKONING
Neutron emission for (n,2n)2a

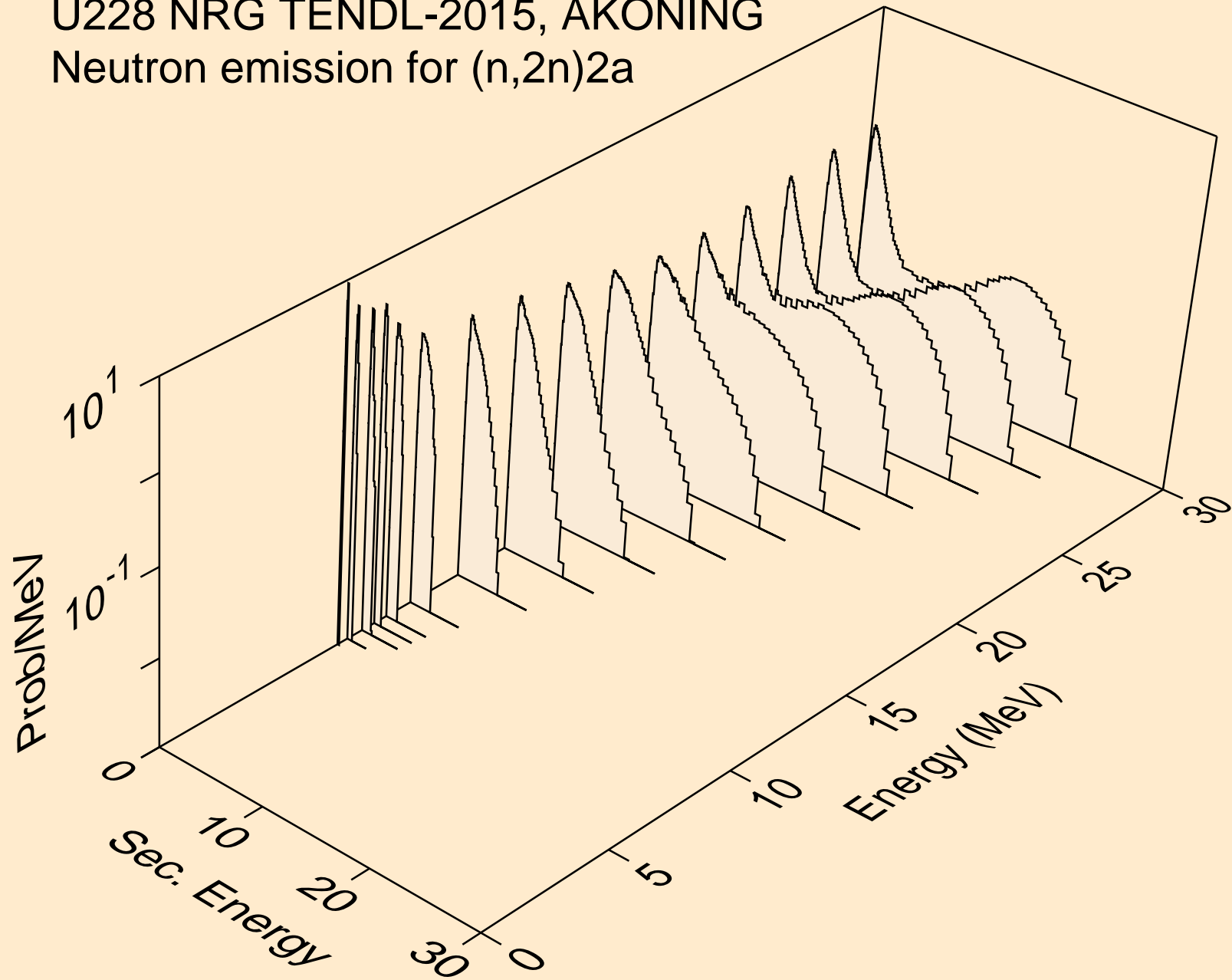

U228 NRG TENDL-2015, AKONING
Neutron emission for (n,n*)d

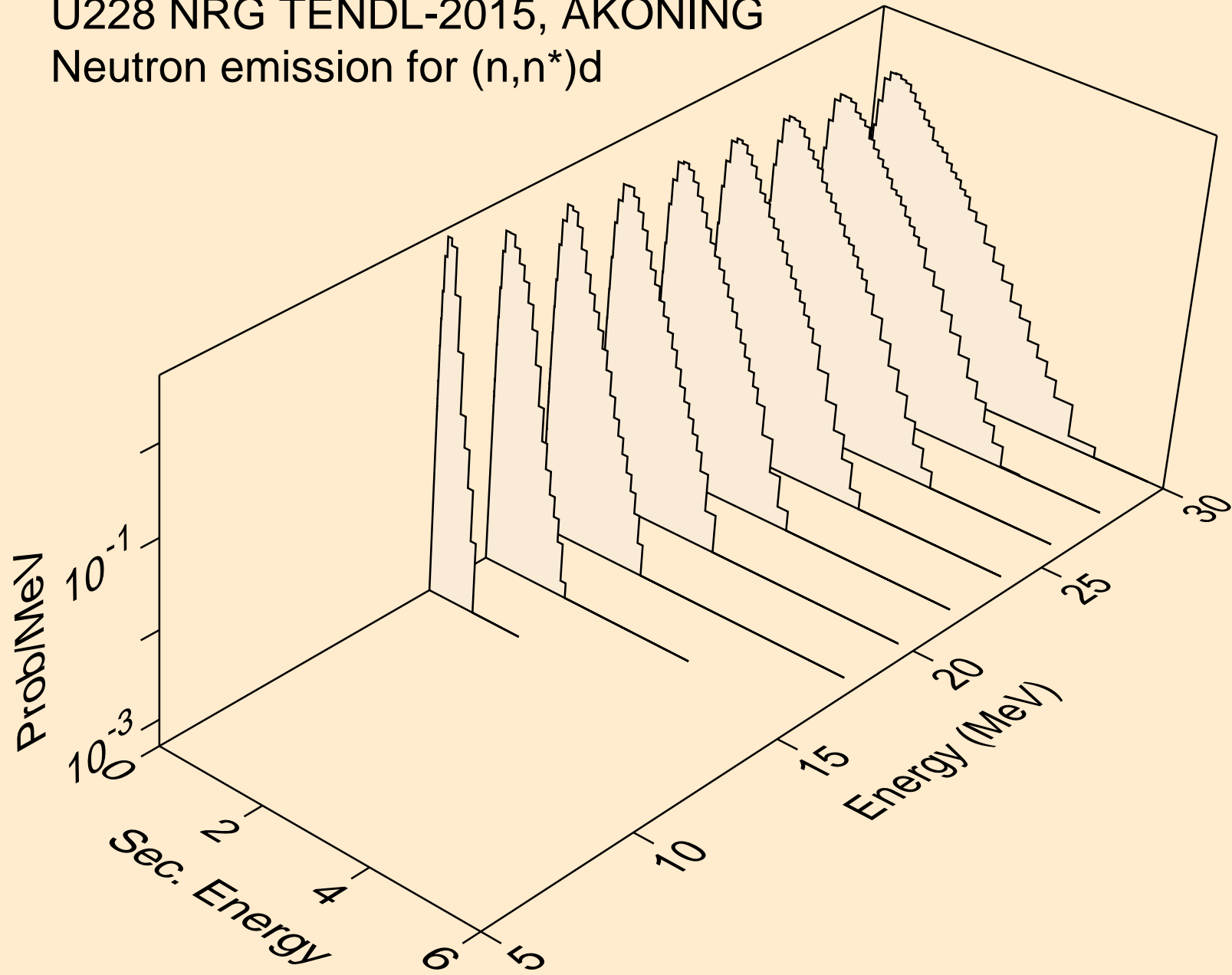

U228 NRG TENDL-2015, AKONING
Neutron emission for (n,n*)t

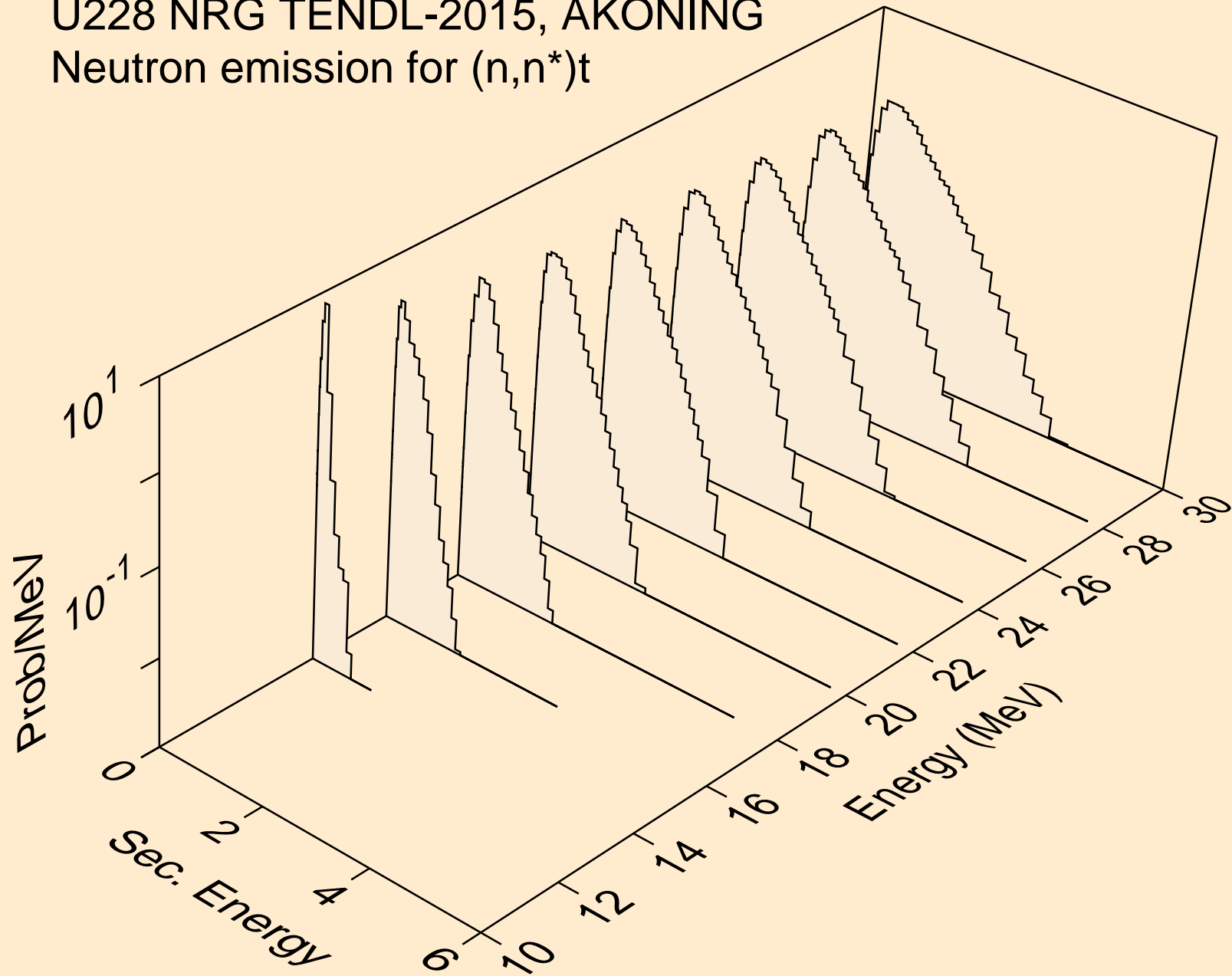

U228 NRG TENDL-2015, AKONING
Neutron emission for (n,n*)he3

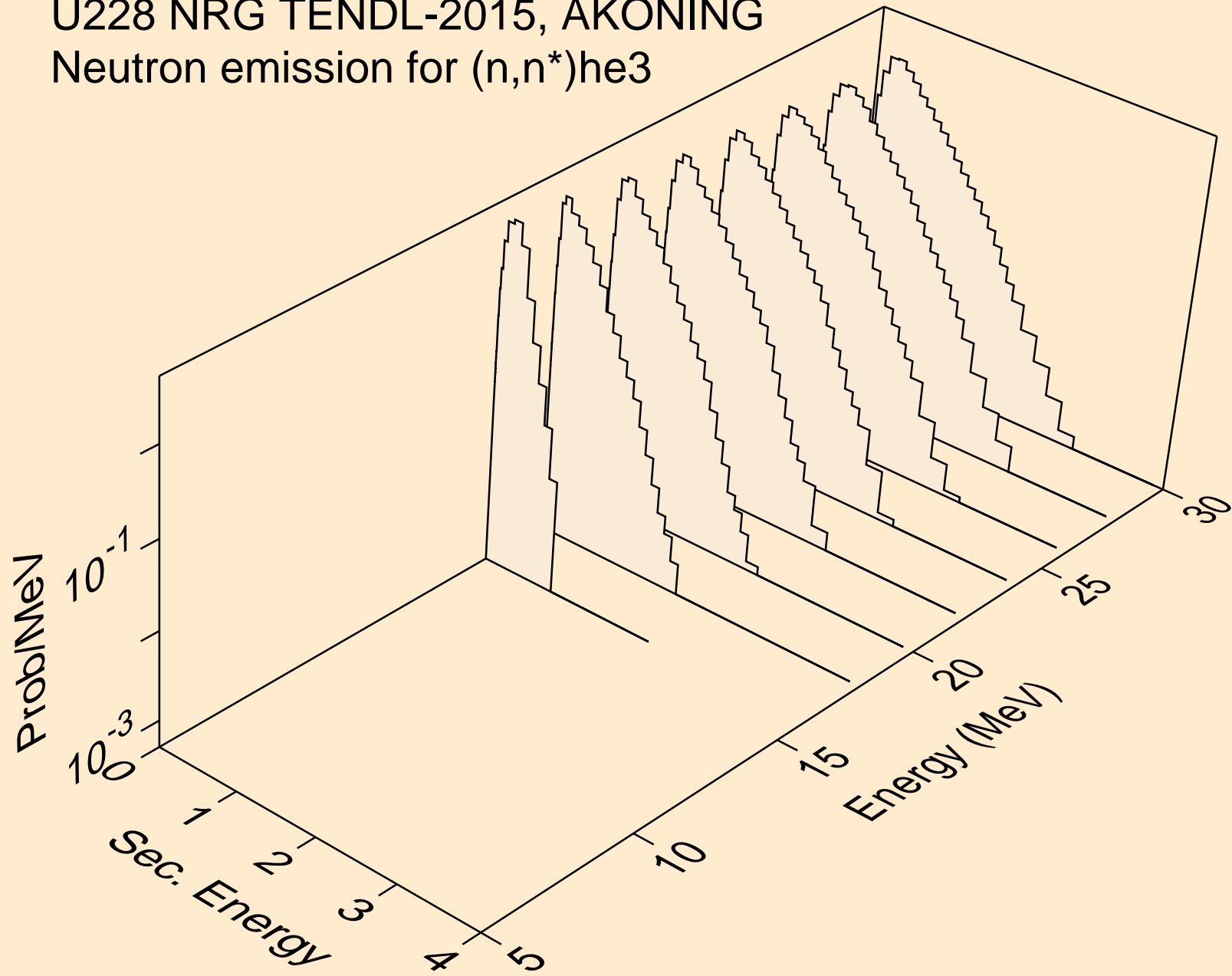

U228 NRG TENDL-2015, AKONING
Neutron emission for (n,n*)d2a

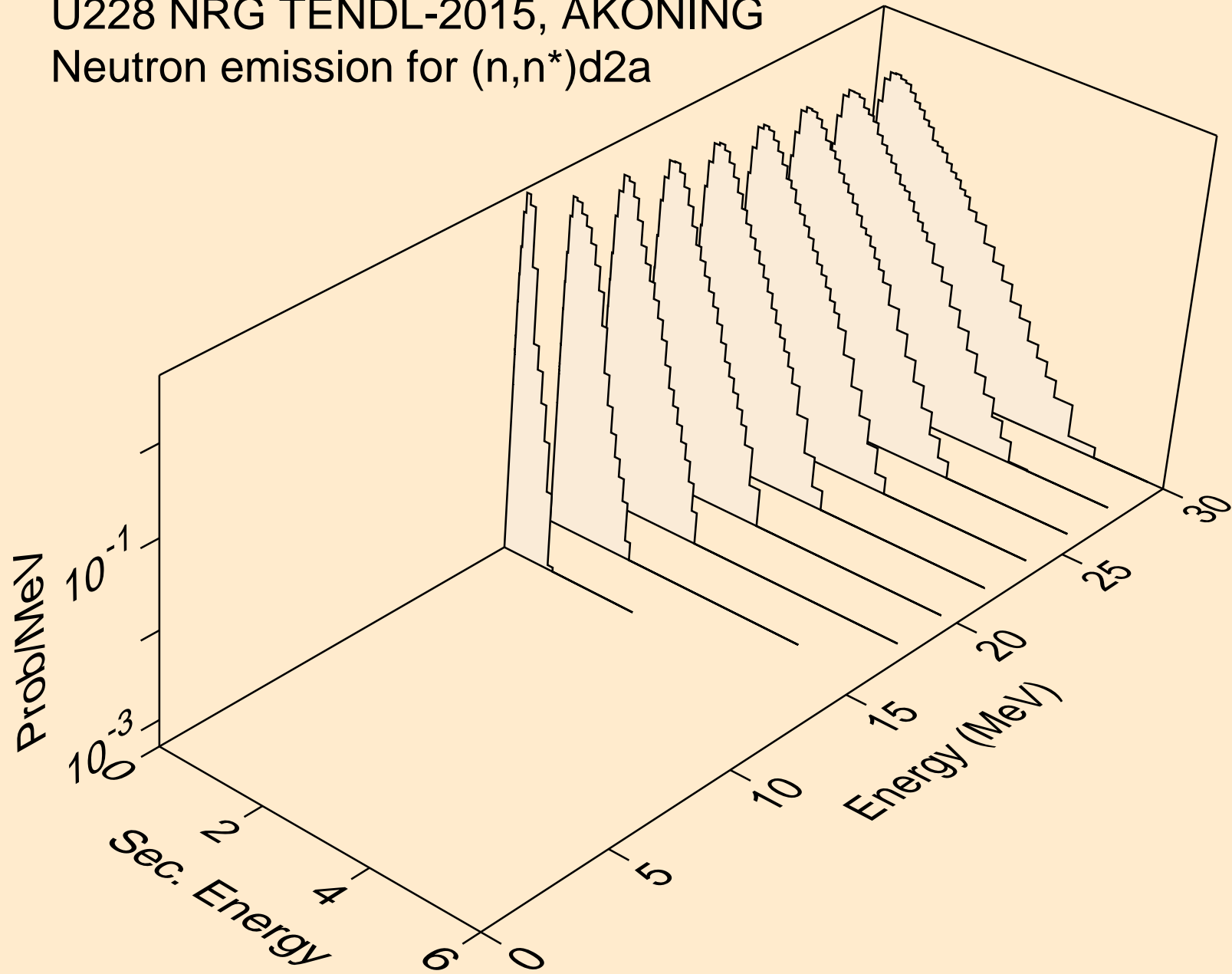

U228 NRG TENDL-2015, AKONING
Neutron emission for (n,n*)t2a

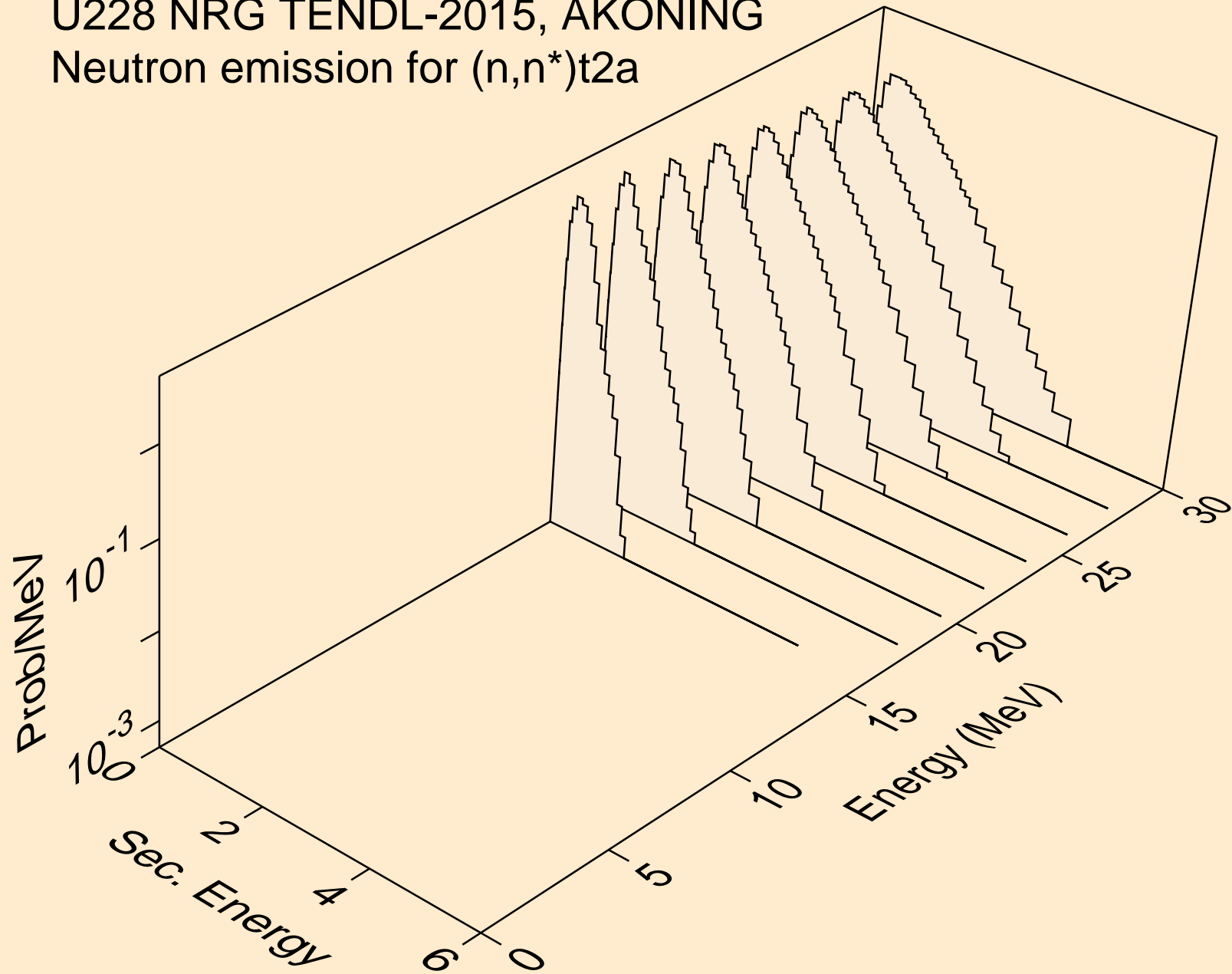

U228 NRG TENDL-2015, AKONING
Neutron emission for (n,4n)

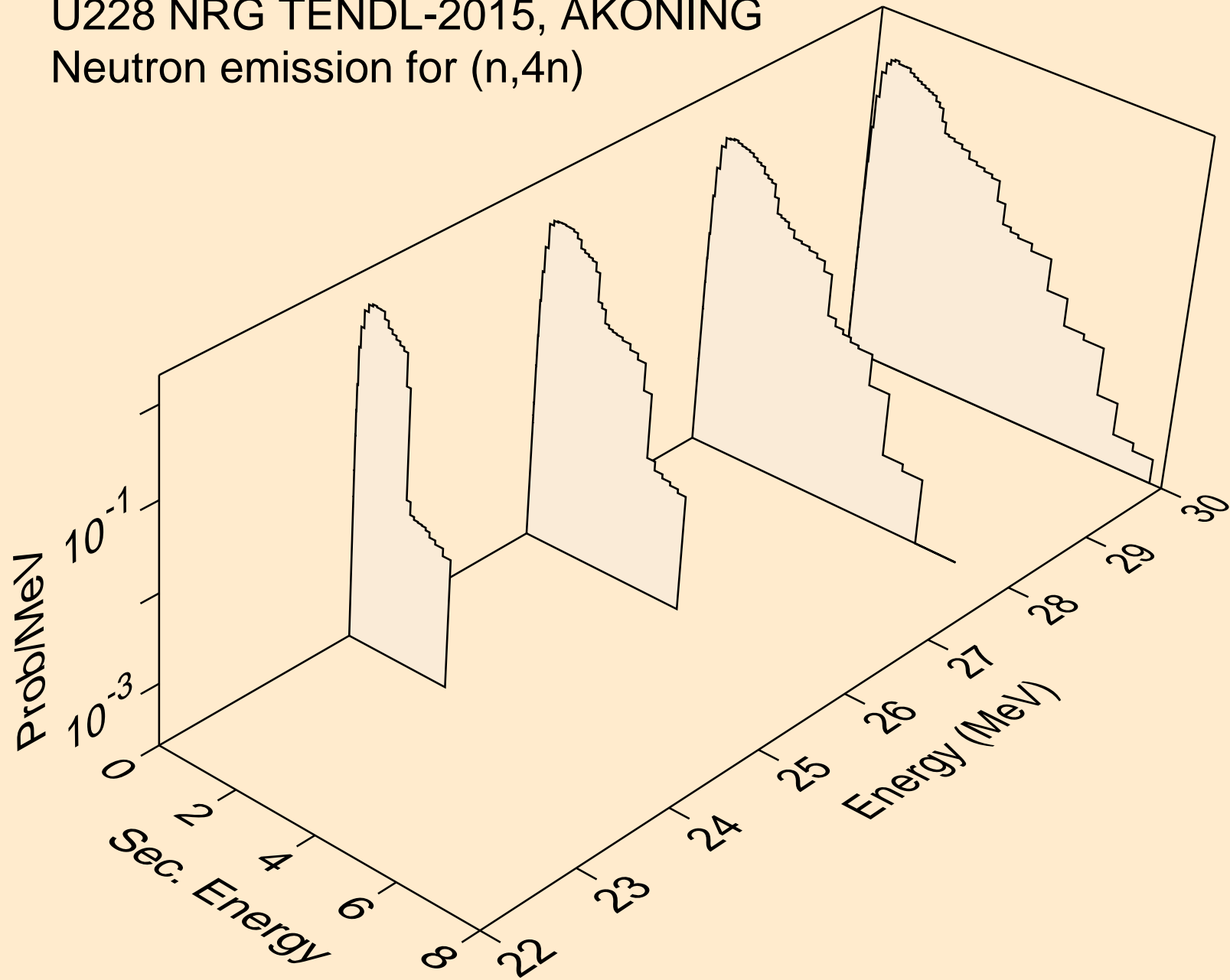

U228 NRG TENDL-2015, AKONING
Neutron emission for (n,2np)

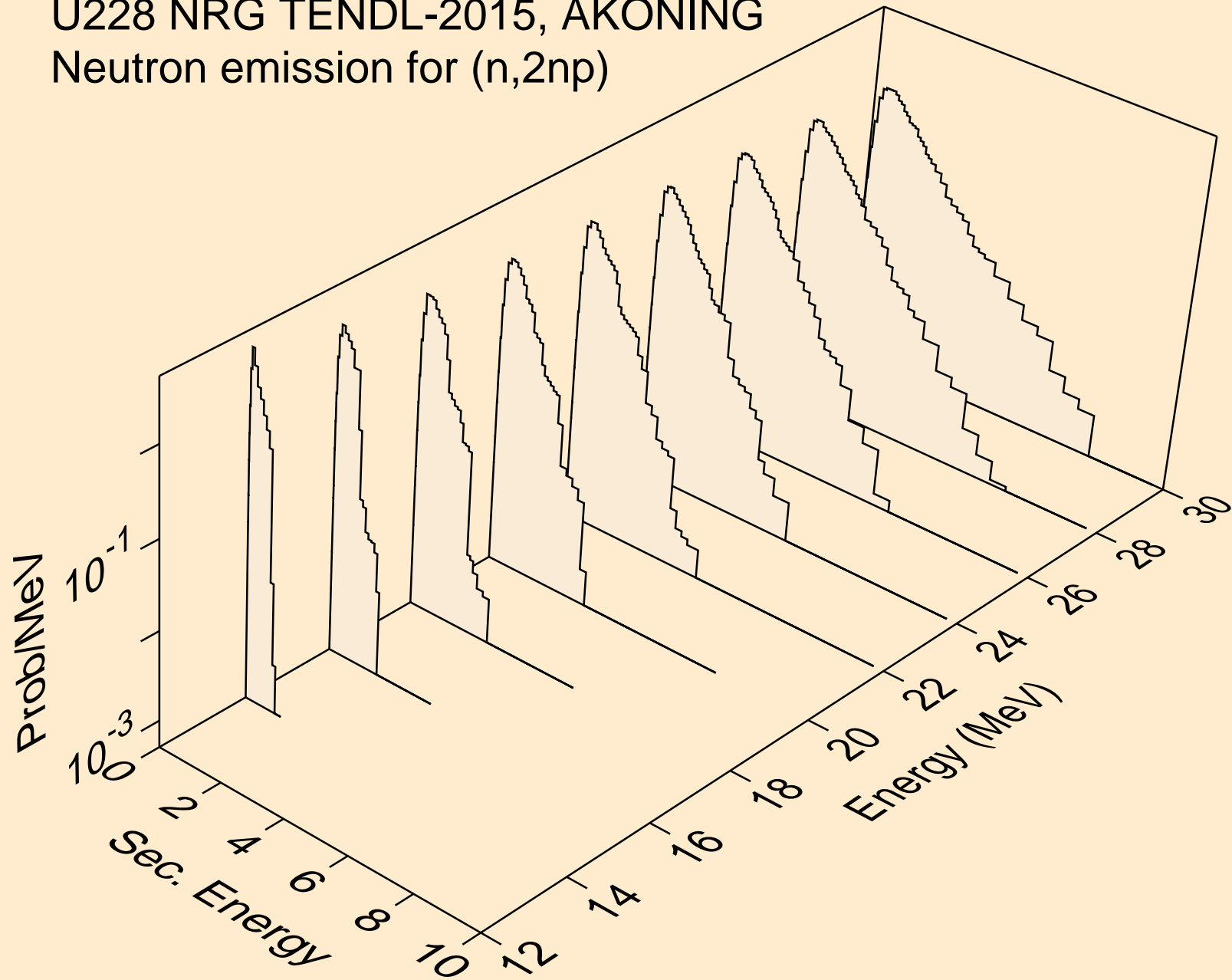

U228 NRG TENDL-2015, AKONING
Neutron emission for (n,3np)

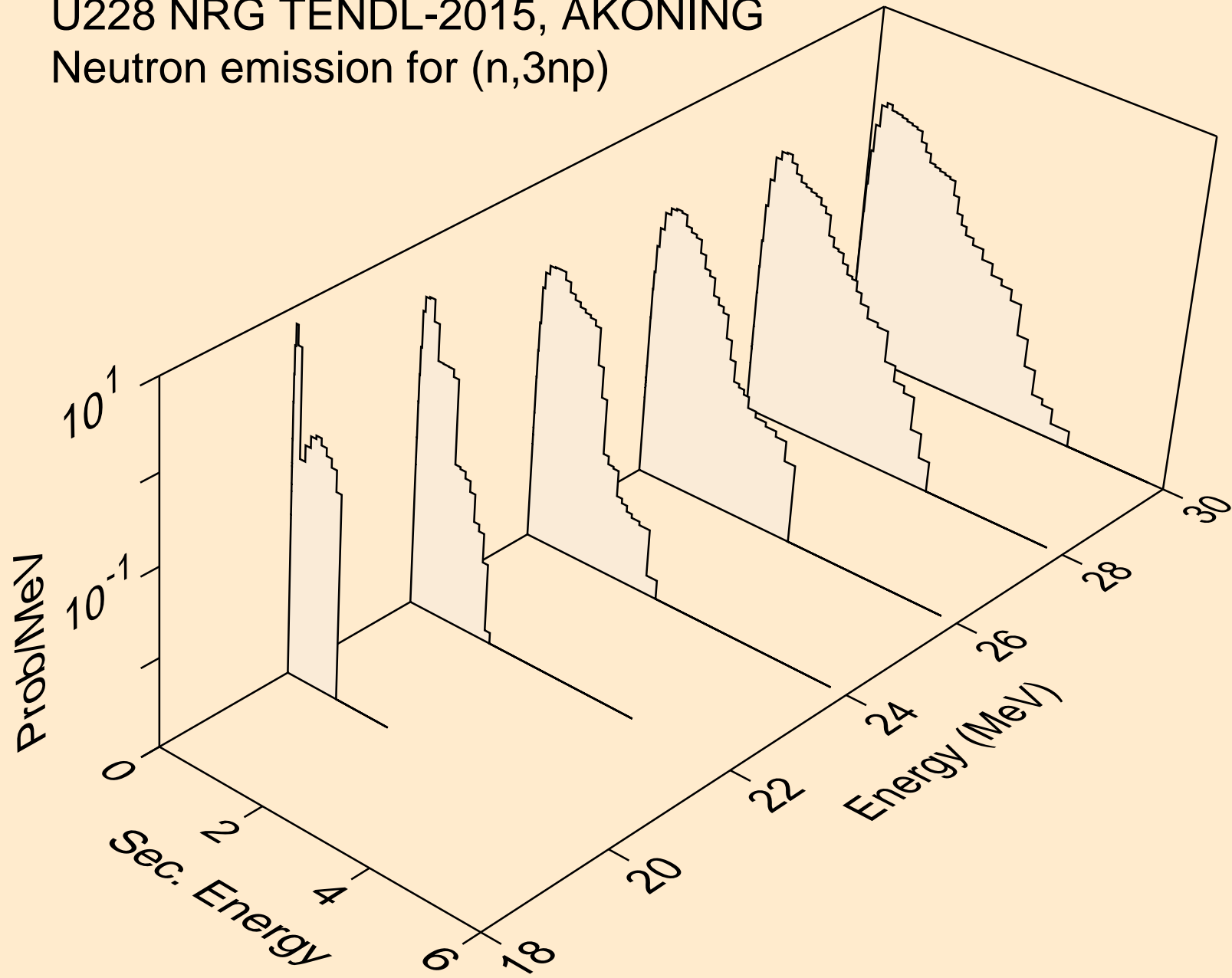

U228 NRG TENDL-2015, AKONING
Neutron emission for (n,2np)

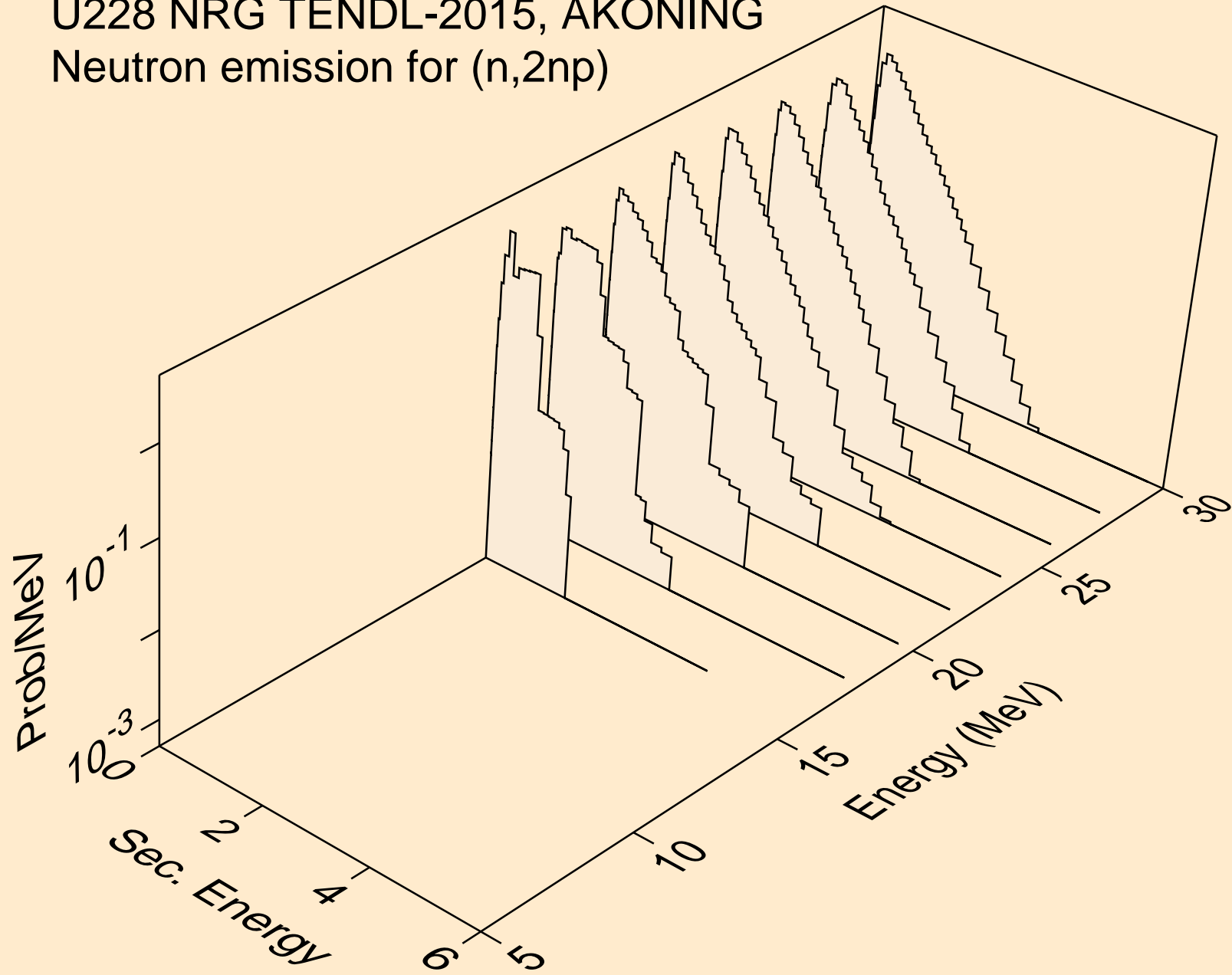

U228 NRG TENDL-2015, AKONING
Neutron emission for (n,npa)

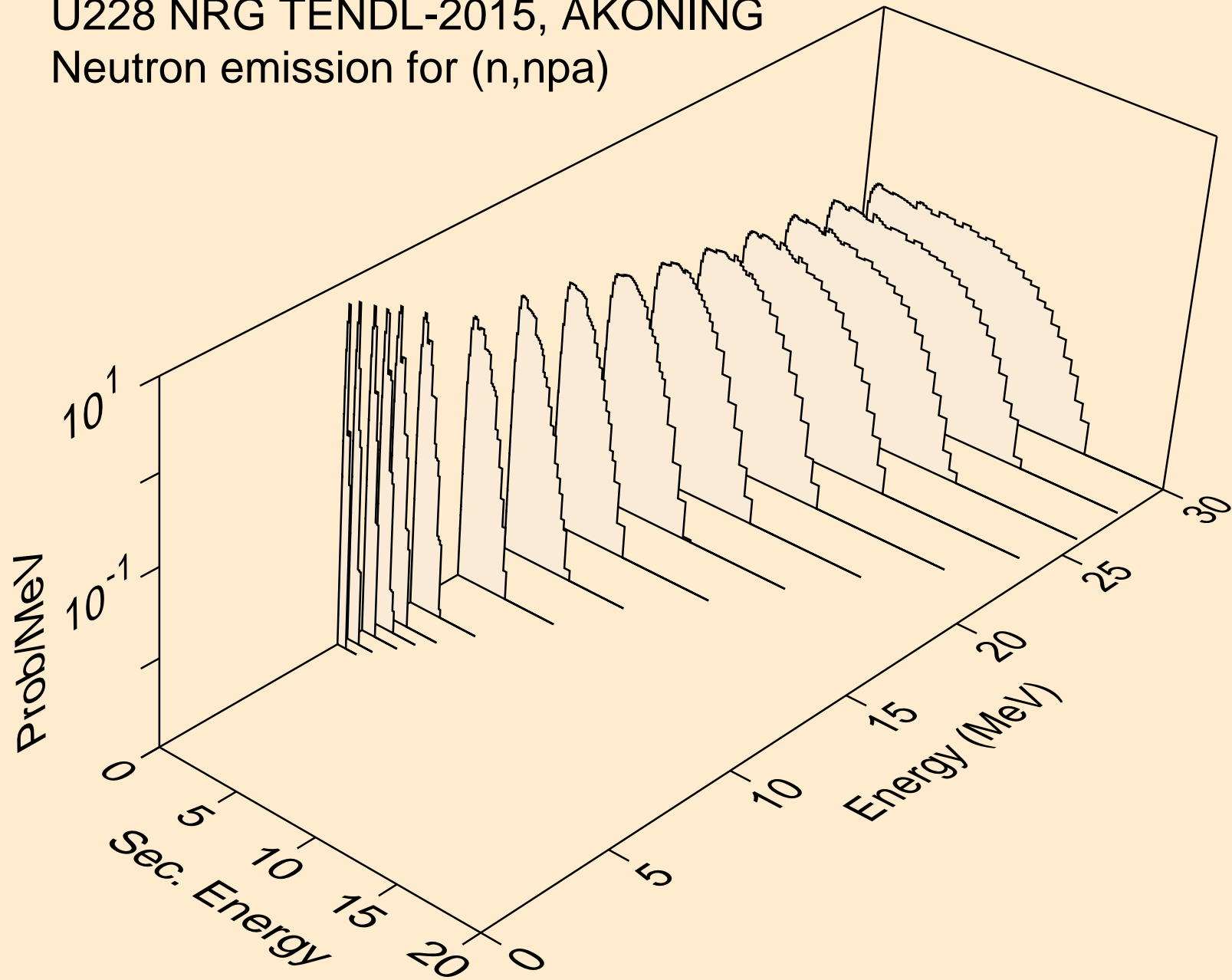

U228 NRG TENDL-2015, AKONING
Neutron emission for (n,n*c)

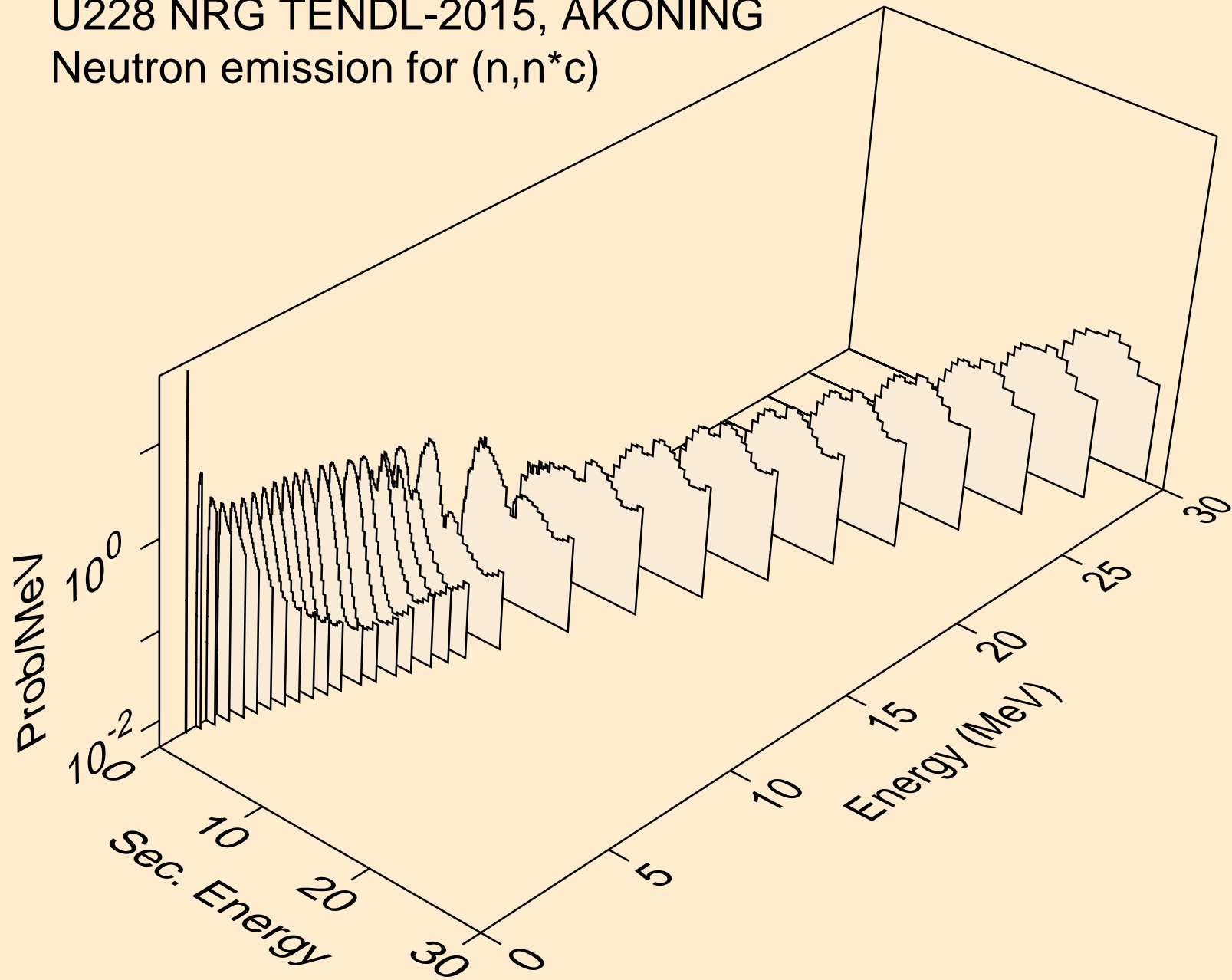

U228 NRG TENDL-2015, AKONING

Delayed nubar

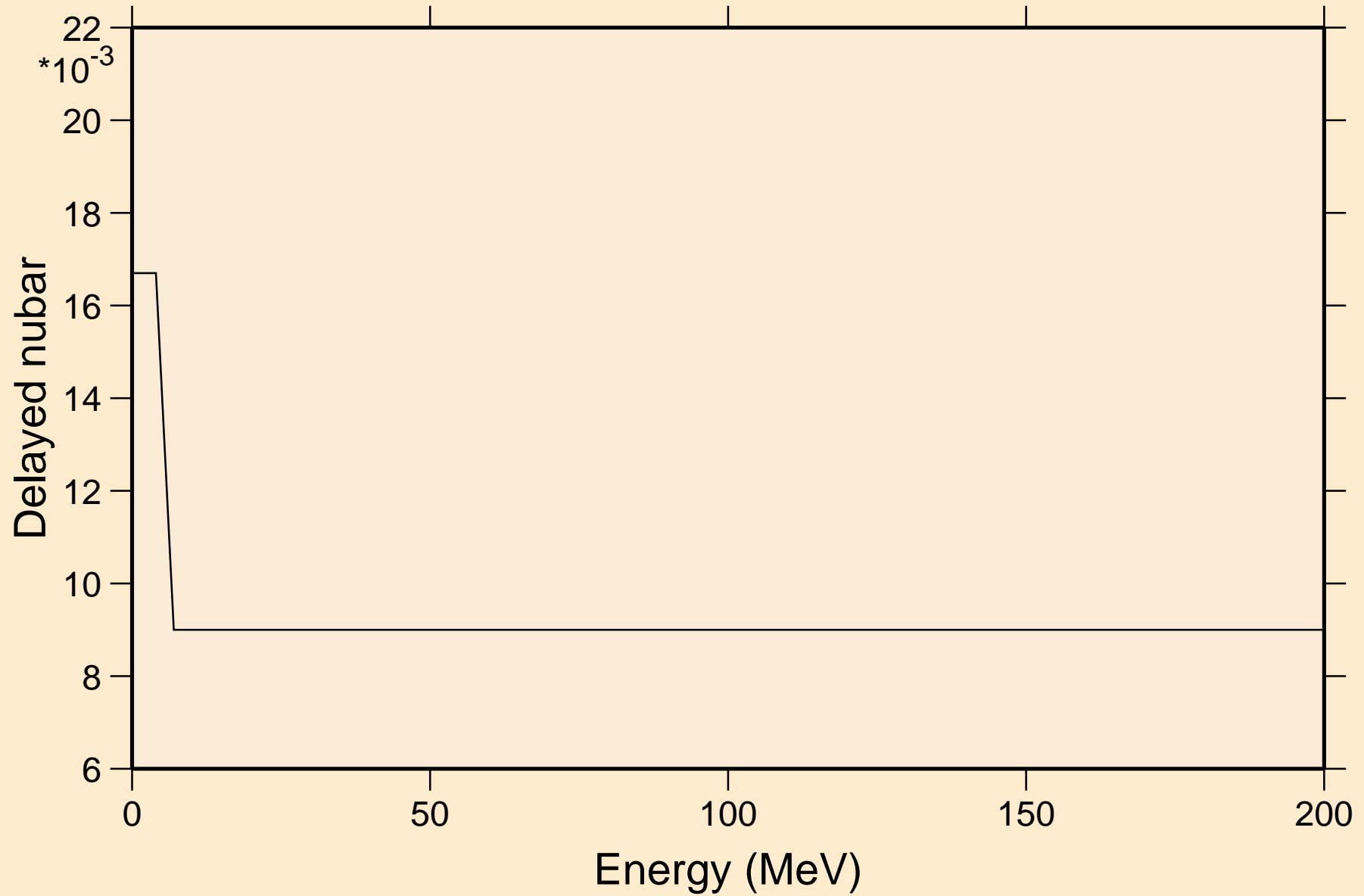

U228 NRG TENDL-2015, AKONING

Delayed neutron spectra

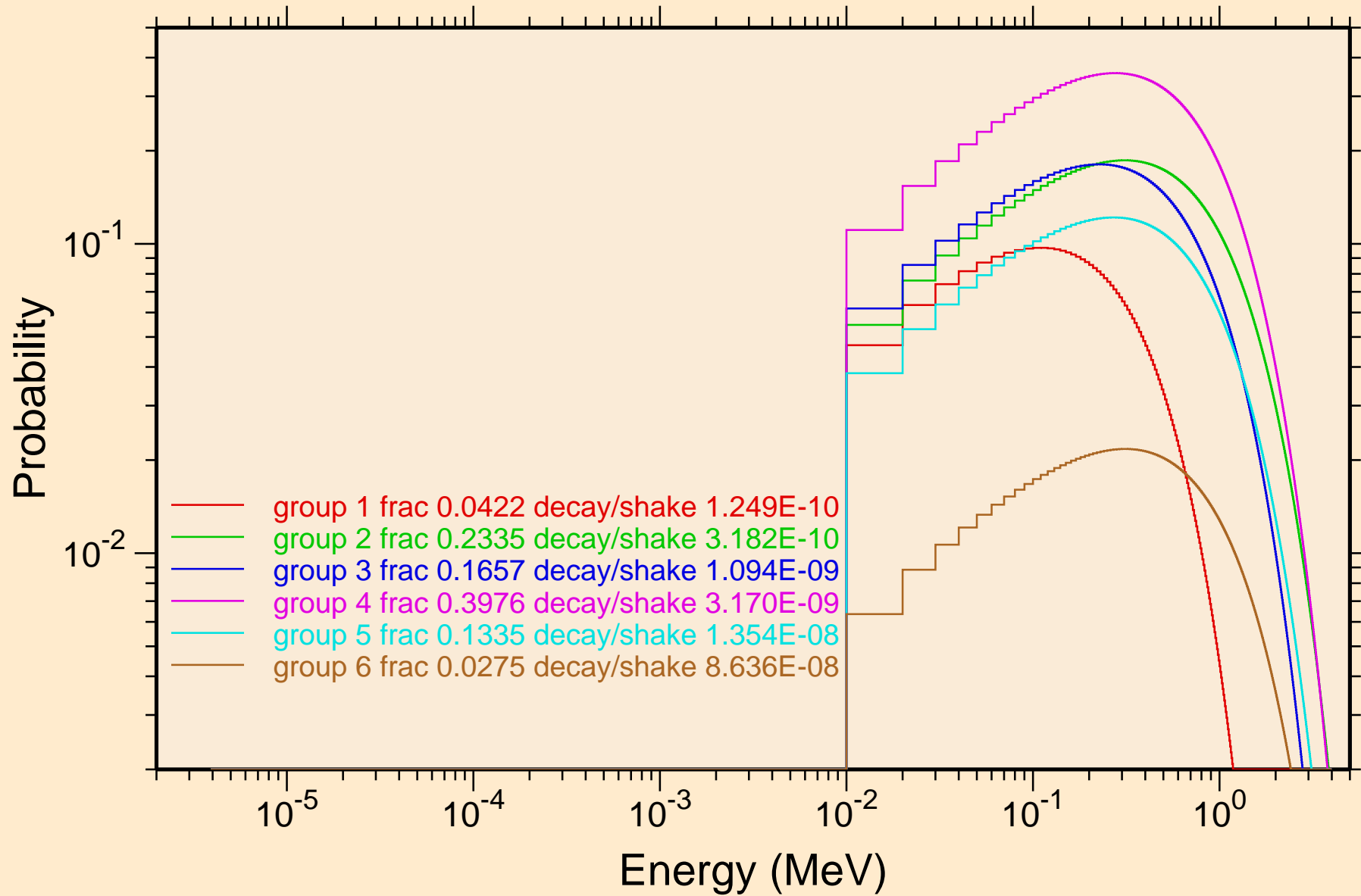

U228 NRG TENDL-2015, AKONING
Photon emission for (n,x)

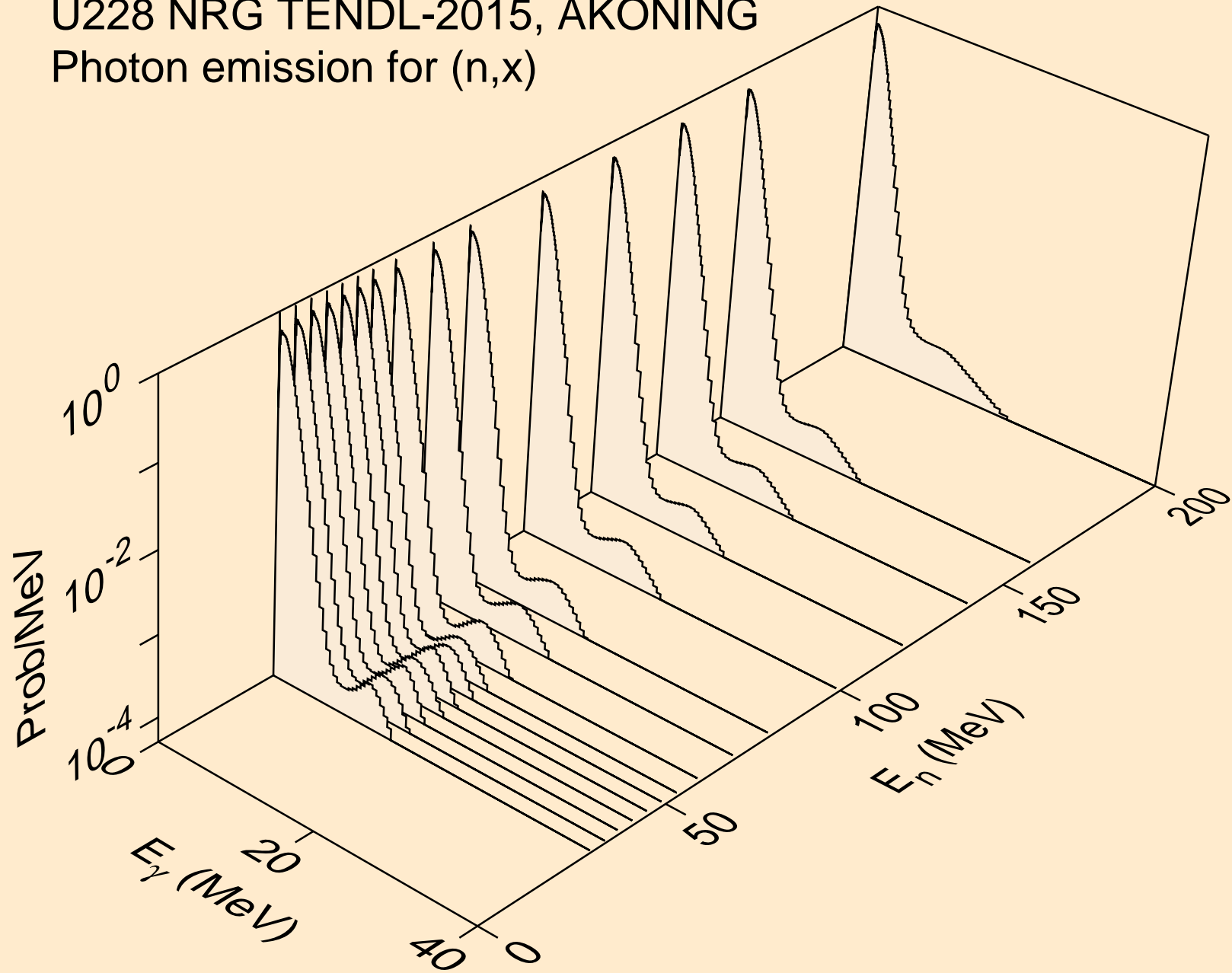

U228 NRG TENDL-2015, AKONING
Photon emission for (n,2nd)

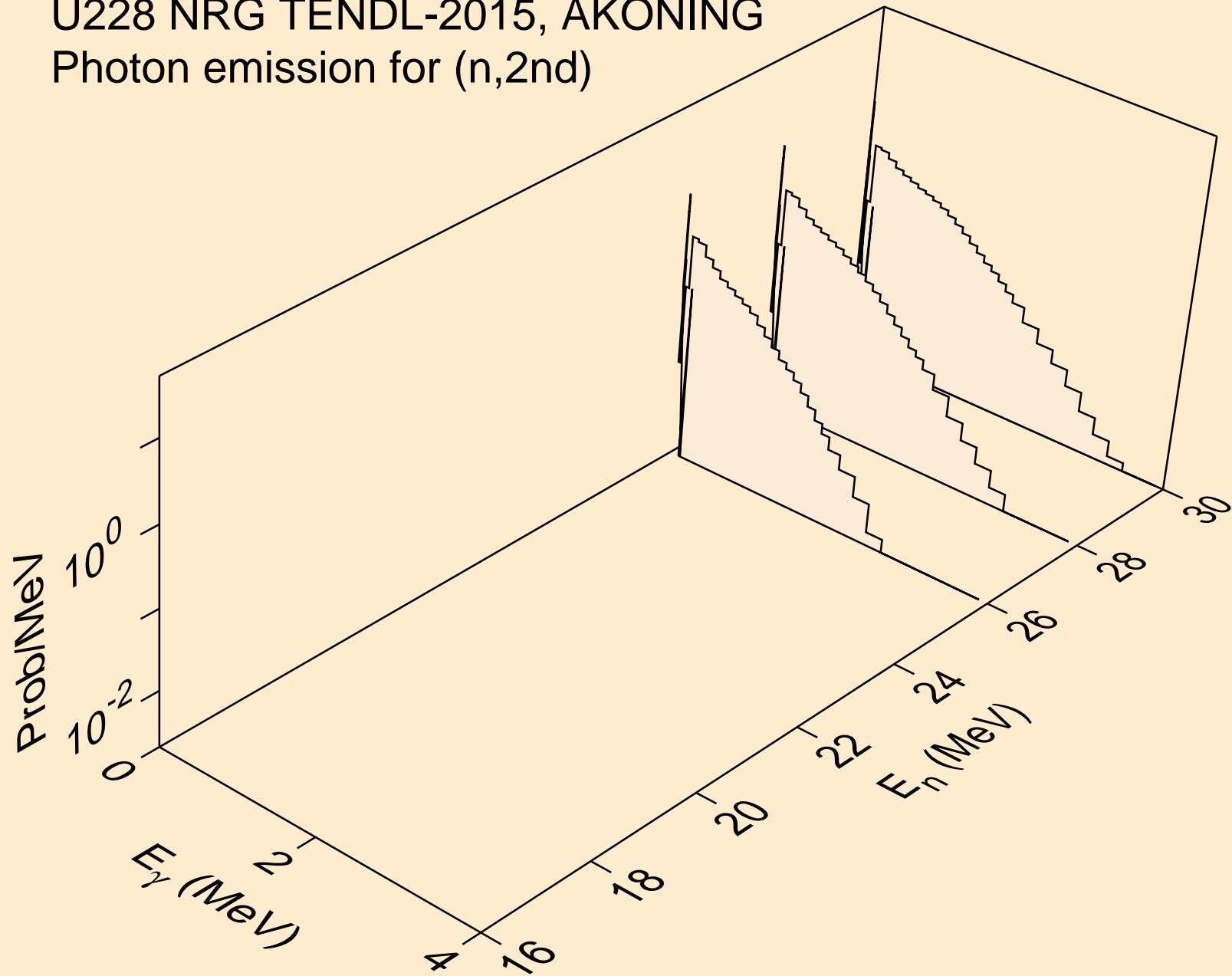

U228 NRG TENDL-2015, AKONING
Photon emission for (n,2n)

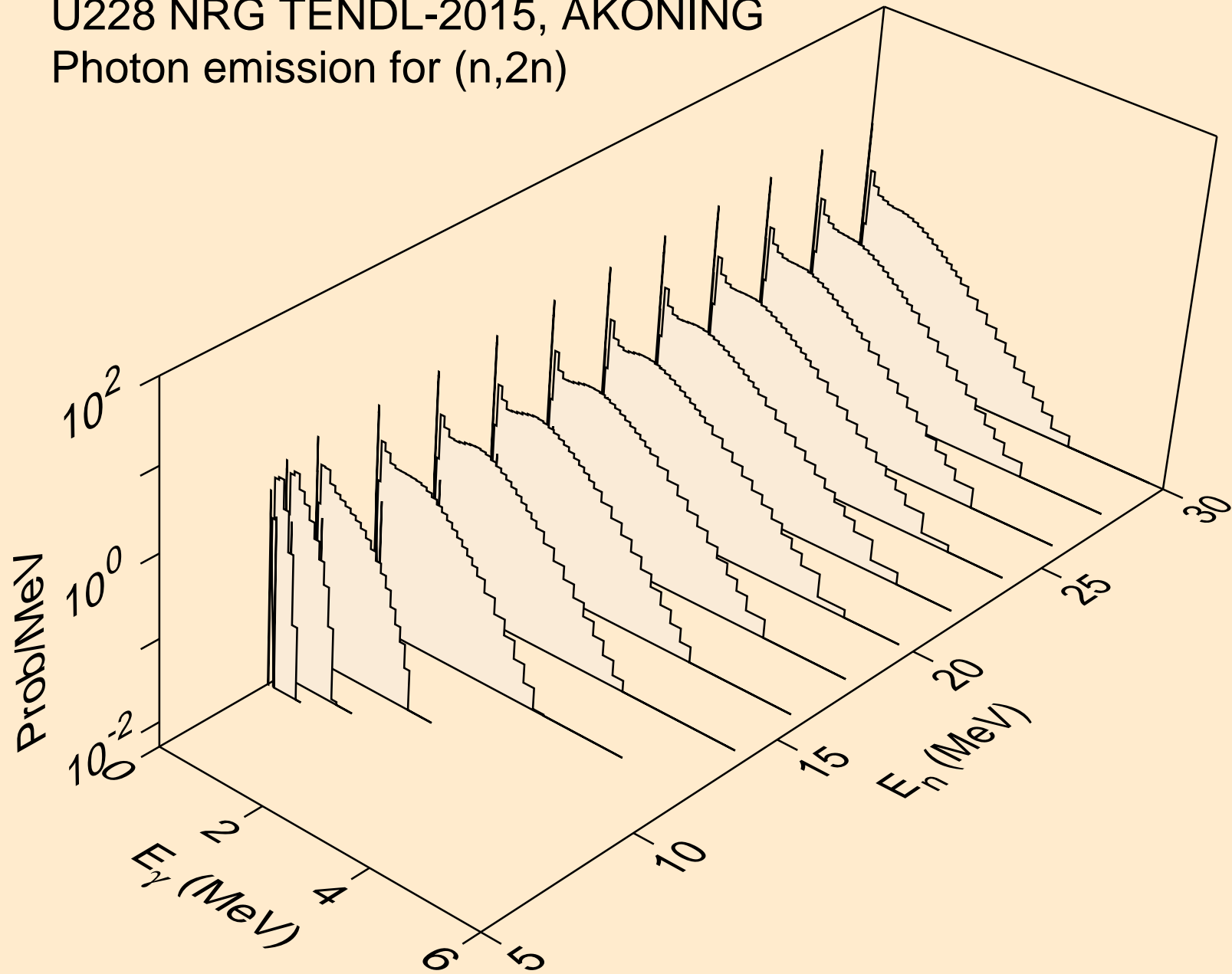

U228 NRG TENDL-2015, AKONING
Photon emission for (n,3n)

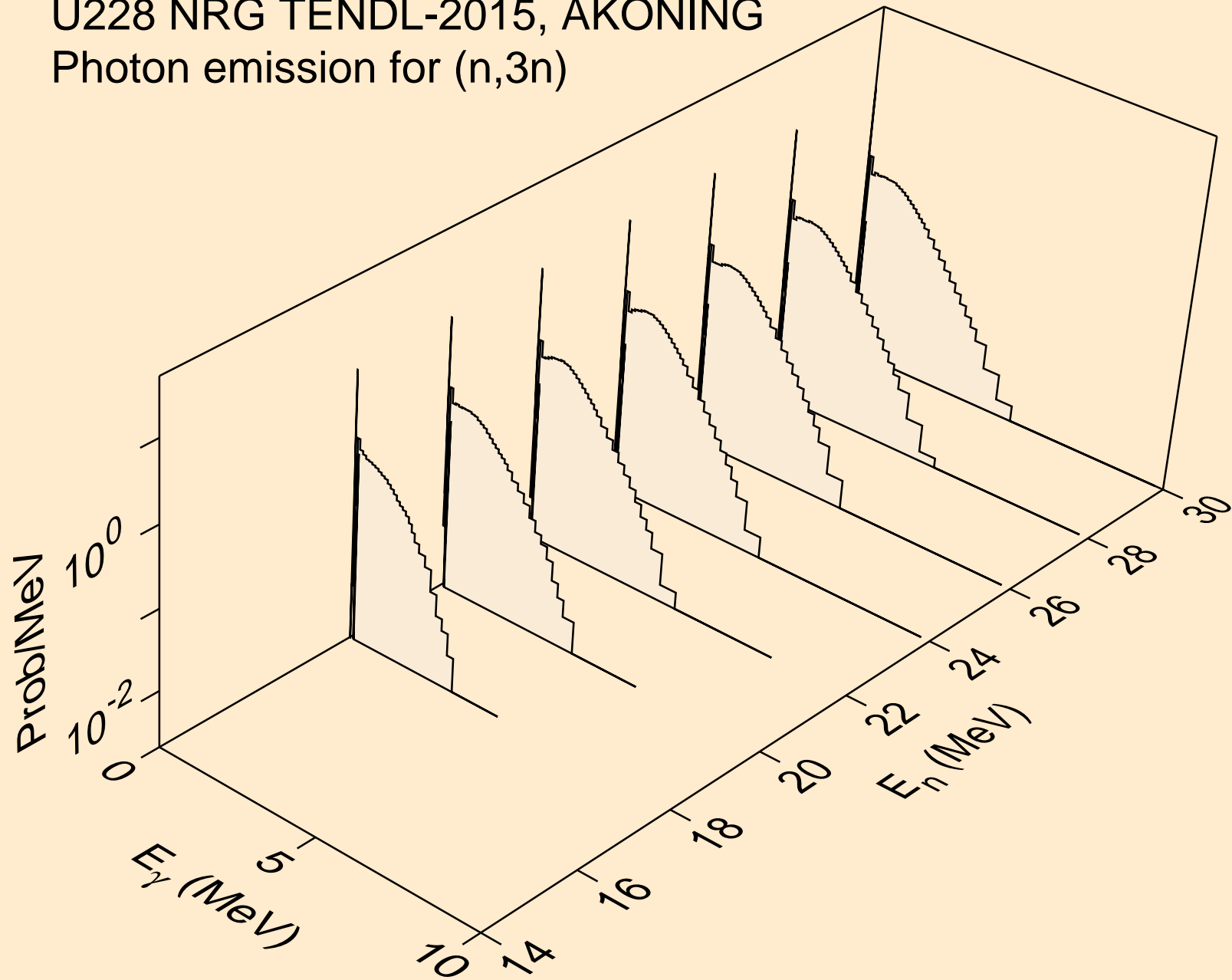

U228 NRG TENDL-2015, AKONING
Photon emission for (n,n*)a

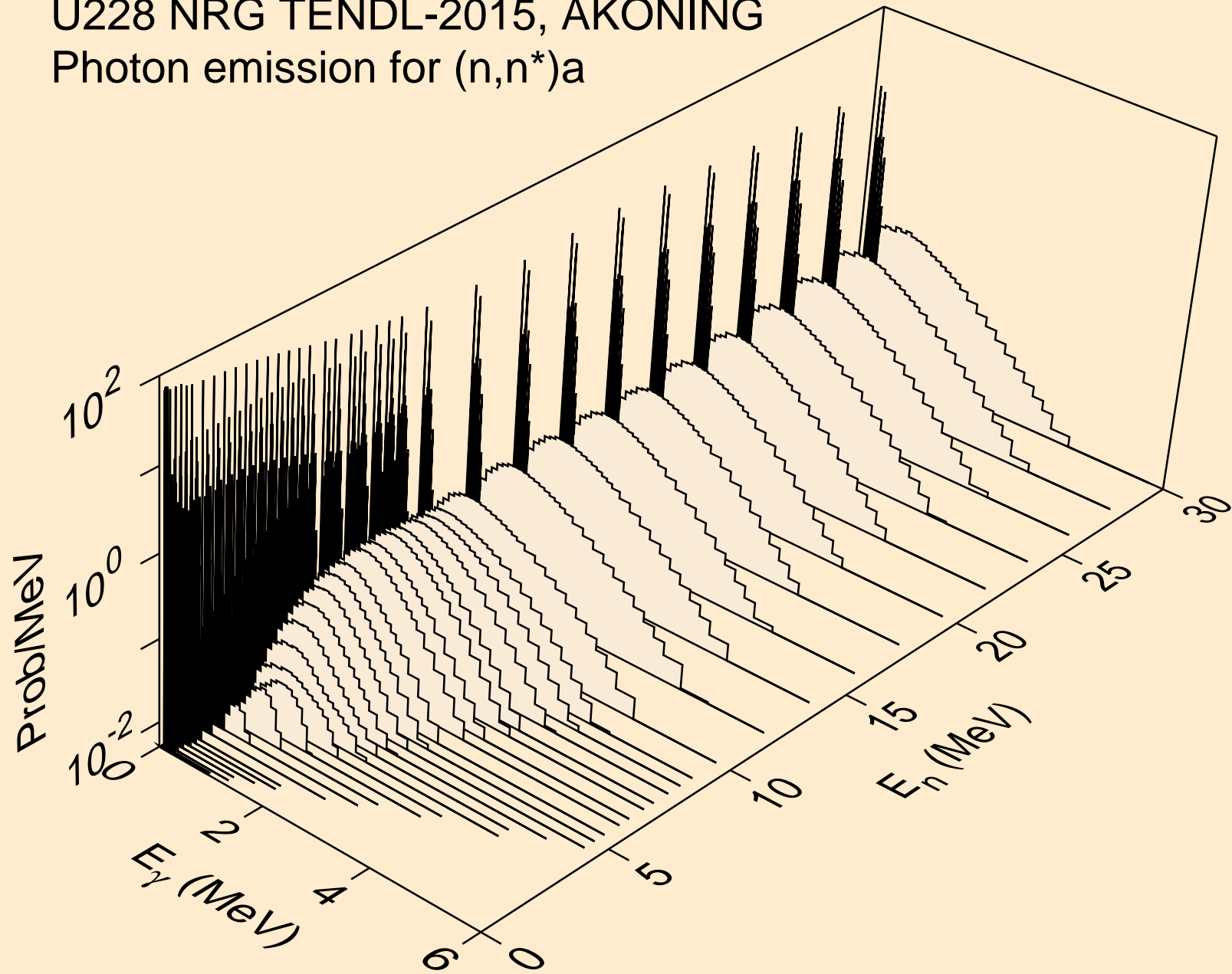

U228 NRG TENDL-2015, AKONING
Photon emission for (n,n*)3a

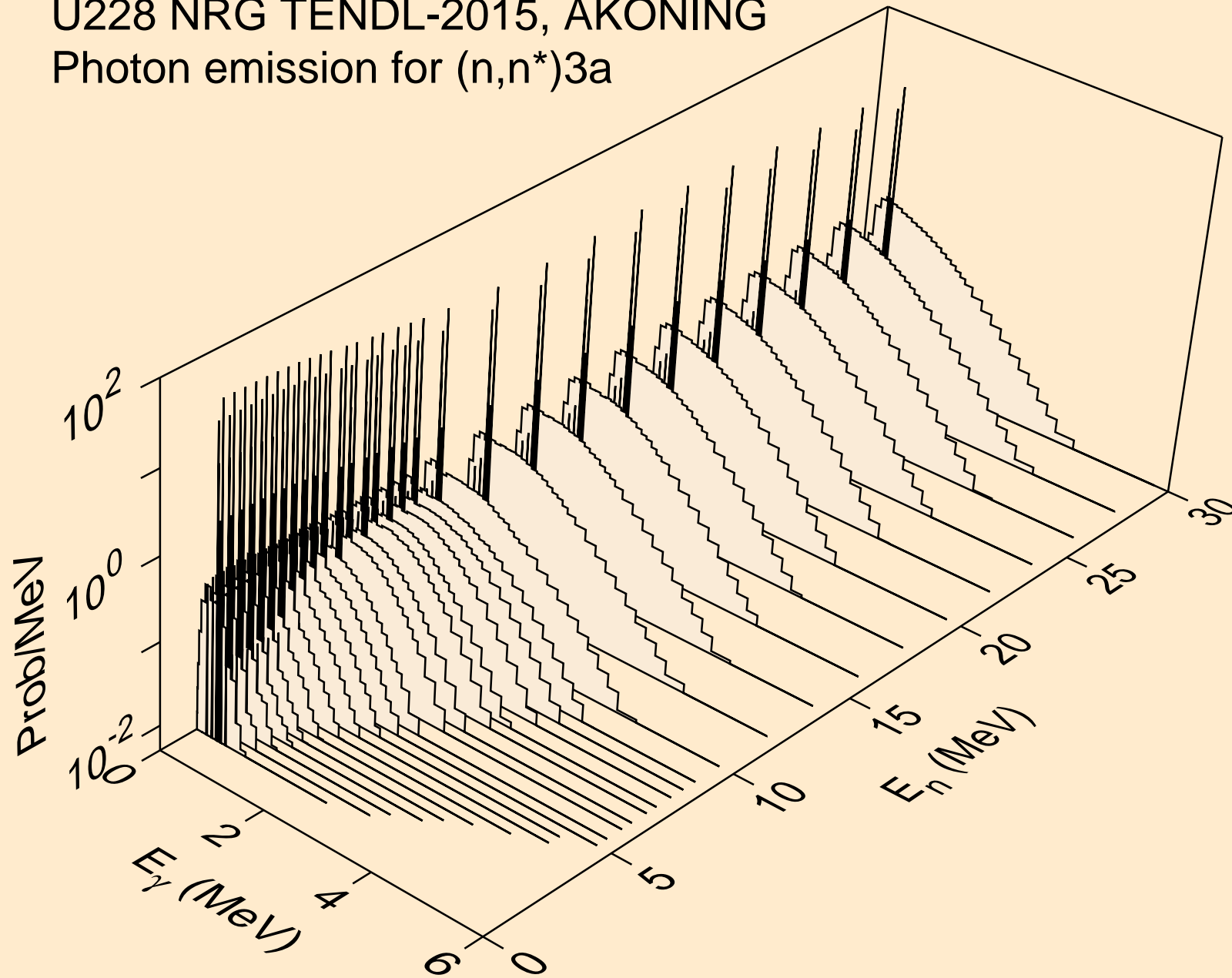

U228 NRG TENDL-2015, AKONING
Photon emission for (n,2n)a

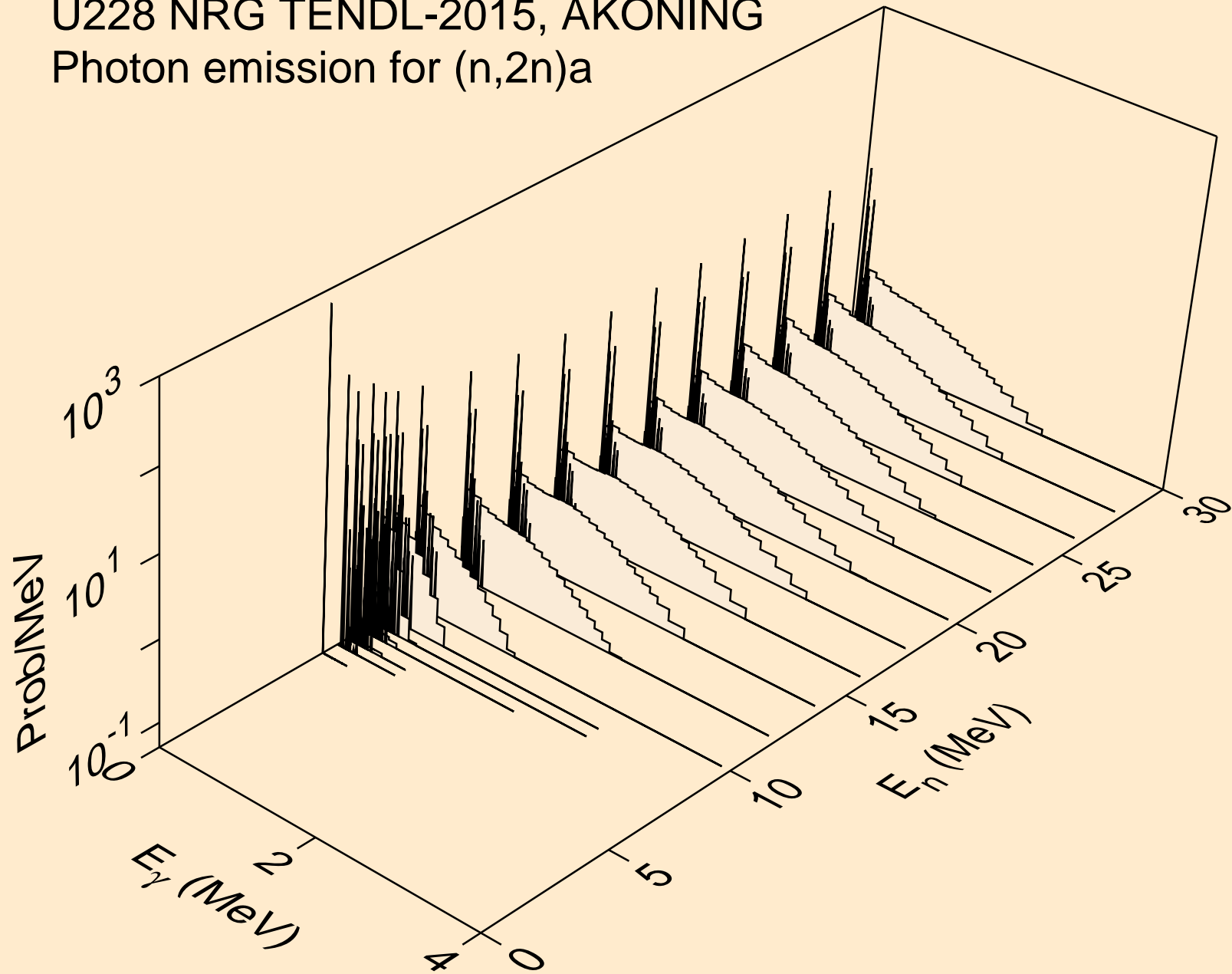

U228 NRG TENDL-2015, AKONING
Photon emission for (n,3n)a

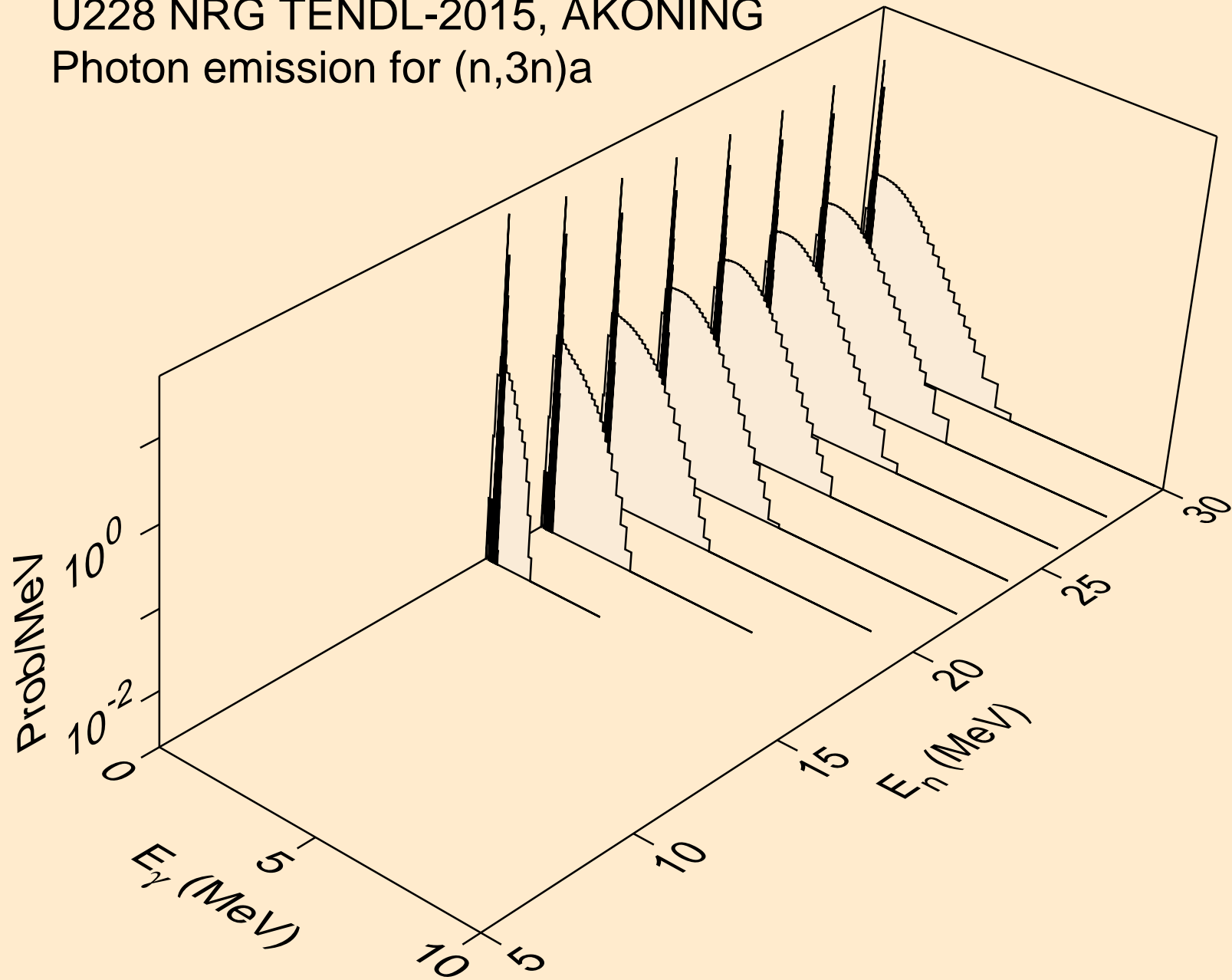

U228 NRG TENDL-2015, AKONING
Photon emission for (n,n*)p

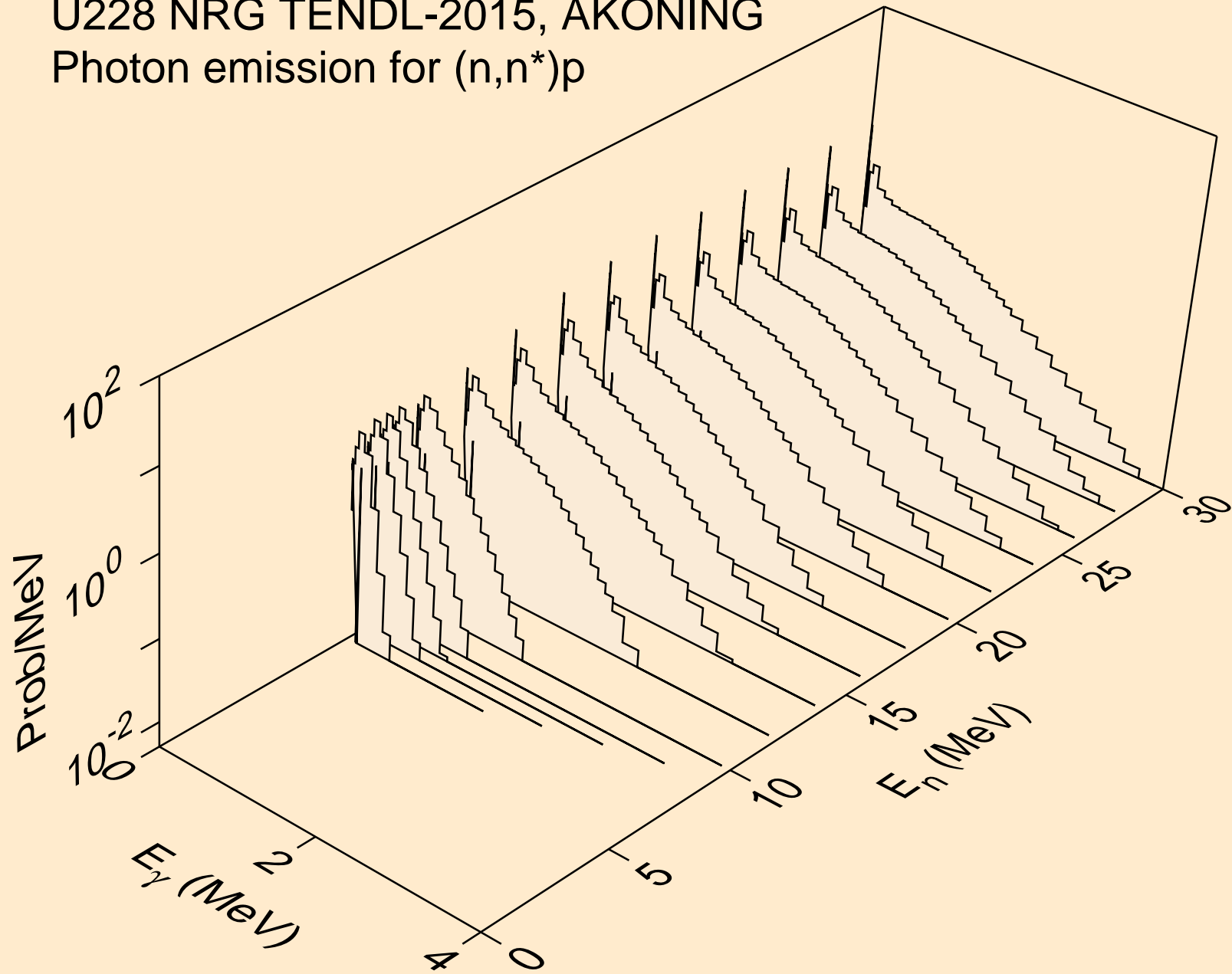

U228 NRG TENDL-2015, AKONING
Photon emission for (n,n*)2a

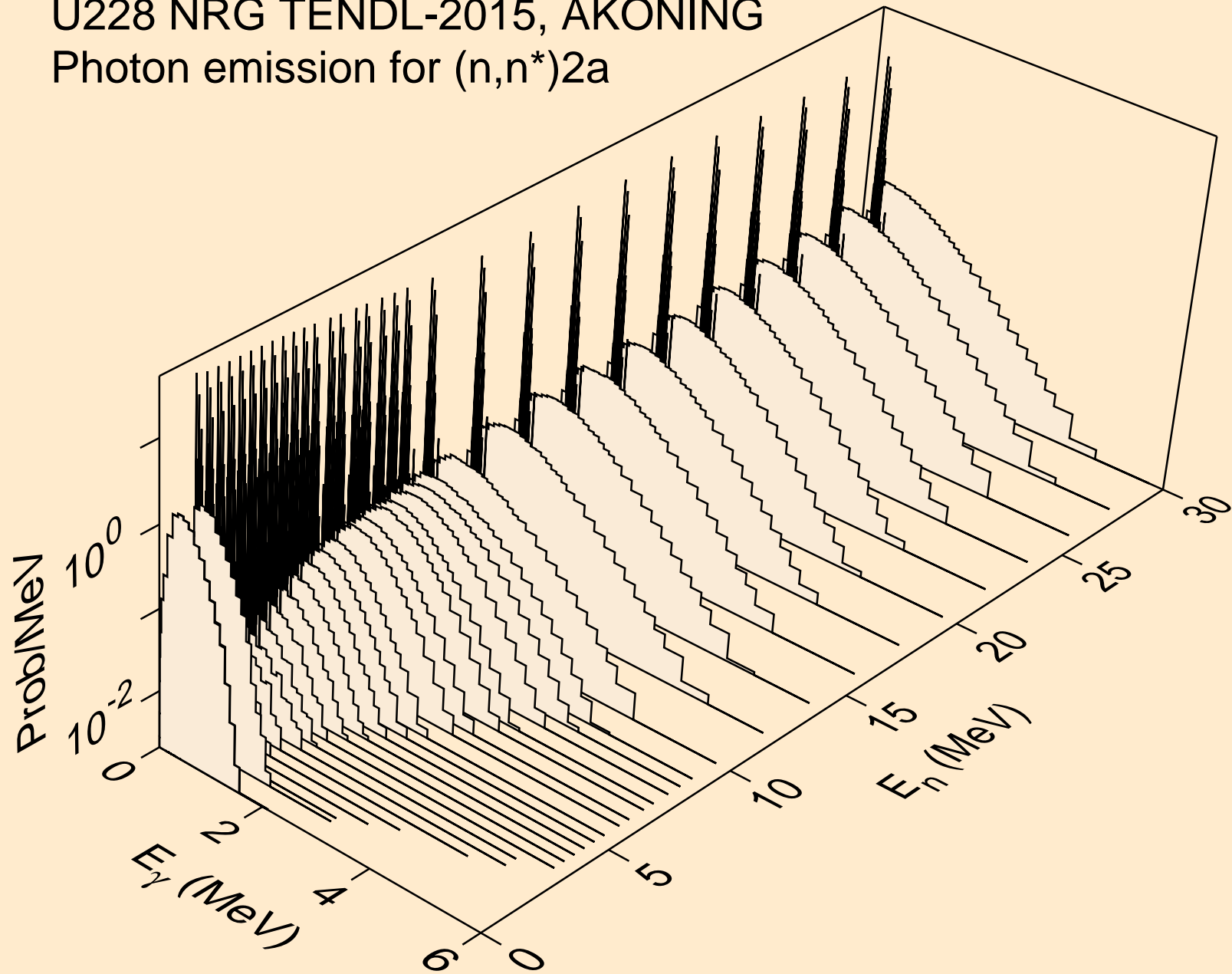

U228 NRG TENDL-2015, AKONING
Photon emission for (n,2n)2a

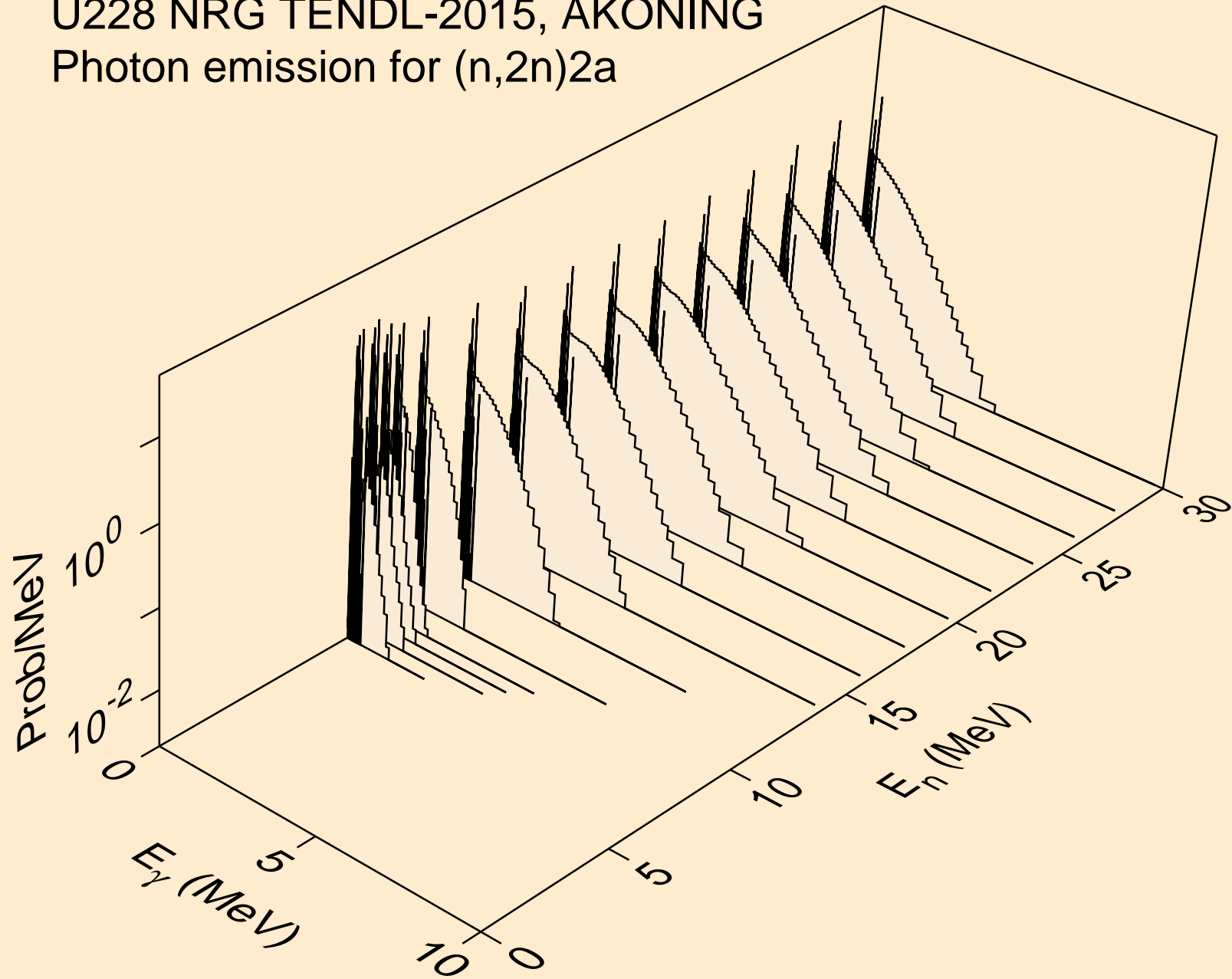

U228 NRG TENDL-2015, AKONING
Photon emission for (n,n*)d

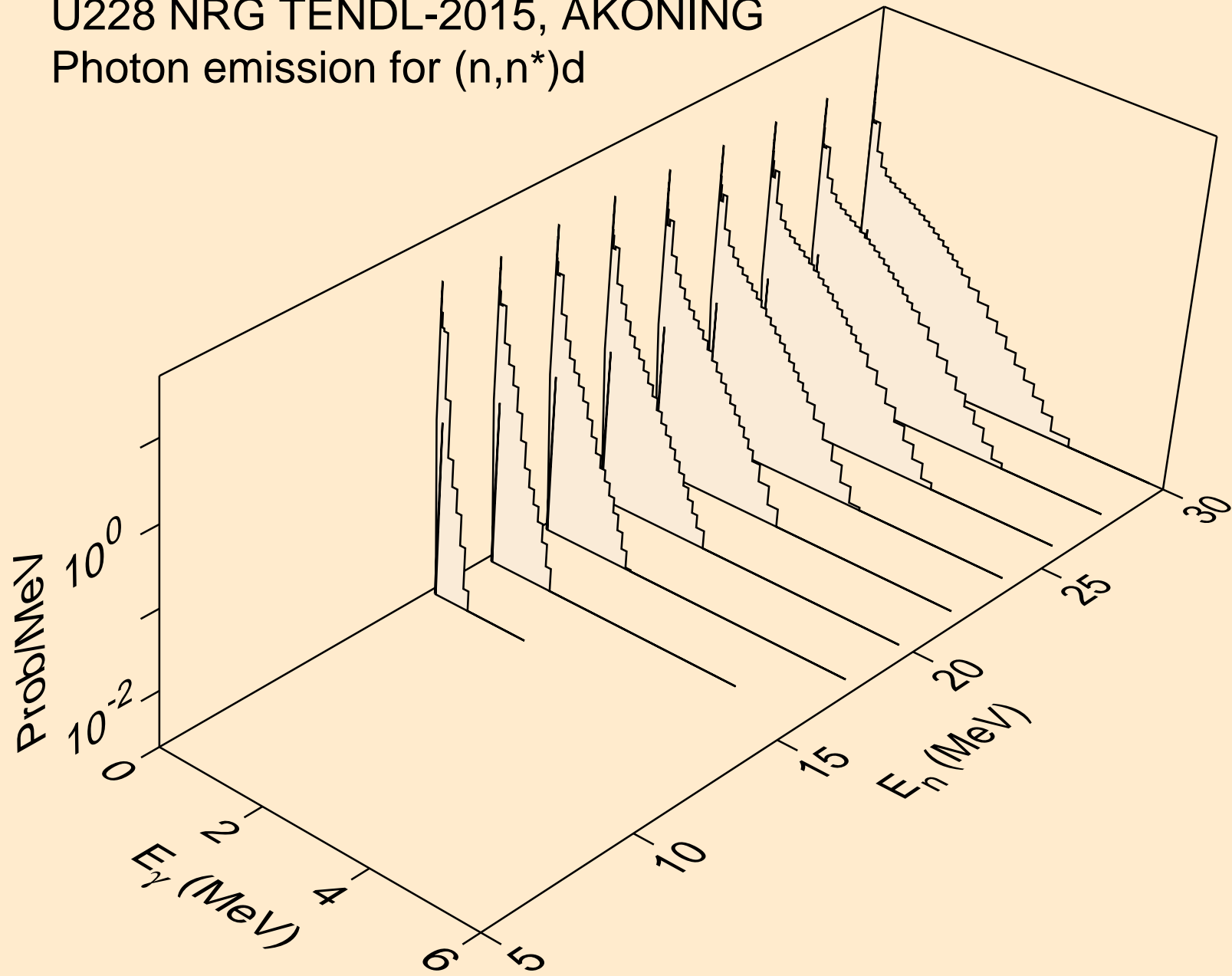

U228 NRG TENDL-2015, AKONING
Photon emission for (n,n*)t

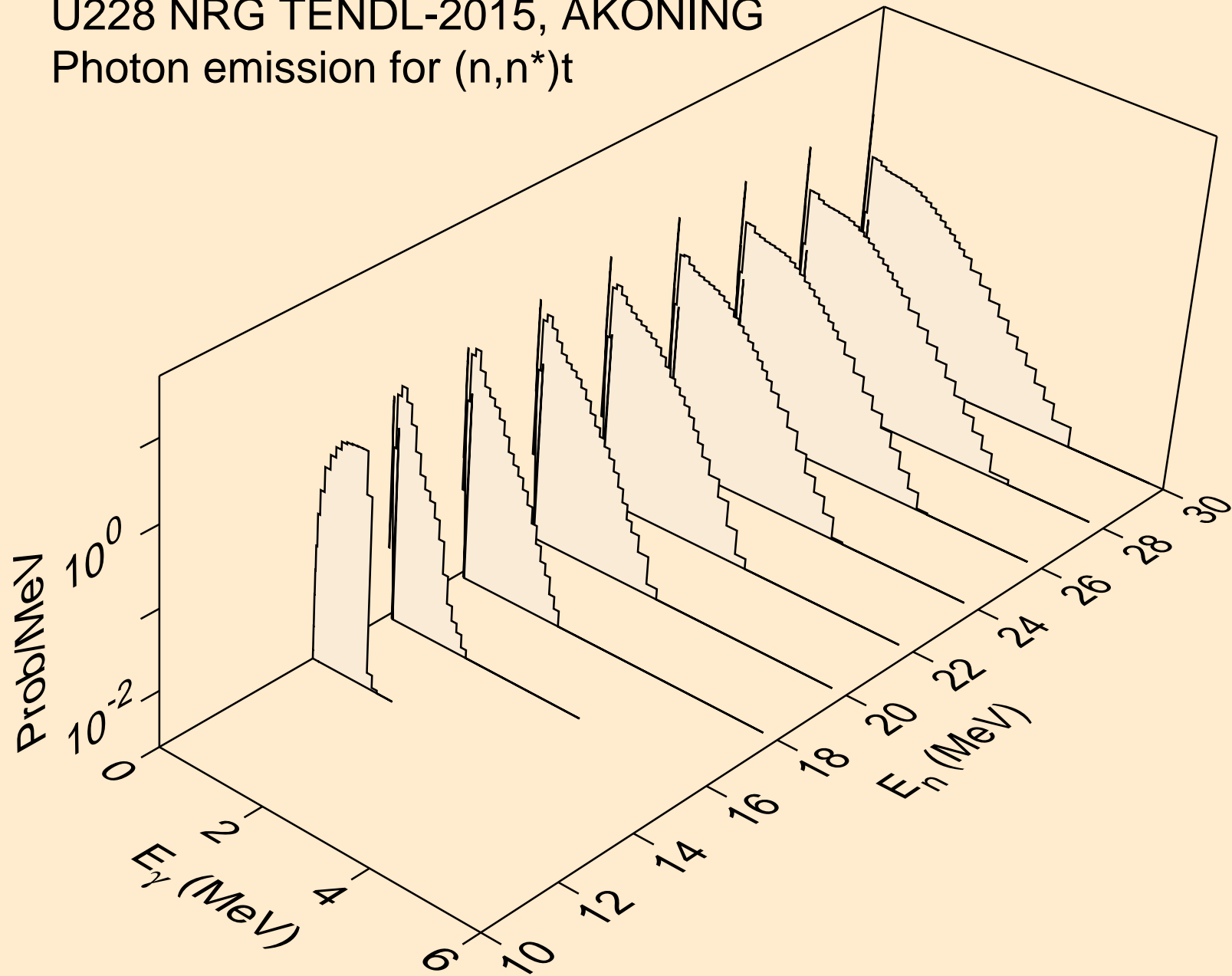

U228 NRG TENDL-2015, AKONING
Photon emission for (n,n*)he3

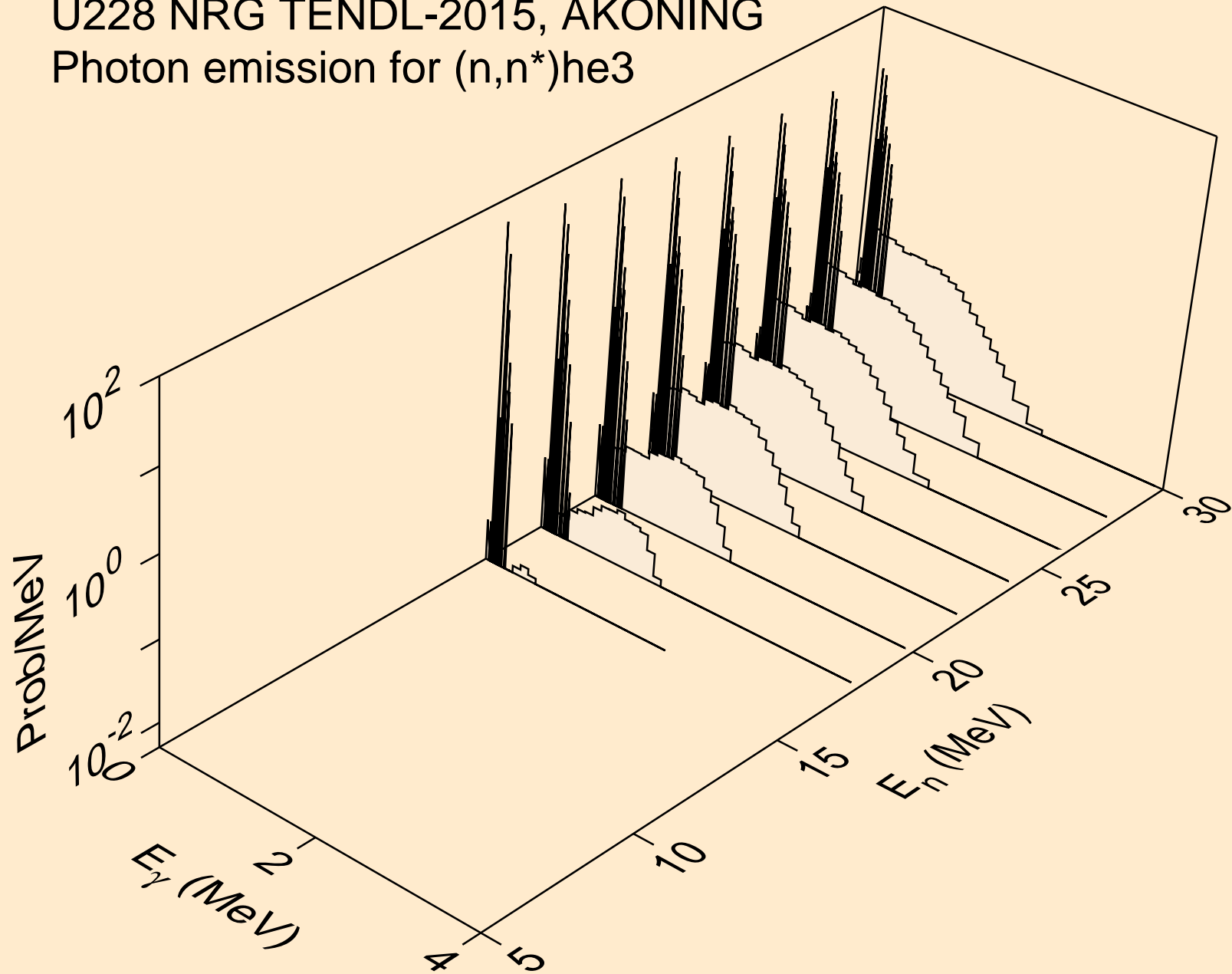

U228 NRG TENDL-2015, AKONING
Photon emission for (n,n*)d2a

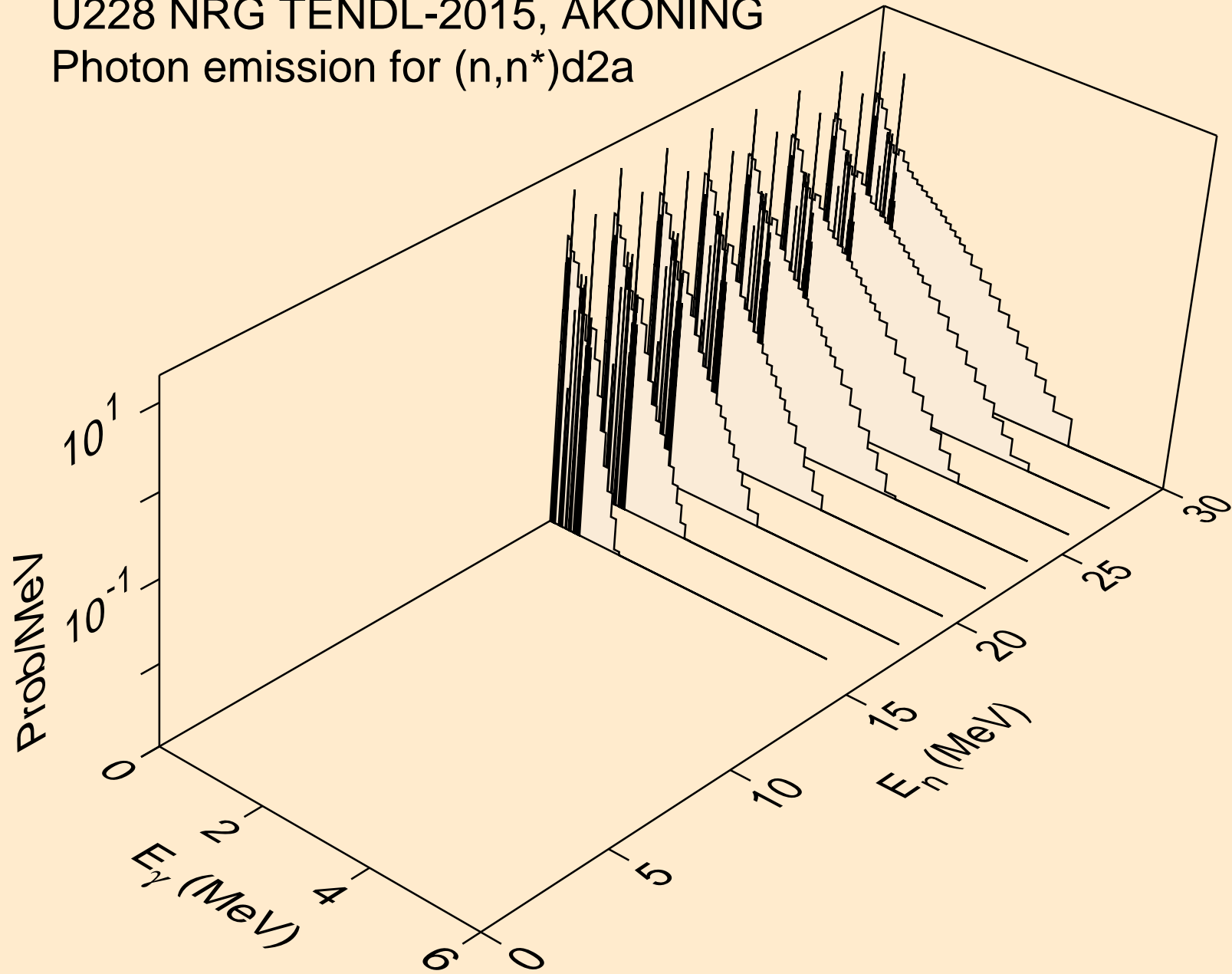

U228 NRG TENDL-2015, AKONING
Photon emission for (n,n*)t2a

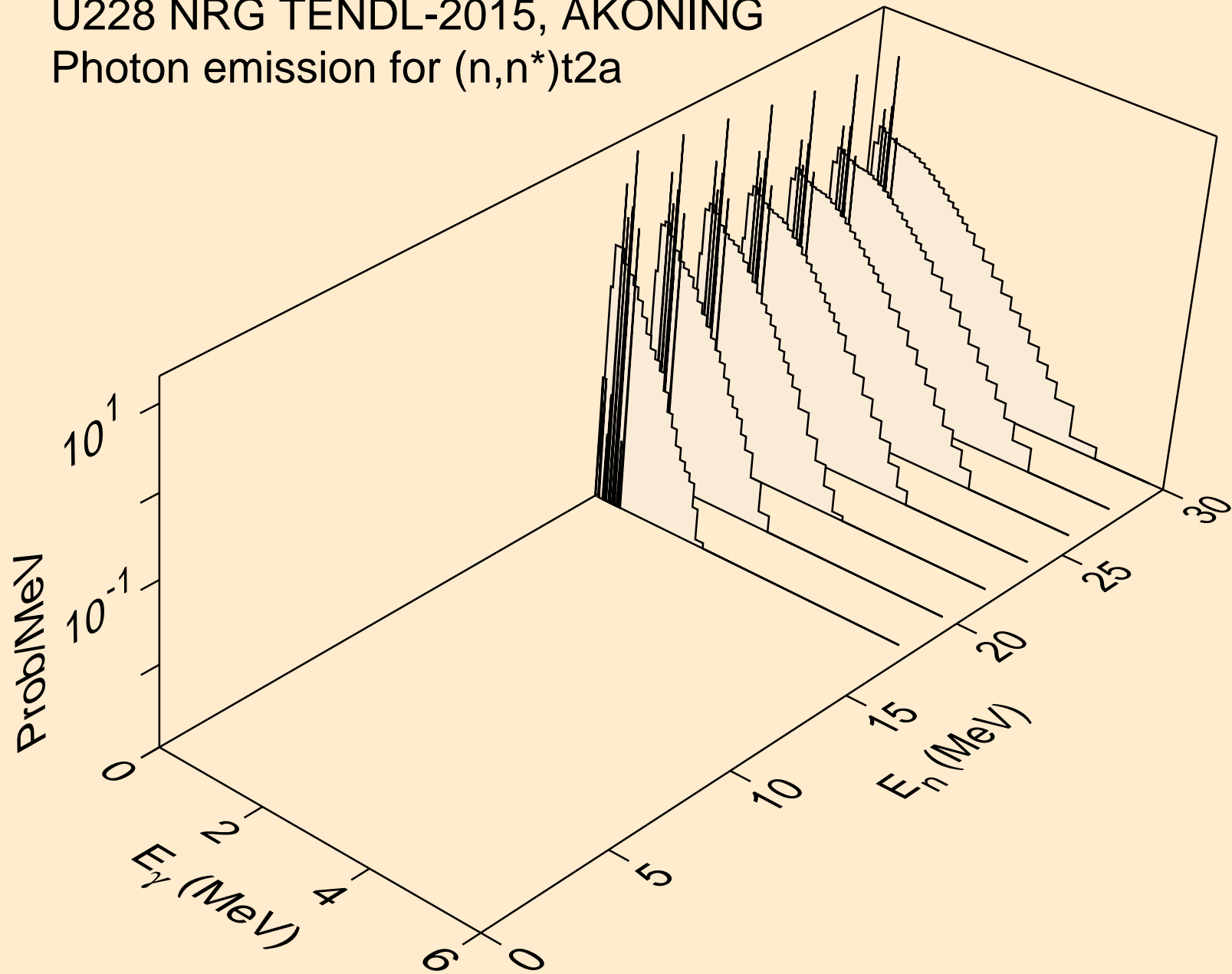

U228 NRG TENDL-2015, AKONING
Photon emission for (n,4n)

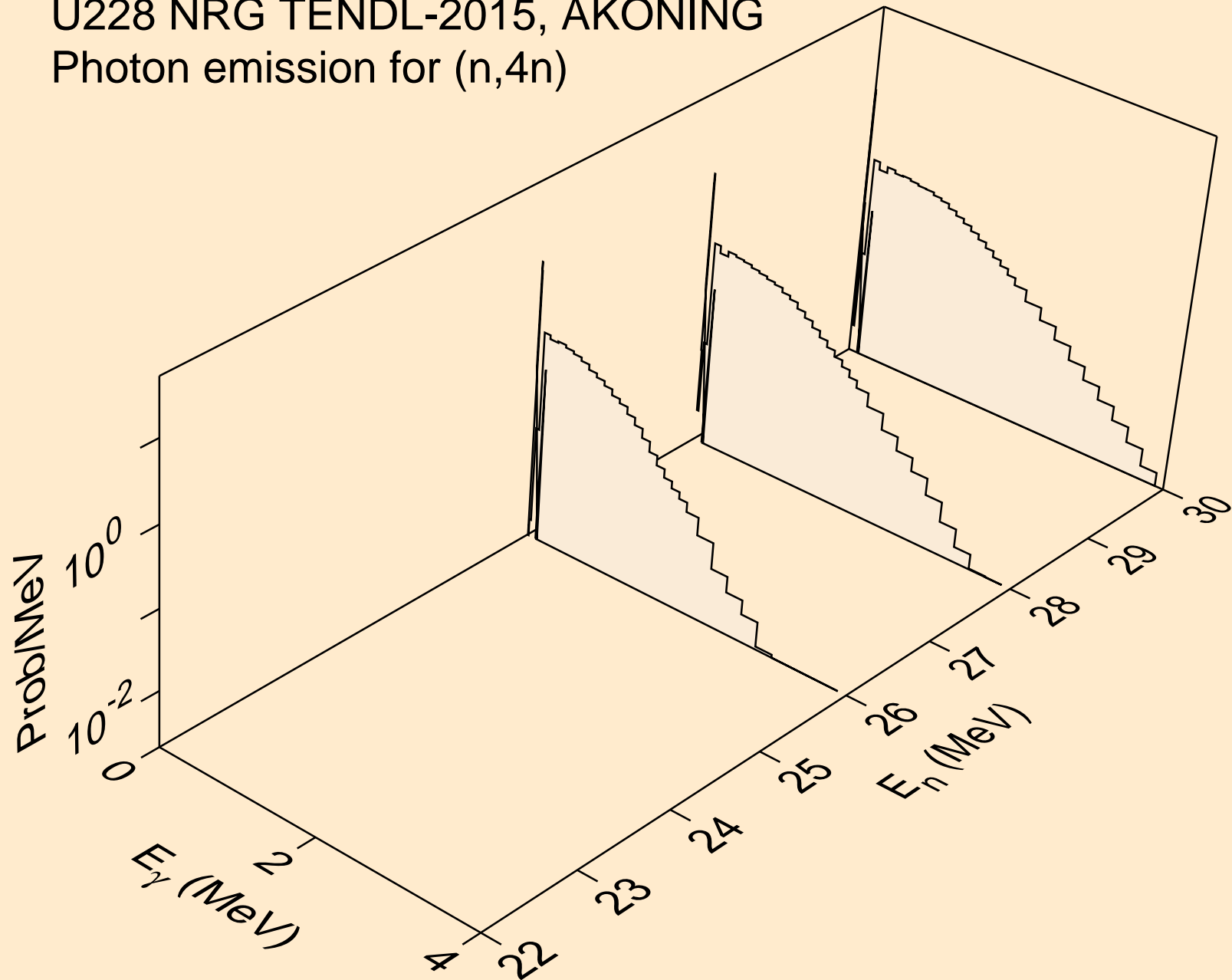

U228 NRG TENDL-2015, AKONING
Photon emission for (n,2np)

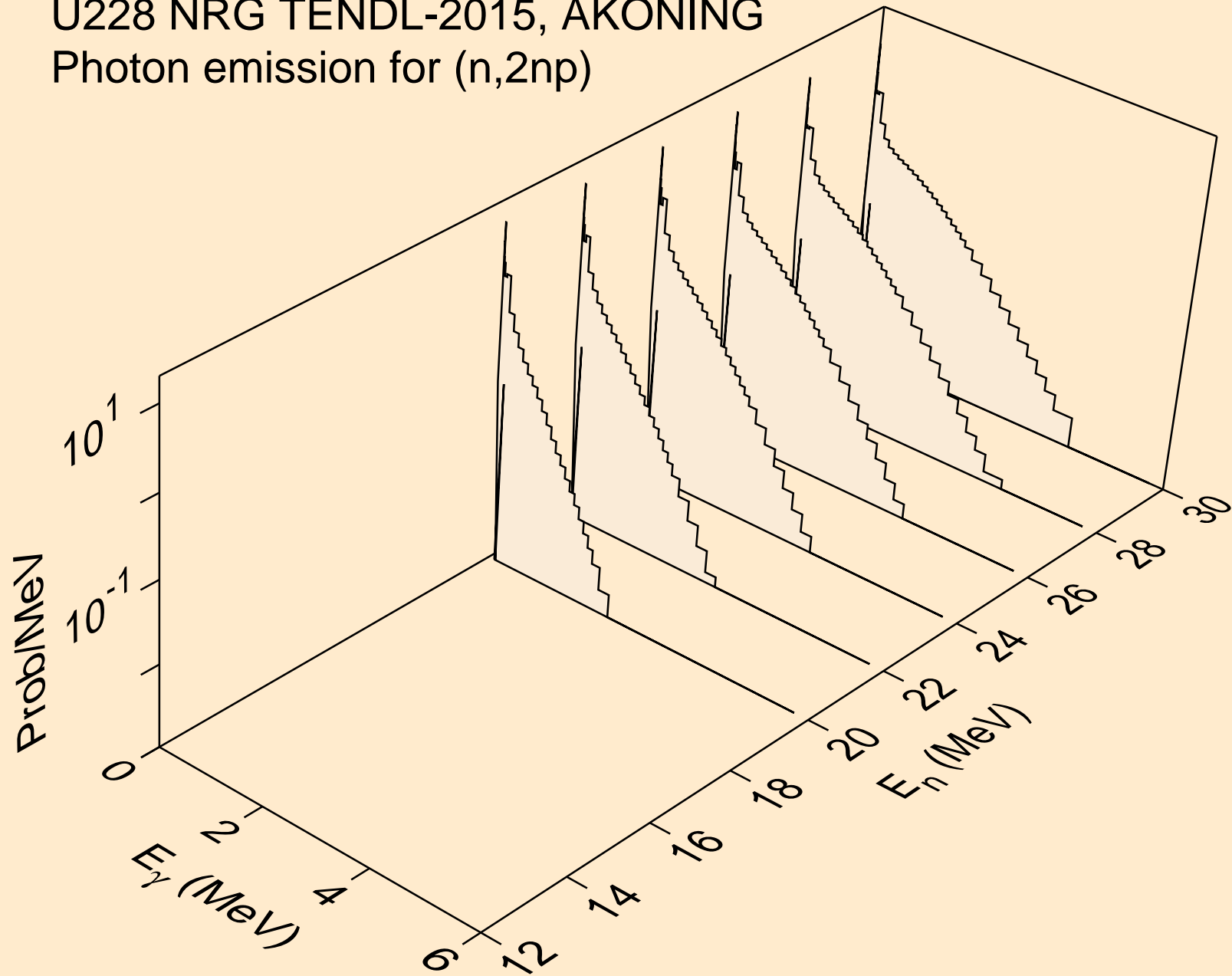

U228 NRG TENDL-2015, AKONING
Photon emission for (n,3np)

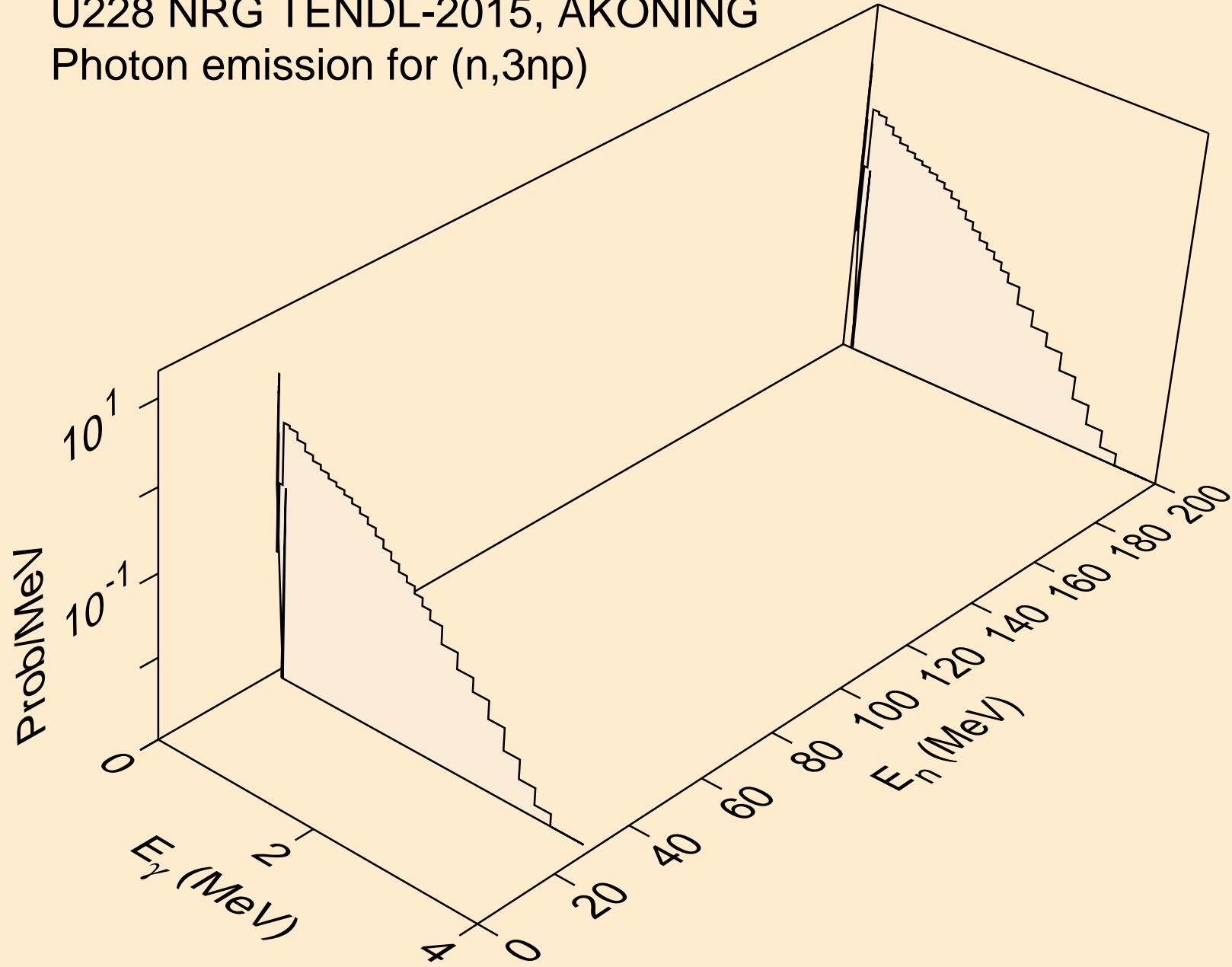

U228 NRG TENDL-2015, AKONING
Photon emission for (n,2np)

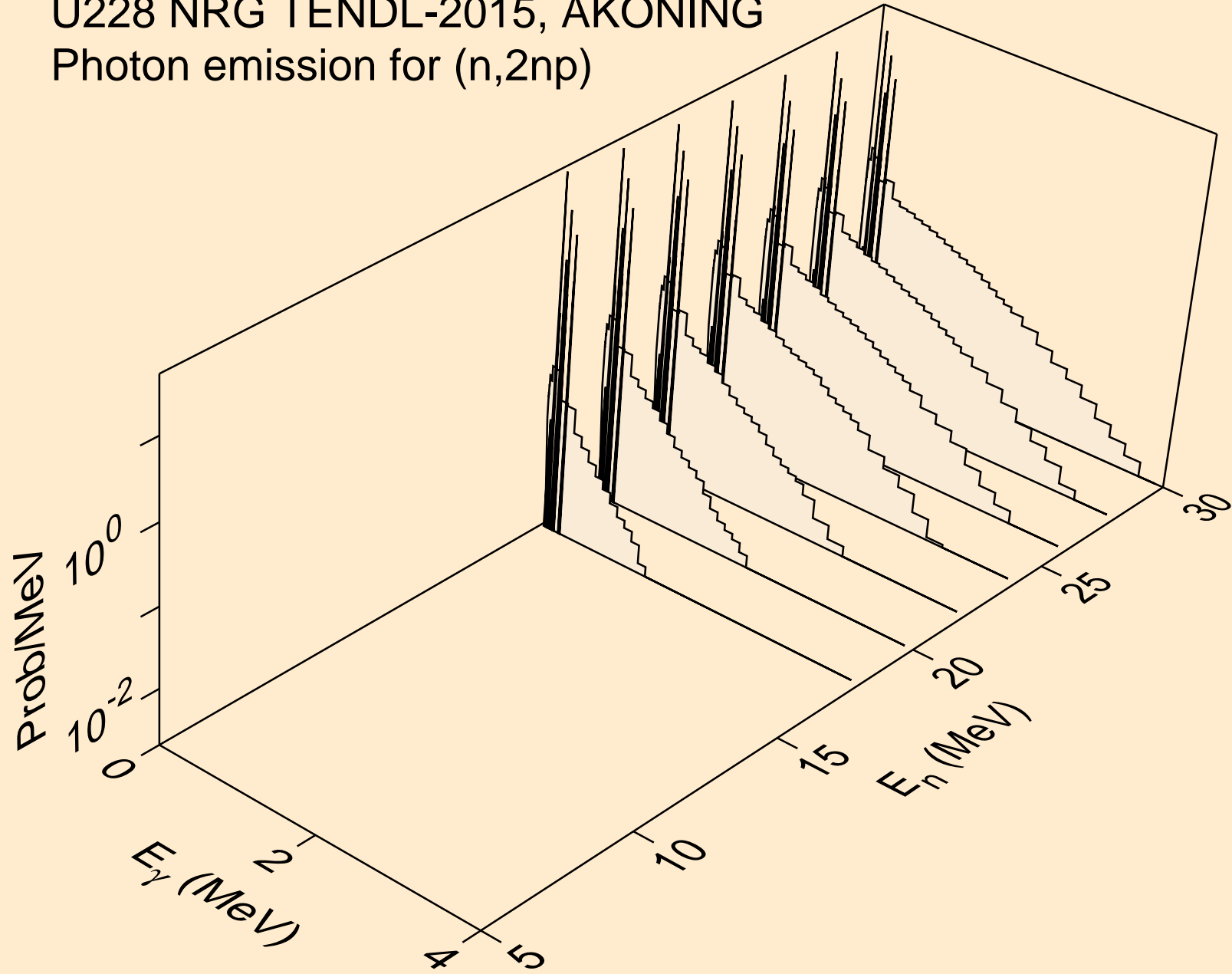

U228 NRG TENDL-2015, AKONING
Photon emission for (n,npa)

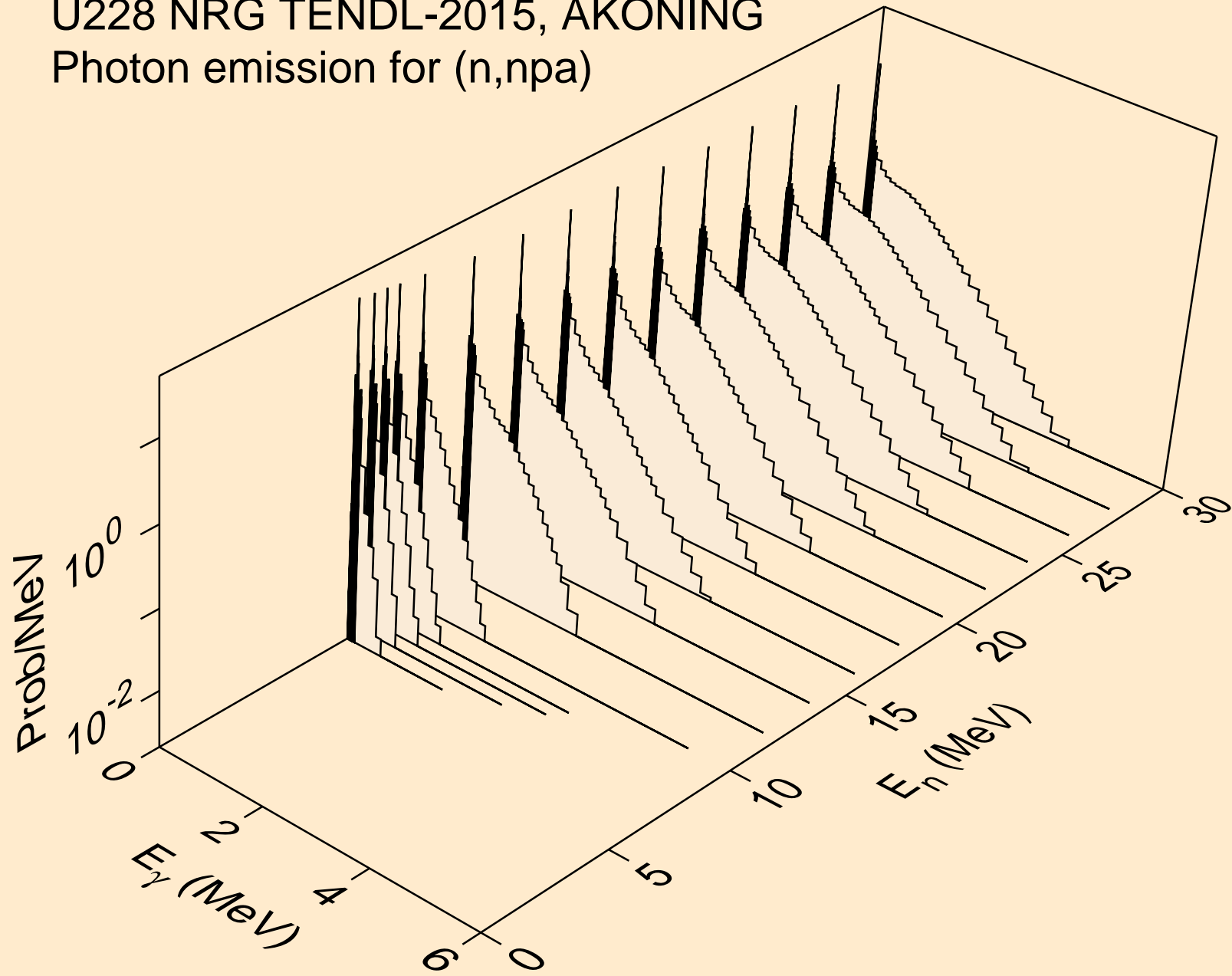

U228 NRG TENDL-2015, AKONING
Photon emission for (n,n*c)

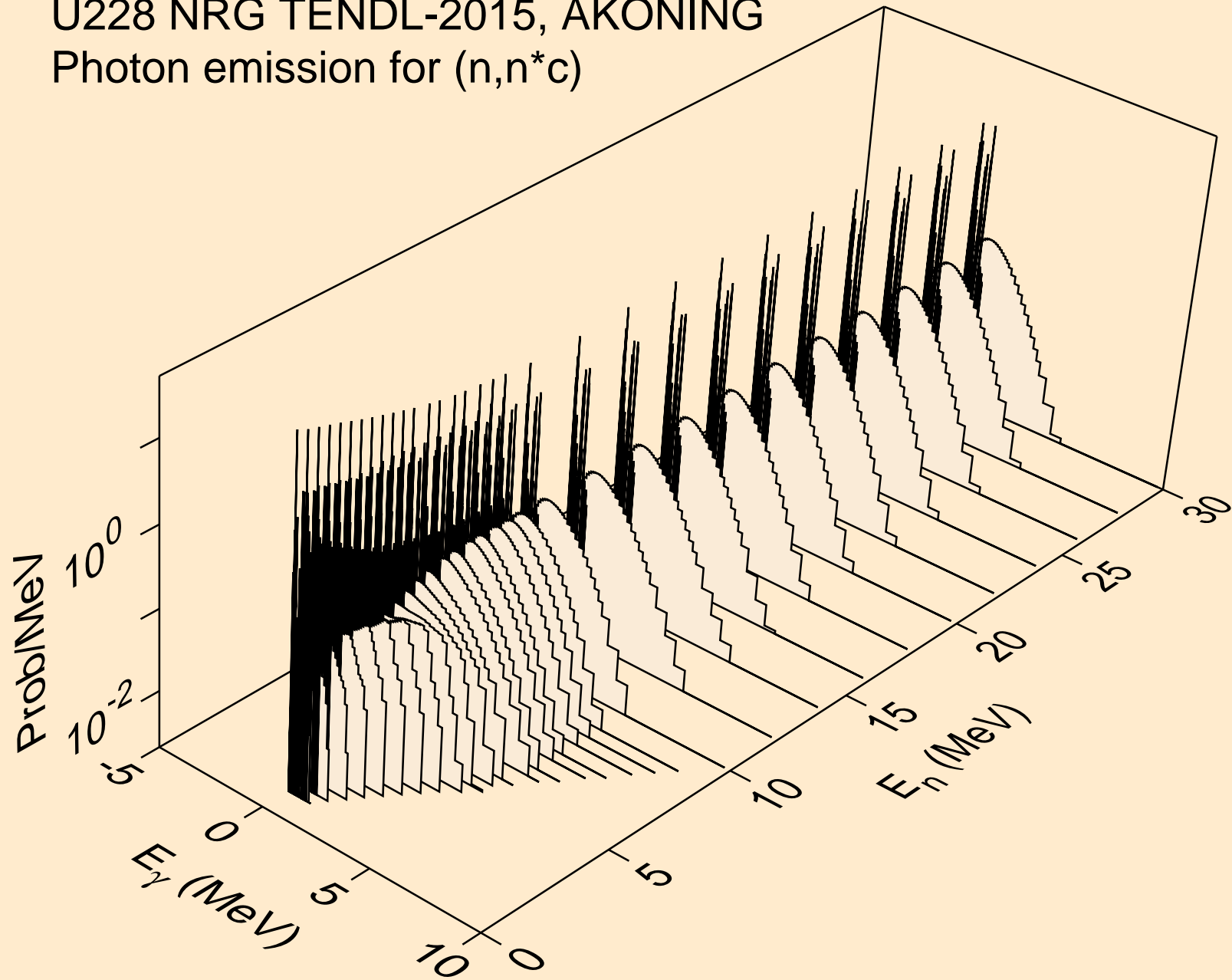

U228 NRG TENDL-2015, AKONING
Photon emission for (n,gma)

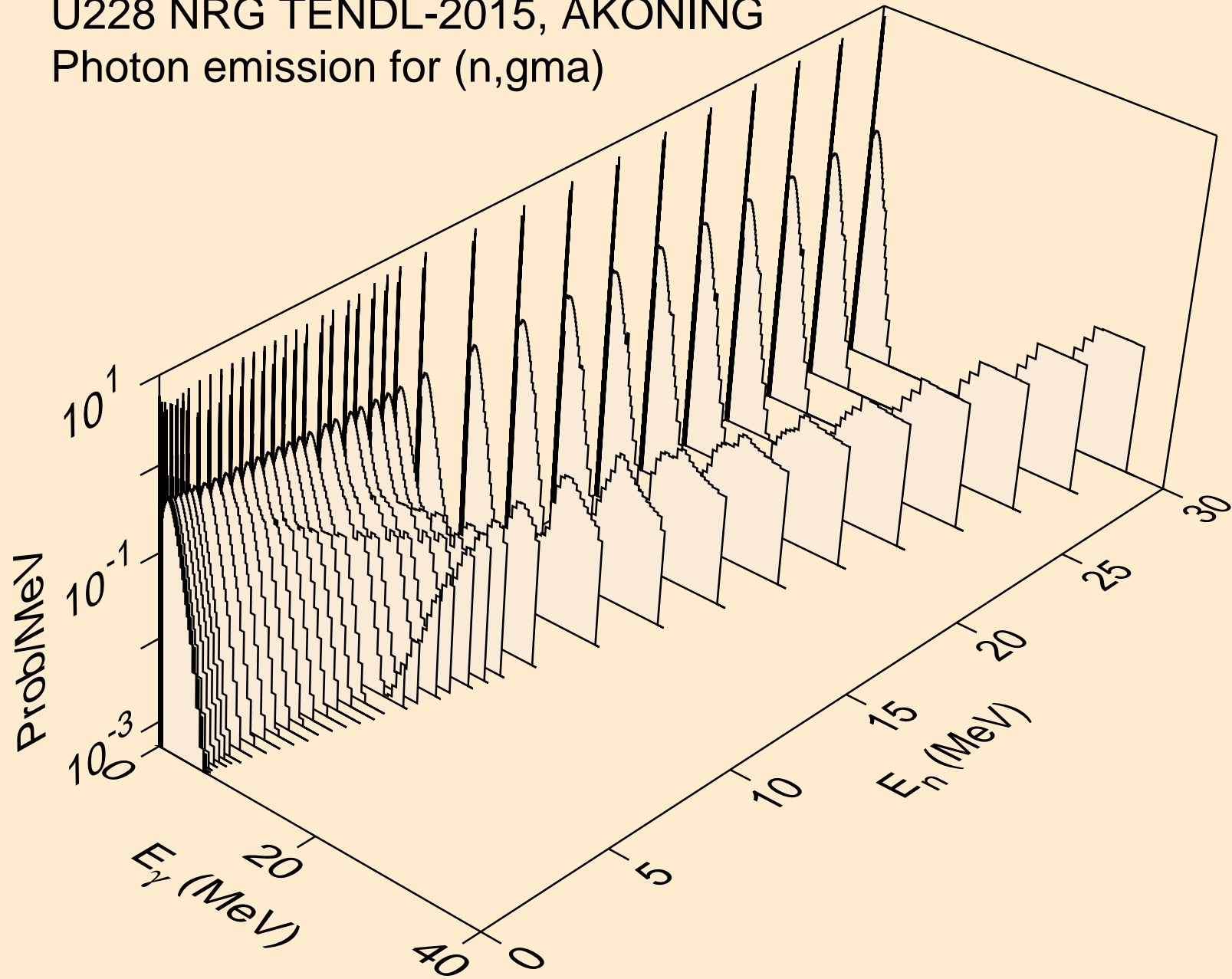

U228 NRG TENDL-2015, AKONING
Photon emission for (n,p)

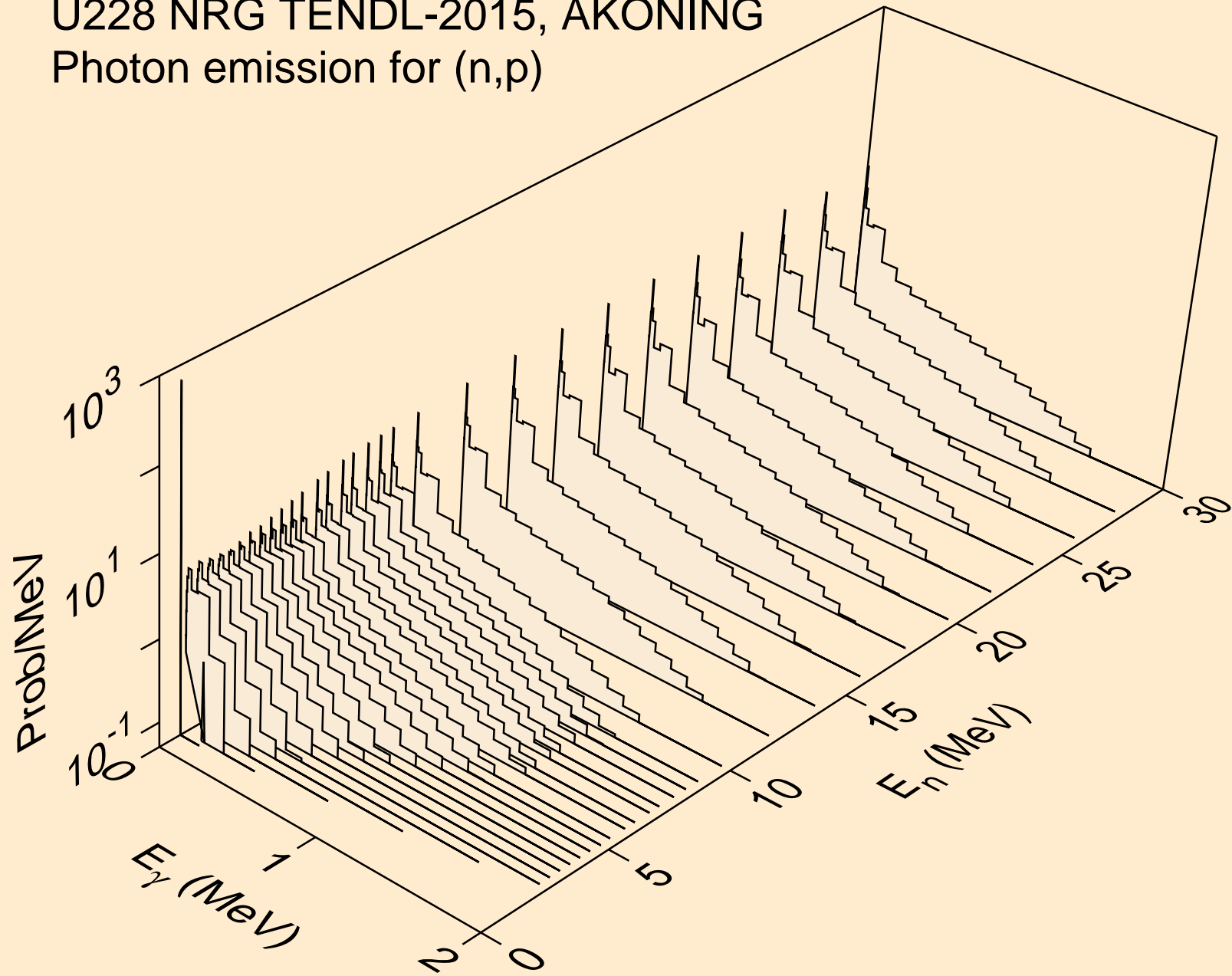

U228 NRG TENDL-2015, AKONING
Photon emission for (n,d)

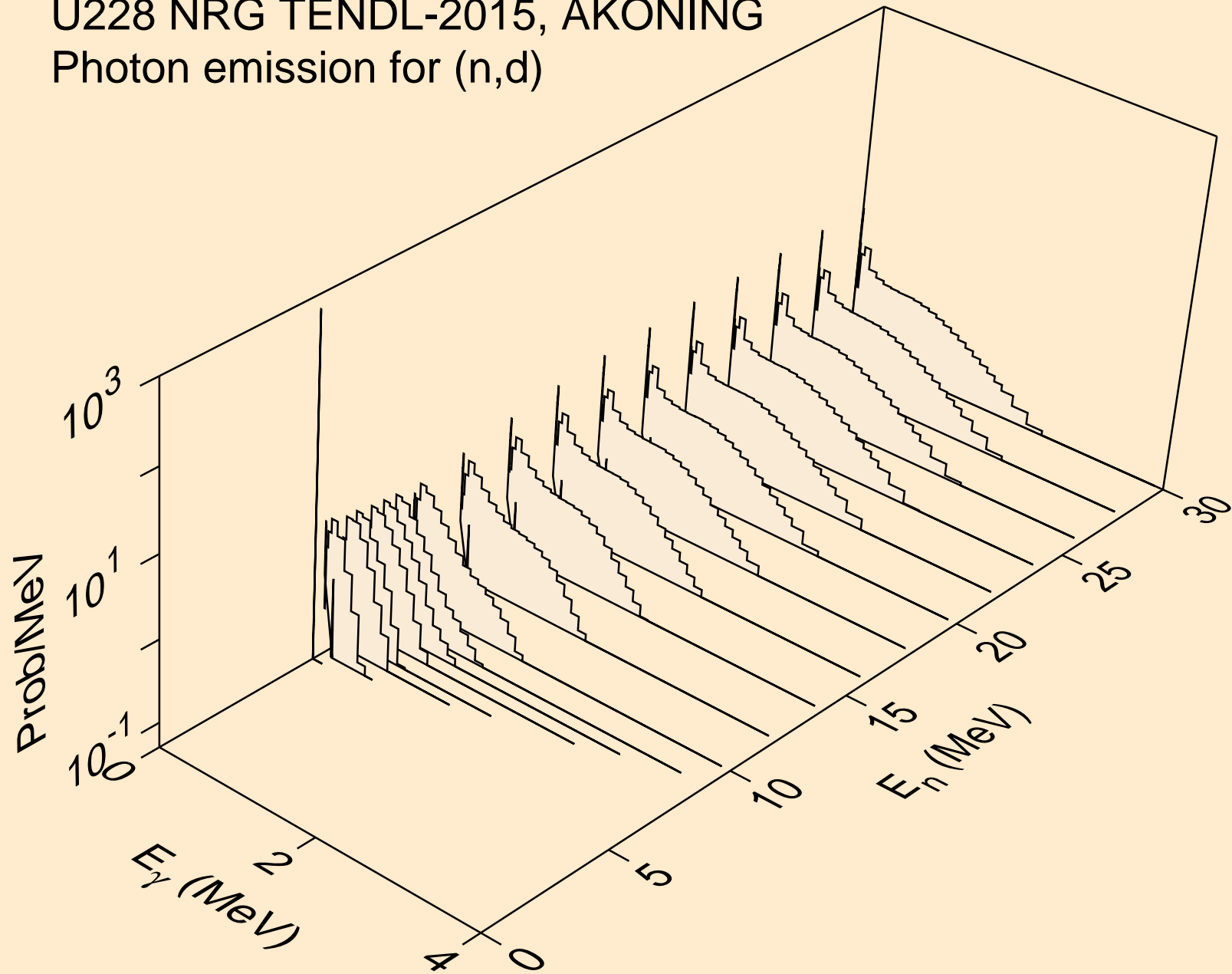

U228 NRG TENDL-2015, AKONING
Photon emission for (n,t)

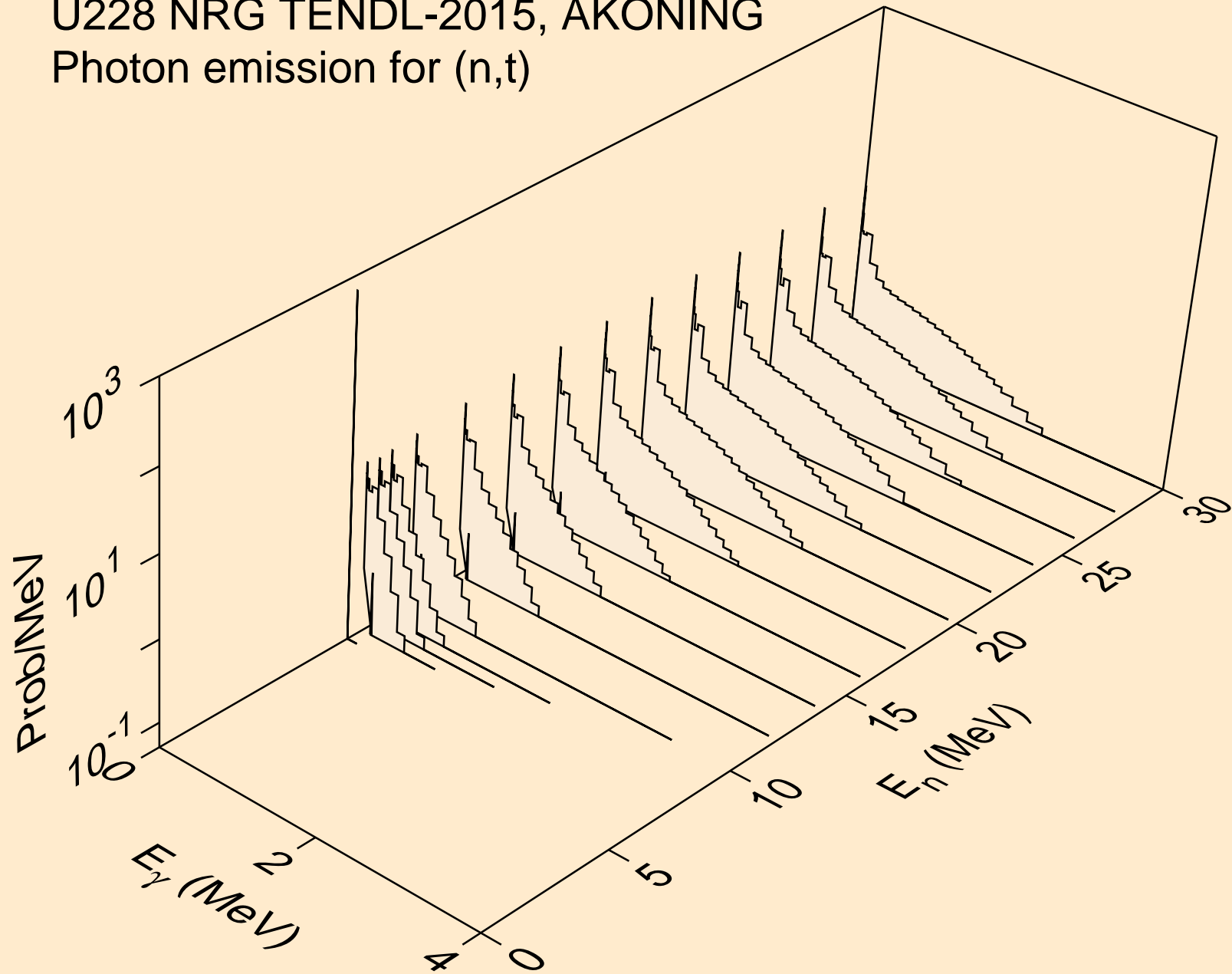

U228 NRG TENDL-2015, AKONING
Photon emission for (n,he3)

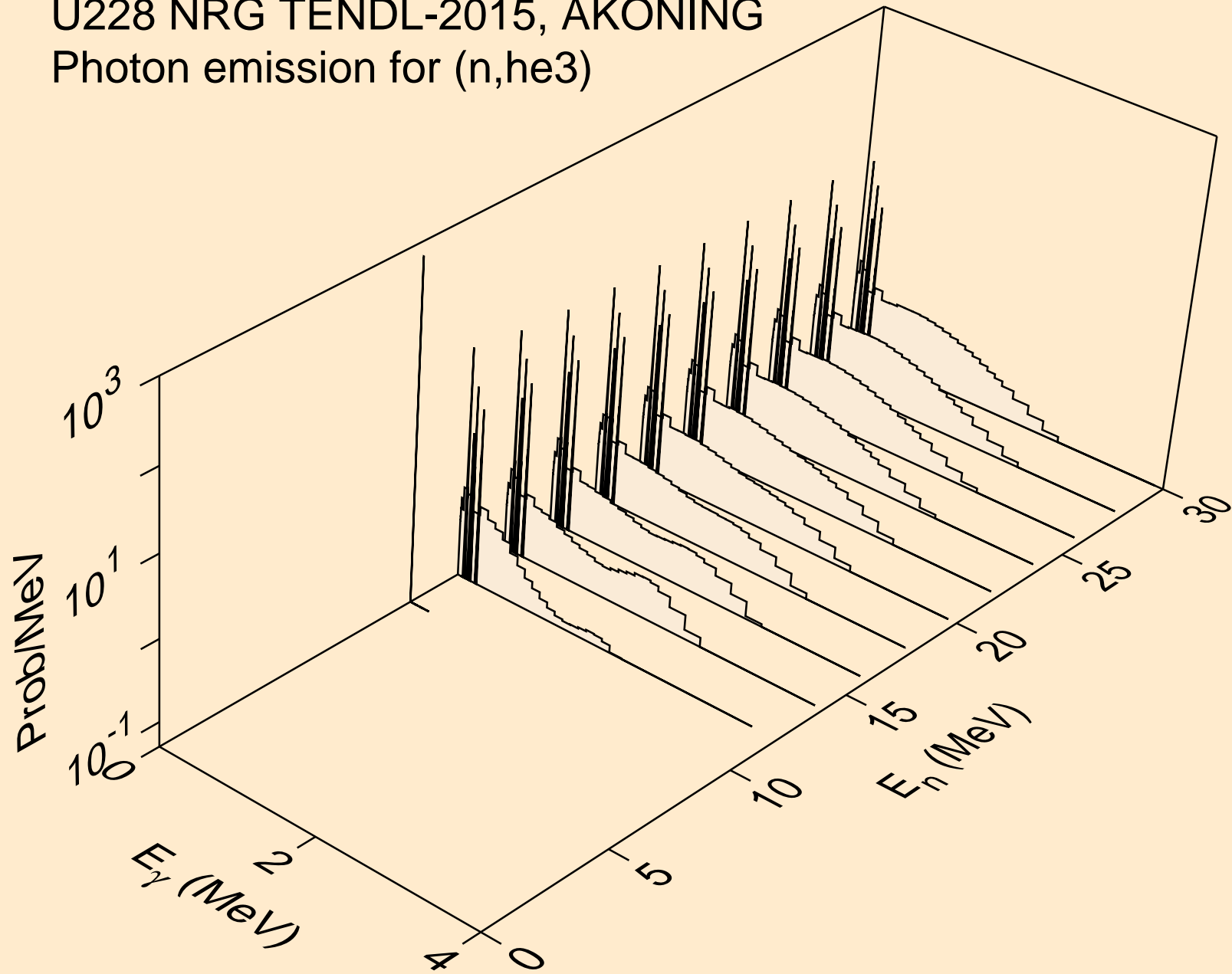

U228 NRG TENDL-2015, AKONING
Photon emission for (n,a)

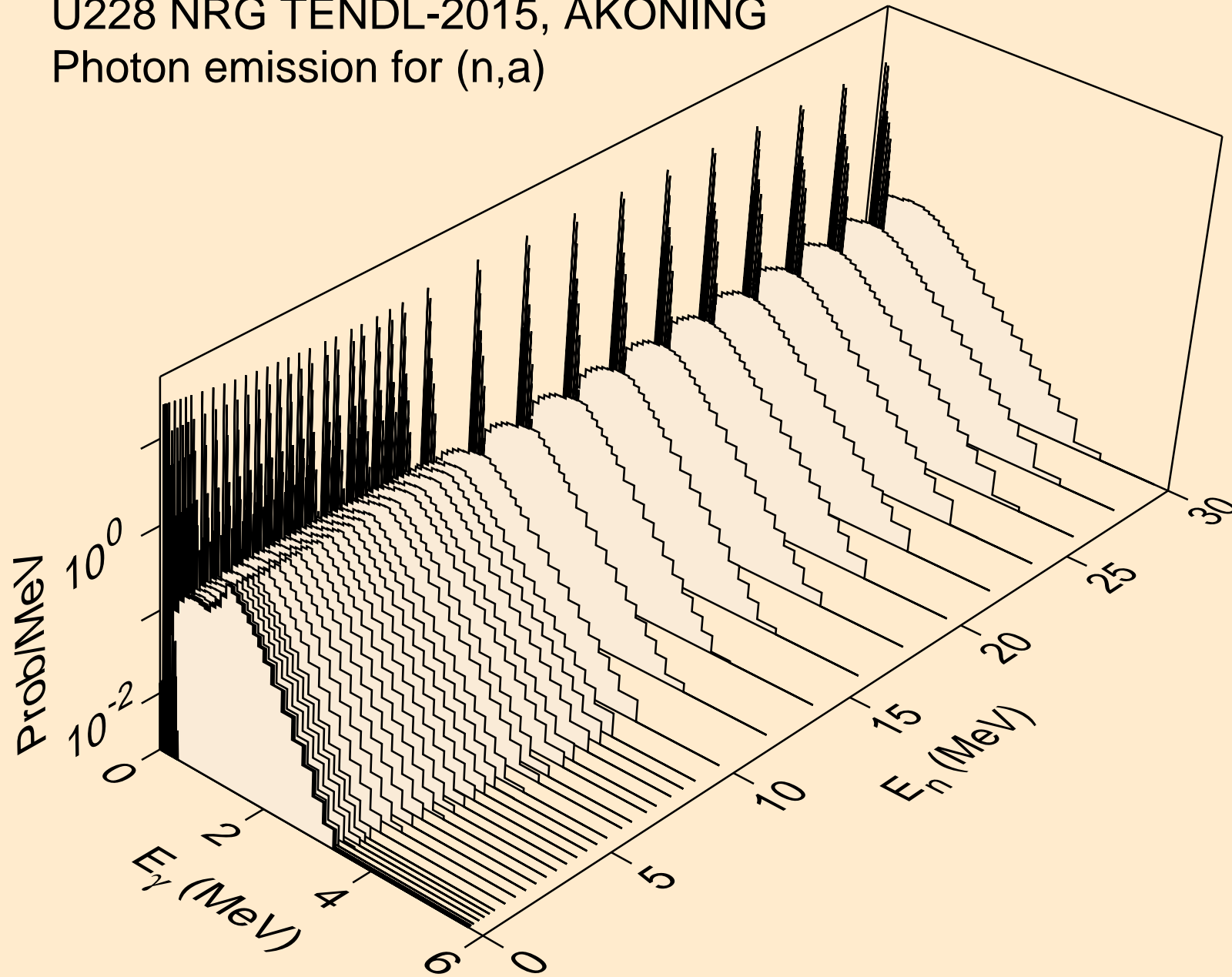

U228 NRG TENDL-2015, AKONING
Photon emission for (n,2a)

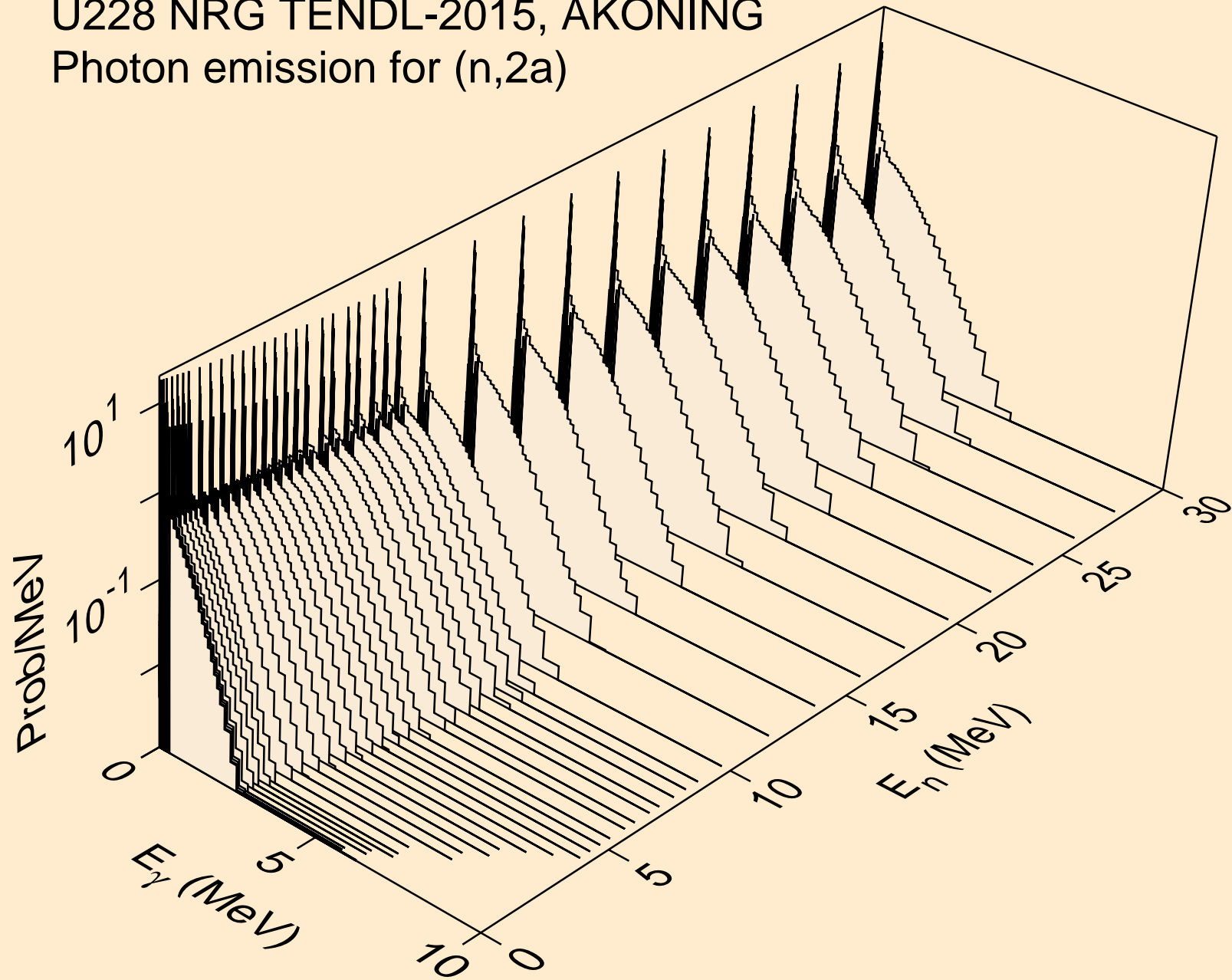

U228 NRG TENDL-2015, AKONING
Photon emission for (n,3a)

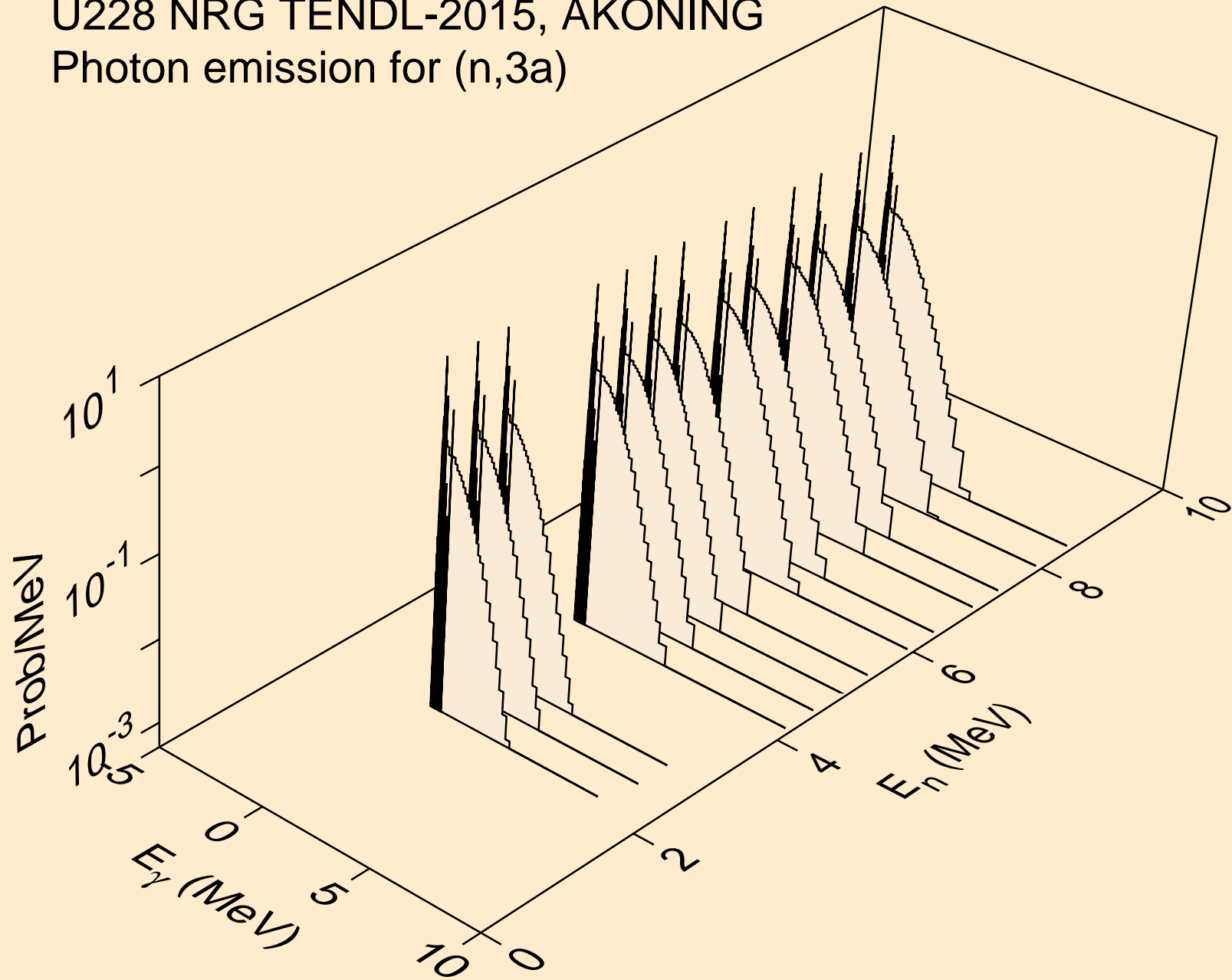

U228 NRG TENDL-2015, AKONING
Photon emission for (n,2p)

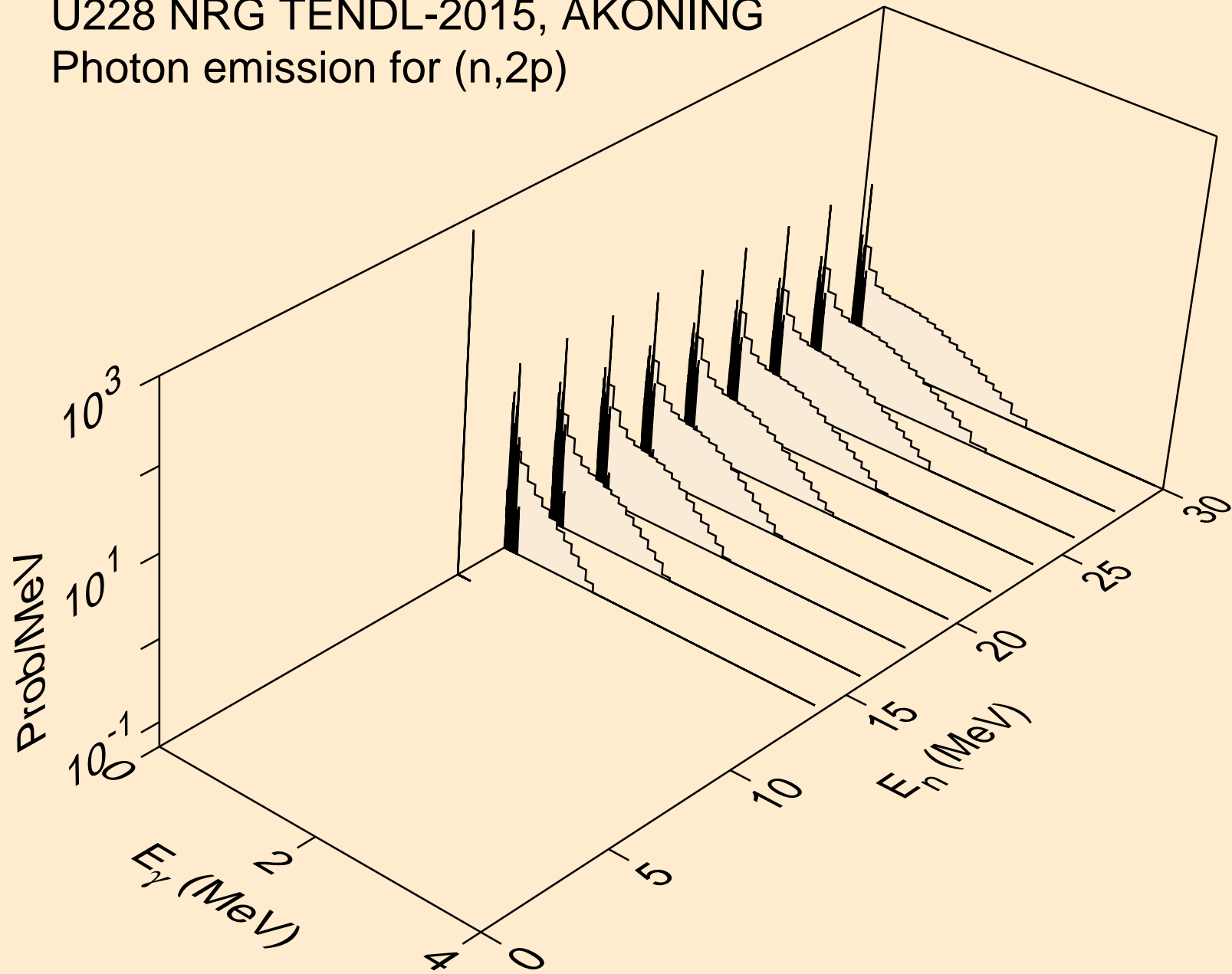

U228 NRG TENDL-2015, AKONING
Photon emission for (n,p α)

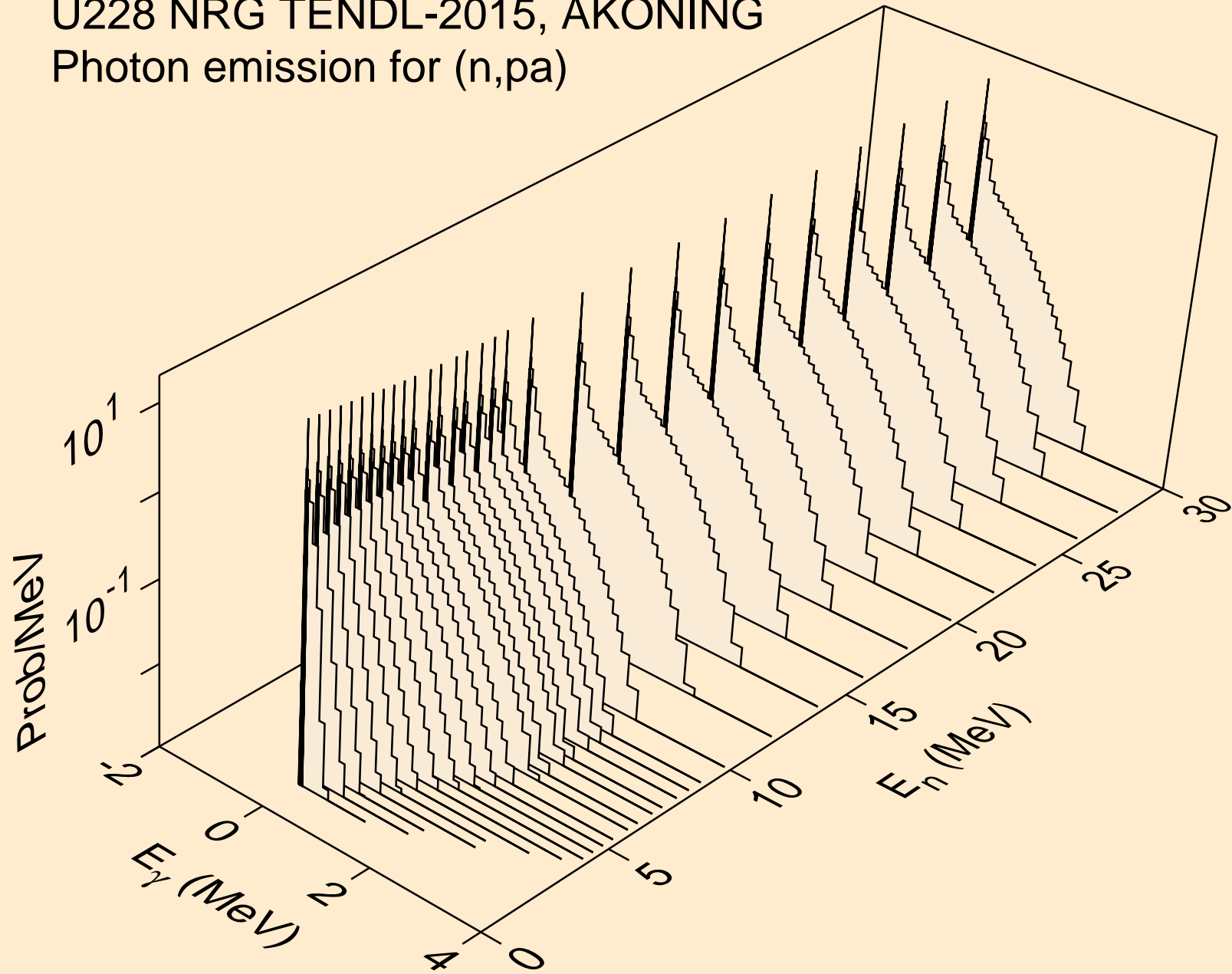

U228 NRG TENDL-2015, AKONING
Photon emission for (n,t2a)

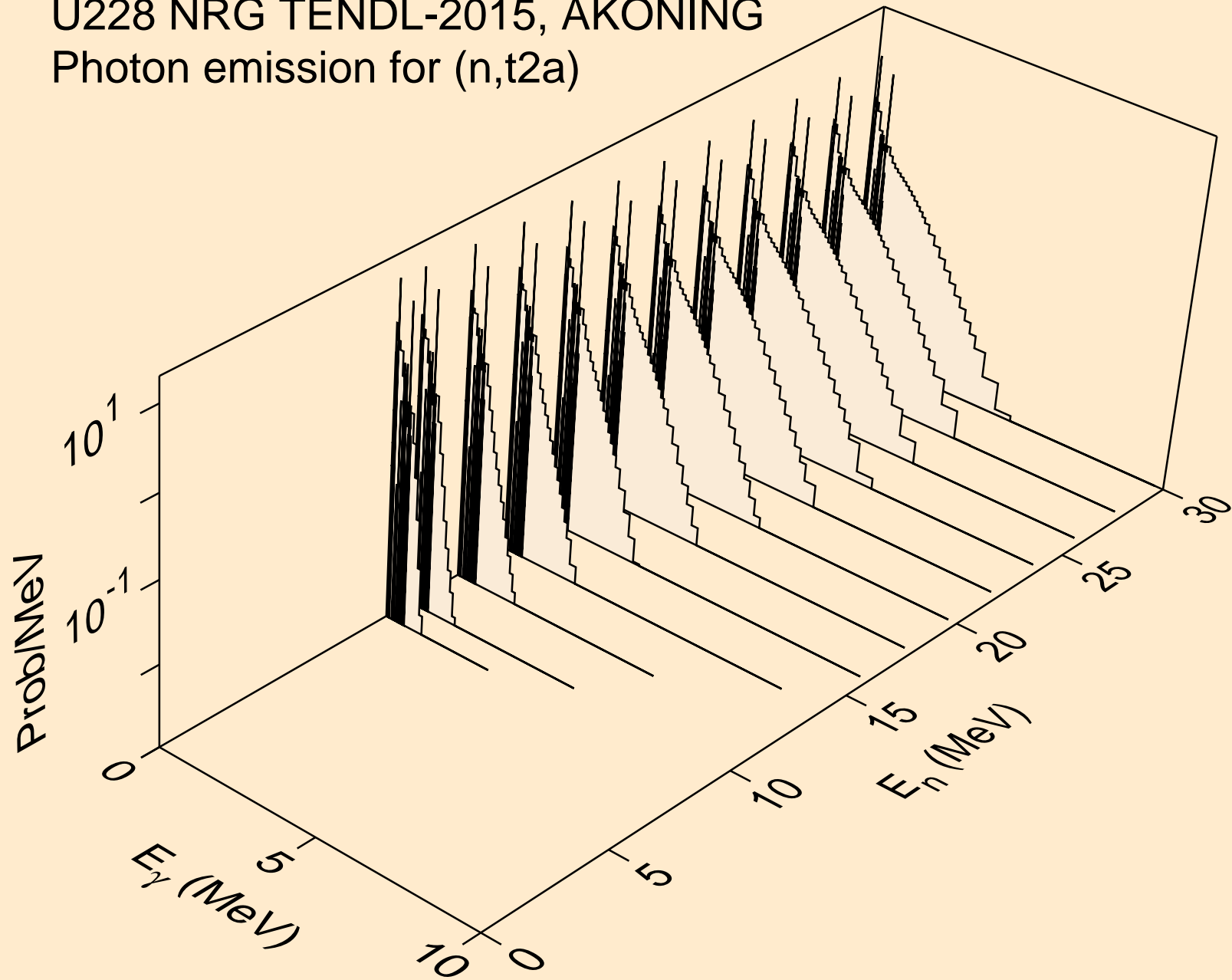

U228 NRG TENDL-2015, AKONING
Photon emission for (n,d2a)

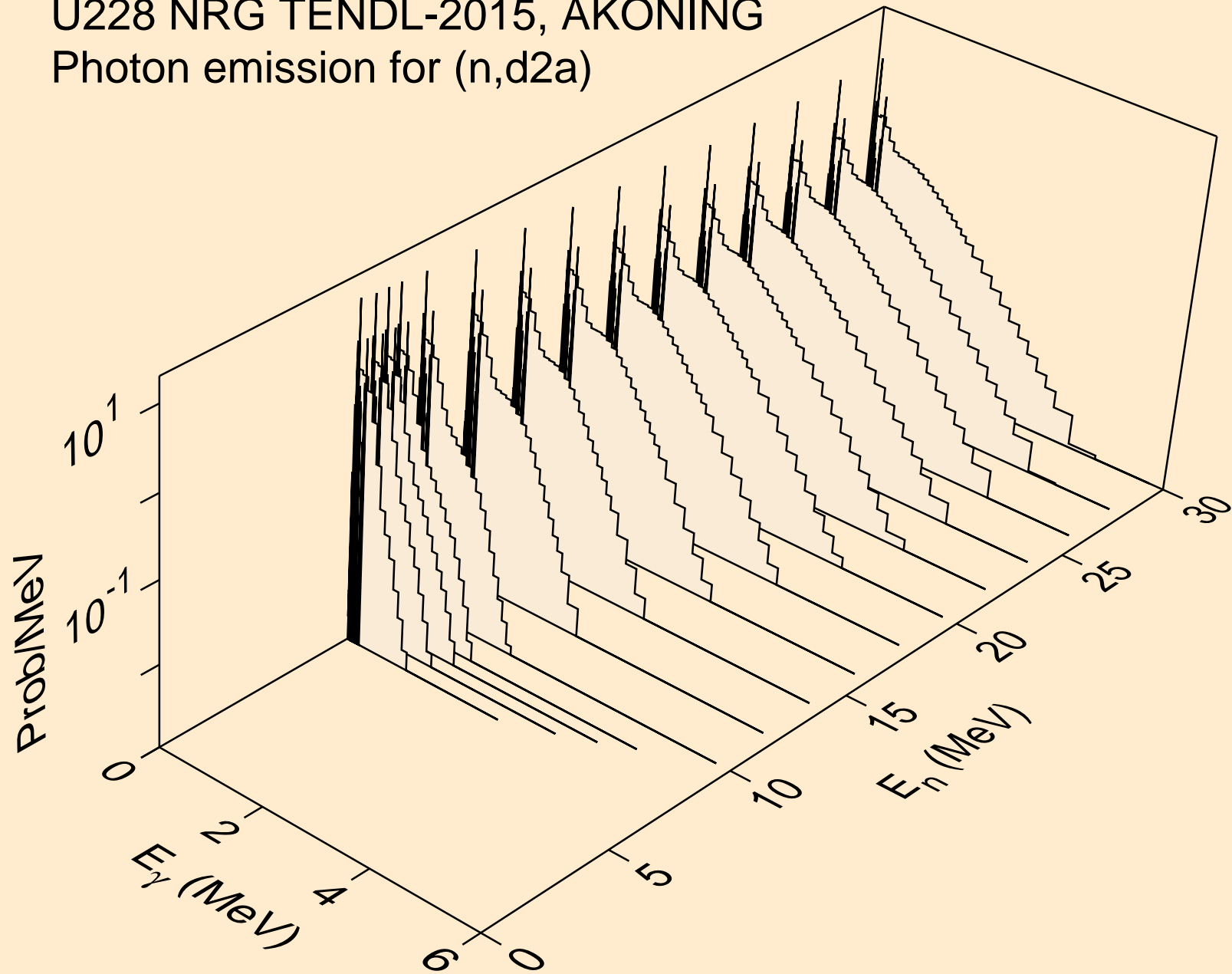

U228 NRG TENDL-2015, AKONING
Photon emission for (n,pd)

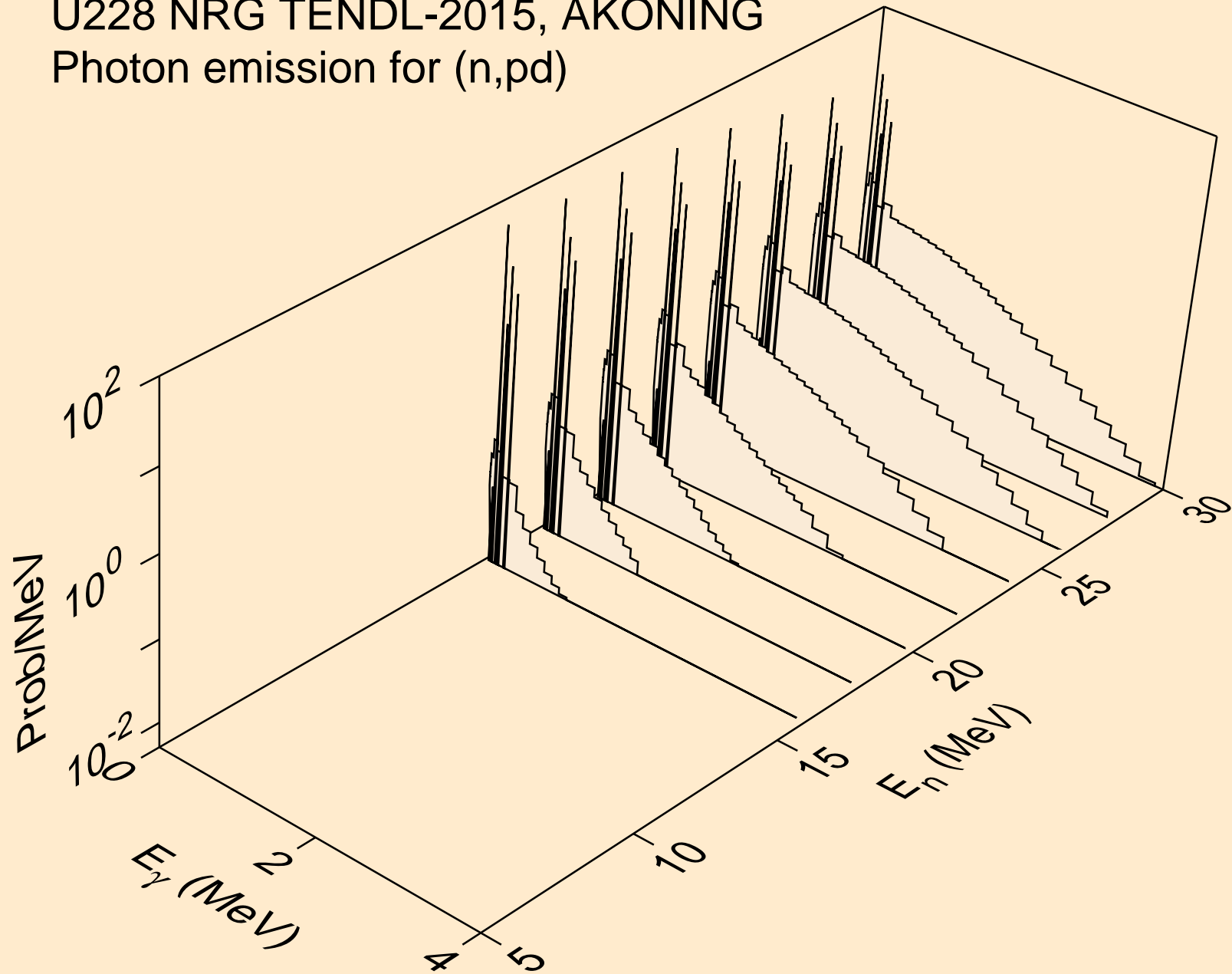

U228 NRG TENDL-2015, AKONING
Photon emission for (n,pt)

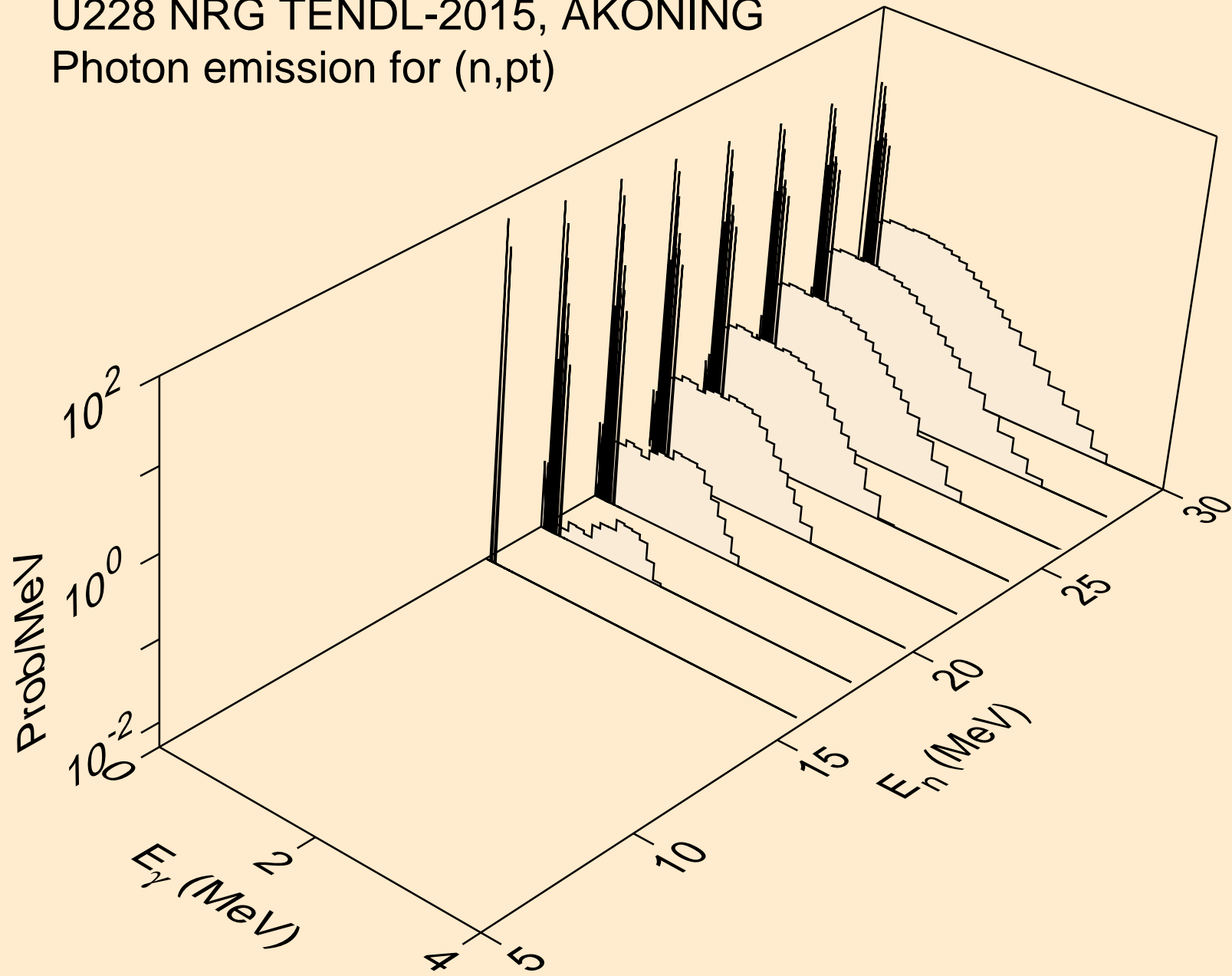

U228 NRG TENDL-2015, AKONING
Photon emission for (n,da)

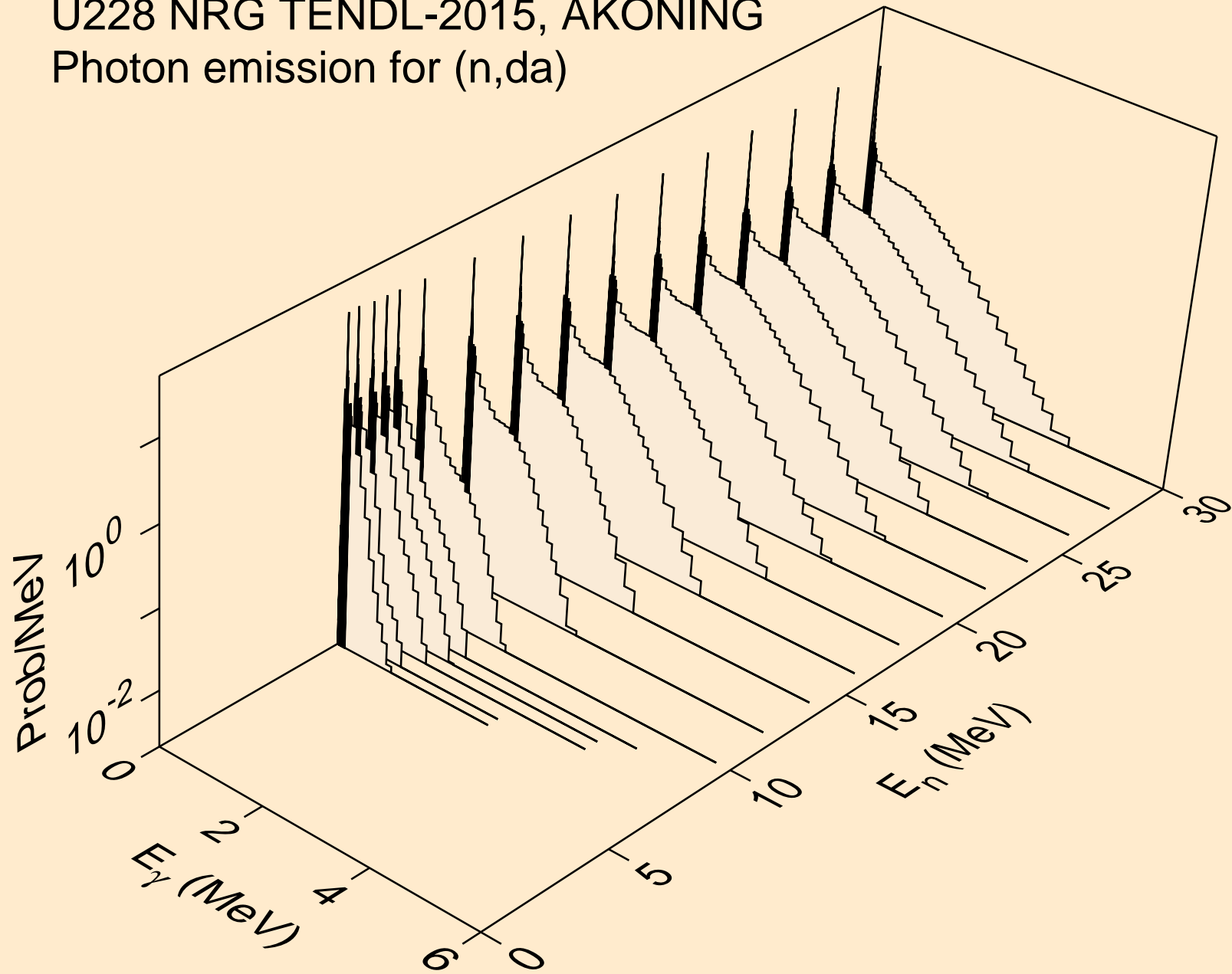

U228 NRG TENDL-2015, AKONING
thermal capture photon spectrum

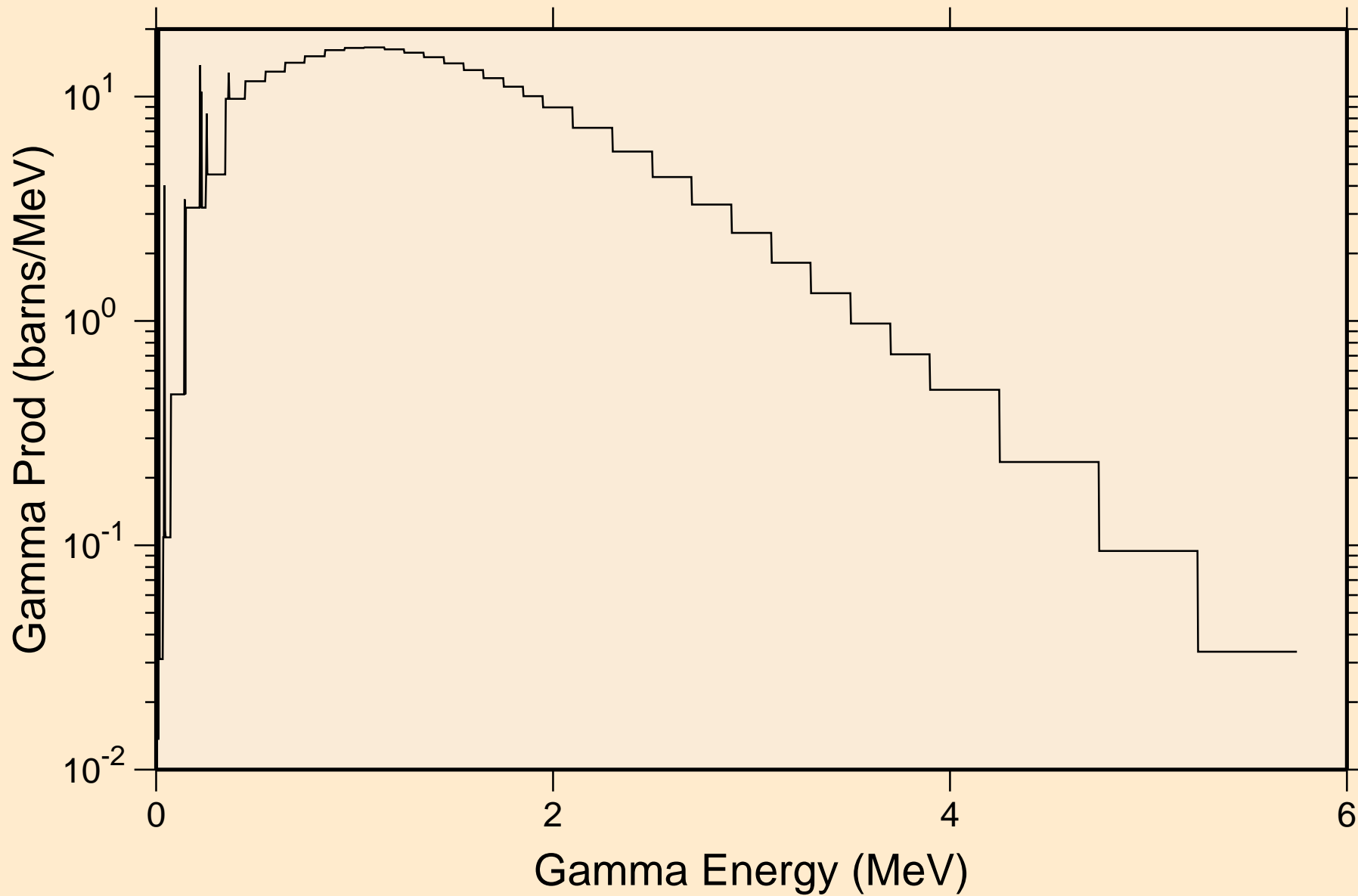

U228 NRG TENDL-2015, AKONING
14 MeV photon spectrum

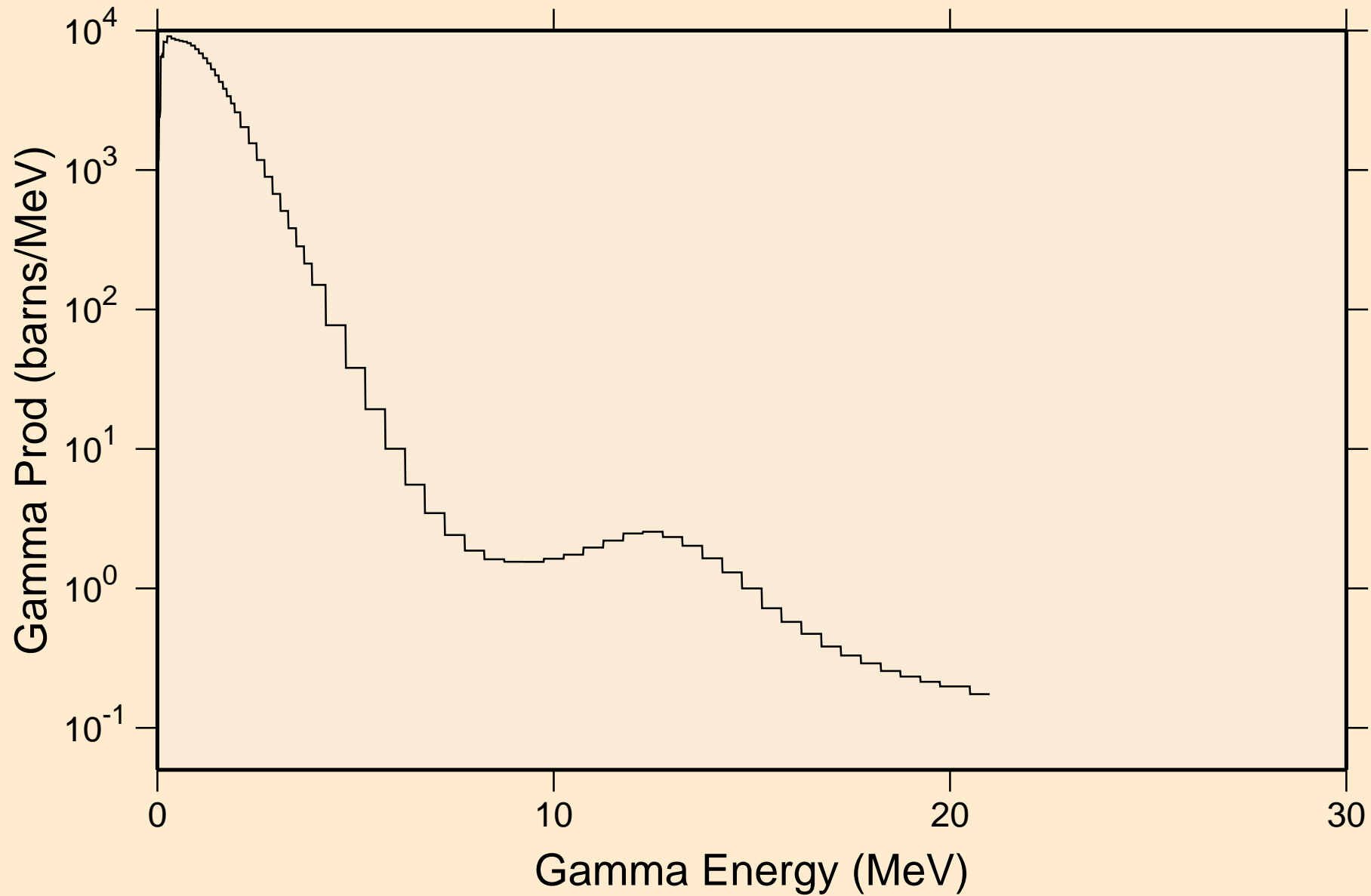

U228 NRG TENDL-2015, AKONING

Particle heating contributions

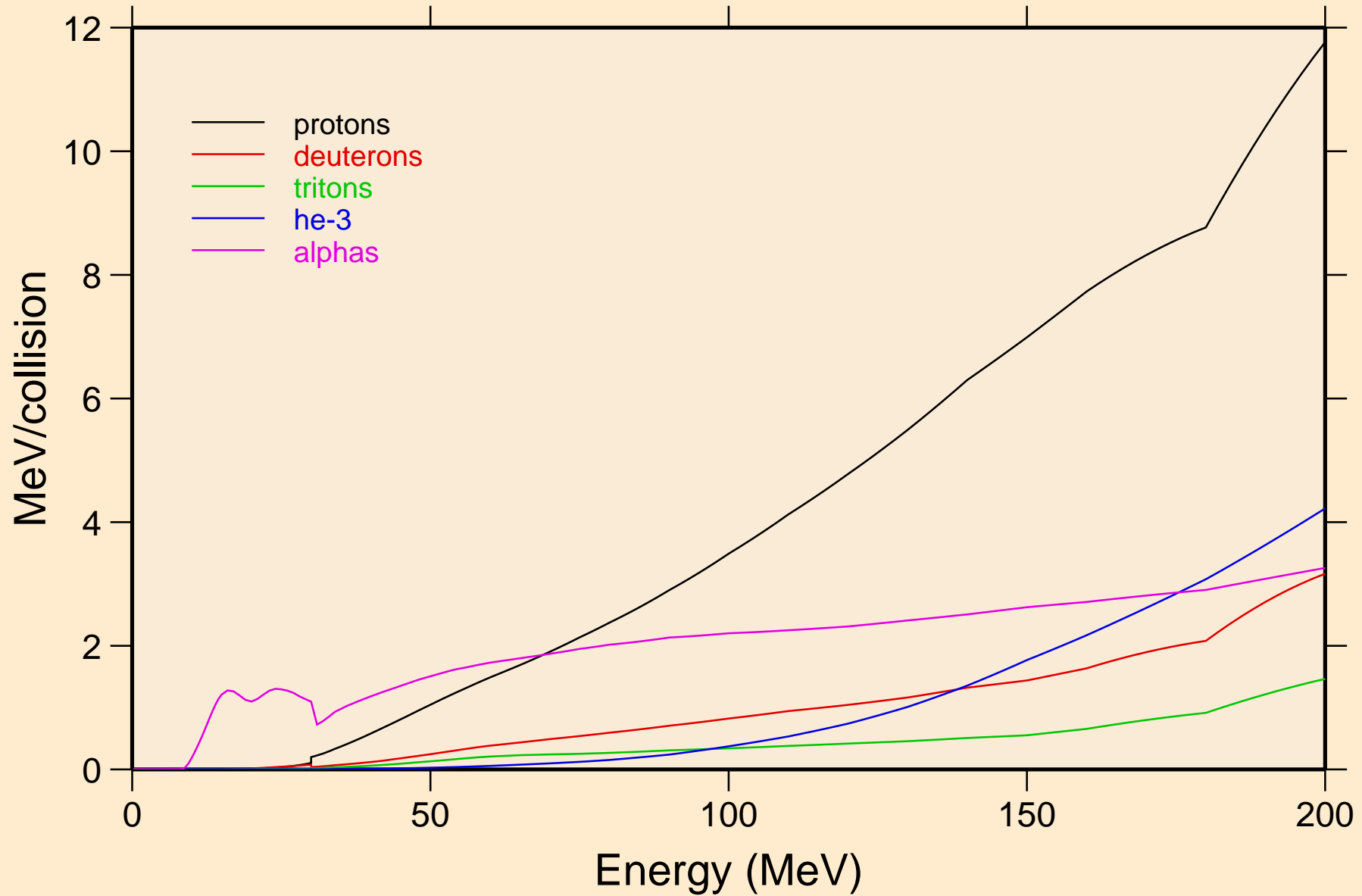

U228 NRG TENDL-2015, AKONING

Recoil Heating

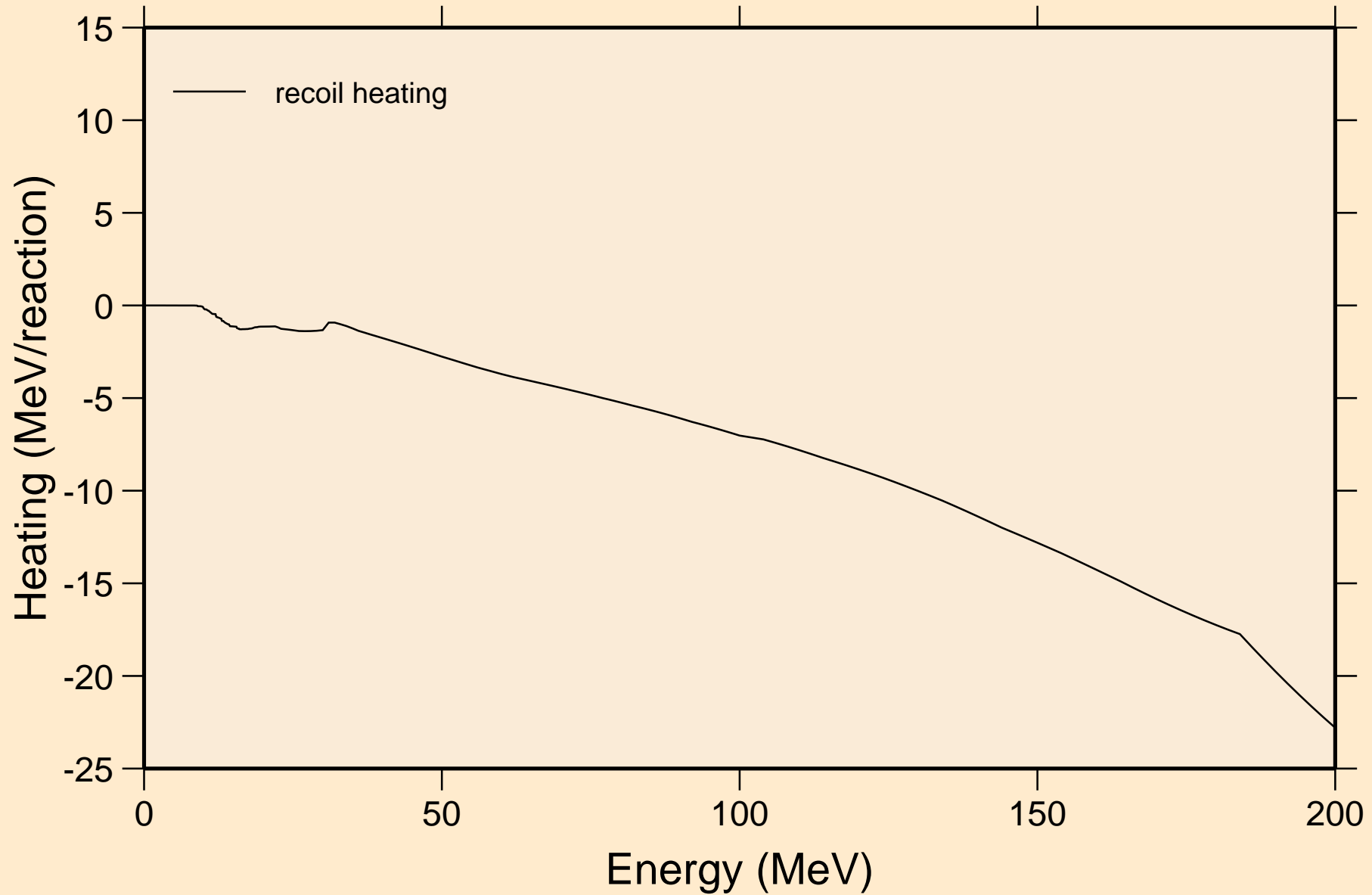

U228 NRG TENDL-2015, AKONING

Particle production cross sections

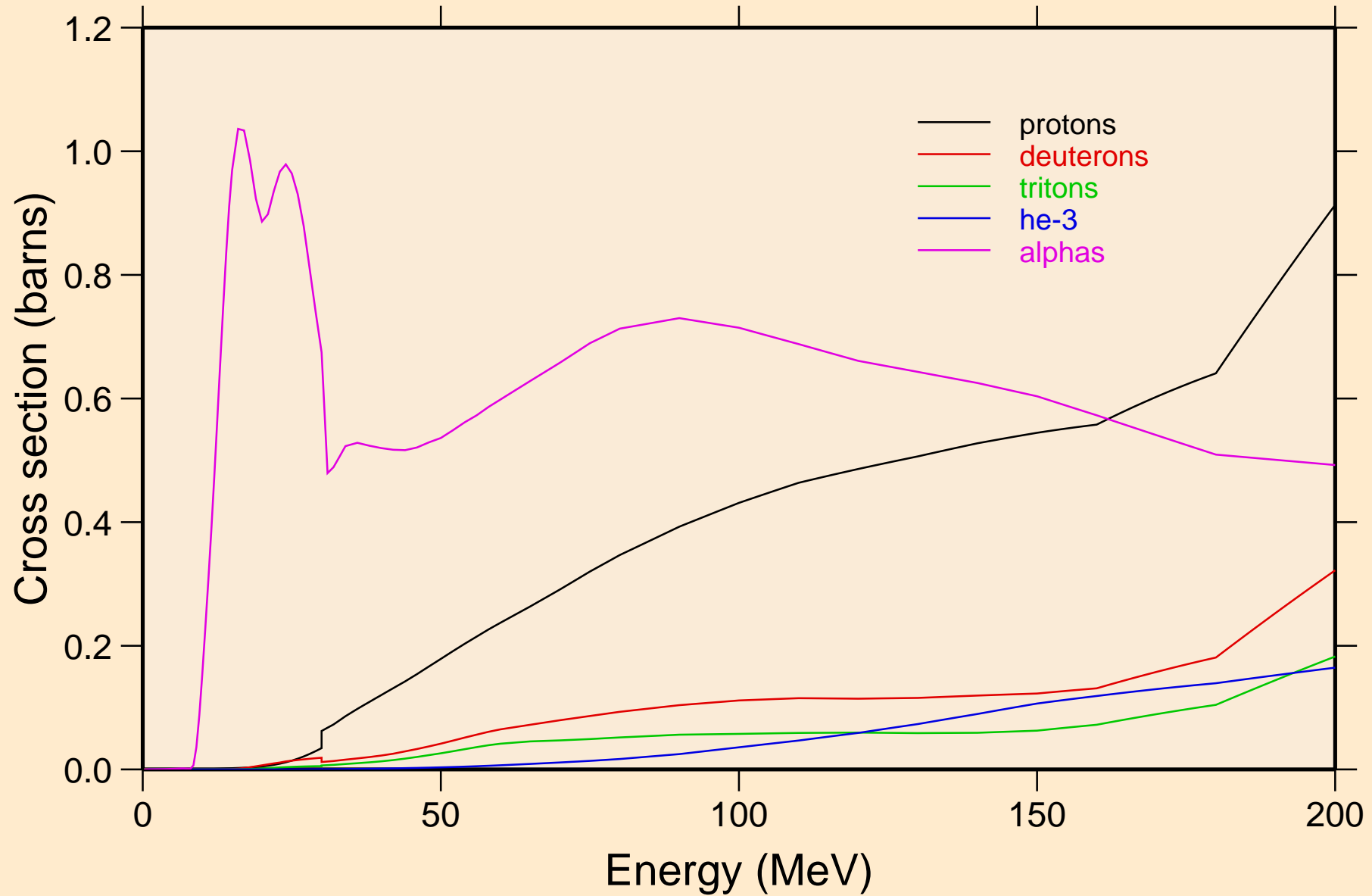

U228 NRG TENDL-2015, AKONING
protons from (n,x)

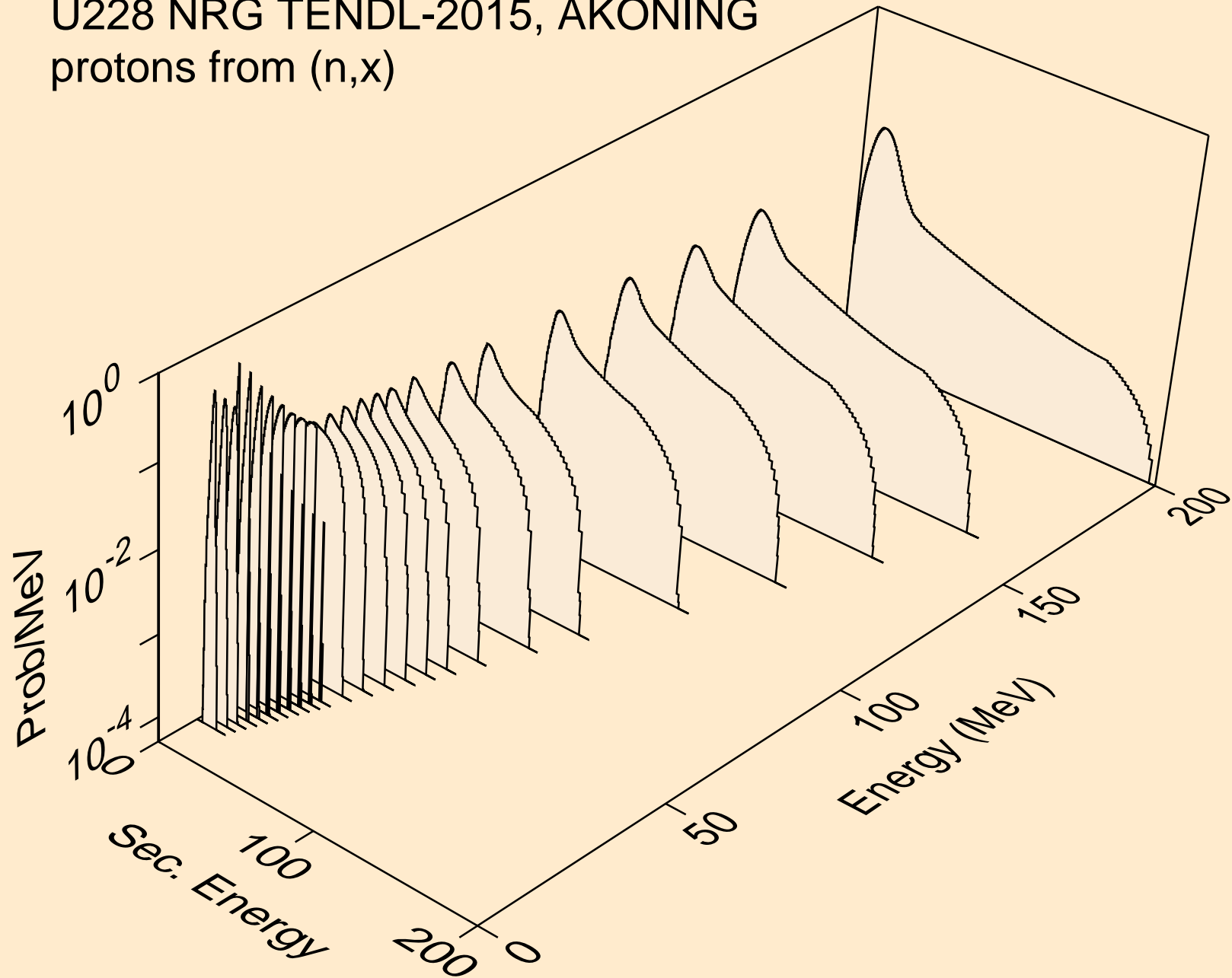

U228 NRG TENDL-2015, AKONING
protons from (n,n*)p

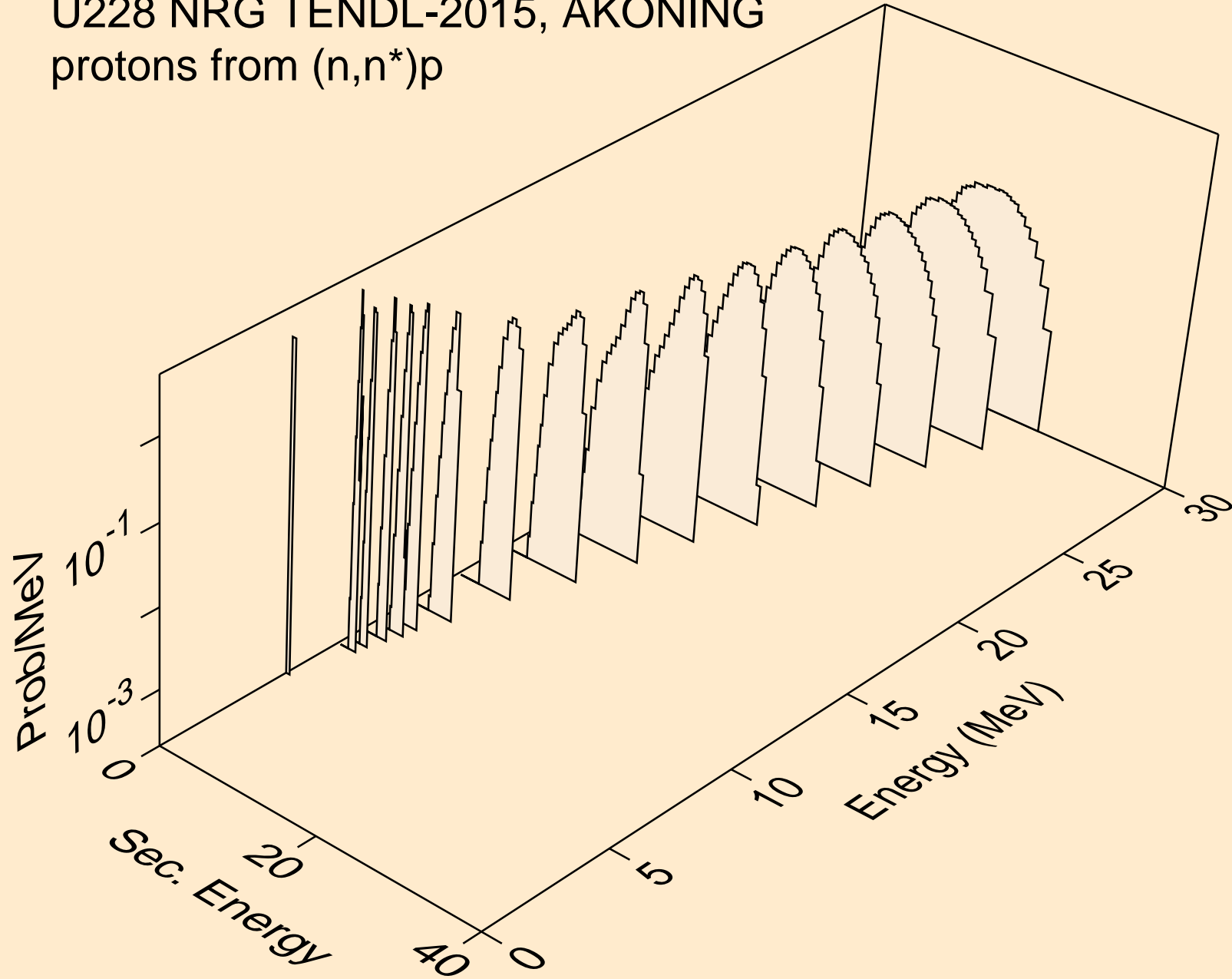

U228 NRG TENDL-2015, AKONING
protons from (n,2np)

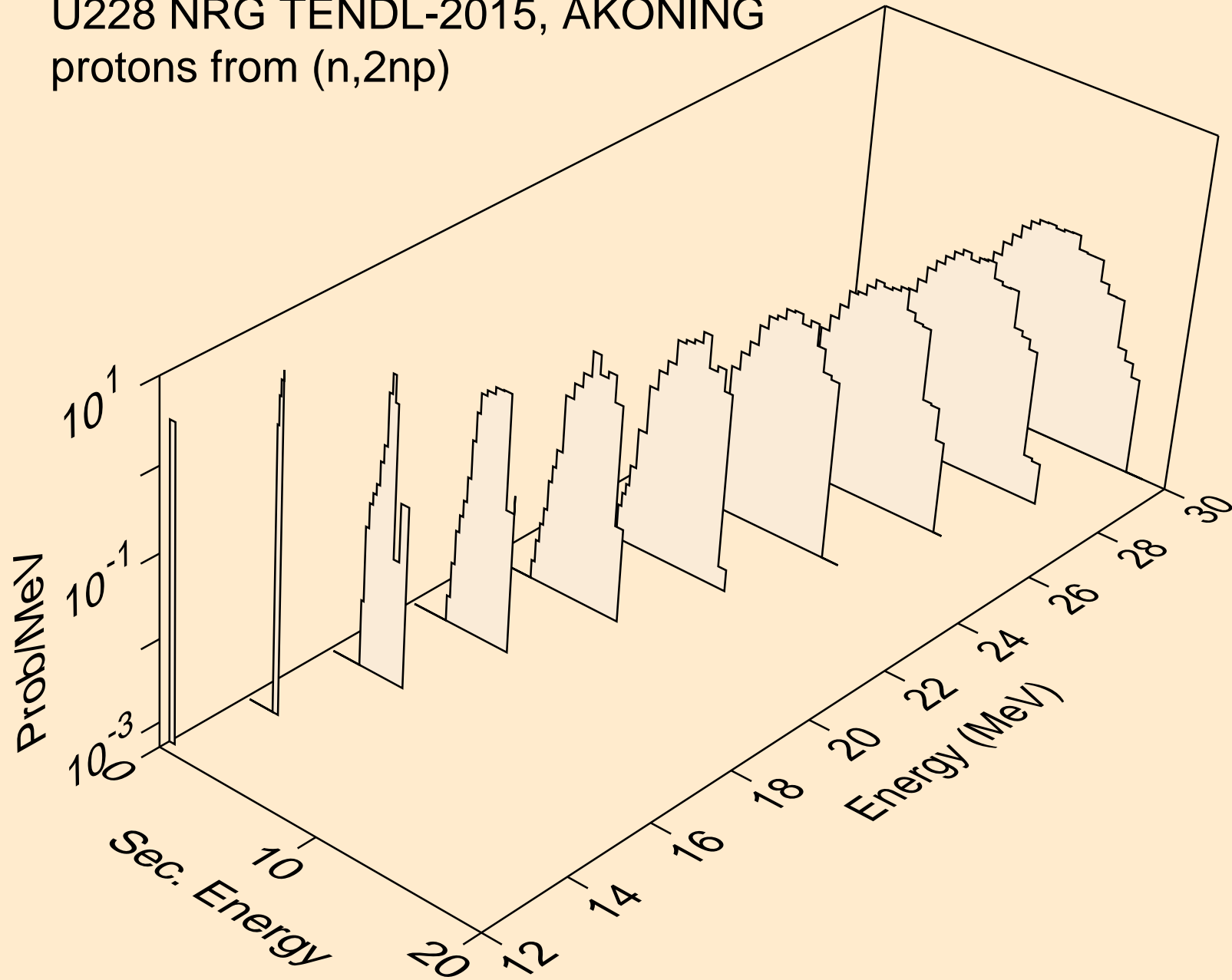

U228 NRG TENDL-2015, AKONING
protons from (n,3np)

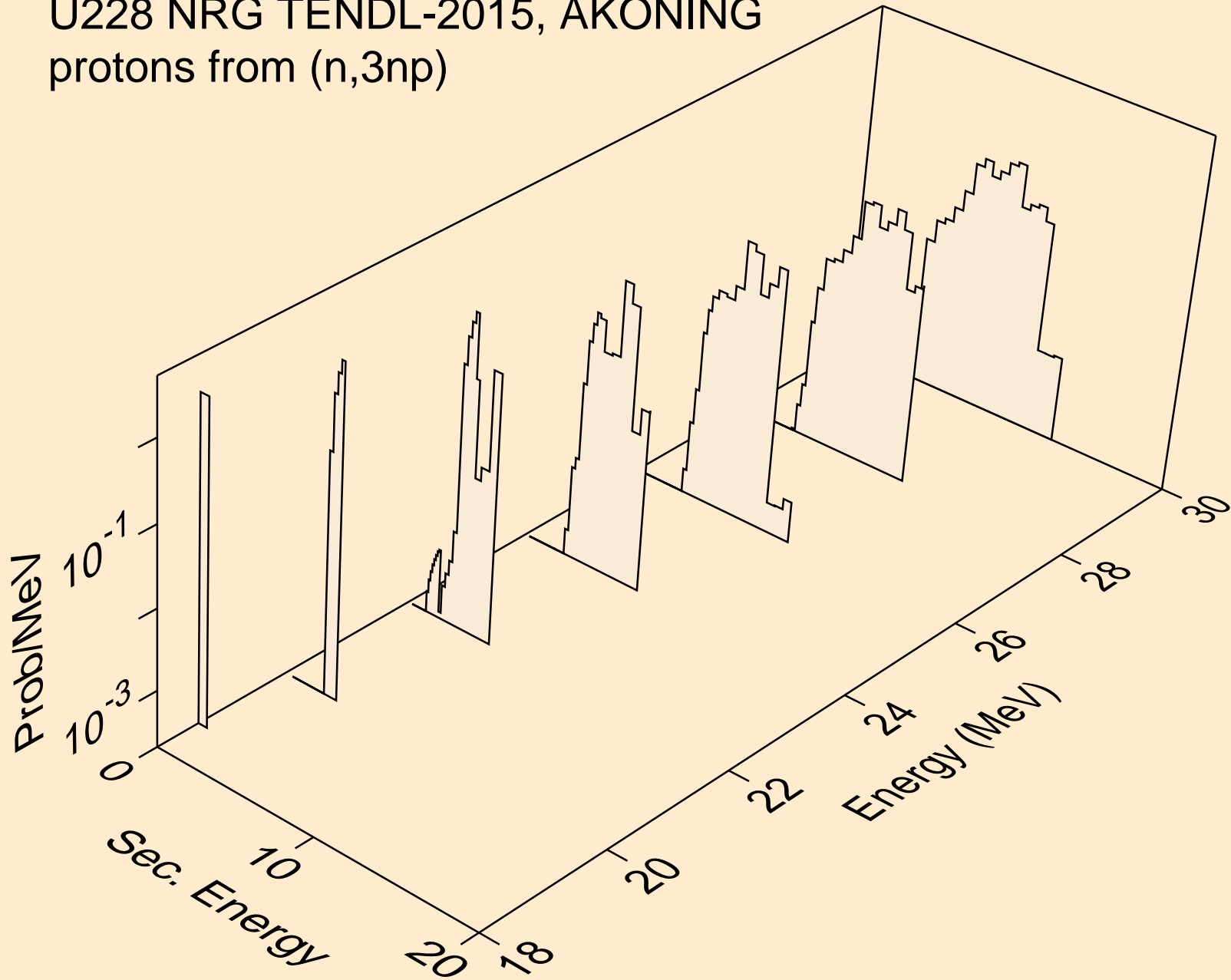

U228 NRG TENDL-2015, AKONING
protons from (n,2np)

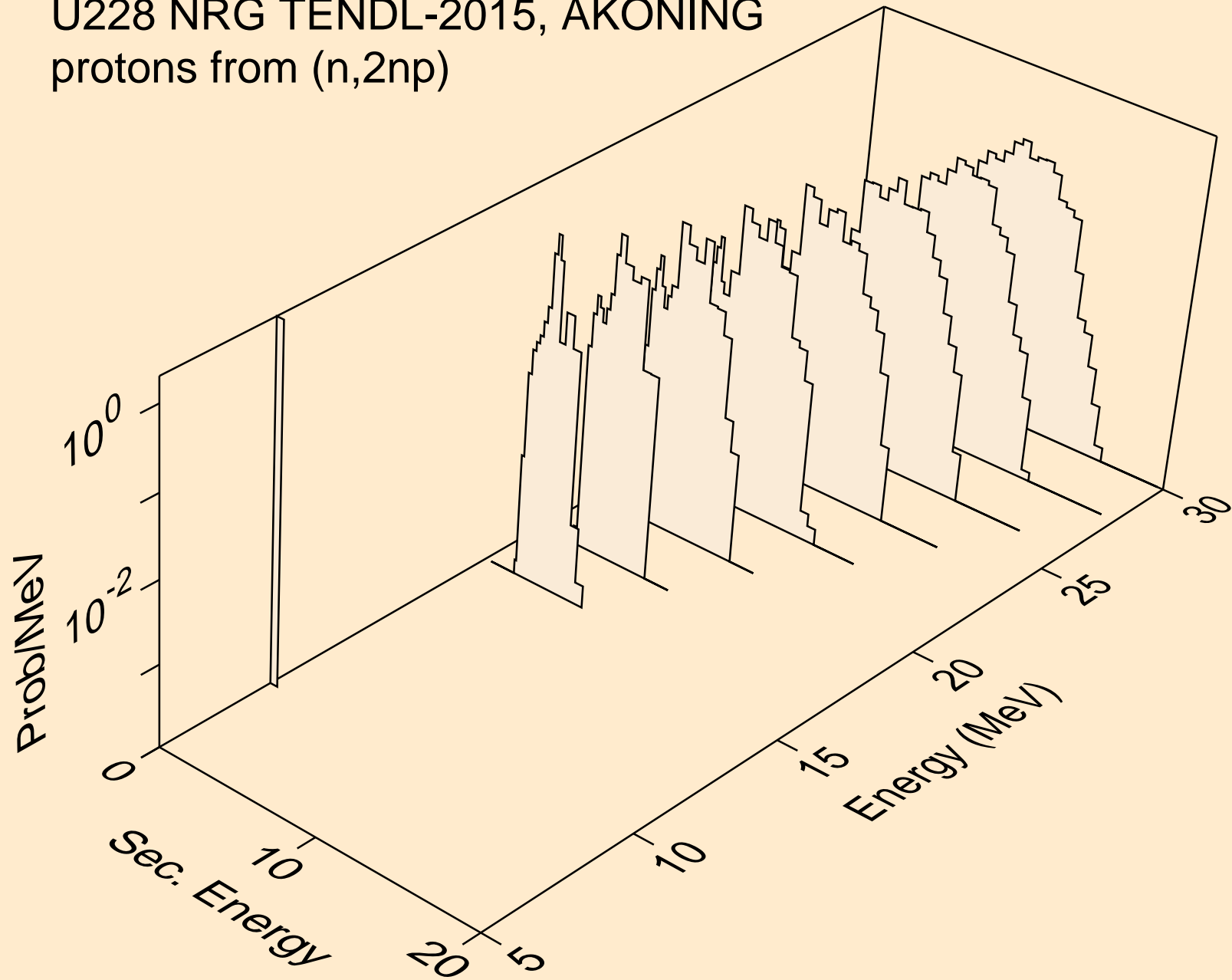

U228 NRG TENDL-2015, AKONING
protons from (n,npa)

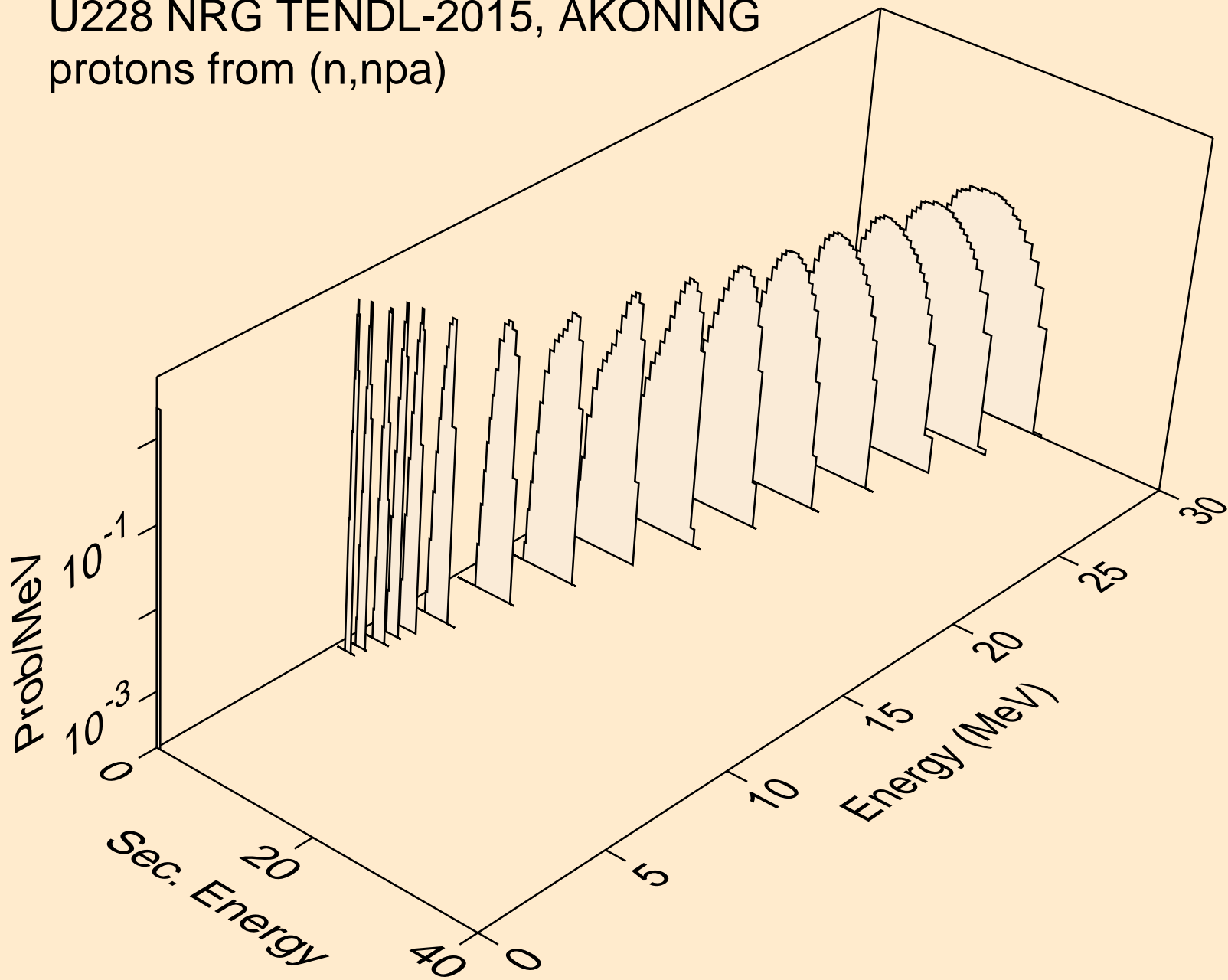

U228 NRG TENDL-2015, AKONING
protons from (n,p)

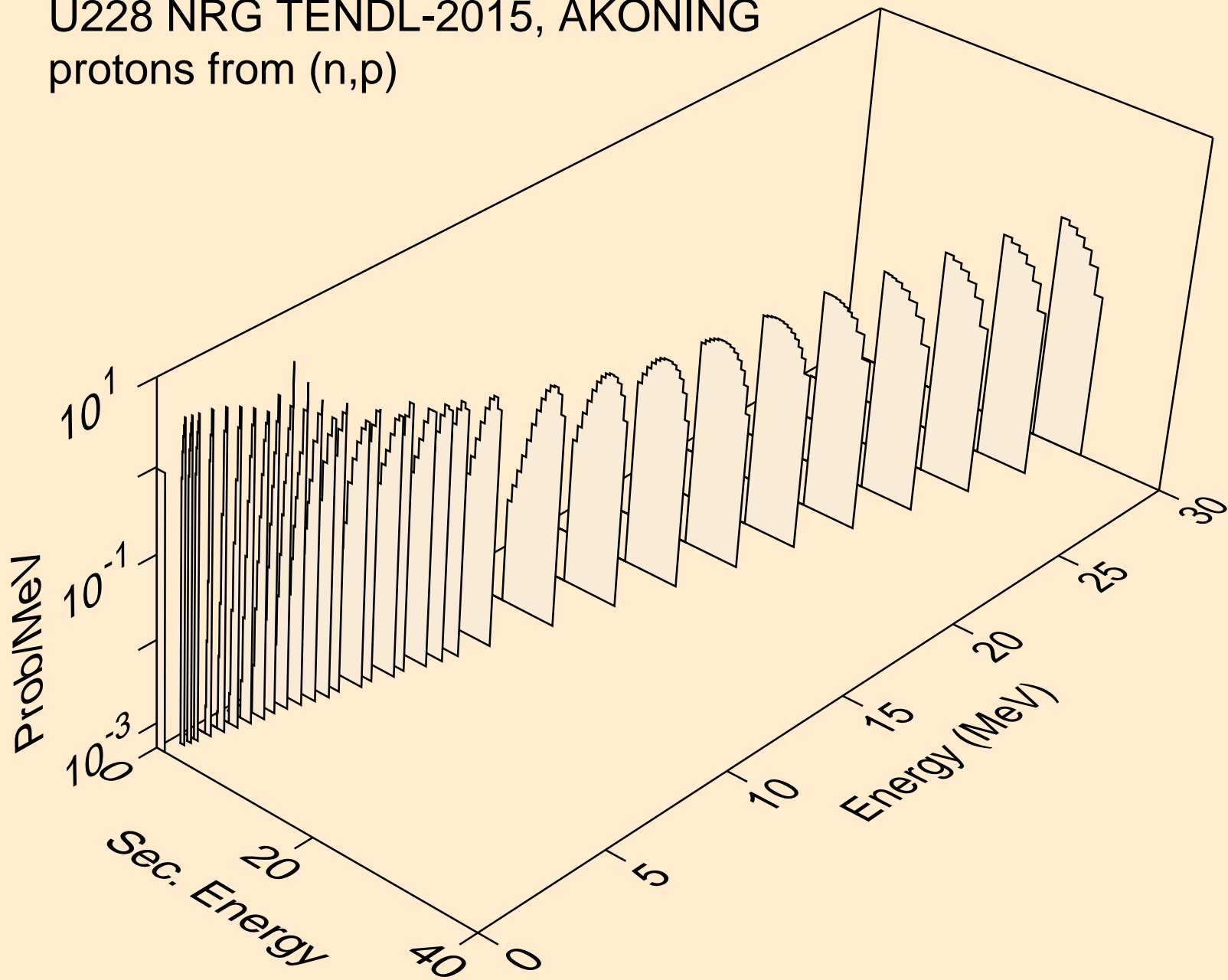

U228 NRG TENDL-2015, AKONING
protons from (n,2p)

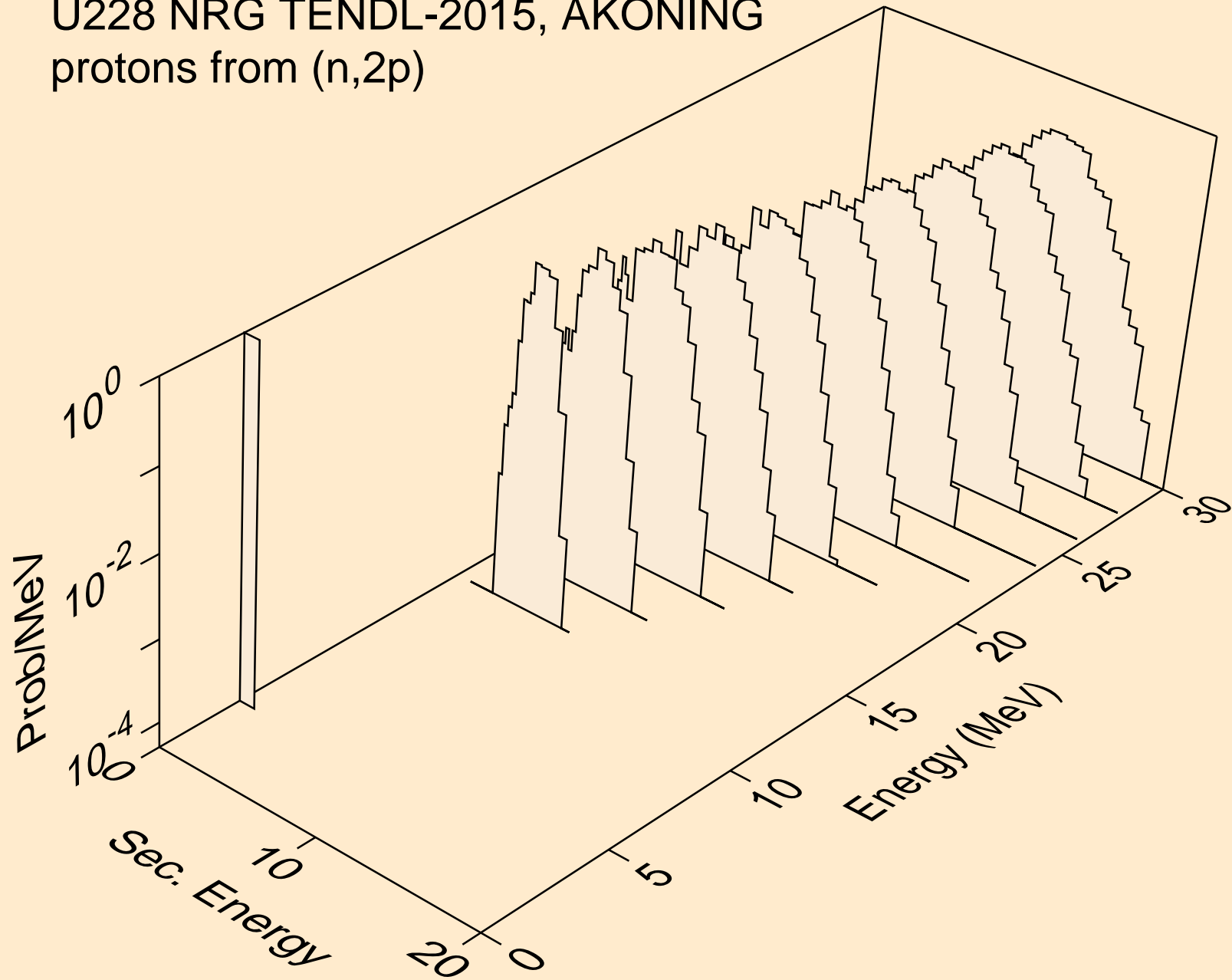

U228 NRG TENDL-2015, AKONING
protons from (n,pa)

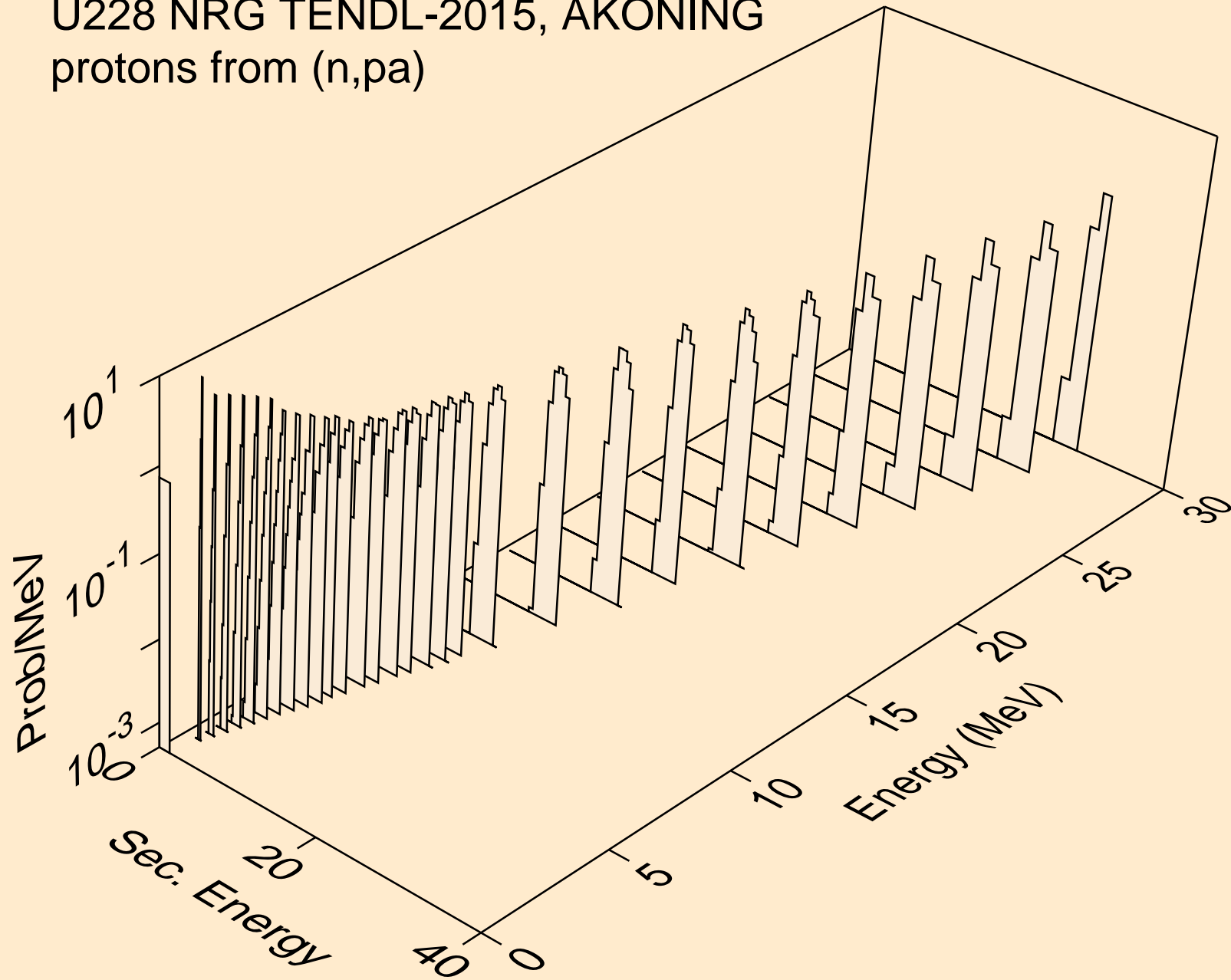

U228 NRG TENDL-2015, AKONING
protons from (n,pd)

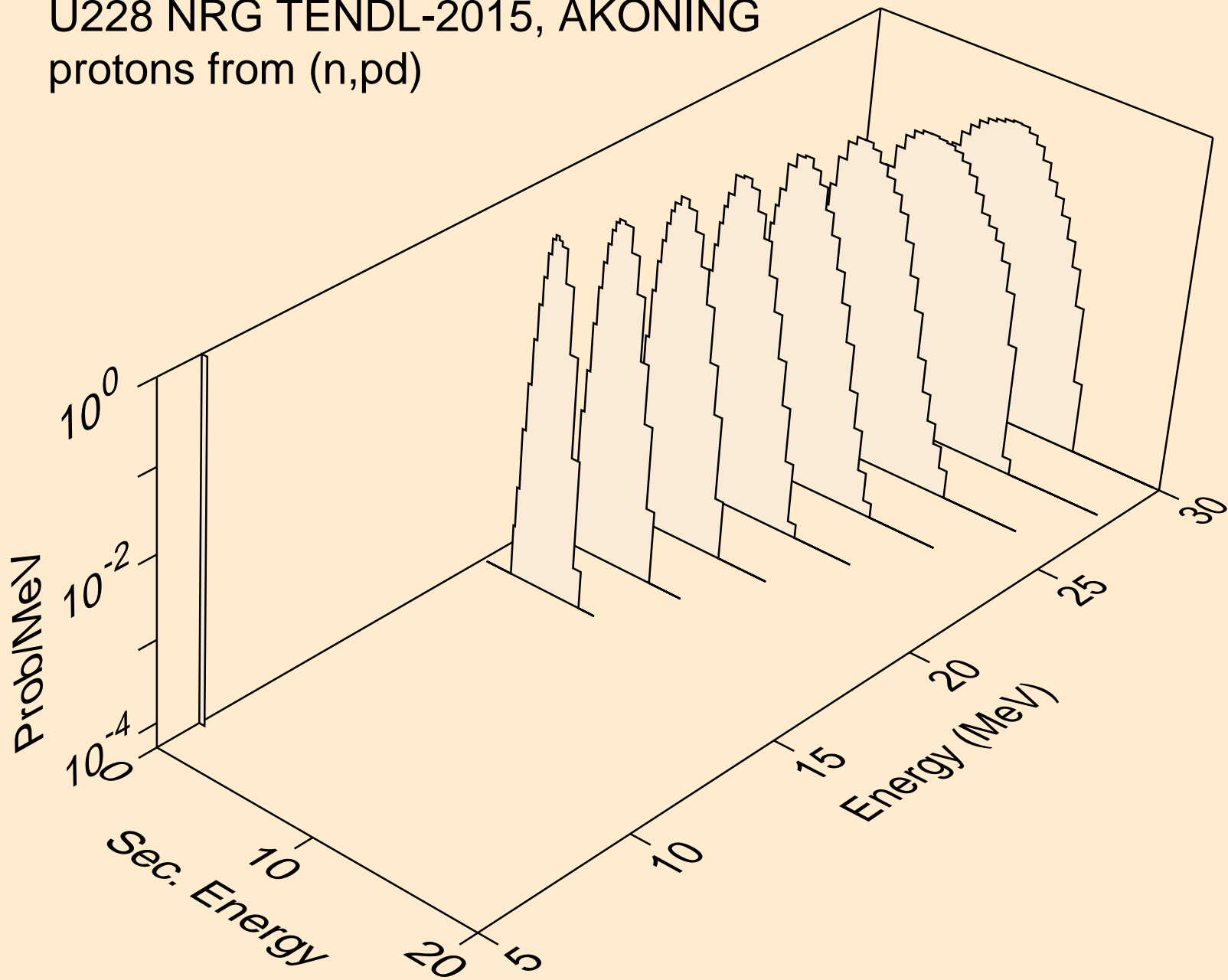

U228 NRG TENDL-2015, AKONING
protons from (n,pt)

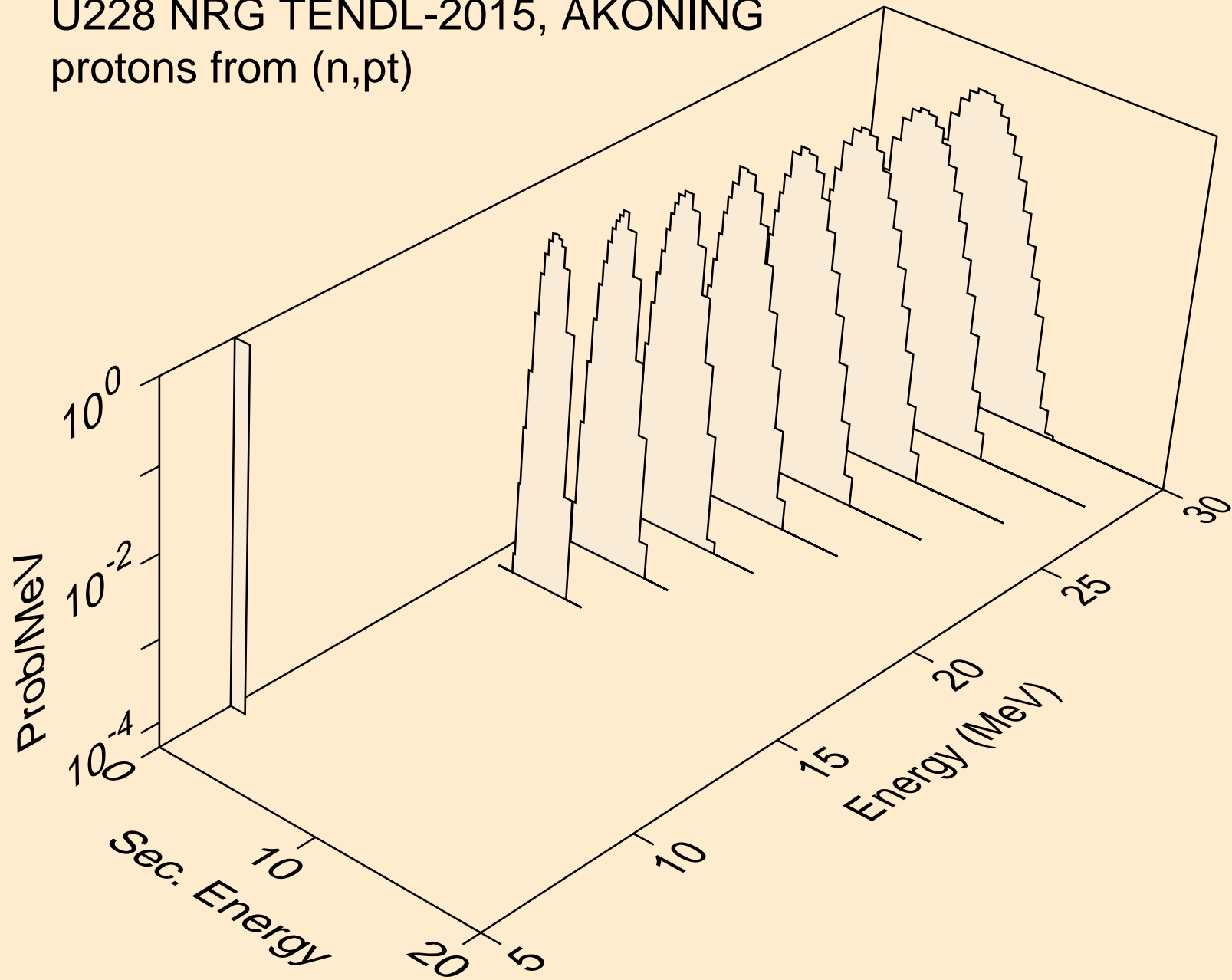

U228 NRG TENDL-2015, AKONING
deuterons from (n,x)

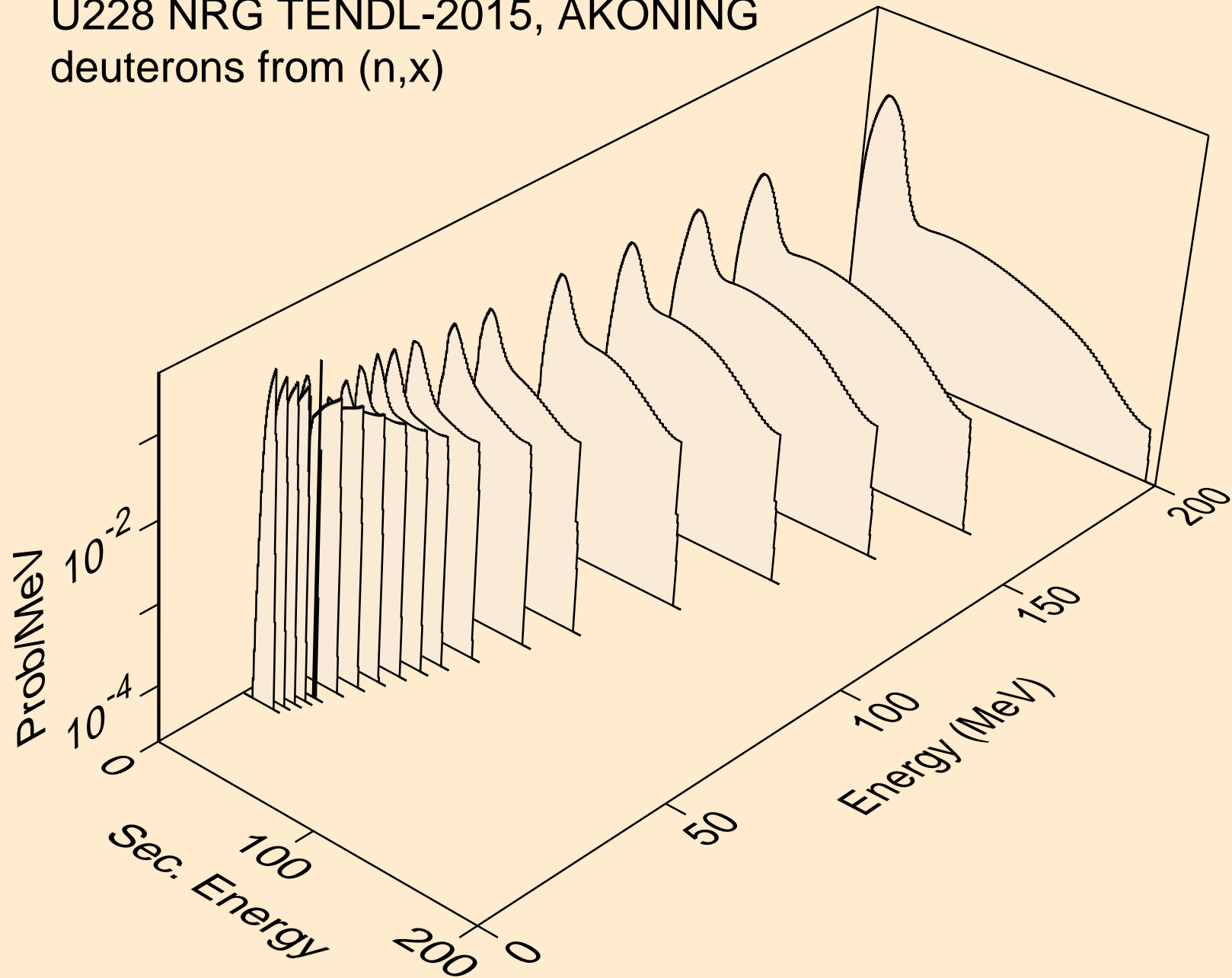

U228 NRG TENDL-2015, AKONING
deuterons from (n,2nd)

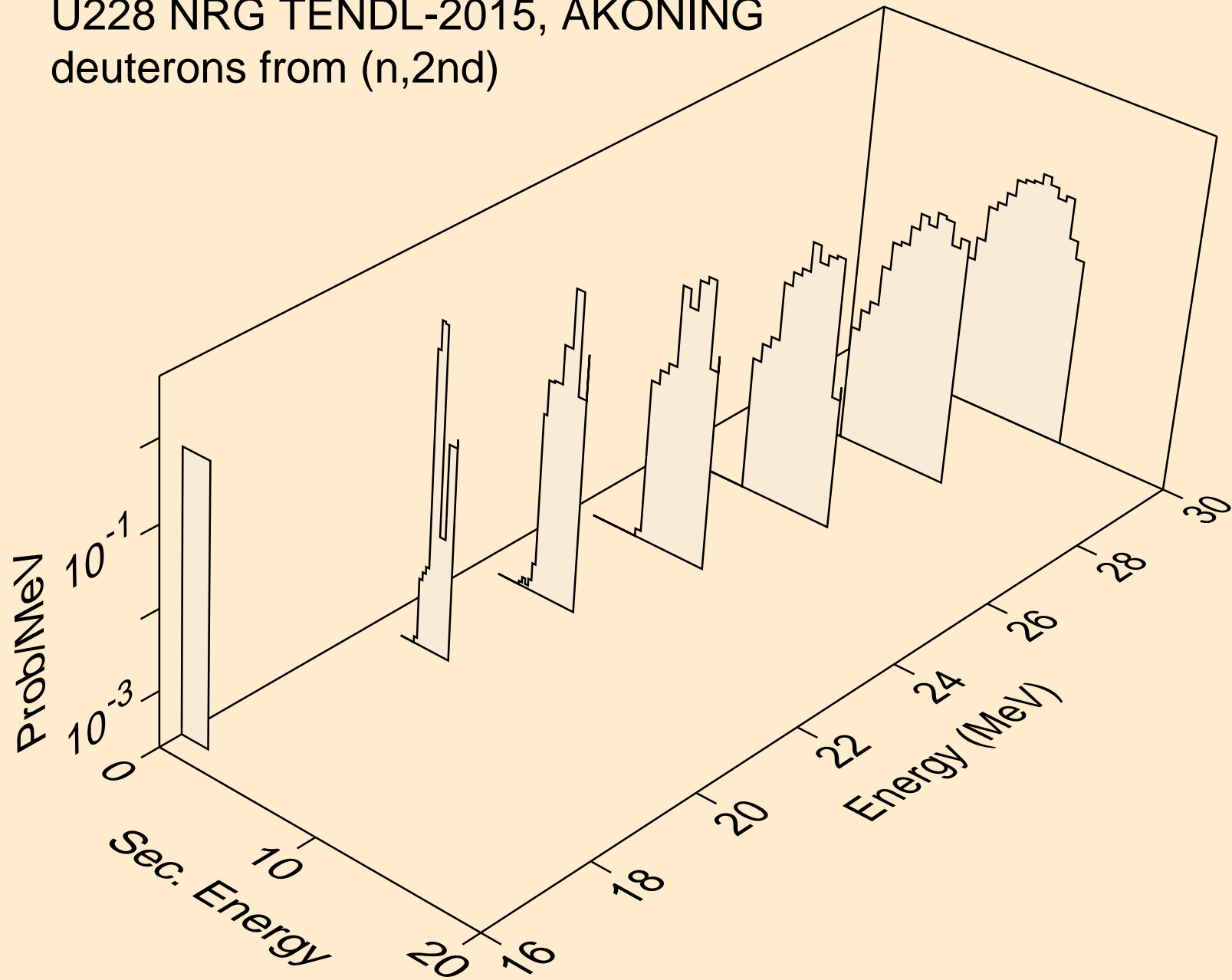

U228 NRG TENDL-2015, AKONING
deuterons from (n,n*)d

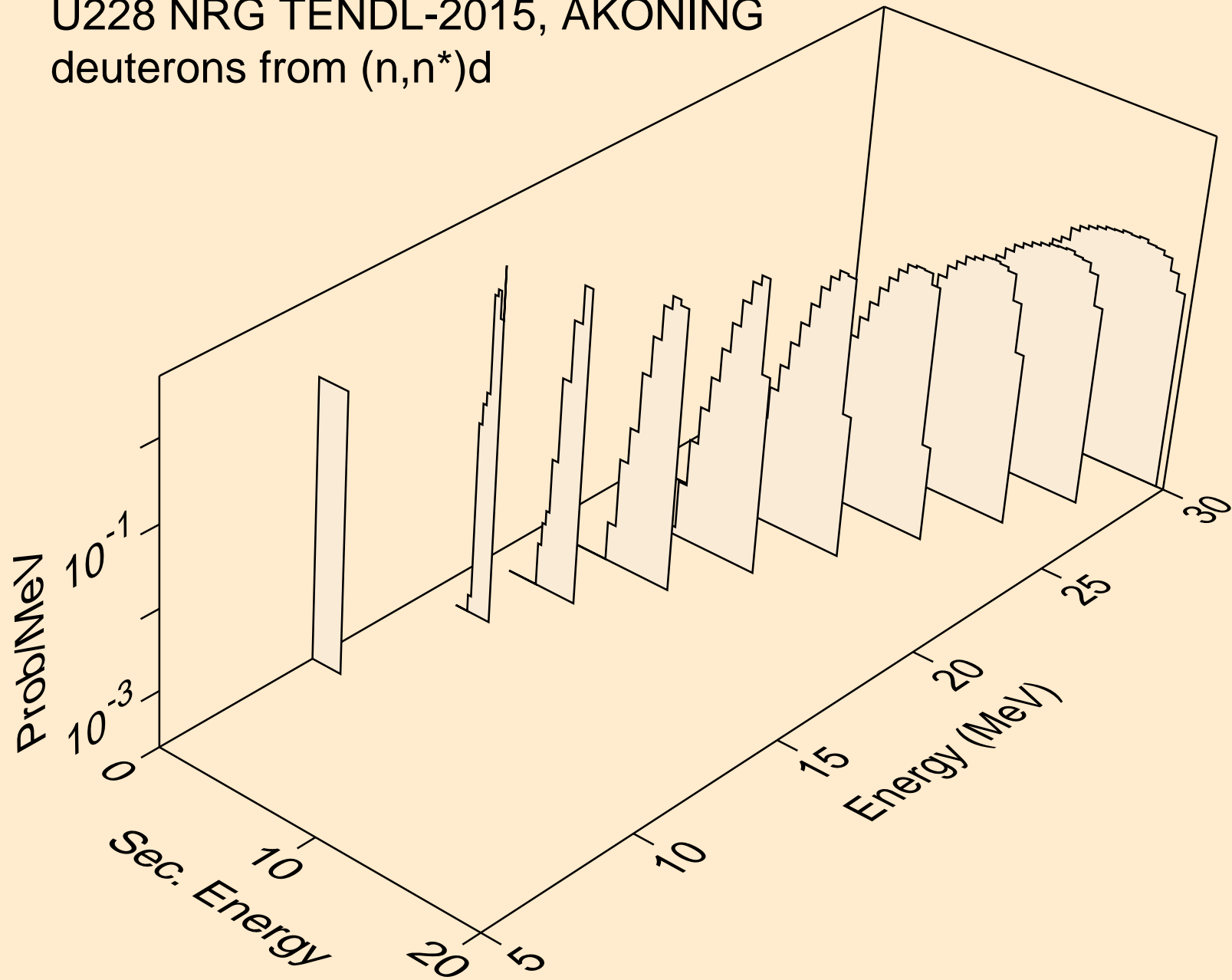

U228 NRG TENDL-2015, AKONING
deuterons from (n,n*)d2a

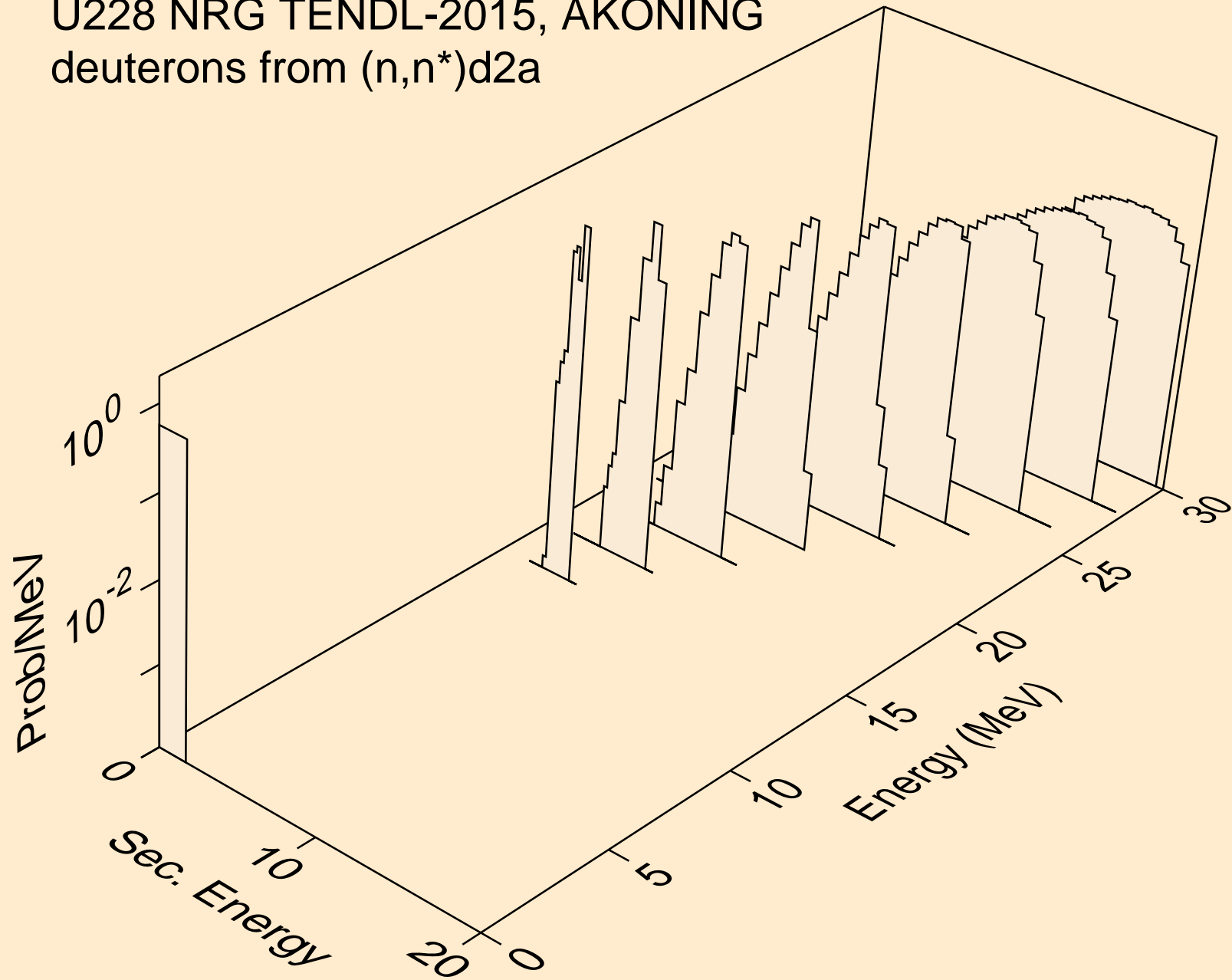

U228 NRG TENDL-2015, AKONING
deuterons from (n,d)

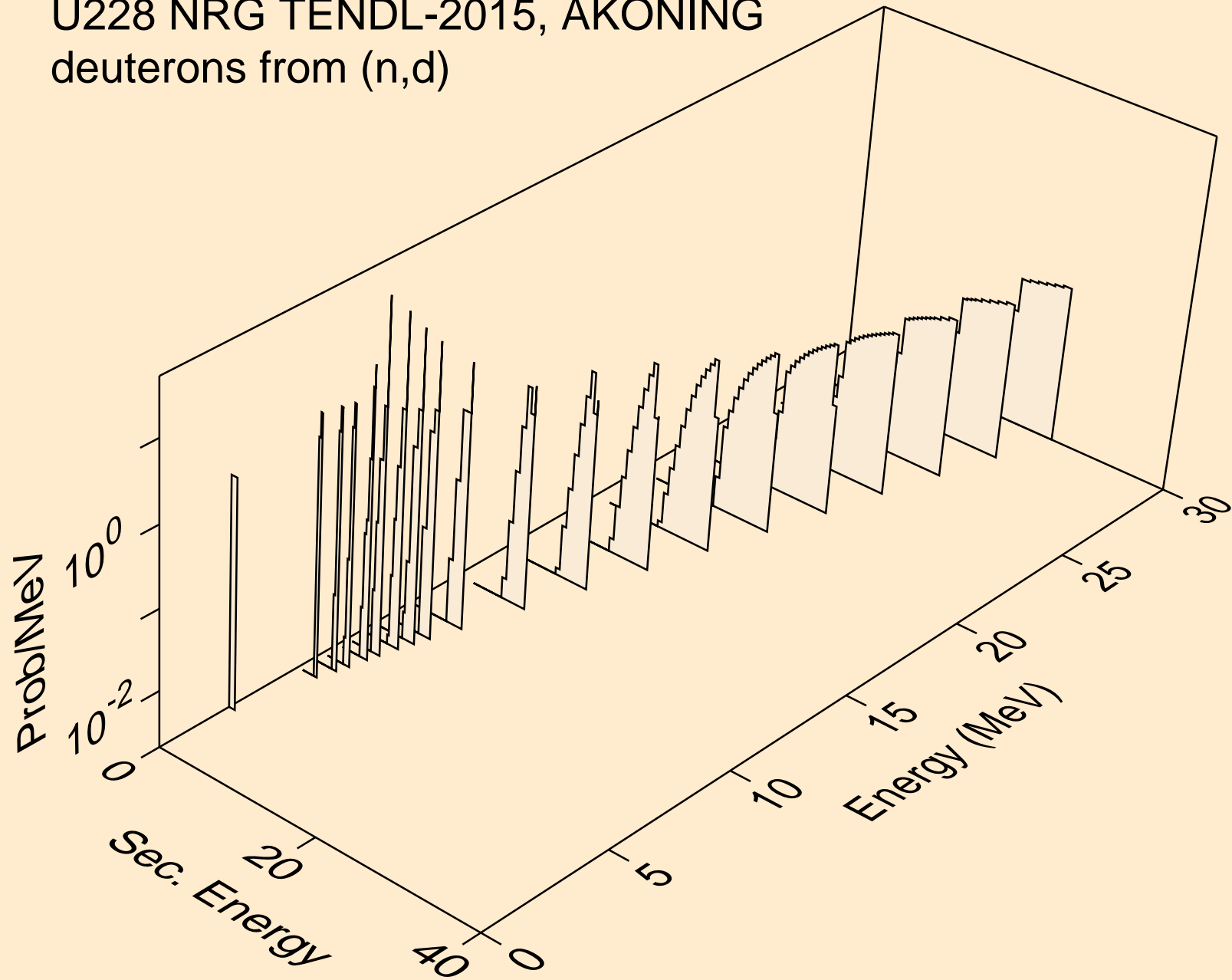

U228 NRG TENDL-2015, AKONING
deuterons from (n,d2a)

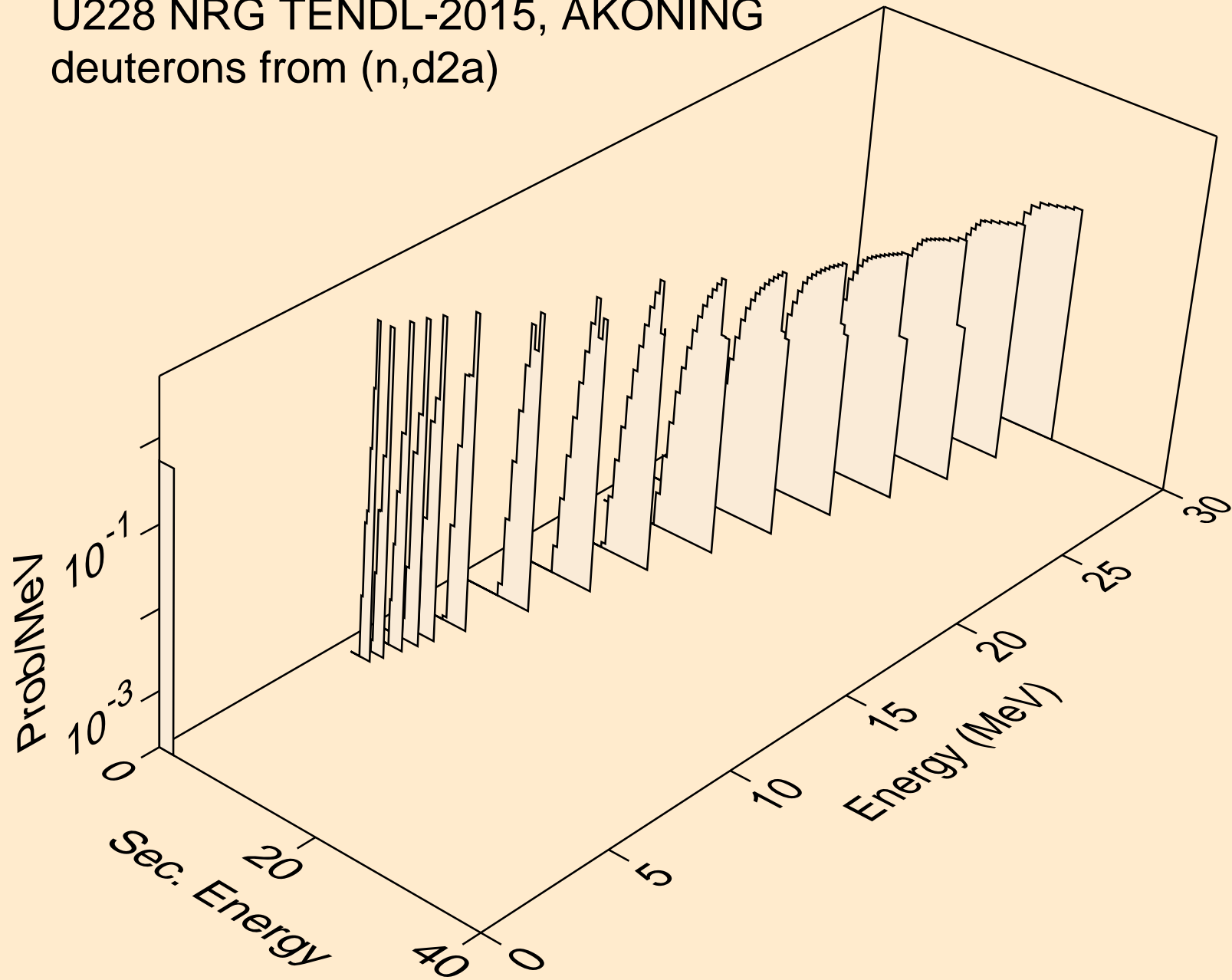

U228 NRG TENDL-2015, AKONING
deuterons from (n,pd)

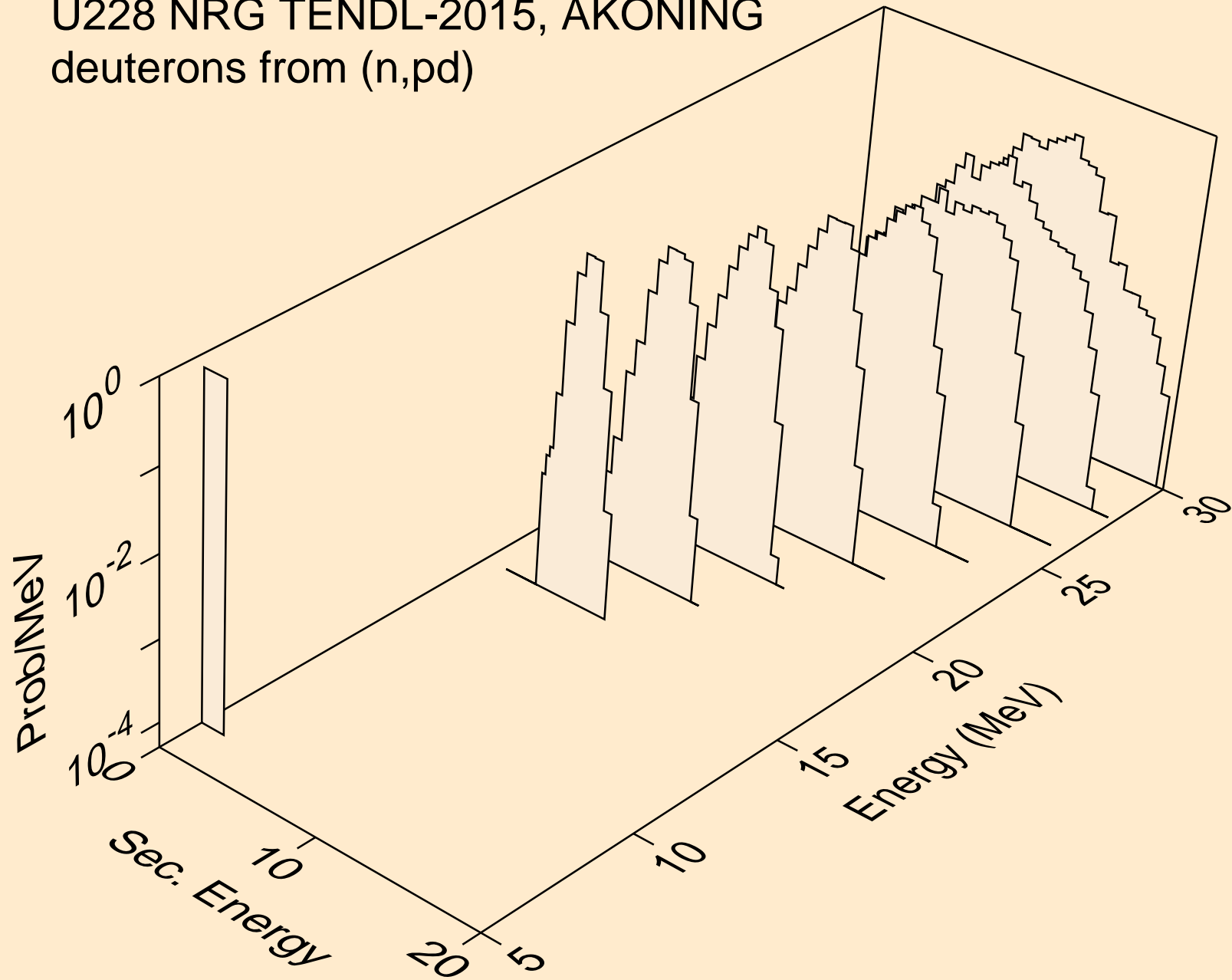

U228 NRG TENDL-2015, AKONING
deuterons from (n,da)

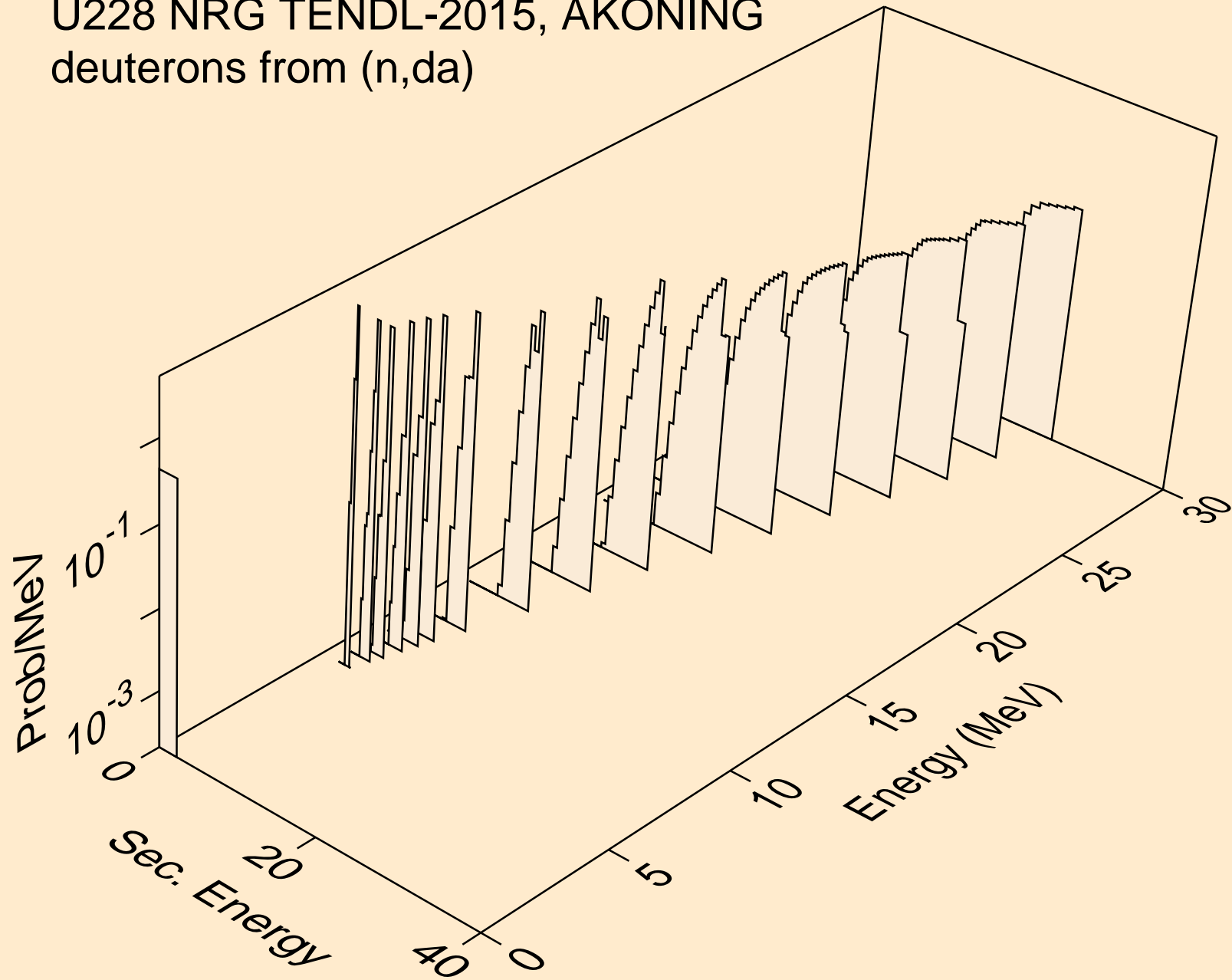

U228 NRG TENDL-2015, AKONING
tritons from (n,x)

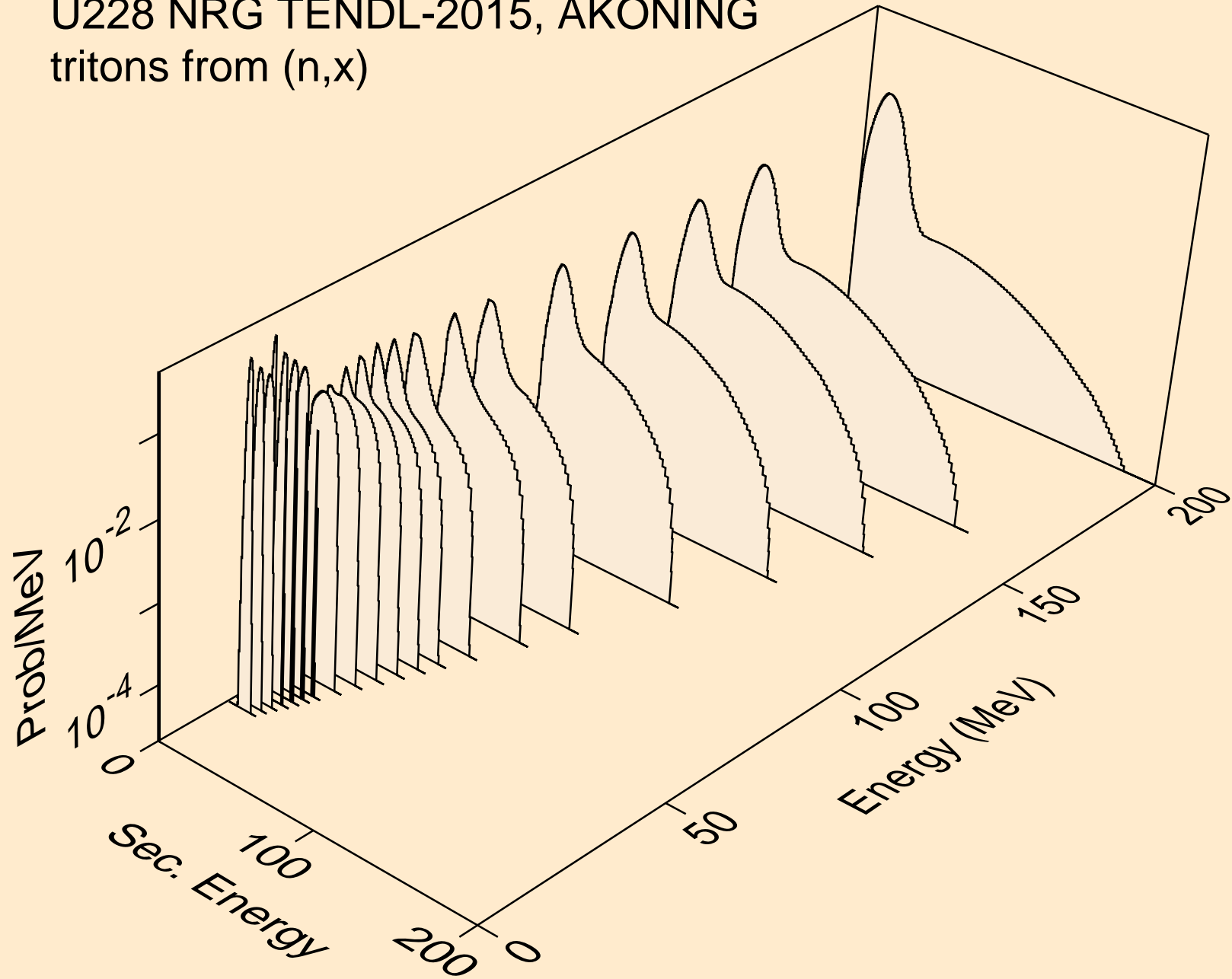

U228 NRG TENDL-2015, AKONING
tritons from (n,n*)t

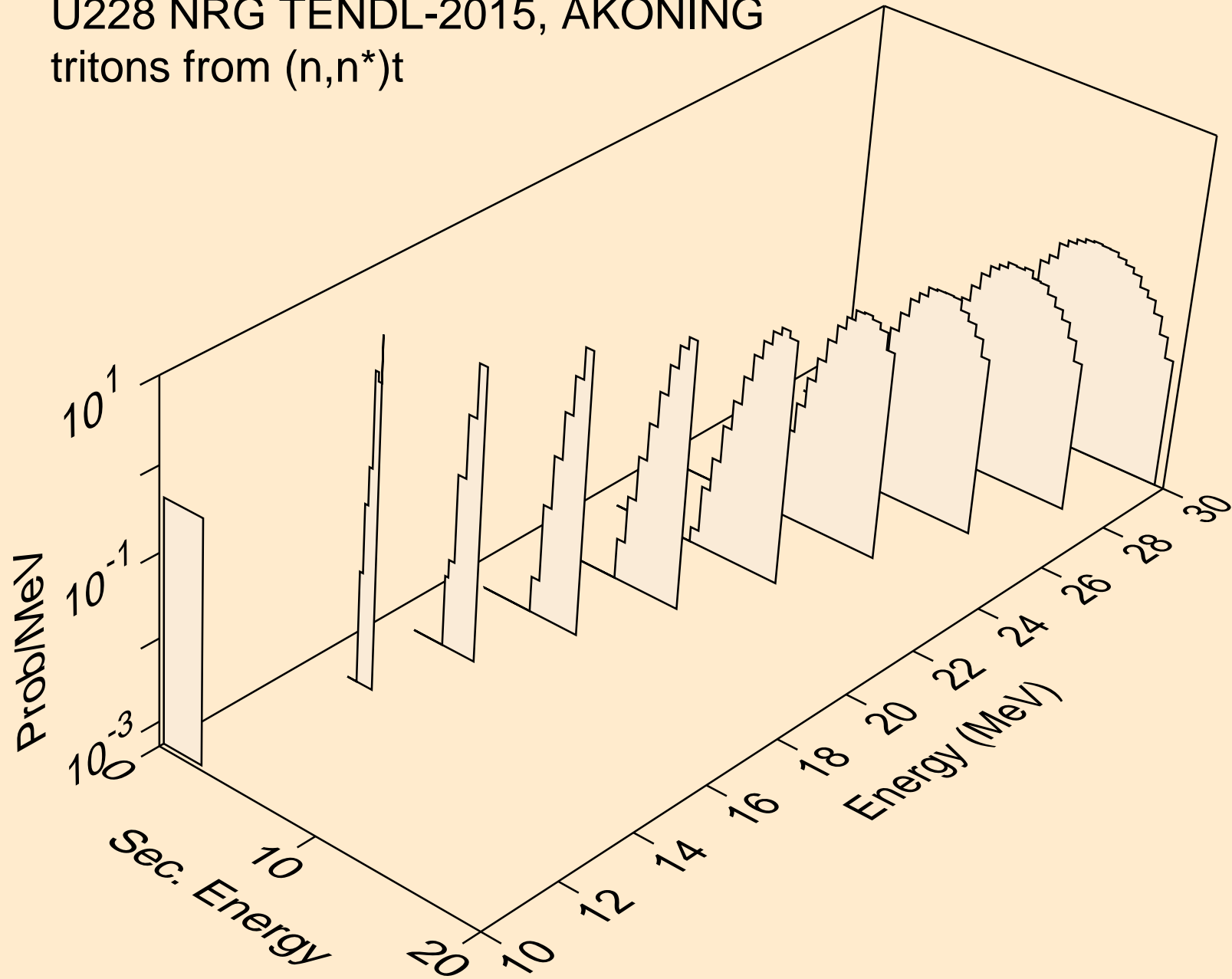

U228 NRG TENDL-2015, AKONING
tritons from (n,n*)t2a

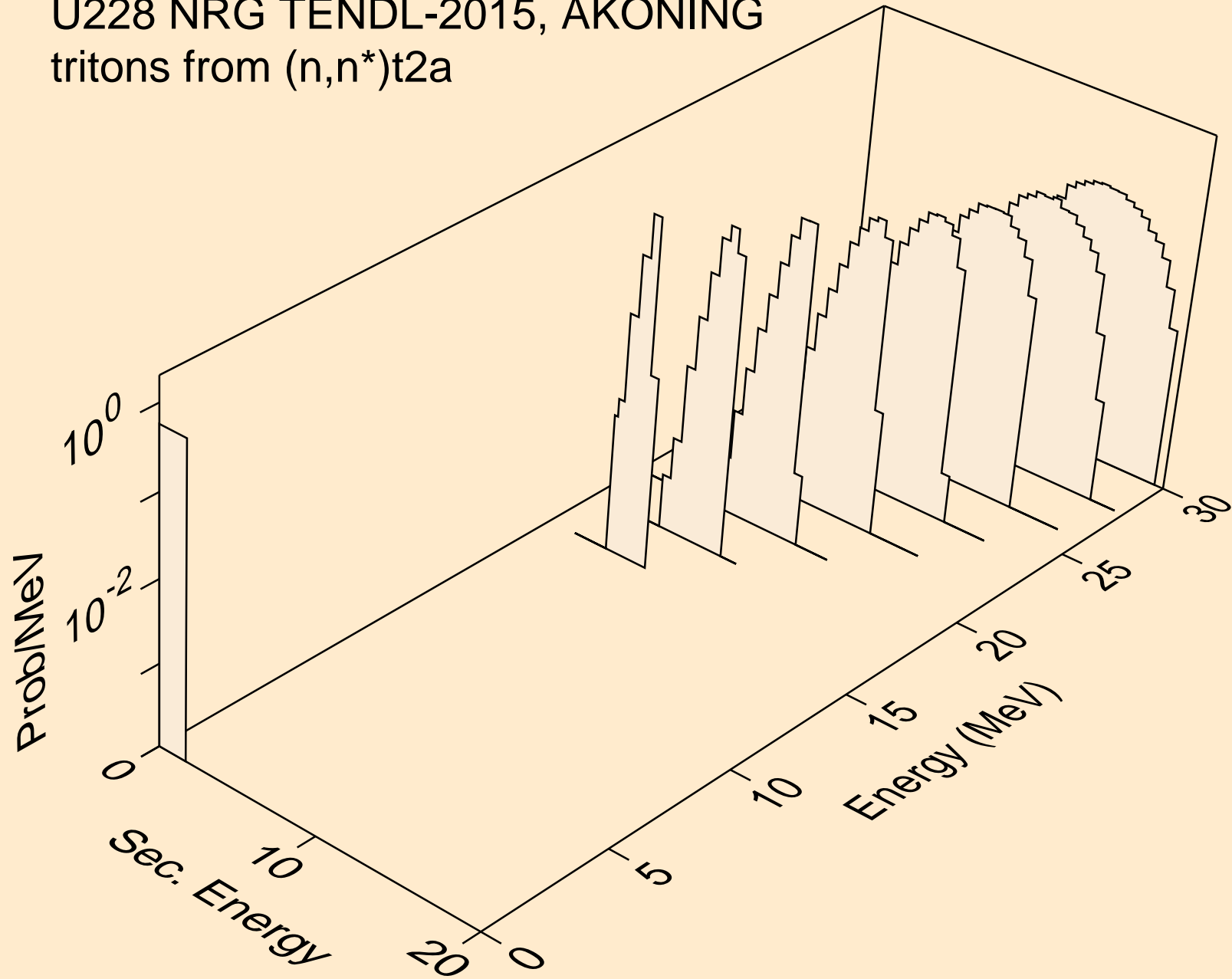

U228 NRG TENDL-2015, AKONING
tritons from (n,t)

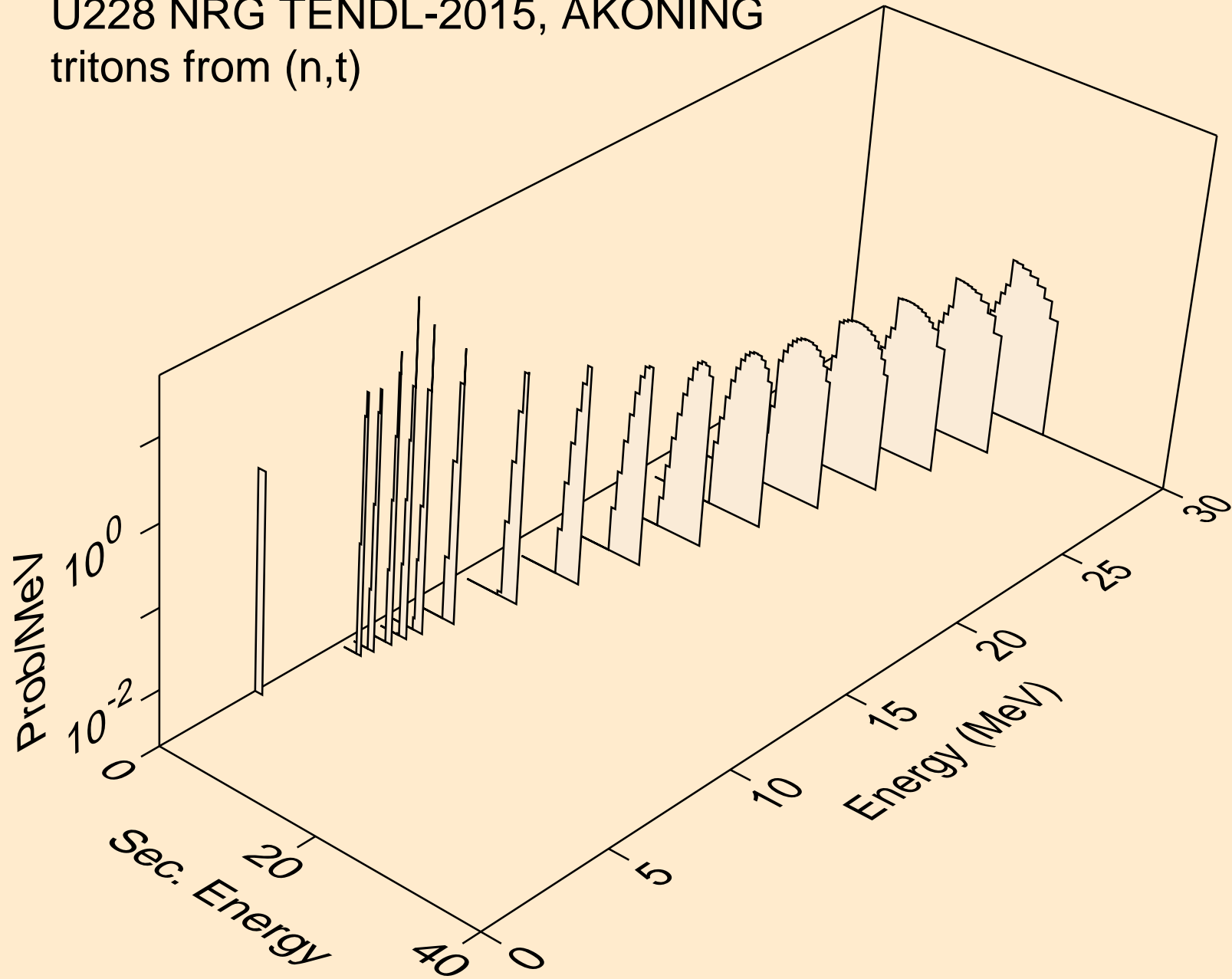

U228 NRG TENDL-2015, AKONING
tritons from (n,t2a)

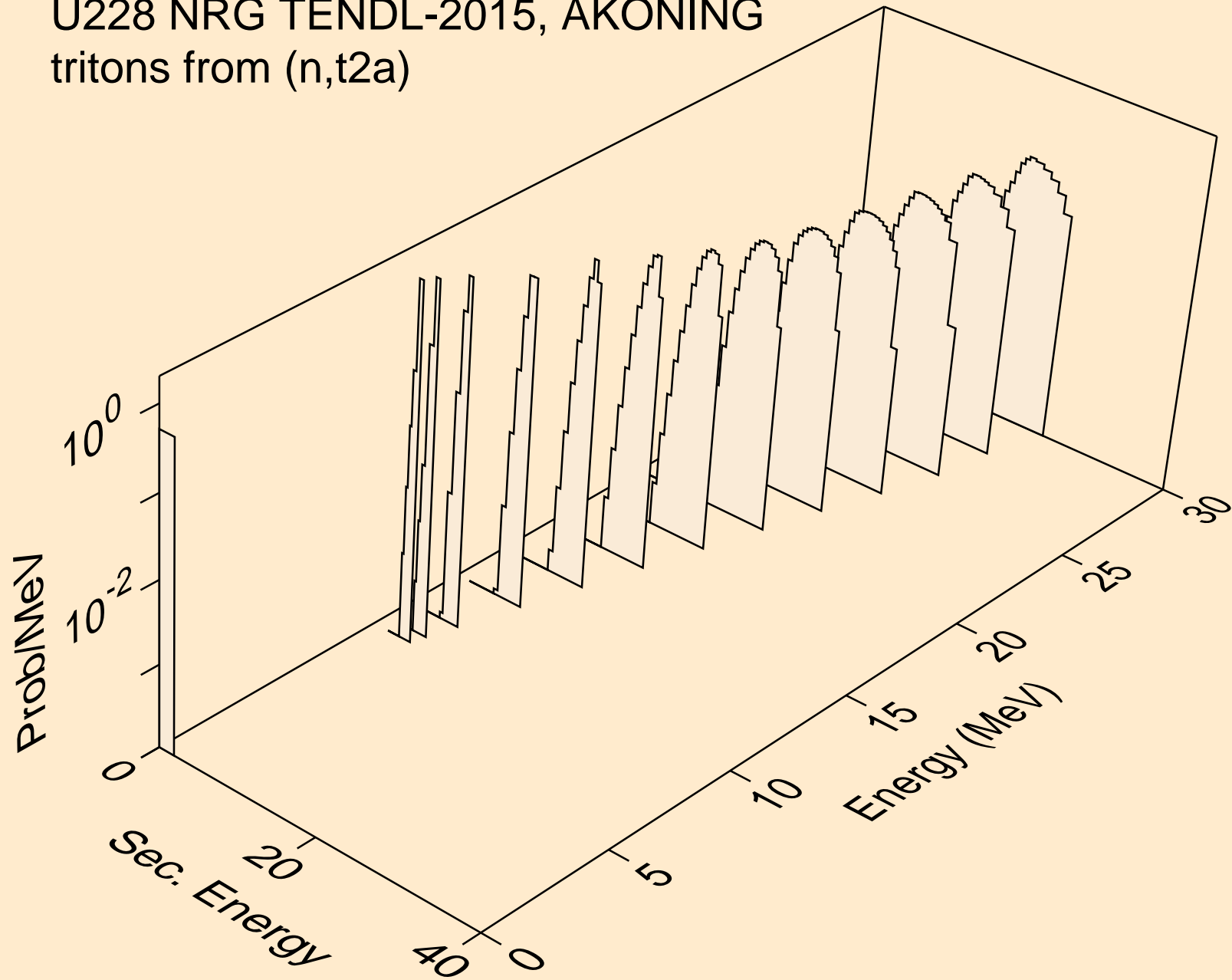

U228 NRG TENDL-2015, AKONING
tritons from (n,pt)

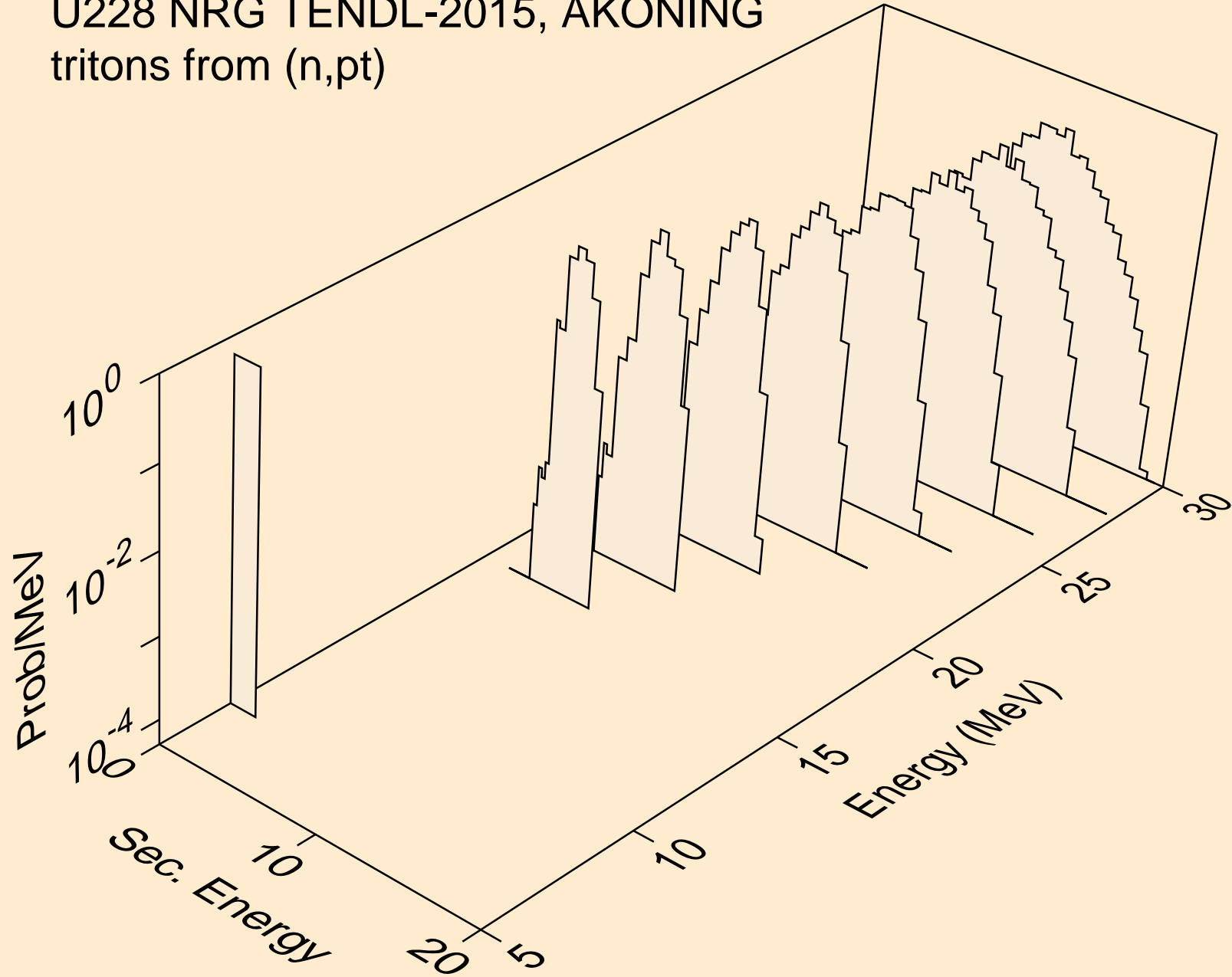

U228 NRG TENDL-2015, AKONING
he3s from (n,x)

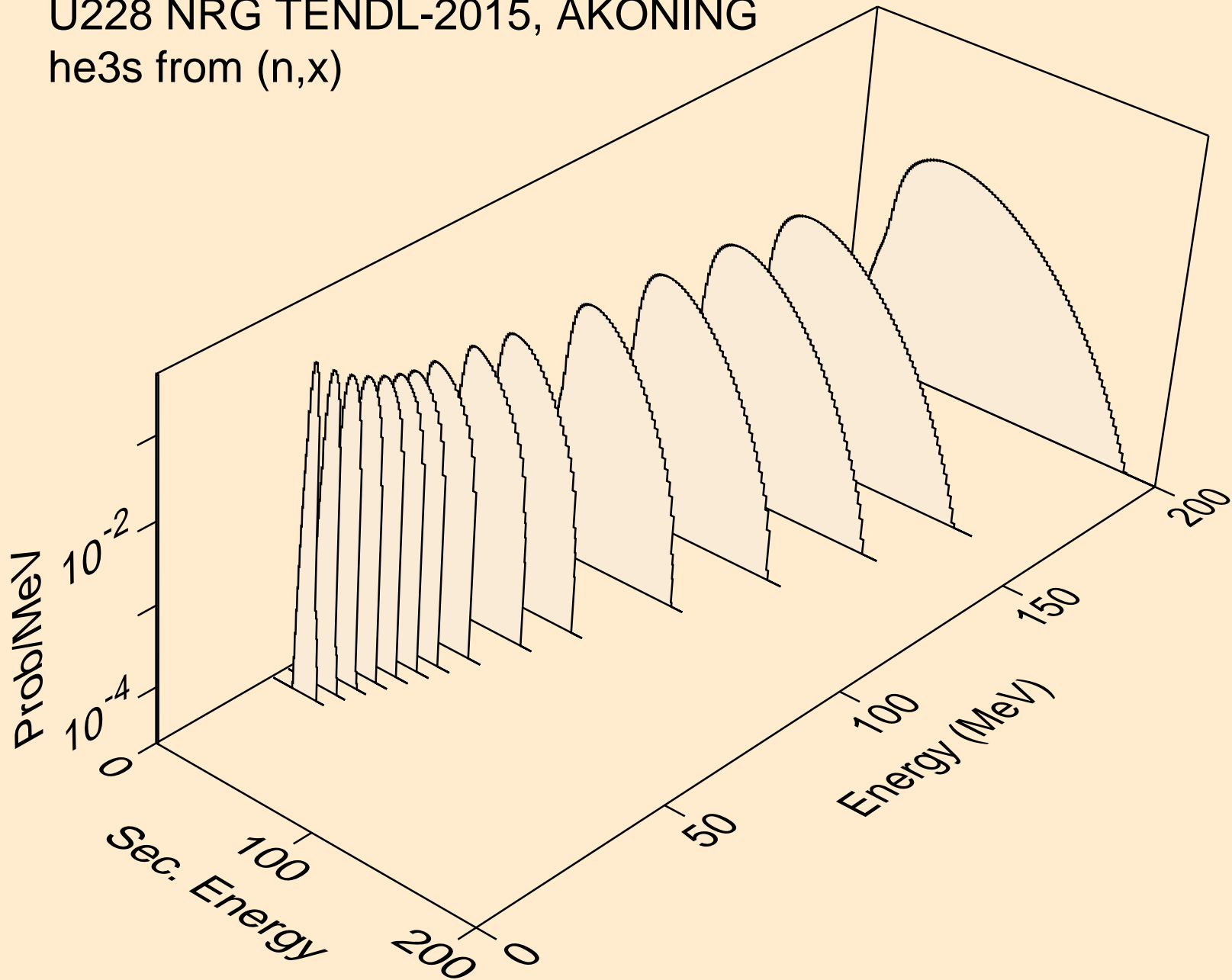

U228 NRG TENDL-2015, AKONING
he3s from (n,n*)he3

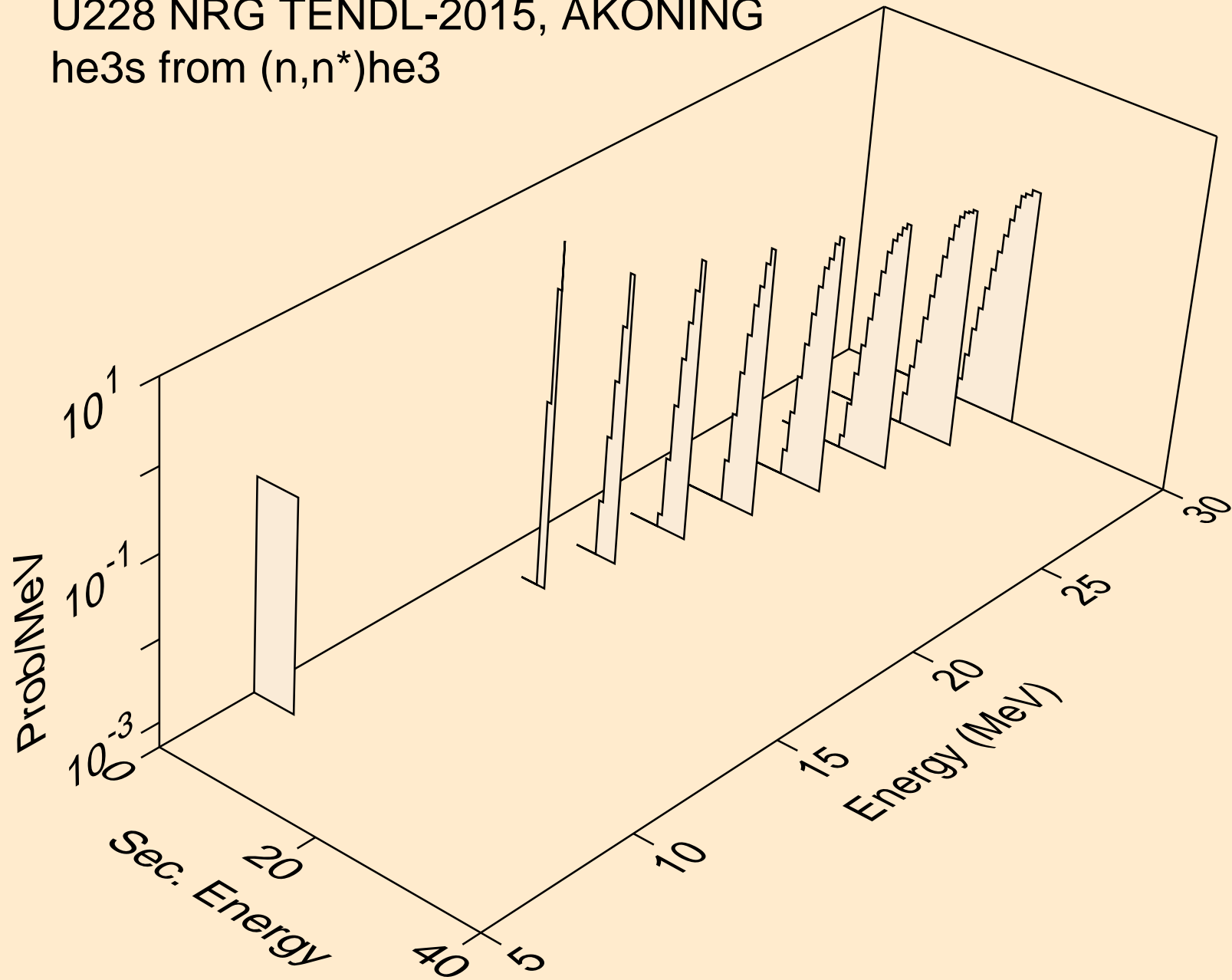

U228 NRG TENDL-2015, AKONING
he3s from (n,he3)

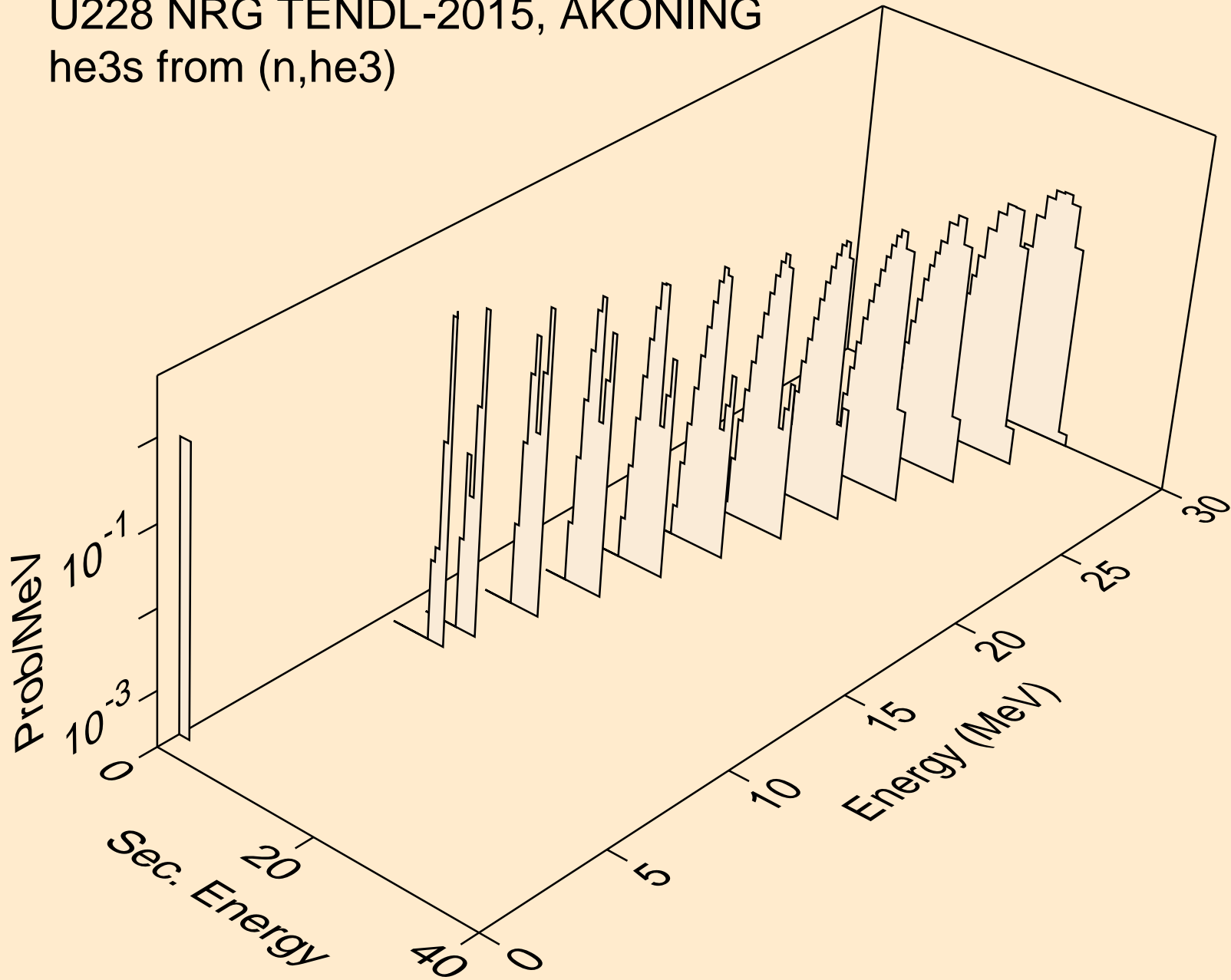

U228 NRG TENDL-2015, AKONING
alphas from (n,x)

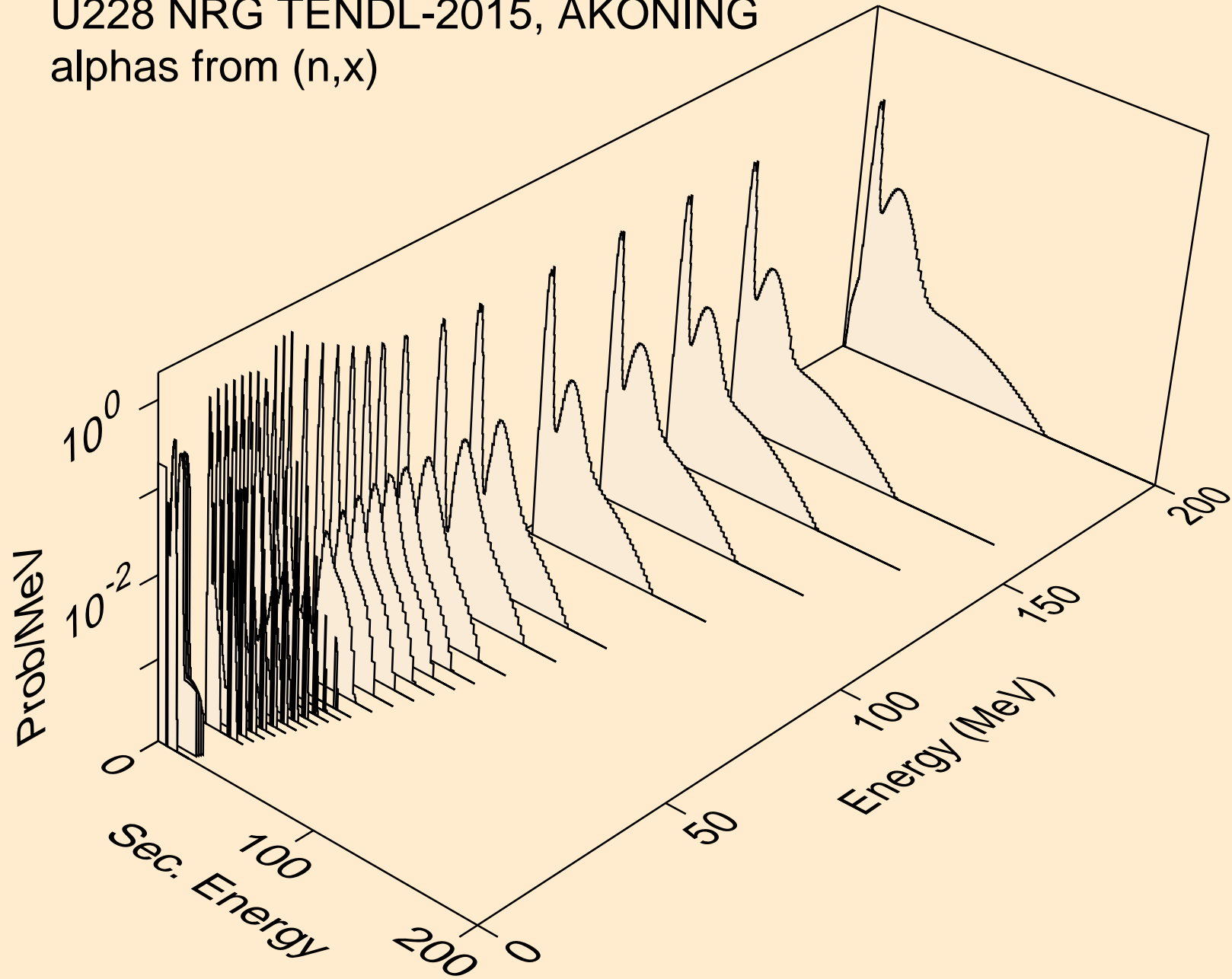

U228 NRG TENDL-2015, AKONING
alphas from (n,n*)a

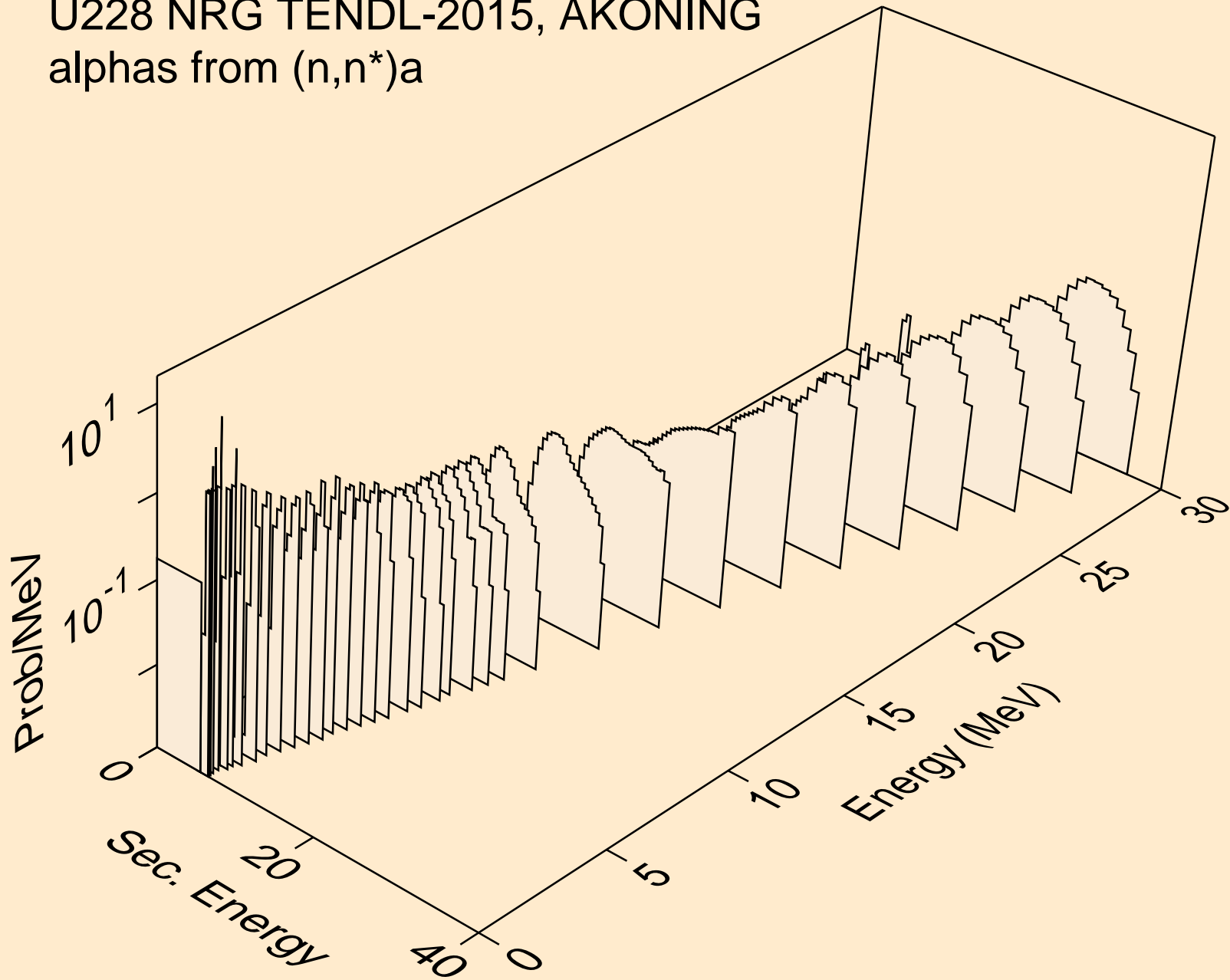

U228 NRG TENDL-2015, AKONING
alphas from (n,n*)3a

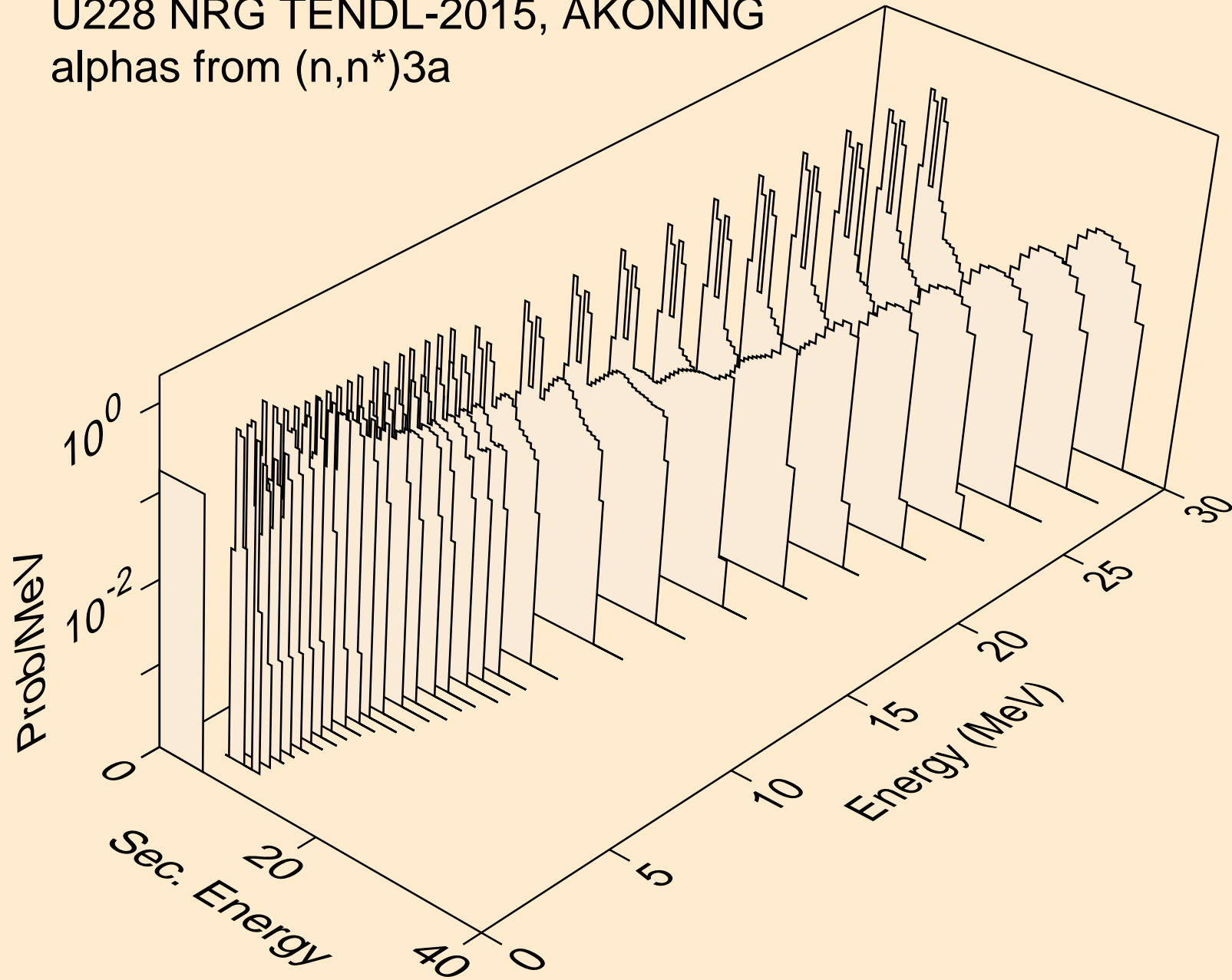

U228 NRG TENDL-2015, AKONING
alphas from (n,2n)a

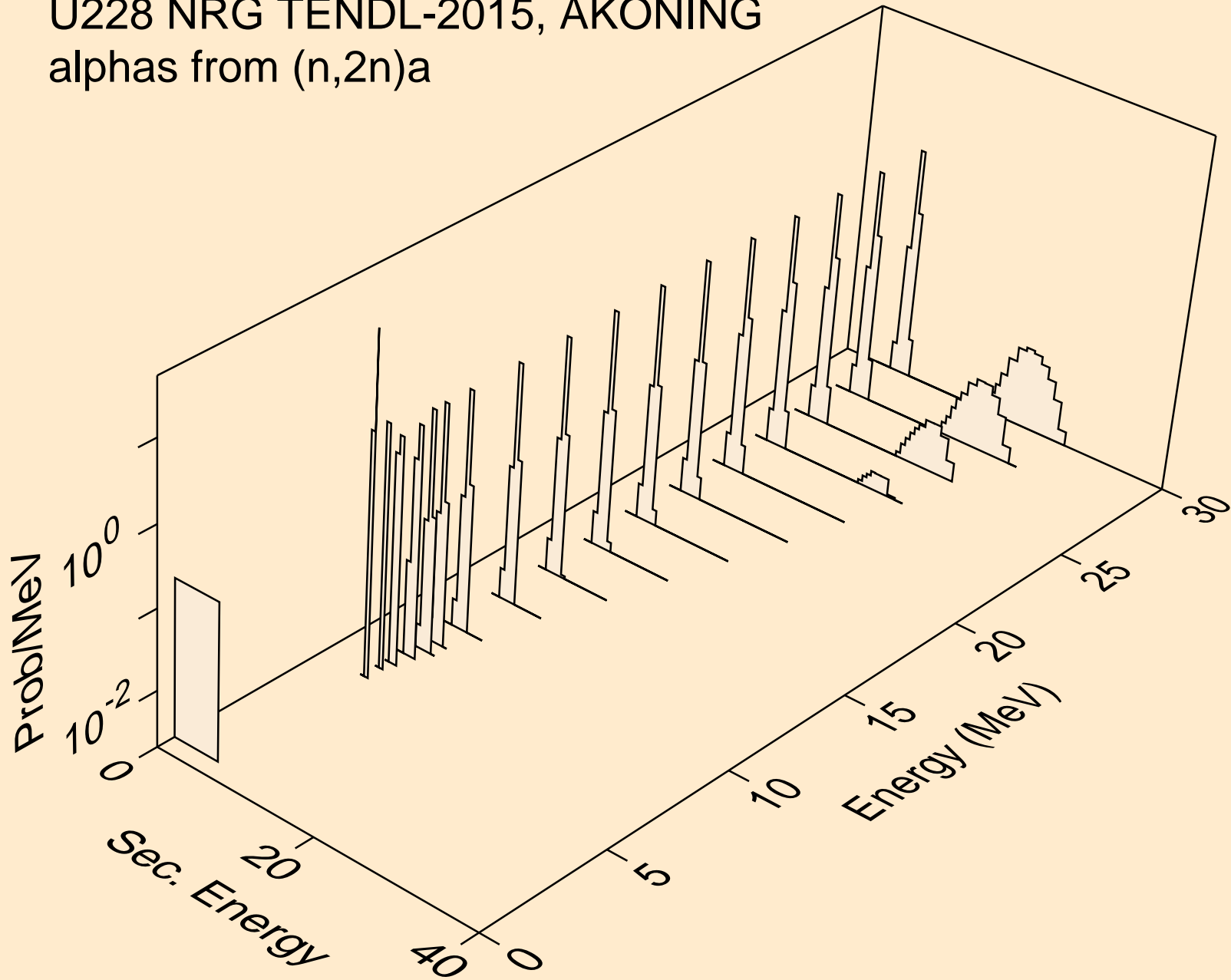

U228 NRG TENDL-2015, AKONING
alphas from (n,3n)a

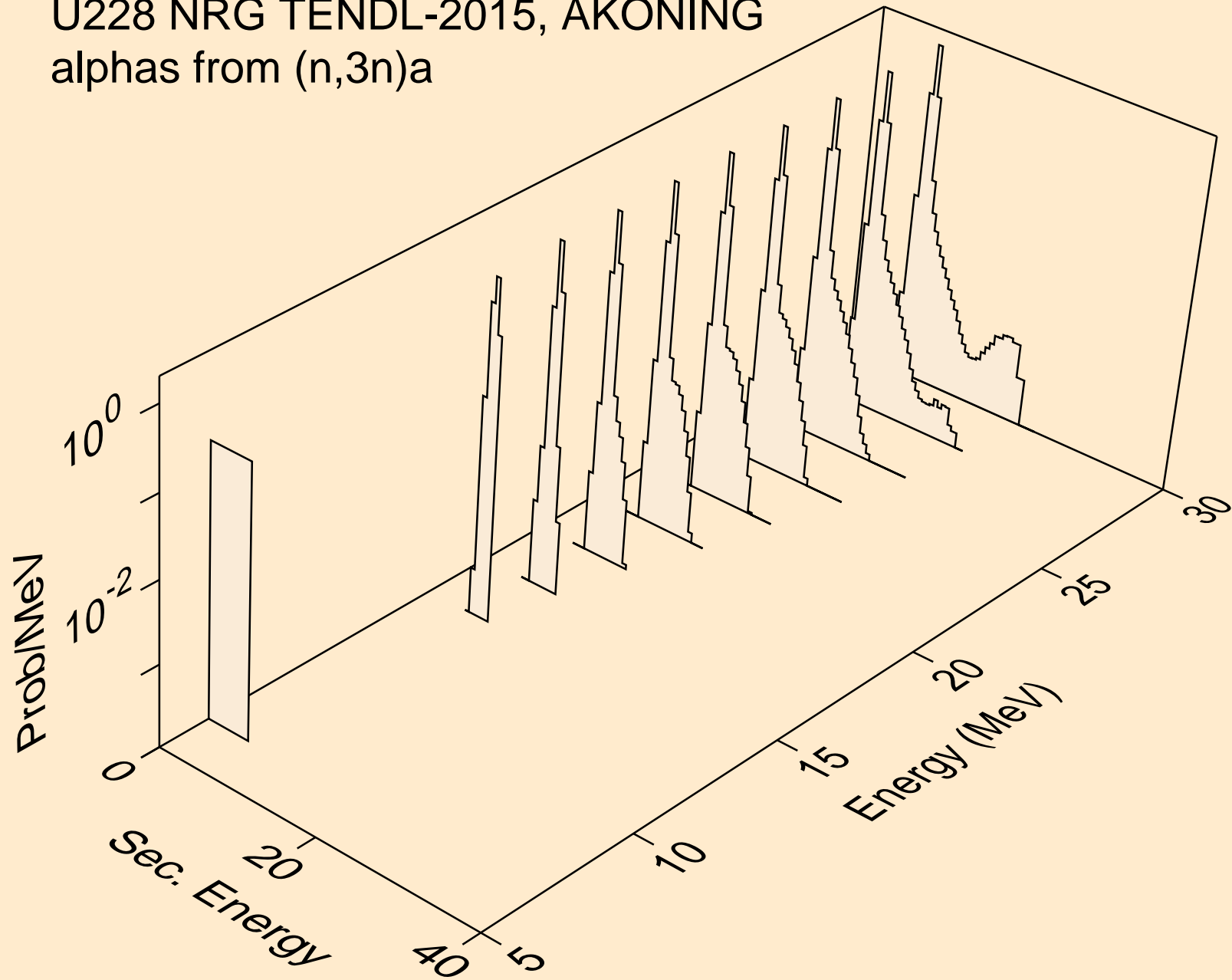

U228 NRG TENDL-2015, AKONING
alphas from (n,n*)2a

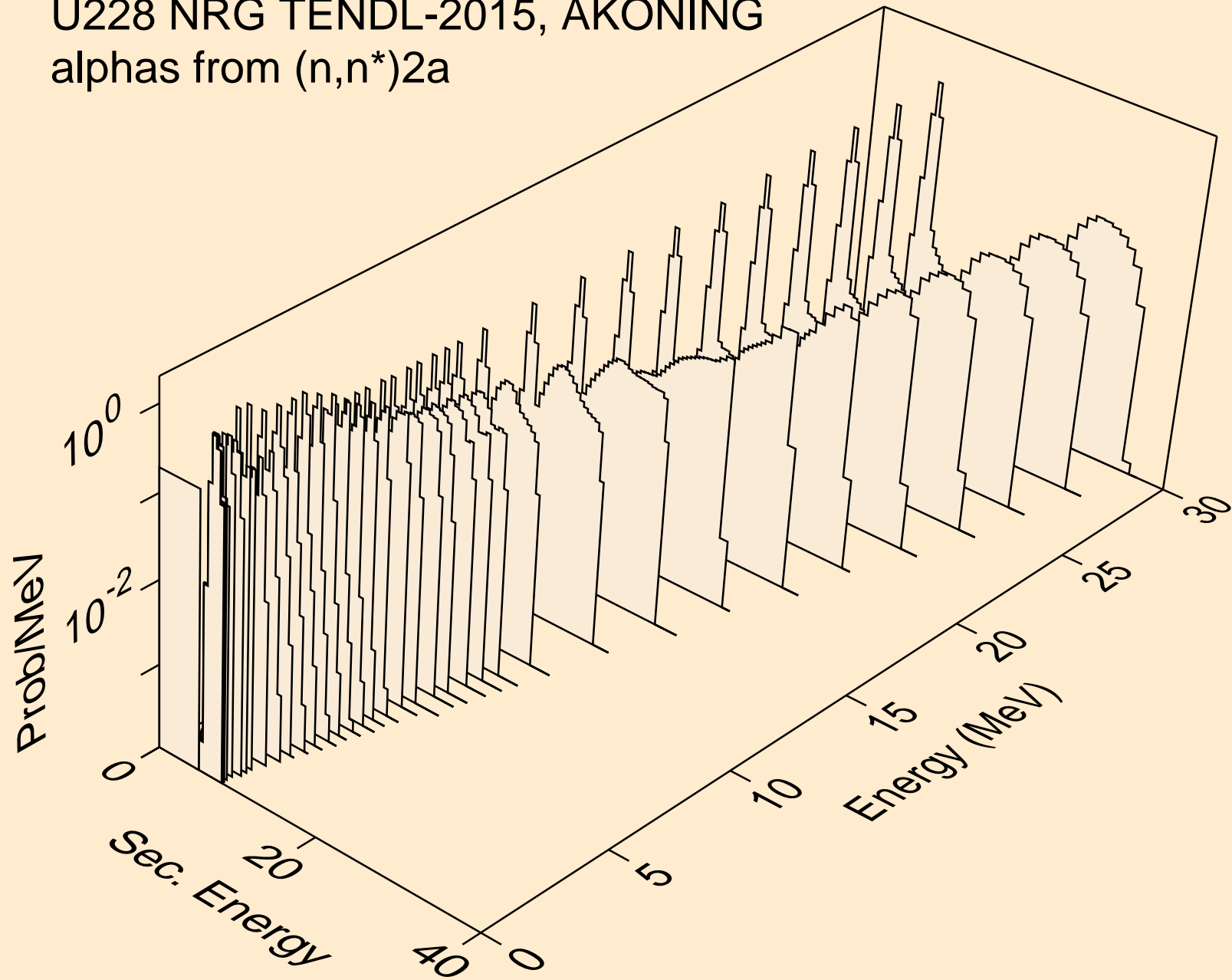

U228 NRG TENDL-2015, AKONING
alphas from (n,2n)2a

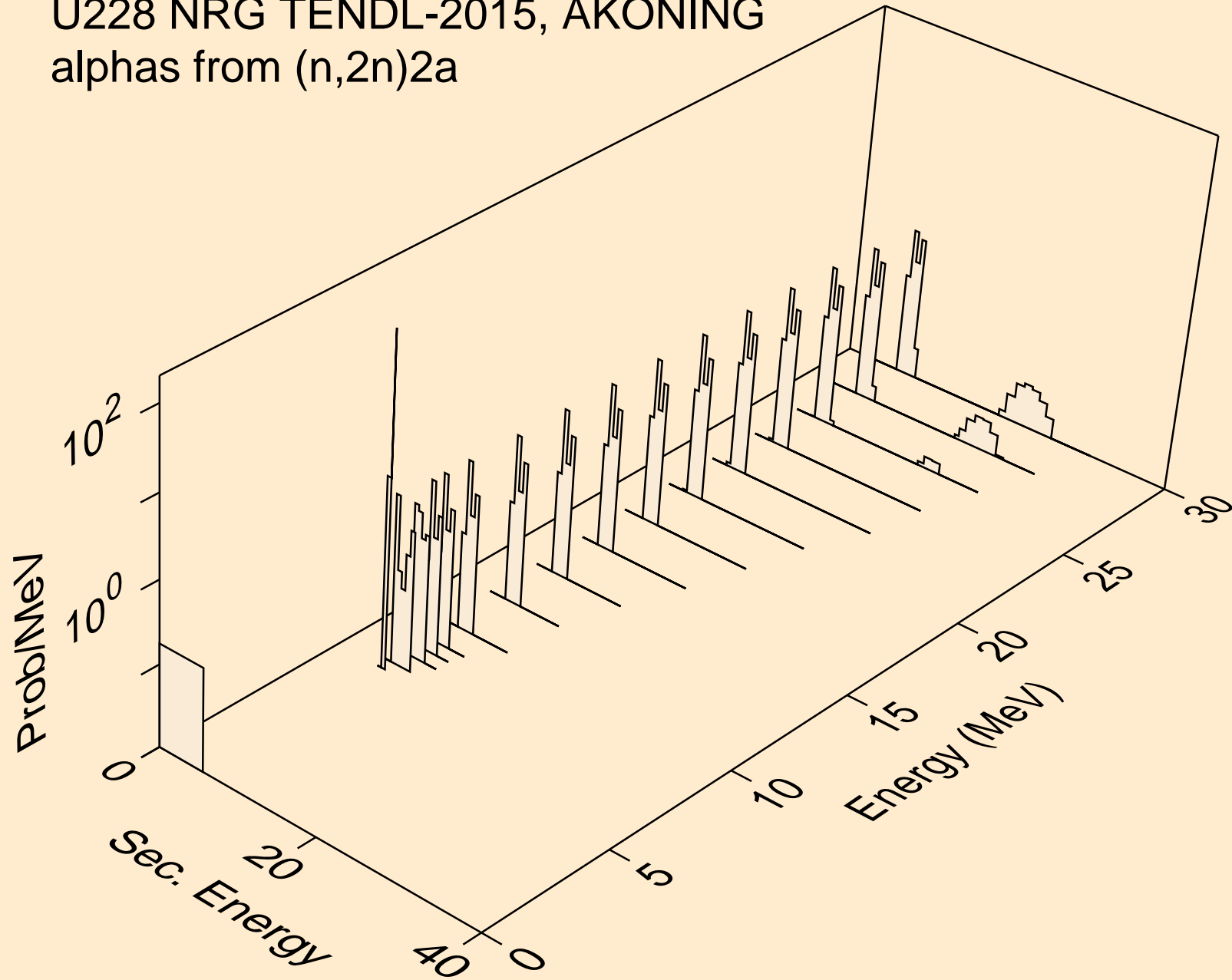

U228 NRG TENDL-2015, AKONING
alphas from (n,n*)d2a

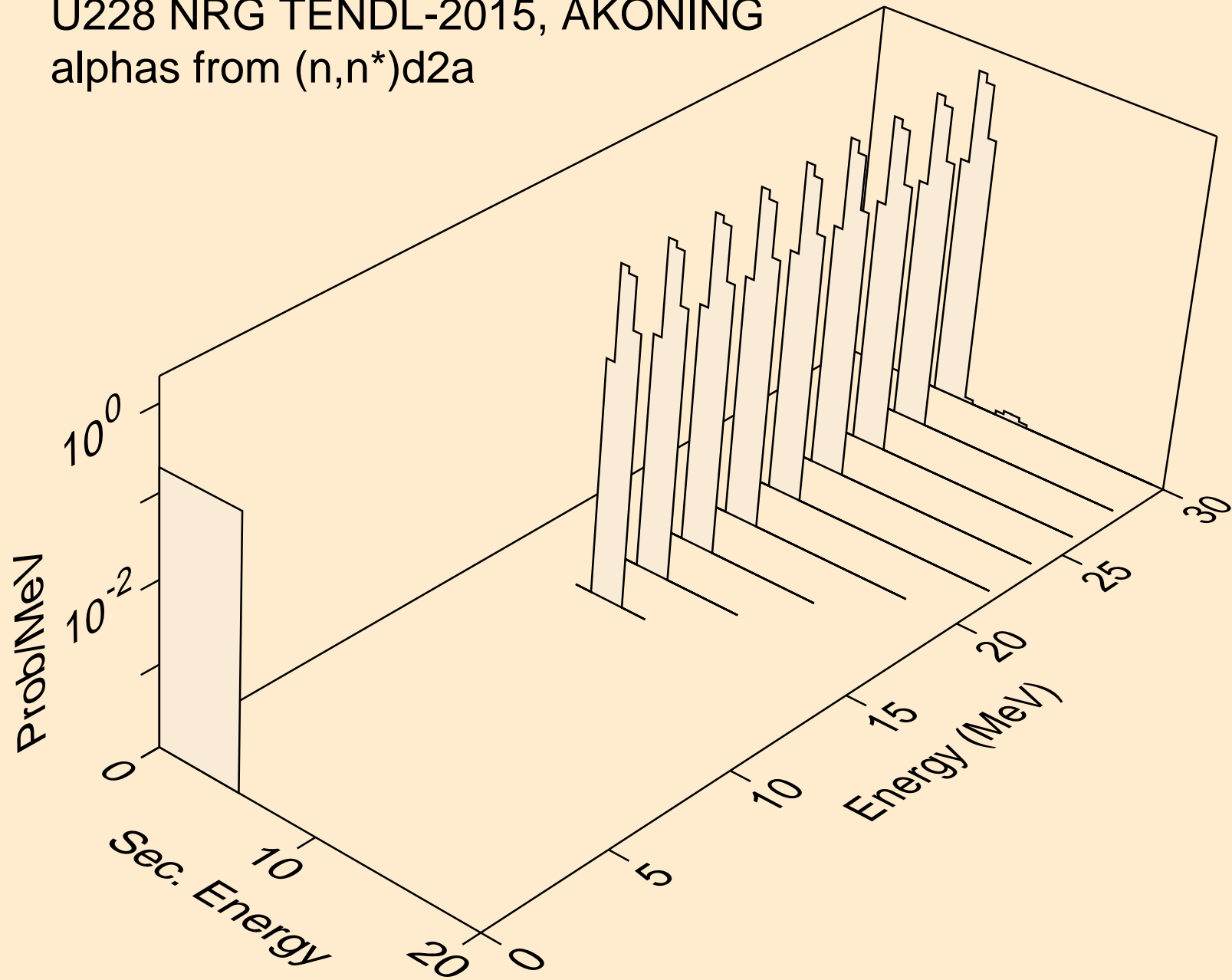

U228 NRG TENDL-2015, AKONING
alphas from (n,n*)t2a

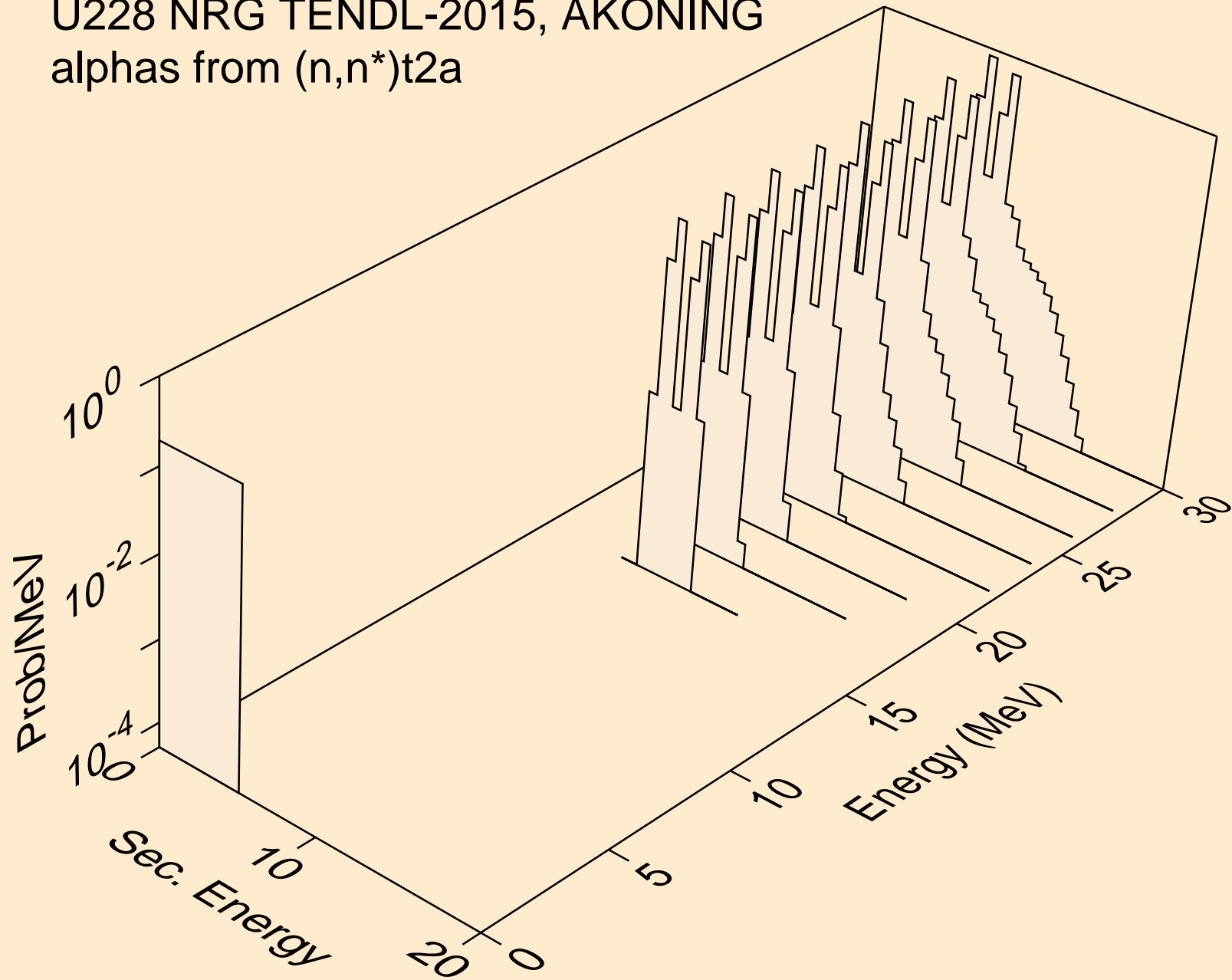

U228 NRG TENDL-2015, AKONING
alphas from (n,npa)

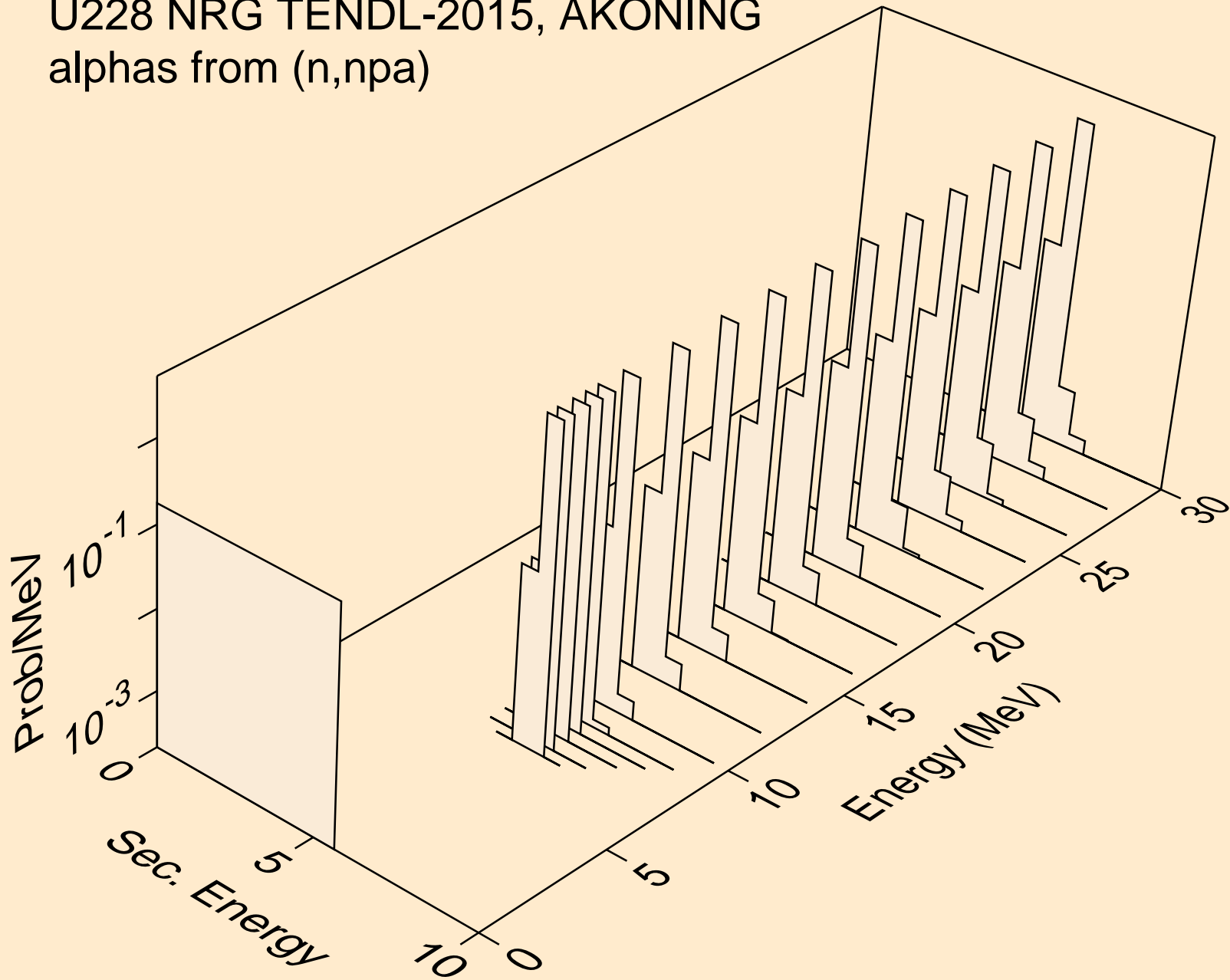

U228 NRG TENDL-2015, AKONING
alphas from (n,a)

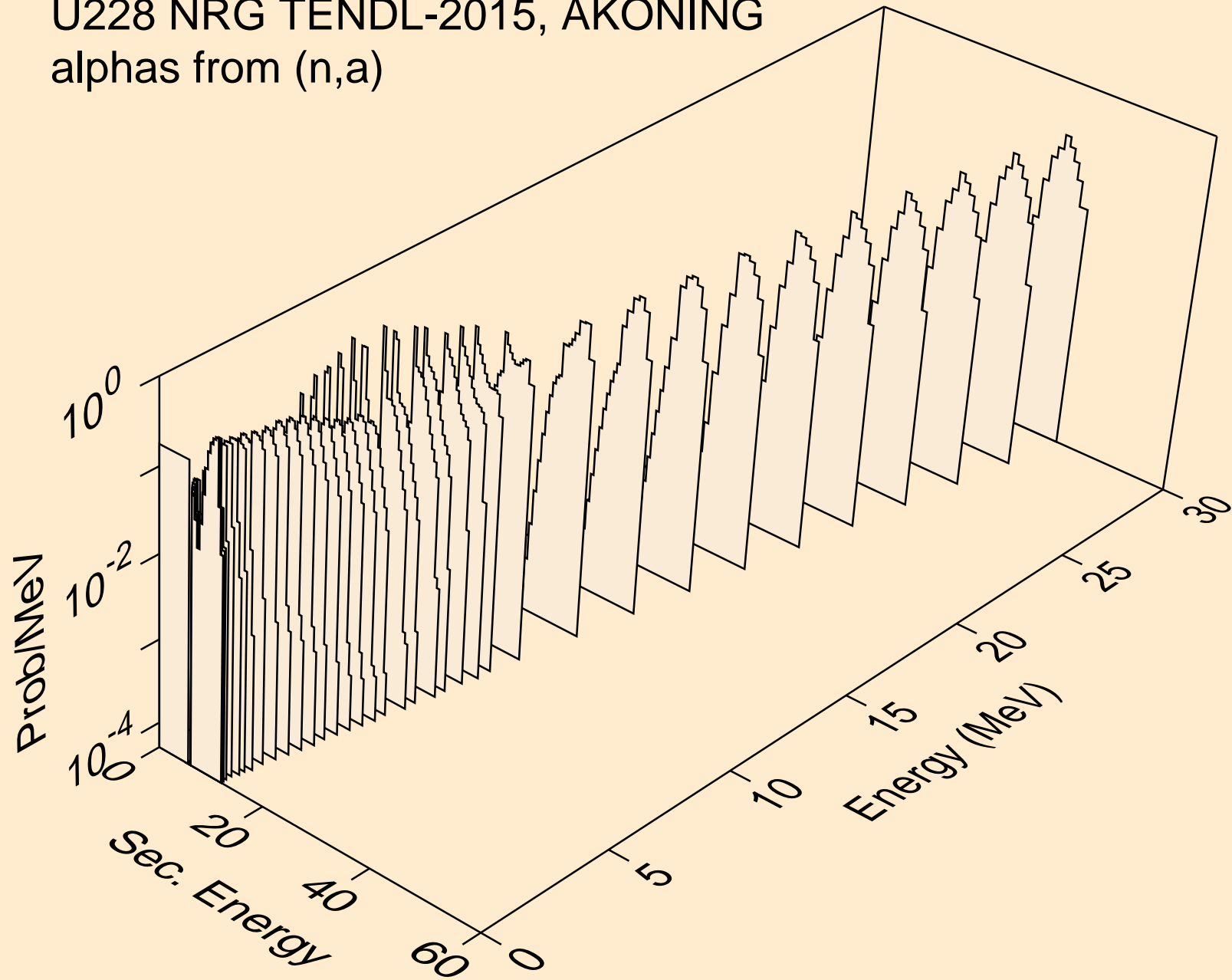

U228 NRG TENDL-2015, AKONING
alphas from (n,2a)

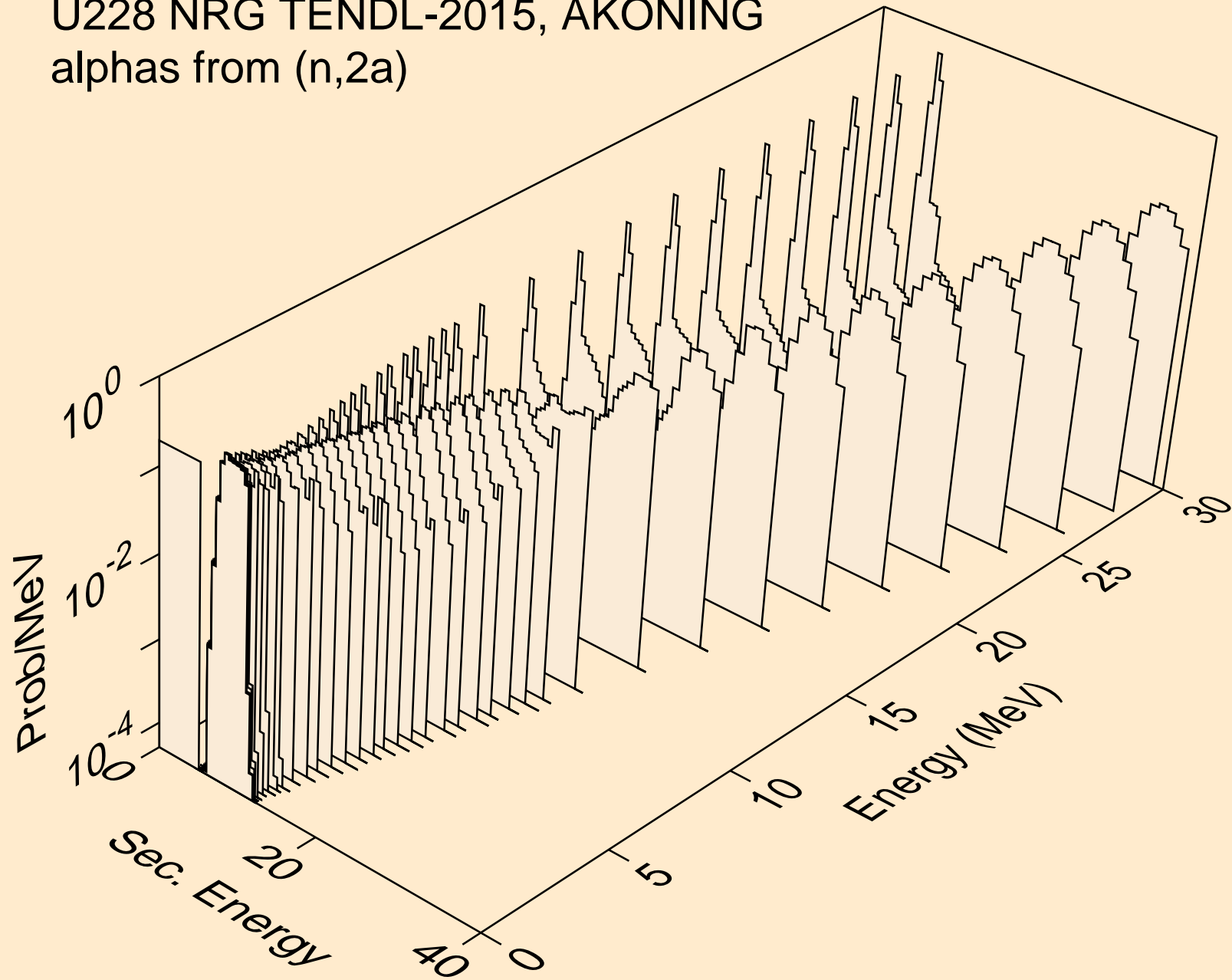

U228 NRG TENDL-2015, AKONING
alphas from (n,3a)

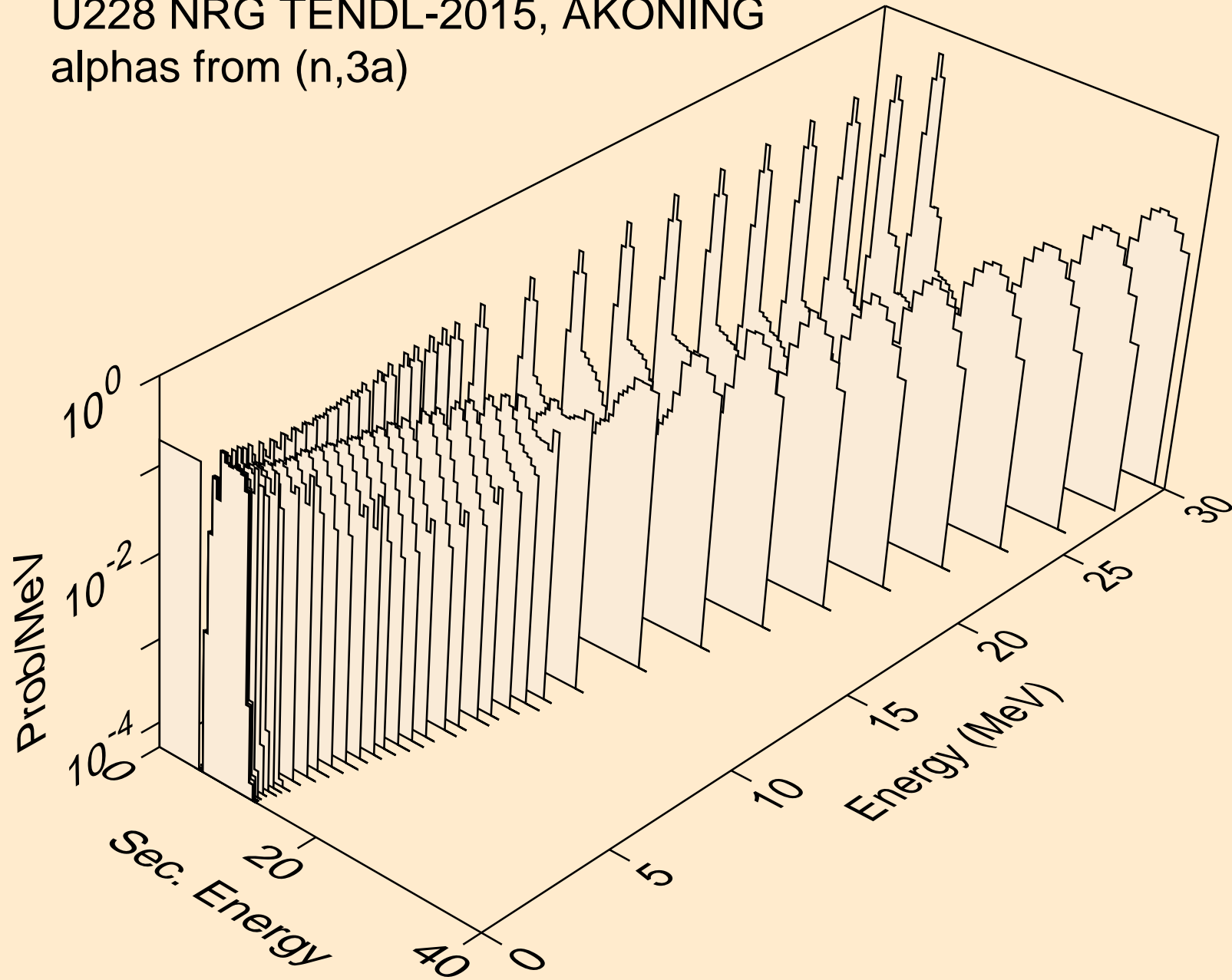

U228 NRG TENDL-2015, AKONING
alphas from (n,pa)

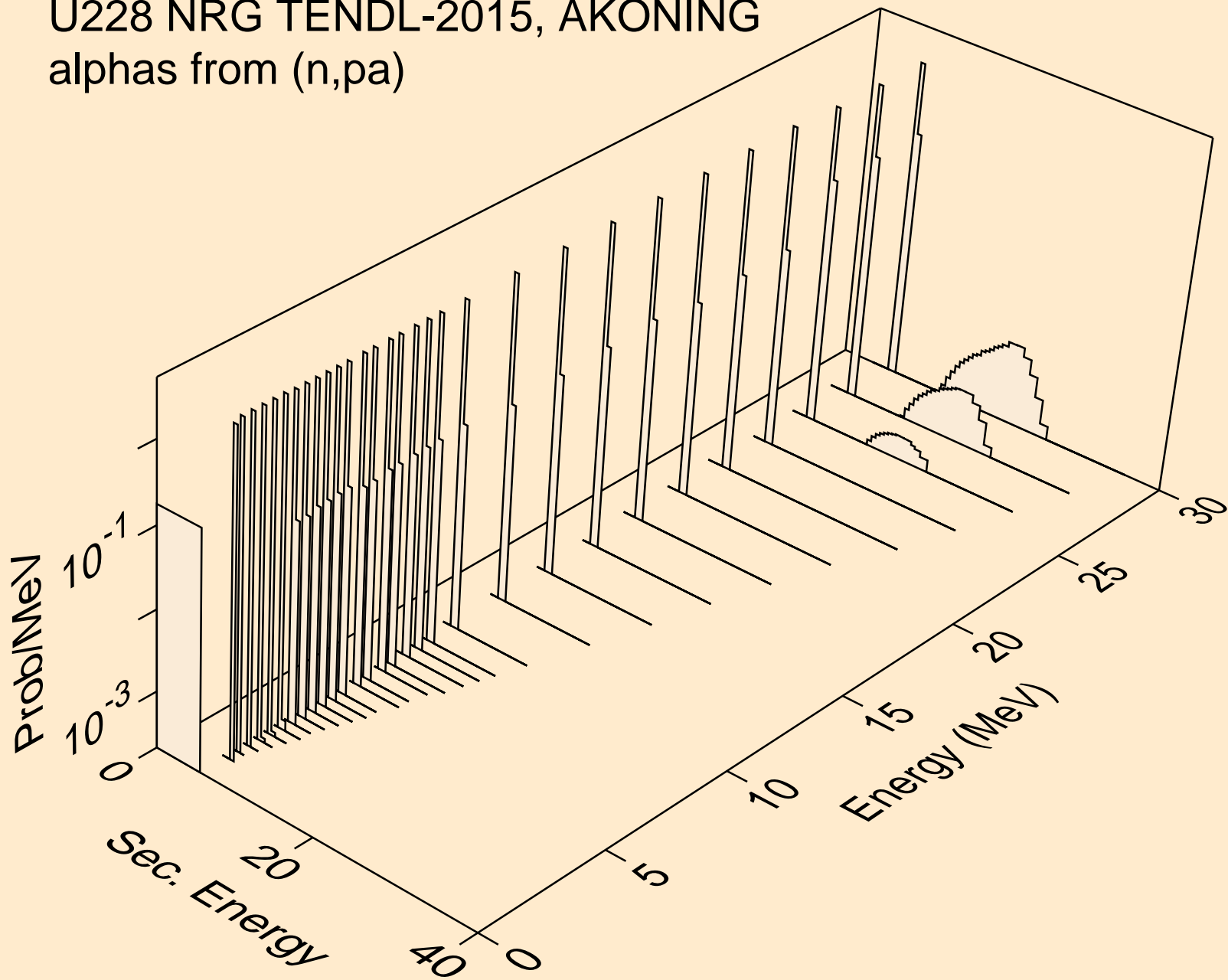

U228 NRG TENDL-2015, AKONING
alphas from (n,t2a)

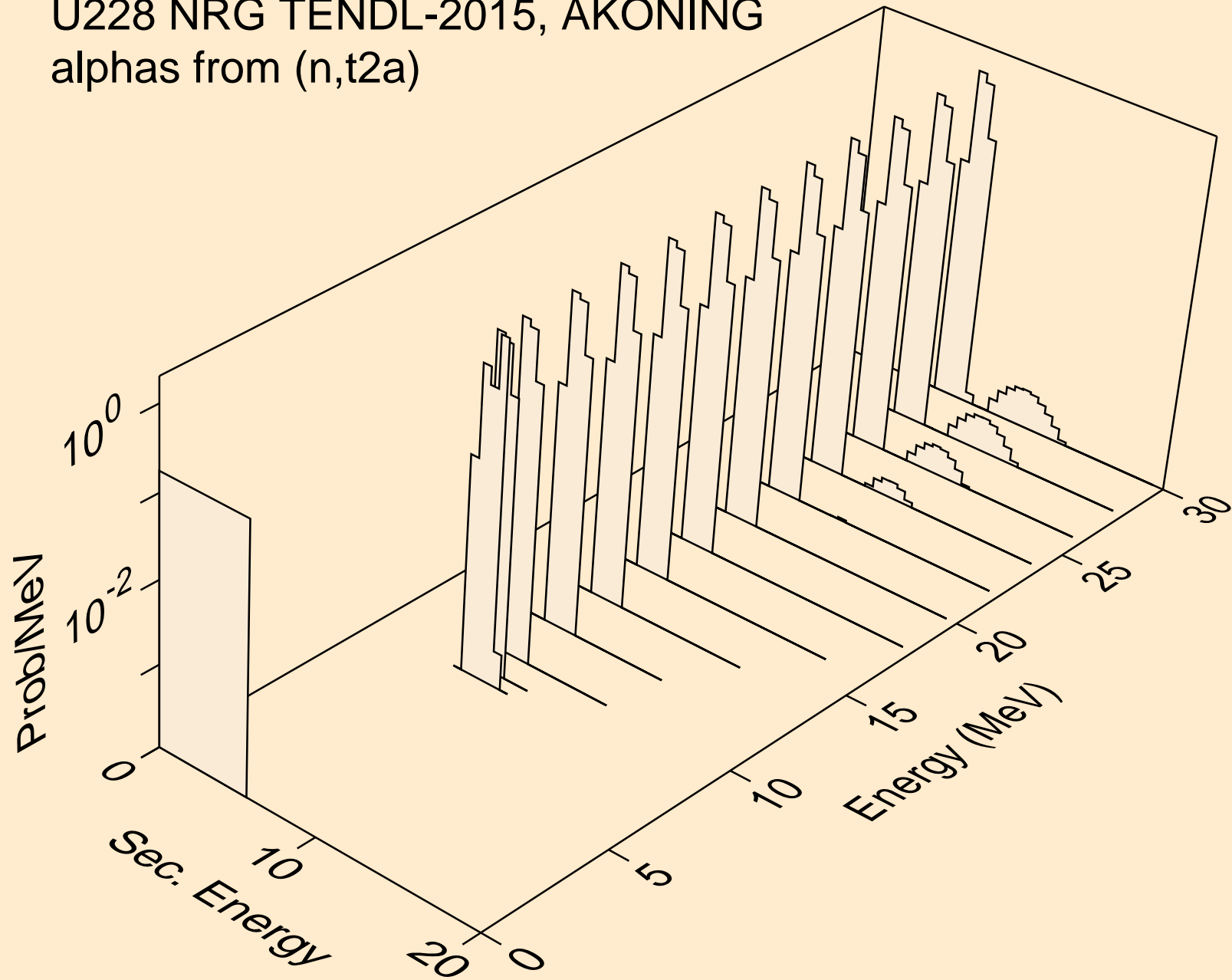

U228 NRG TENDL-2015, AKONING
alphas from (n,d2a)

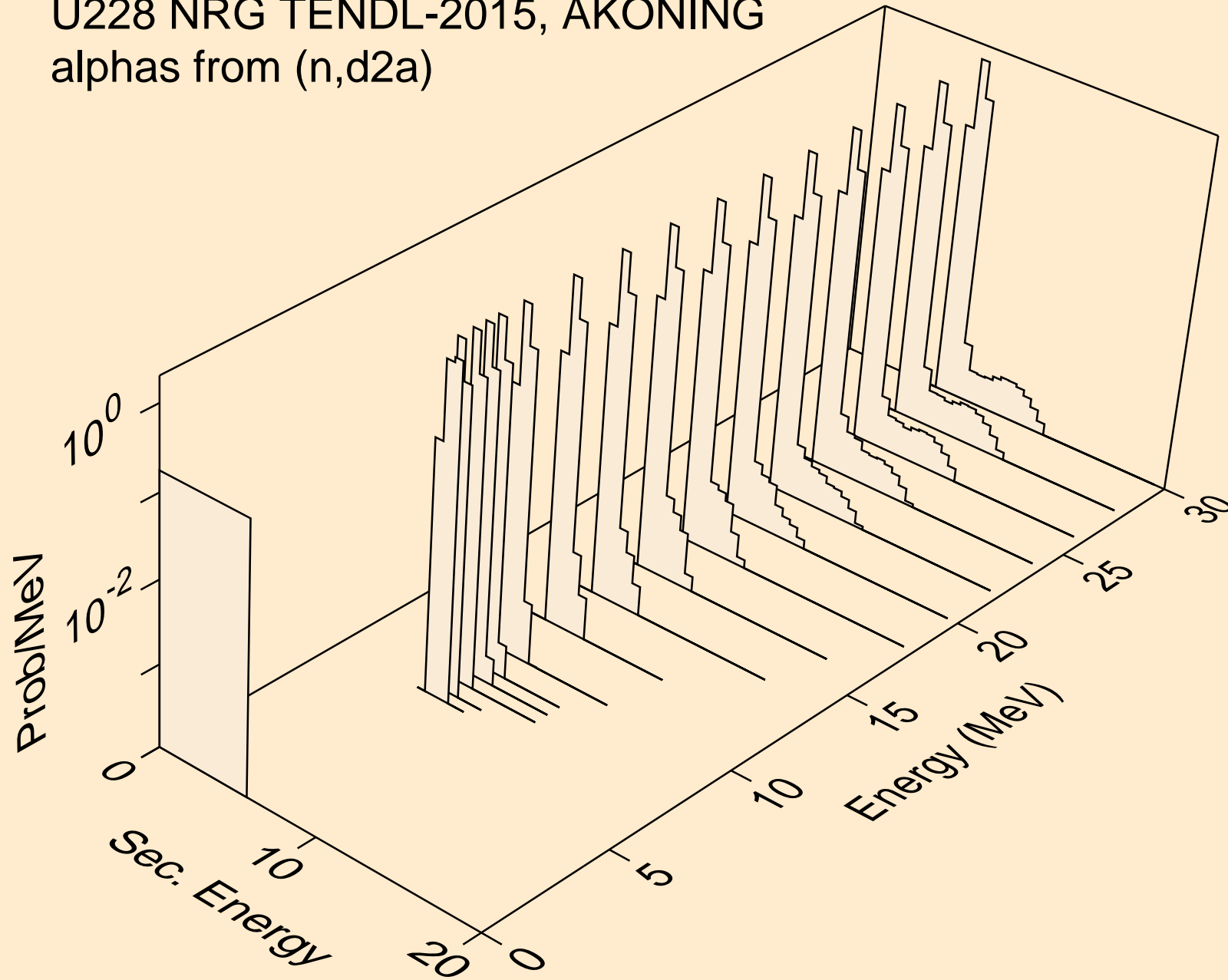

U228 NRG TENDL-2015, AKONING
alphas from (n,da)

