

# U239 NRG TENDL-2015, AKONING

## Principal cross sections

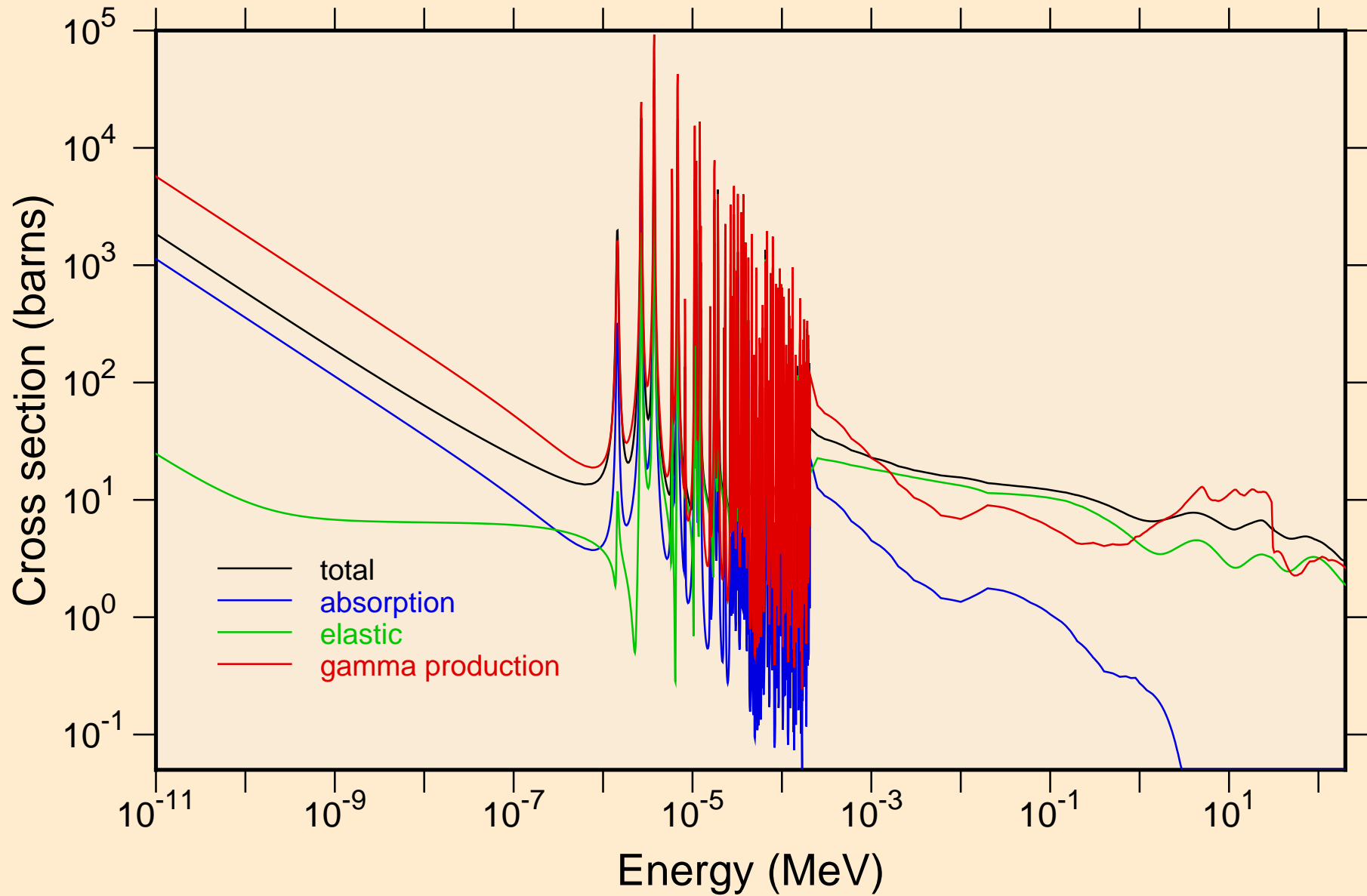

U239 NRG TENDL-2015, AKONING  
resonance total cross section

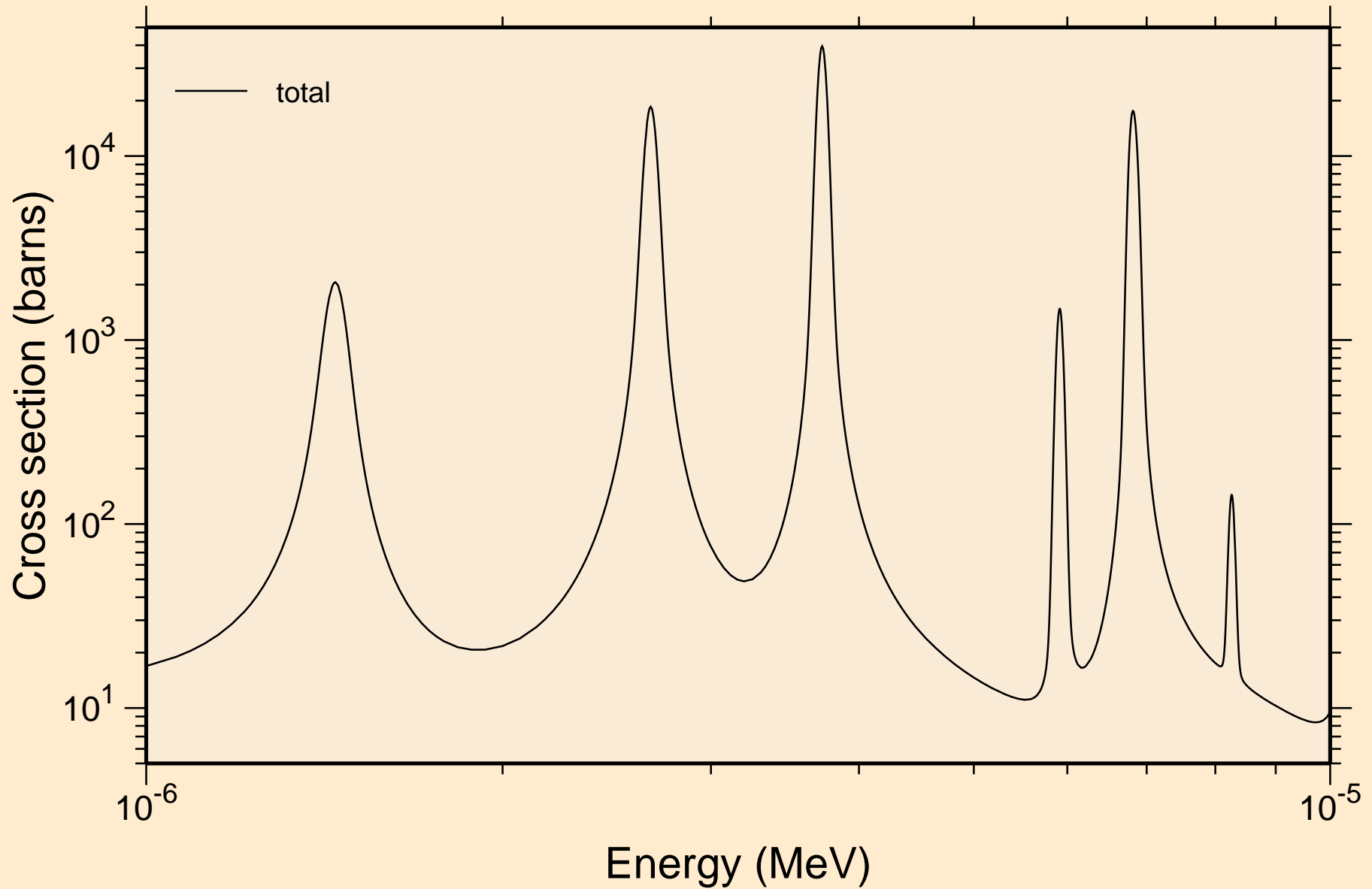

U239 NRG TENDL-2015, AKONING  
resonance total cross section

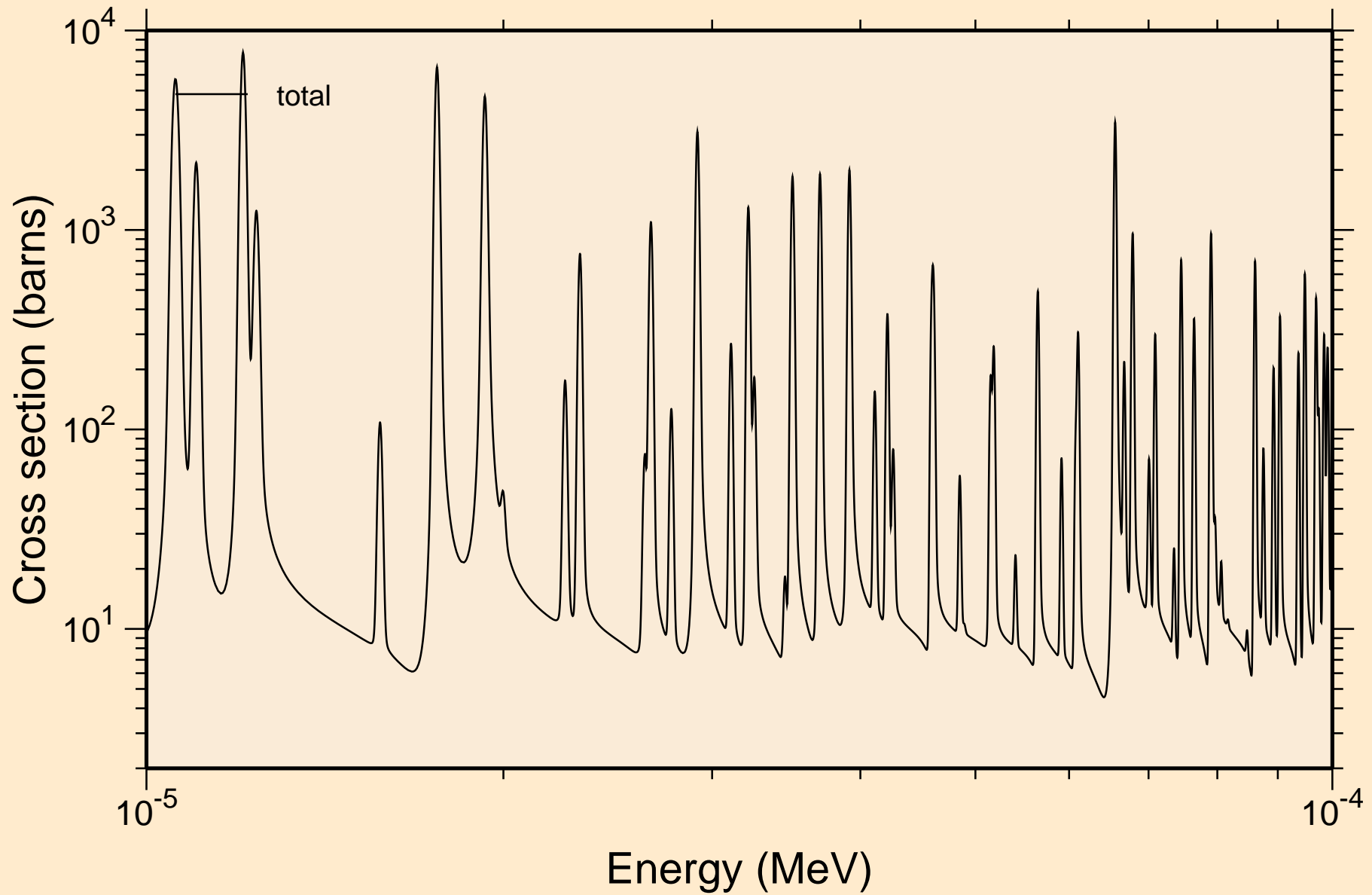

U239 NRG TENDL-2015, AKONING  
resonance total cross section

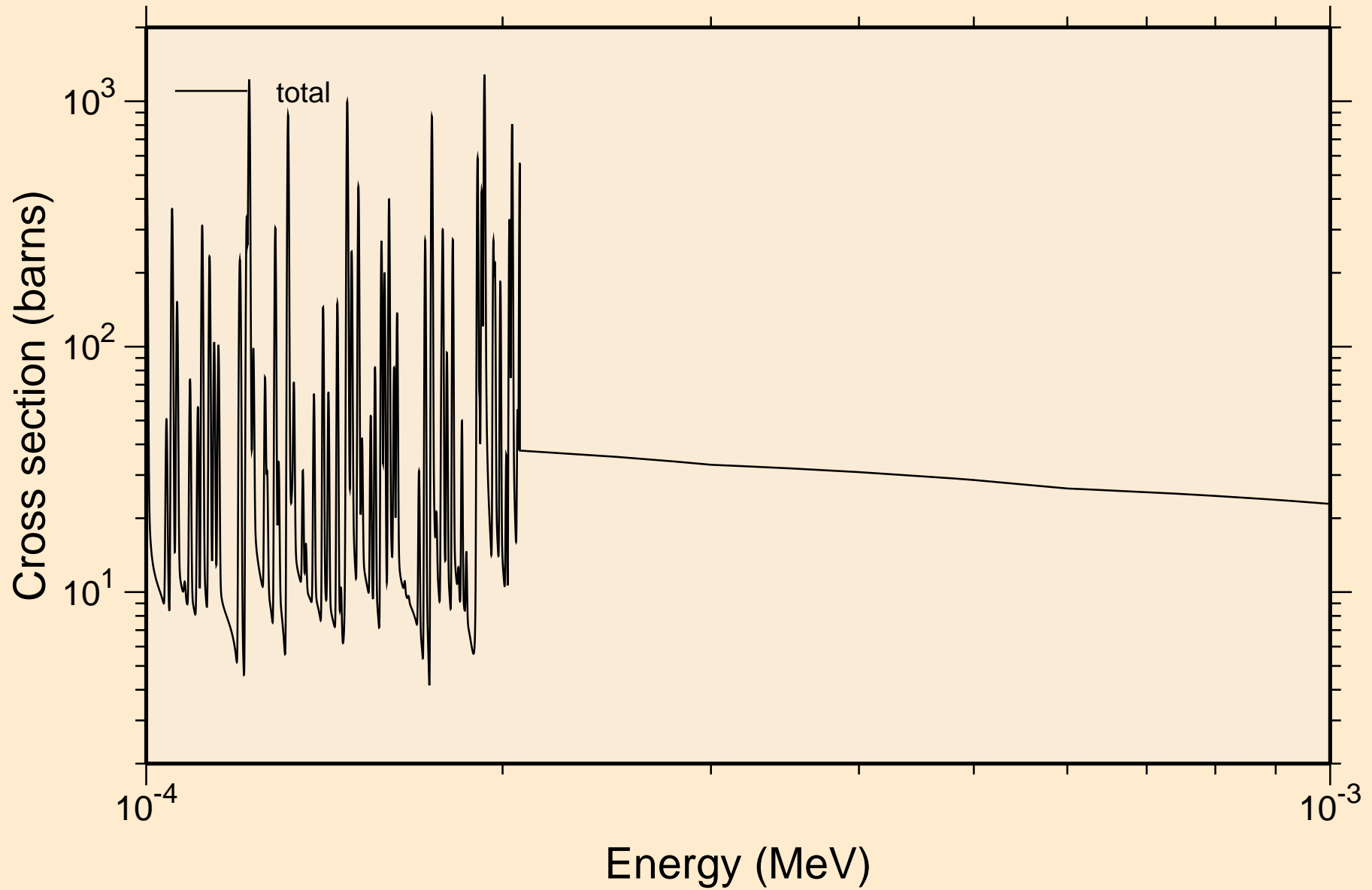

U239 NRG TENDL-2015, AKONING  
resonance total cross section

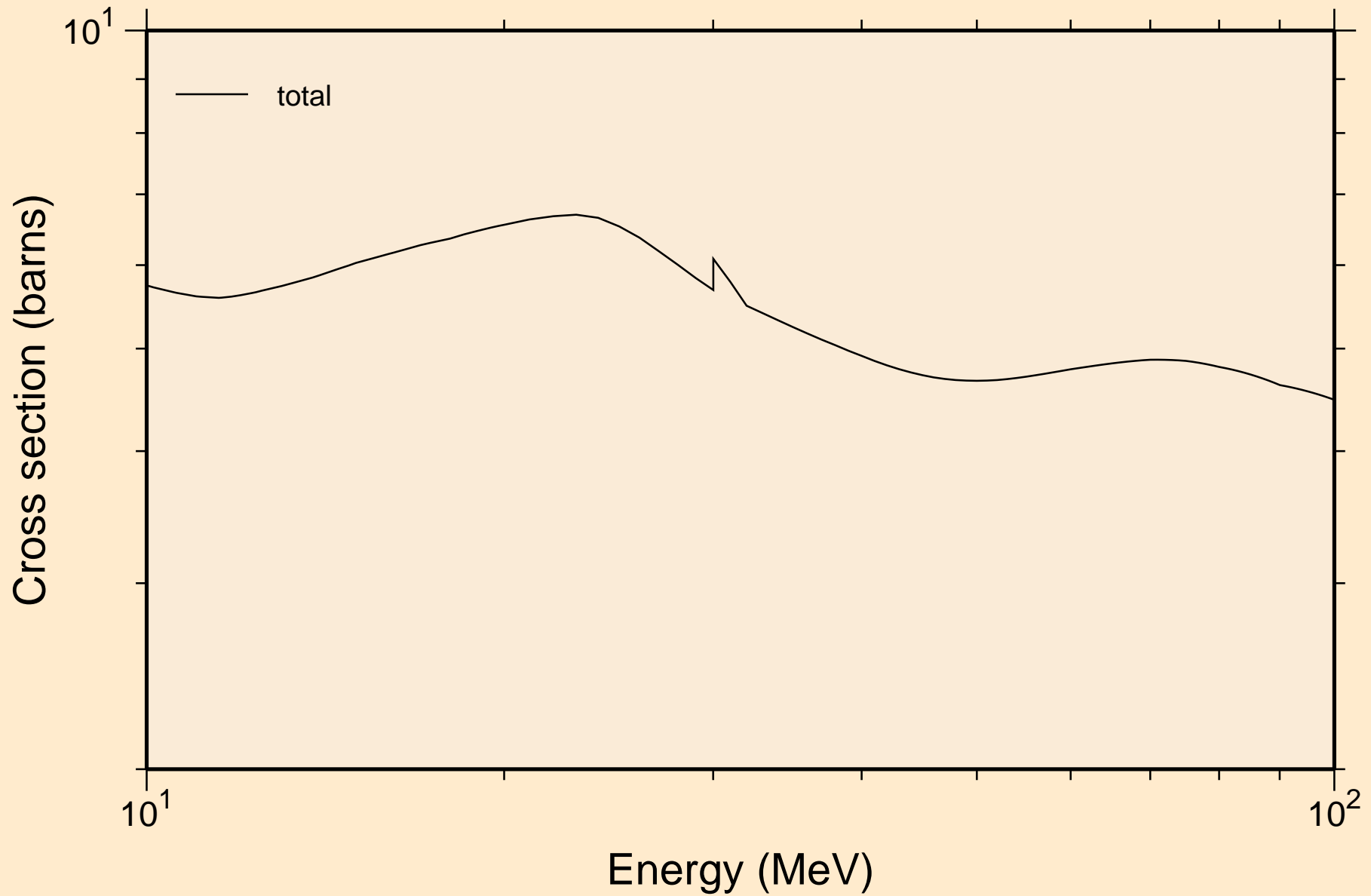

# U239 NRG TENDL-2015, AKONING resonance absorption cross sections

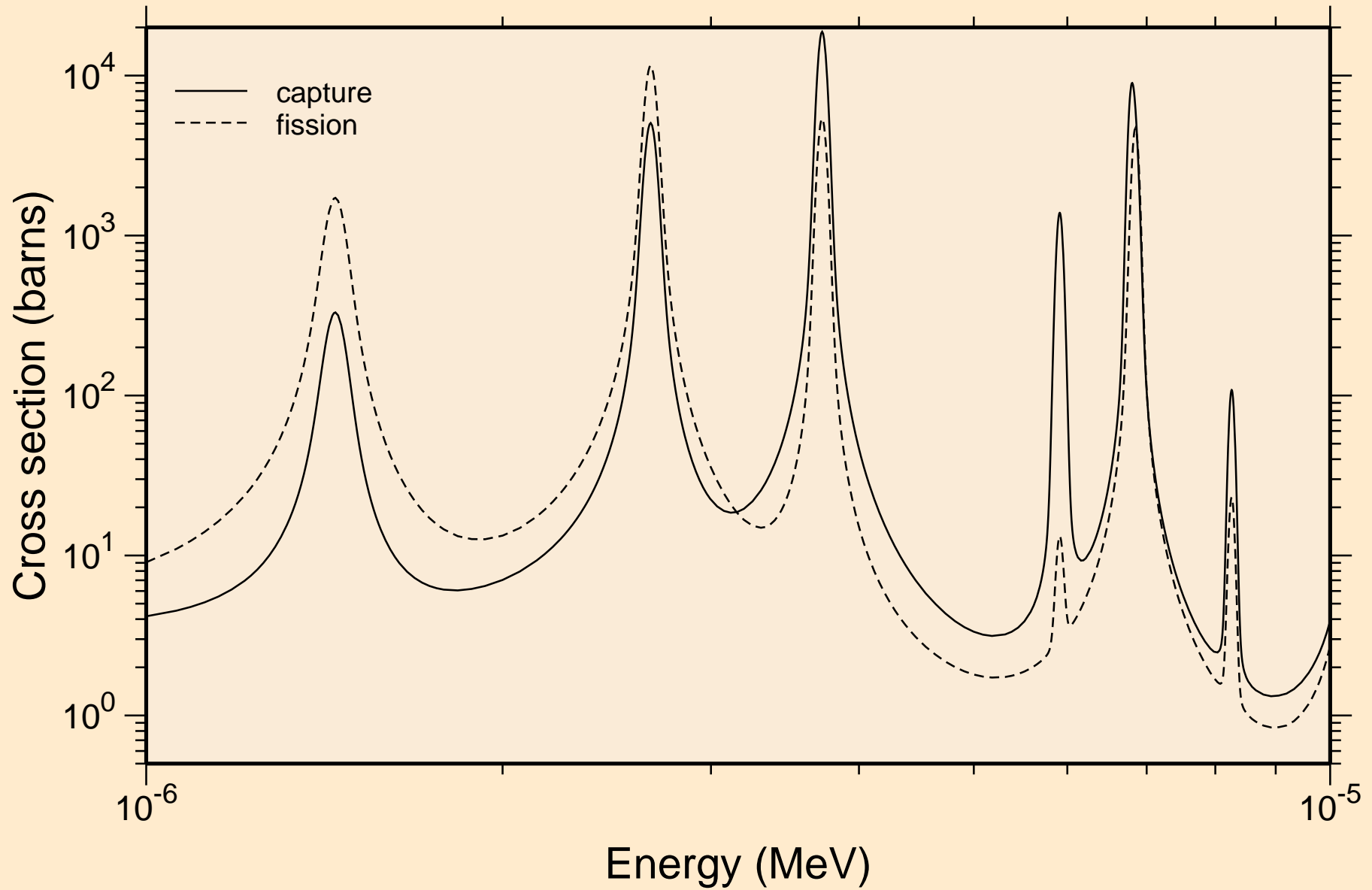

U239 NRG TENDL-2015, AKONING  
resonance absorption cross sections

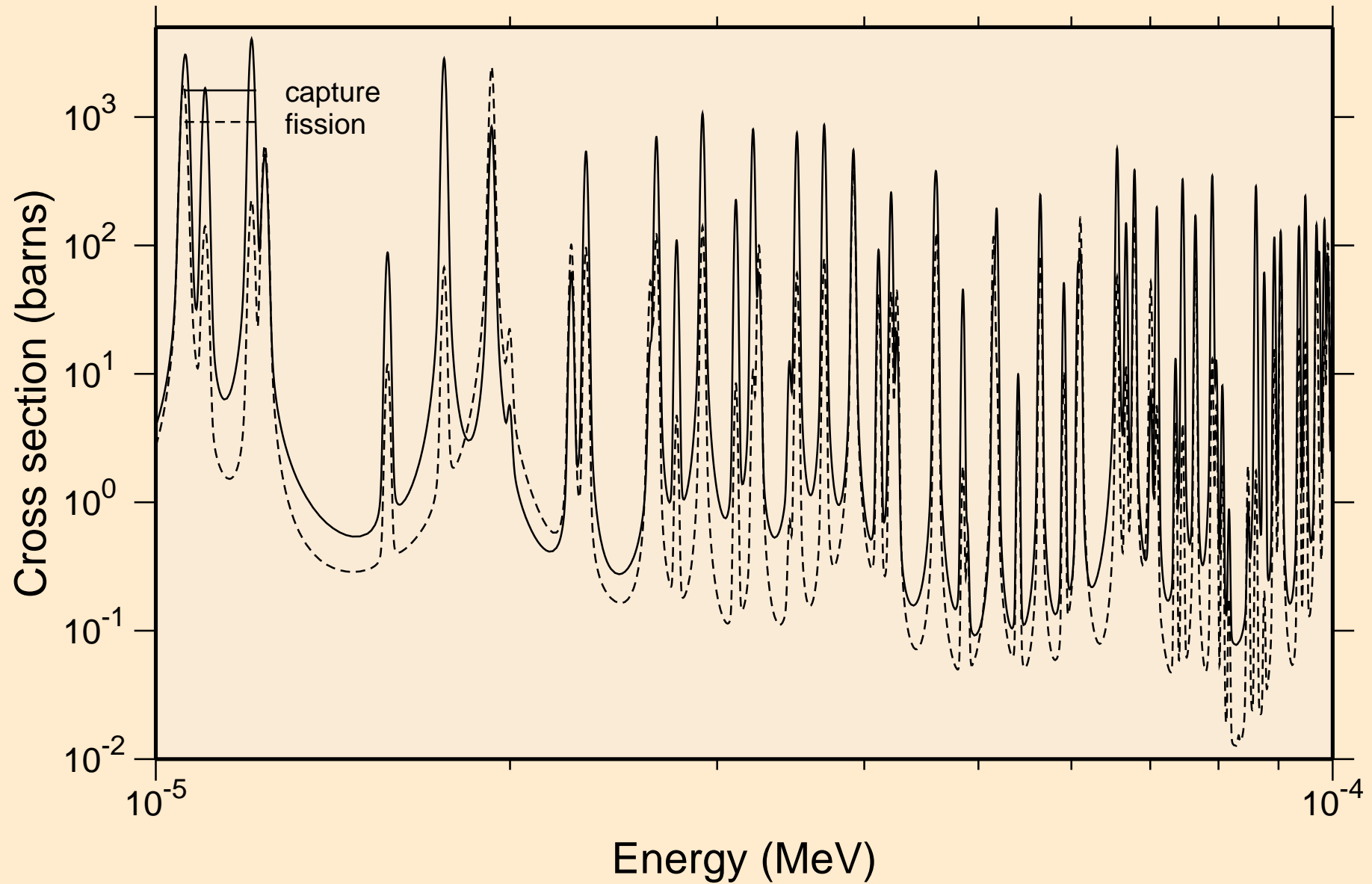

U239 NRG TENDL-2015, AKONING  
resonance absorption cross sections

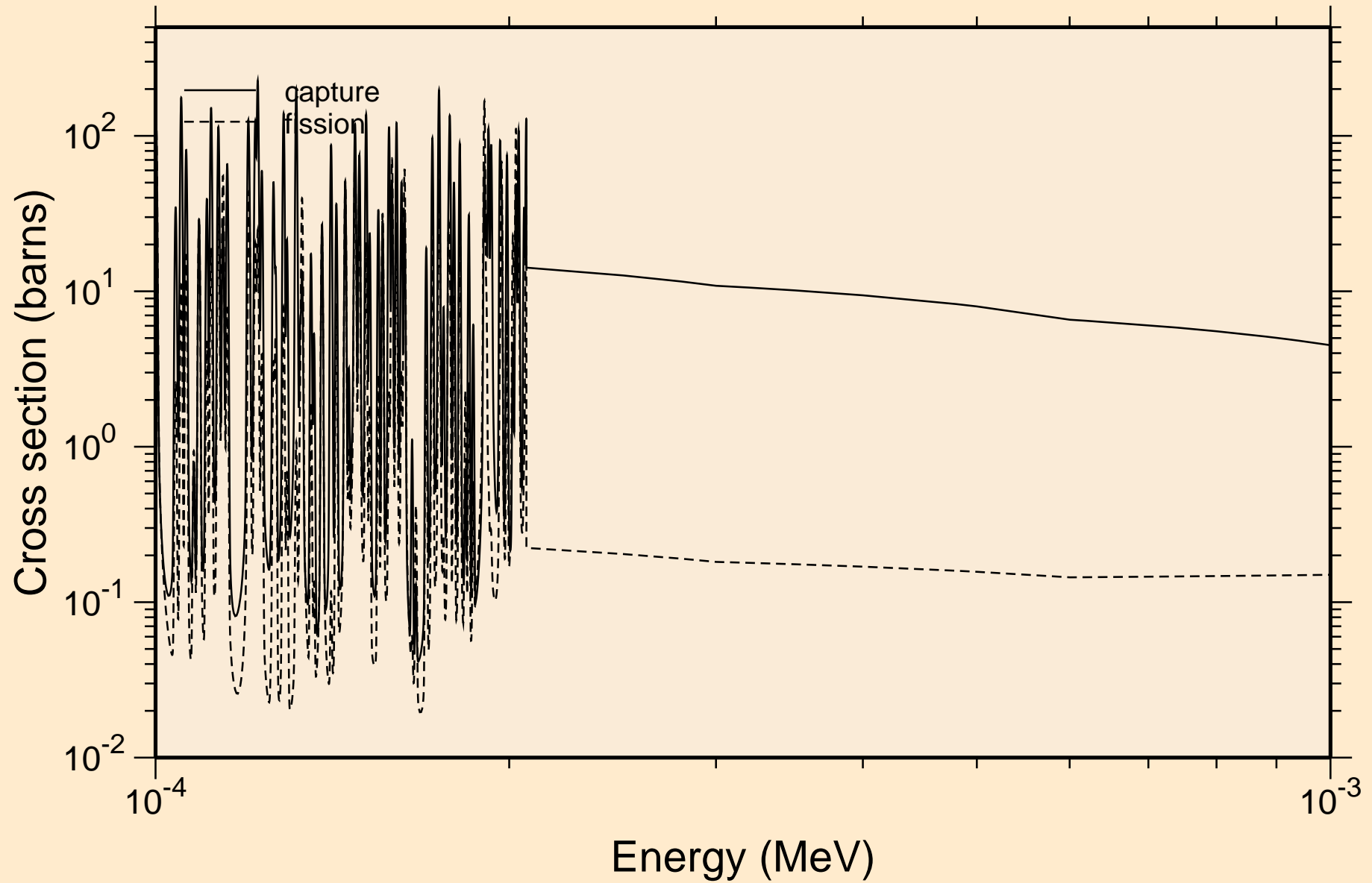



# U239 NRG TENDL-2015, AKONING resonance absorption cross sections

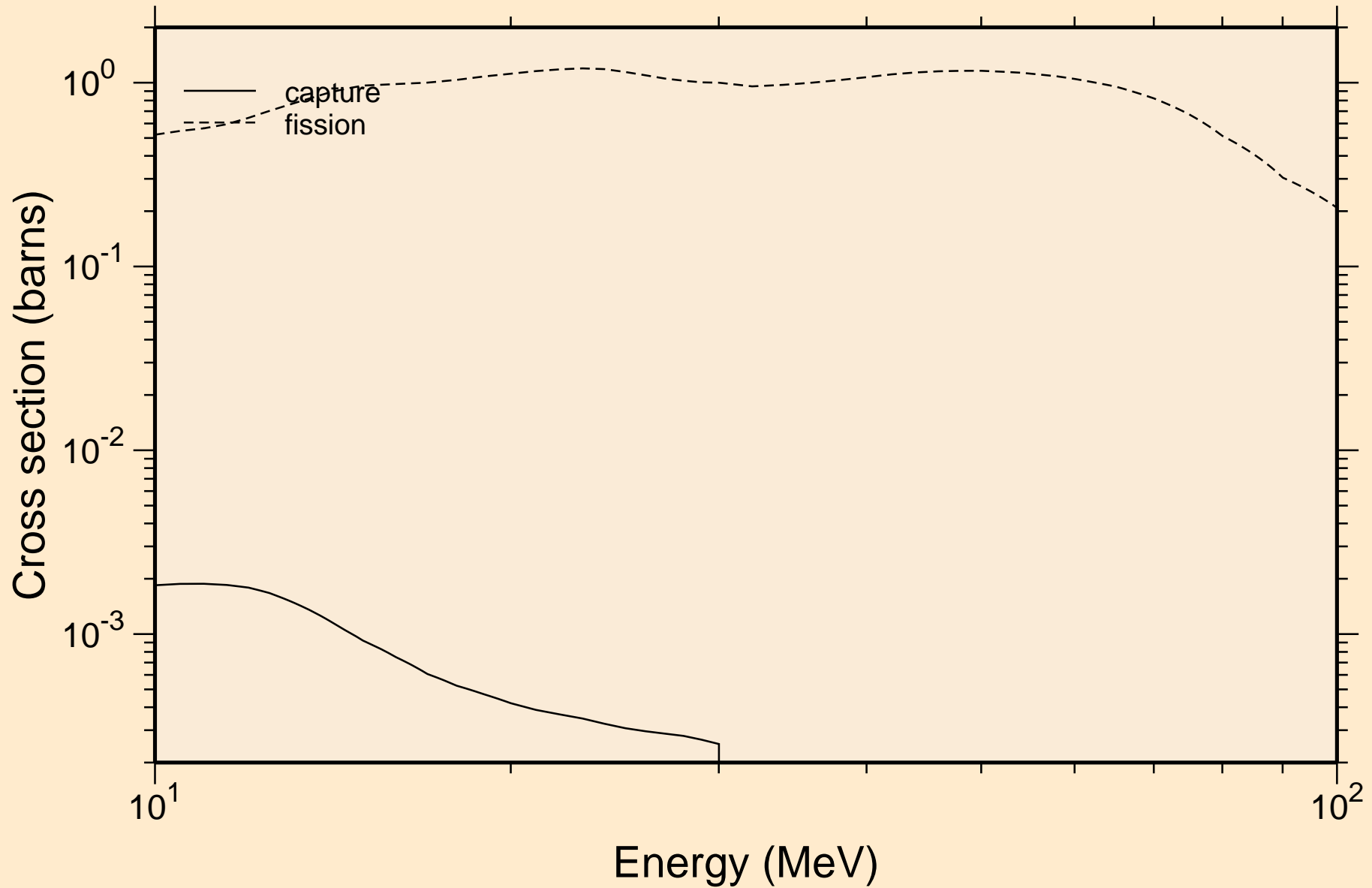

# U239 NRG TENDL-2015, AKONING

## Non-threshold reactions

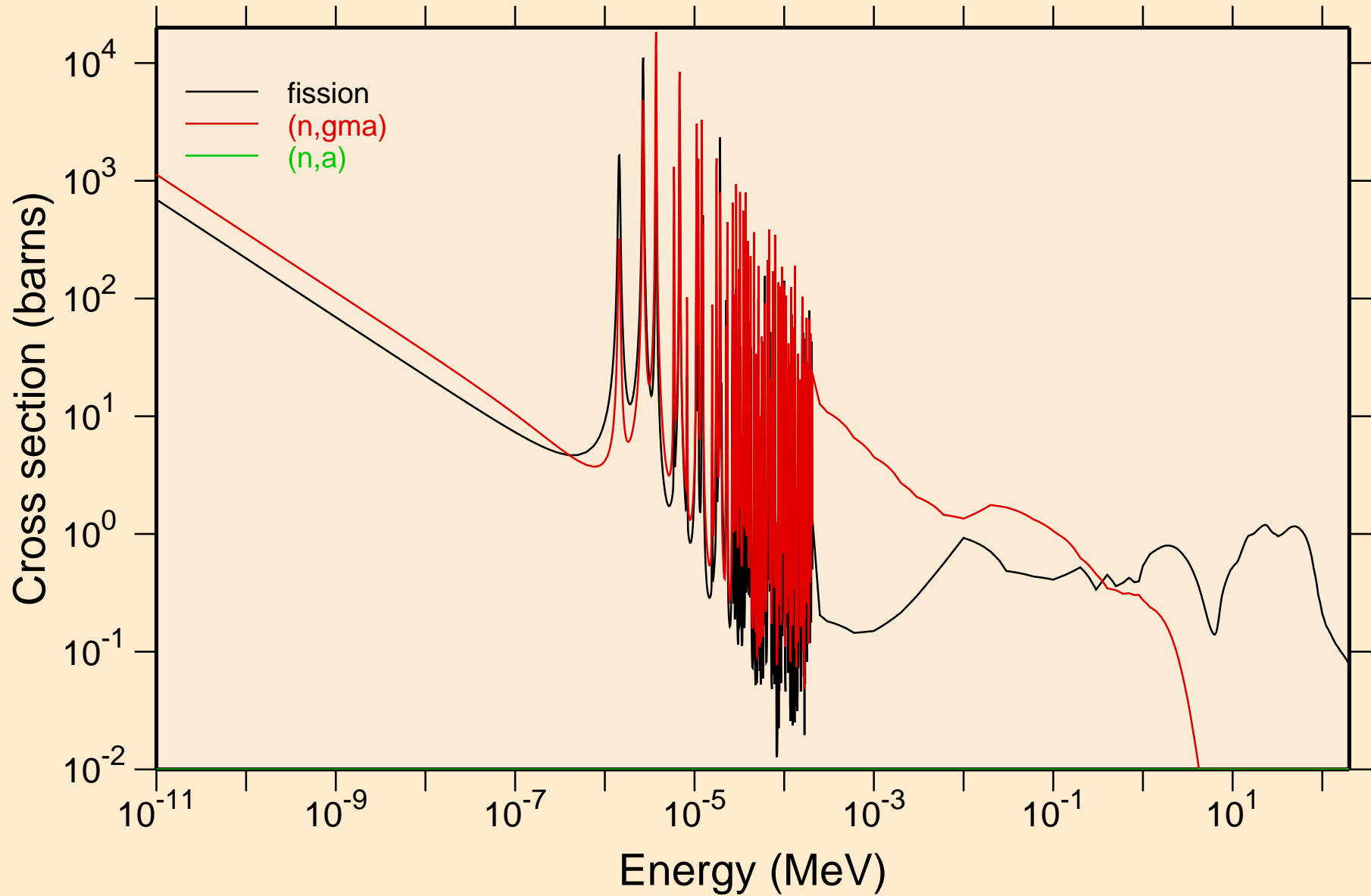

# U239 NRG TENDL-2015, AKONING

## Principal cross sections

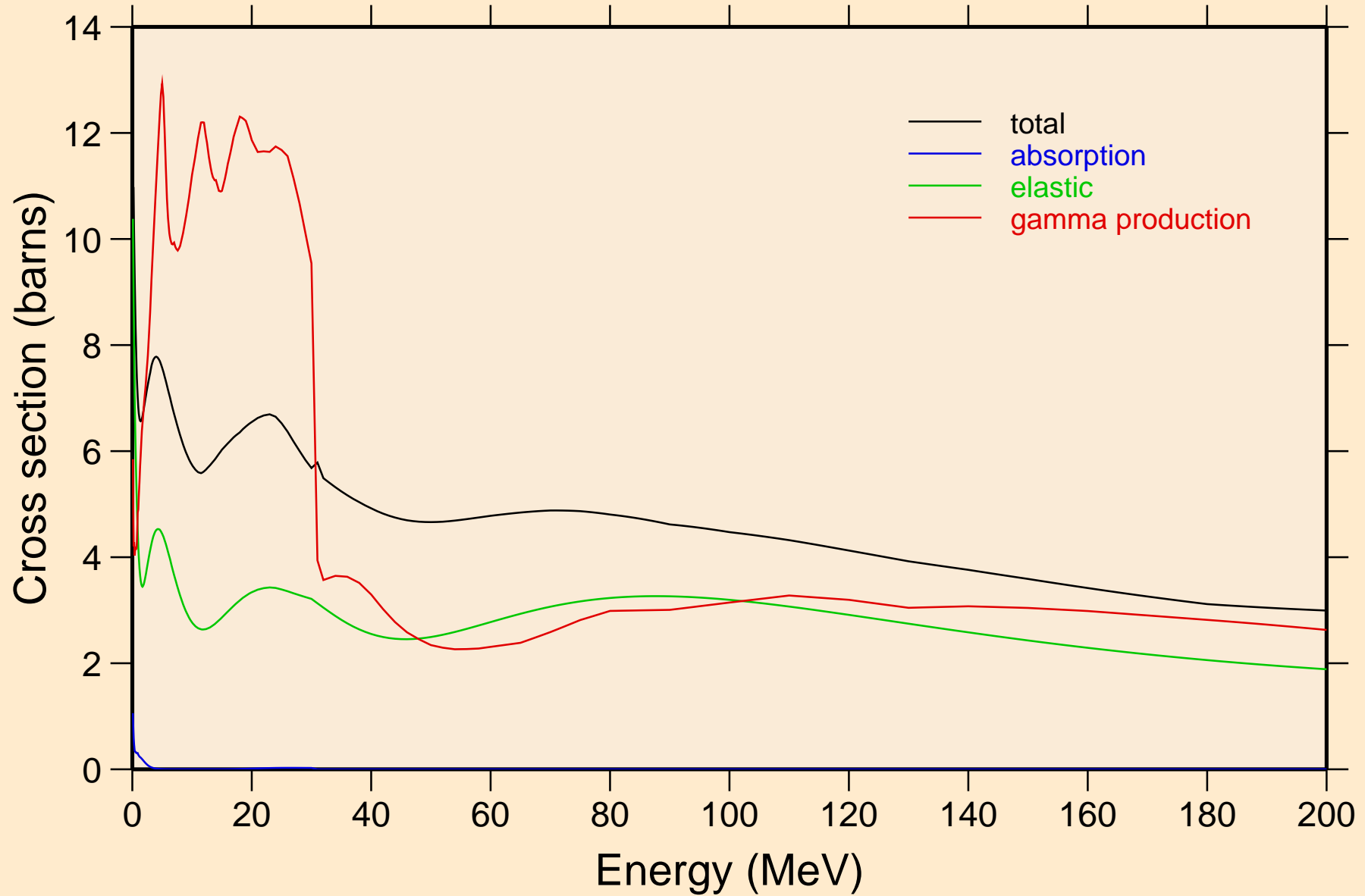

# U239 NRG TENDL-2015, AKONING

## Non-threshold reactions

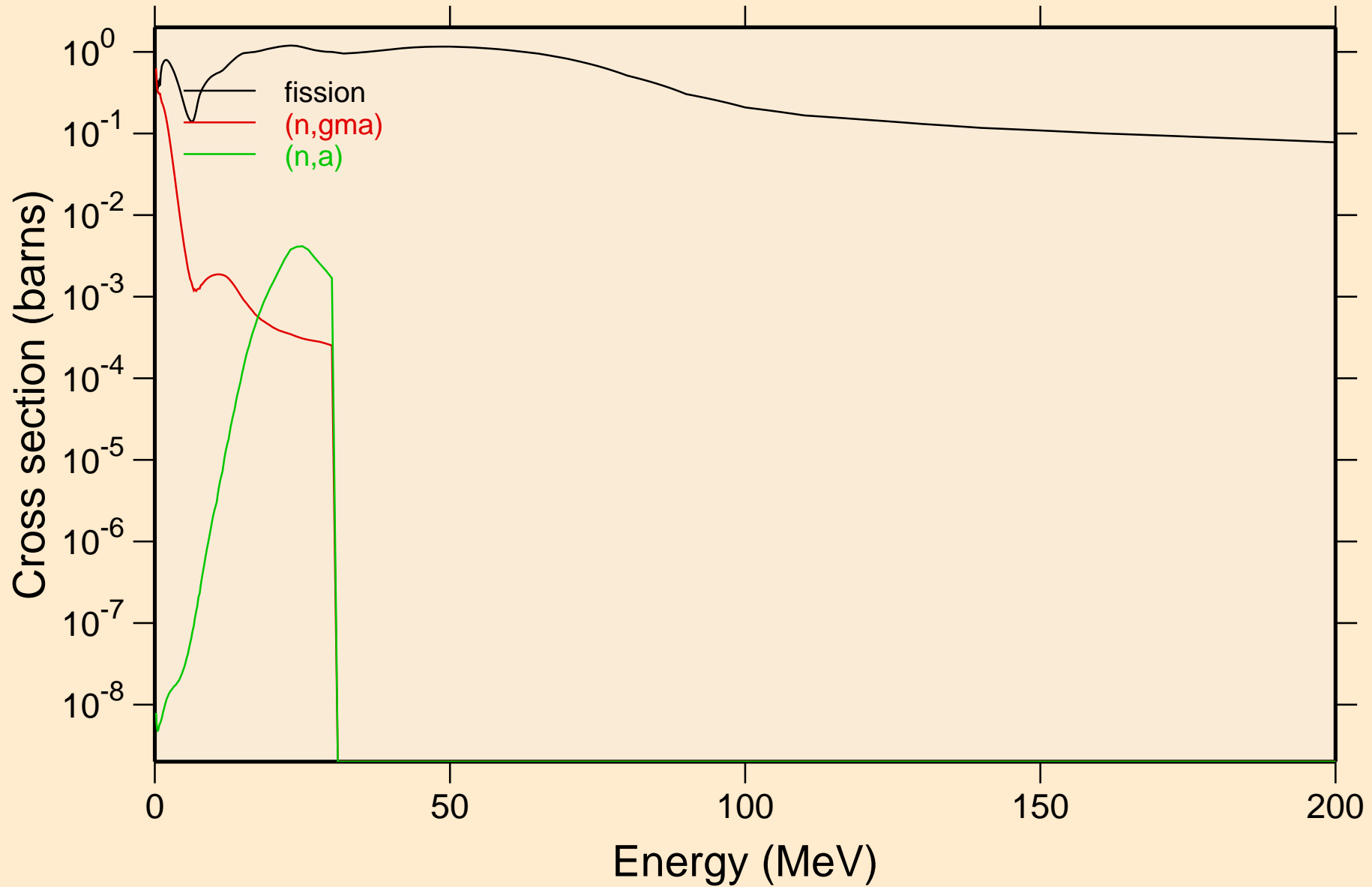

# U239 NRG TENDL-2015, AKONING

## Inelastic levels

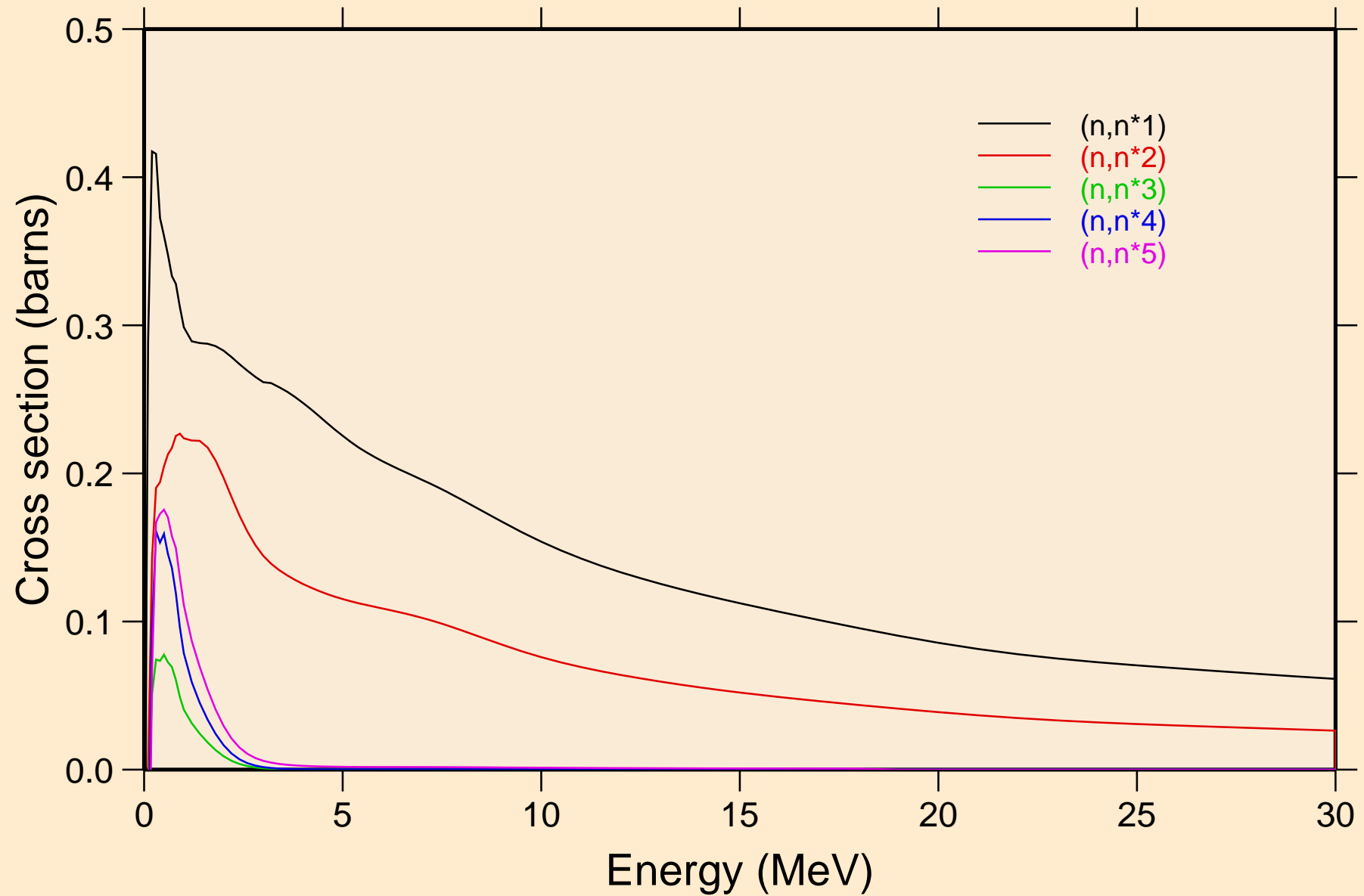

# U239 NRG TENDL-2015, AKONING

## Inelastic levels

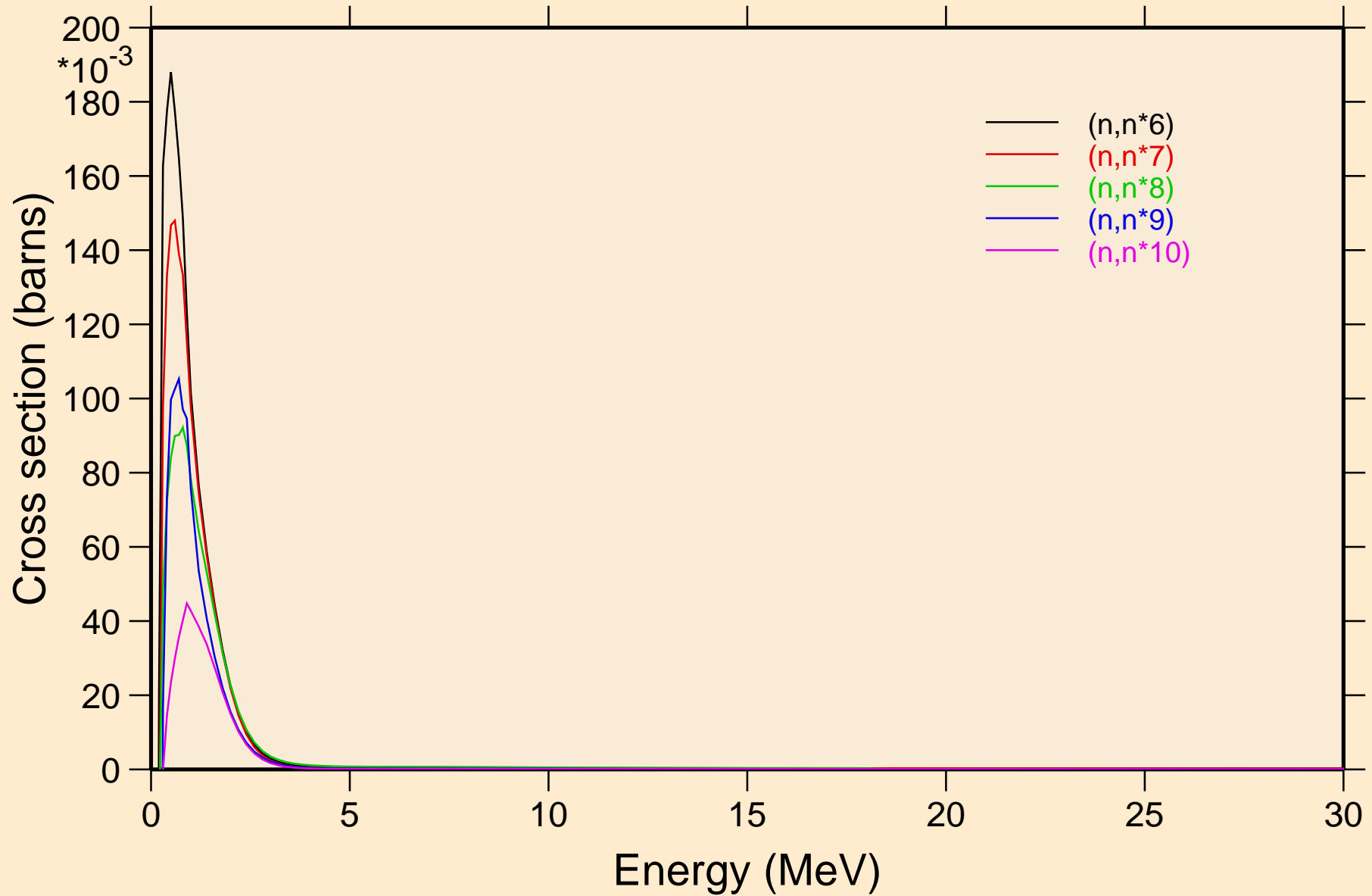

# U239 NRG TENDL-2015, AKONING

## Inelastic levels

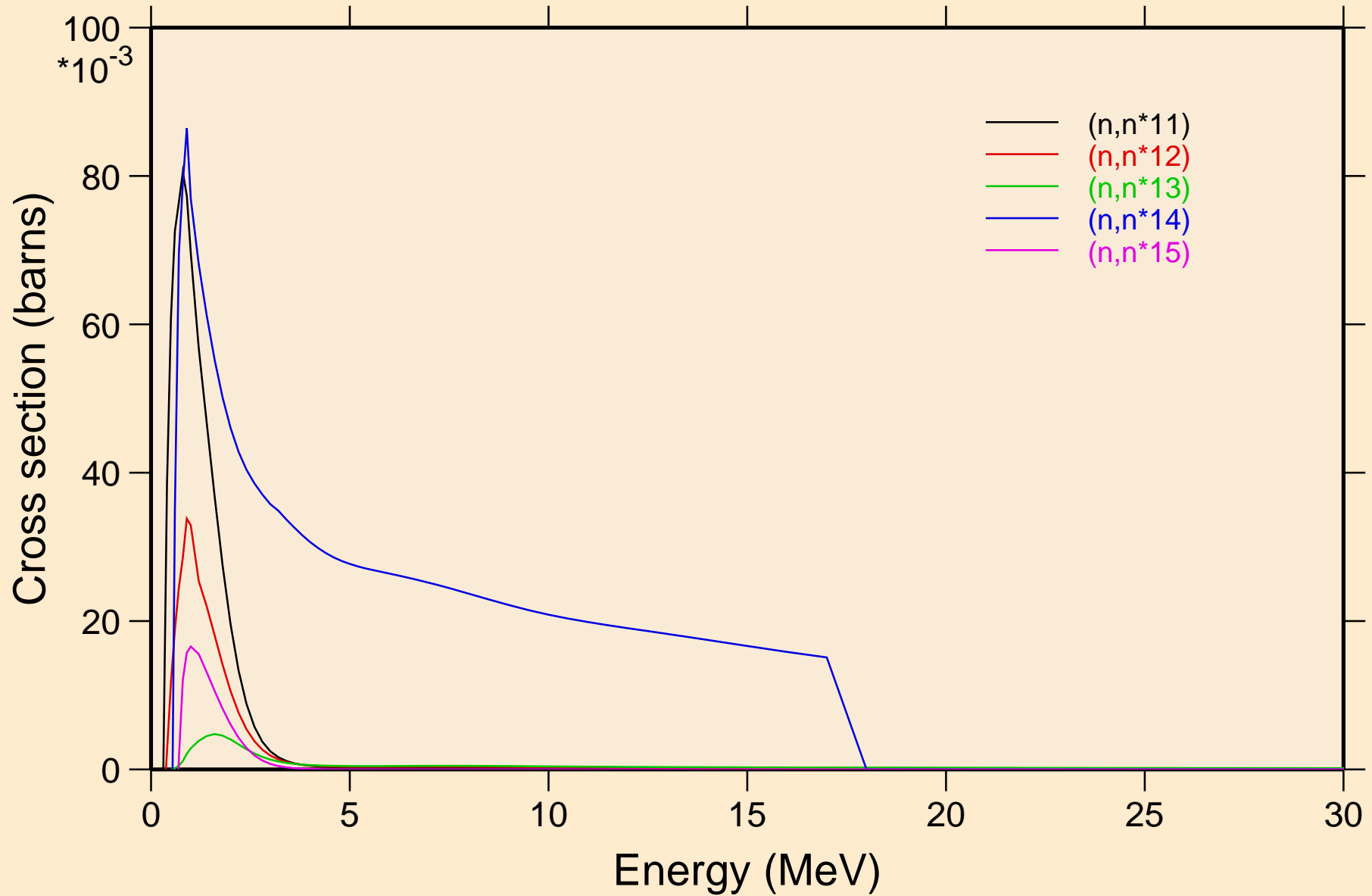

# U239 NRG TENDL-2015, AKONING

## Inelastic levels

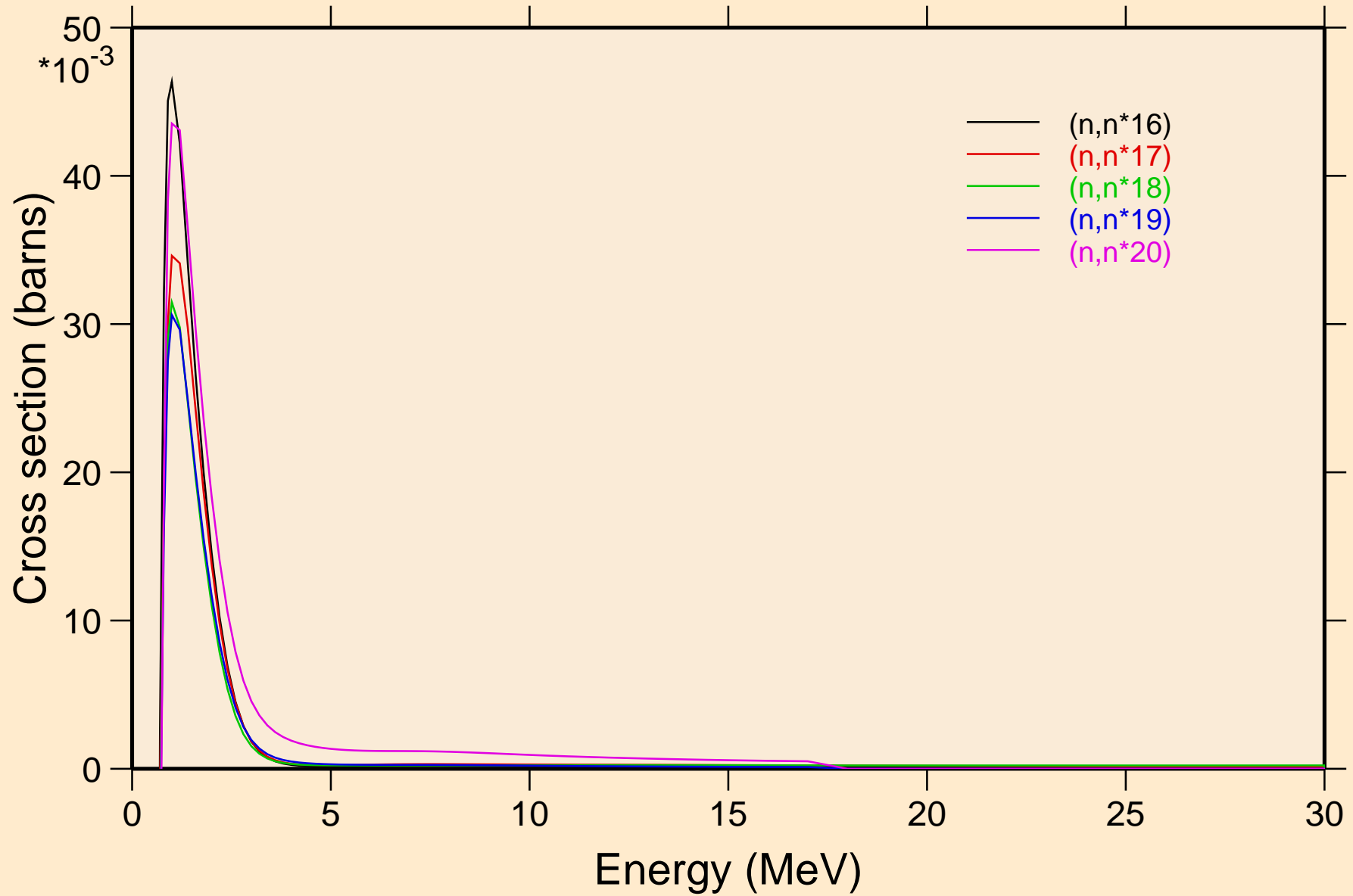



# U239 NRG TENDL-2015, AKONING

## Inelastic levels

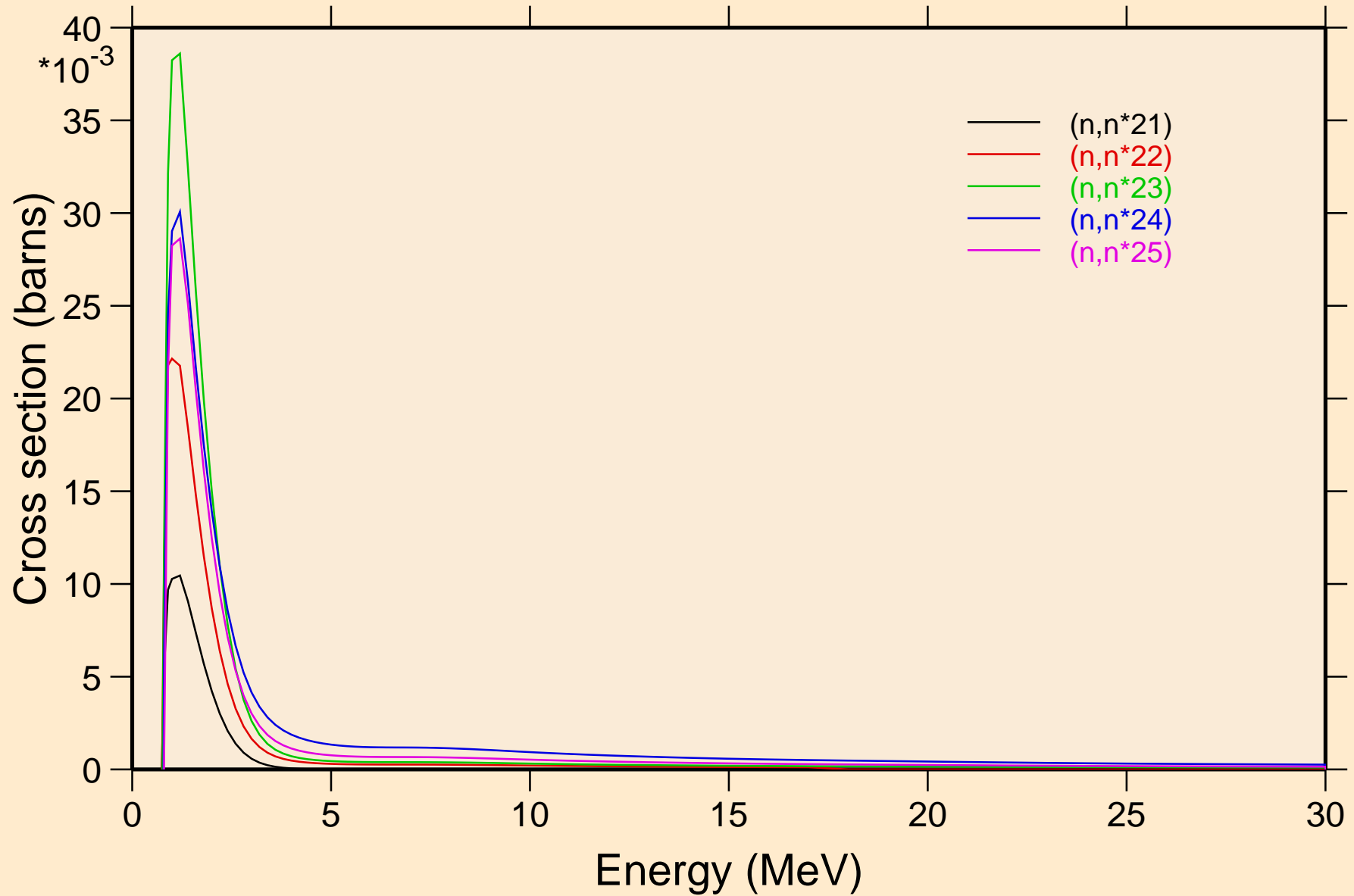

# U239 NRG TENDL-2015, AKONING

## Inelastic levels

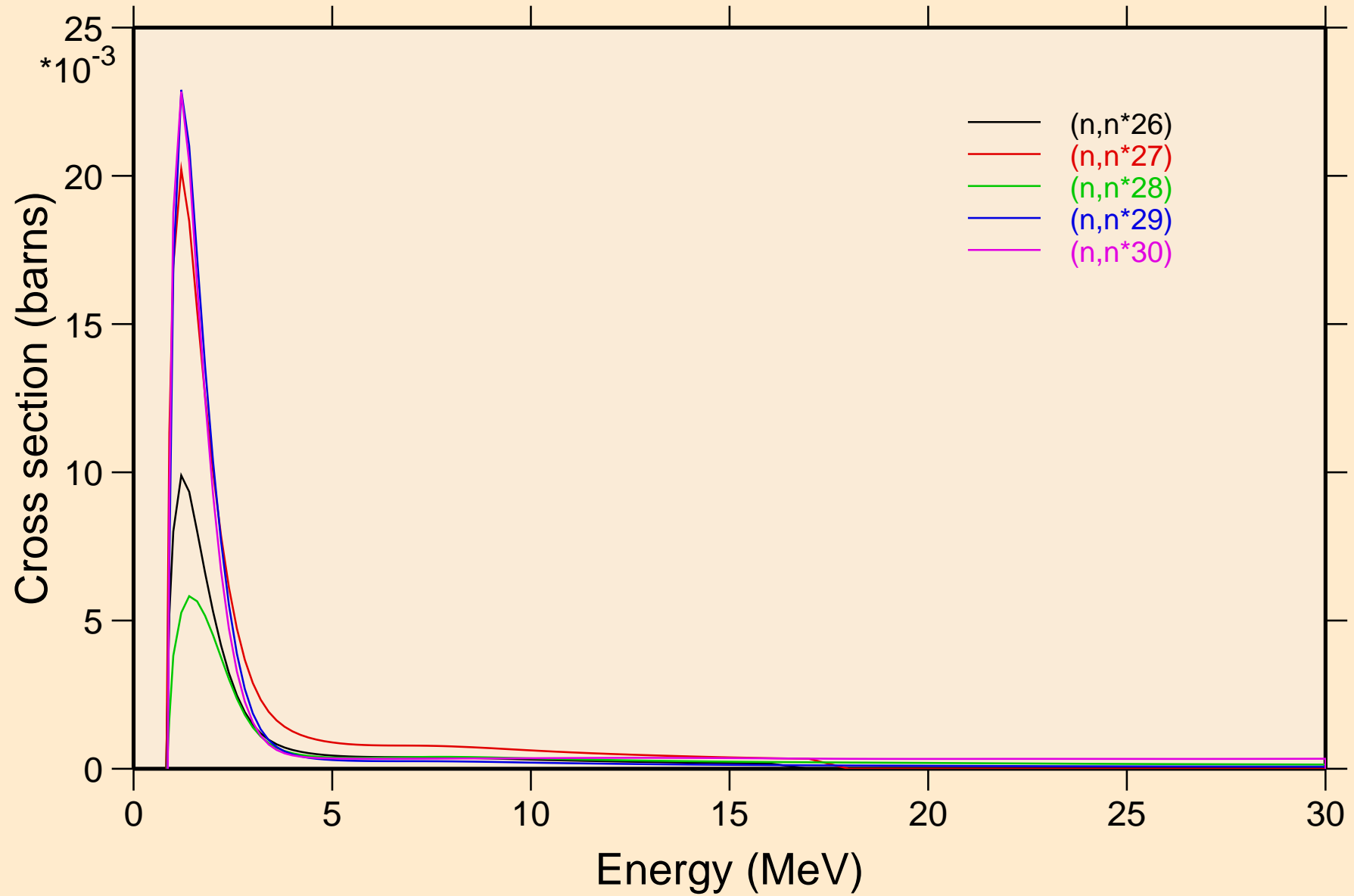

# U239 NRG TENDL-2015, AKONING

## Threshold reactions

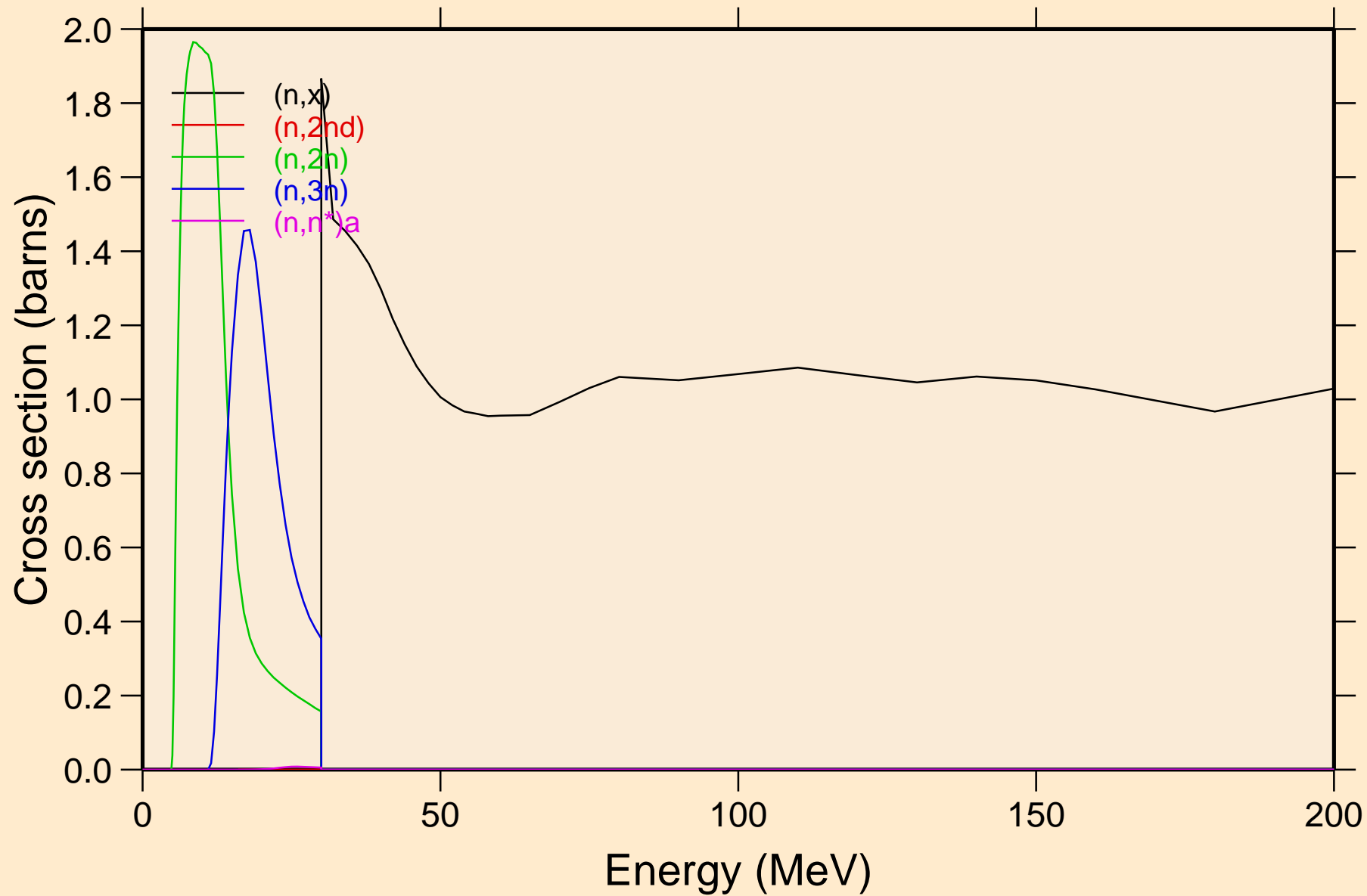

# U239 NRG TENDL-2015, AKONING

## Threshold reactions

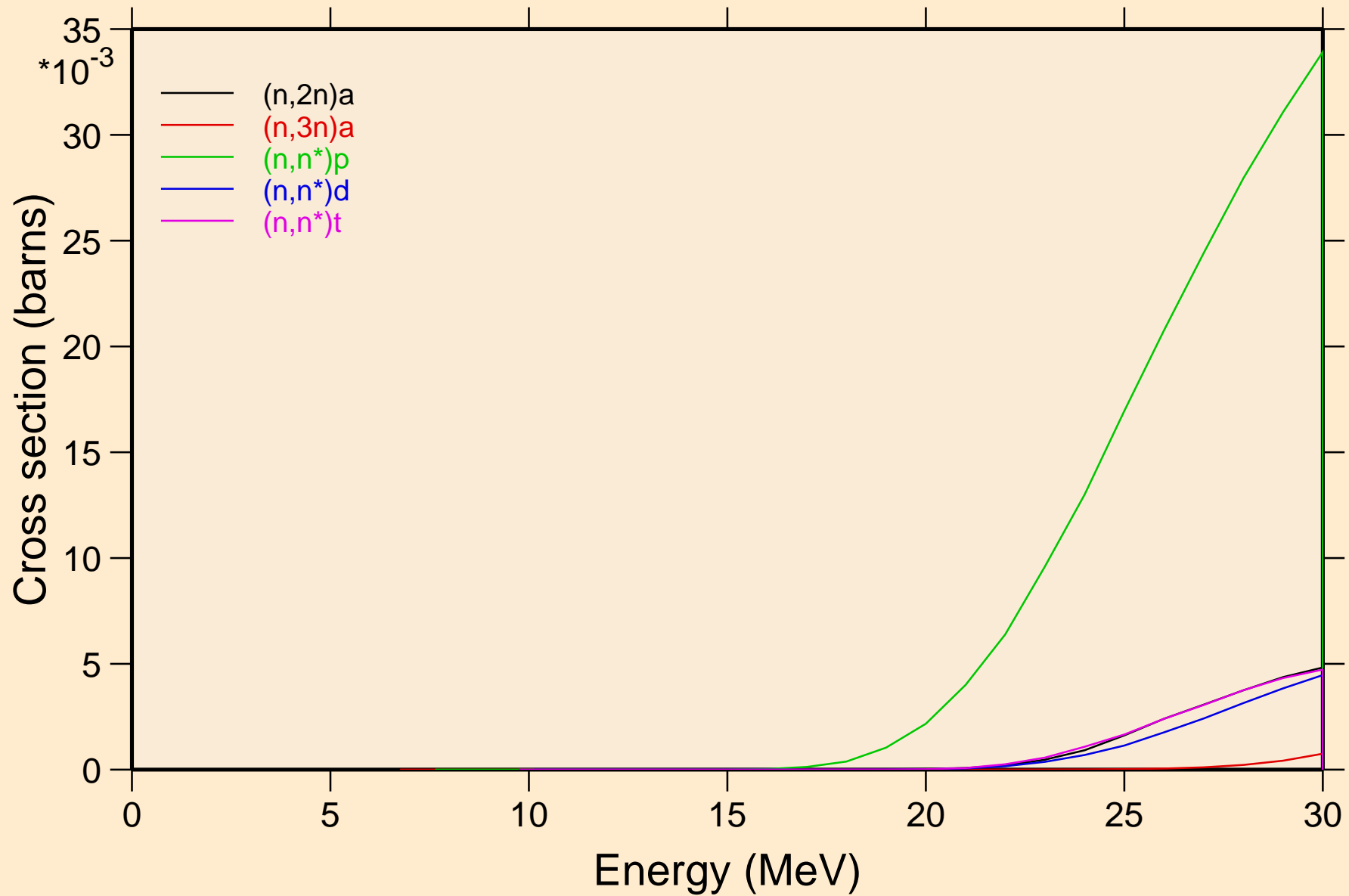

# U239 NRG TENDL-2015, AKONING

## Threshold reactions

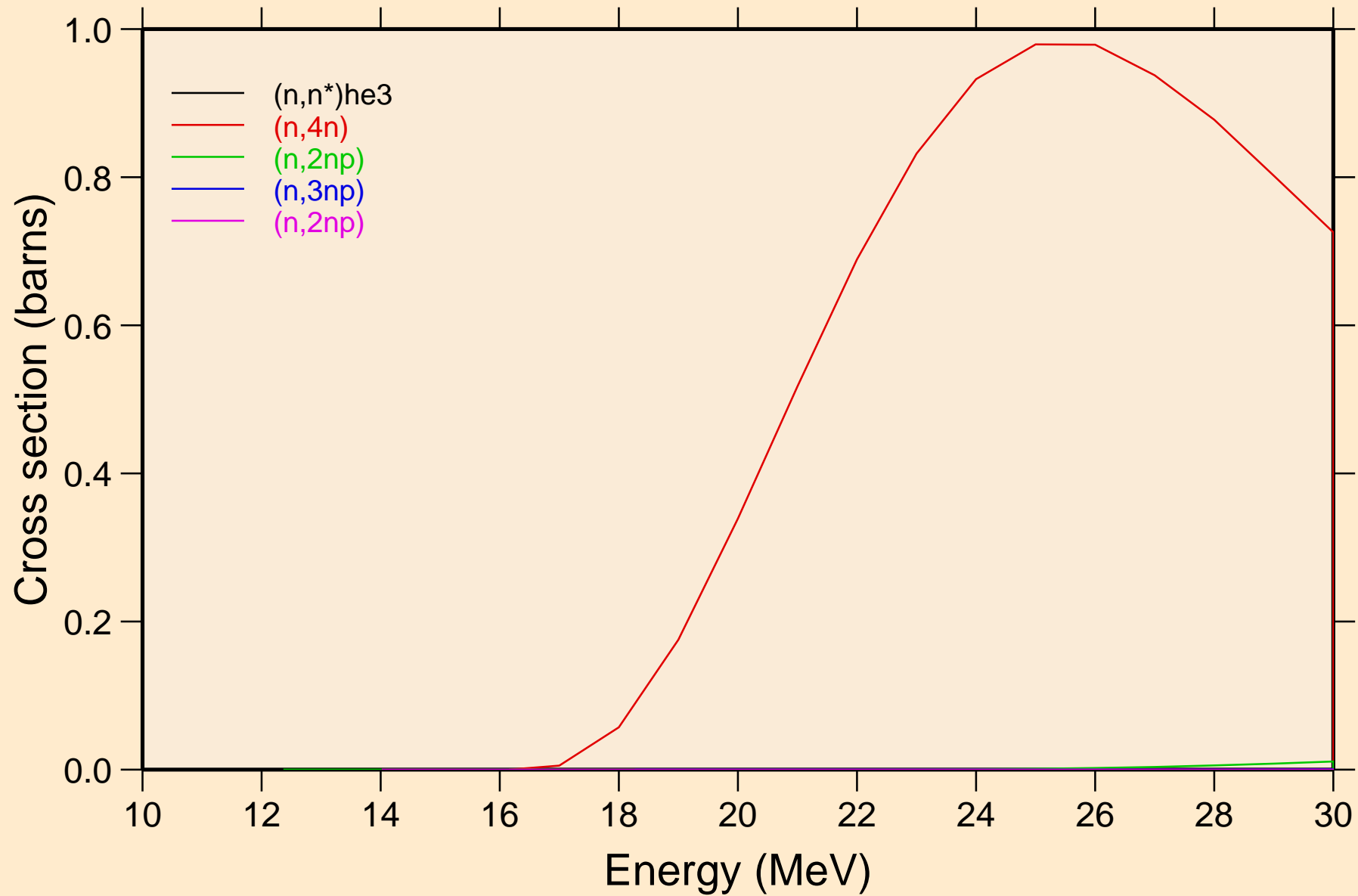

# U239 NRG TENDL-2015, AKONING

## Threshold reactions

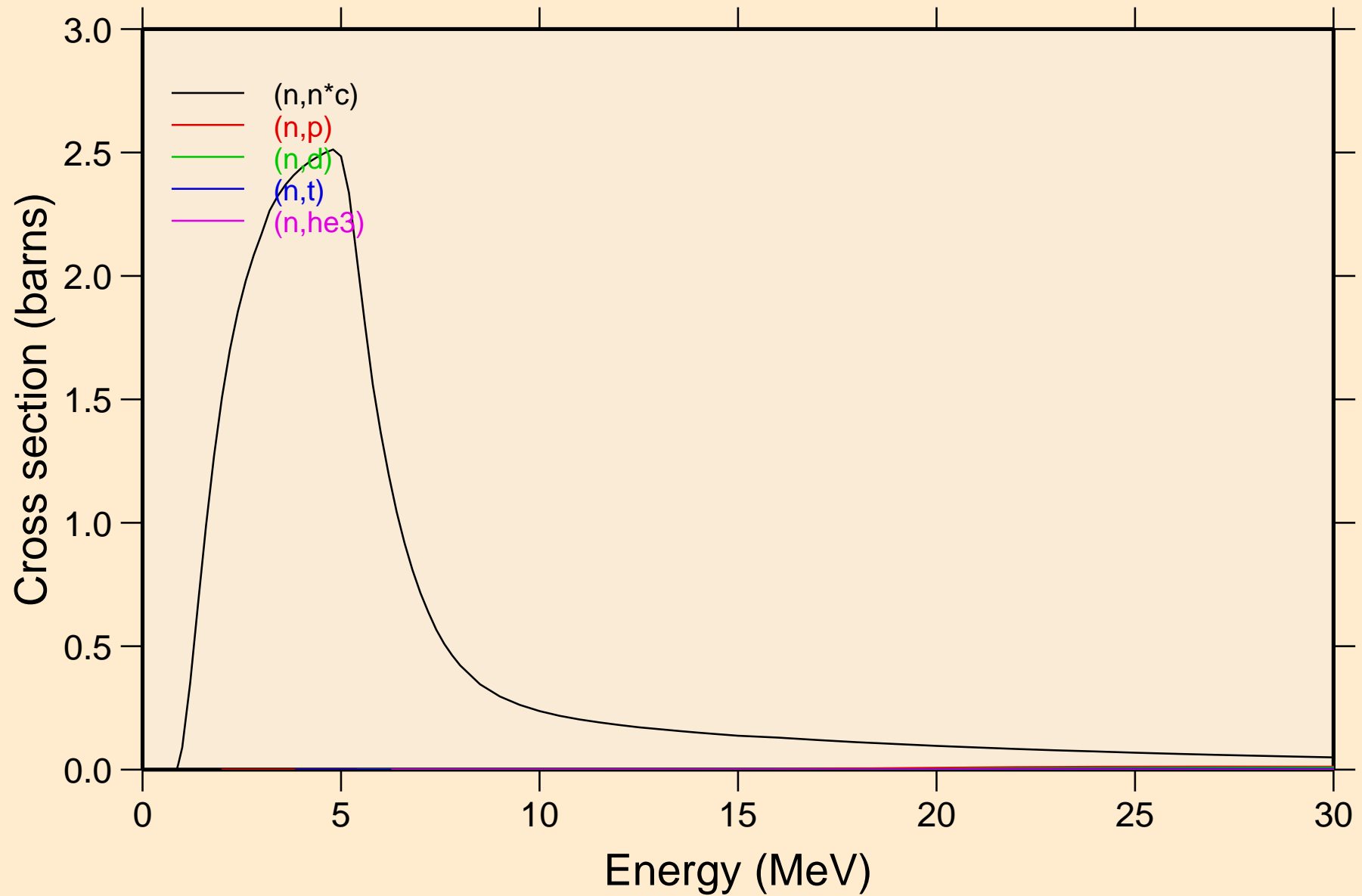

# U239 NRG TENDL-2015, AKONING

## Threshold reactions

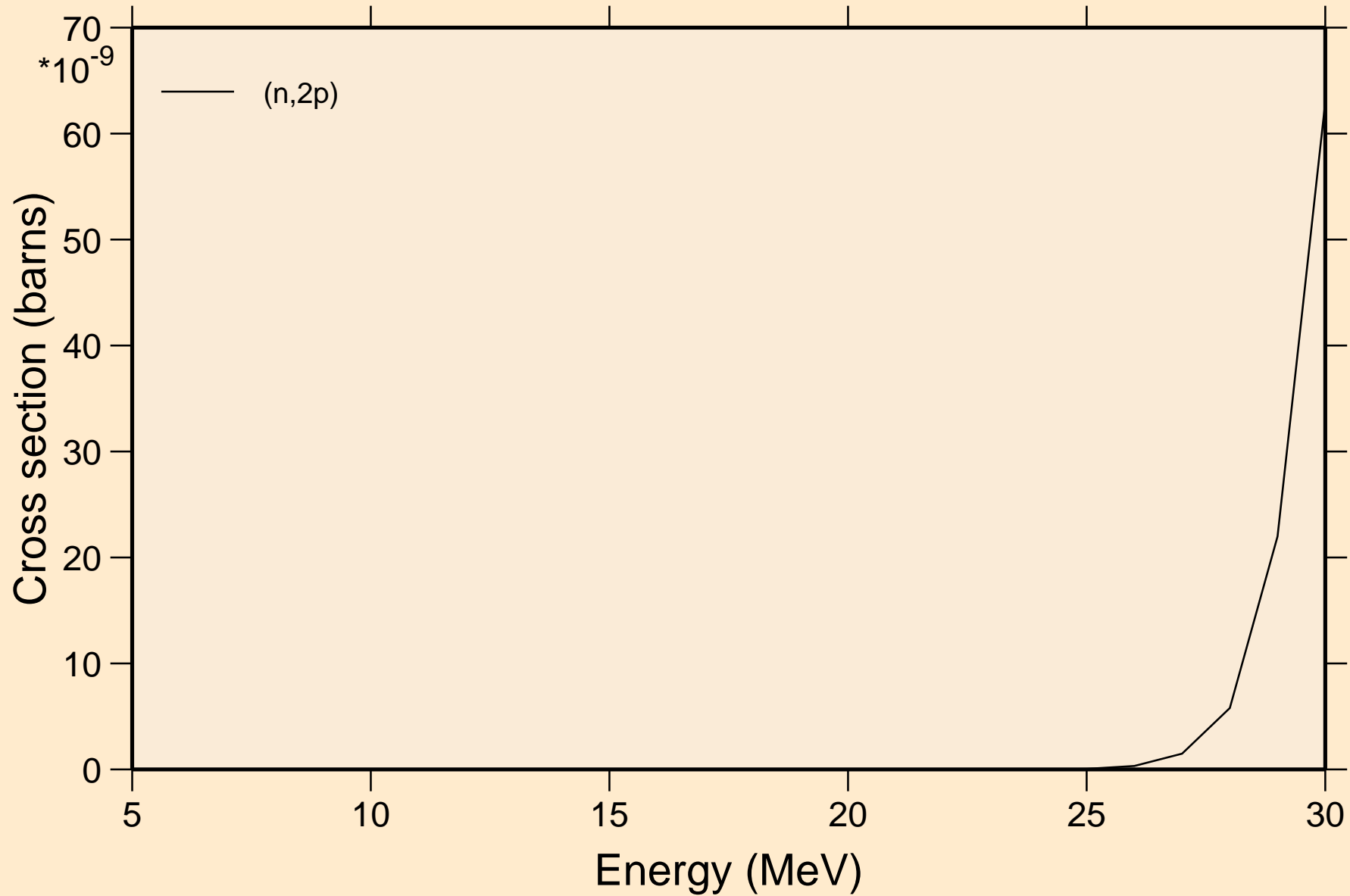

U239 NRG TENDL-2015, AKONING  
angular distribution for elastic

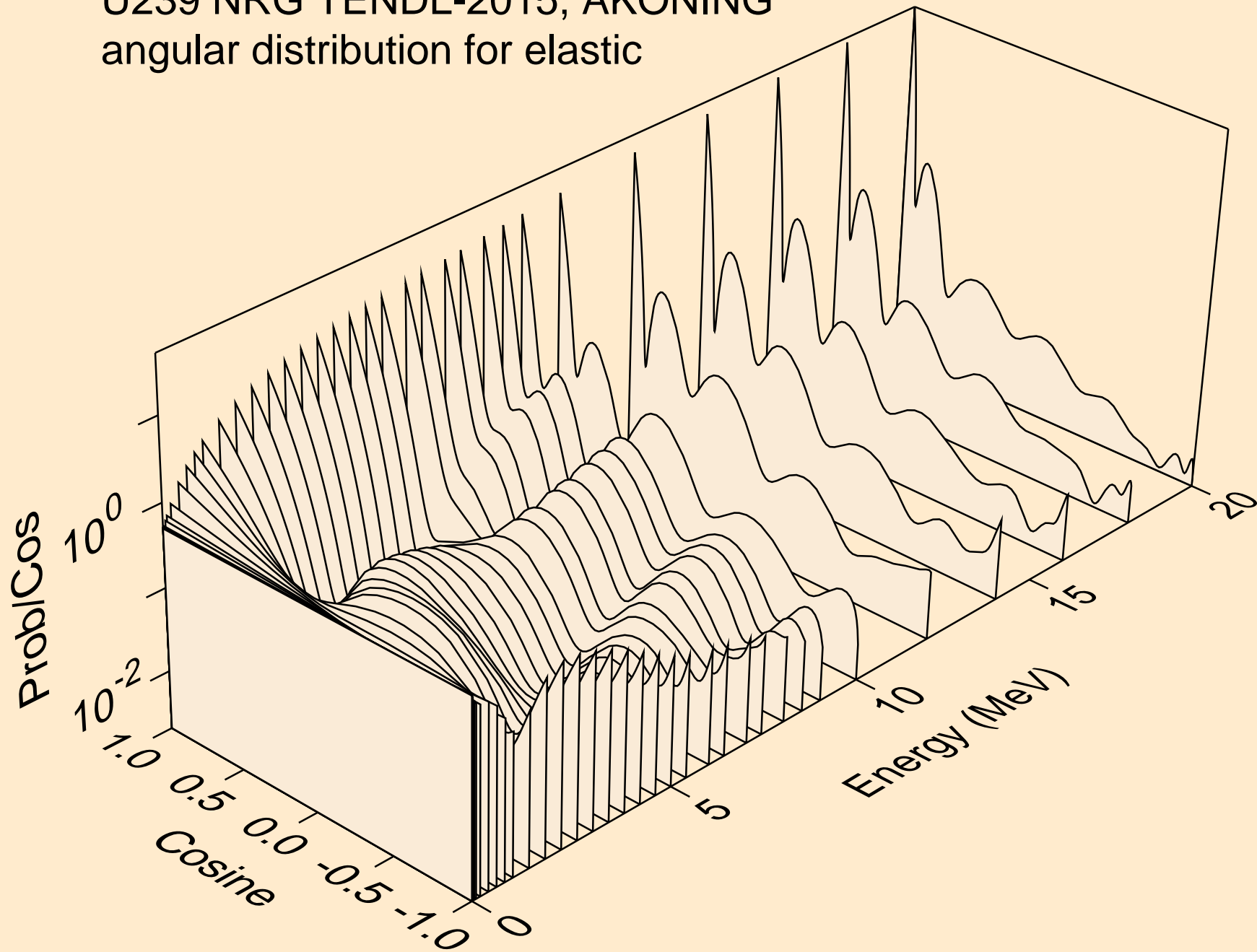



U239 NRG TENDL-2015, AKONING  
angular distribution for elastic

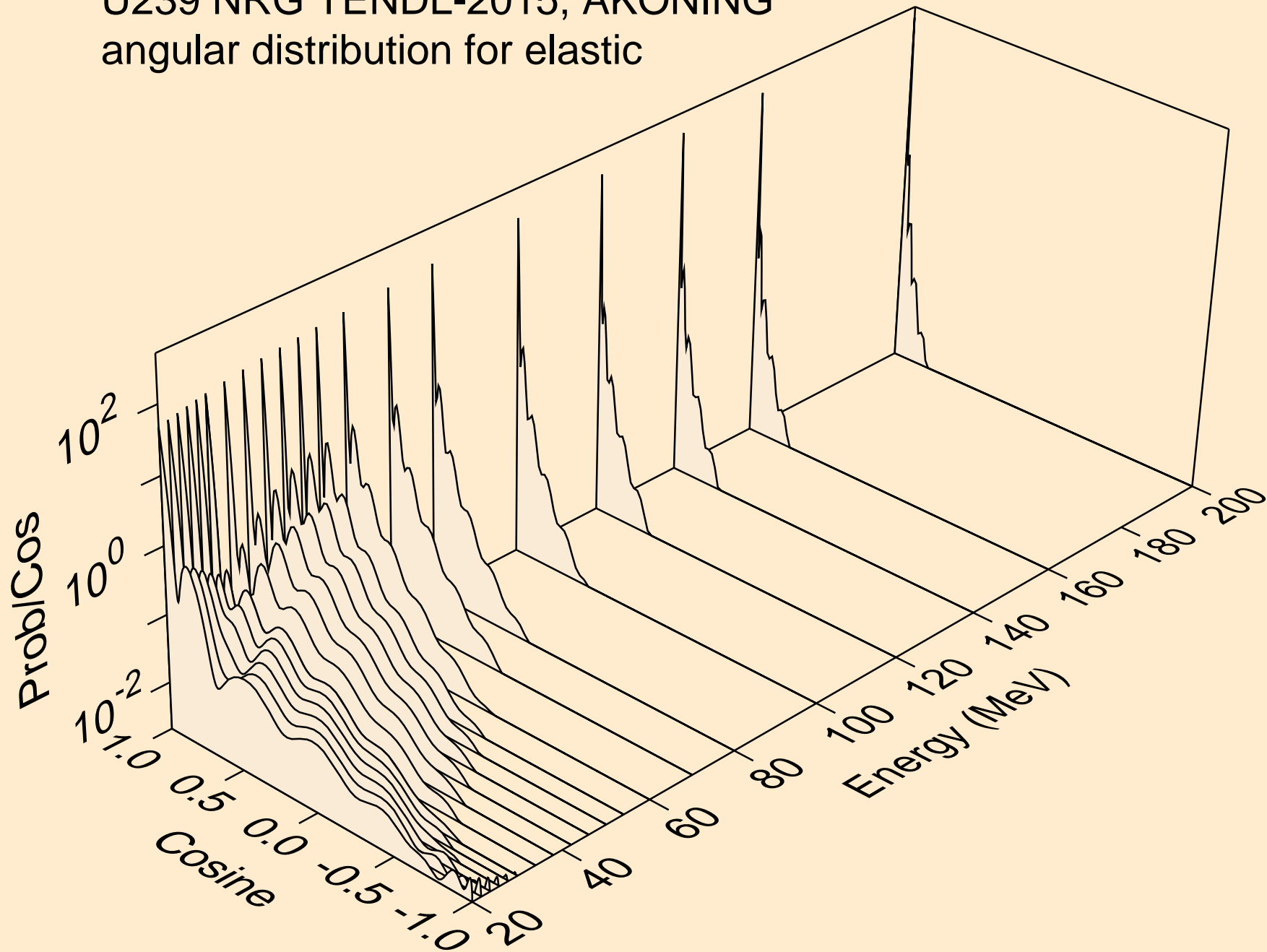

U239 NRG TENDL-2015, AKONING  
angular distribution for (n,n\*1)

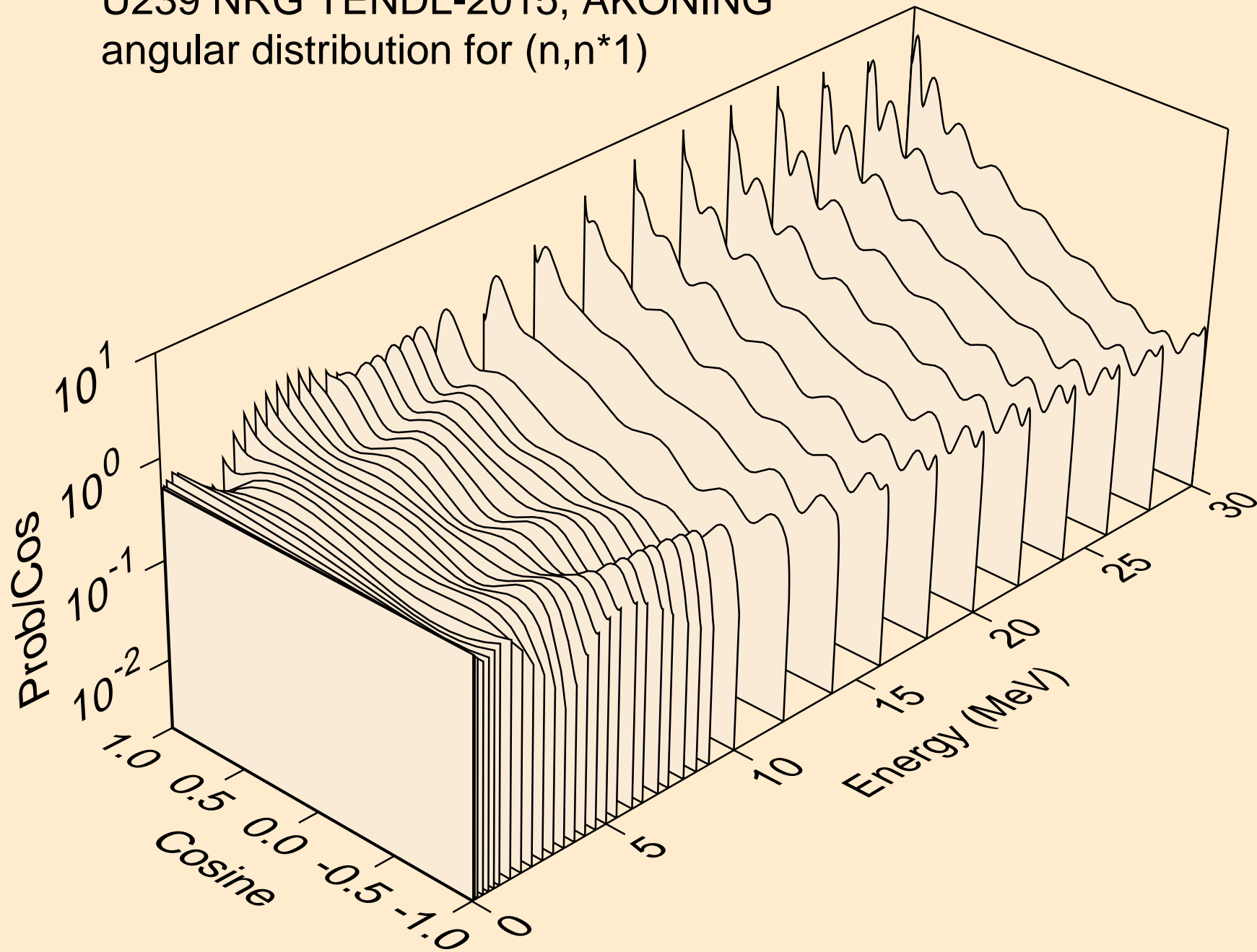

U239 NRG TENDL-2015, AKONING  
angular distribution for (n,n\*2)

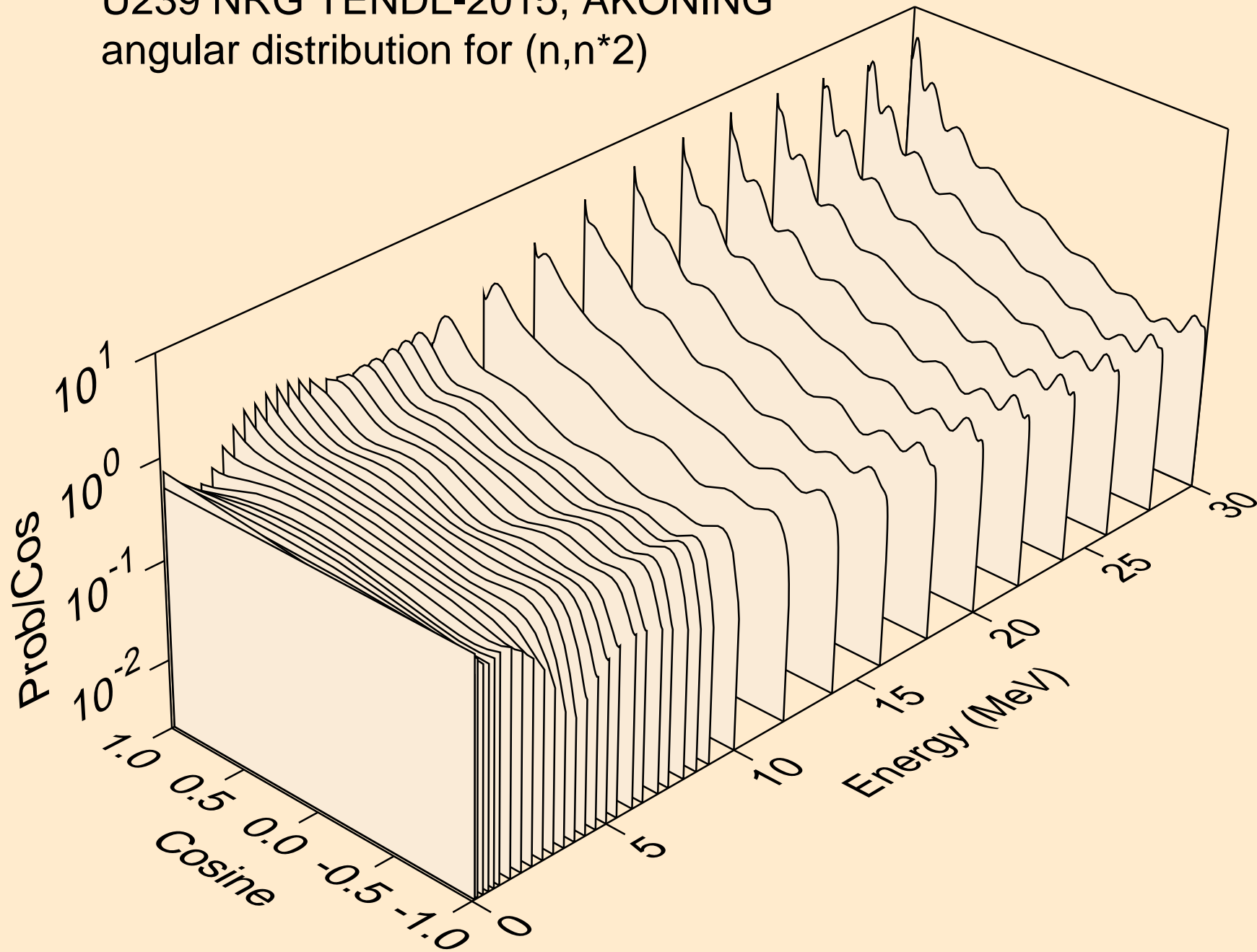

U239 NRG TENDL-2015, AKONING  
angular distribution for (n,n\*3)

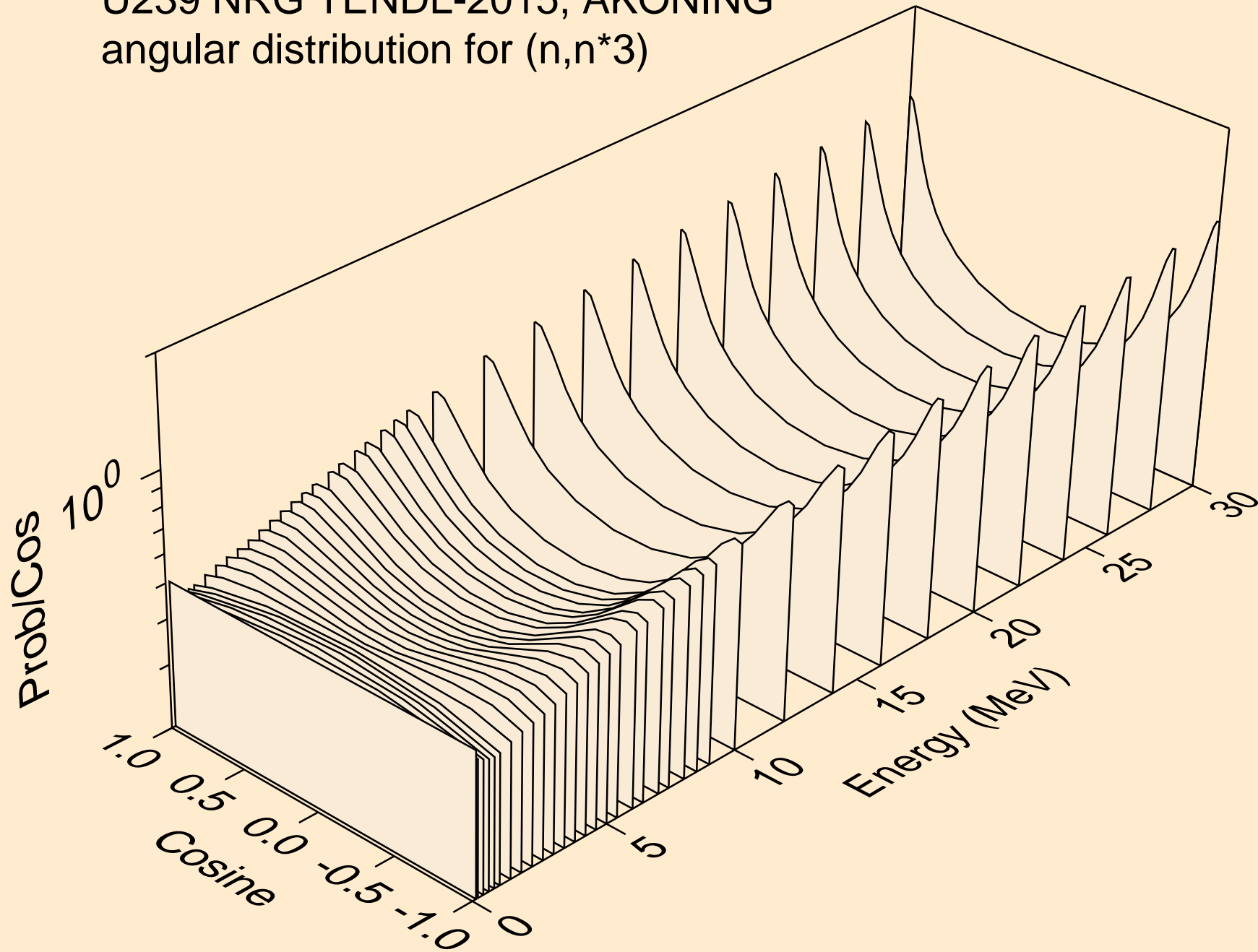

U239 NRG TENDL-2015, AKONING  
angular distribution for (n,n\*4)

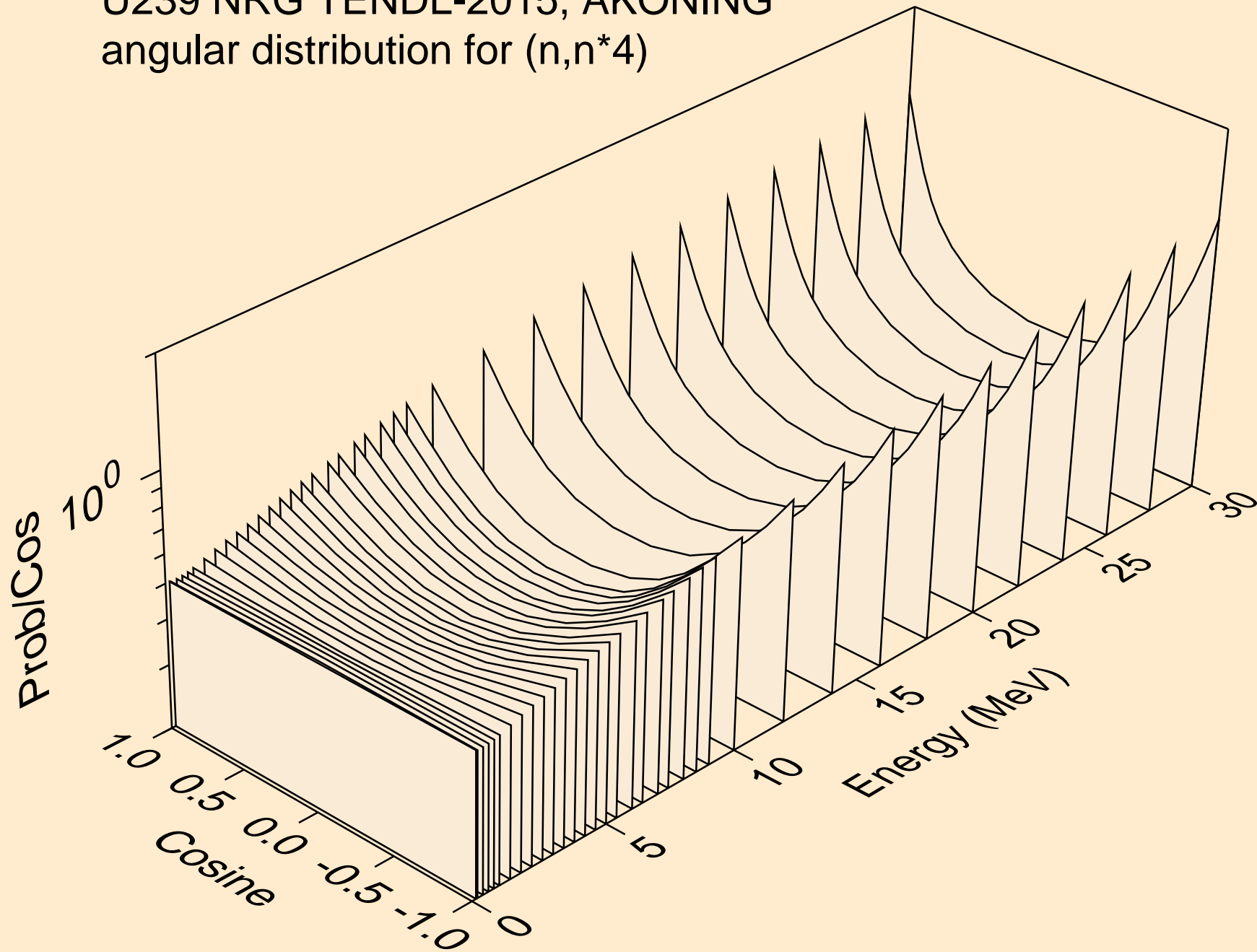

U239 NRG TENDL-2015, AKONING  
angular distribution for (n,n\*5)

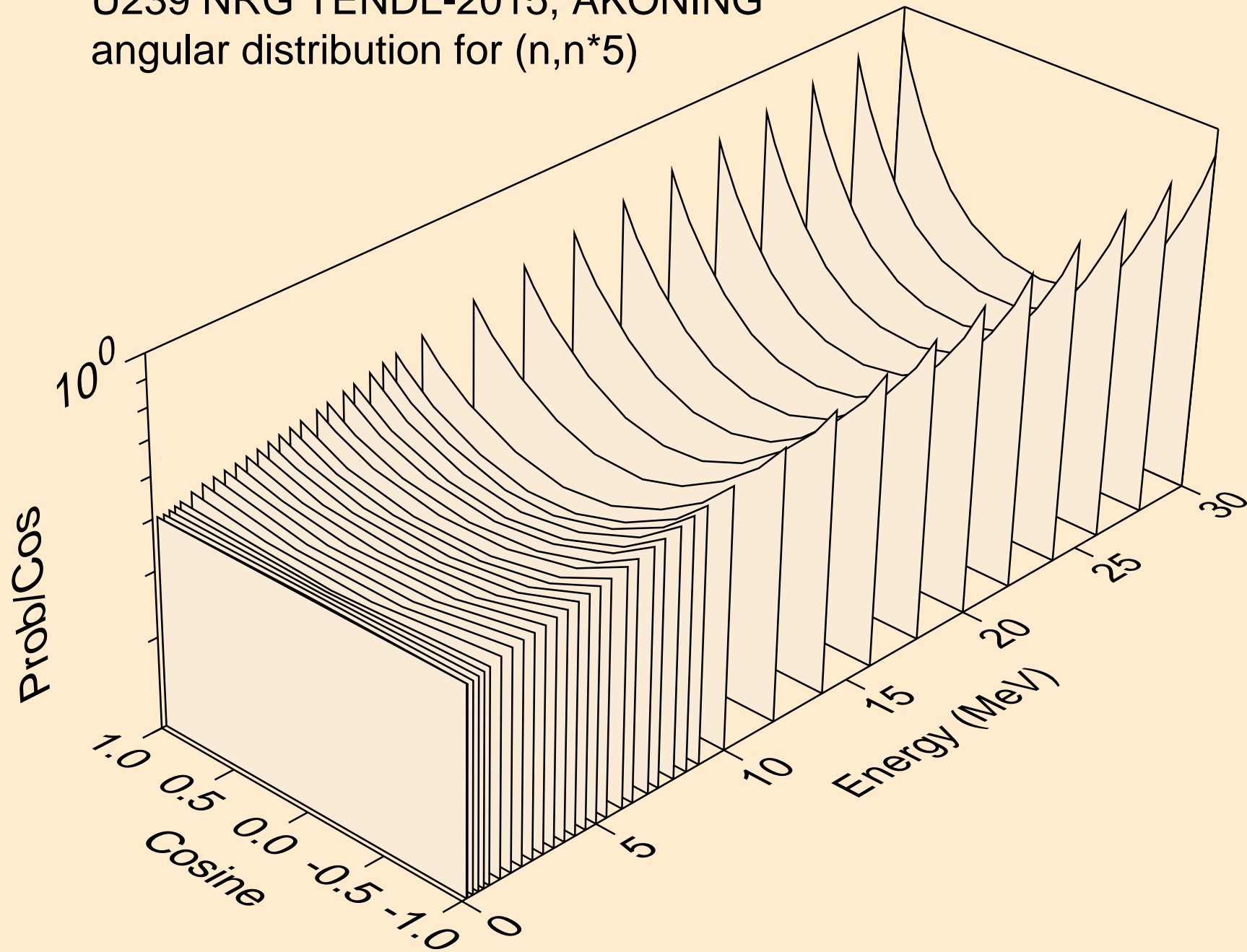

U239 NRG TENDL-2015, AKONING  
angular distribution for (n,n\*6)

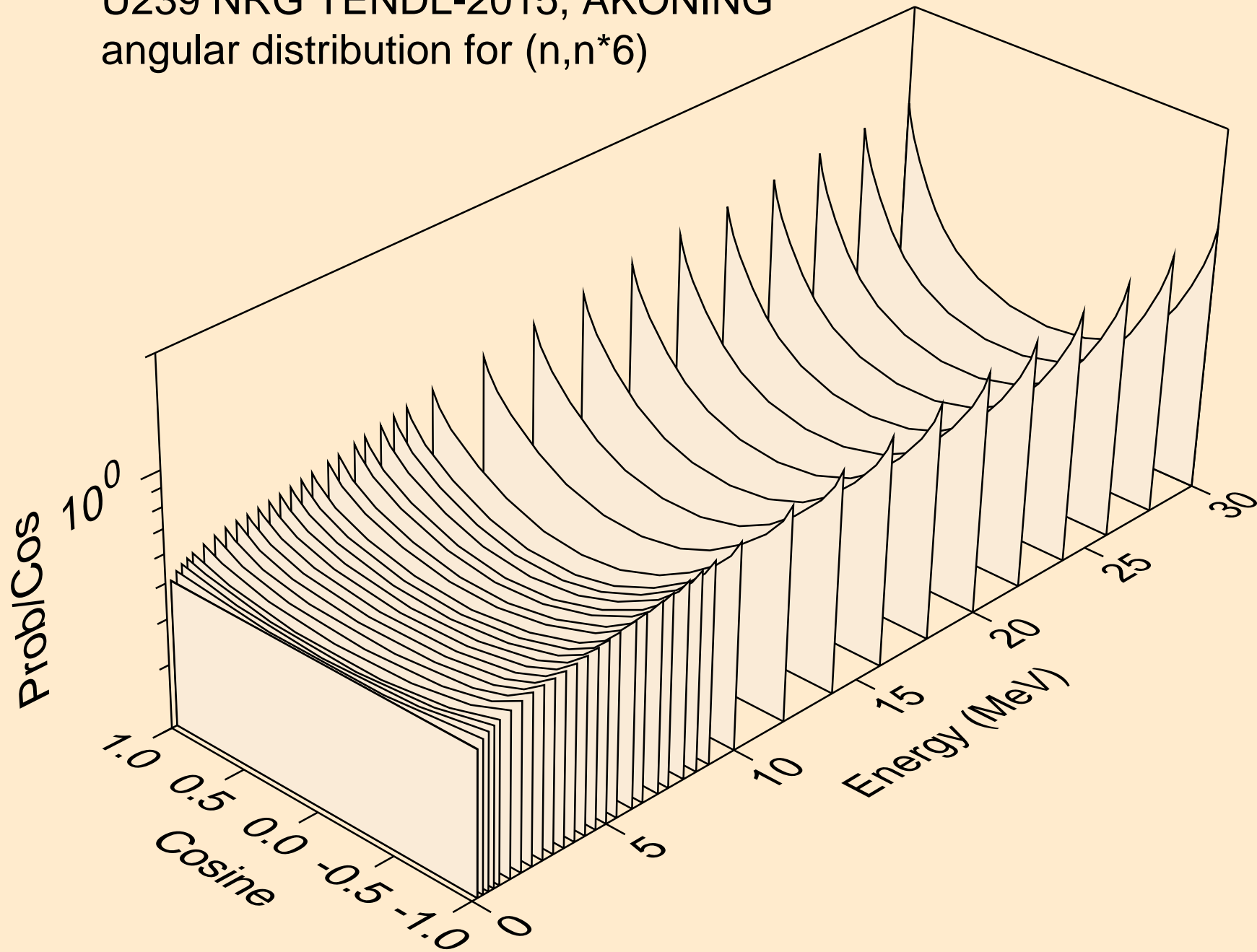

U239 NRG TENDL-2015, AKONING  
angular distribution for (n,n\*7)

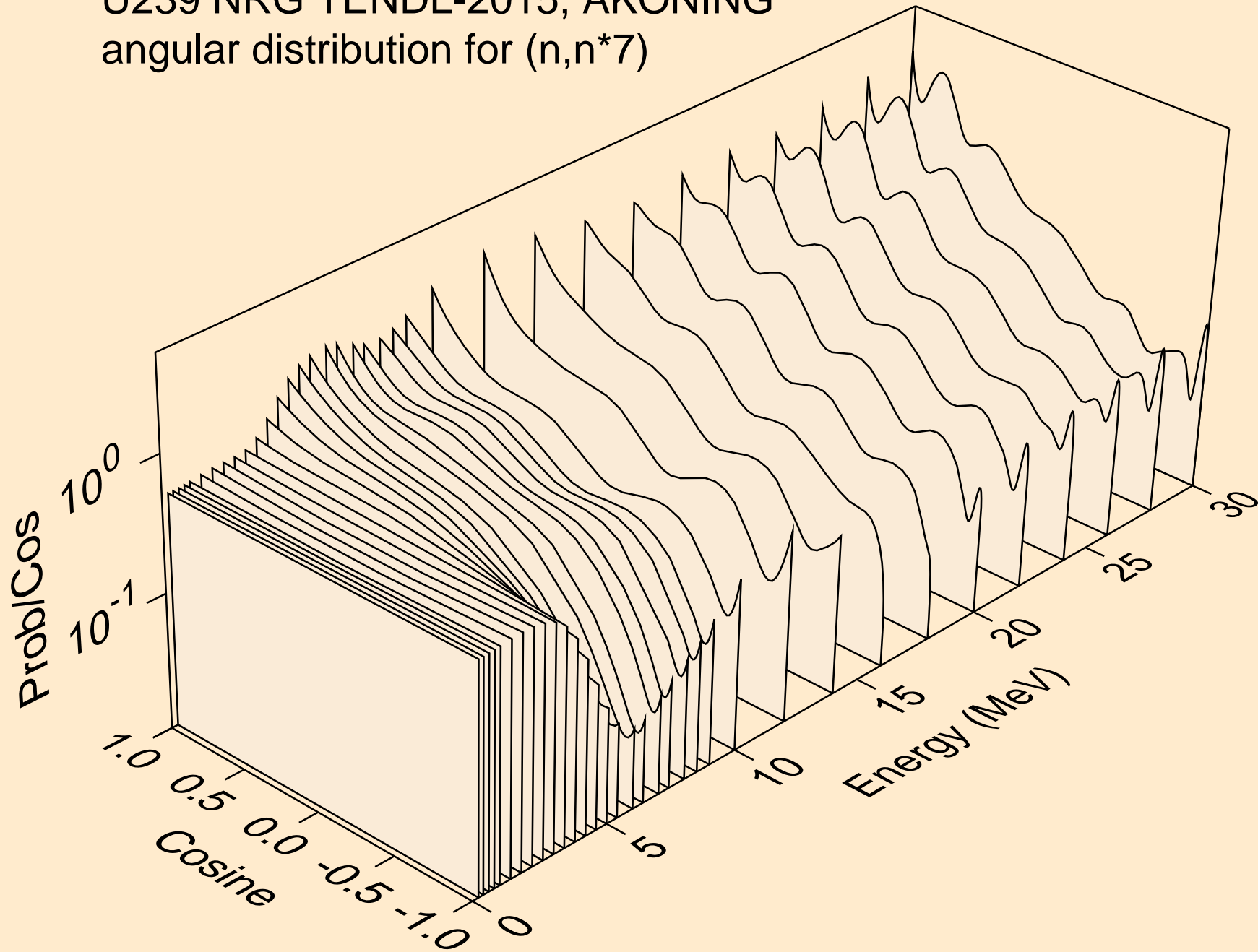



U239 NRG TENDL-2015, AKONING  
angular distribution for (n,n\*8)

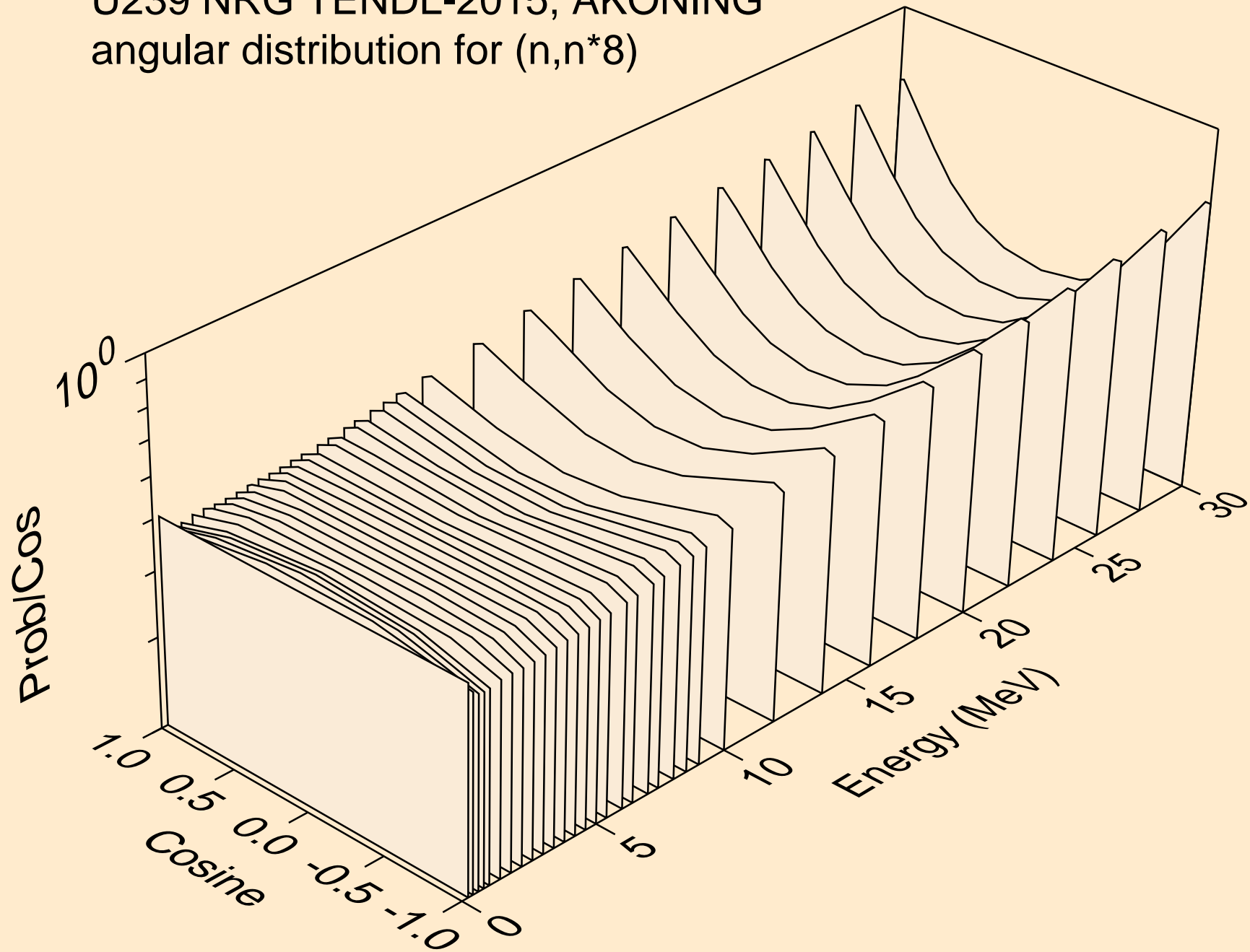

U239 NRG TENDL-2015, AKONING  
angular distribution for (n,n\*9)

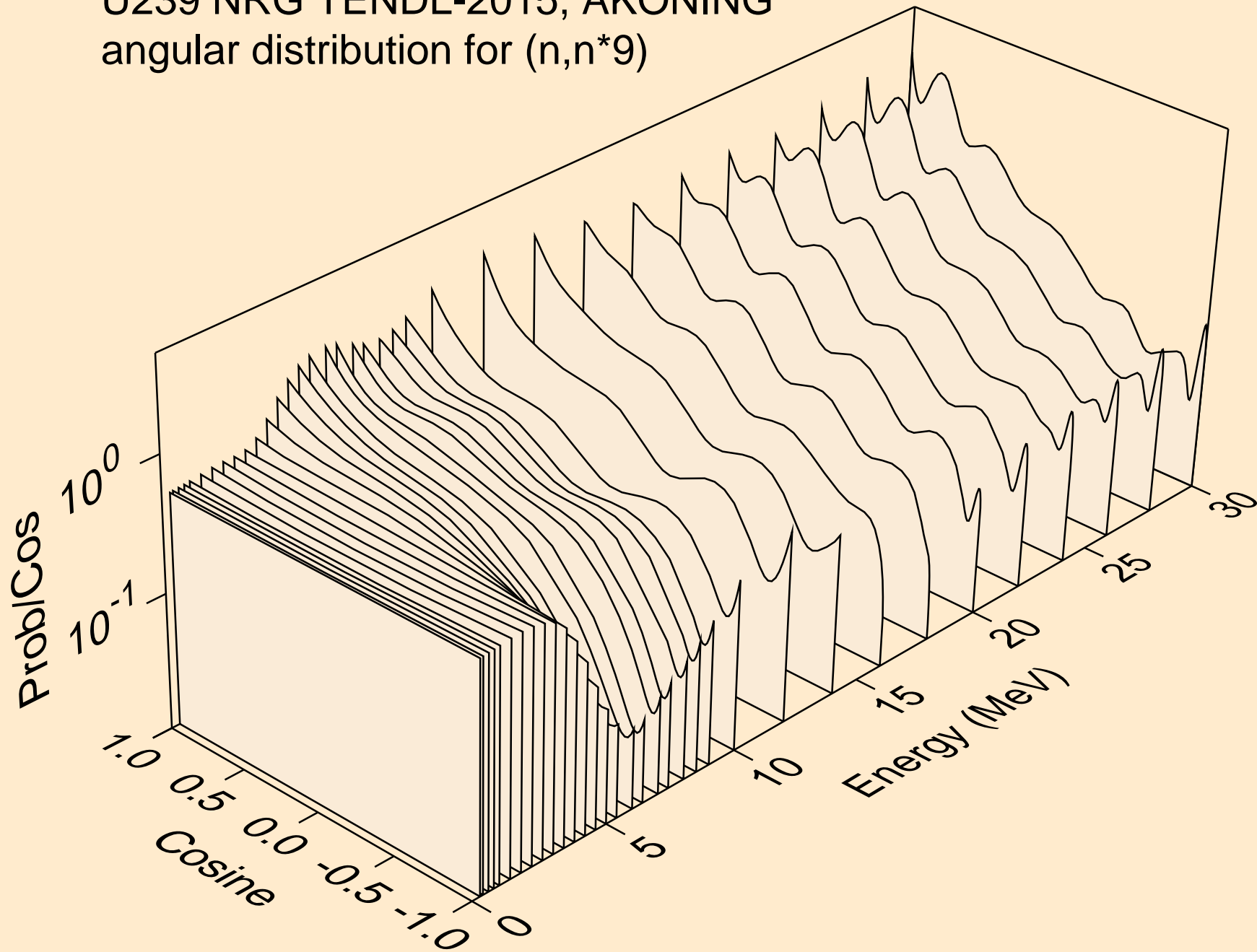

U239 NRG TENDL-2015, AKONING  
angular distribution for (n,n\*10)

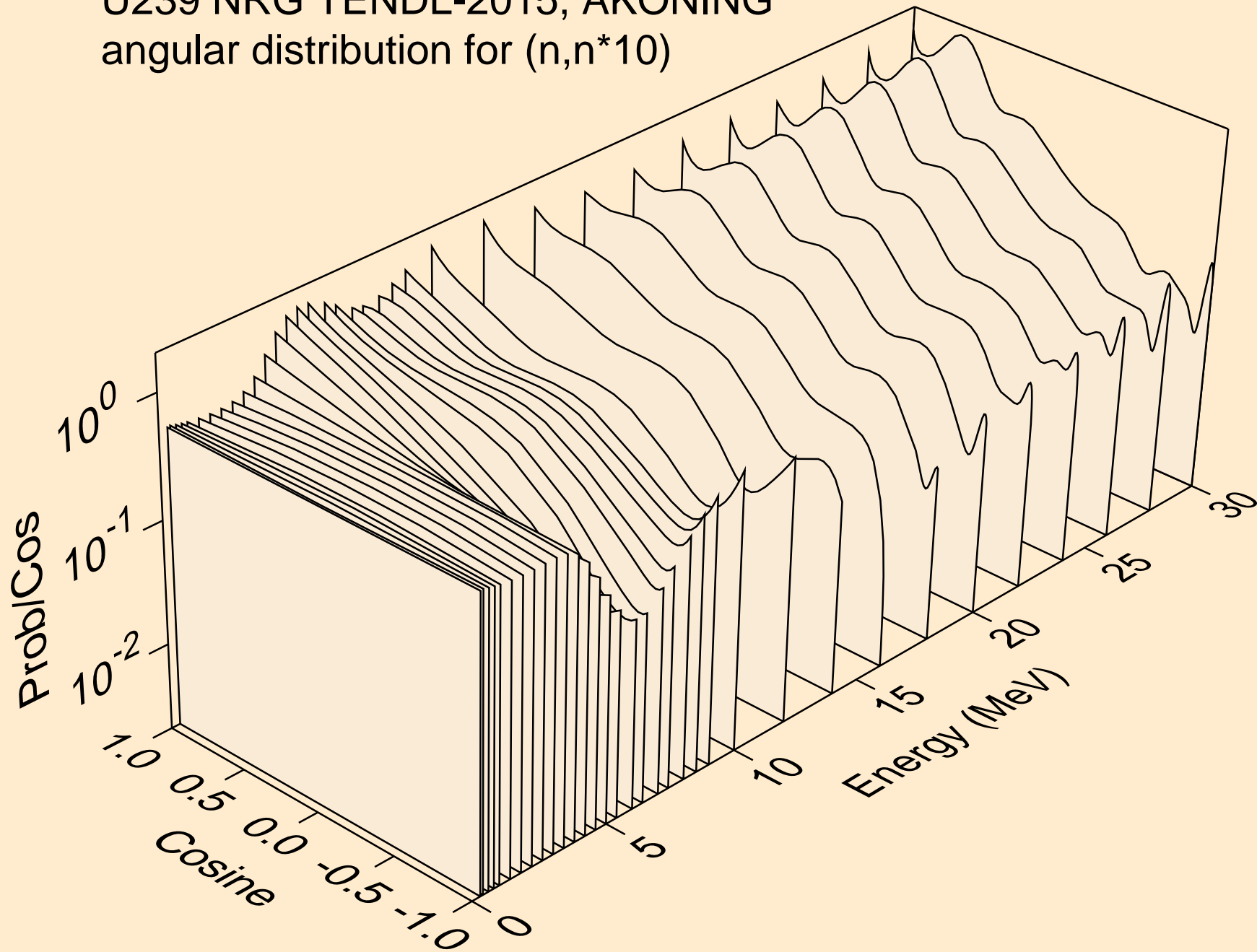

U239 NRG TENDL-2015, AKONING  
angular distribution for (n,n\*11)

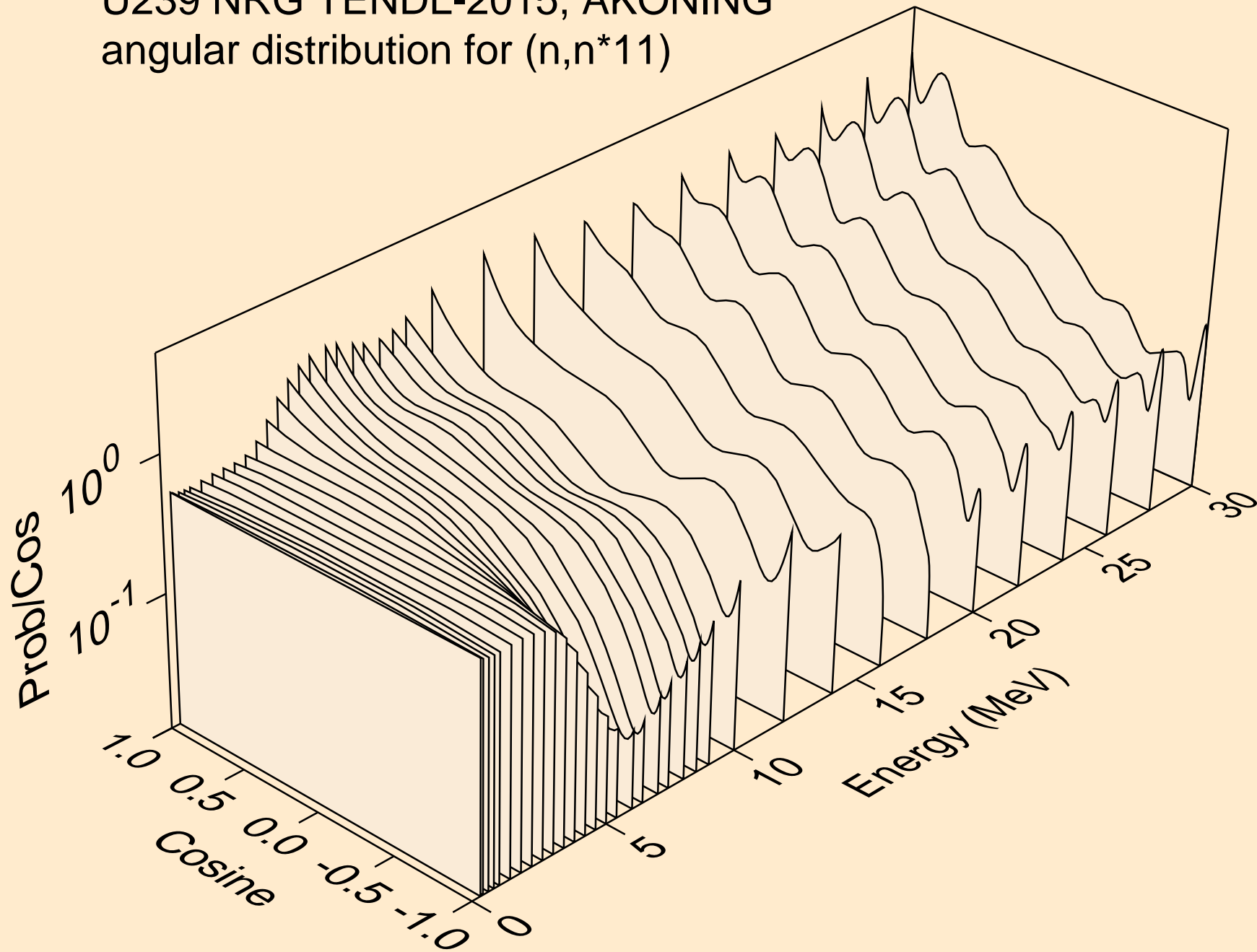

U239 NRG TENDL-2015, AKONING  
angular distribution for (n,n\*12)

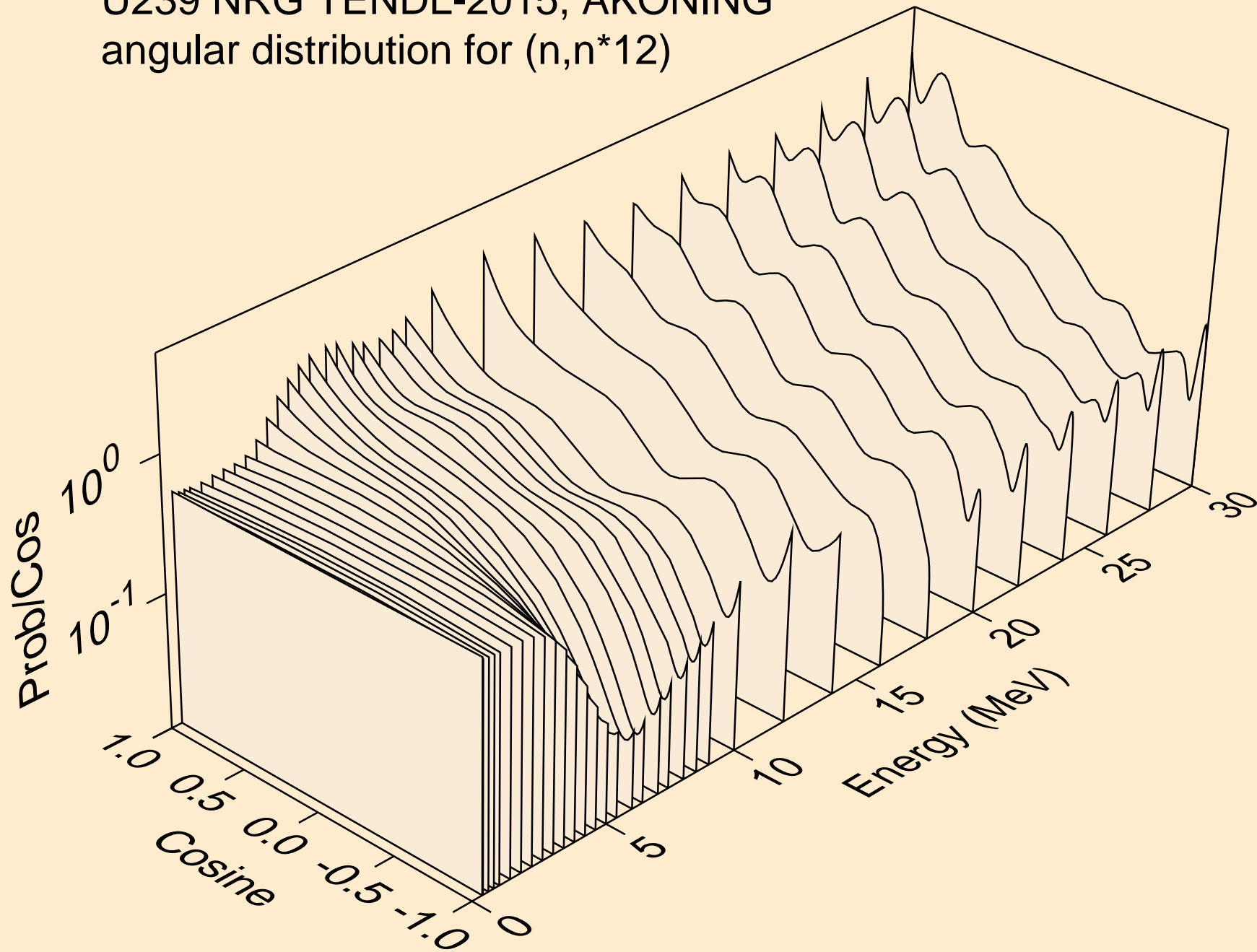

U239 NRG TENDL-2015, AKONING  
angular distribution for (n,n\*13)

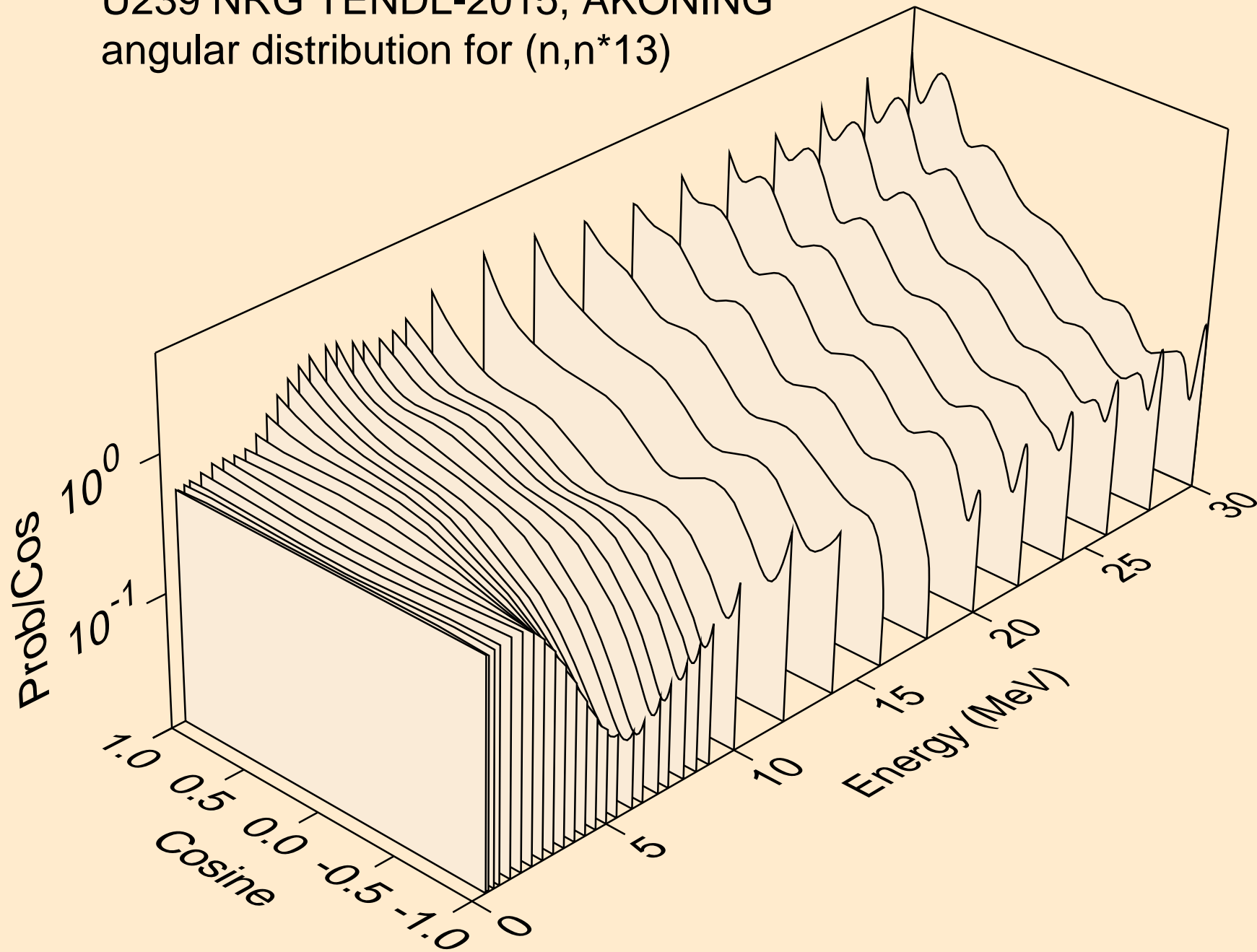

U239 NRG TENDL-2015, AKONING  
angular distribution for (n,n\*14)

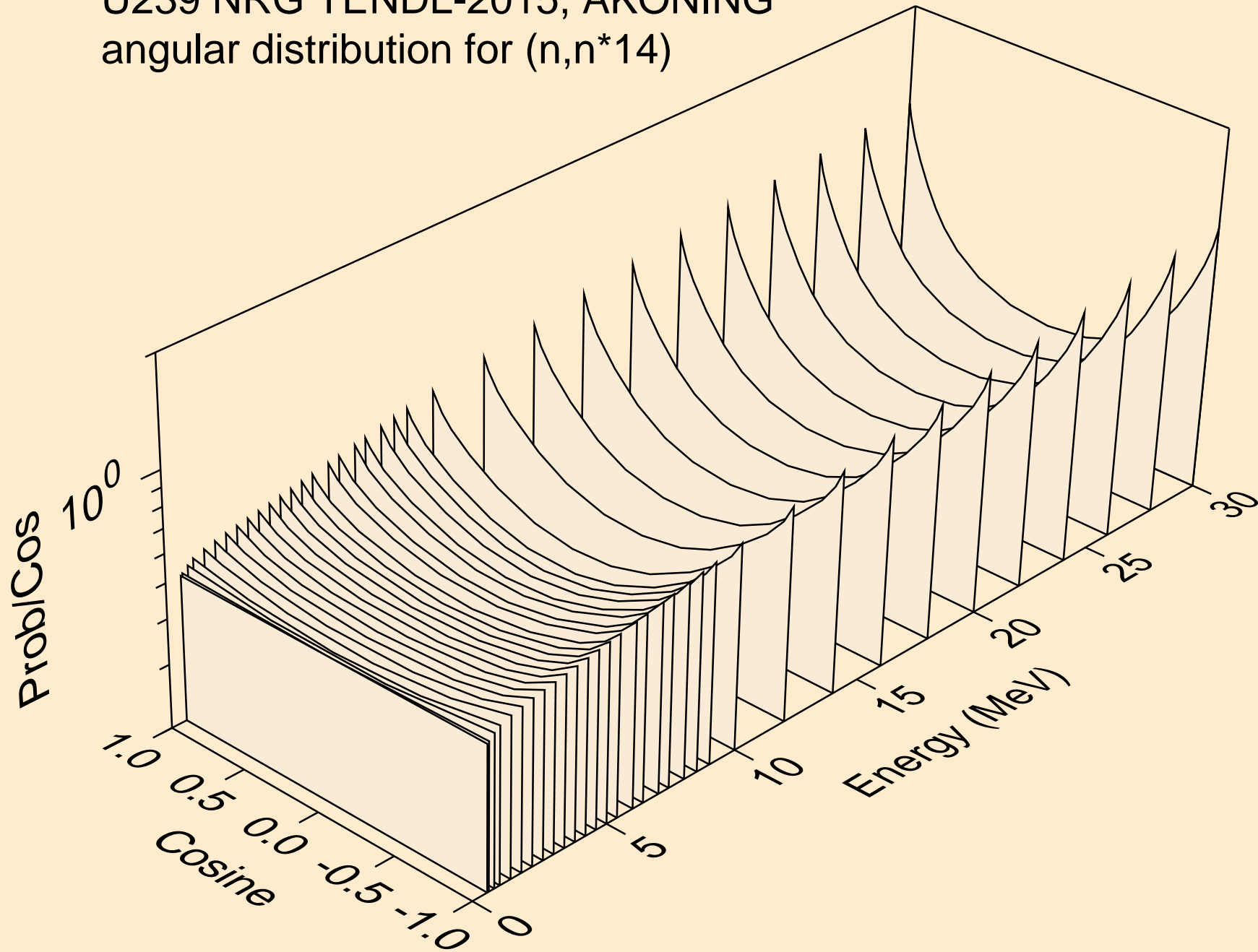

U239 NRG TENDL-2015, AKONING  
angular distribution for (n,n\*15)

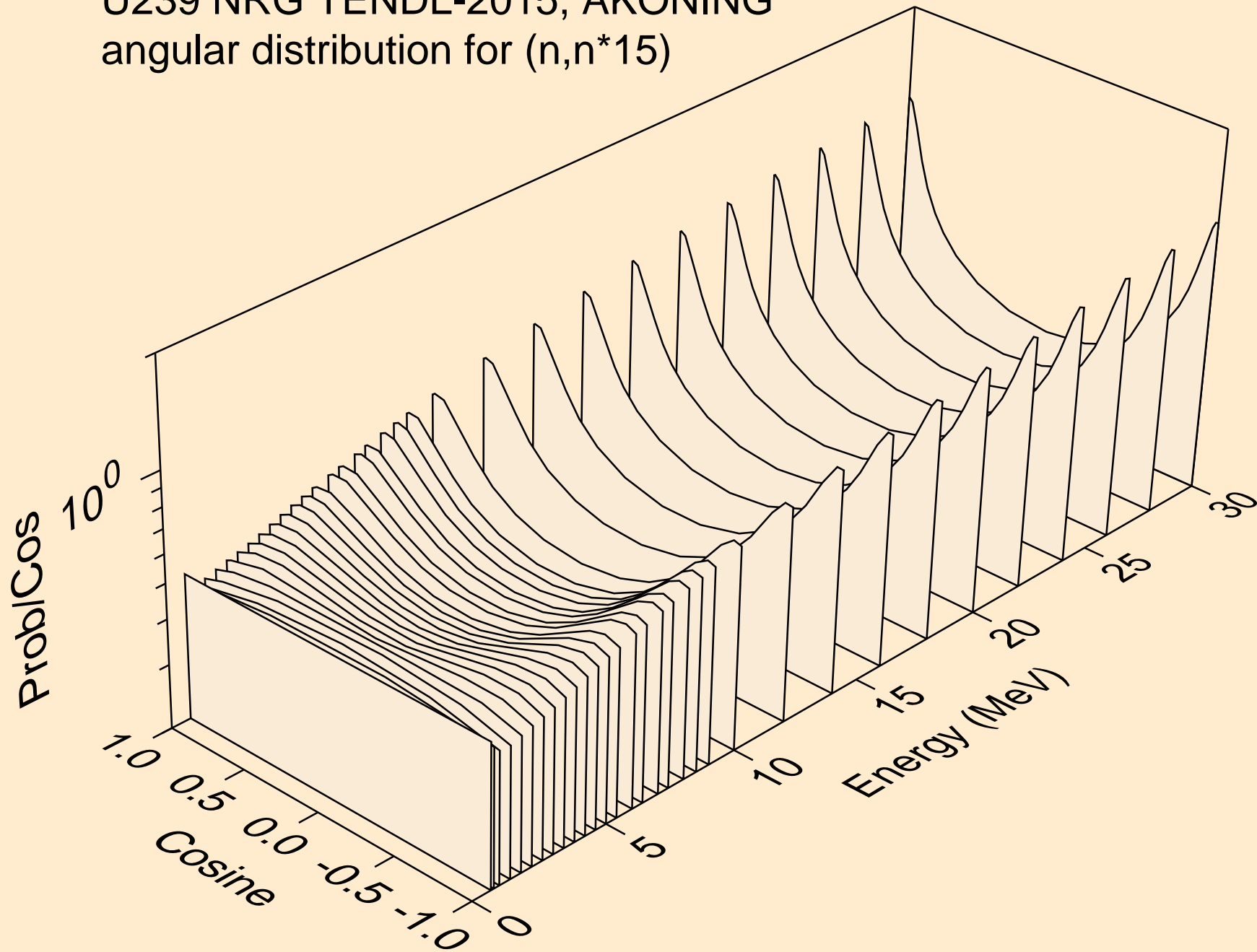



U239 NRG TENDL-2015, AKONING  
angular distribution for (n,n\*16)

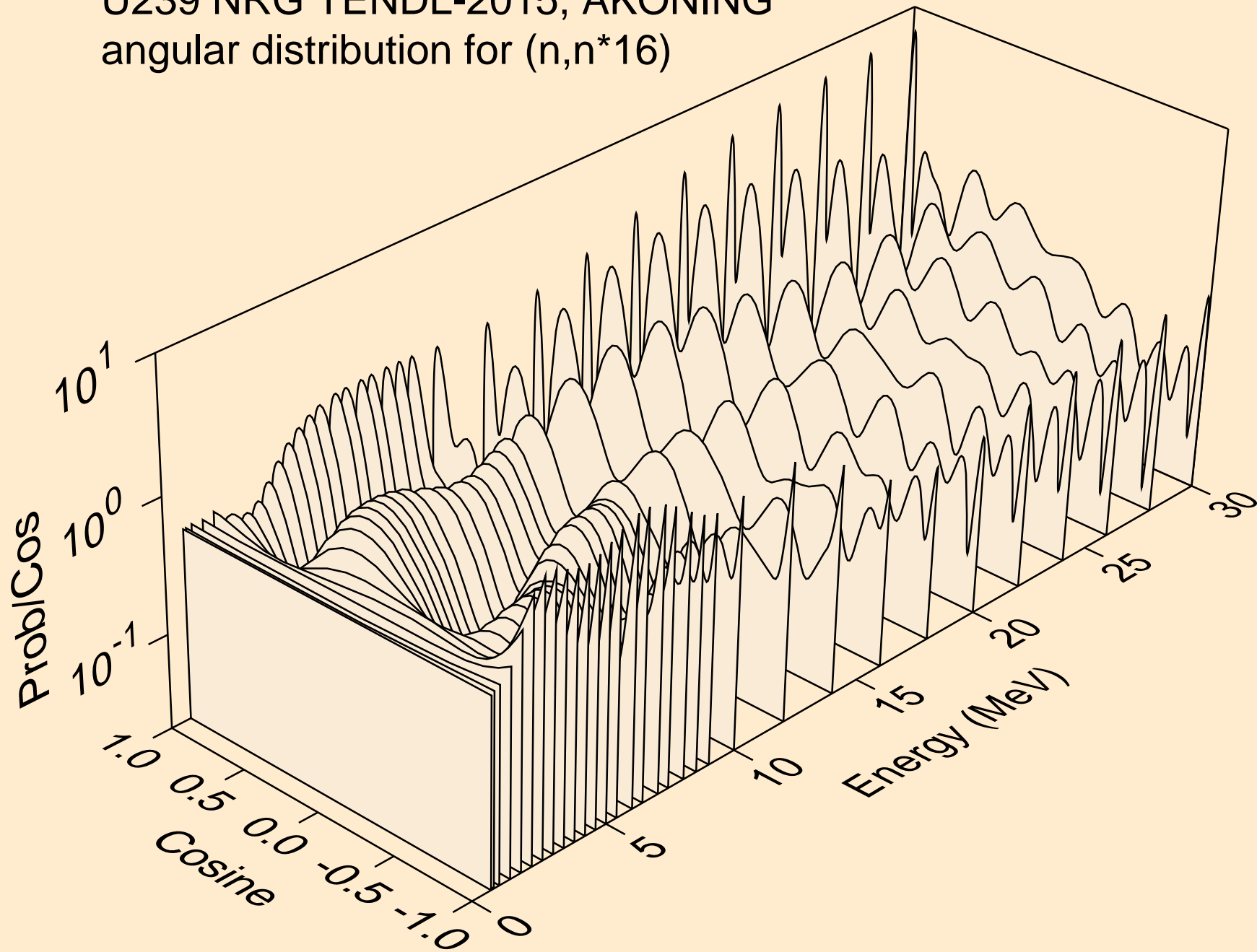

U239 NRG TENDL-2015, AKONING  
angular distribution for (n,n\*17)

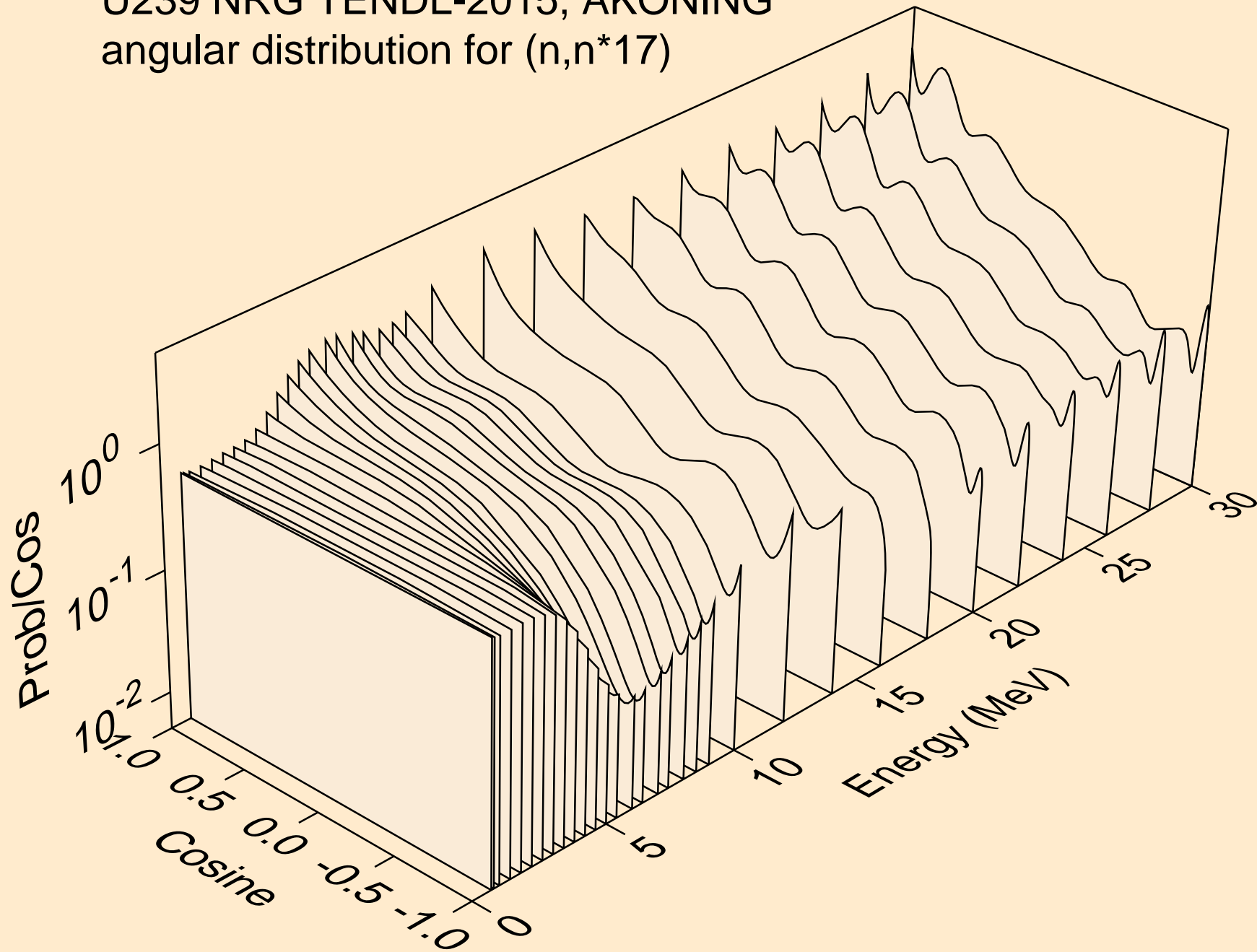

U239 NRG TENDL-2015, AKONING  
angular distribution for (n,n\*18)

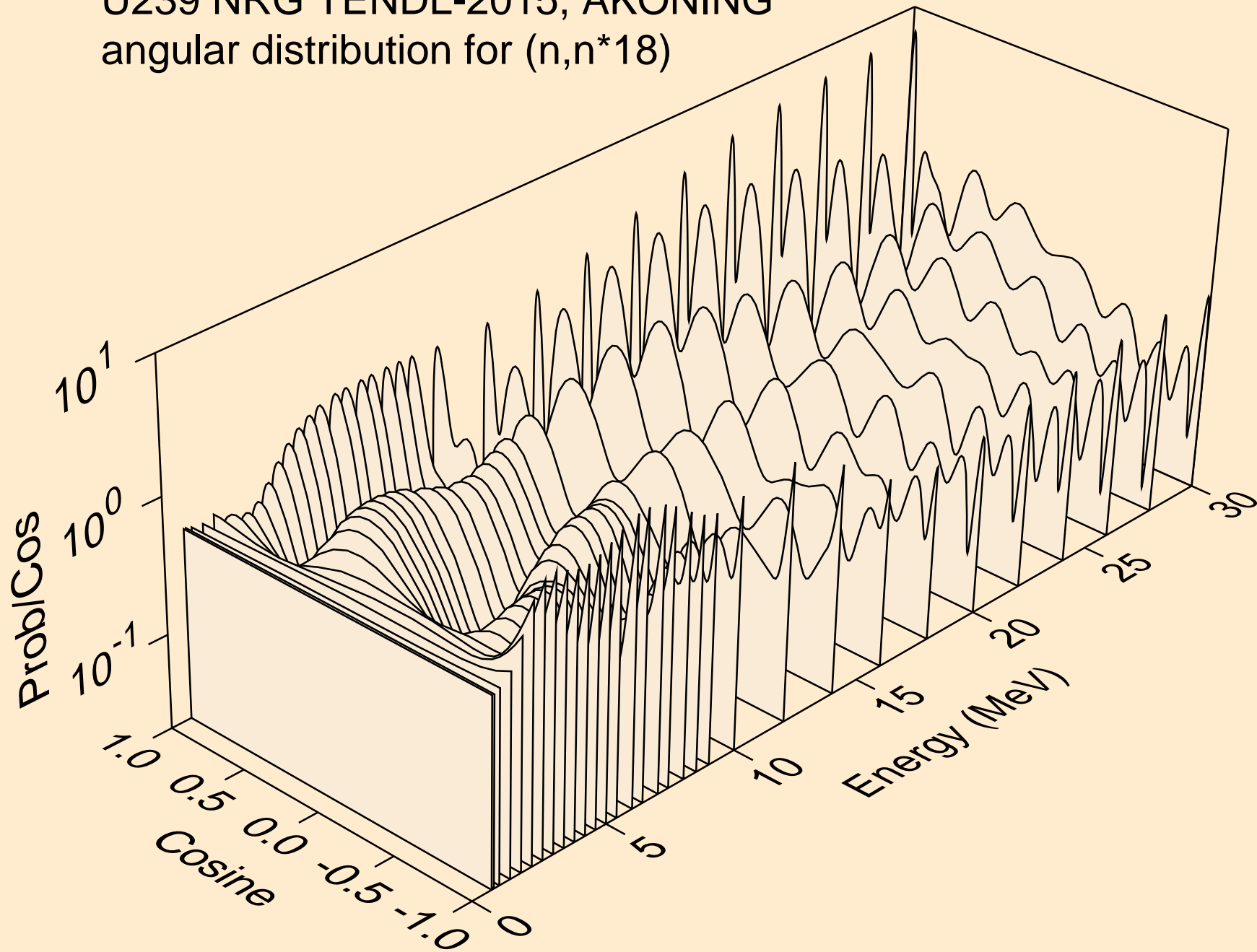

U239 NRG TENDL-2015, AKONING  
angular distribution for (n,n\*19)

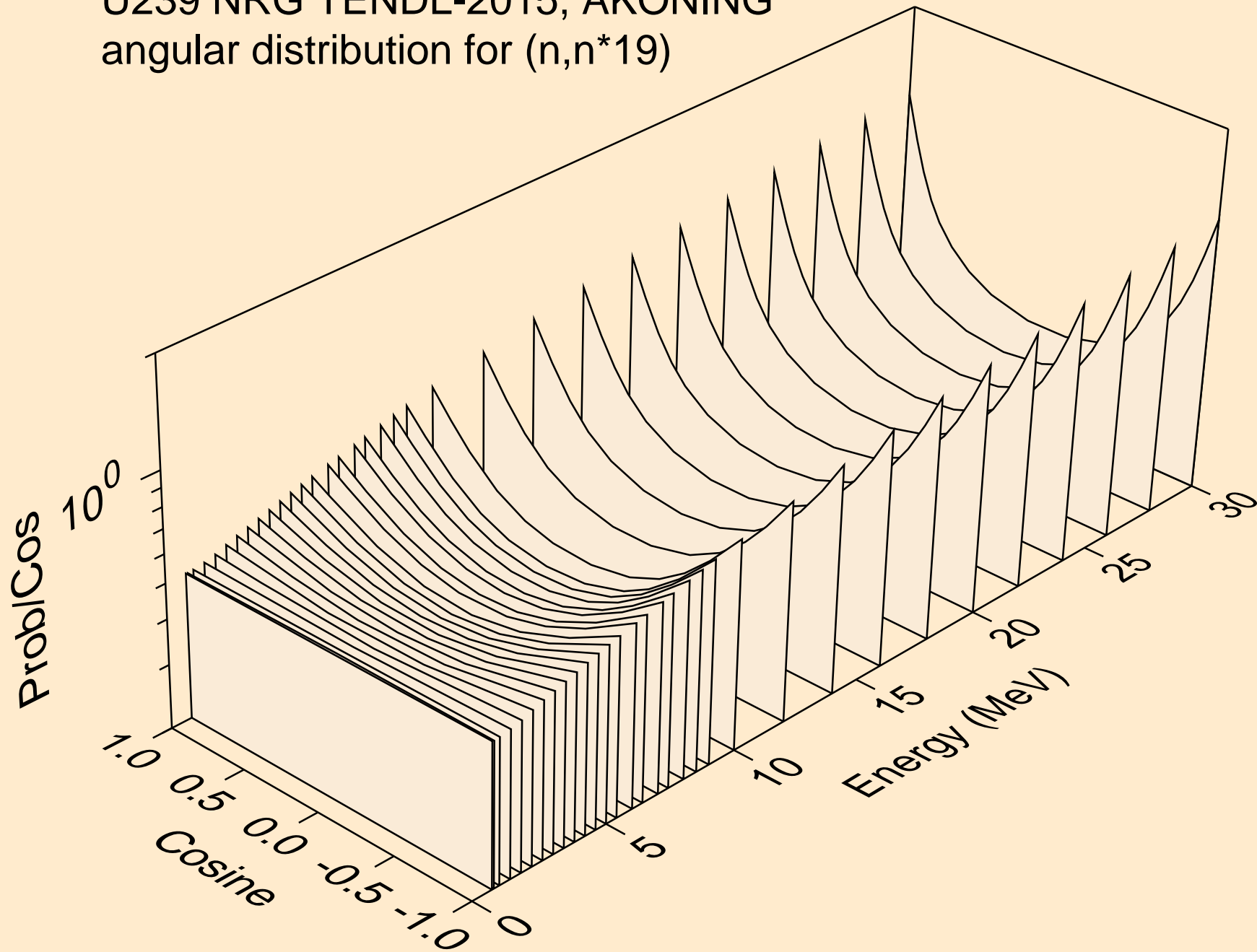

U239 NRG TENDL-2015, AKONING  
angular distribution for (n,n\*20)

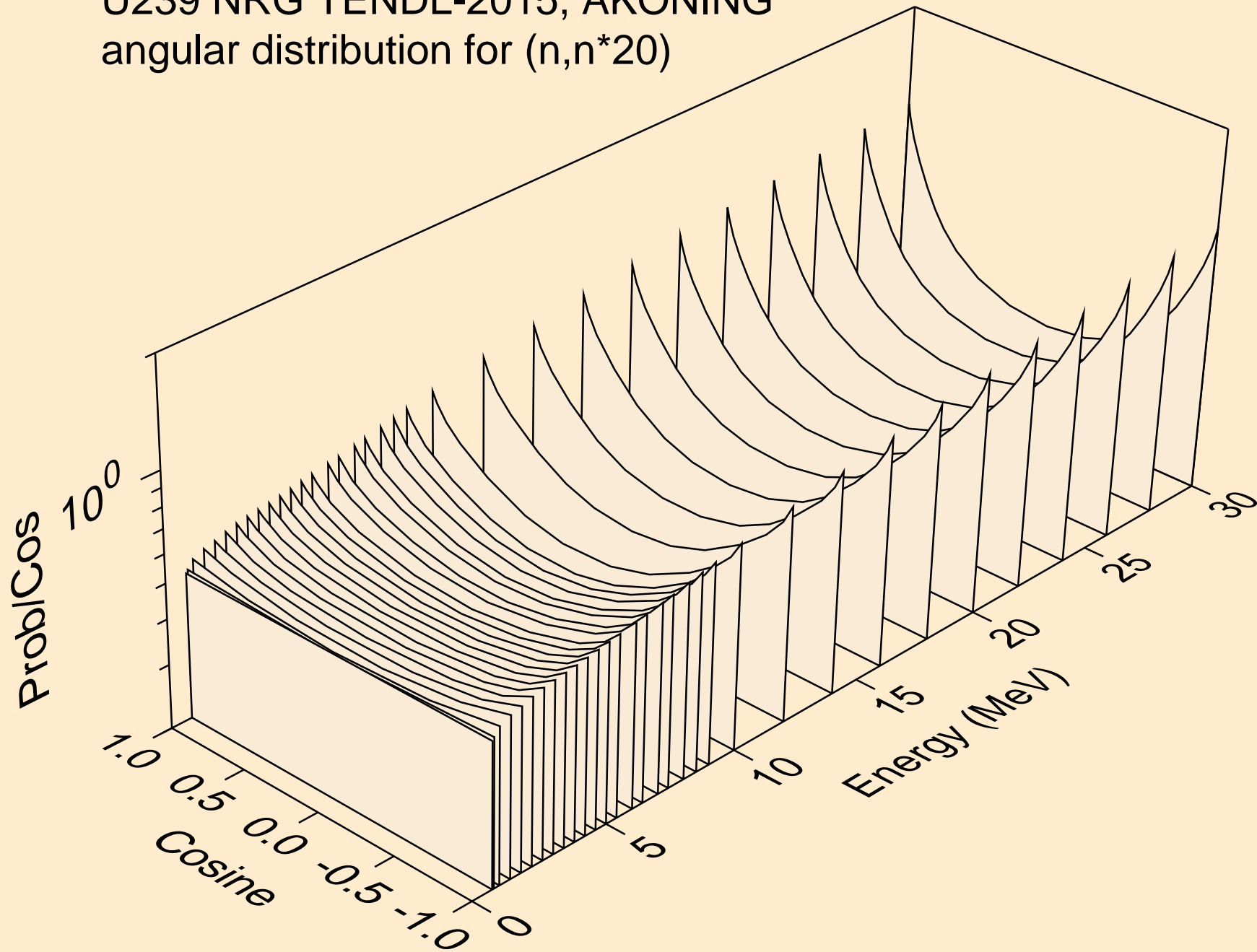

U239 NRG TENDL-2015, AKONING  
angular distribution for (n,n\*21)

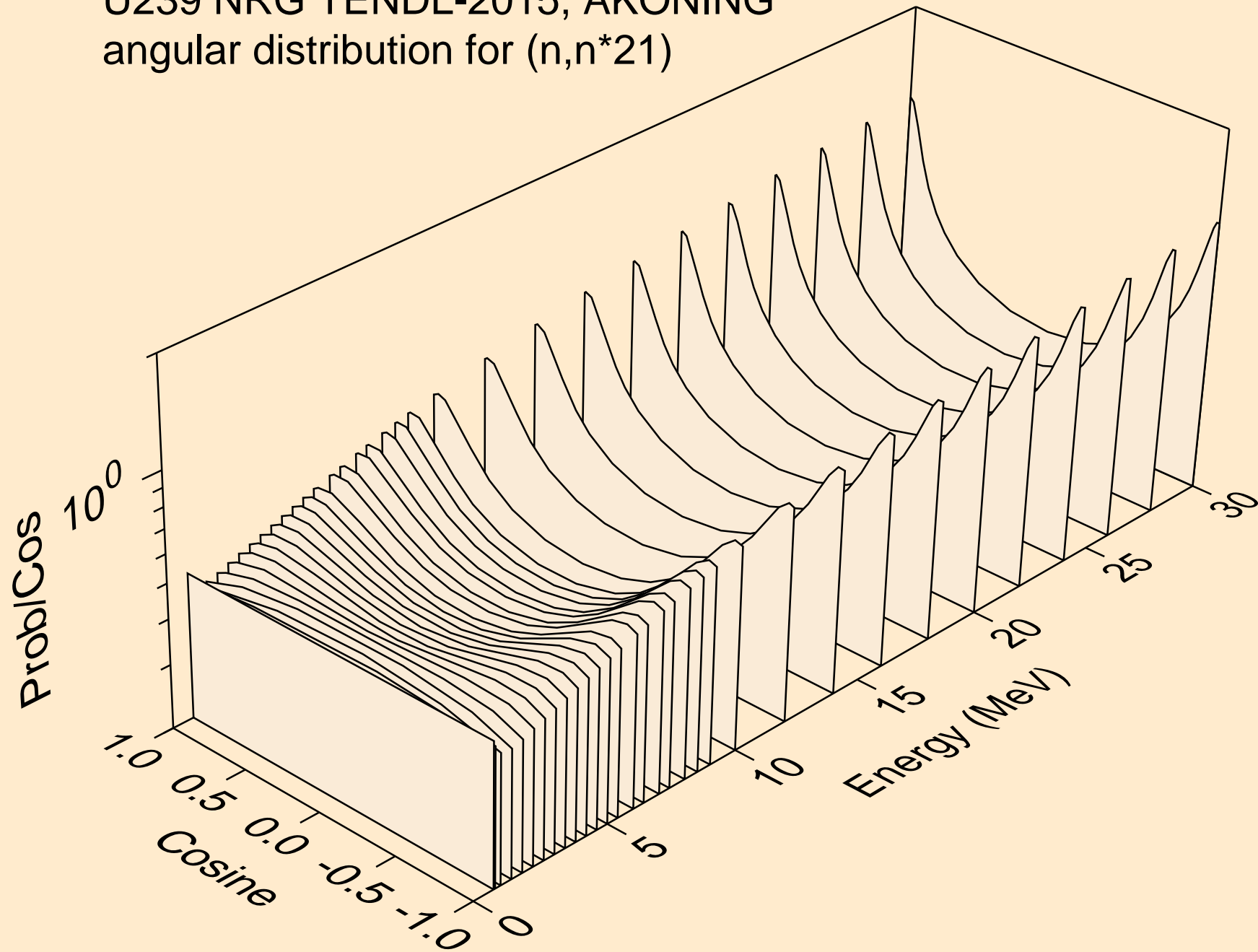

U239 NRG TENDL-2015, AKONING  
angular distribution for (n,n\*22)

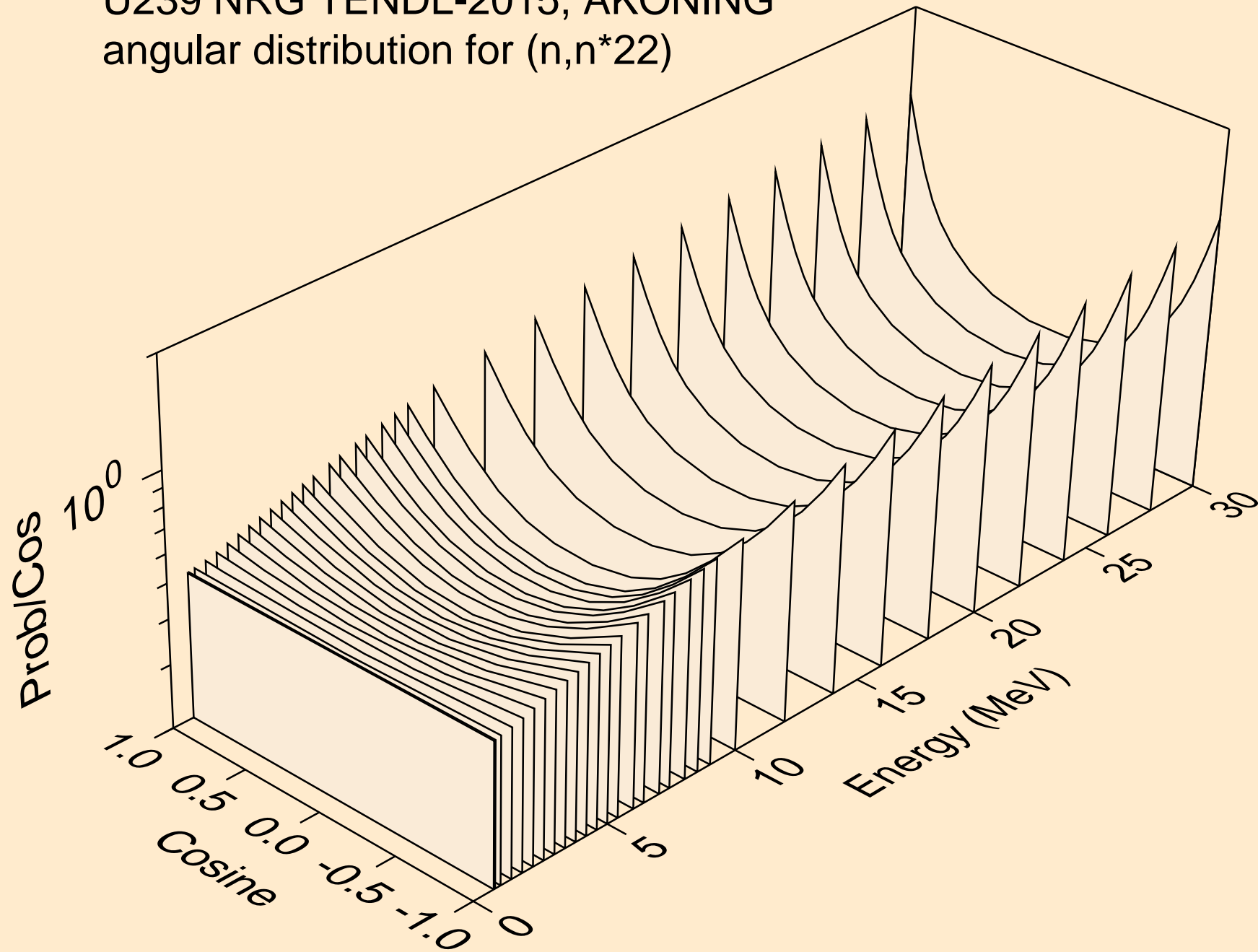

U239 NRG TENDL-2015, AKONING  
angular distribution for (n,n\*23)

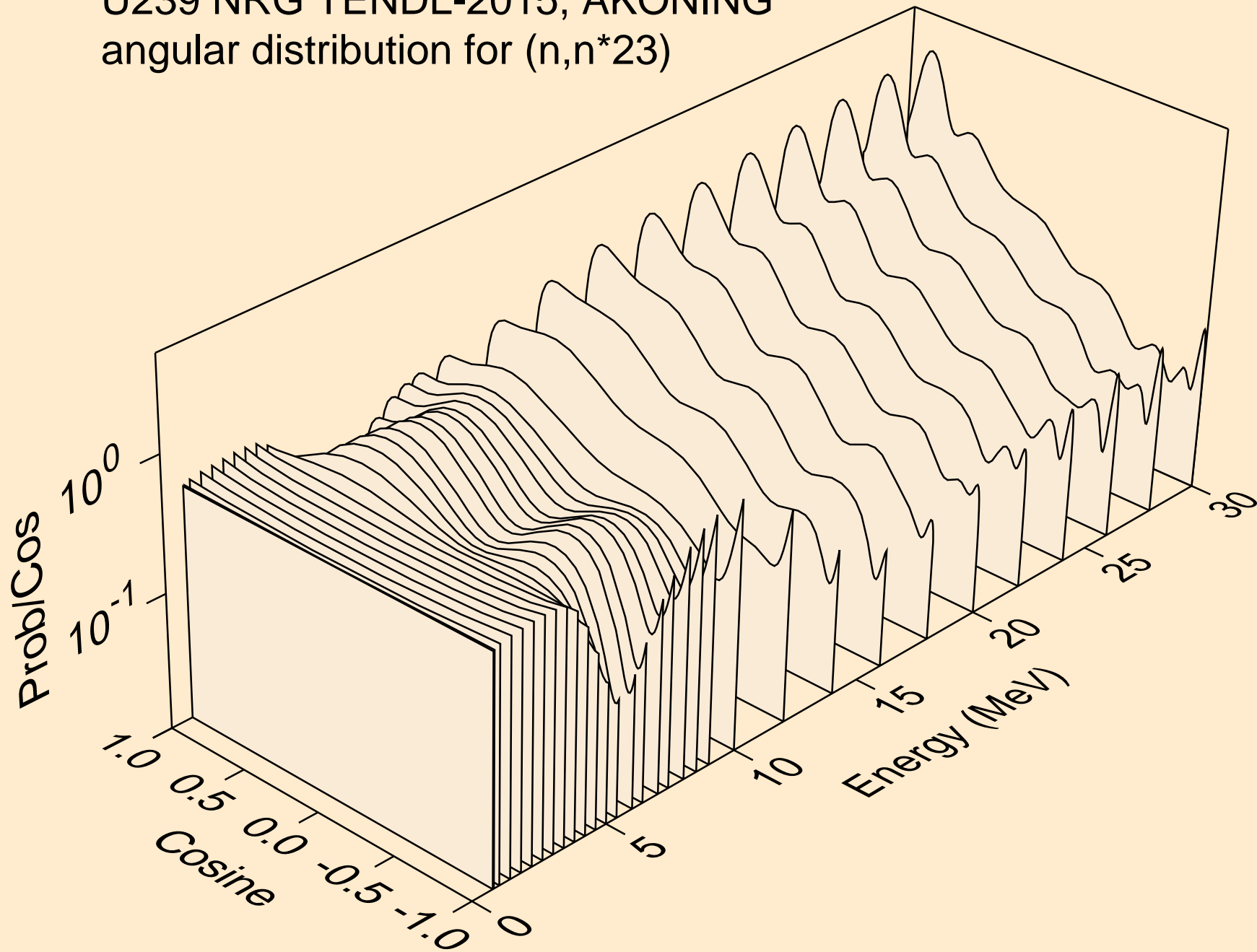



U239 NRG TENDL-2015, AKONING  
angular distribution for (n,n\*24)

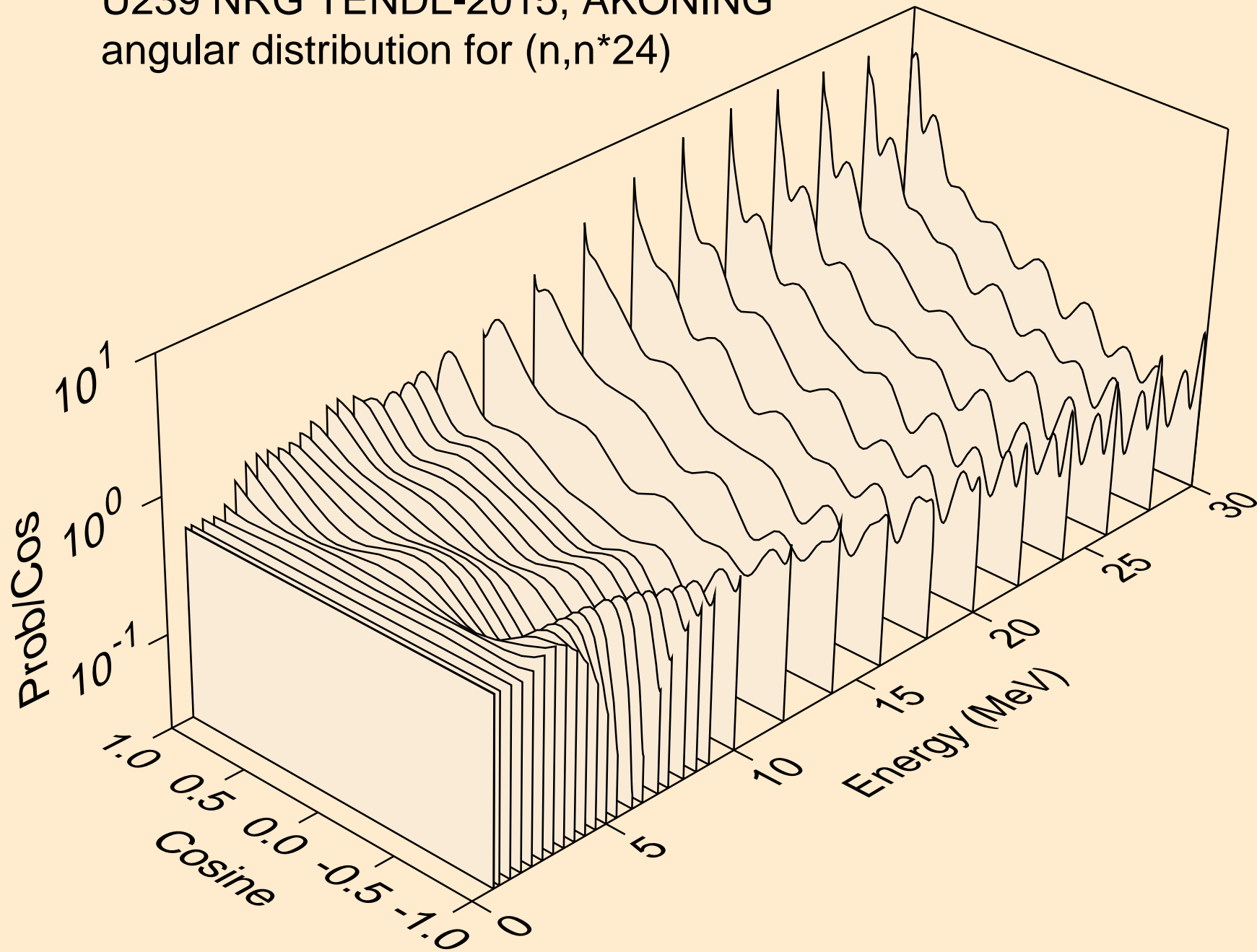

U239 NRG TENDL-2015, AKONING  
angular distribution for (n,n\*25)

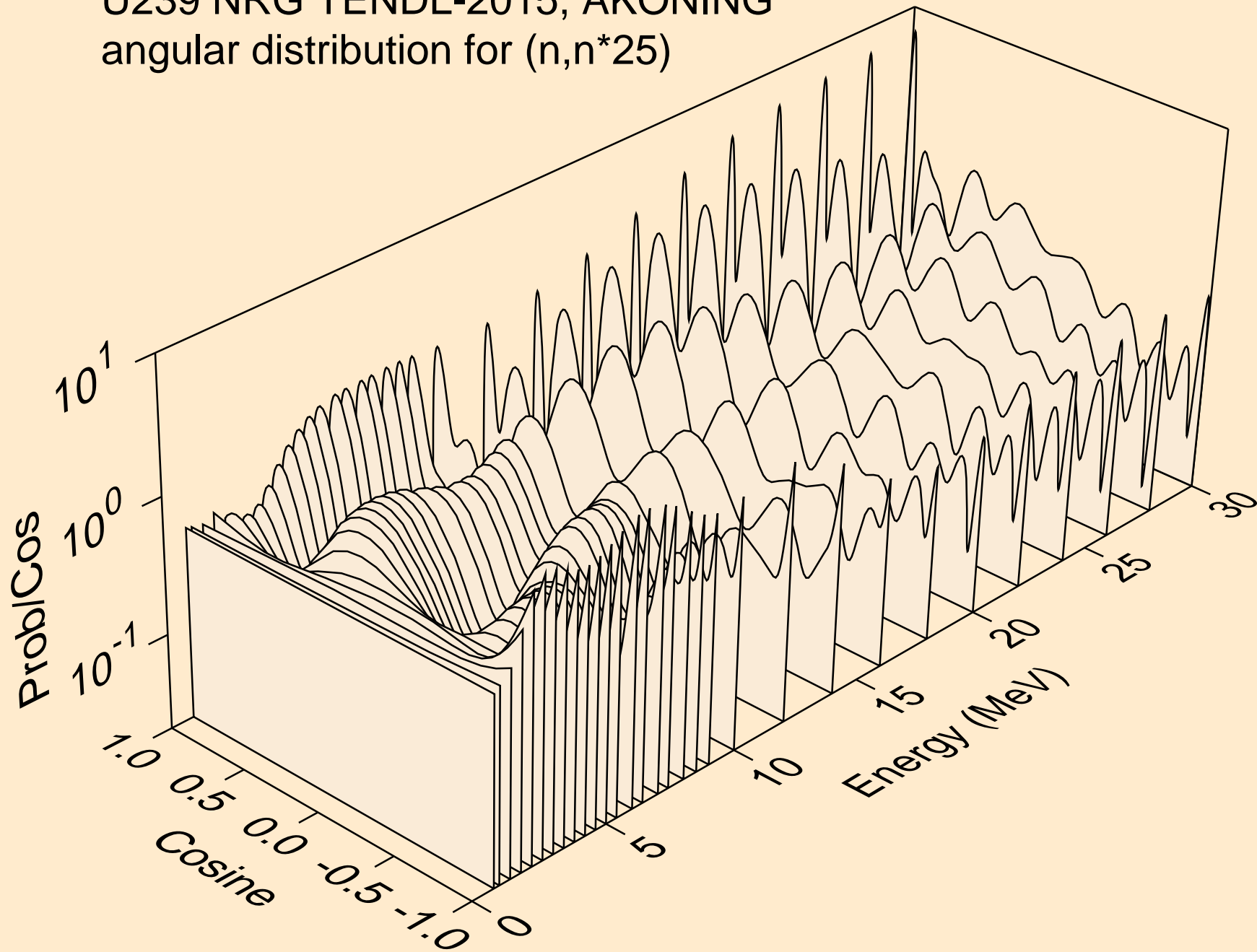

U239 NRG TENDL-2015, AKONING  
angular distribution for (n,n\*26)

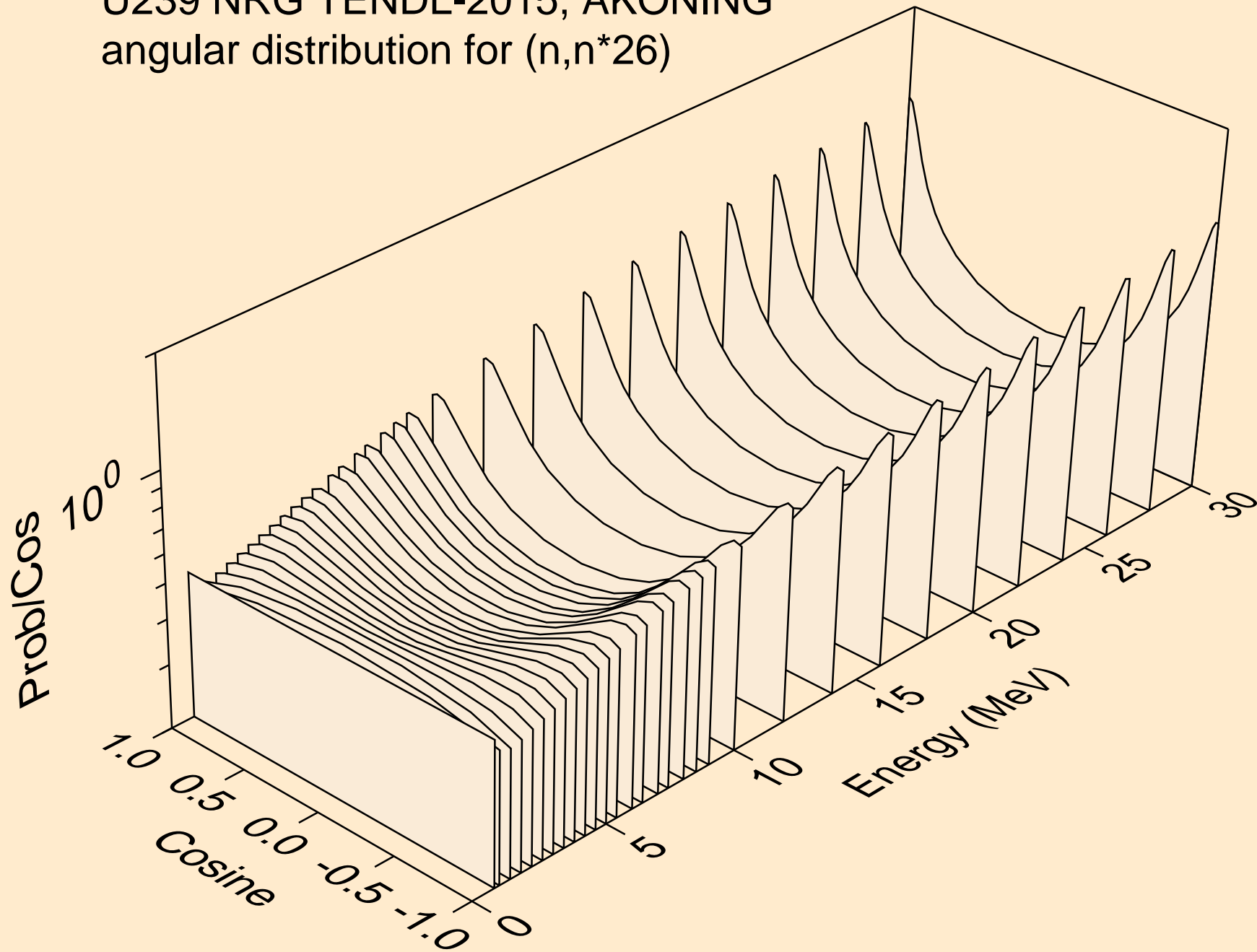

U239 NRG TENDL-2015, AKONING  
angular distribution for (n,n\*27)

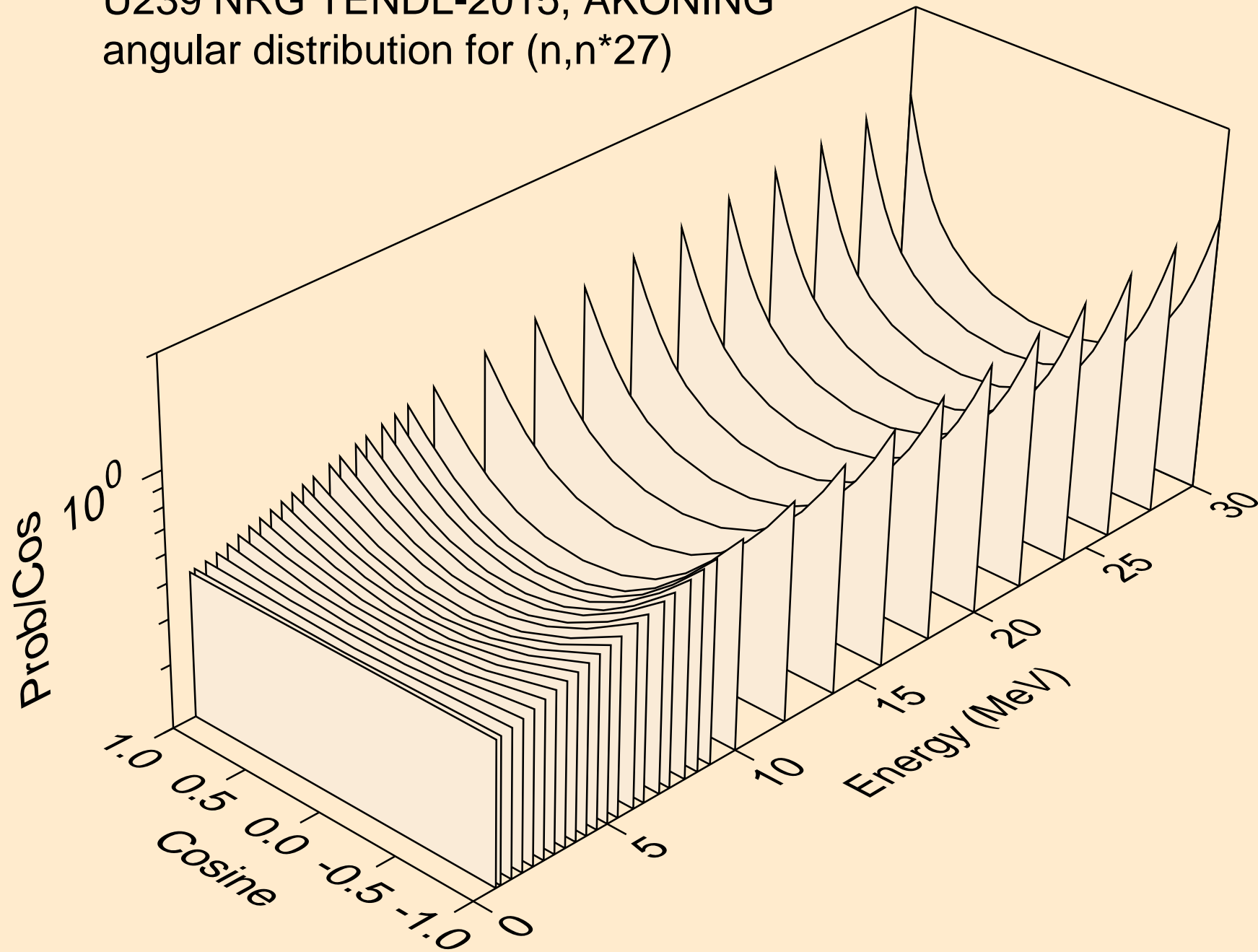

U239 NRG TENDL-2015, AKONING  
angular distribution for (n,n\*28)

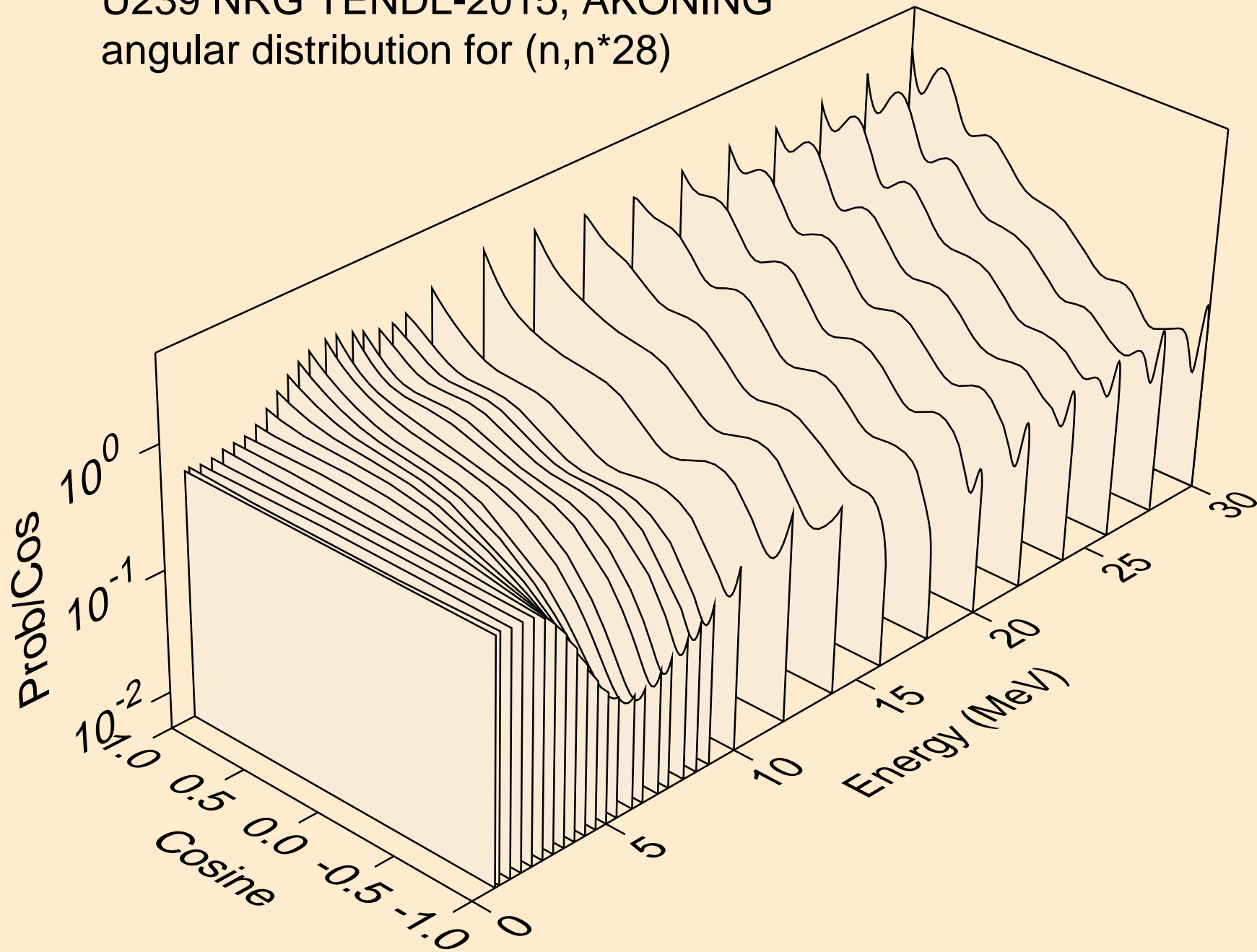

U239 NRG TENDL-2015, AKONING  
angular distribution for (n,n\*29)

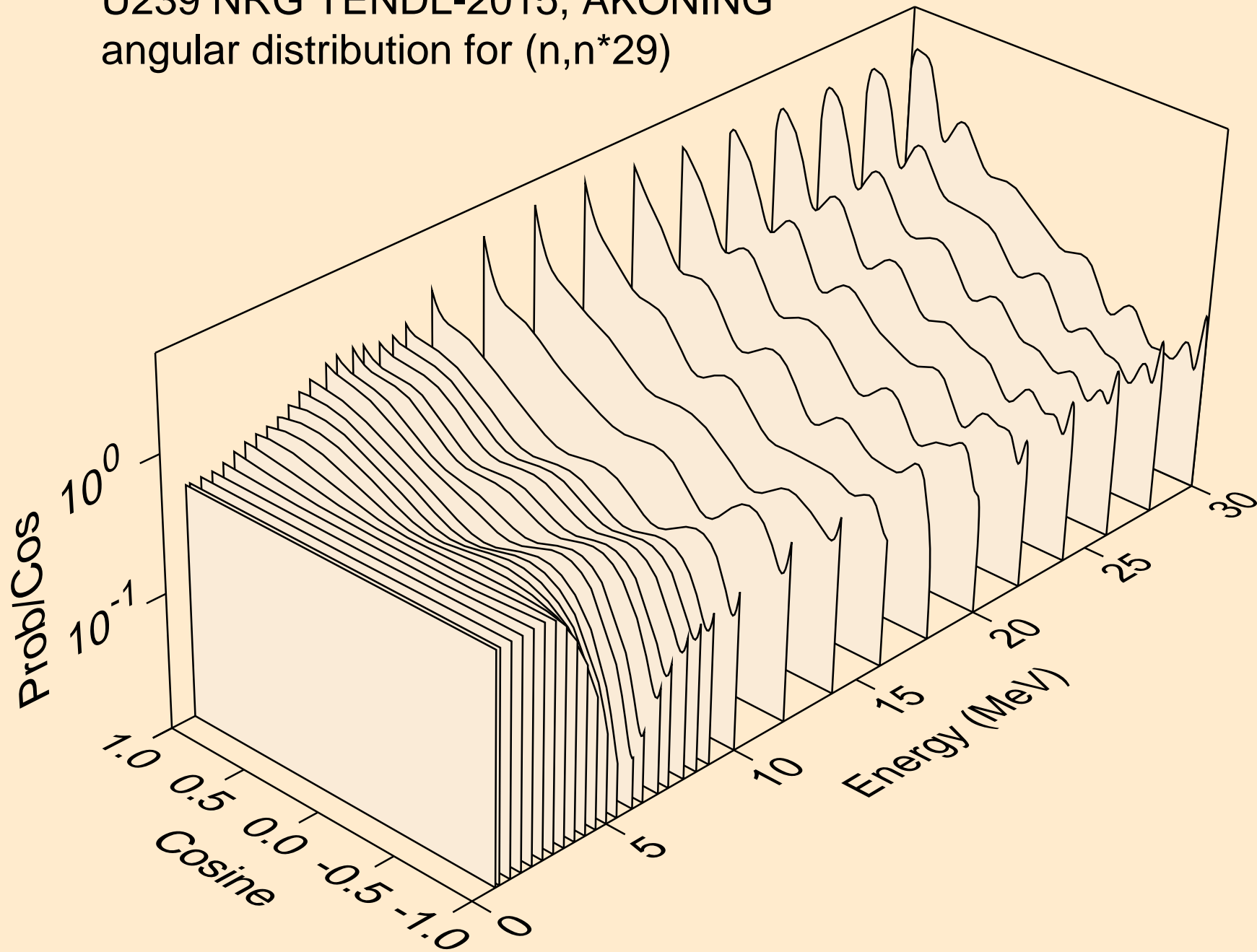

U239 NRG TENDL-2015, AKONING  
angular distribution for (n,n\*30)

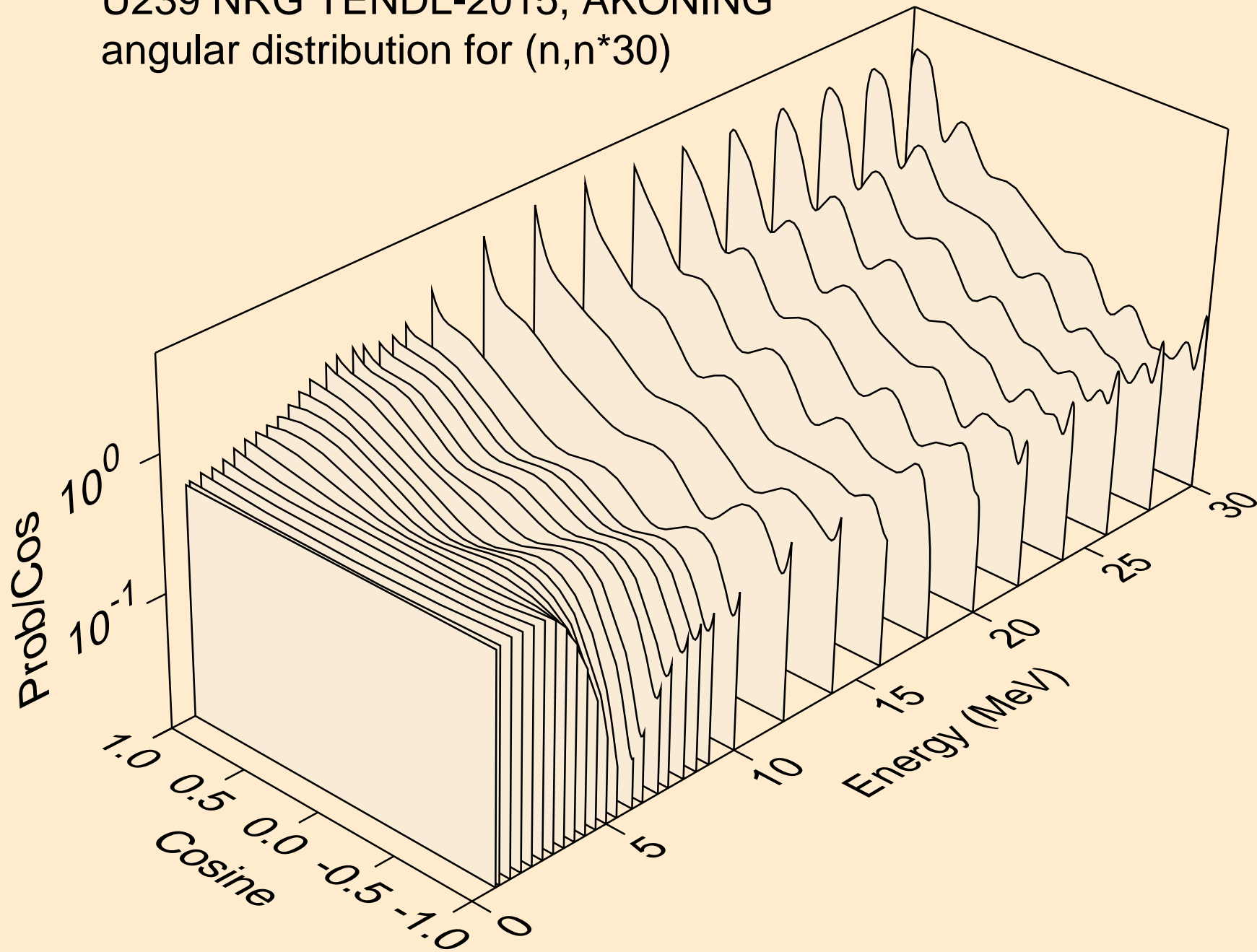

# U239 NRG TENDL-2015, AKONING

Total fission nubar

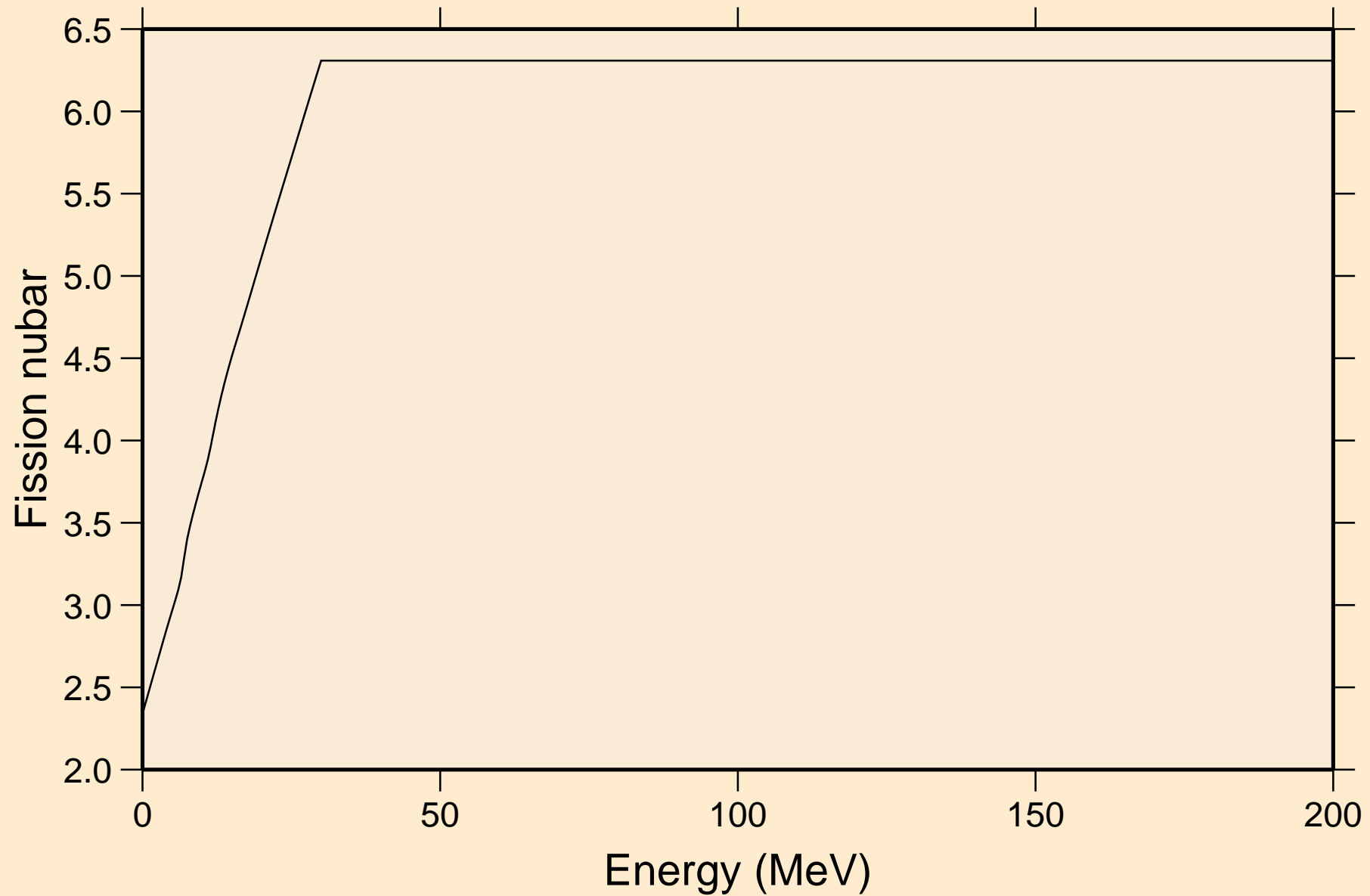



U239 NRG TENDL-2015, AKONING  
Neutron emission for (n,x)

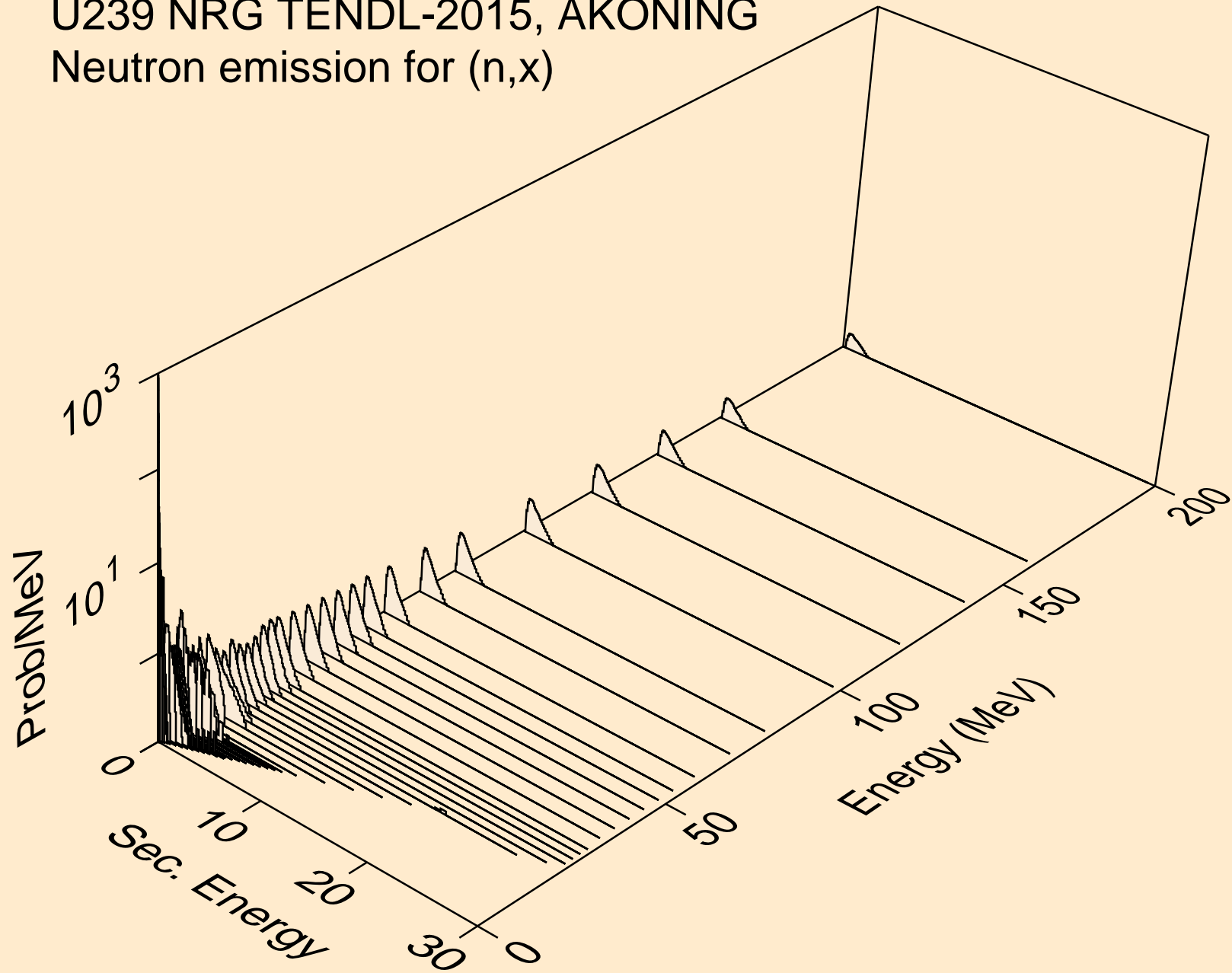

U239 NRG TENDL-2015, AKONING  
Neutron emission for (n,2nd)

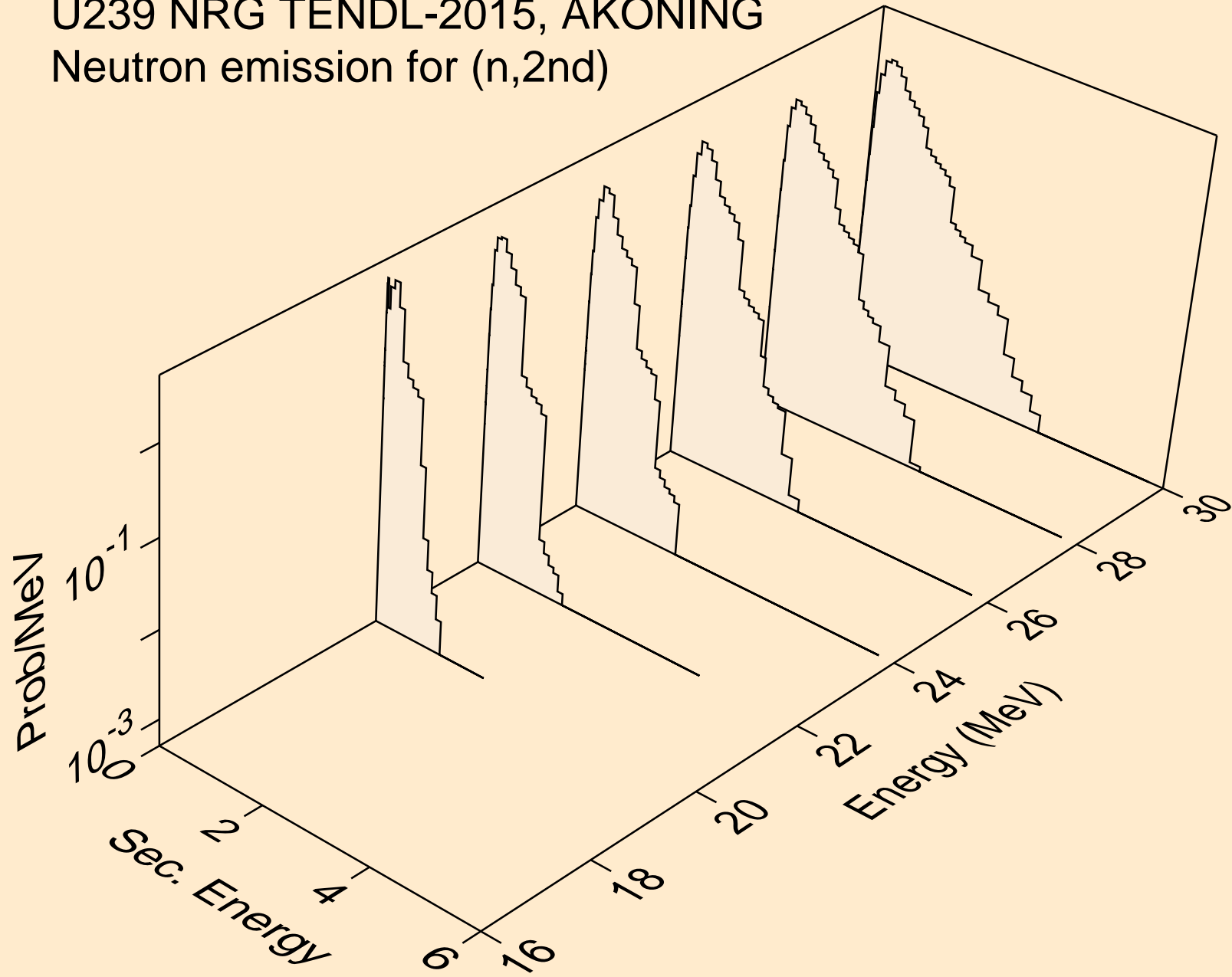

U239 NRG TENDL-2015, AKONING  
Neutron emission for (n,2n)

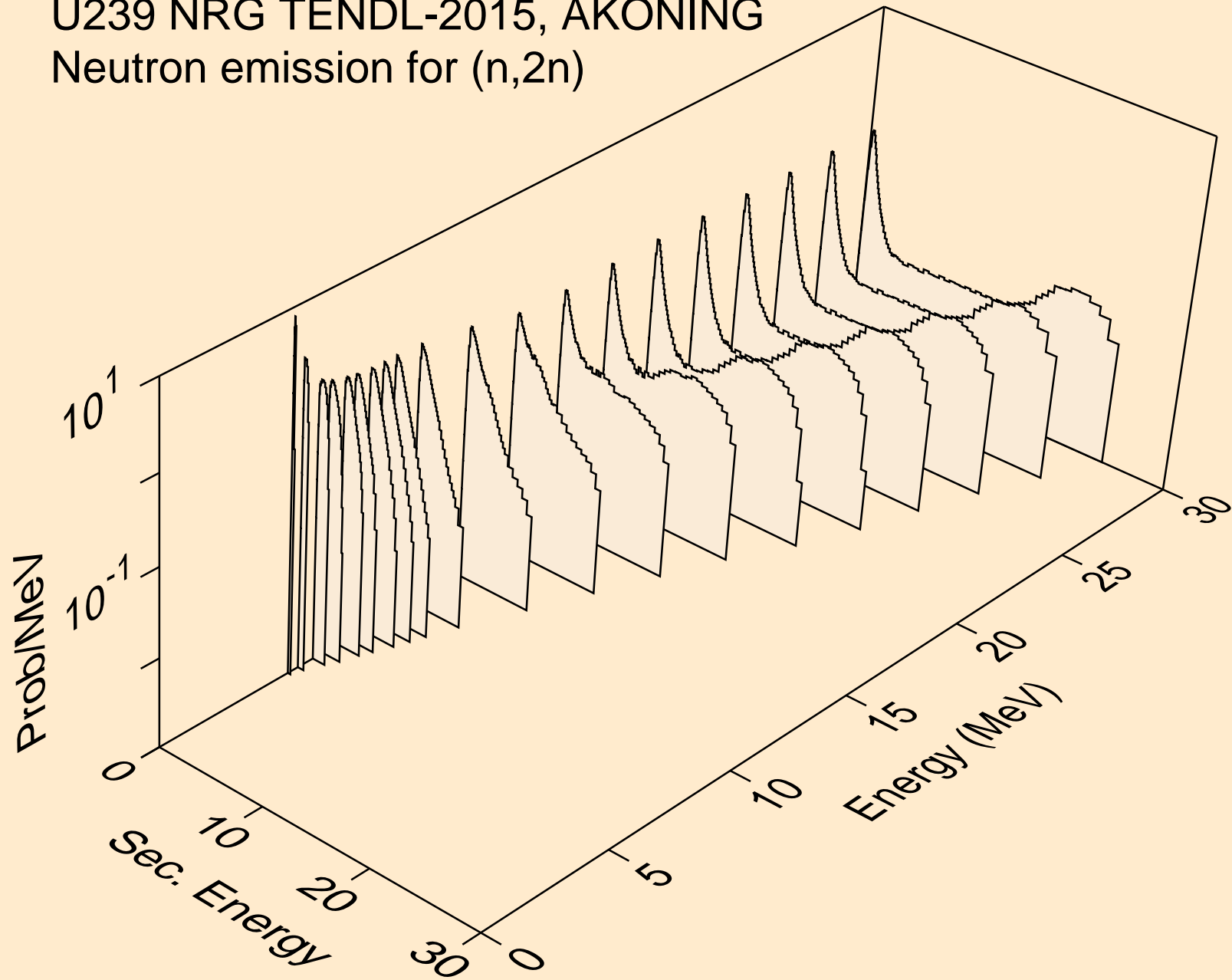

U239 NRG TENDL-2015, AKONING  
Neutron emission for (n,3n)

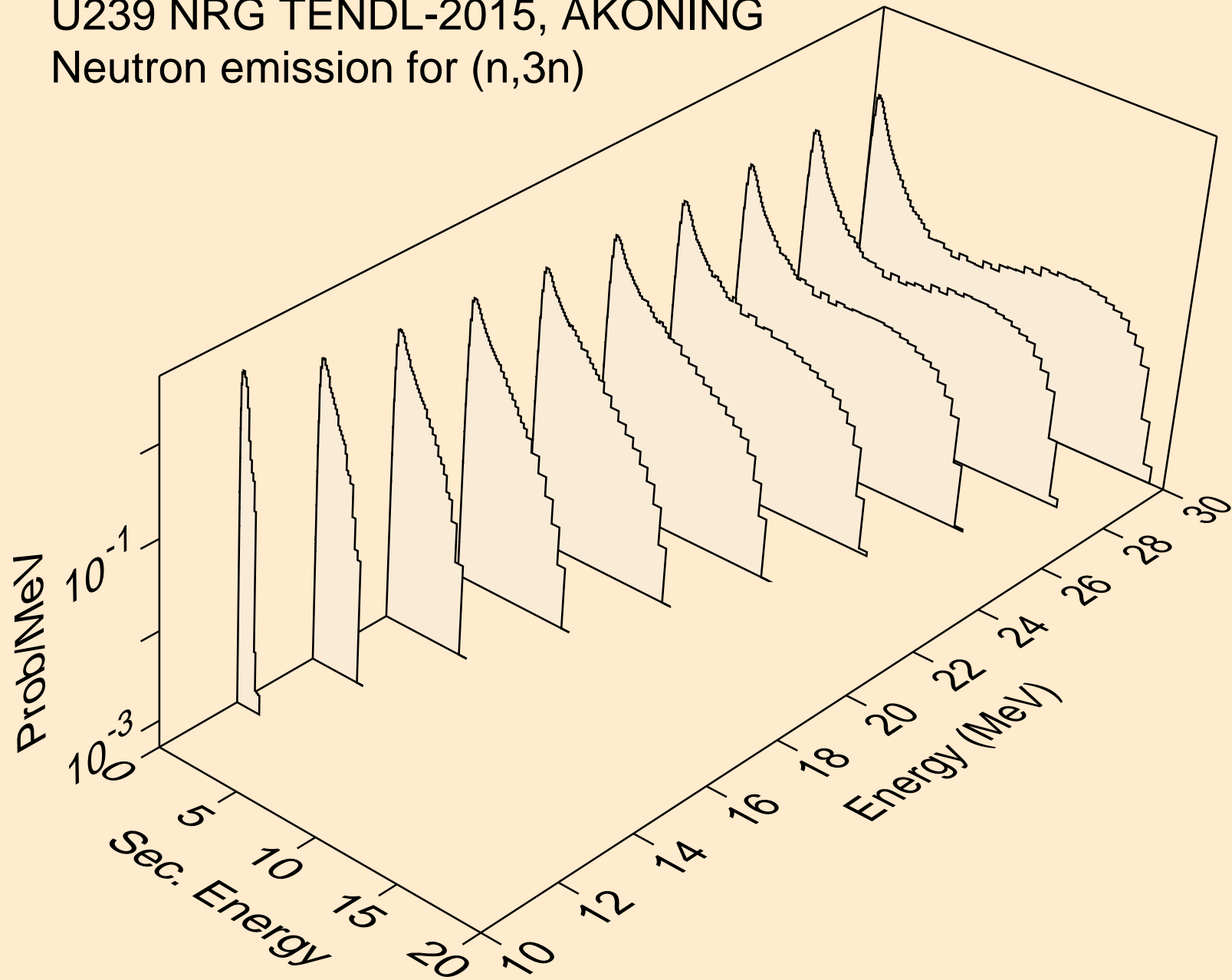

U239 NRG TENDL-2015, AKONING  
Neutron emission for fission

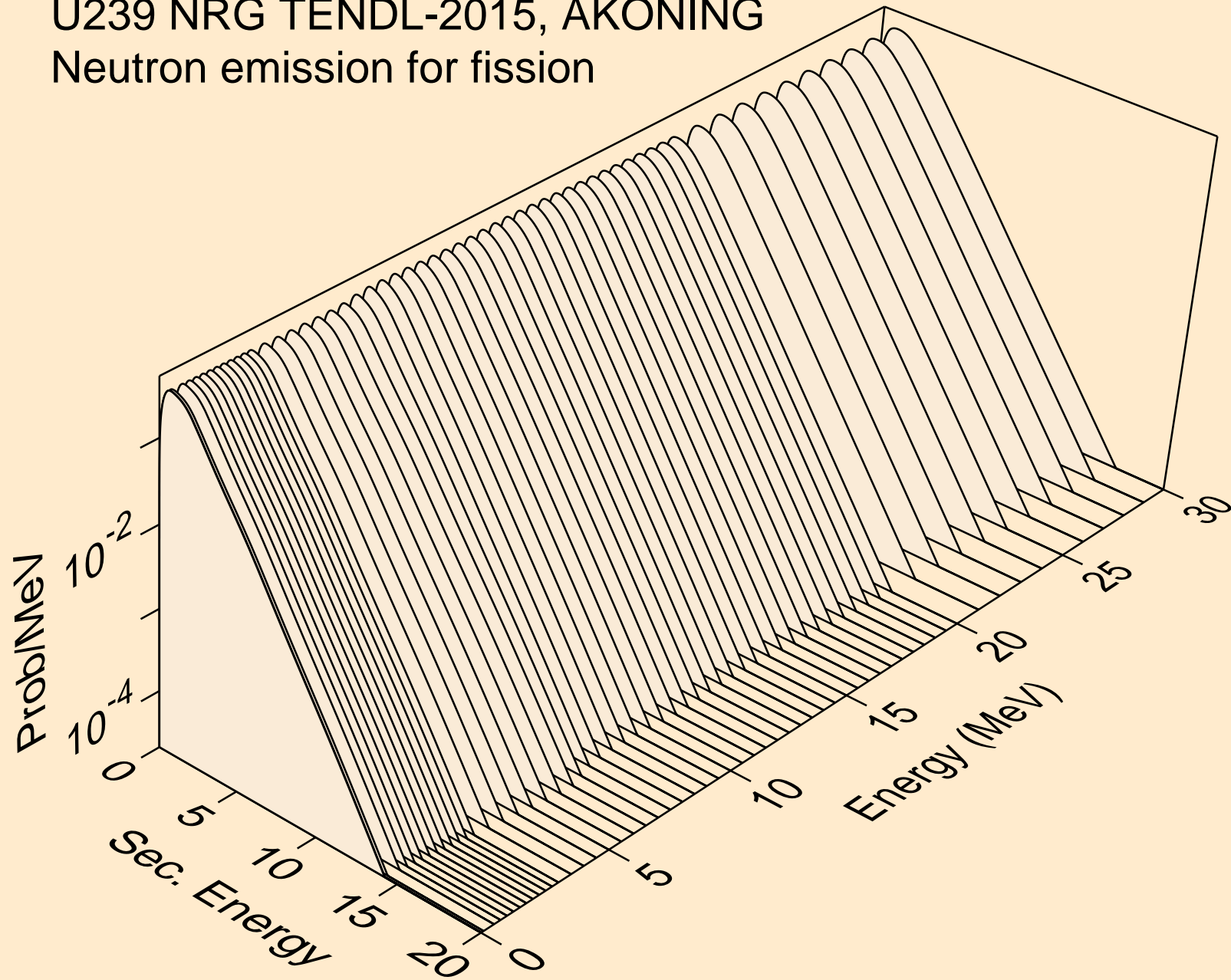

U239 NRG TENDL-2015, AKONING  
Neutron emission for (n,n\*)a

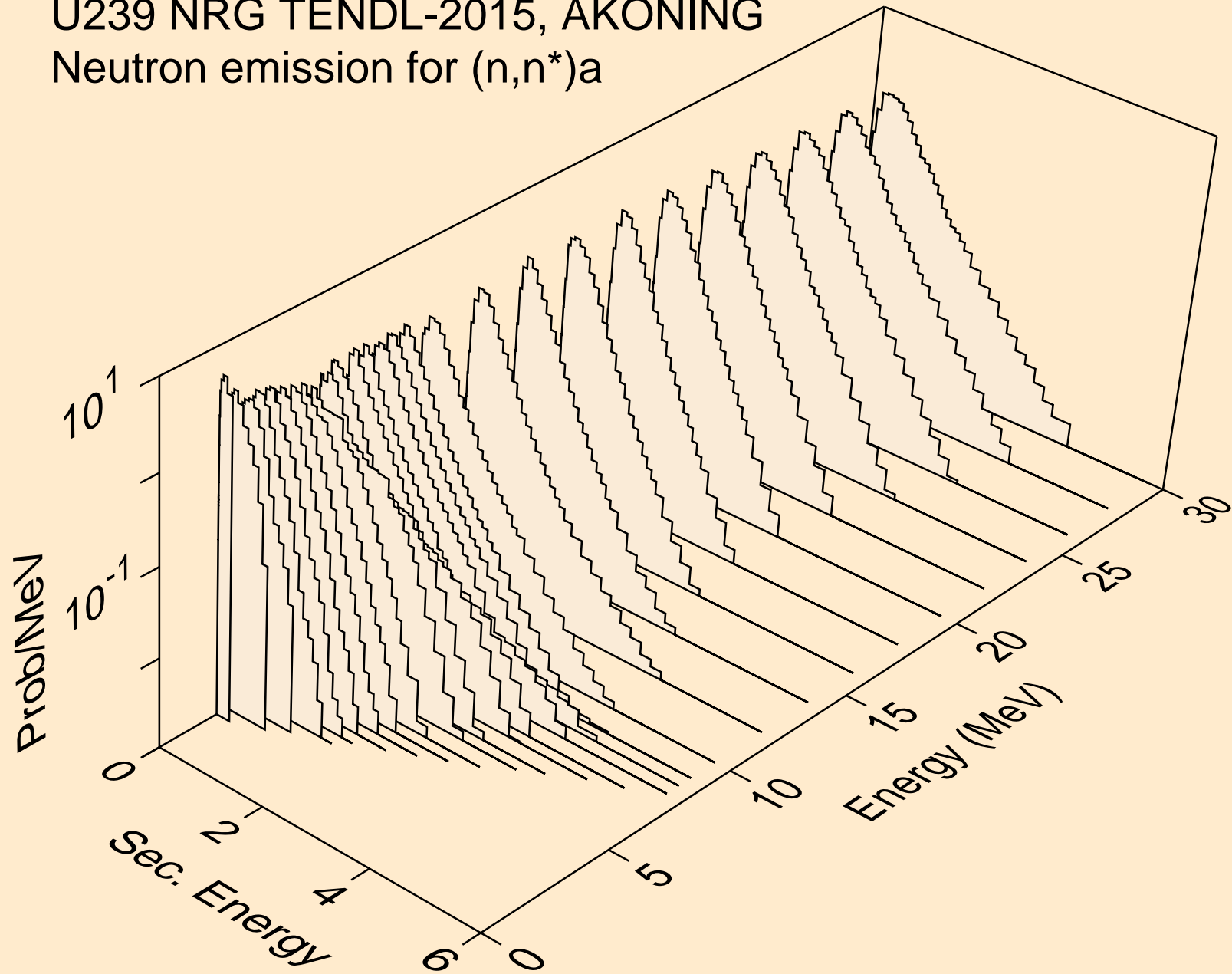

U239 NRG TENDL-2015, AKONING  
Neutron emission for (n,2n)a

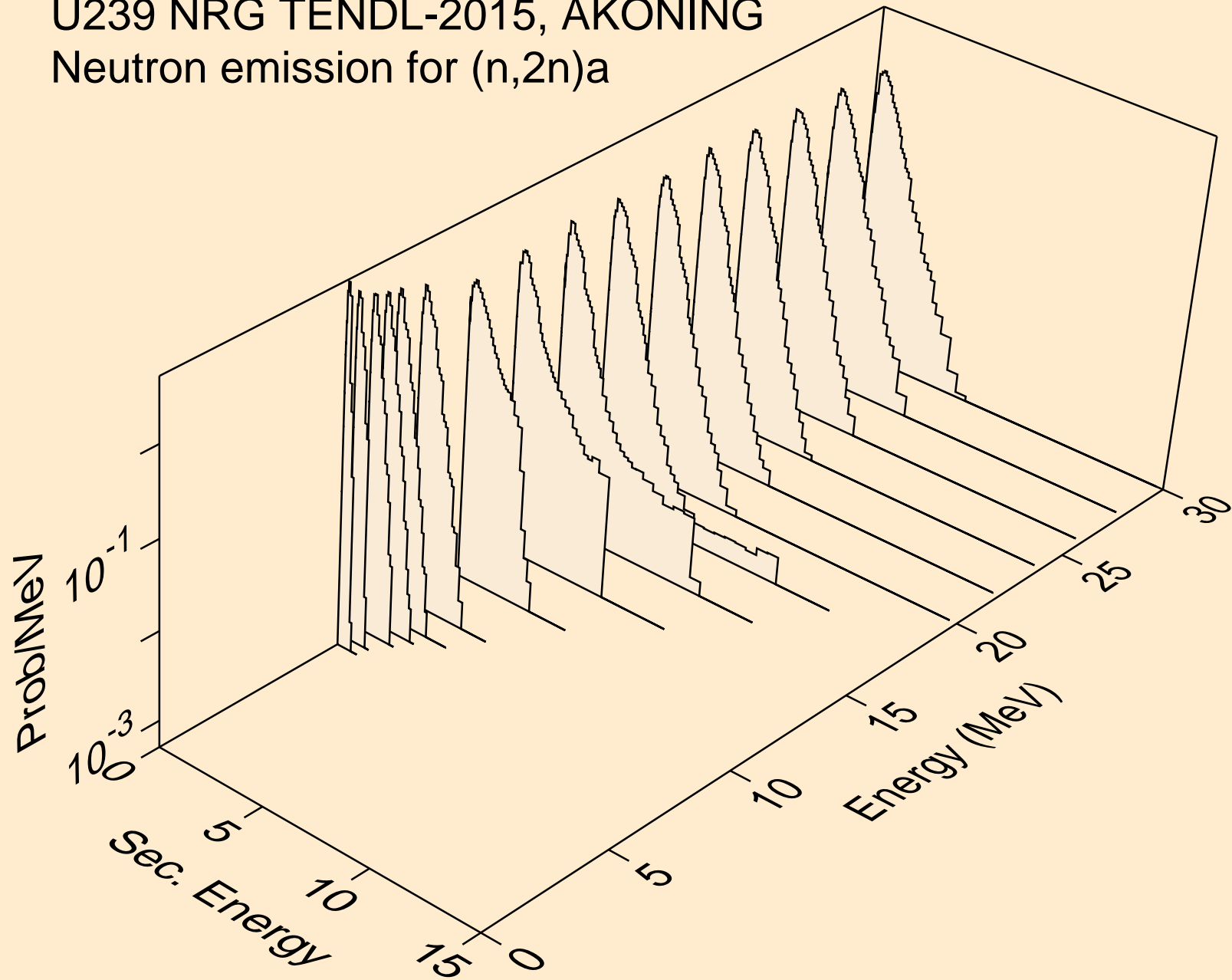

U239 NRG TENDL-2015, AKONING  
Neutron emission for (n,3n)a

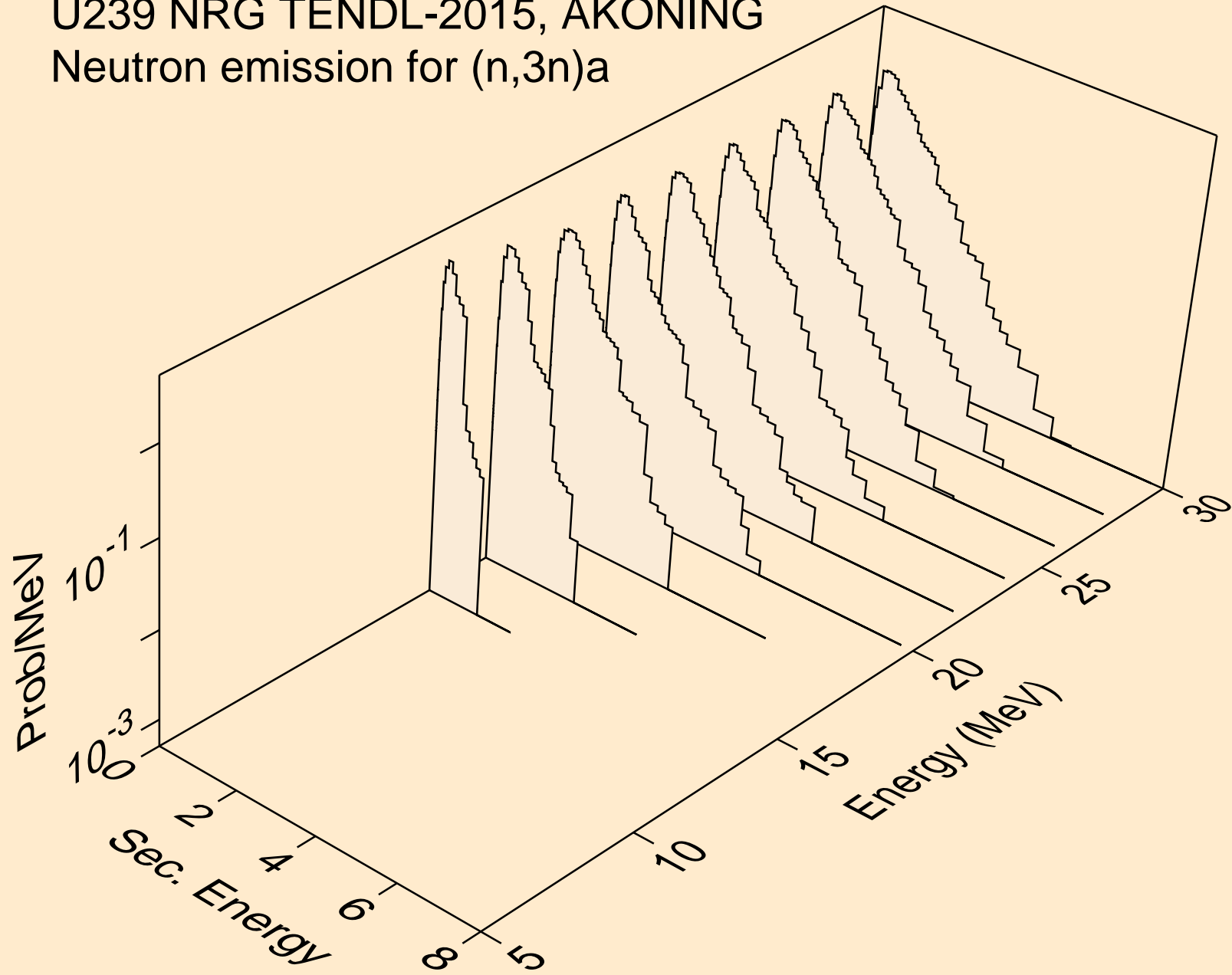



U239 NRG TENDL-2015, AKONING  
Neutron emission for (n,n\*)p

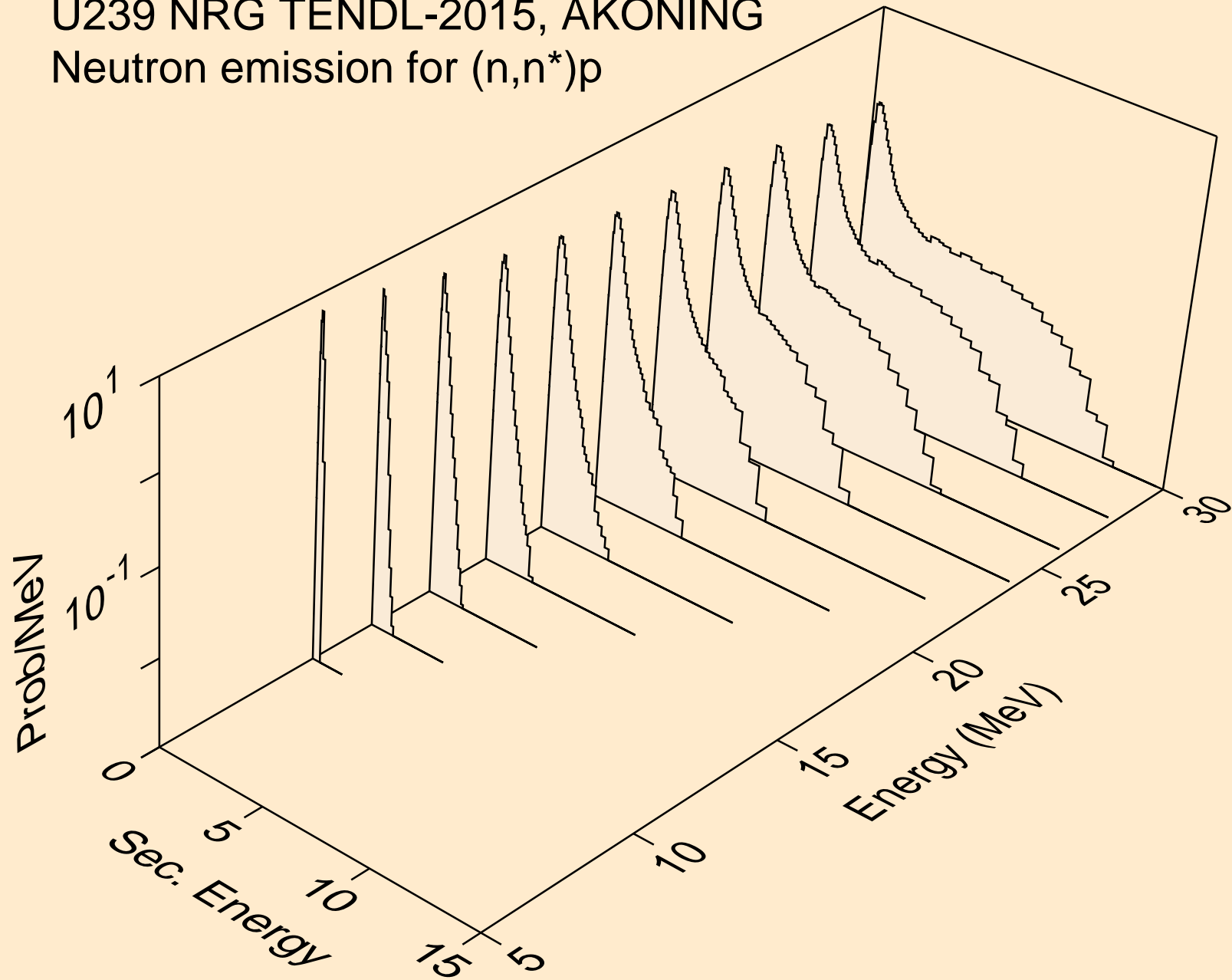

U239 NRG TENDL-2015, AKONING  
Neutron emission for (n,n\*)d

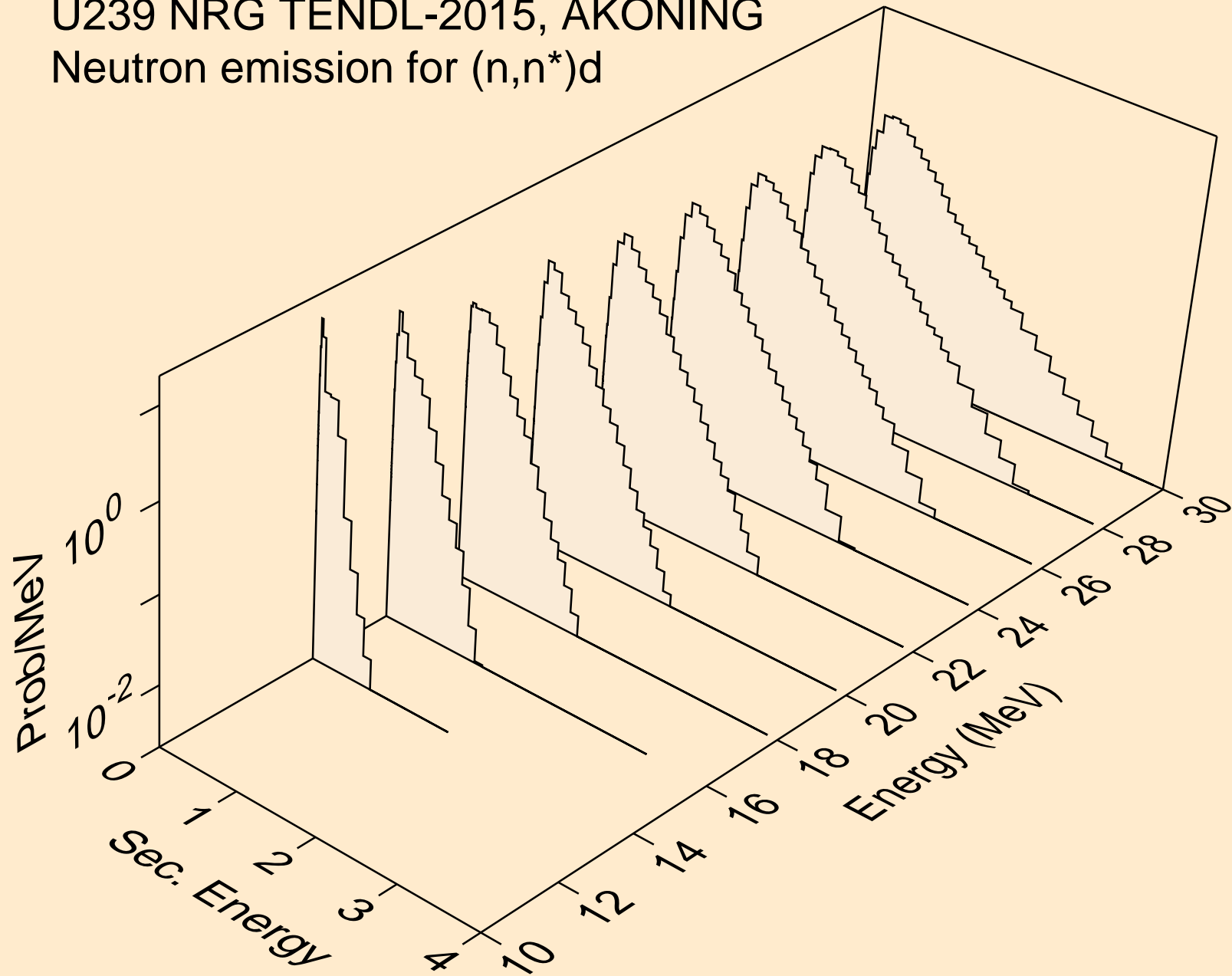

U239 NRG TENDL-2015, AKONING  
Neutron emission for (n,n\*)t

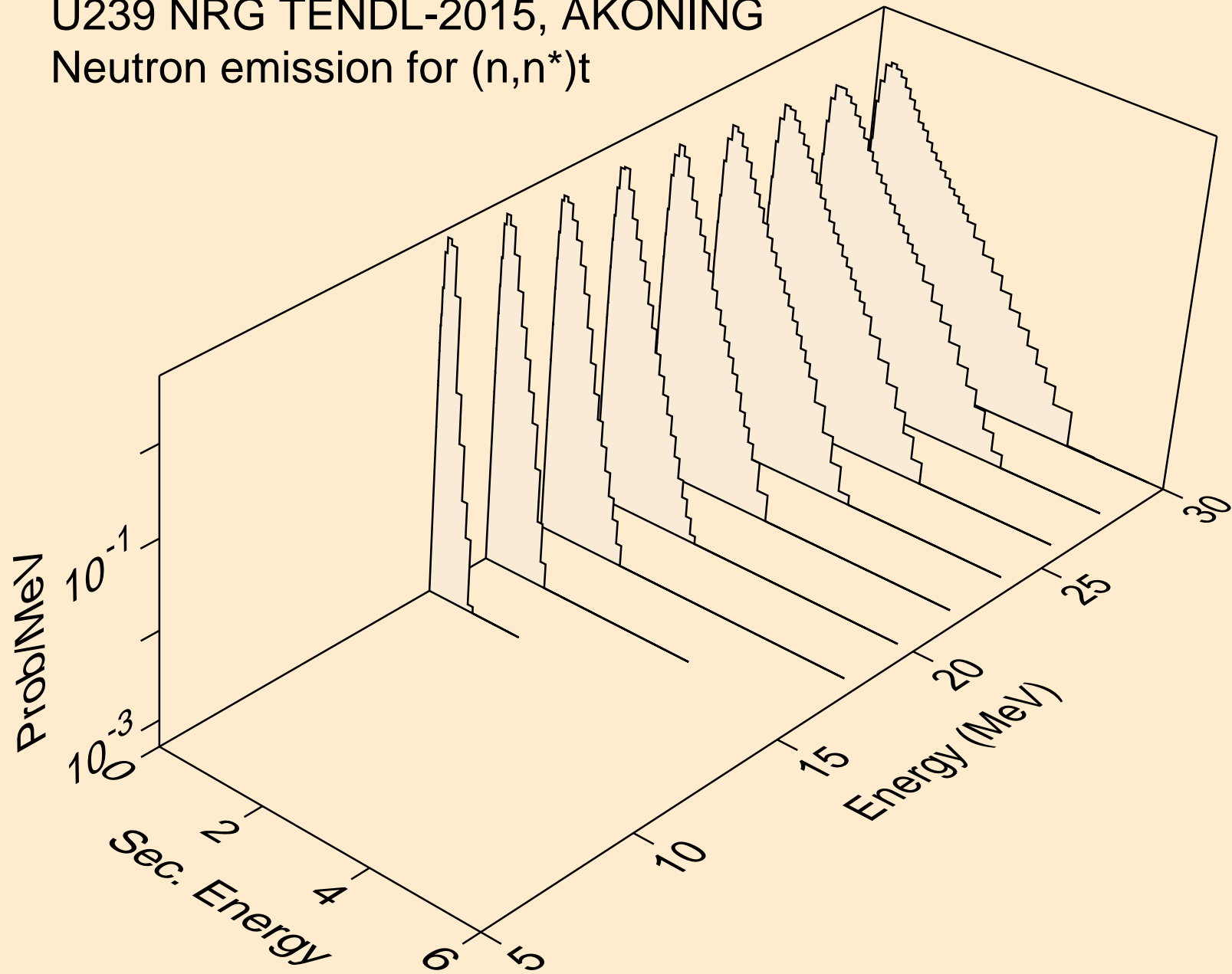

U239 NRG TENDL-2015, AKONING  
Neutron emission for (n,n\*)he3

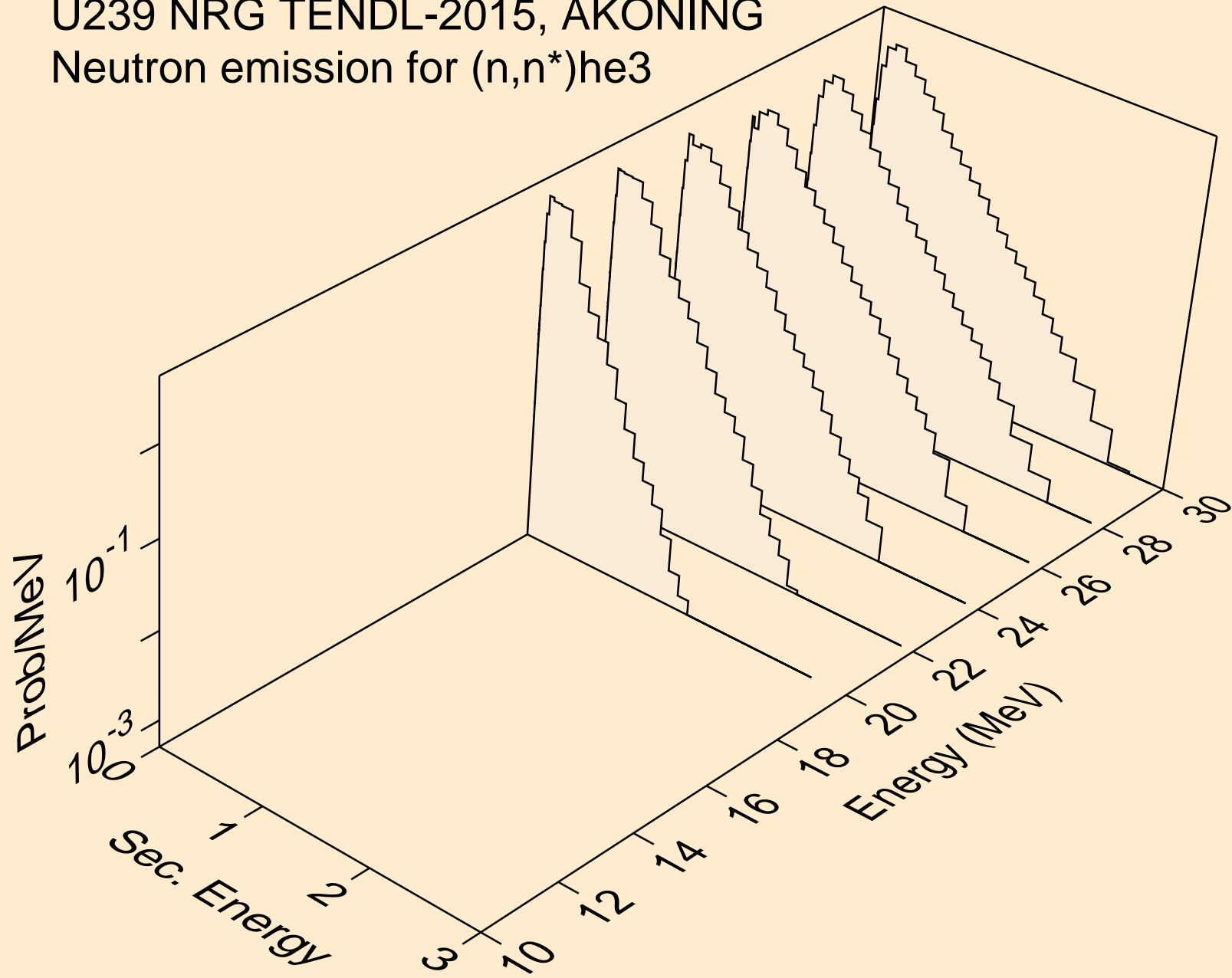

U239 NRG TENDL-2015, AKONING  
Neutron emission for (n,4n)

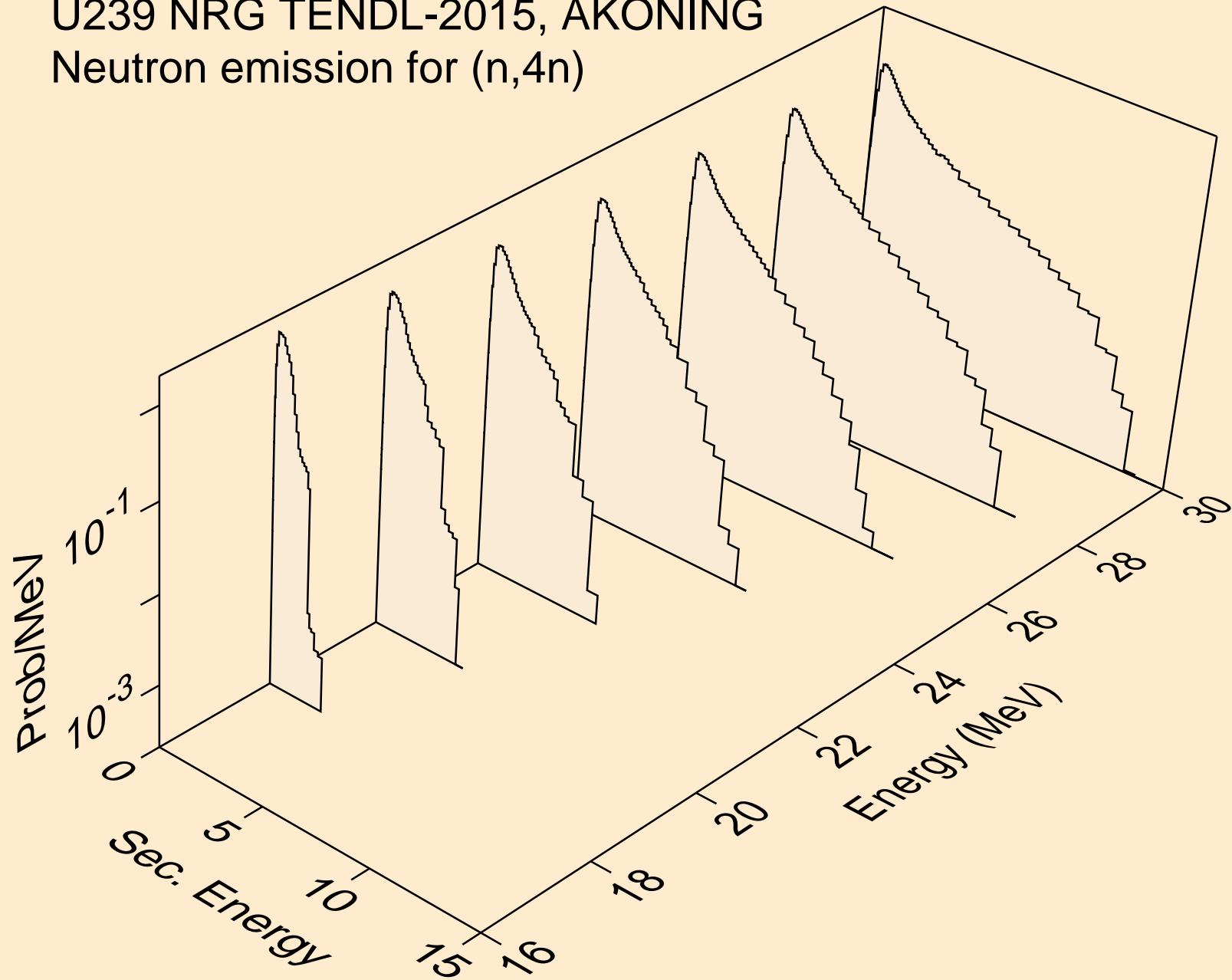

U239 NRG TENDL-2015, AKONING  
Neutron emission for (n,2np)

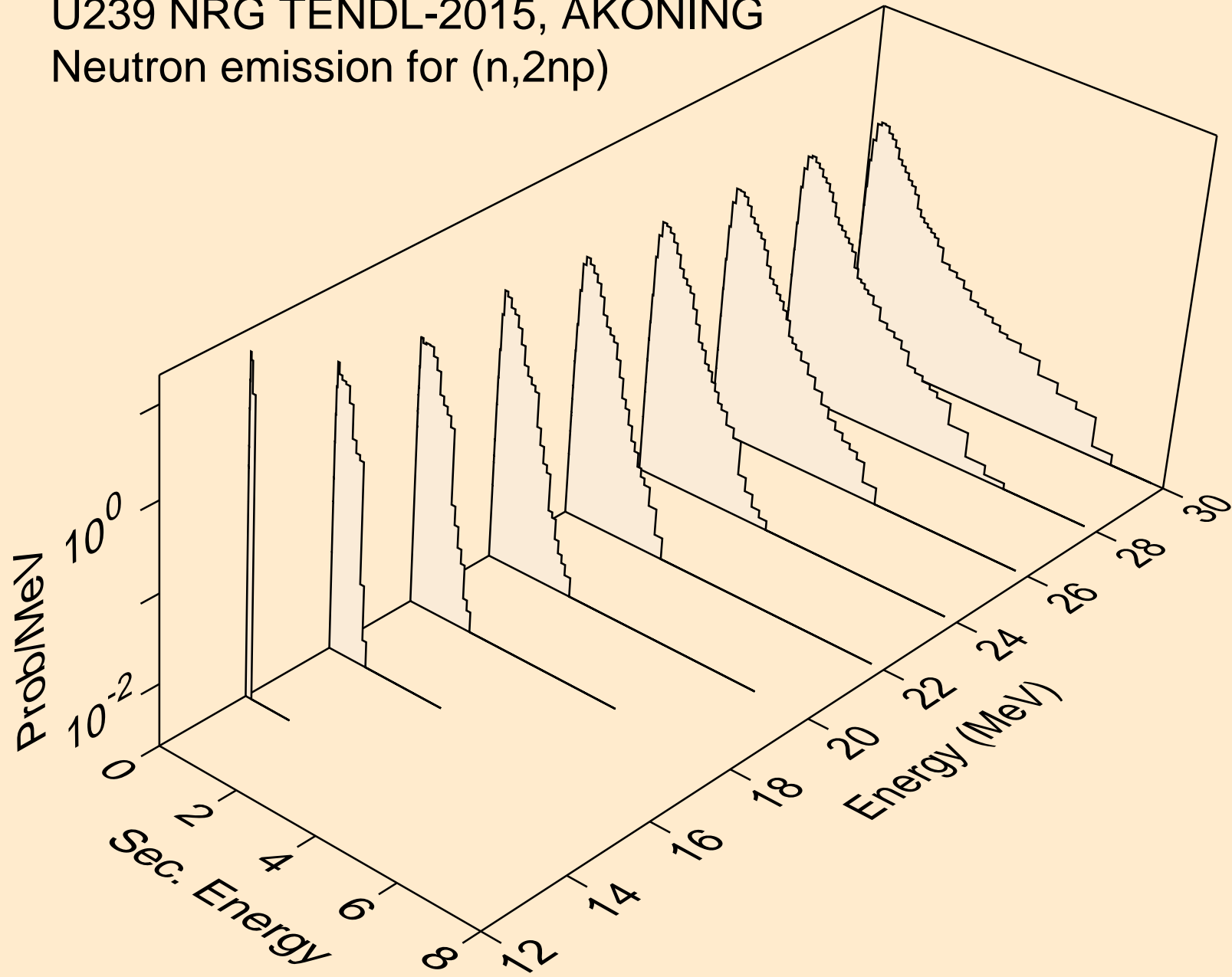

U239 NRG TENDL-2015, AKONING  
Neutron emission for (n,3np)

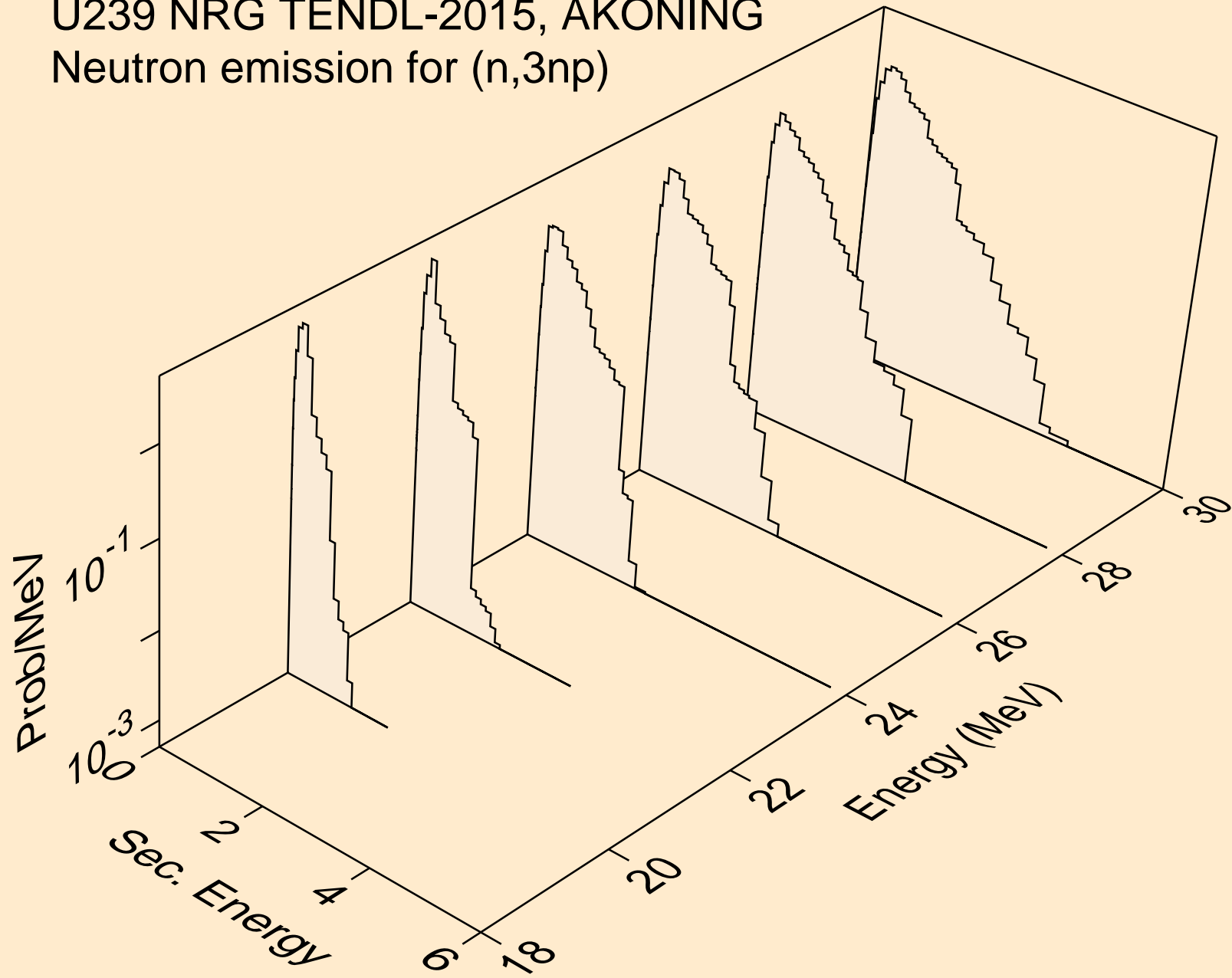

U239 NRG TENDL-2015, AKONING  
Neutron emission for (n,2np)

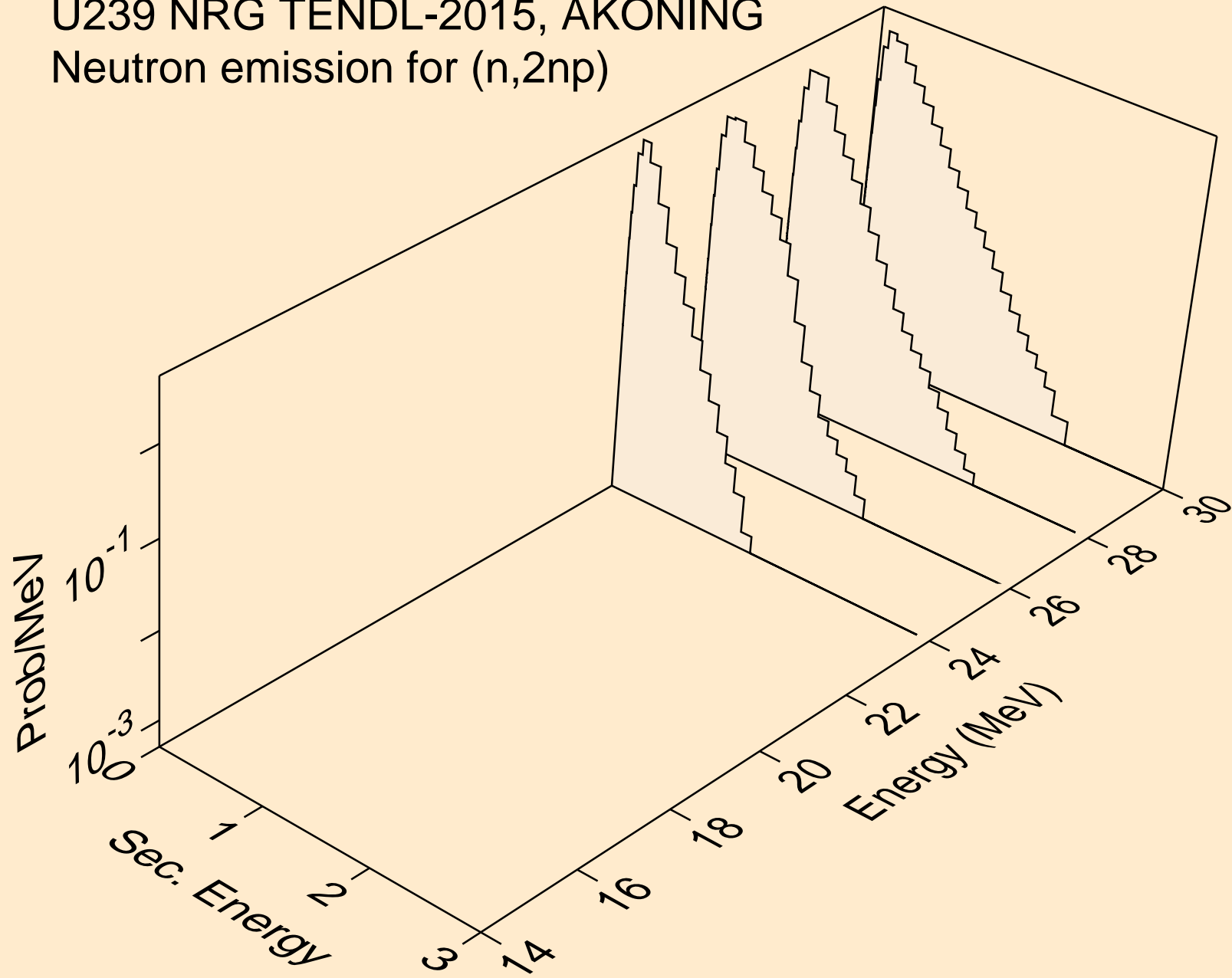



U239 NRG TENDL-2015, AKONING  
Neutron emission for (n,n\*c)

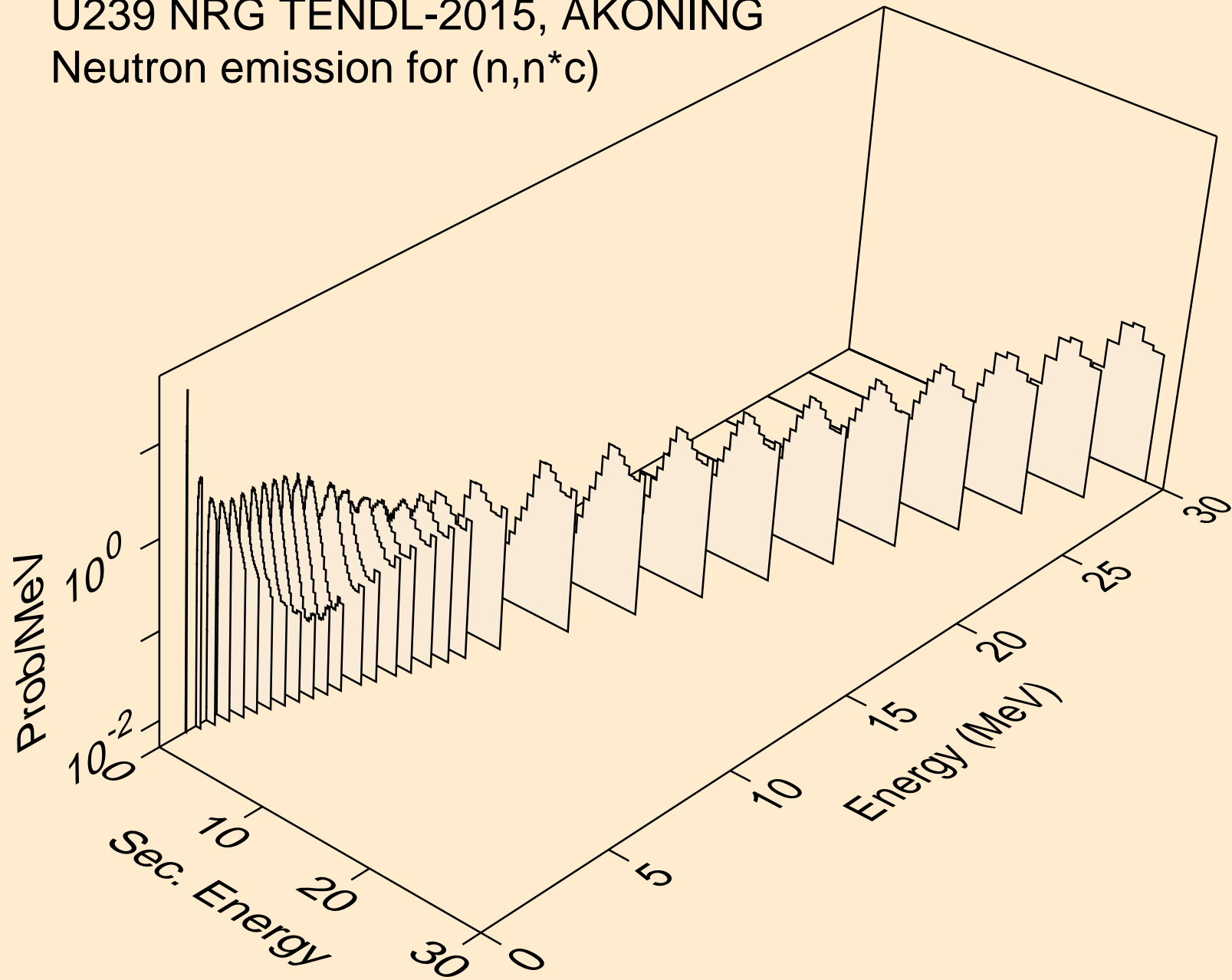

# U239 NRG TENDL-2015, AKONING

Delayed nubar

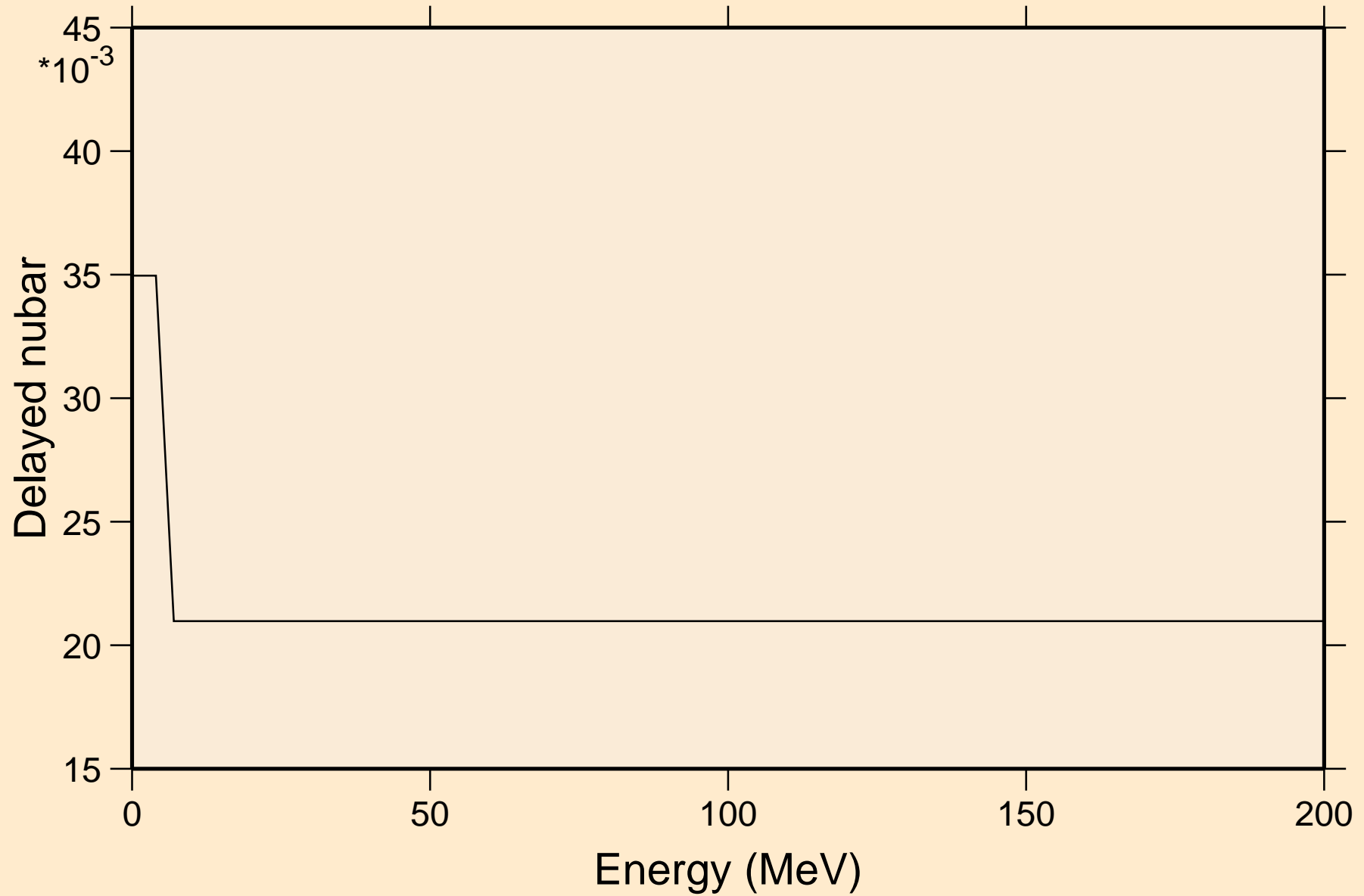

# U239 NRG TENDL-2015, AKONING

## Delayed neutron spectra

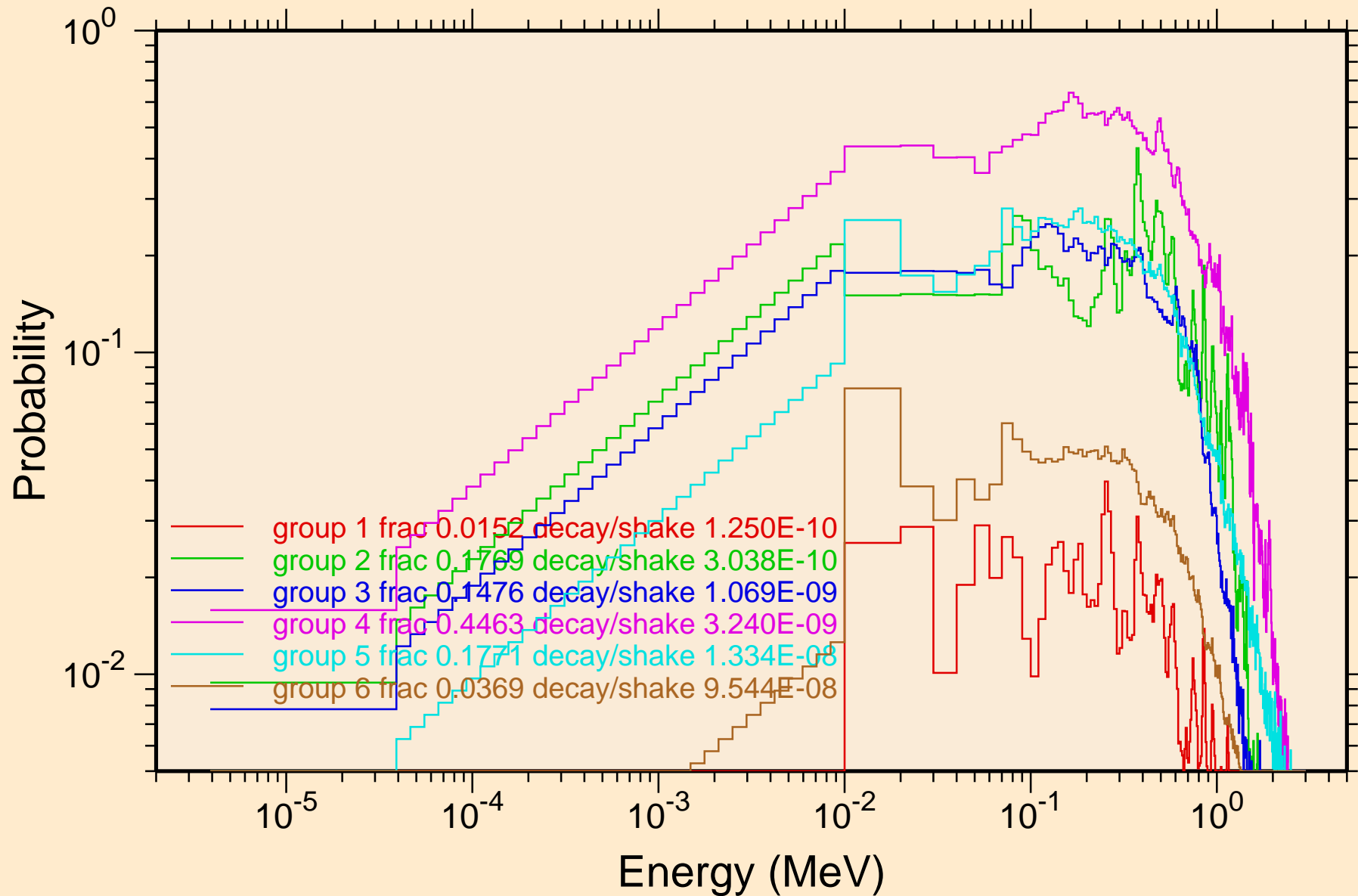

U239 NRG TENDL-2015, AKONING  
Photon emission for (n,x)

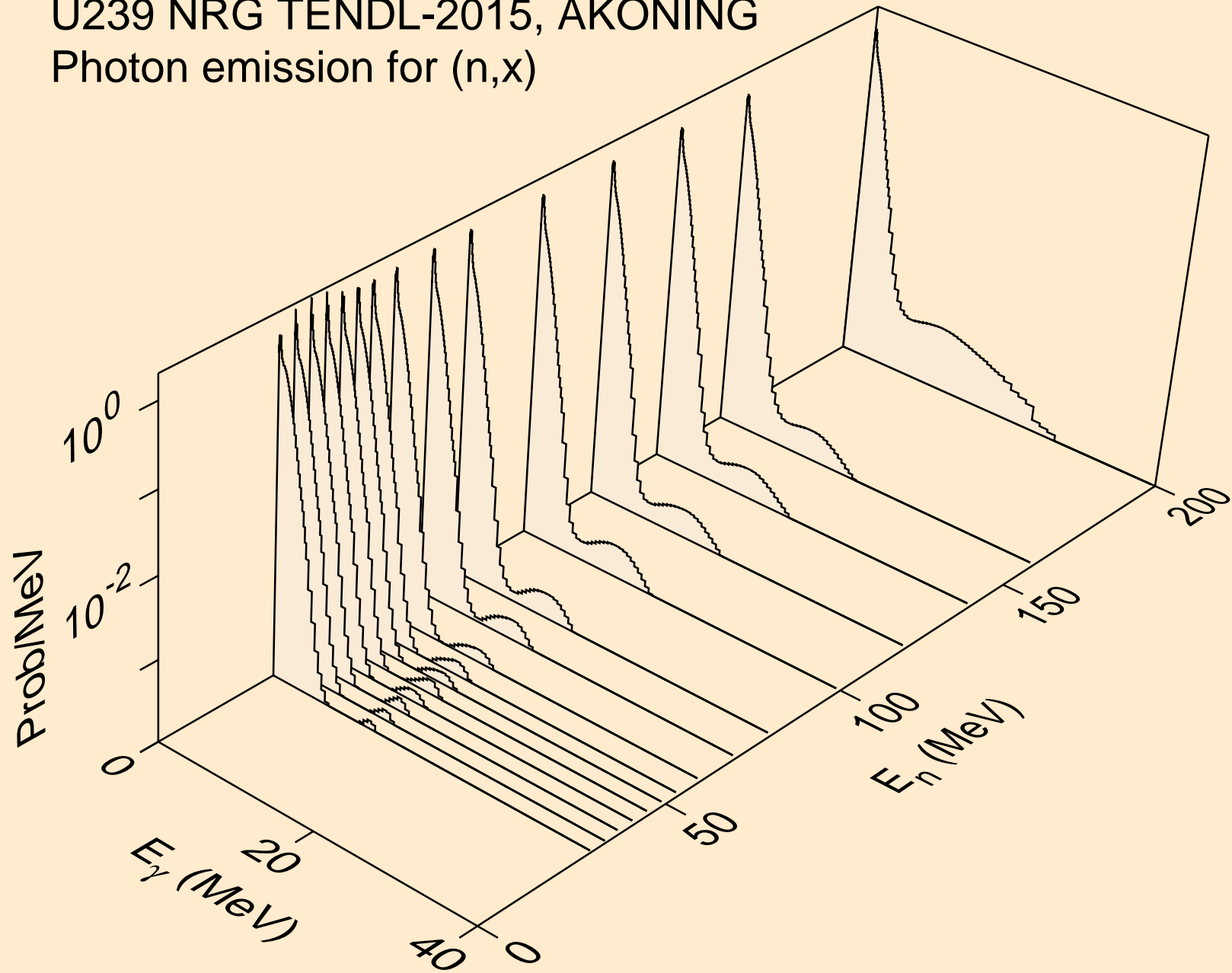

U239 NRG TENDL-2015, AKONING  
Photon emission for (n,2nd)

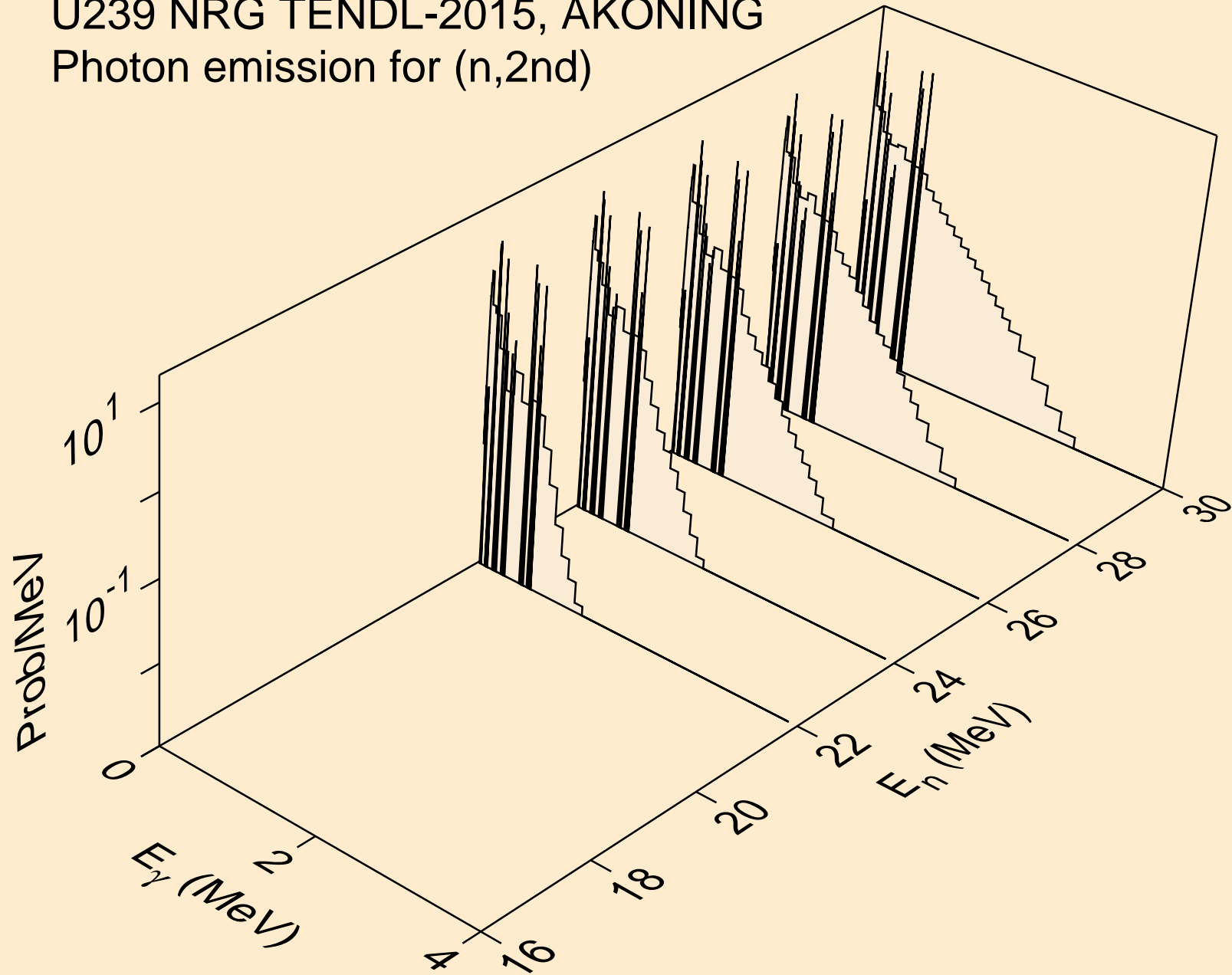

U239 NRG TENDL-2015, AKONING  
Photon emission for (n,2n)

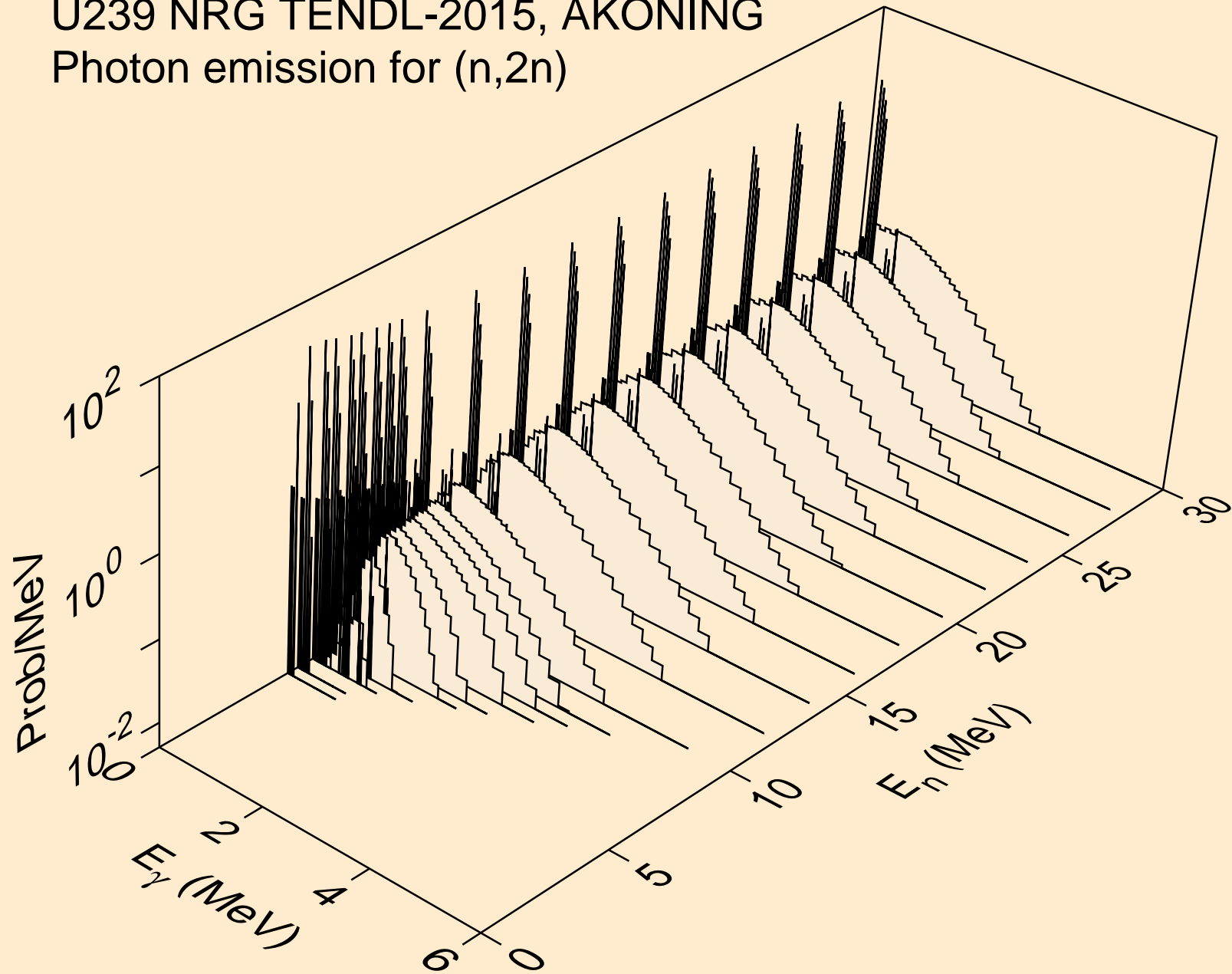

U239 NRG TENDL-2015, AKONING  
Photon emission for (n,3n)

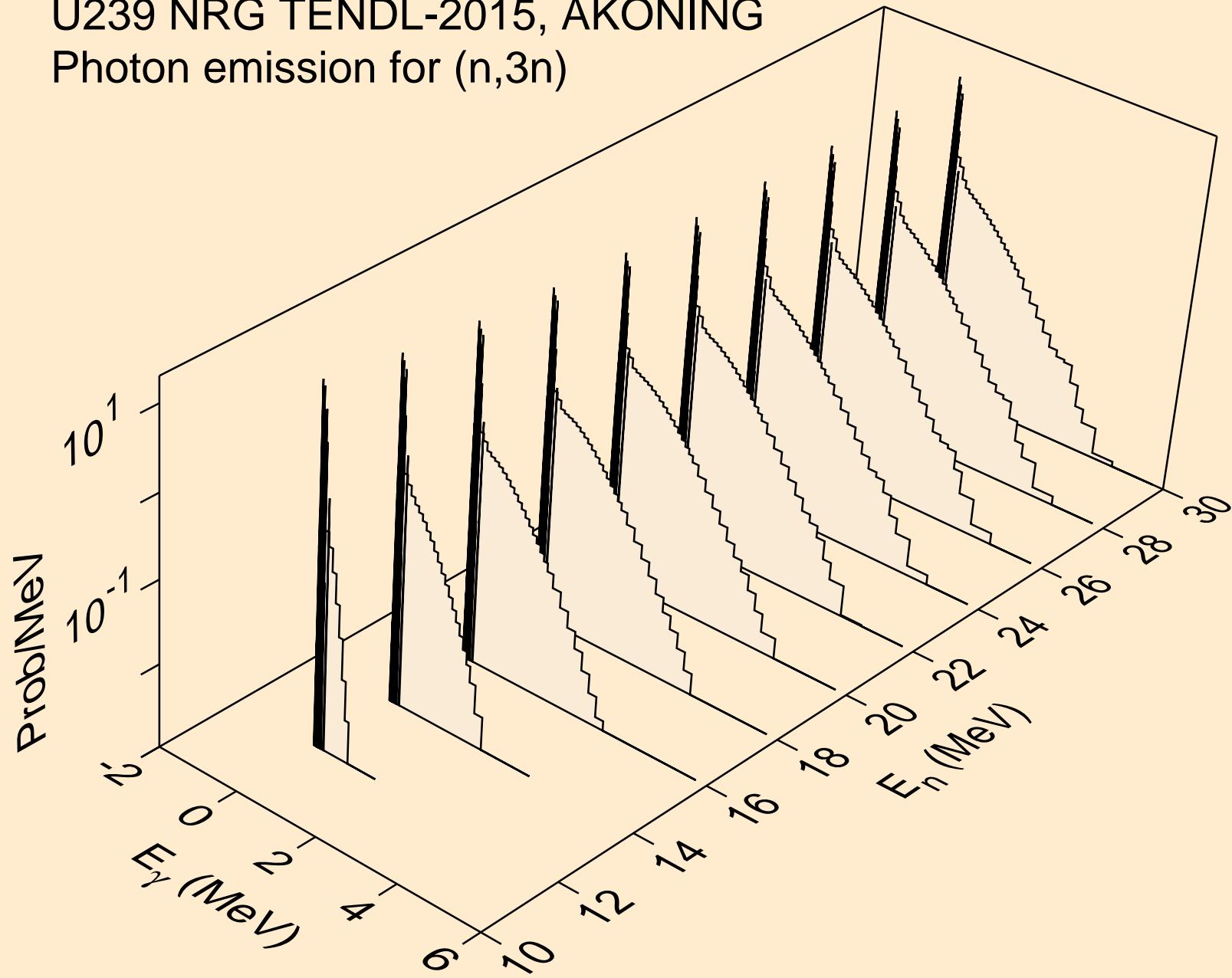

U239 NRG TENDL-2015, AKONING  
Photon emission for (n,n\*)a

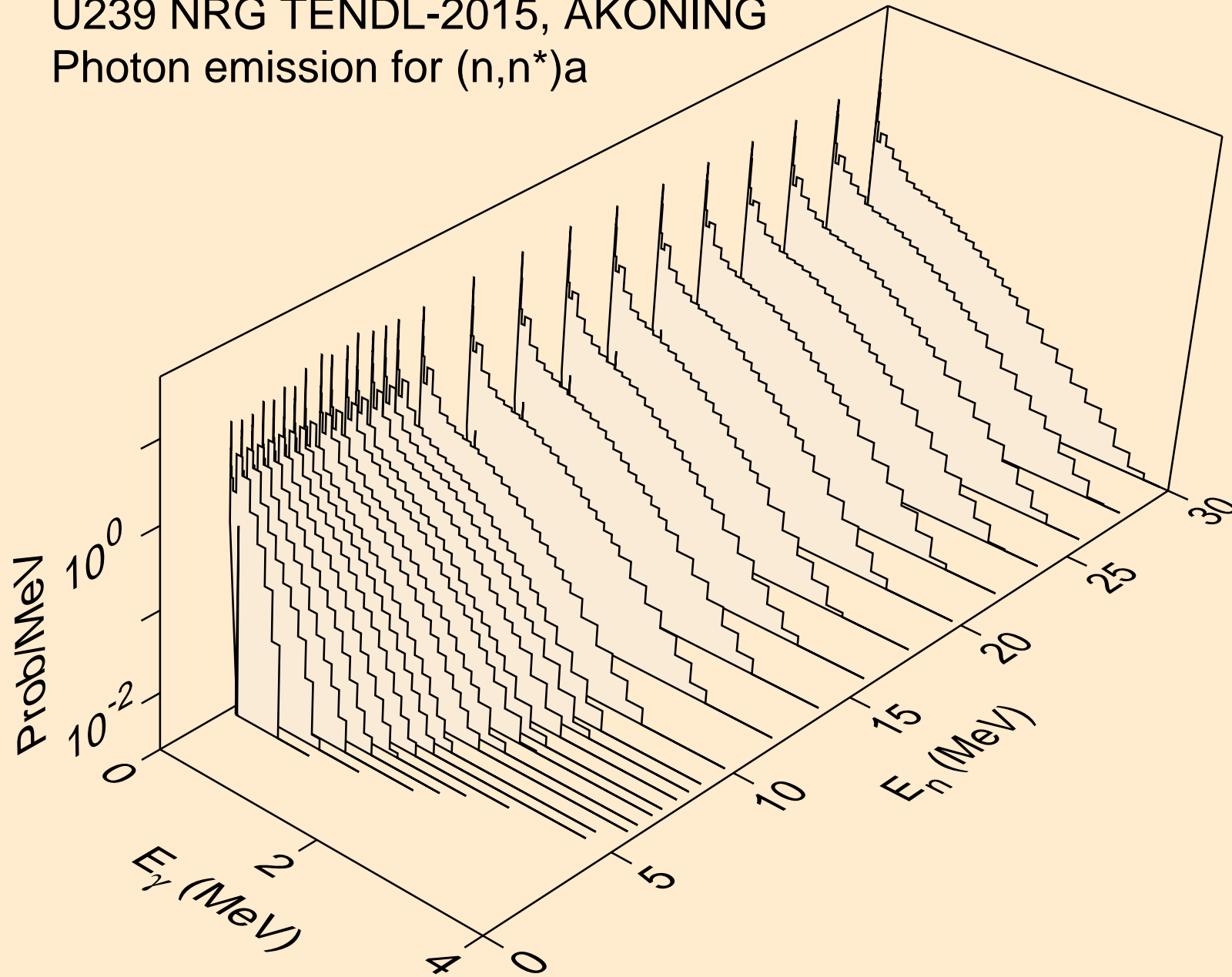



U239 NRG TENDL-2015, AKONING  
Photon emission for (n,2n)a

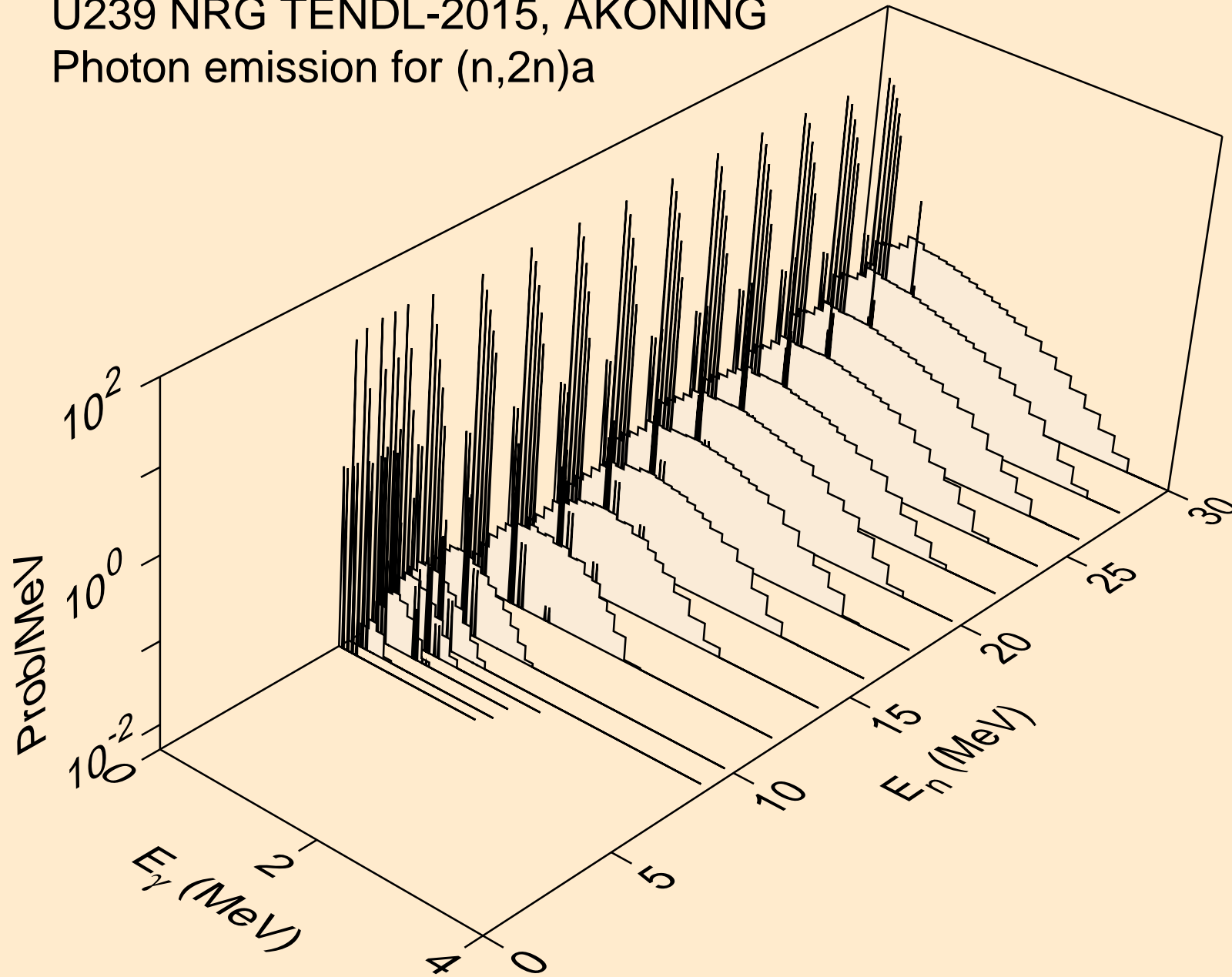

U239 NRG TENDL-2015, AKONING  
Photon emission for (n,3n)a

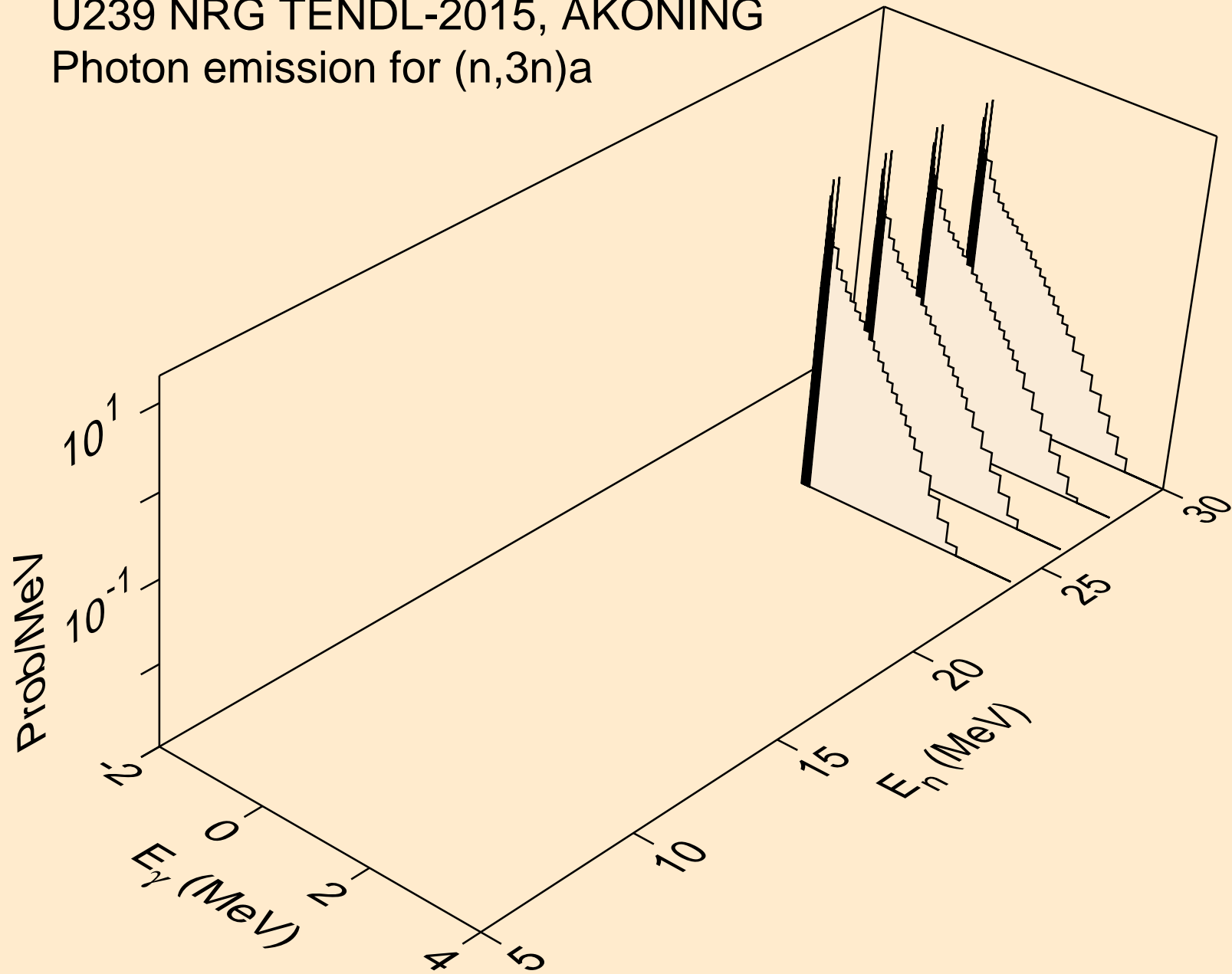

U239 NRG TENDL-2015, AKONING  
Photon emission for (n,n\*)p

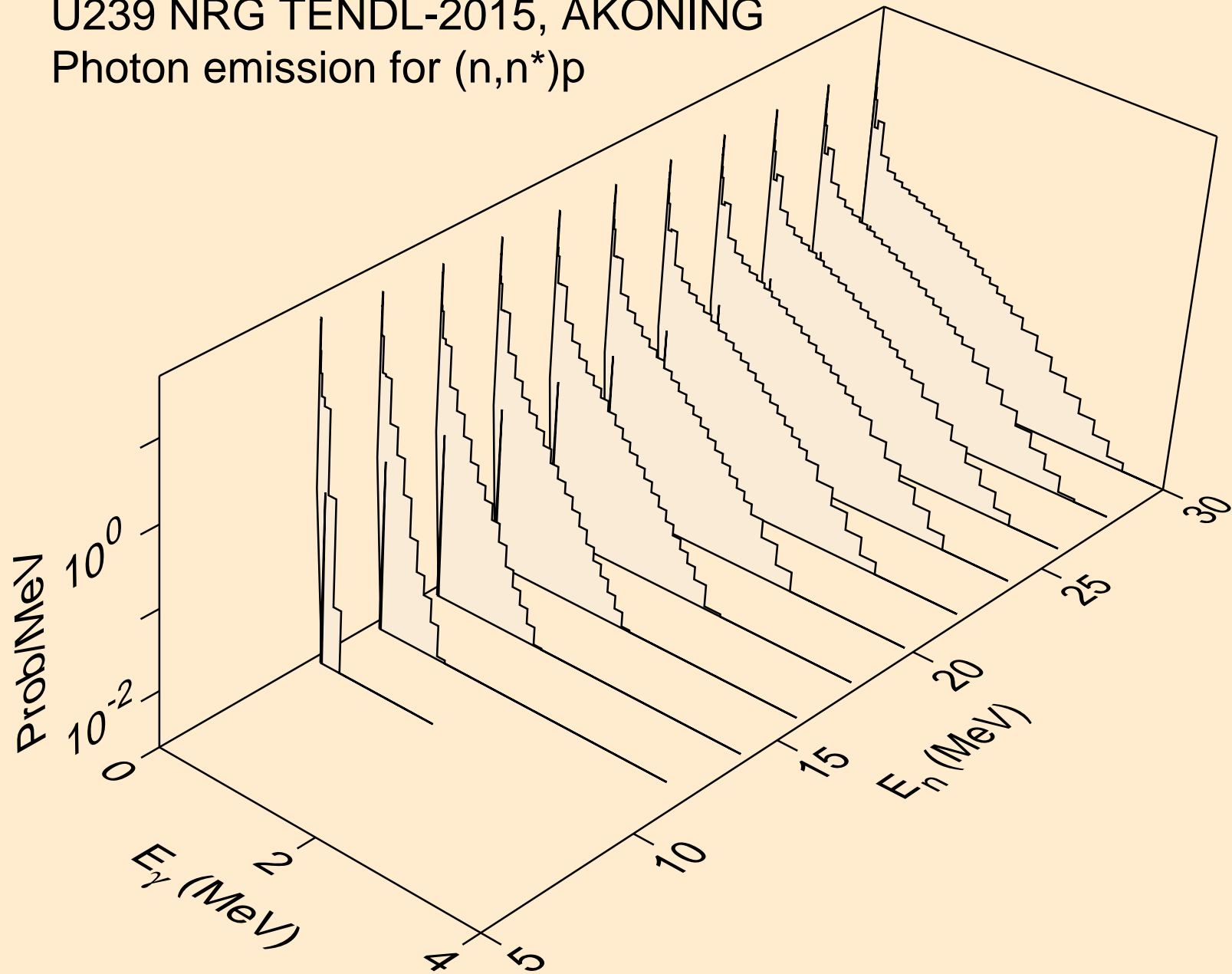

U239 NRG TENDL-2015, AKONING  
Photon emission for (n,n\*)d

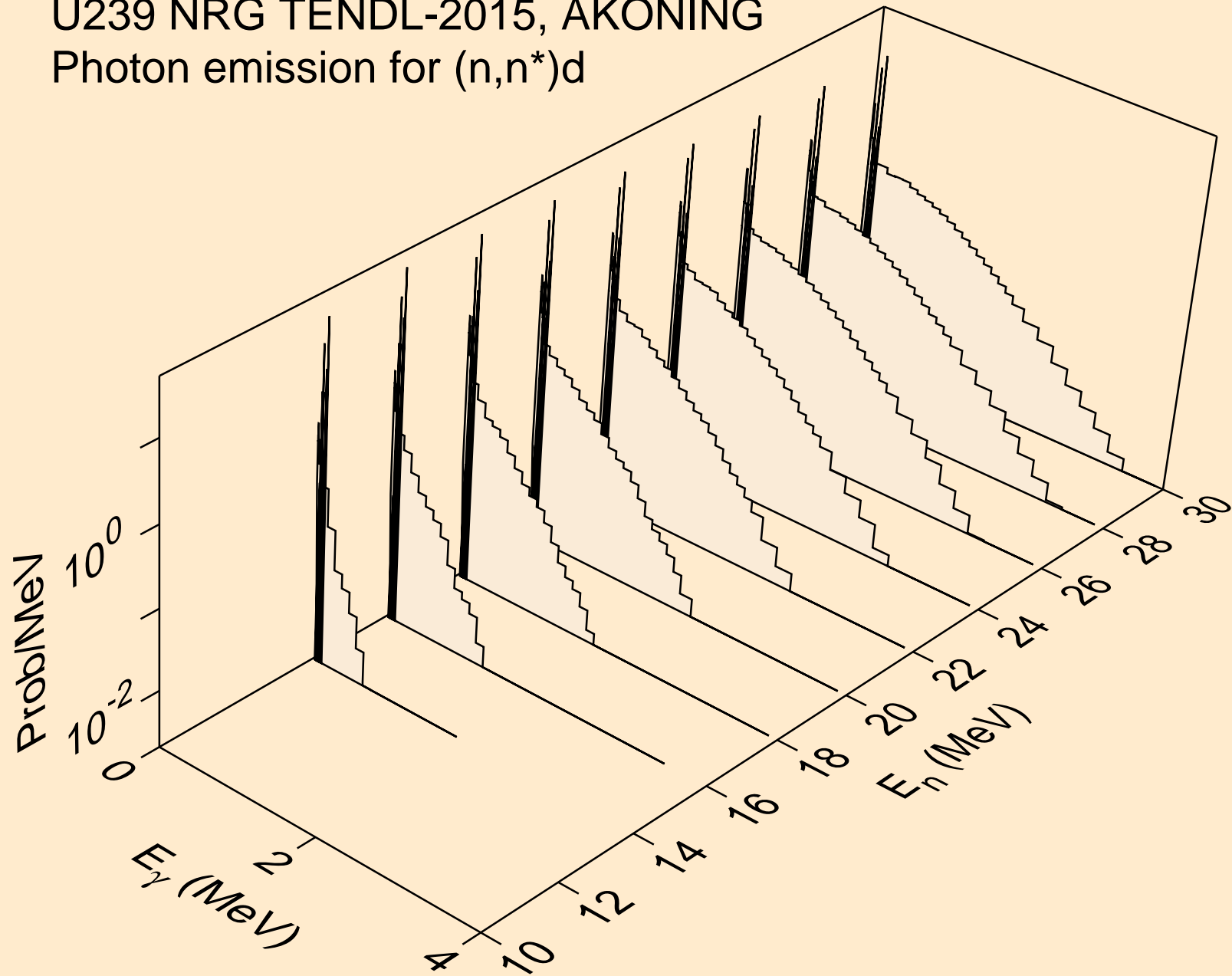

U239 NRG TENDL-2015, AKONING  
Photon emission for (n,n\*)t

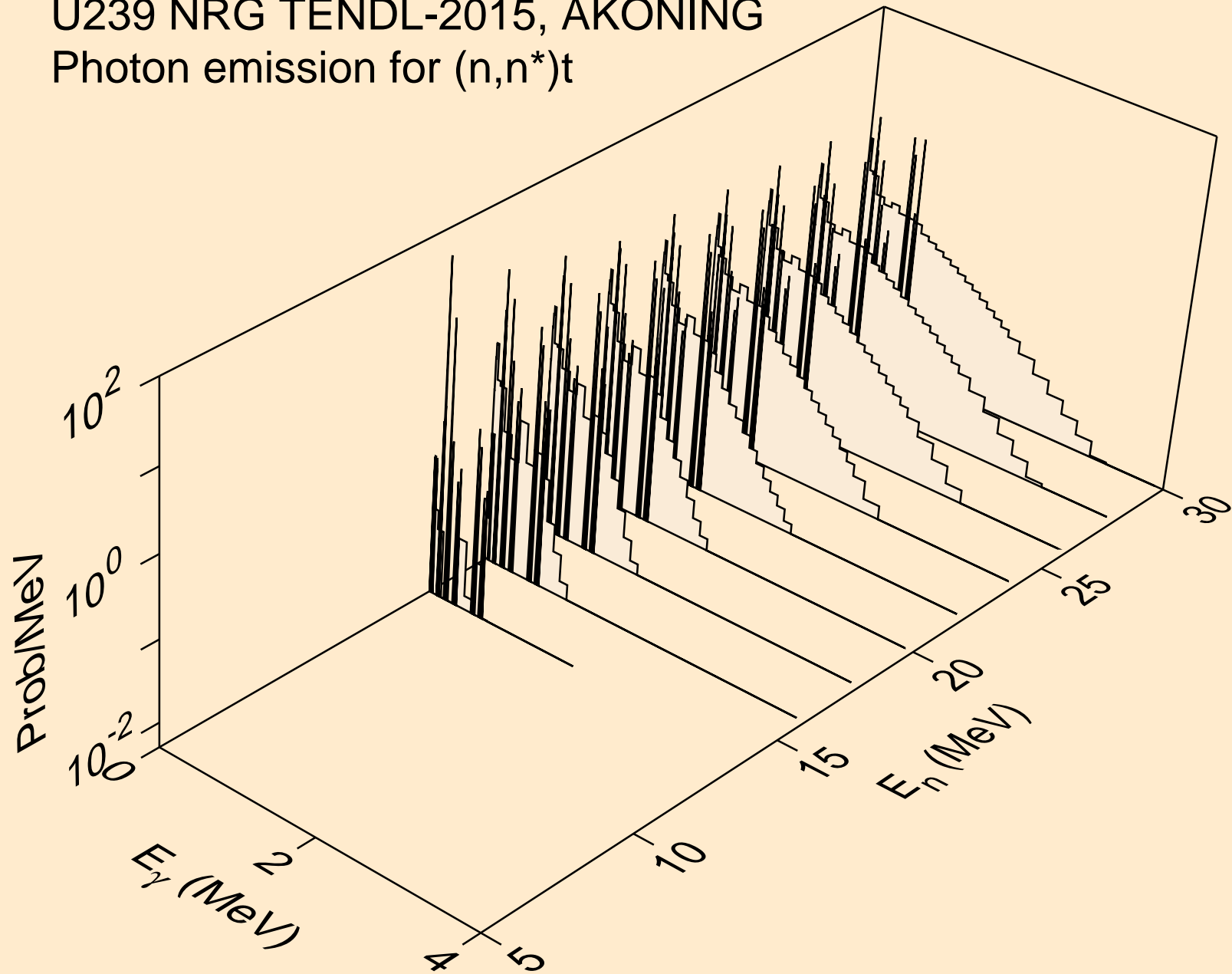

U239 NRG TENDL-2015, AKONING  
Photon emission for (n,n\*)he3

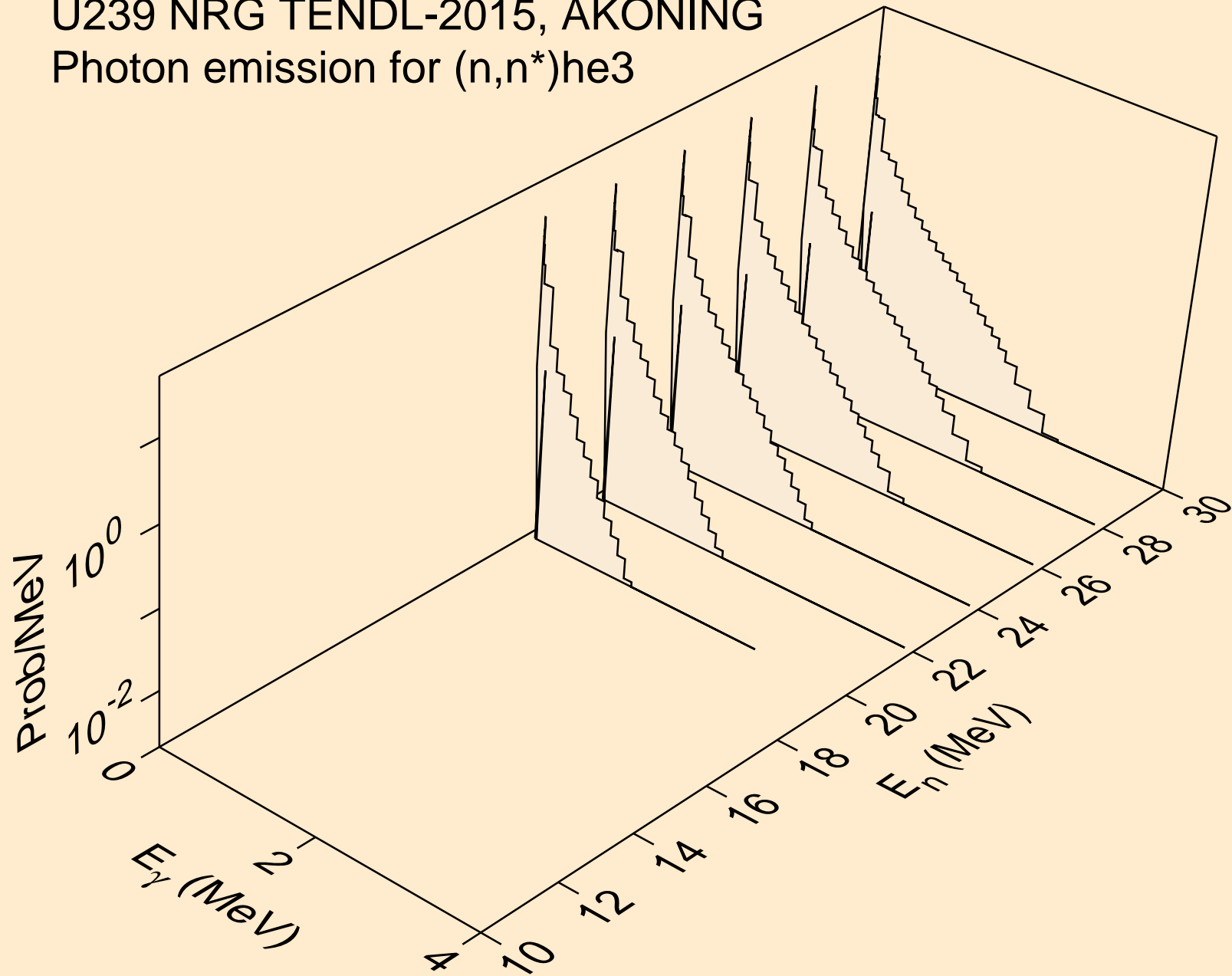

U239 NRG TENDL-2015, AKONING  
Photon emission for (n,4n)

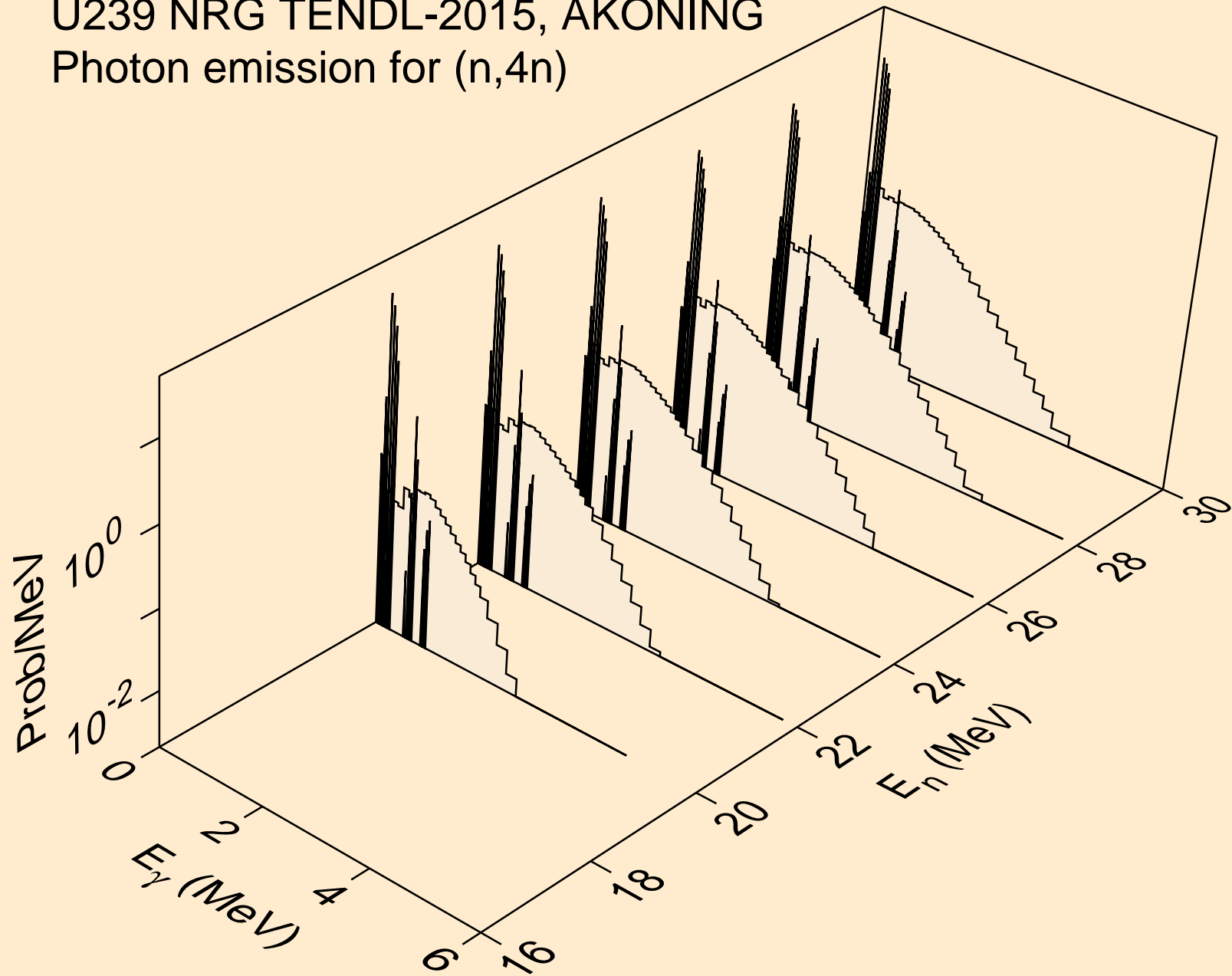

U239 NRG TENDL-2015, AKONING  
Photon emission for (n,2np)

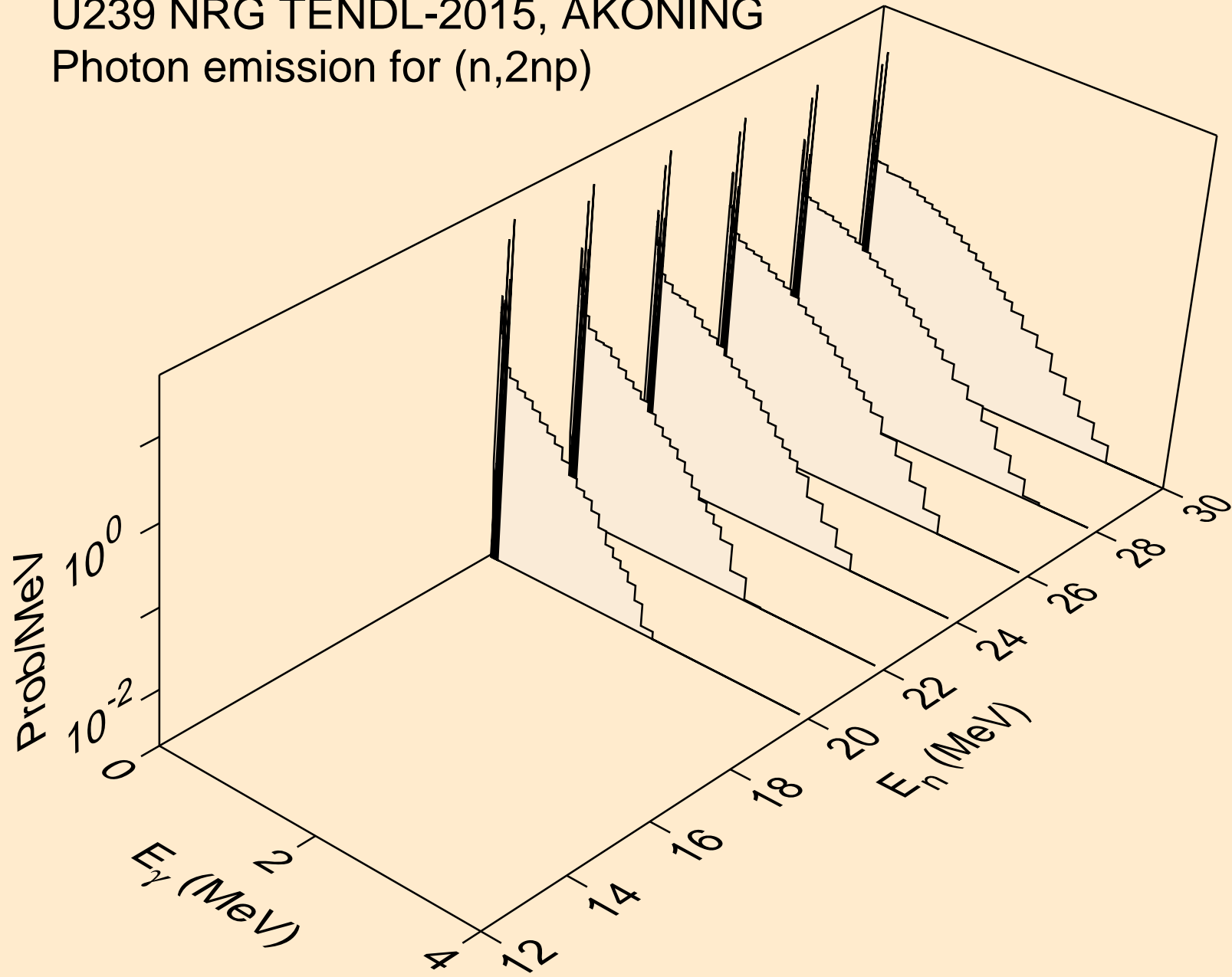



U239 NRG TENDL-2015, AKONING  
Photon emission for (n,3np)

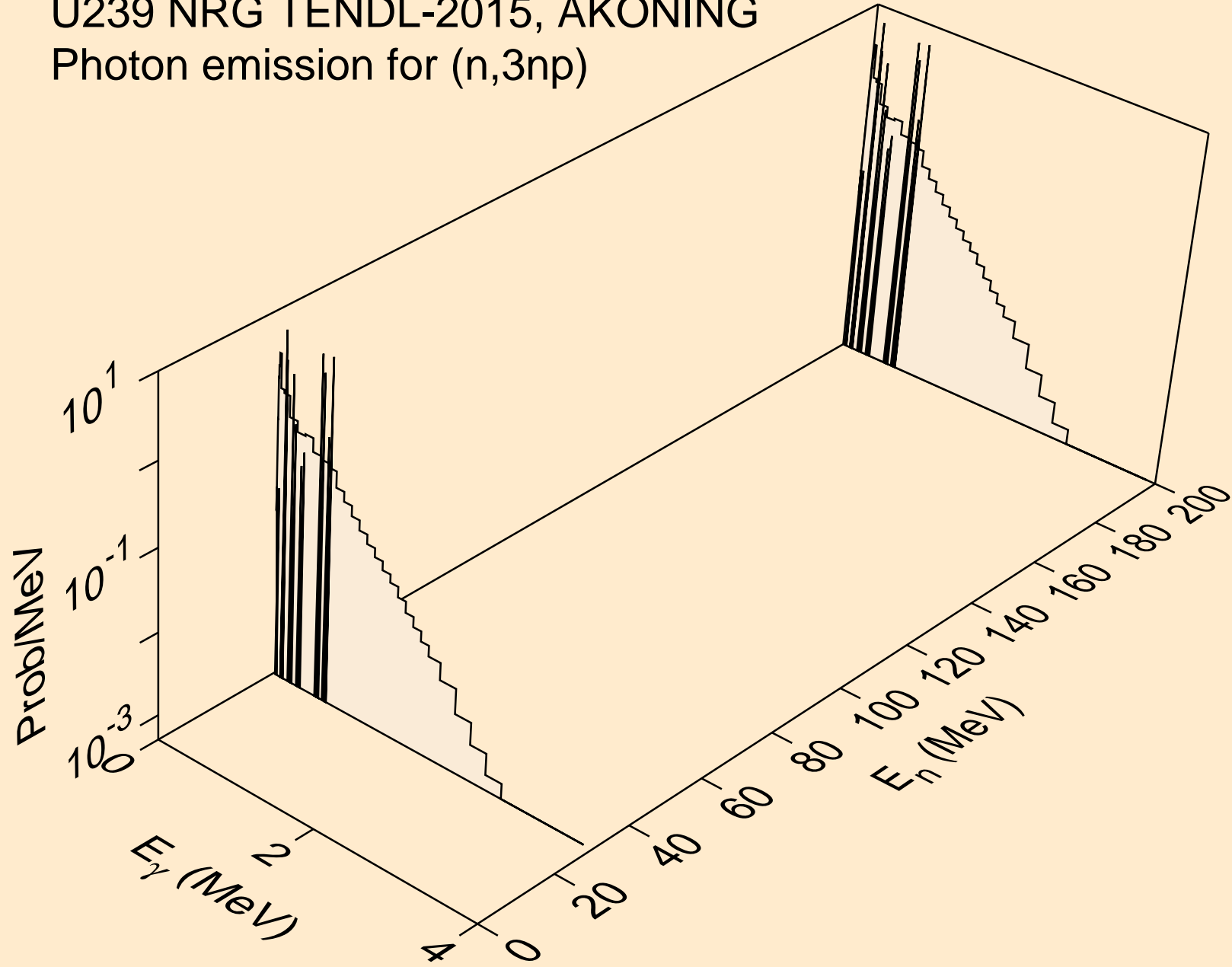

U239 NRG TENDL-2015, AKONING  
Photon emission for (n,2np)

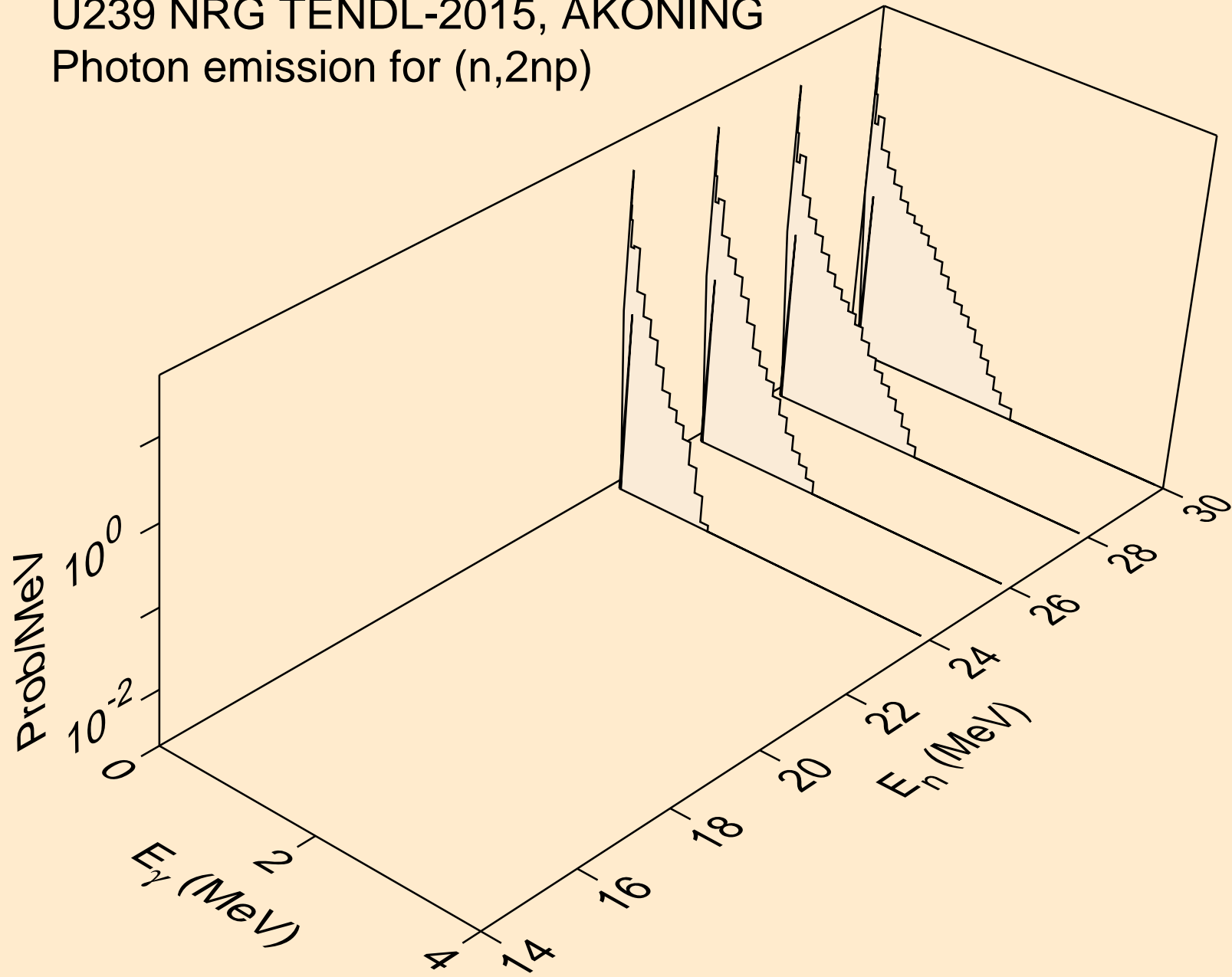

U239 NRG TENDL-2015, AKONING  
Photon emission for (n,n\*c)

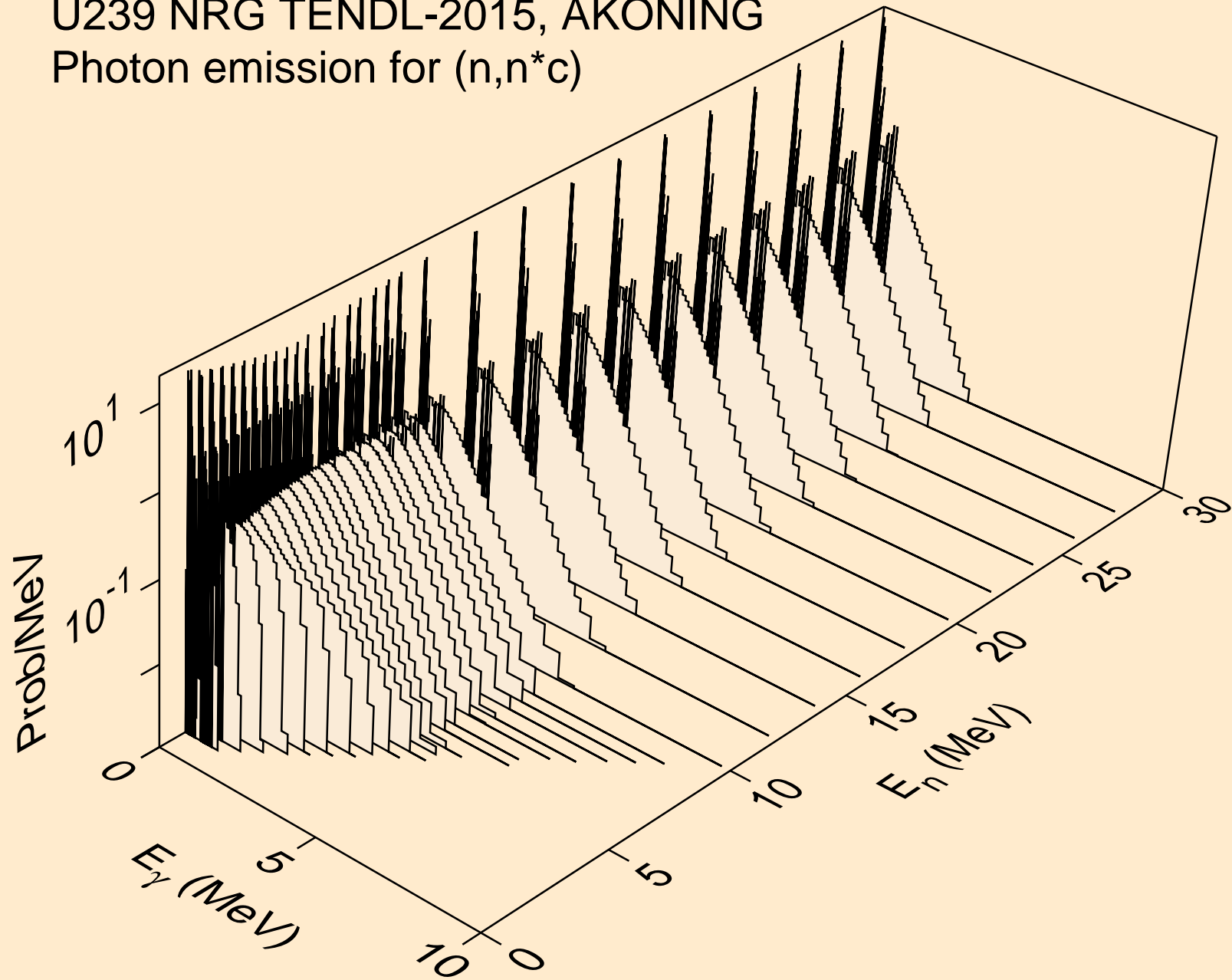

U239 NRG TENDL-2015, AKONING  
Photon emission for (n,gma)

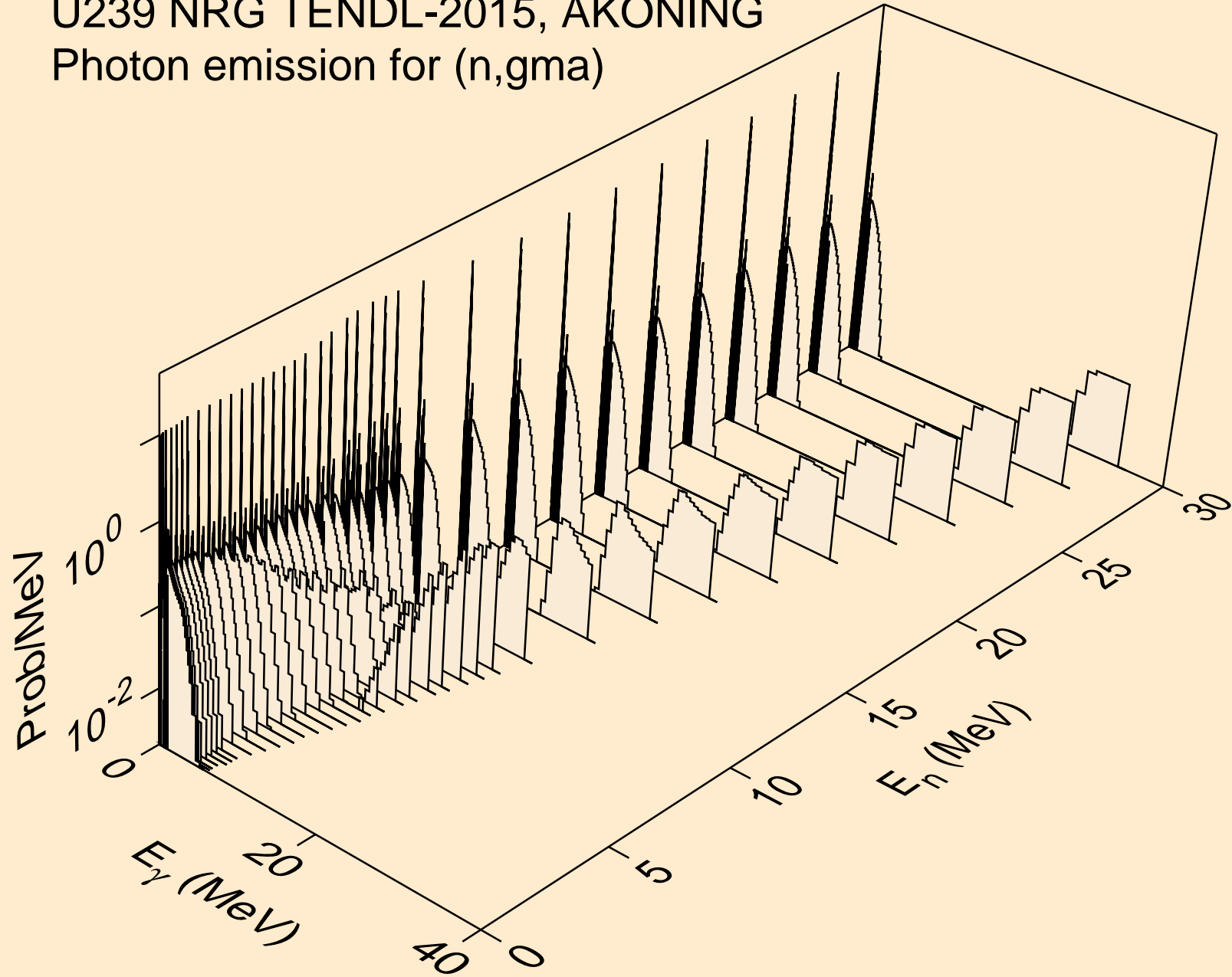

U239 NRG TENDL-2015, AKONING  
Photon emission for (n,p)

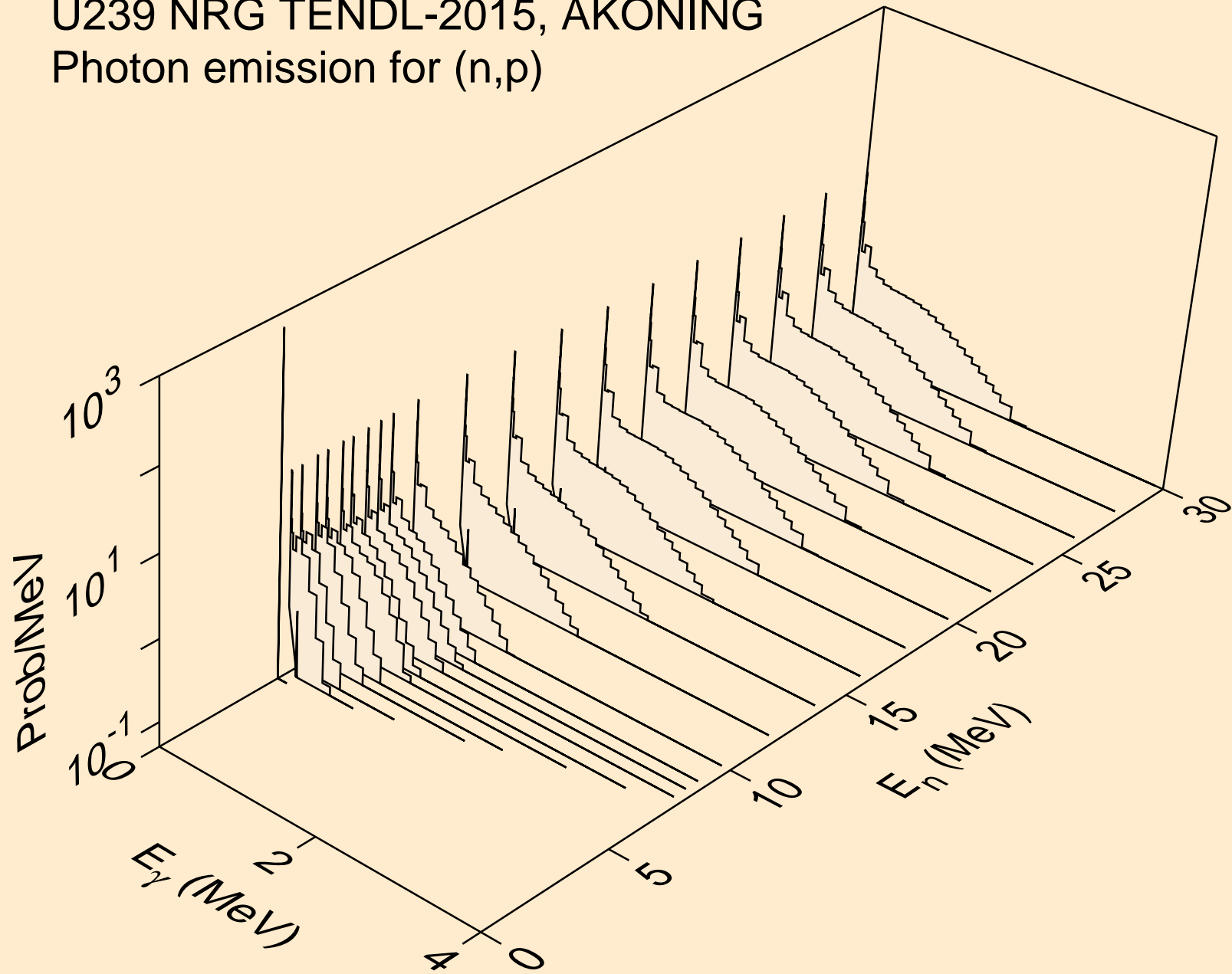

U239 NRG TENDL-2015, AKONING  
Photon emission for (n,d)

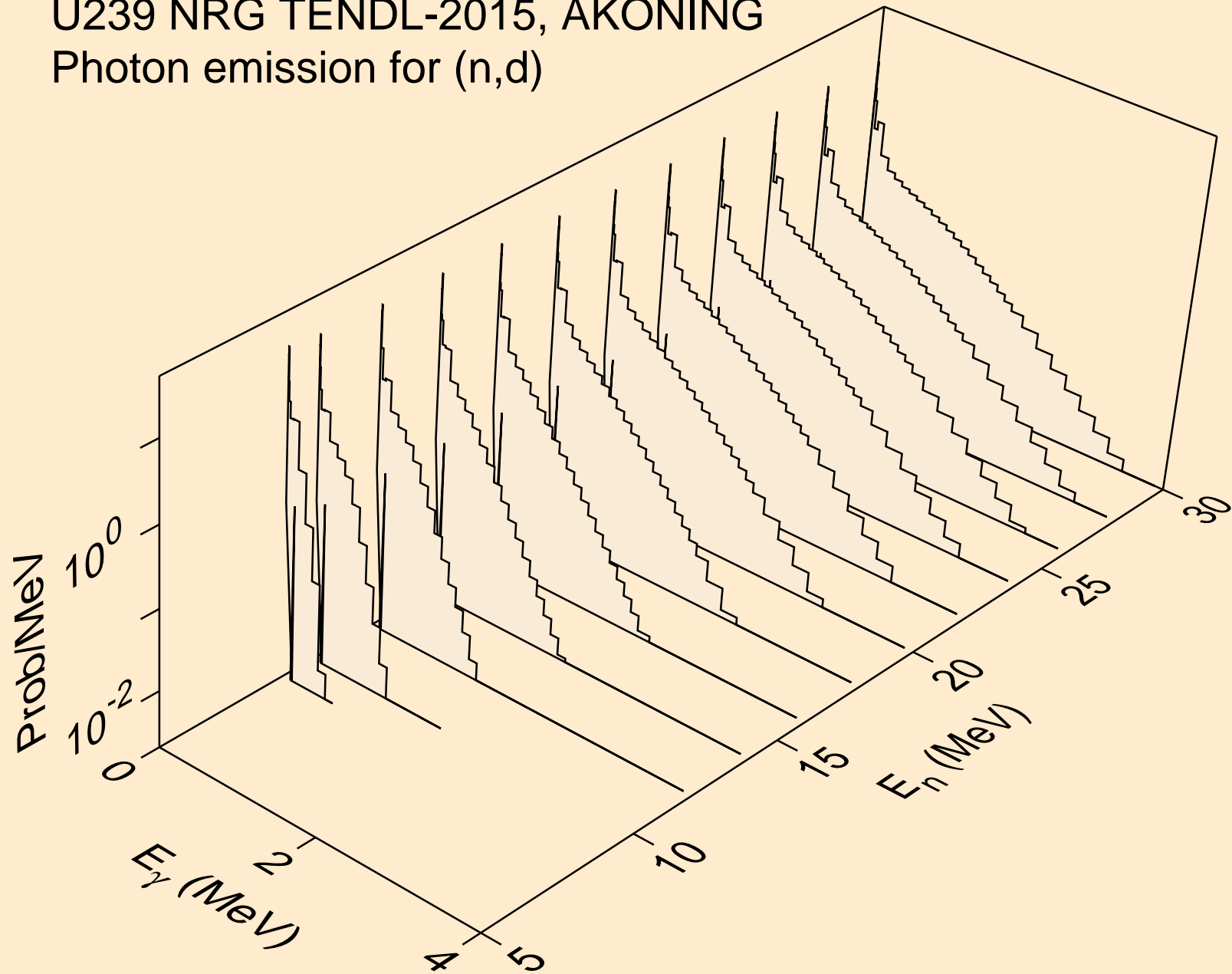

U239 NRG TENDL-2015, AKONING  
Photon emission for (n,t)

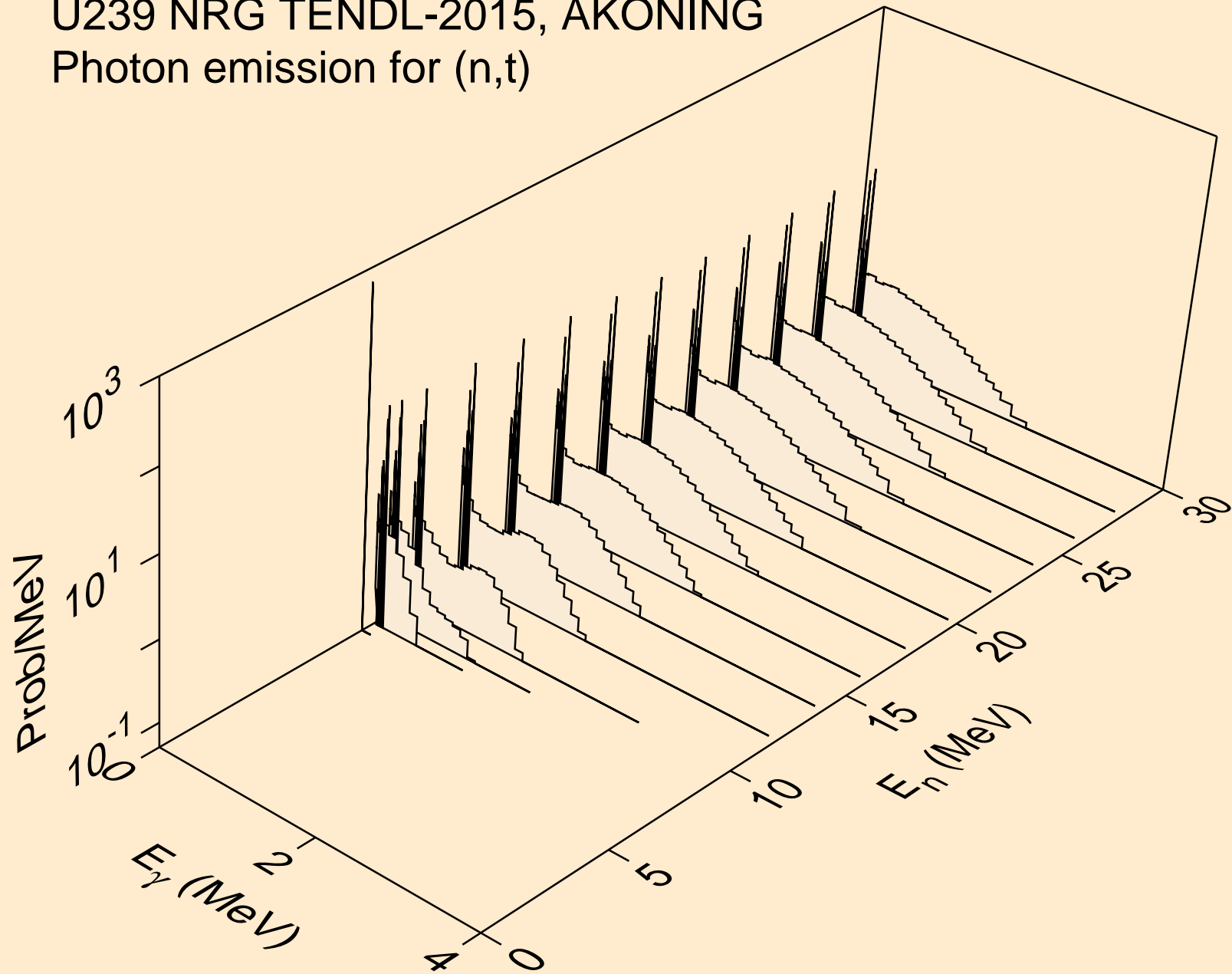

U239 NRG TENDL-2015, AKONING  
Photon emission for (n,he3)

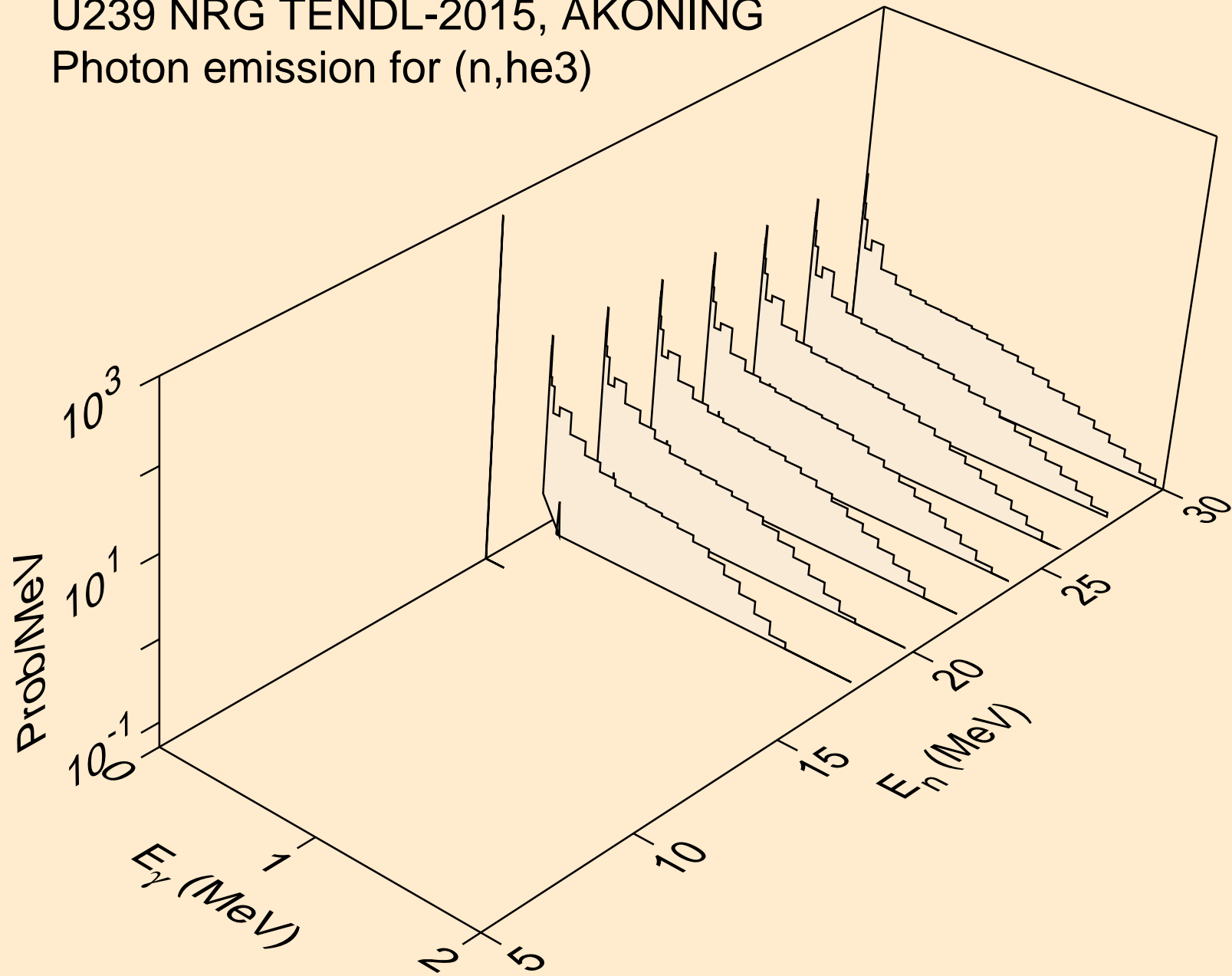



U239 NRG TENDL-2015, AKONING  
Photon emission for (n,a)

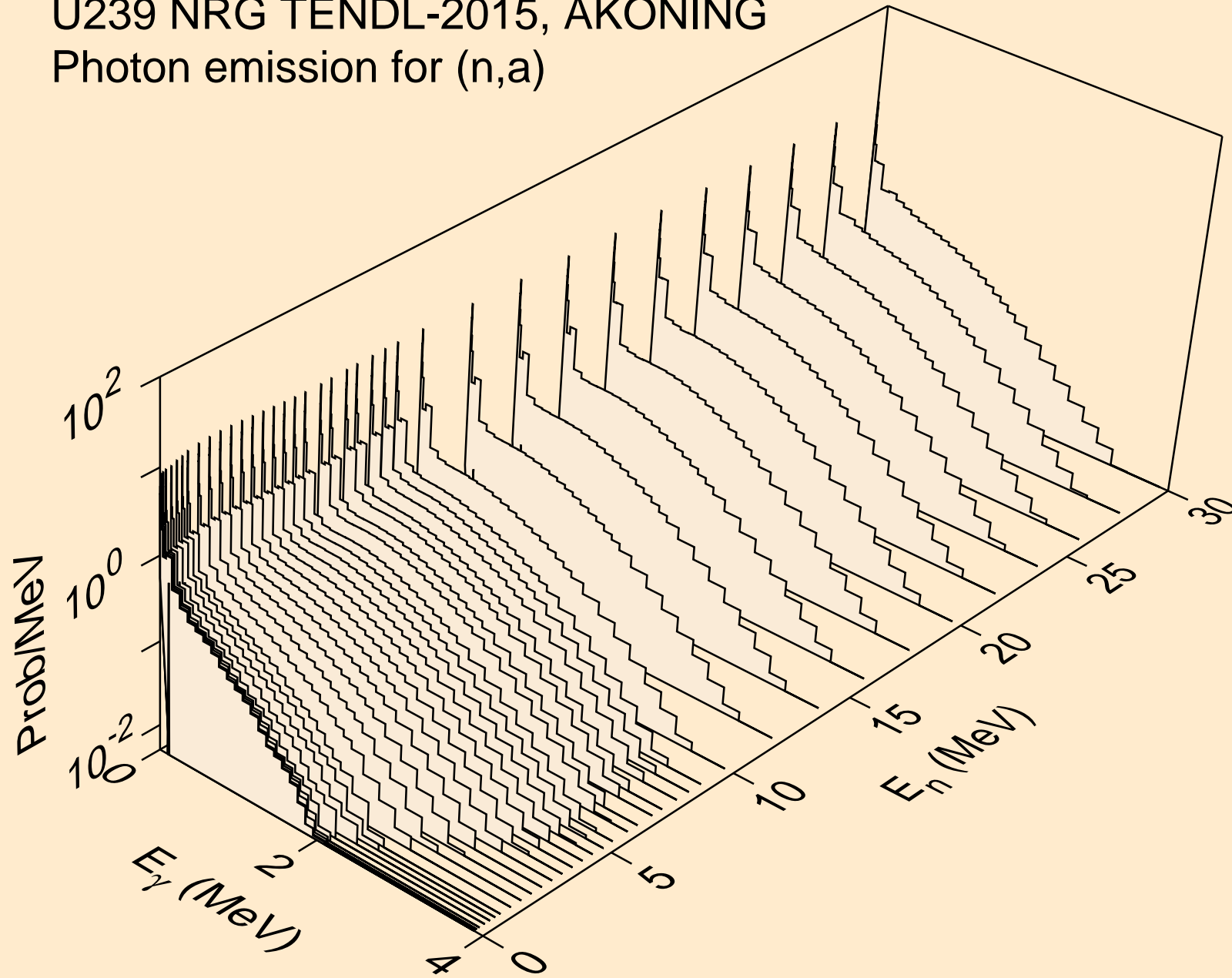

U239 NRG TENDL-2015, AKONING  
Photon emission for (n,2p)

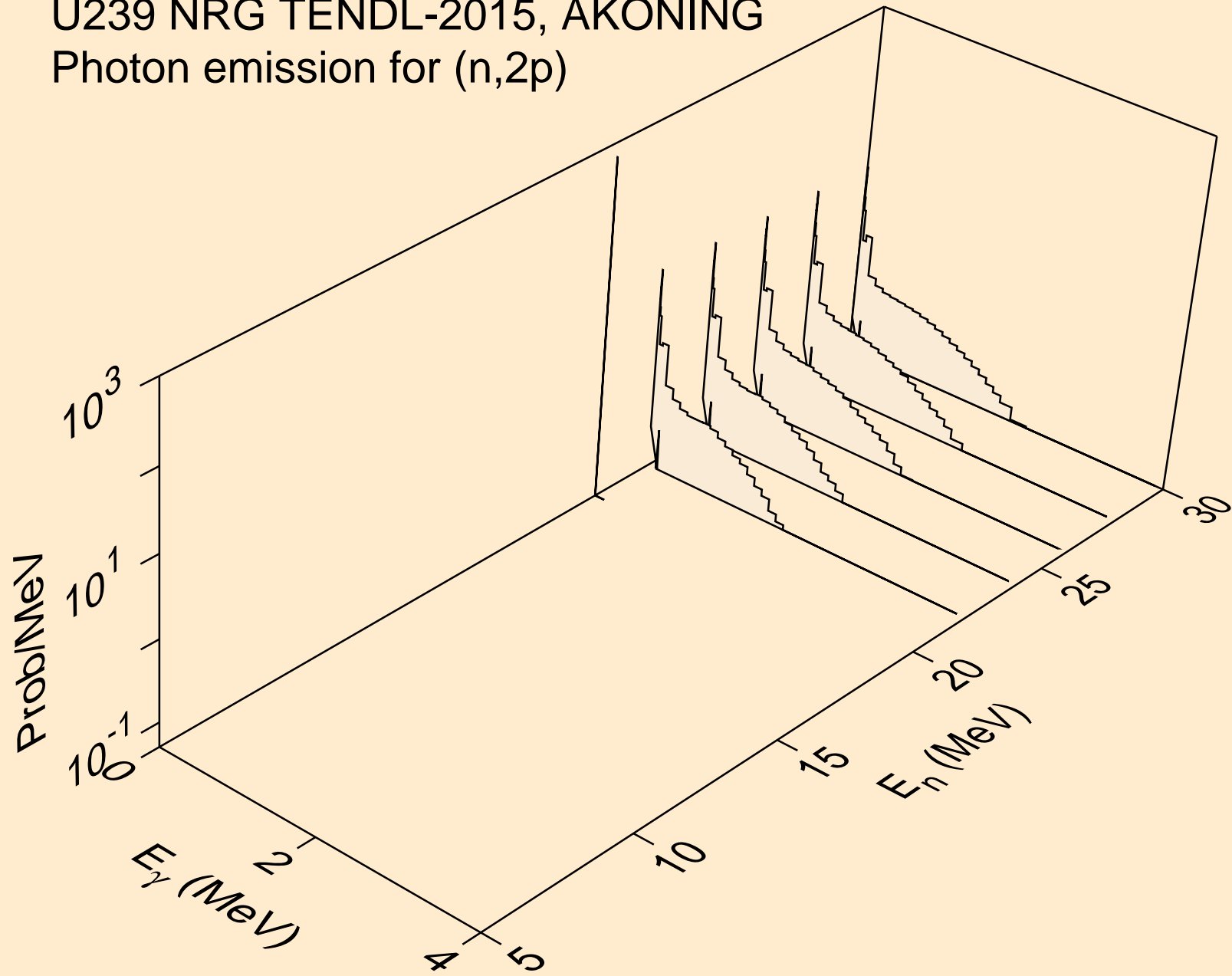

U239 NRG TENDL-2015, AKONING  
thermal capture photon spectrum

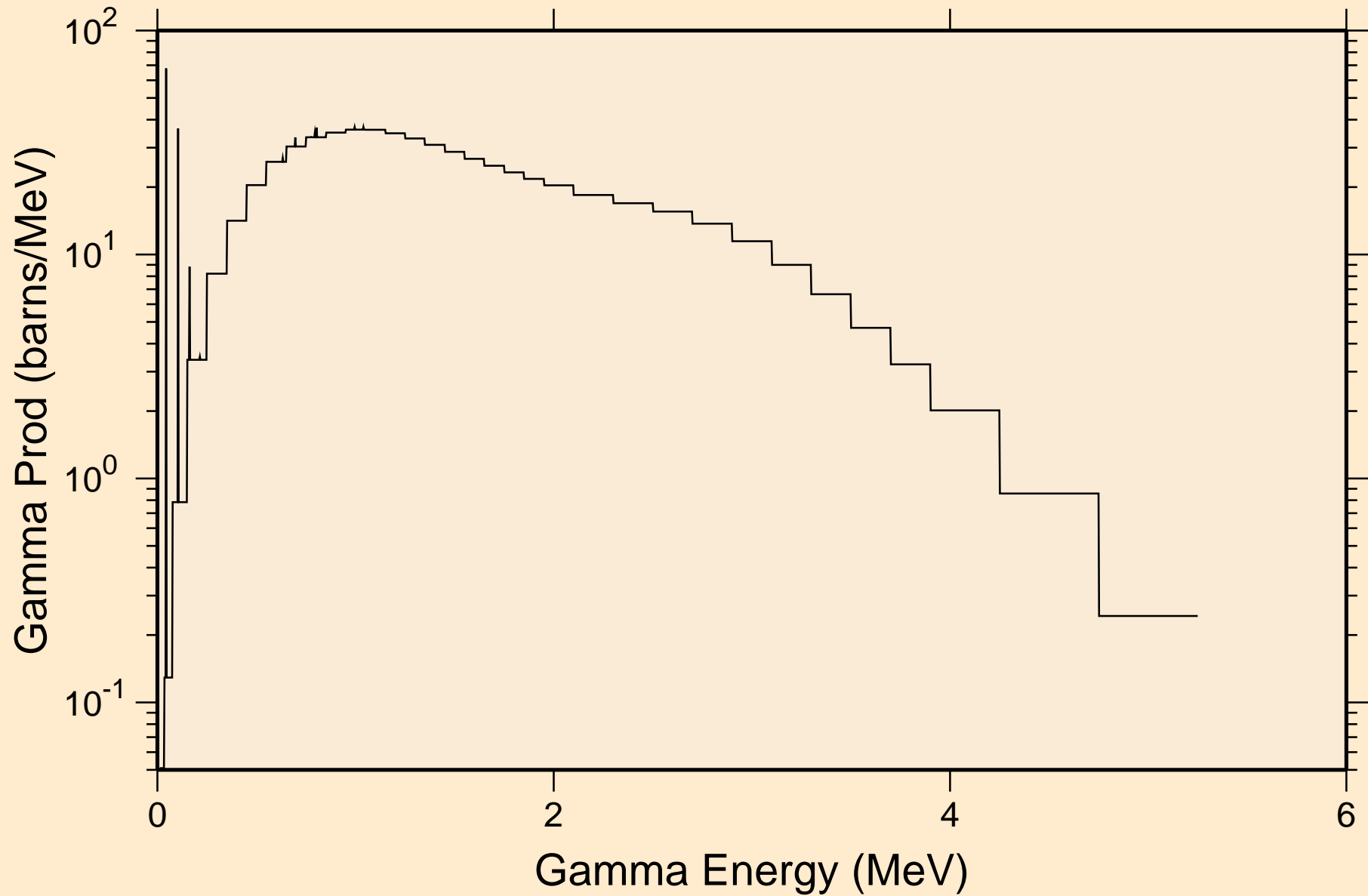

U239 NRG TENDL-2015, AKONING  
14 MeV photon spectrum

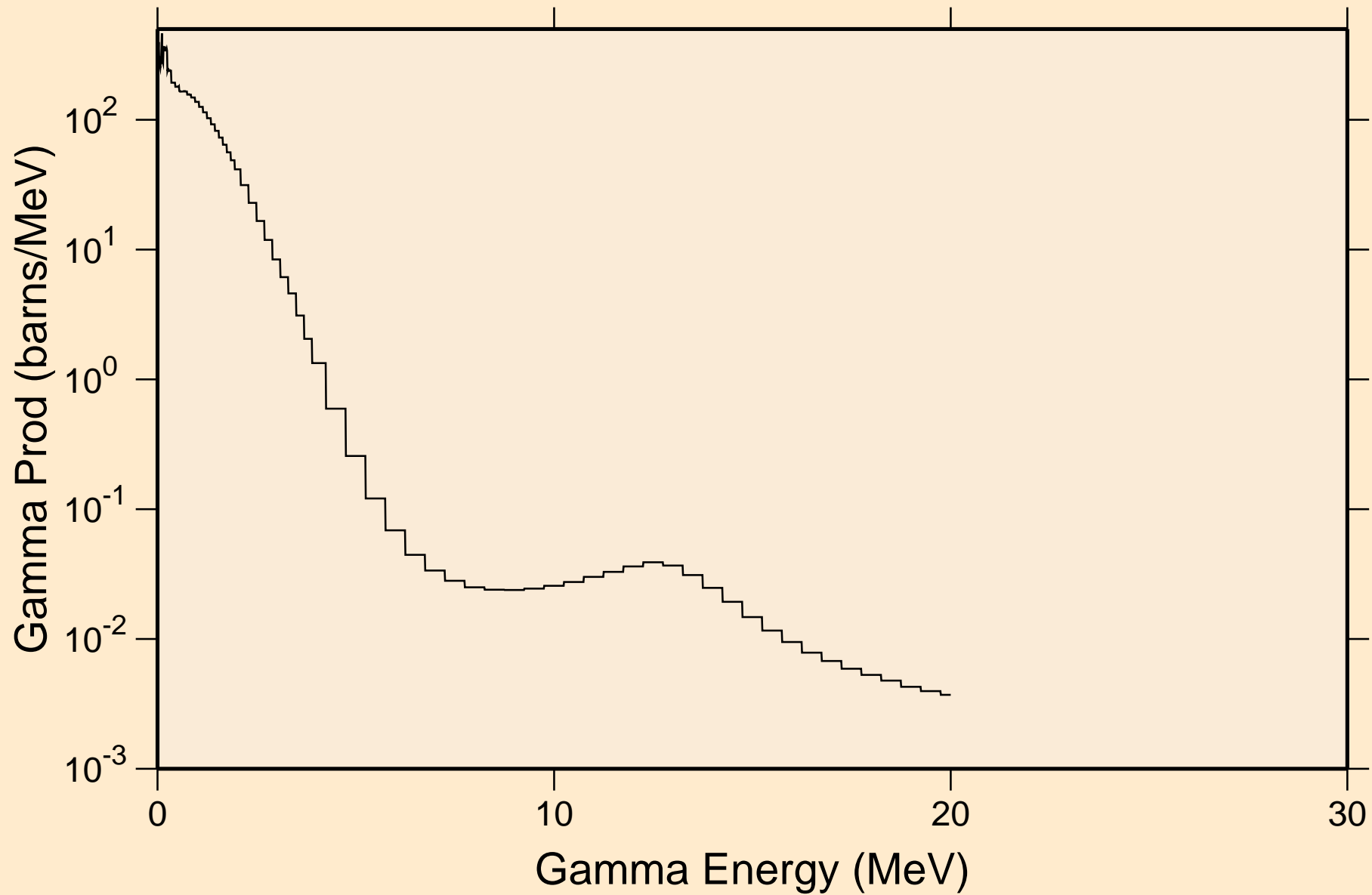

# U239 NRG TENDL-2015, AKONING

## Particle heating contributions

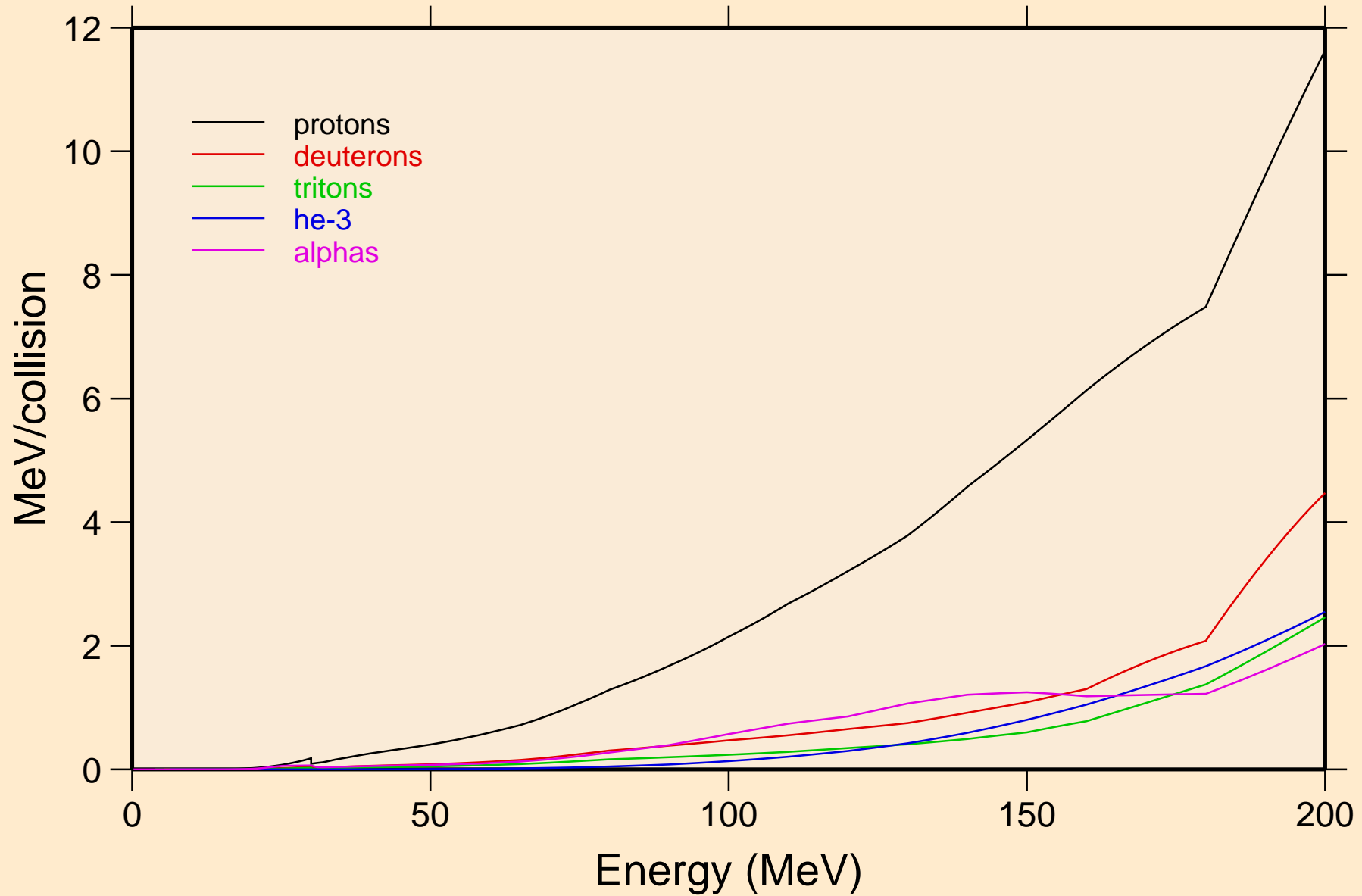

# U239 NRG TENDL-2015, AKONING

## Recoil Heating

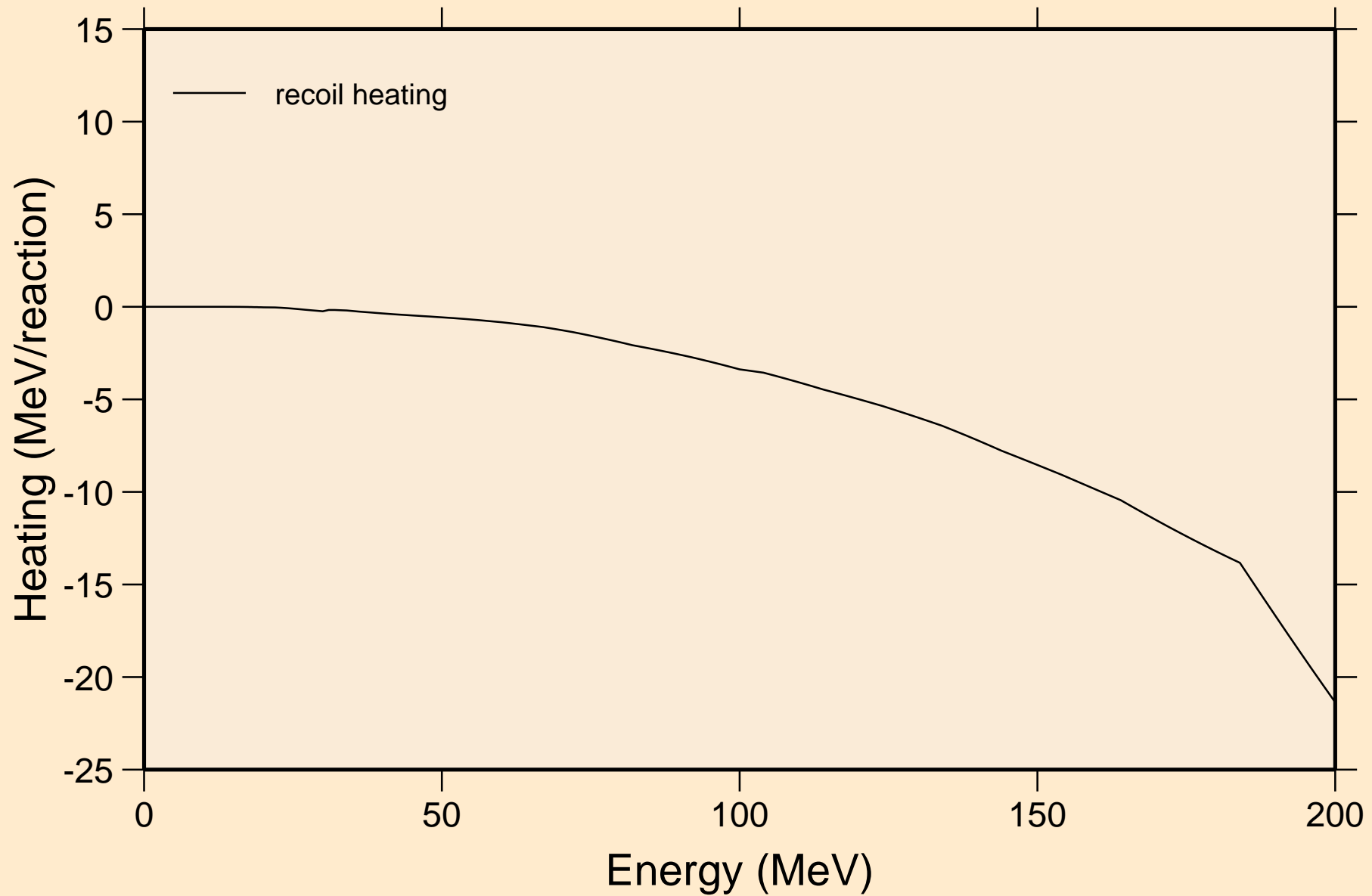

# U239 NRG TENDL-2015, AKONING

## Particle production cross sections

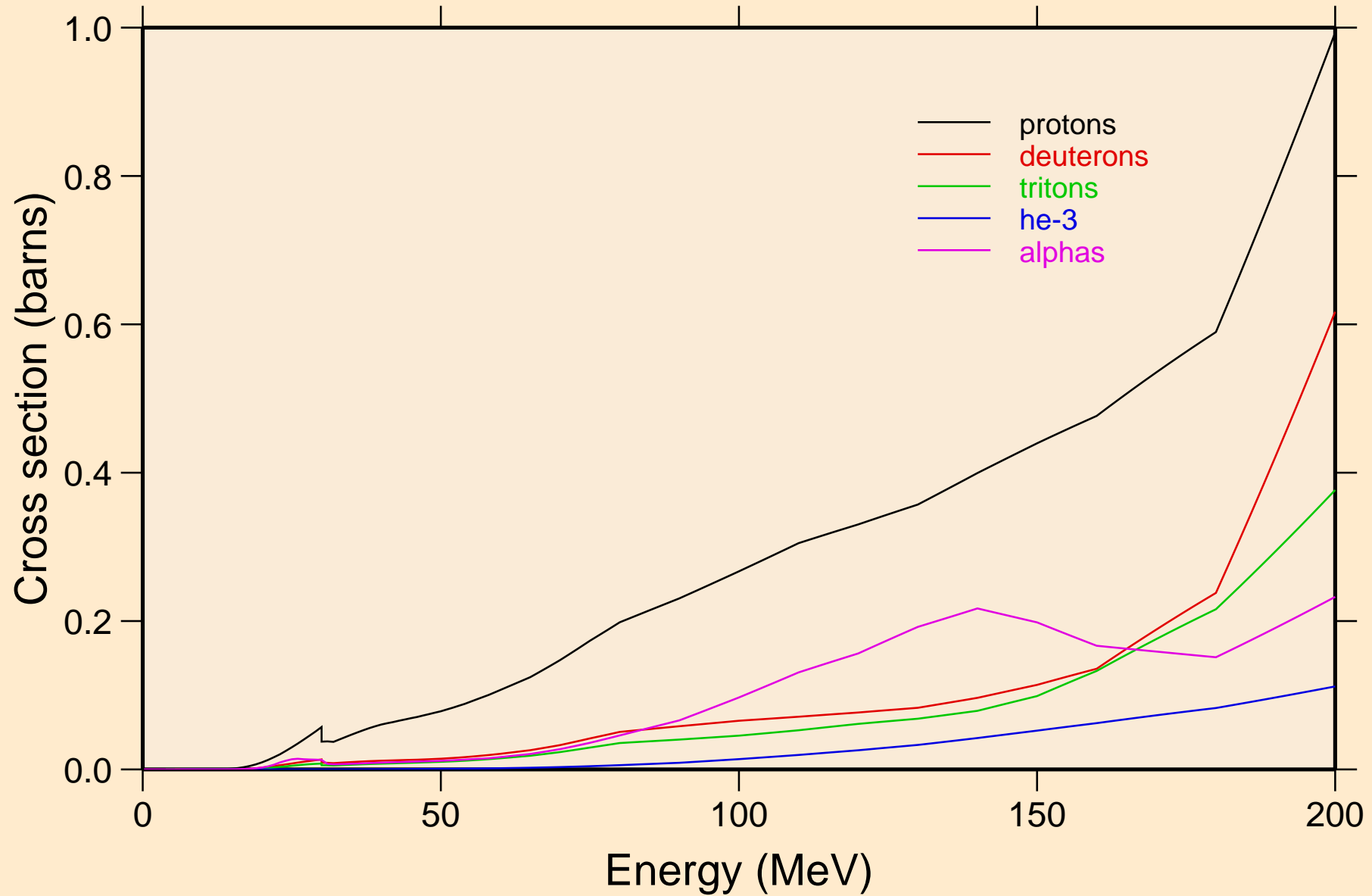

U239 NRG TENDL-2015, AKONING  
protons from (n,x)

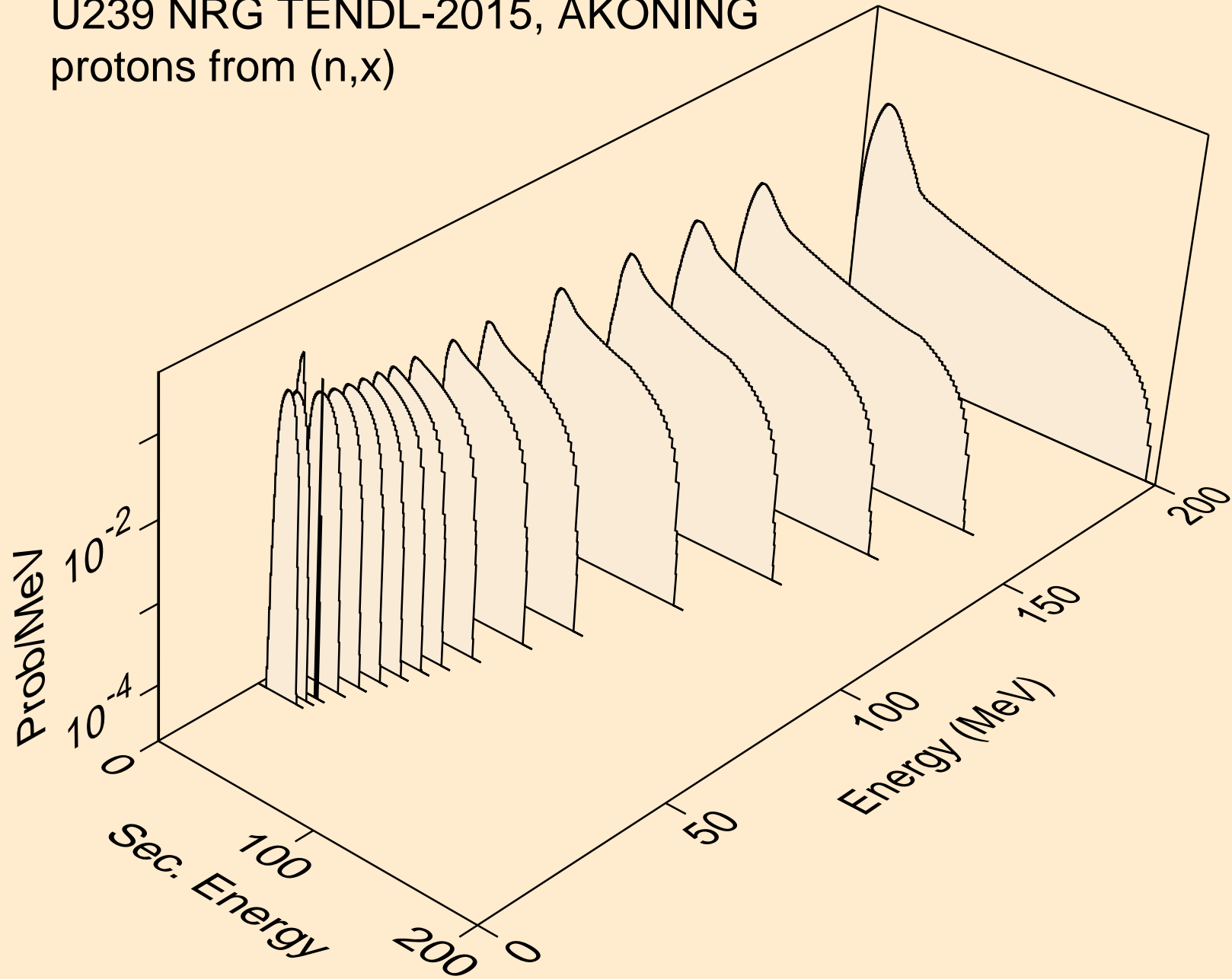



U239 NRG TENDL-2015, AKONING  
protons from (n,n\*)p

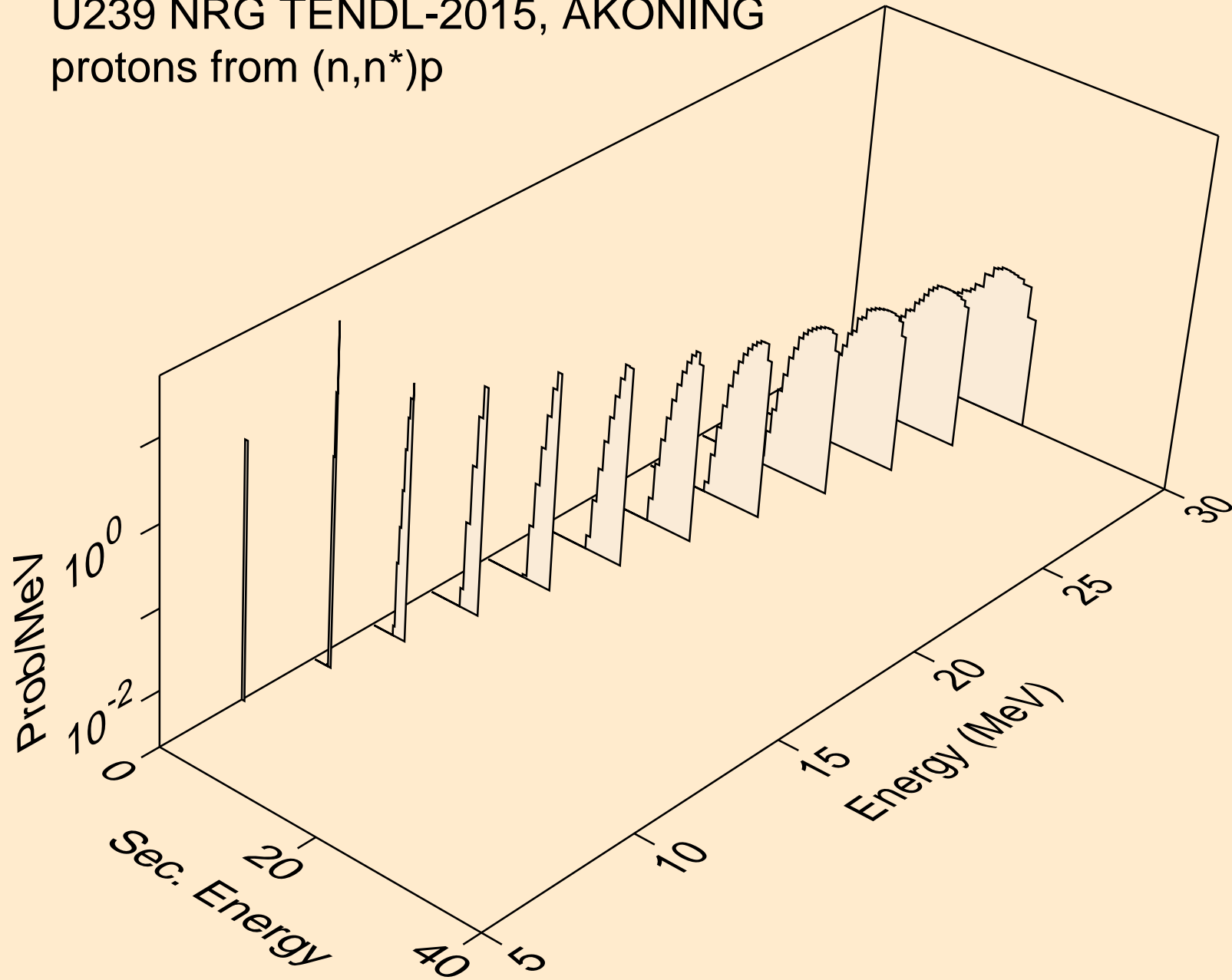

U239 NRG TENDL-2015, AKONING  
protons from (n,2np)

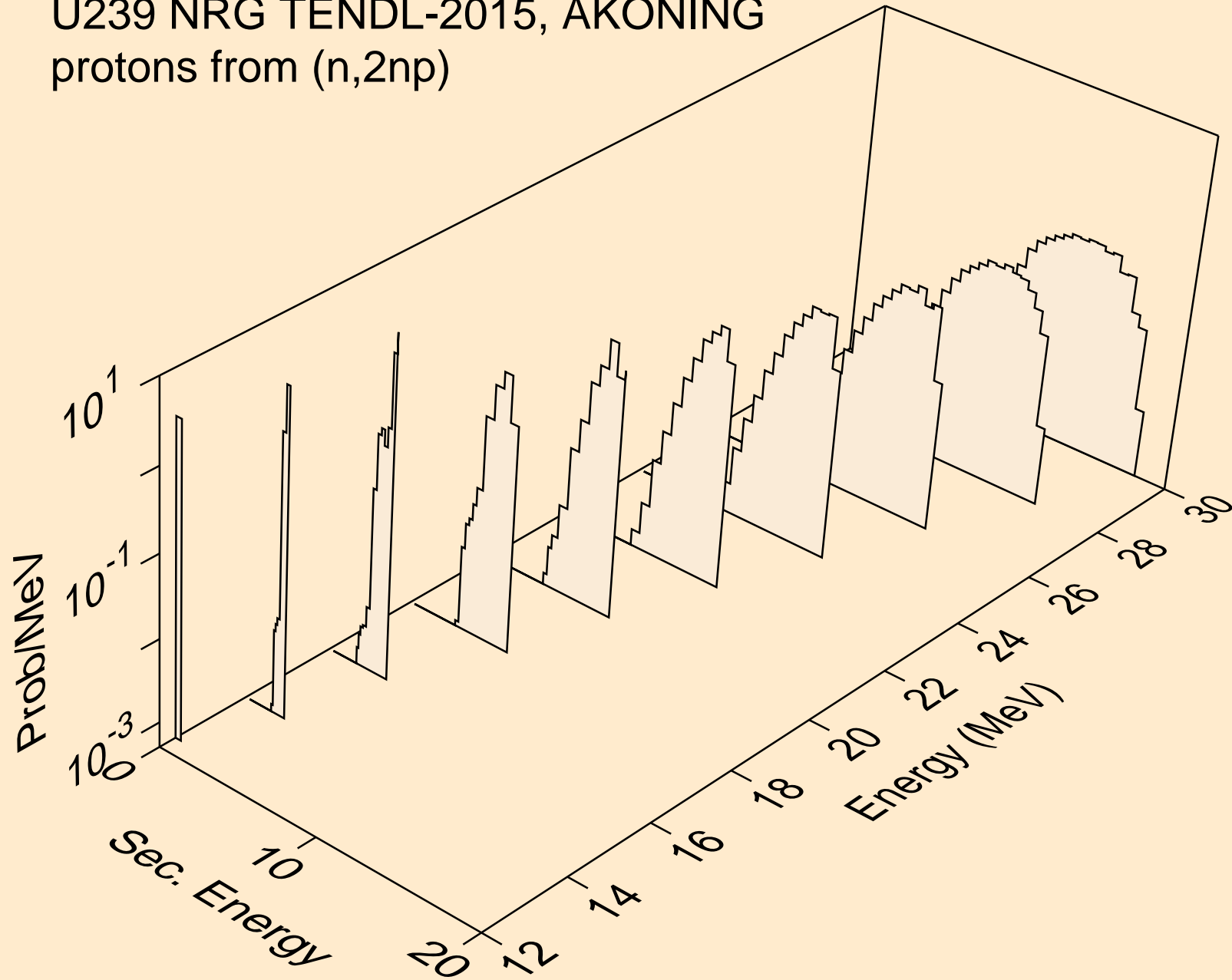

U239 NRG TENDL-2015, AKONING  
protons from (n,3np)

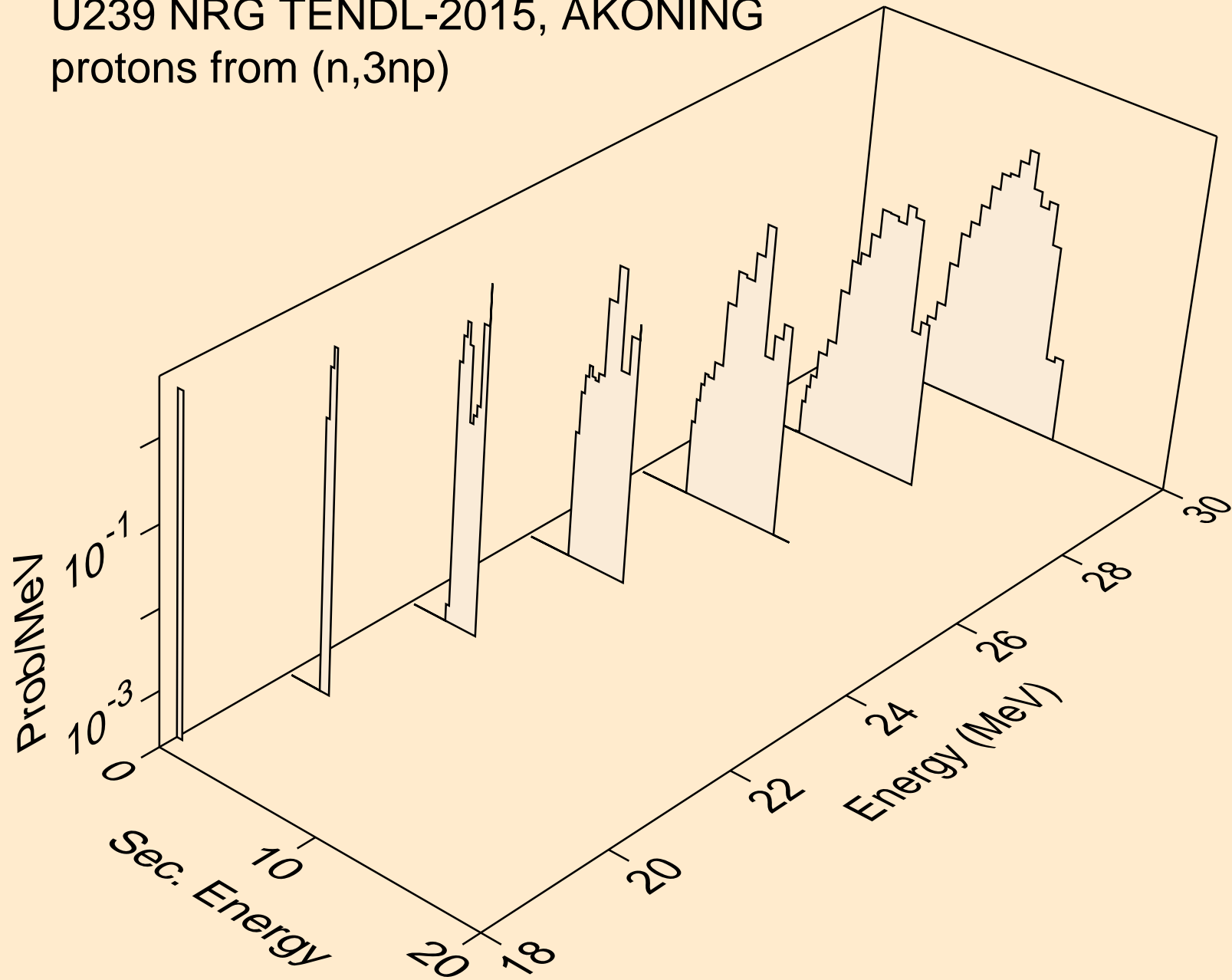

U239 NRG TENDL-2015, AKONING  
protons from (n,2np)

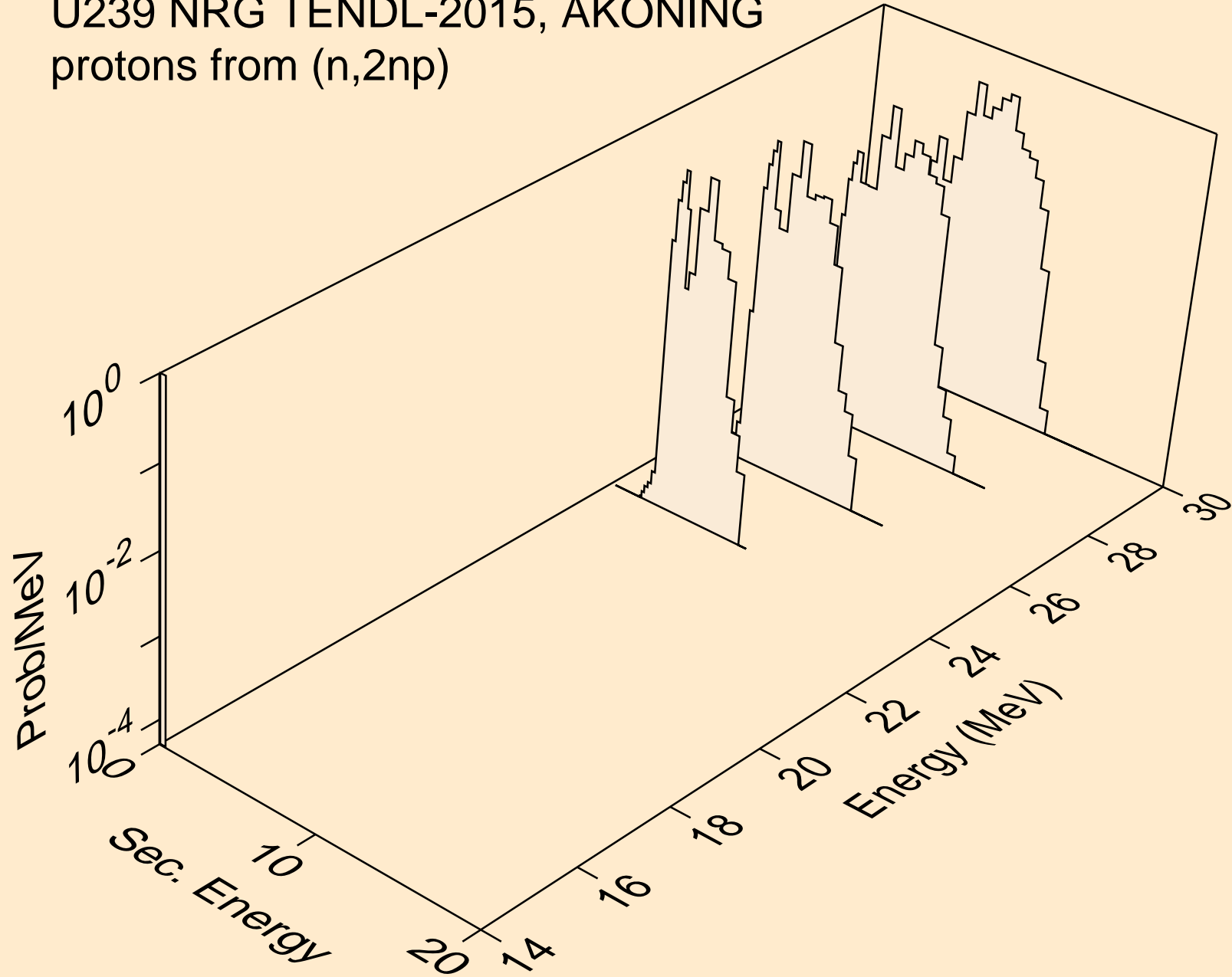

U239 NRG TENDL-2015, AKONING  
protons from (n,p)

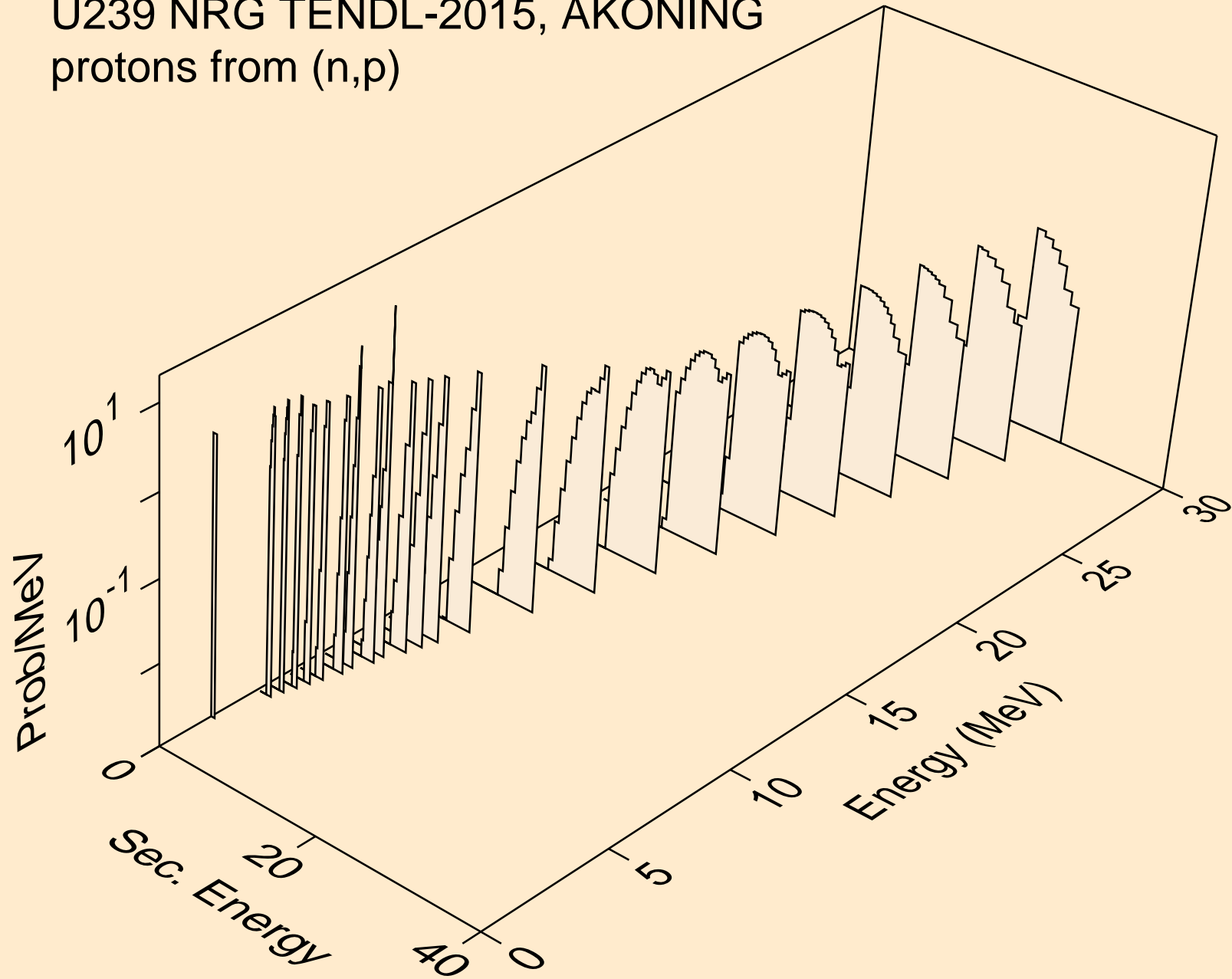

U239 NRG TENDL-2015, AKONING  
protons from (n,2p)

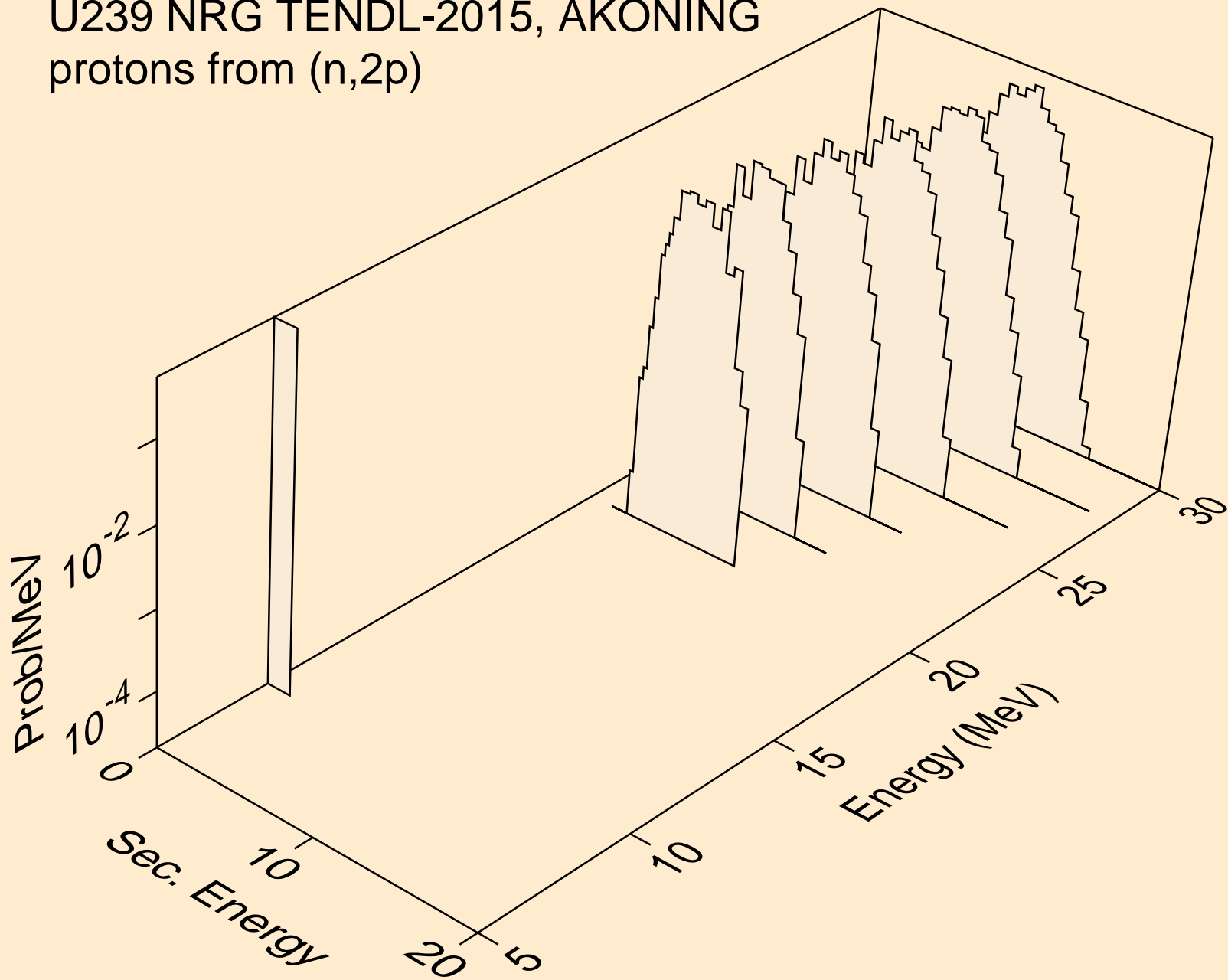

U239 NRG TENDL-2015, AKONING  
deuterons from (n,x)

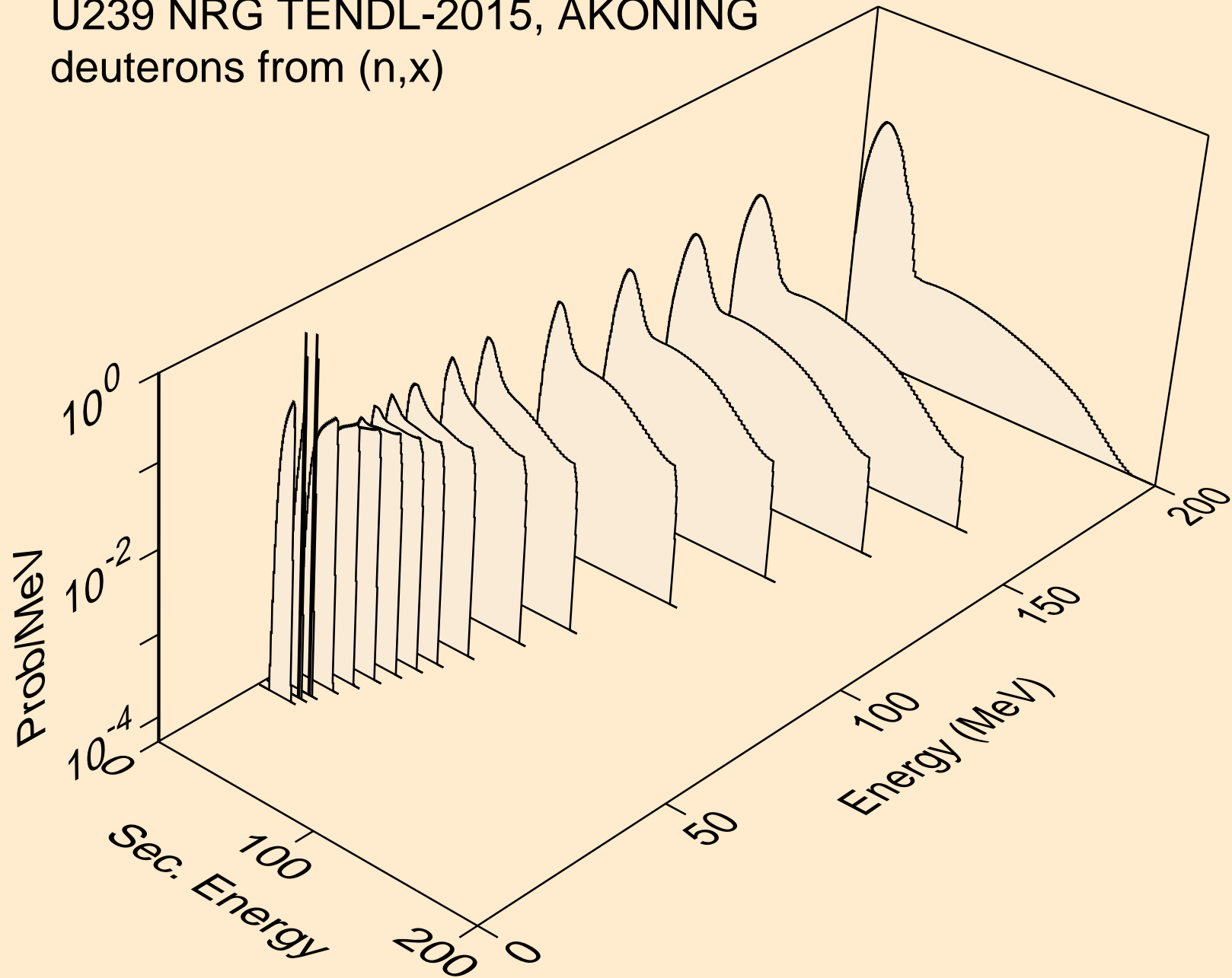

U239 NRG TENDL-2015, AKONING  
deuterons from (n,2nd)

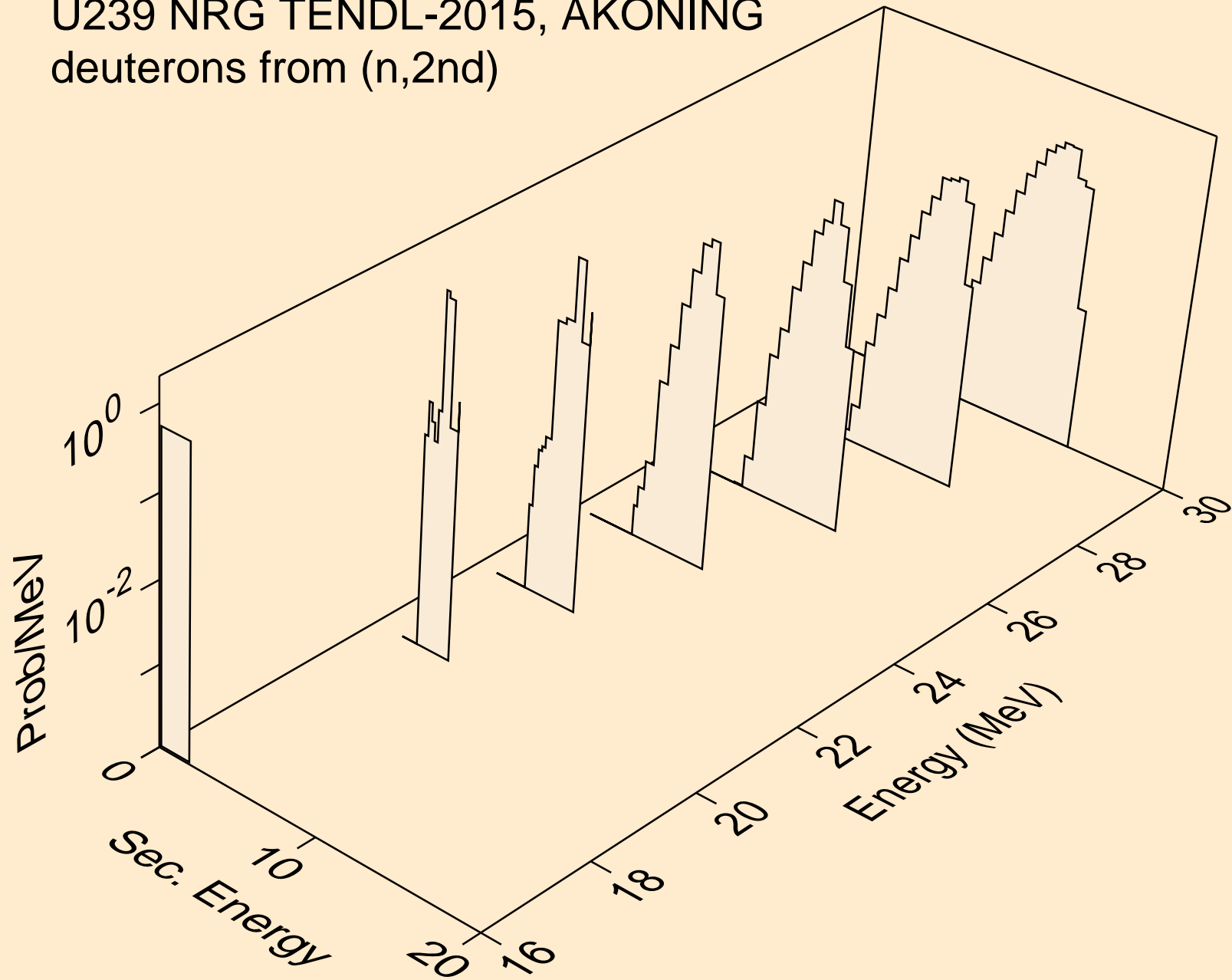



U239 NRG TENDL-2015, AKONING  
deuterons from (n,n\*)d

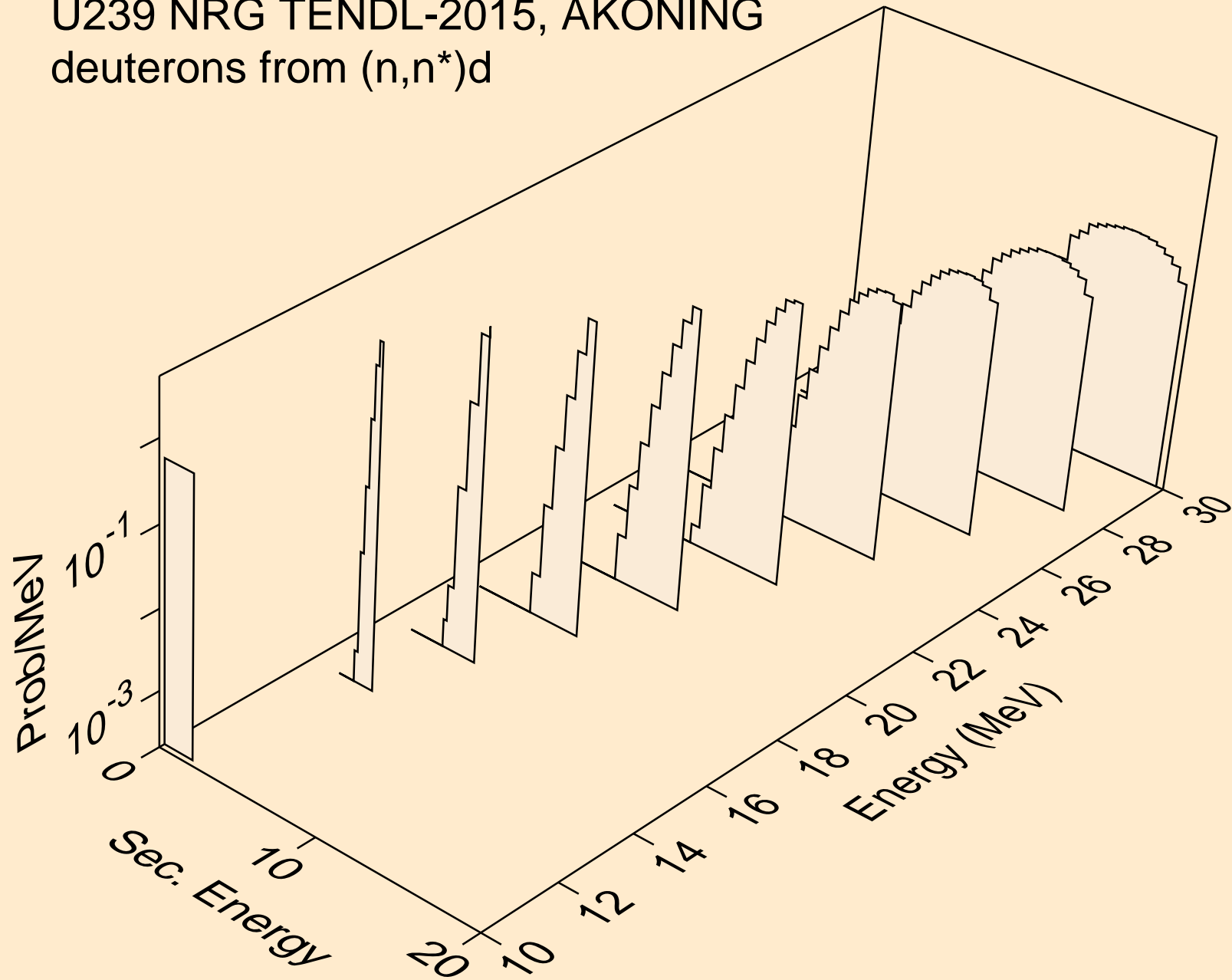

U239 NRG TENDL-2015, AKONING  
deuterons from (n,d)

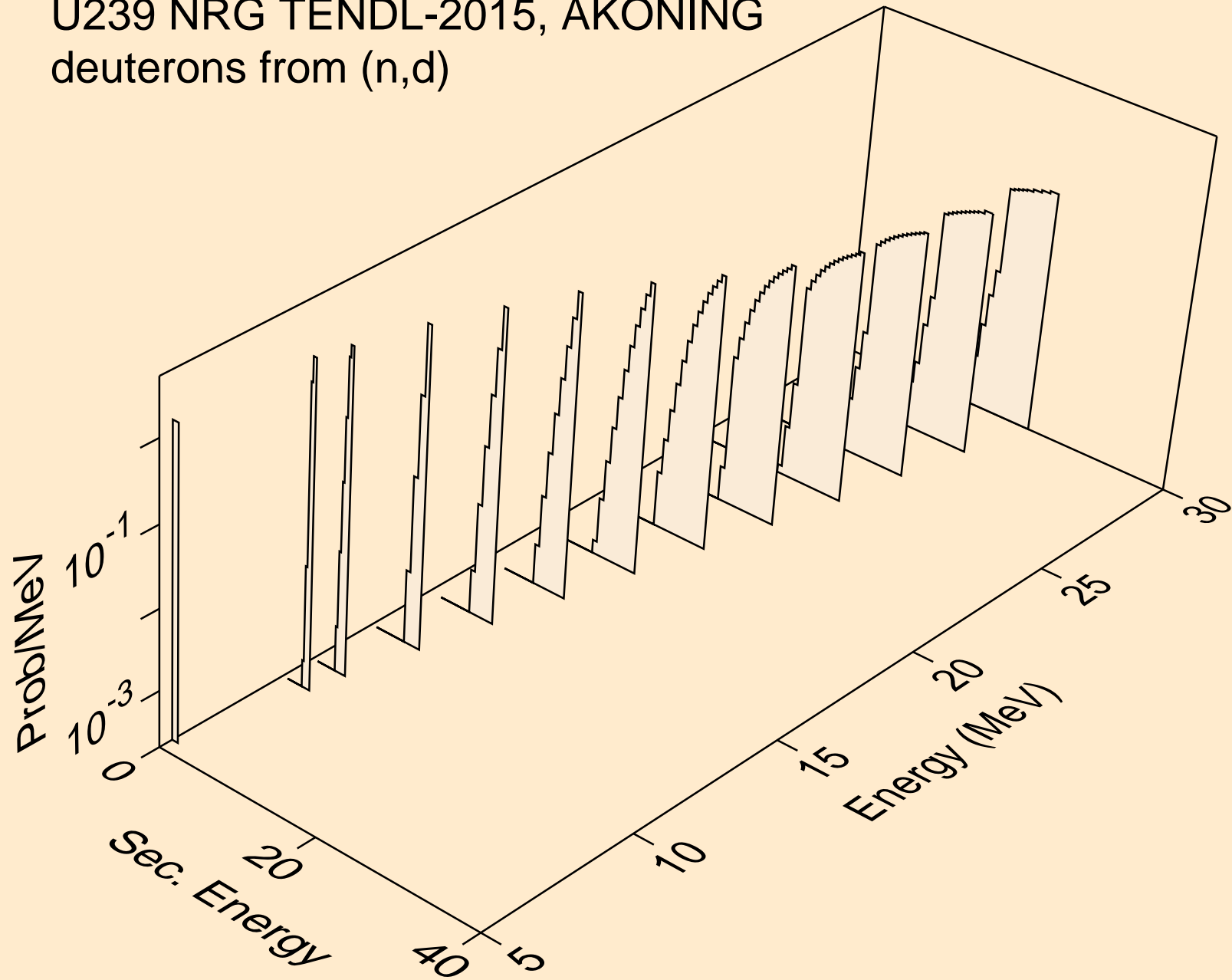

U239 NRG TENDL-2015, AKONING  
tritons from (n,x)

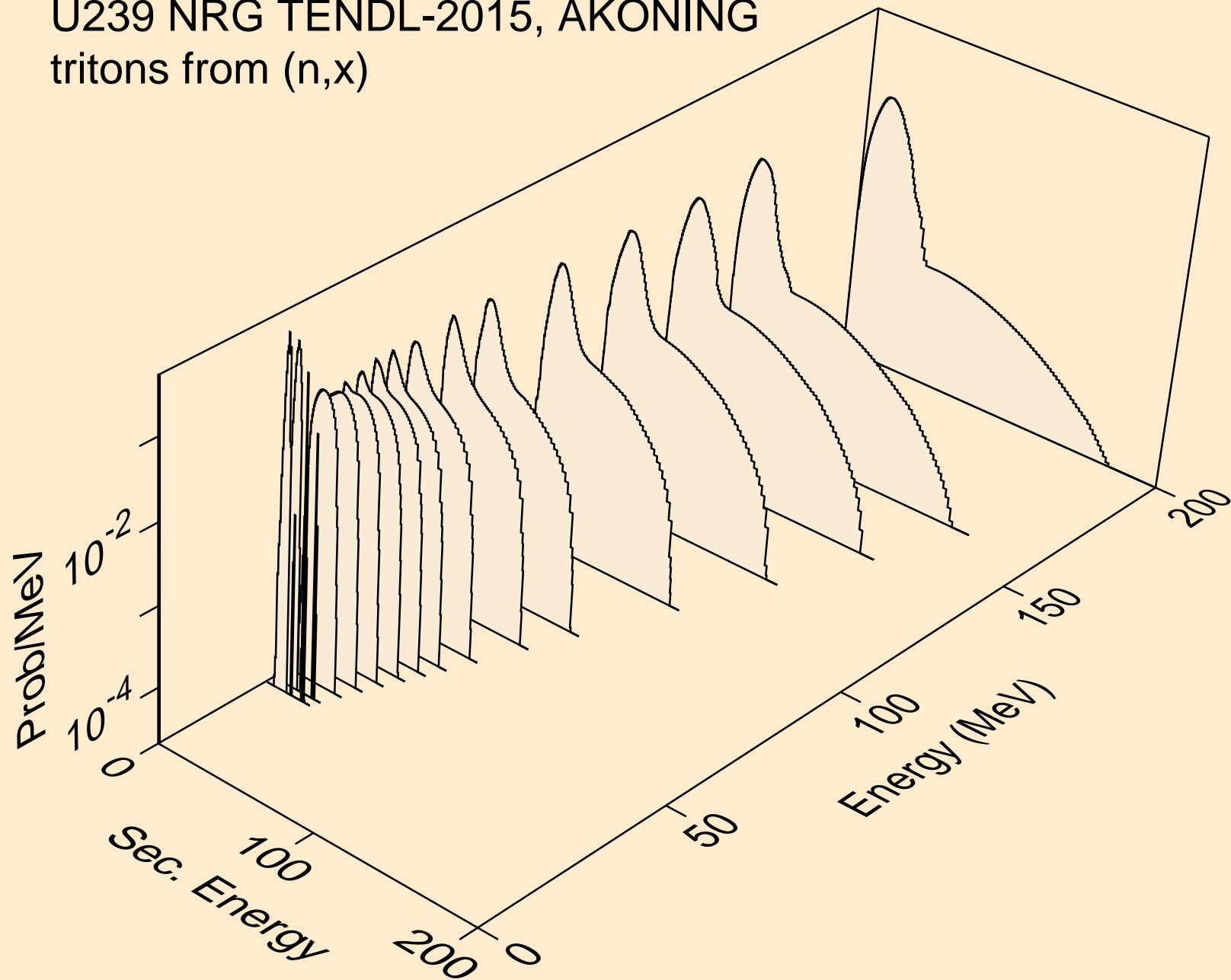

U239 NRG TENDL-2015, AKONING  
tritons from (n,n\*)t

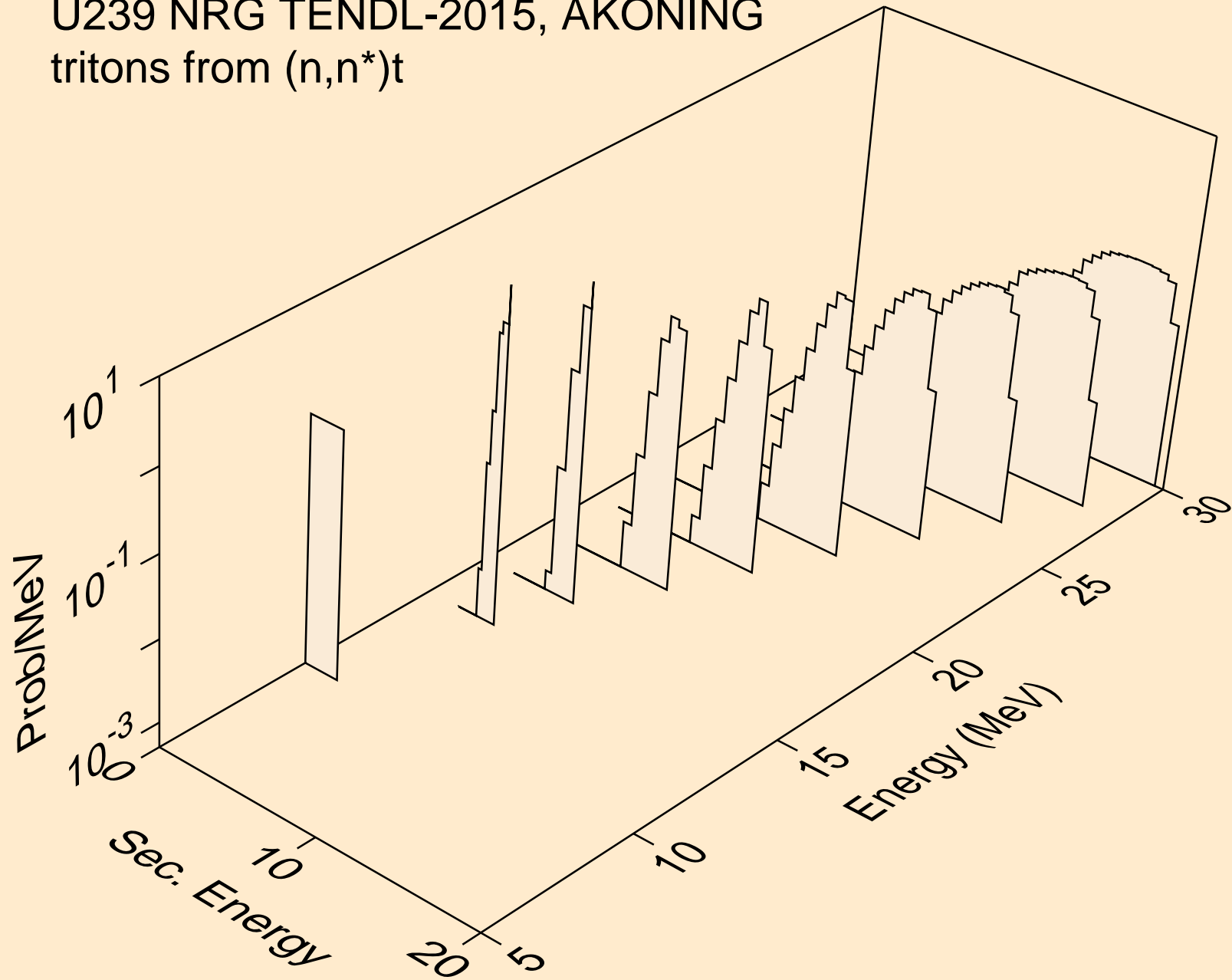

U239 NRG TENDL-2015, AKONING  
tritons from (n,t)

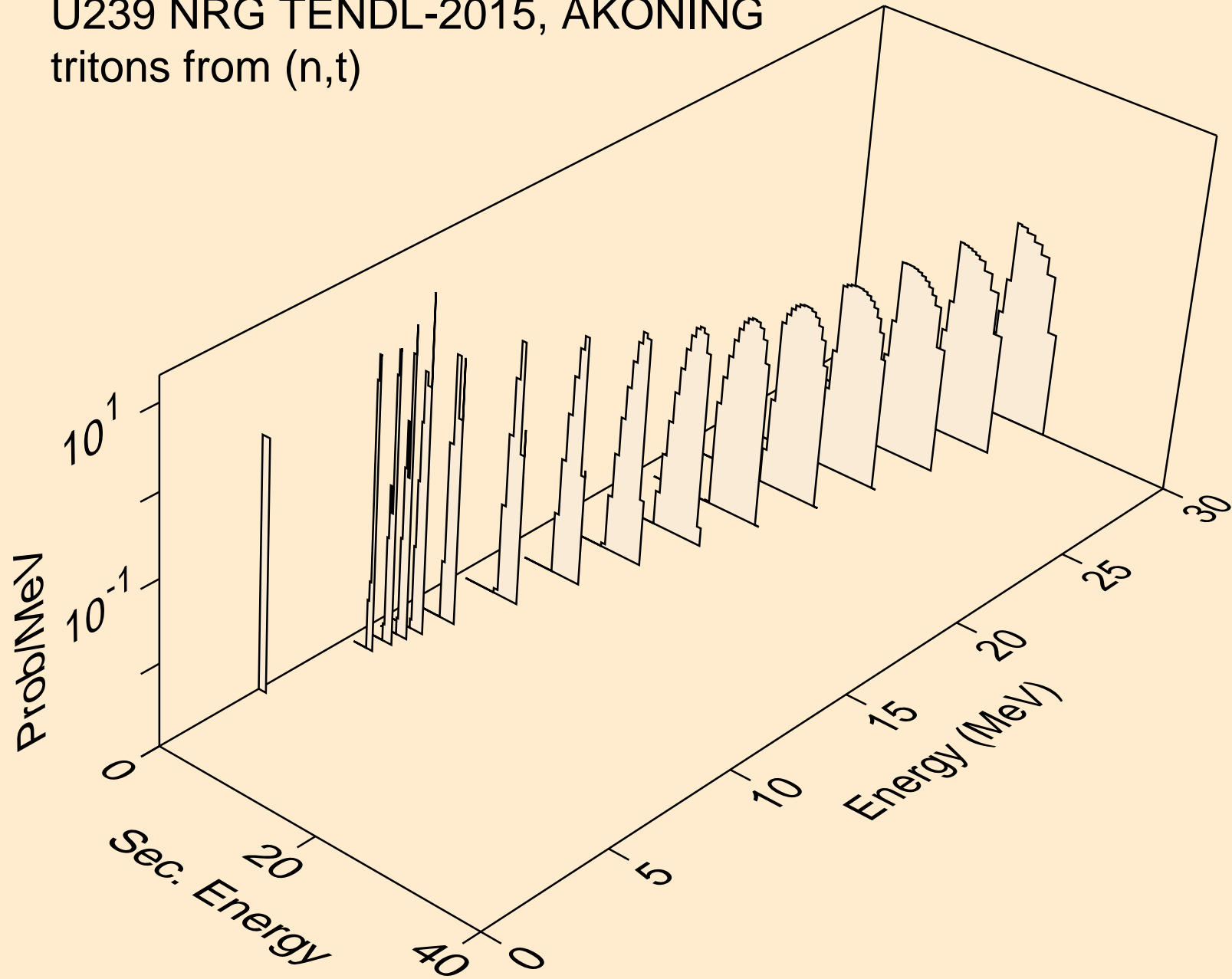

U239 NRG TENDL-2015, AKONING  
he3s from (n,x)

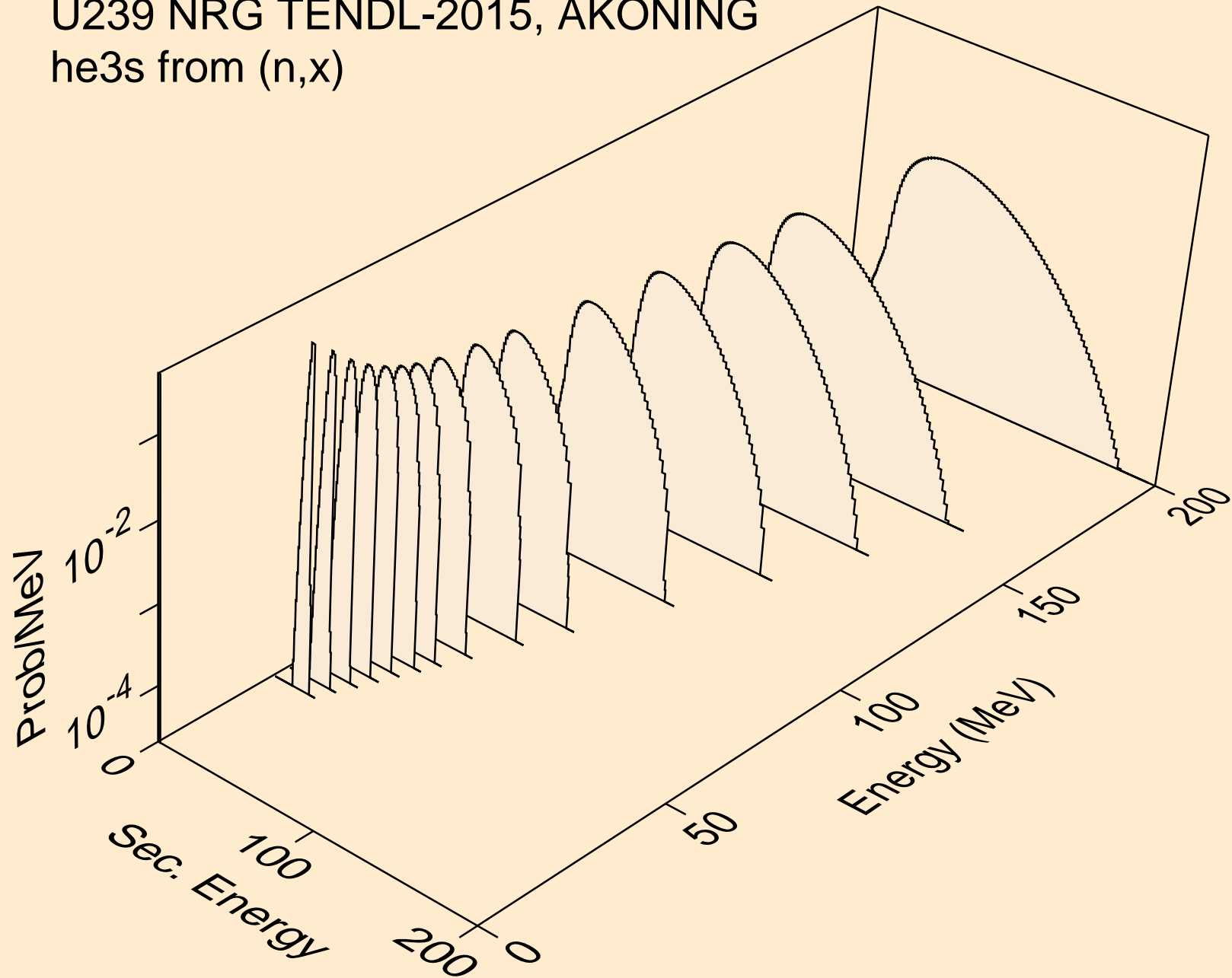

U239 NRG TENDL-2015, AKONING  
he3s from (n,n\*)he3

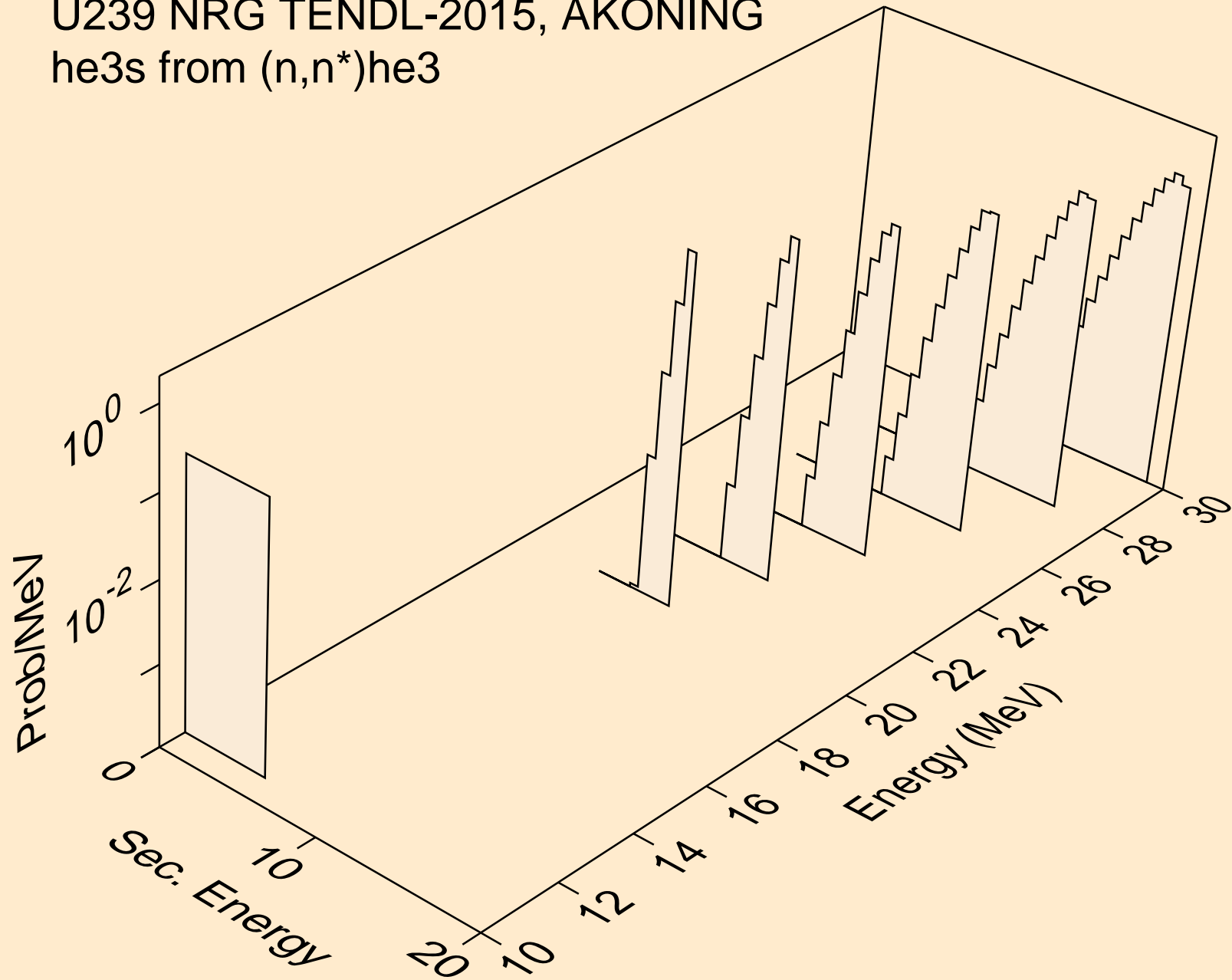

U239 NRG TENDL-2015, AKONING  
he3s from (n,he3)

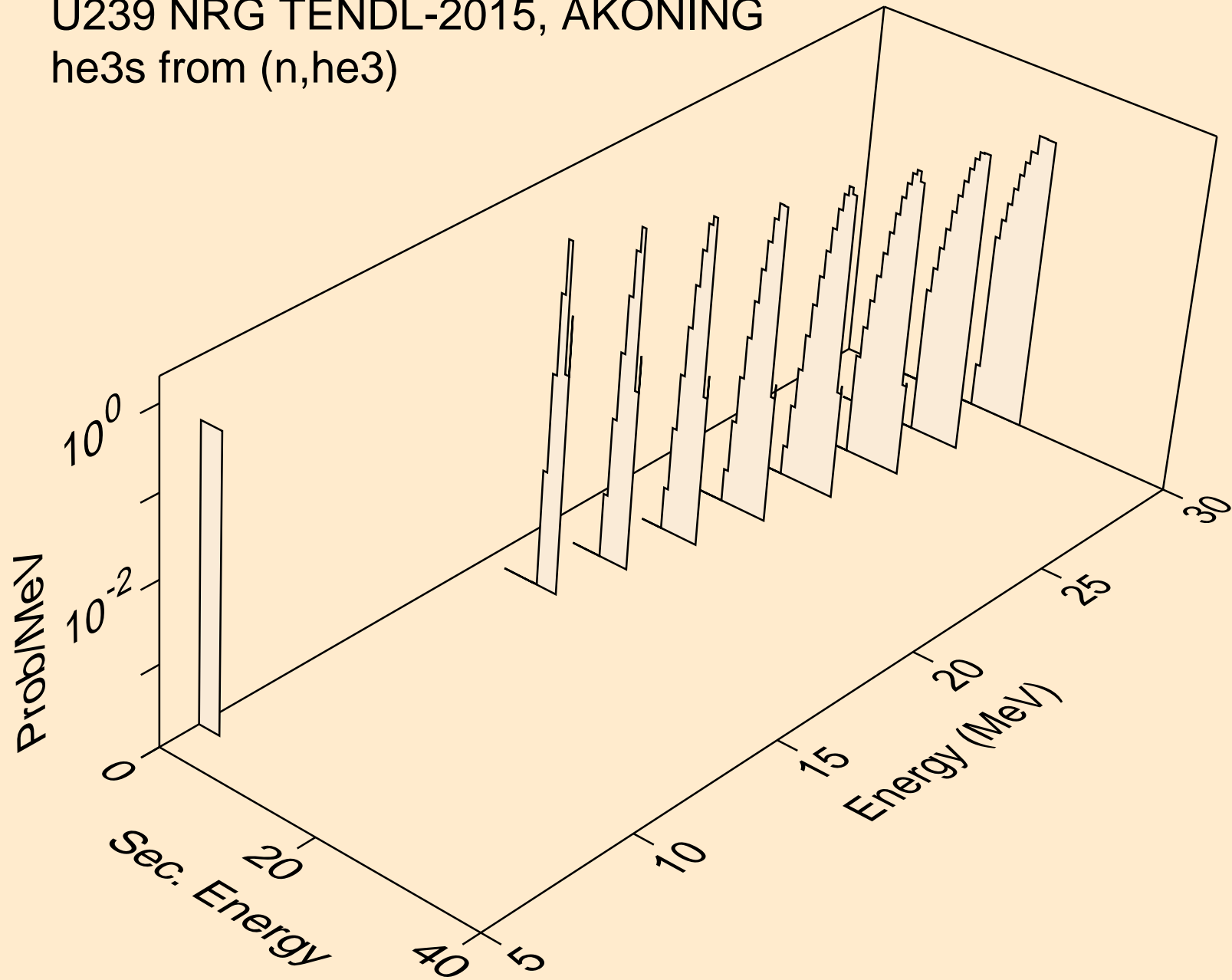



U239 NRG TENDL-2015, AKONING  
alphas from (n,x)

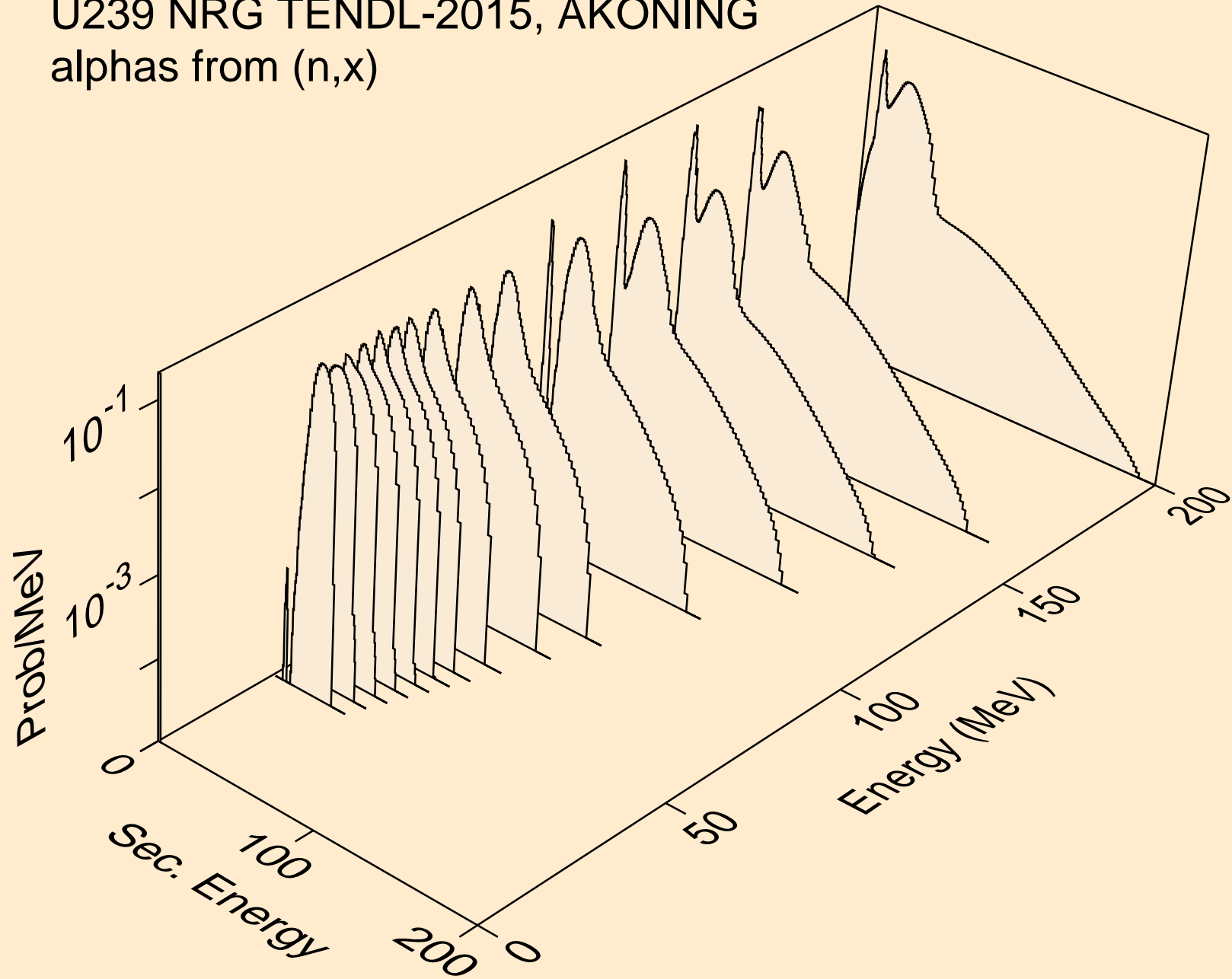

U239 NRG TENDL-2015, AKONING  
alphas from (n,n\*)a

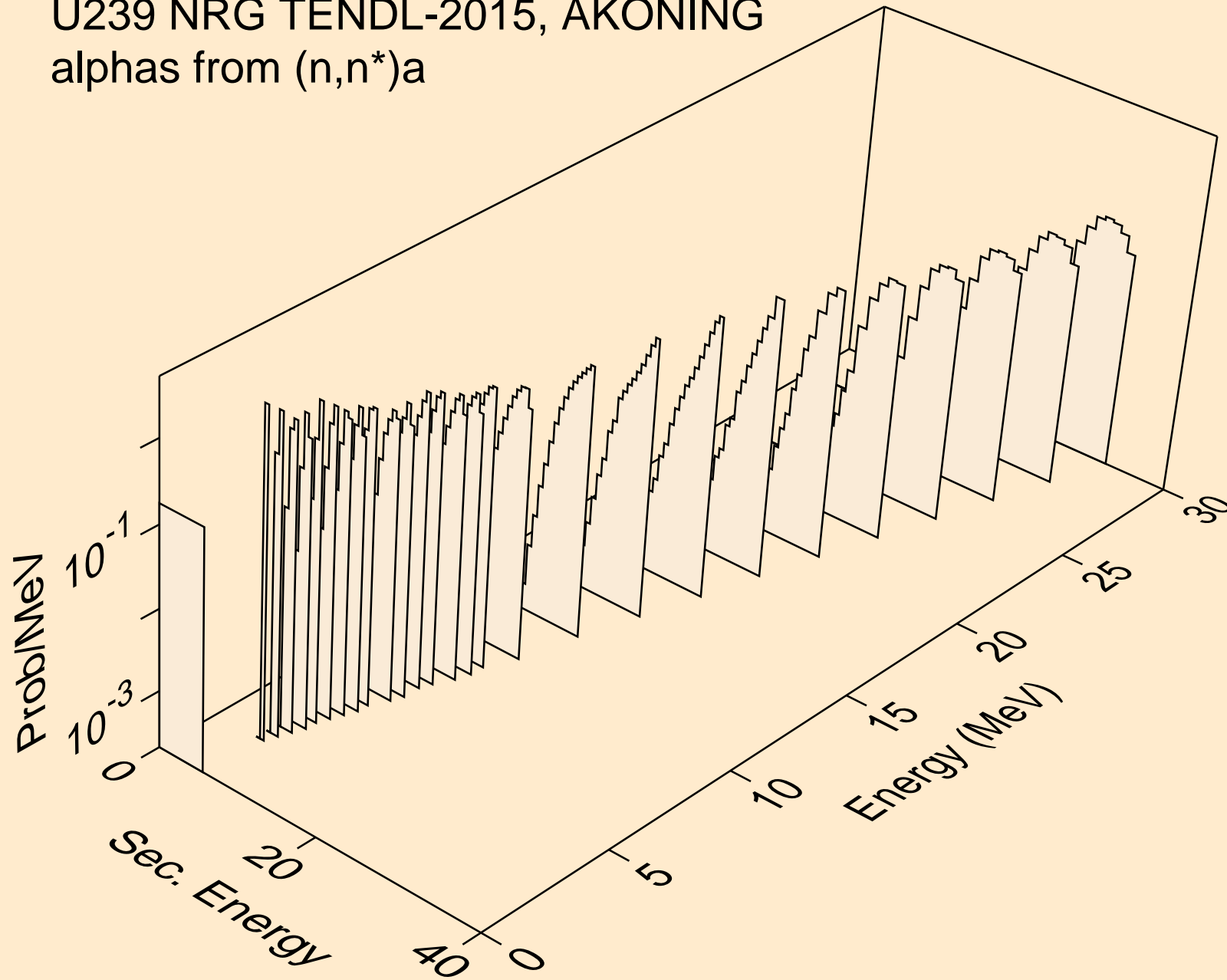

U239 NRG TENDL-2015, AKONING  
alphas from (n,2n)a

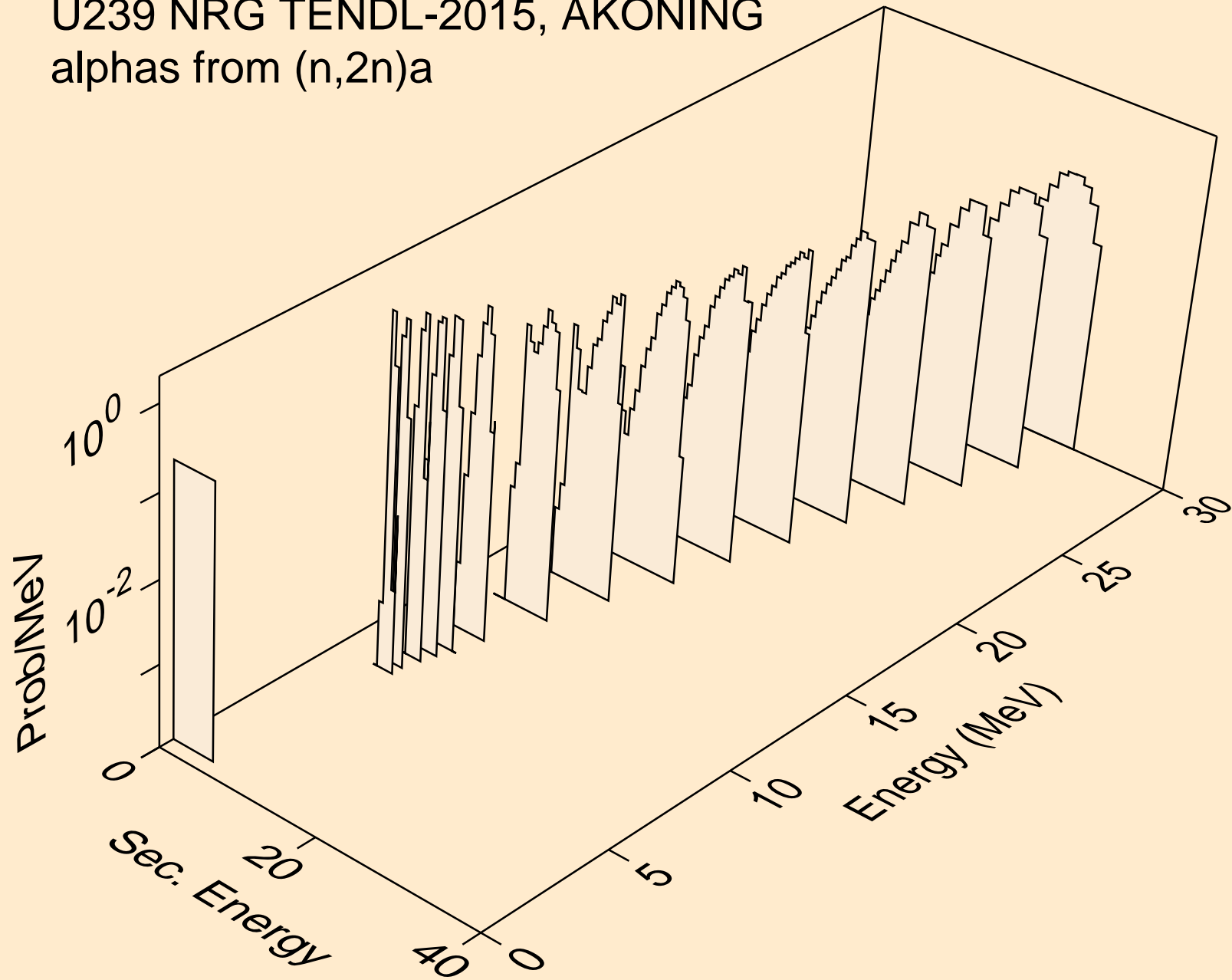

U239 NRG TENDL-2015, AKONING  
alphas from (n,3n)a

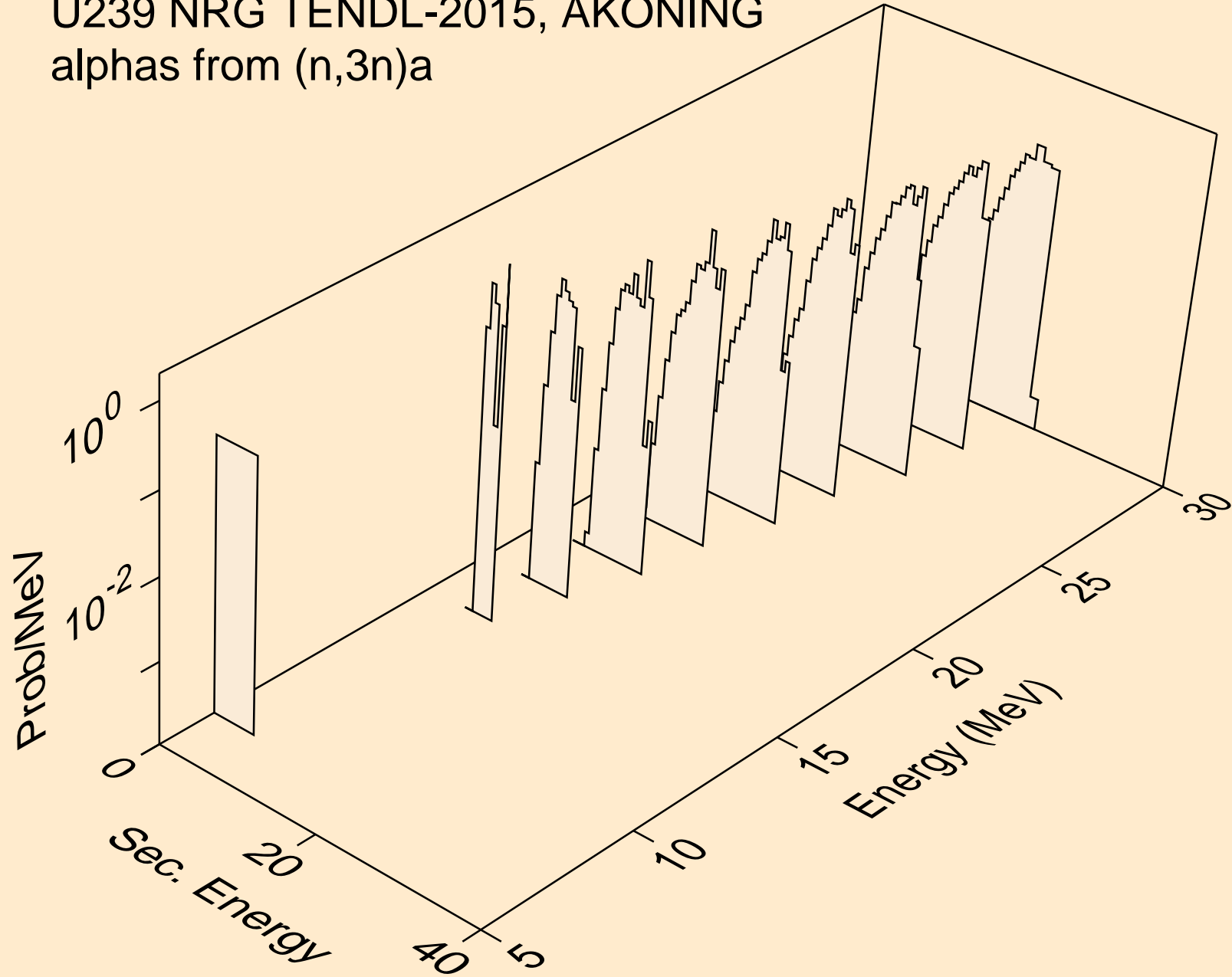

U239 NRG TENDL-2015, AKONING  
alphas from (n,a)

