

# U241 NRG TENDL-2015, AKONING

## Principal cross sections

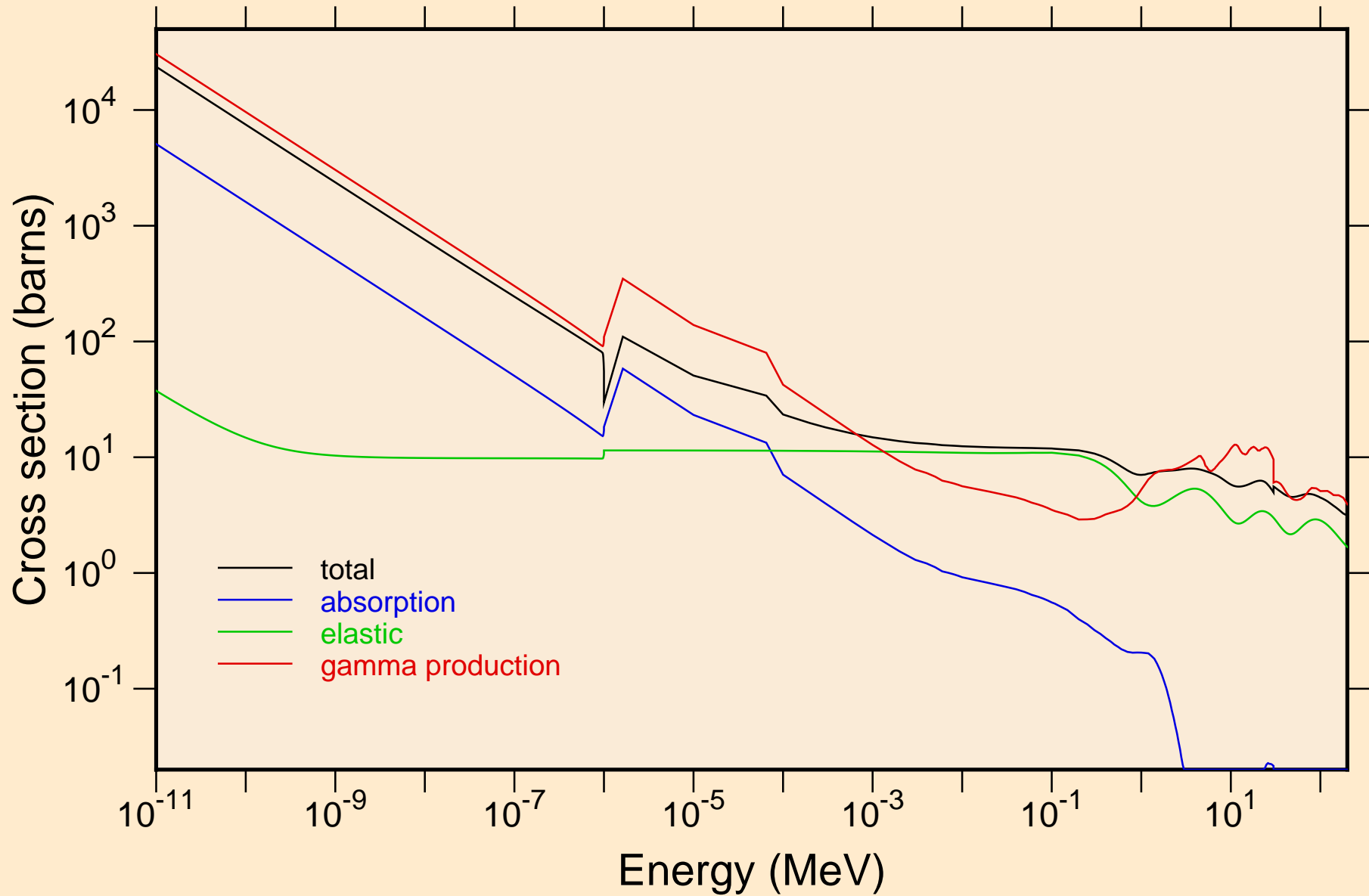

# U241 NRG TENDL-2015, AKONING

## Non-threshold reactions

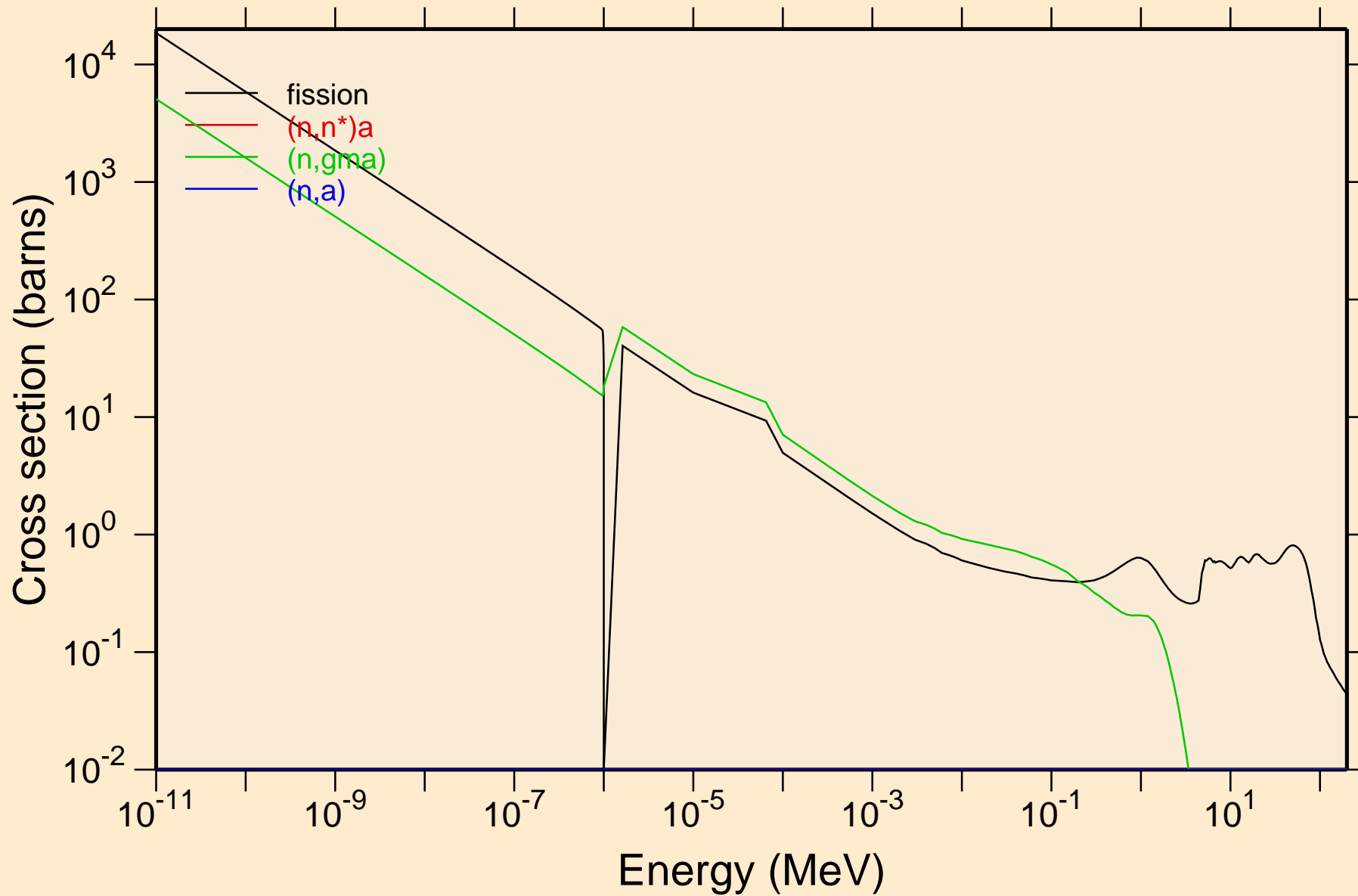

# U241 NRG TENDL-2015, AKONING

## Principal cross sections

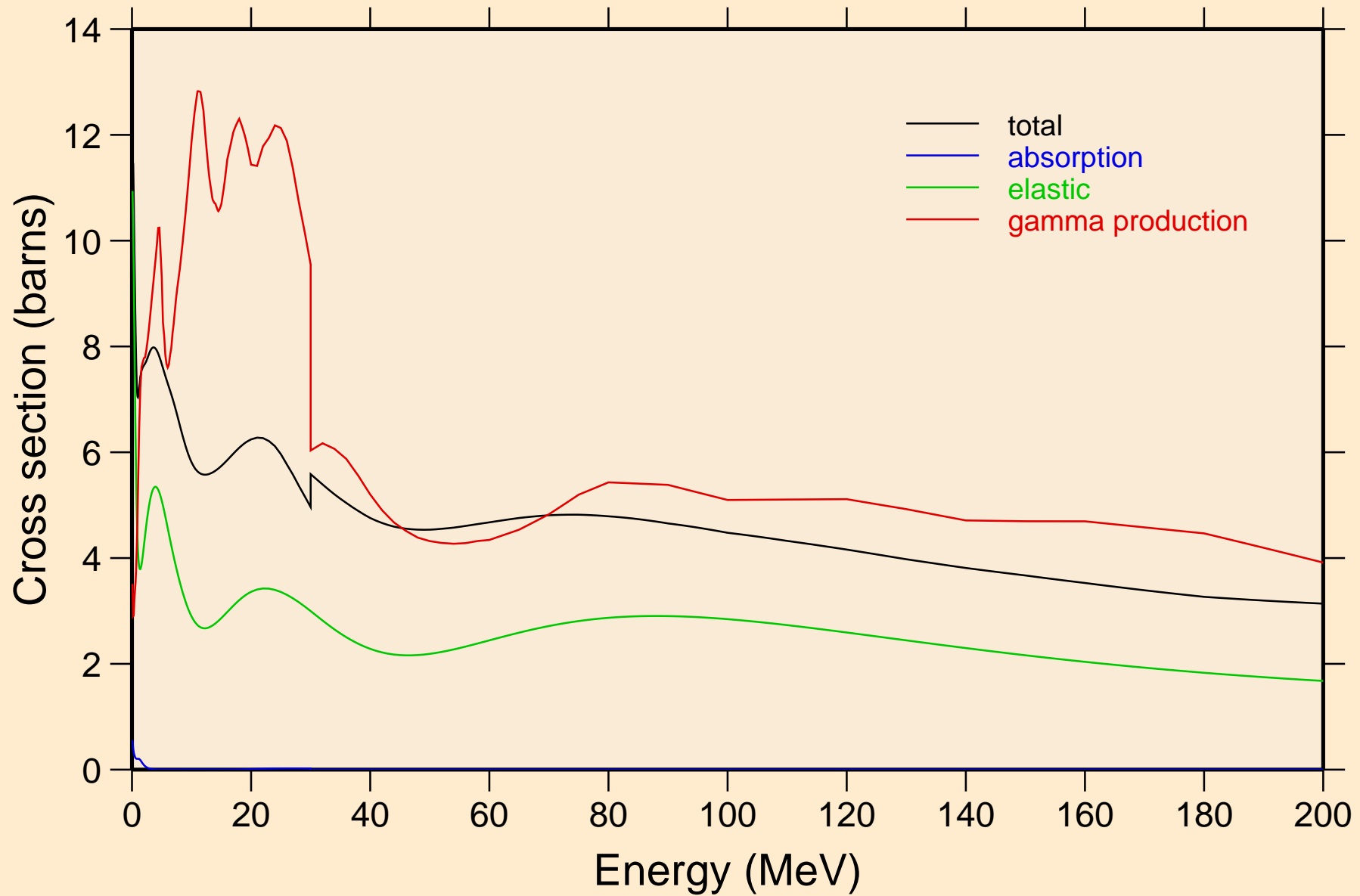

# U241 NRG TENDL-2015, AKONING

## Non-threshold reactions

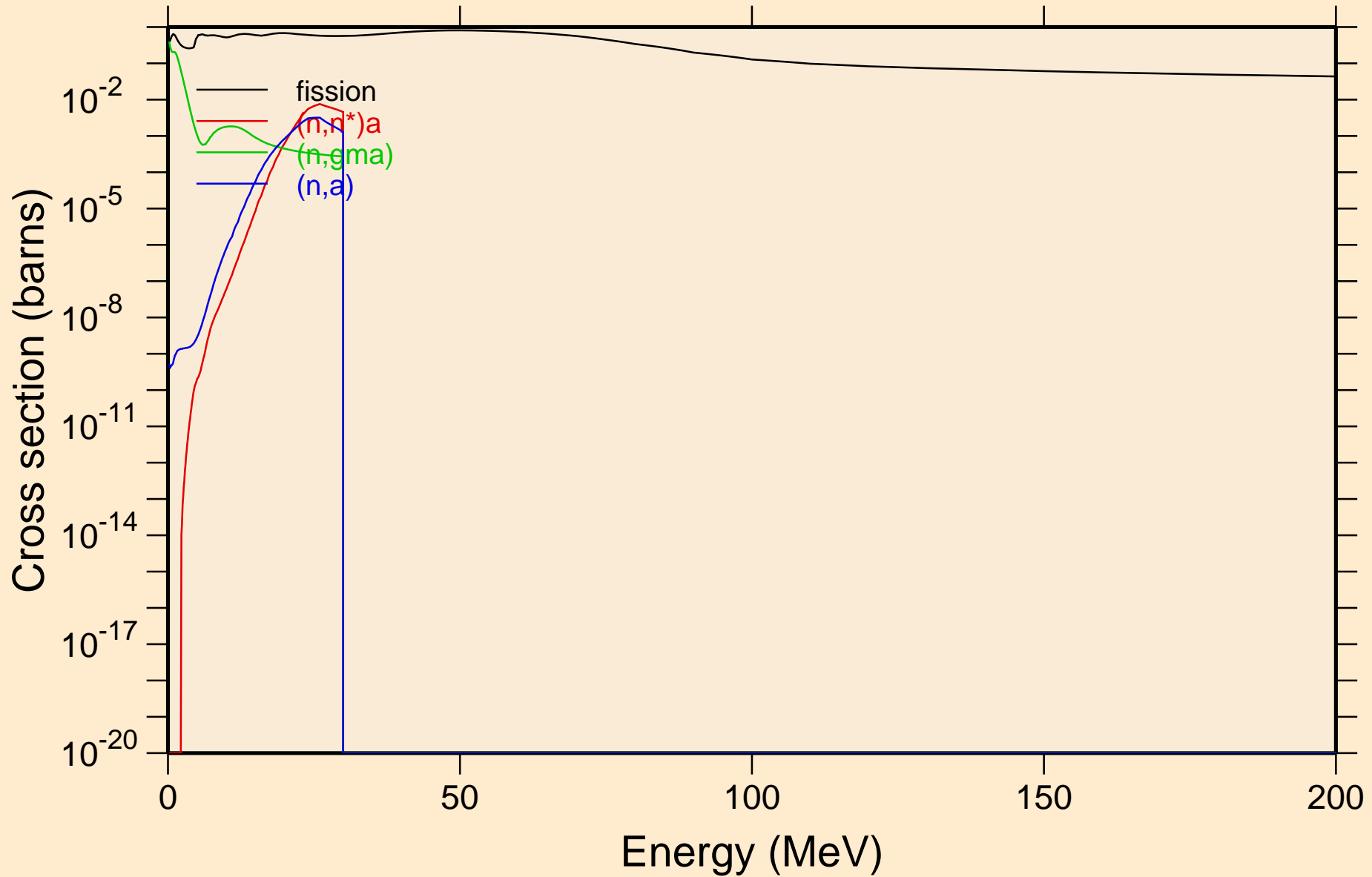

# U241 NRG TENDL-2015, AKONING

## Inelastic levels

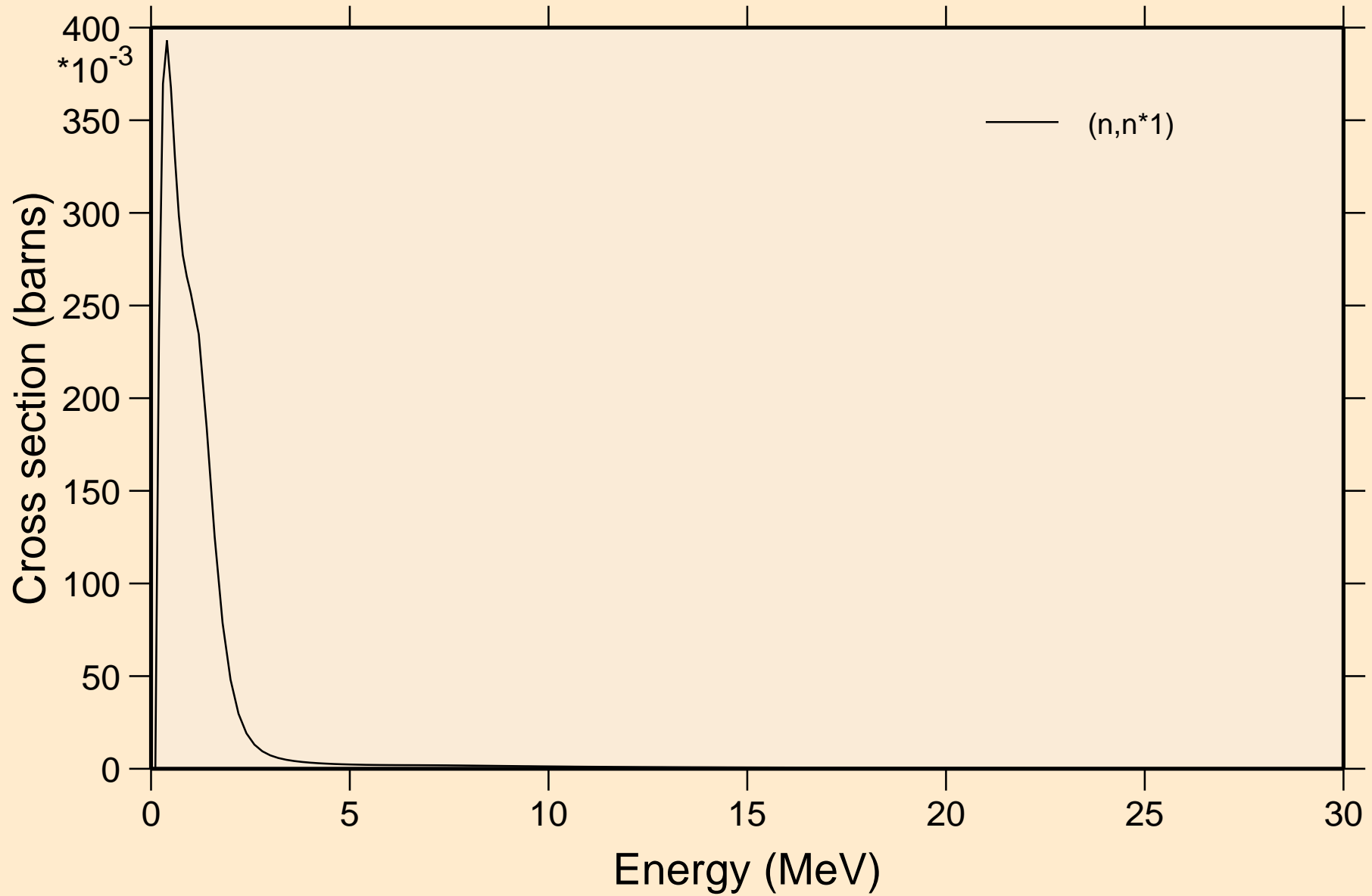

# U241 NRG TENDL-2015, AKONING

## Threshold reactions

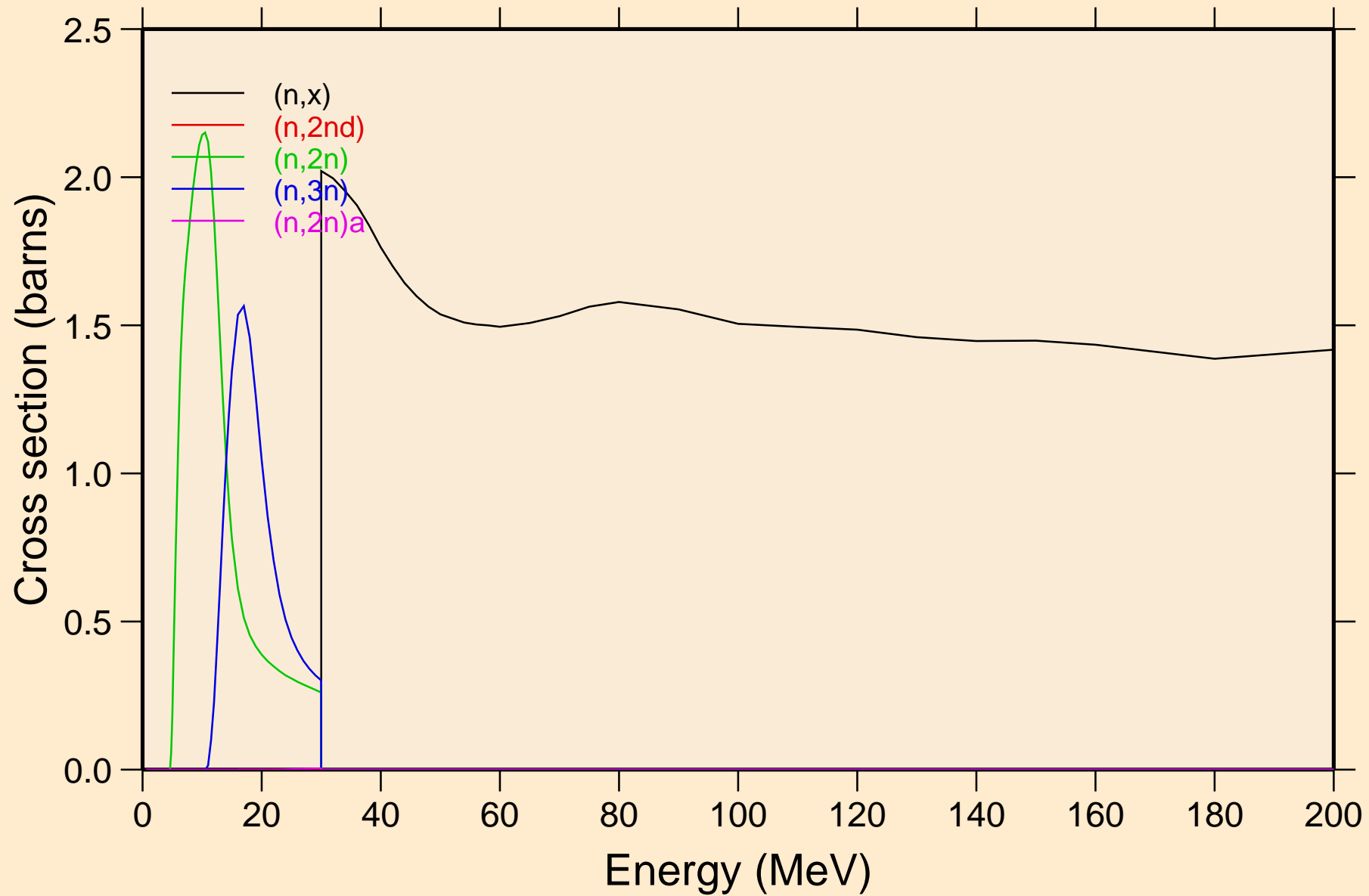

# U241 NRG TENDL-2015, AKONING

## Threshold reactions

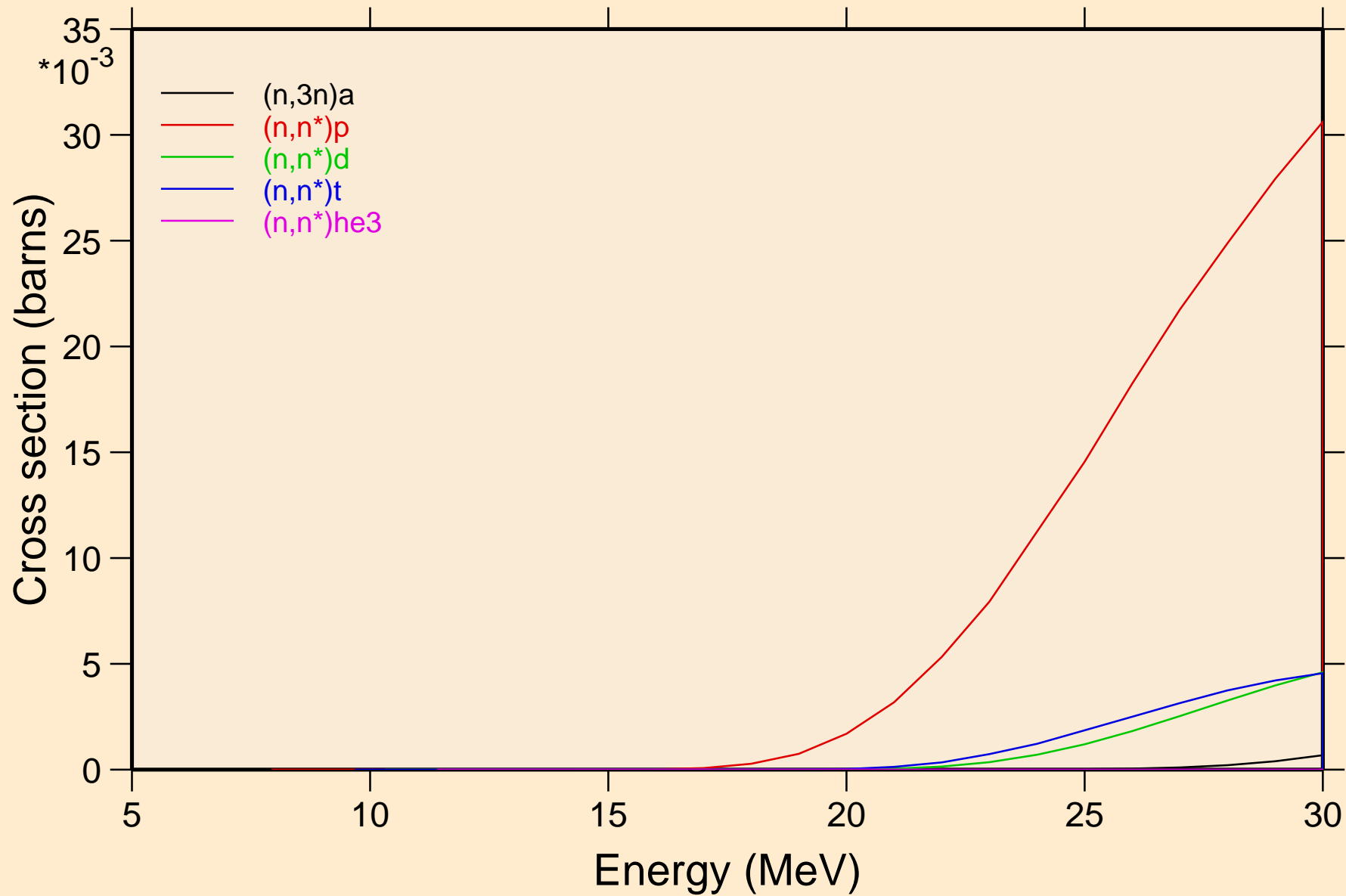

# U241 NRG TENDL-2015, AKONING

## Threshold reactions

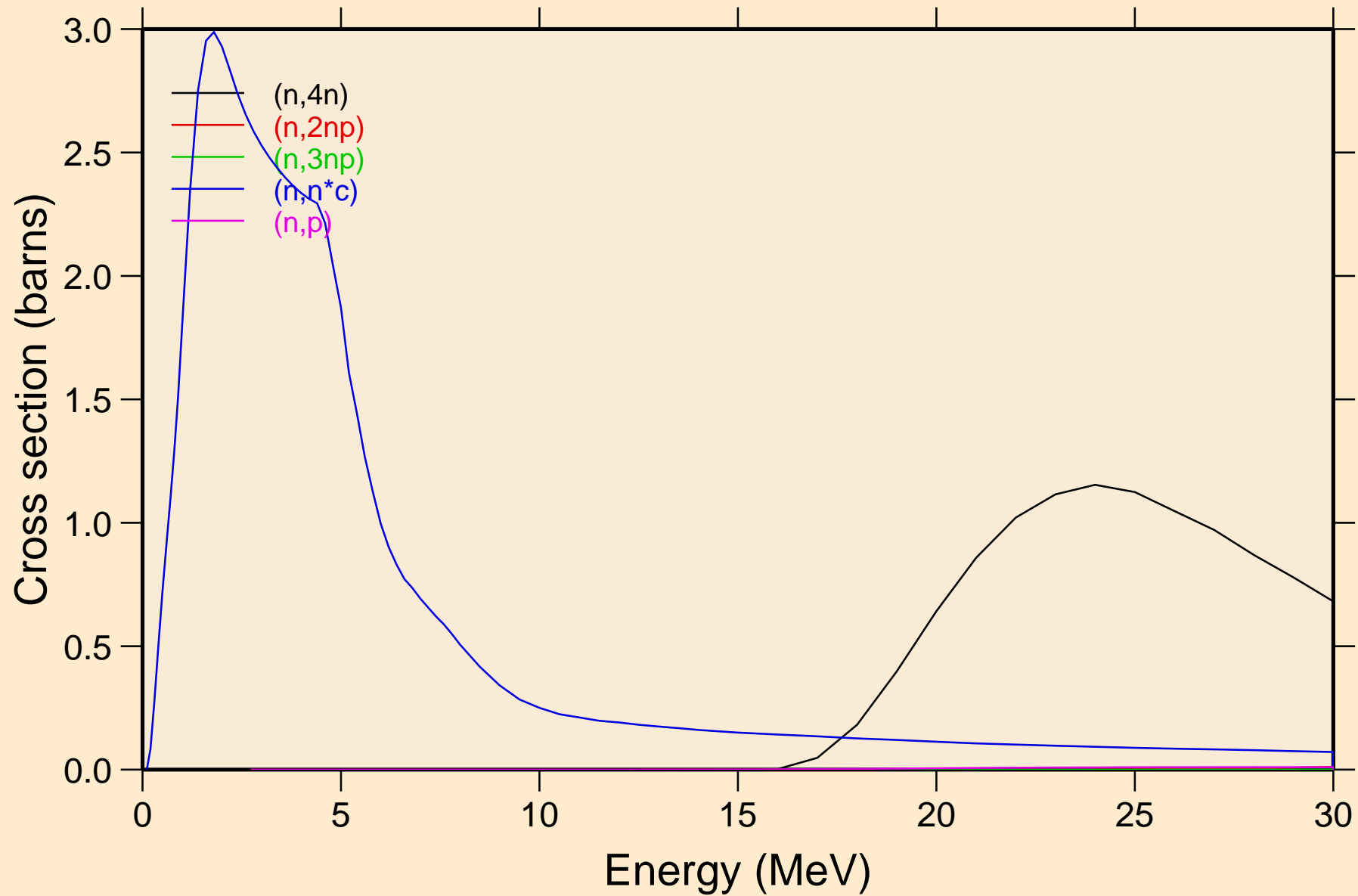



# U241 NRG TENDL-2015, AKONING

## Threshold reactions

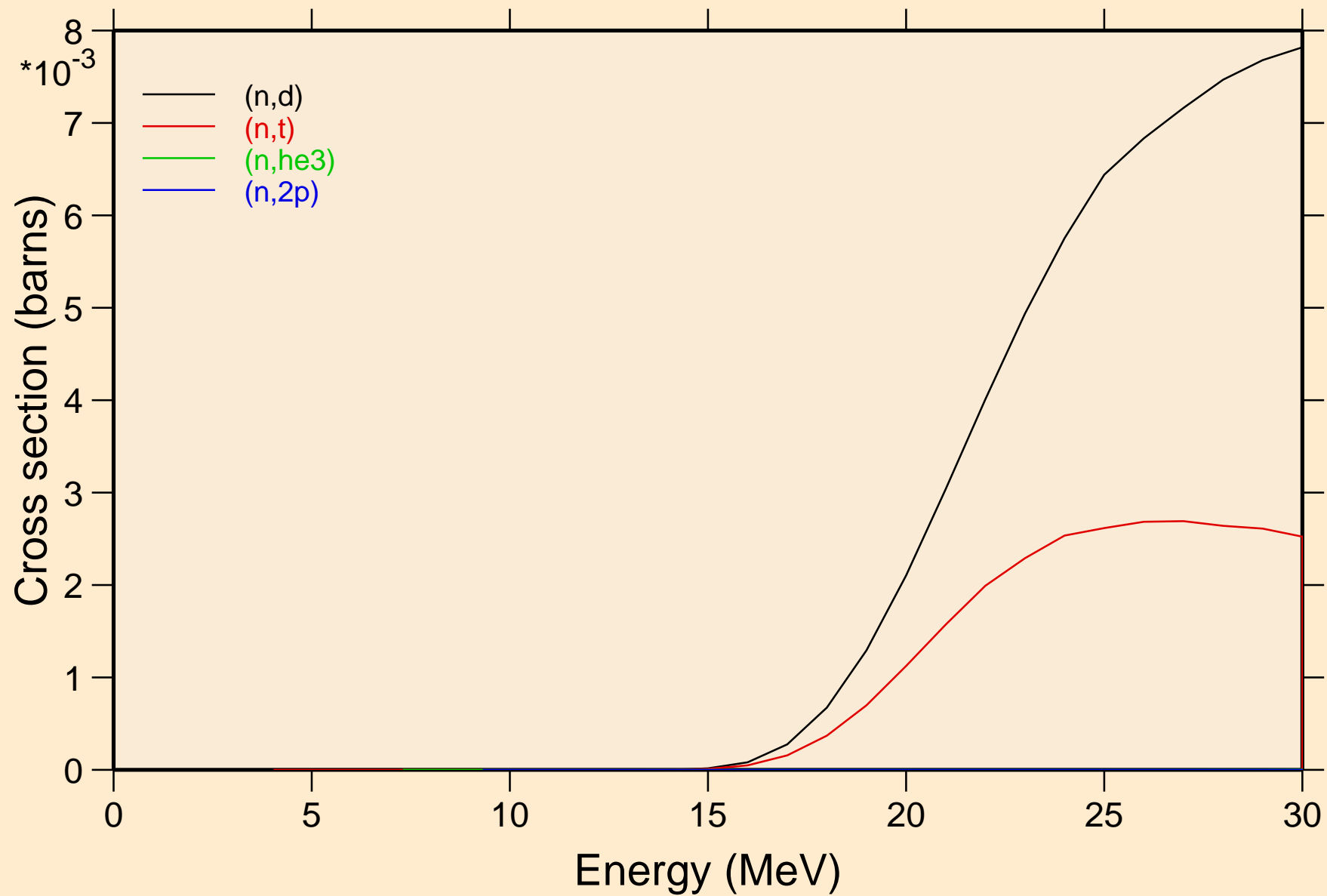

U241 NRG TENDL-2015, AKONING  
angular distribution for elastic

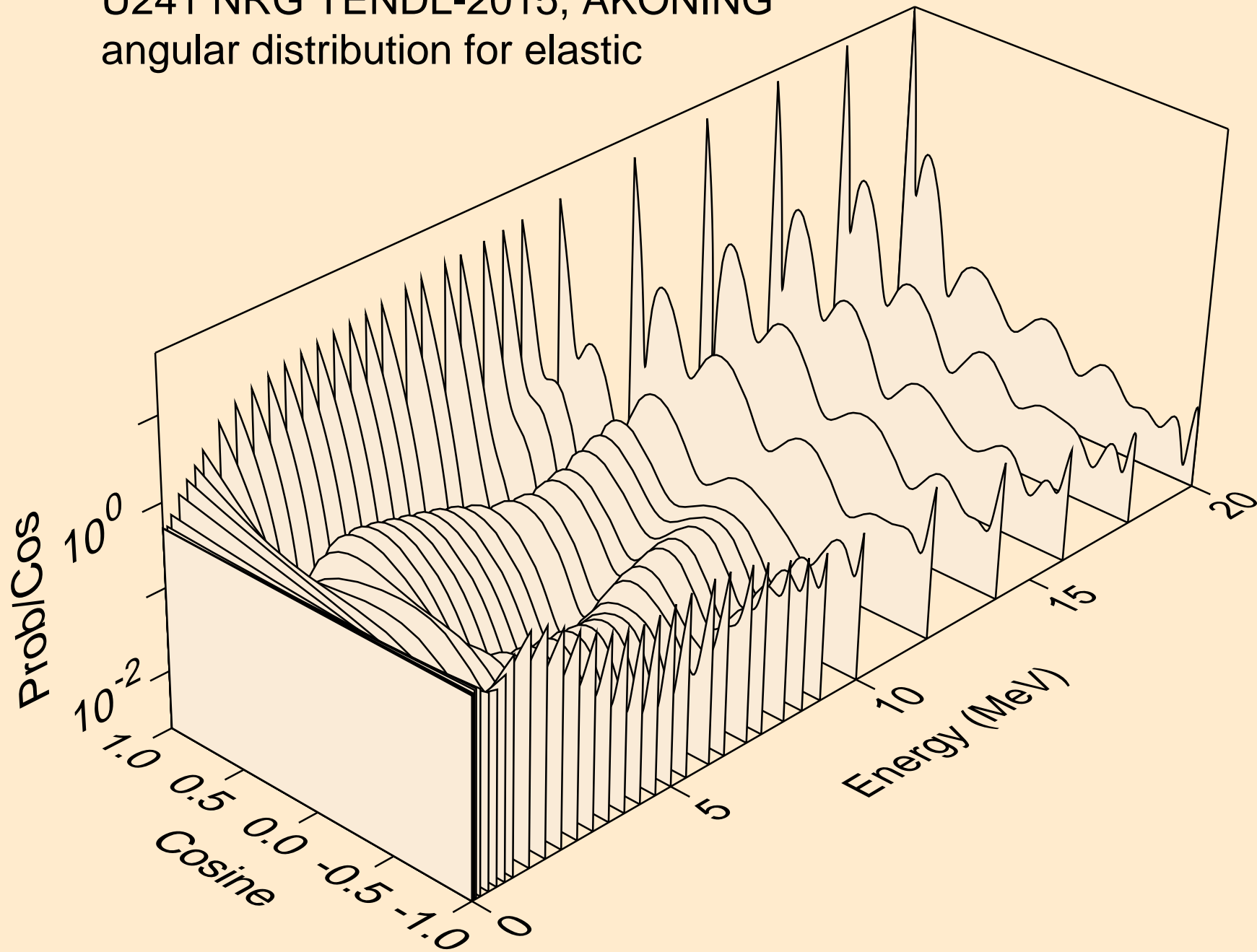

U241 NRG TENDL-2015, AKONING  
angular distribution for elastic

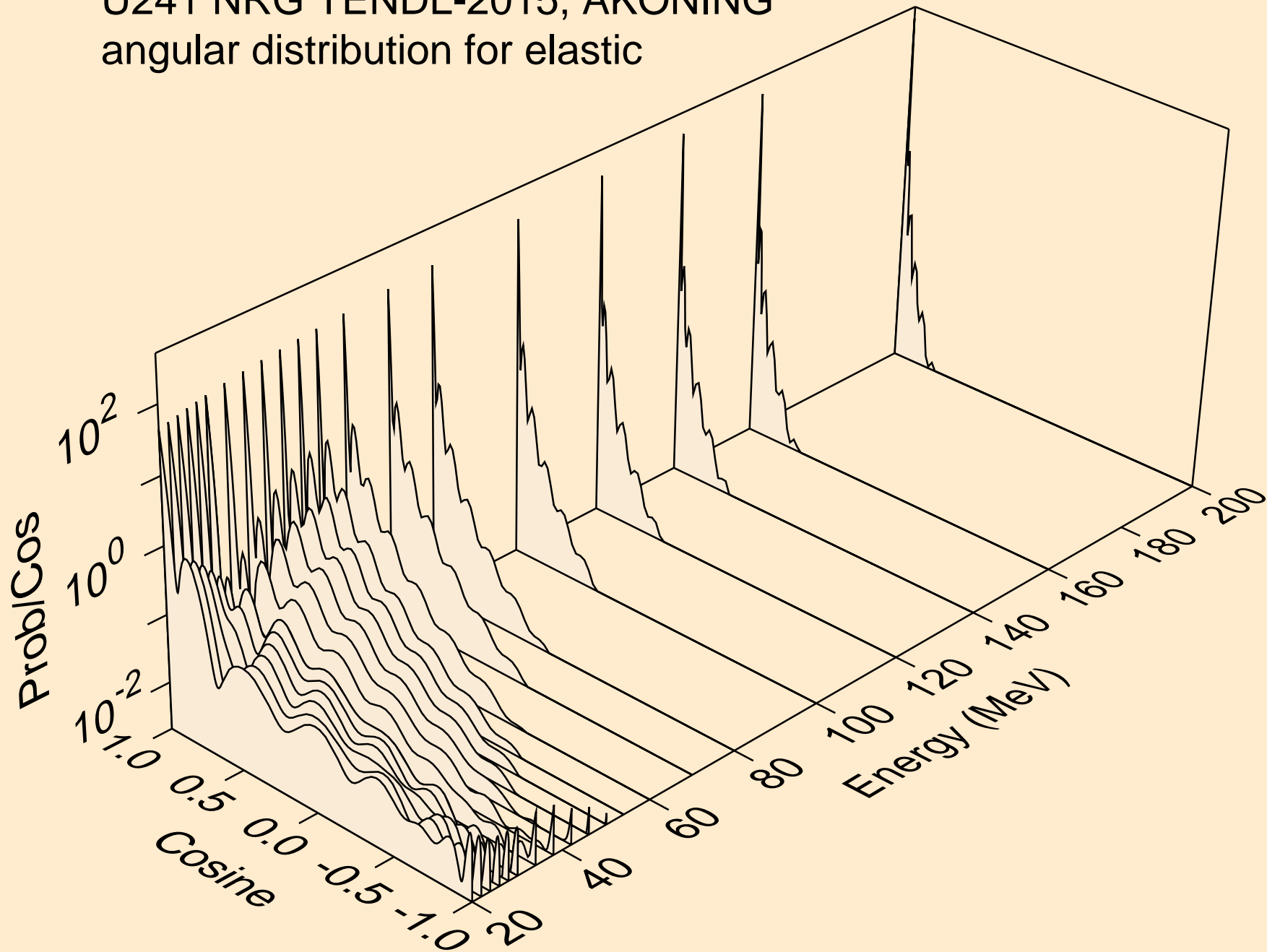

U241 NRG TENDL-2015, AKONING  
angular distribution for (n,n\*1)

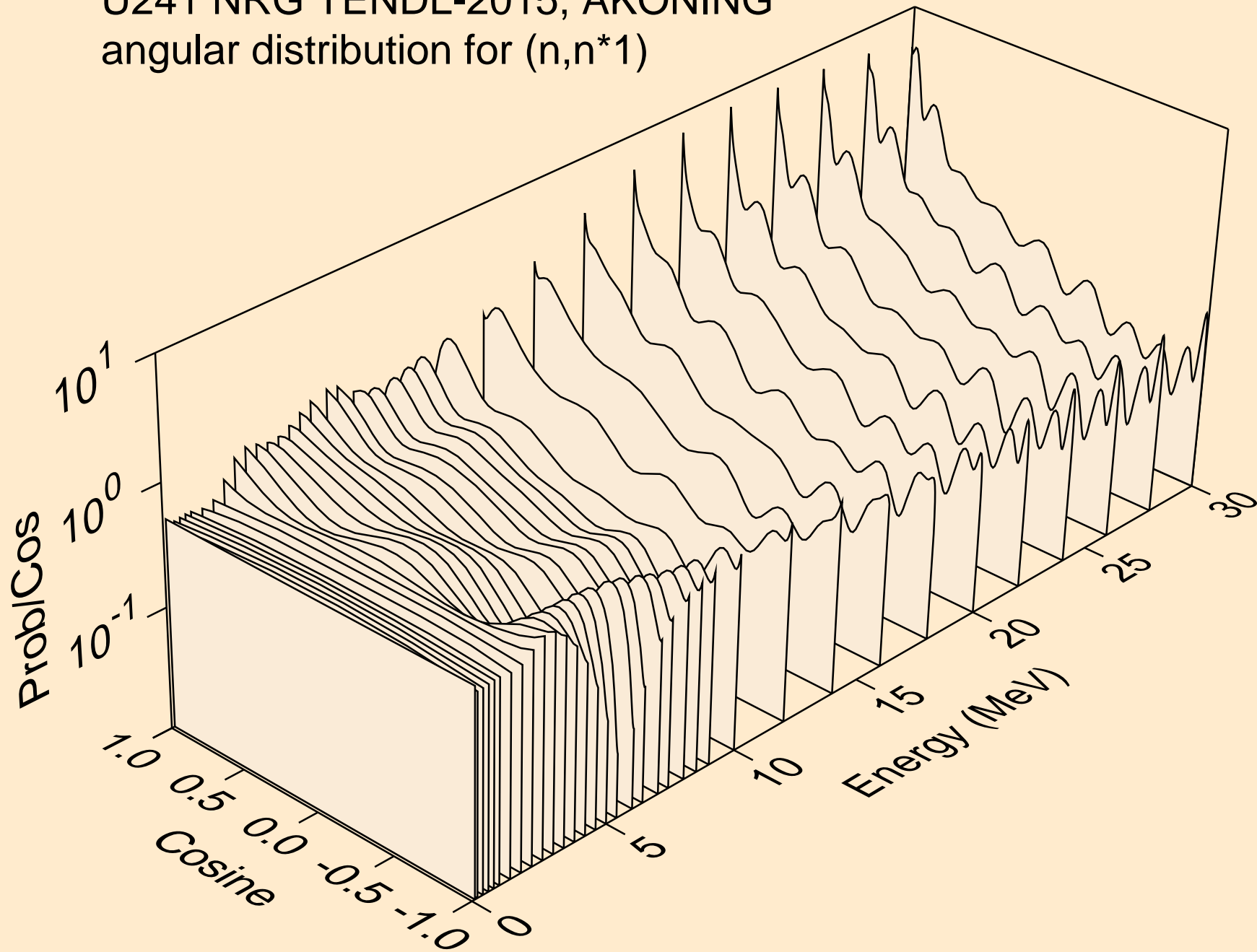

# U241 NRG TENDL-2015, AKONING

Total fission nubar

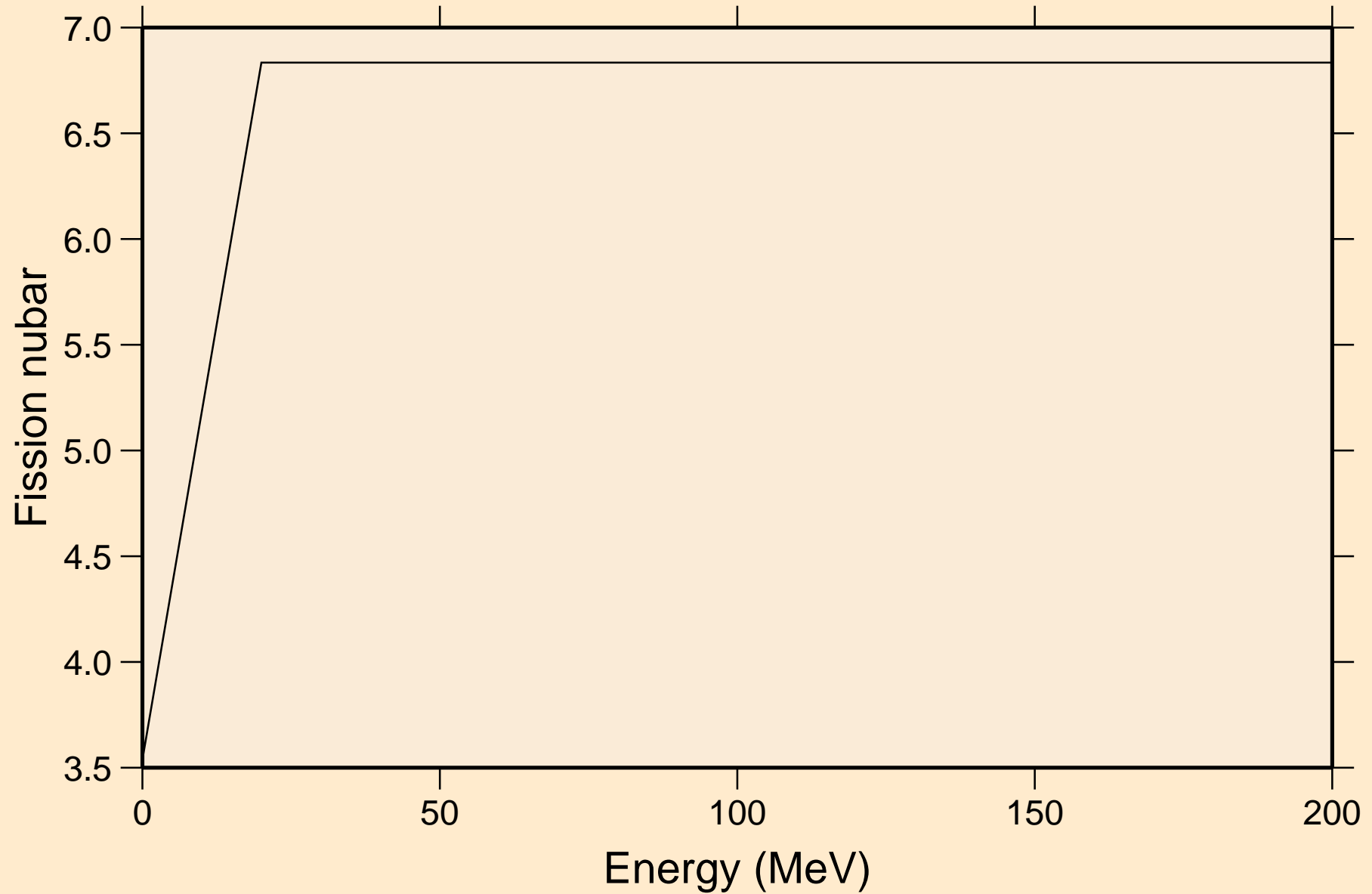

U241 NRG TENDL-2015, AKONING  
Neutron emission for (n,x)

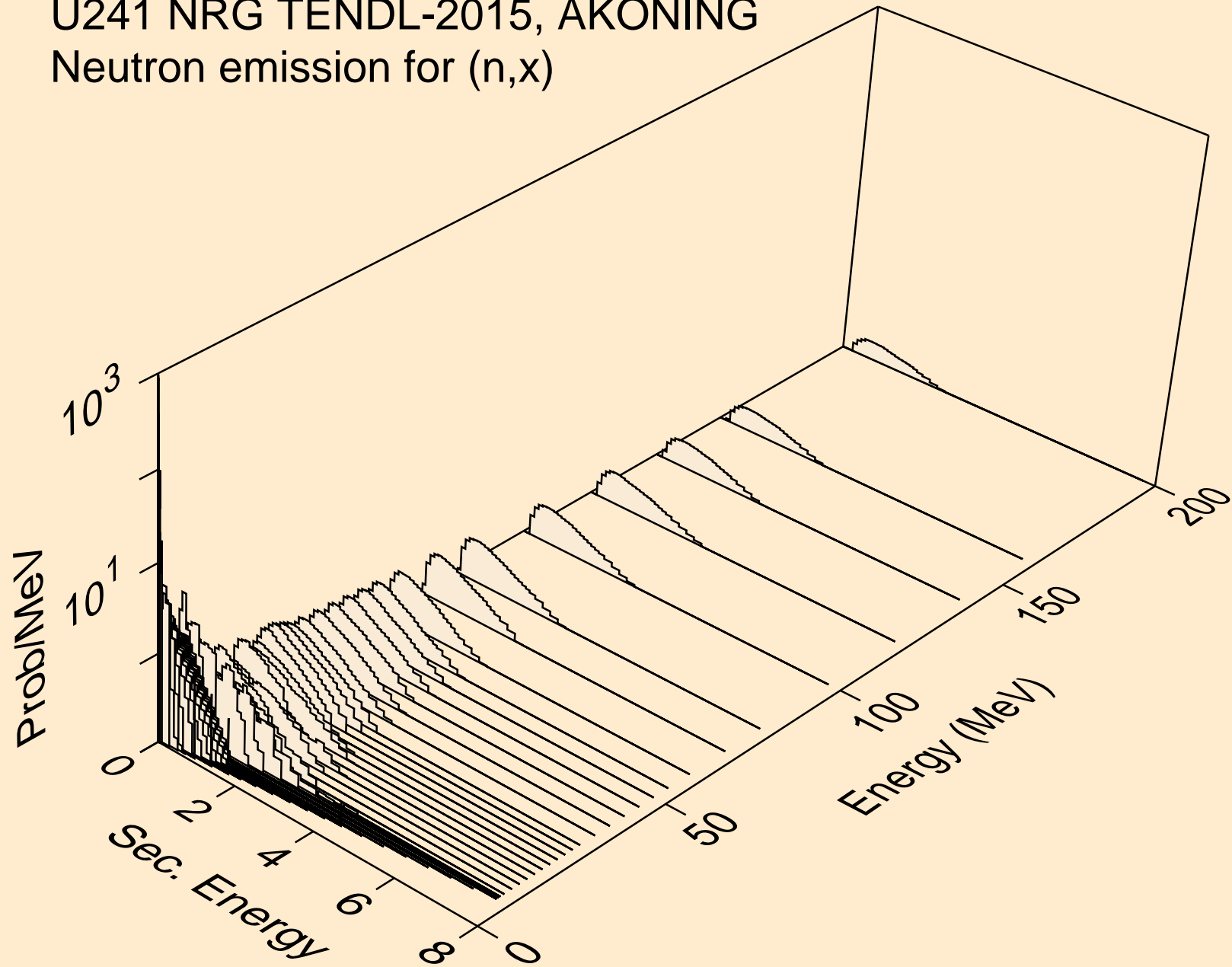

U241 NRG TENDL-2015, AKONING  
Neutron emission for (n,2nd)

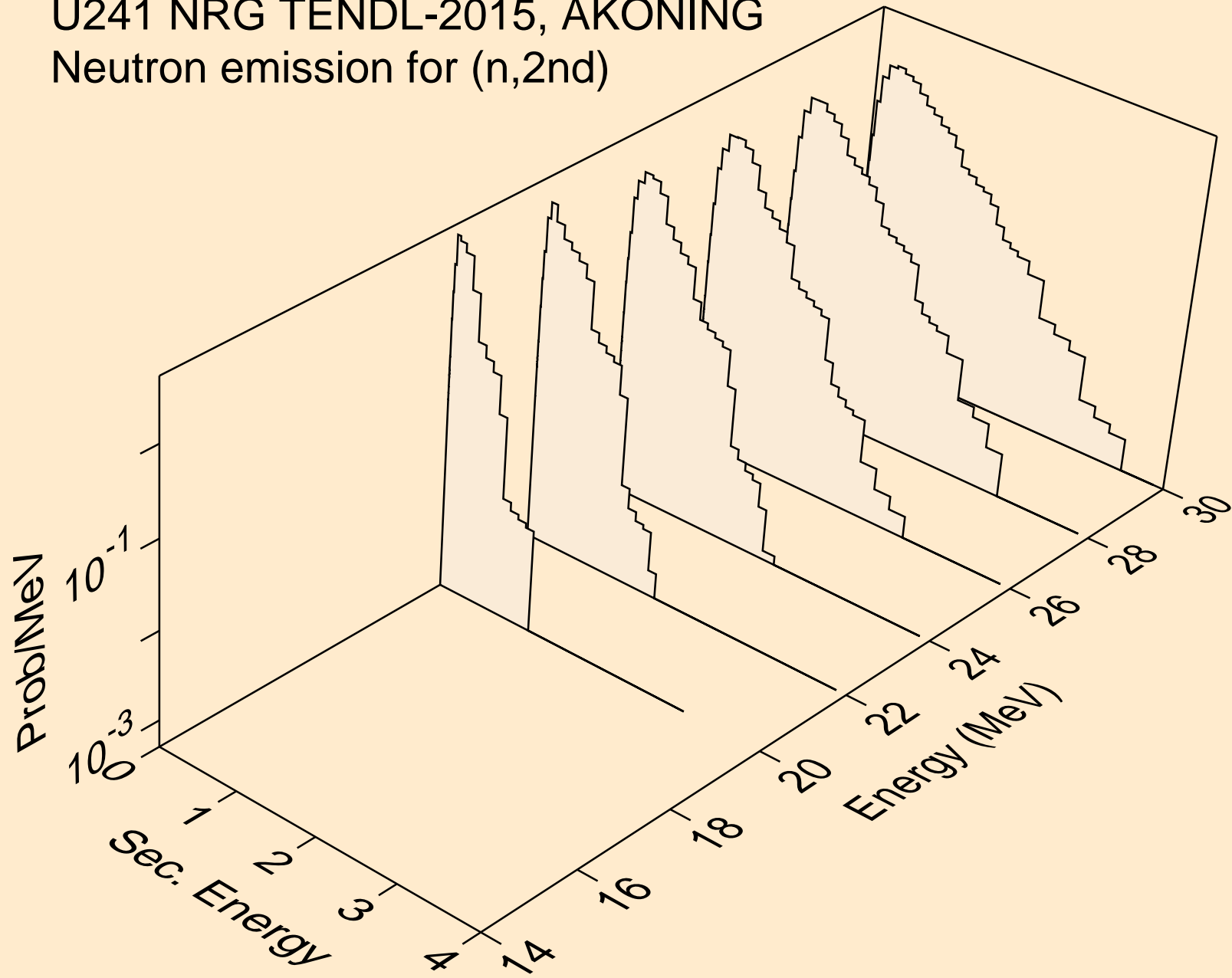

U241 NRG TENDL-2015, AKONING  
Neutron emission for (n,2n)

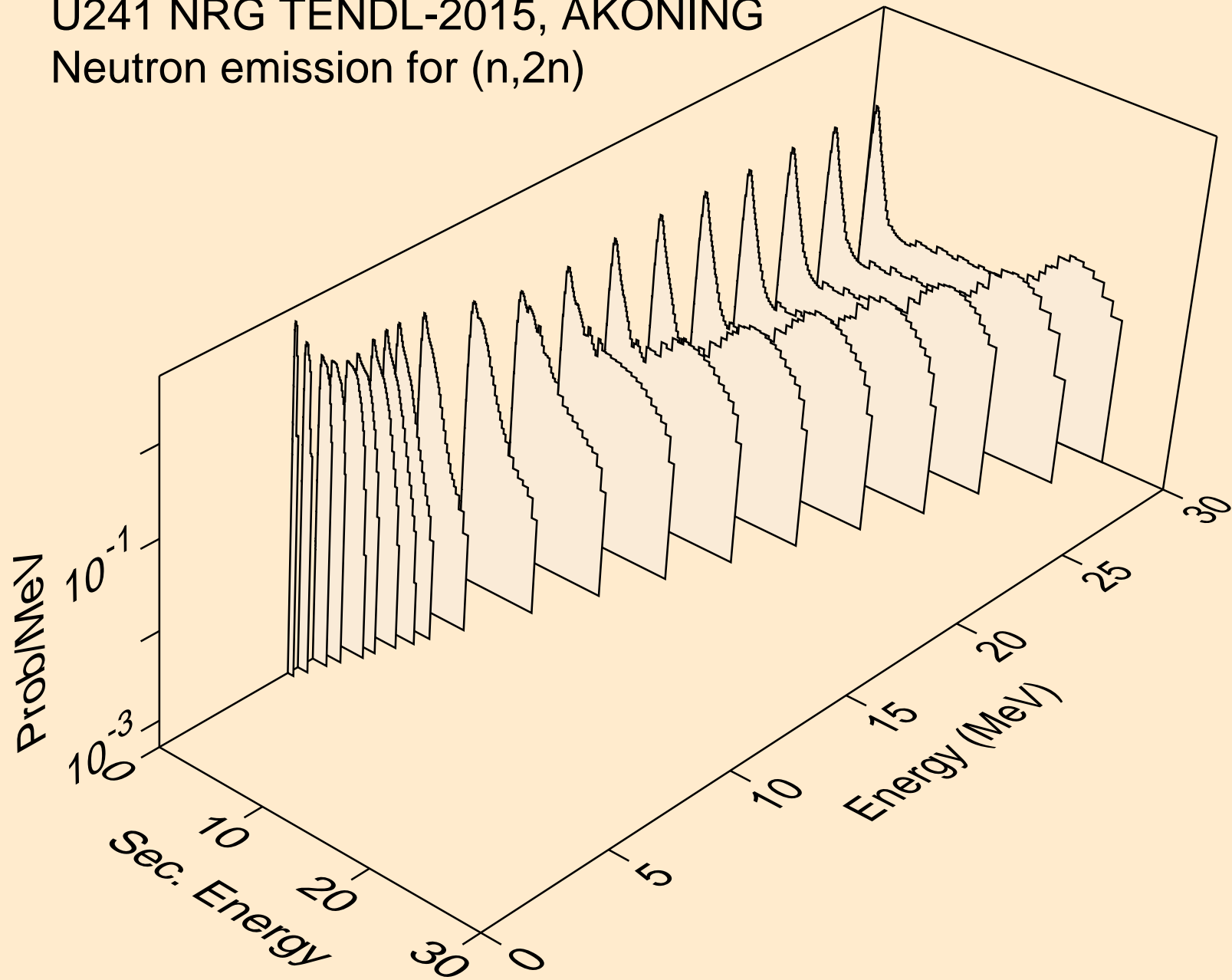



U241 NRG TENDL-2015, AKONING  
Neutron emission for (n,3n)

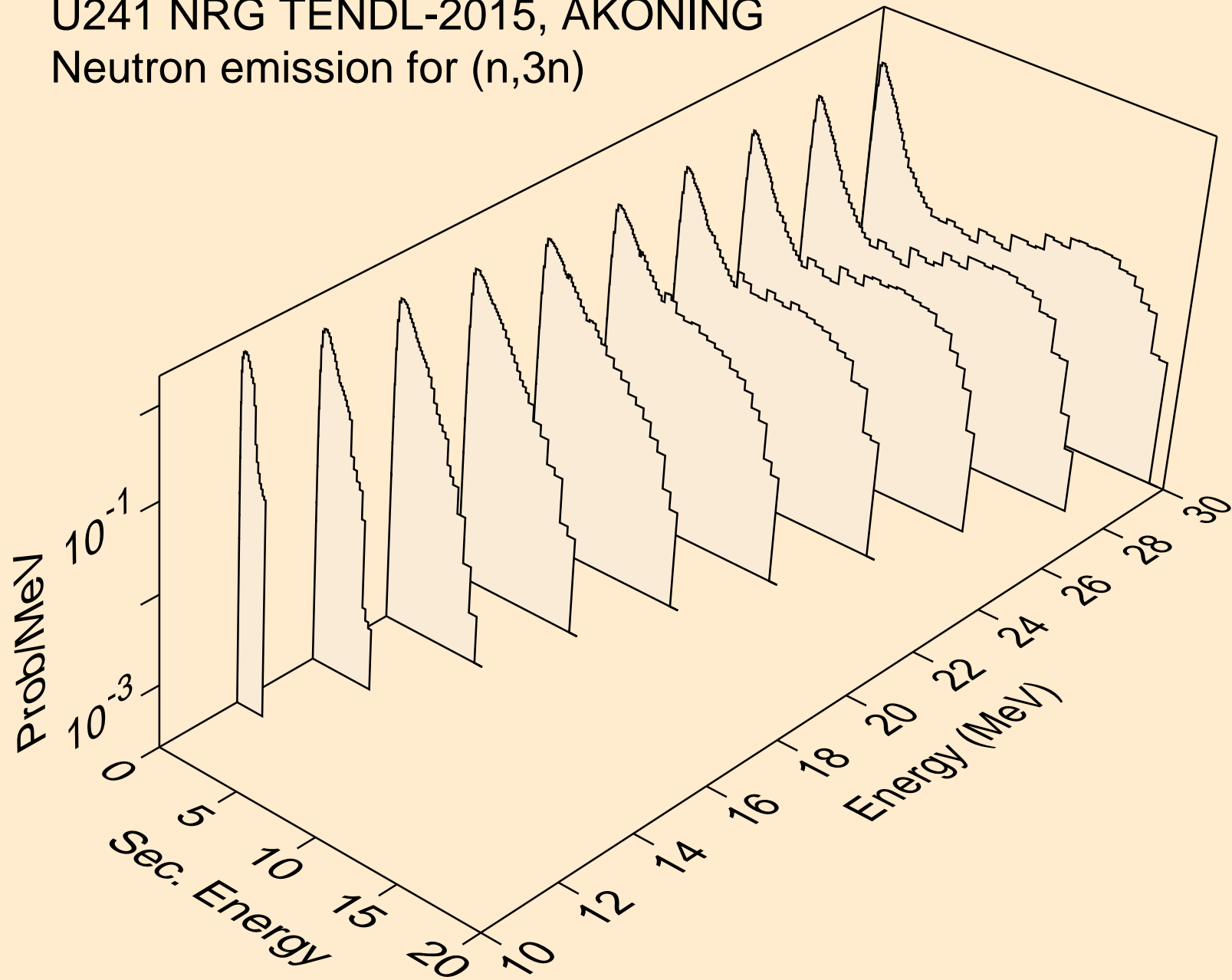

U241 NRG TENDL-2015, AKONING  
Neutron emission for fission

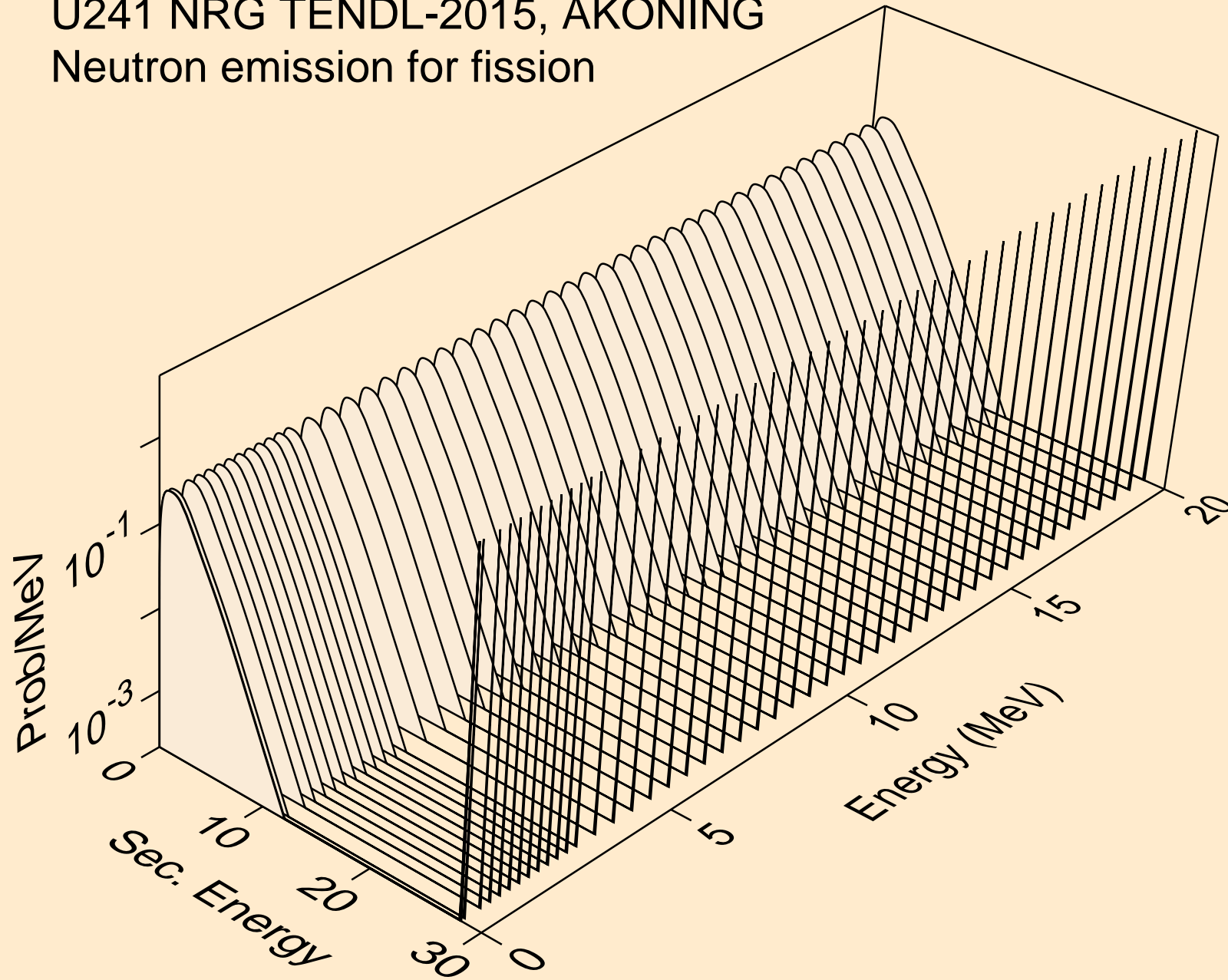

U241 NRG TENDL-2015, AKONING  
Neutron emission for (n,n\*)a

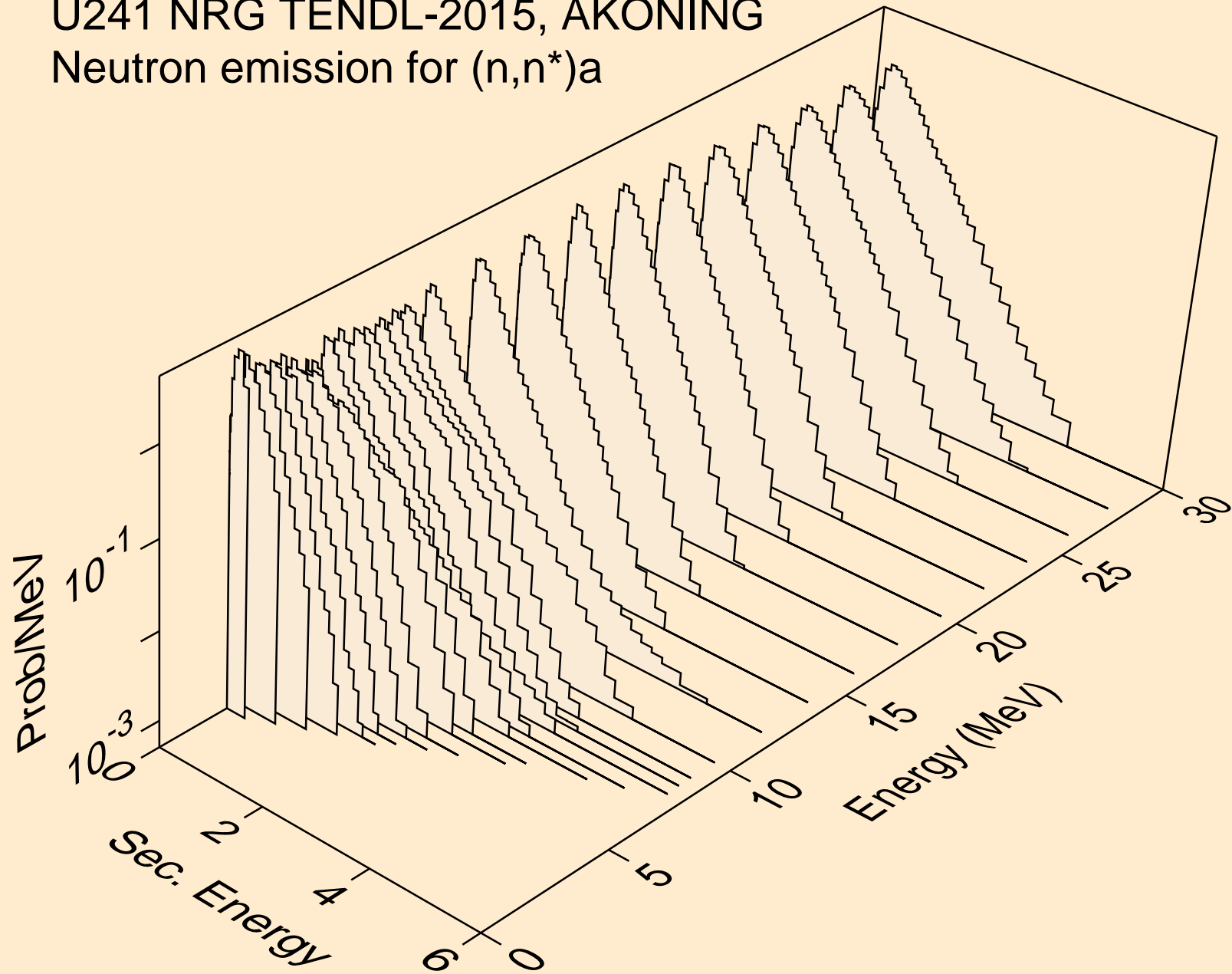

U241 NRG TENDL-2015, AKONING  
Neutron emission for (n,2n)a

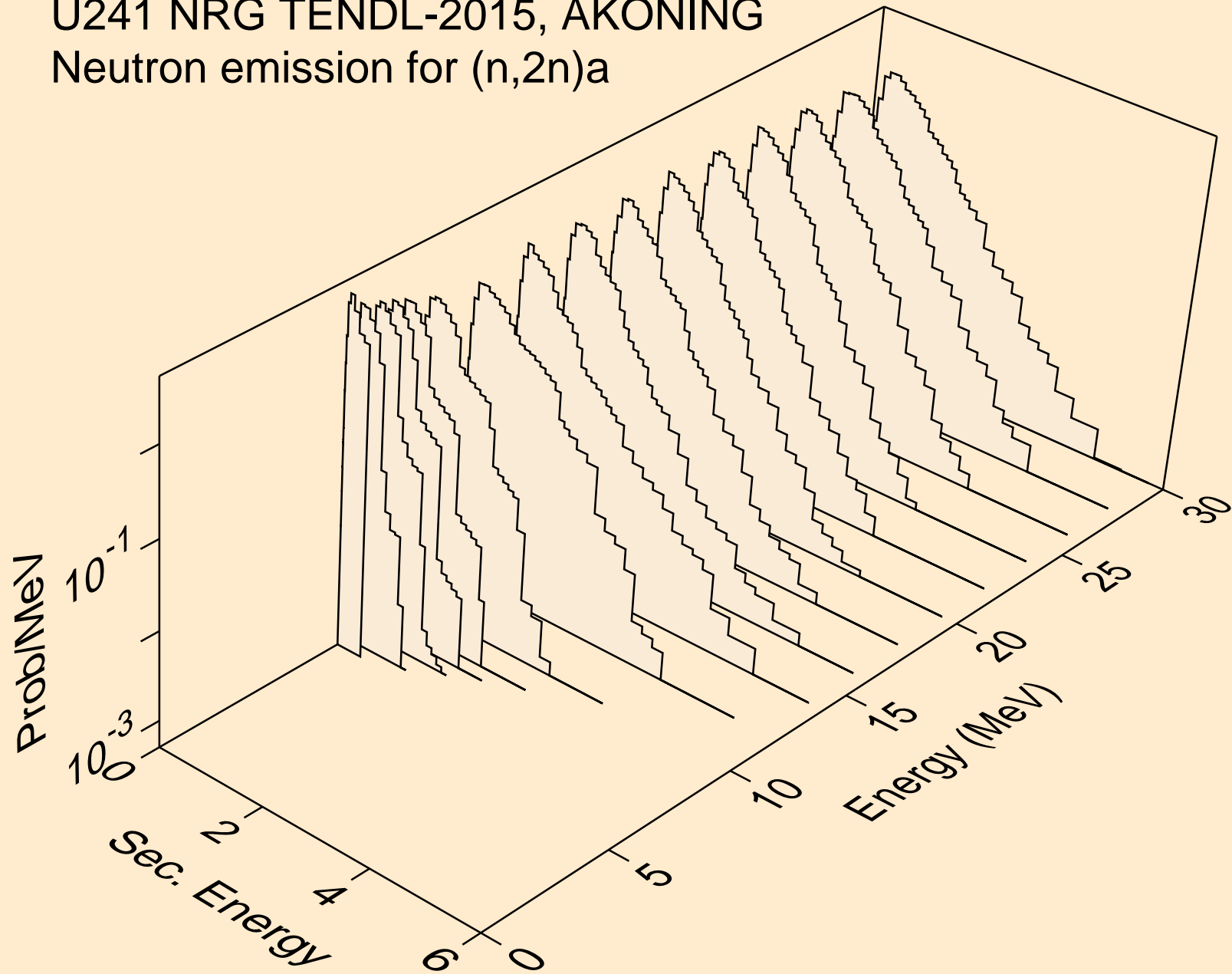

U241 NRG TENDL-2015, AKONING  
Neutron emission for (n,3n)a

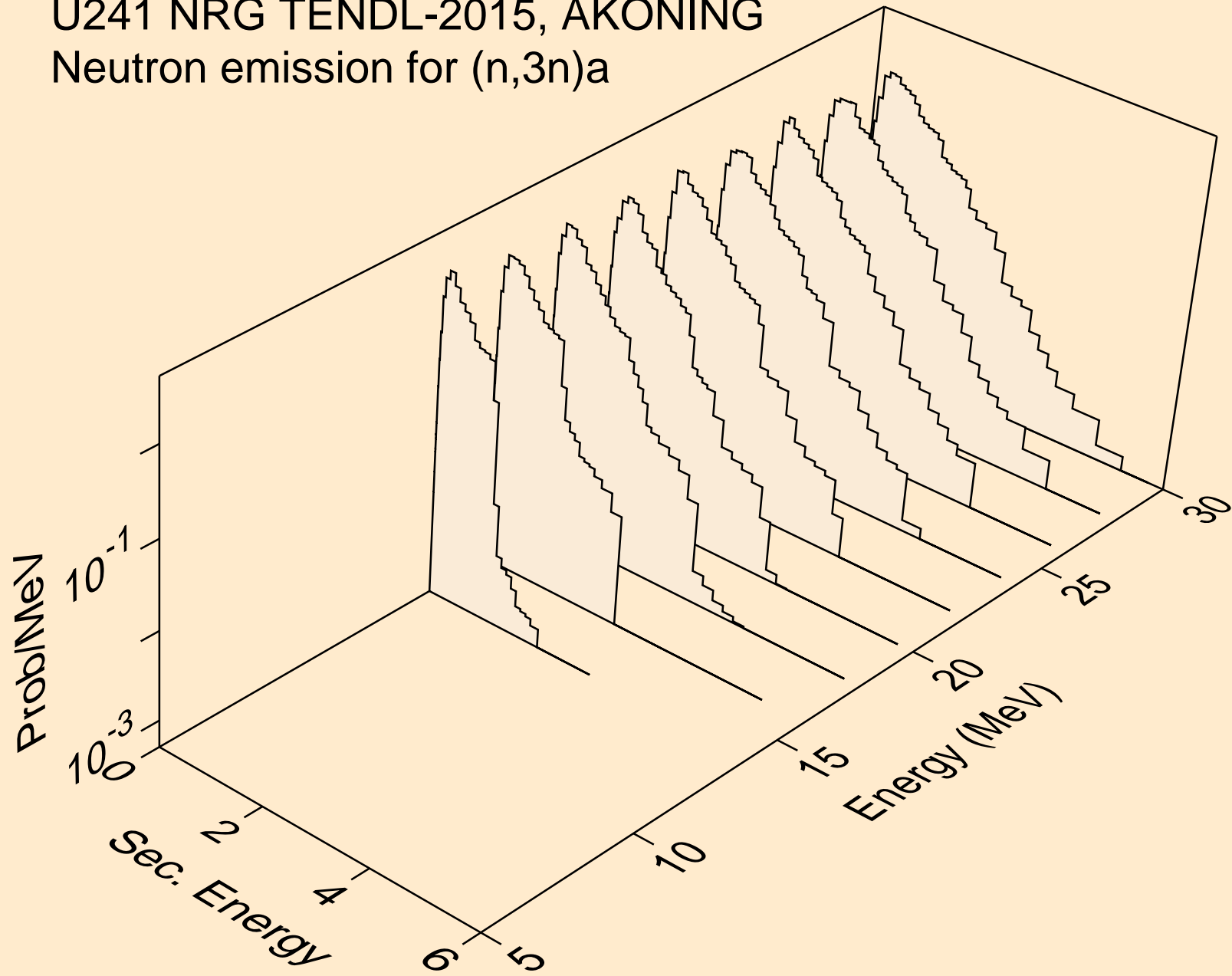

U241 NRG TENDL-2015, AKONING  
Neutron emission for (n,n\*)p

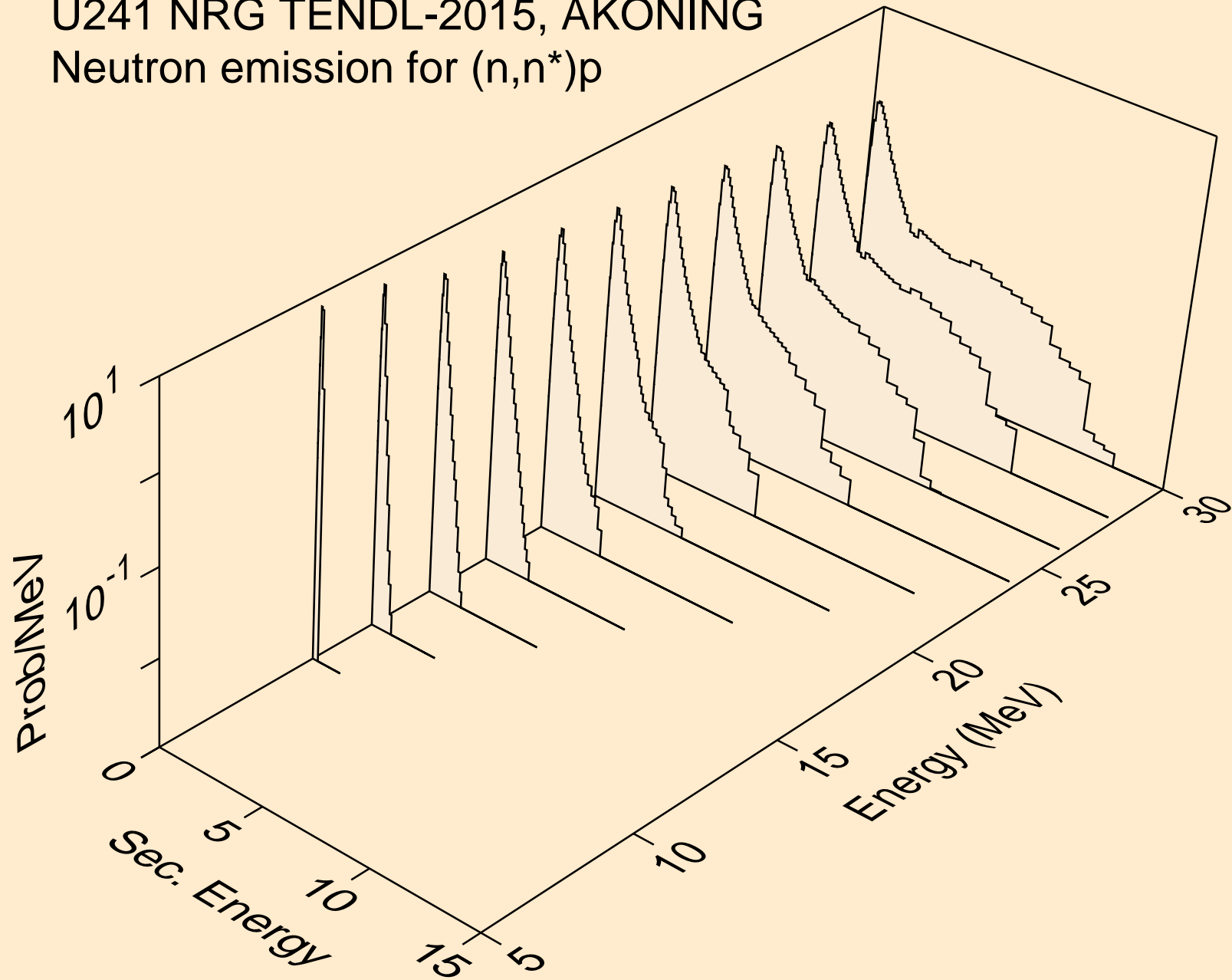

U241 NRG TENDL-2015, AKONING  
Neutron emission for (n,n\*)d

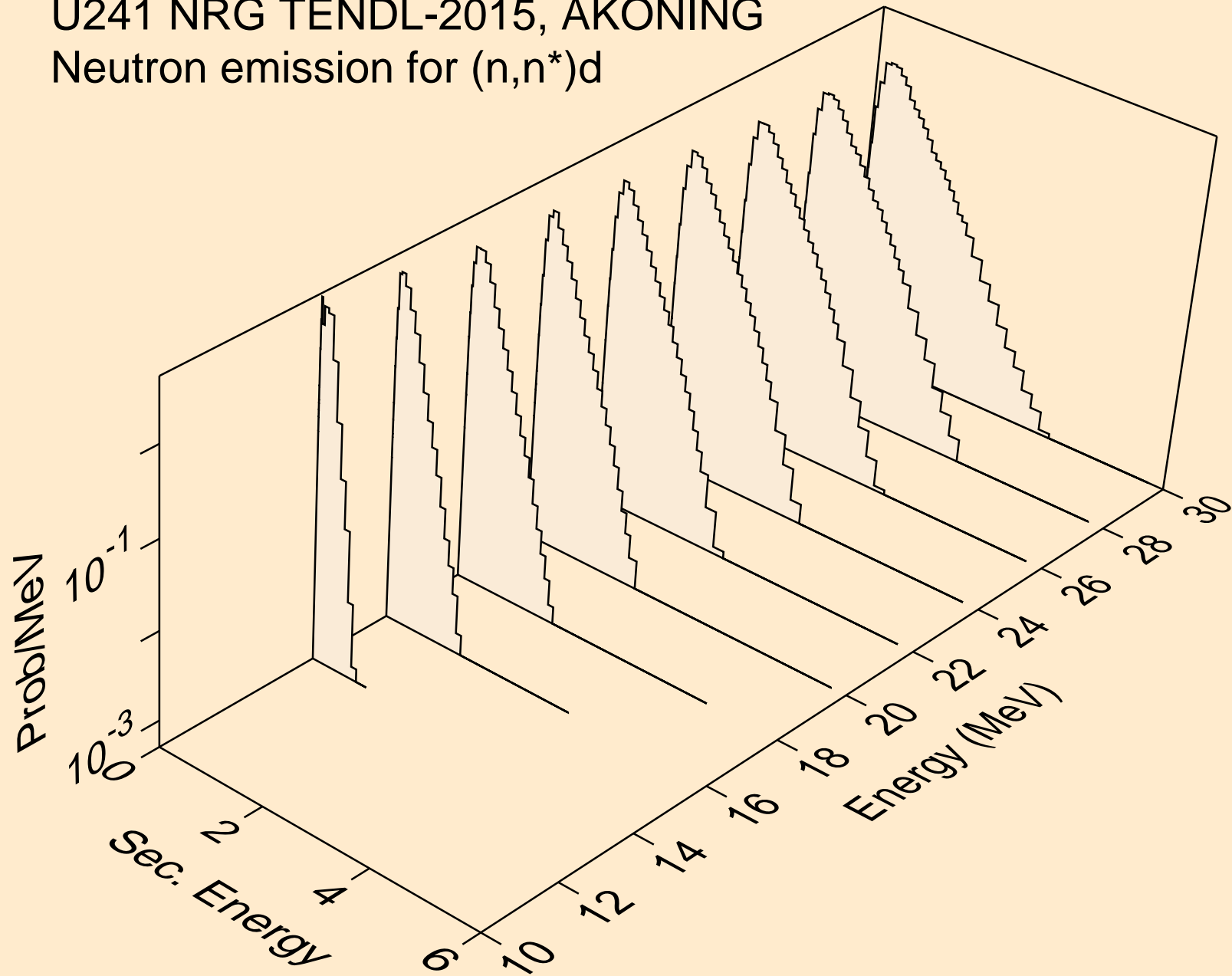

U241 NRG TENDL-2015, AKONING  
Neutron emission for (n,n\*)t

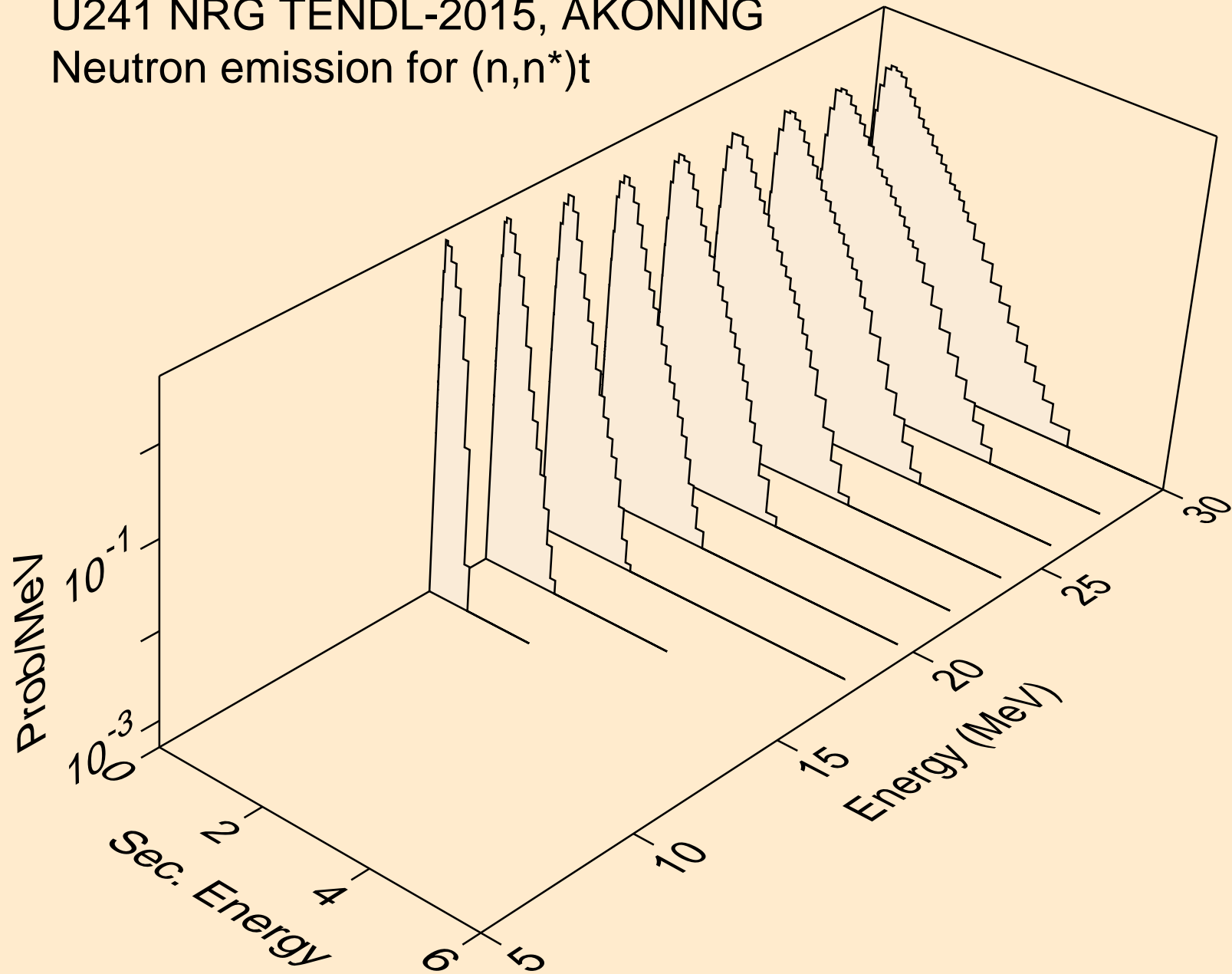



U241 NRG TENDL-2015, AKONING  
Neutron emission for (n,n\*)he3

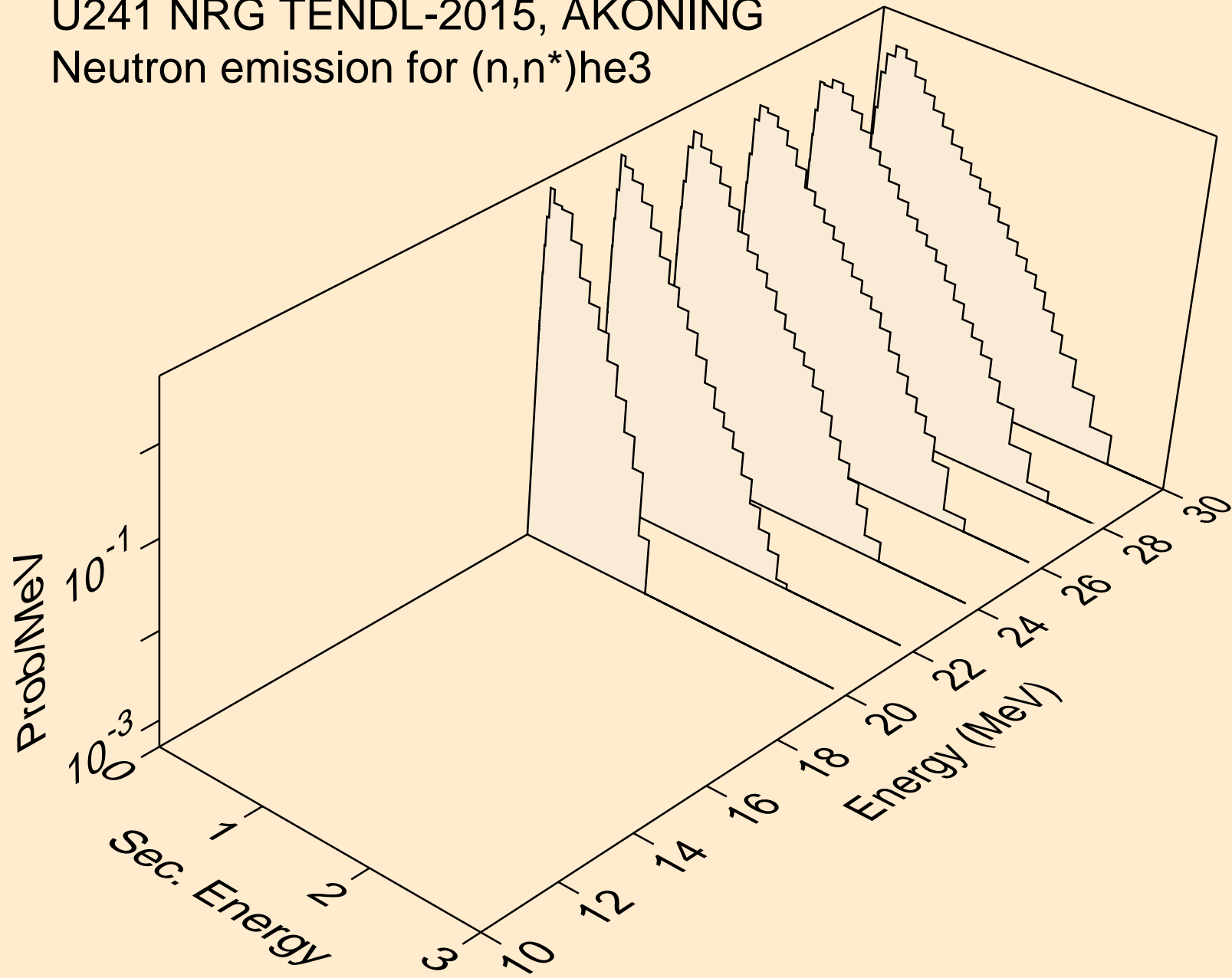

U241 NRG TENDL-2015, AKONING  
Neutron emission for (n,4n)

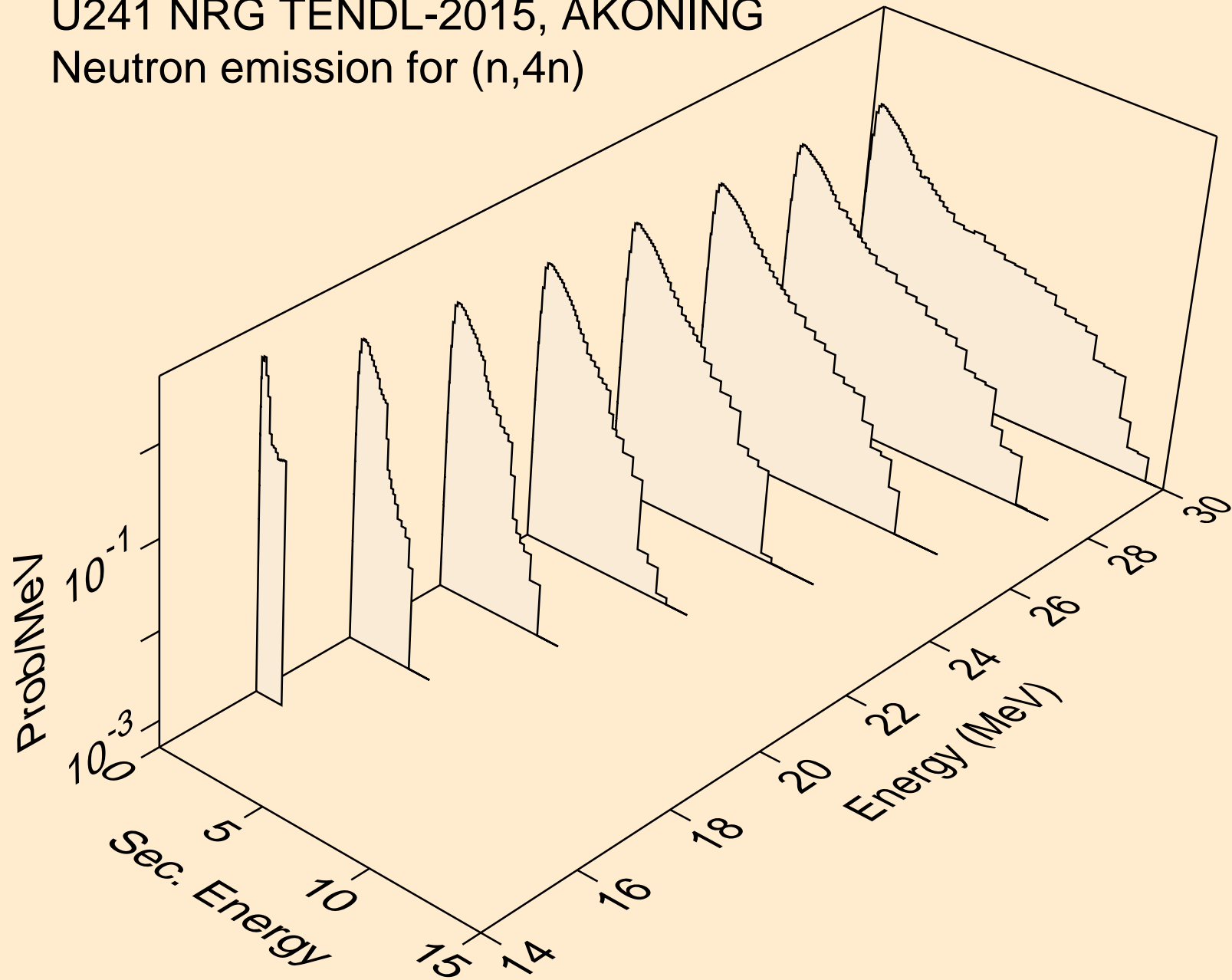

U241 NRG TENDL-2015, AKONING  
Neutron emission for (n,2np)

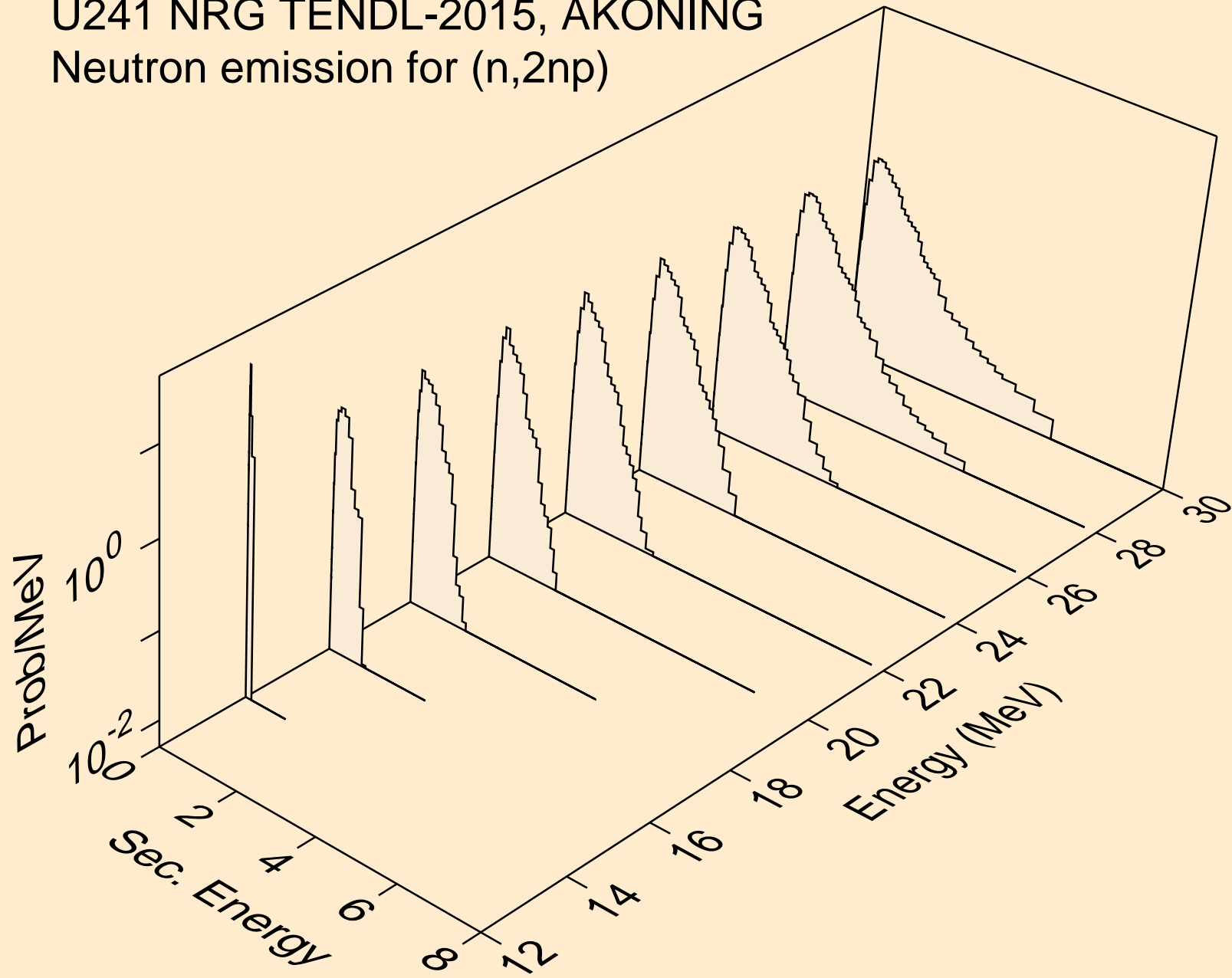

U241 NRG TENDL-2015, AKONING  
Neutron emission for (n,3np)

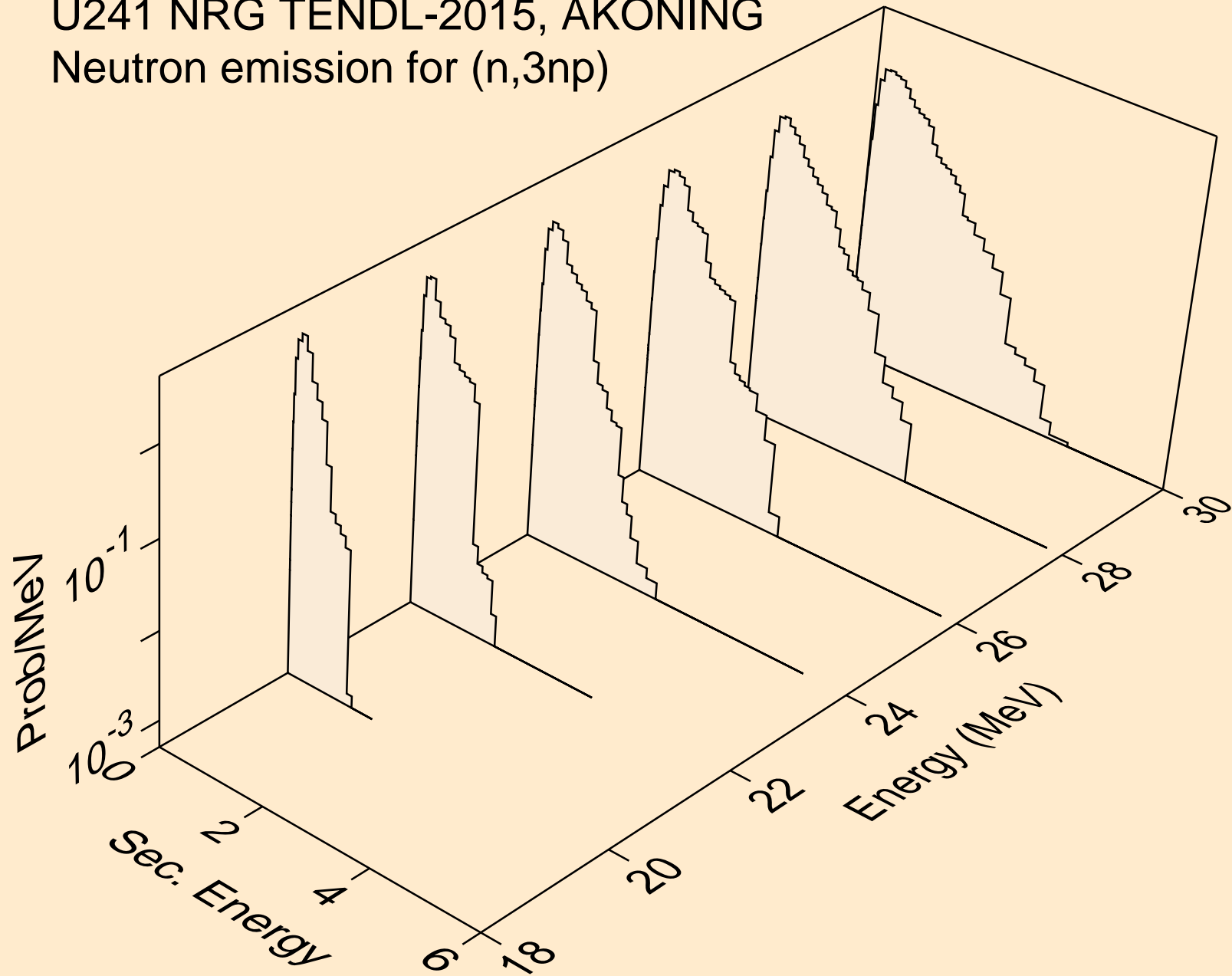

U241 NRG TENDL-2015, AKONING  
Neutron emission for (n,n\*c)

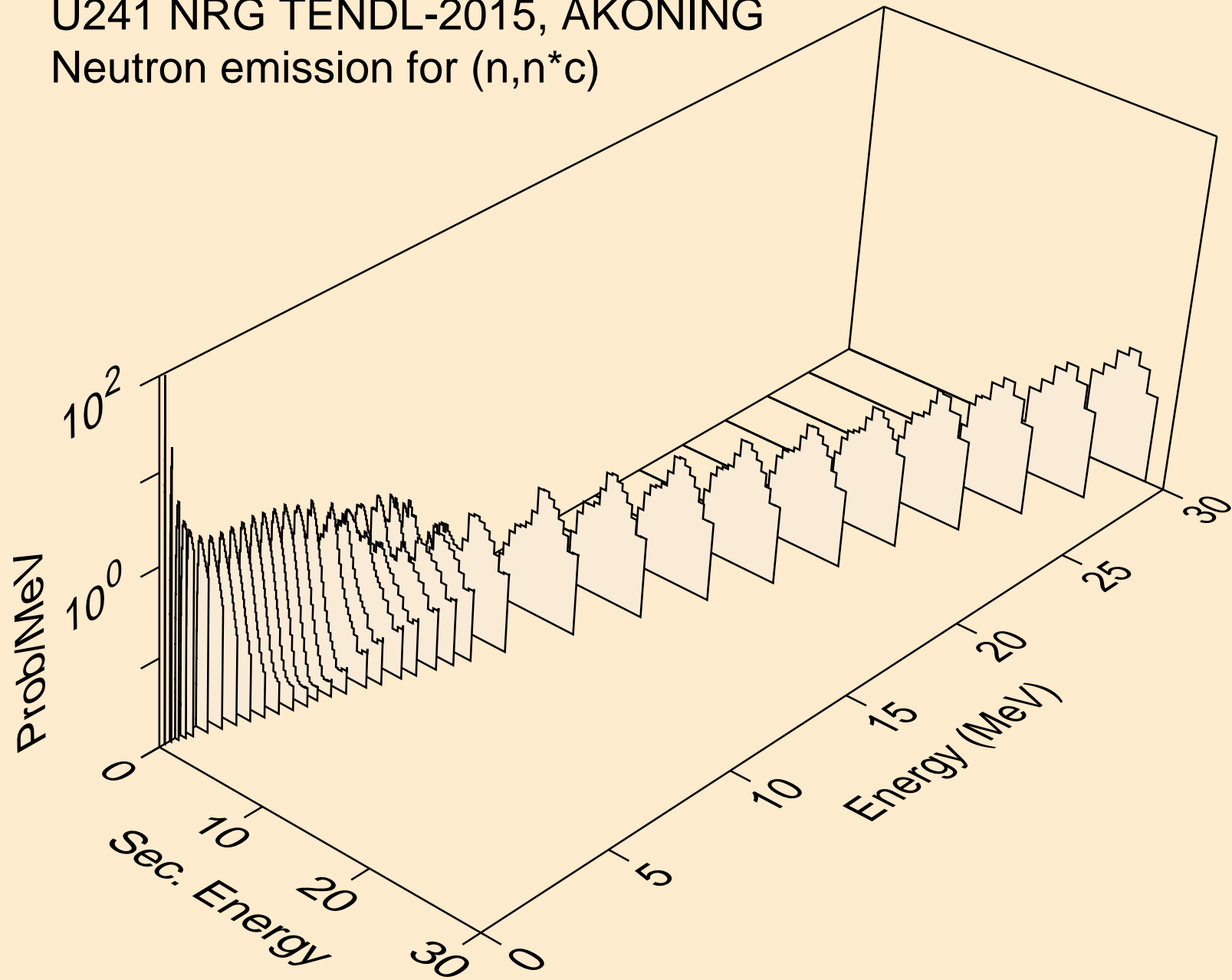

# U241 NRG TENDL-2015, AKONING

Delayed nubar

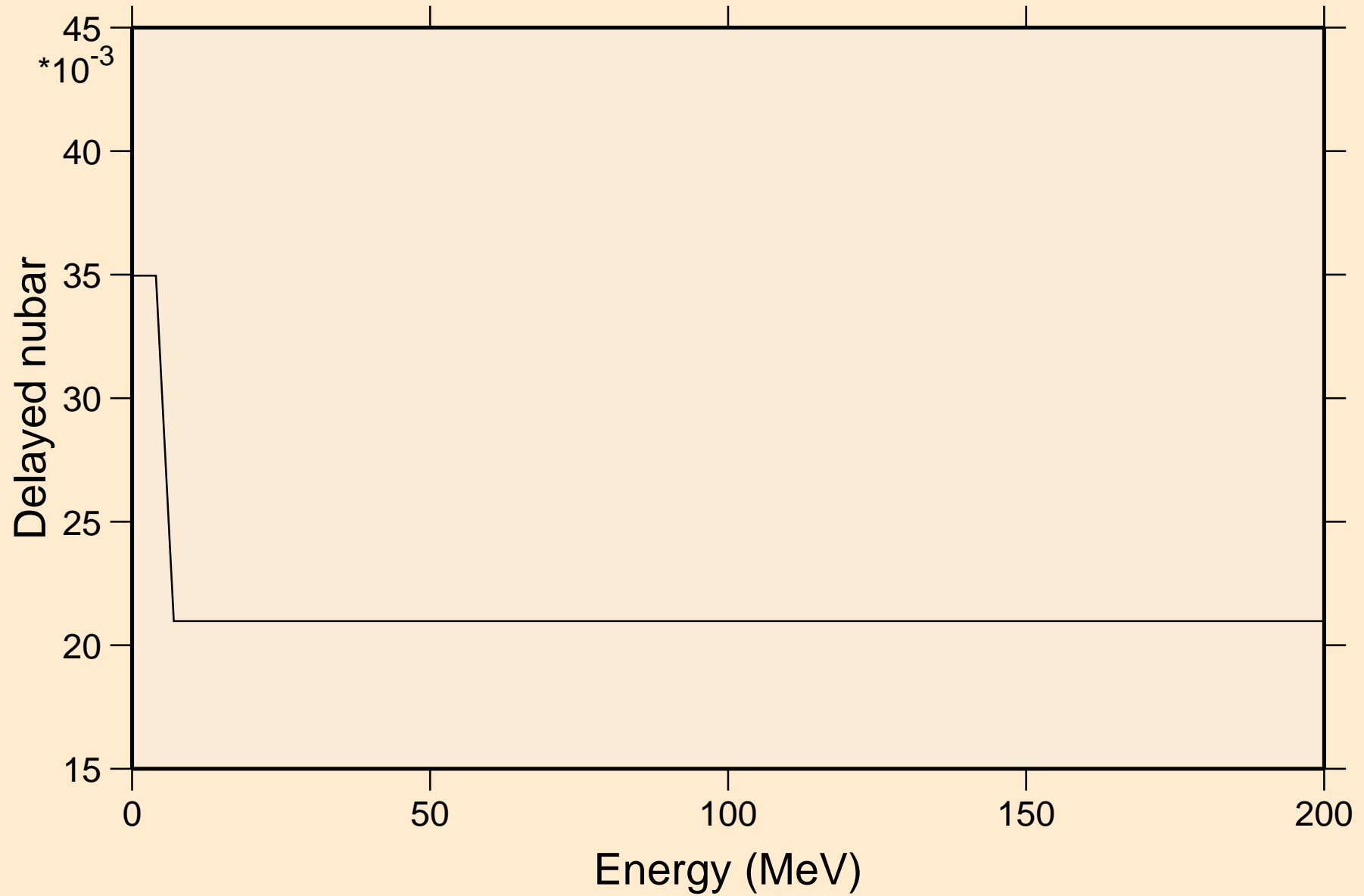

# U241 NRG TENDL-2015, AKONING

## Delayed neutron spectra

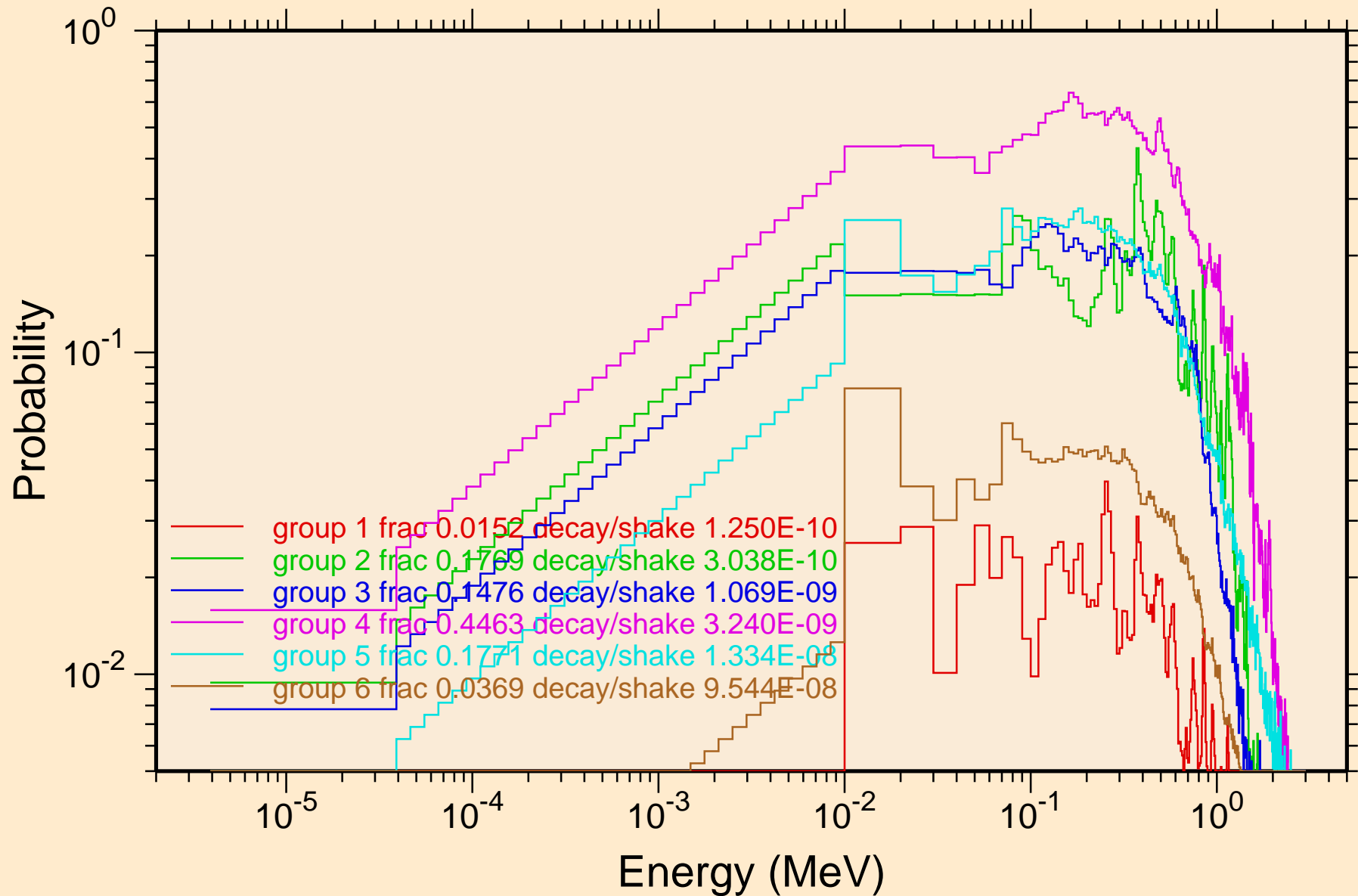

U241 NRG TENDL-2015, AKONING  
Photon emission for (n,x)

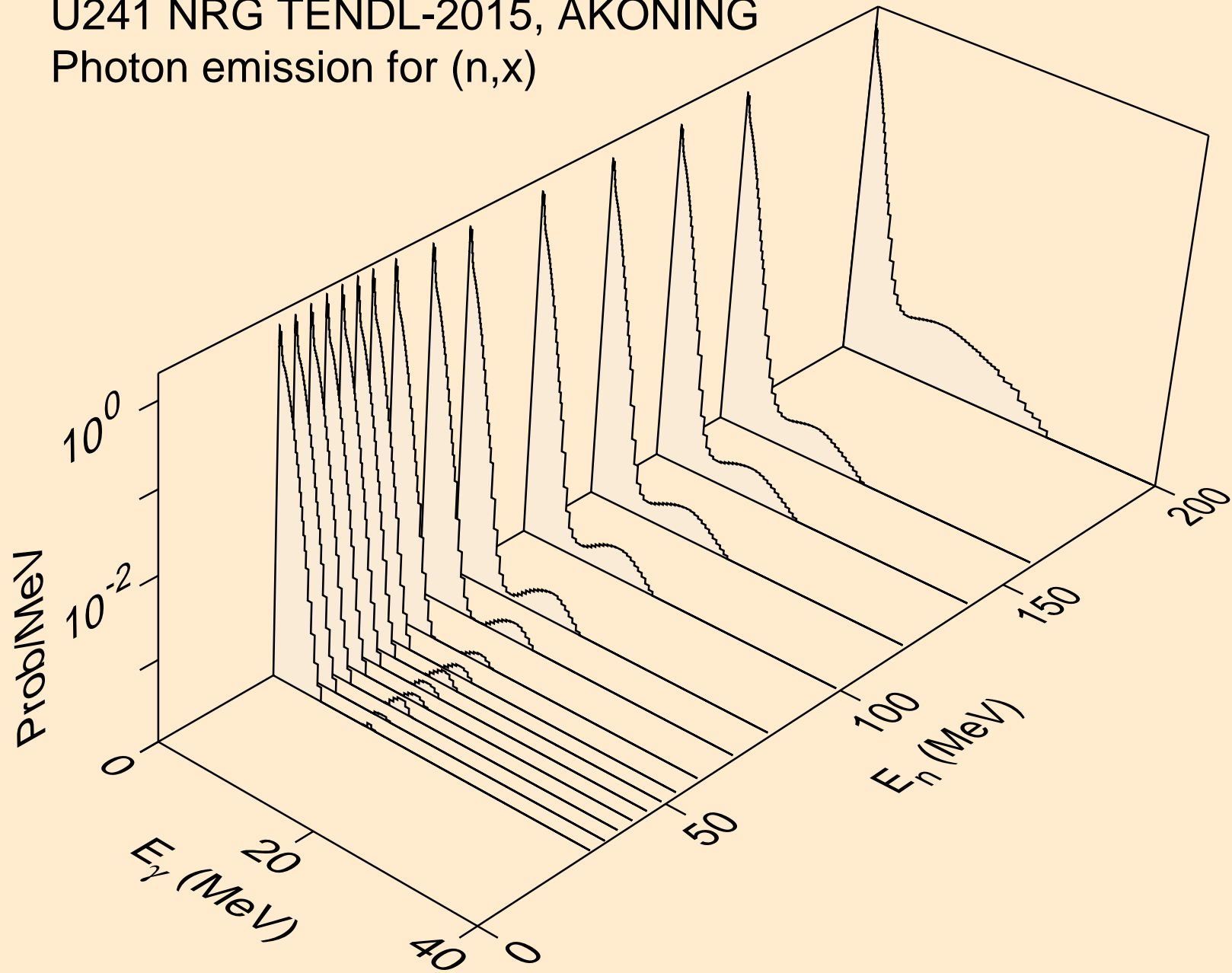



U241 NRG TENDL-2015, AKONING  
Photon emission for (n,2nd)

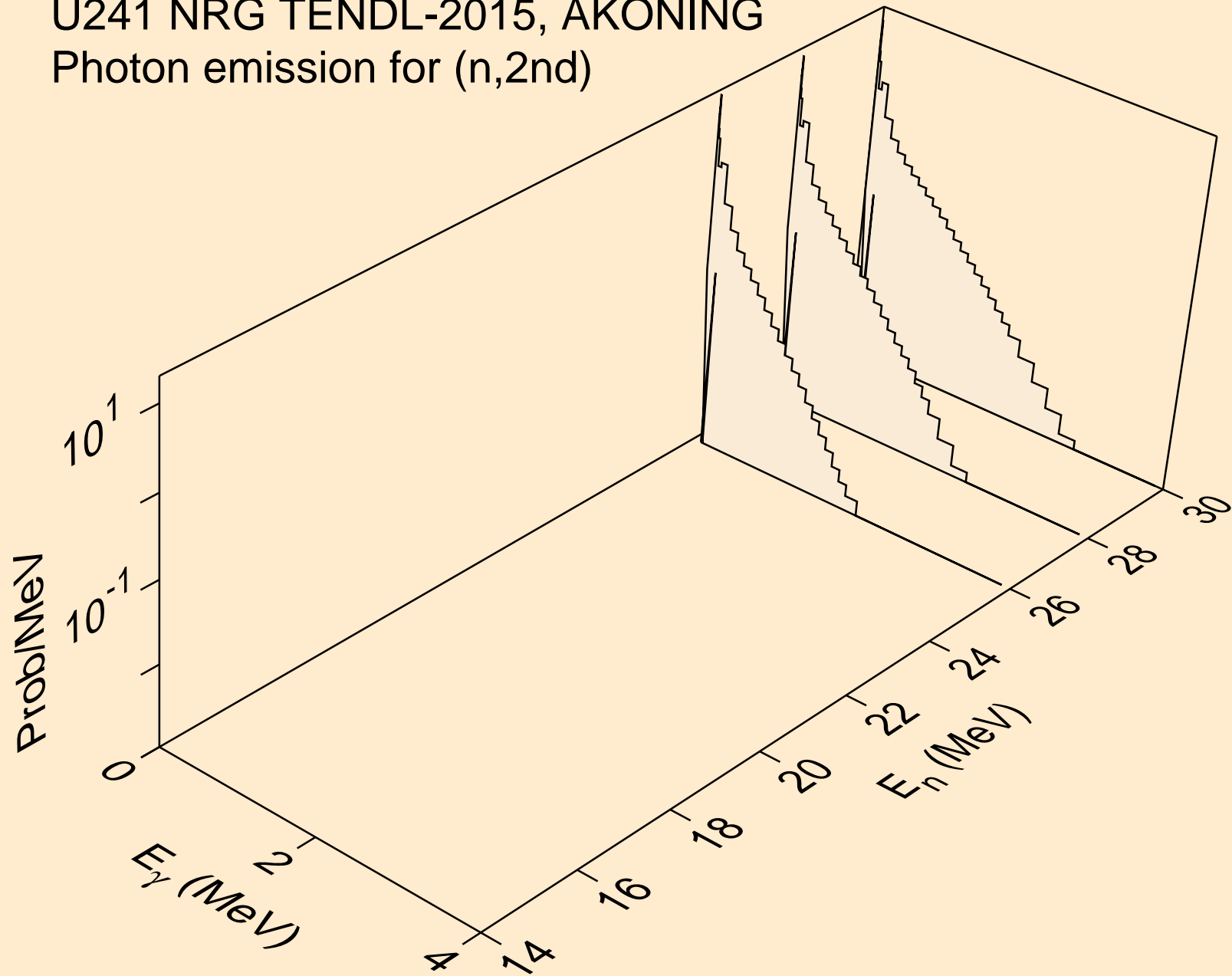

U241 NRG TENDL-2015, AKONING  
Photon emission for (n,2n)

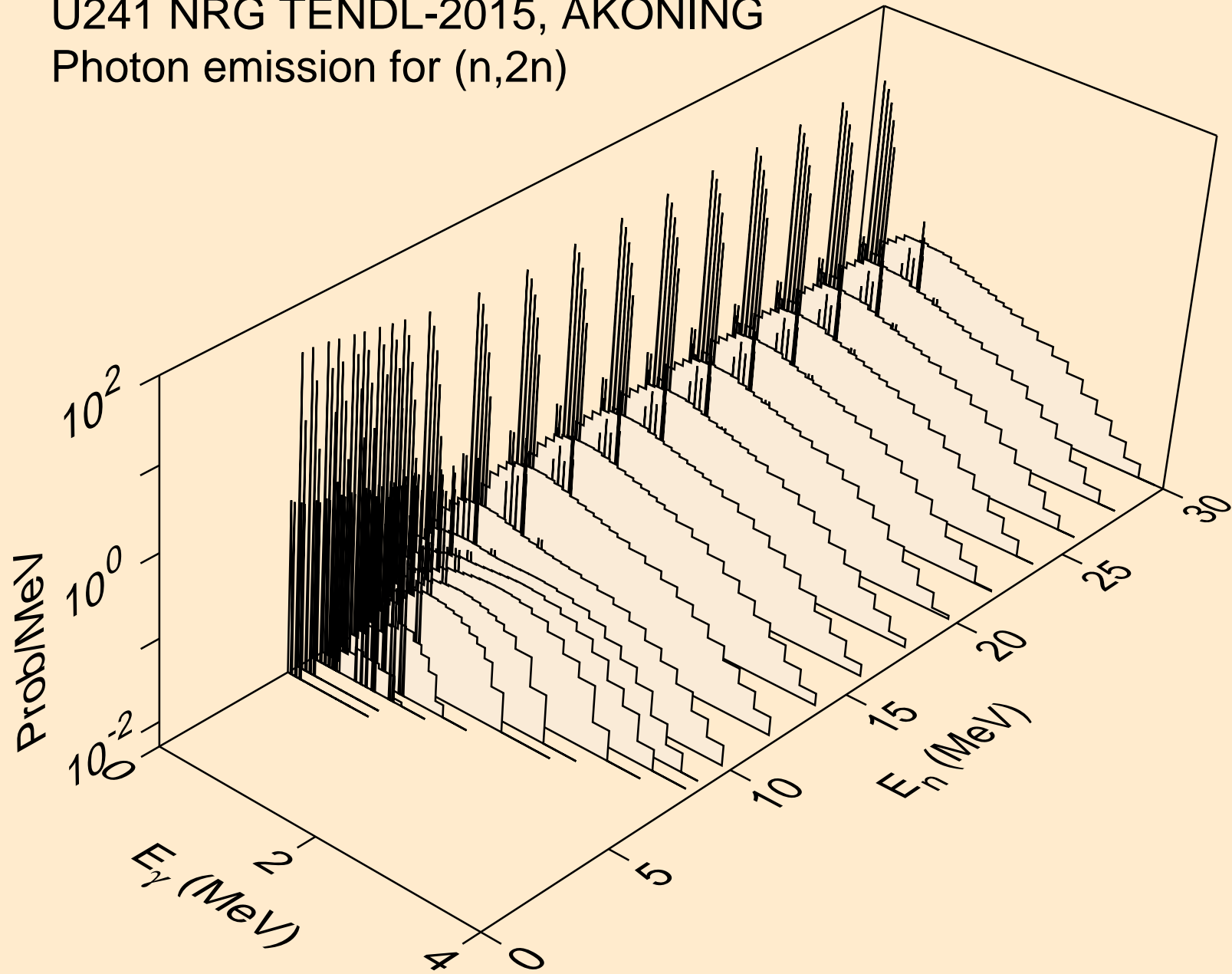

U241 NRG TENDL-2015, AKONING  
Photon emission for (n,3n)

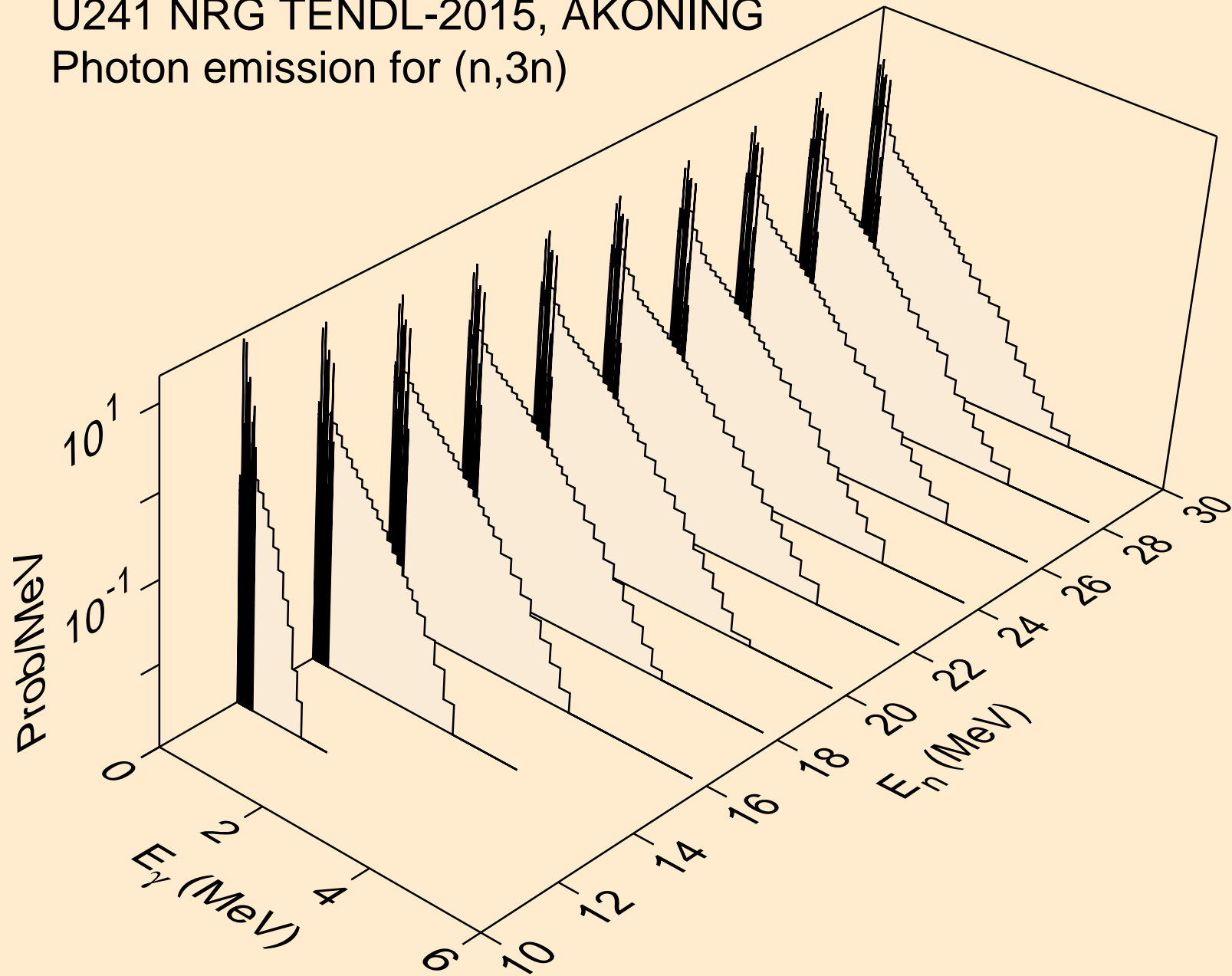

U241 NRG TENDL-2015, AKONING  
Photon emission for (n,n\*)a

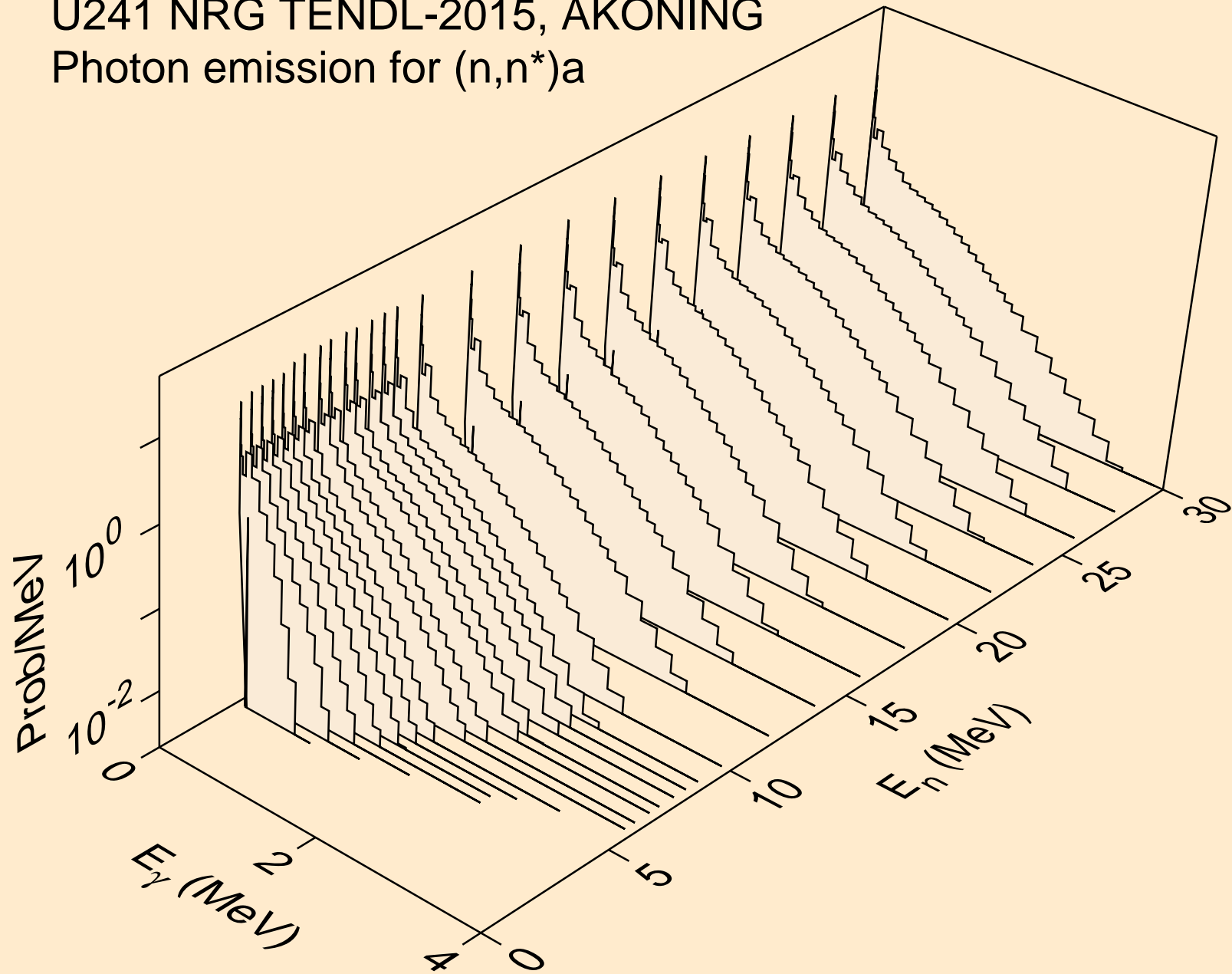

U241 NRG TENDL-2015, AKONING  
Photon emission for (n,2n)a

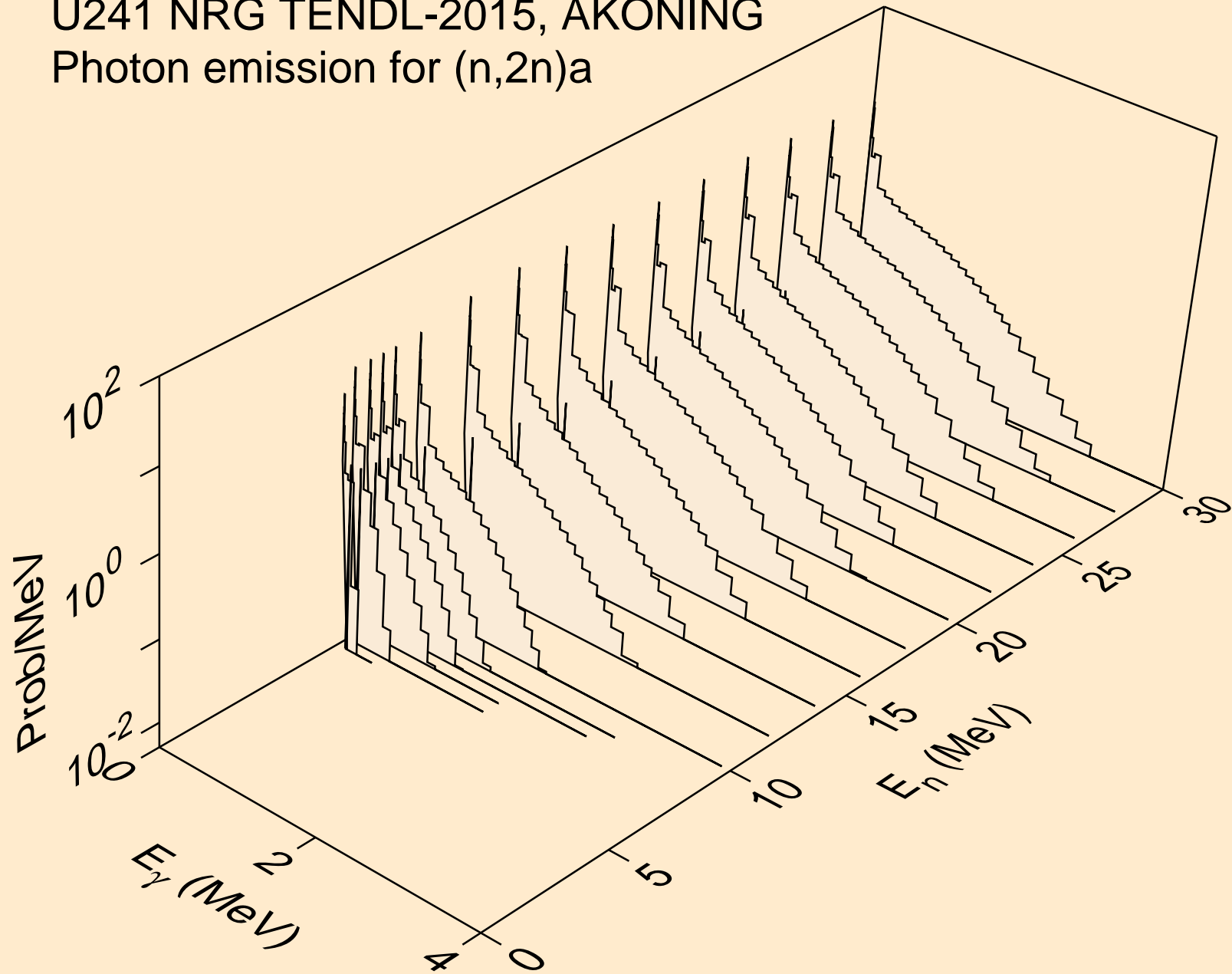

U241 NRG TENDL-2015, AKONING  
Photon emission for (n,3n)a

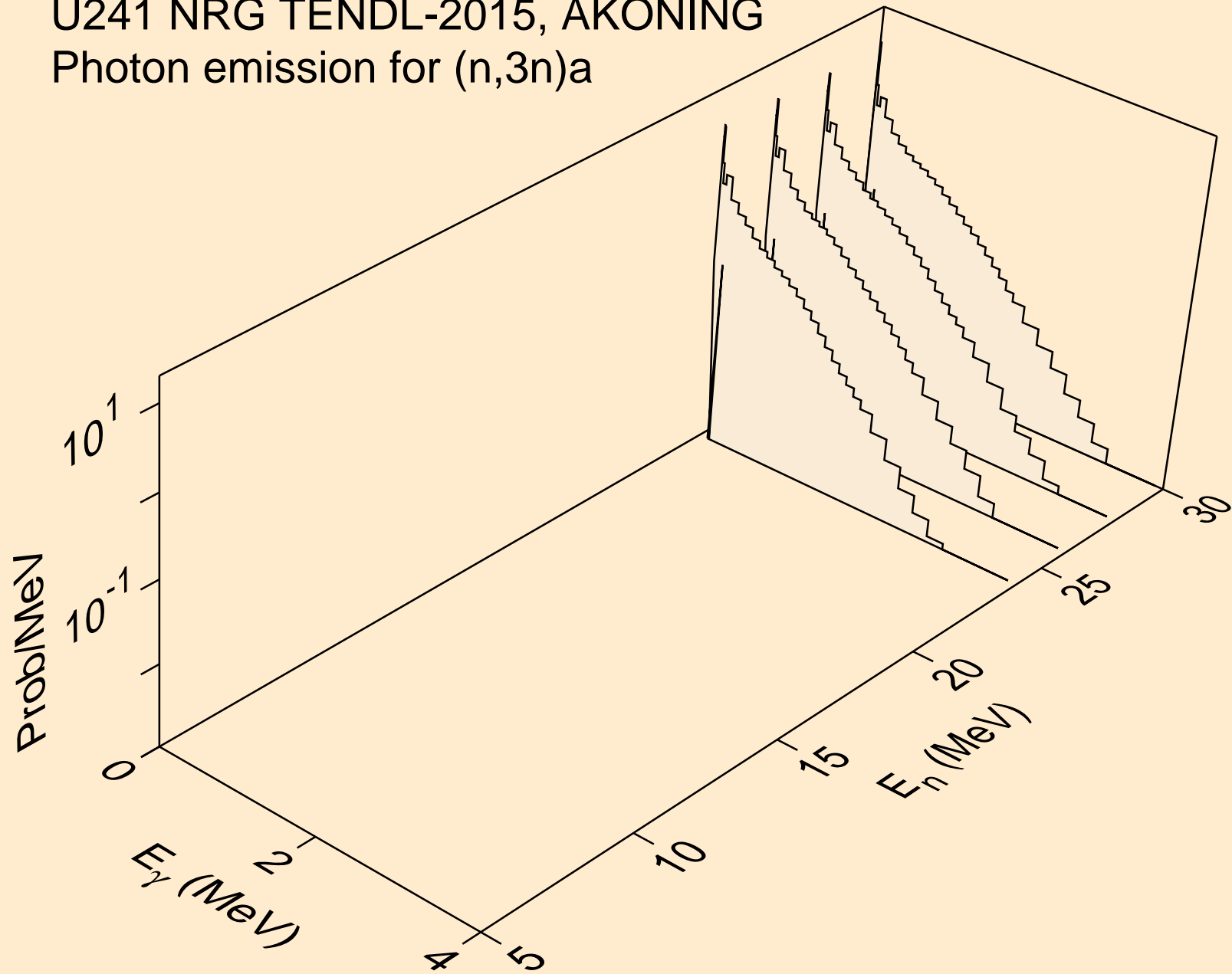

U241 NRG TENDL-2015, AKONING  
Photon emission for (n,n\*)p

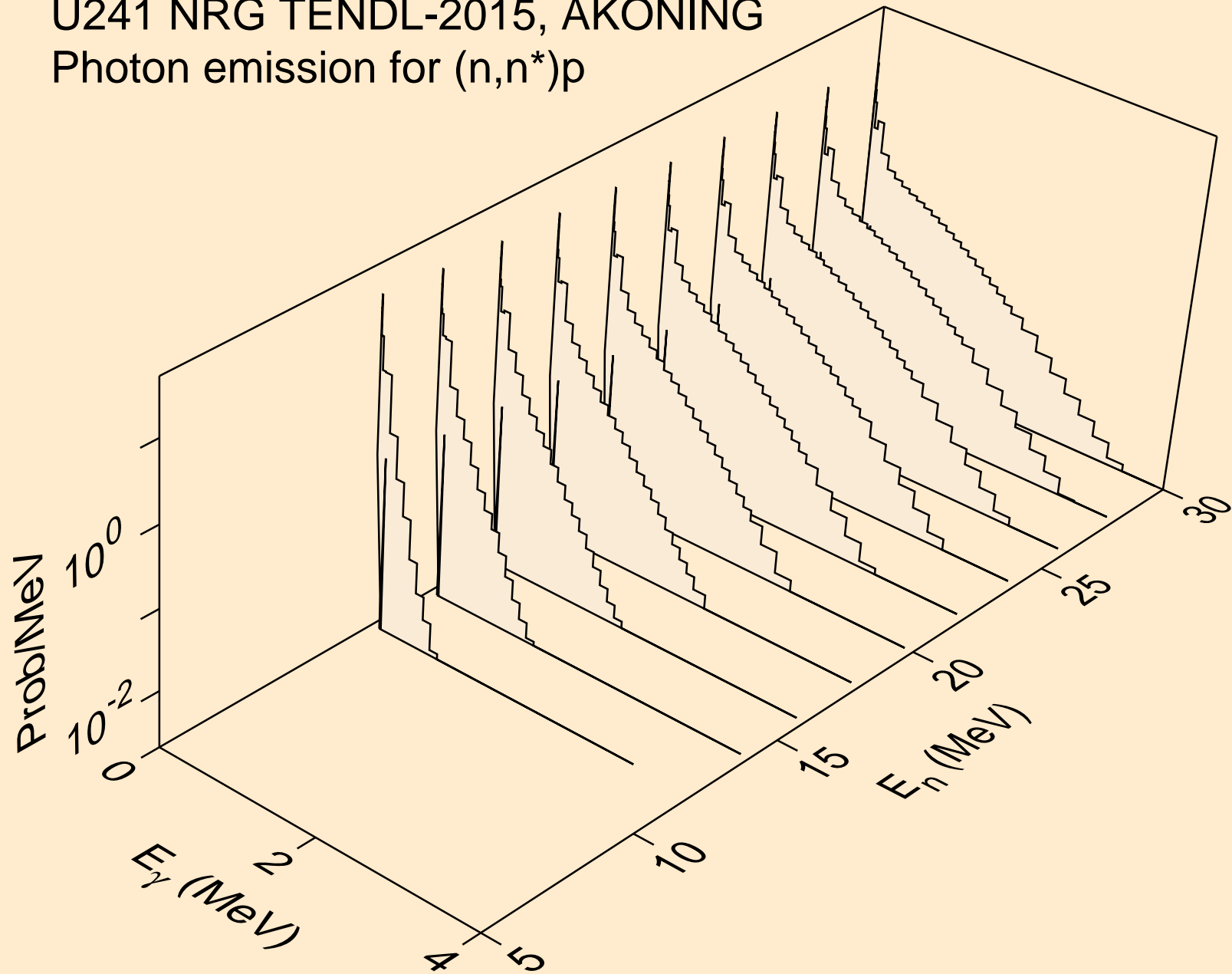

U241 NRG TENDL-2015, AKONING  
Photon emission for (n,n\*)d

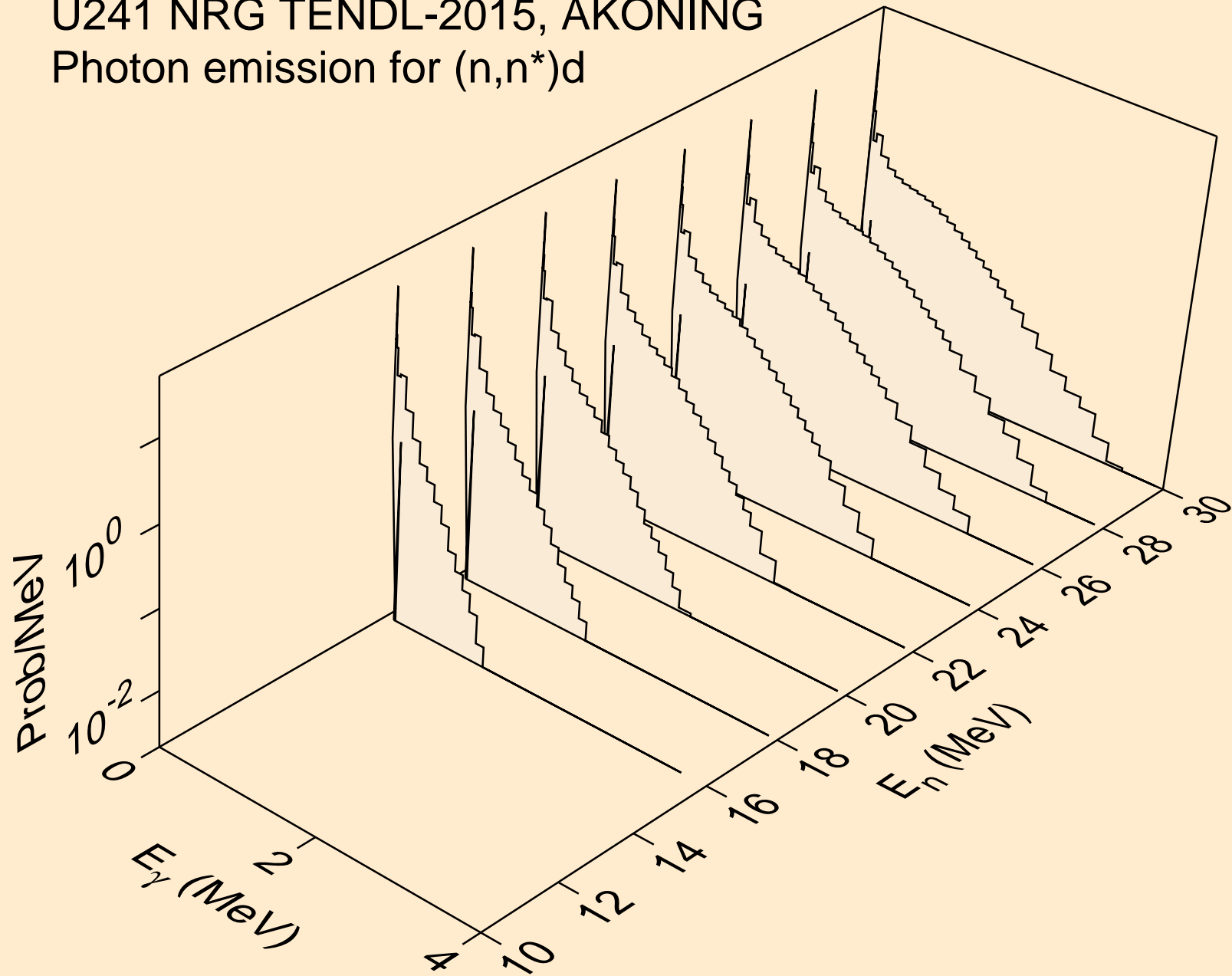



U241 NRG TENDL-2015, AKONING  
Photon emission for (n,n\*)t

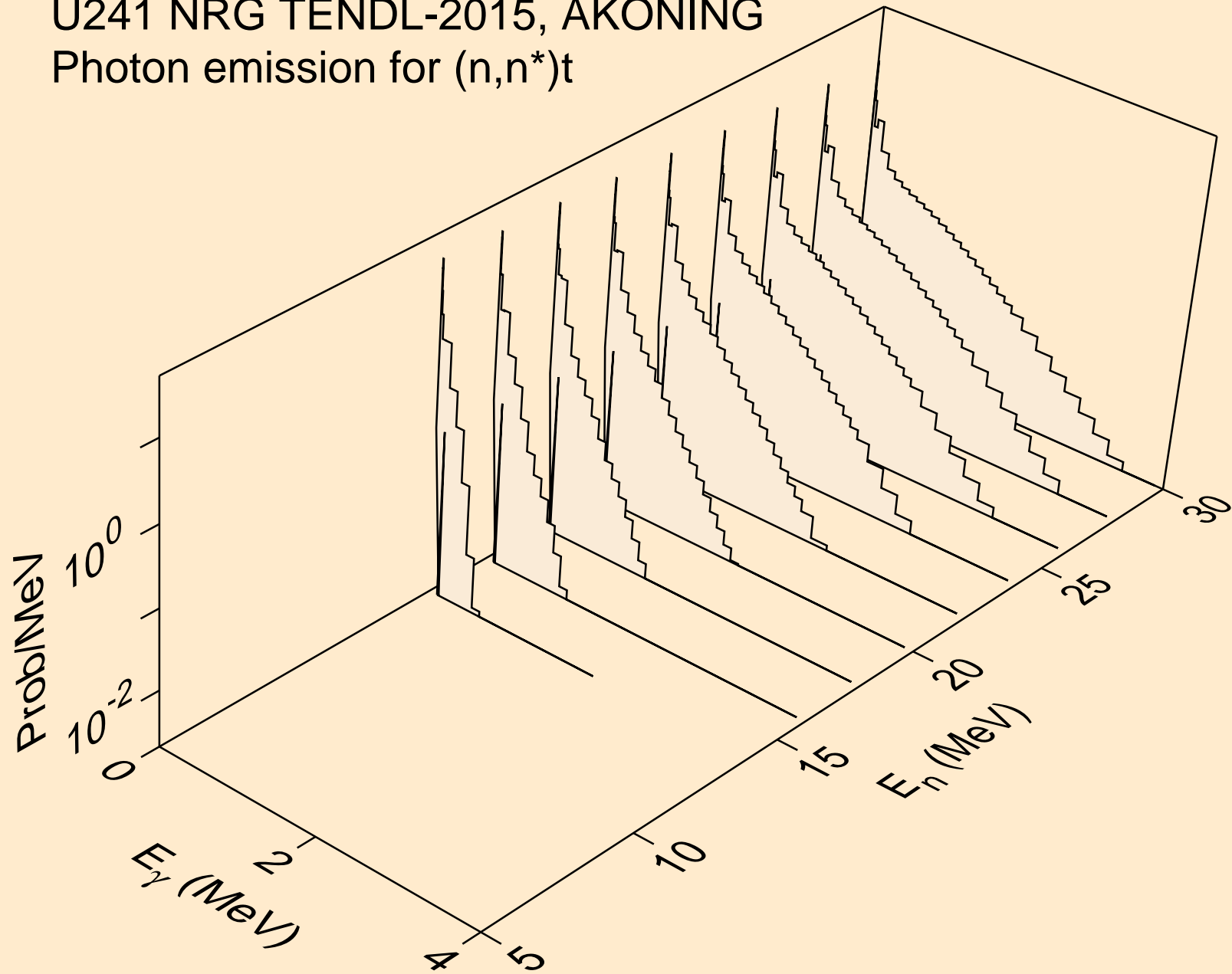

U241 NRG TENDL-2015, AKONING  
Photon emission for (n,n\*)he3

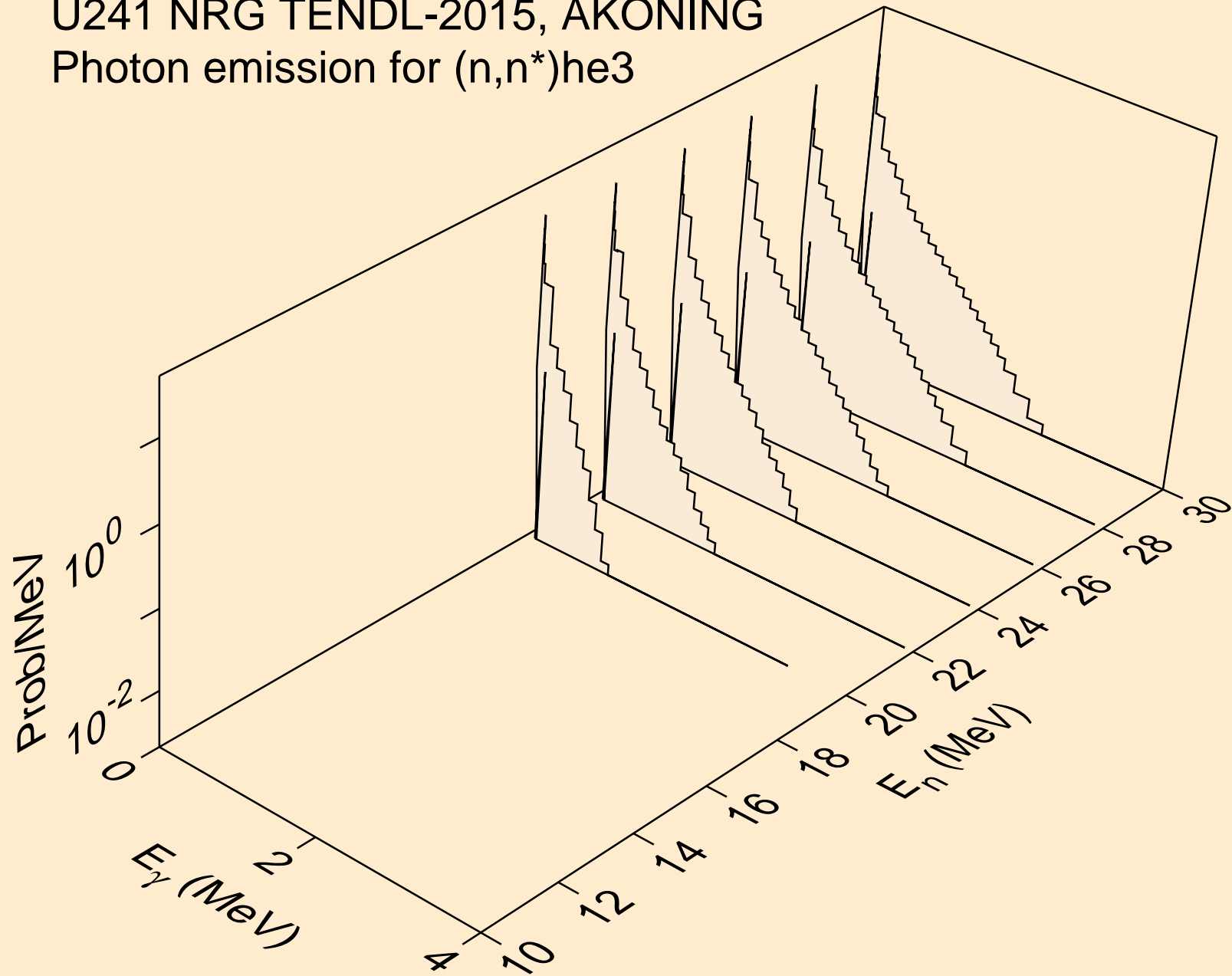

U241 NRG TENDL-2015, AKONING  
Photon emission for (n,4n)

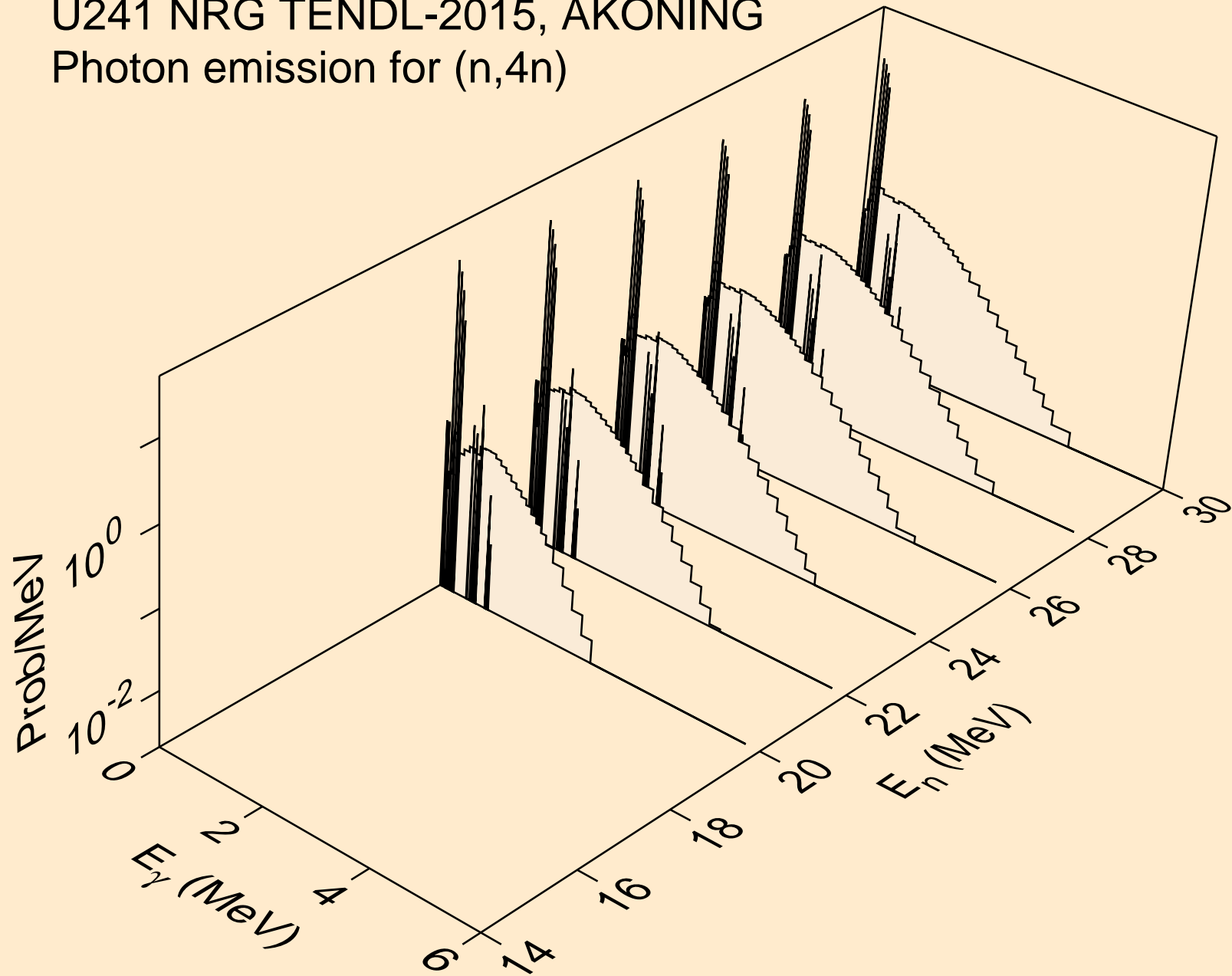

U241 NRG TENDL-2015, AKONING  
Photon emission for (n,2np)

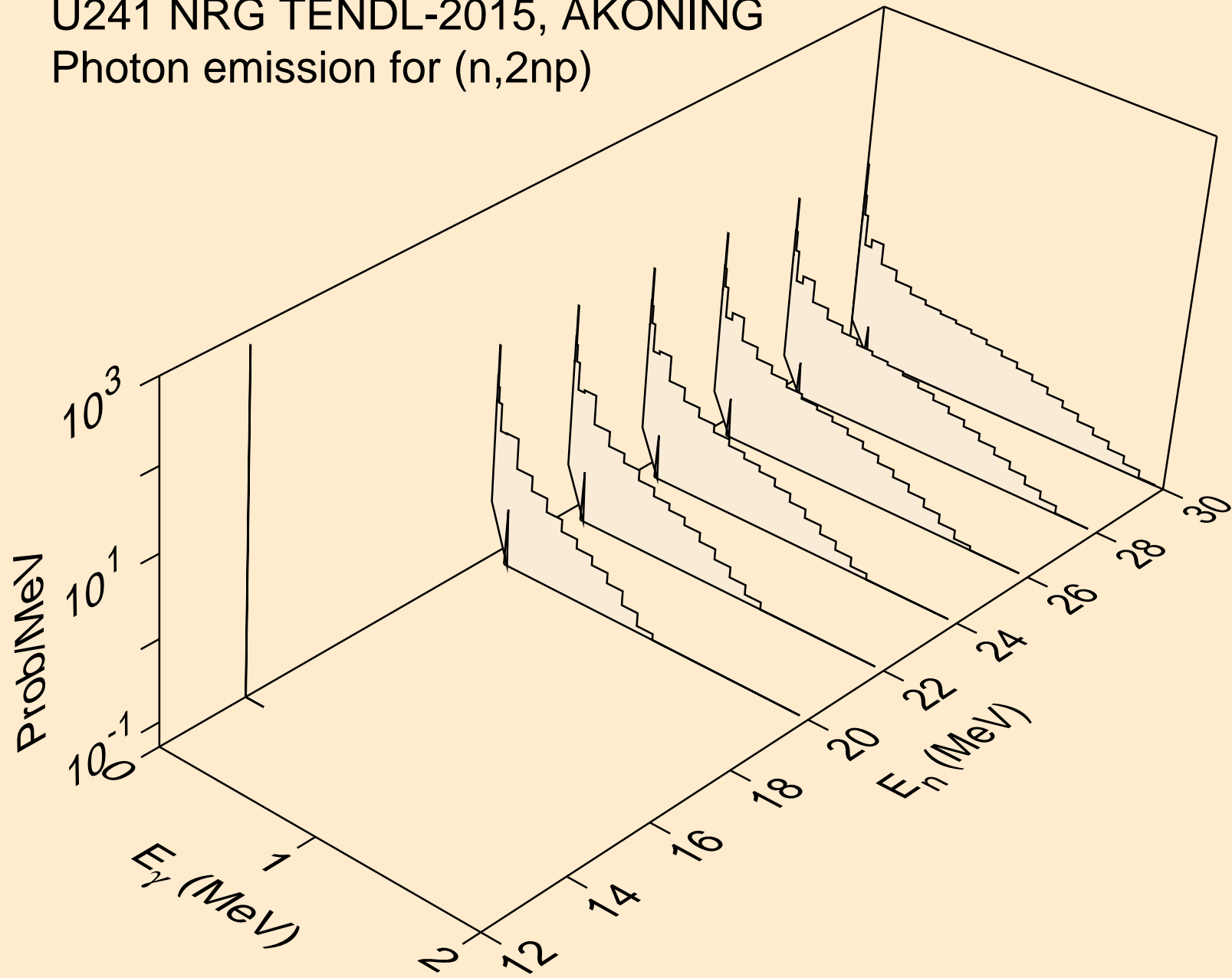

U241 NRG TENDL-2015, AKONING  
Photon emission for (n,3np)

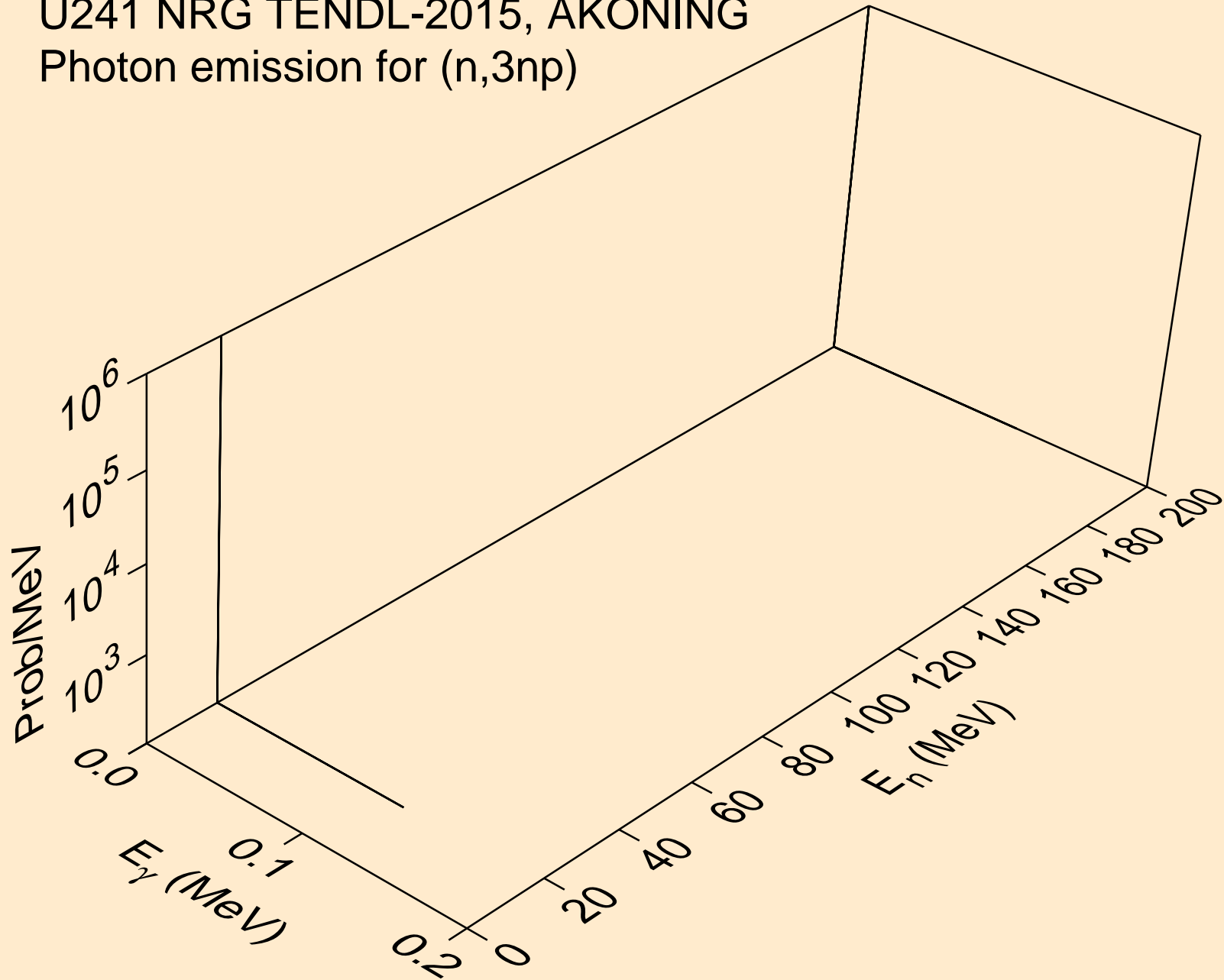

U241 NRG TENDL-2015, AKONING  
Photon emission for (n,n\*c)

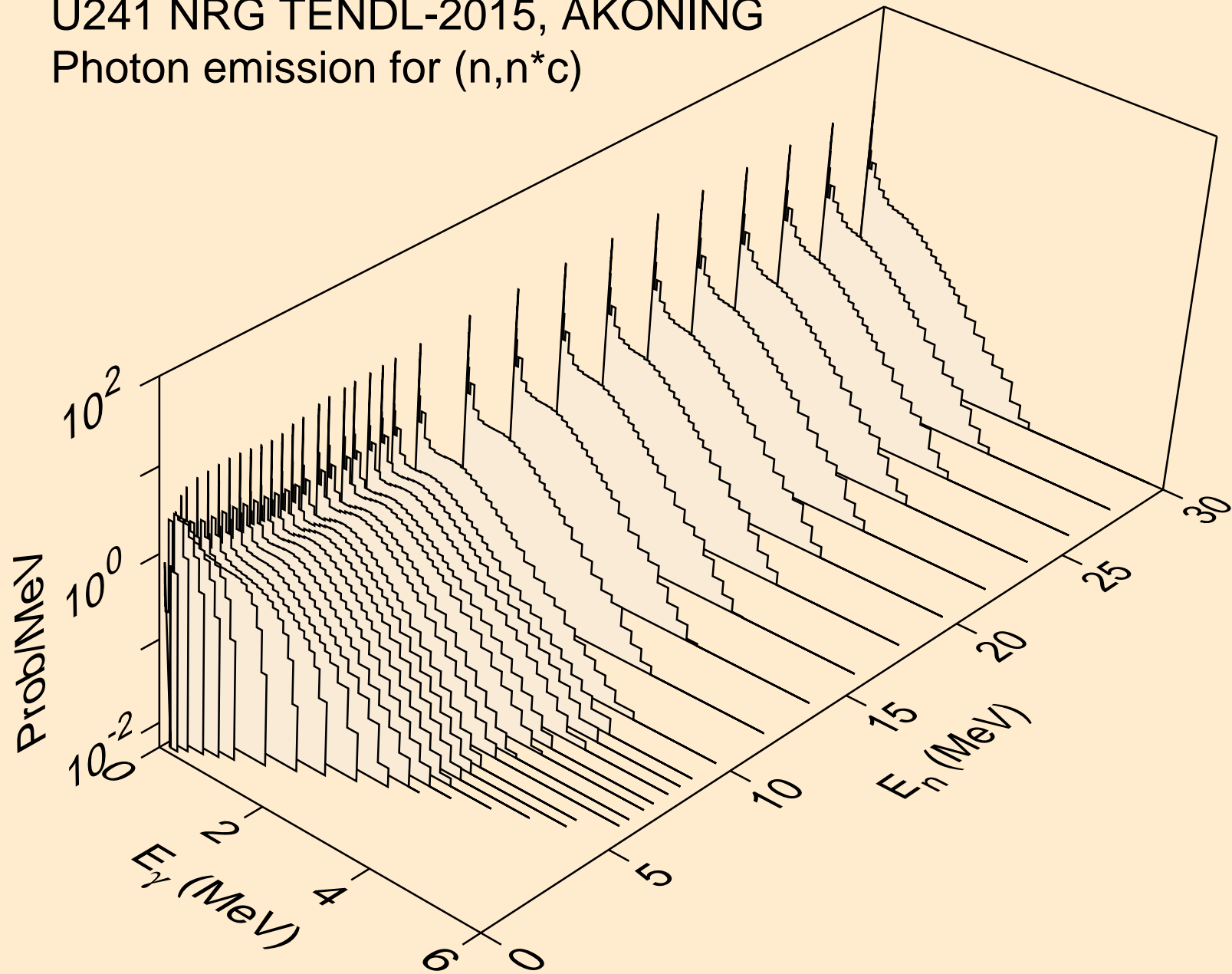

U241 NRG TENDL-2015, AKONING  
Photon emission for (n,gma)

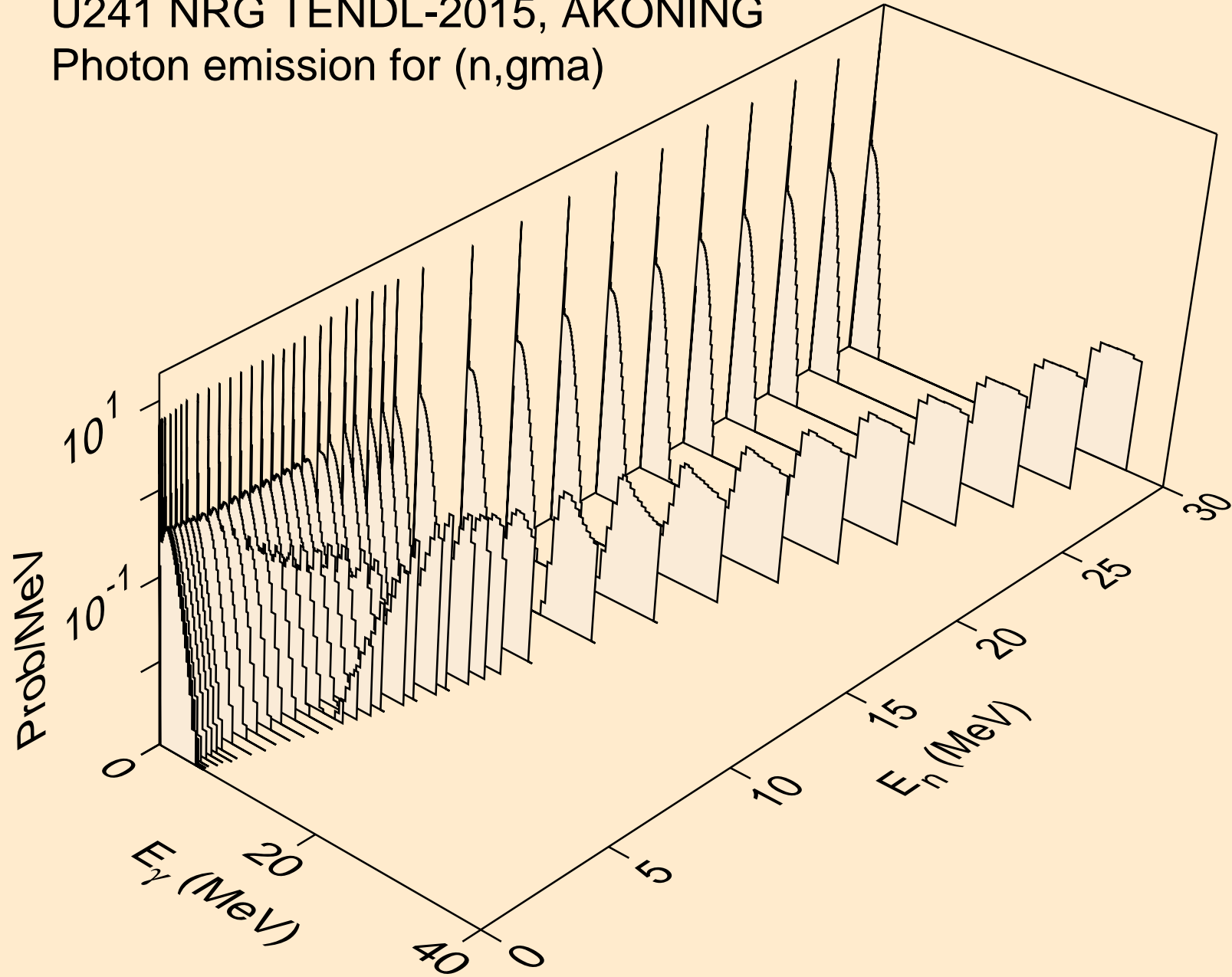

U241 NRG TENDL-2015, AKONING  
Photon emission for (n,p)

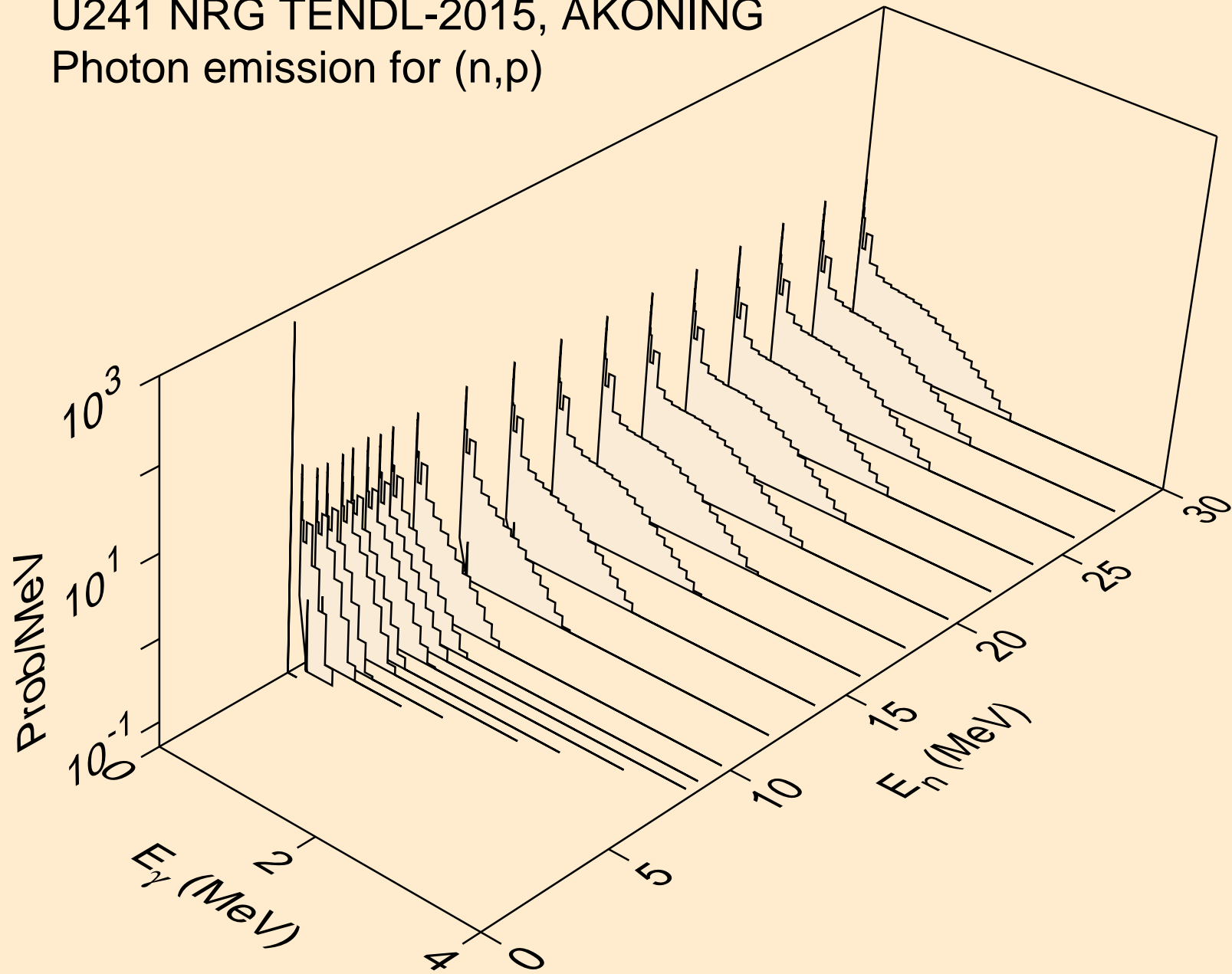



U241 NRG TENDL-2015, AKONING  
Photon emission for (n,d)

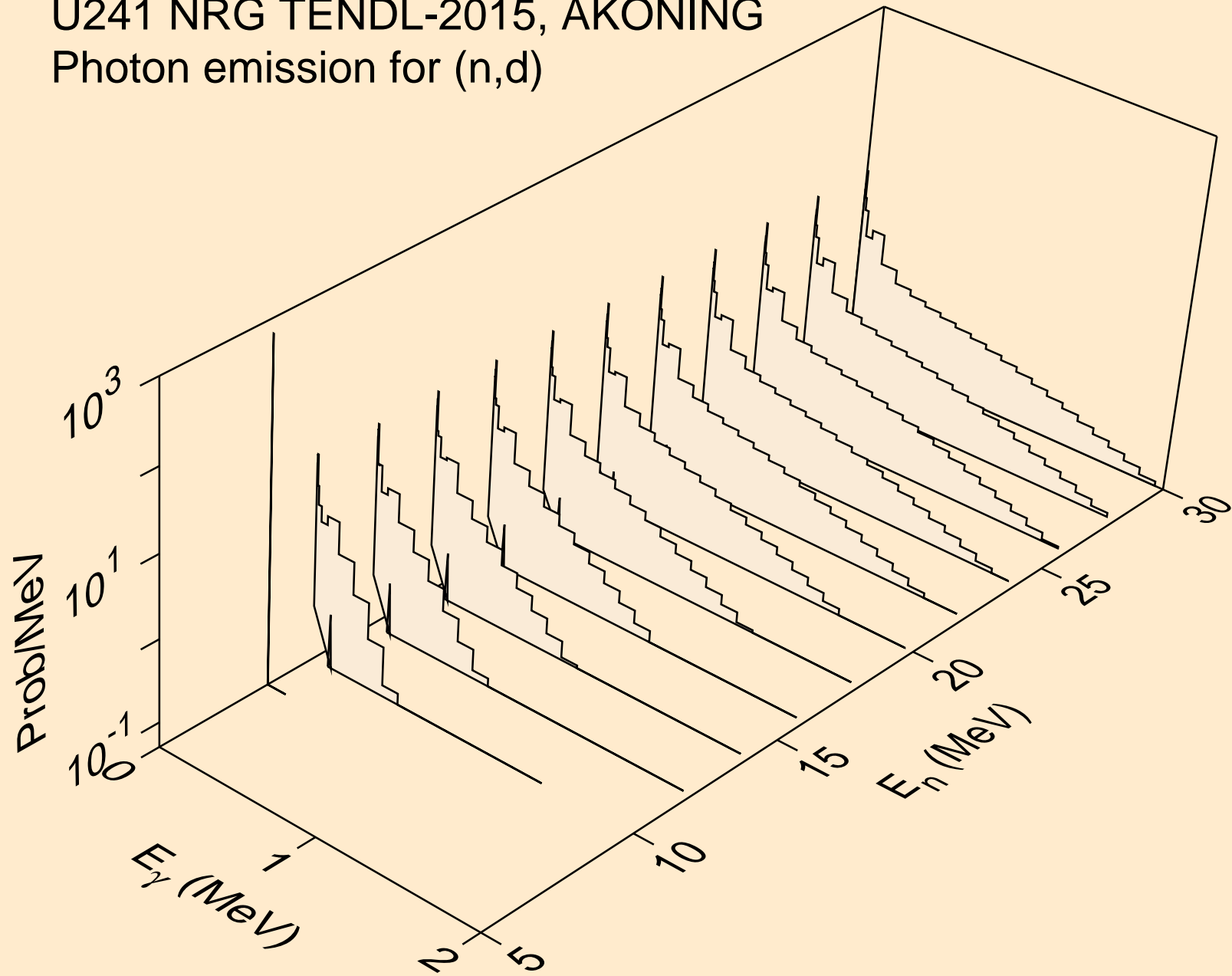

U241 NRG TENDL-2015, AKONING  
Photon emission for (n,t)

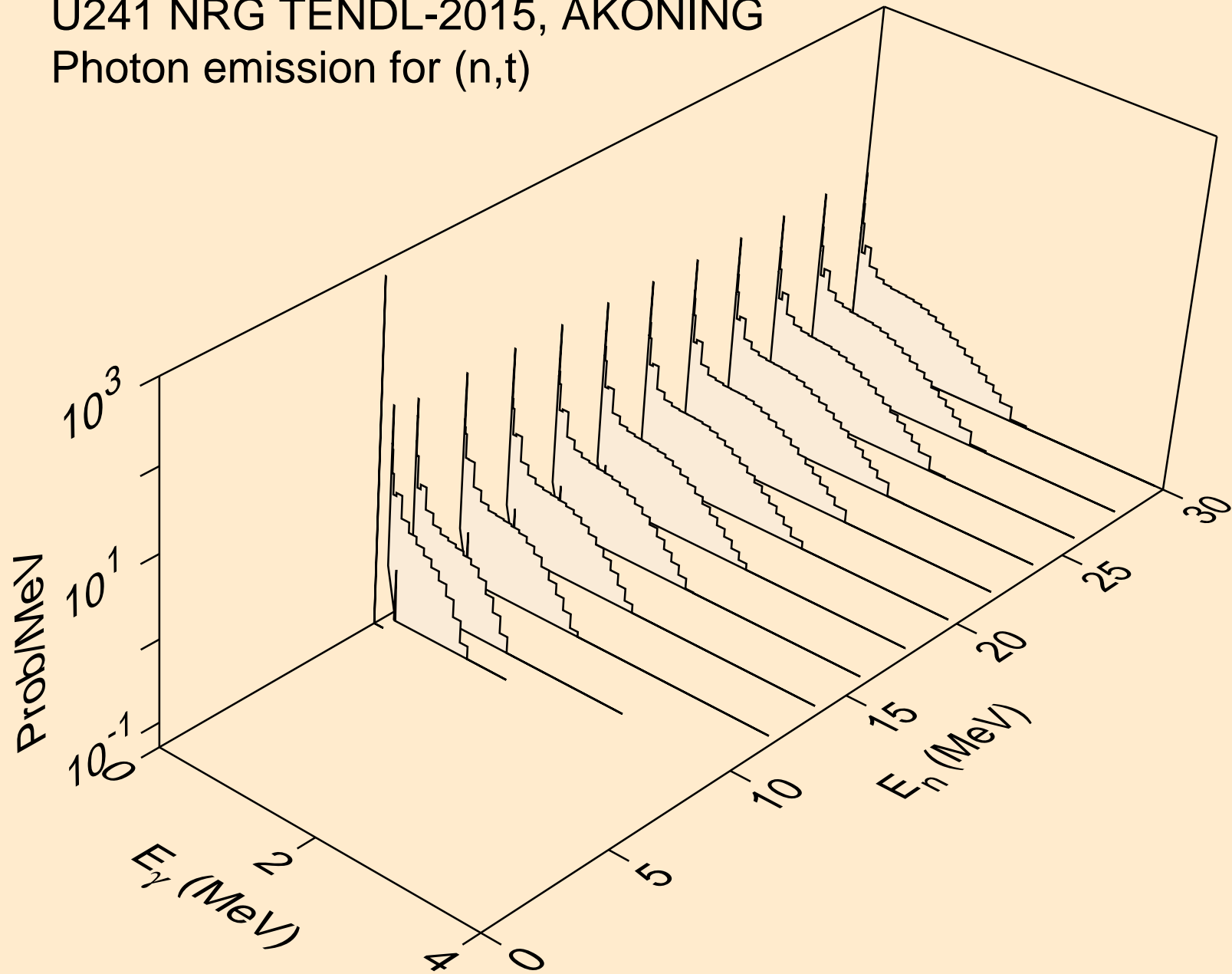

U241 NRG TENDL-2015, AKONING  
Photon emission for (n,he3)

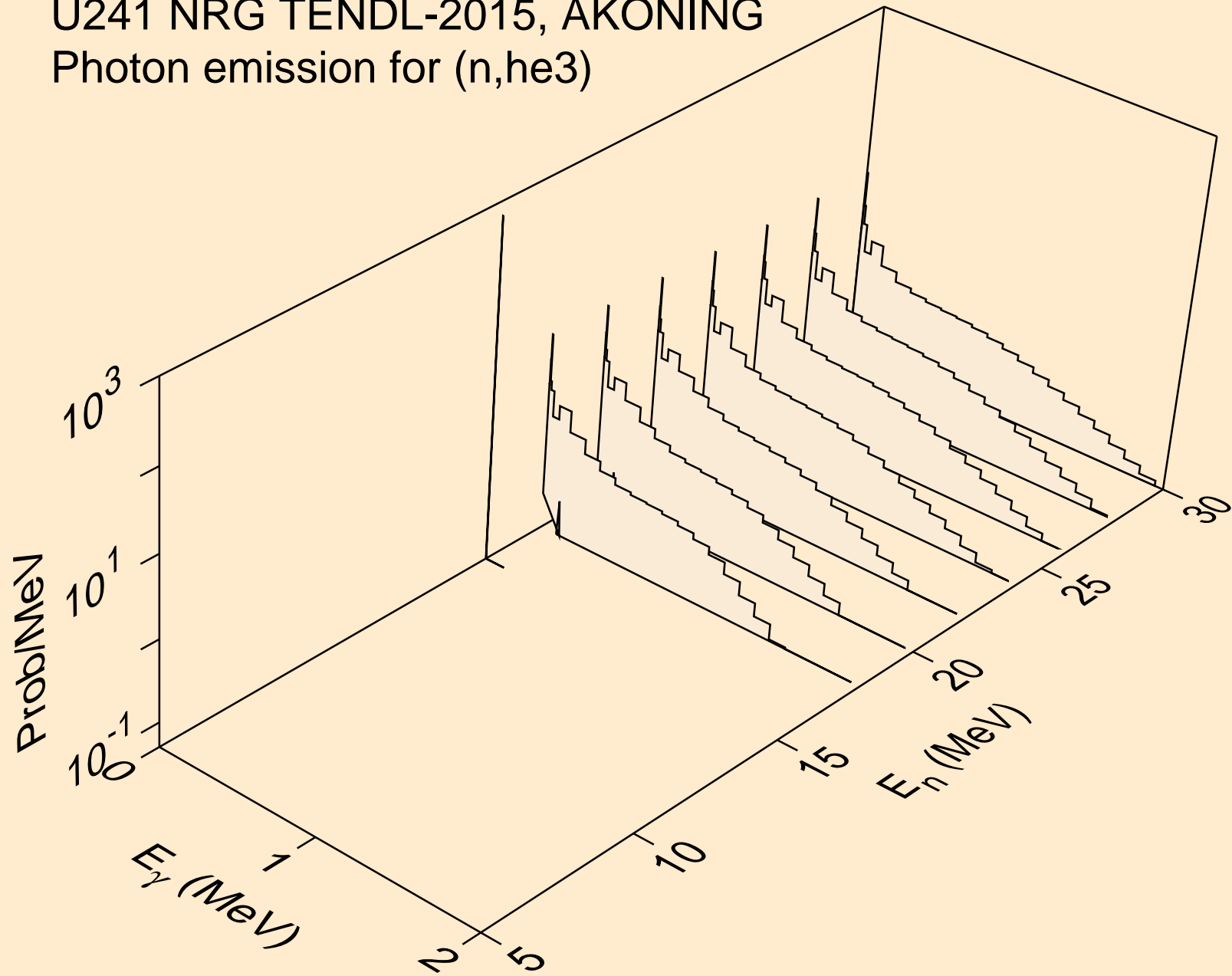

U241 NRG TENDL-2015, AKONING  
Photon emission for (n,a)

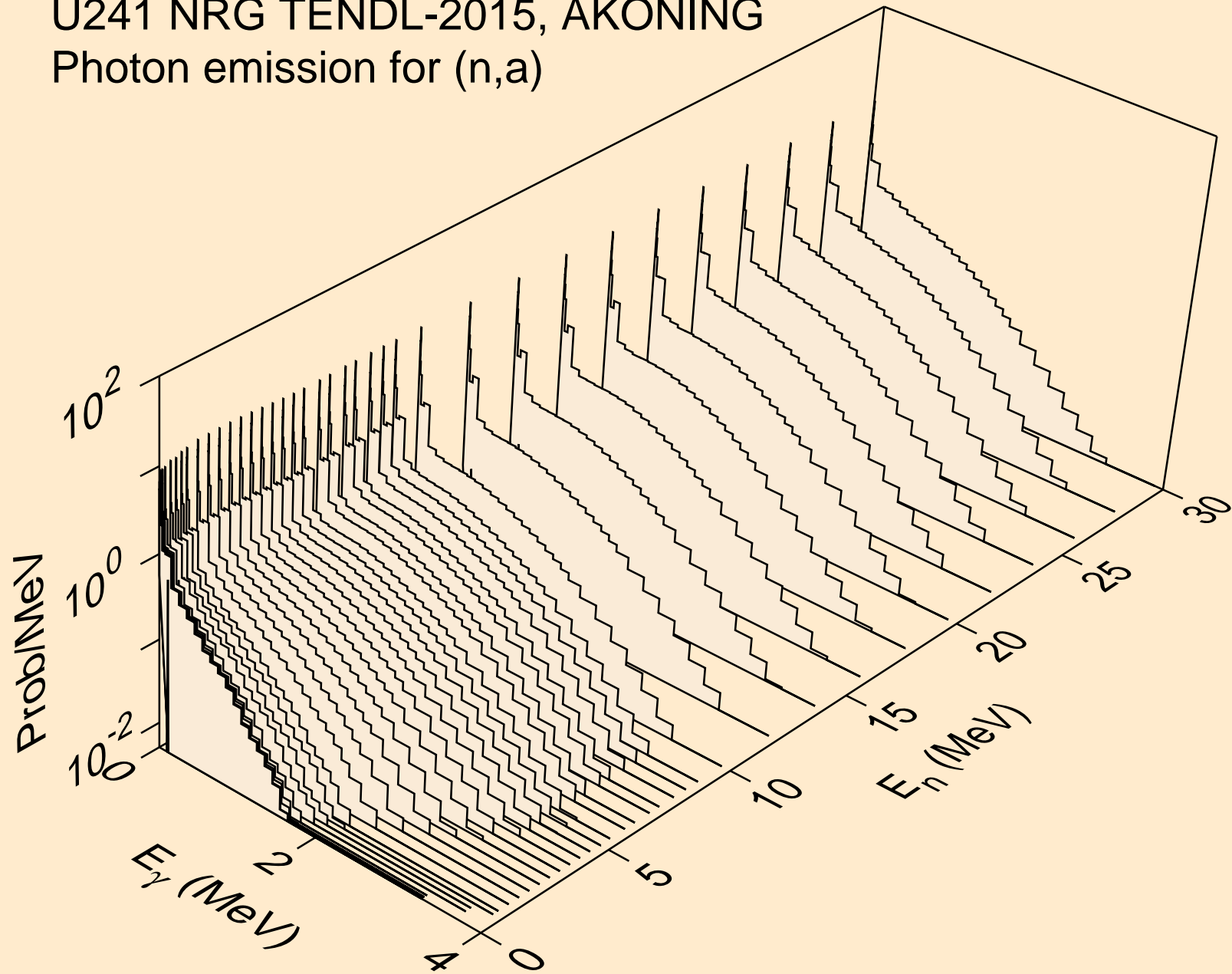

U241 NRG TENDL-2015, AKONING  
Photon emission for (n,2p)

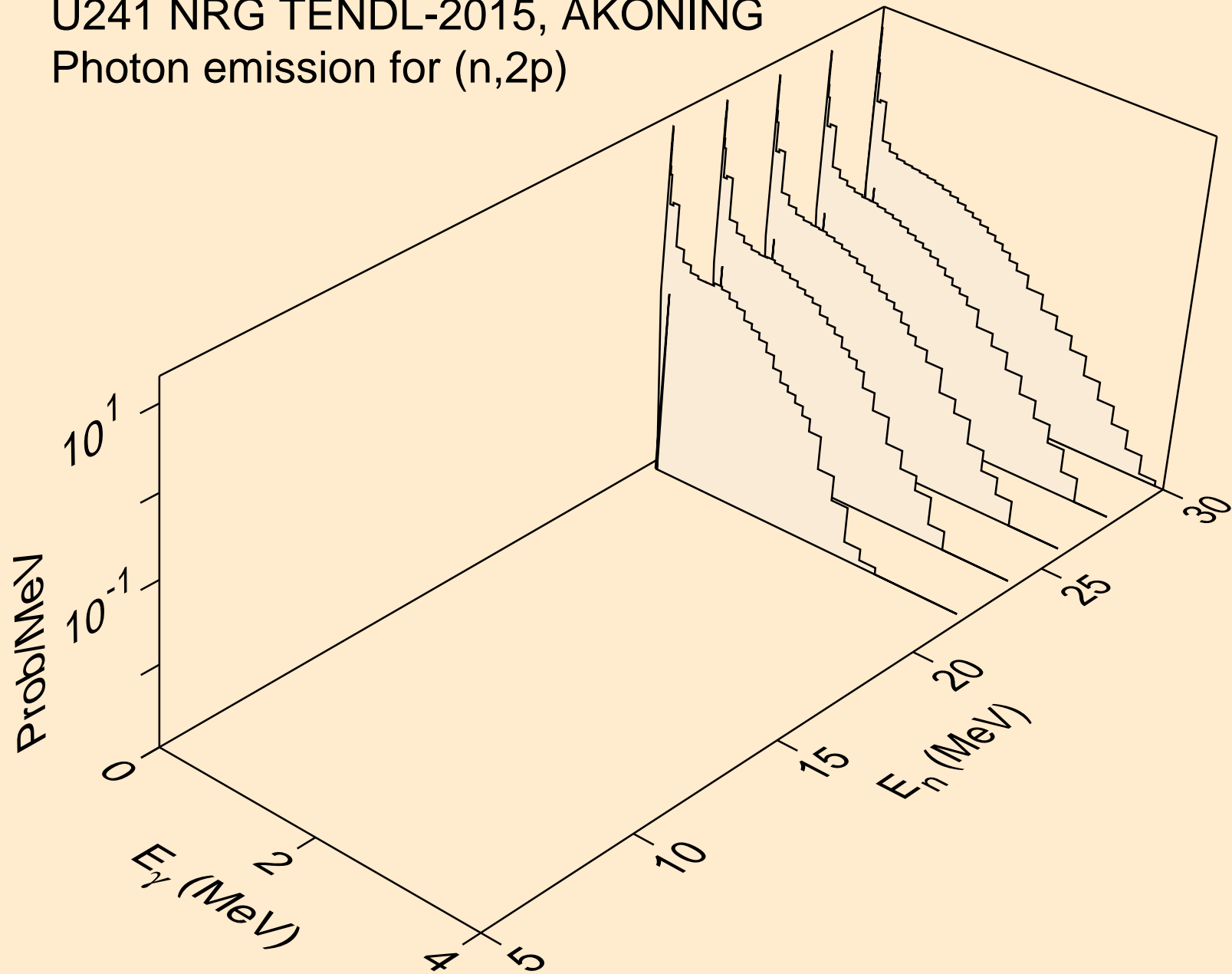

U241 NRG TENDL-2015, AKONING  
thermal capture photon spectrum

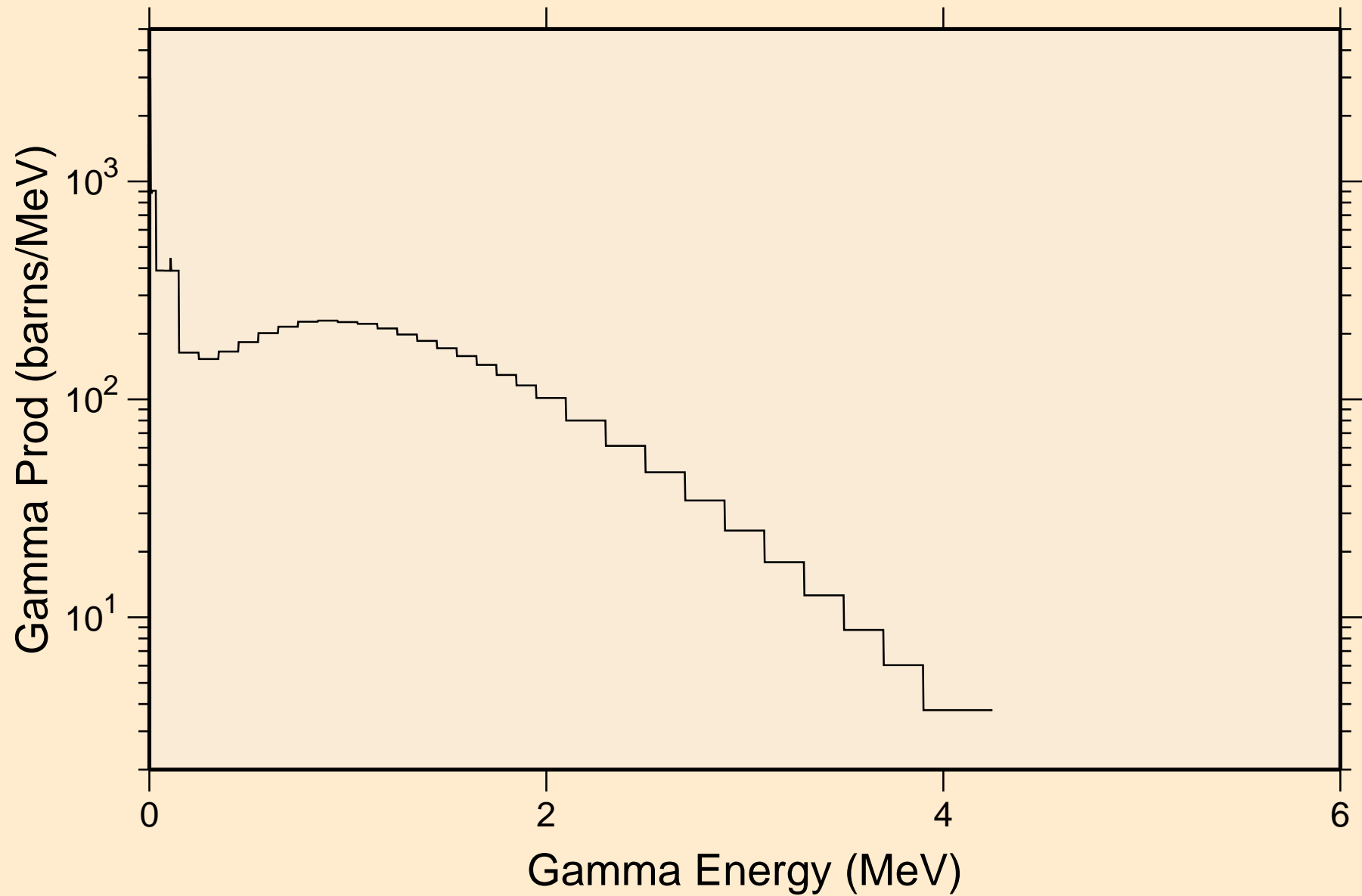

U241 NRG TENDL-2015, AKONING  
14 MeV photon spectrum

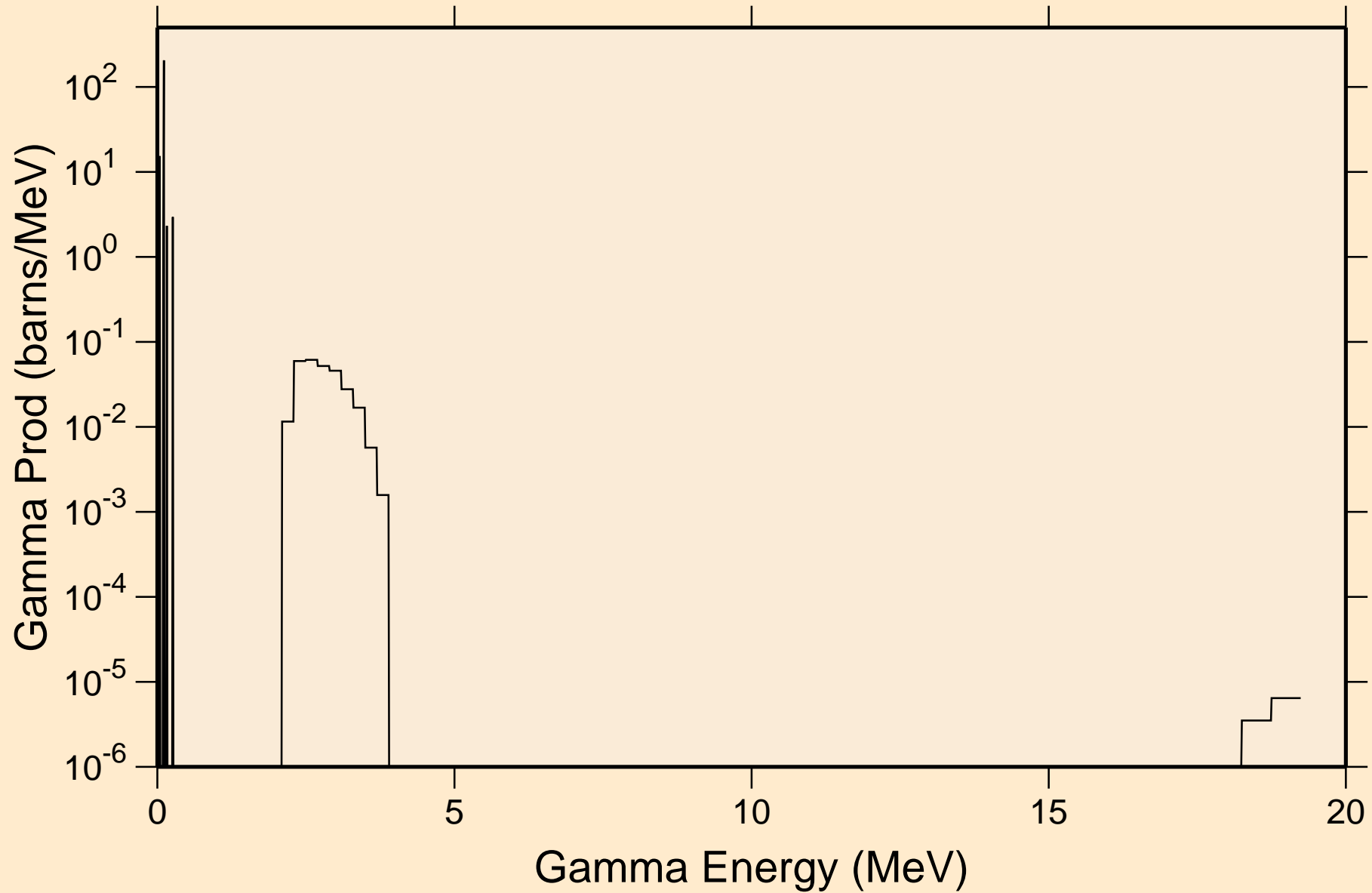

# U241 NRG TENDL-2015, AKONING

## Particle heating contributions

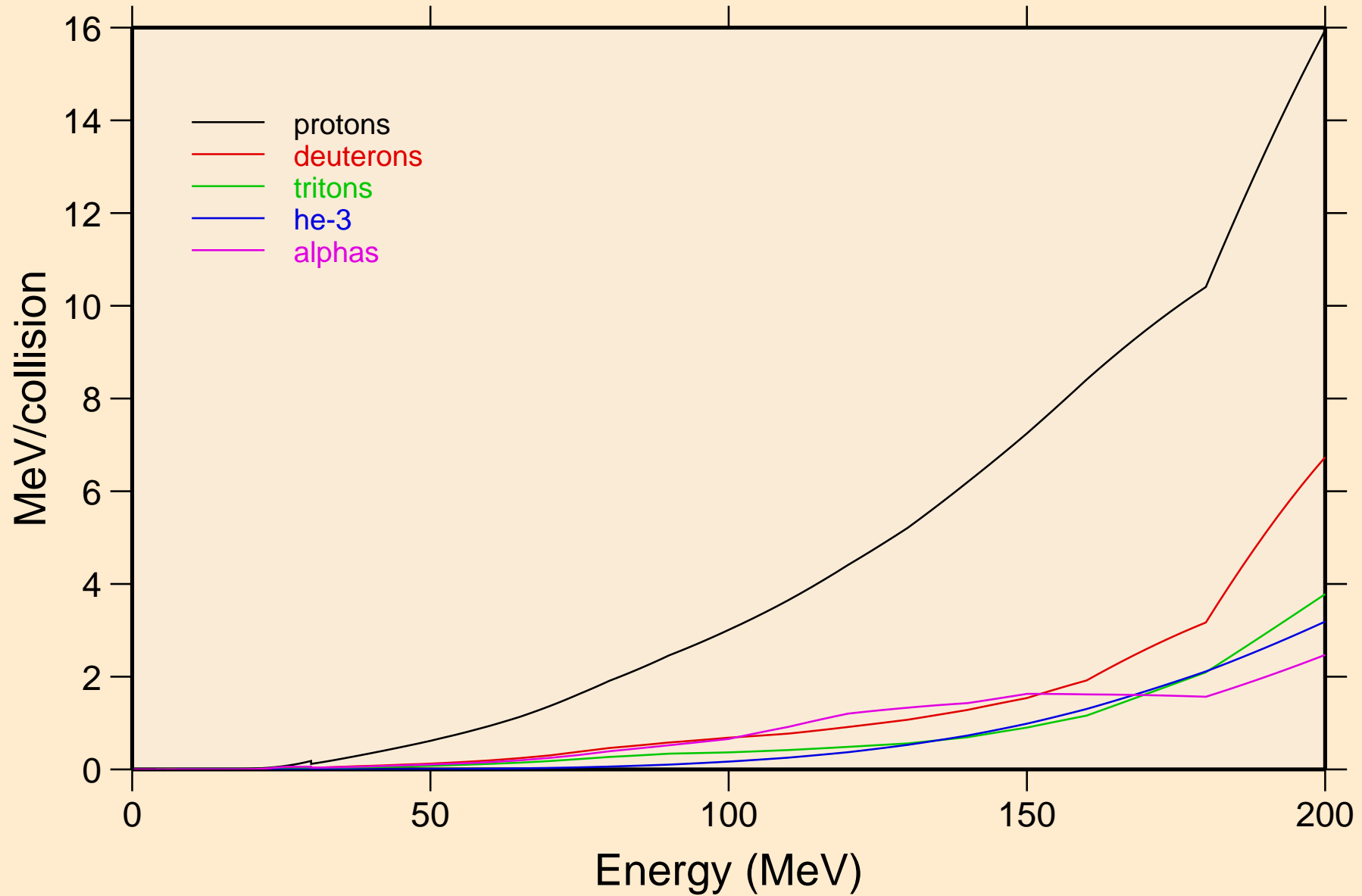



# U241 NRG TENDL-2015, AKONING

## Recoil Heating

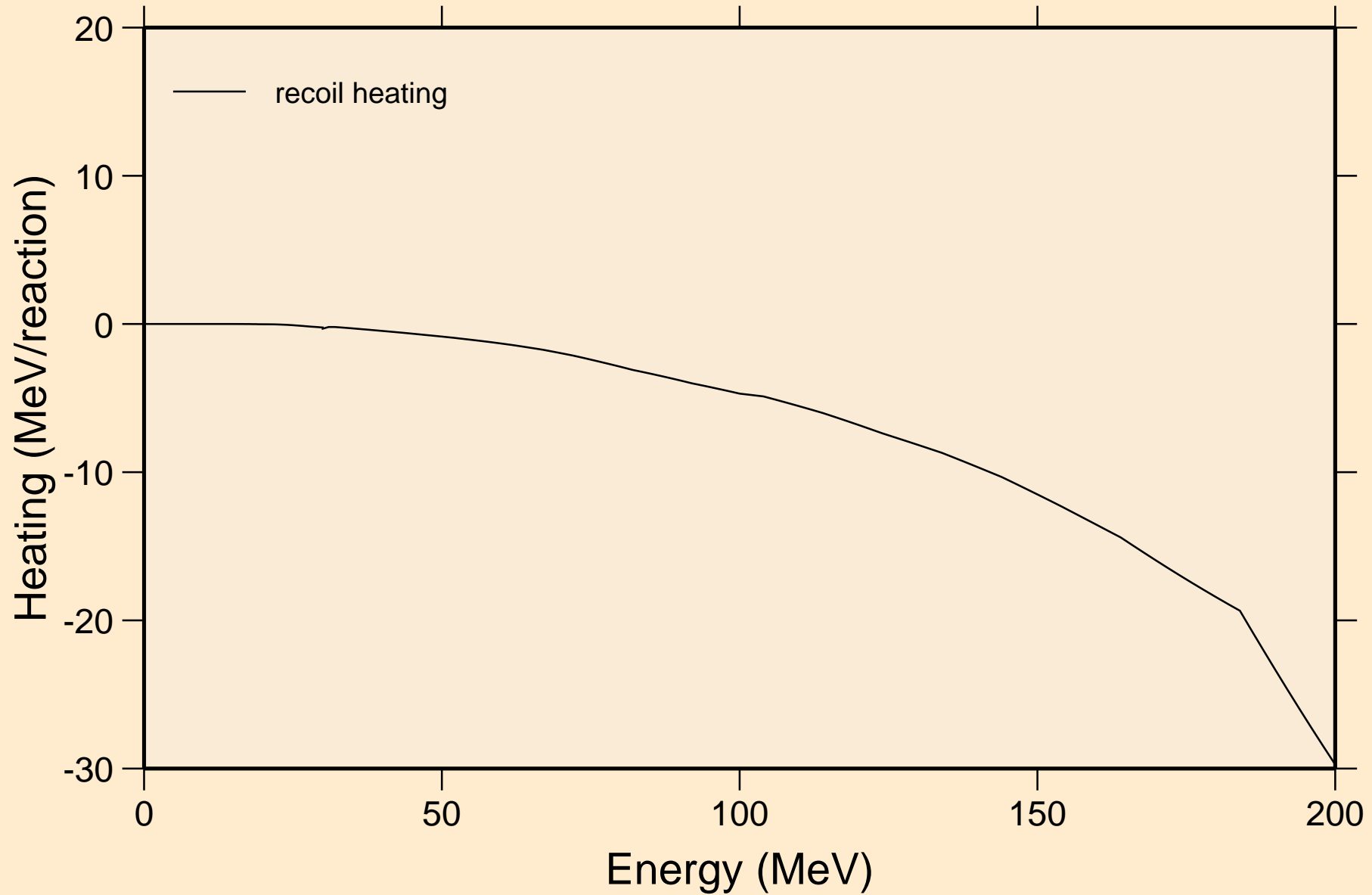

# U241 NRG TENDL-2015, AKONING

## Particle production cross sections

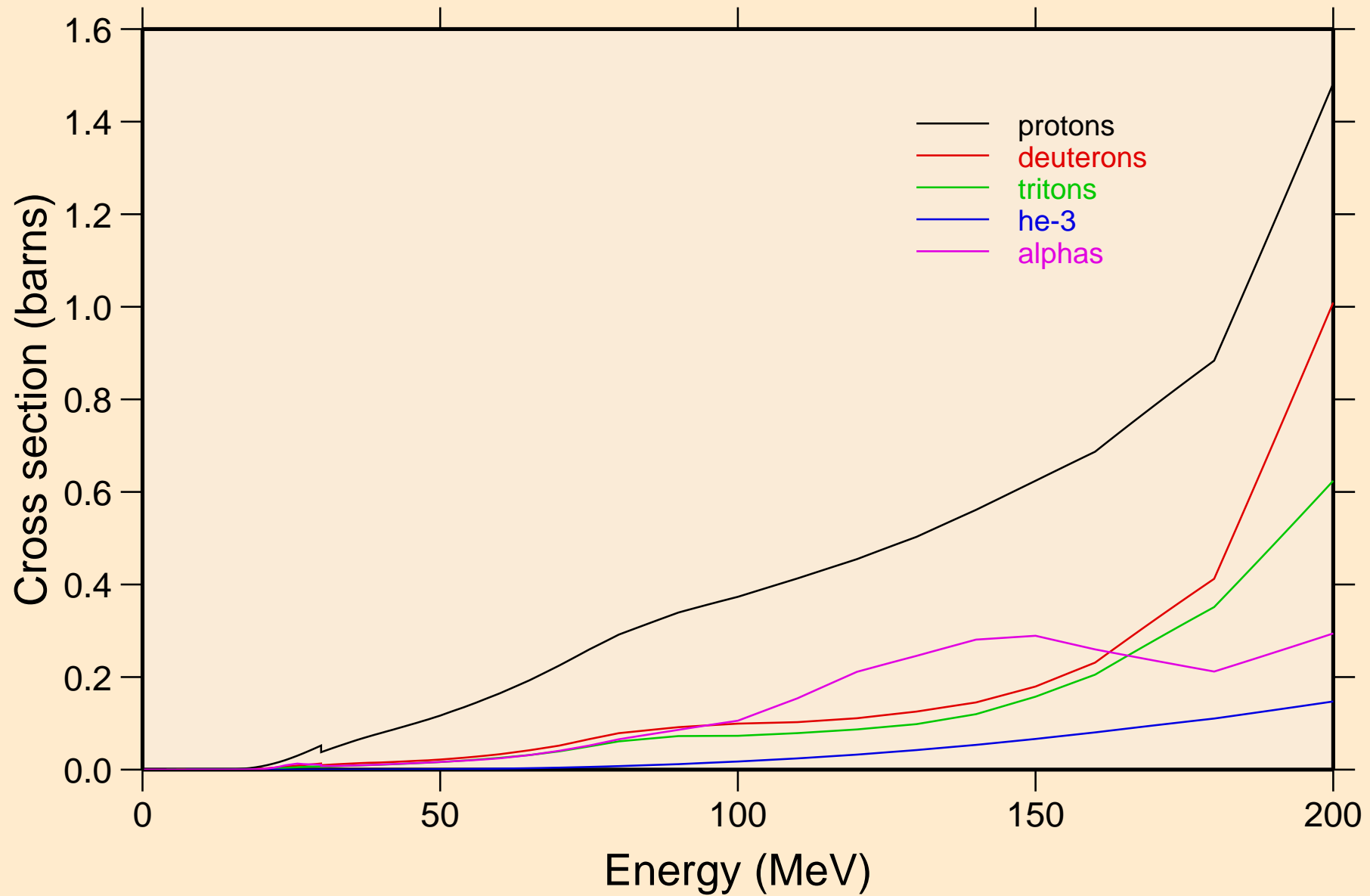

U241 NRG TENDL-2015, AKONING  
protons from (n,x)

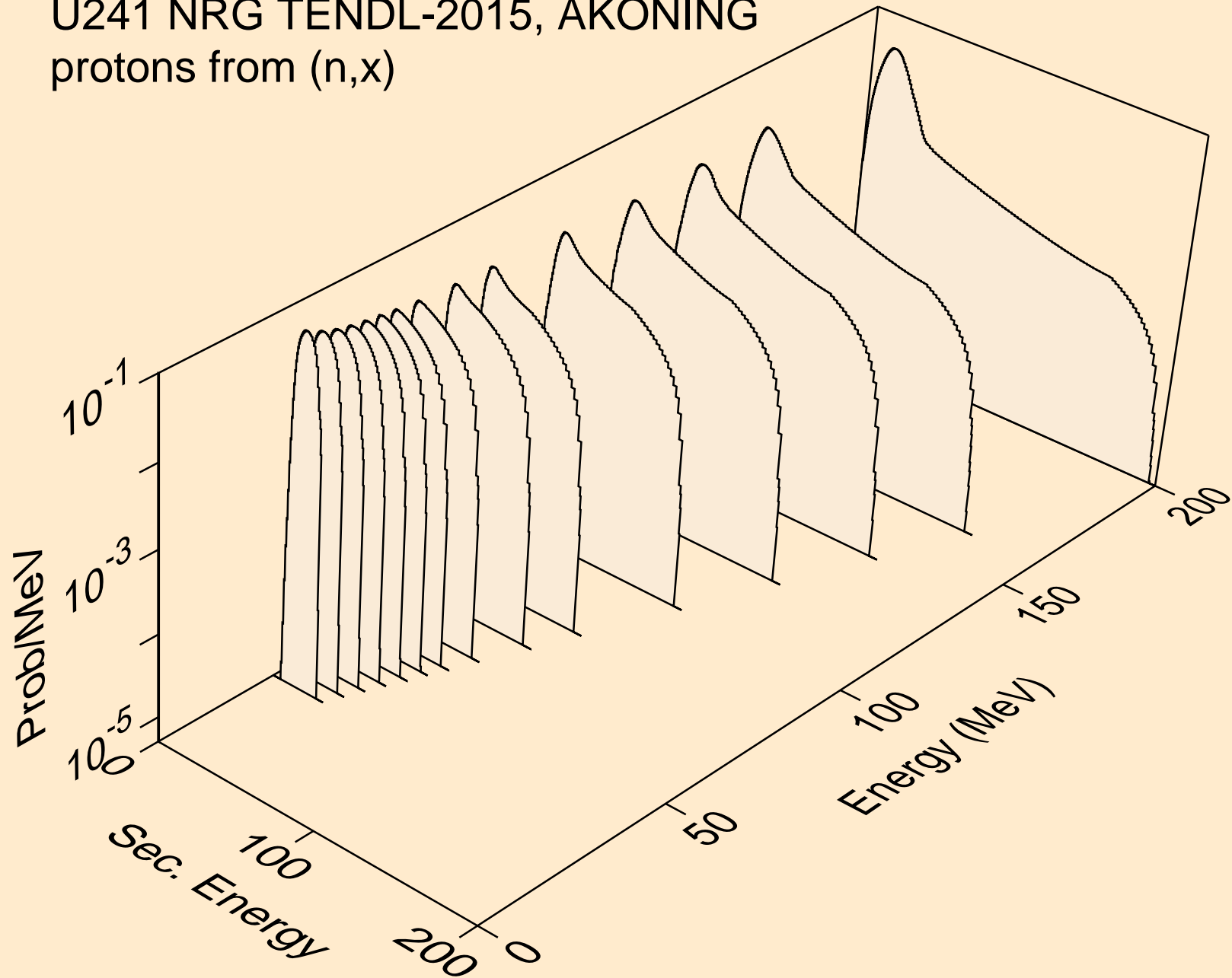

U241 NRG TENDL-2015, AKONING  
protons from (n,n\*)p

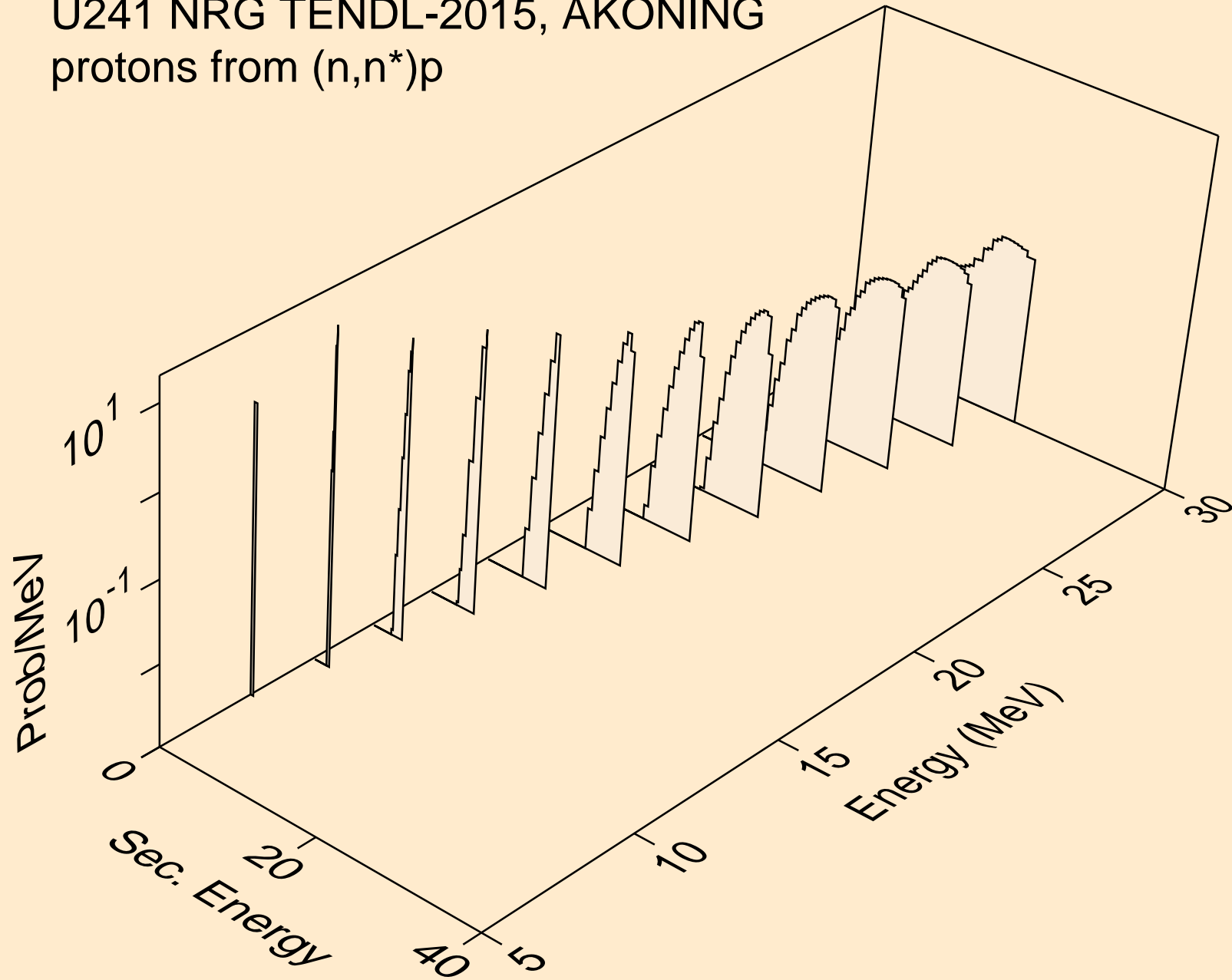

U241 NRG TENDL-2015, AKONING  
protons from (n,2np)

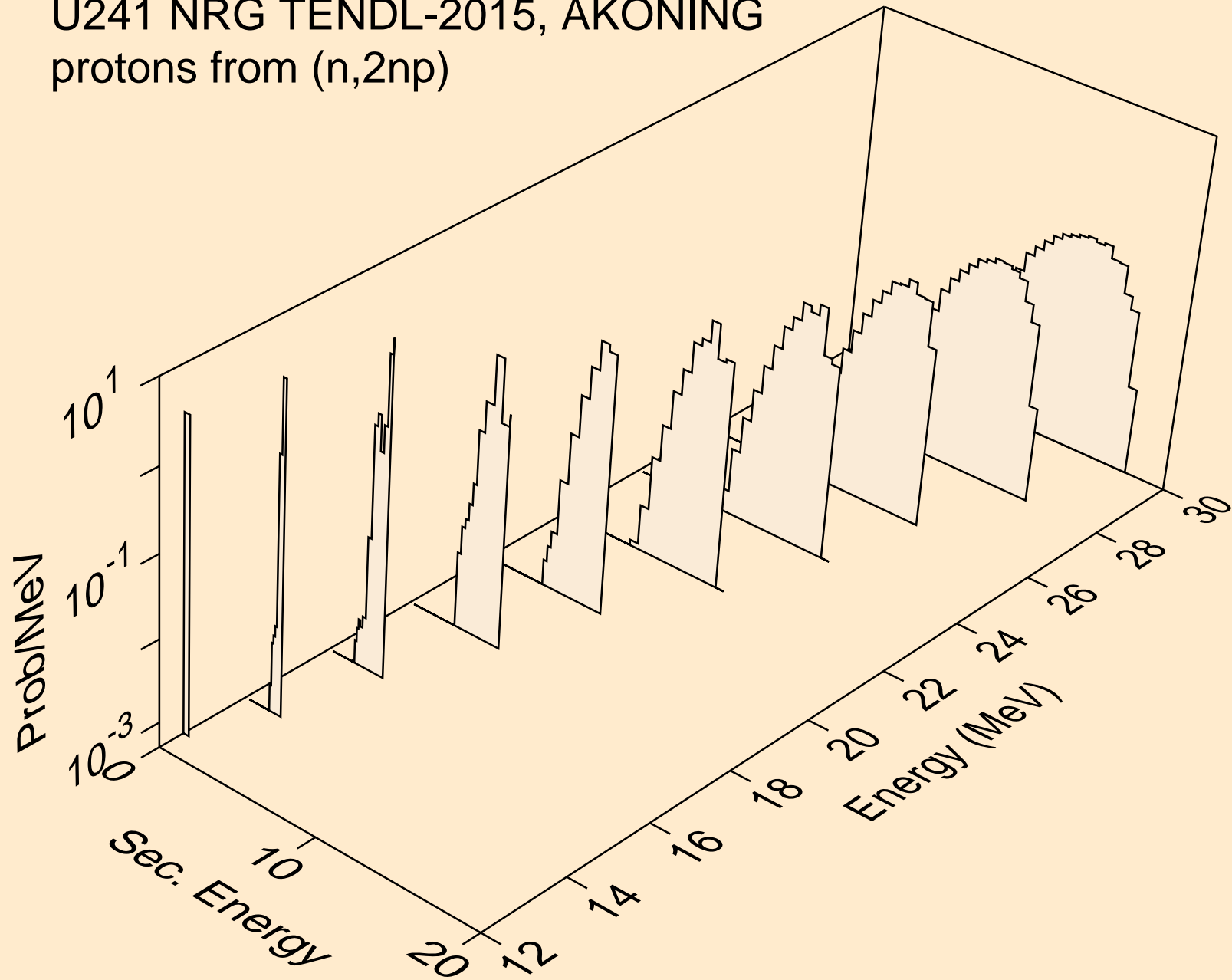

U241 NRG TENDL-2015, AKONING  
protons from (n,3np)

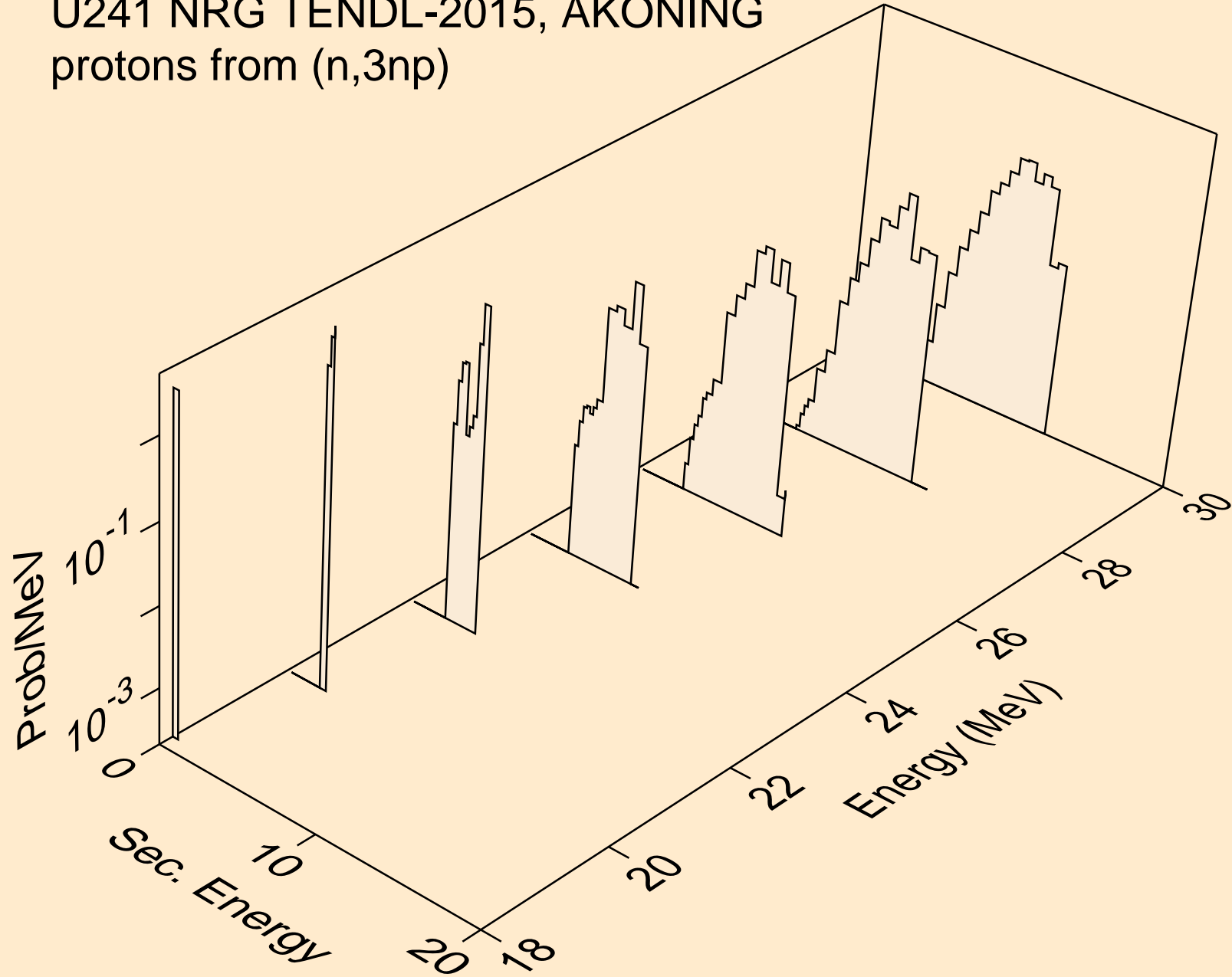

U241 NRG TENDL-2015, AKONING  
protons from (n,p)

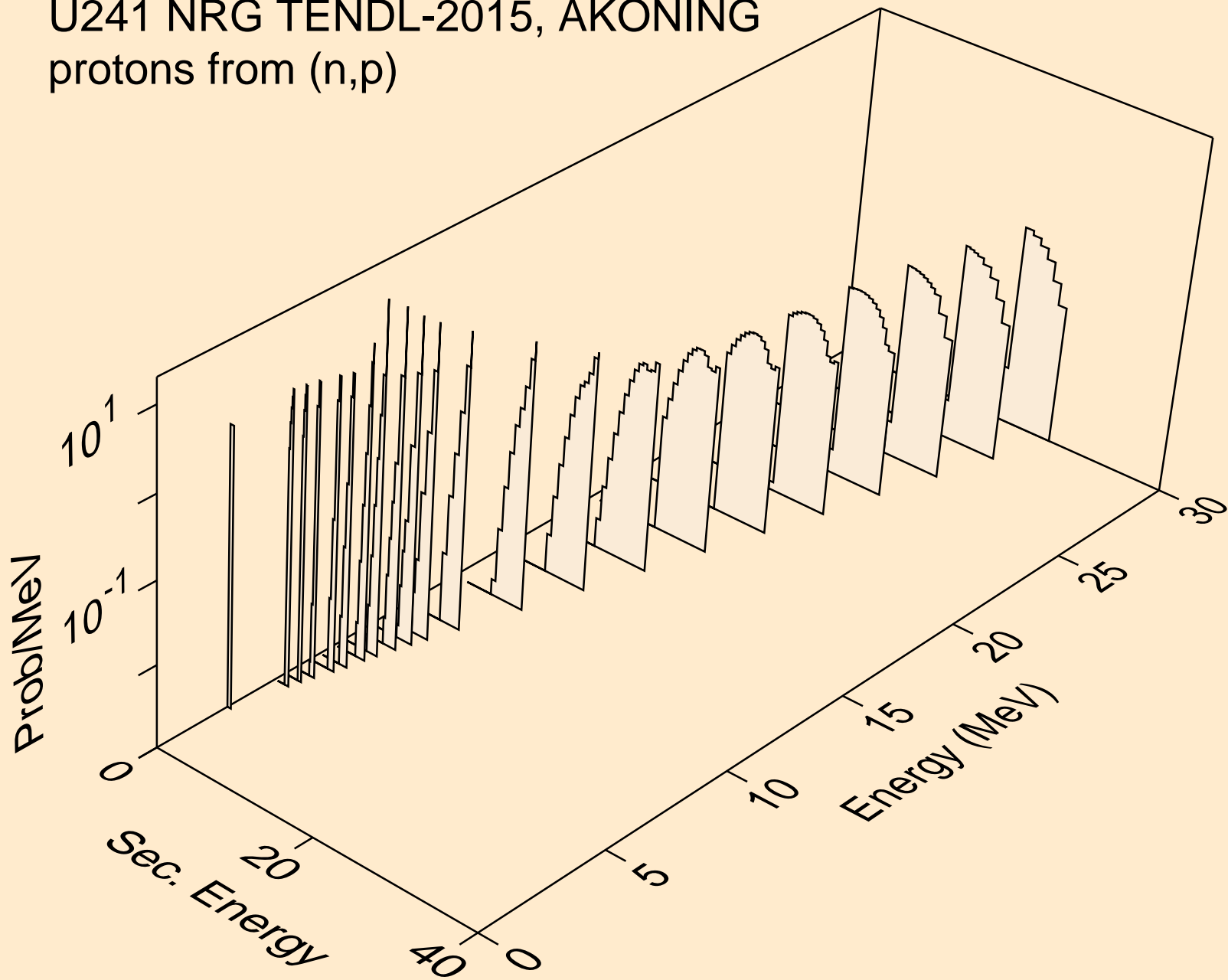

U241 NRG TENDL-2015, AKONING  
protons from (n,2p)

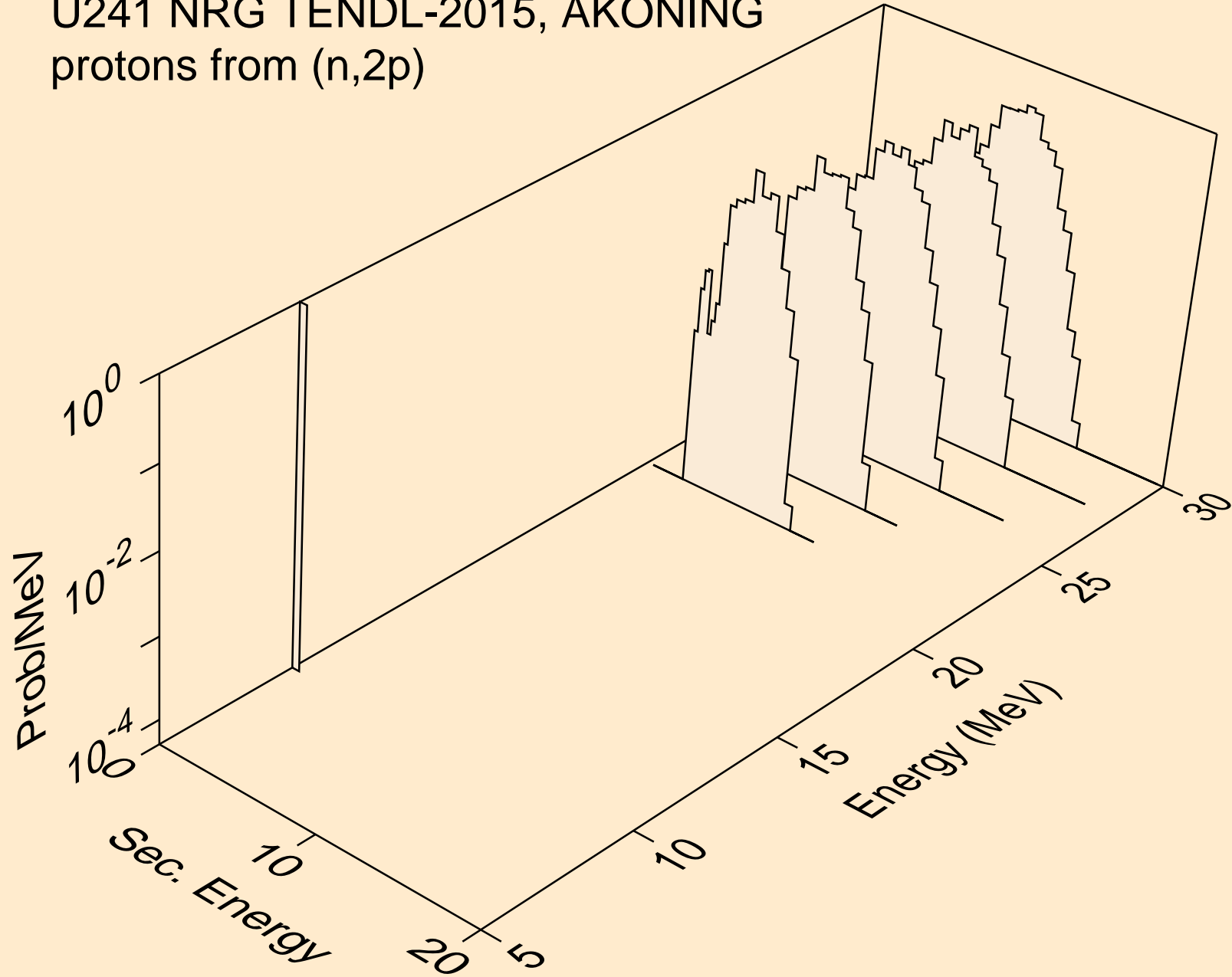



U241 NRG TENDL-2015, AKONING  
deuterons from (n,x)

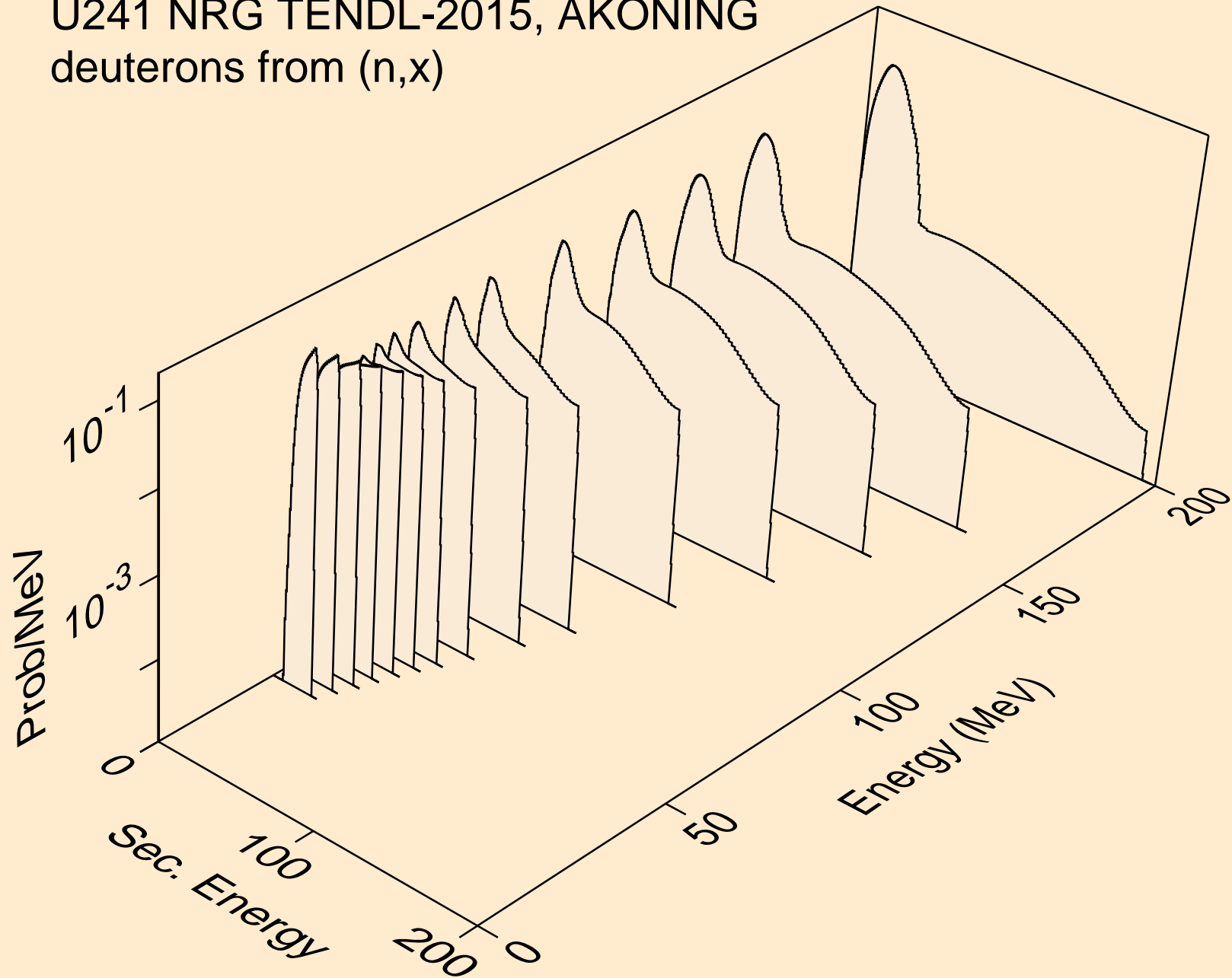

U241 NRG TENDL-2015, AKONING  
deuterons from (n,2nd)

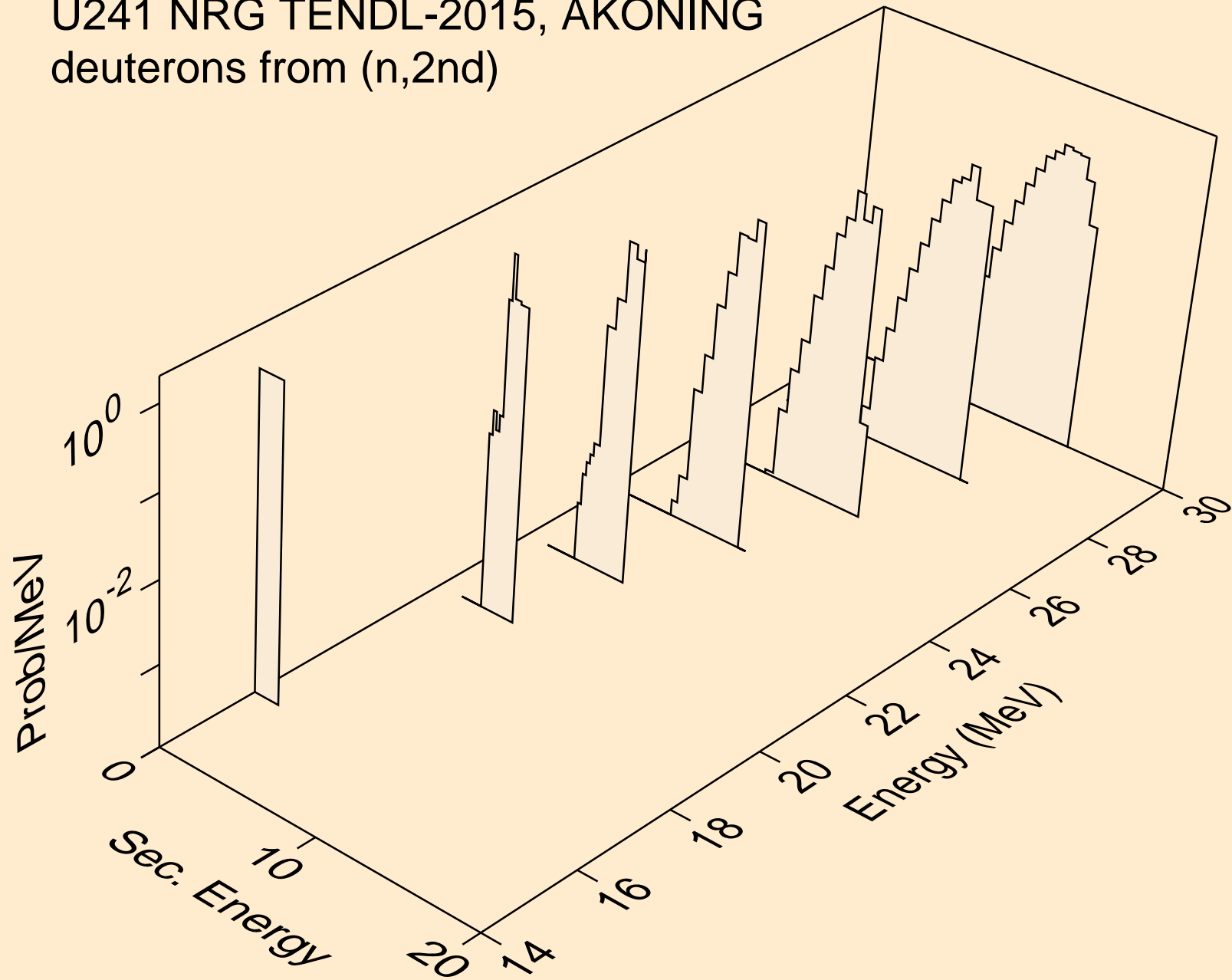

U241 NRG TENDL-2015, AKONING  
deuterons from (n,n\*)d

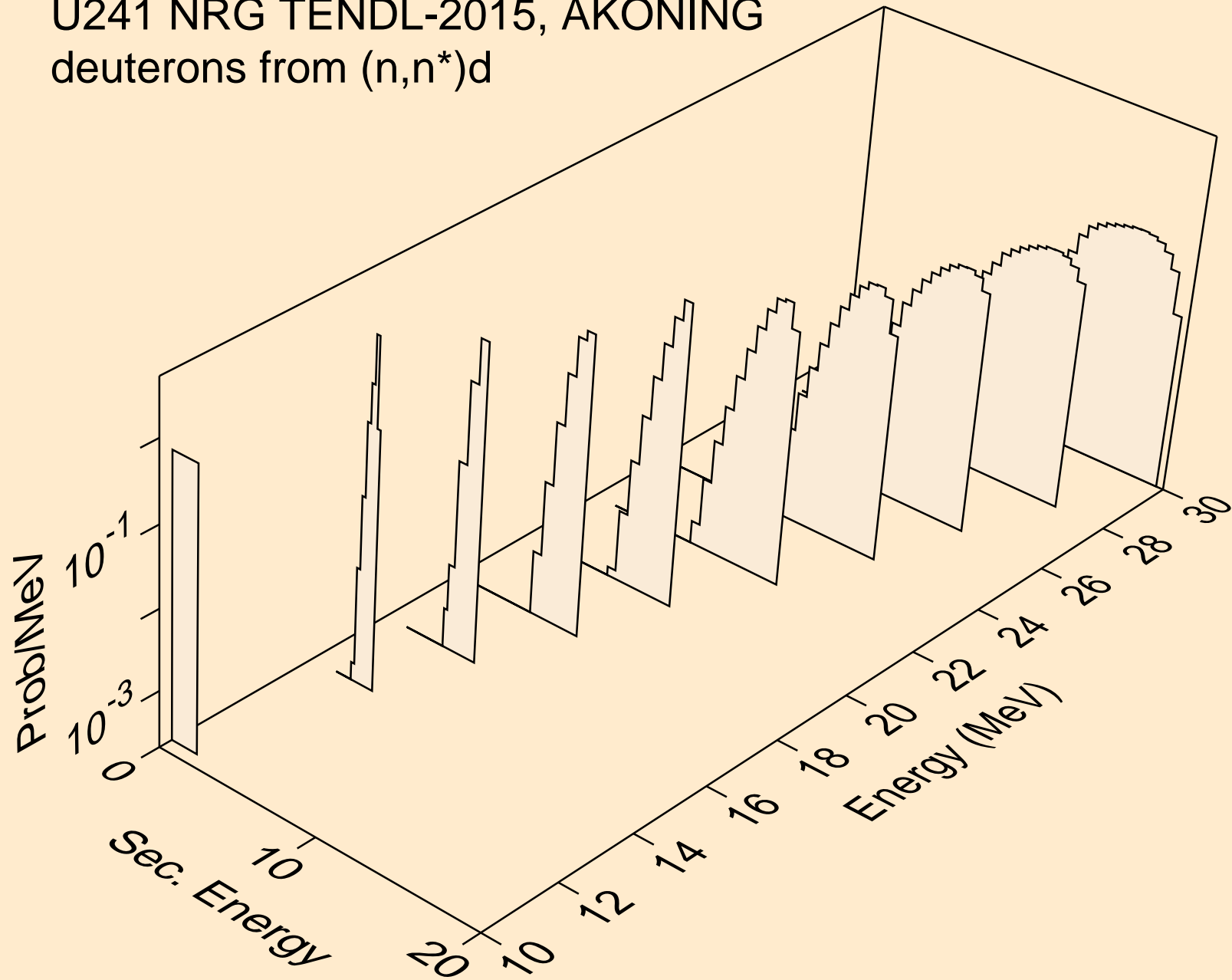

U241 NRG TENDL-2015, AKONING  
deuterons from (n,d)

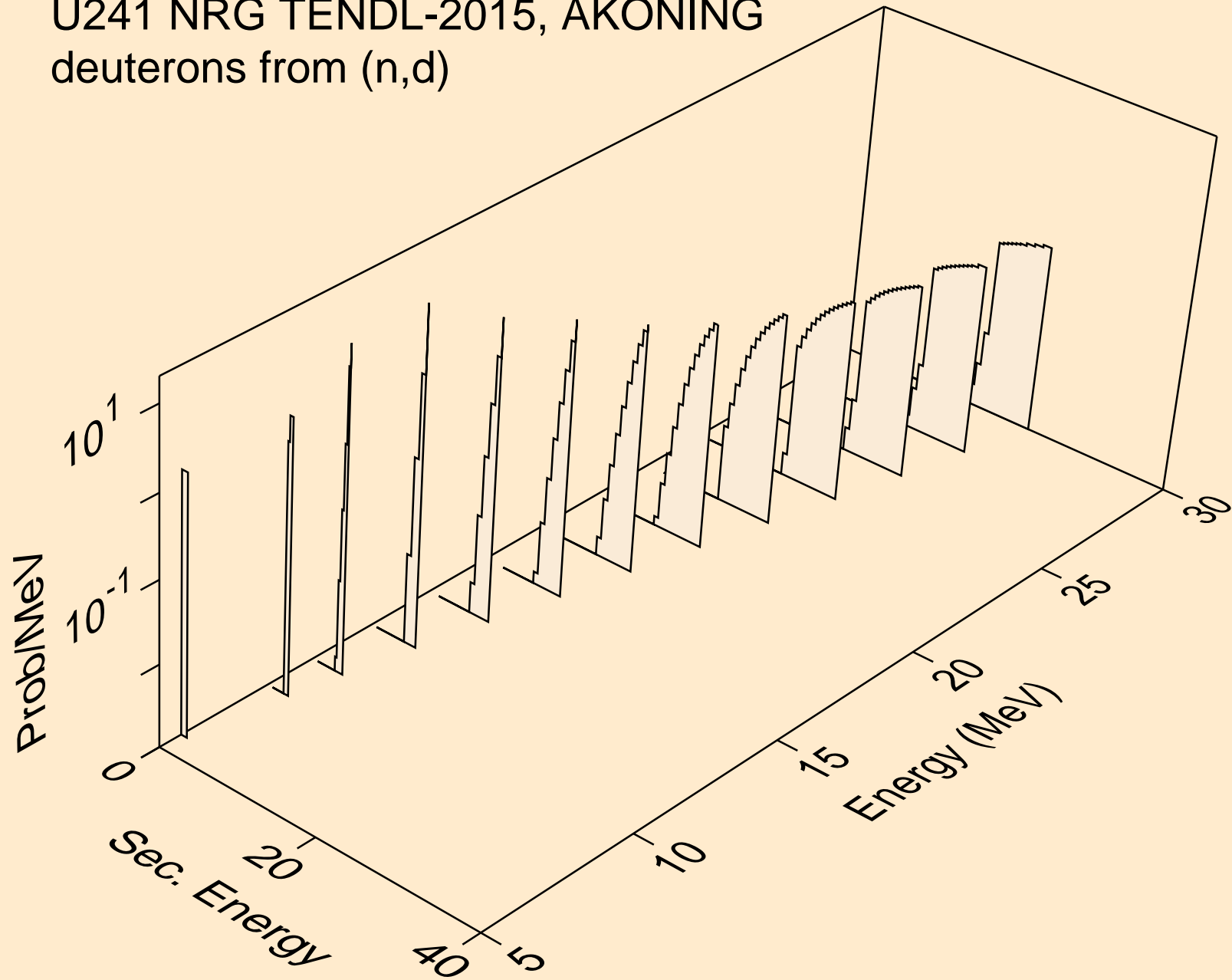

U241 NRG TENDL-2015, AKONING  
tritons from (n,x)

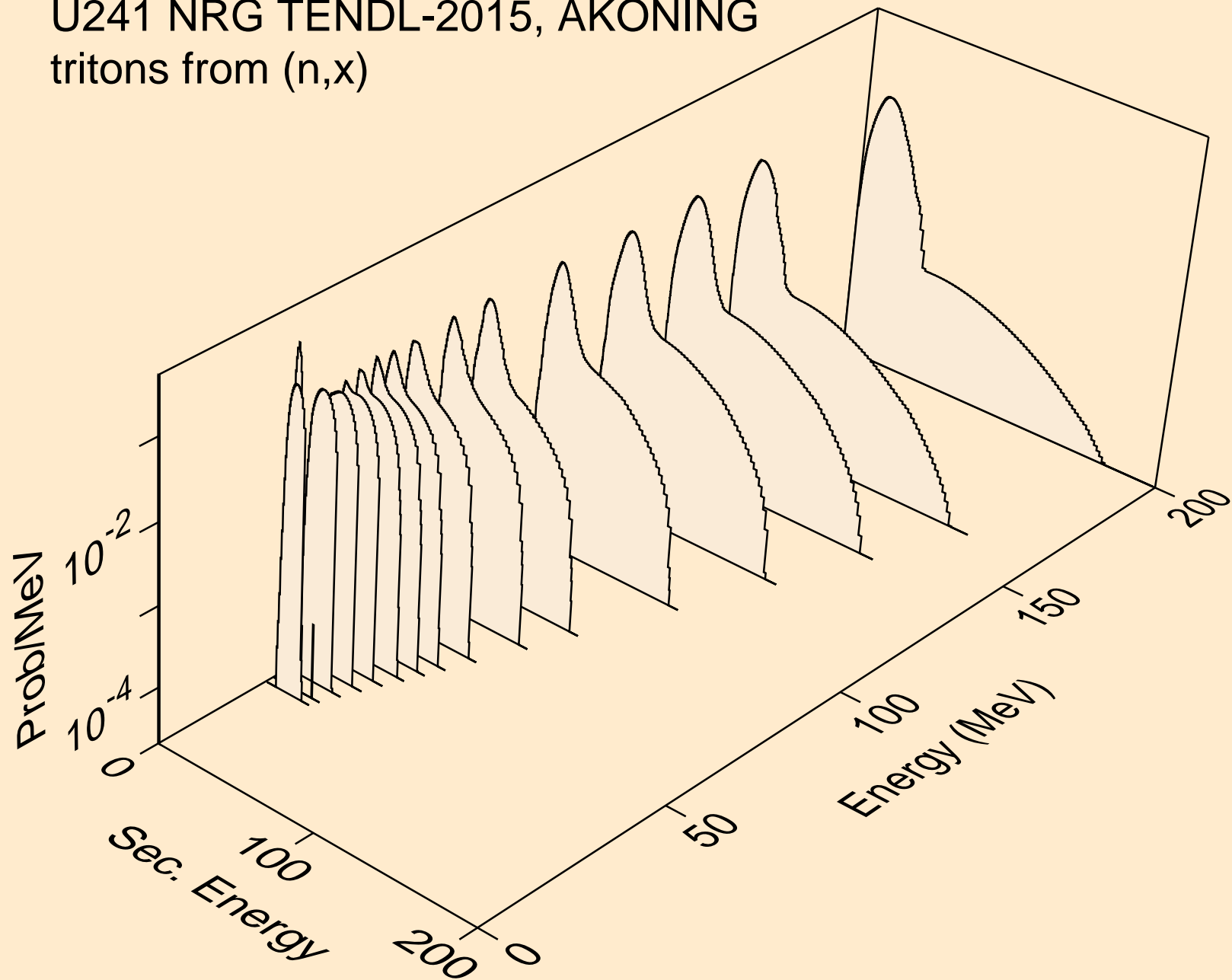

U241 NRG TENDL-2015, AKONING  
tritons from (n,n\*)t

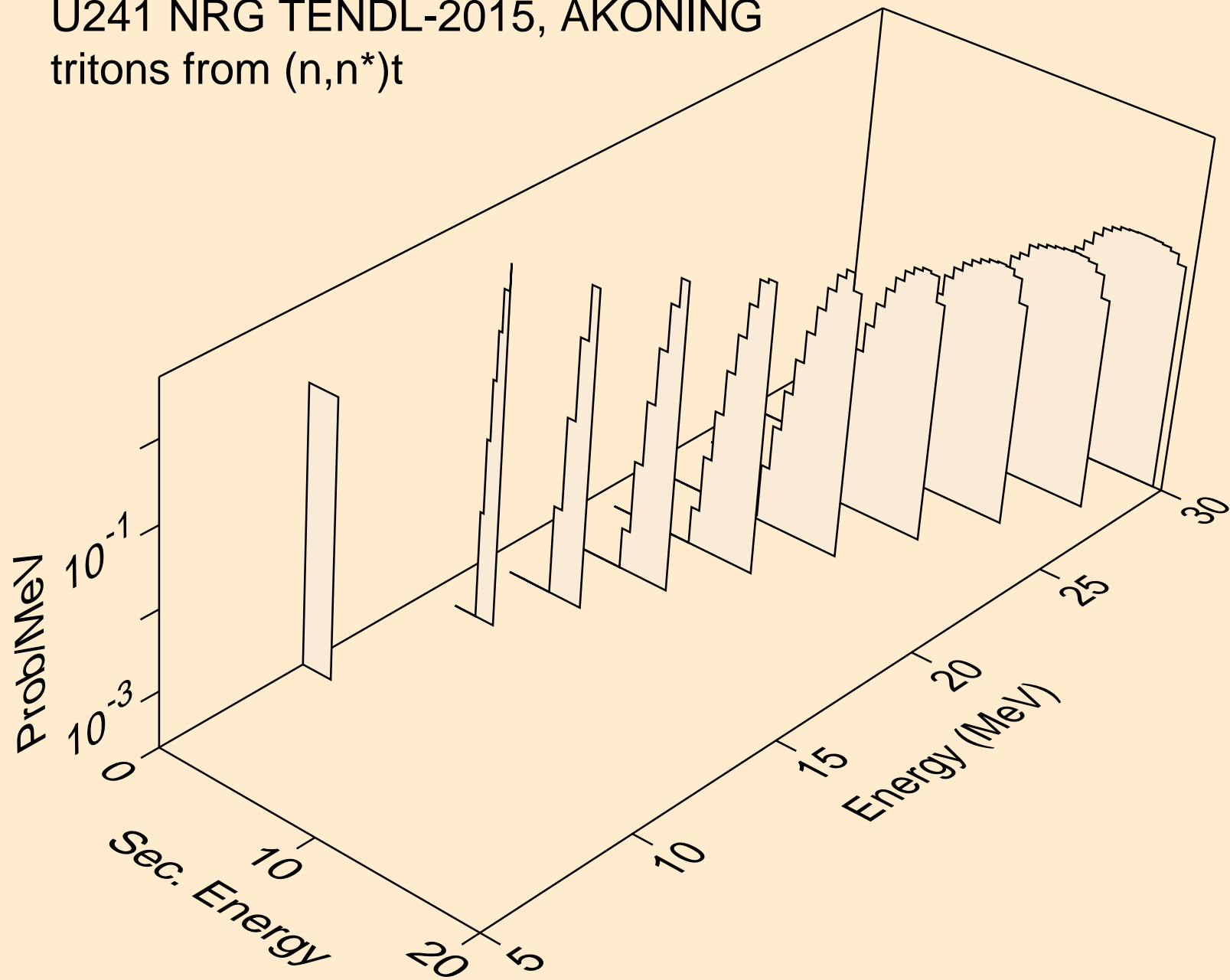

U241 NRG TENDL-2015, AKONING  
tritons from (n,t)

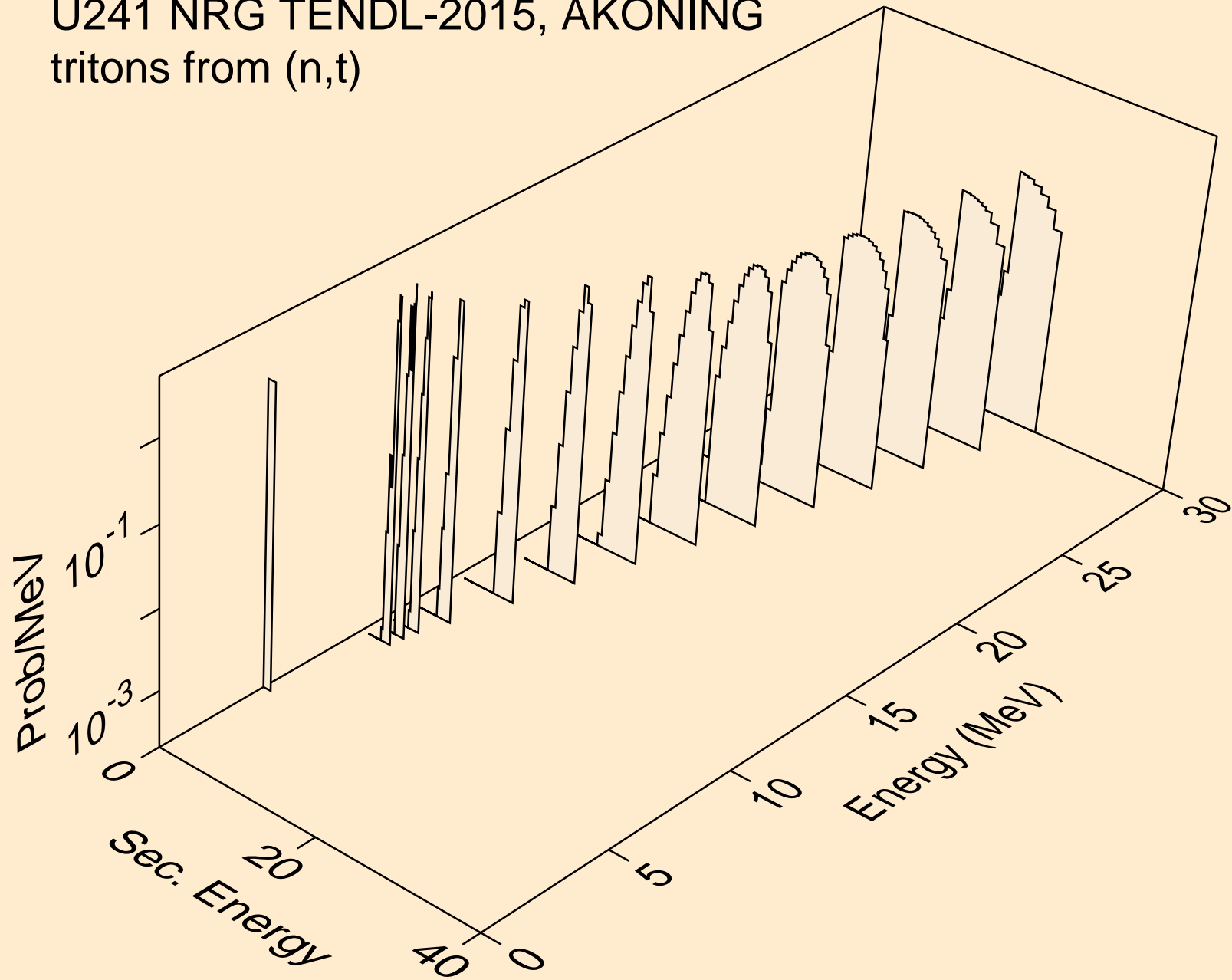

U241 NRG TENDL-2015, AKONING  
he3s from (n,x)

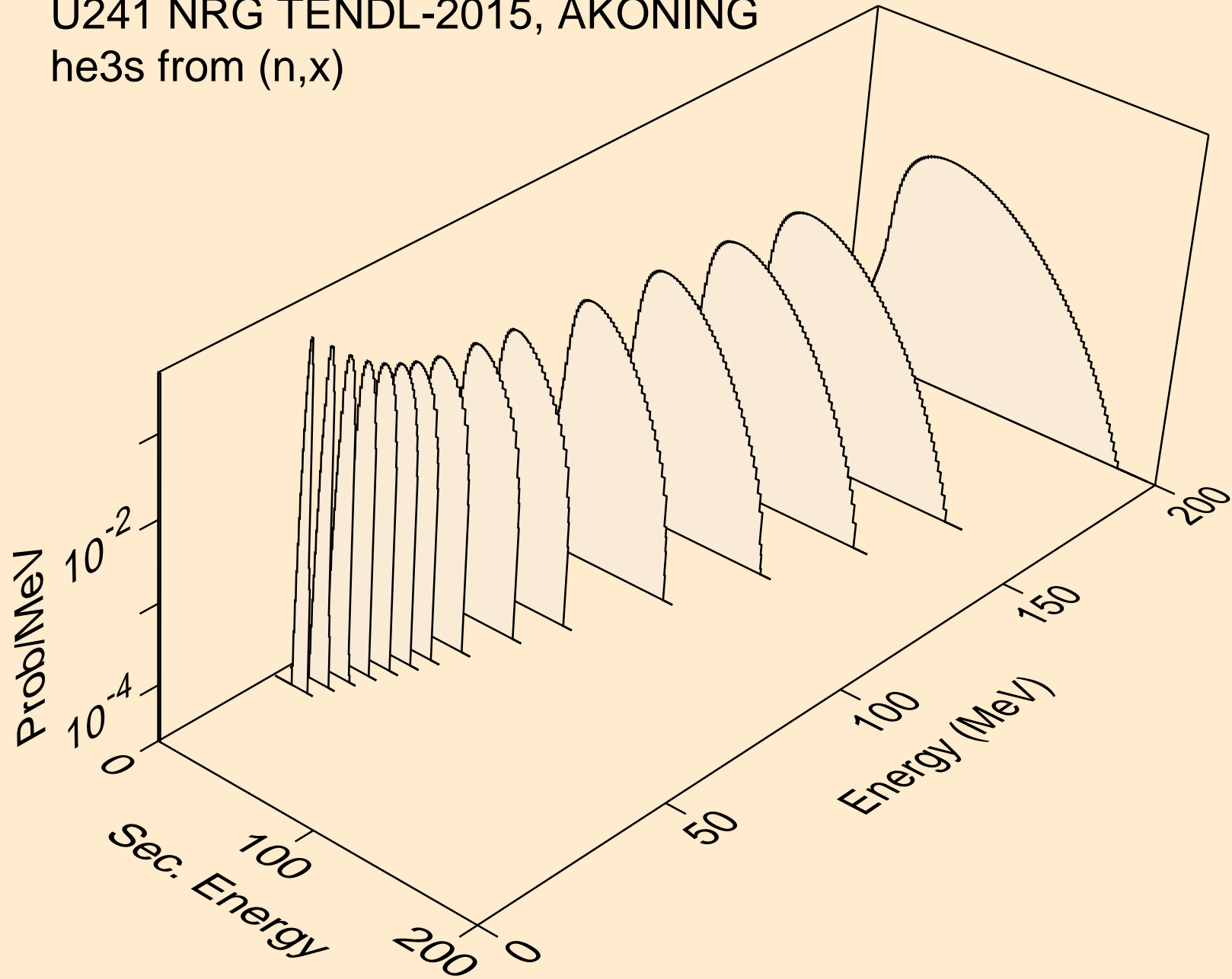



U241 NRG TENDL-2015, AKONING  
he3s from (n,n\*)he3

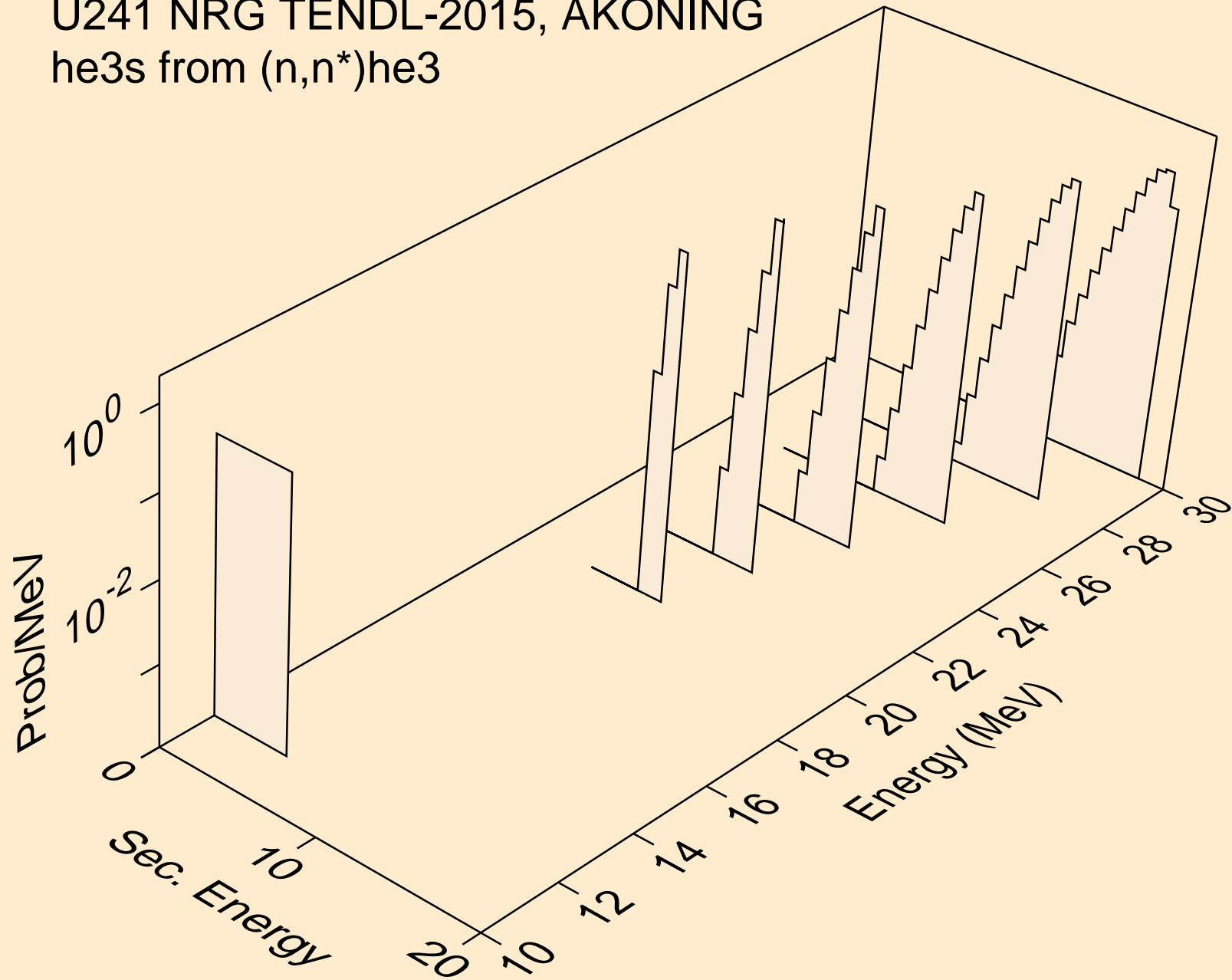

U241 NRG TENDL-2015, AKONING  
he3s from (n,he3)

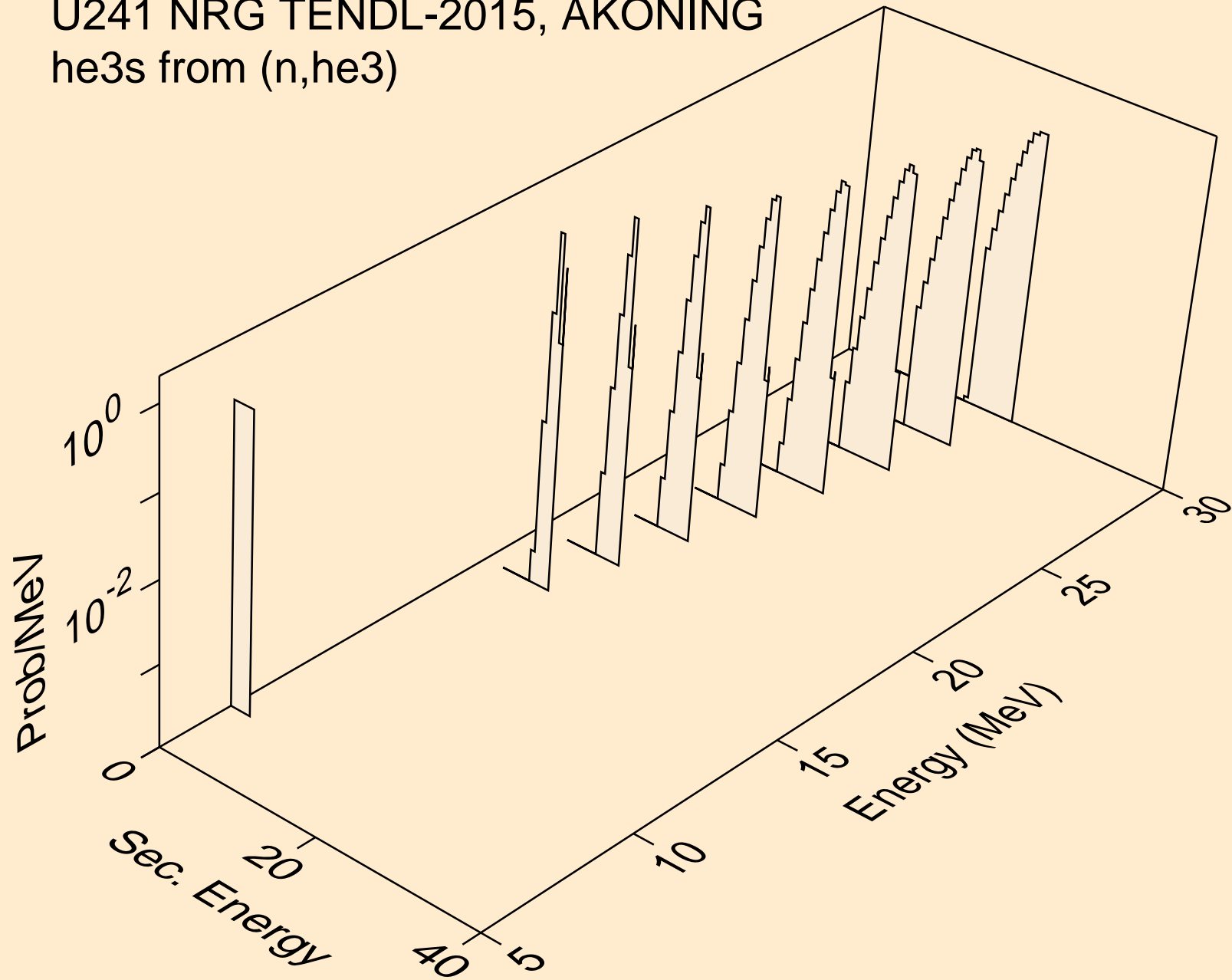

U241 NRG TENDL-2015, AKONING  
alphas from (n,x)

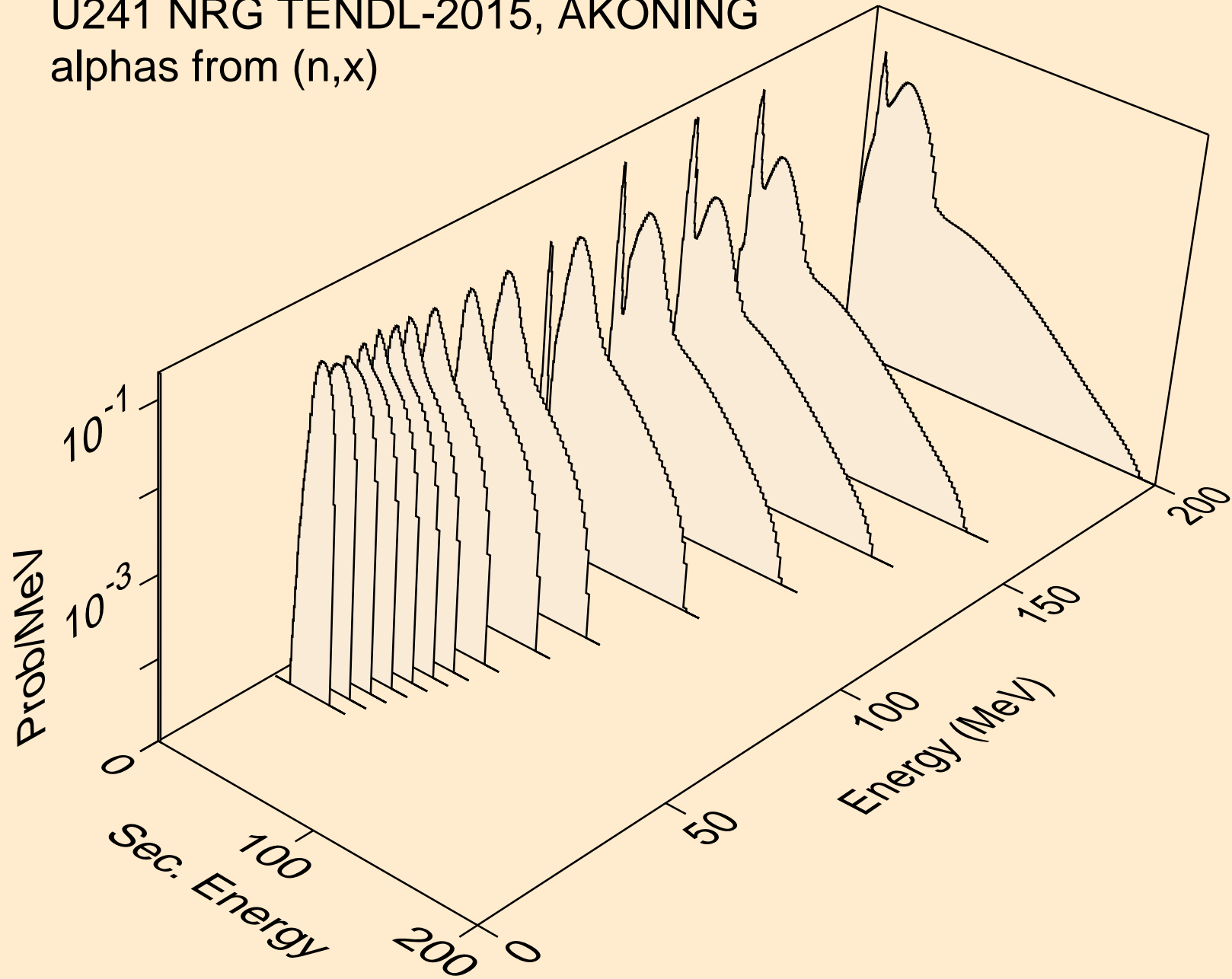

U241 NRG TENDL-2015, AKONING  
alphas from (n,n\*)a

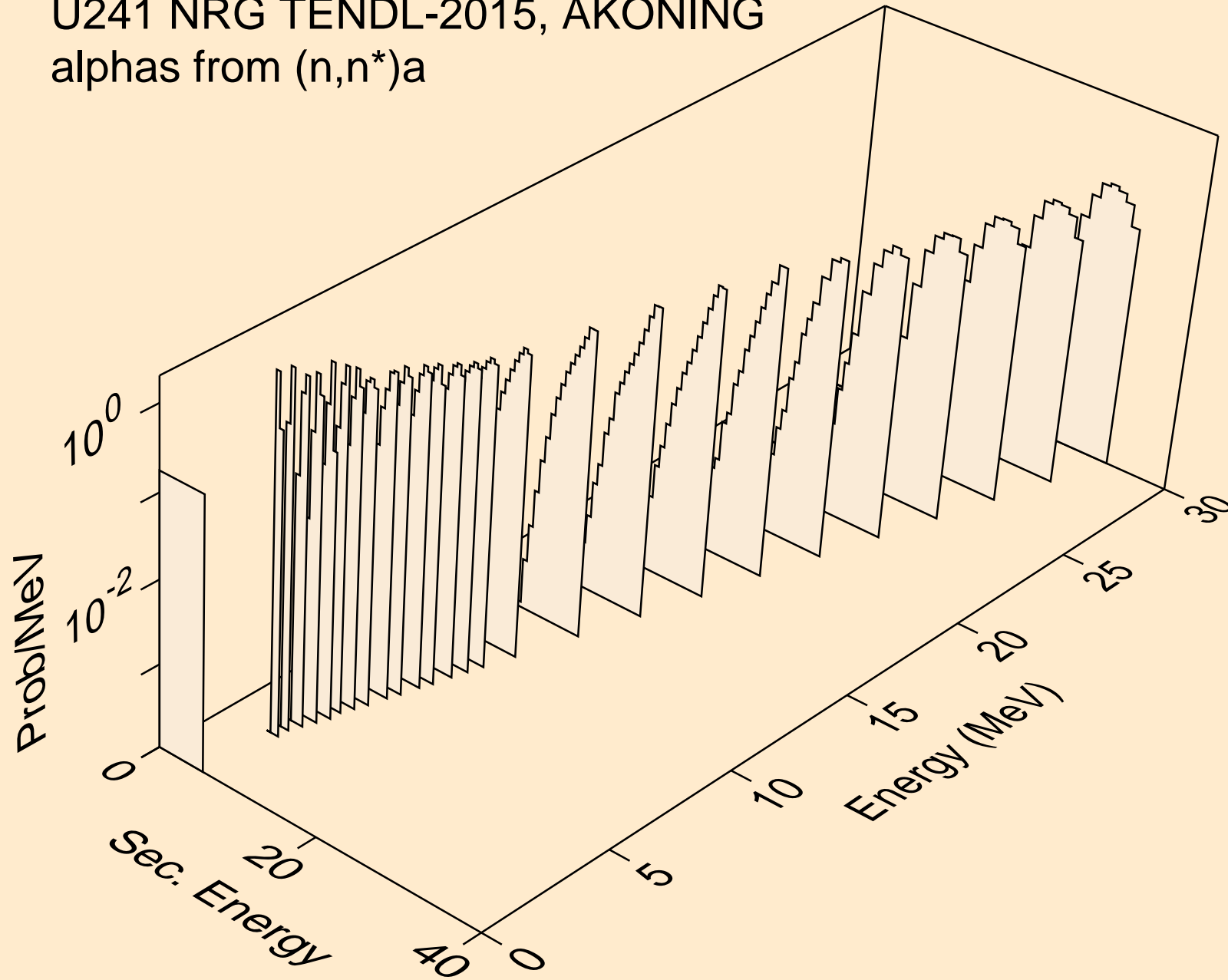

U241 NRG TENDL-2015, AKONING  
alphas from (n,2n)a

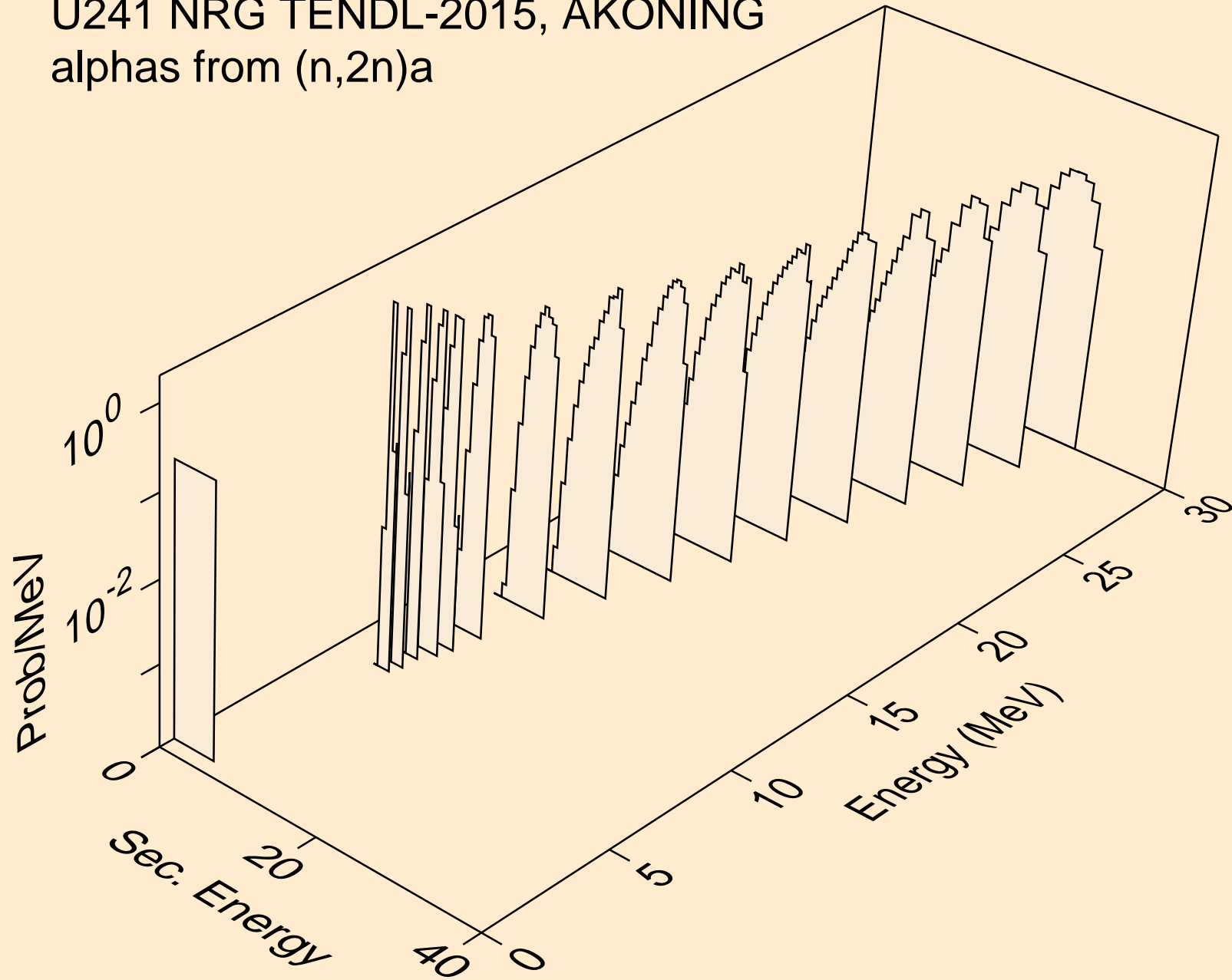

U241 NRG TENDL-2015, AKONING  
alphas from (n,3n)a

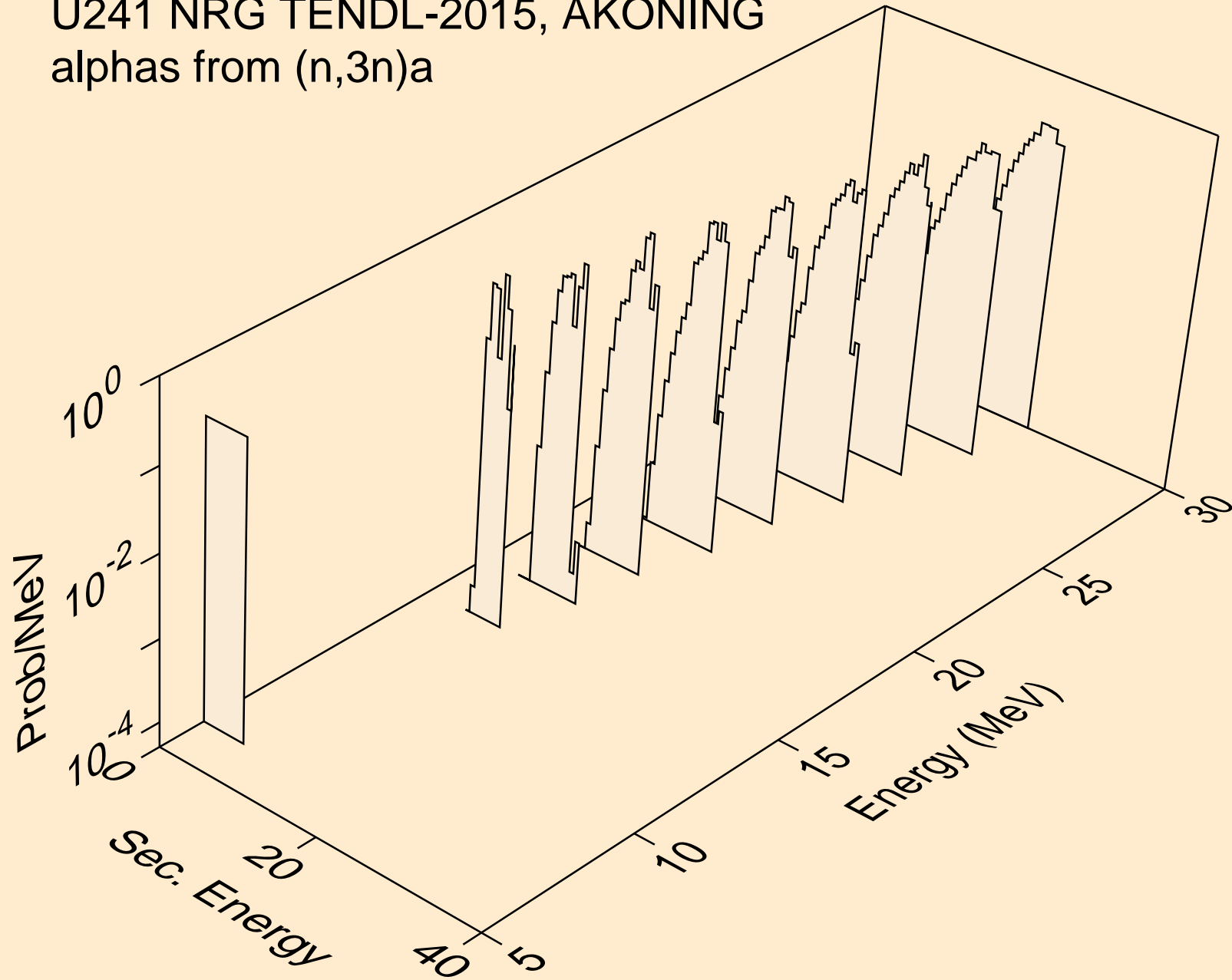

U241 NRG TENDL-2015, AKONING  
alphas from (n,a)

