

U242 NRG TENDL-2015, AKONING

Principal cross sections

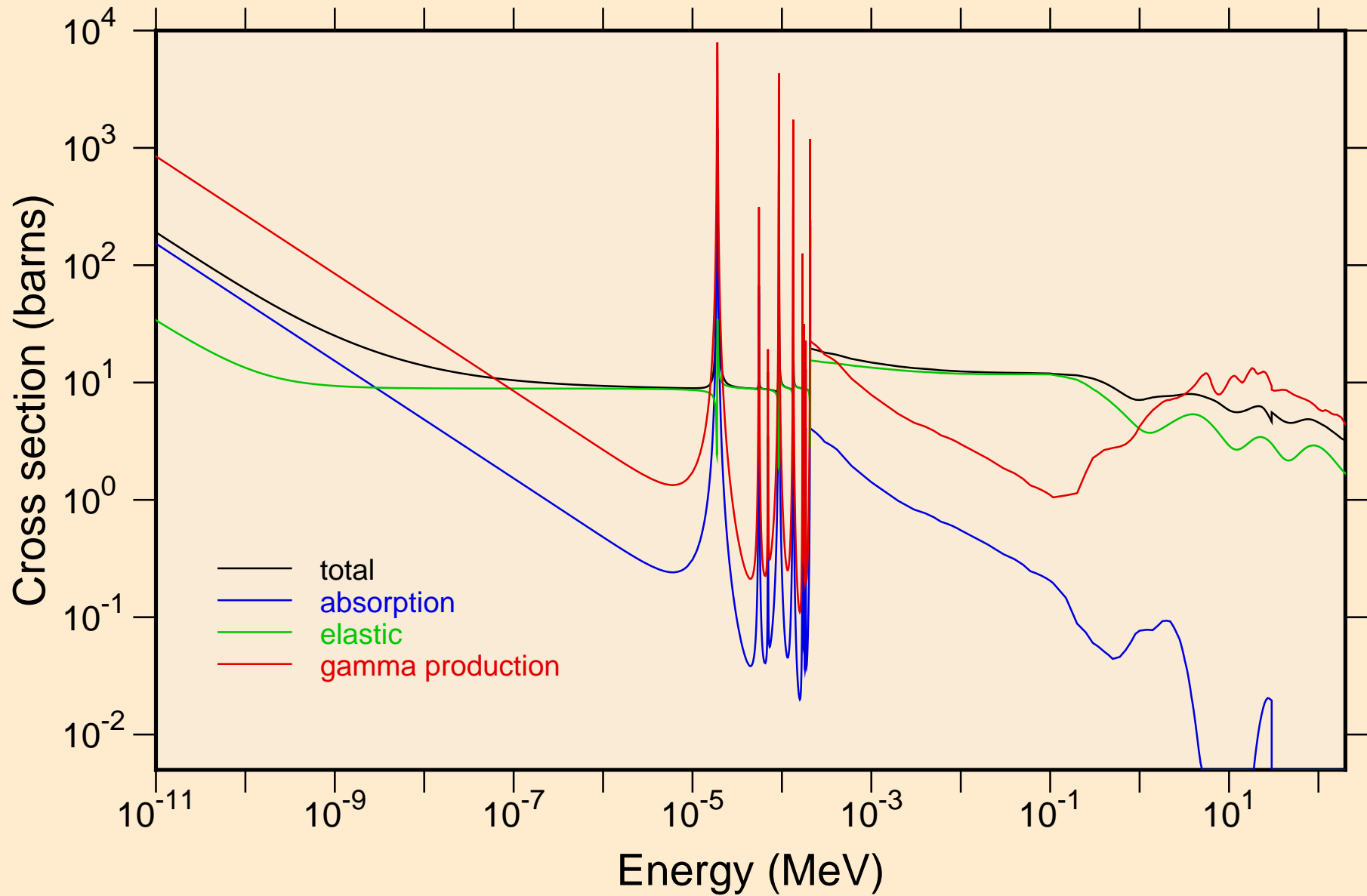

U242 NRG TENDL-2015, AKONING

Non-threshold reactions

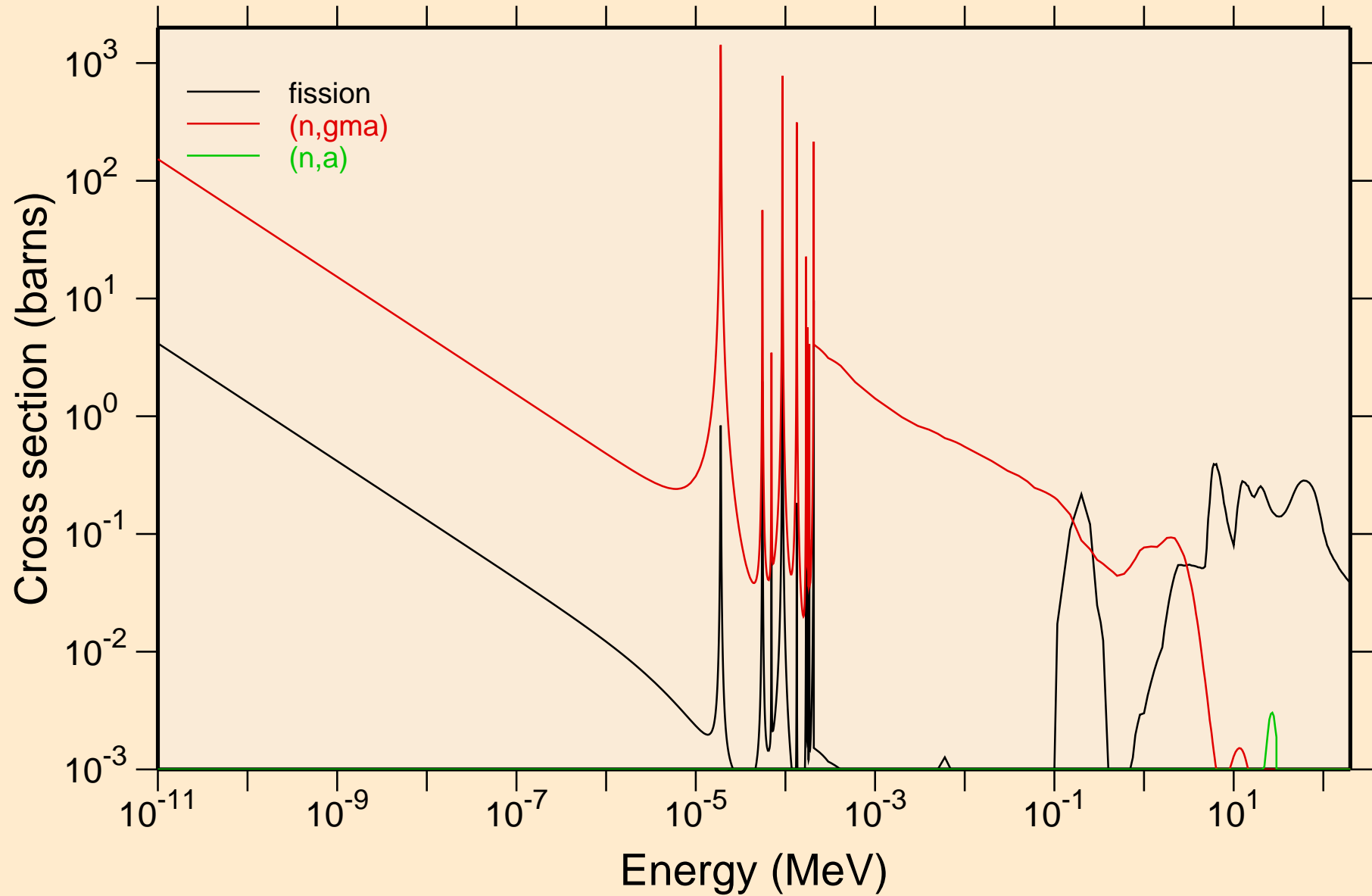

U242 NRG TENDL-2015, AKONING

Principal cross sections

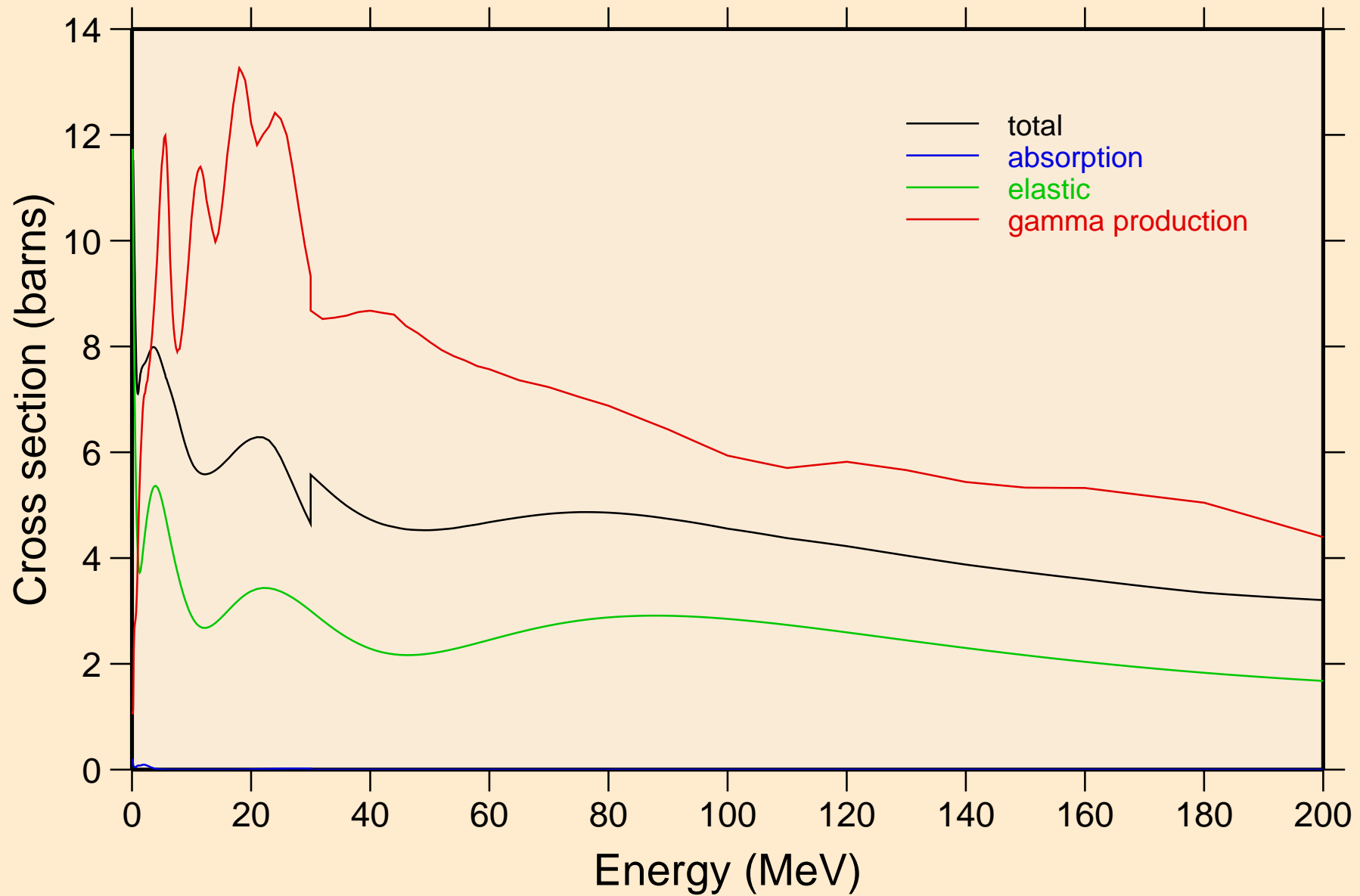

U242 NRG TENDL-2015, AKONING

Non-threshold reactions

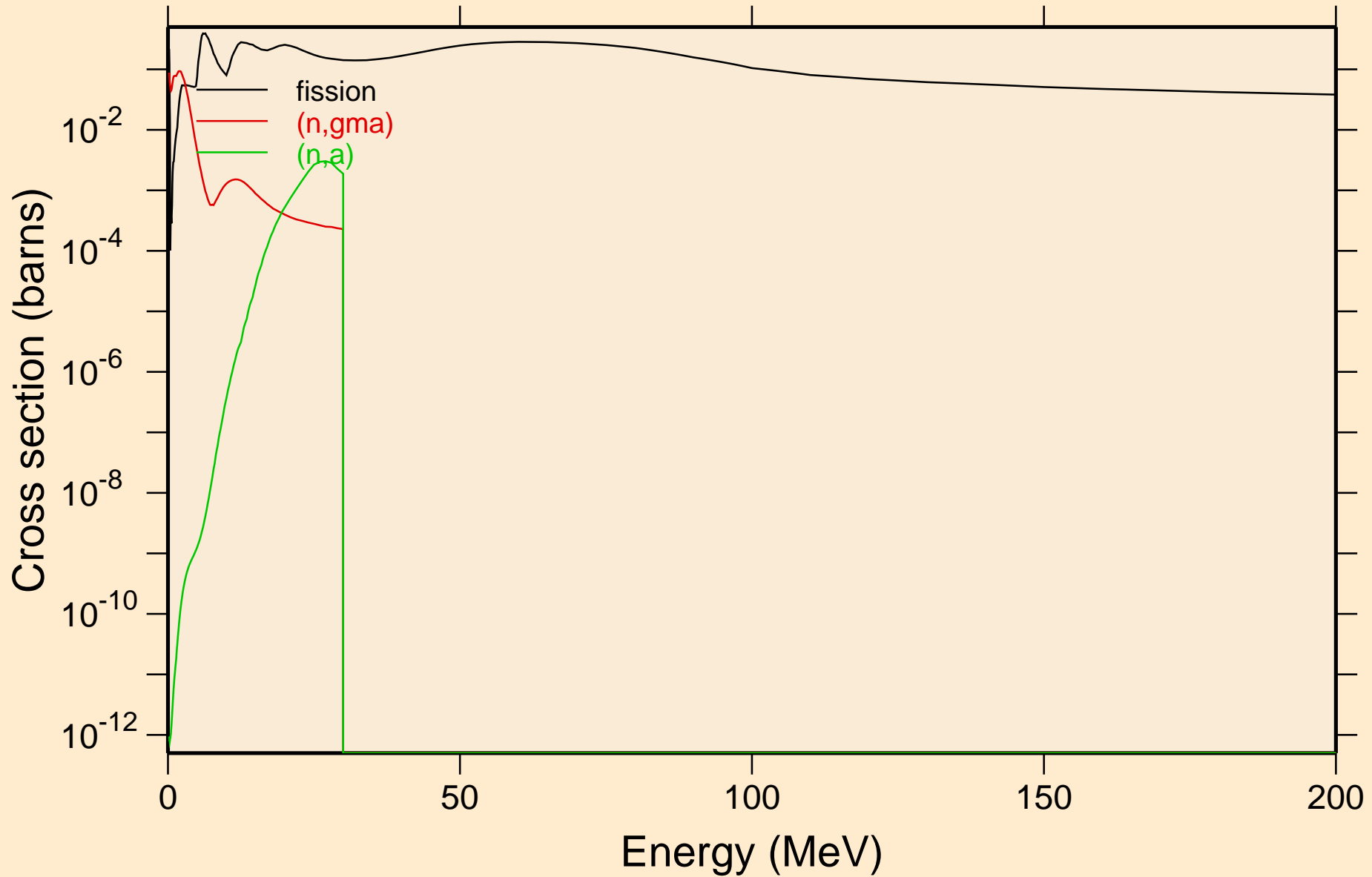

U242 NRG TENDL-2015, AKONING
Inelastic levels

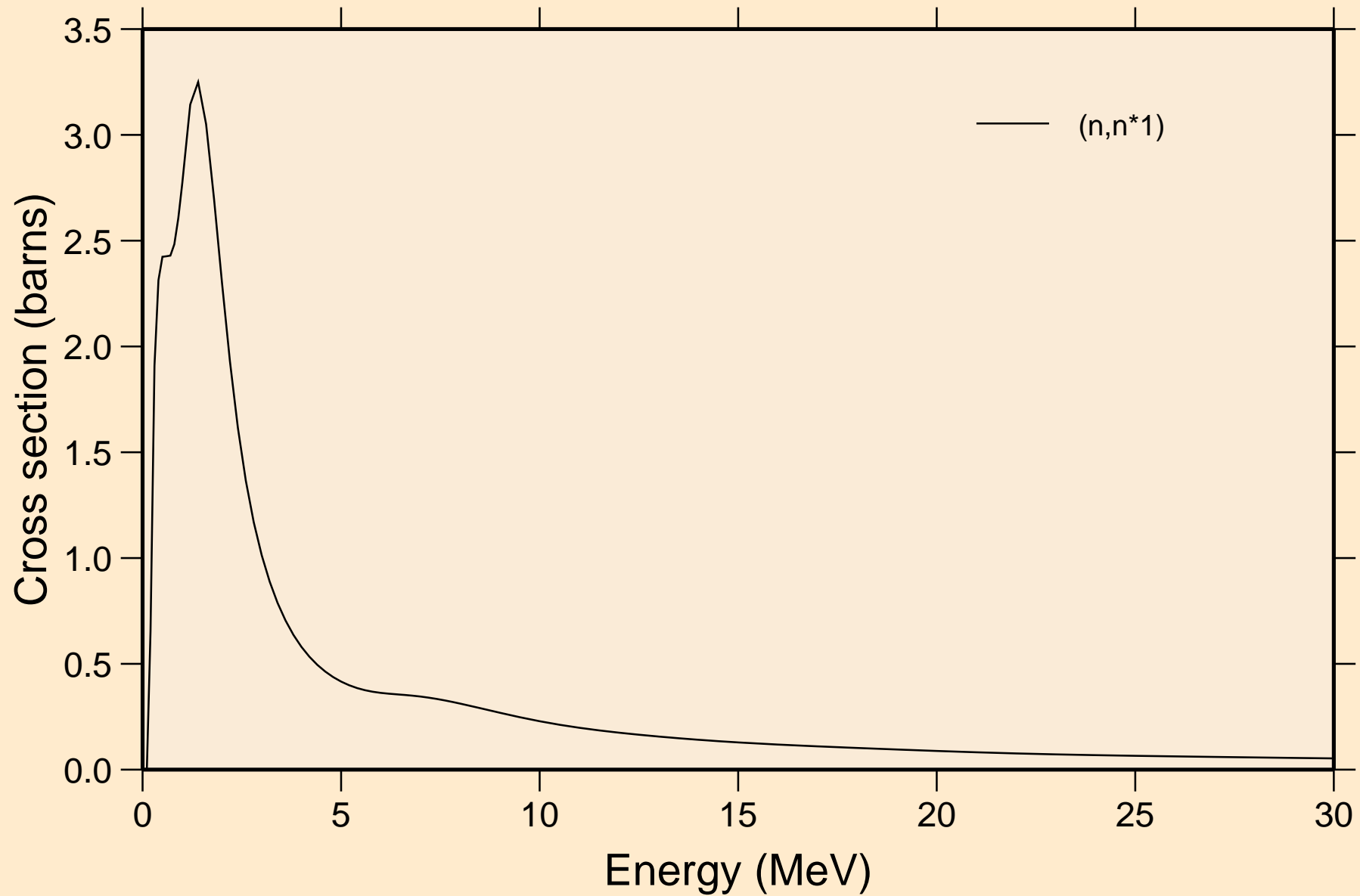

U242 NRG TENDL-2015, AKONING

Threshold reactions

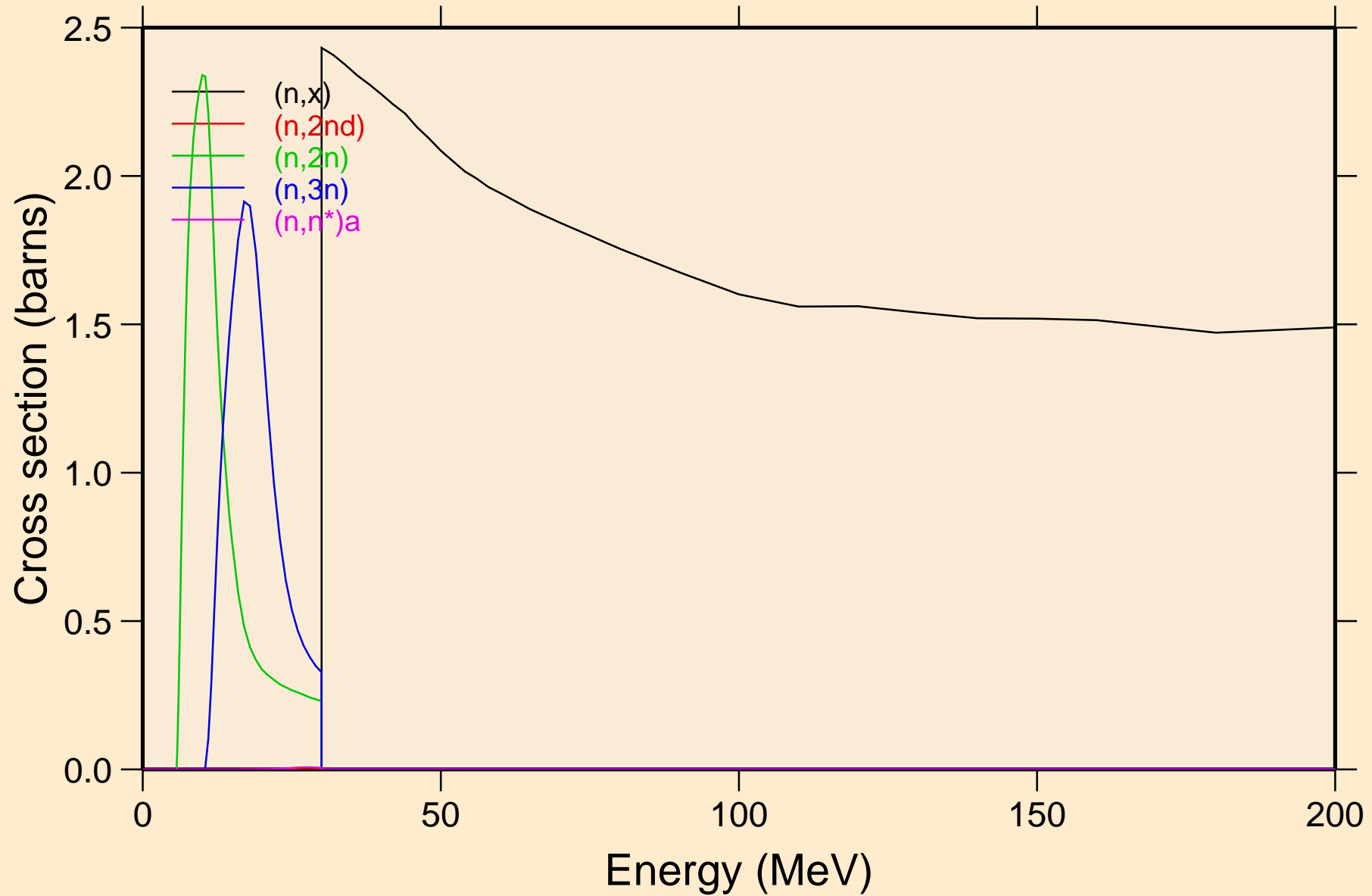

U242 NRG TENDL-2015, AKONING

Threshold reactions

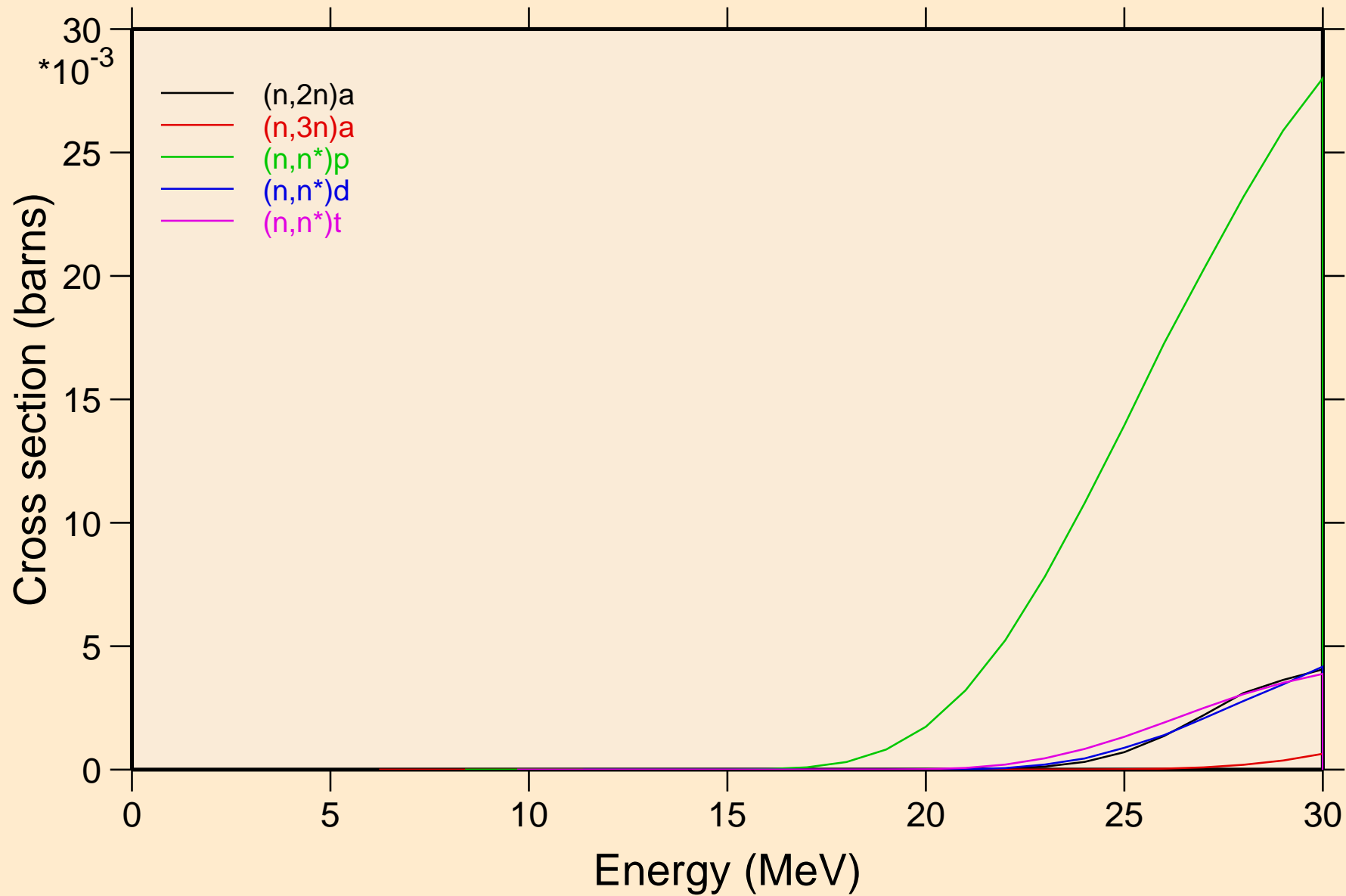

U242 NRG TENDL-2015, AKONING

Threshold reactions

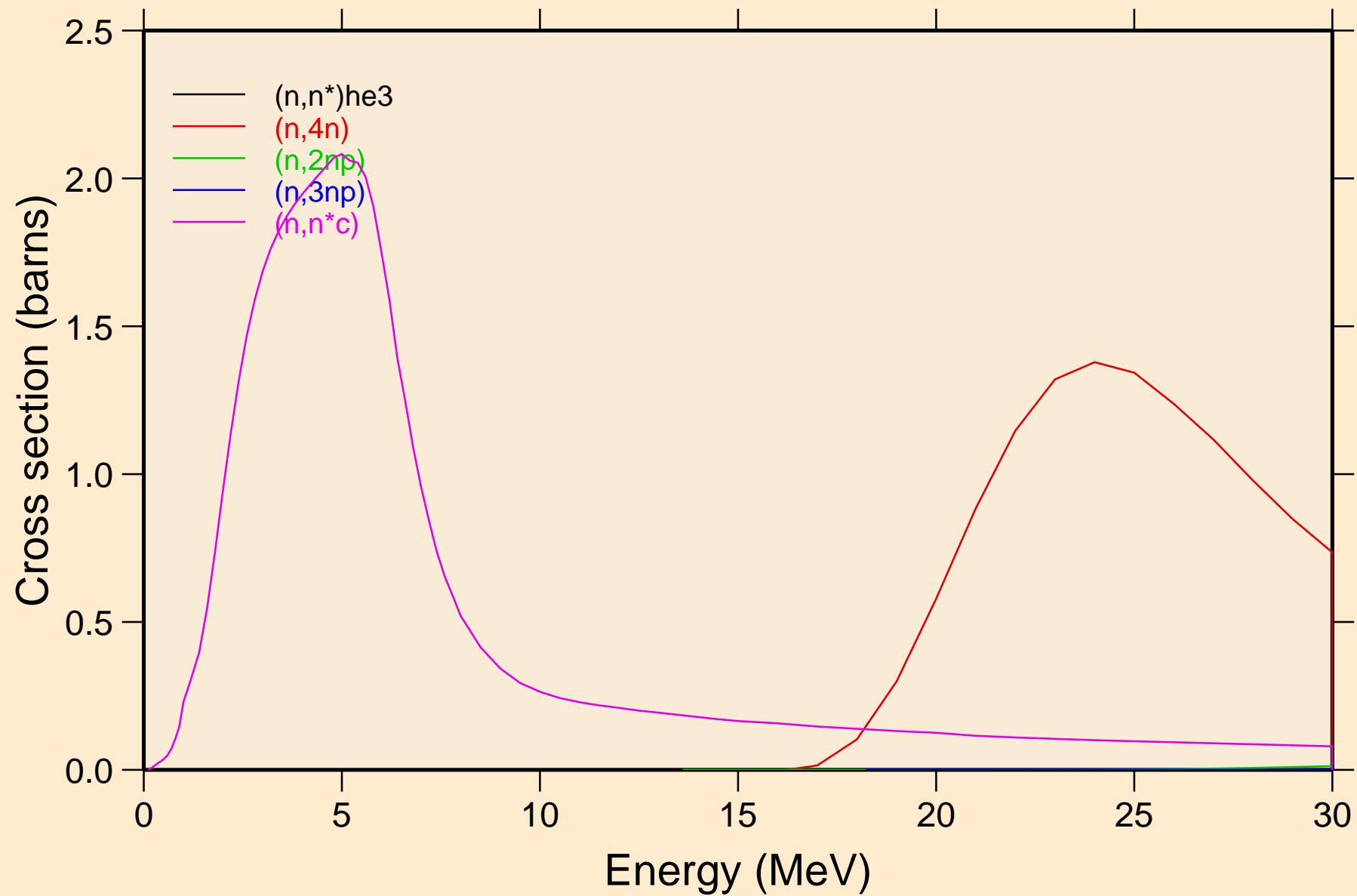

U242 NRG TENDL-2015, AKONING

Threshold reactions

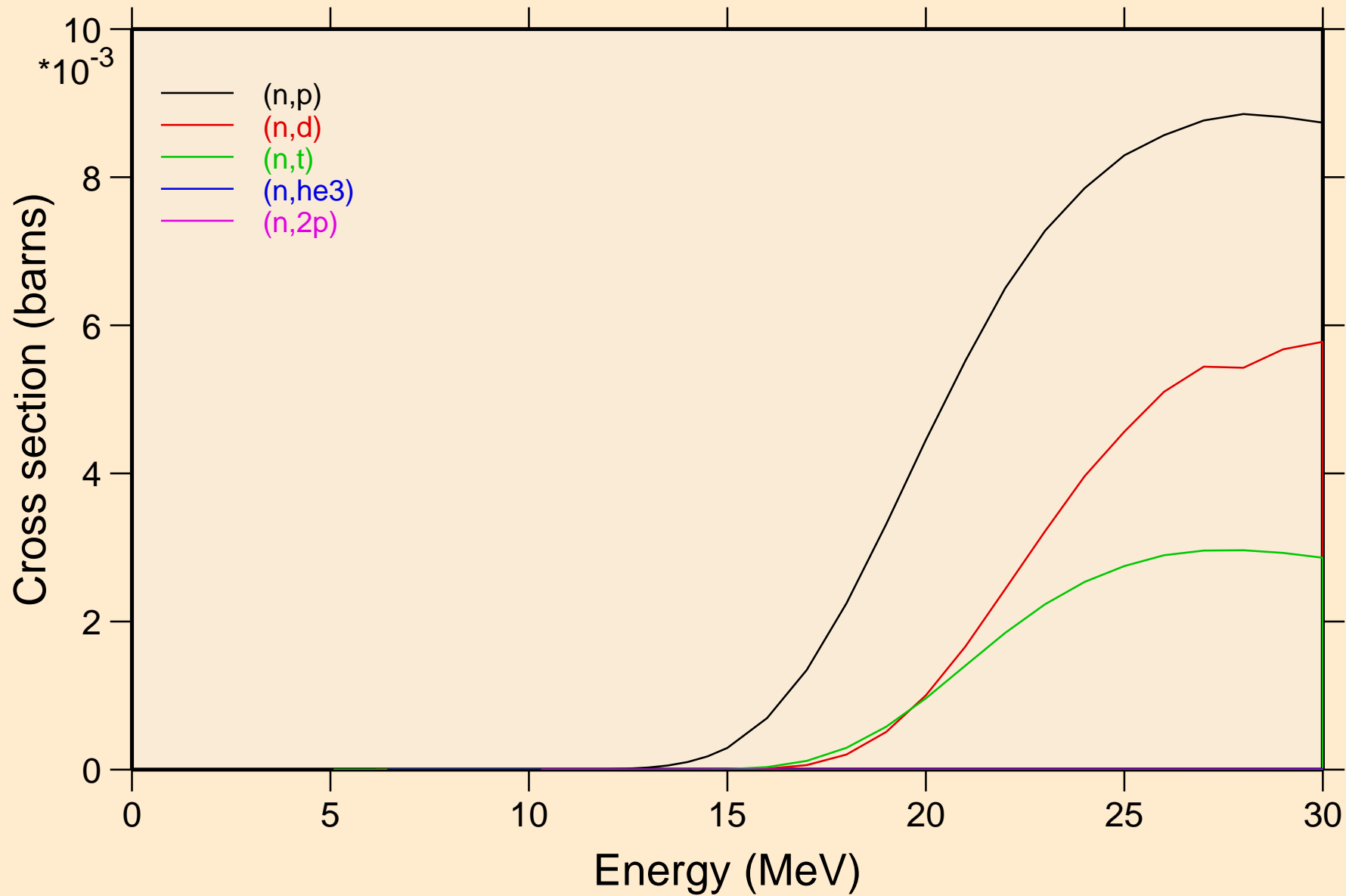

U242 NRG TENDL-2015, AKONING
angular distribution for elastic

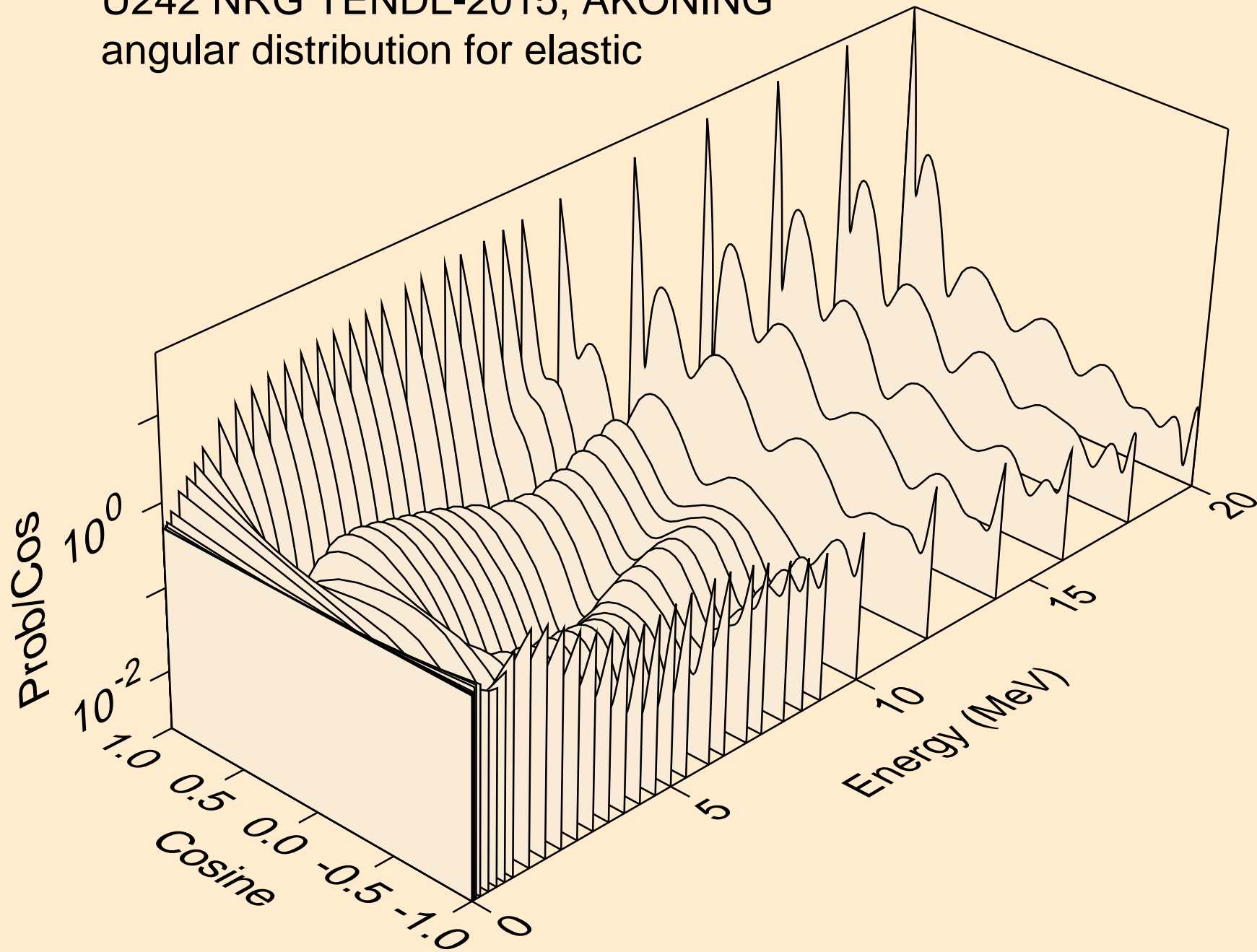

U242 NRG TENDL-2015, AKONING
angular distribution for elastic

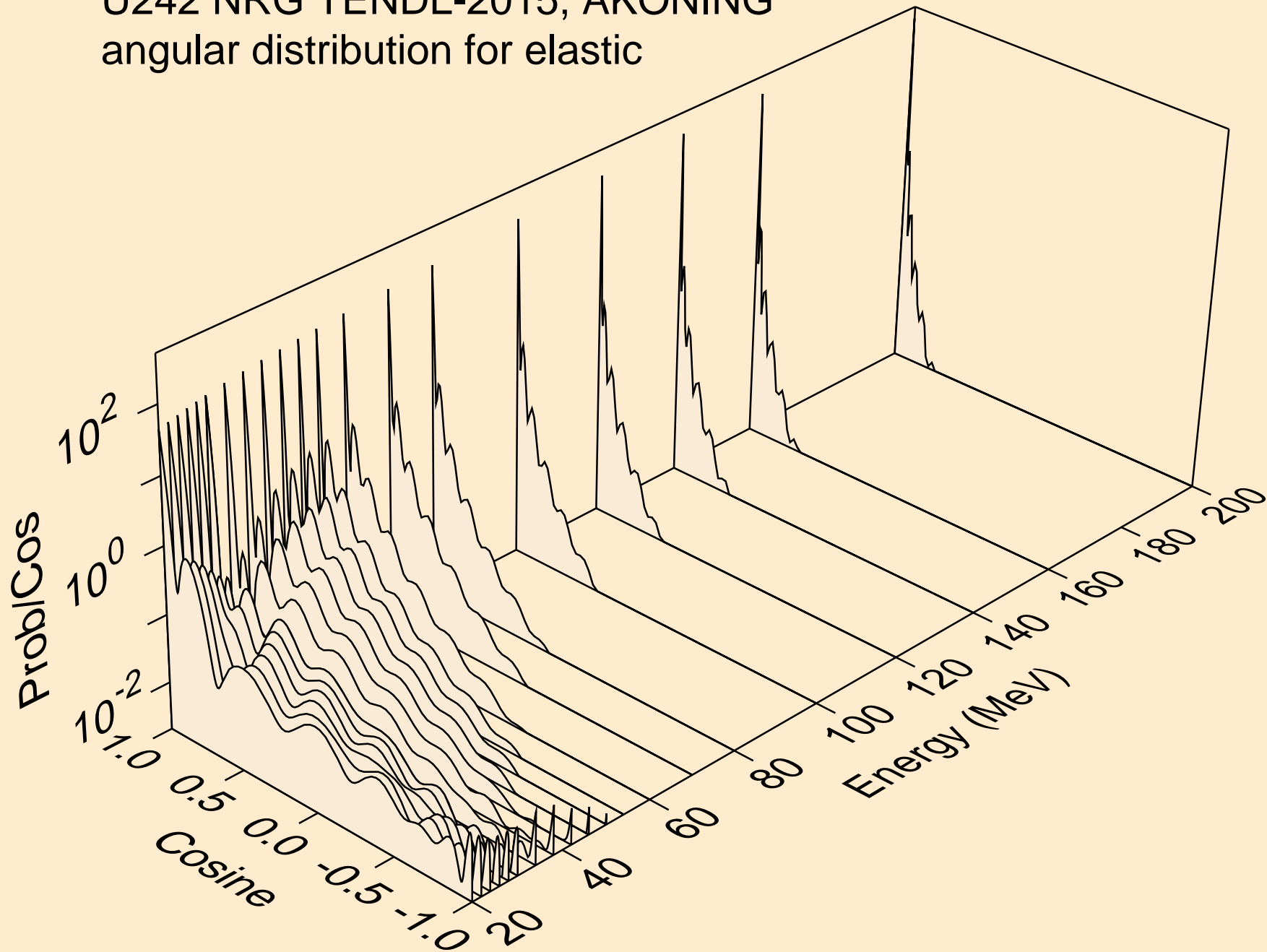

U242 NRG TENDL-2015, AKONING
angular distribution for (n,n*1)

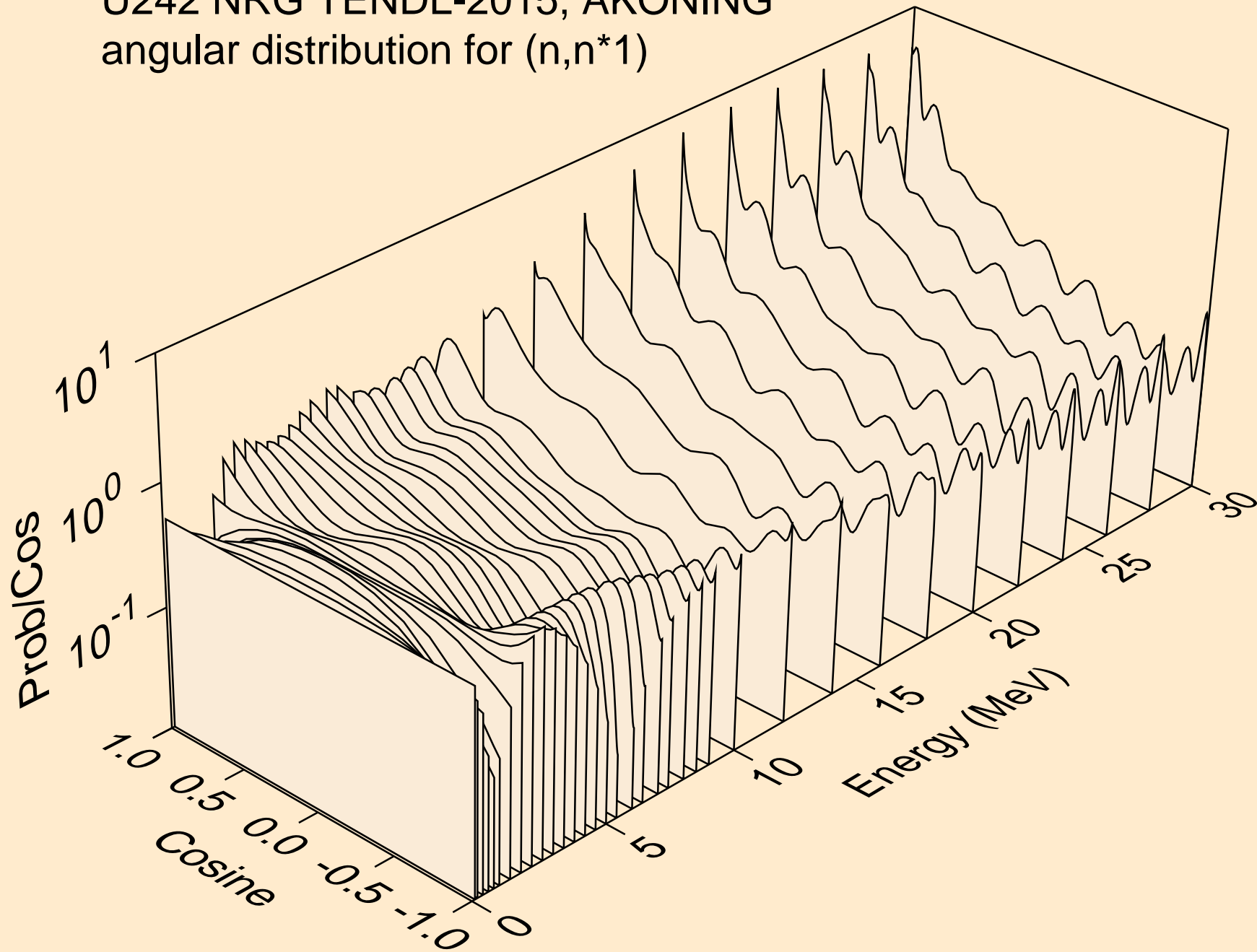

U242 NRG TENDL-2015, AKONING

Total fission nubar

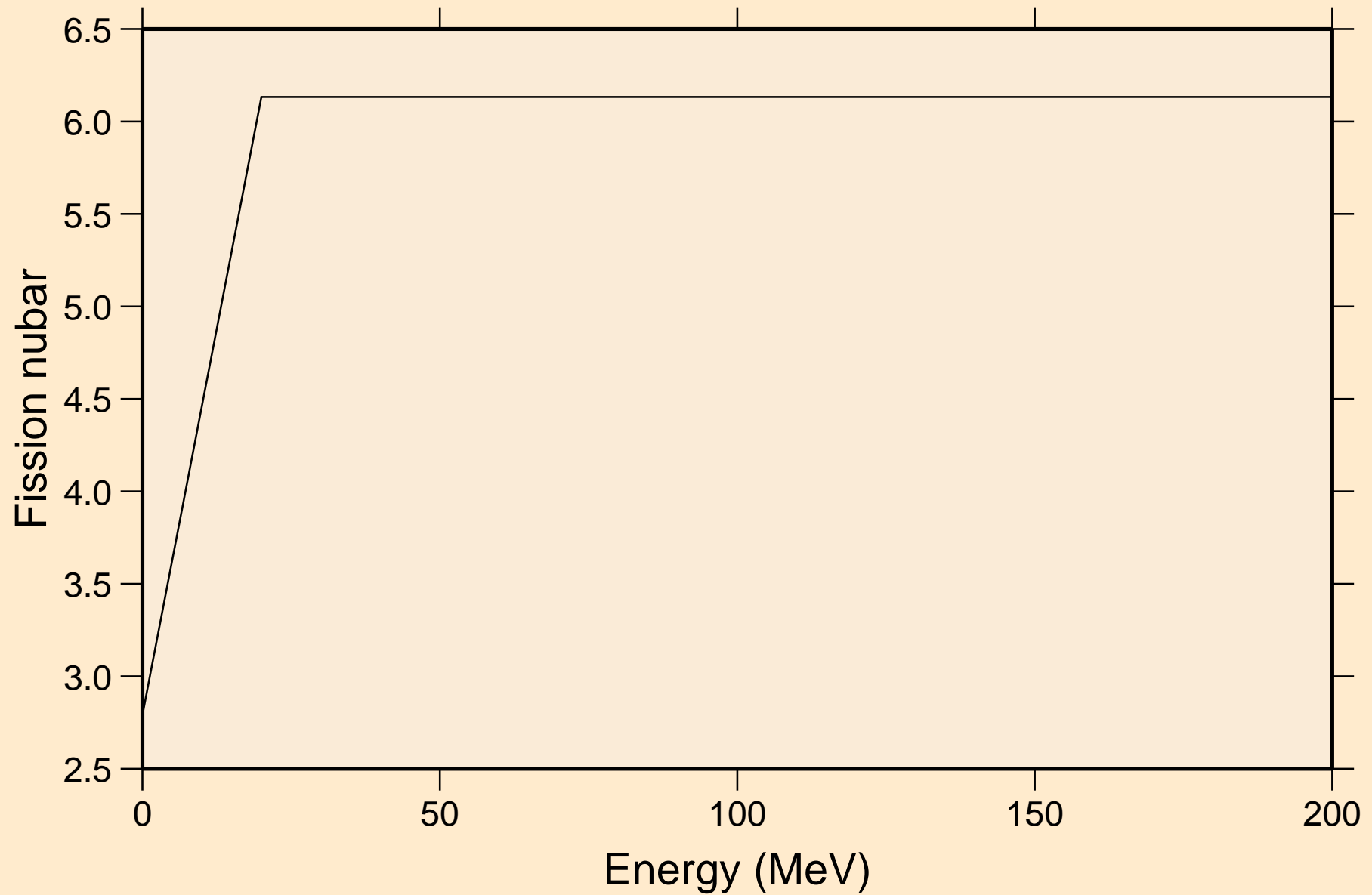

U242 NRG TENDL-2015, AKONING
Neutron emission for (n,x)

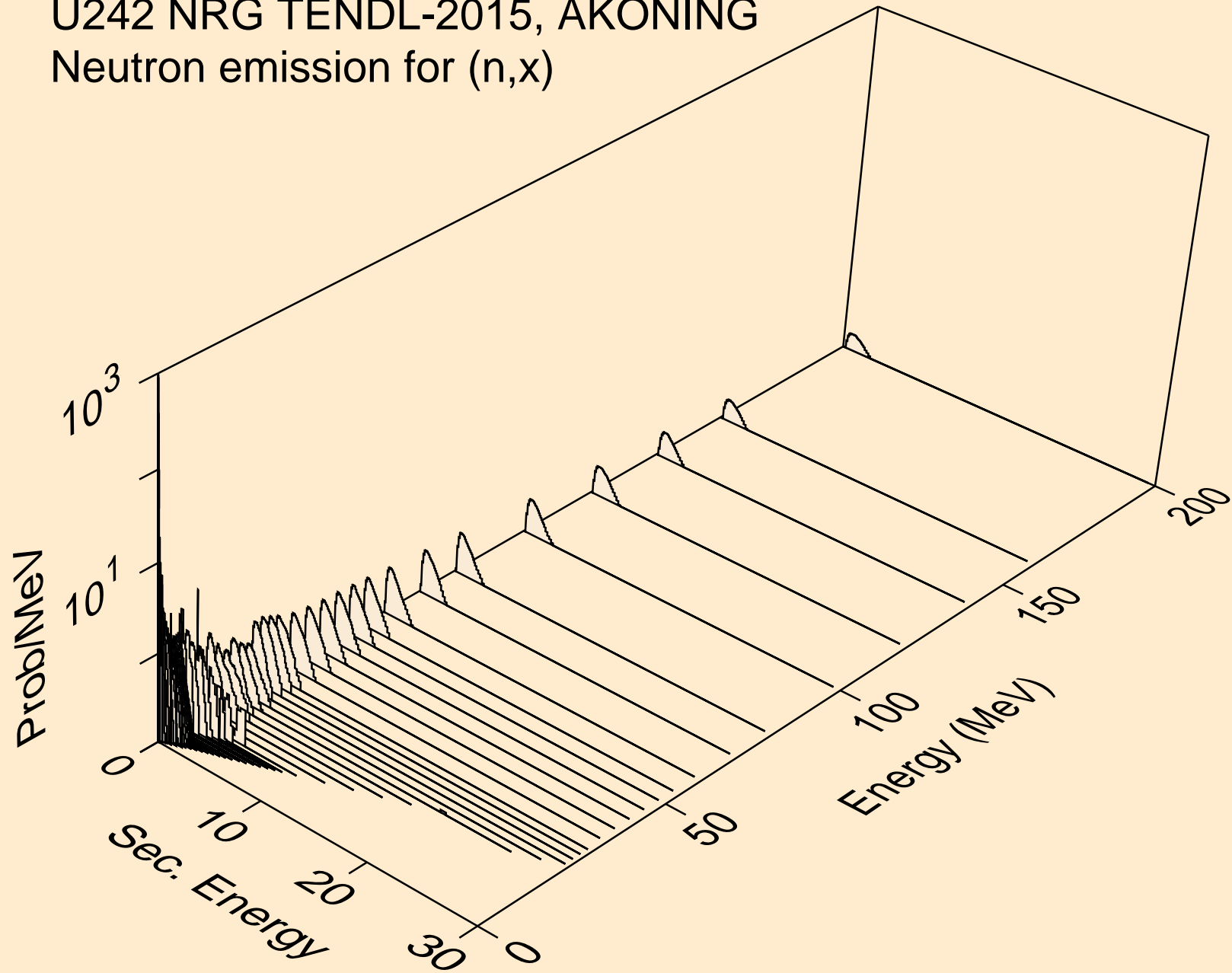

U242 NRG TENDL-2015, AKONING
Neutron emission for (n,2nd)

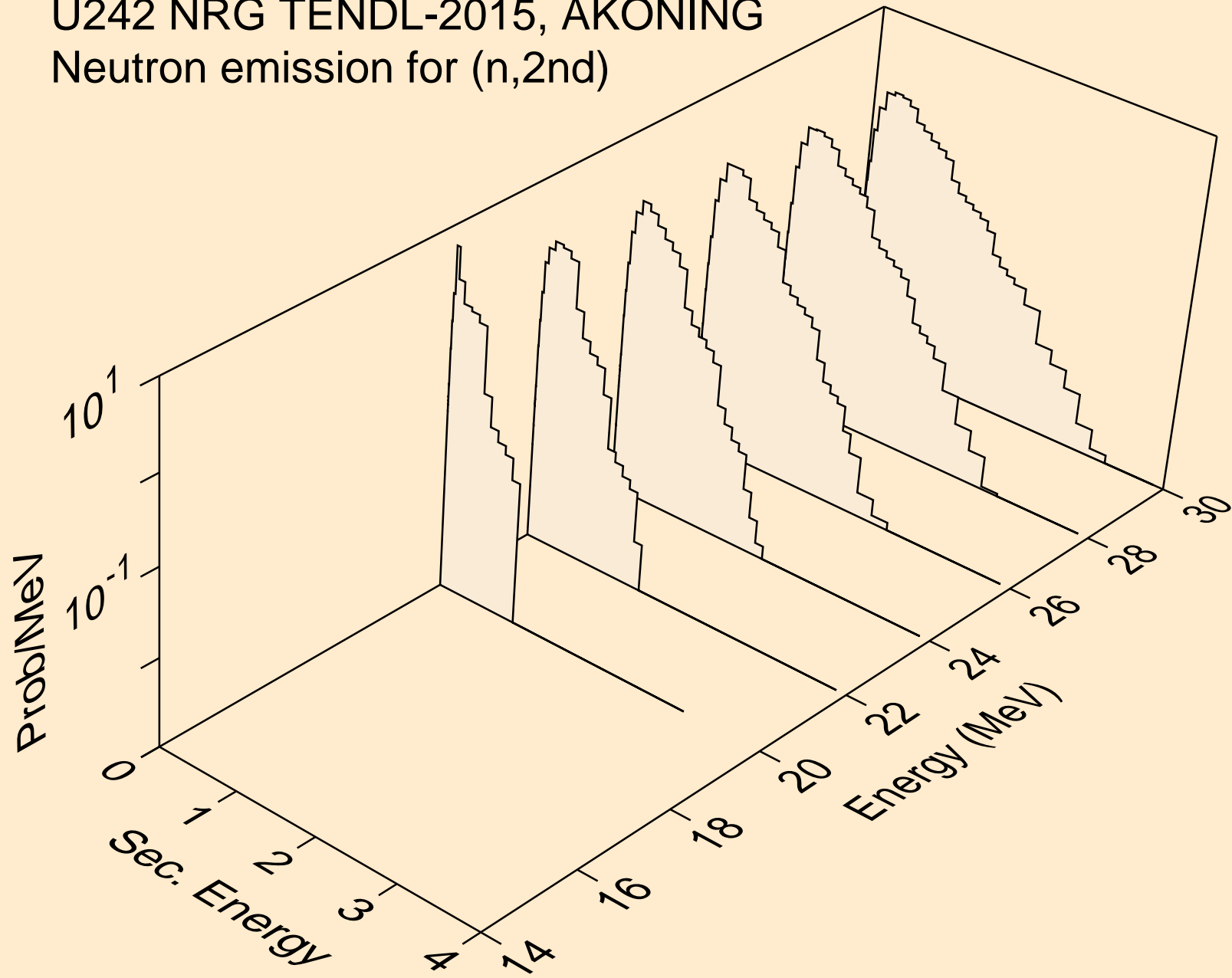

U242 NRG TENDL-2015, AKONING
Neutron emission for (n,2n)

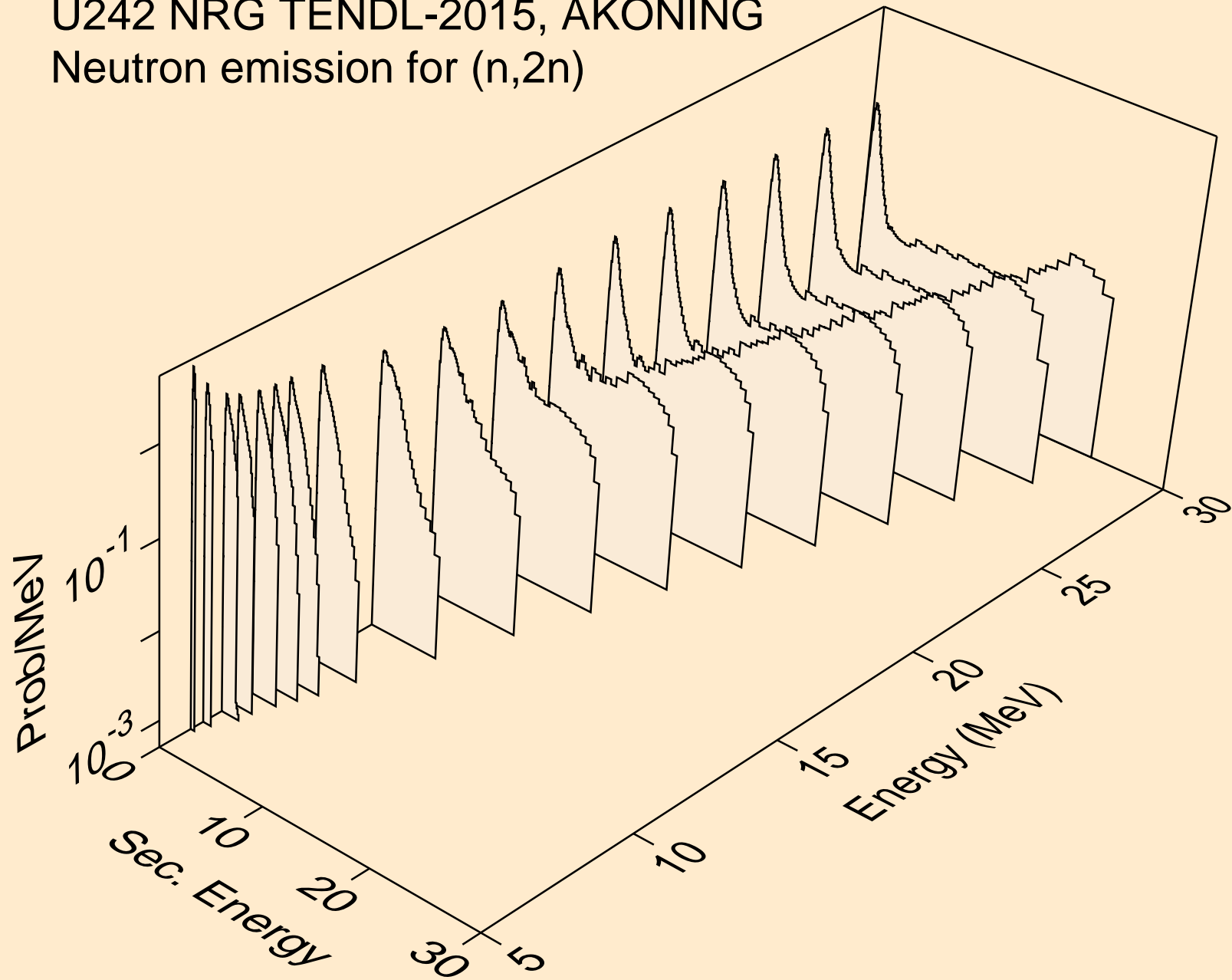

U242 NRG TENDL-2015, AKONING
Neutron emission for (n,3n)

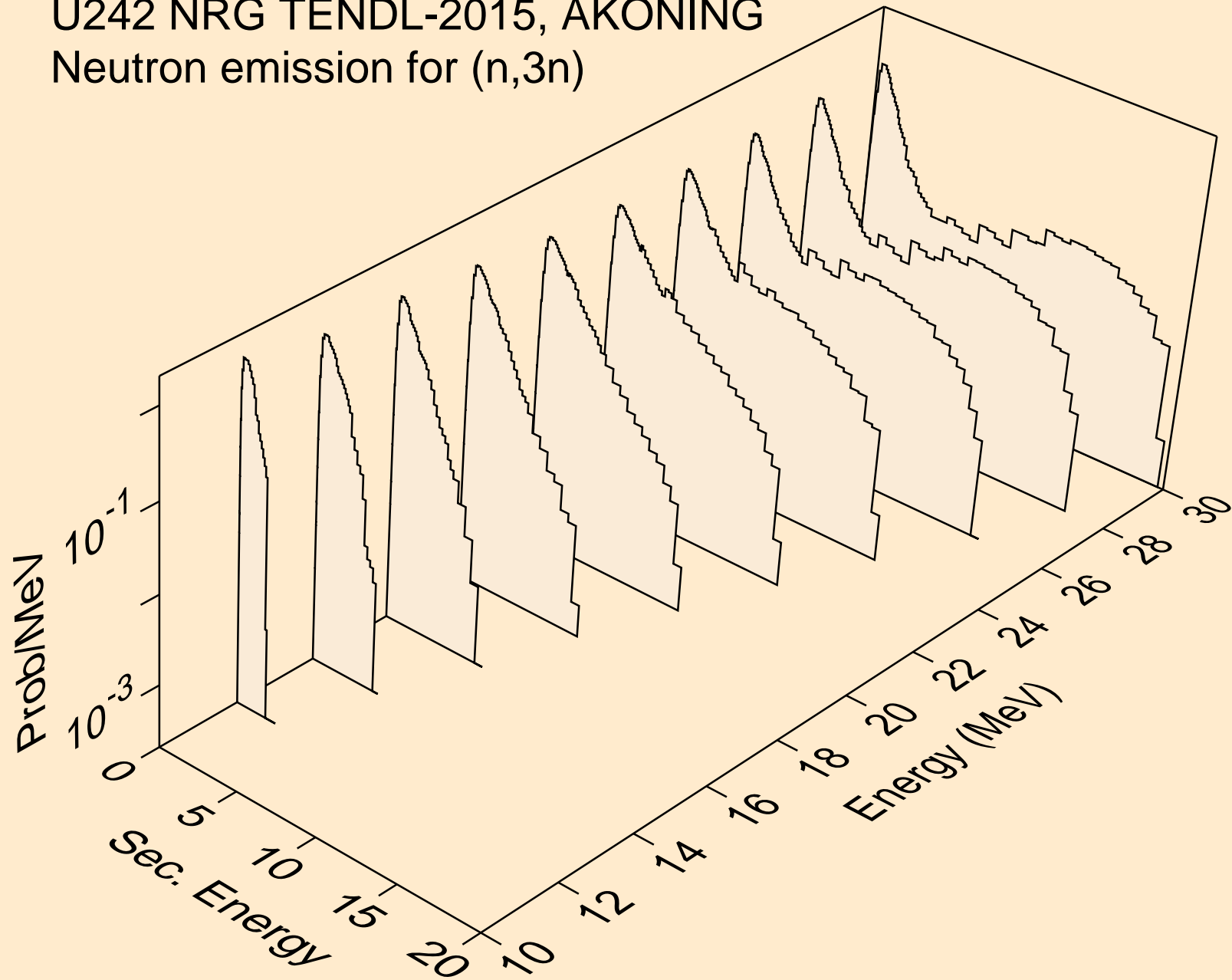

U242 NRG TENDL-2015, AKONING
Neutron emission for fission

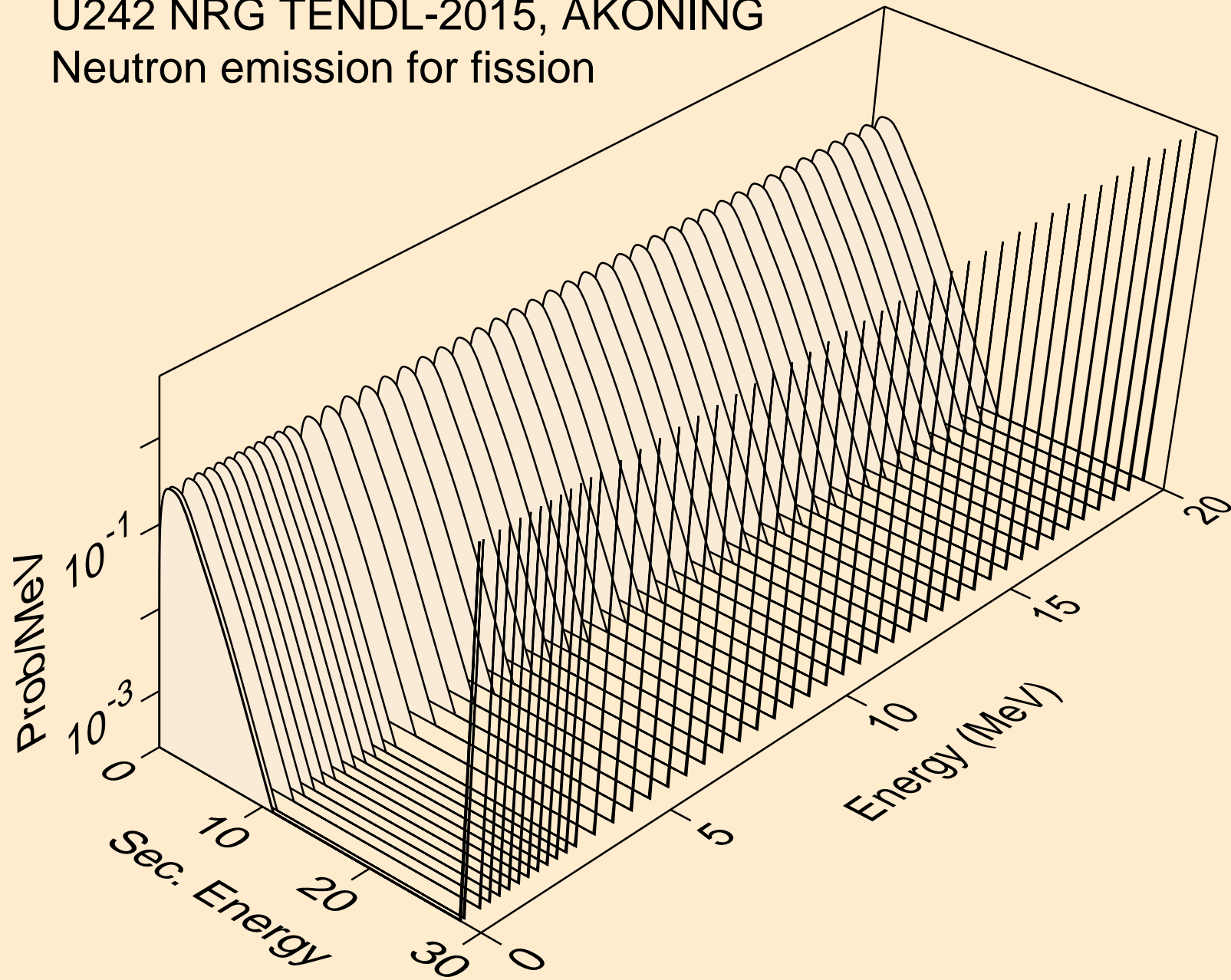

U242 NRG TENDL-2015, AKONING
Neutron emission for (n,n*)a

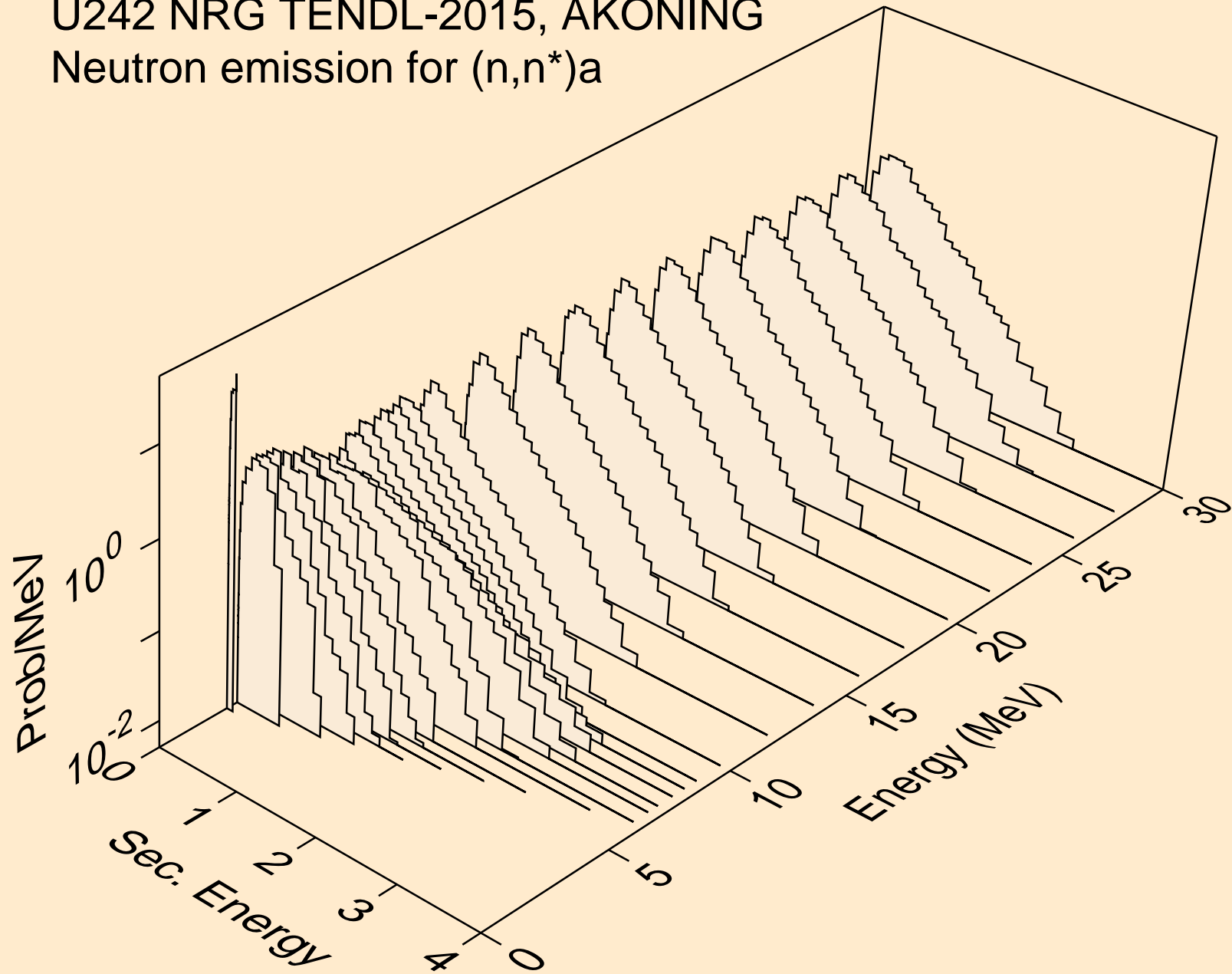

U242 NRG TENDL-2015, AKONING
Neutron emission for (n,2n)a

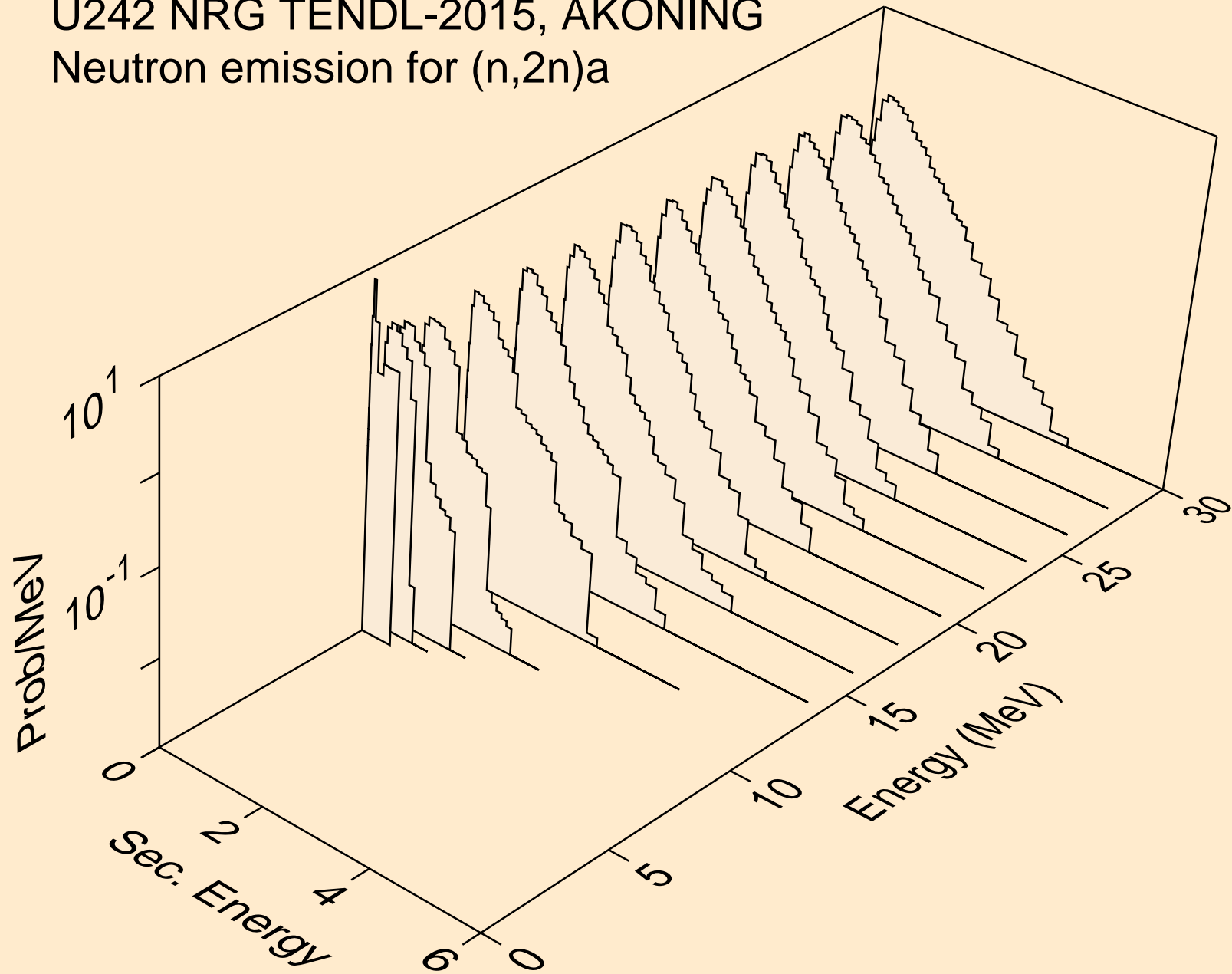

U242 NRG TENDL-2015, AKONING
Neutron emission for (n,3n)a

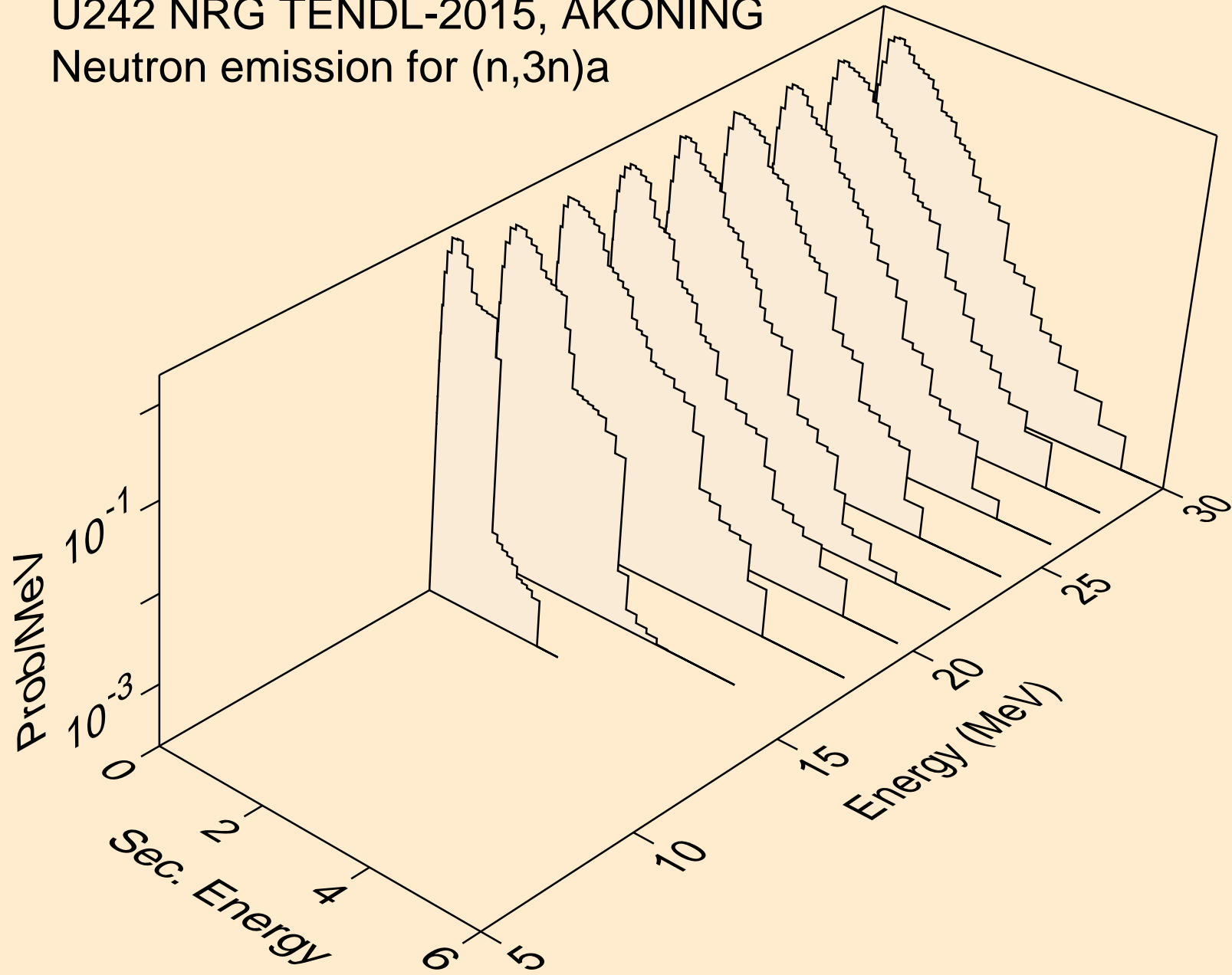

U242 NRG TENDL-2015, AKONING
Neutron emission for (n,n*)p

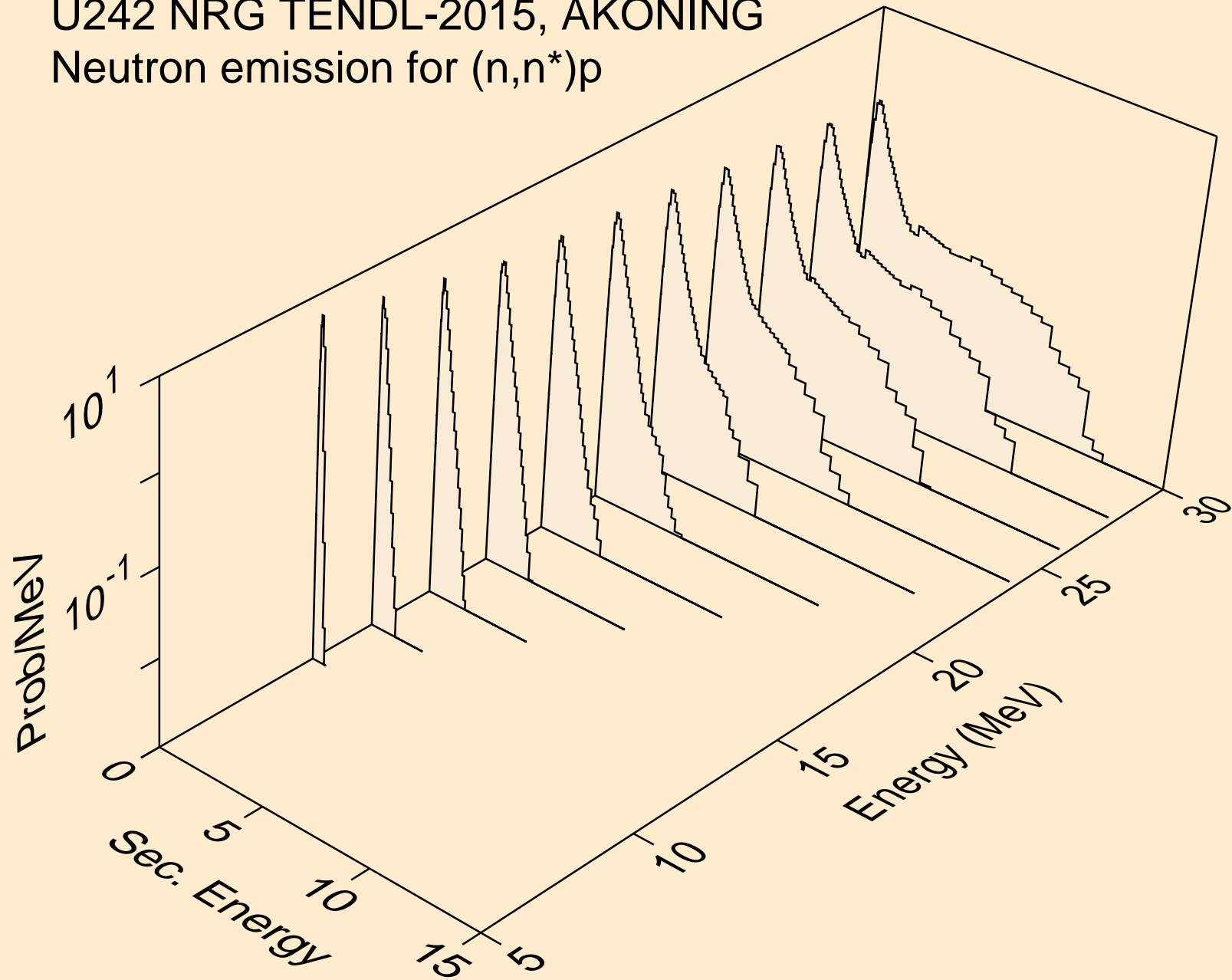

U242 NRG TENDL-2015, AKONING
Neutron emission for (n,n*)d

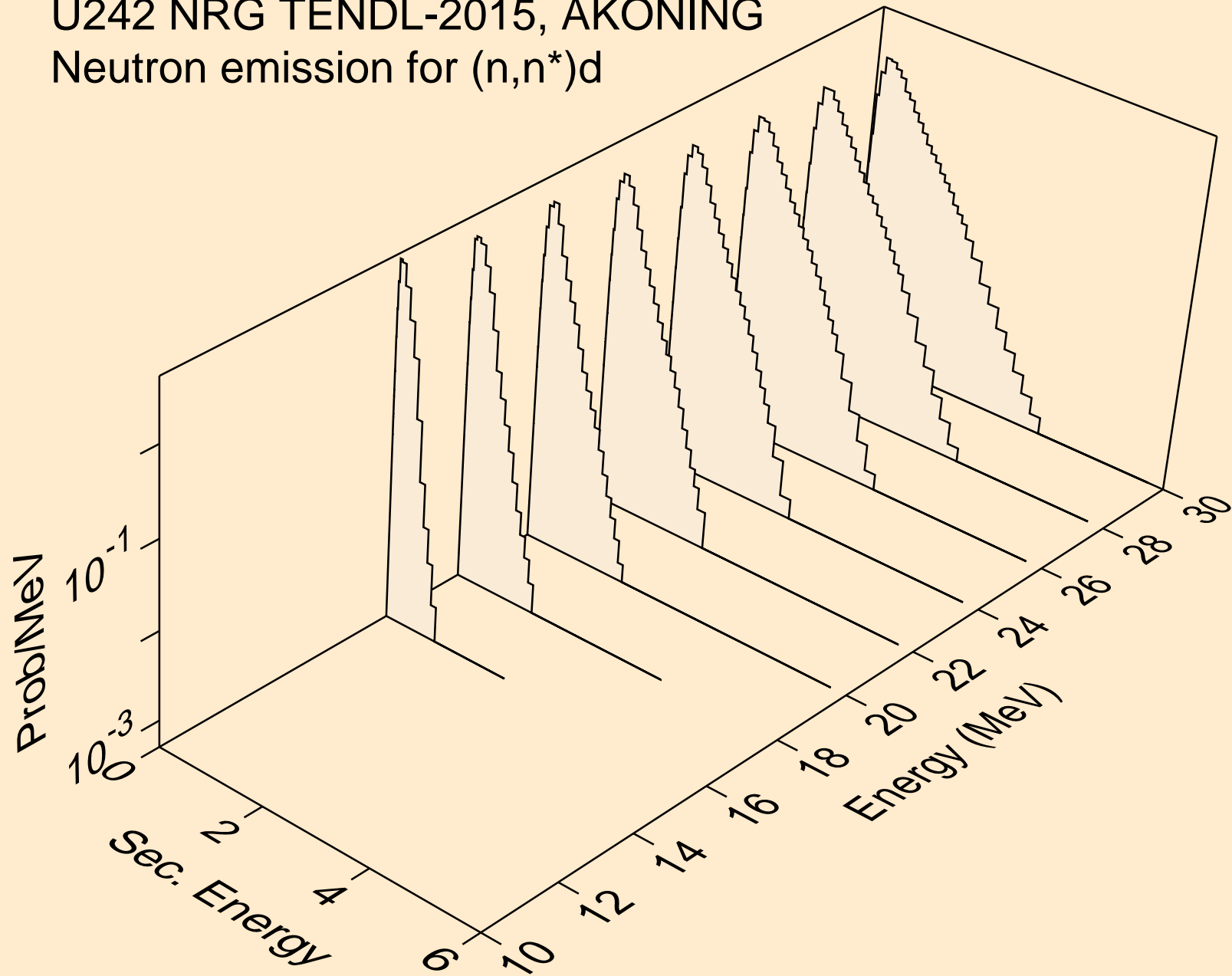

U242 NRG TENDL-2015, AKONING
Neutron emission for (n,n*)t

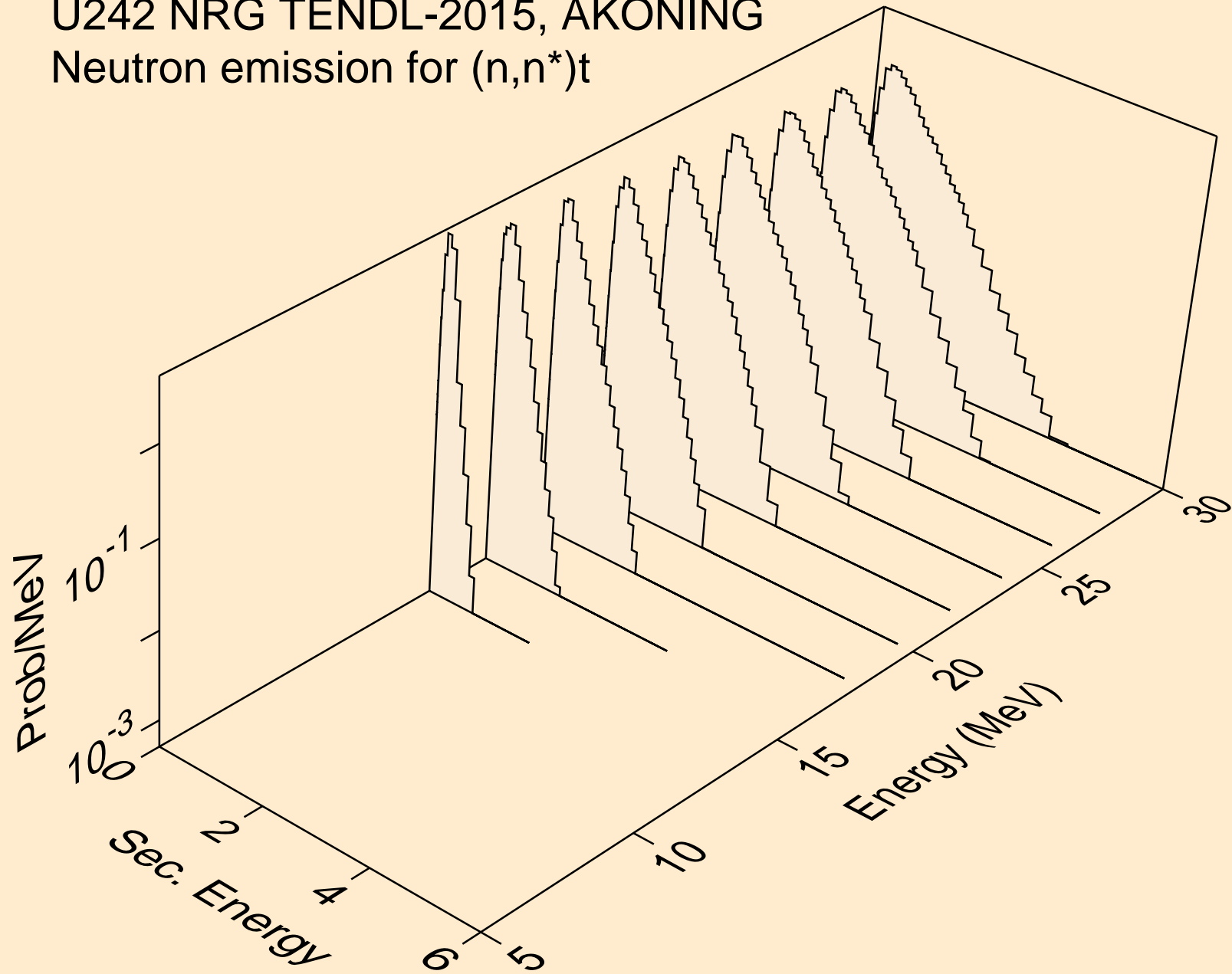

U242 NRG TENDL-2015, AKONING
Neutron emission for (n,n*)he3

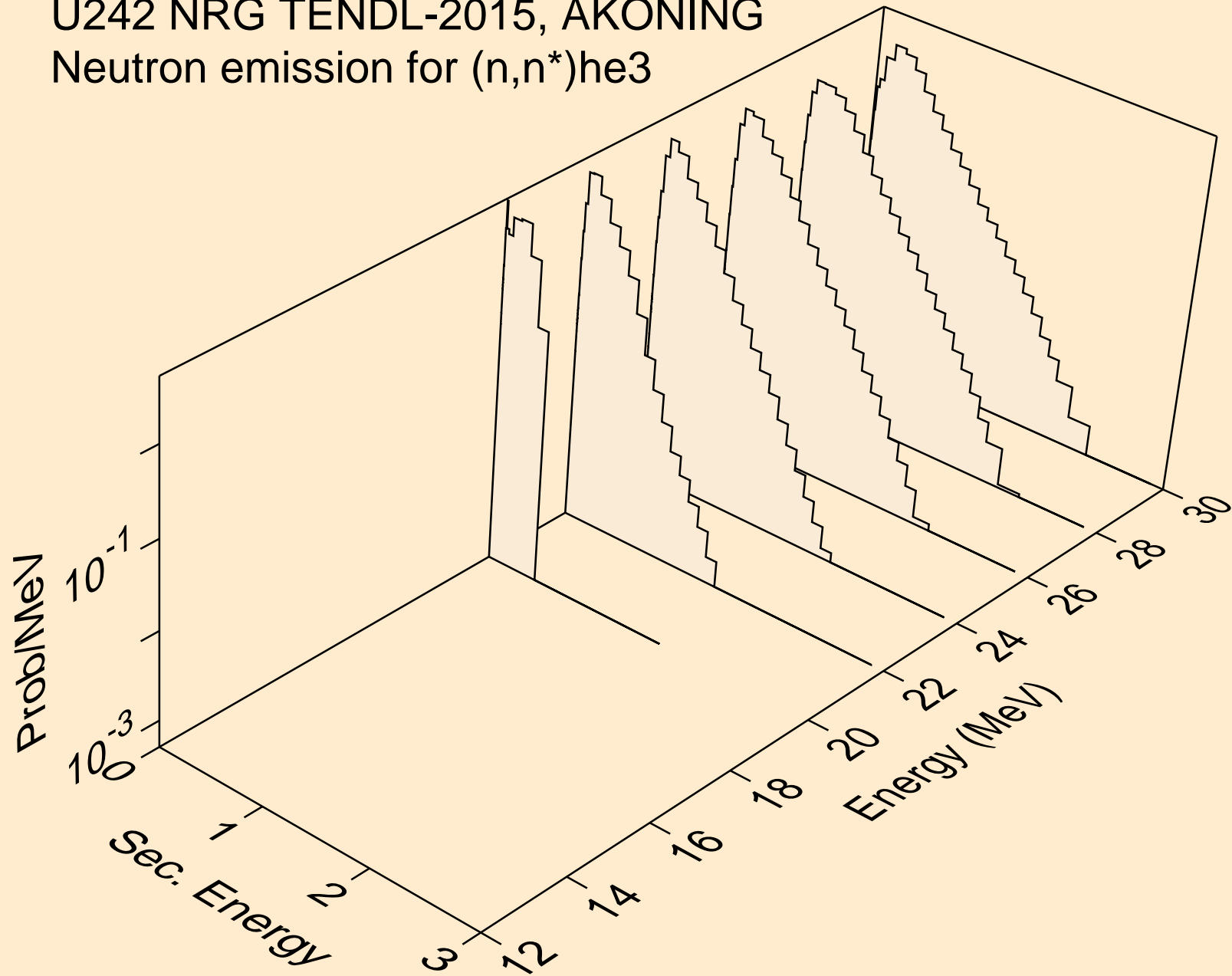

U242 NRG TENDL-2015, AKONING
Neutron emission for (n,4n)

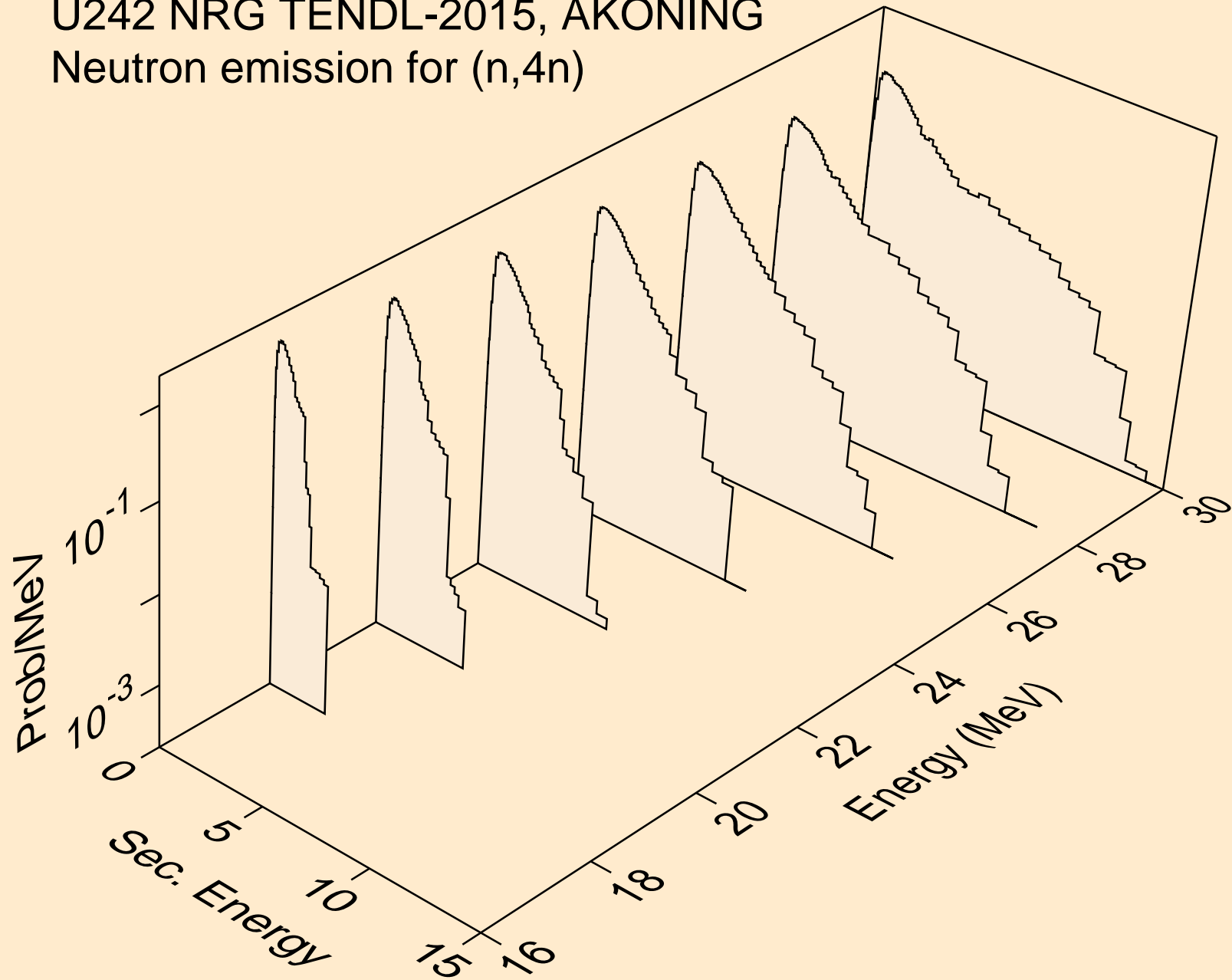

U242 NRG TENDL-2015, AKONING
Neutron emission for (n,2np)

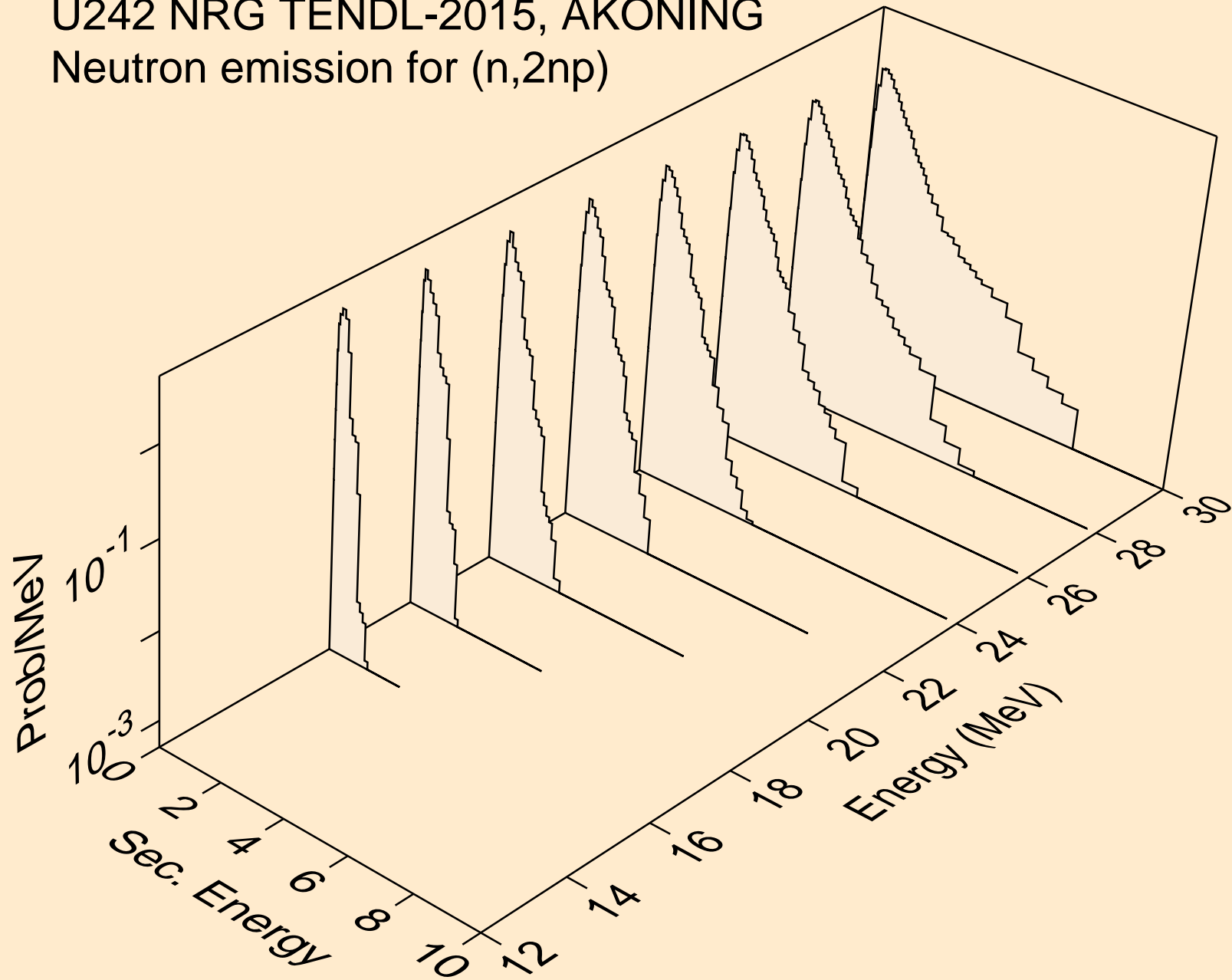

U242 NRG TENDL-2015, AKONING
Neutron emission for (n,3np)

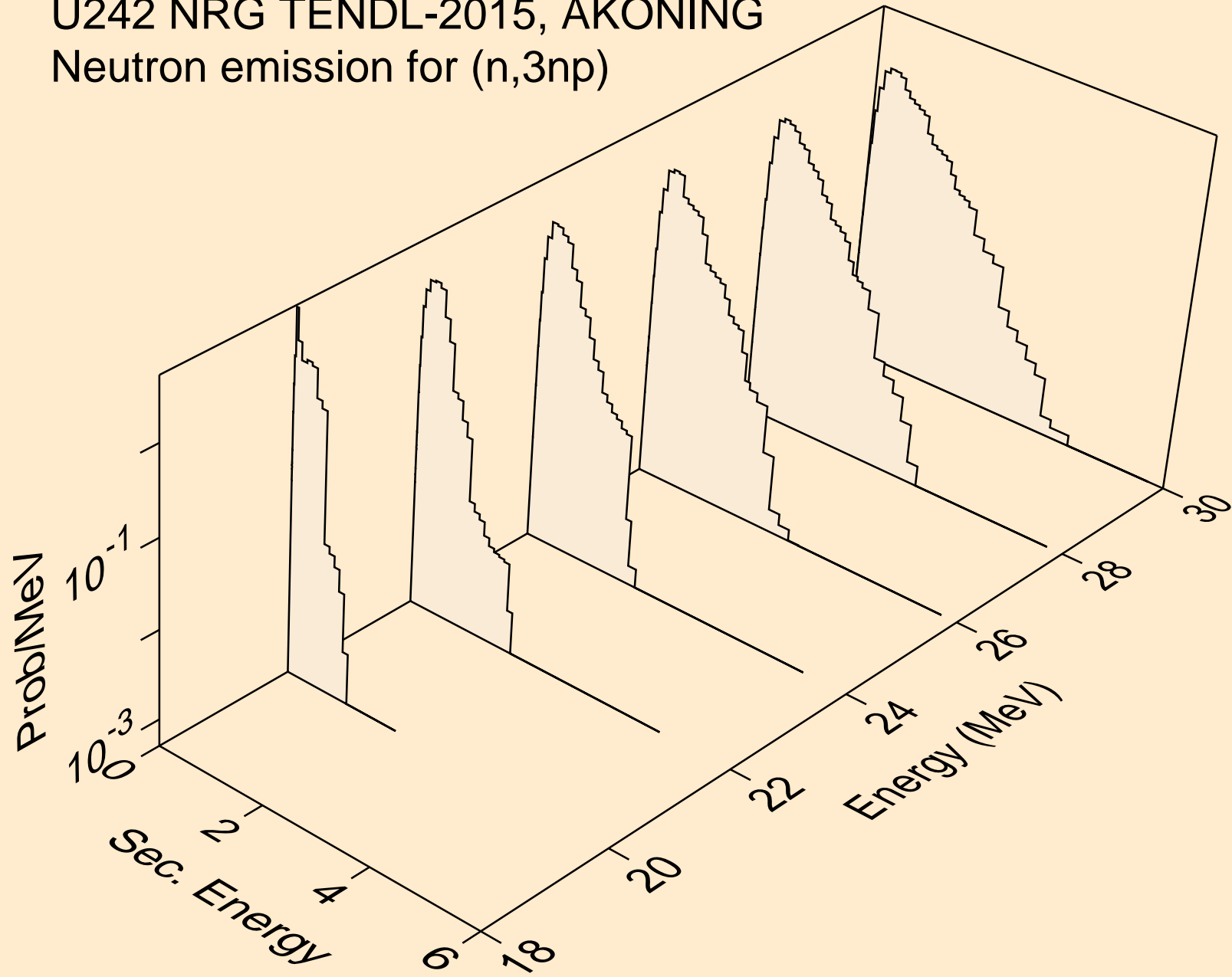

U242 NRG TENDL-2015, AKONING
Neutron emission for (n,n*c)

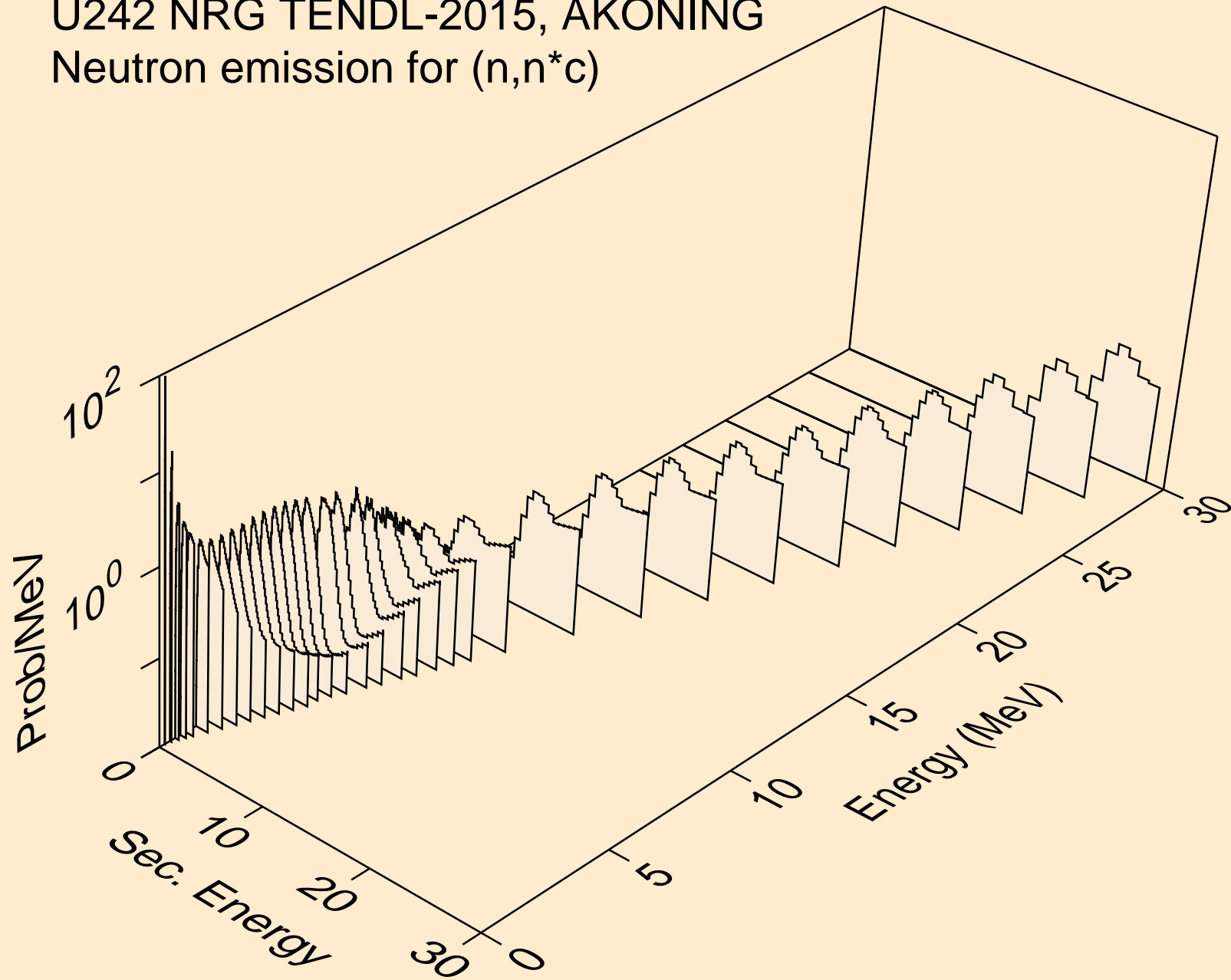

U242 NRG TENDL-2015, AKONING

Delayed nubar

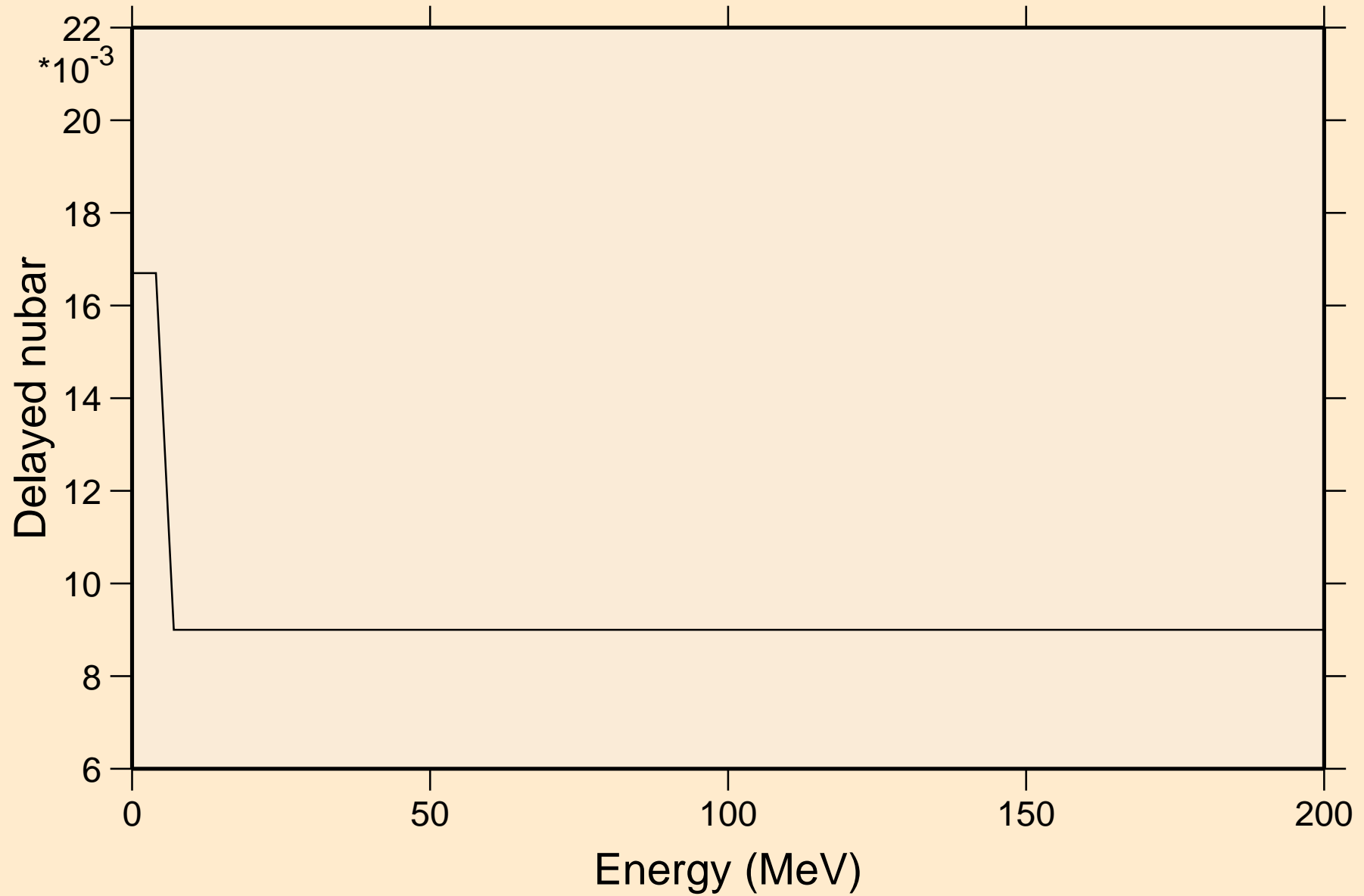

U242 NRG TENDL-2015, AKONING

Delayed neutron spectra

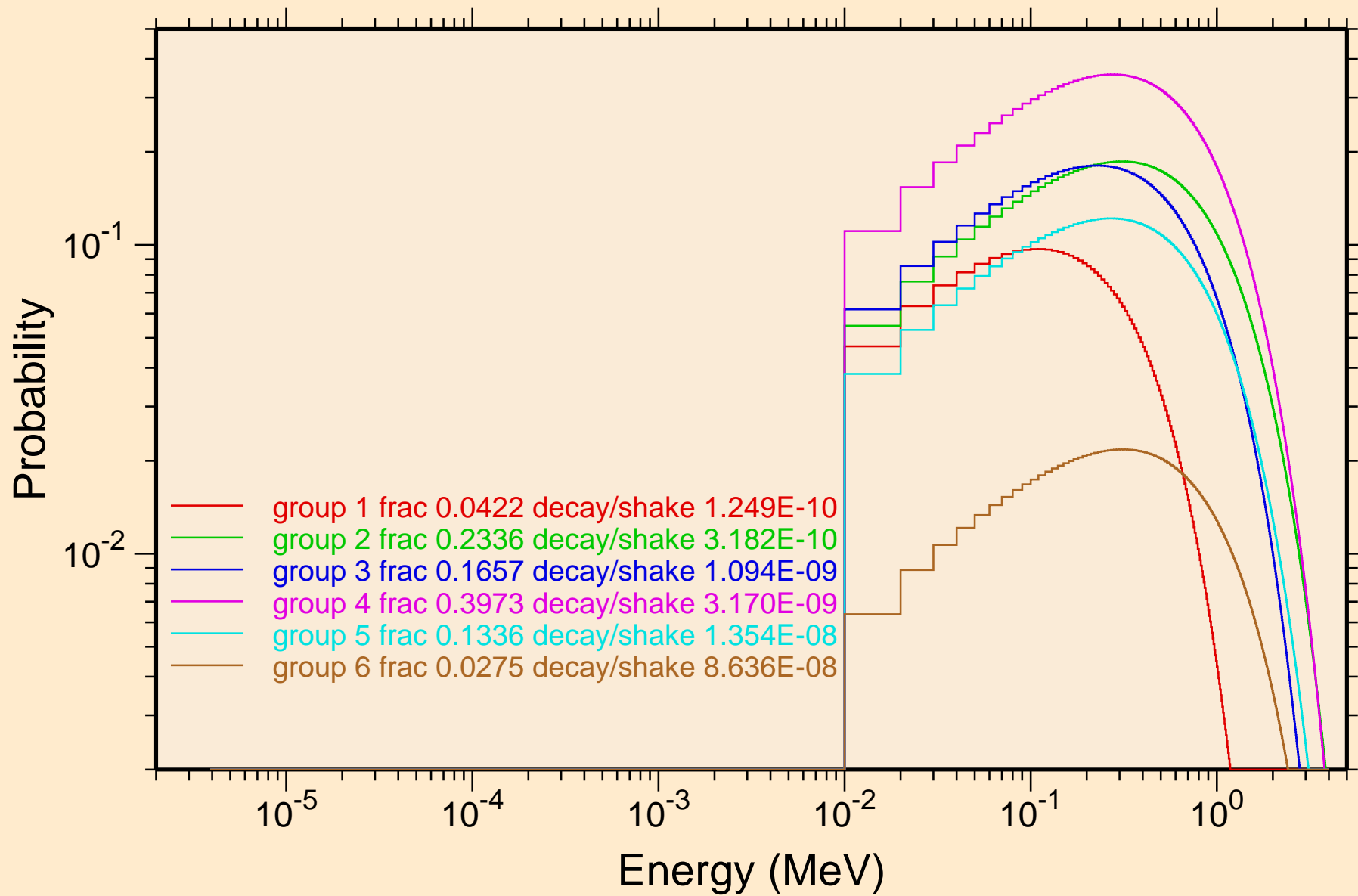

U242 NRG TENDL-2015, AKONING
Photon emission for (n,x)

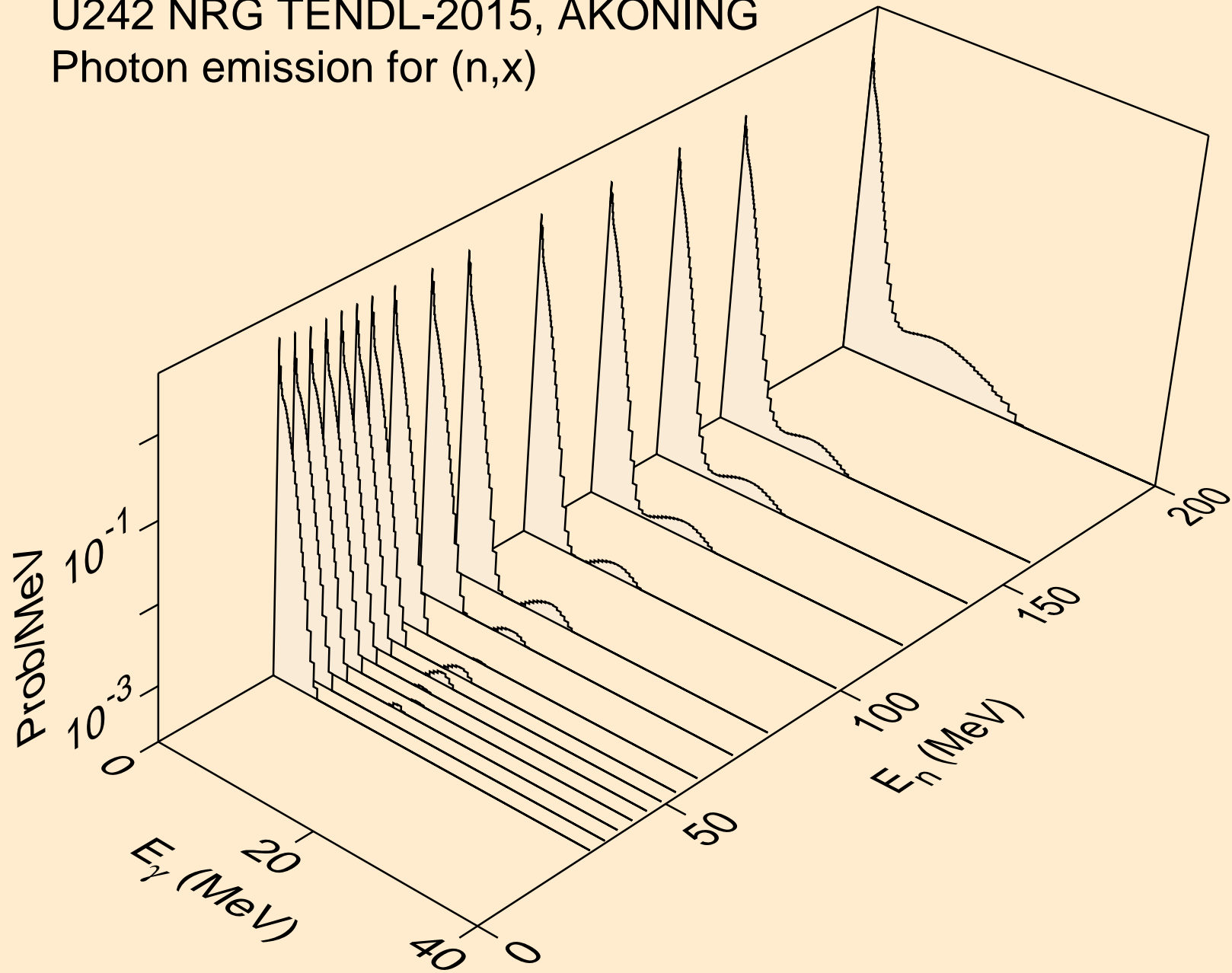

U242 NRG TENDL-2015, AKONING
Photon emission for (n,2nd)

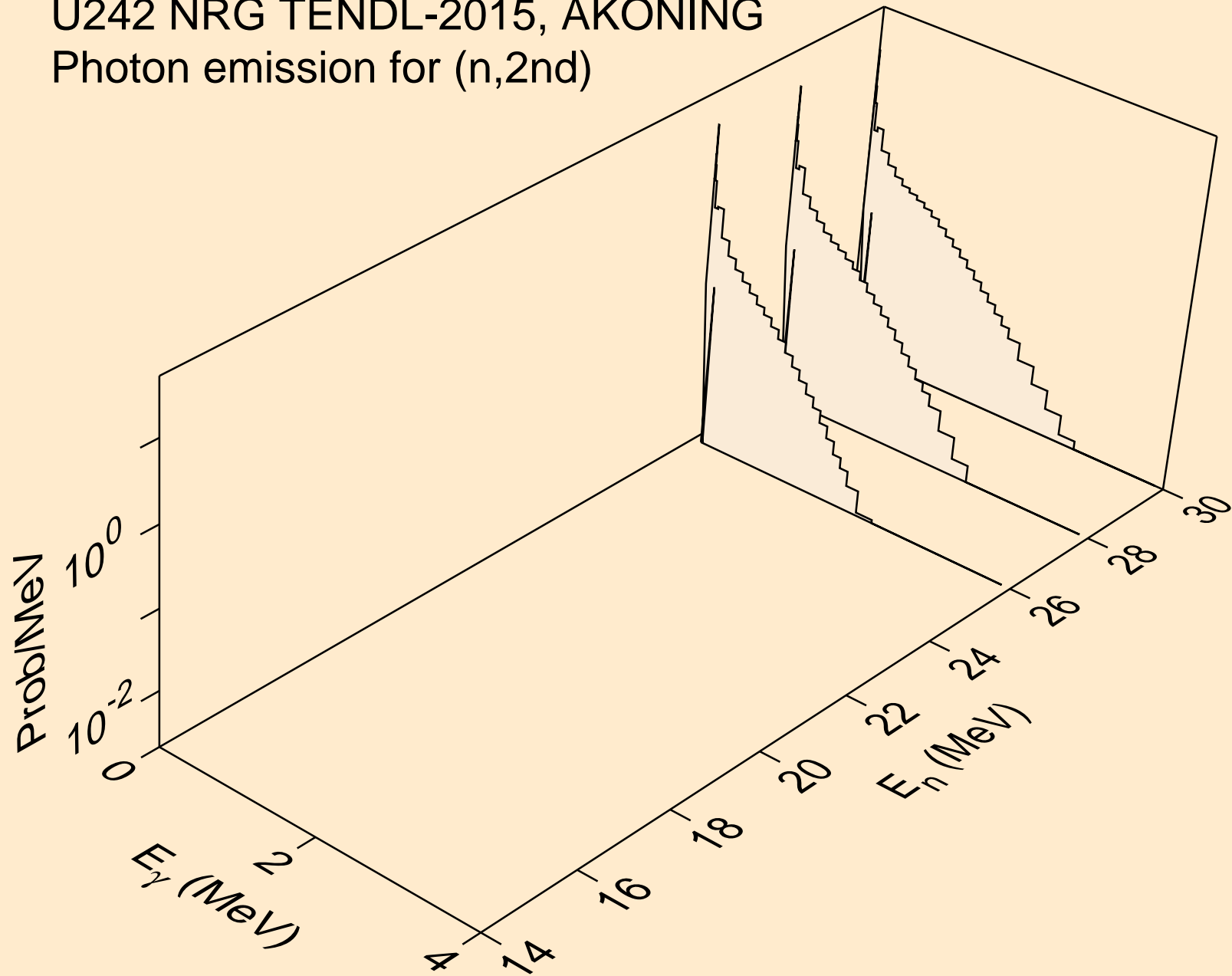

U242 NRG TENDL-2015, AKONING
Photon emission for (n,2n)

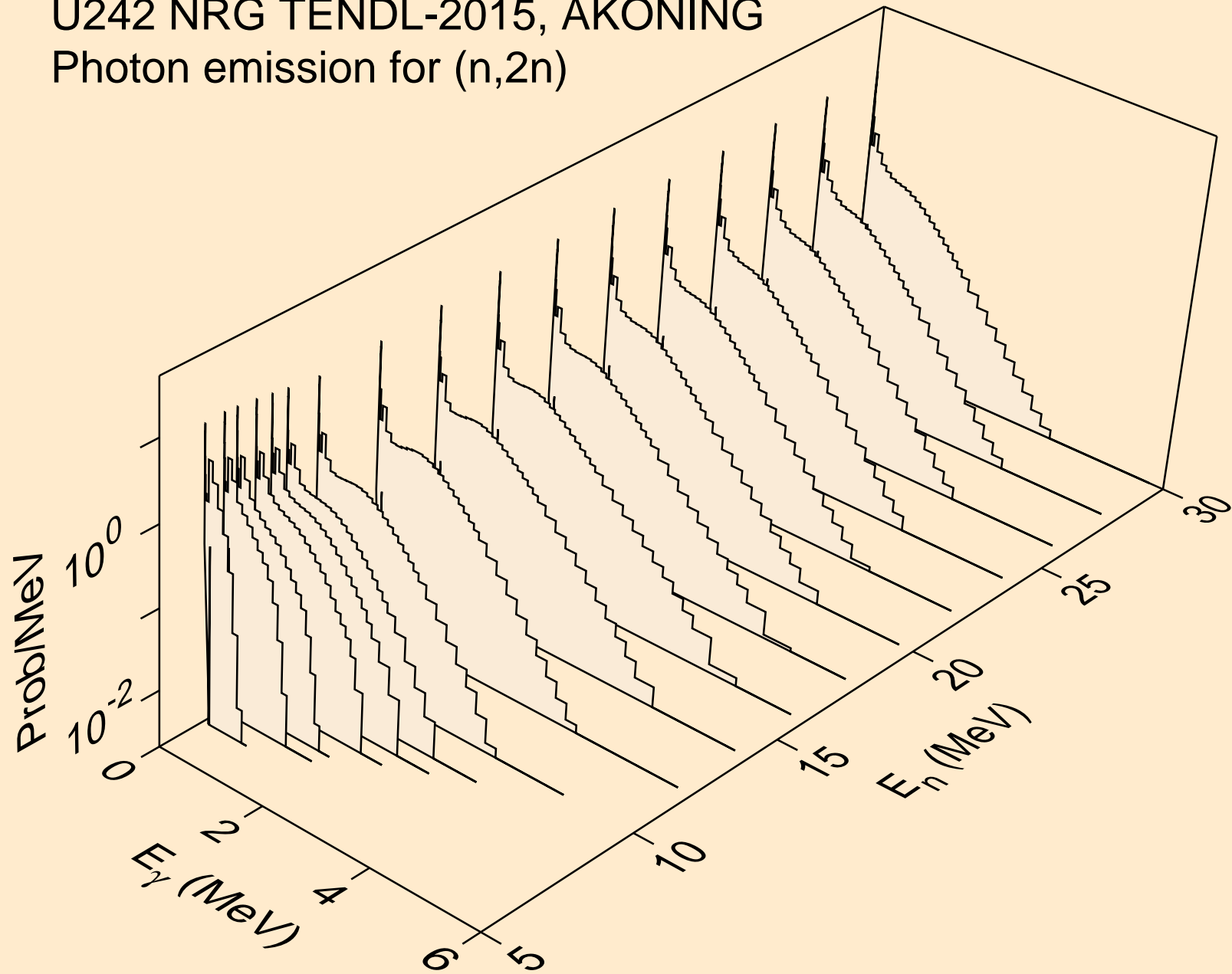

U242 NRG TENDL-2015, AKONING
Photon emission for (n,3n)

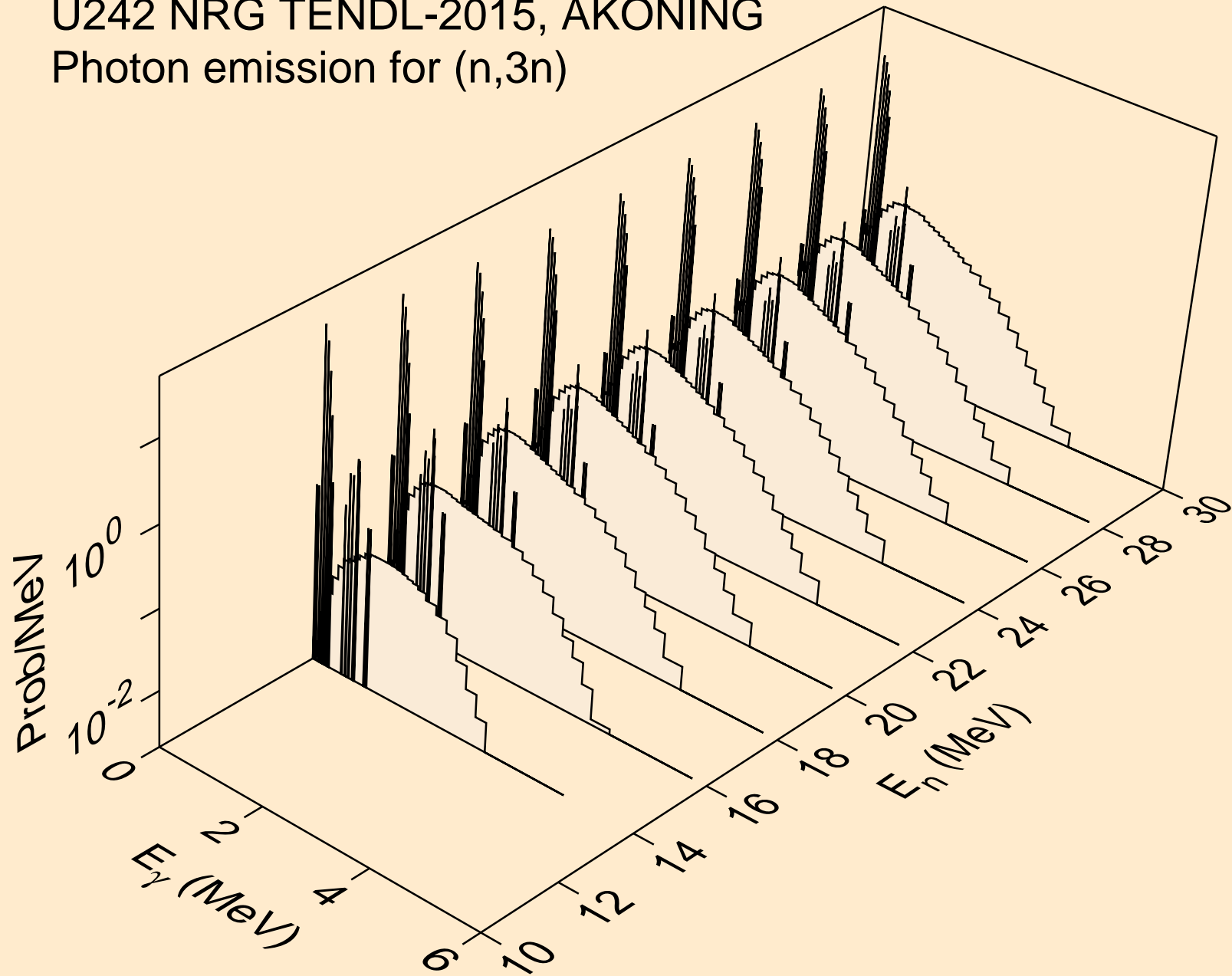

U242 NRG TENDL-2015, AKONING
Photon emission for (n,n*)a

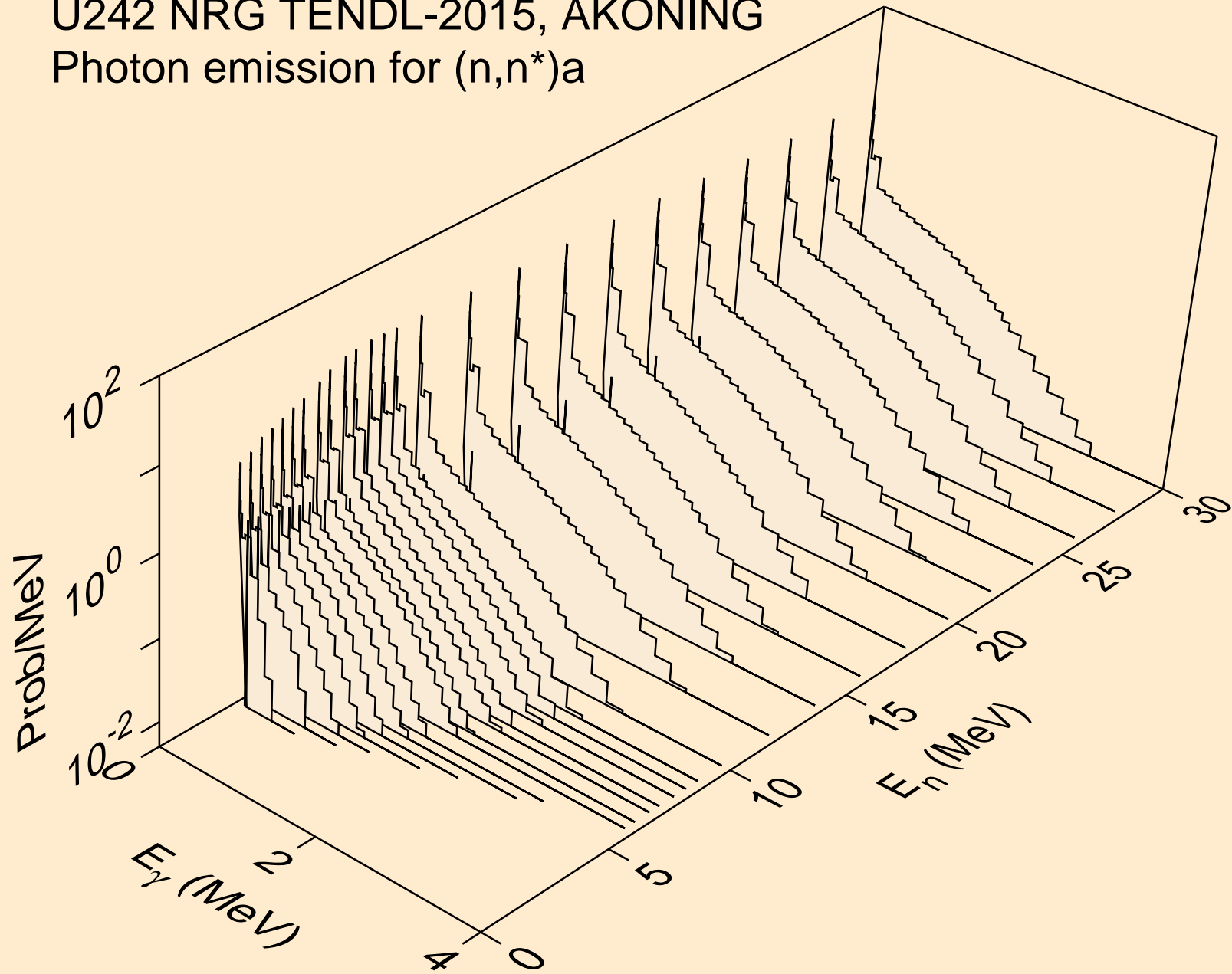

U242 NRG TENDL-2015, AKONING
Photon emission for (n,2n)a

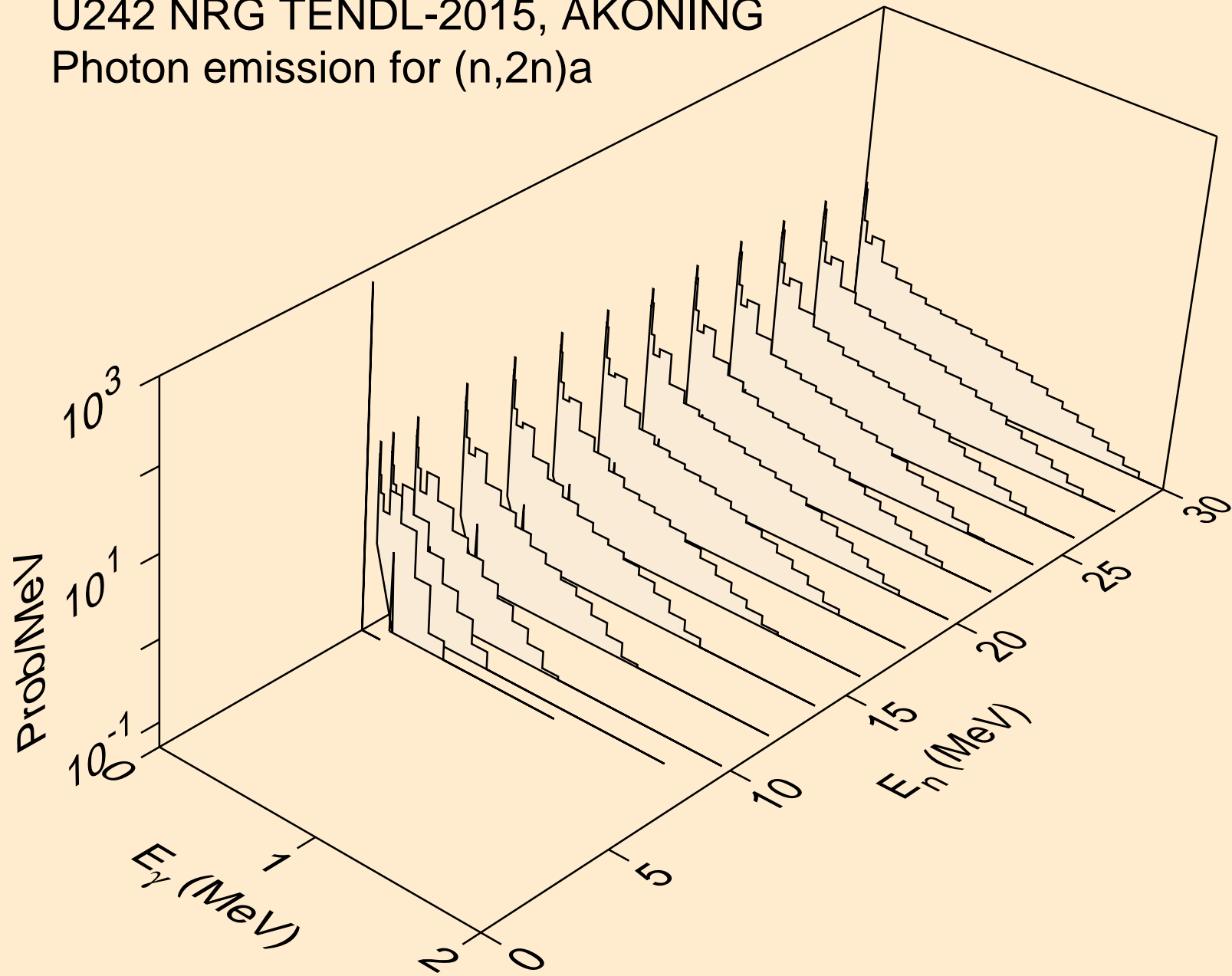

U242 NRG TENDL-2015, AKONING
Photon emission for (n,3n)a

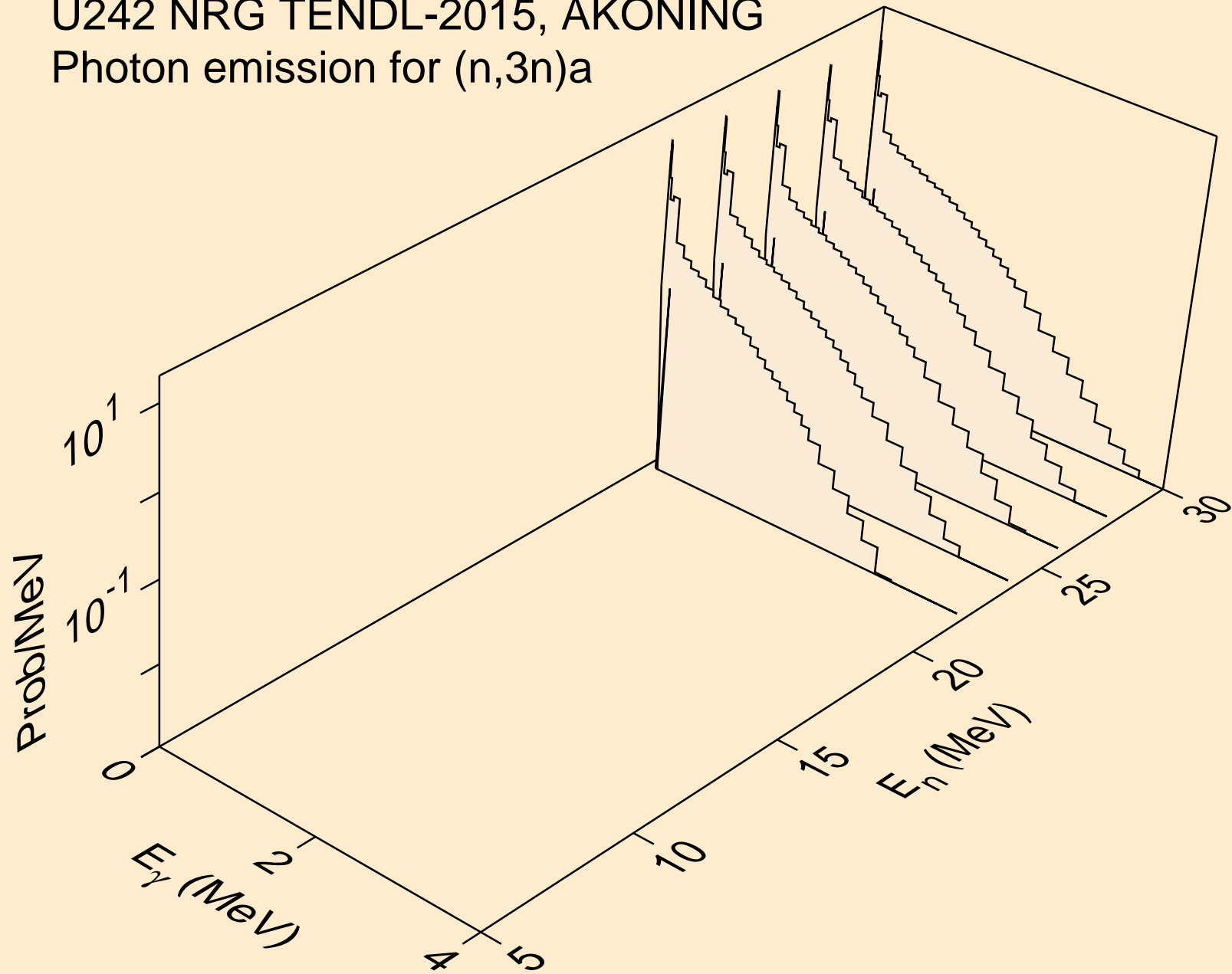

U242 NRG TENDL-2015, AKONING
Photon emission for (n,n*)p

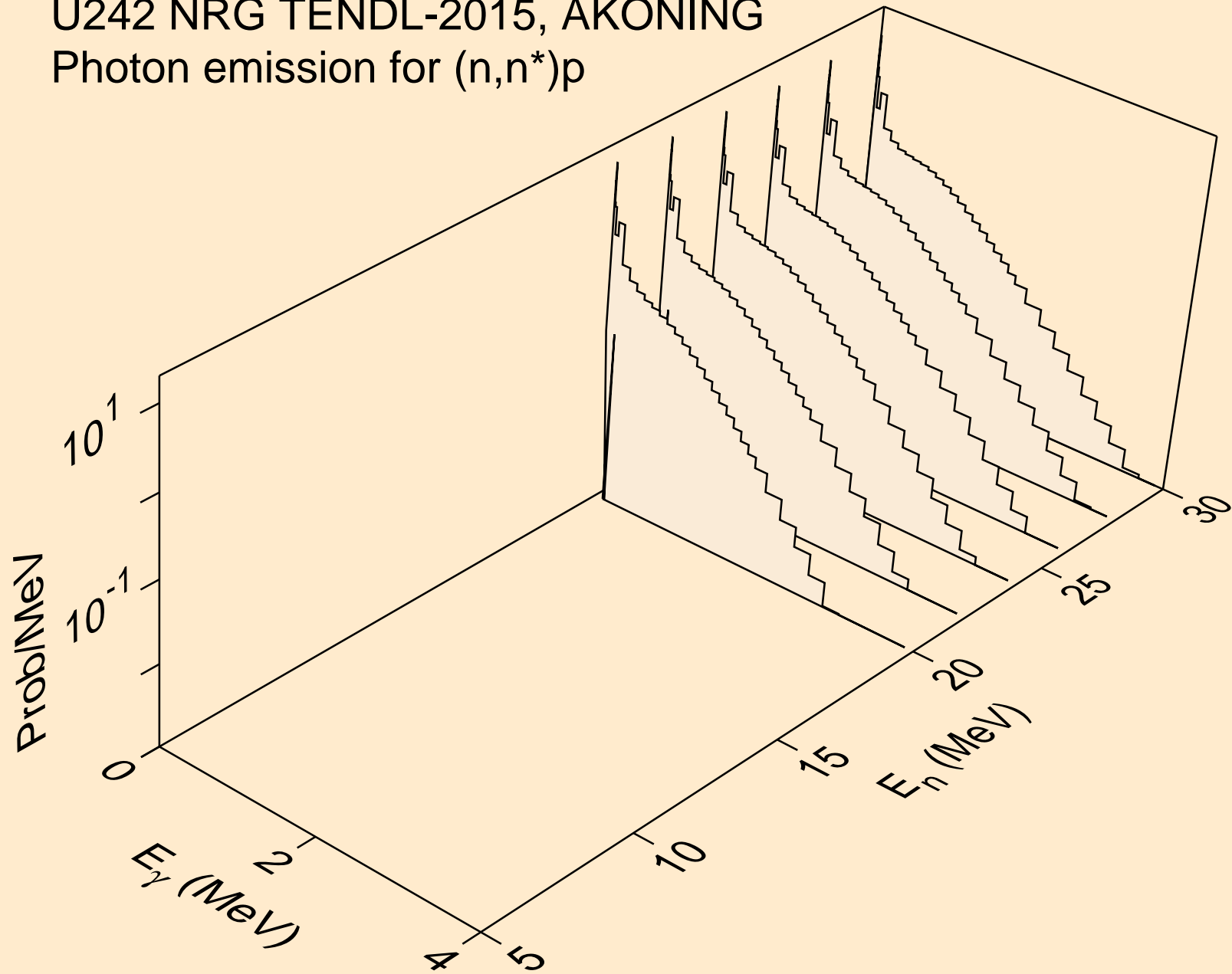

U242 NRG TENDL-2015, AKONING
Photon emission for (n,n*)d

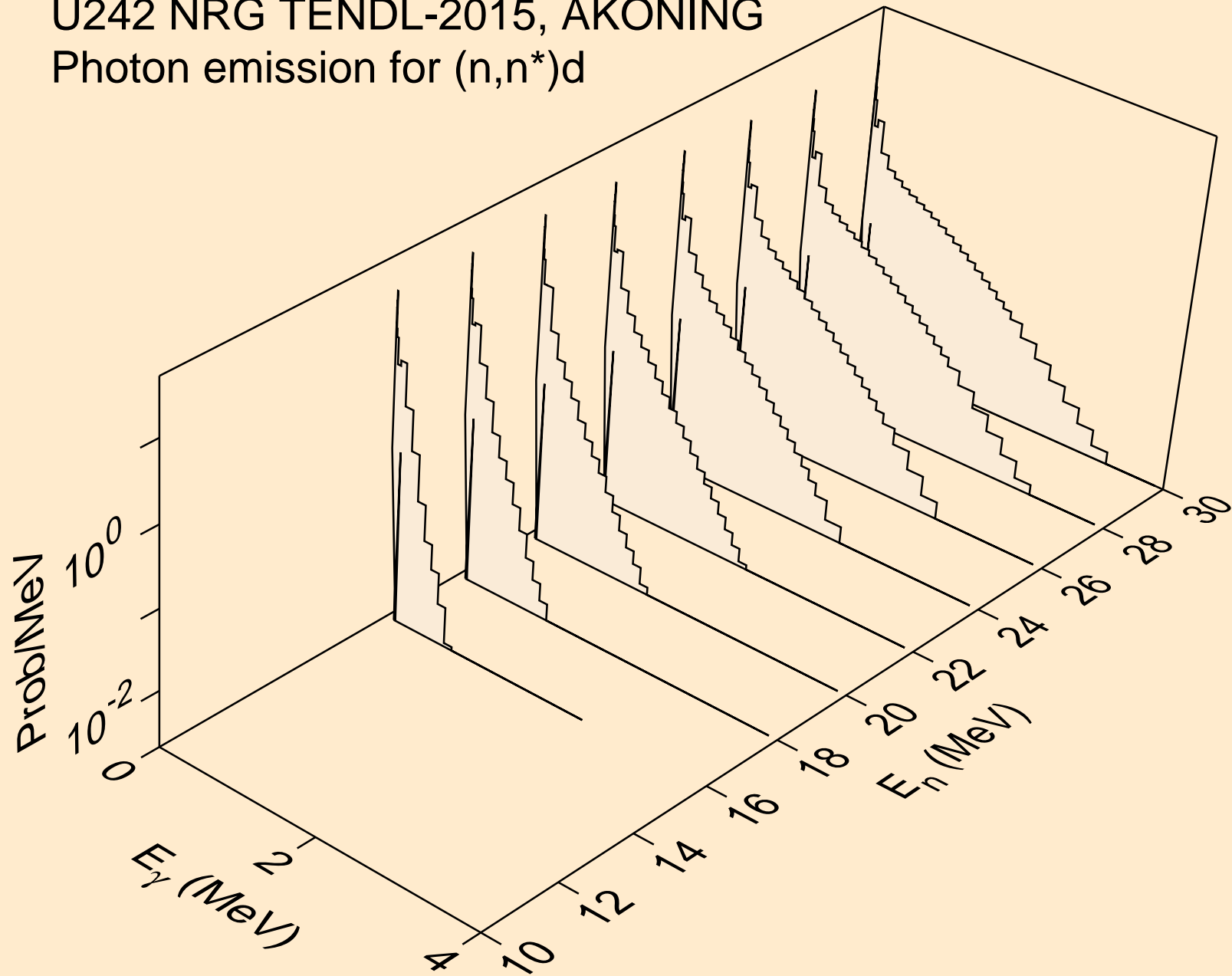

U242 NRG TENDL-2015, AKONING
Photon emission for (n,n*)t

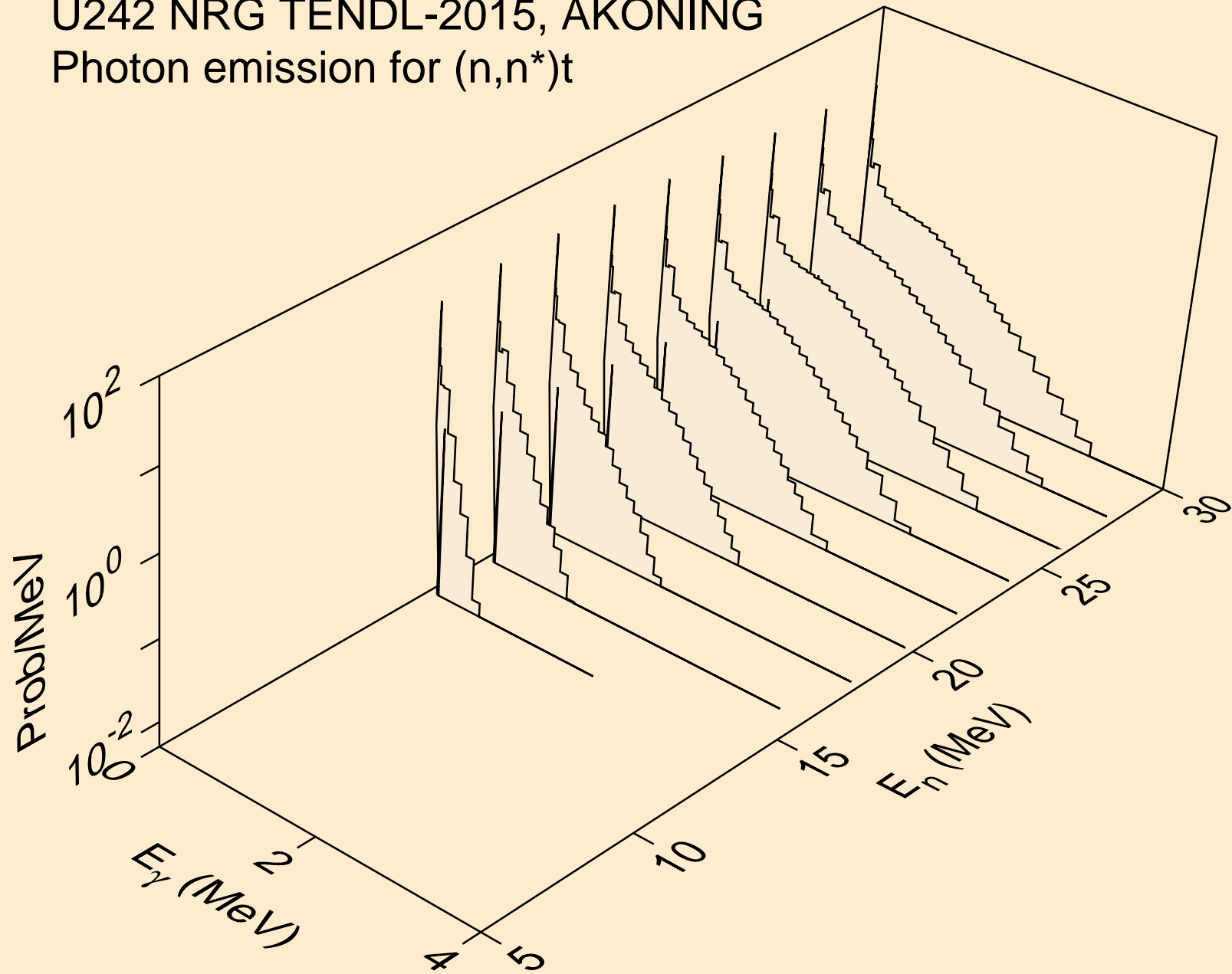

U242 NRG TENDL-2015, AKONING
Photon emission for (n,n*)he3

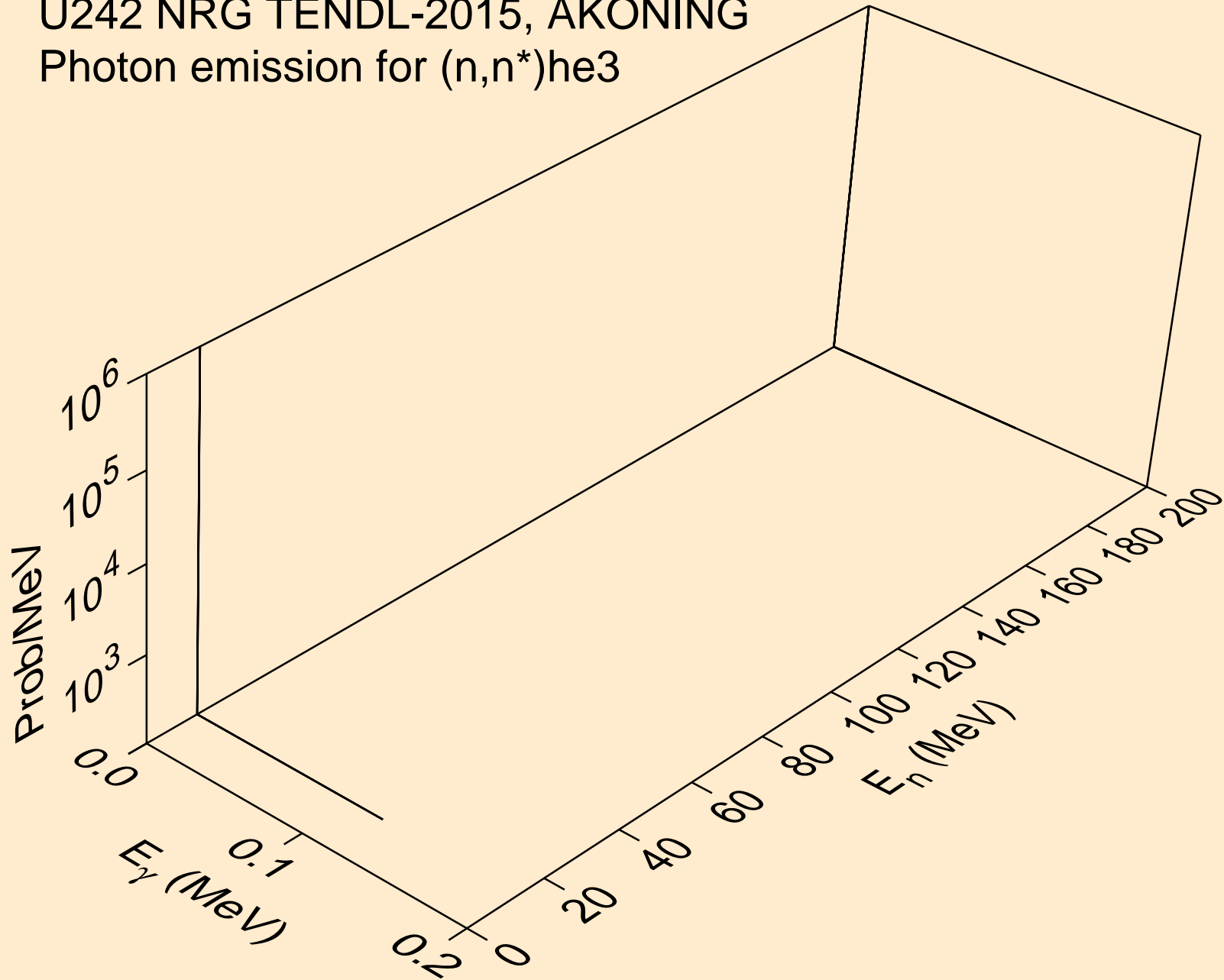

U242 NRG TENDL-2015, AKONING
Photon emission for (n,4n)

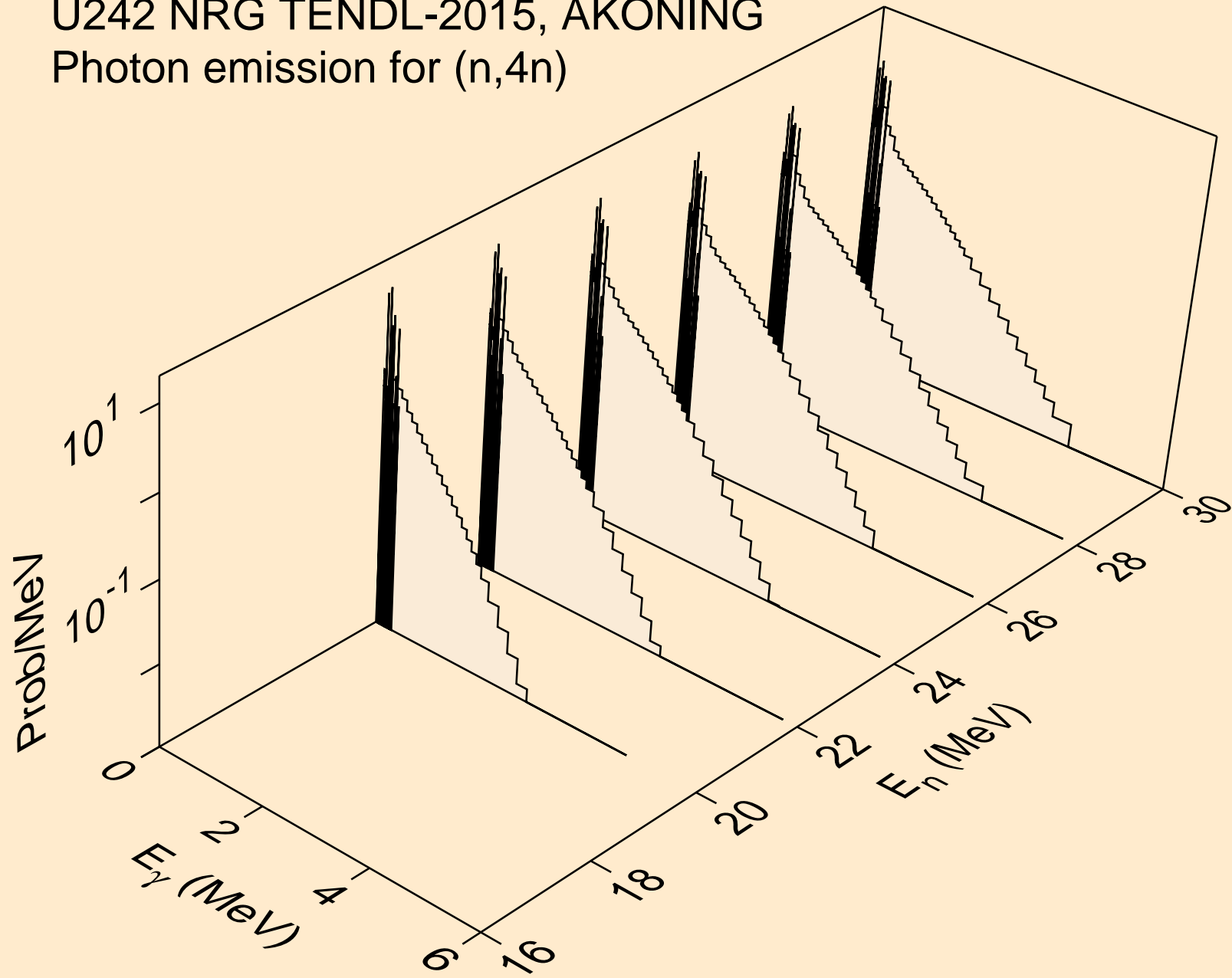

U242 NRG TENDL-2015, AKONING
Photon emission for (n,2np)

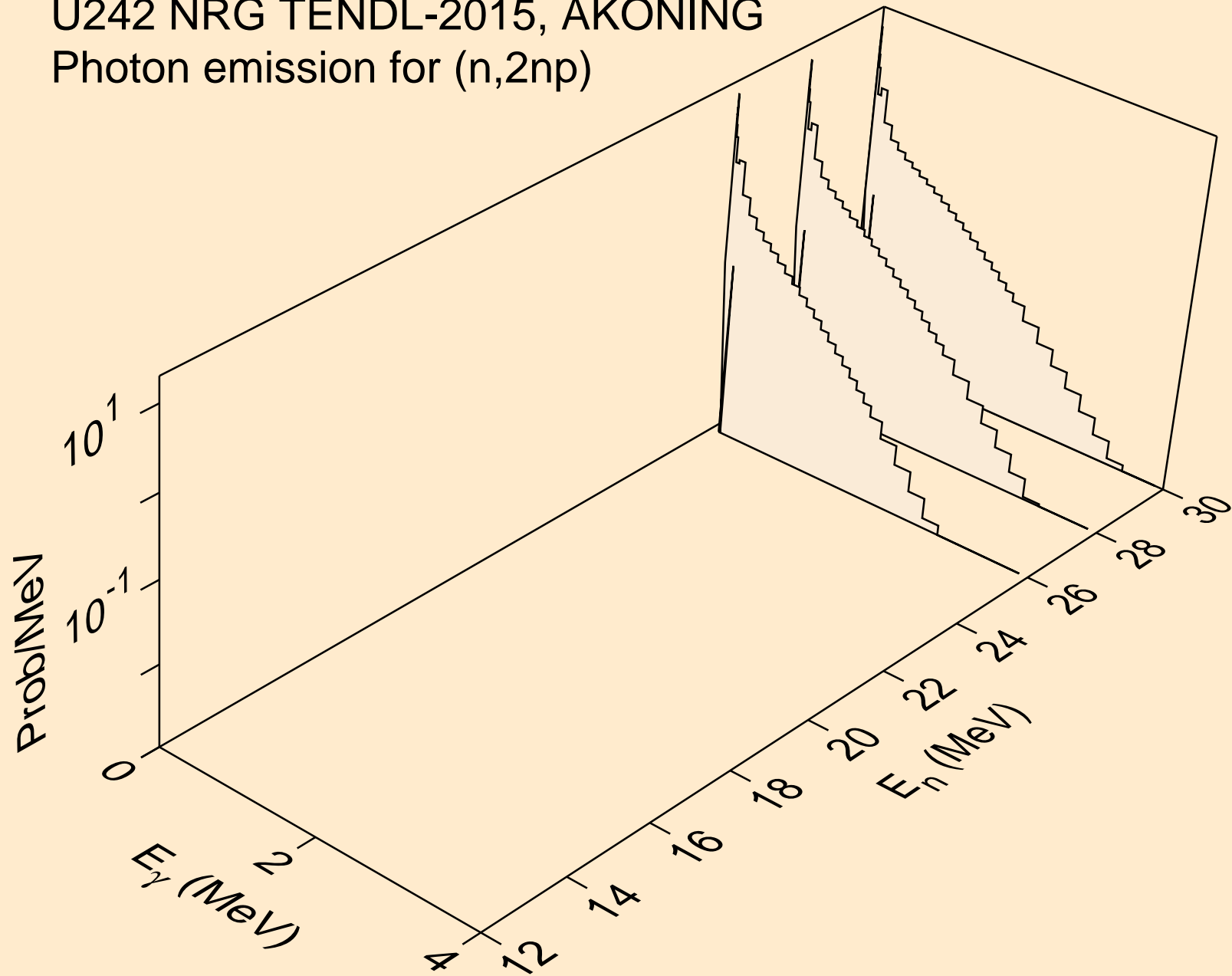

U242 NRG TENDL-2015, AKONING
Photon emission for (n,3np)

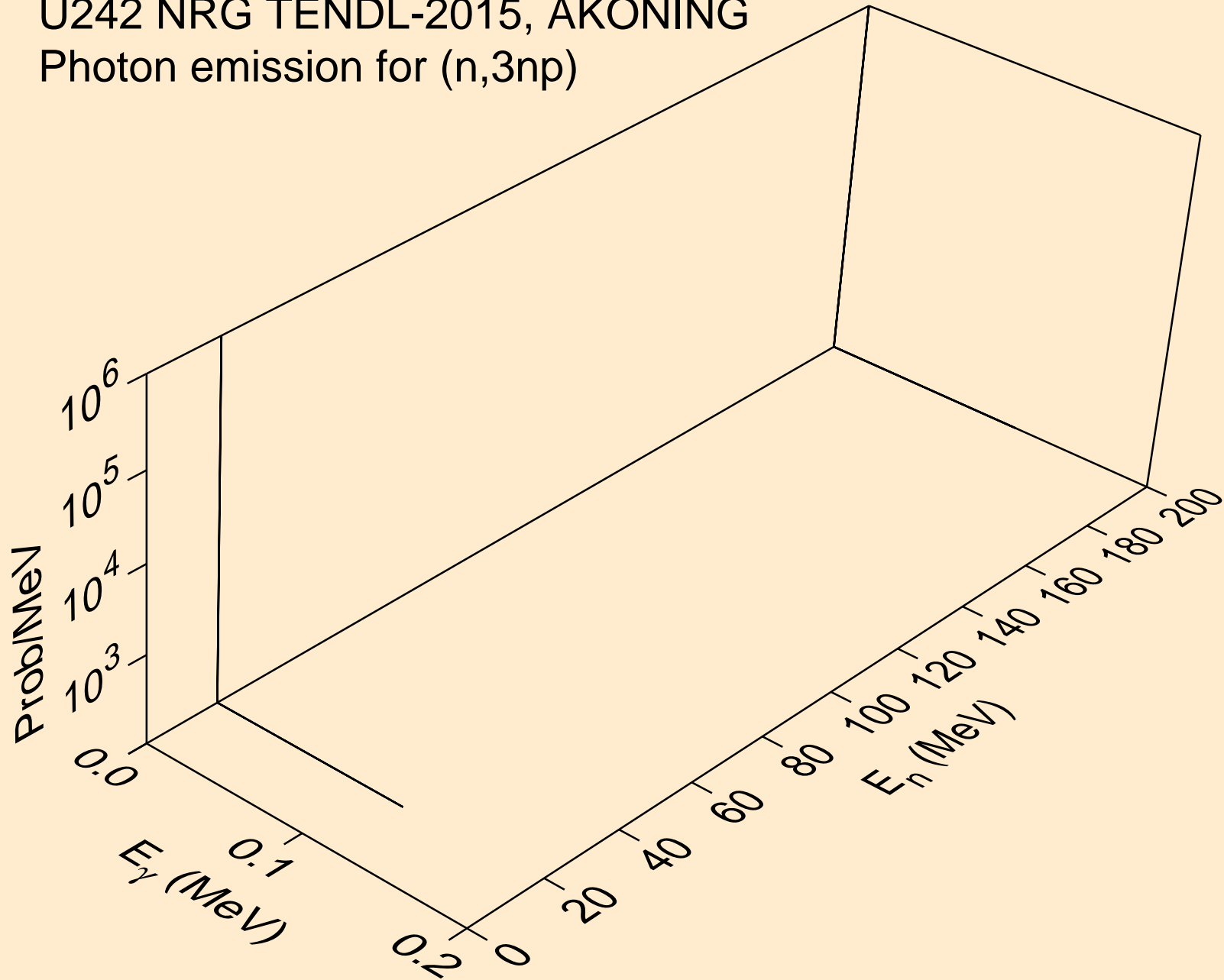

U242 NRG TENDL-2015, AKONING
Photon emission for (n,n*c)

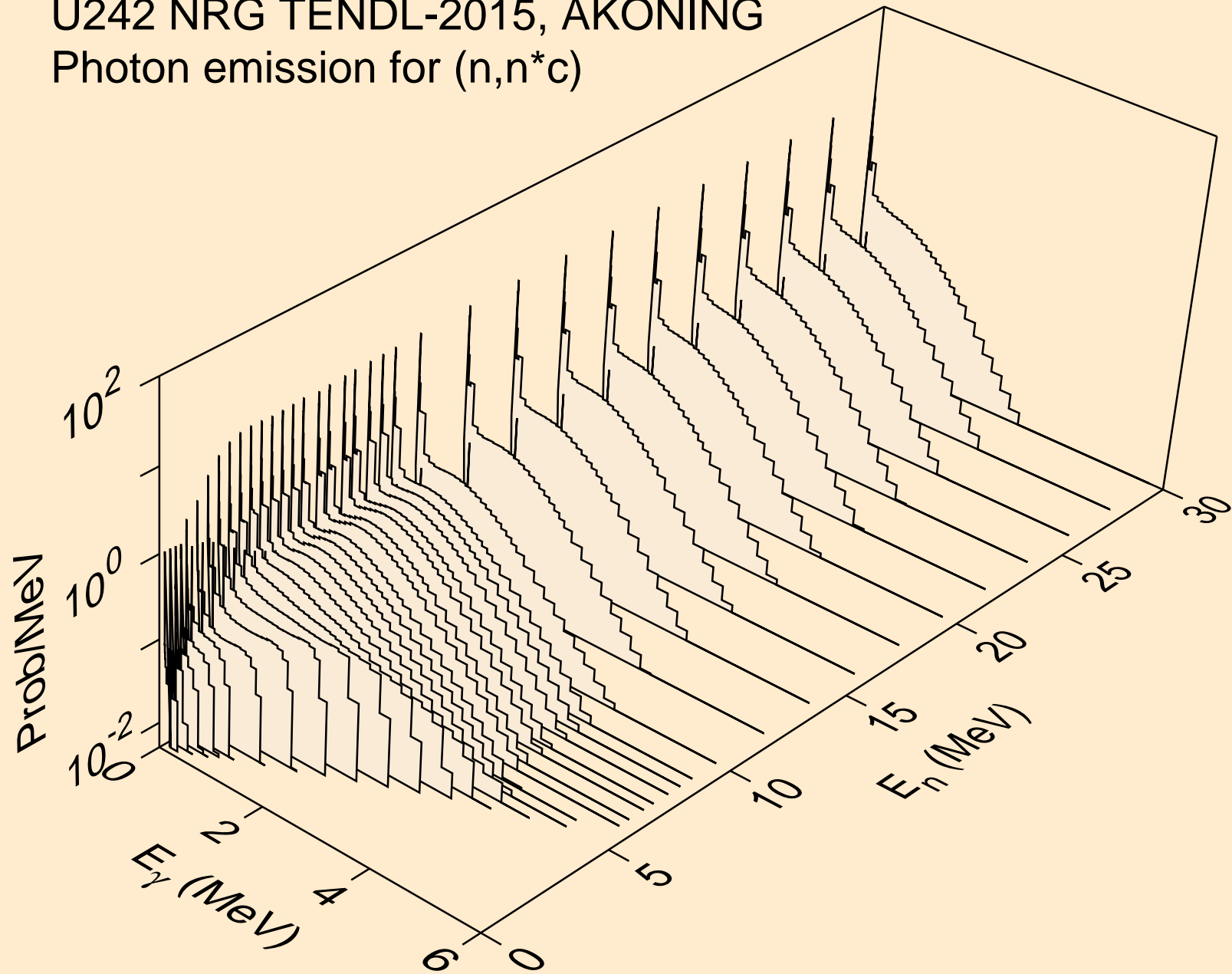

U242 NRG TENDL-2015, AKONING
Photon emission for (n,gma)

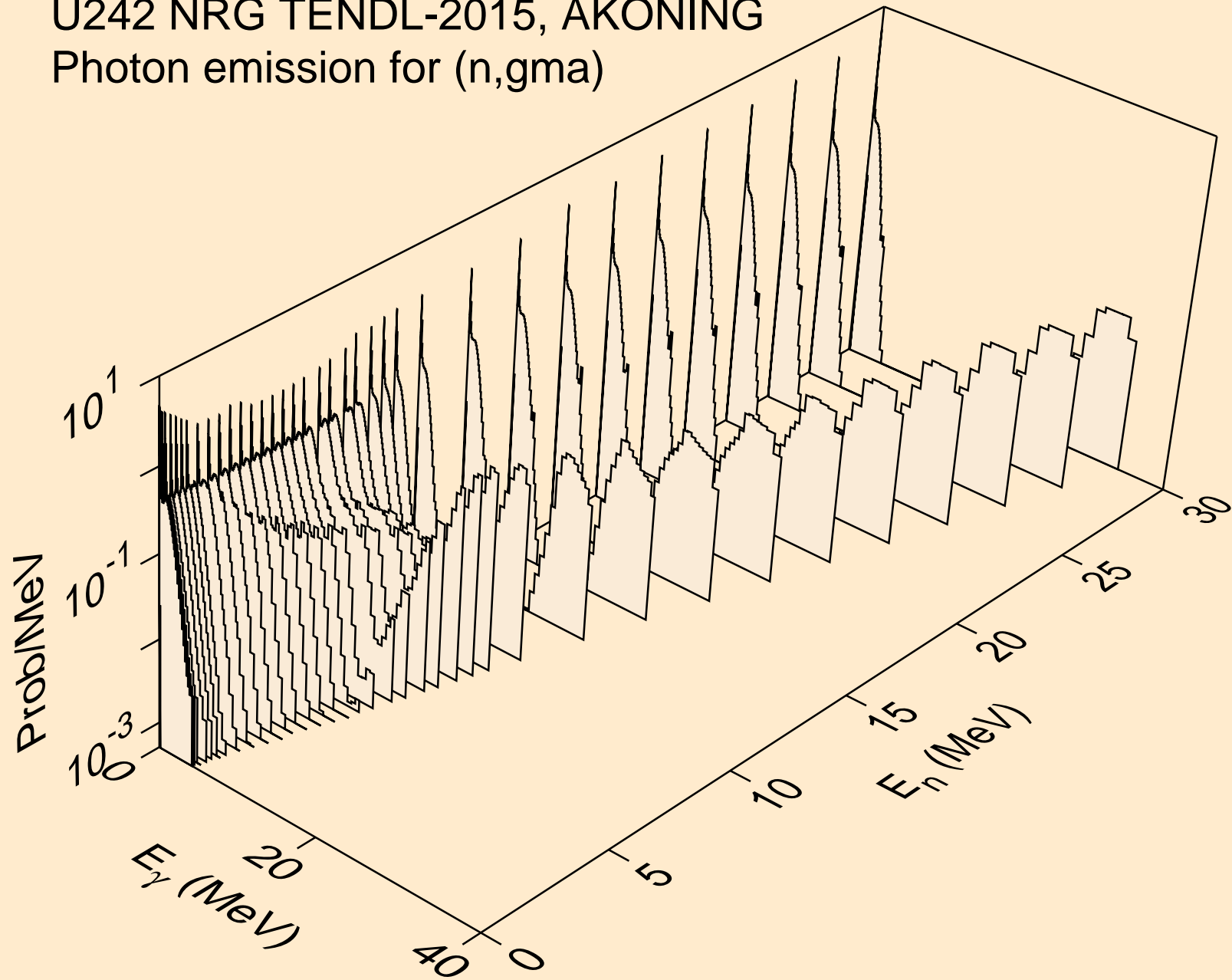

U242 NRG TENDL-2015, AKONING
Photon emission for (n,p)

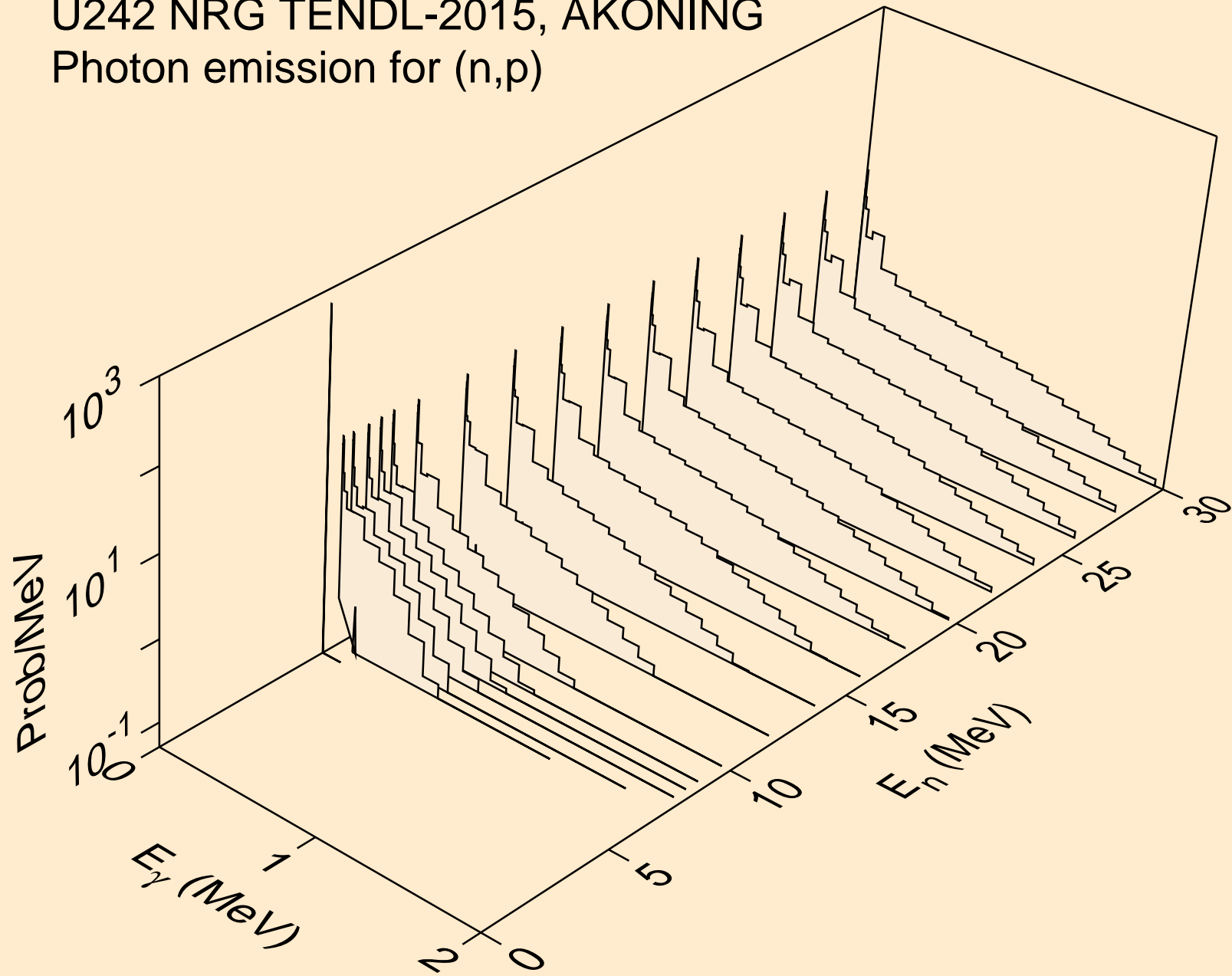

U242 NRG TENDL-2015, AKONING
Photon emission for (n,d)

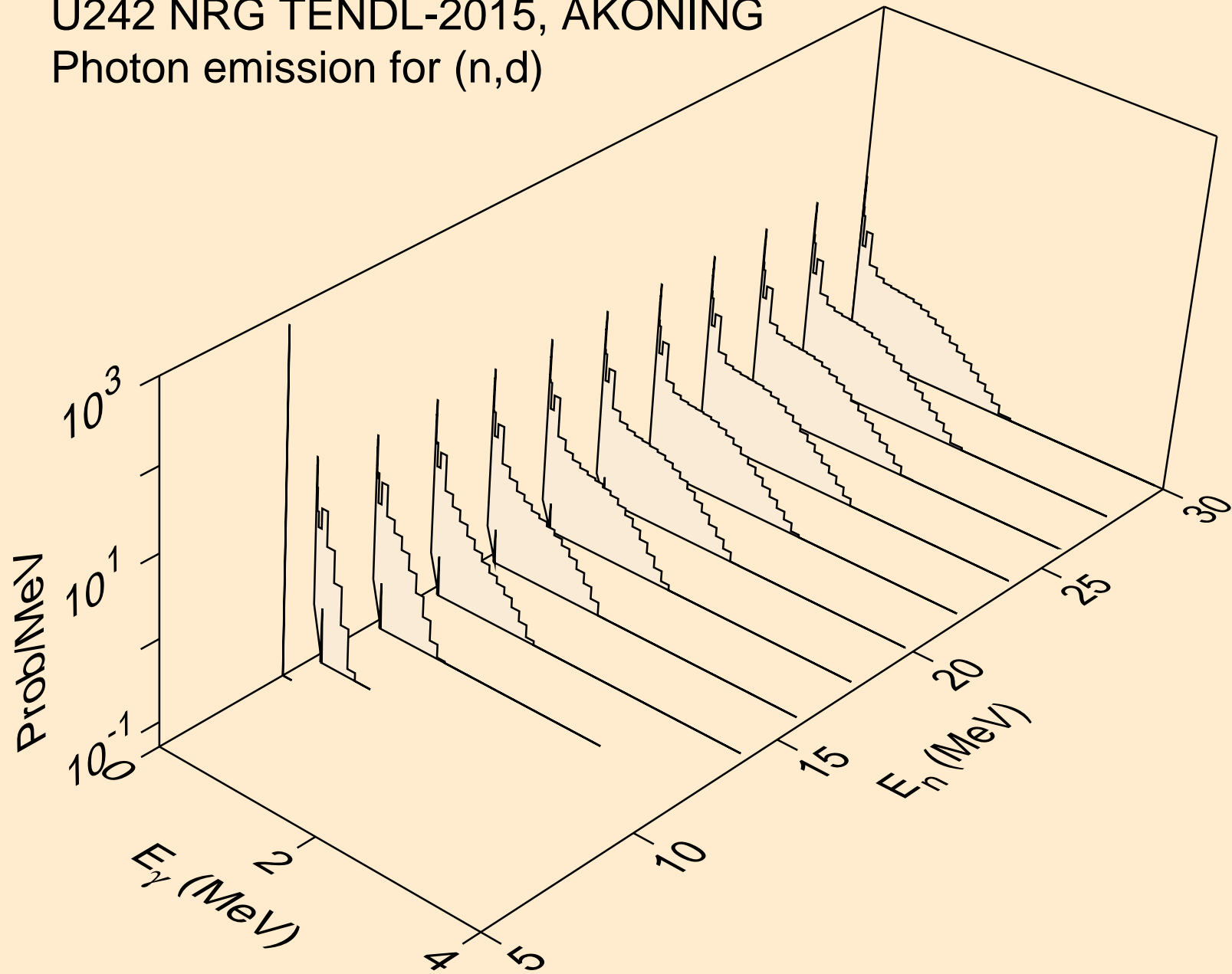

U242 NRG TENDL-2015, AKONING
Photon emission for (n,t)

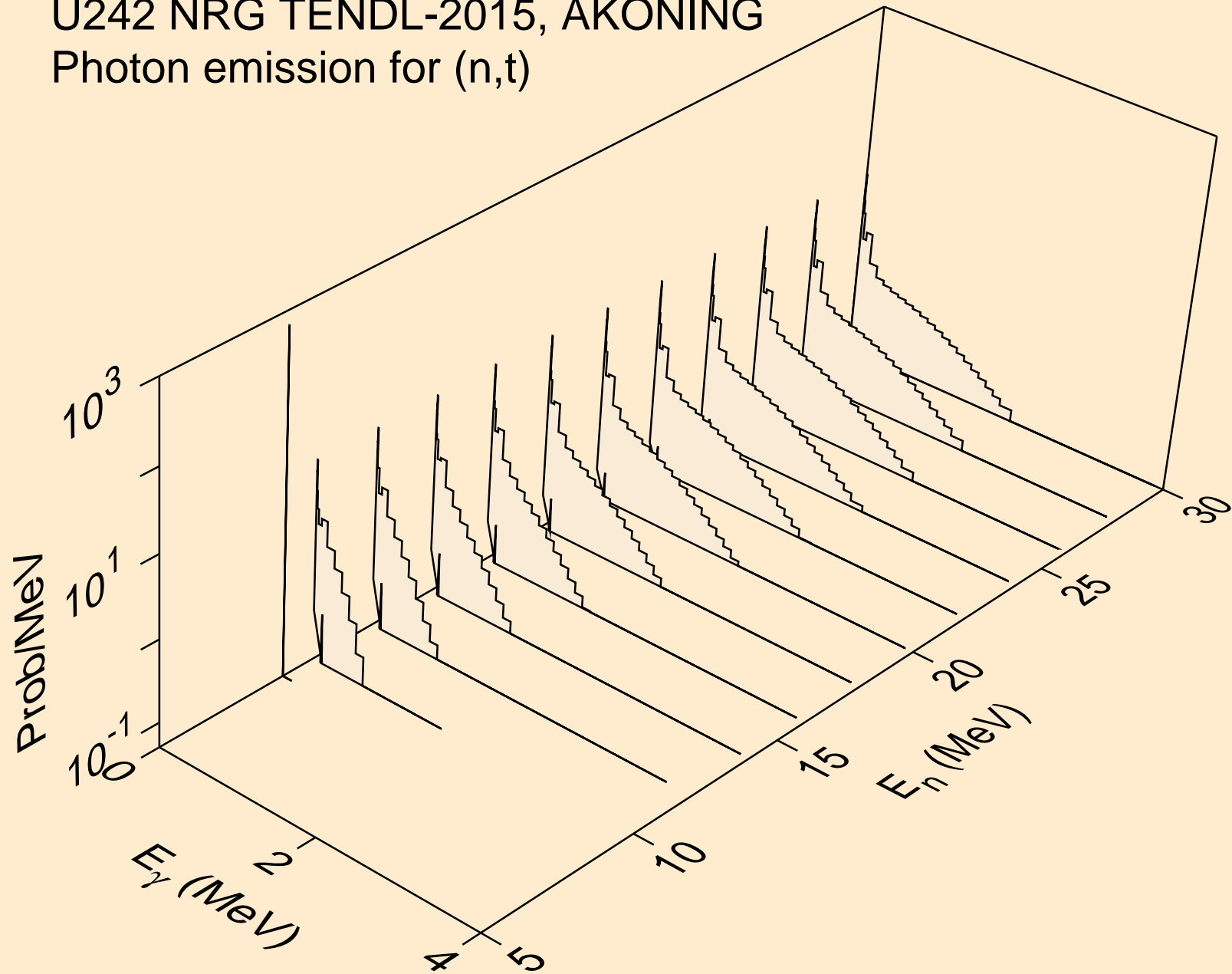

U242 NRG TENDL-2015, AKONING
Photon emission for (n,he3)

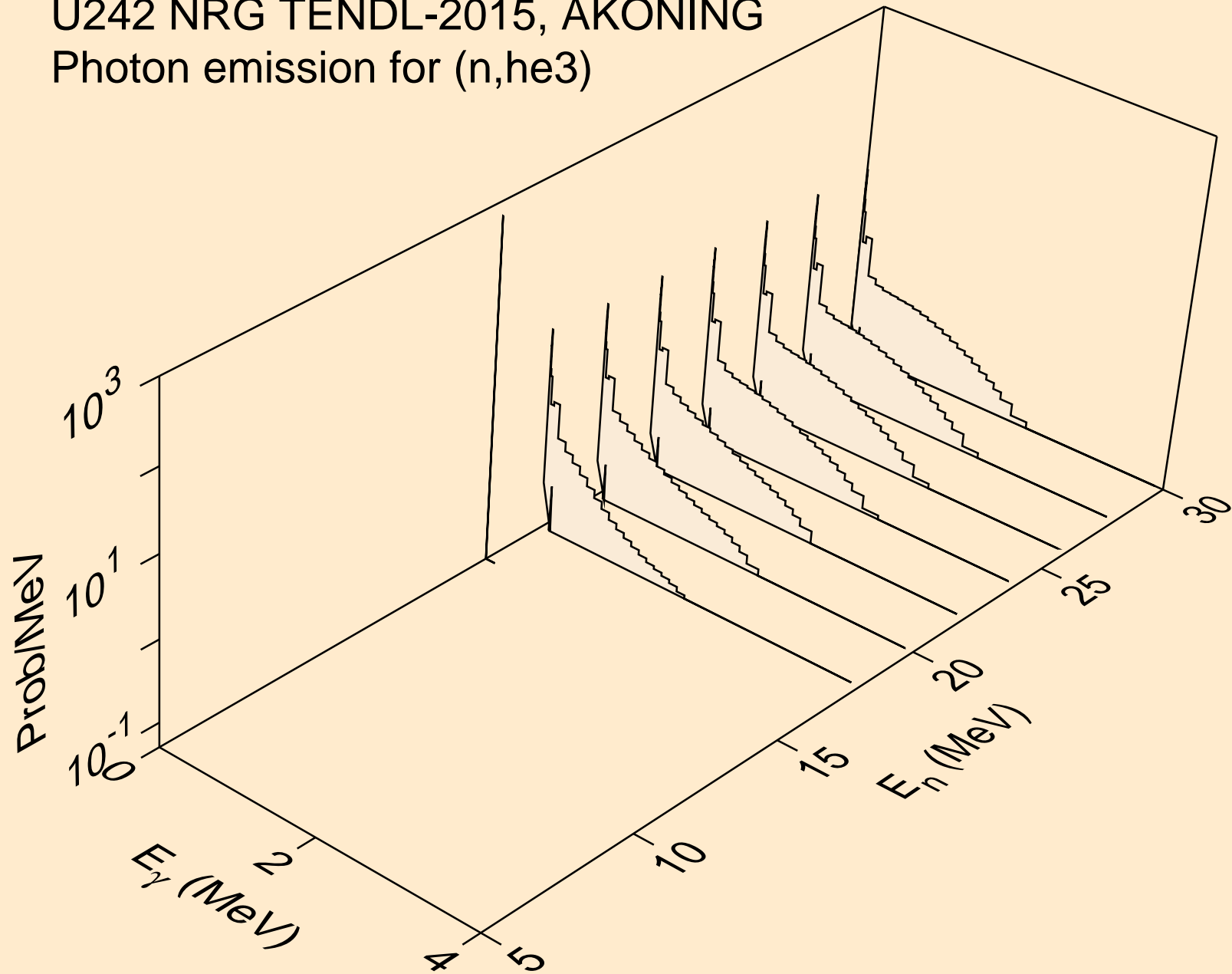

U242 NRG TENDL-2015, AKONING
Photon emission for (n,a)

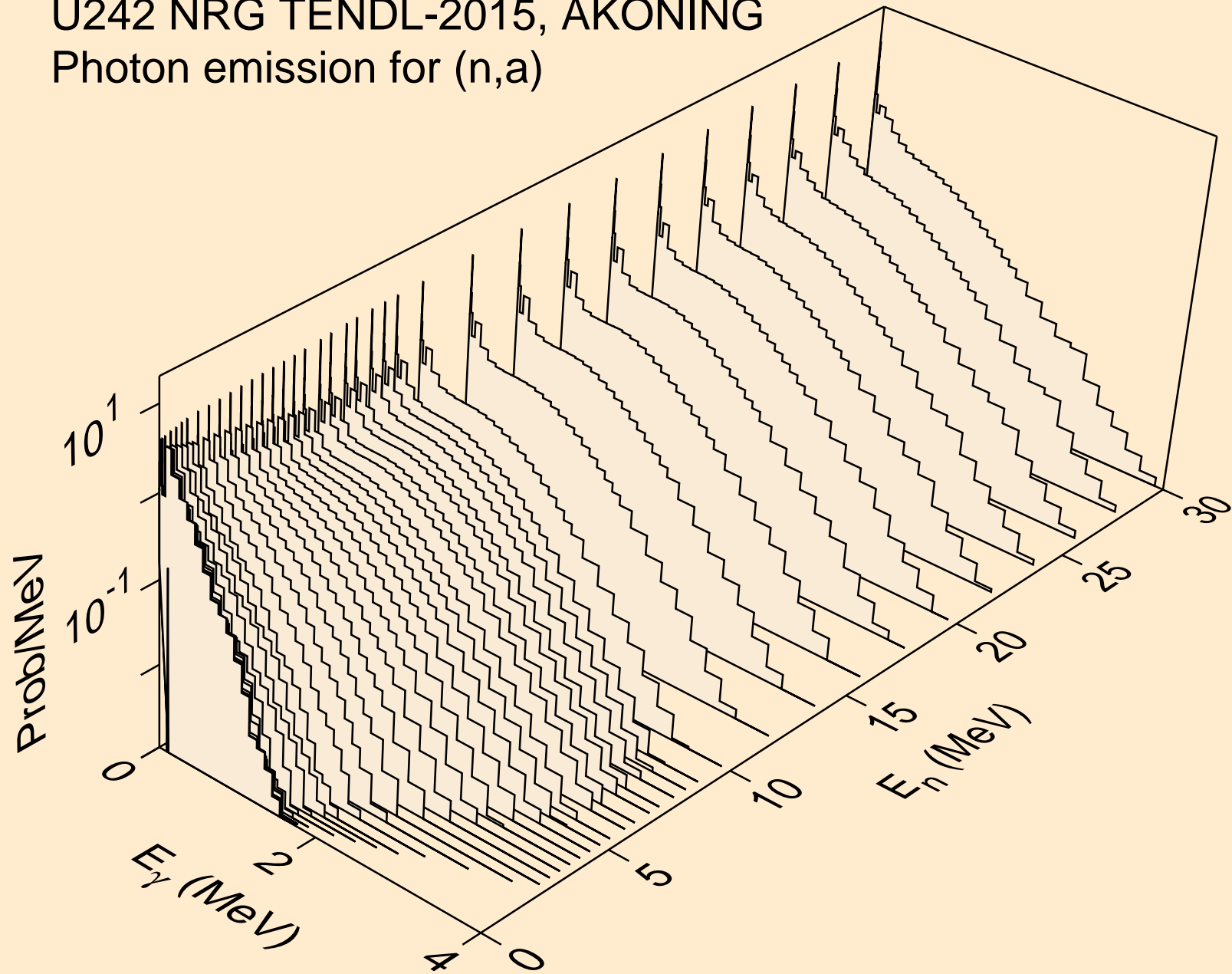

U242 NRG TENDL-2015, AKONING
Photon emission for (n,2p)

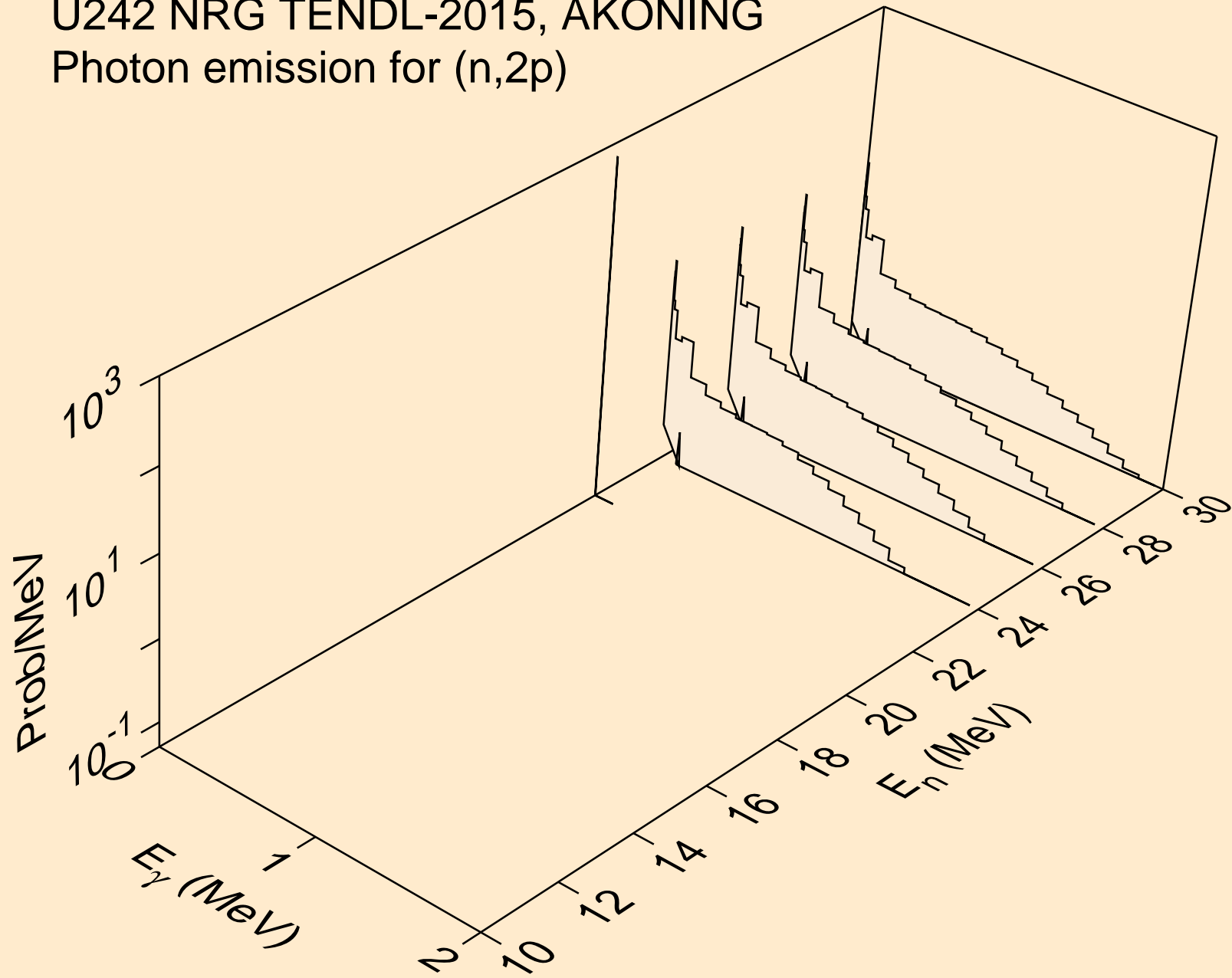

U242 NRG TENDL-2015, AKONING
thermal capture photon spectrum

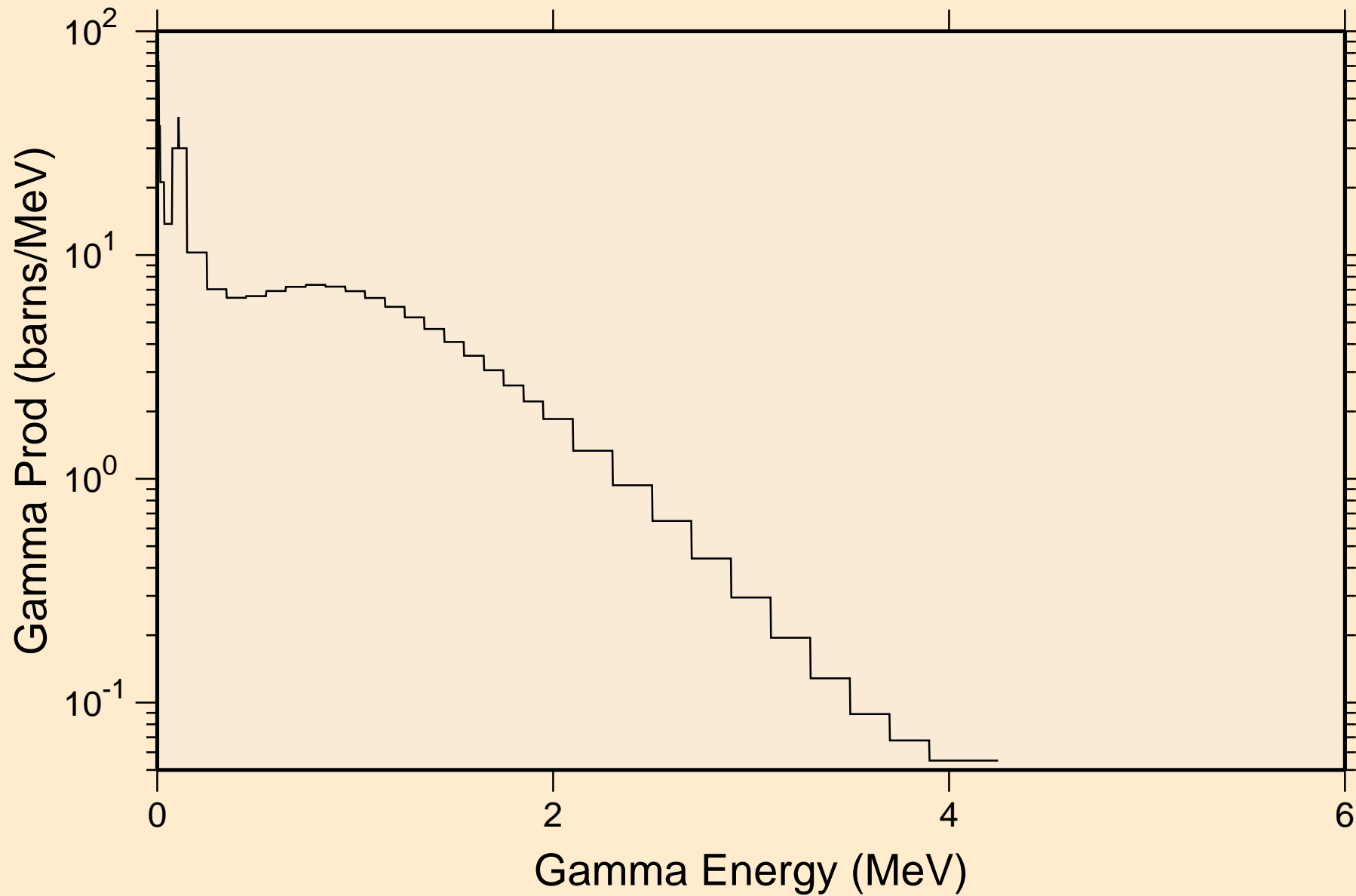

U242 NRG TENDL-2015, AKONING
14 MeV photon spectrum

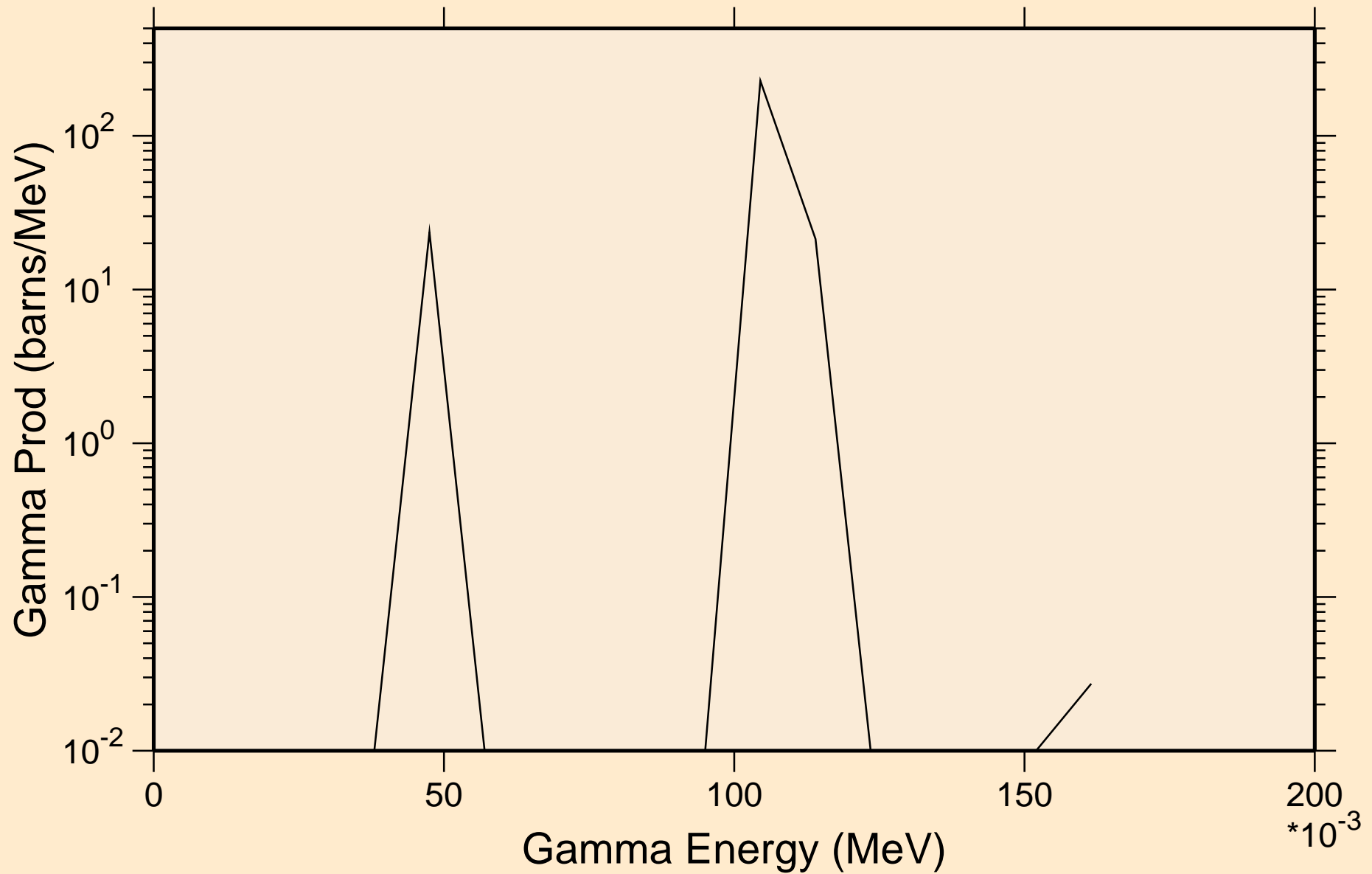

U242 NRG TENDL-2015, AKONING

Particle heating contributions

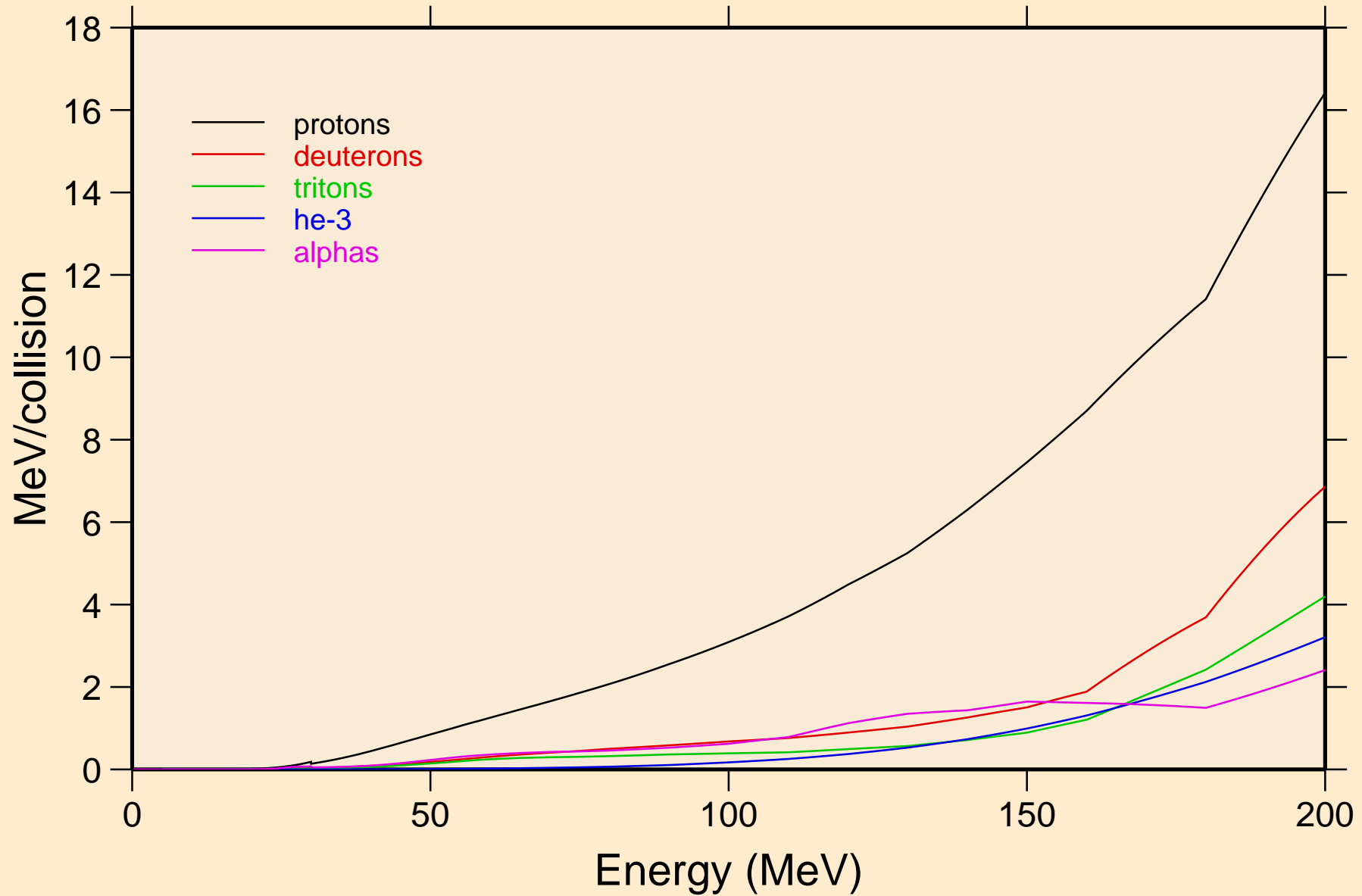

U242 NRG TENDL-2015, AKONING

Recoil Heating

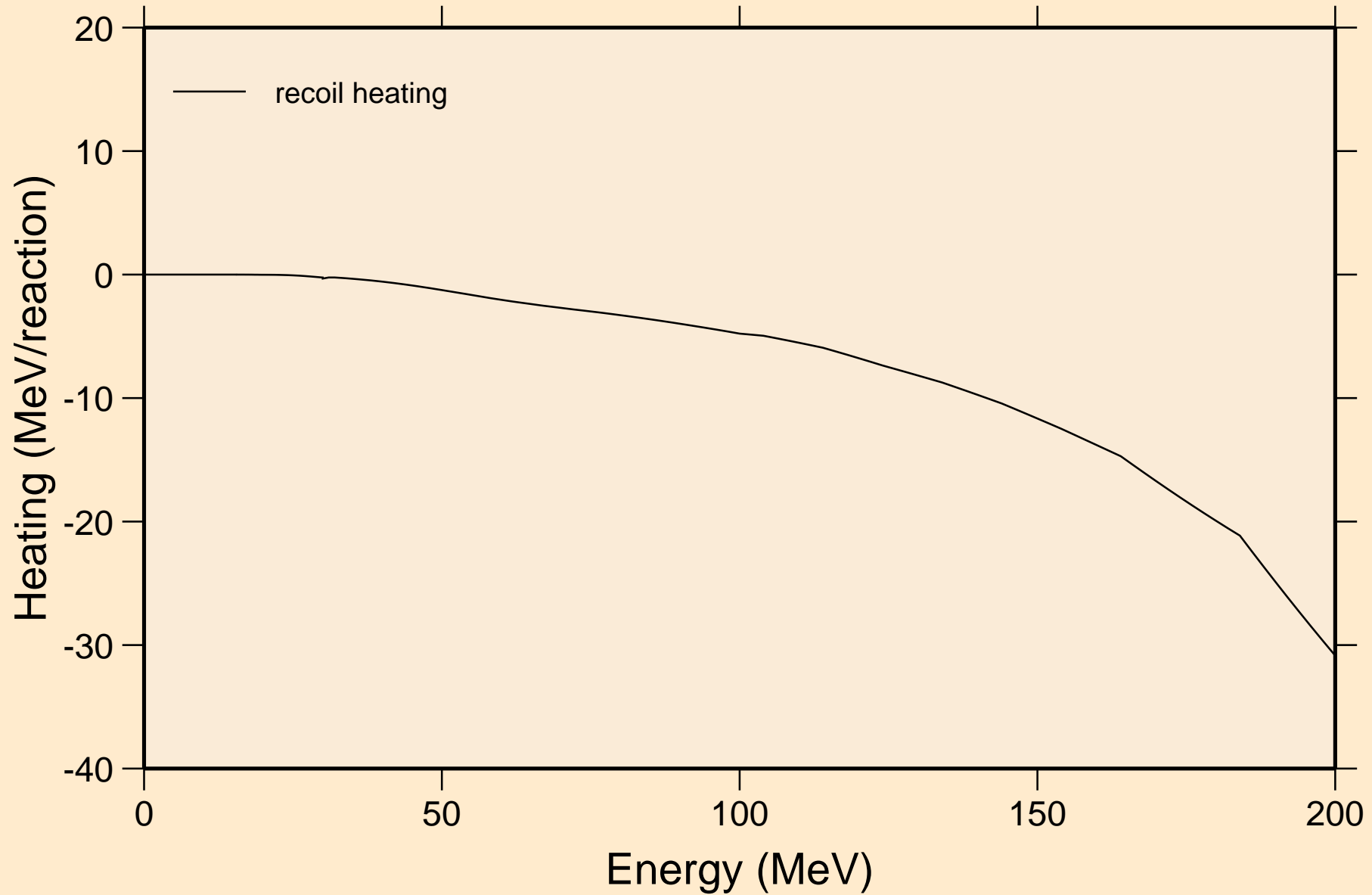

U242 NRG TENDL-2015, AKONING

Particle production cross sections

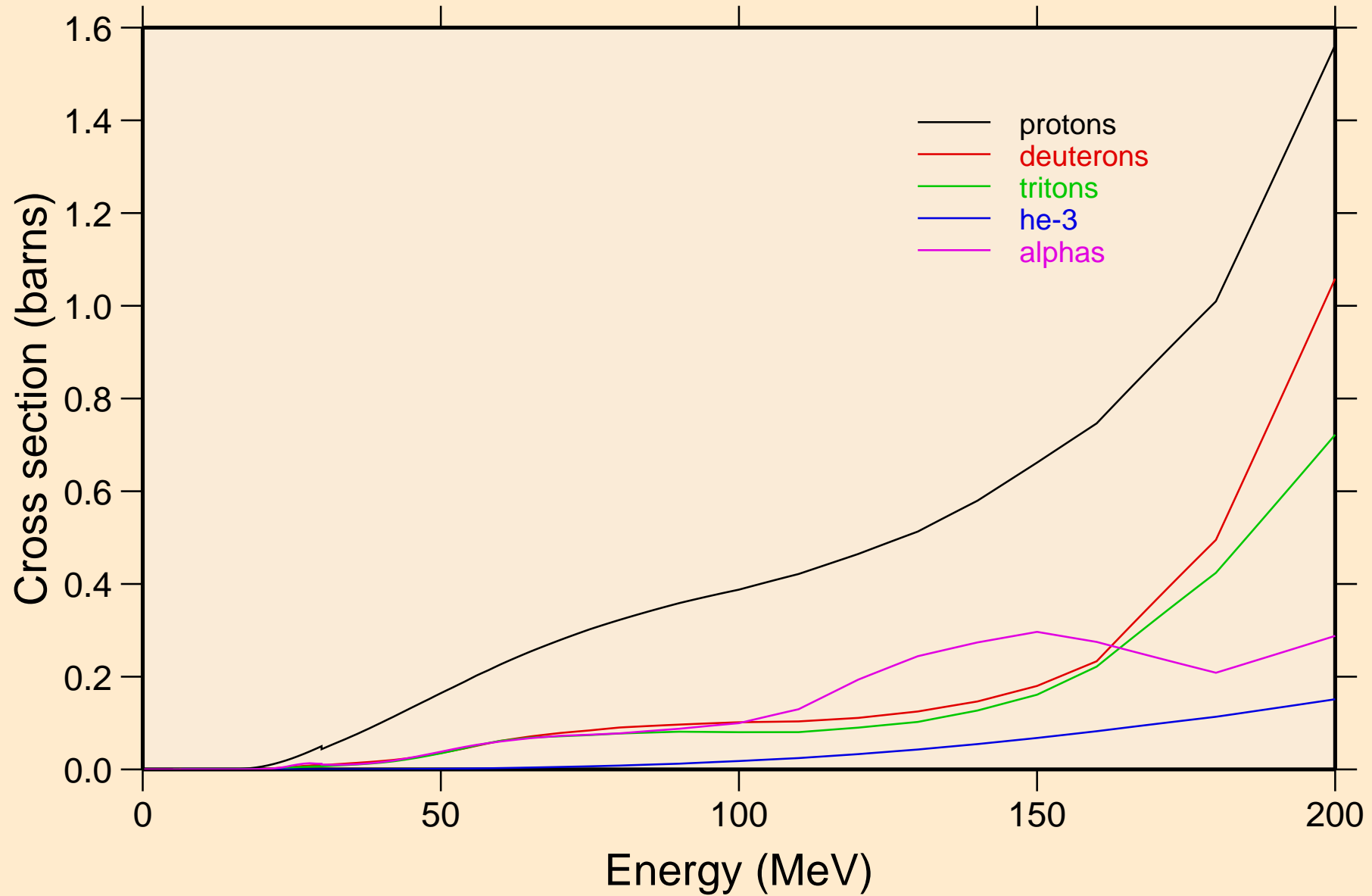

U242 NRG TENDL-2015, AKONING
protons from (n,x)

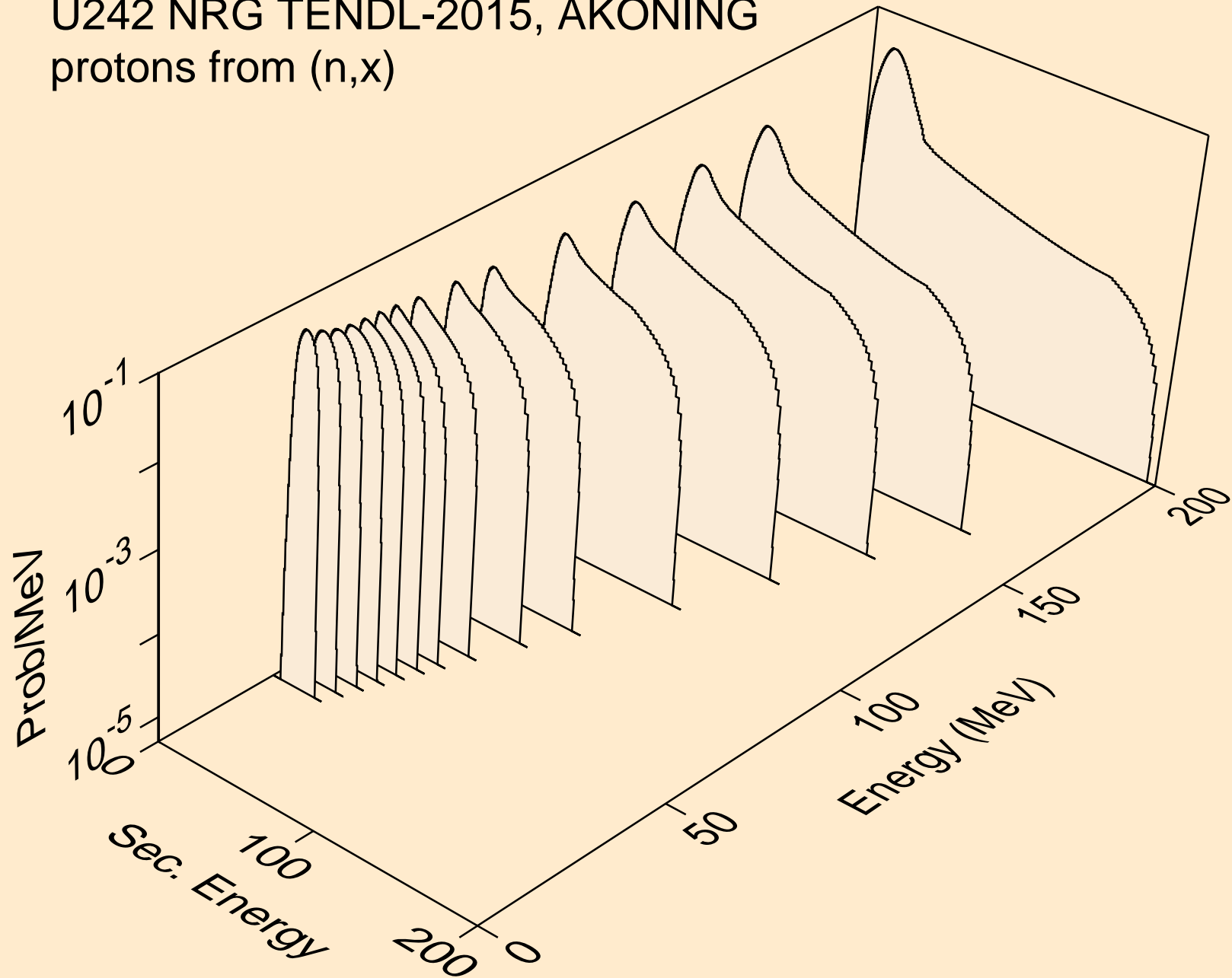

U242 NRG TENDL-2015, AKONING
protons from (n,n*)p

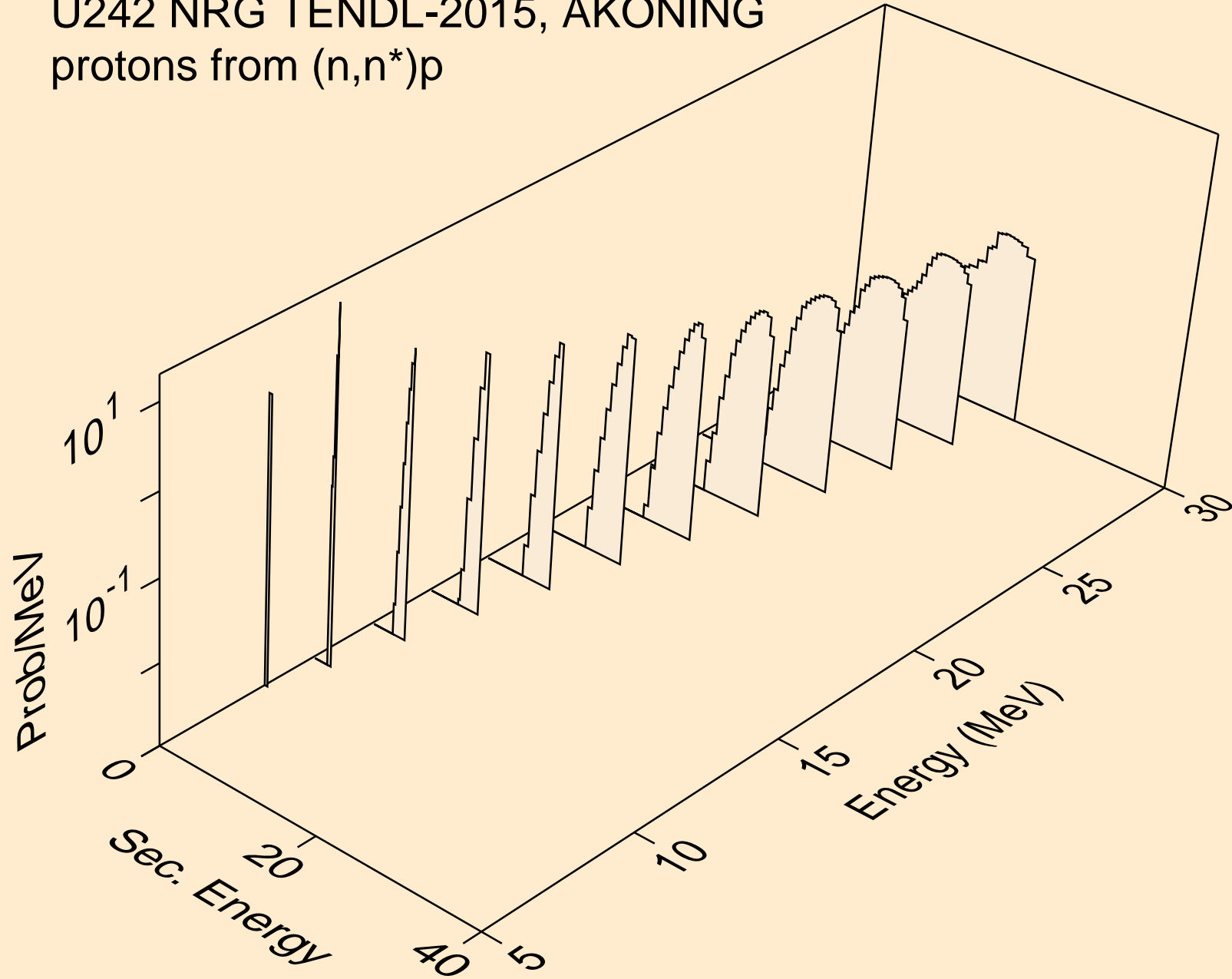

U242 NRG TENDL-2015, AKONING
protons from (n,2np)

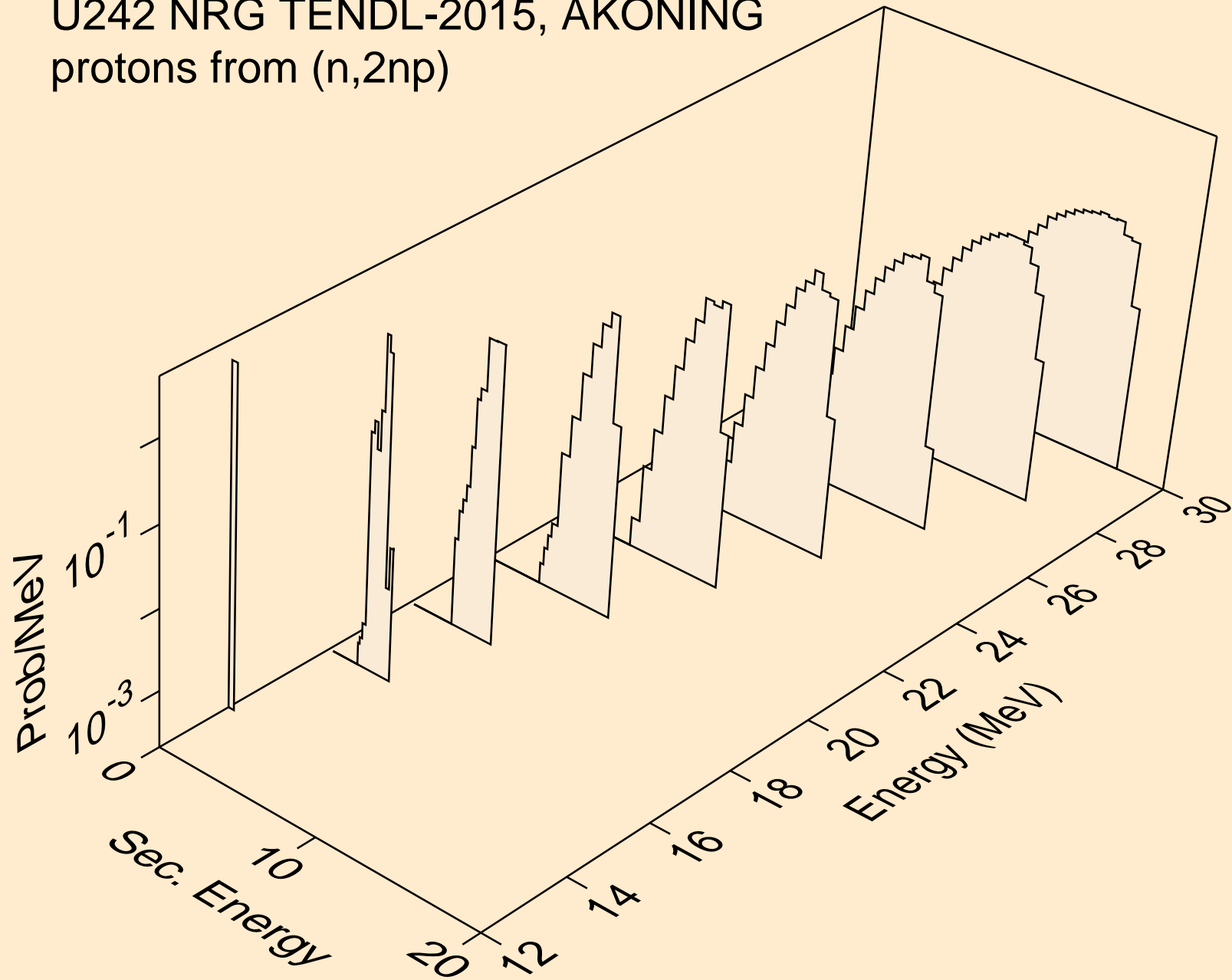

U242 NRG TENDL-2015, AKONING
protons from (n,3np)

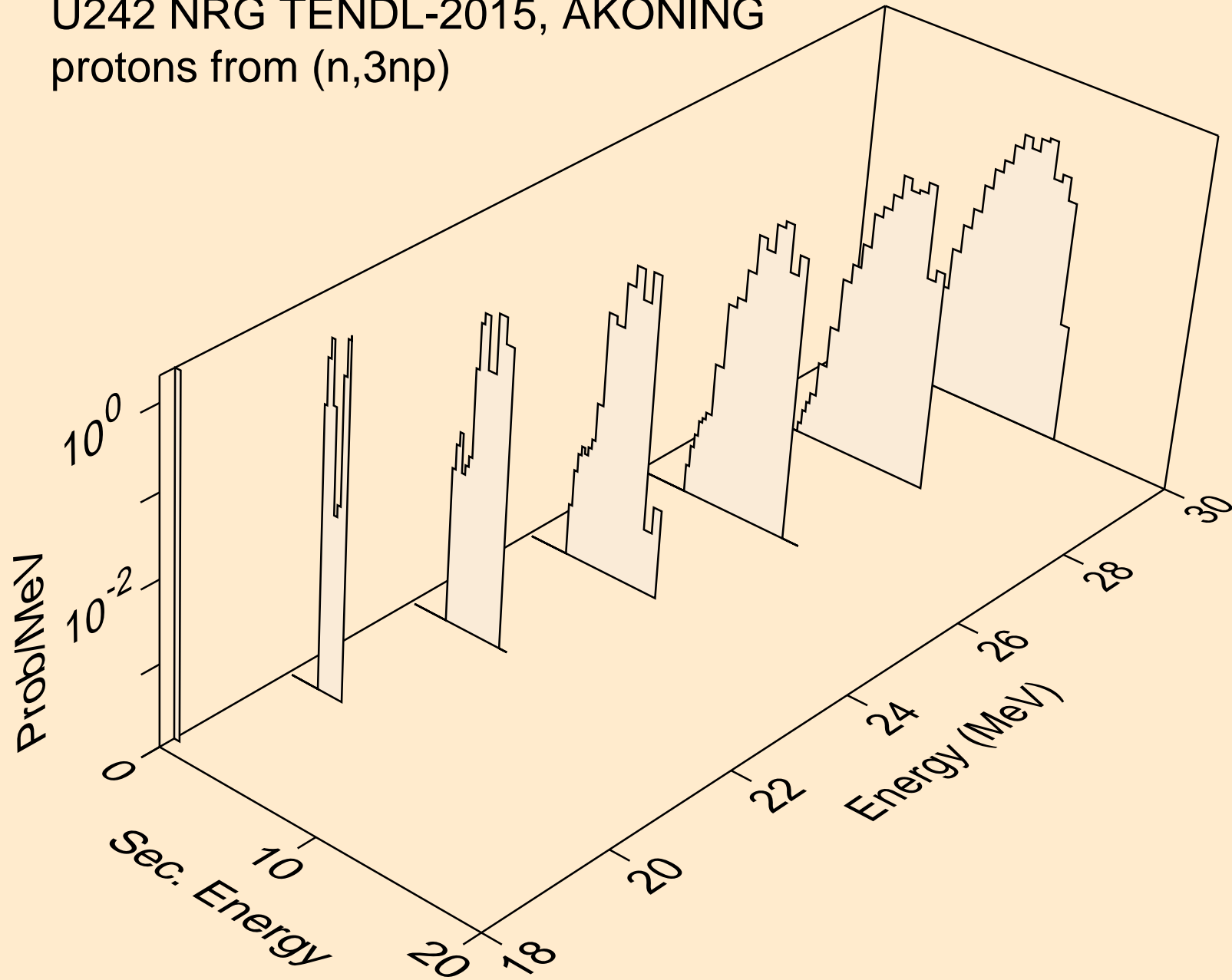

U242 NRG TENDL-2015, AKONING
protons from (n,p)

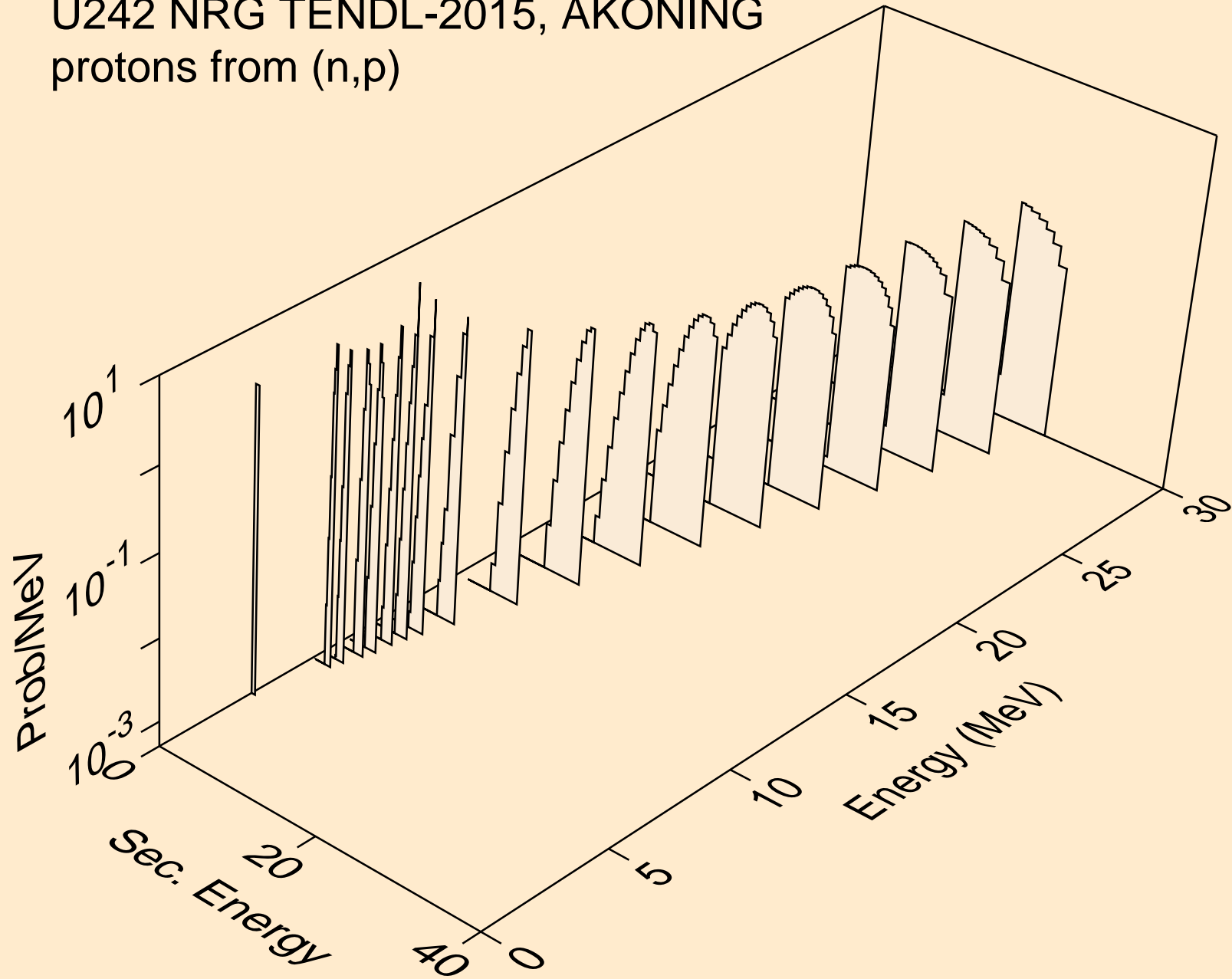

U242 NRG TENDL-2015, AKONING
protons from (n,2p)

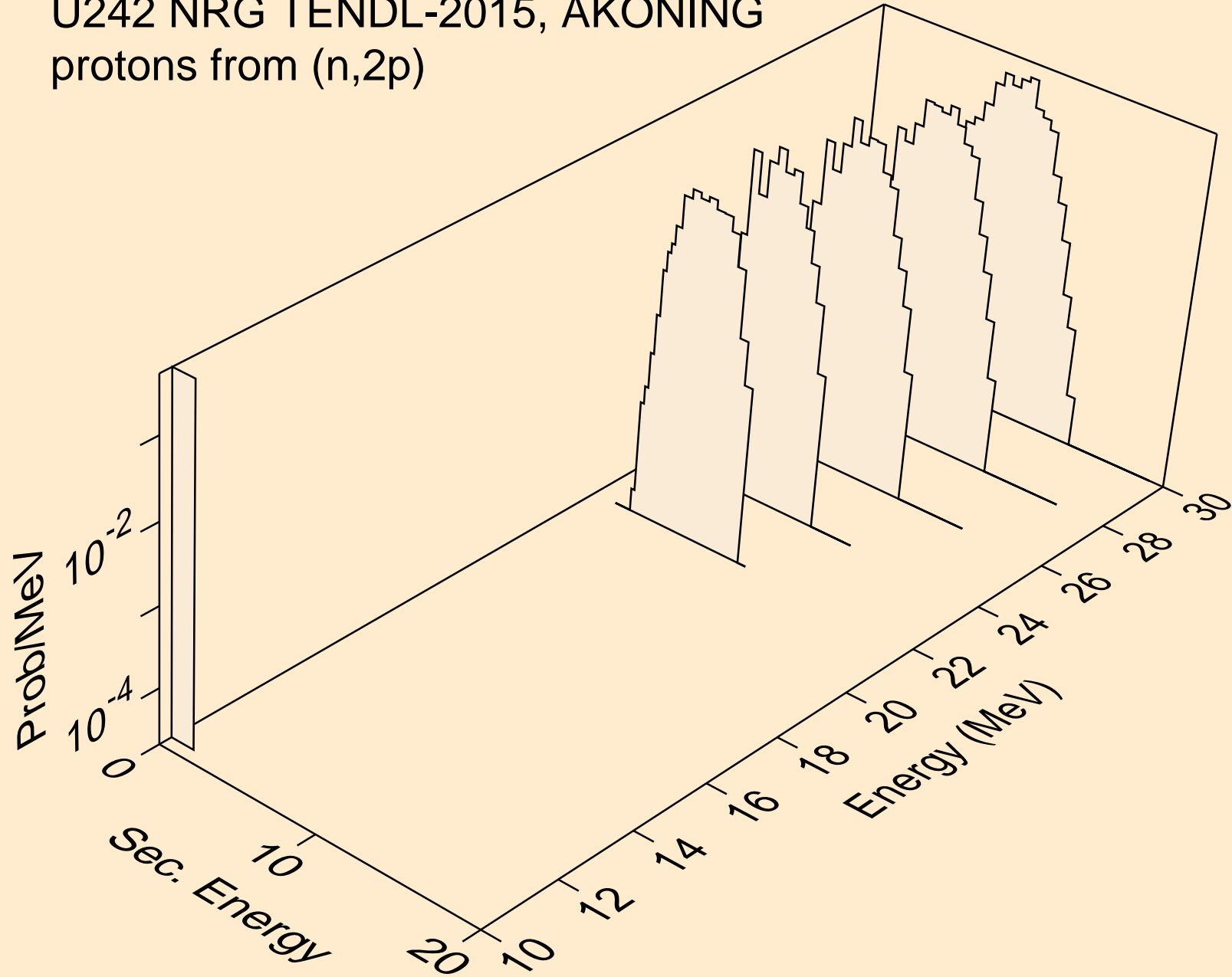

U242 NRG TENDL-2015, AKONING
deuterons from (n,x)

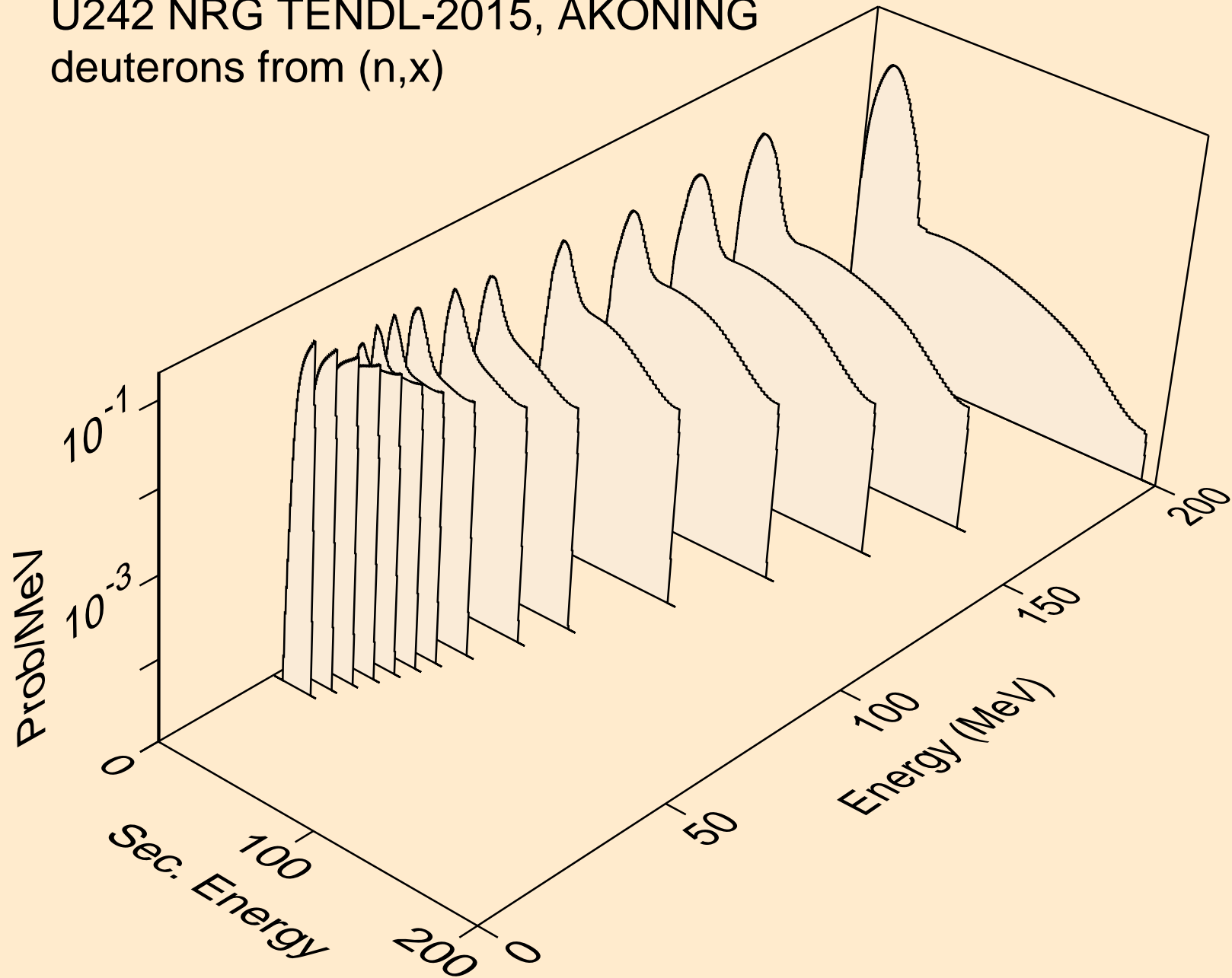

U242 NRG TENDL-2015, AKONING
deuterons from (n,2nd)

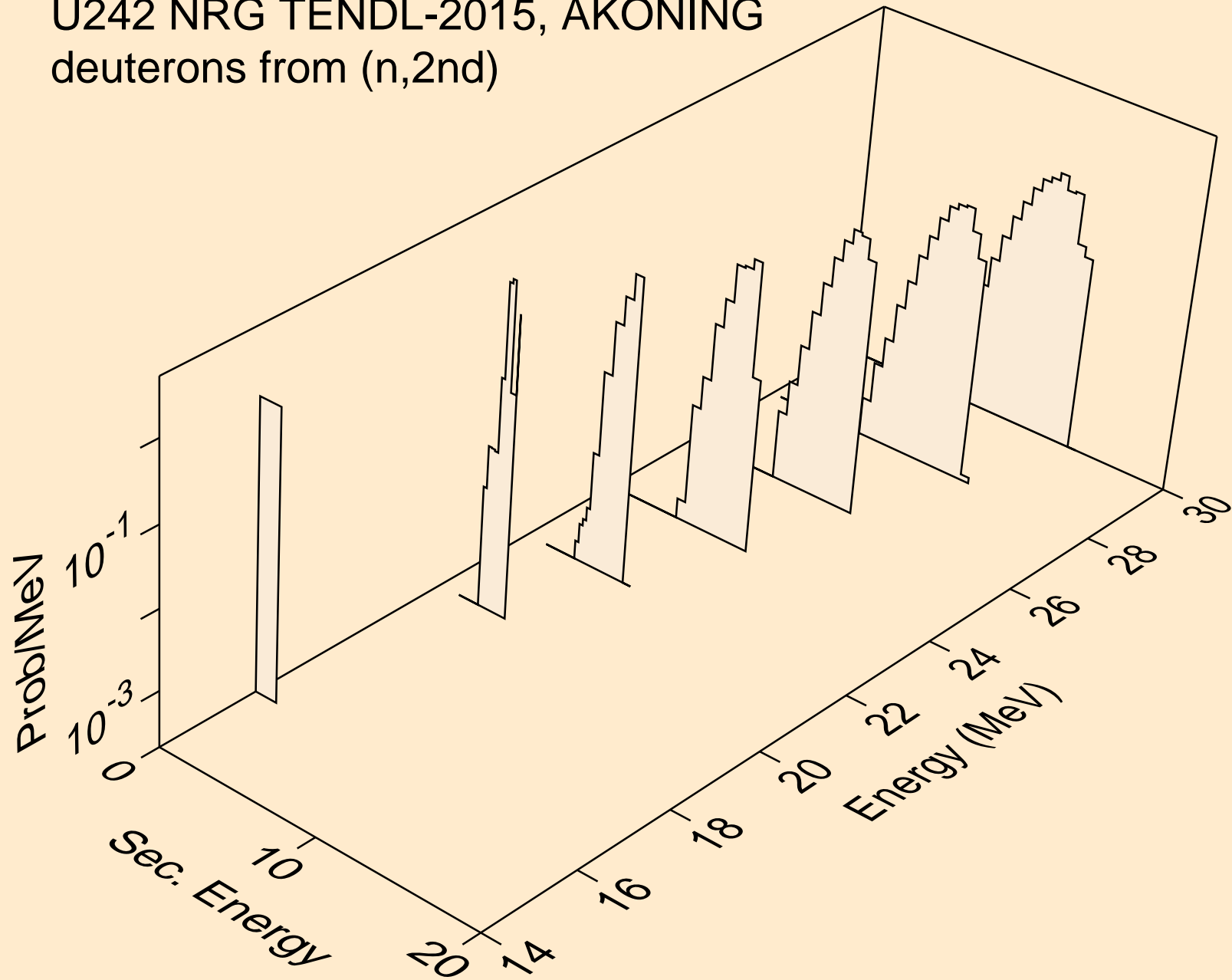

U242 NRG TENDL-2015, AKONING
deuterons from (n,n*)d

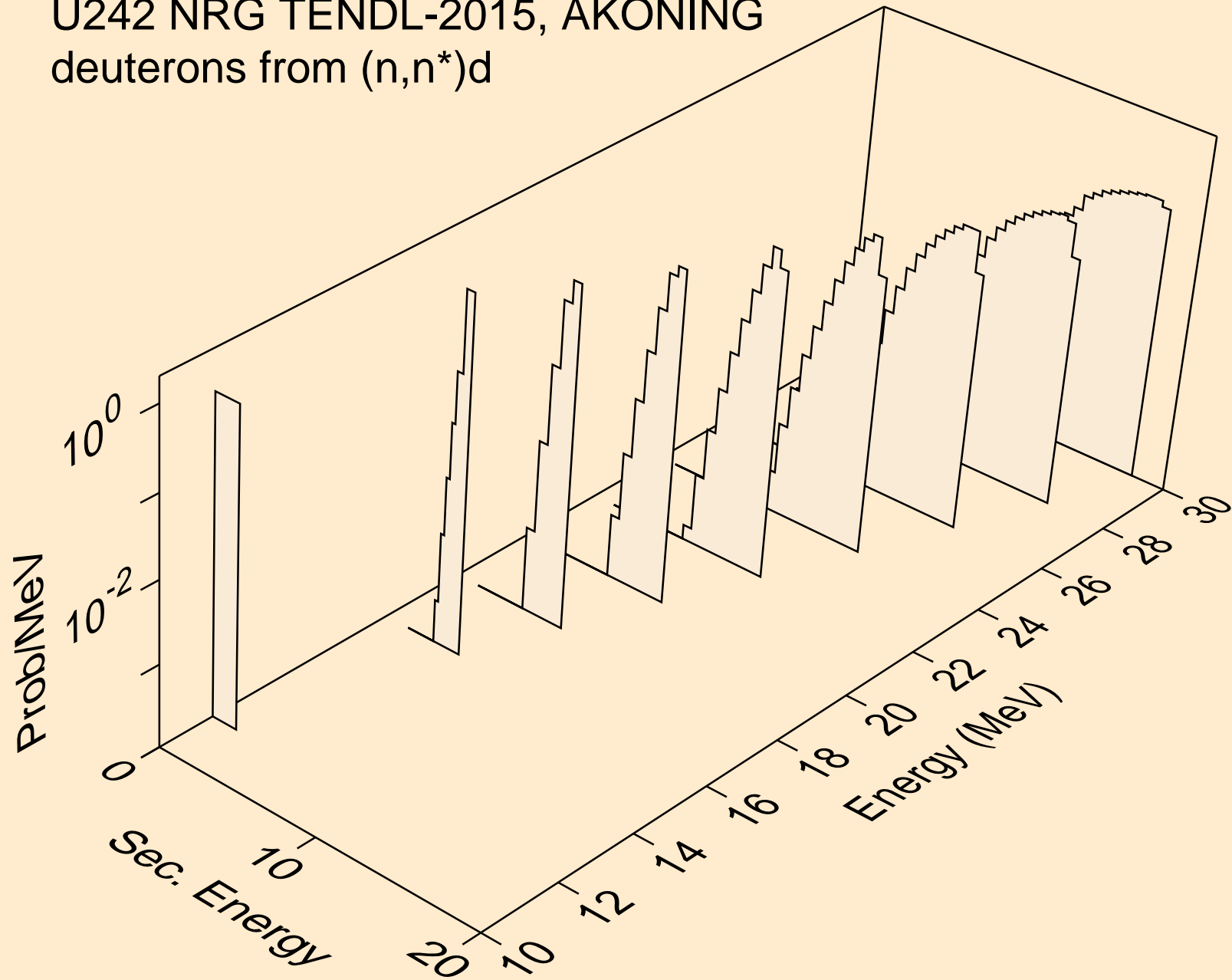

U242 NRG TENDL-2015, AKONING
deuterons from (n,d)

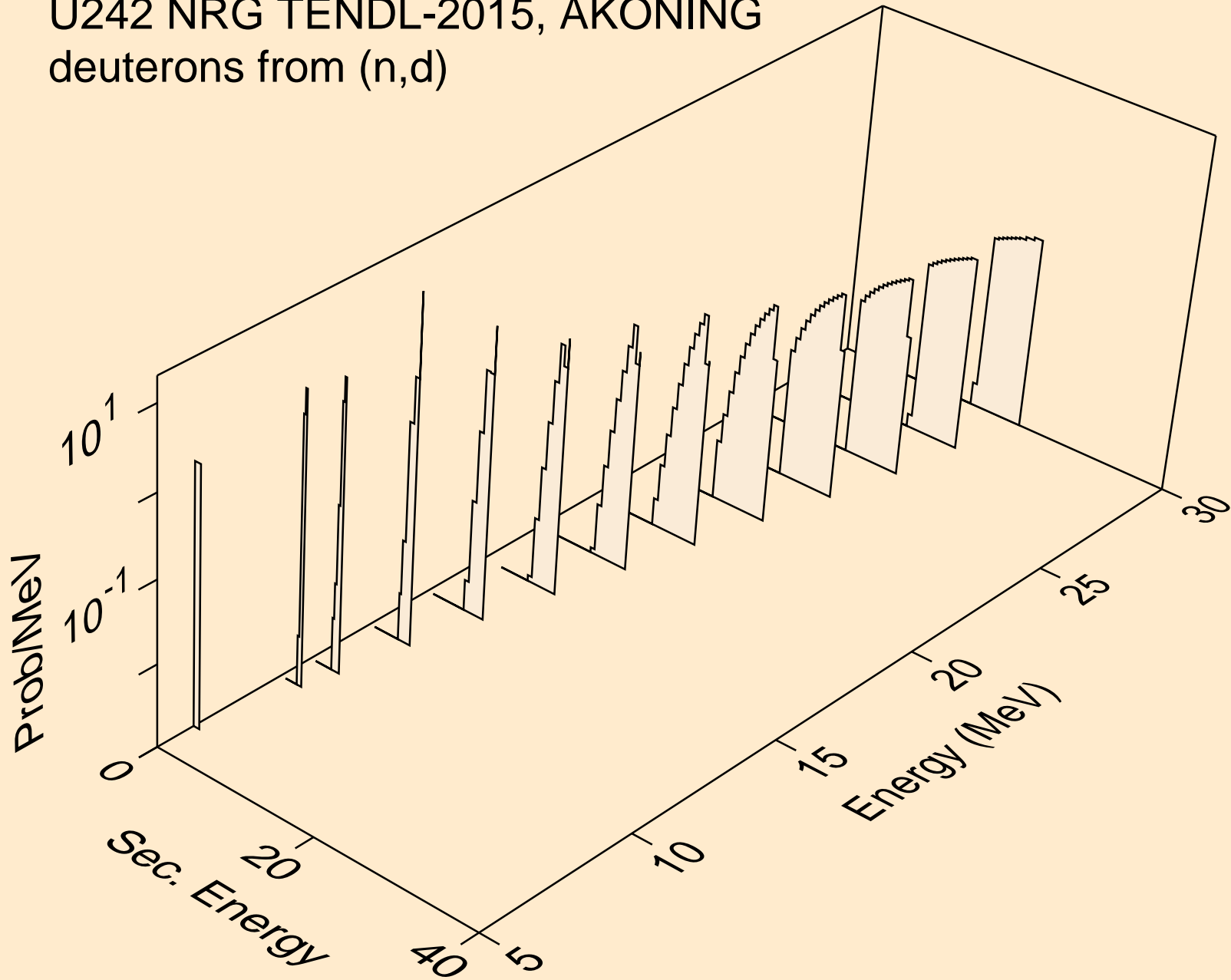

U242 NRG TENDL-2015, AKONING
tritons from (n,x)

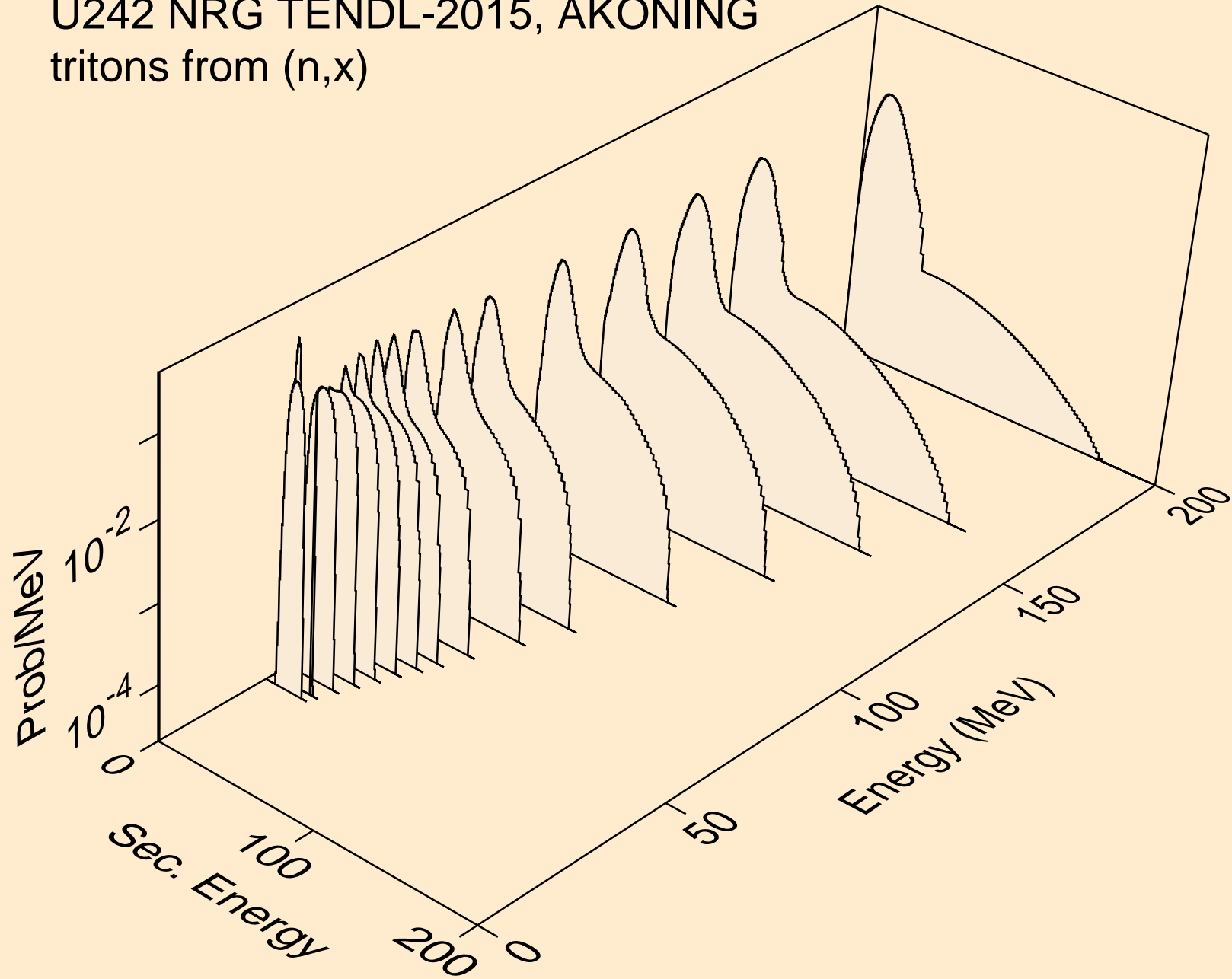

U242 NRG TENDL-2015, AKONING
tritons from (n,n*)t

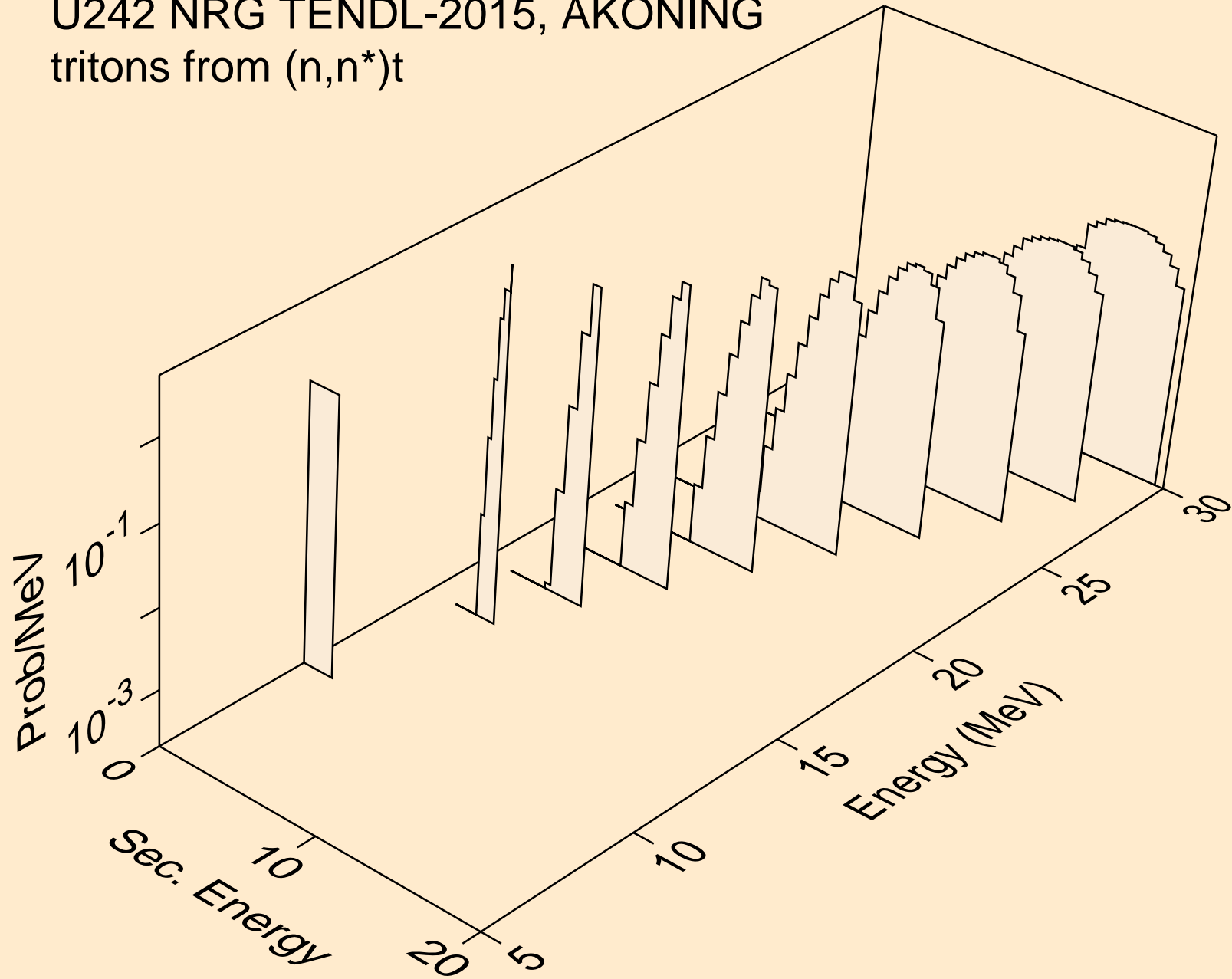

U242 NRG TENDL-2015, AKONING
tritons from (n,t)

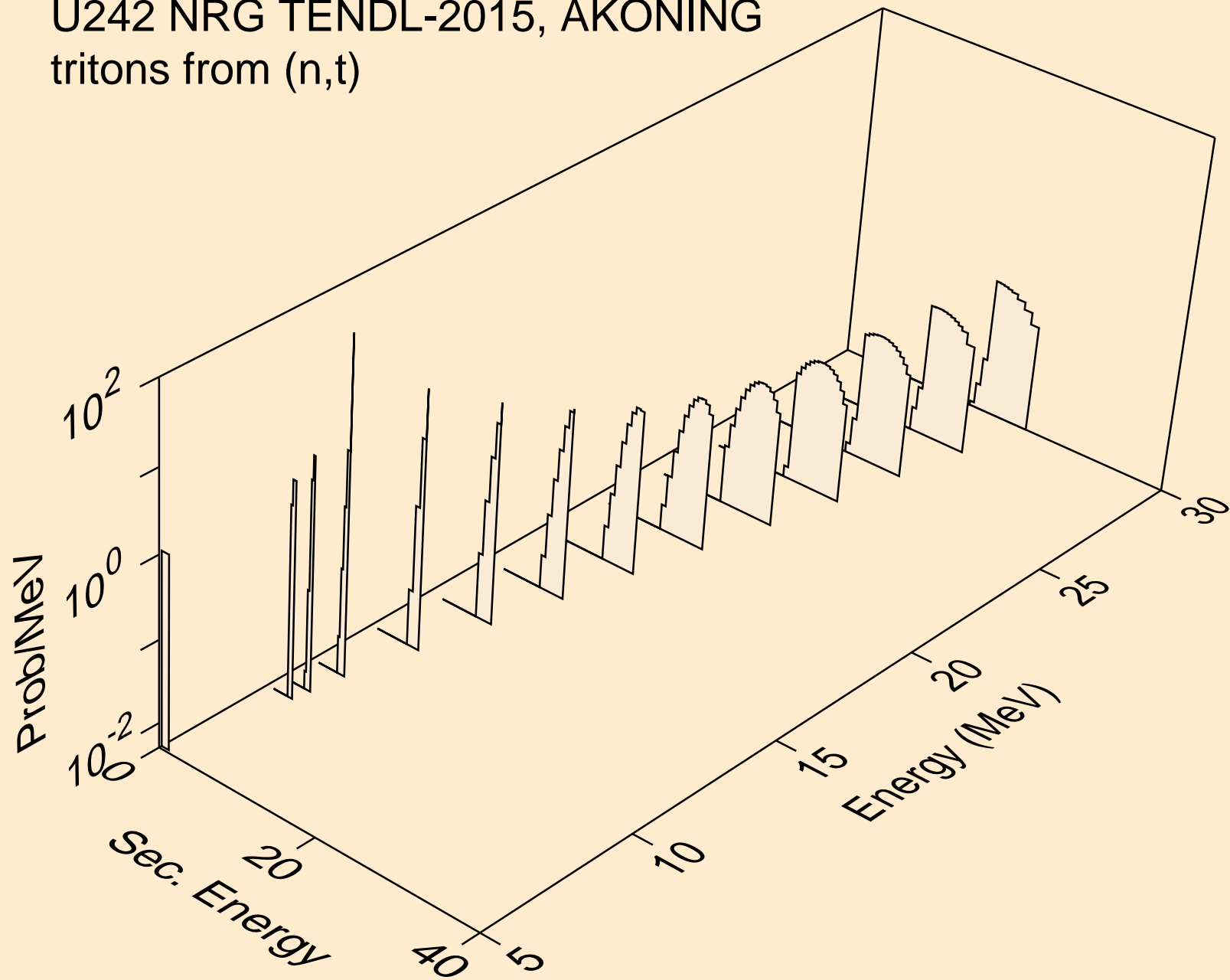

U242 NRG TENDL-2015, AKONING
he3s from (n,x)

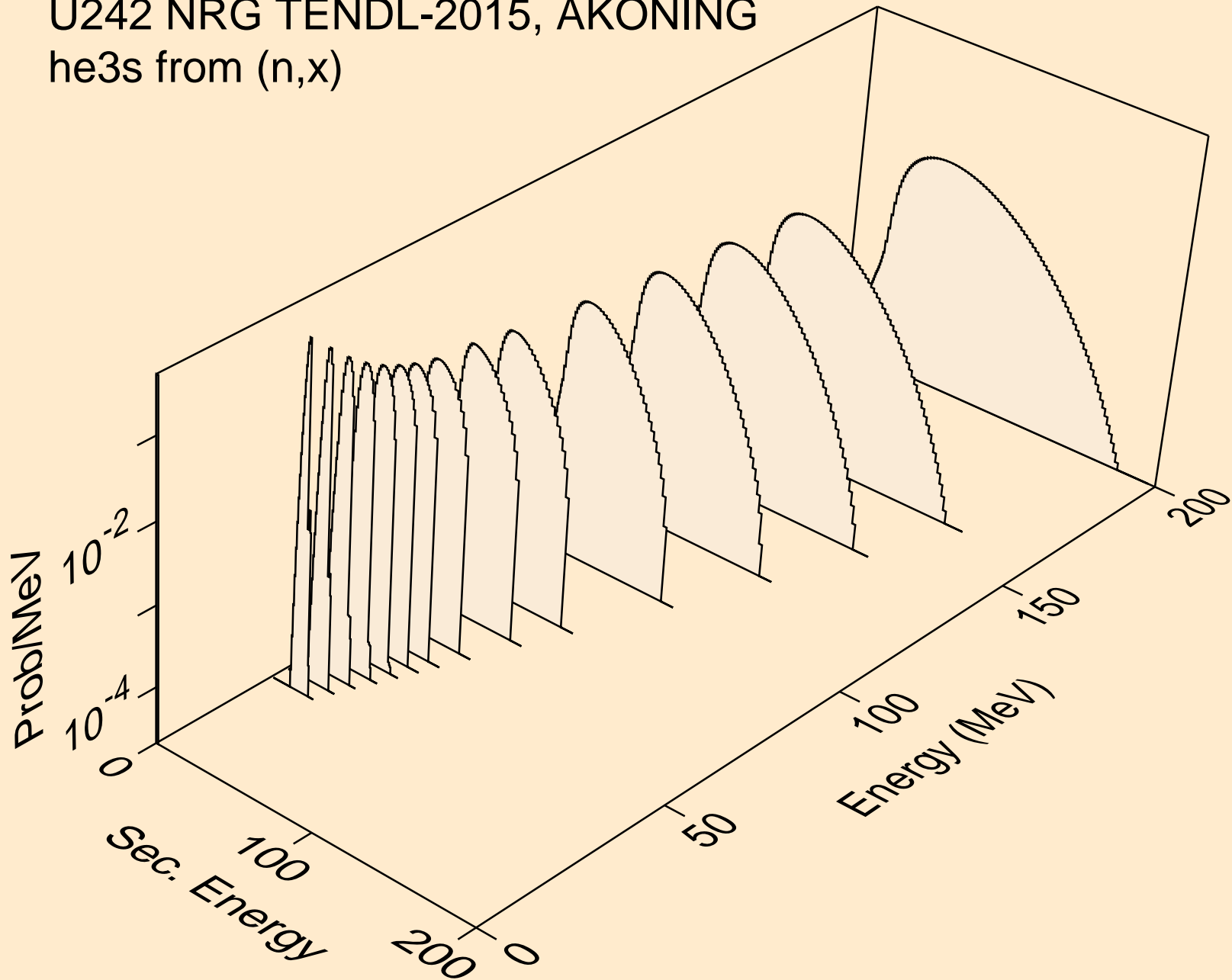

U242 NRG TENDL-2015, AKONING
he3s from (n,n*)he3

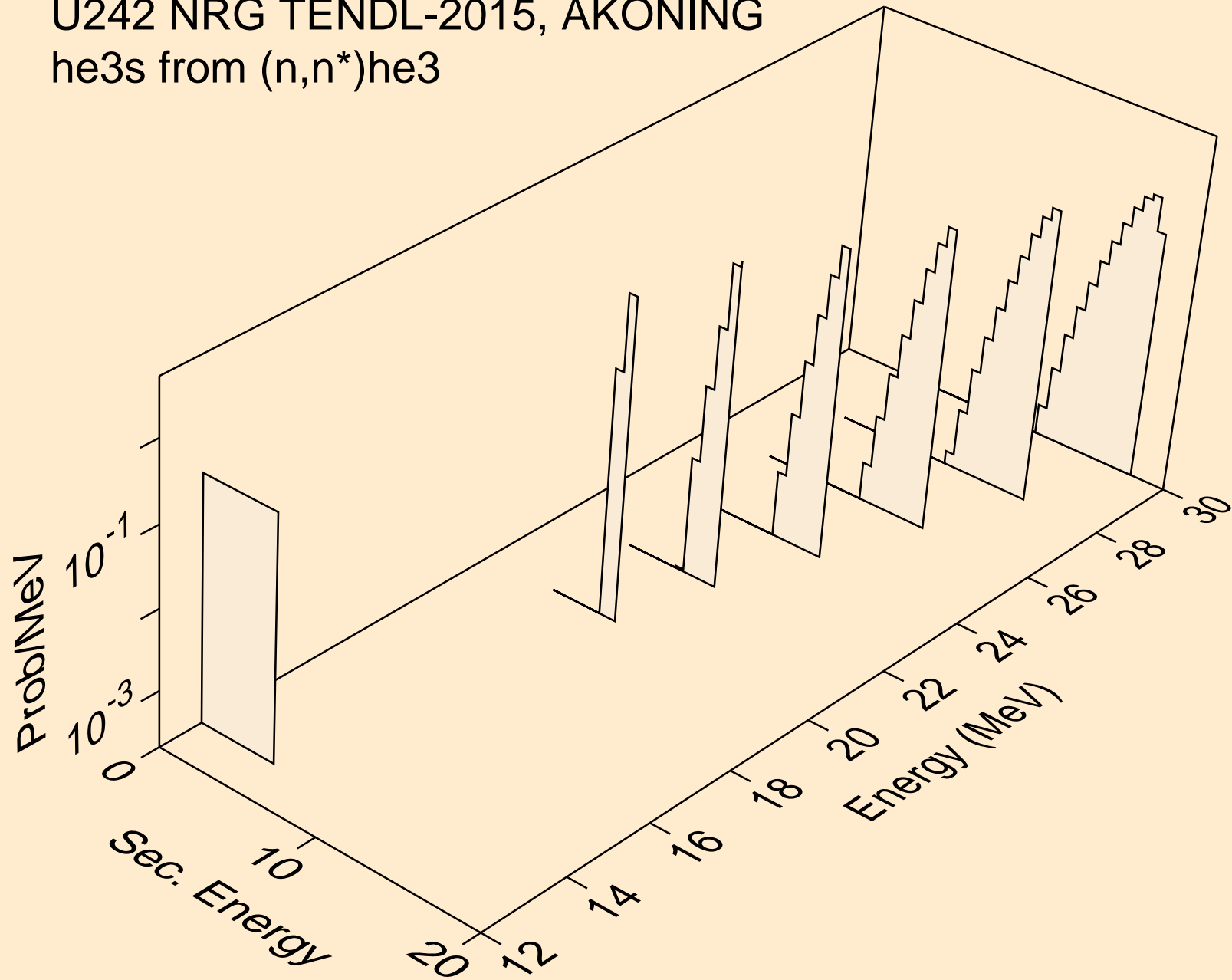

U242 NRG TENDL-2015, AKONING
he3s from (n,he3)

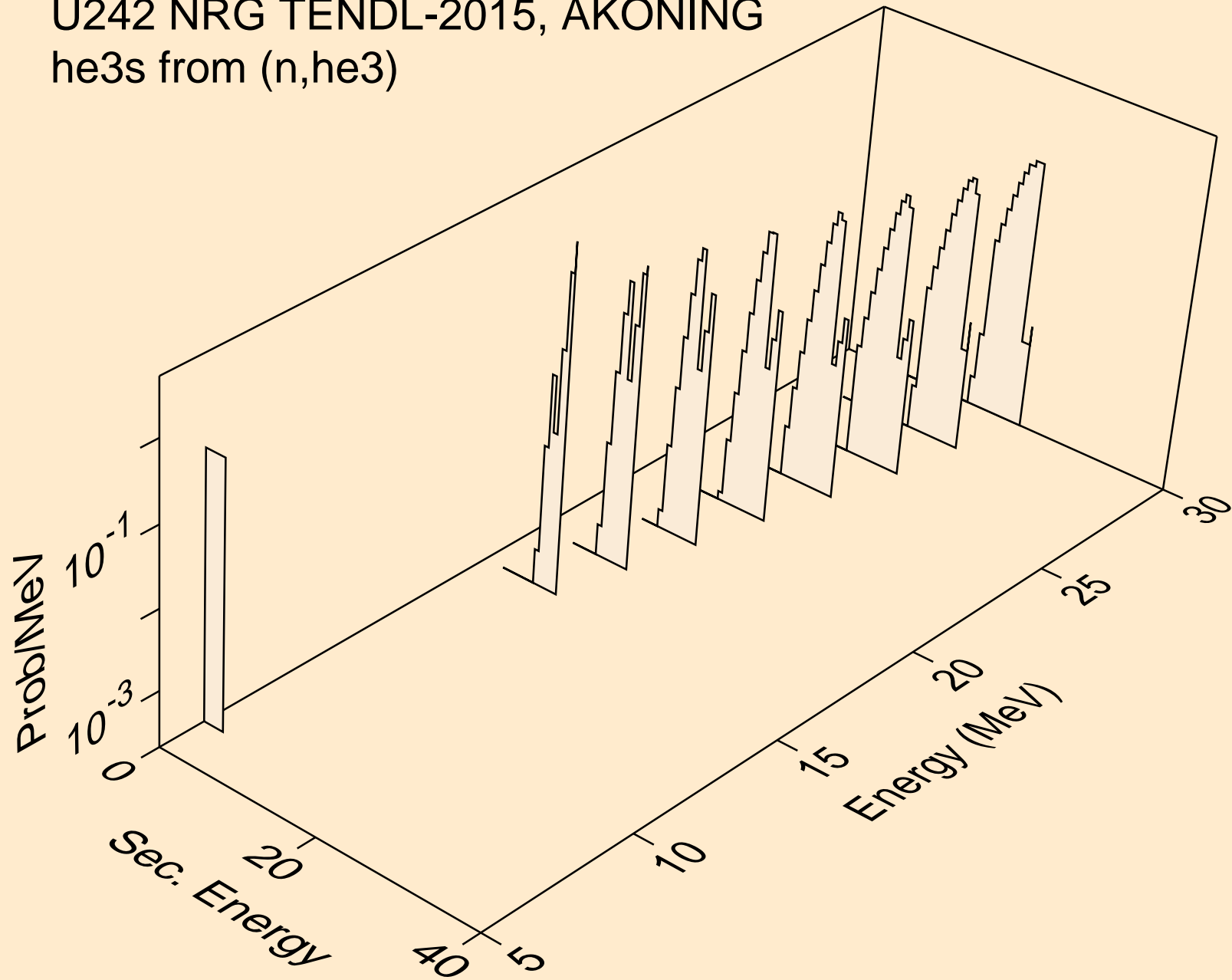

U242 NRG TENDL-2015, AKONING
alphas from (n,x)

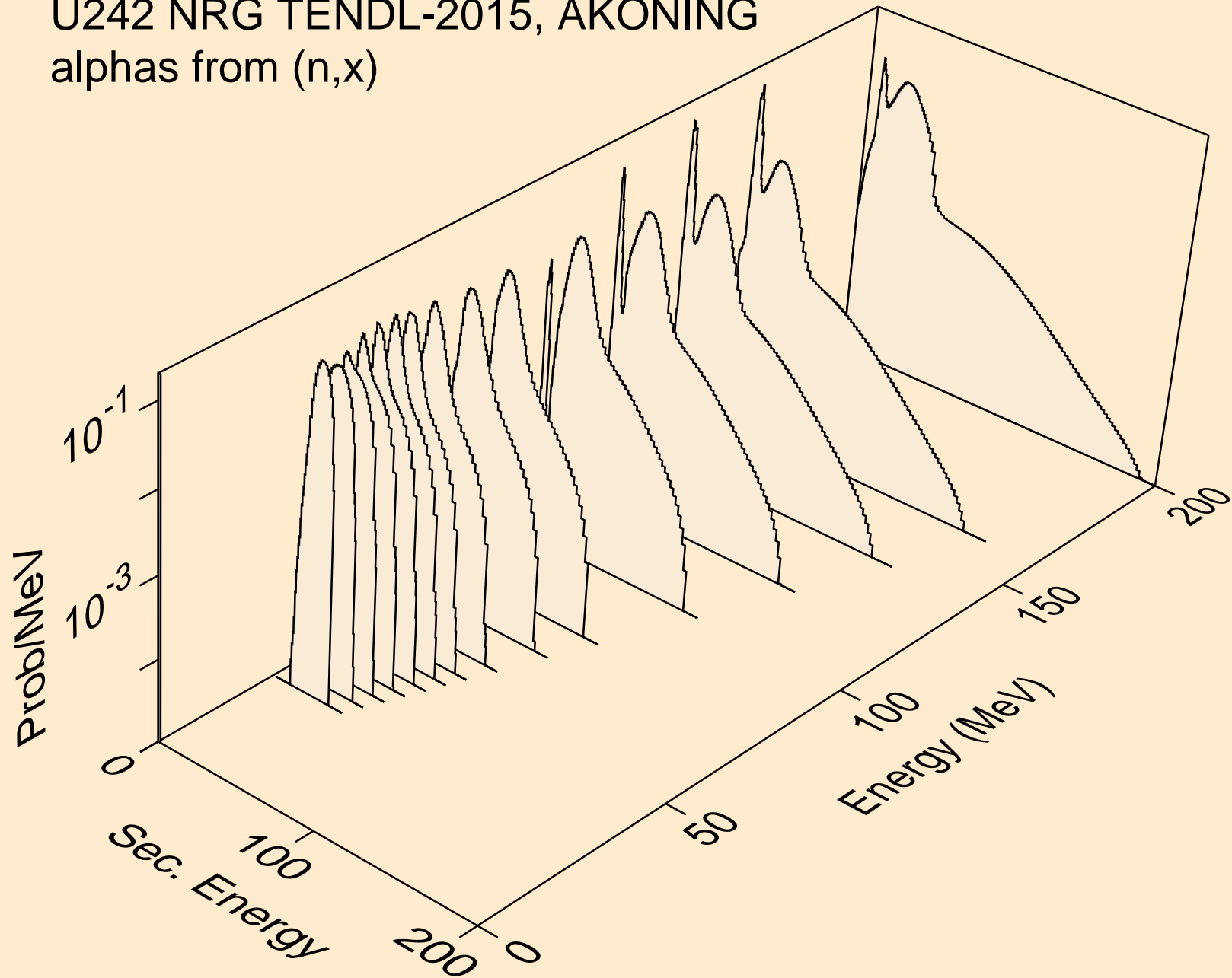

U242 NRG TENDL-2015, AKONING
alphas from (n,n*)a

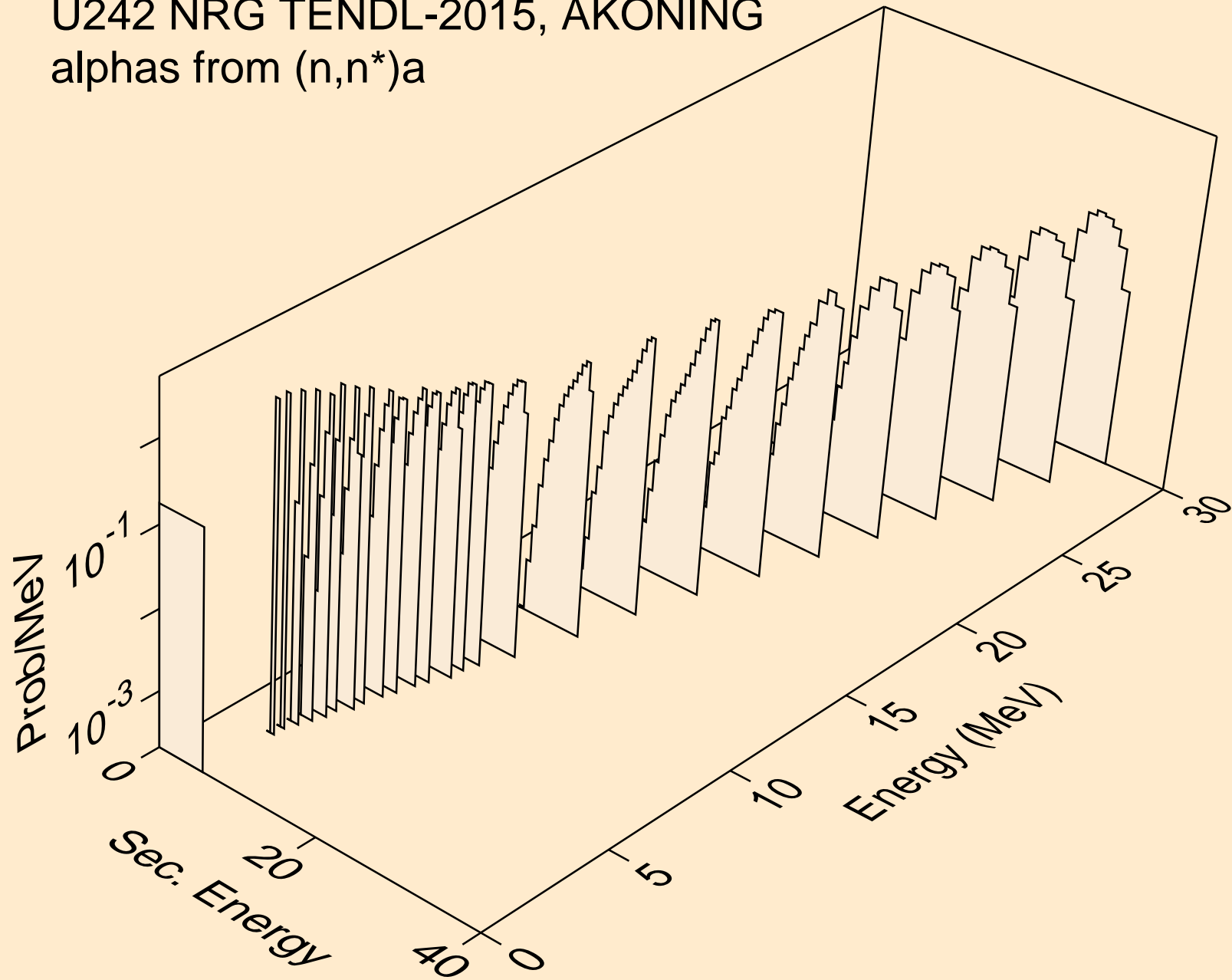

U242 NRG TENDL-2015, AKONING
alphas from (n,2n)a

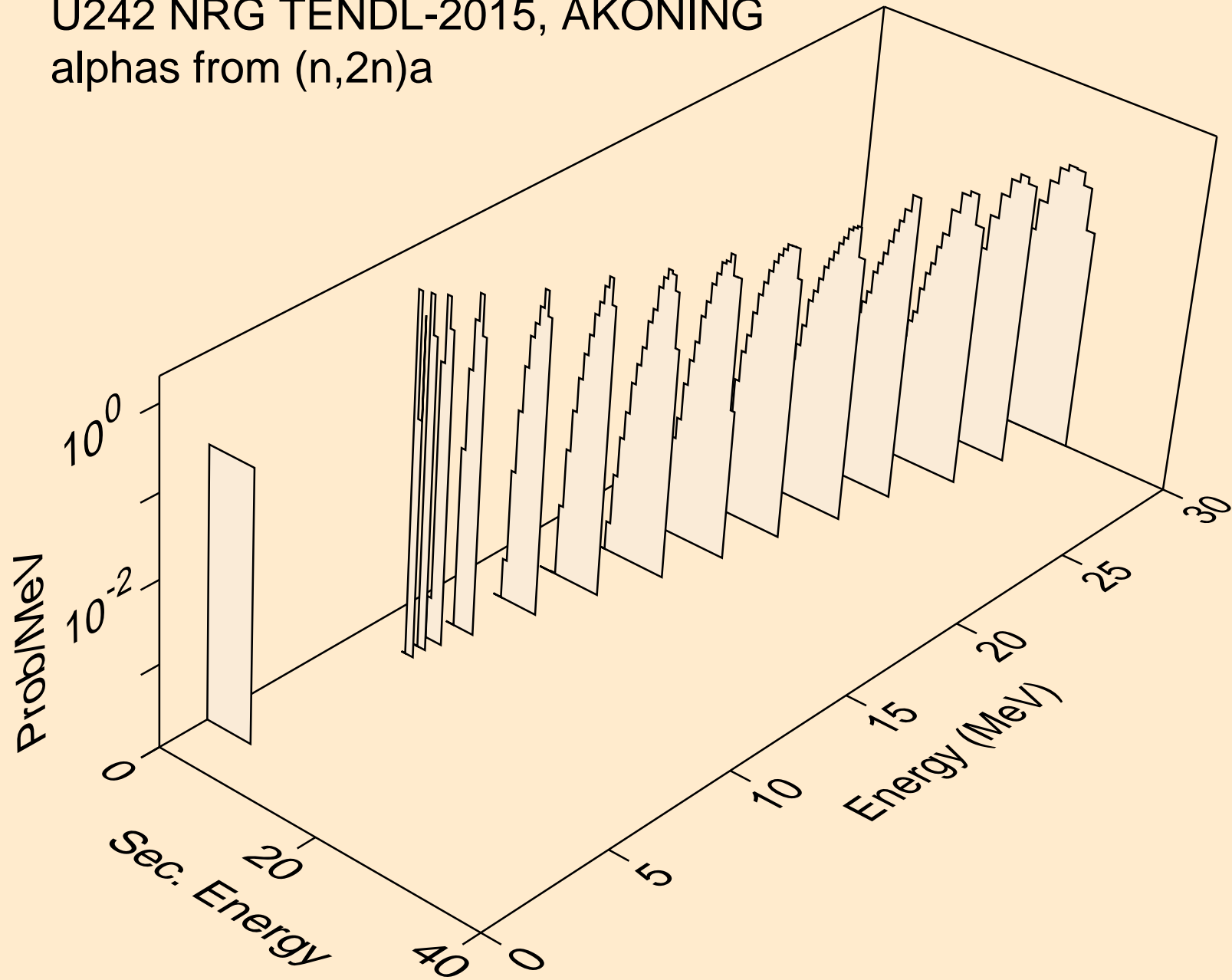

U242 NRG TENDL-2015, AKONING
alphas from (n,3n)a

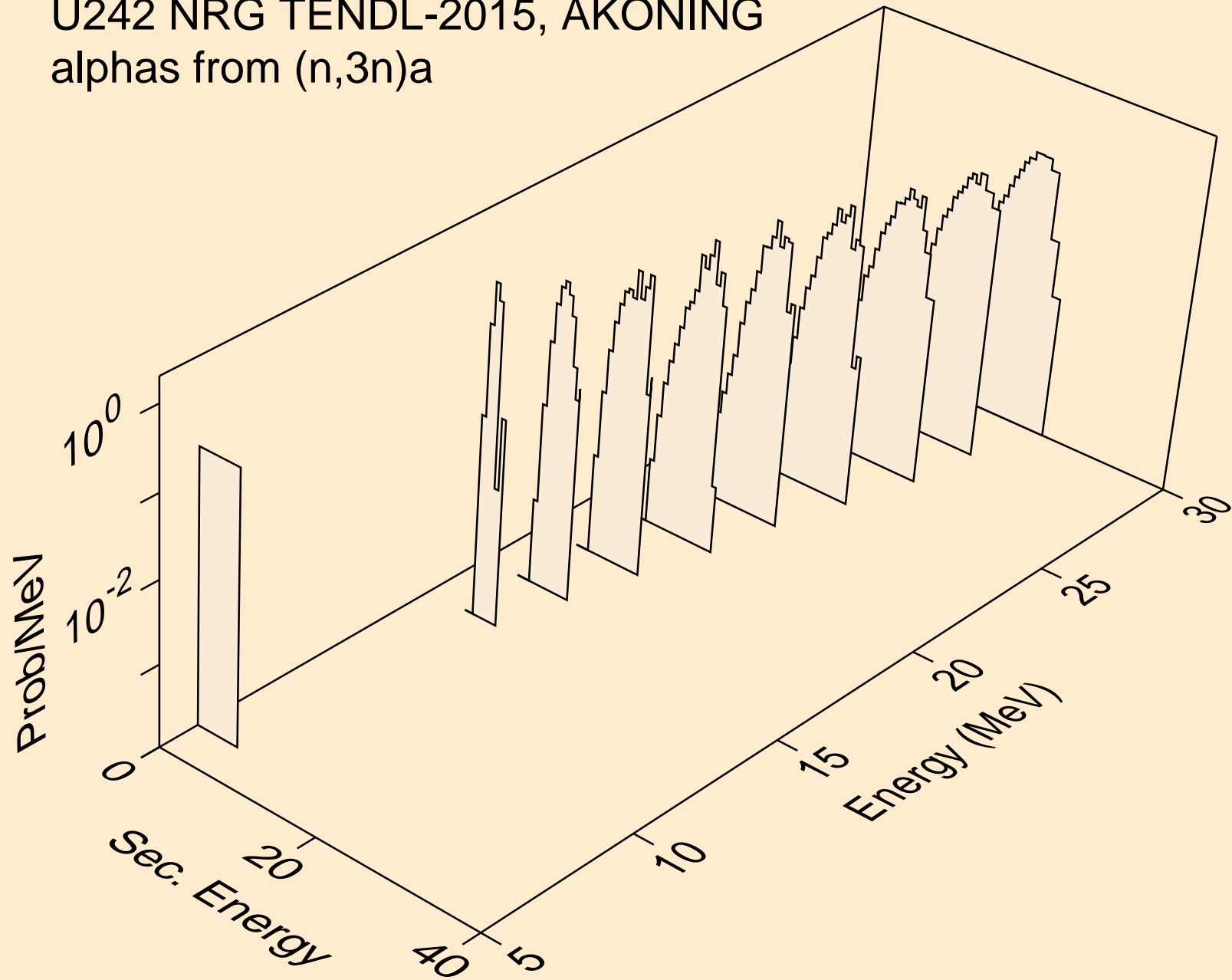

U242 NRG TENDL-2015, AKONING
alphas from (n,a)

