

W192 NRG TENDL-2015, AKONING

Principal cross sections

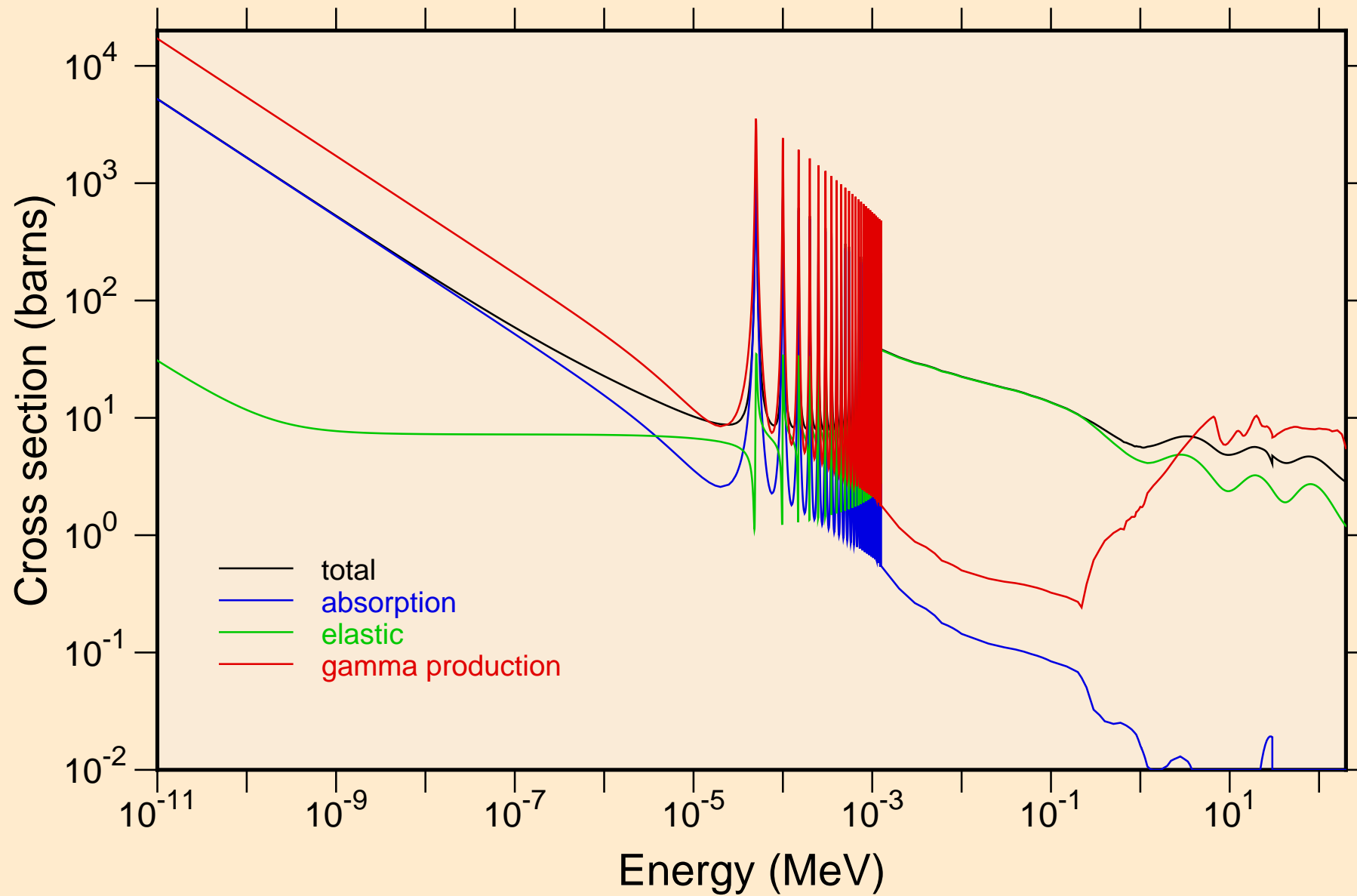

W192 NRG TENDL-2015, AKONING
resonance total cross section

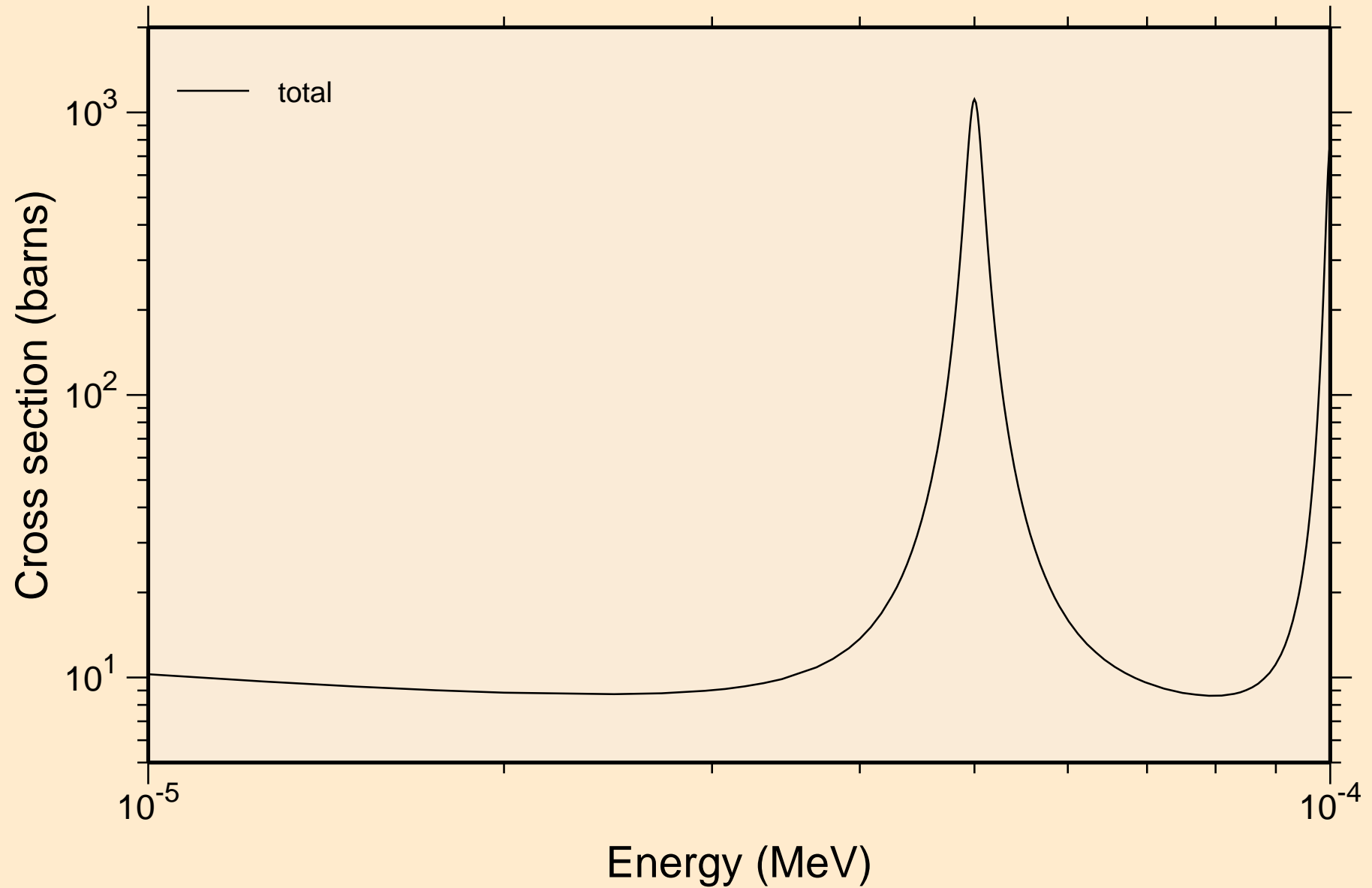

W192 NRG TENDL-2015, AKONING
resonance total cross section

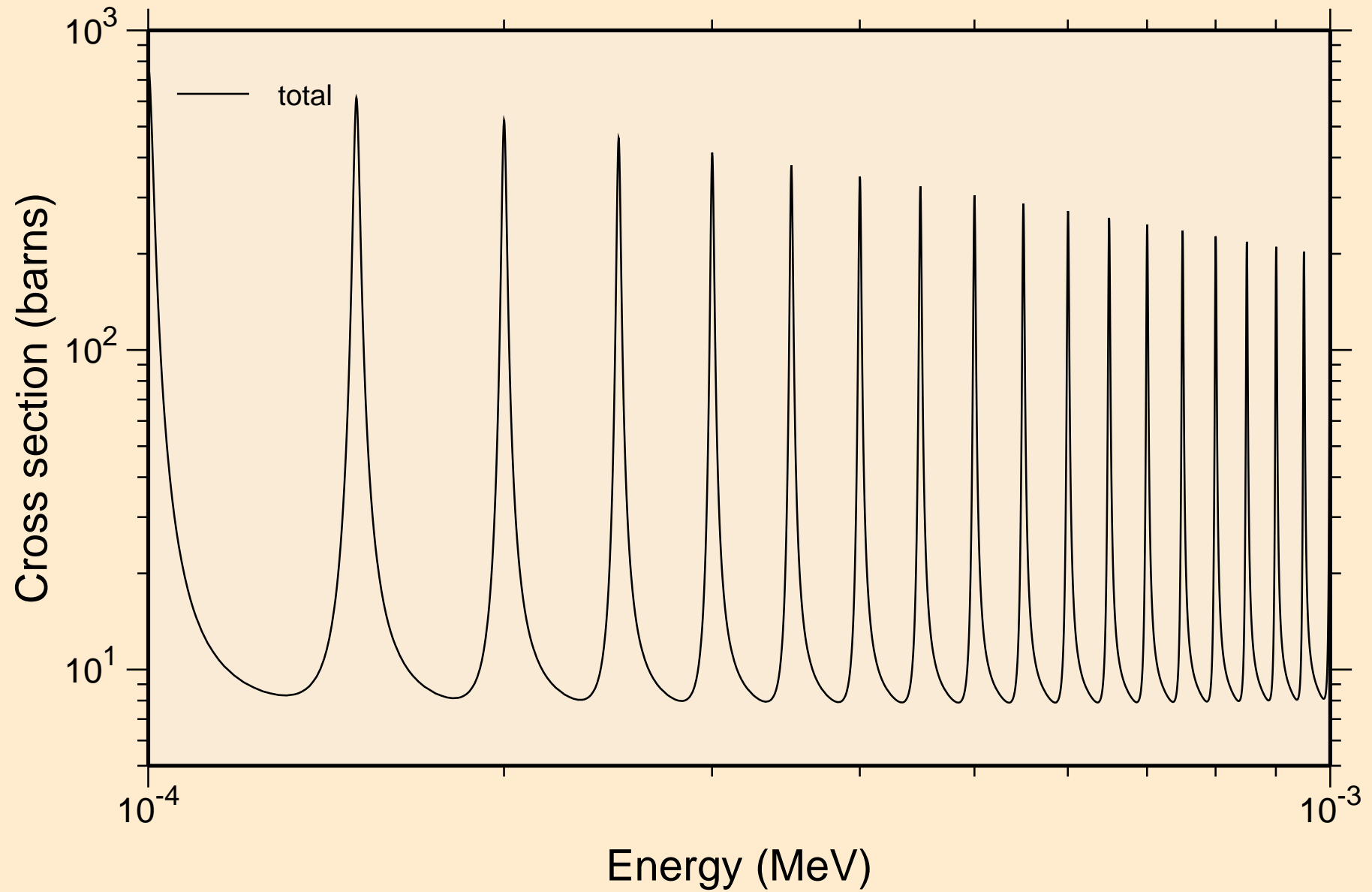

W192 NRG TENDL-2015, AKONING
resonance total cross section

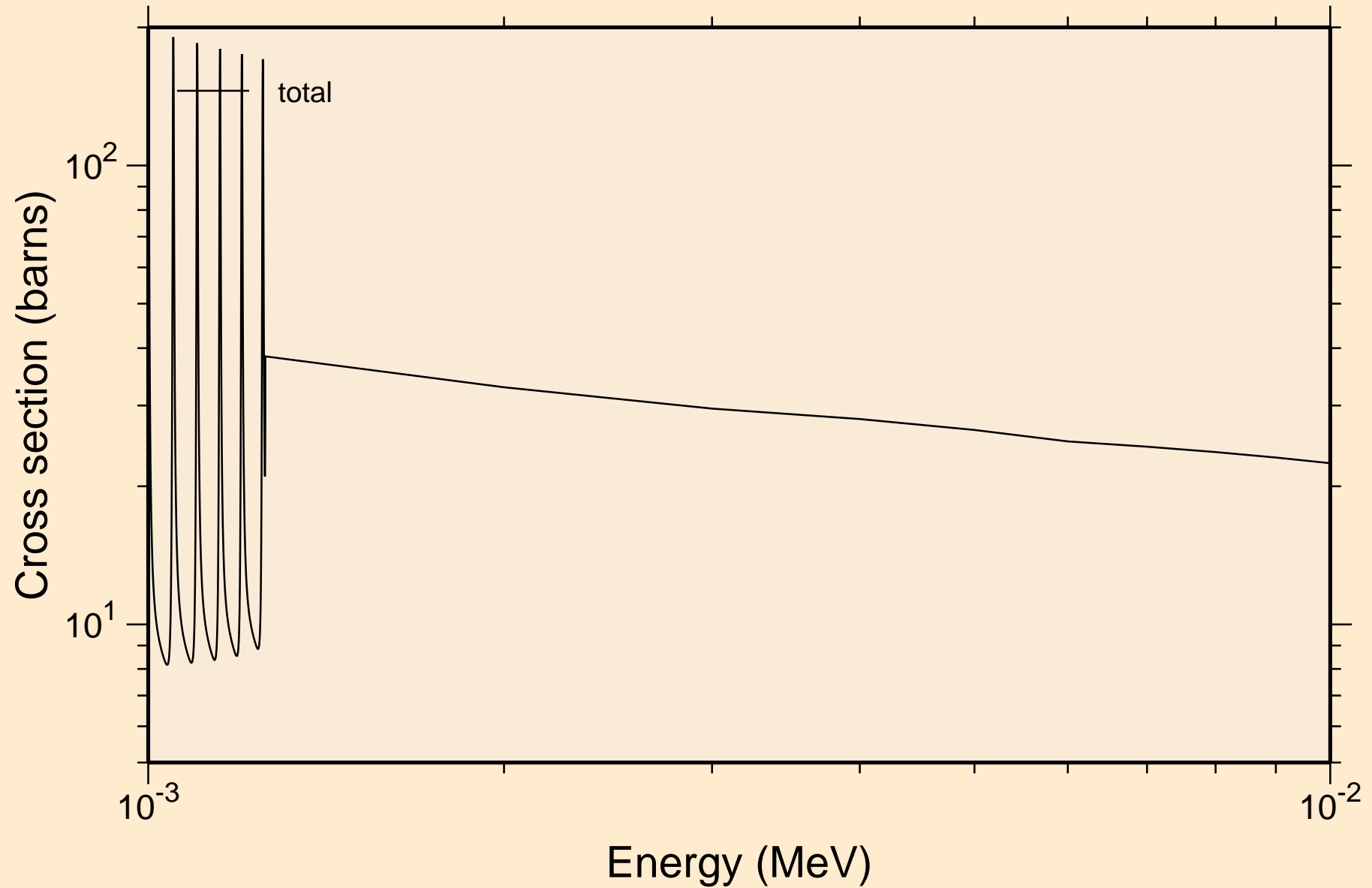

W192 NRG TENDL-2015, AKONING
resonance total cross section

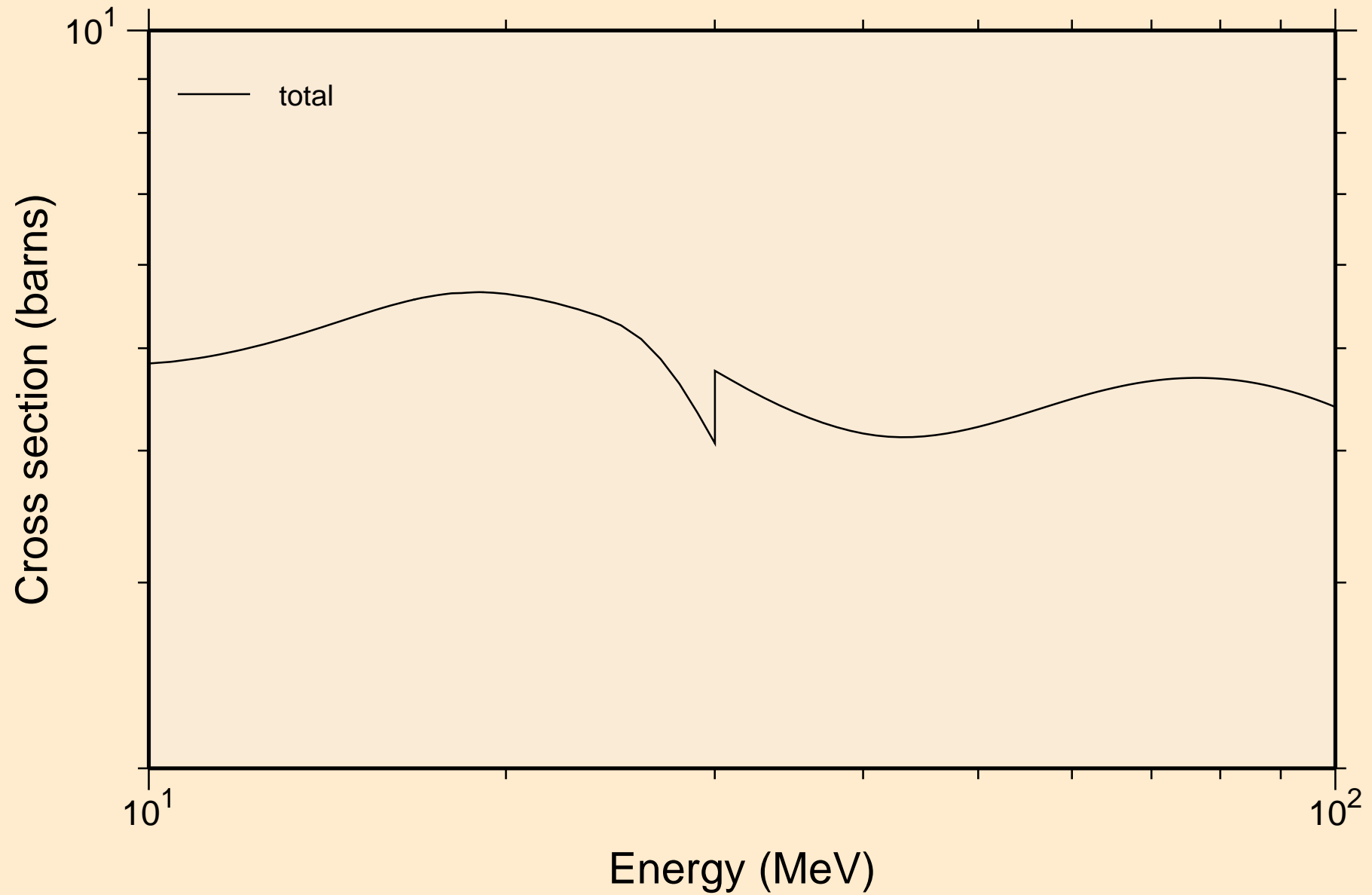

W192 NRG TENDL-2015, AKONING
resonance absorption cross sections

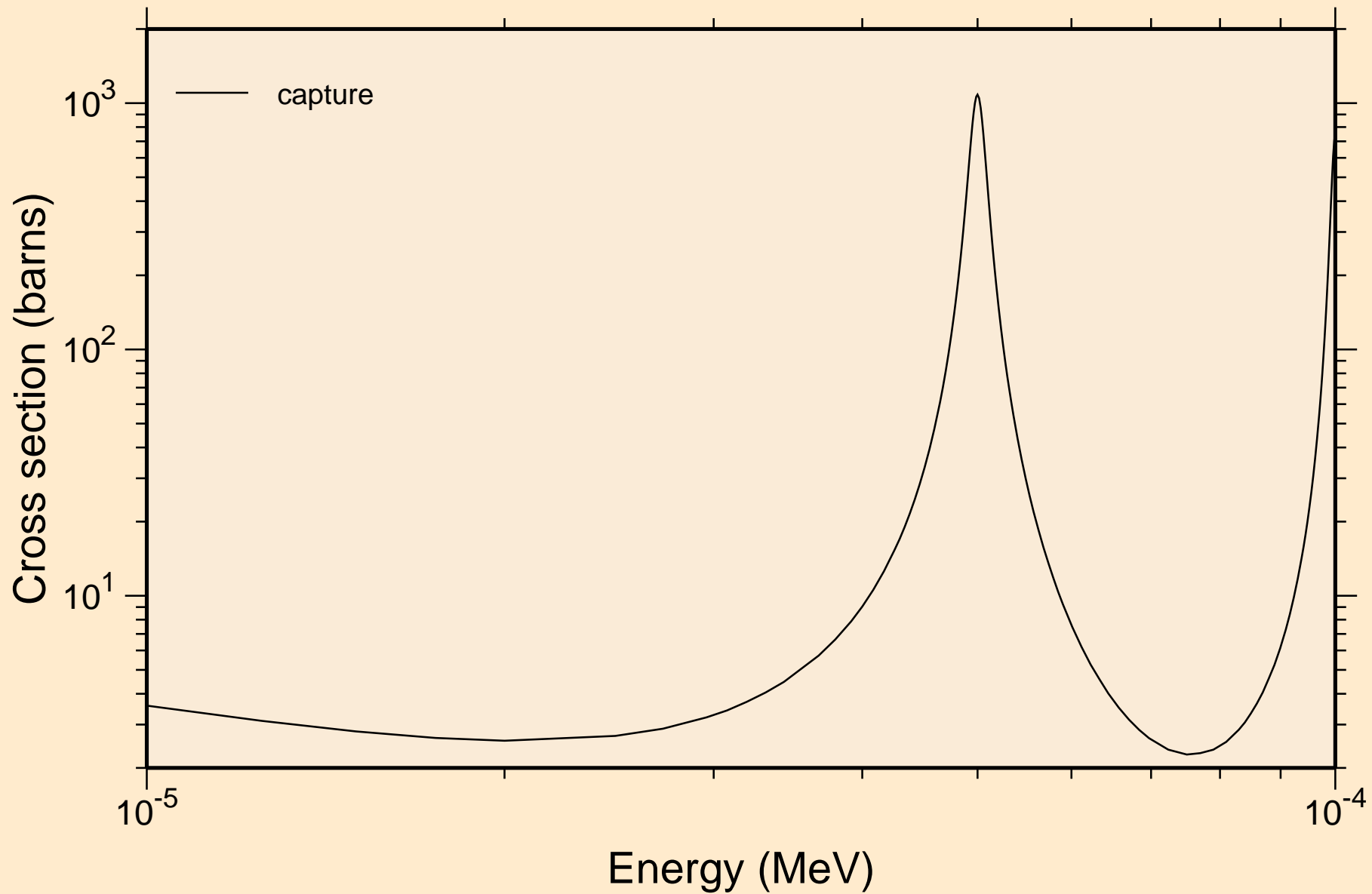

W192 NRG TENDL-2015, AKONING
resonance absorption cross sections

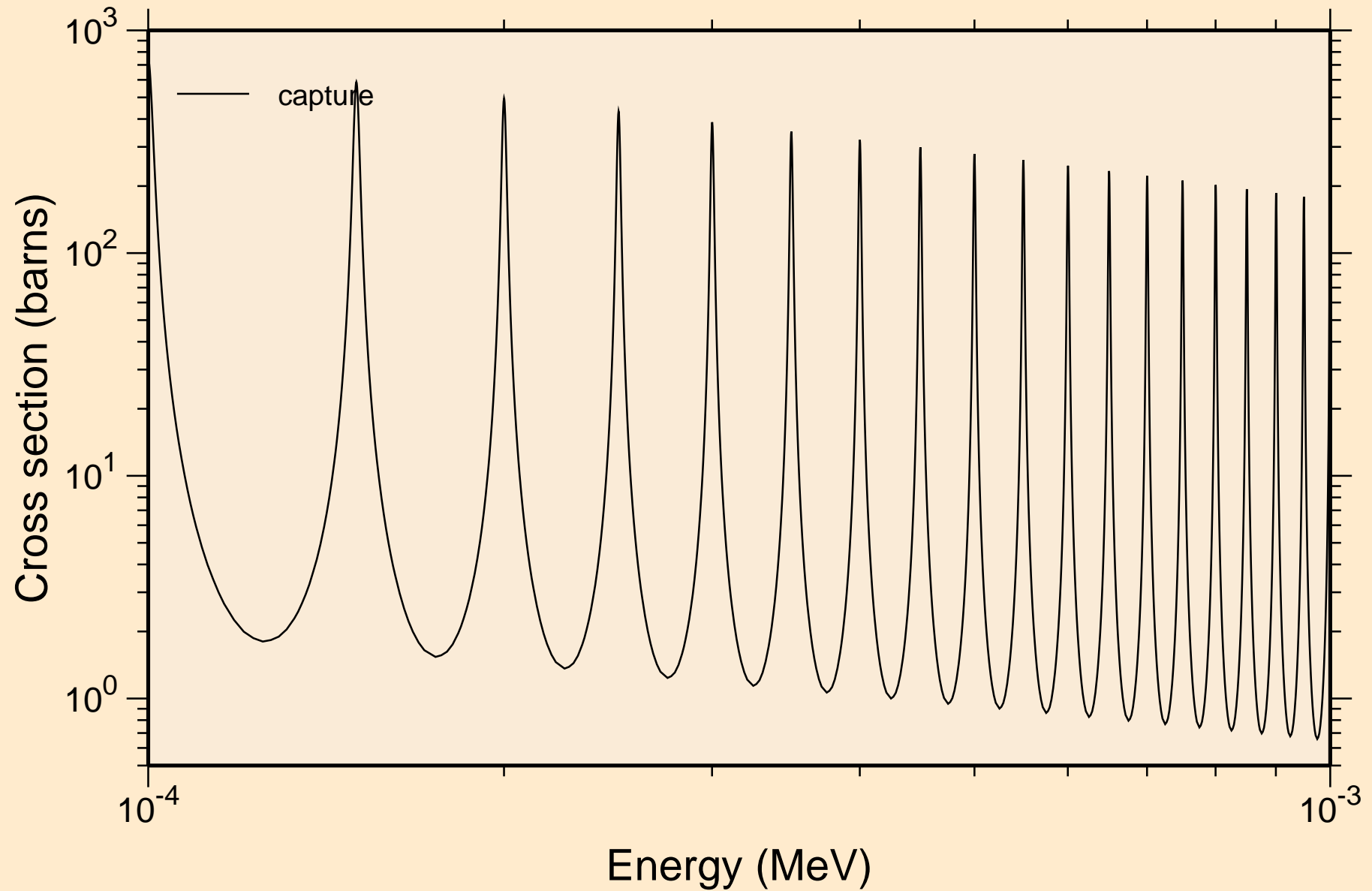

W192 NRG TENDL-2015, AKONING
resonance absorption cross sections

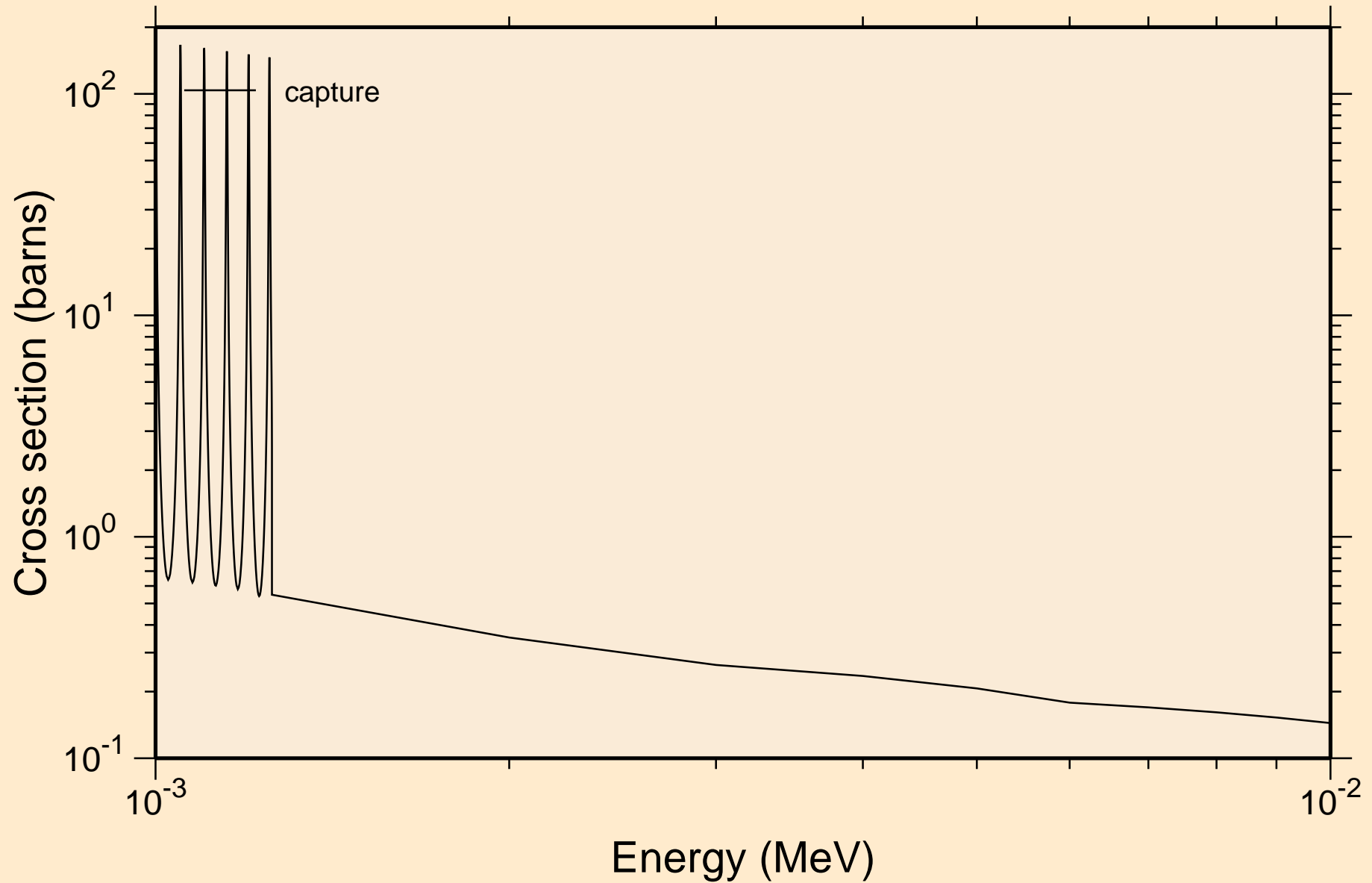

W192 NRG TENDL-2015, AKONING
resonance absorption cross sections

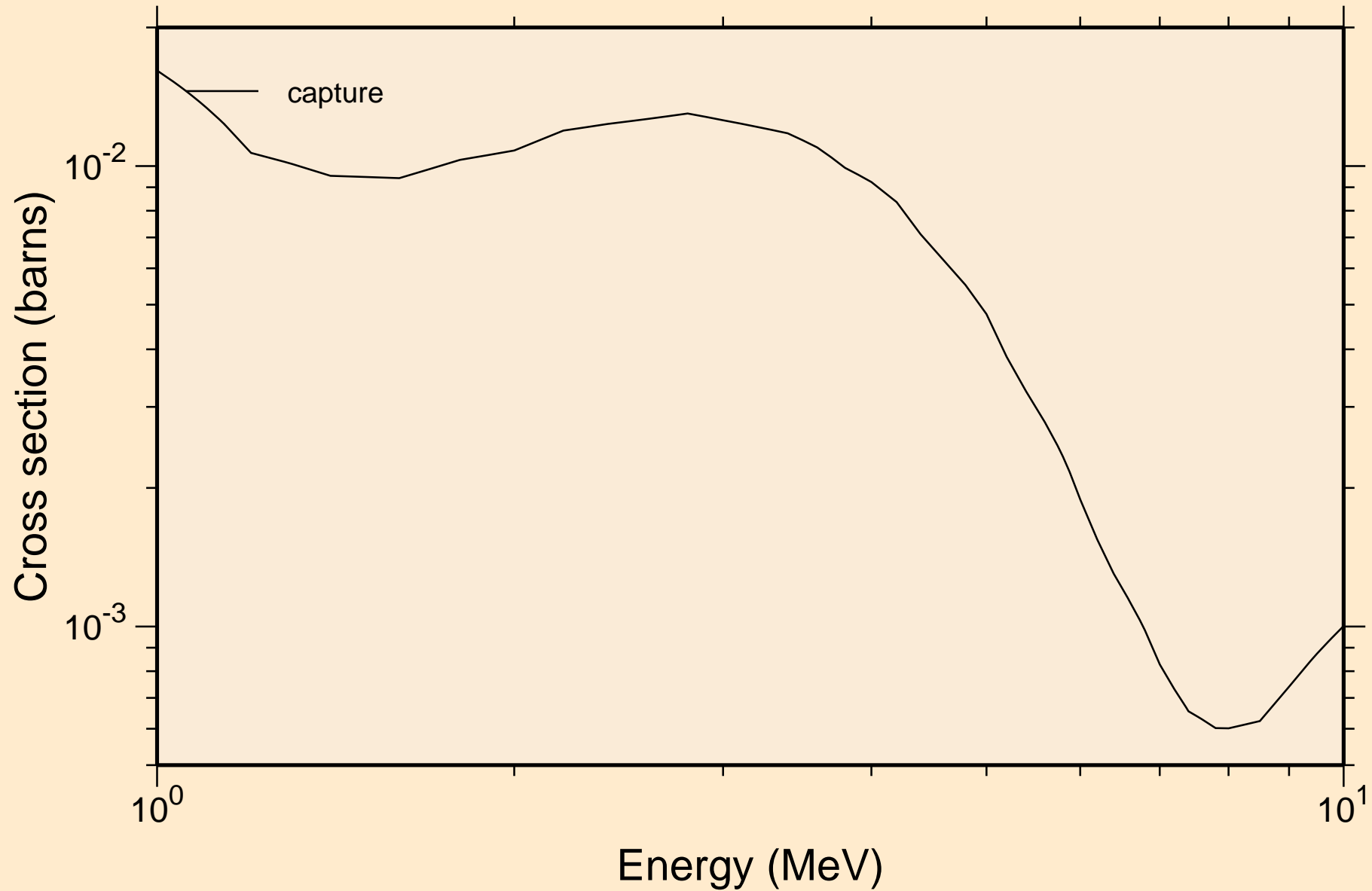

W192 NRG TENDL-2015, AKONING
Non-threshold reactions

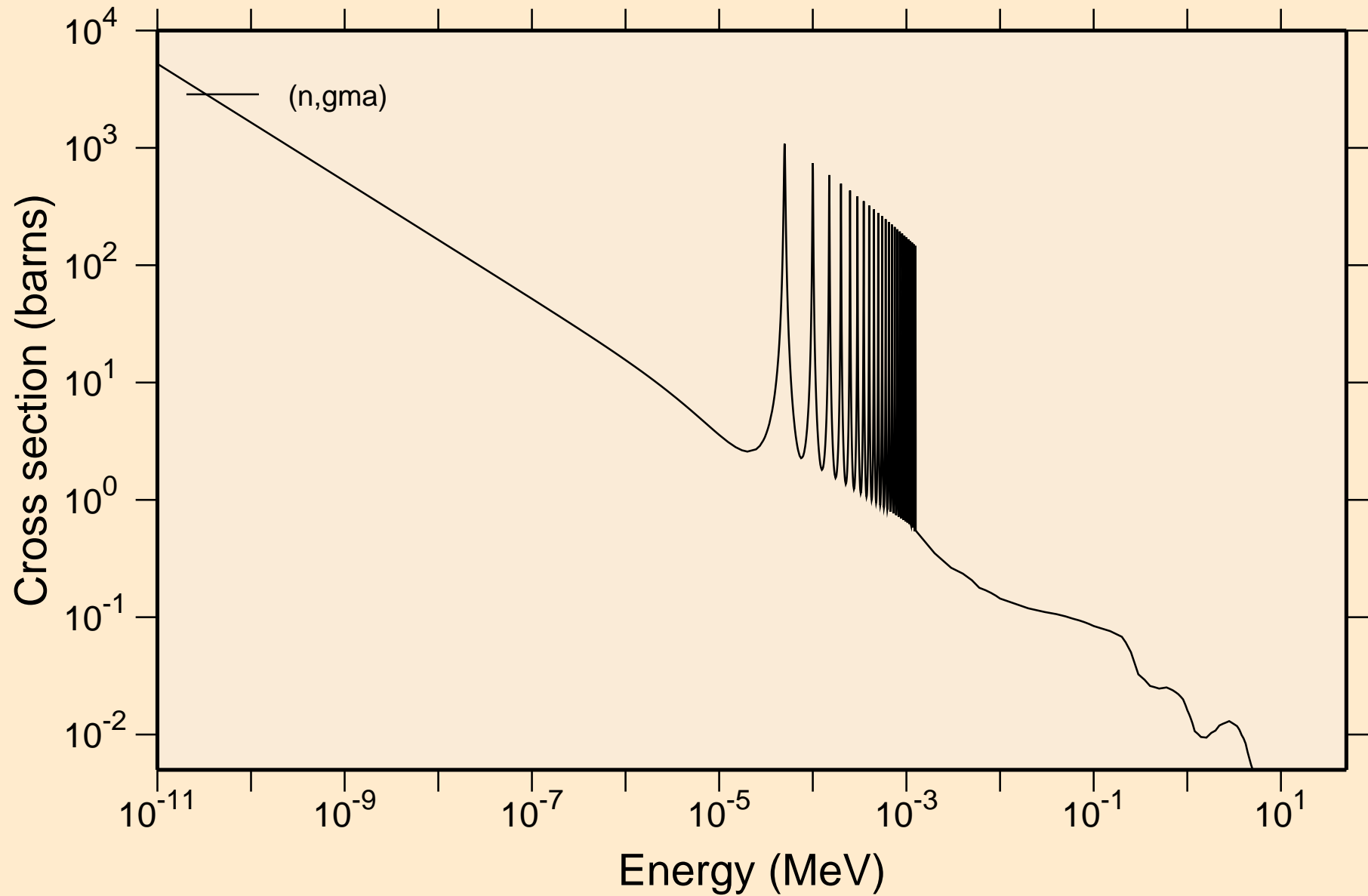

W192 NRG TENDL-2015, AKONING

Principal cross sections

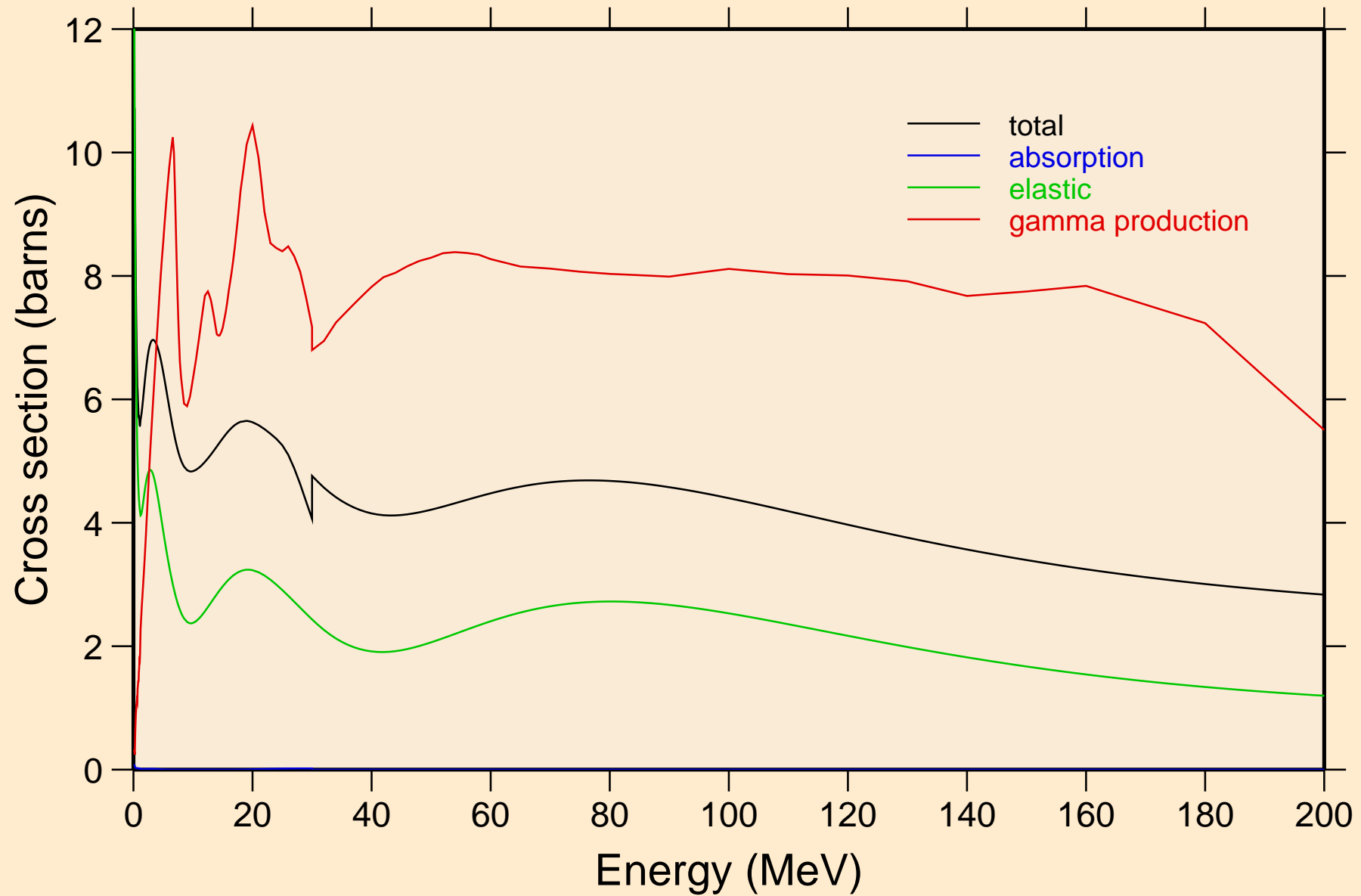

W192 NRG TENDL-2015, AKONING
Non-threshold reactions

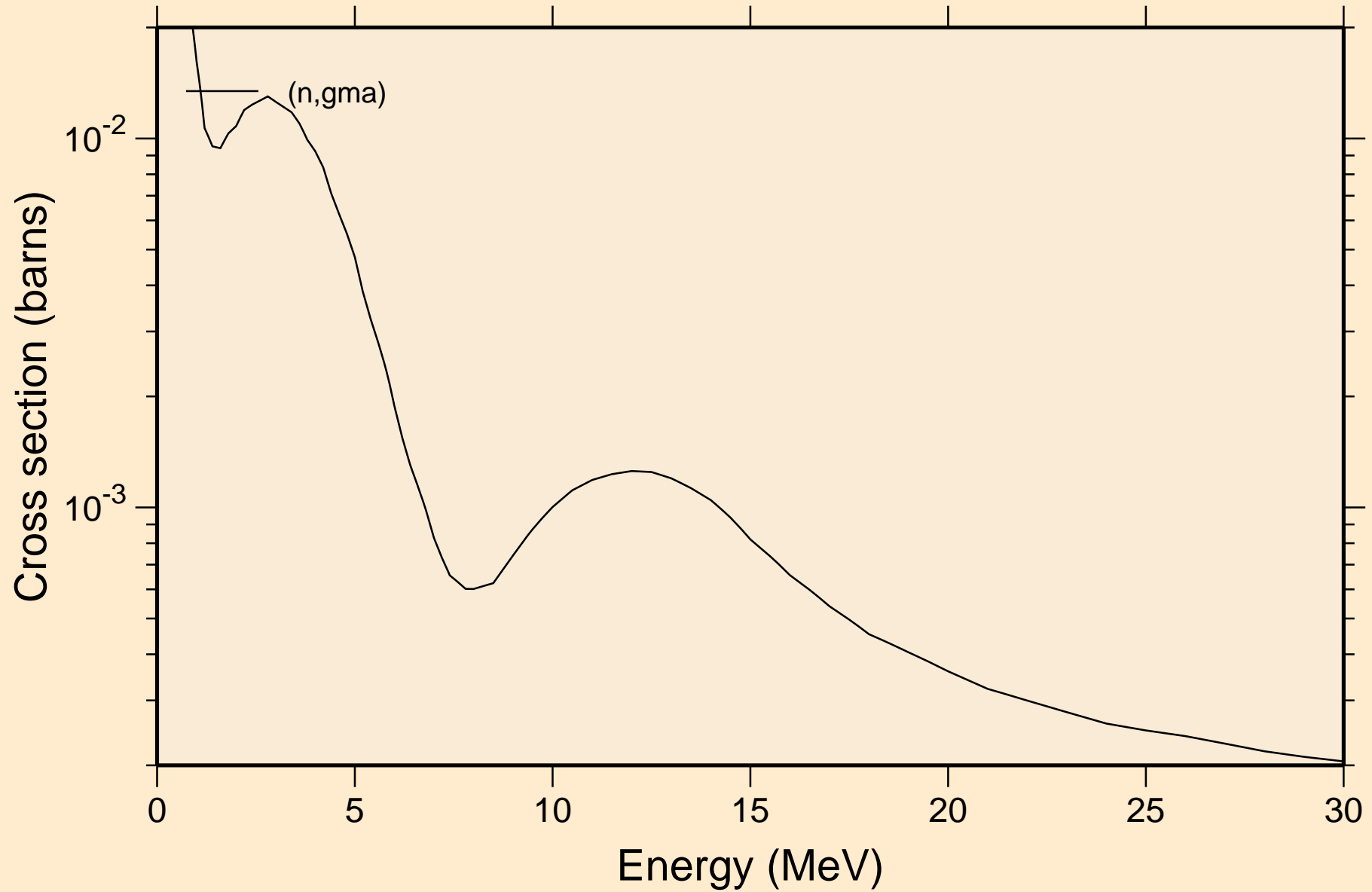

W192 NRG TENDL-2015, AKONING
Inelastic levels

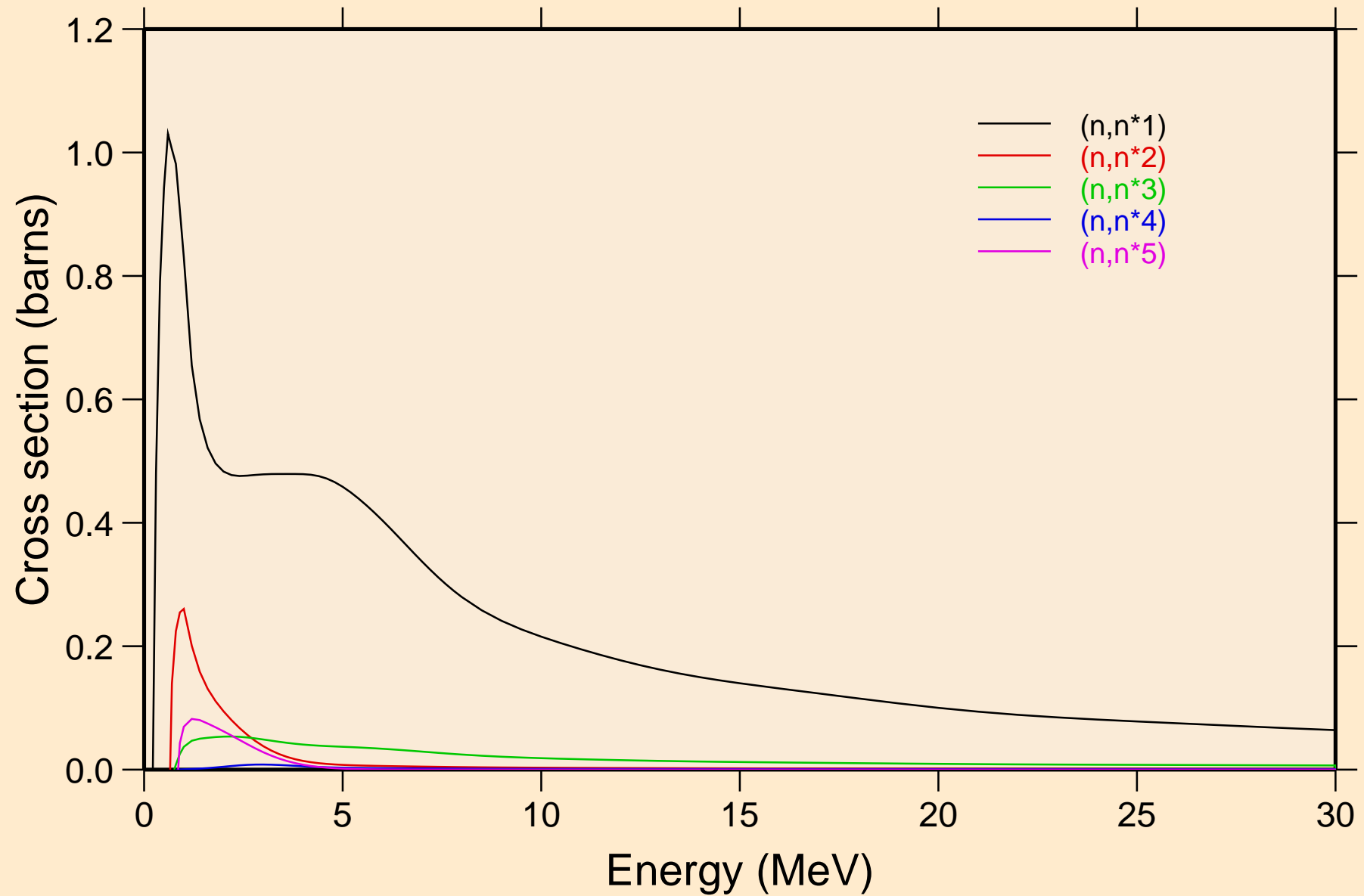

W192 NRG TENDL-2015, AKONING

Inelastic levels

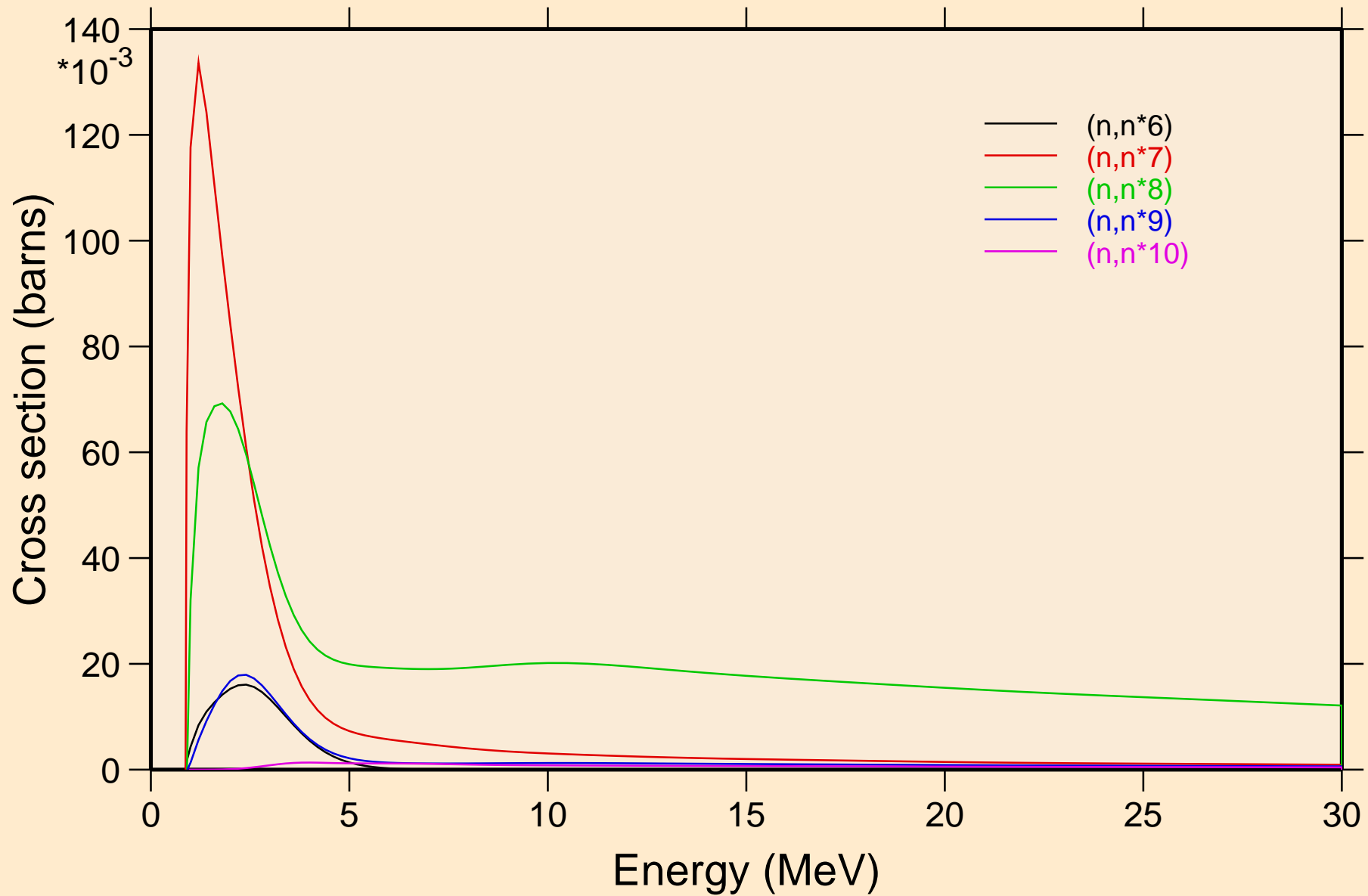

W192 NRG TENDL-2015, AKONING

Inelastic levels

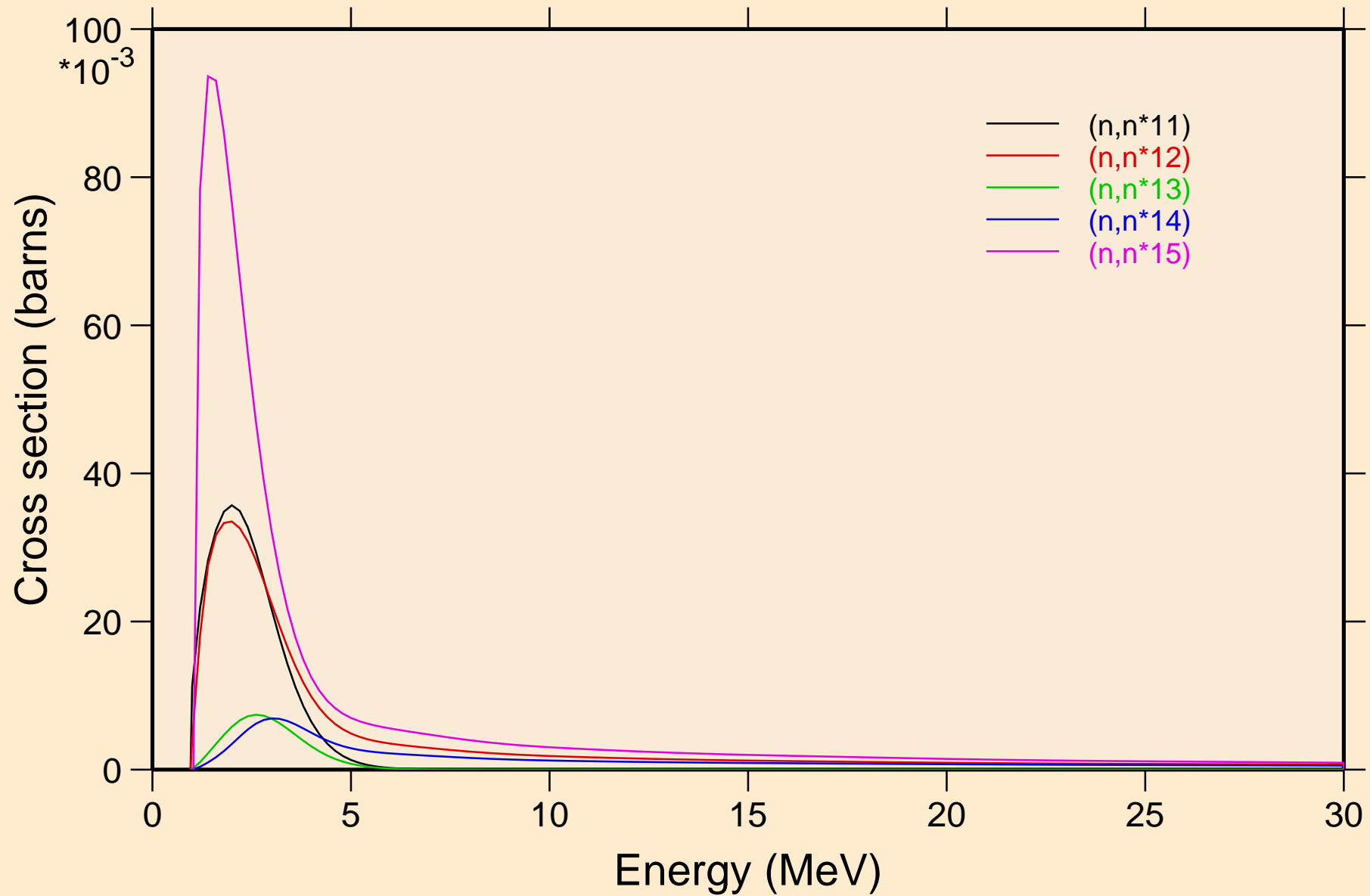

W192 NRG TENDL-2015, AKONING

Inelastic levels

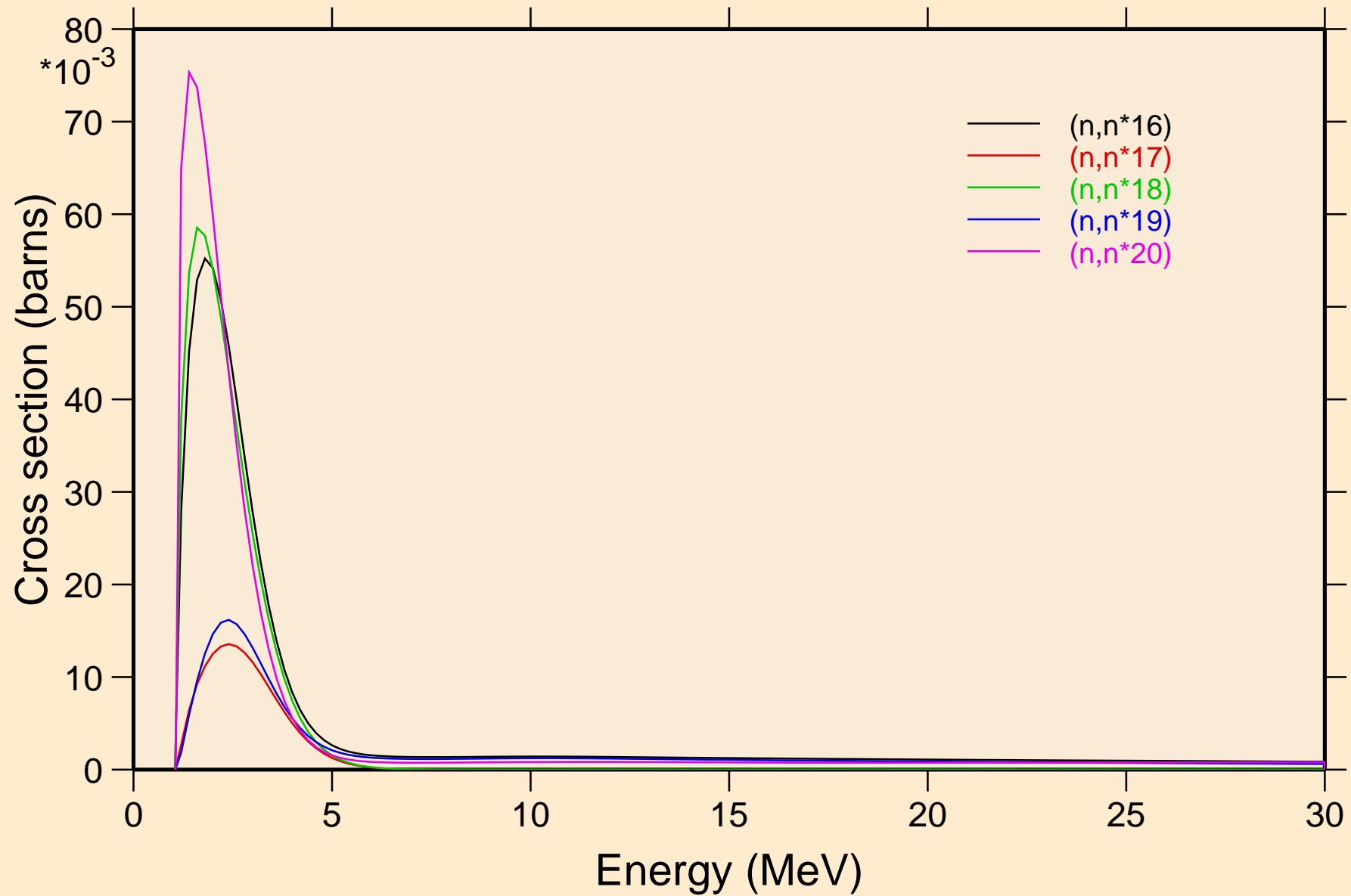

W192 NRG TENDL-2015, AKONING

Inelastic levels

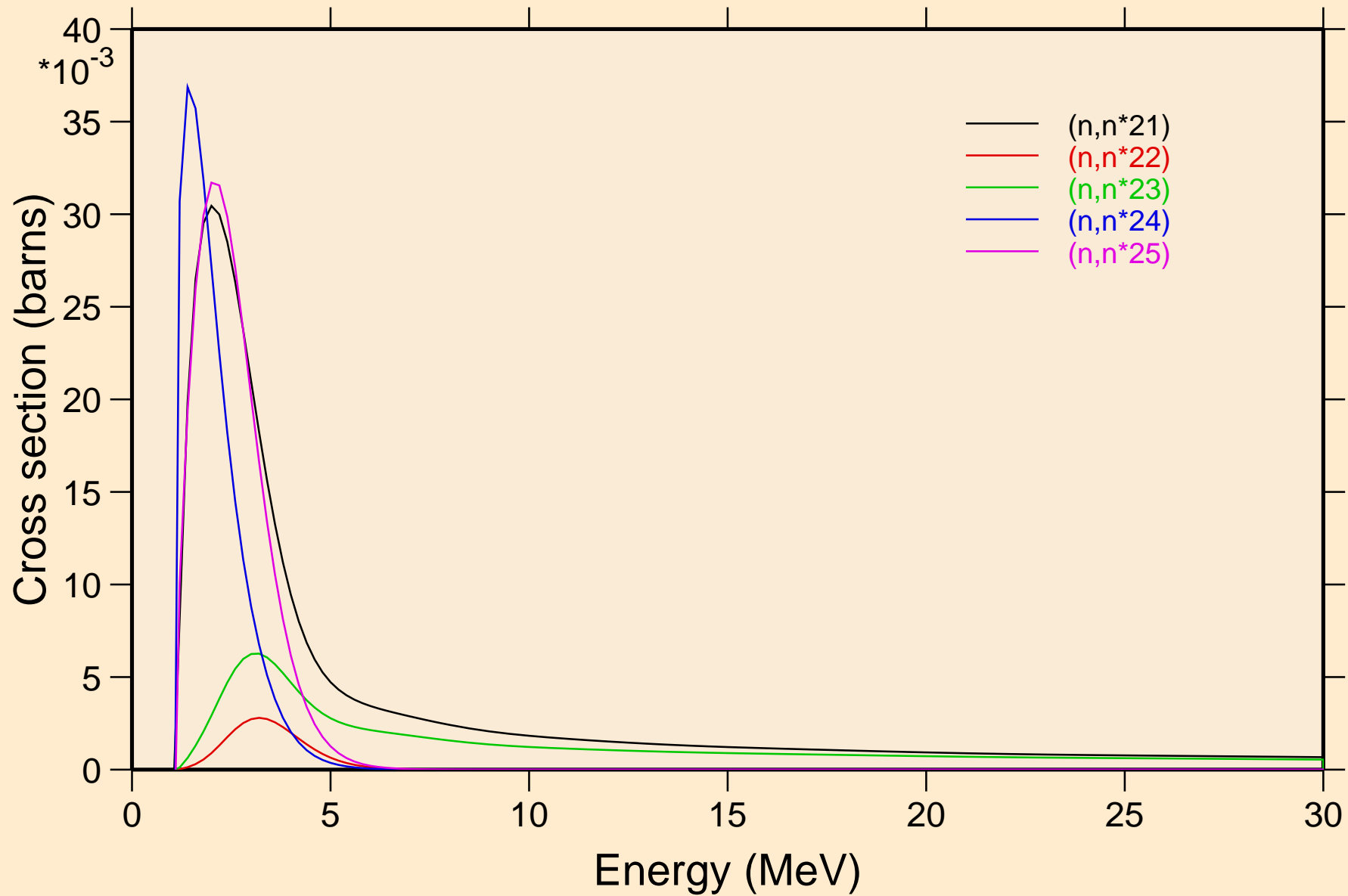

W192 NRG TENDL-2015, AKONING

Inelastic levels

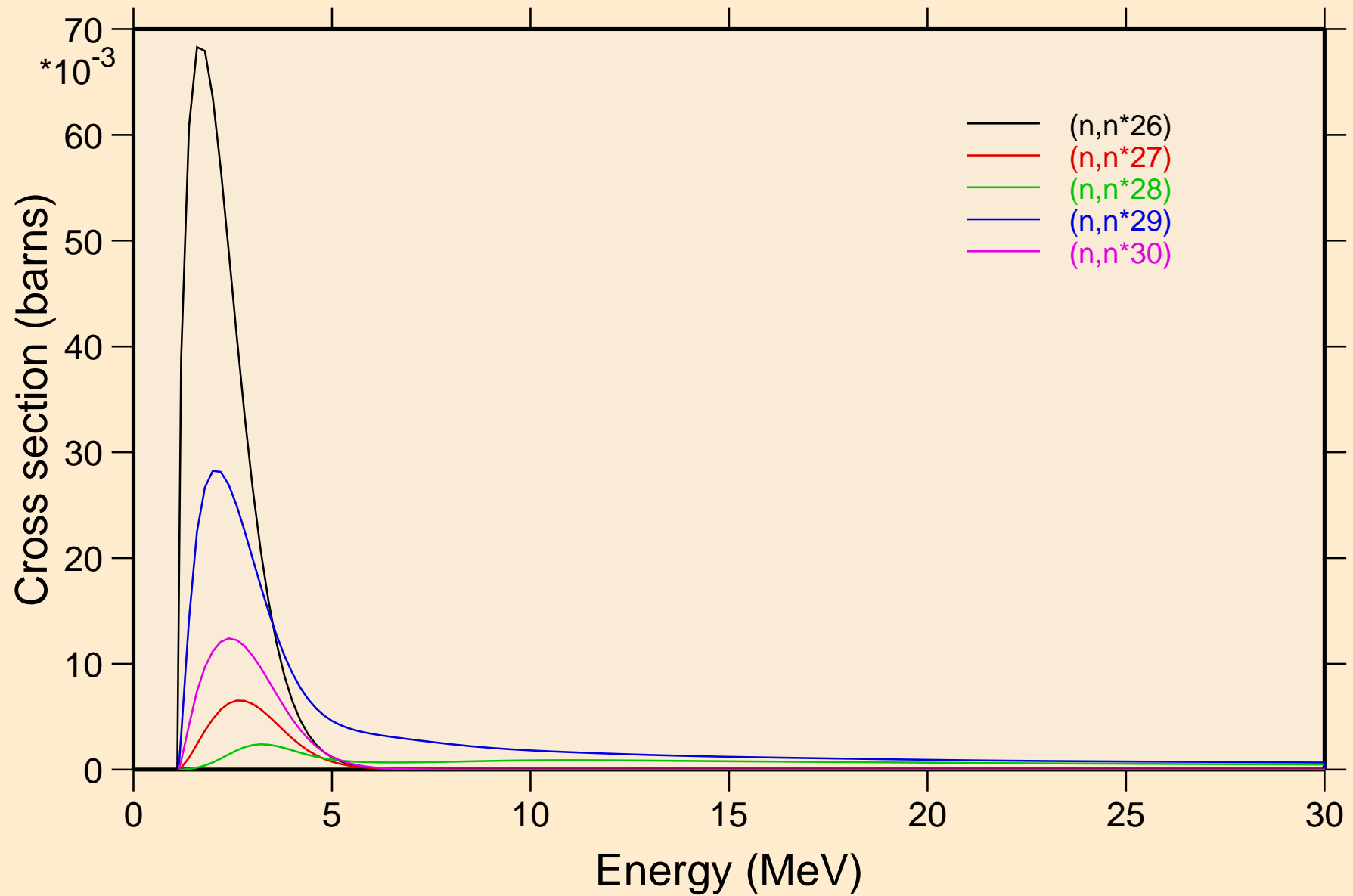

W192 NRG TENDL-2015, AKONING

Threshold reactions

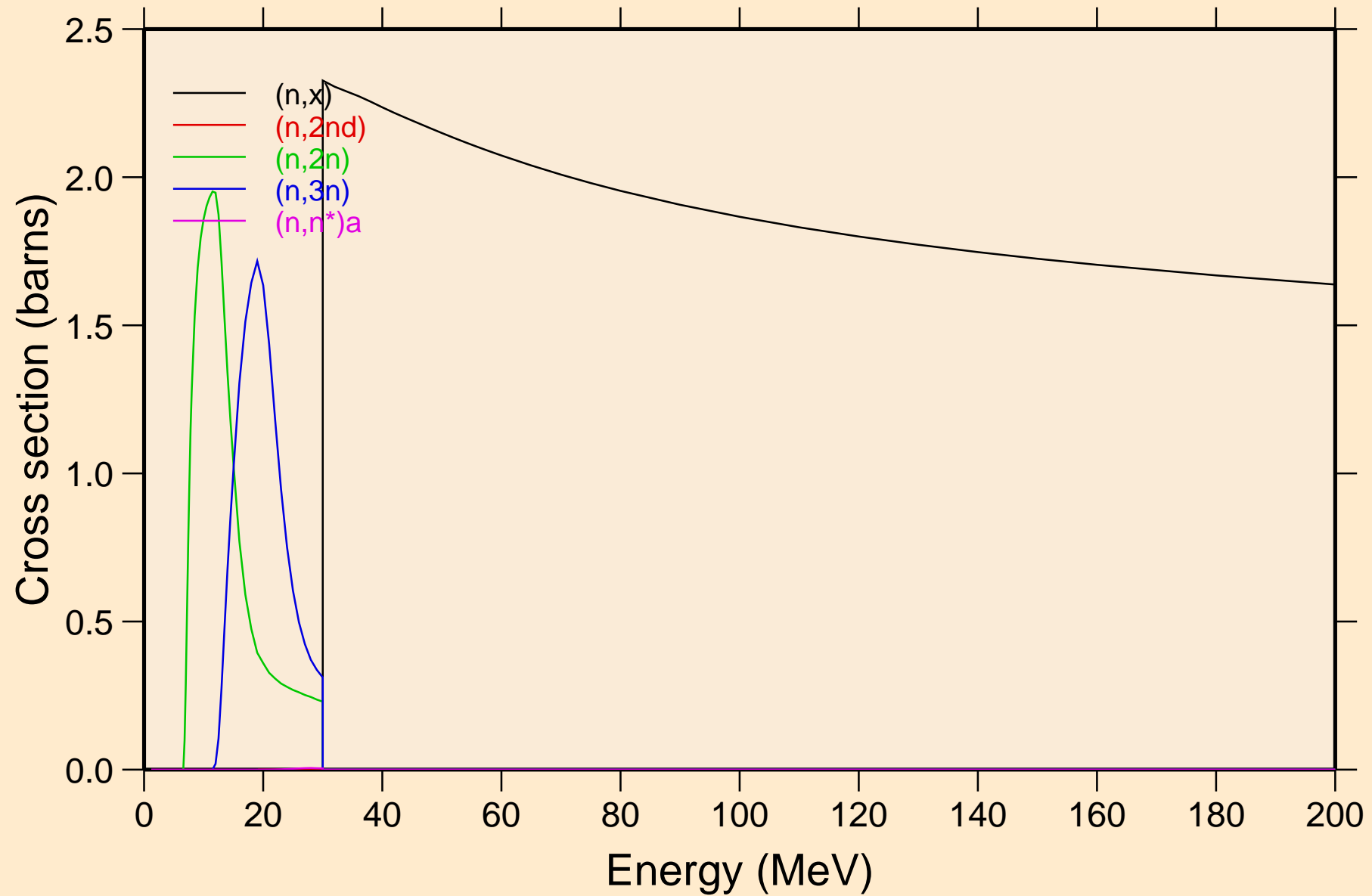

W192 NRG TENDL-2015, AKONING

Threshold reactions

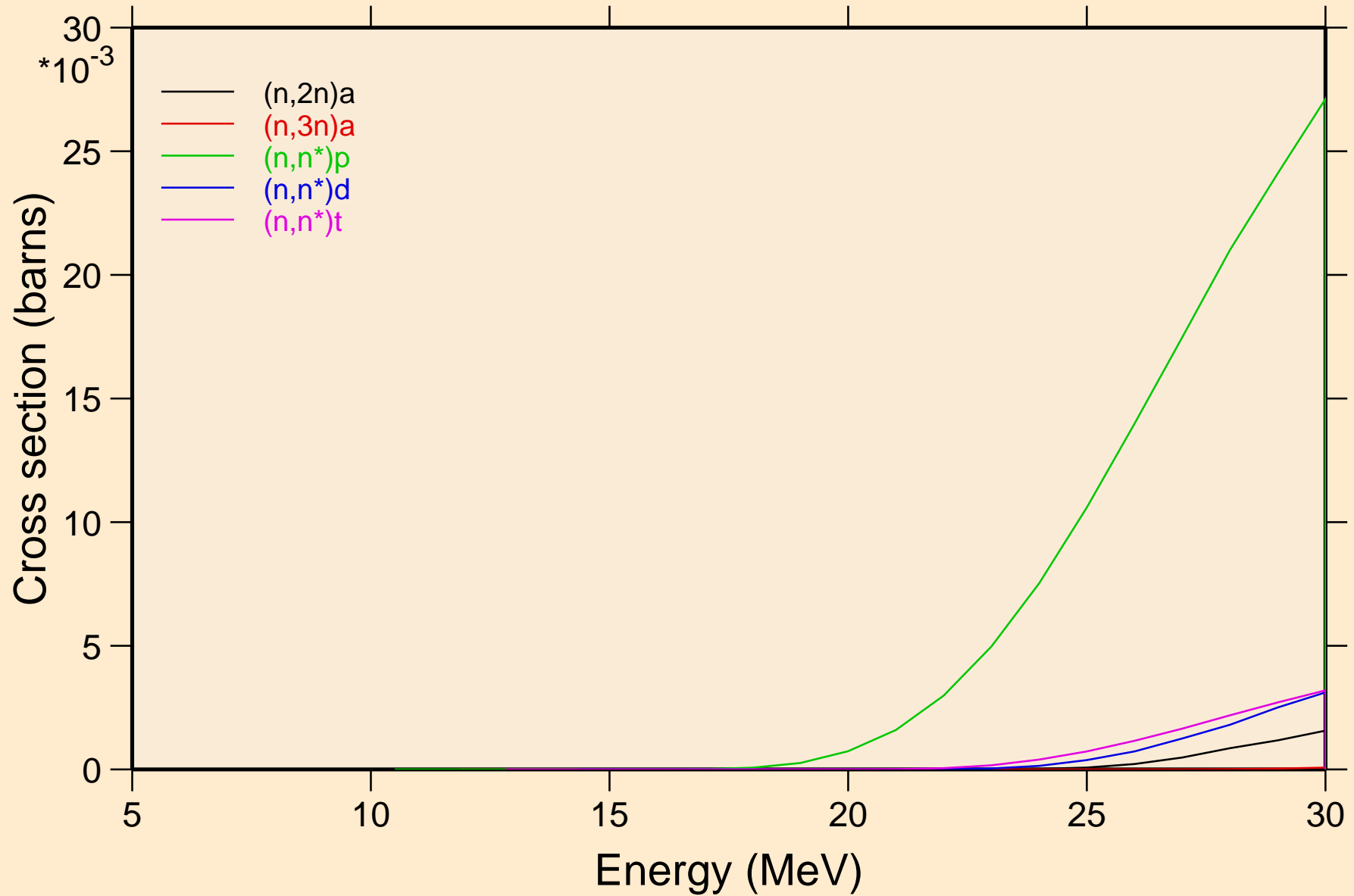

W192 NRG TENDL-2015, AKONING

Threshold reactions

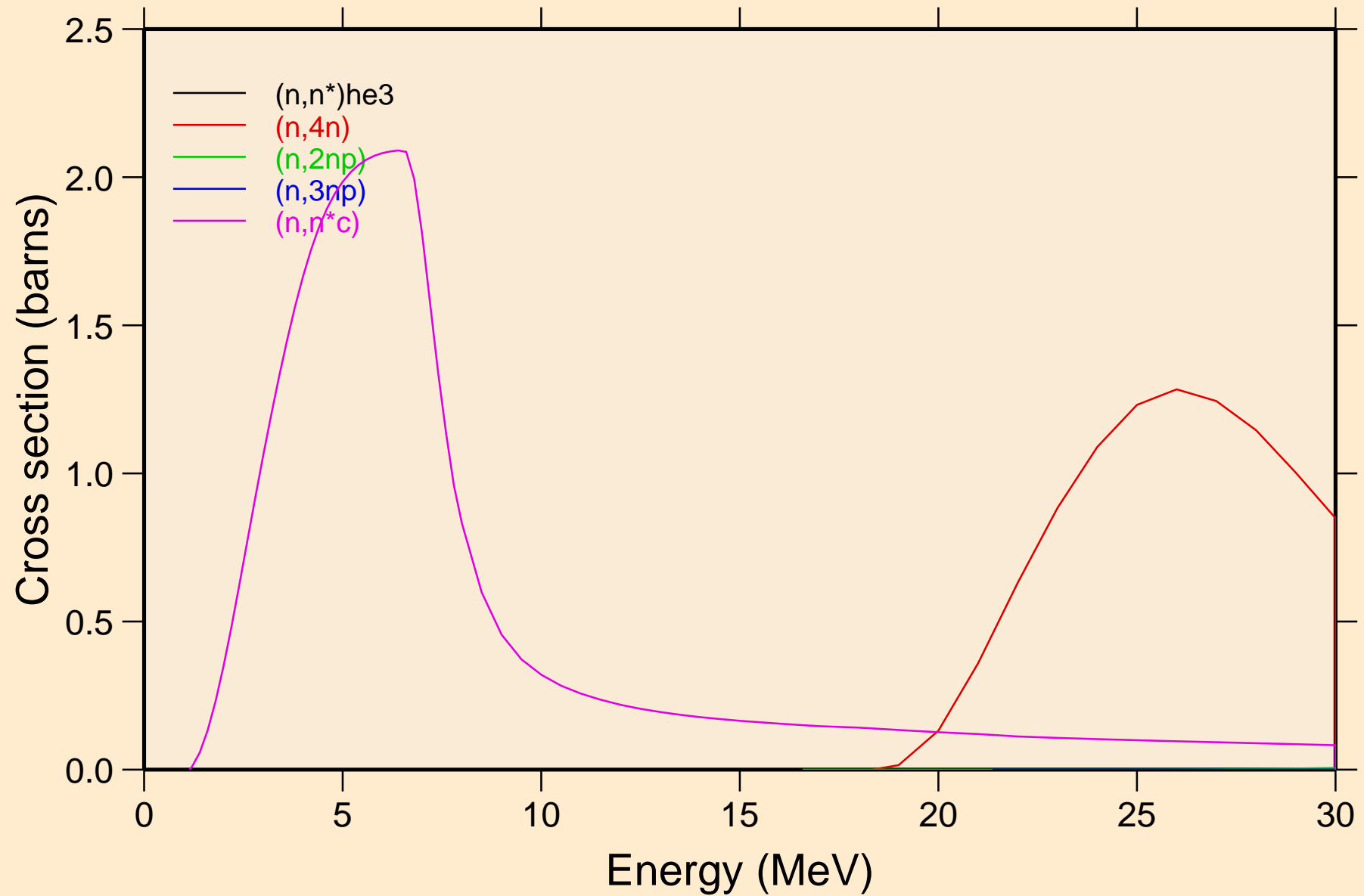

W192 NRG TENDL-2015, AKONING

Threshold reactions

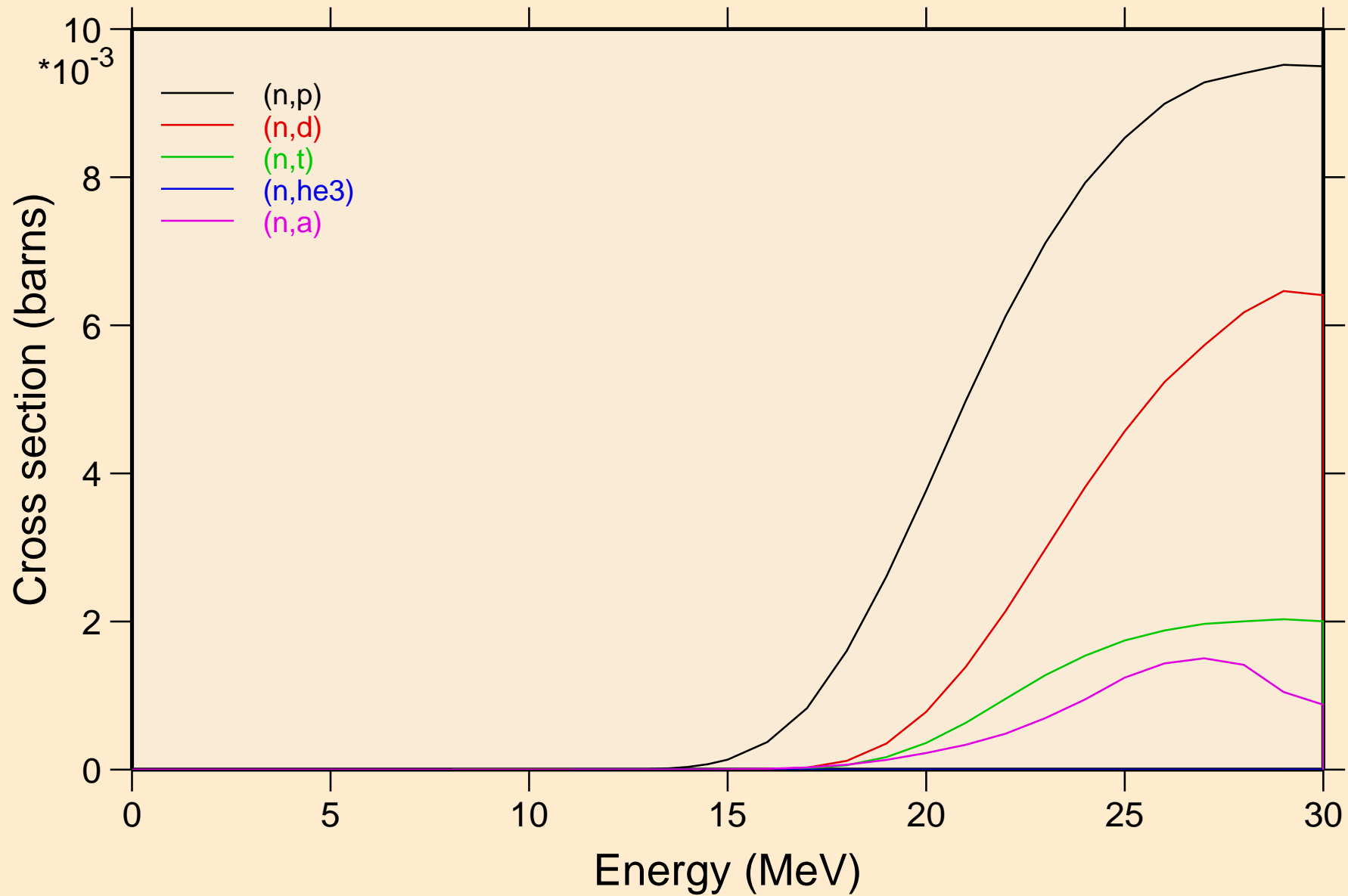

W192 NRG TENDL-2015, AKONING
angular distribution for elastic

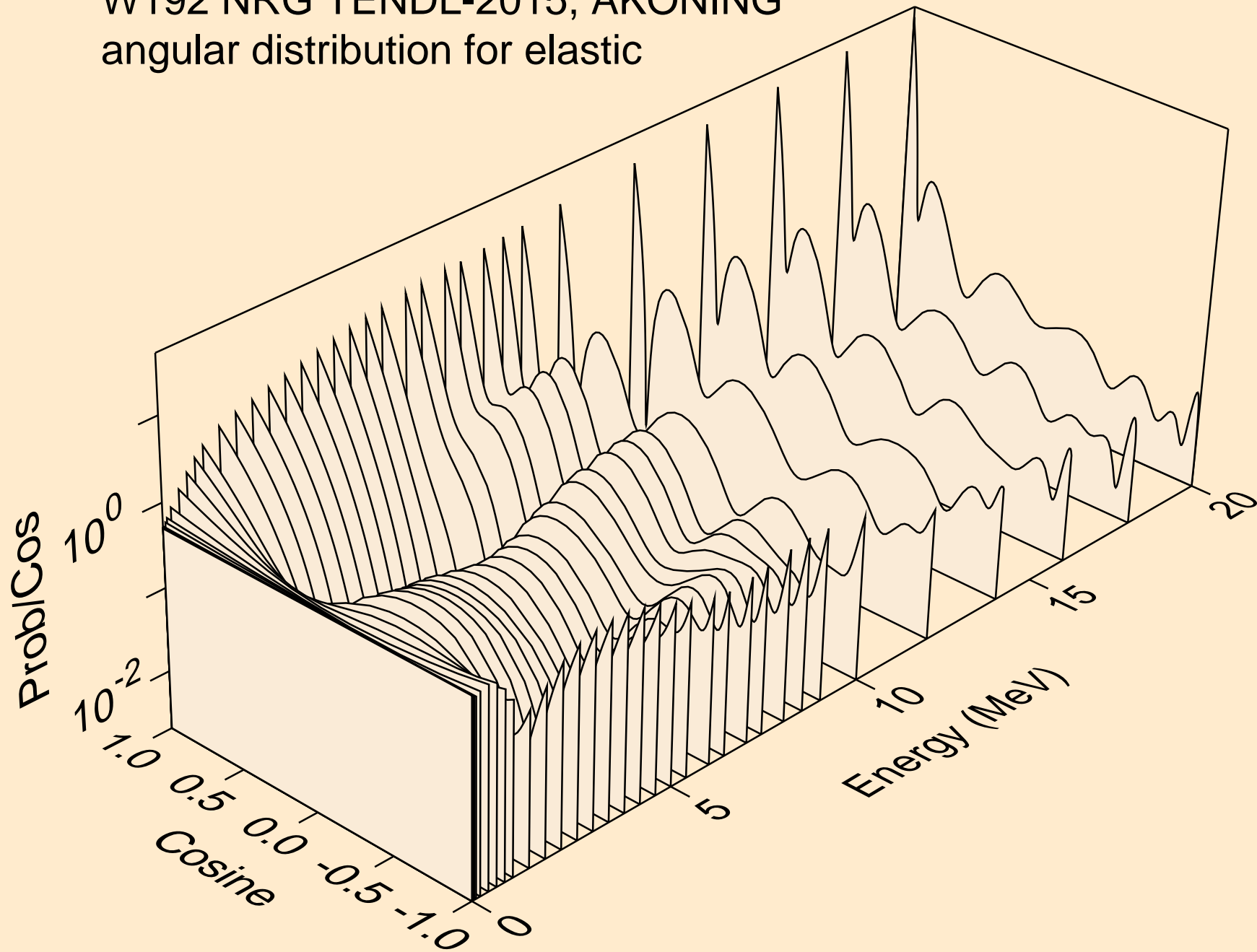

W192 NRG TENDL-2015, AKONING
angular distribution for elastic

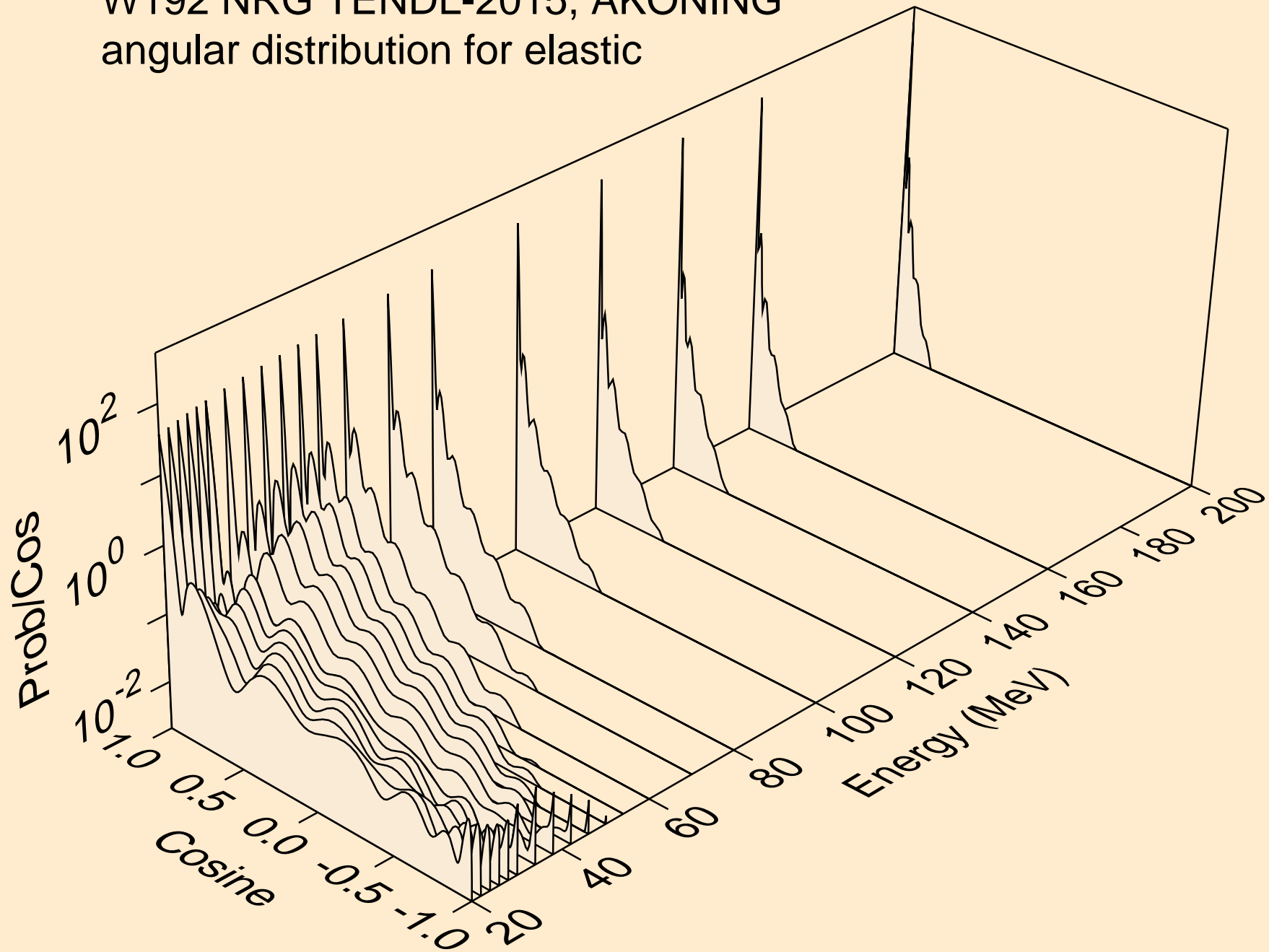

W192 NRG TENDL-2015, AKONING
angular distribution for (n,n*1)

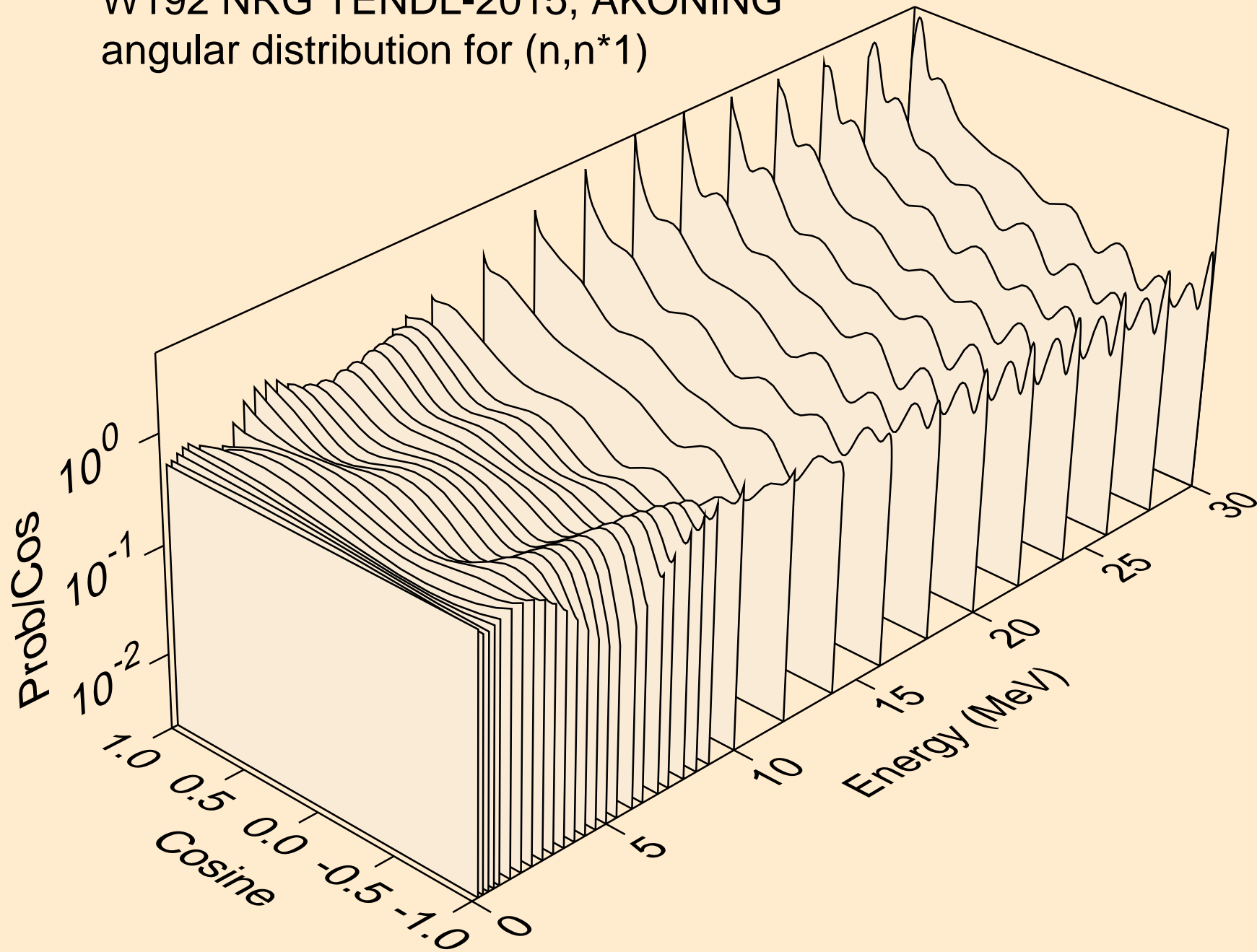

W192 NRG TENDL-2015, AKONING
angular distribution for (n,n*2)

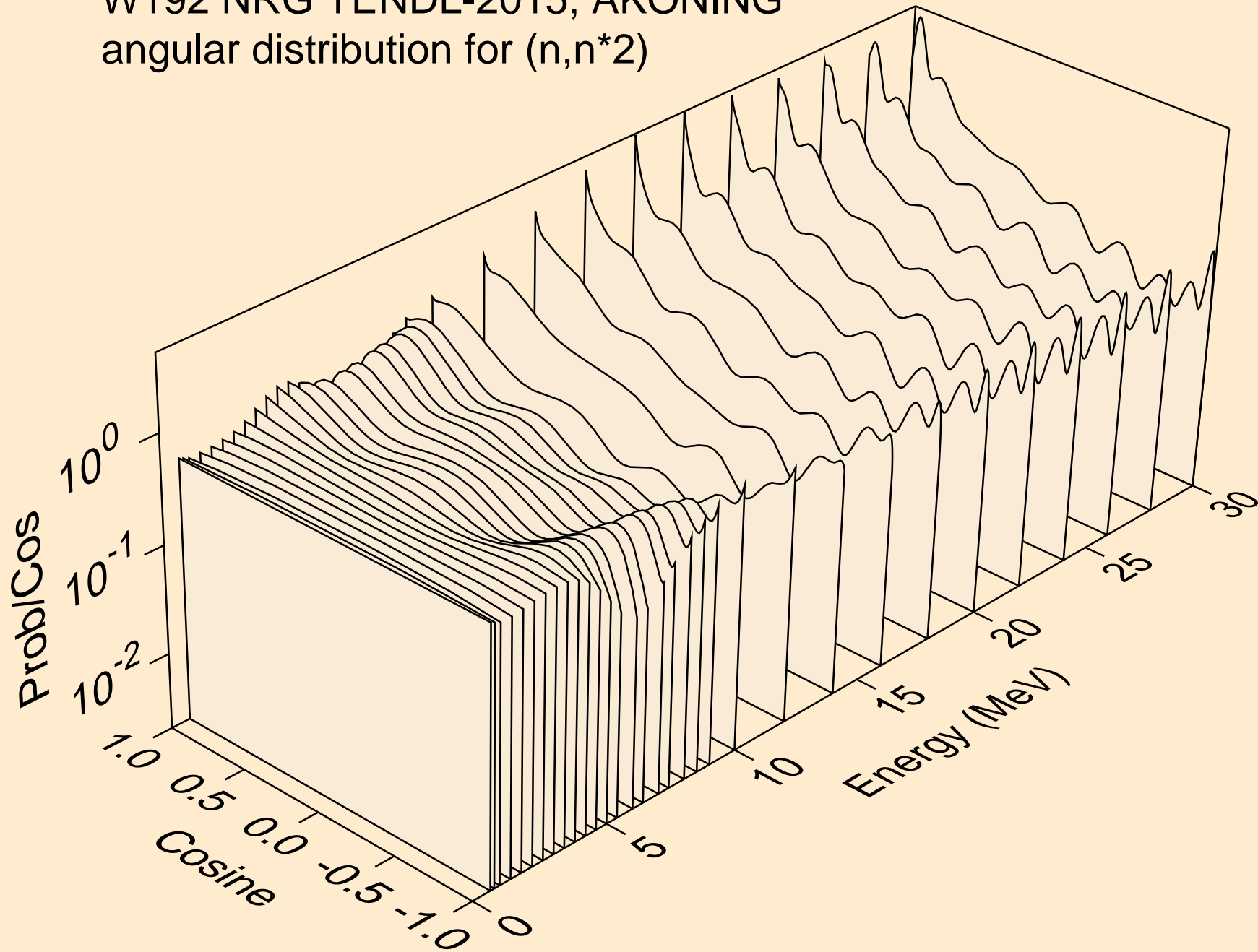

W192 NRG TENDL-2015, AKONING
angular distribution for (n,n*3)

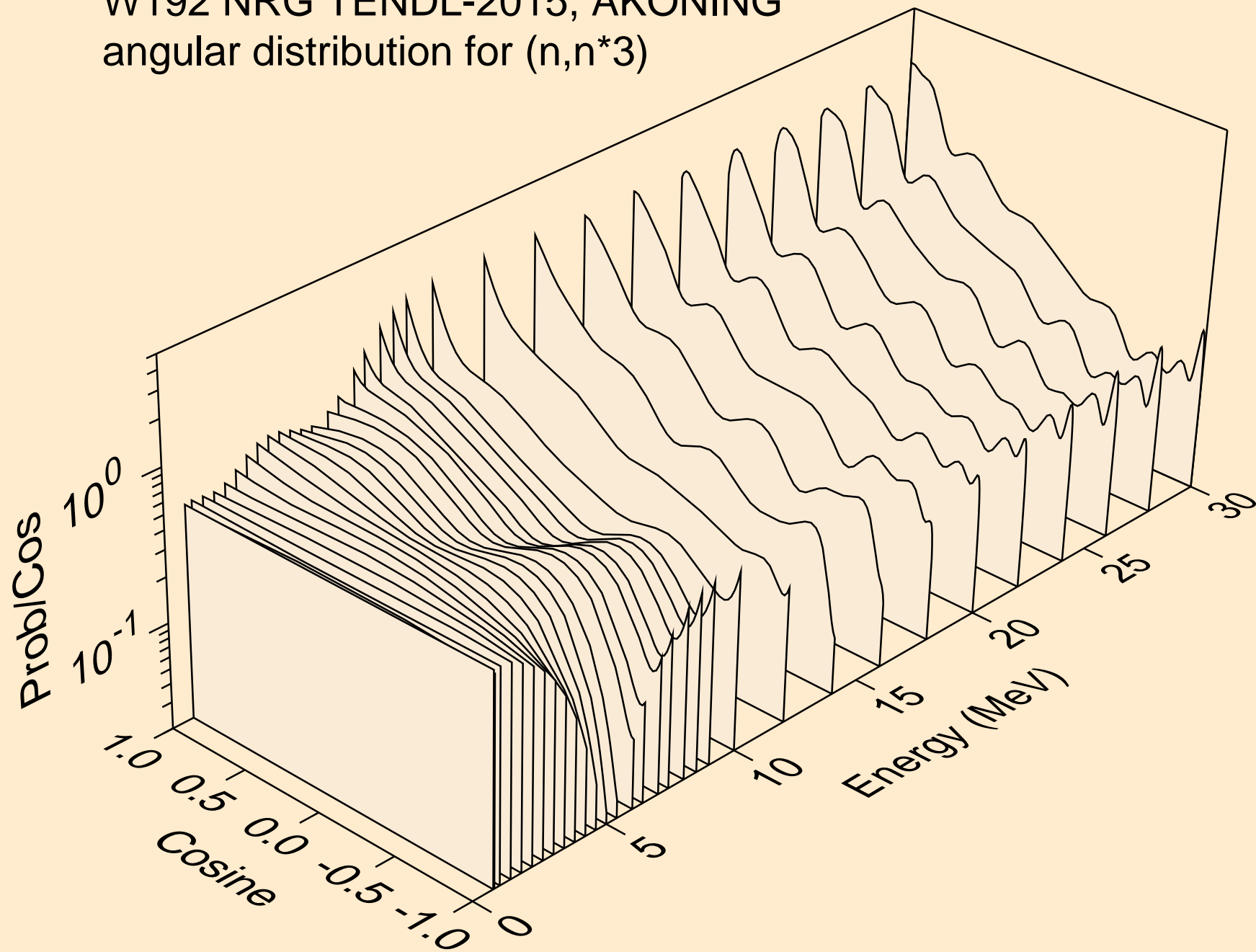

W192 NRG TENDL-2015, AKONING
angular distribution for (n,n*4)

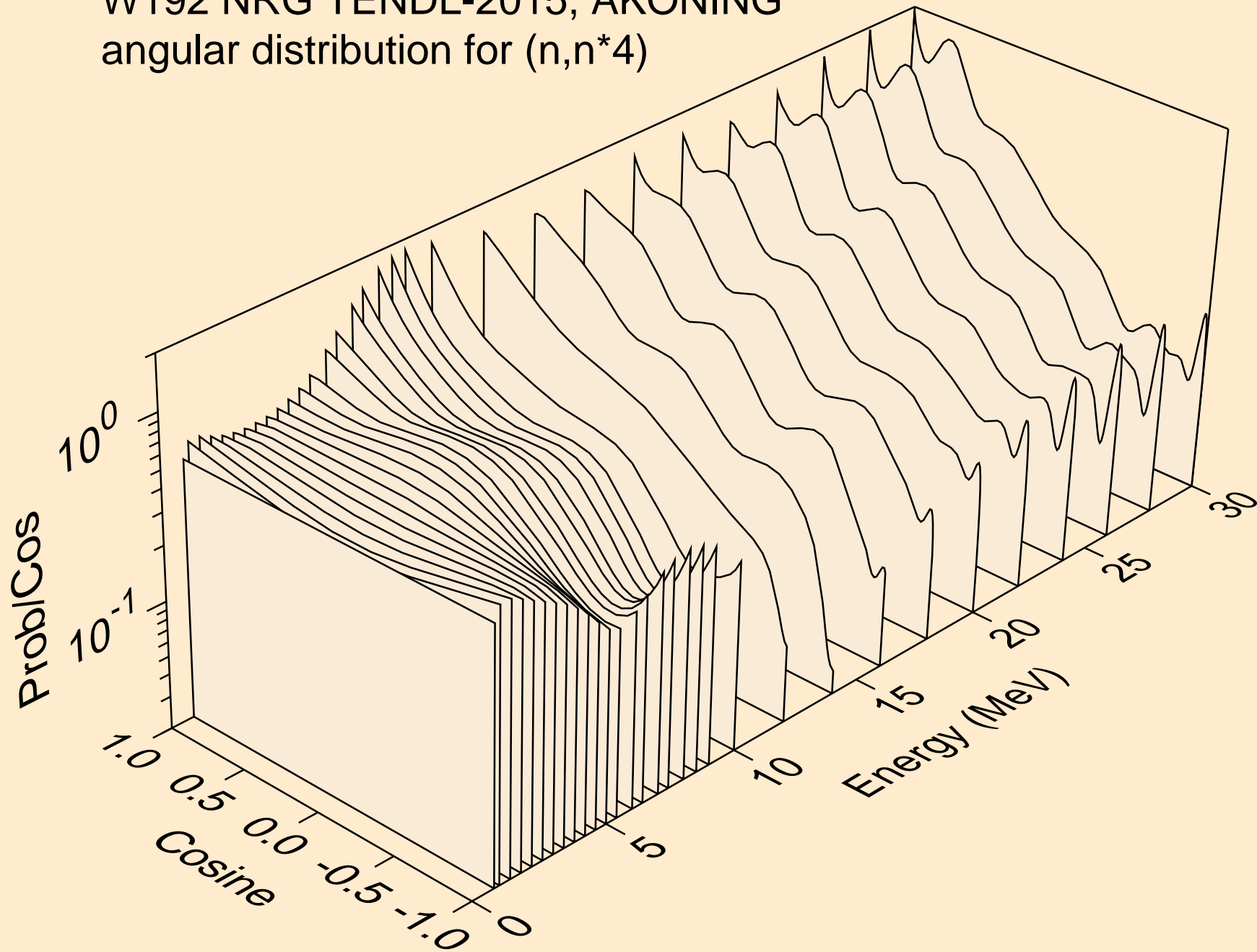

W192 NRG TENDL-2015, AKONING
angular distribution for (n,n*5)

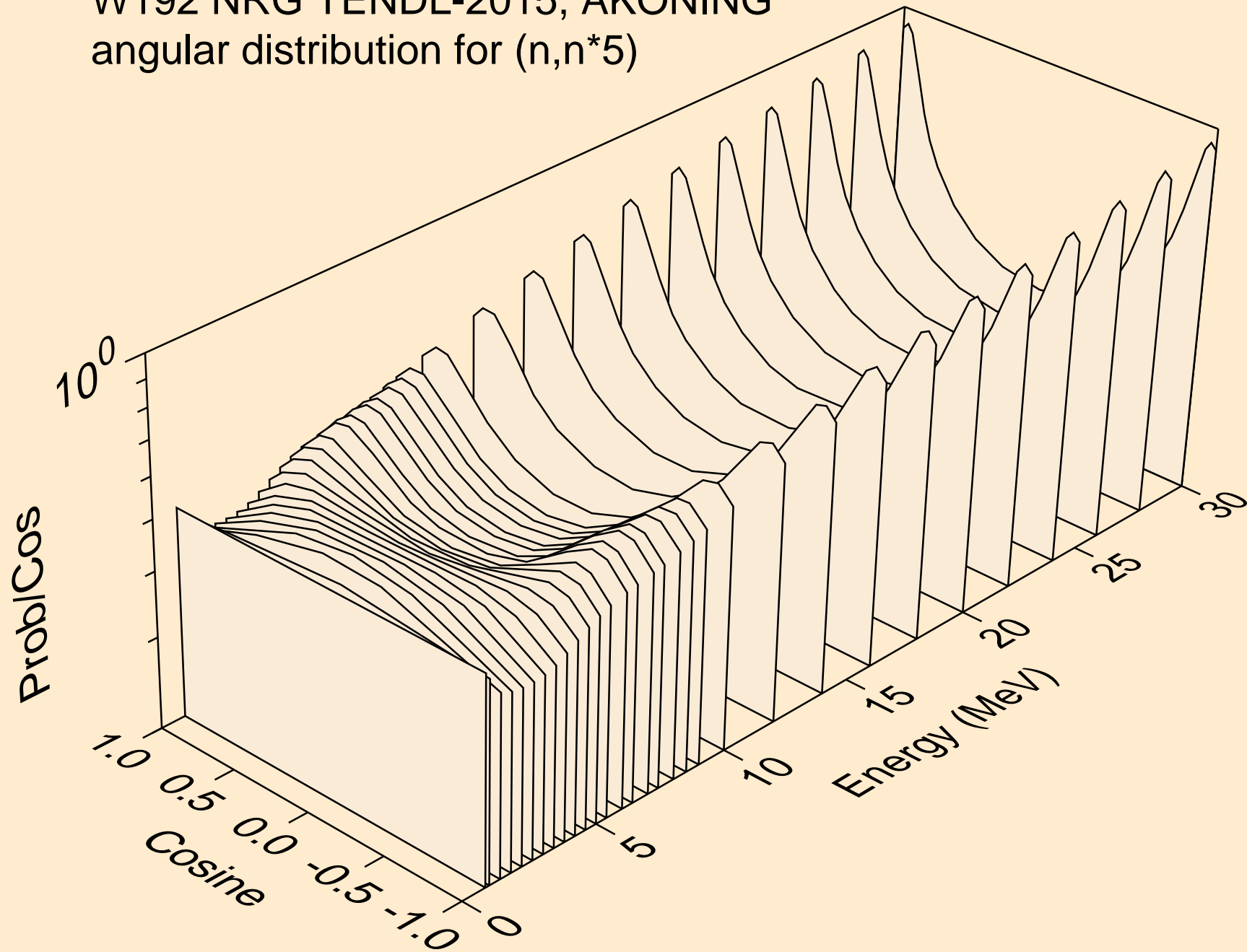

W192 NRG TENDL-2015, AKONING
angular distribution for (n,n*6)

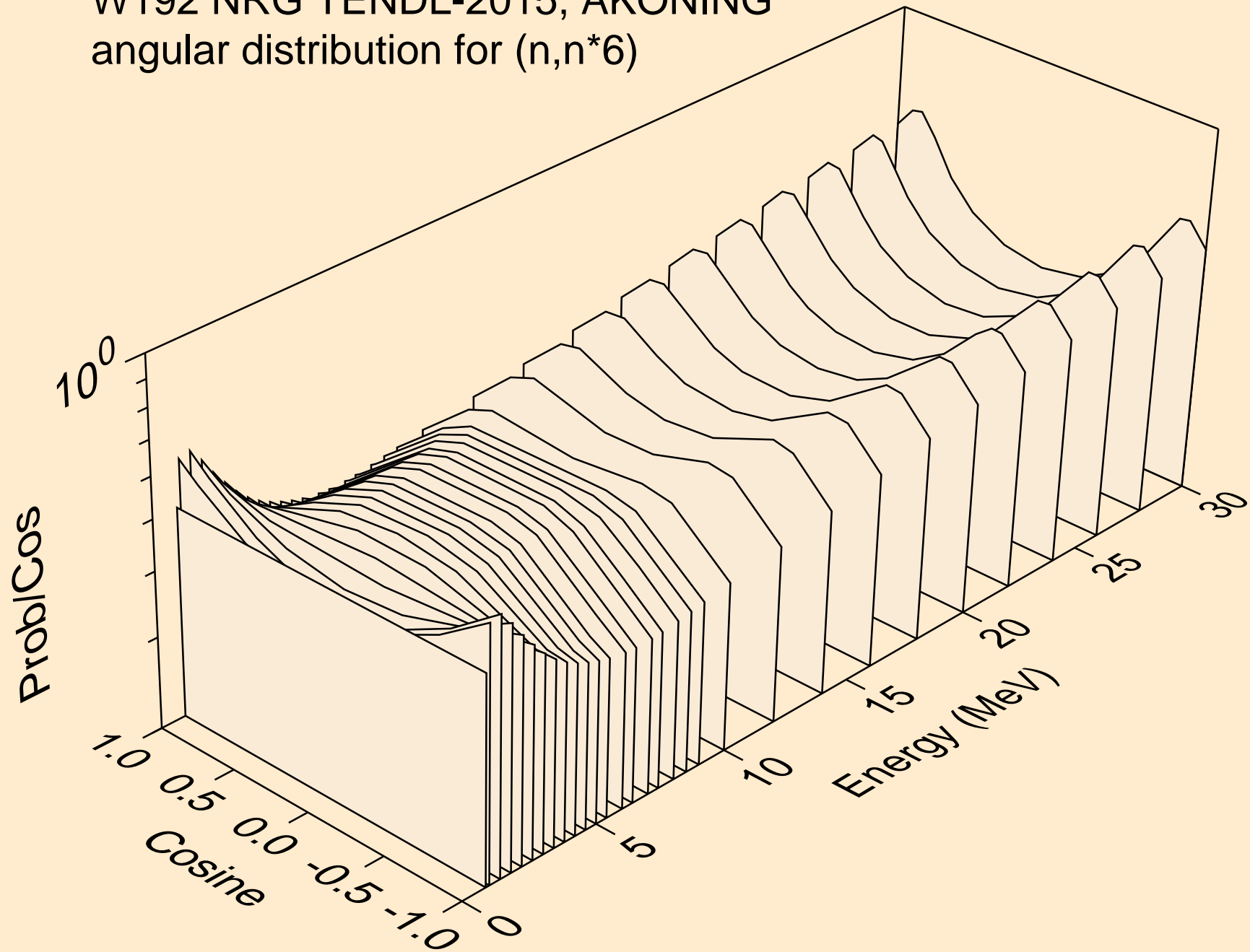

W192 NRG TENDL-2015, AKONING
angular distribution for (n,n*7)

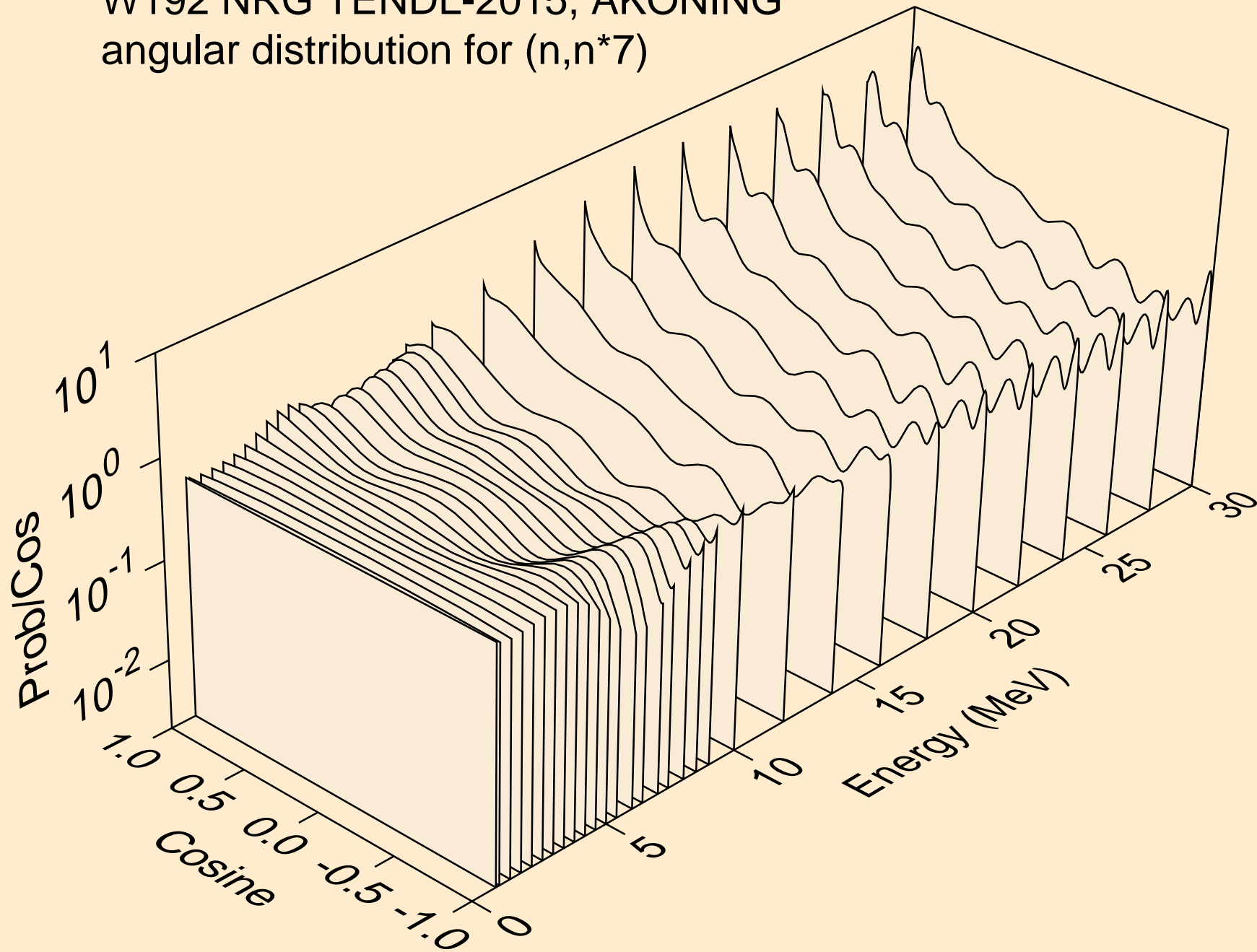

W192 NRG TENDL-2015, AKONING
angular distribution for (n,n*8)

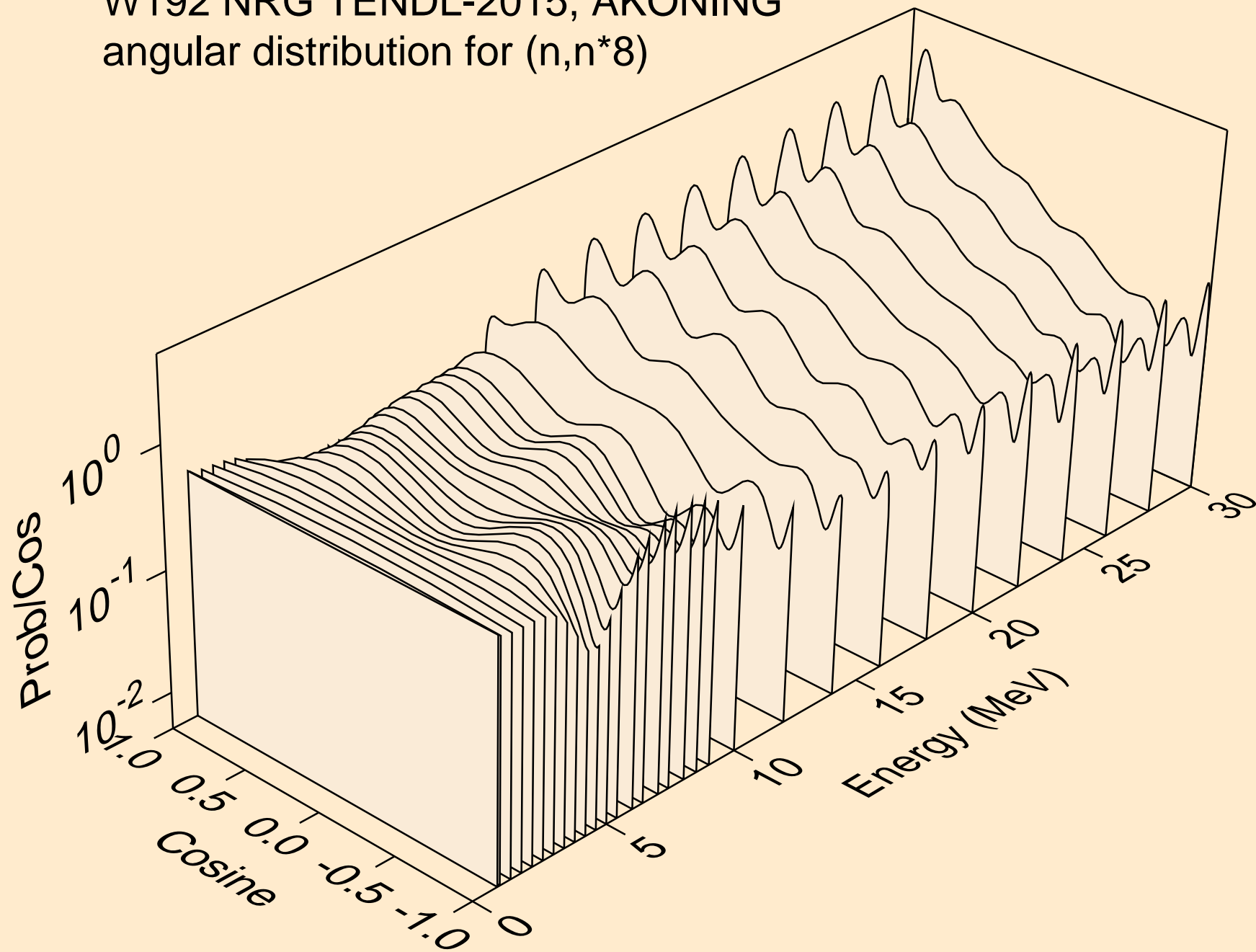

W192 NRG TENDL-2015, AKONING
angular distribution for (n,n*9)

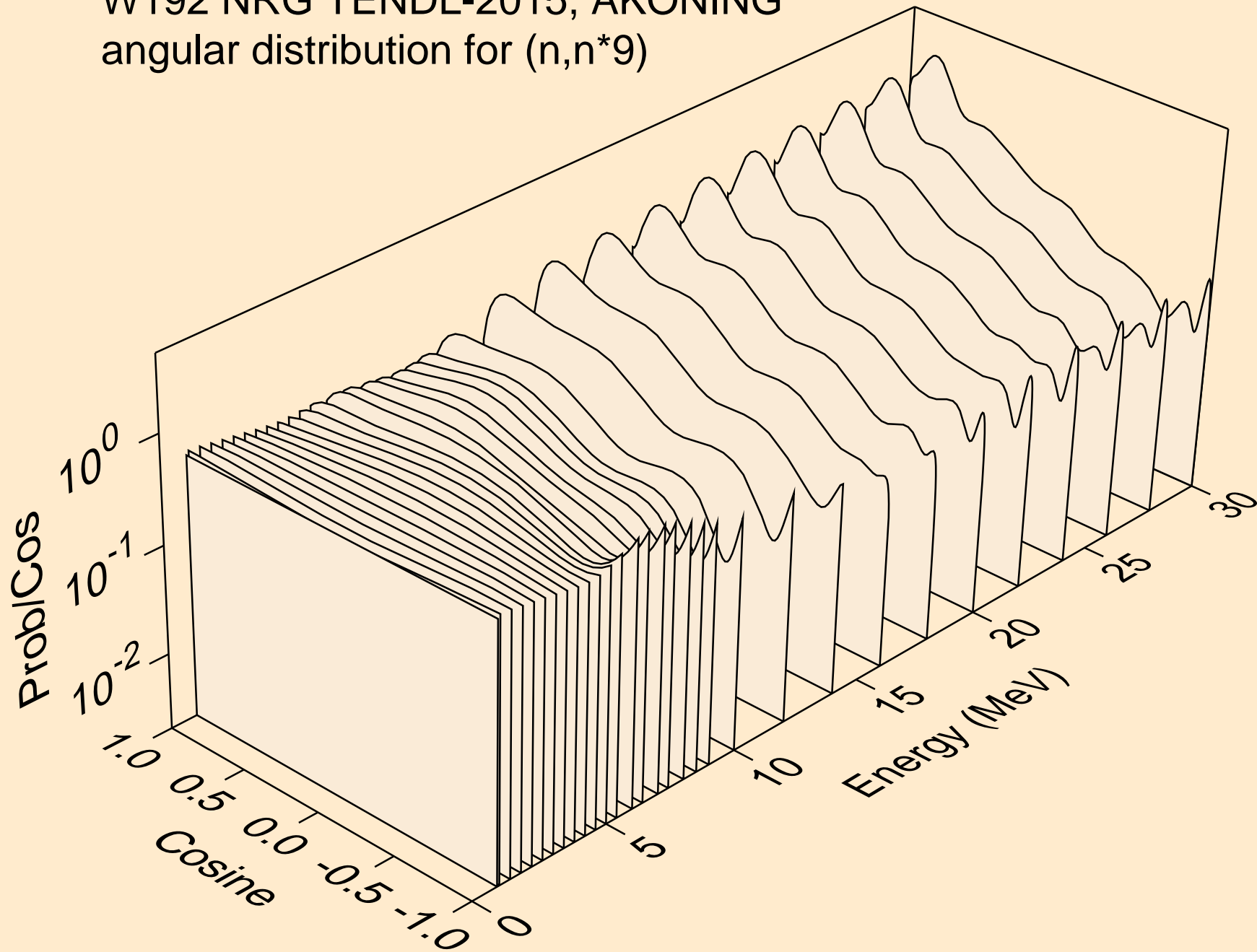

W192 NRG TENDL-2015, AKONING
angular distribution for (n,n*10)

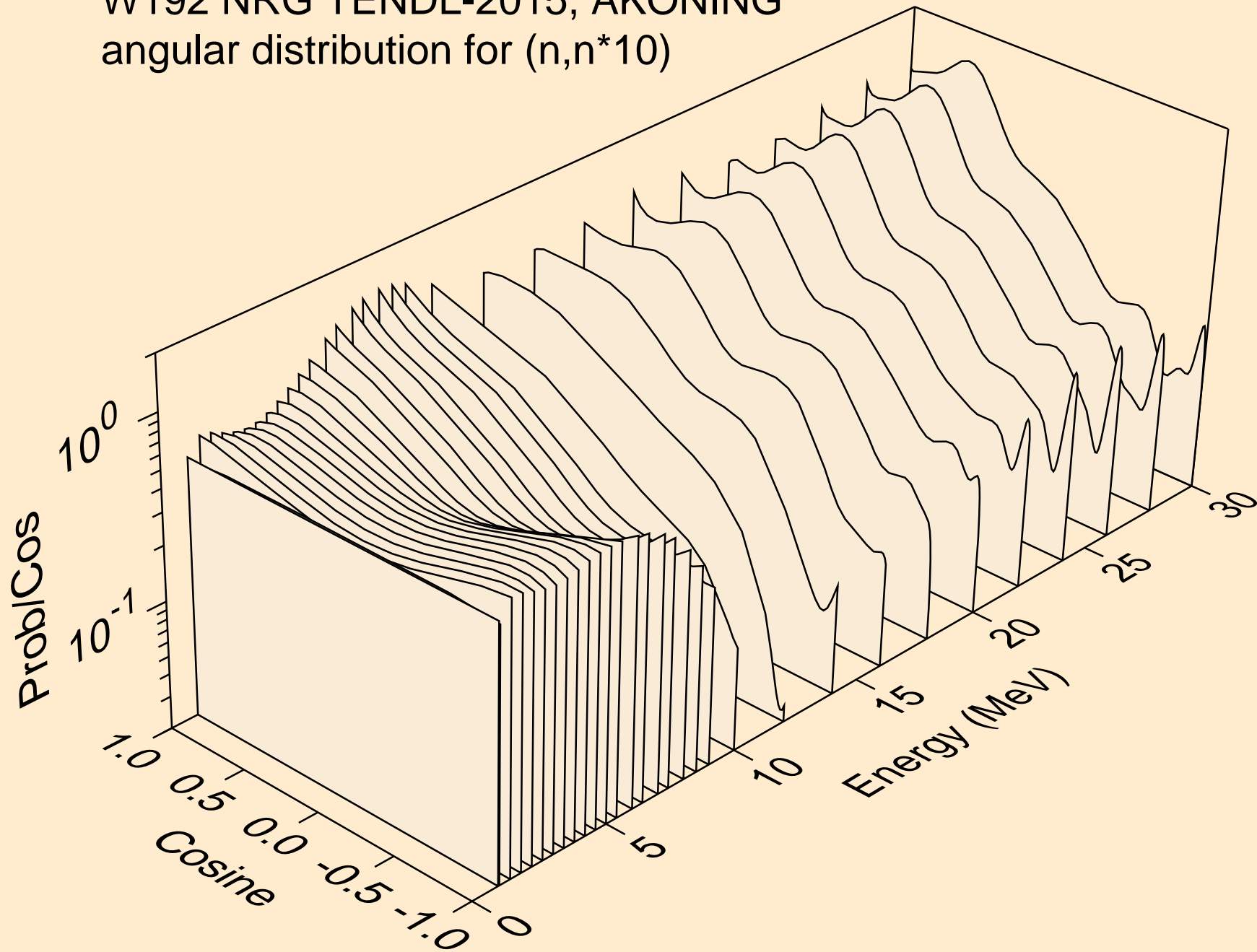

W192 NRG TENDL-2015, AKONING
angular distribution for (n,n*11)

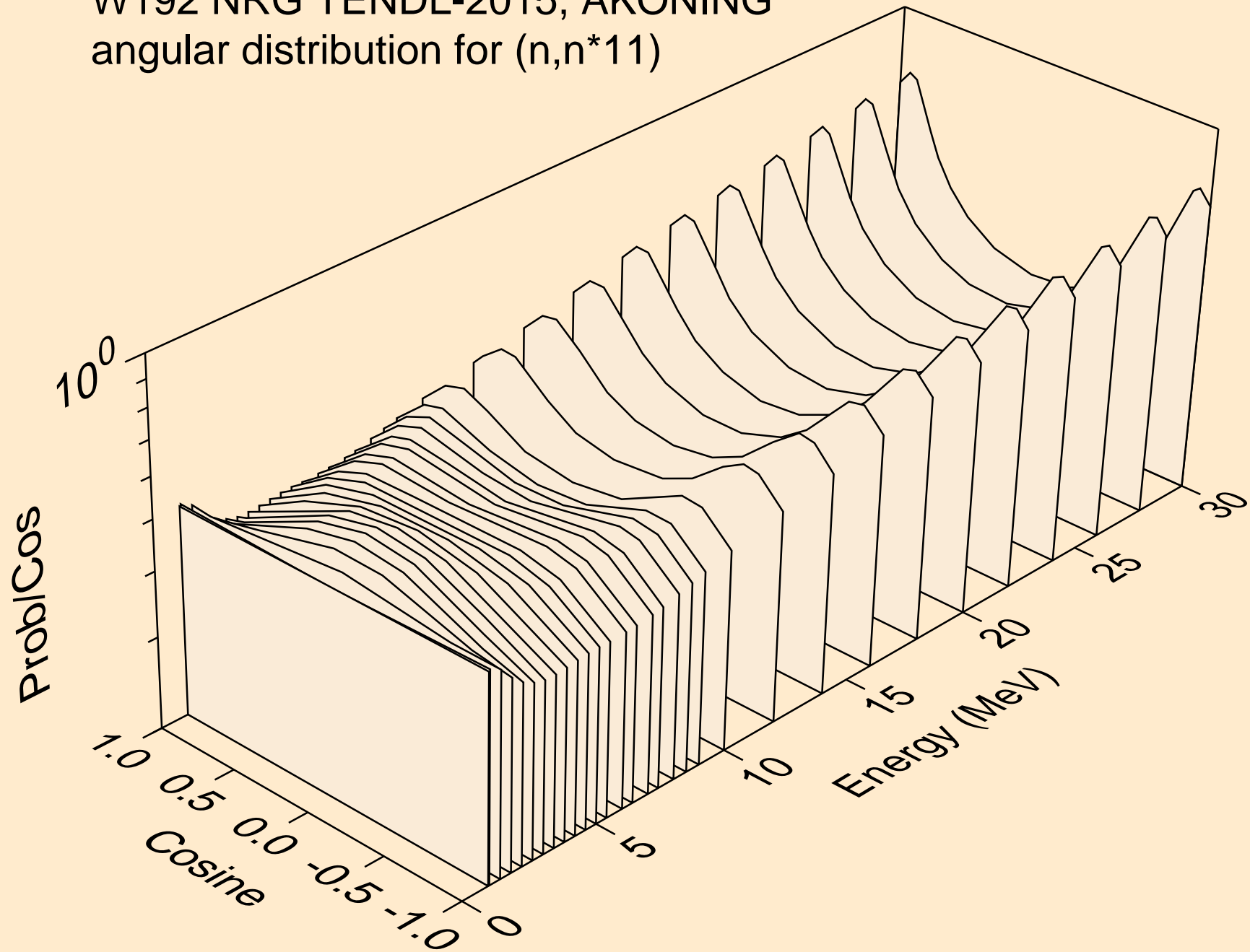

W192 NRG TENDL-2015, AKONING
angular distribution for (n,n*12)

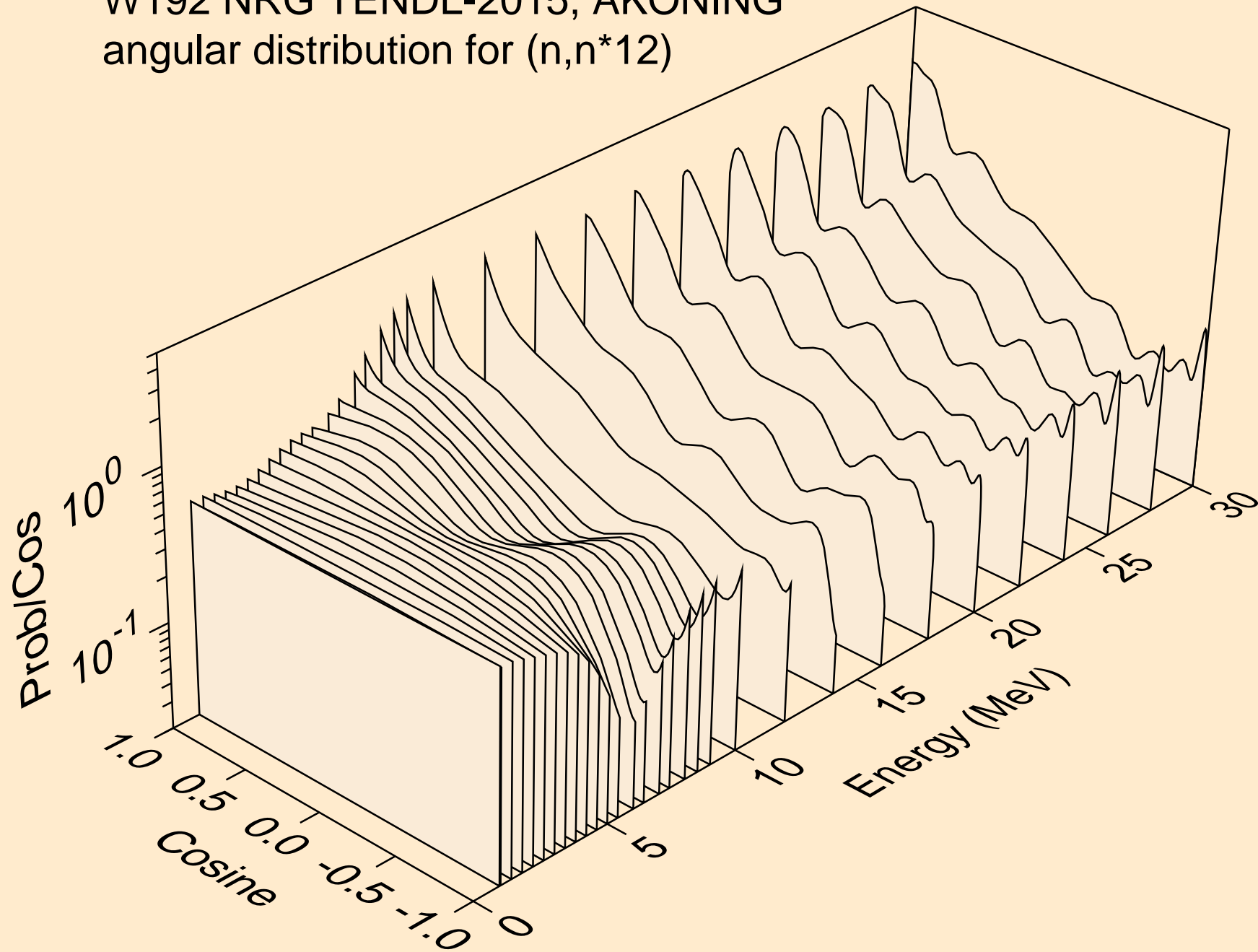

W192 NRG TENDL-2015, AKONING
angular distribution for (n,n*13)

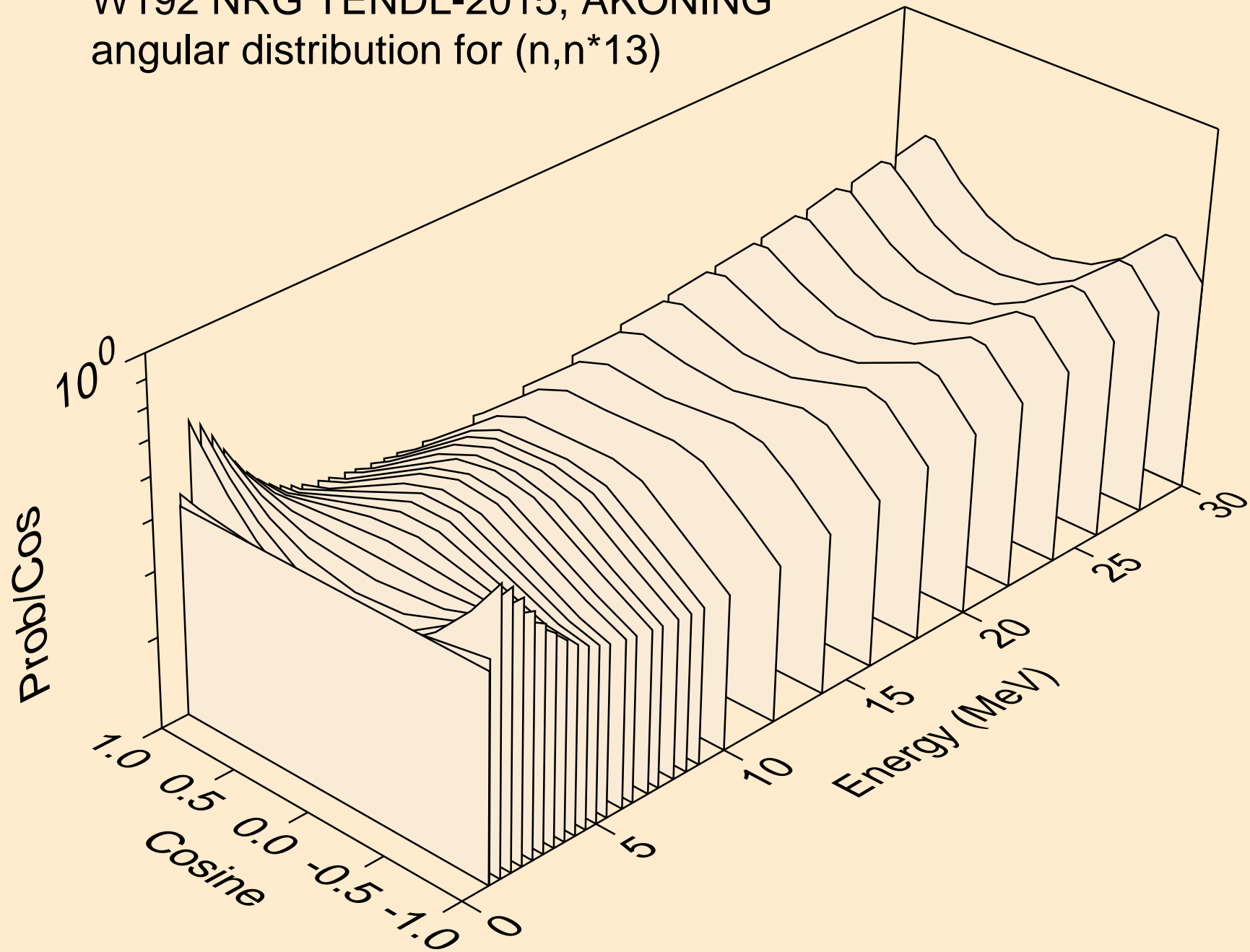

W192 NRG TENDL-2015, AKONING
angular distribution for (n,n*14)

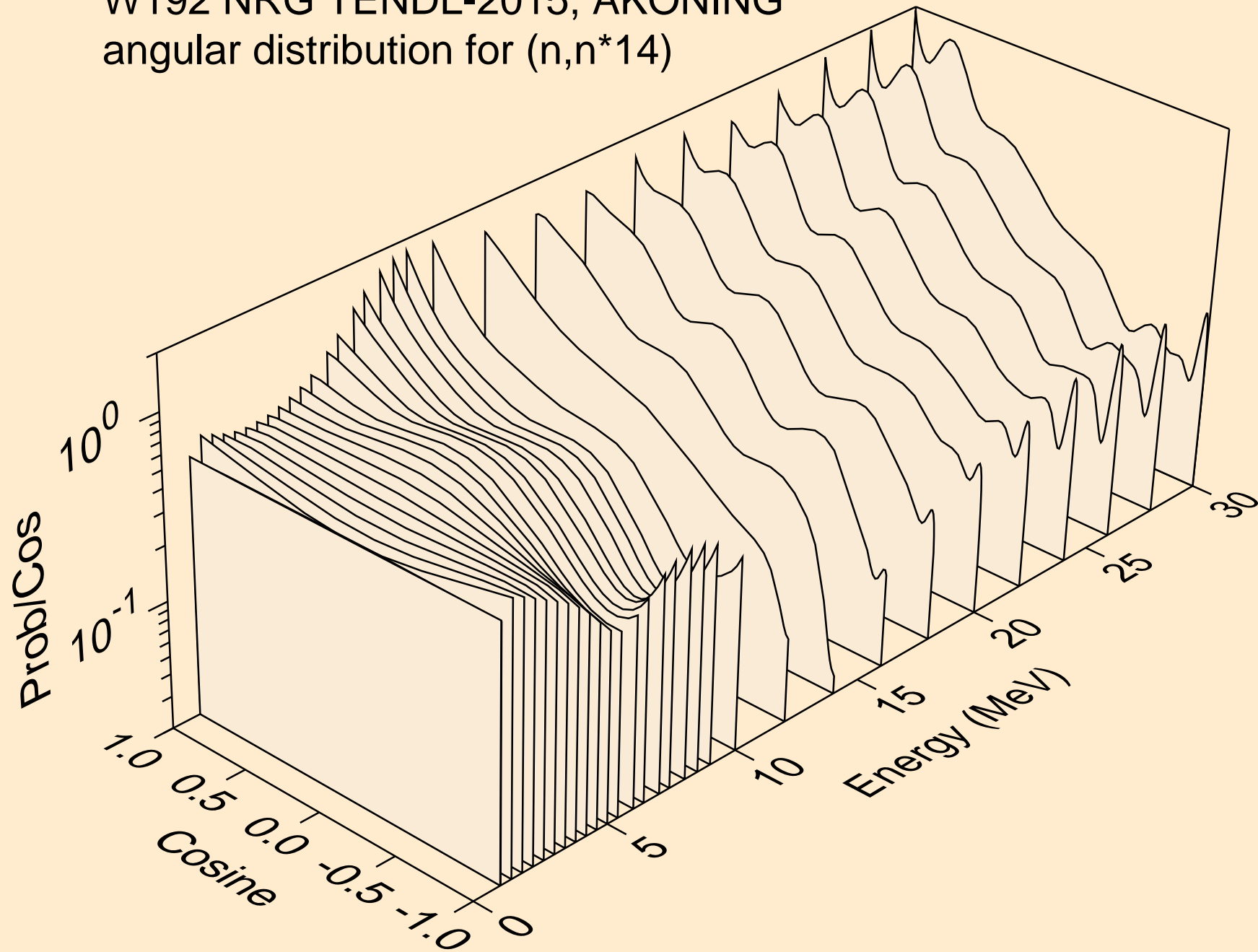

W192 NRG TENDL-2015, AKONING
angular distribution for (n,n*15)

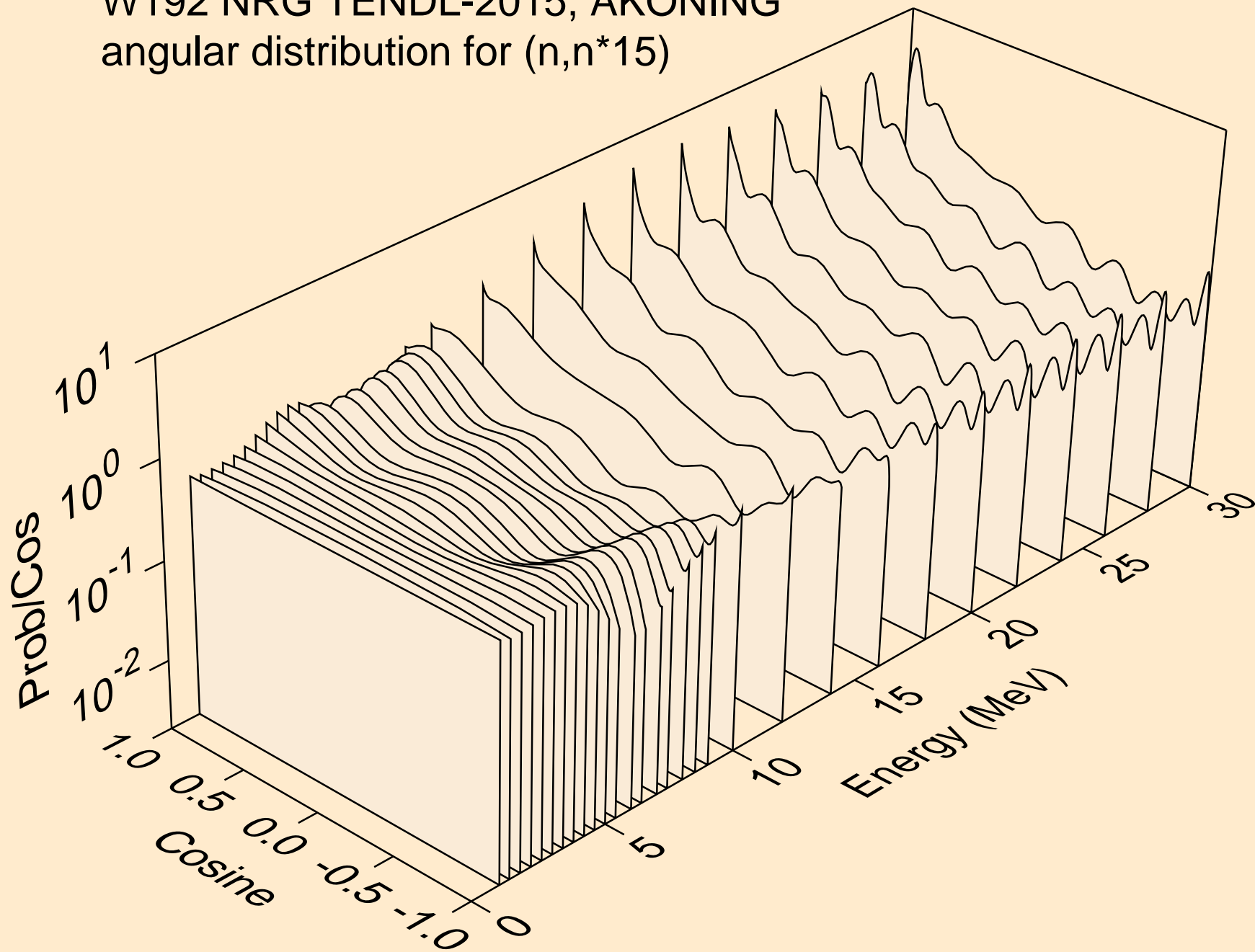

W192 NRG TENDL-2015, AKONING
angular distribution for (n,n*16)

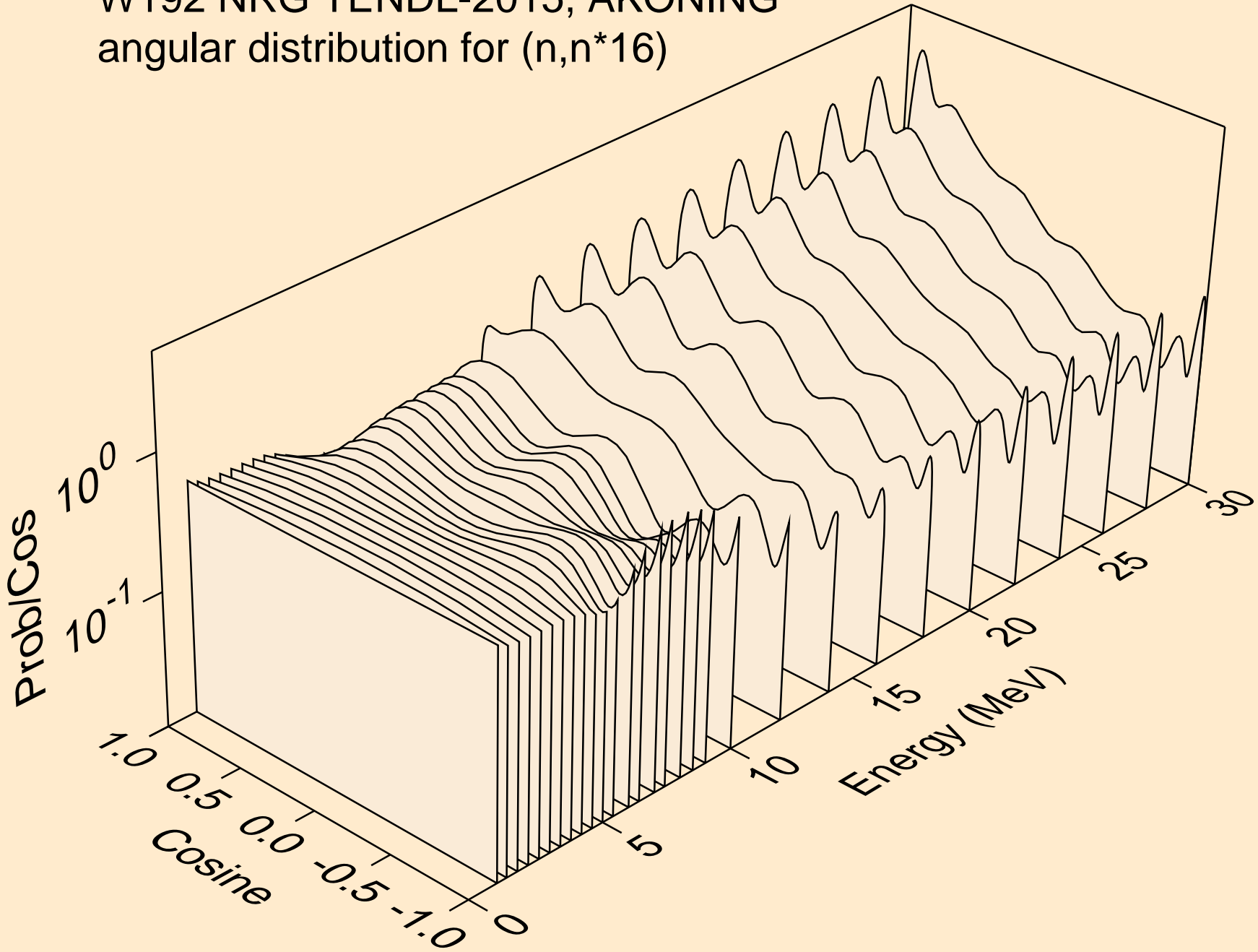

W192 NRG TENDL-2015, AKONING
angular distribution for (n,n*17)

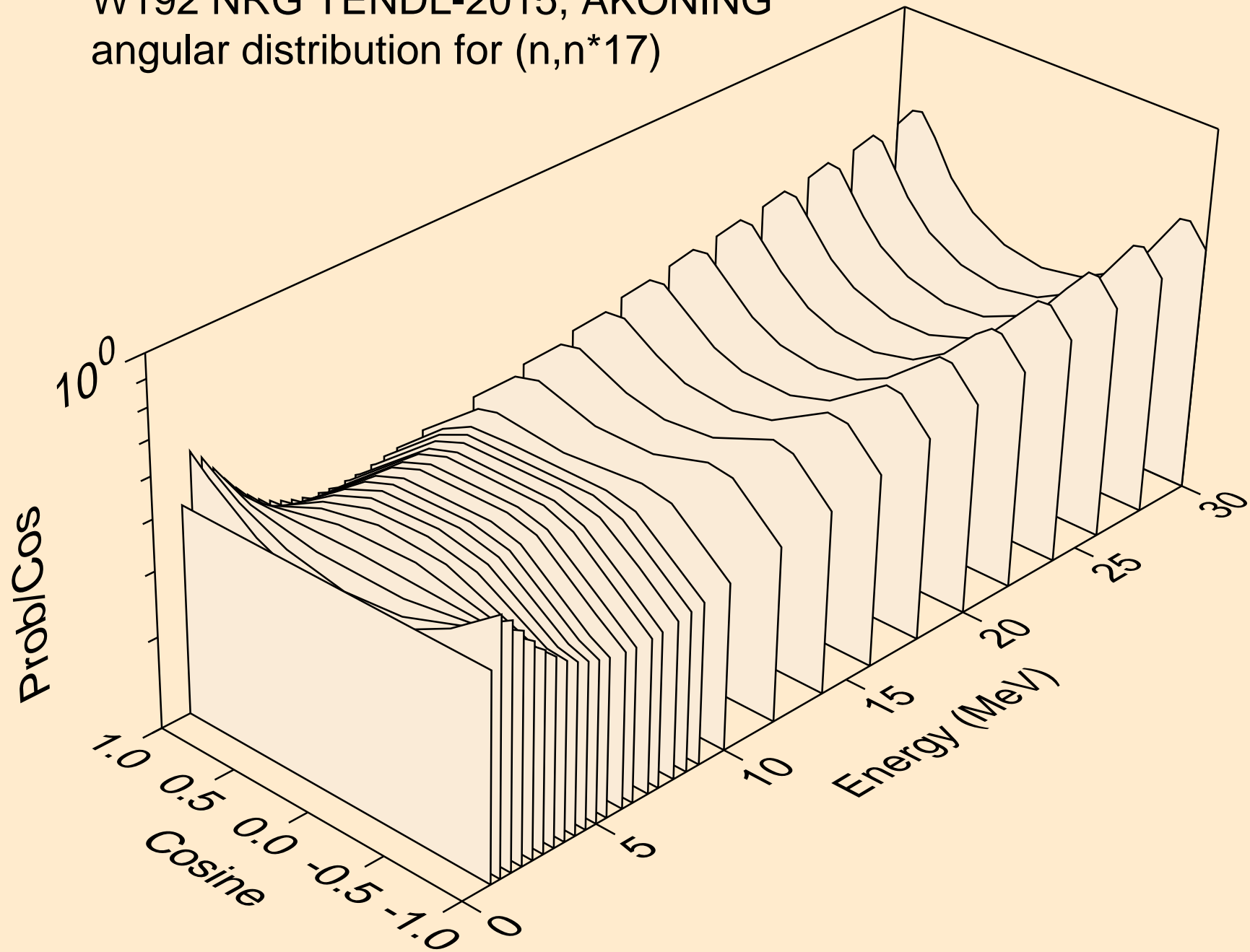

W192 NRG TENDL-2015, AKONING
angular distribution for (n,n*18)

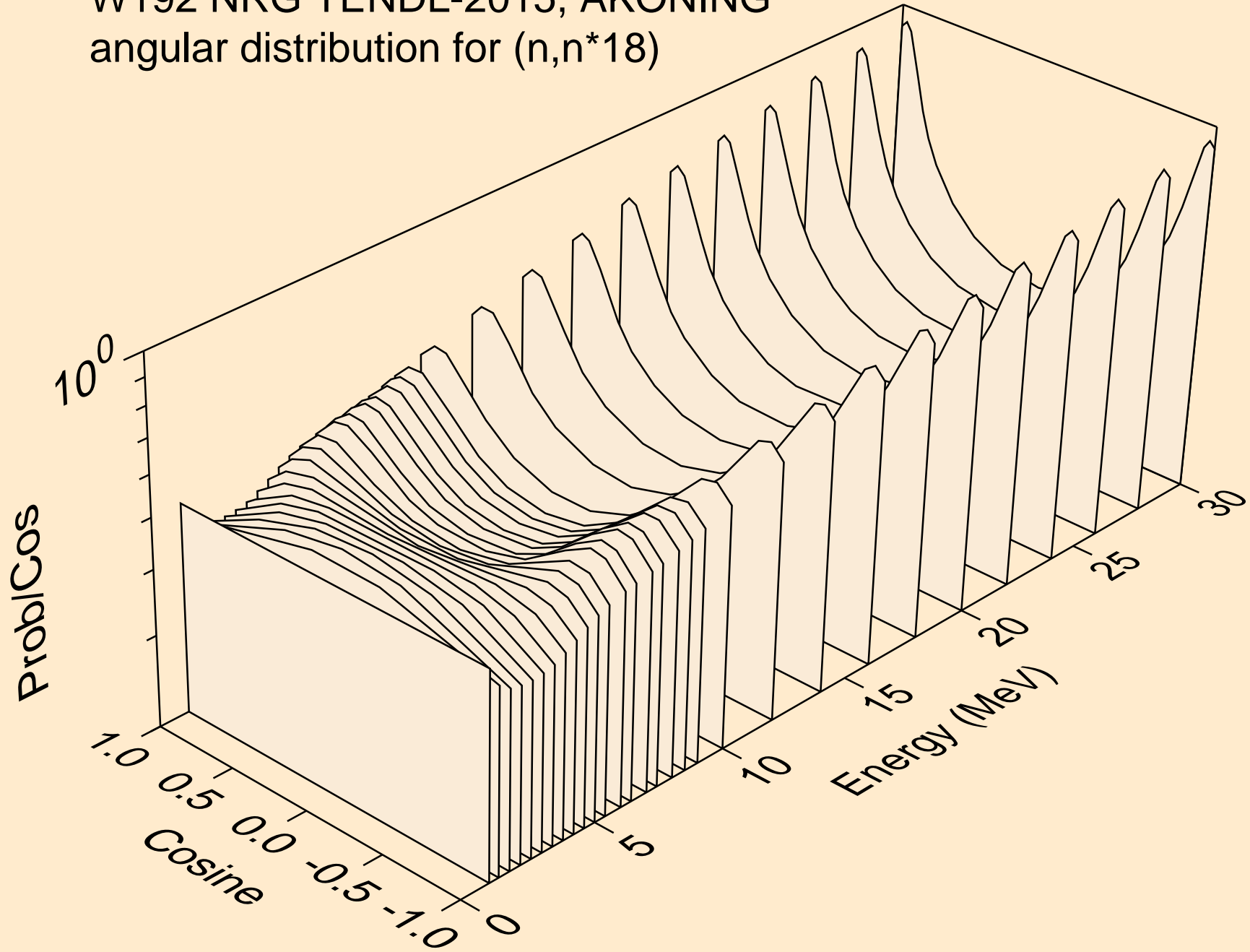

W192 NRG TENDL-2015, AKONING
angular distribution for (n,n*19)

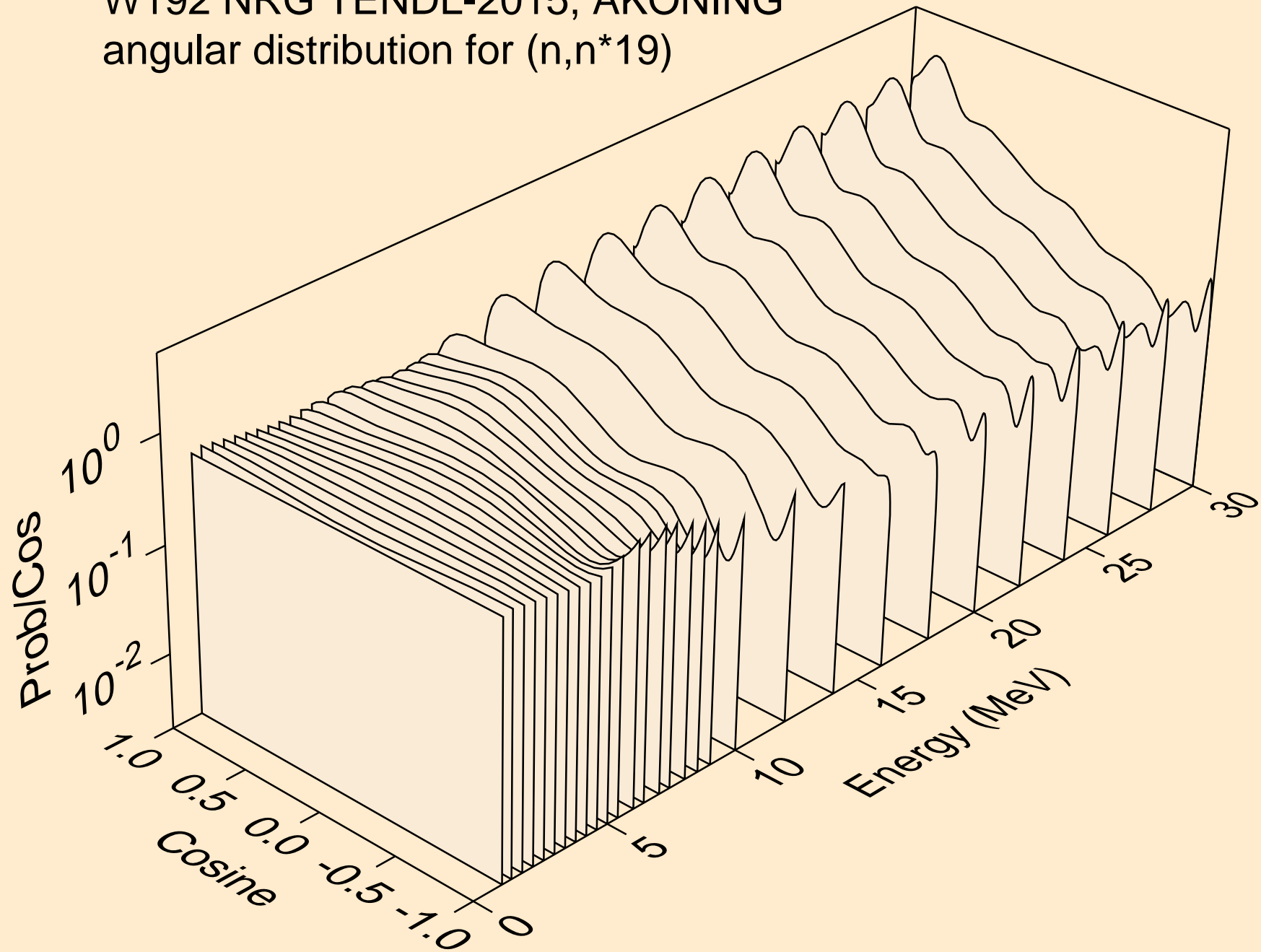

W192 NRG TENDL-2015, AKONING
angular distribution for (n,n*20)

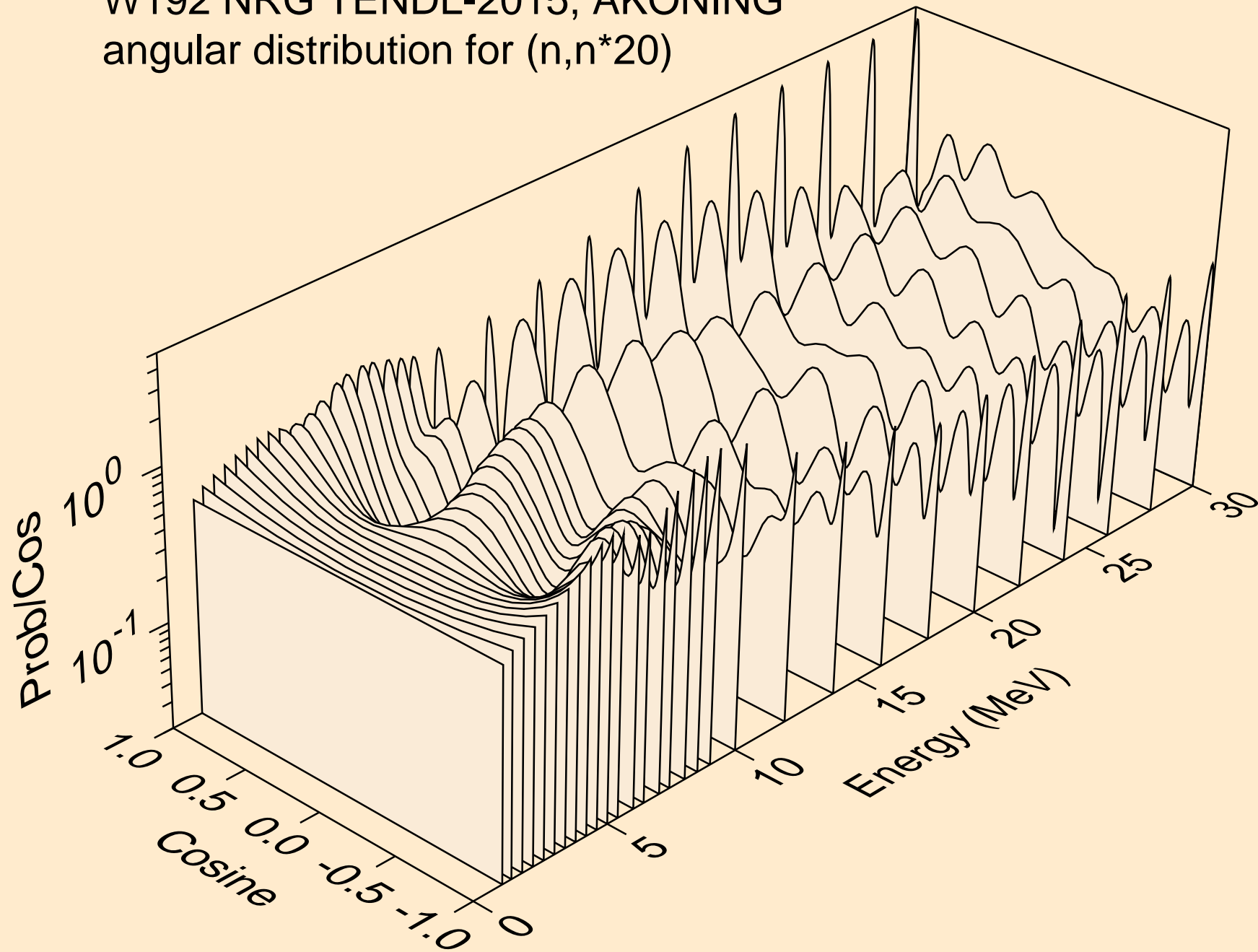

W192 NRG TENDL-2015, AKONING
angular distribution for (n,n*21)

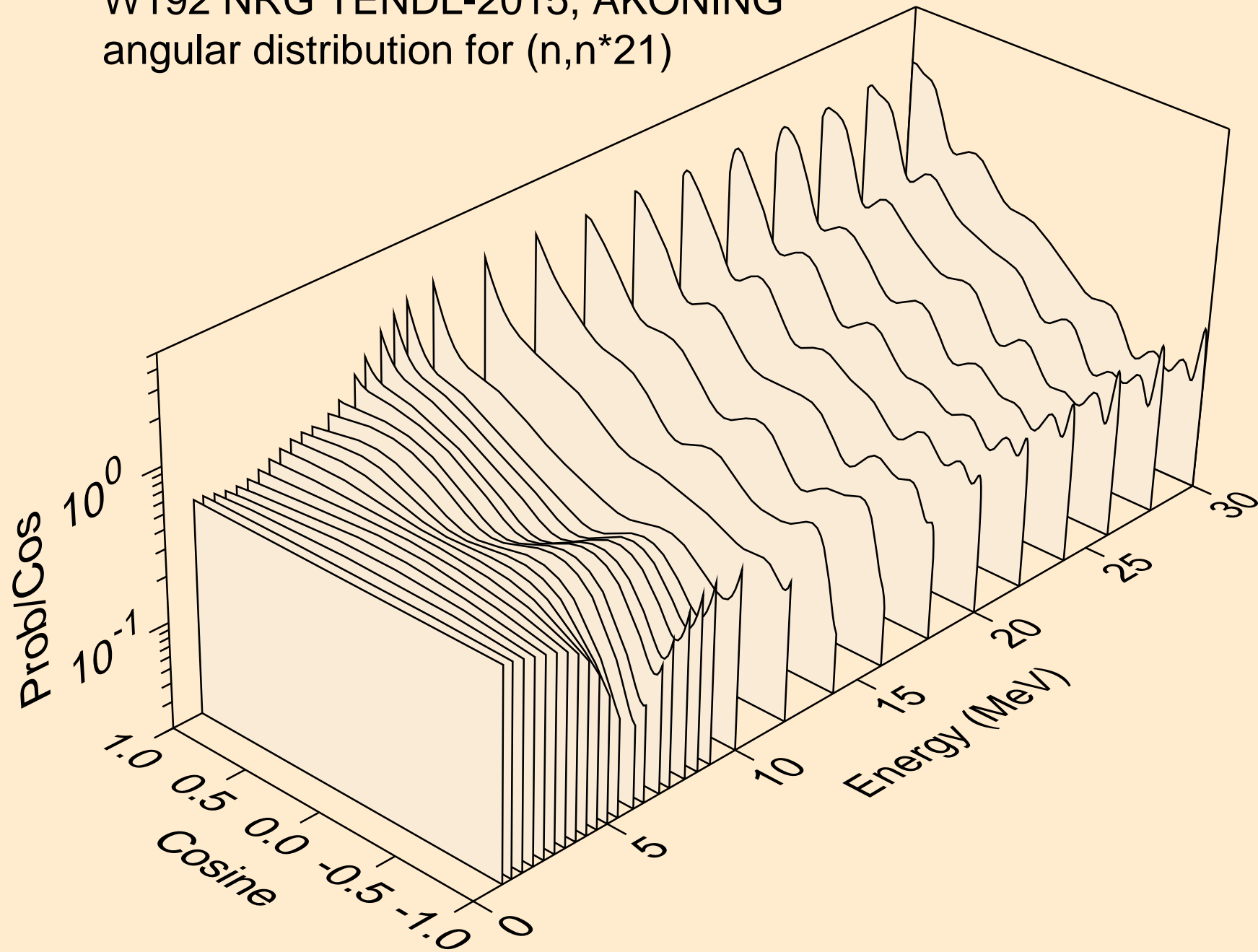

W192 NRG TENDL-2015, AKONING
angular distribution for (n,n*22)

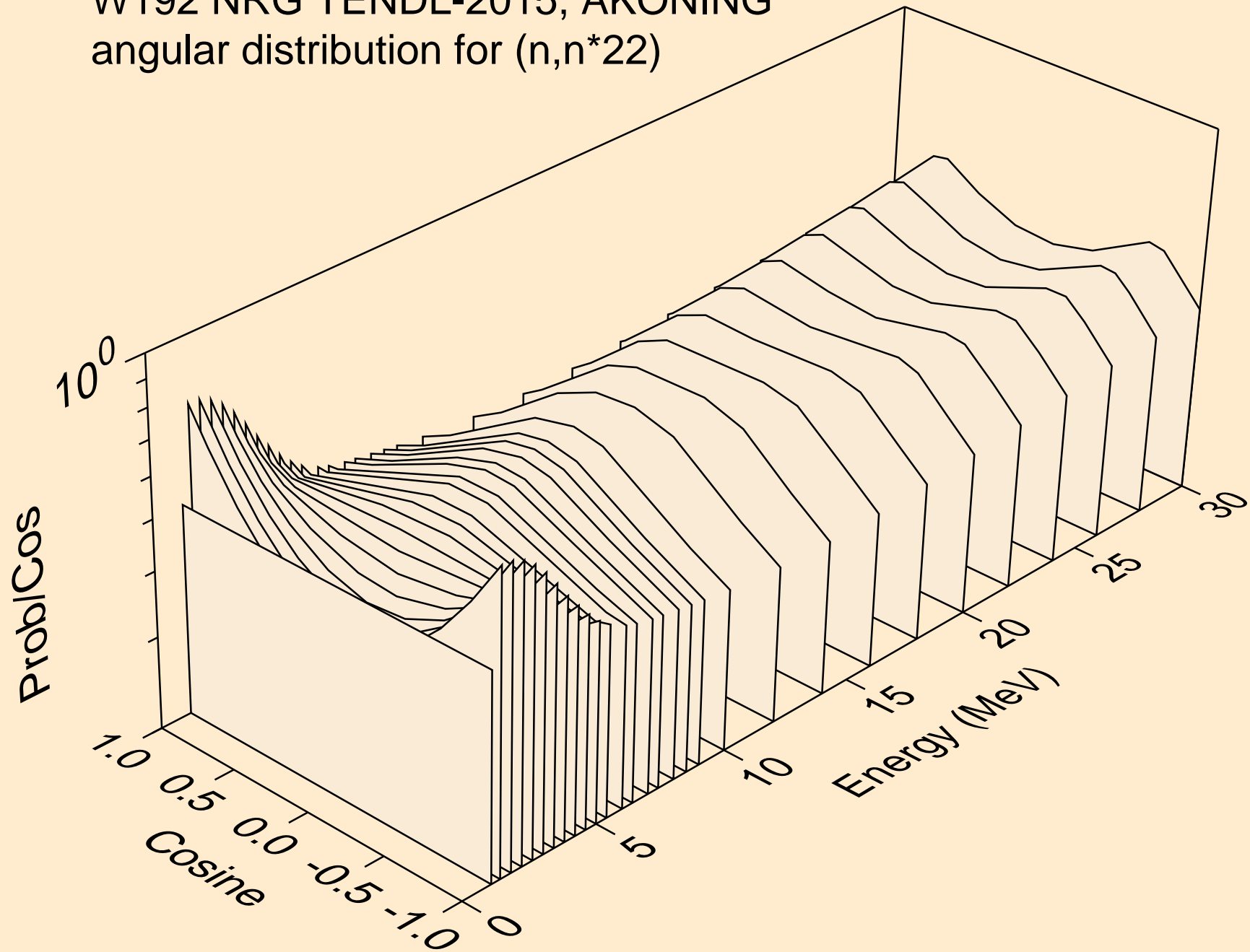

W192 NRG TENDL-2015, AKONING
angular distribution for (n,n*23)

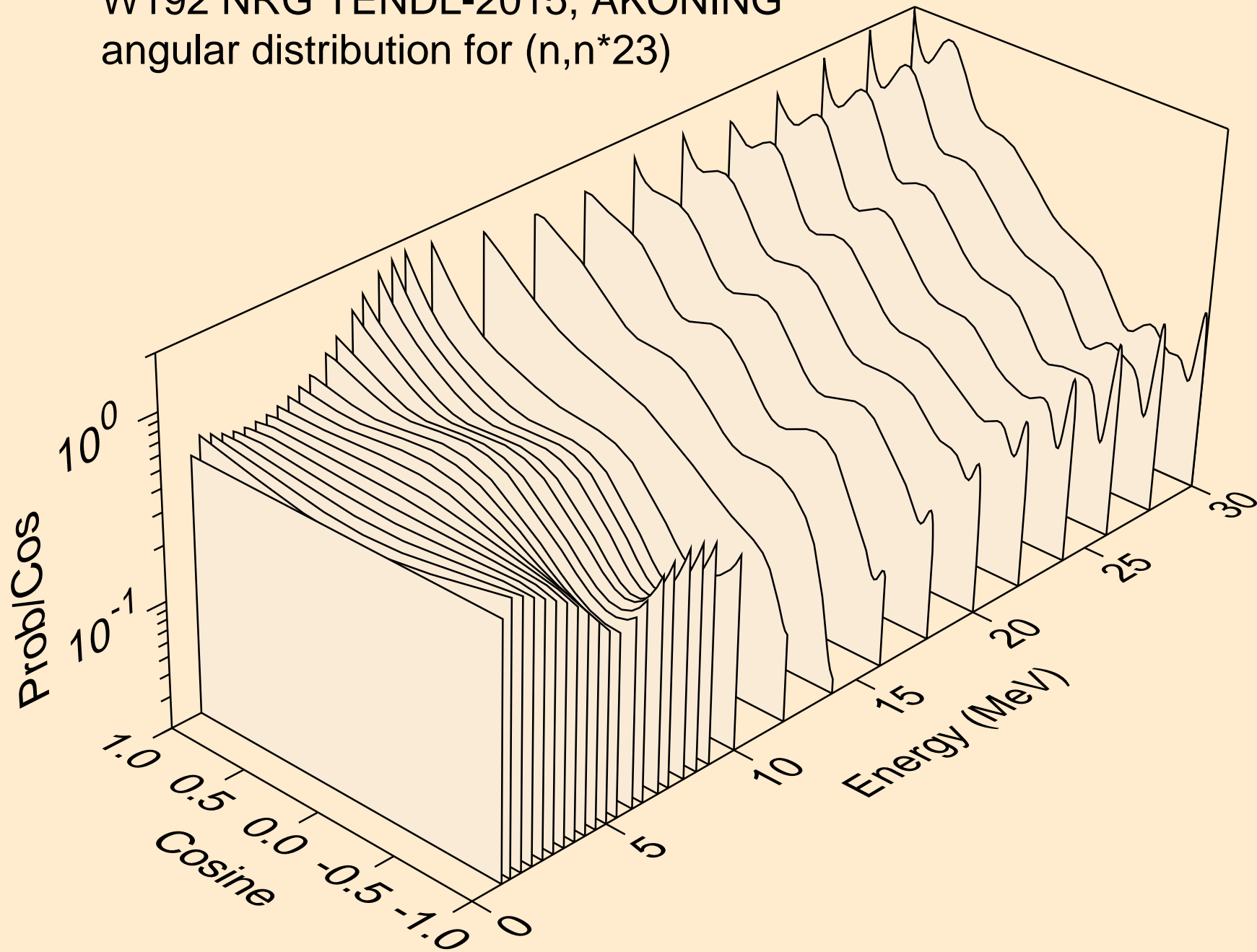

W192 NRG TENDL-2015, AKONING
angular distribution for (n,n*24)

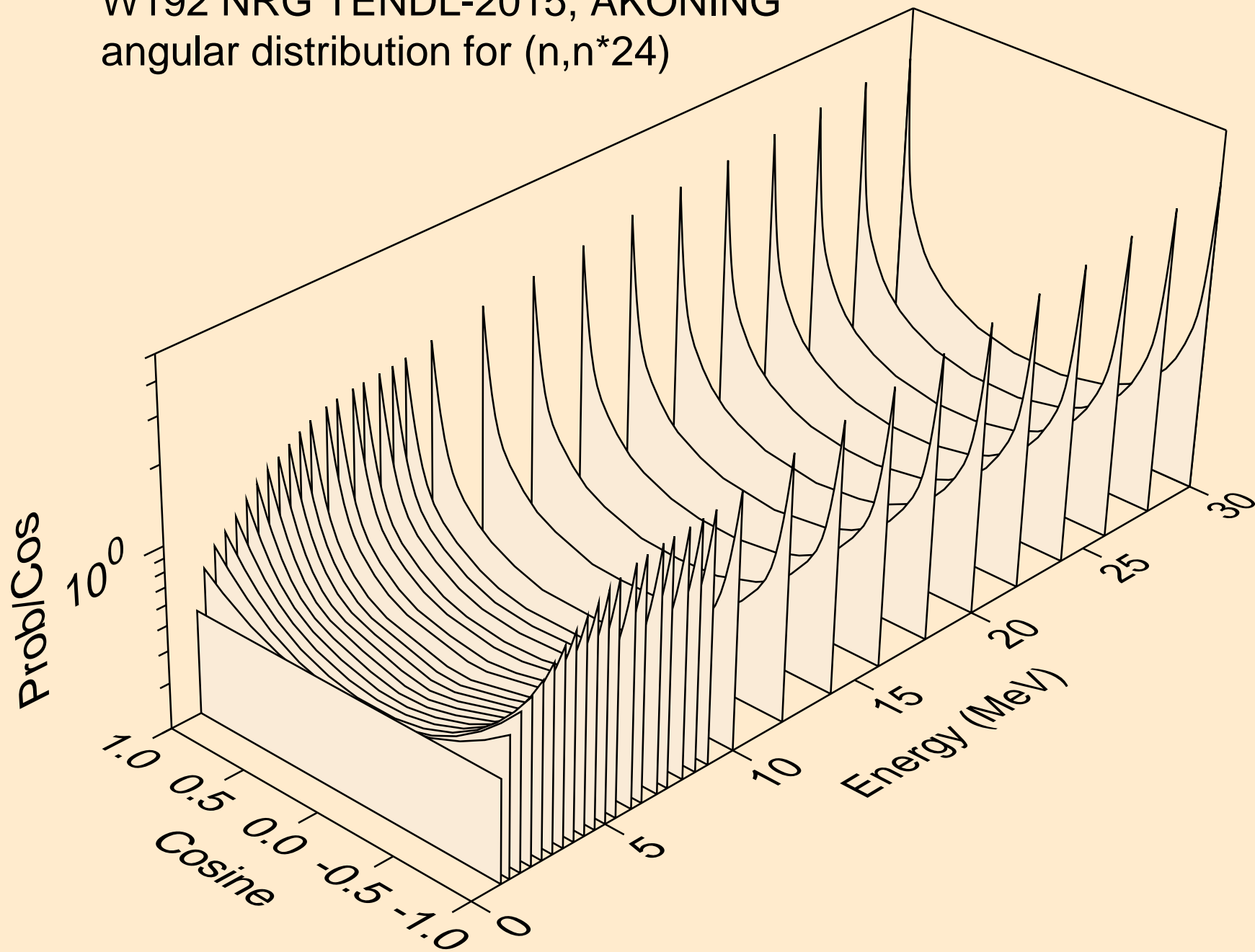

W192 NRG TENDL-2015, AKONING
angular distribution for (n,n*25)

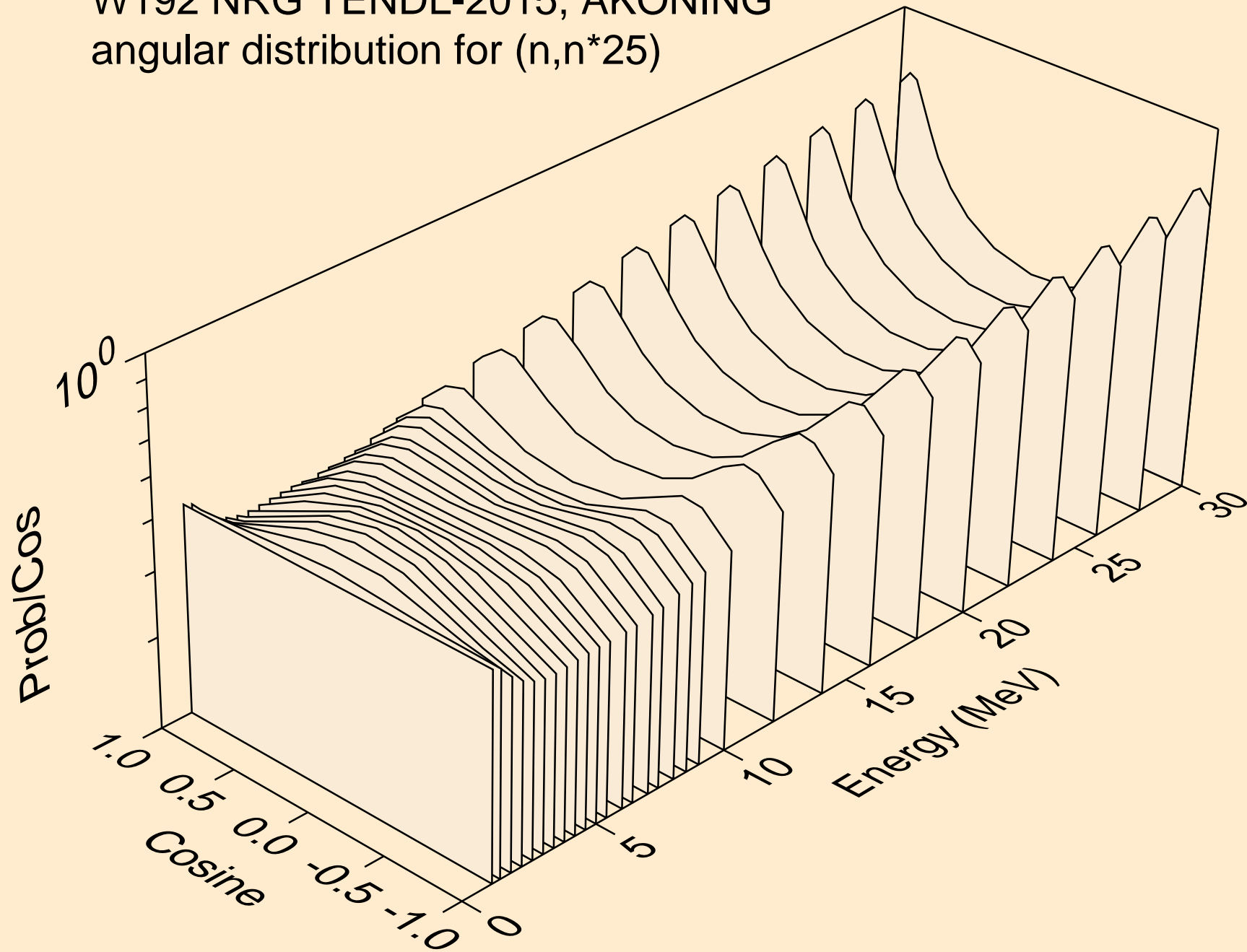

W192 NRG TENDL-2015, AKONING
angular distribution for (n,n*26)

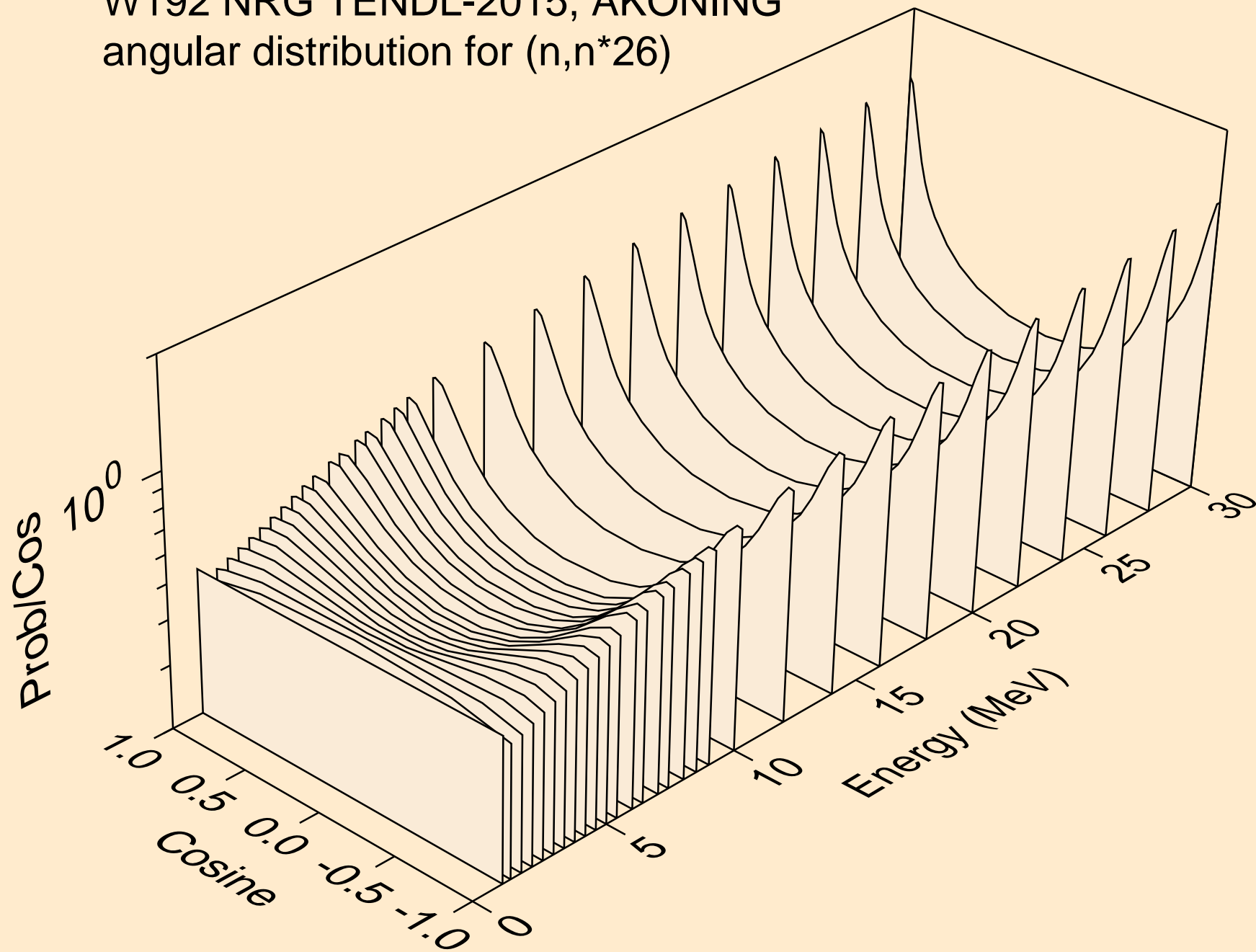

W192 NRG TENDL-2015, AKONING
angular distribution for (n,n*27)

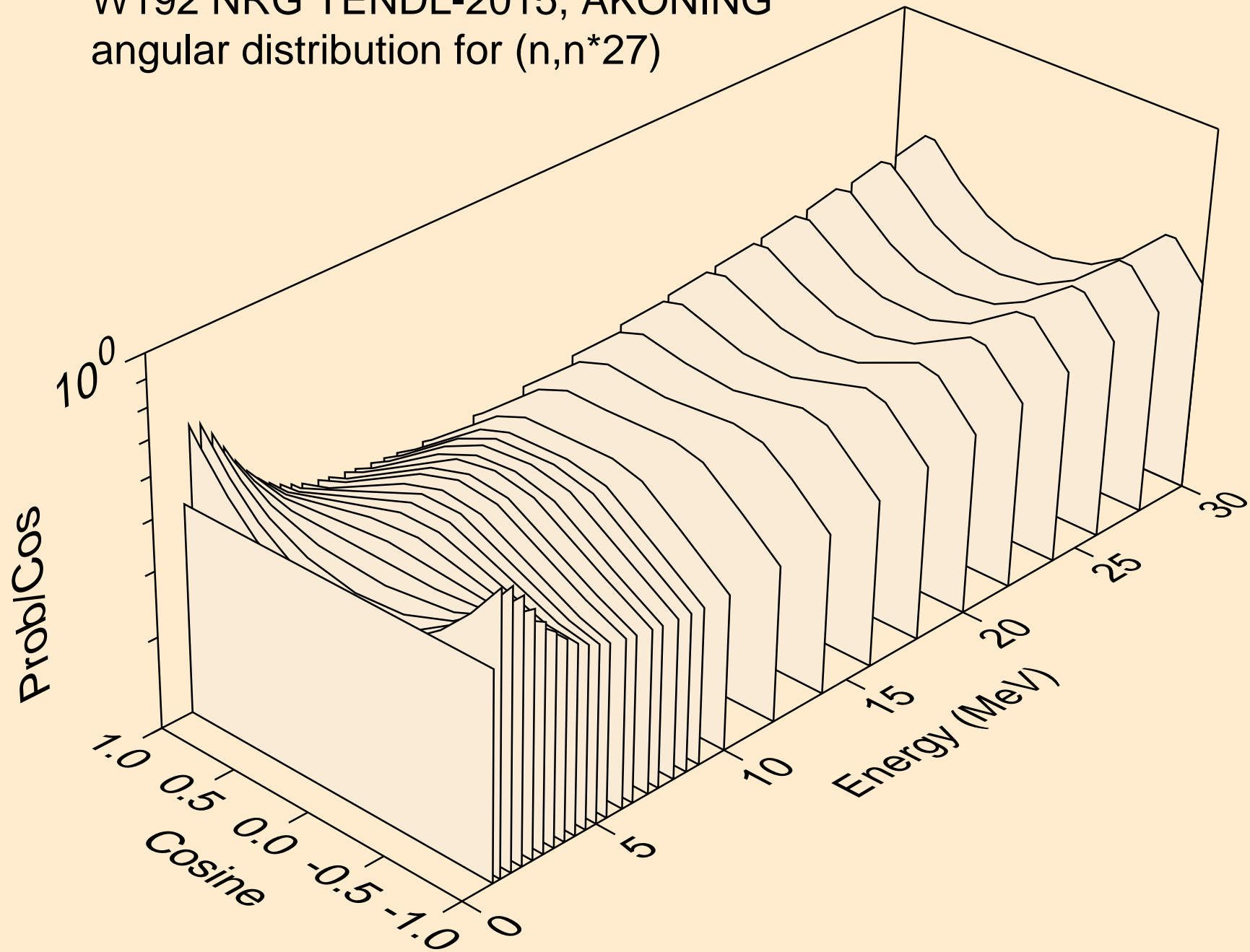

W192 NRG TENDL-2015, AKONING
angular distribution for (n,n*28)

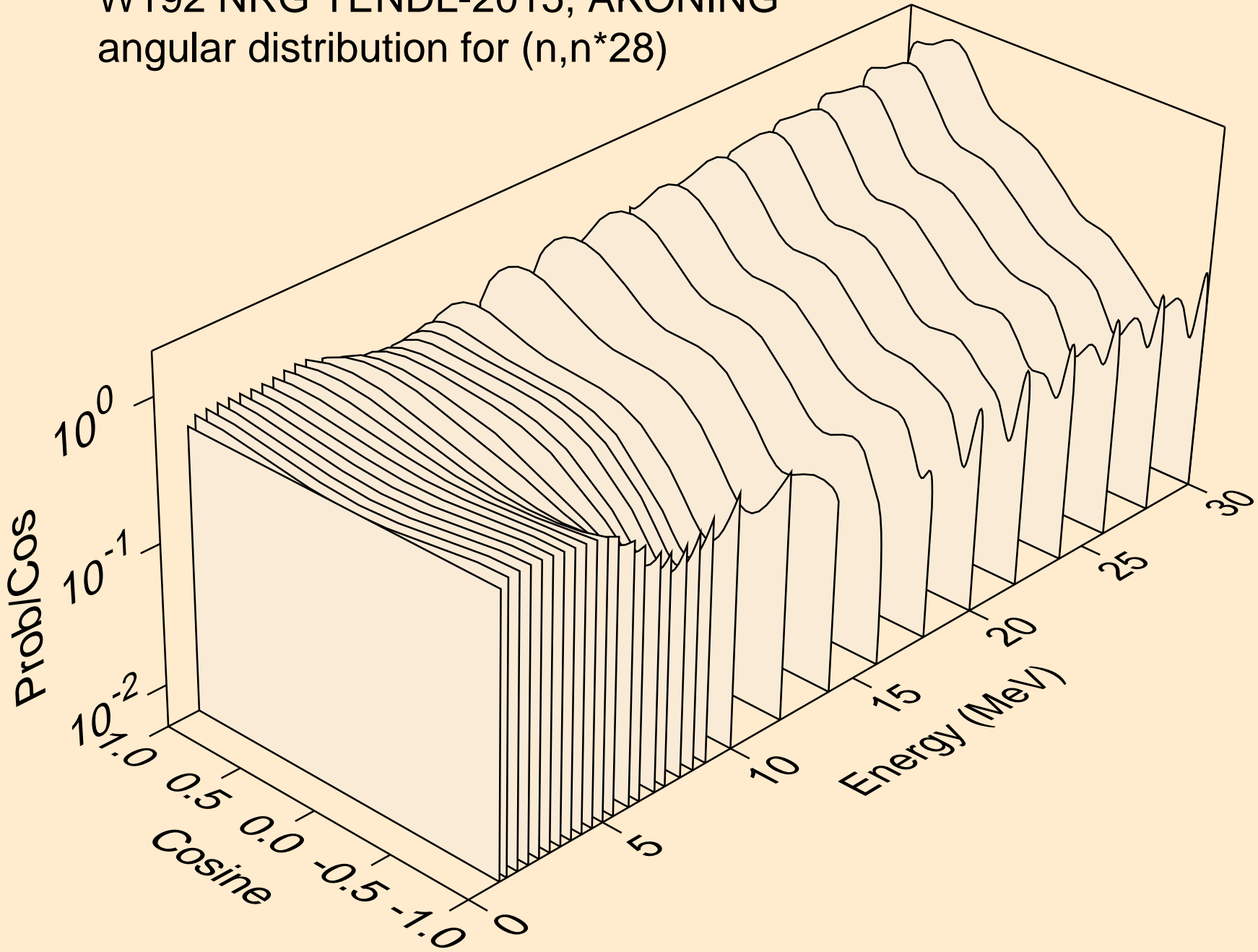

W192 NRG TENDL-2015, AKONING
angular distribution for (n,n*29)

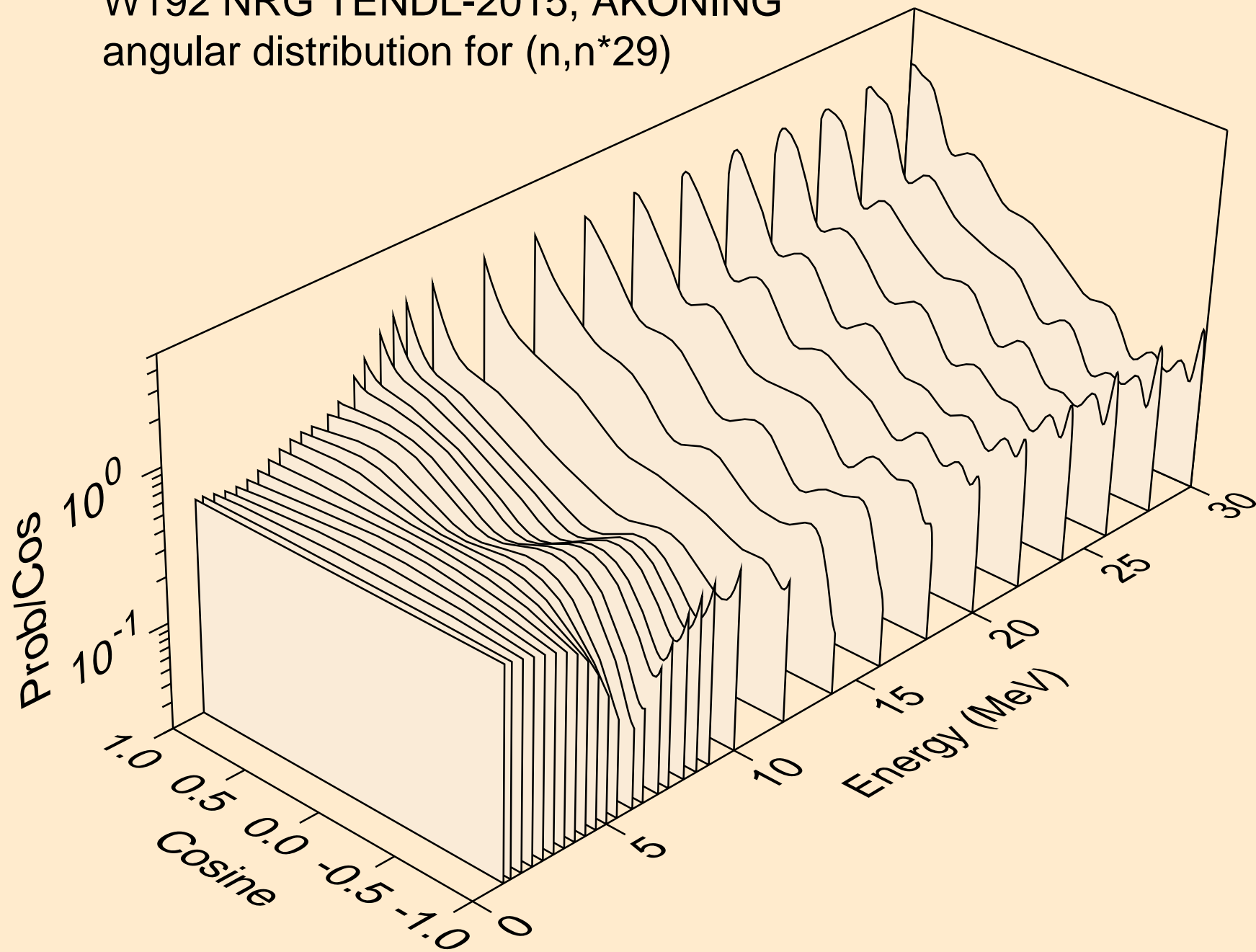

W192 NRG TENDL-2015, AKONING
angular distribution for (n,n*30)

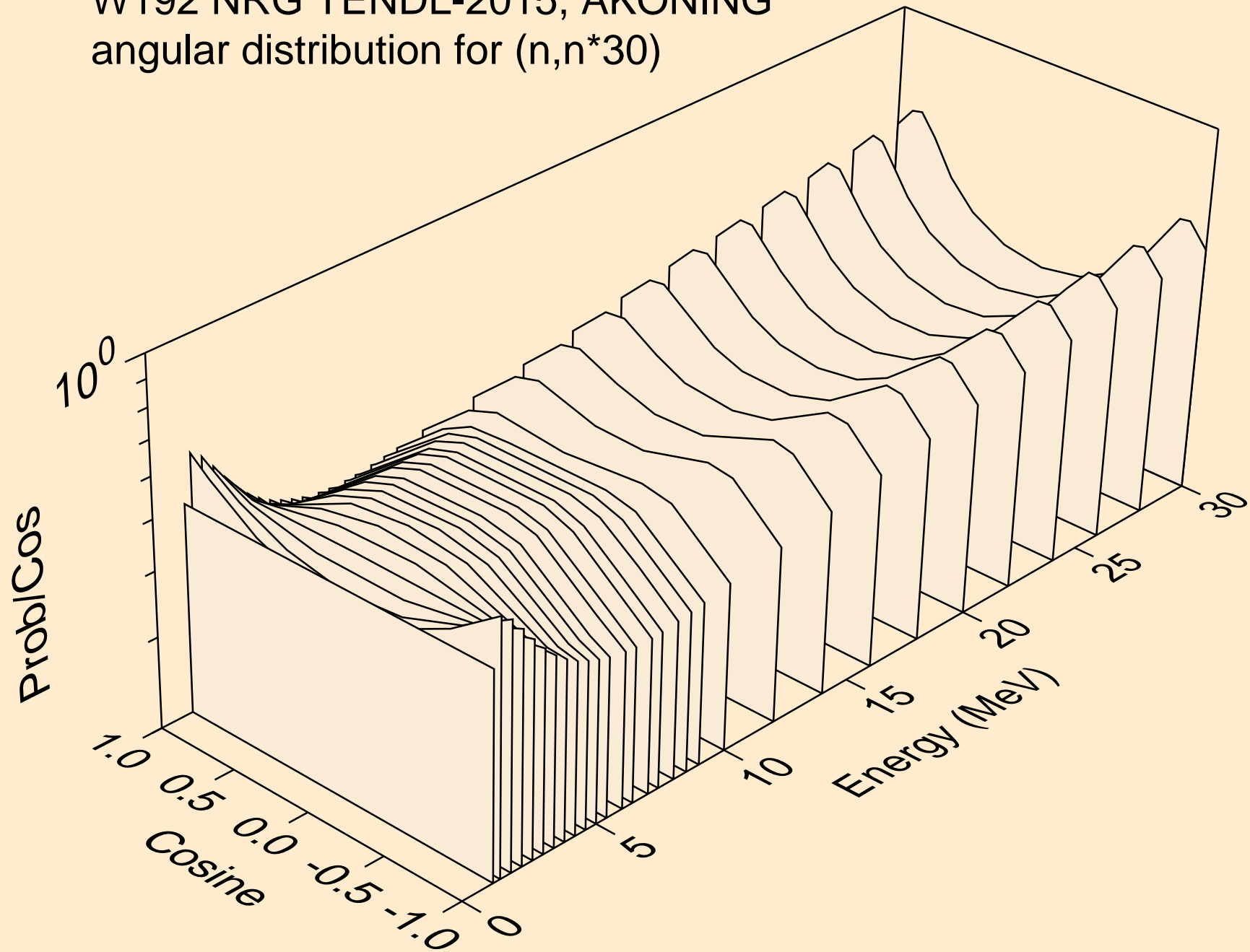

W192 NRG TENDL-2015, AKONING
Neutron emission for (n,x)

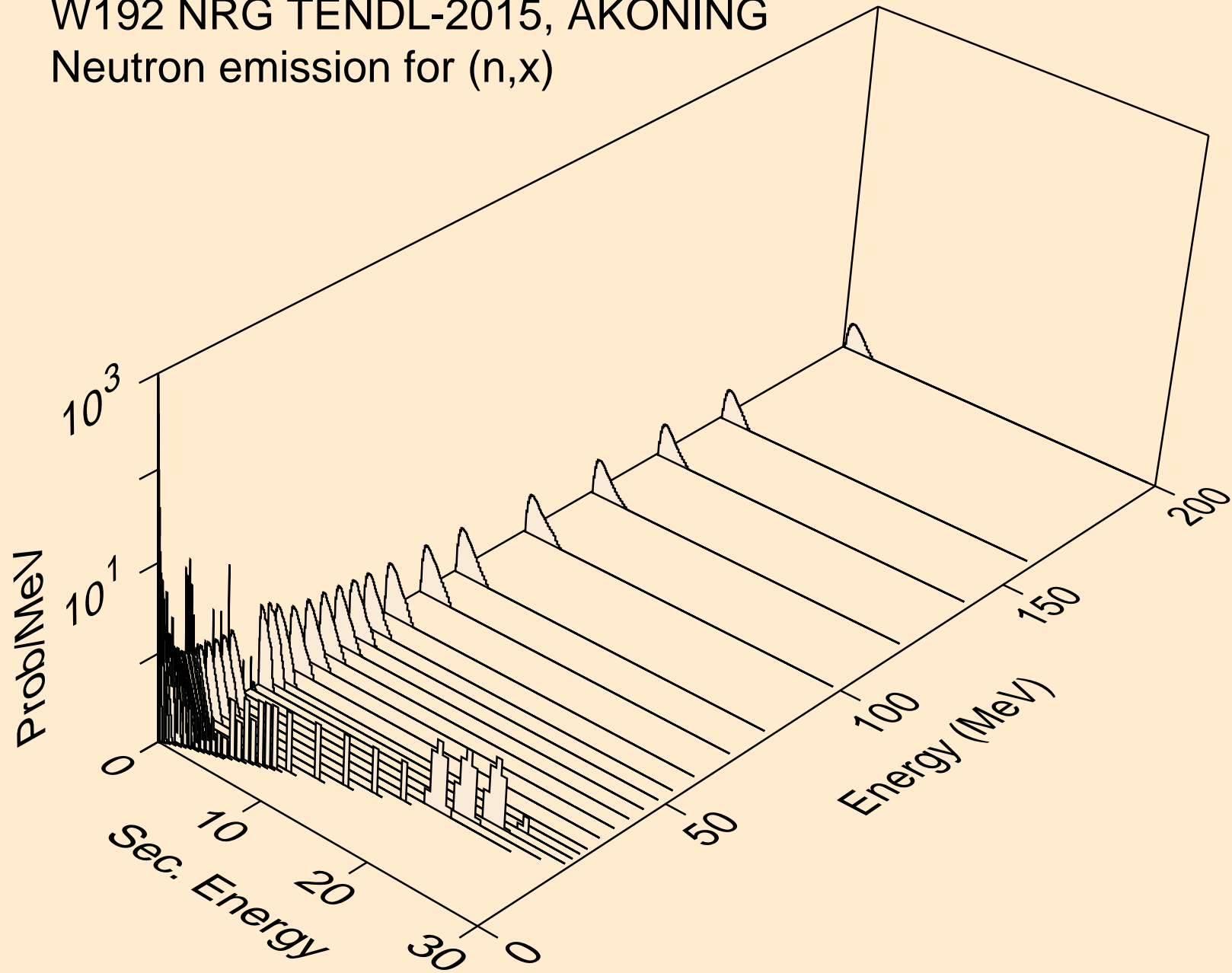

W192 NRG TENDL-2015, AKONING
Neutron emission for (n,2nd)

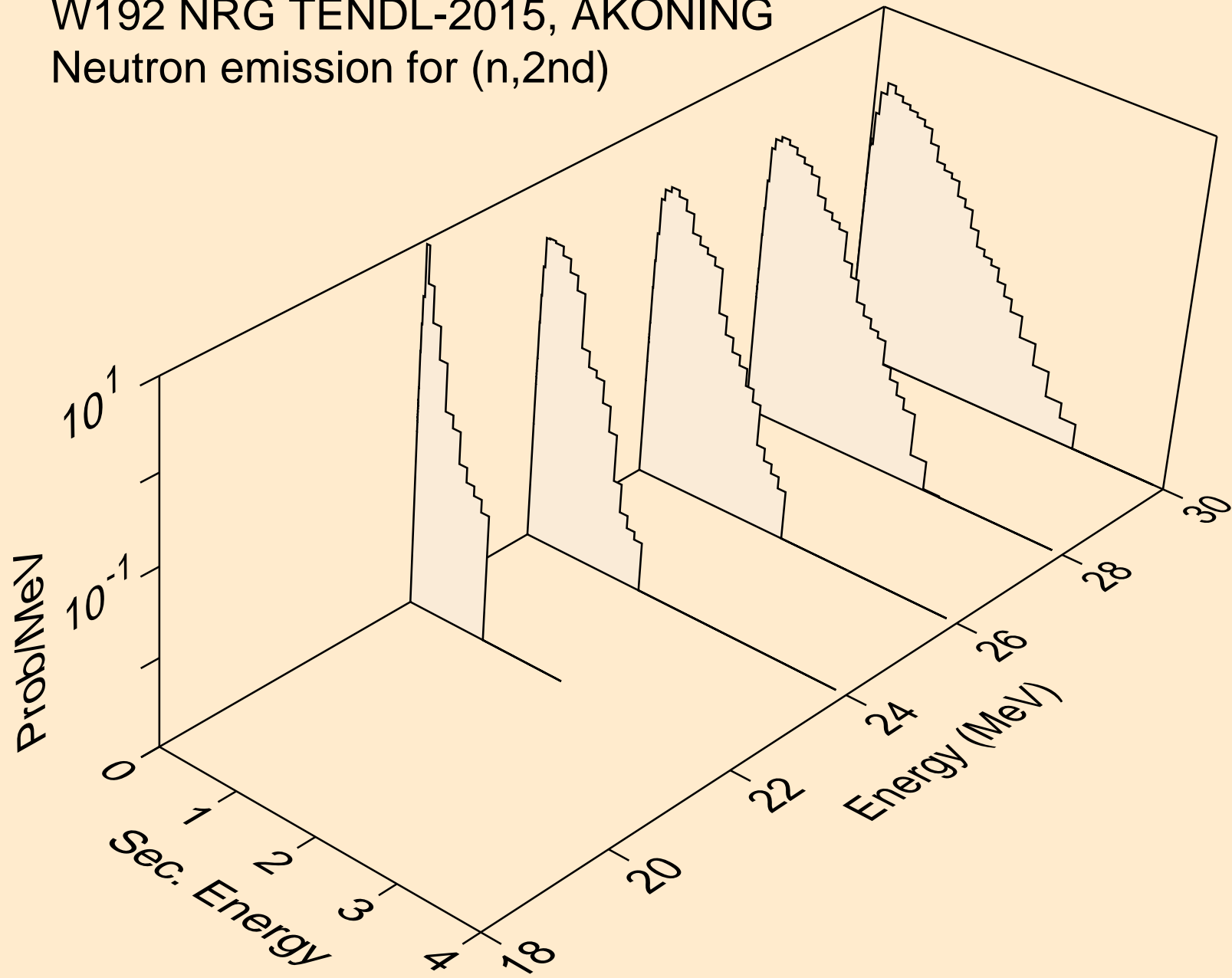

W192 NRG TENDL-2015, AKONING
Neutron emission for (n,2n)

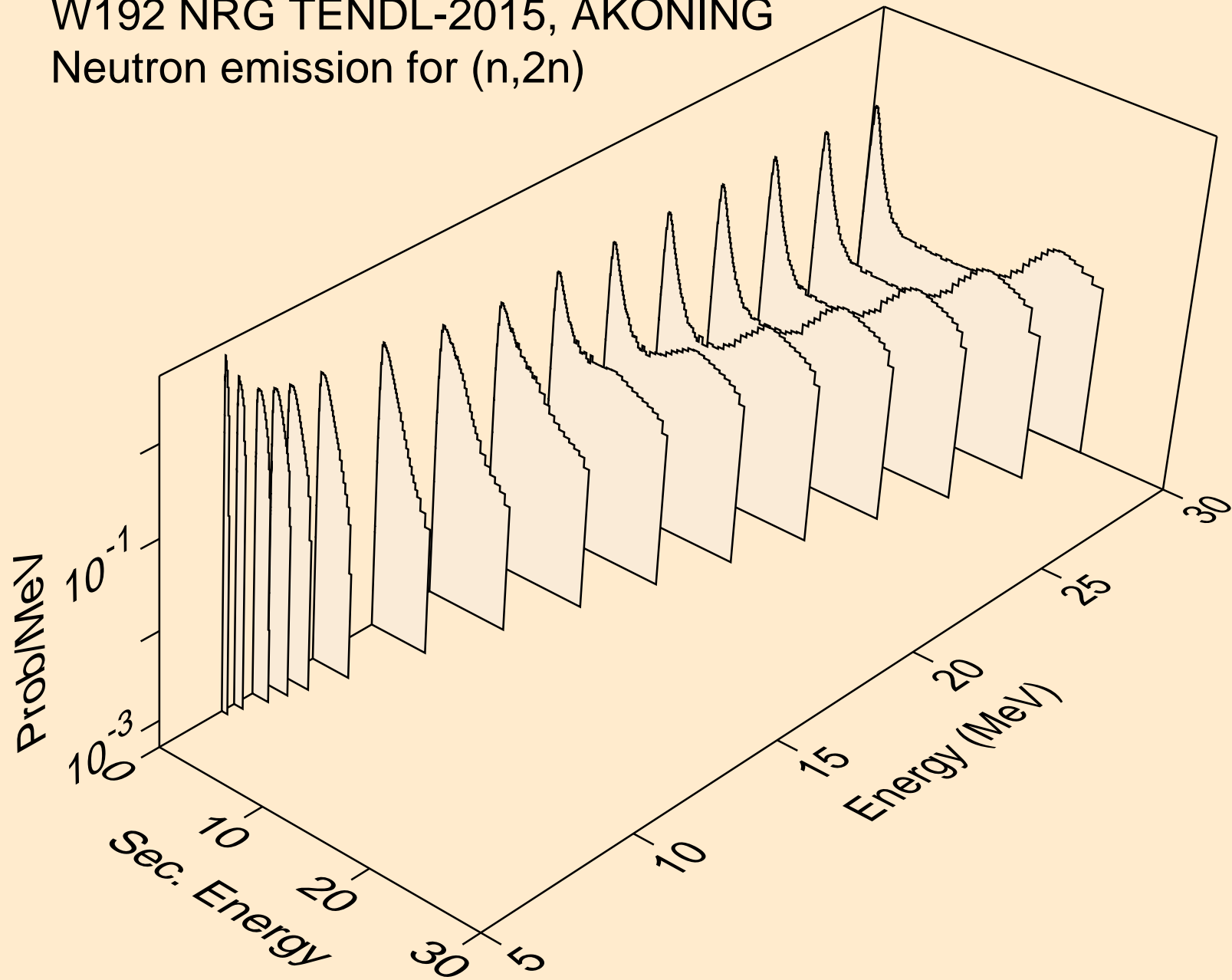

W192 NRG TENDL-2015, AKONING
Neutron emission for (n,3n)

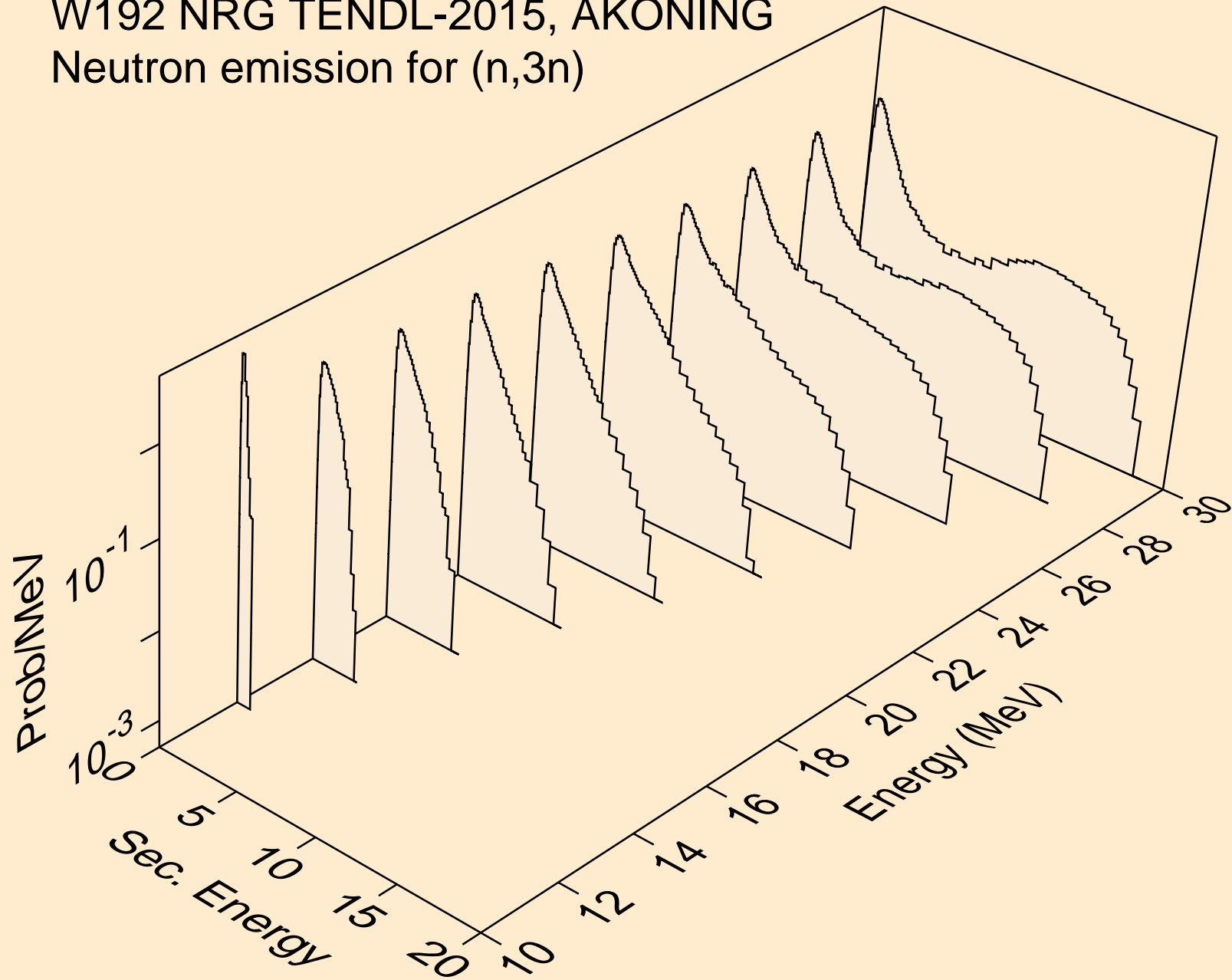

W192 NRG TENDL-2015, AKONING
Neutron emission for (n,n*)a

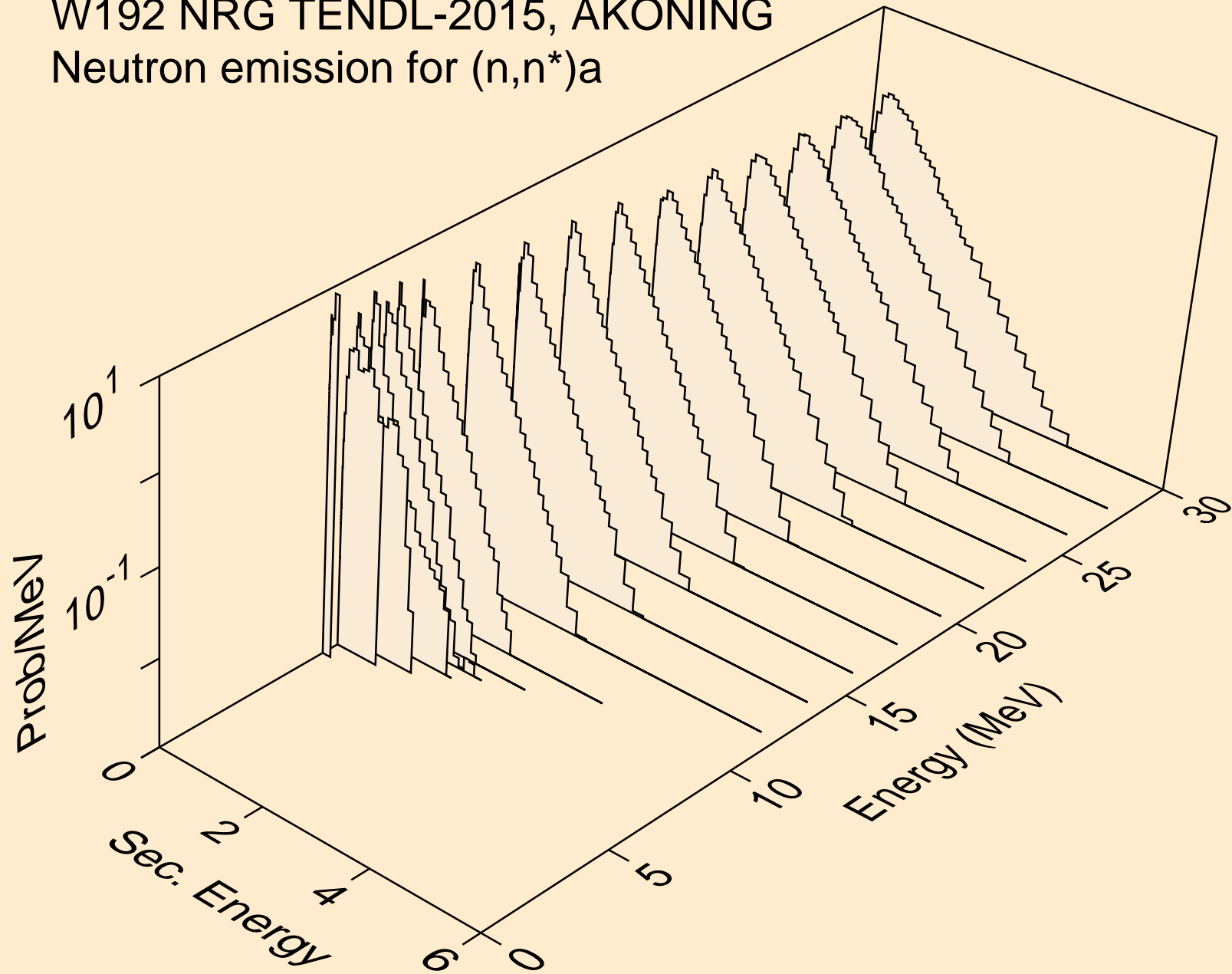

W192 NRG TENDL-2015, AKONING
Neutron emission for (n,2n)a

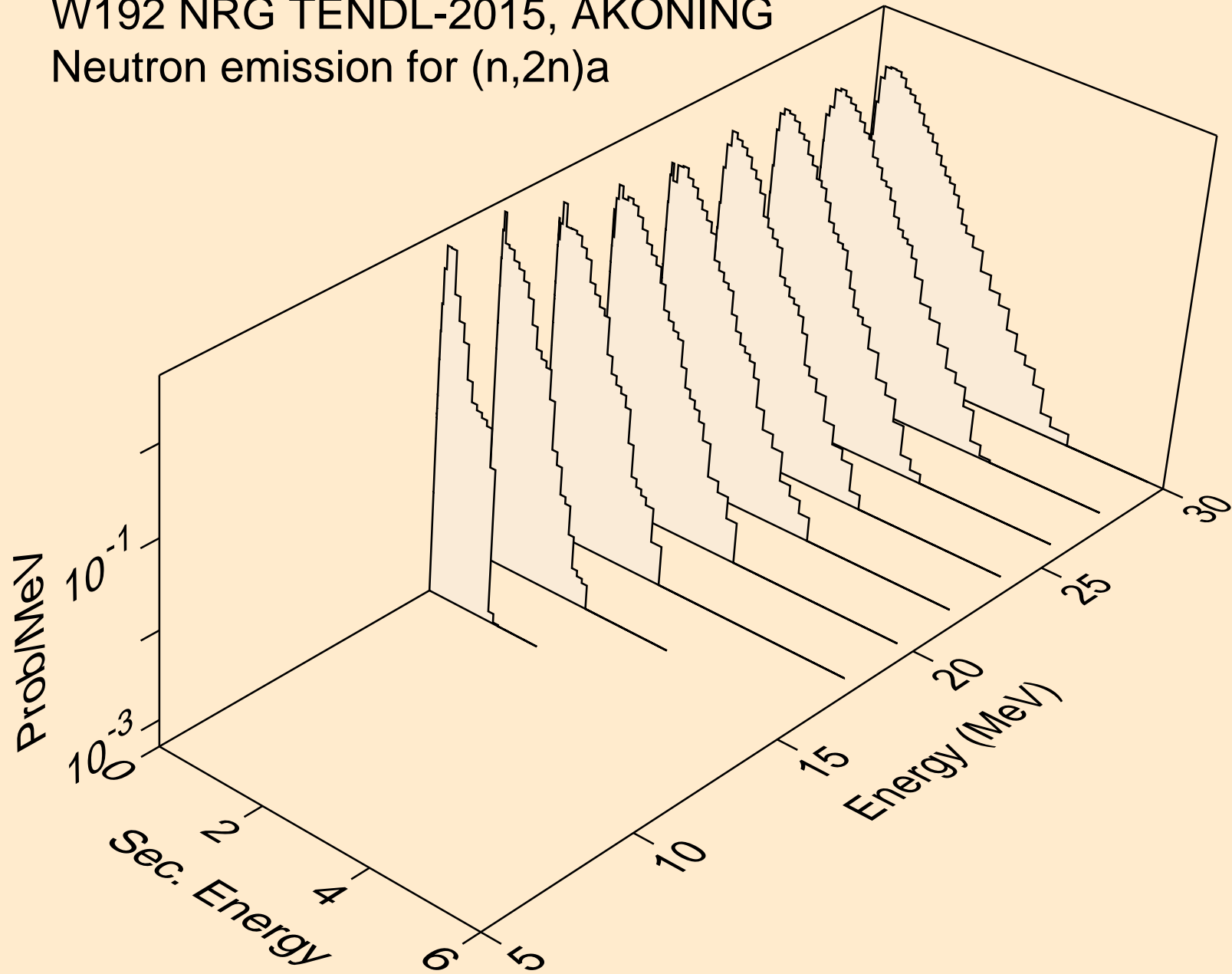

W192 NRG TENDL-2015, AKONING
Neutron emission for (n,3n)a

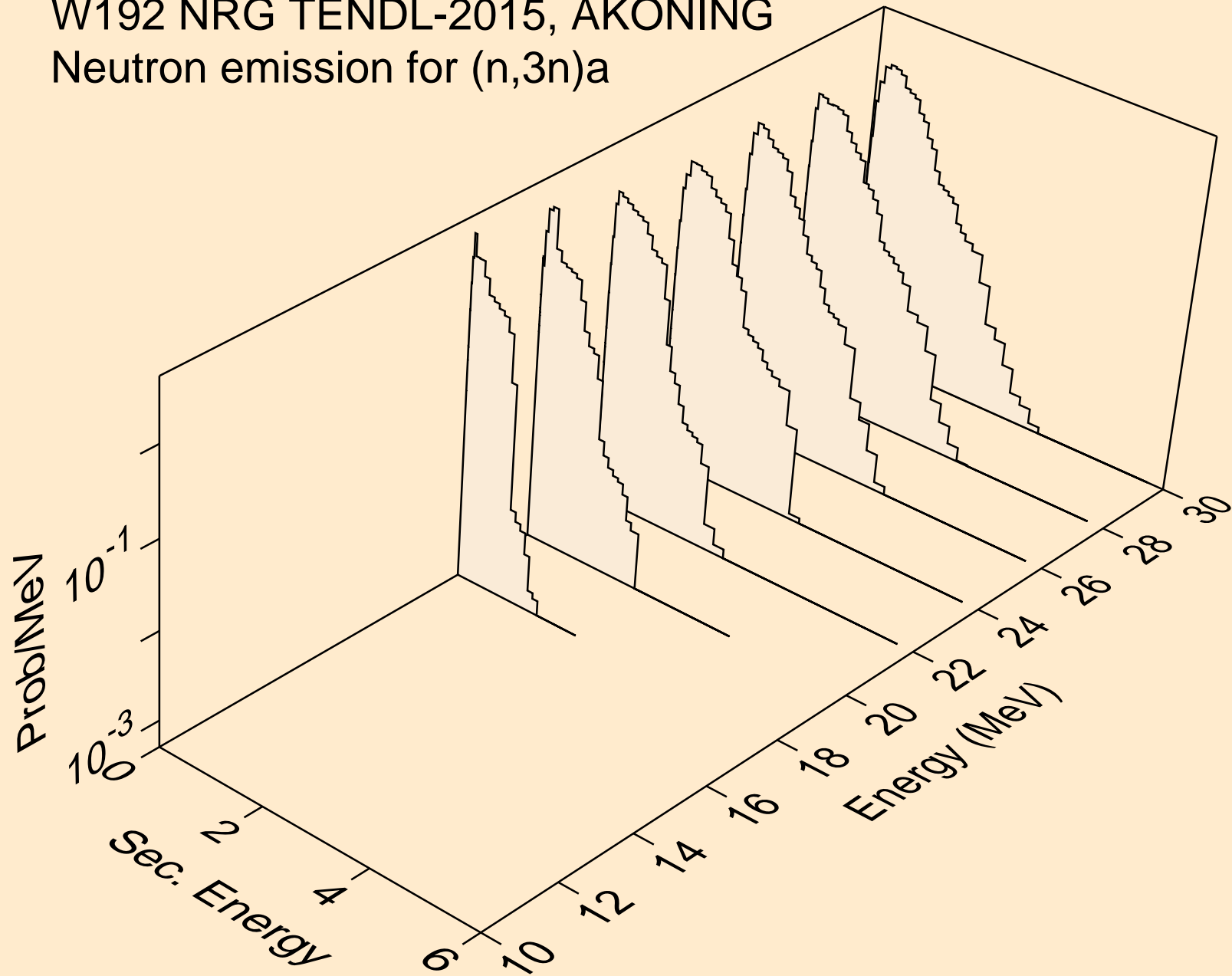

W192 NRG TENDL-2015, AKONING
Neutron emission for (n,n*)p

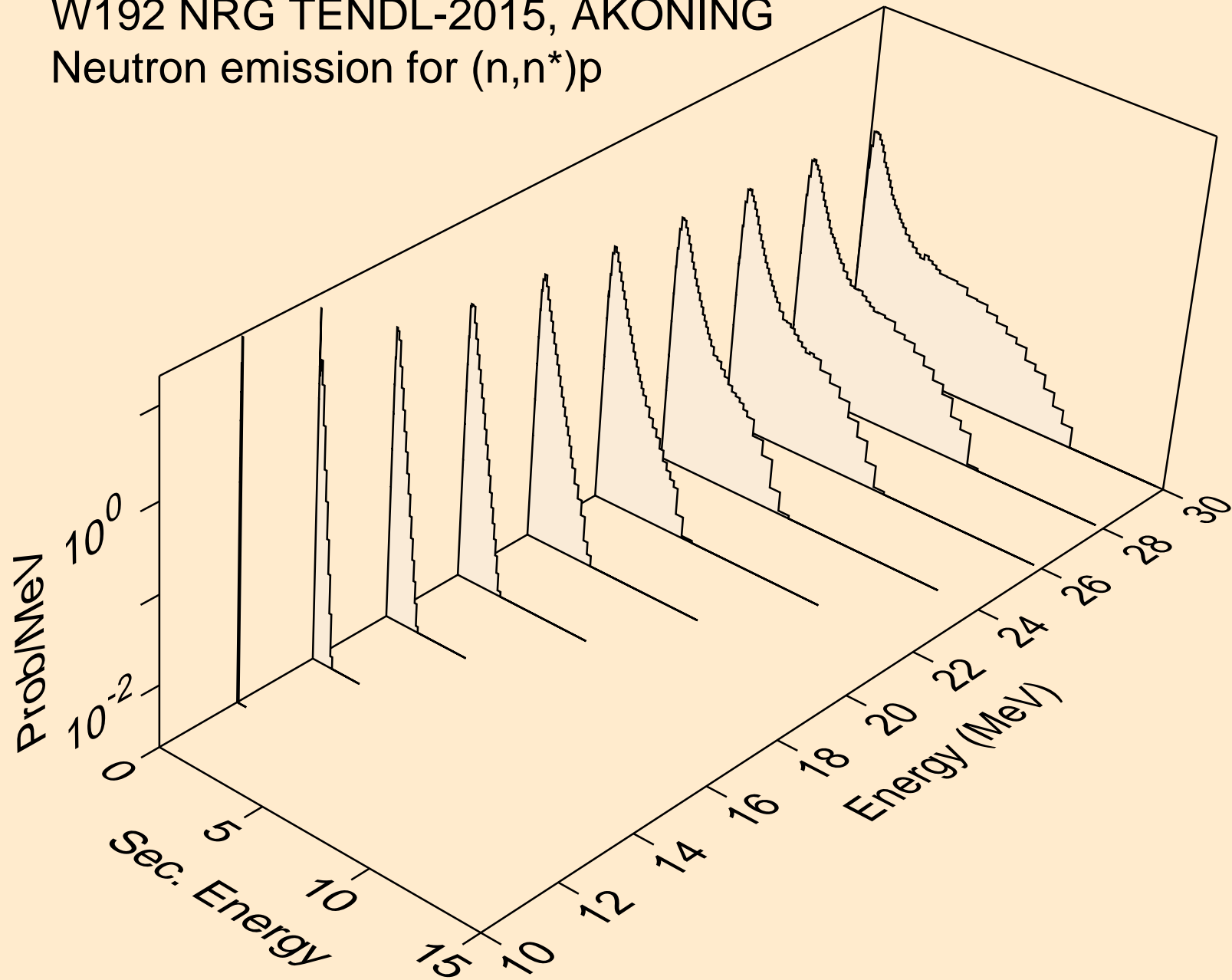

W192 NRG TENDL-2015, AKONING
Neutron emission for (n,n*)d

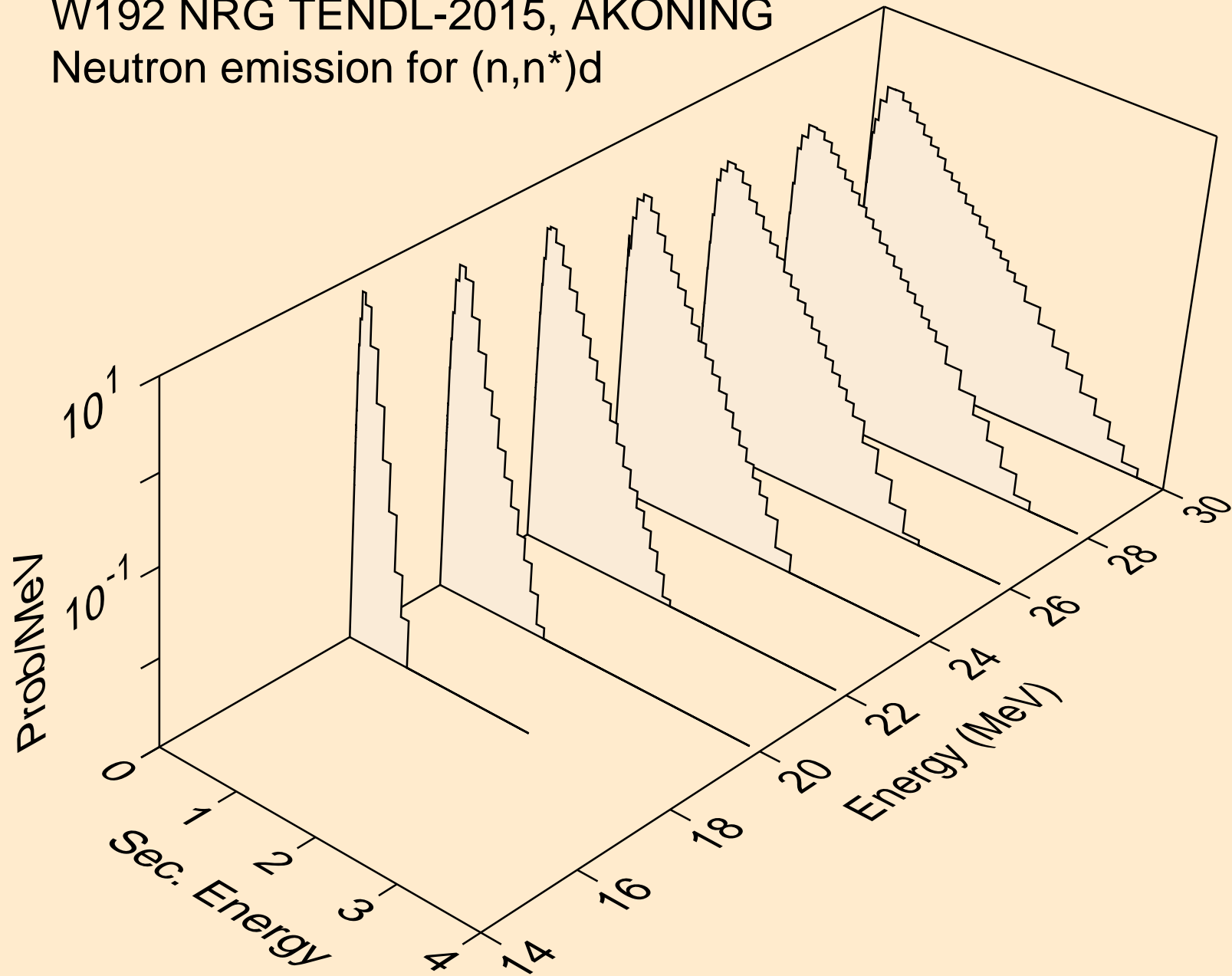

W192 NRG TENDL-2015, AKONING
Neutron emission for (n,n*)t

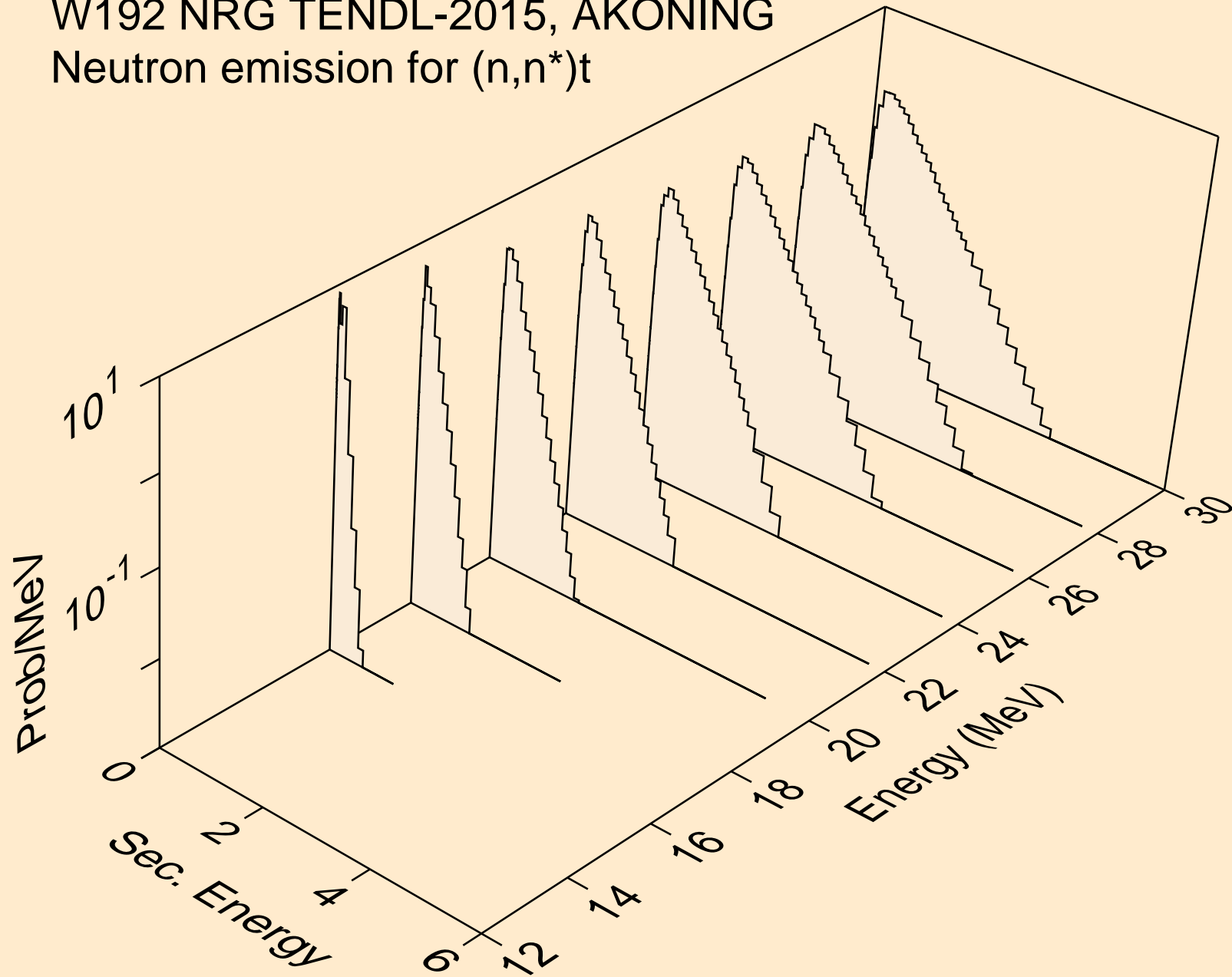

W192 NRG TENDL-2015, AKONING
Neutron emission for (n,n*)he3

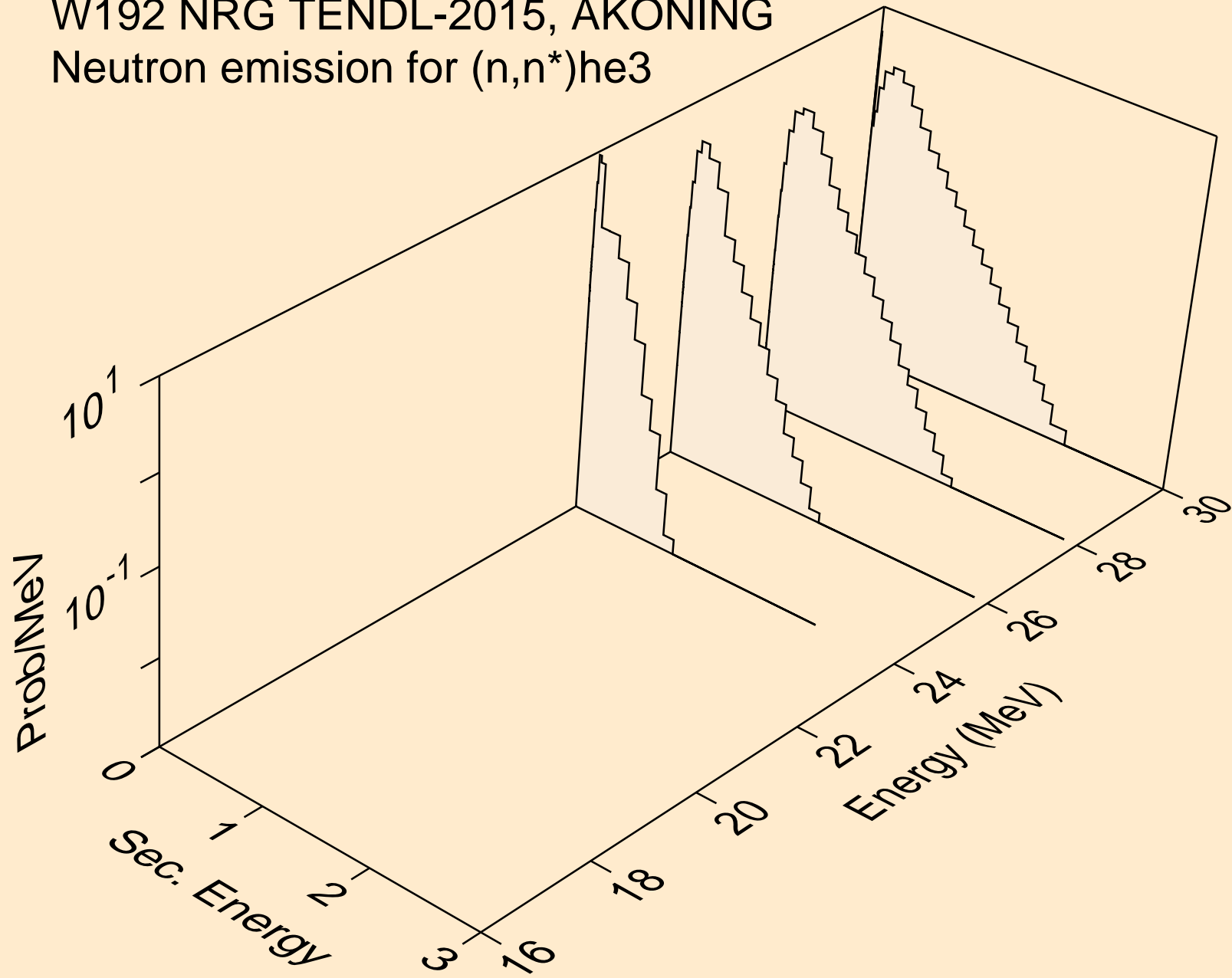

W192 NRG TENDL-2015, AKONING
Neutron emission for (n,4n)

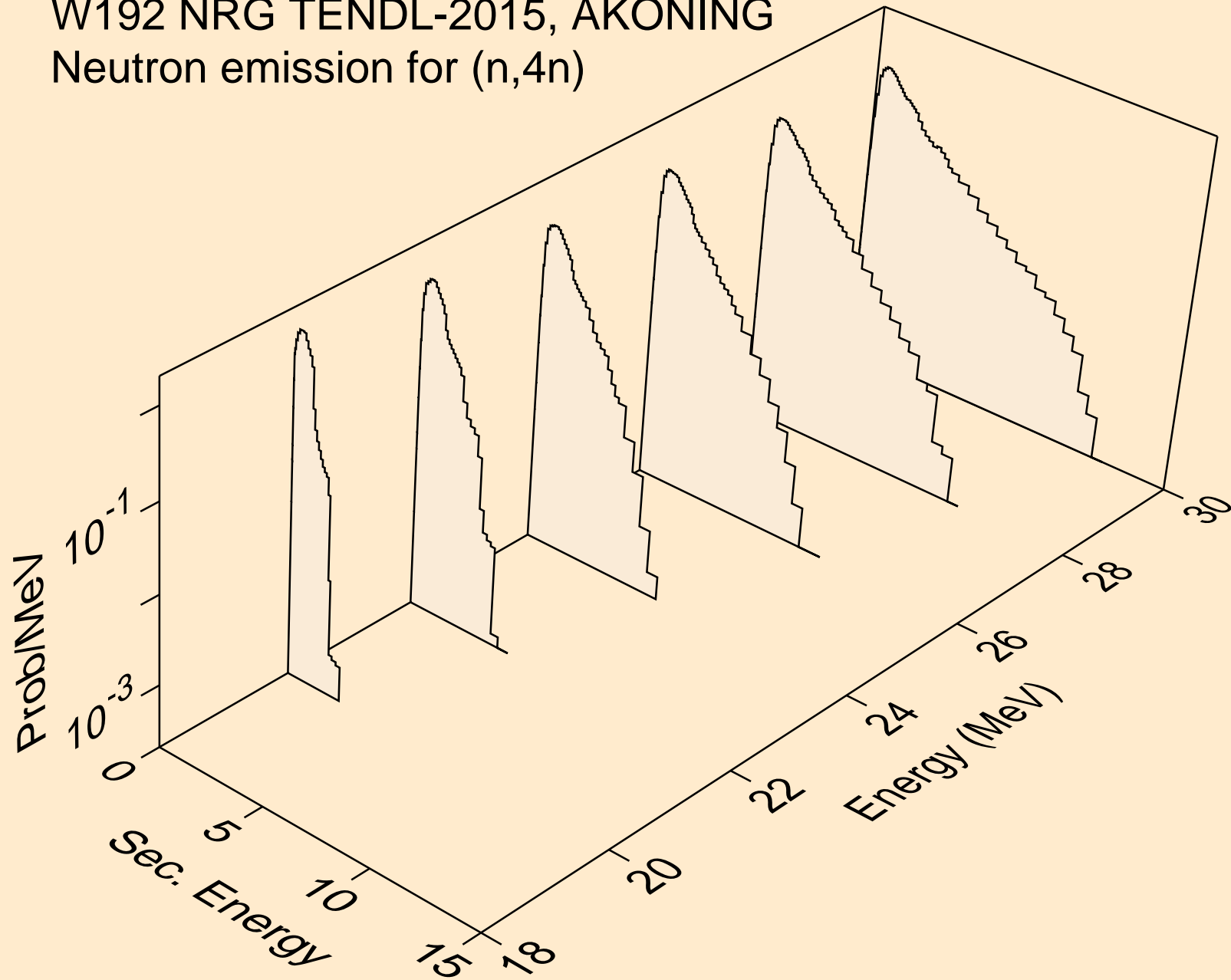

W192 NRG TENDL-2015, AKONING
Neutron emission for (n,2np)

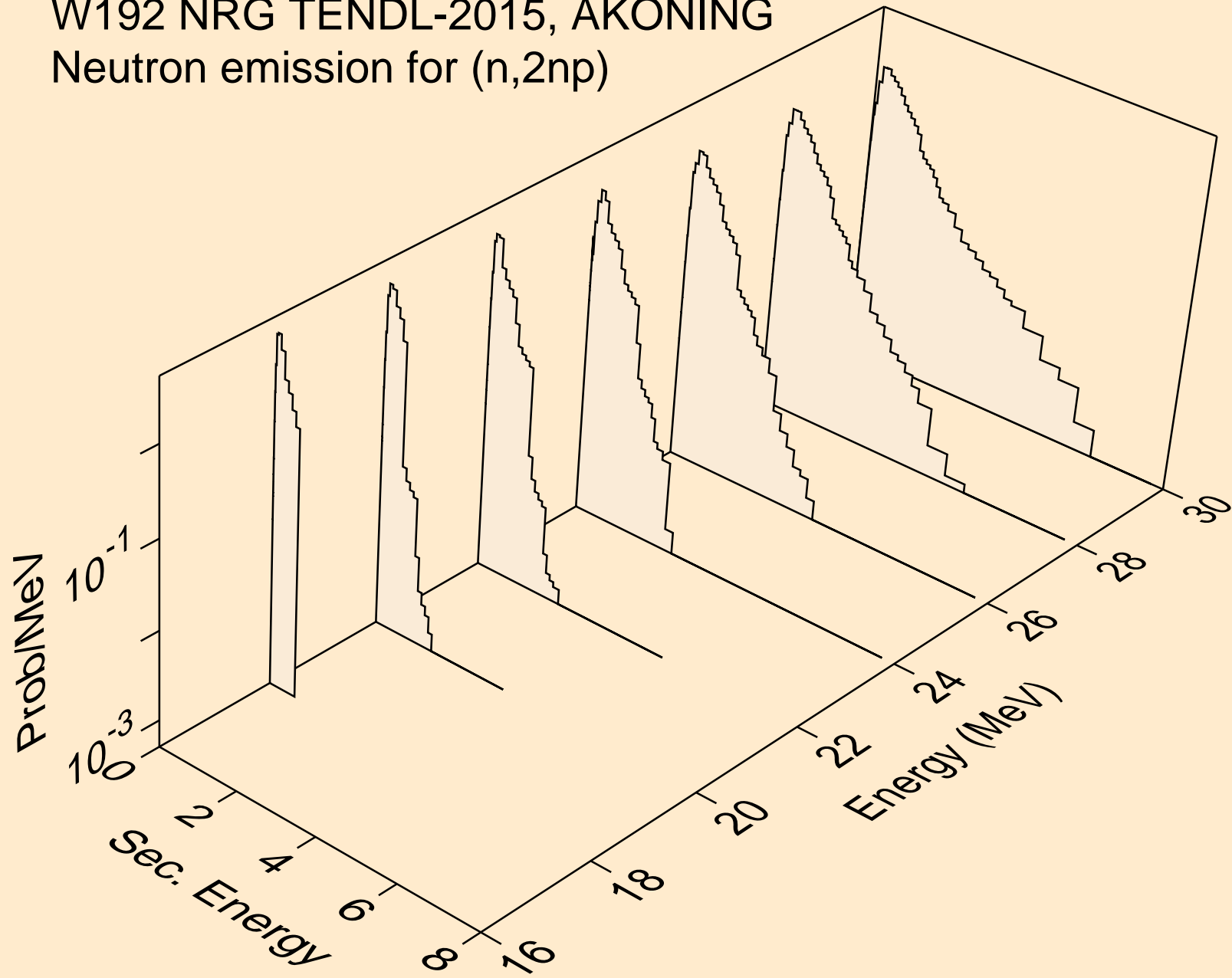

W192 NRG TENDL-2015, AKONING
Neutron emission for (n,3np)

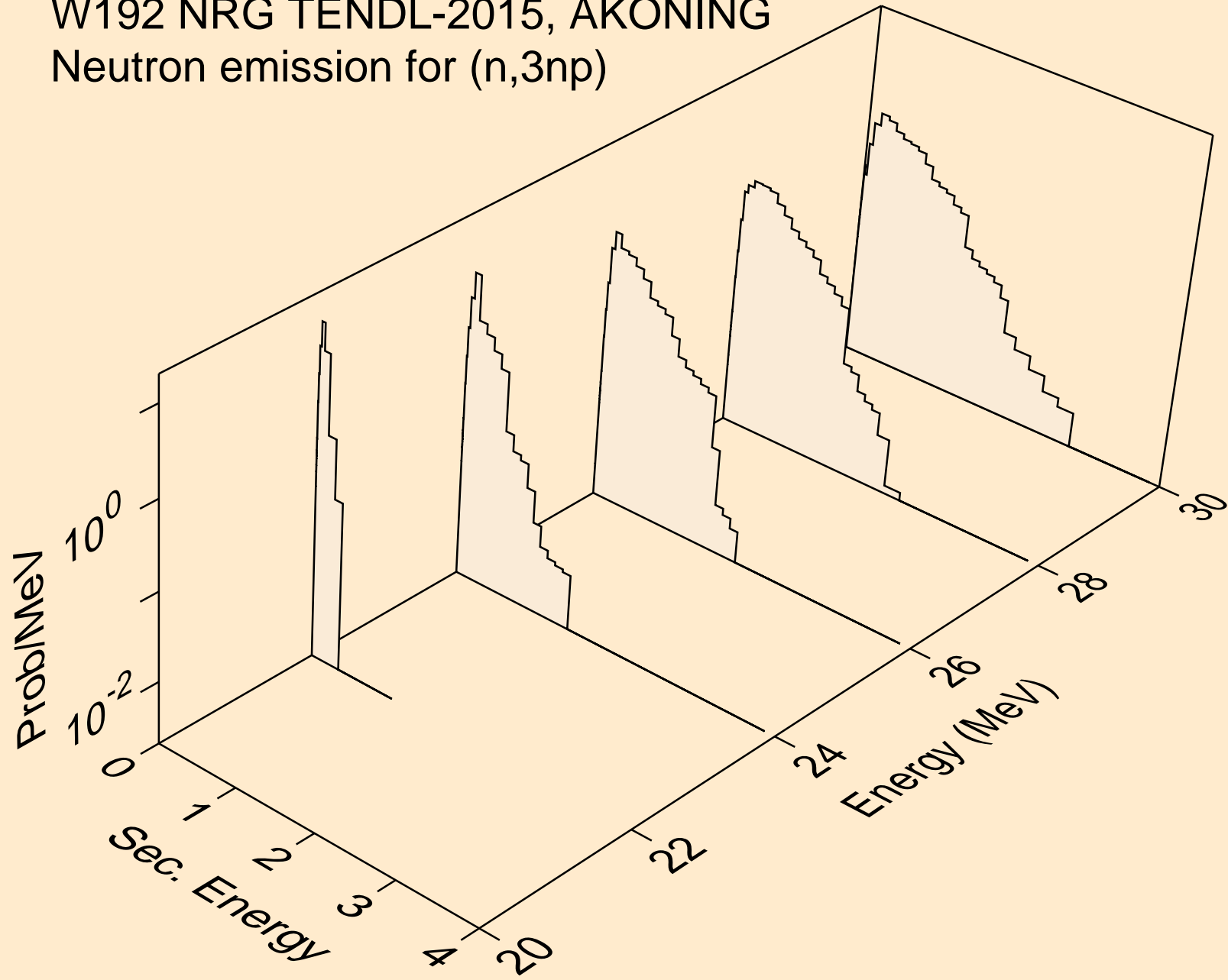

W192 NRG TENDL-2015, AKONING
Neutron emission for (n,n*c)

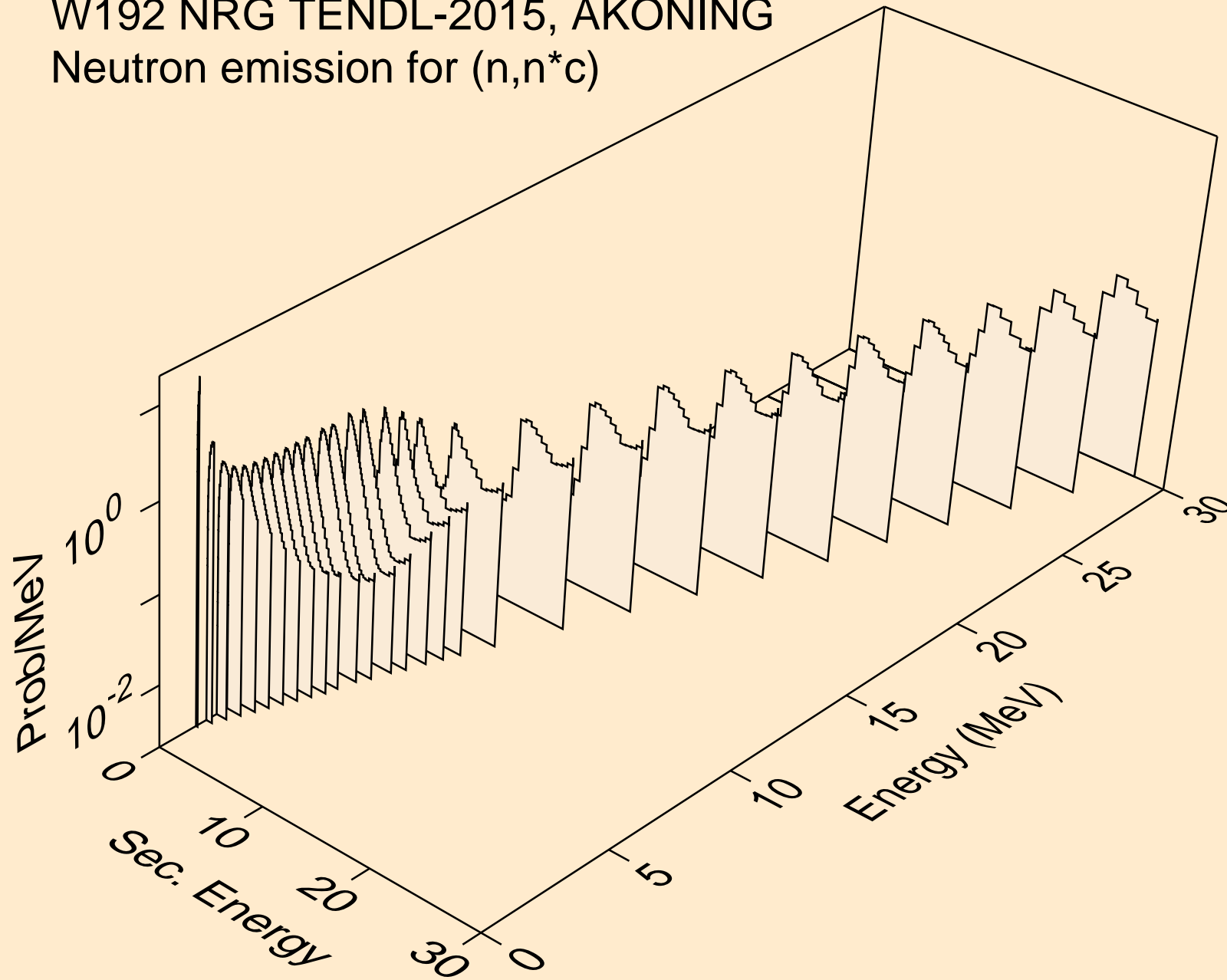

W192 NRG TENDL-2015, AKONING
Photon emission for (n,x)

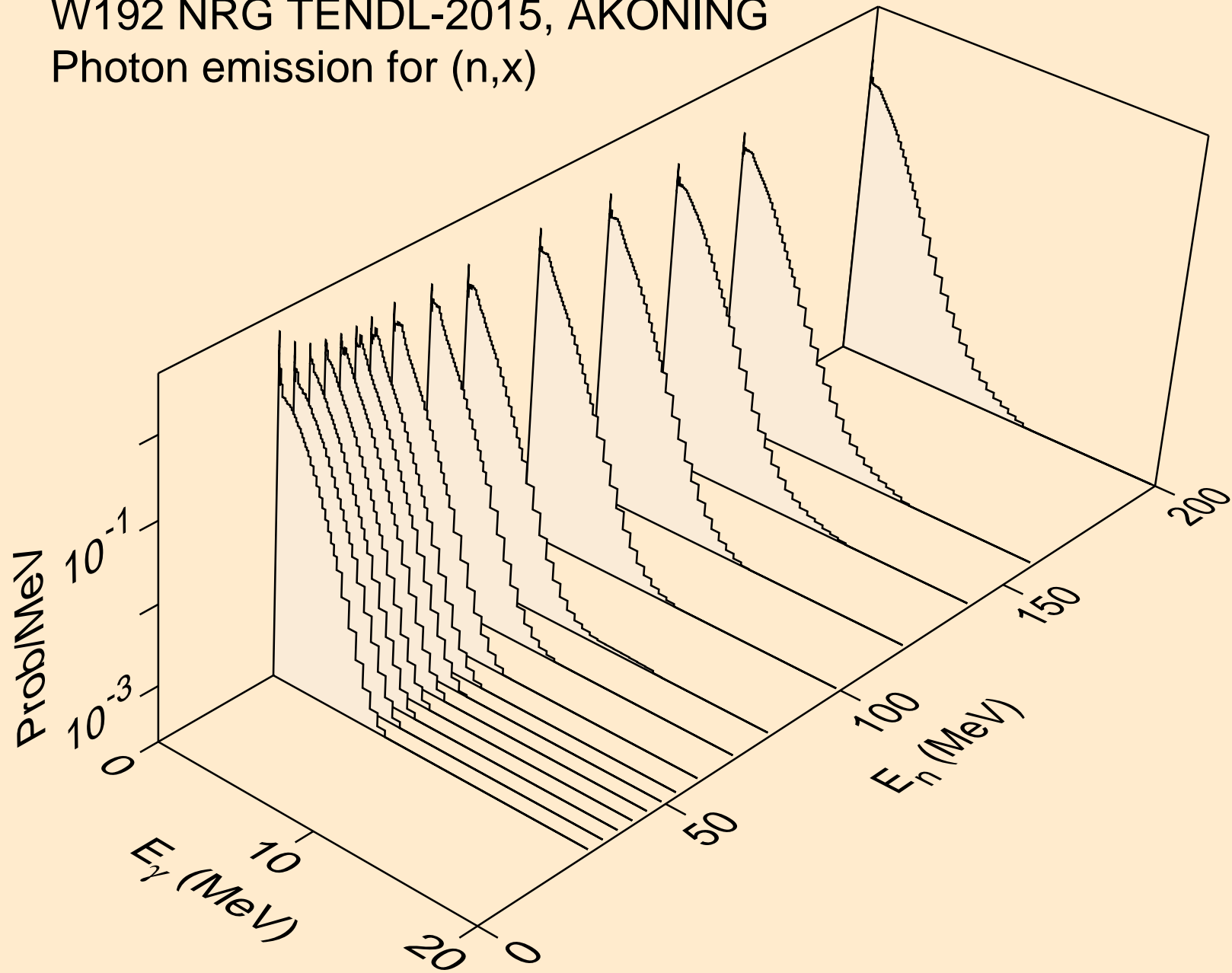

W192 NRG TENDL-2015, AKONING
Photon emission for (n,2nd)

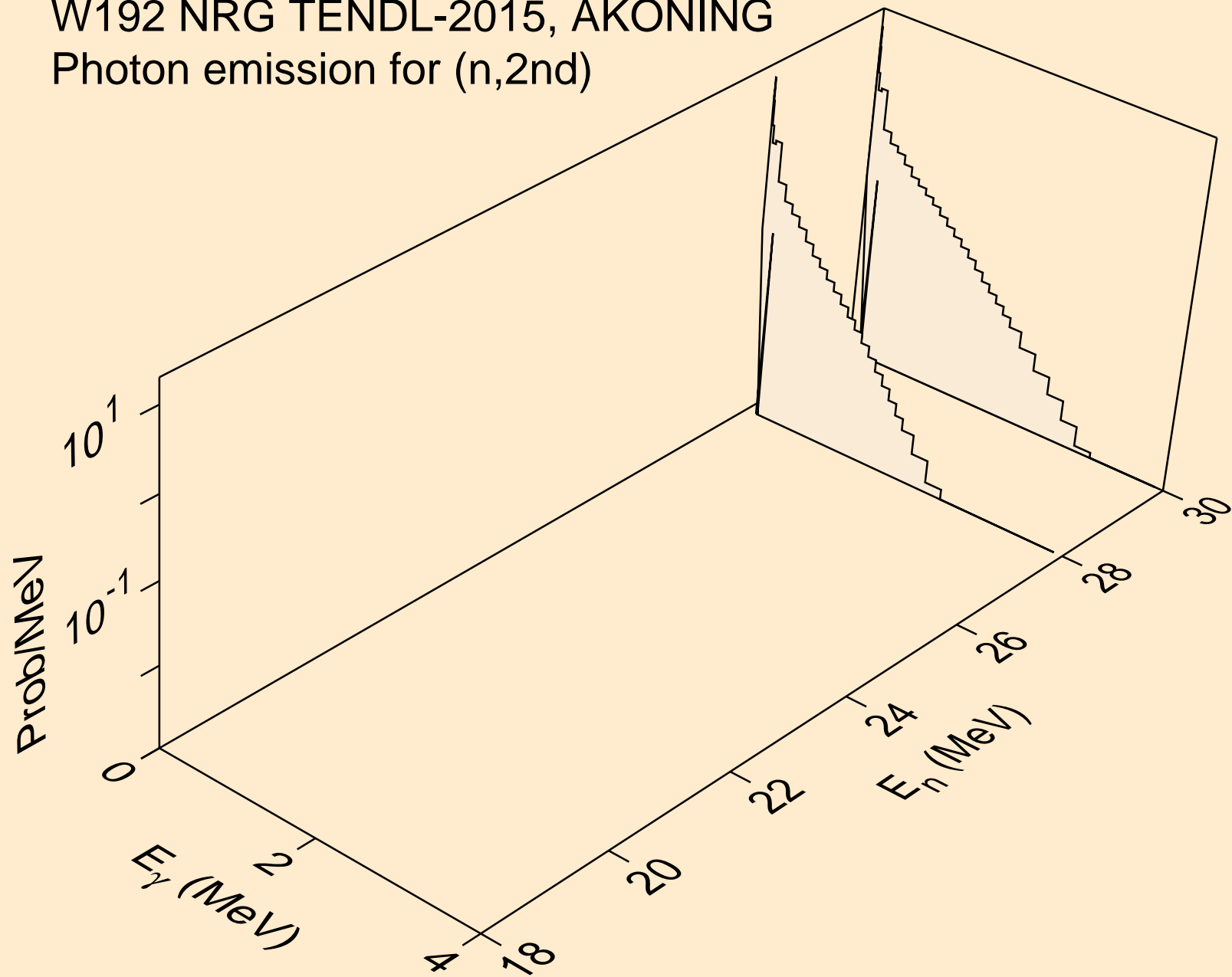

W192 NRG TENDL-2015, AKONING
Photon emission for (n,2n)

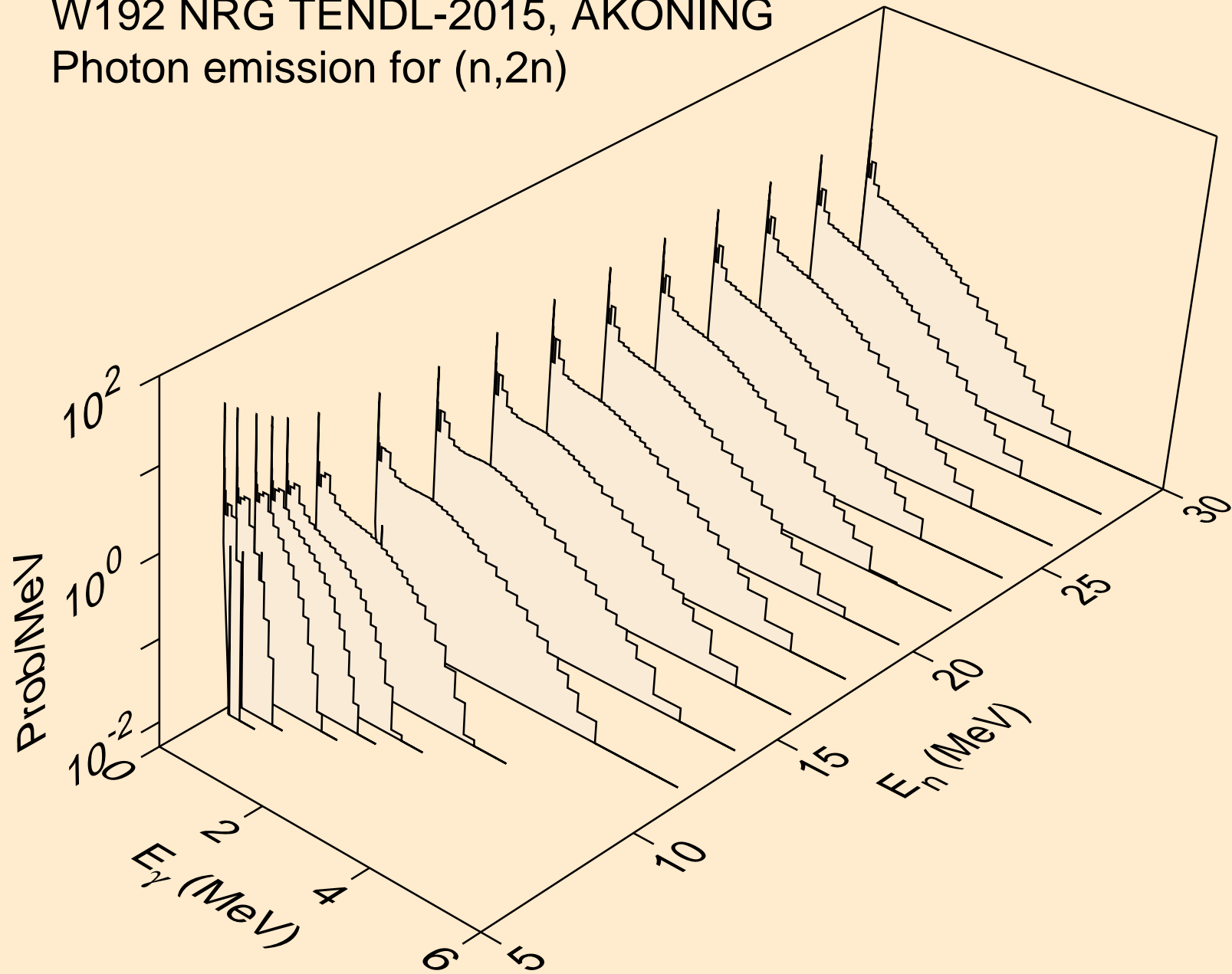

W192 NRG TENDL-2015, AKONING
Photon emission for (n,3n)

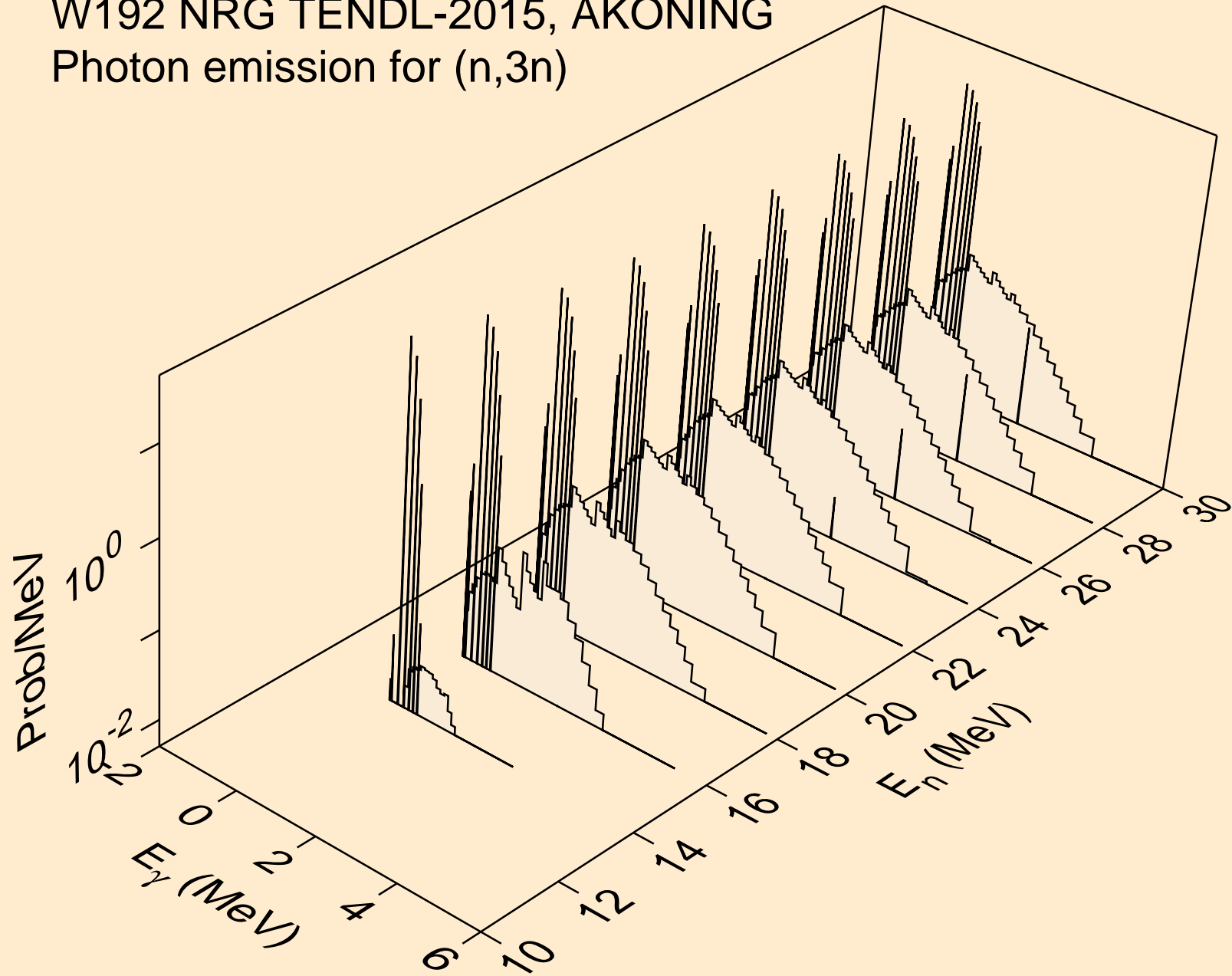

W192 NRG TENDL-2015, AKONING
Photon emission for (n,n*)a

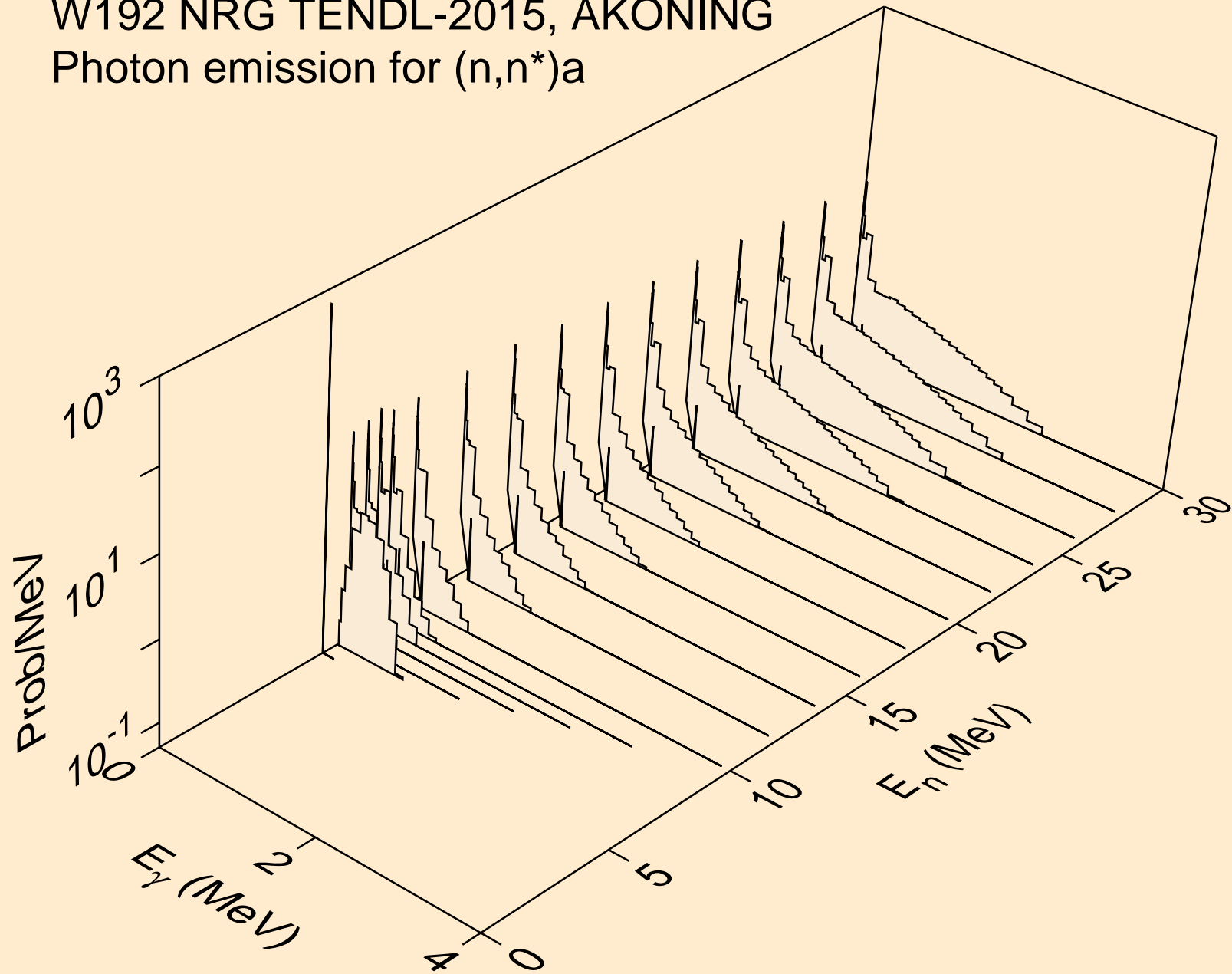

W192 NRG TENDL-2015, AKONING
Photon emission for (n,2n)a

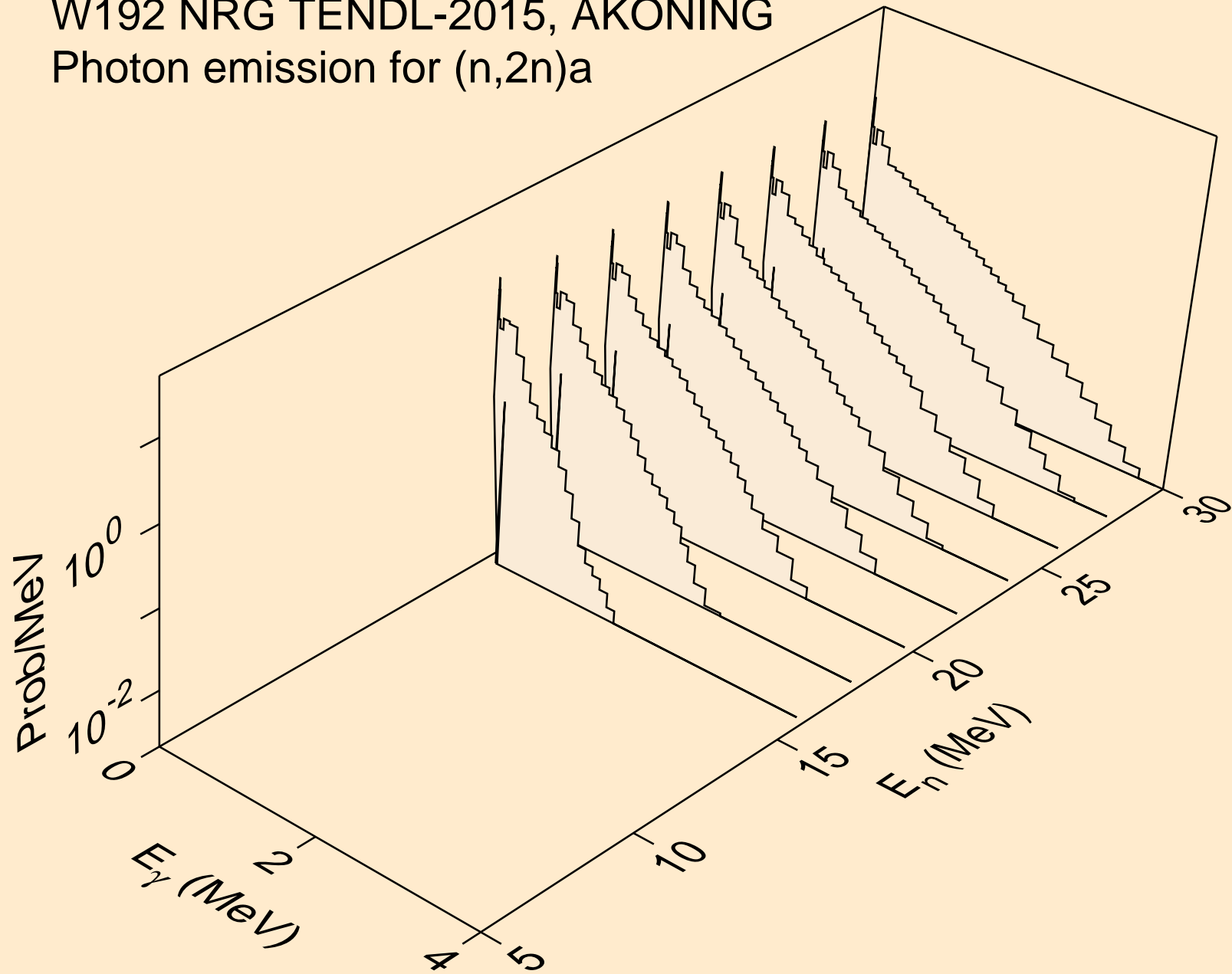

W192 NRG TENDL-2015, AKONING
Photon emission for (n,3n)a

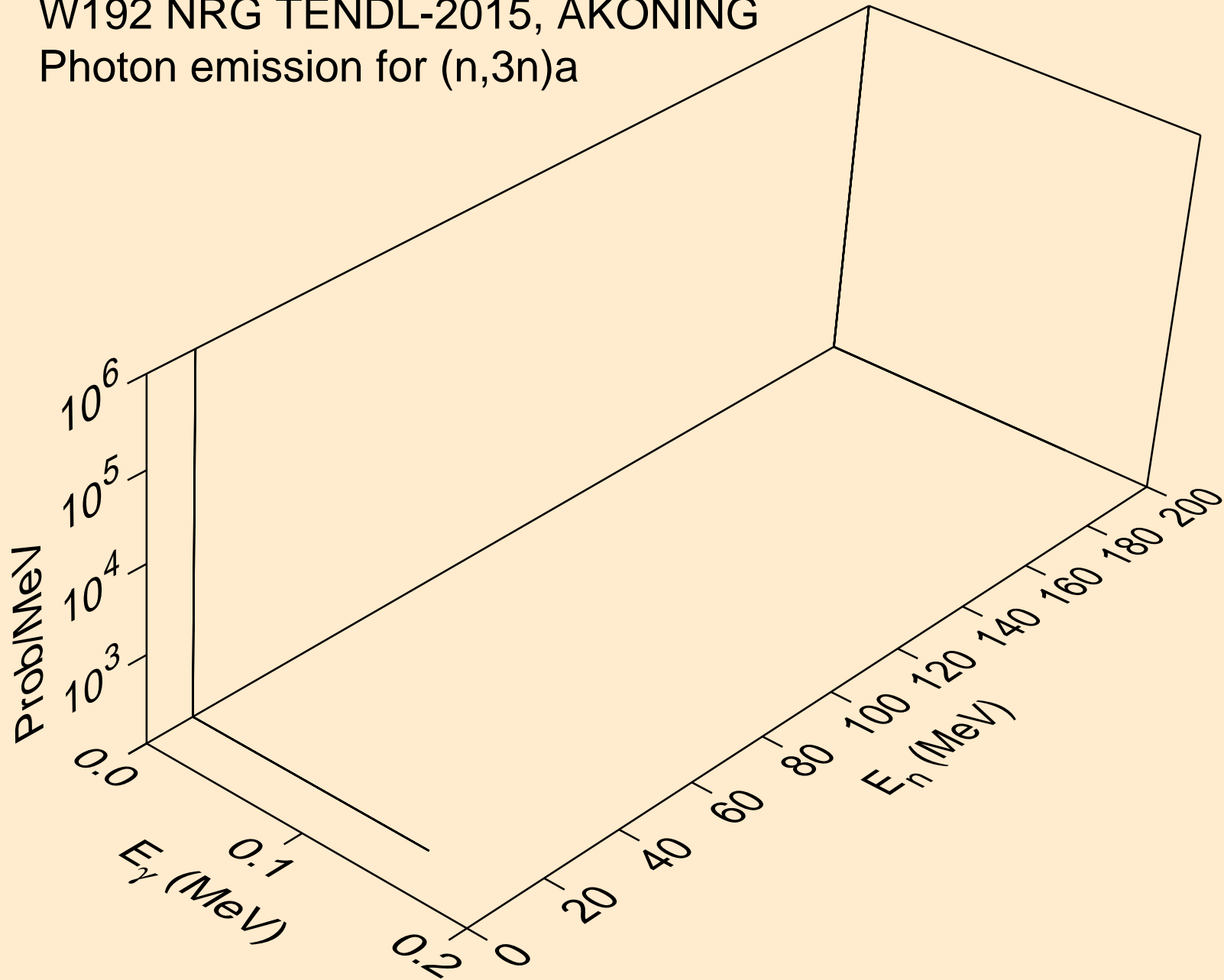

W192 NRG TENDL-2015, AKONING
Photon emission for (n,n*)p

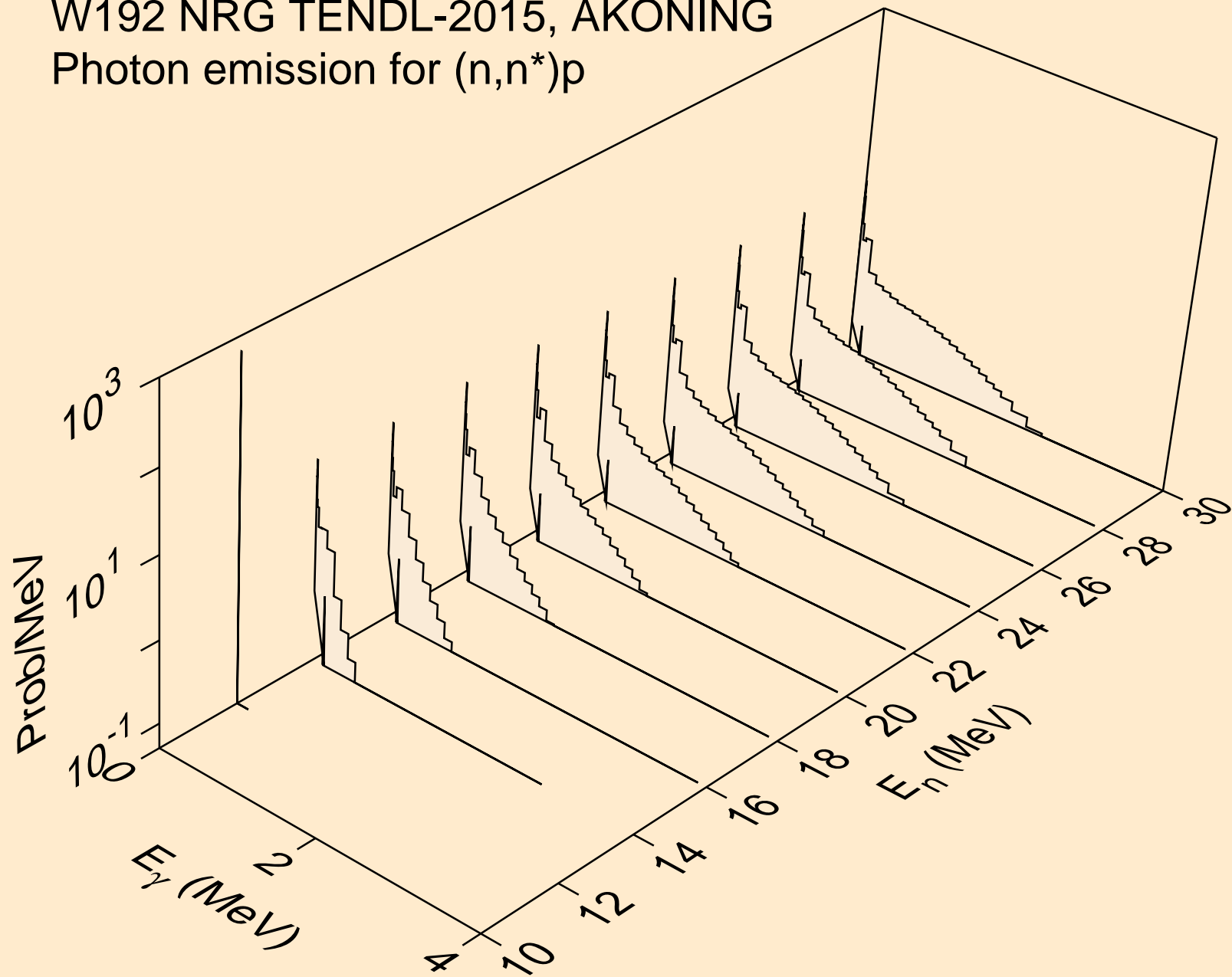

W192 NRG TENDL-2015, AKONING
Photon emission for (n,n*)d

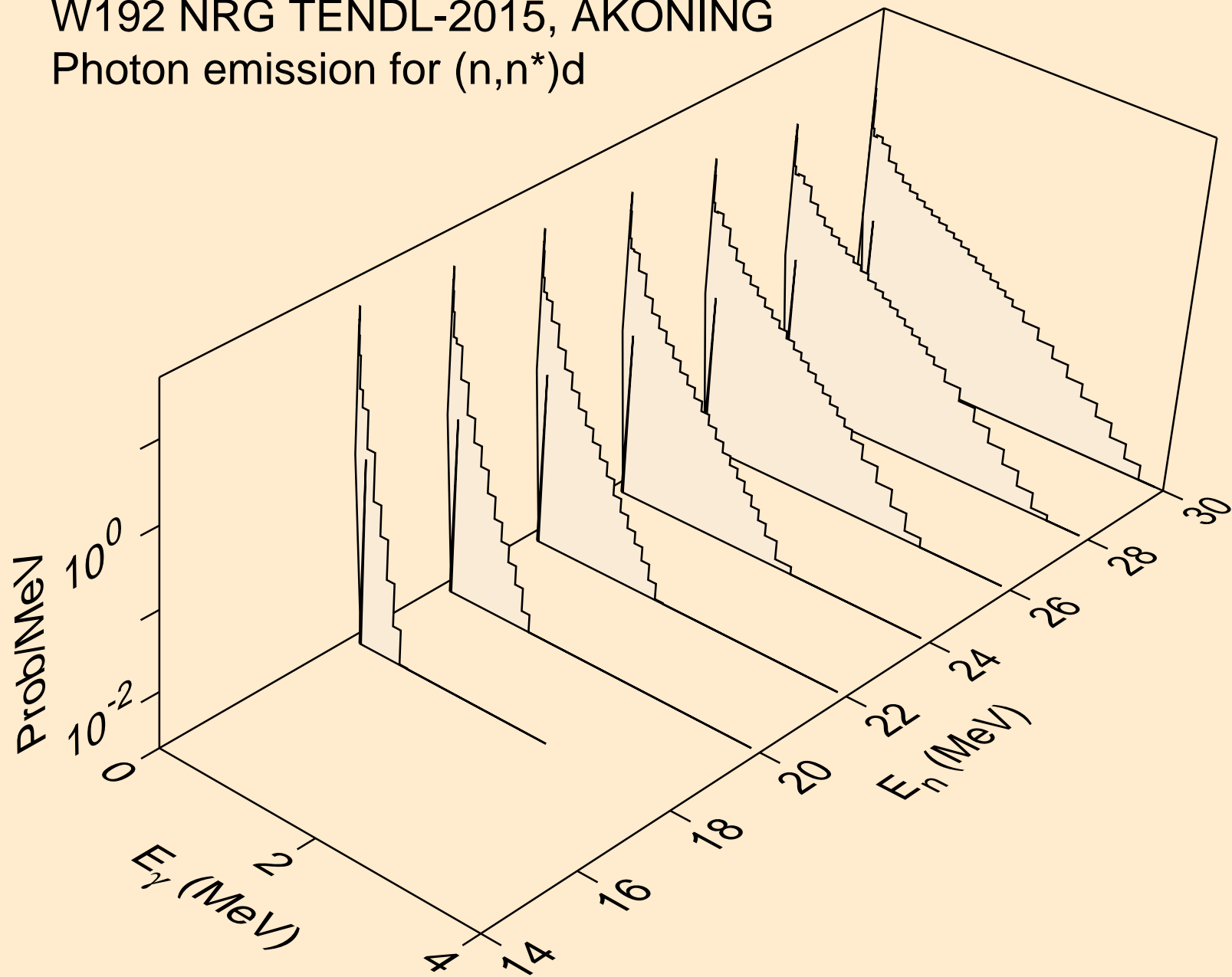

W192 NRG TENDL-2015, AKONING
Photon emission for (n,n*)t

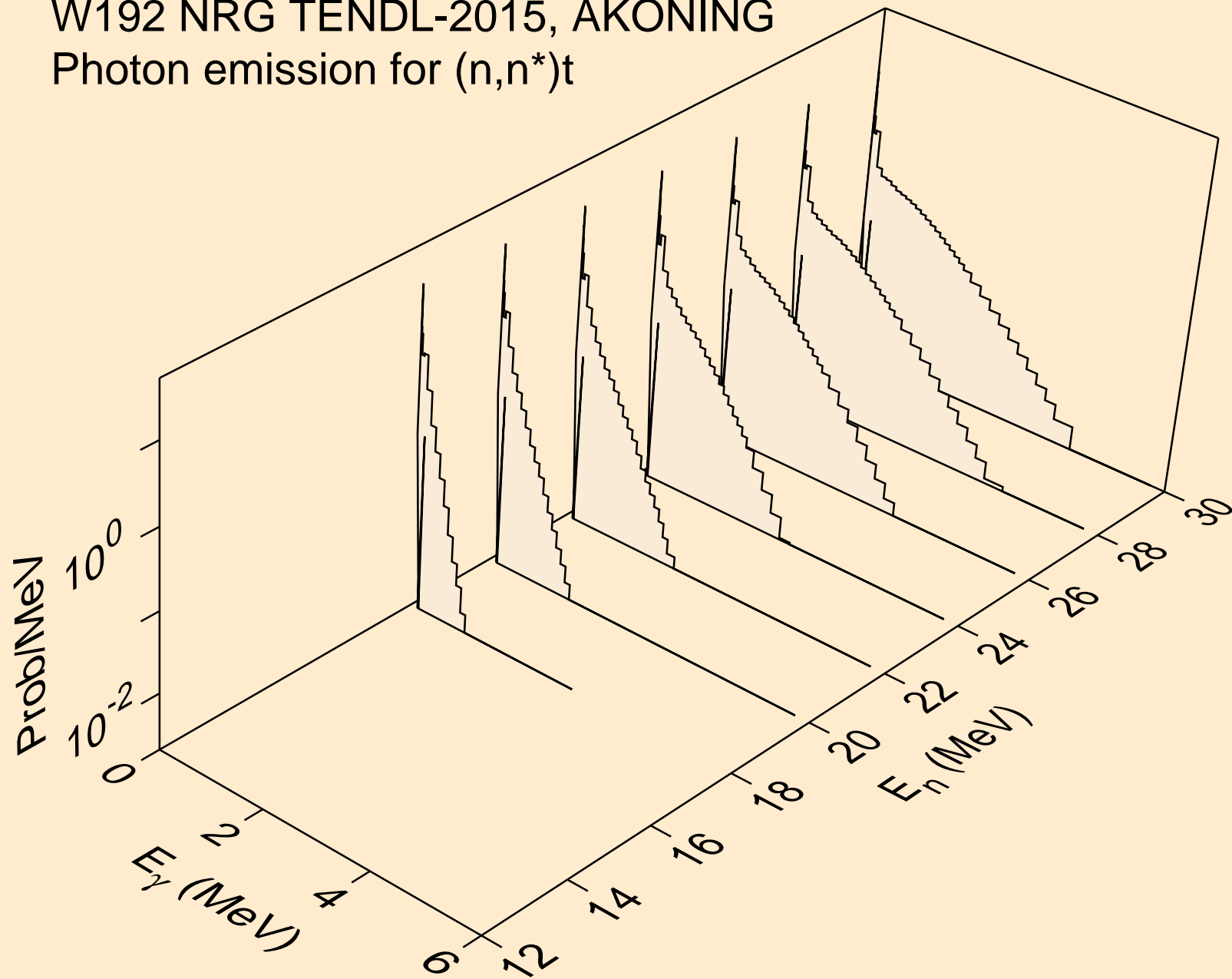

W192 NRG TENDL-2015, AKONING
Photon emission for (n,n*)he3

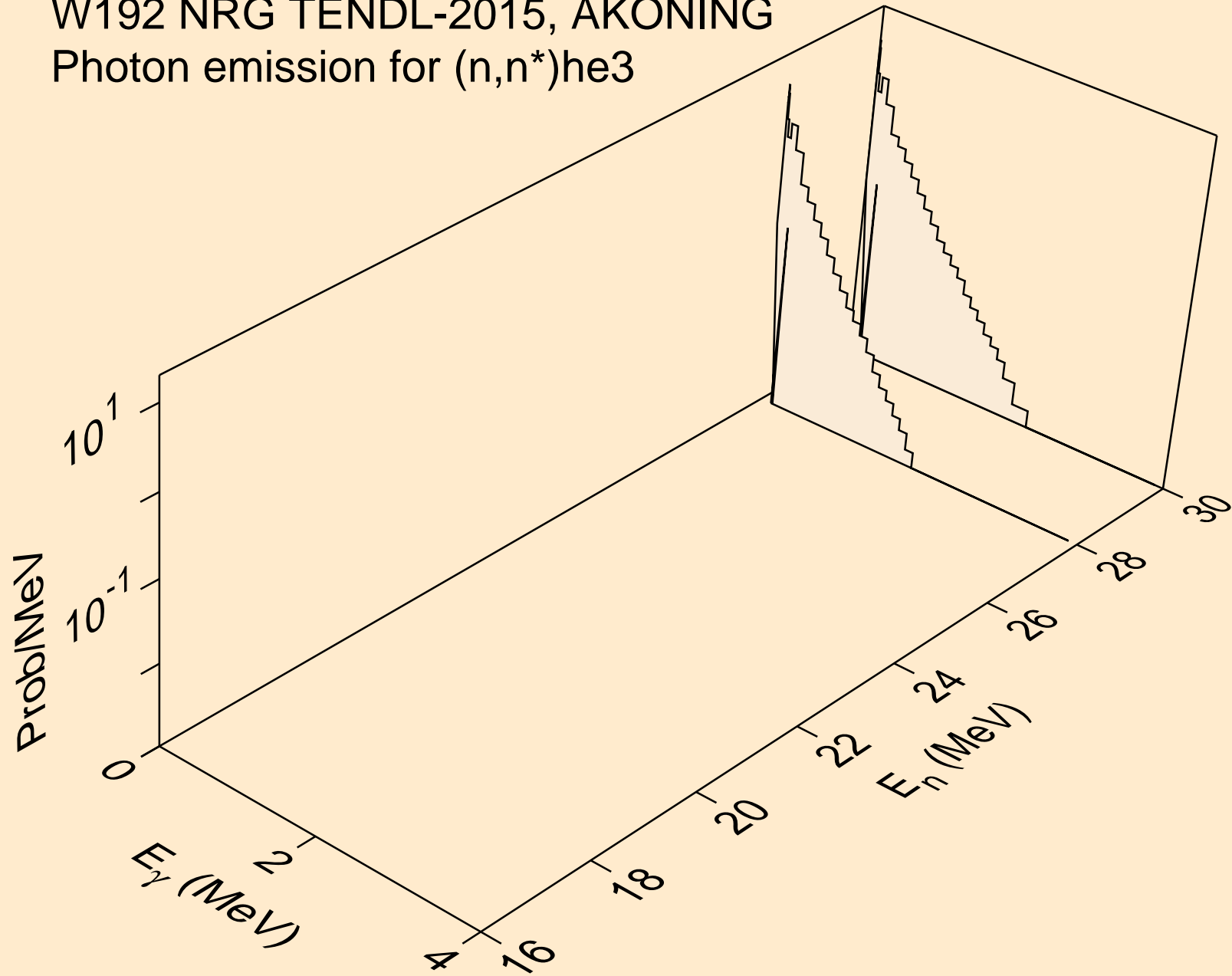

W192 NRG TENDL-2015, AKONING
Photon emission for (n,4n)

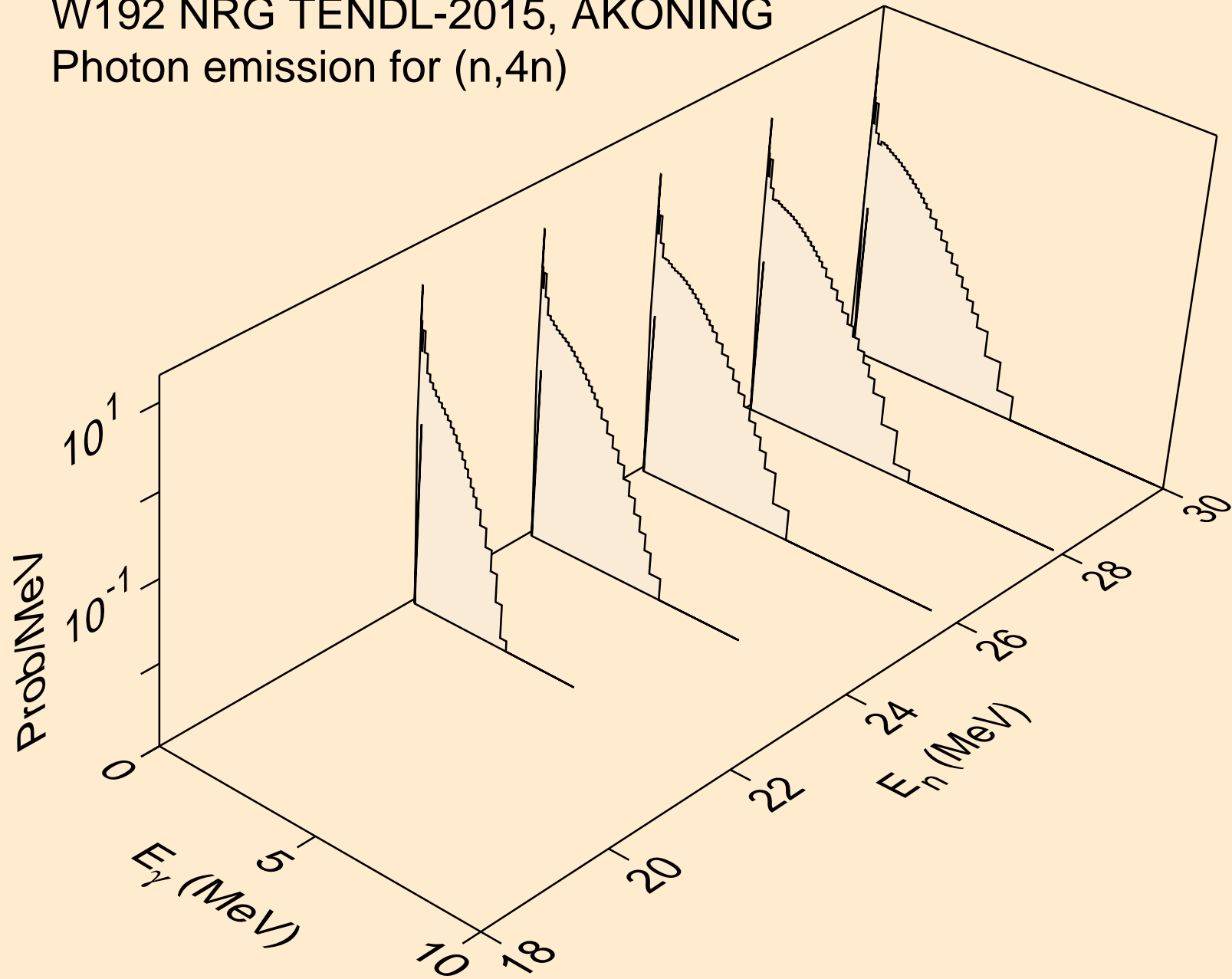

W192 NRG TENDL-2015, AKONING
Photon emission for (n,2np)

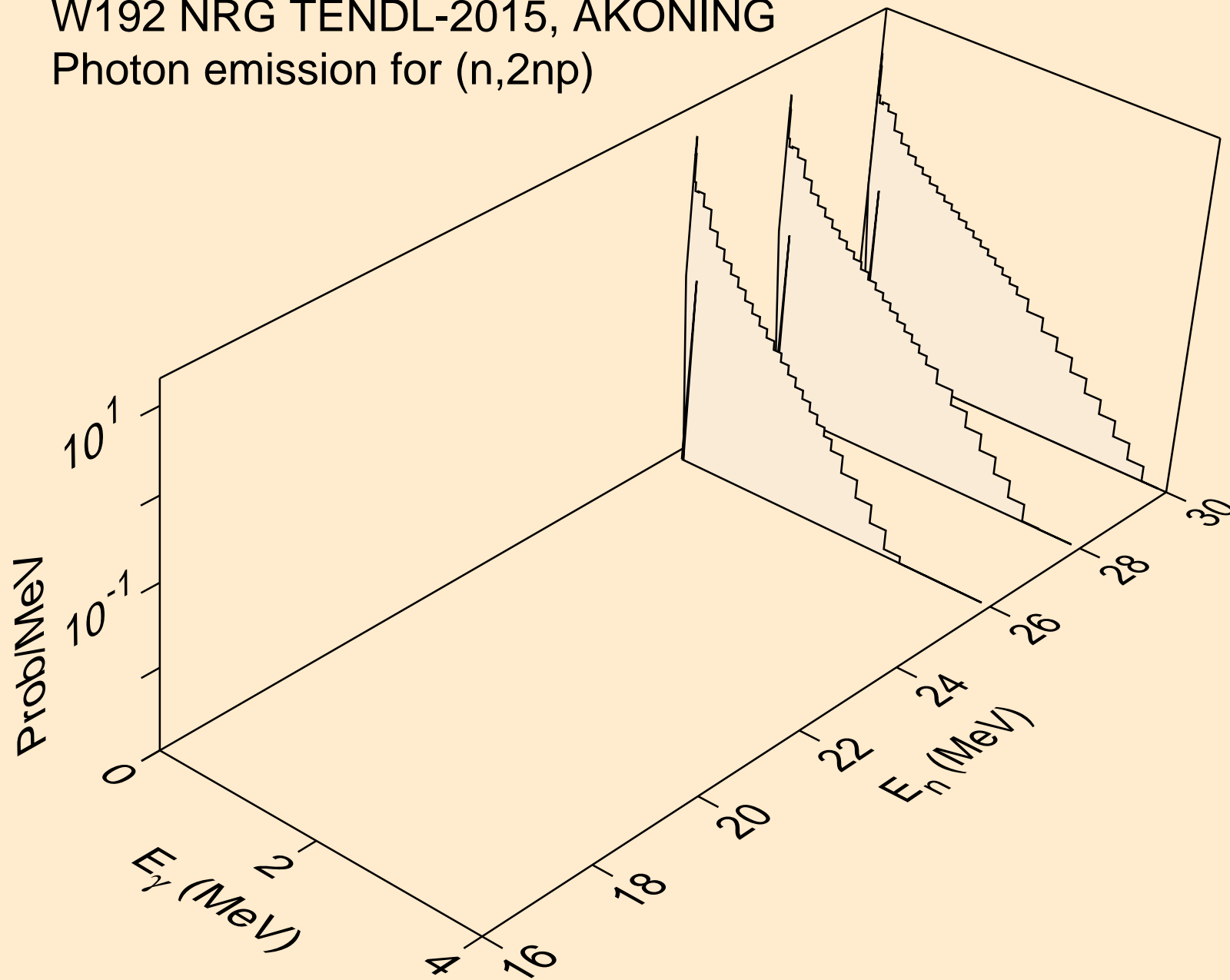

W192 NRG TENDL-2015, AKONING
Photon emission for (n,3np)

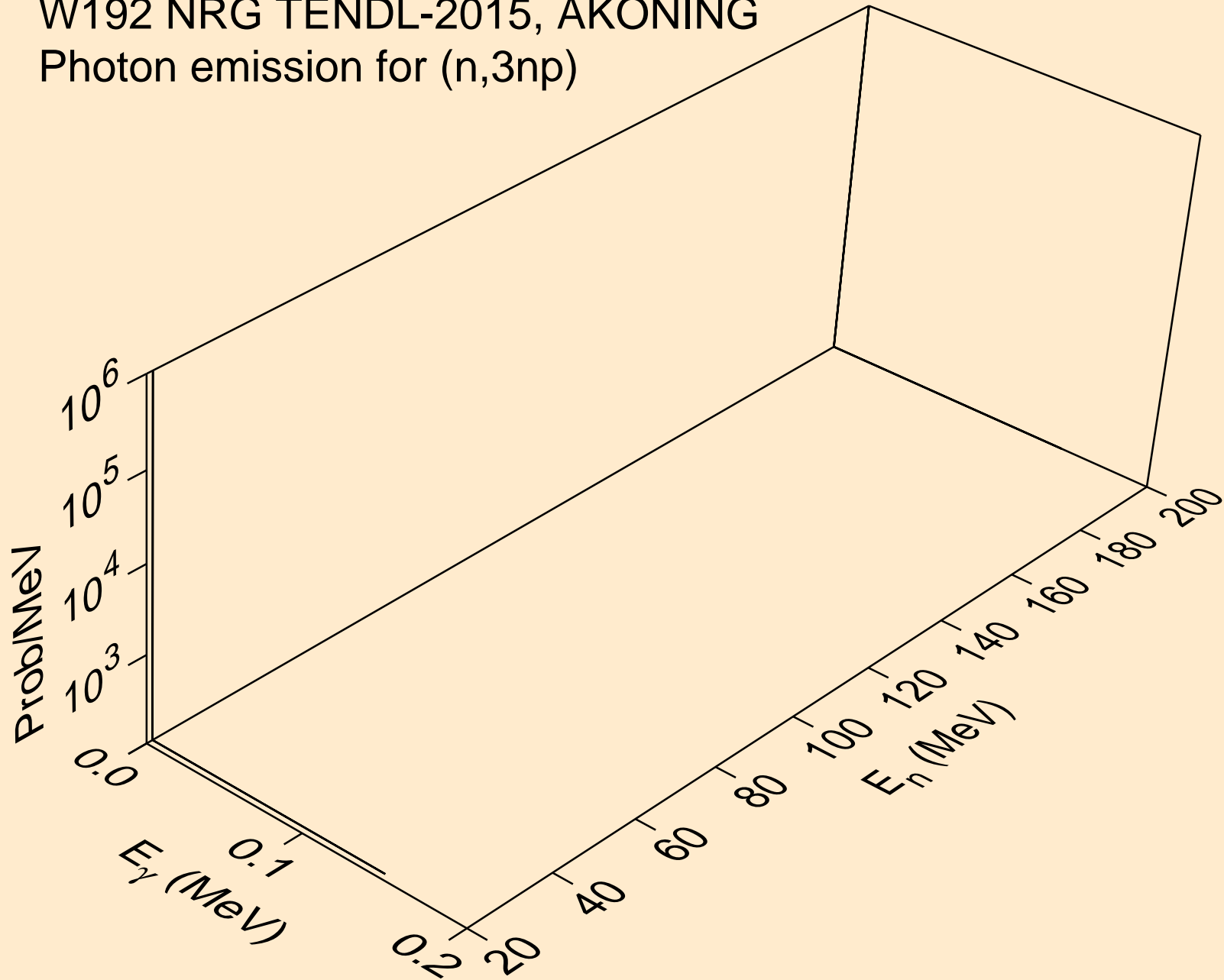

W192 NRG TENDL-2015, AKONING
Photon emission for (n,n*c)

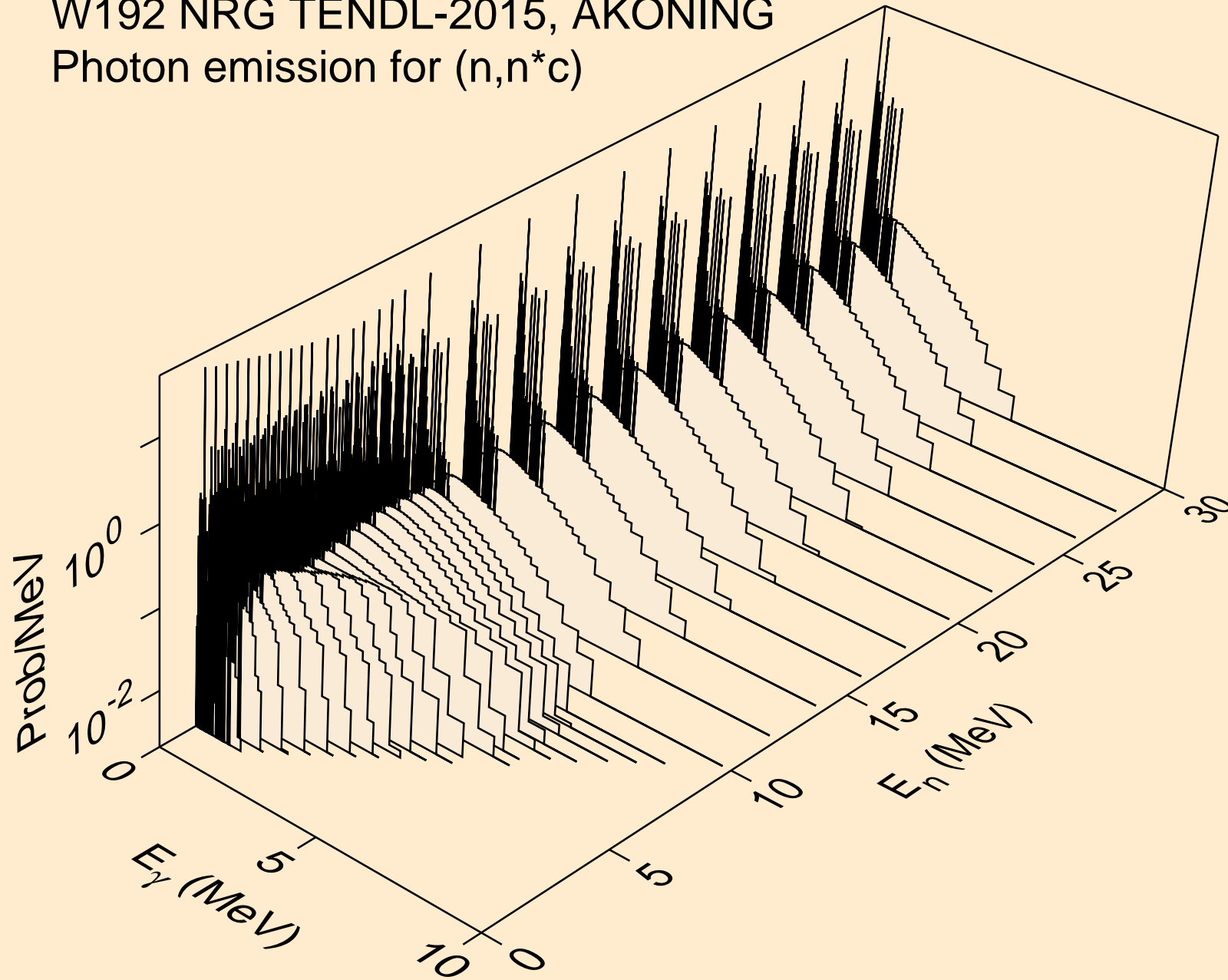

W192 NRG TENDL-2015, AKONING
Photon emission for (n,gma)

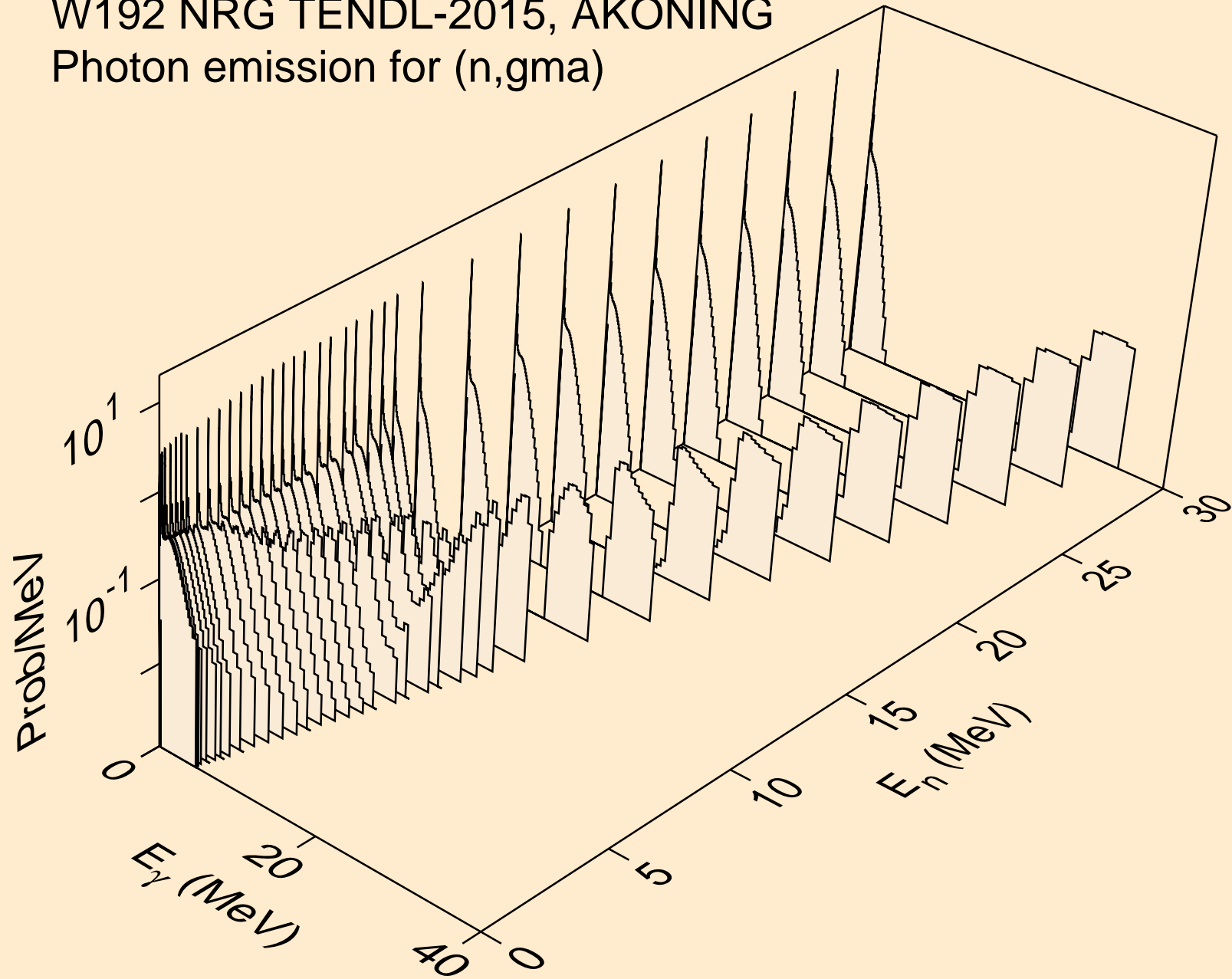

W192 NRG TENDL-2015, AKONING
Photon emission for (n,p)

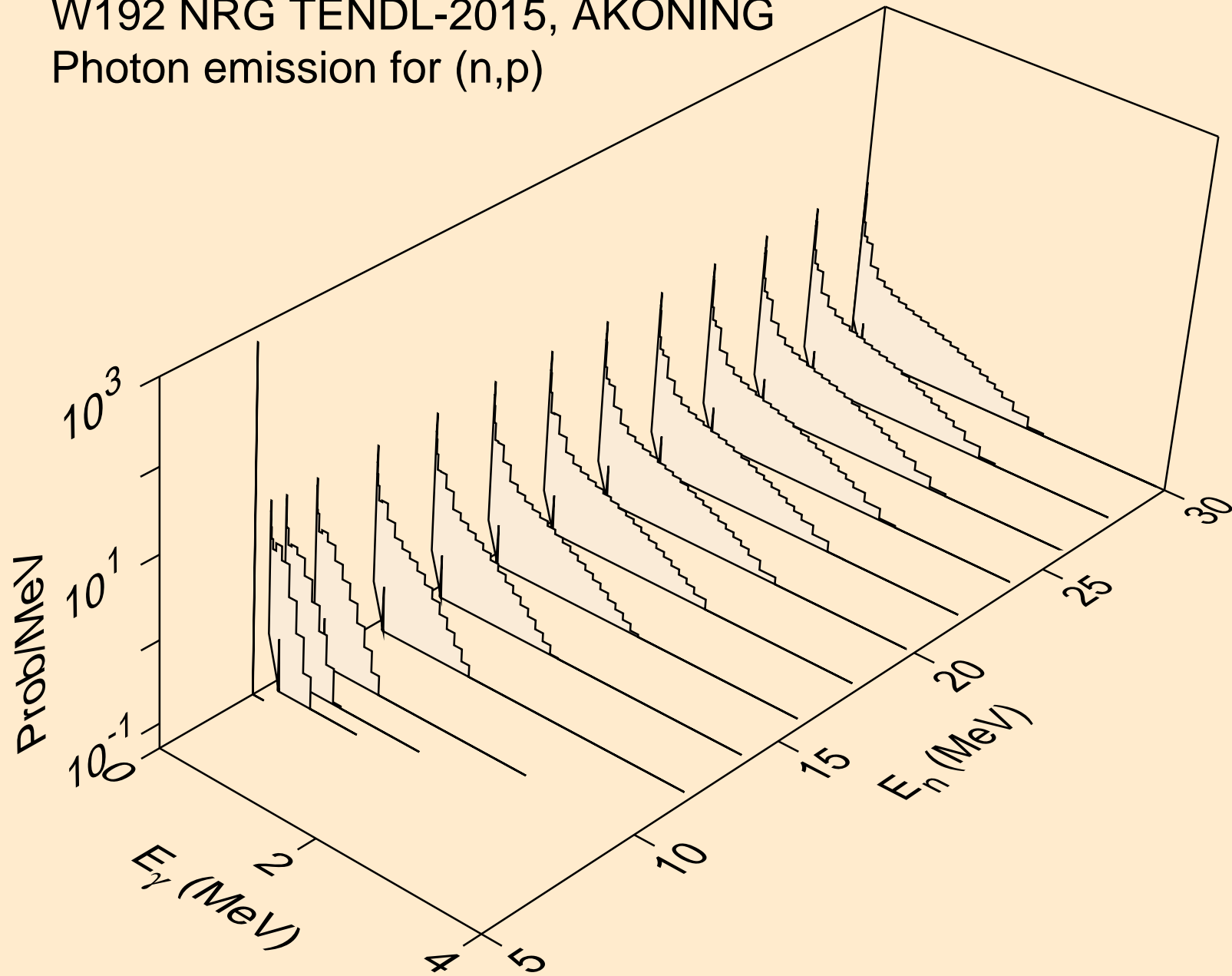

W192 NRG TENDL-2015, AKONING
Photon emission for (n,d)

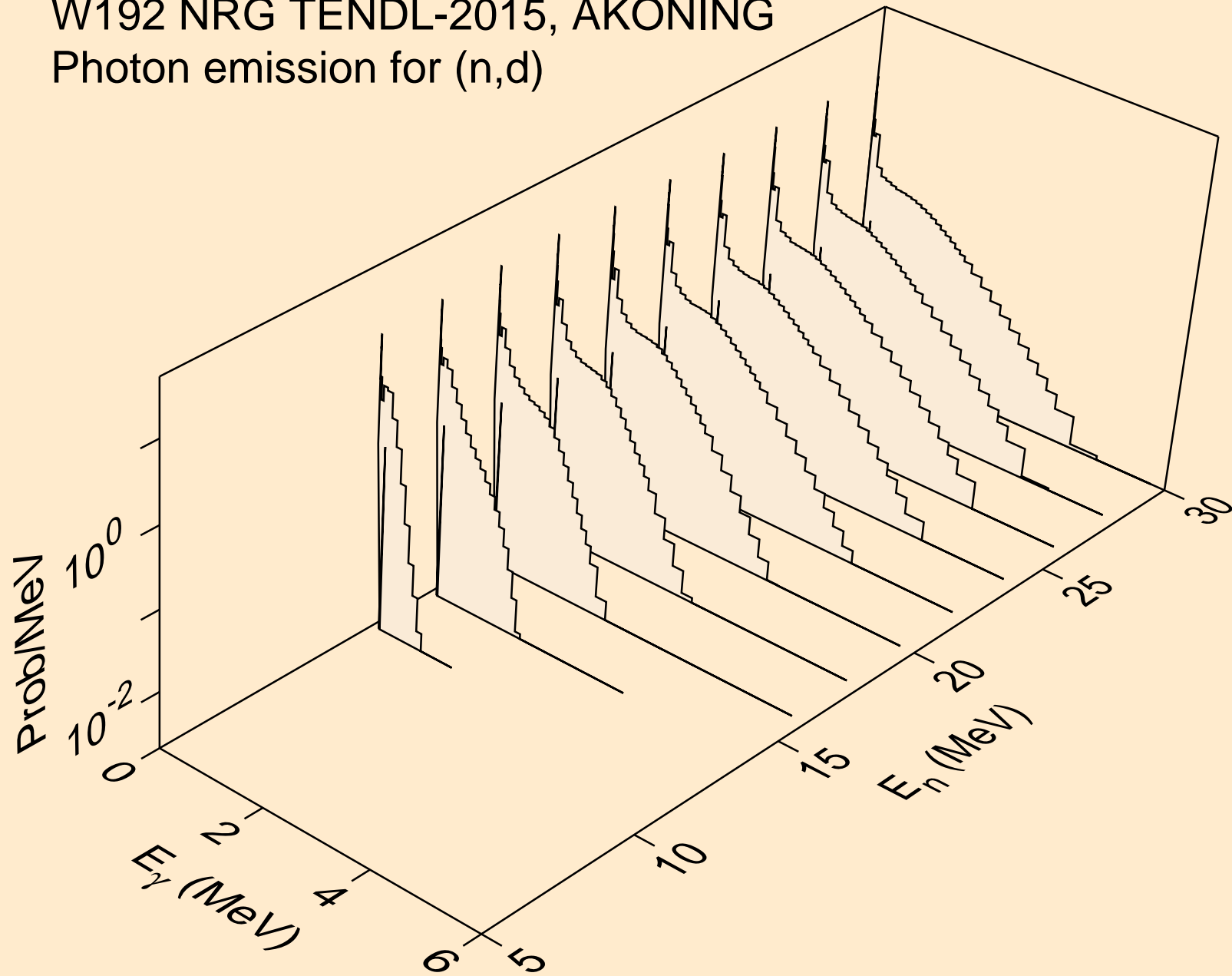

W192 NRG TENDL-2015, AKONING
Photon emission for (n,t)

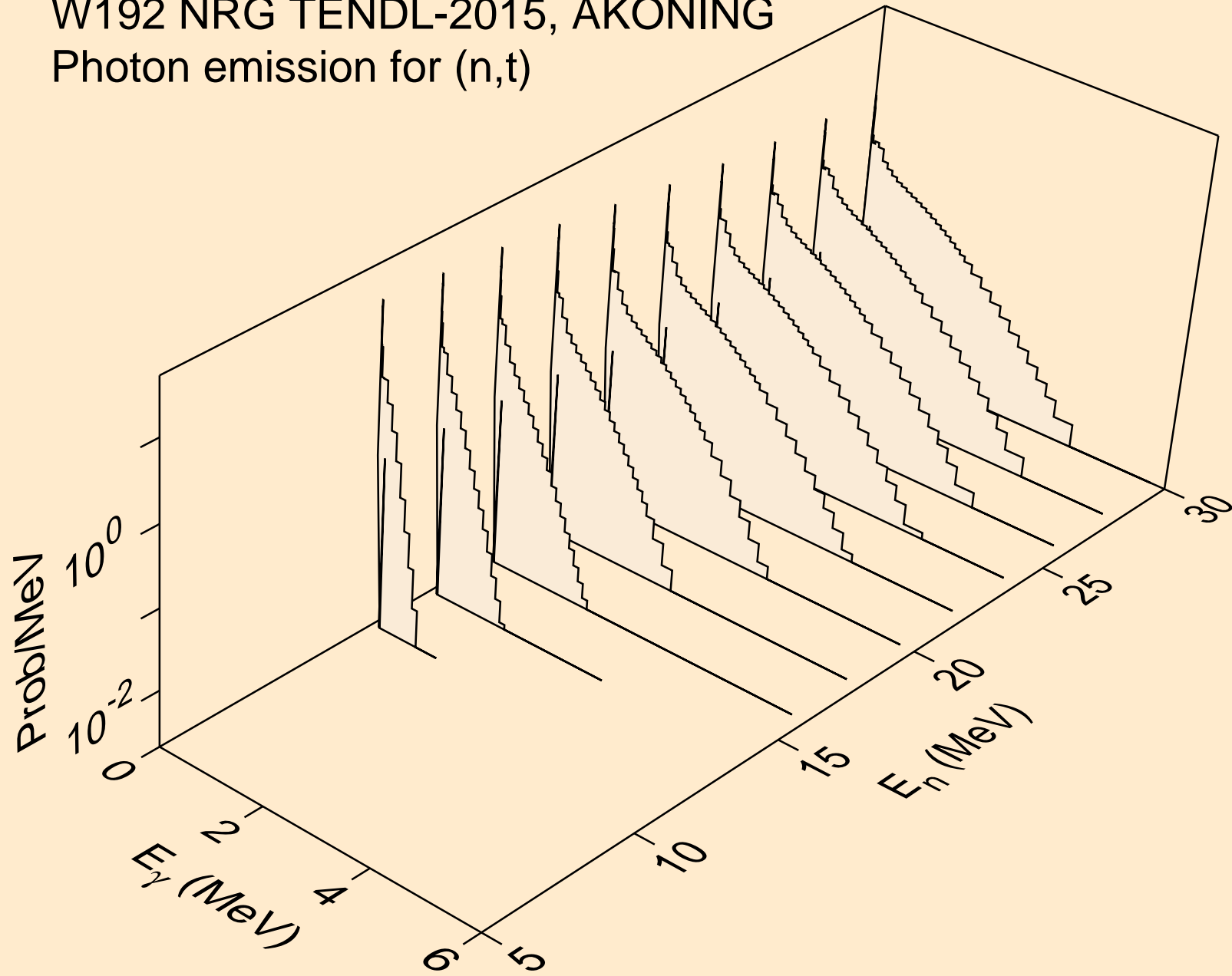

W192 NRG TENDL-2015, AKONING
Photon emission for (n,he3)

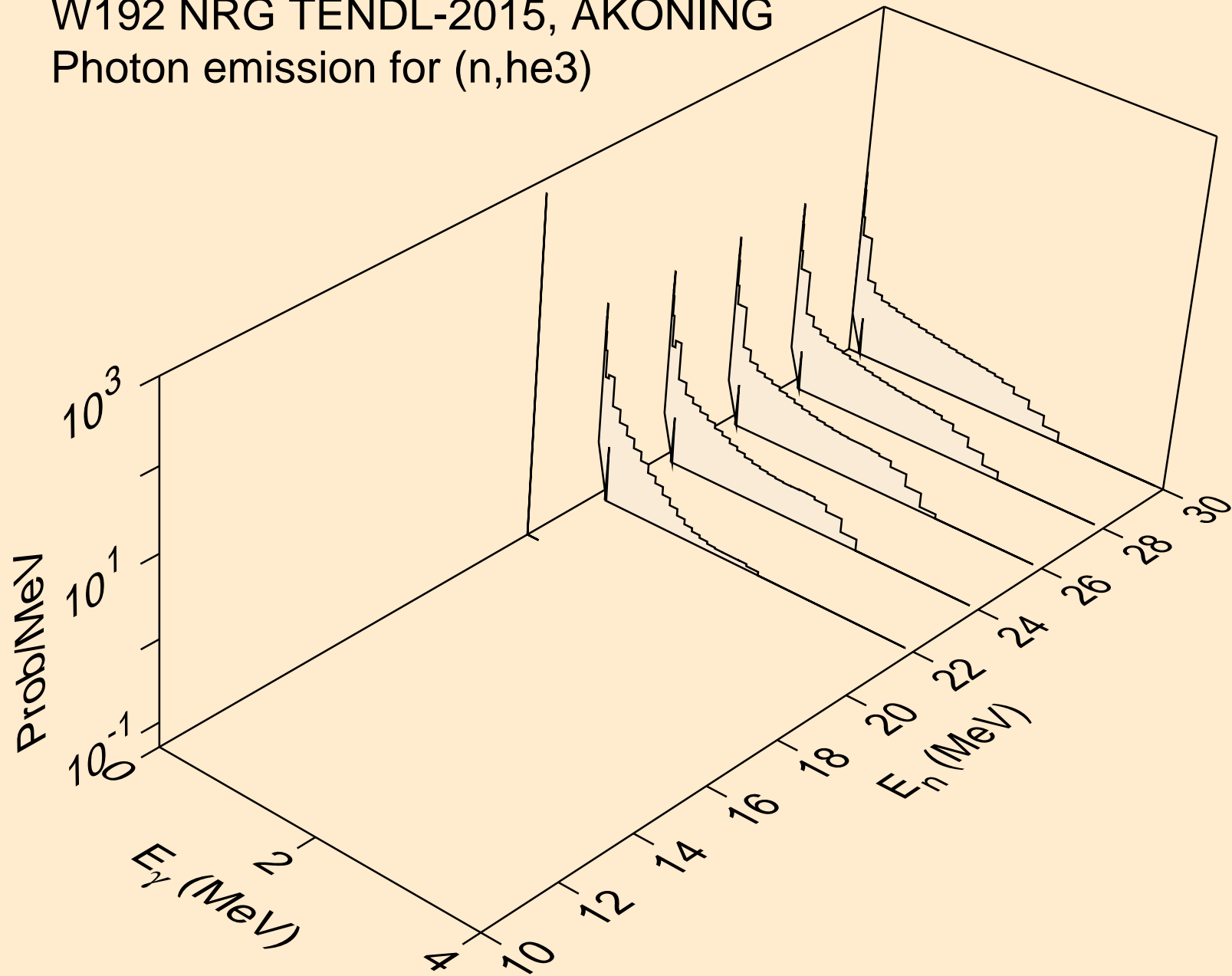

W192 NRG TENDL-2015, AKONING
Photon emission for (n,a)

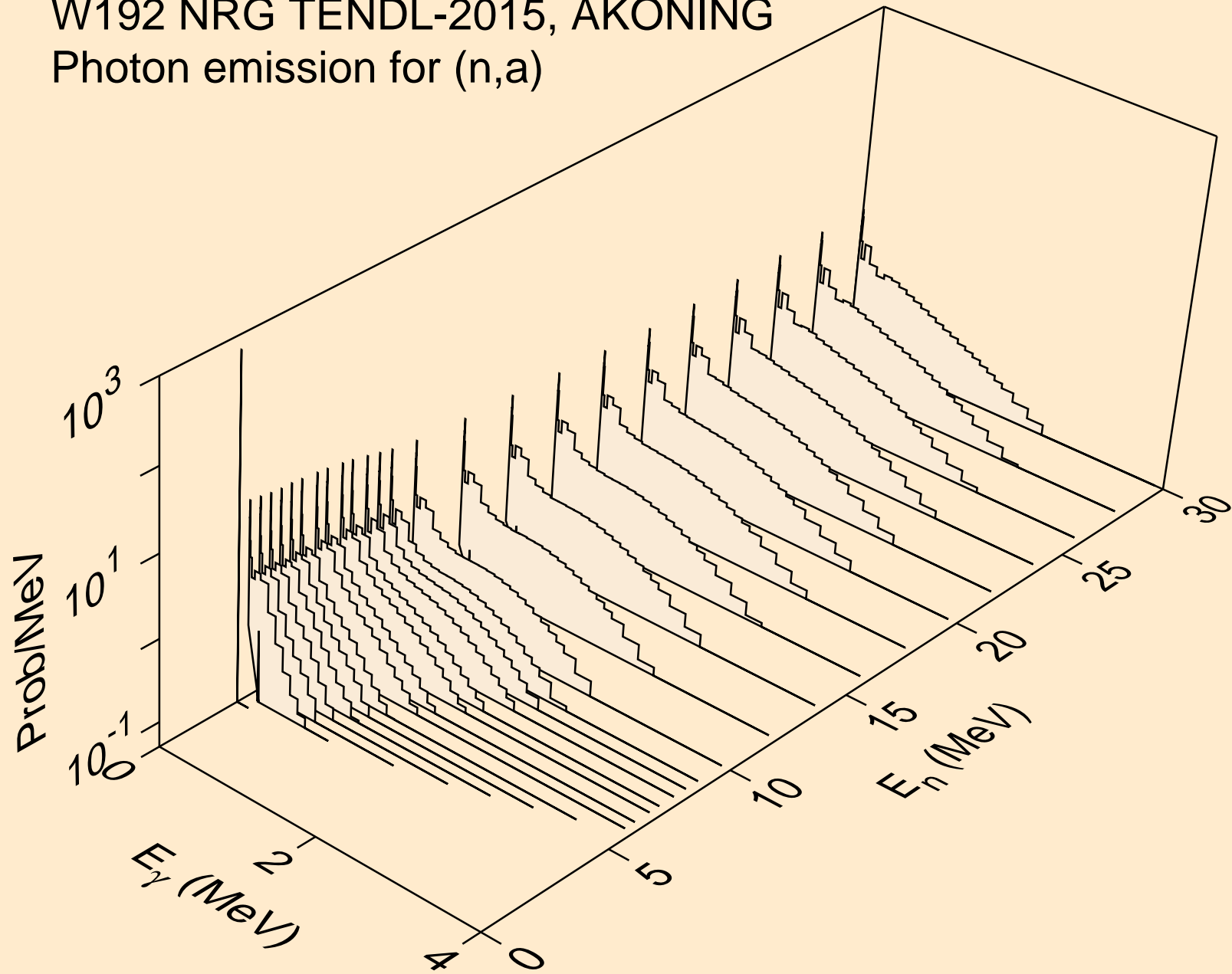

W192 NRG TENDL-2015, AKONING
thermal capture photon spectrum

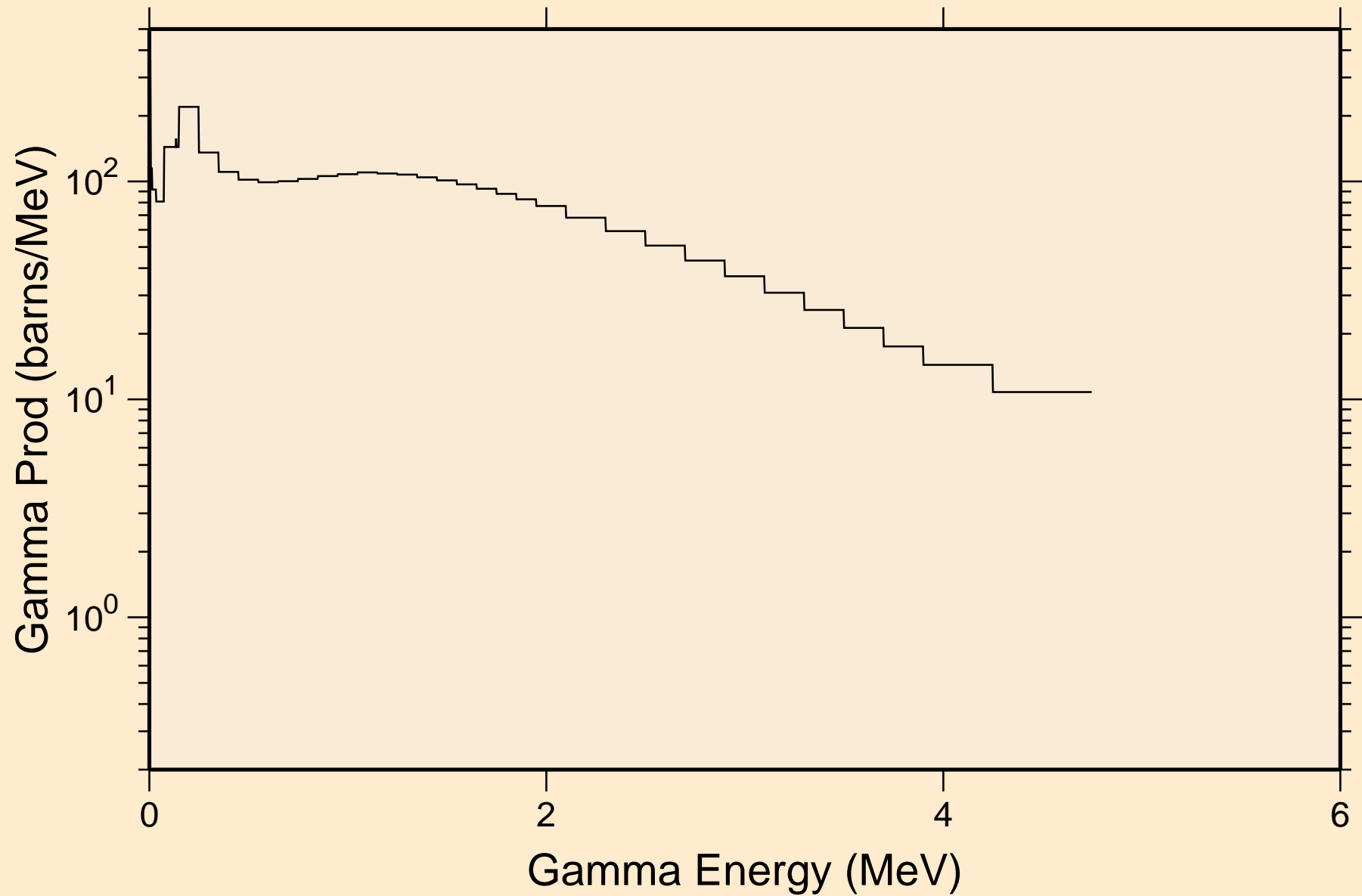

W192 NRG TENDL-2015, AKONING
14 MeV photon spectrum

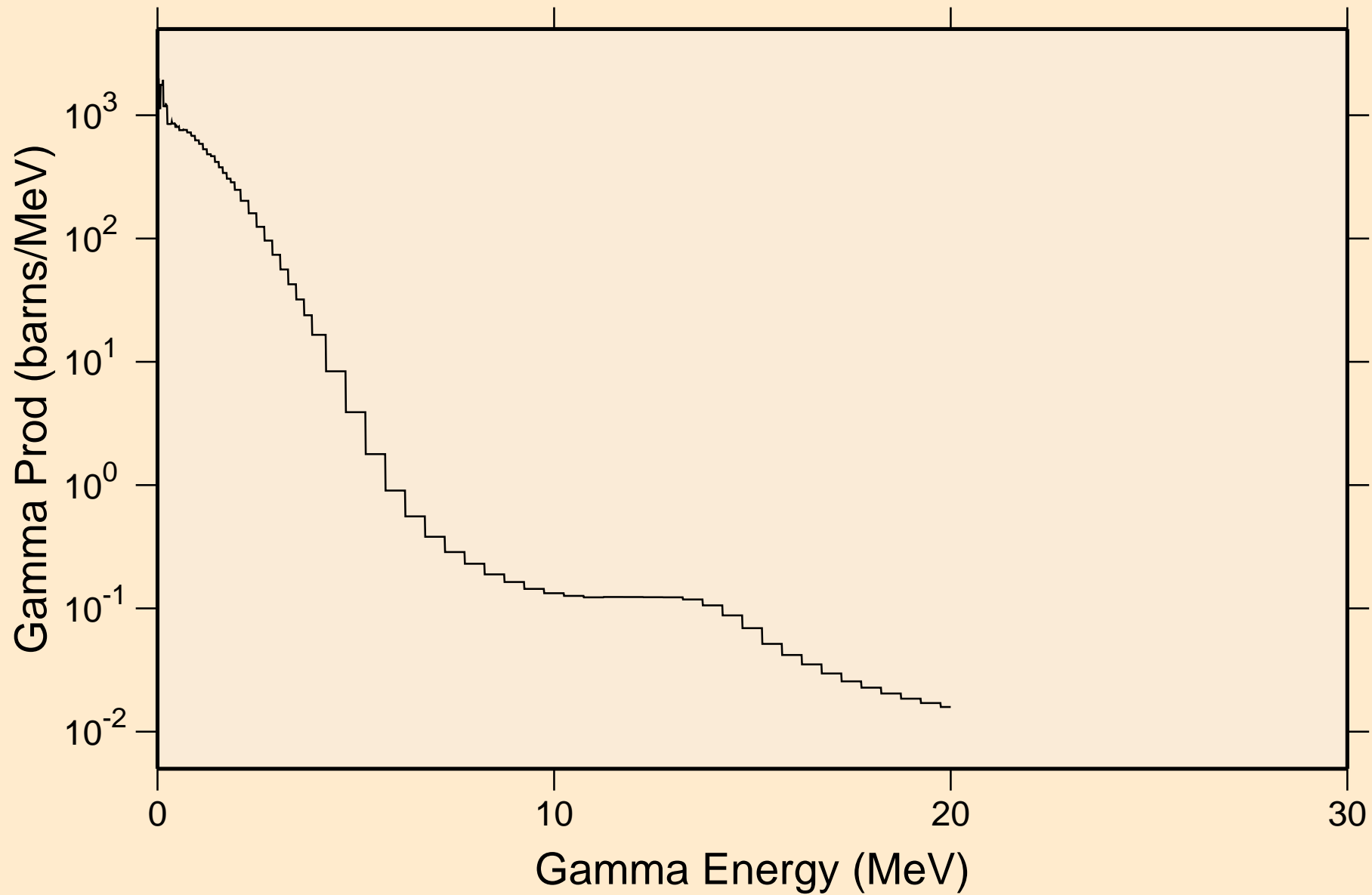

W192 NRG TENDL-2015, AKONING

Particle heating contributions

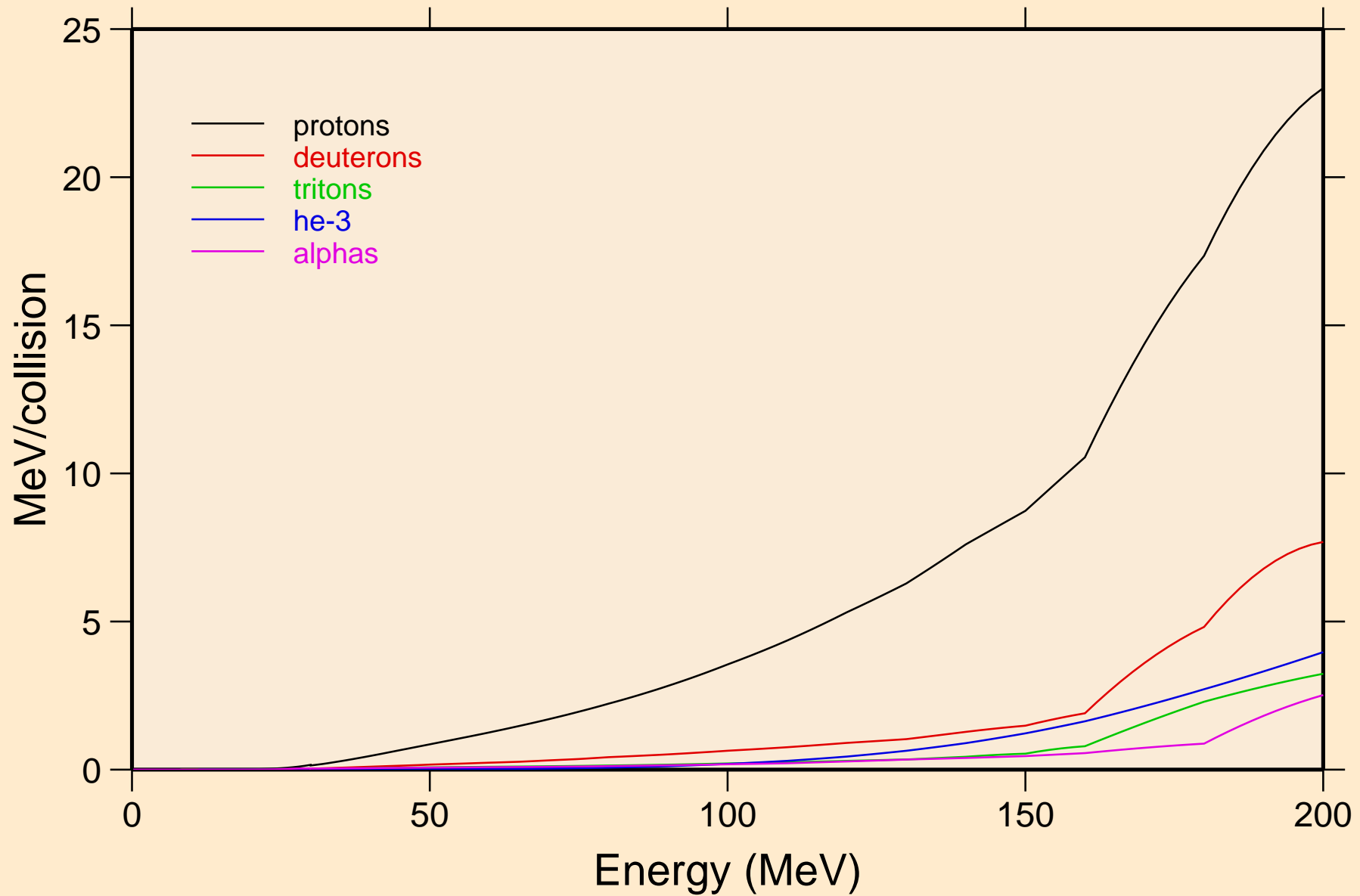

W192 NRG TENDL-2015, AKONING

Recoil Heating

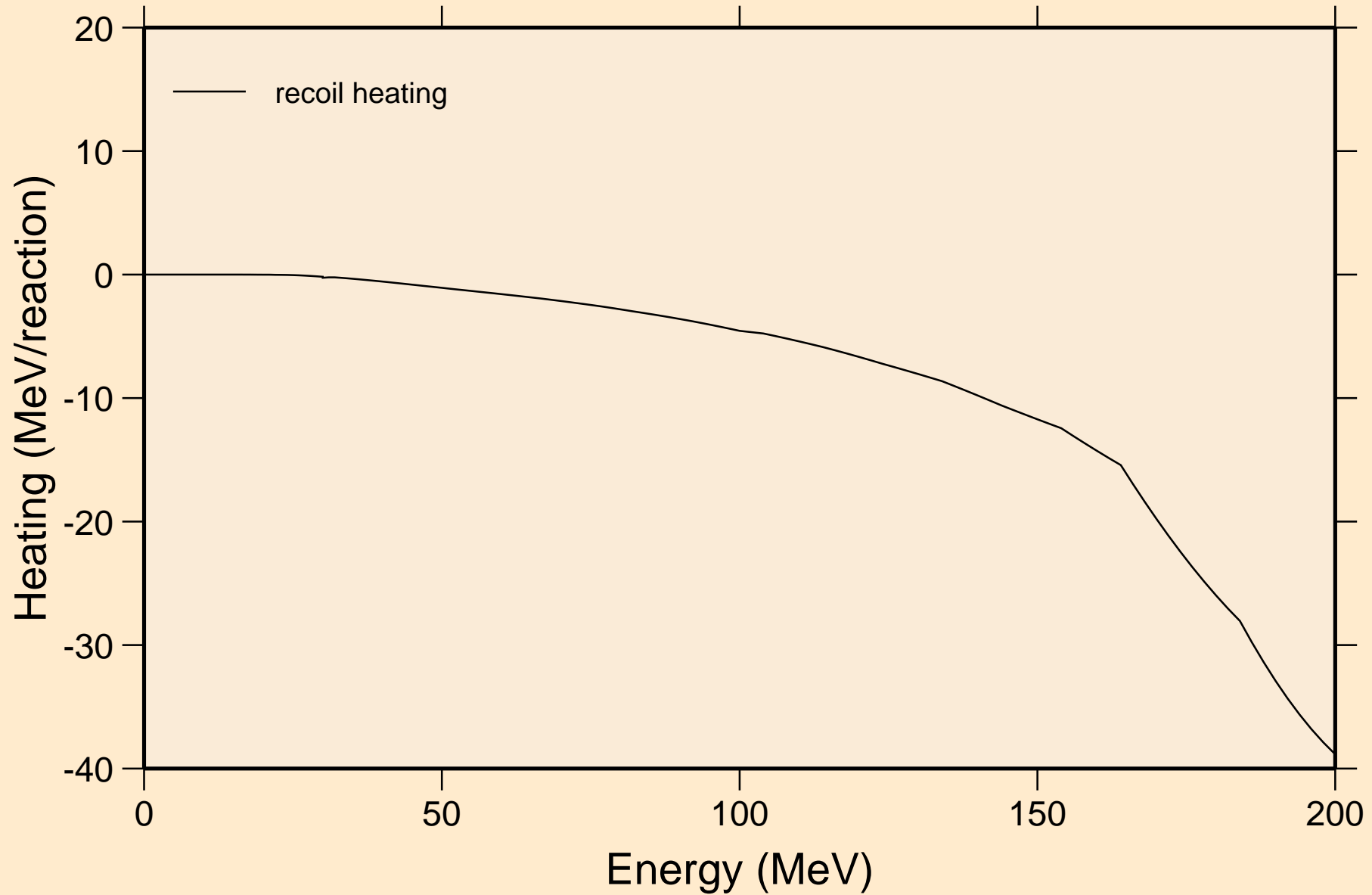

W192 NRG TENDL-2015, AKONING

Particle production cross sections

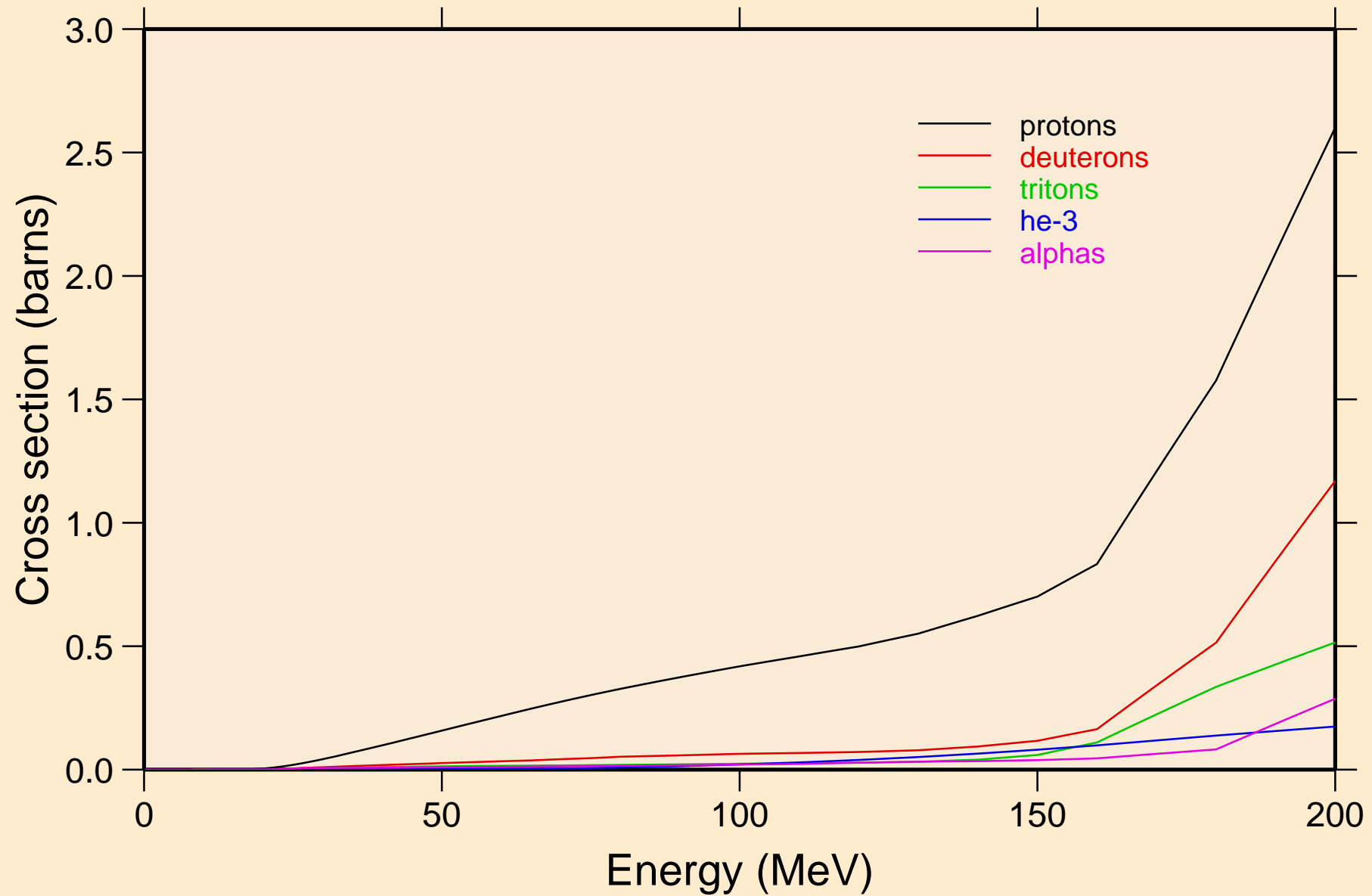

W192 NRG TENDL-2015, AKONING
protons from (n,x)

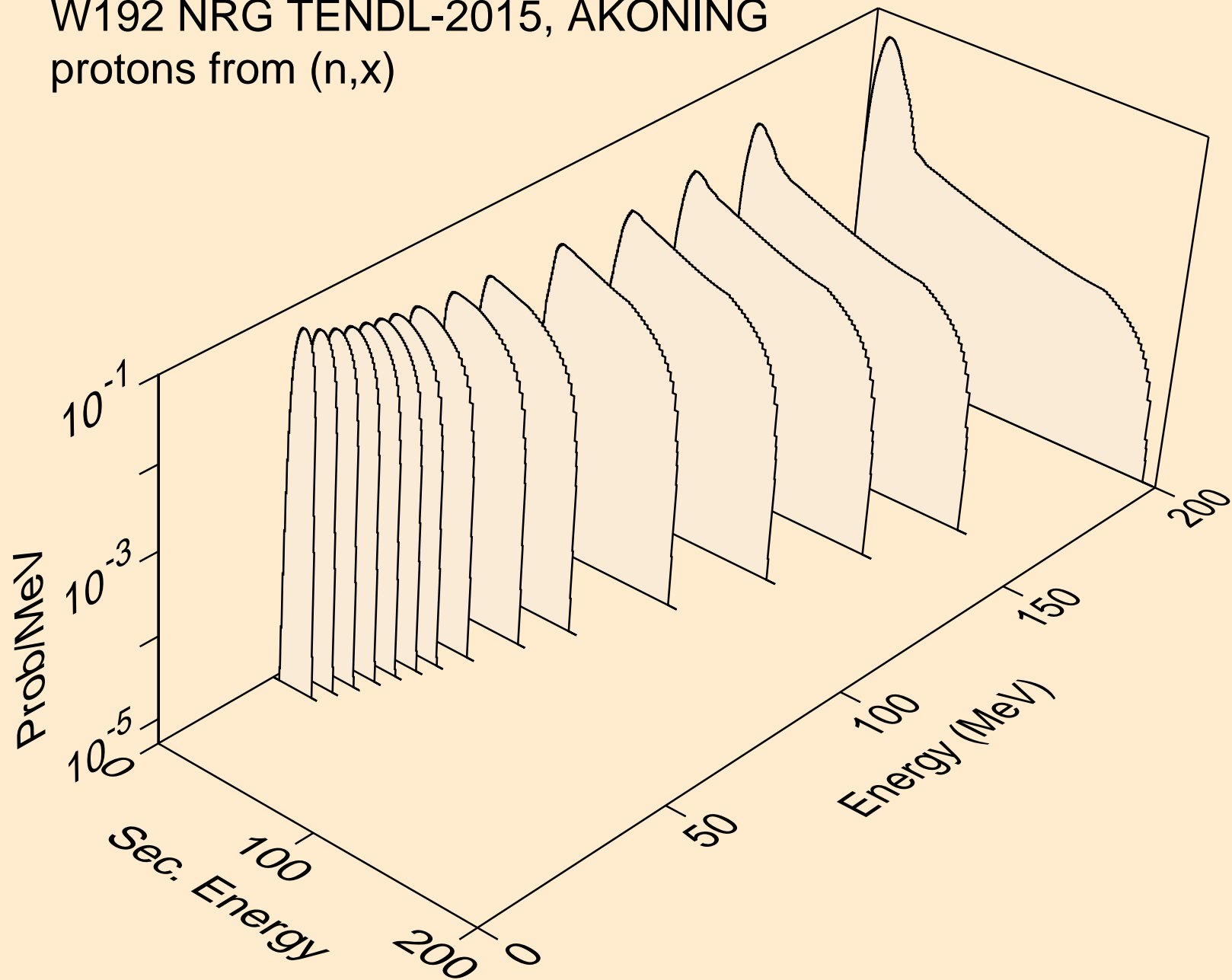

W192 NRG TENDL-2015, AKONING
protons from (n,n*)p

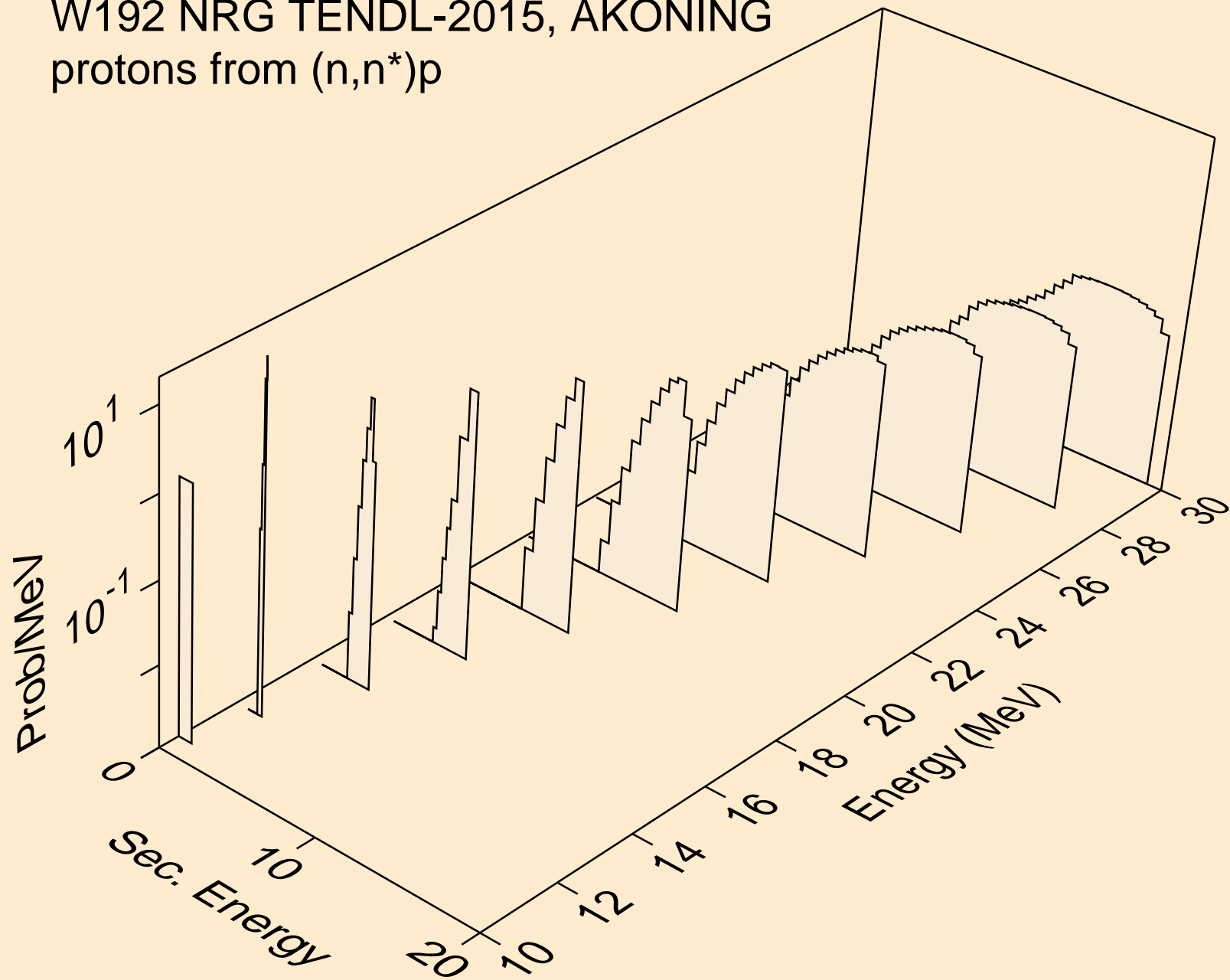

W192 NRG TENDL-2015, AKONING
protons from (n,2np)

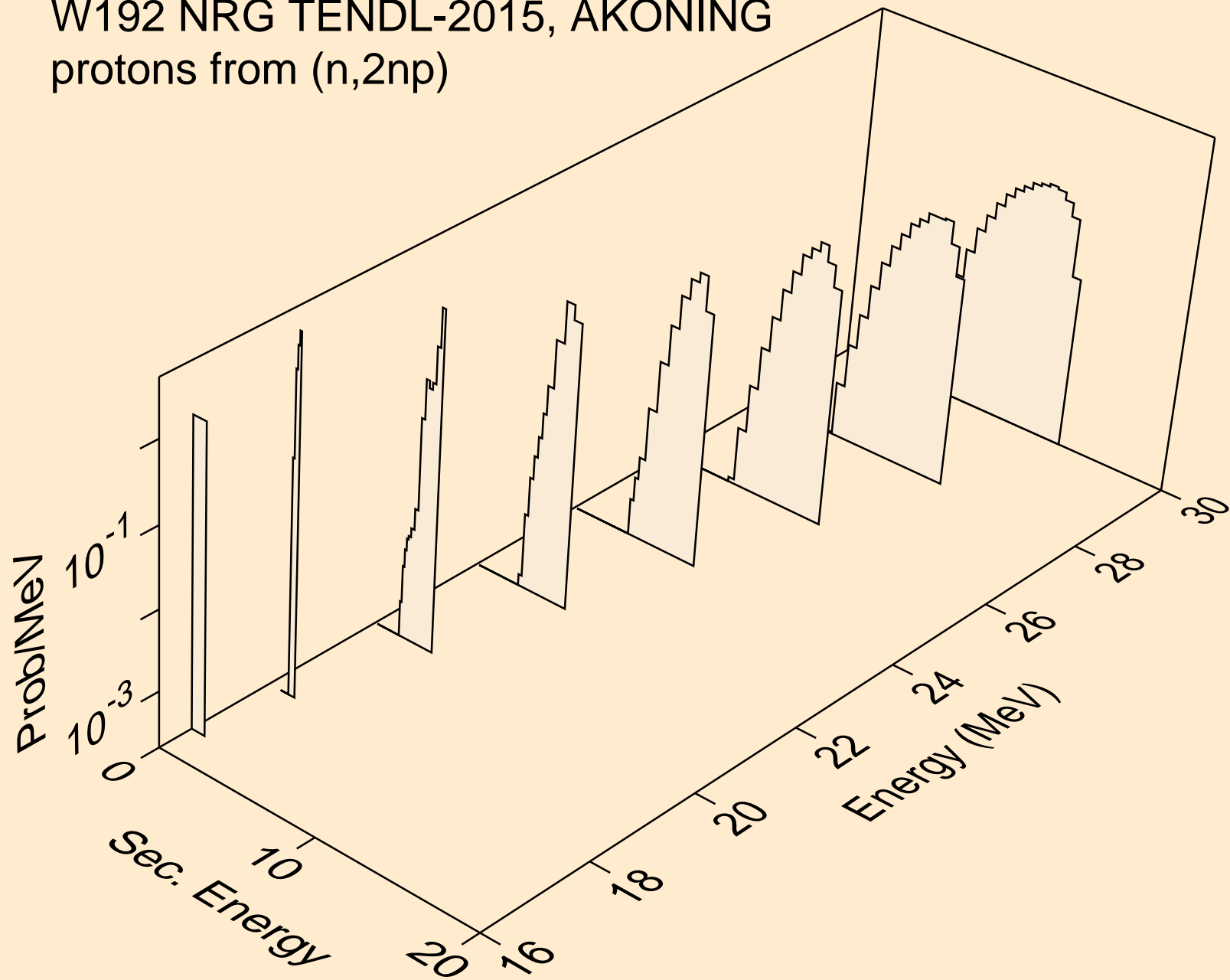

W192 NRG TENDL-2015, AKONING
protons from (n,3np)

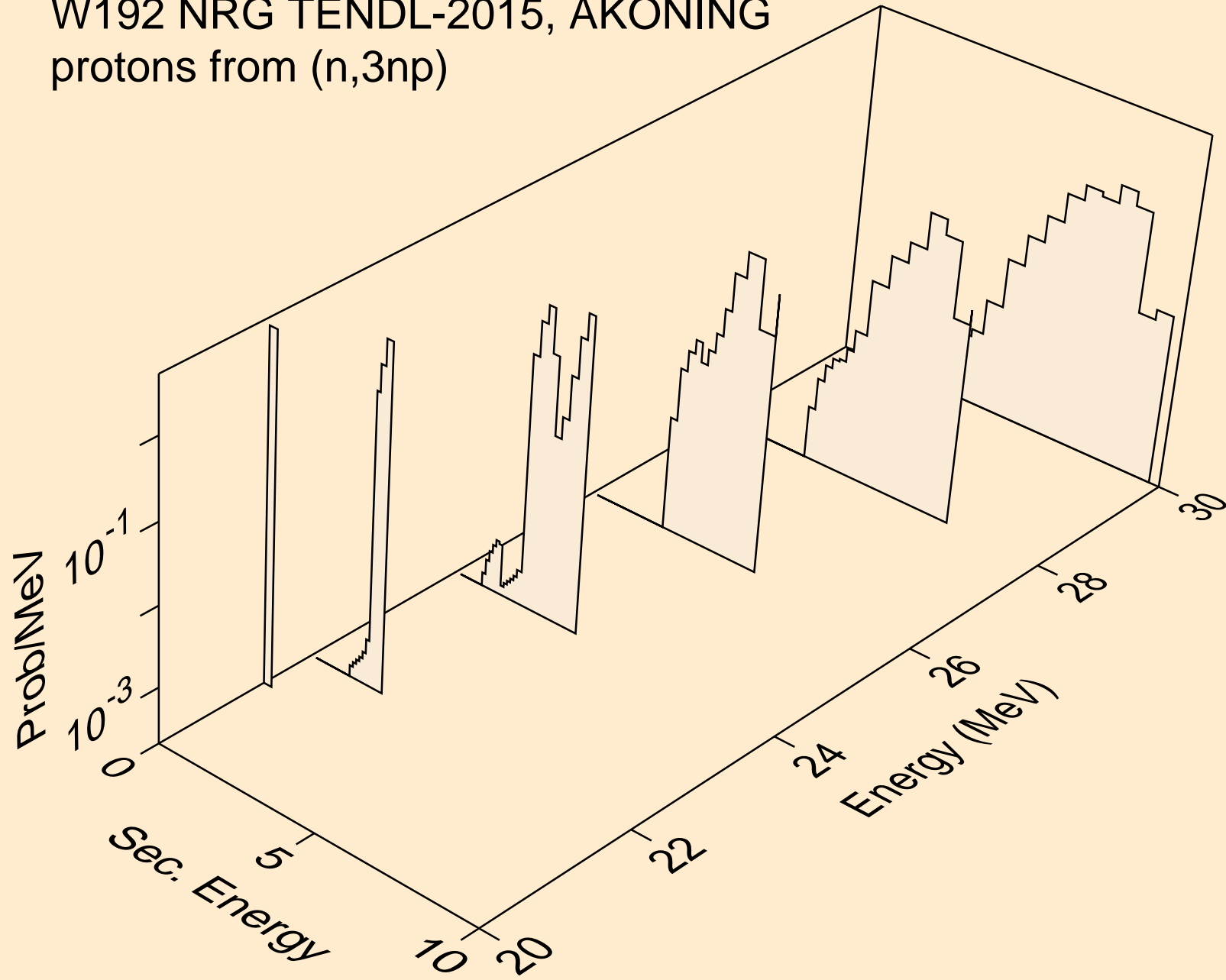

W192 NRG TENDL-2015, AKONING
protons from (n,p)

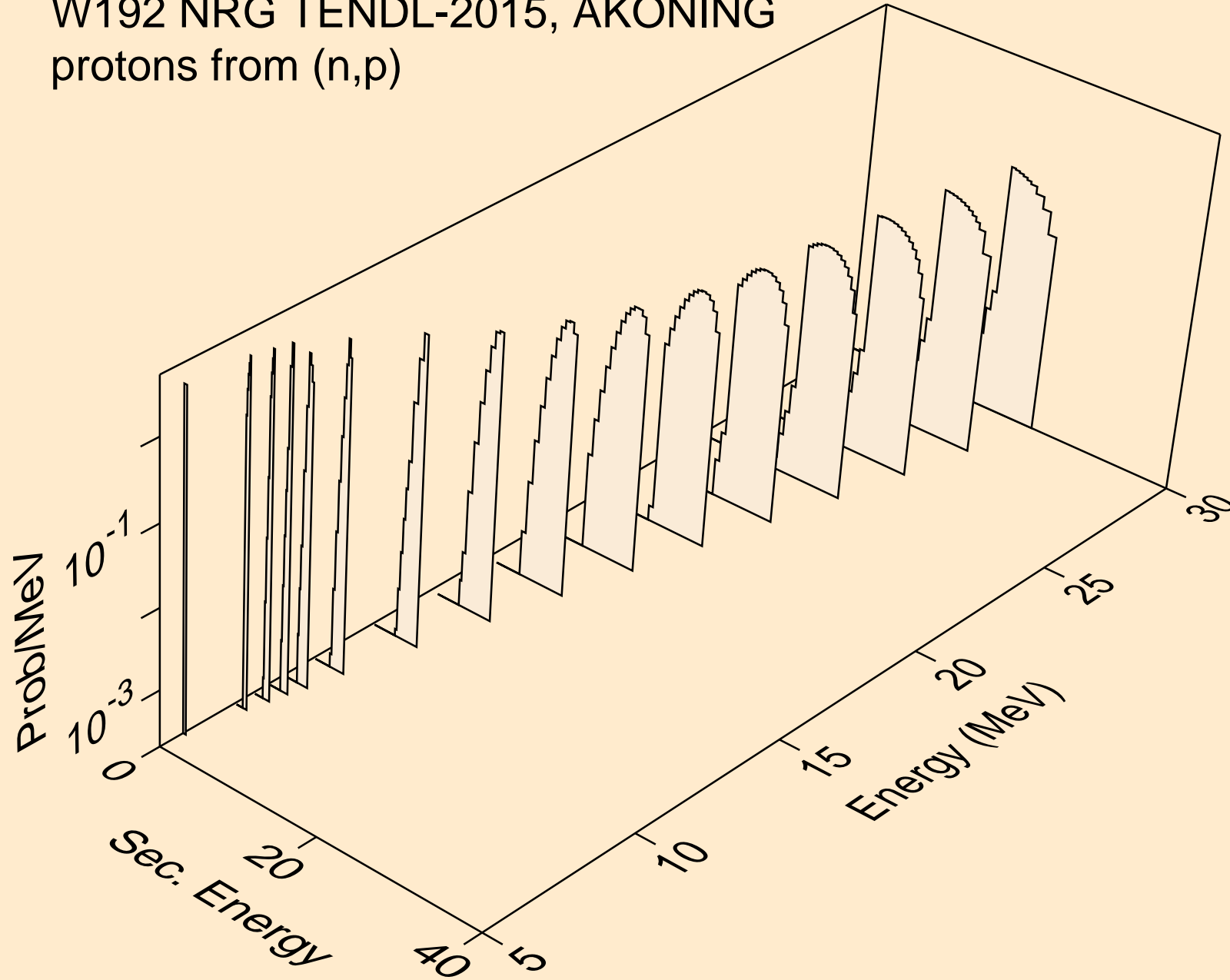

W192 NRG TENDL-2015, AKONING
deuterons from (n,x)

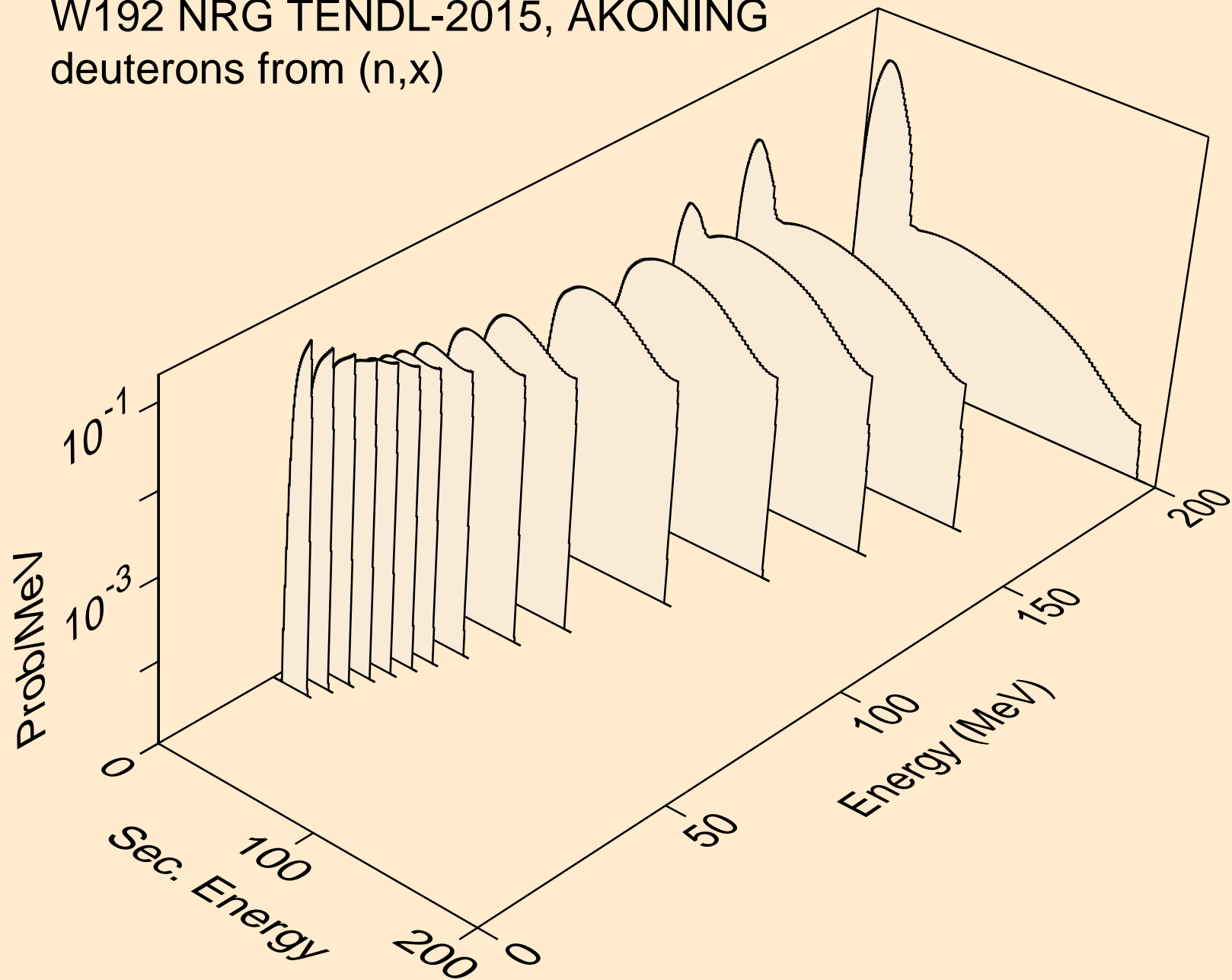

W192 NRG TENDL-2015, AKONING
deuterons from (n,2nd)

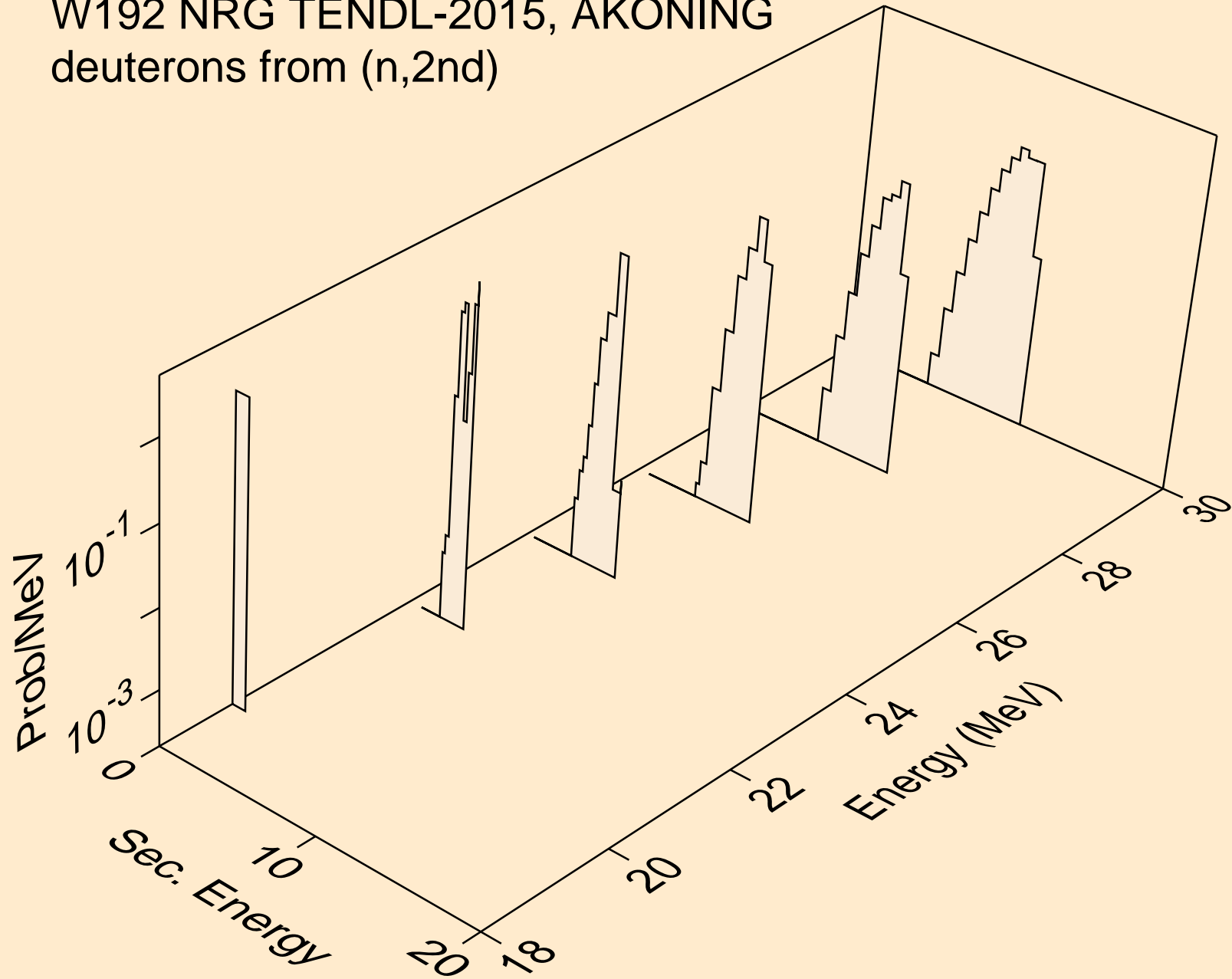

W192 NRG TENDL-2015, AKONING
deuterons from (n,n*)d

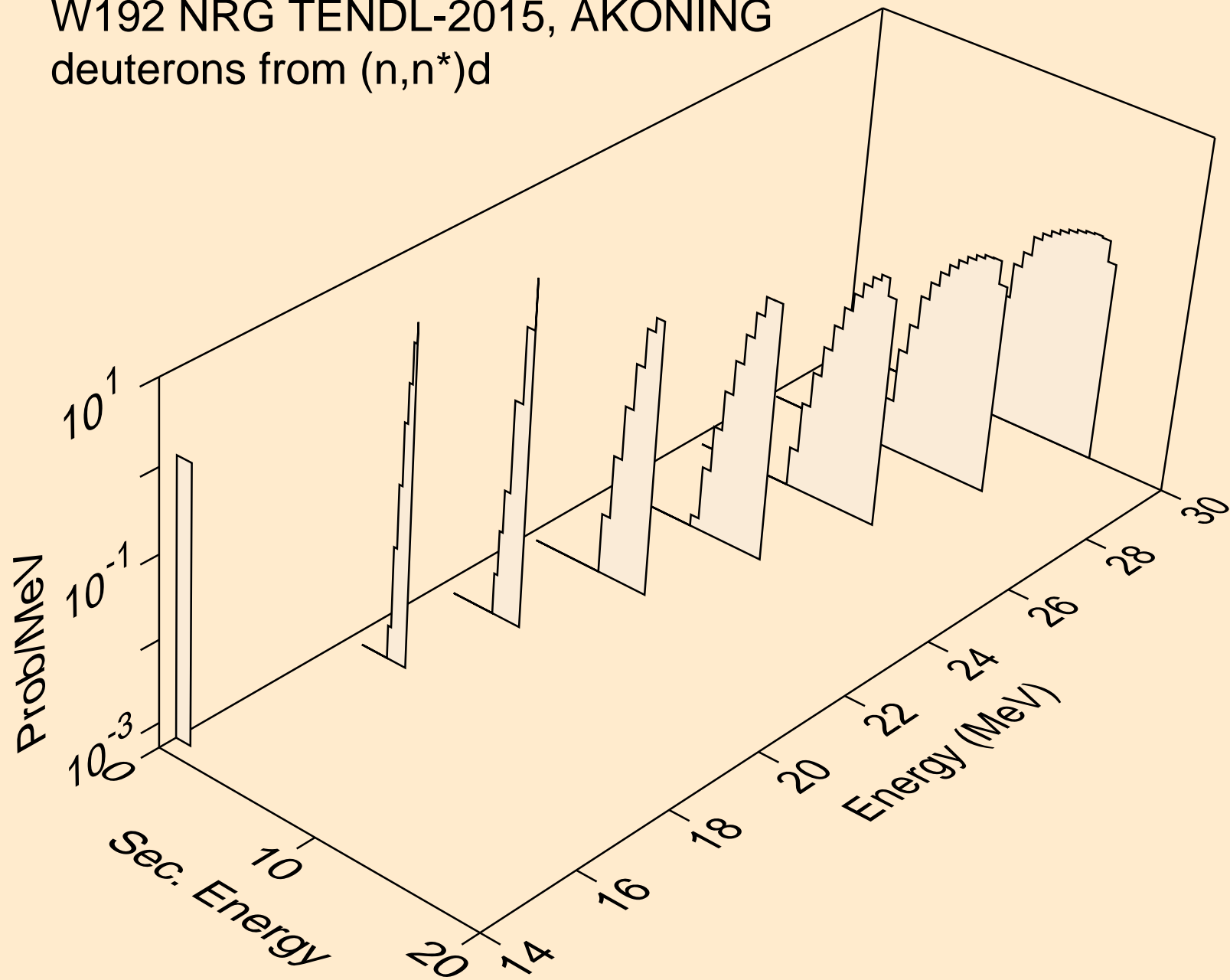

W192 NRG TENDL-2015, AKONING
deuterons from (n,d)

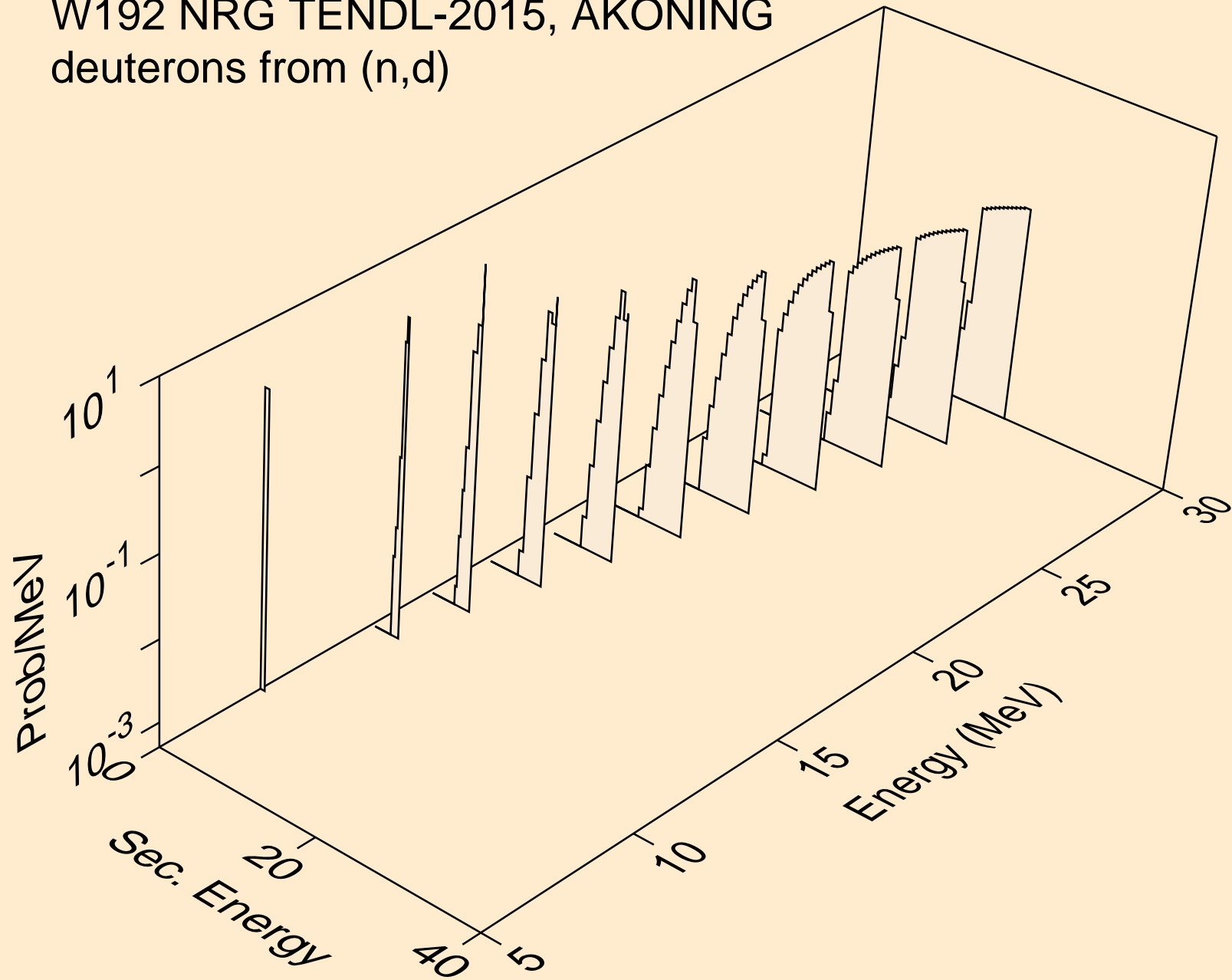

W192 NRG TENDL-2015, AKONING
tritons from (n,x)

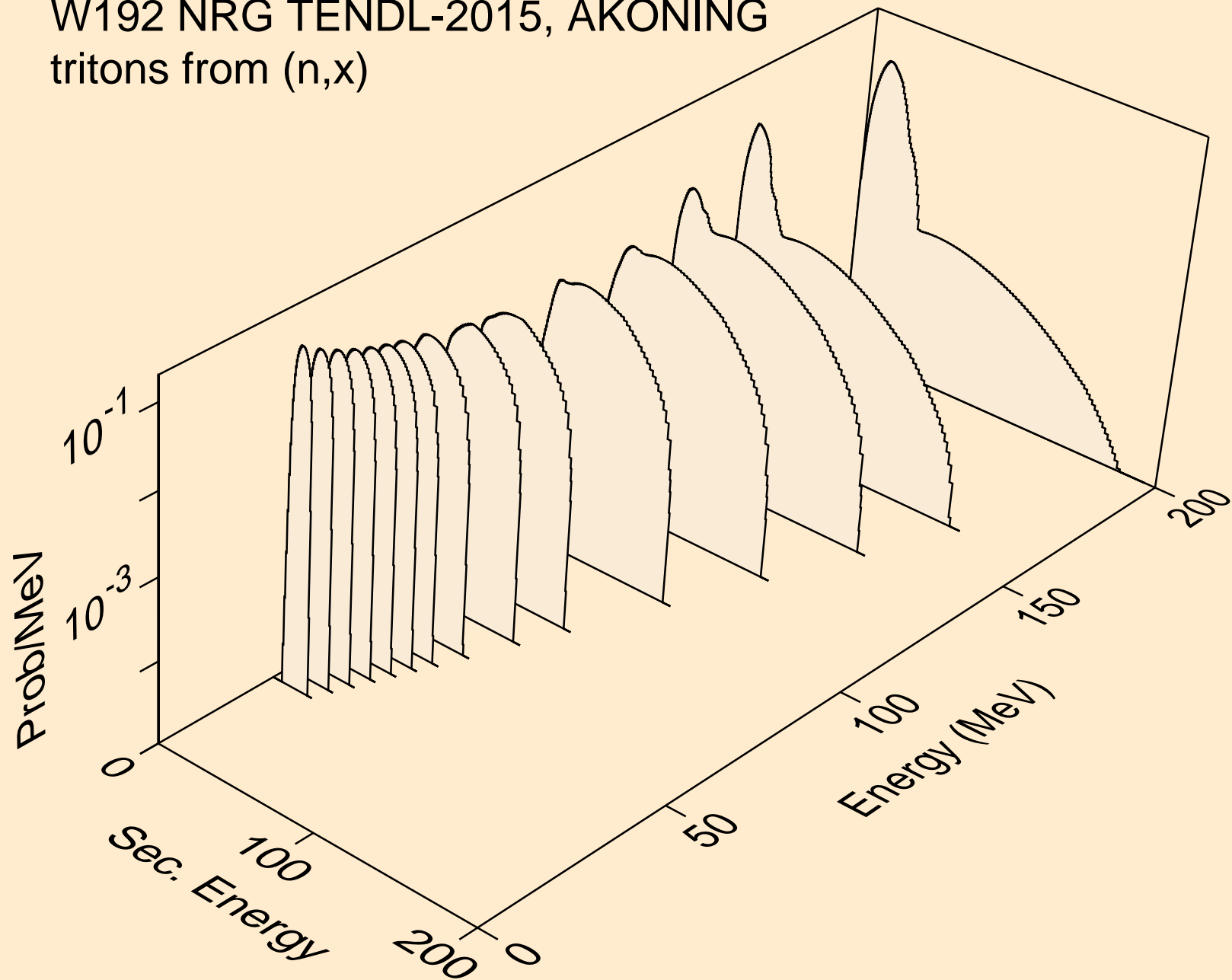

W192 NRG TENDL-2015, AKONING
tritons from (n,n*)t

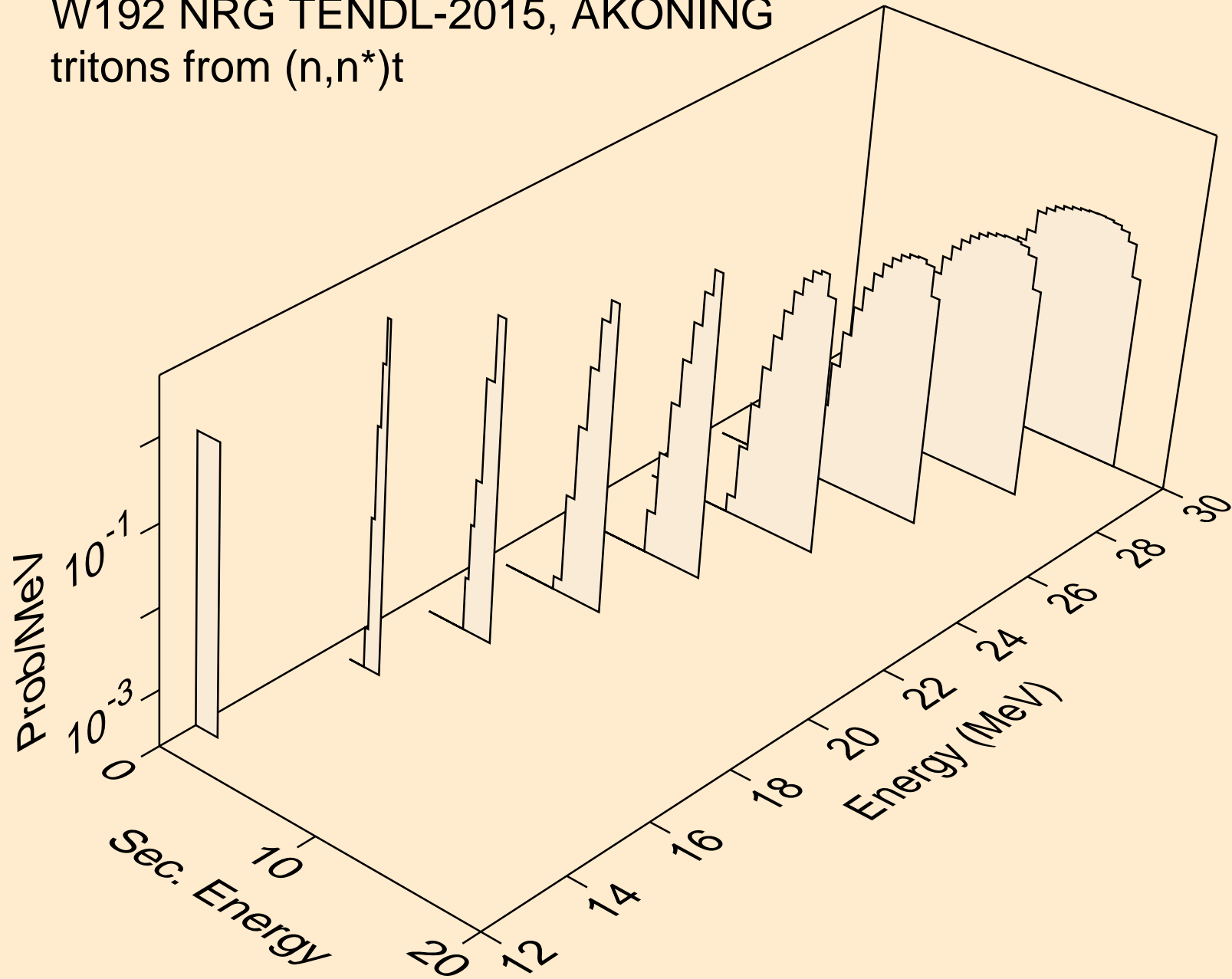

W192 NRG TENDL-2015, AKONING
tritons from (n,t)

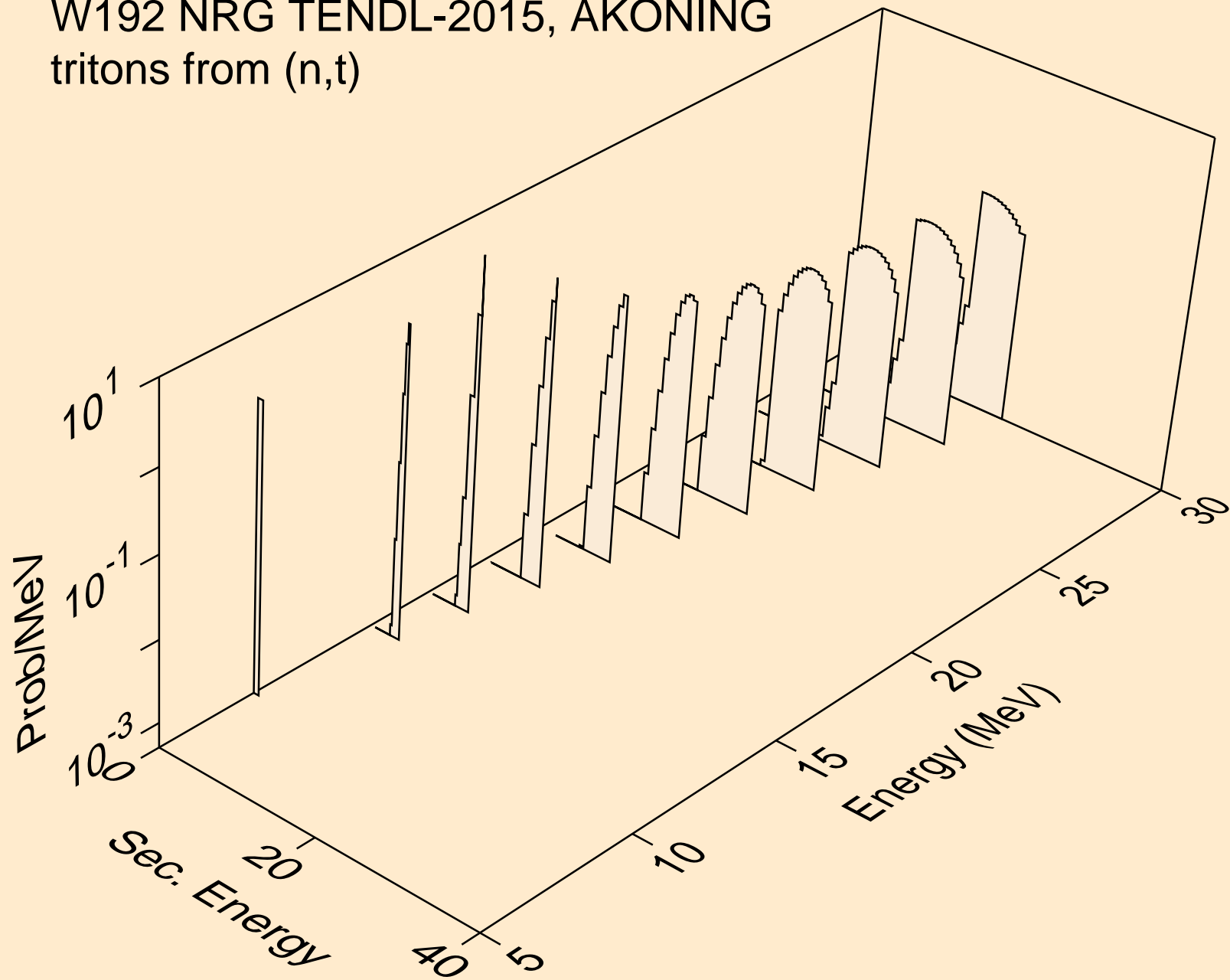

W192 NRG TENDL-2015, AKONING
he3s from (n,x)

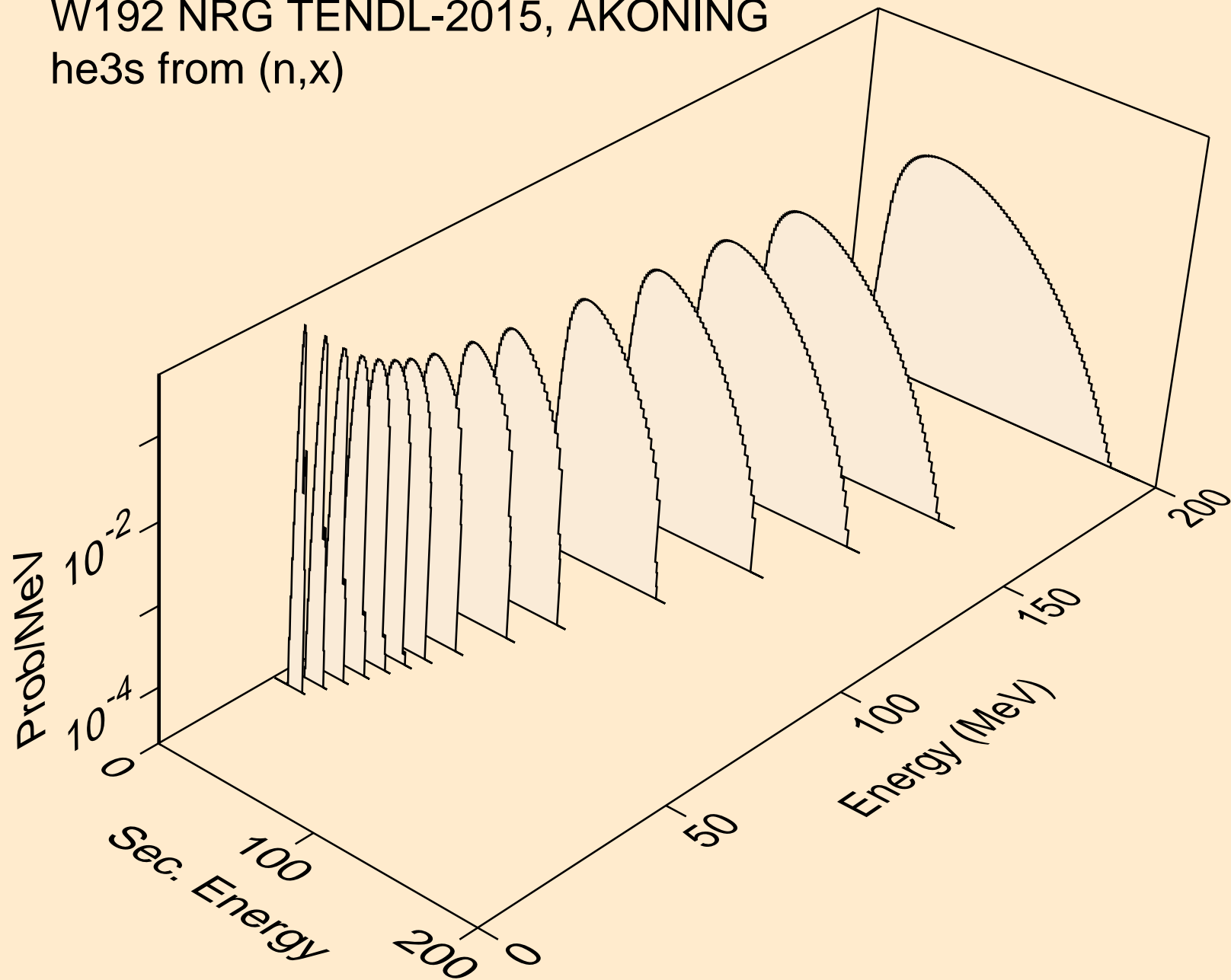

W192 NRG TENDL-2015, AKONING
he3s from (n,n*)he3

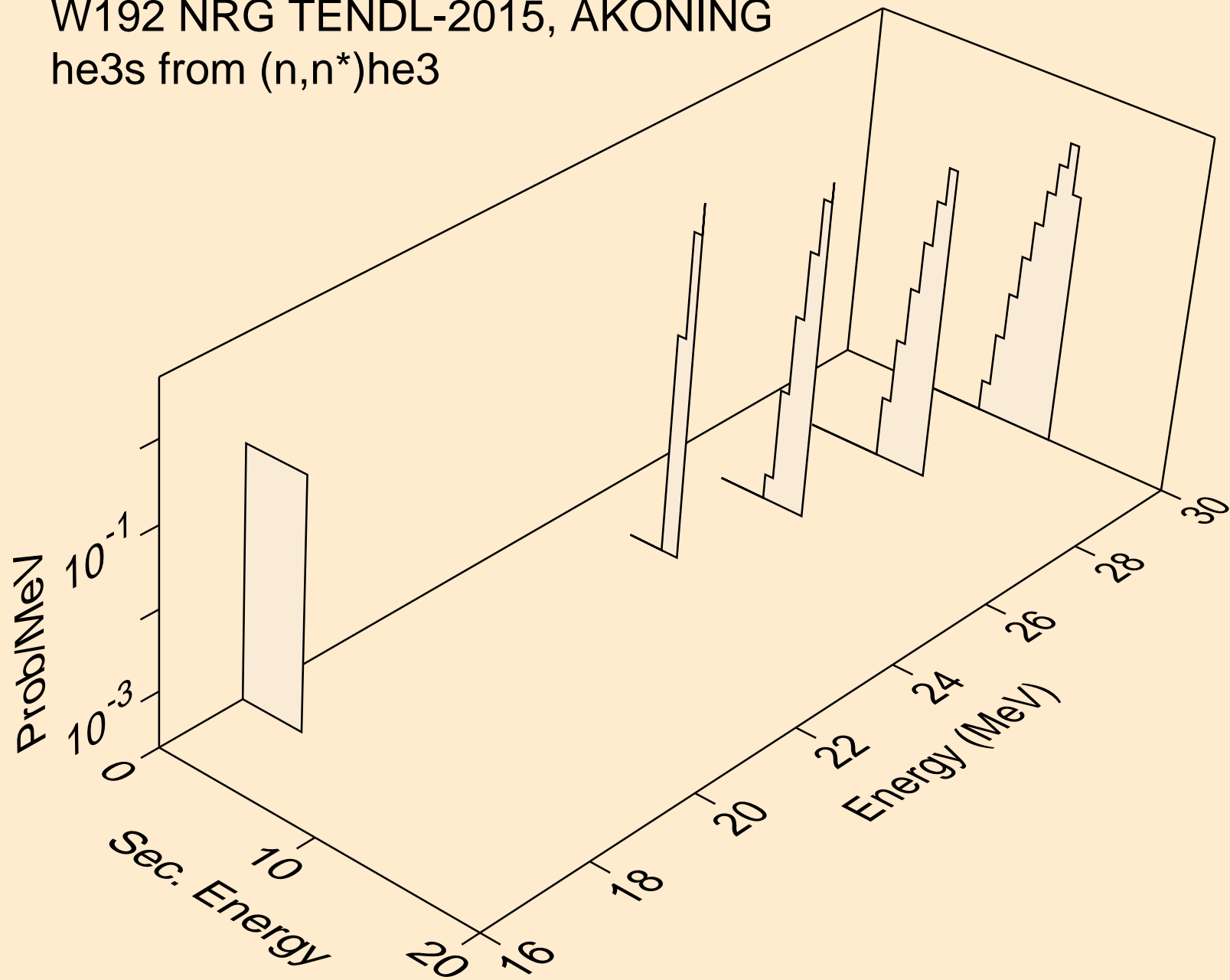

W192 NRG TENDL-2015, AKONING
he3s from (n,he3)

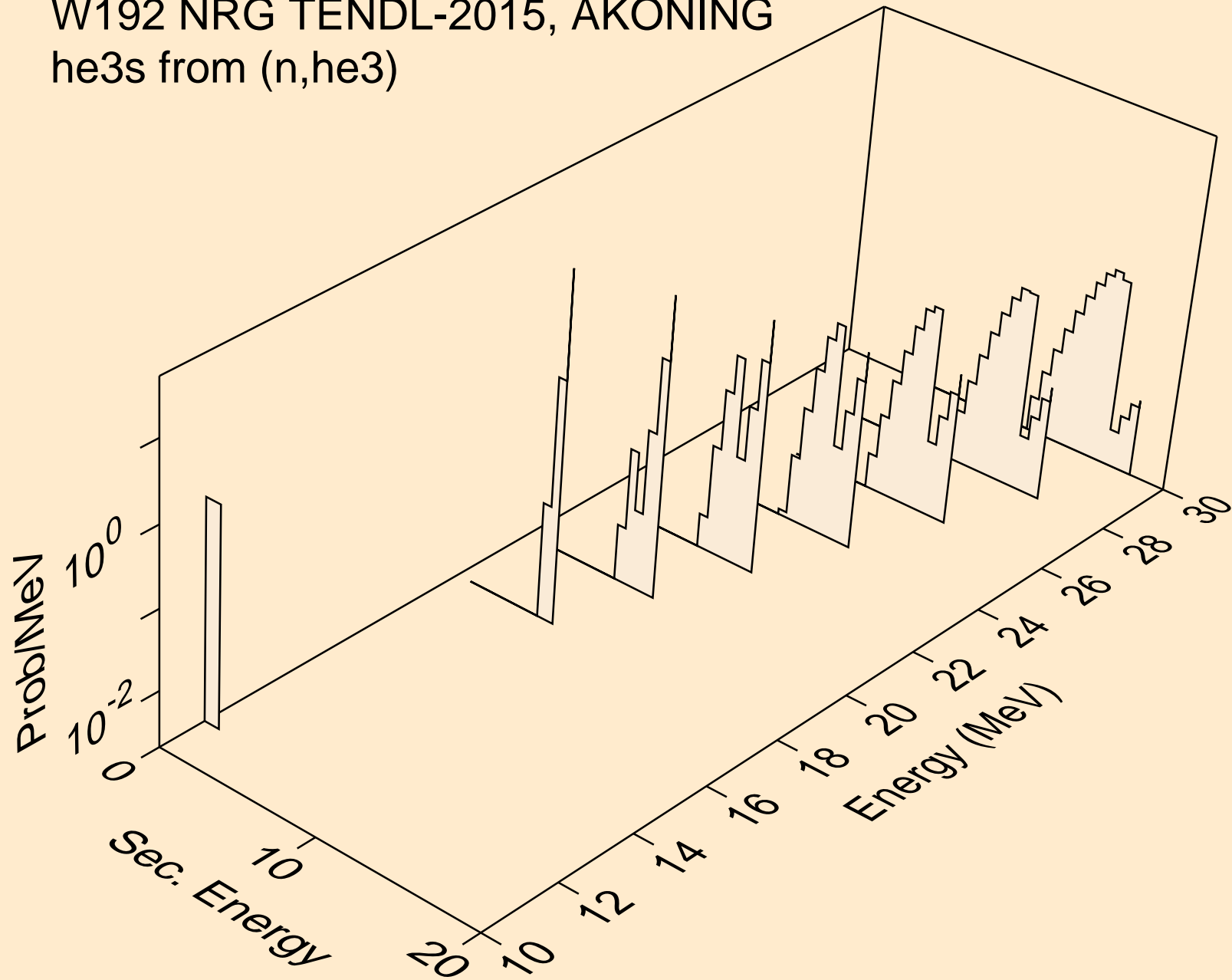

W192 NRG TENDL-2015, AKONING
alphas from (n,x)

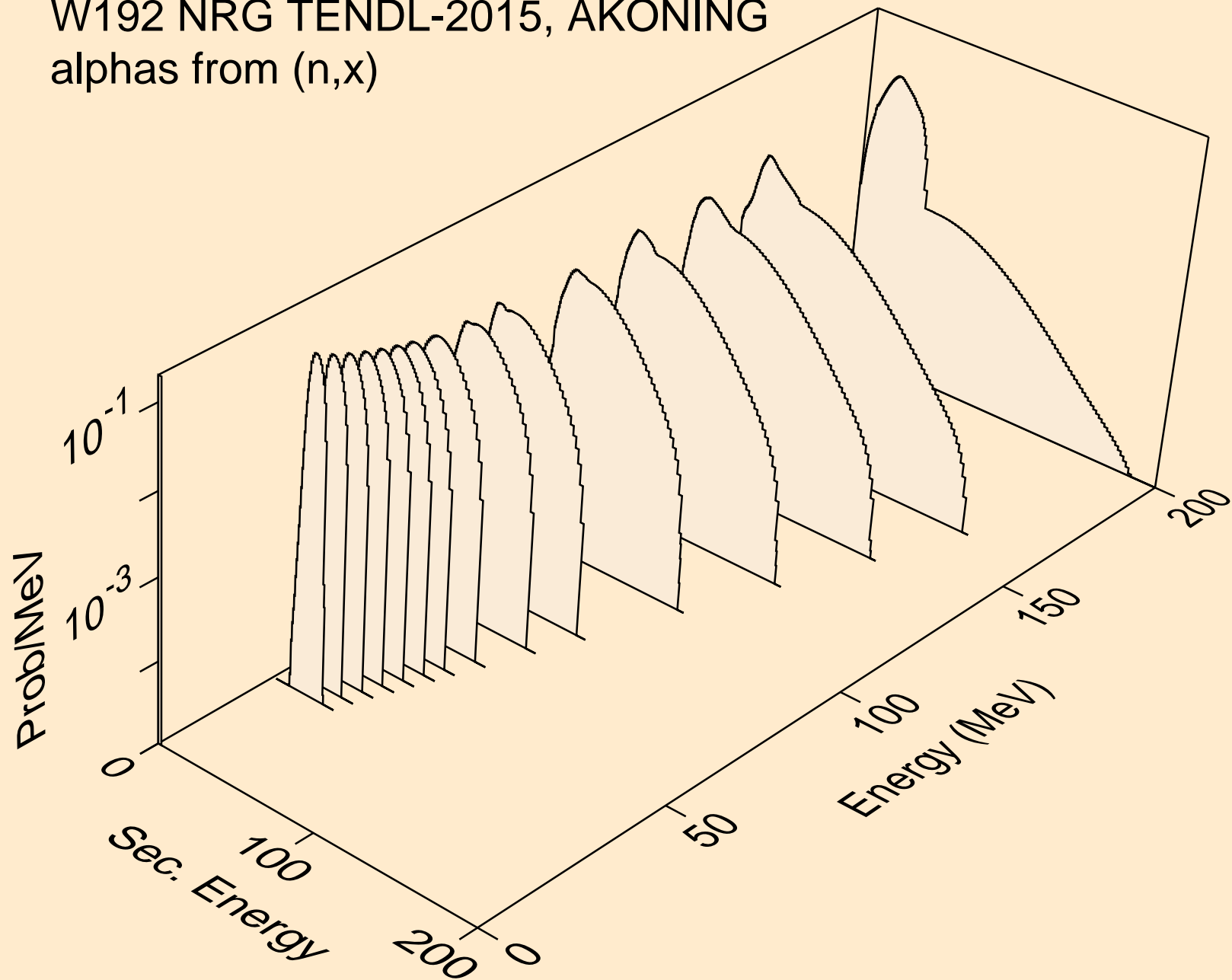

W192 NRG TENDL-2015, AKONING
alphas from (n,n*)a

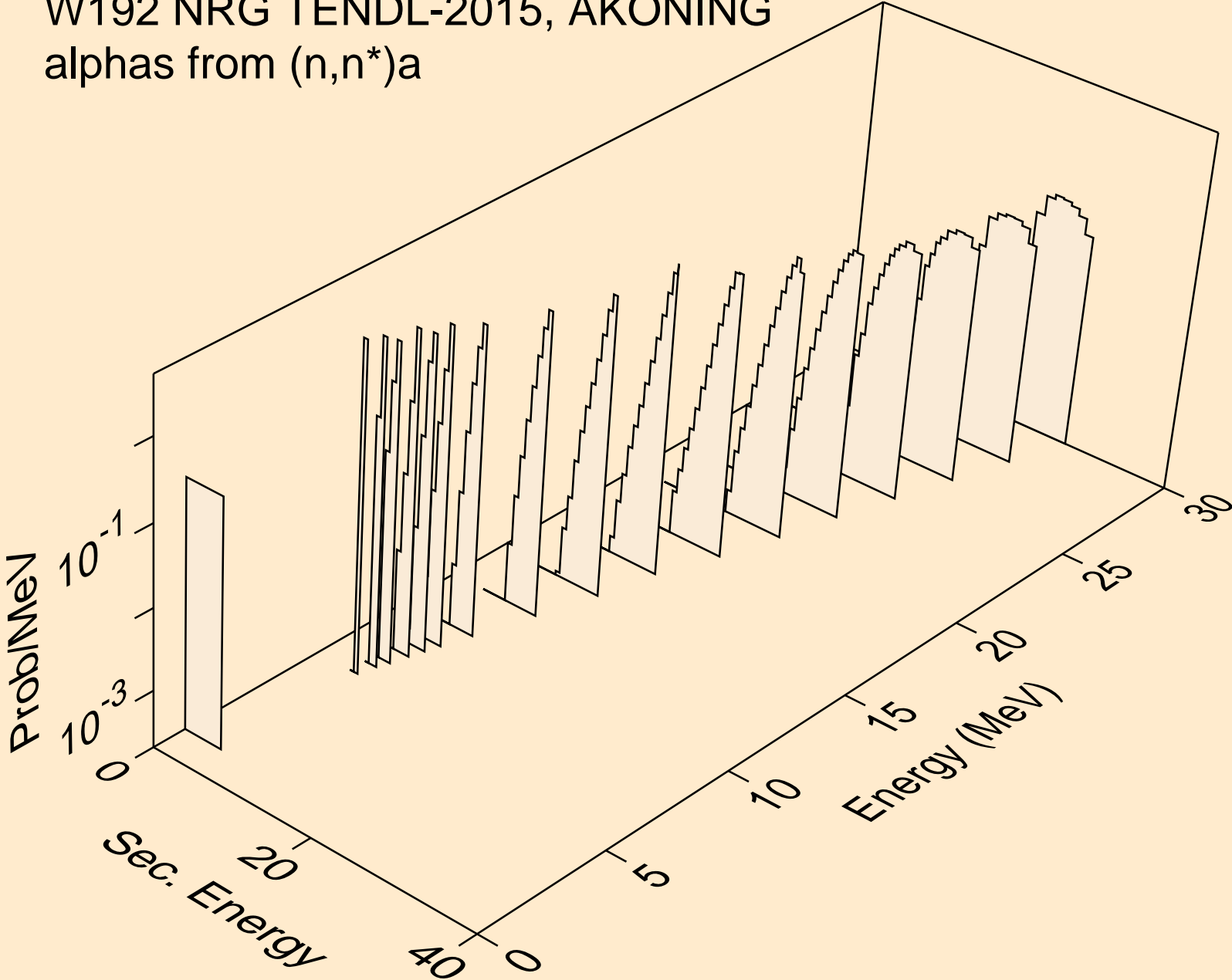

W192 NRG TENDL-2015, AKONING
alphas from (n,2n)a

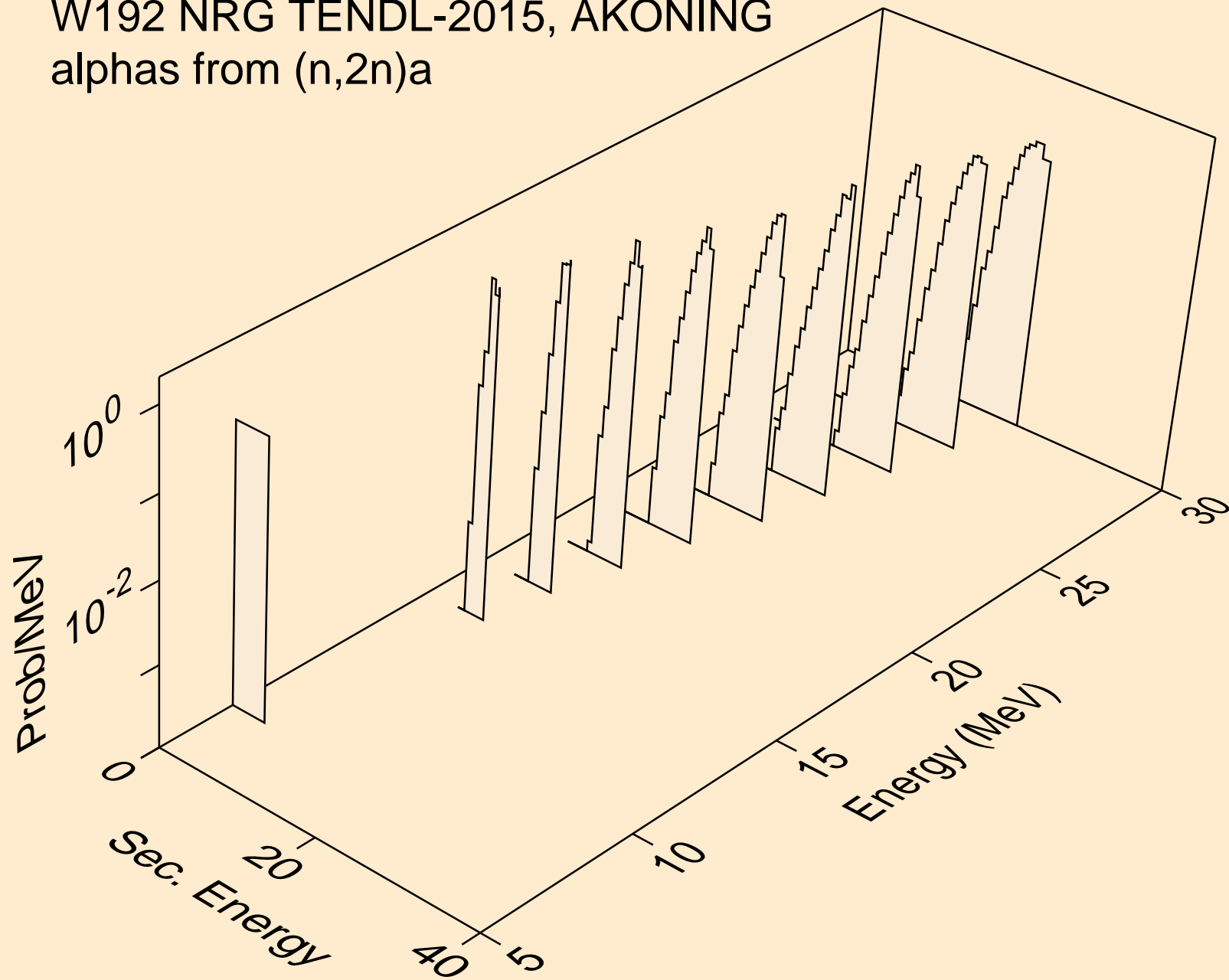

W192 NRG TENDL-2015, AKONING
alphas from (n,3n)a

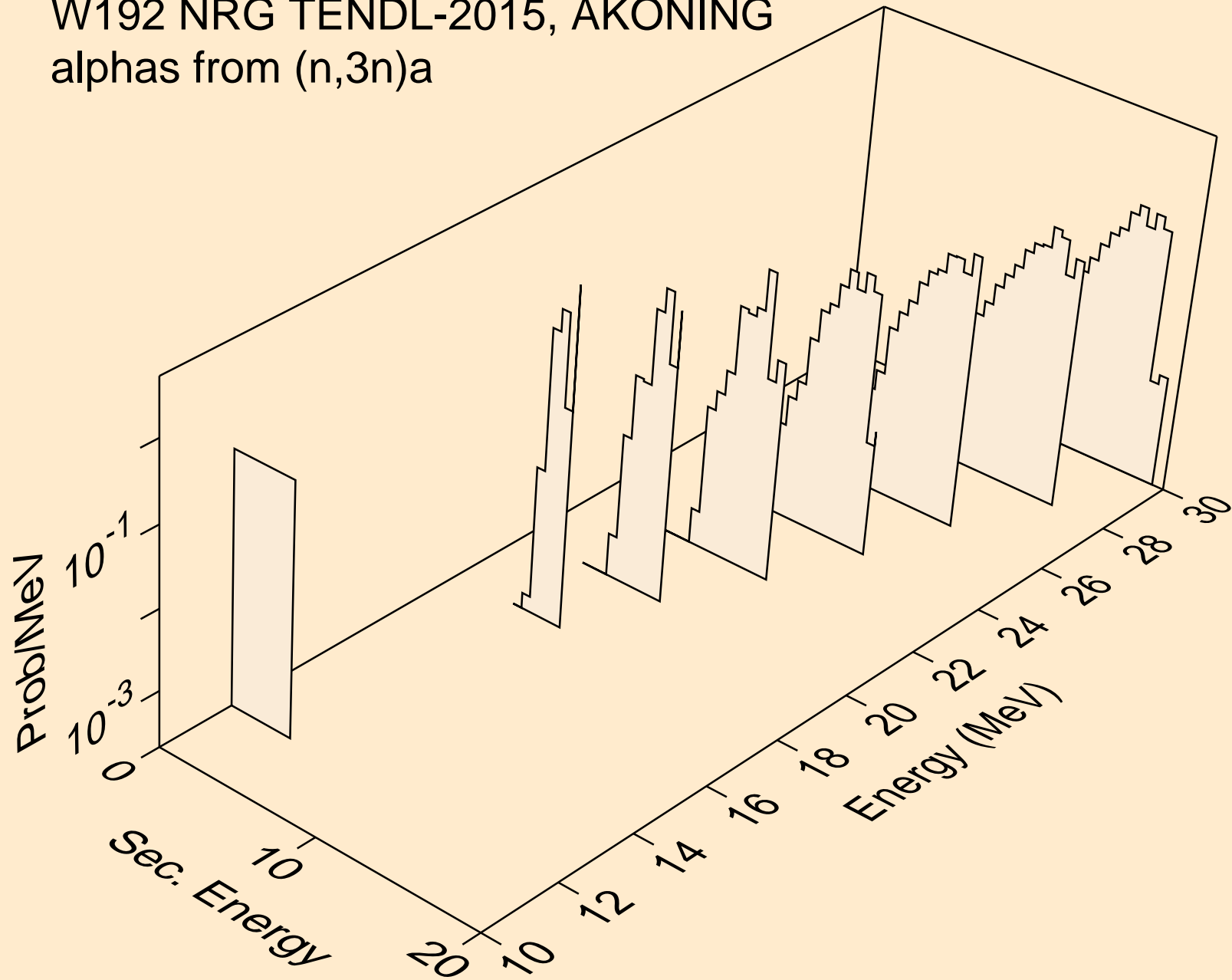

W192 NRG TENDL-2015, AKONING
alphas from (n,a)

