

XE113 NRG TENDL-2015, AKONING

Principal cross sections

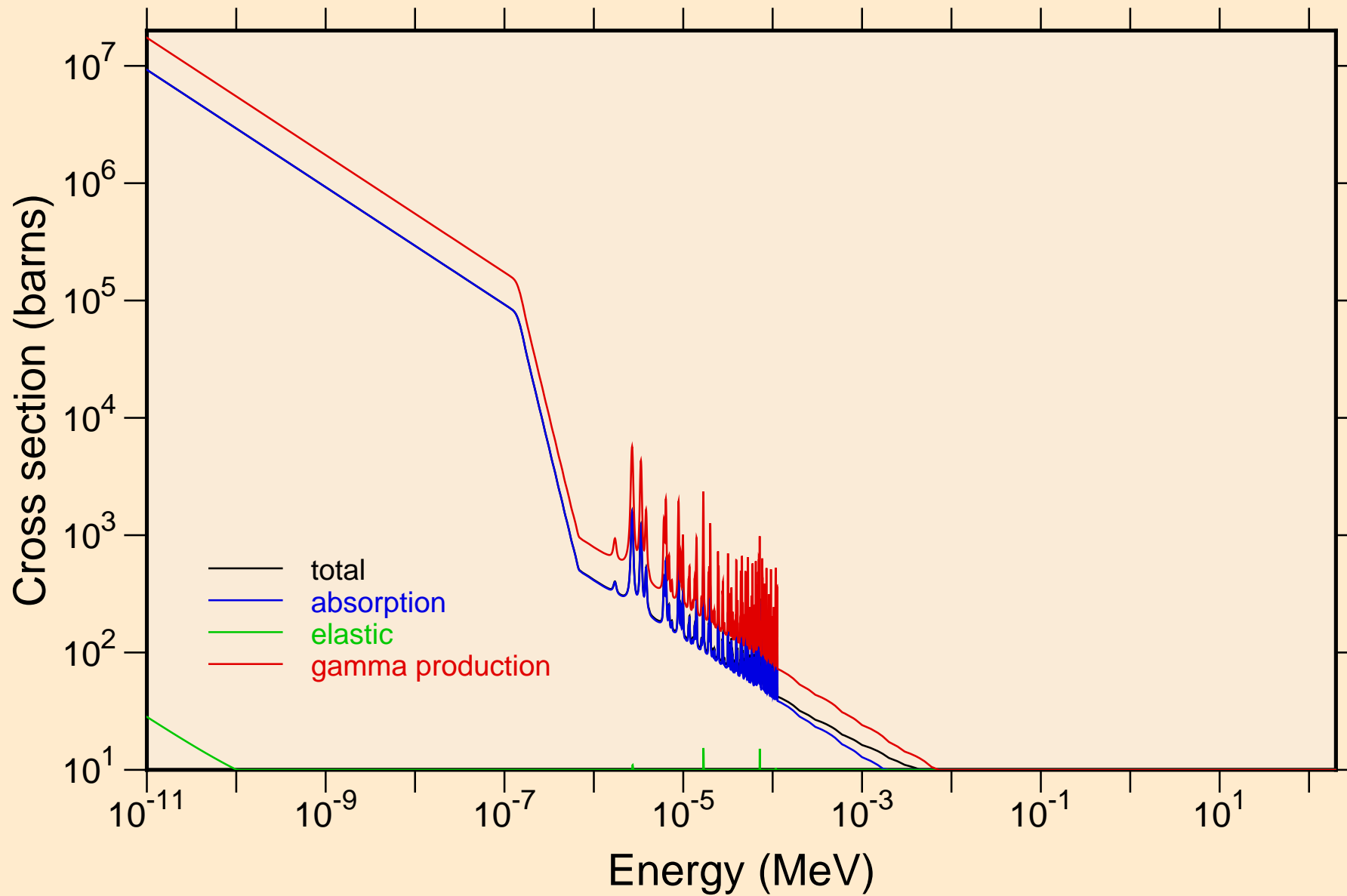

XE113 NRG TENDL-2015, AKONING
resonance total cross section

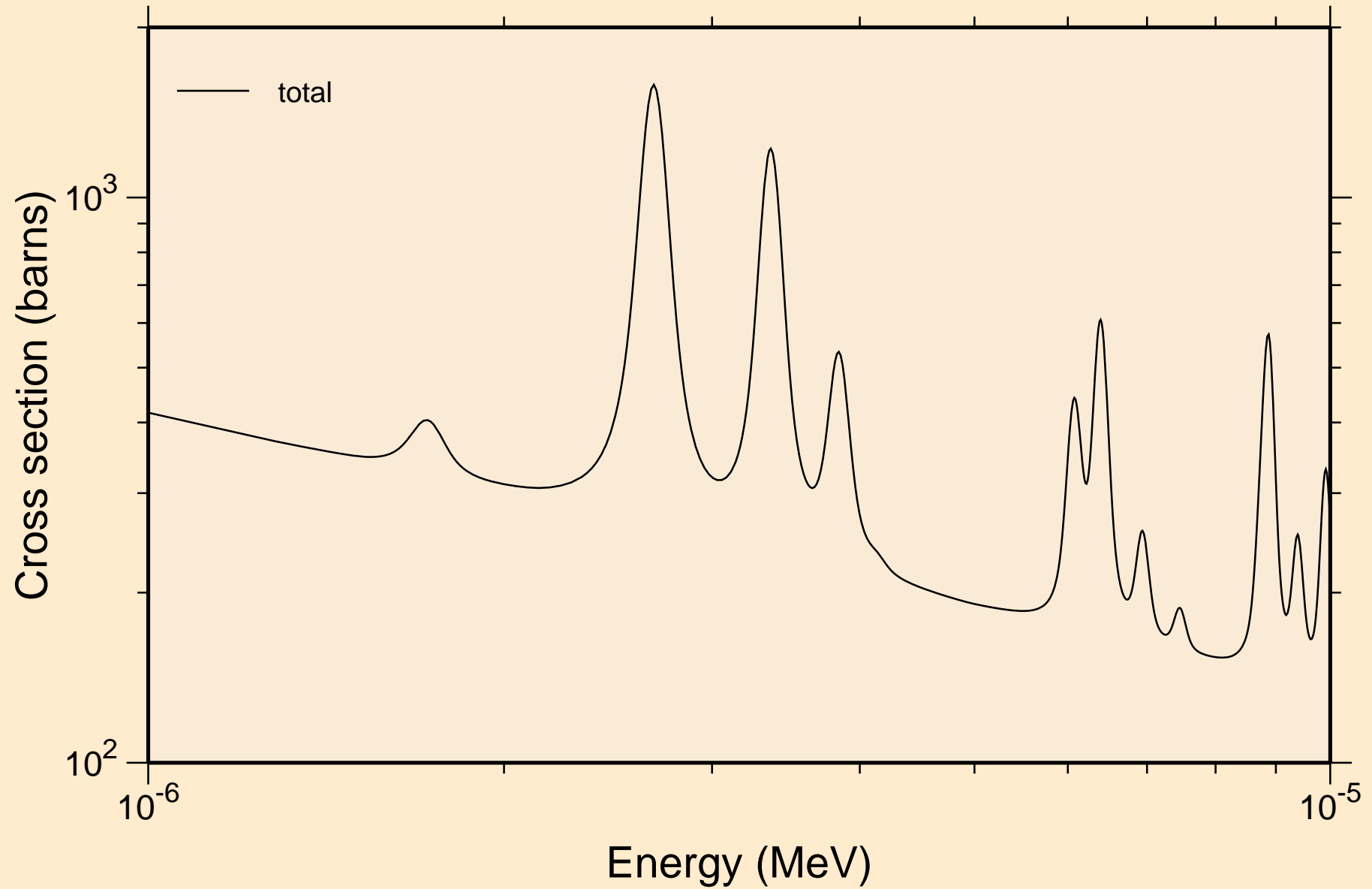

XE113 NRG TENDL-2015, AKONING
resonance total cross section

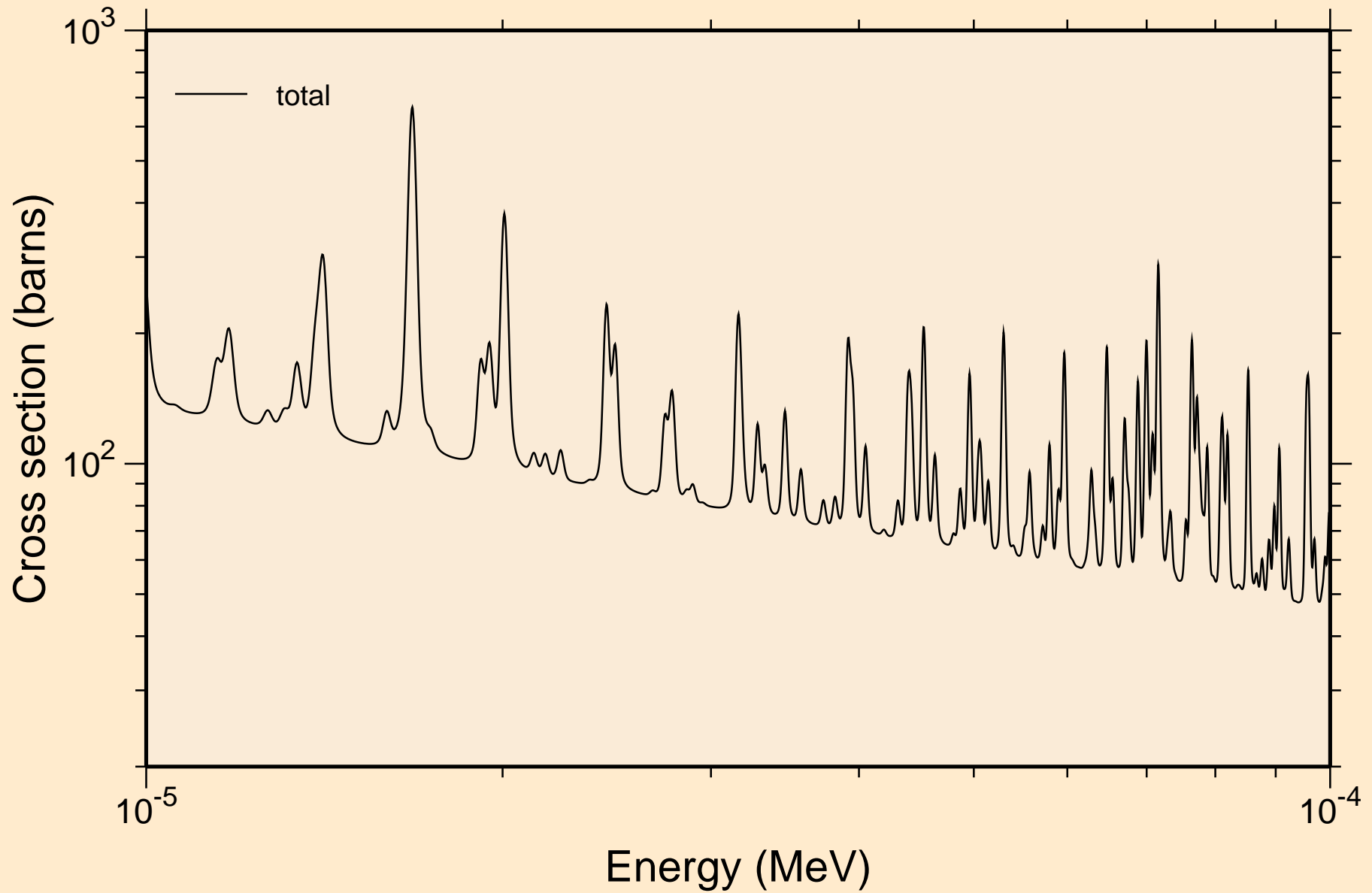

XE113 NRG TENDL-2015, AKONING
resonance total cross section

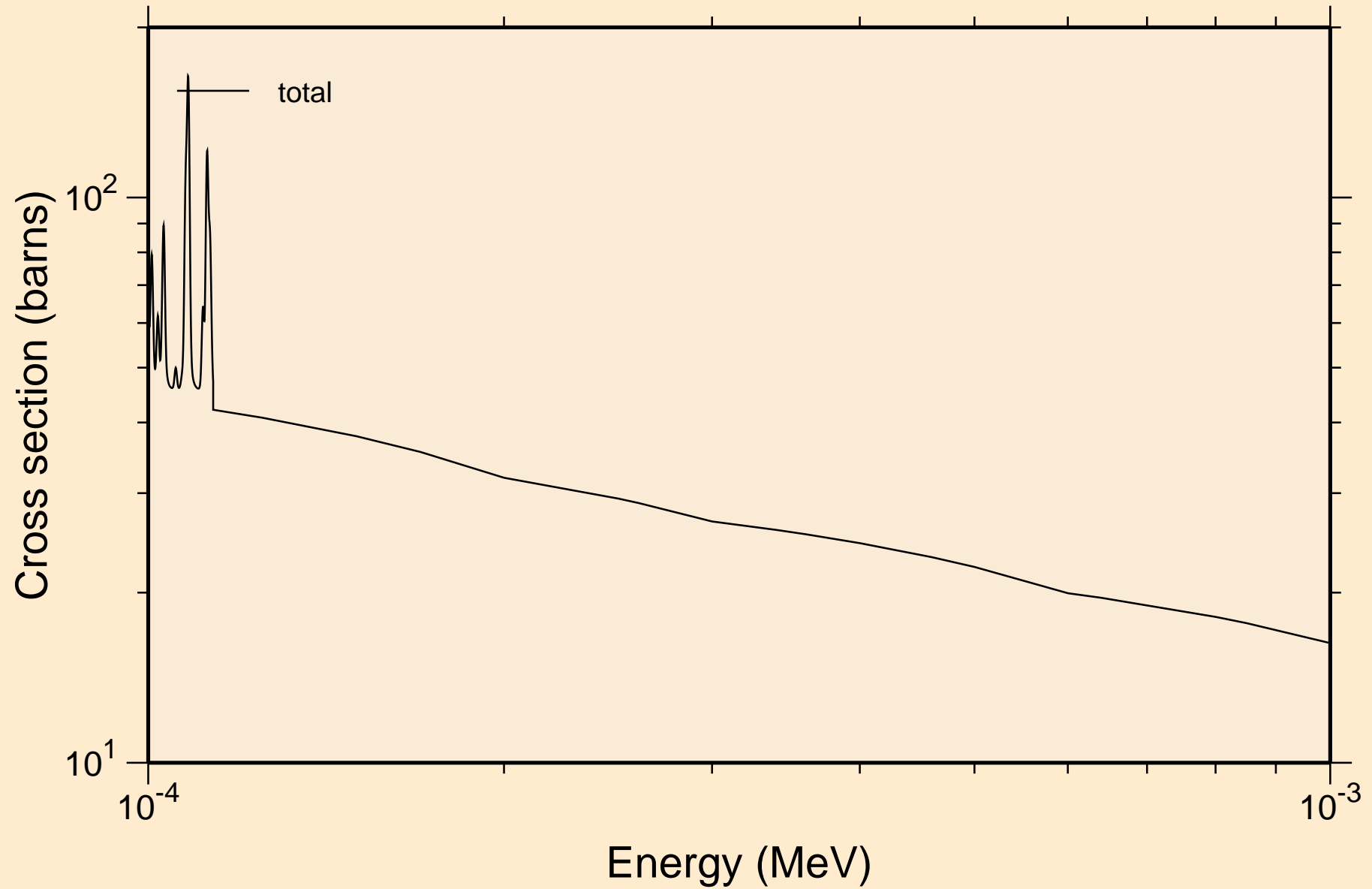

XE113 NRG TENDL-2015, AKONING
resonance total cross section

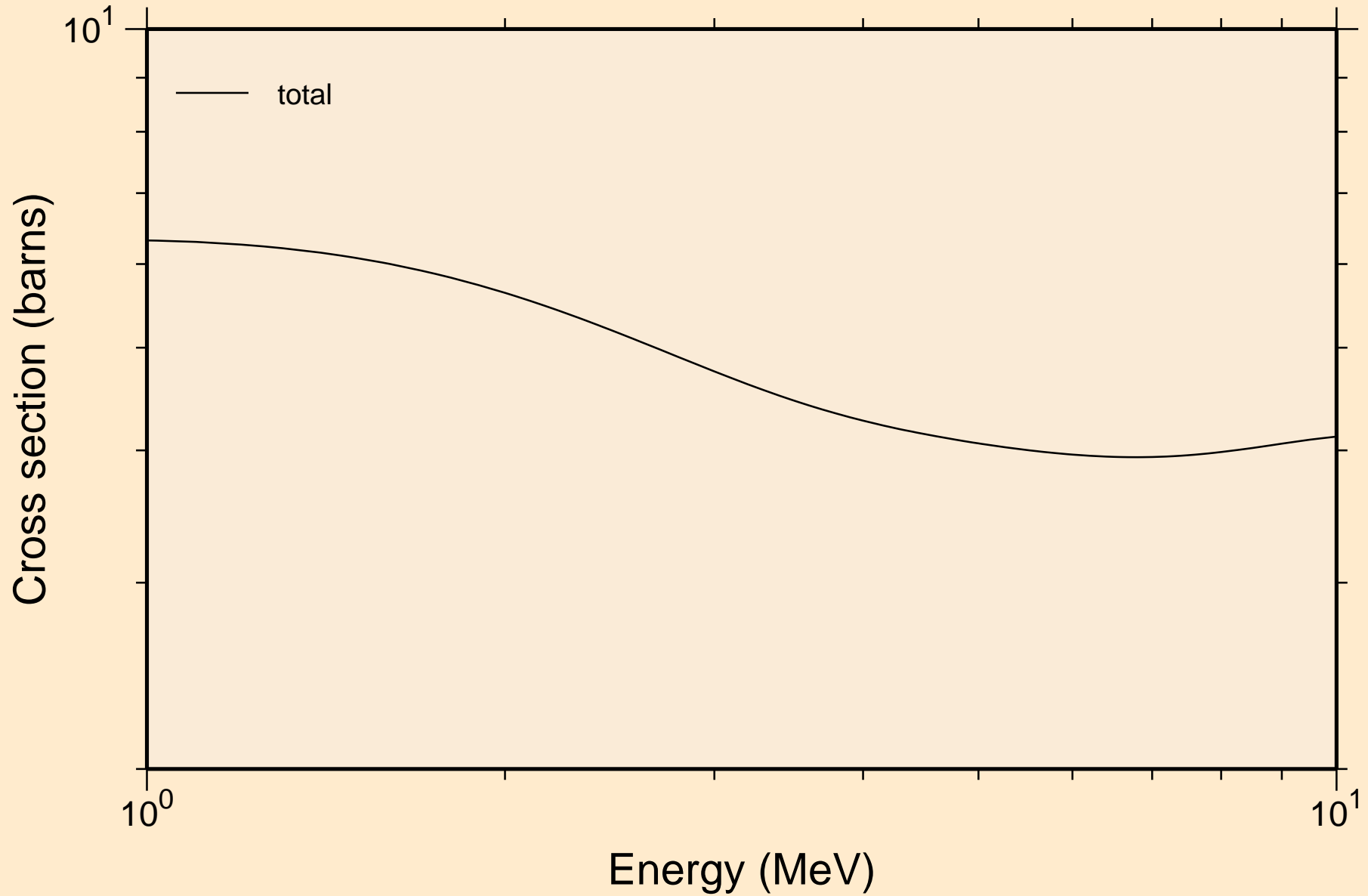

XE113 NRG TENDL-2015, AKONING
resonance absorption cross sections

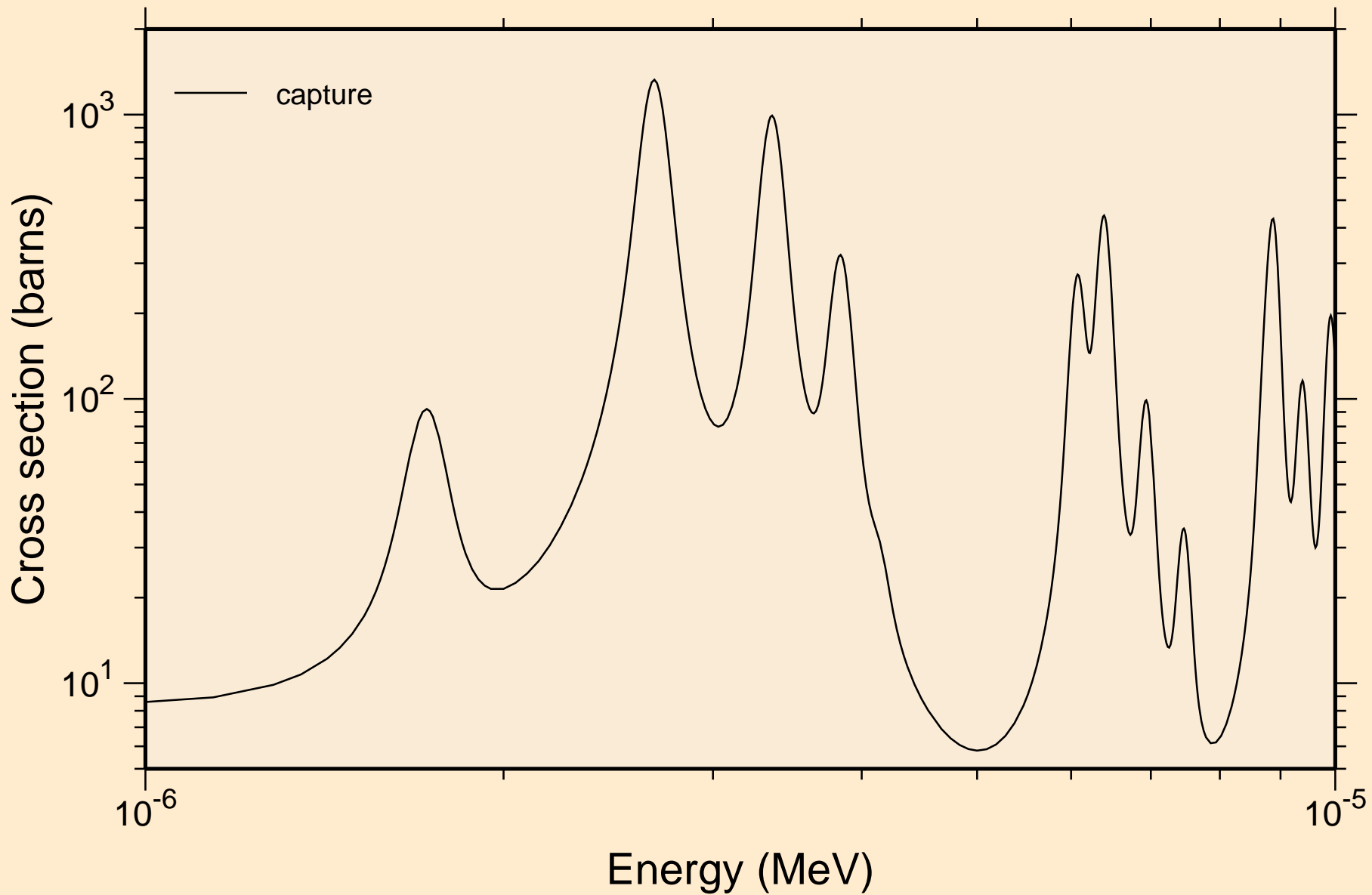

XE113 NRG TENDL-2015, AKONING
resonance absorption cross sections

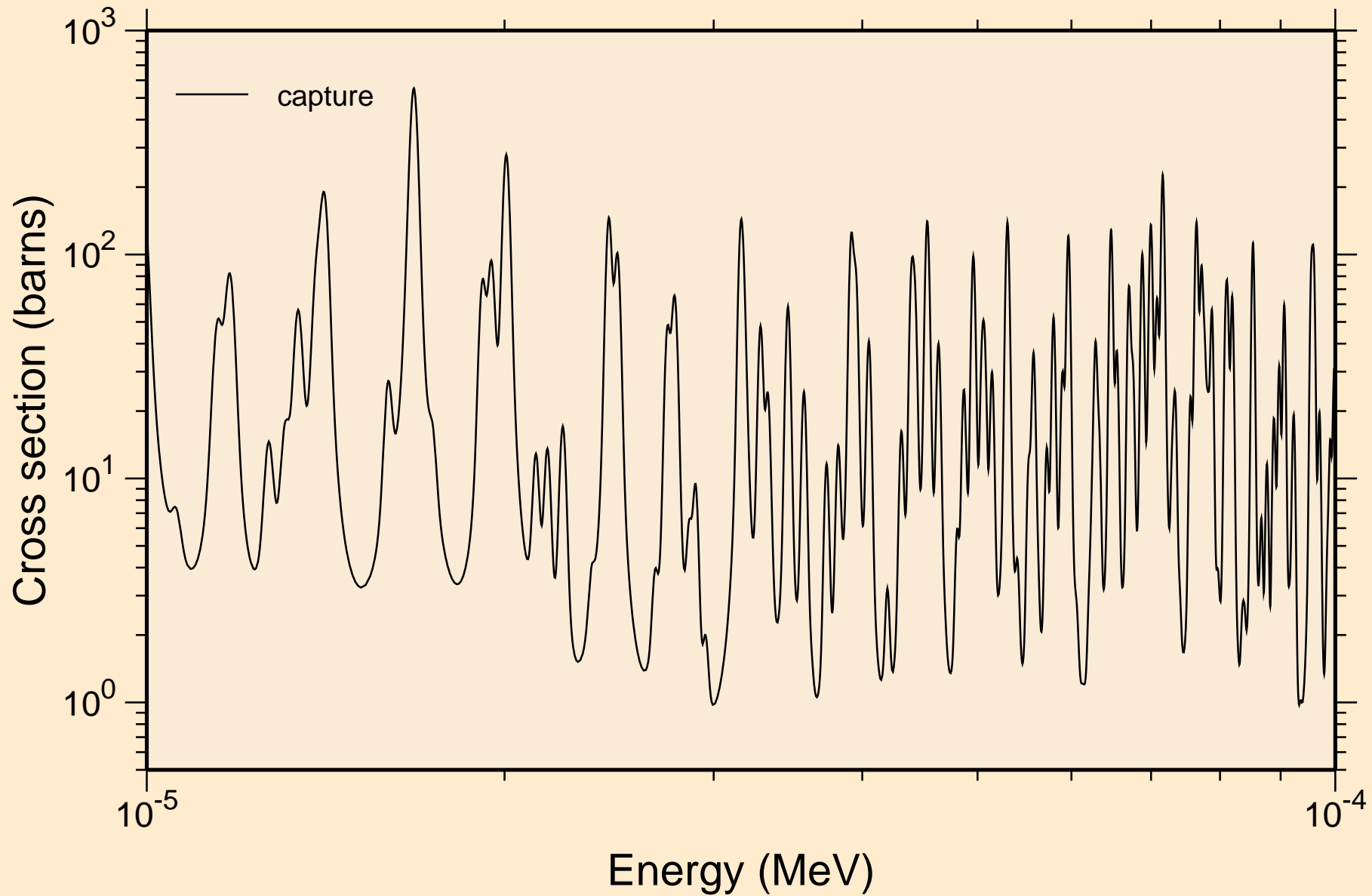

XE113 NRG TENDL-2015, AKONING resonance absorption cross sections

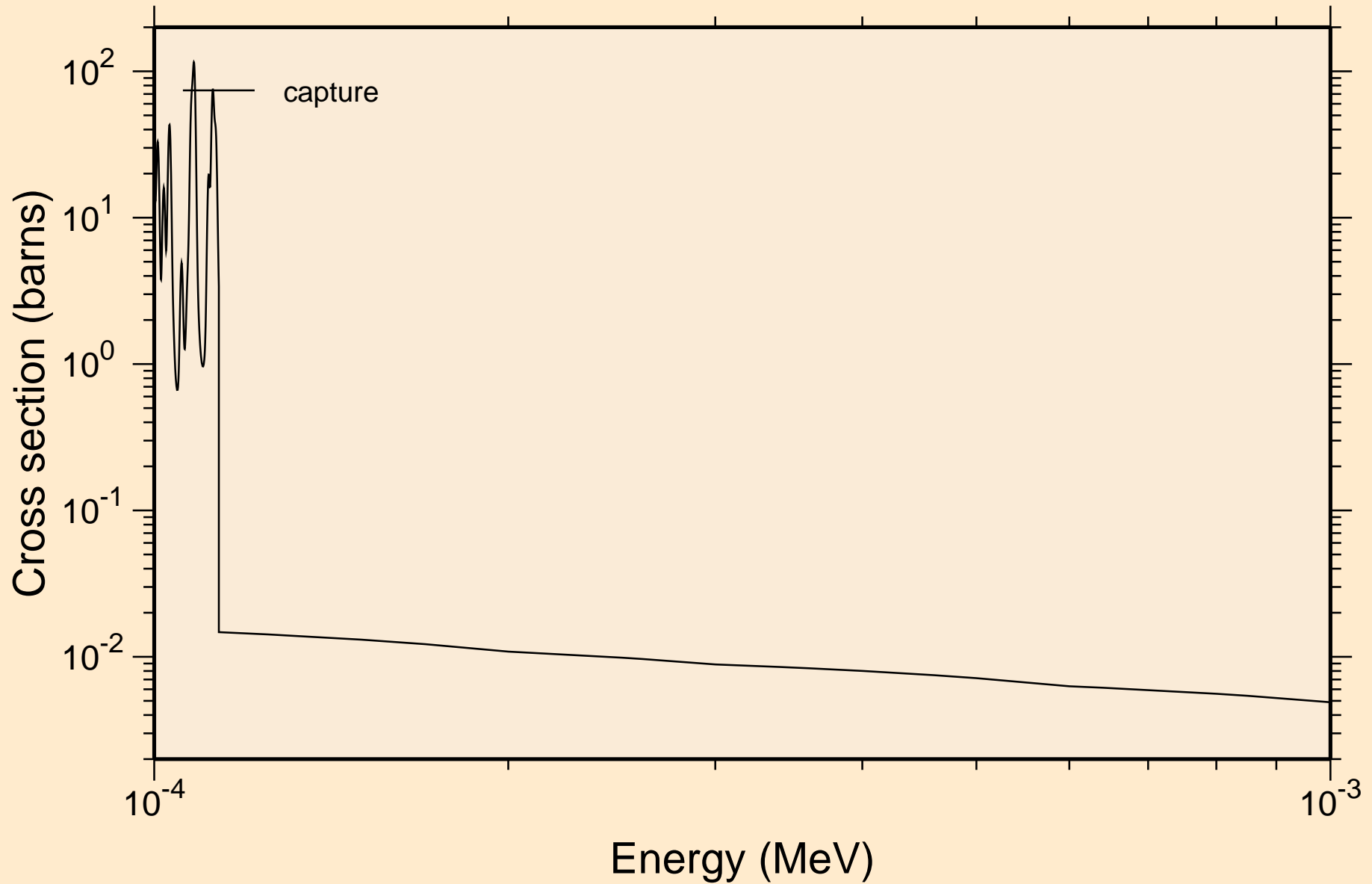

XE113 NRG TENDL-2015, AKONING resonance absorption cross sections

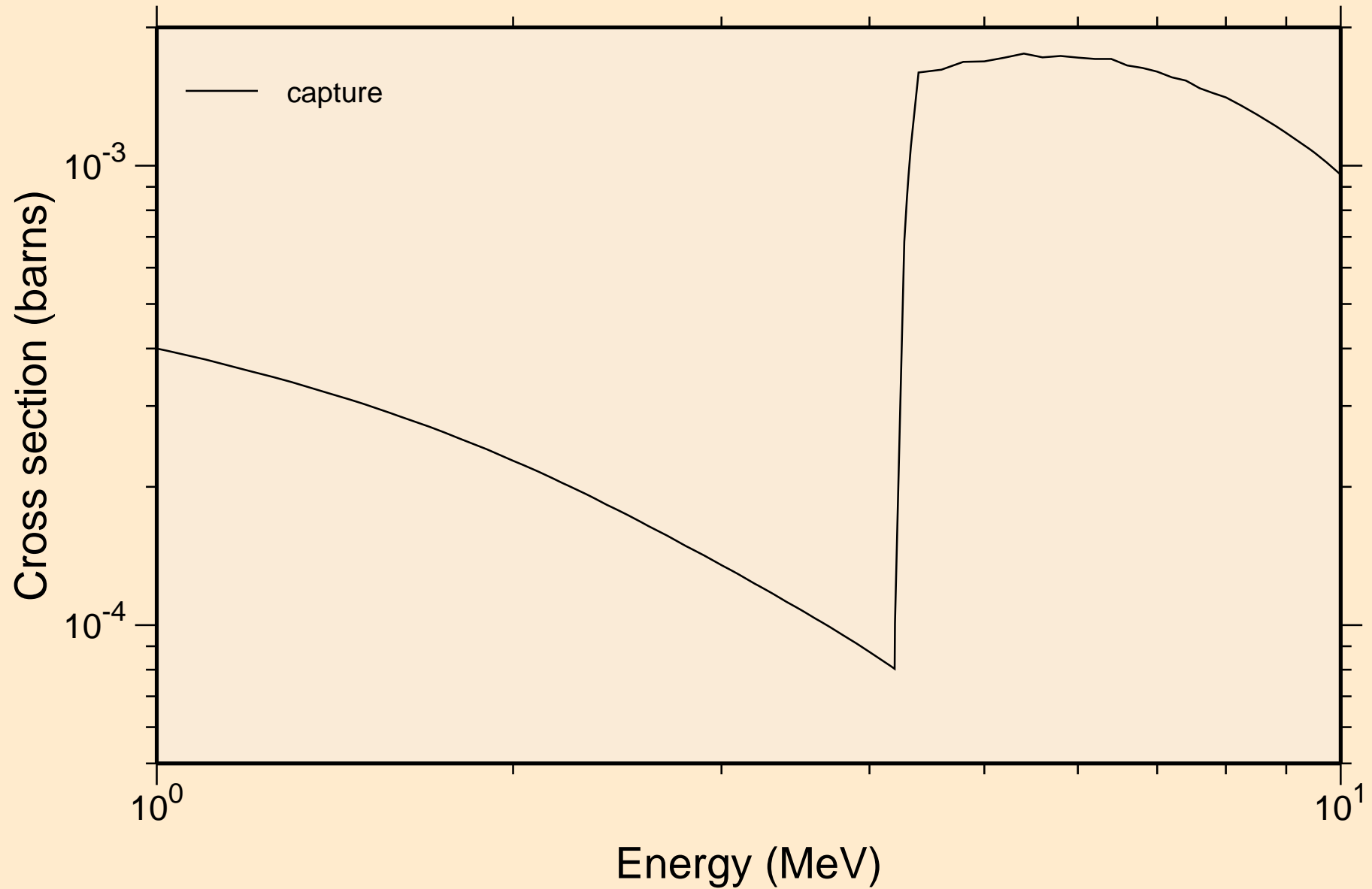

XE113 NRG TENDL-2015, AKONING

Non-threshold reactions

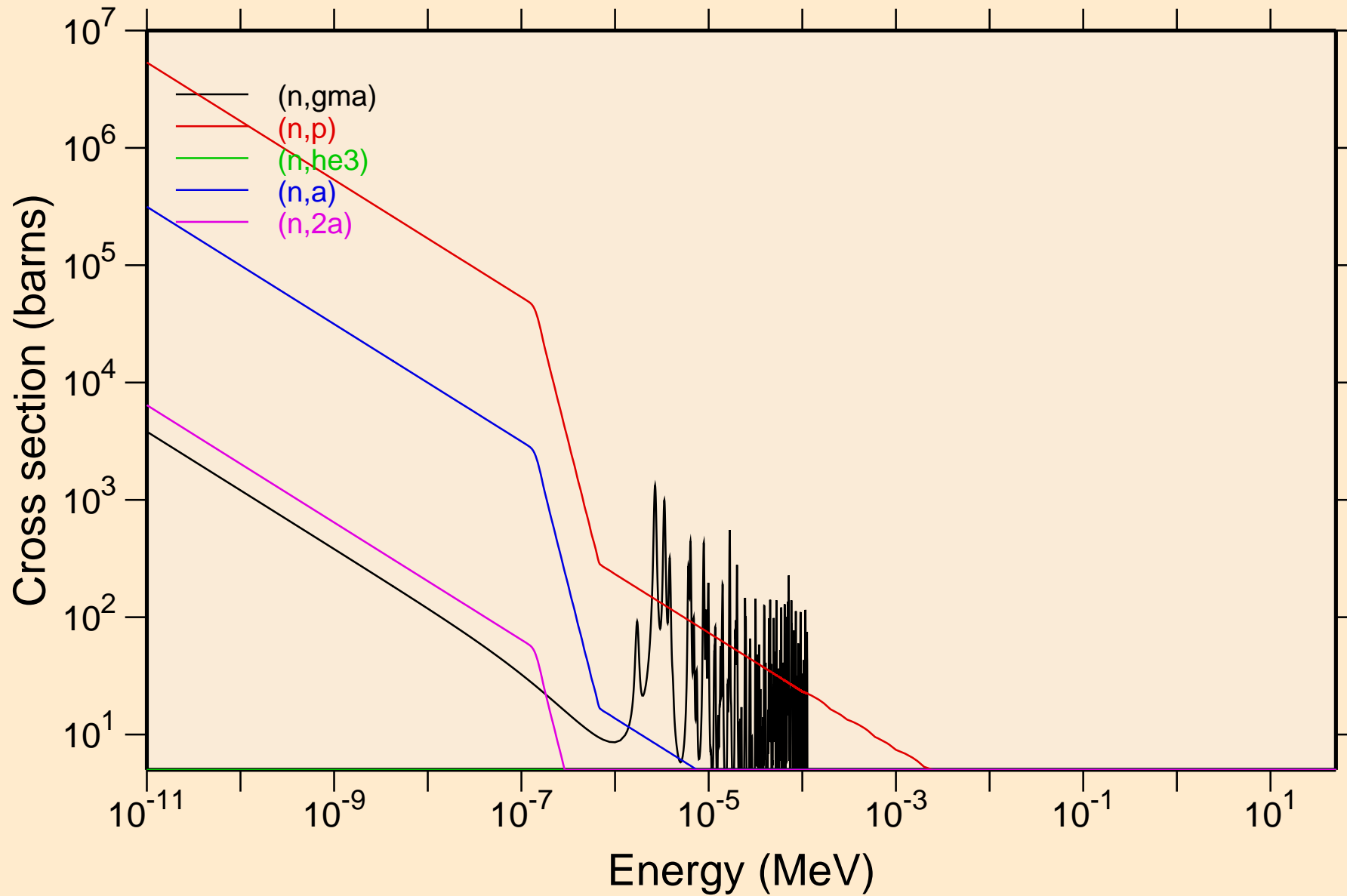

XE113 NRG TENDL-2015, AKONING

Non-threshold reactions

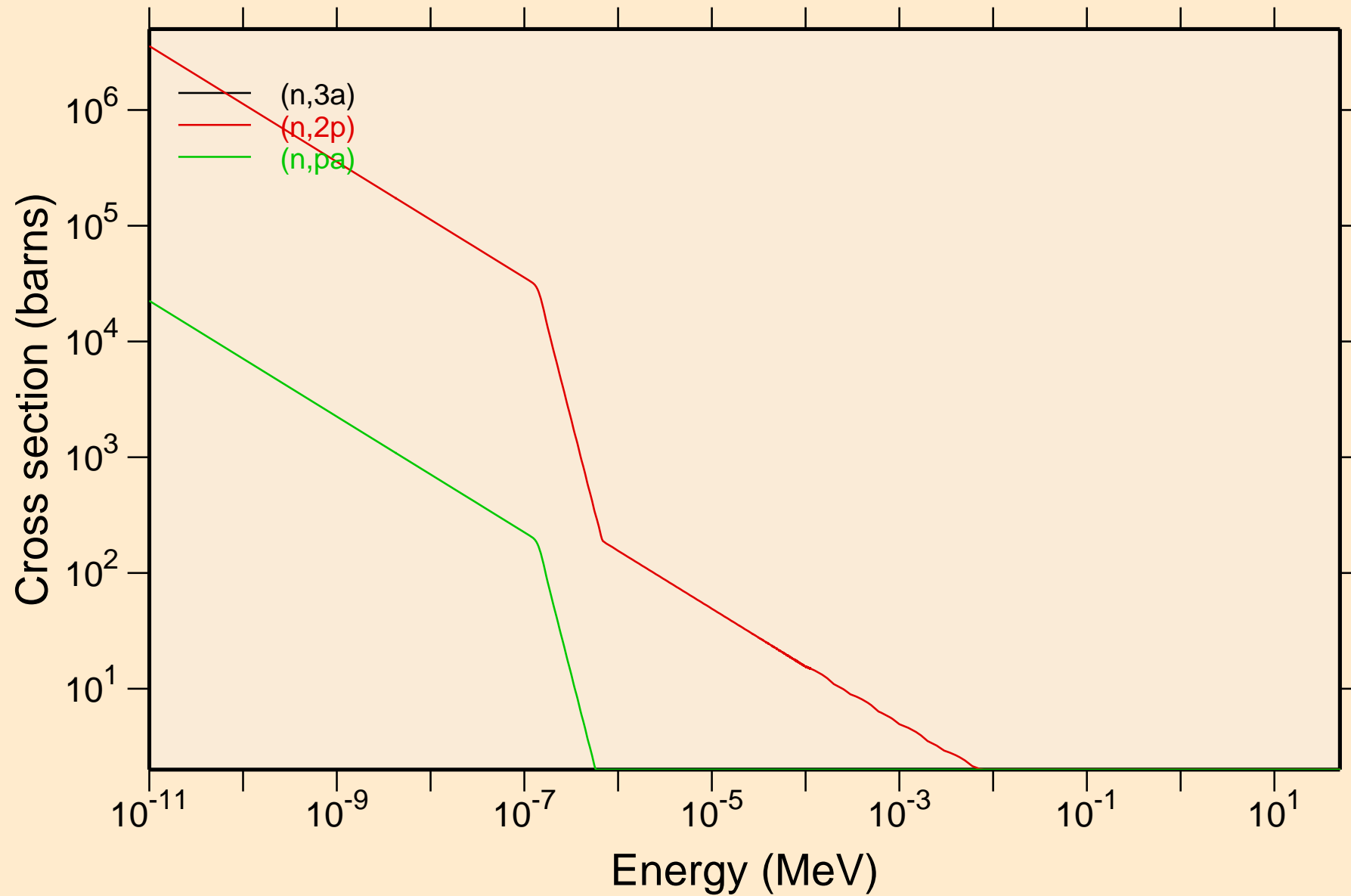

XE113 NRG TENDL-2015, AKONING

Principal cross sections

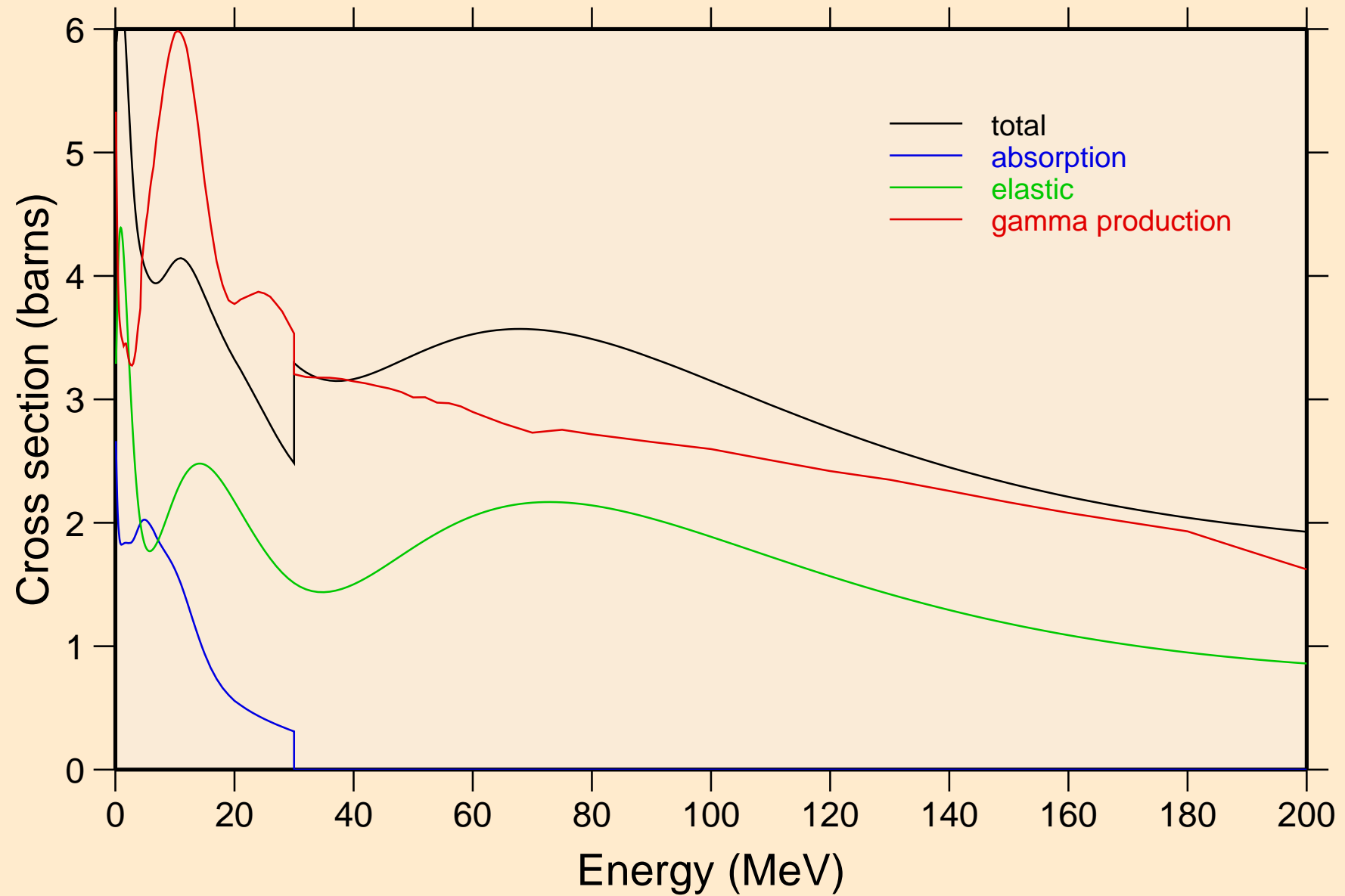

XE113 NRG TENDL-2015, AKONING

Non-threshold reactions

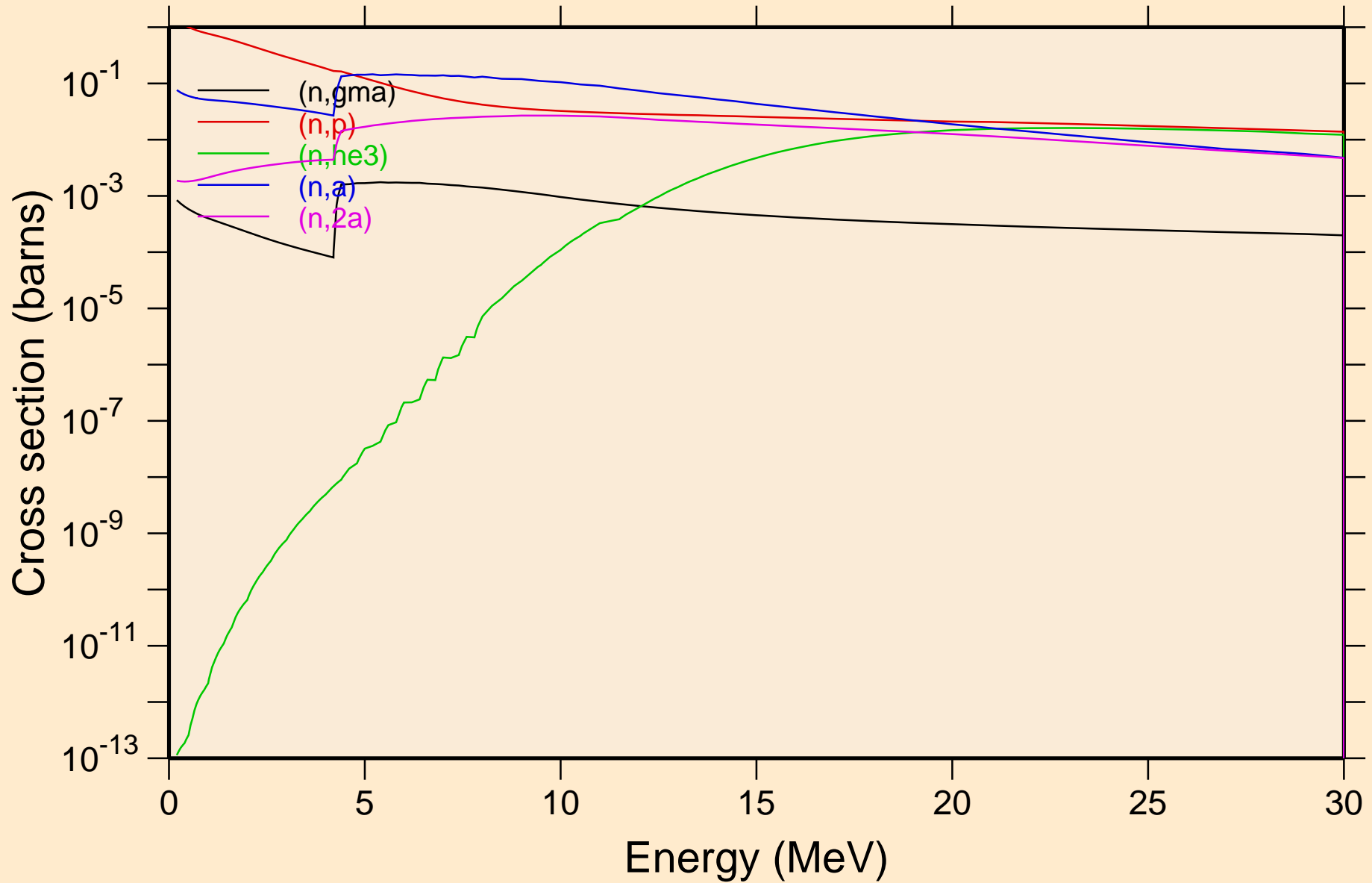

XE113 NRG TENDL-2015, AKONING

Non-threshold reactions

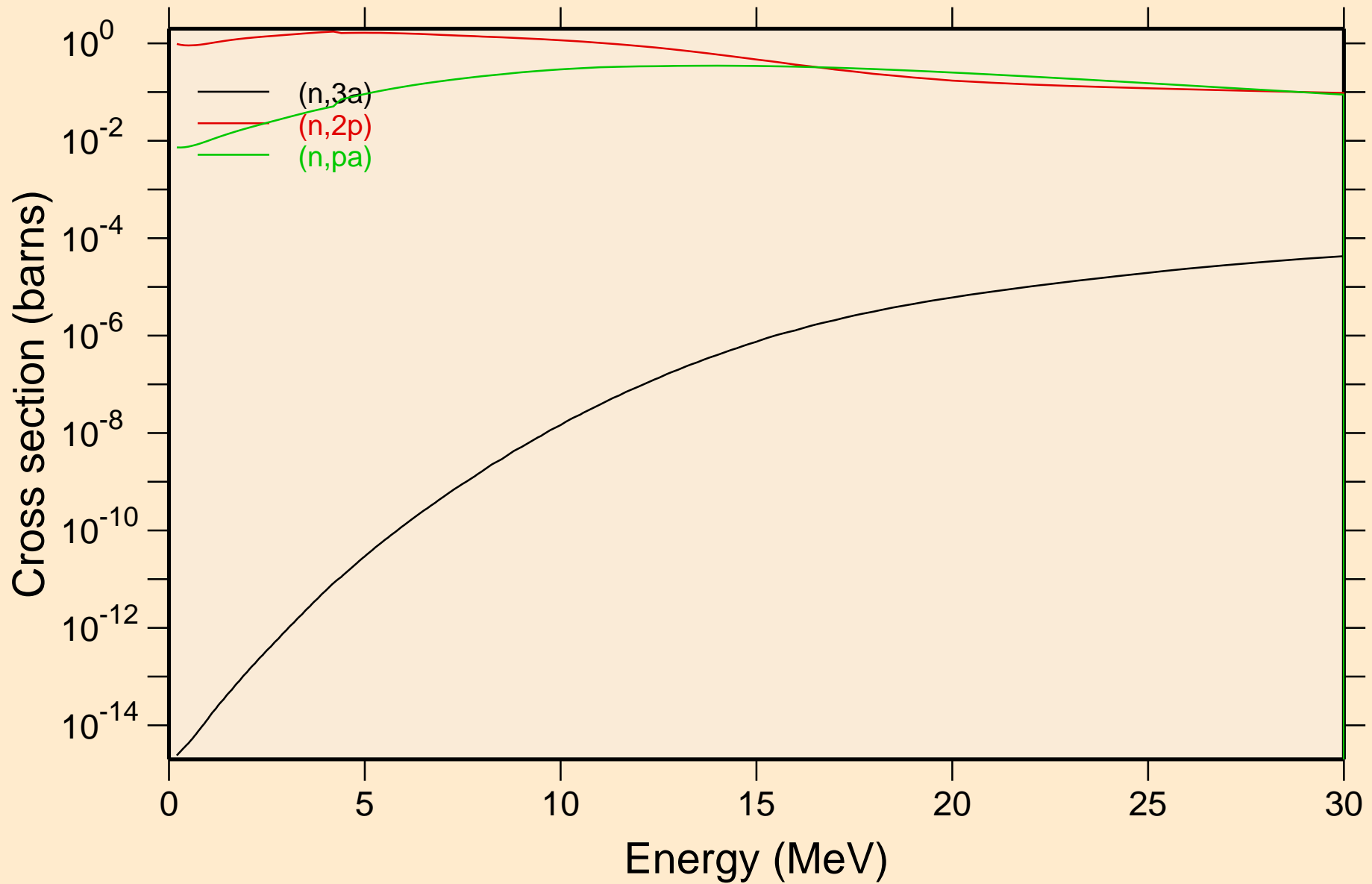

XE113 NRG TENDL-2015, AKONING

Inelastic levels

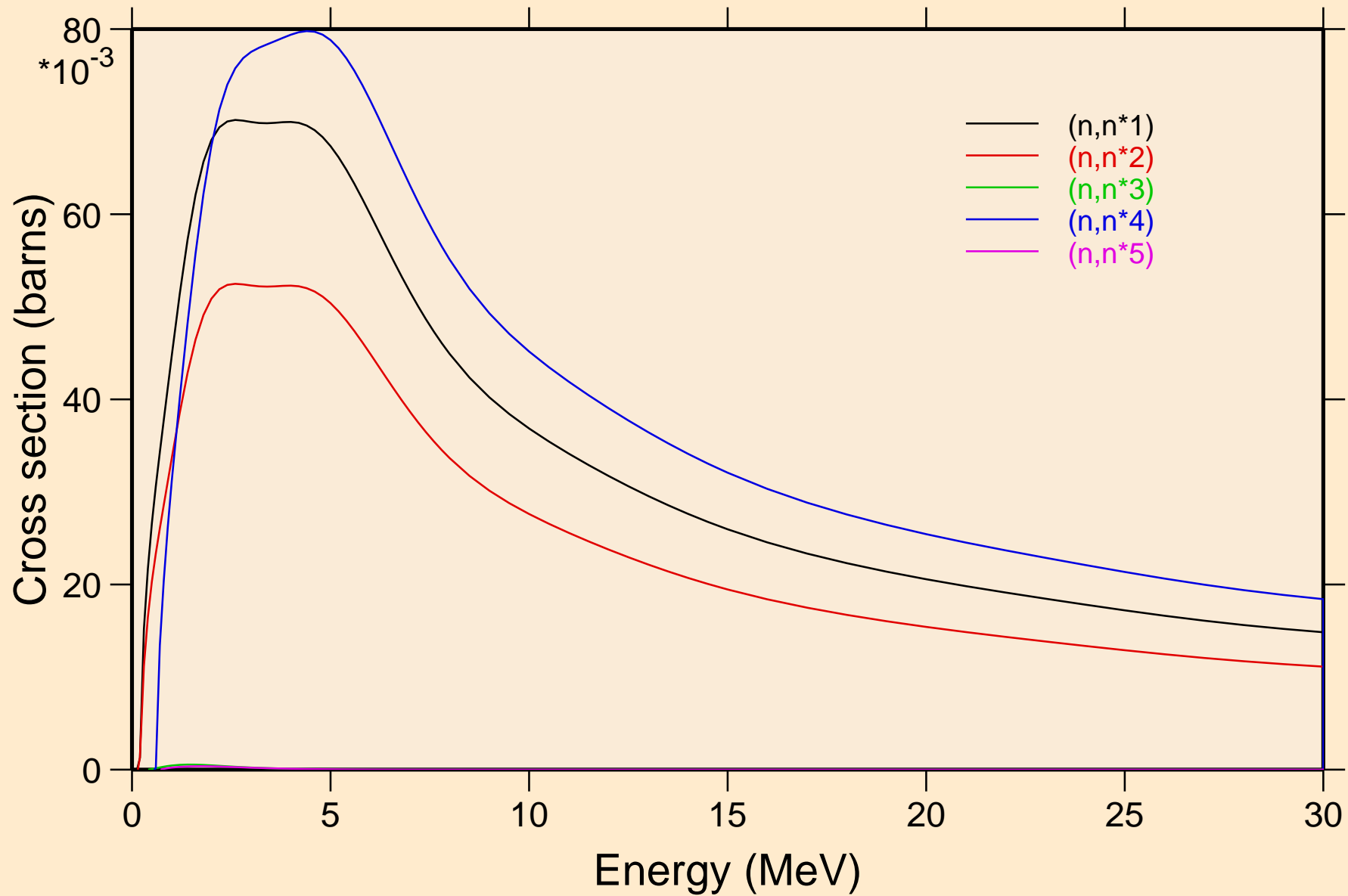

XE113 NRG TENDL-2015, AKONING

Inelastic levels

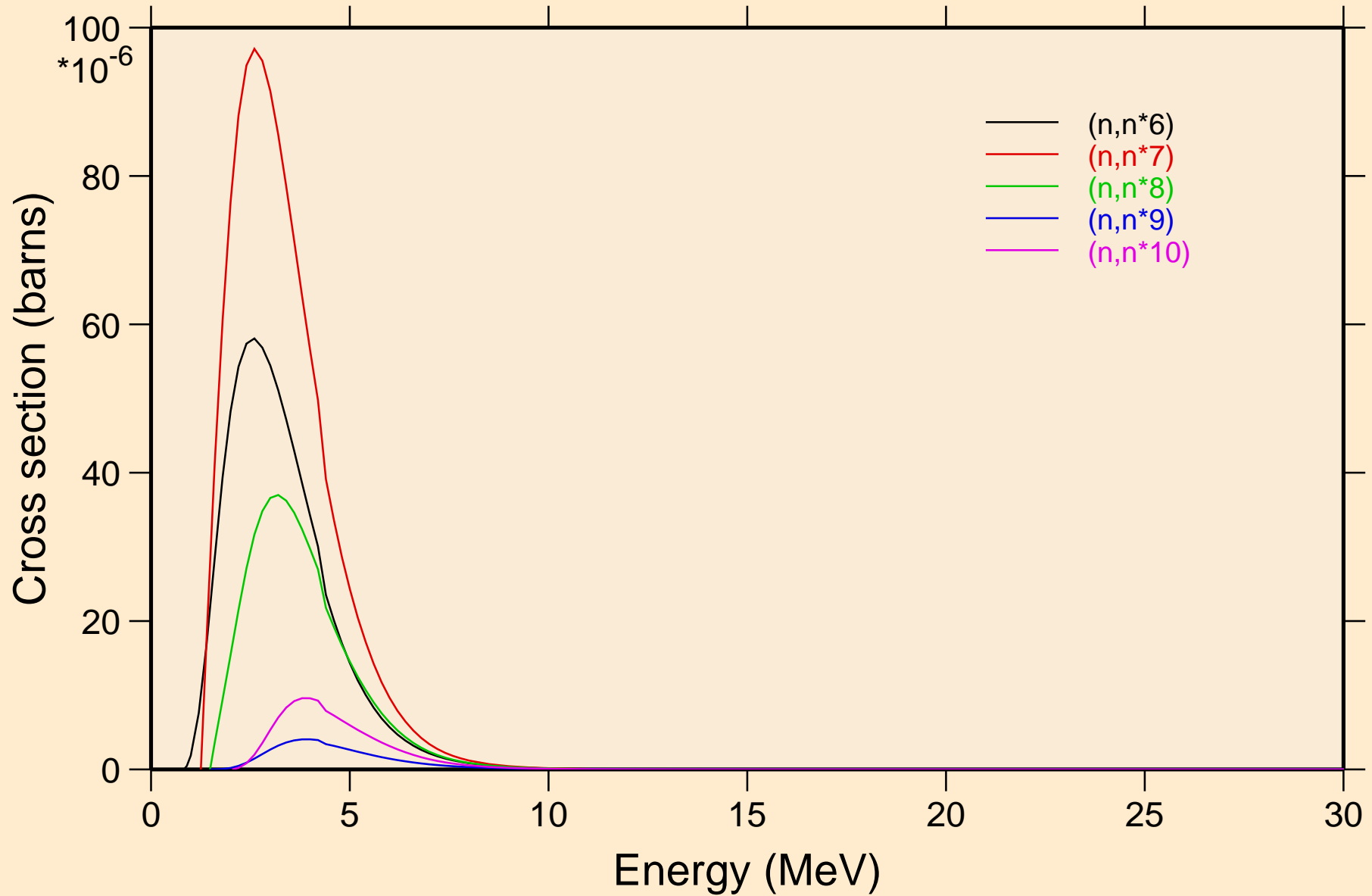

XE113 NRG TENDL-2015, AKONING

Inelastic levels

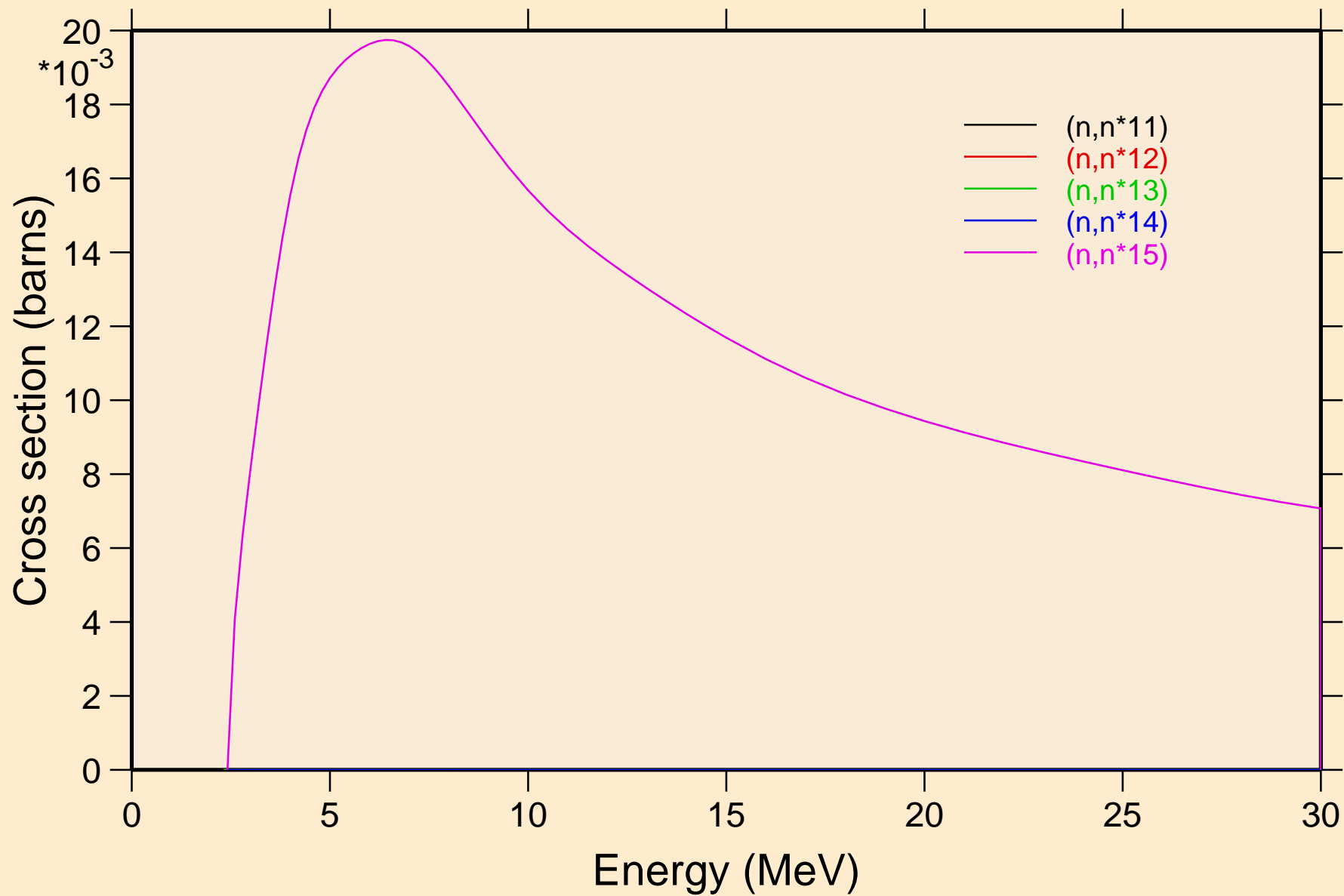

XE113 NRG TENDL-2015, AKONING

Threshold reactions

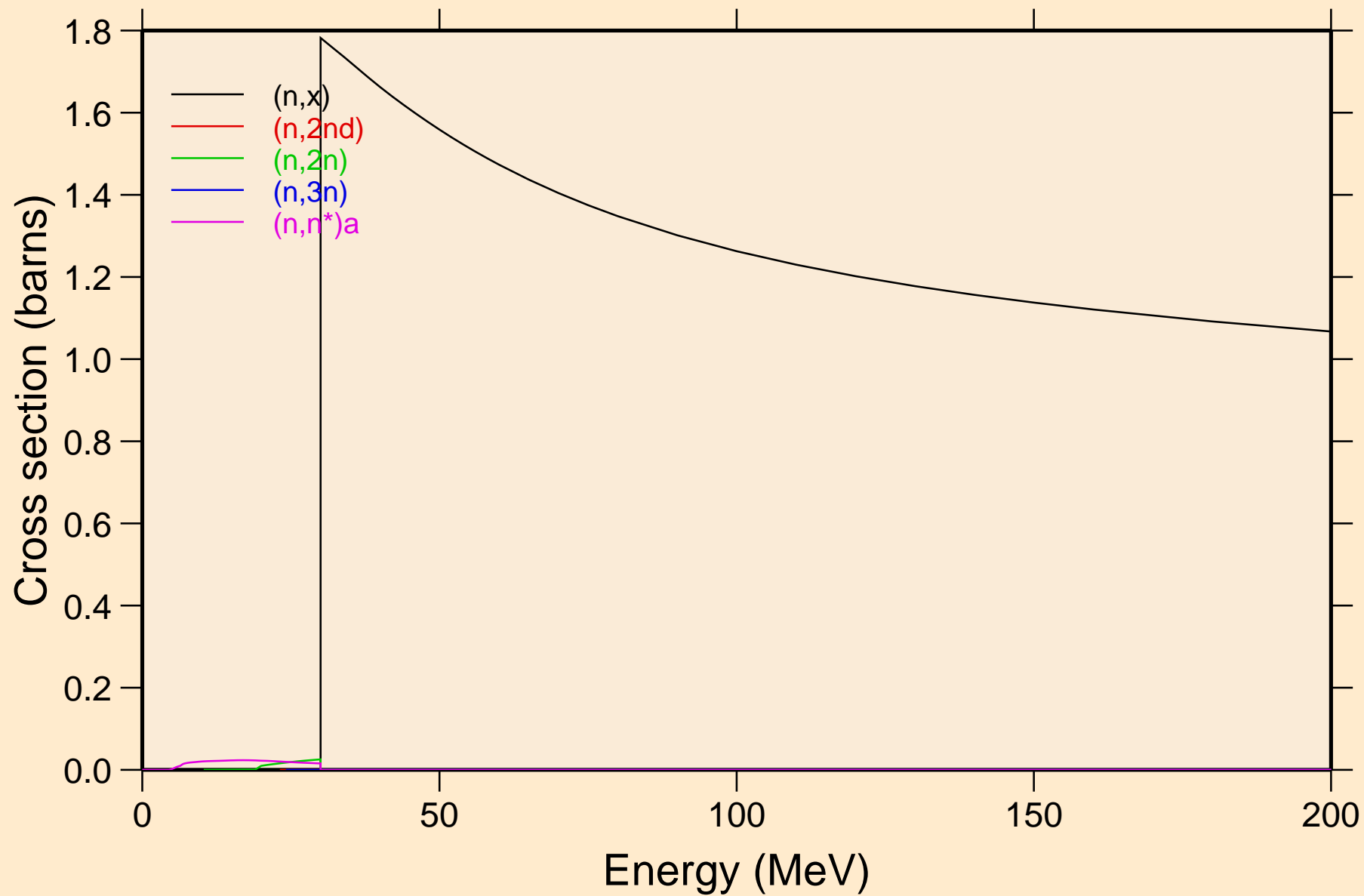

XE113 NRG TENDL-2015, AKONING

Threshold reactions

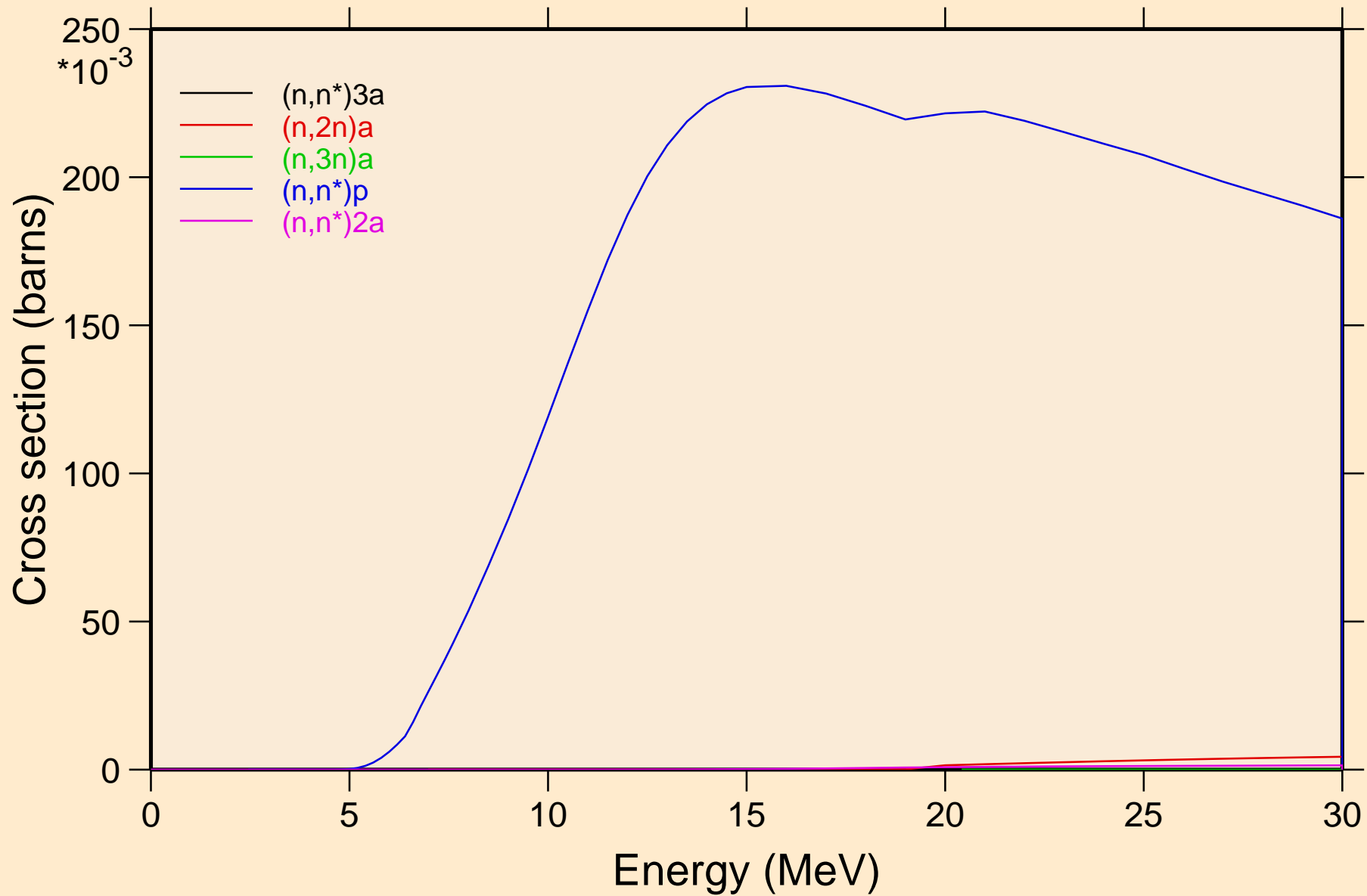

XE113 NRG TENDL-2015, AKONING

Threshold reactions

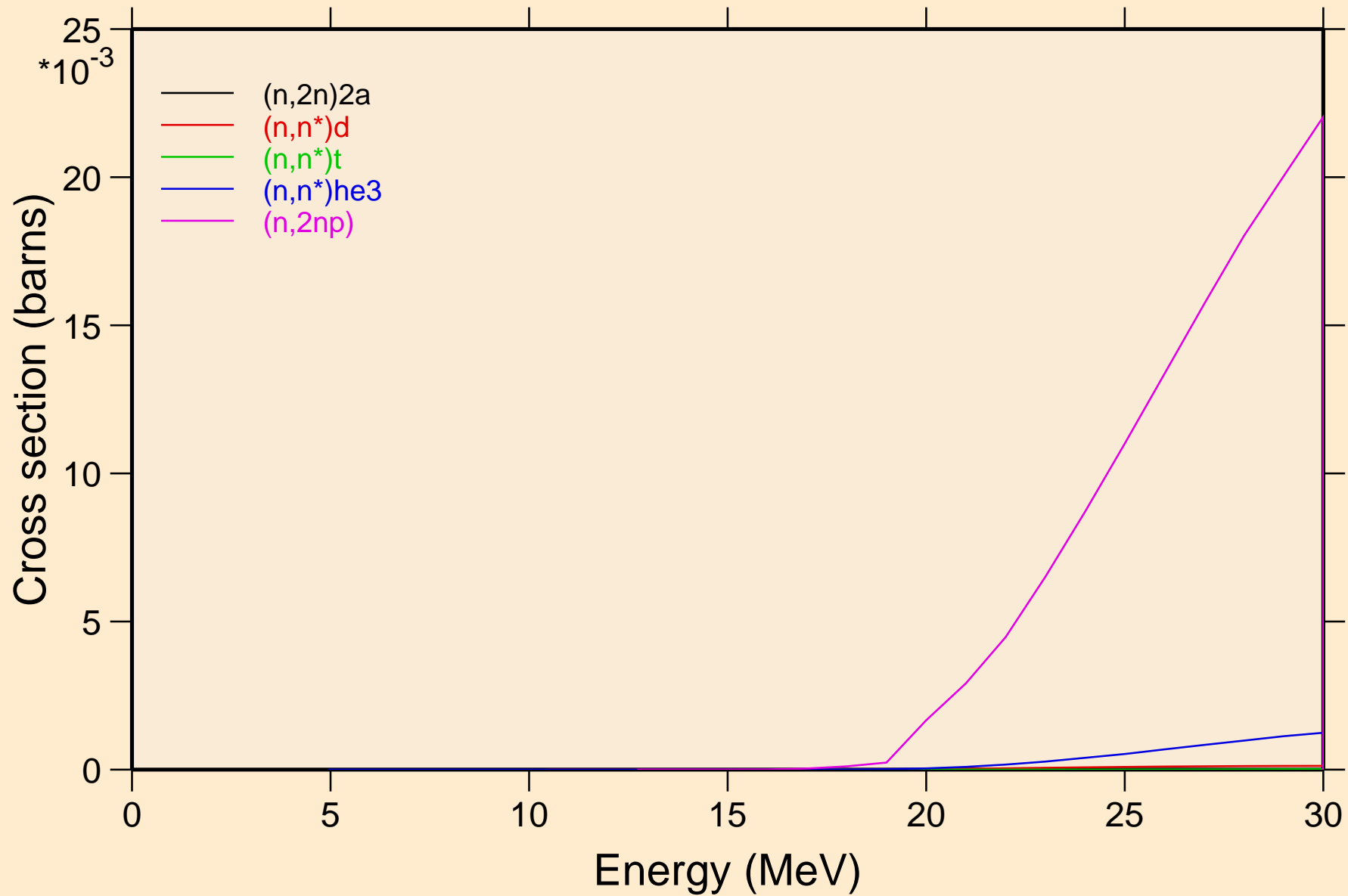

XE113 NRG TENDL-2015, AKONING

Threshold reactions

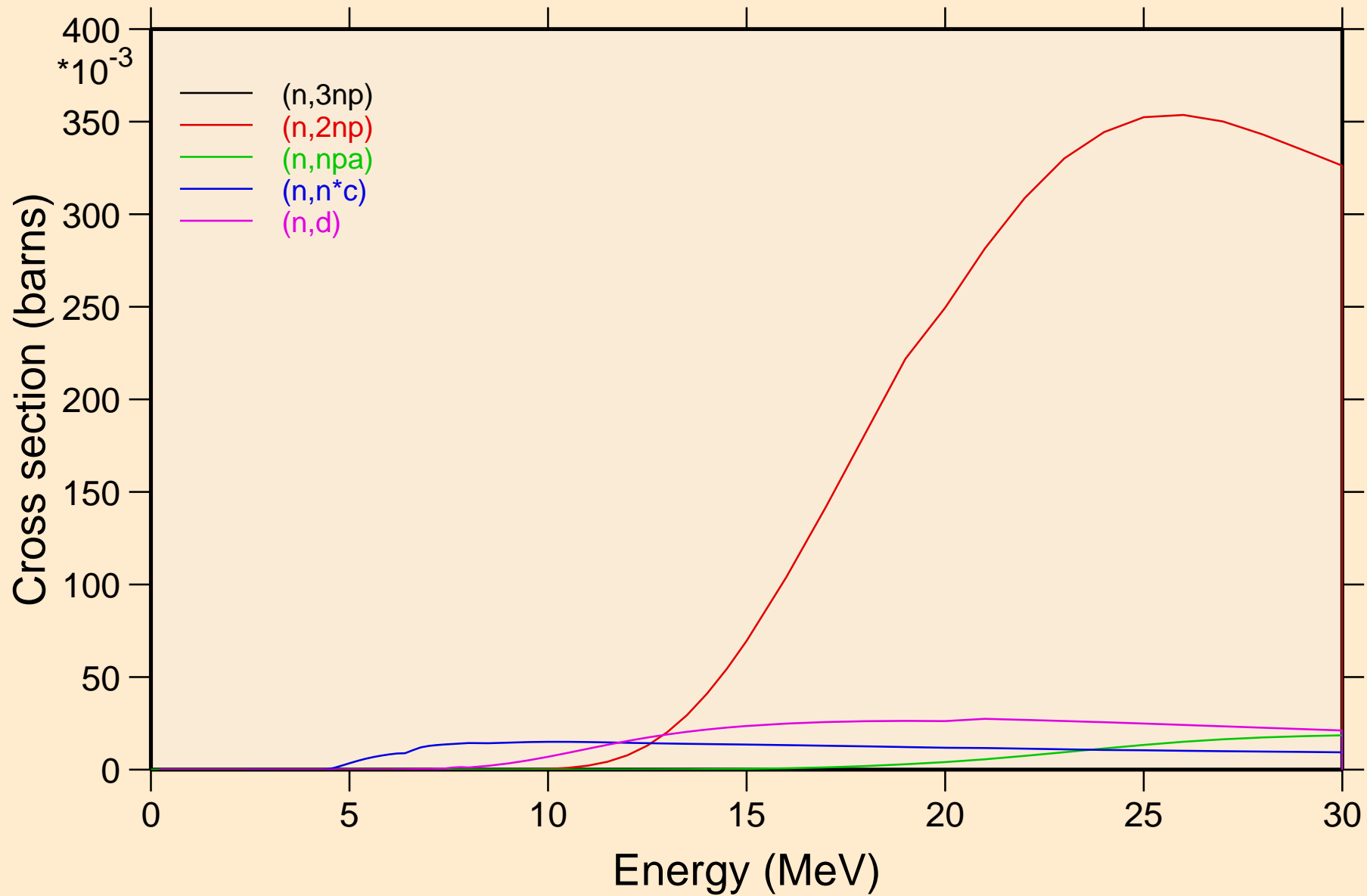

XE113 NRG TENDL-2015, AKONING

Threshold reactions

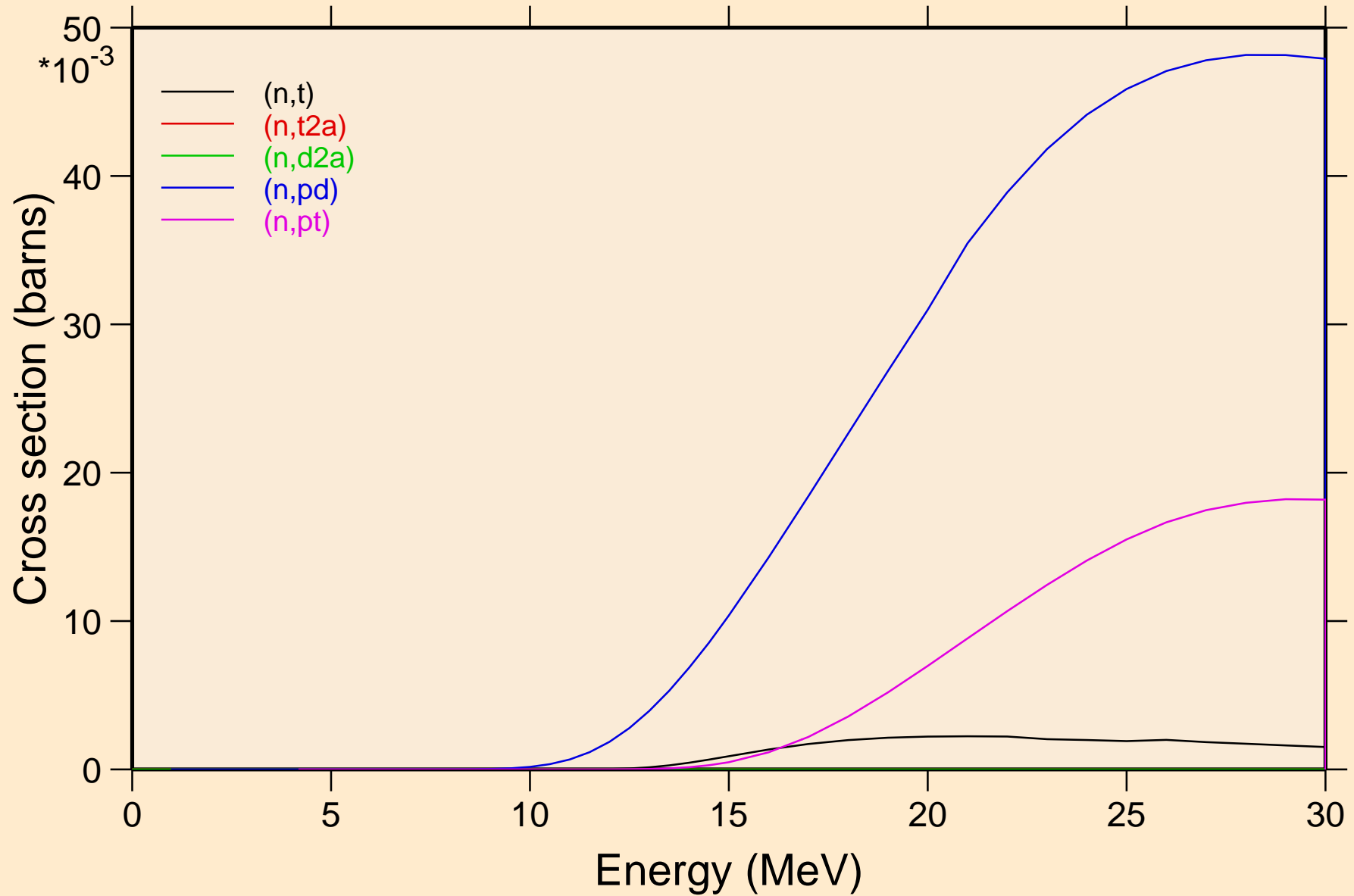

XE113 NRG TENDL-2015, AKONING

Threshold reactions

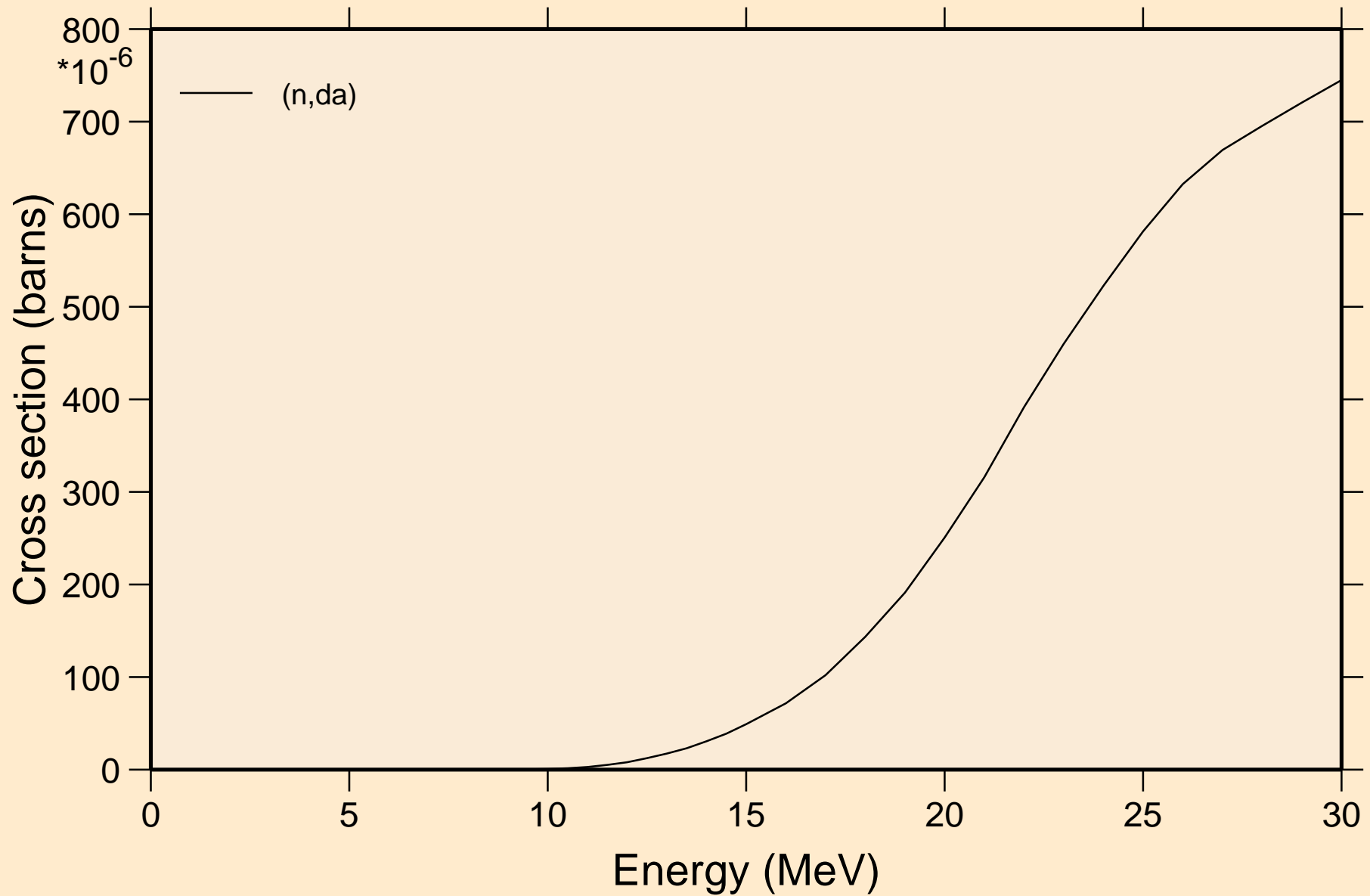

XE113 NRG TENDL-2015, AKONING
angular distribution for elastic

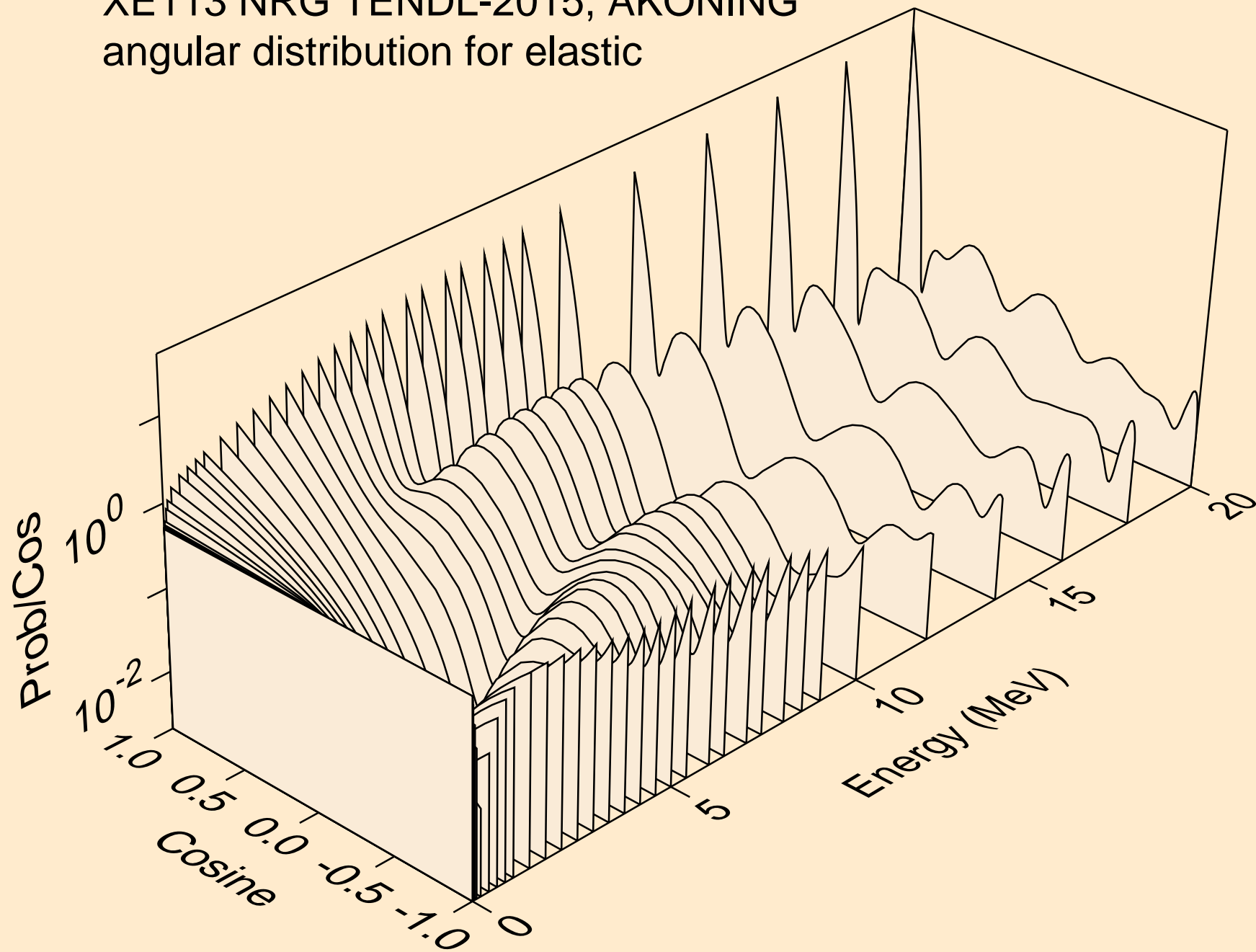

XE113 NRG TENDL-2015, AKONING
angular distribution for elastic

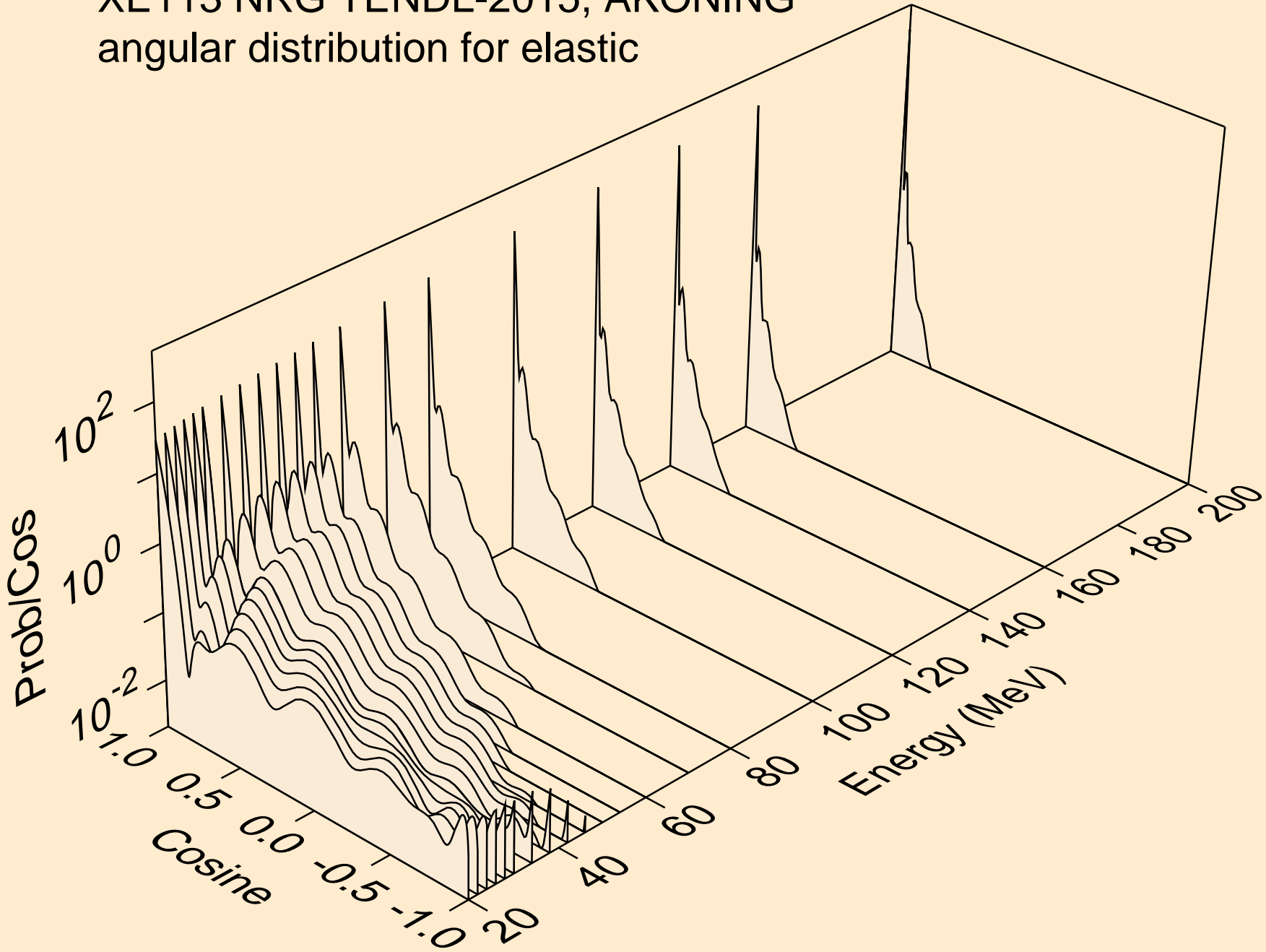

XE113 NRG TENDL-2015, AKONING
angular distribution for (n,n*1)

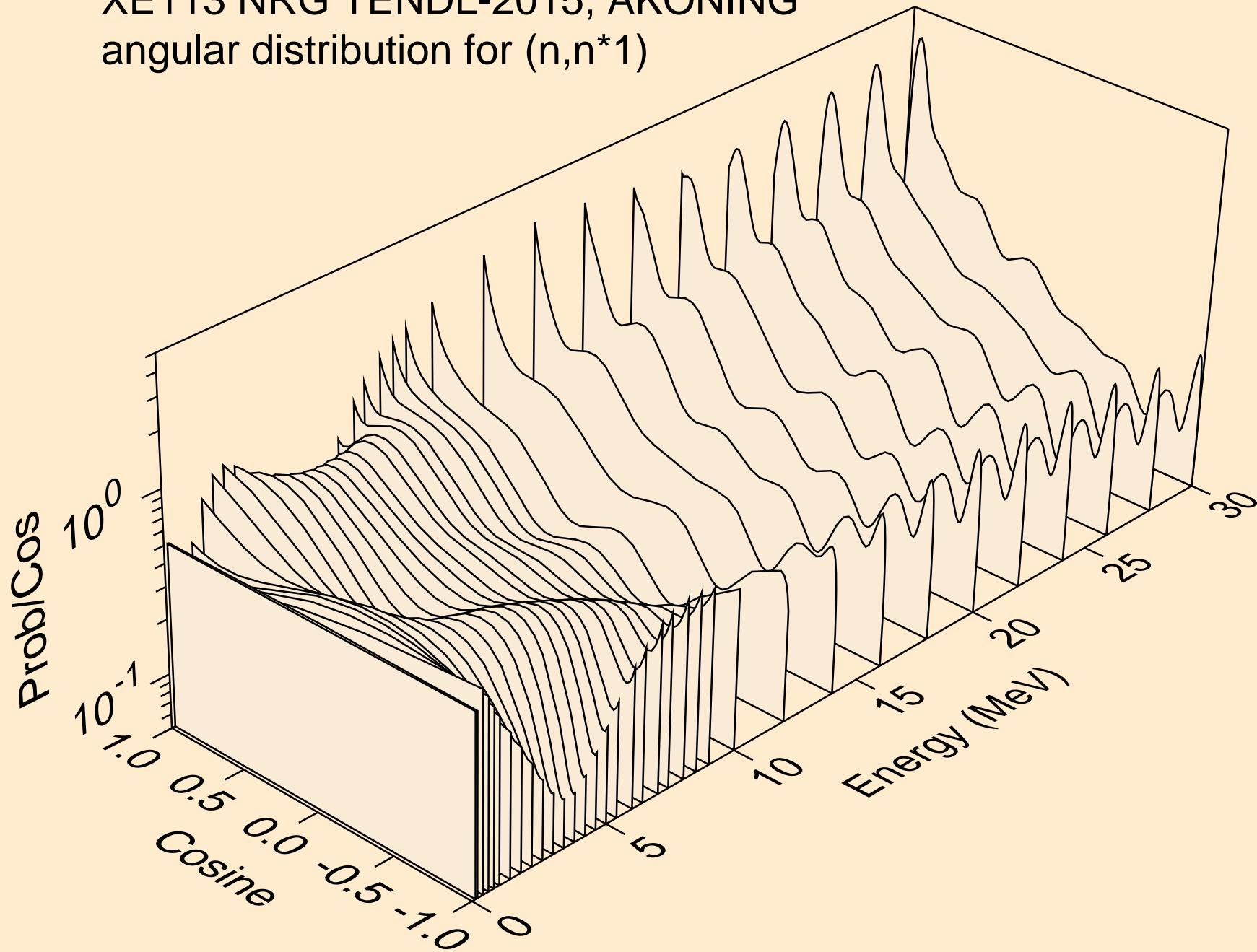

XE113 NRG TENDL-2015, AKONING
angular distribution for (n,n*2)

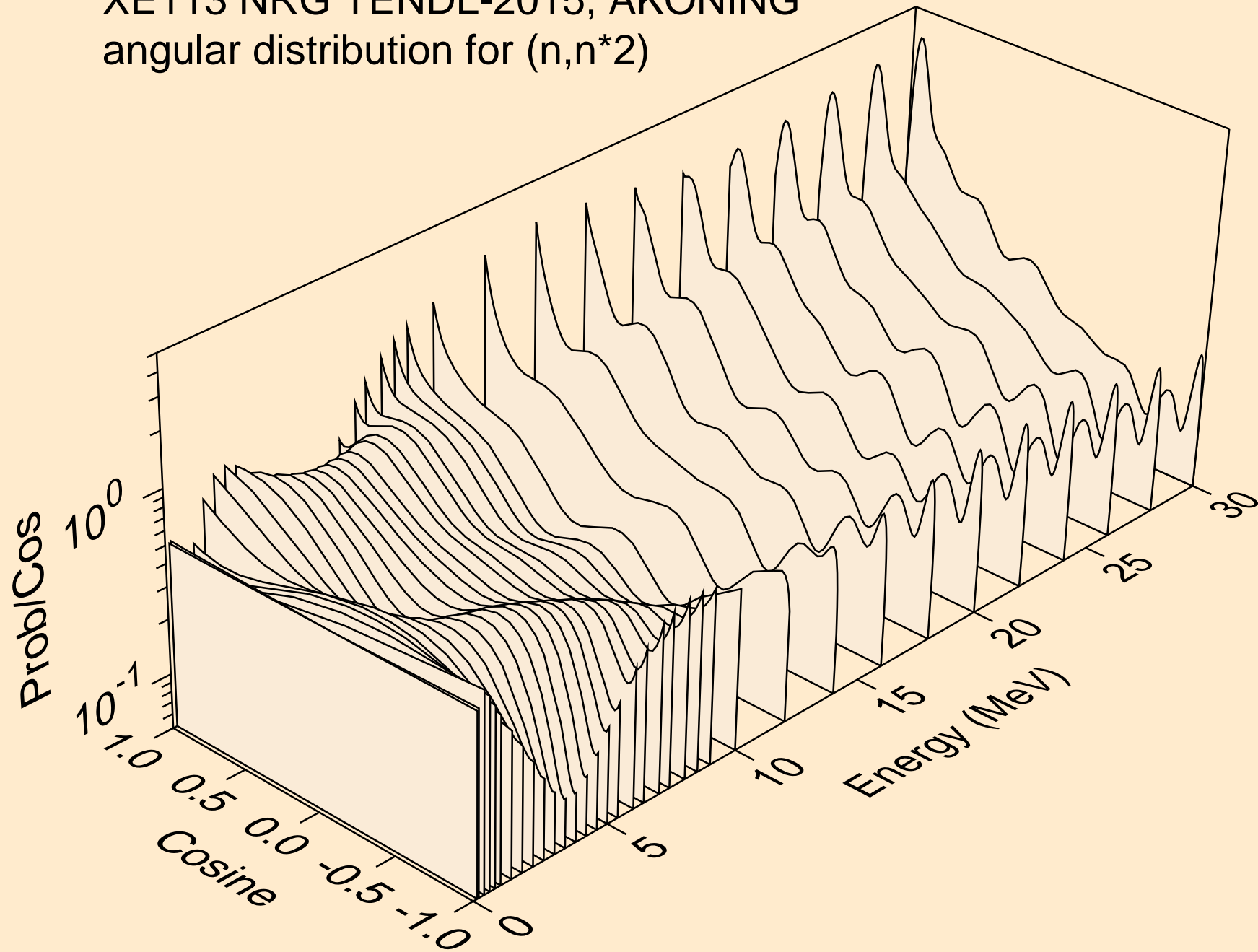

XE113 NRG TENDL-2015, AKONING
angular distribution for (n,n*3)

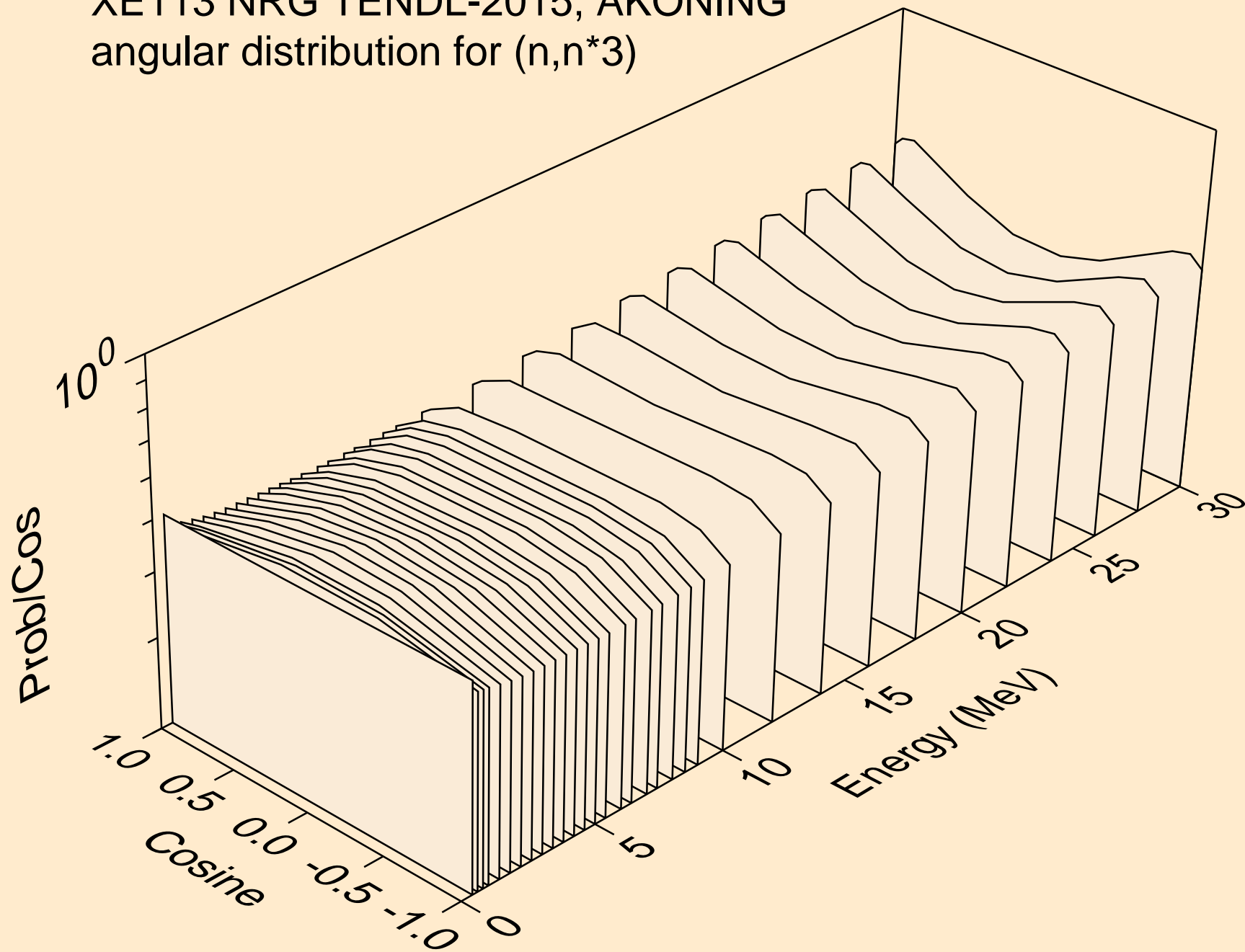

XE113 NRG TENDL-2015, AKONING
angular distribution for (n,n*4)

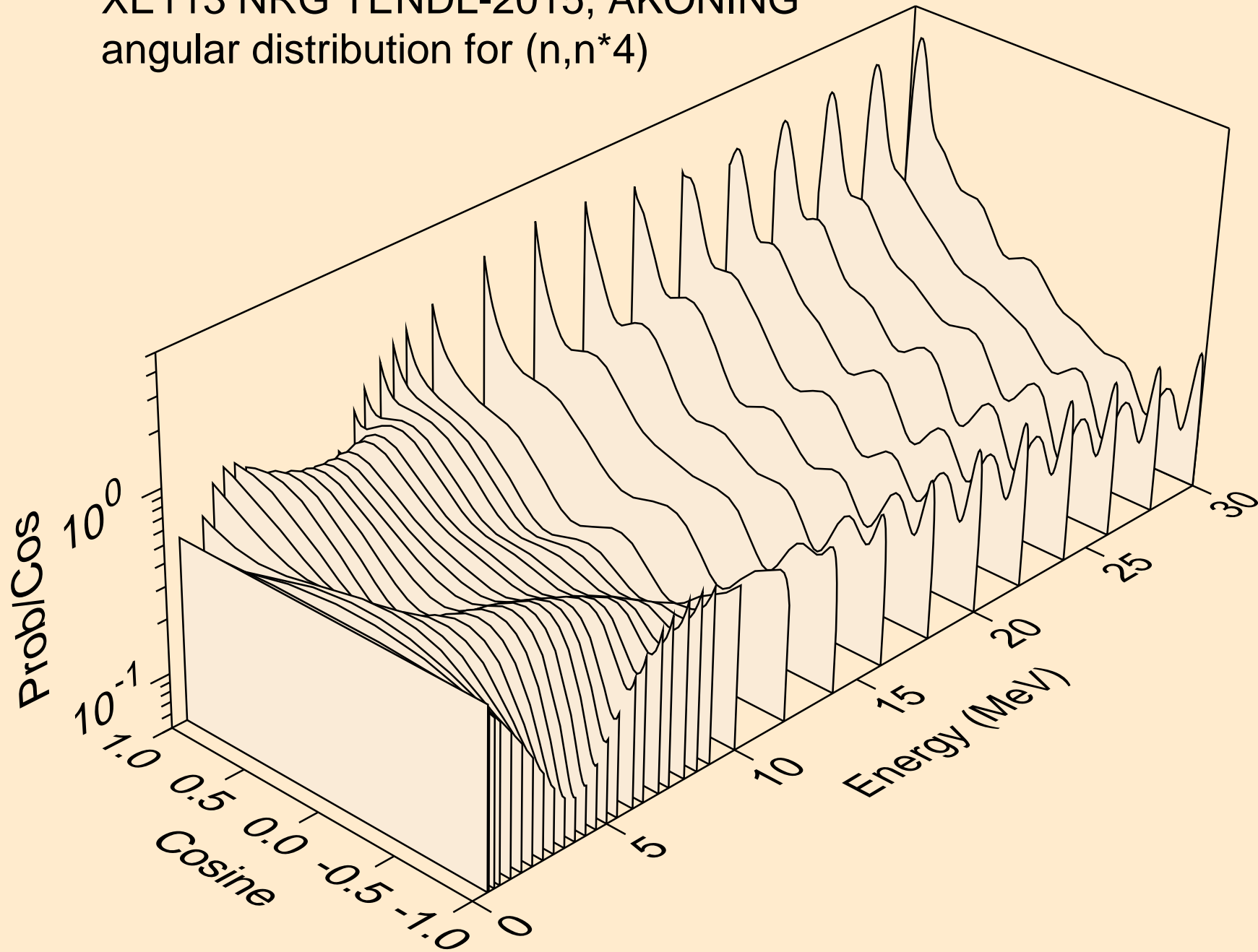

XE113 NRG TENDL-2015, AKONING
angular distribution for (n,n*5)

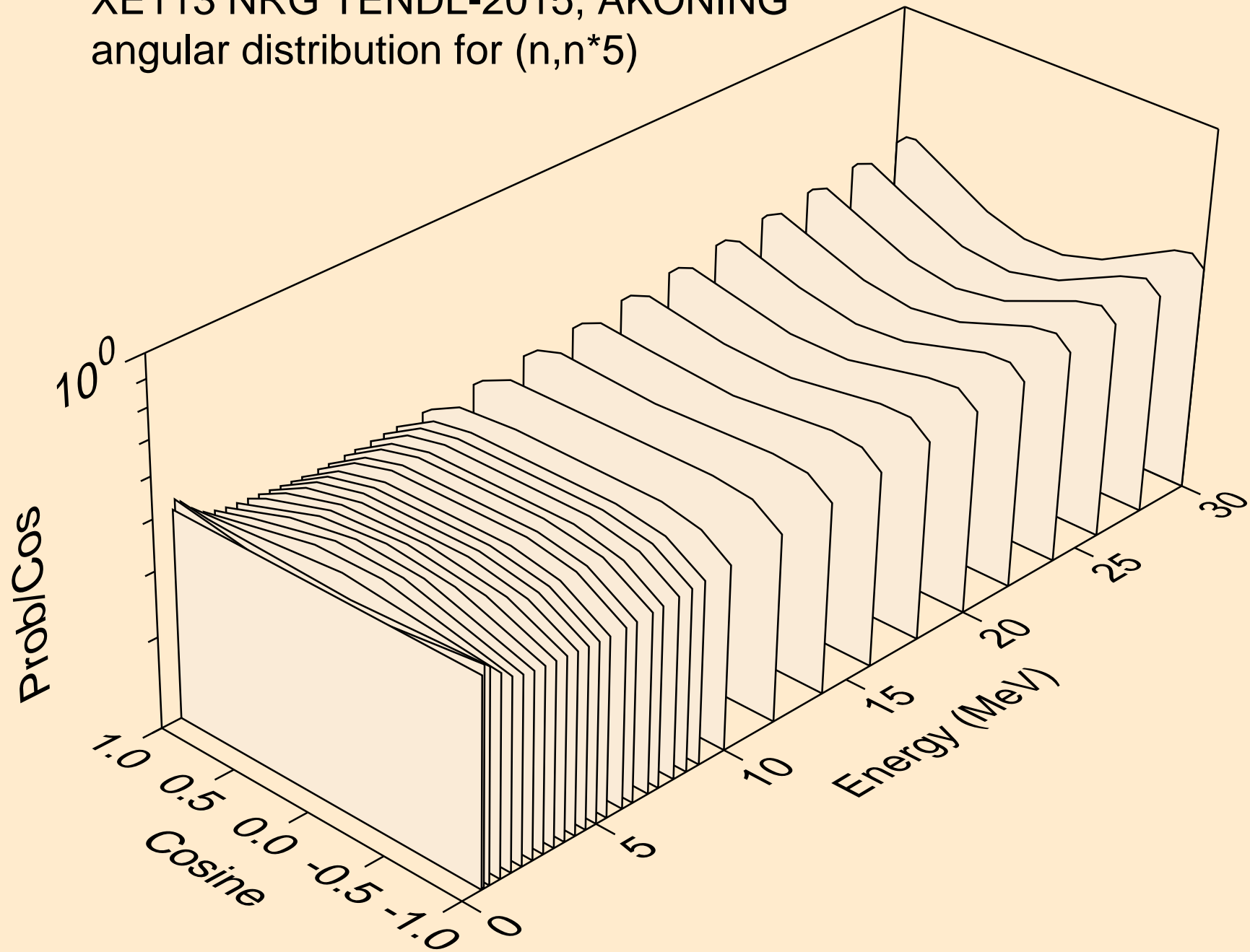

XE113 NRG TENDL-2015, AKONING
angular distribution for (n,n*6)

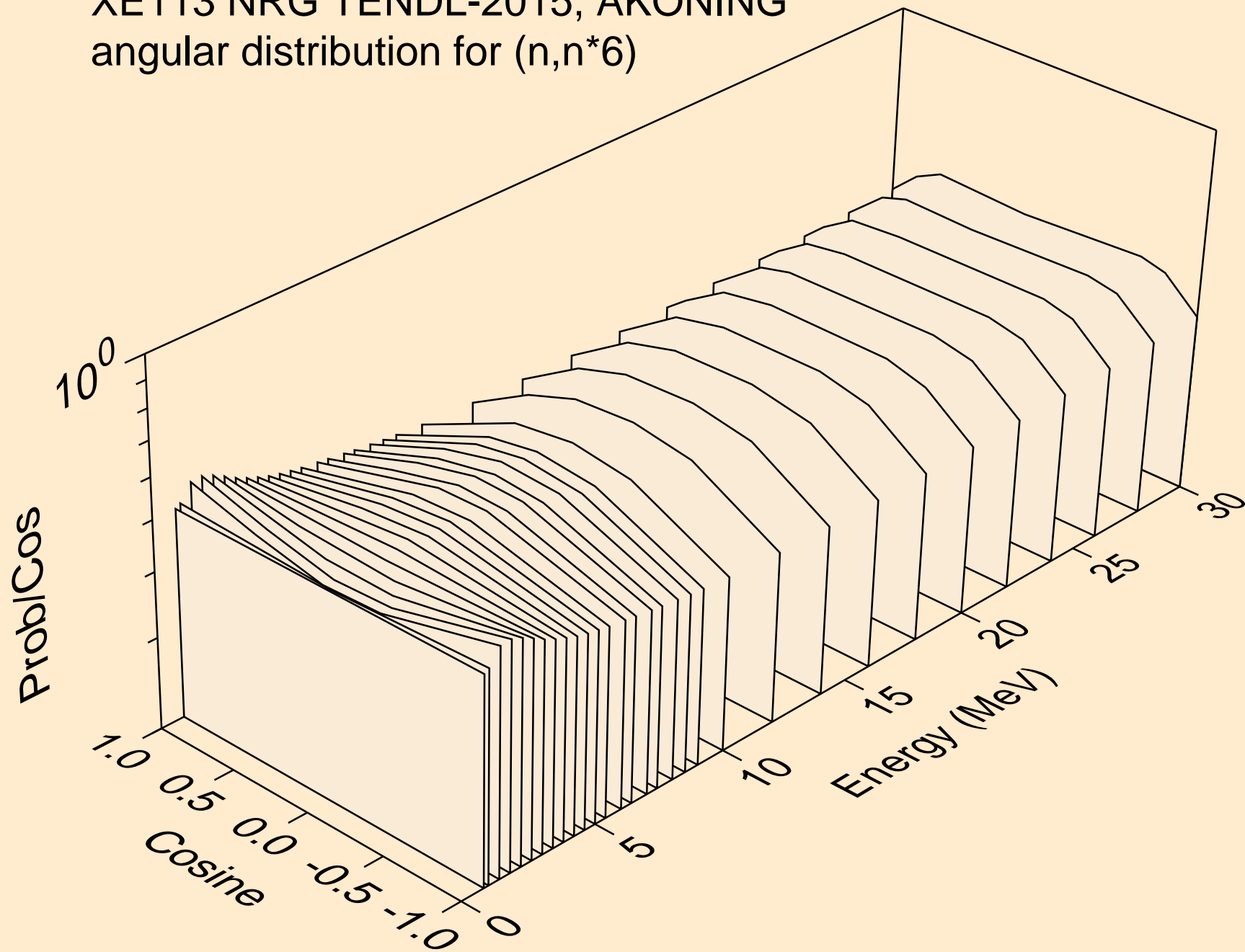

XE113 NRG TENDL-2015, AKONING
angular distribution for (n,n*7)

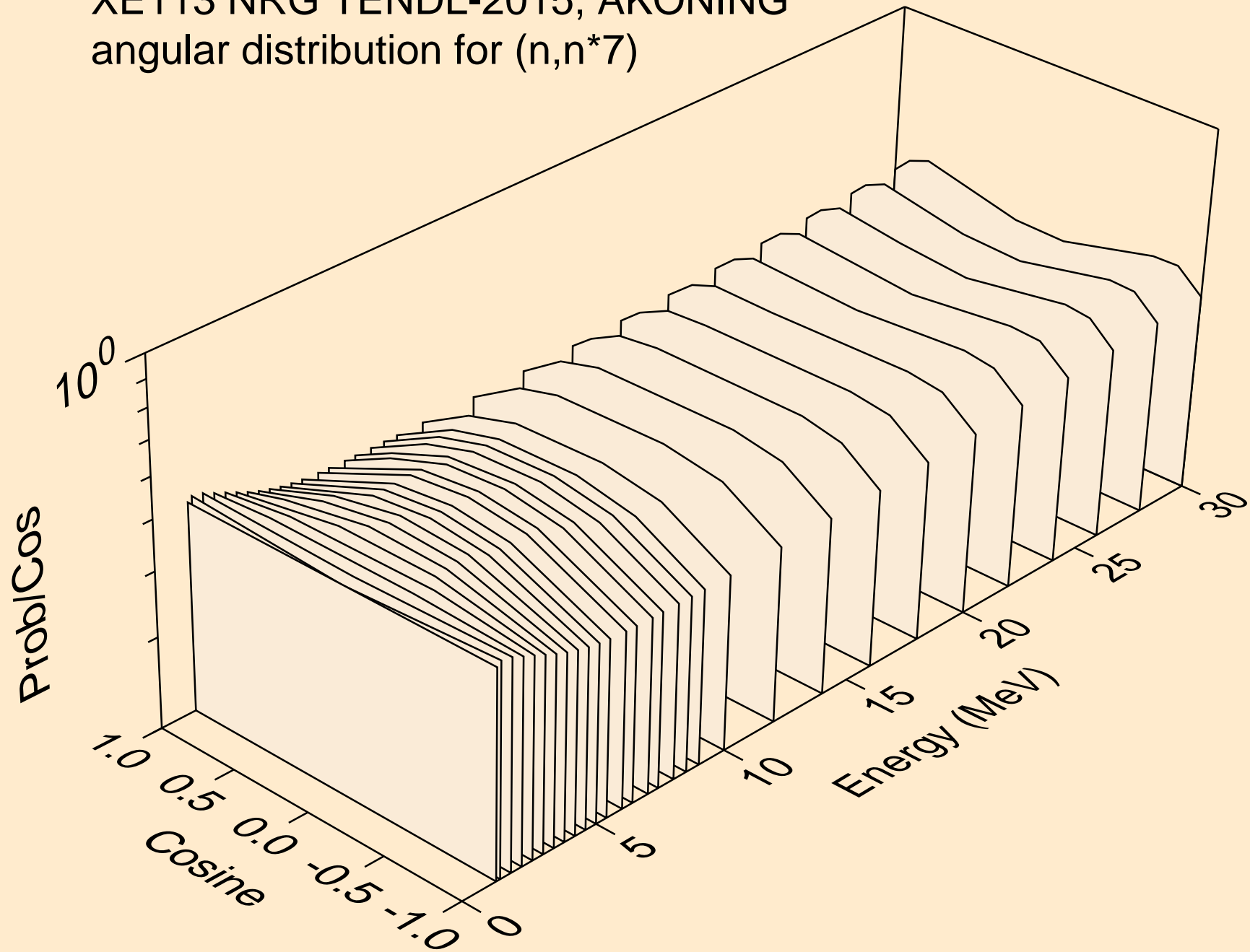

XE113 NRG TENDL-2015, AKONING
angular distribution for (n,n*8)

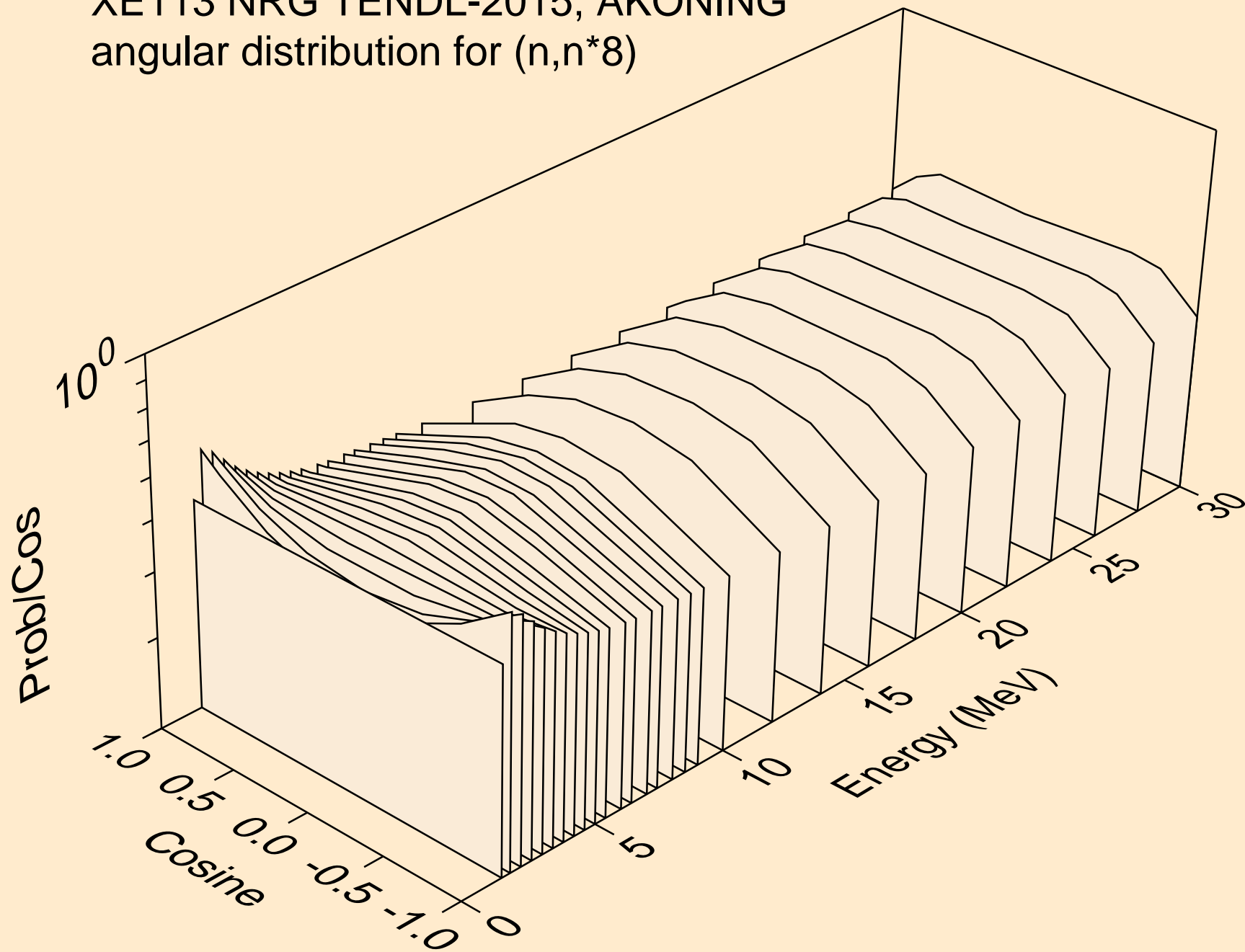

XE113 NRG TENDL-2015, AKONING
angular distribution for (n,n*9)

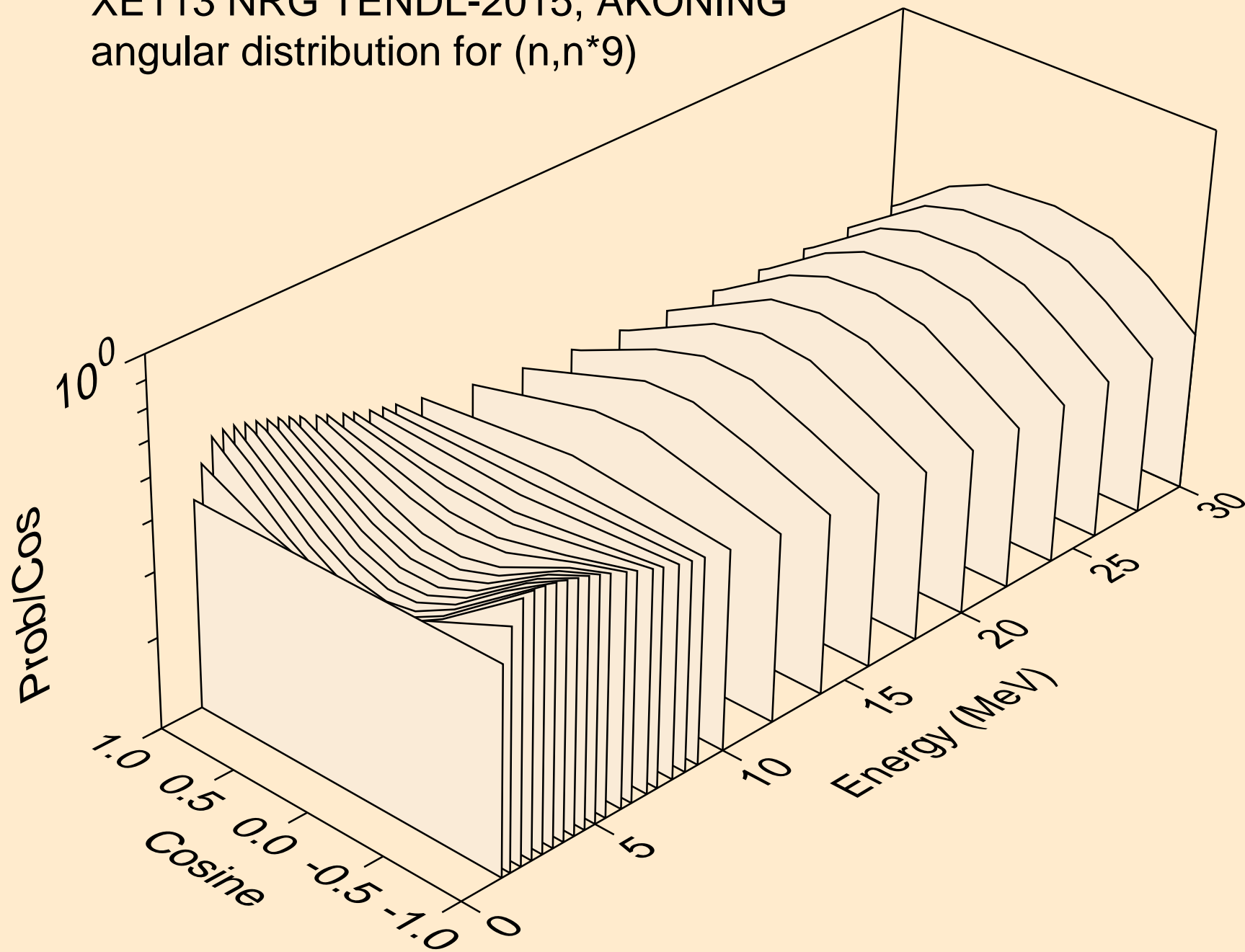

XE113 NRG TENDL-2015, AKONING
angular distribution for (n,n*10)

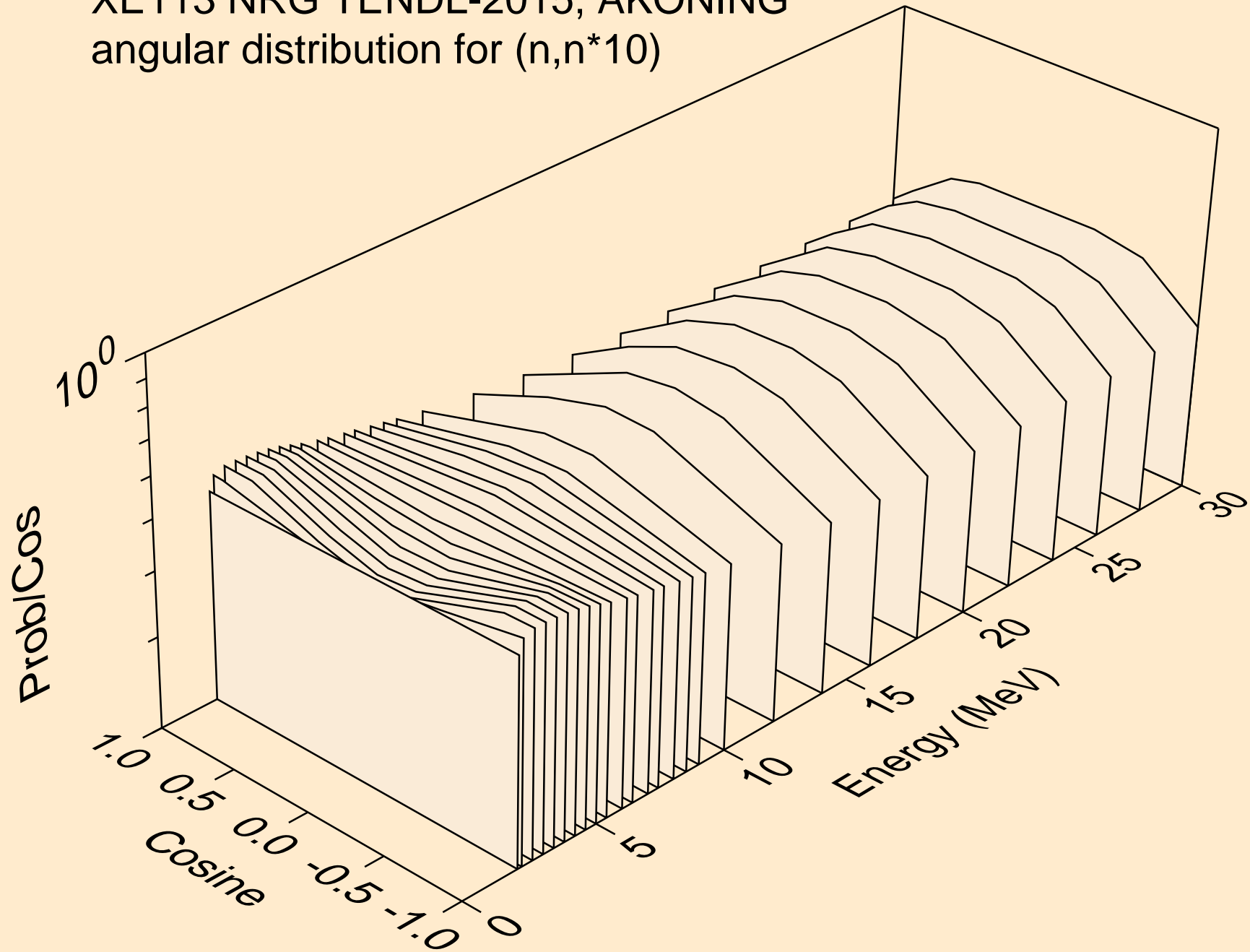

XE113 NRG TENDL-2015, AKONING
angular distribution for (n,n*11)

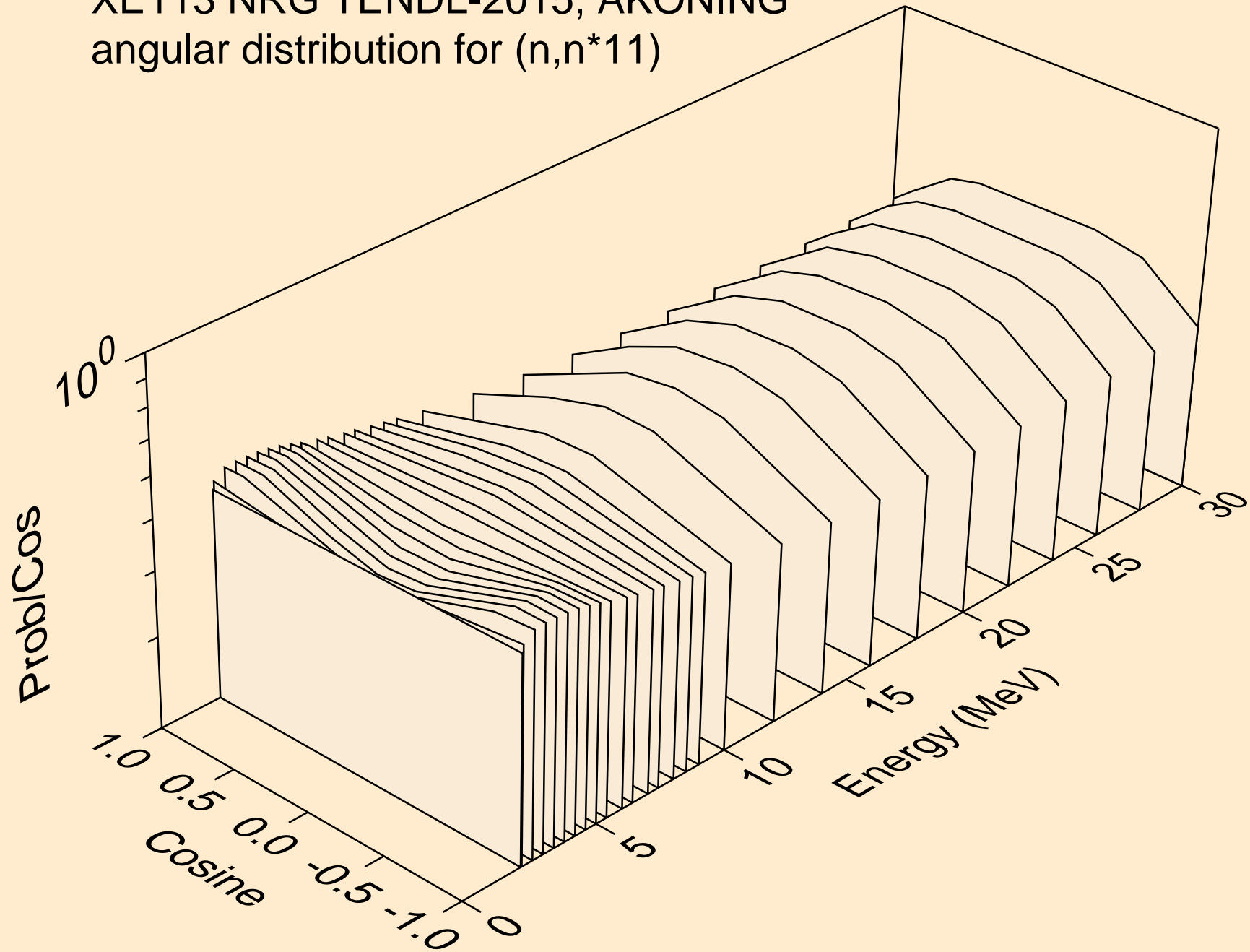

XE113 NRG TENDL-2015, AKONING
angular distribution for (n,n*12)

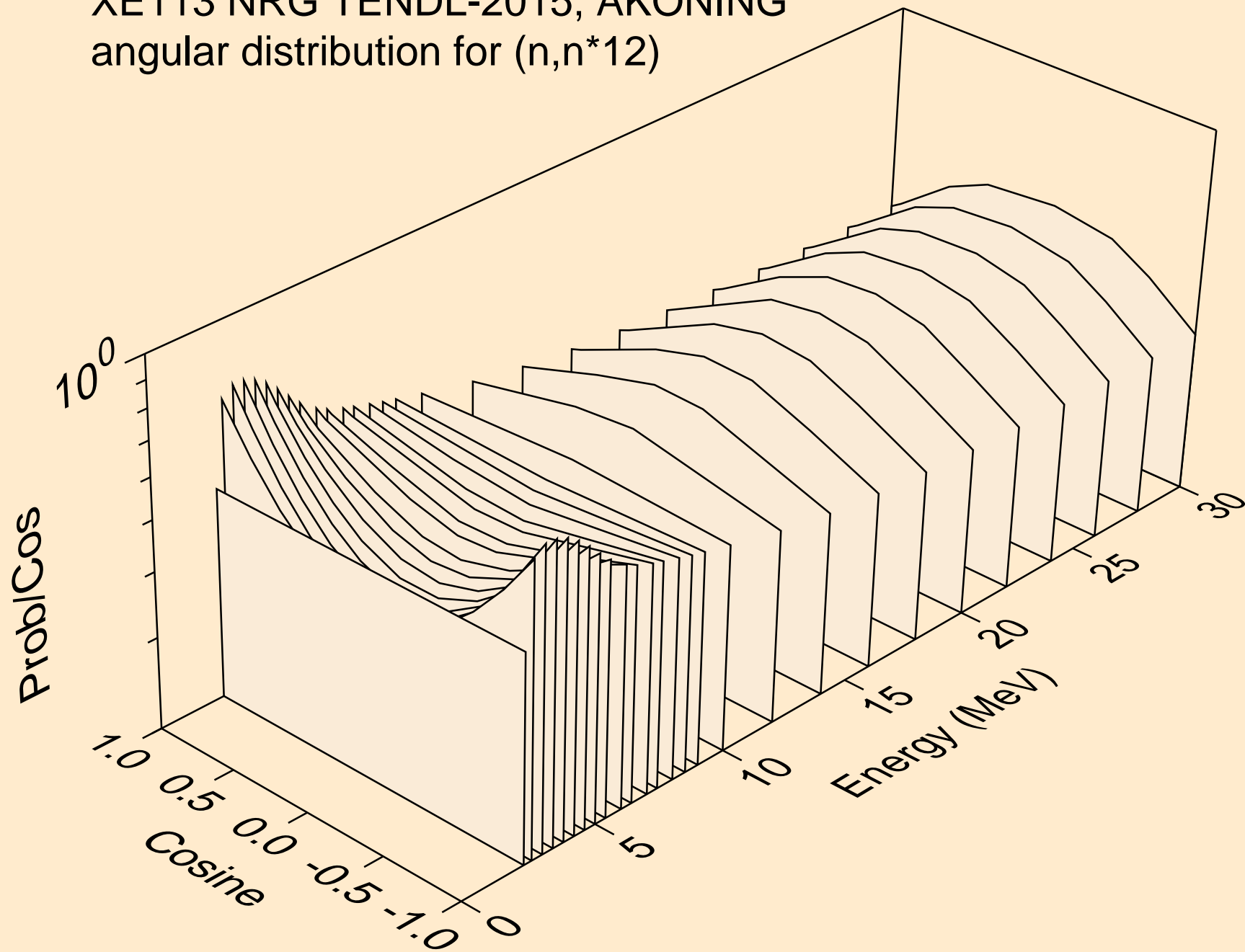

XE113 NRG TENDL-2015, AKONING
angular distribution for (n,n*13)

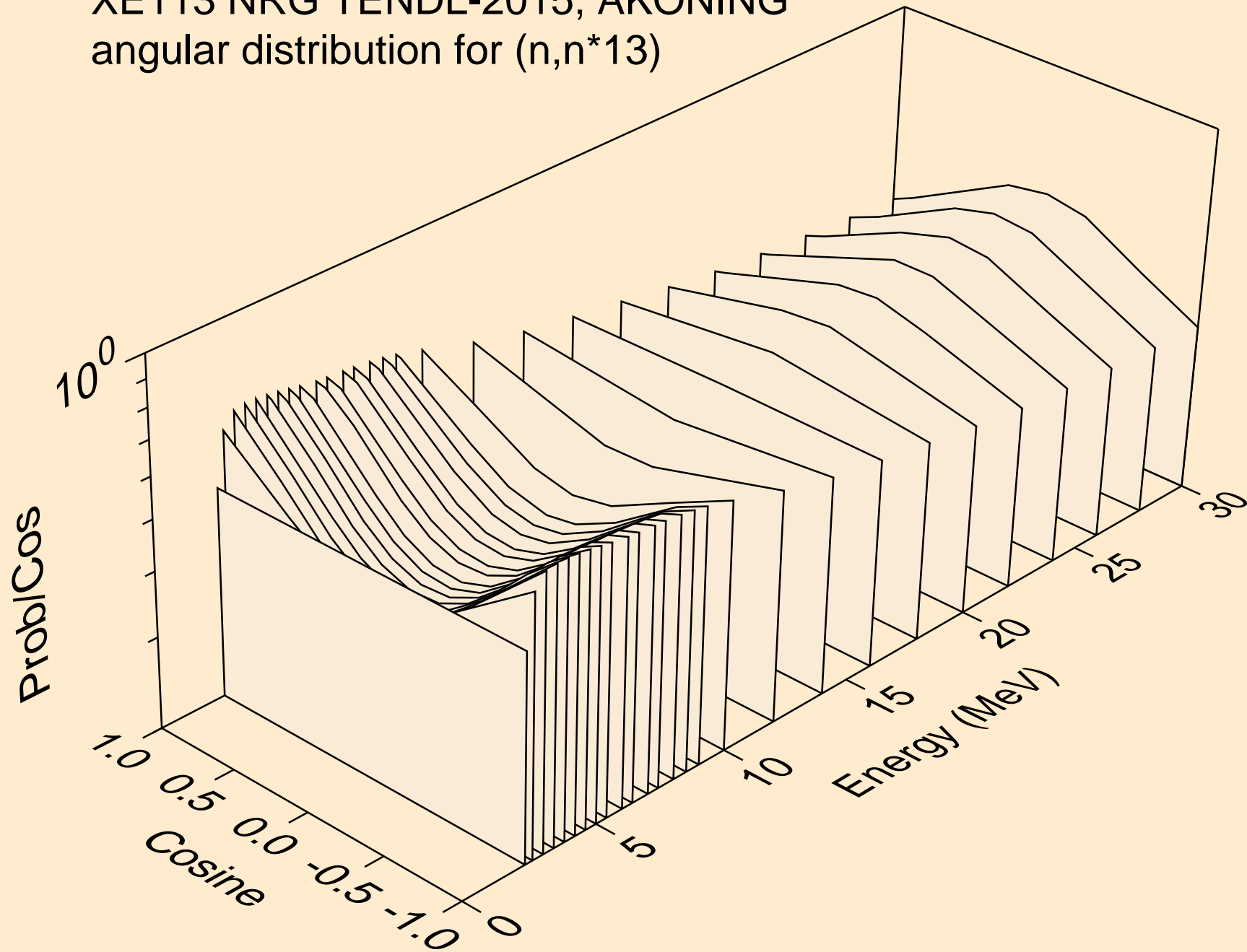

XE113 NRG TENDL-2015, AKONING
angular distribution for (n,n*14)

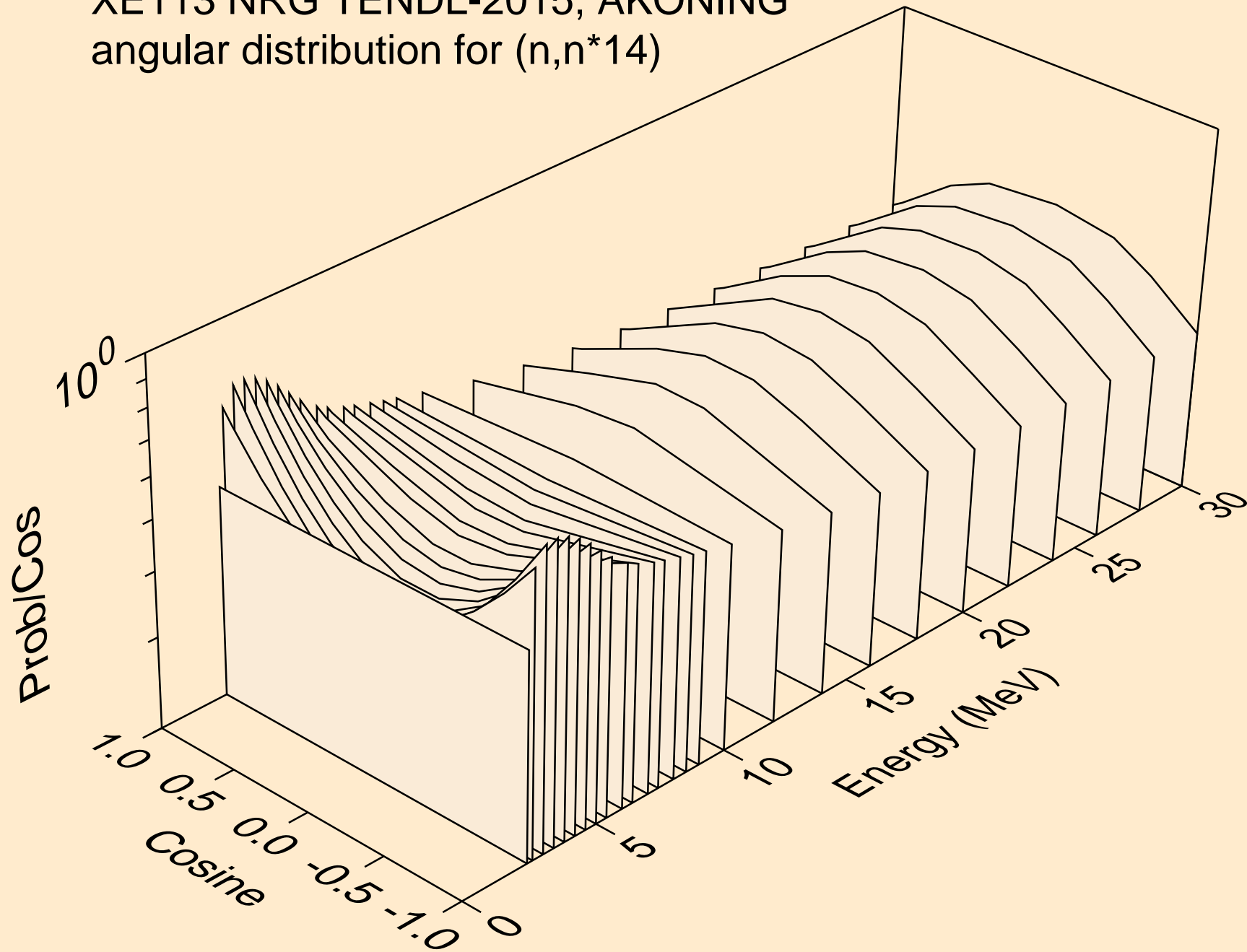

XE113 NRG TENDL-2015, AKONING
angular distribution for (n,n*15)

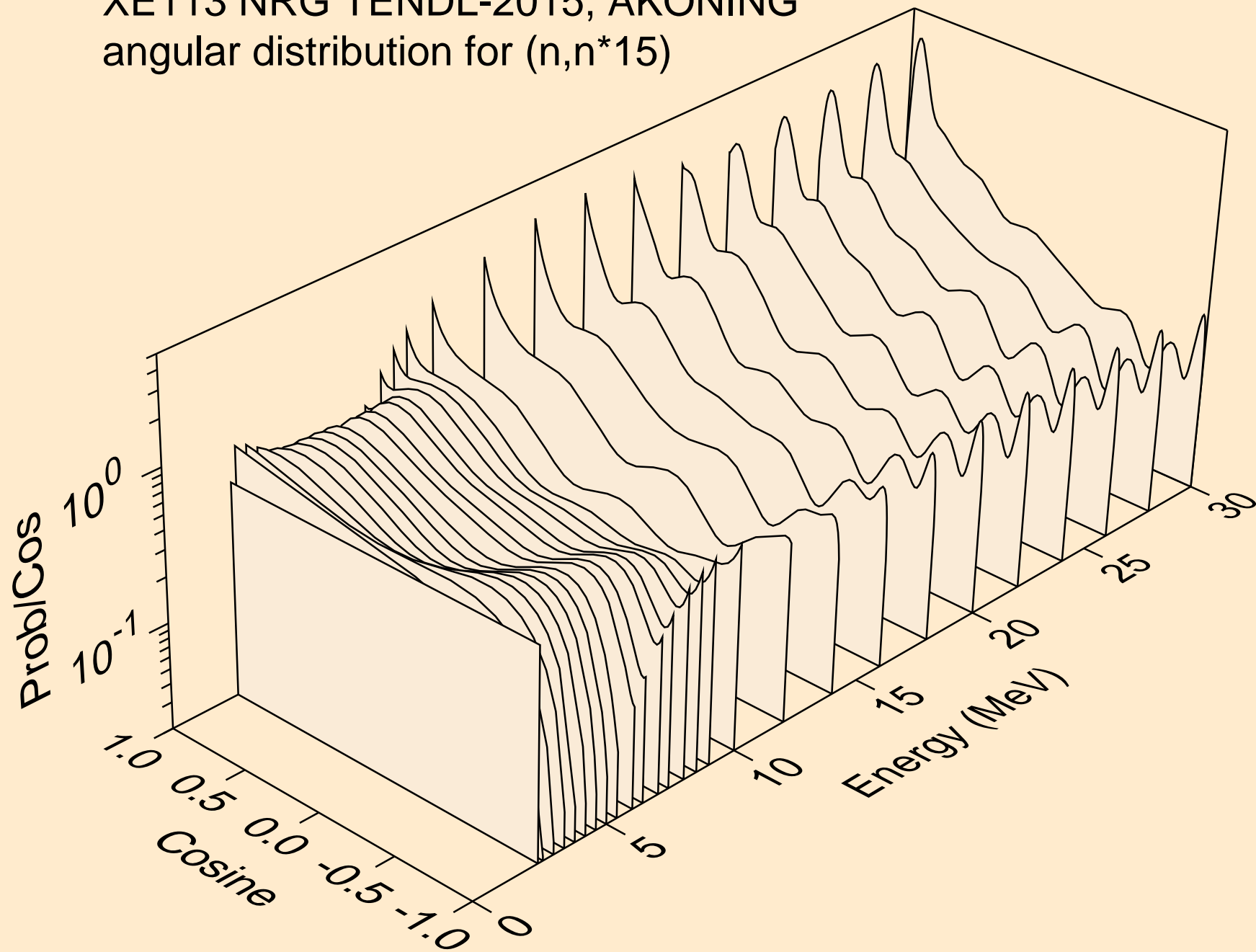

XE113 NRG TENDL-2015, AKONING
Neutron emission for (n,x)

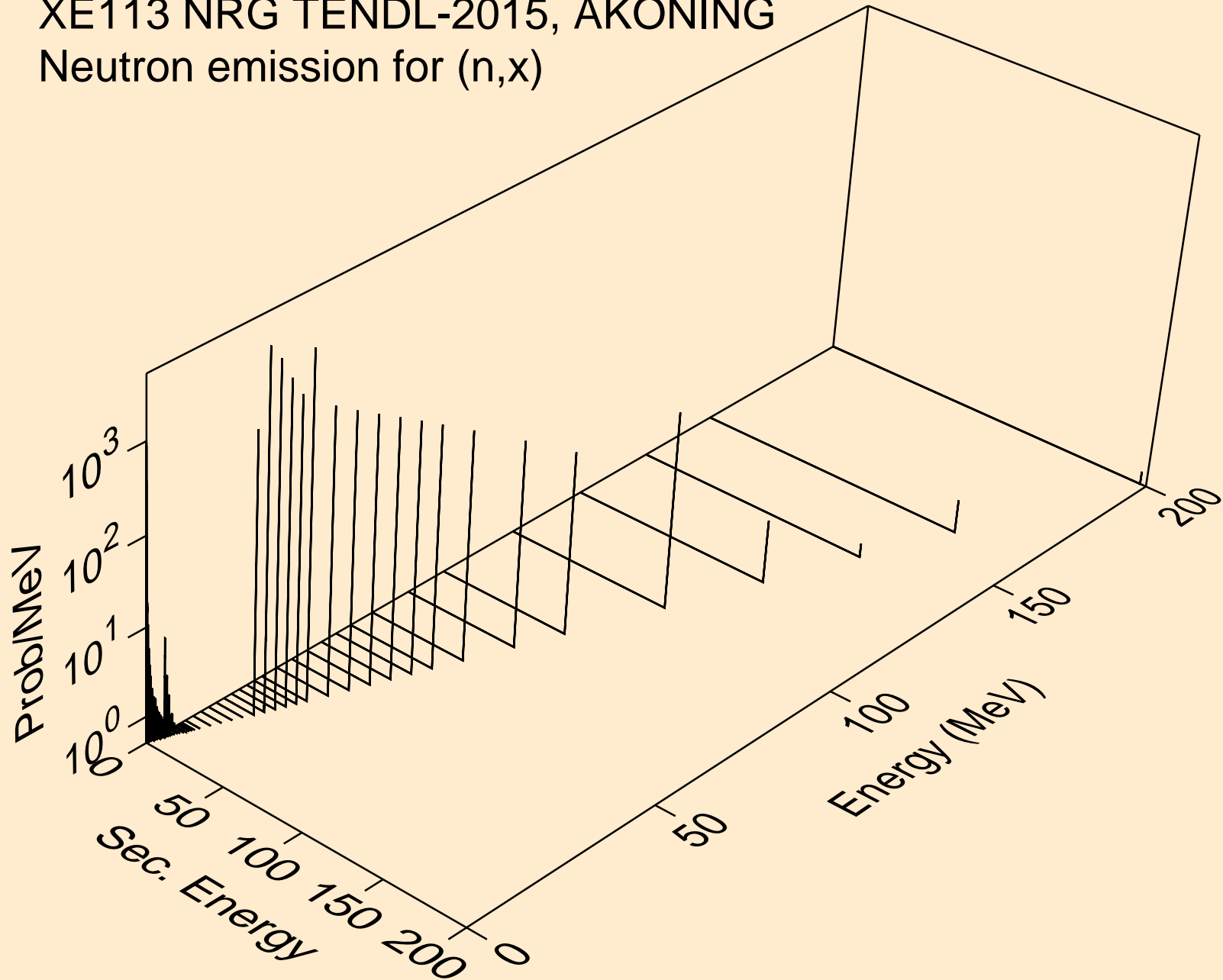

XE113 NRG TENDL-2015, AKONING
Neutron emission for (n,2nd)

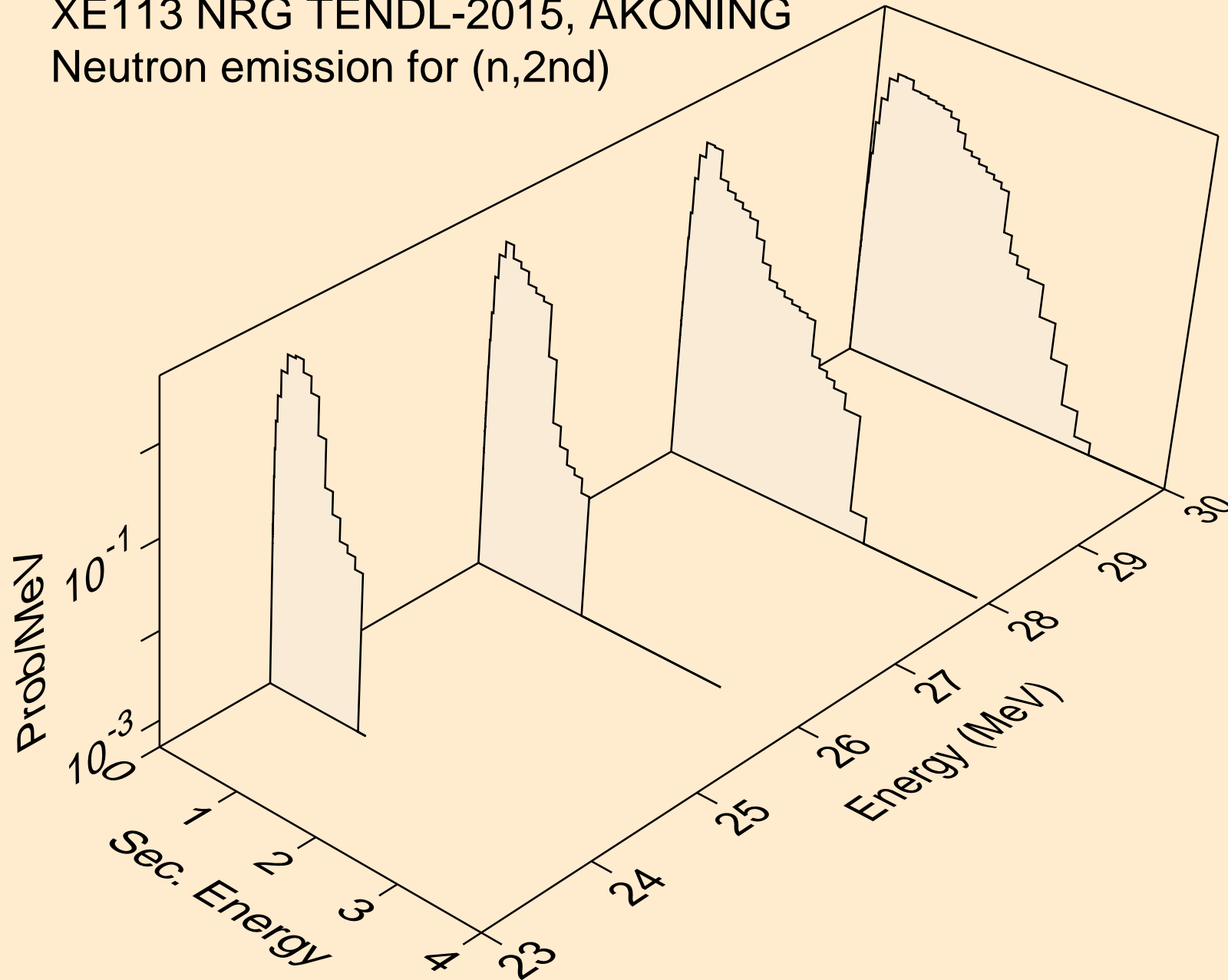

XE113 NRG TENDL-2015, AKONING
Neutron emission for (n,2n)

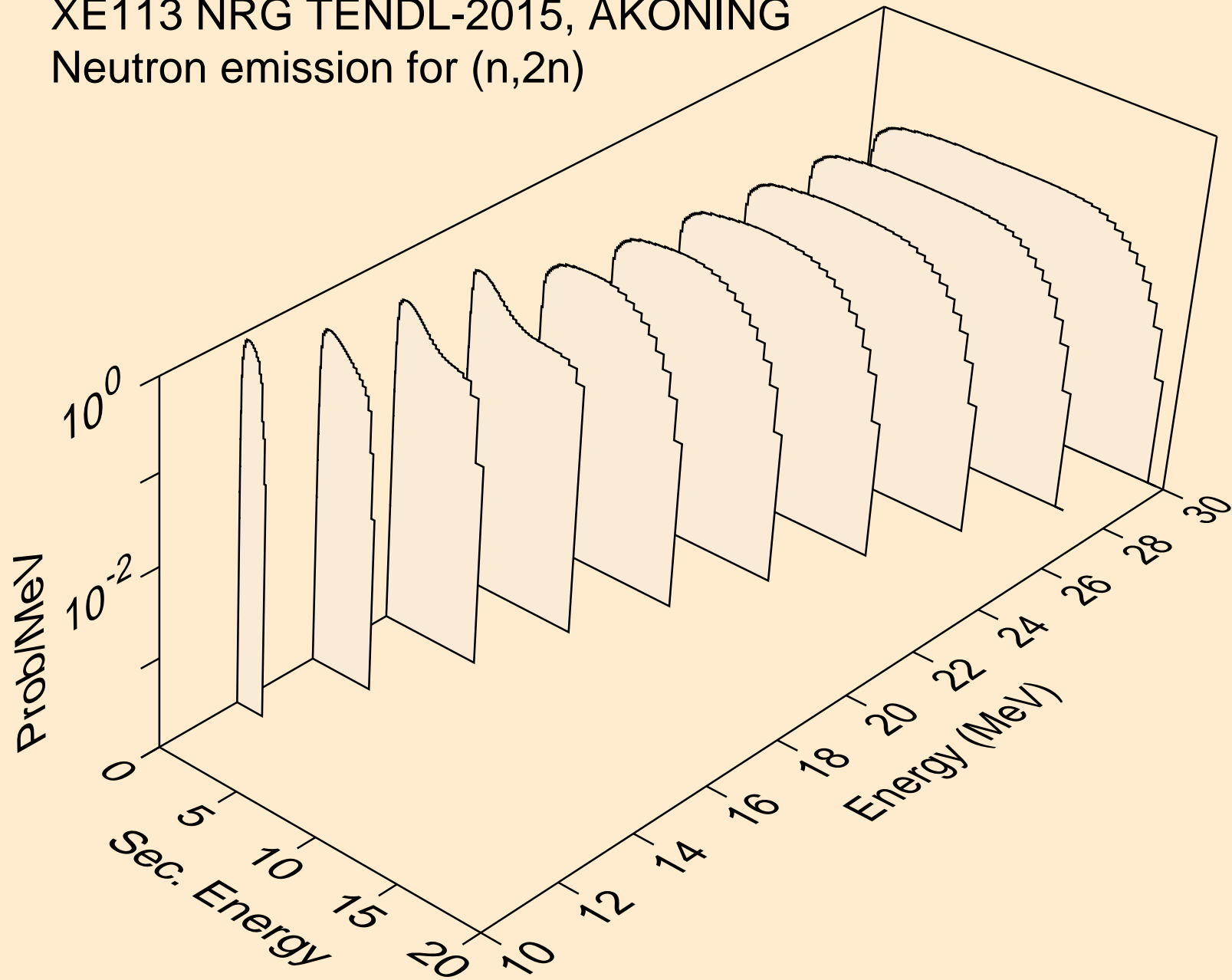

XE113 NRG TENDL-2015, AKONING
Neutron emission for (n,3n)

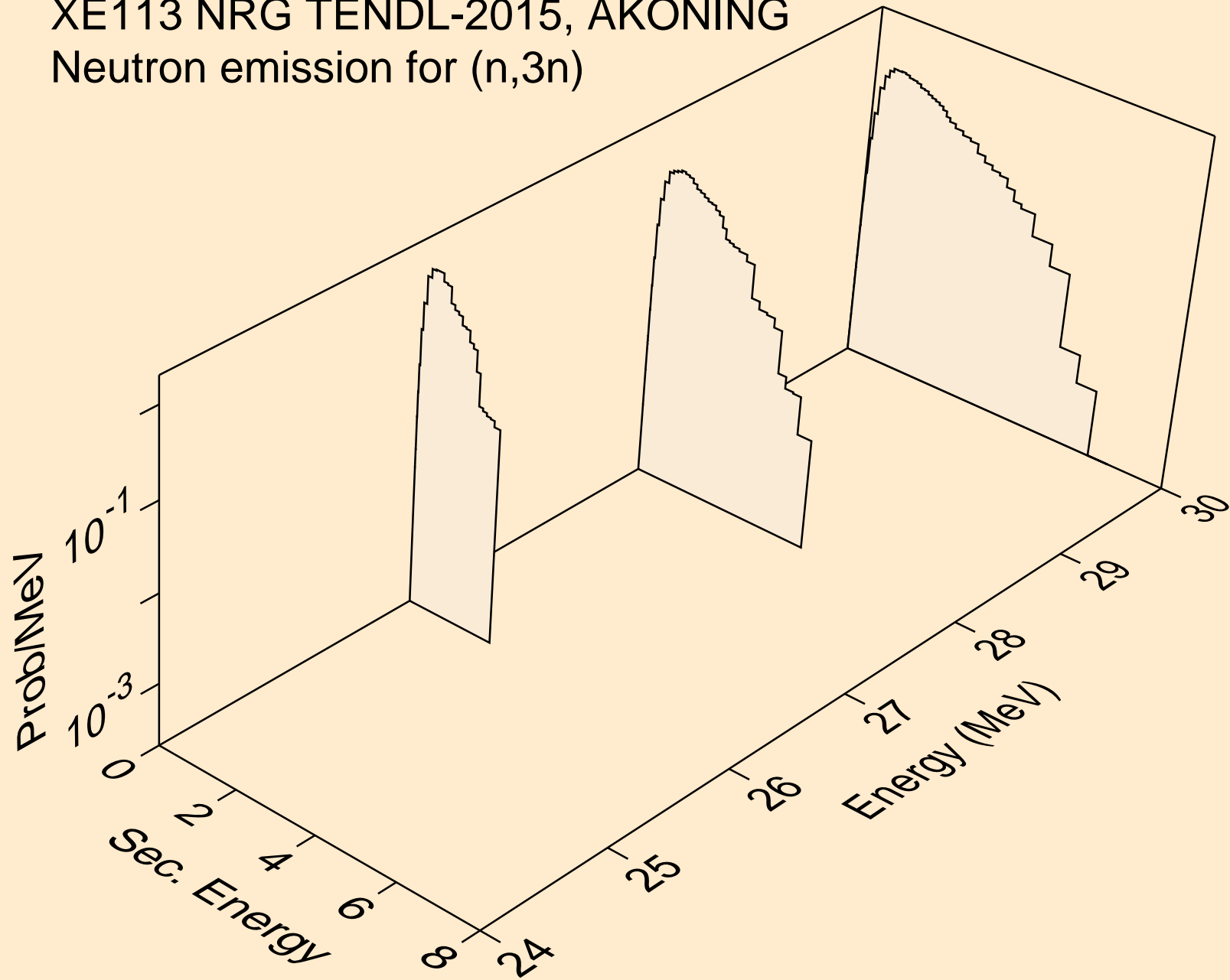

XE113 NRG TENDL-2015, AKONING
Neutron emission for (n,n*)a

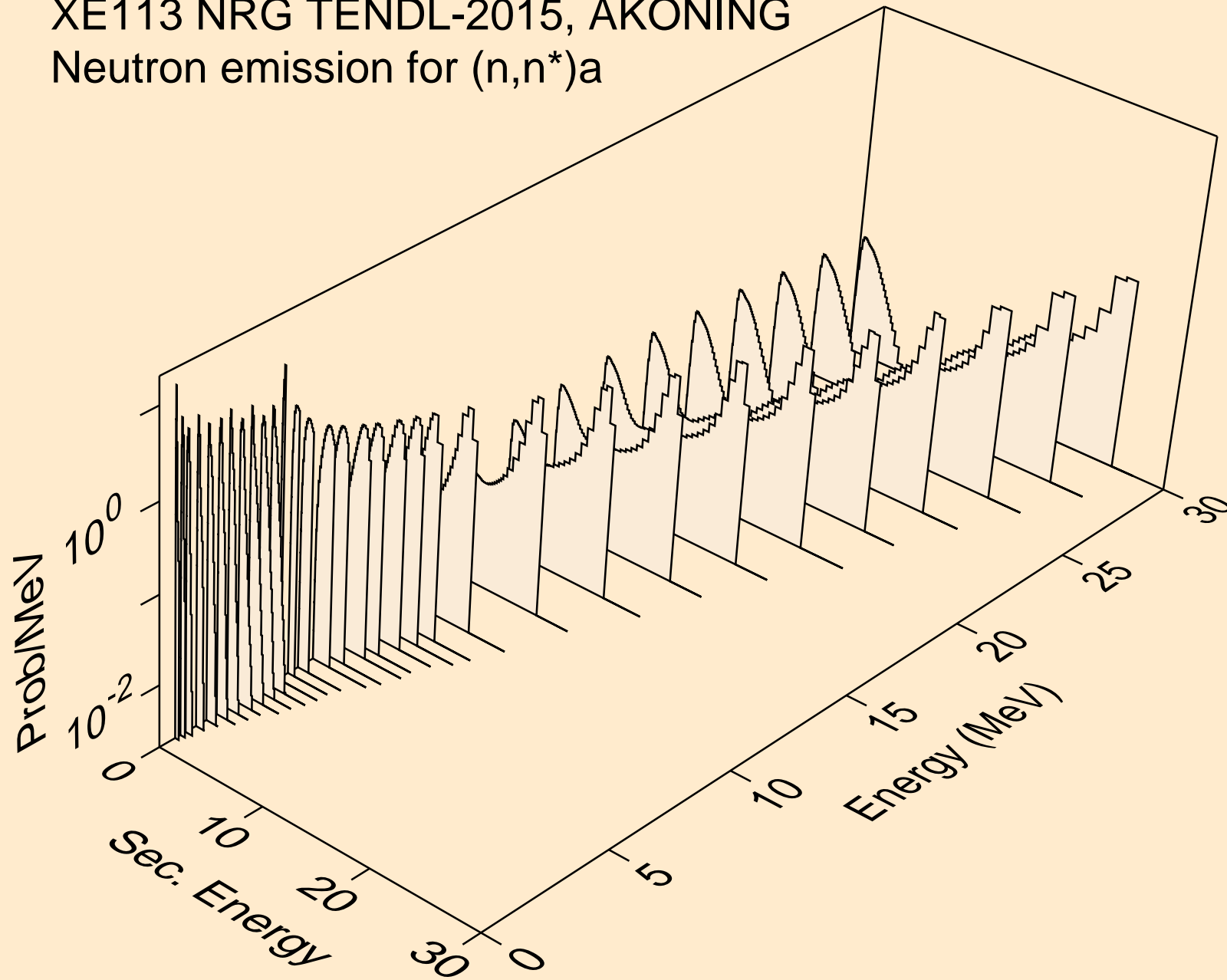

XE113 NRG TENDL-2015, AKONING
Neutron emission for (n,n*)3a

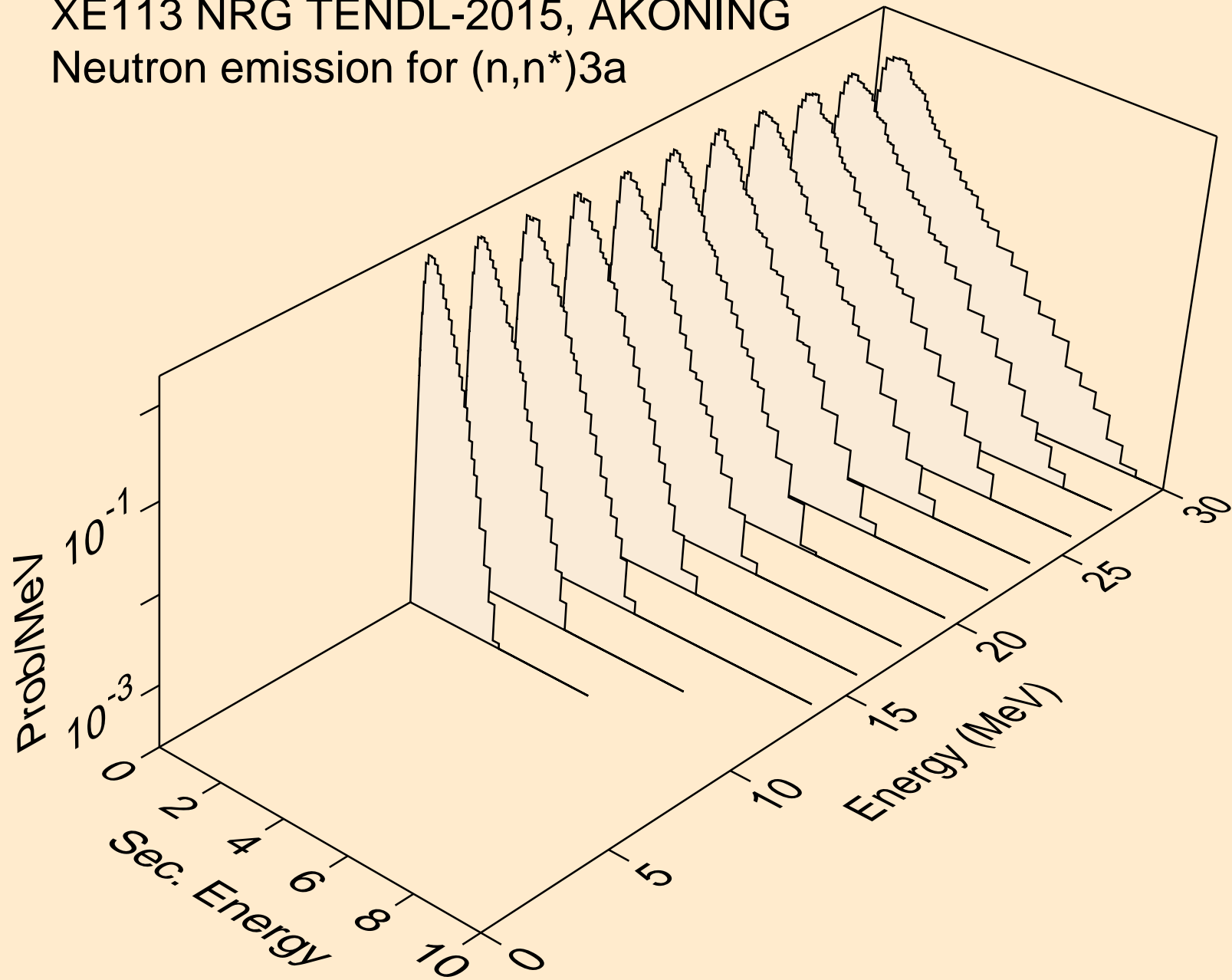

XE113 NRG TENDL-2015, AKONING
Neutron emission for (n,2n)a

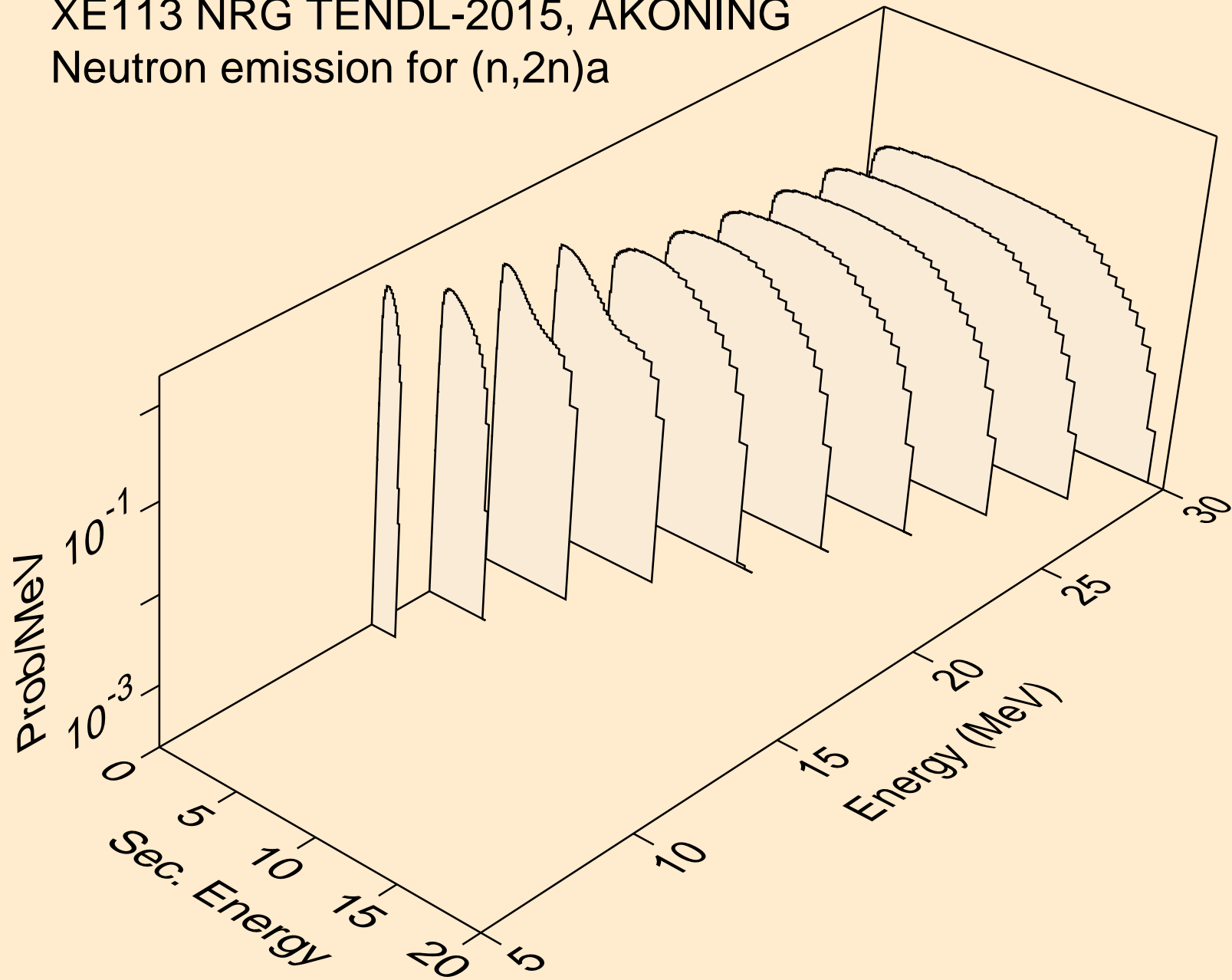

XE113 NRG TENDL-2015, AKONING
Neutron emission for (n,3n)a

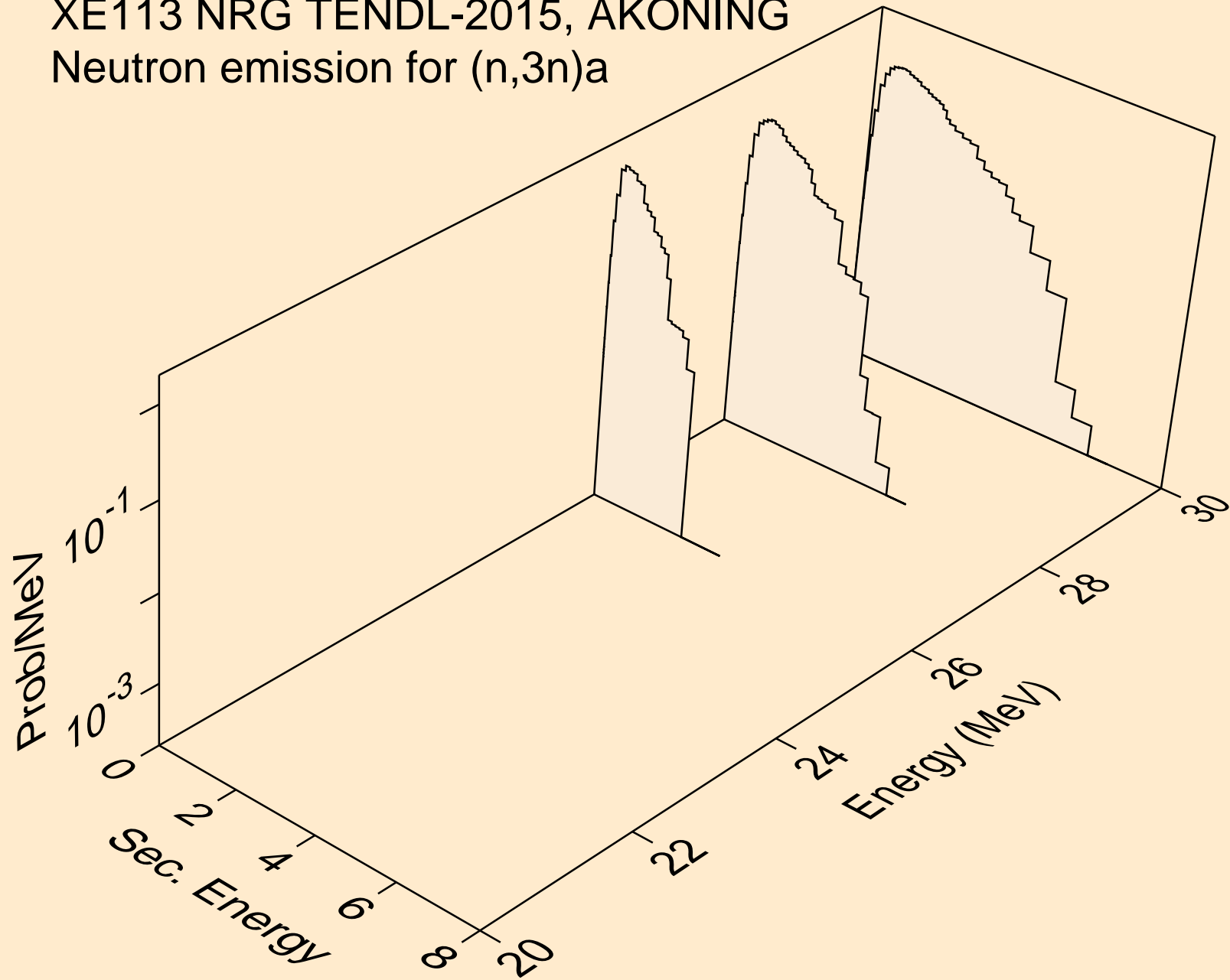

XE113 NRG TENDL-2015, AKONING
Neutron emission for (n,n*)p

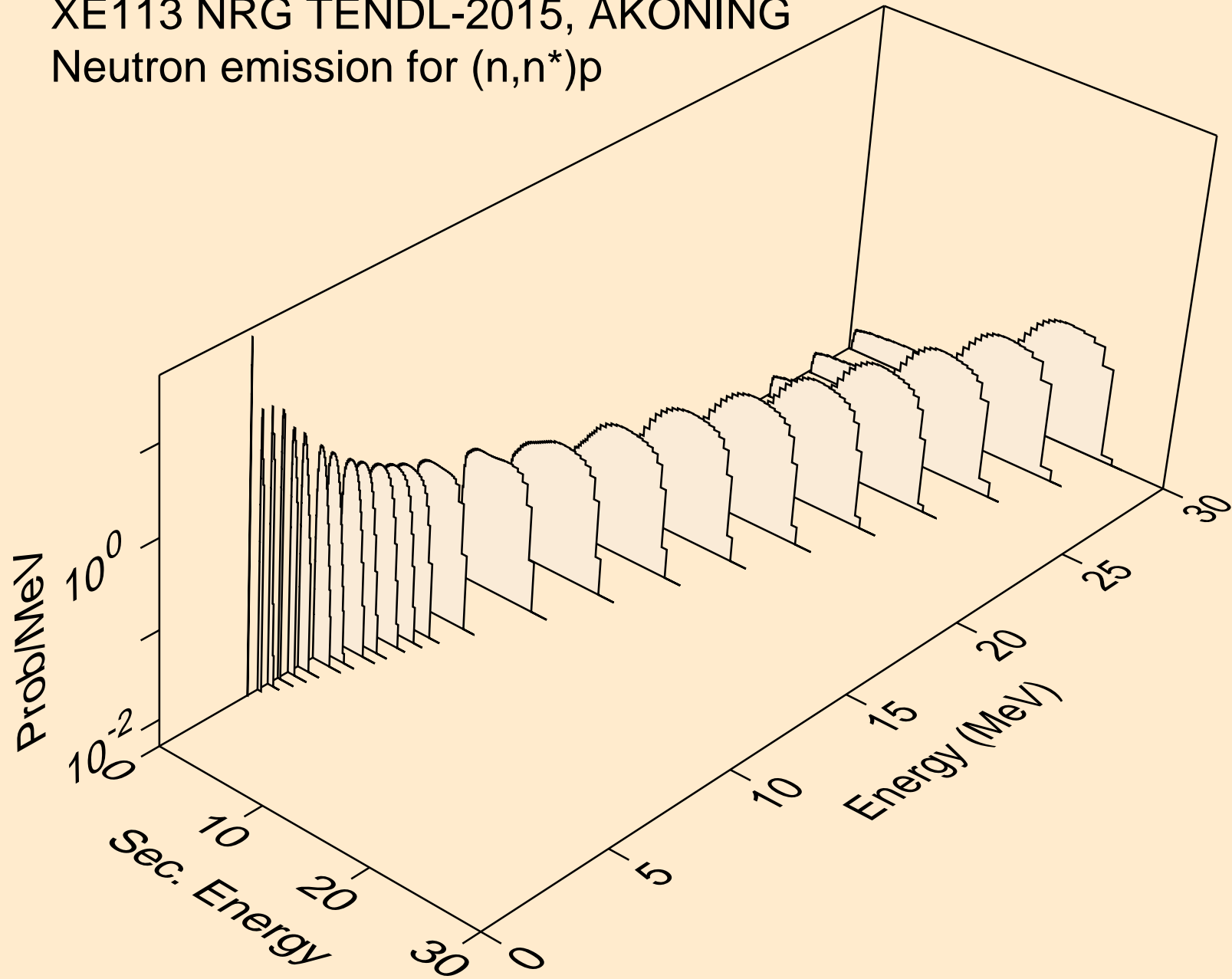

XE113 NRG TENDL-2015, AKONING
Neutron emission for (n,n*)2a

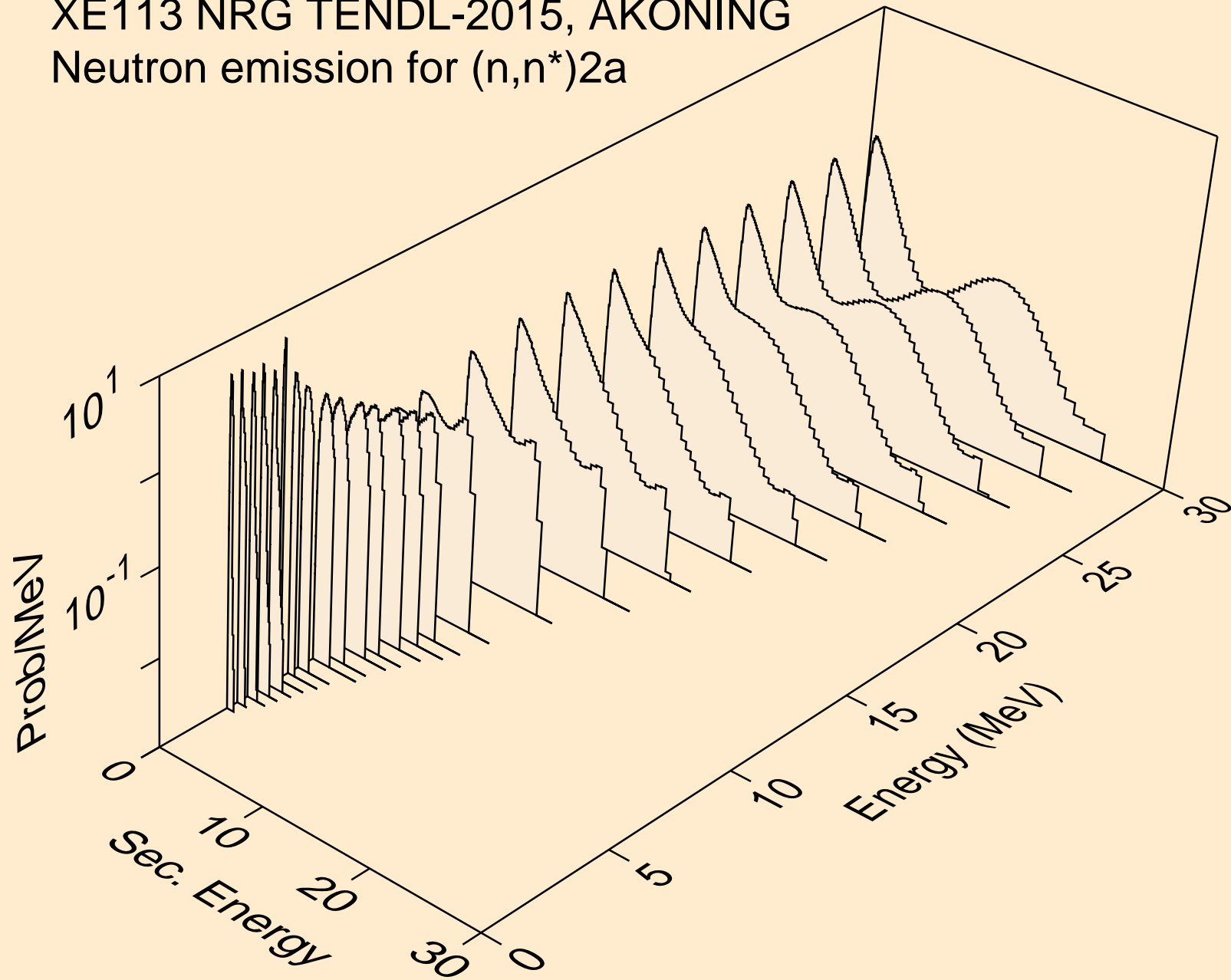

XE113 NRG TENDL-2015, AKONING
Neutron emission for (n,2n)2a

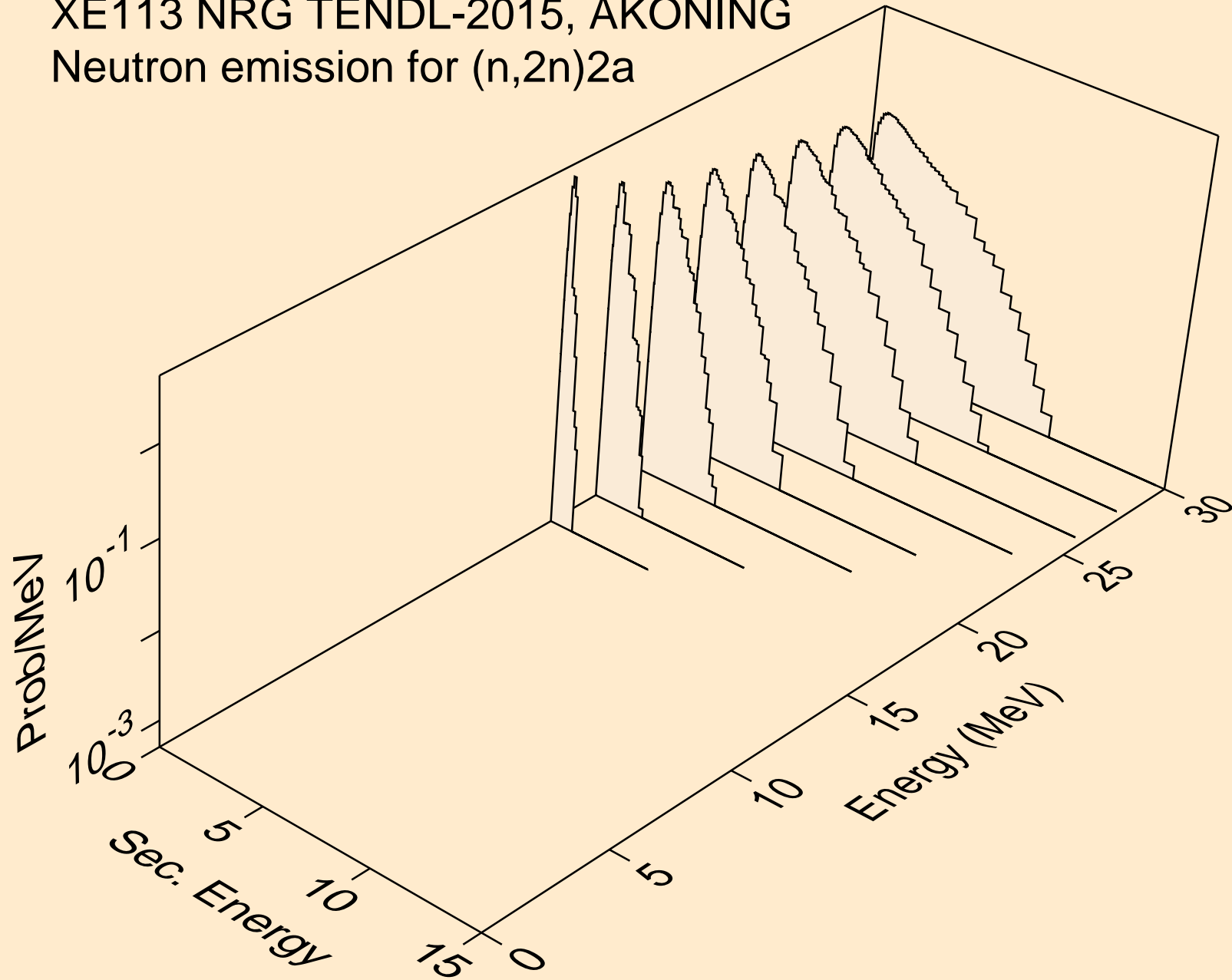

XE113 NRG TENDL-2015, AKONING
Neutron emission for (n,n*)d

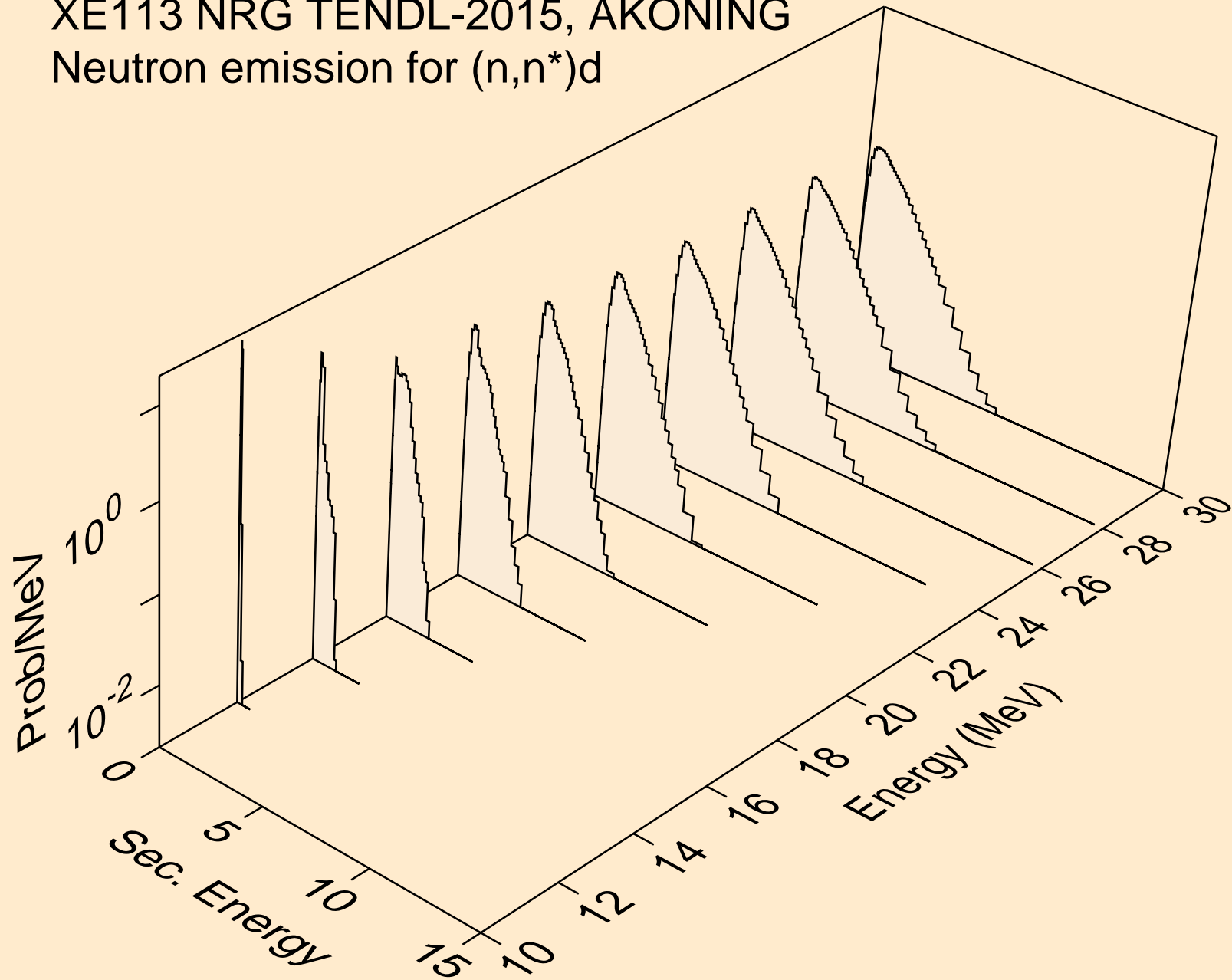

XE113 NRG TENDL-2015, AKONING
Neutron emission for (n,n*)t

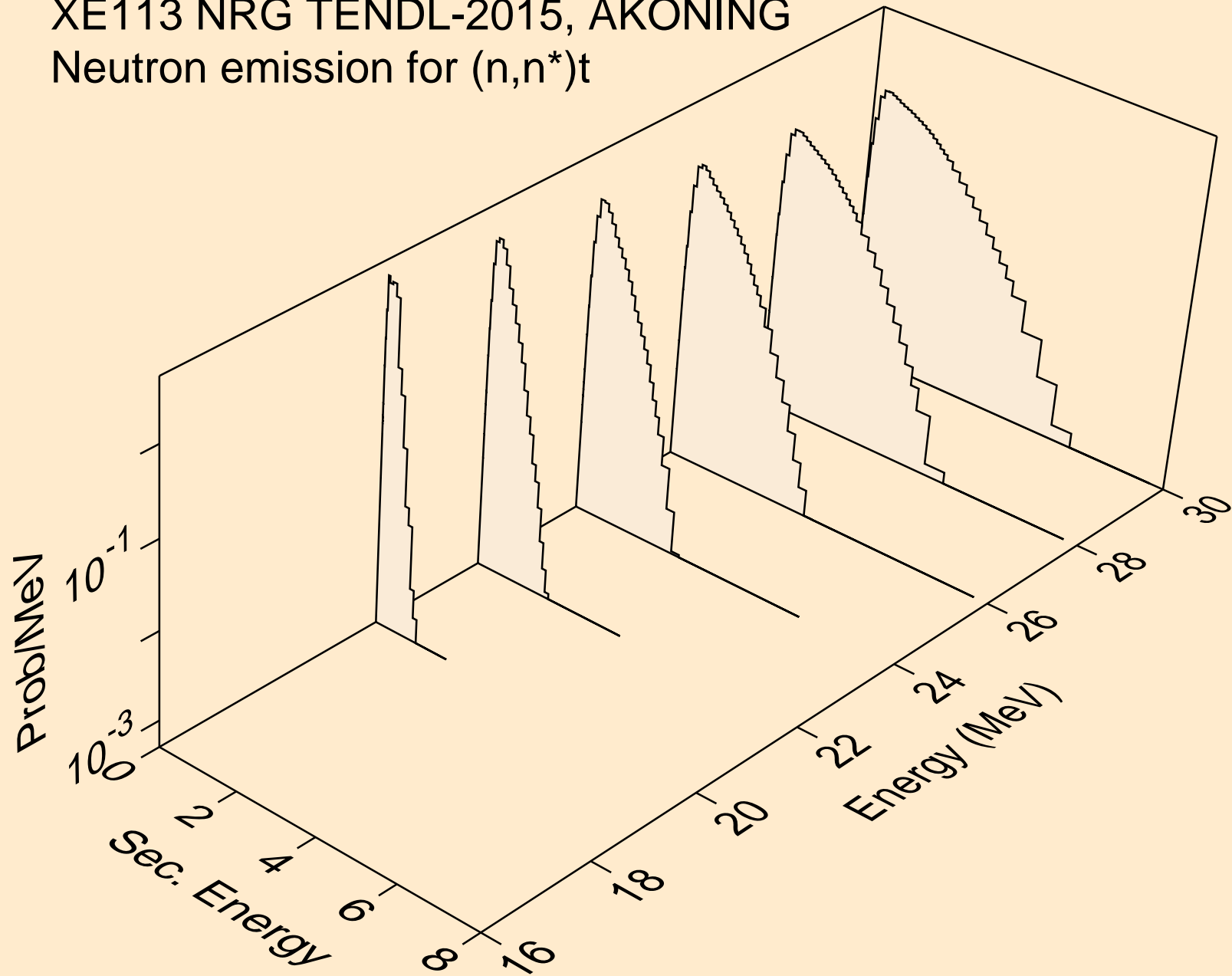

XE113 NRG TENDL-2015, AKONING
Neutron emission for (n,n*)he3

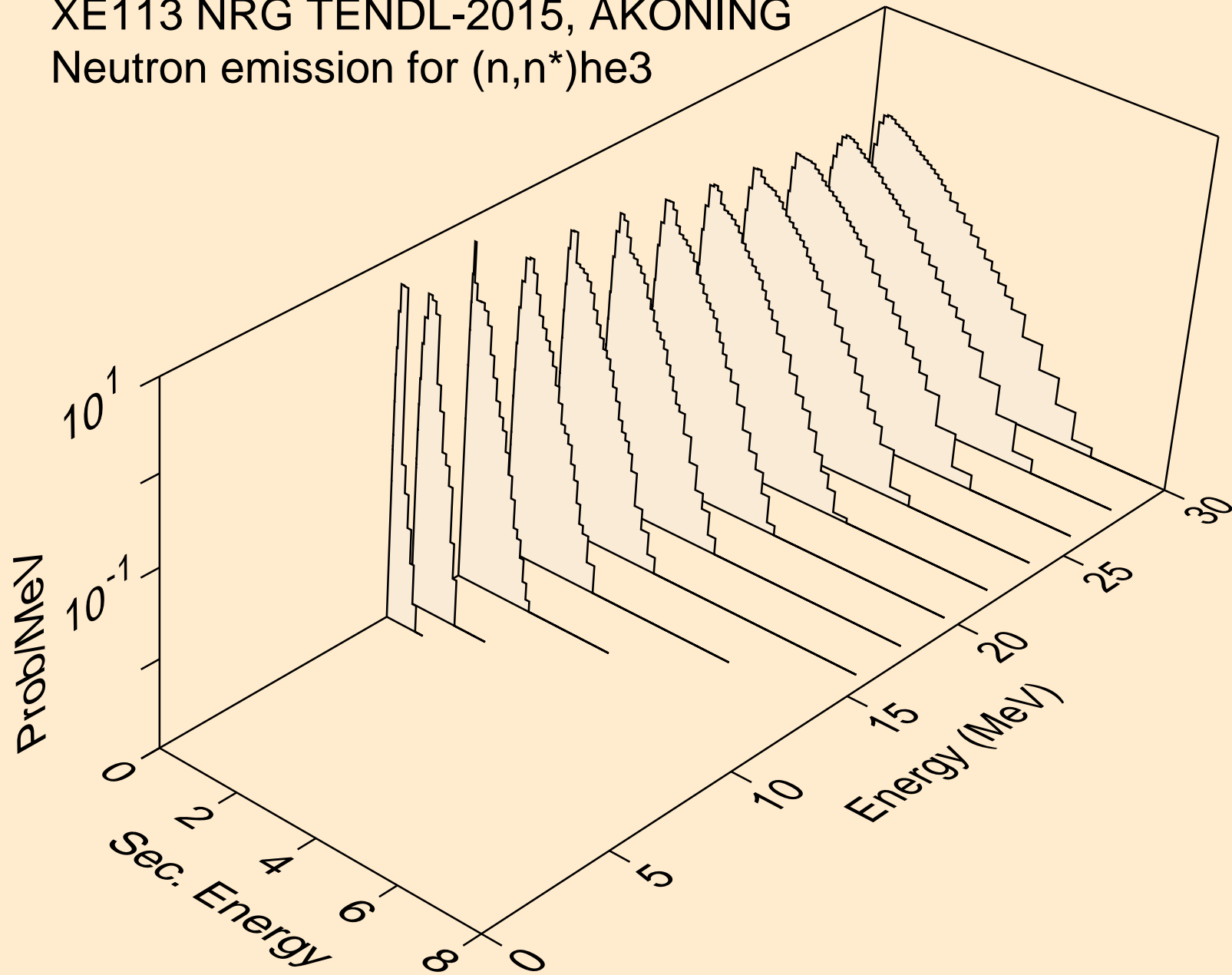

XE113 NRG TENDL-2015, AKONING
Neutron emission for (n,2np)

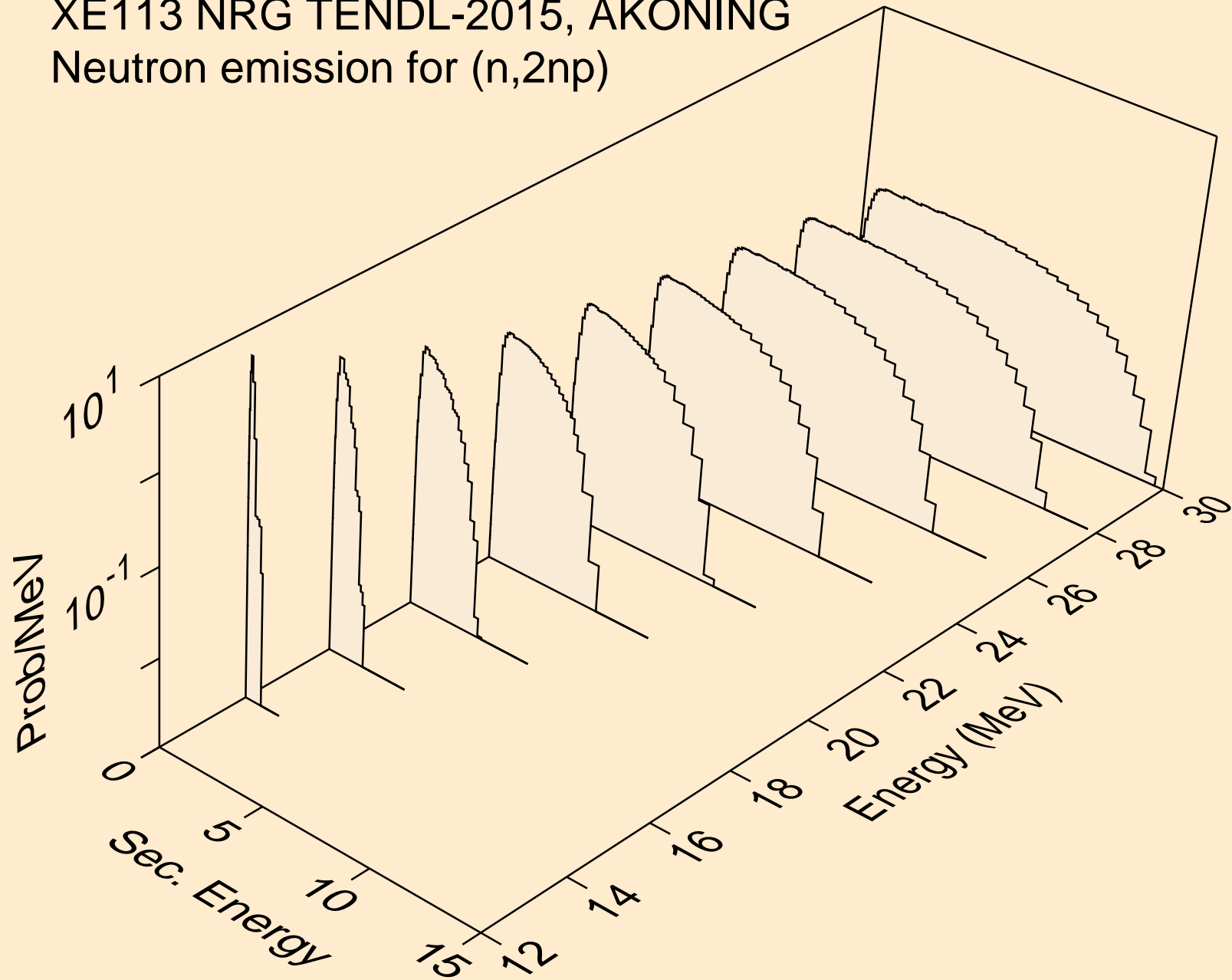

XE113 NRG TENDL-2015, AKONING
Neutron emission for (n,3np)

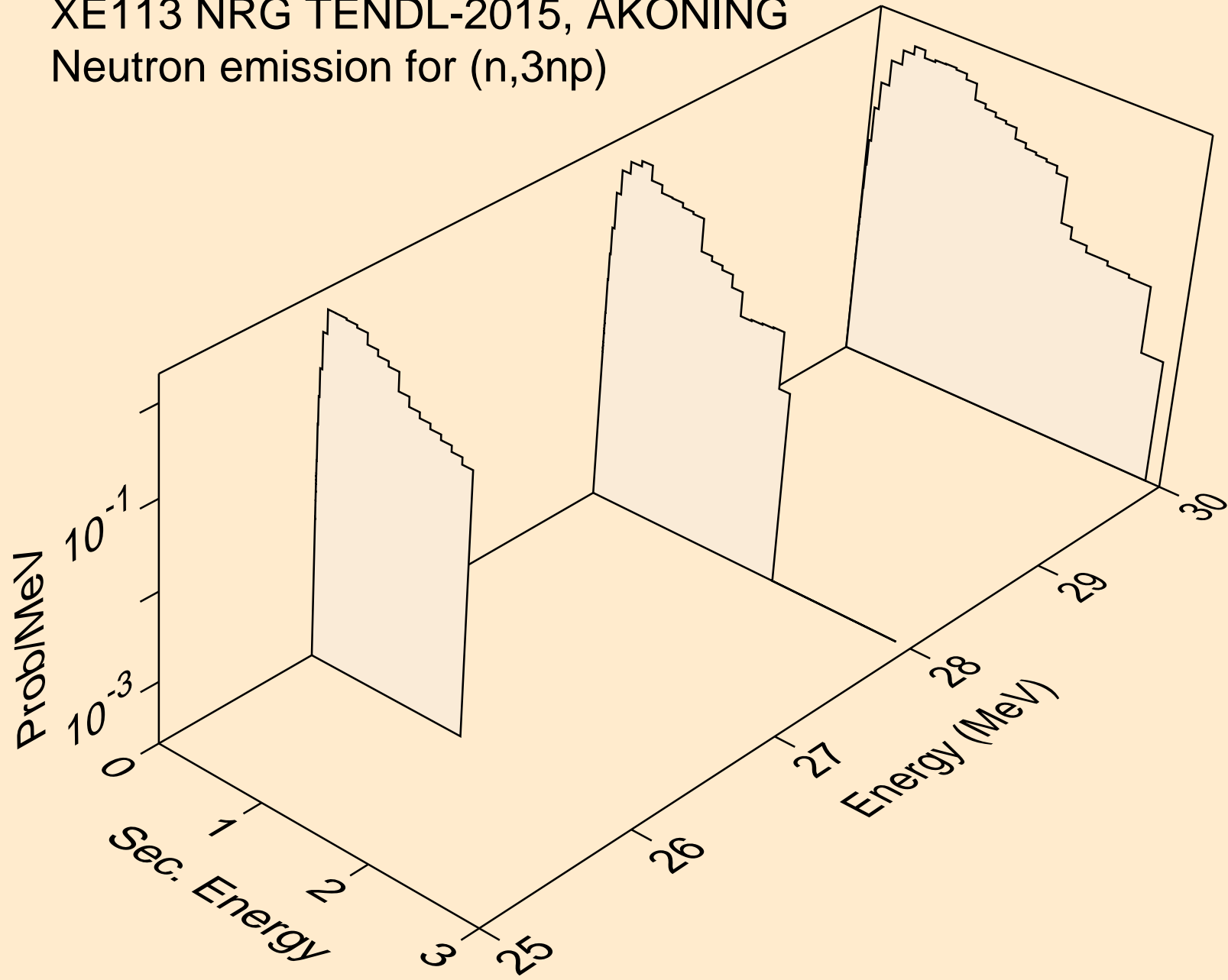

XE113 NRG TENDL-2015, AKONING
Neutron emission for (n,2np)

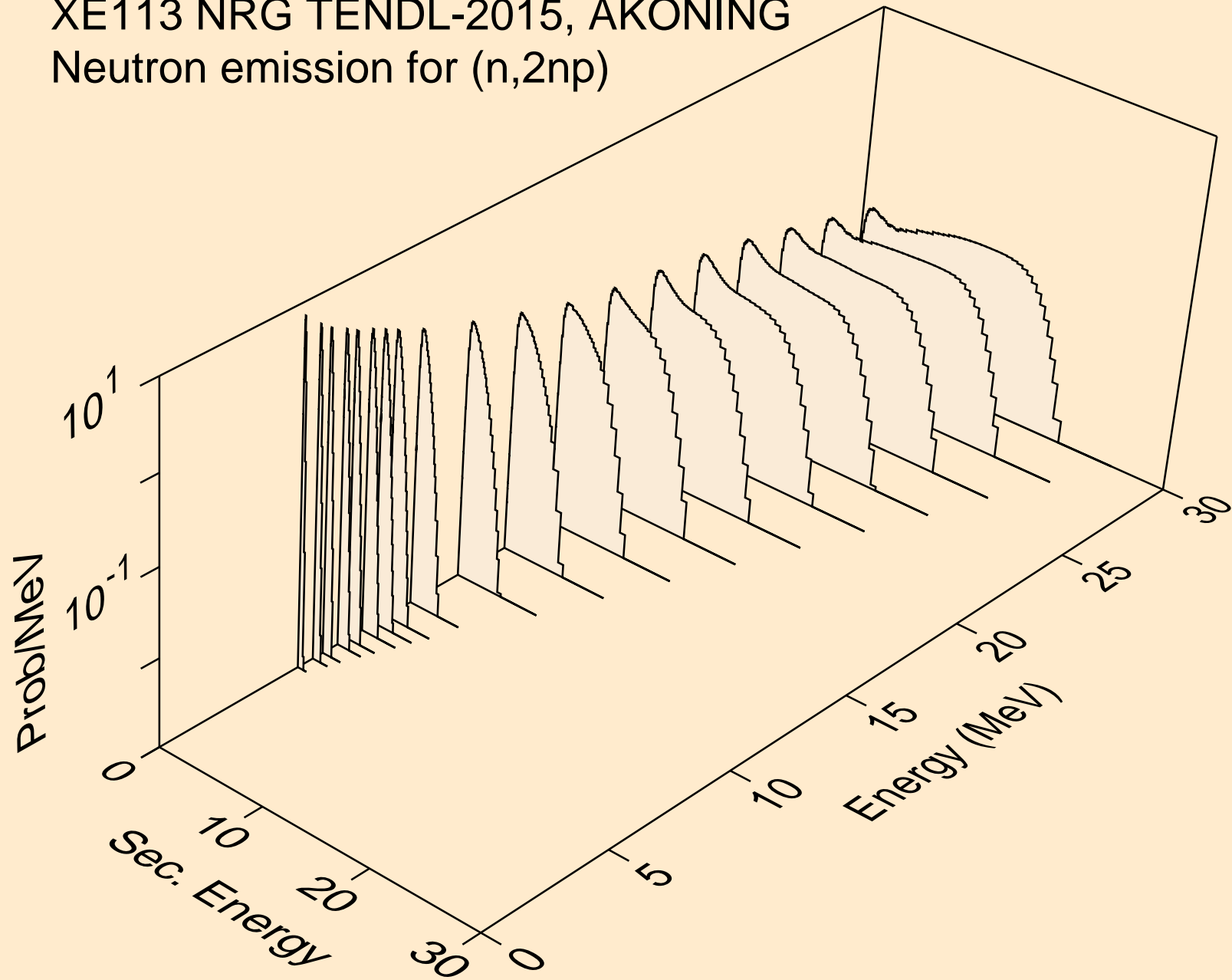

XE113 NRG TENDL-2015, AKONING
Neutron emission for (n,npa)

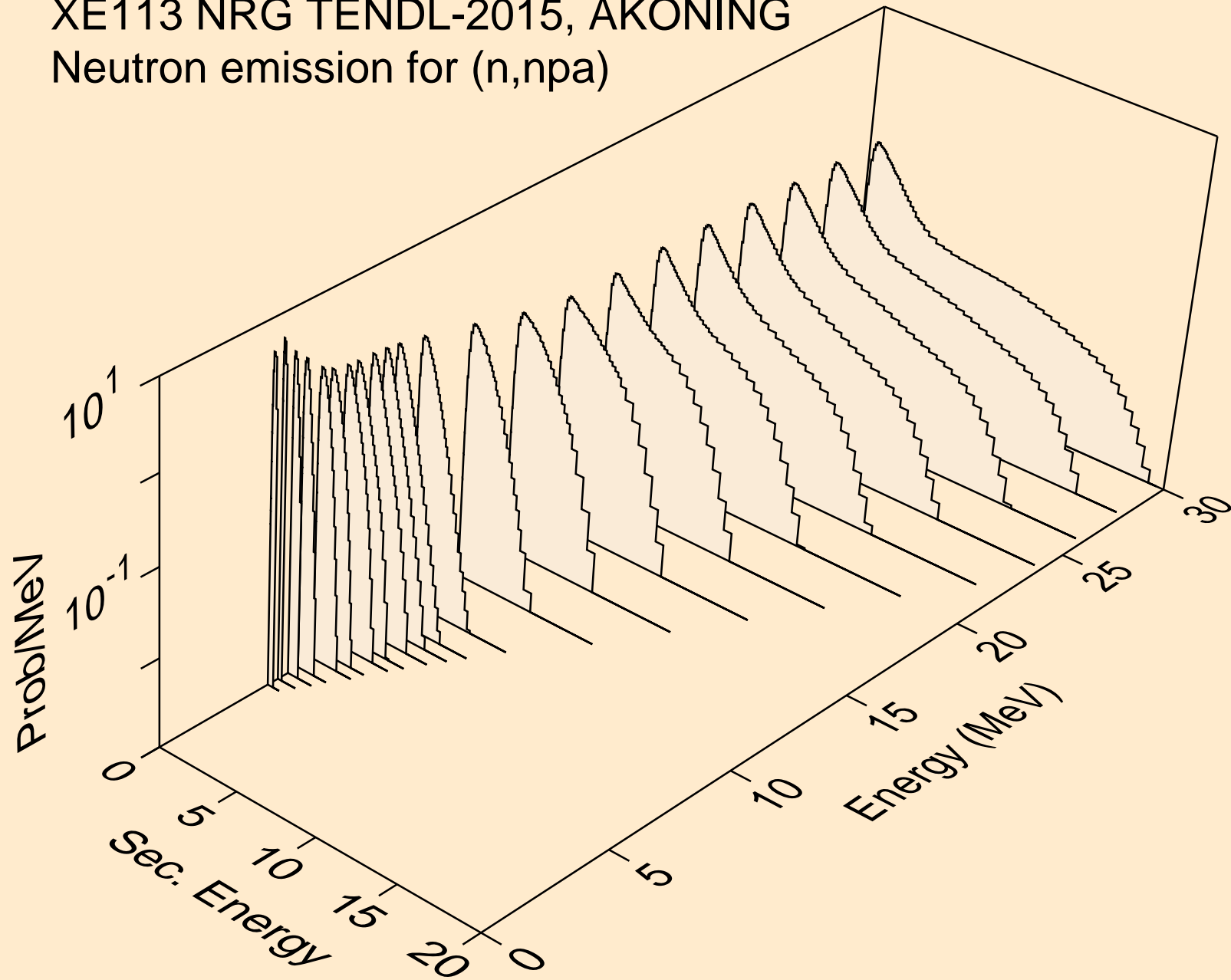

XE113 NRG TENDL-2015, AKONING
Neutron emission for (n,n*c)

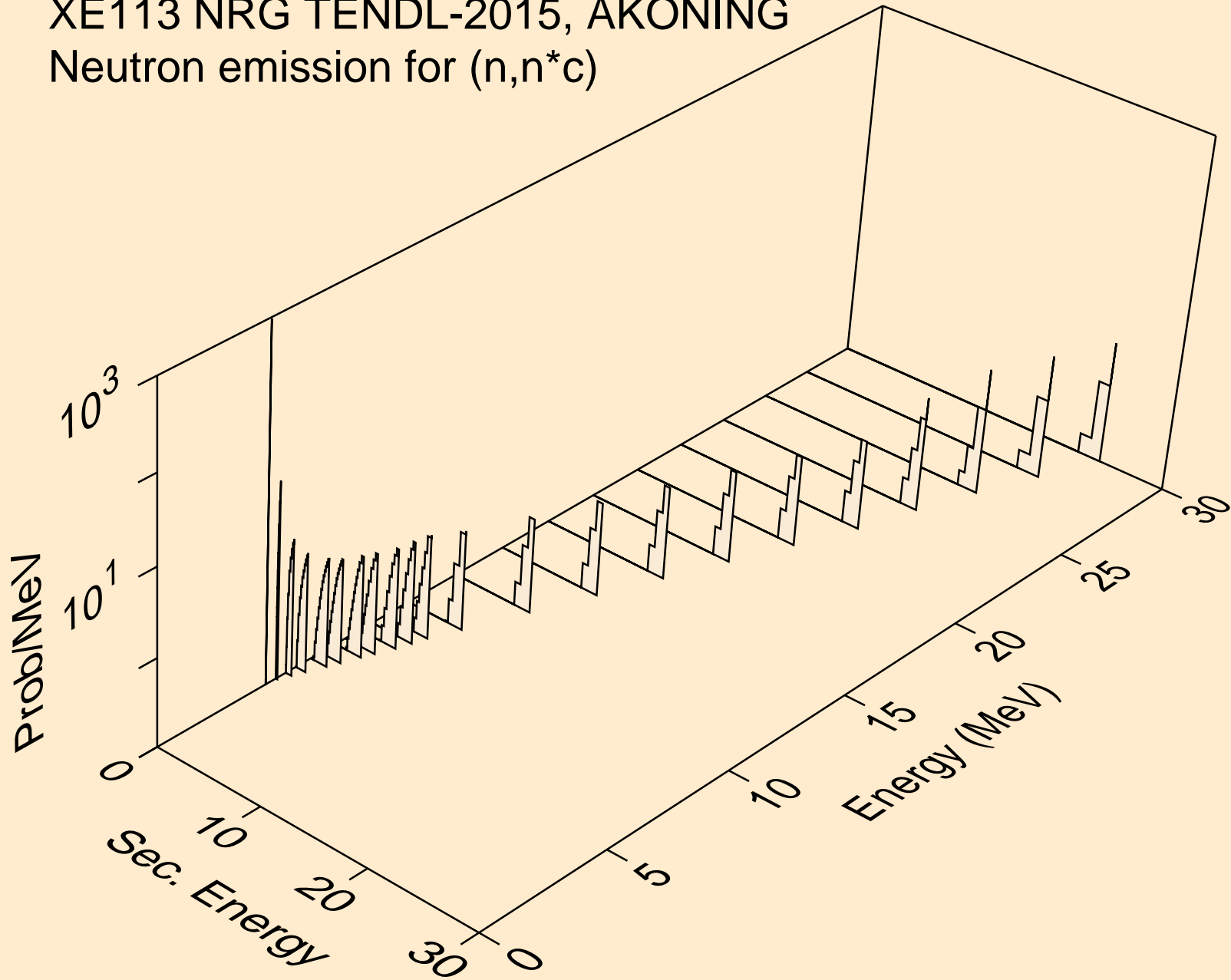

XE113 NRG TENDL-2015, AKONING
Photon emission for (n,x)

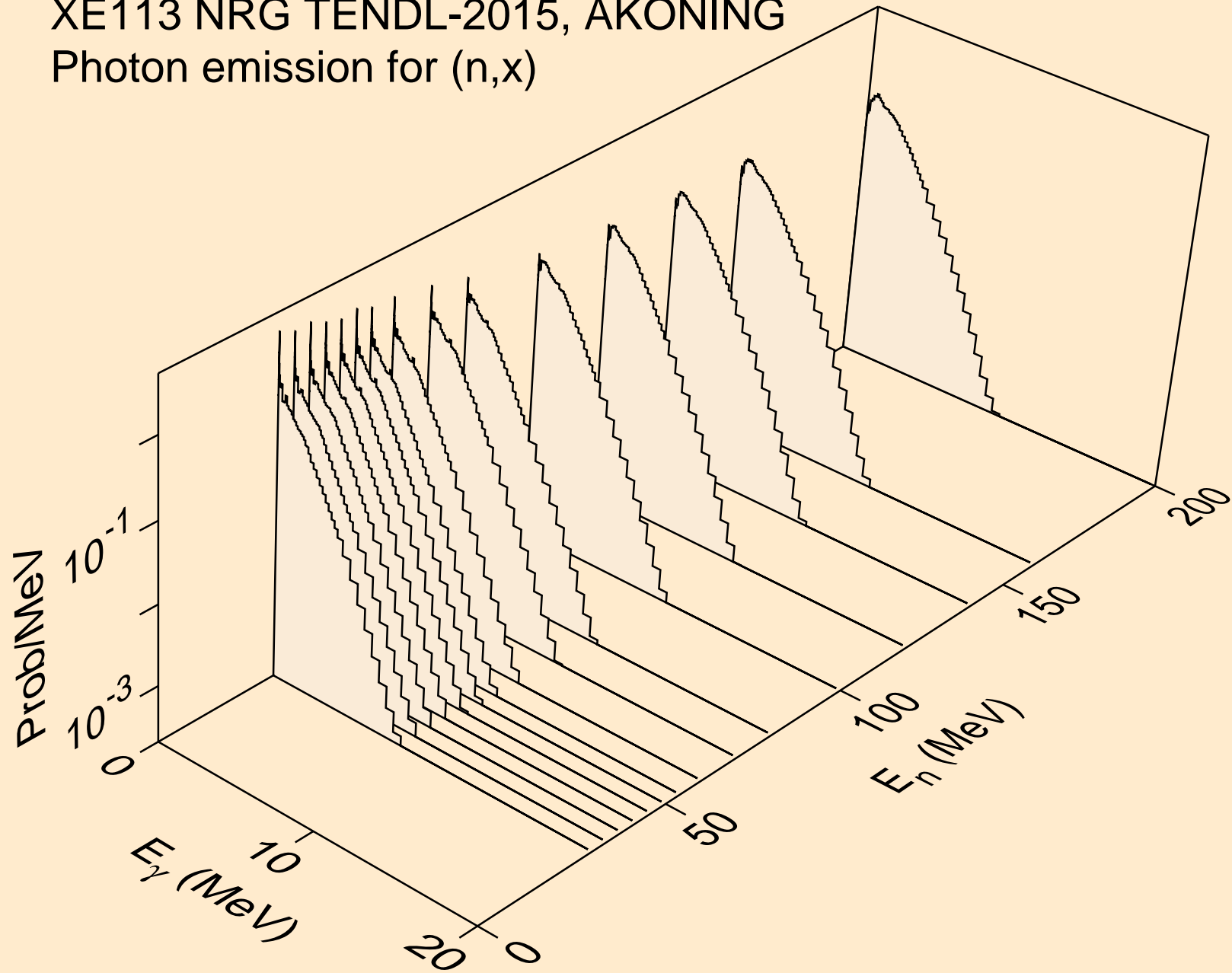

XE113 NRG TENDL-2015, AKONING
Photon emission for (n,2nd)

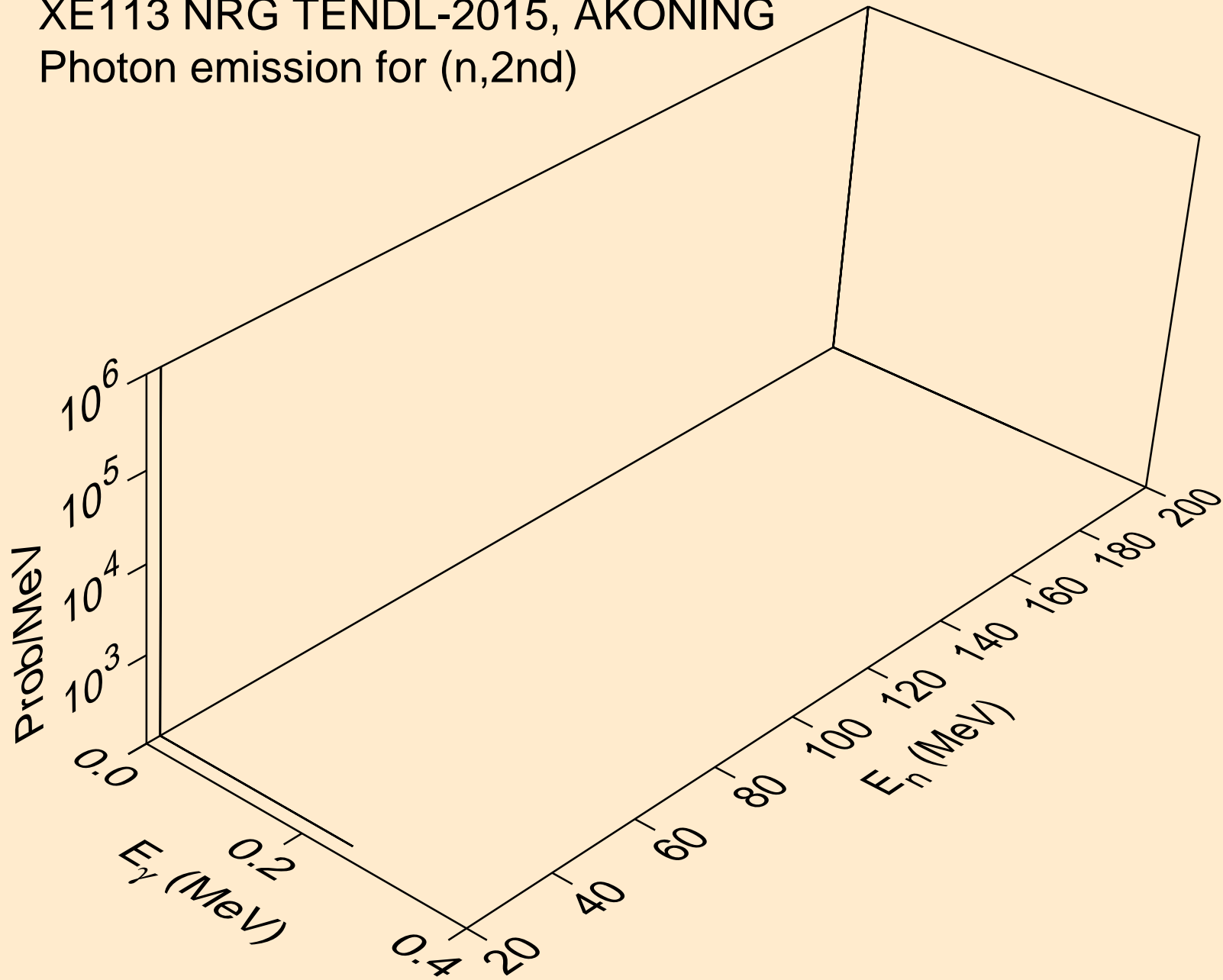

XE113 NRG TENDL-2015, AKONING
Photon emission for (n,2n)

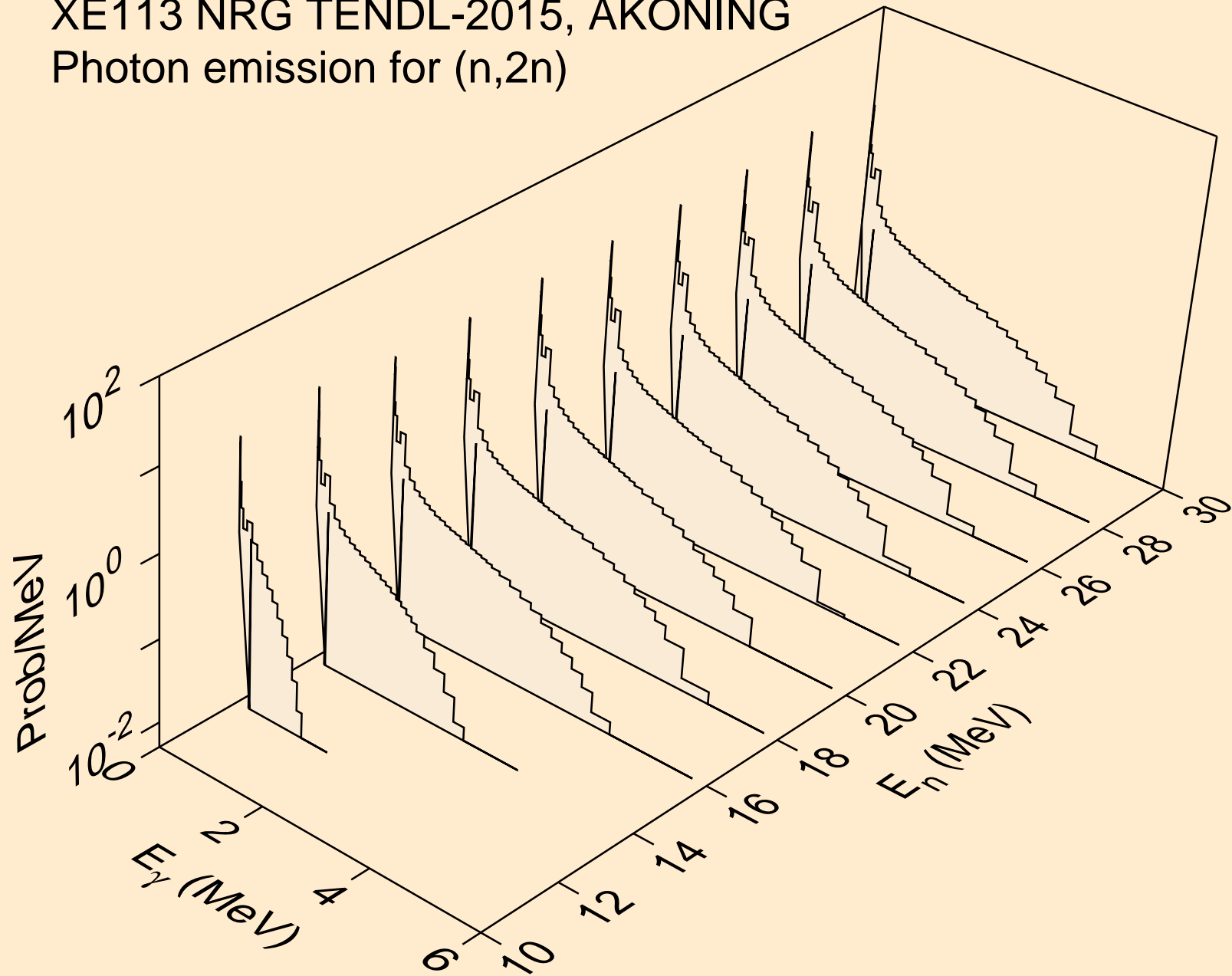

XE113 NRG TENDL-2015, AKONING
Photon emission for (n,3n)

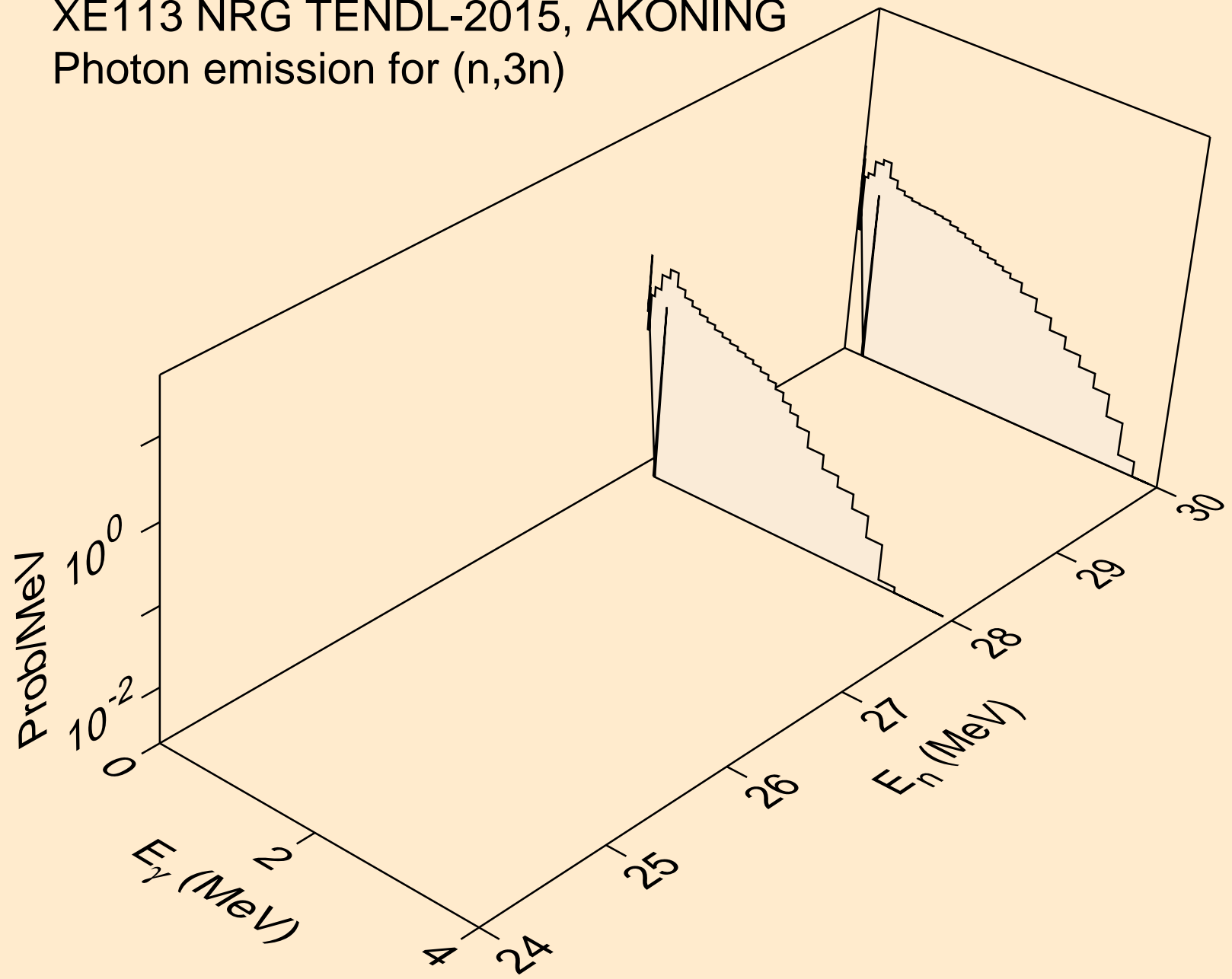

XE113 NRG TENDL-2015, AKONING
Photon emission for (n,n*)a

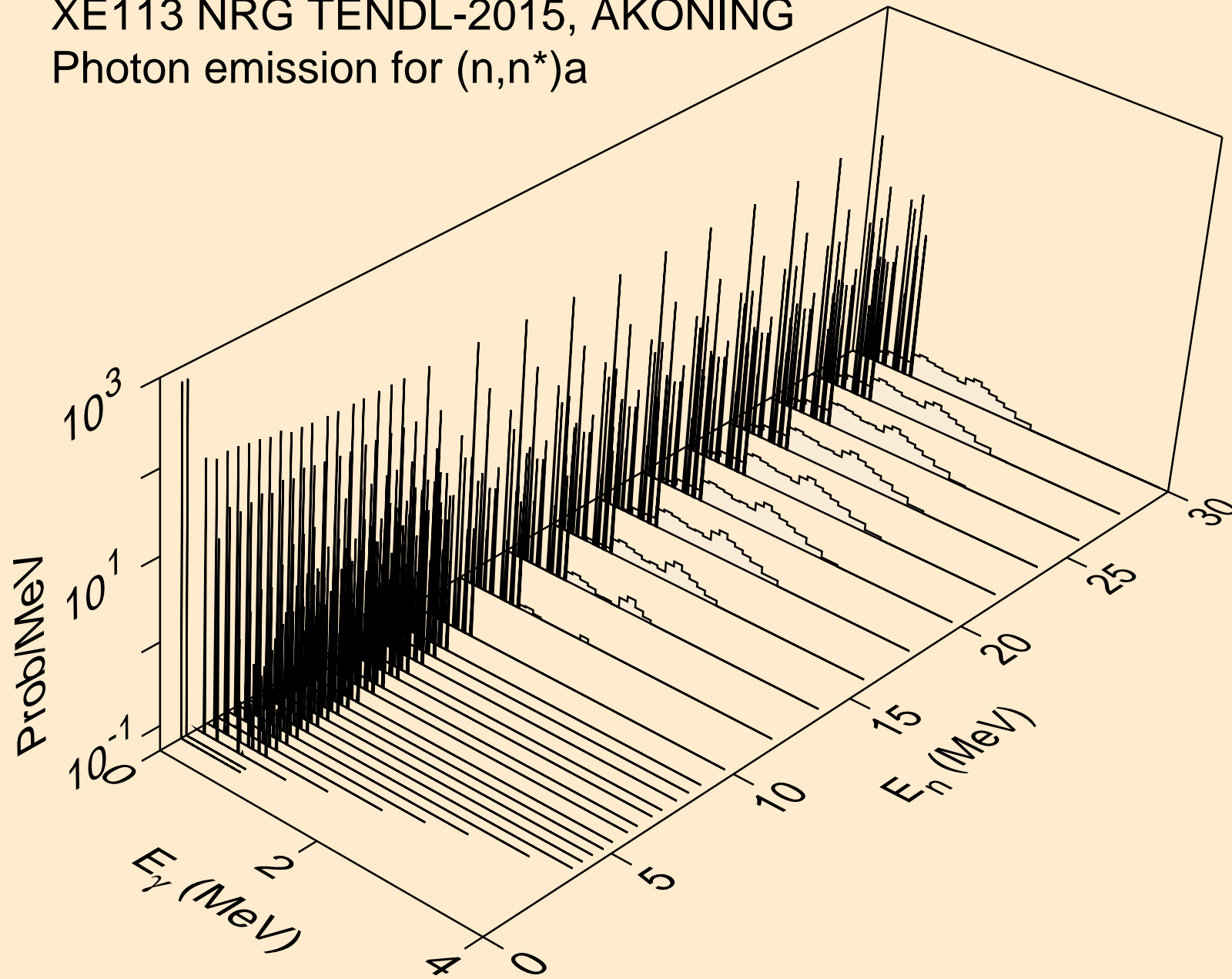

XE113 NRG TENDL-2015, AKONING
Photon emission for (n,n*)3a

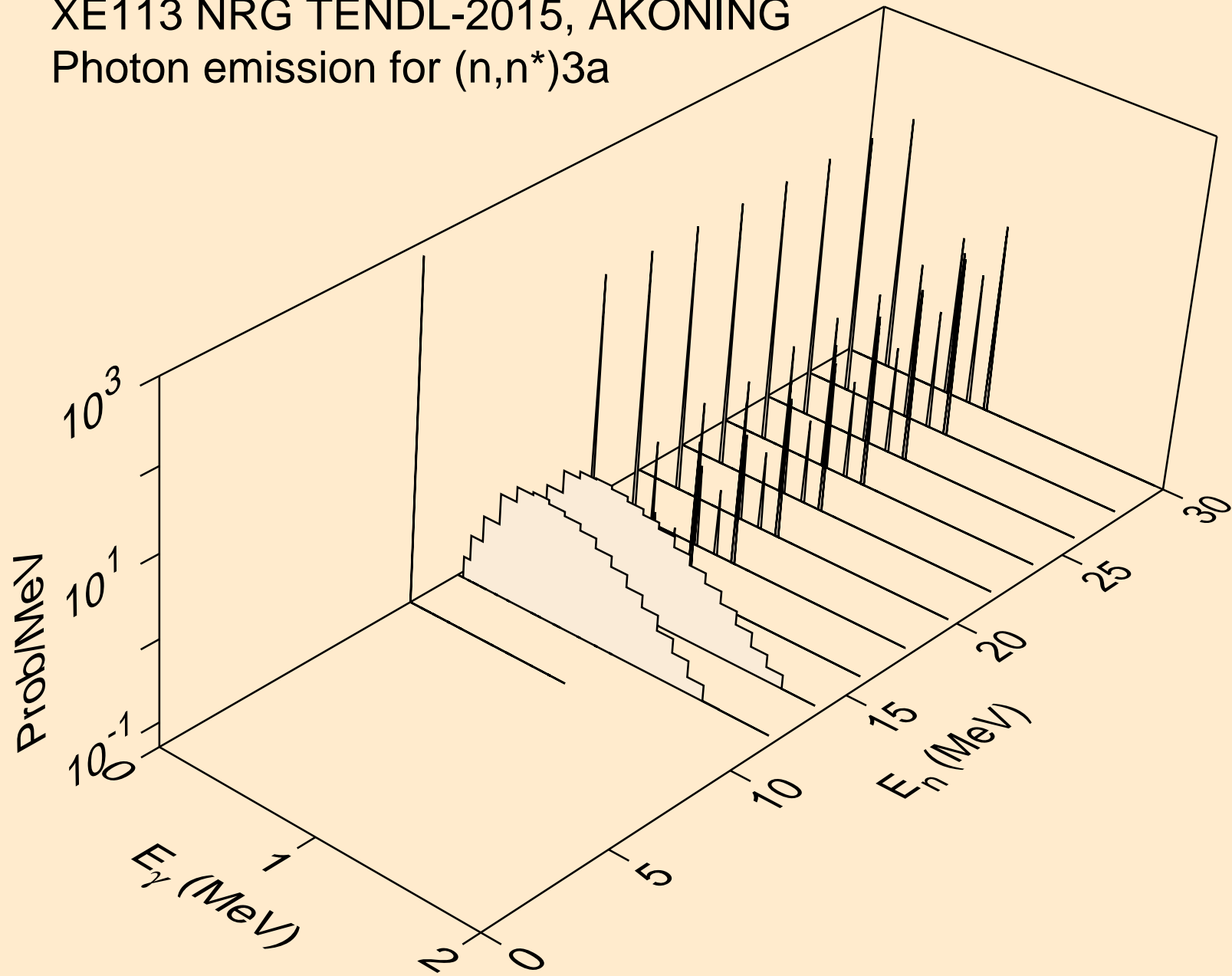

XE113 NRG TENDL-2015, AKONING
Photon emission for (n,2n)_a

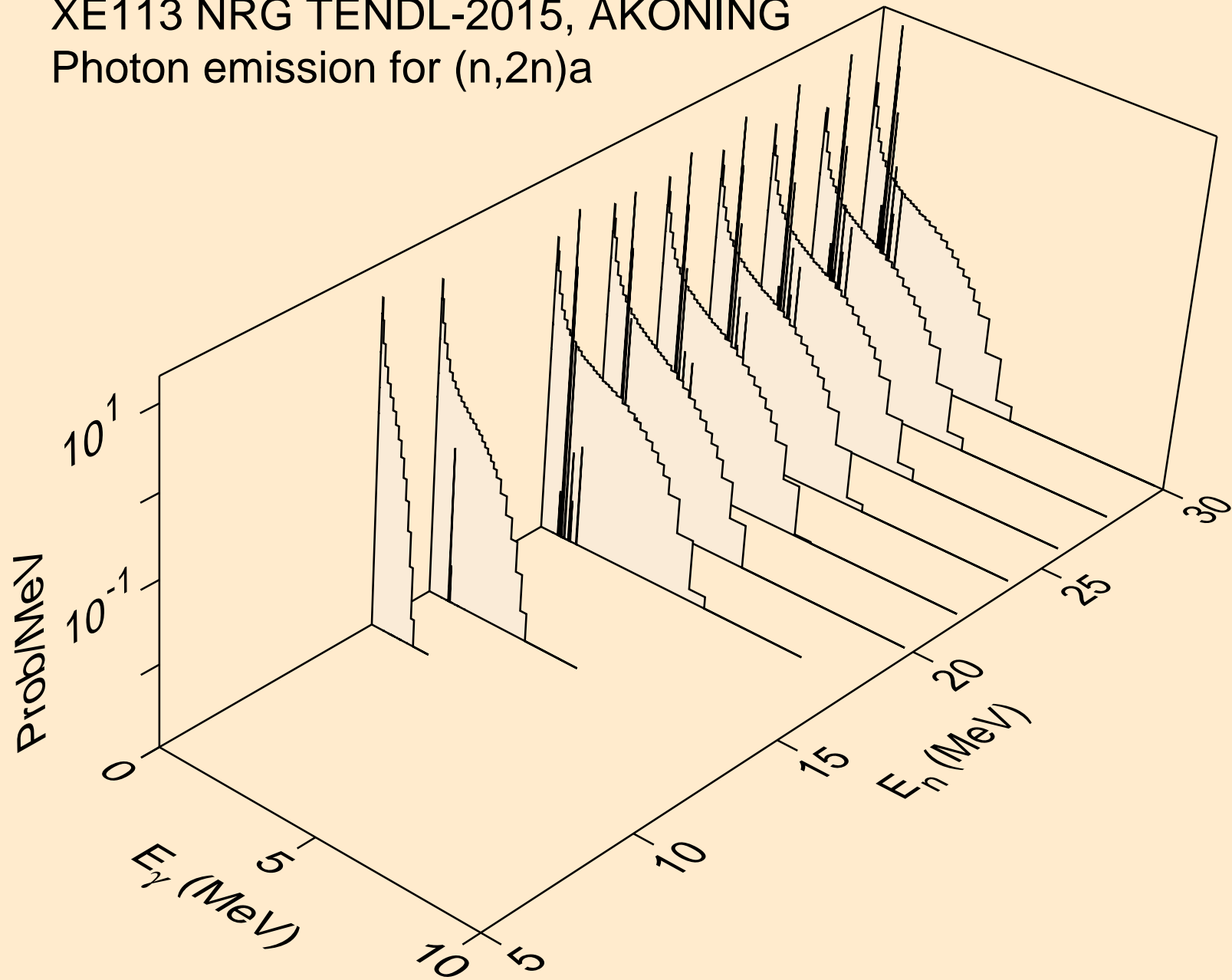

XE113 NRG TENDL-2015, AKONING
Photon emission for (n,3n)a

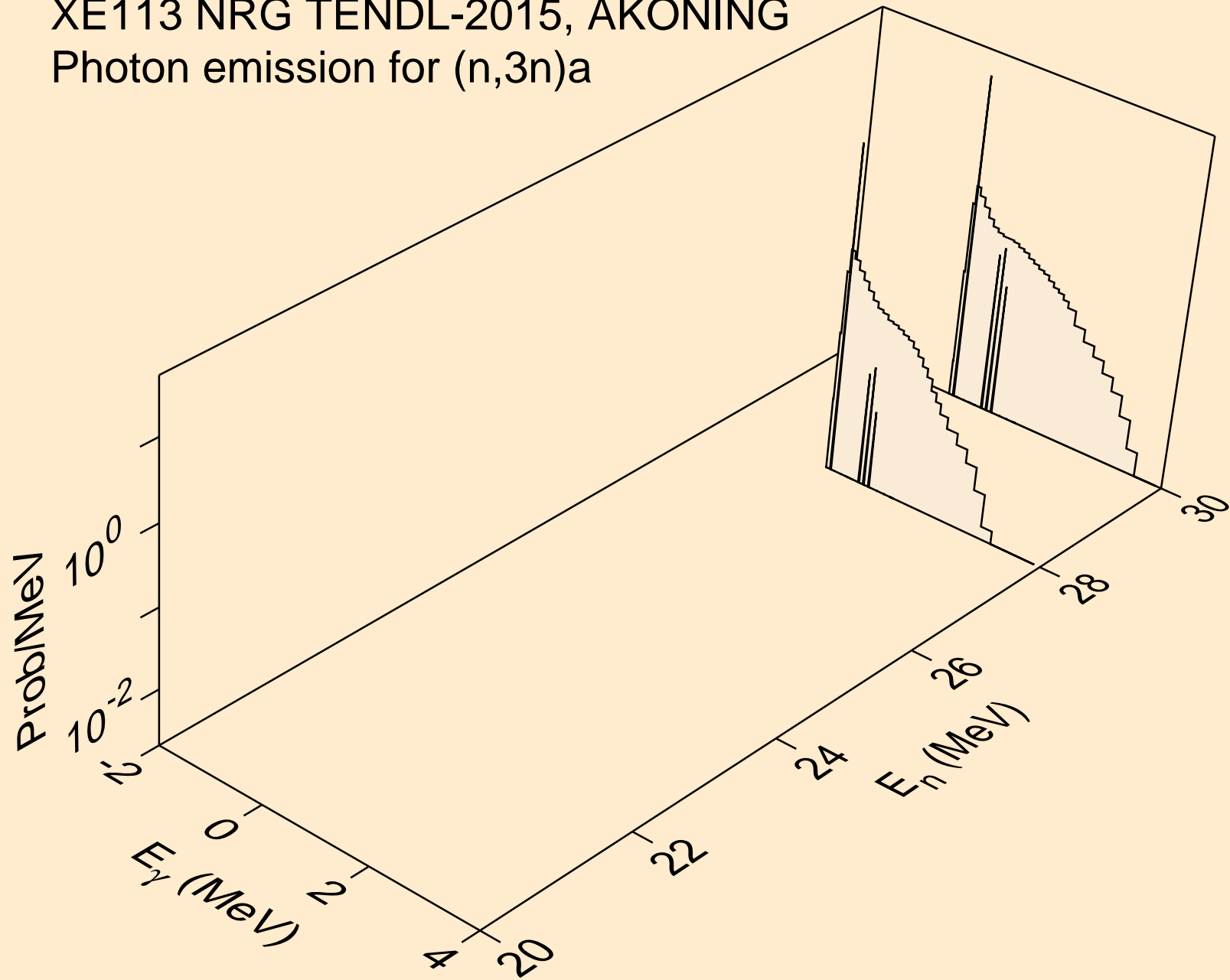

XE113 NRG TENDL-2015, AKONING
Photon emission for (n,n*)p

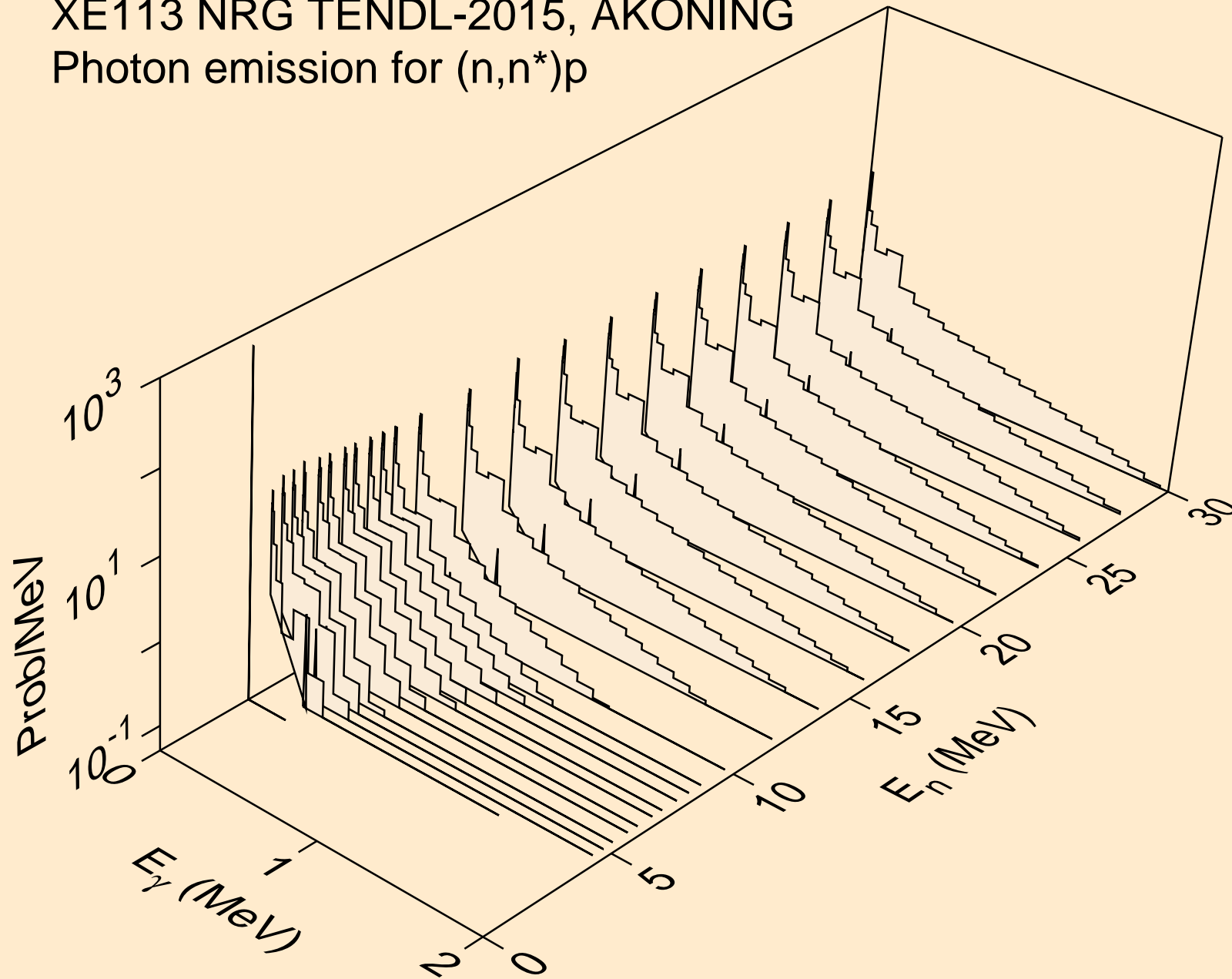

XE113 NRG TENDL-2015, AKONING
Photon emission for (n,n*)2a

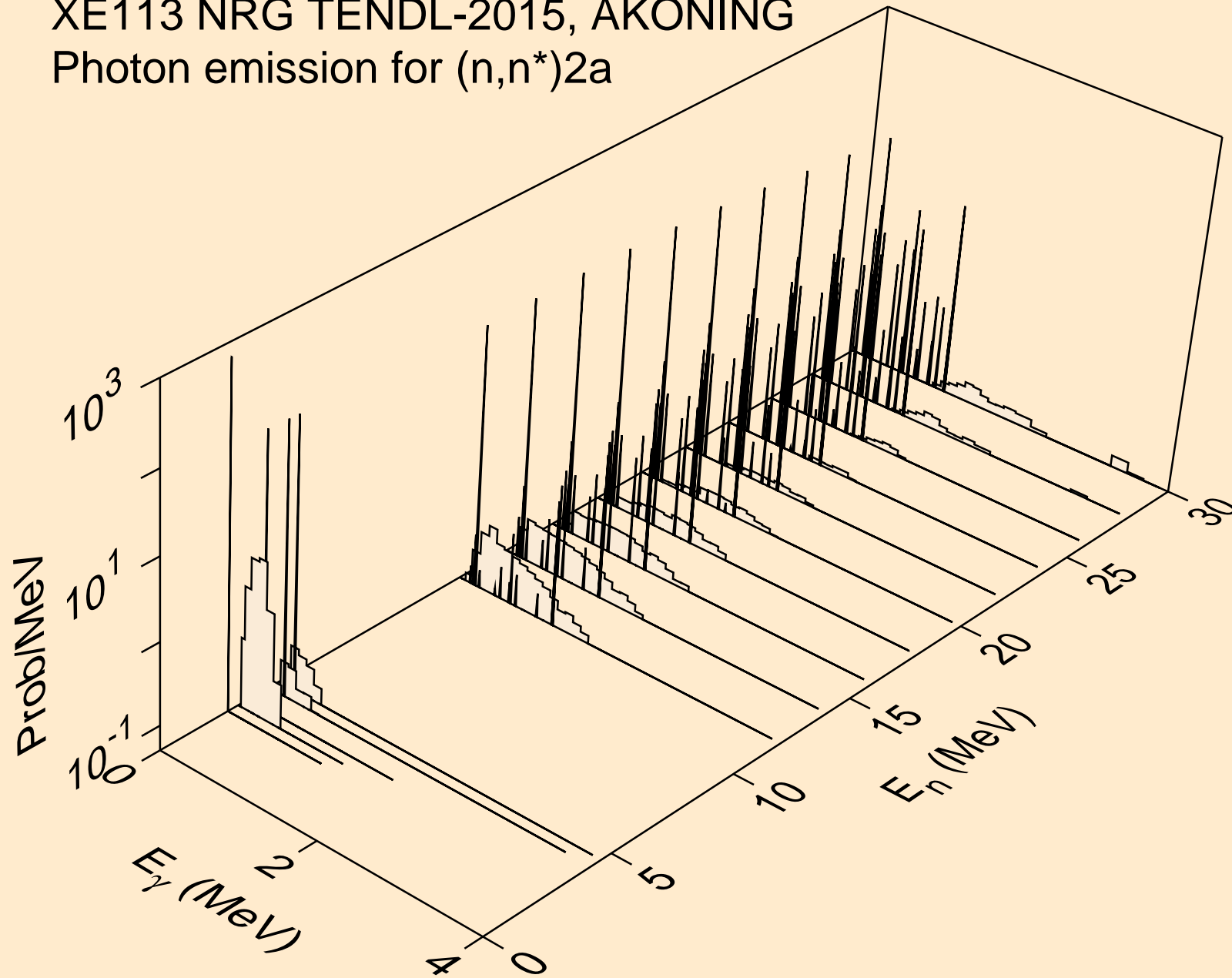

XE113 NRG TENDL-2015, AKONING
Photon emission for (n,2n)2a

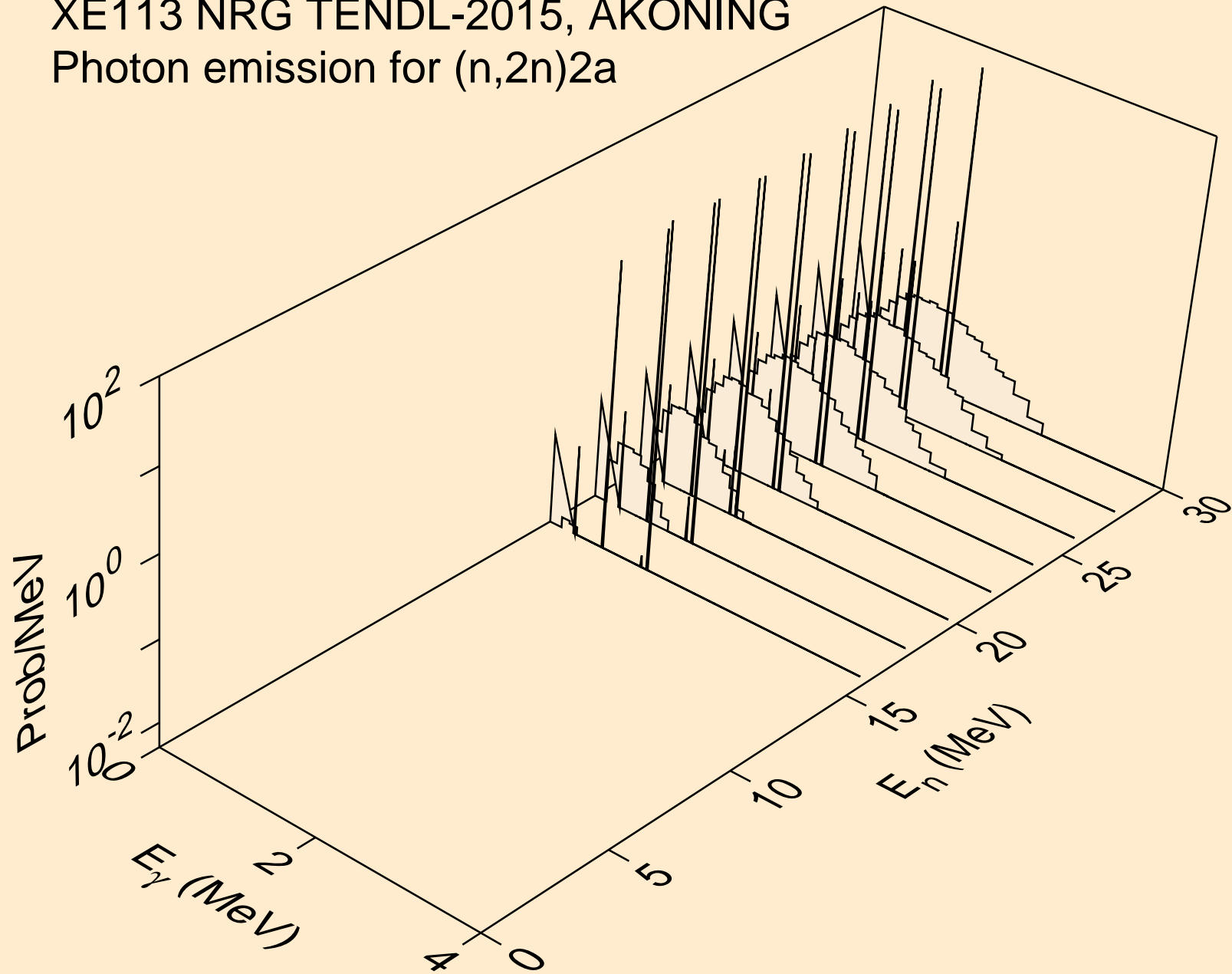

XE113 NRG TENDL-2015, AKONING
Photon emission for (n,n*)d

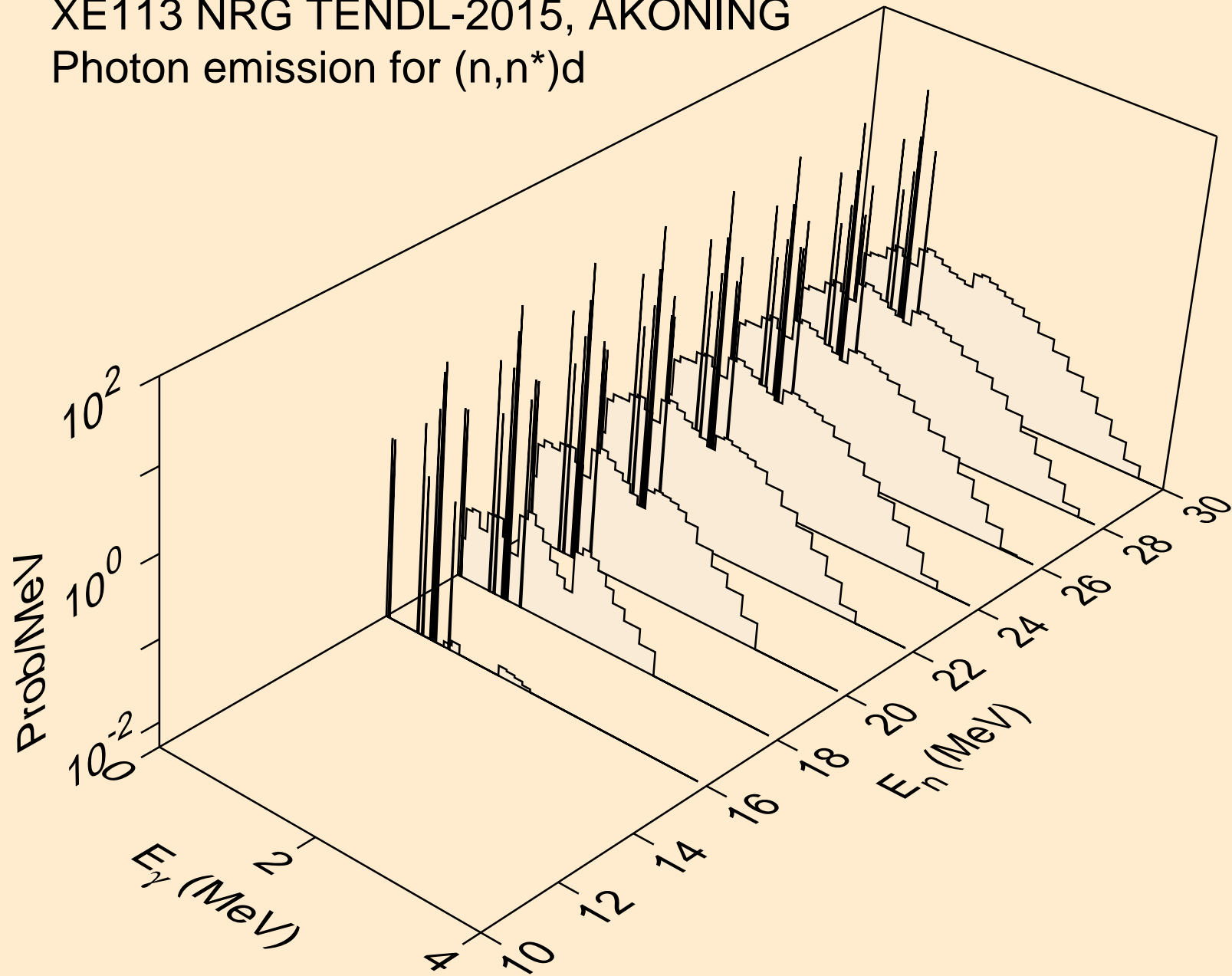

XE113 NRG TENDL-2015, AKONING
Photon emission for (n,n*)t

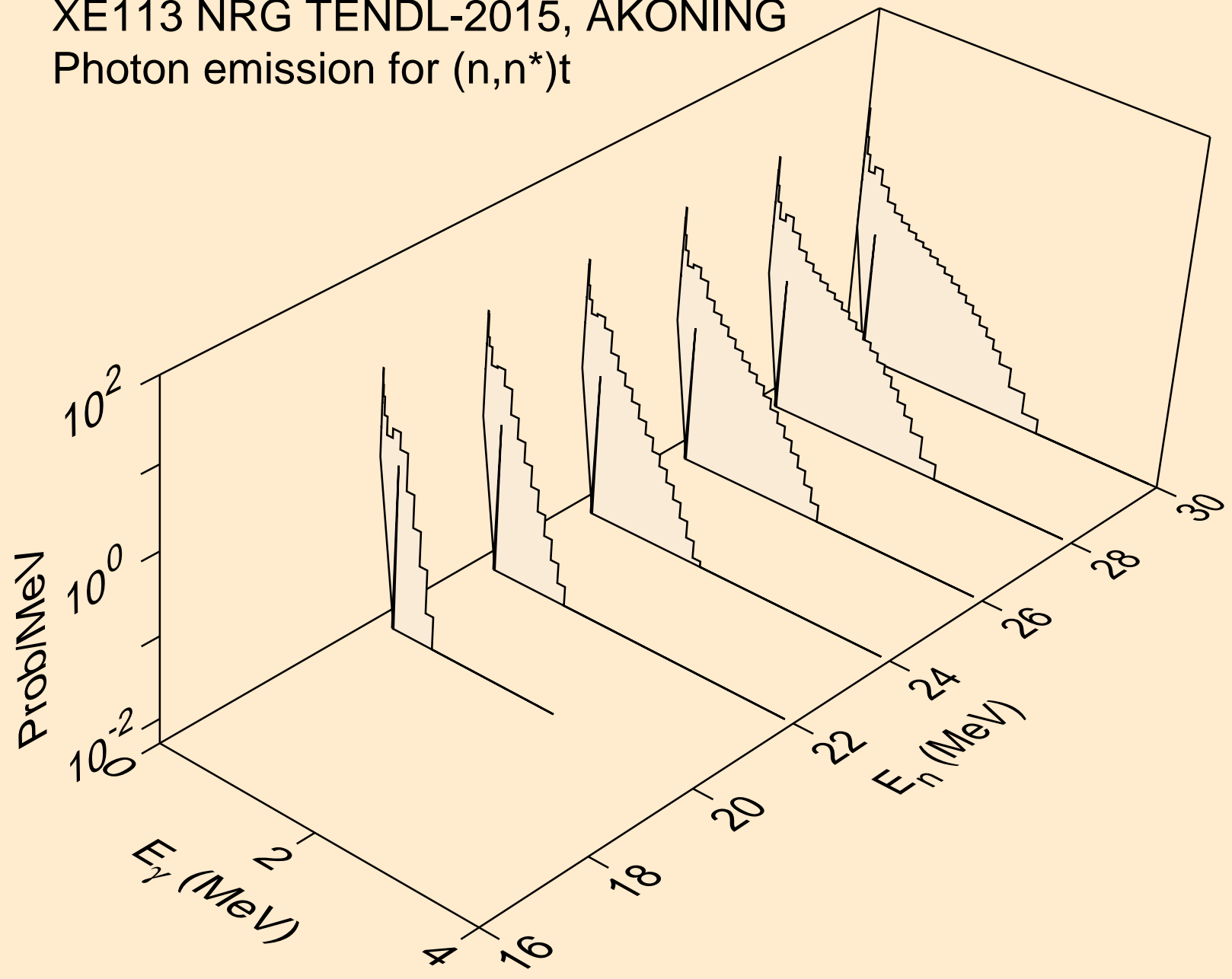

XE113 NRG TENDL-2015, AKONING
Photon emission for (n,n*)he3

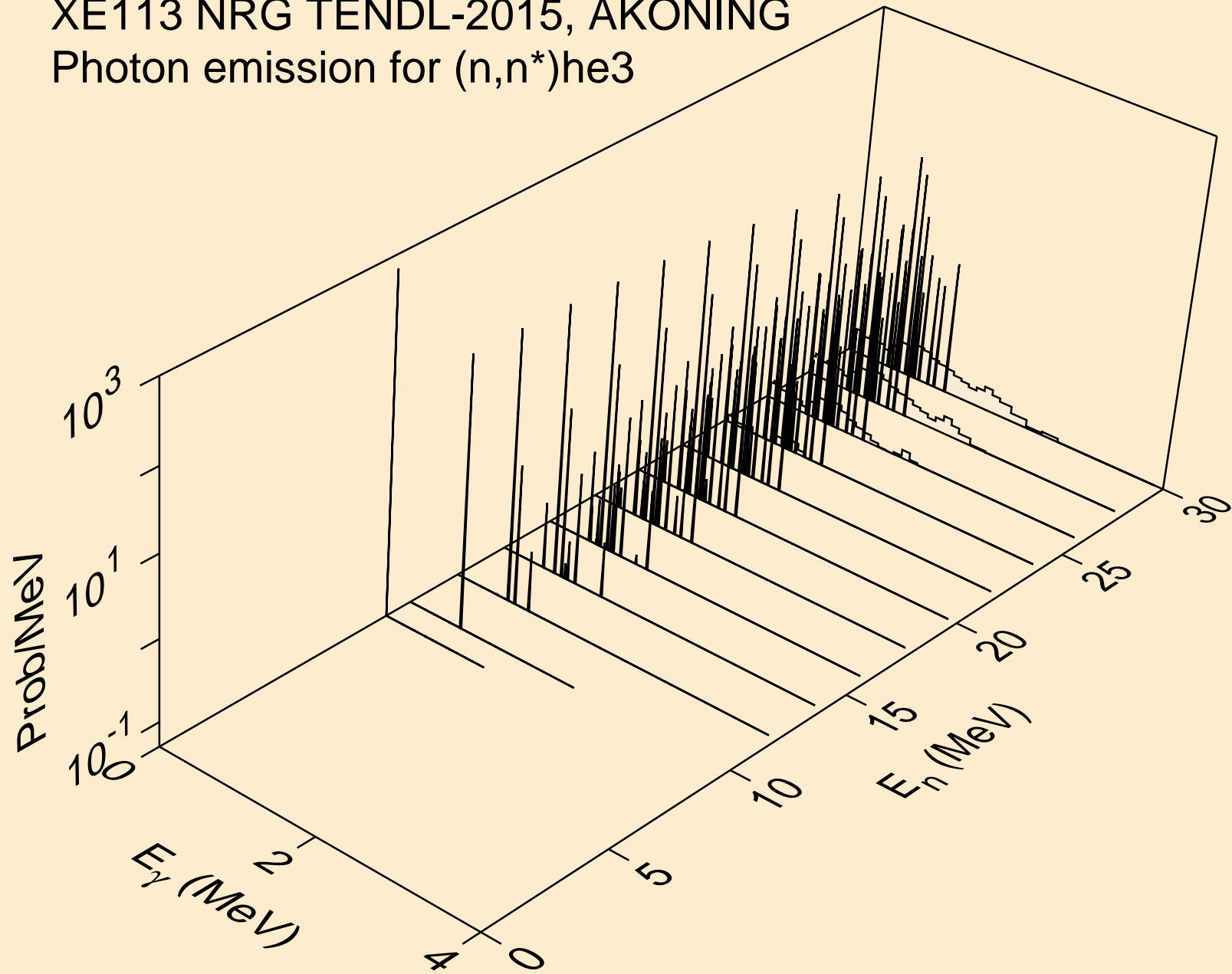

XE113 NRG TENDL-2015, AKONING
Photon emission for (n,2np)

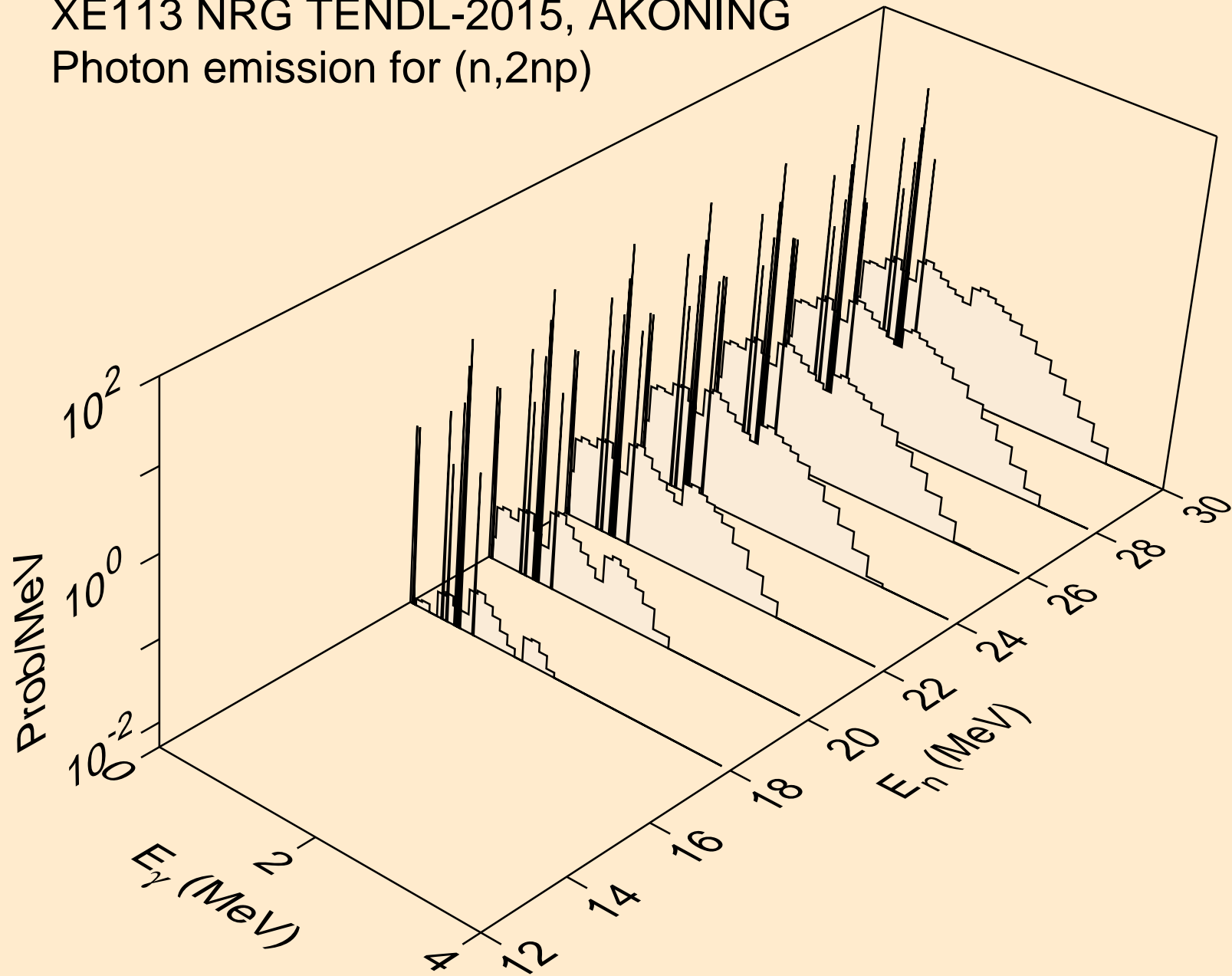

XE113 NRG TENDL-2015, AKONING
Photon emission for (n,3np)

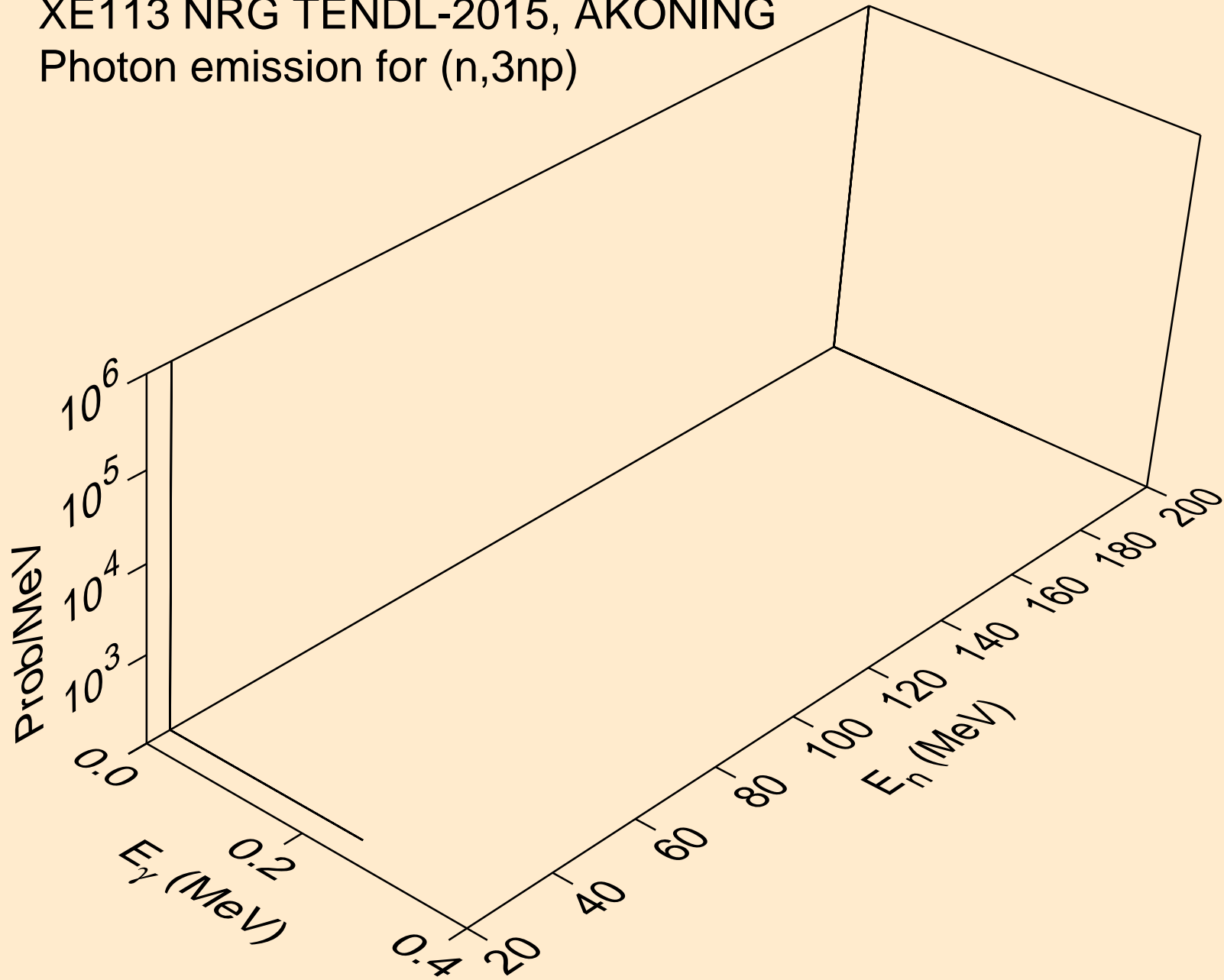

XE113 NRG TENDL-2015, AKONING
Photon emission for (n,2np)

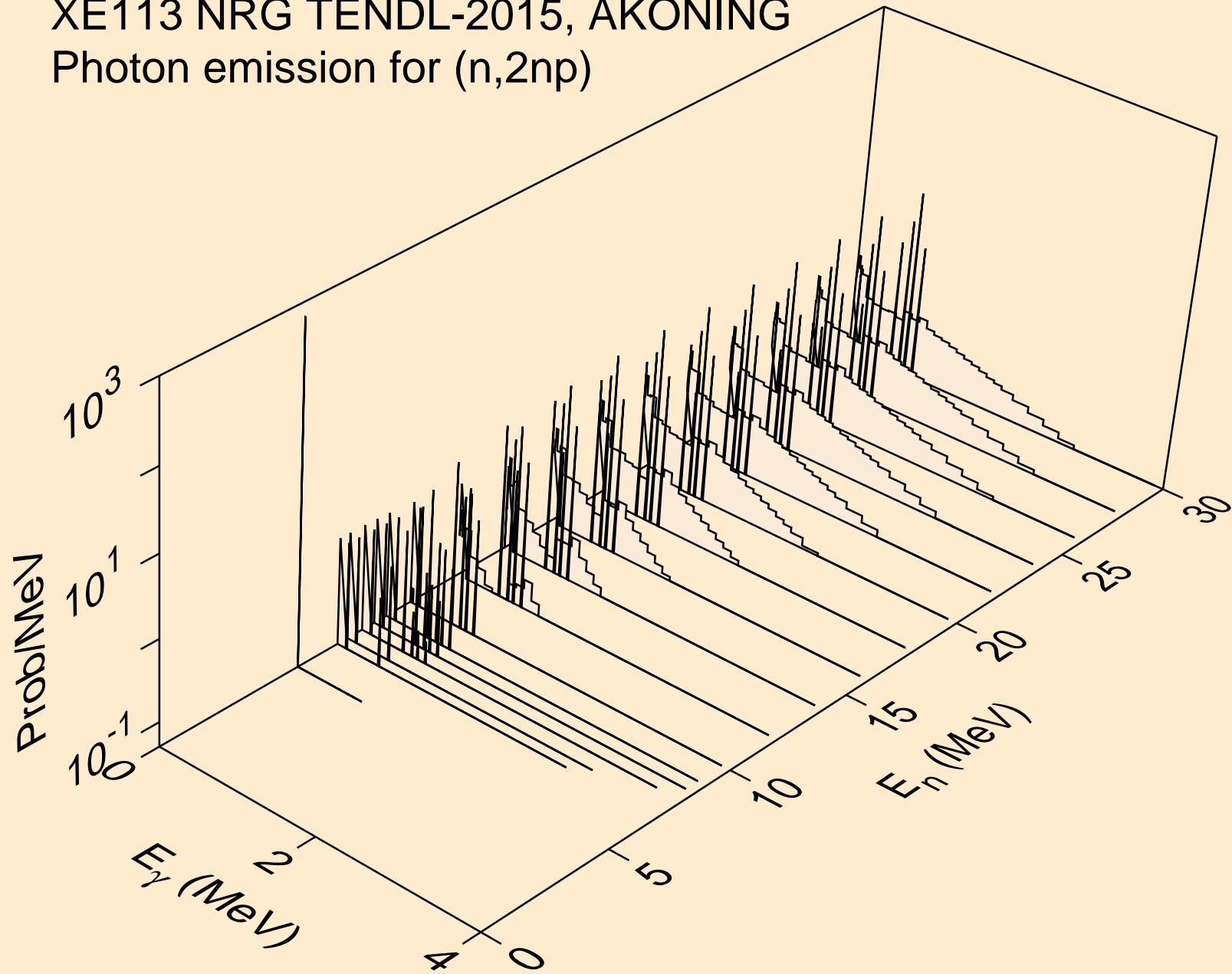

XE113 NRG TENDL-2015, AKONING
Photon emission for (n,npa)

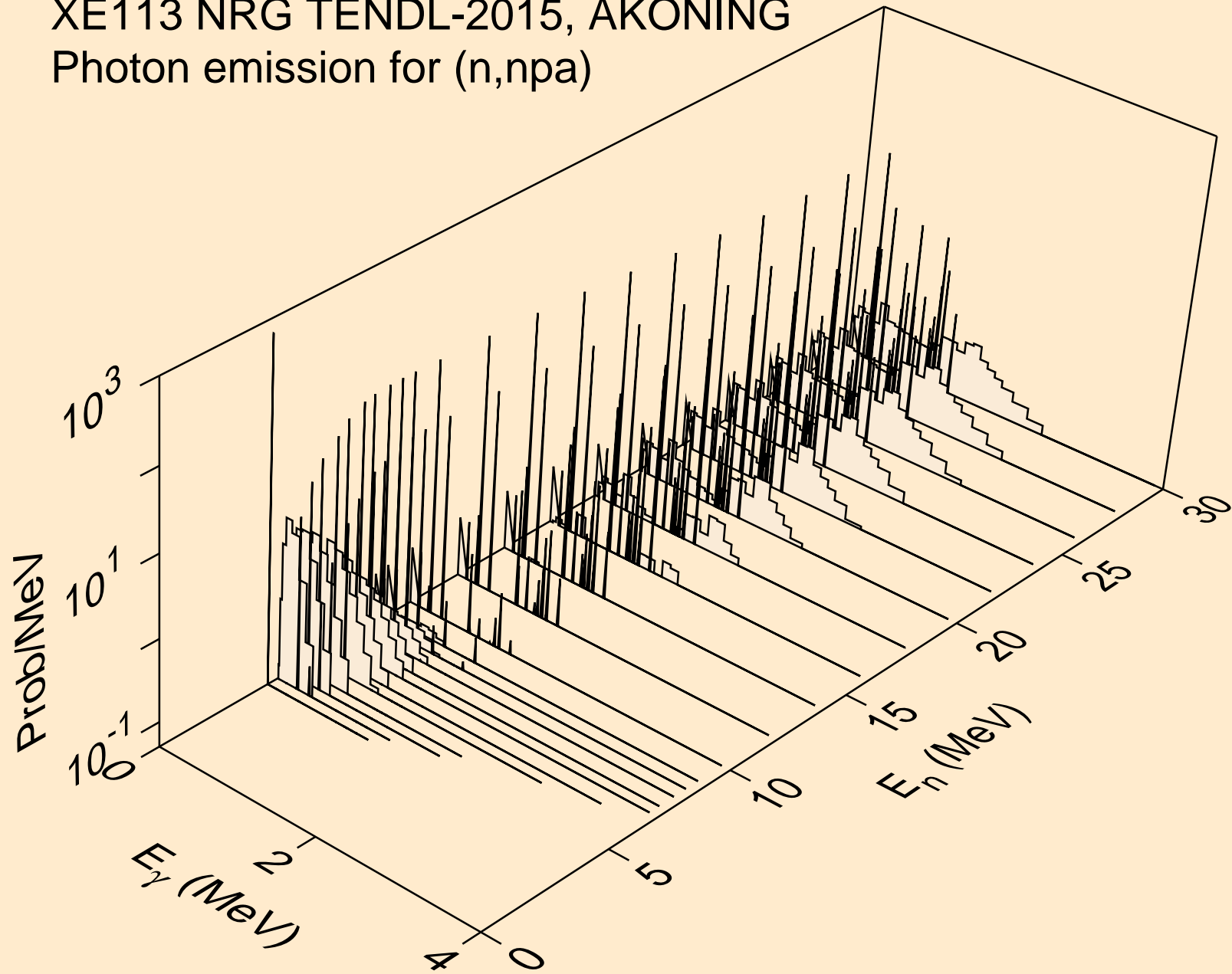

XE113 NRG TENDL-2015, AKONING
Photon emission for (n,n*c)

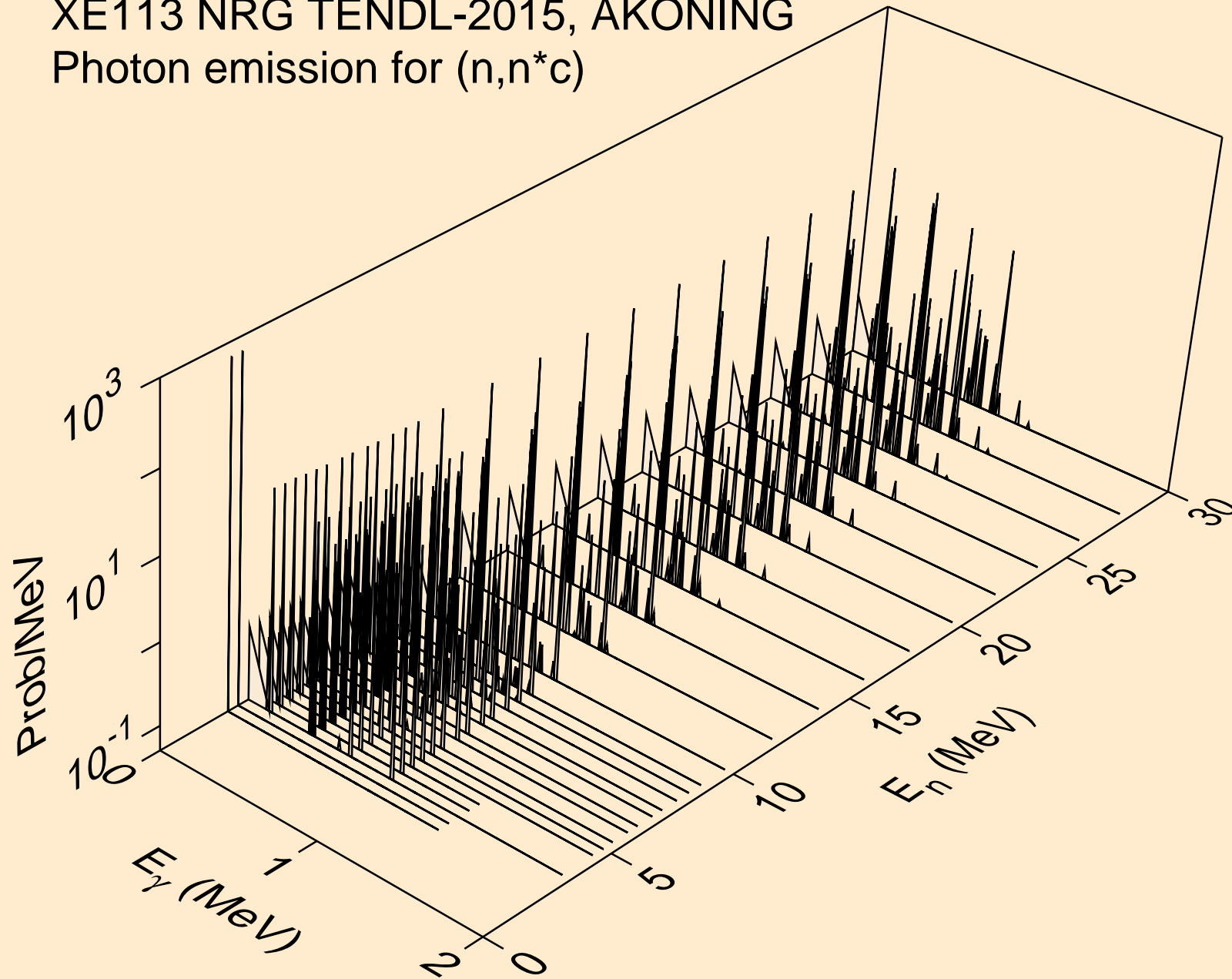

XE113 NRG TENDL-2015, AKONING
Photon emission for (n,gma)

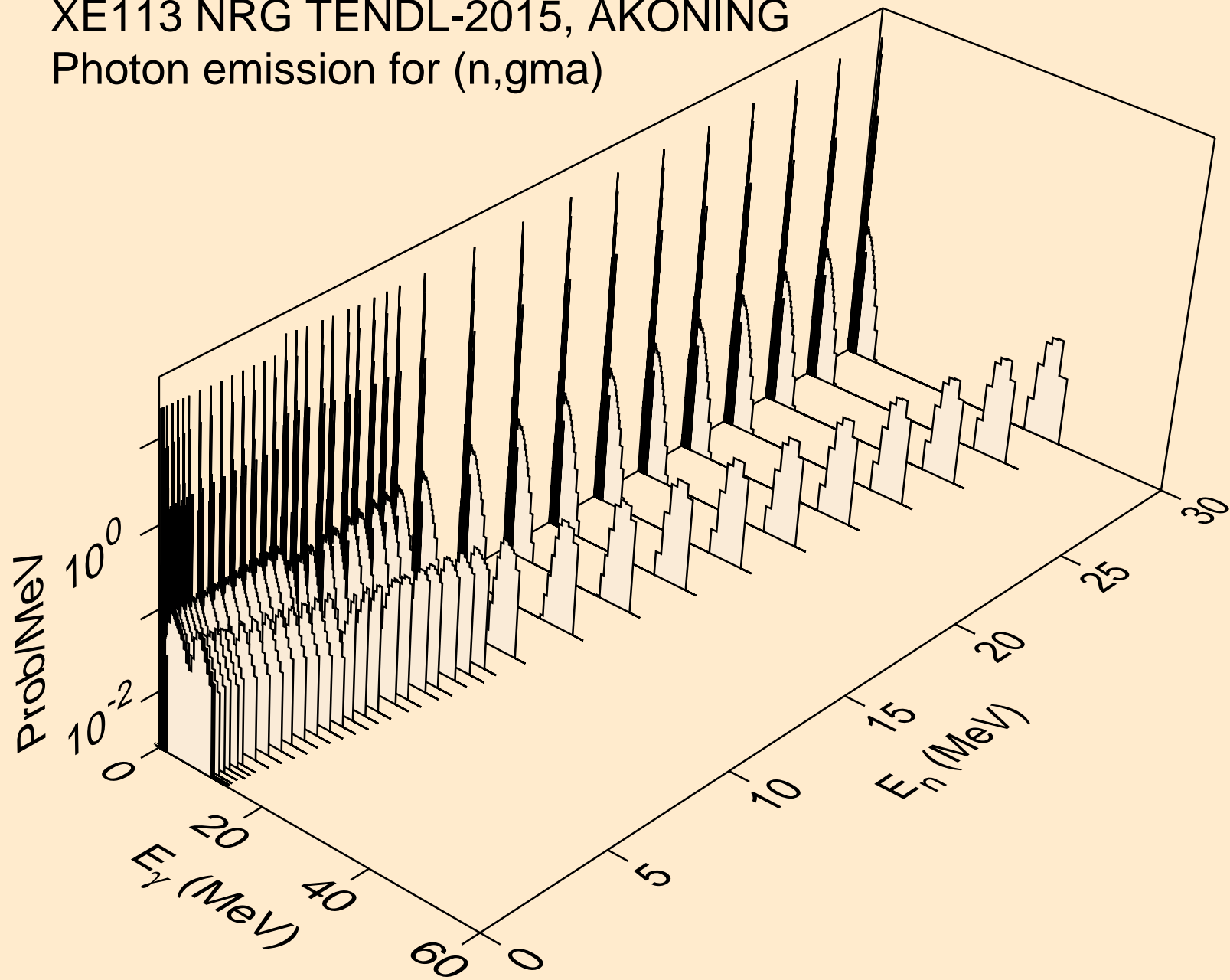

XE113 NRG TENDL-2015, AKONING
Photon emission for (n,p)

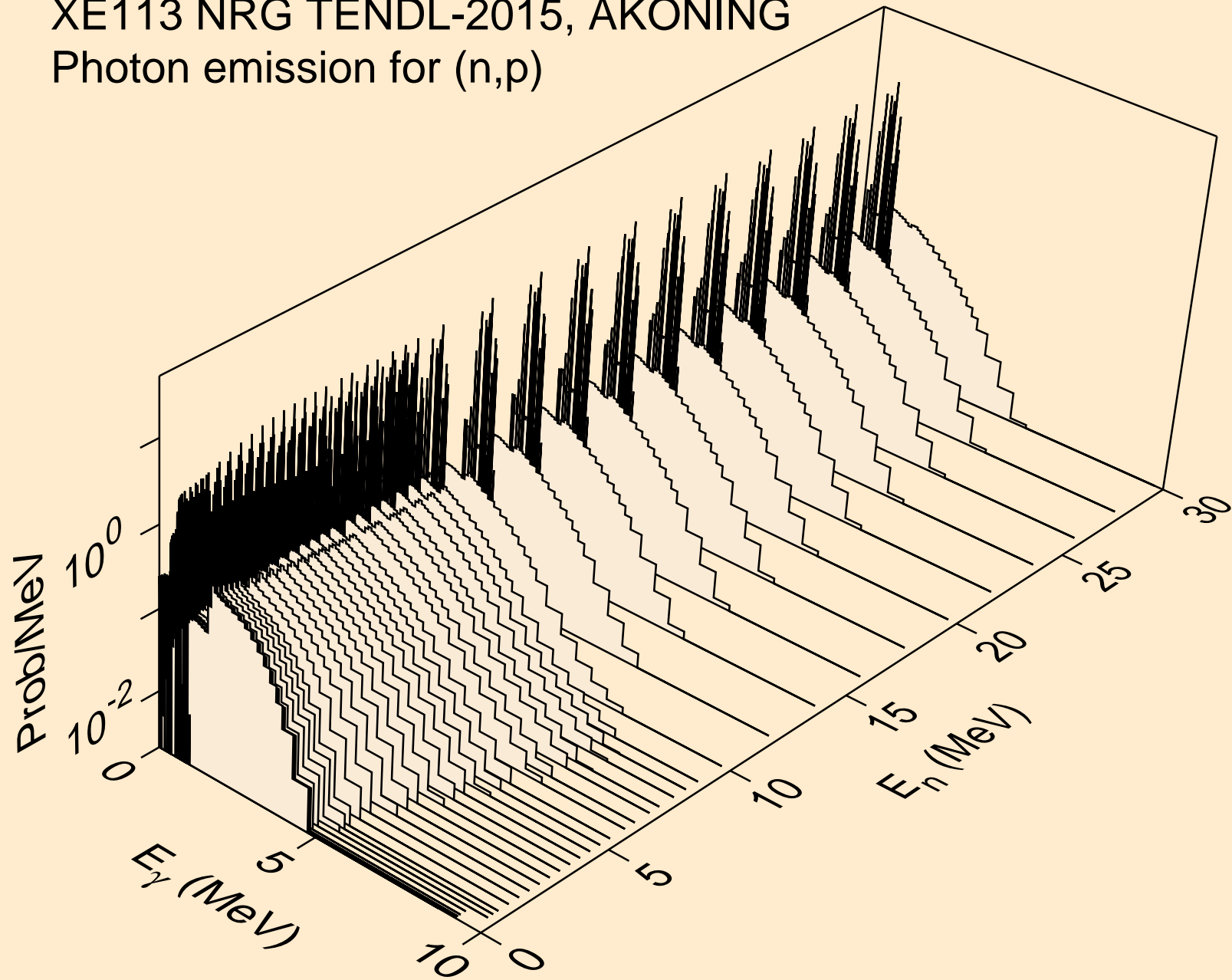

XE113 NRG TENDL-2015, AKONING
Photon emission for (n,d)

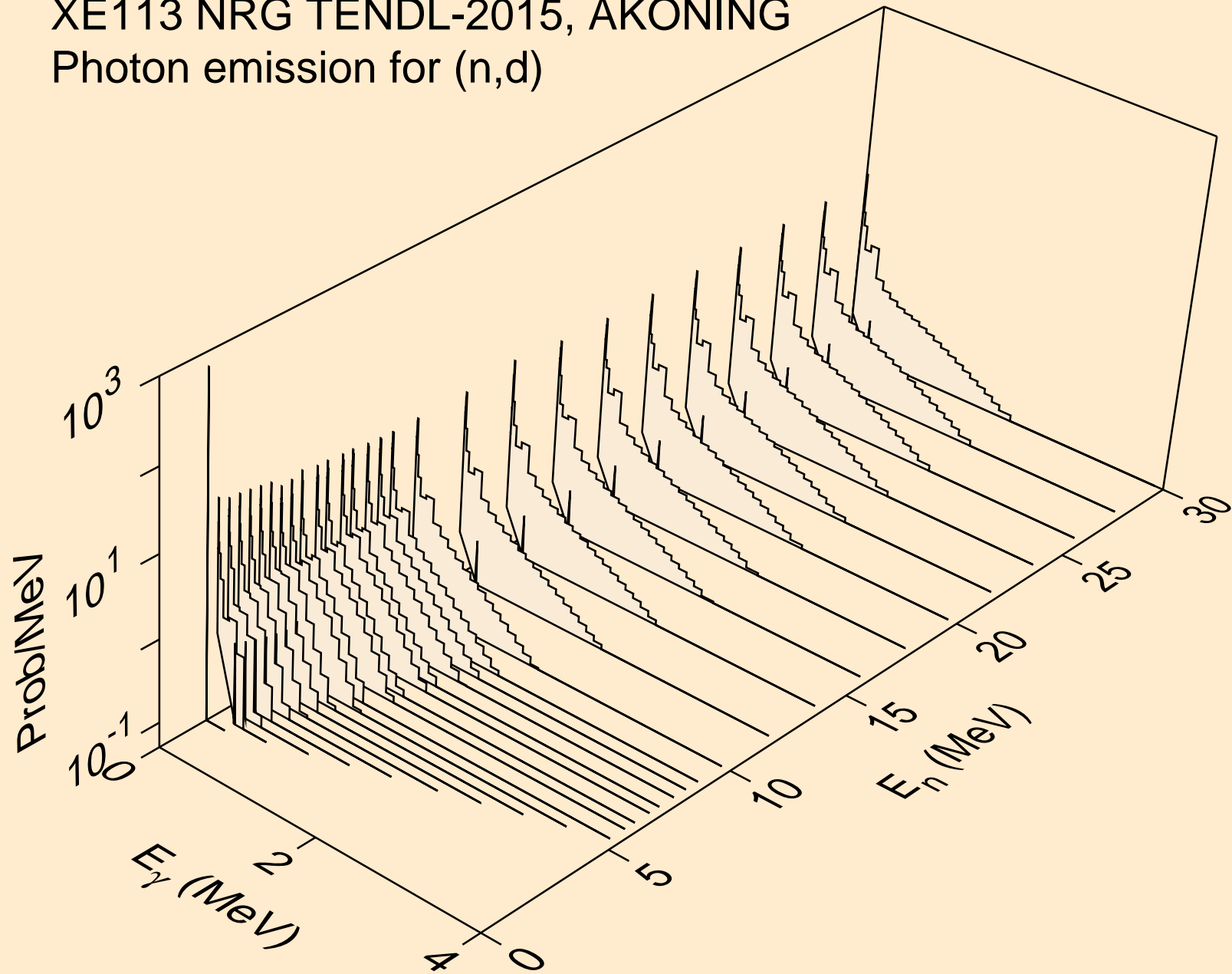

XE113 NRG TENDL-2015, AKONING
Photon emission for (n,t)

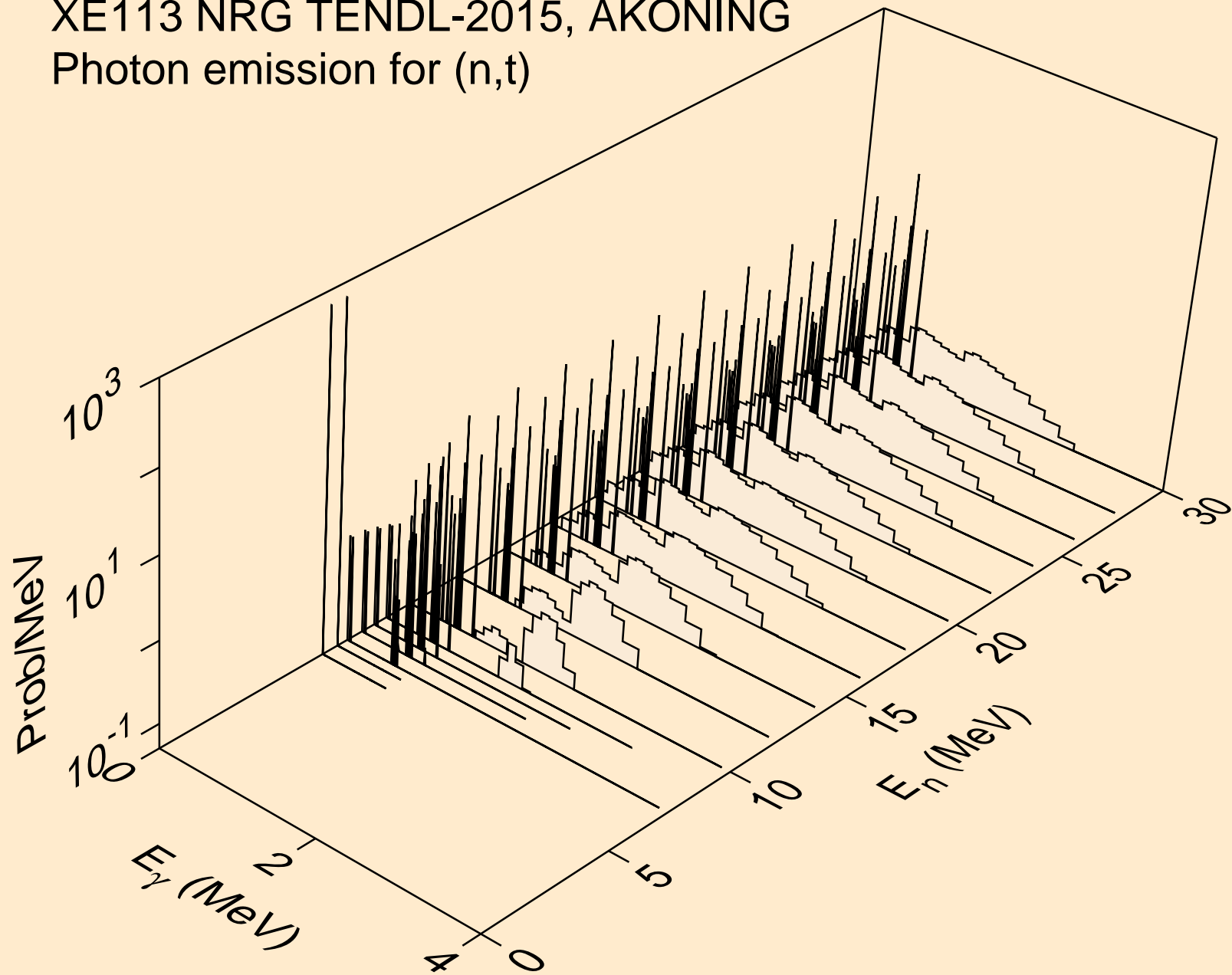

XE113 NRG TENDL-2015, AKONING
Photon emission for (n,he3)

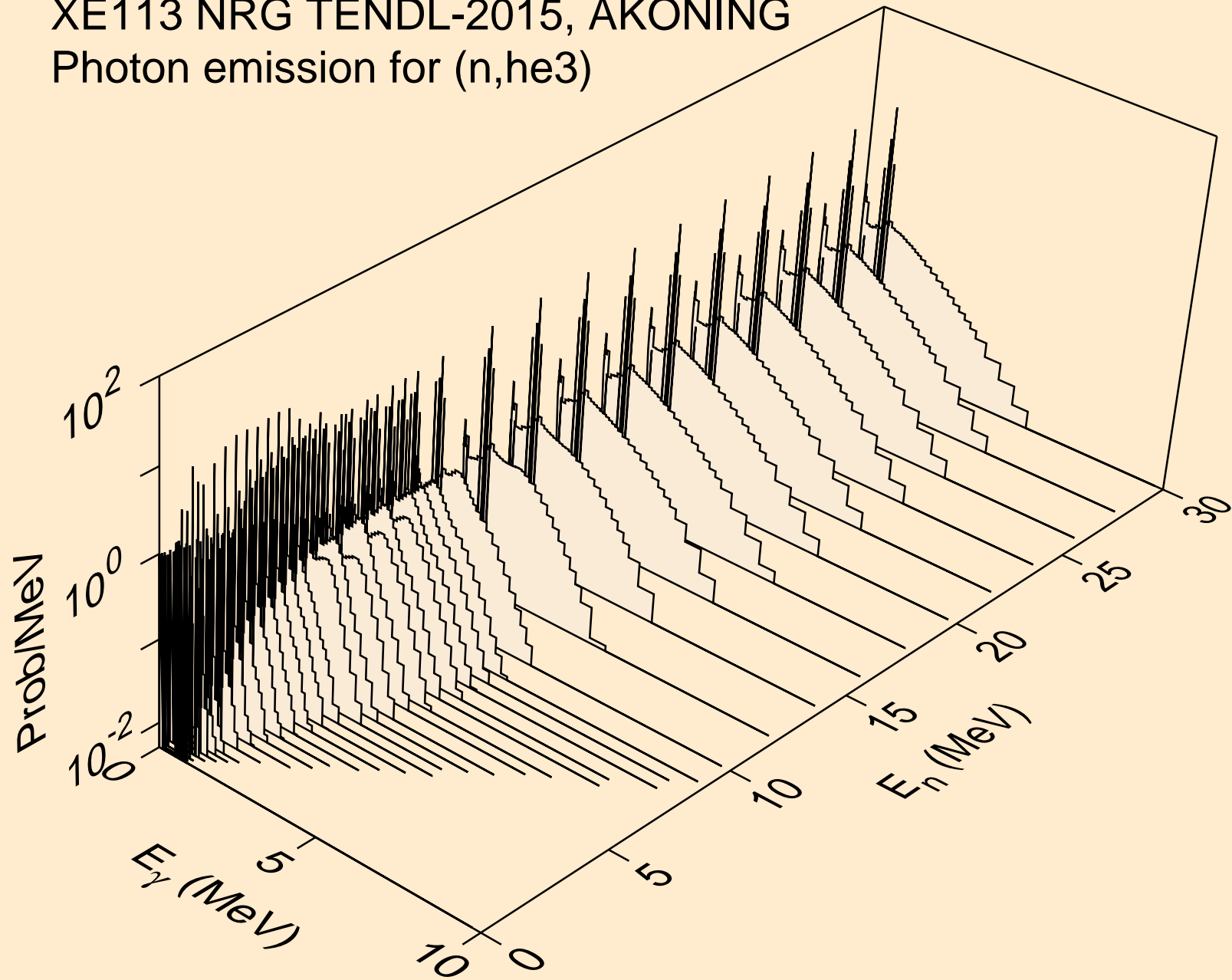

XE113 NRG TENDL-2015, AKONING
Photon emission for (n,a)

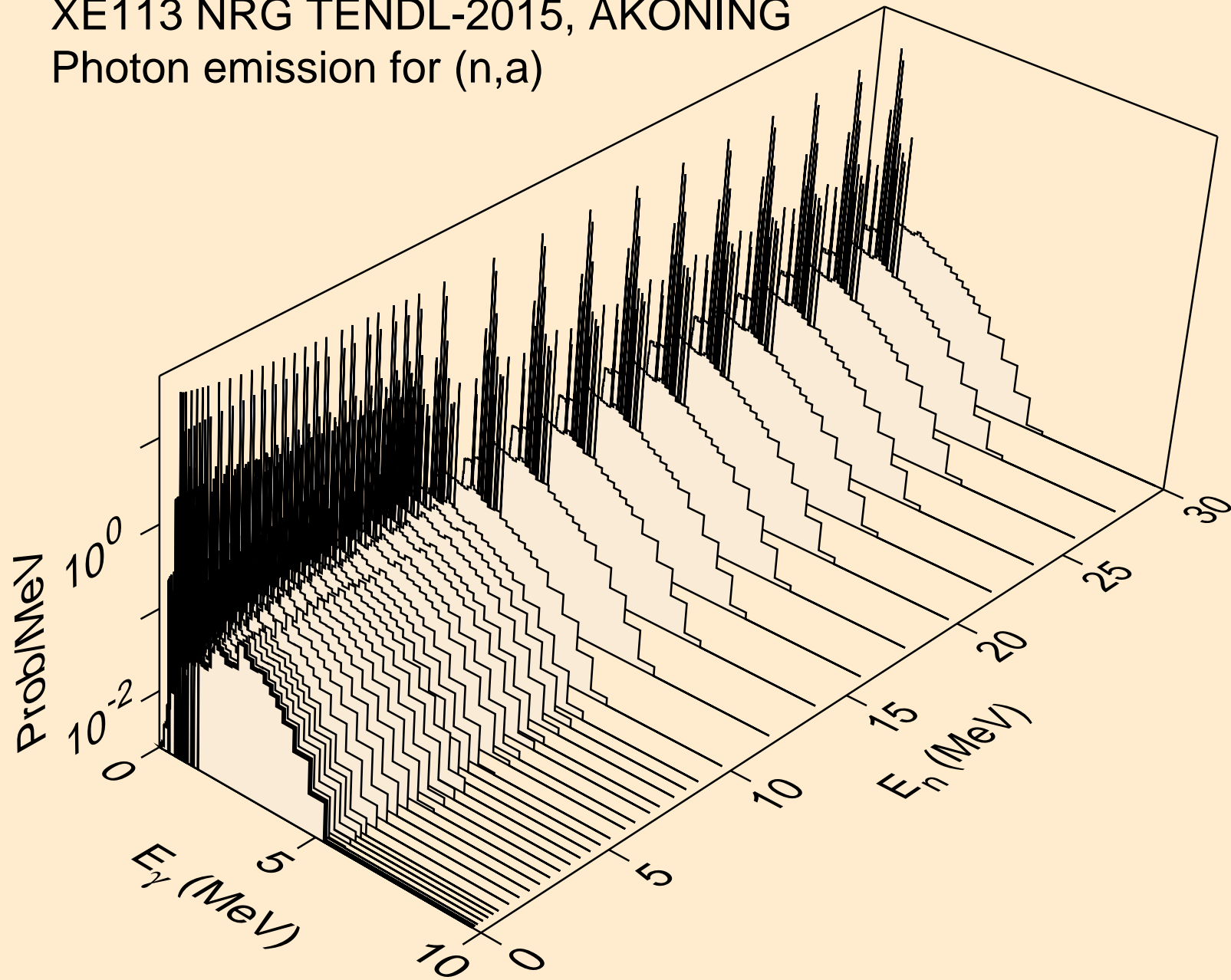

XE113 NRG TENDL-2015, AKONING
Photon emission for (n,2a)

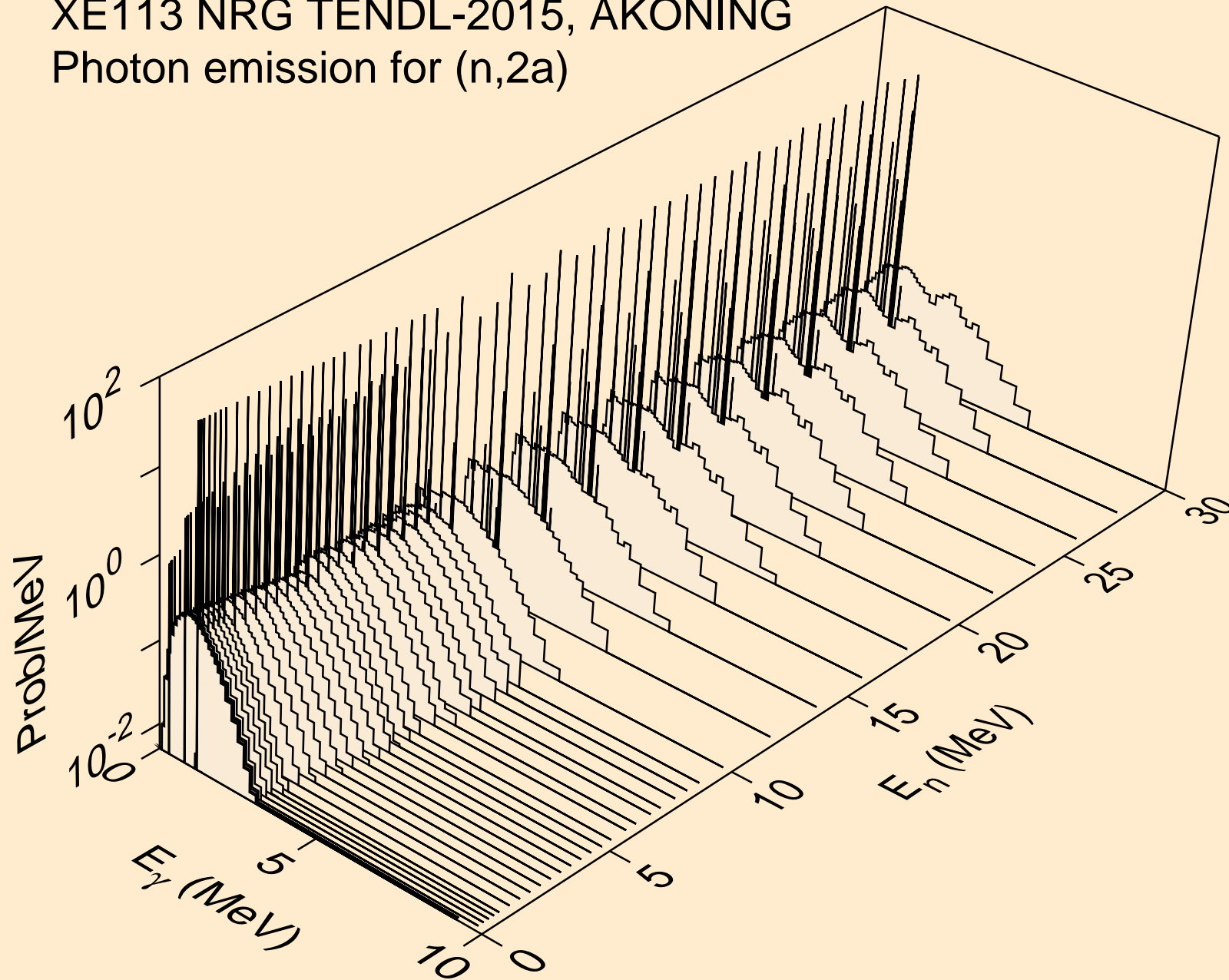

XE113 NRG TENDL-2015, AKONING
Photon emission for (n,3a)

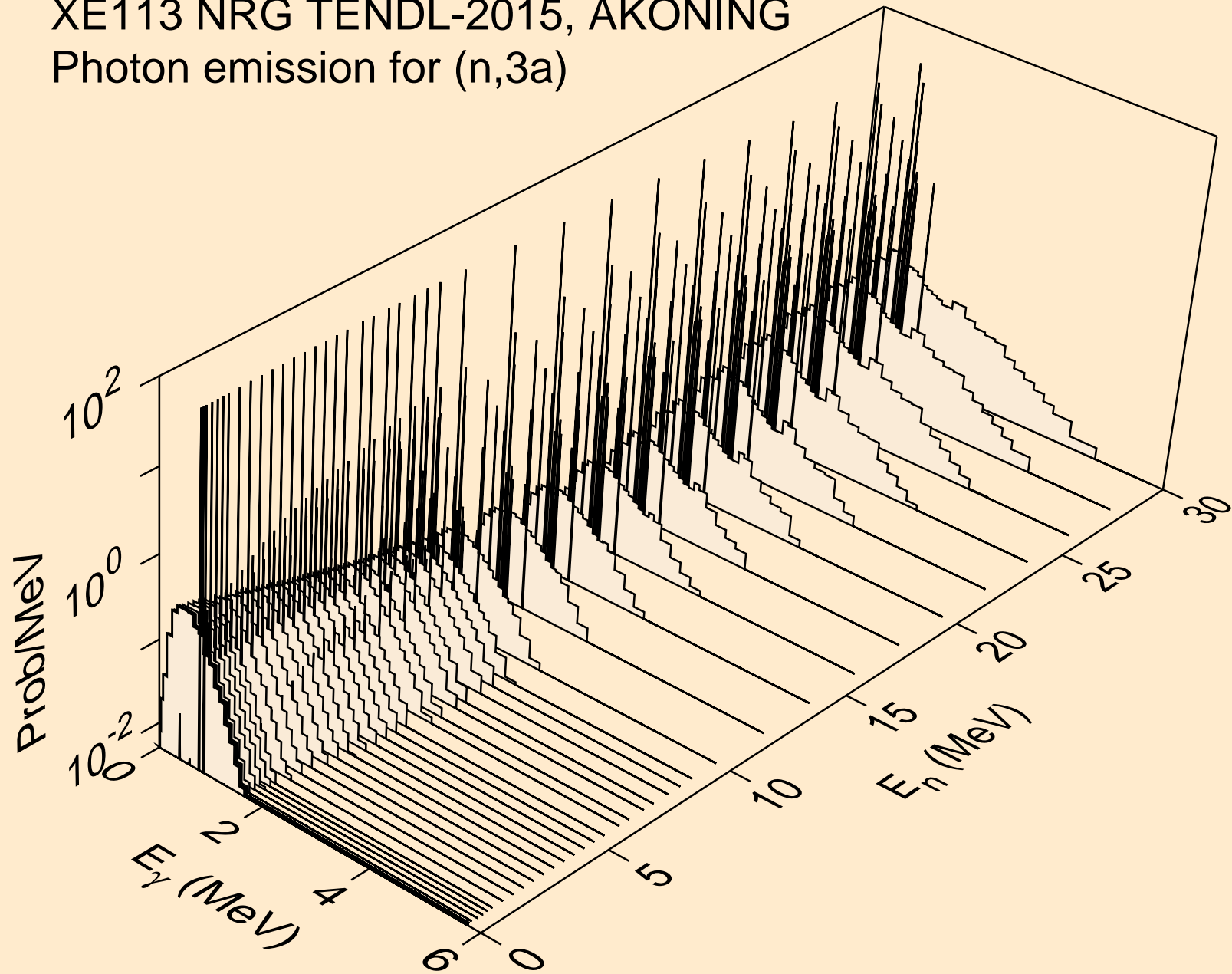

XE113 NRG TENDL-2015, AKONING
Photon emission for (n,2p)

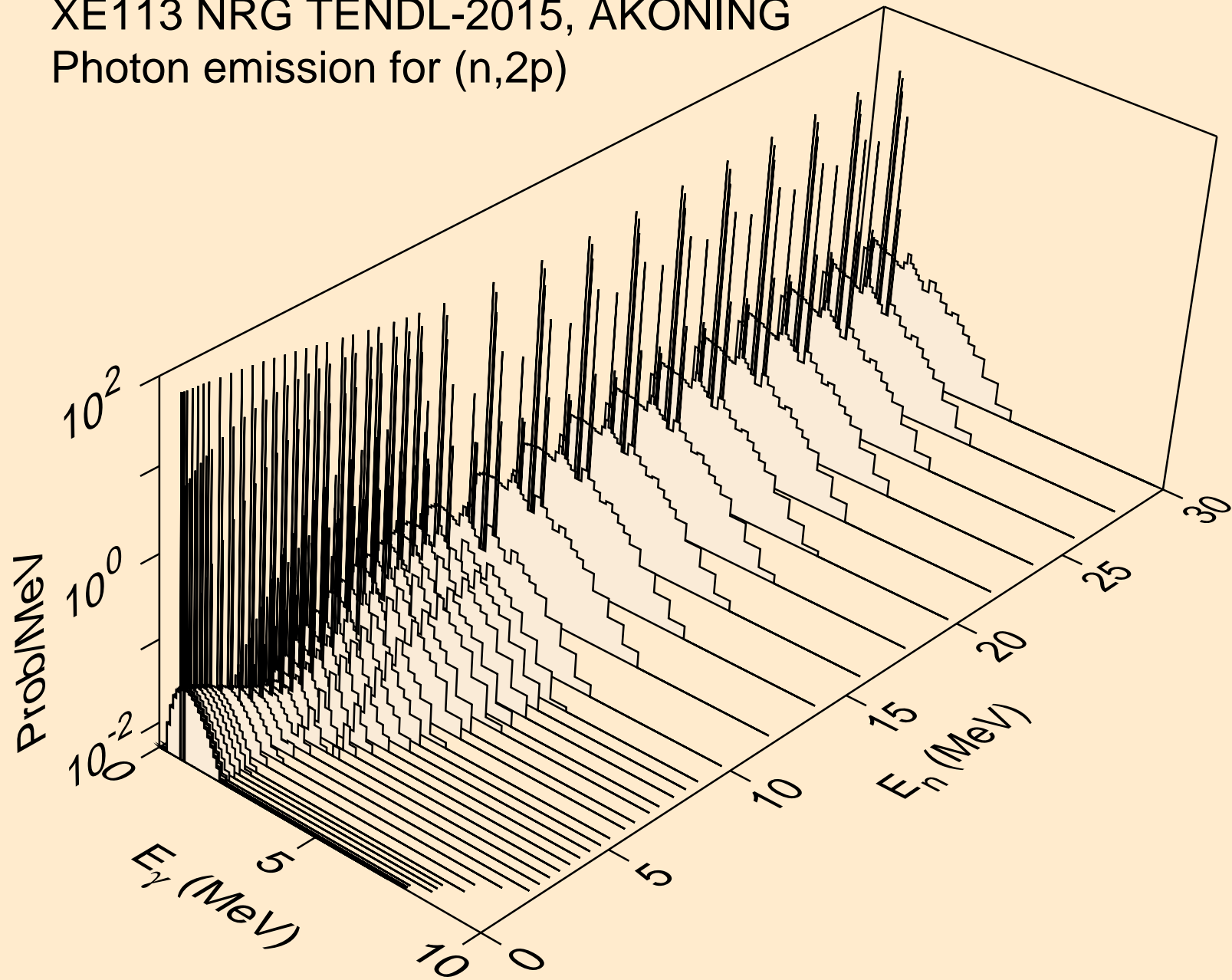

XE113 NRG TENDL-2015, AKONING
Photon emission for (n,p α)

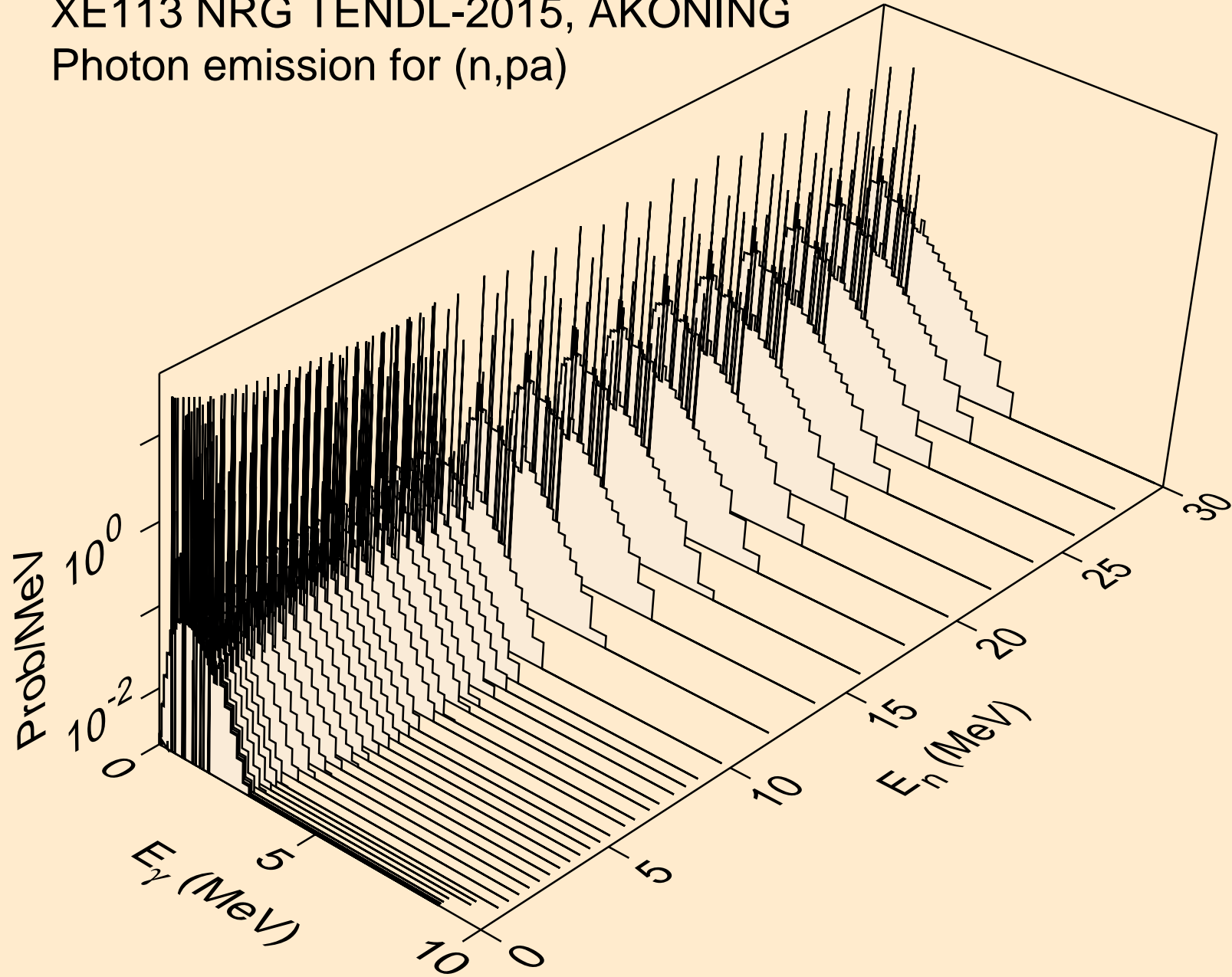

XE113 NRG TENDL-2015, AKONING
Photon emission for (n,t2a)

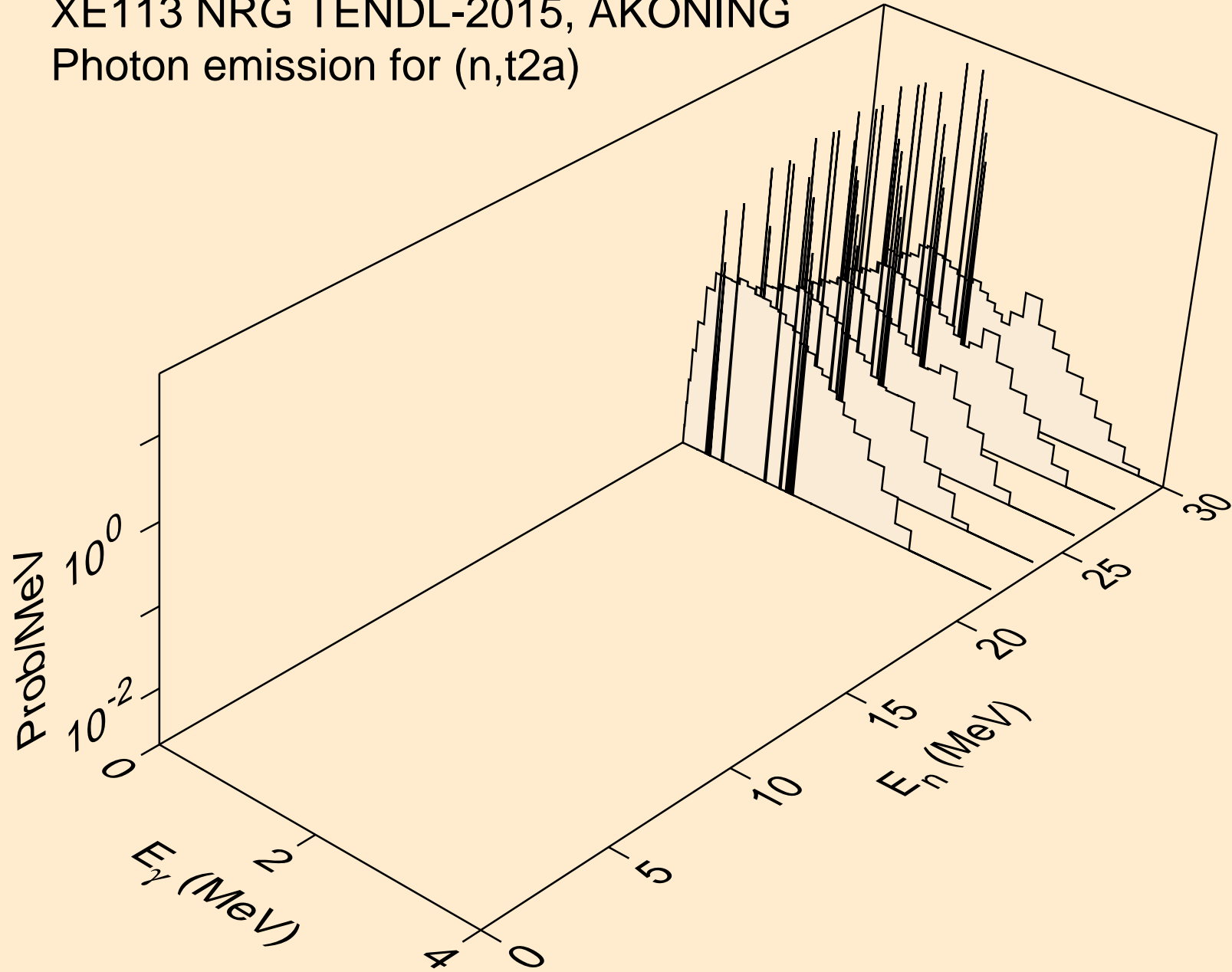

XE113 NRG TENDL-2015, AKONING
Photon emission for (n,d2a)

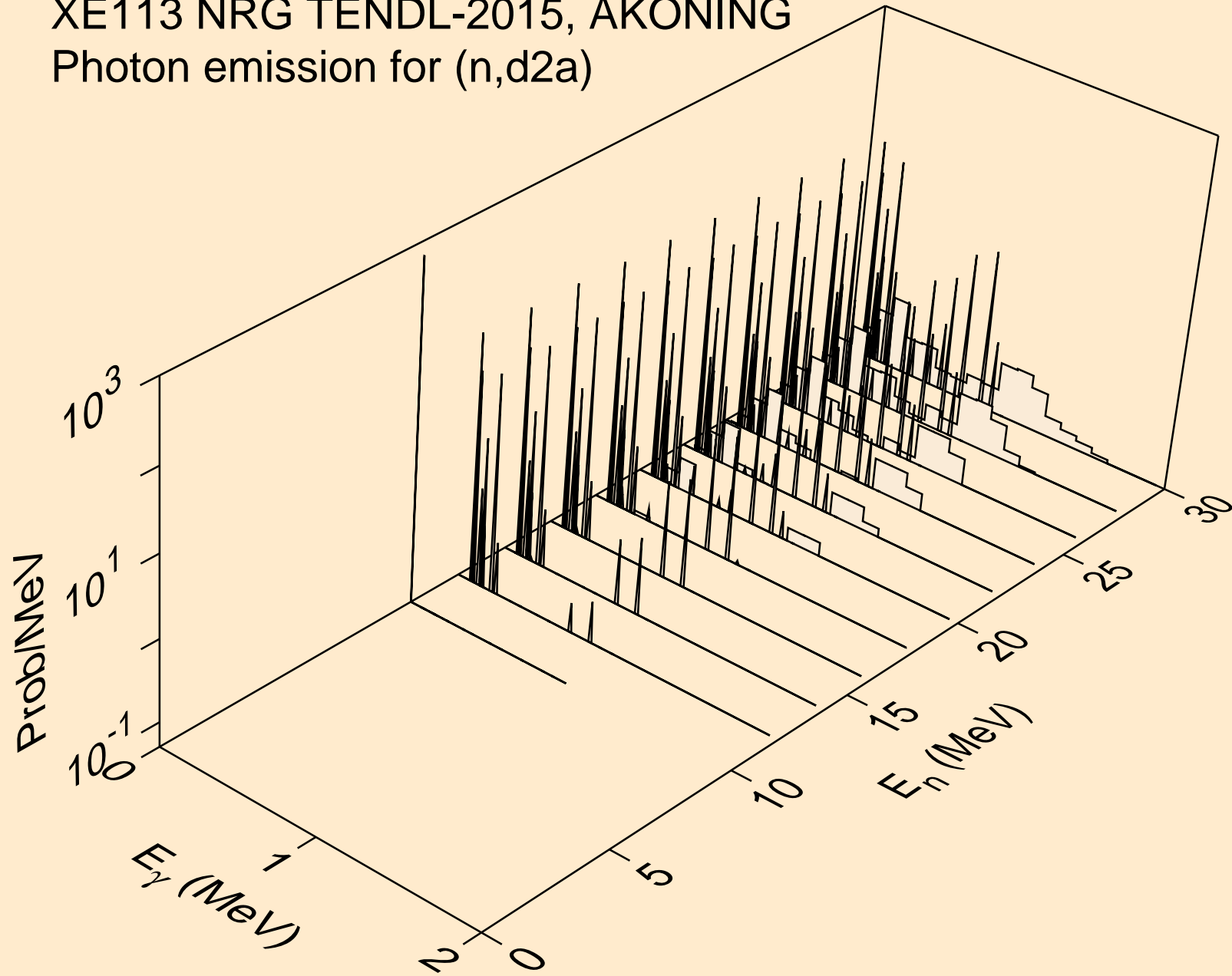

XE113 NRG TENDL-2015, AKONING
Photon emission for (n,pd)

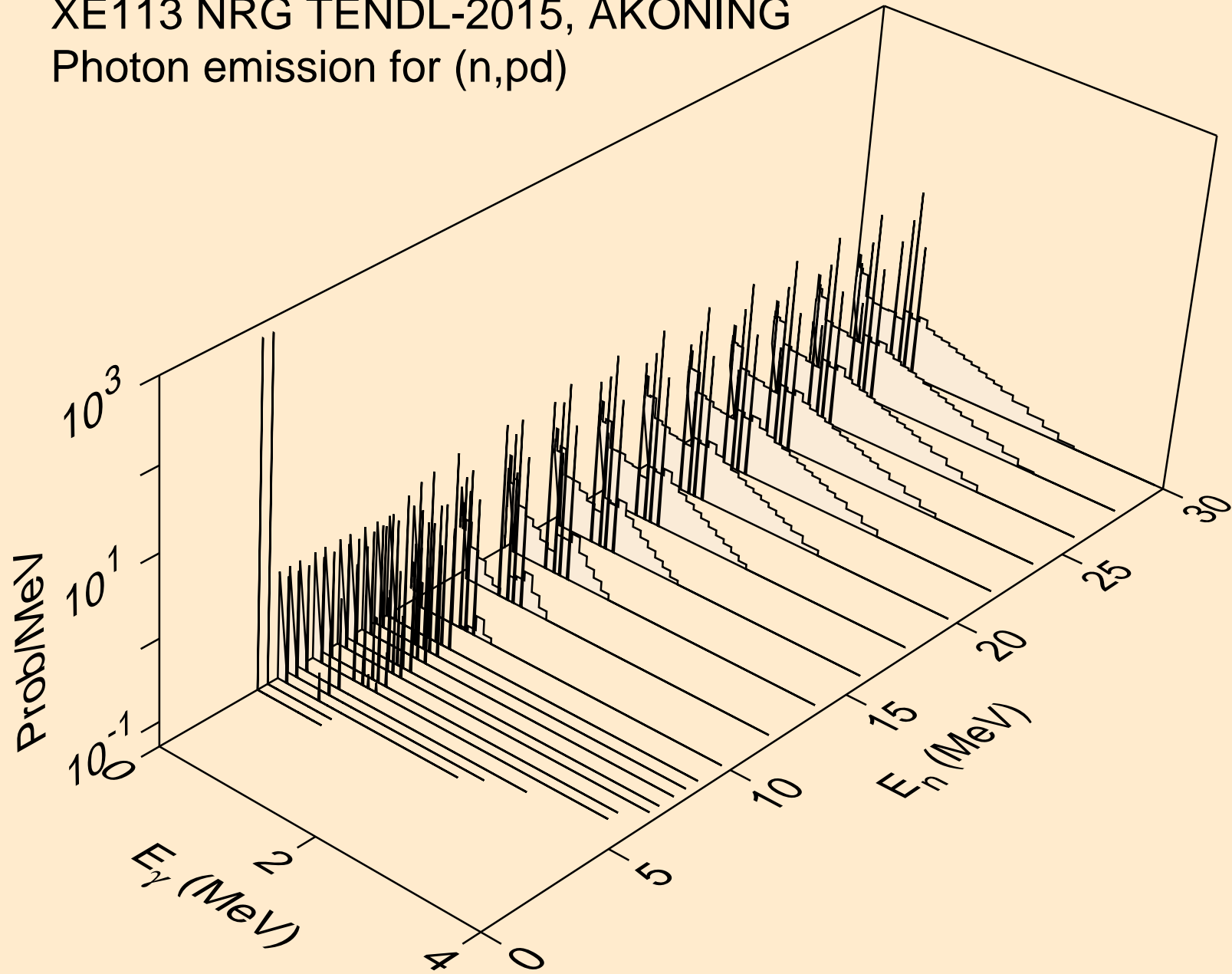

XE113 NRG TENDL-2015, AKONING
Photon emission for (n,pt)

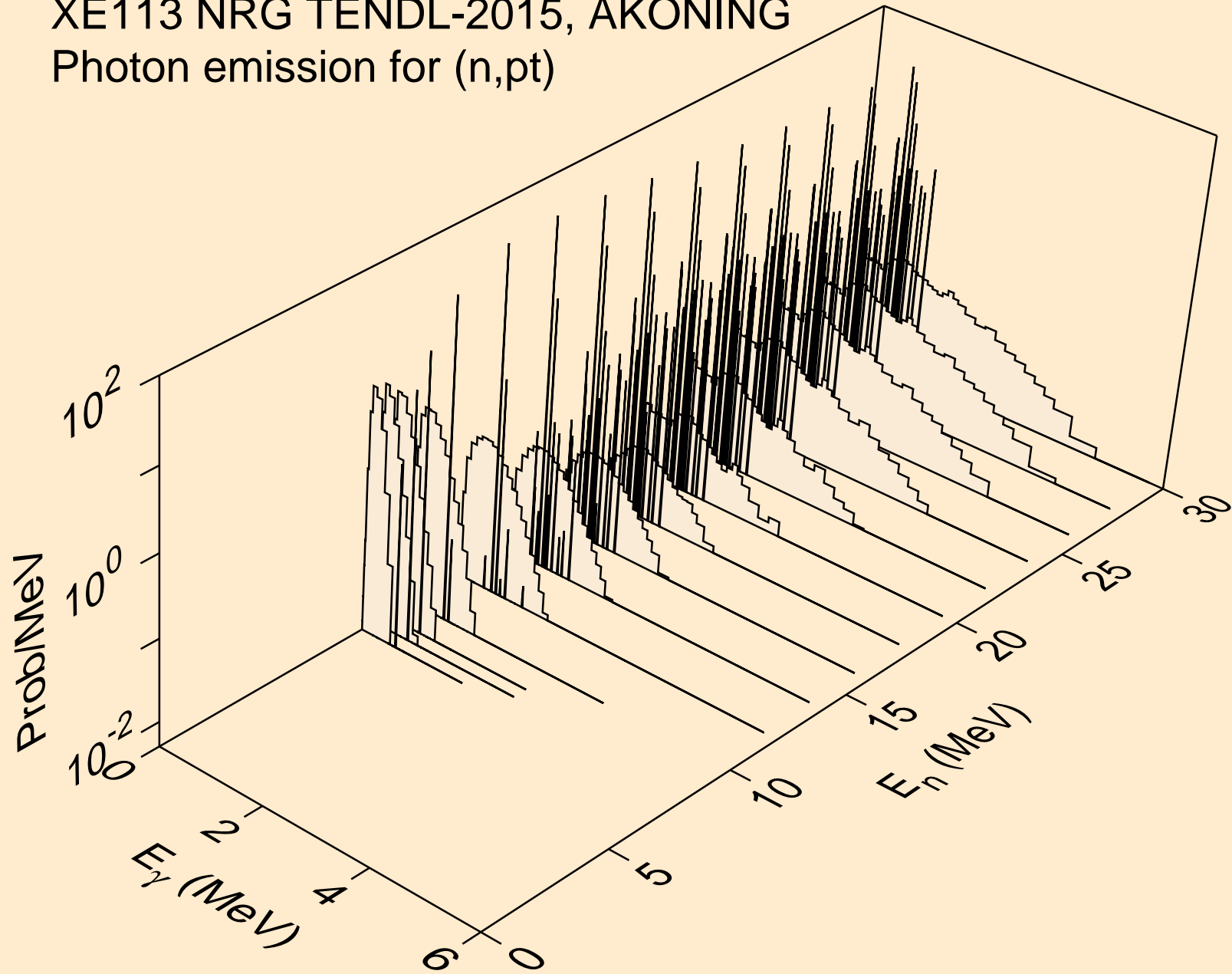

XE113 NRG TENDL-2015, AKONING
Photon emission for (n,da)

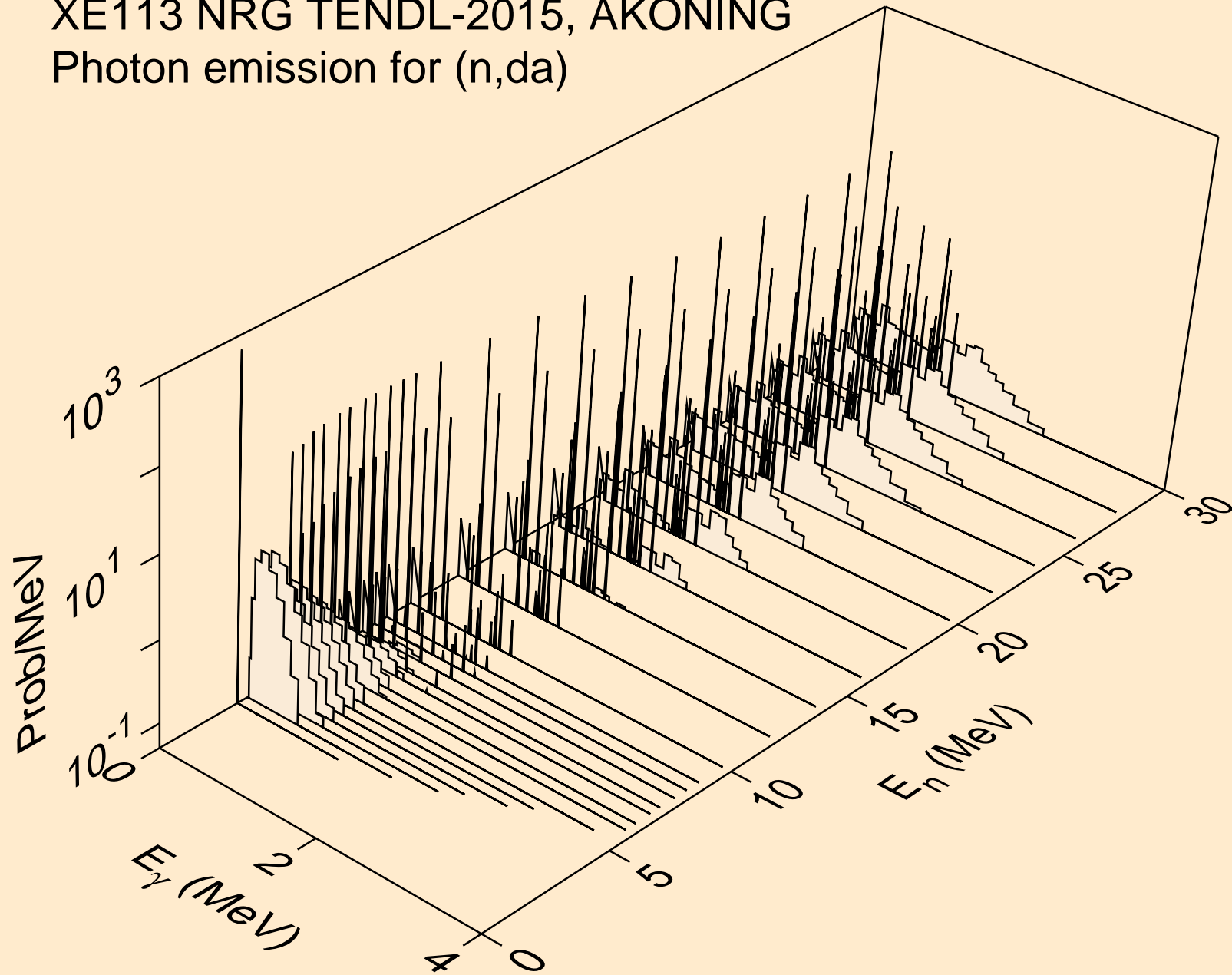

XE113 NRG TENDL-2015, AKONING
thermal capture photon spectrum

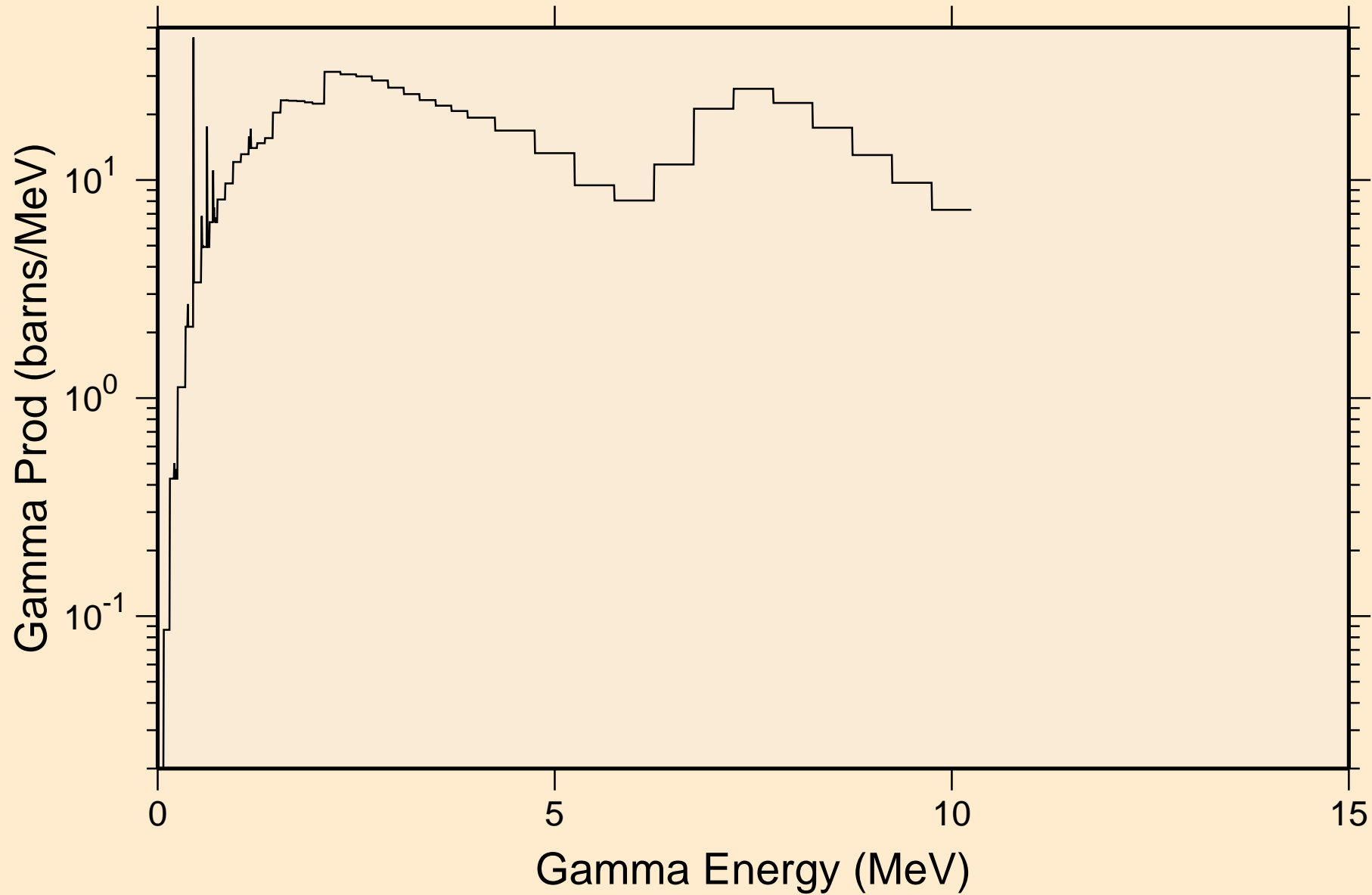

XE113 NRG TENDL-2015, AKONING
14 MeV photon spectrum

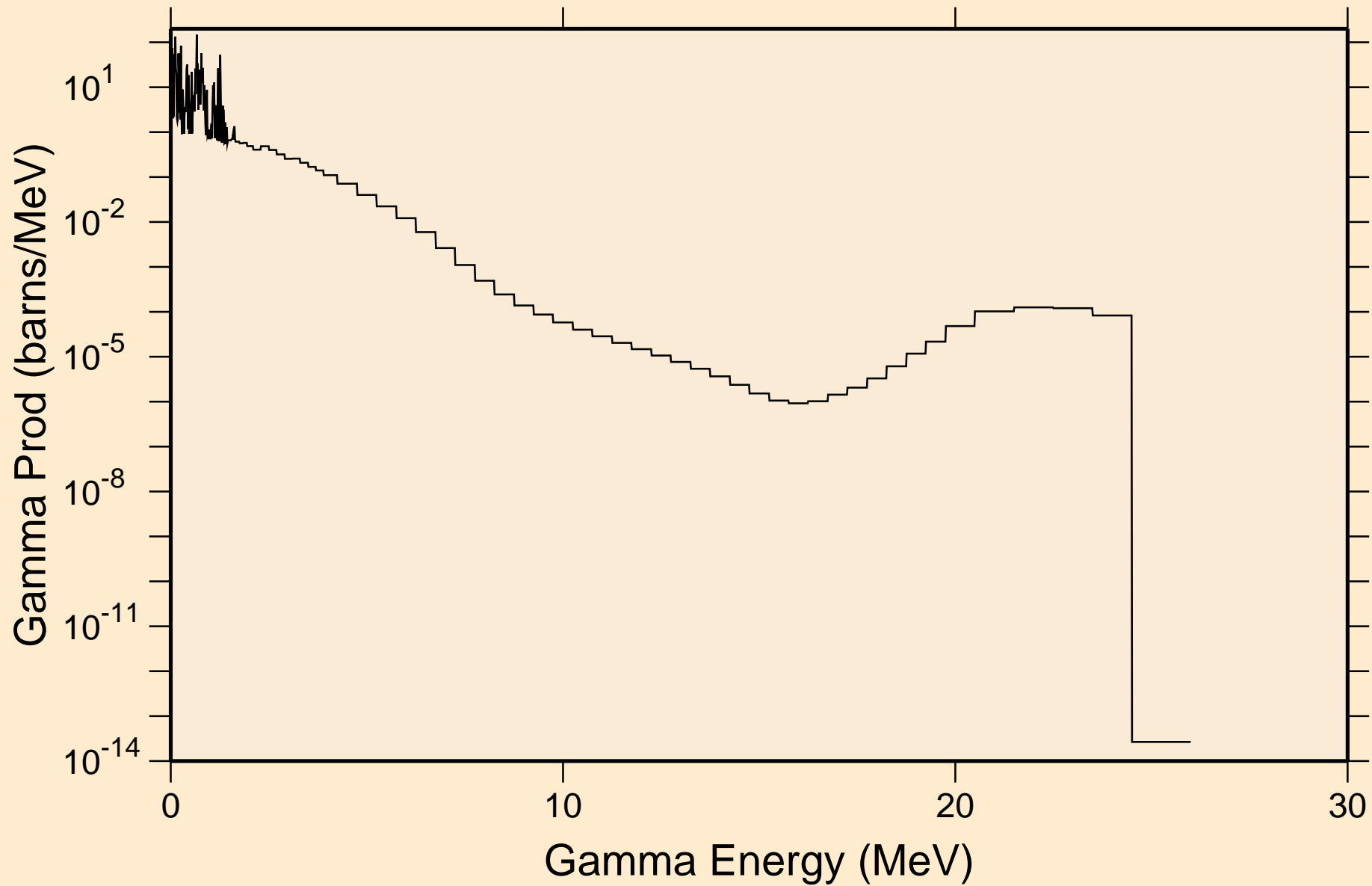

XE113 NRG TENDL-2015, AKONING

Particle heating contributions

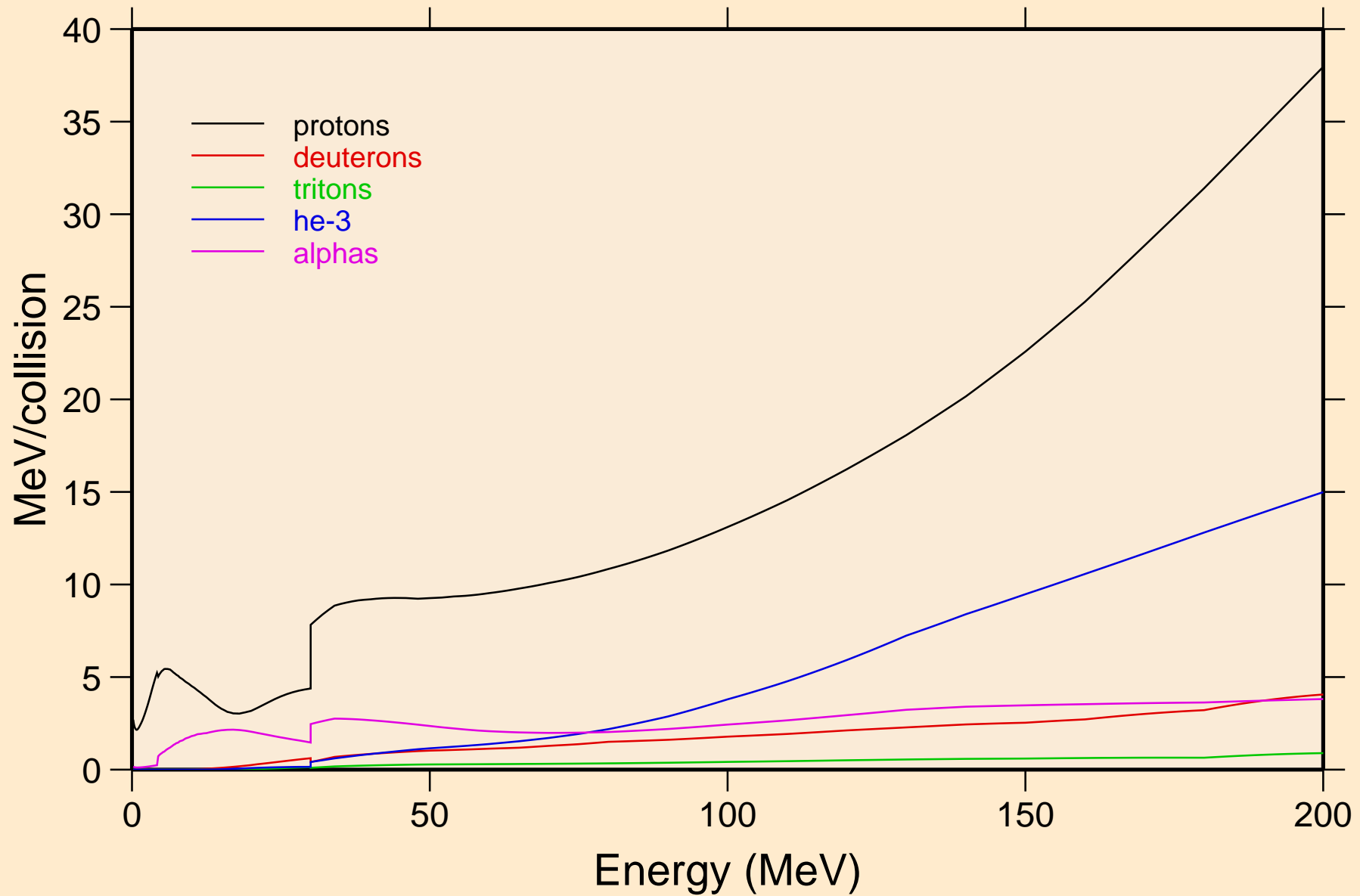

XE113 NRG TENDL-2015, AKONING

Recoil Heating

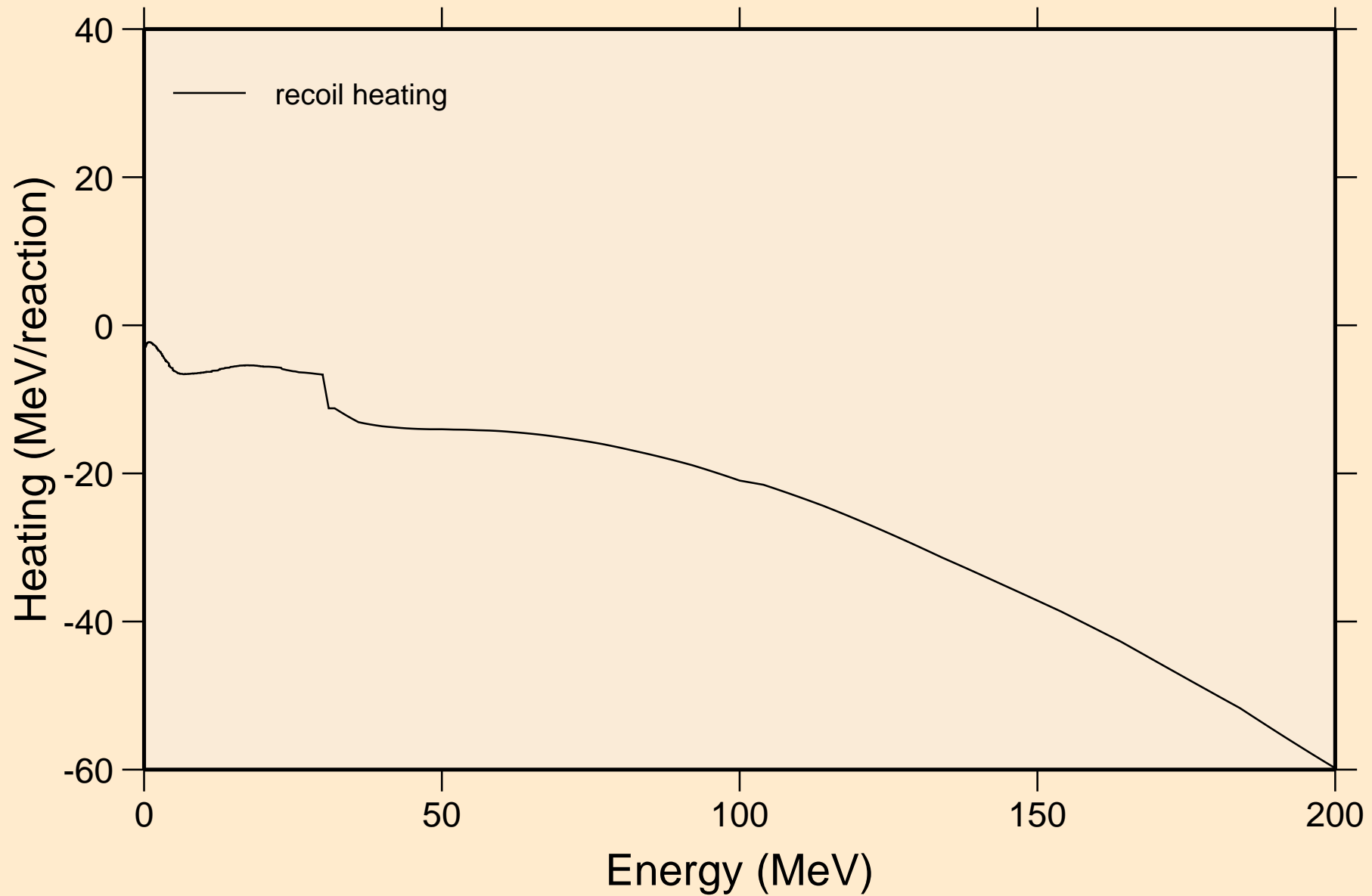

XE113 NRG TENDL-2015, AKONING

Particle production cross sections

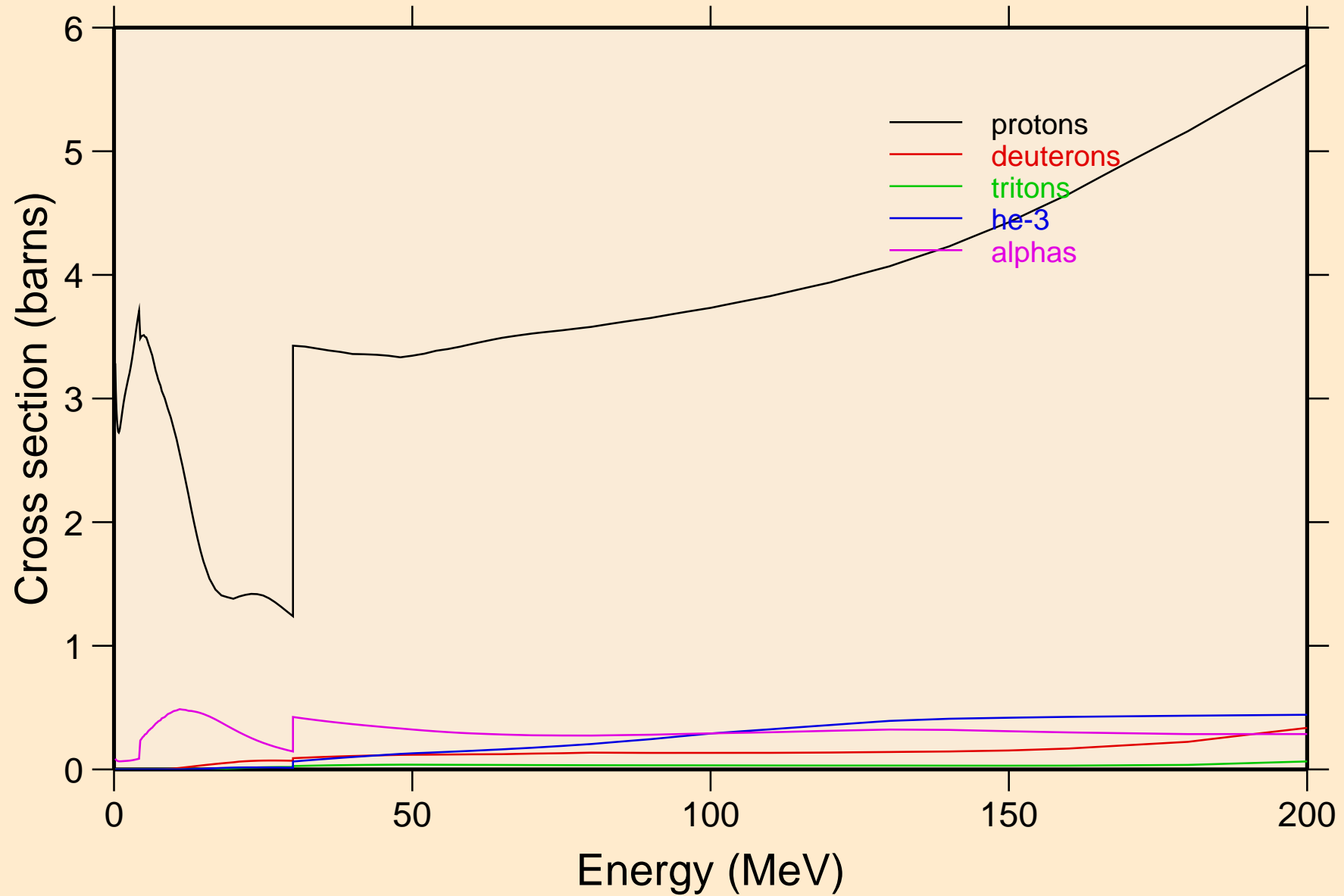

XE113 NRG TENDL-2015, AKONING
protons from (n,x)

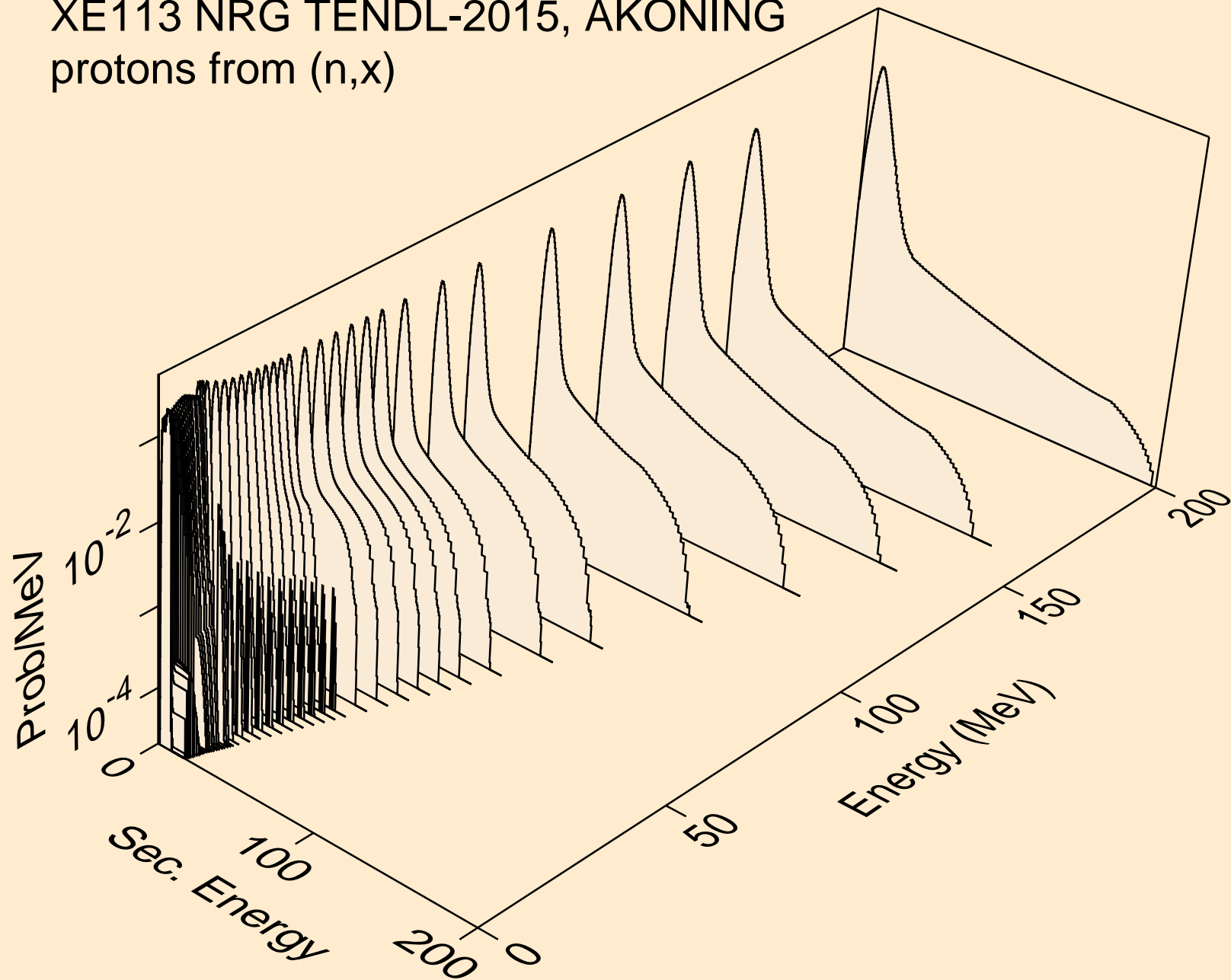

XE113 NRG TENDL-2015, AKONING
protons from (n,n*)p

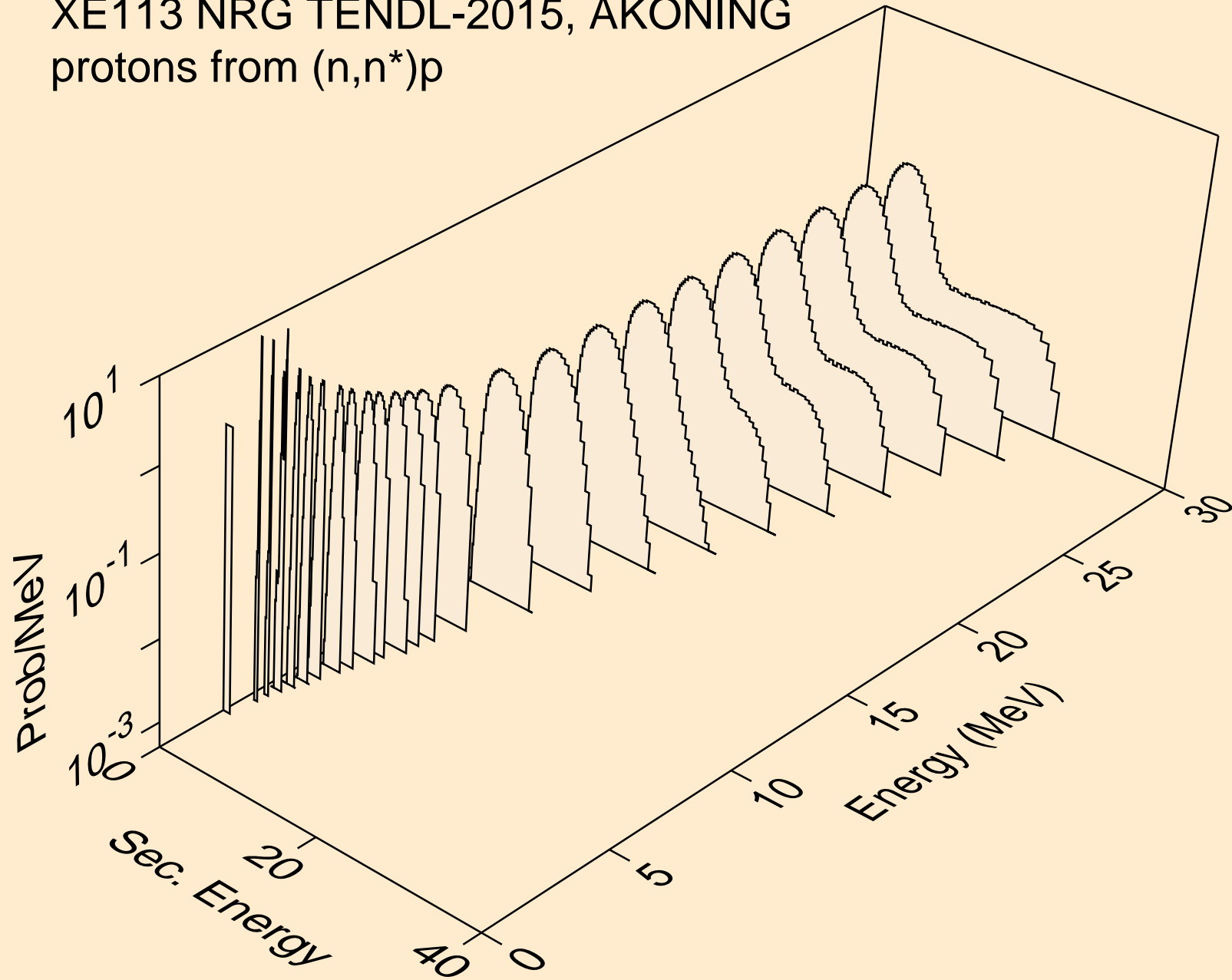

XE113 NRG TENDL-2015, AKONING
protons from (n,2np)

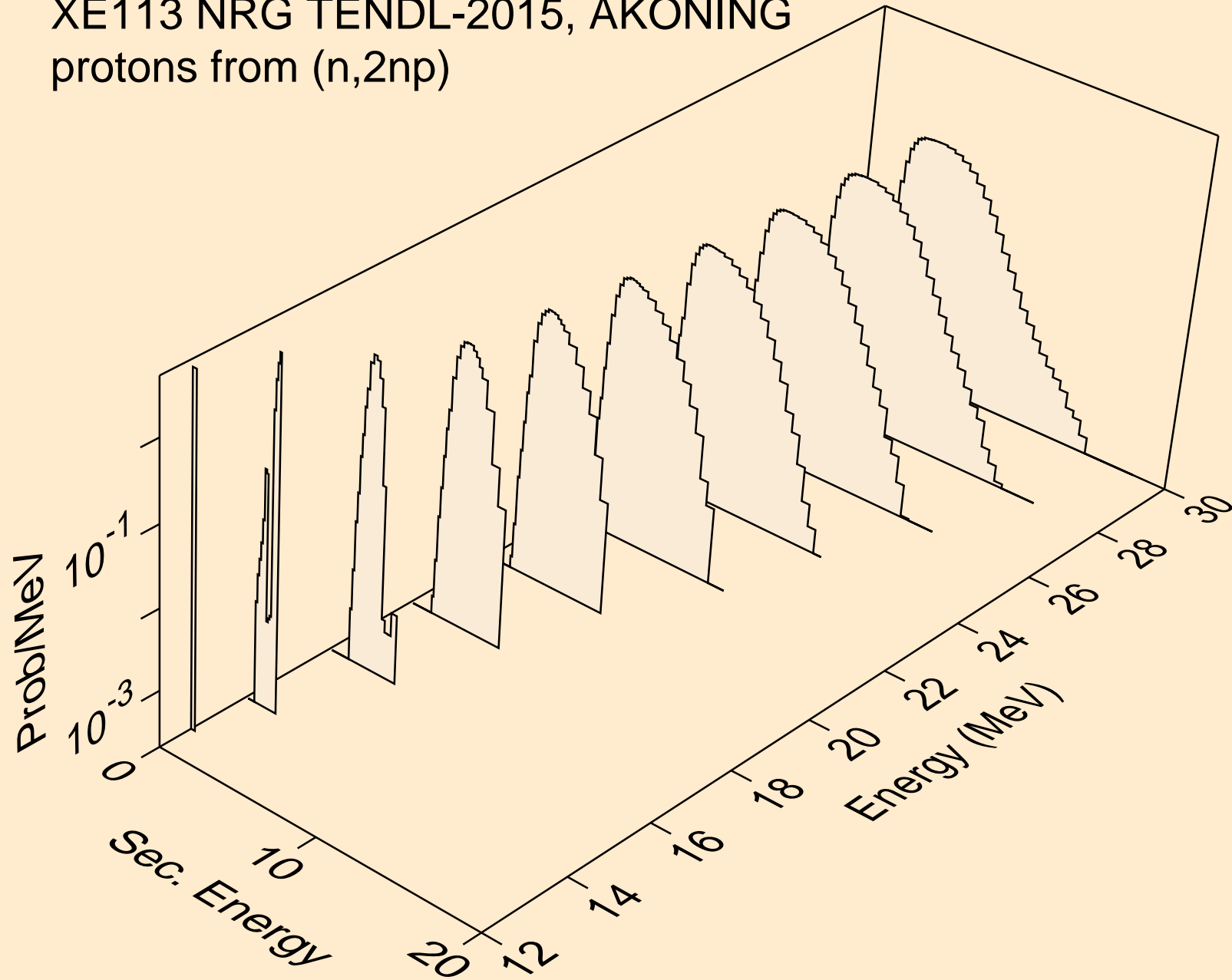

XE113 NRG TENDL-2015, AKONING
protons from (n,3np)

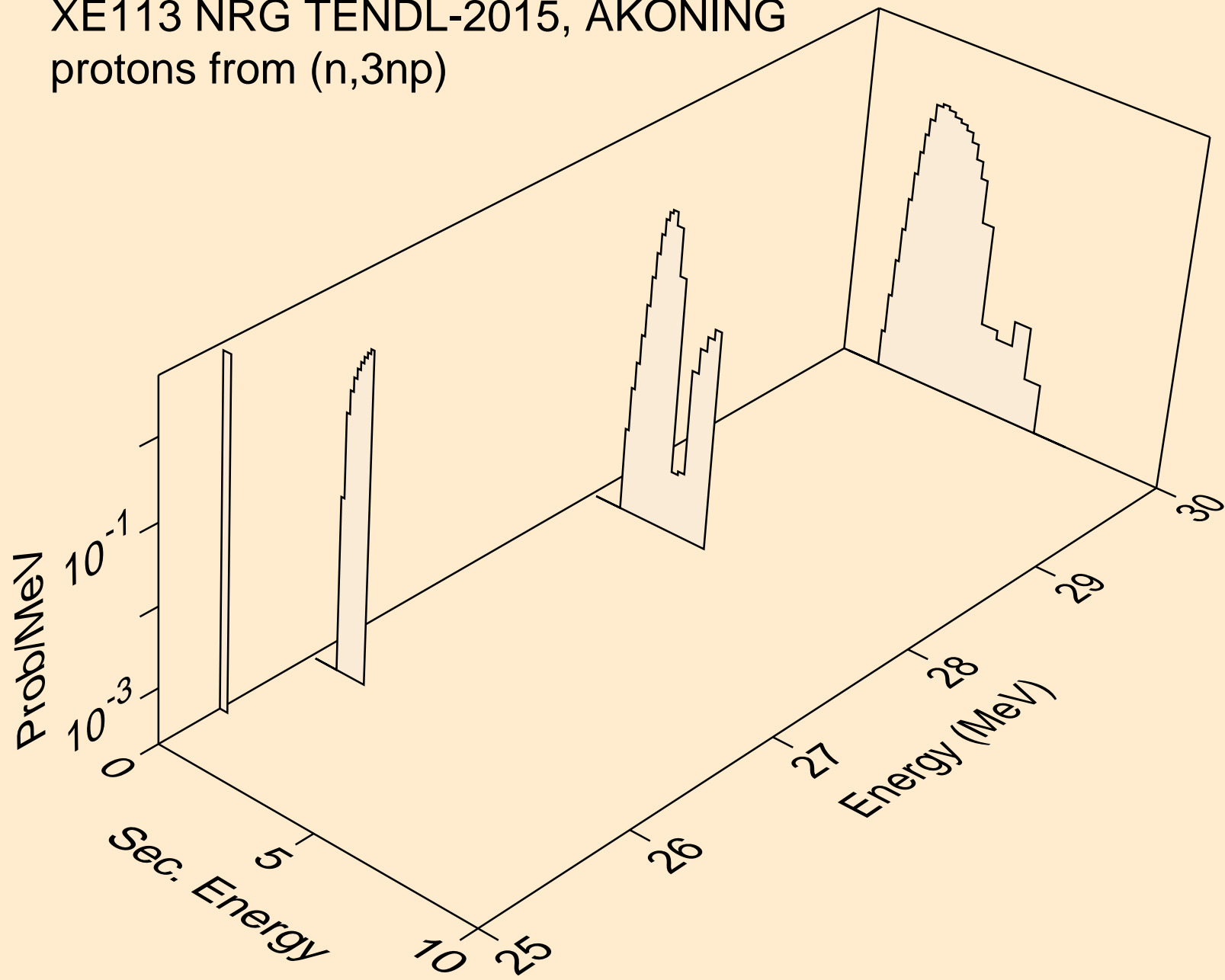

XE113 NRG TENDL-2015, AKONING
protons from (n,2np)

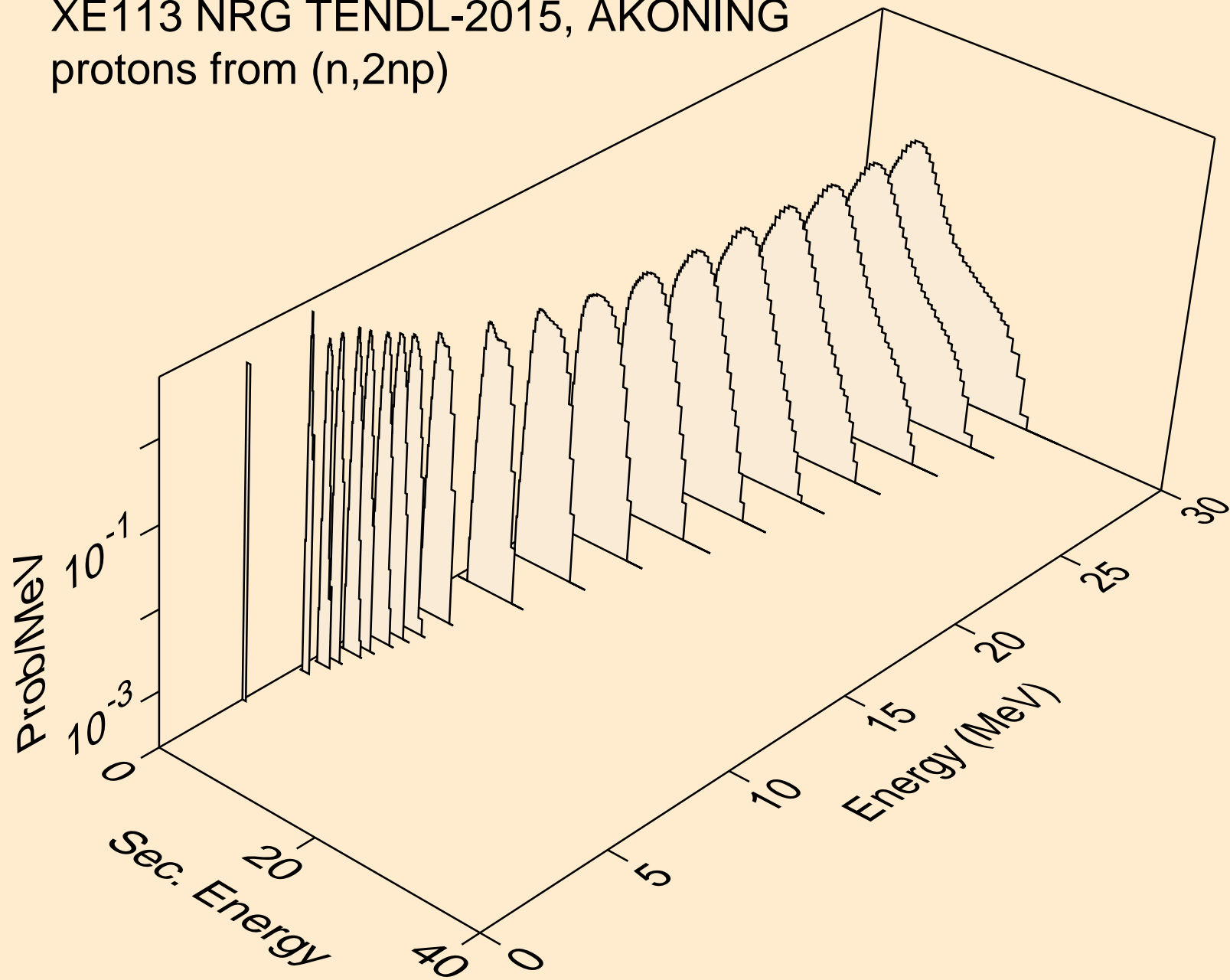

XE113 NRG TENDL-2015, AKONING
protons from (n,npa)

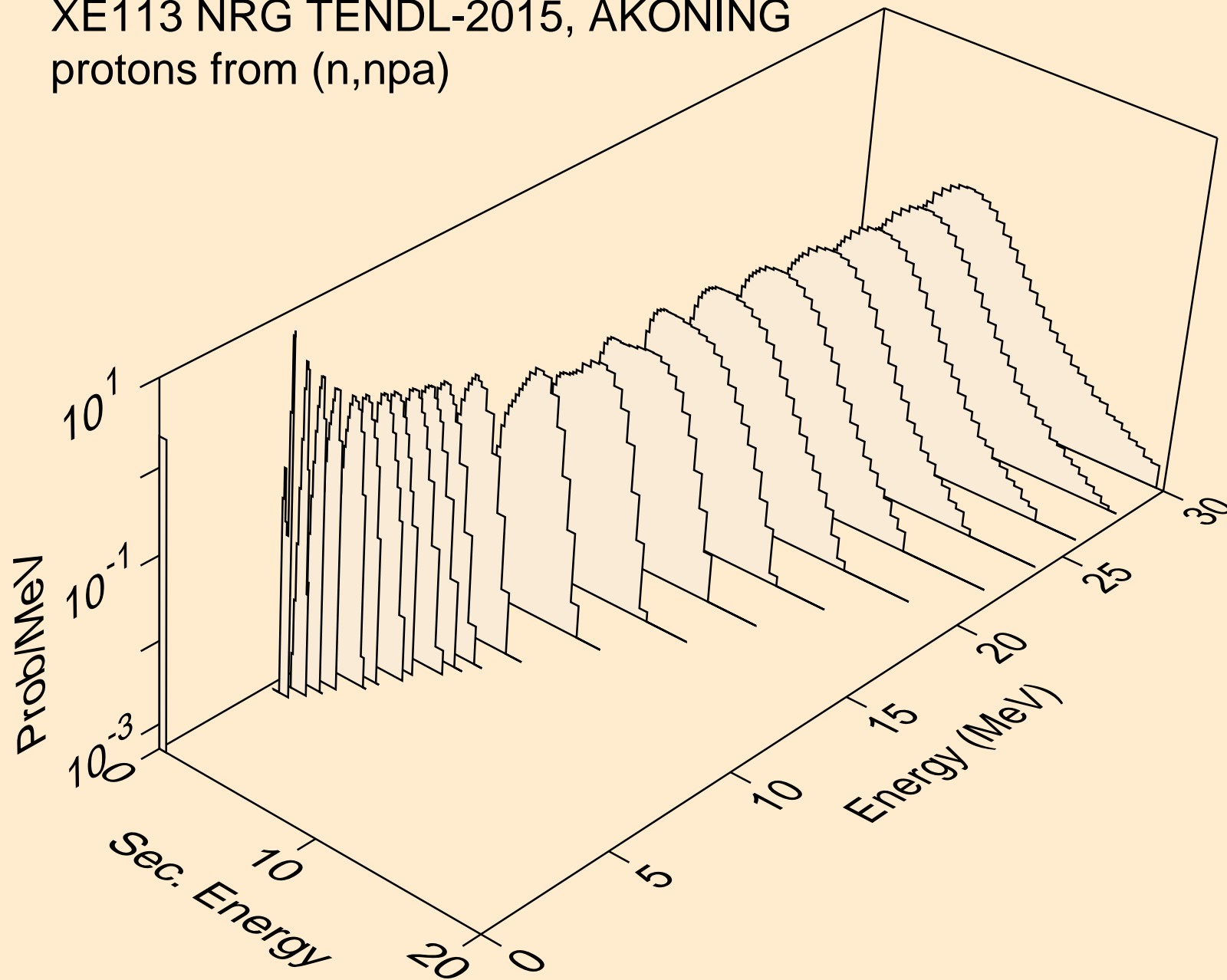

XE113 NRG TENDL-2015, AKONING
protons from (n,p)

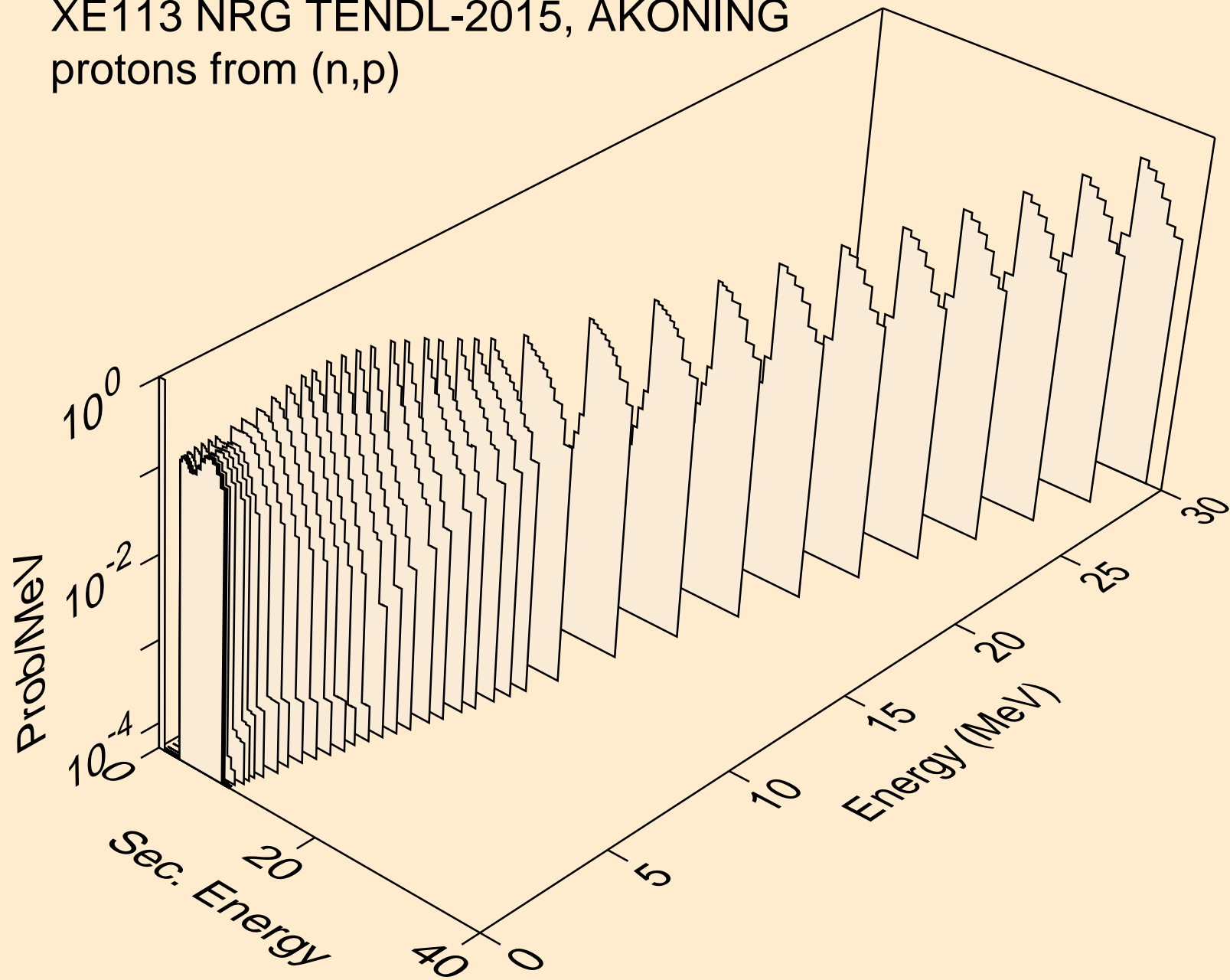

XE113 NRG TENDL-2015, AKONING
protons from (n,2p)

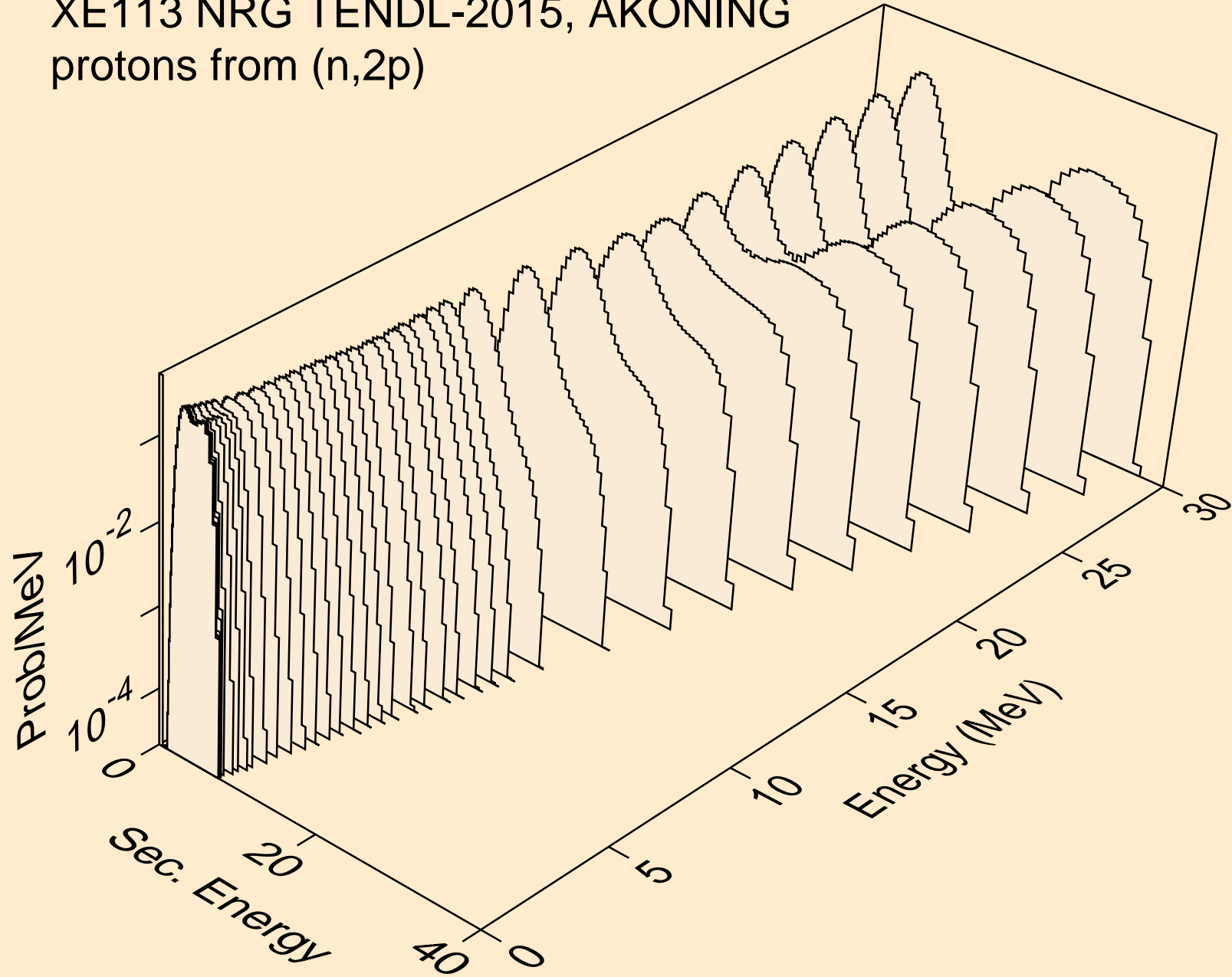

XE113 NRG TENDL-2015, AKONING
protons from (n,pa)

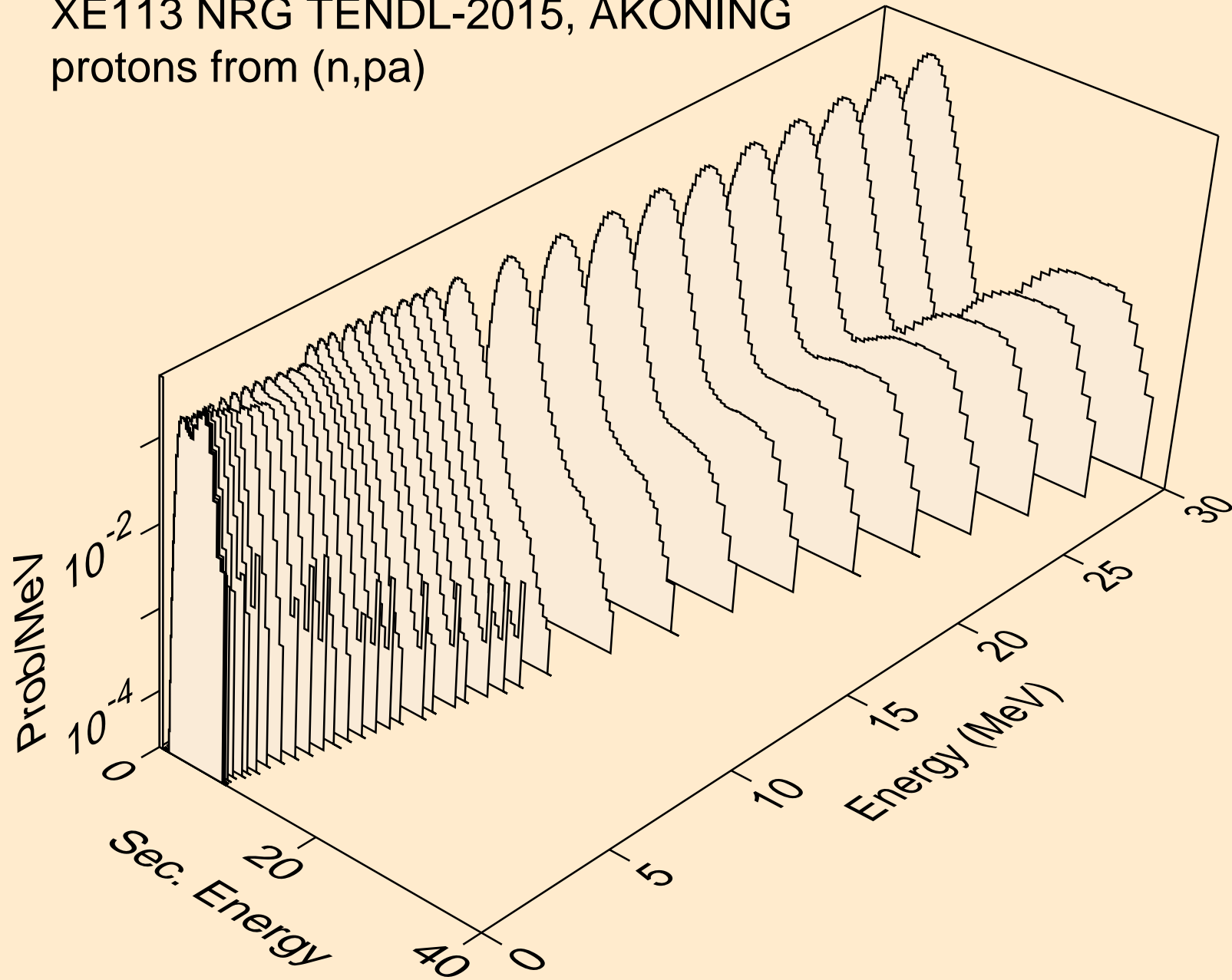

XE113 NRG TENDL-2015, AKONING
protons from (n,pd)

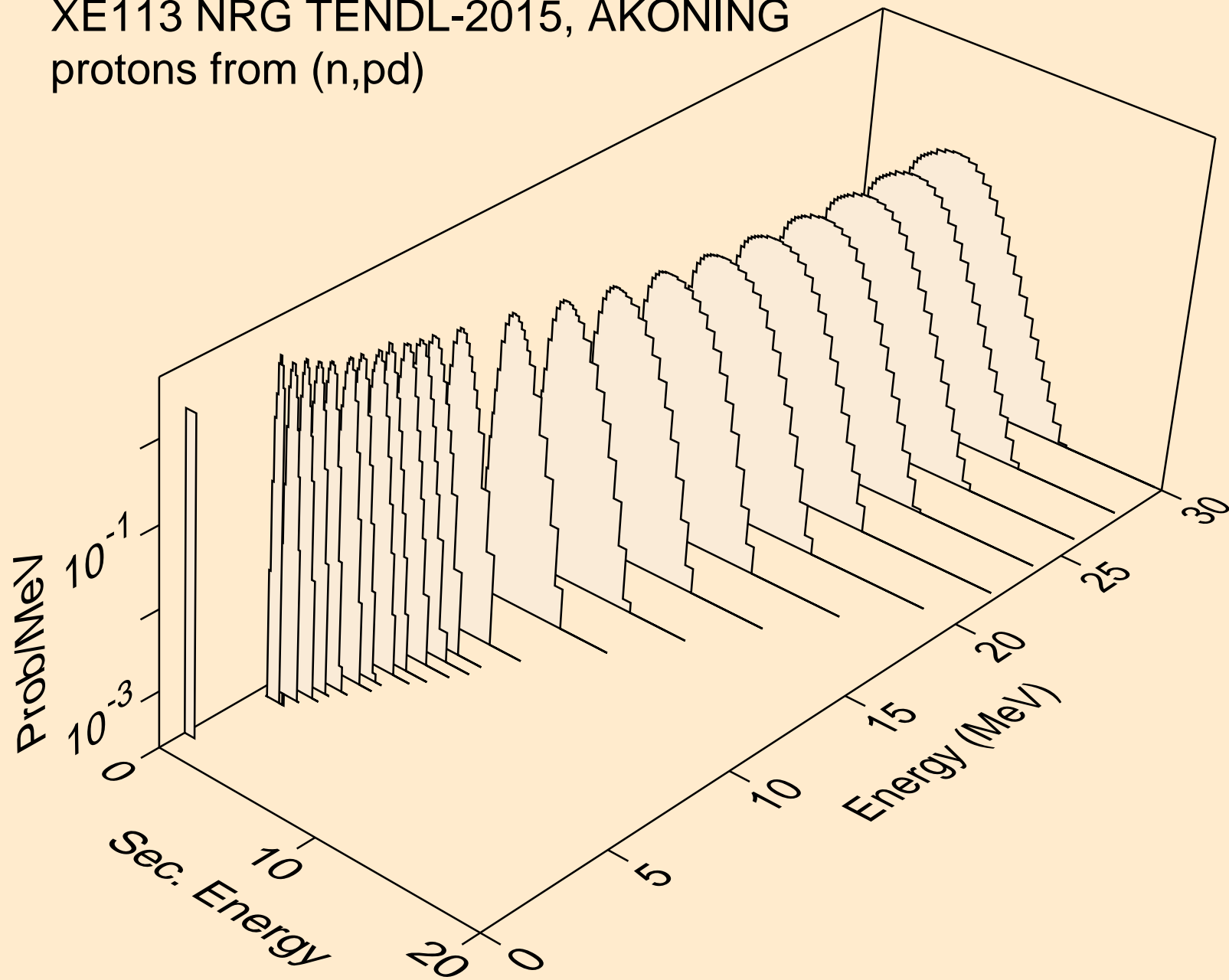

XE113 NRG TENDL-2015, AKONING
protons from (n,pt)

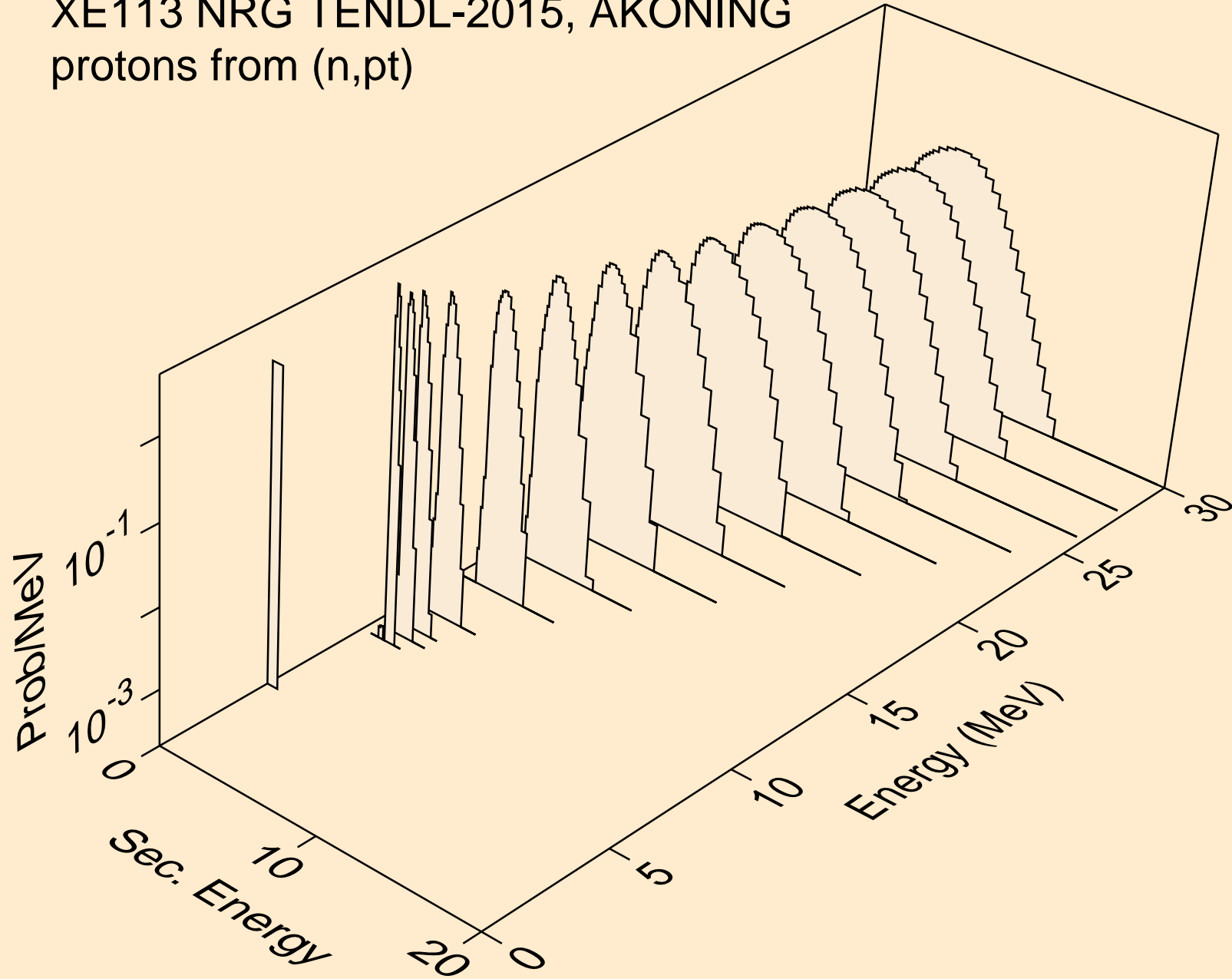

XE113 NRG TENDL-2015, AKONING
deuterons from (n,x)

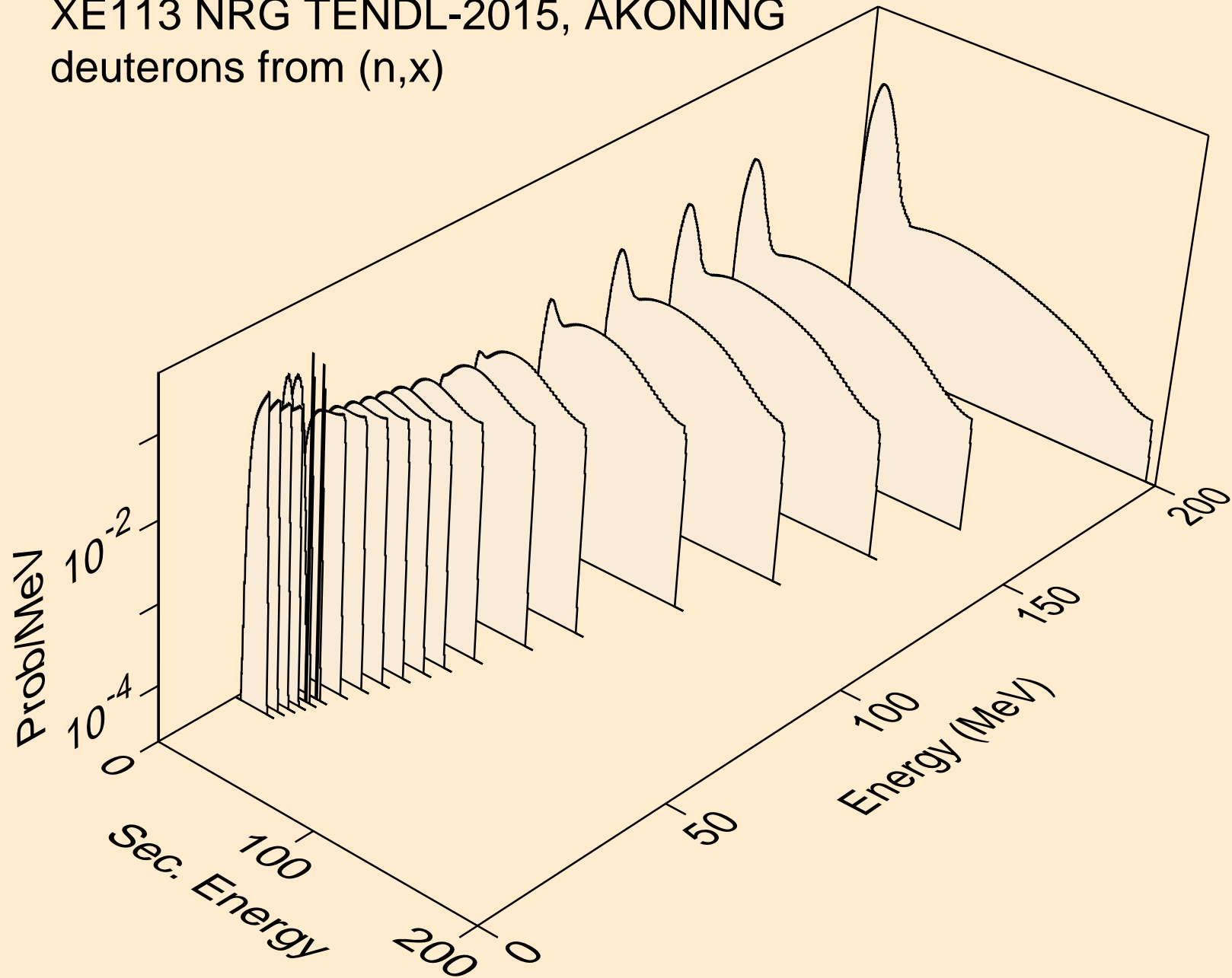

XE113 NRG TENDL-2015, AKONING
deuterons from (n,2nd)

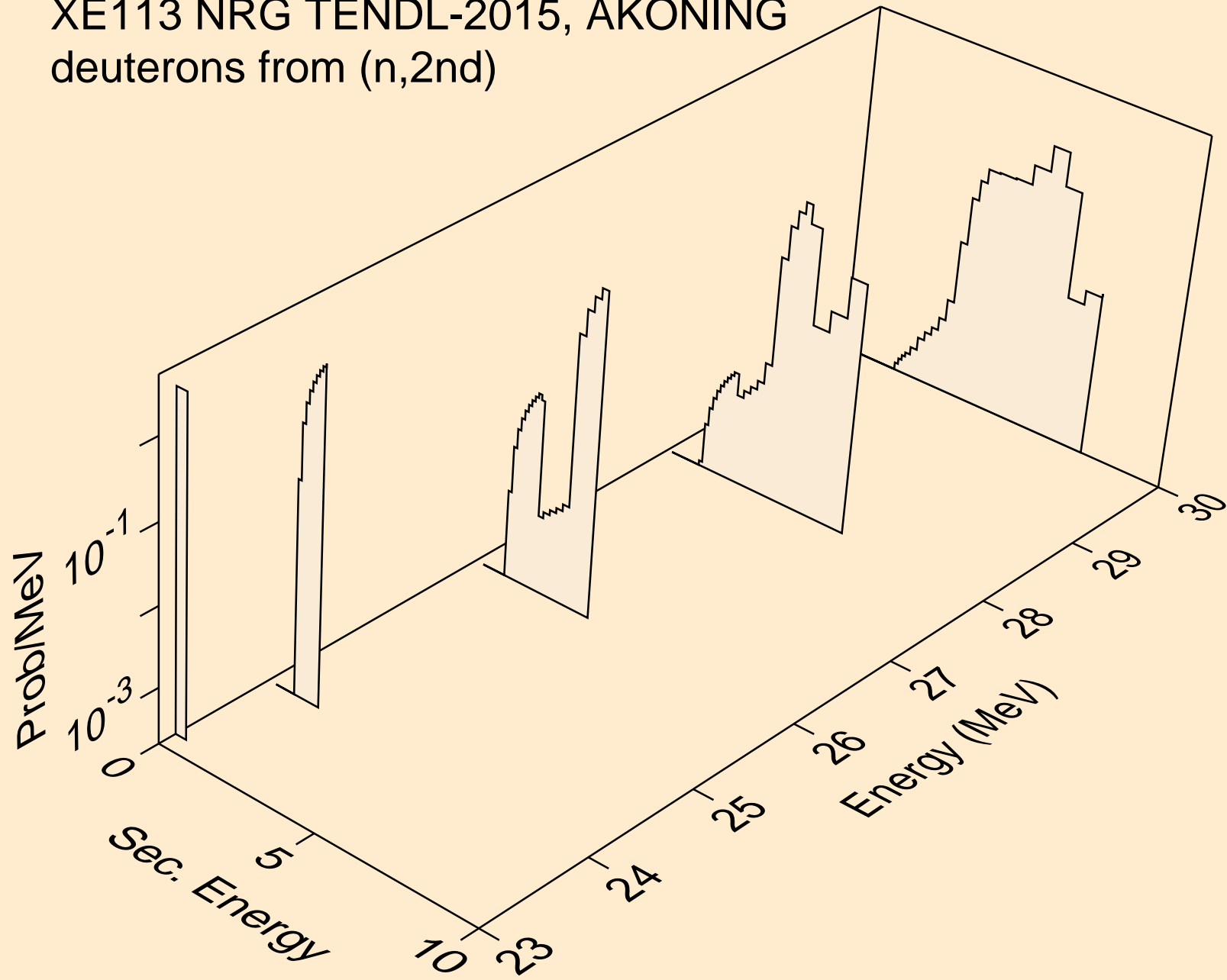

XE113 NRG TENDL-2015, AKONING
deuterons from (n,n*)d

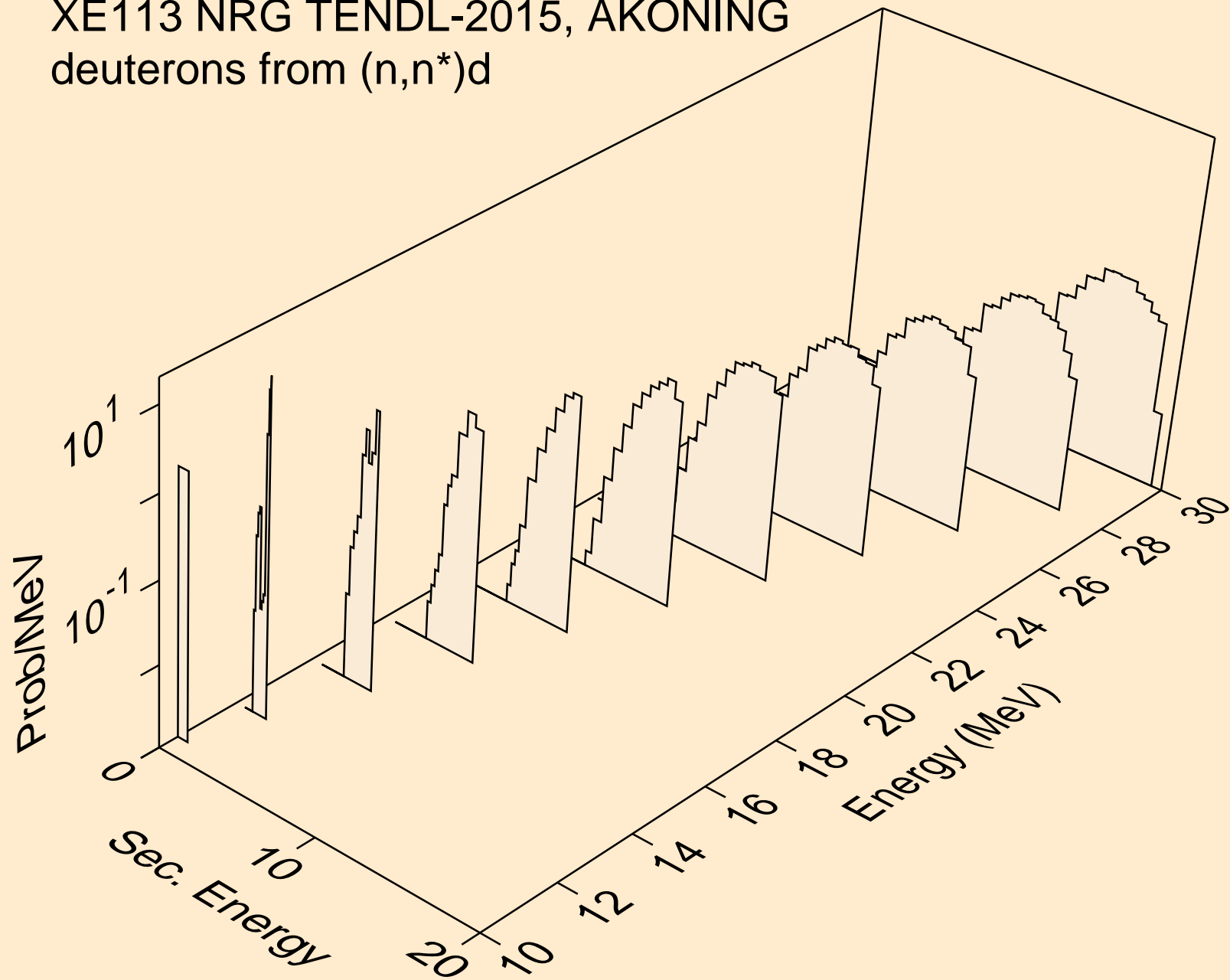

XE113 NRG TENDL-2015, AKONING
deuterons from (n,d)

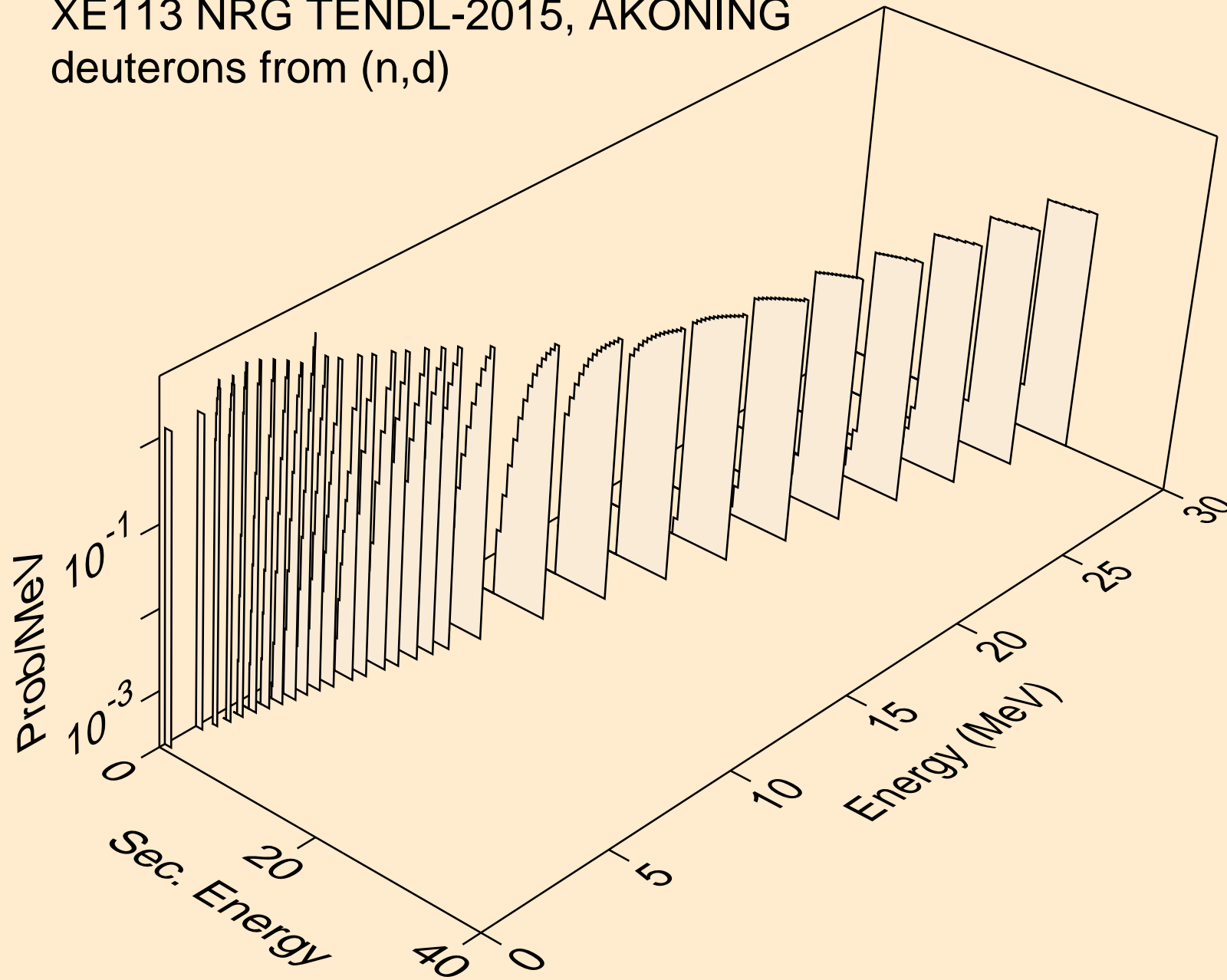

XE113 NRG TENDL-2015, AKONING
deuterons from (n,d2a)

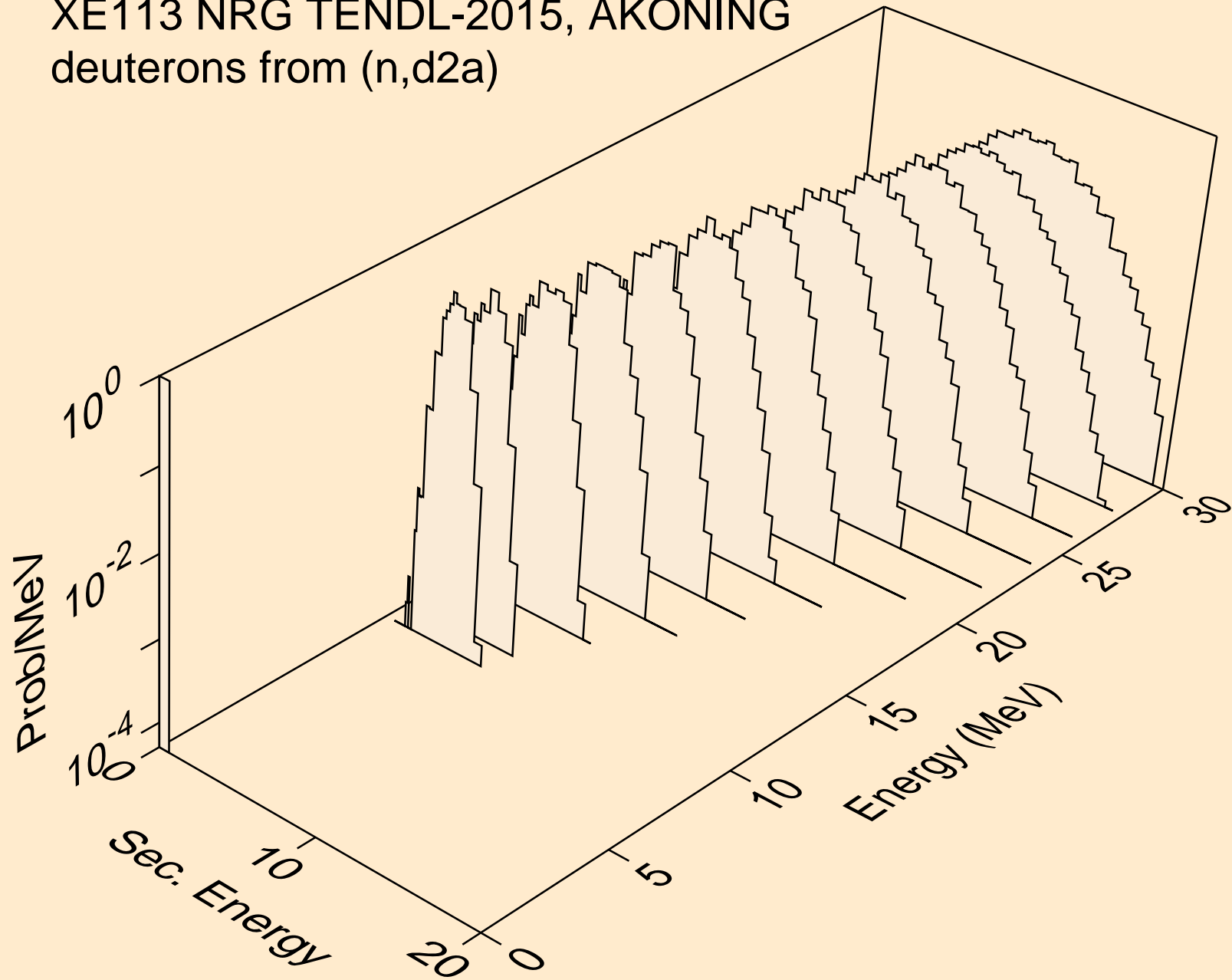

XE113 NRG TENDL-2015, AKONING
deuterons from (n,pd)

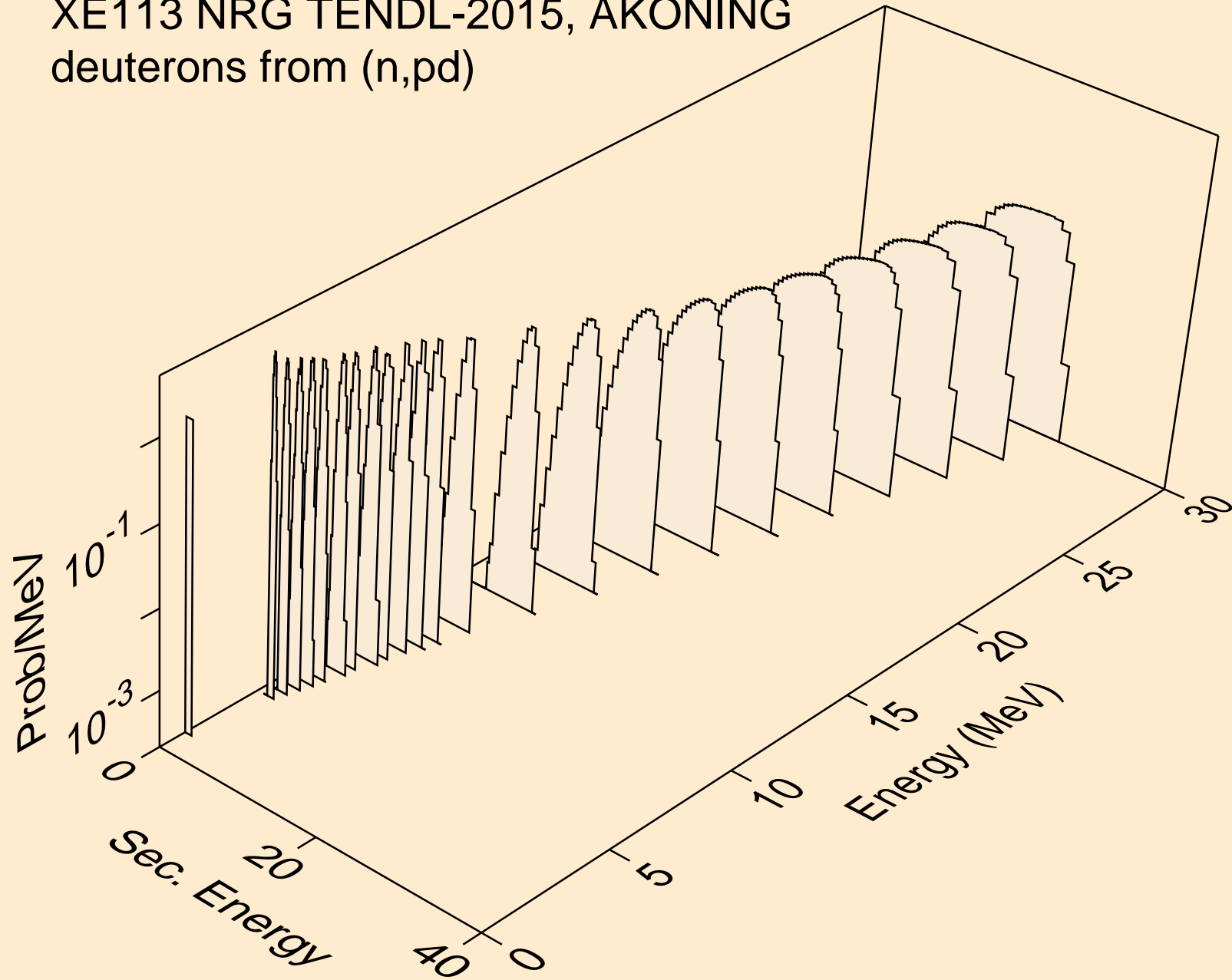

XE113 NRG TENDL-2015, AKONING
deuterons from (n,da)

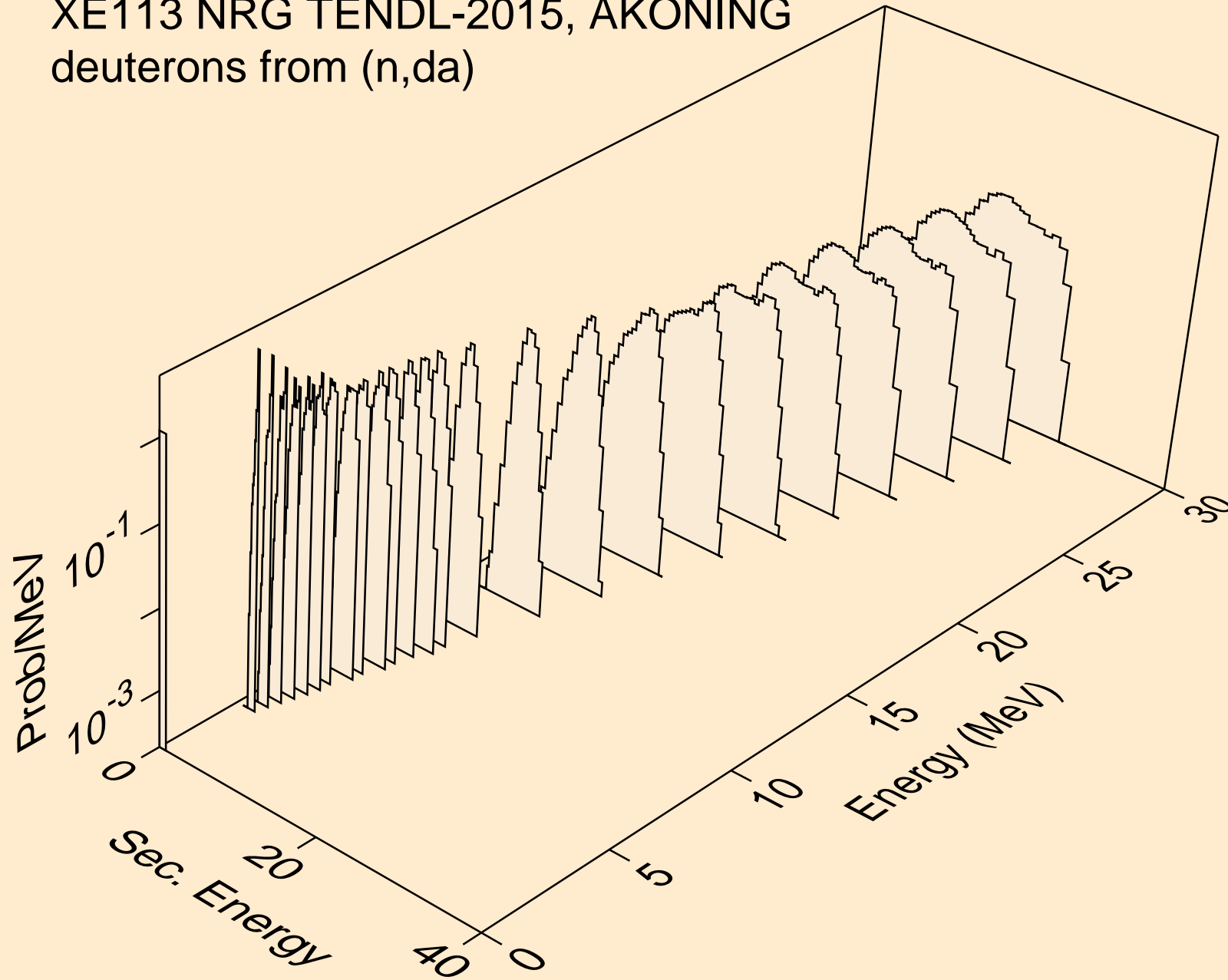

XE113 NRG TENDL-2015, AKONING
tritons from (n,x)

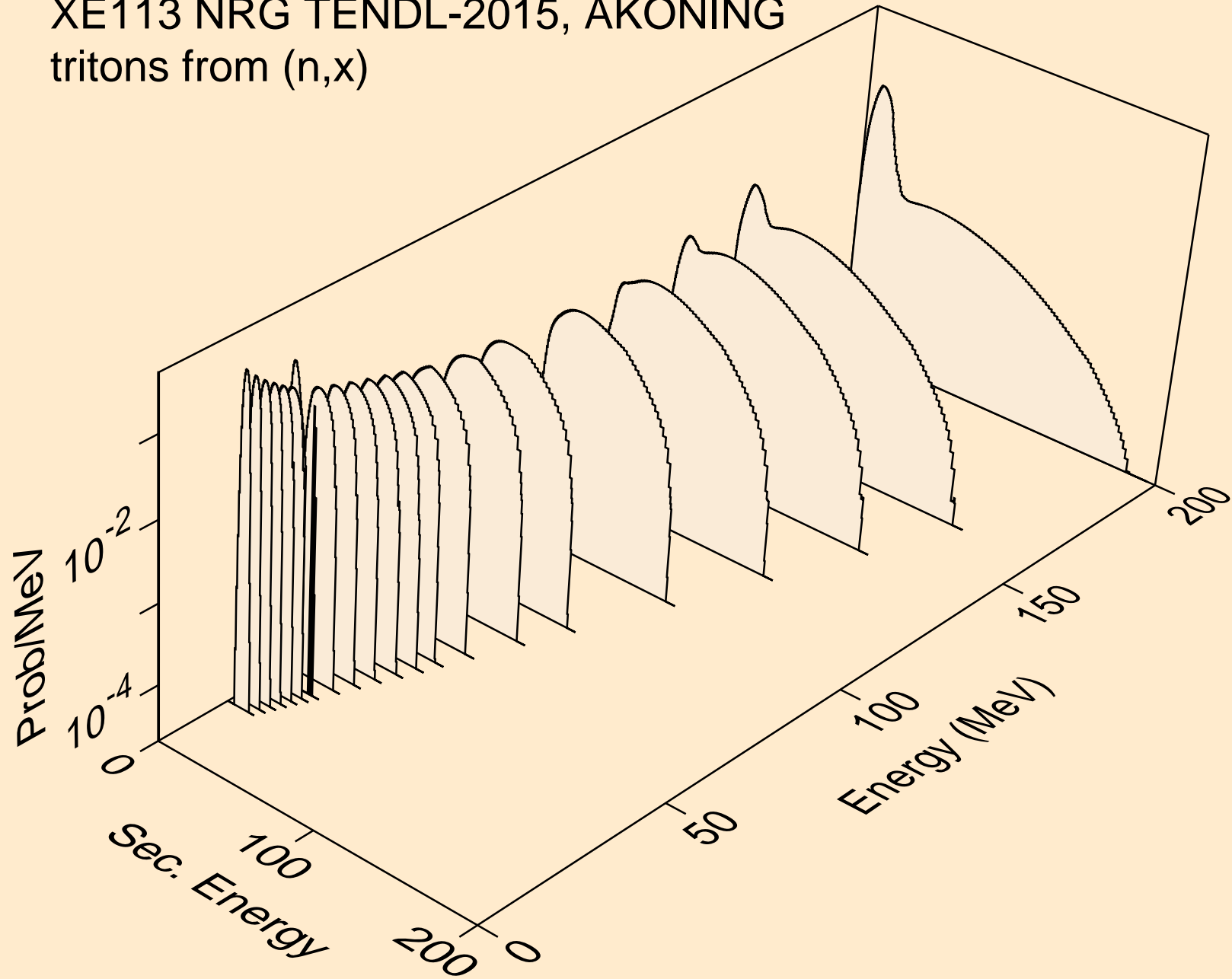

XE113 NRG TENDL-2015, AKONING
tritons from (n,n*)t

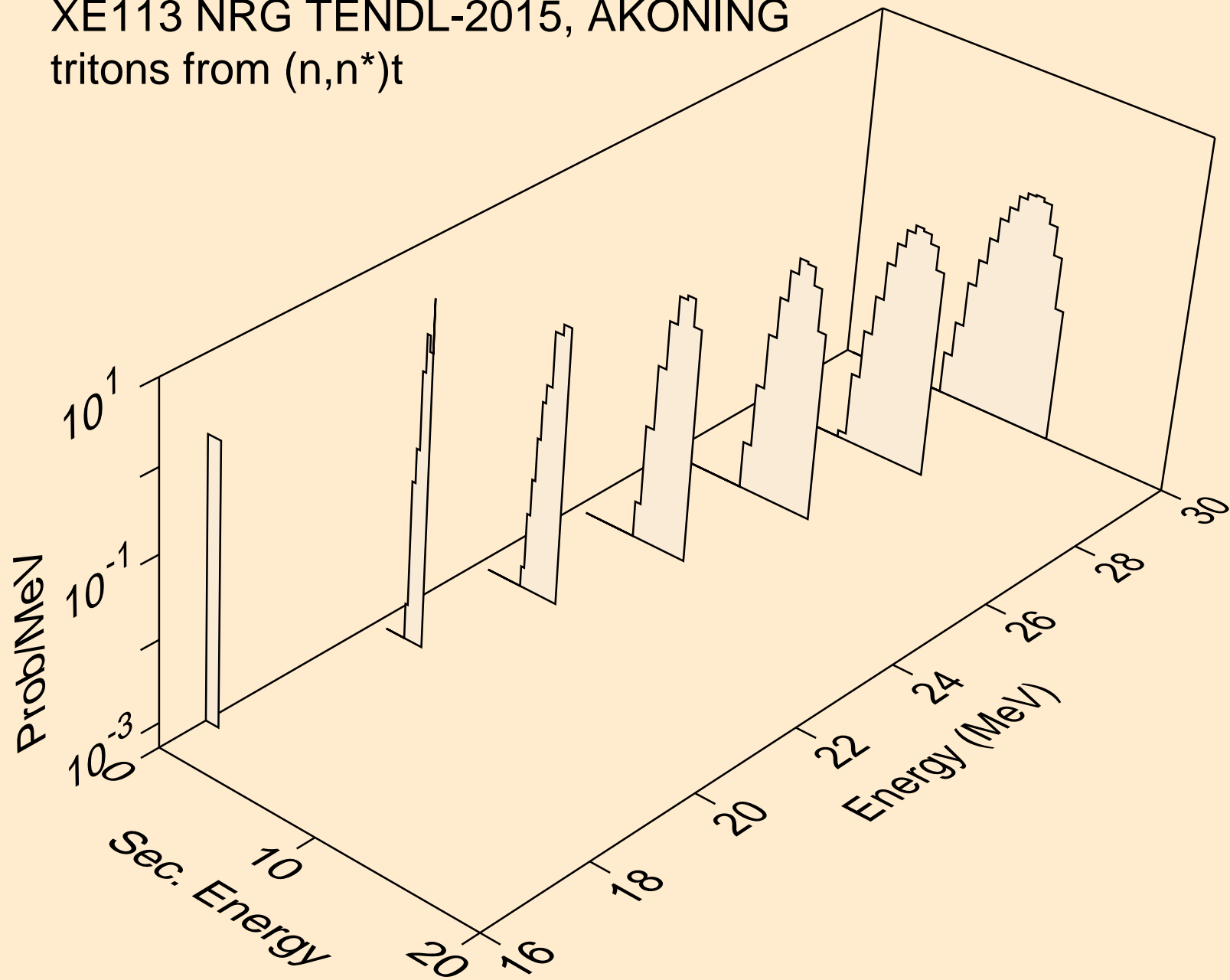

XE113 NRG TENDL-2015, AKONING
tritons from (n,t)

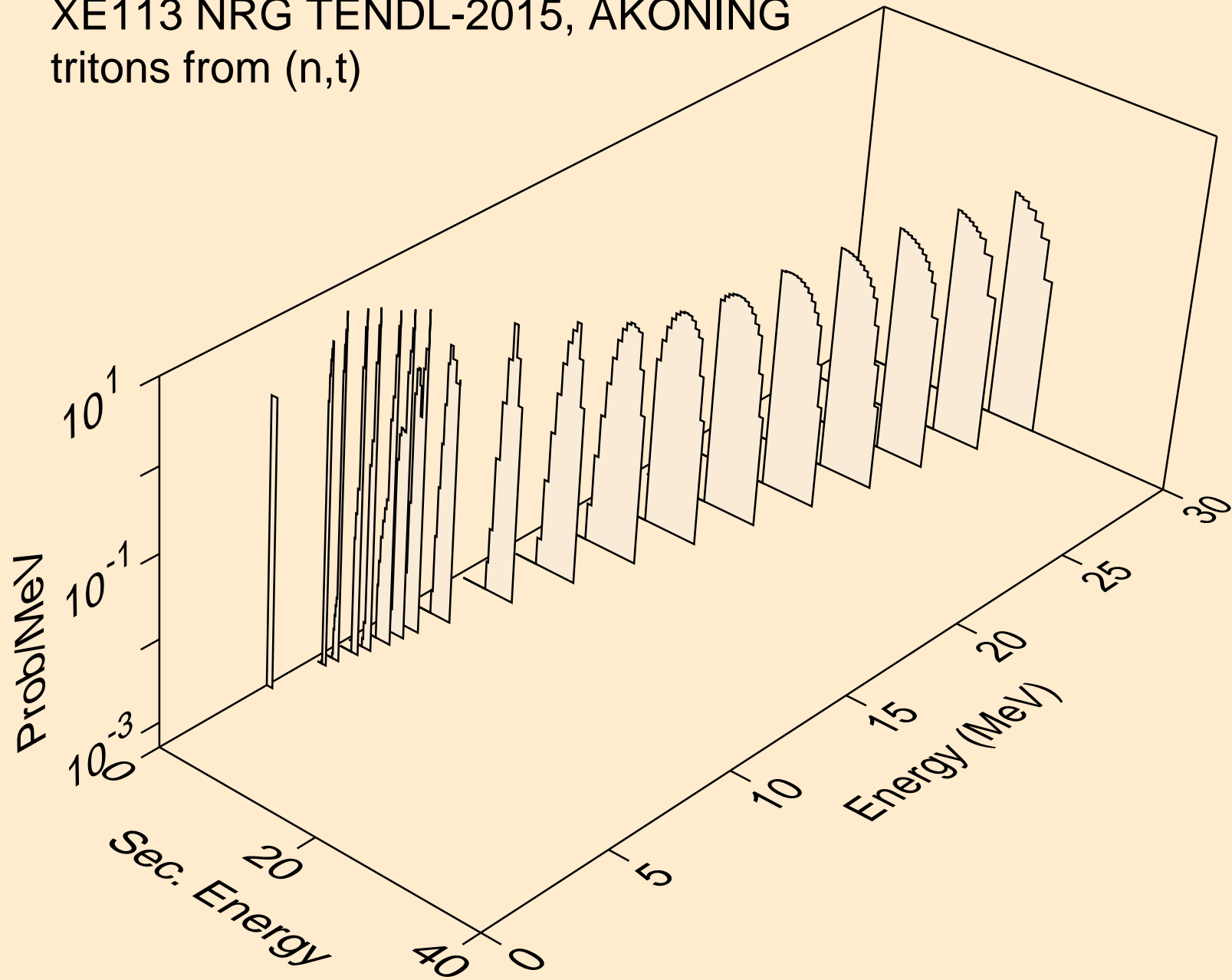

XE113 NRG TENDL-2015, AKONING
tritons from (n,t2a)

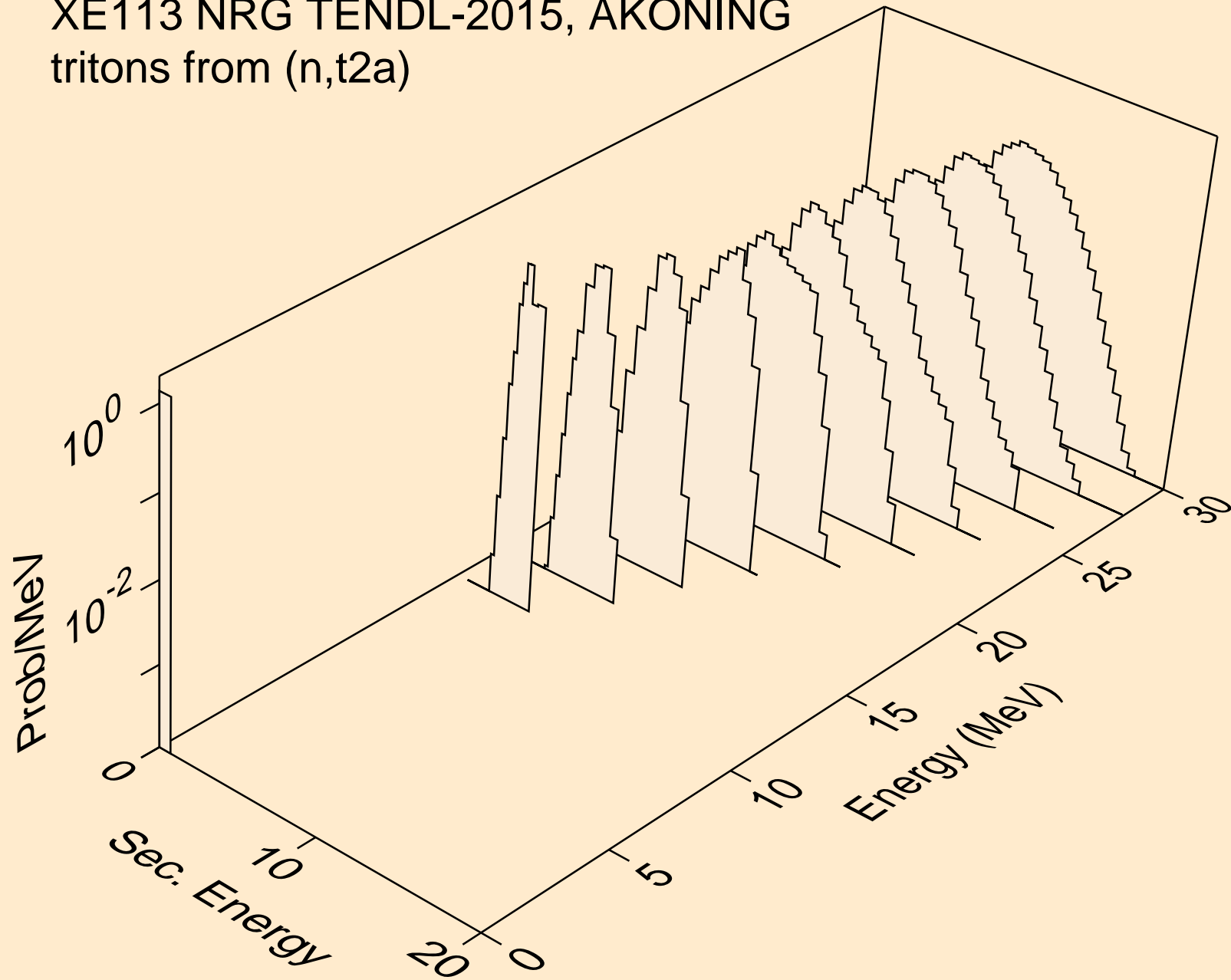

XE113 NRG TENDL-2015, AKONING
tritons from (n,pt)

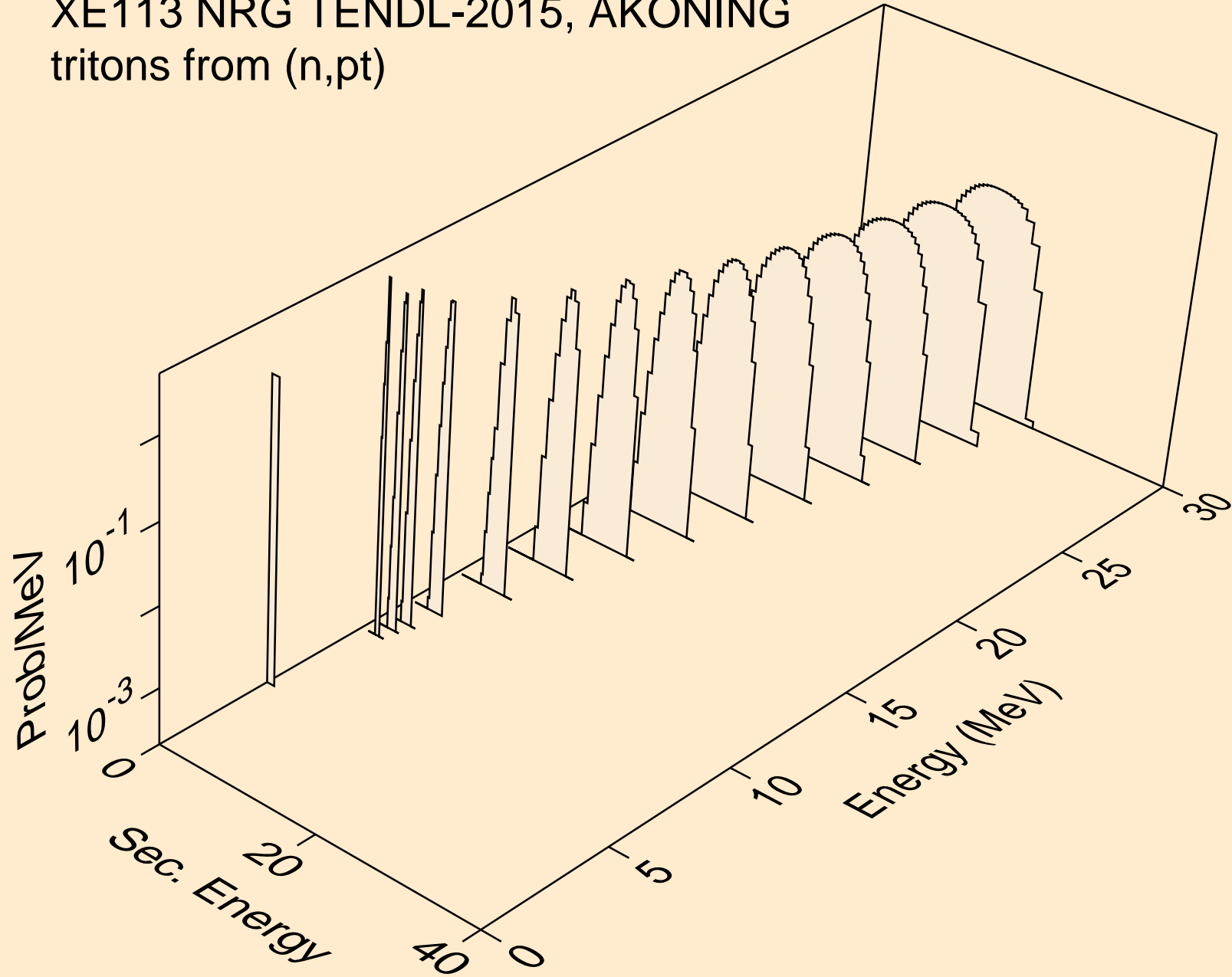

XE113 NRG TENDL-2015, AKONING
he3s from (n,x)

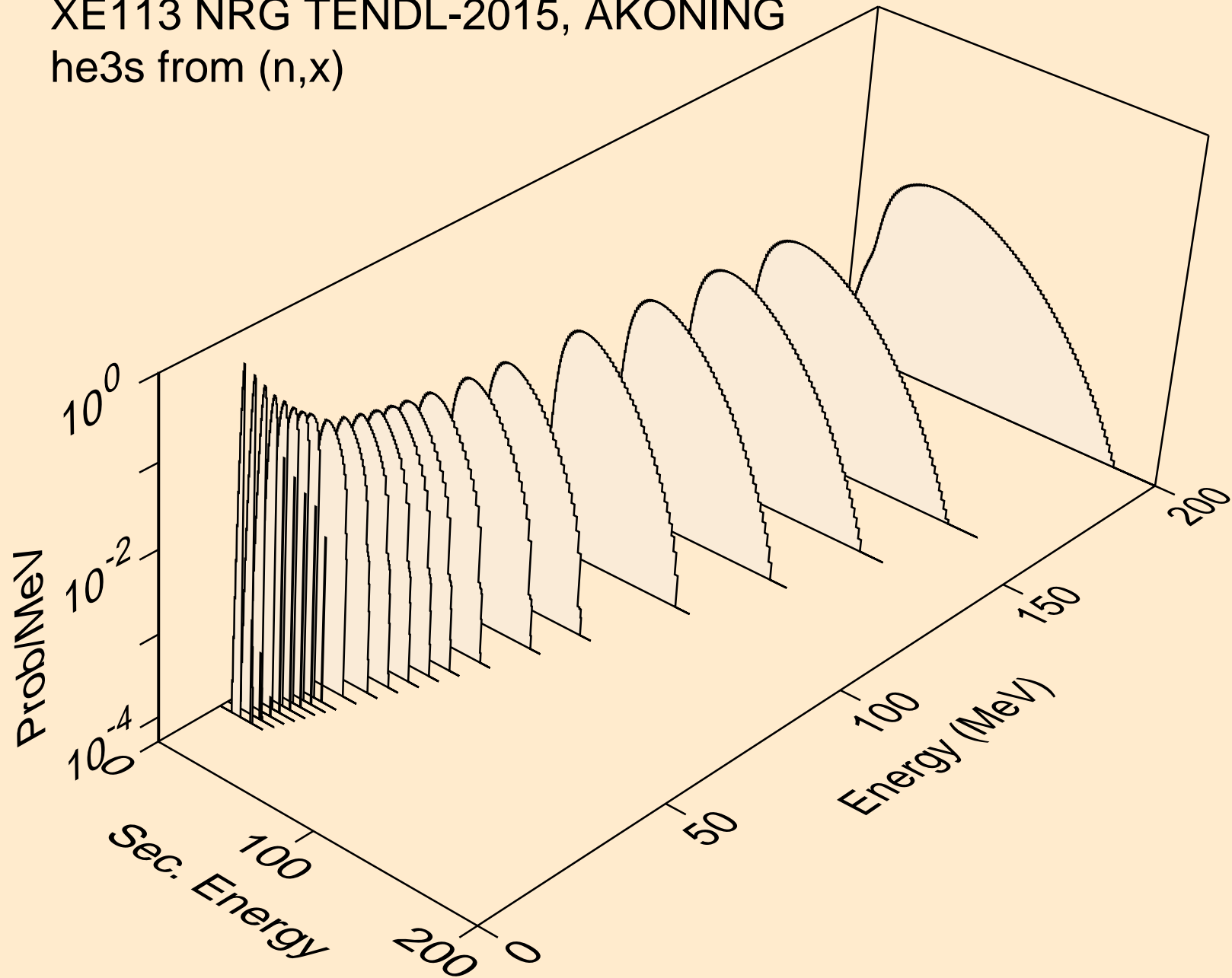

XE113 NRG TENDL-2015, AKONING
he3s from (n,n*)he3

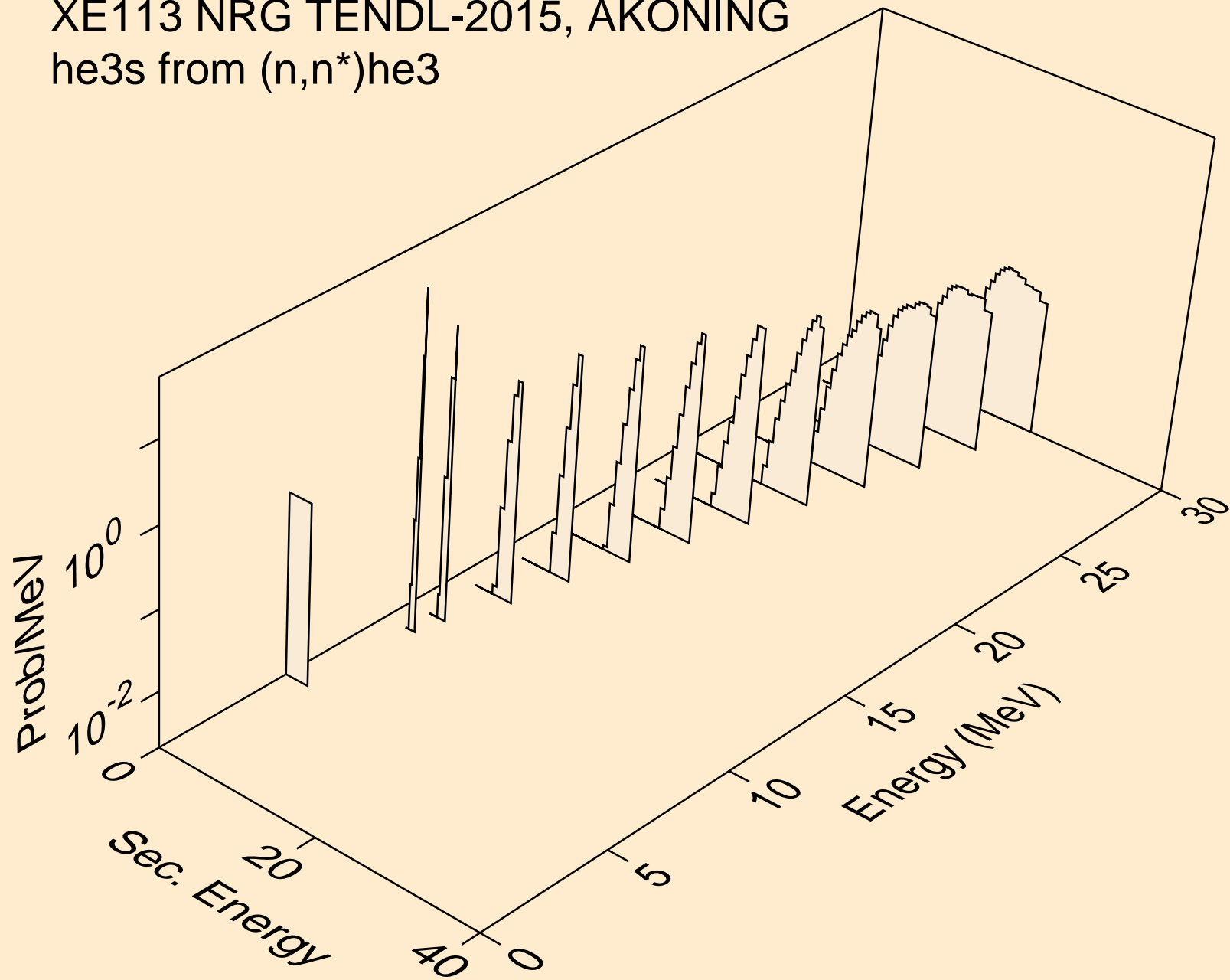

XE113 NRG TENDL-2015, AKONING
he3s from (n,he3)

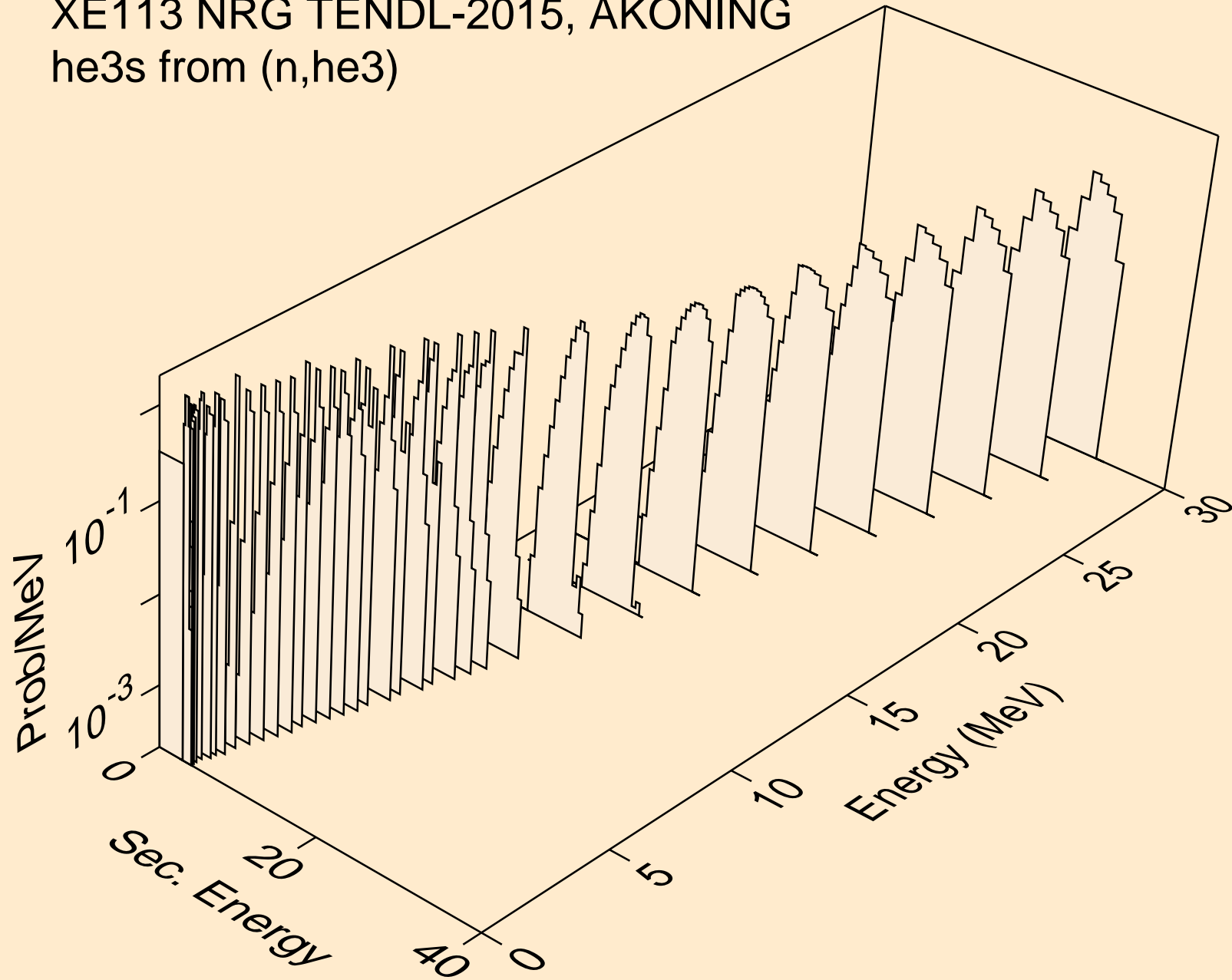

XE113 NRG TENDL-2015, AKONING
alphas from (n,x)

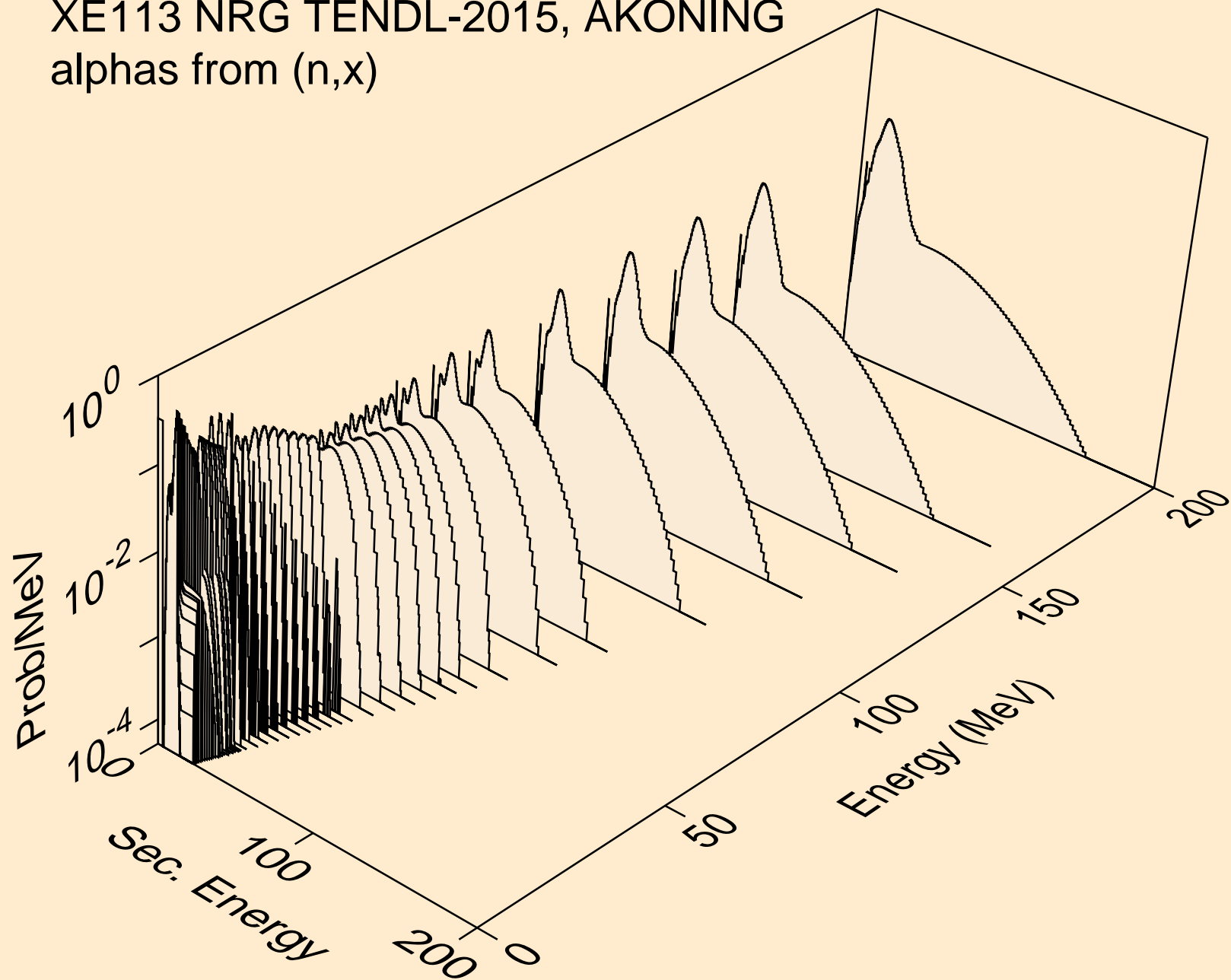

XE113 NRG TENDL-2015, AKONING
alphas from (n,n*)a

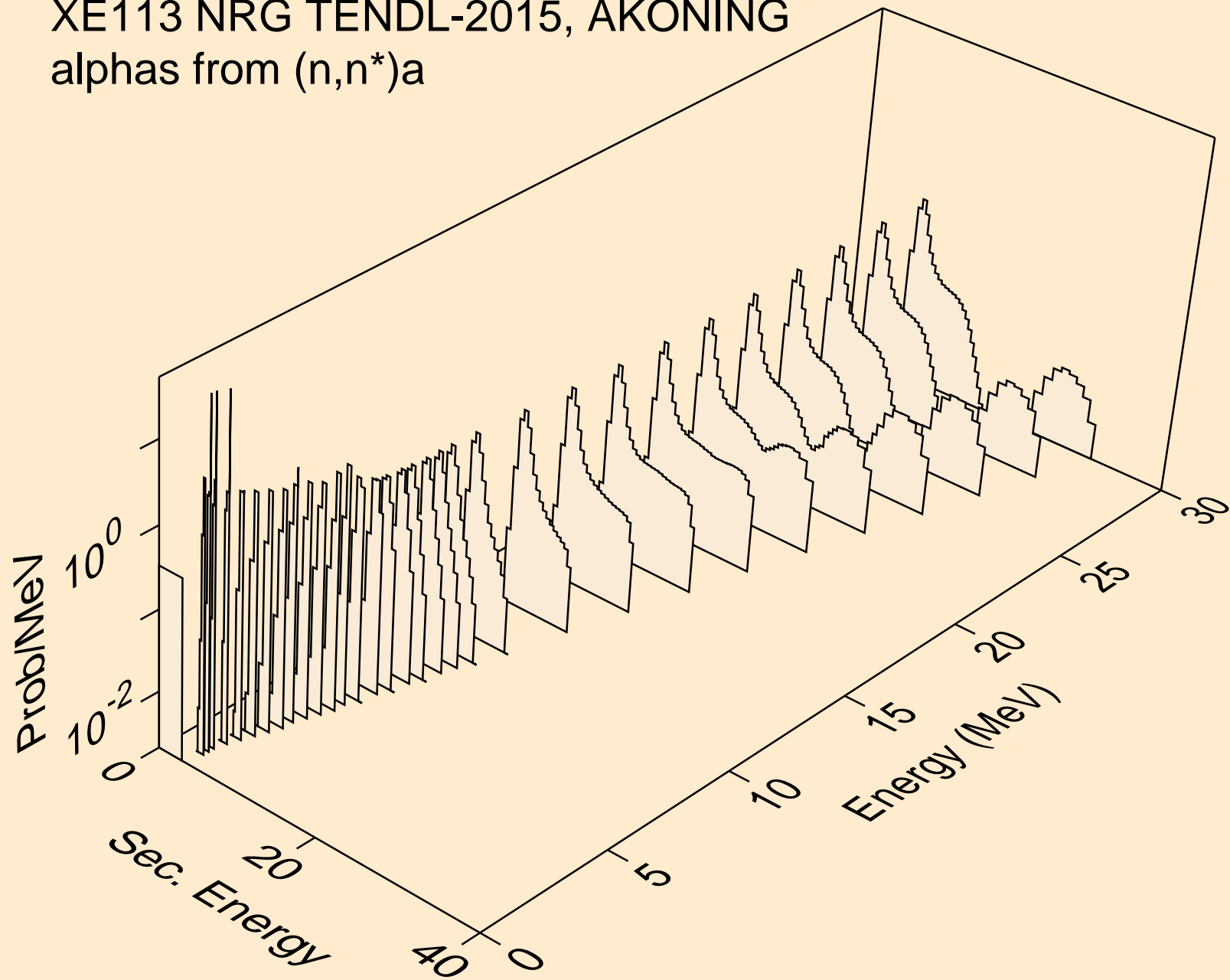

XE113 NRG TENDL-2015, AKONING
alphas from (n,n*)3a

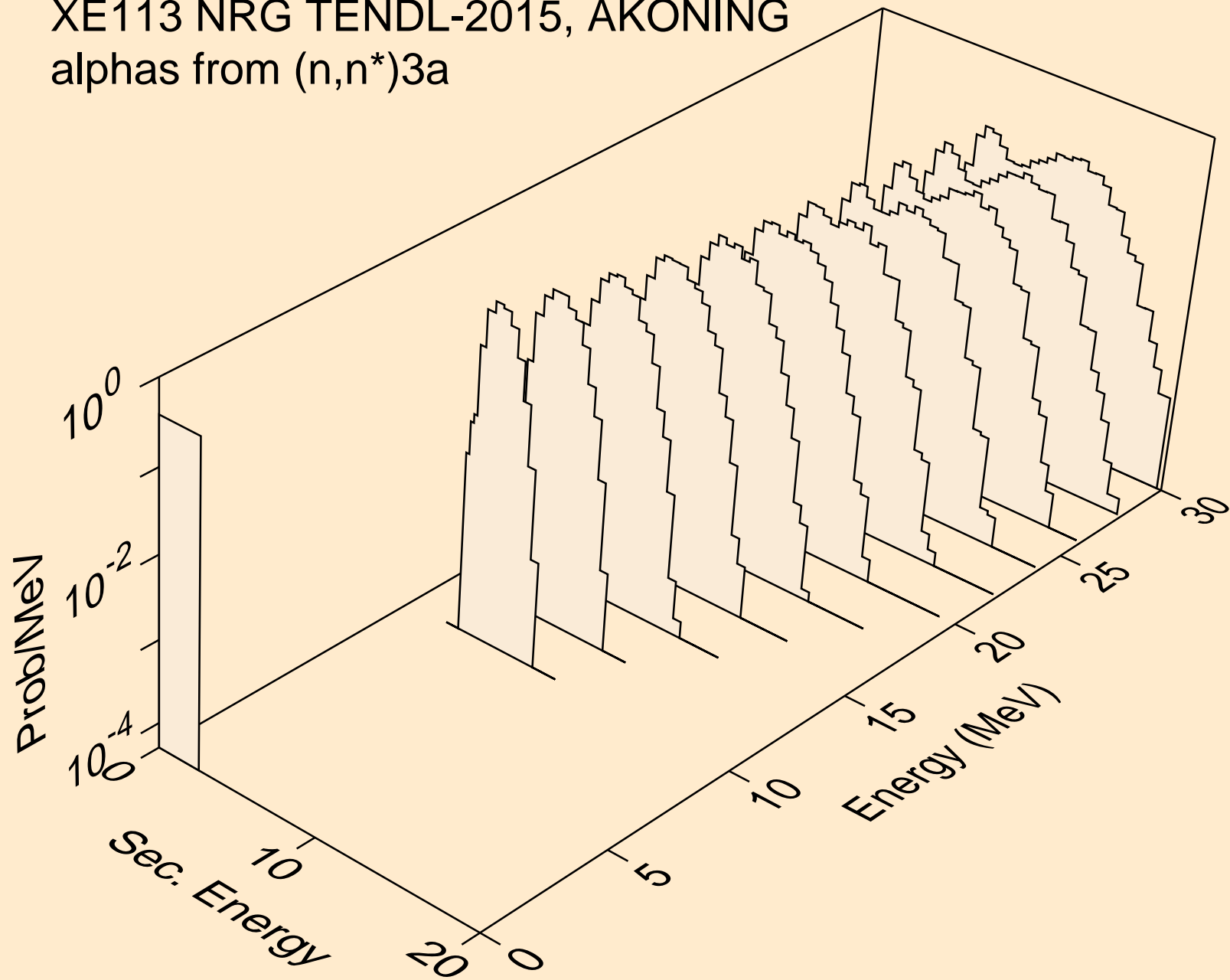

XE113 NRG TENDL-2015, AKONING
alphas from (n,2n)a

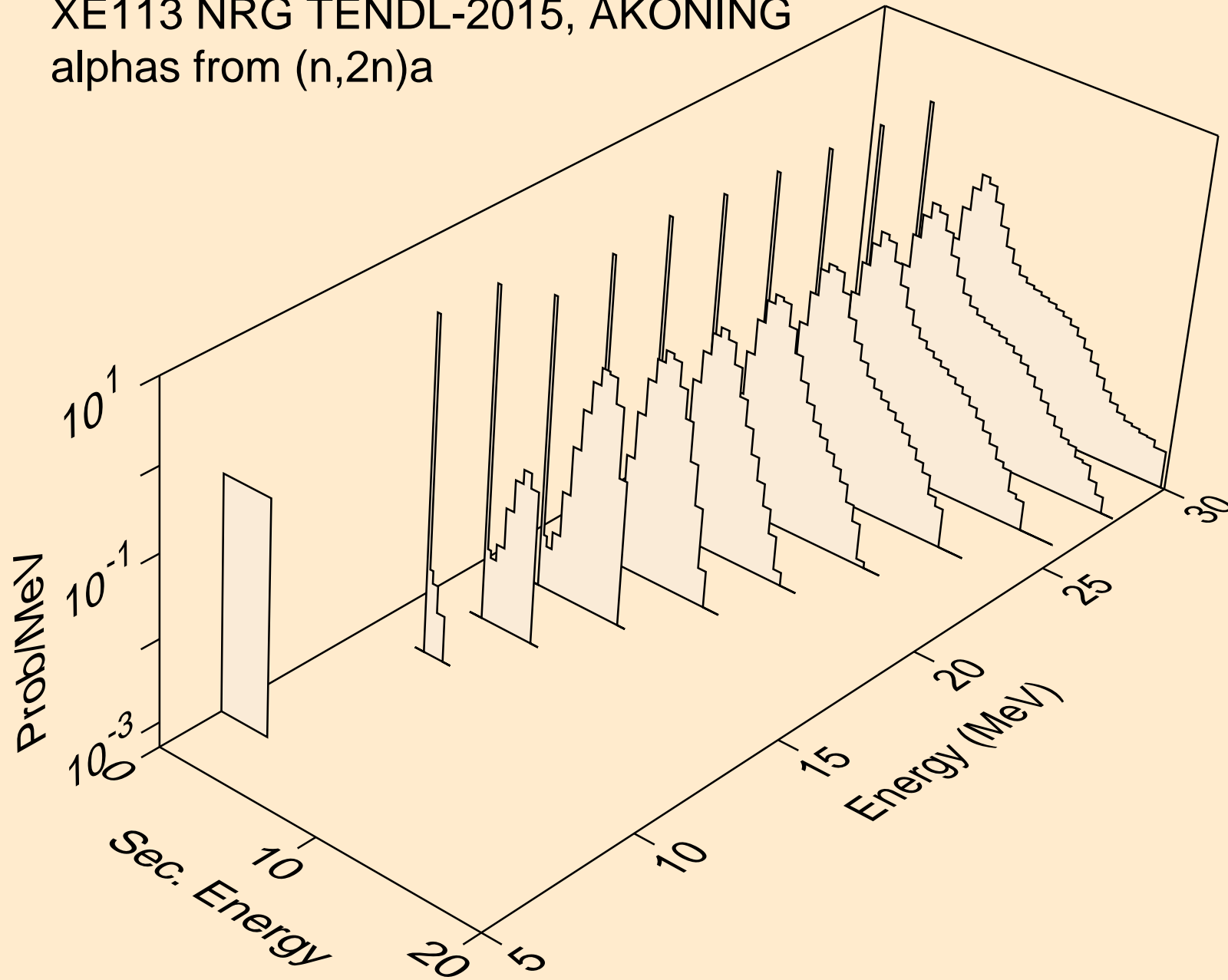

XE113 NRG TENDL-2015, AKONING
alphas from (n,3n)a

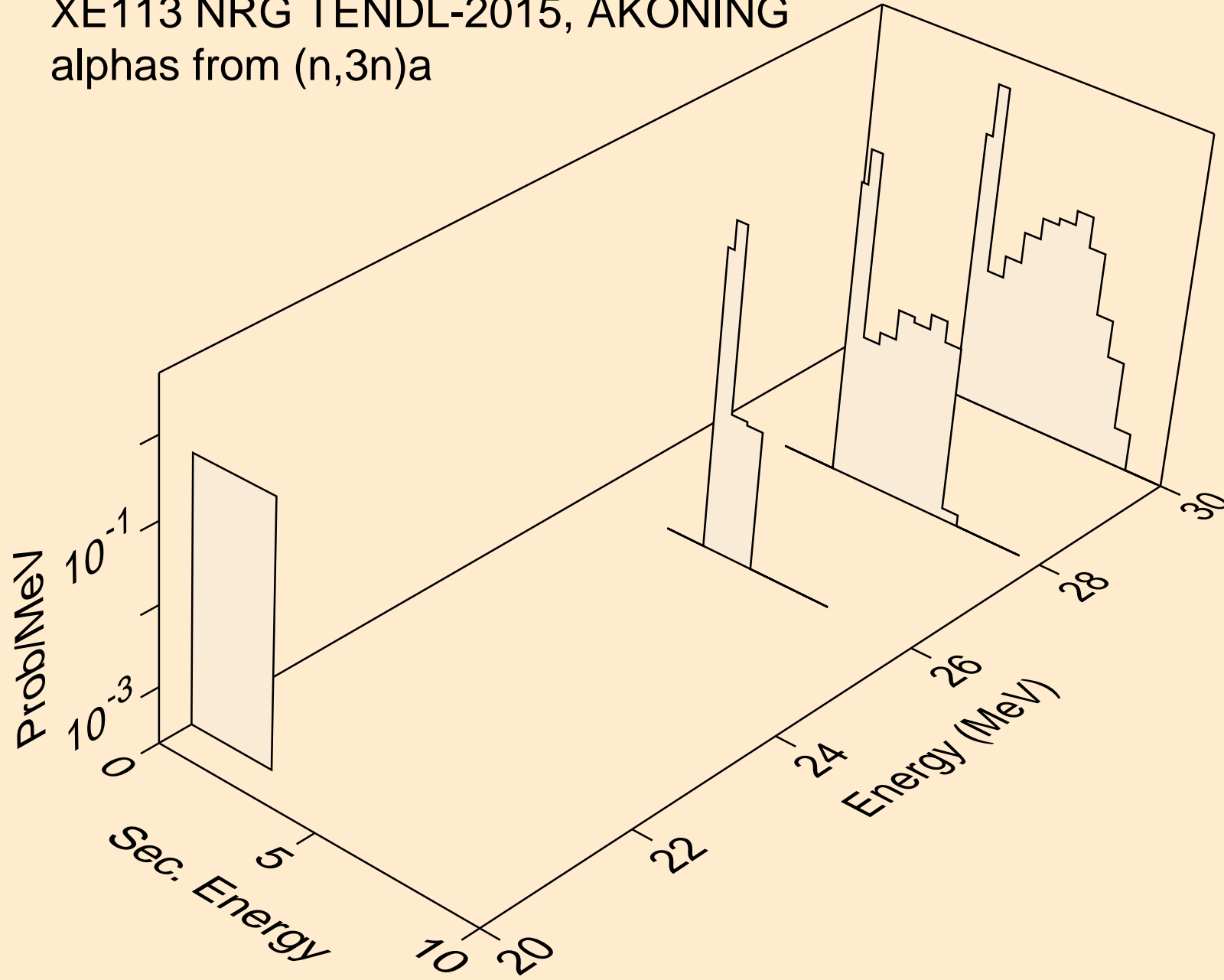

XE113 NRG TENDL-2015, AKONING
alphas from (n,n*)2a

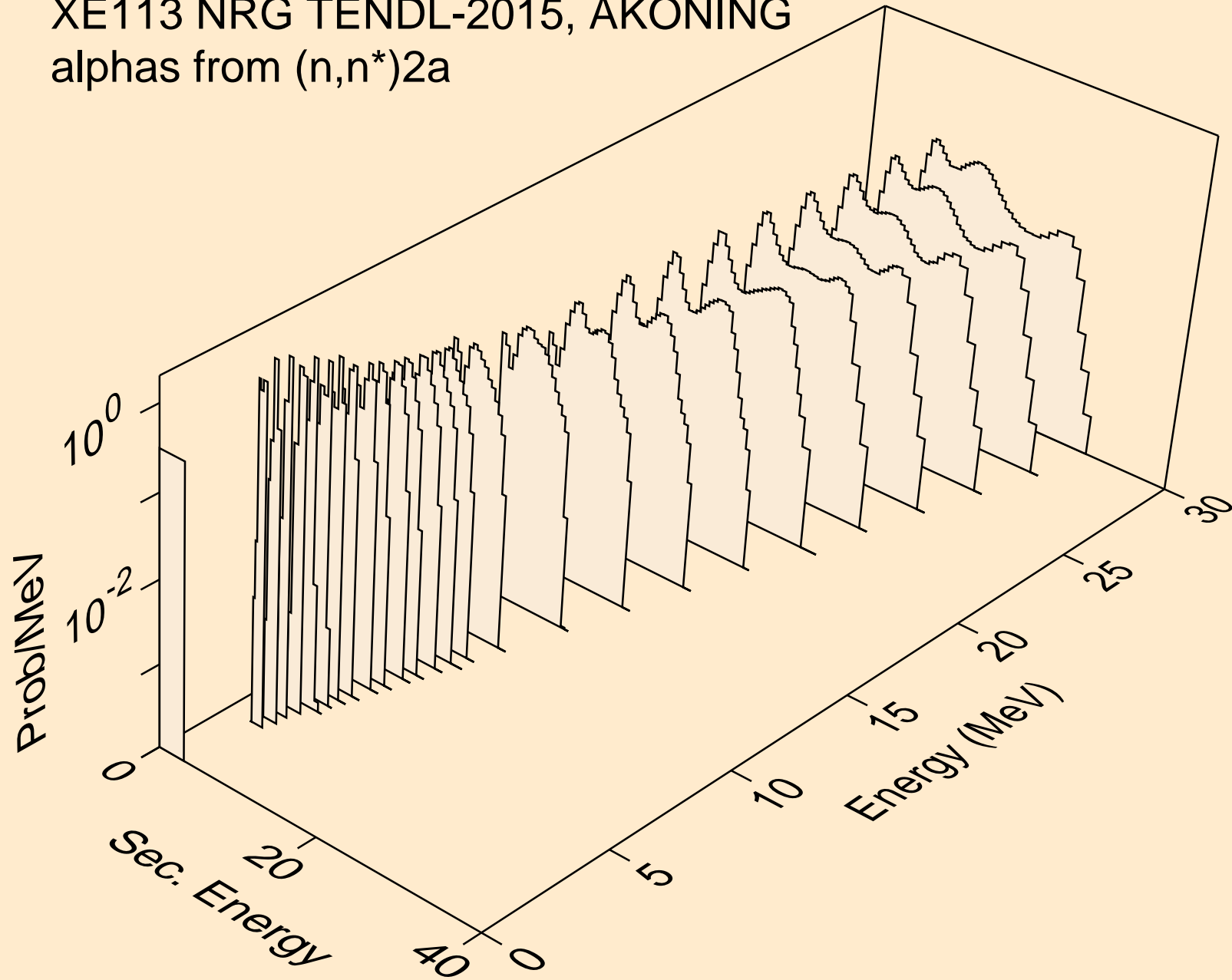

XE113 NRG TENDL-2015, AKONING
alphas from (n,2n)2a

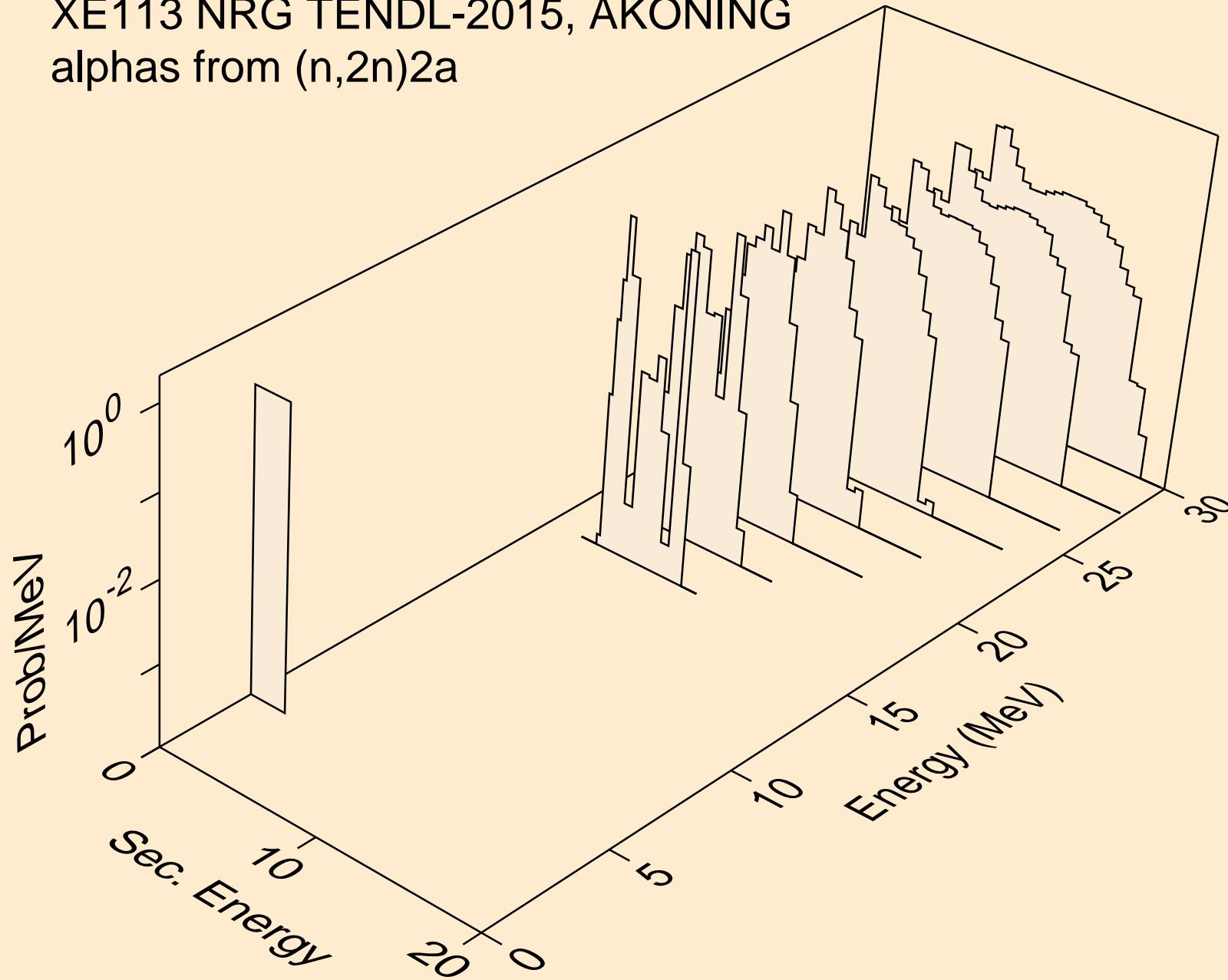

XE113 NRG TENDL-2015, AKONING
alphas from (n,npa)

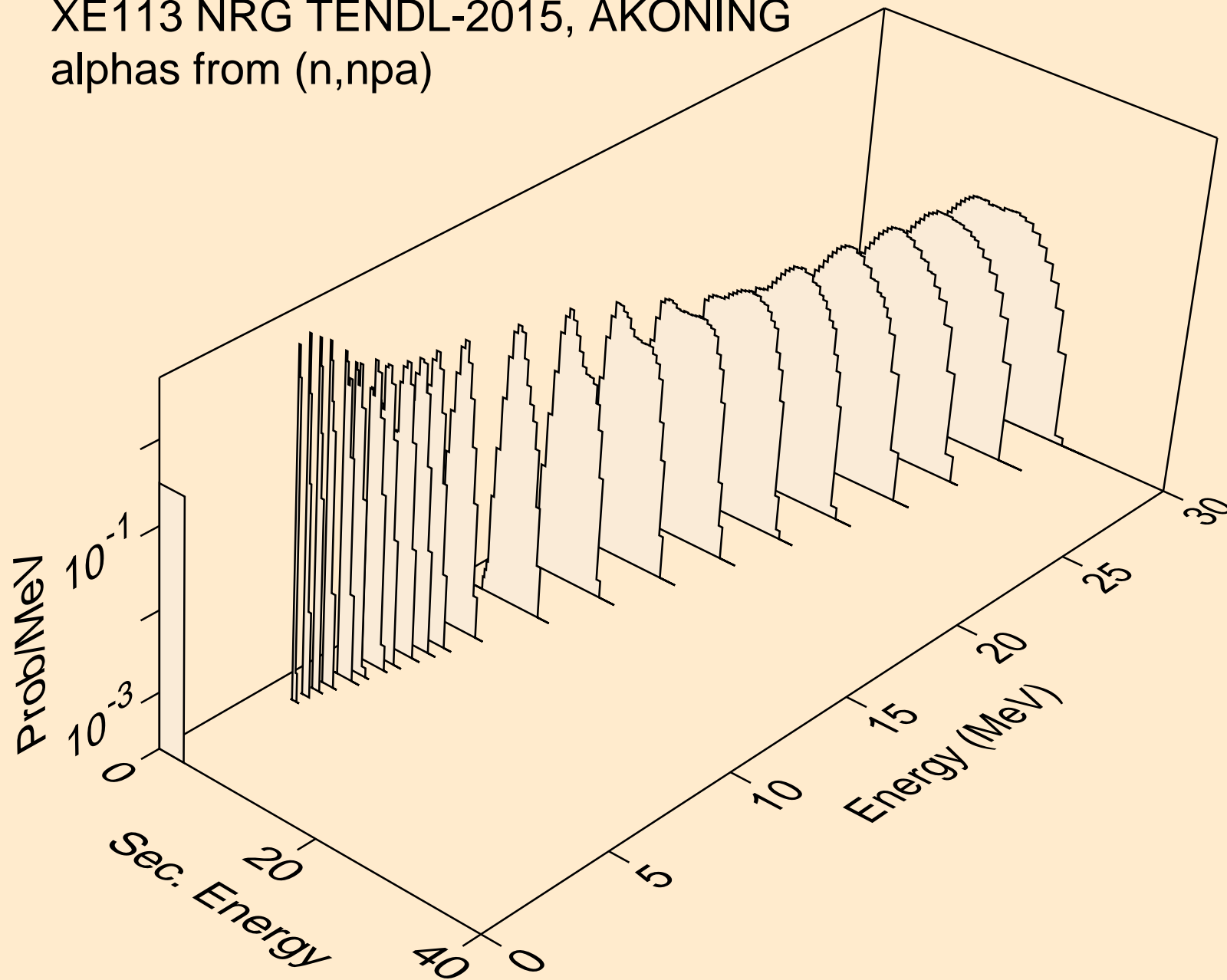

XE113 NRG TENDL-2015, AKONING
alphas from (n,a)

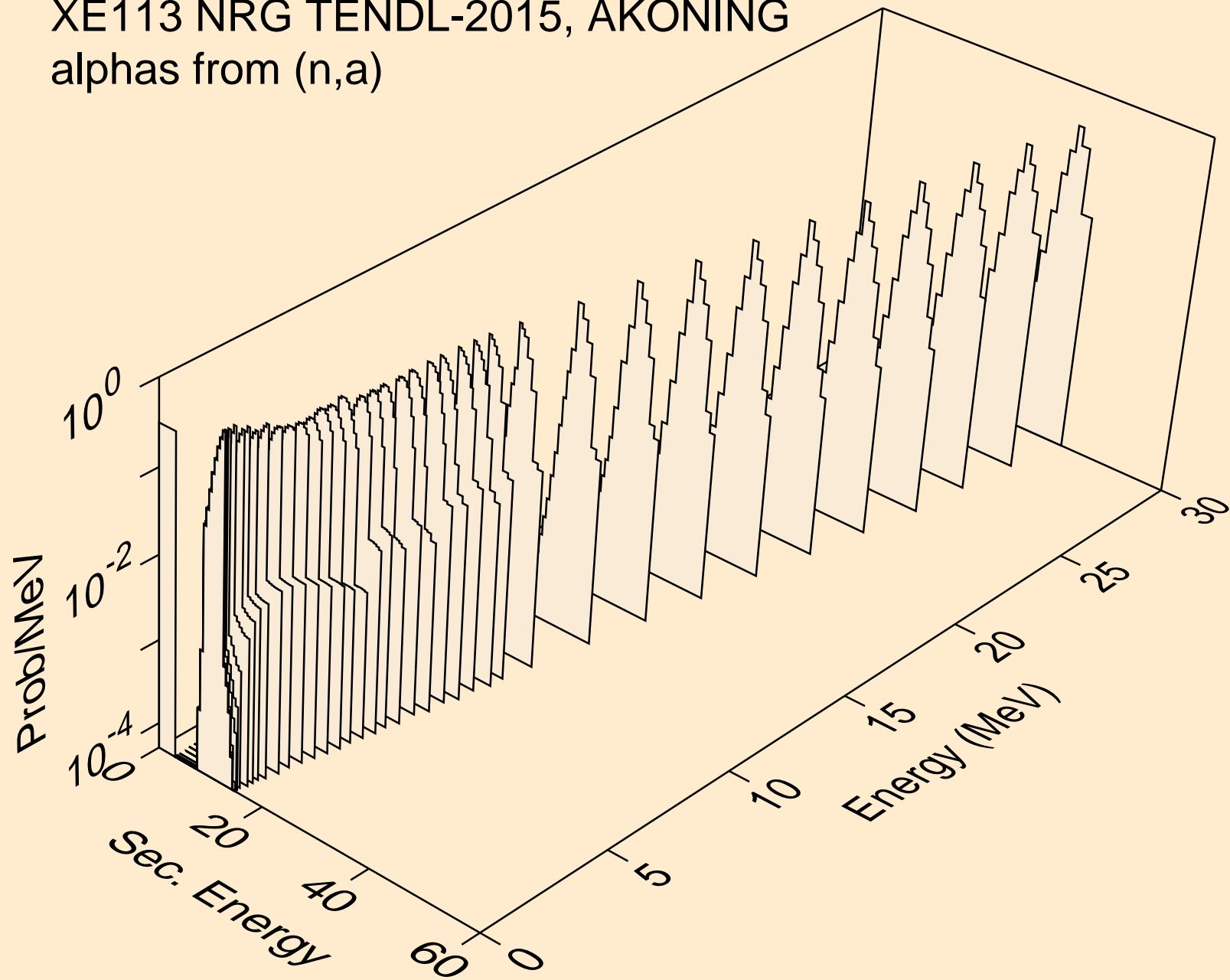

XE113 NRG TENDL-2015, AKONING
alphas from (n,2a)

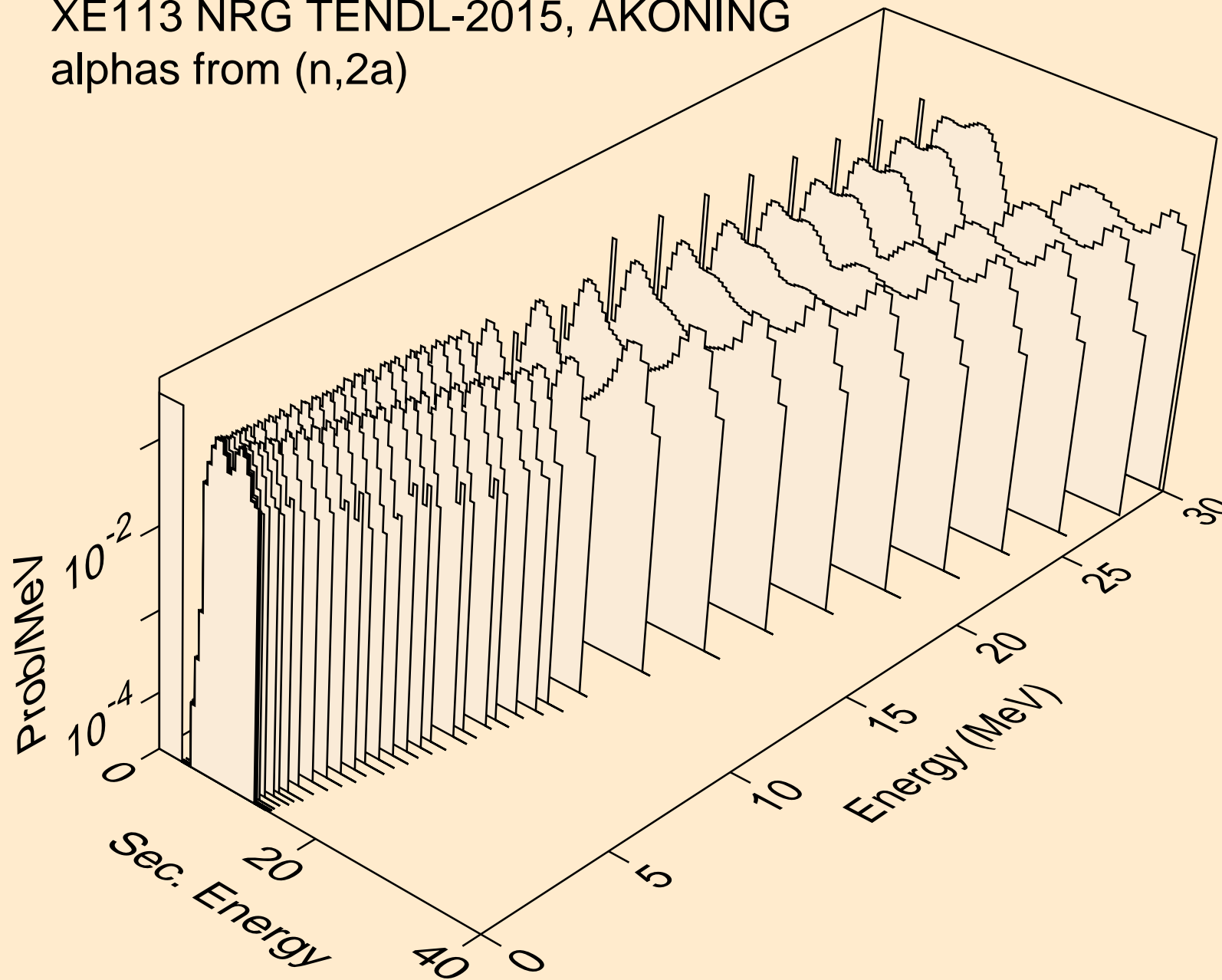

XE113 NRG TENDL-2015, AKONING
alphas from (n,3a)

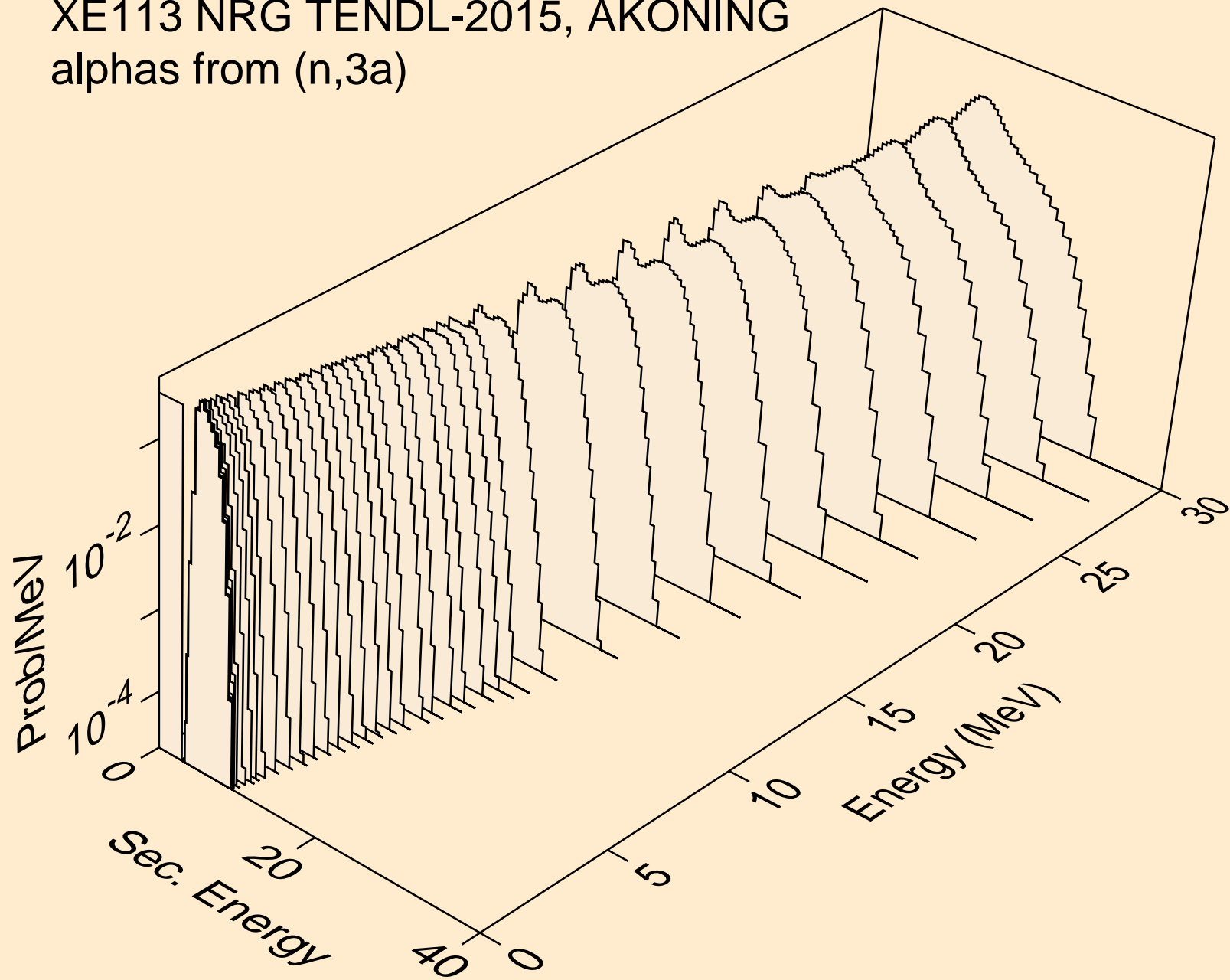

XE113 NRG TENDL-2015, AKONING
alphas from (n,pa)

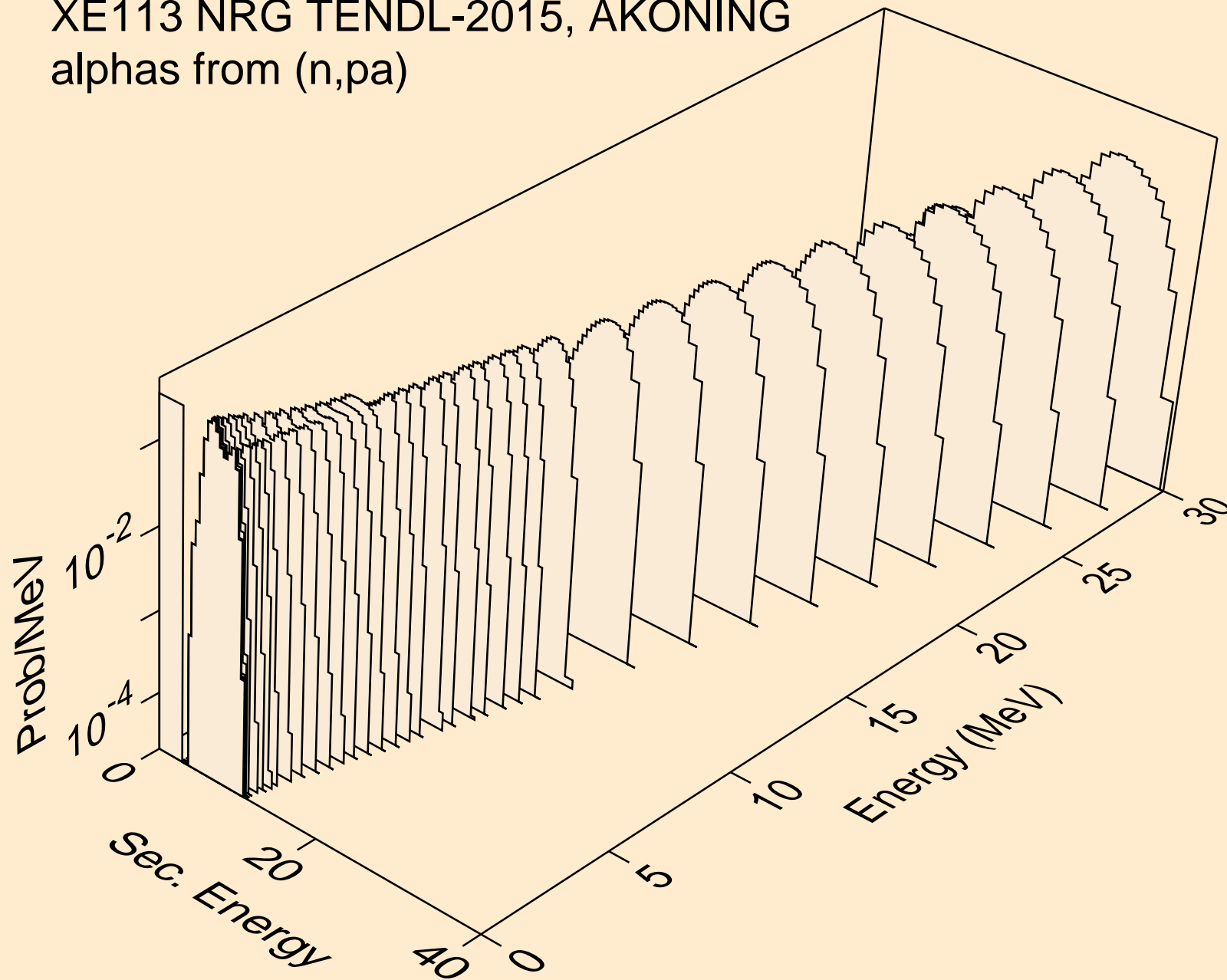

XE113 NRG TENDL-2015, AKONING
alphas from (n,t2a)

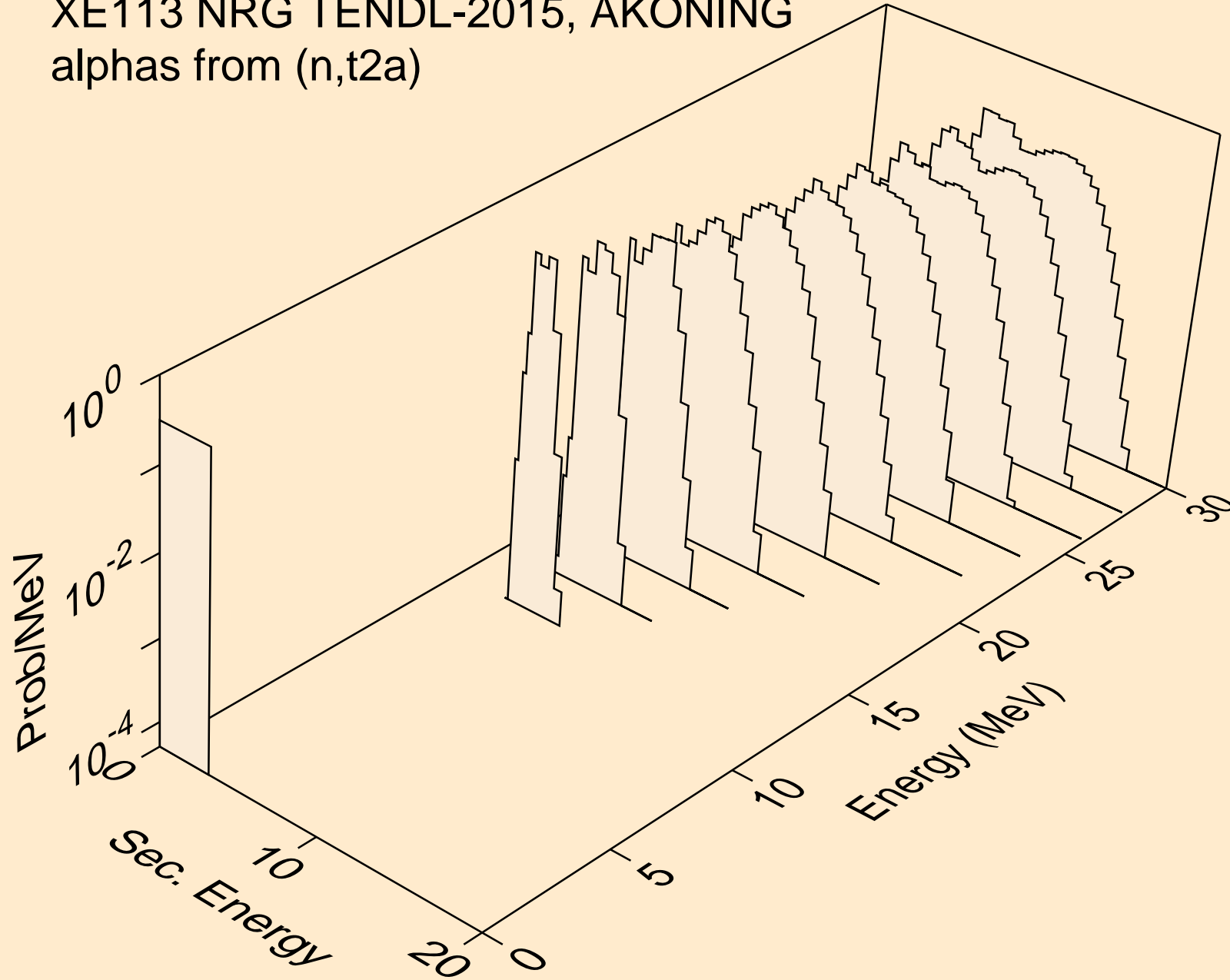

XE113 NRG TENDL-2015, AKONING
alphas from (n,d2a)

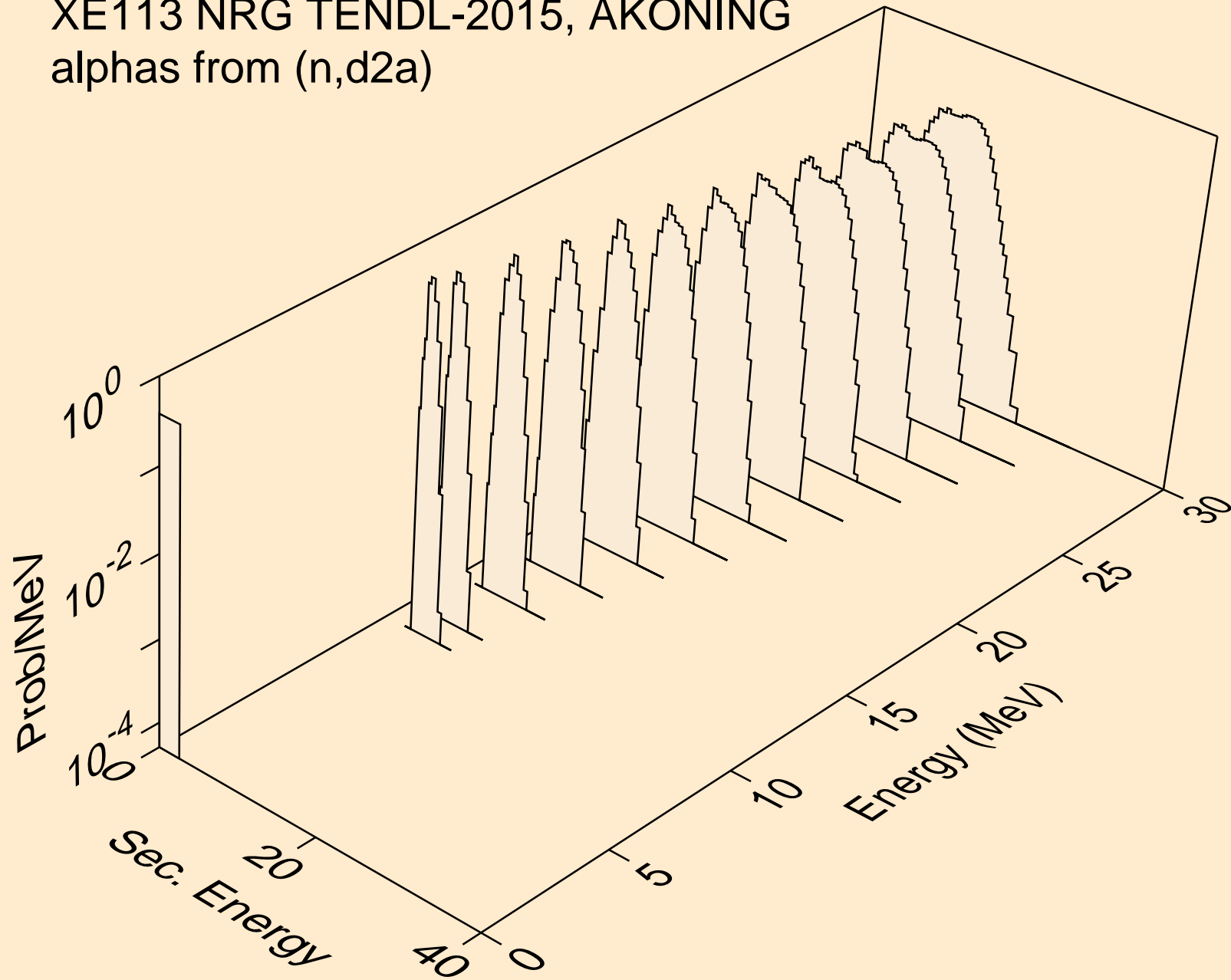

XE113 NRG TENDL-2015, AKONING
alphas from (n,da)

