

YB151M NRG TENDL-2015, AKONING

Principal cross sections

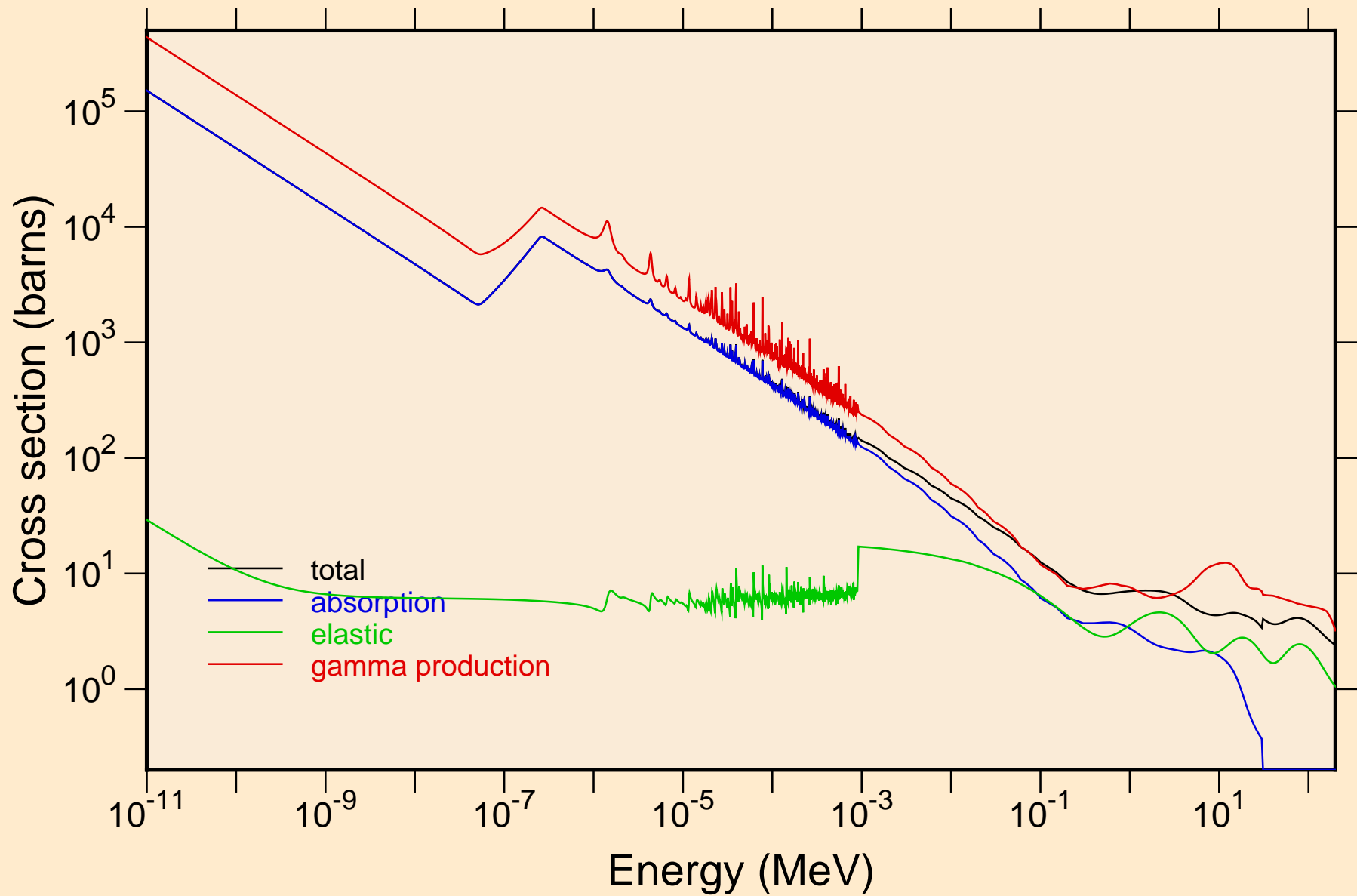

YB151M NRG TENDL-2015, AKONING
resonance total cross section

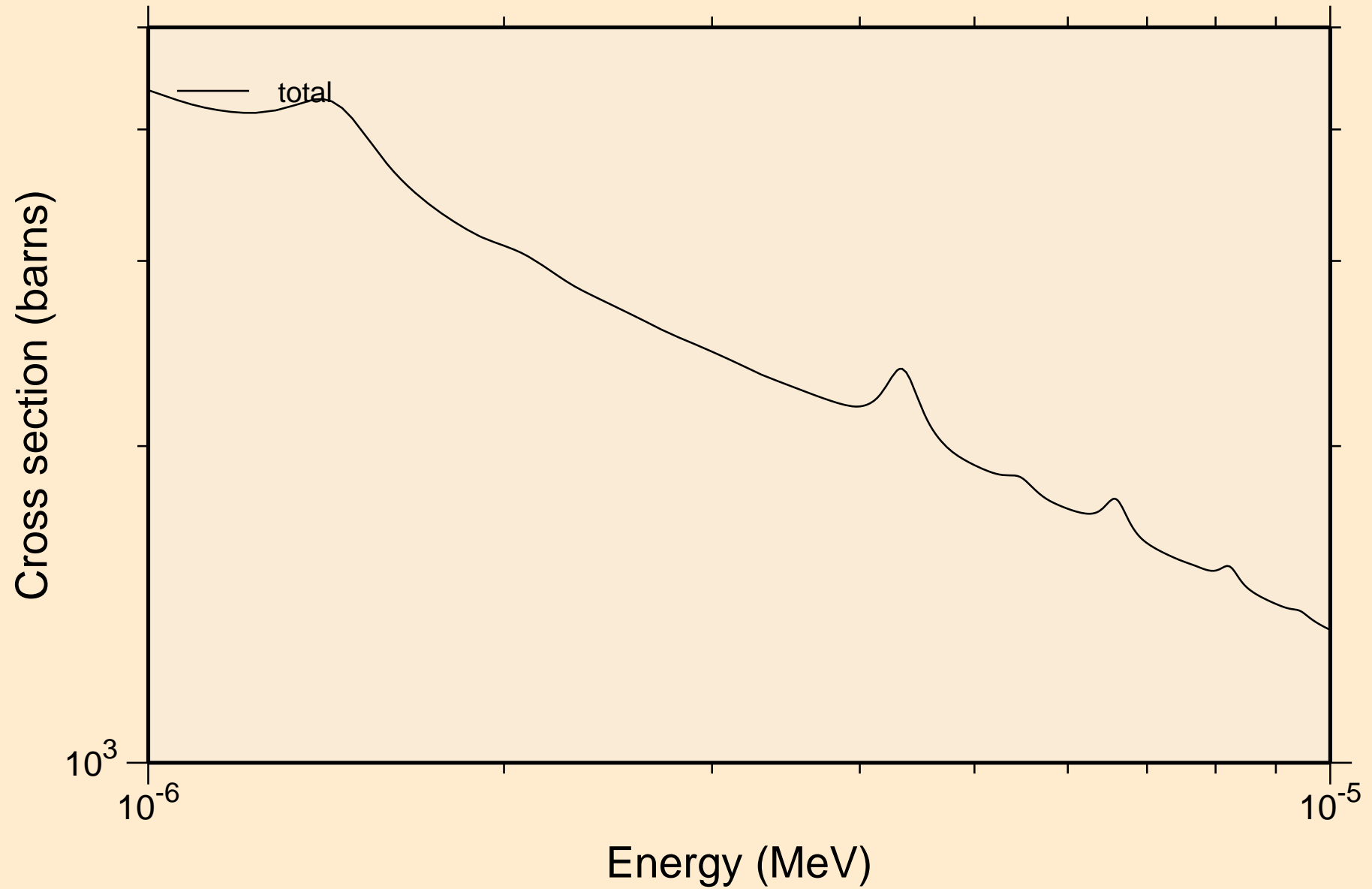

YB151M NRG TENDL-2015, AKONING
resonance total cross section

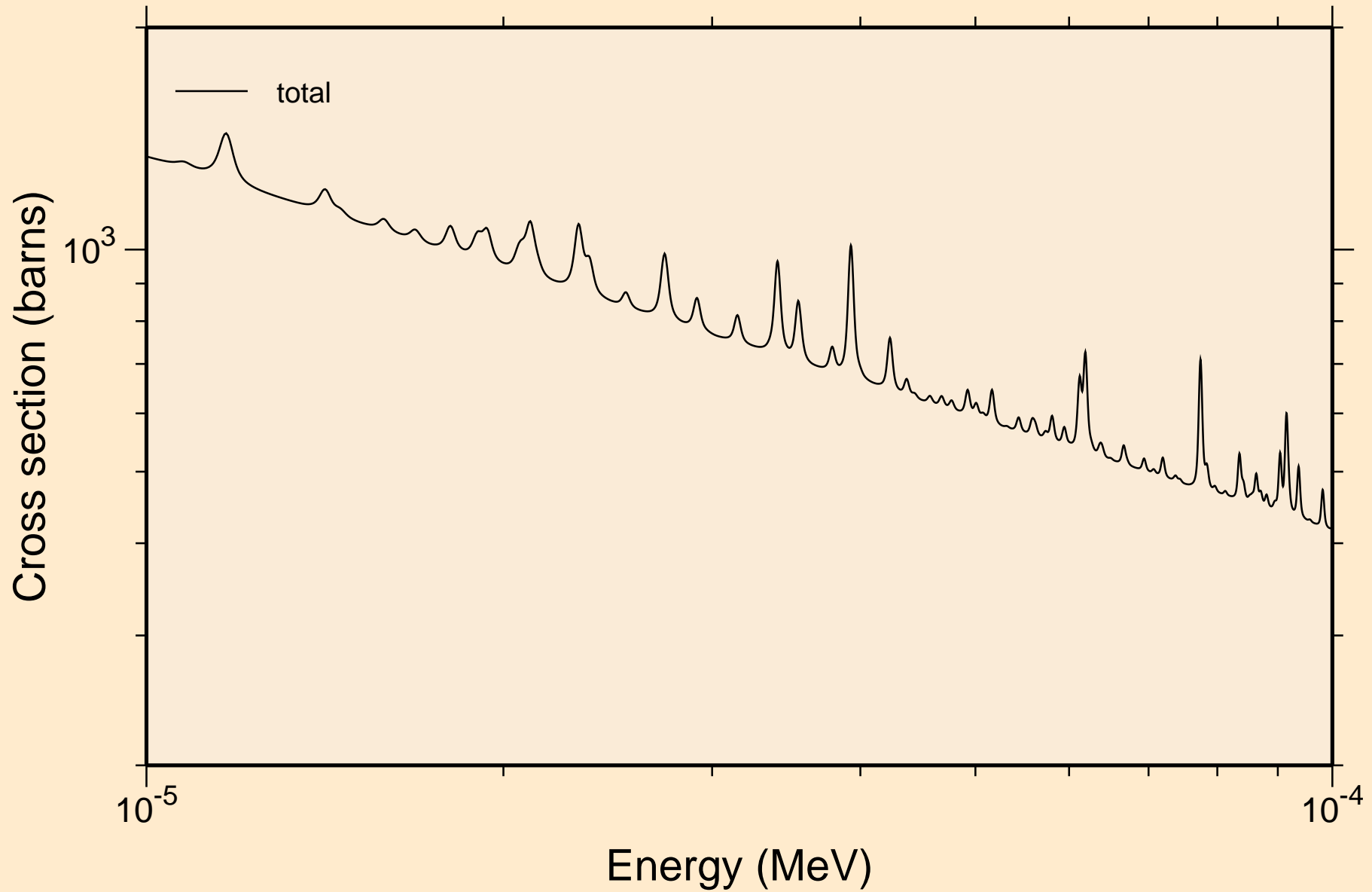

YB151M NRG TENDL-2015, AKONING
resonance total cross section

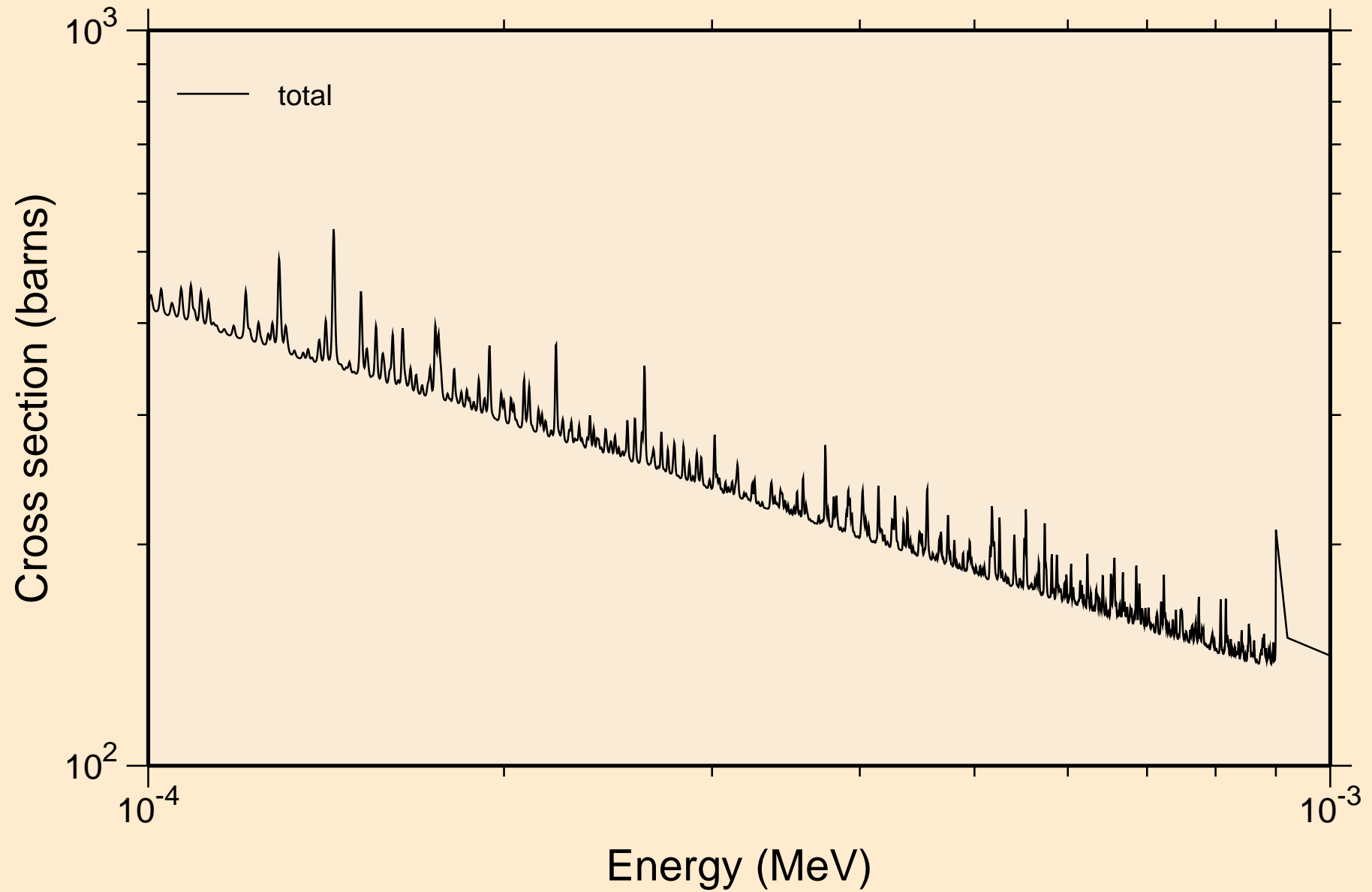

YB151M NRG TENDL-2015, AKONING
resonance total cross section

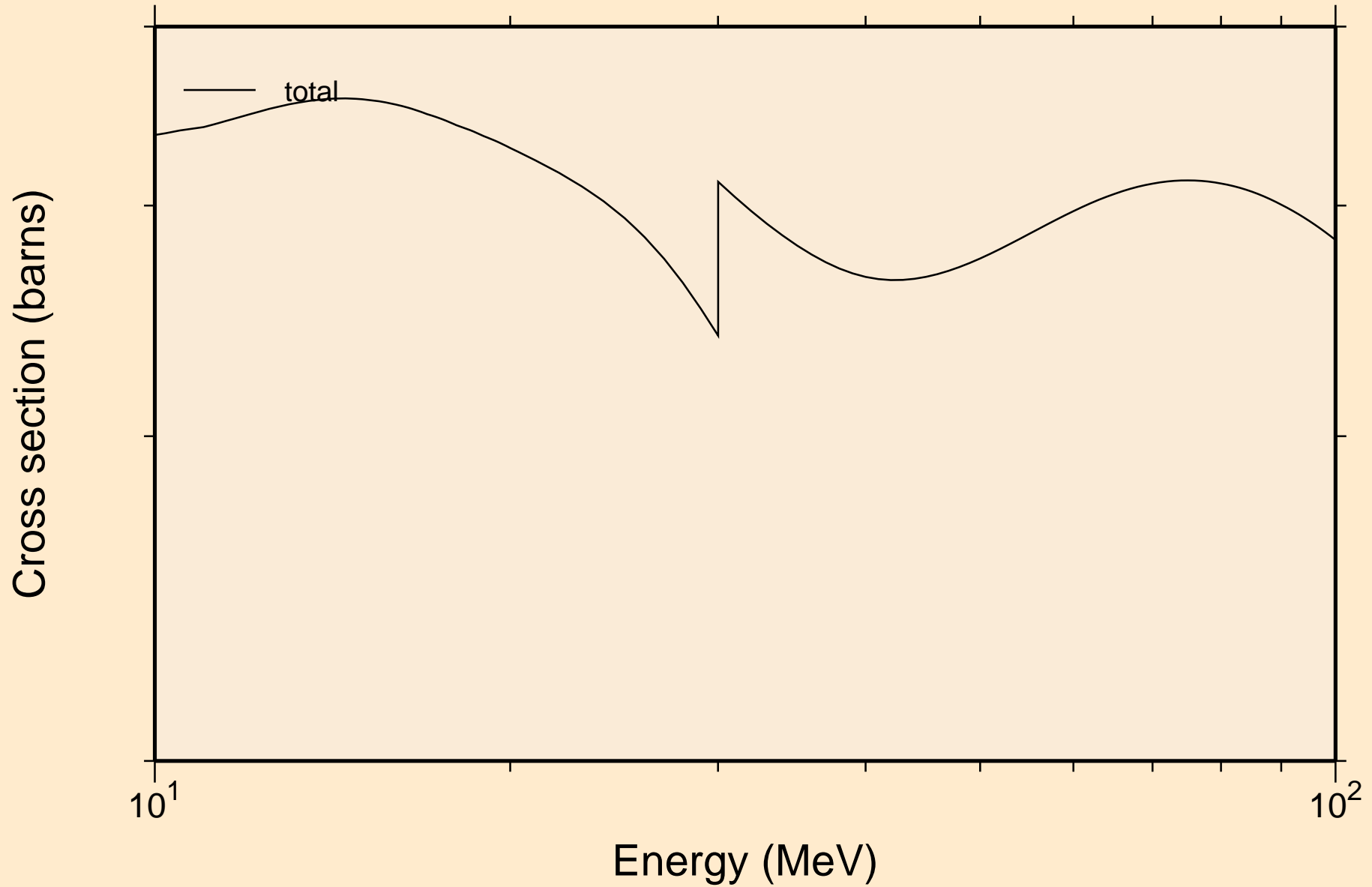

YB151M NRG TENDL-2015, AKONING
resonance absorption cross sections

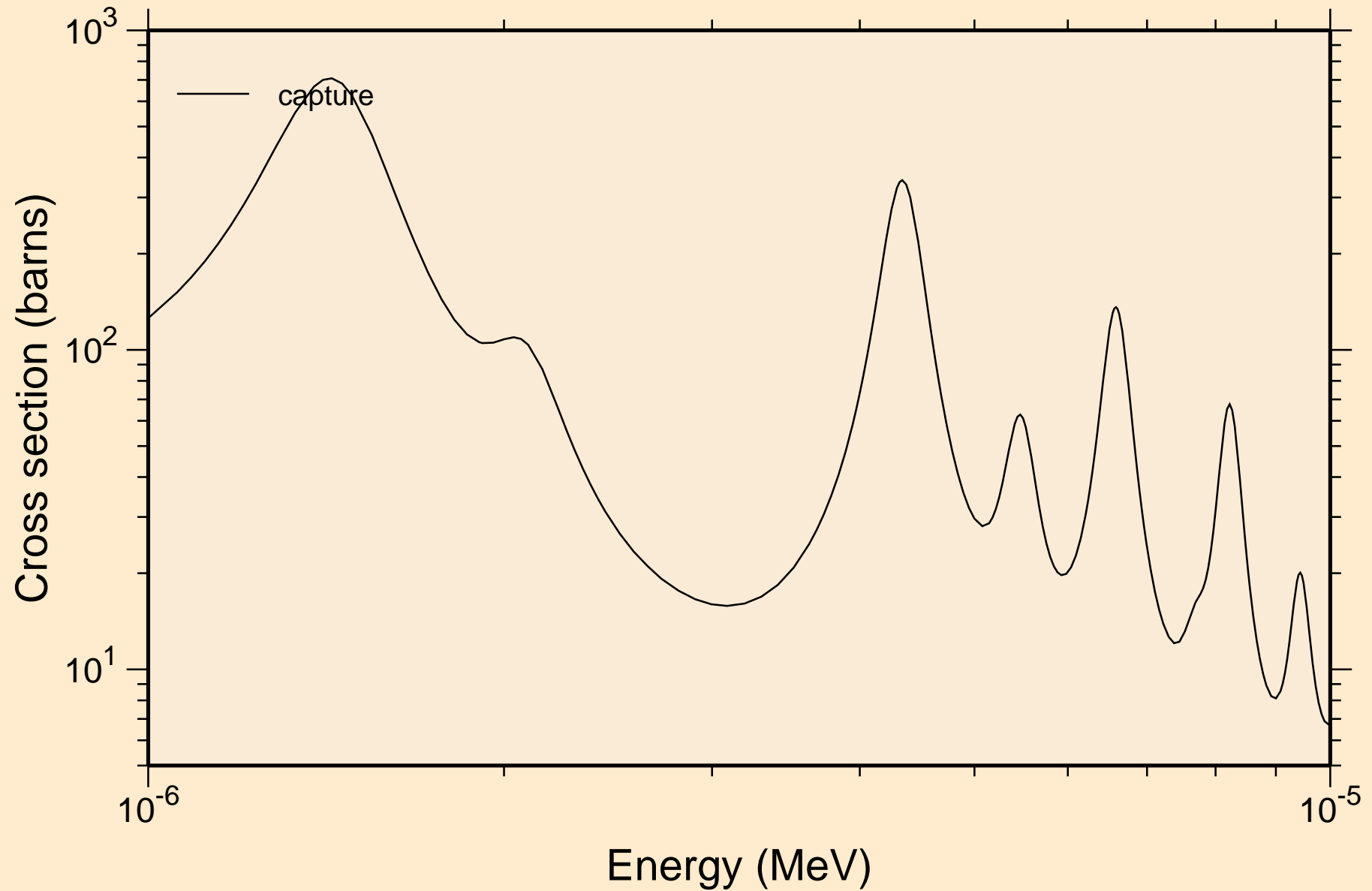

YB151M NRG TENDL-2015, AKONING
resonance absorption cross sections

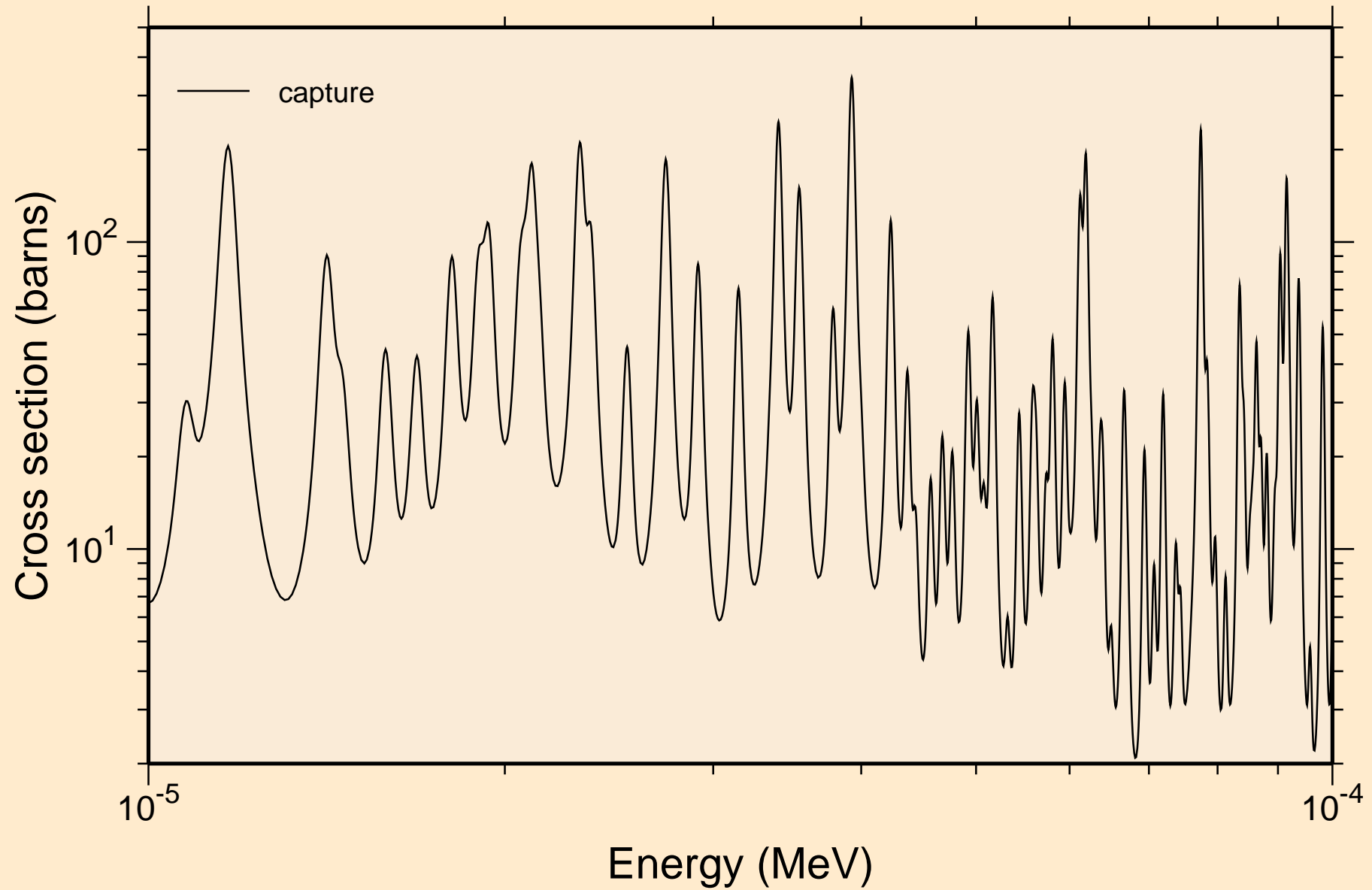

YB151M NRG TENDL-2015, AKONING
resonance absorption cross sections

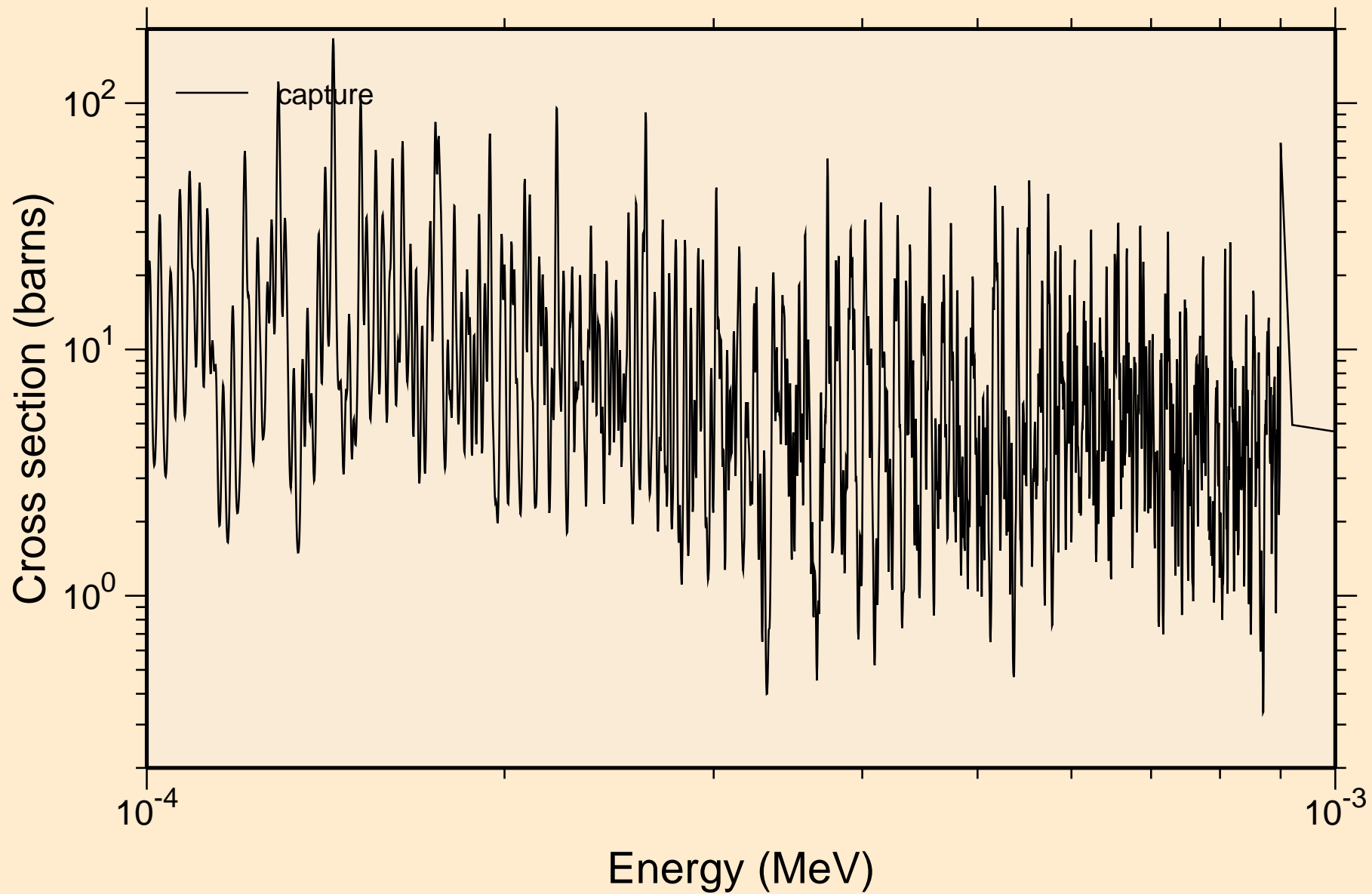

YB151M NRG TENDL-2015, AKONING
resonance absorption cross sections

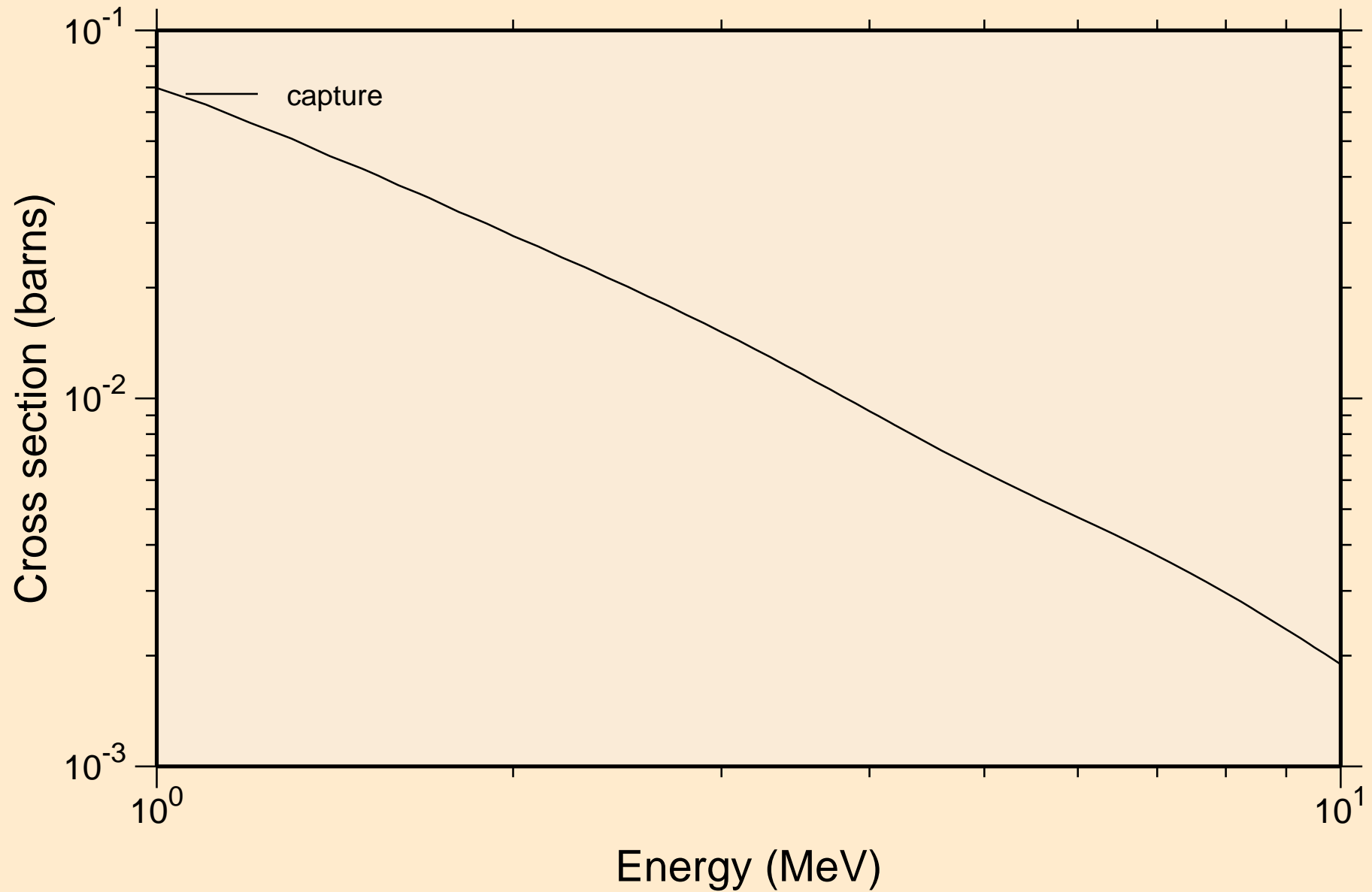

YB151M NRG TENDL-2015, AKONING

Non-threshold reactions

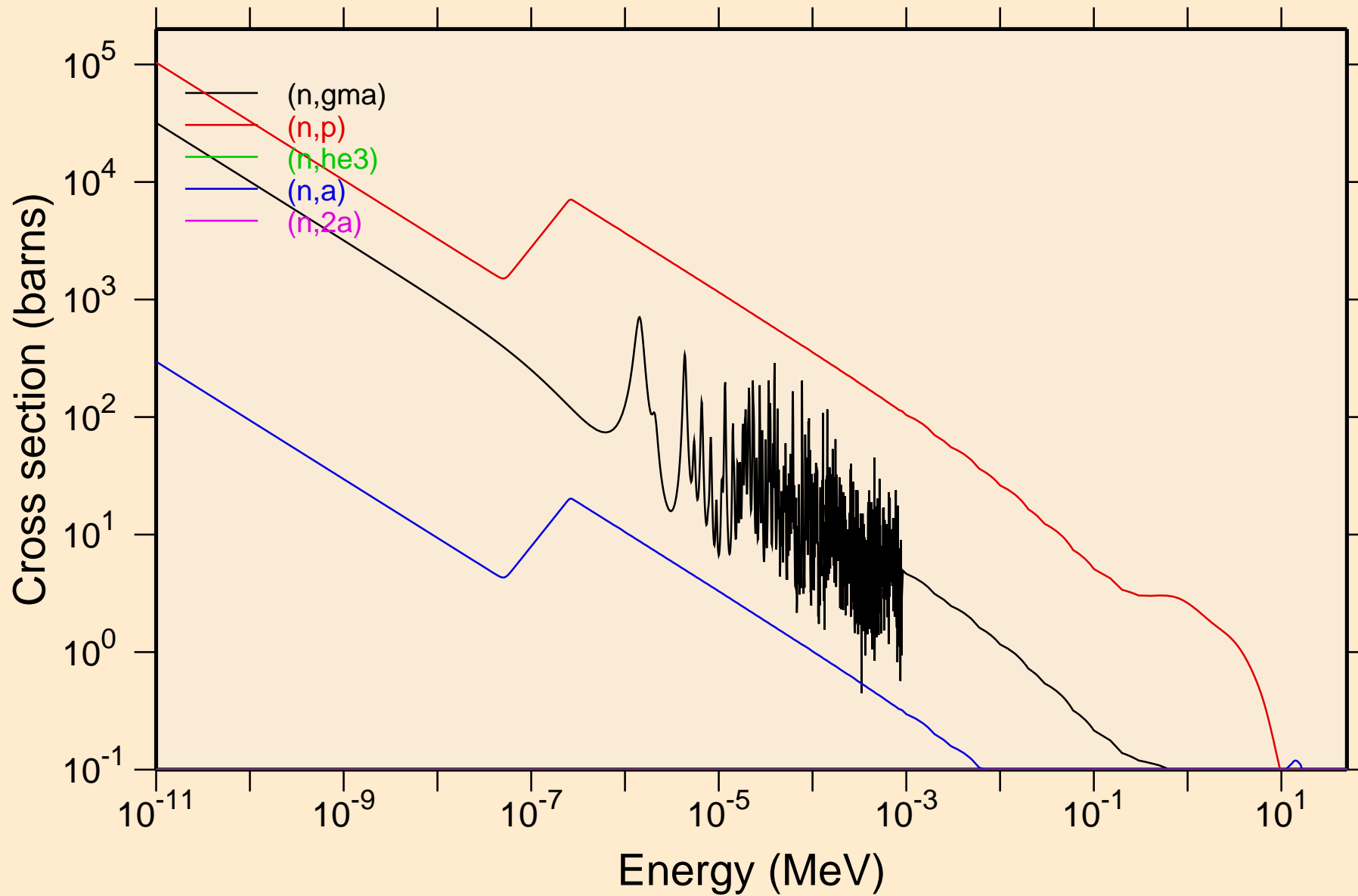

YB151M NRG TENDL-2015, AKONING

Non-threshold reactions

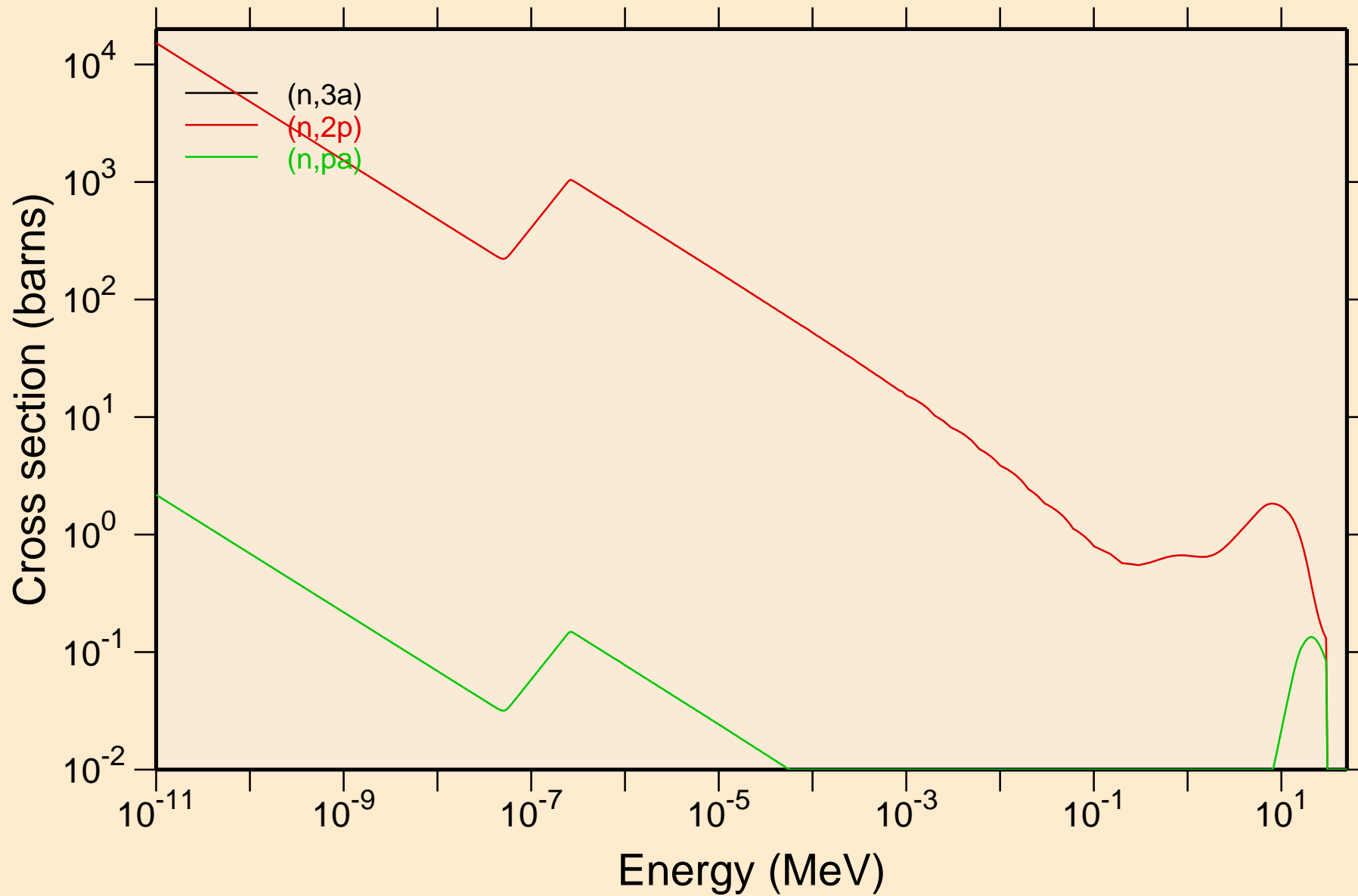

YB151M NRG TENDL-2015, AKONING

Principal cross sections

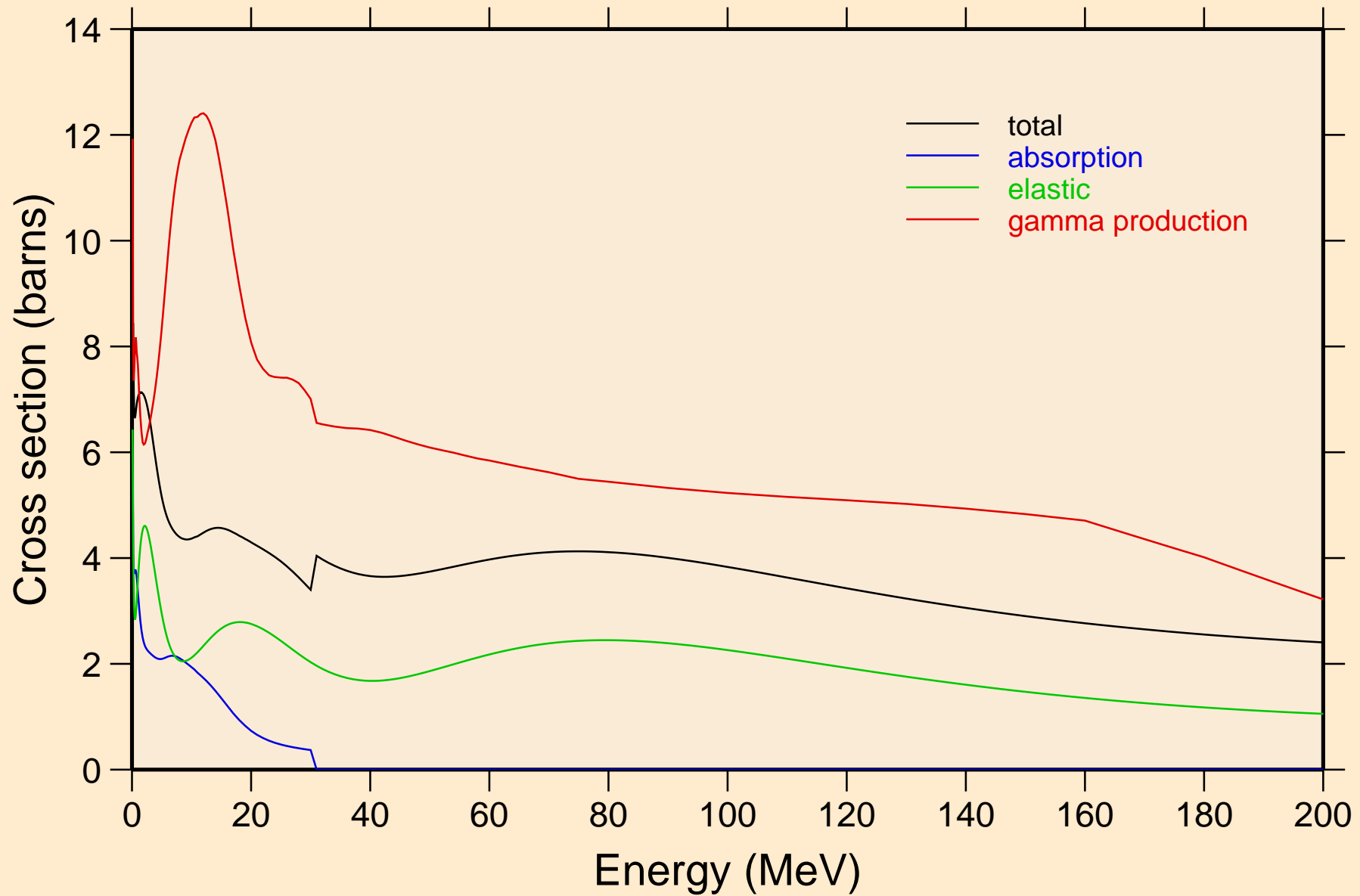

YB151M NRG TENDL-2015, AKONING

Non-threshold reactions

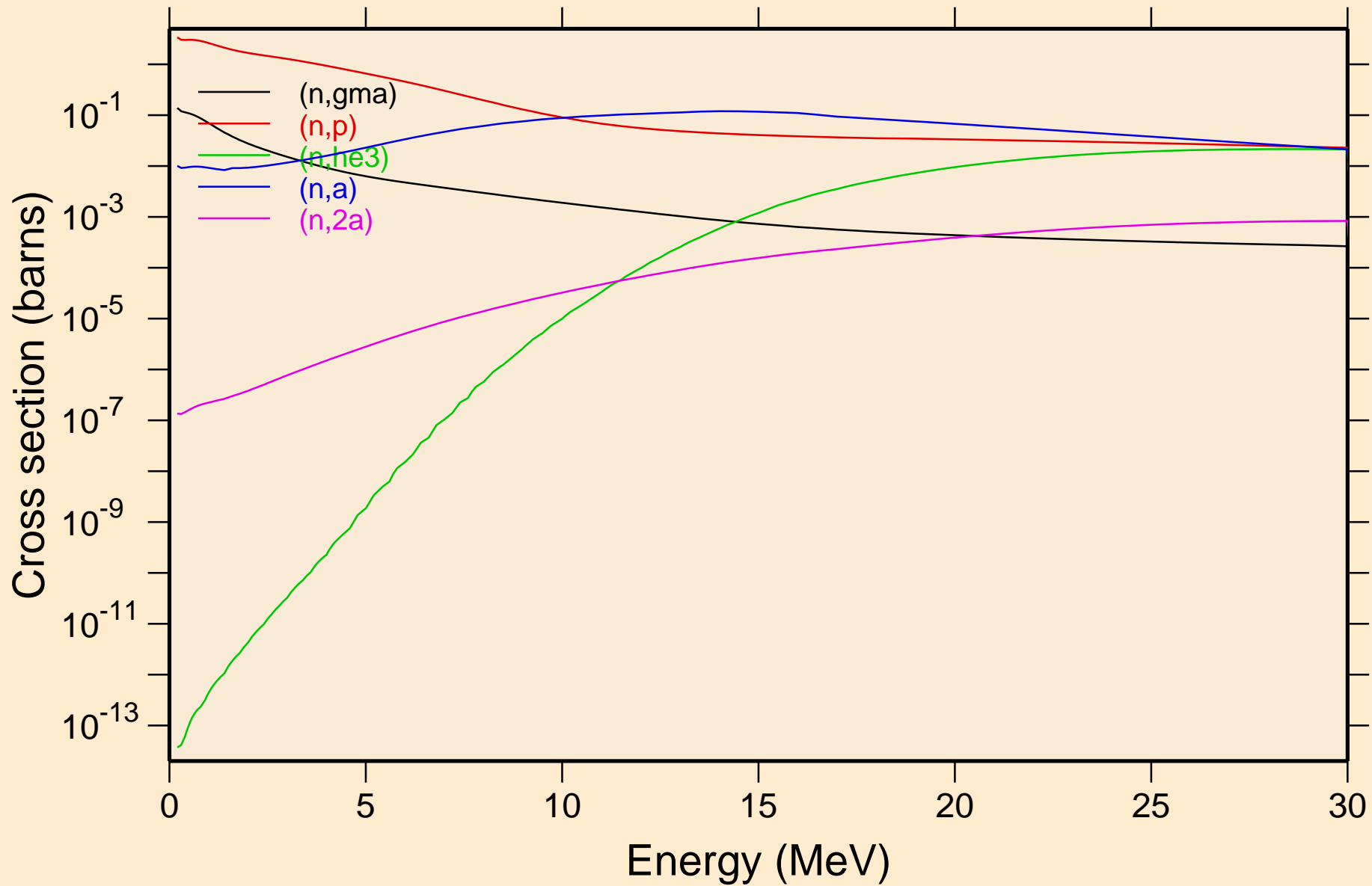

YB151M NRG TENDL-2015, AKONING

Non-threshold reactions

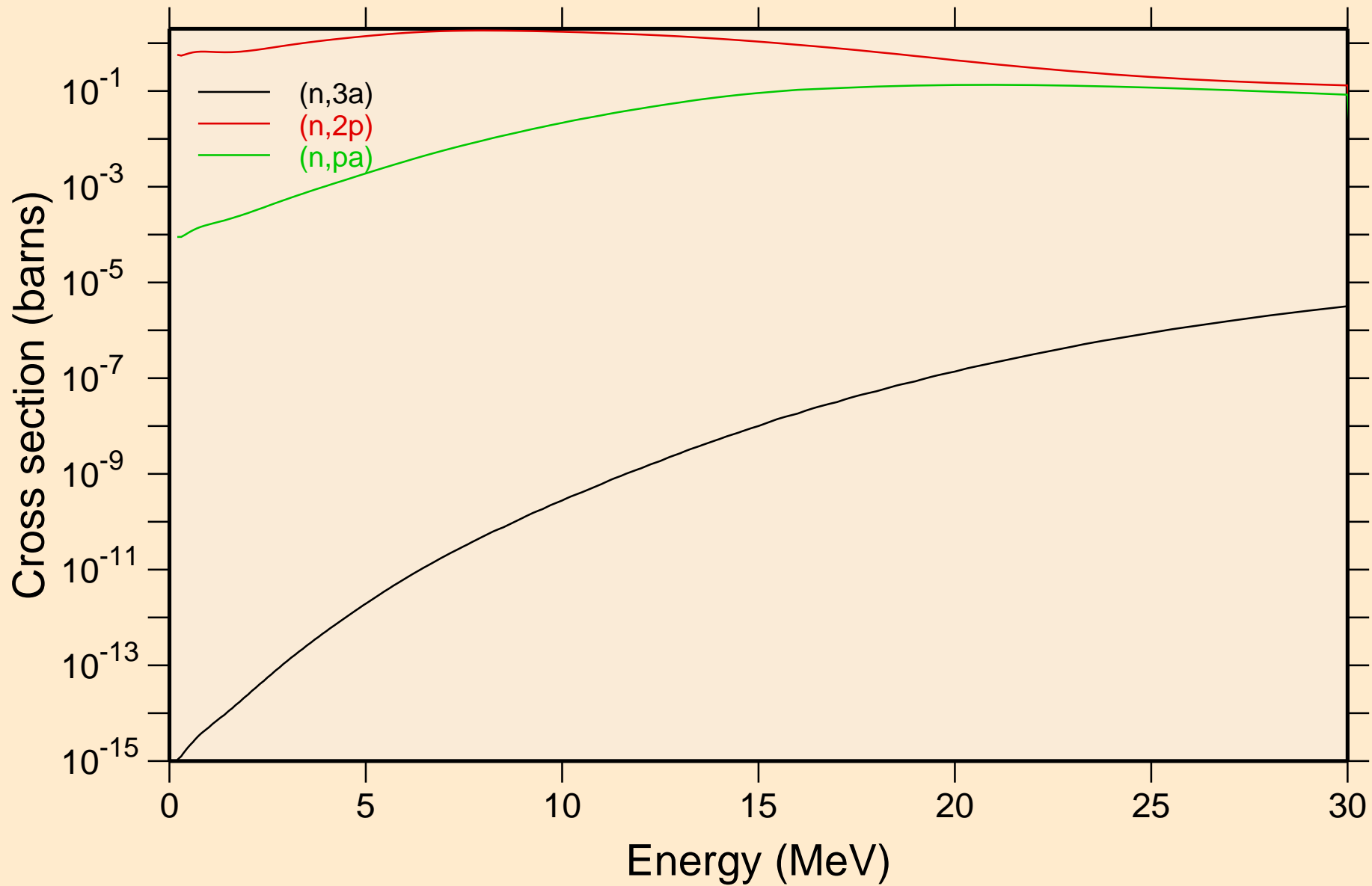

YB151M NRG TENDL-2015, AKONING

Inelastic levels

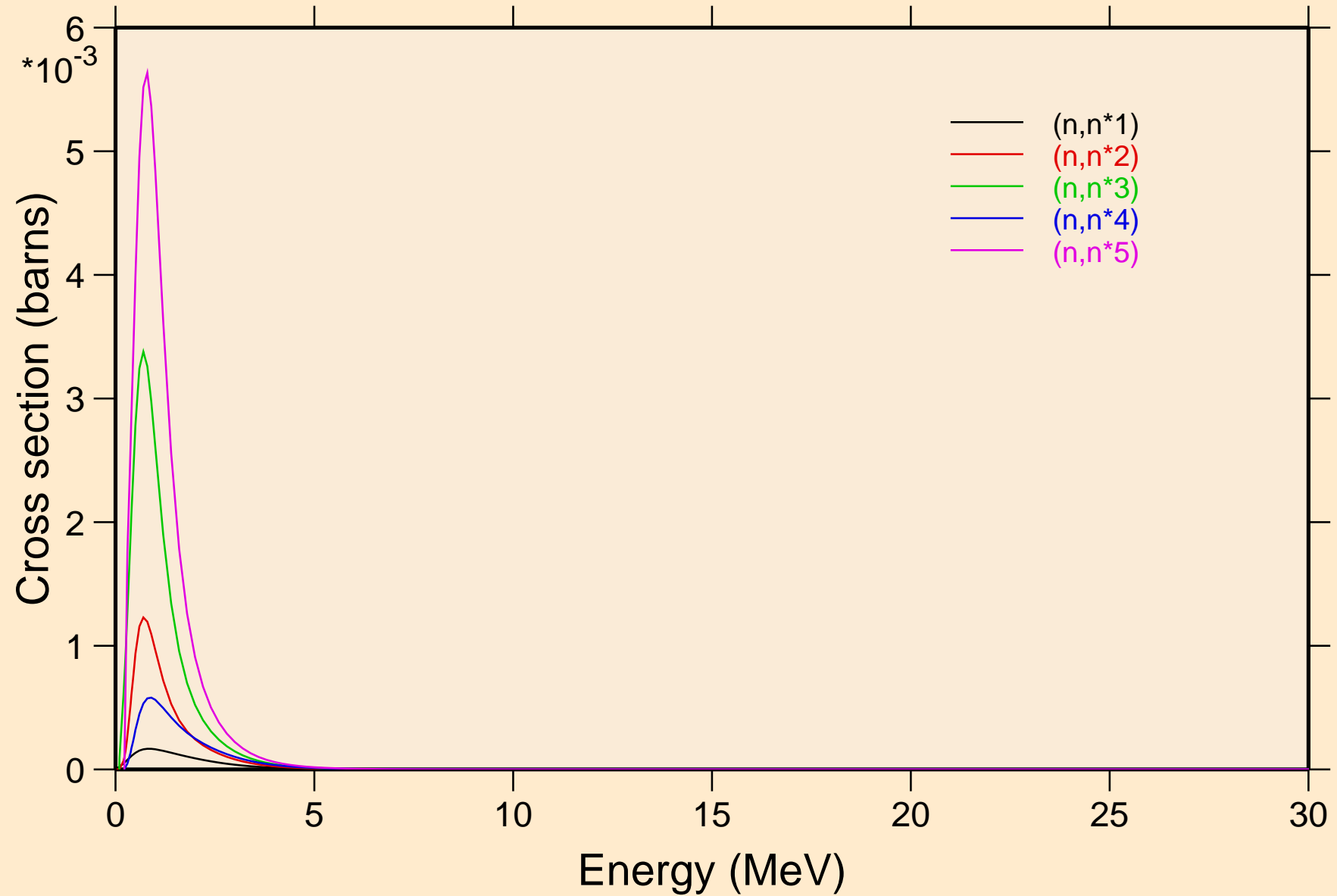

YB151M NRG TENDL-2015, AKONING
Inelastic levels

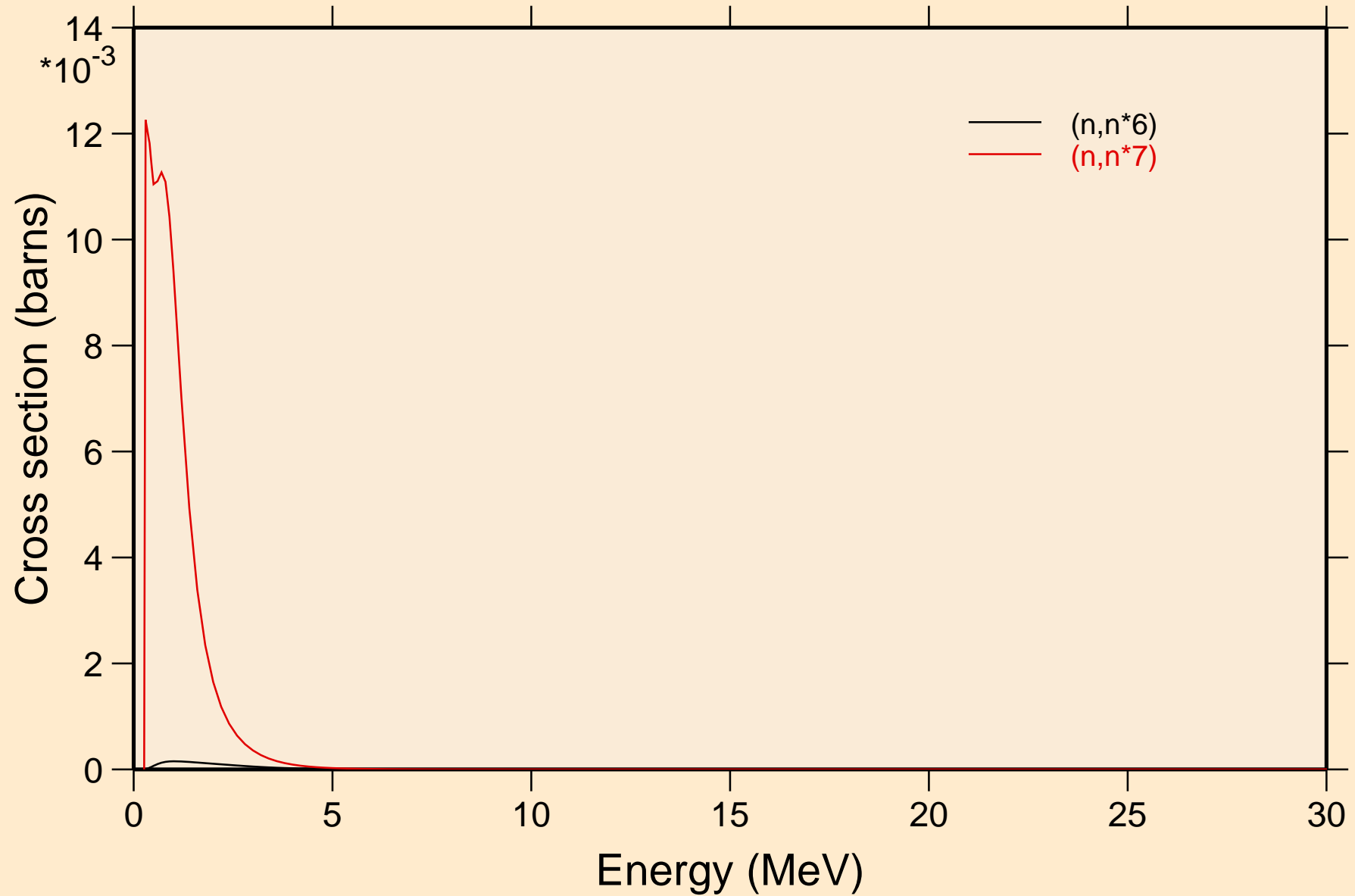

YB151M NRG TENDL-2015, AKONING

Threshold reactions

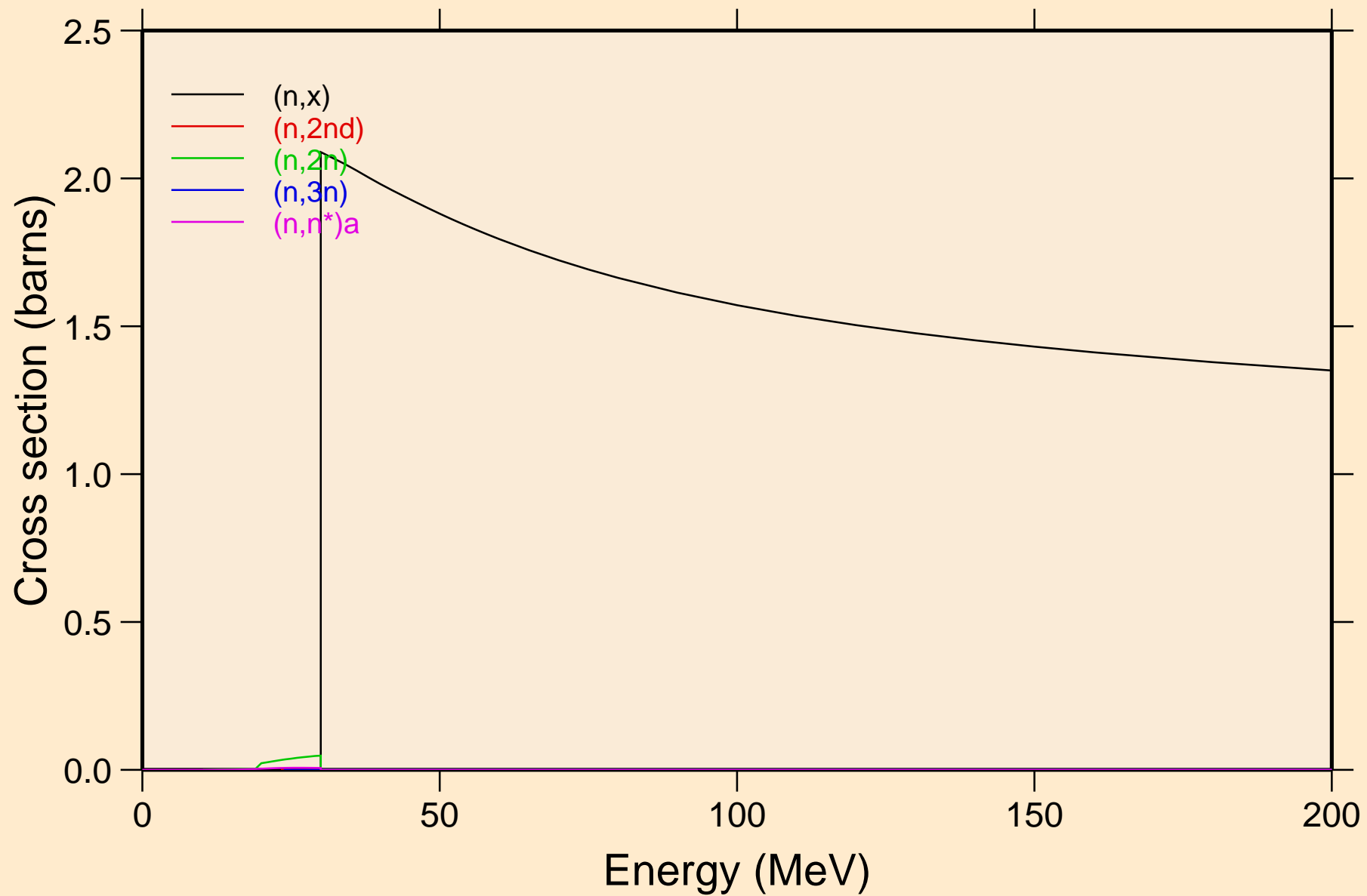

YB151M NRG TENDL-2015, AKONING

Threshold reactions

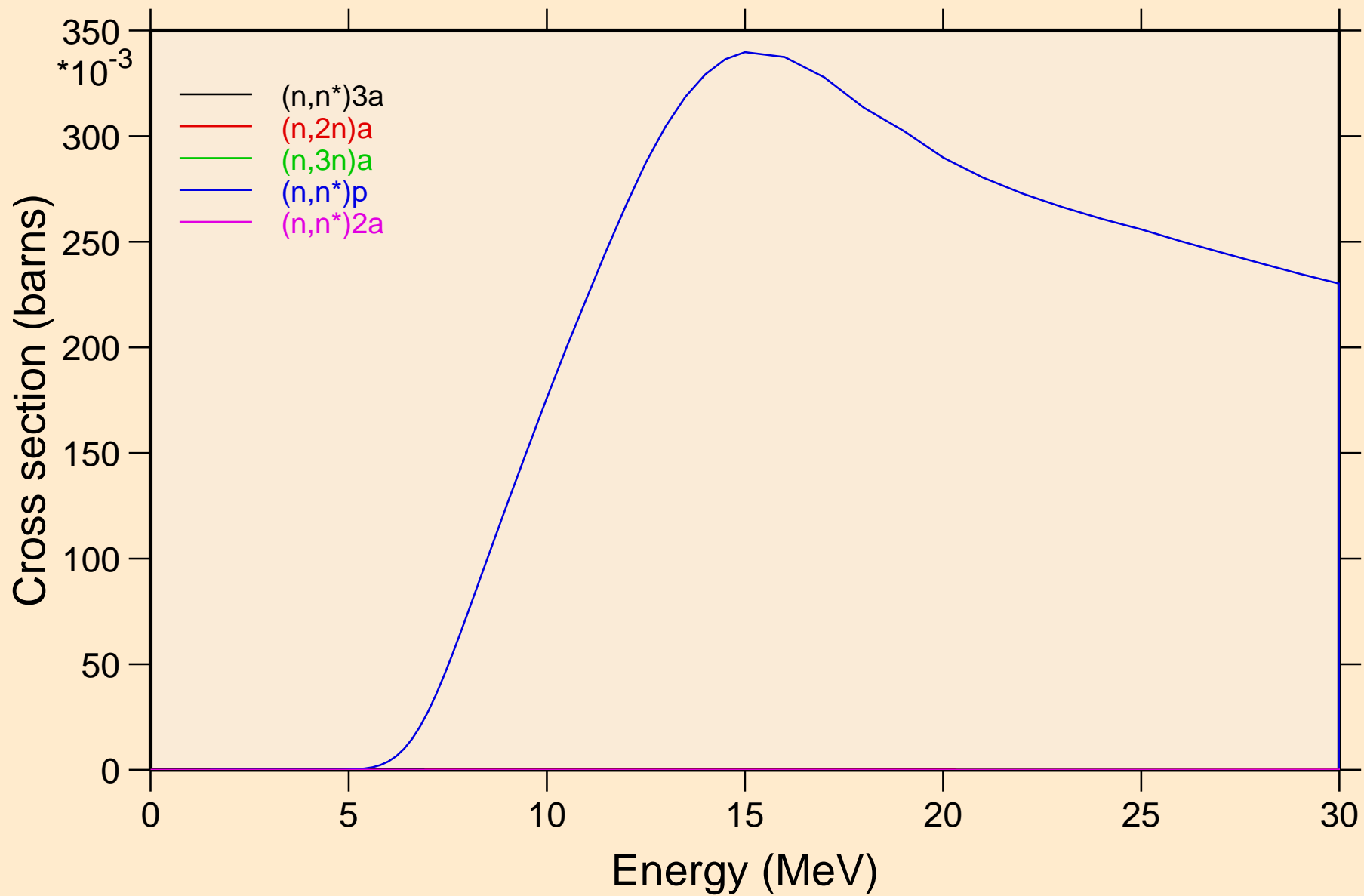

YB151M NRG TENDL-2015, AKONING

Threshold reactions

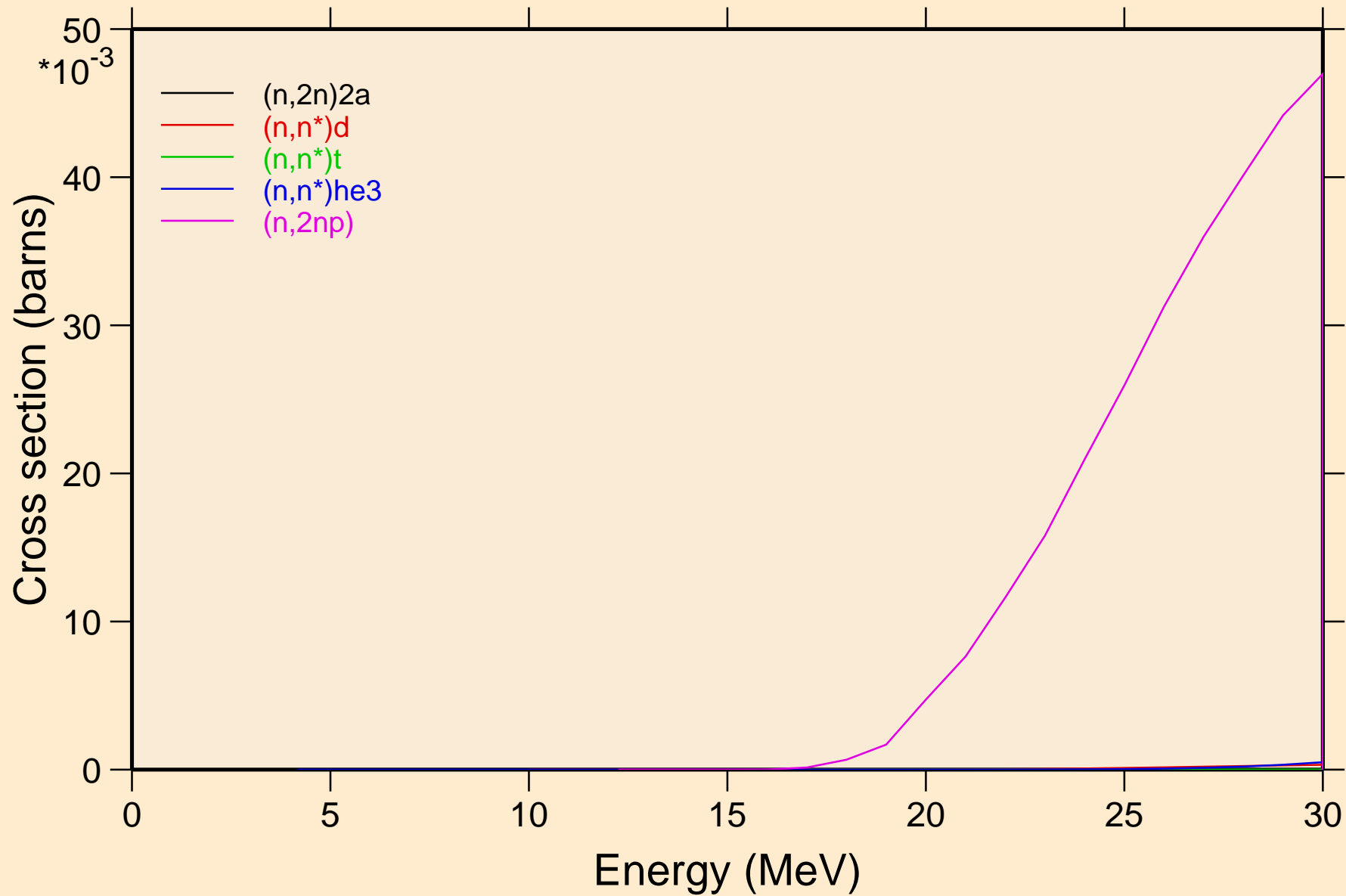

YB151M NRG TENDL-2015, AKONING

Threshold reactions

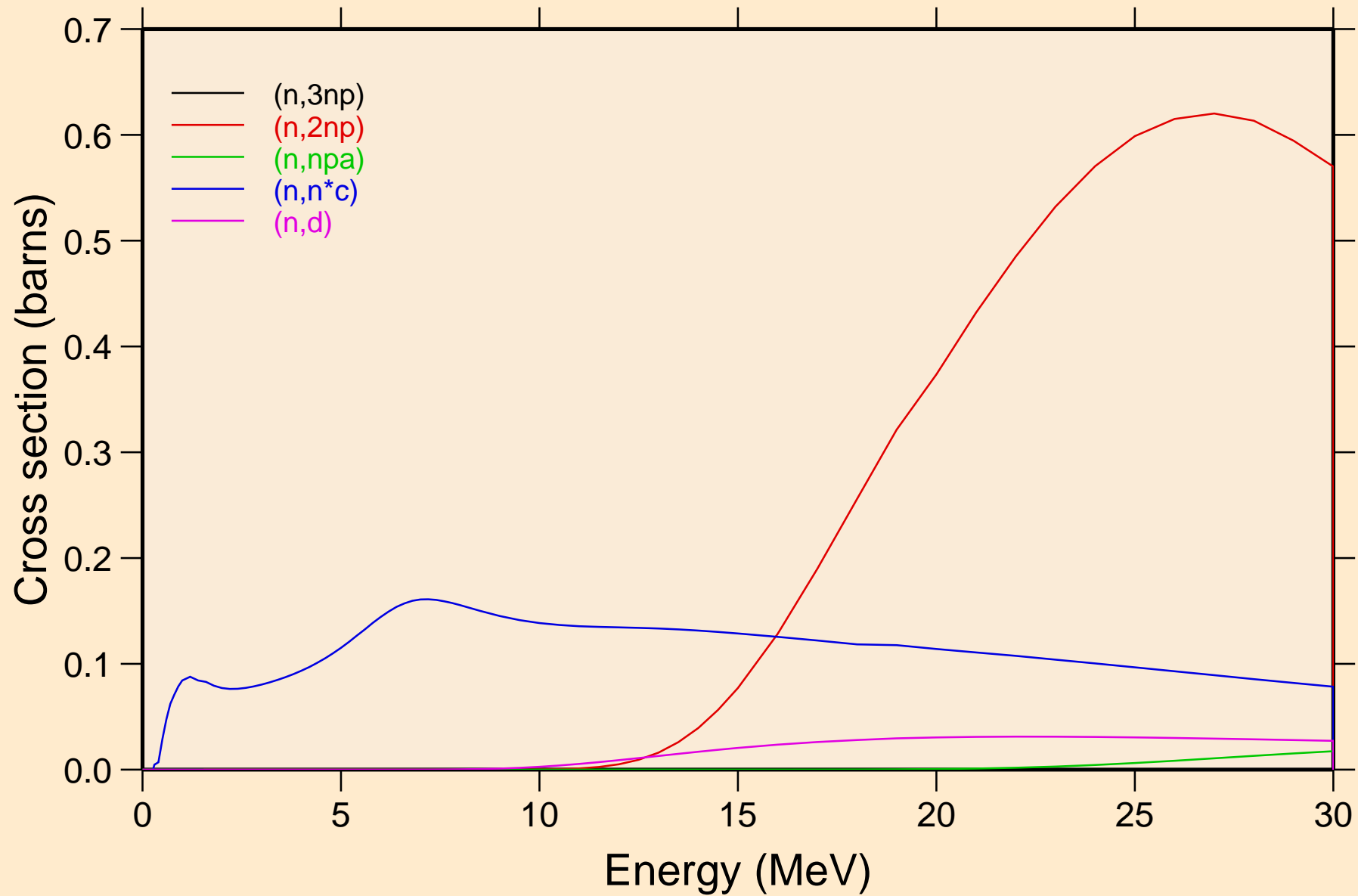

YB151M NRG TENDL-2015, AKONING

Threshold reactions

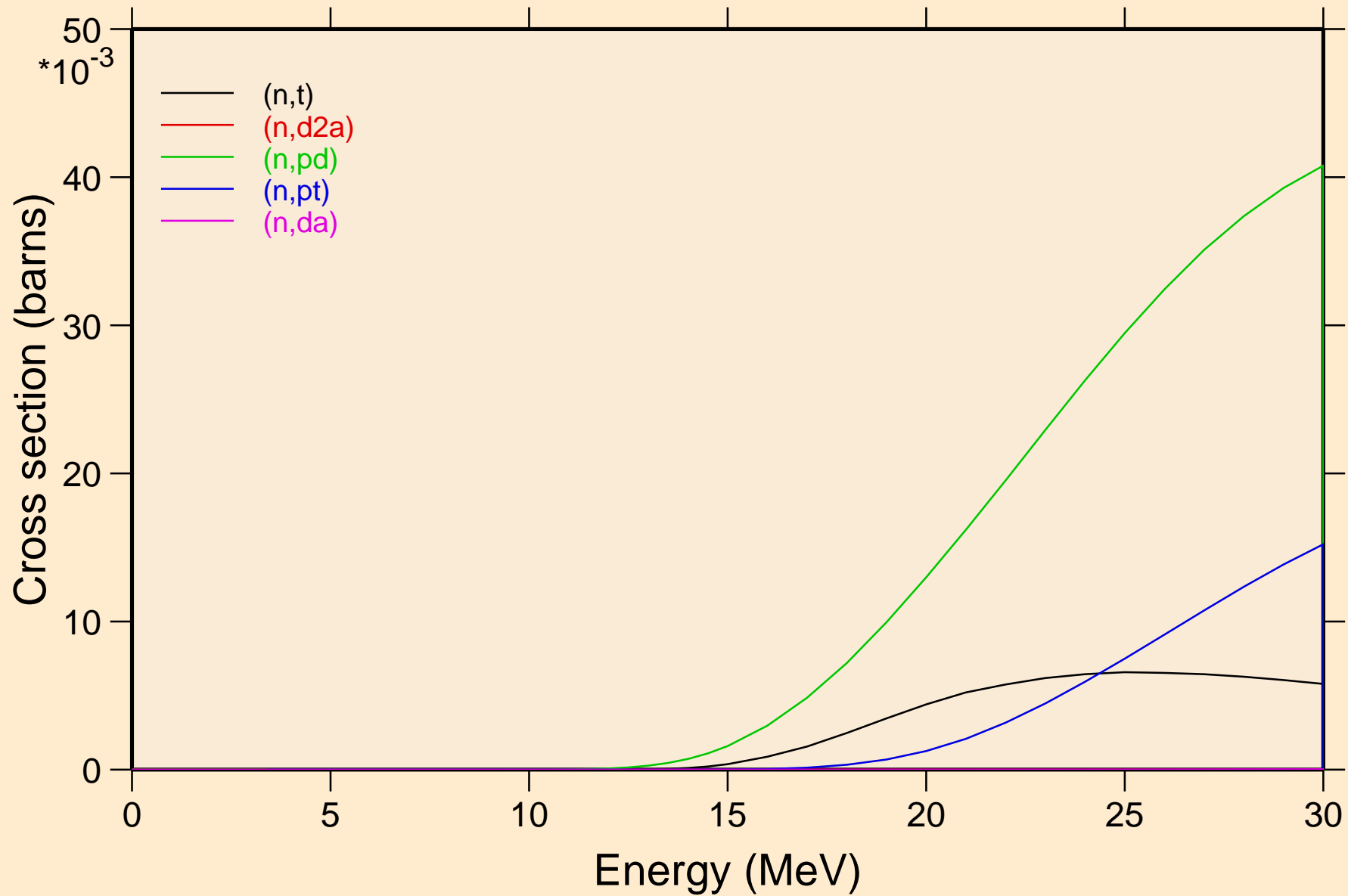

YB151M NRG TENDL-2015, AKONING
angular distribution for elastic

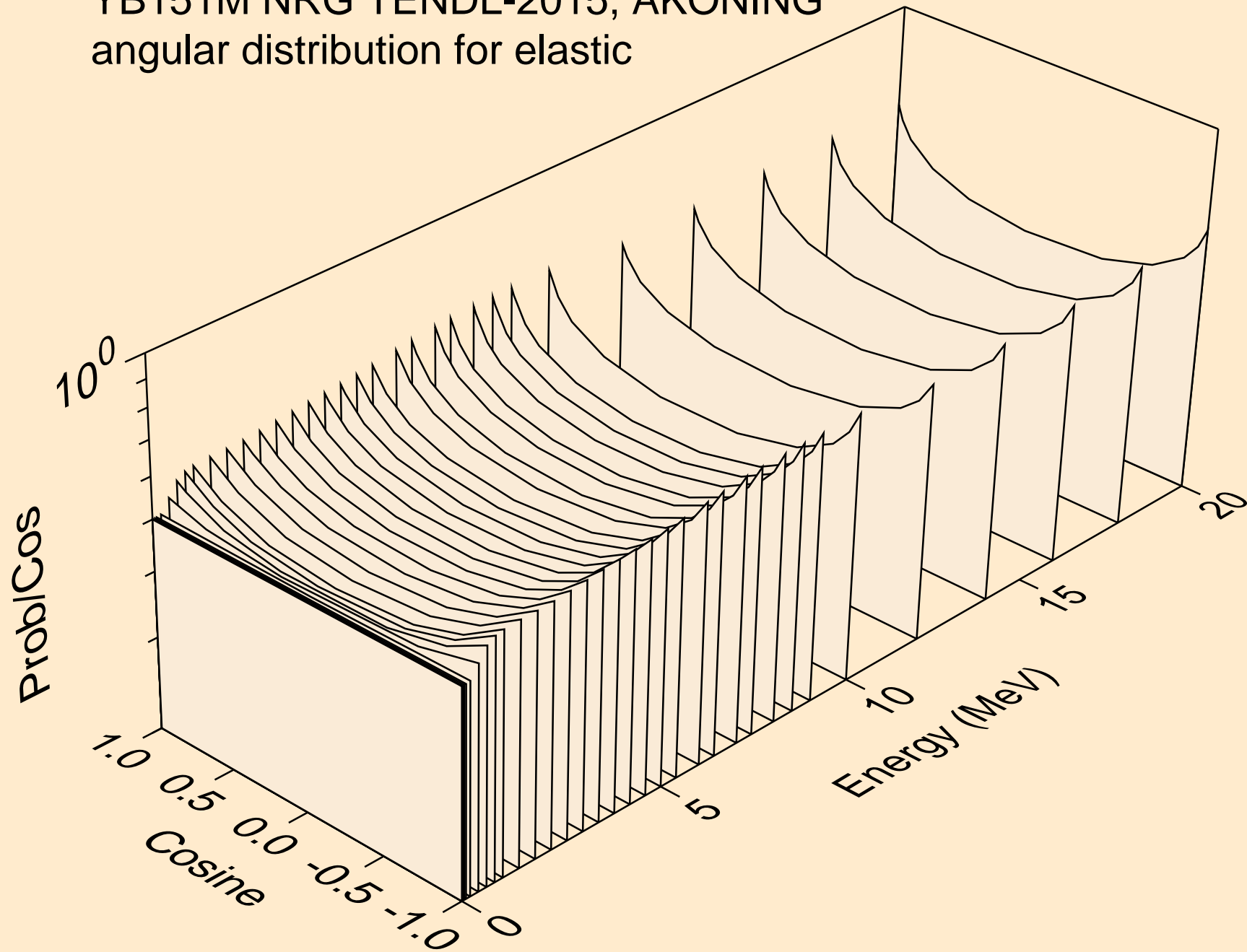

YB151M NRG TENDL-2015, AKONING
angular distribution for elastic

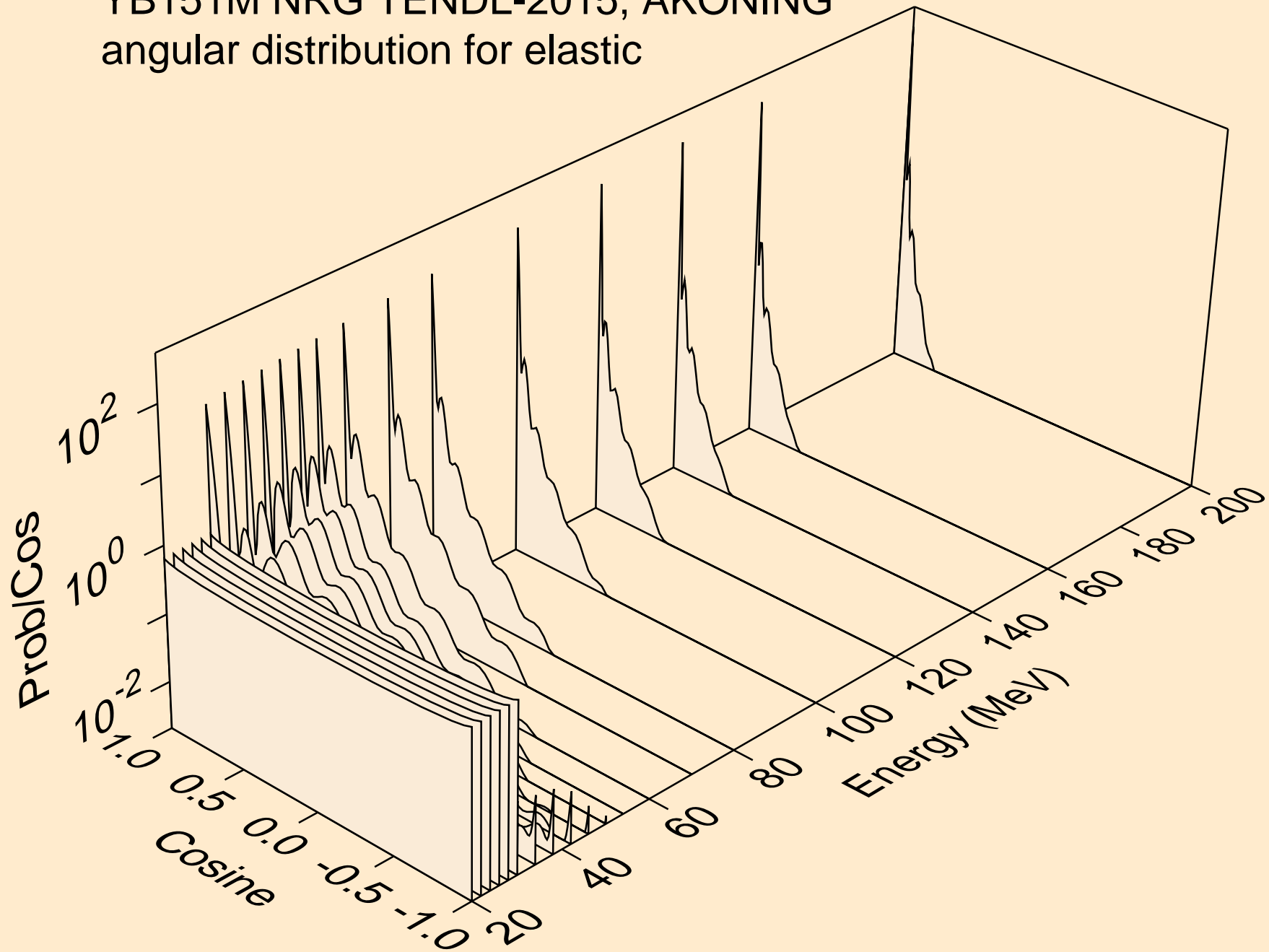

YB151M NRG TENDL-2015, AKONING
angular distribution for (n,n*1)

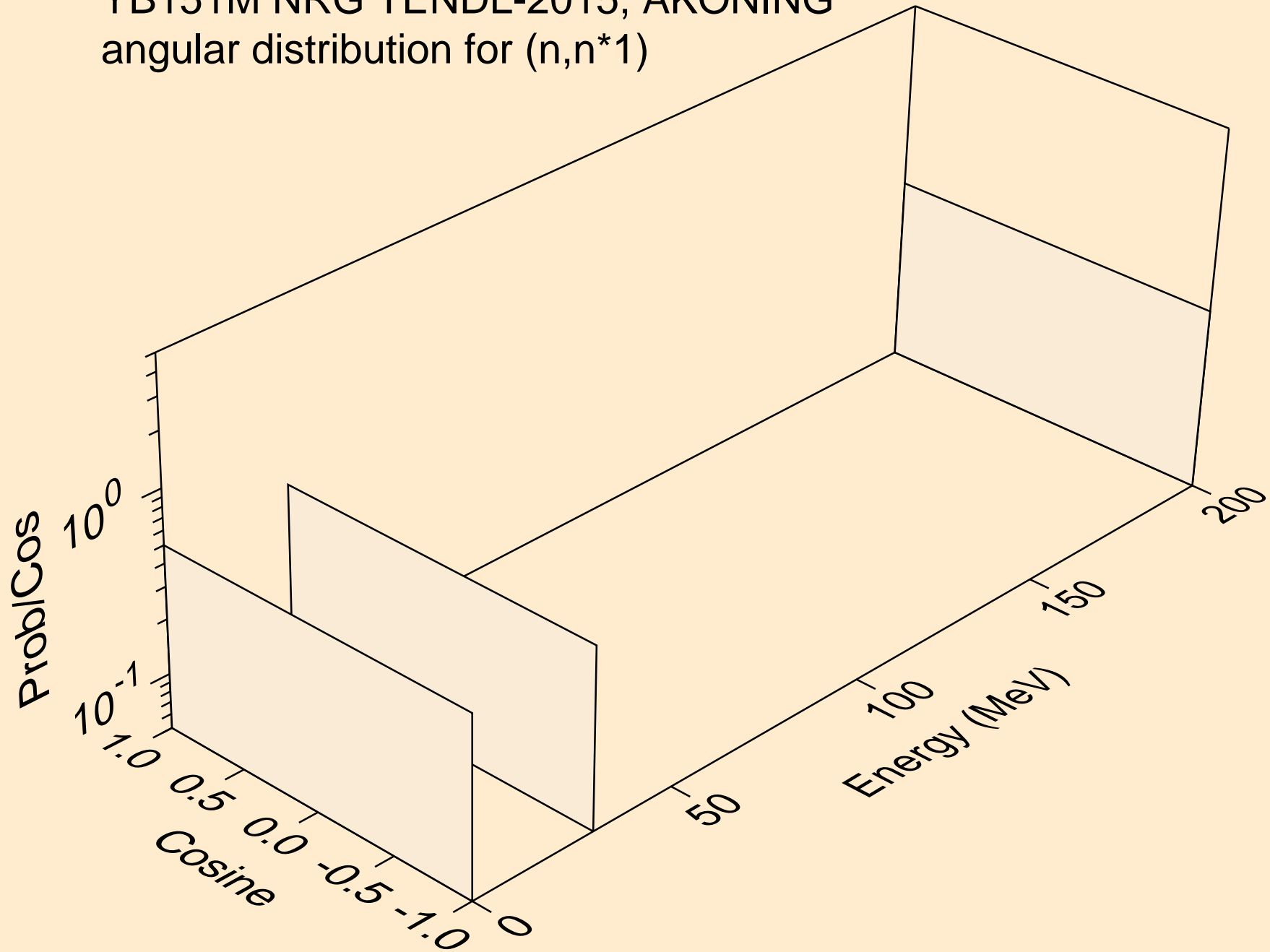

YB151M NRG TENDL-2015, AKONING
angular distribution for (n,n*2)

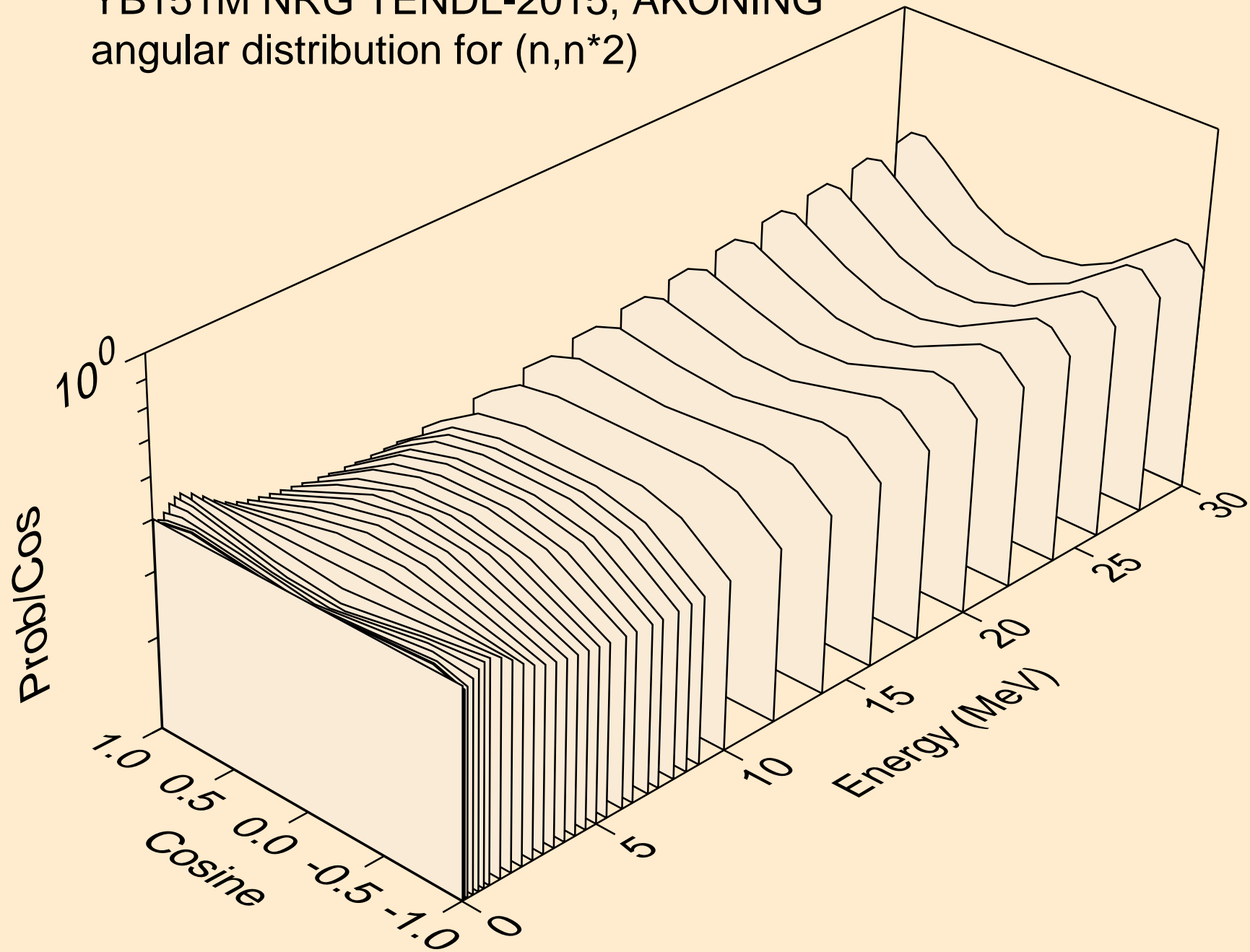

YB151M NRG TENDL-2015, AKONING
angular distribution for (n,n*3)

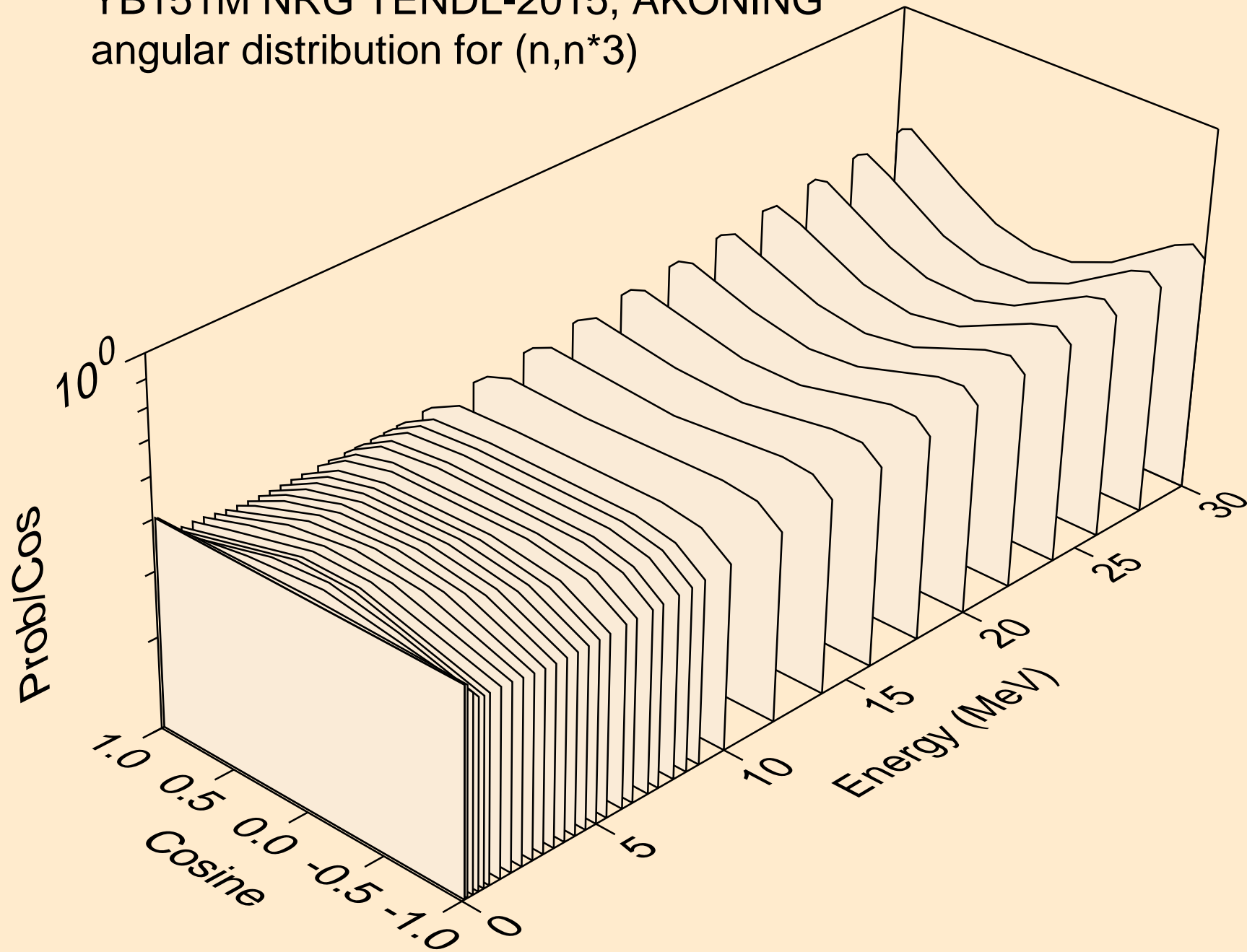

YB151M NRG TENDL-2015, AKONING
angular distribution for (n,n*4)

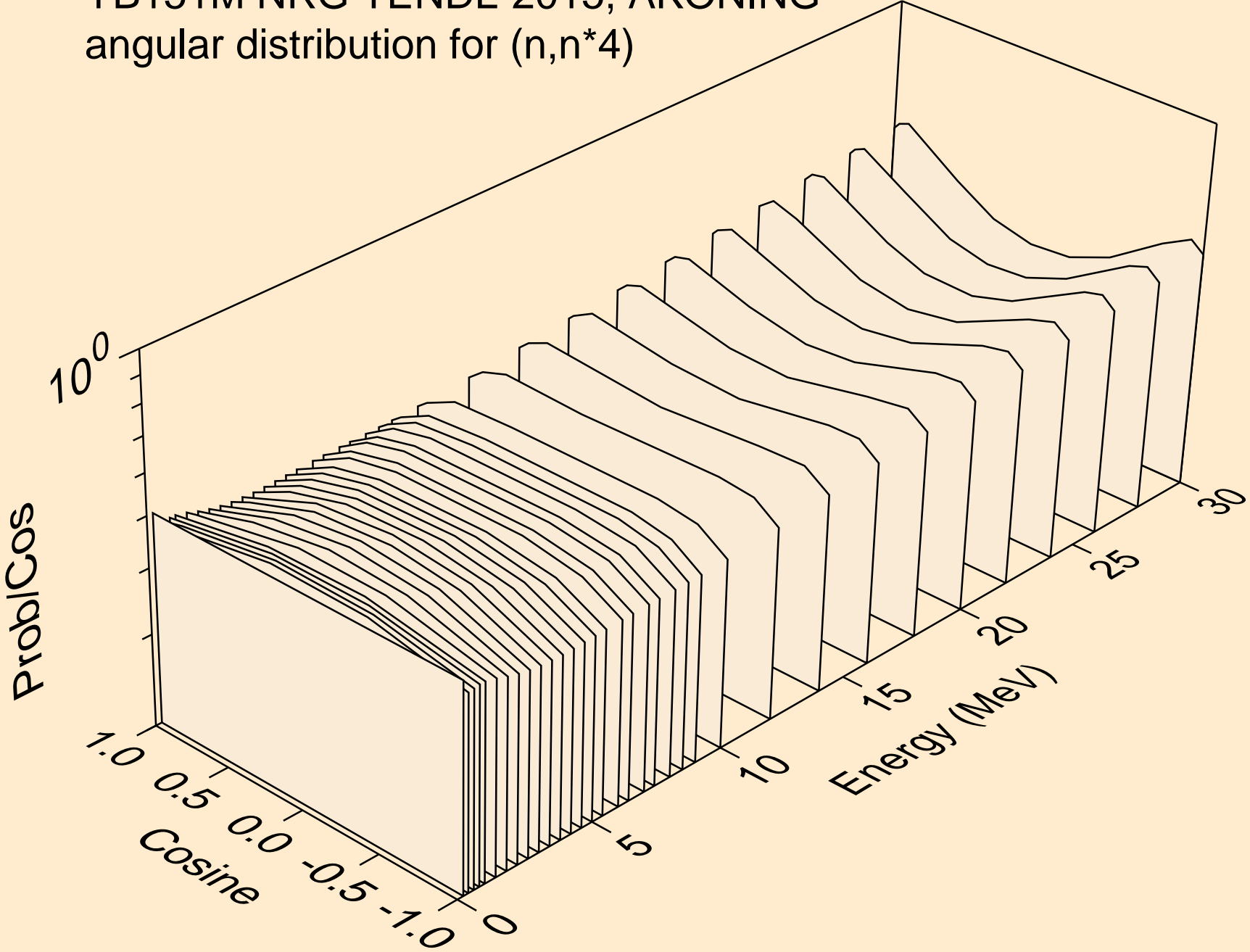

YB151M NRG TENDL-2015, AKONING
angular distribution for (n,n*5)

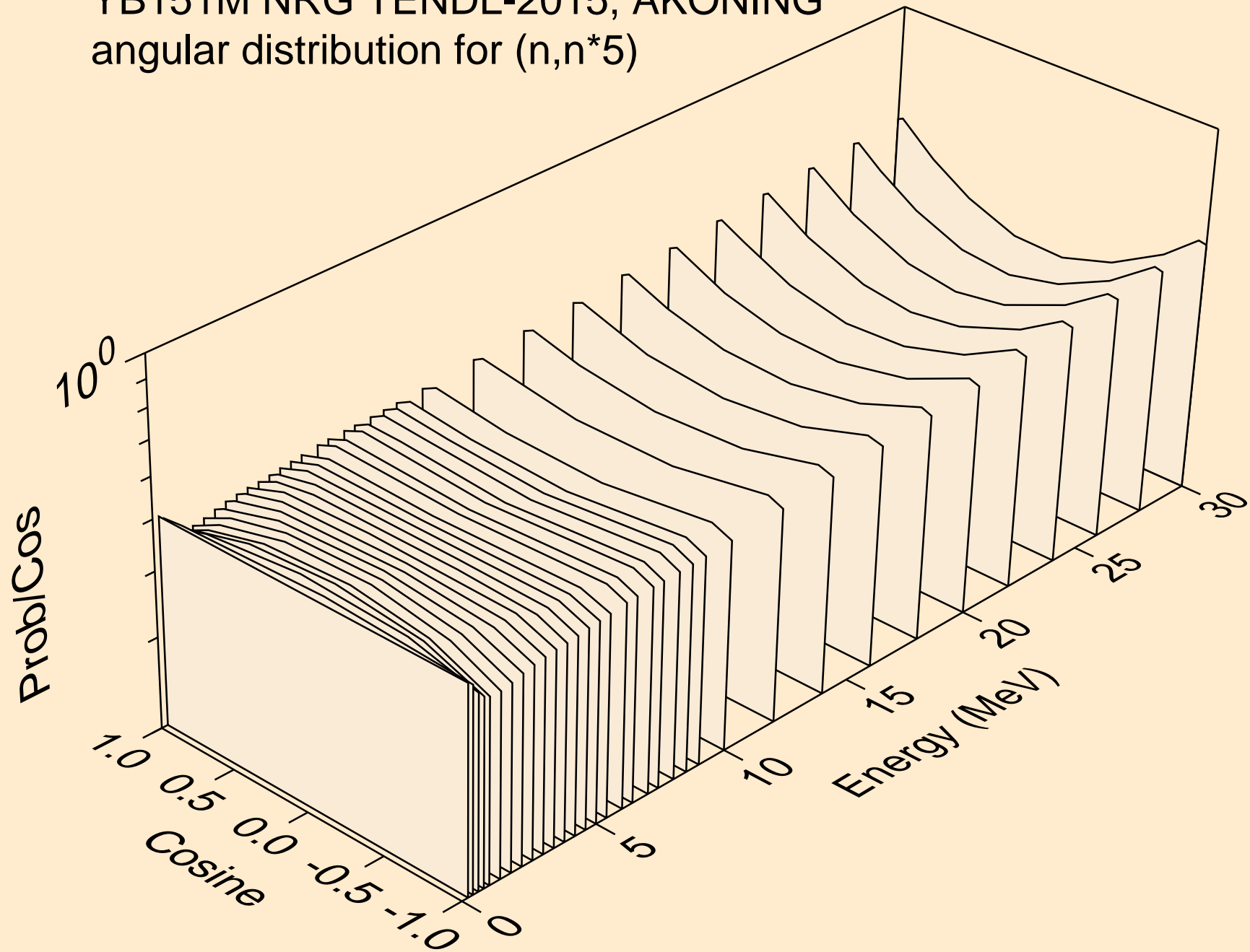

YB151M NRG TENDL-2015, AKONING
angular distribution for (n,n*6)

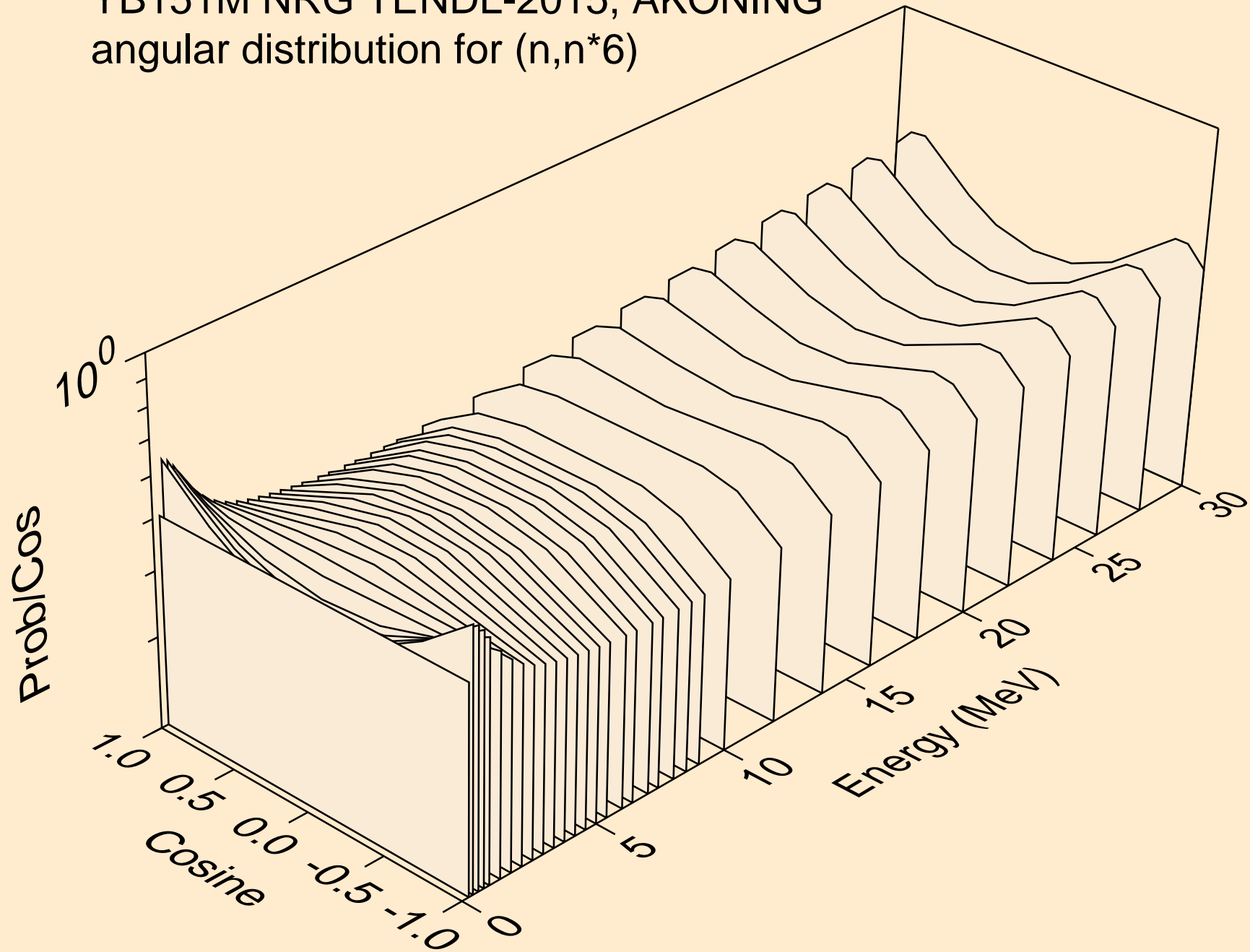

YB151M NRG TENDL-2015, AKONING
angular distribution for (n,n*7)

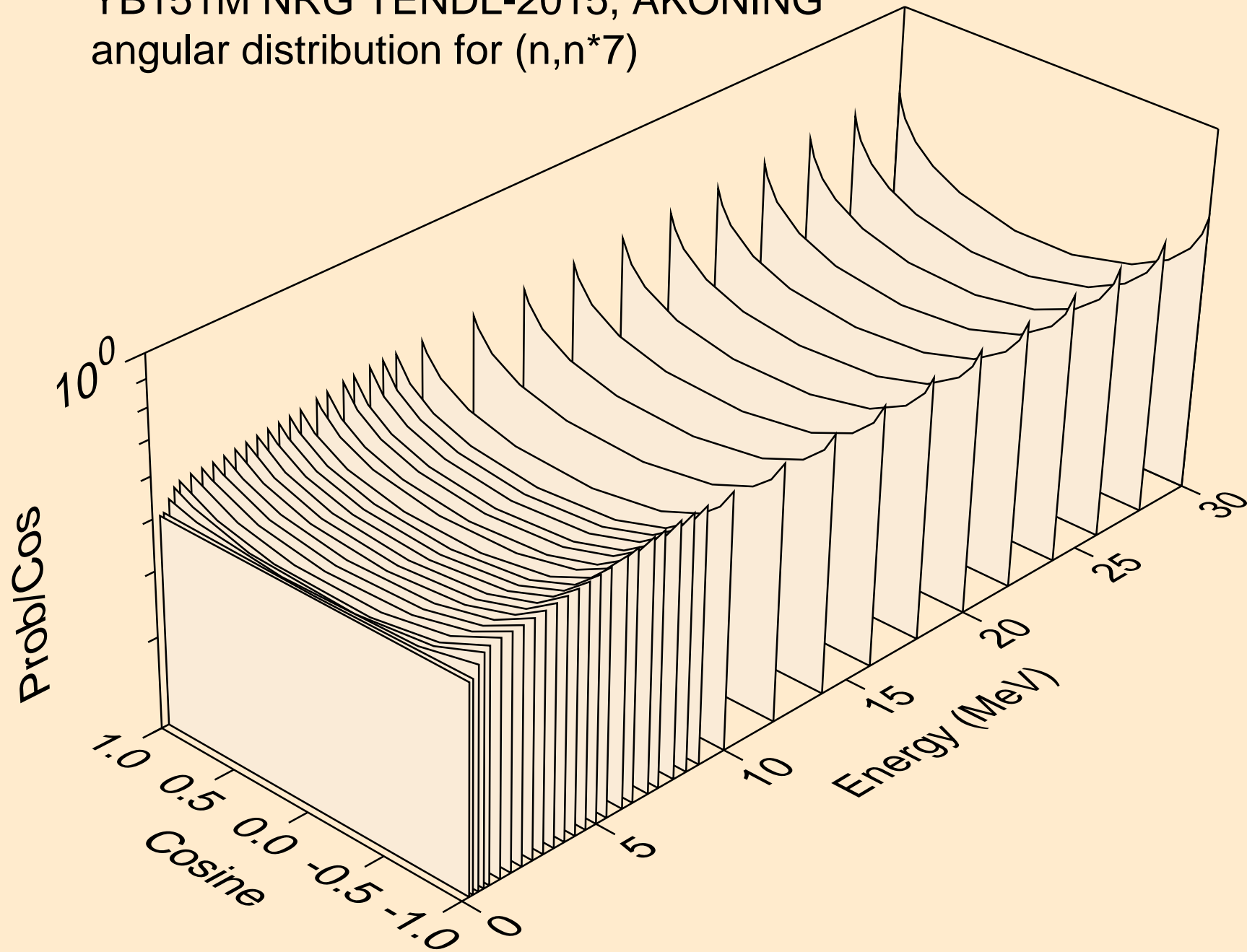

YB151M NRG TENDL-2015, AKONING
Neutron emission for (n,x)

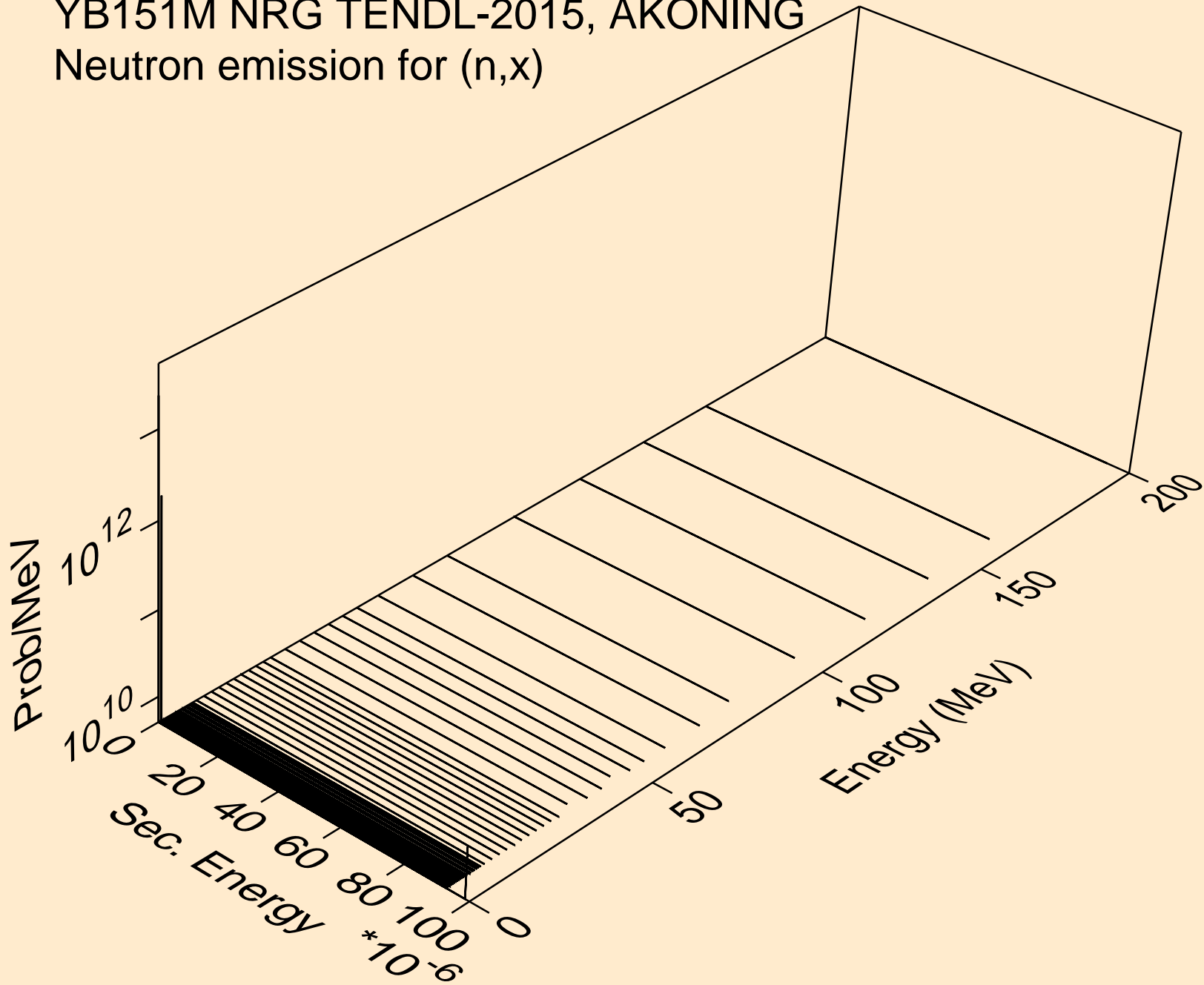

YB151M NRG TENDL-2015, AKONING
Neutron emission for (n,2nd)

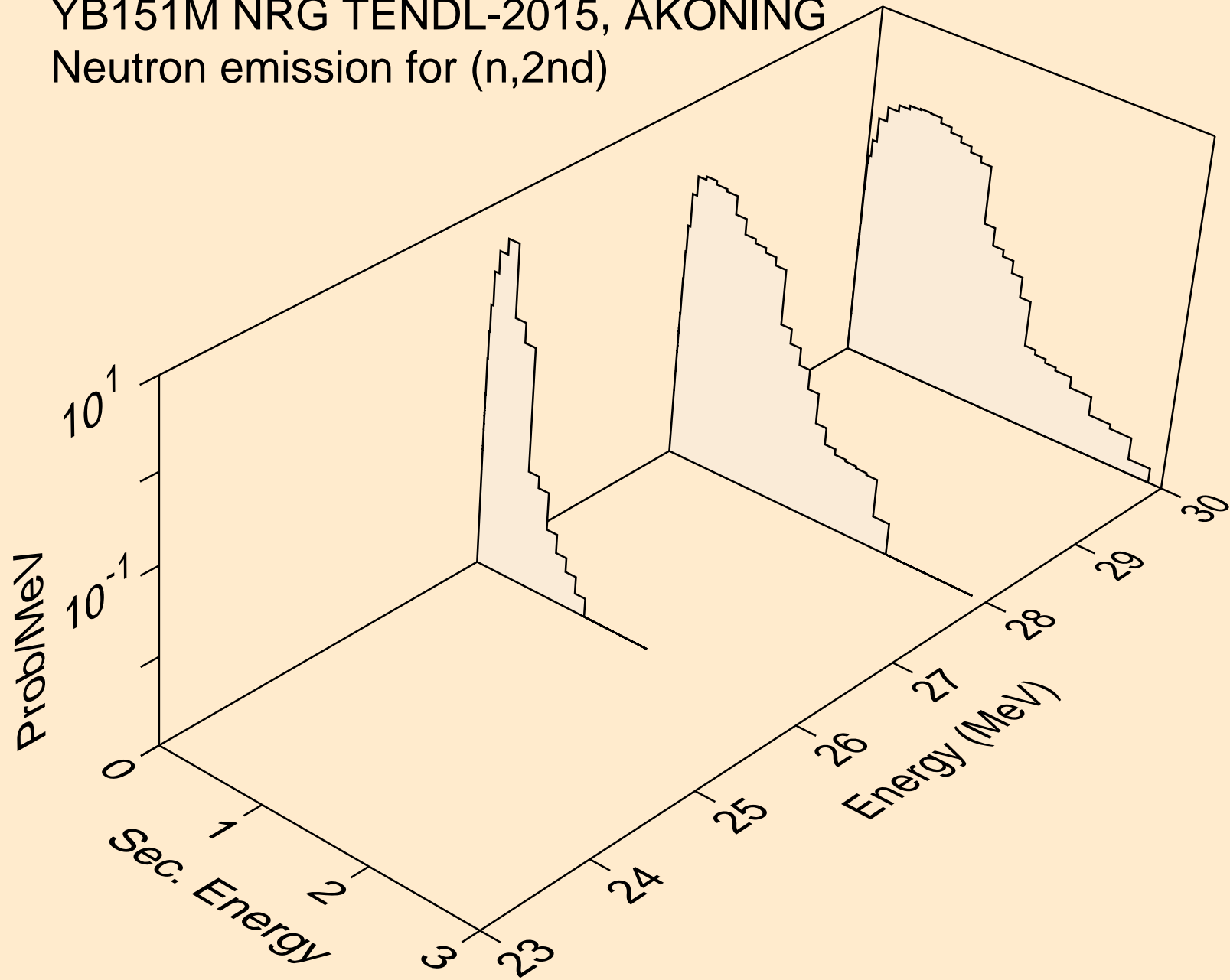

YB151M NRG TENDL-2015, AKONING
Neutron emission for (n,2n)

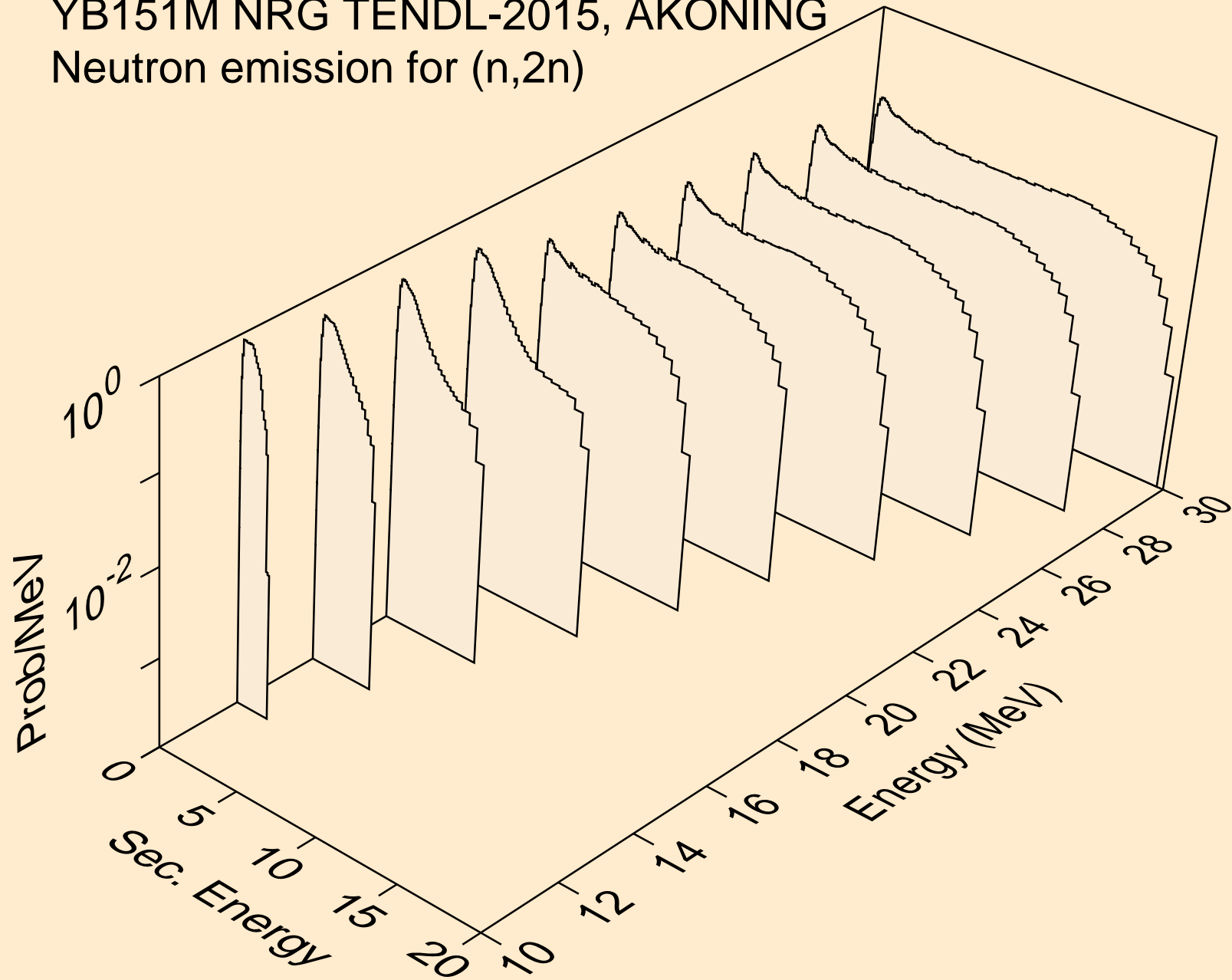

YB151M NRG TENDL-2015, AKONING
Neutron emission for (n,3n)

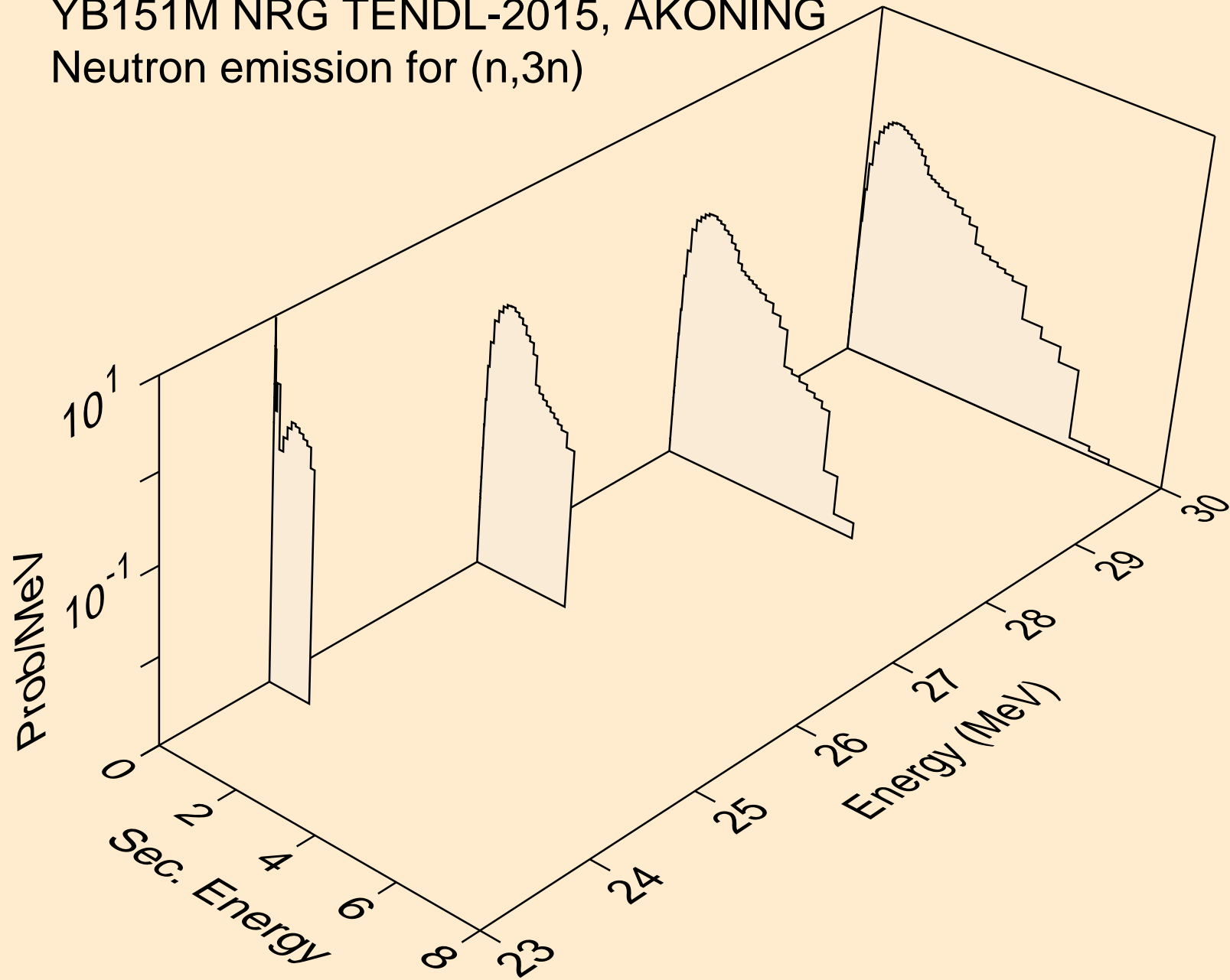

YB151M NRG TENDL-2015, AKONING
Neutron emission for (n,n*)a

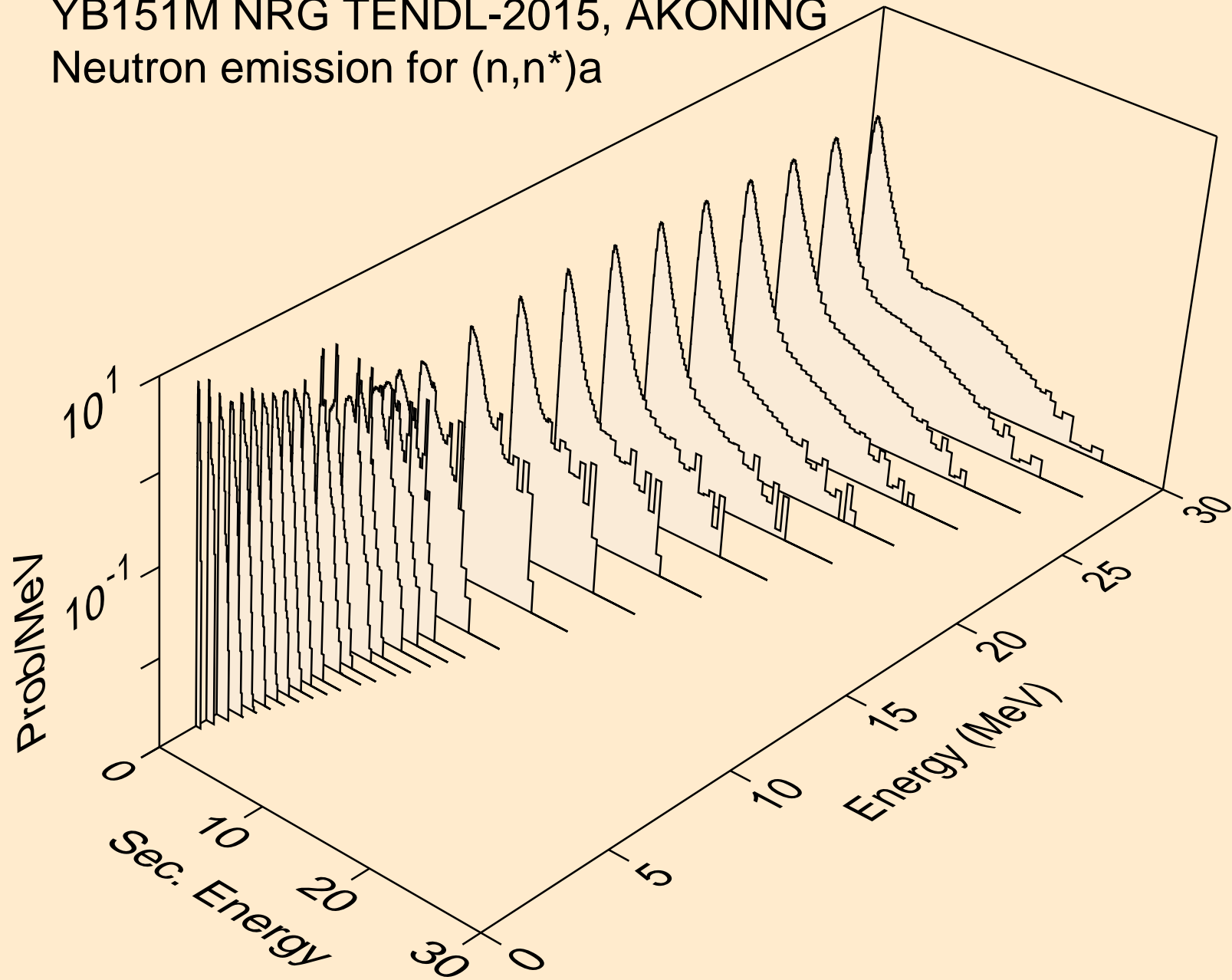

YB151M NRG TENDL-2015, AKONING
Neutron emission for (n,n*)3a

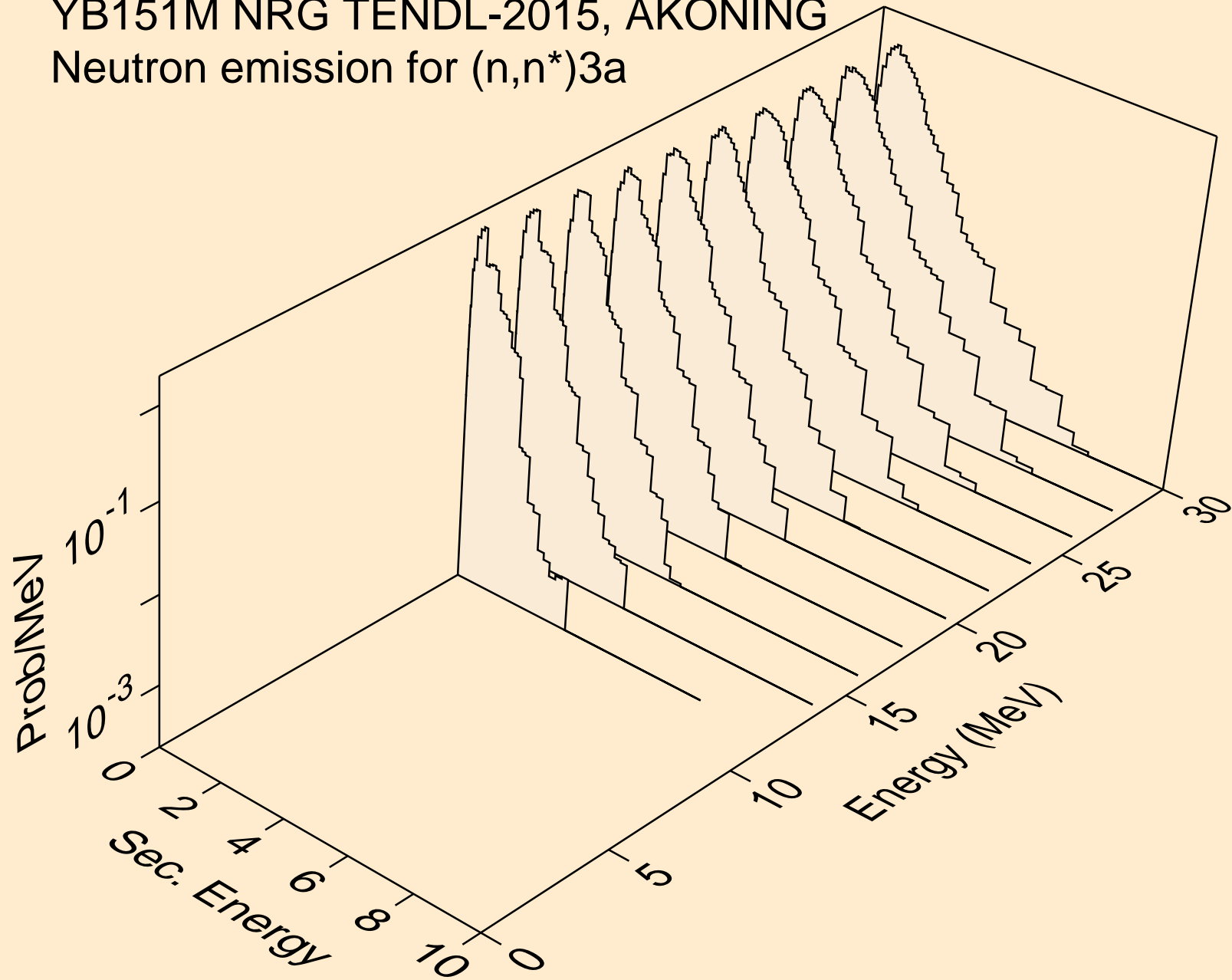

YB151M NRG TENDL-2015, AKONING
Neutron emission for (n,2n)a

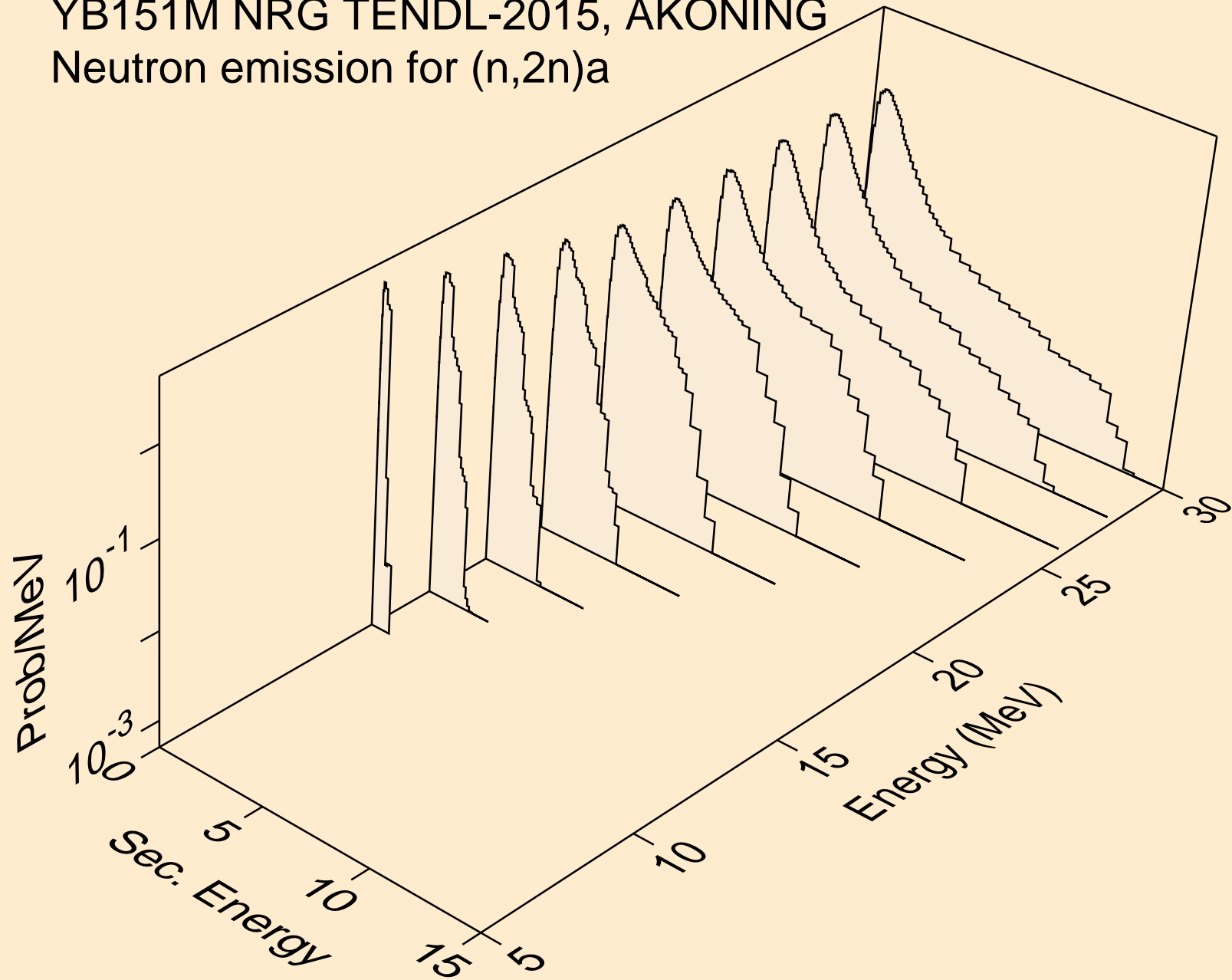

YB151M NRG TENDL-2015, AKONING
Neutron emission for (n,3n)a

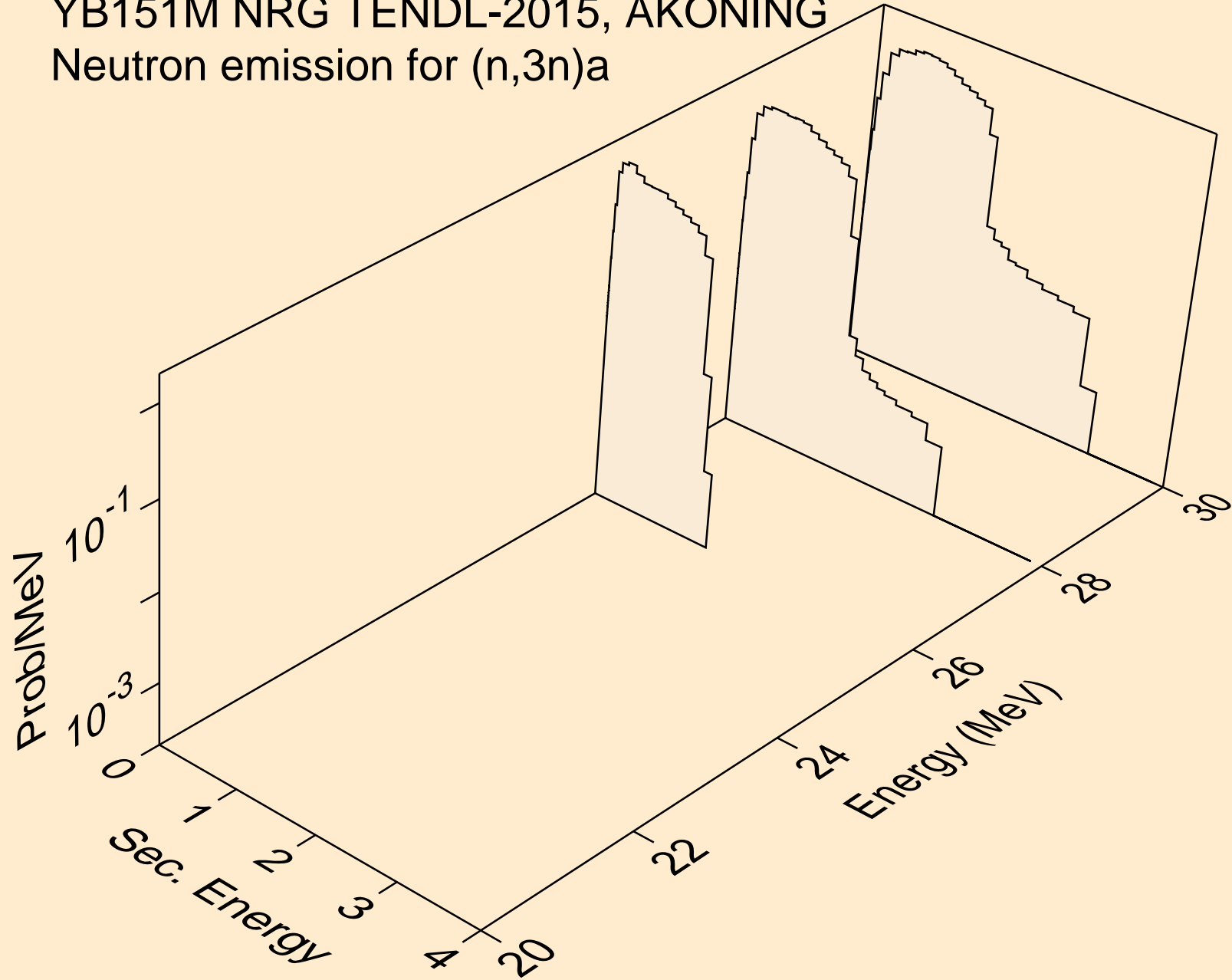

YB151M NRG TENDL-2015, AKONING
Neutron emission for (n,n*)p

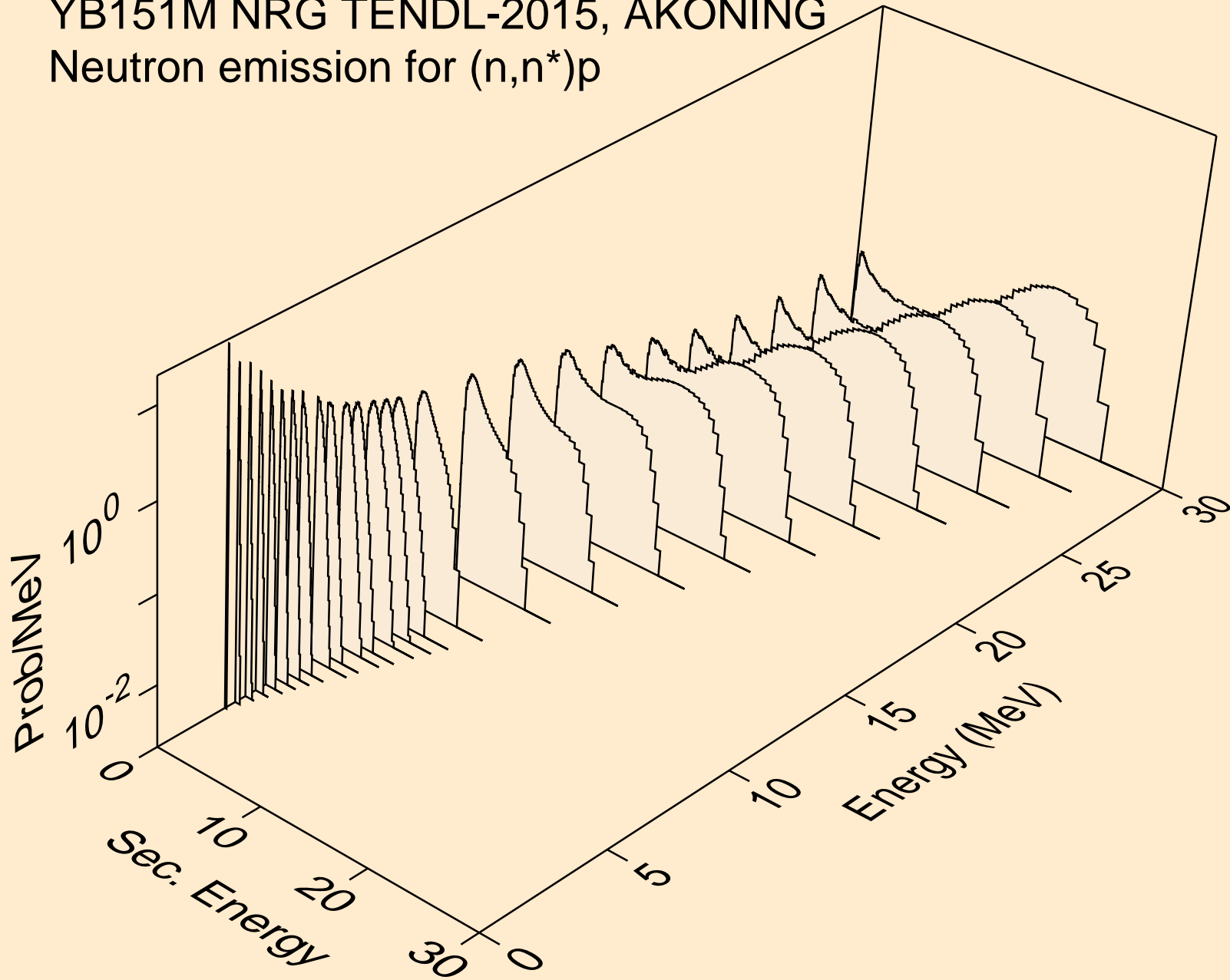

YB151M NRG TENDL-2015, AKONING
Neutron emission for (n,n*)2a

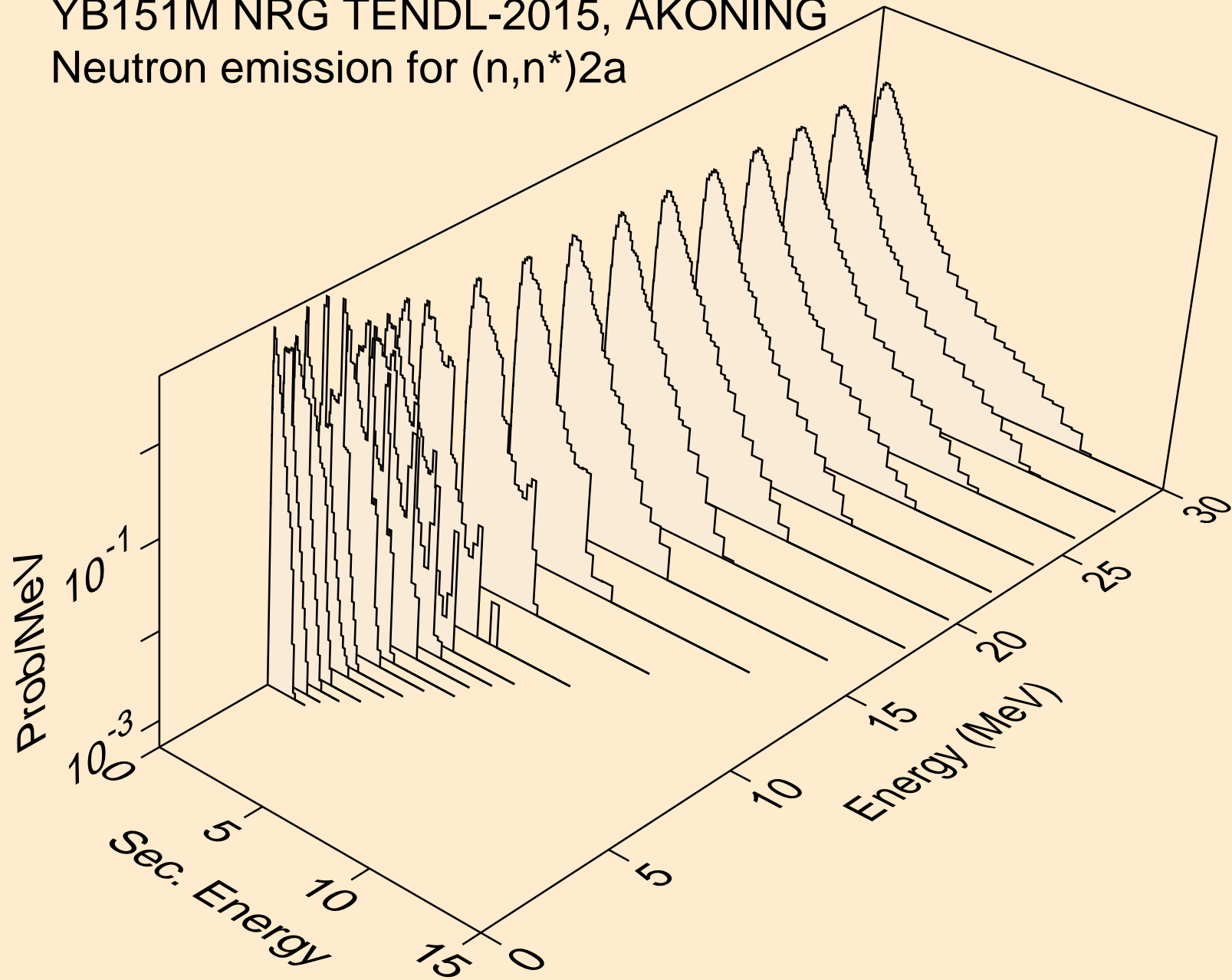

YB151M NRG TENDL-2015, AKONING
Neutron emission for (n,2n)2a

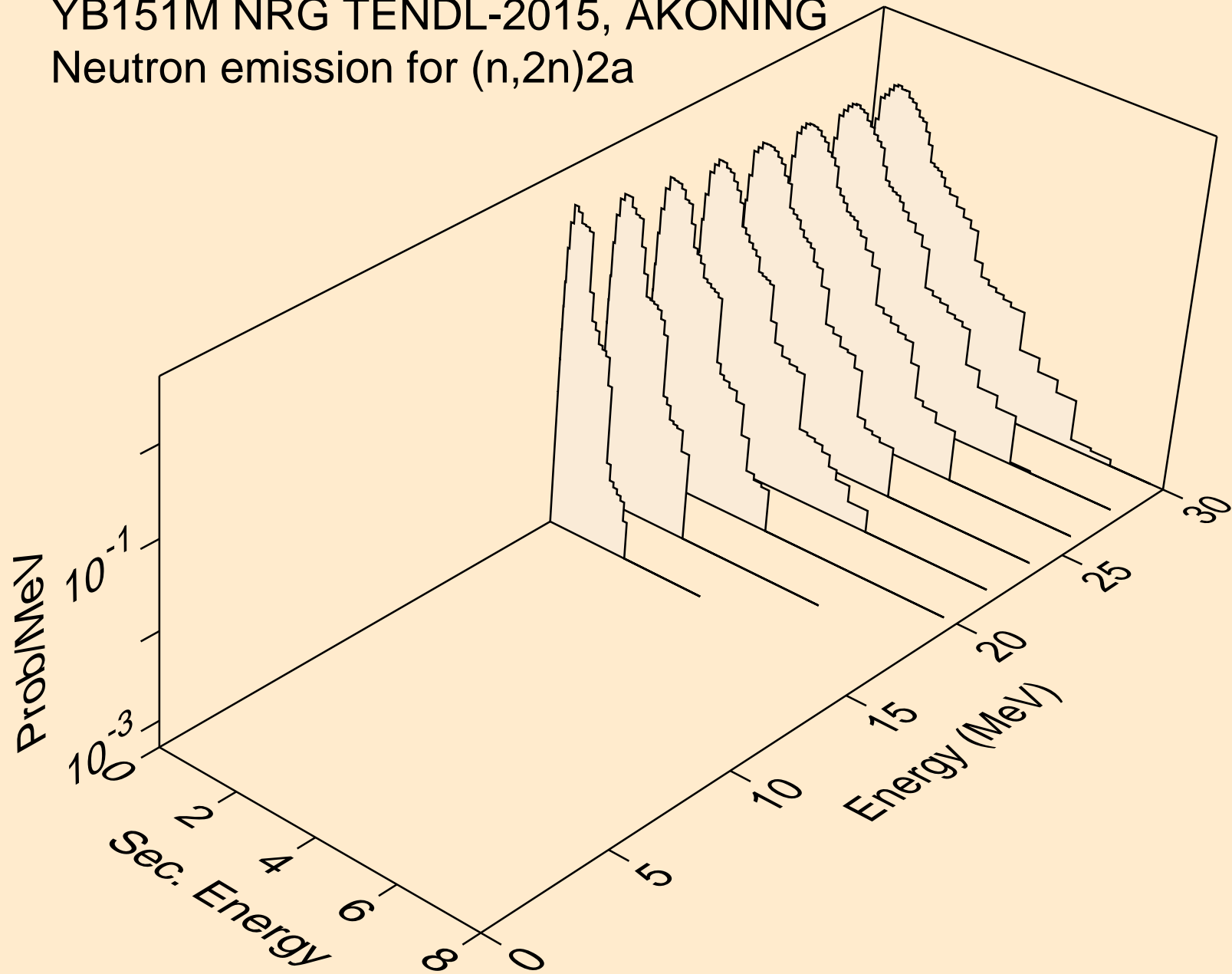

YB151M NRG TENDL-2015, AKONING
Neutron emission for (n,n*)d

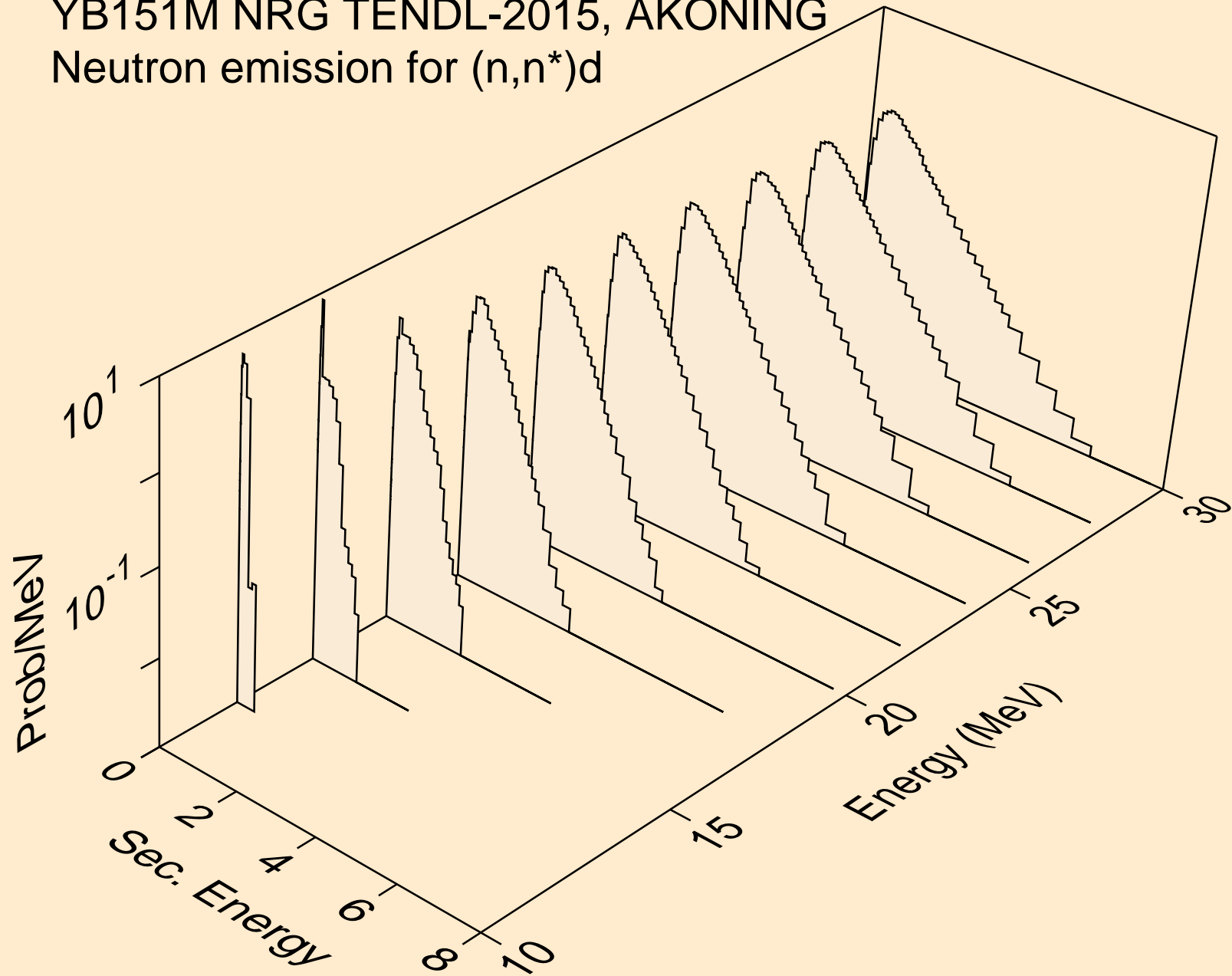

YB151M NRG TENDL-2015, AKONING
Neutron emission for (n,n*)t

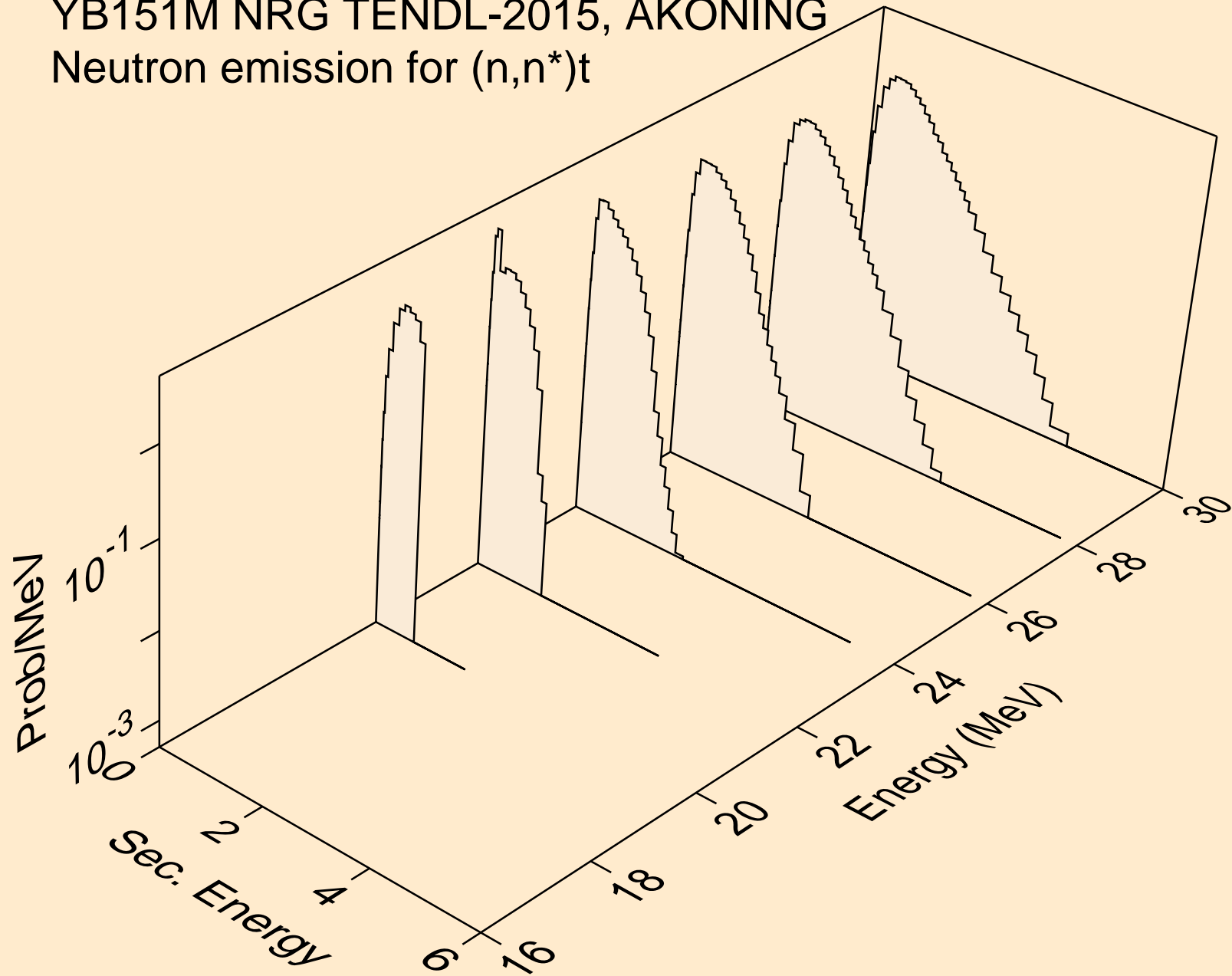

YB151M NRG TENDL-2015, AKONING
Neutron emission for (n,n*)he3

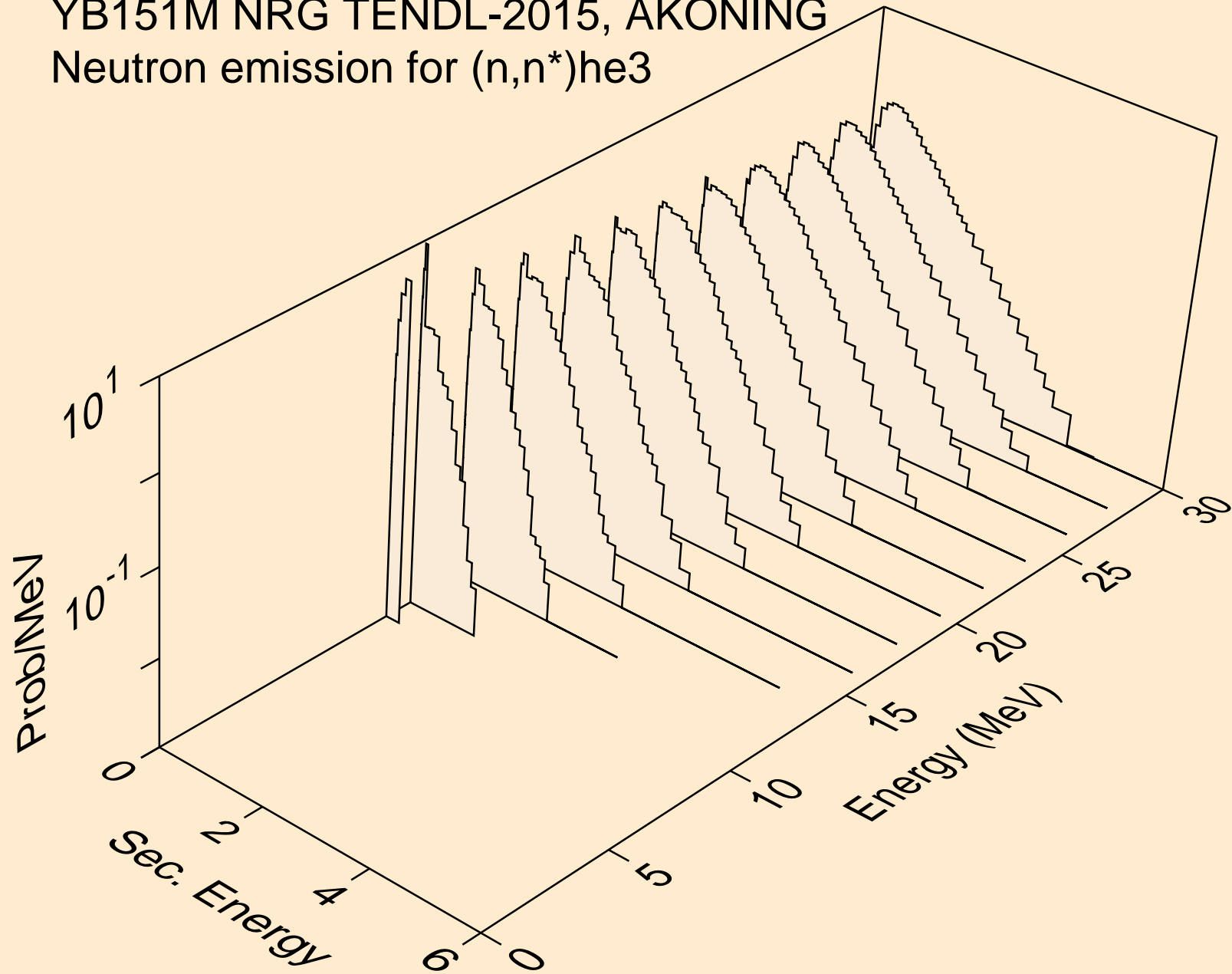

YB151M NRG TENDL-2015, AKONING
Neutron emission for (n,2np)

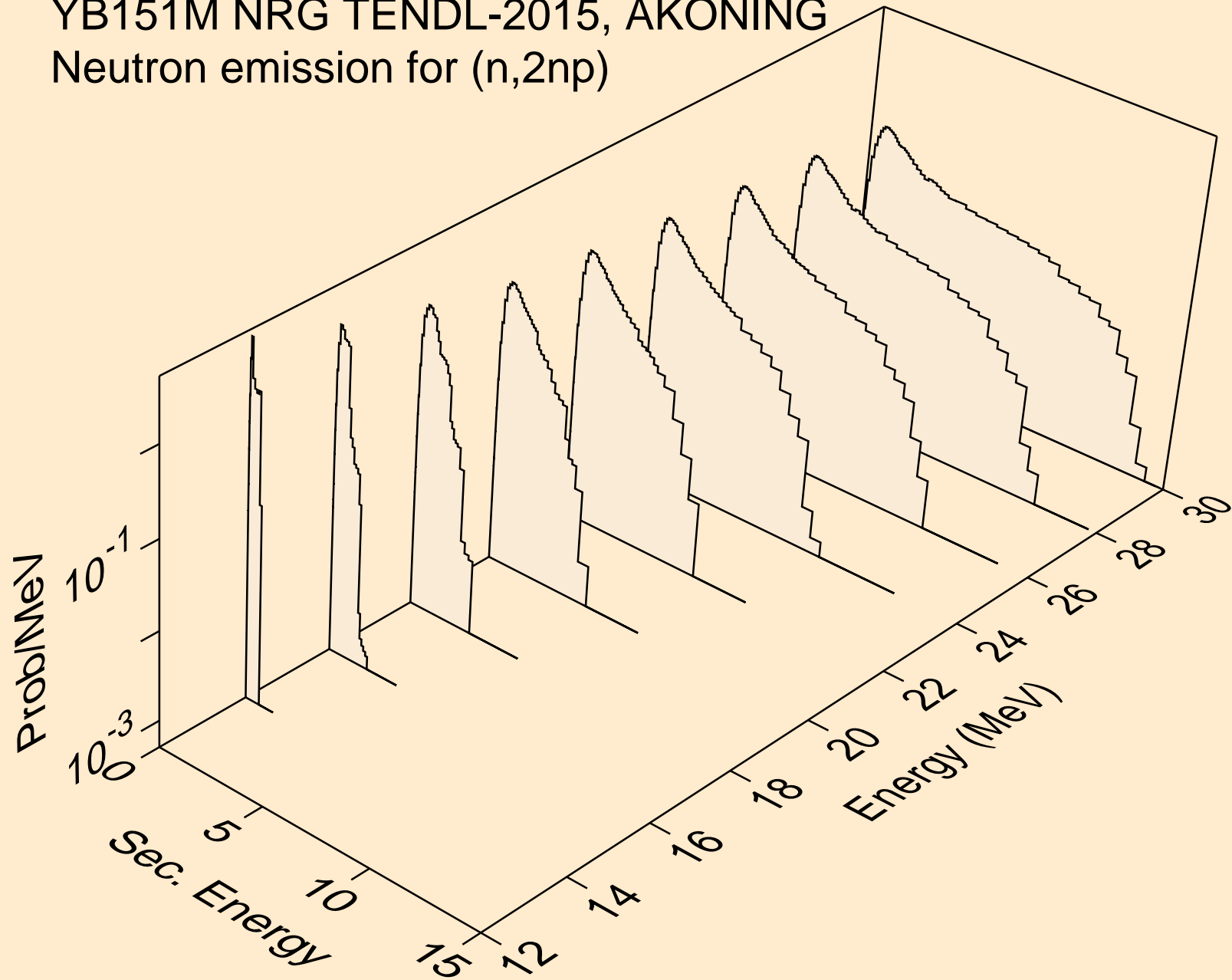

YB151M NRG TENDL-2015, AKONING
Neutron emission for (n,3np)

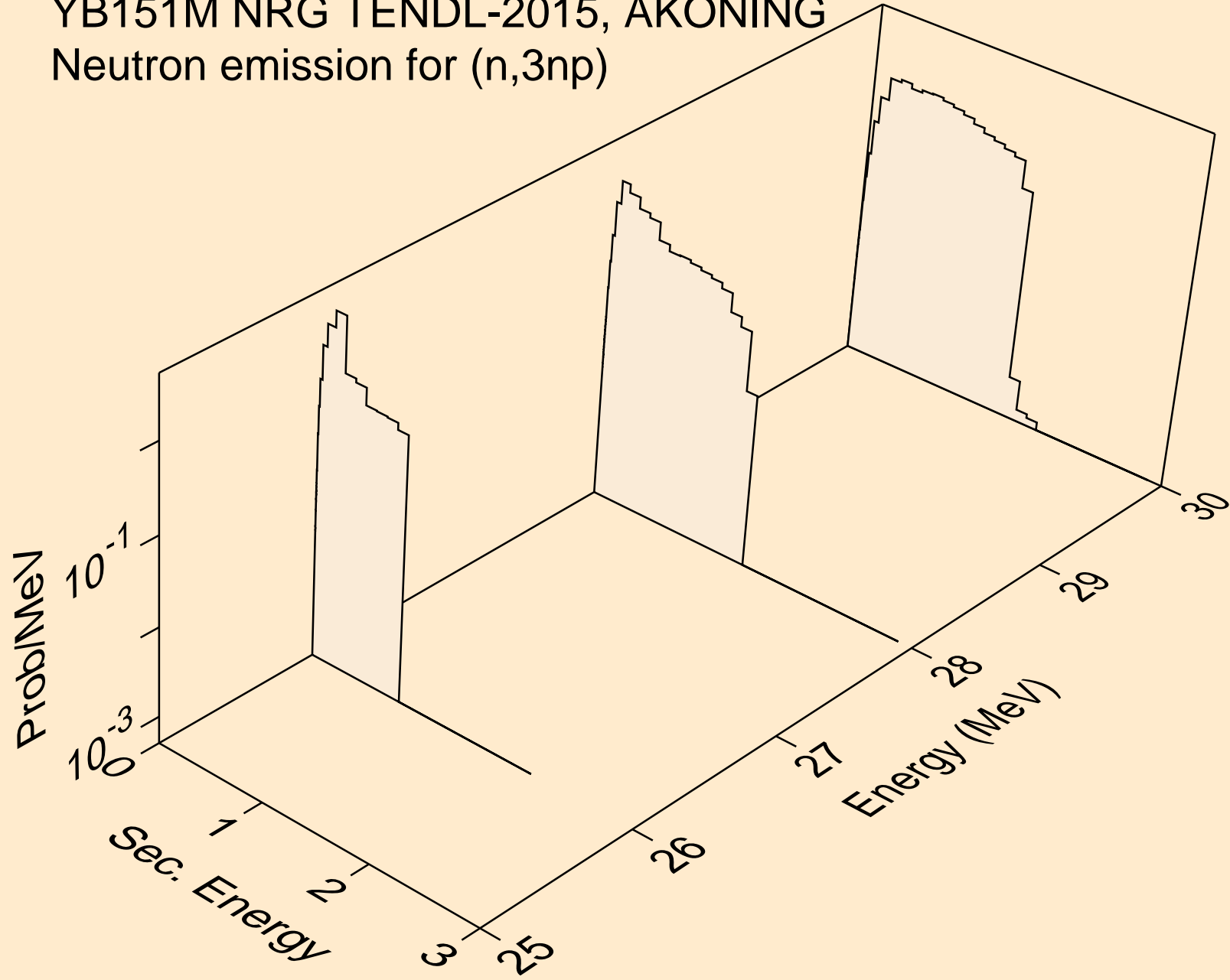

YB151M NRG TENDL-2015, AKONING
Neutron emission for (n,2np)

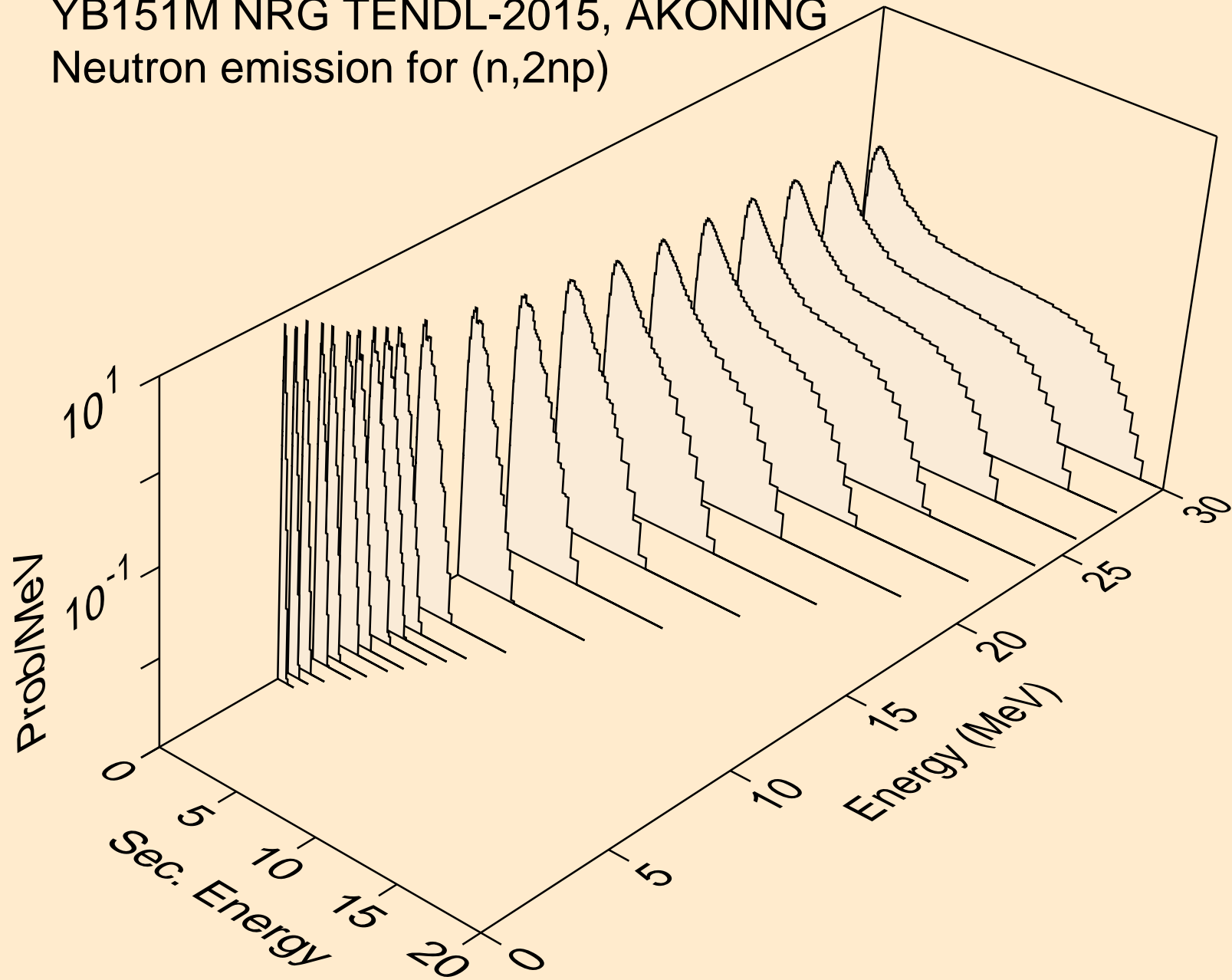

YB151M NRG TENDL-2015, AKONING
Neutron emission for (n,npa)

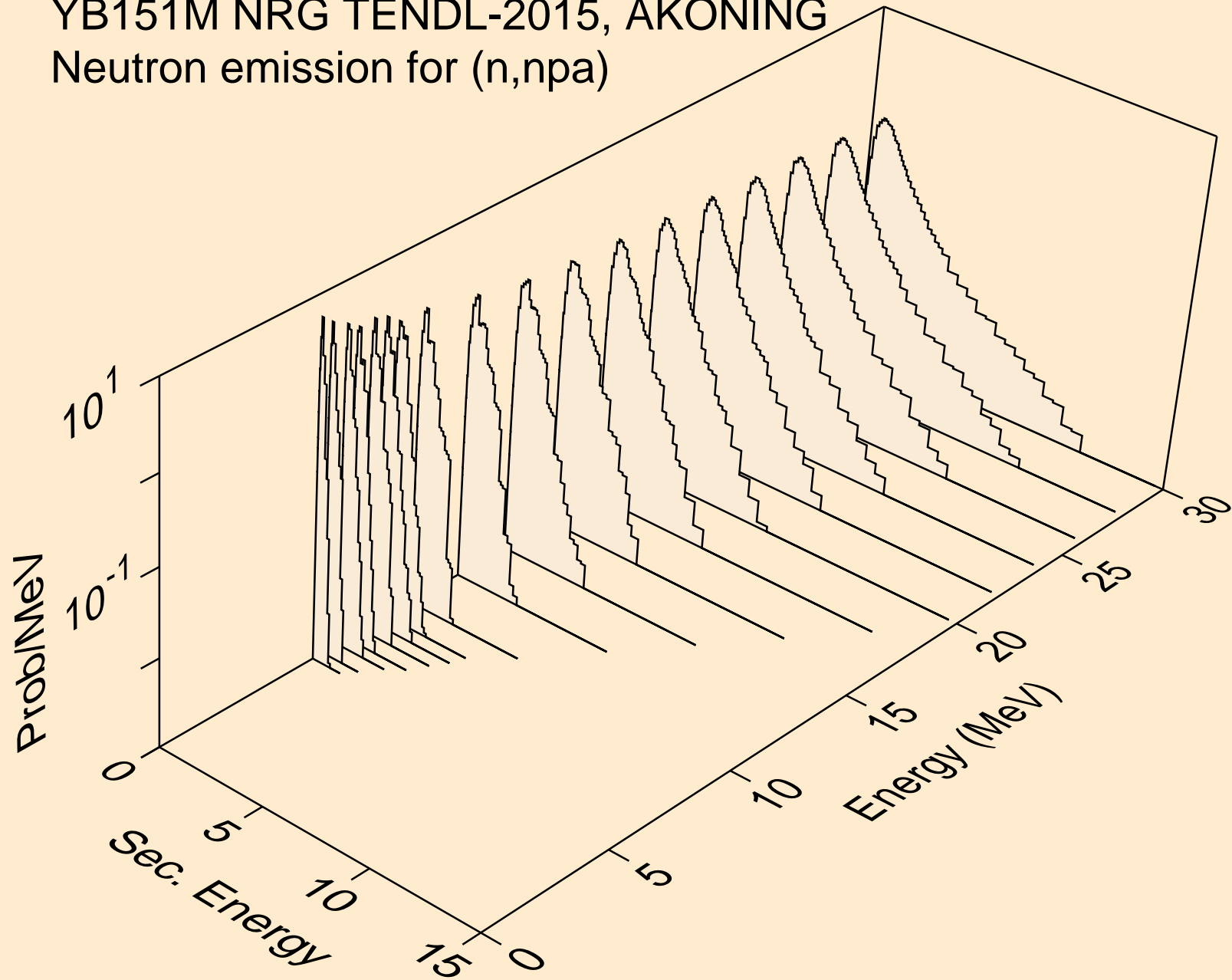

YB151M NRG TENDL-2015, AKONING
Neutron emission for (n,n*c)

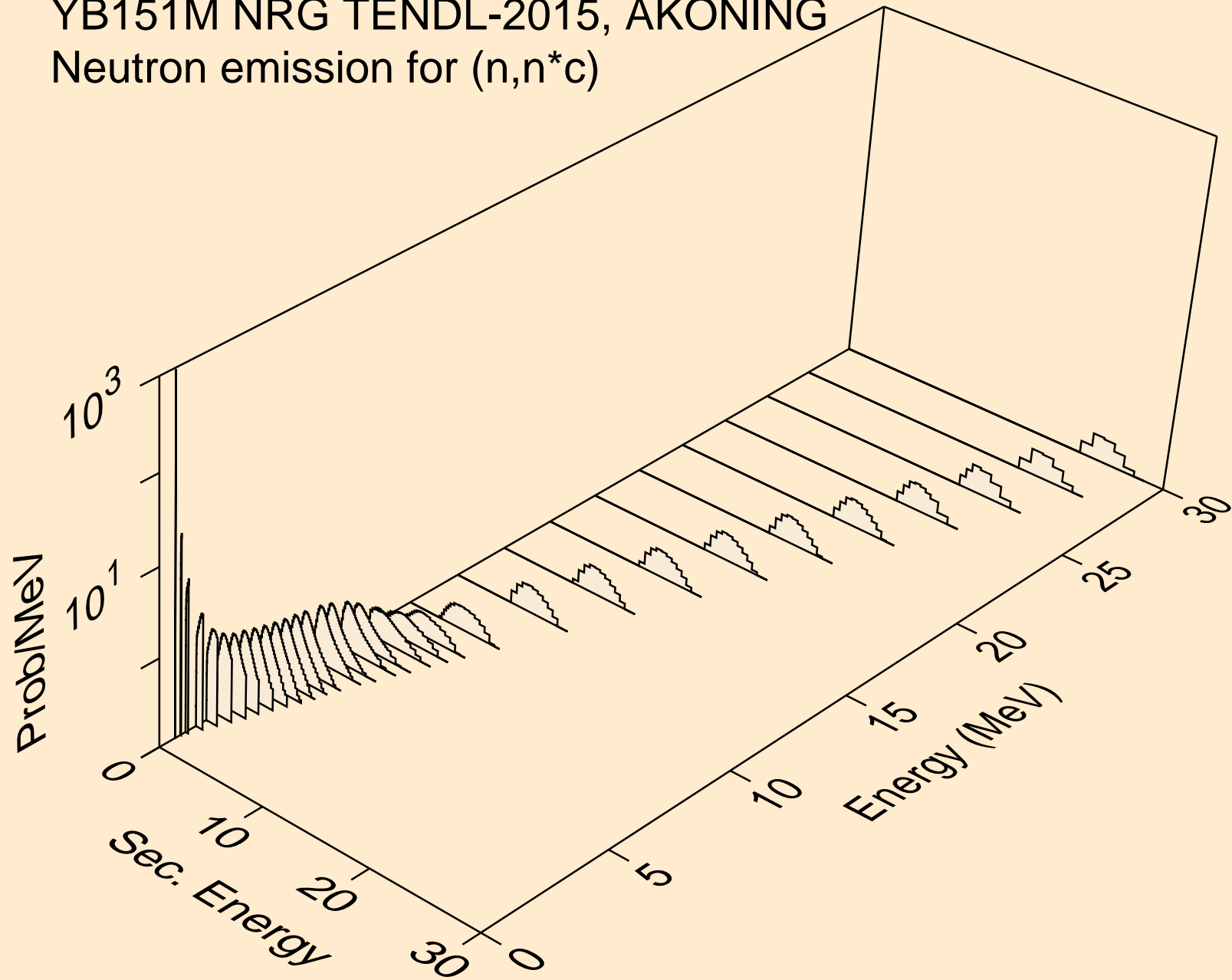

YB151M NRG TENDL-2015, AKONING
Photon emission for (n,x)

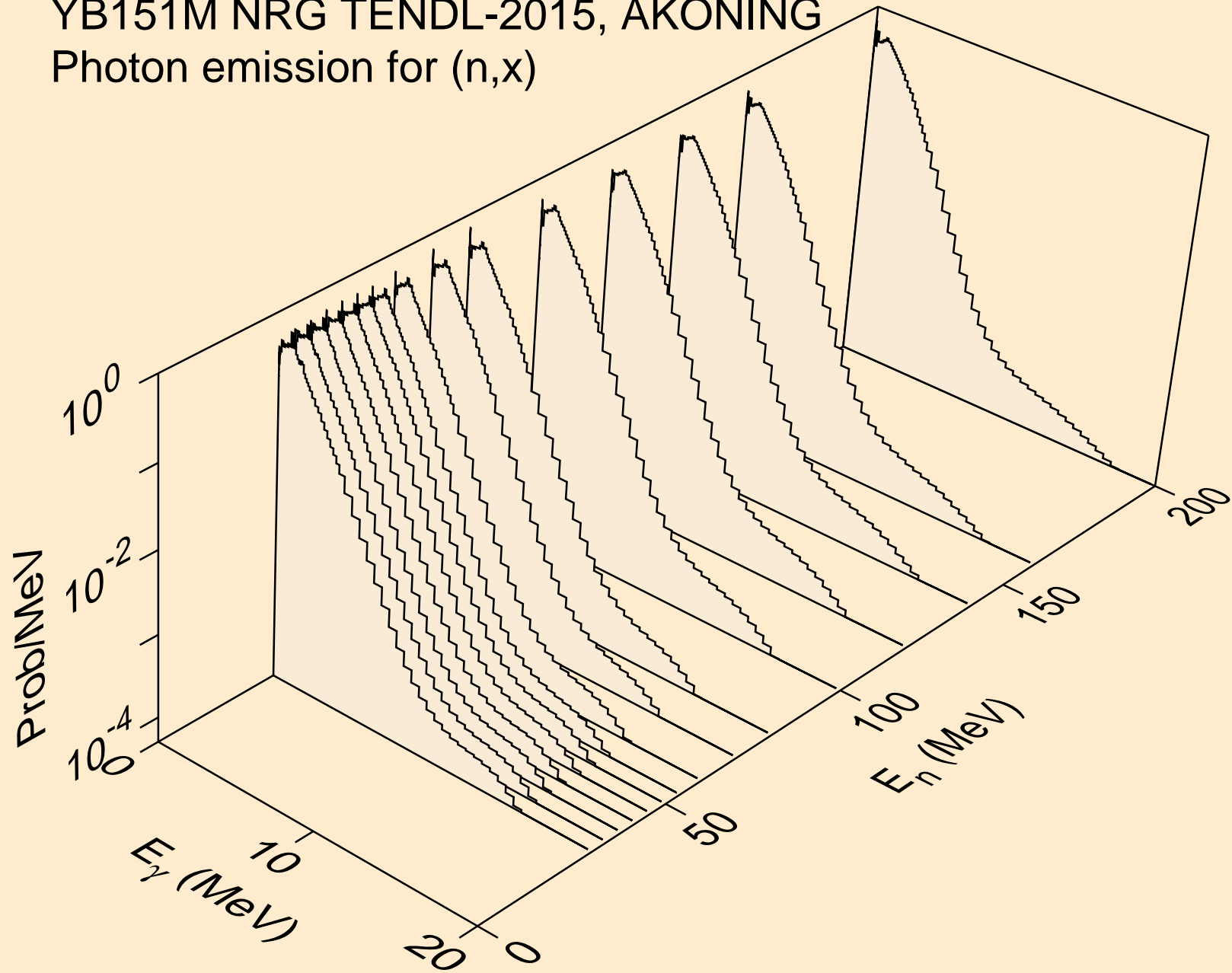

YB151M NRG TENDL-2015, AKONING
Photon emission for (n,2nd)

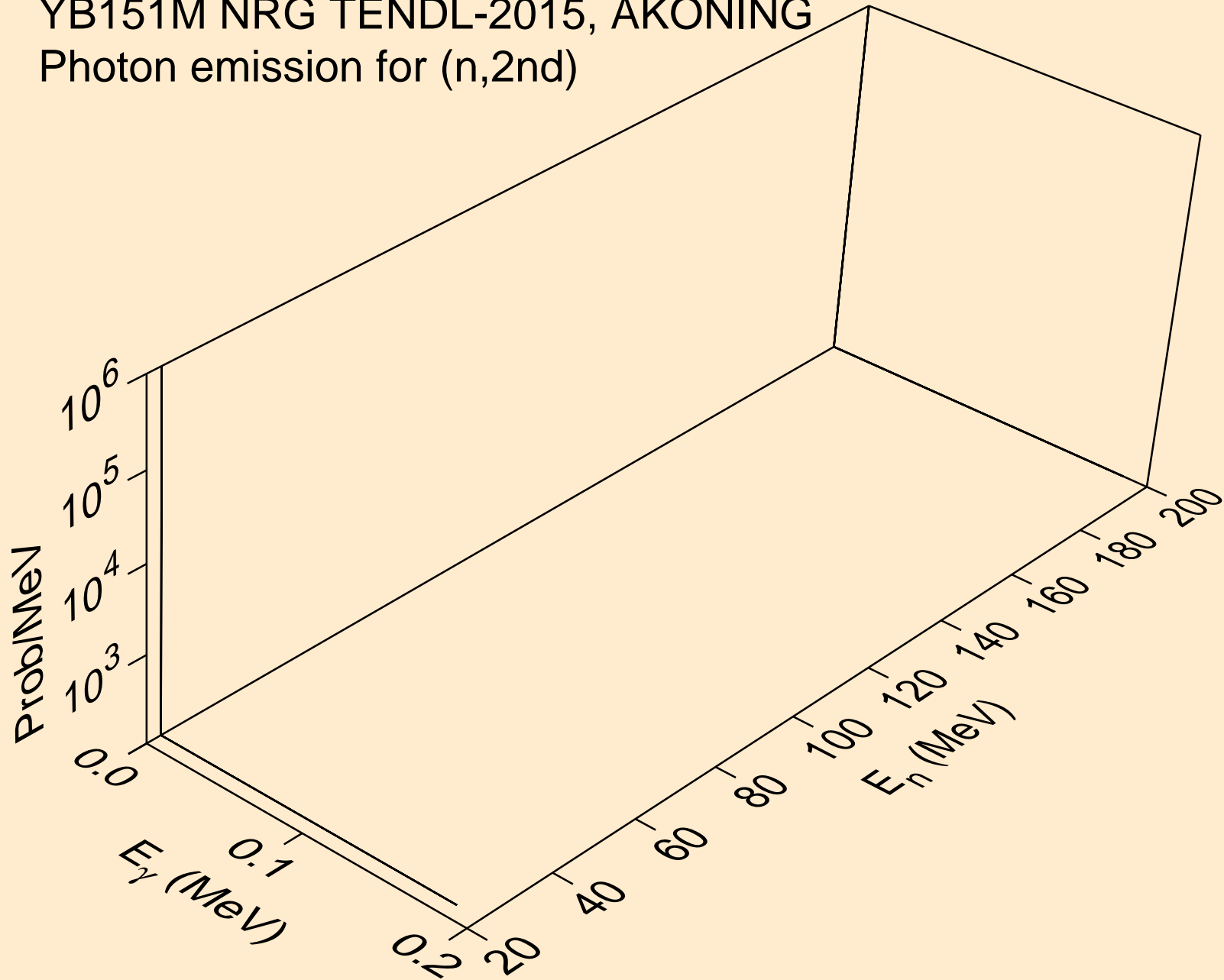

YB151M NRG TENDL-2015, AKONING
Photon emission for (n,2n)

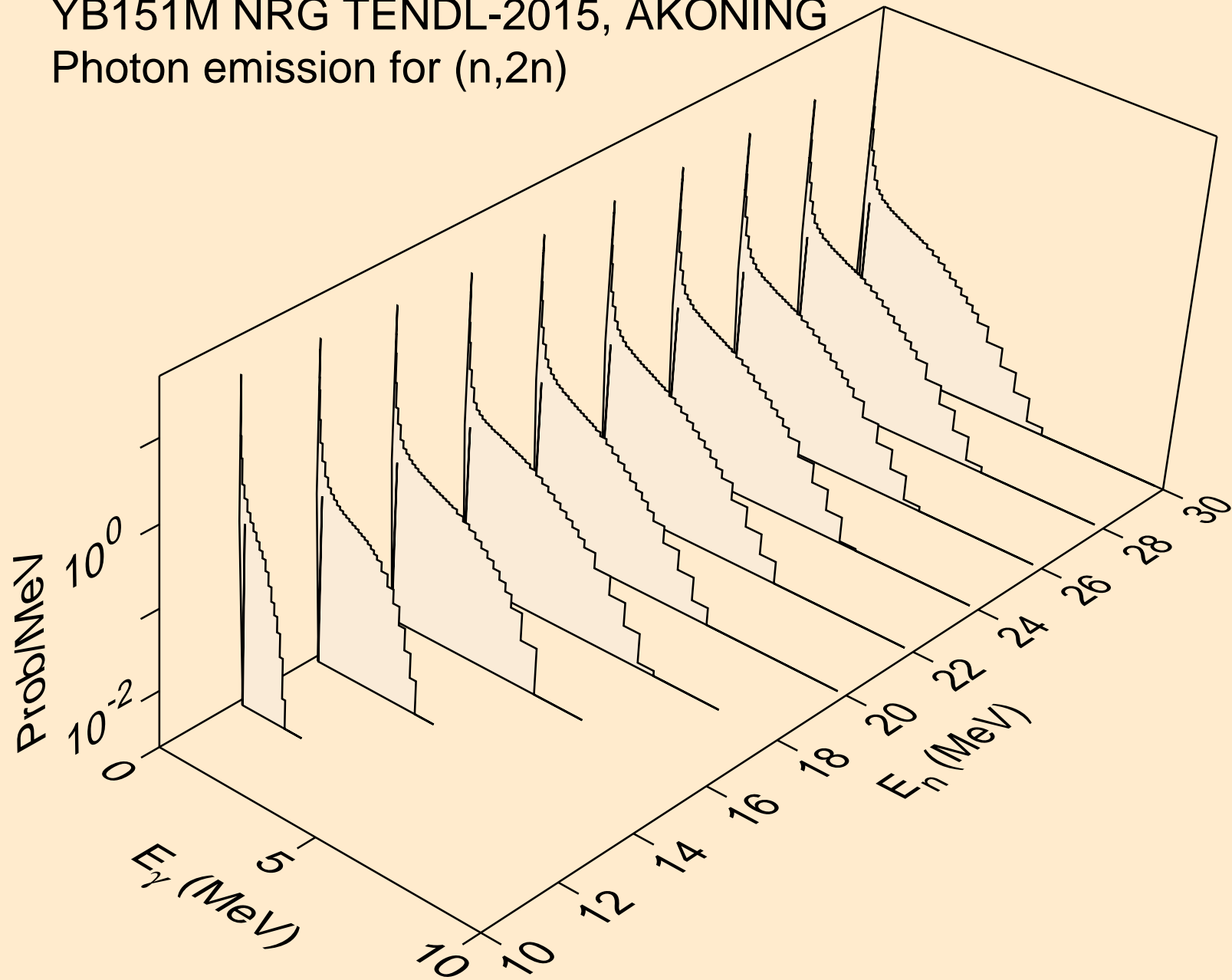

YB151M NRG TENDL-2015, AKONING
Photon emission for (n,3n)

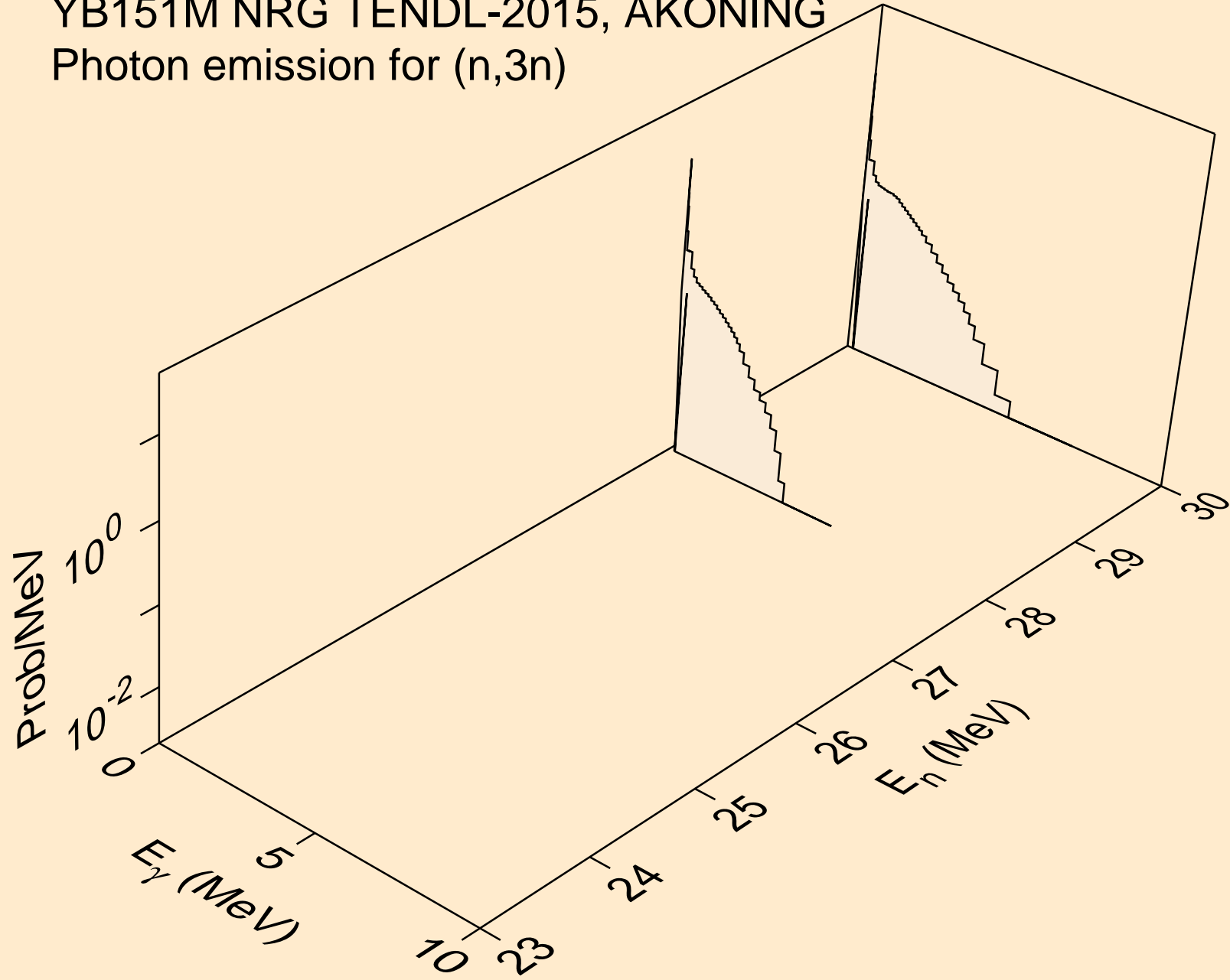

YB151M NRG TENDL-2015, AKONING
Photon emission for (n,n*)a

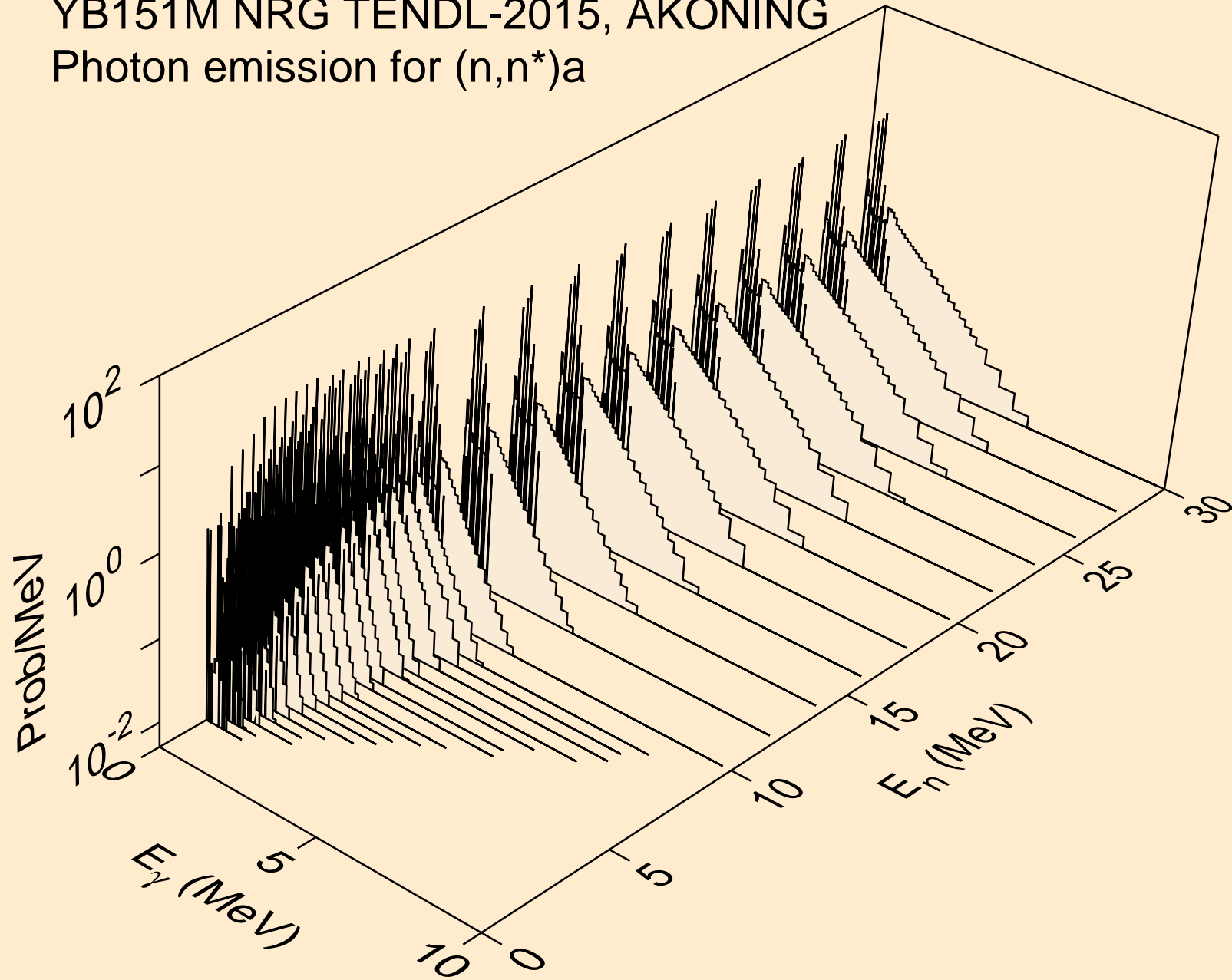

YB151M NRG TENDL-2015, AKONING
Photon emission for (n,n*)3a

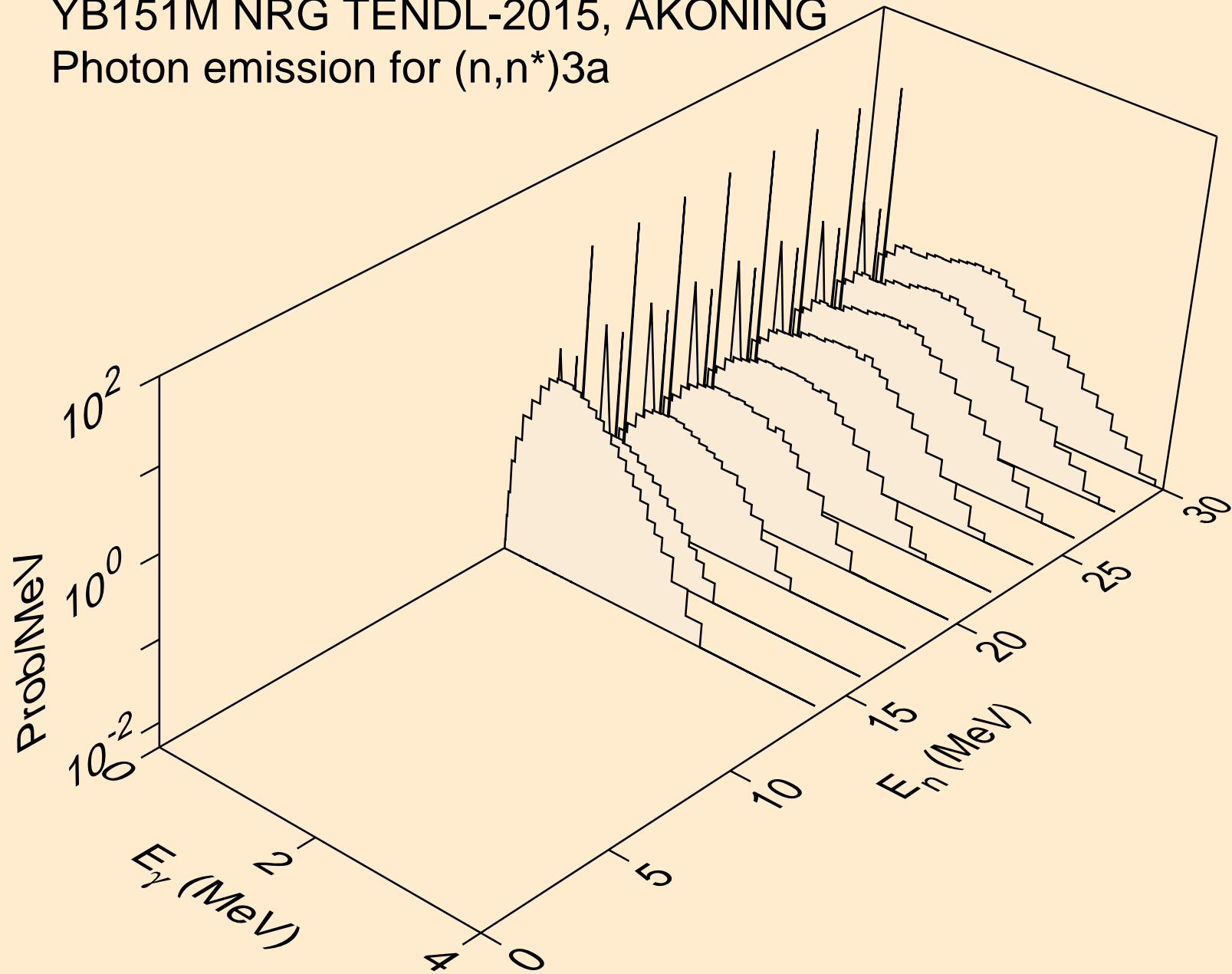

YB151M NRG TENDL-2015, AKONING
Photon emission for (n,2n)a

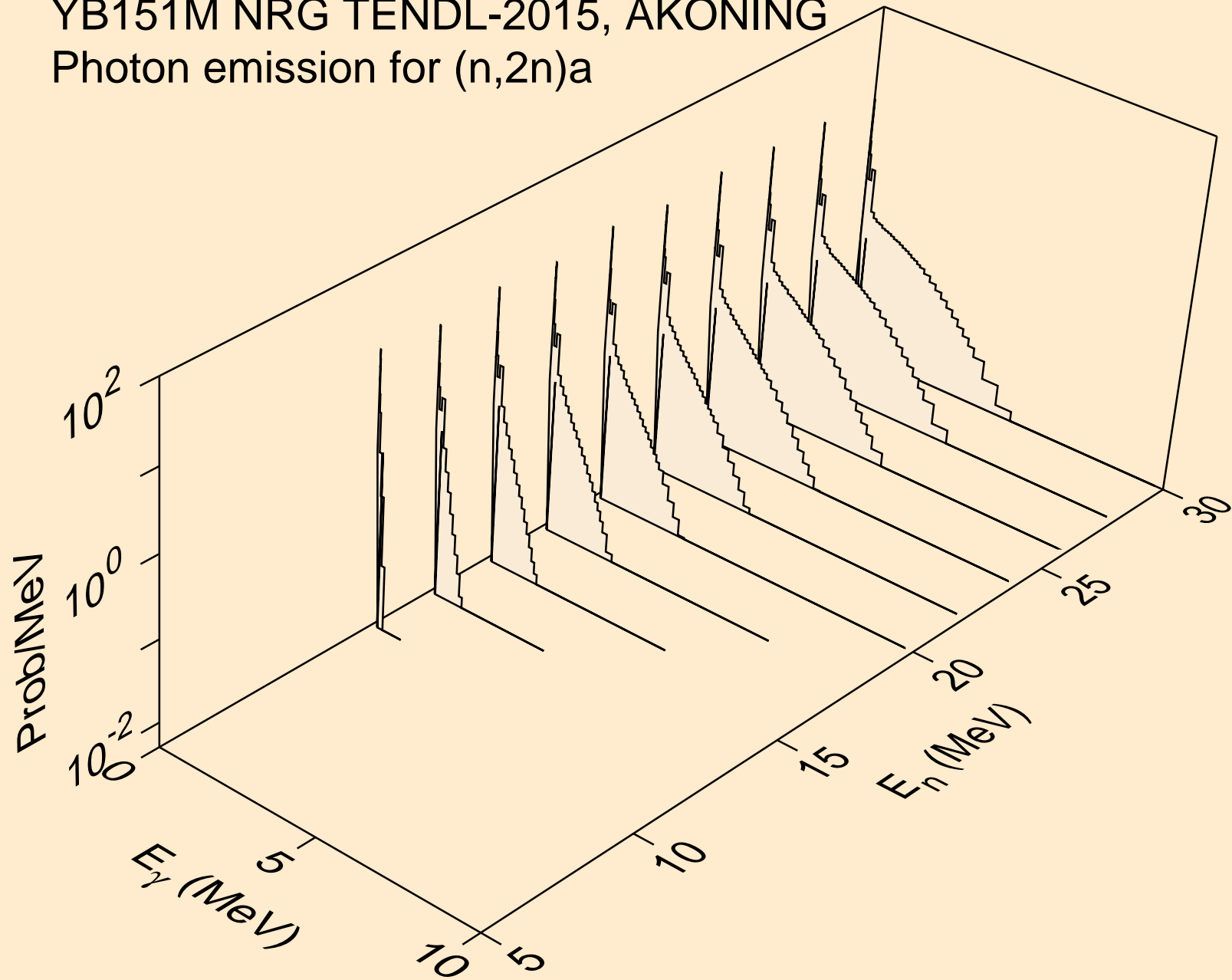

YB151M NRG TENDL-2015, AKONING
Photon emission for (n,3n)a

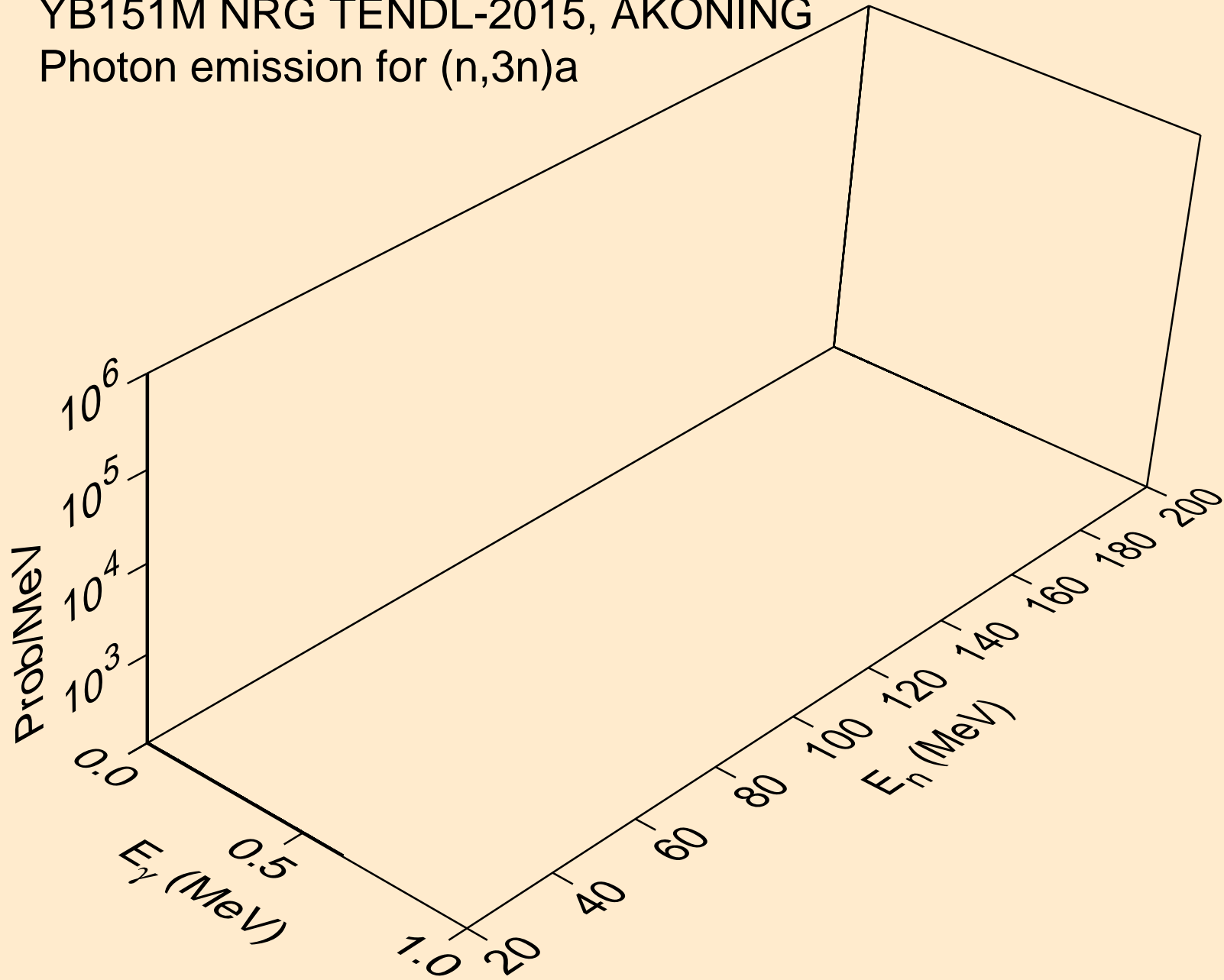

YB151M NRG TENDL-2015, AKONING
Photon emission for (n,n*)p

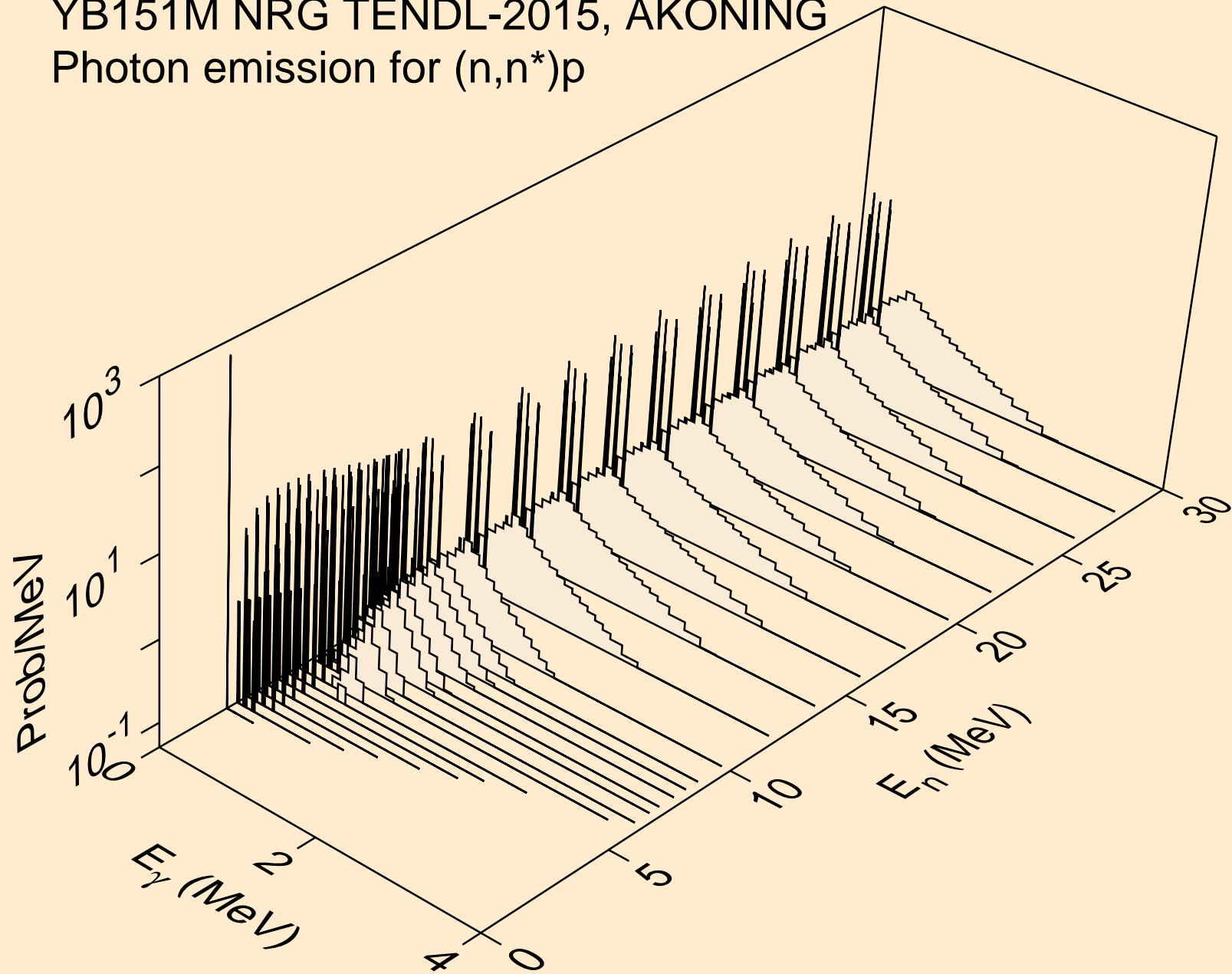

YB151M NRG TENDL-2015, AKONING
Photon emission for (n,n*)2a

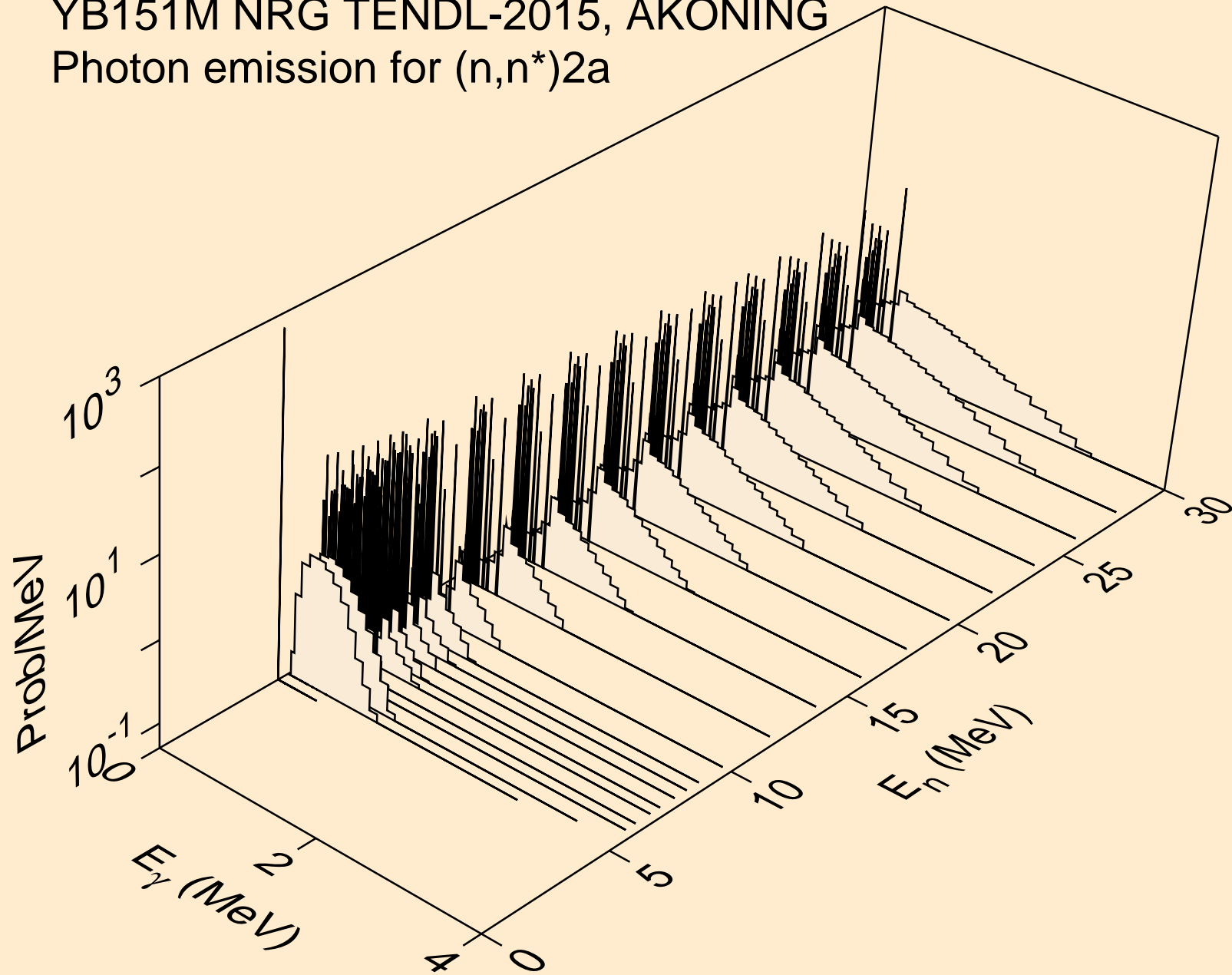

YB151M NRG TENDL-2015, AKONING
Photon emission for (n,2n)2a

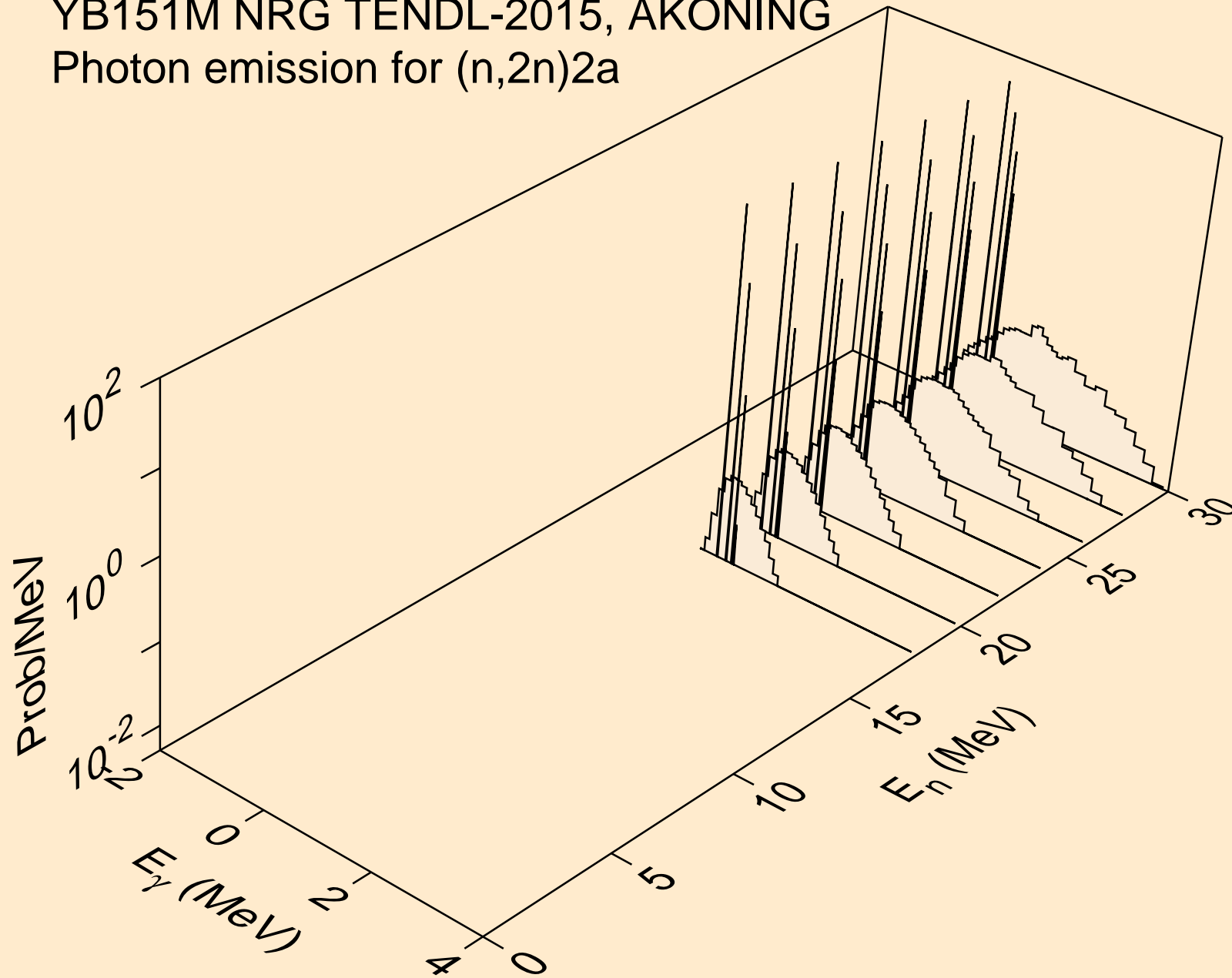

YB151M NRG TENDL-2015, AKONING
Photon emission for (n,n*)d

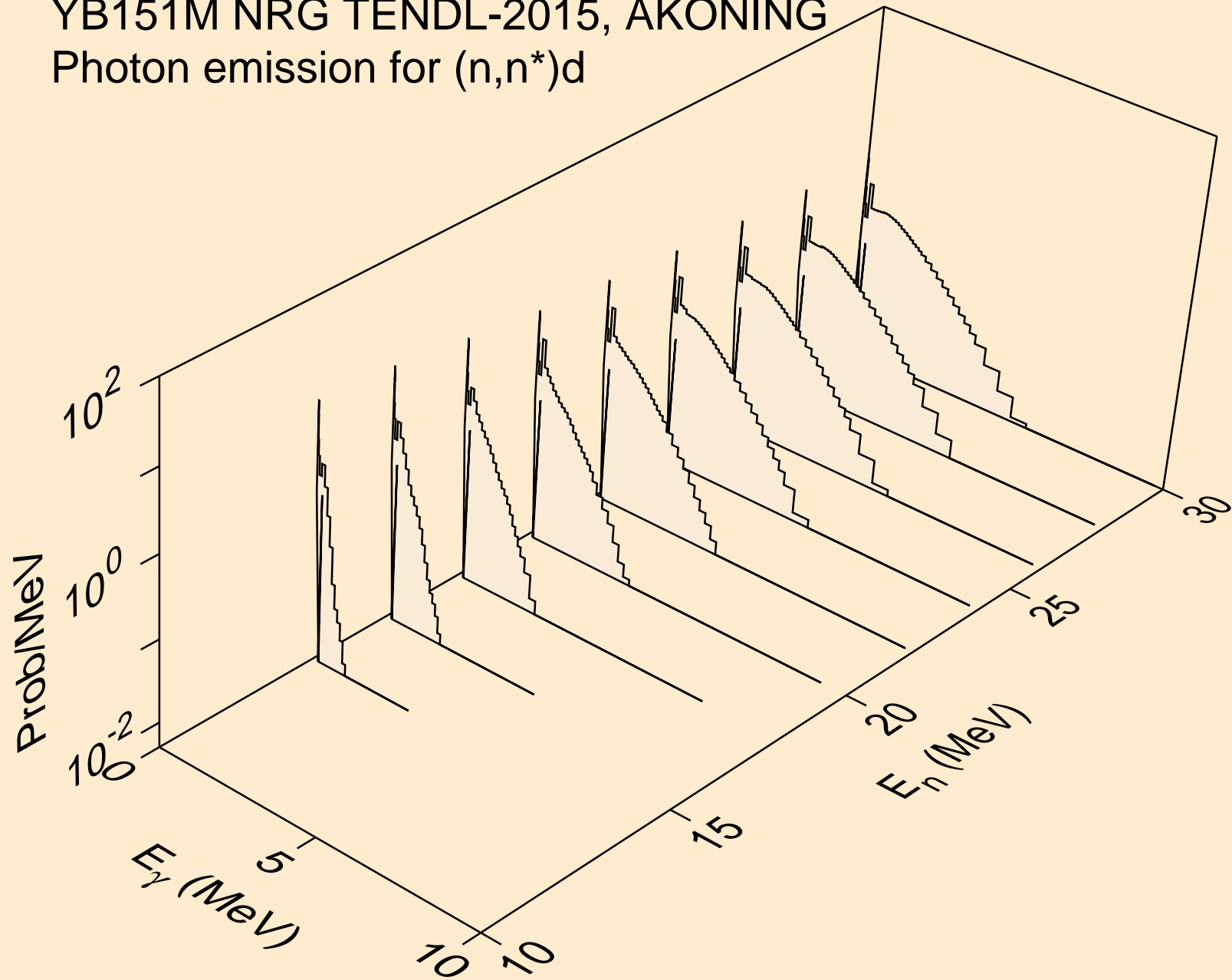

YB151M NRG TENDL-2015, AKONING
Photon emission for (n,n*)t

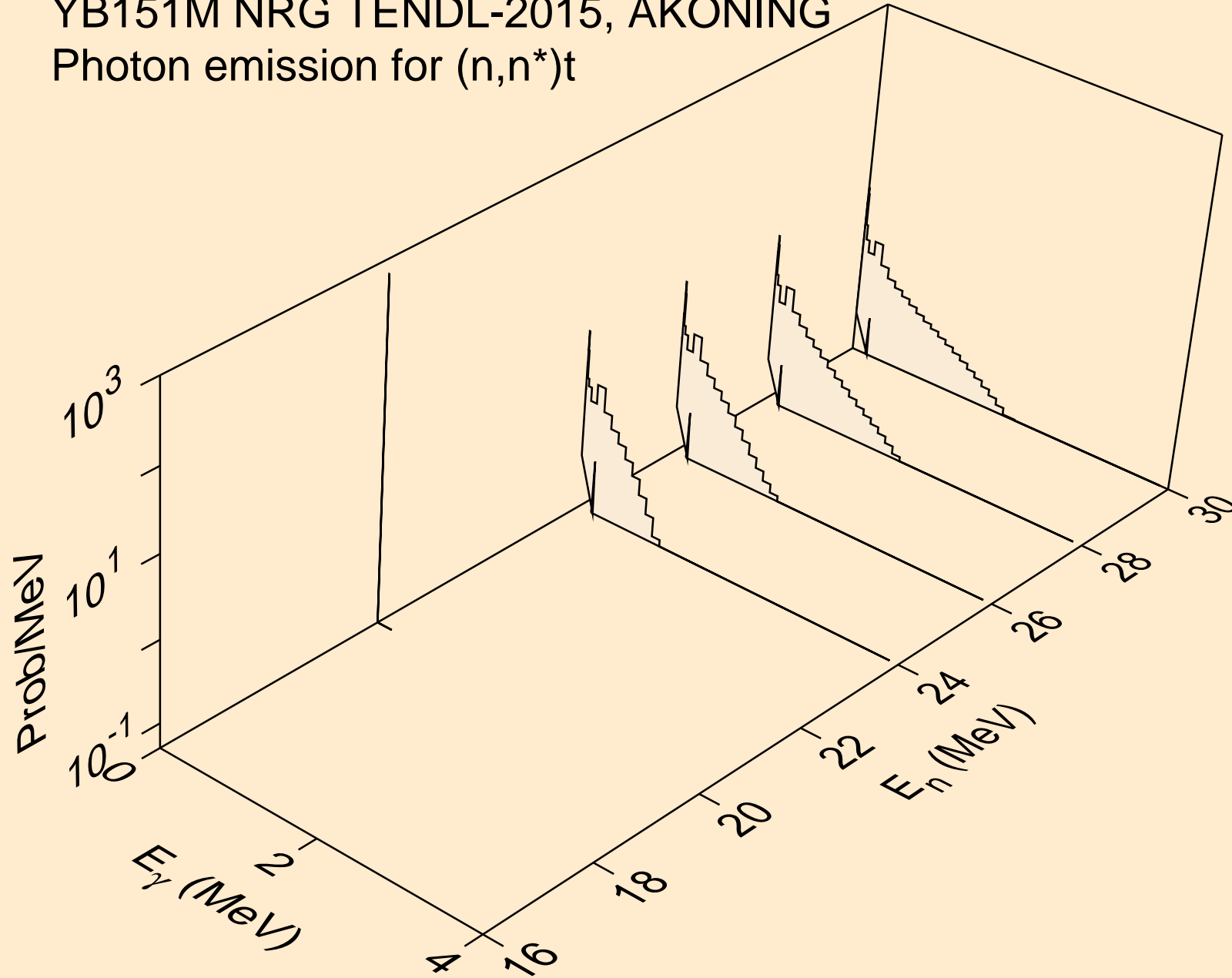

YB151M NRG TENDL-2015, AKONING
Photon emission for (n,n*)he3

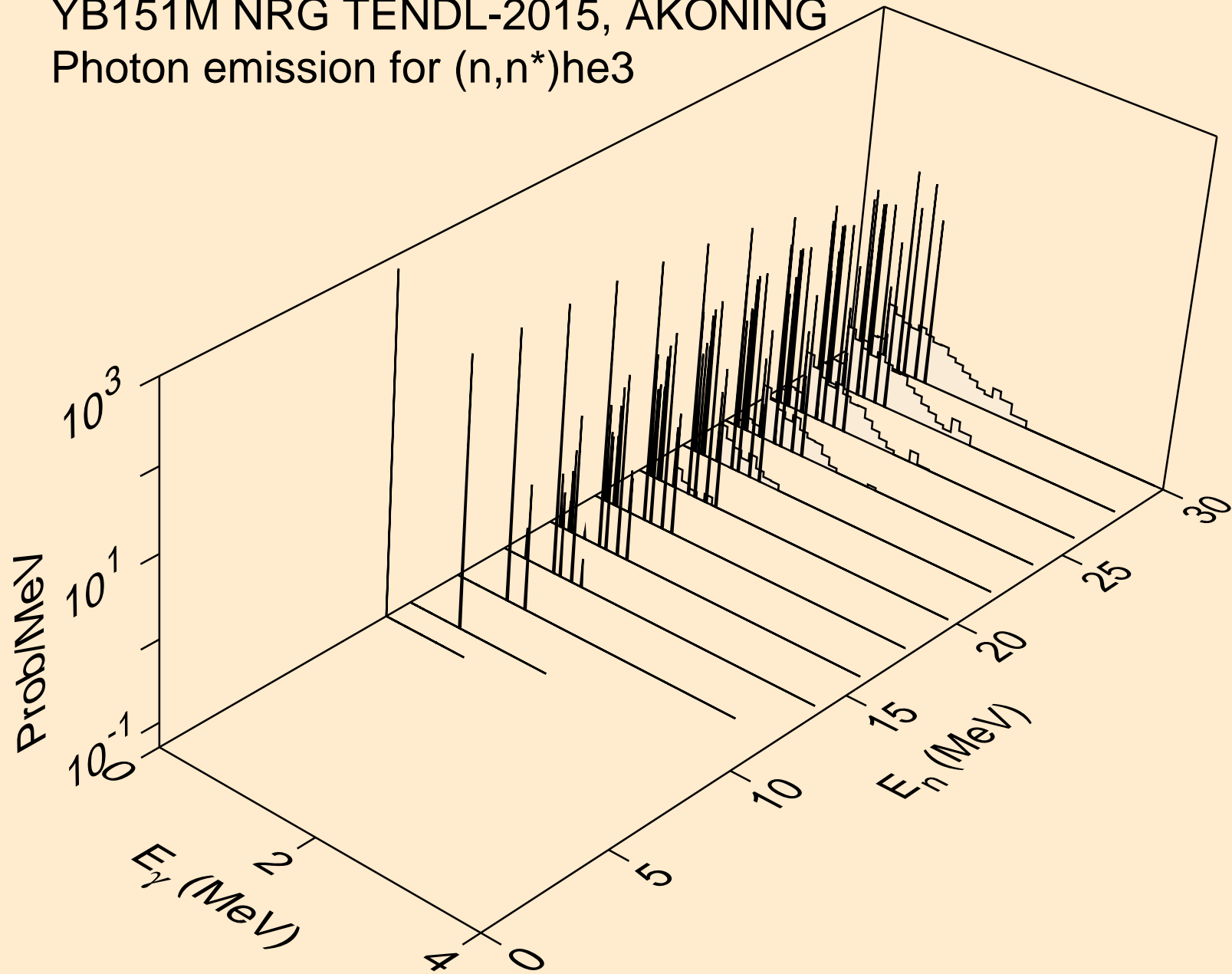

YB151M NRG TENDL-2015, AKONING
Photon emission for (n,2np)

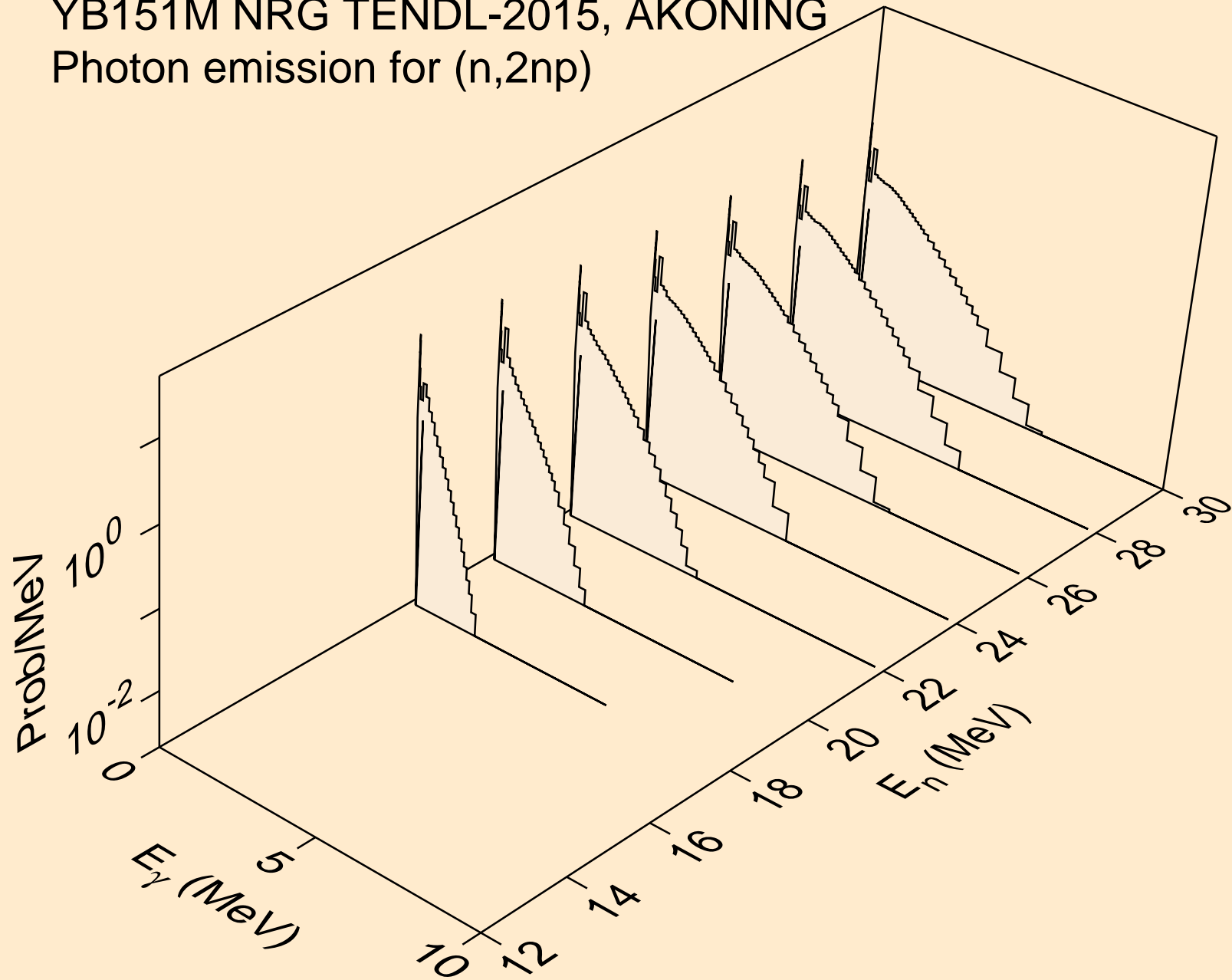

YB151M NRG TENDL-2015, AKONING
Photon emission for (n,3np)

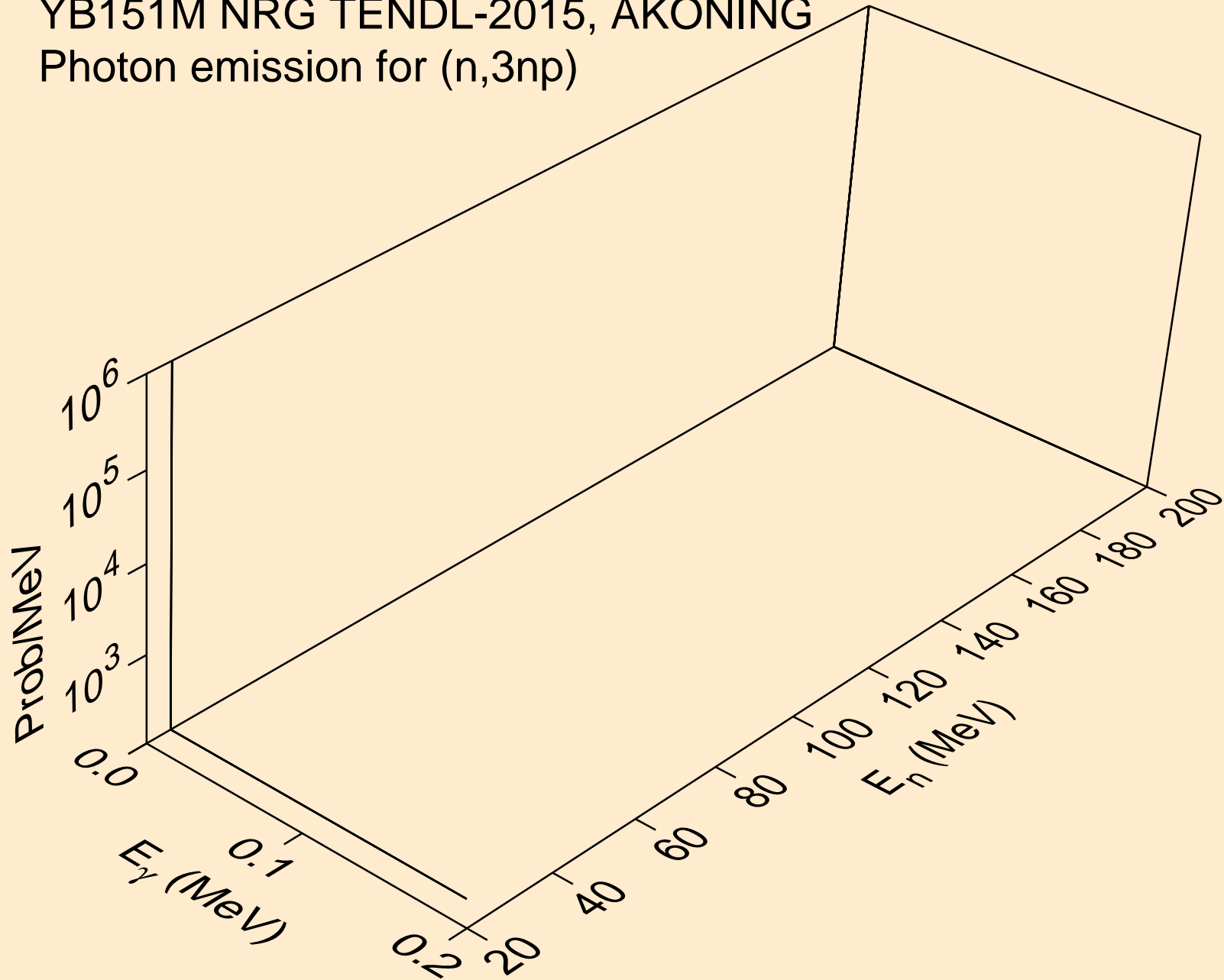

YB151M NRG TENDL-2015, AKONING
Photon emission for (n,2np)

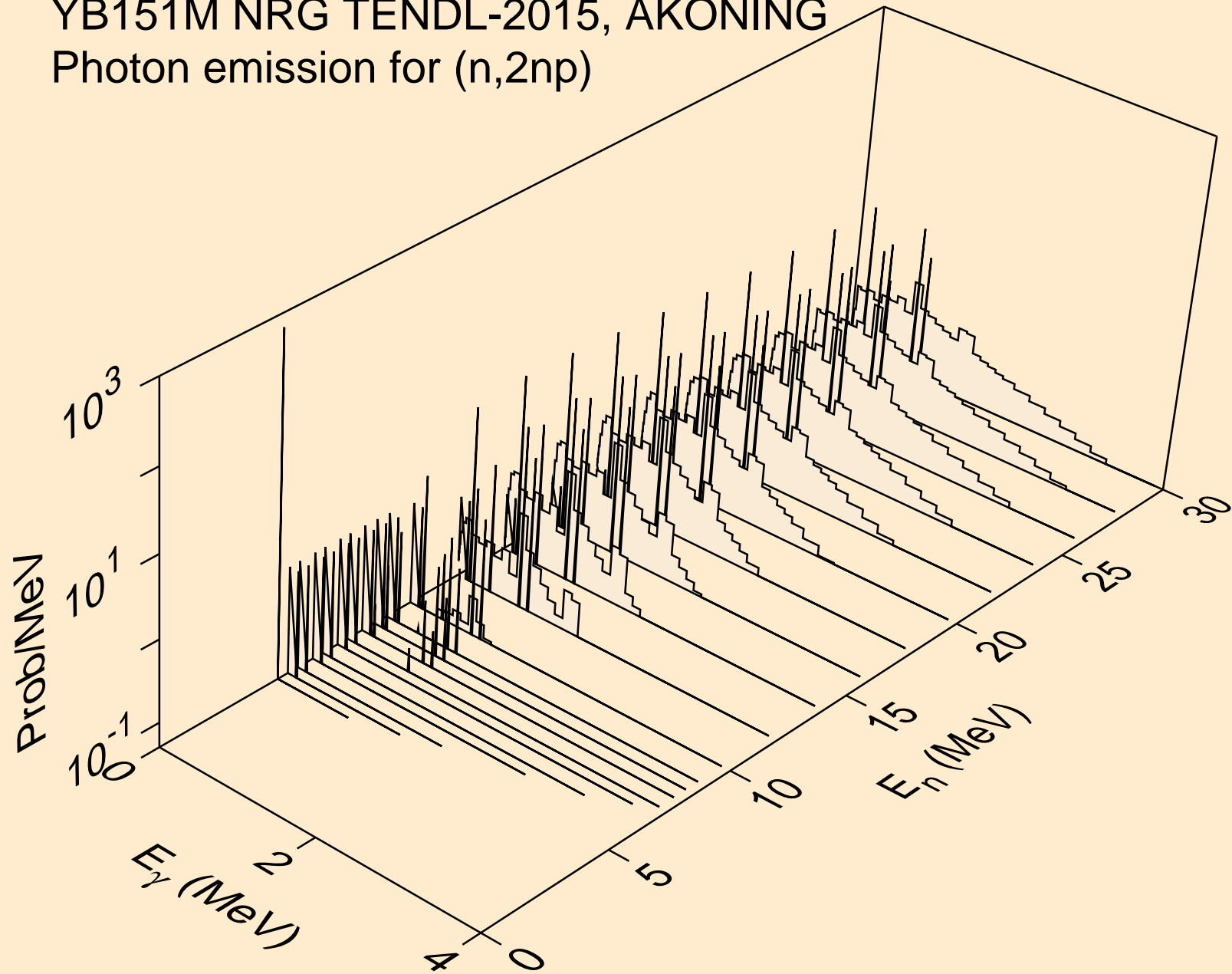

YB151M NRG TENDL-2015, AKONING
Photon emission for (n,npa)

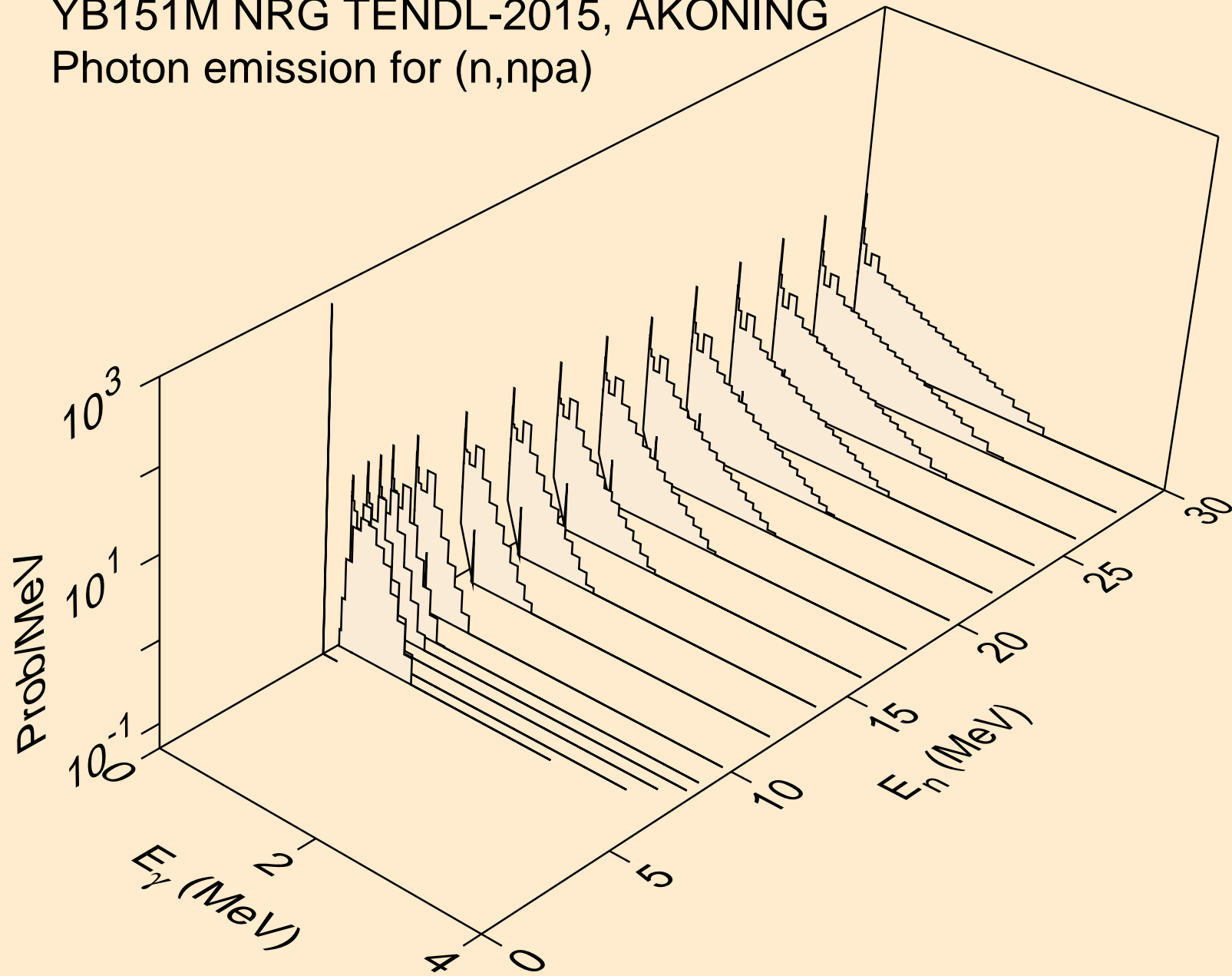

YB151M NRG TENDL-2015, AKONING
Photon emission for (n,n*2)

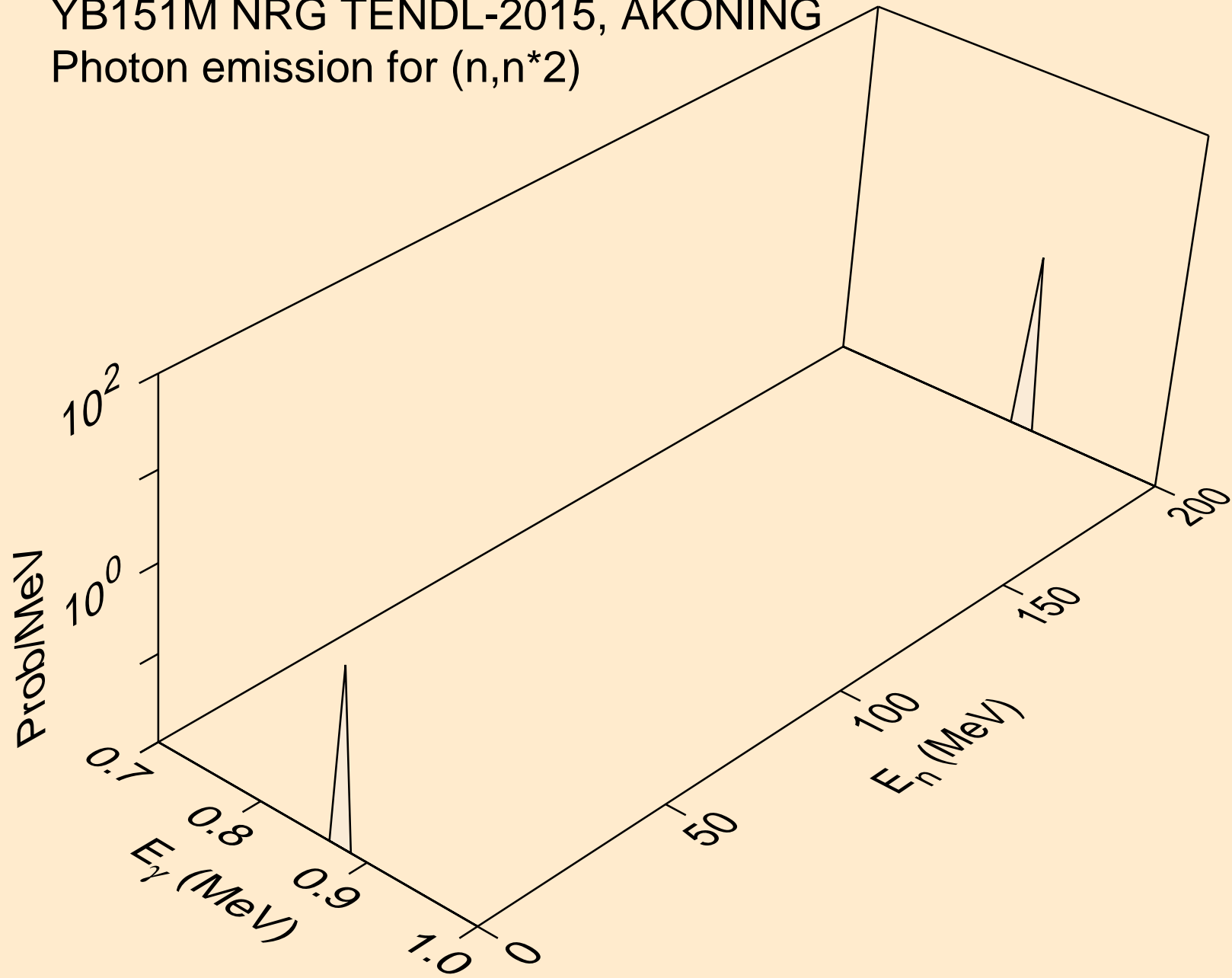

YB151M NRG TENDL-2015, AKONING
Photon emission for (n,n*3)

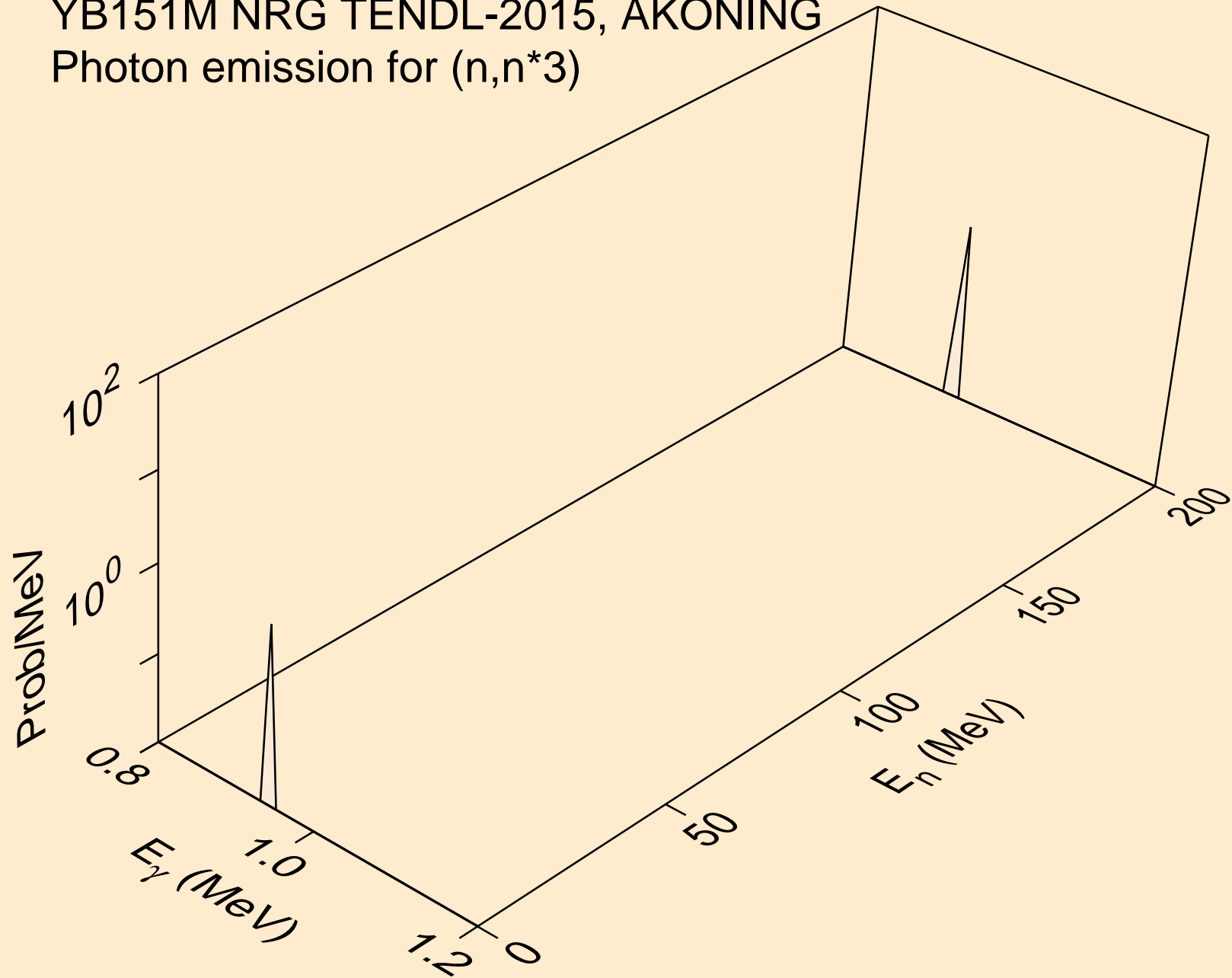

YB151M NRG TENDL-2015, AKONING
Photon emission for (n,n*4)

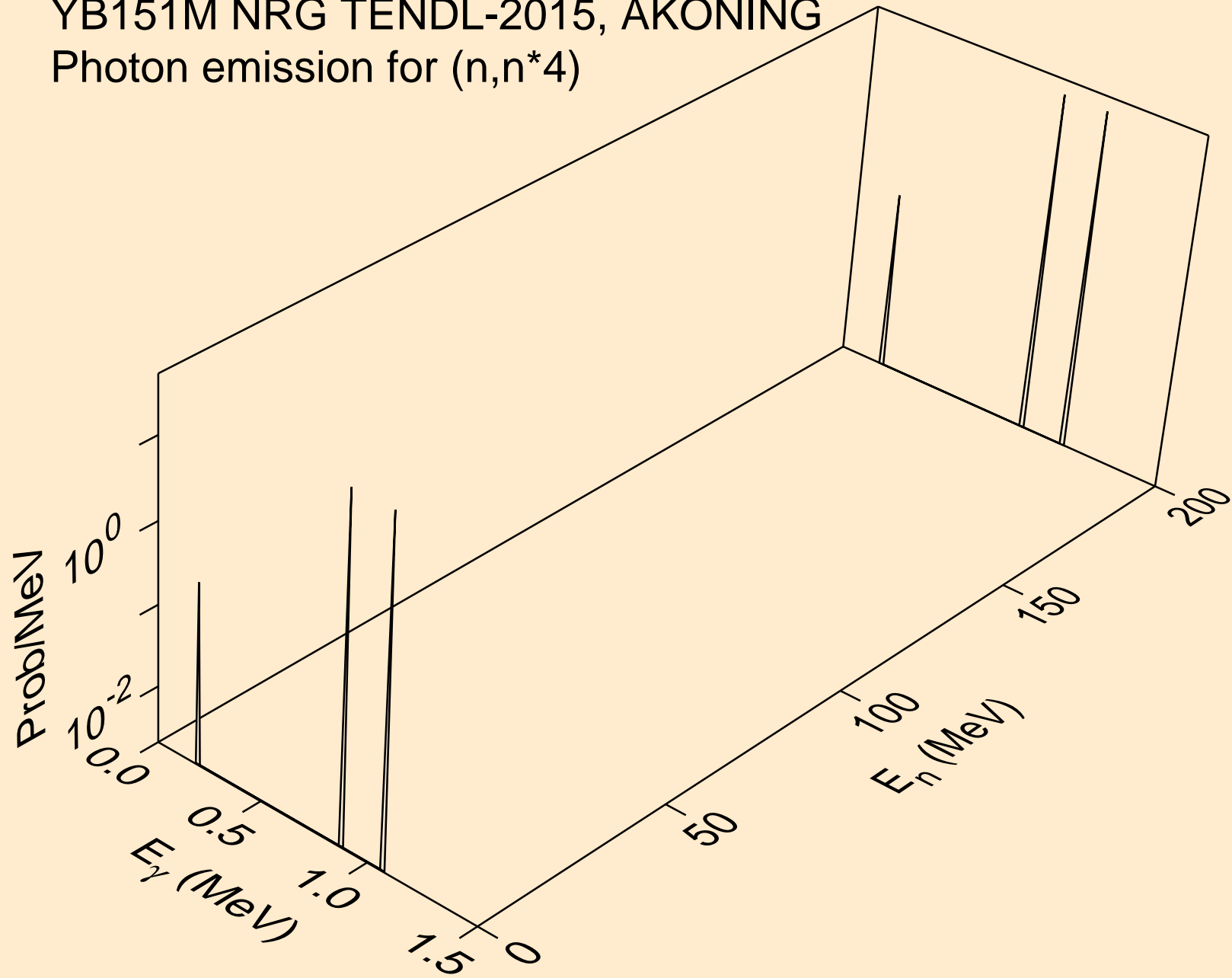

YB151M NRG TENDL-2015, AKONING
Photon emission for (n,n*5)

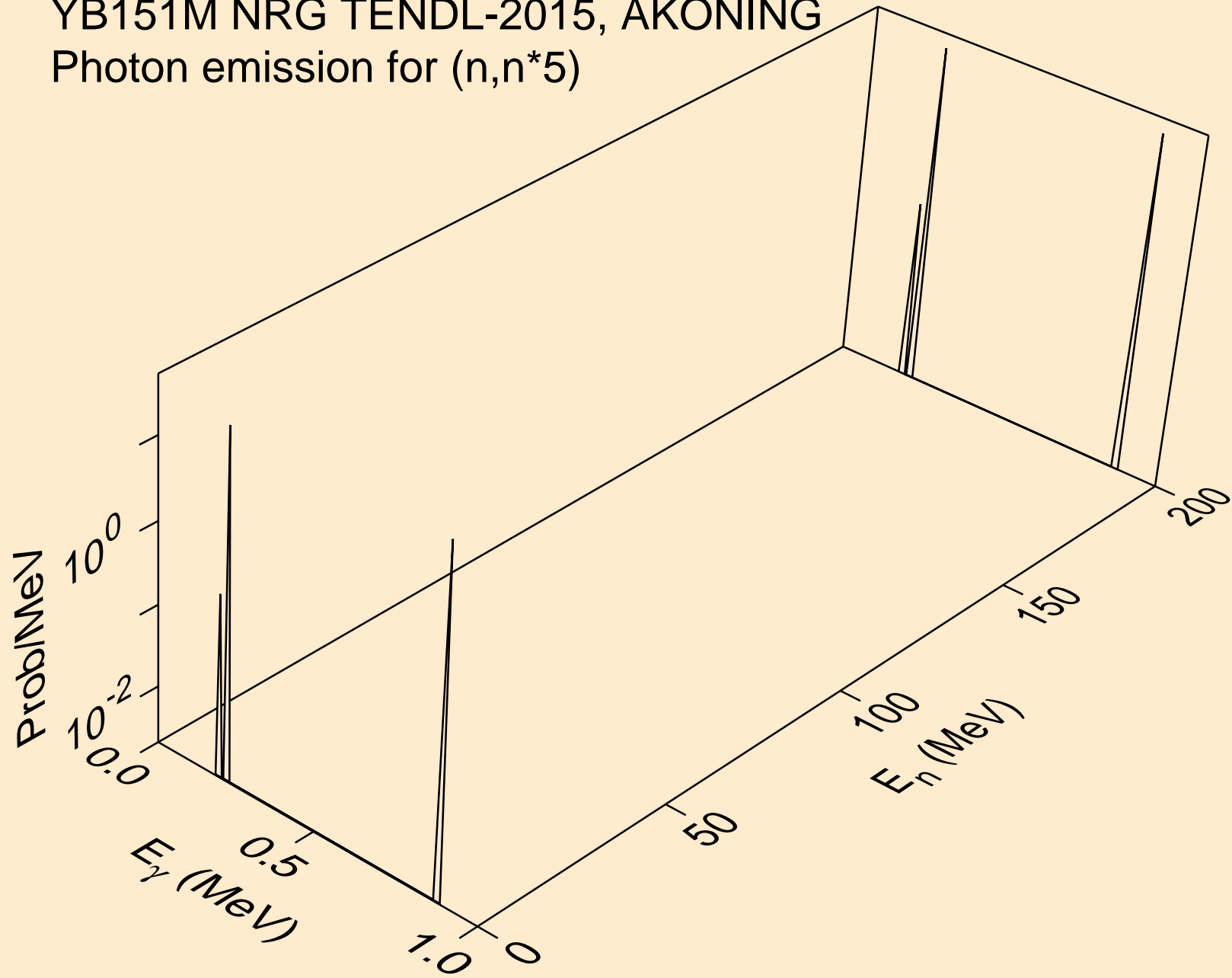

YB151M NRG TENDL-2015, AKONING
Photon emission for (n,n*6)

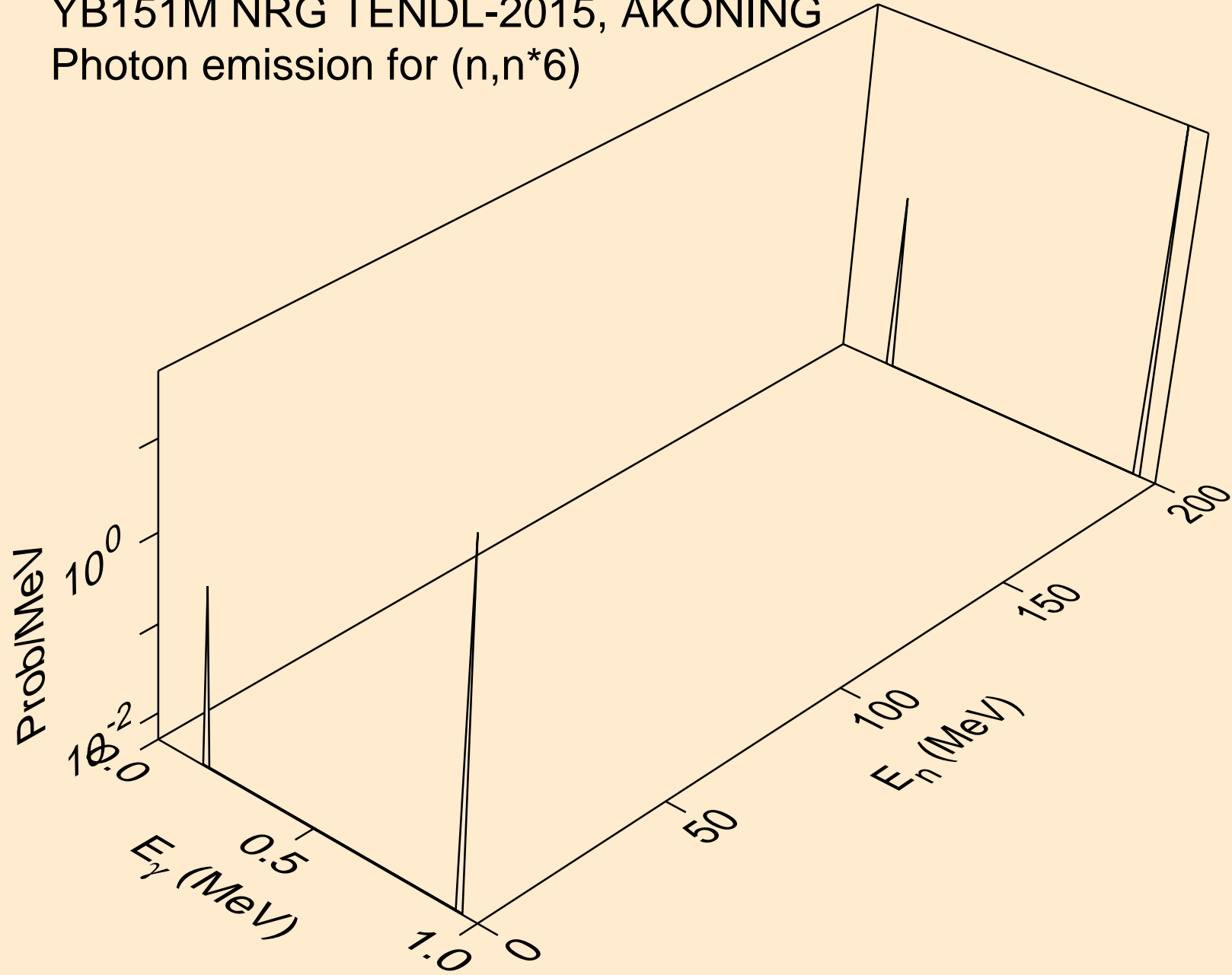

YB151M NRG TENDL-2015, AKONING
Photon emission for (n,n*7)

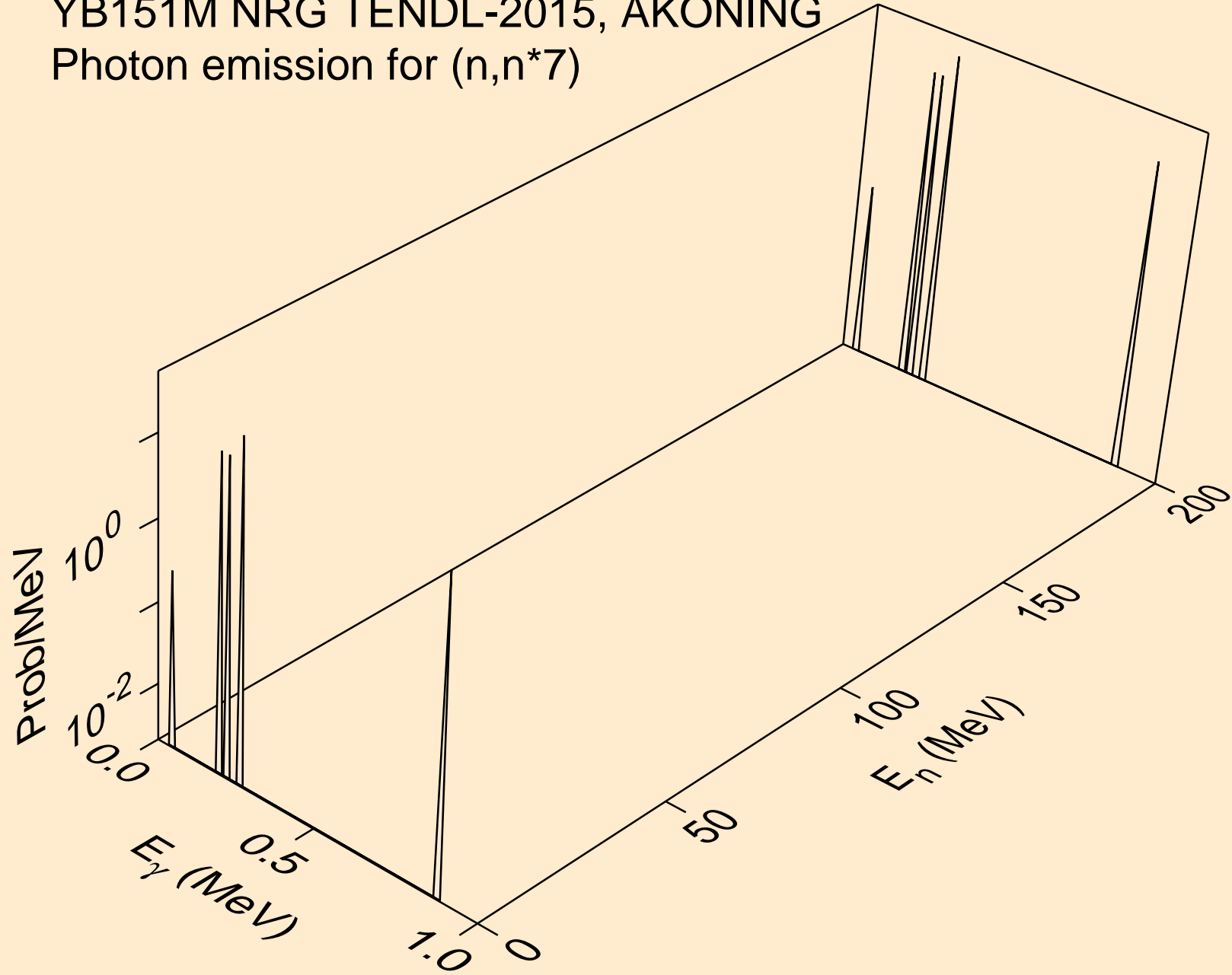

YB151M NRG TENDL-2015, AKONING
Photon emission for (n,n*c)

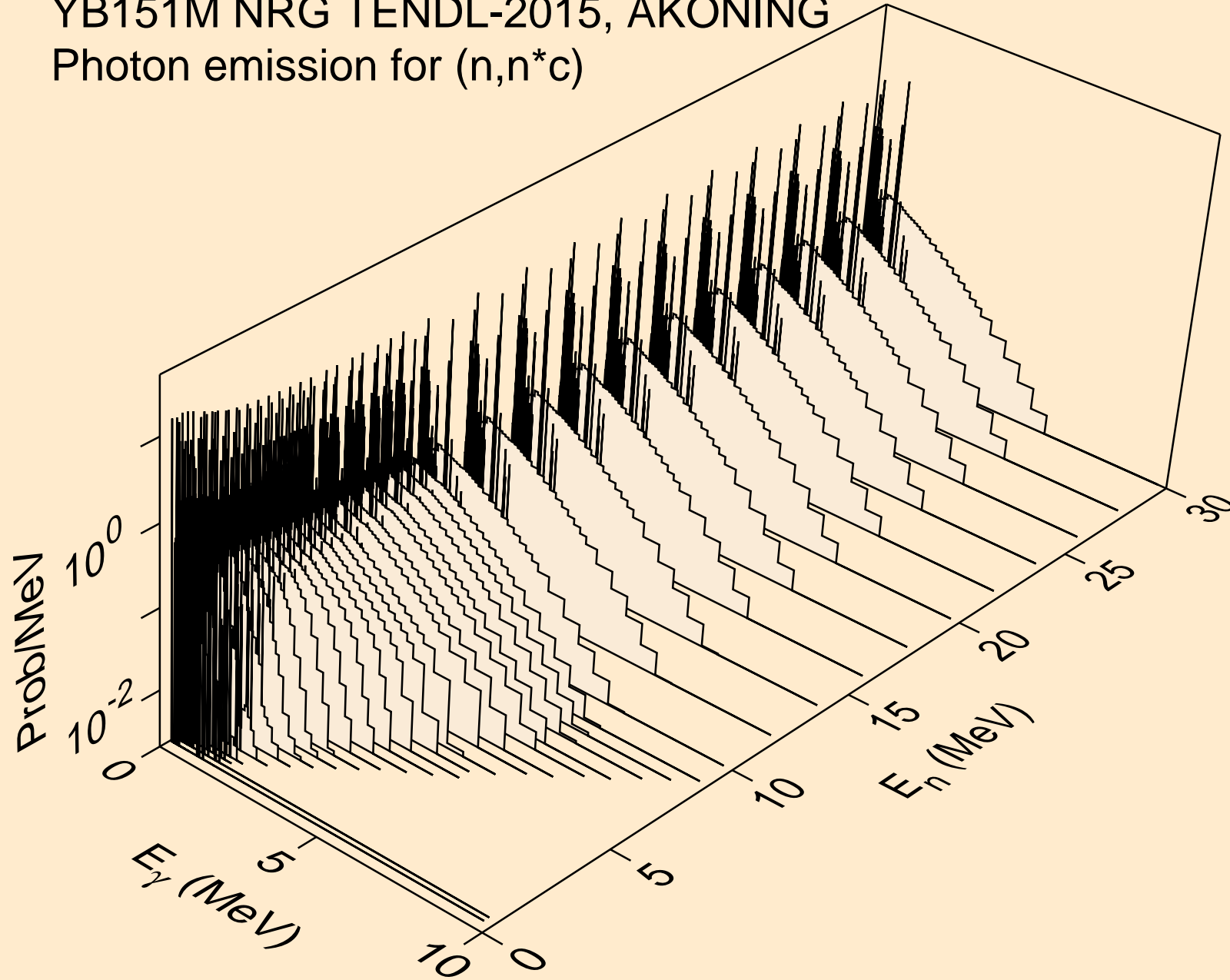

YB151M NRG TENDL-2015, AKONING
Photon emission for (n,gma)

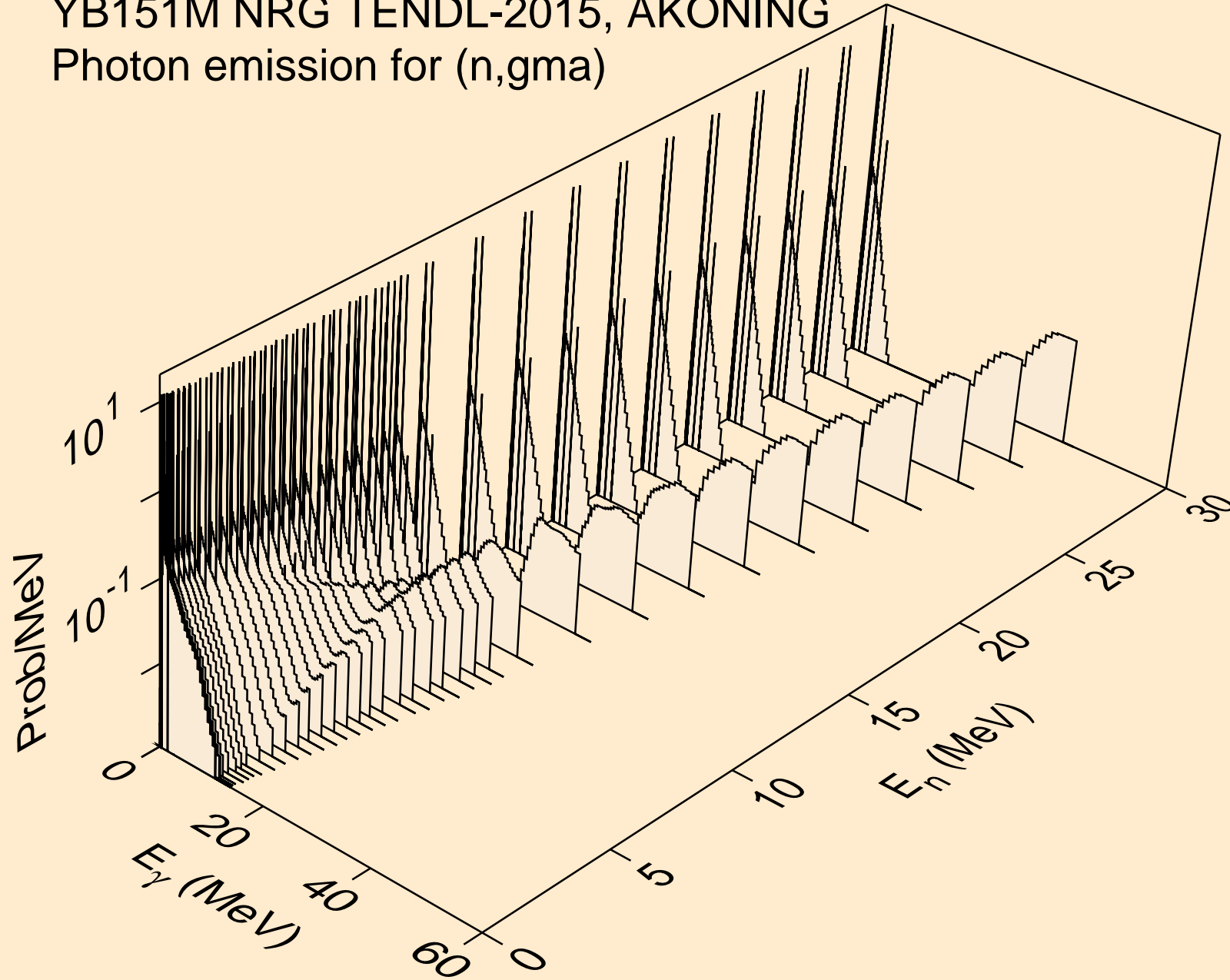

YB151M NRG TENDL-2015, AKONING
Photon emission for (n,p)

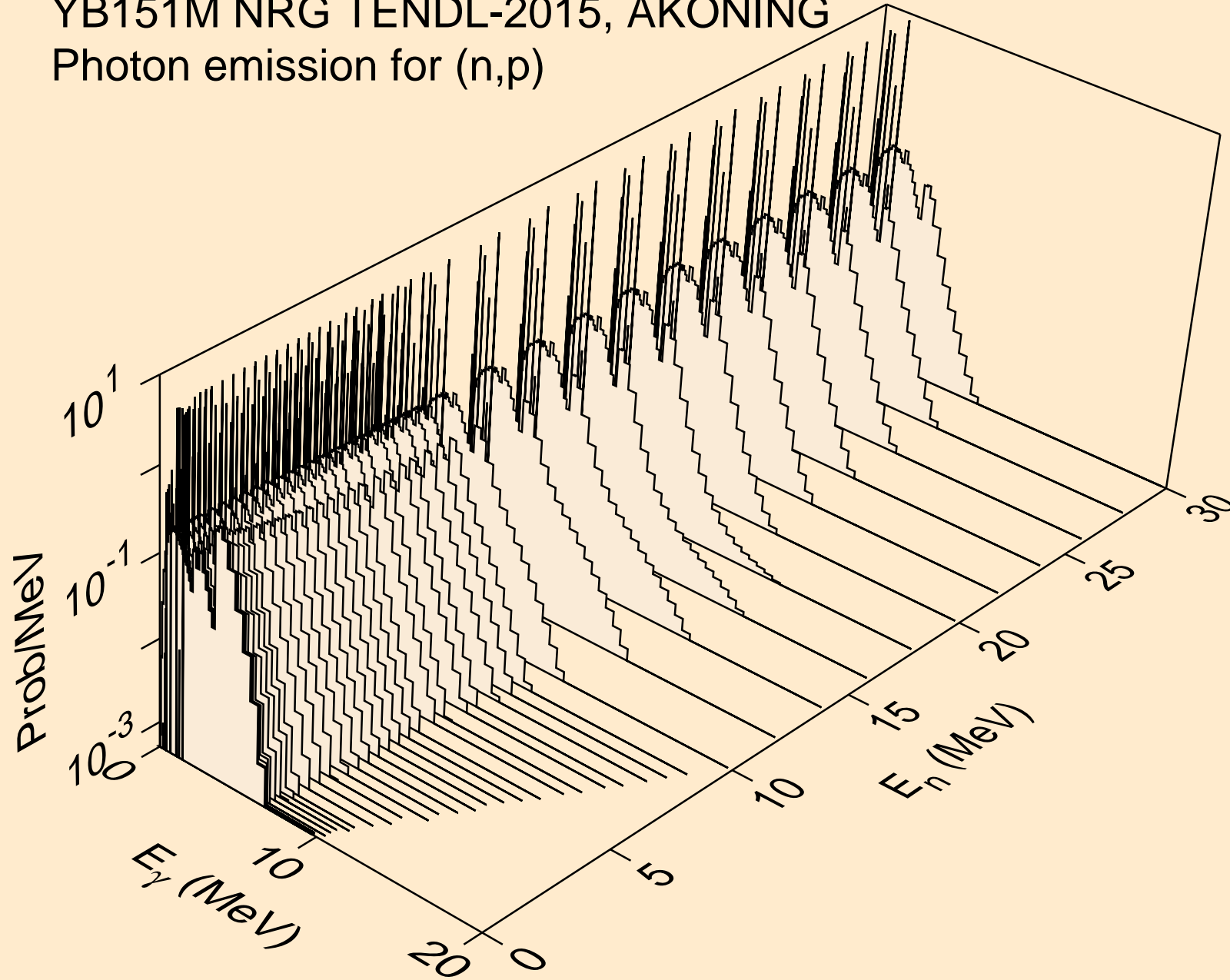

YB151M NRG TENDL-2015, AKONING
Photon emission for (n,d)

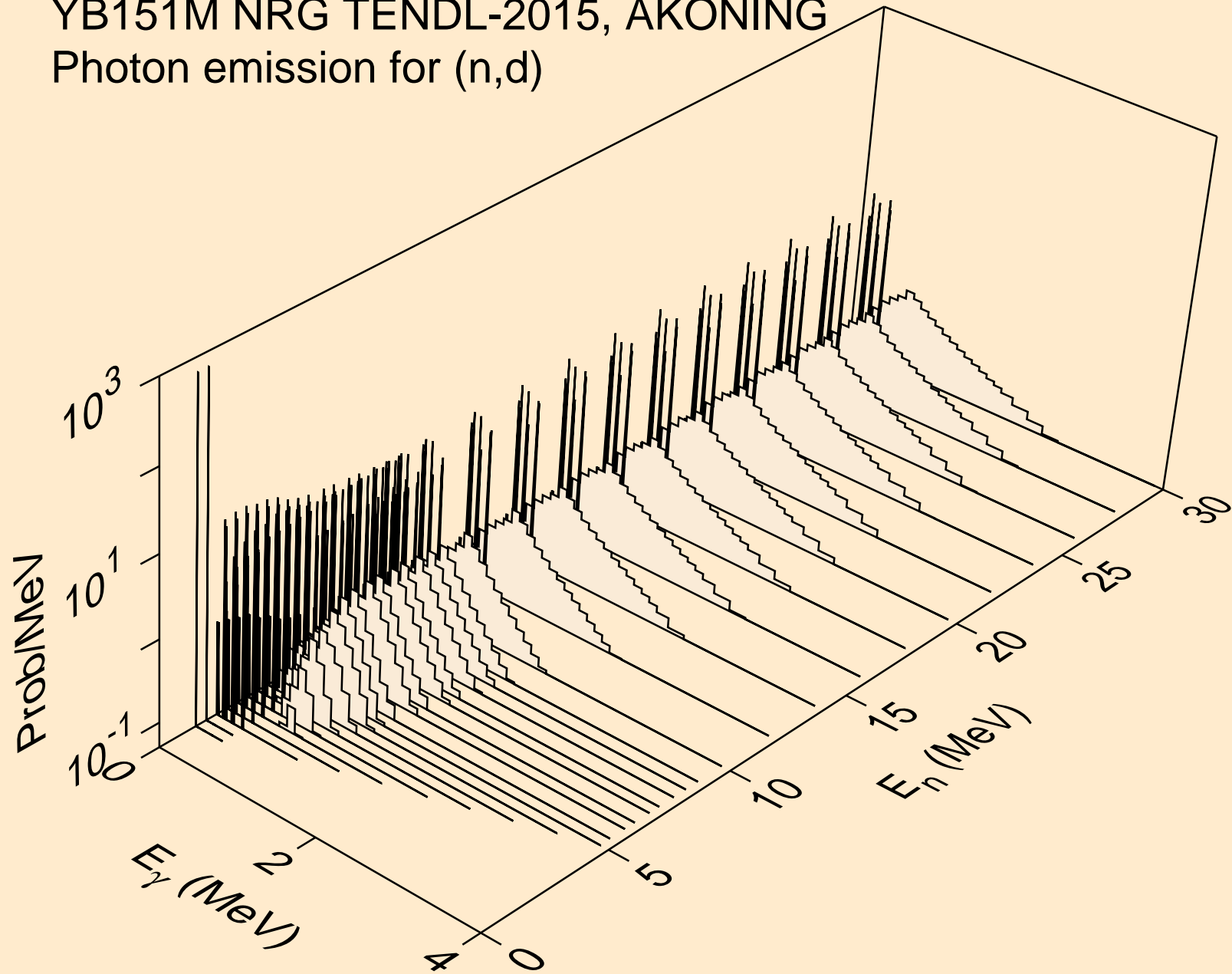

YB151M NRG TENDL-2015, AKONING
Photon emission for (n,t)

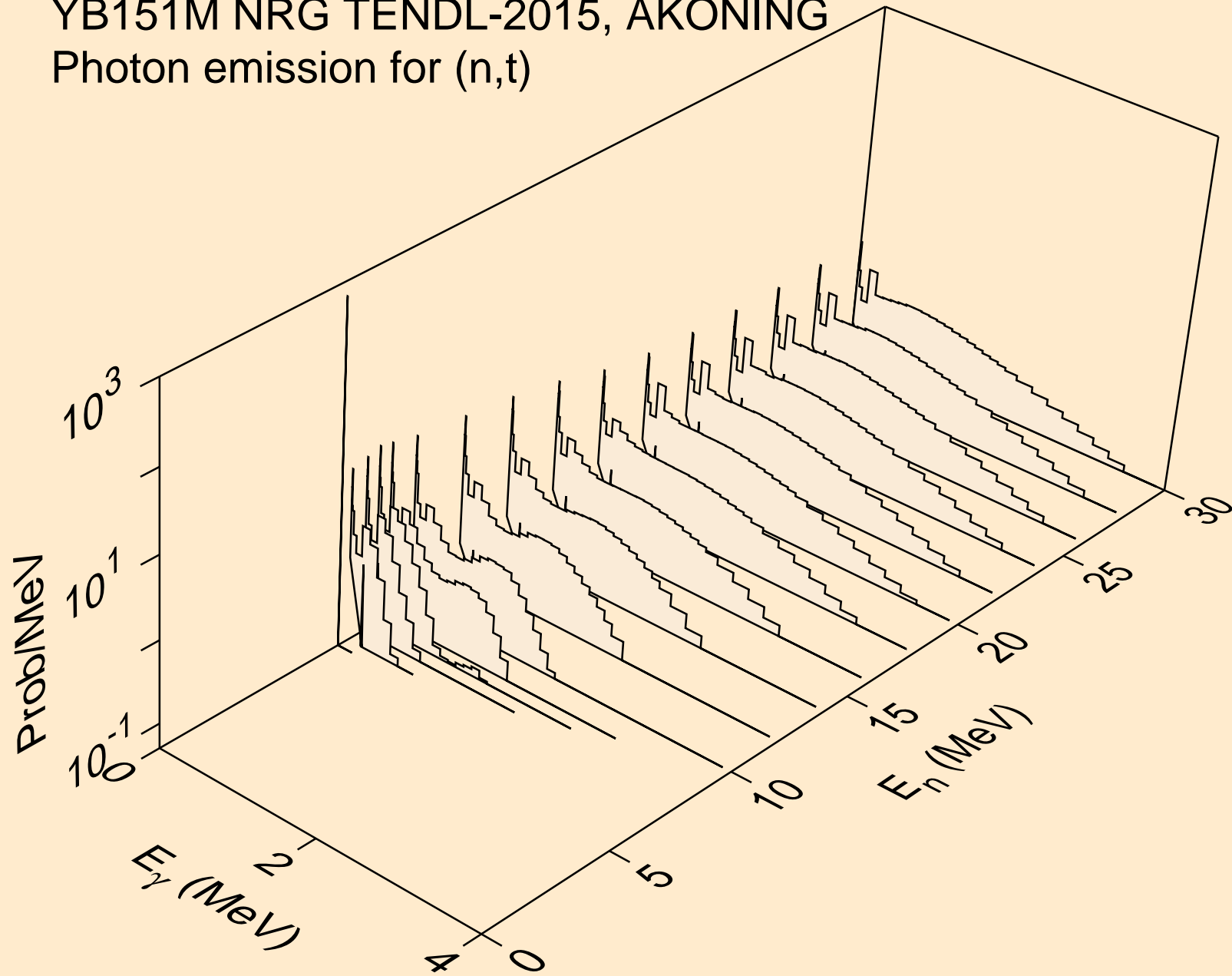

YB151M NRG TENDL-2015, AKONING
Photon emission for (n,he3)

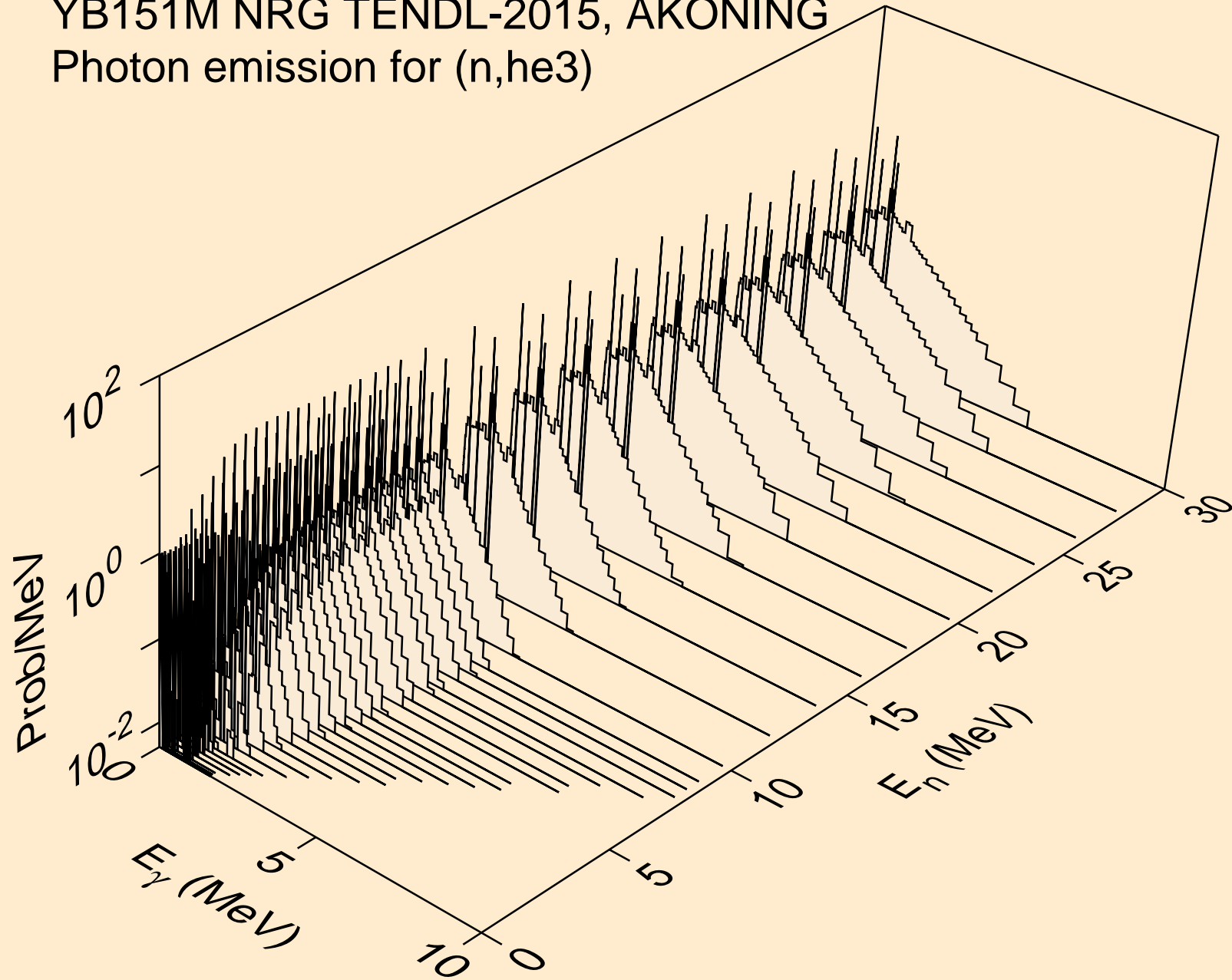

YB151M NRG TENDL-2015, AKONING
Photon emission for (n,a)

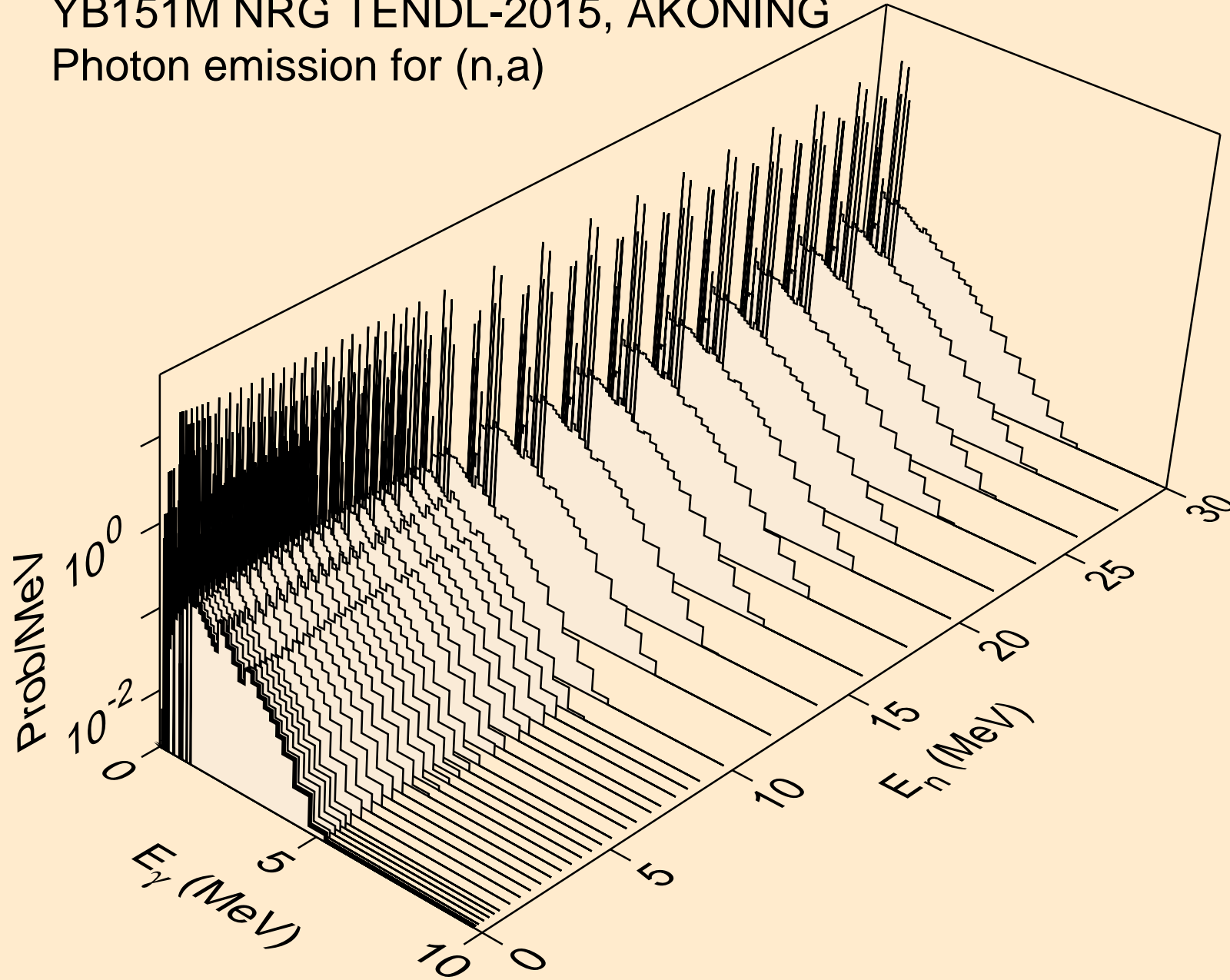

YB151M NRG TENDL-2015, AKONING
Photon emission for (n,2a)

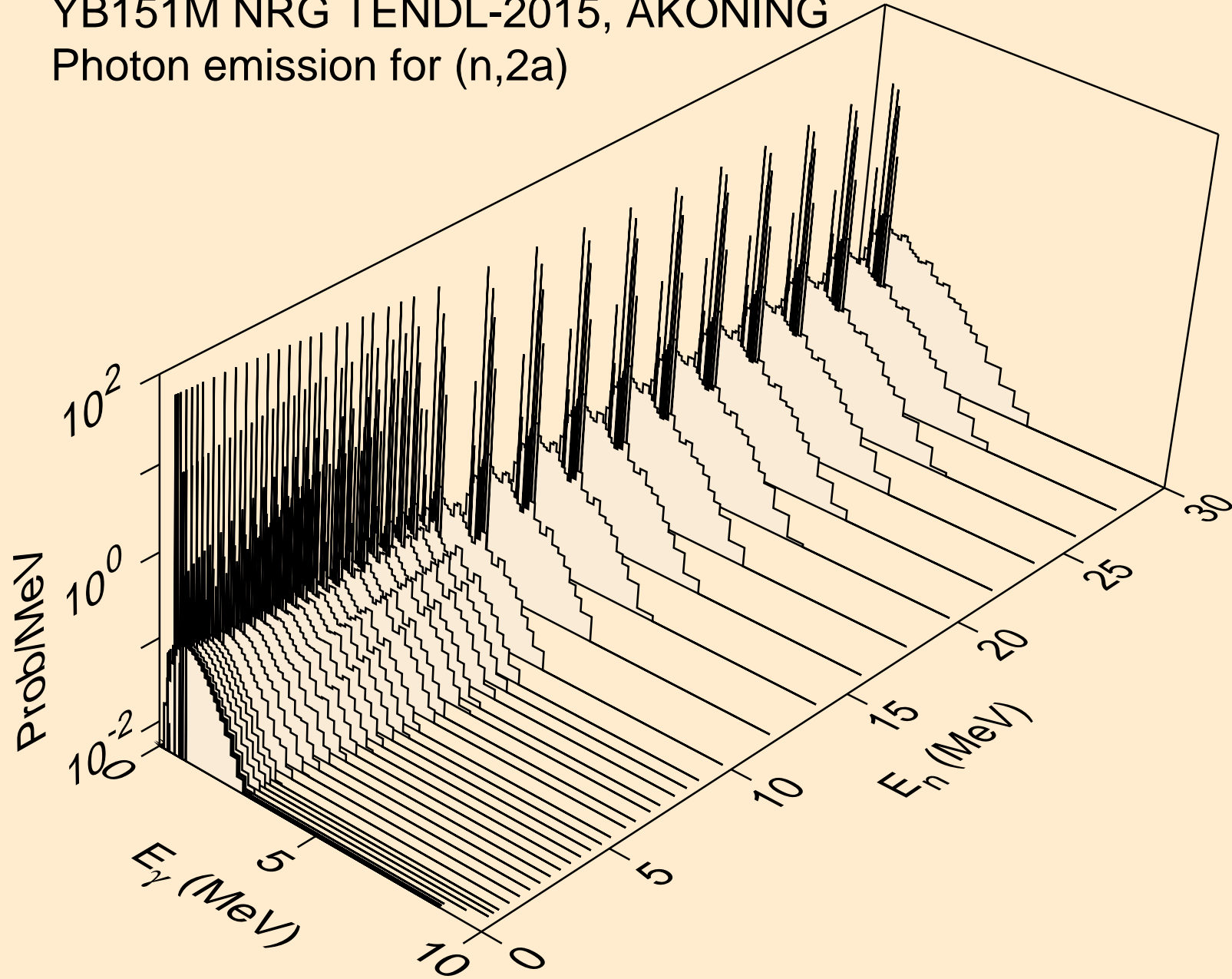

YB151M NRG TENDL-2015, AKONING
Photon emission for (n,3a)

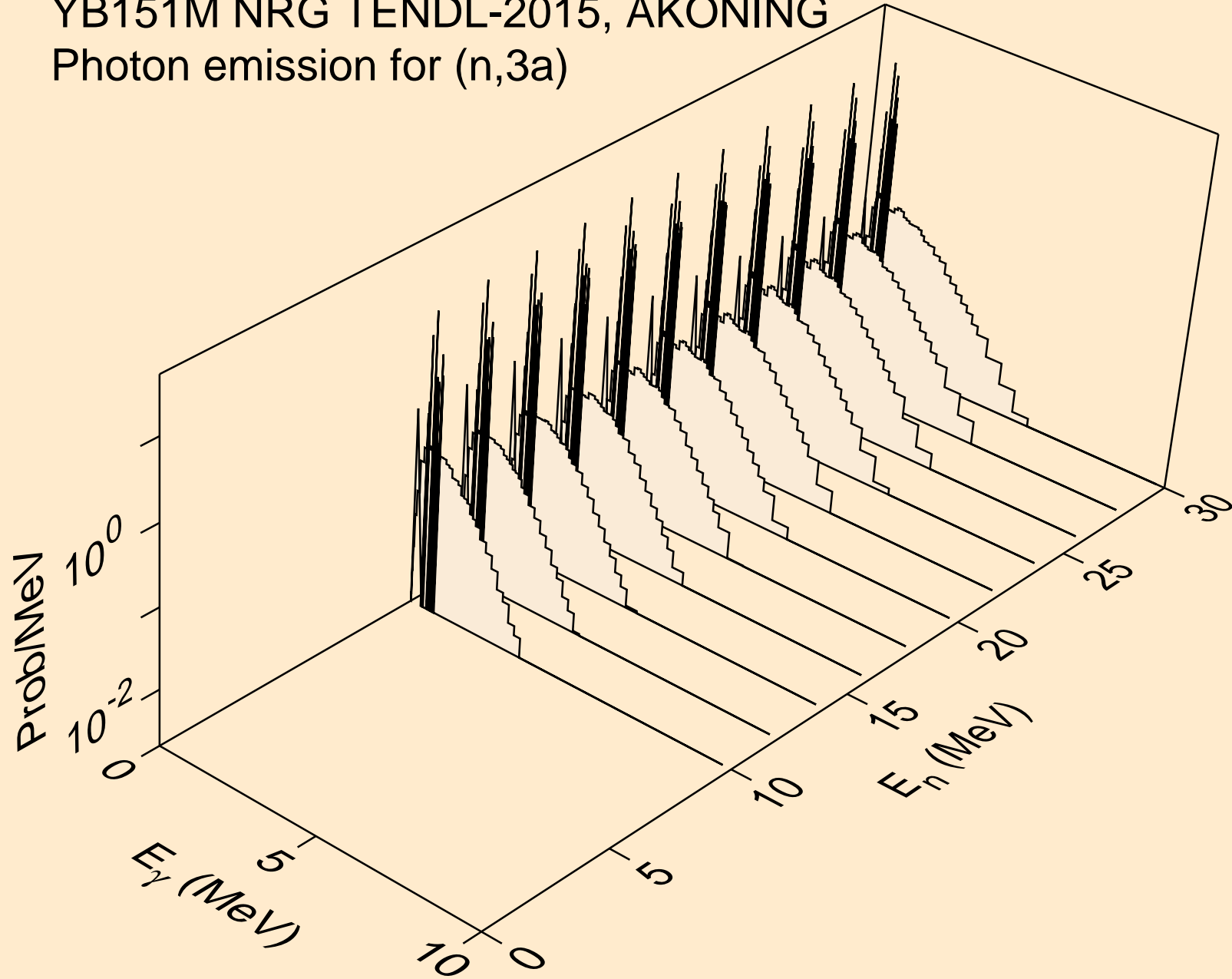

YB151M NRG TENDL-2015, AKONING
Photon emission for (n,2p)

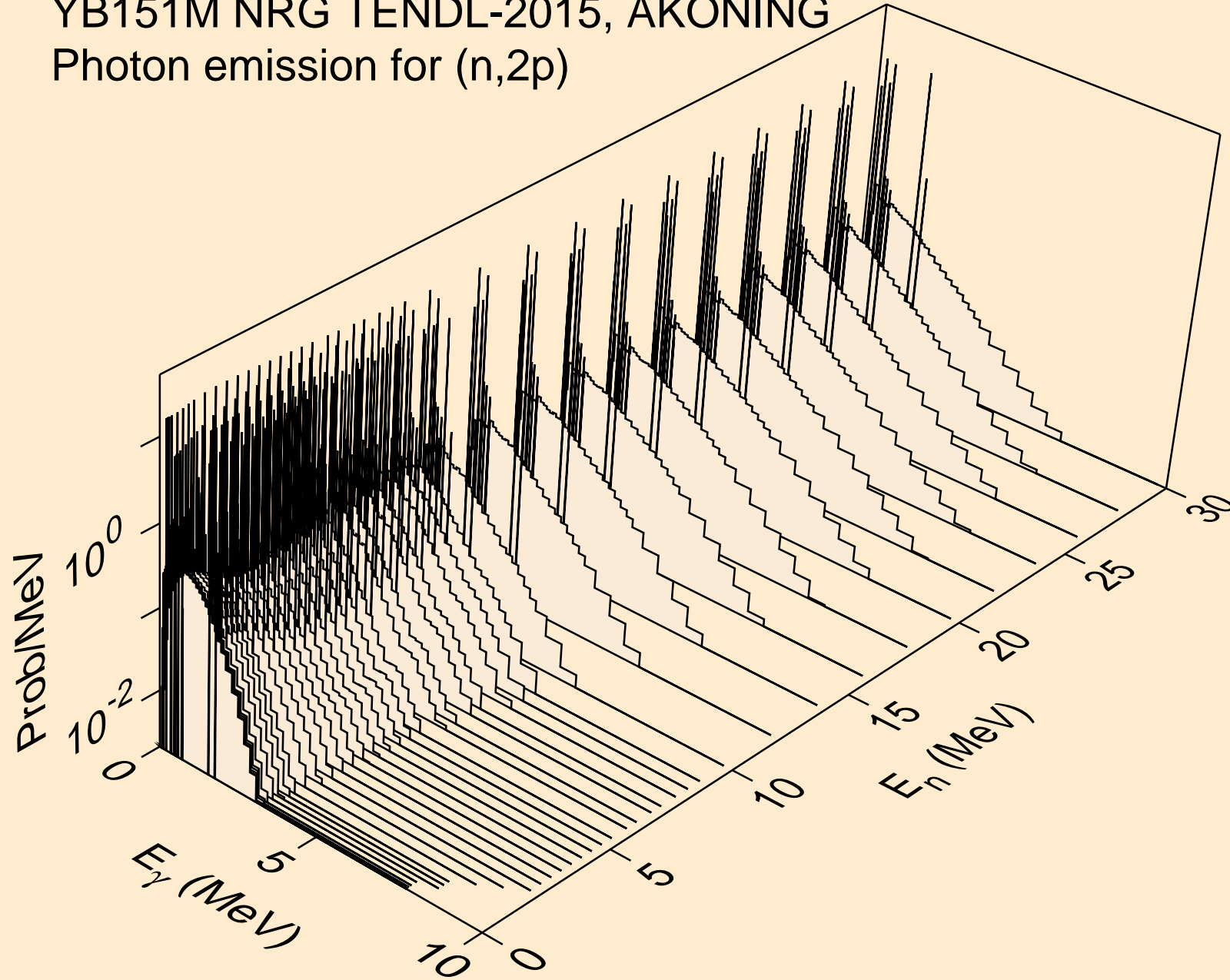

YB151M NRG TENDL-2015, AKONING
Photon emission for (n,pa)

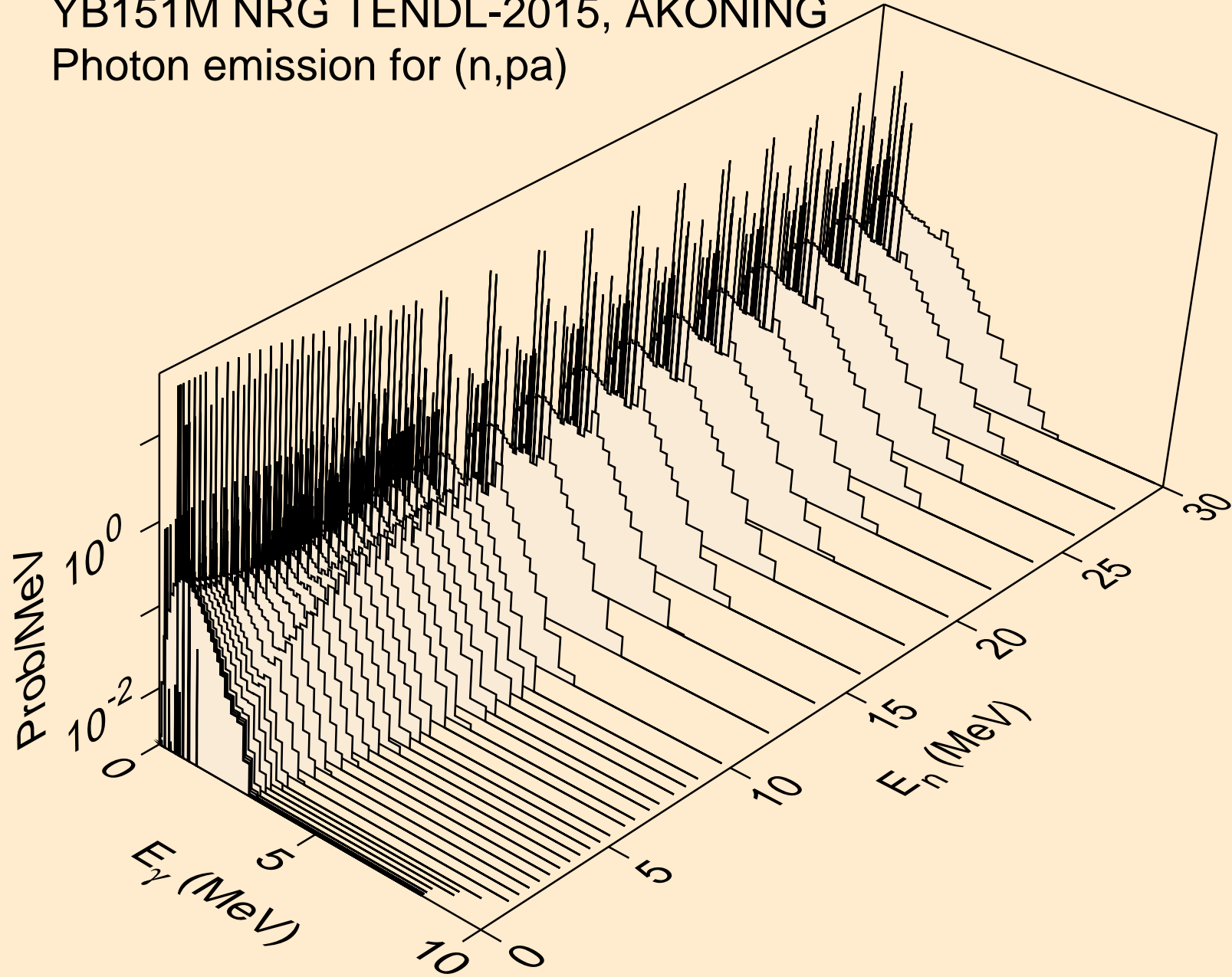

YB151M NRG TENDL-2015, AKONING
Photon emission for (n,d2a)

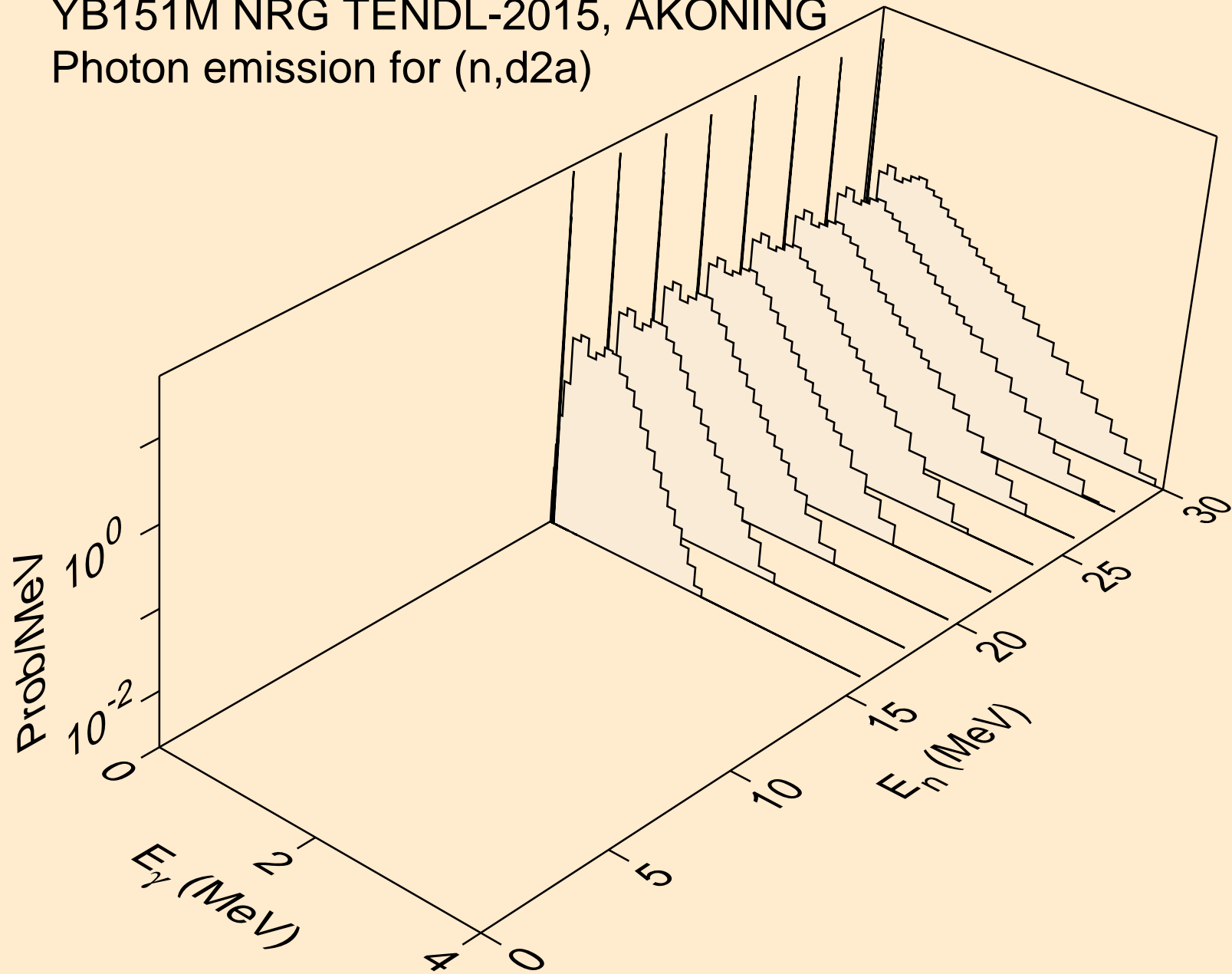

YB151M NRG TENDL-2015, AKONING
Photon emission for (n,pd)

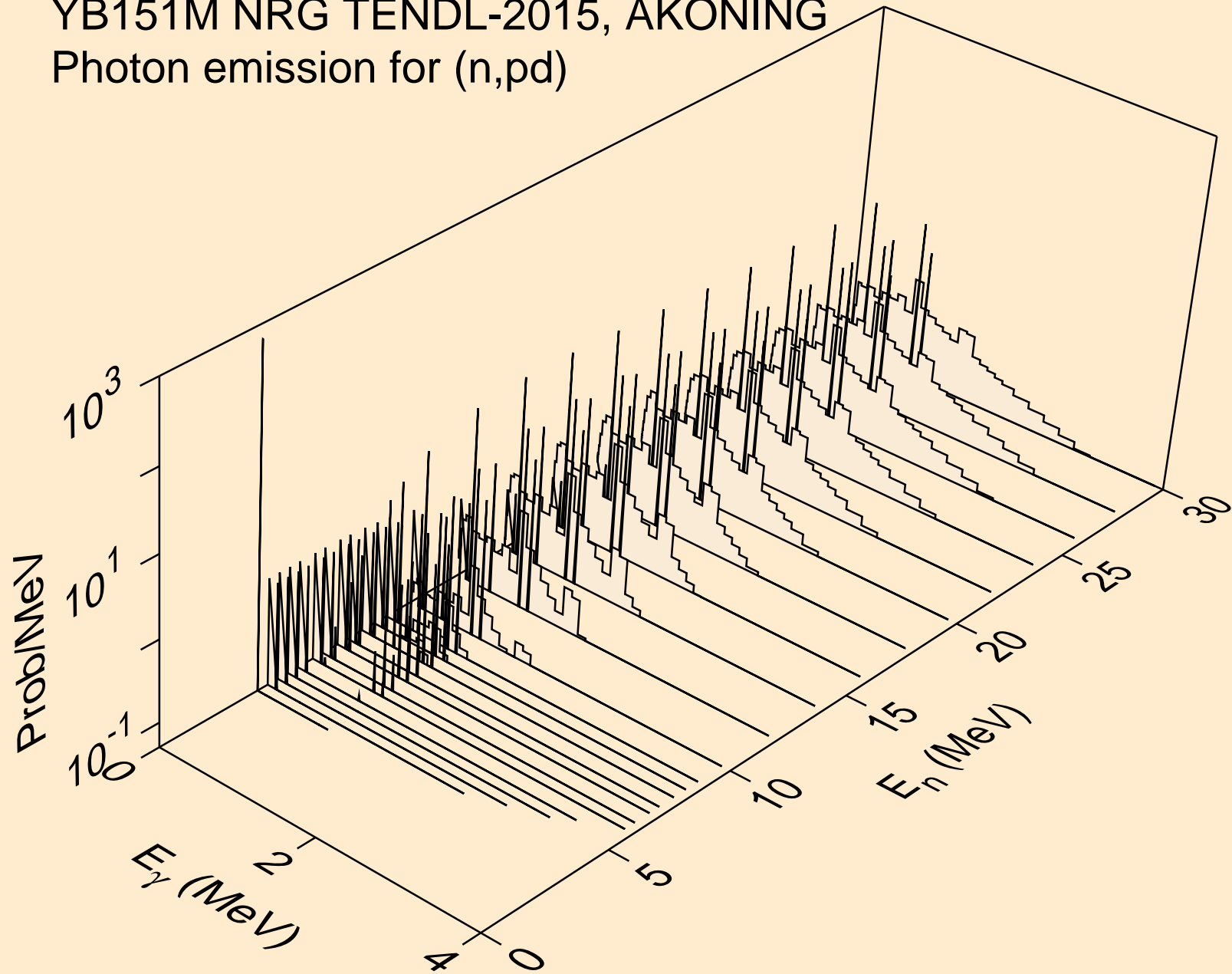

YB151M NRG TENDL-2015, AKONING
Photon emission for (n,pt)

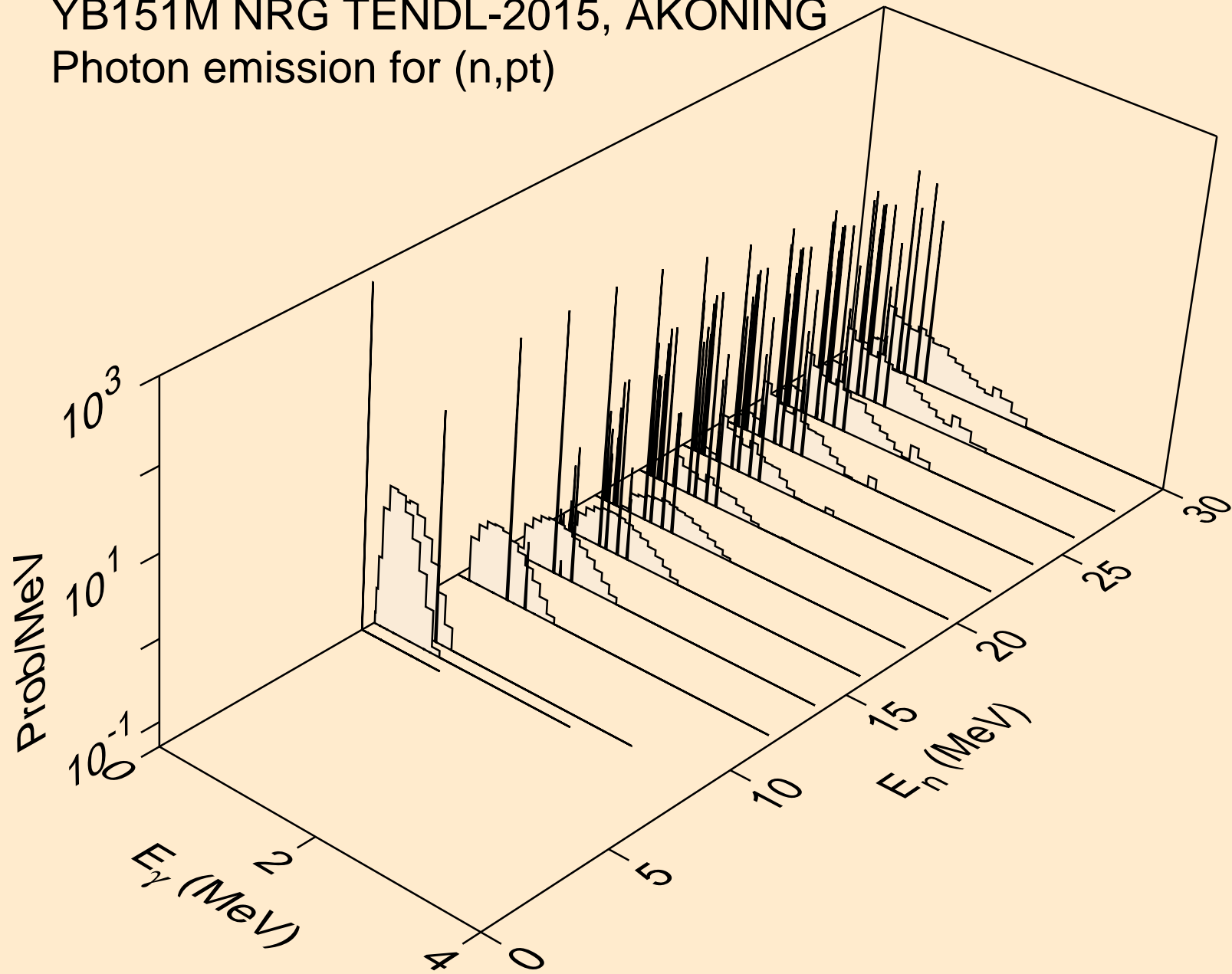

YB151M NRG TENDL-2015, AKONING
Photon emission for (n,da)

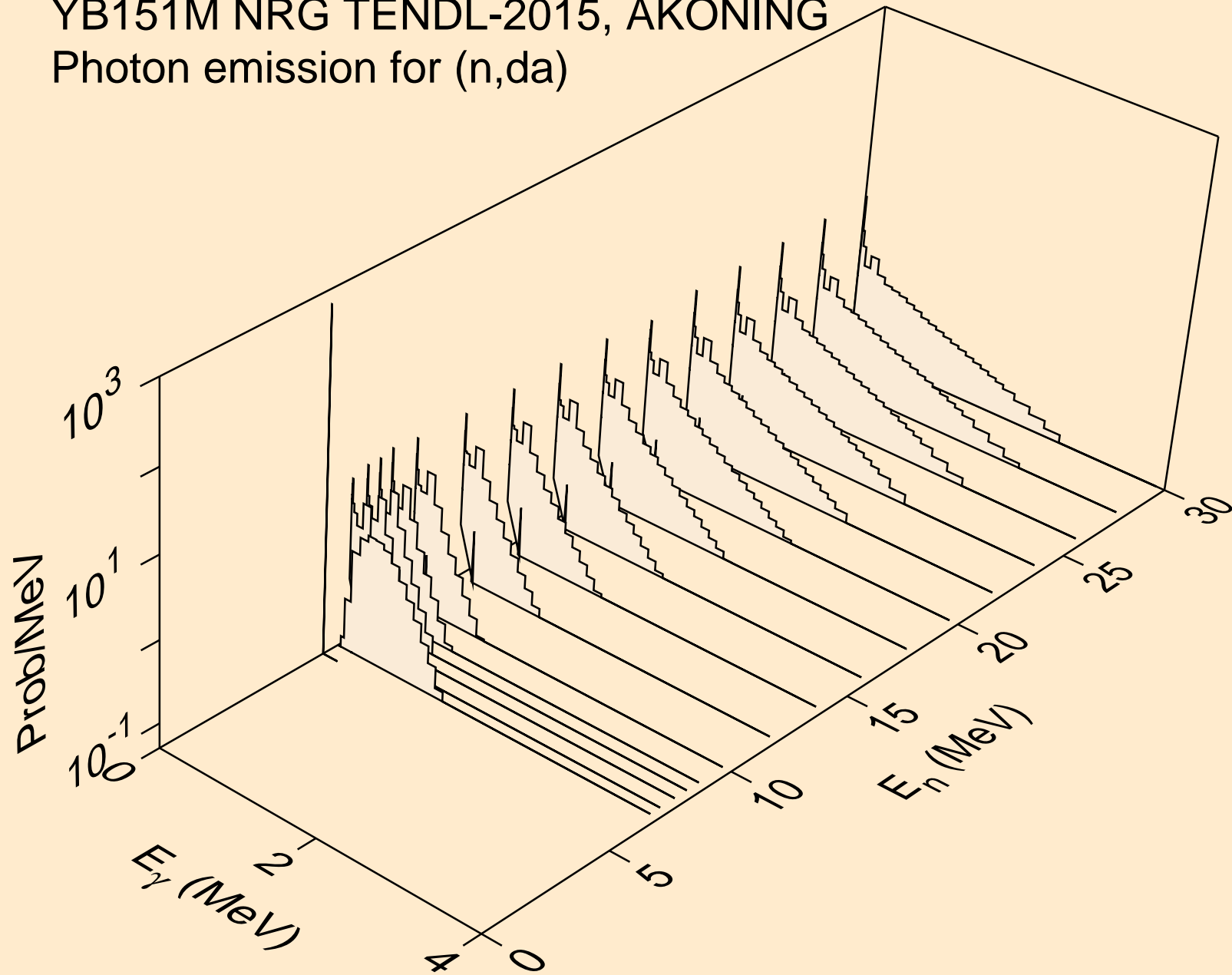

YB151M NRG TENDL-2015, AKONING
thermal capture photon spectrum

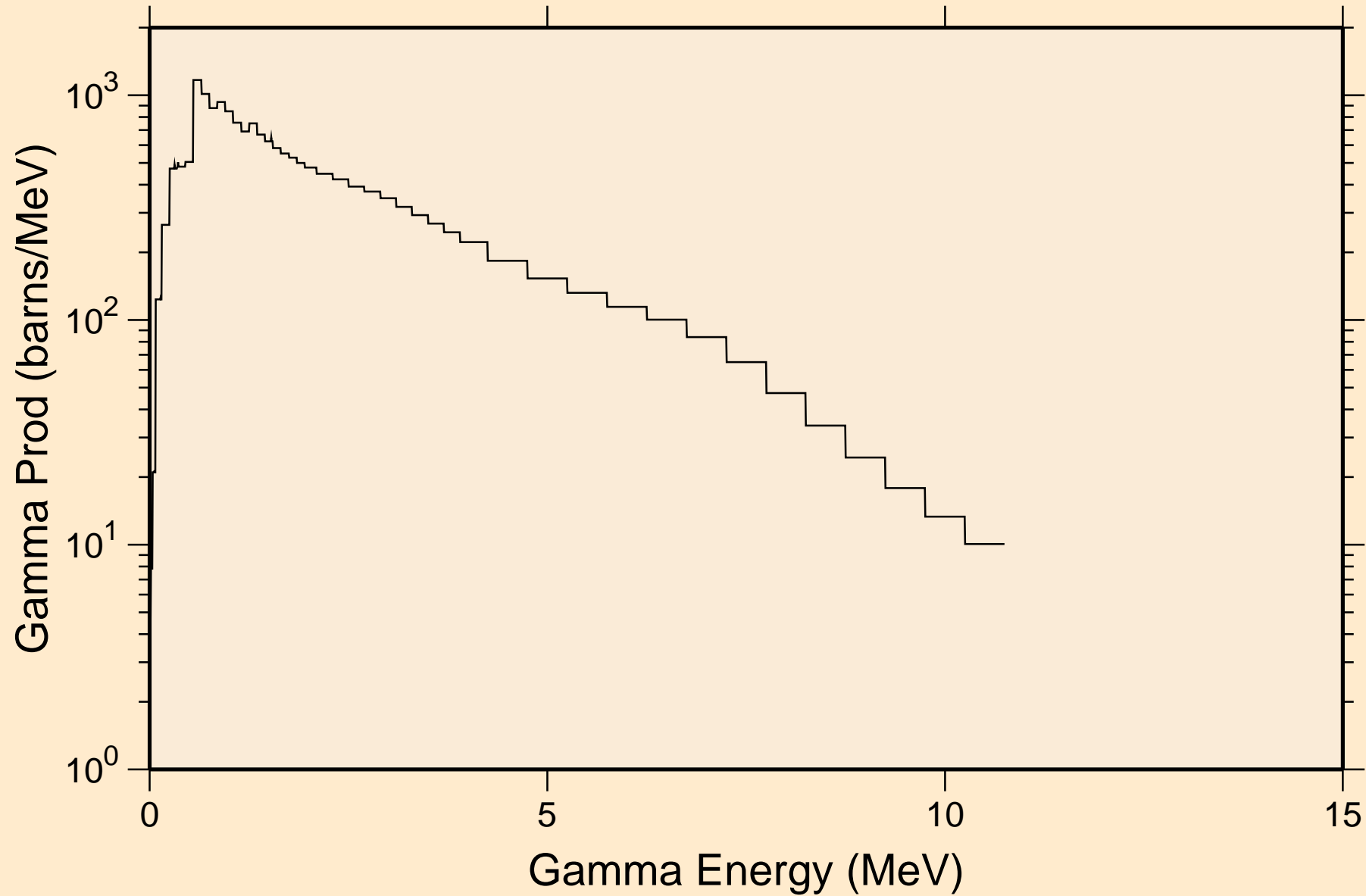

YB151M NRG TENDL-2015, AKONING
14 MeV photon spectrum

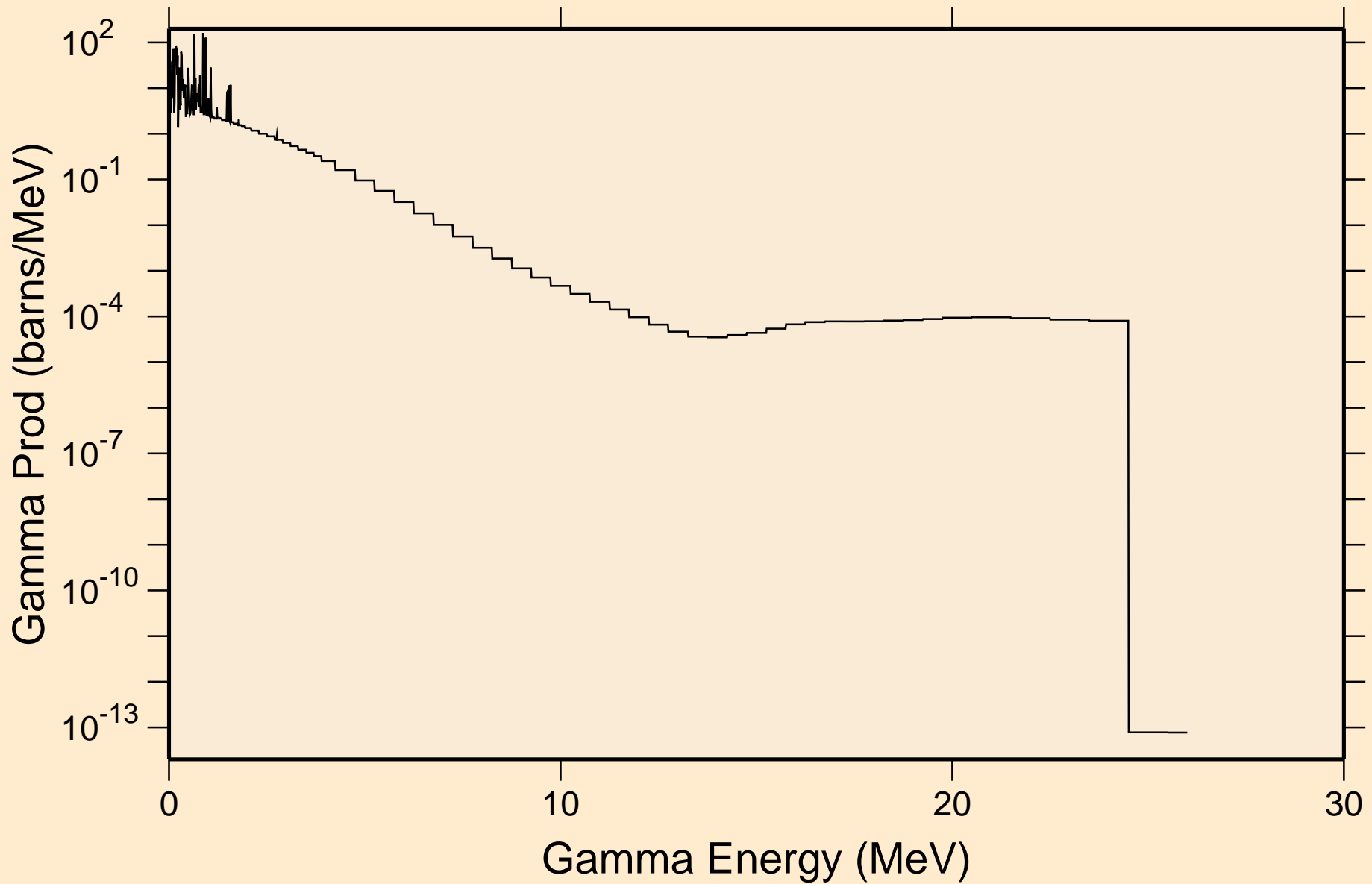

YB151M NRG TENDL-2015, AKONING

Particle heating contributions

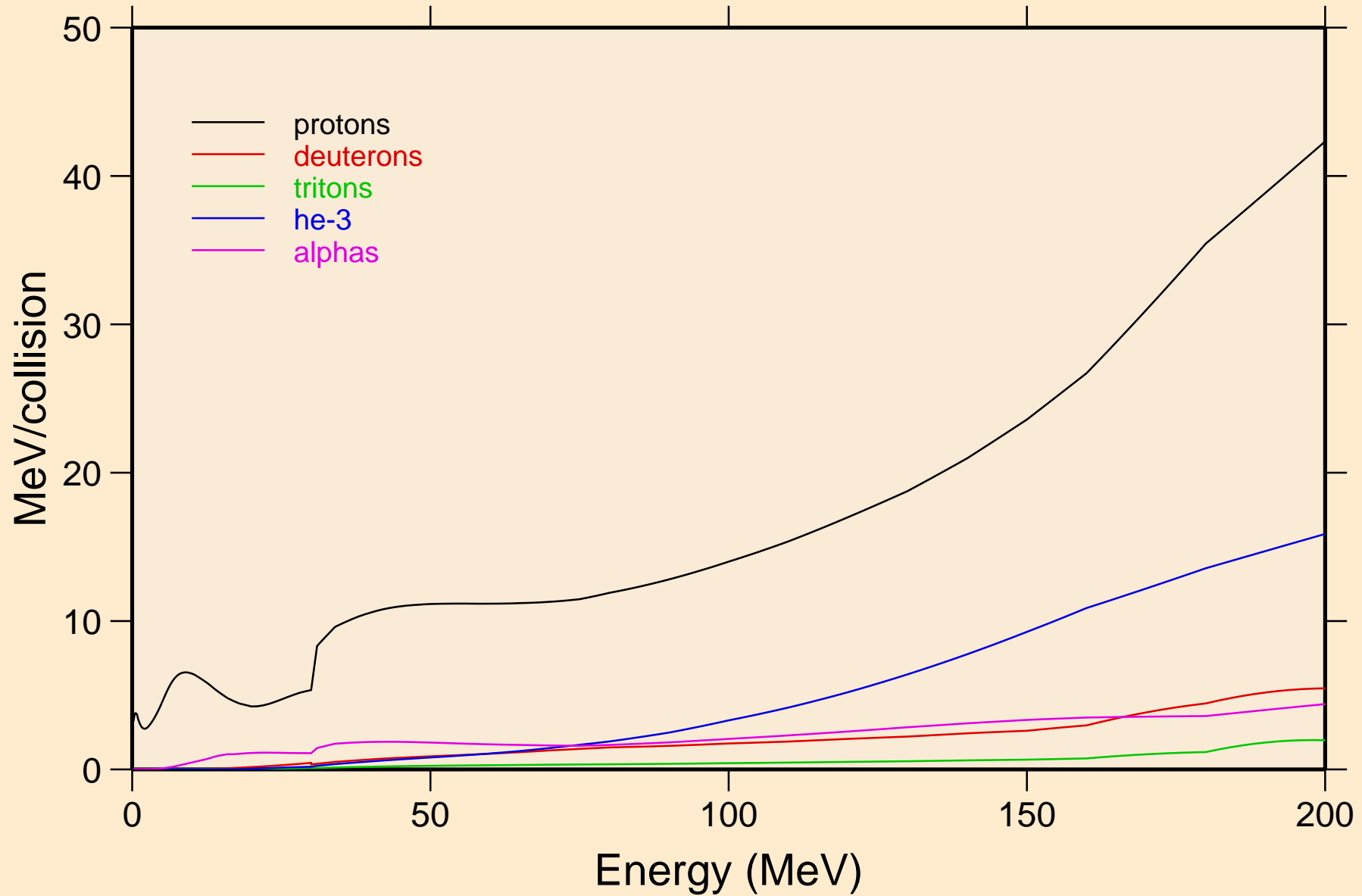

YB151M NRG TENDL-2015, AKONING

Recoil Heating

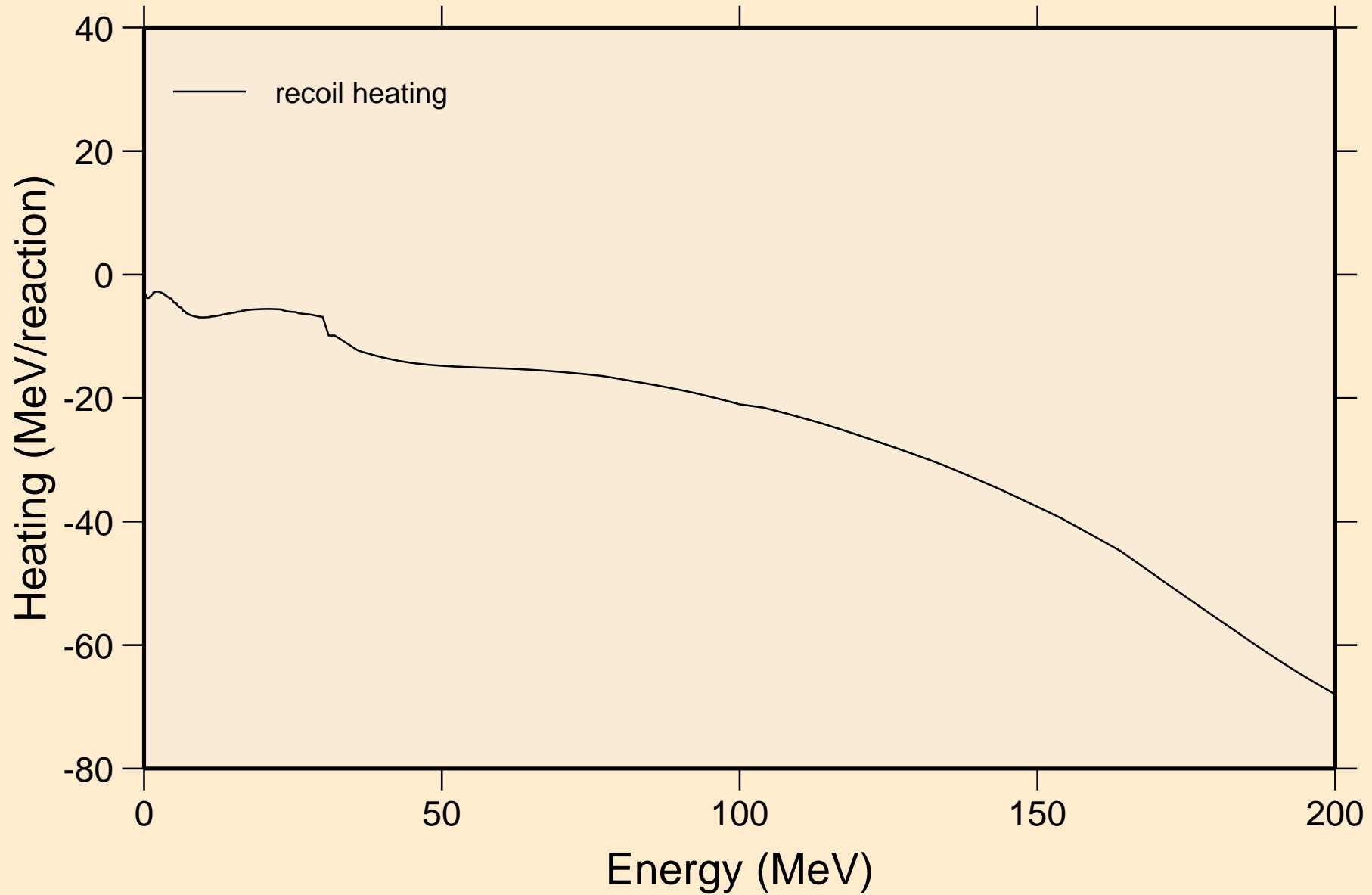

YB151M NRG TENDL-2015, AKONING

Particle production cross sections

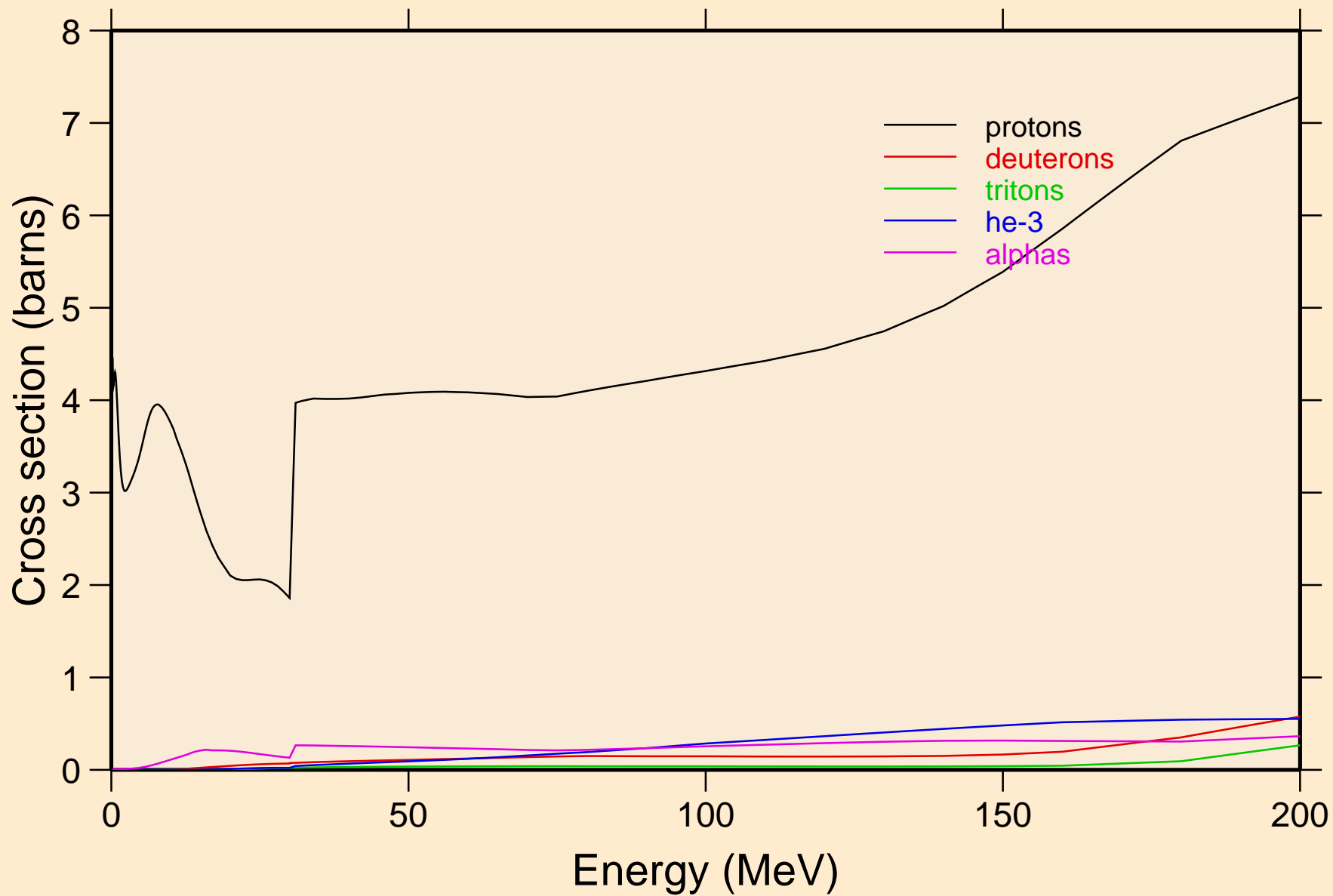

YB151M NRG TENDL-2015, AKONING
protons from (n,x)

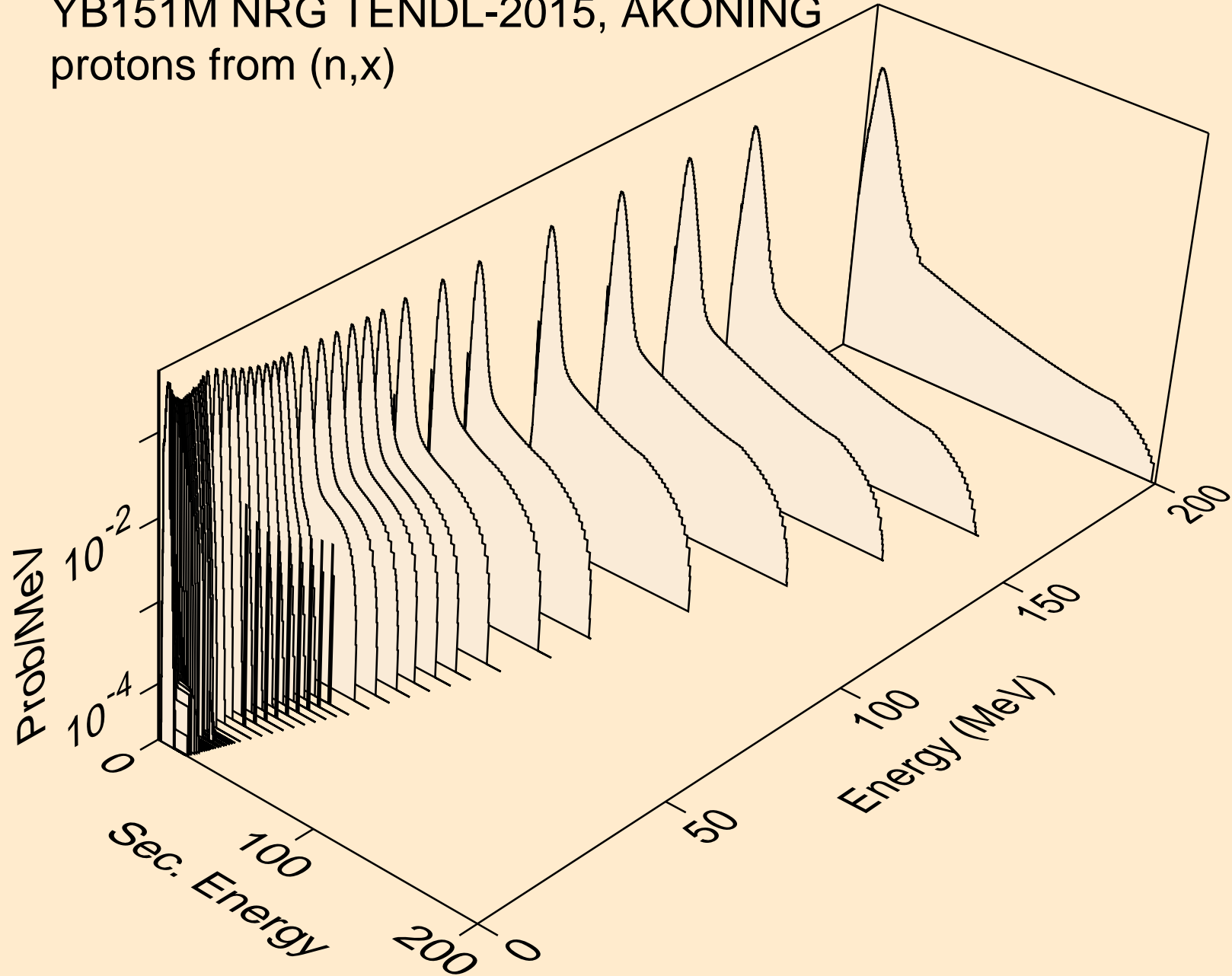

YB151M NRG TENDL-2015, AKONING
protons from (n,n*)p

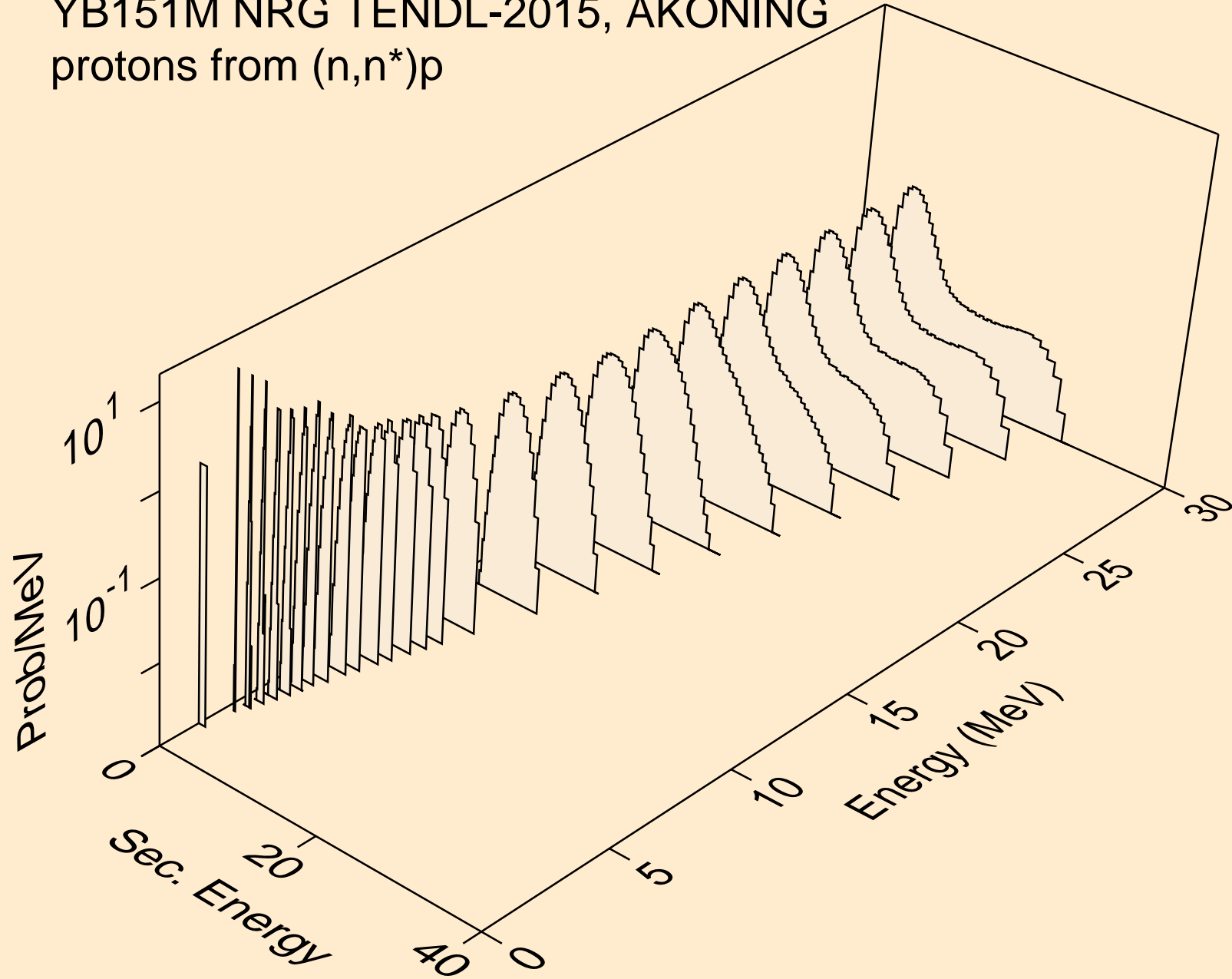

YB151M NRG TENDL-2015, AKONING
protons from (n,2np)

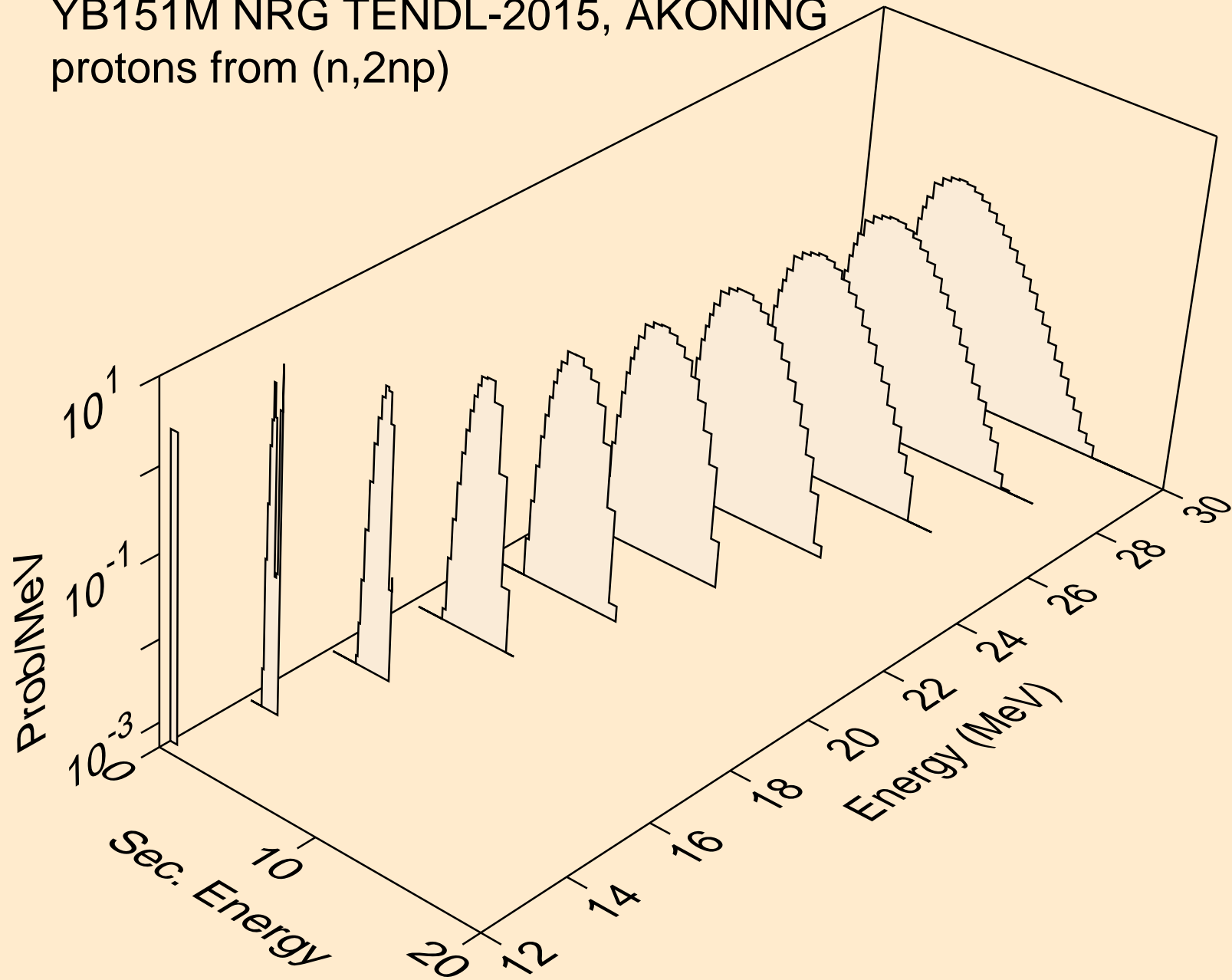

YB151M NRG TENDL-2015, AKONING
protons from (n,3np)

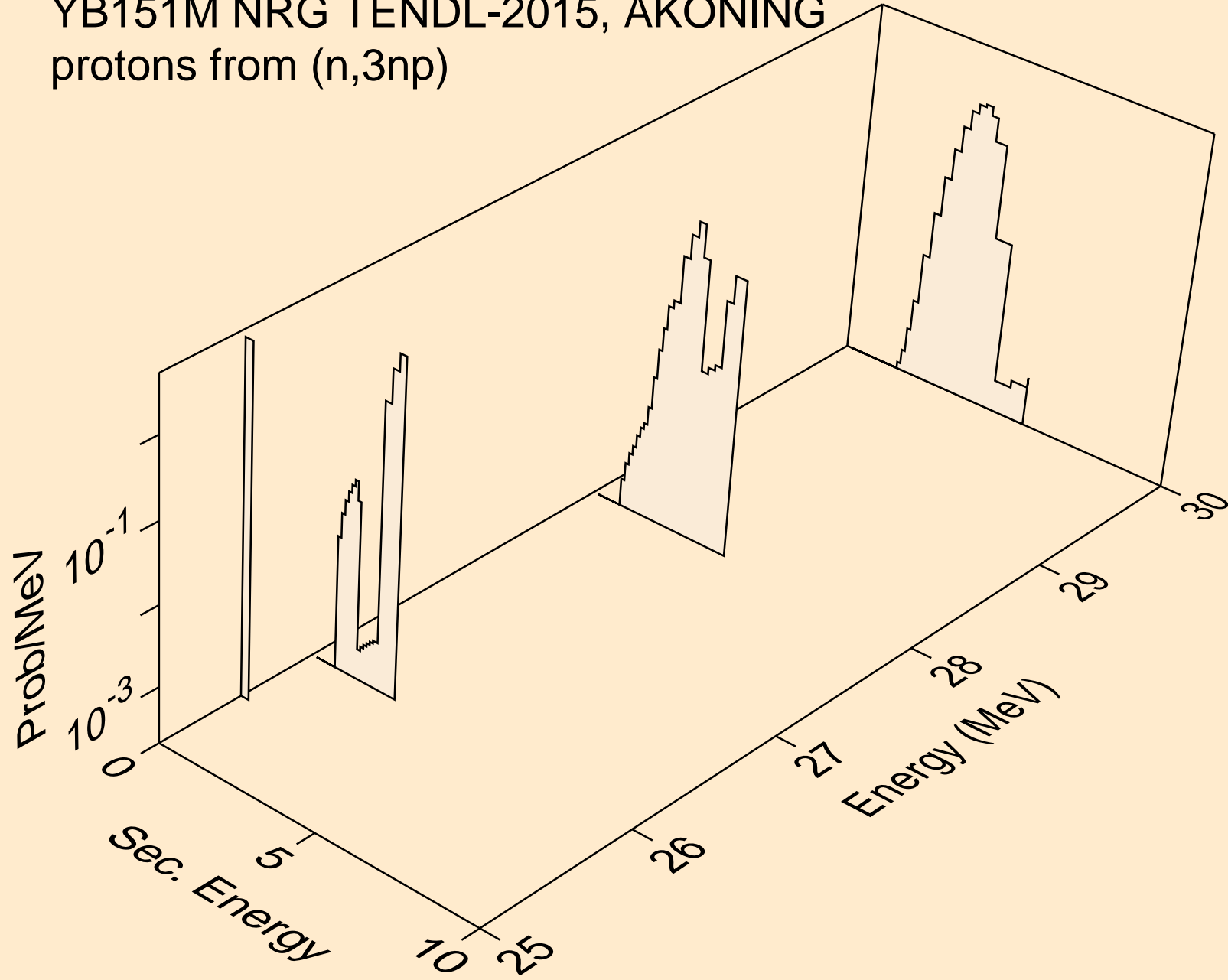

YB151M NRG TENDL-2015, AKONING
protons from (n,2np)

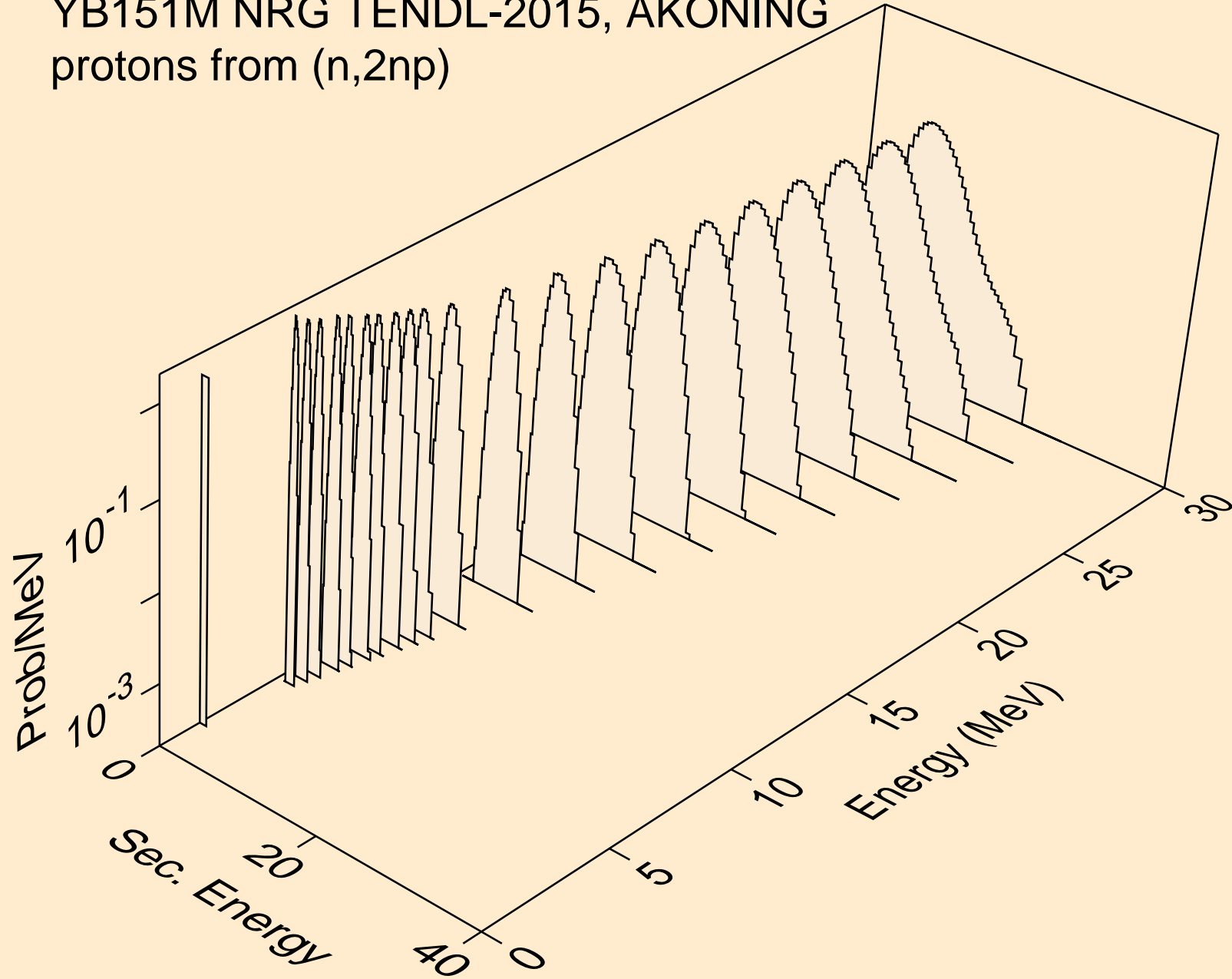

YB151M NRG TENDL-2015, AKONING
protons from (n,npa)

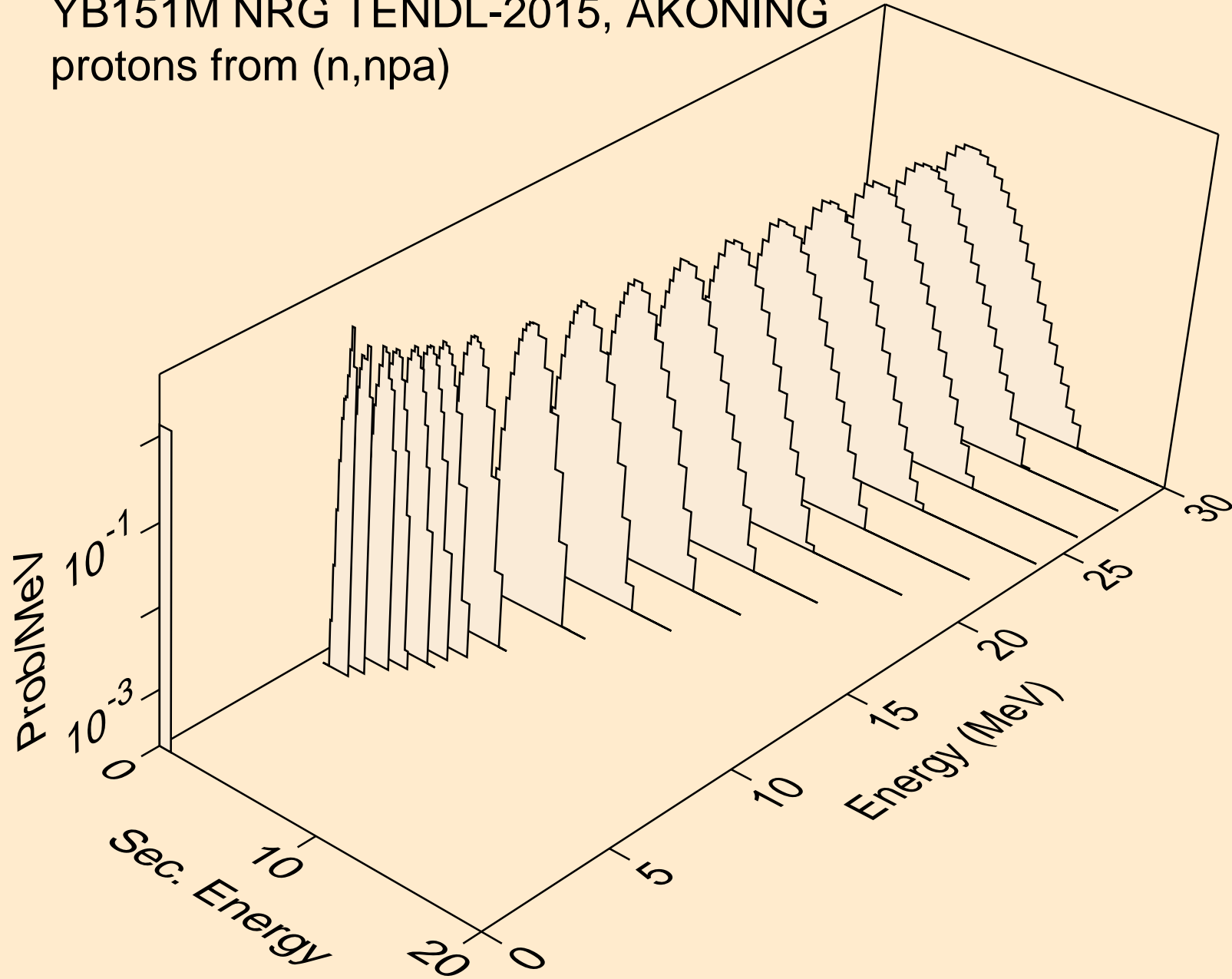

YB151M NRG TENDL-2015, AKONING
protons from (n,p)

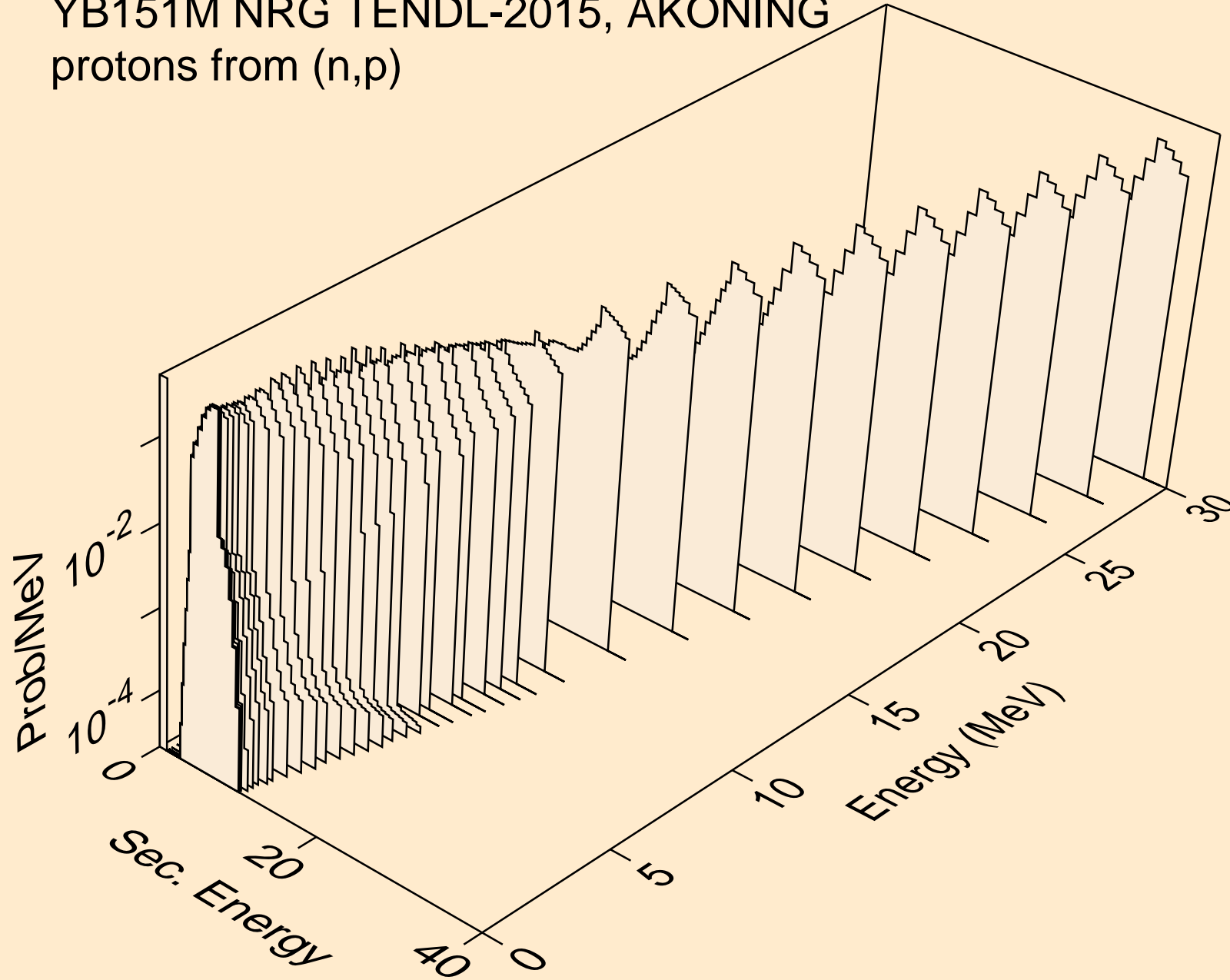

YB151M NRG TENDL-2015, AKONING
protons from (n,2p)

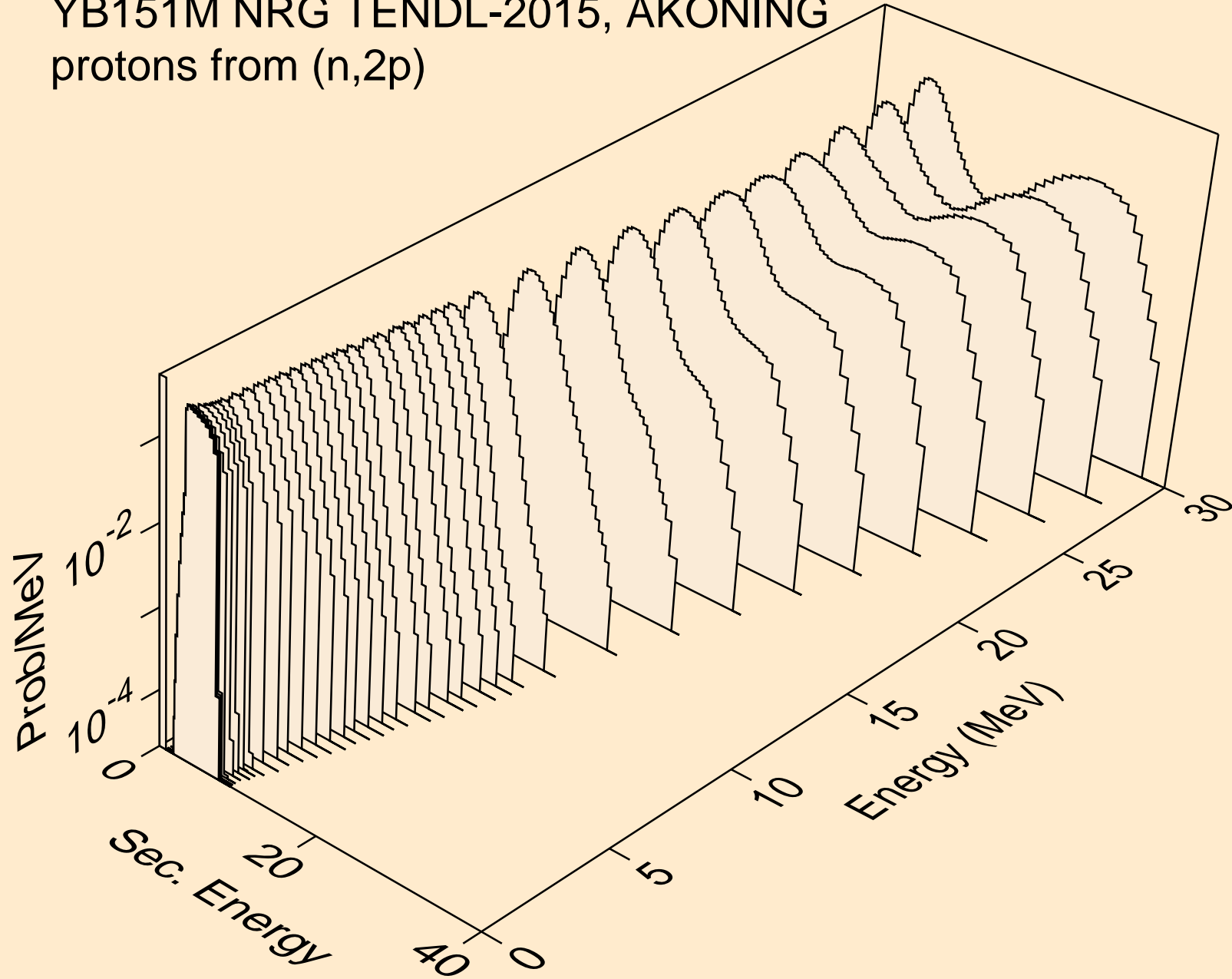

YB151M NRG TENDL-2015, AKONING
protons from (n,pa)

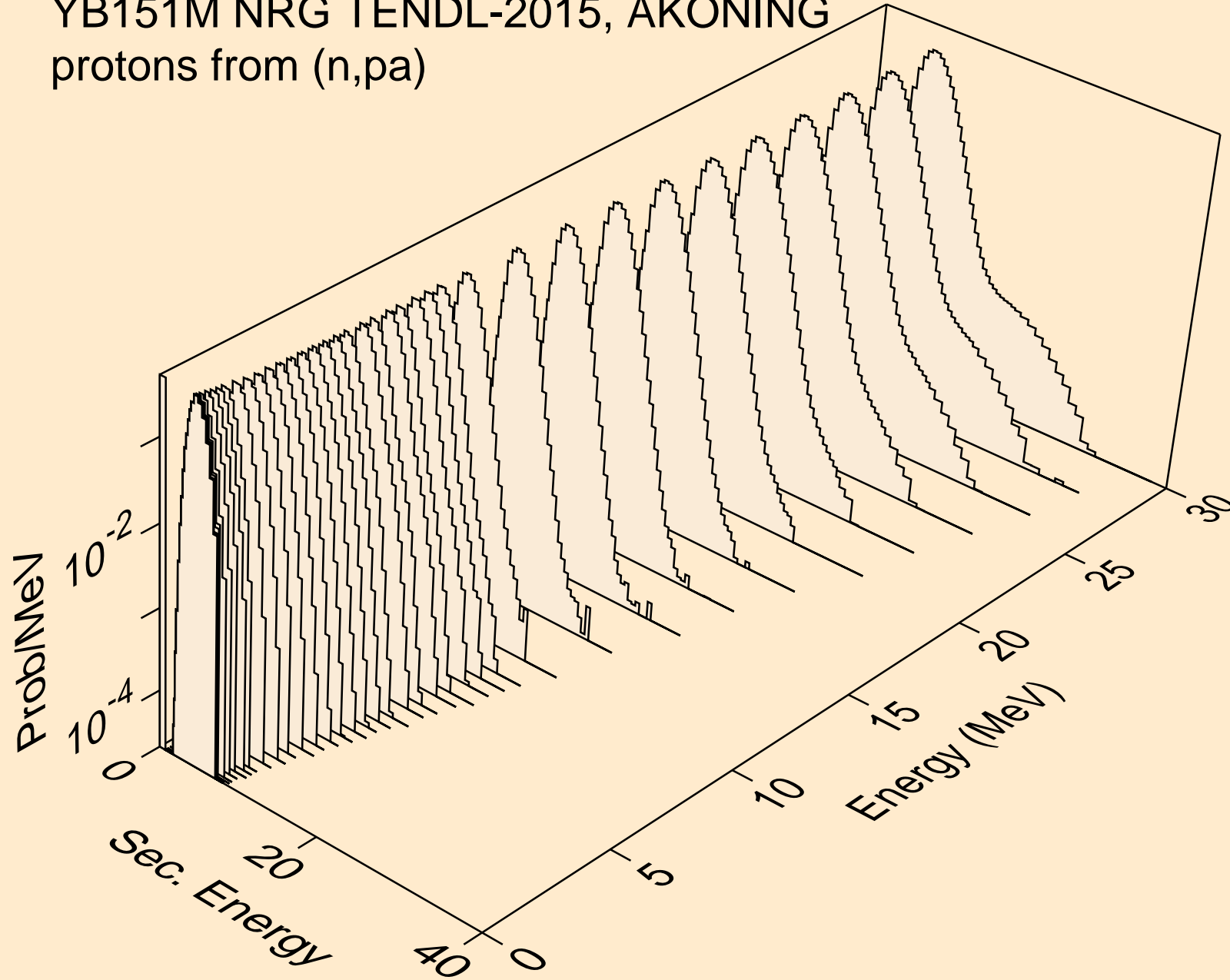

YB151M NRG TENDL-2015, AKONING
protons from (n,pd)

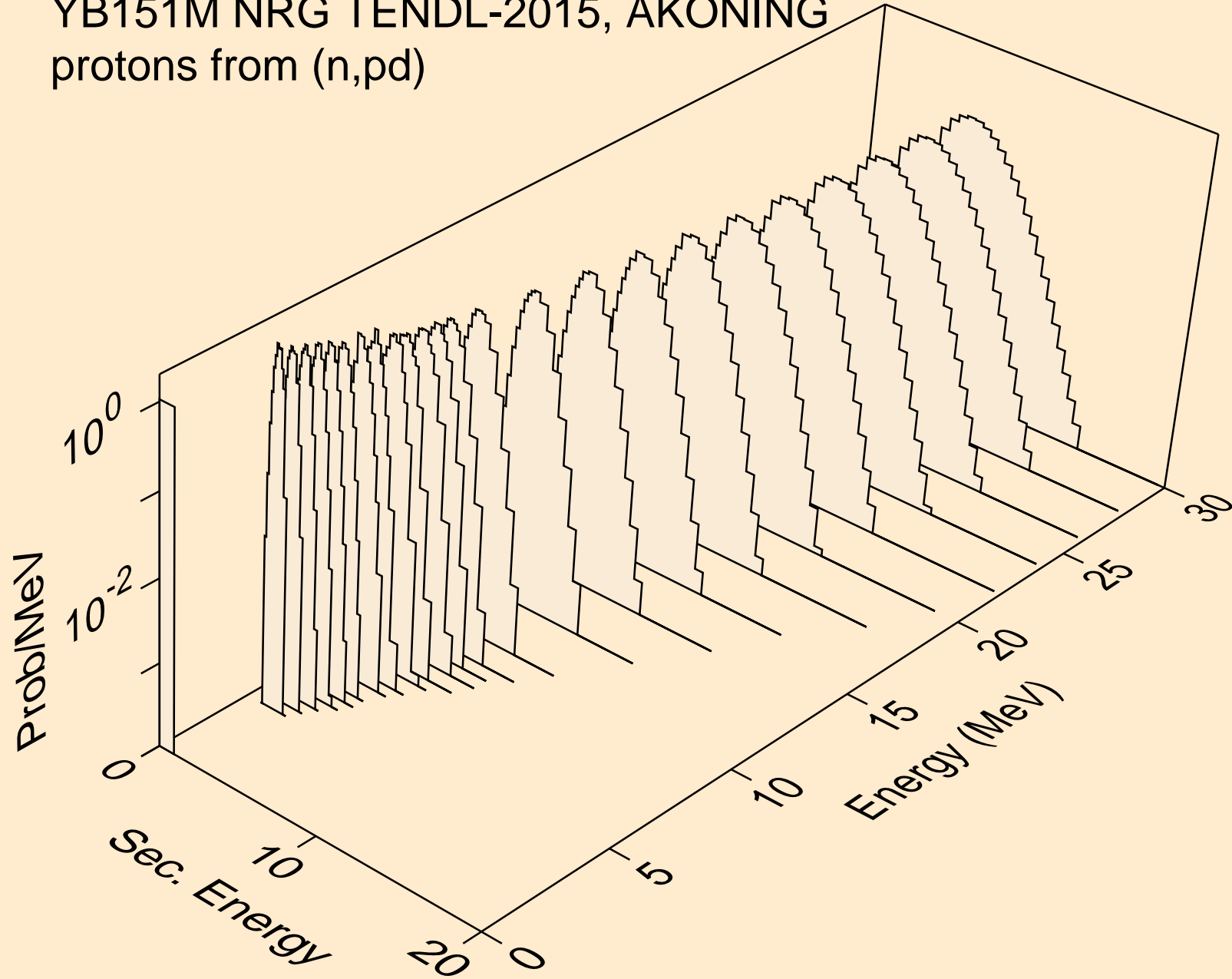

YB151M NRG TENDL-2015, AKONING
protons from (n,pt)

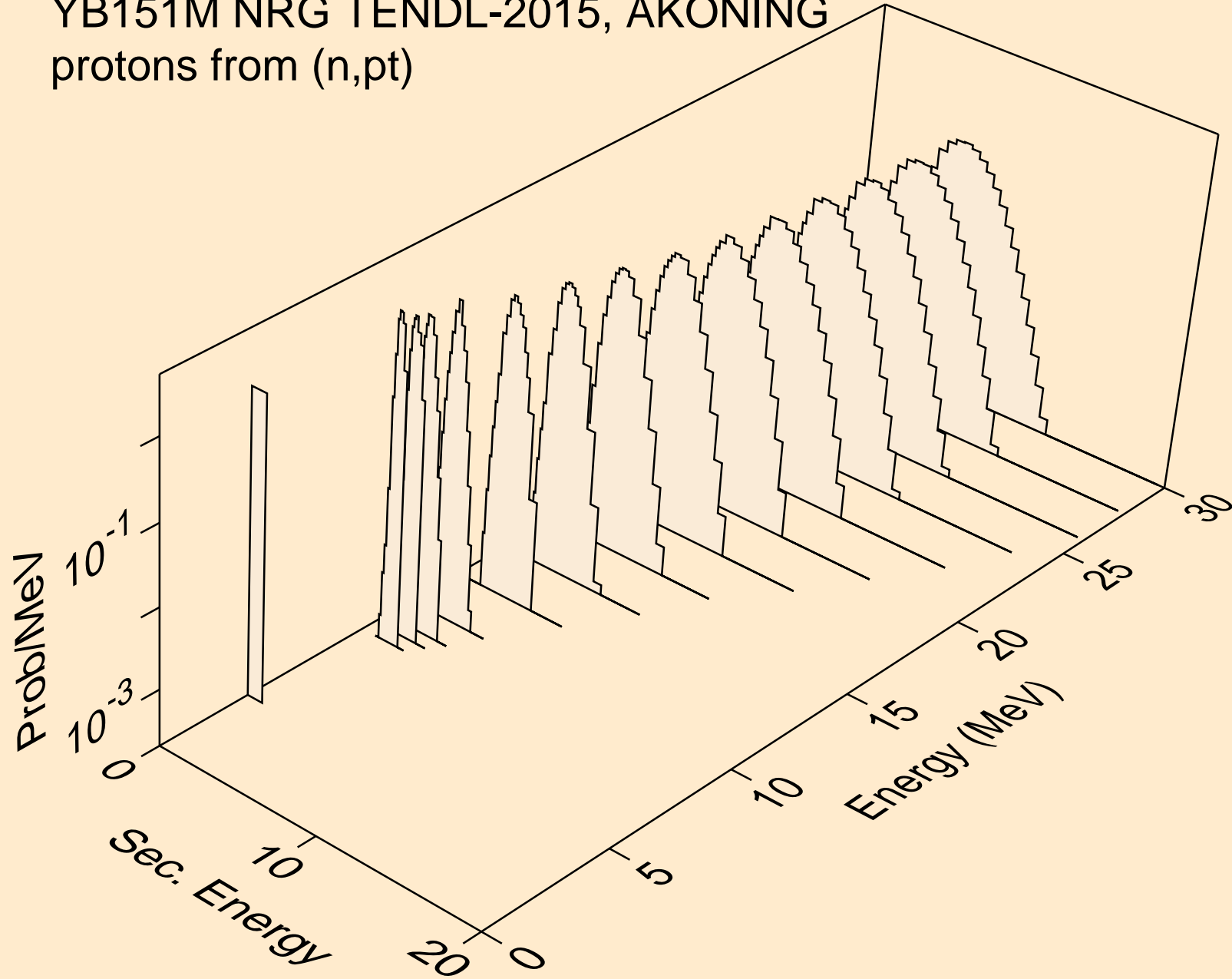

YB151M NRG TENDL-2015, AKONING
deuterons from (n,x)

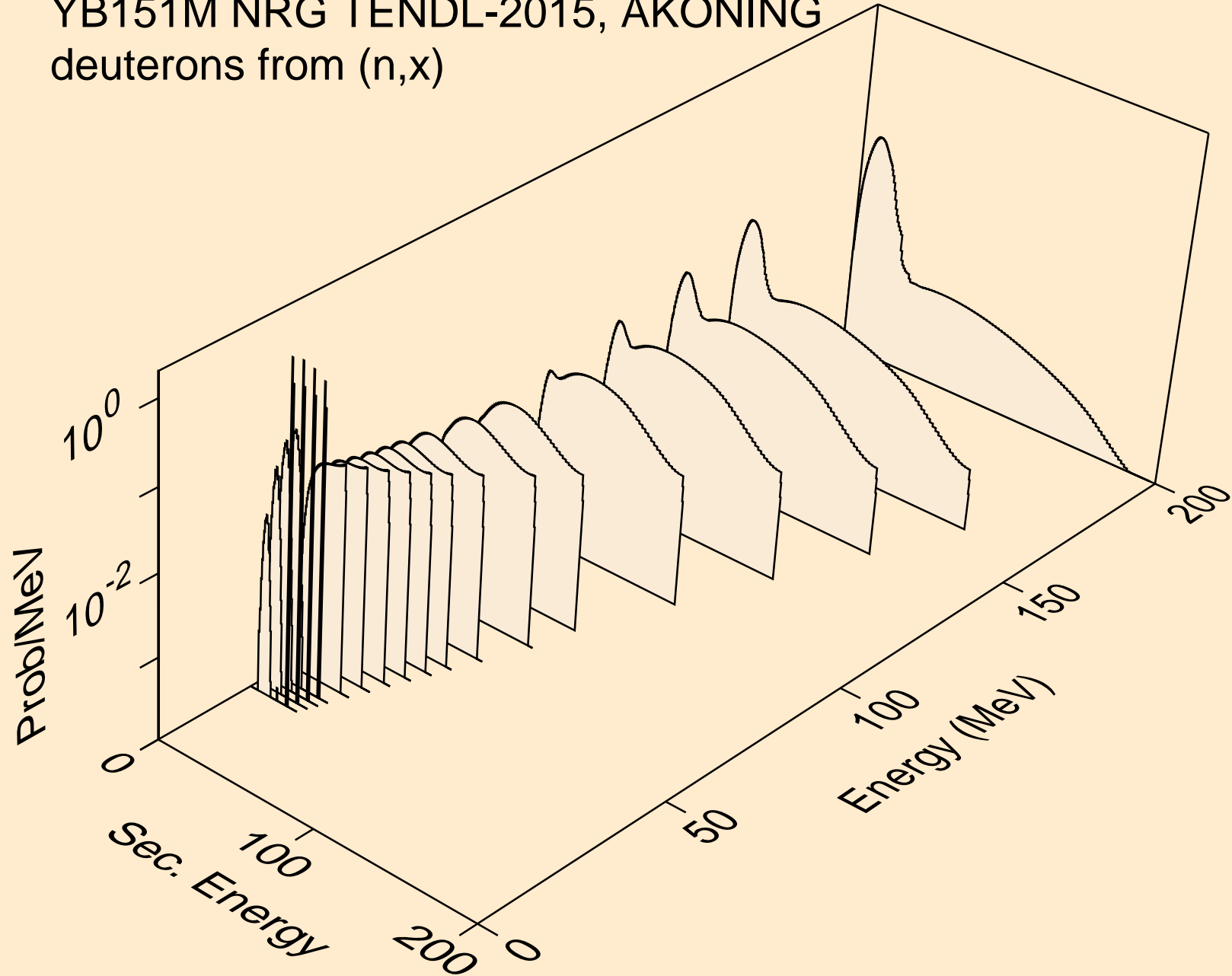

YB151M NRG TENDL-2015, AKONING
deuterons from (n,2nd)

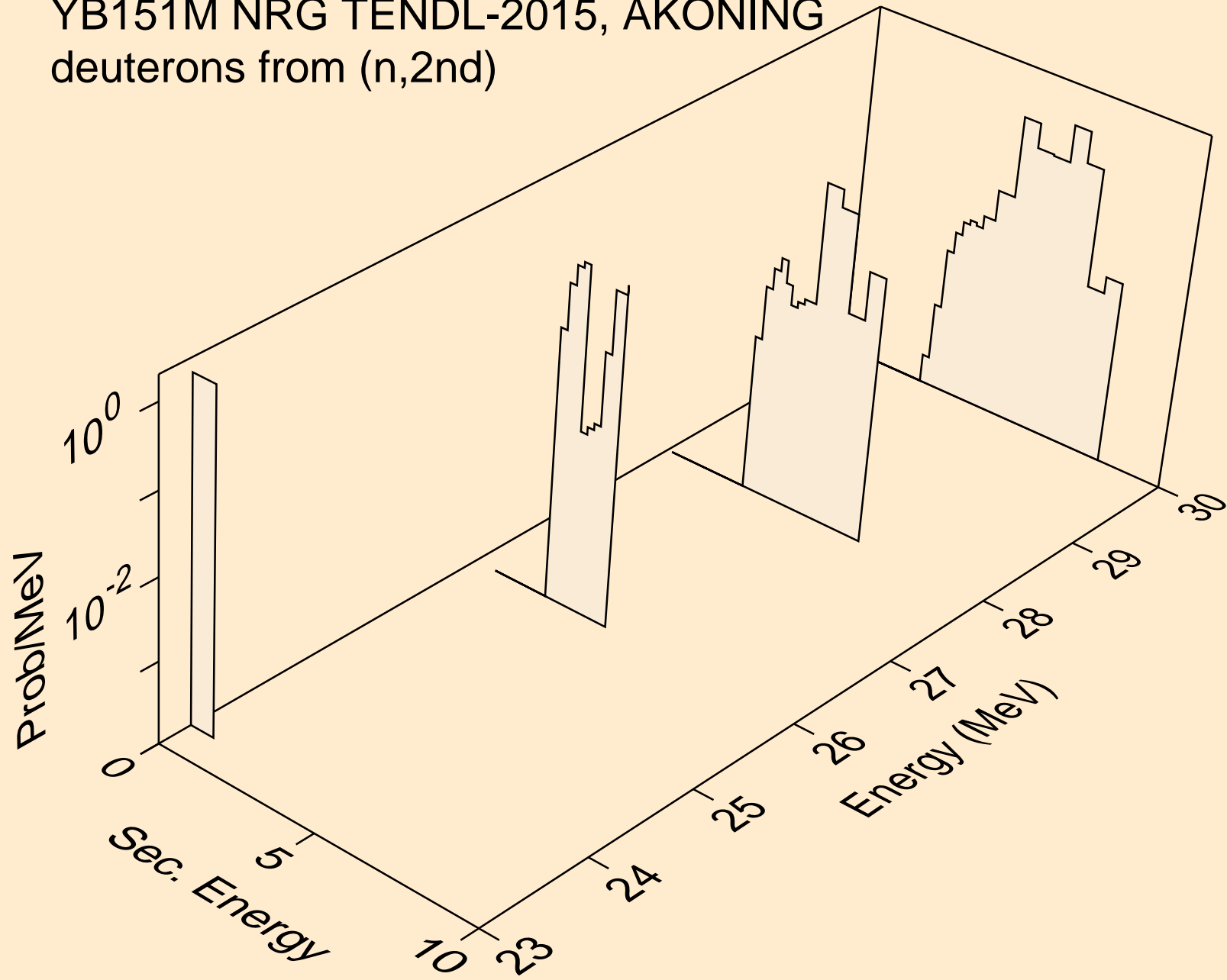

YB151M NRG TENDL-2015, AKONING
deuterons from (n,n*)d

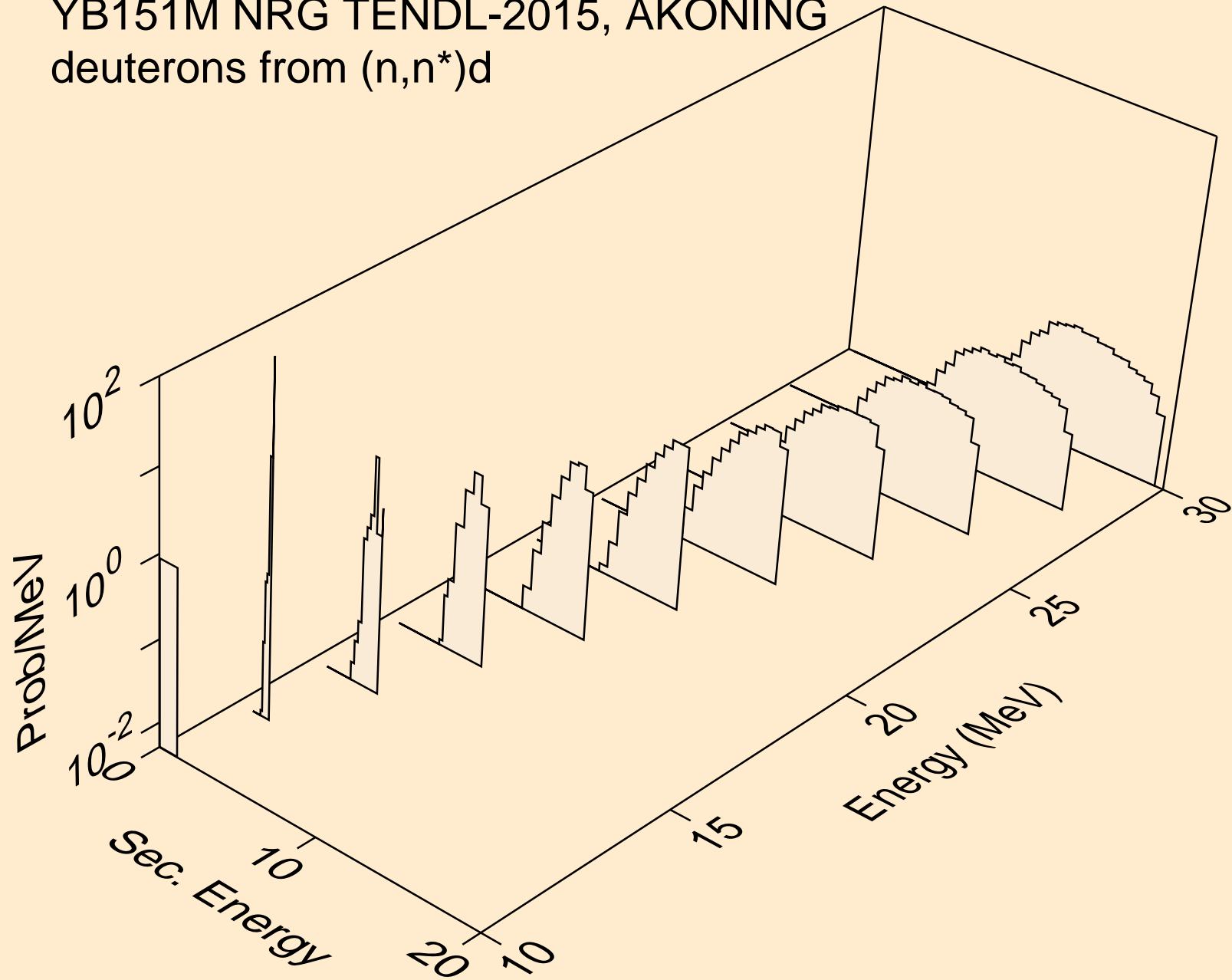

YB151M NRG TENDL-2015, AKONING
deuterons from (n,d)

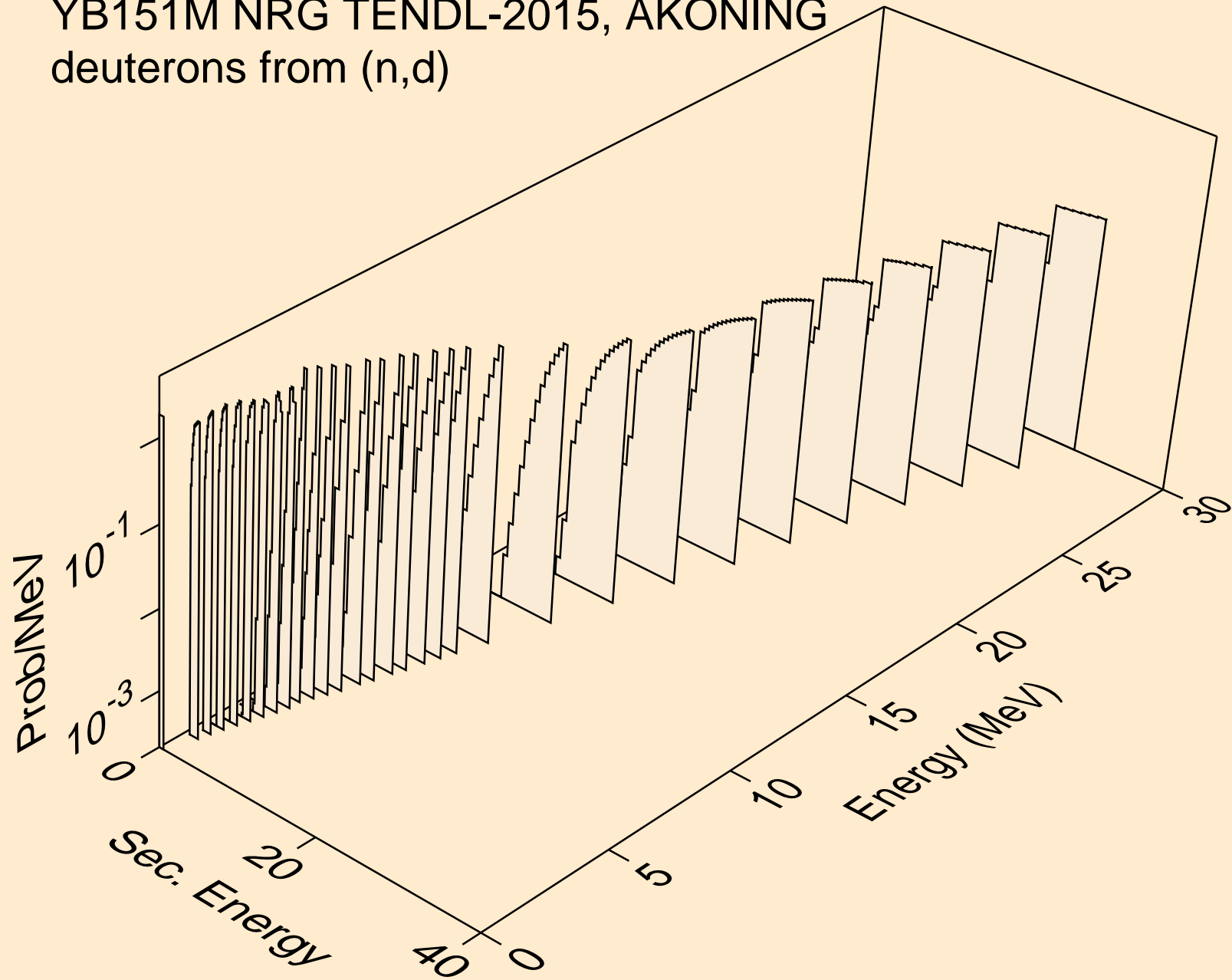

YB151M NRG TENDL-2015, AKONING
deuterons from (n,d2a)

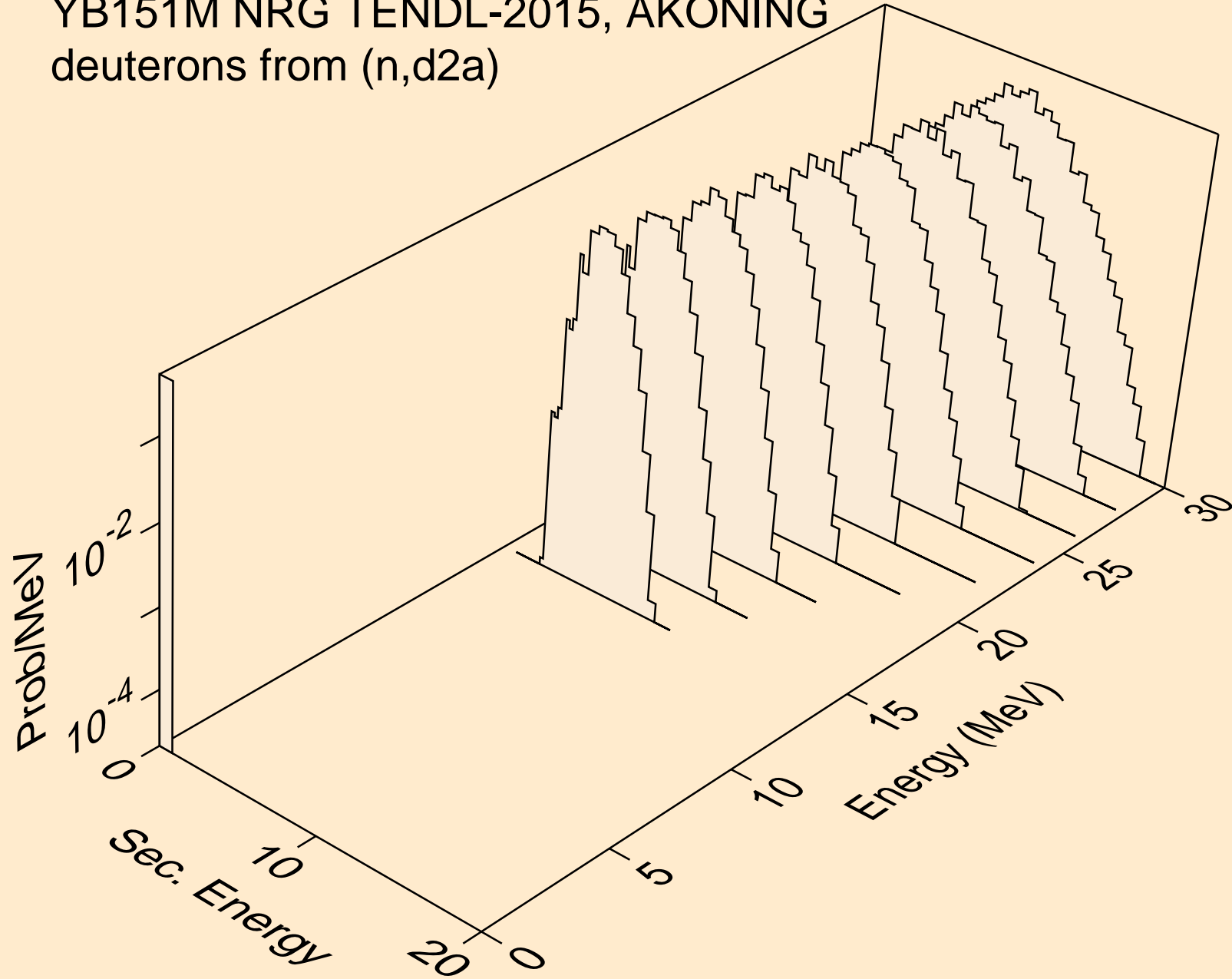

YB151M NRG TENDL-2015, AKONING
deuterons from (n,pd)

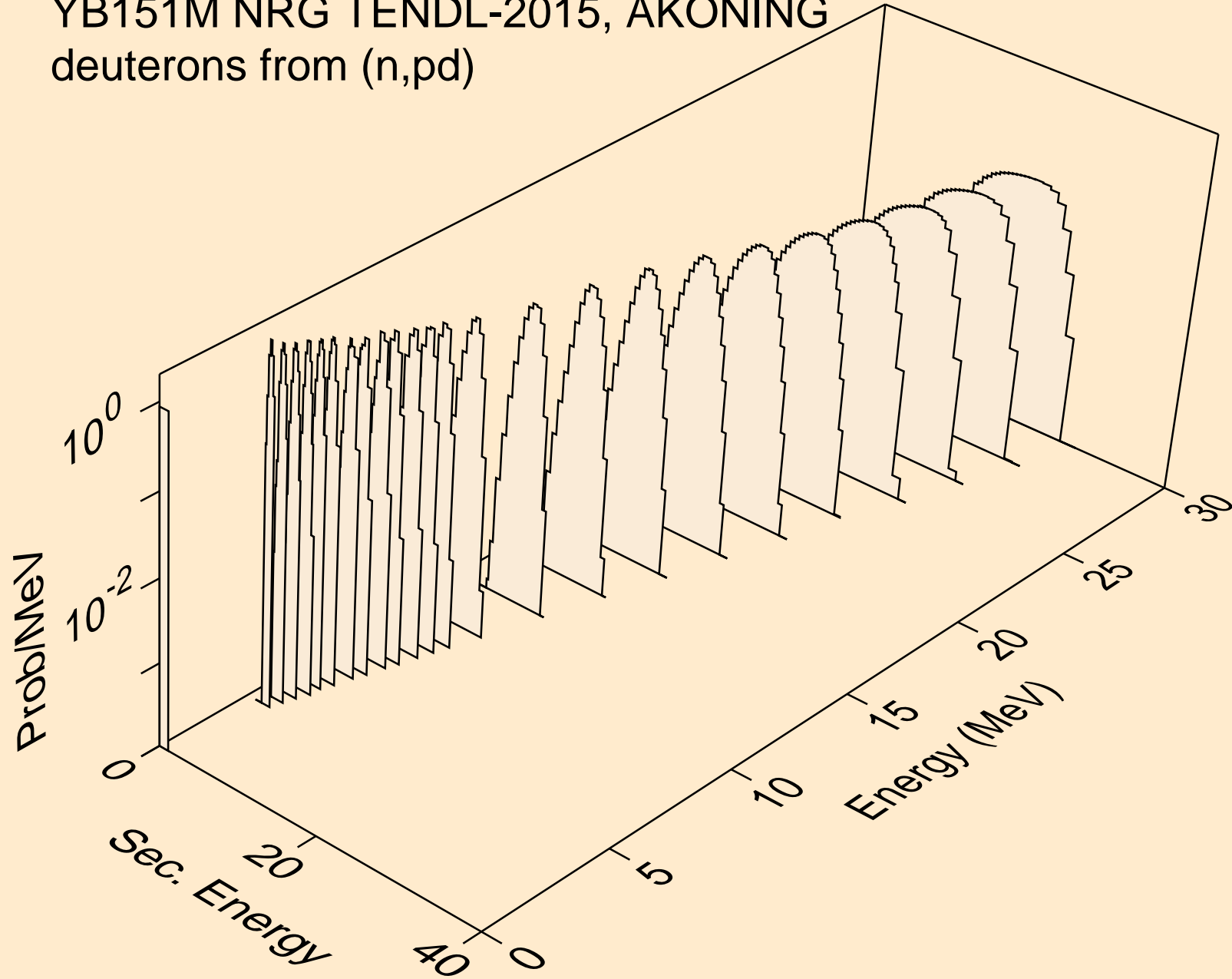

YB151M NRG TENDL-2015, AKONING
deuterons from (n,da)

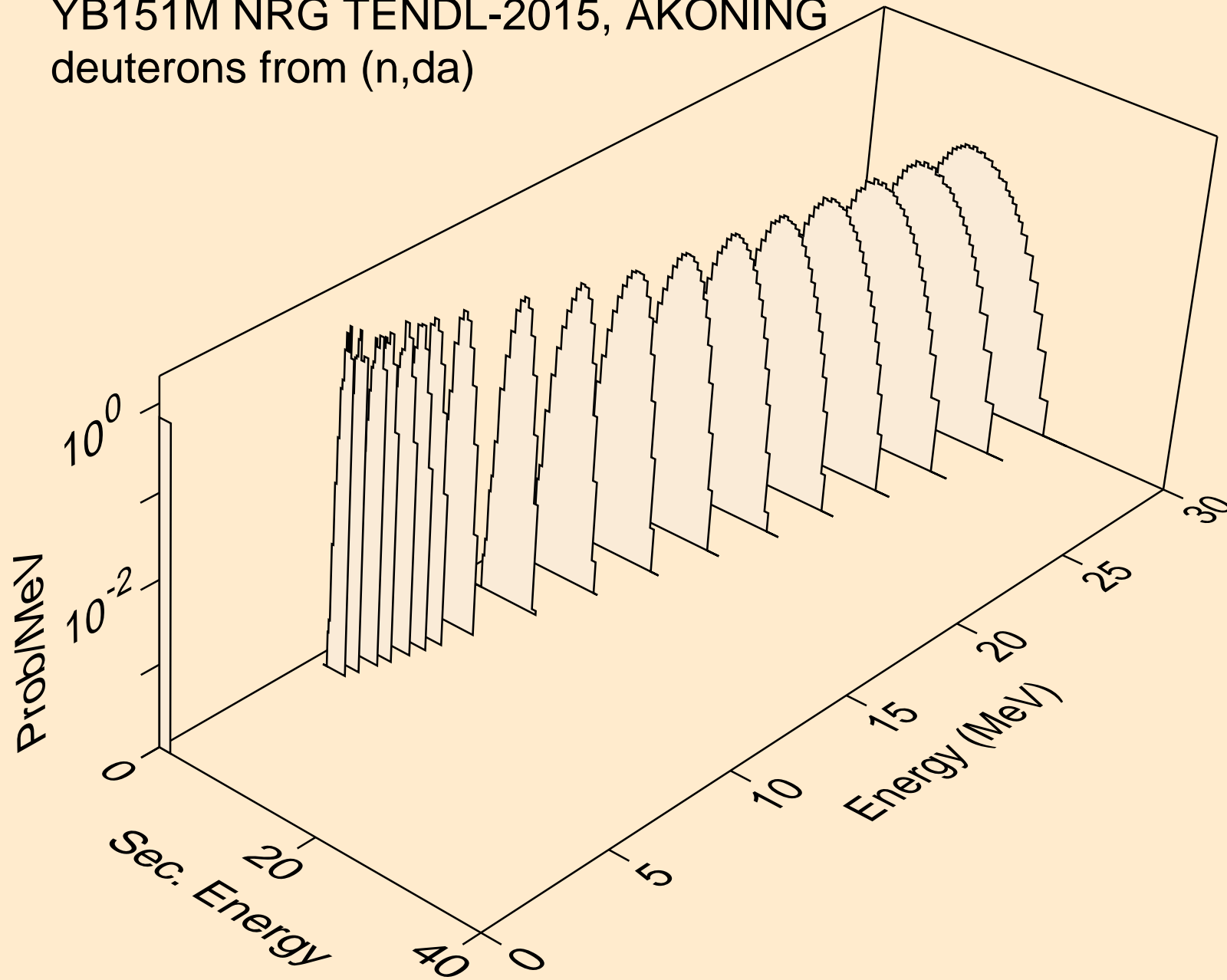

YB151M NRG TENDL-2015, AKONING
tritons from (n,x)

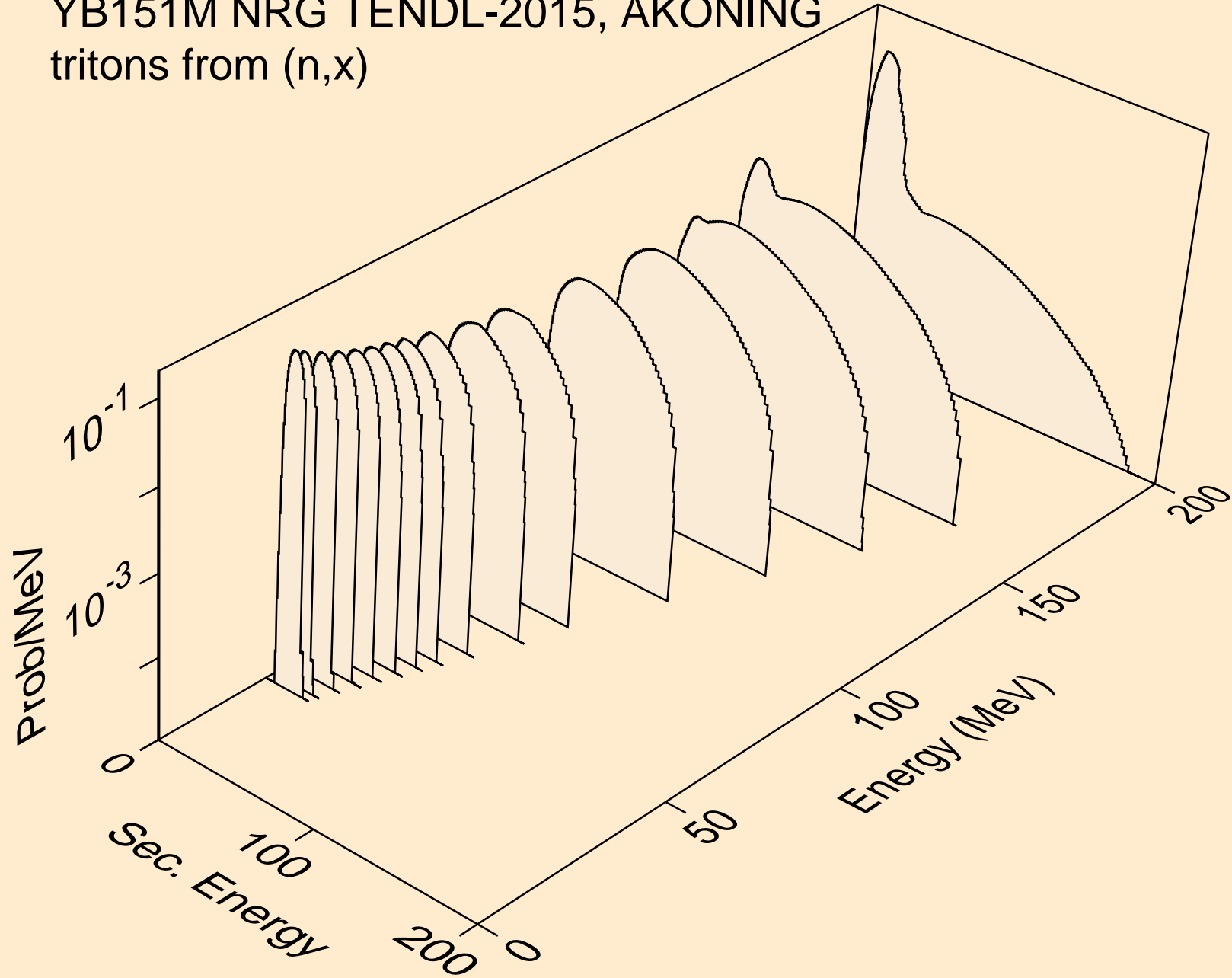

YB151M NRG TENDL-2015, AKONING
tritons from (n,n*)t

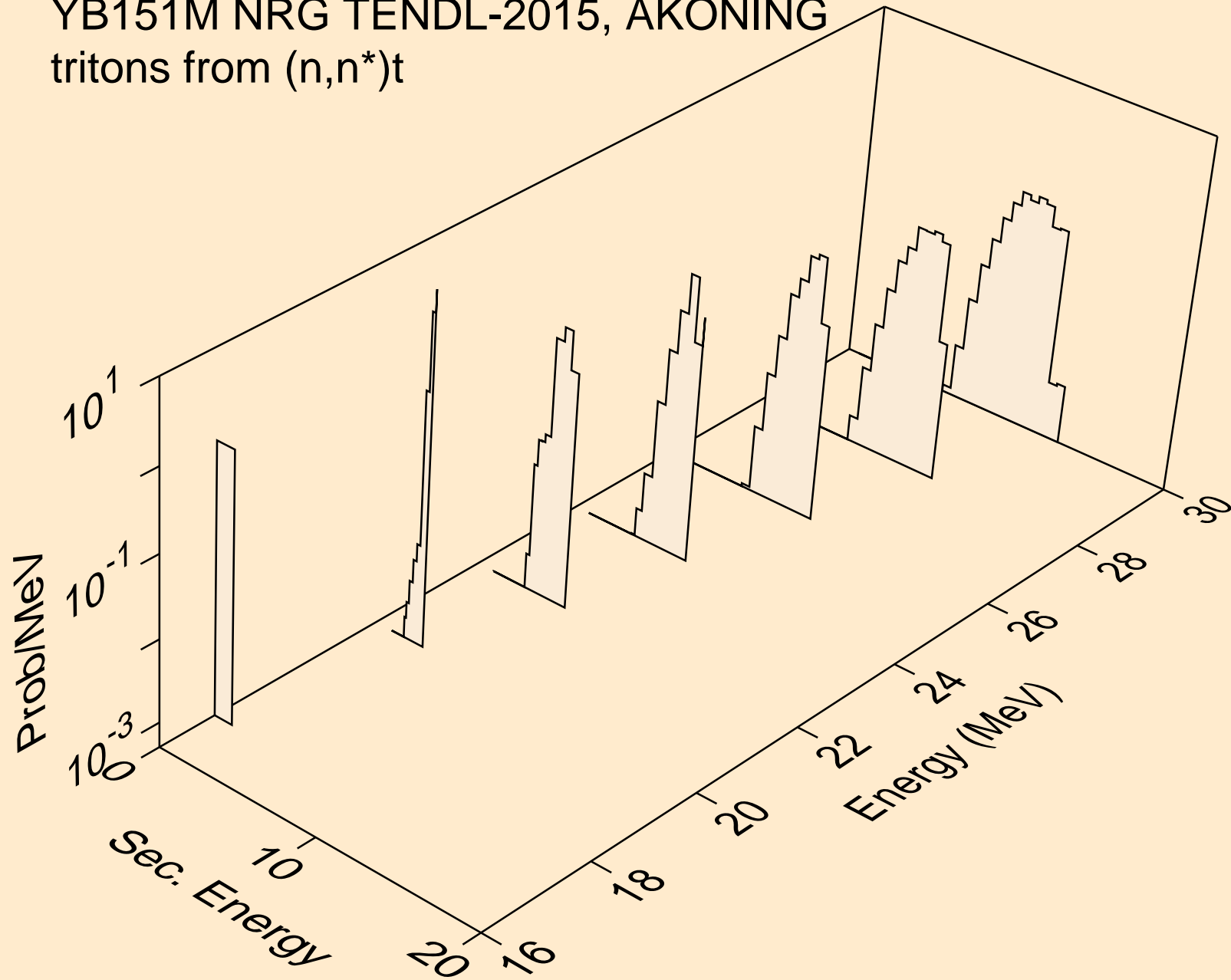

YB151M NRG TENDL-2015, AKONING
tritons from (n,t)

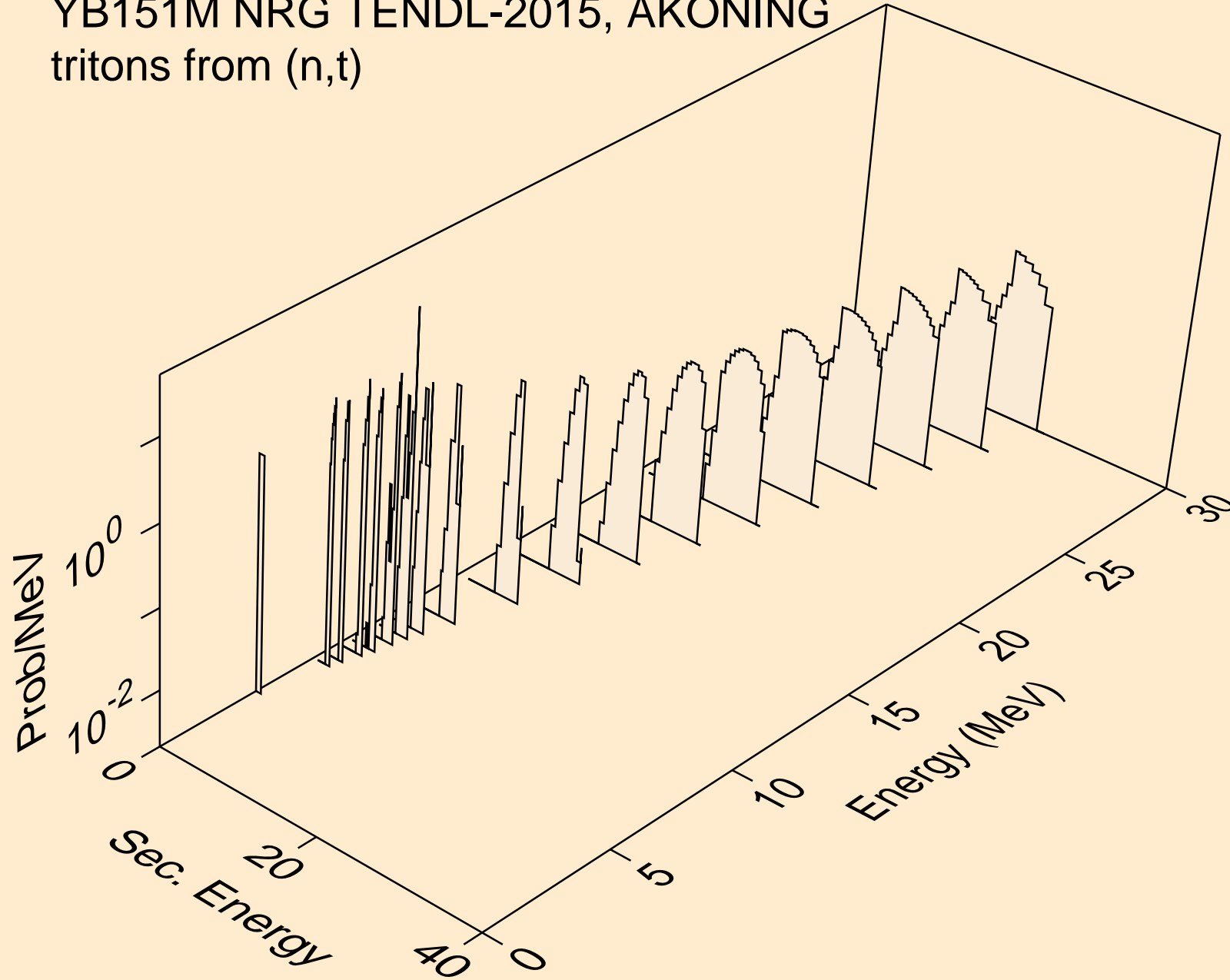

YB151M NRG TENDL-2015, AKONING
tritons from (n,pt)

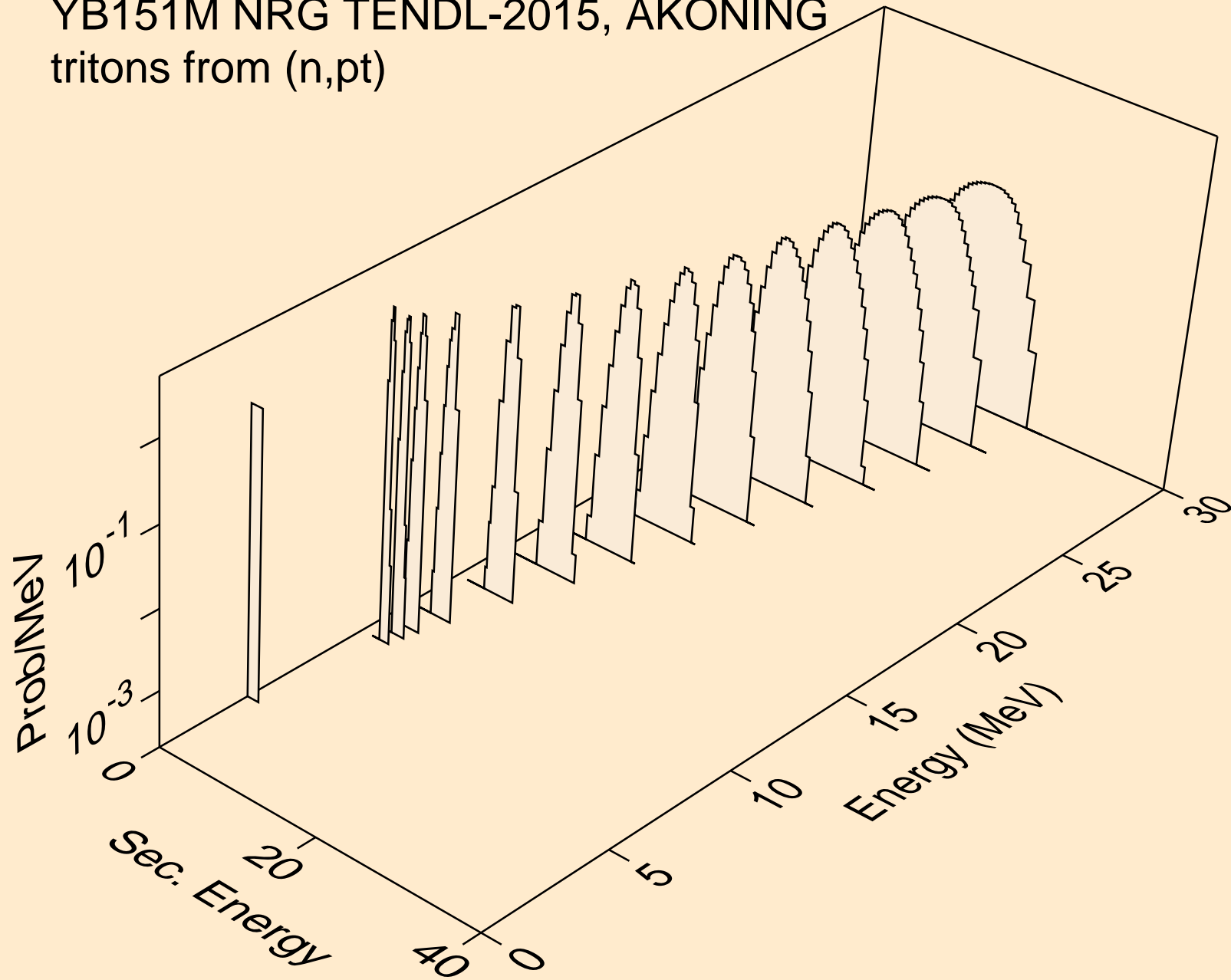

YB151M NRG TENDL-2015, AKONING
he3s from (n,x)

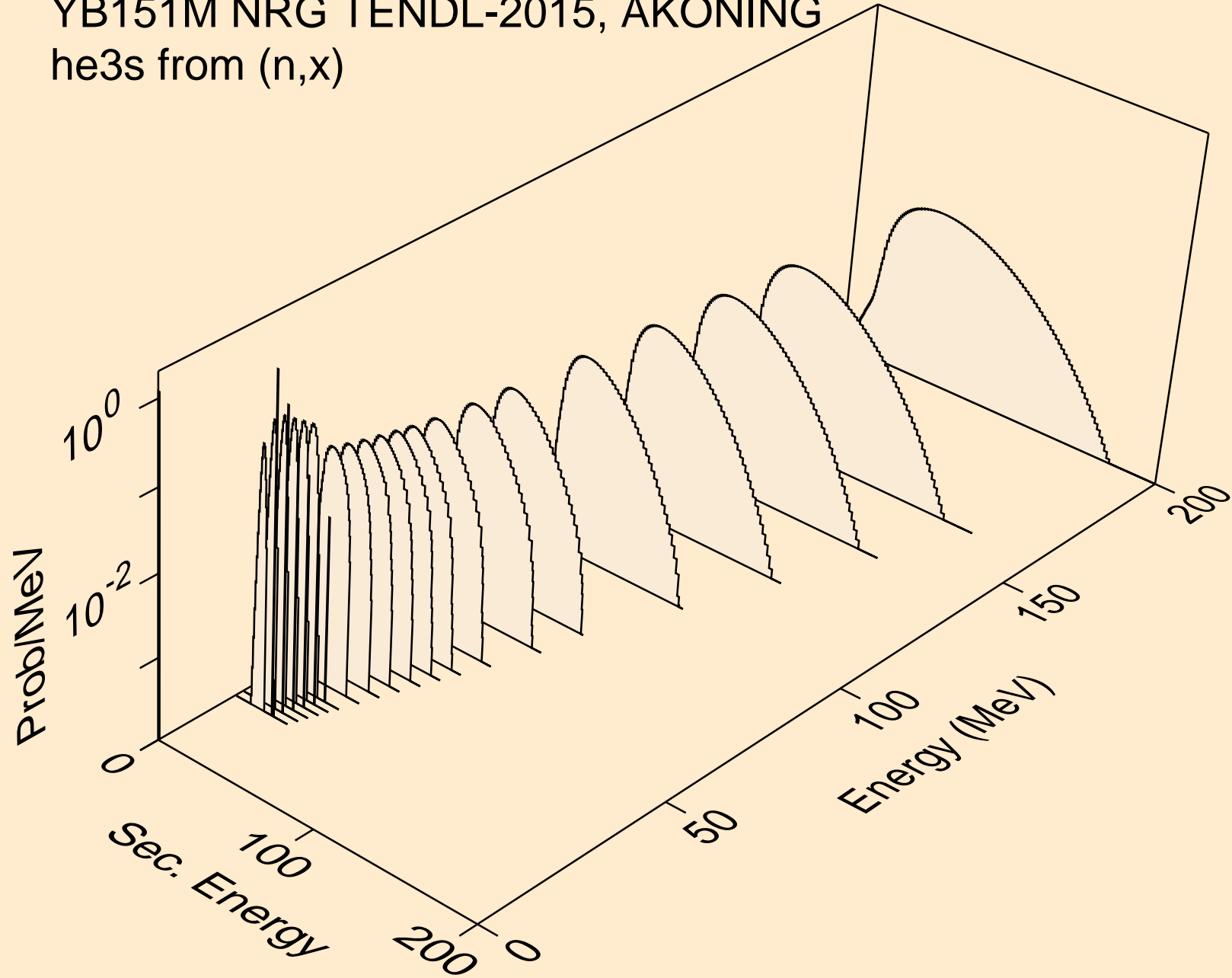

YB151M NRG TENDL-2015, AKONING
he3s from (n,n*)he3

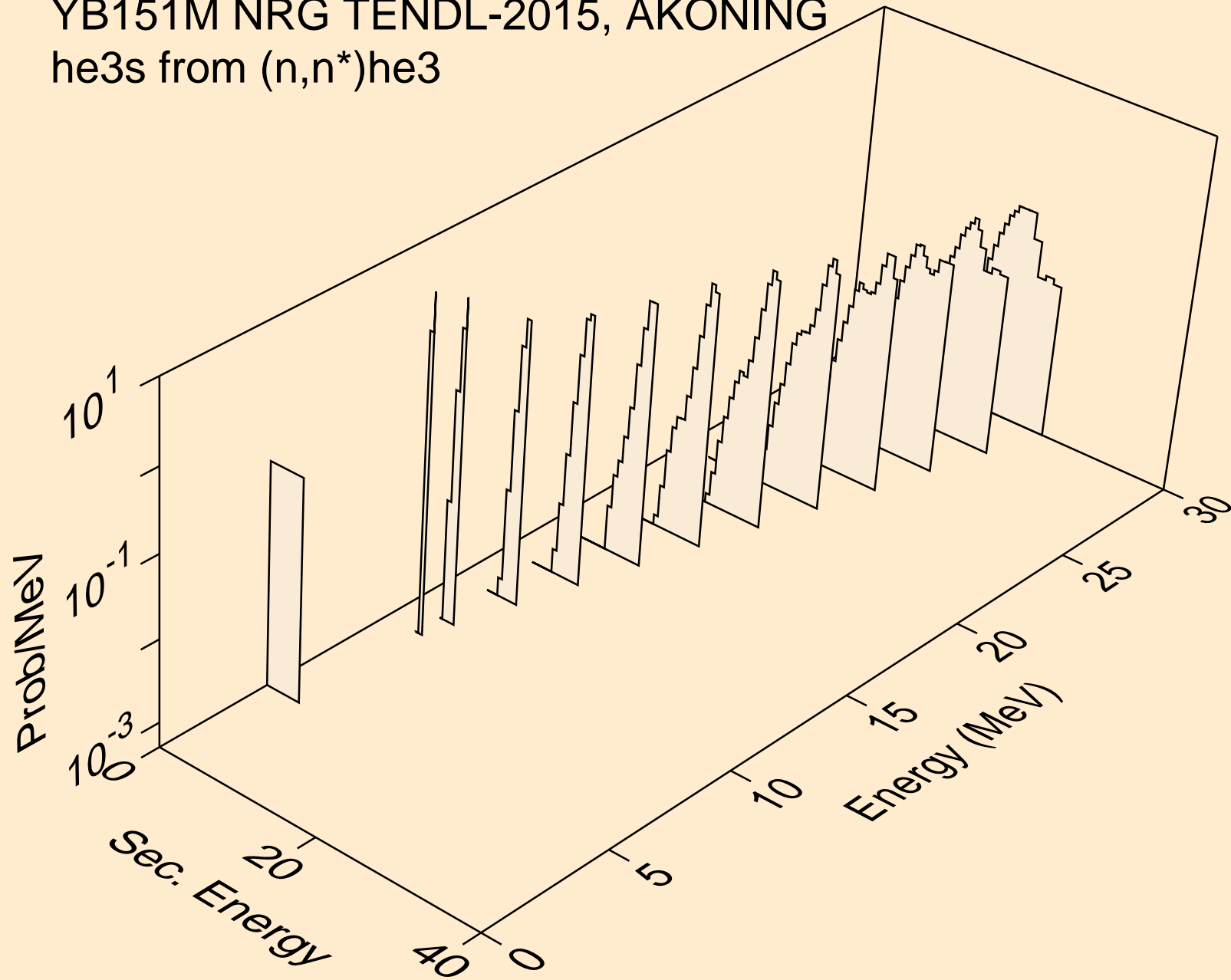

YB151M NRG TENDL-2015, AKONING
he3s from (n,he3)

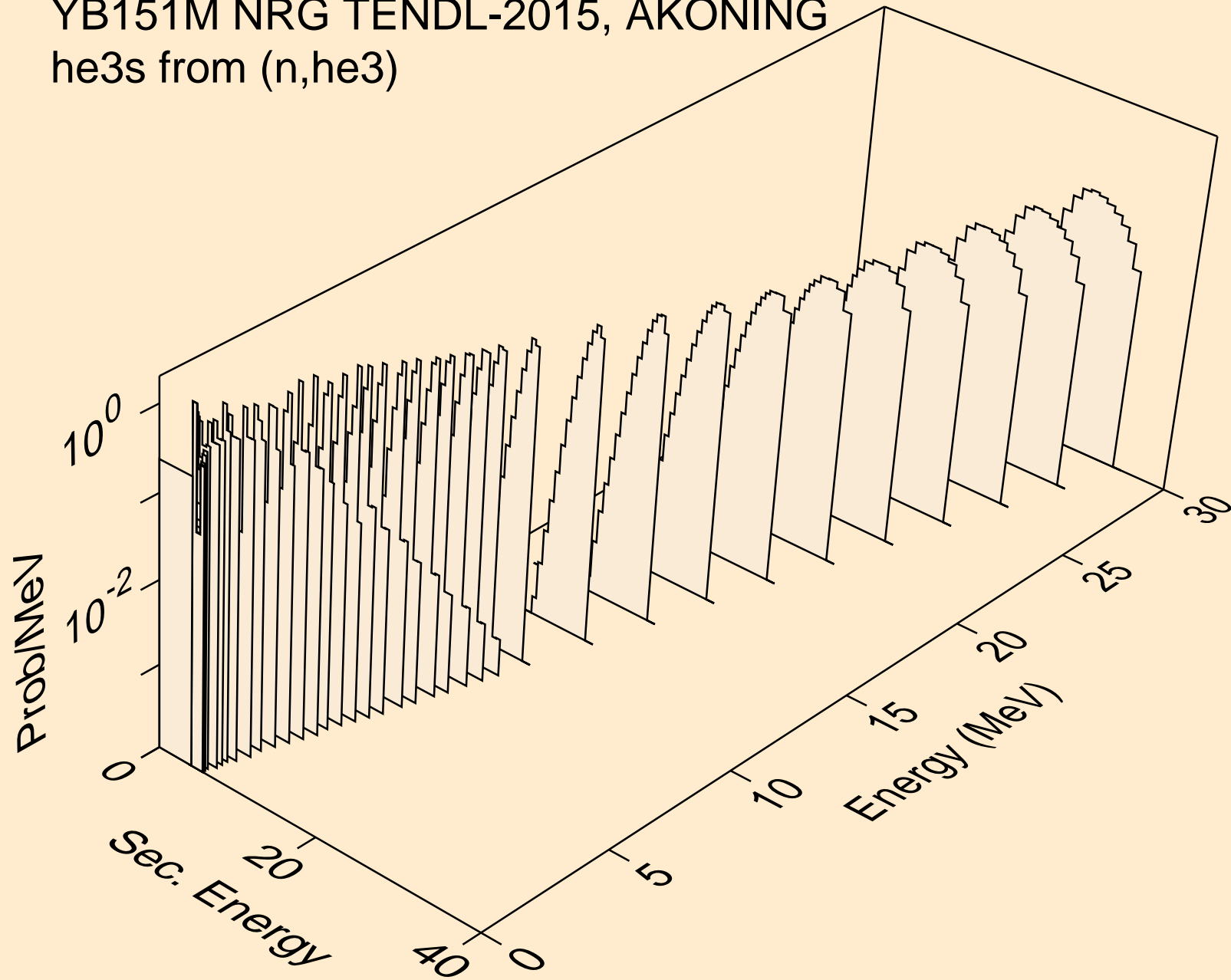

YB151M NRG TENDL-2015, AKONING
alphas from (n,x)

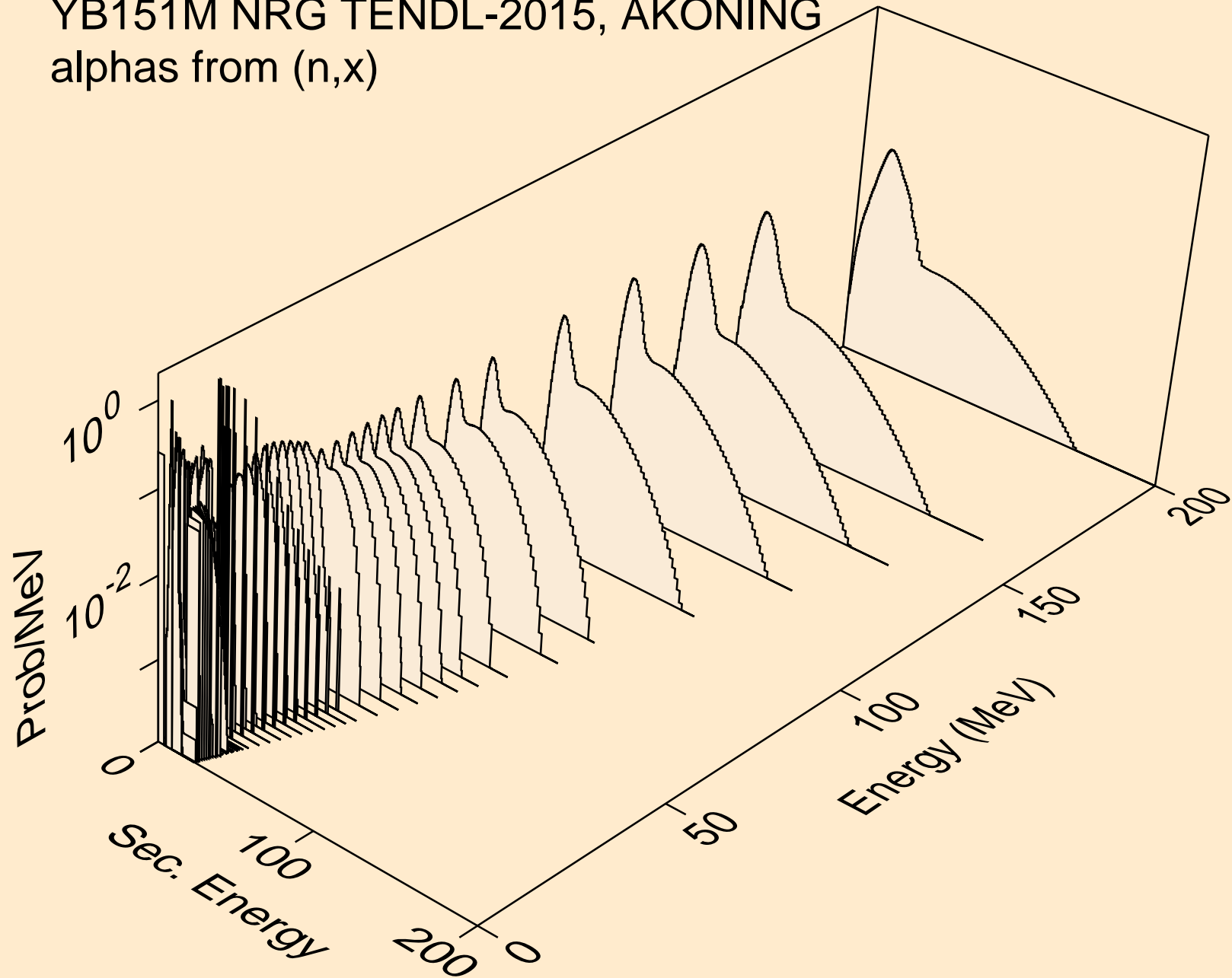

YB151M NRG TENDL-2015, AKONING
alphas from (n,n*)a

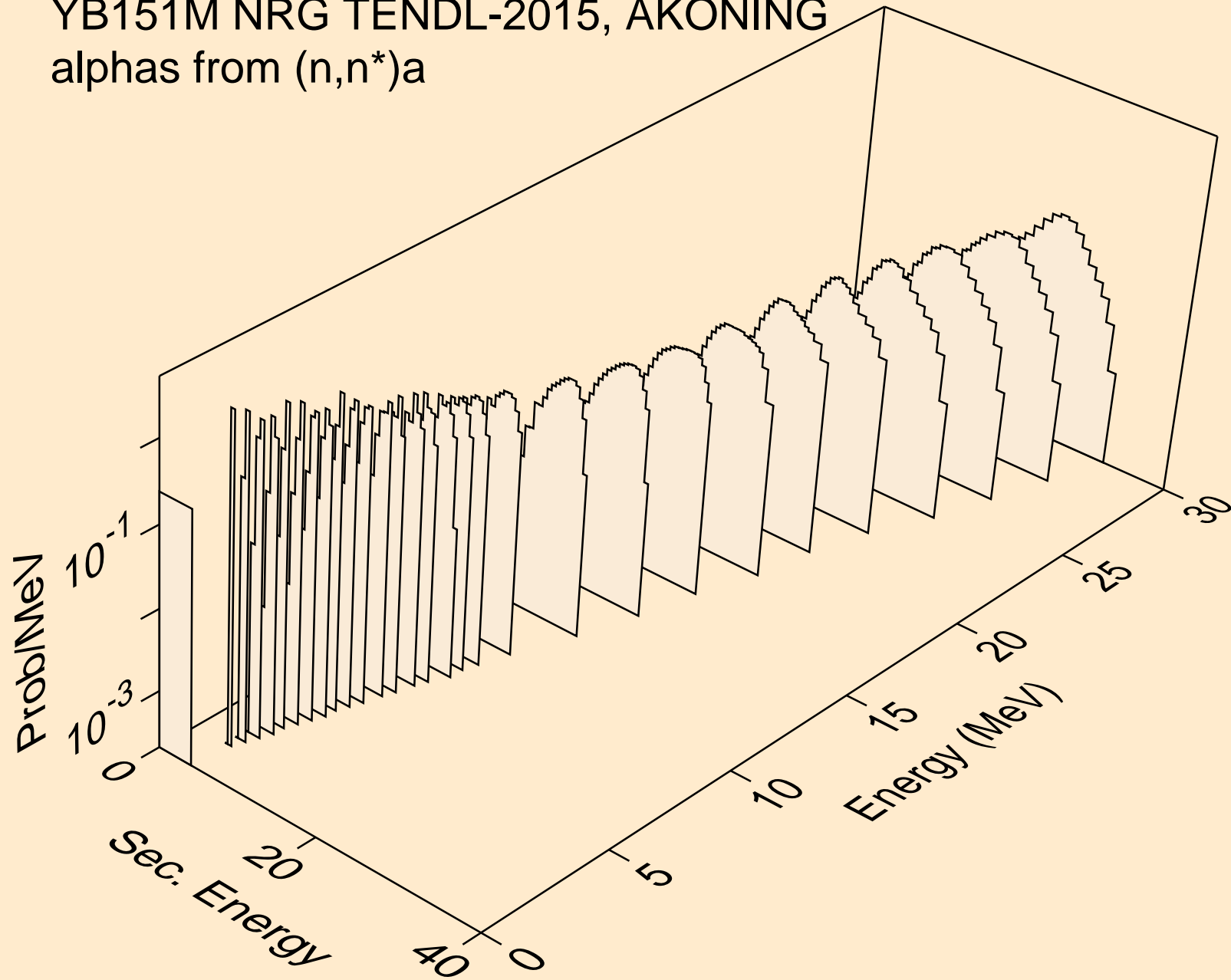

YB151M NRG TENDL-2015, AKONING
alphas from (n,n*)3a

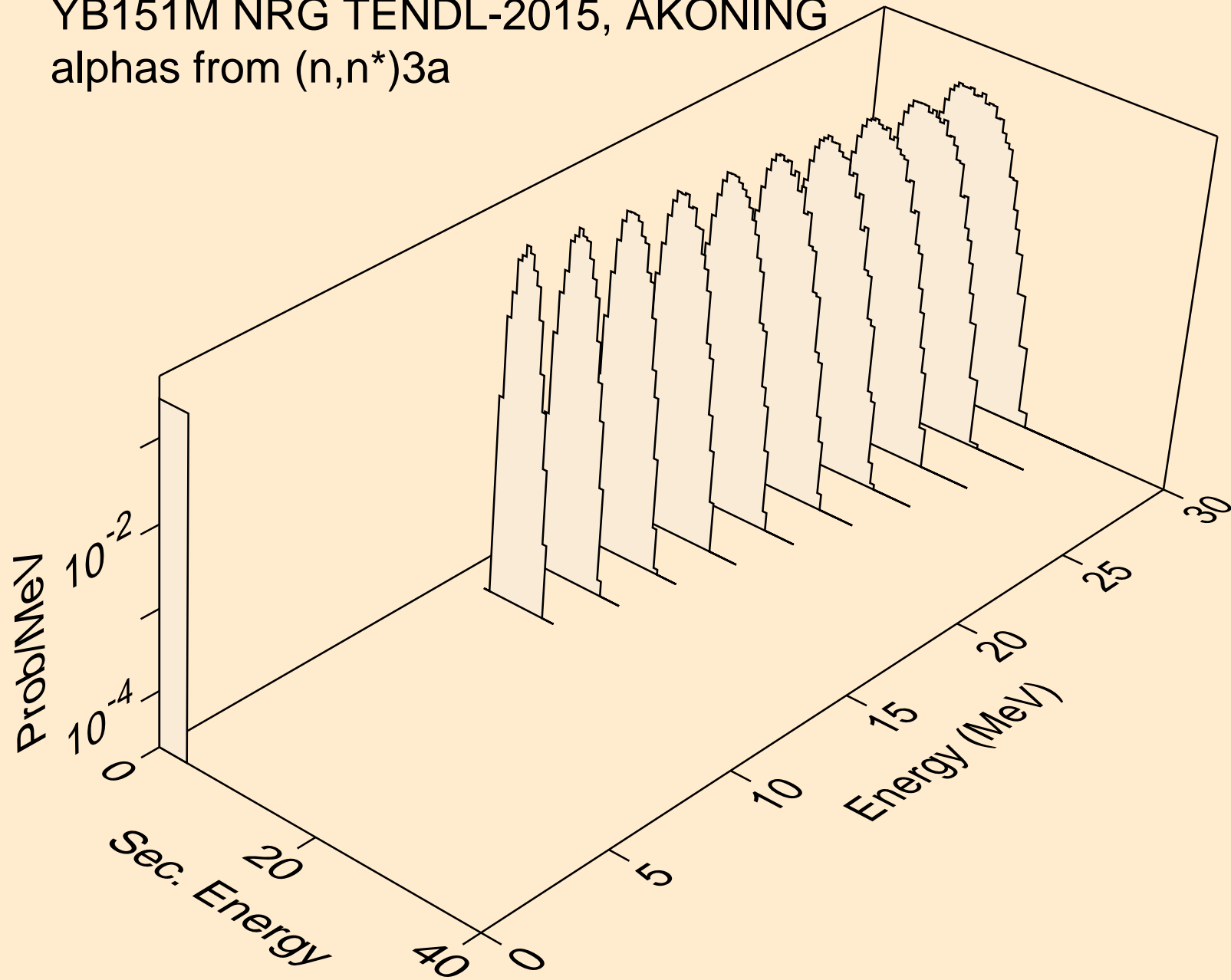

YB151M NRG TENDL-2015, AKONING
alphas from (n,2n)a

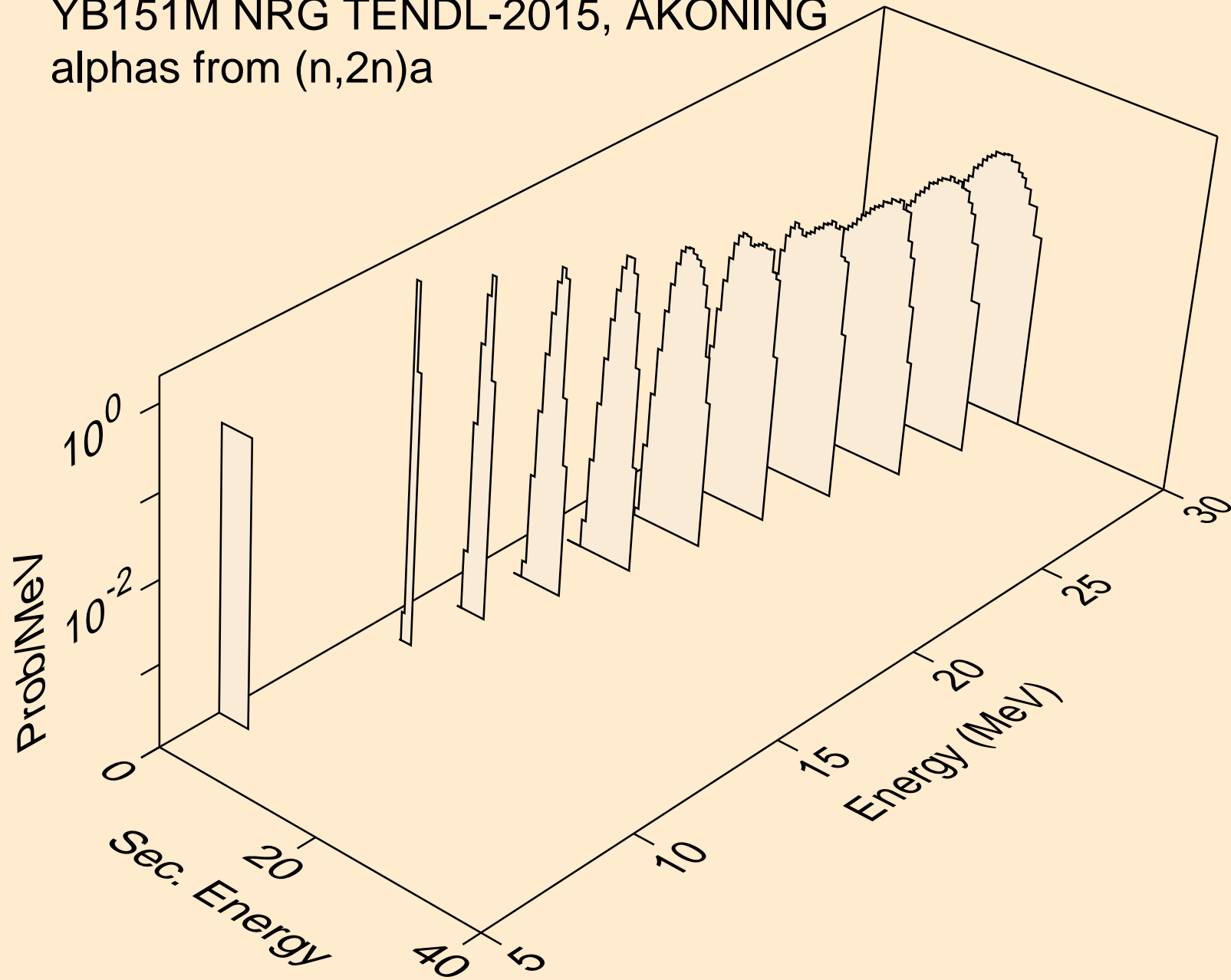

YB151M NRG TENDL-2015, AKONING
alphas from (n,3n)a

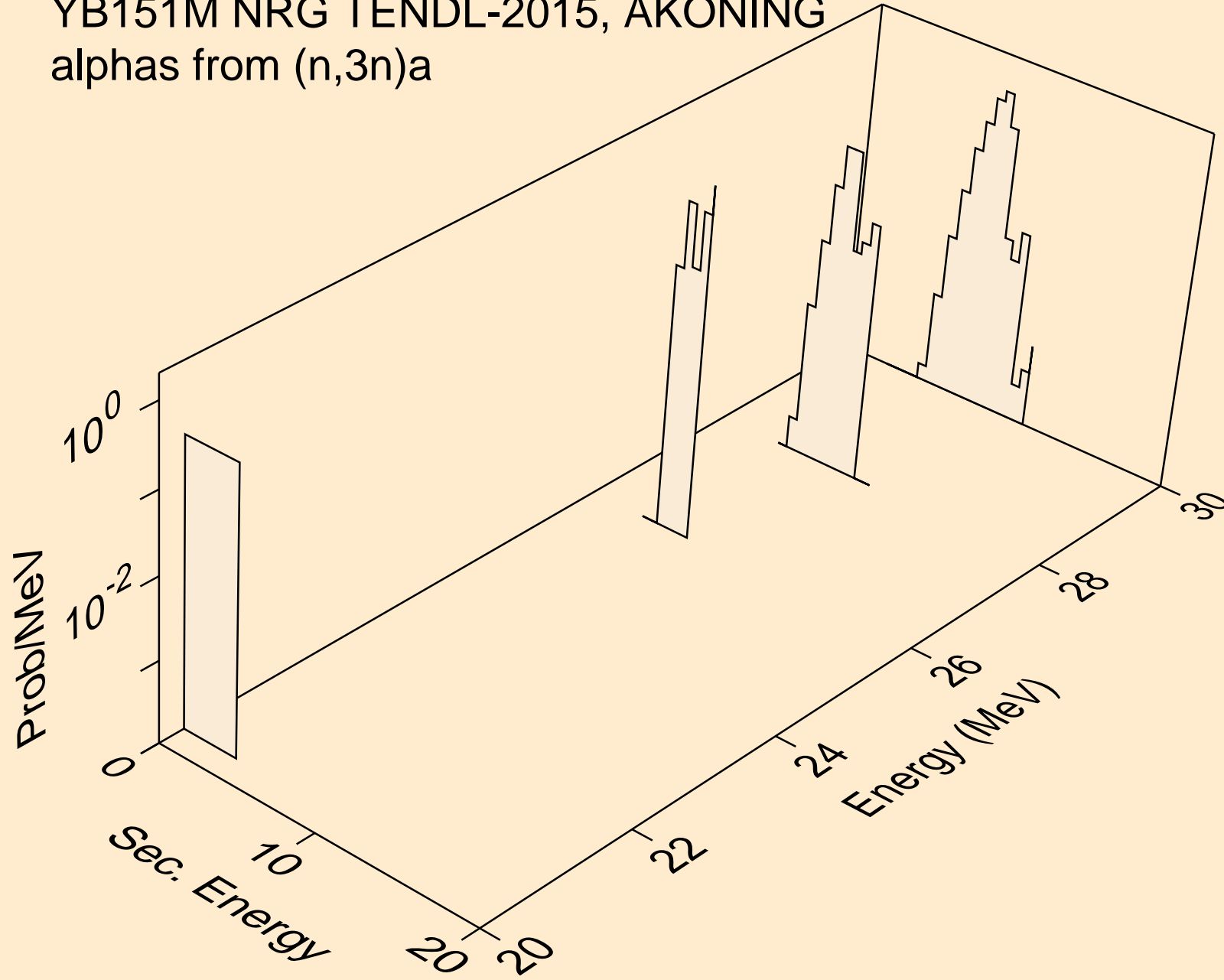

YB151M NRG TENDL-2015, AKONING
alphas from (n,n*)2a

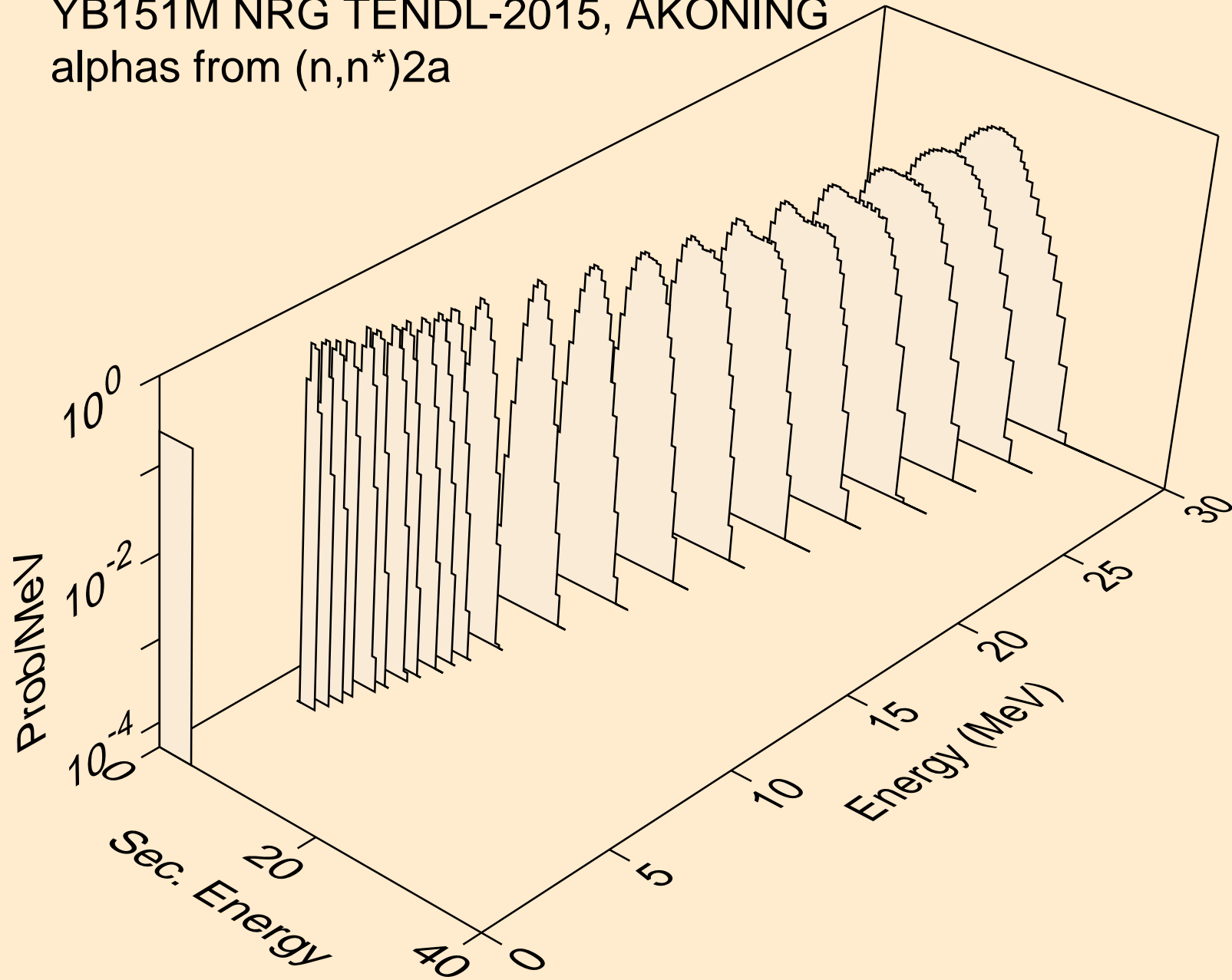

YB151M NRG TENDL-2015, AKONING
alphas from (n,2n)2a

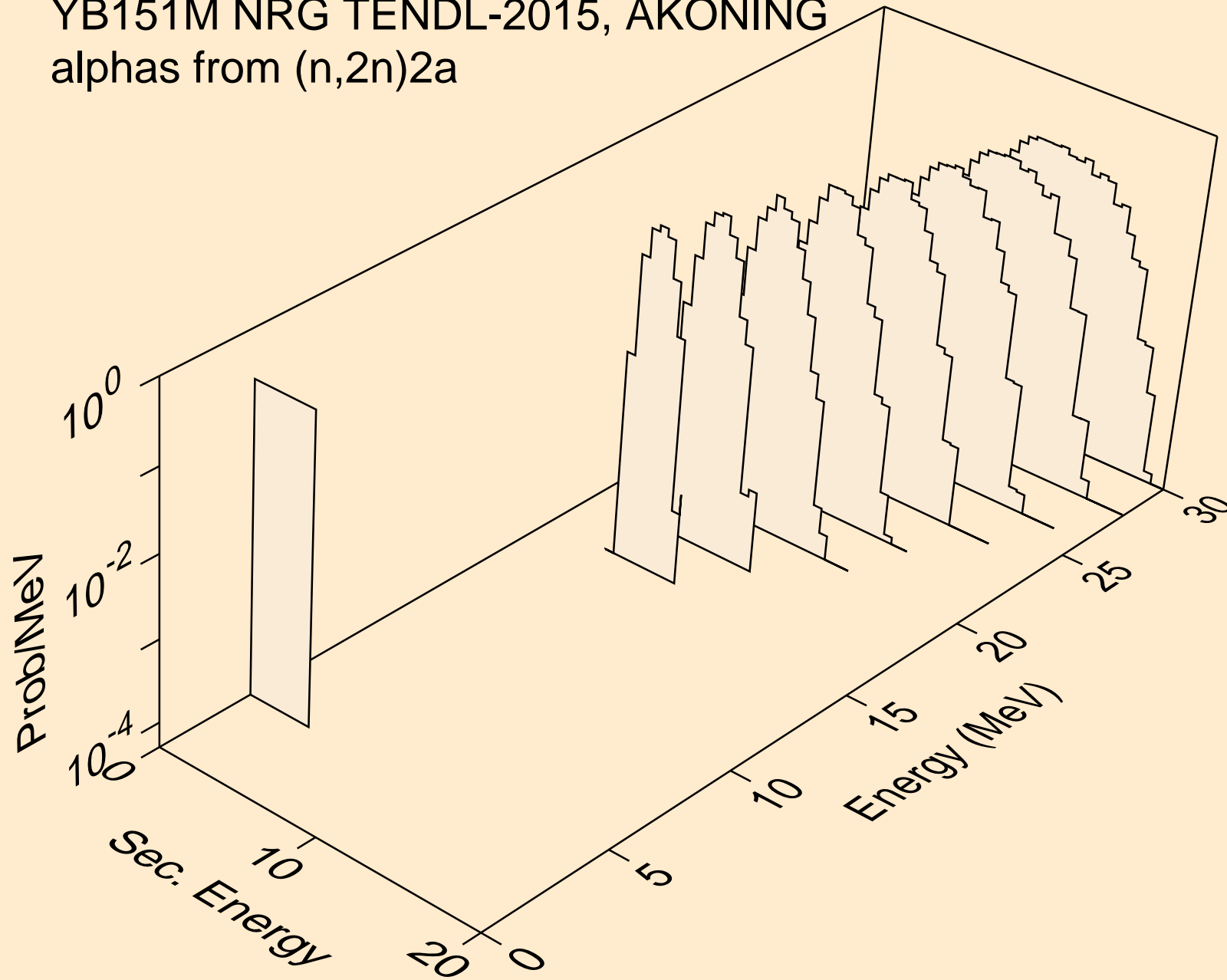

YB151M NRG TENDL-2015, AKONING
alphas from (n,npa)

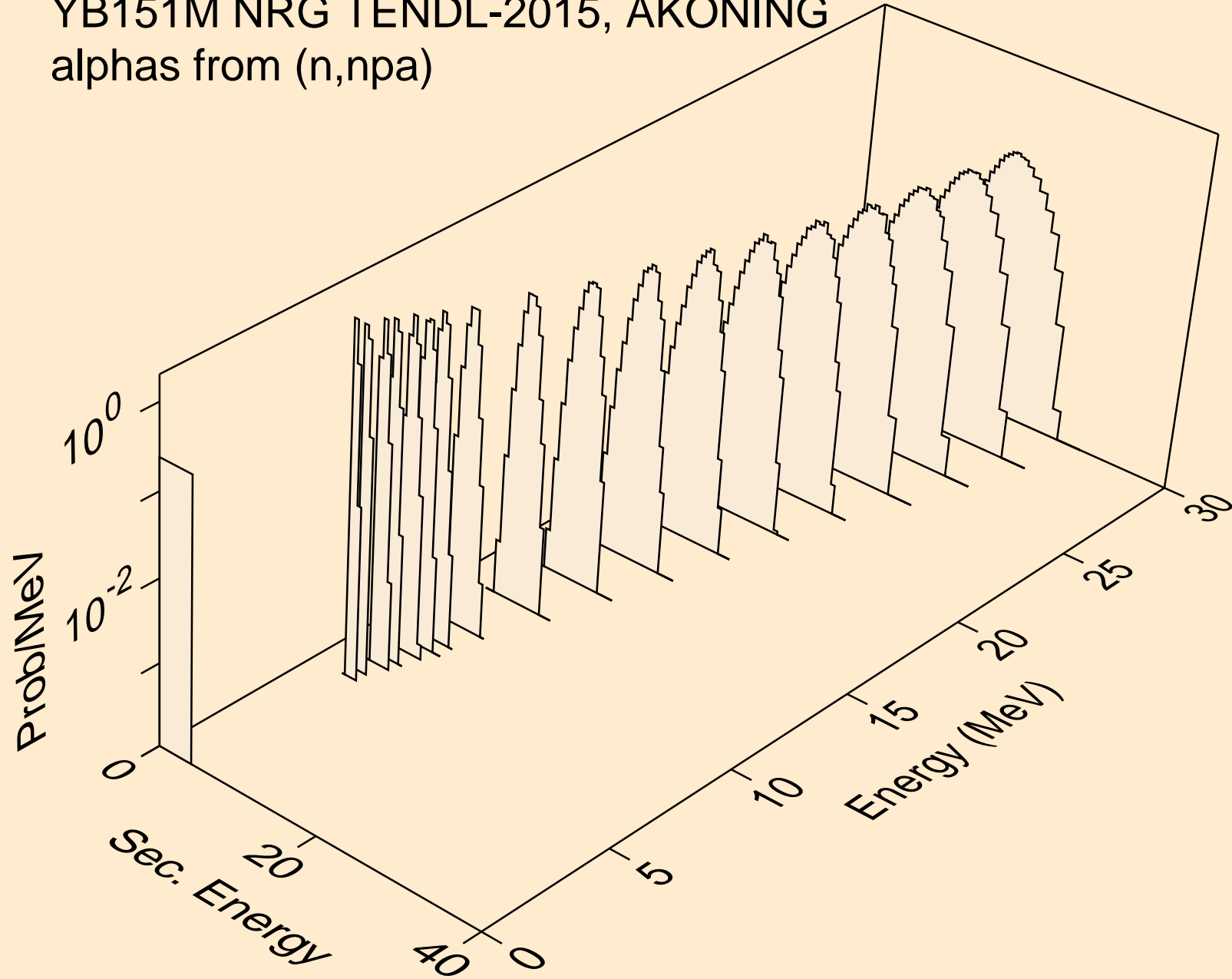

YB151M NRG TENDL-2015, AKONING
alphas from (n,a)

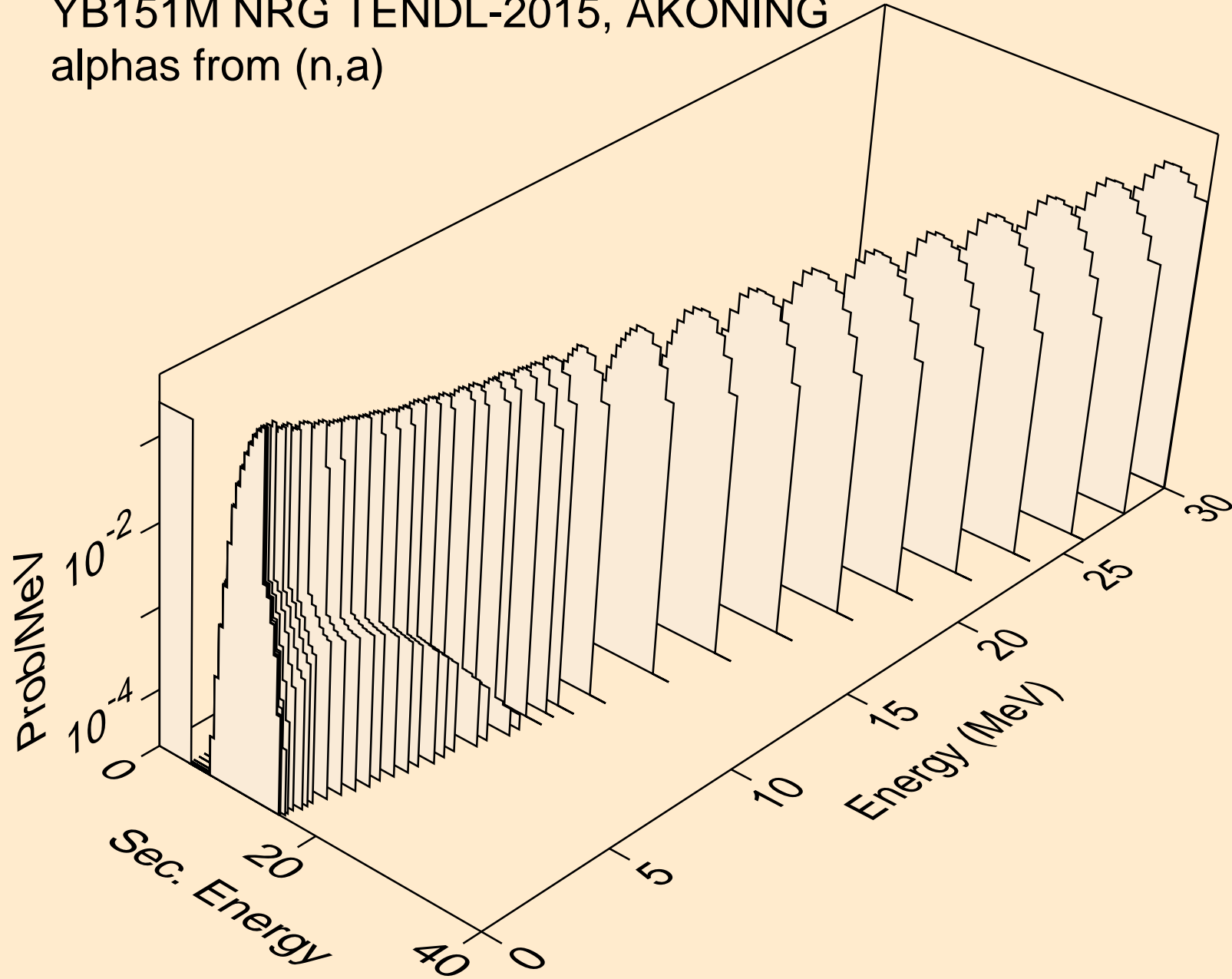

YB151M NRG TENDL-2015, AKONING
alphas from (n,2a)

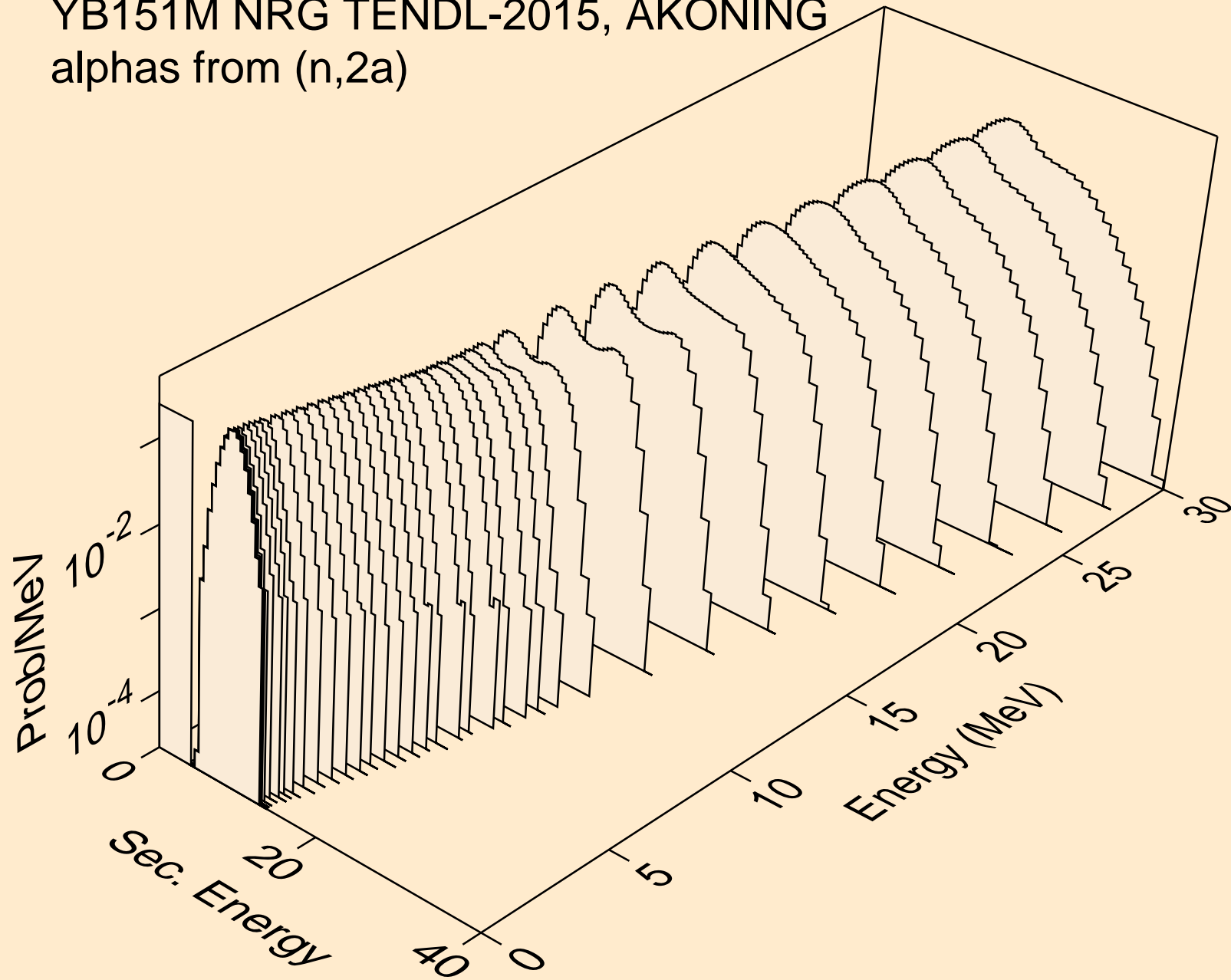

YB151M NRG TENDL-2015, AKONING
alphas from (n,3a)

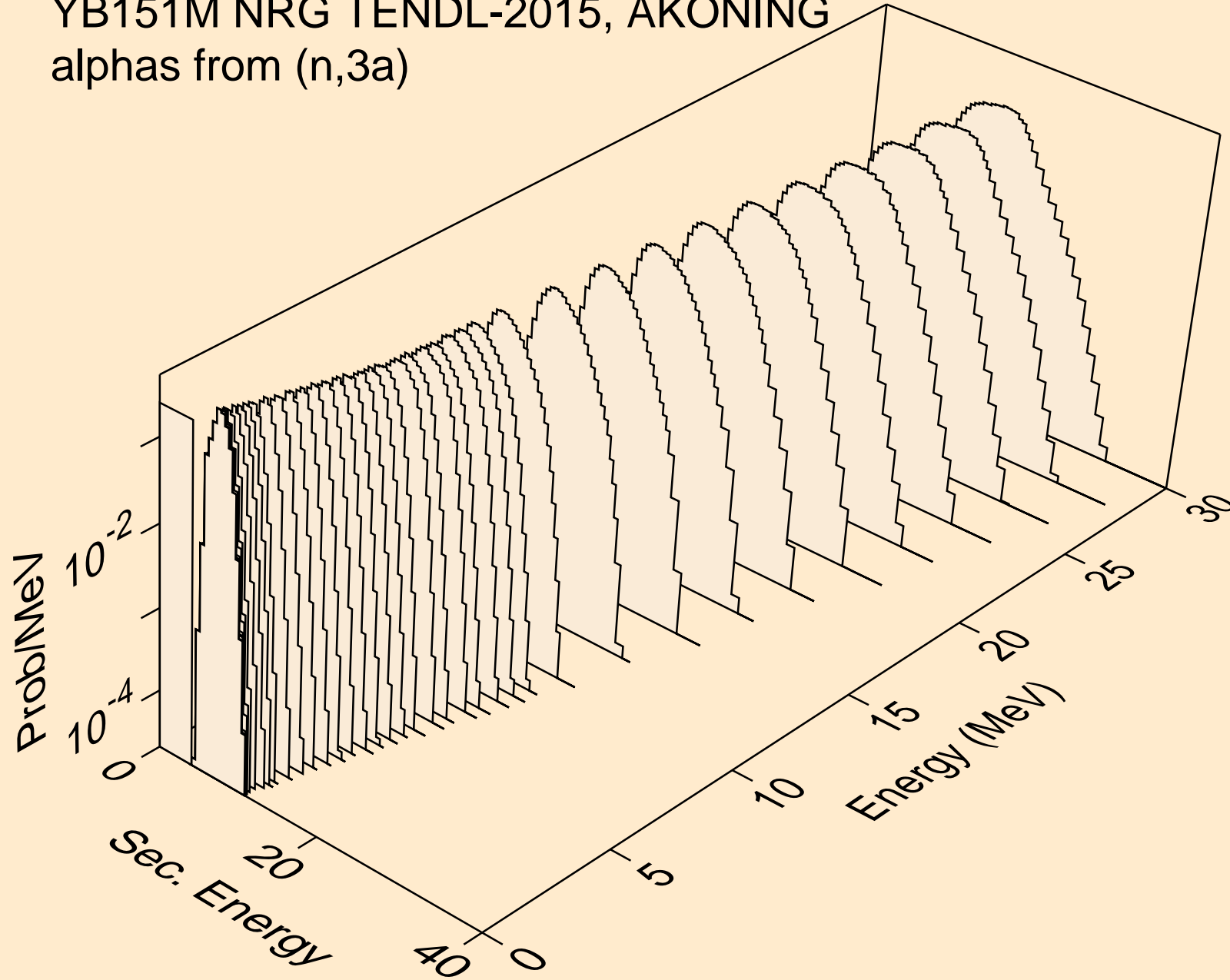

YB151M NRG TENDL-2015, AKONING
alphas from (n,pa)

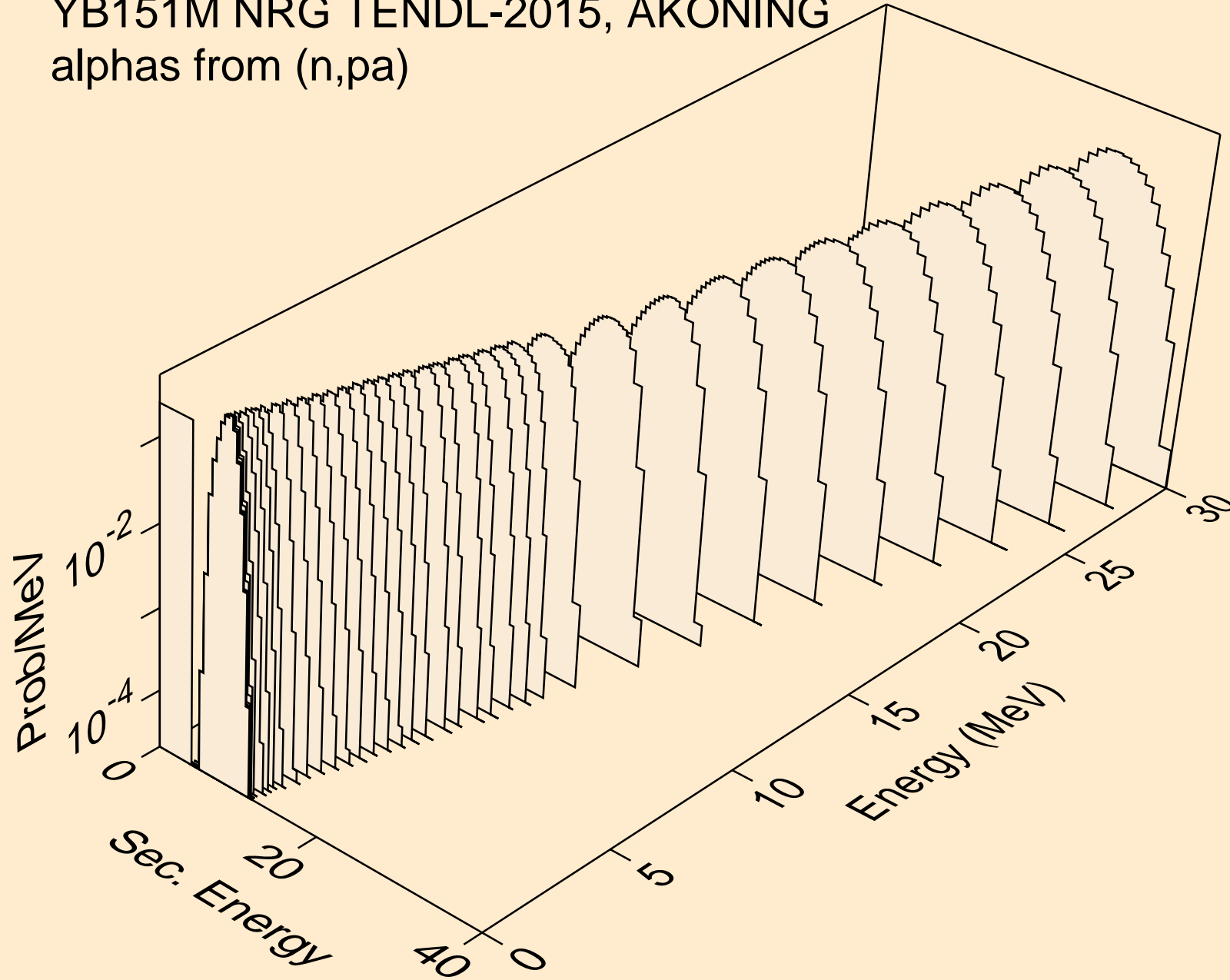

YB151M NRG TENDL-2015, AKONING
alphas from (n,d2a)

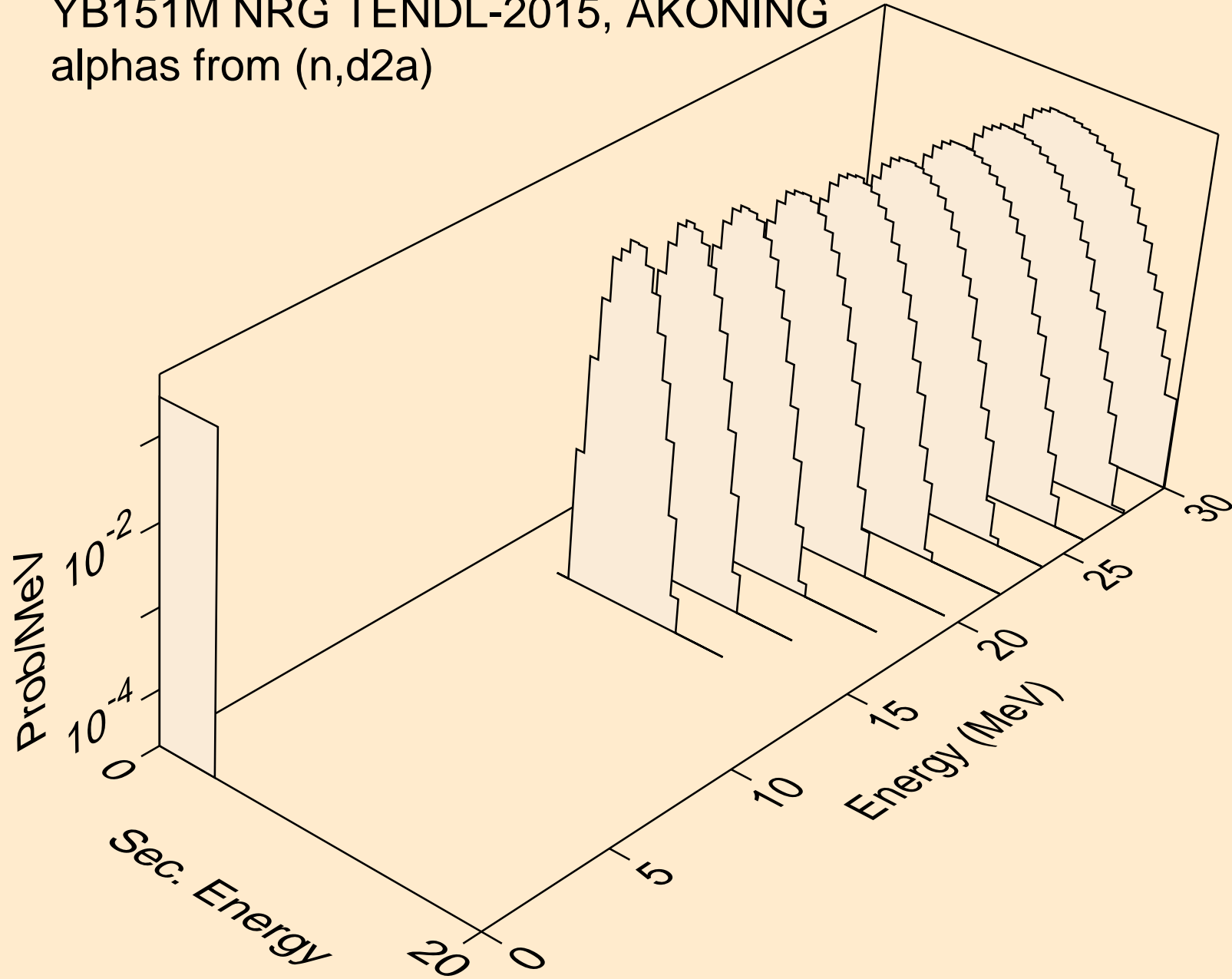

YB151M NRG TENDL-2015, AKONING
alphas from (n,da)

