

YB179 NRG TENDL-2015, AKONING

Principal cross sections

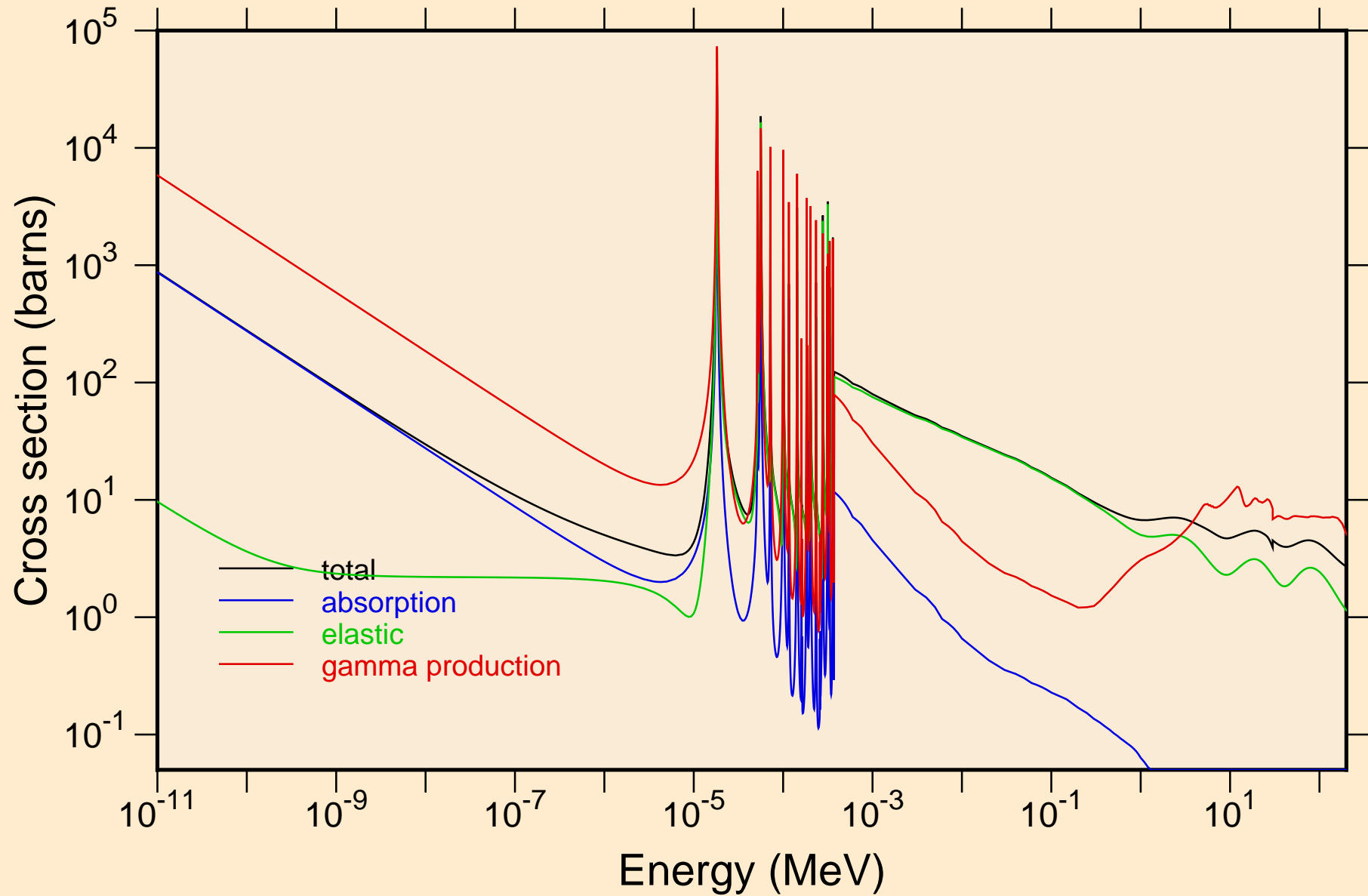

YB179 NRG TENDL-2015, AKONING
resonance total cross section

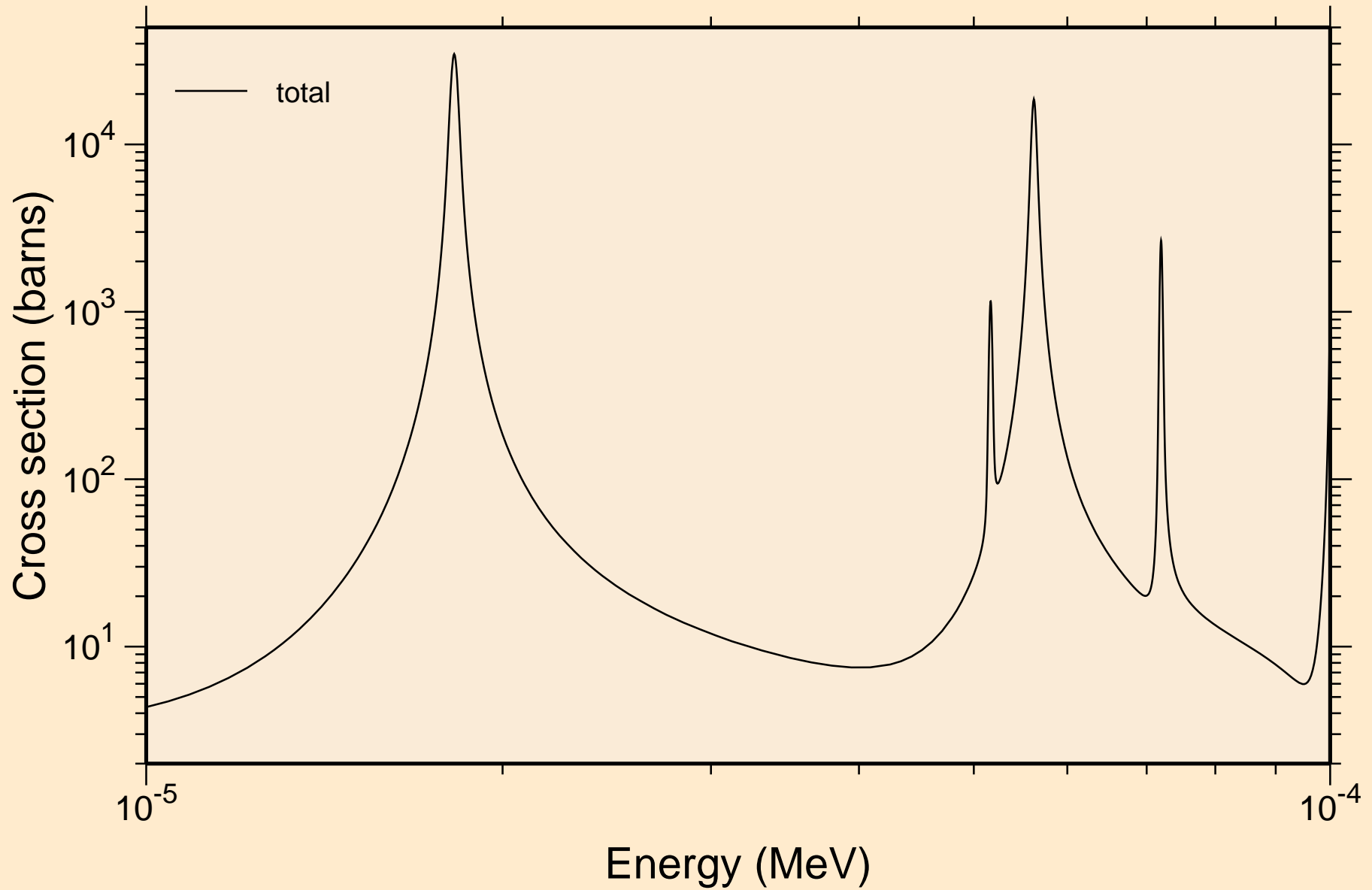

YB179 NRG TENDL-2015, AKONING
resonance total cross section

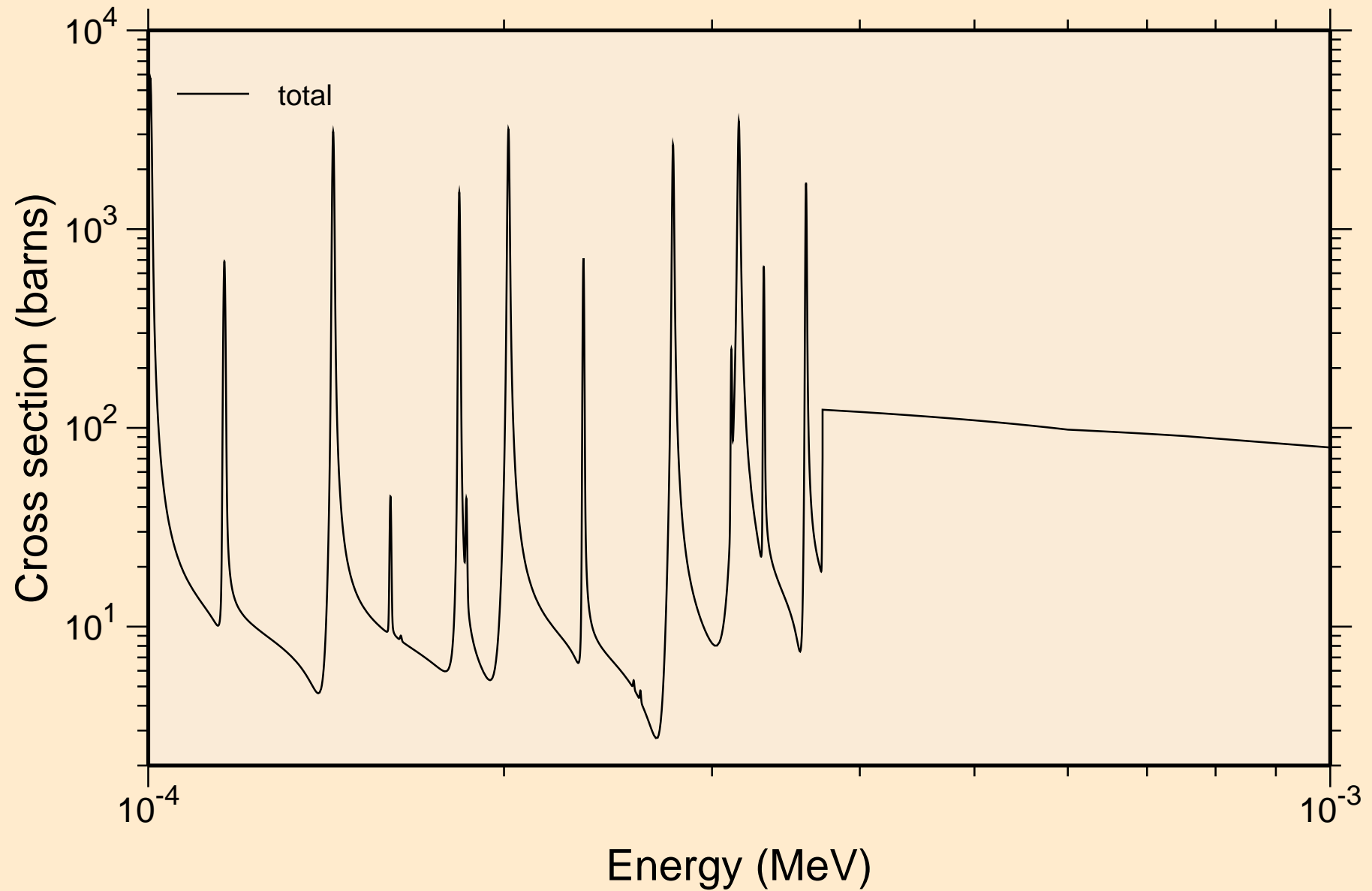

YB179 NRG TENDL-2015, AKONING
resonance total cross section

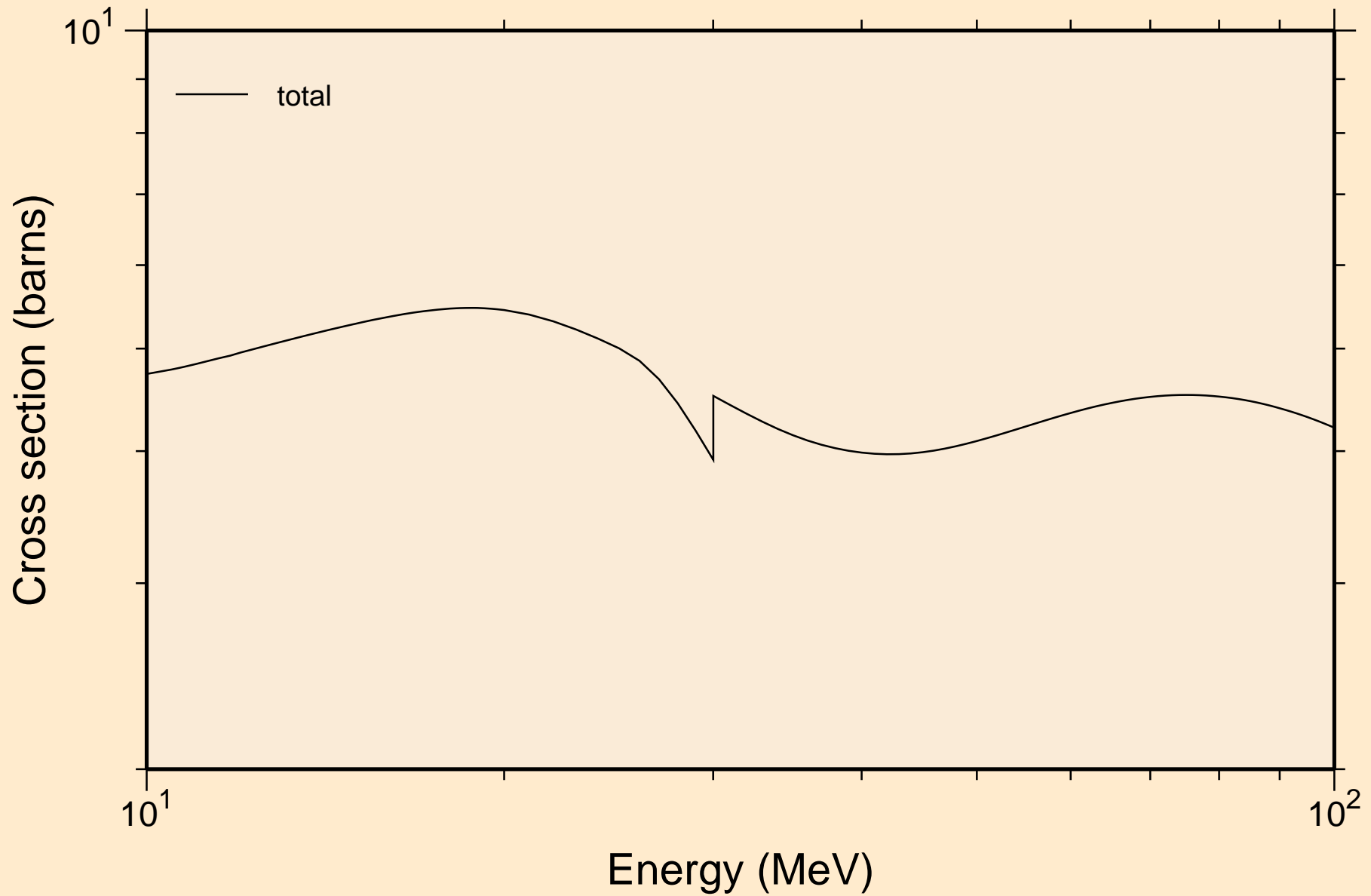

YB179 NRG TENDL-2015, AKONING
resonance absorption cross sections

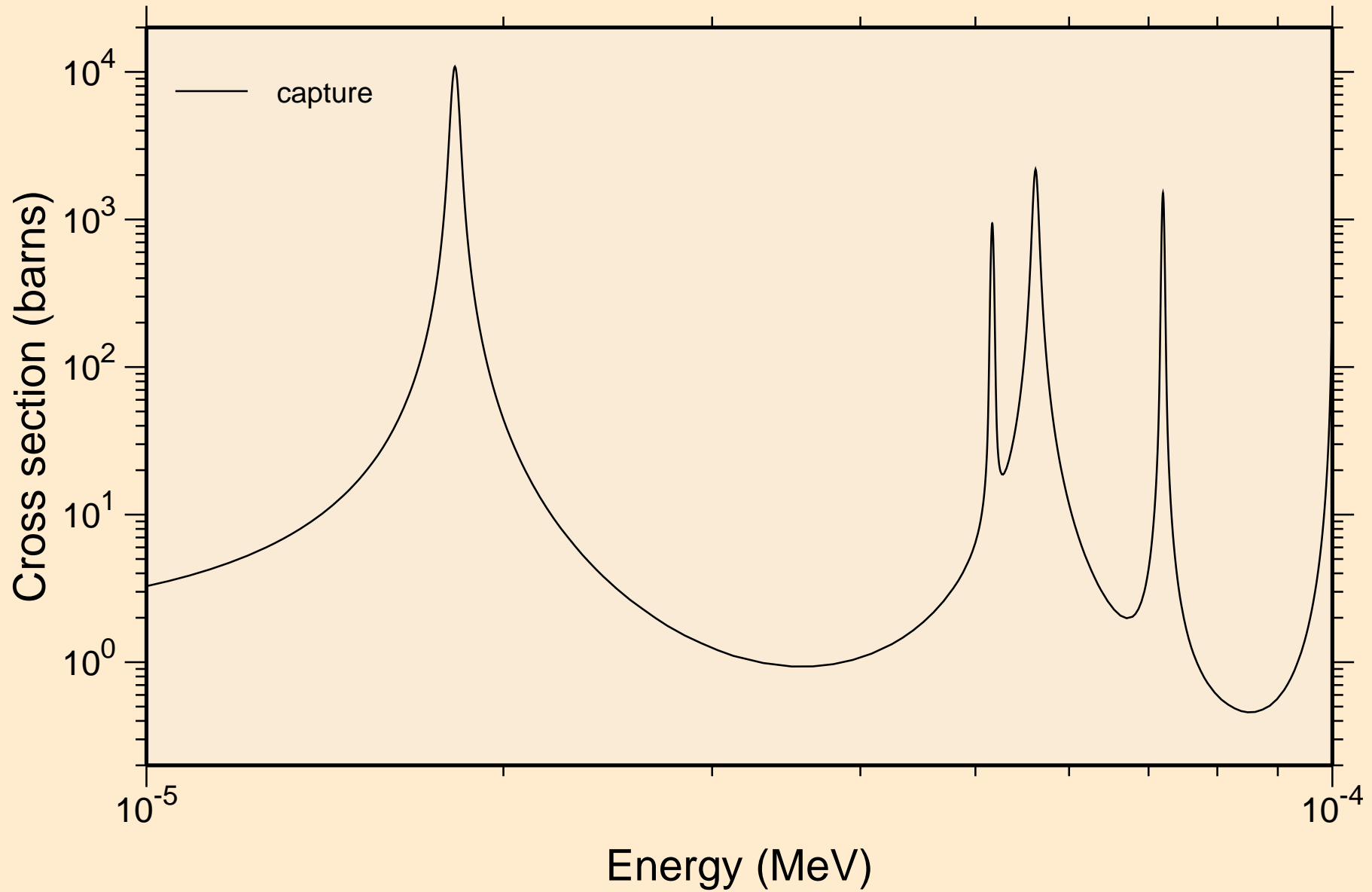

YB179 NRG TENDL-2015, AKONING
resonance absorption cross sections

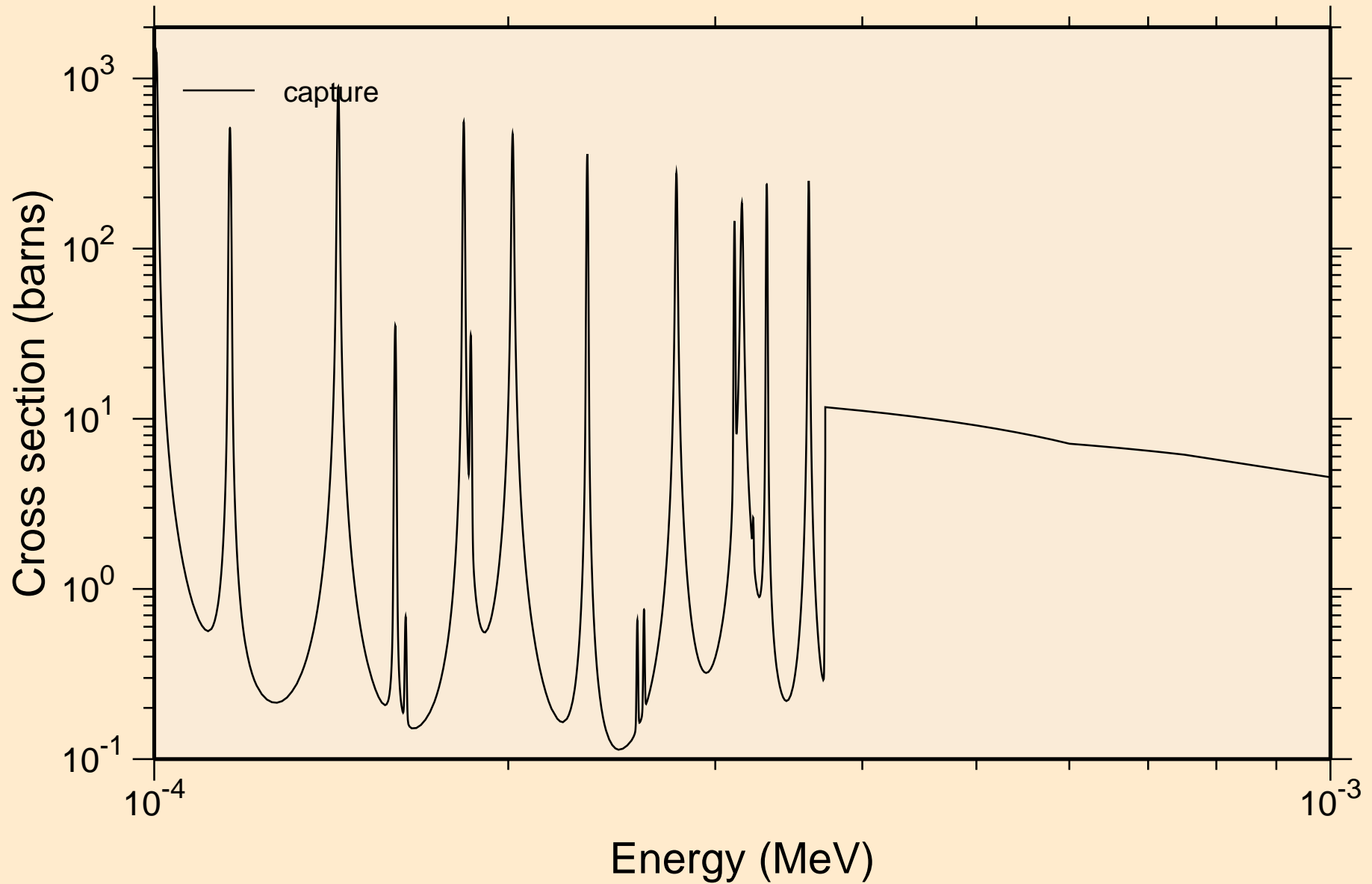

YB179 NRG TENDL-2015, AKONING
resonance absorption cross sections

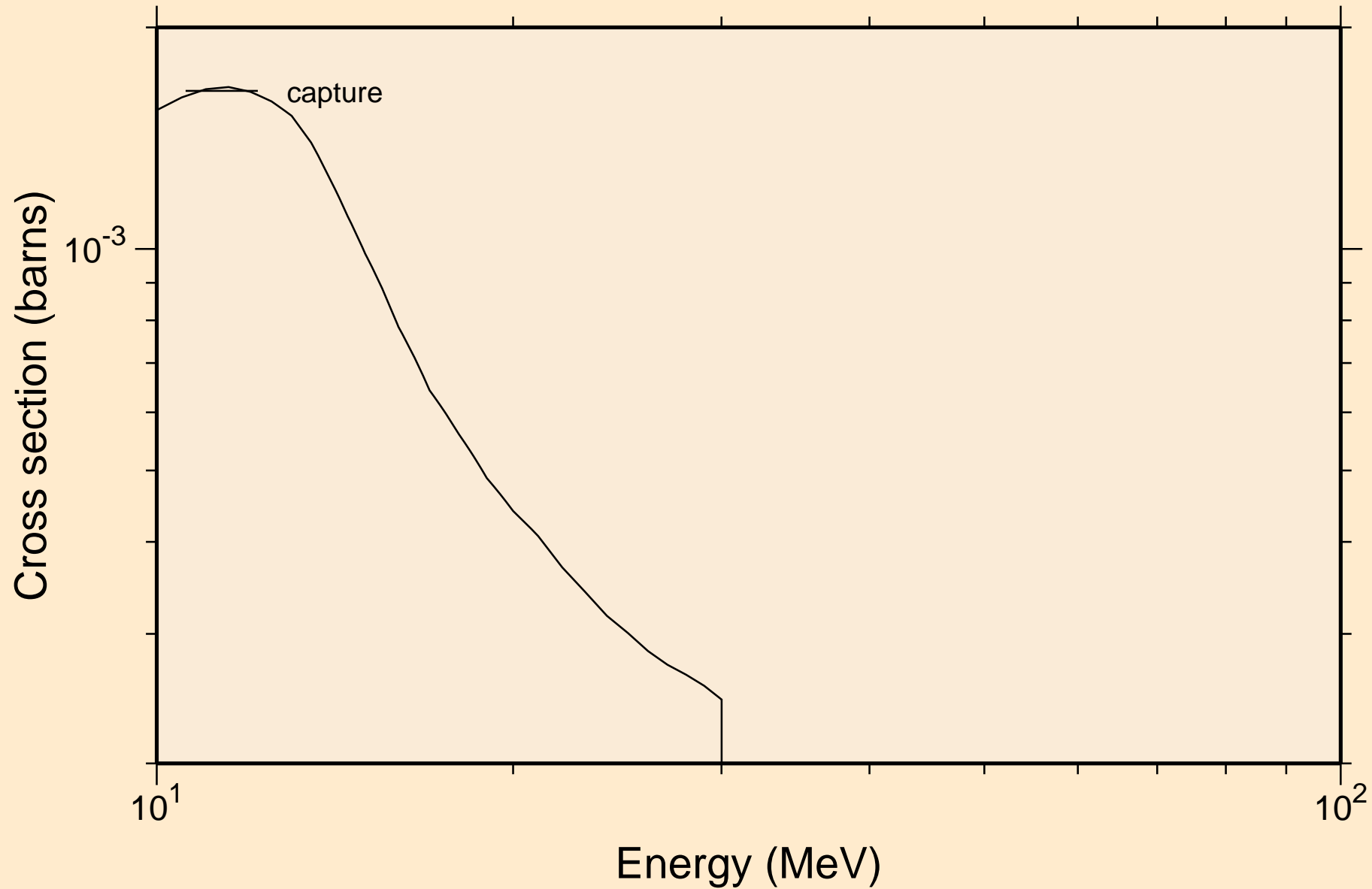

YB179 NRG TENDL-2015, AKONING
Non-threshold reactions

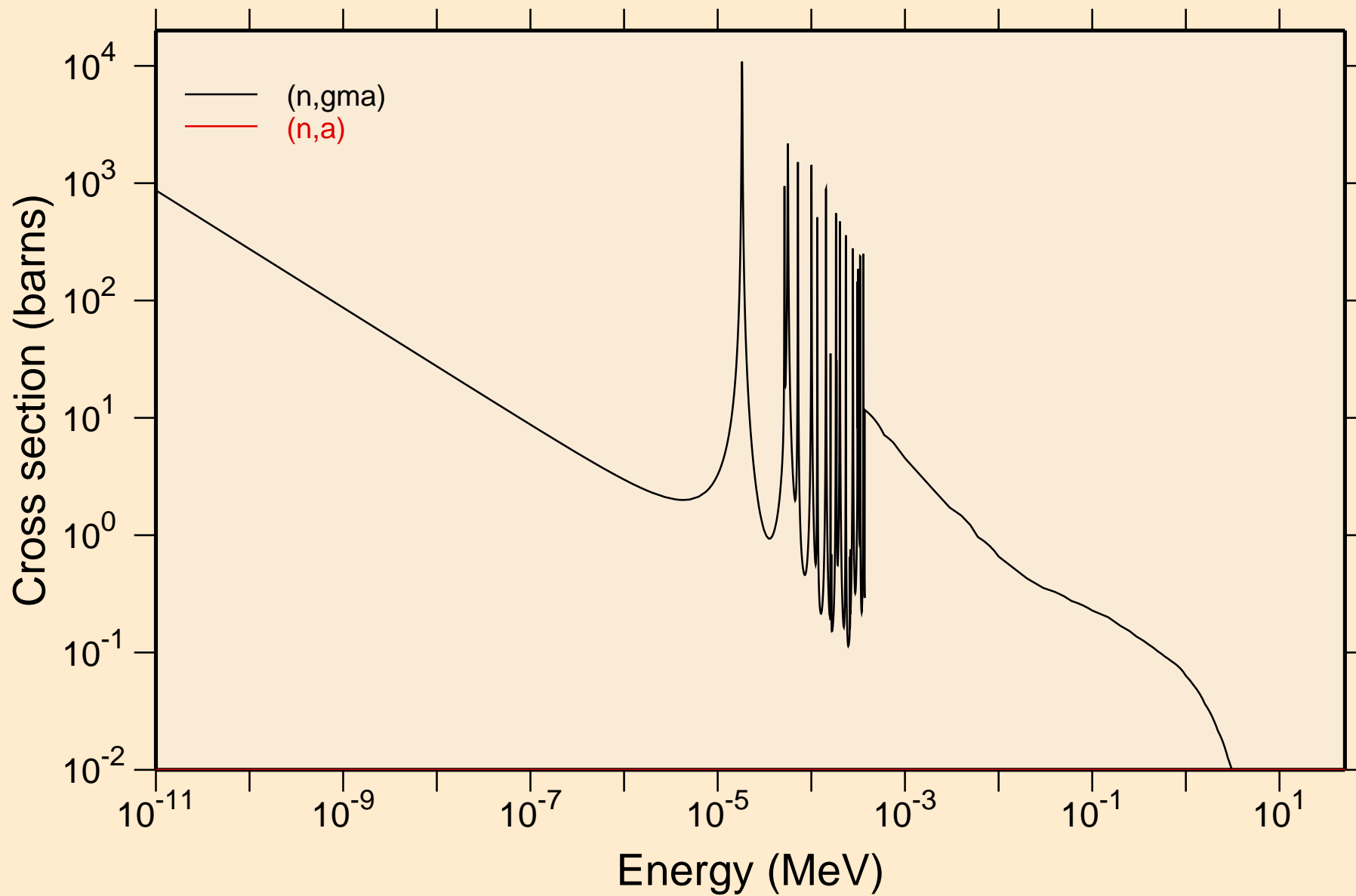

YB179 NRG TENDL-2015, AKONING

Principal cross sections

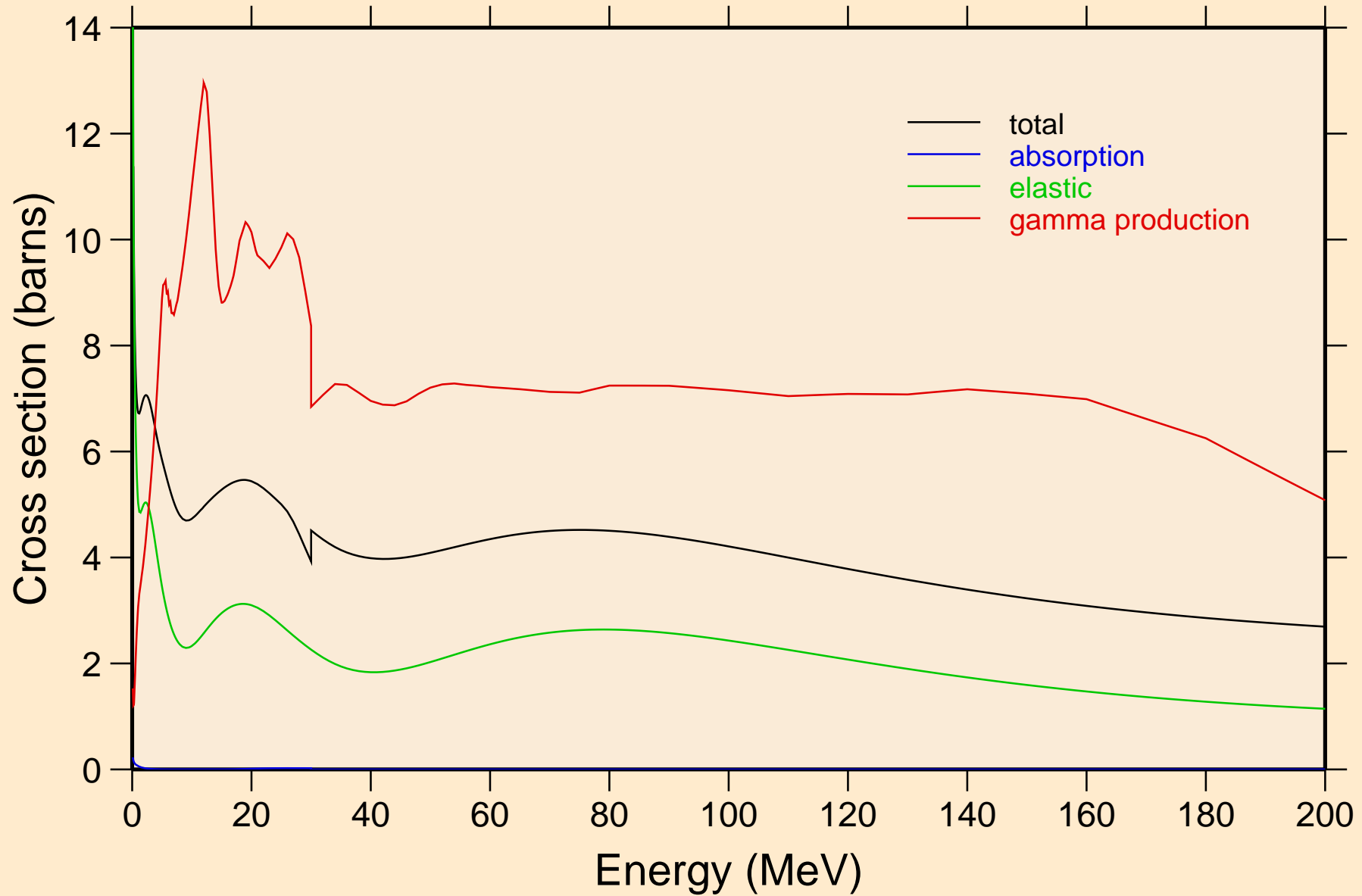

YB179 NRG TENDL-2015, AKONING
Non-threshold reactions

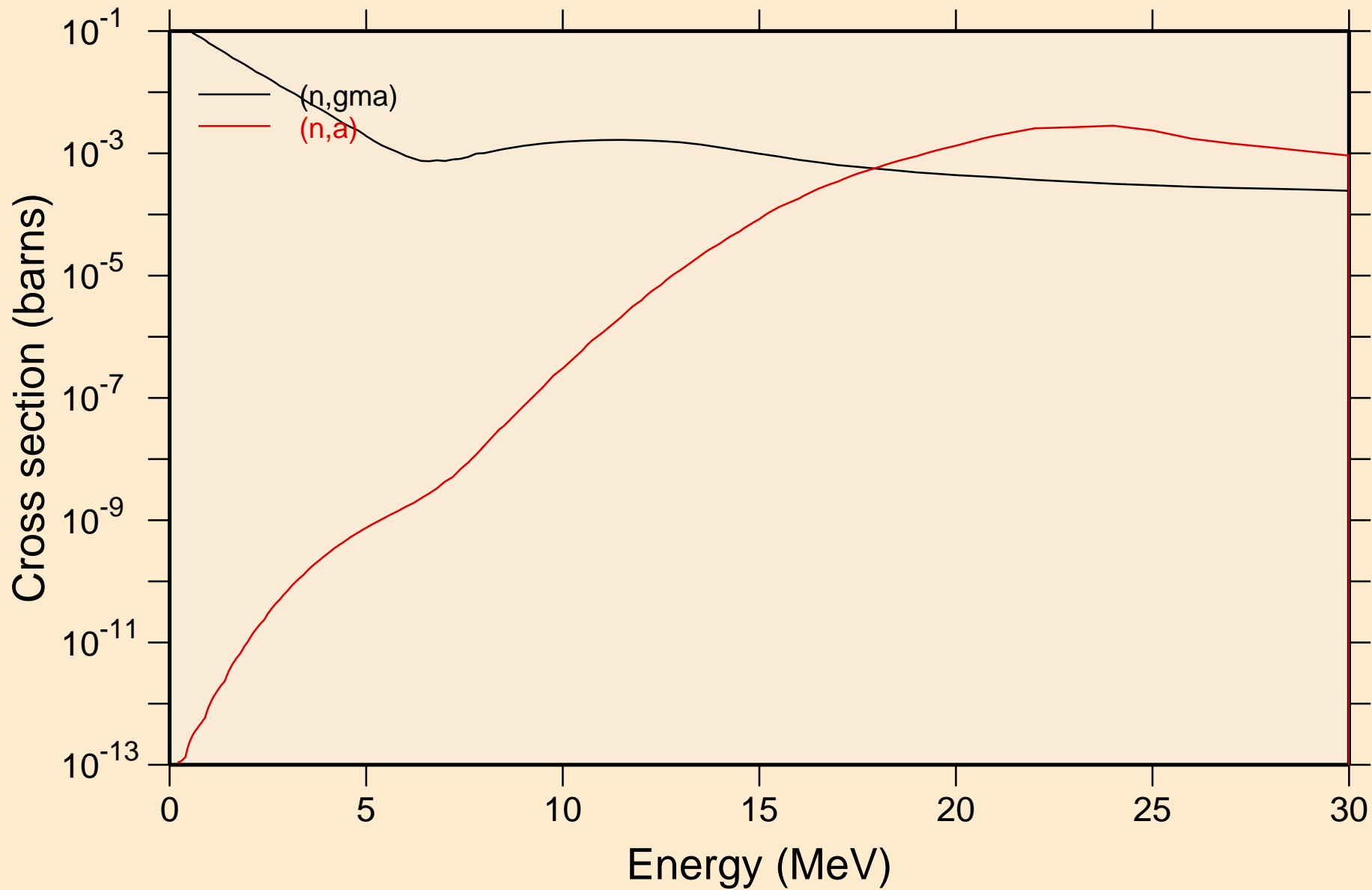

YB179 NRG TENDL-2015, AKONING
Inelastic levels

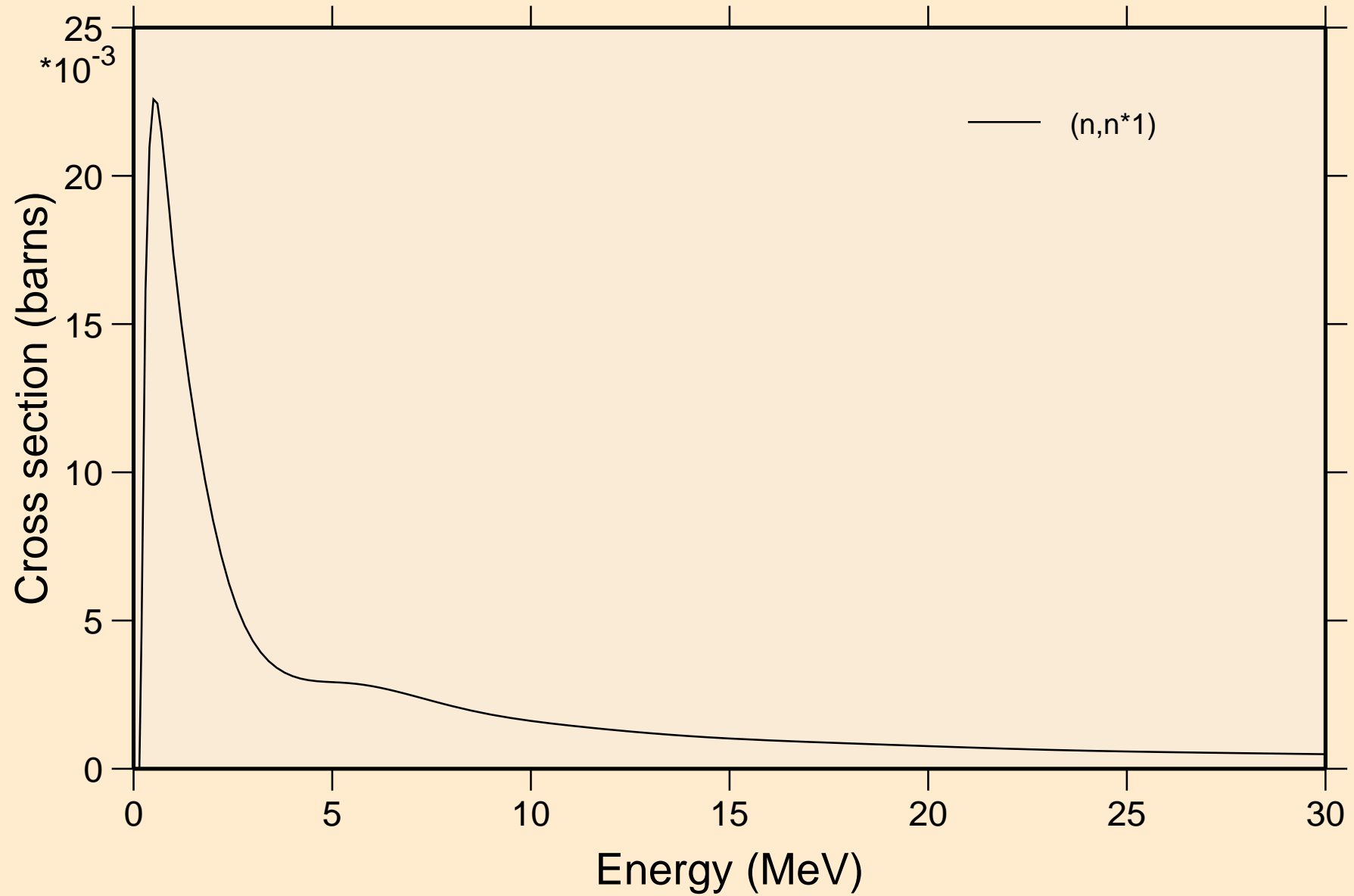

YB179 NRG TENDL-2015, AKONING

Threshold reactions

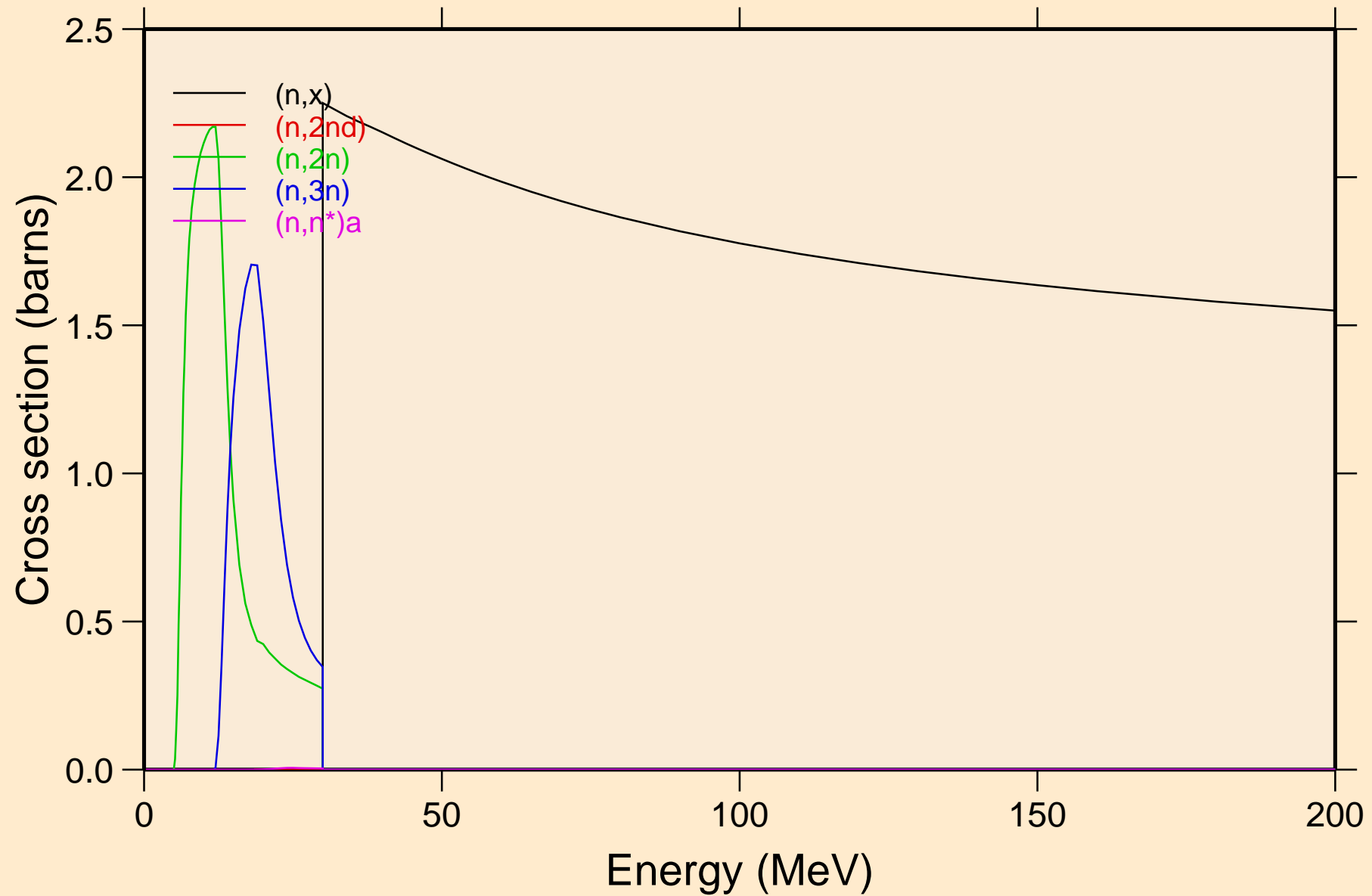

YB179 NRG TENDL-2015, AKONING

Threshold reactions

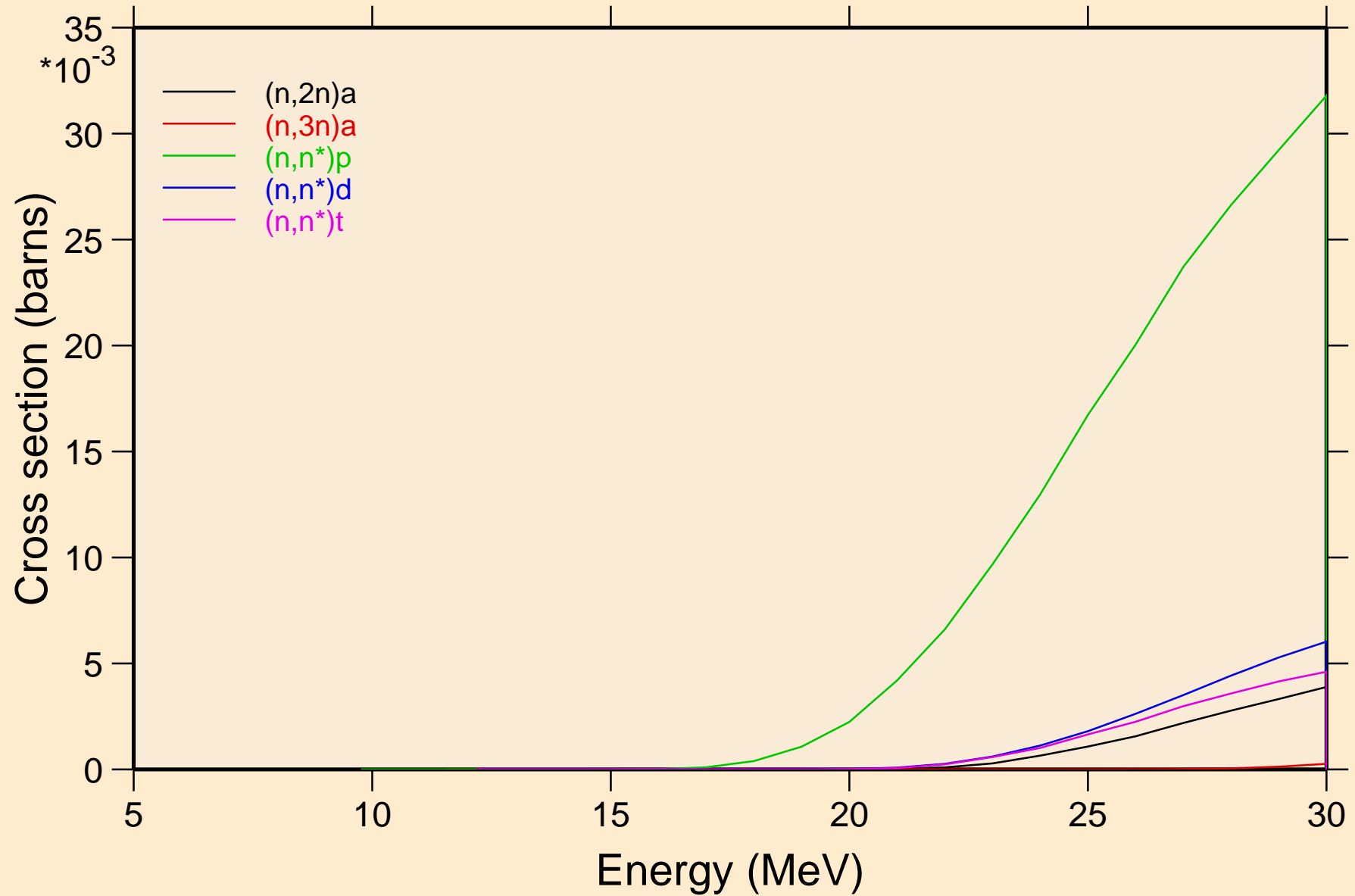

YB179 NRG TENDL-2015, AKONING

Threshold reactions

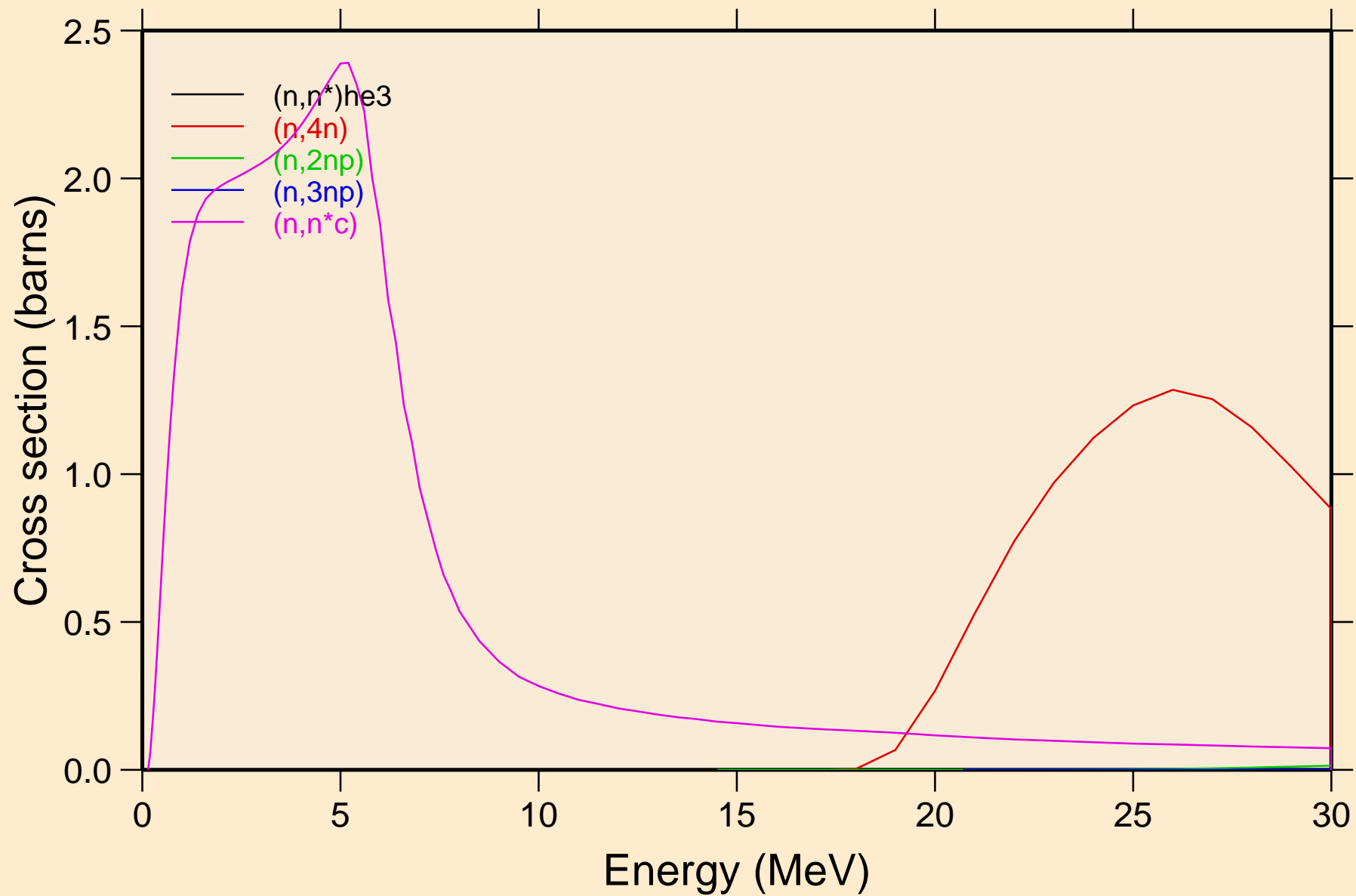

YB179 NRG TENDL-2015, AKONING

Threshold reactions

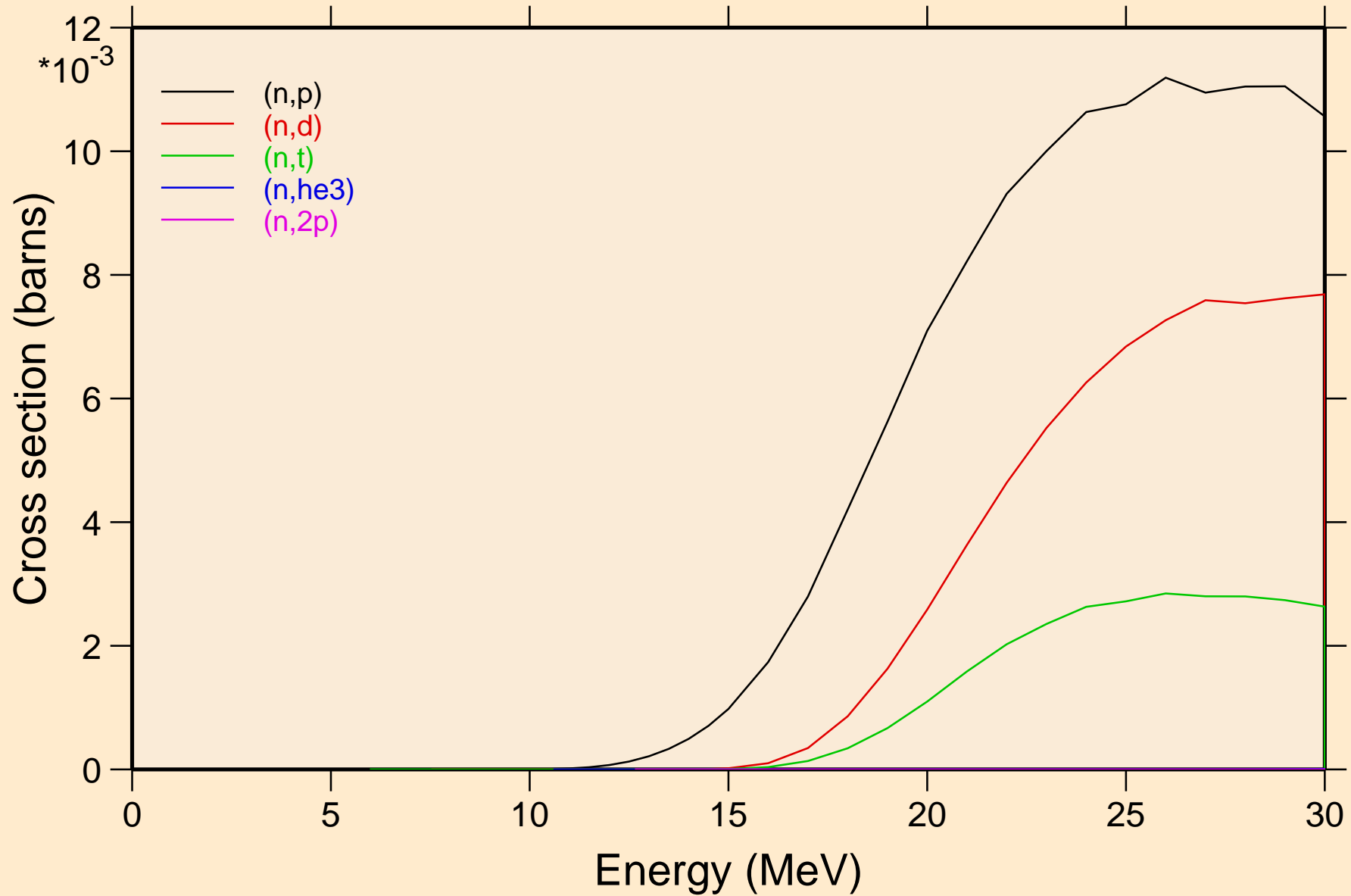

YB179 NRG TENDL-2015, AKONING
angular distribution for elastic

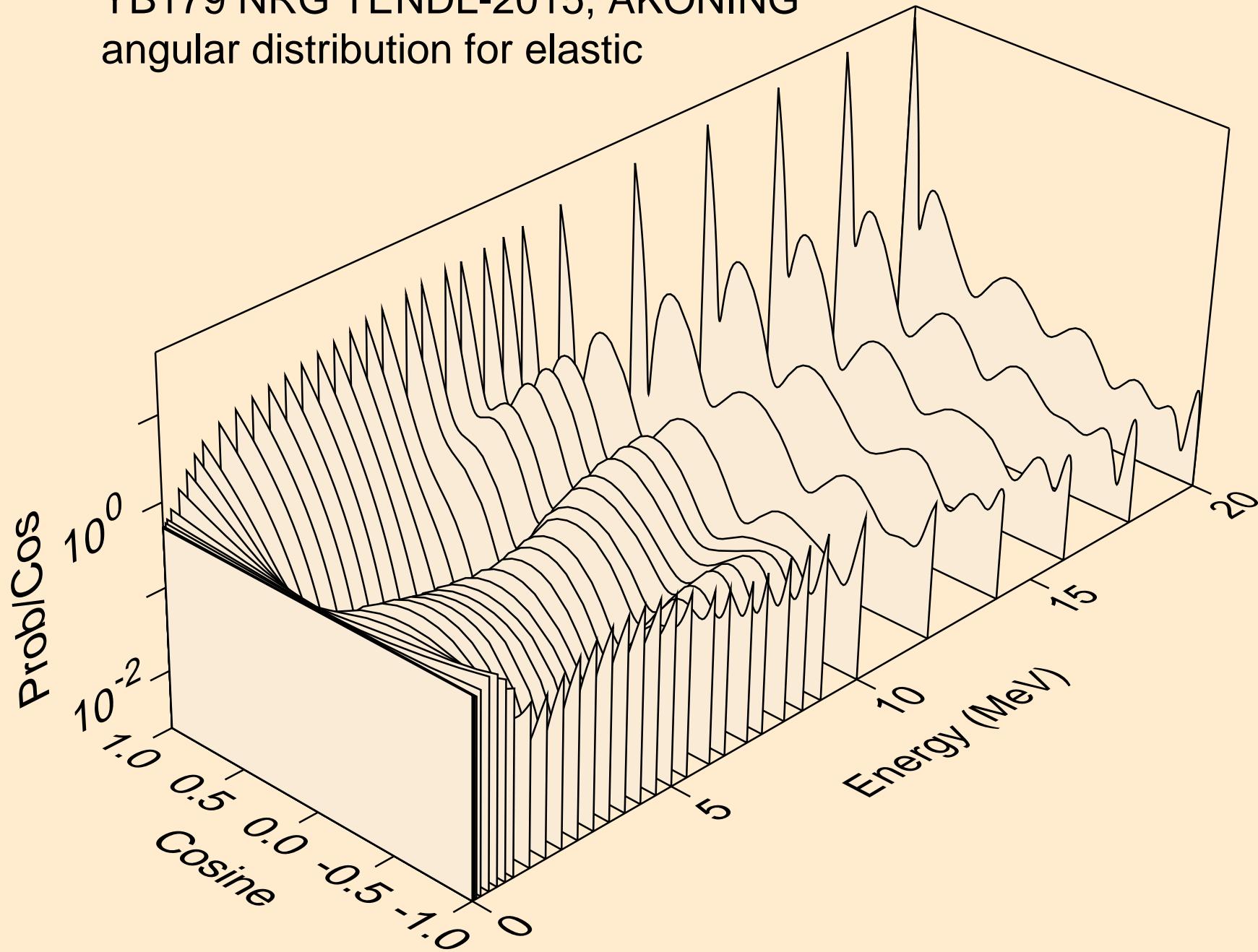

YB179 NRG TENDL-2015, AKONING
angular distribution for elastic

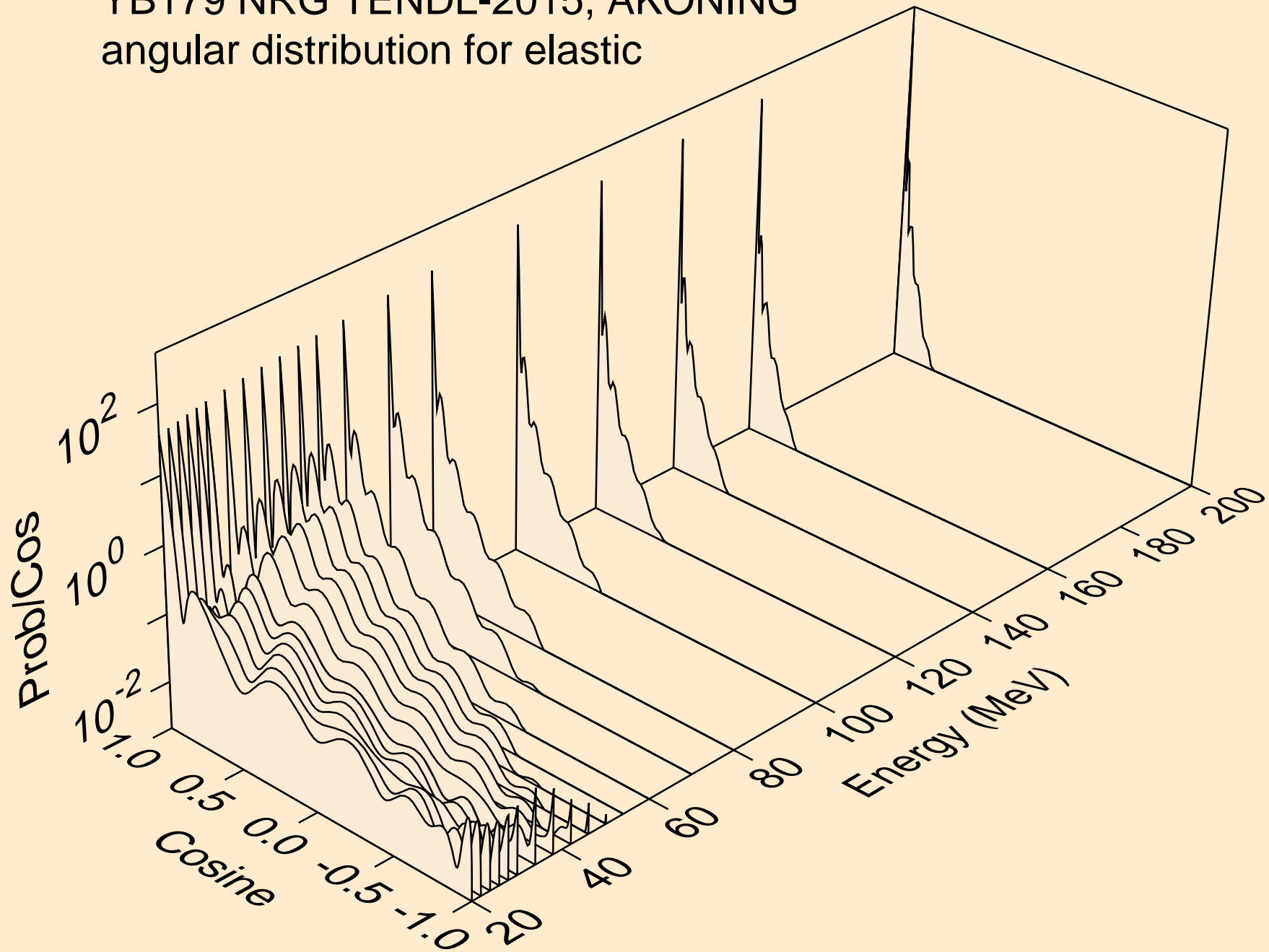

YB179 NRG TENDL-2015, AKONING
angular distribution for (n,n*1)

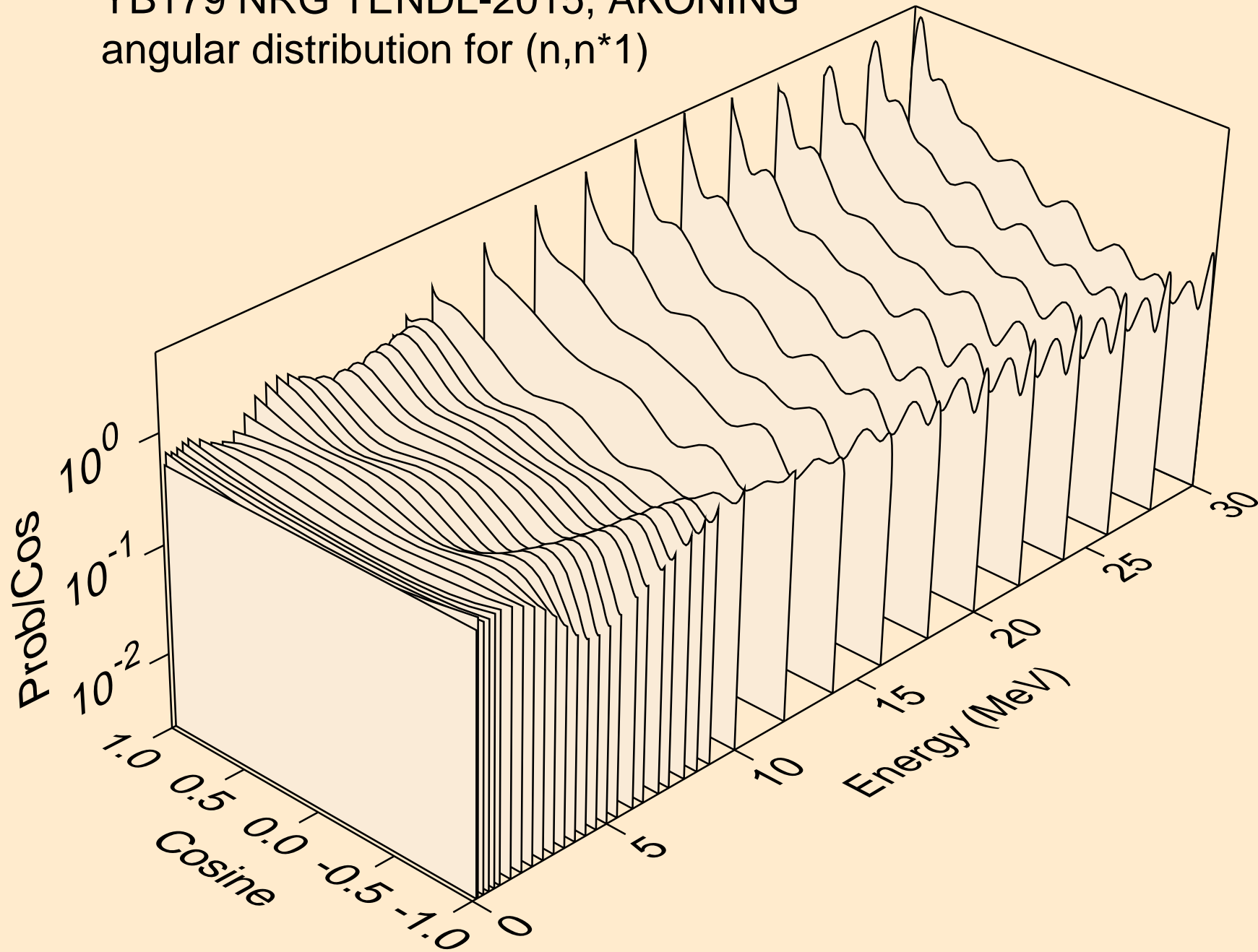

YB179 NRG TENDL-2015, AKONING
Neutron emission for (n,x)

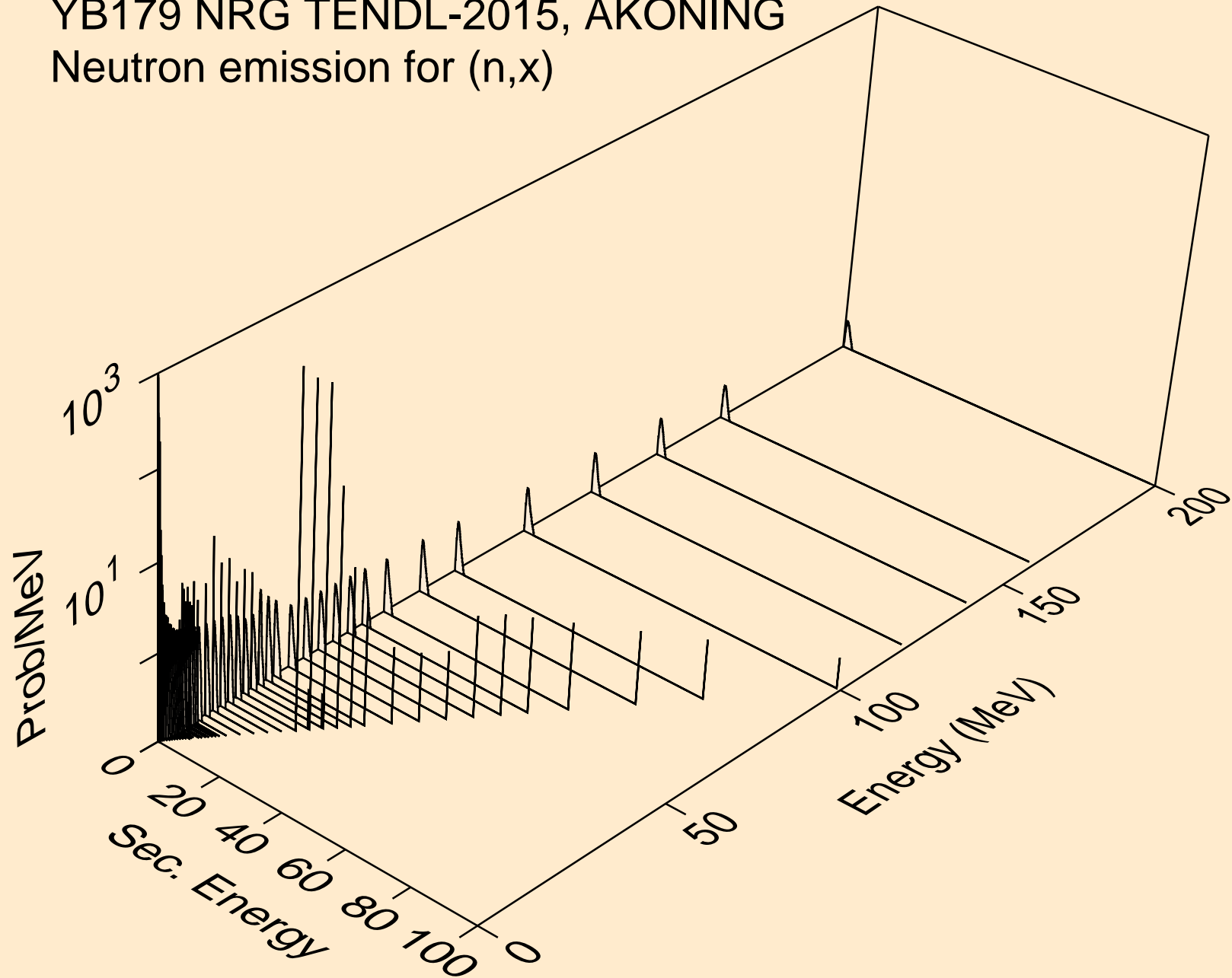

YB179 NRG TENDL-2015, AKONING
Neutron emission for (n,2nd)

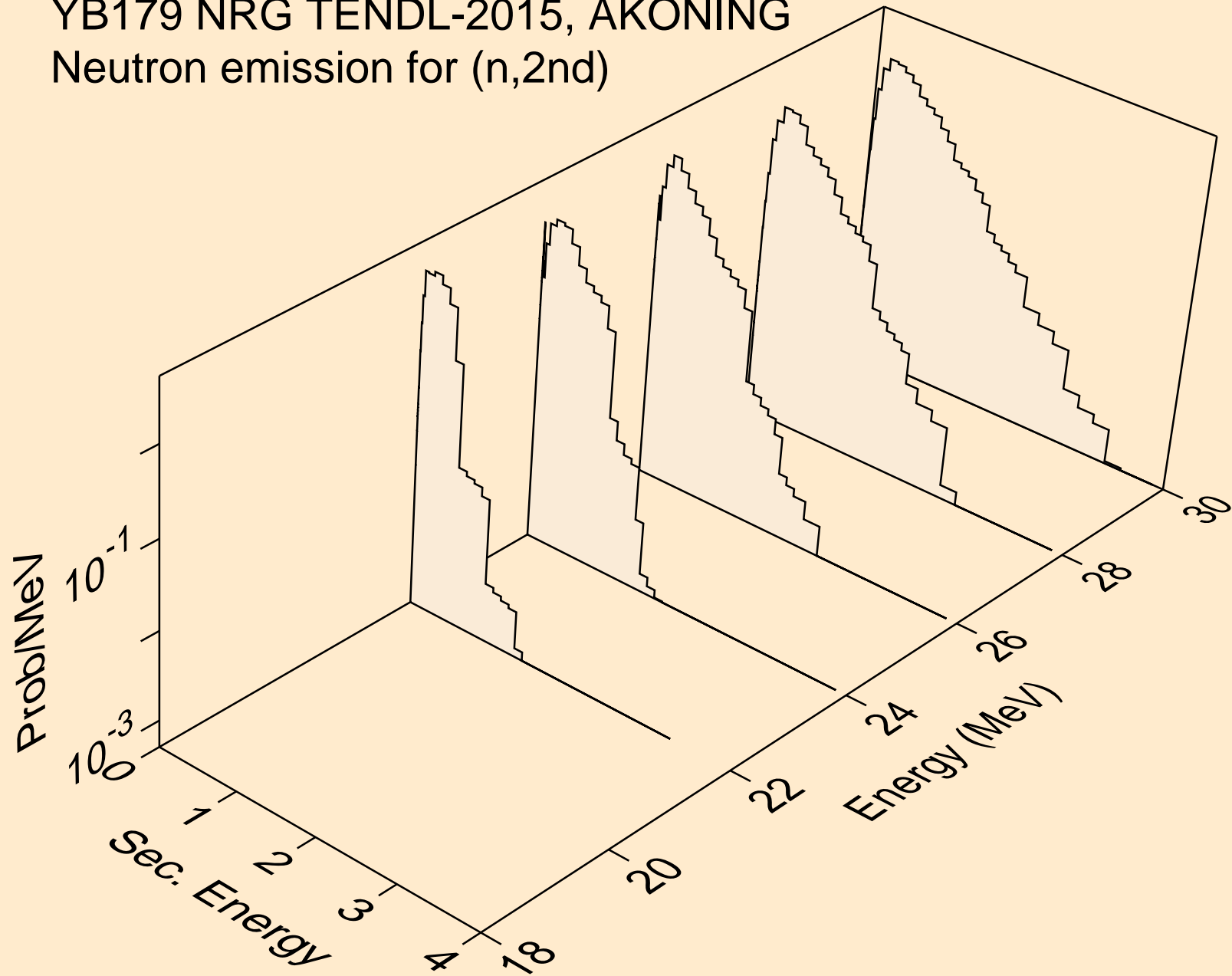

YB179 NRG TENDL-2015, AKONING
Neutron emission for (n,2n)

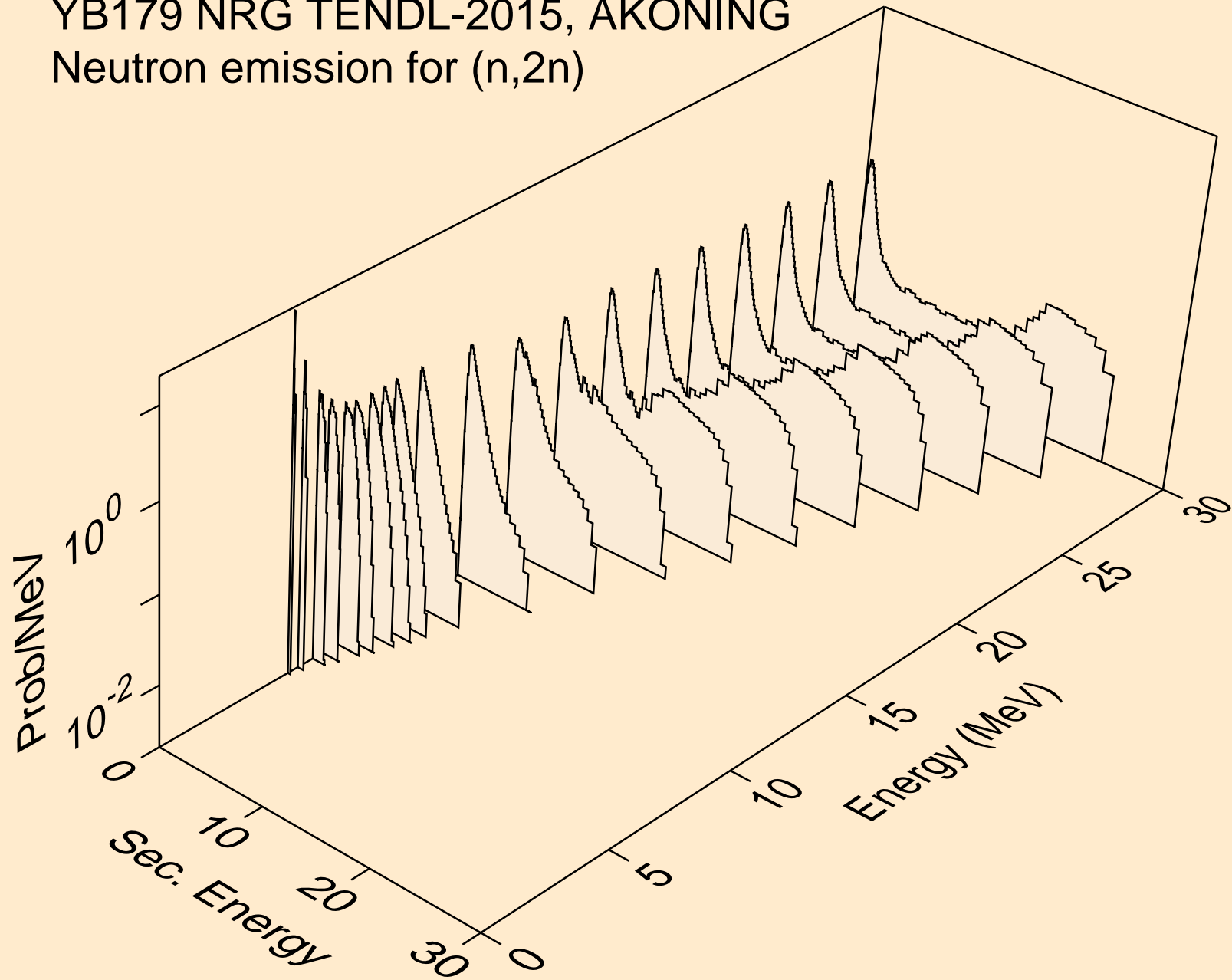

YB179 NRG TENDL-2015, AKONING
Neutron emission for (n,3n)

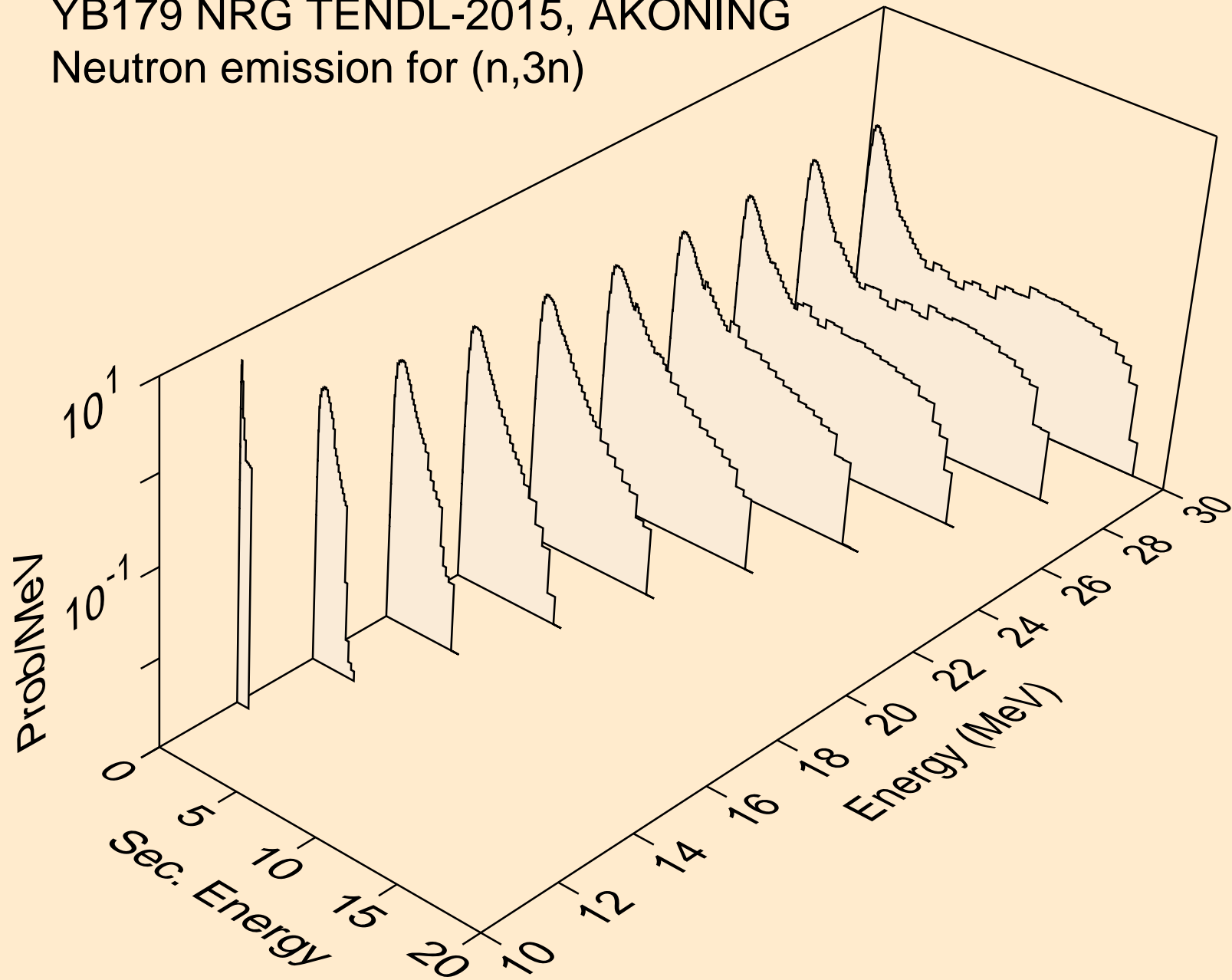

YB179 NRG TENDL-2015, AKONING
Neutron emission for (n,n*)a

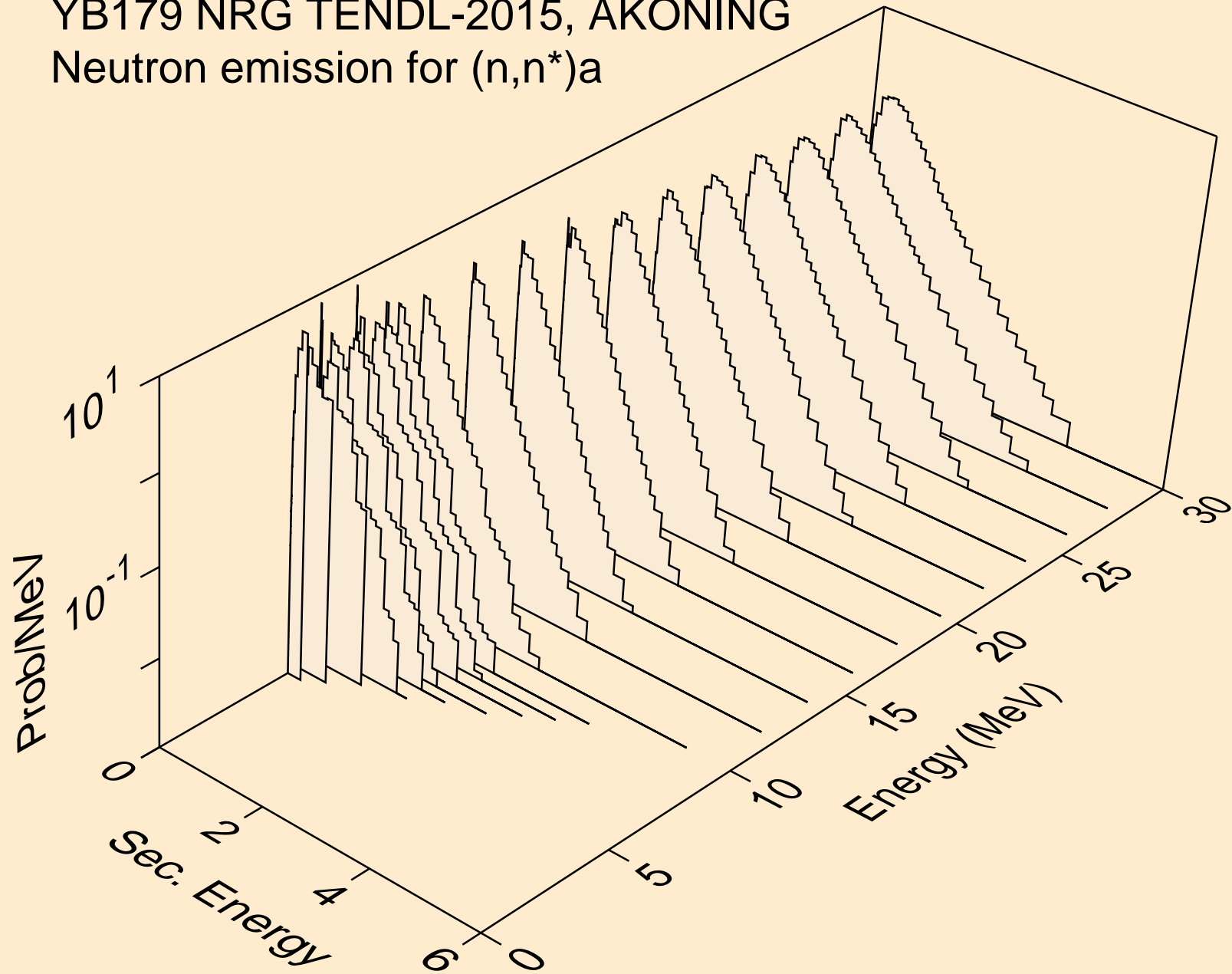

YB179 NRG TENDL-2015, AKONING
Neutron emission for (n,2n)a

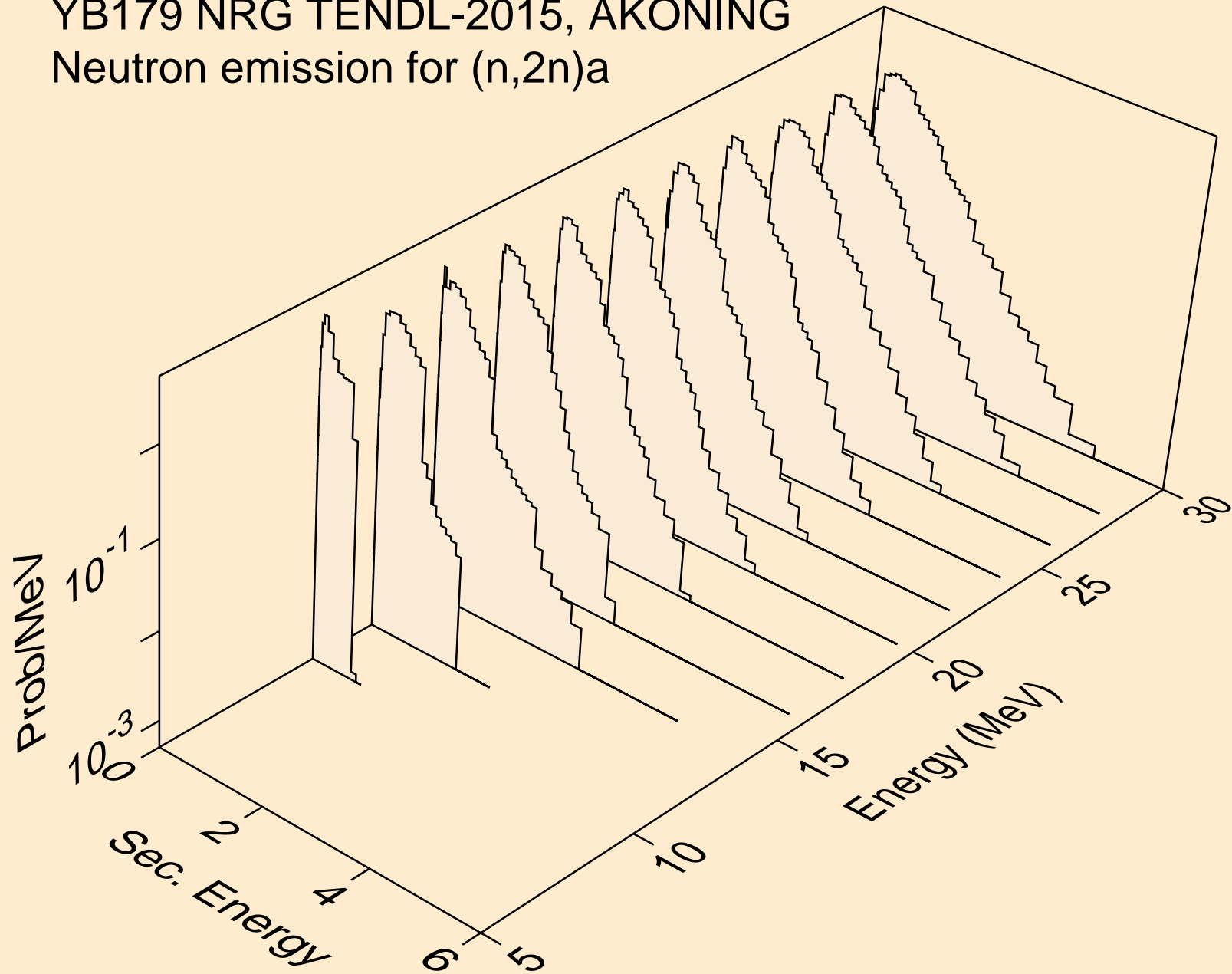

YB179 NRG TENDL-2015, AKONING
Neutron emission for (n,3n)a

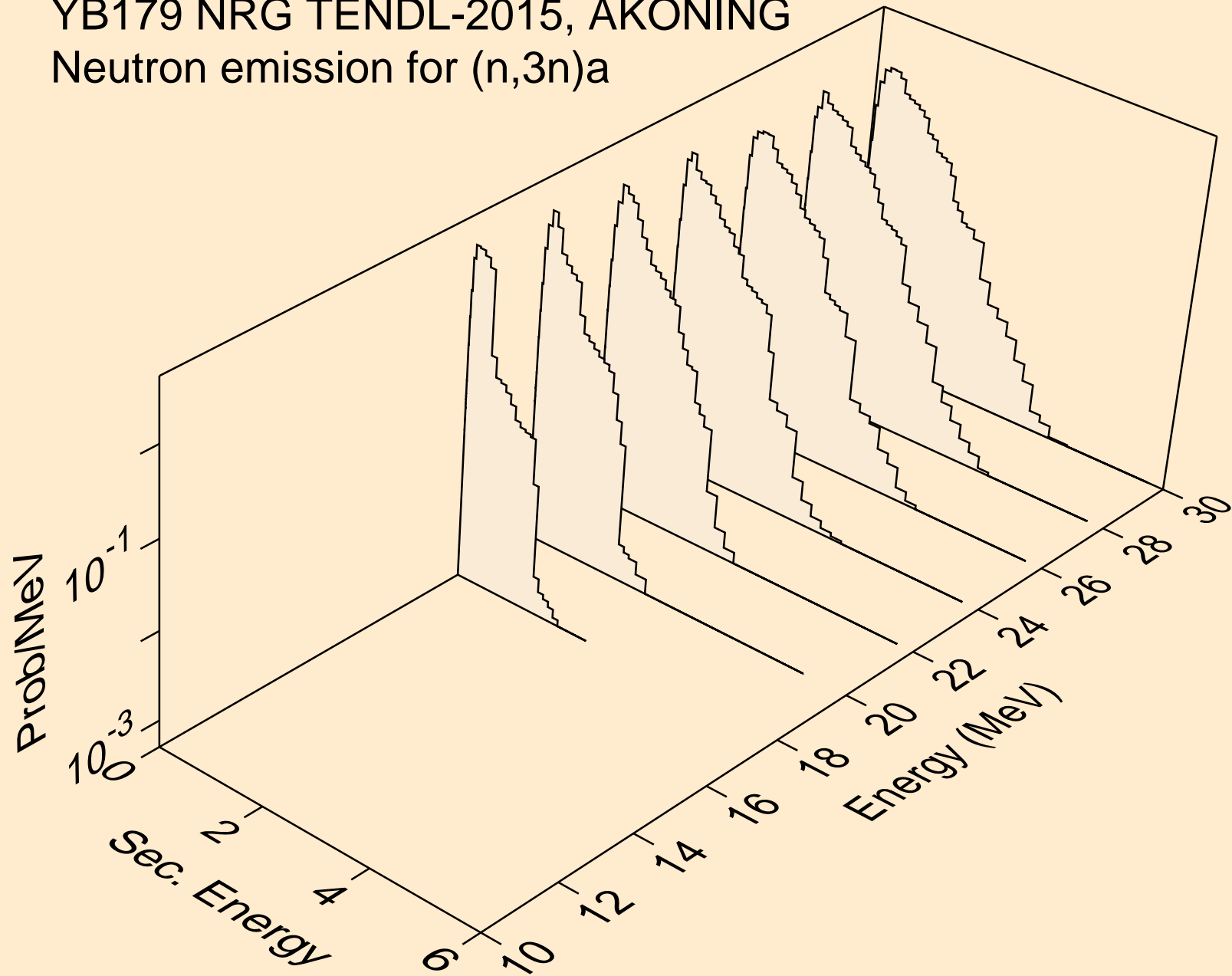

YB179 NRG TENDL-2015, AKONING
Neutron emission for (n,n*)p

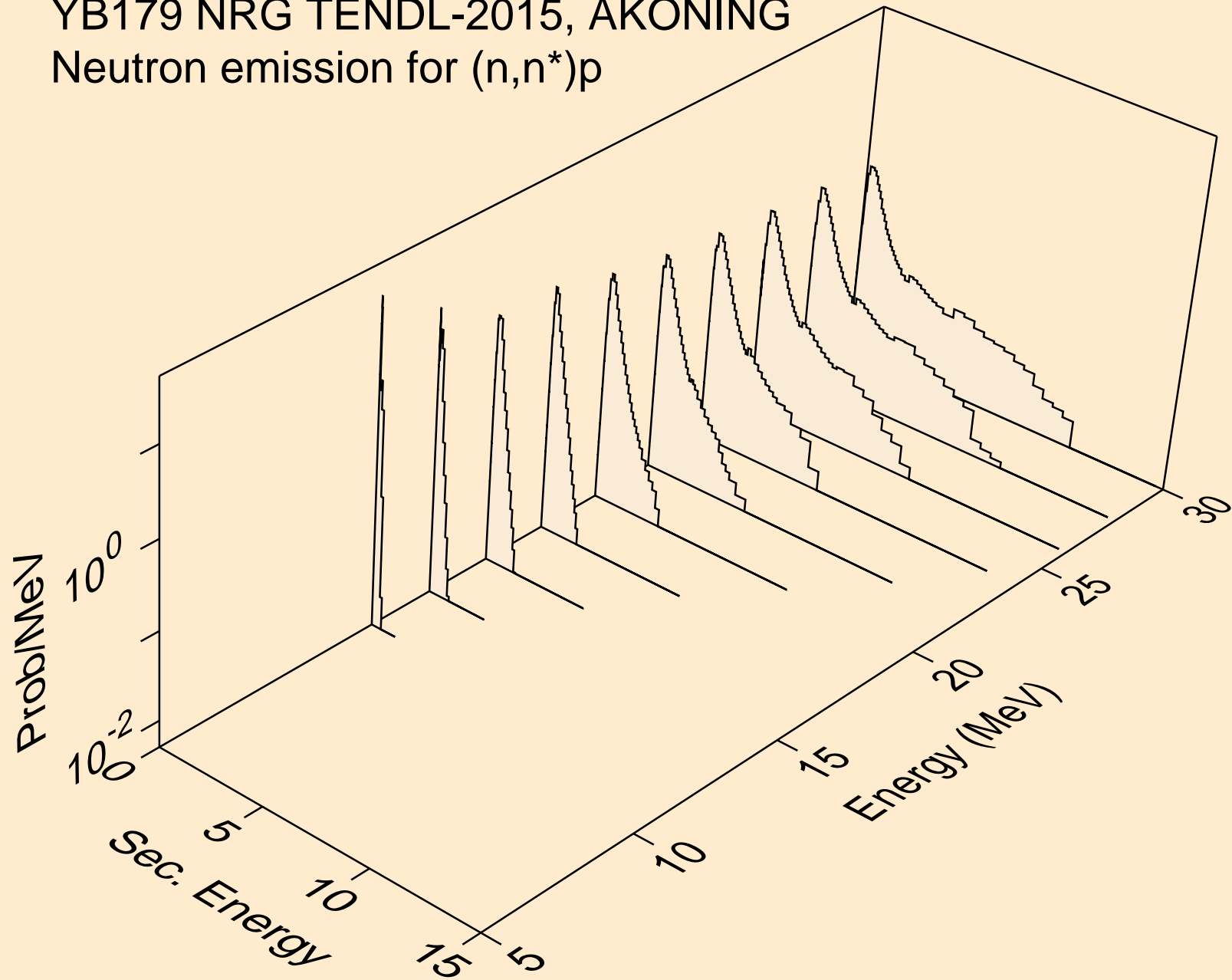

YB179 NRG TENDL-2015, AKONING
Neutron emission for (n,n*)d

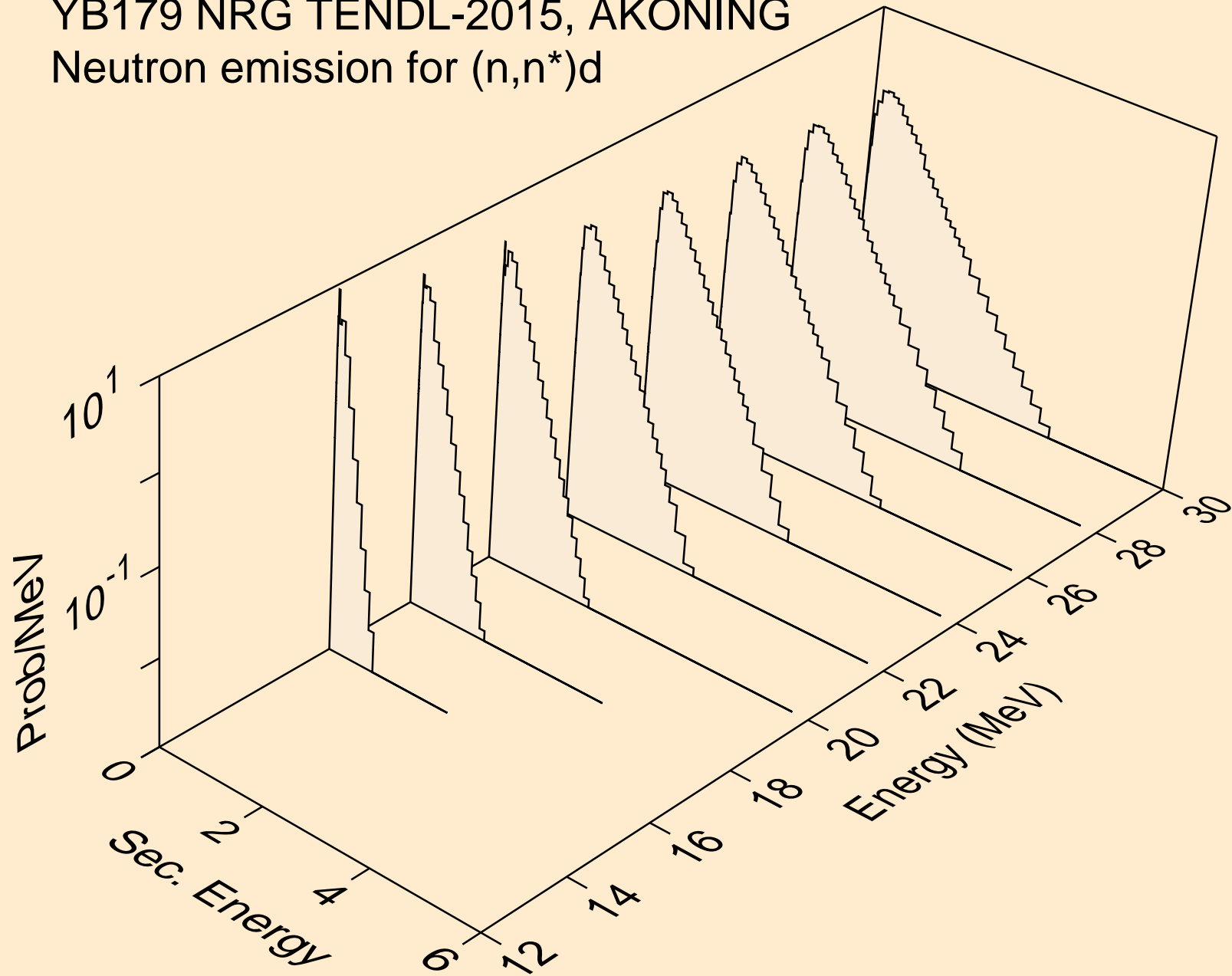

YB179 NRG TENDL-2015, AKONING
Neutron emission for (n,n*)t

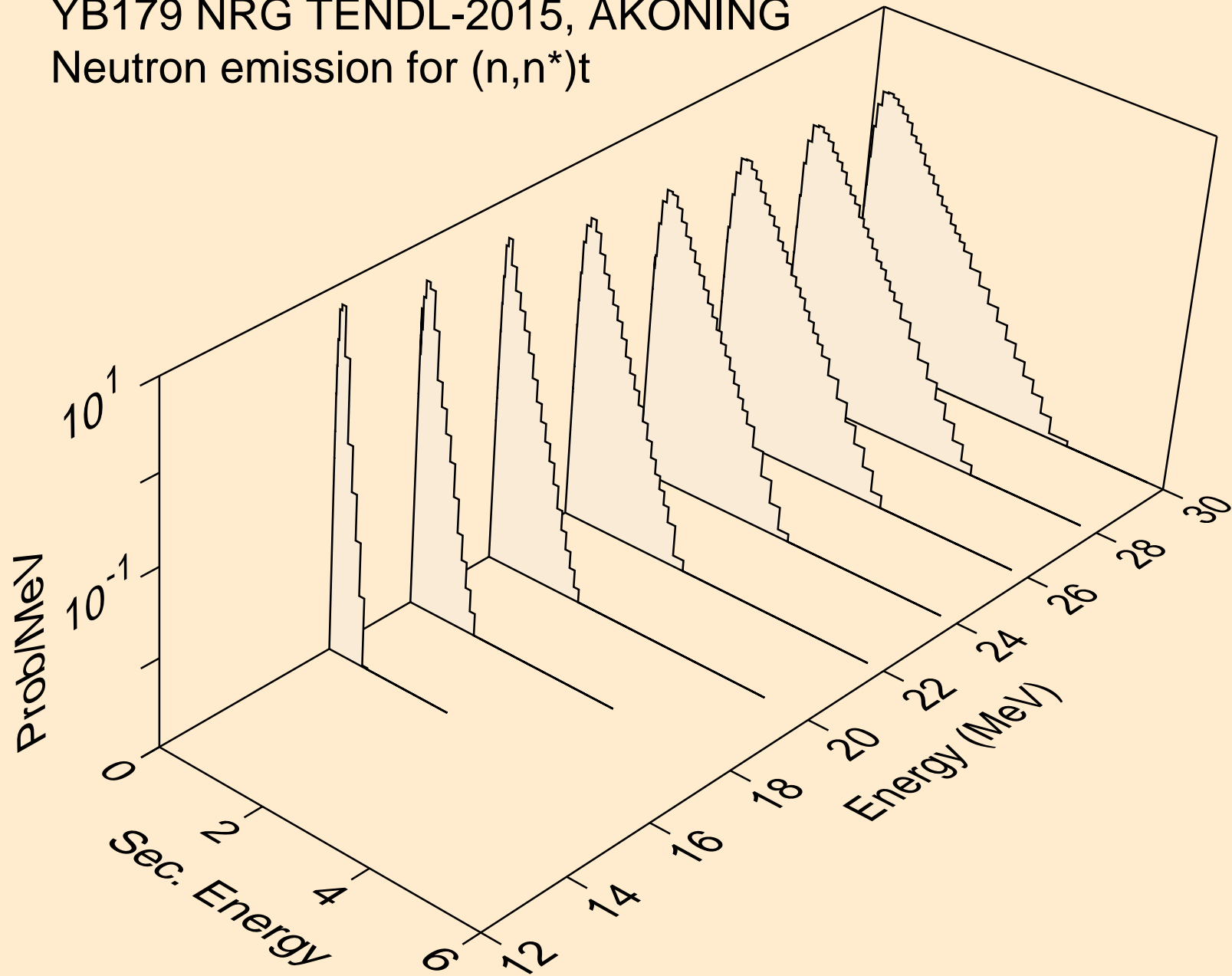

YB179 NRG TENDL-2015, AKONING
Neutron emission for (n,n*)he3

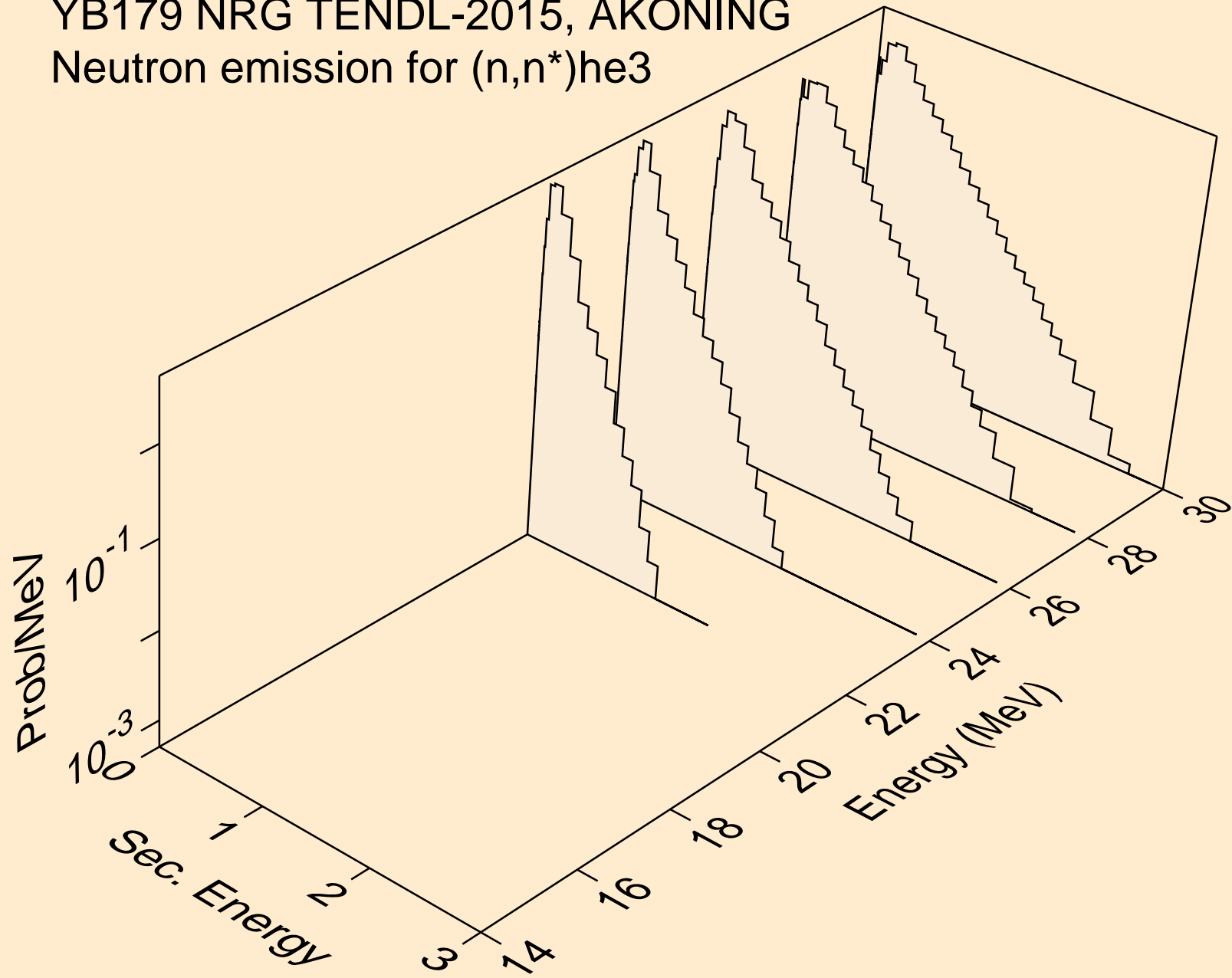

YB179 NRG TENDL-2015, AKONING
Neutron emission for (n,4n)

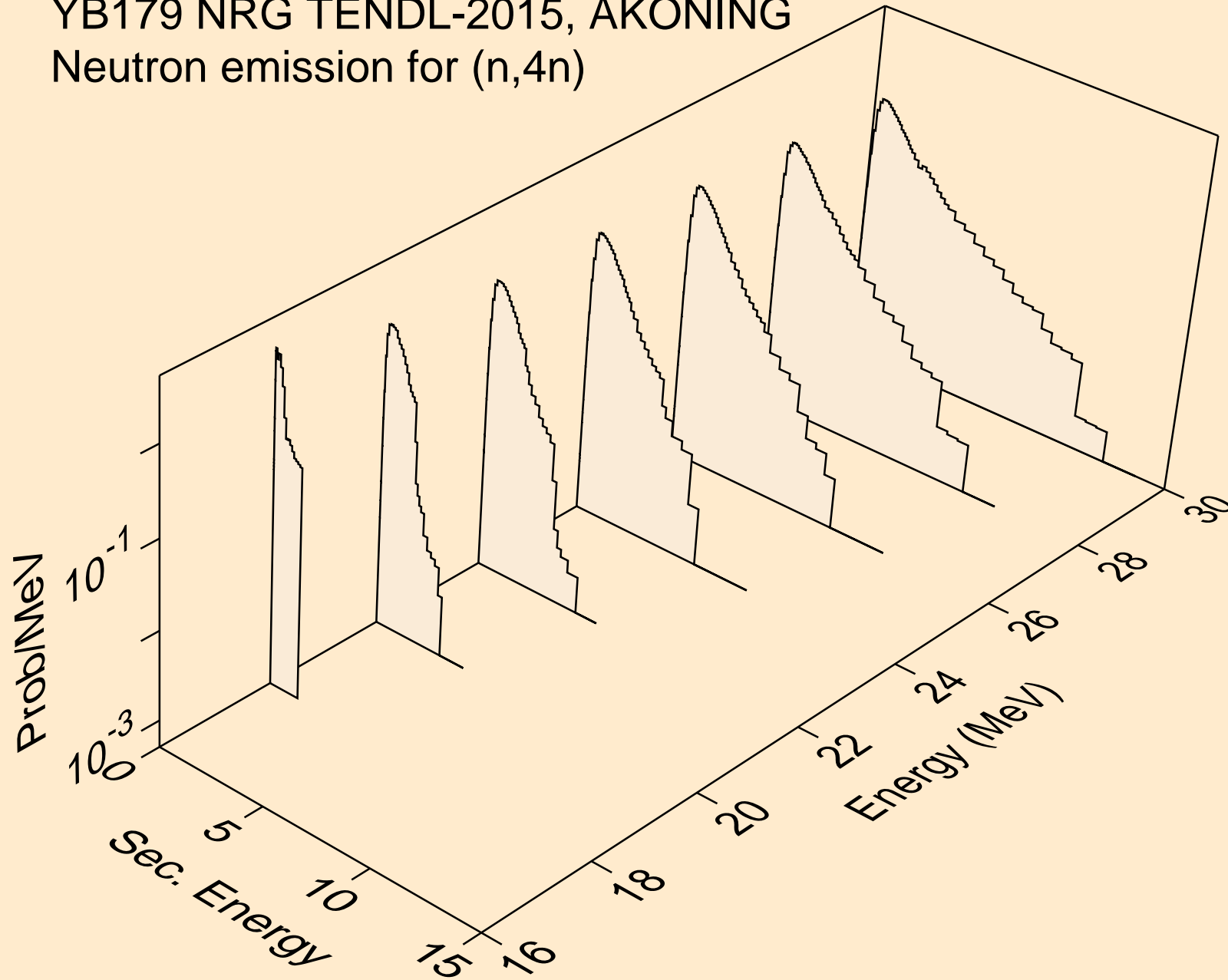

YB179 NRG TENDL-2015, AKONING
Neutron emission for (n,2np)

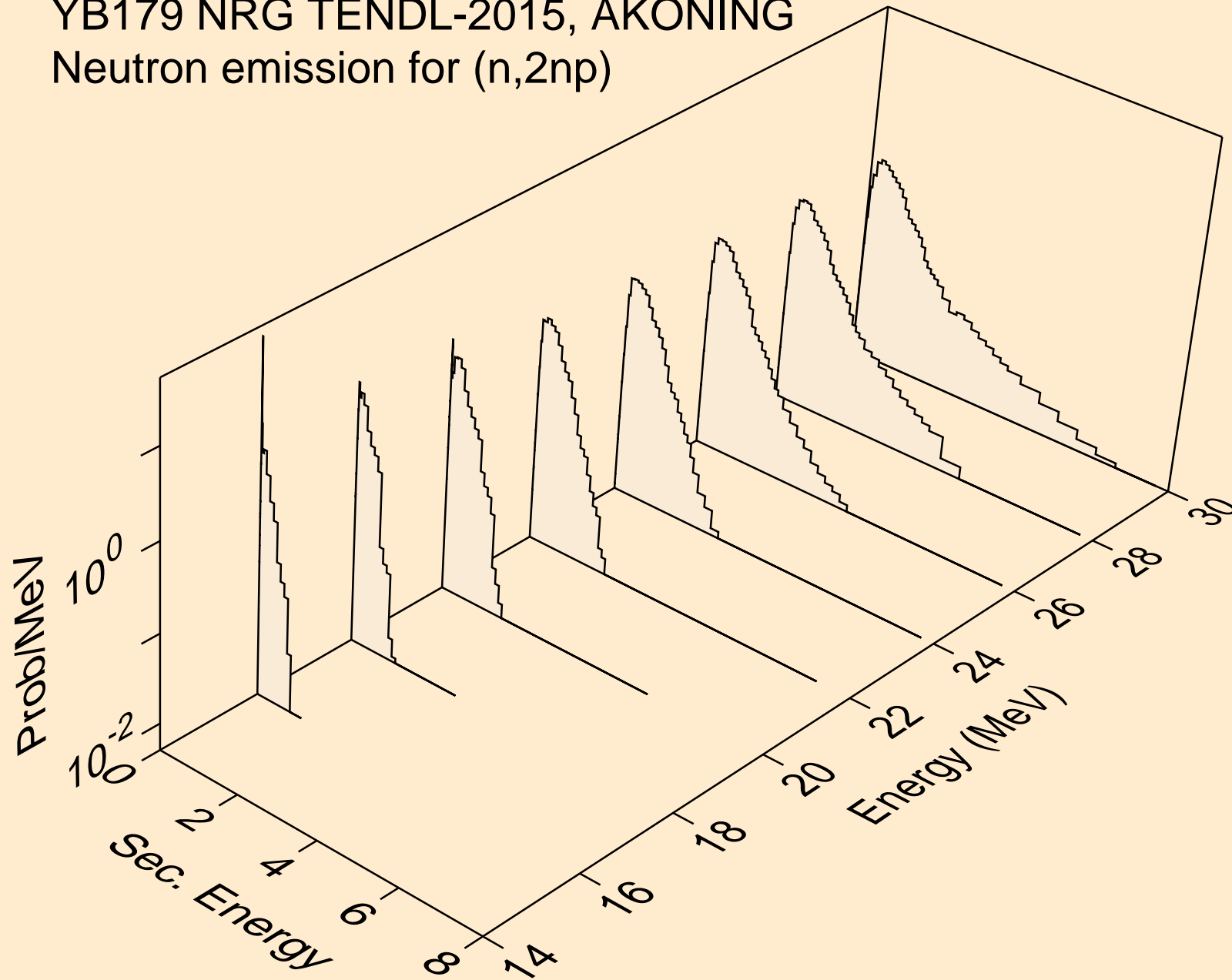

YB179 NRG TENDL-2015, AKONING
Neutron emission for (n,3np)

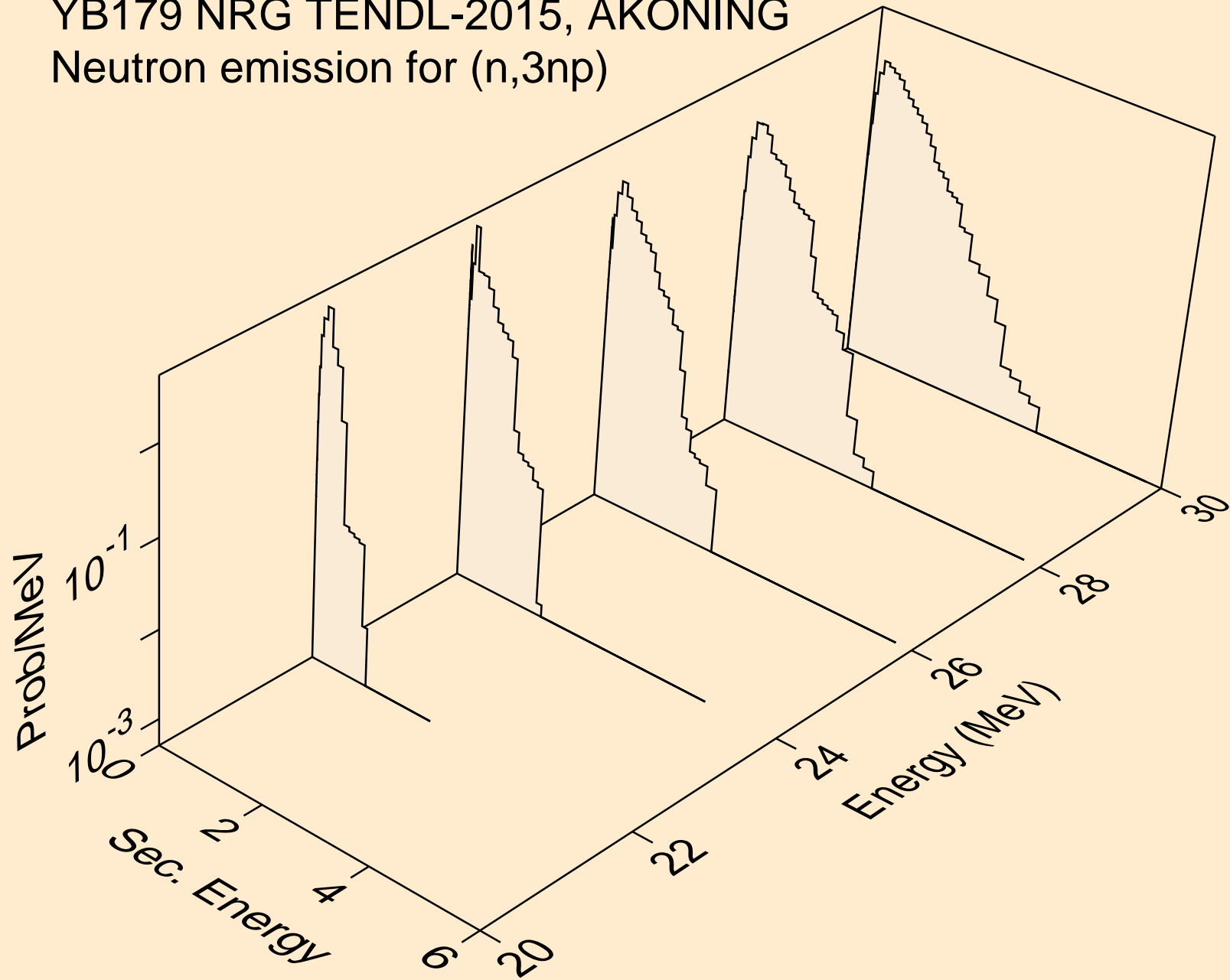

YB179 NRG TENDL-2015, AKONING
Neutron emission for (n,n*c)

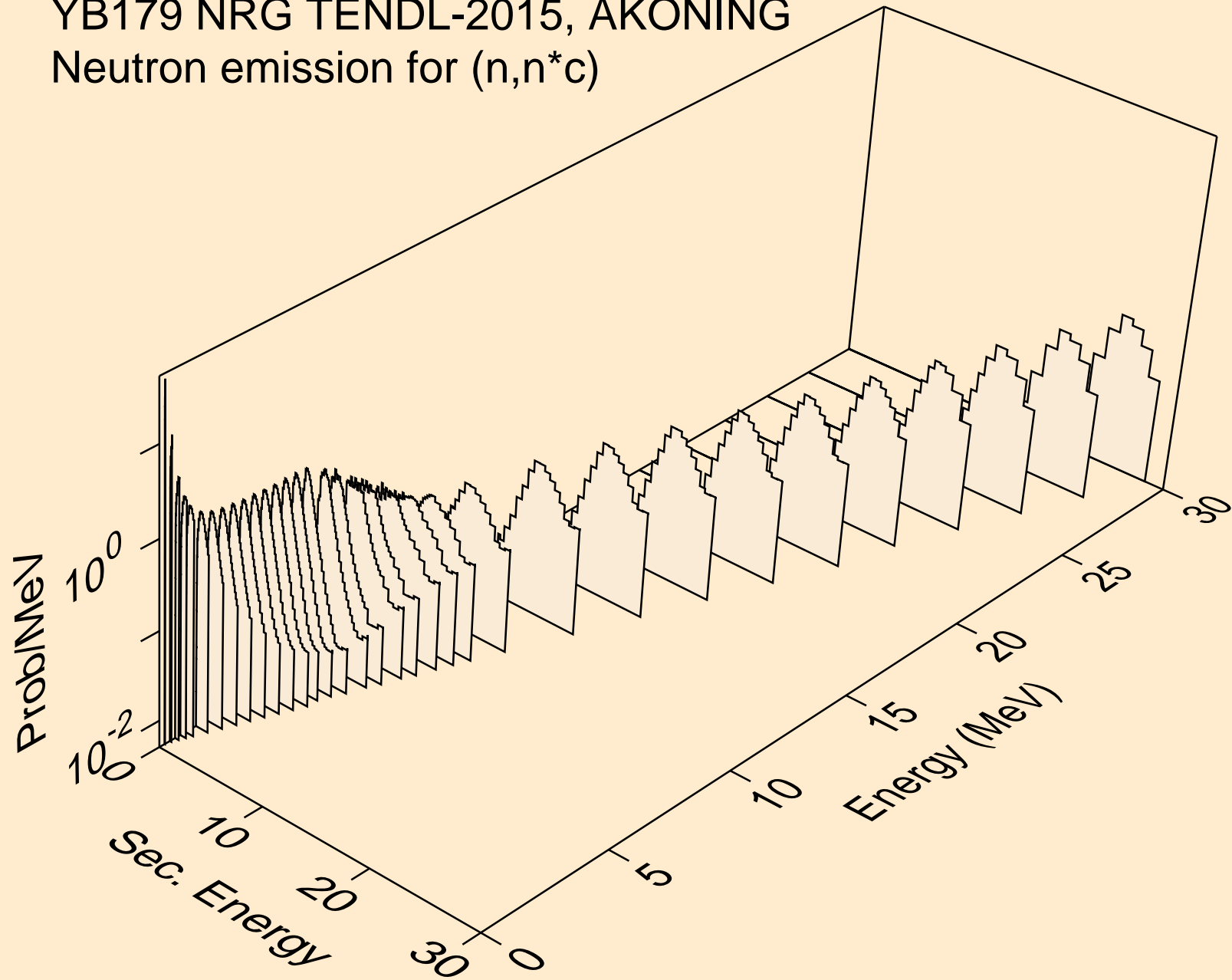

YB179 NRG TENDL-2015, AKONING
Photon emission for (n,x)

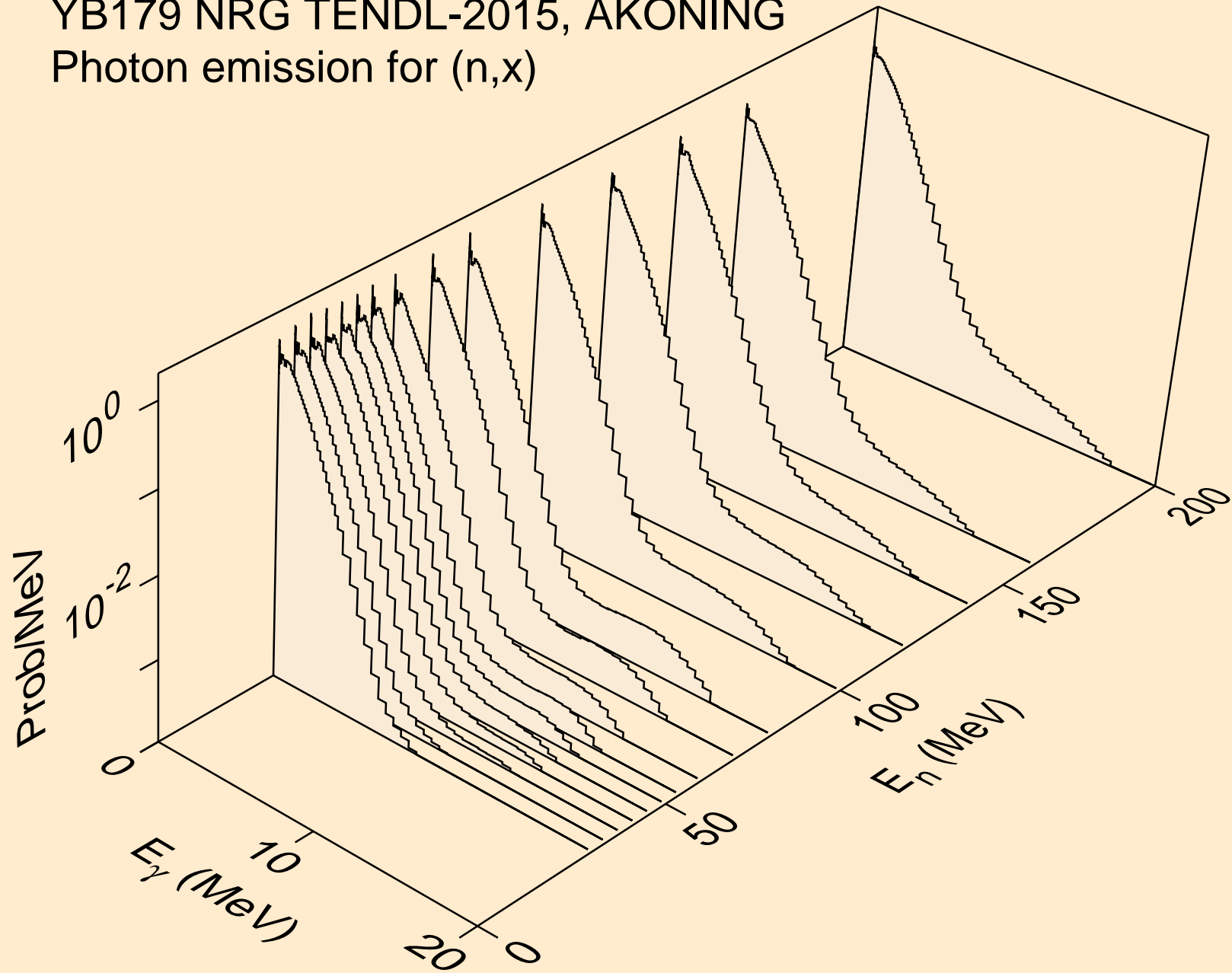

YB179 NRG TENDL-2015, AKONING
Photon emission for (n,2nd)

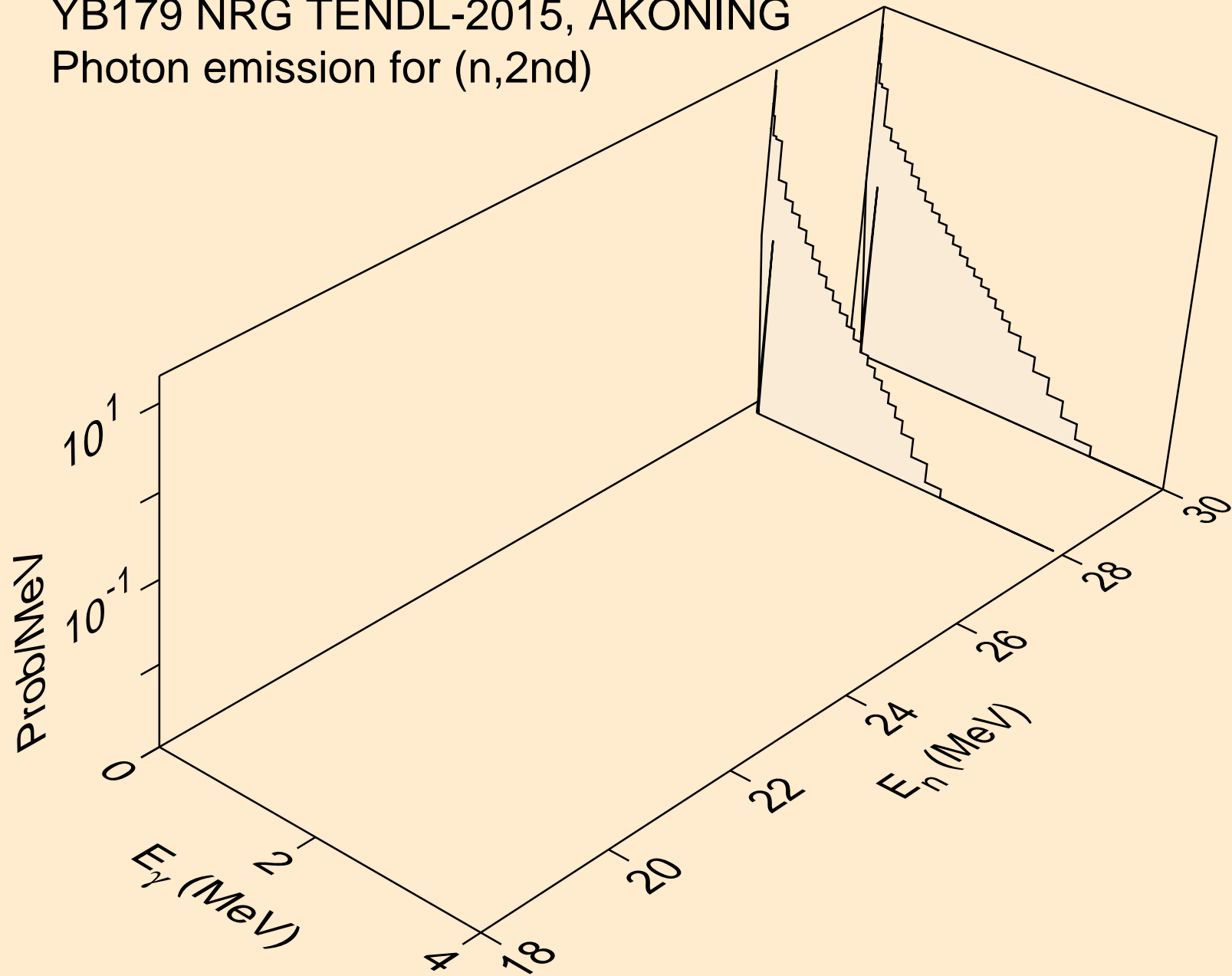

YB179 NRG TENDL-2015, AKONING
Photon emission for (n,2n)

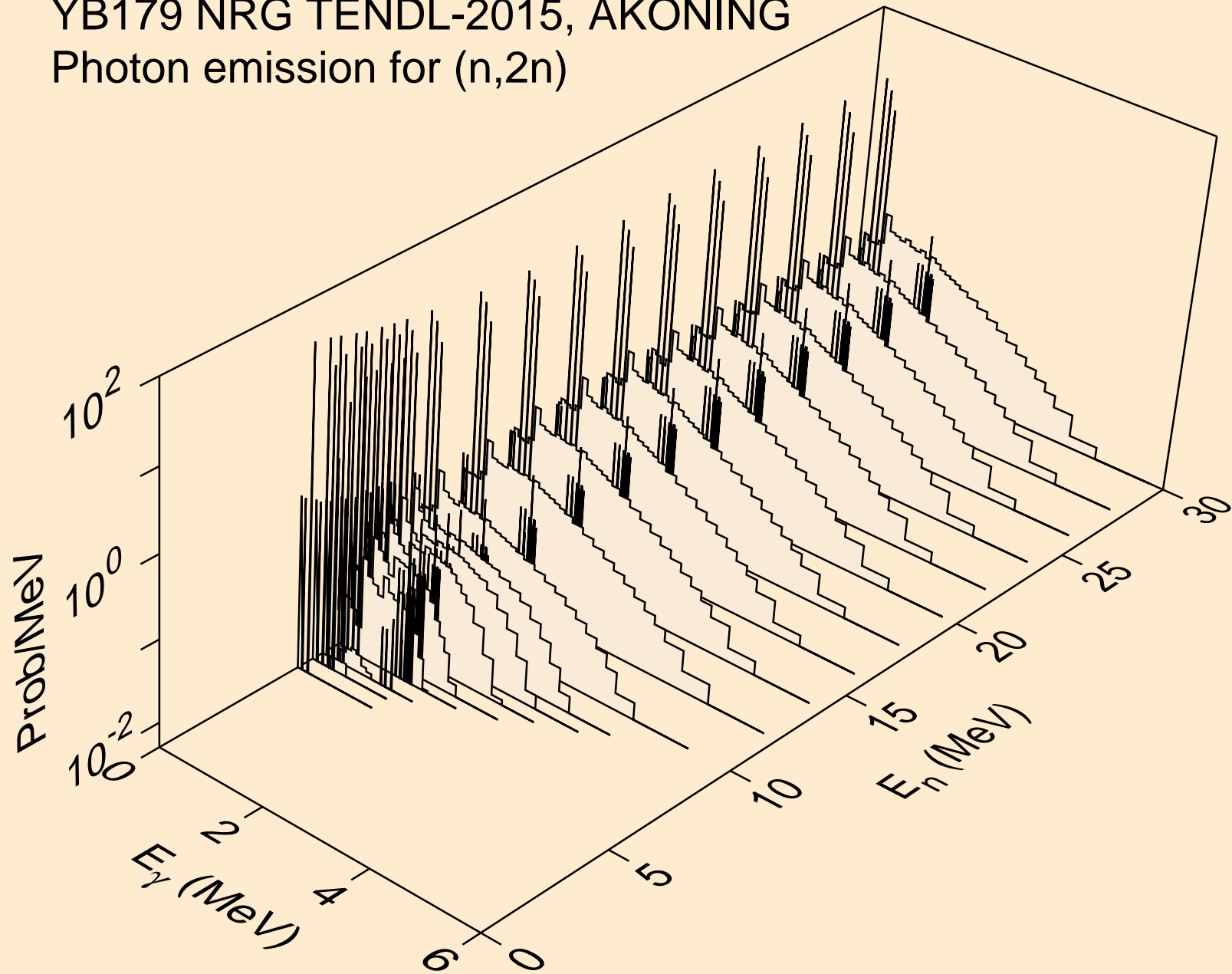

YB179 NRG TENDL-2015, AKONING
Photon emission for (n,3n)

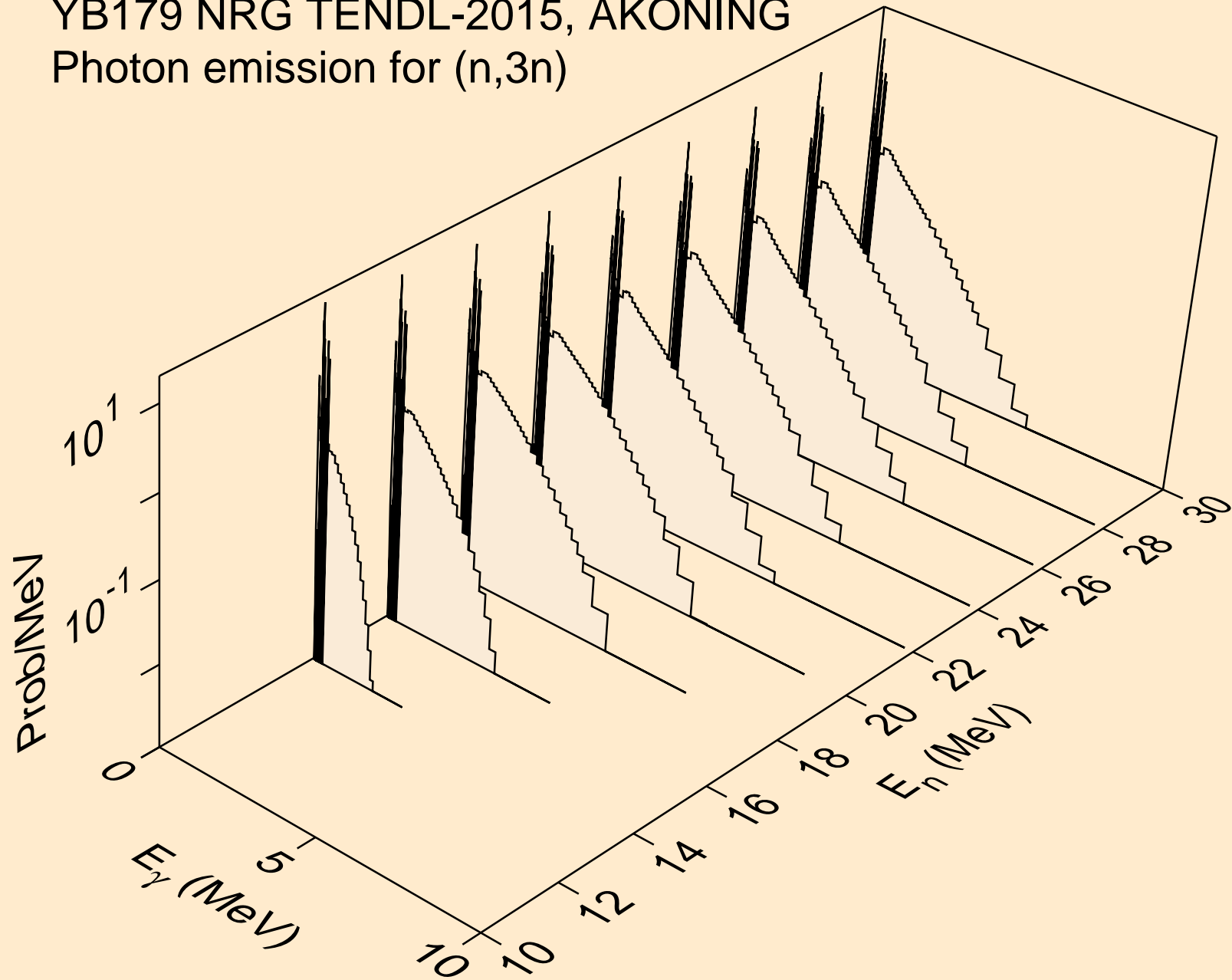

YB179 NRG TENDL-2015, AKONING
Photon emission for (n,n*)a

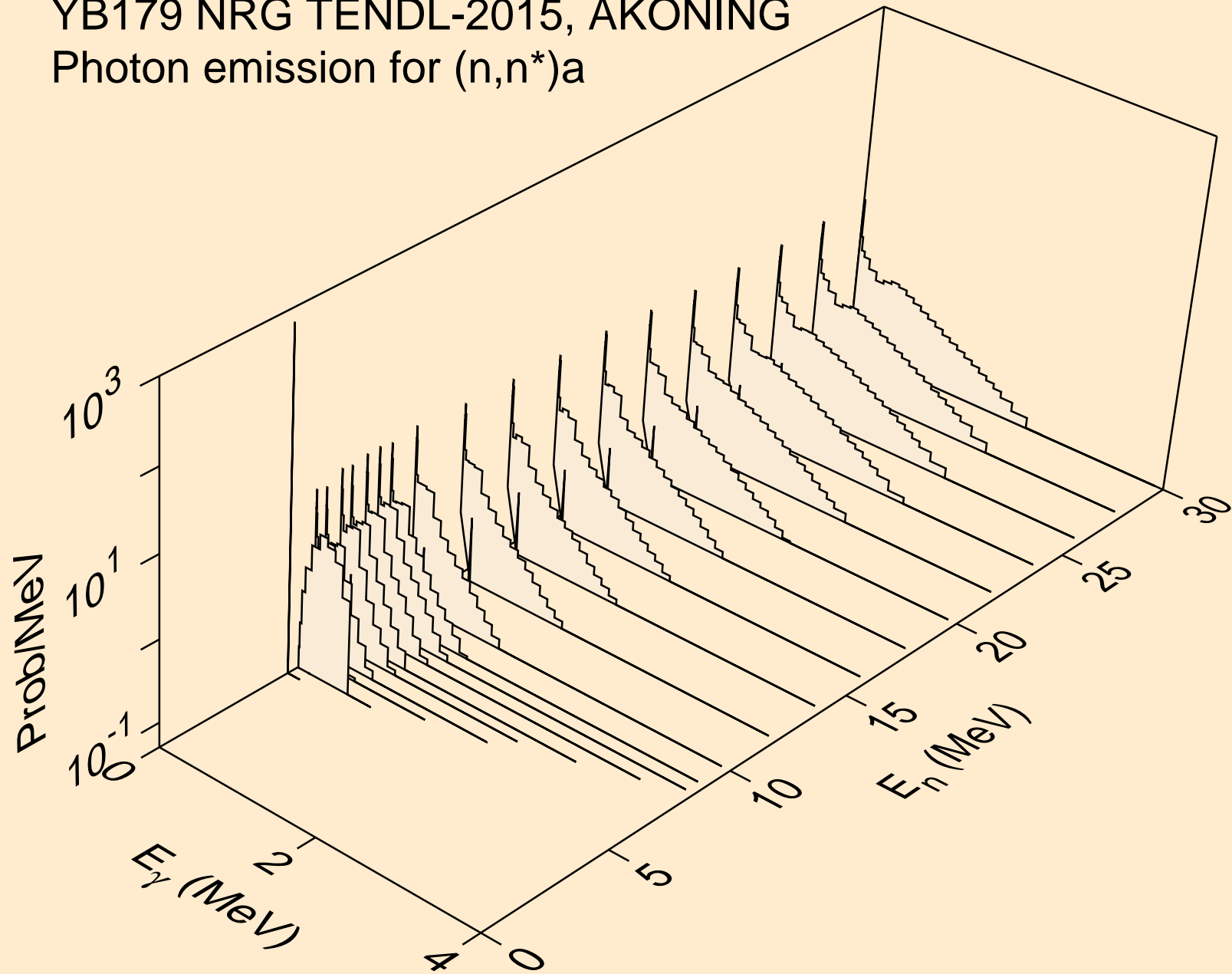

YB179 NRG TENDL-2015, AKONING
Photon emission for (n,2n) α

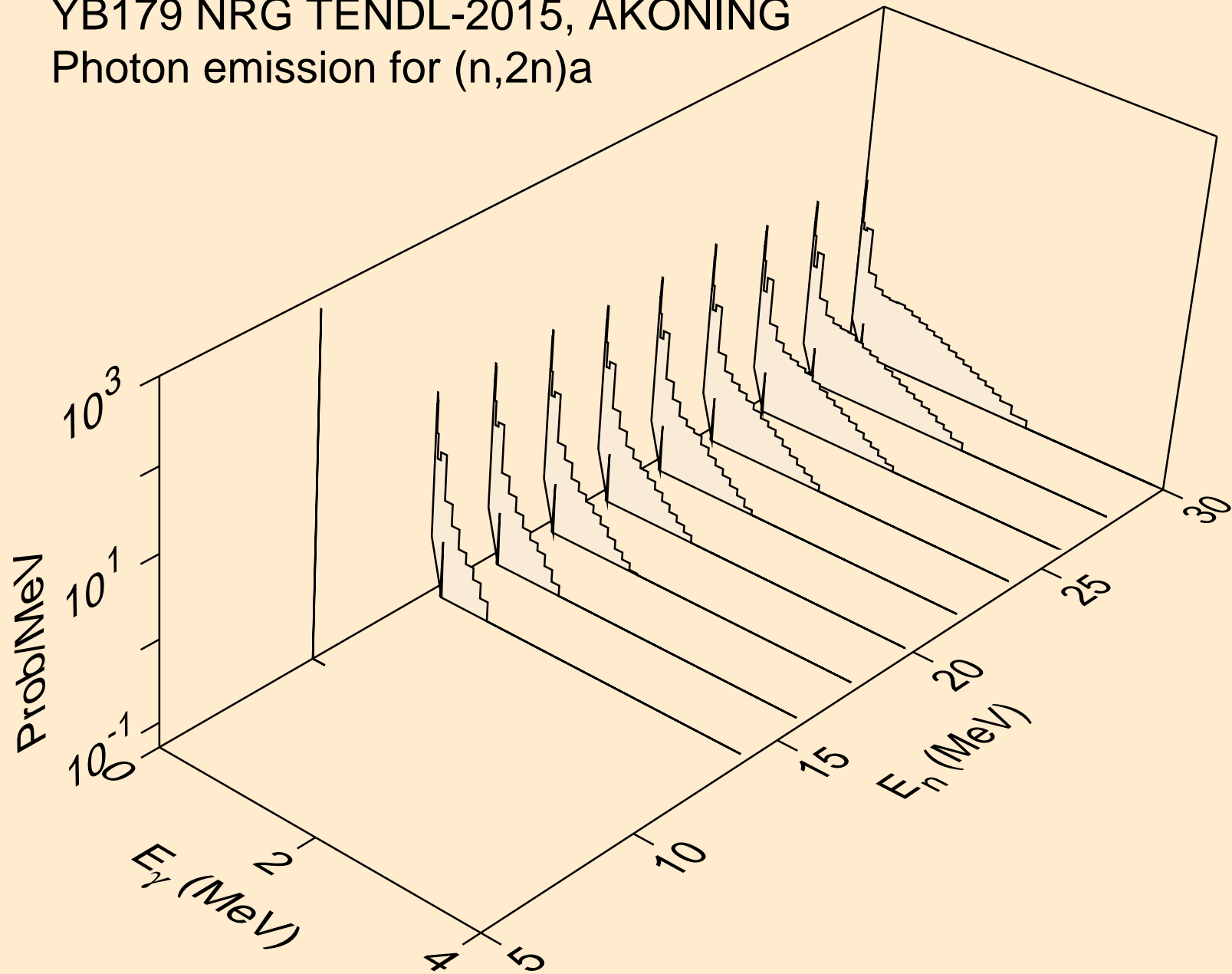

YB179 NRG TENDL-2015, AKONING
Photon emission for (n,3n)a

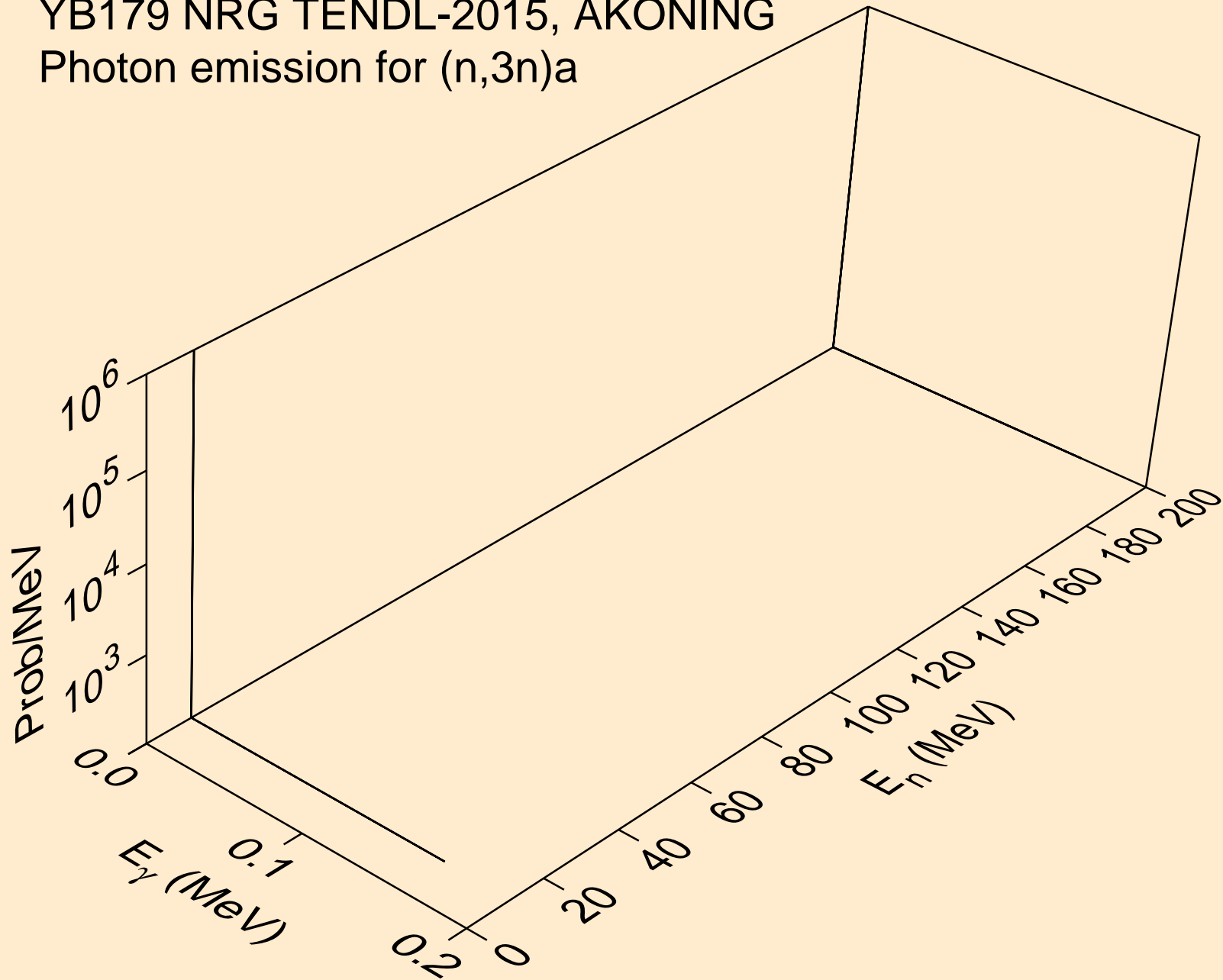

YB179 NRG TENDL-2015, AKONING

Photon emission for (n,n*)p

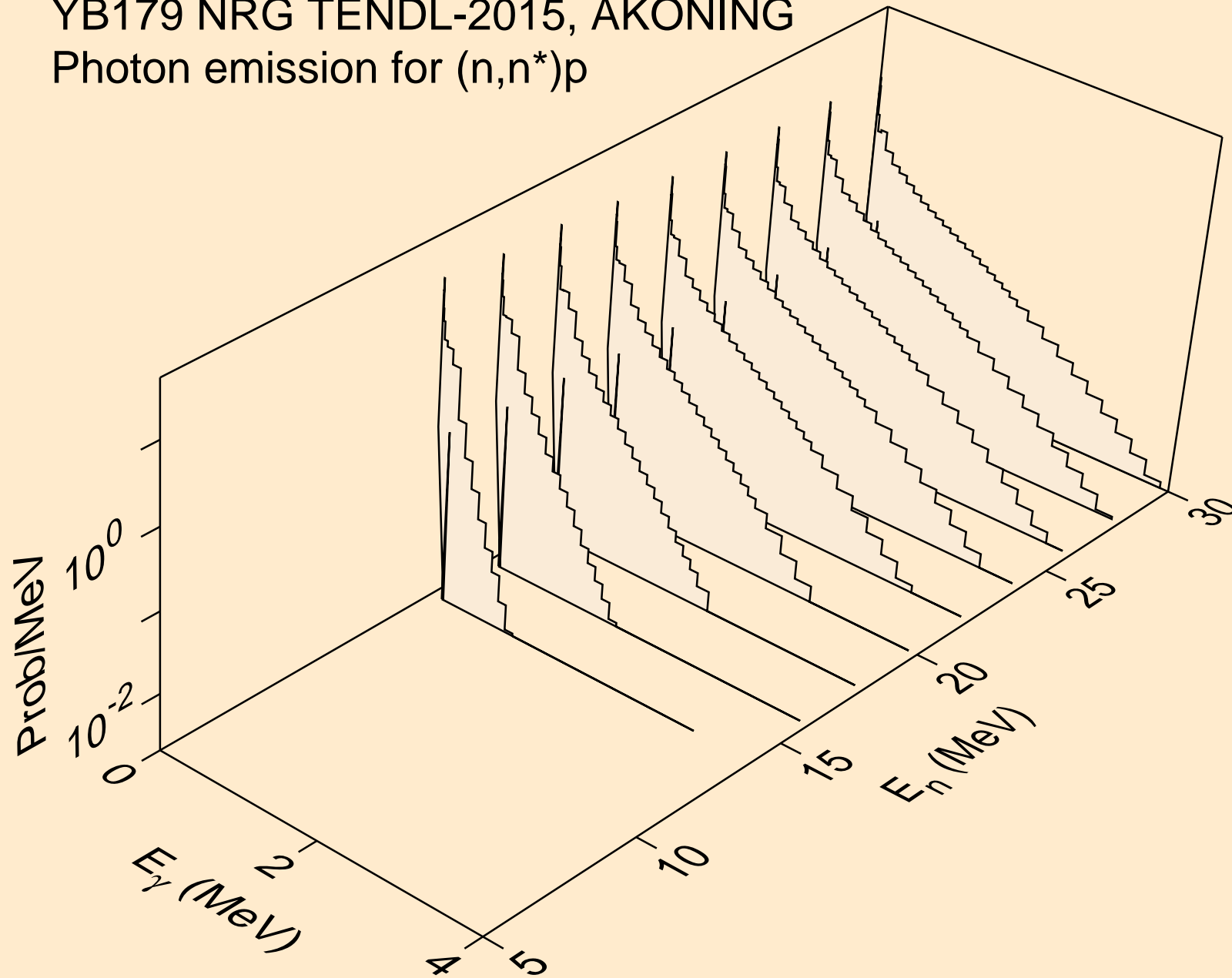

YB179 NRG TENDL-2015, AKONING
Photon emission for (n,n*)d

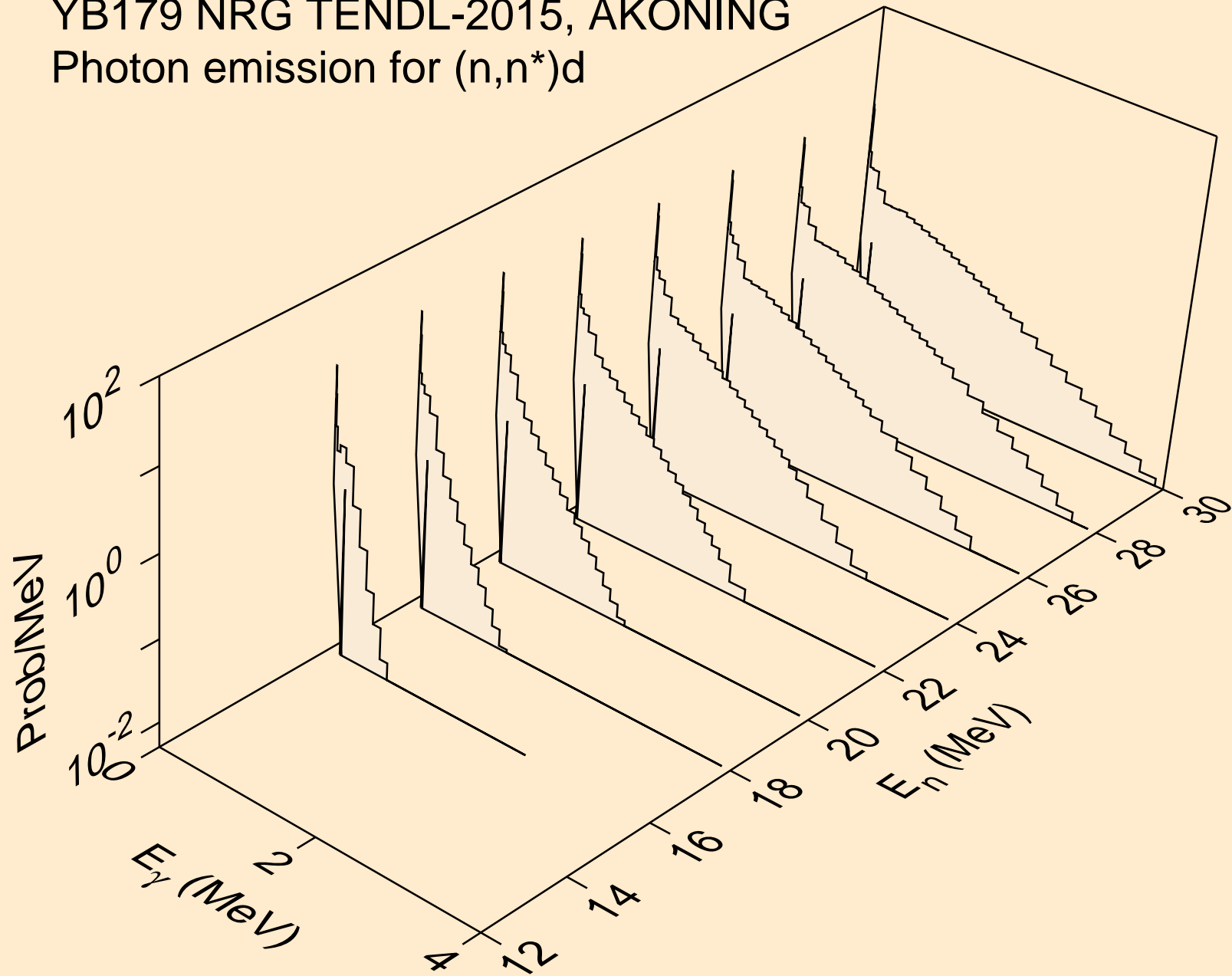

YB179 NRG TENDL-2015, AKONING
Photon emission for (n,n*)t

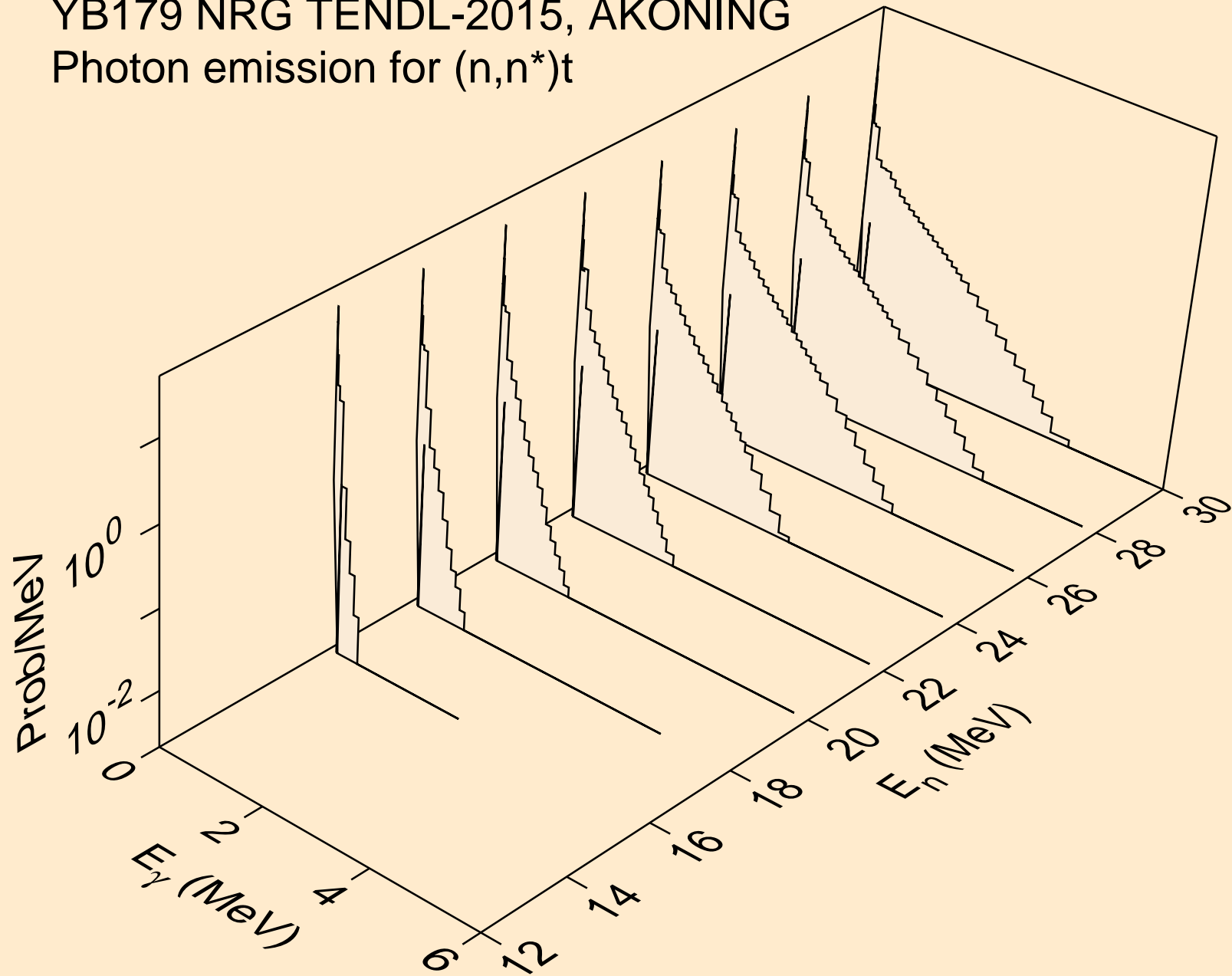

YB179 NRG TENDL-2015, AKONING
Photon emission for (n,n*)he3

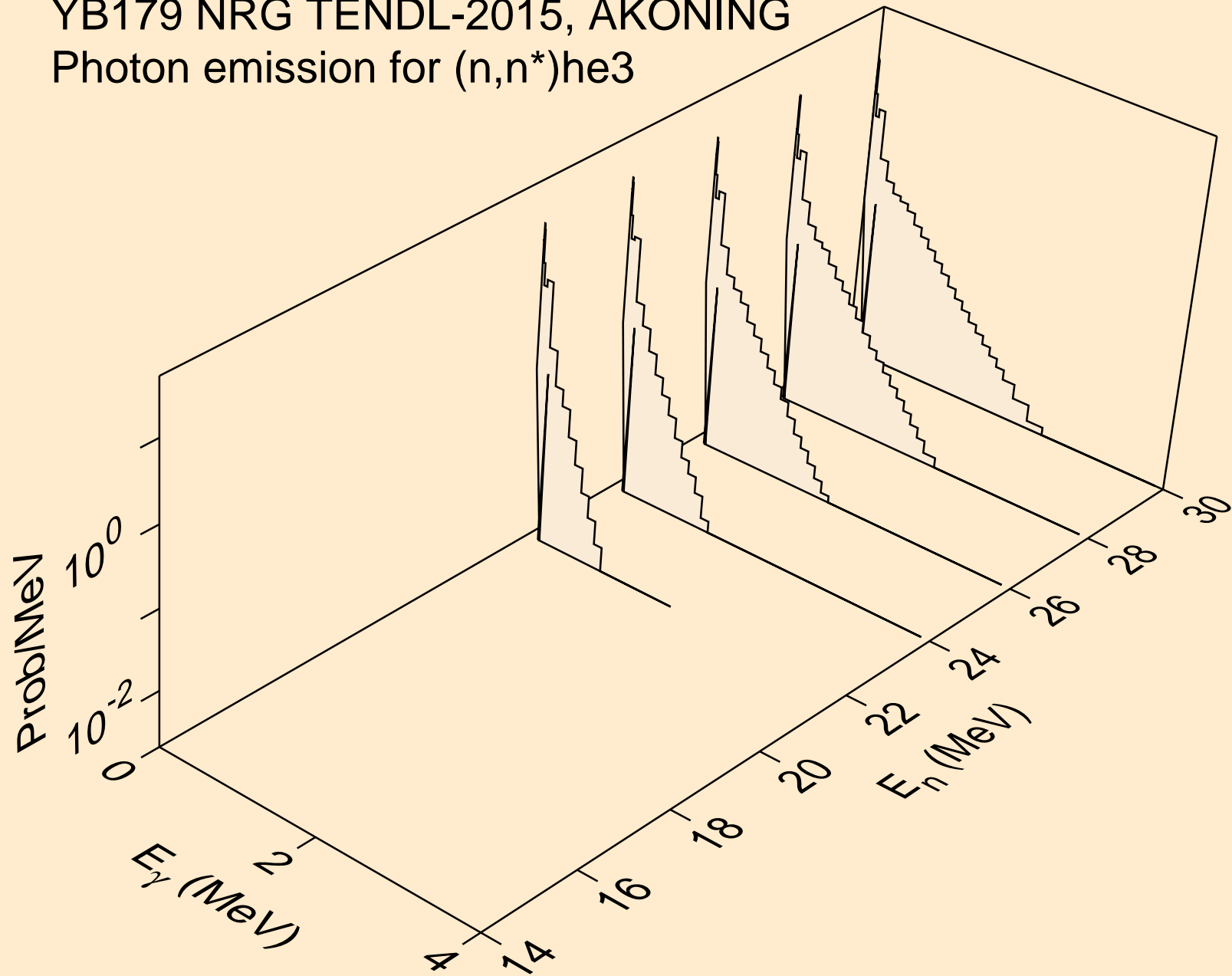

YB179 NRG TENDL-2015, AKONING
Photon emission for (n,4n)

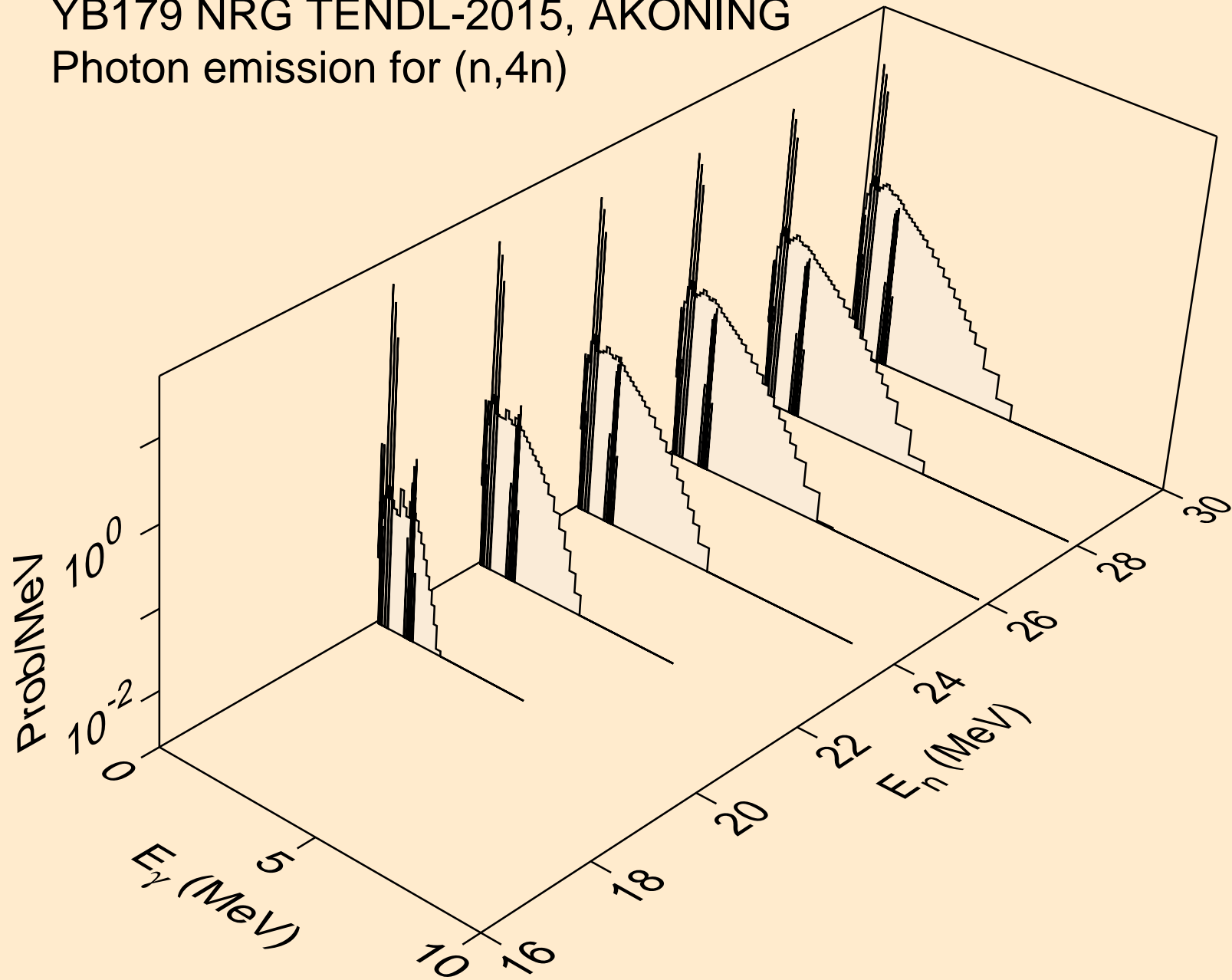

YB179 NRG TENDL-2015, AKONING
Photon emission for (n,2np)

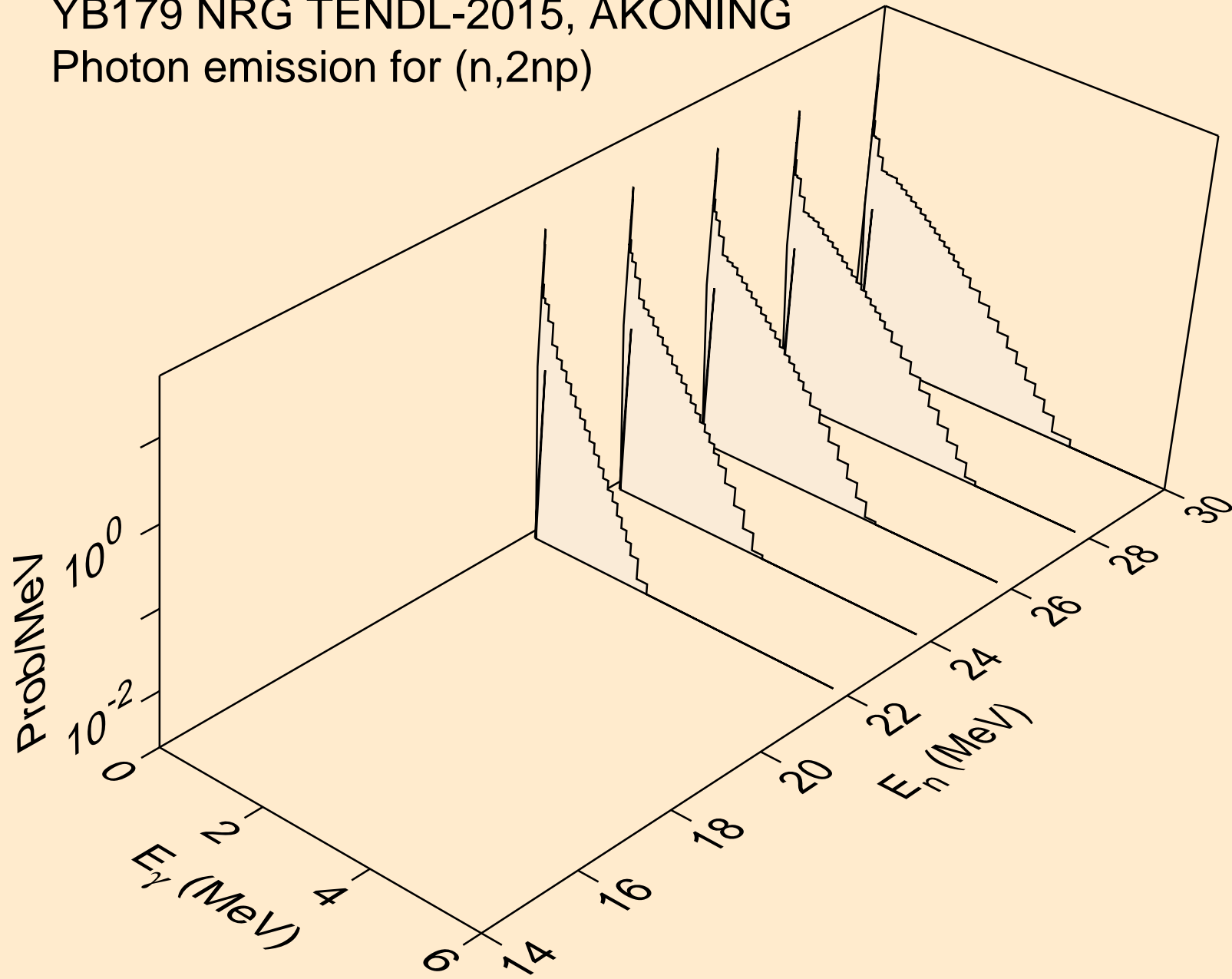

YB179 NRG TENDL-2015, AKONING
Photon emission for (n,3np)

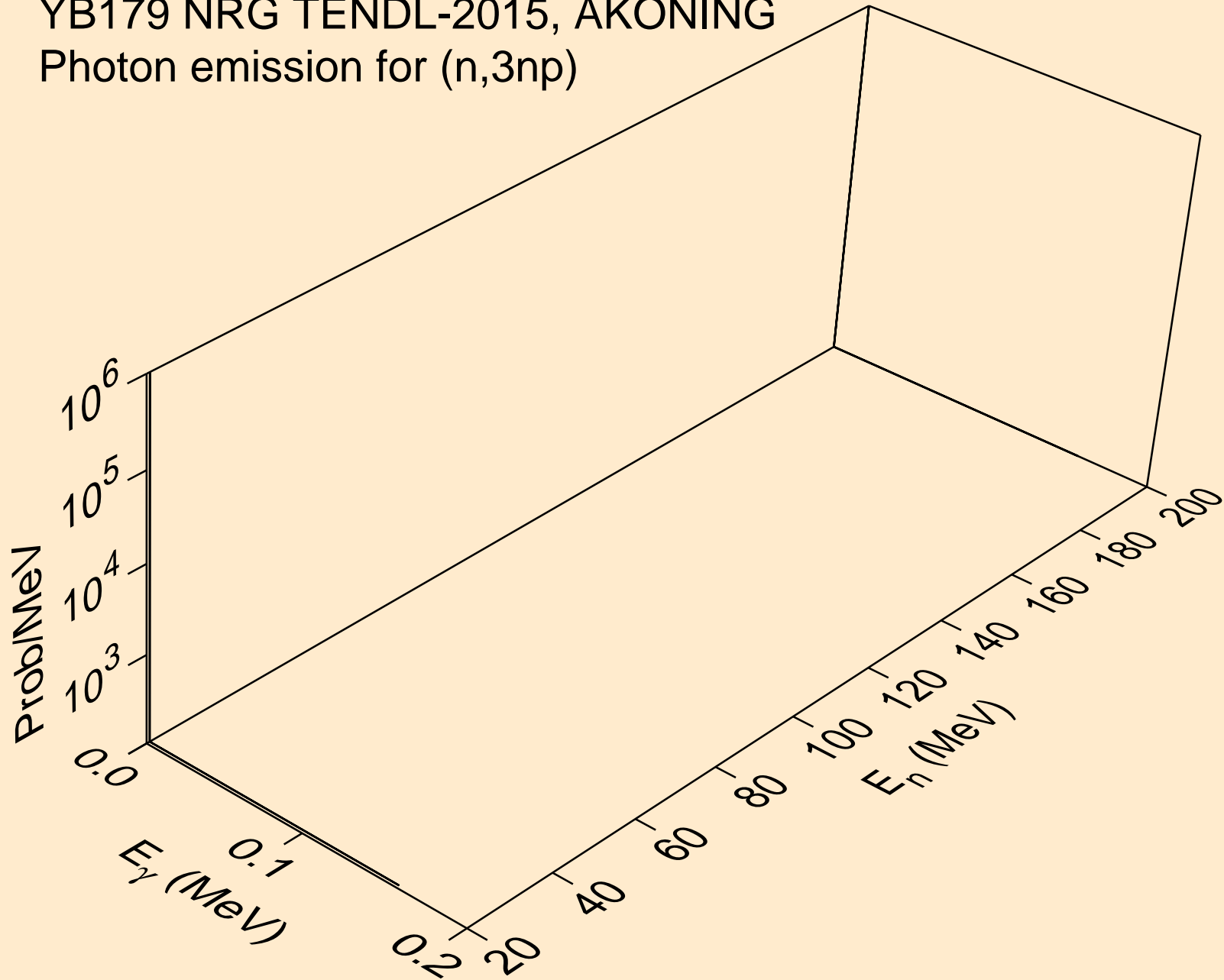

YB179 NRG TENDL-2015, AKONING
Photon emission for (n,n*c)

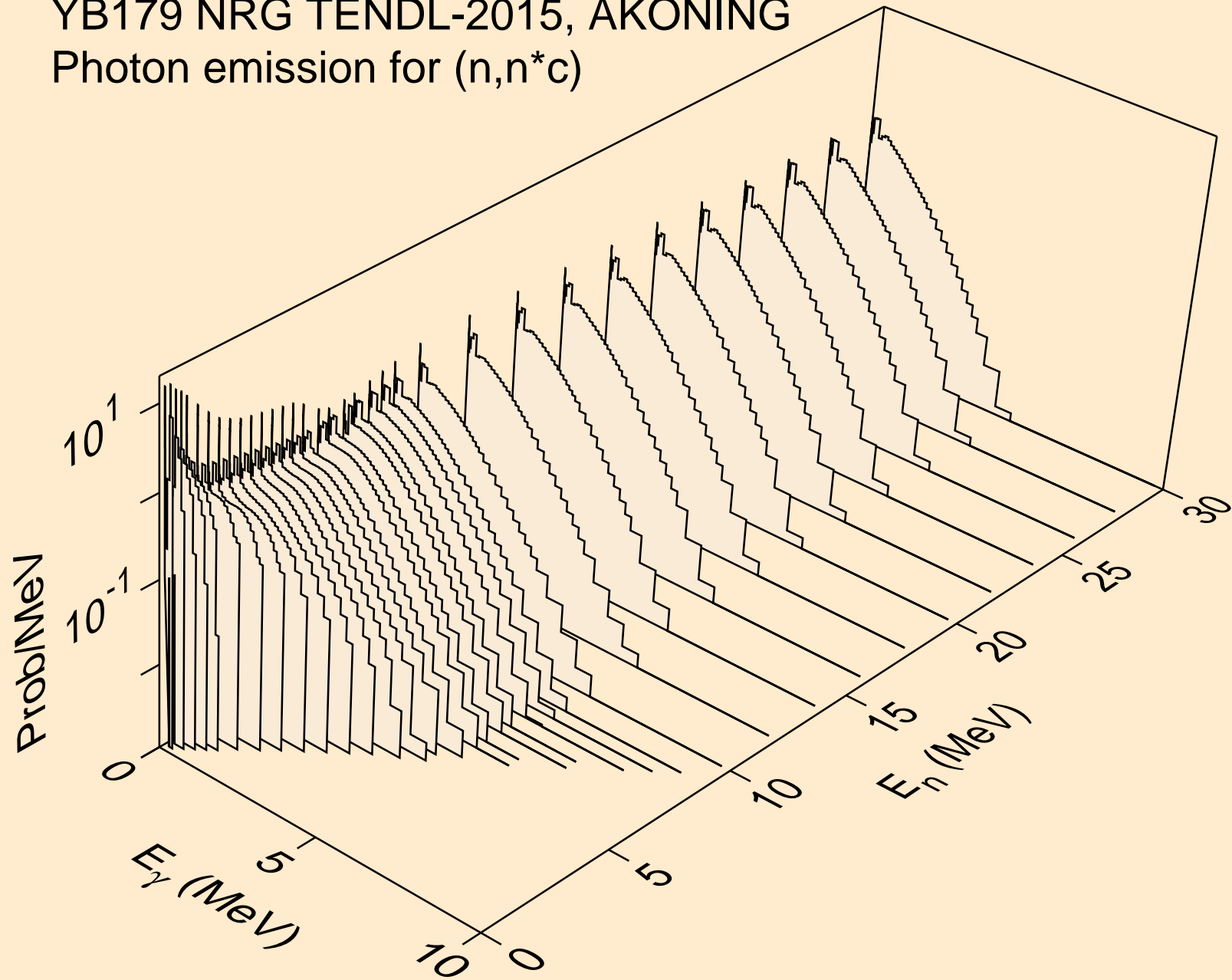

YB179 NRG TENDL-2015, AKONING
Photon emission for (n,gma)

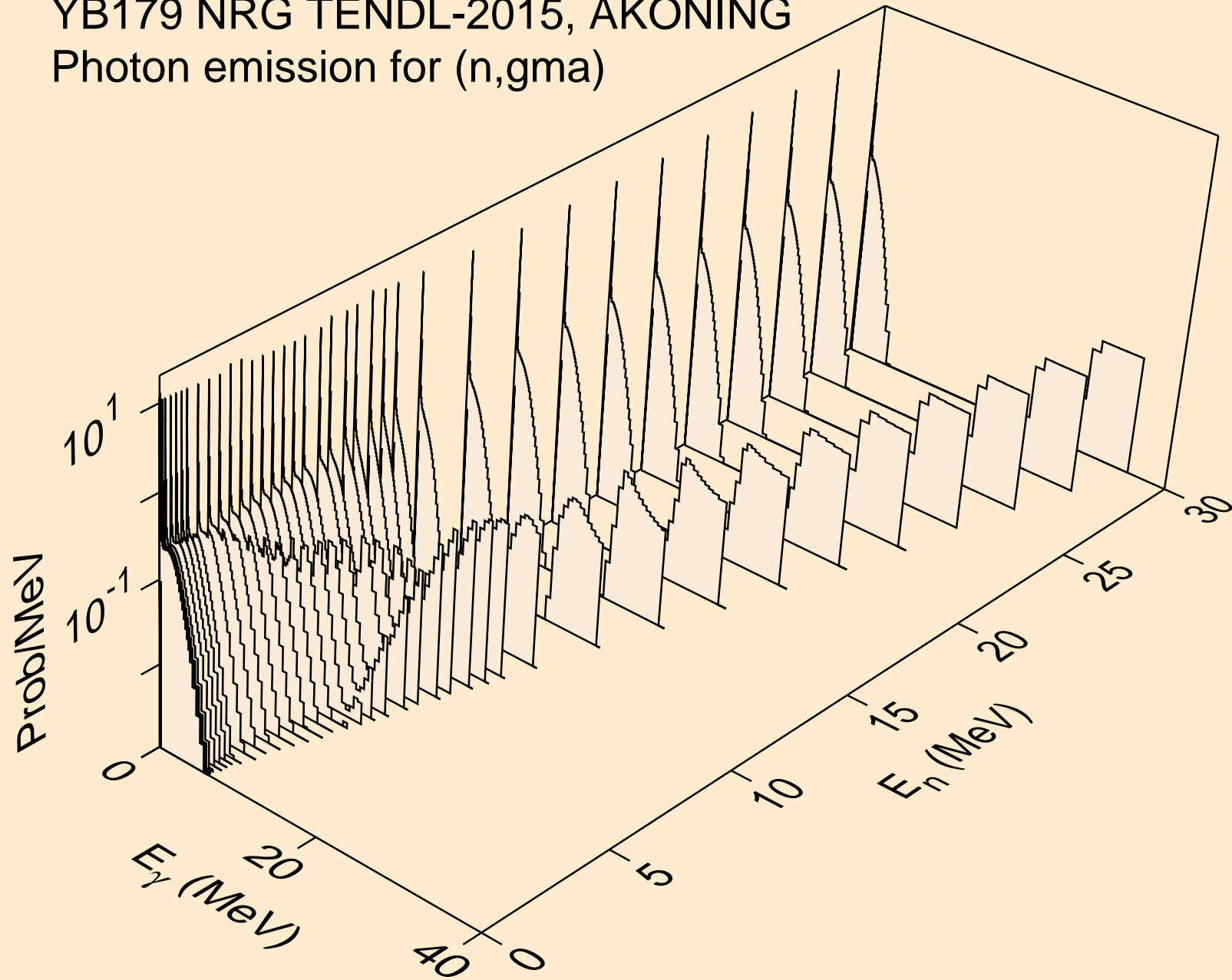

YB179 NRG TENDL-2015, AKONING
Photon emission for (n,p)

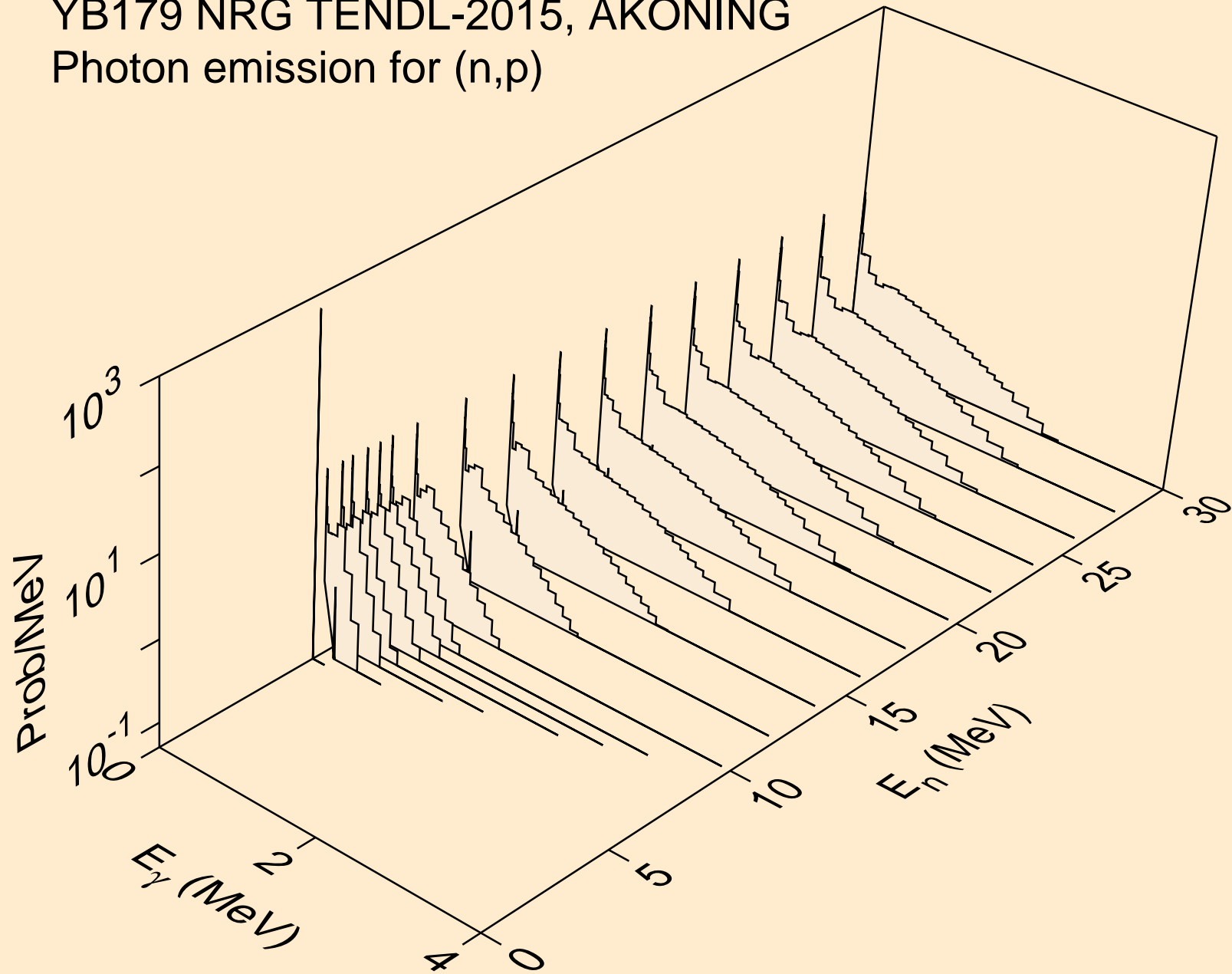

YB179 NRG TENDL-2015, AKONING
Photon emission for (n,d)

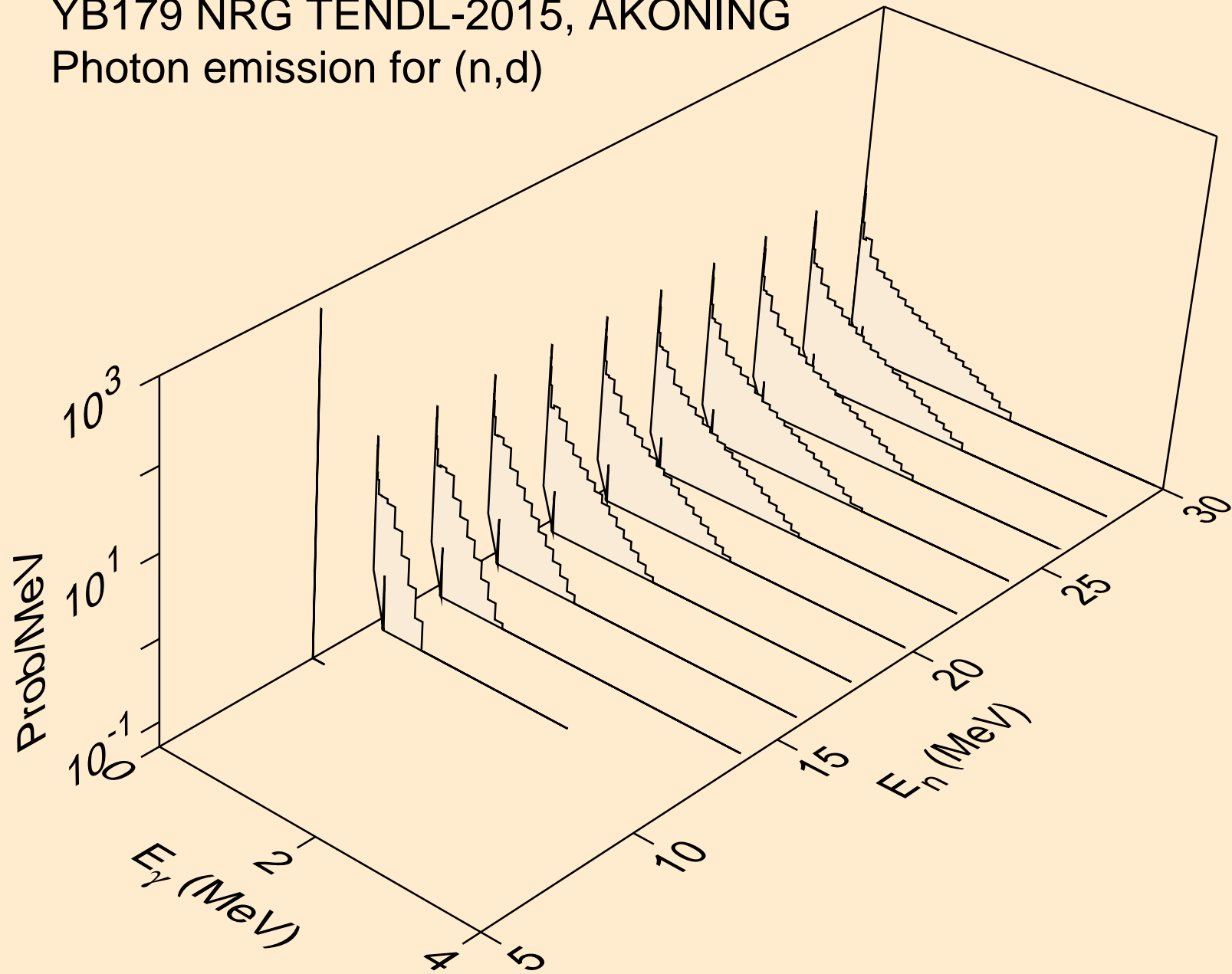

YB179 NRG TENDL-2015, AKONING
Photon emission for (n,t)

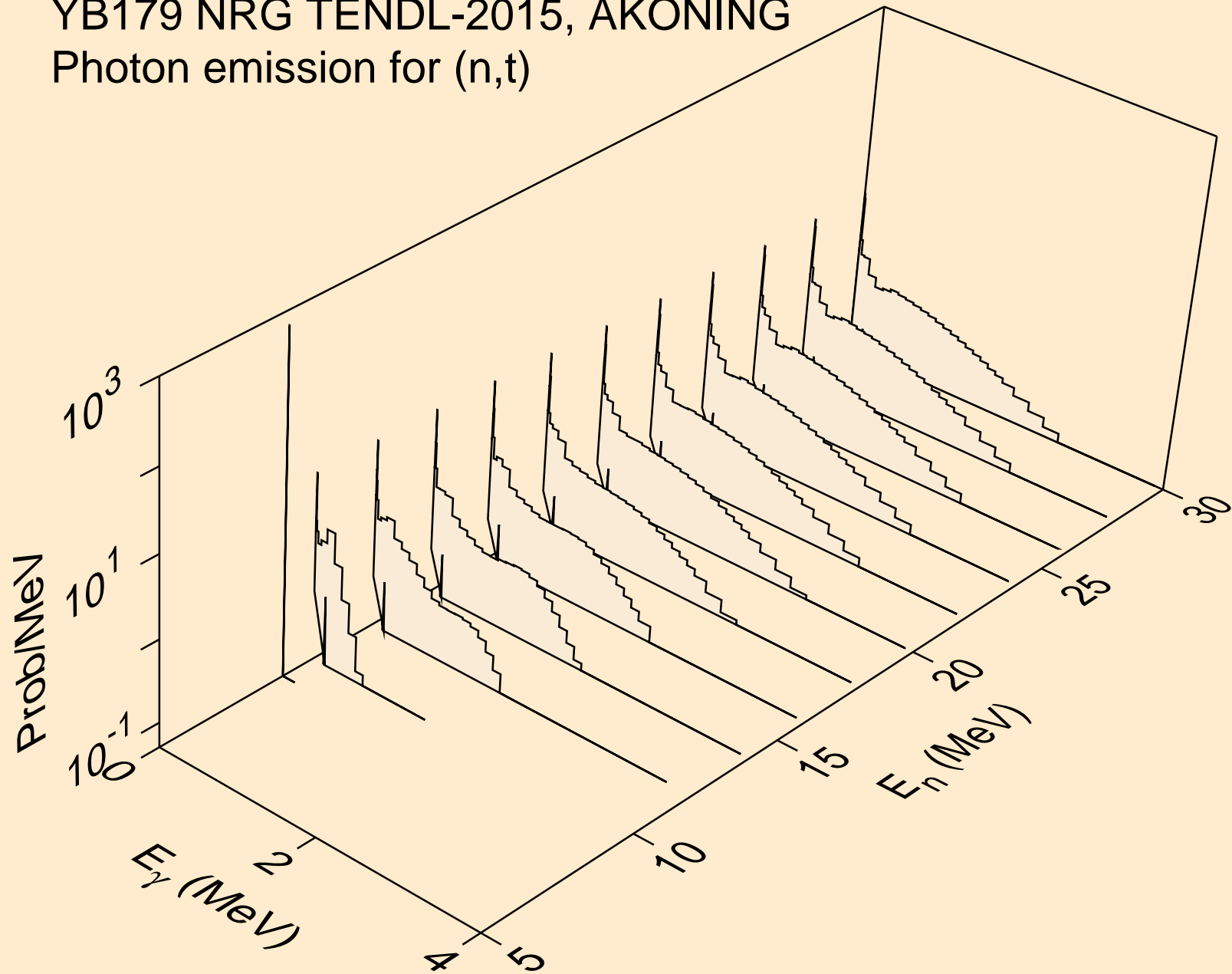

YB179 NRG TENDL-2015, AKONING
Photon emission for (n,he3)

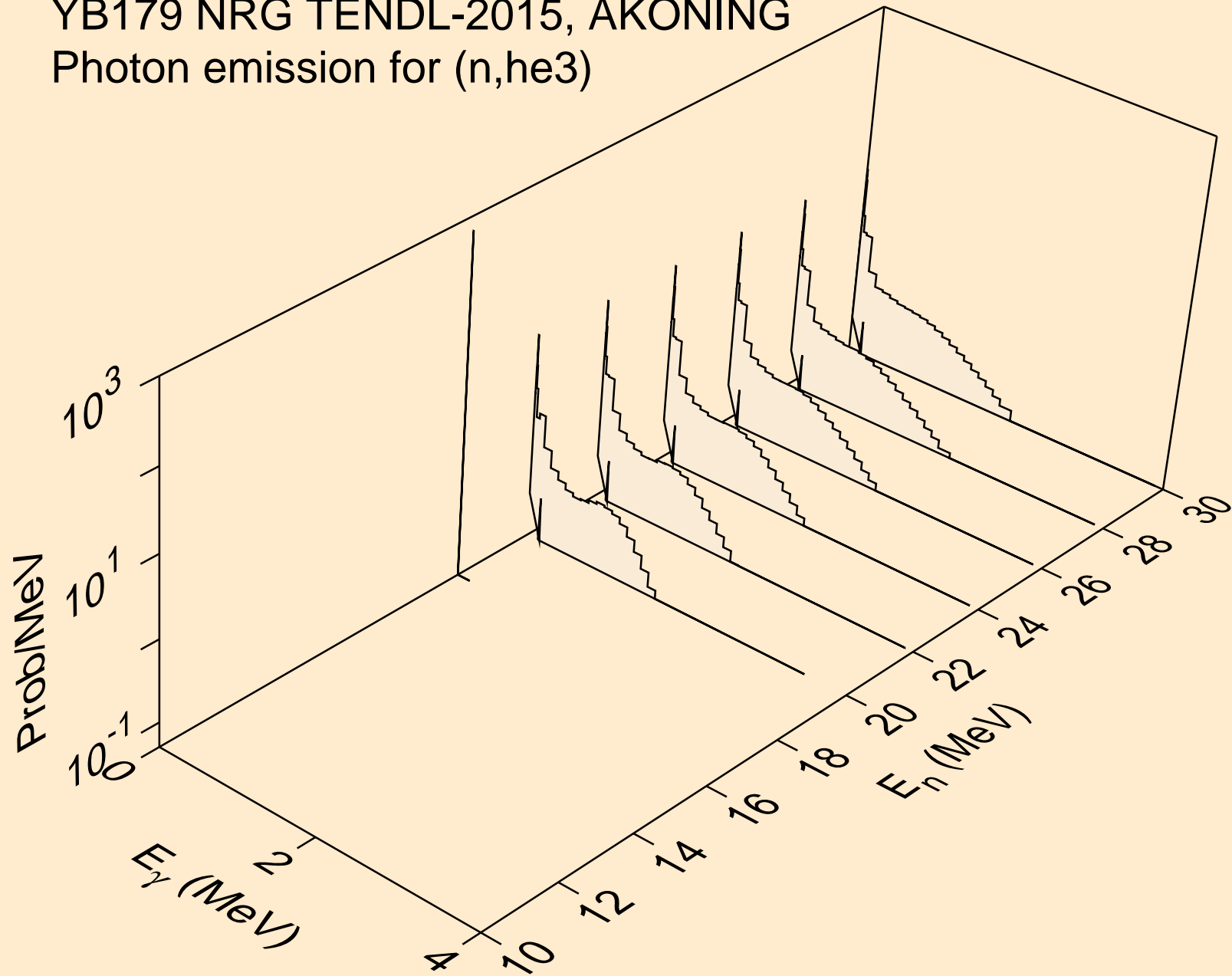

YB179 NRG TENDL-2015, AKONING
Photon emission for (n,a)

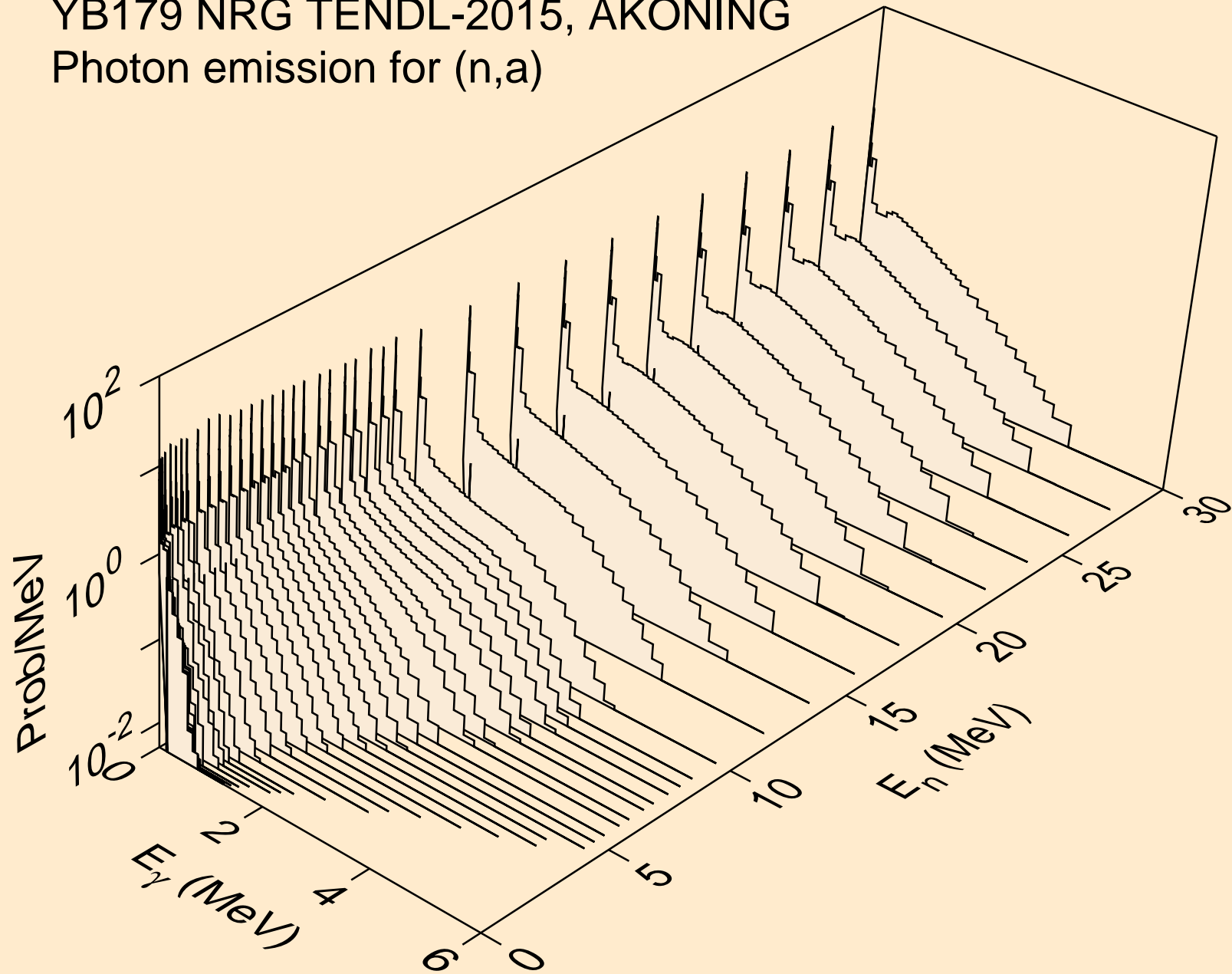

YB179 NRG TENDL-2015, AKONING
Photon emission for (n,2p)

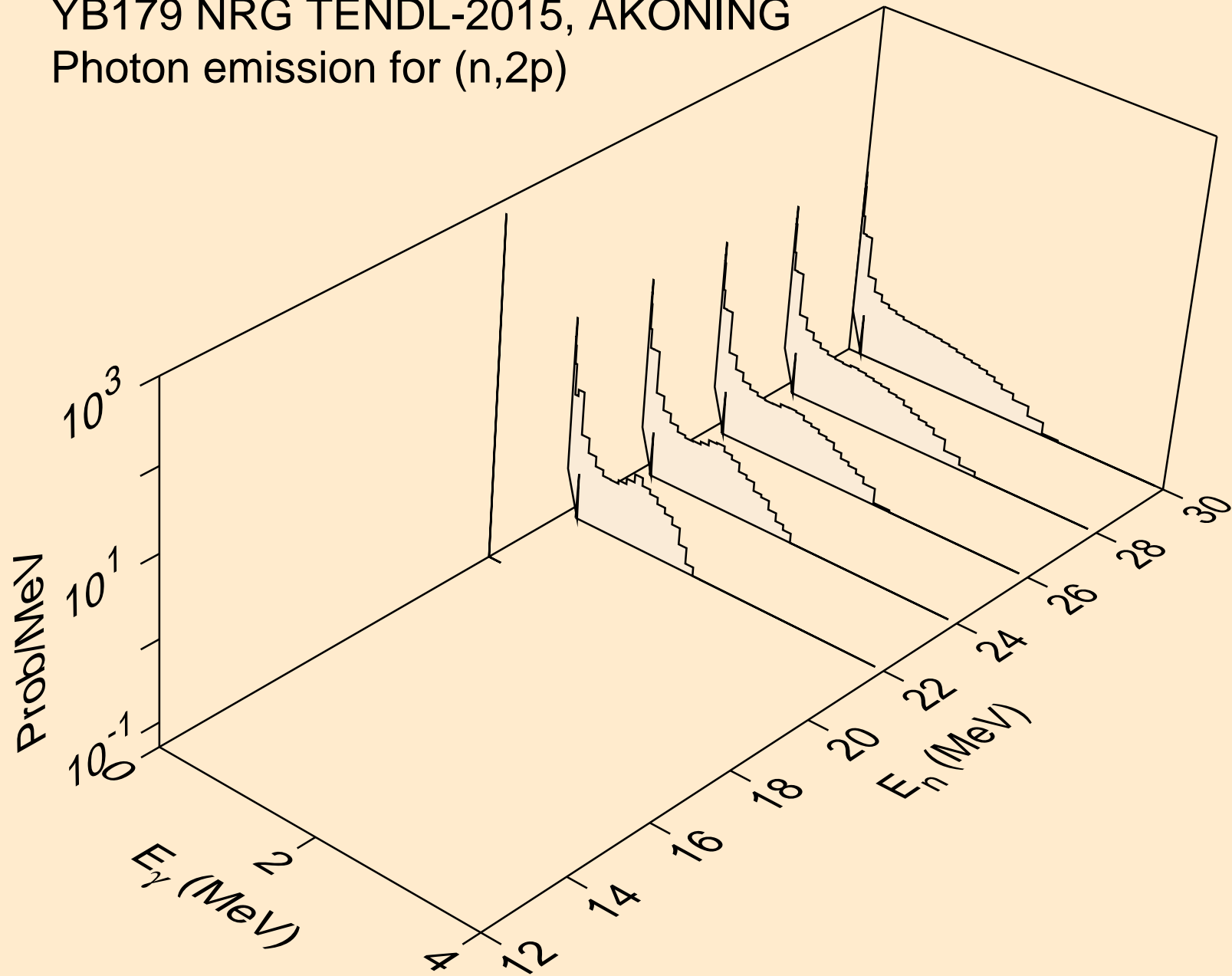

YB179 NRG TENDL-2015, AKONING
thermal capture photon spectrum

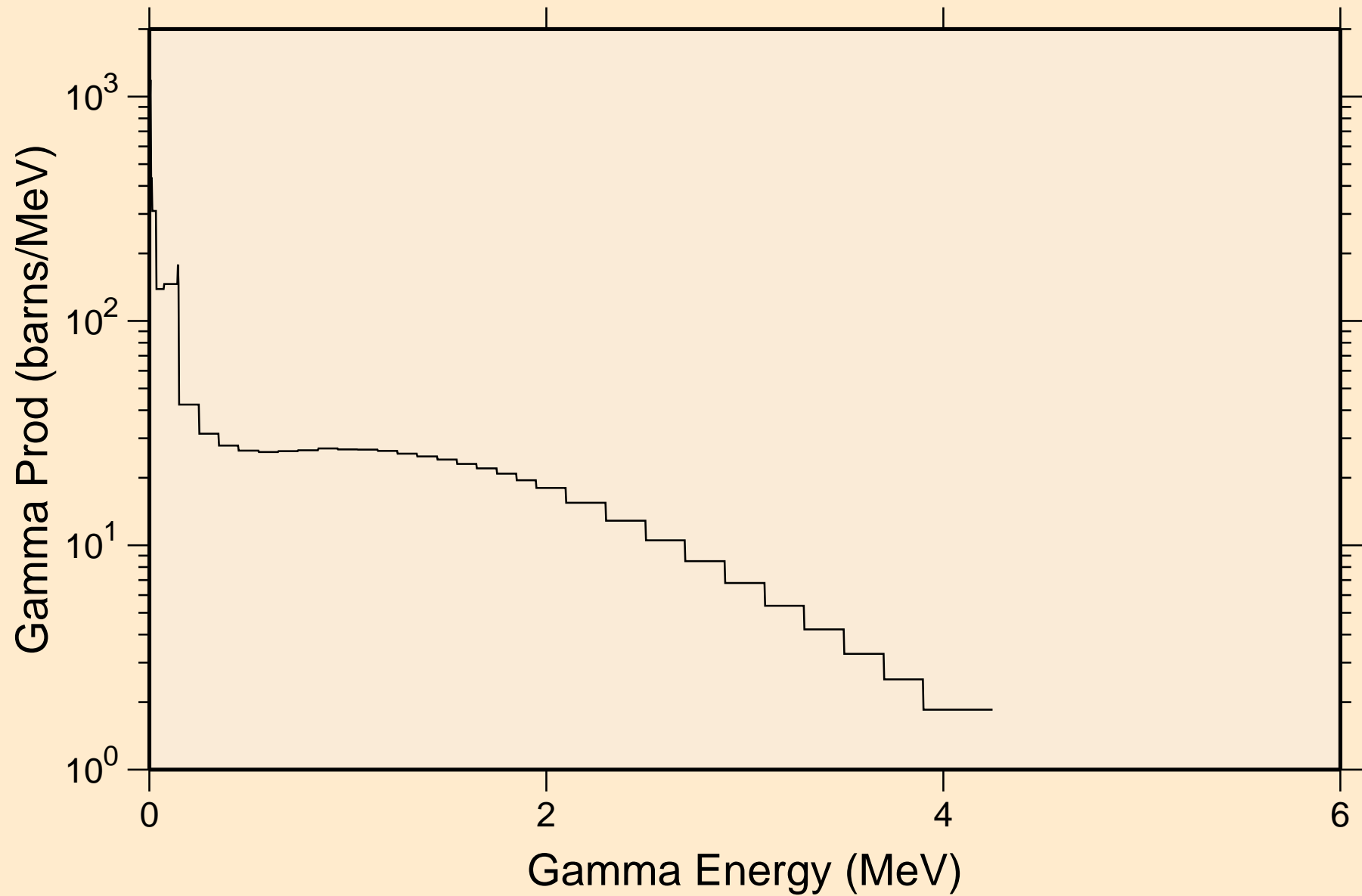

YB179 NRG TENDL-2015, AKONING
14 MeV photon spectrum

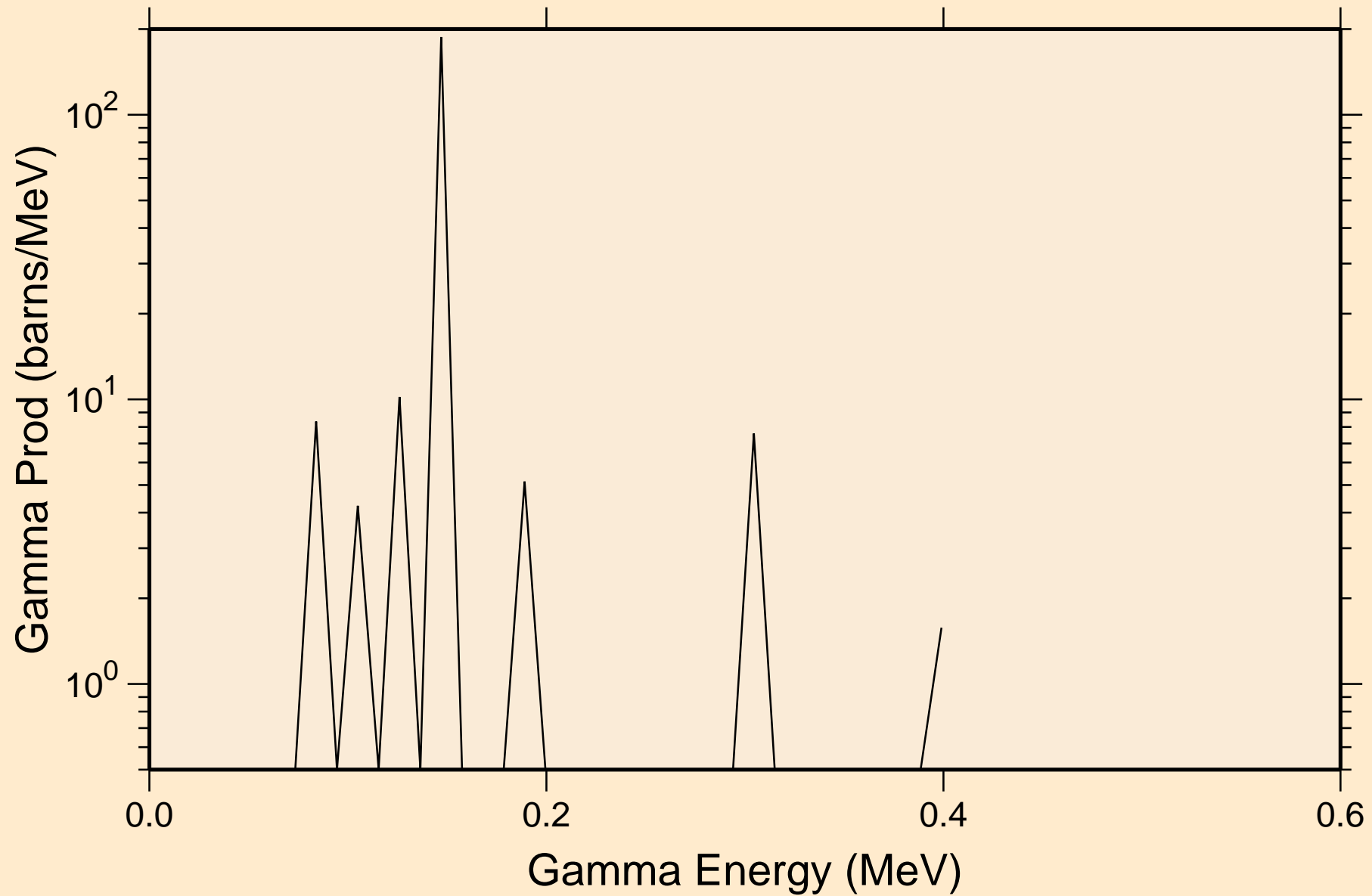

YB179 NRG TENDL-2015, AKONING

Particle heating contributions

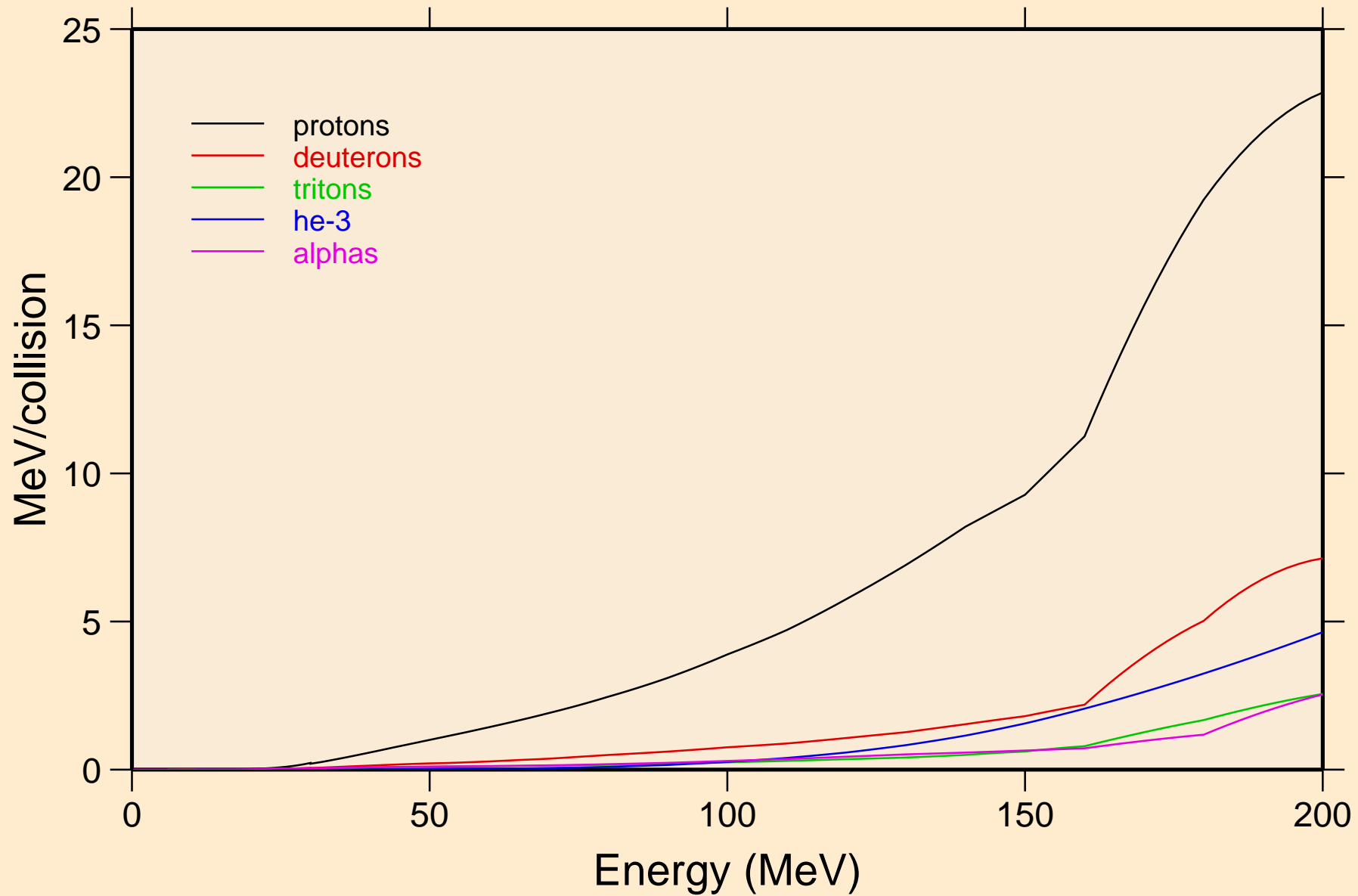

YB179 NRG TENDL-2015, AKONING

Recoil Heating

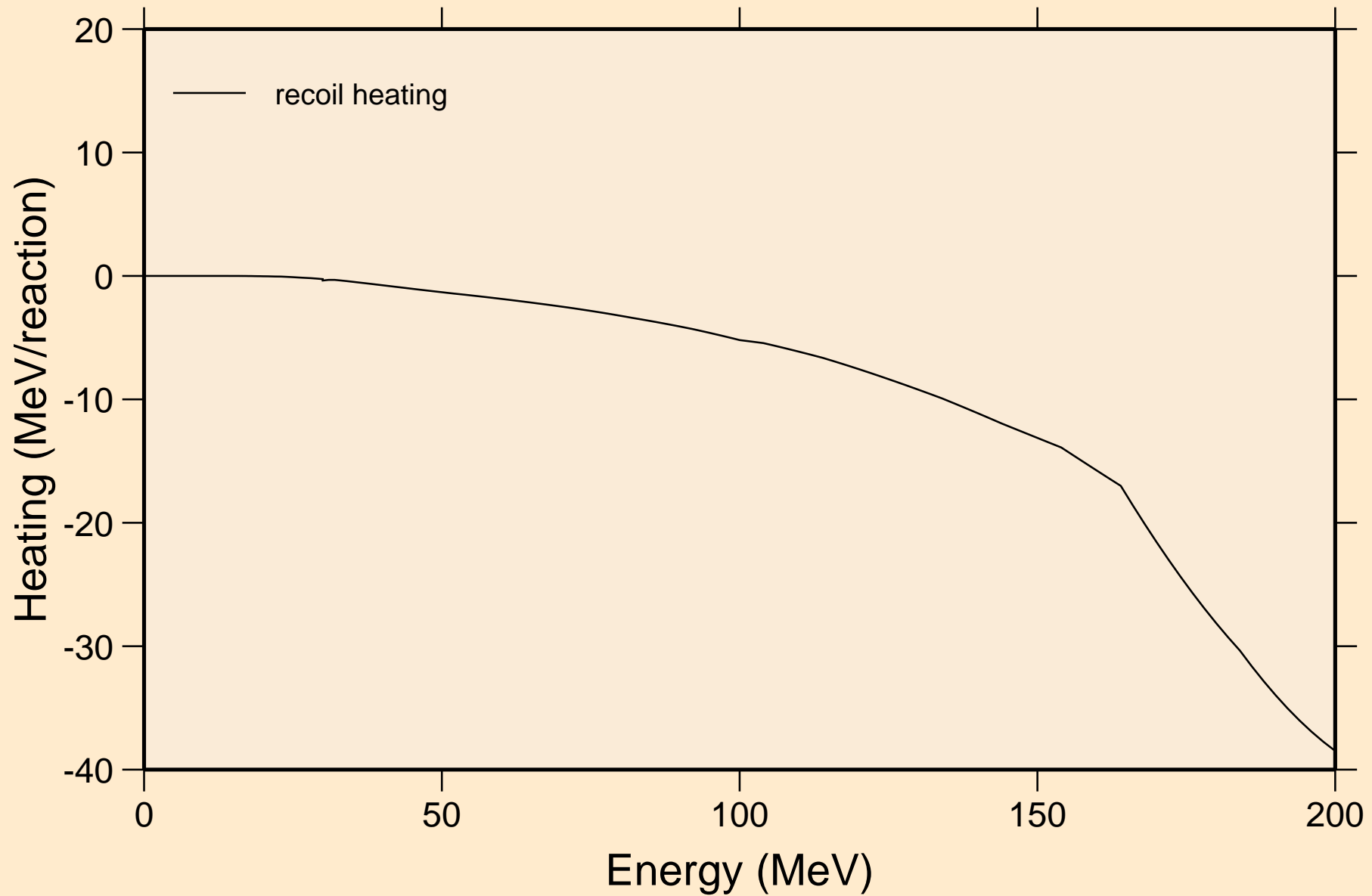

YB179 NRG TENDL-2015, AKONING

Particle production cross sections

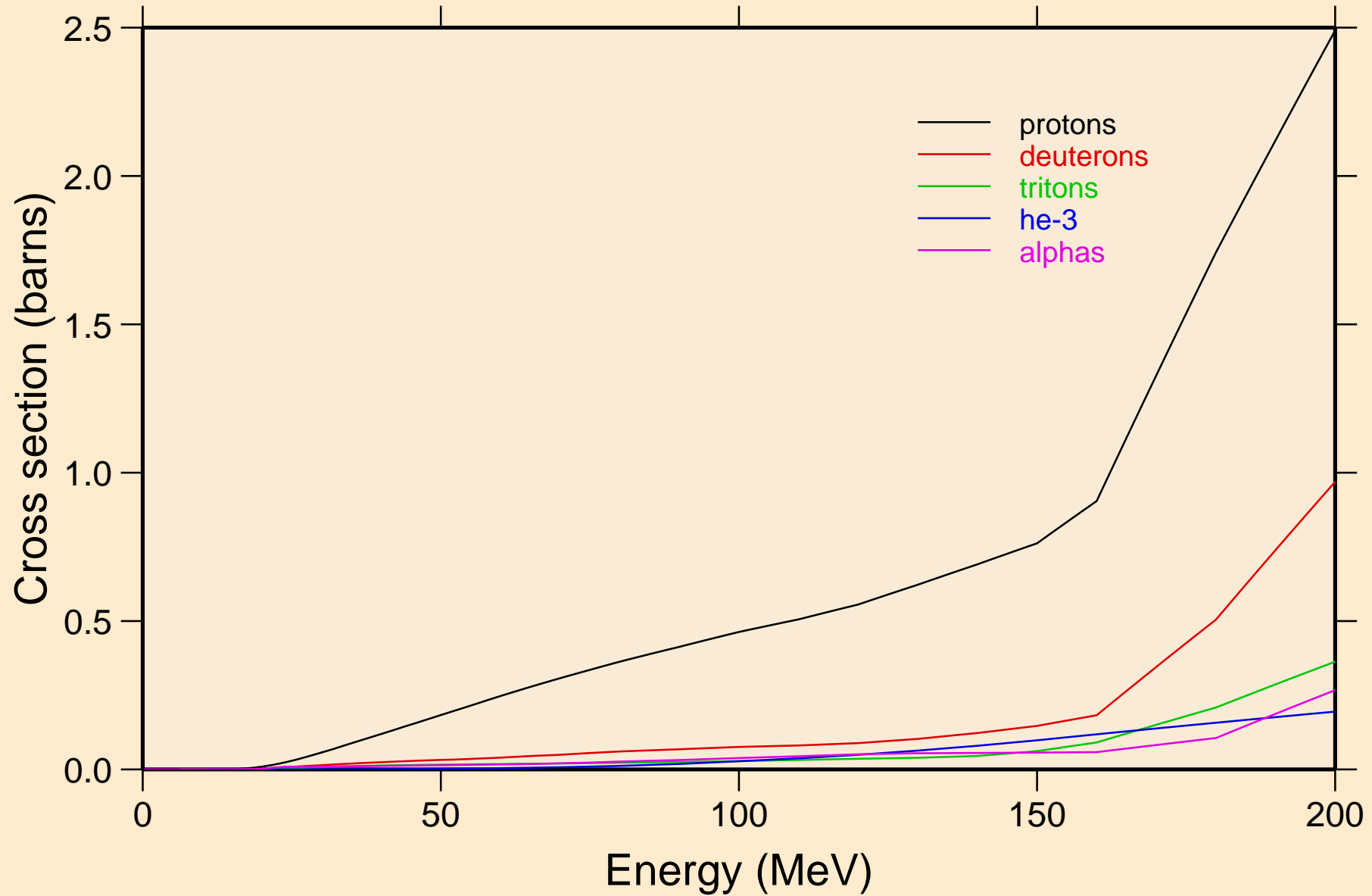

YB179 NRG TENDL-2015, AKONING
protons from (n,x)

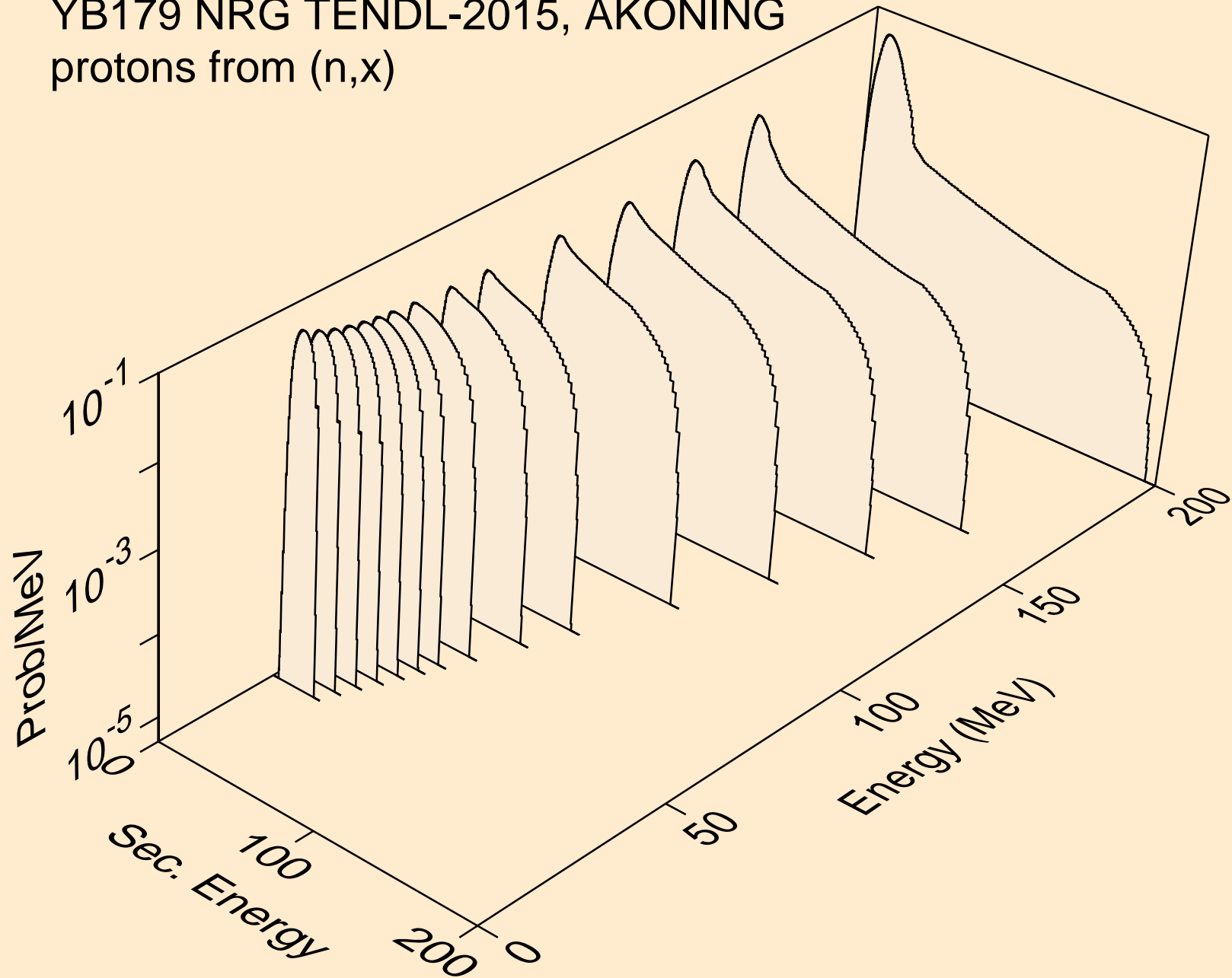

YB179 NRG TENDL-2015, AKONING
protons from (n,n*)p

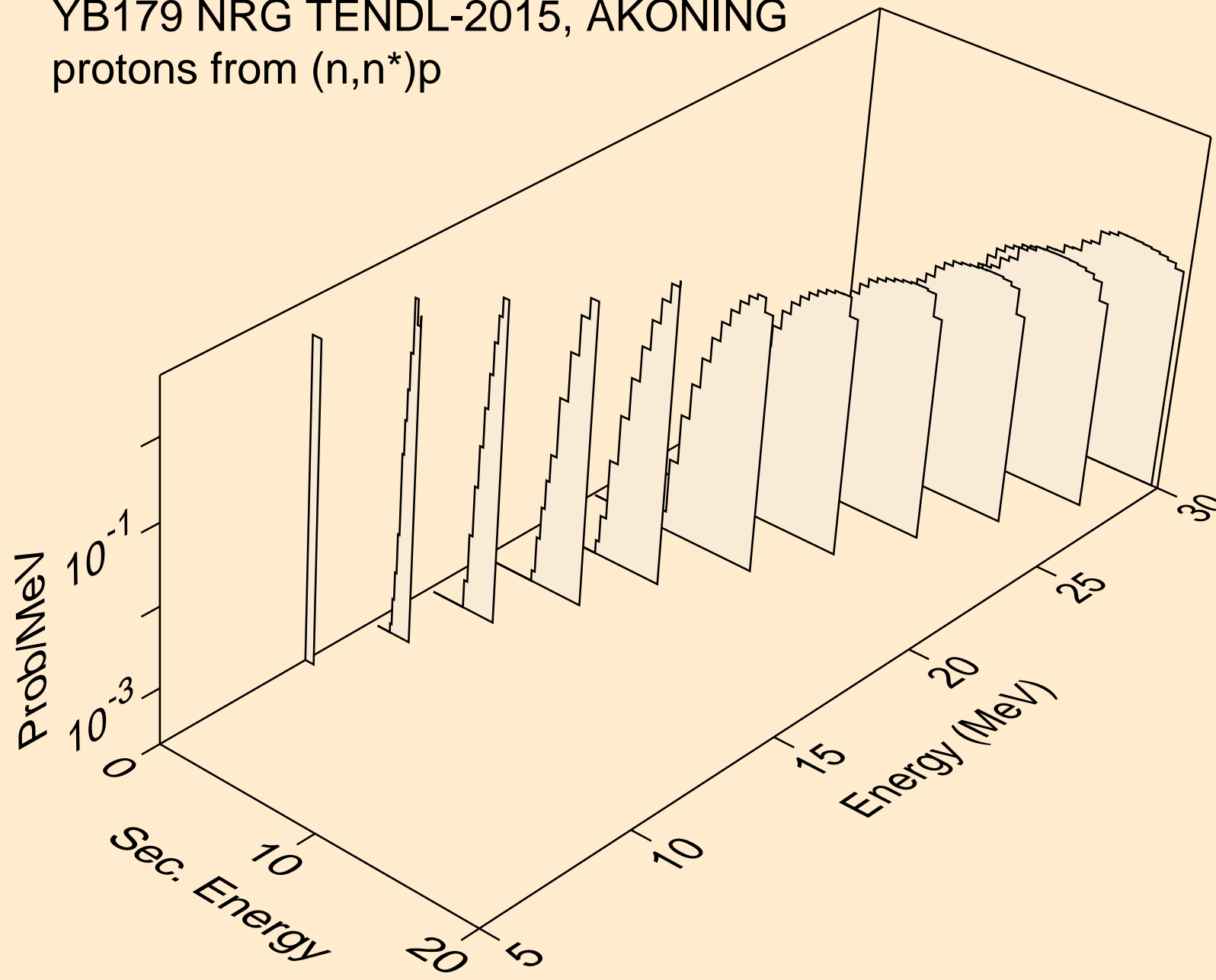

YB179 NRG TENDL-2015, AKONING
protons from (n,2np)

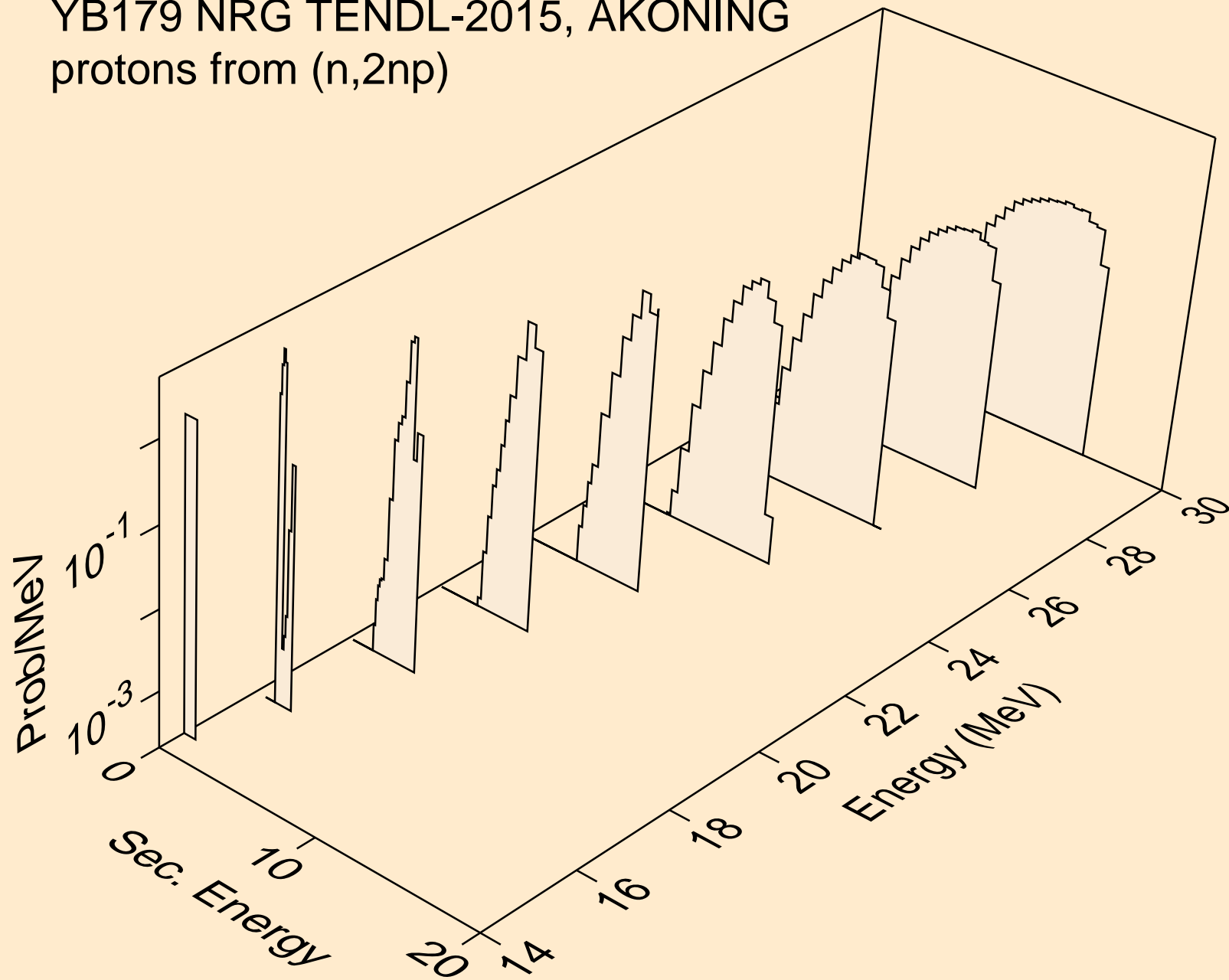

YB179 NRG TENDL-2015, AKONING
protons from (n,3np)

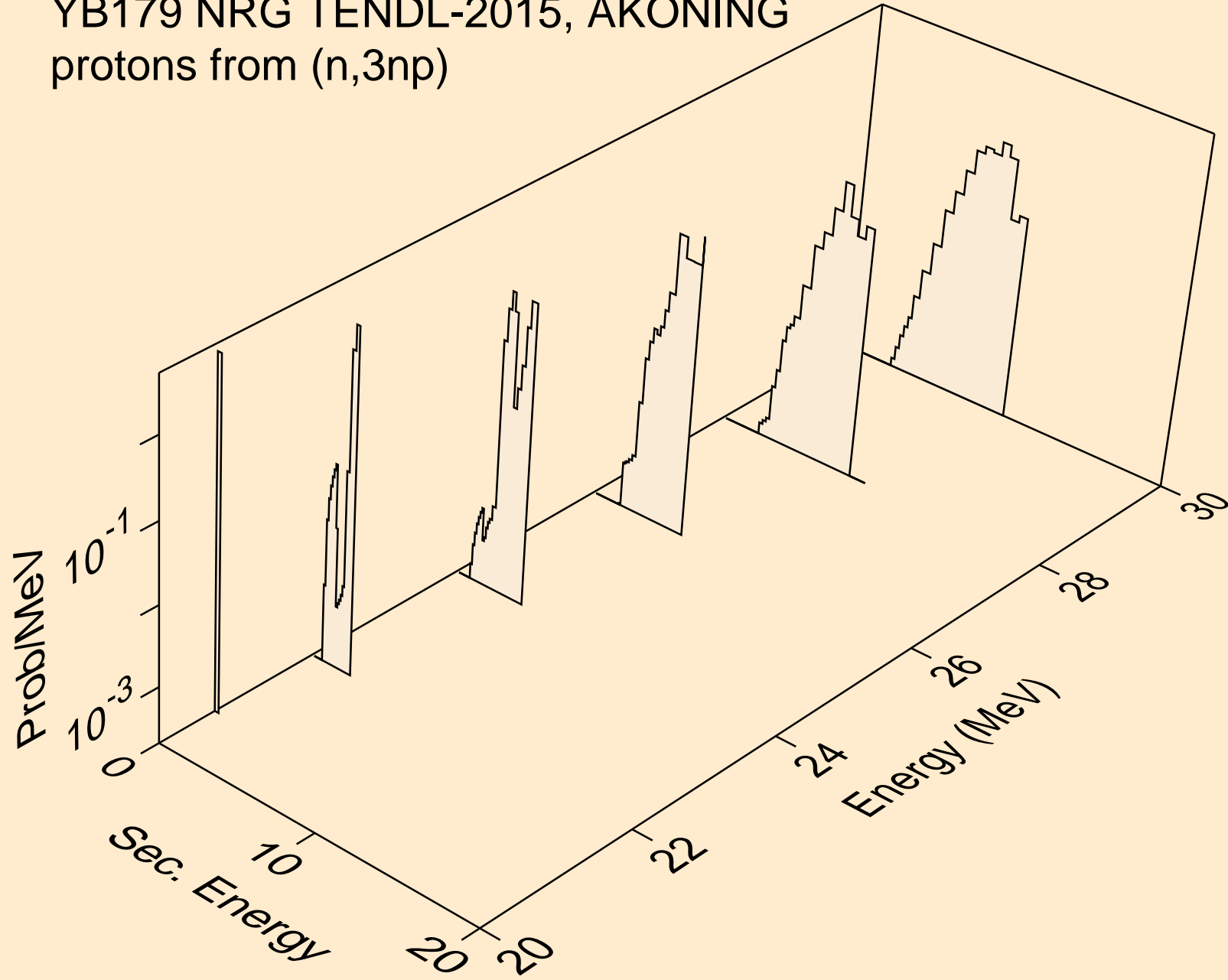

YB179 NRG TENDL-2015, AKONING
protons from (n,p)

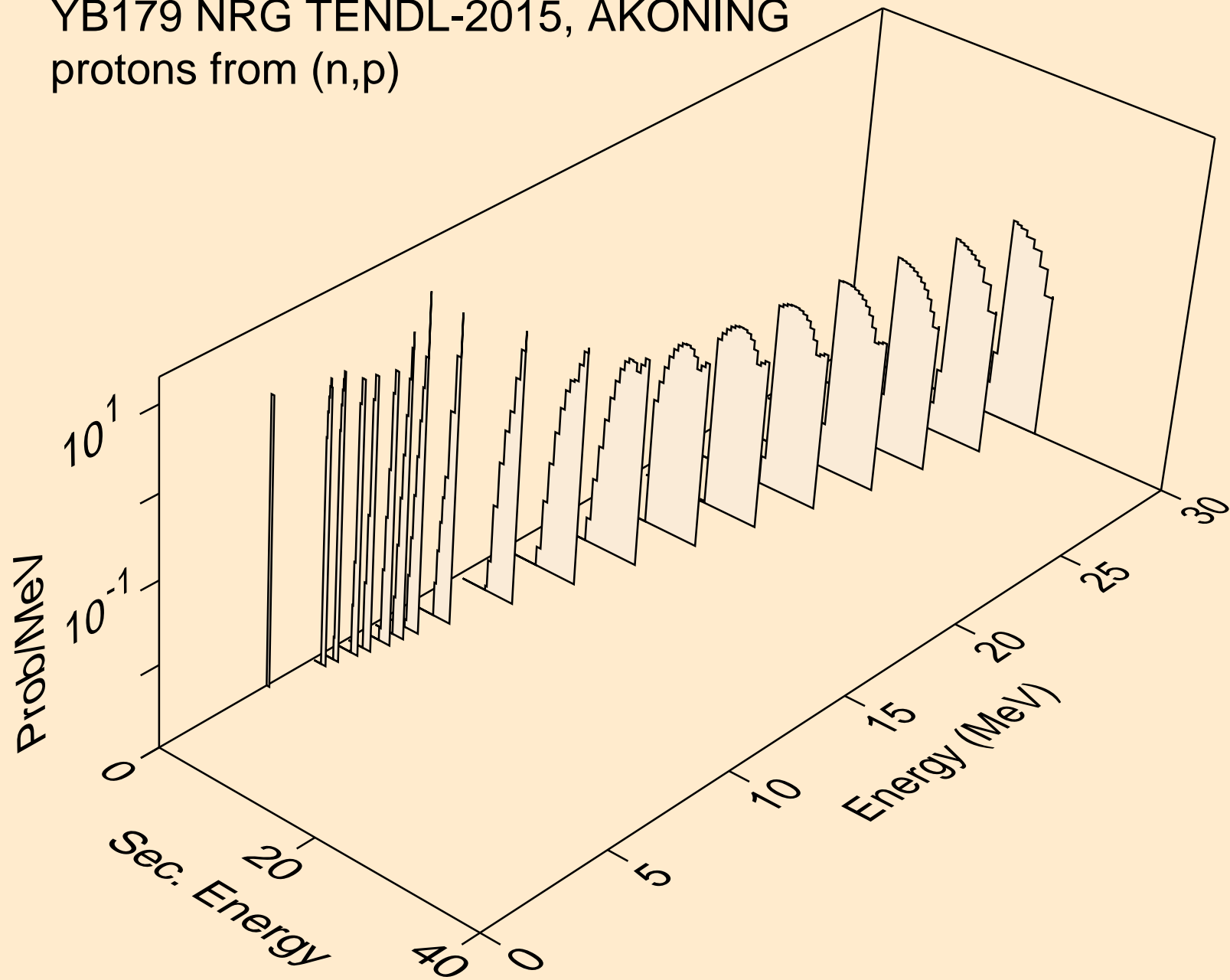

YB179 NRG TENDL-2015, AKONING
protons from (n,2p)

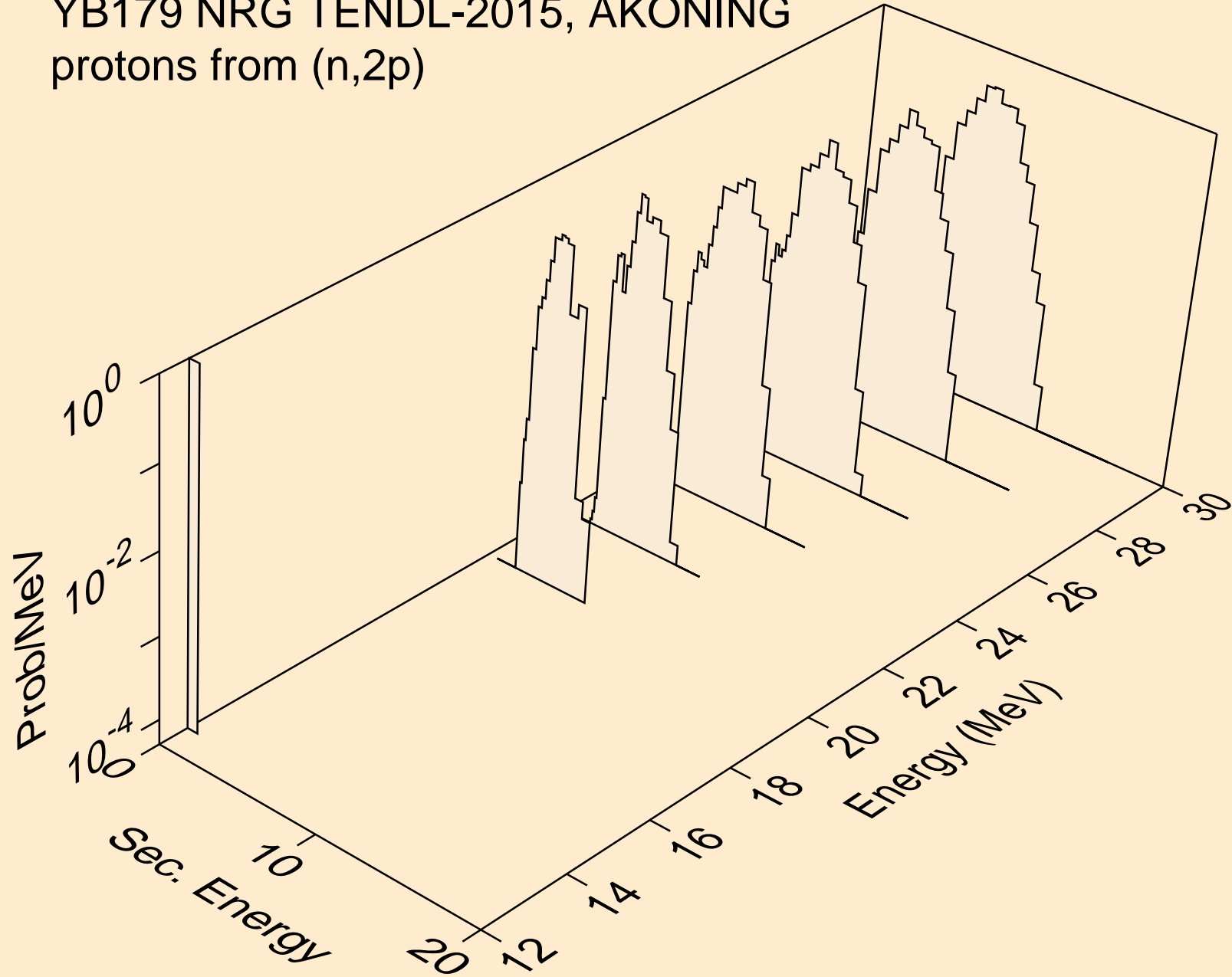

YB179 NRG TENDL-2015, AKONING
deuterons from (n,x)

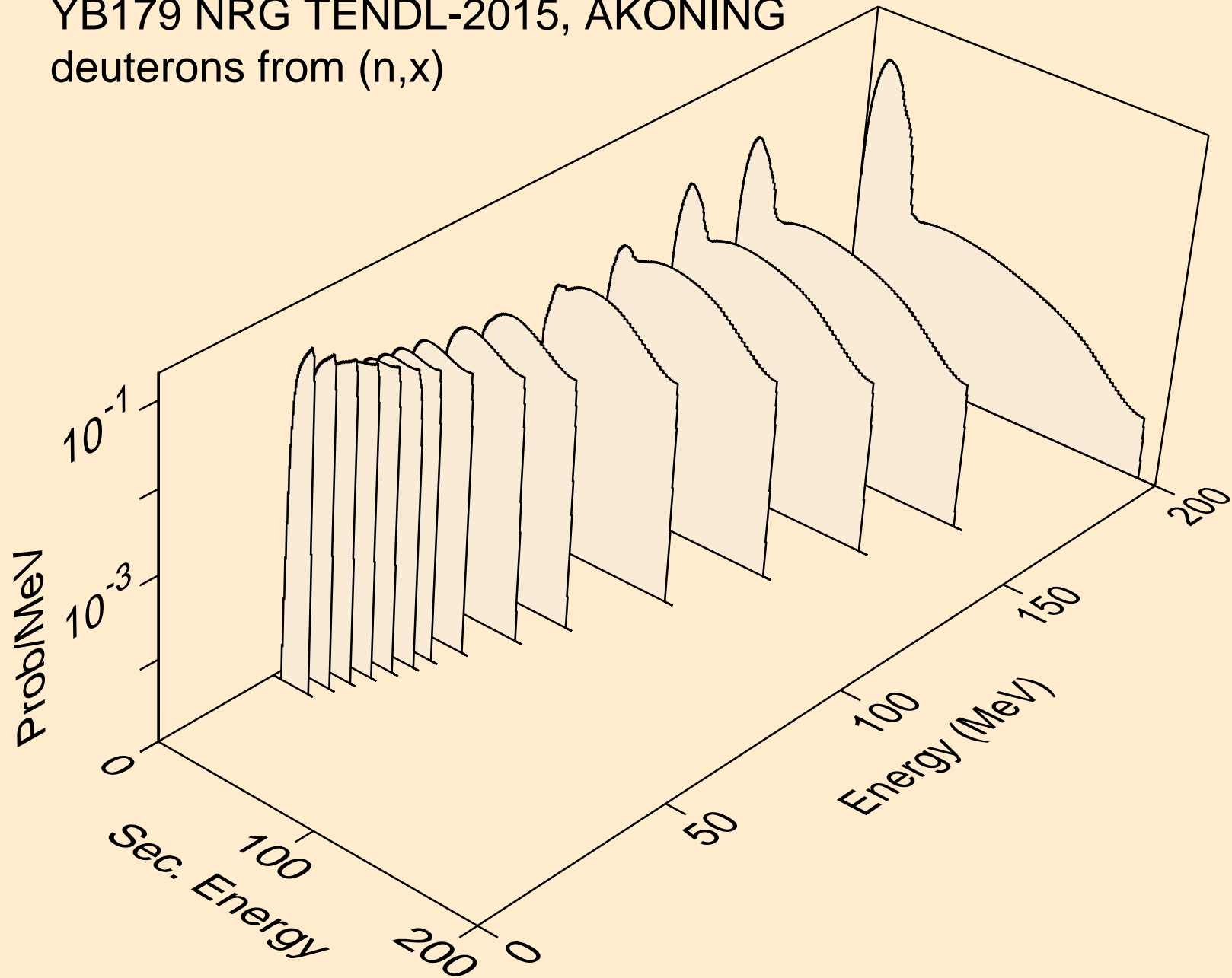

YB179 NRG TENDL-2015, AKONING
deuterons from (n,2nd)

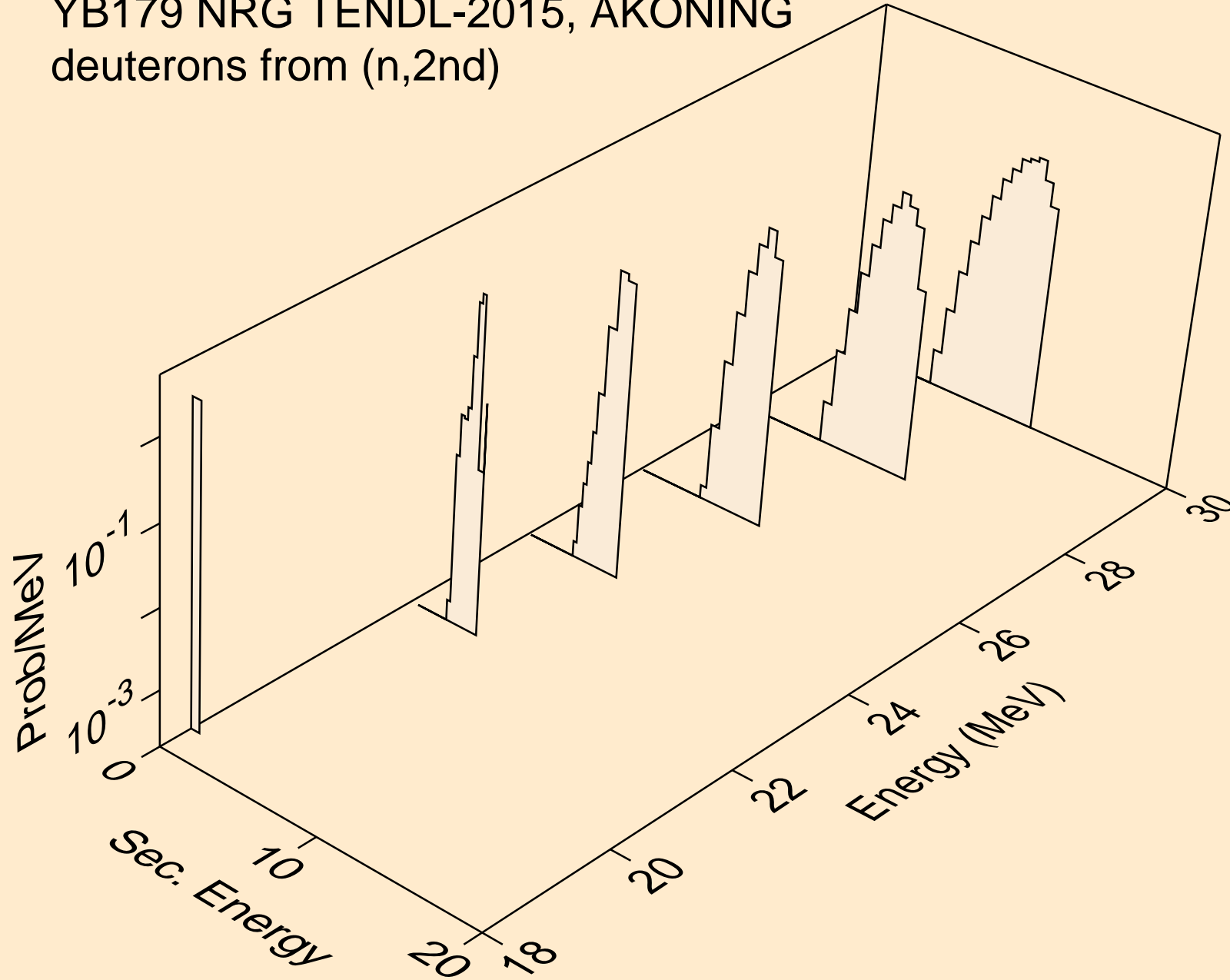

YB179 NRG TENDL-2015, AKONING
deuterons from (n,n*)d

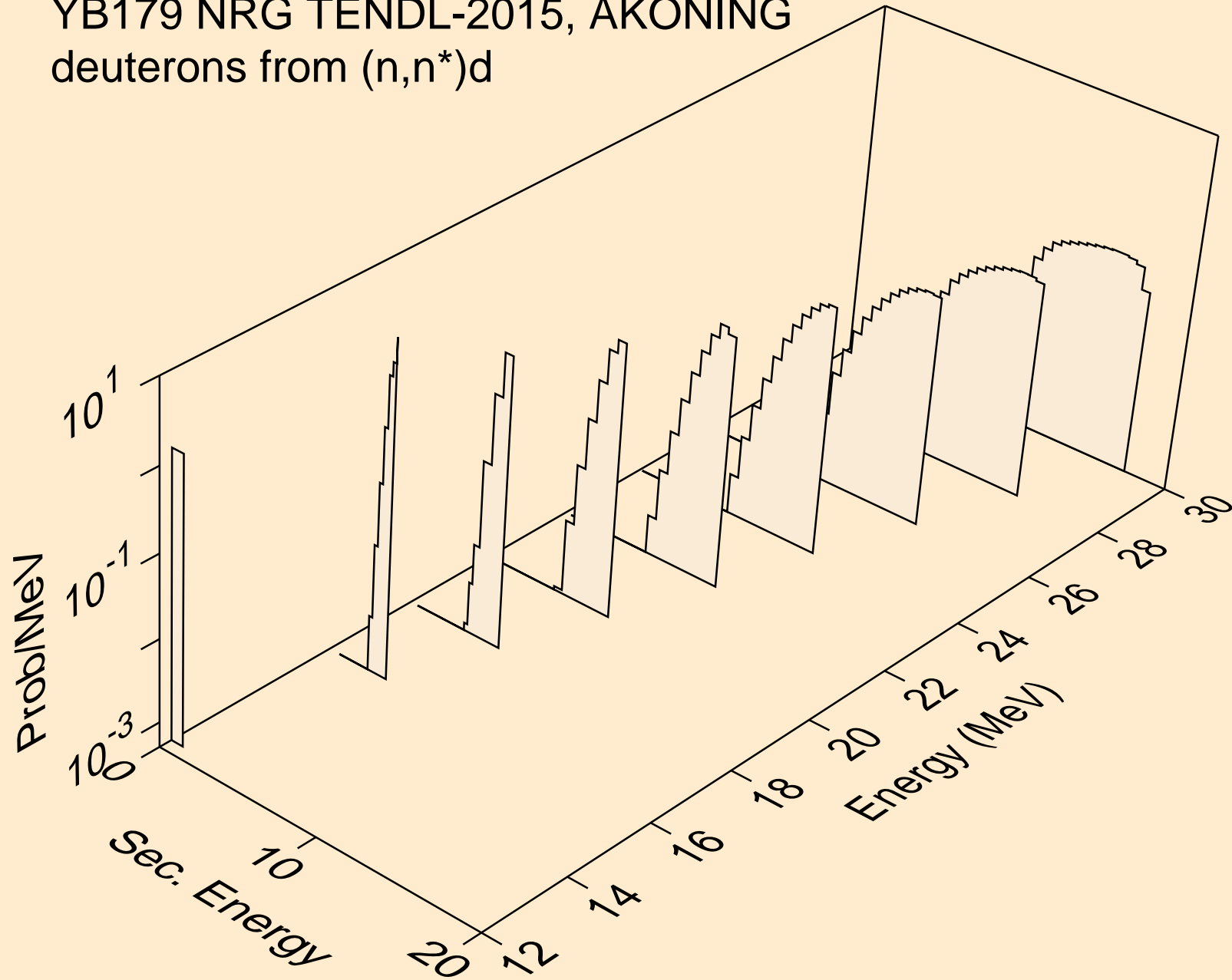

YB179 NRG TENDL-2015, AKONING
deuterons from (n,d)

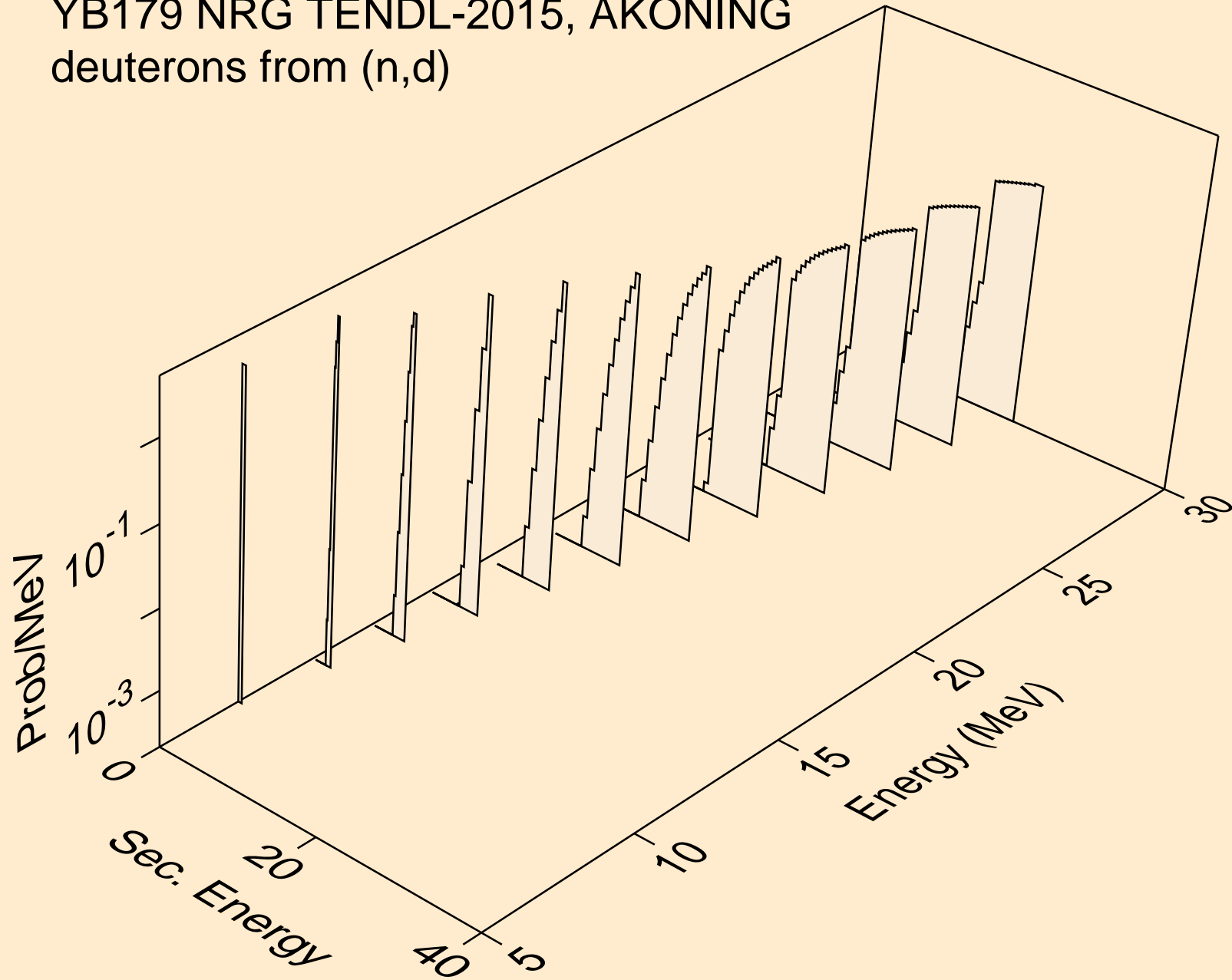

YB179 NRG TENDL-2015, AKONING
tritons from (n,x)

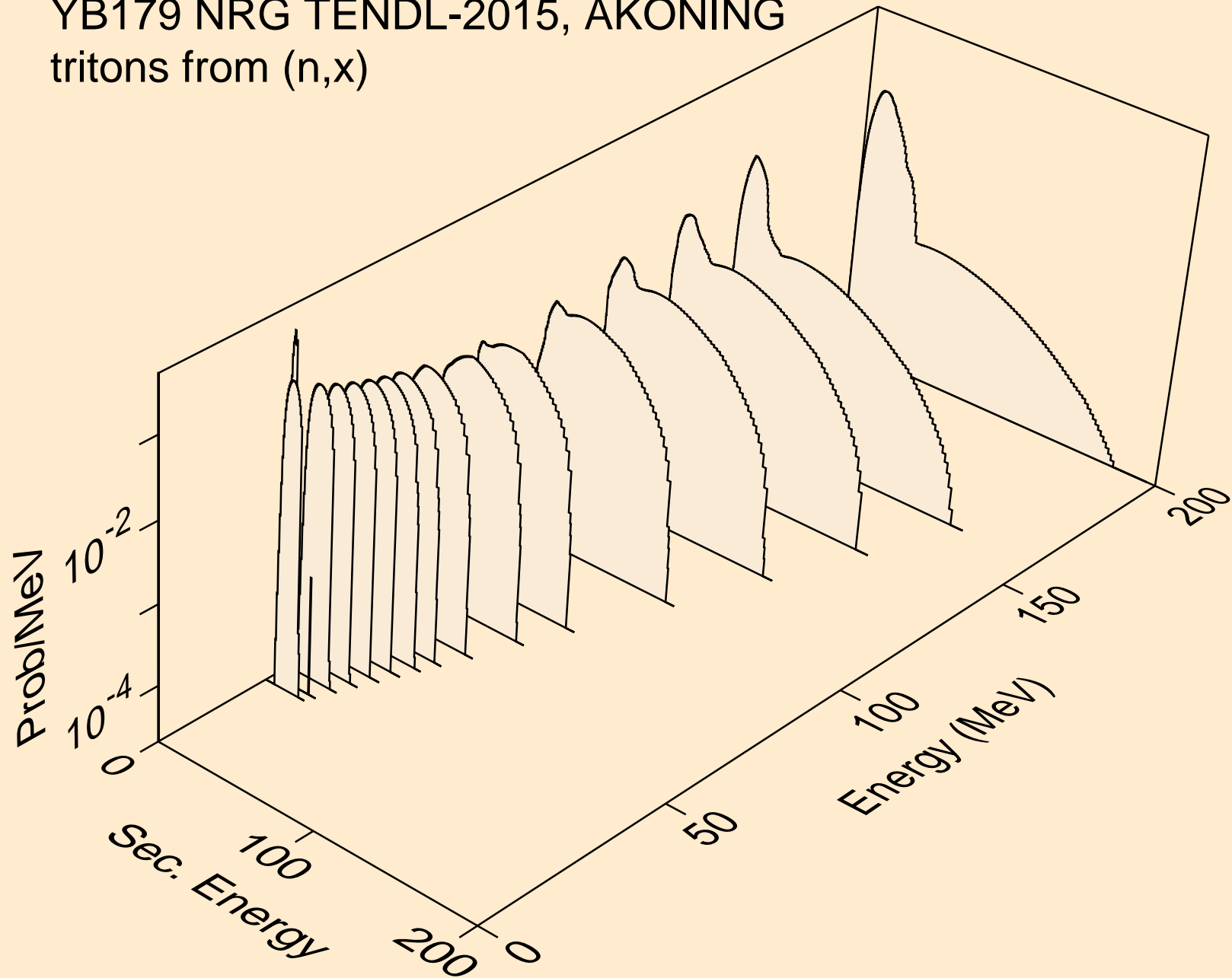

YB179 NRG TENDL-2015, AKONING
tritons from (n,n*)t

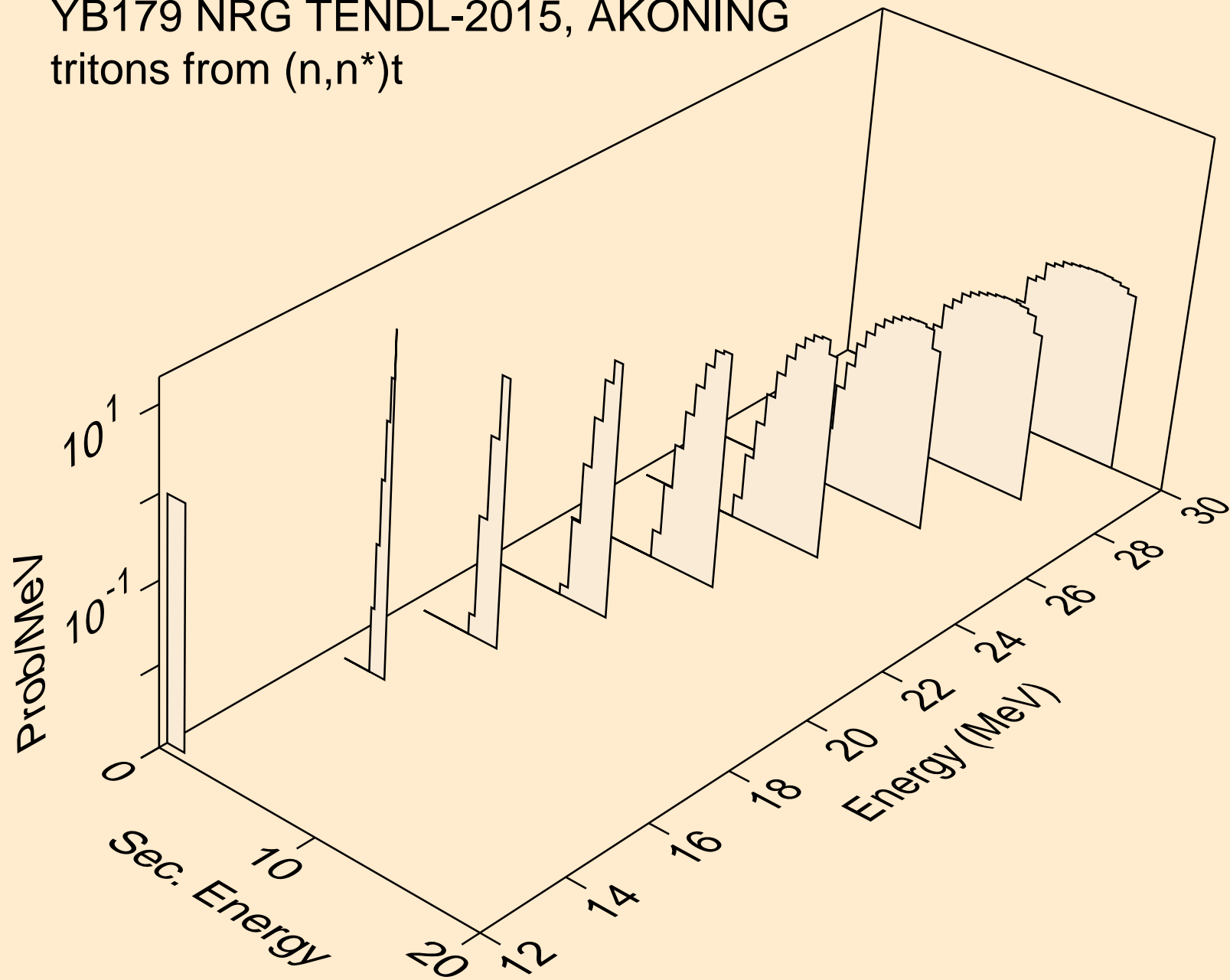

YB179 NRG TENDL-2015, AKONING
tritons from (n,t)

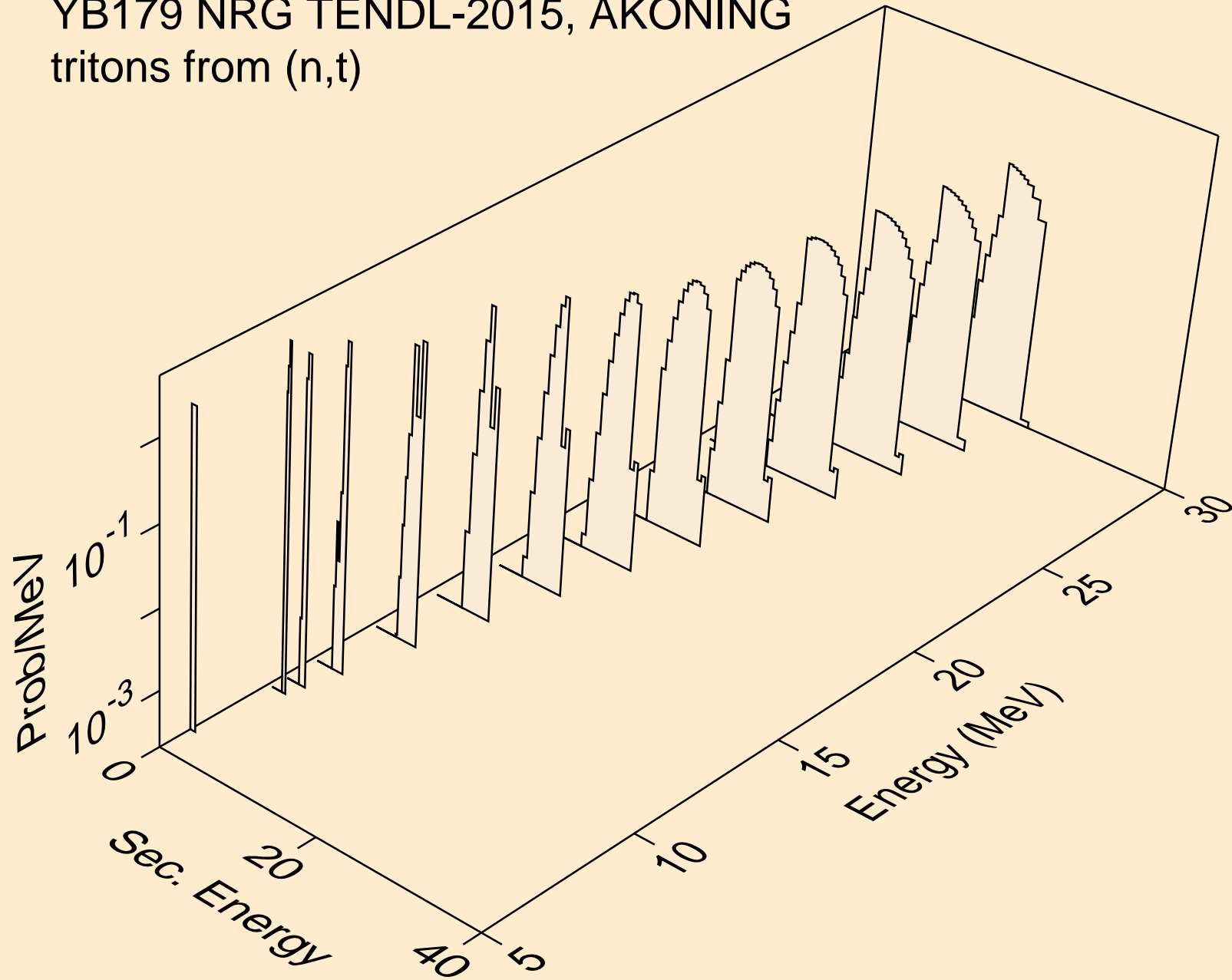

YB179 NRG TENDL-2015, AKONING
he3s from (n,x)

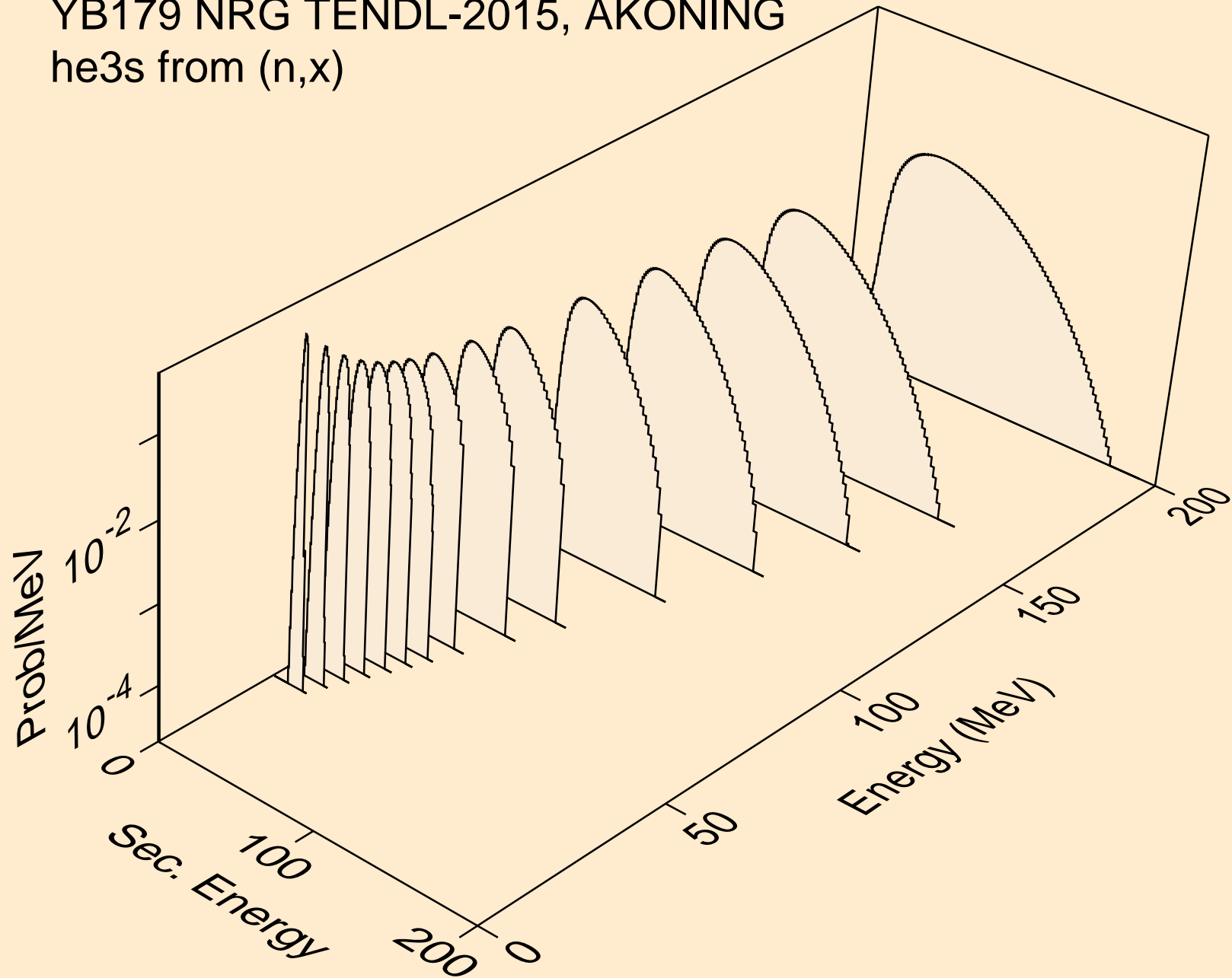

YB179 NRG TENDL-2015, AKONING
he3s from (n,n*)he3

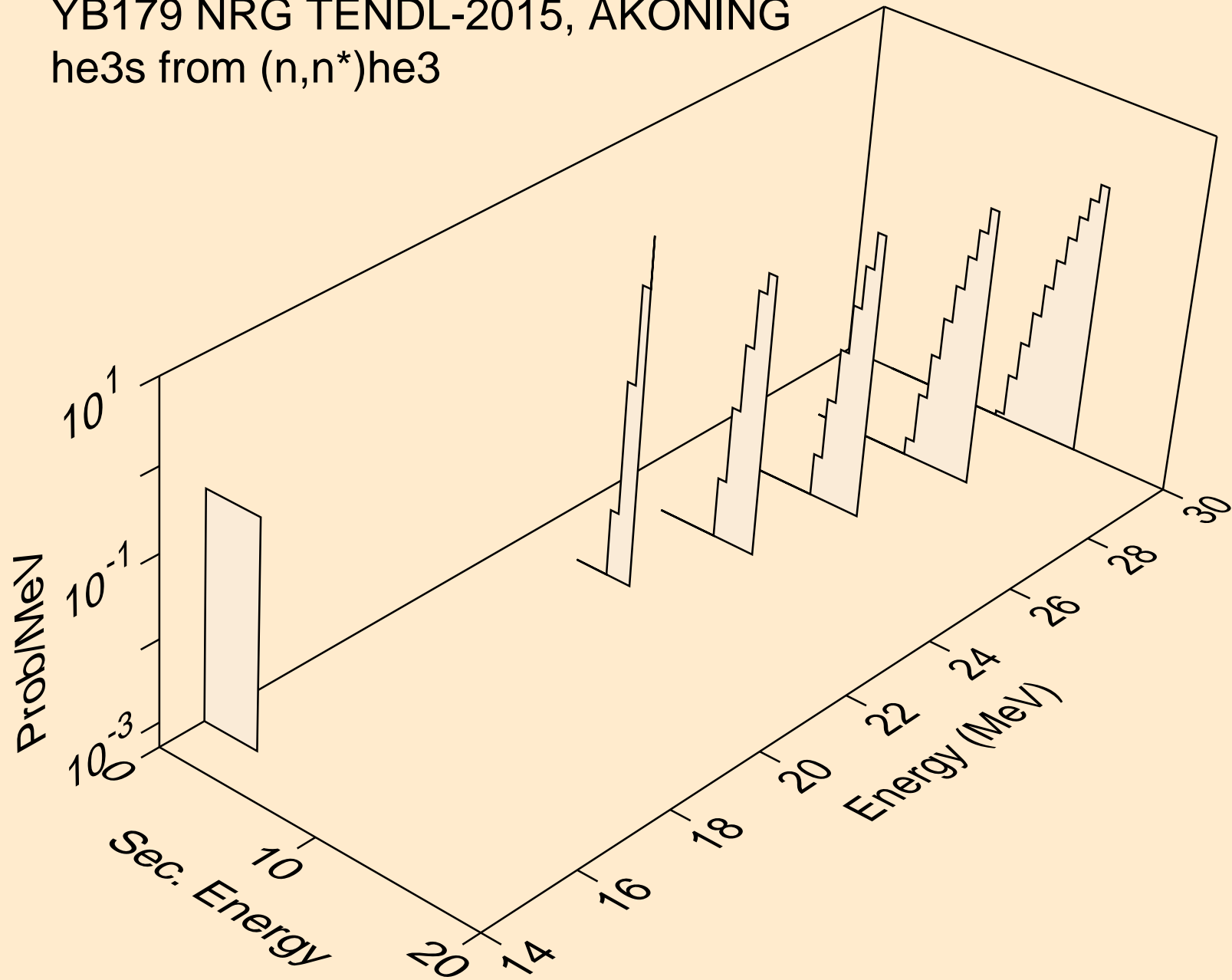

YB179 NRG TENDL-2015, AKONING
he3s from (n,he3)

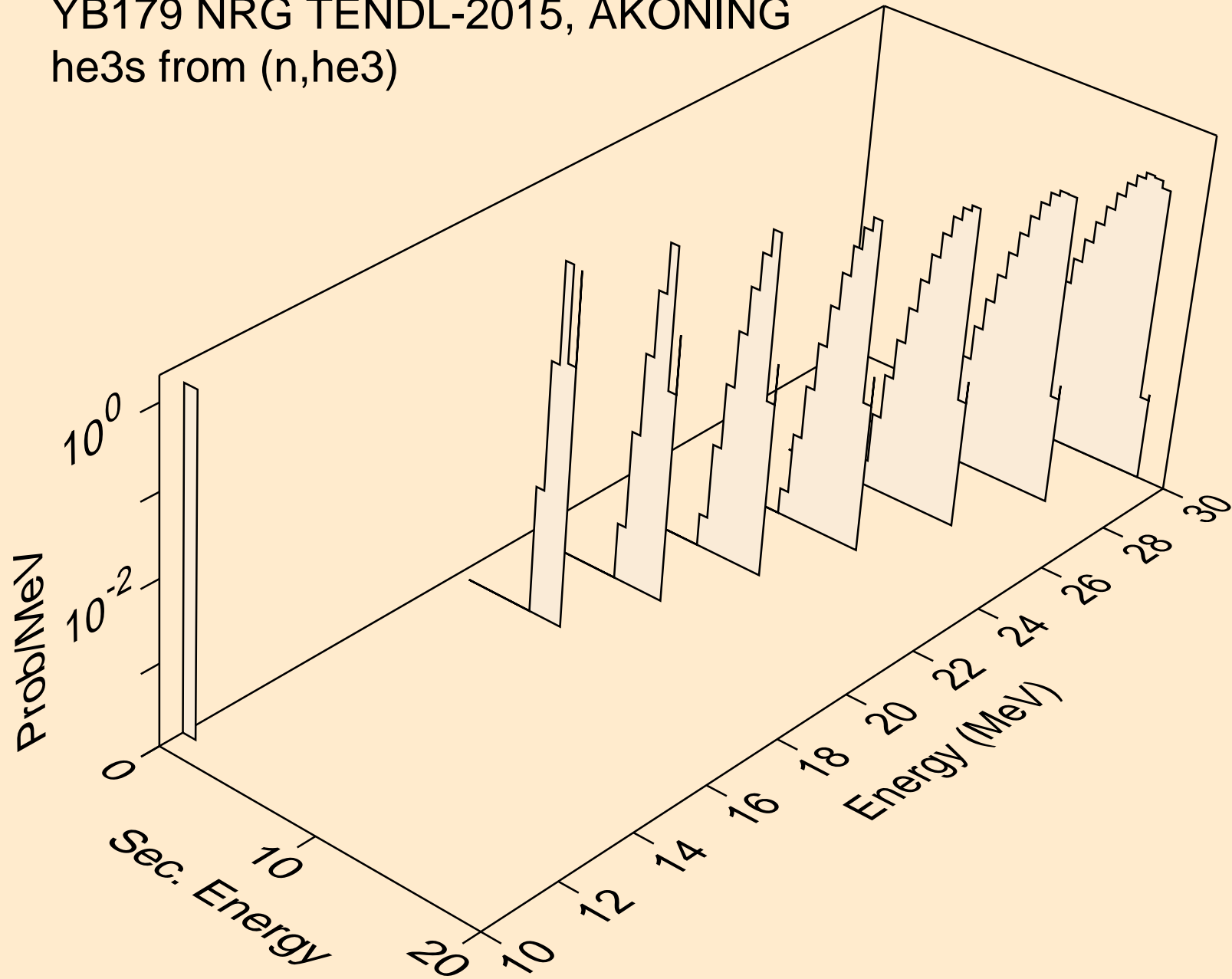

YB179 NRG TENDL-2015, AKONING
alphas from (n,x)

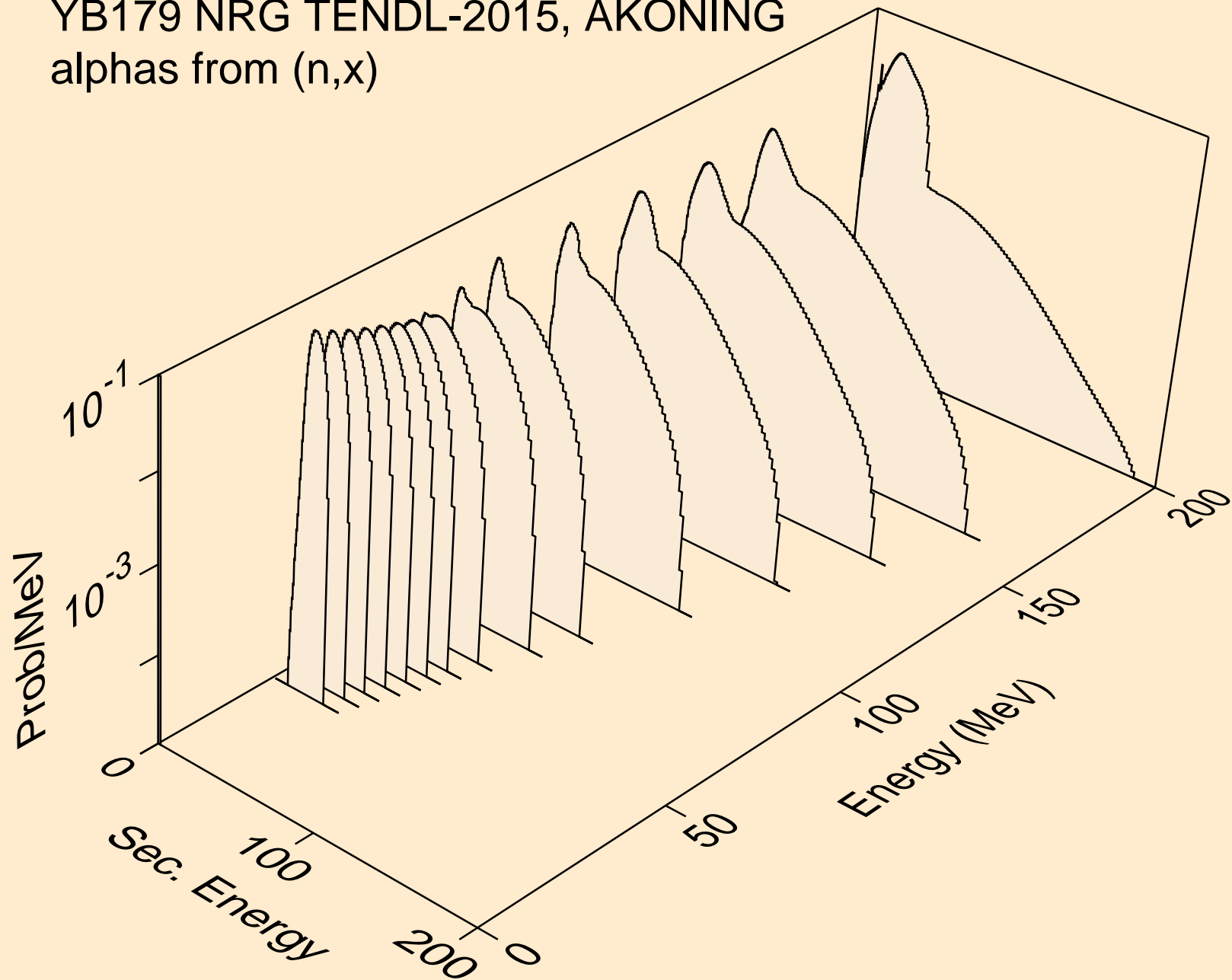

YB179 NRG TENDL-2015, AKONING
alphas from (n,n*)a

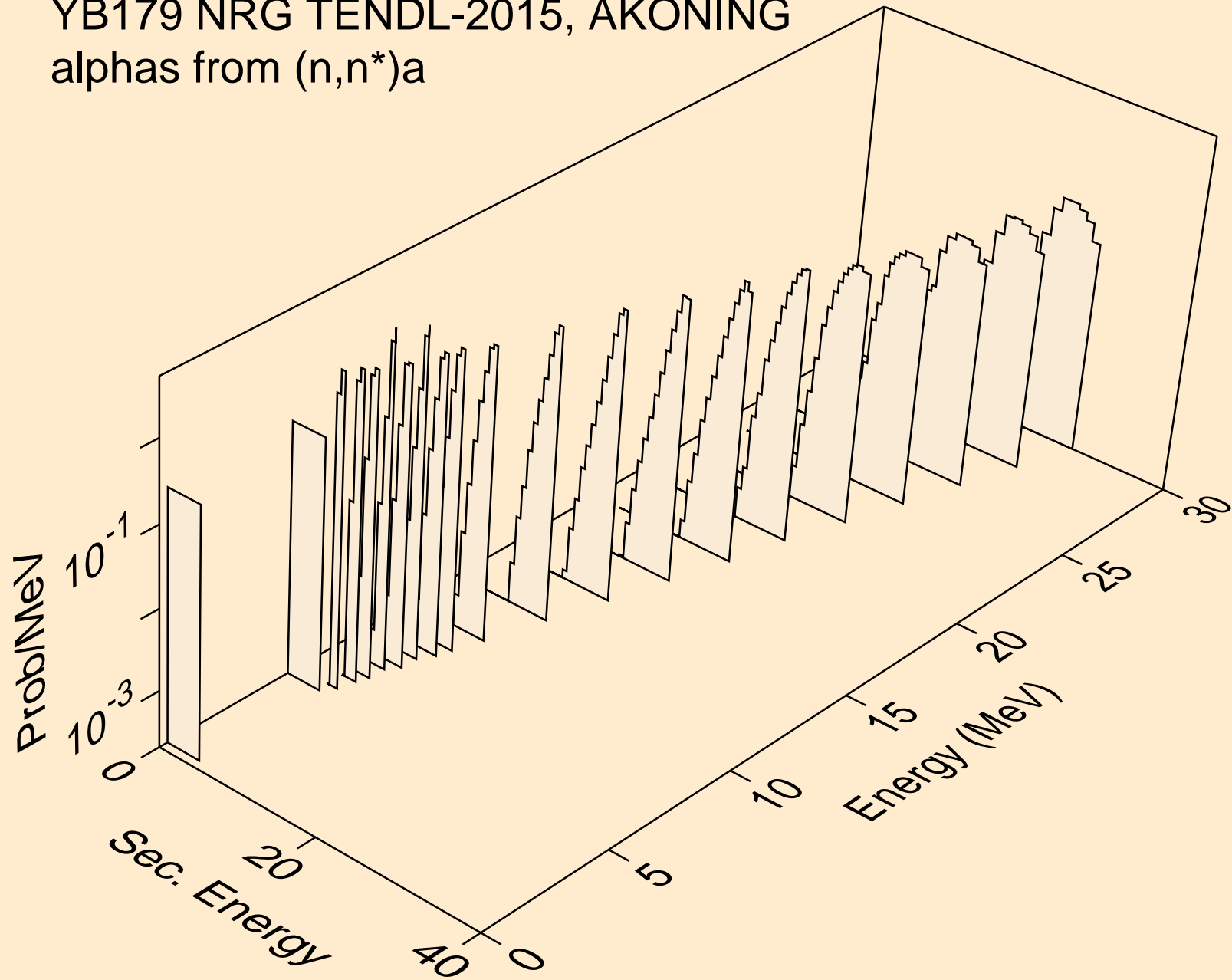

YB179 NRG TENDL-2015, AKONING
alphas from (n,2n)a

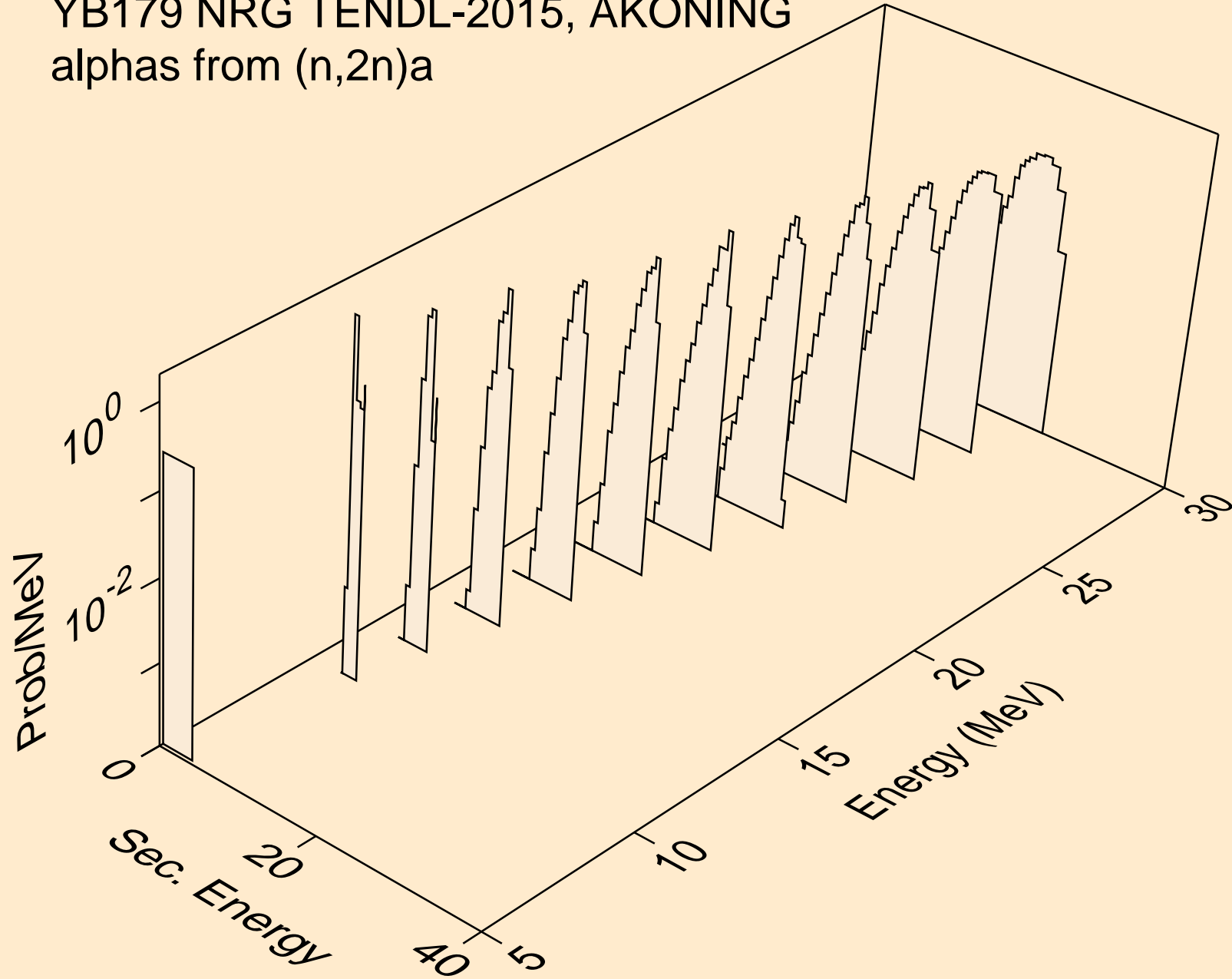

YB179 NRG TENDL-2015, AKONING
alphas from (n,3n)a

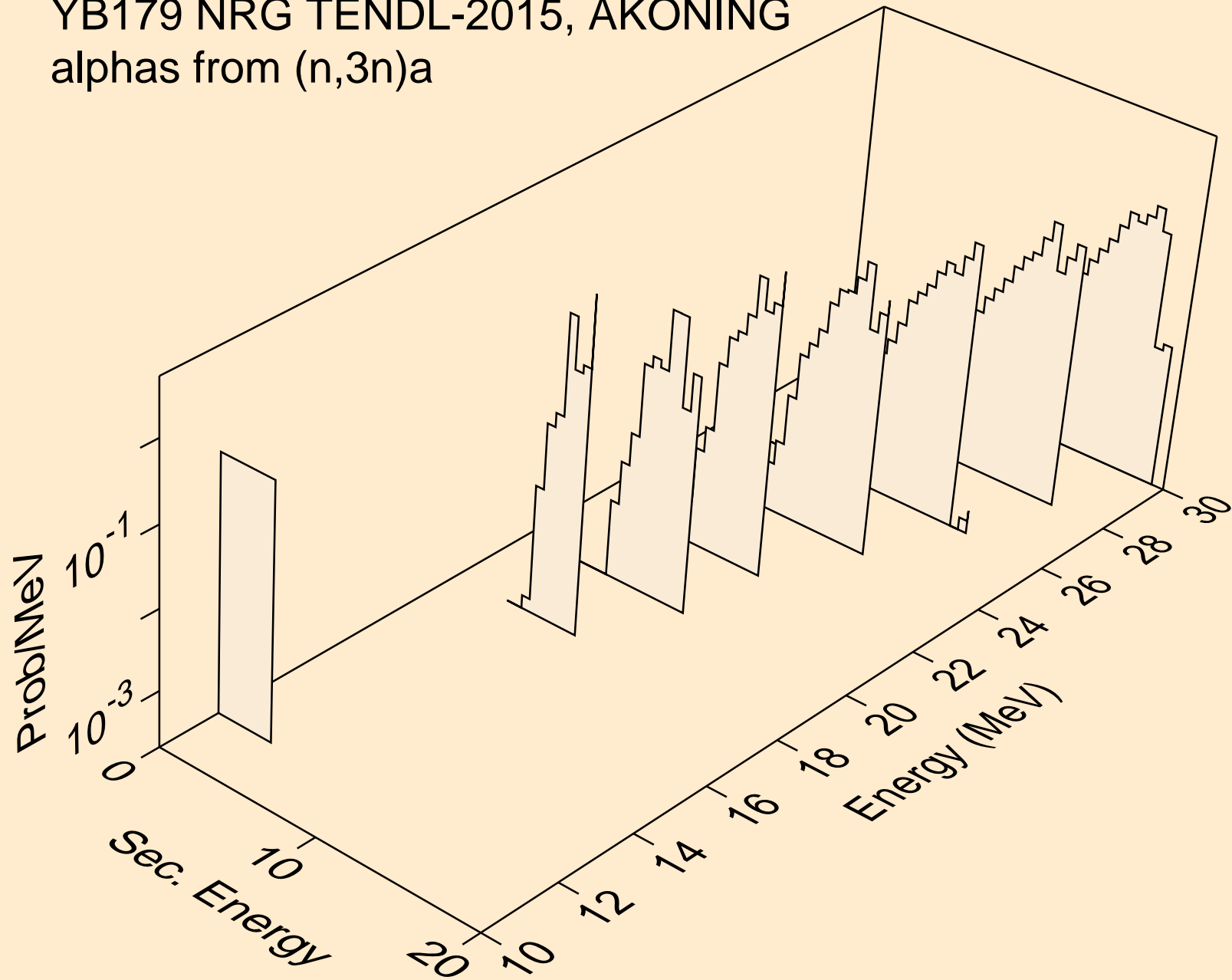

YB179 NRG TENDL-2015, AKONING
alphas from (n,a)

