

ZN071M NRG TENDL-2015, AKONING

Principal cross sections

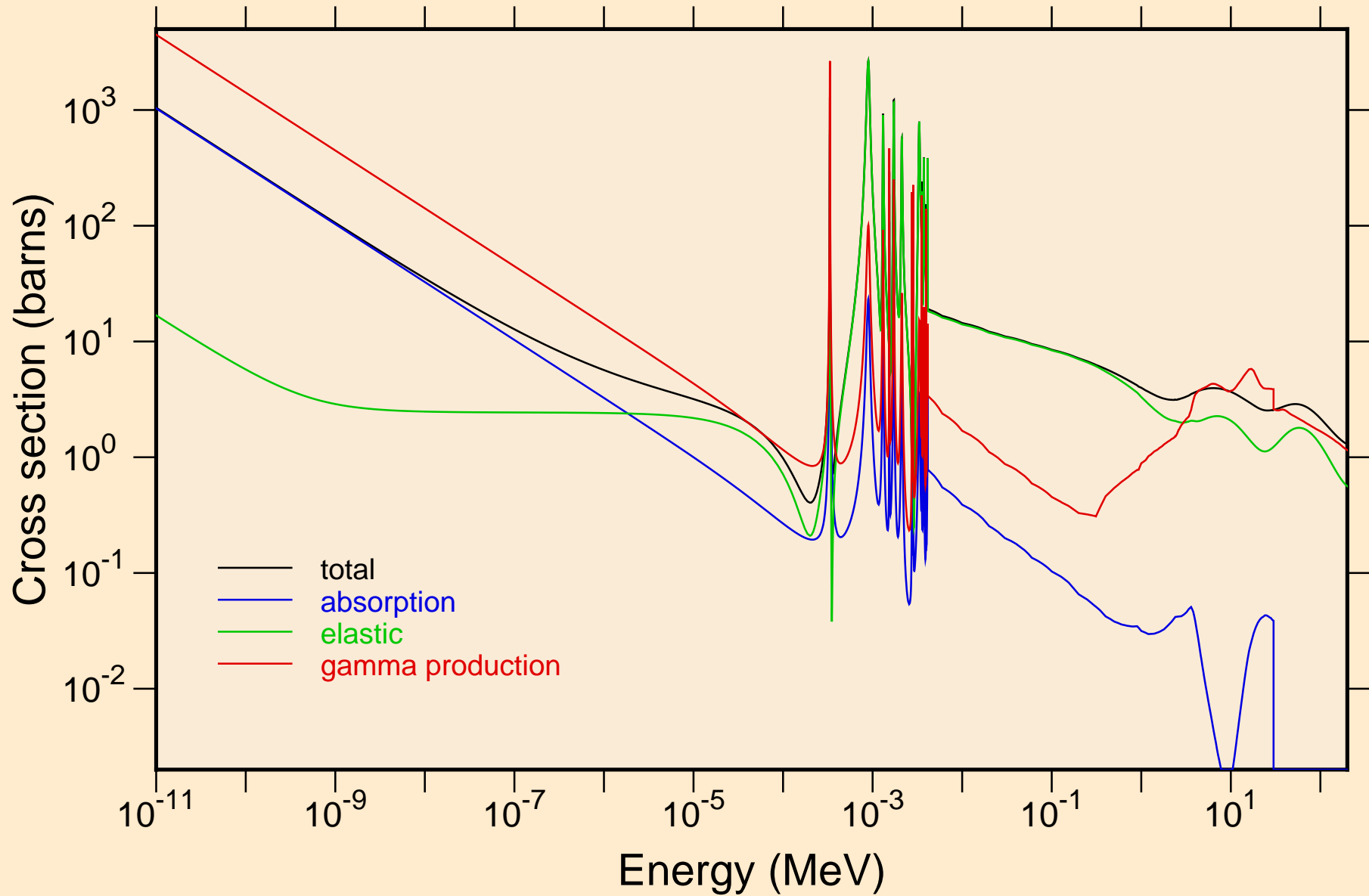

ZN071M NRG TENDL-2015, AKONING
resonance total cross section

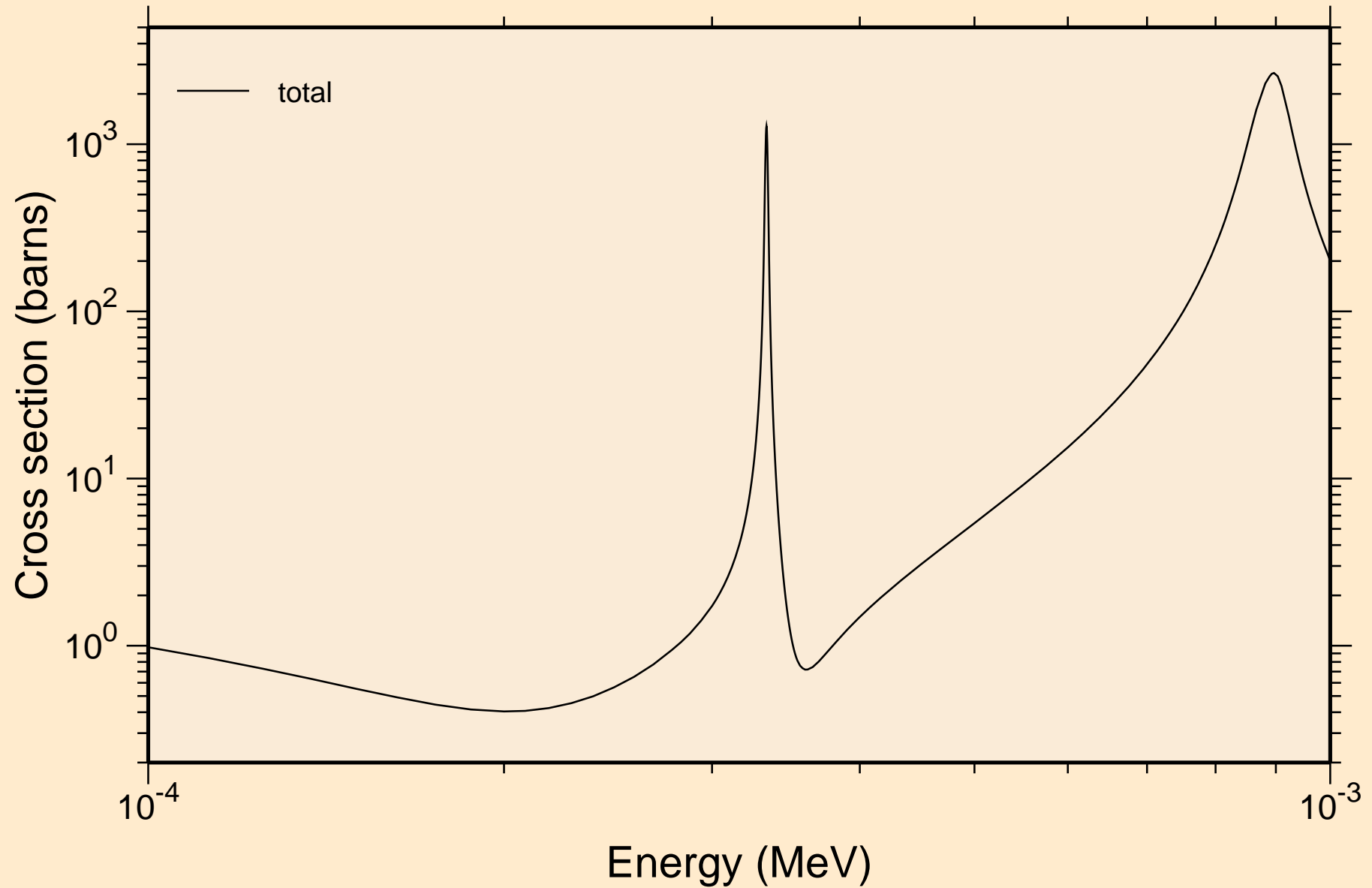

ZN071M NRG TENDL-2015, AKONING
resonance total cross section

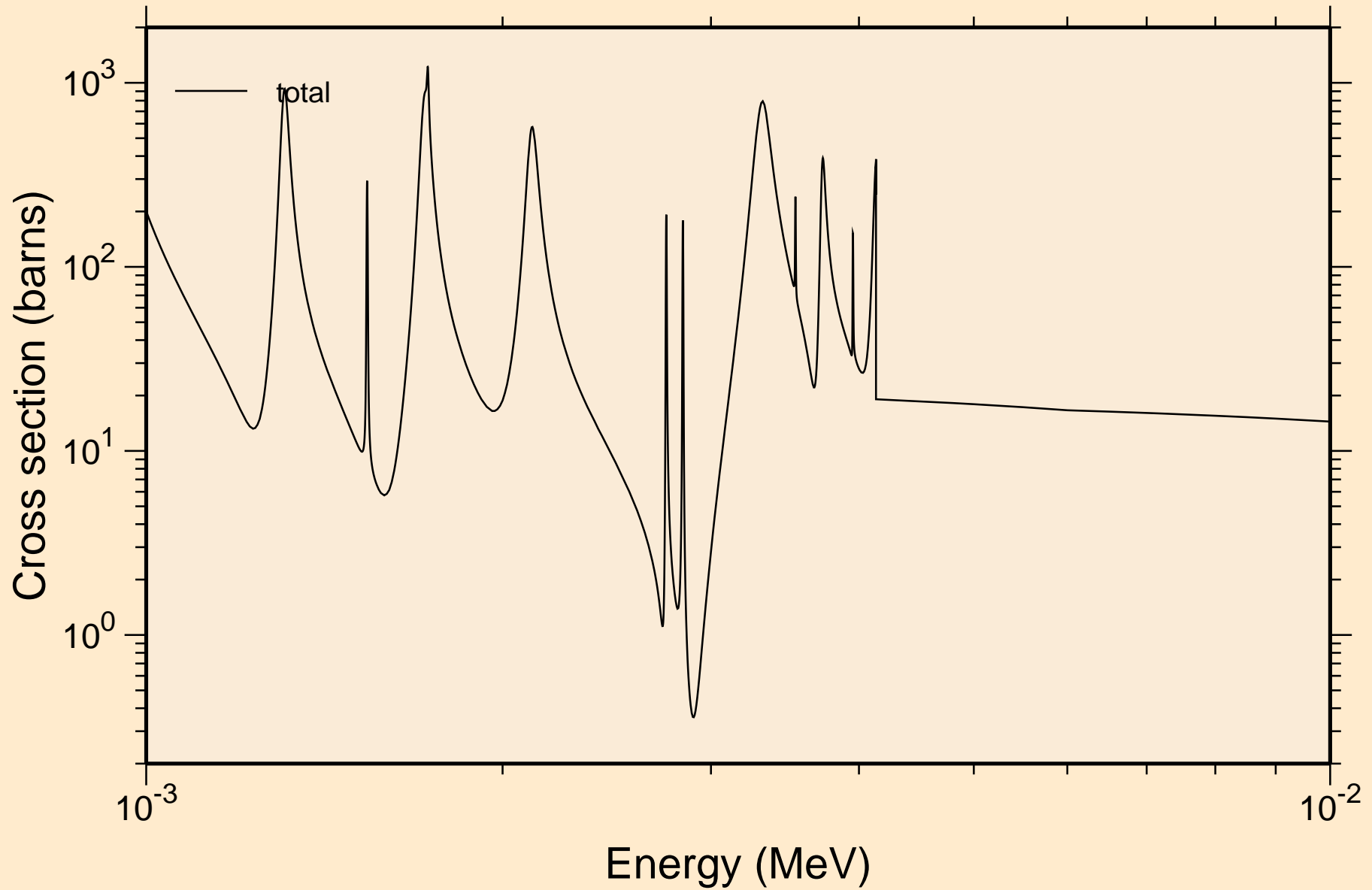

ZN071M NRG TENDL-2015, AKONING
resonance total cross section

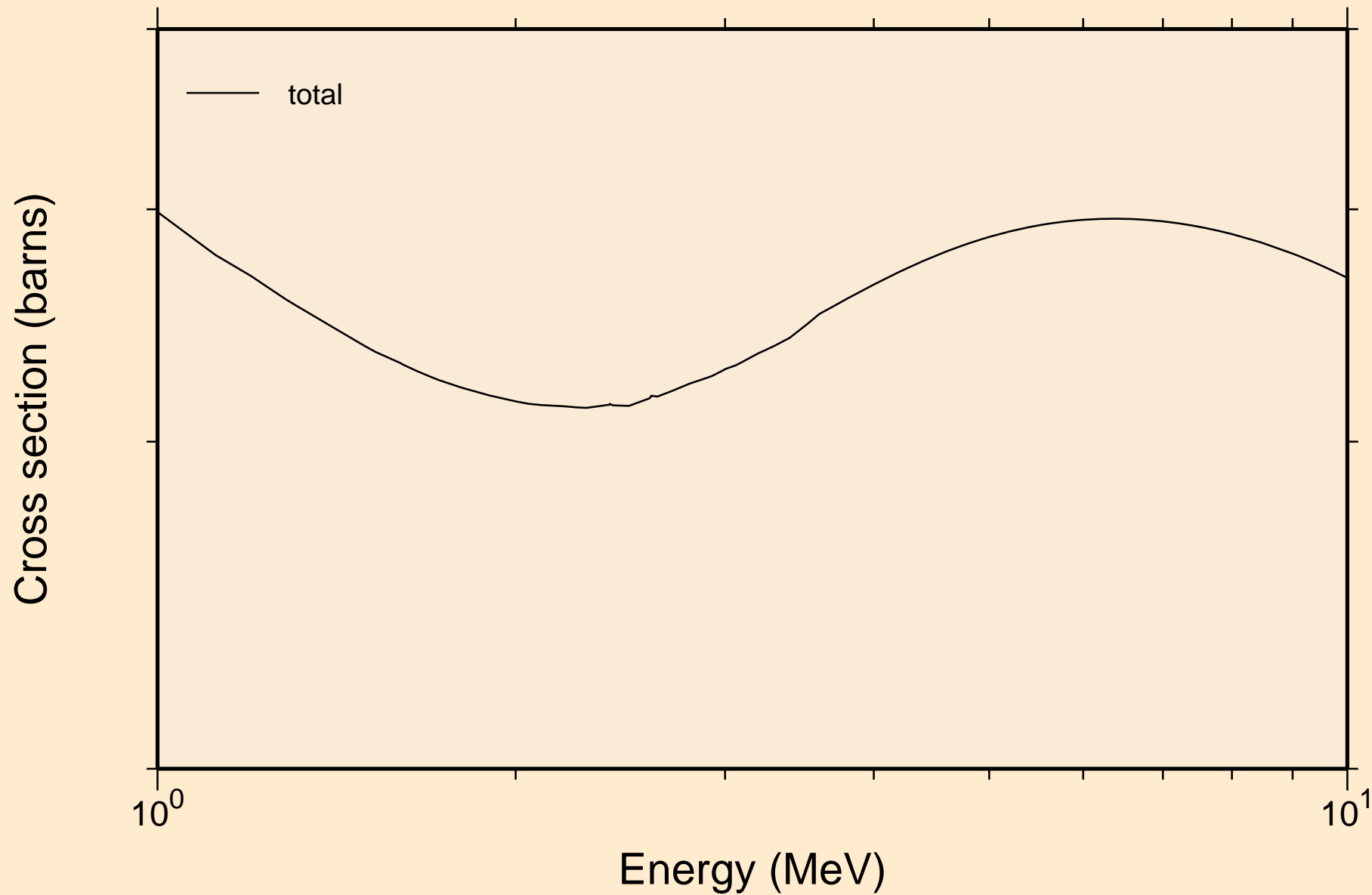

ZN071M NRG TENDL-2015, AKONING
resonance absorption cross sections

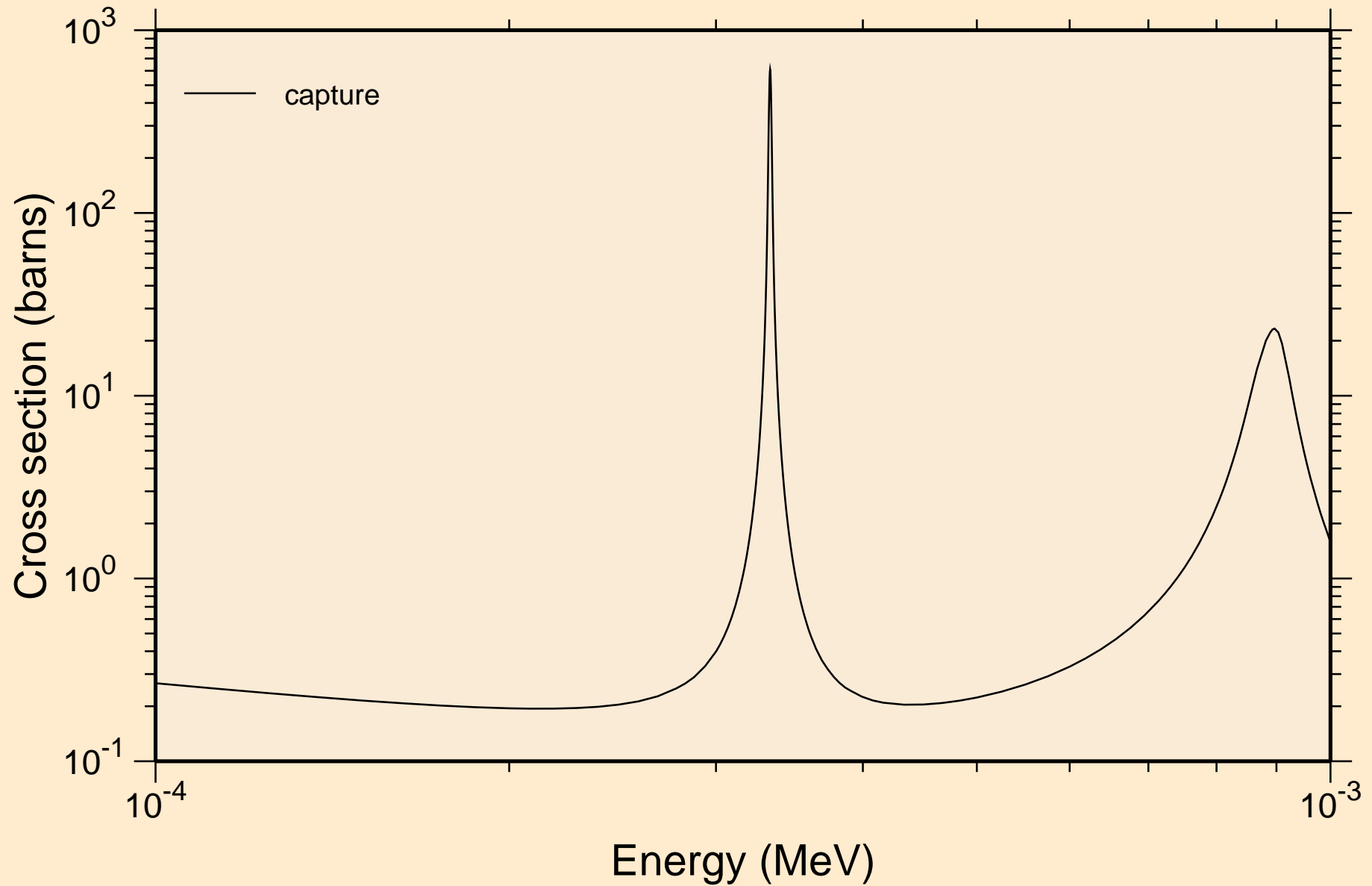

ZN071M NRG TENDL-2015, AKONING resonance absorption cross sections

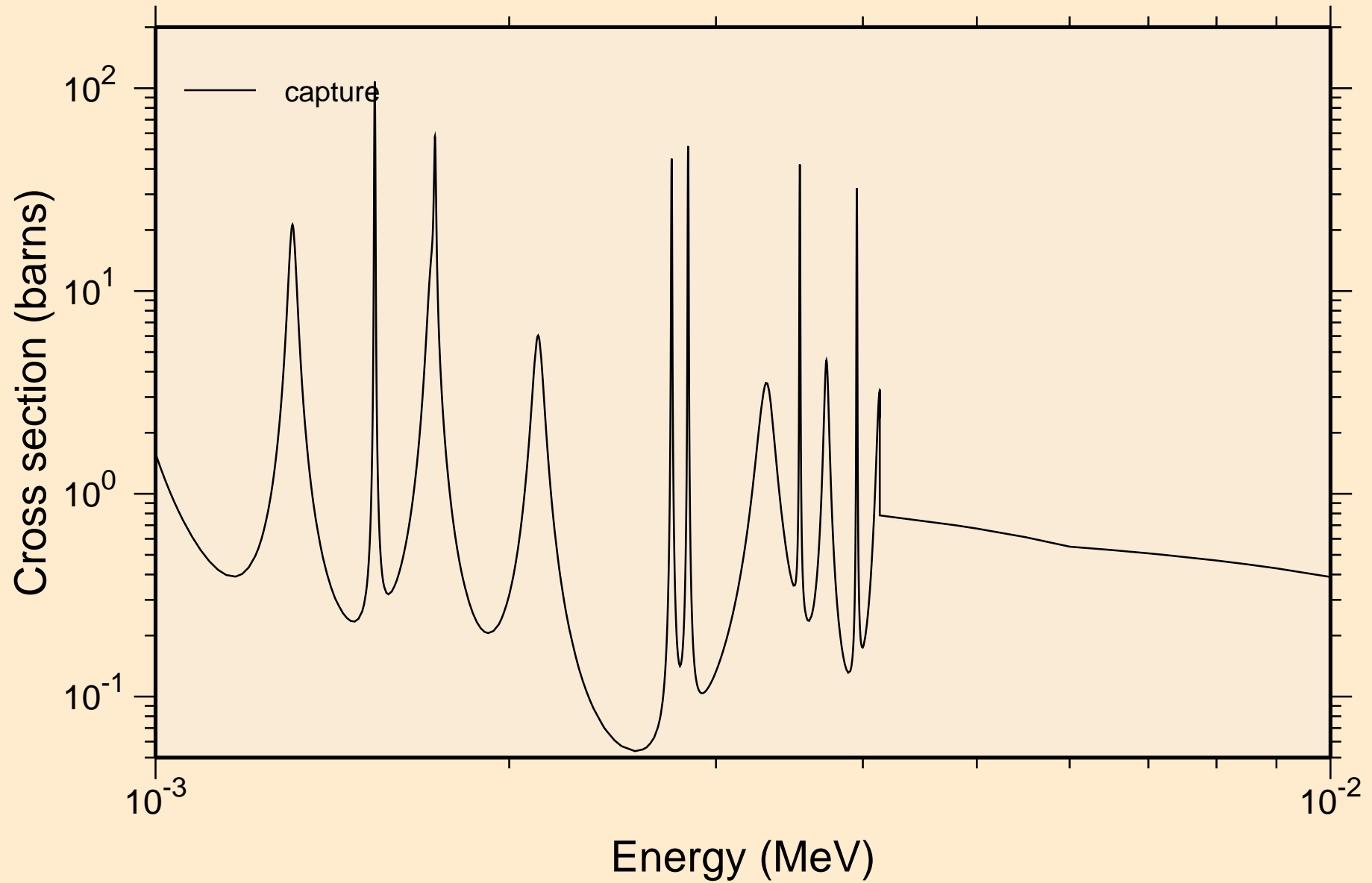

ZN071M NRG TENDL-2015, AKONING
resonance absorption cross sections

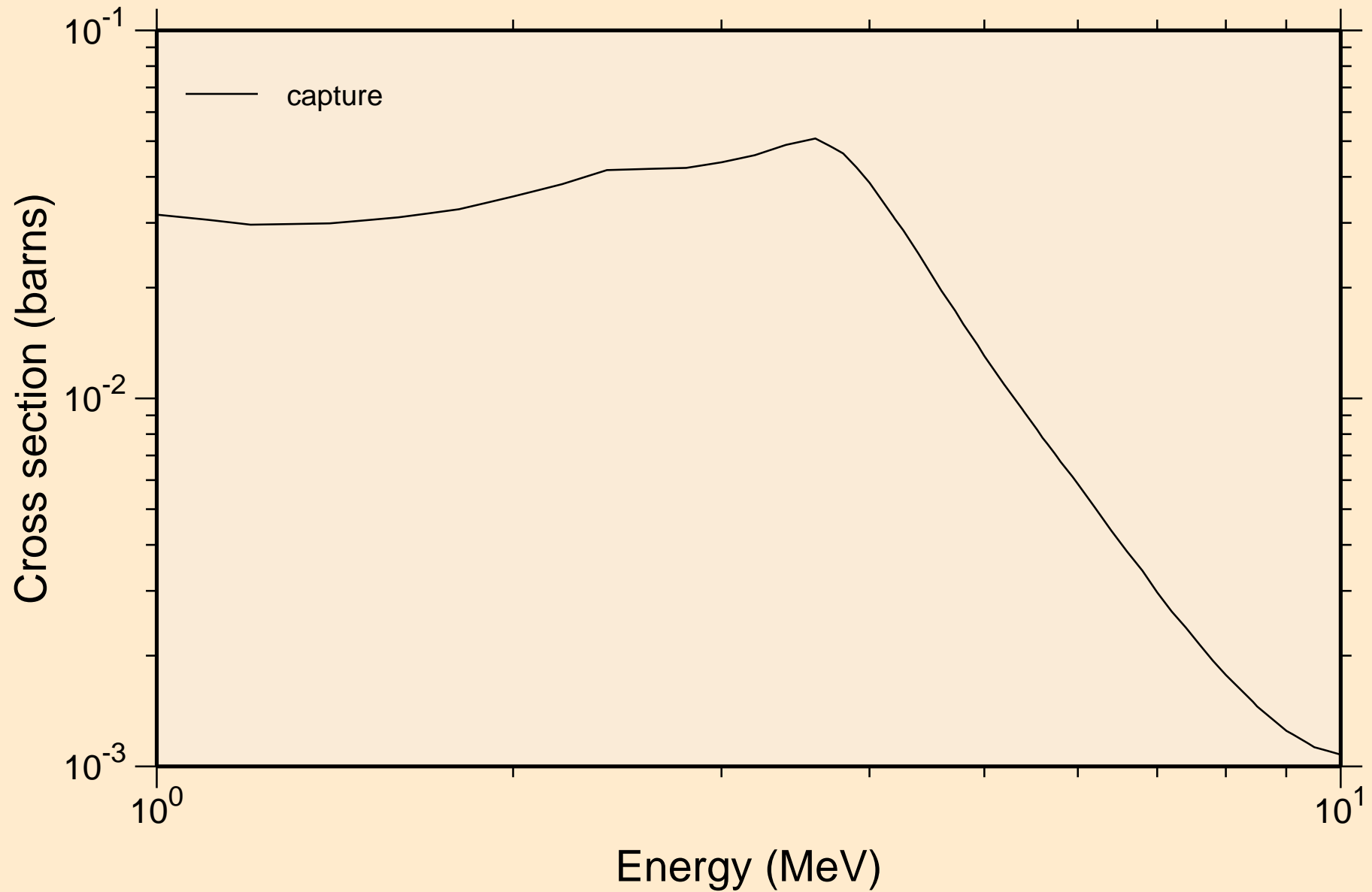

ZN071M NRG TENDL-2015, AKONING
Non-threshold reactions

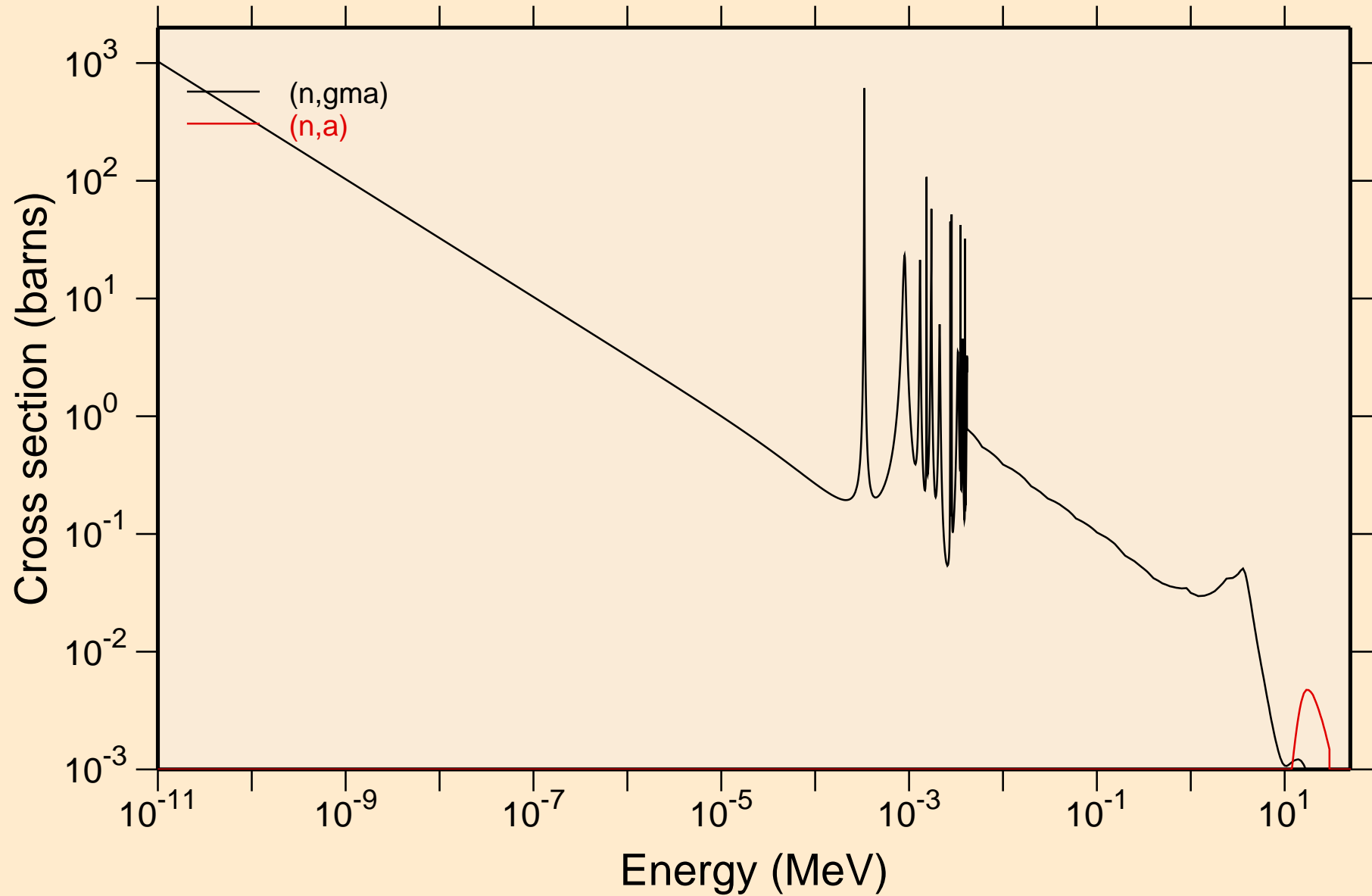

ZN071M NRG TENDL-2015, AKONING

Principal cross sections

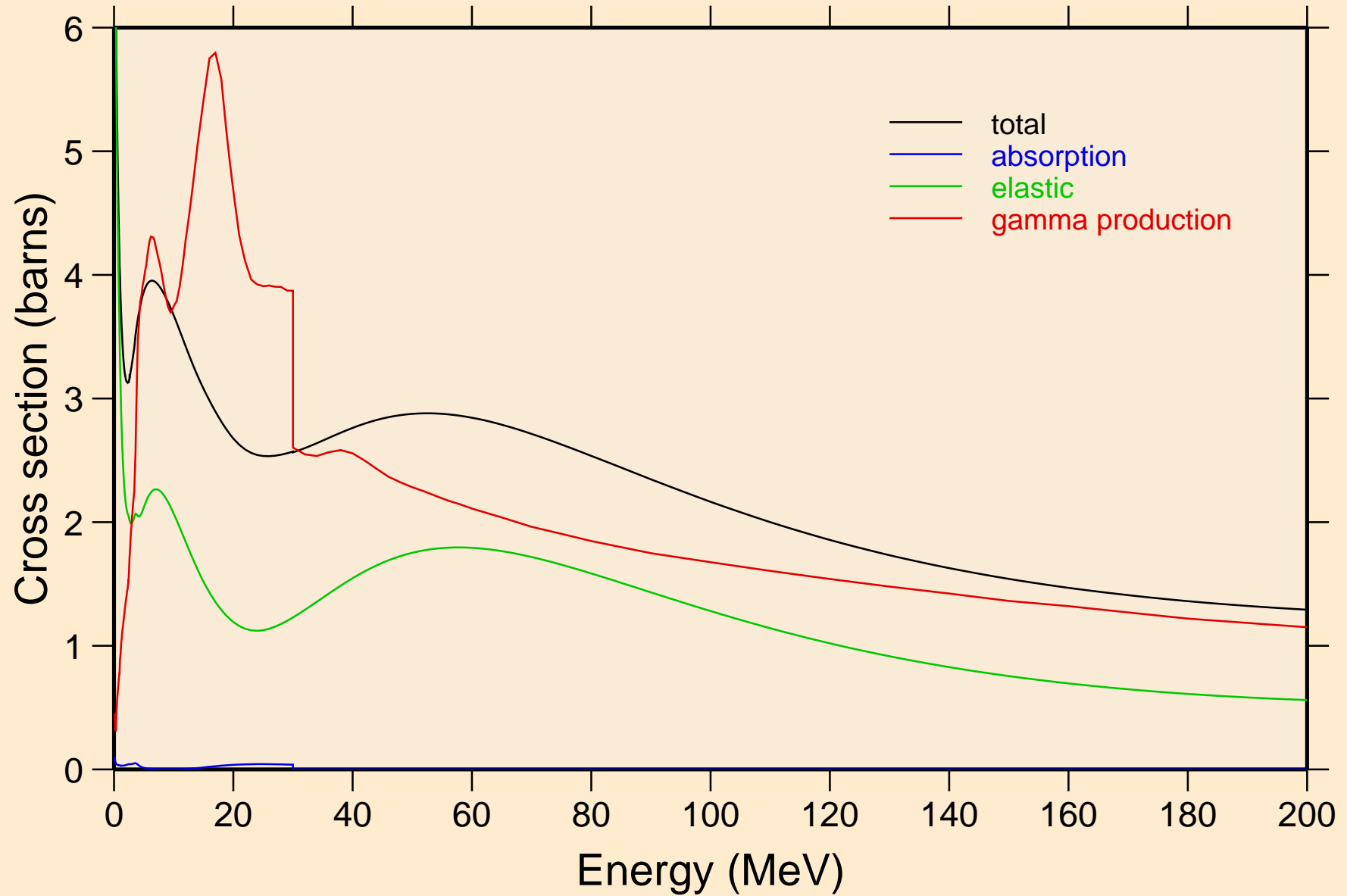

ZN071M NRG TENDL-2015, AKONING

Non-threshold reactions

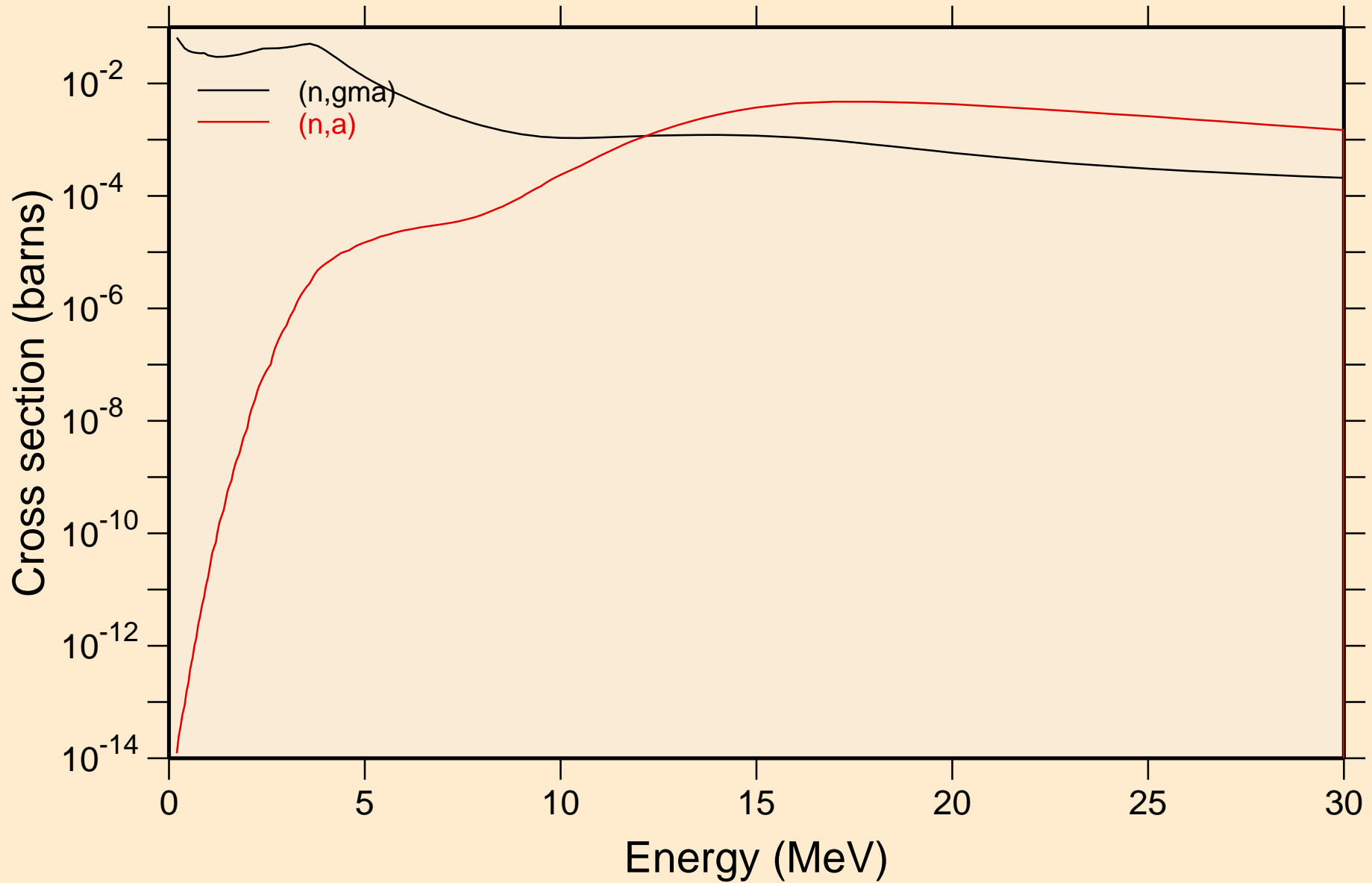

ZN071M NRG TENDL-2015, AKONING

Inelastic levels

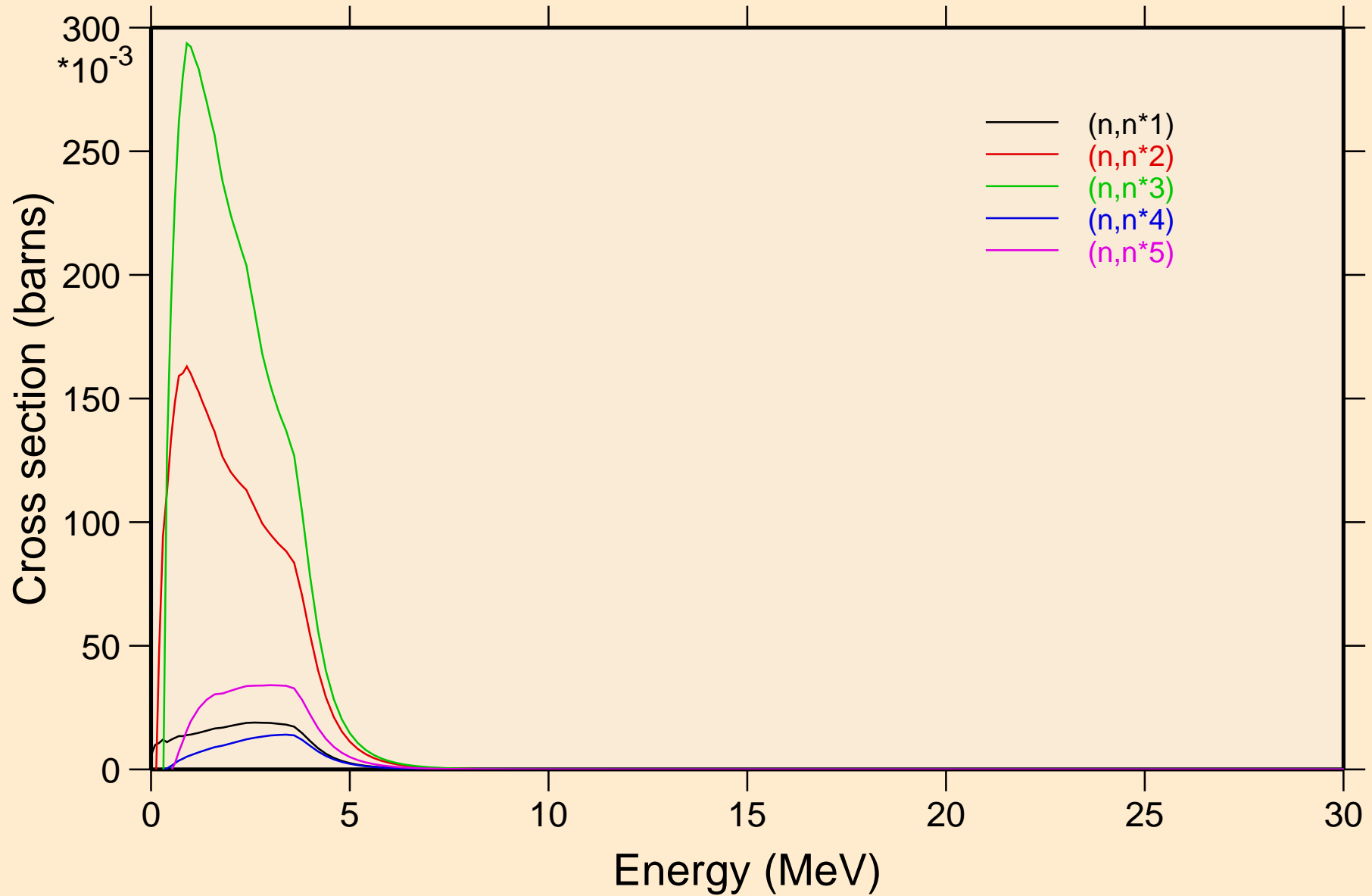

ZN071M NRG TENDL-2015, AKONING

Inelastic levels

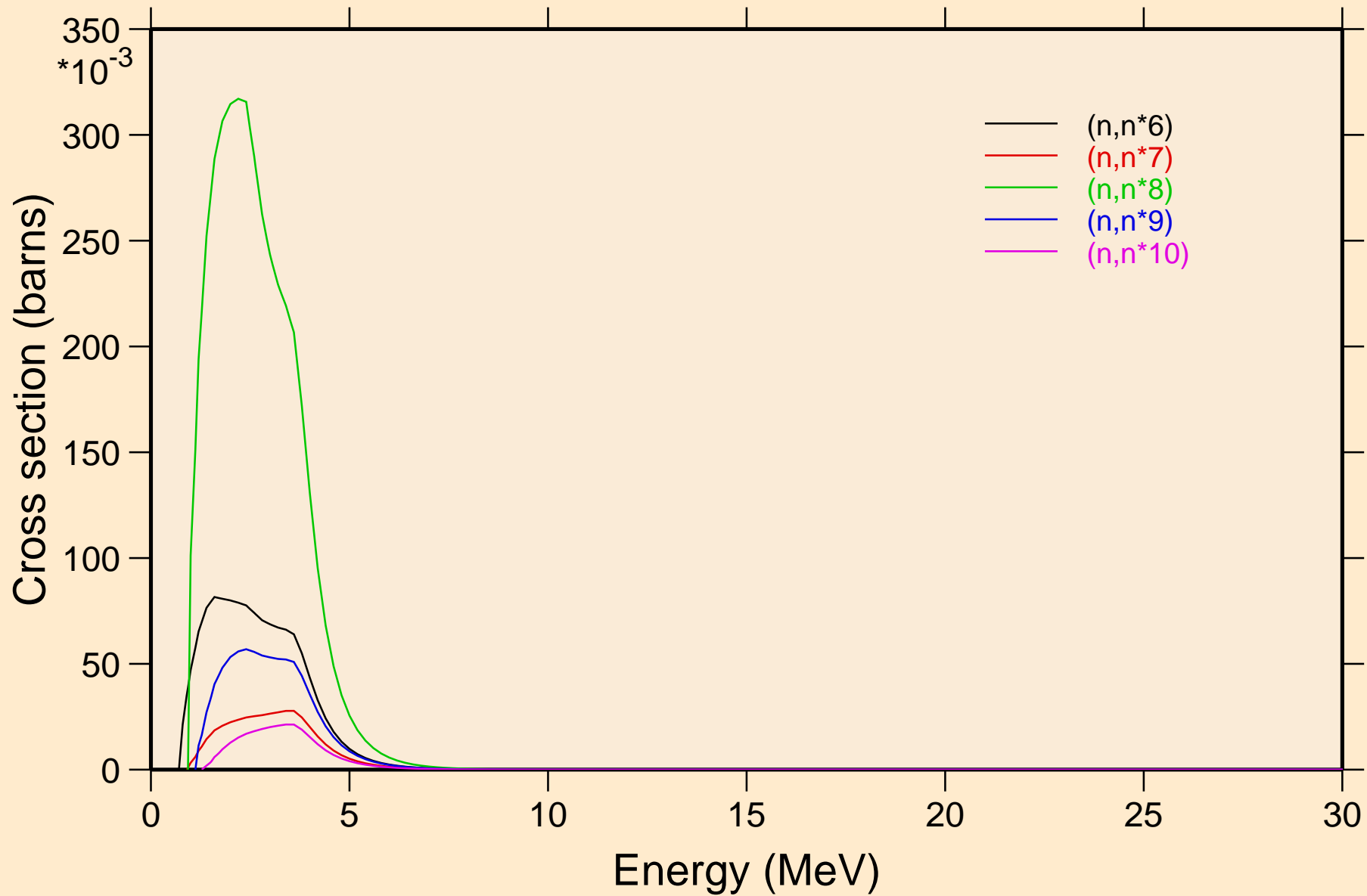

ZN071M NRG TENDL-2015, AKONING

Inelastic levels

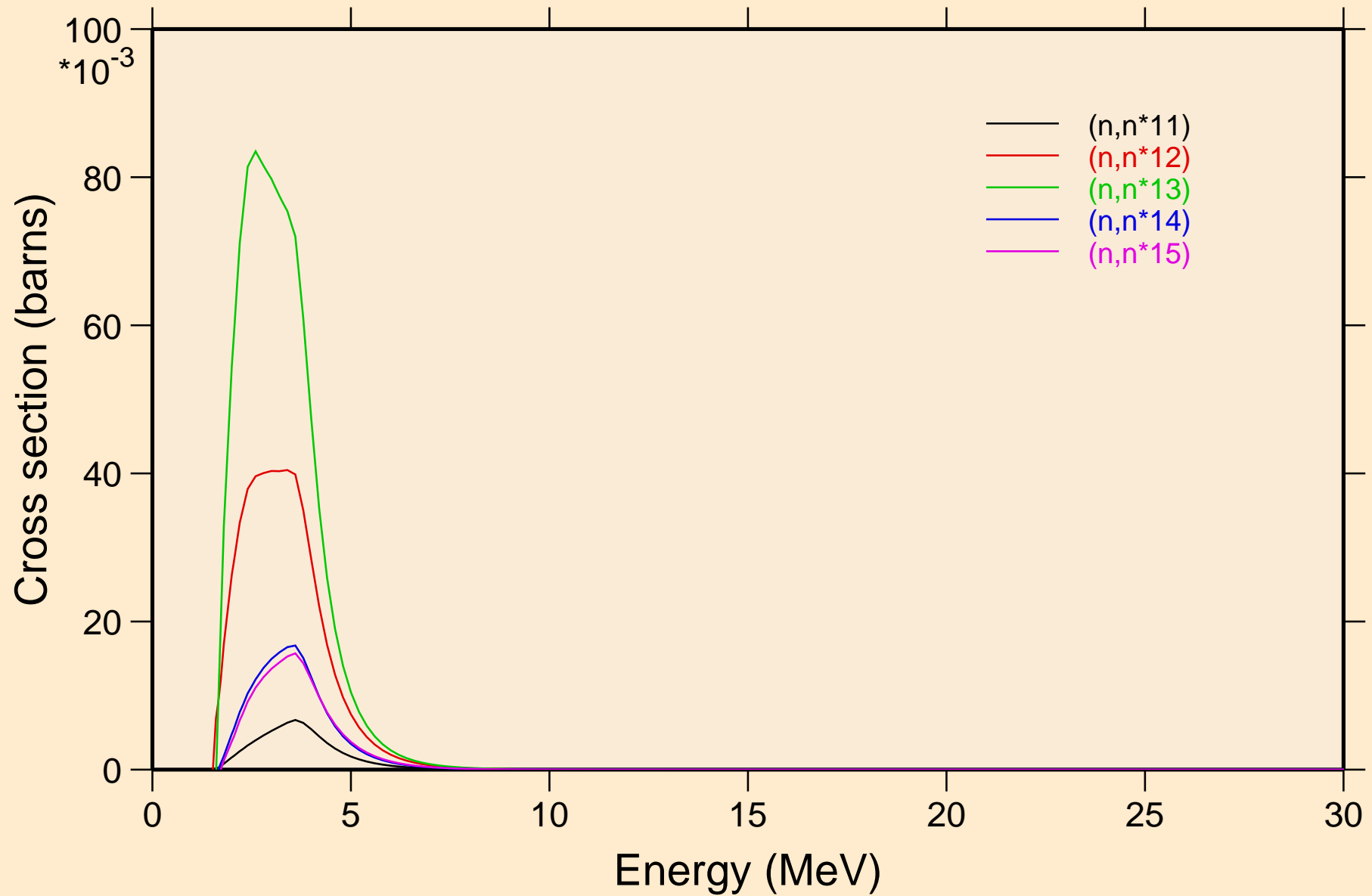

ZN071M NRG TENDL-2015, AKONING

Inelastic levels

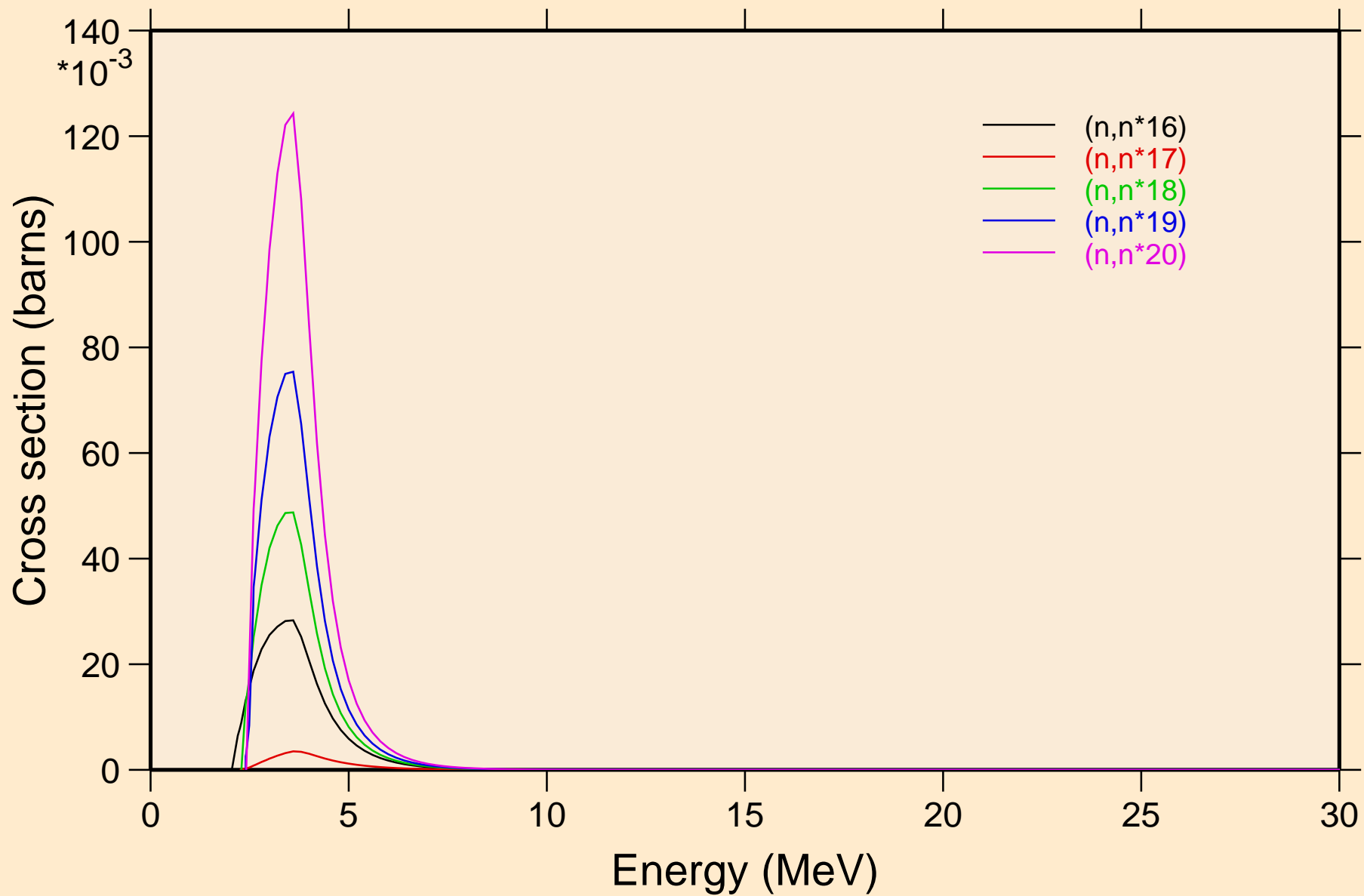

ZN071M NRG TENDL-2015, AKONING

Inelastic levels

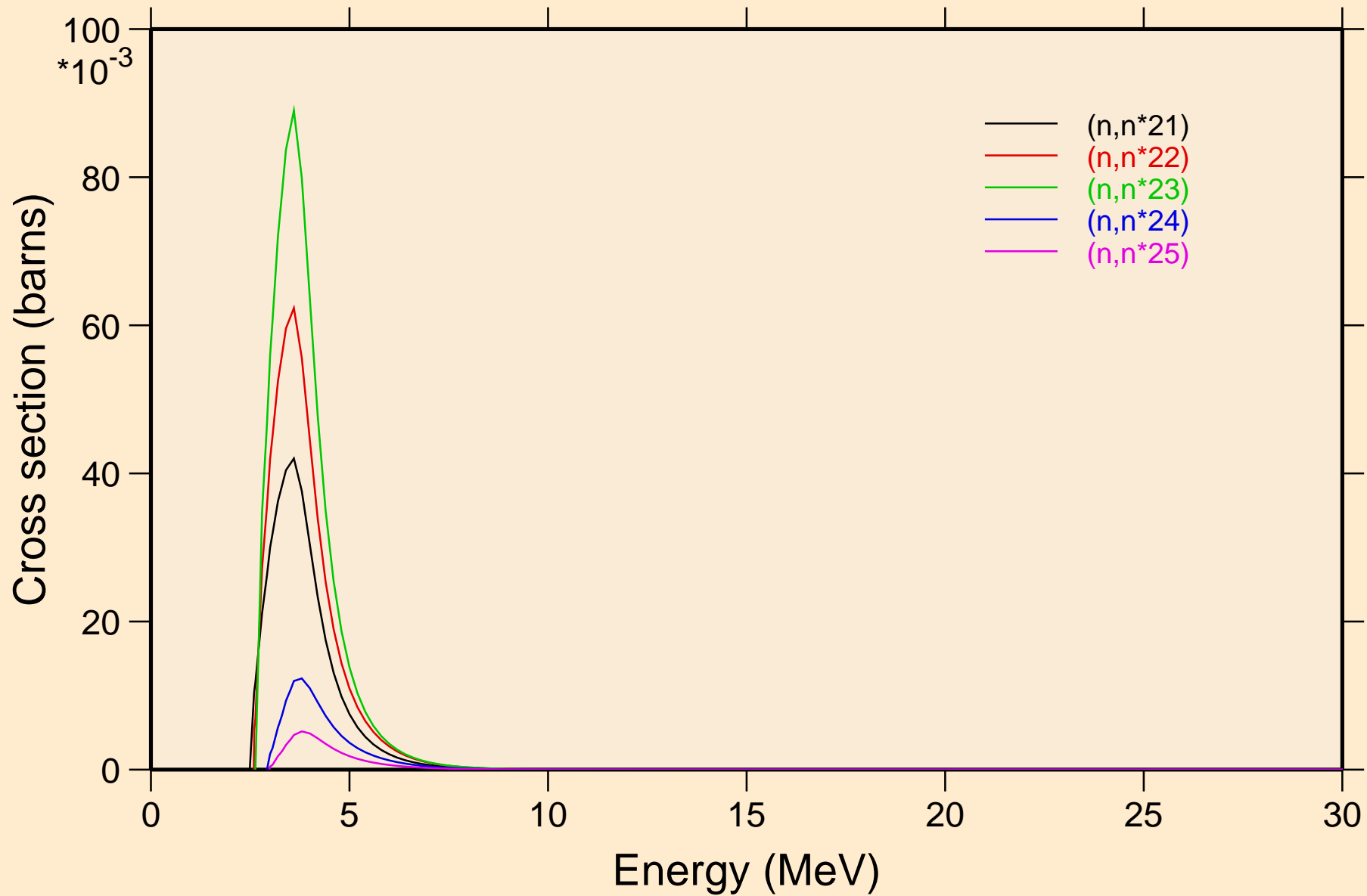

ZN071M NRG TENDL-2015, AKONING
Inelastic levels

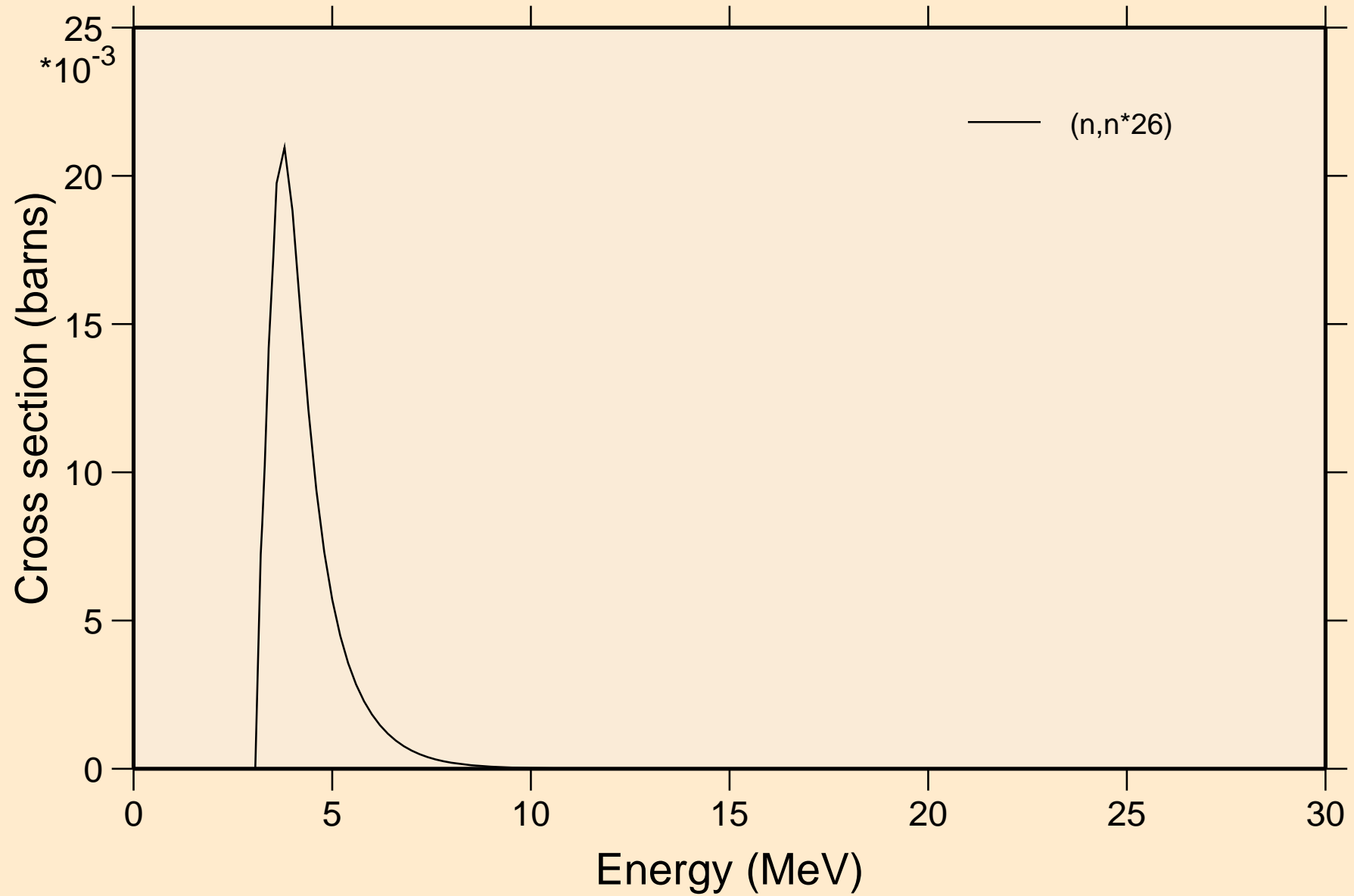

ZN071M NRG TENDL-2015, AKONING

Threshold reactions

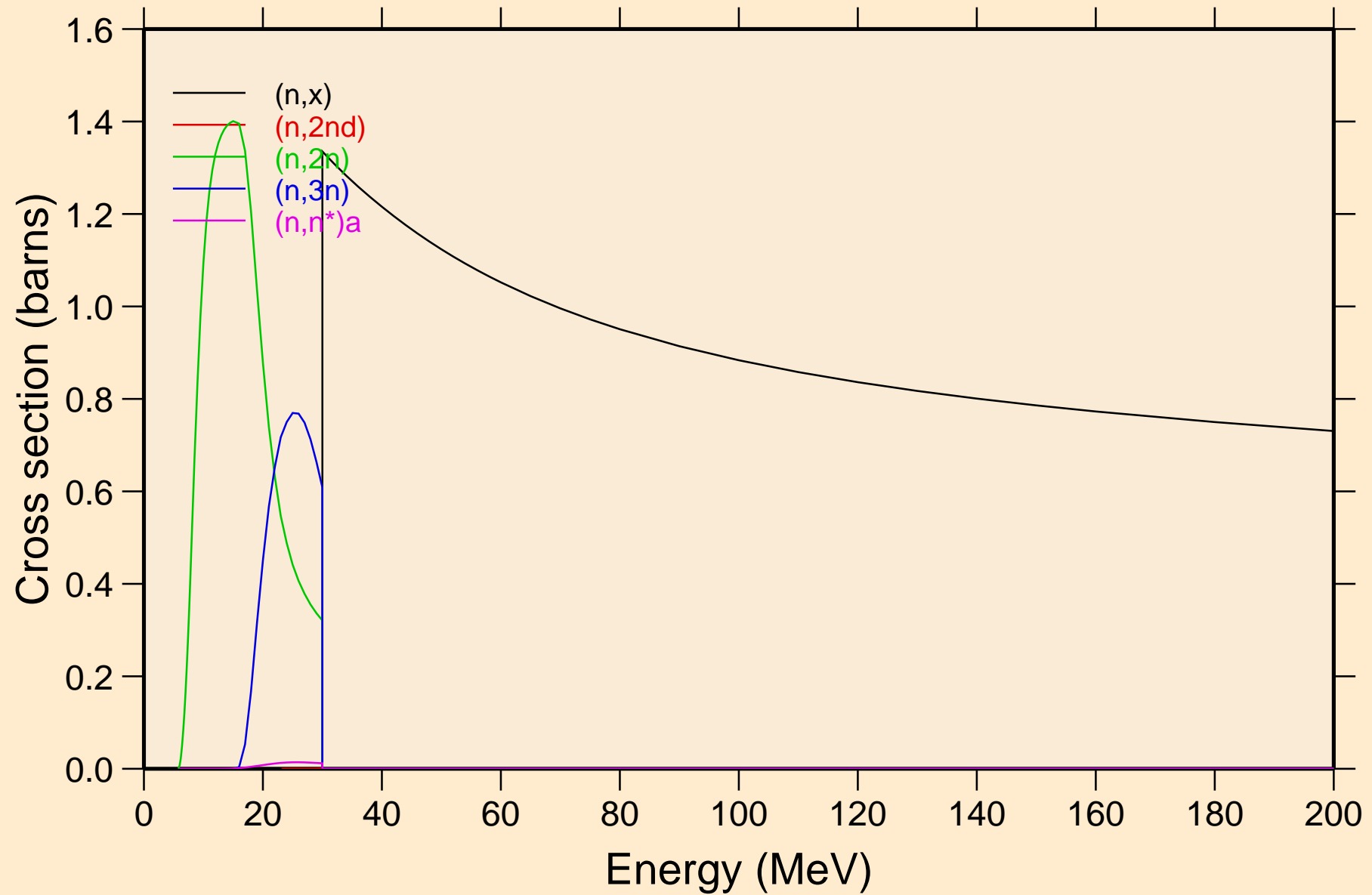

ZN071M NRG TENDL-2015, AKONING

Threshold reactions

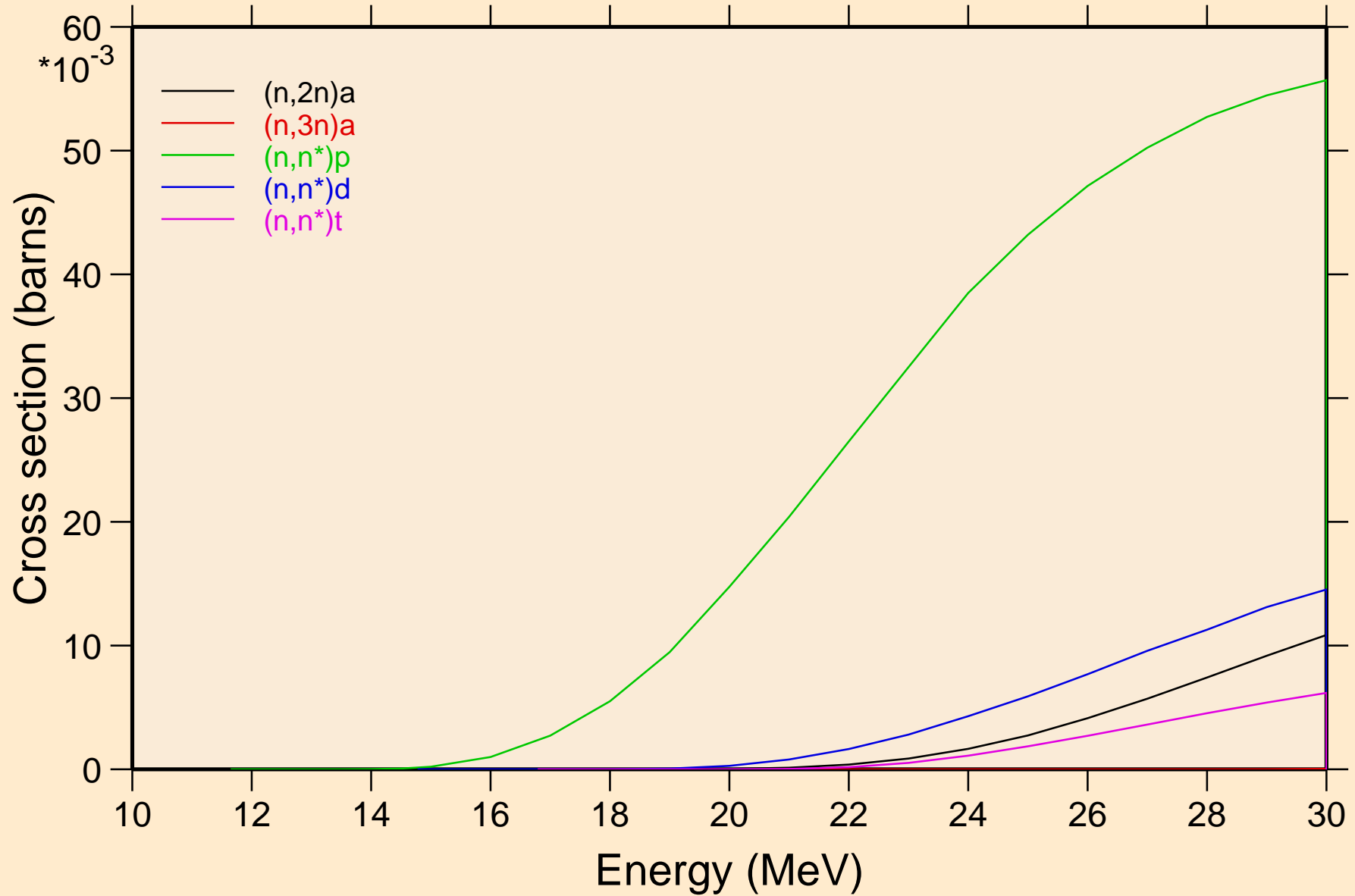

ZN071M NRG TENDL-2015, AKONING

Threshold reactions

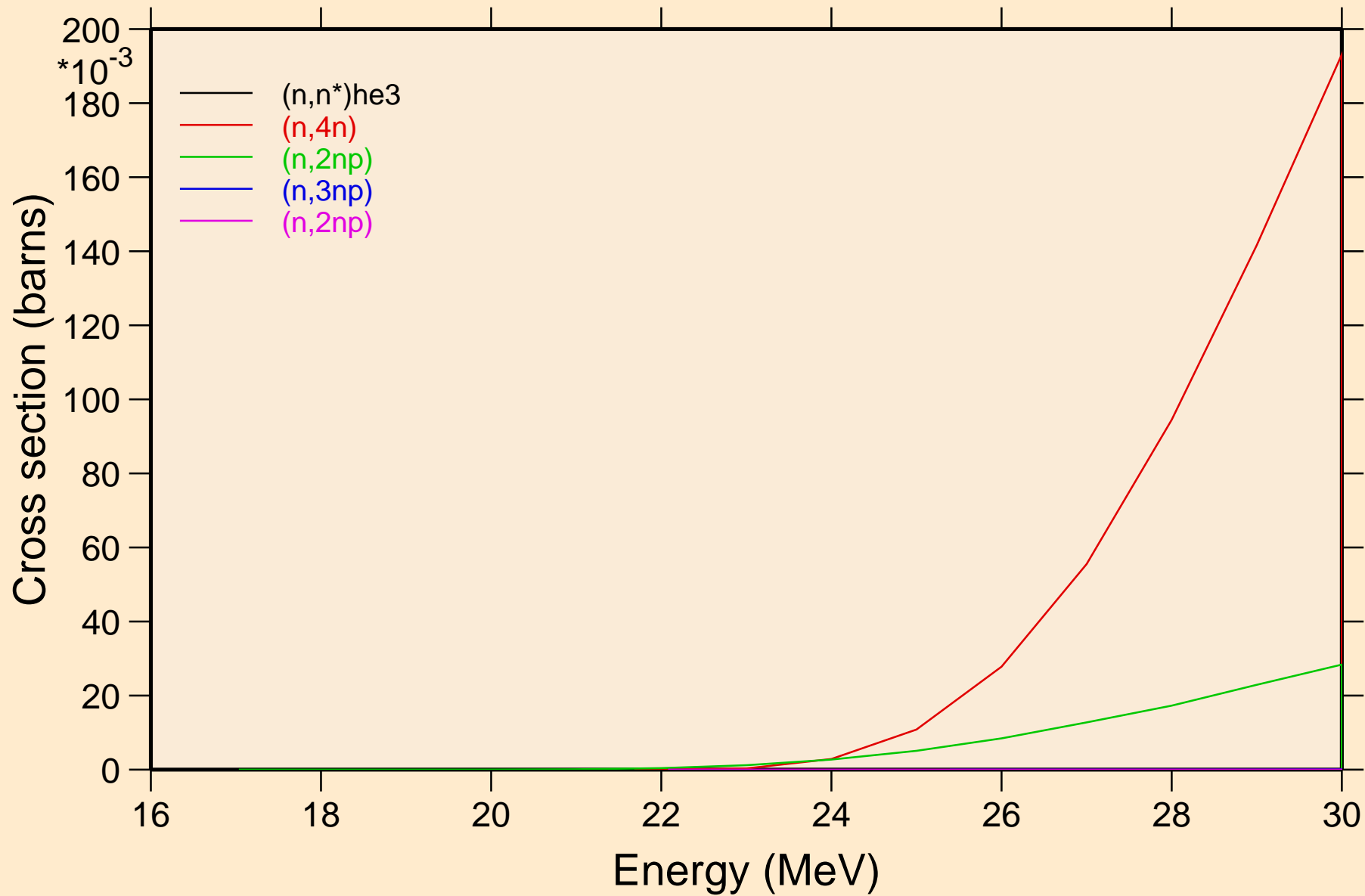

ZN071M NRG TENDL-2015, AKONING

Threshold reactions

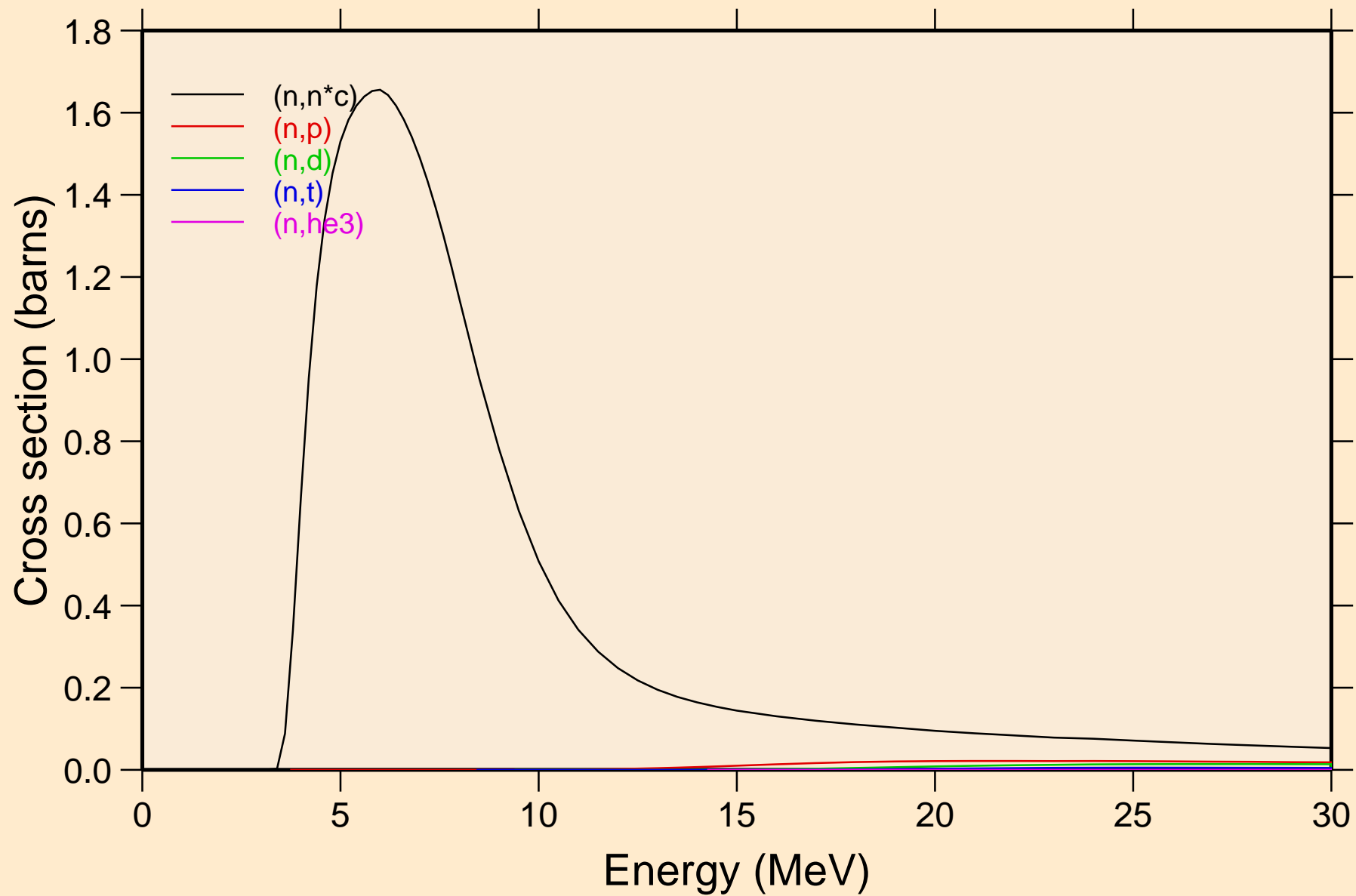

ZN071M NRG TENDL-2015, AKONING

Threshold reactions

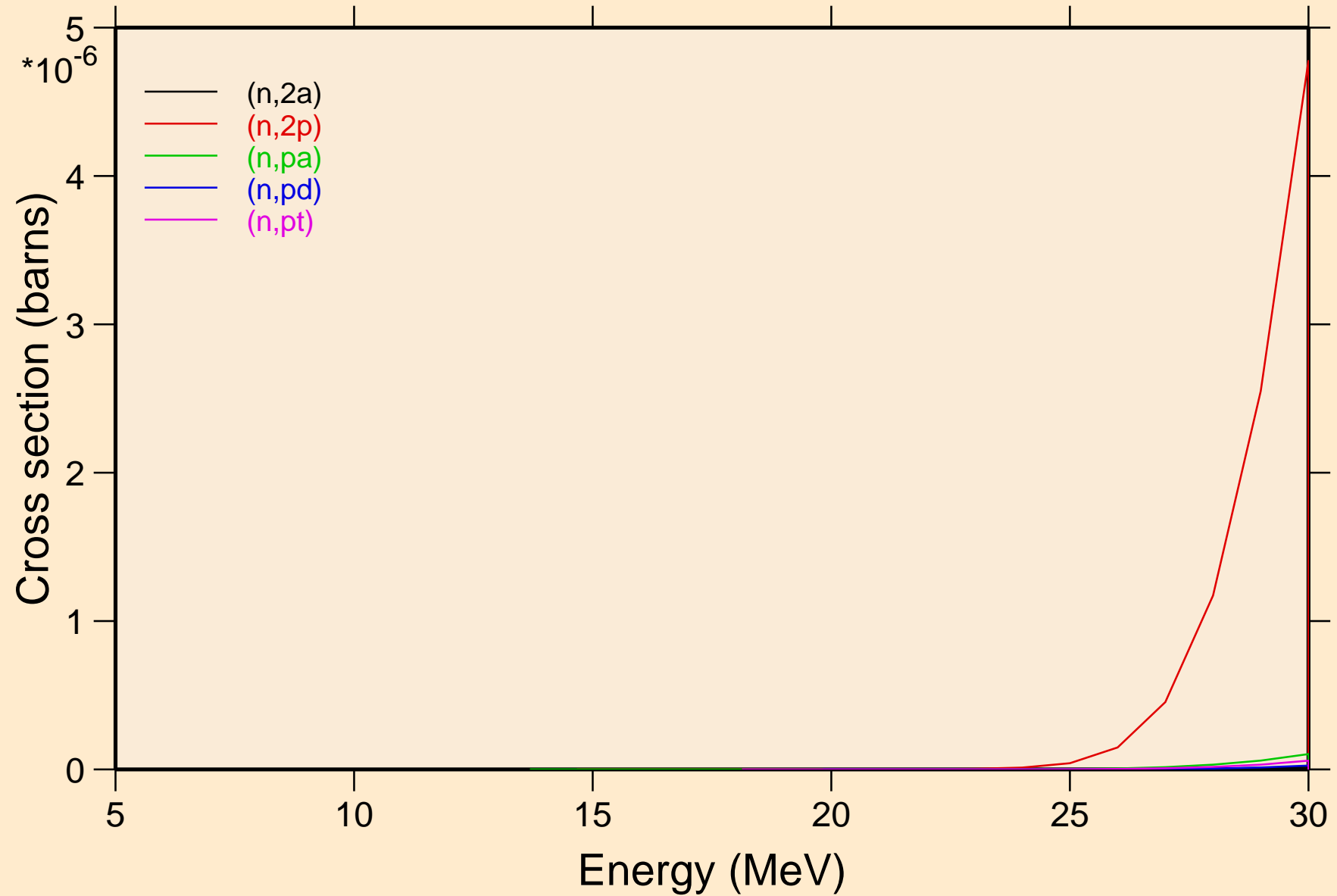

ZN071M NRG TENDL-2015, AKONING
angular distribution for elastic

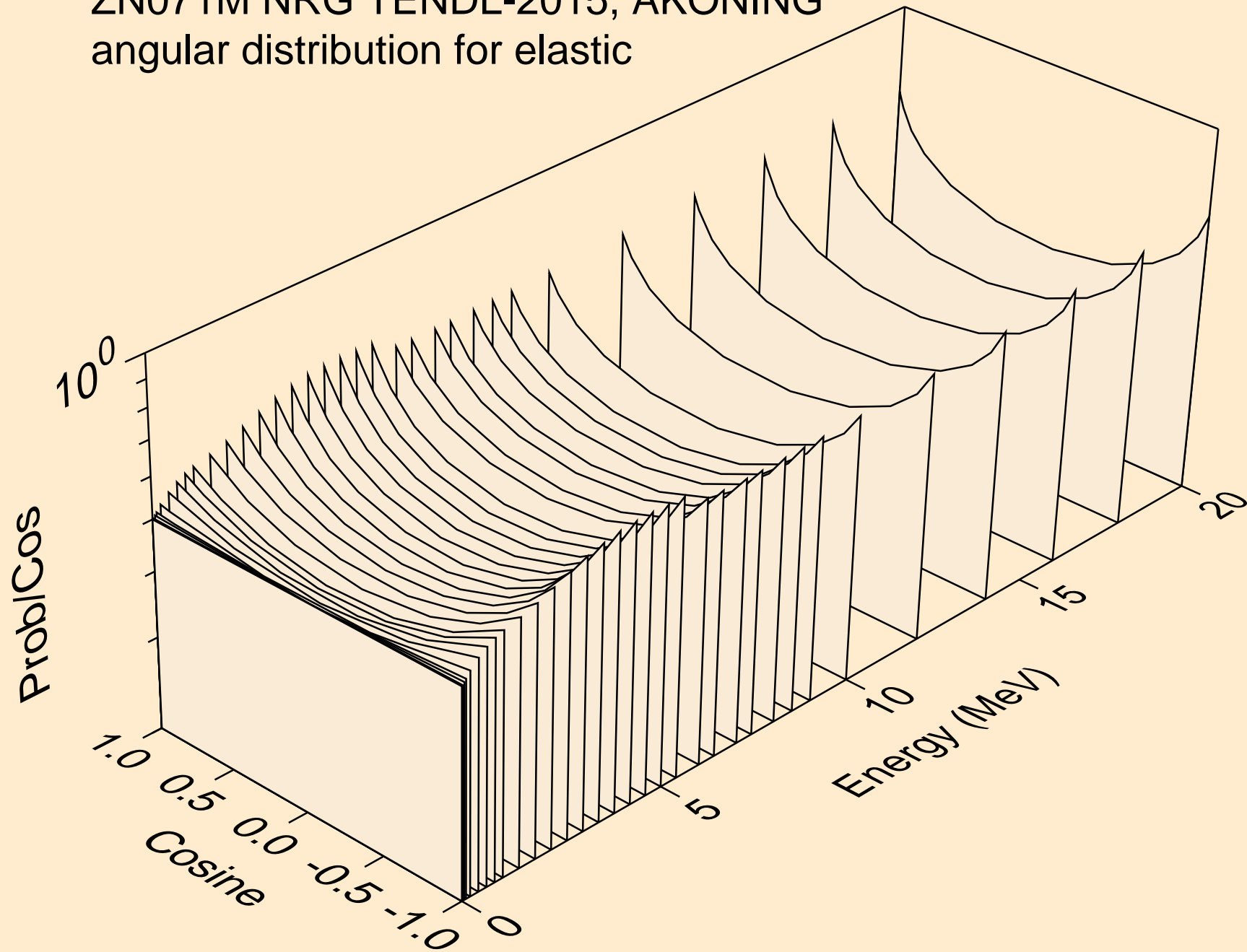

ZN071M NRG TENDL-2015, AKONING
angular distribution for elastic

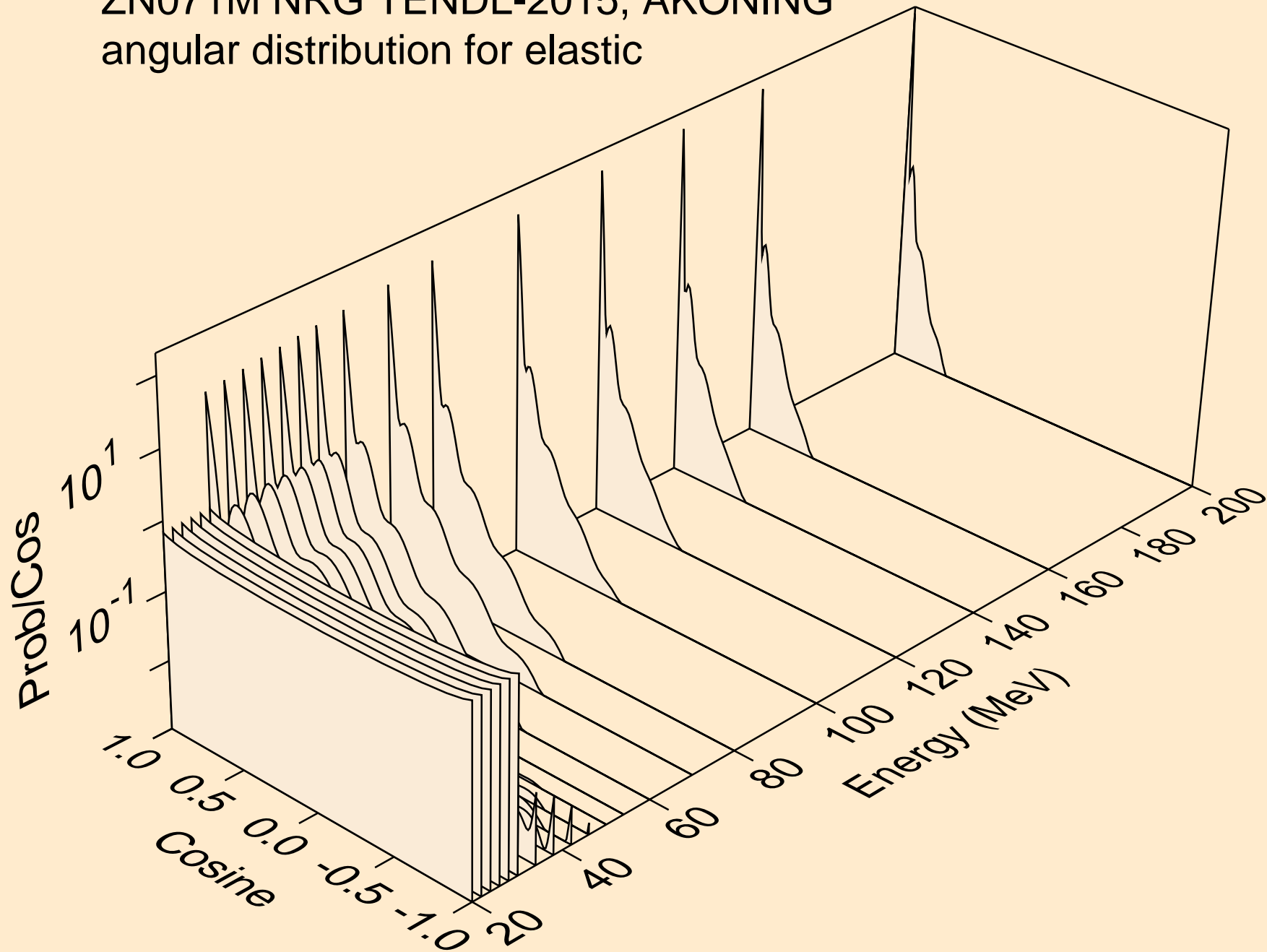

ZN071M NRG TENDL-2015, AKONING
angular distribution for (n,n*1)

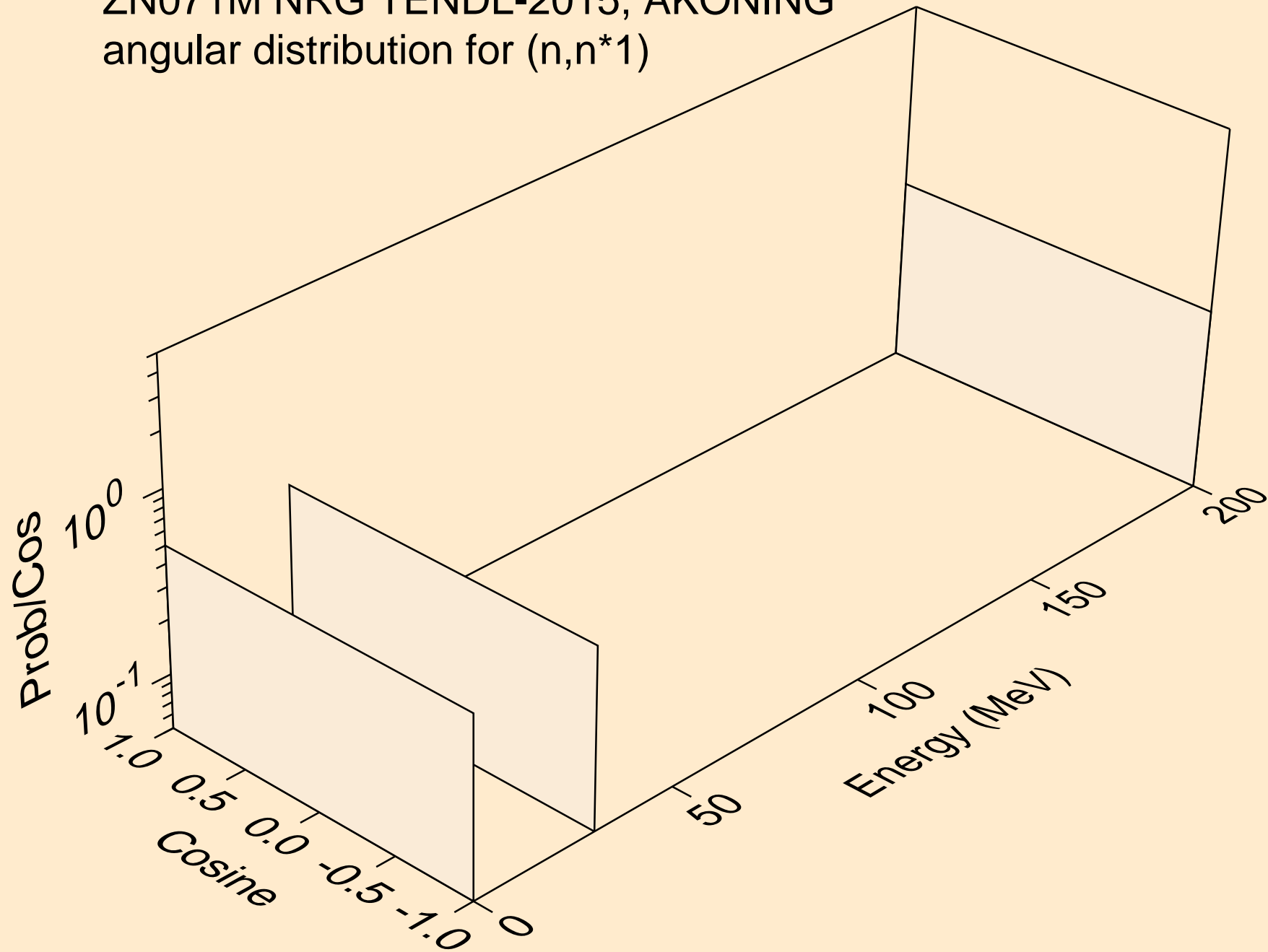

ZN071M NRG TENDL-2015, AKONING
angular distribution for (n,n*2)

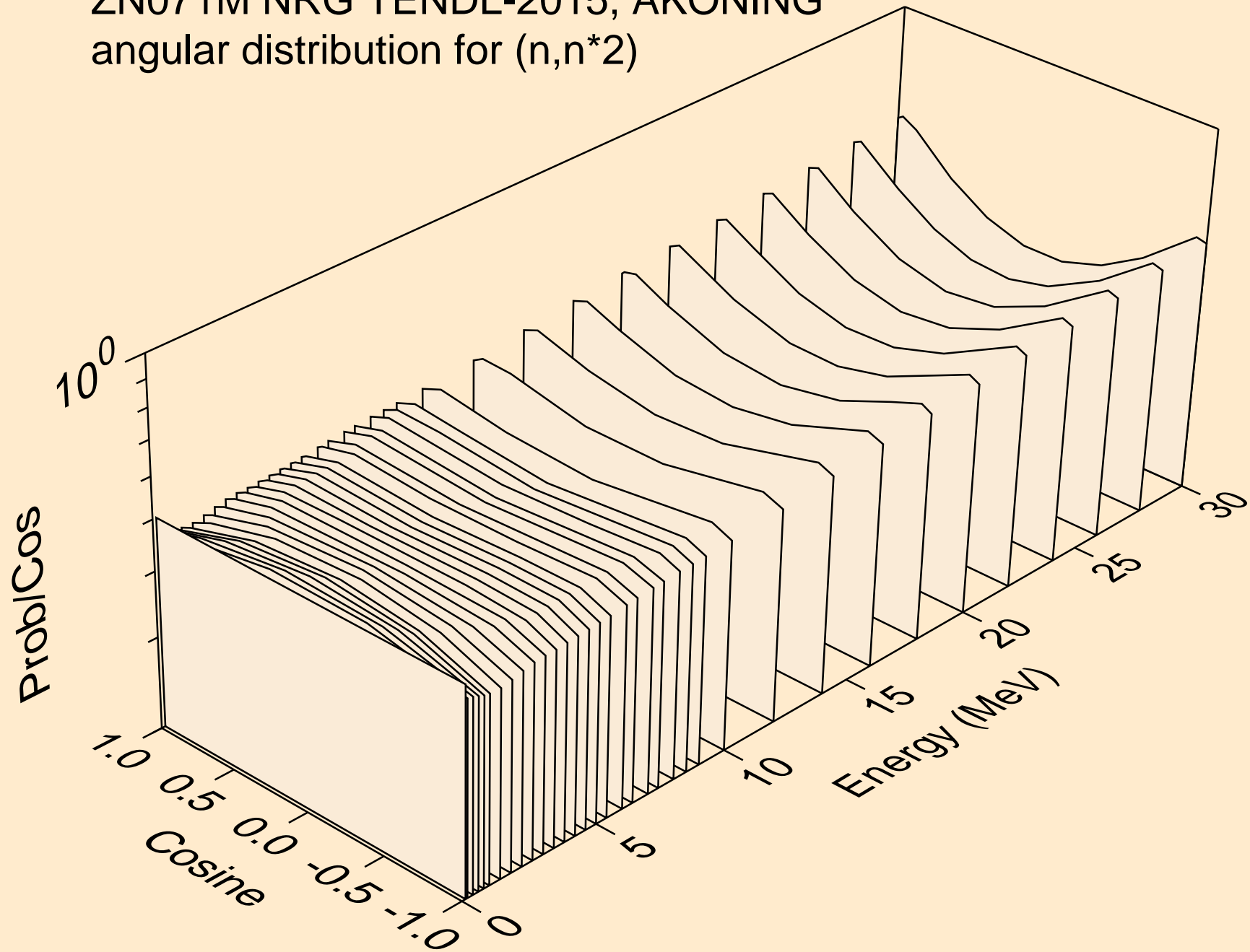

ZN071M NRG TENDL-2015, AKONING
angular distribution for (n,n*3)

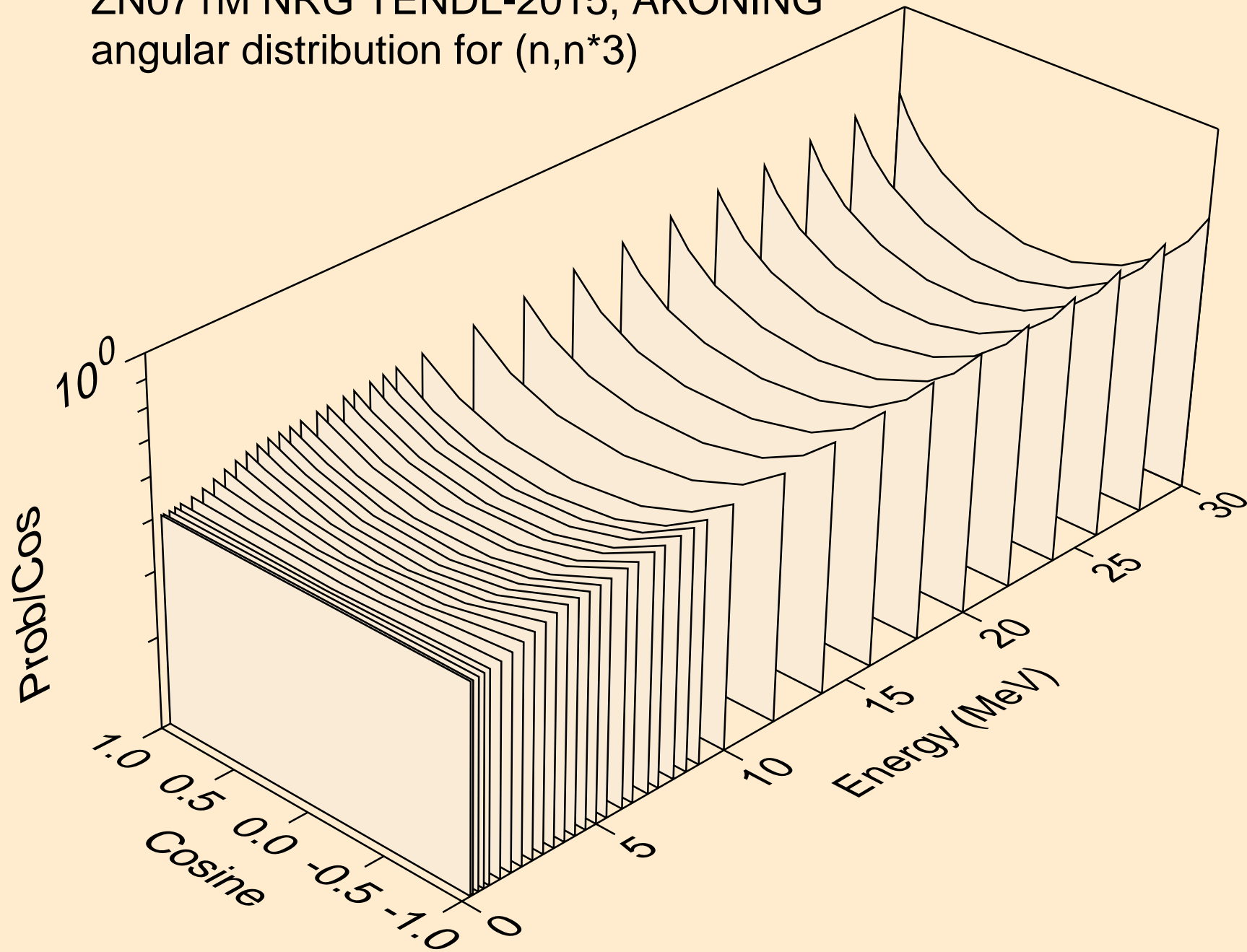

ZN071M NRG TENDL-2015, AKONING
angular distribution for (n,n*4)

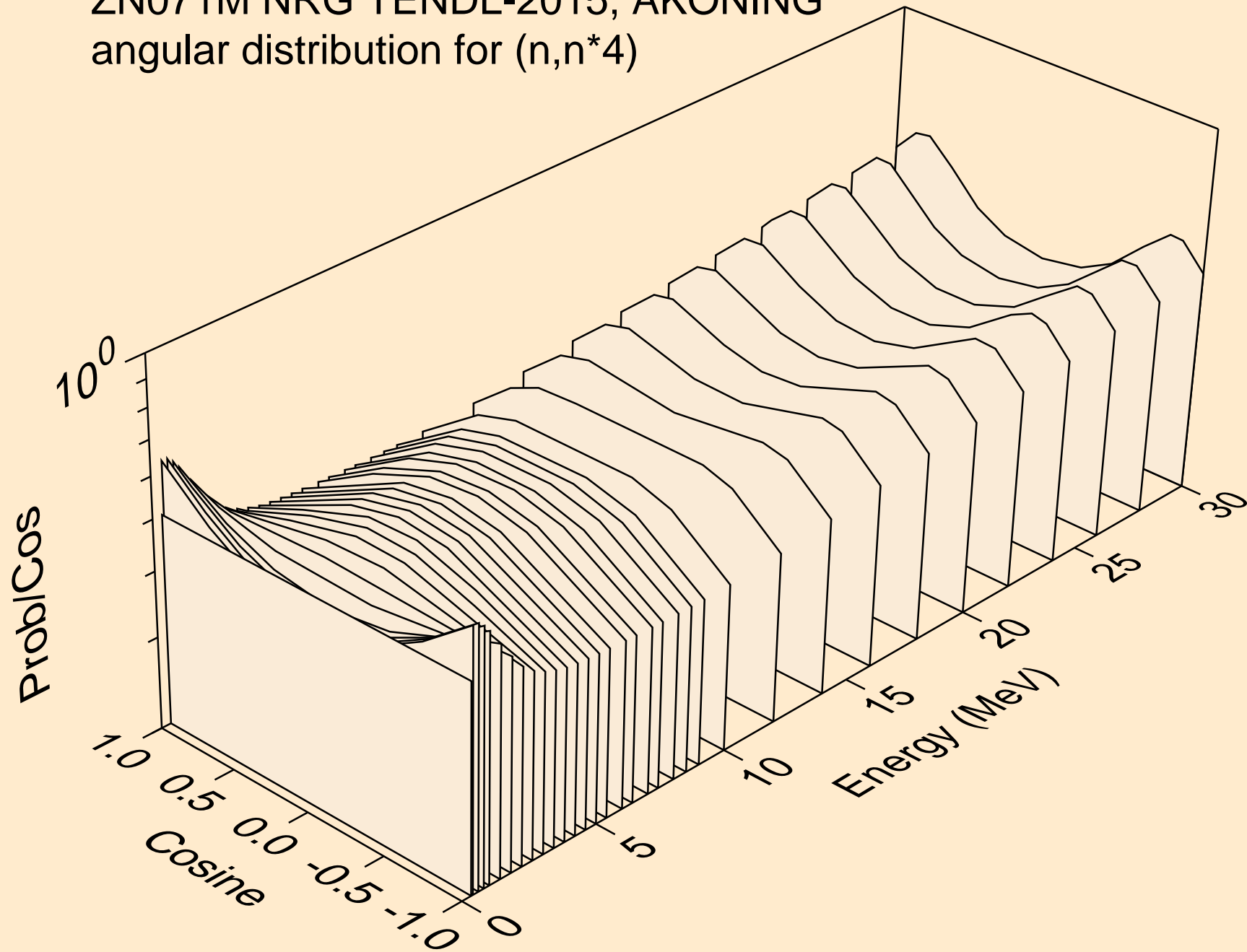

ZN071M NRG TENDL-2015, AKONING
angular distribution for (n,n*5)

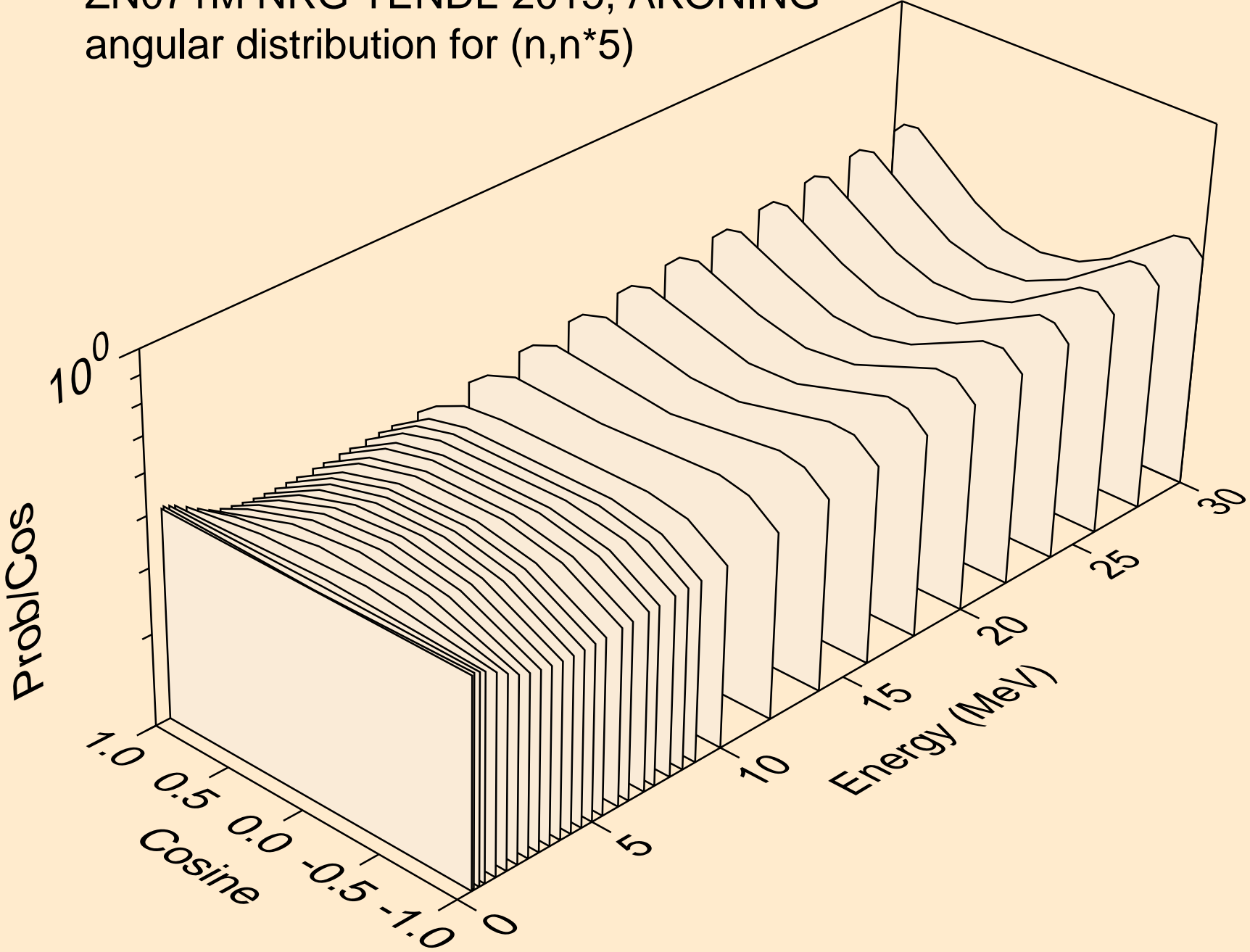

ZN071M NRG TENDL-2015, AKONING
angular distribution for (n,n*6)

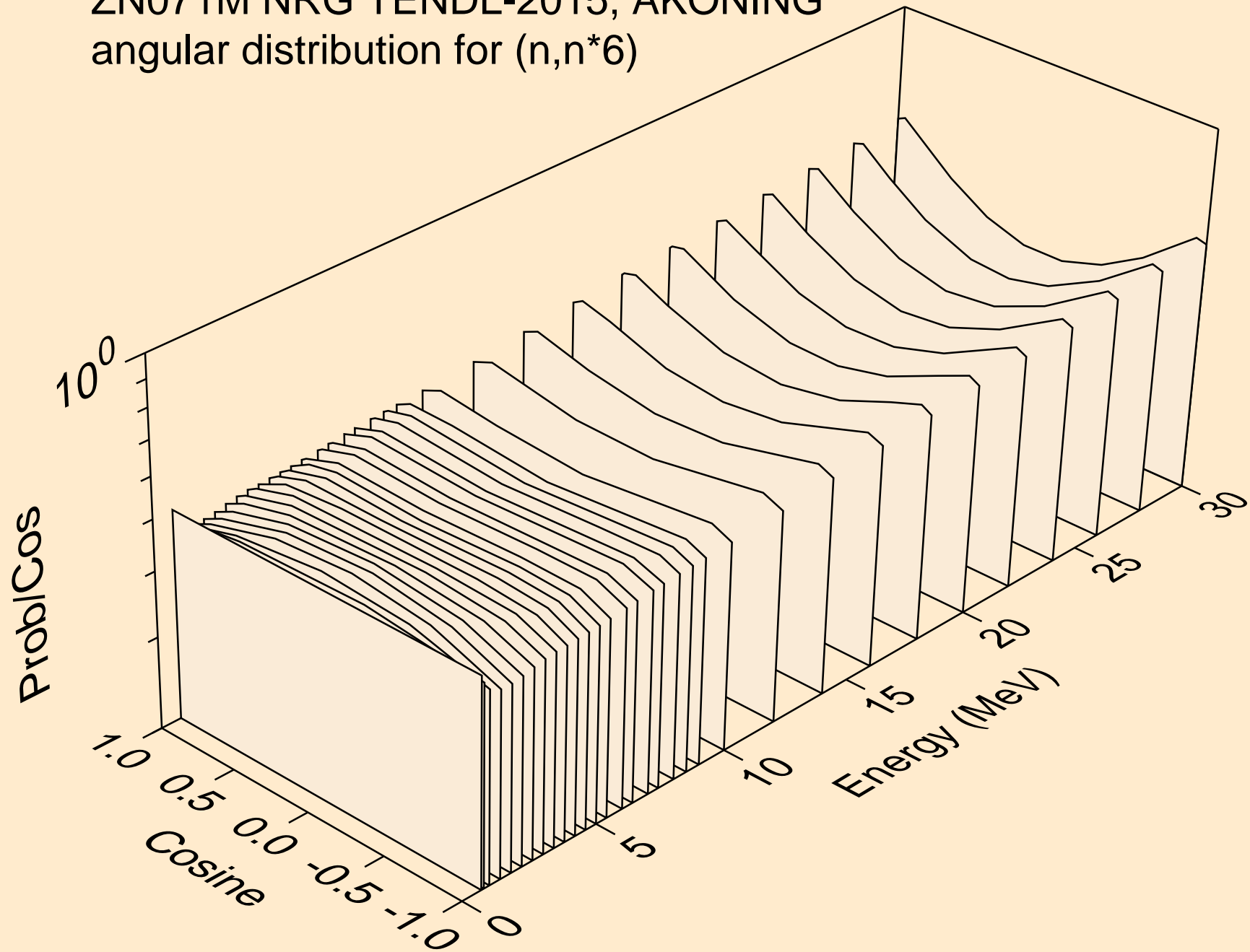

ZN071M NRG TENDL-2015, AKONING
angular distribution for (n,n*7)

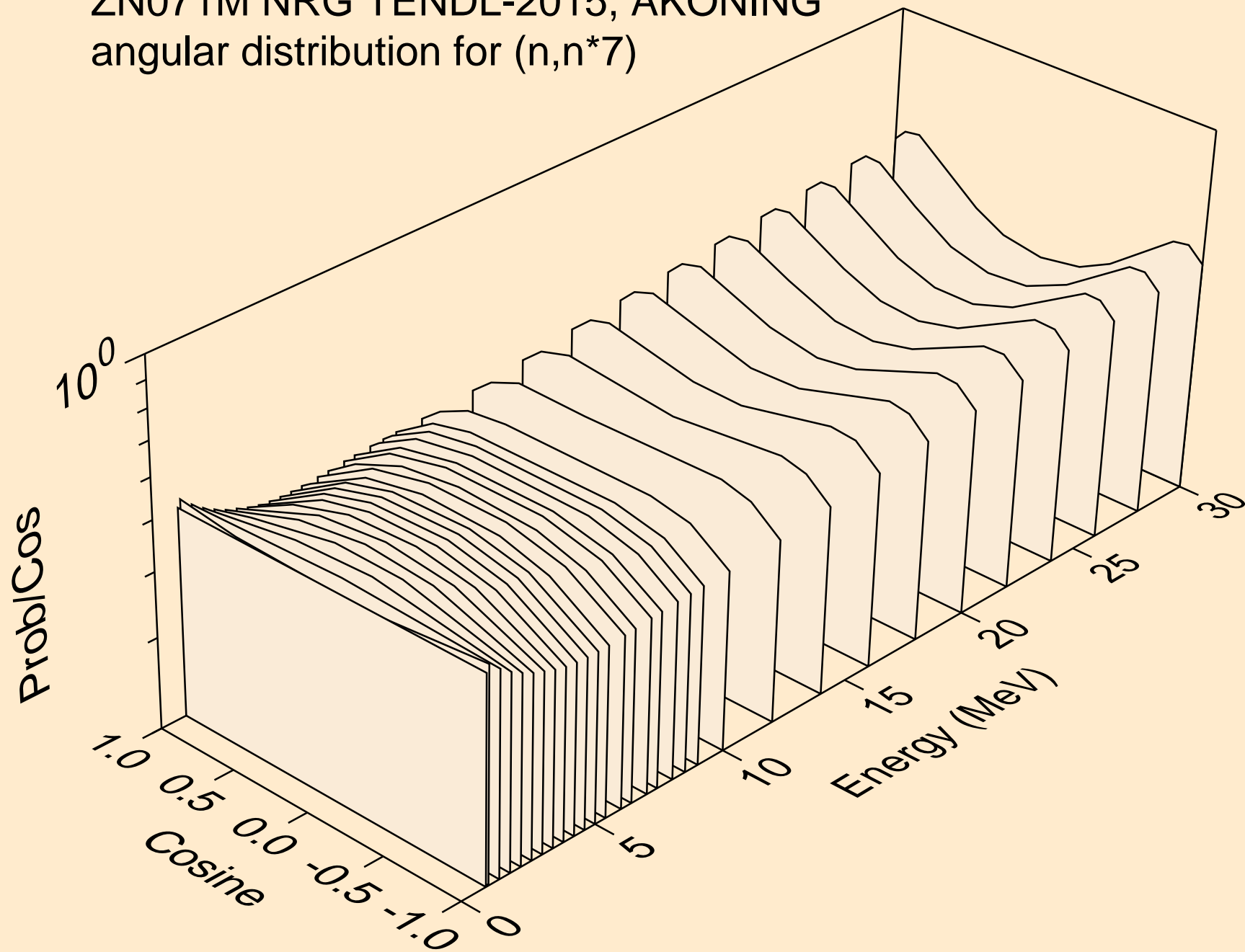

ZN071M NRG TENDL-2015, AKONING
angular distribution for (n,n*8)

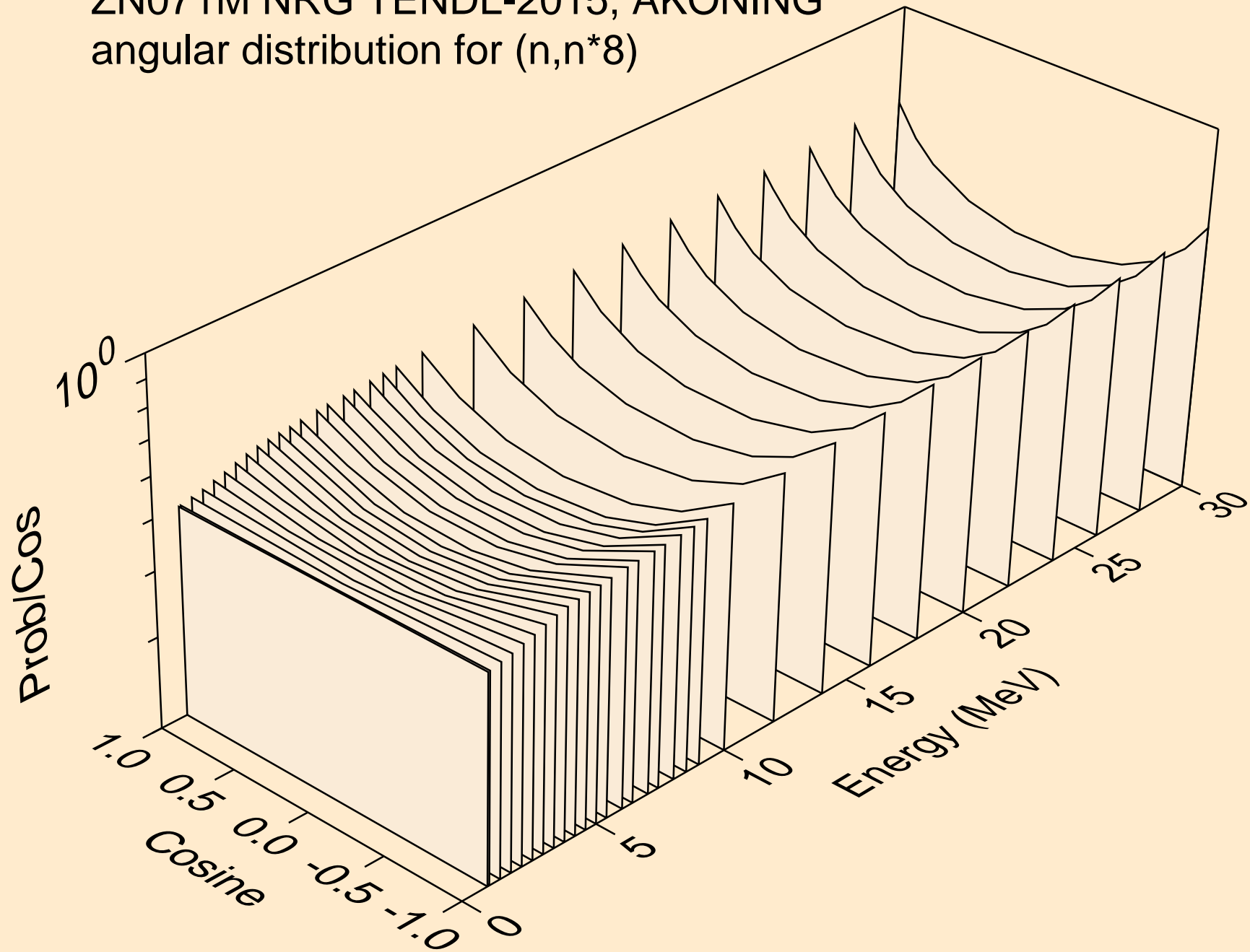

ZN071M NRG TENDL-2015, AKONING
angular distribution for (n,n*9)

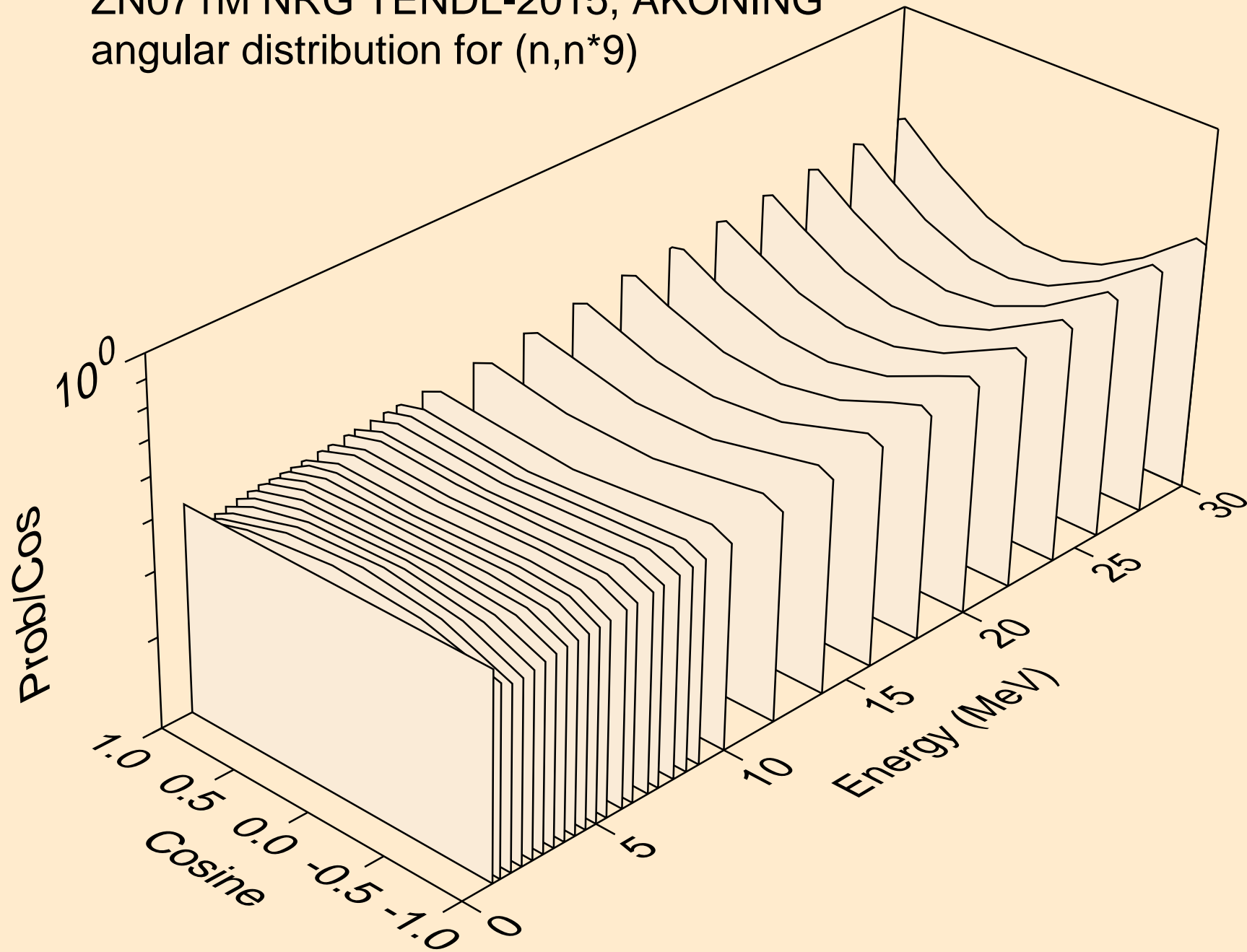

ZN071M NRG TENDL-2015, AKONING
angular distribution for (n,n*10)

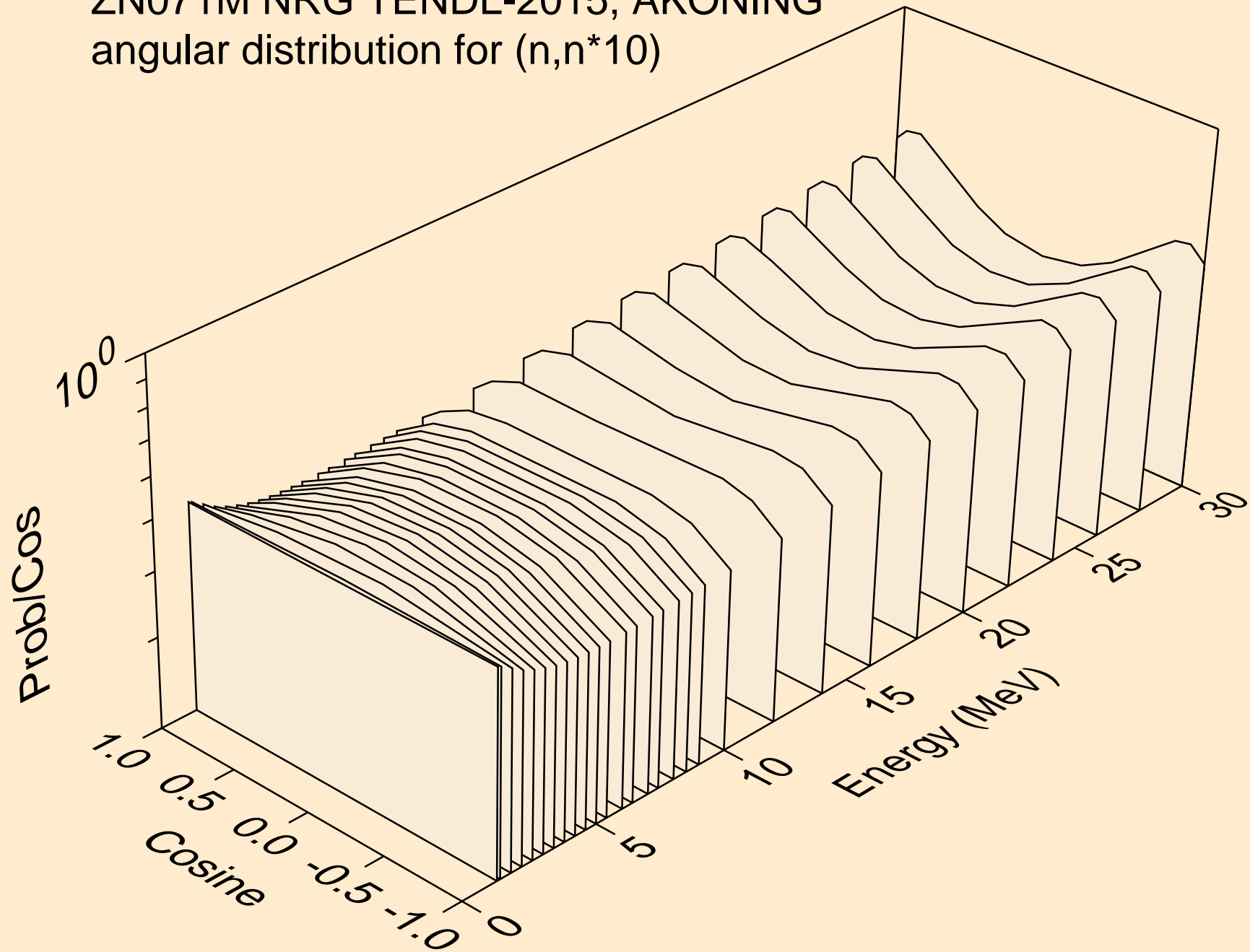

ZN071M NRG TENDL-2015, AKONING
angular distribution for (n,n*11)

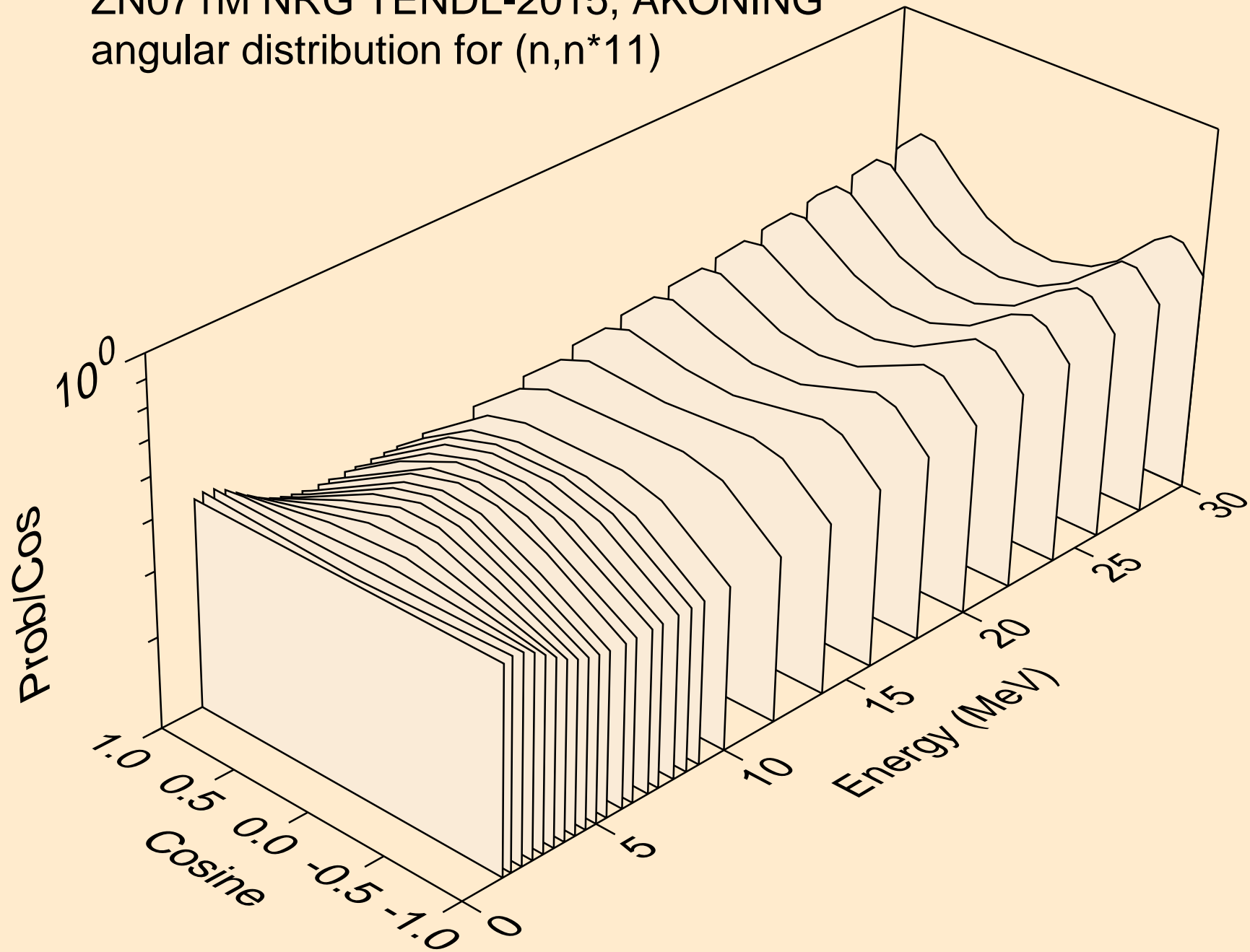

ZN071M NRG TENDL-2015, AKONING
angular distribution for (n,n*12)

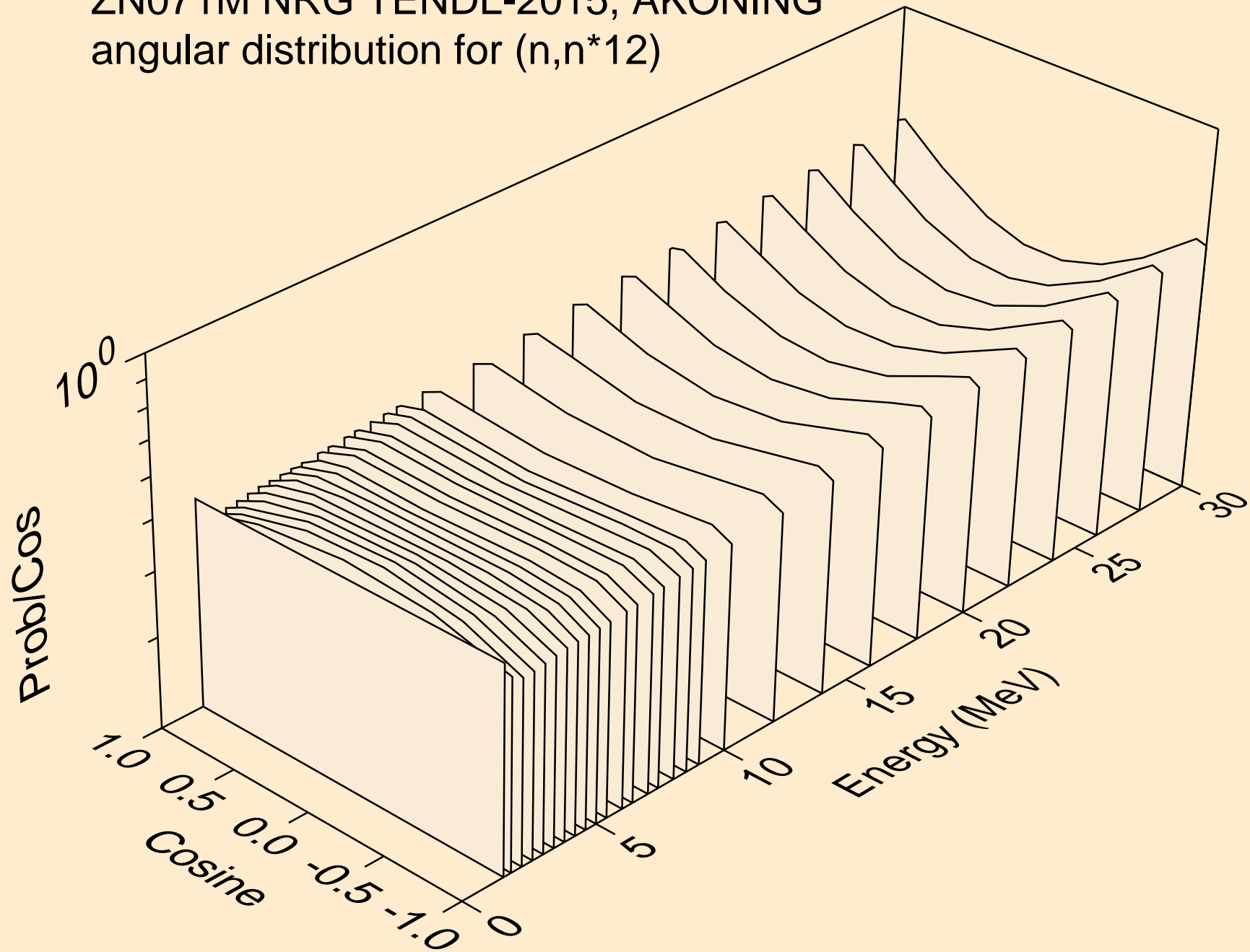

ZN071M NRG TENDL-2015, AKONING
angular distribution for (n,n*13)

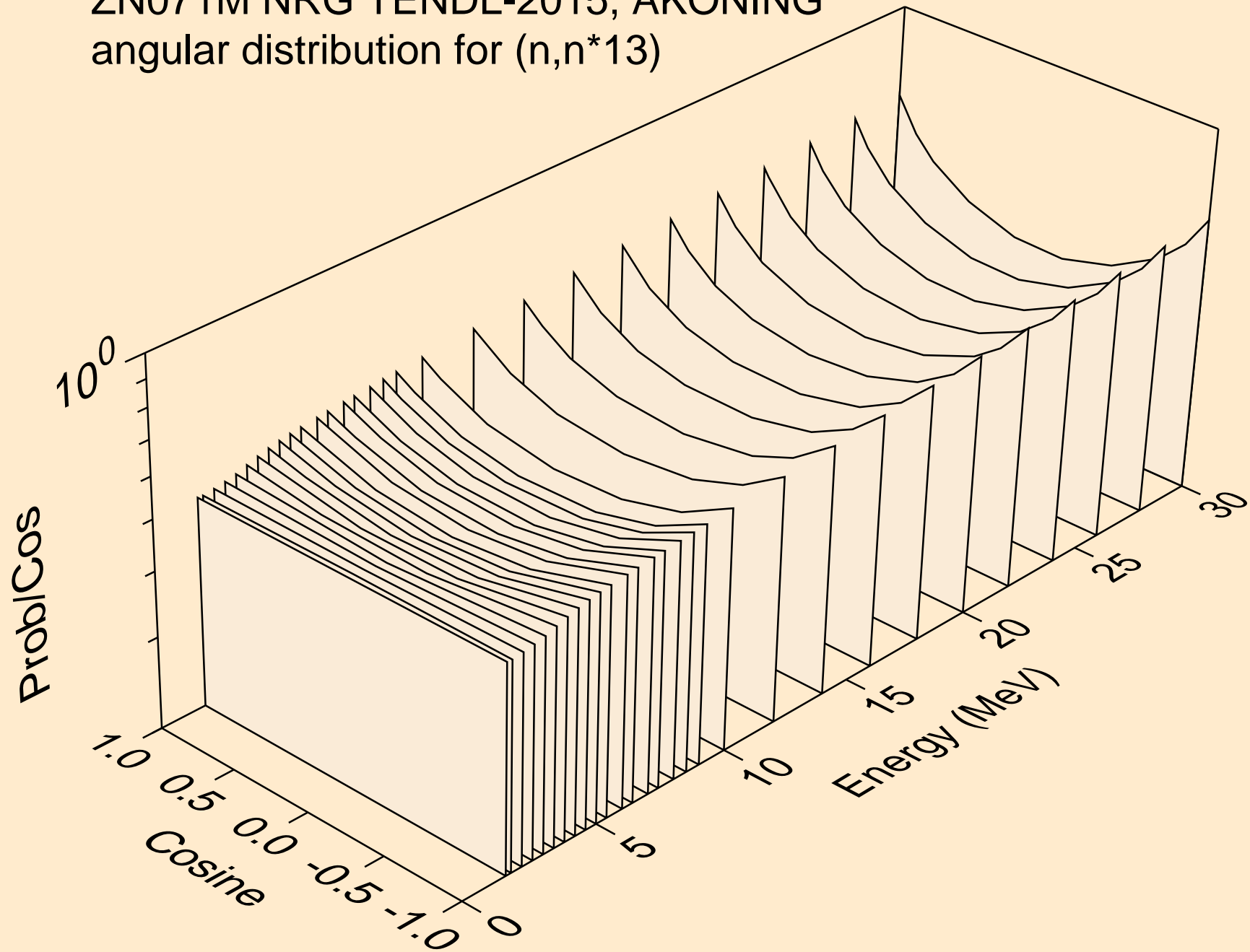

ZN071M NRG TENDL-2015, AKONING
angular distribution for (n,n*14)

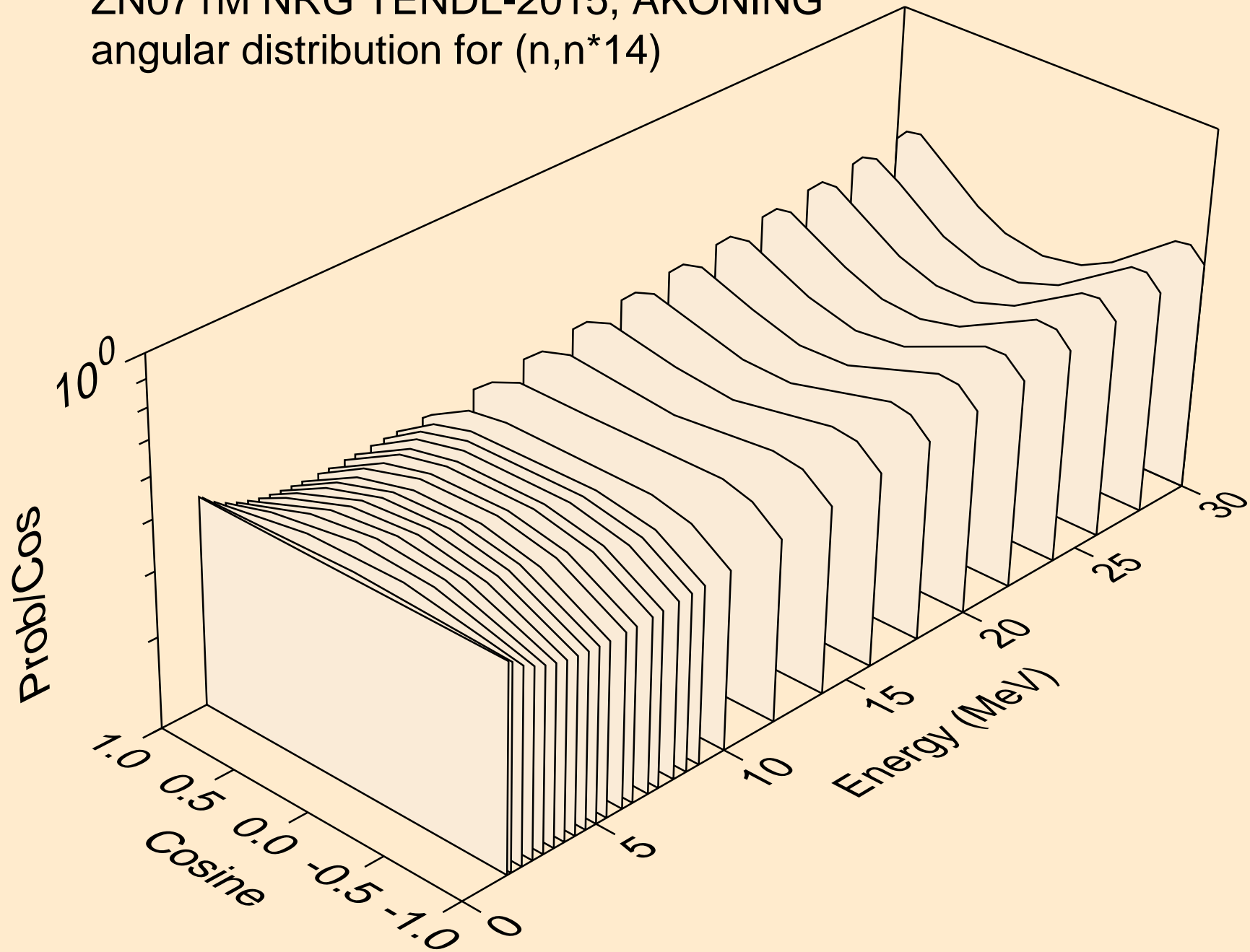

ZN071M NRG TENDL-2015, AKONING
angular distribution for (n,n*15)

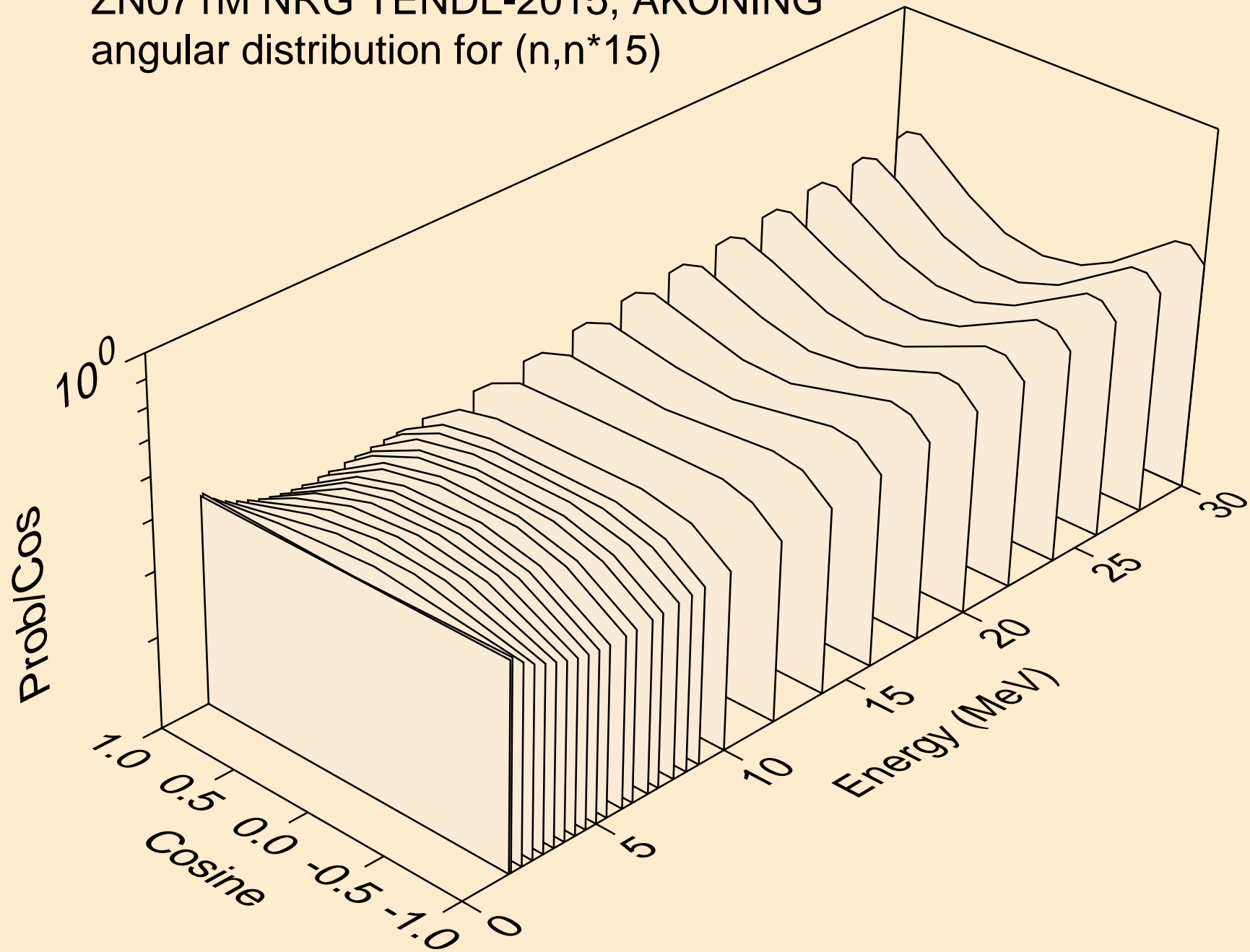

ZN071M NRG TENDL-2015, AKONING
angular distribution for (n,n*16)

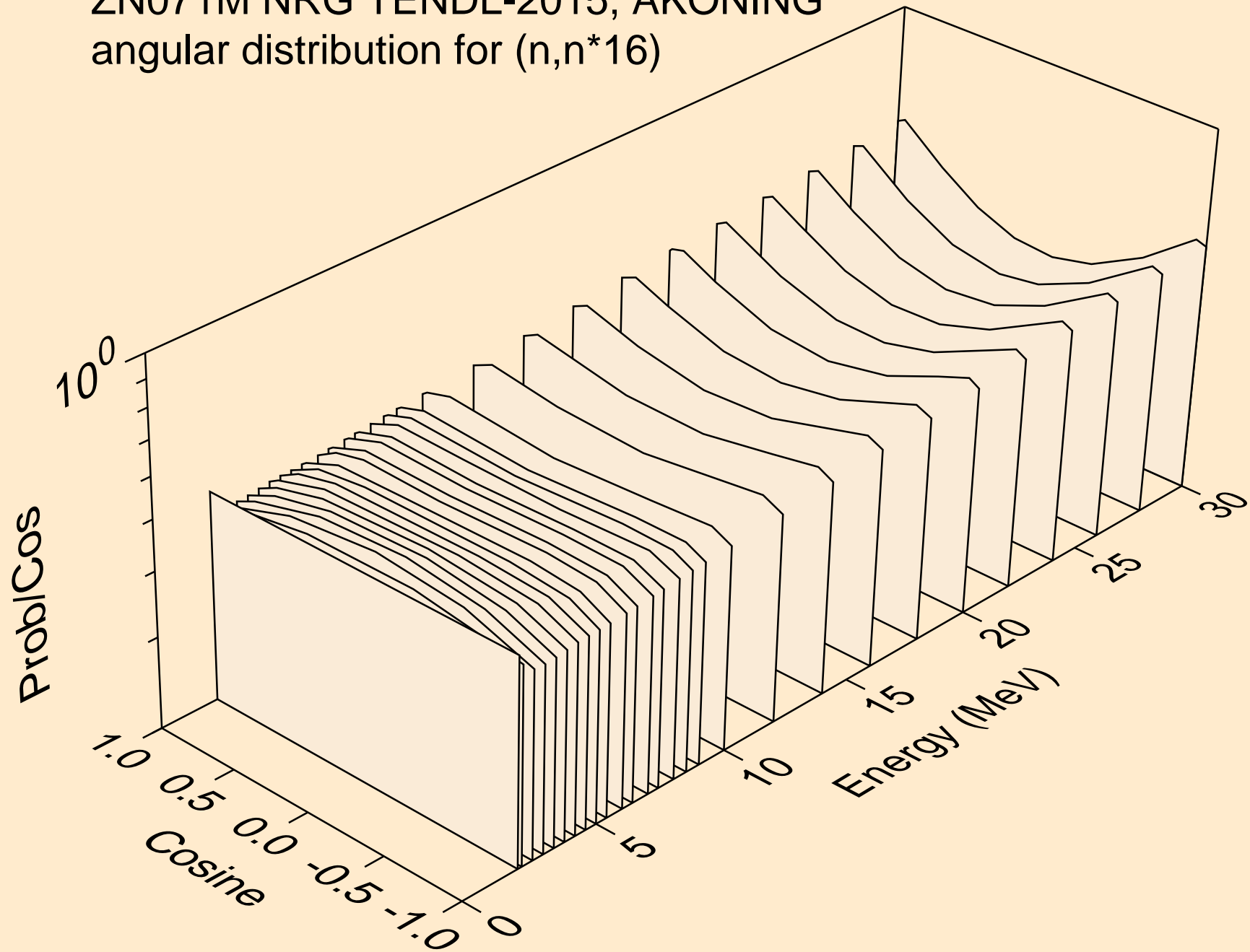

ZN071M NRG TENDL-2015, AKONING
angular distribution for (n,n*17)

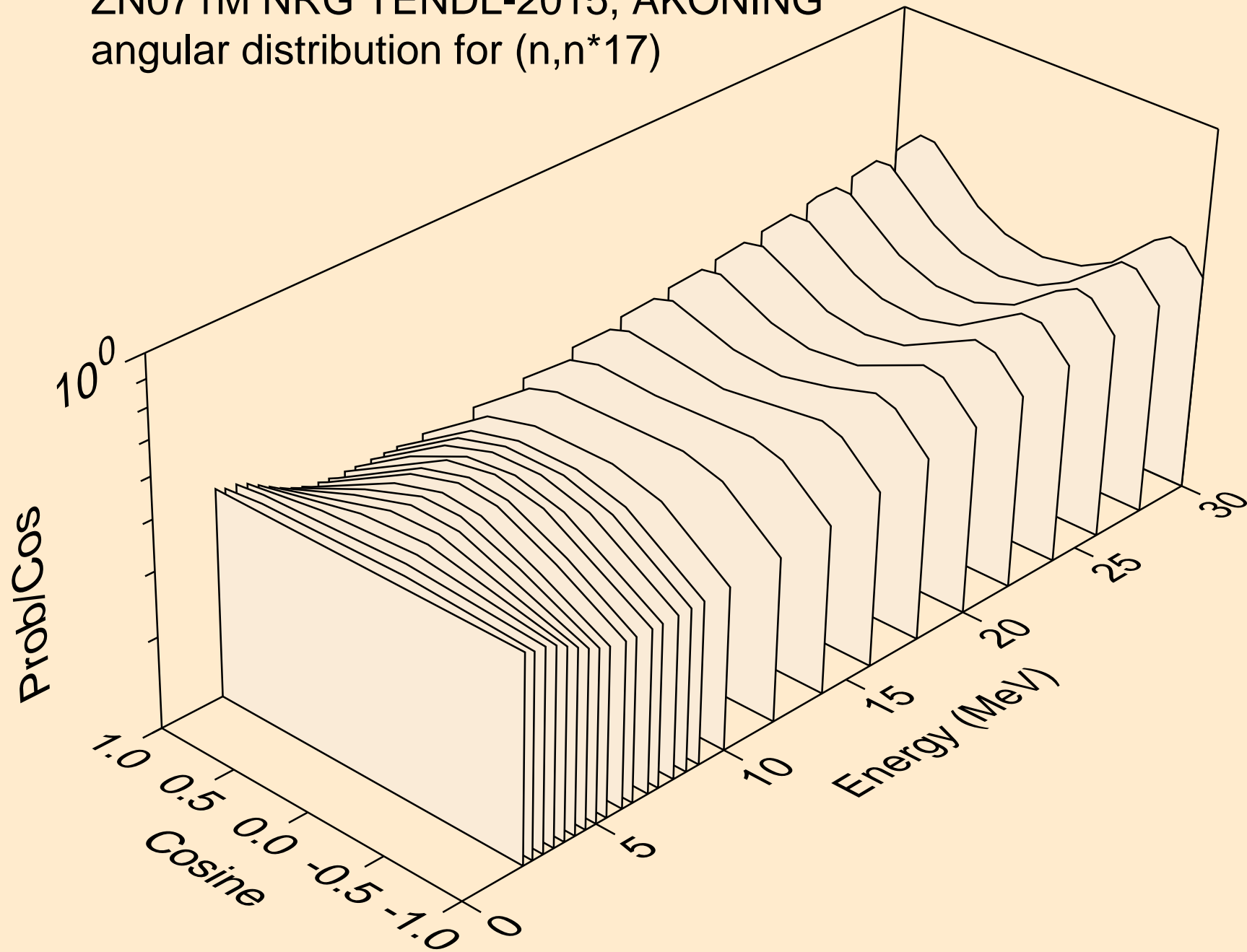

ZN071M NRG TENDL-2015, AKONING
angular distribution for (n,n*18)

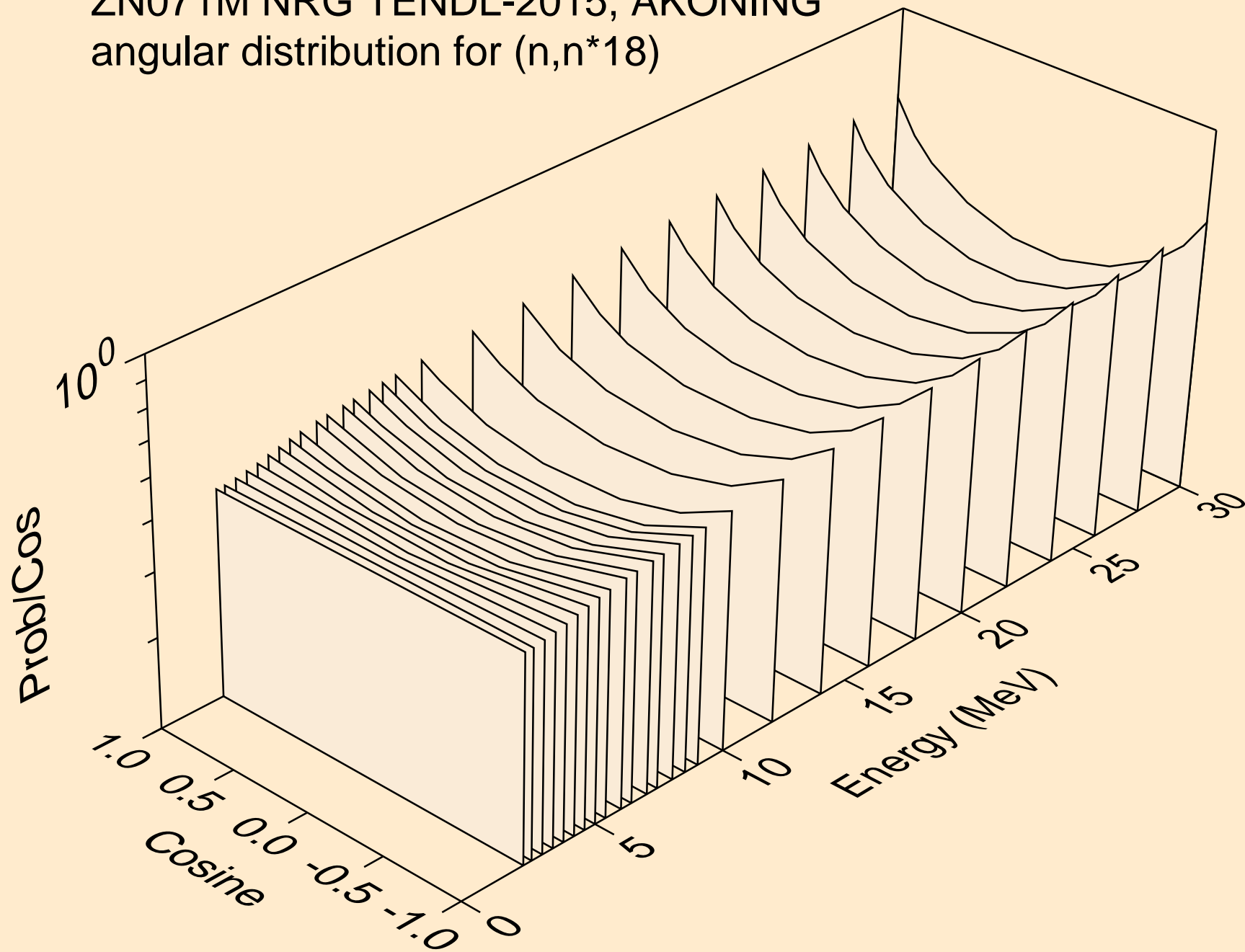

ZN071M NRG TENDL-2015, AKONING
angular distribution for (n,n*19)

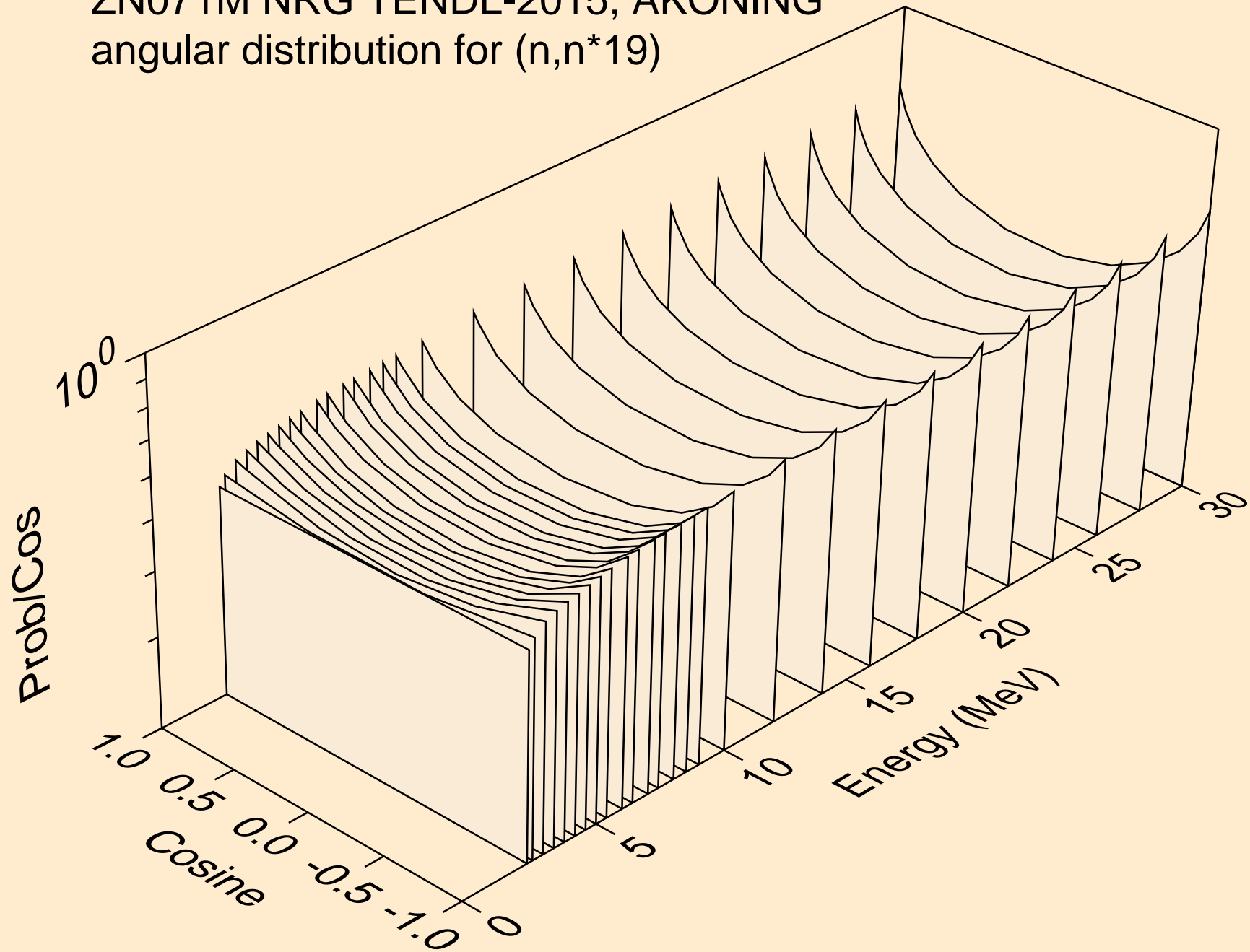

ZN071M NRG TENDL-2015, AKONING
angular distribution for (n,n*20)

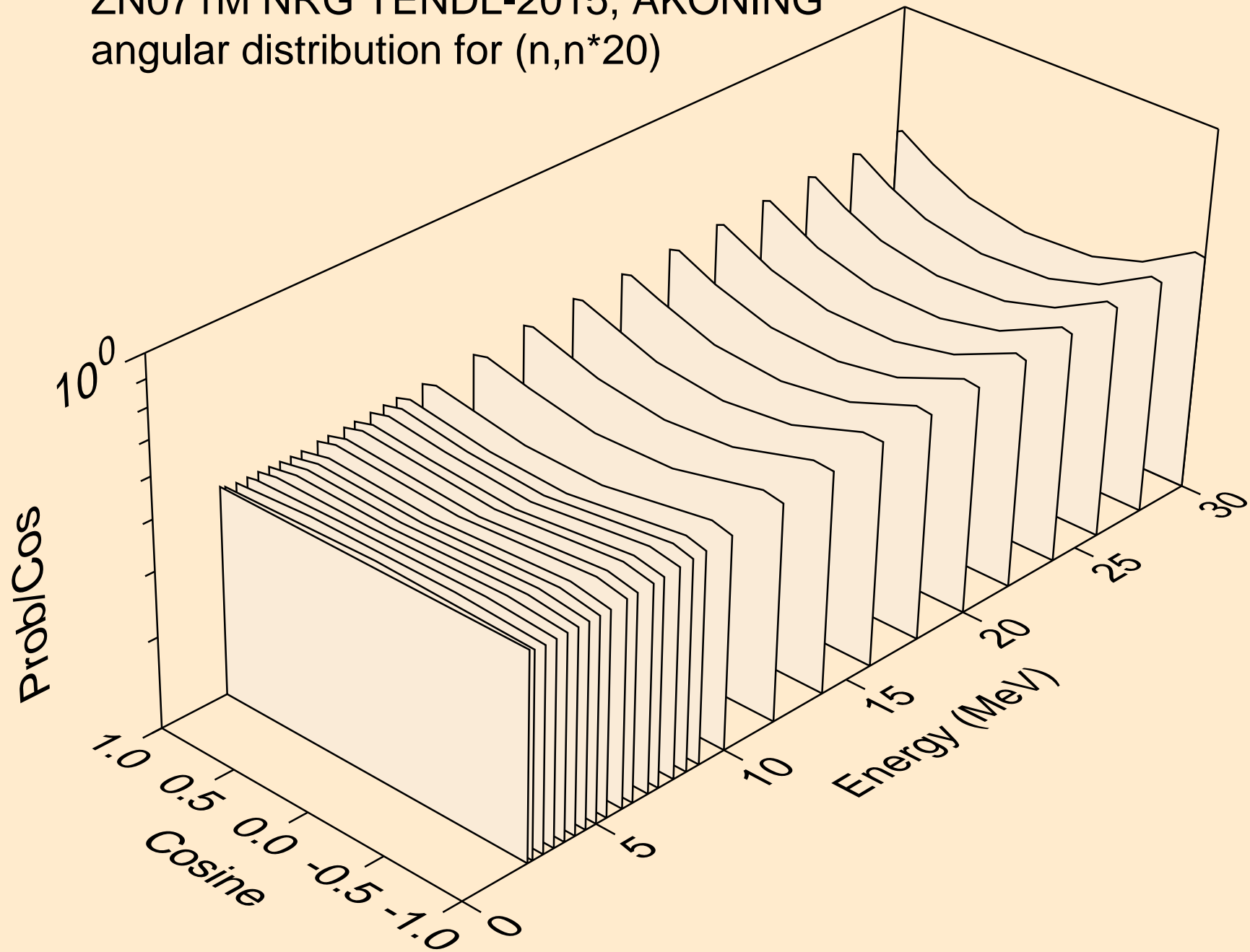

ZN071M NRG TENDL-2015, AKONING
angular distribution for (n,n*21)

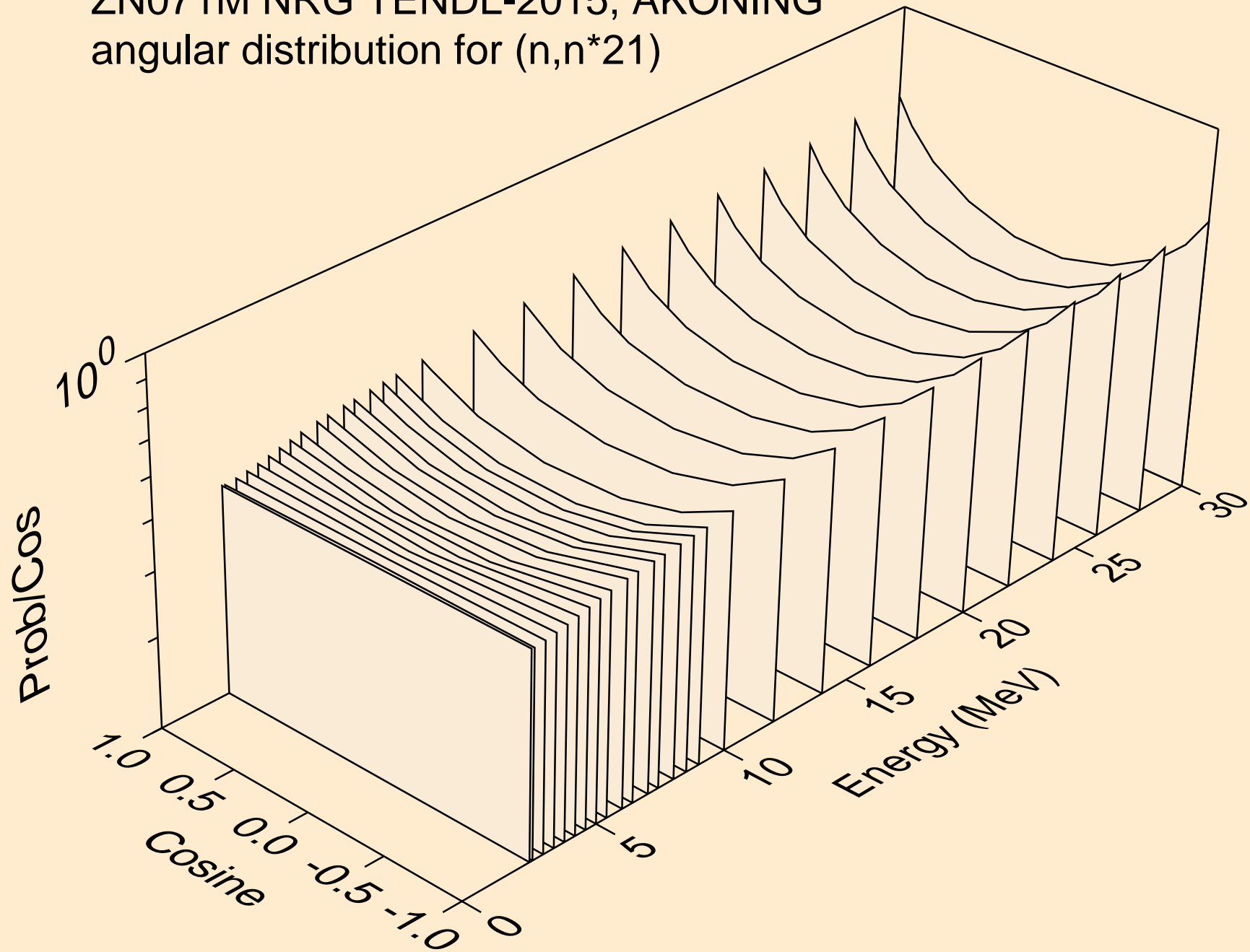

ZN071M NRG TENDL-2015, AKONING
angular distribution for (n,n*22)

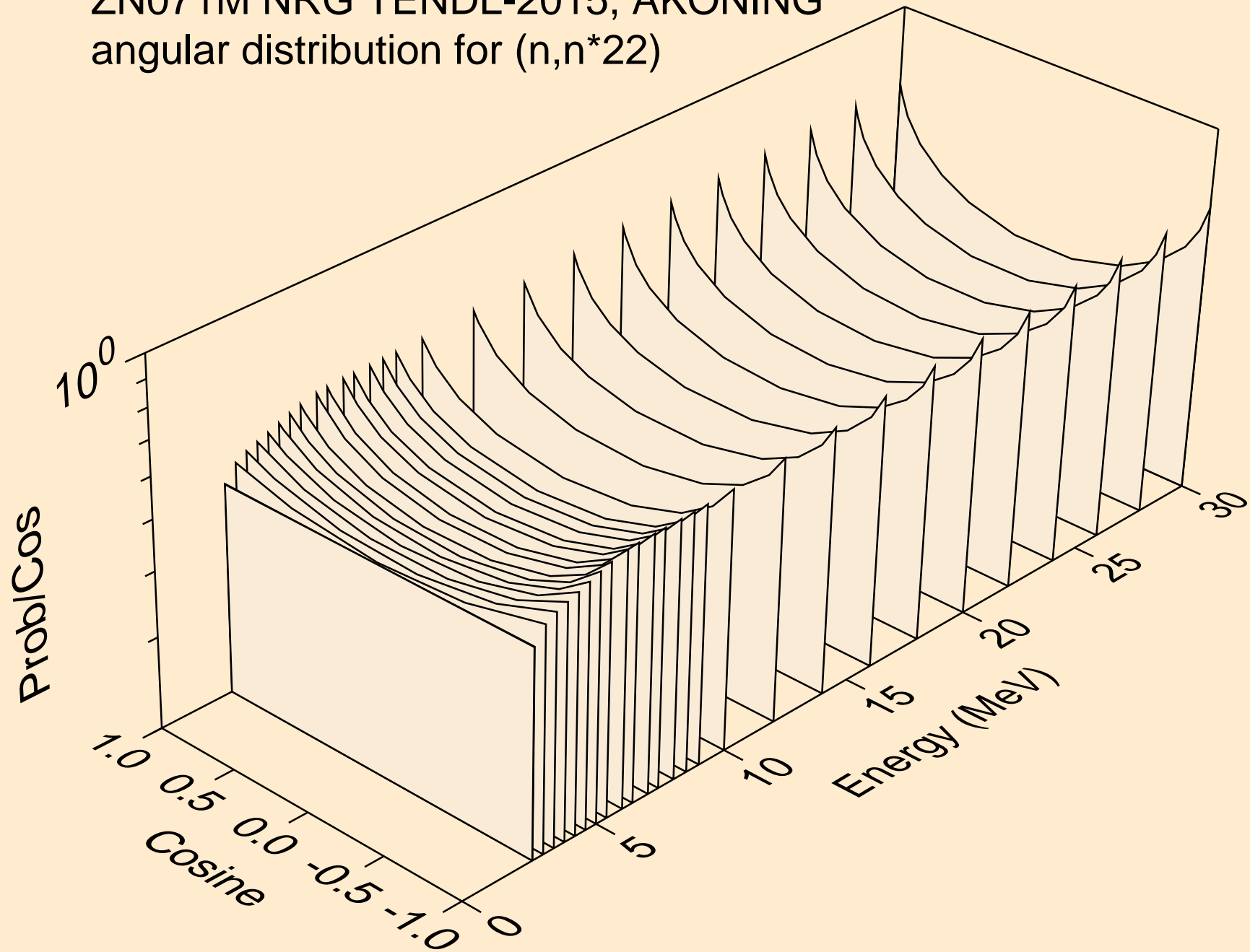

ZN071M NRG TENDL-2015, AKONING
angular distribution for (n,n*23)

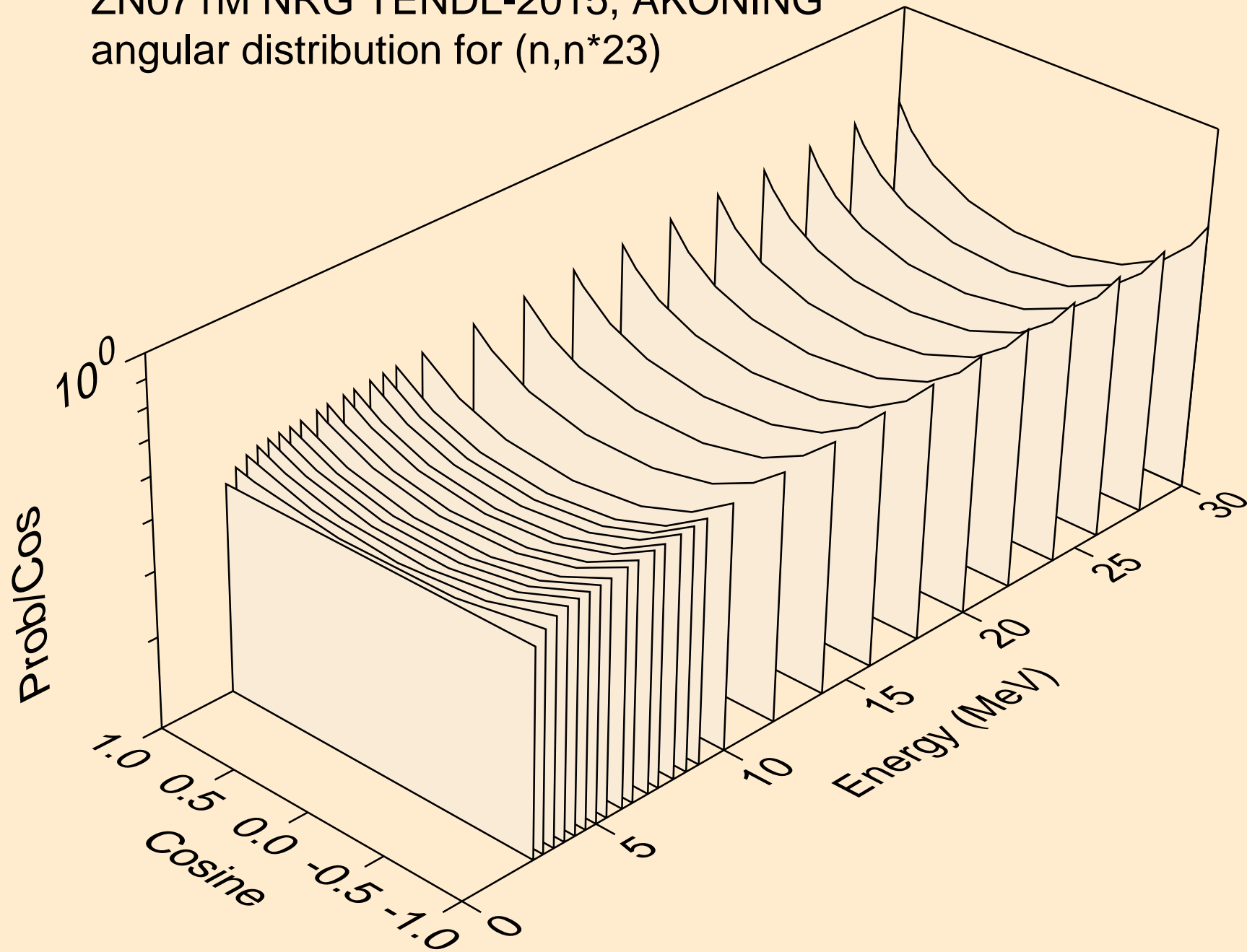

ZN071M NRG TENDL-2015, AKONING
angular distribution for (n,n*24)

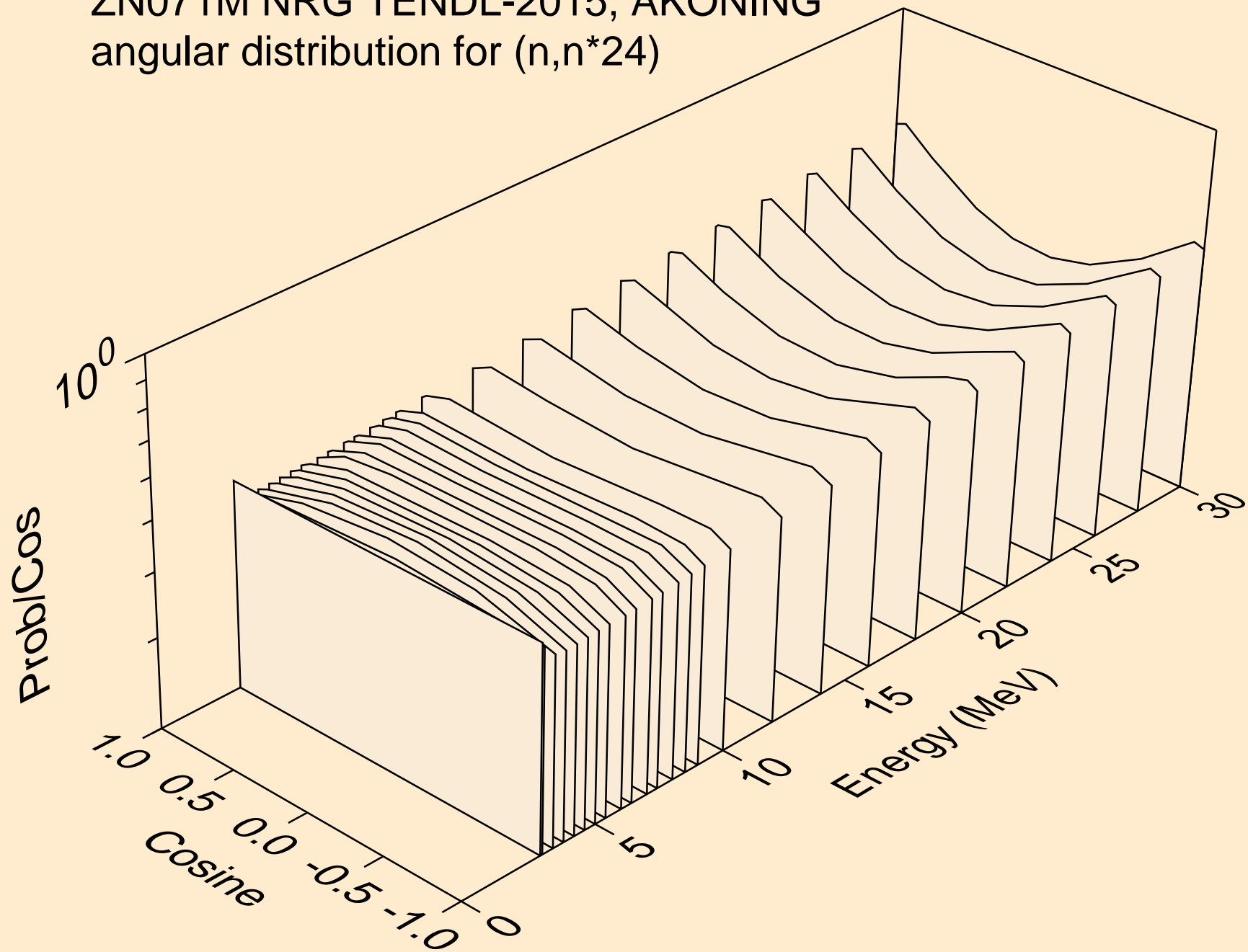

ZN071M NRG TENDL-2015, AKONING
angular distribution for (n,n*25)

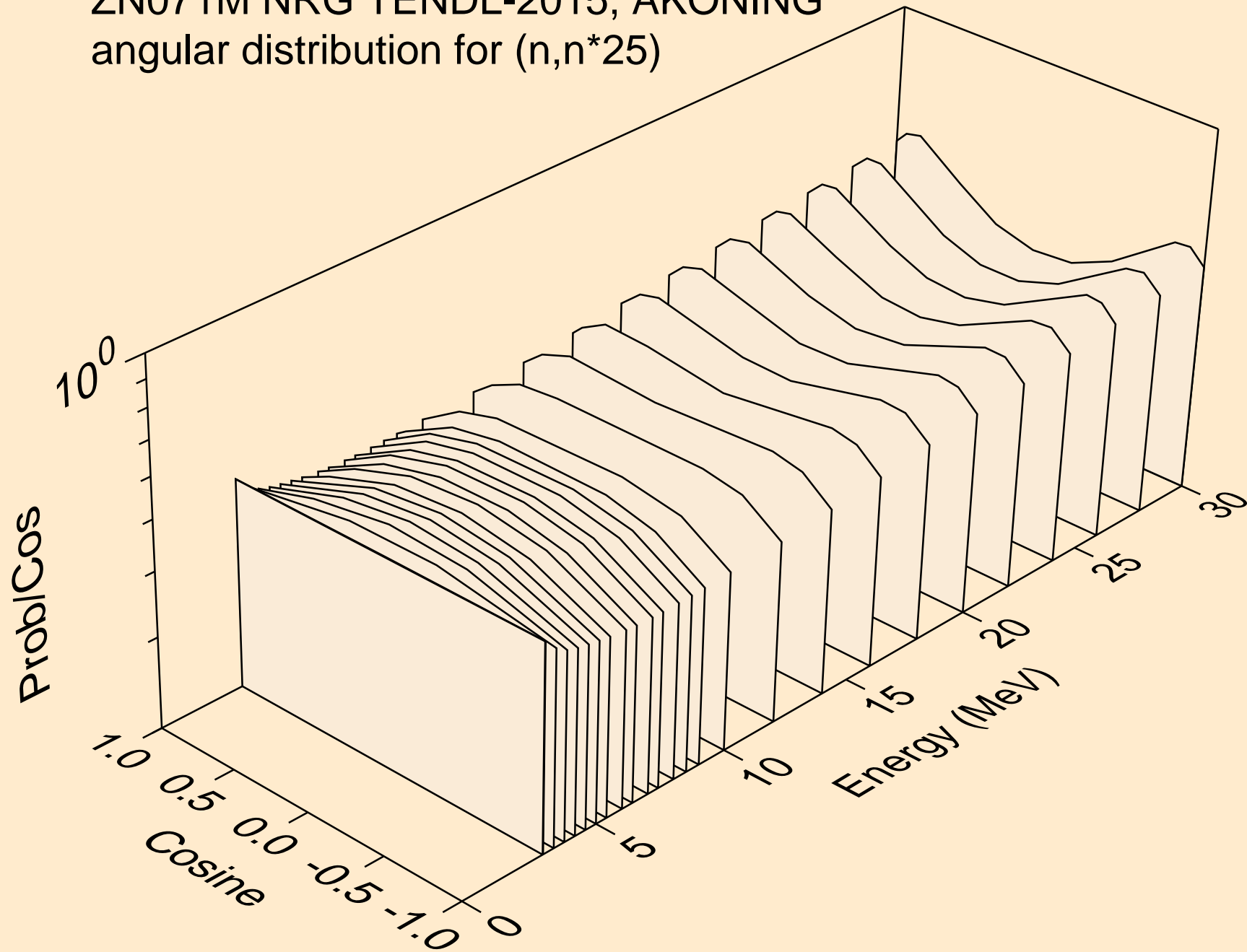

ZN071M NRG TENDL-2015, AKONING
angular distribution for (n,n*26)

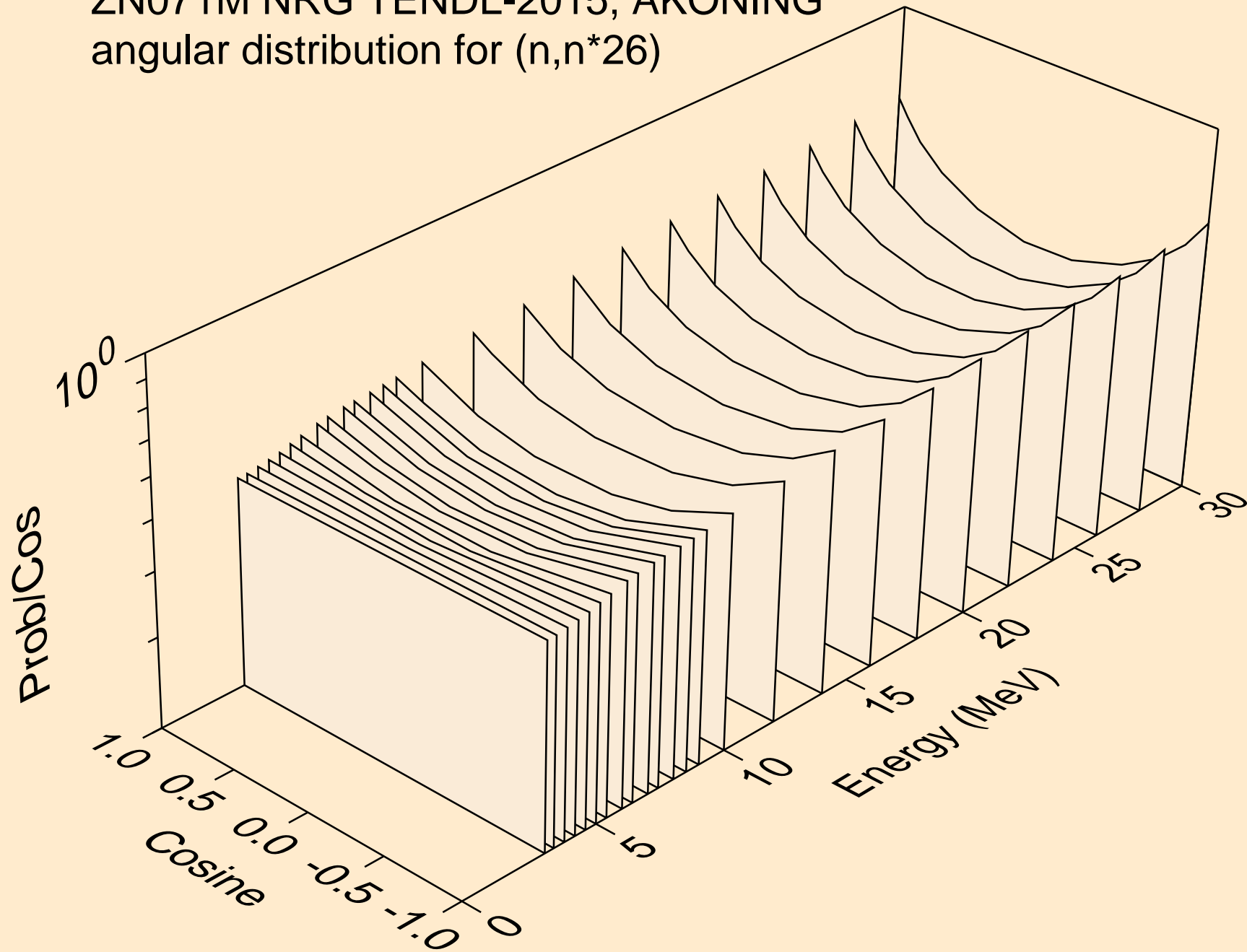

ZN071M NRG TENDL-2015, AKONING
Neutron emission for (n,x)

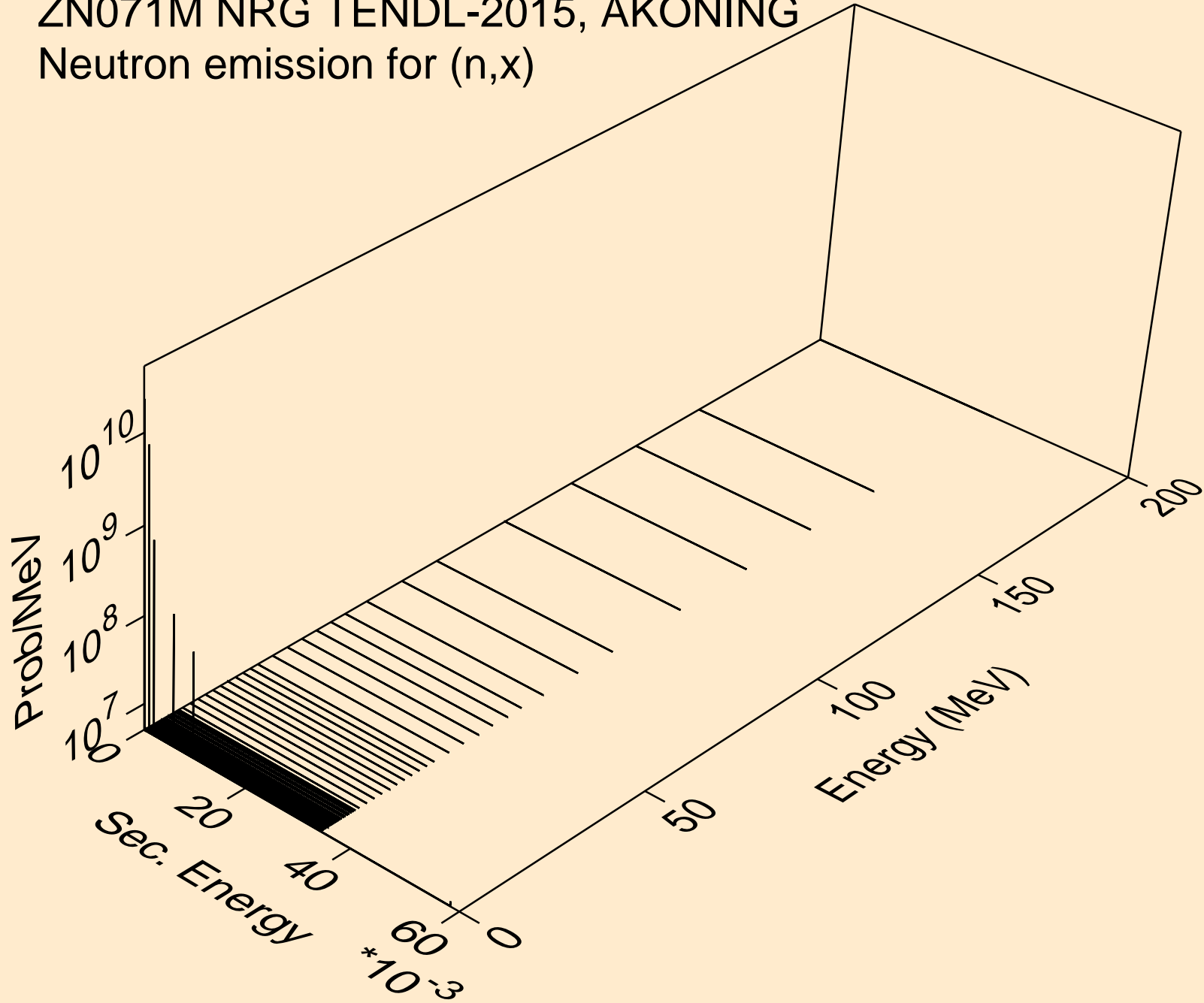

ZN071M NRG TENDL-2015, AKONING
Neutron emission for (n,2nd)

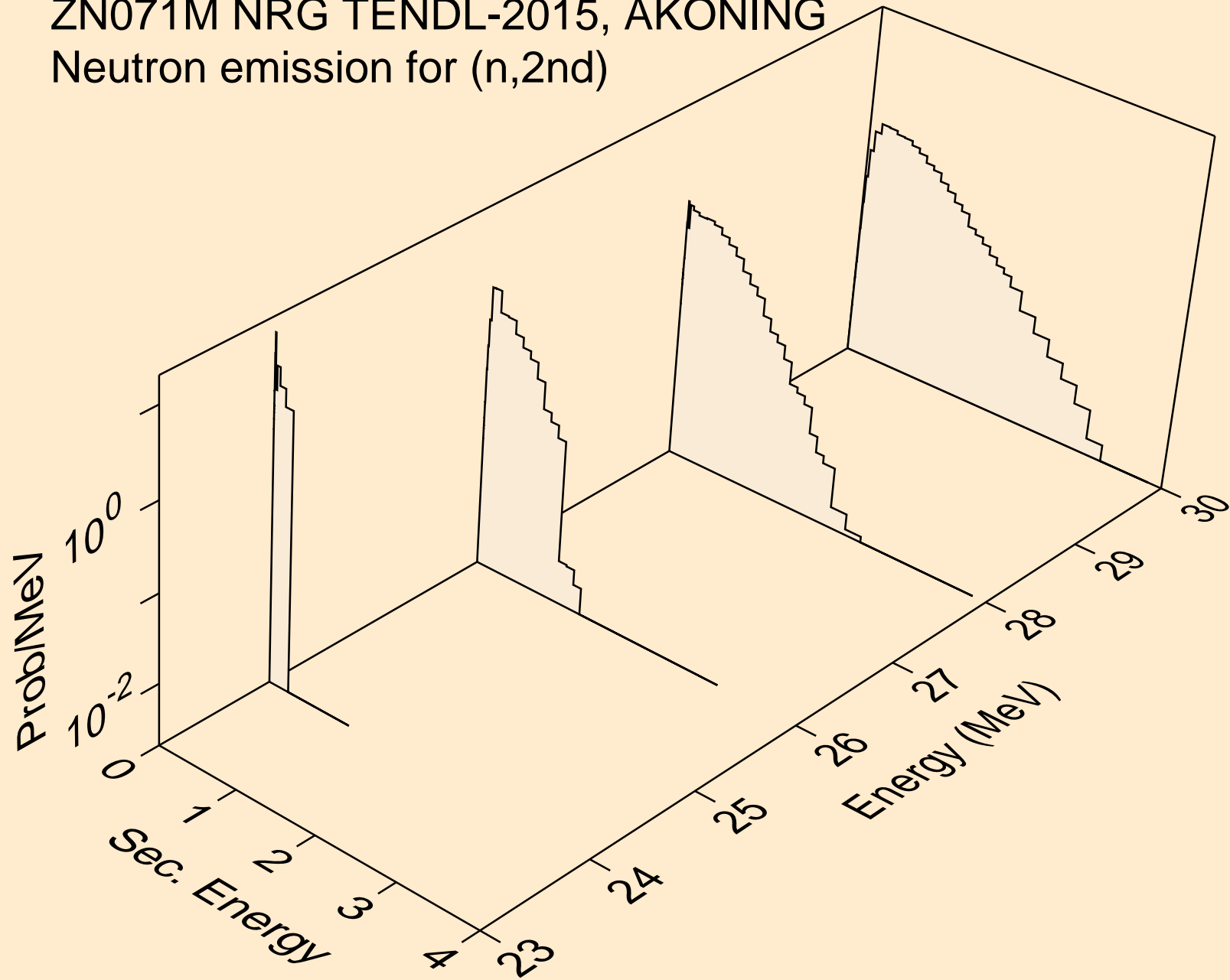

ZN071M NRG TENDL-2015, AKONING
Neutron emission for (n,2n)

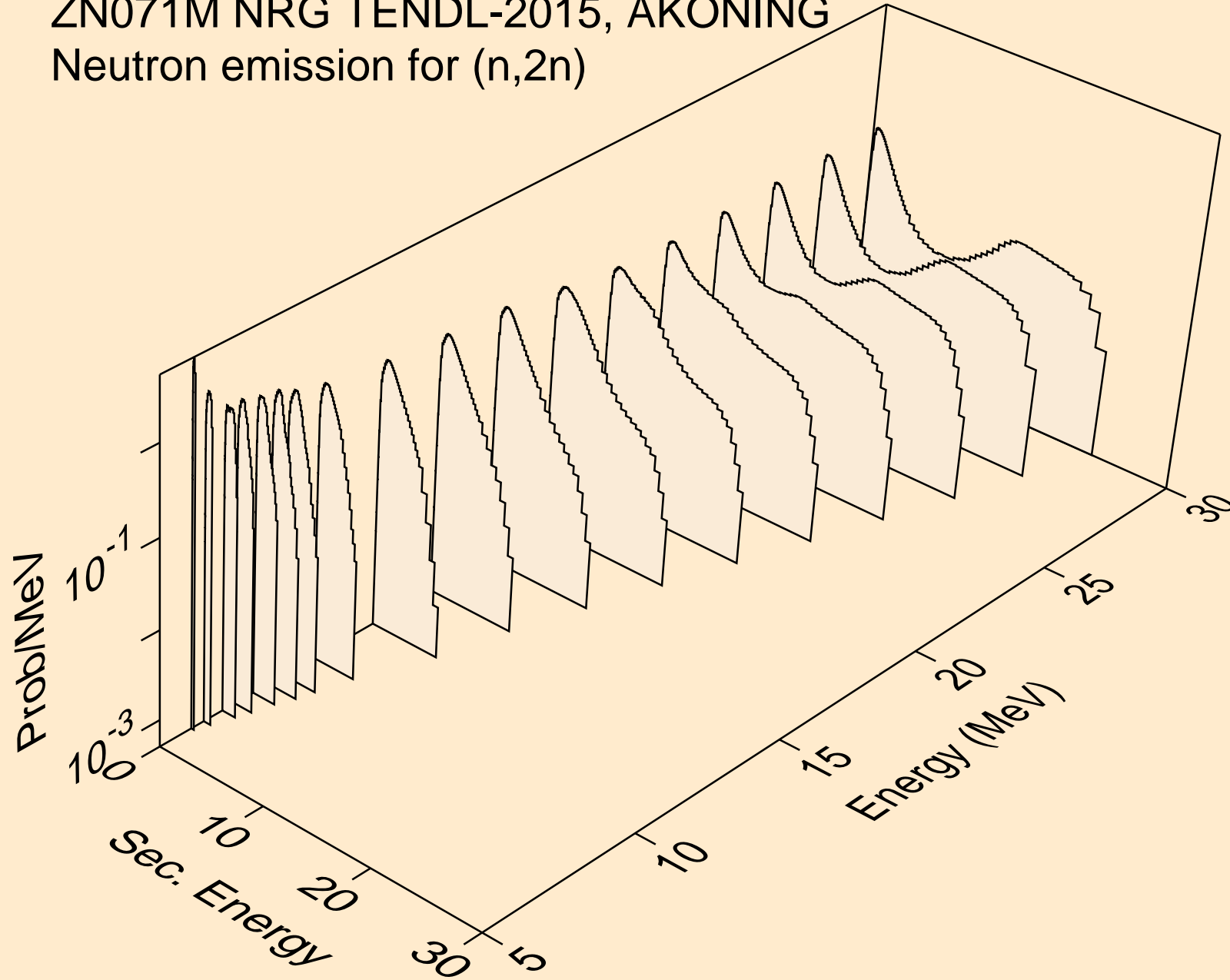

ZN071M NRG TENDL-2015, AKONING
Neutron emission for (n,3n)

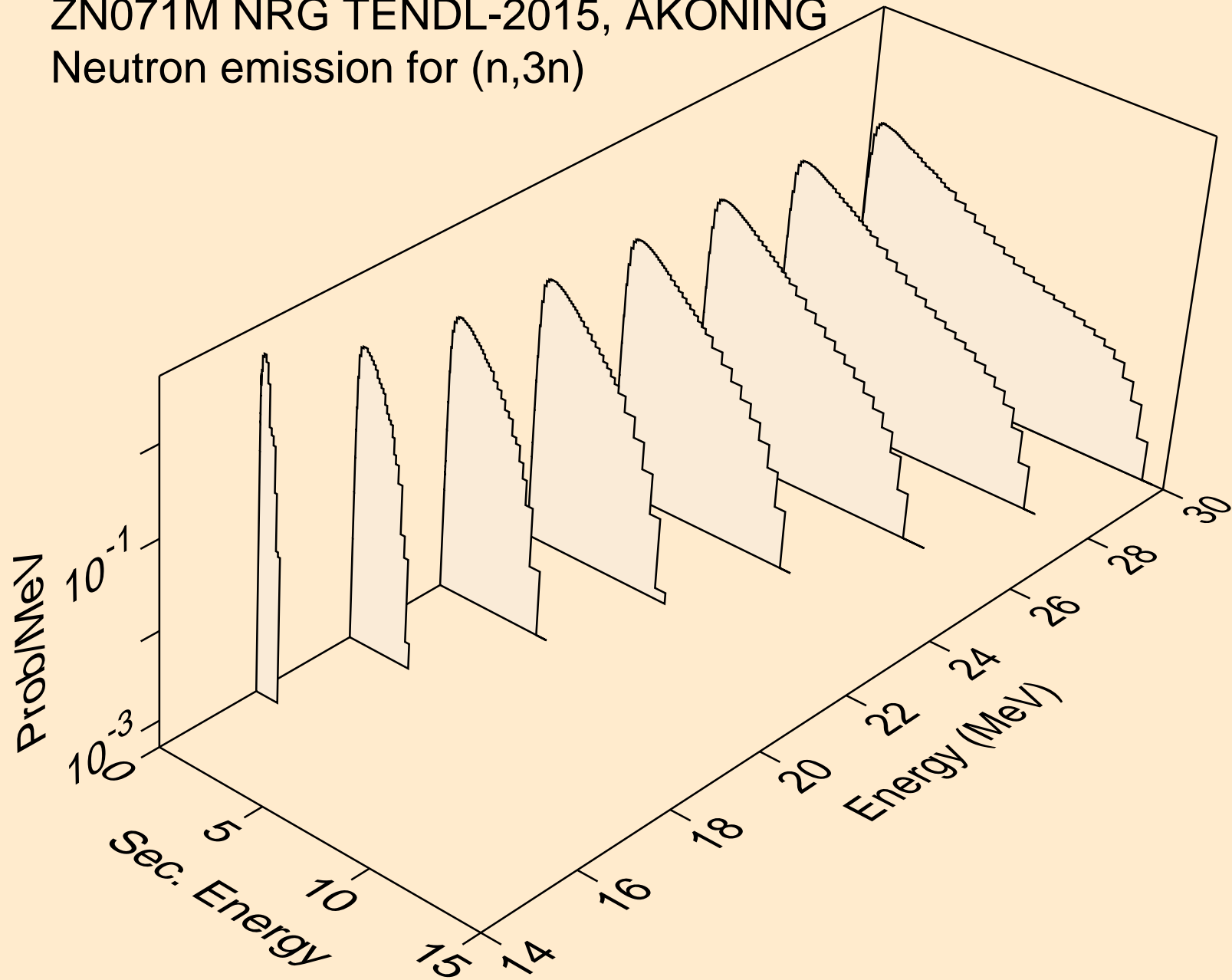

ZN071M NRG TENDL-2015, AKONING
Neutron emission for (n,n*)a

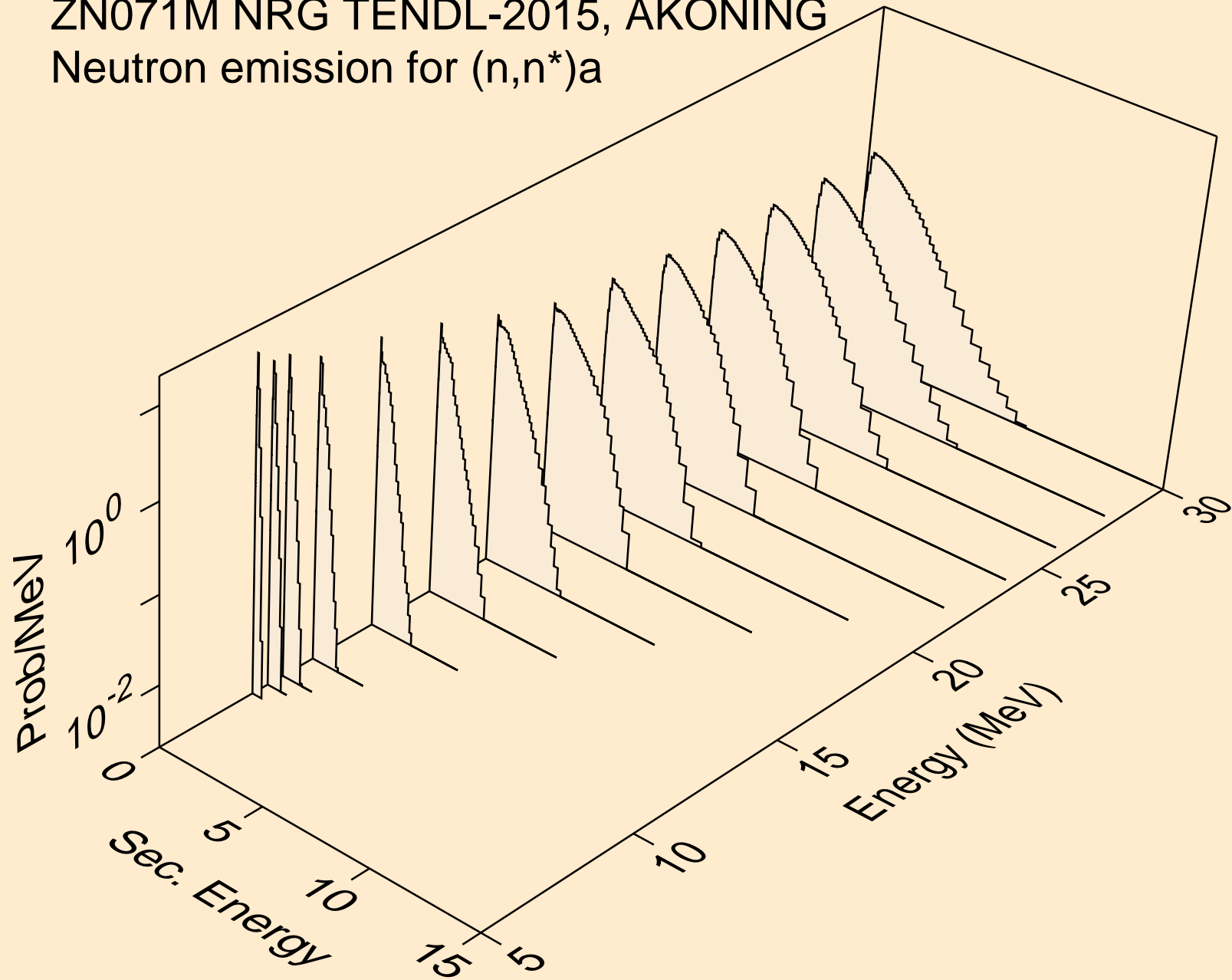

ZN071M NRG TENDL-2015, AKONING
Neutron emission for (n,2n)a

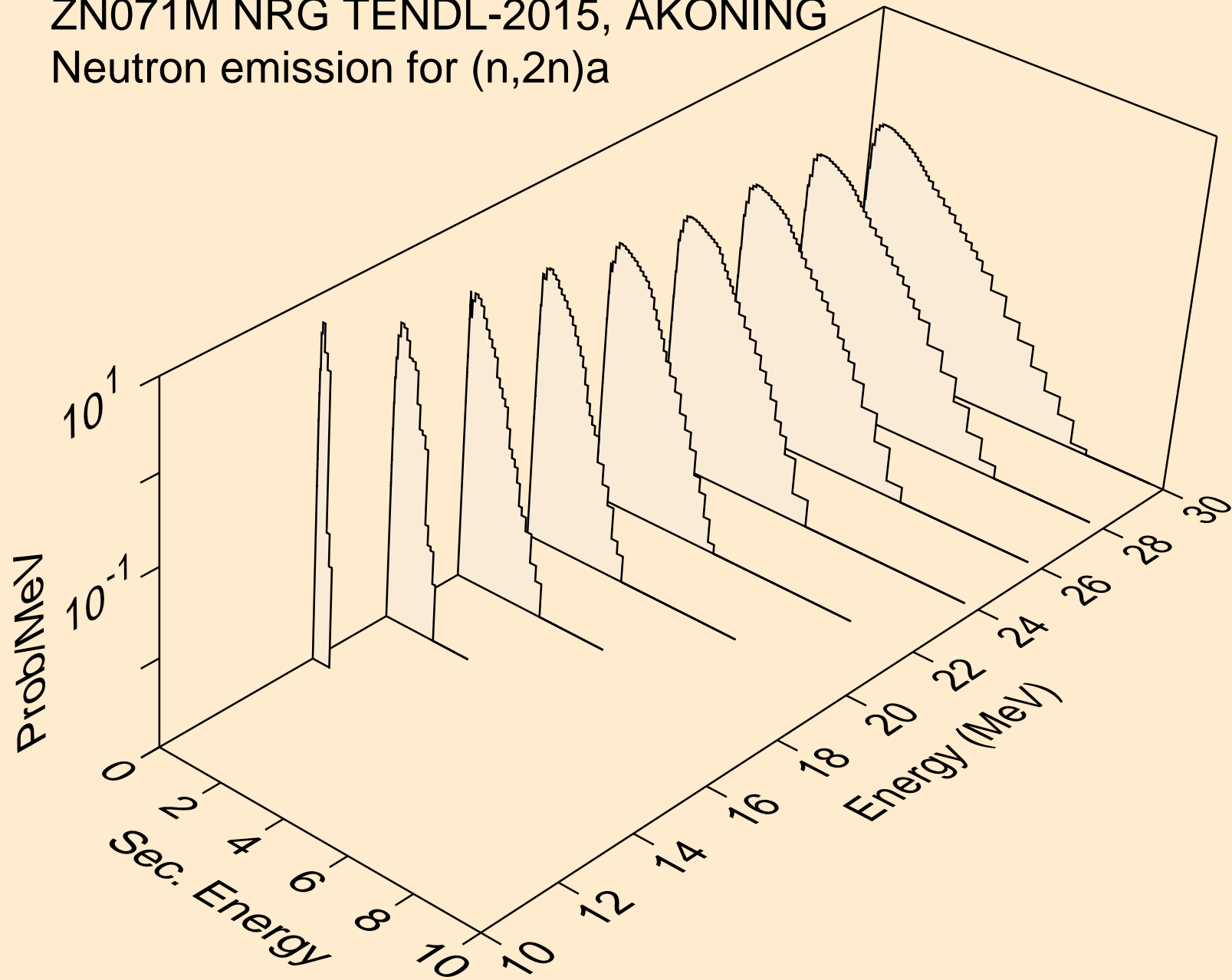

ZN071M NRG TENDL-2015, AKONING
Neutron emission for (n,3n)a

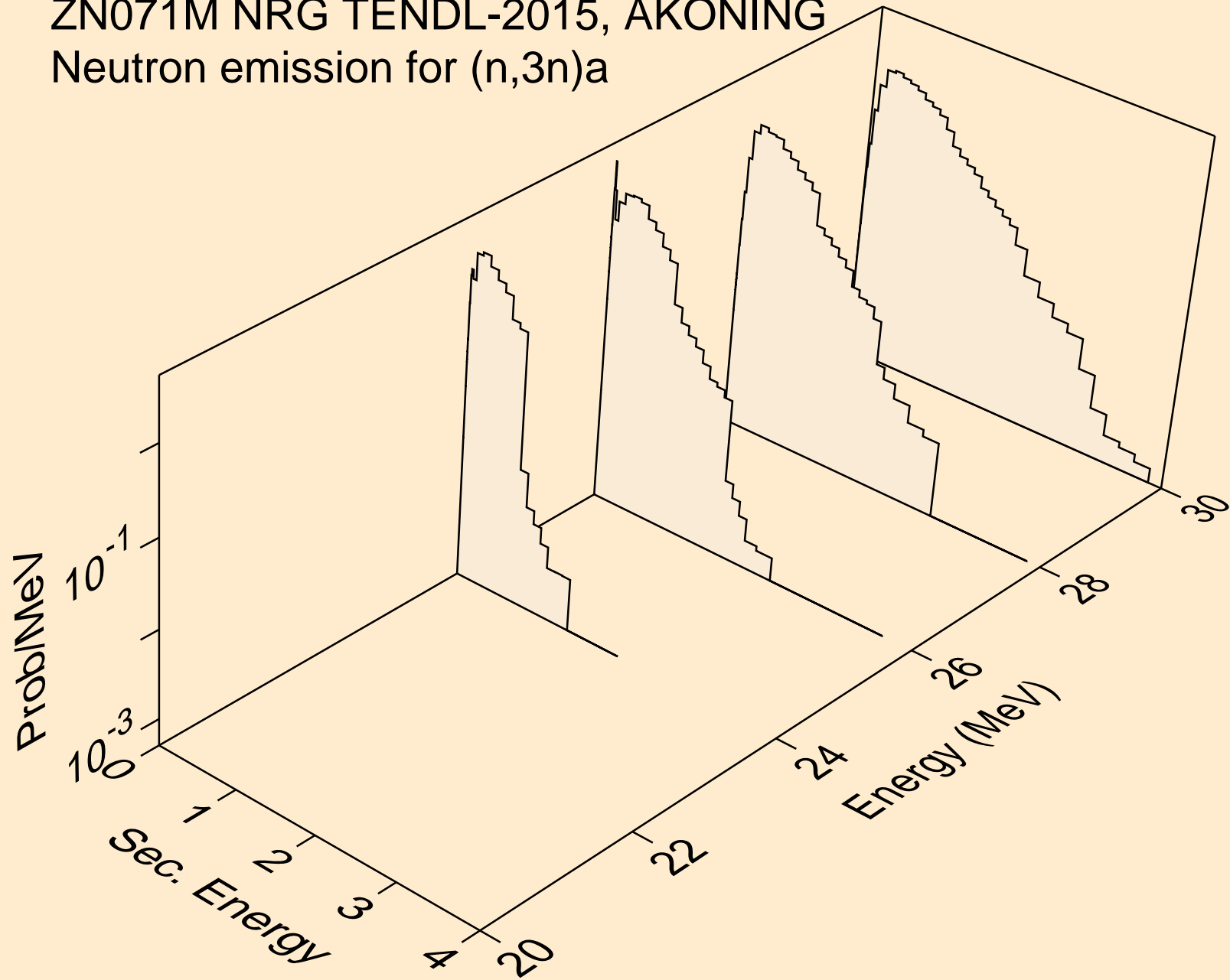

ZN071M NRG TENDL-2015, AKONING
Neutron emission for (n,n*)p

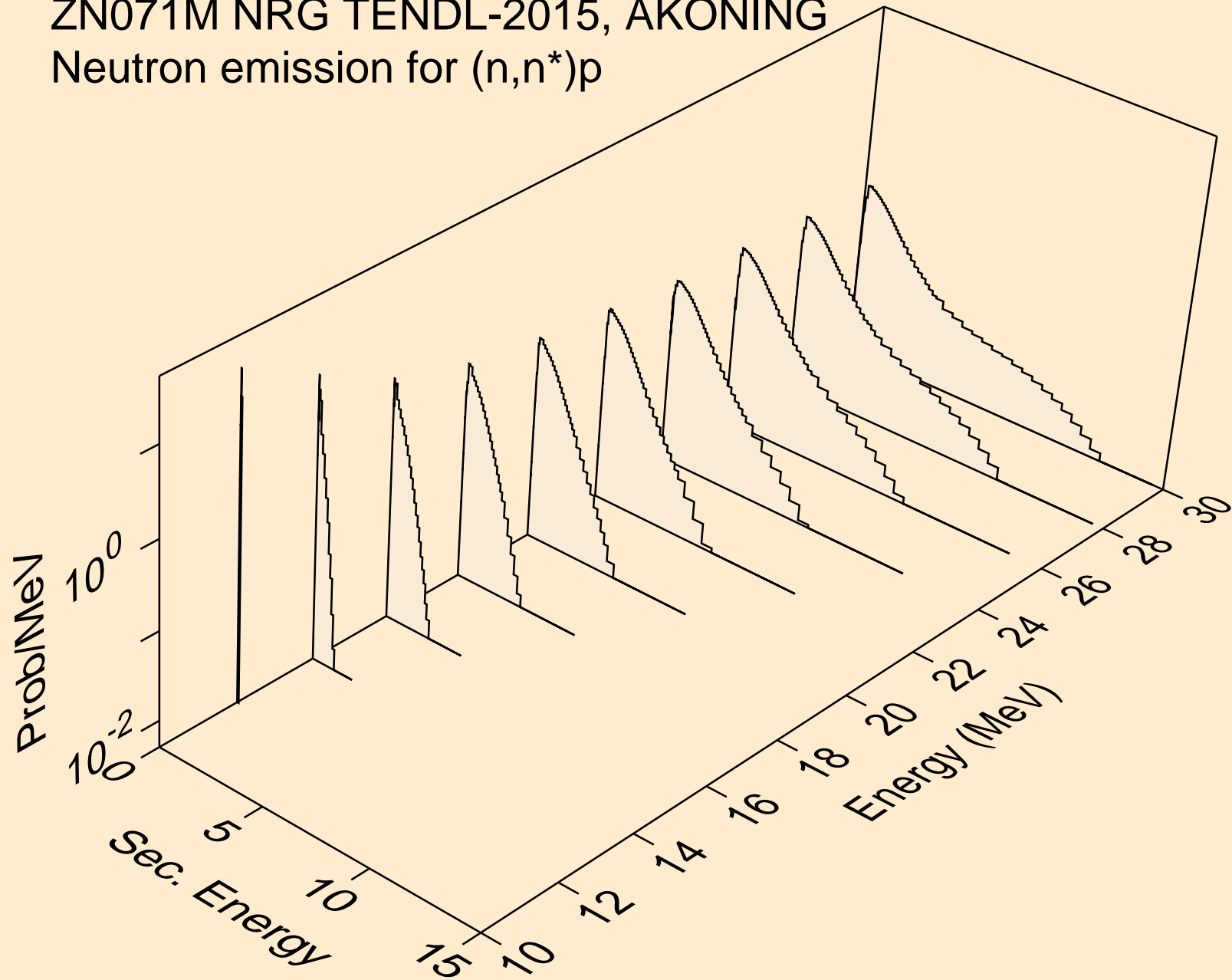

ZN071M NRG TENDL-2015, AKONING
Neutron emission for (n,n*)d

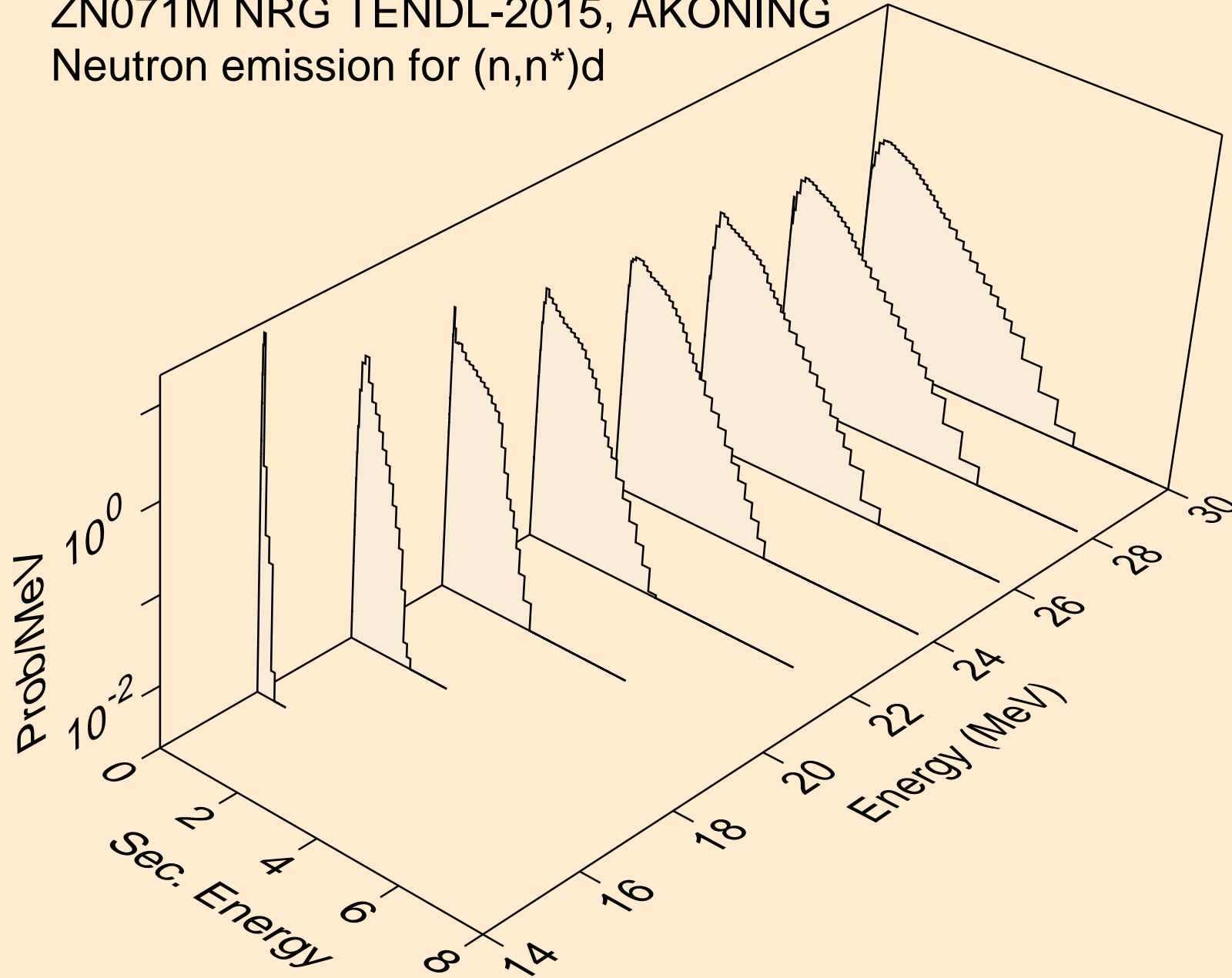

ZN071M NRG TENDL-2015, AKONING
Neutron emission for (n,n*)t

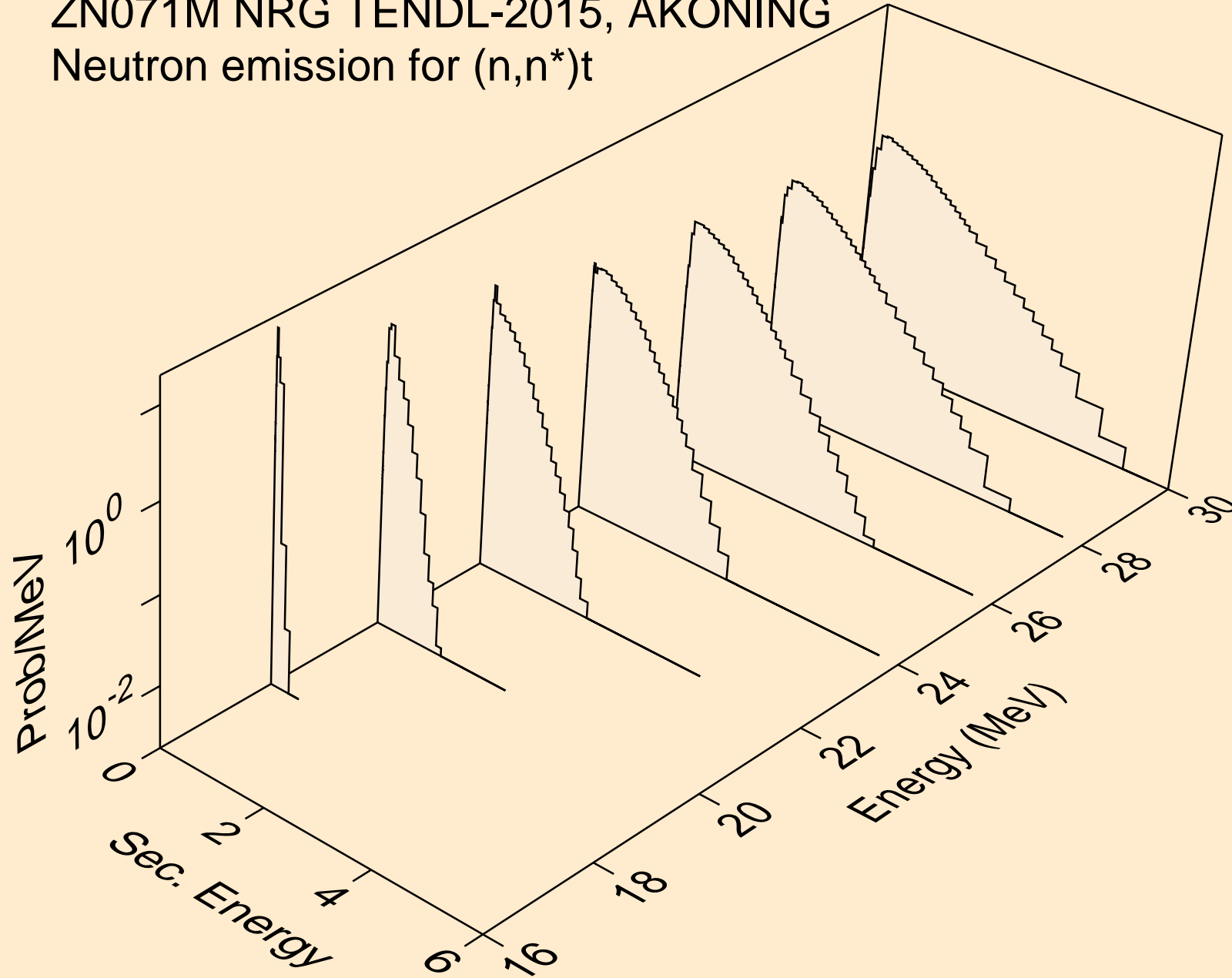

ZN071M NRG TENDL-2015, AKONING
Neutron emission for (n,n*)he3

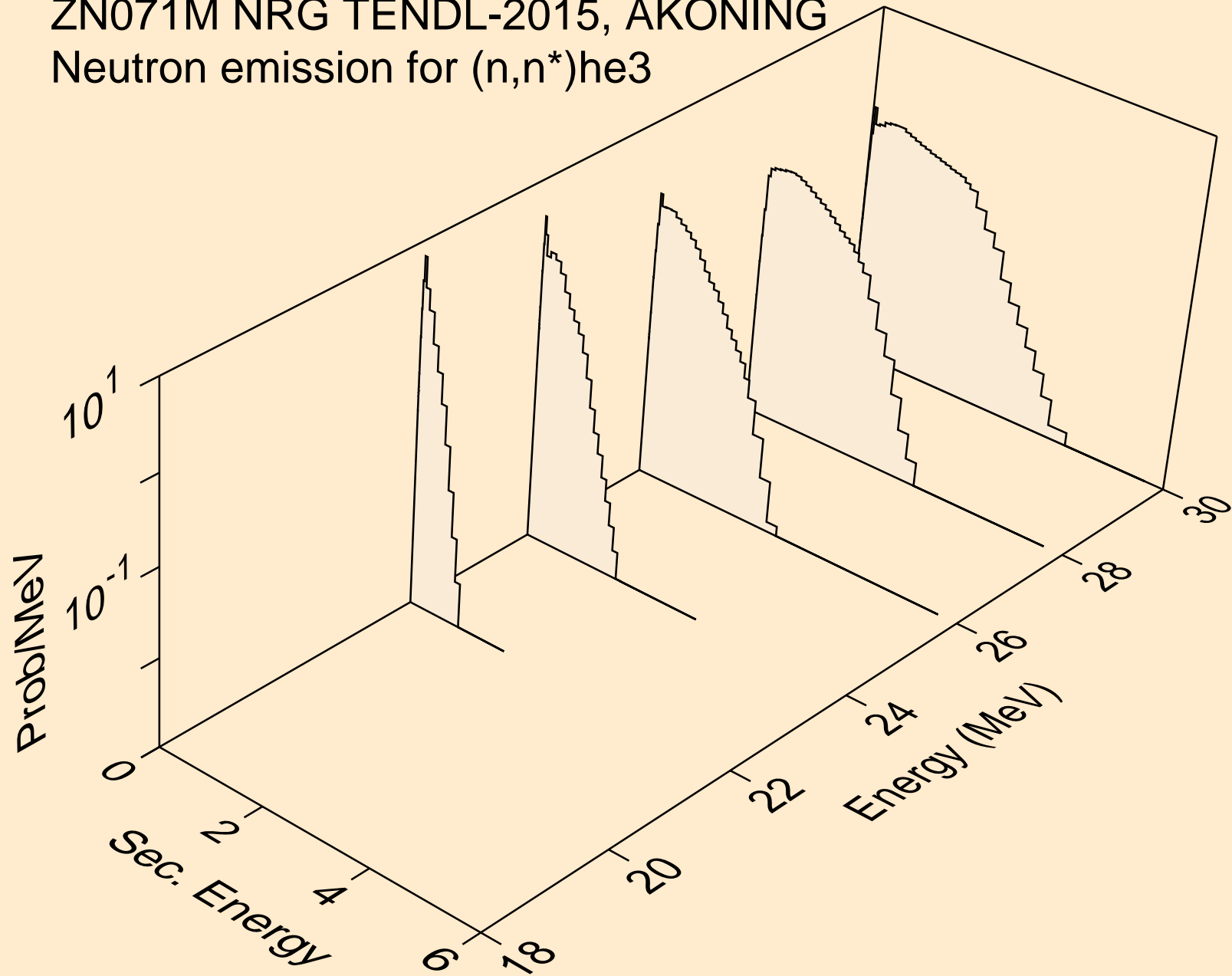

ZN071M NRG TENDL-2015, AKONING
Neutron emission for (n,4n)

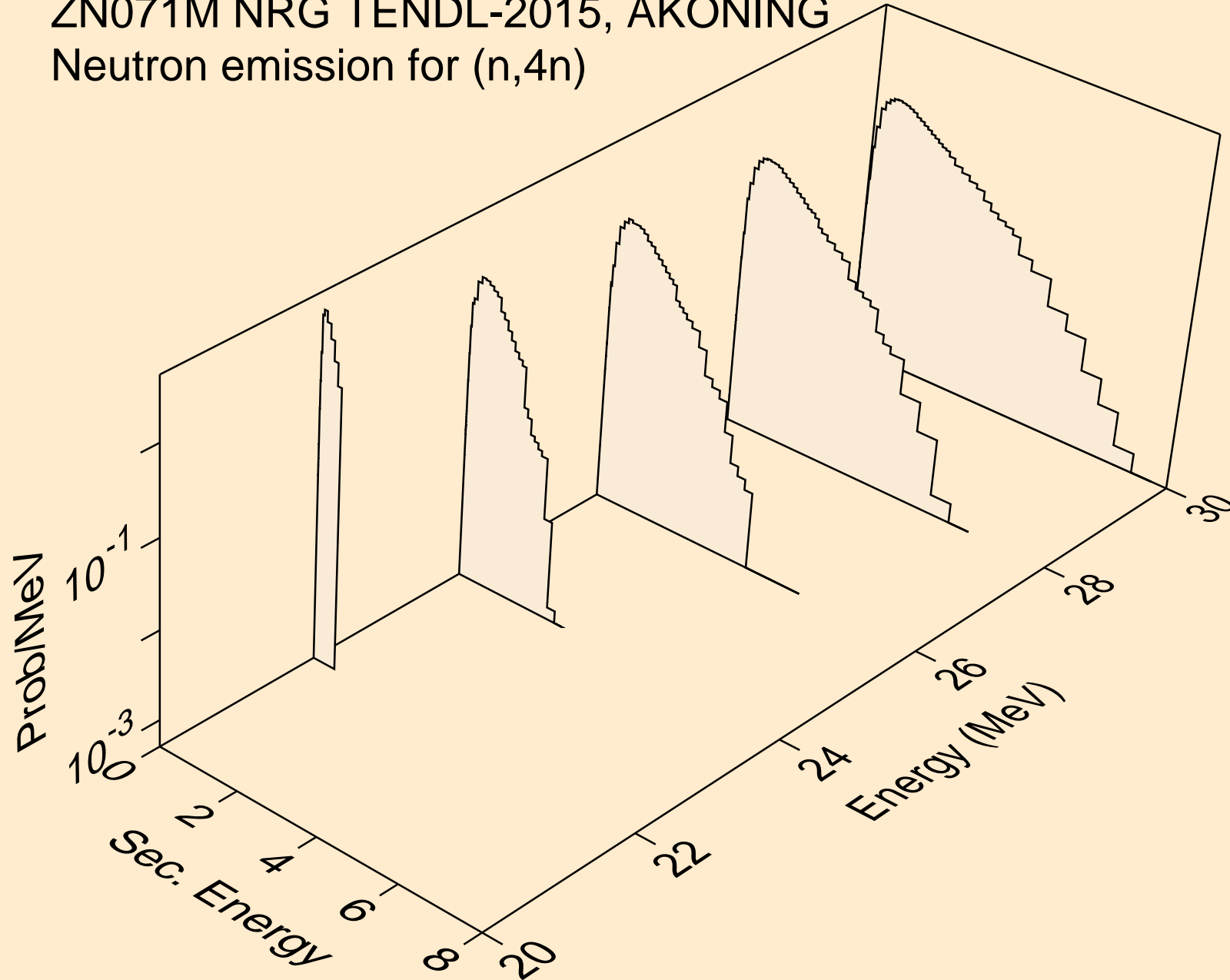

ZN071M NRG TENDL-2015, AKONING
Neutron emission for (n,2np)

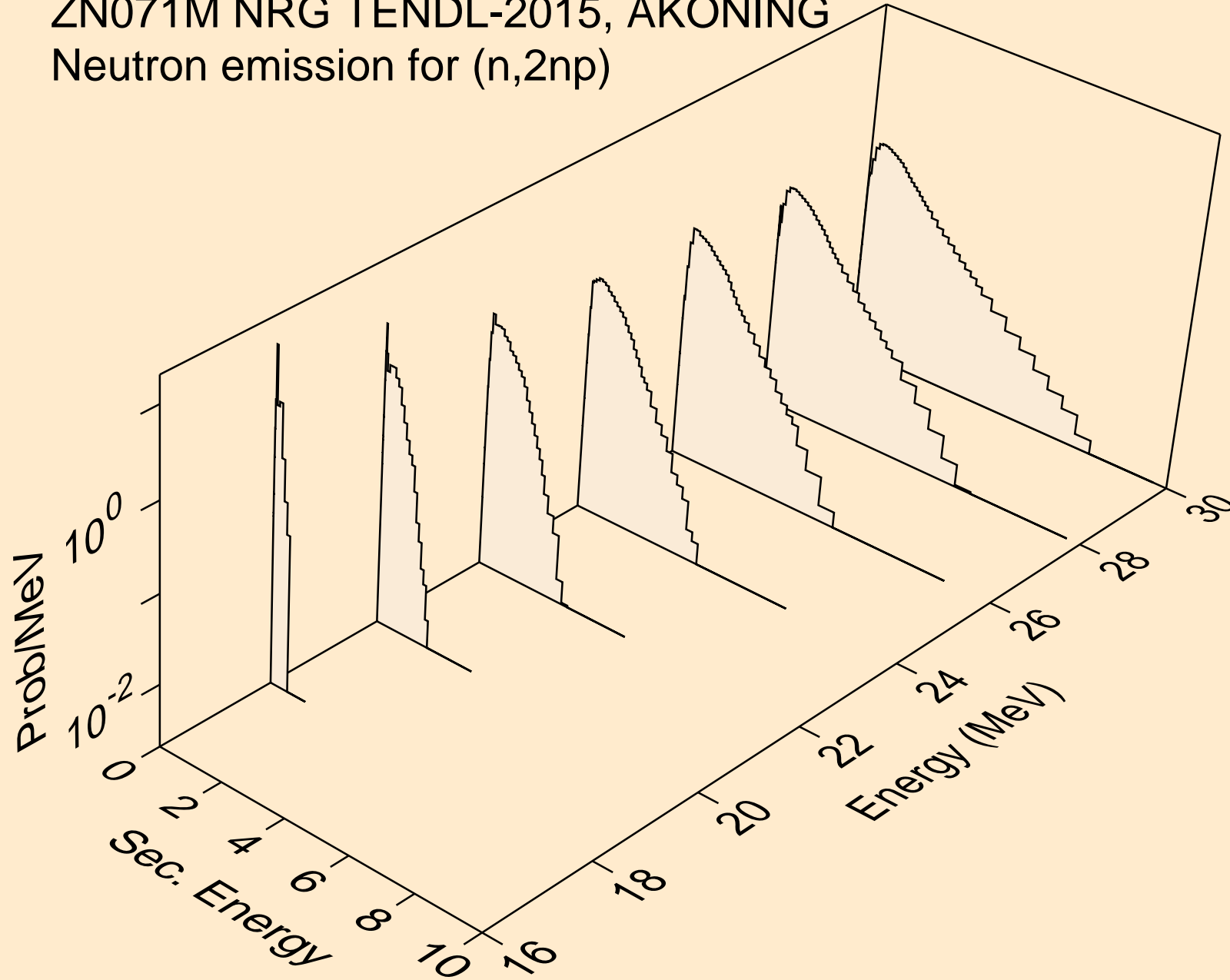

ZN071M NRG TENDL-2015, AKONING
Neutron emission for (n,3np)

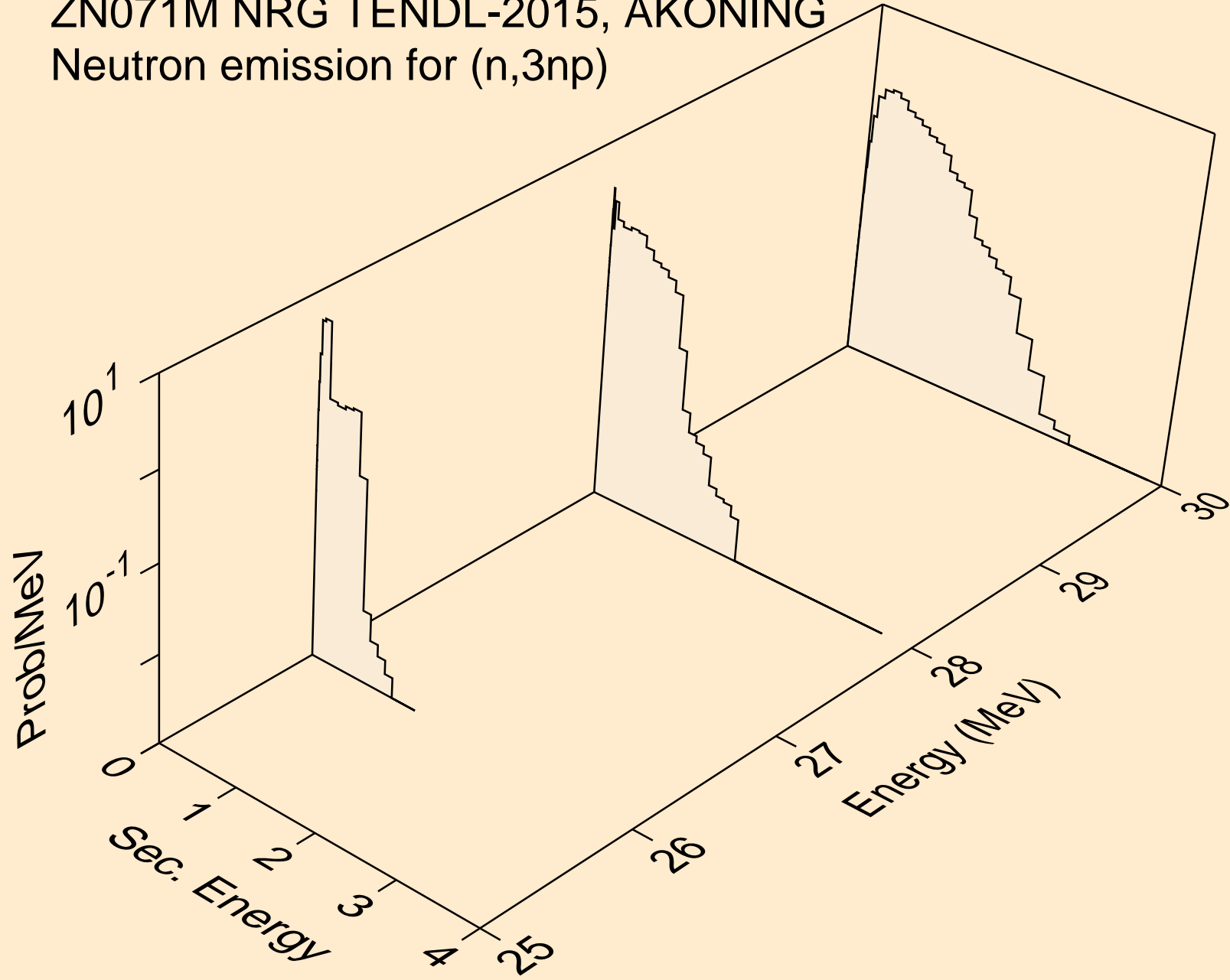

ZN071M NRG TENDL-2015, AKONING
Neutron emission for (n,2np)

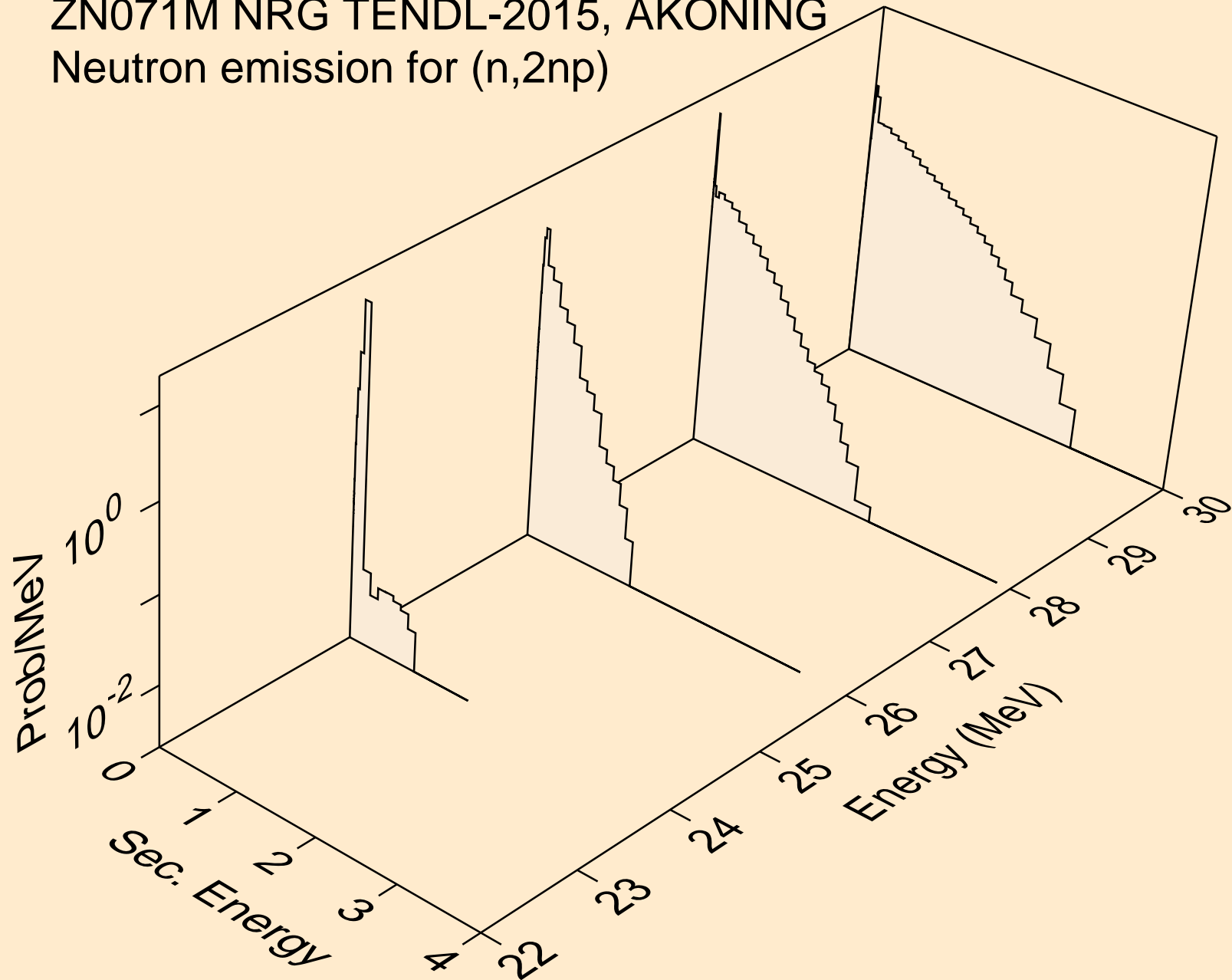

ZN071M NRG TENDL-2015, AKONING
Neutron emission for (n,n*c)

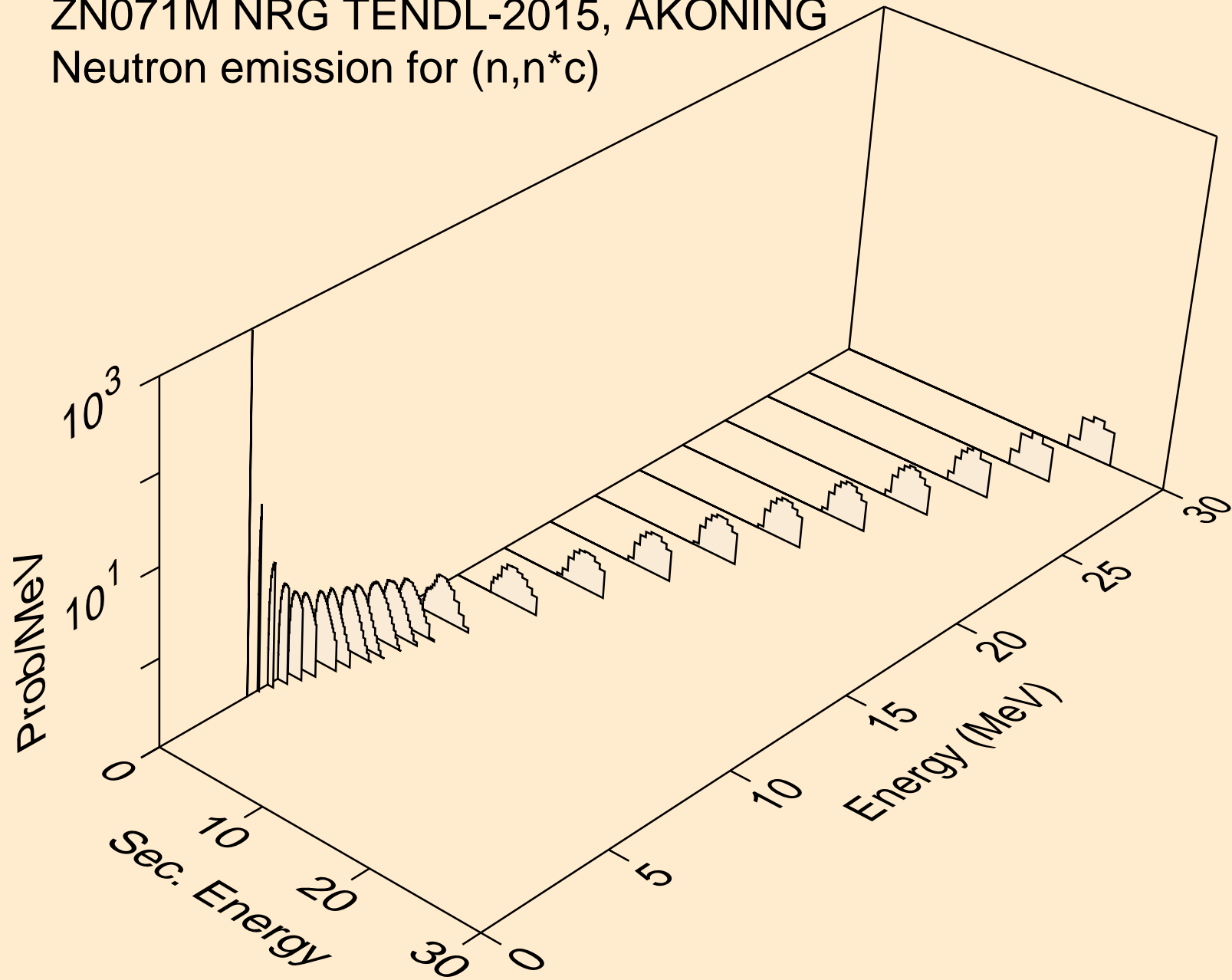

ZN071M NRG TENDL-2015, AKONING
Photon emission for (n,x)

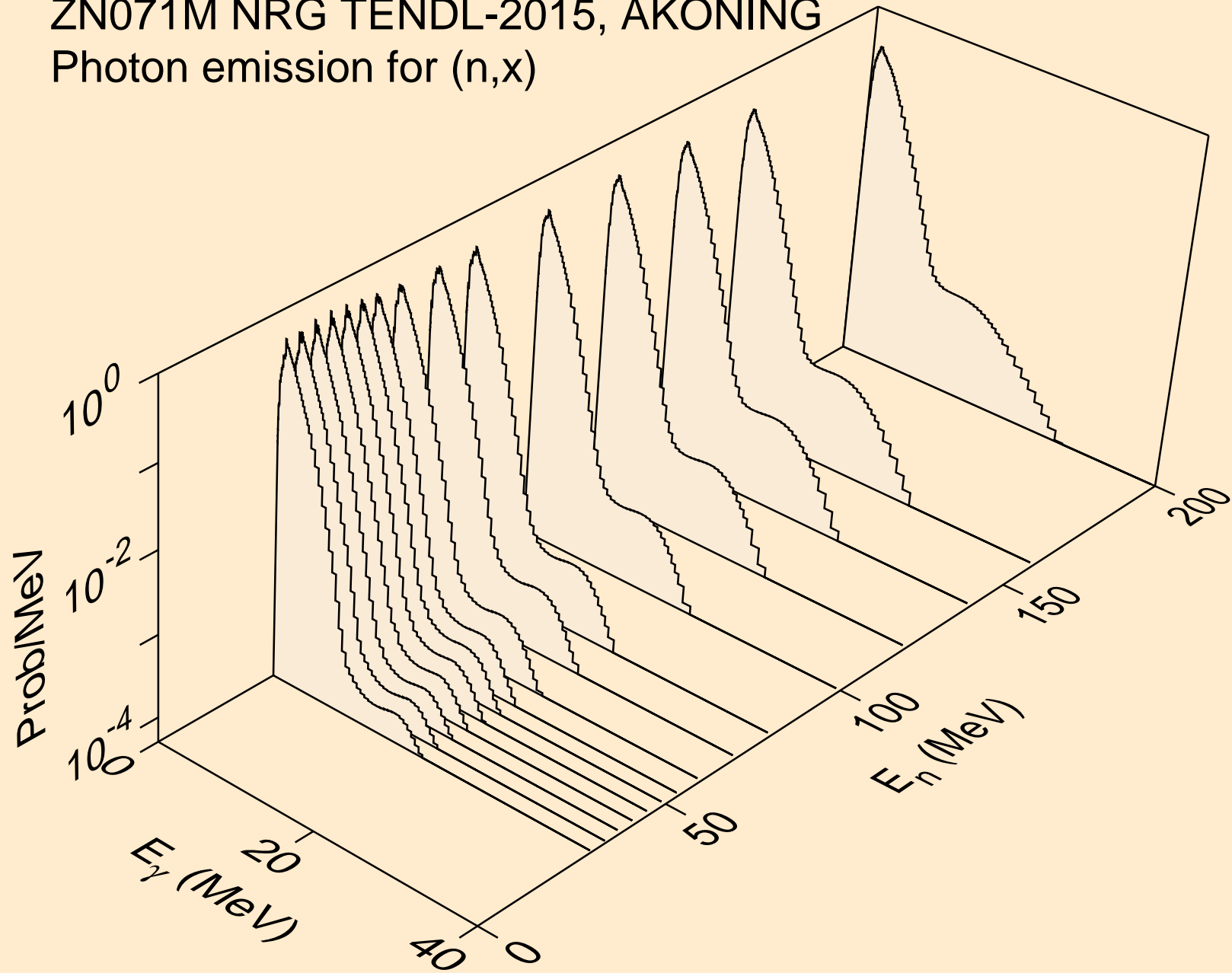

ZN071M NRG TENDL-2015, AKONING
Photon emission for (n,2nd)

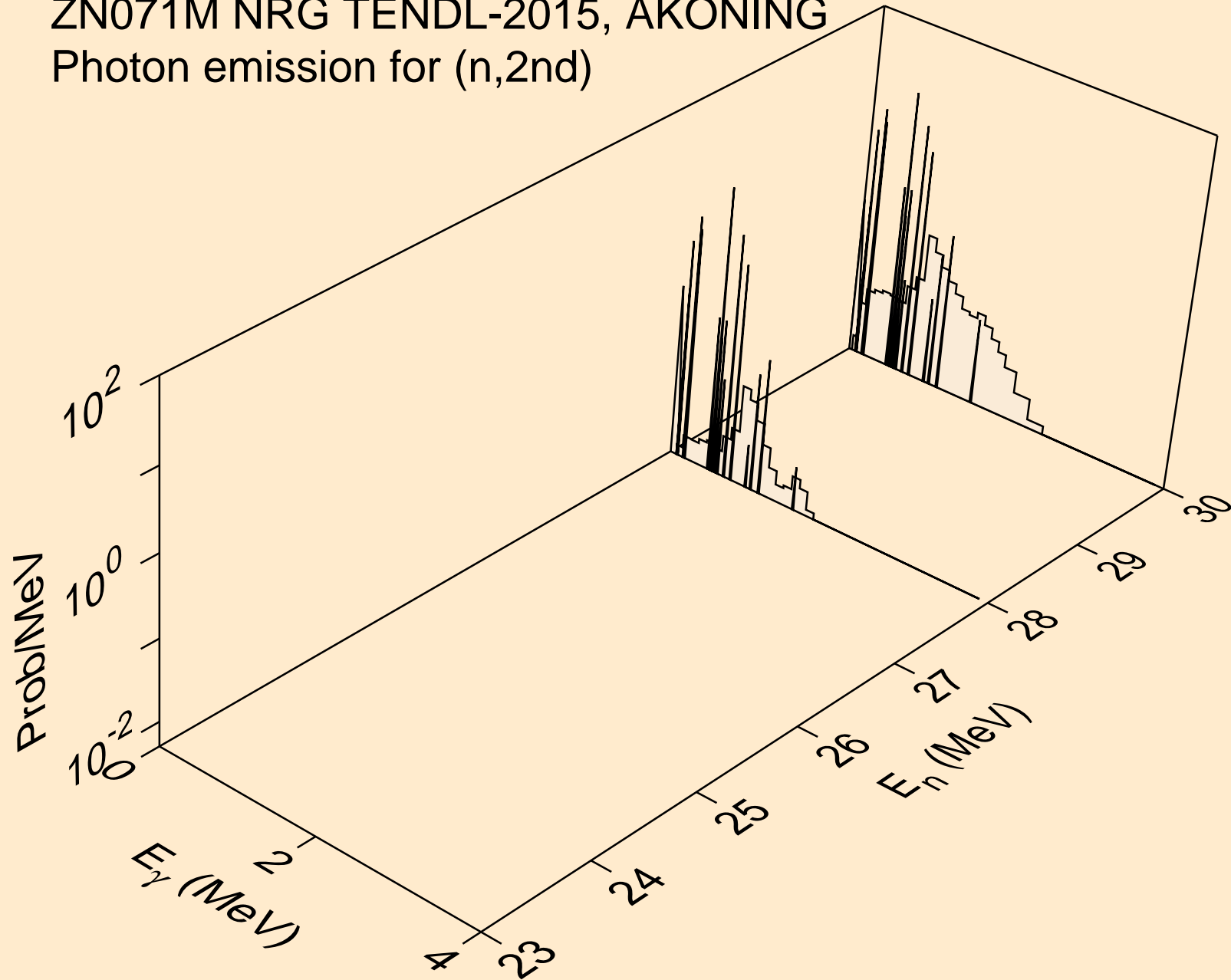

ZN071M NRG TENDL-2015, AKONING
Photon emission for (n,2n)

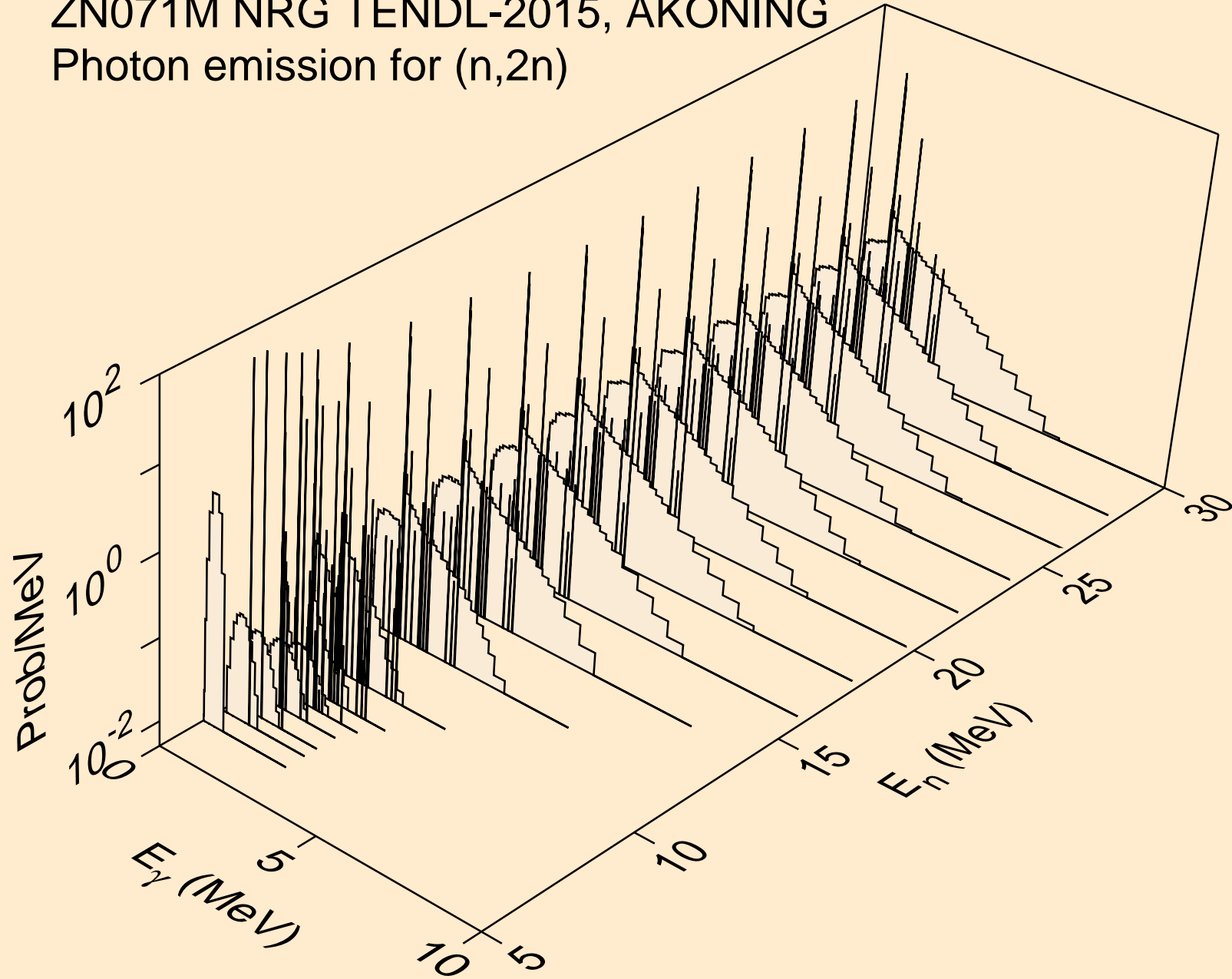

ZN071M NRG TENDL-2015, AKONING
Photon emission for (n,3n)

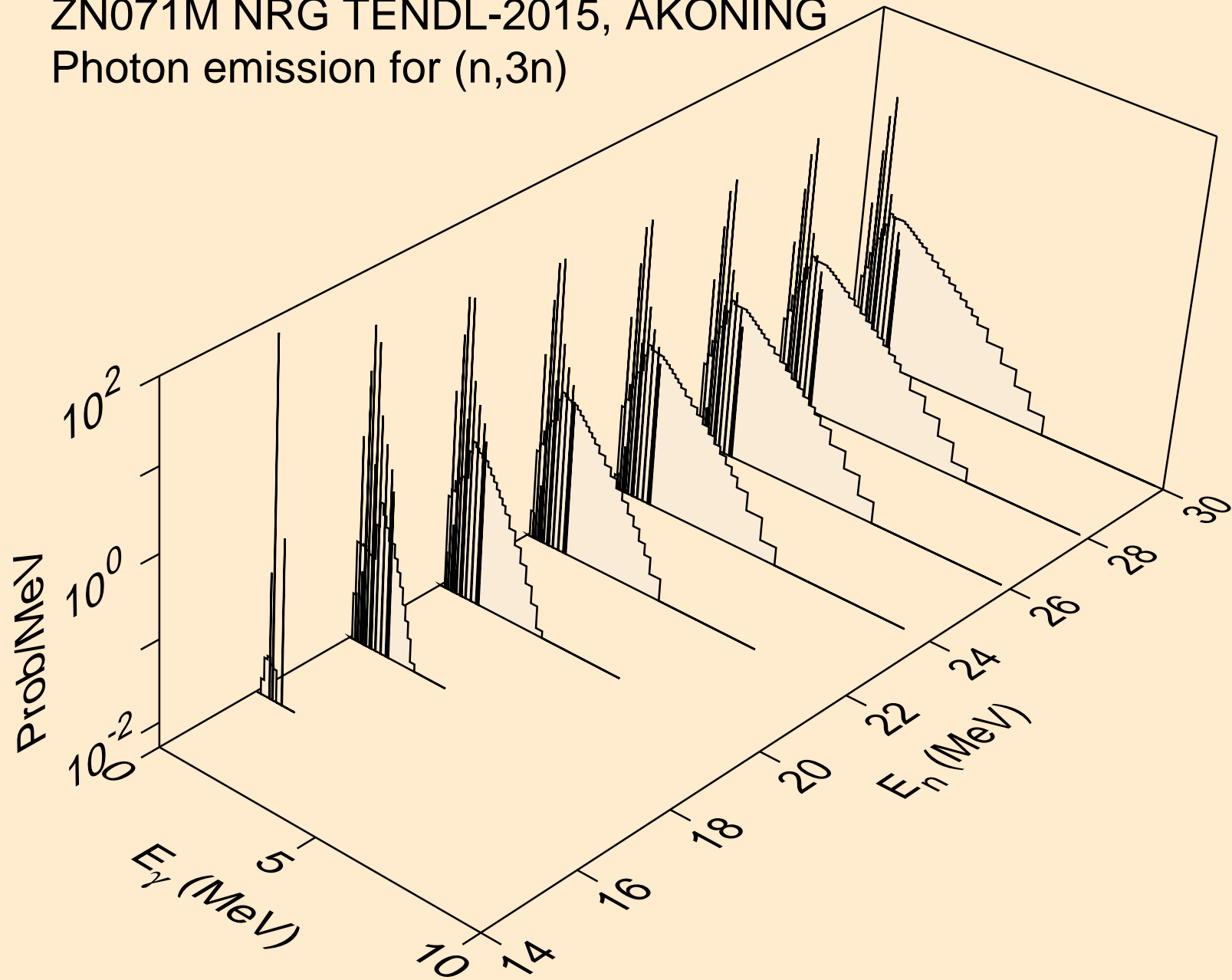

ZN071M NRG TENDL-2015, AKONING
Photon emission for (n,n*)a

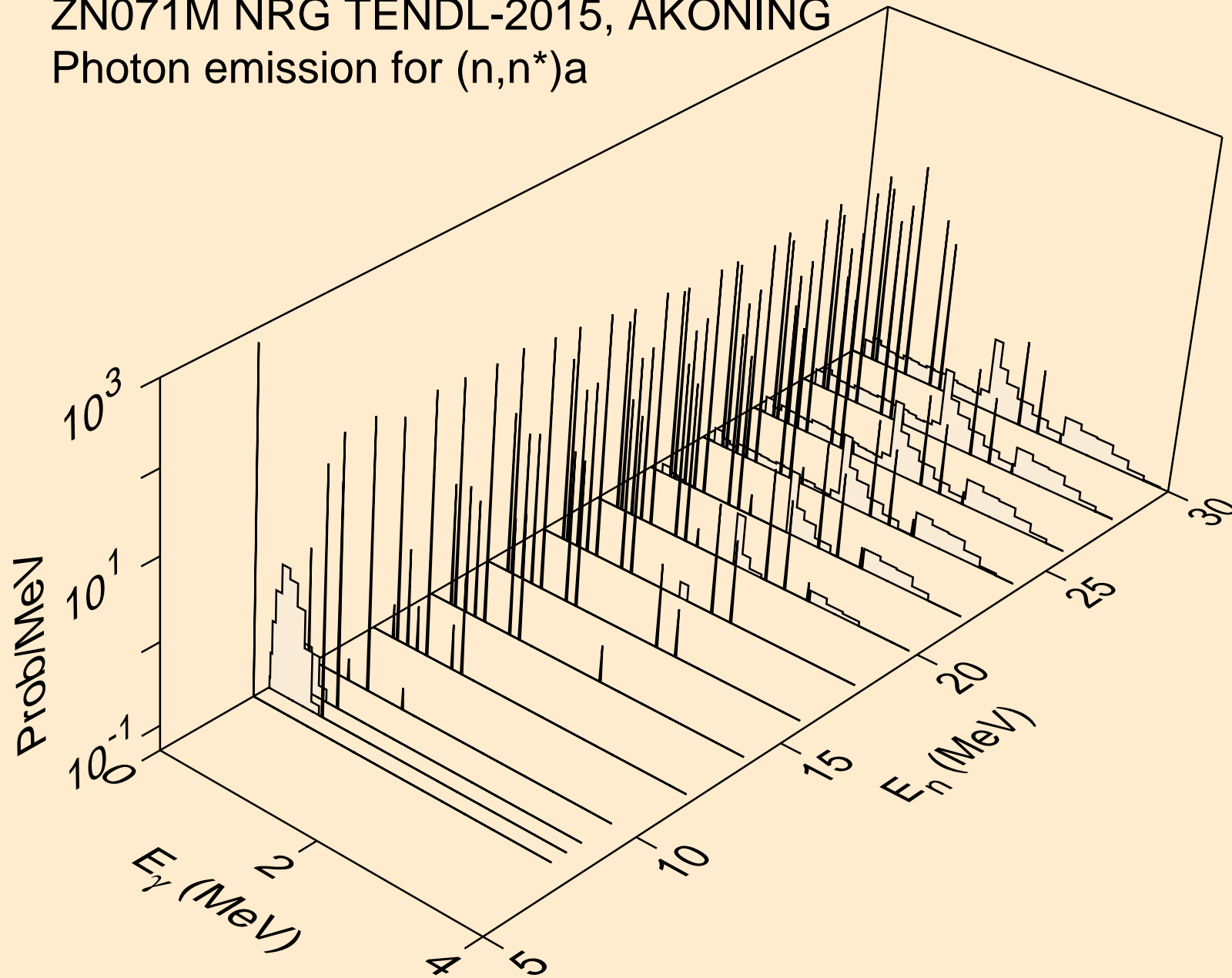

ZN071M NRG TENDL-2015, AKONING
Photon emission for (n,2n)a

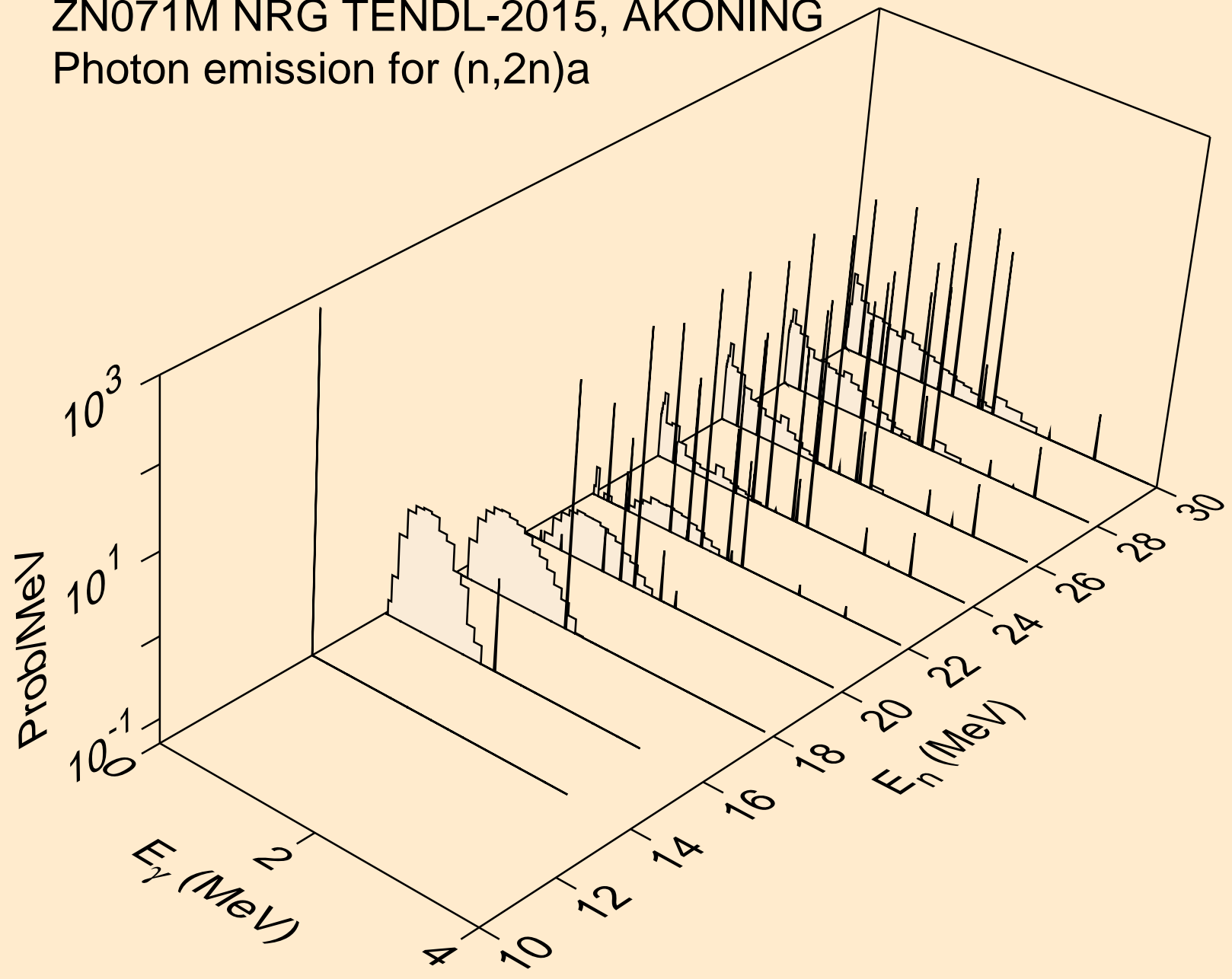

ZN071M NRG TENDL-2015, AKONING
Photon emission for (n,3n)a

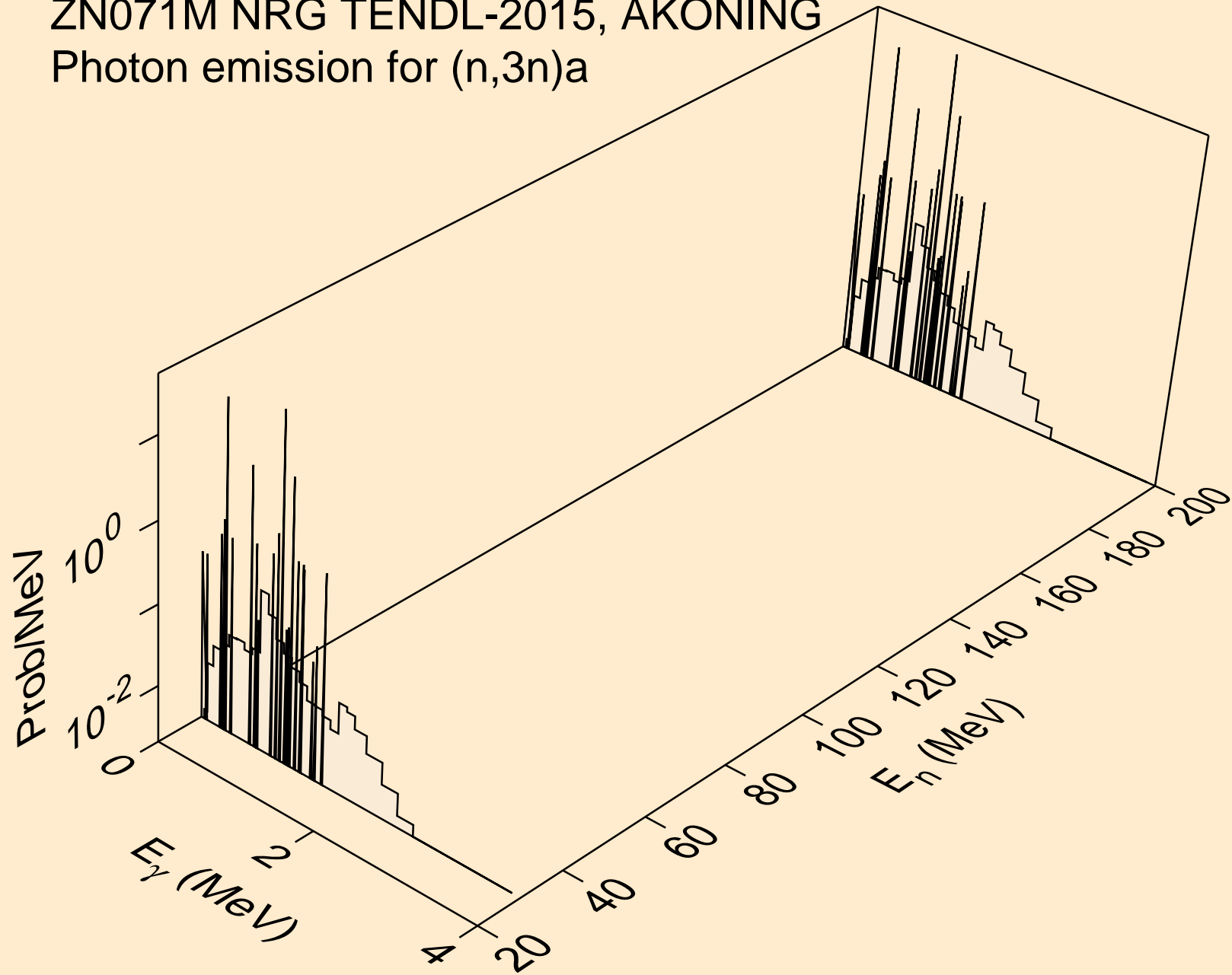

ZN071M NRG TENDL-2015, AKONING
Photon emission for (n,n*)p

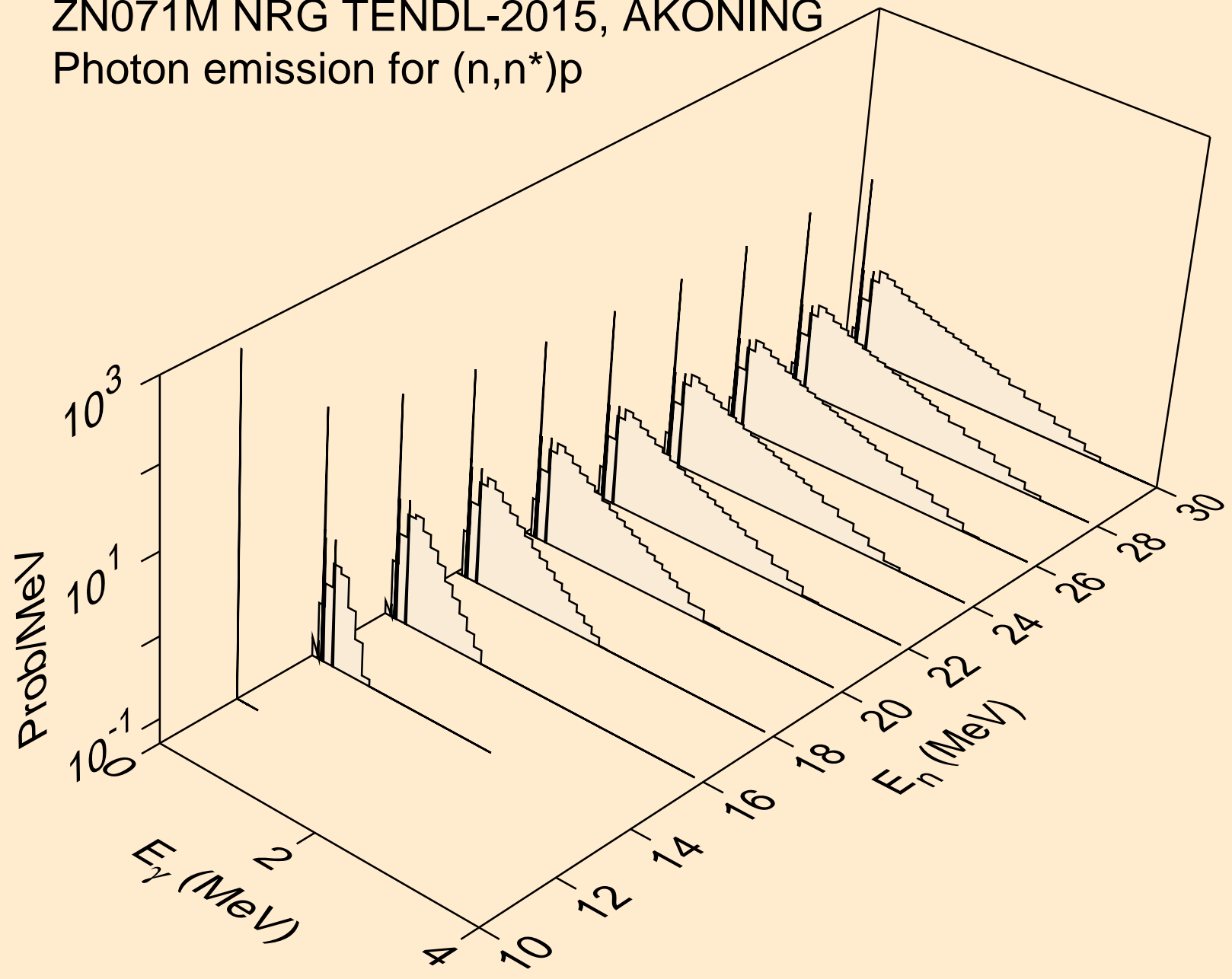

ZN071M NRG TENDL-2015, AKONING
Photon emission for (n,n*)d

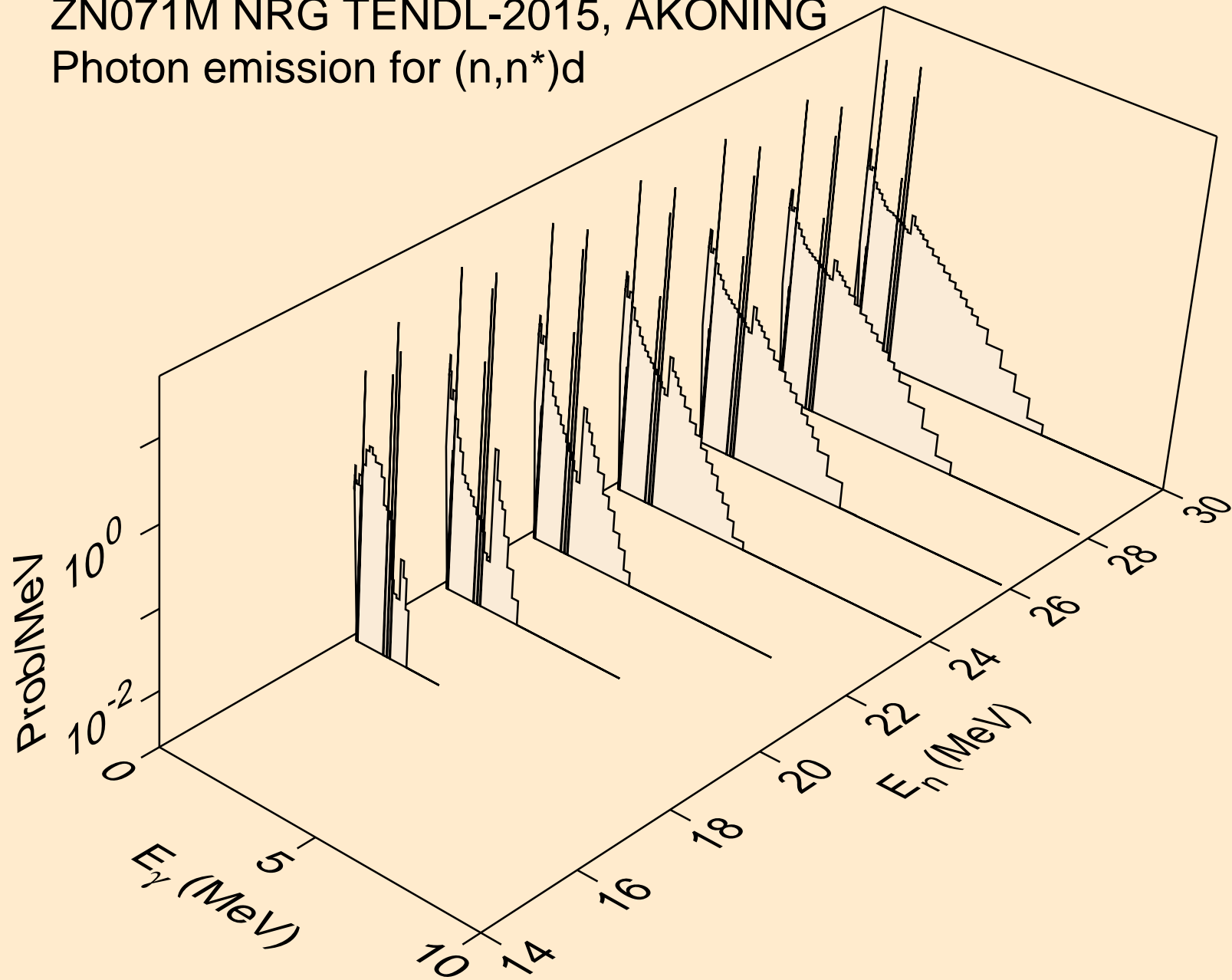

ZN071M NRG TENDL-2015, AKONING
Photon emission for (n,n*)t

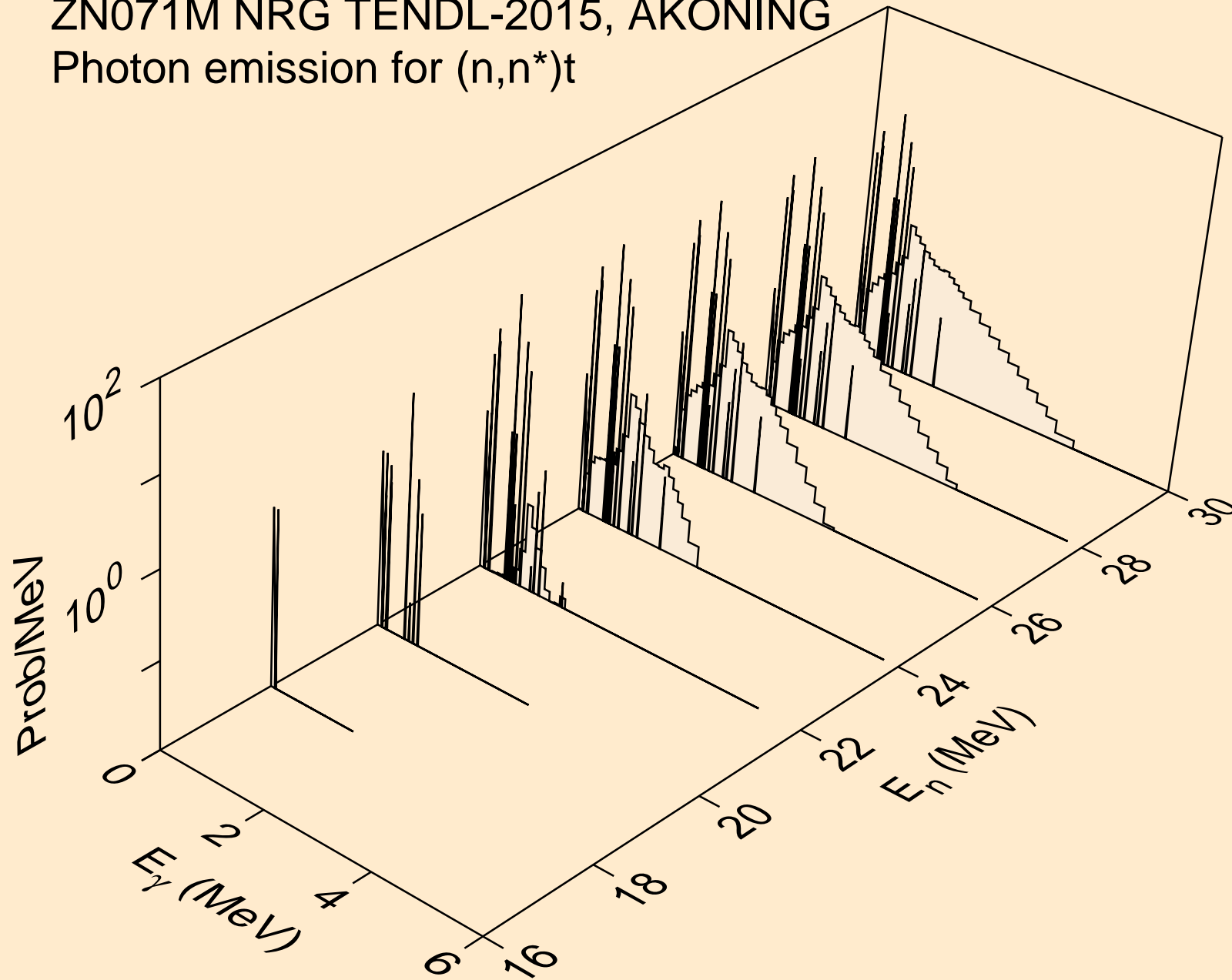

ZN071M NRG TENDL-2015, AKONING
Photon emission for (n,n*)he3

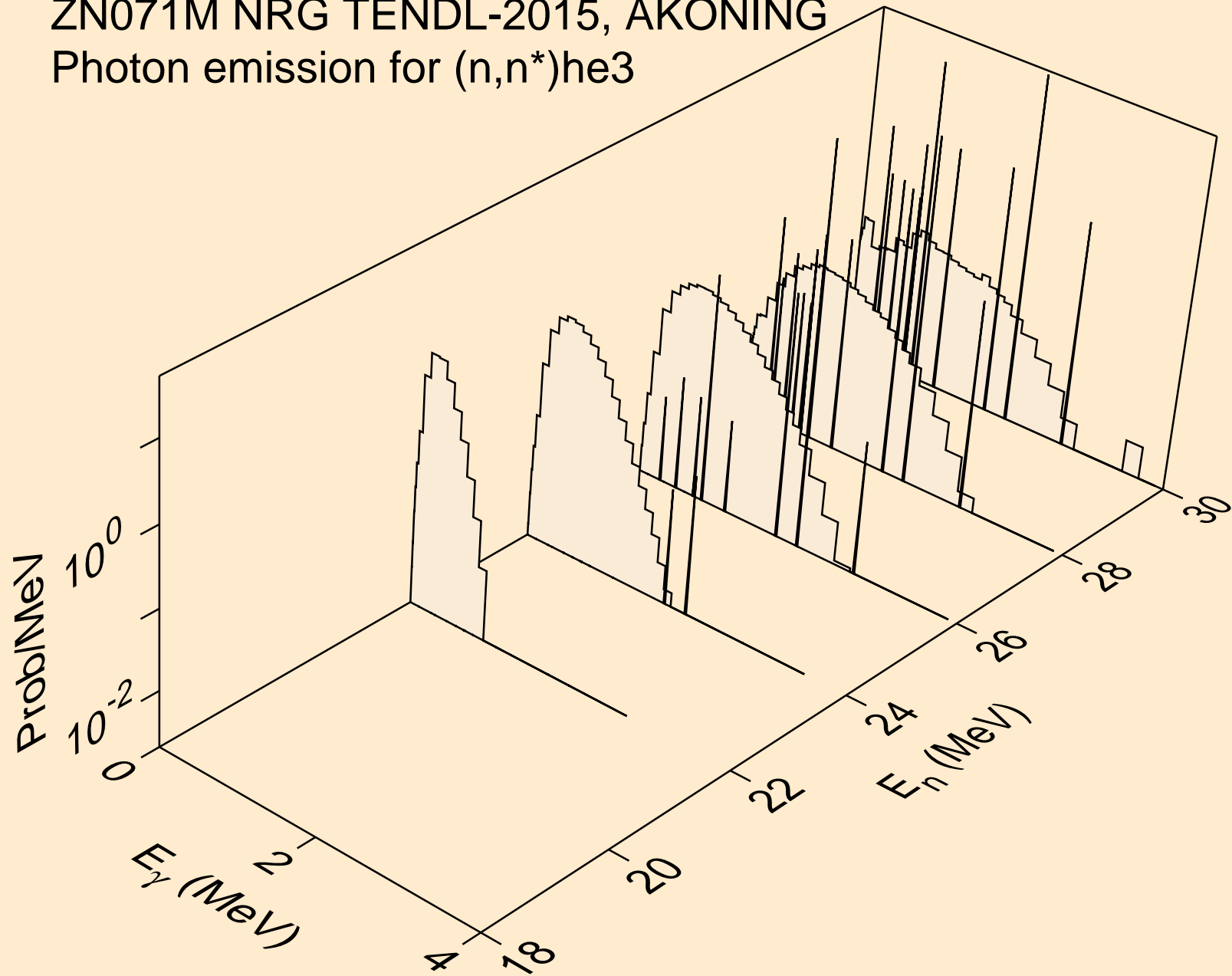

ZN071M NRG TENDL-2015, AKONING
Photon emission for (n,4n)

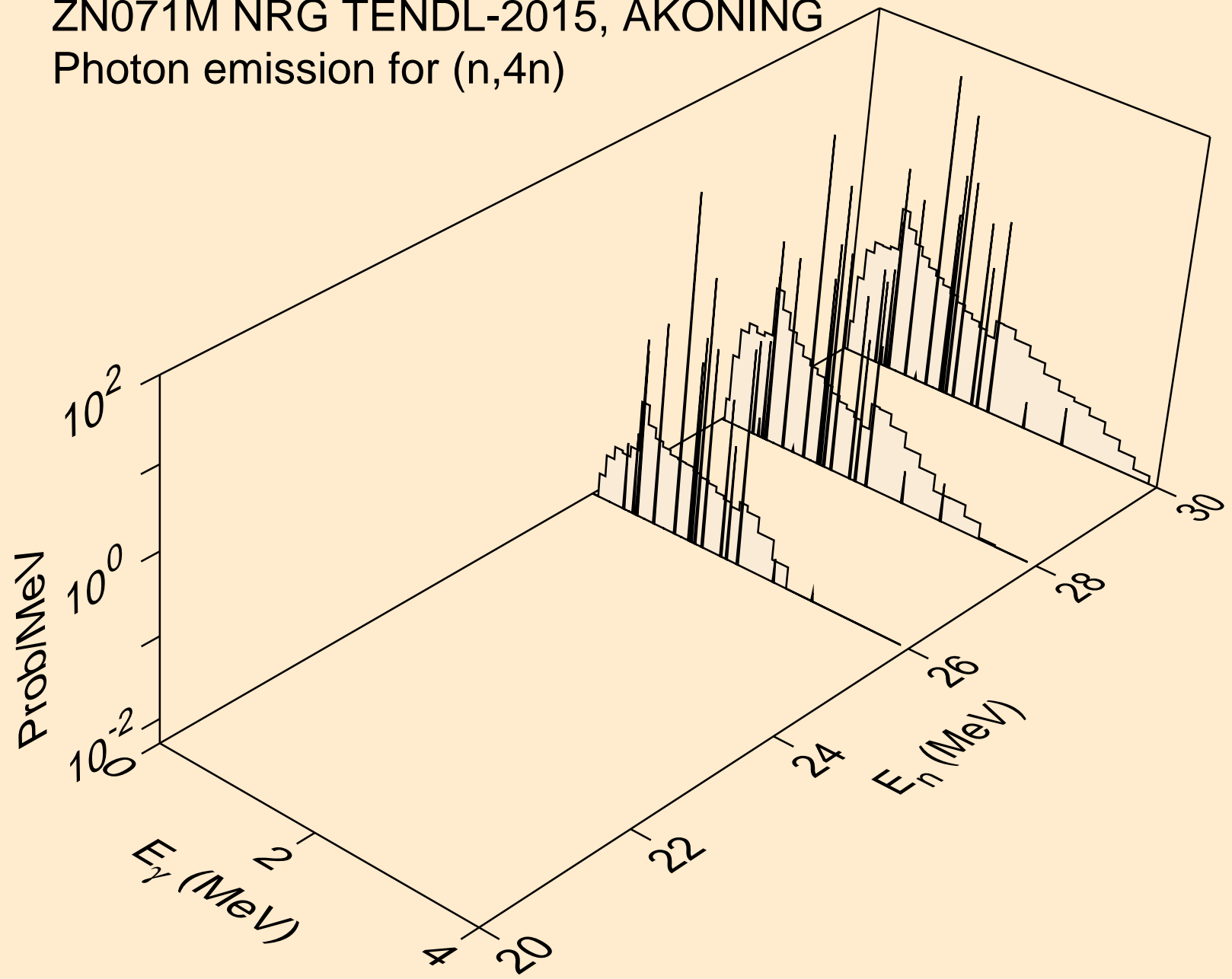

ZN071M NRG TENDL-2015, AKONING
Photon emission for (n,2np)

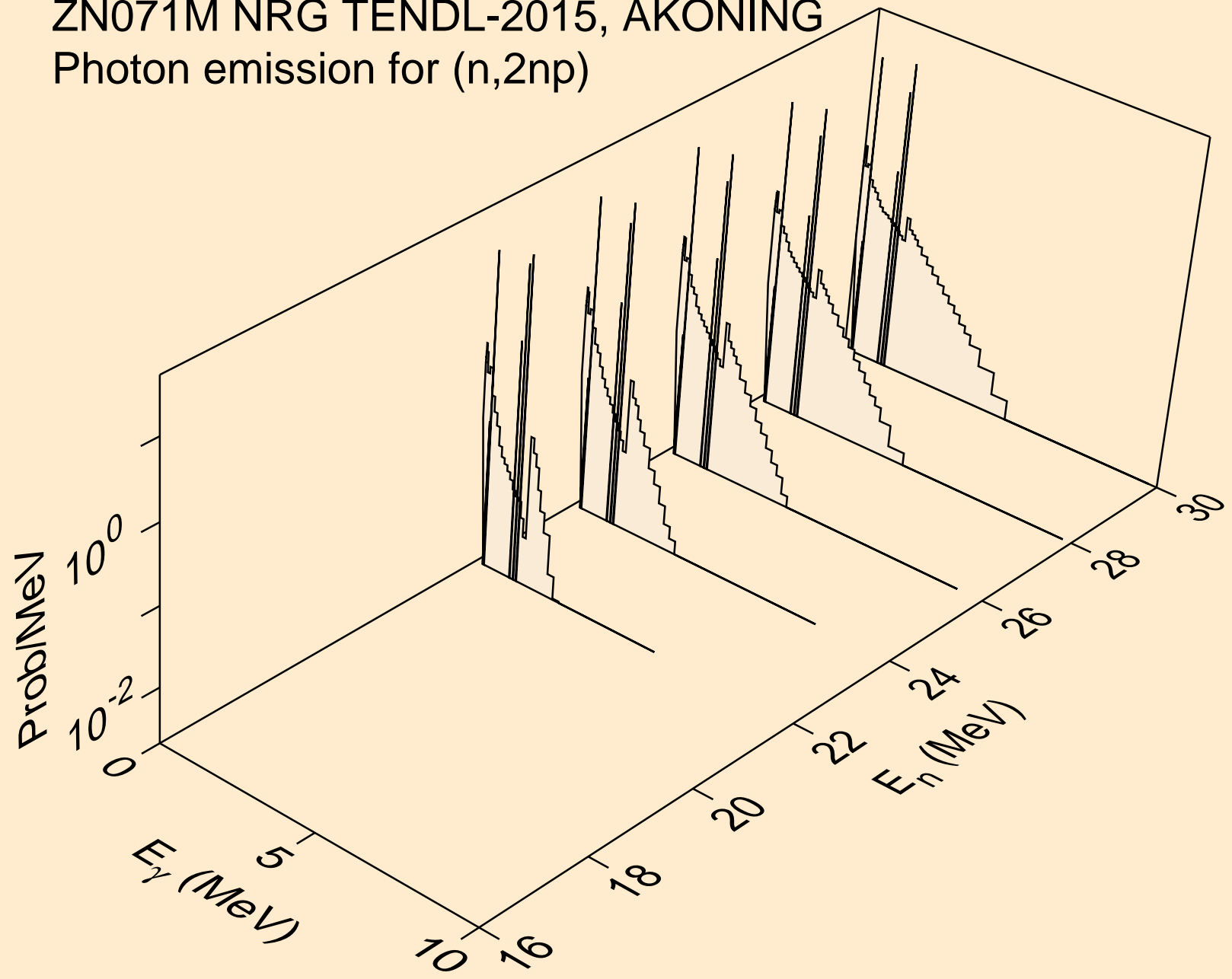

ZN071M NRG TENDL-2015, AKONING
Photon emission for (n,3np)

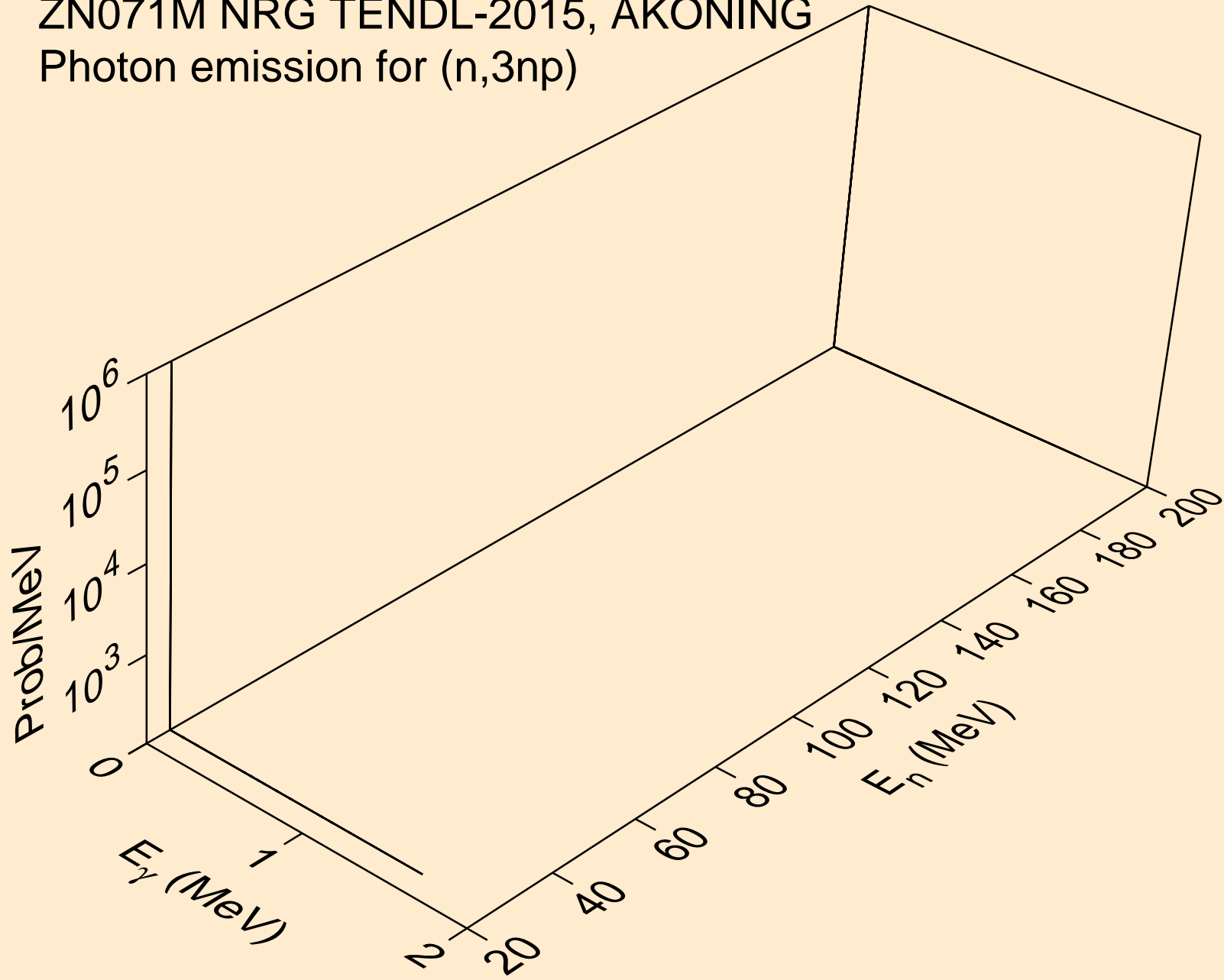

ZN071M NRG TENDL-2015, AKONING
Photon emission for (n,2np)

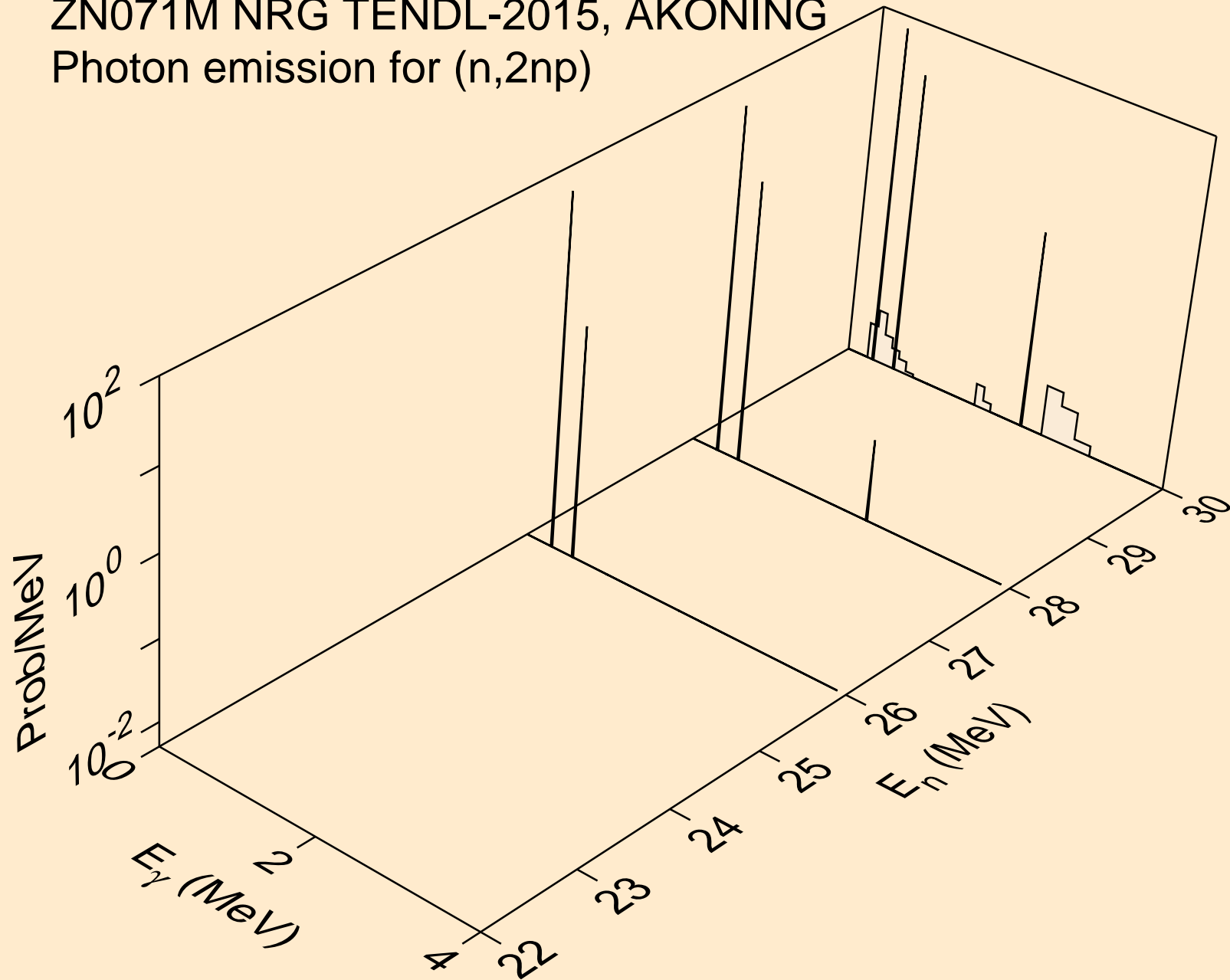

ZN071M NRG TENDL-2015, AKONING
Photon emission for (n,n*2)

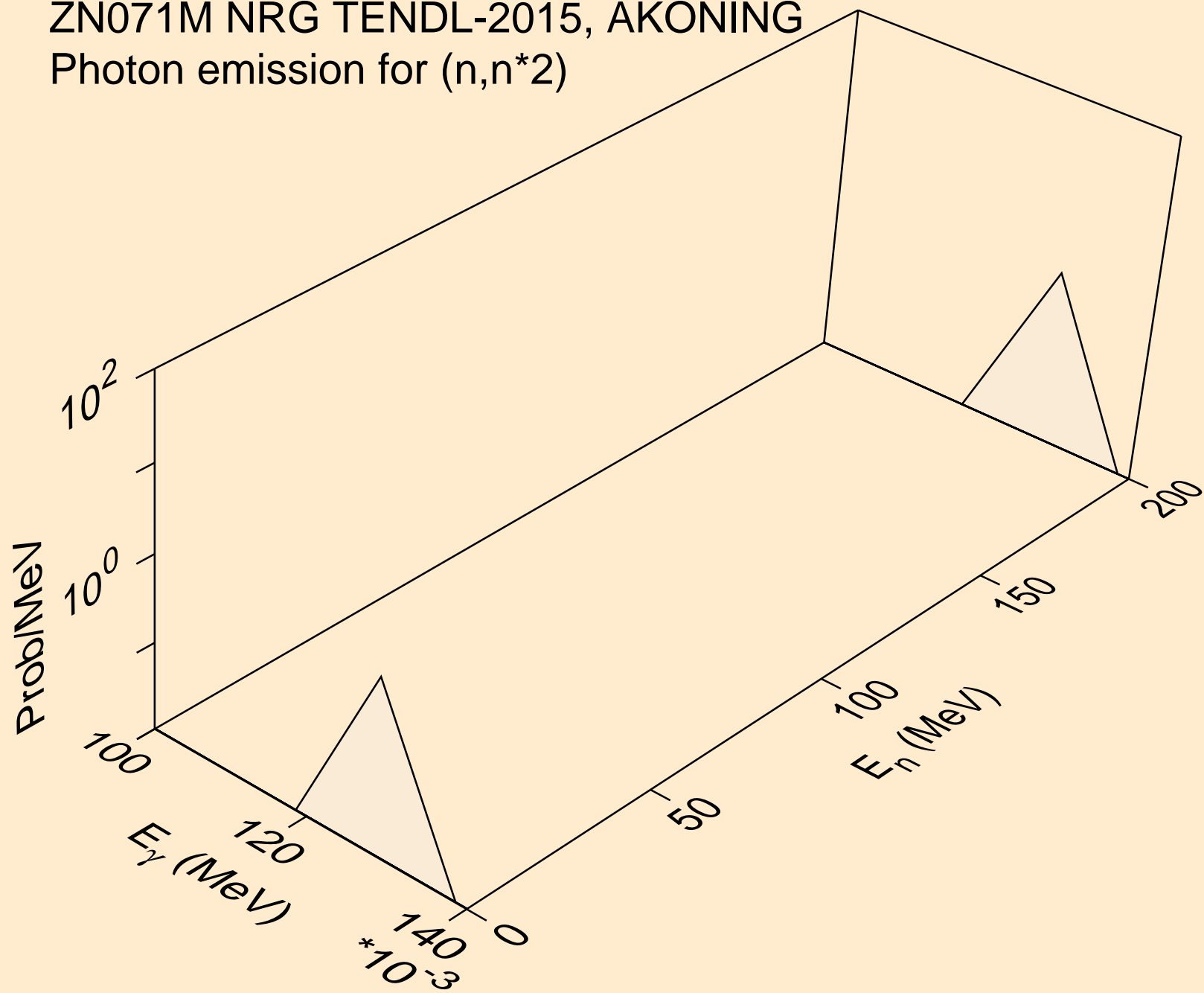

ZN071M NRG TENDL-2015, AKONING
Photon emission for (n,n*3)

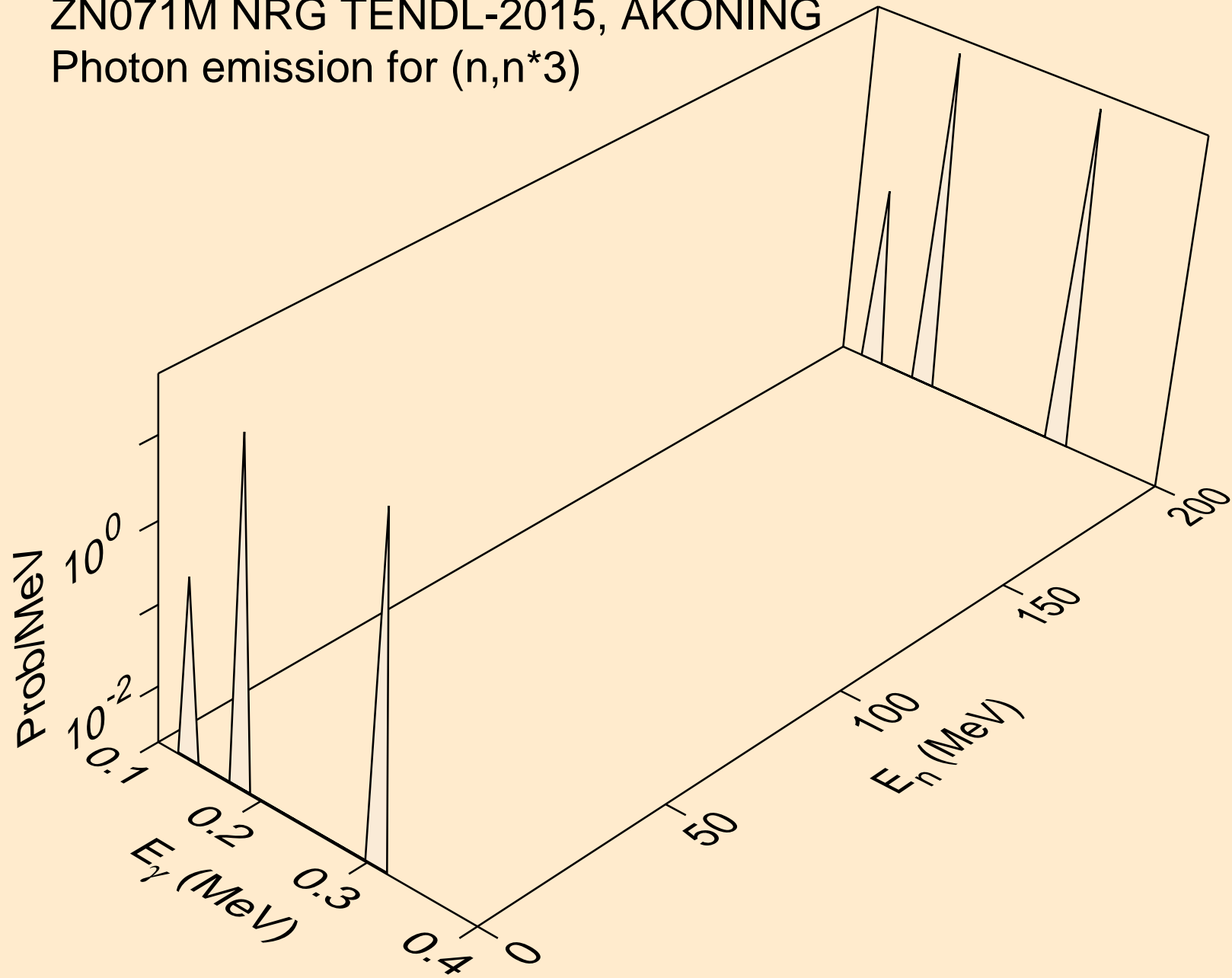

ZN071M NRG TENDL-2015, AKONING
Photon emission for (n,n*4)

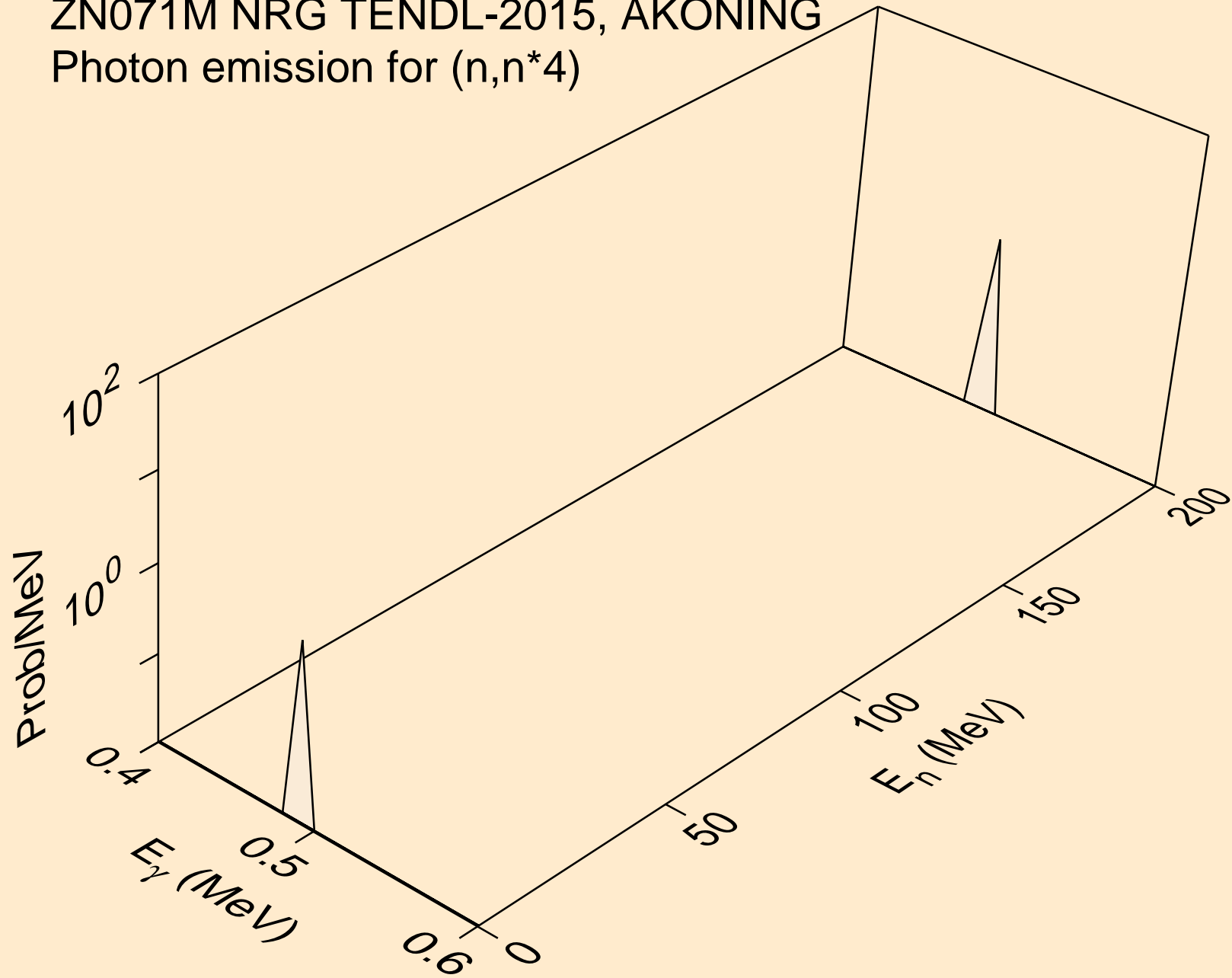

ZN071M NRG TENDL-2015, AKONING
Photon emission for (n,n*5)

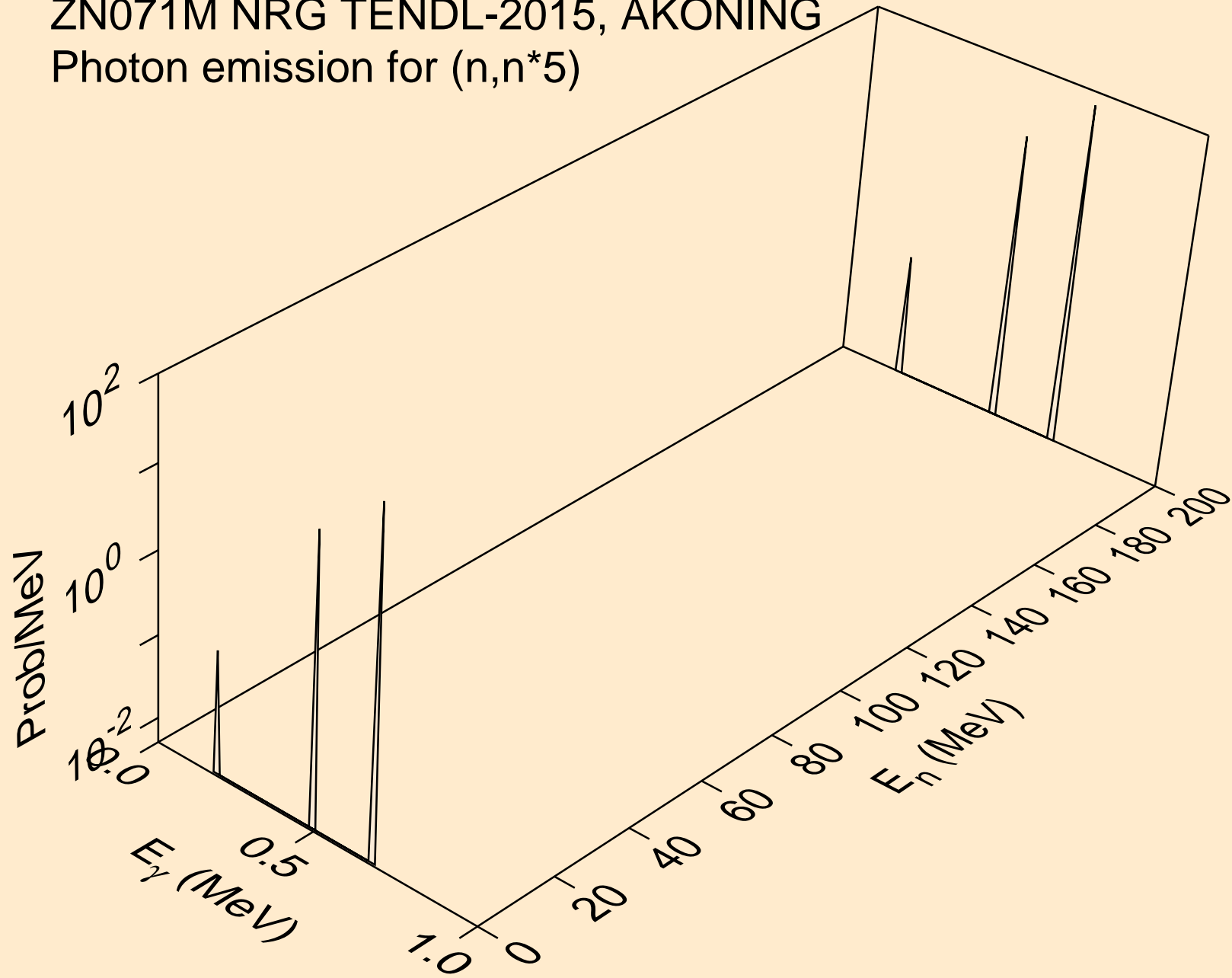

ZN071M NRG TENDL-2015, AKONING
Photon emission for (n,n*6)

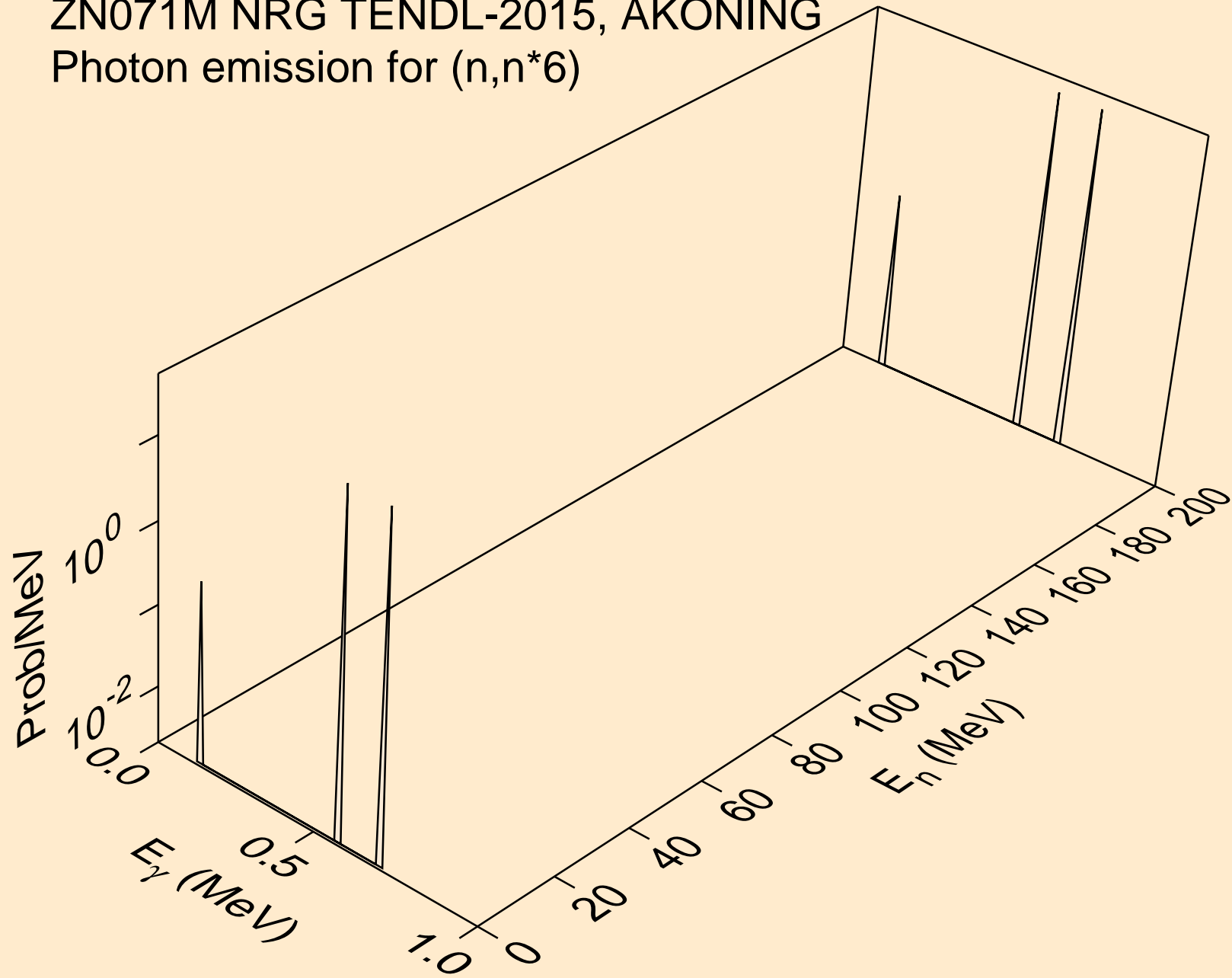

ZN071M NRG TENDL-2015, AKONING
Photon emission for (n,n*7)

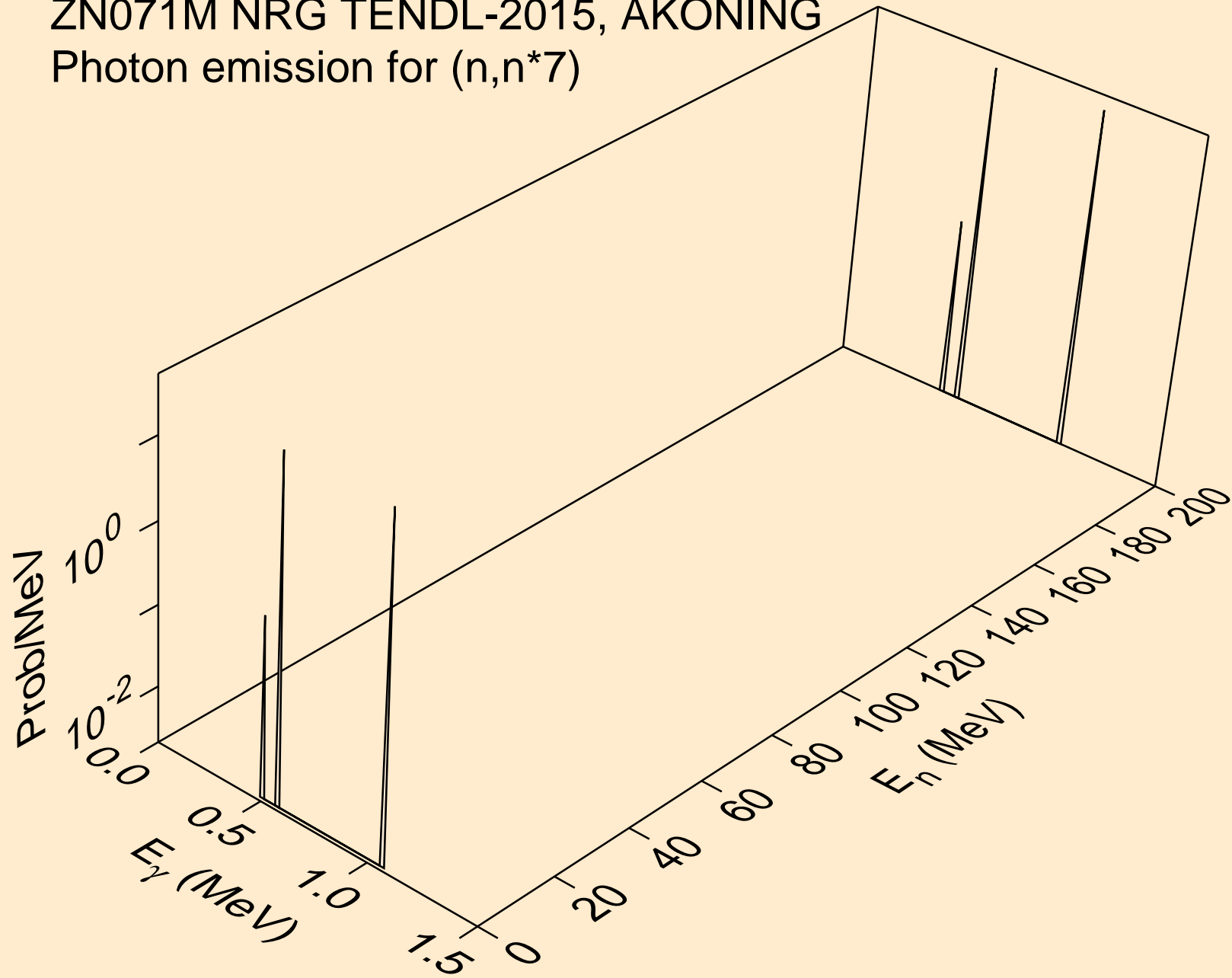

ZN071M NRG TENDL-2015, AKONING
Photon emission for (n,n*8)

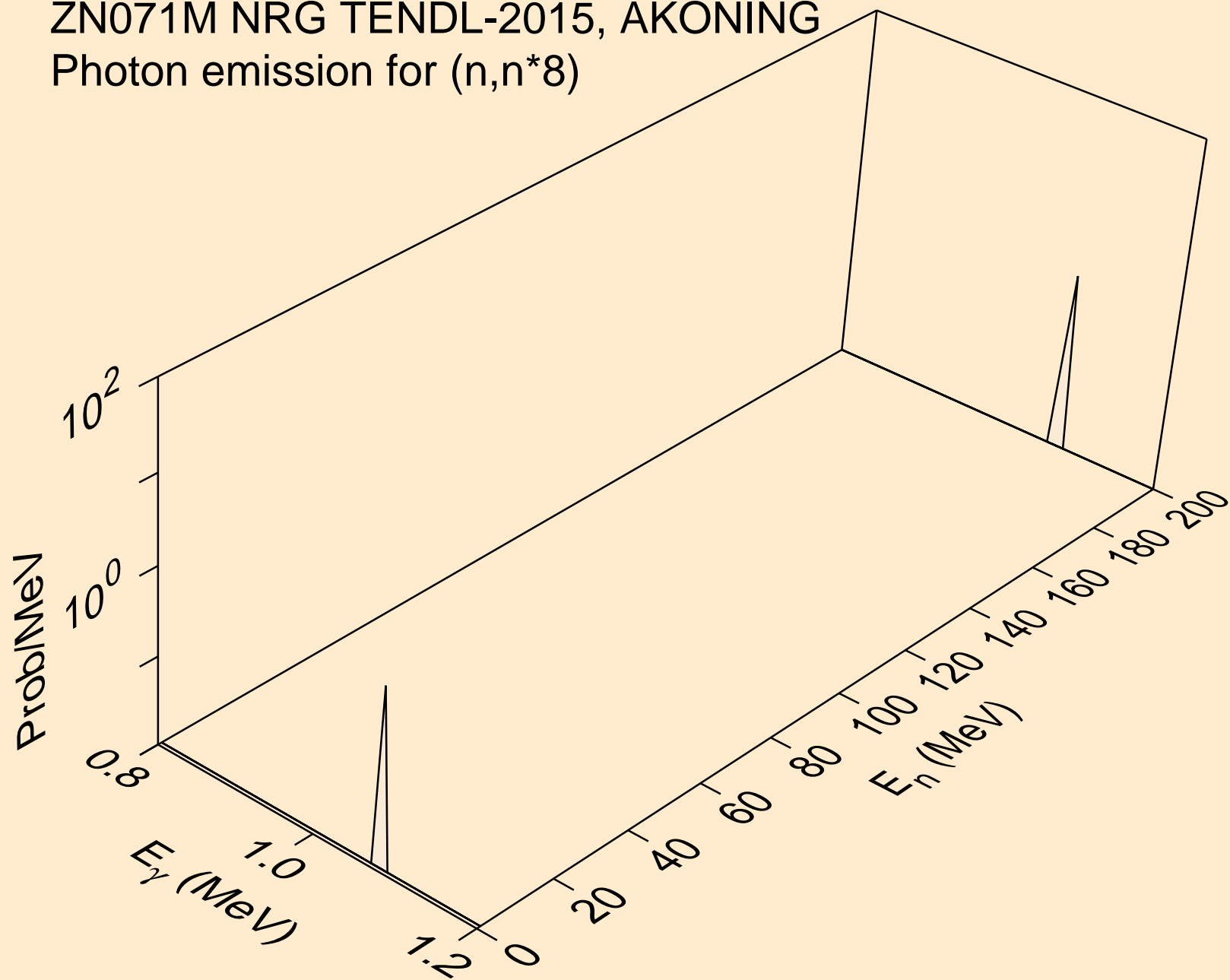

ZN071M NRG TENDL-2015, AKONING
Photon emission for (n,n*9)

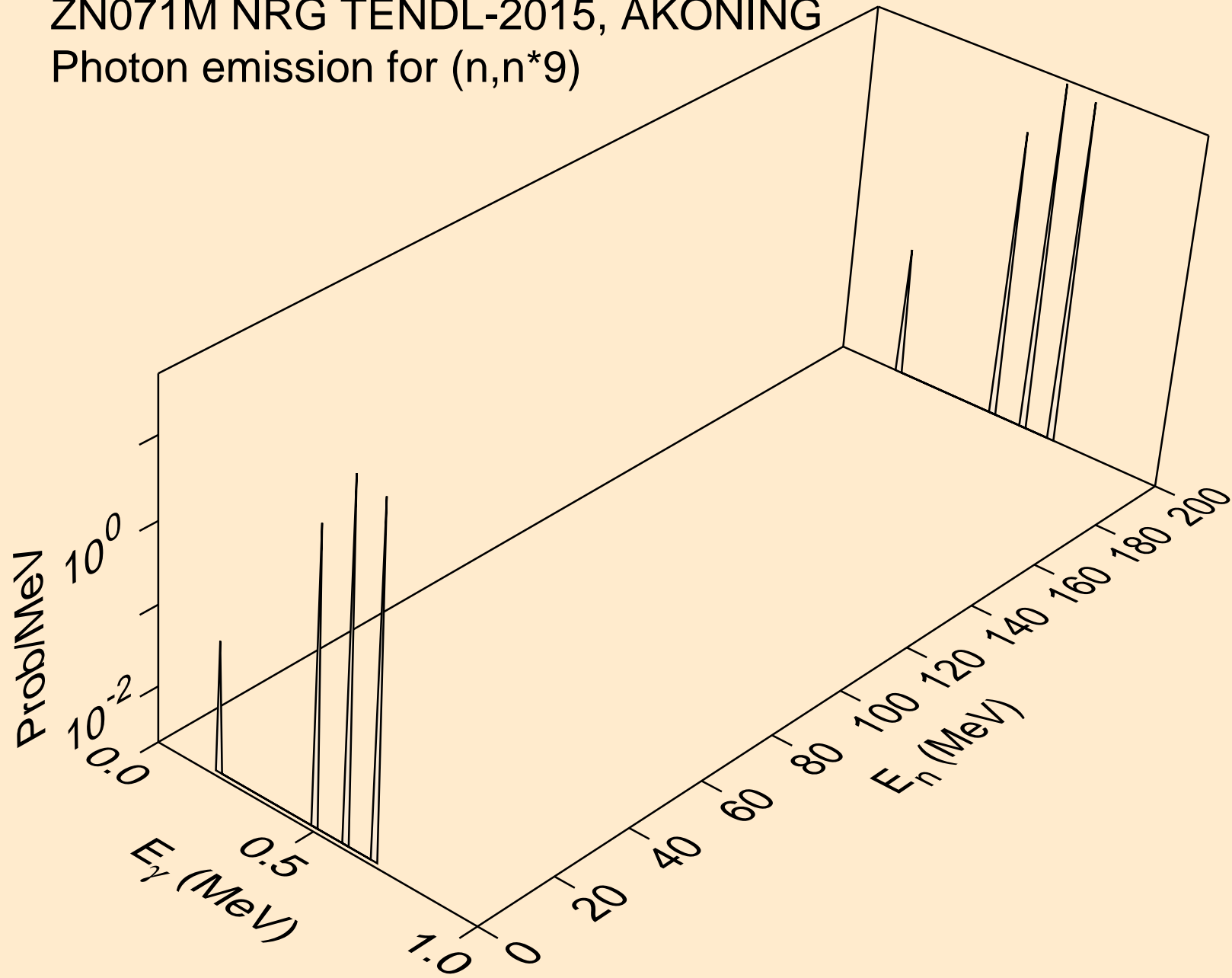

ZN071M NRG TENDL-2015, AKONING
Photon emission for (n,n*10)

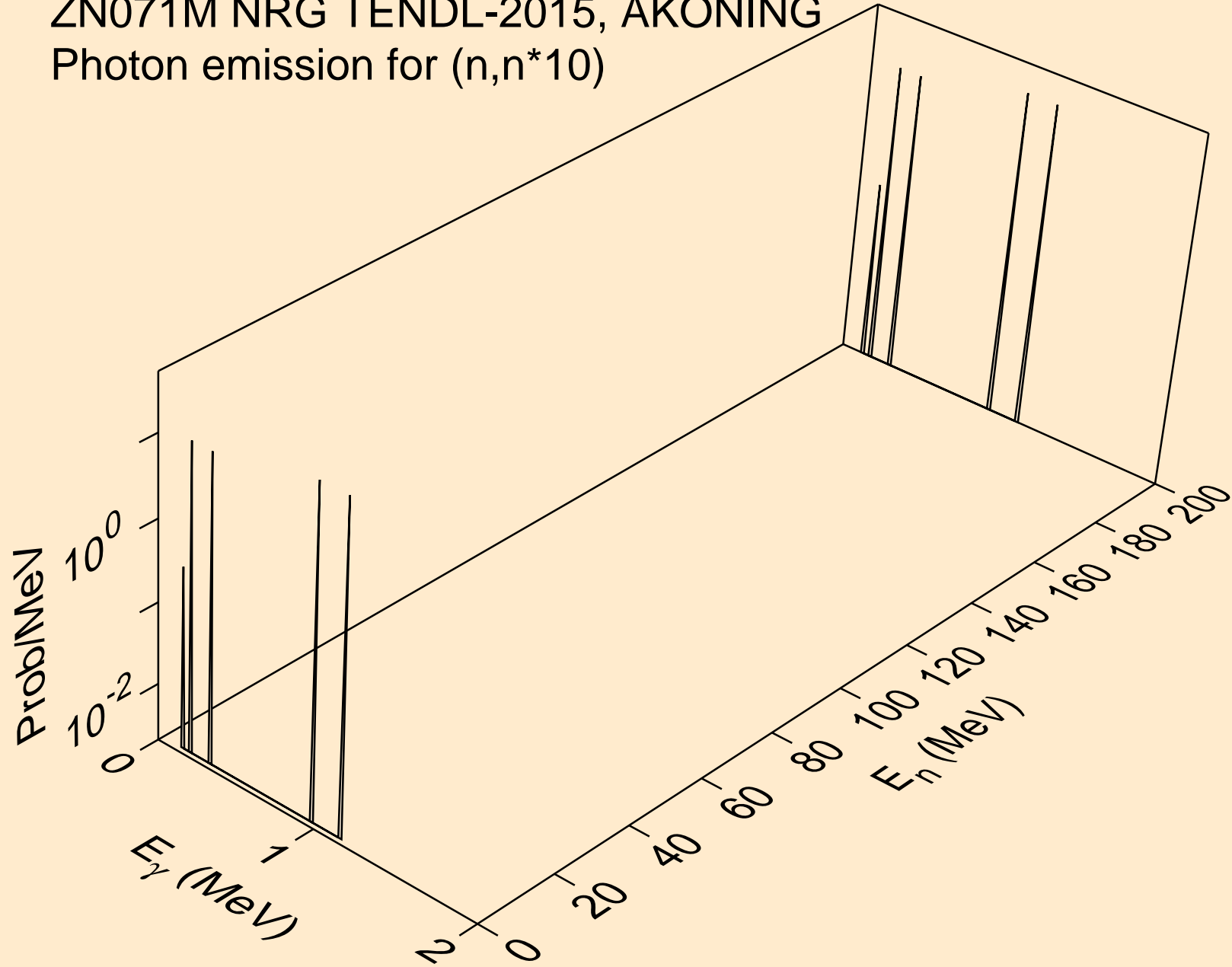

ZN071M NRG TENDL-2015, AKONING
Photon emission for (n,n*11)

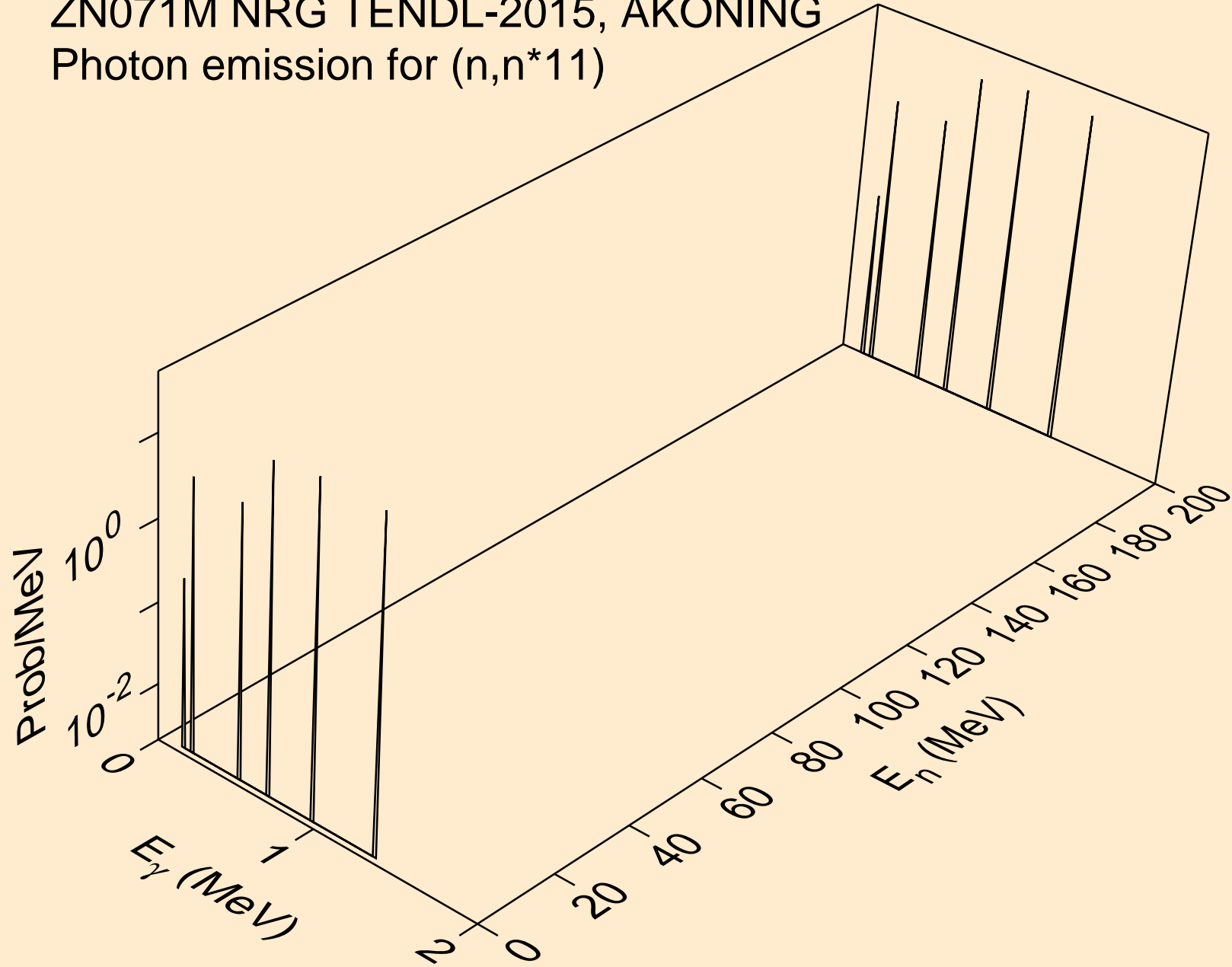

ZN071M NRG TENDL-2015, AKONING
Photon emission for (n,n*12)

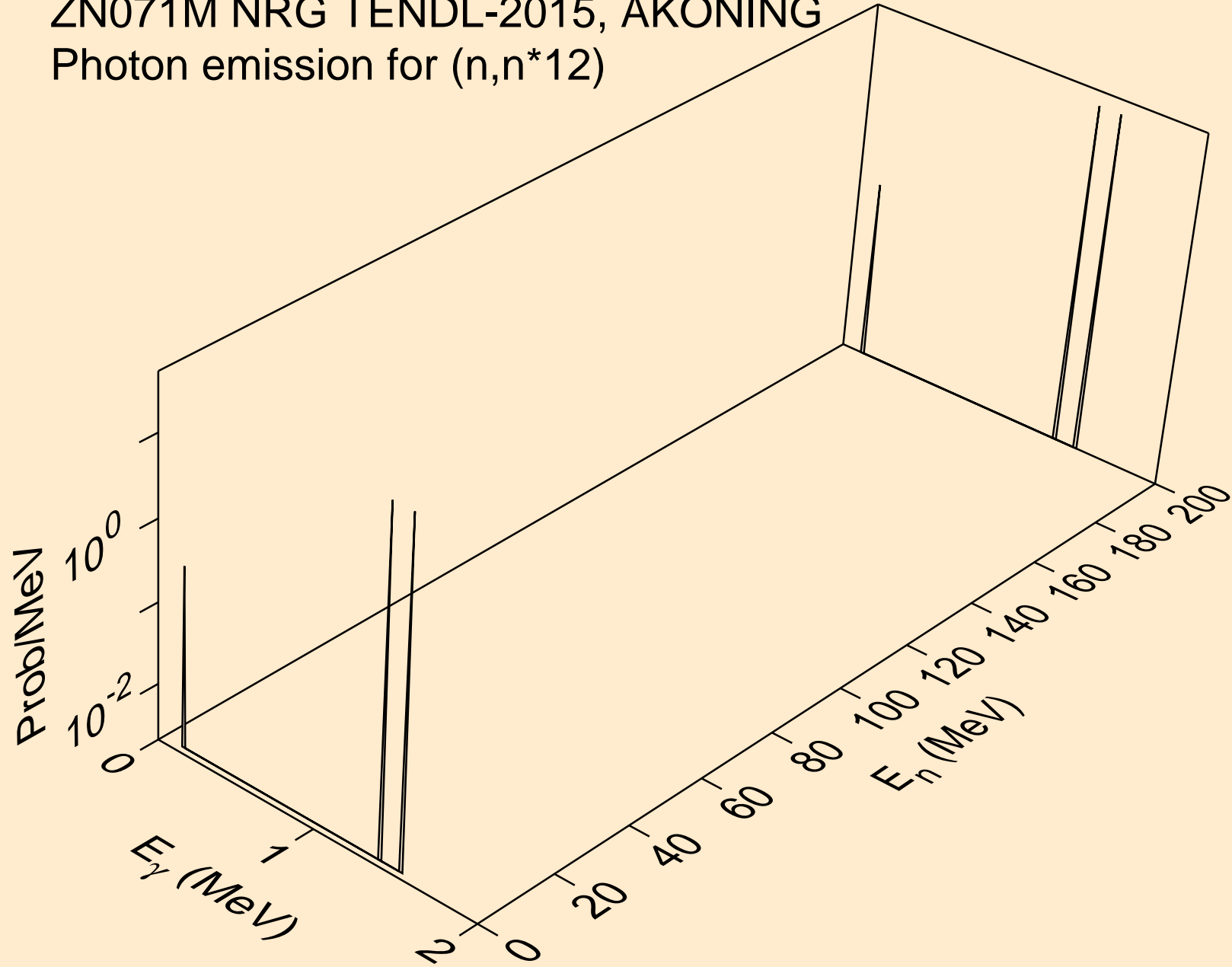

ZN071M NRG TENDL-2015, AKONING
Photon emission for (n,n*13)

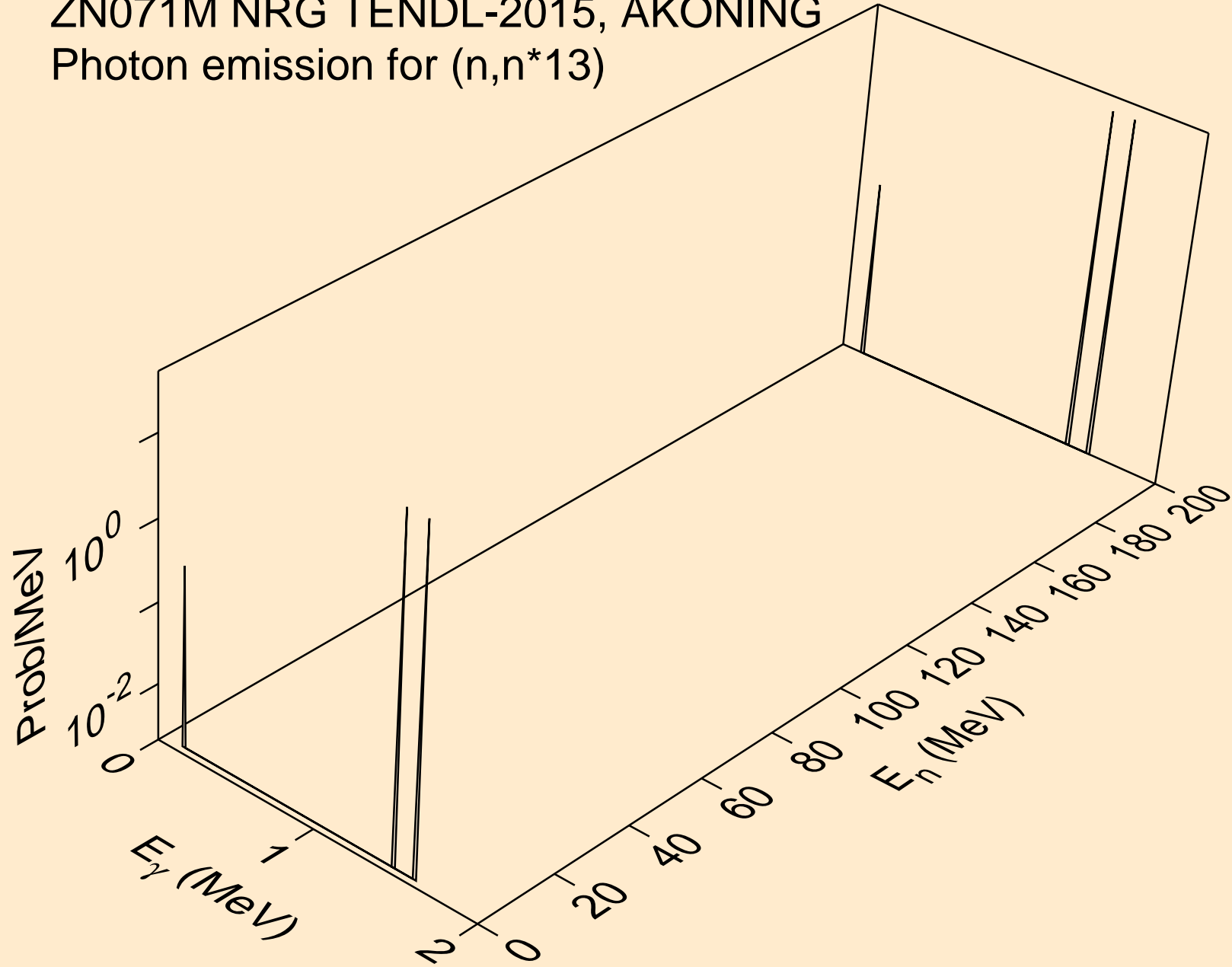

ZN071M NRG TENDL-2015, AKONING
Photon emission for (n,n*14)

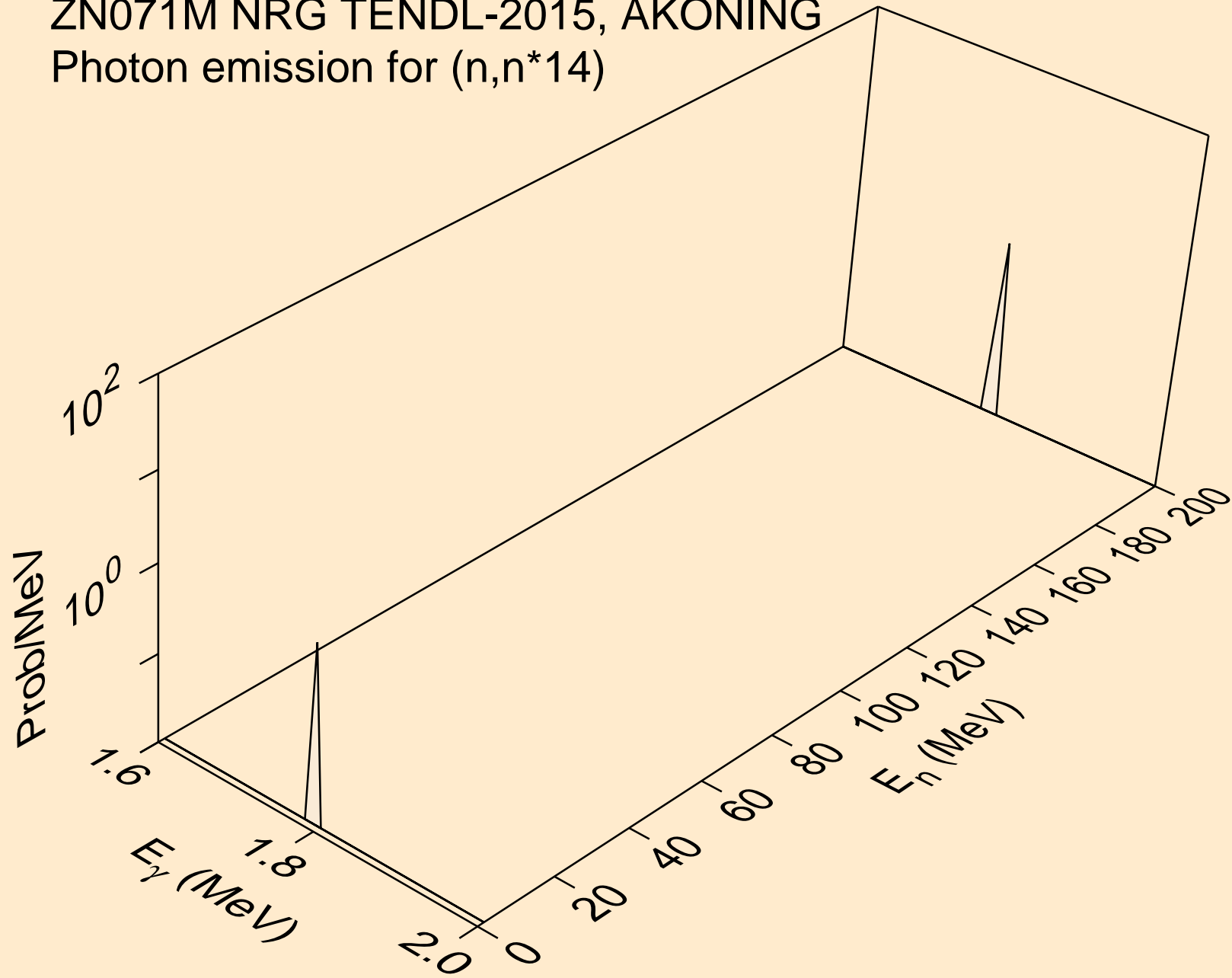

ZN071M NRG TENDL-2015, AKONING
Photon emission for (n,n*15)

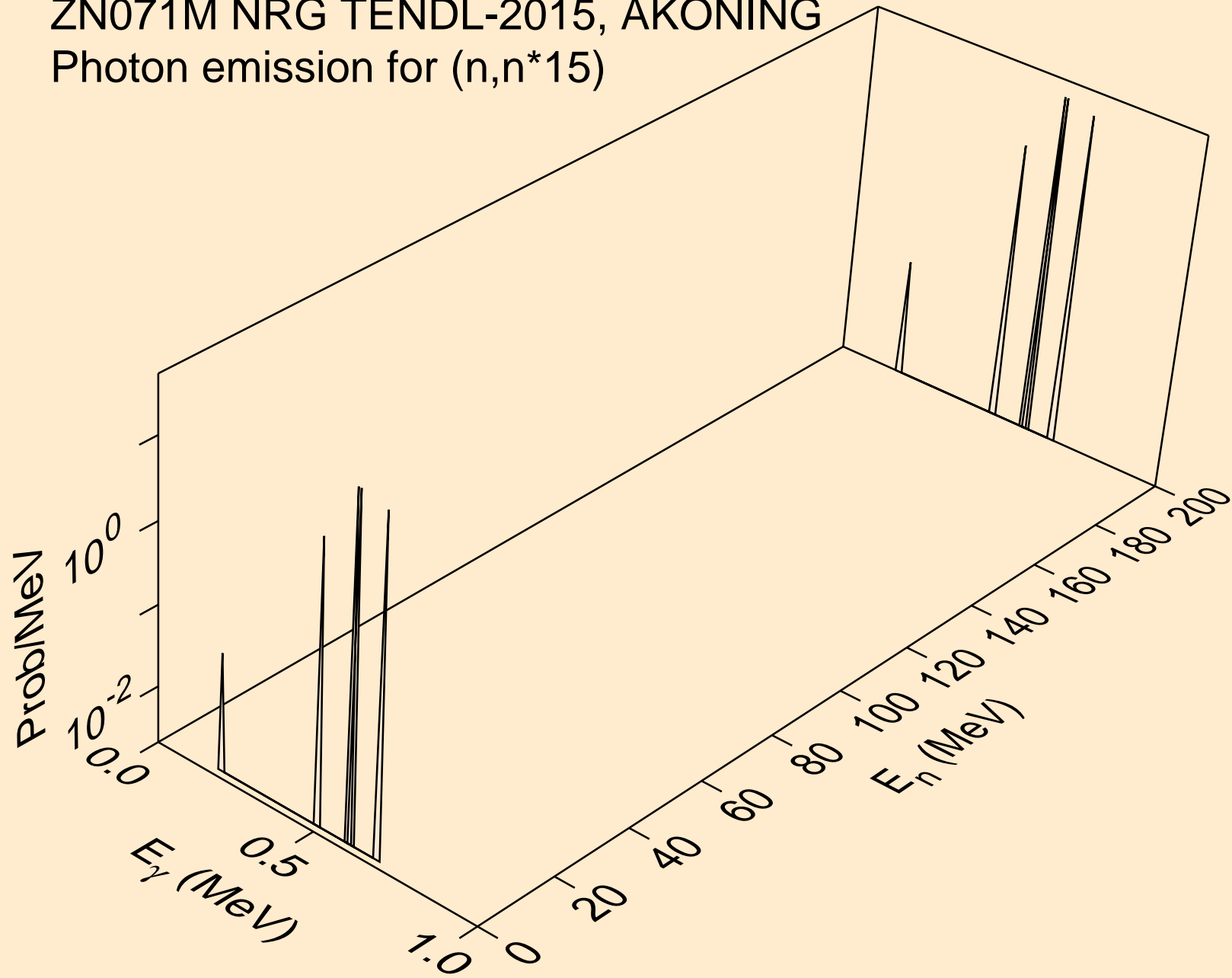

ZN071M NRG TENDL-2015, AKONING
Photon emission for (n,n*16)

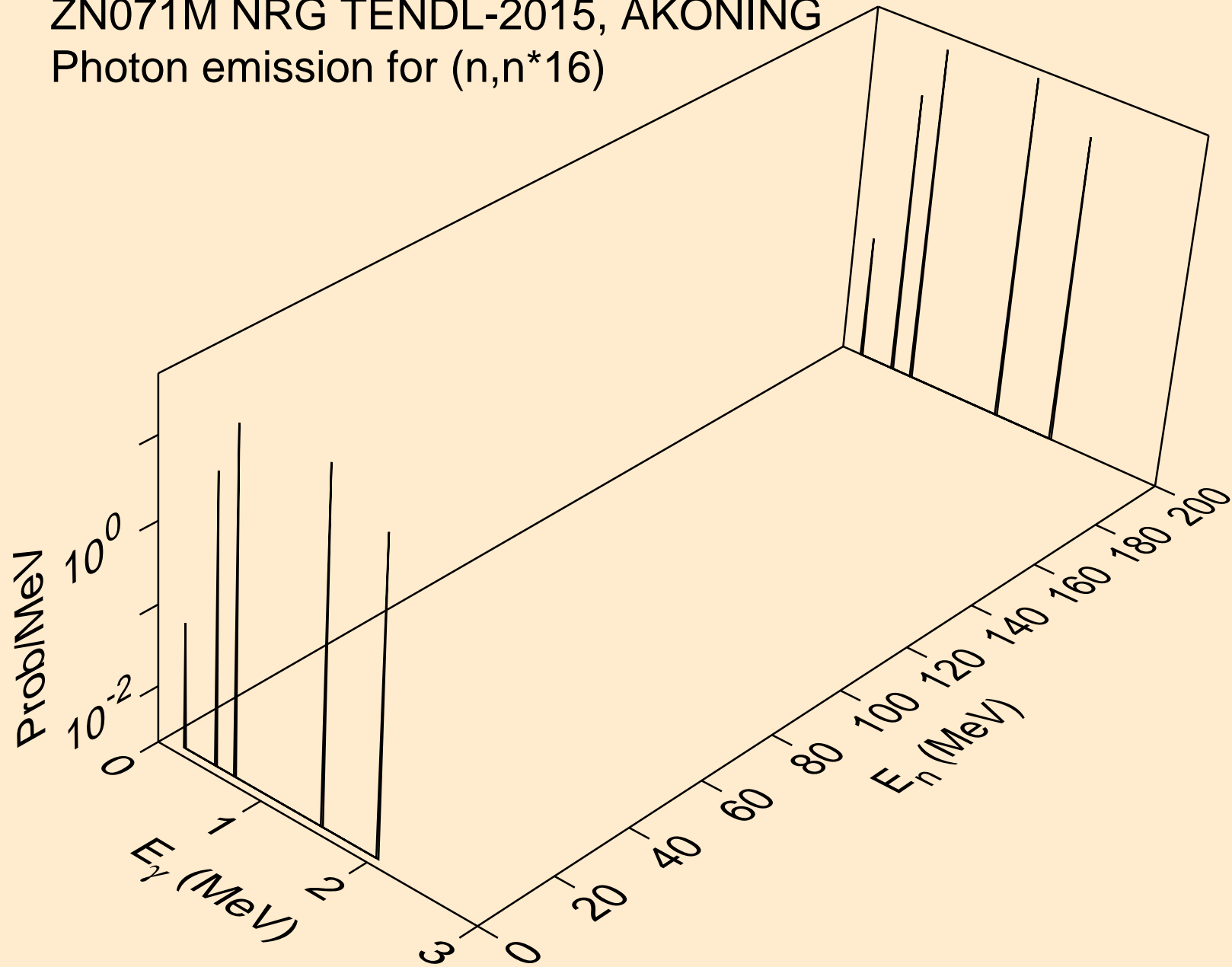

ZN071M NRG TENDL-2015, AKONING
Photon emission for (n,n*17)

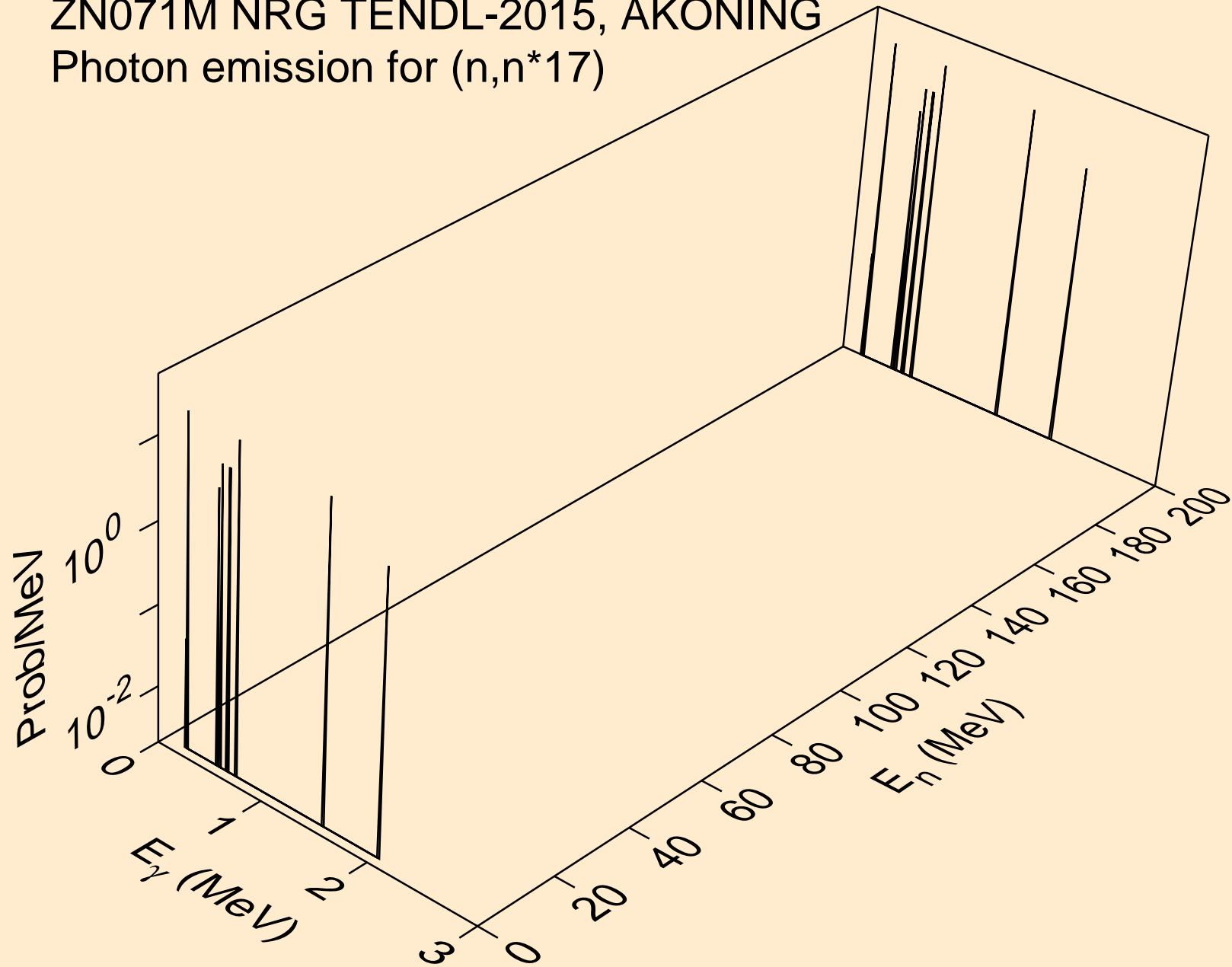

ZN071M NRG TENDL-2015, AKONING
Photon emission for (n,n*18)

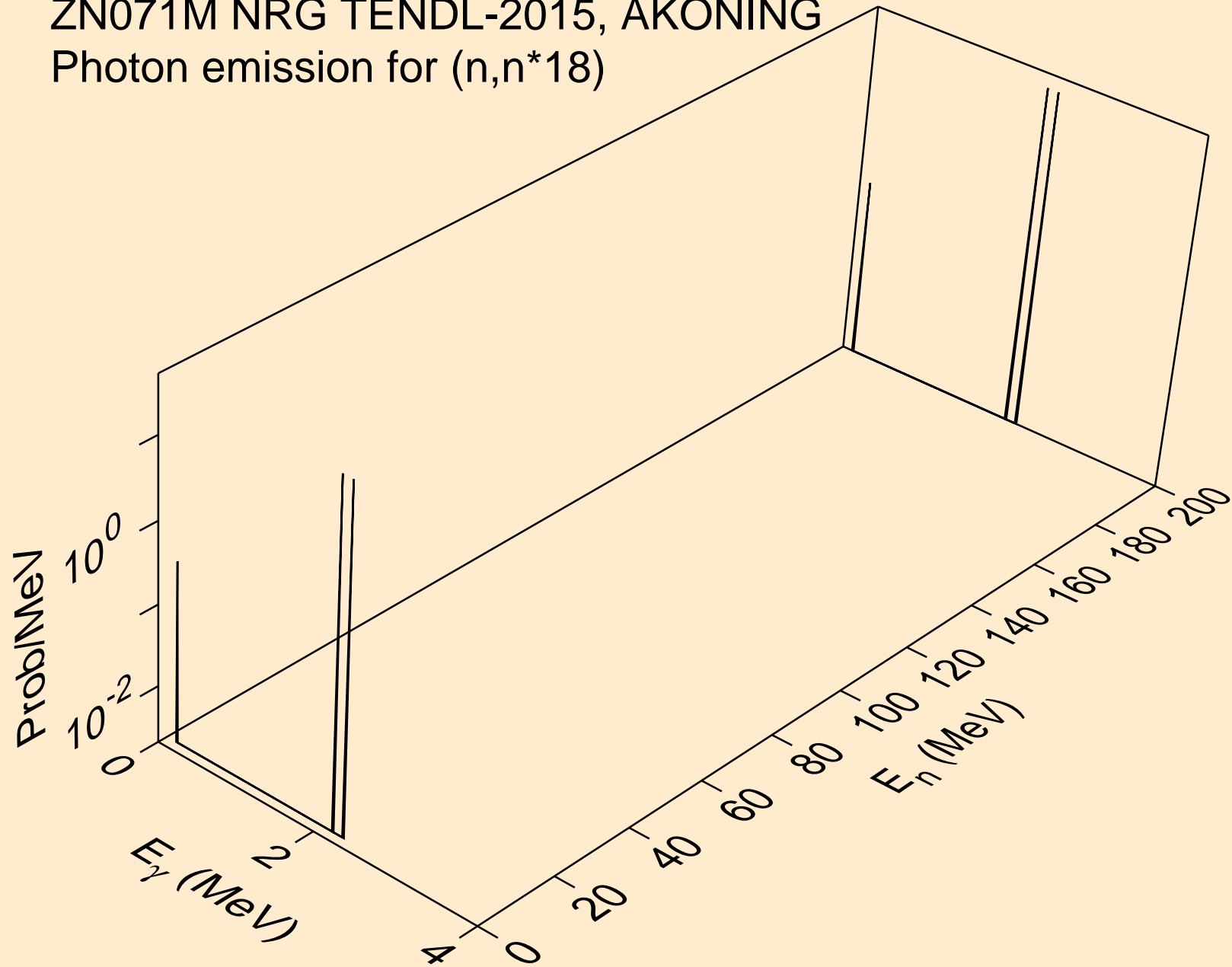

ZN071M NRG TENDL-2015, AKONING
Photon emission for (n,n*19)

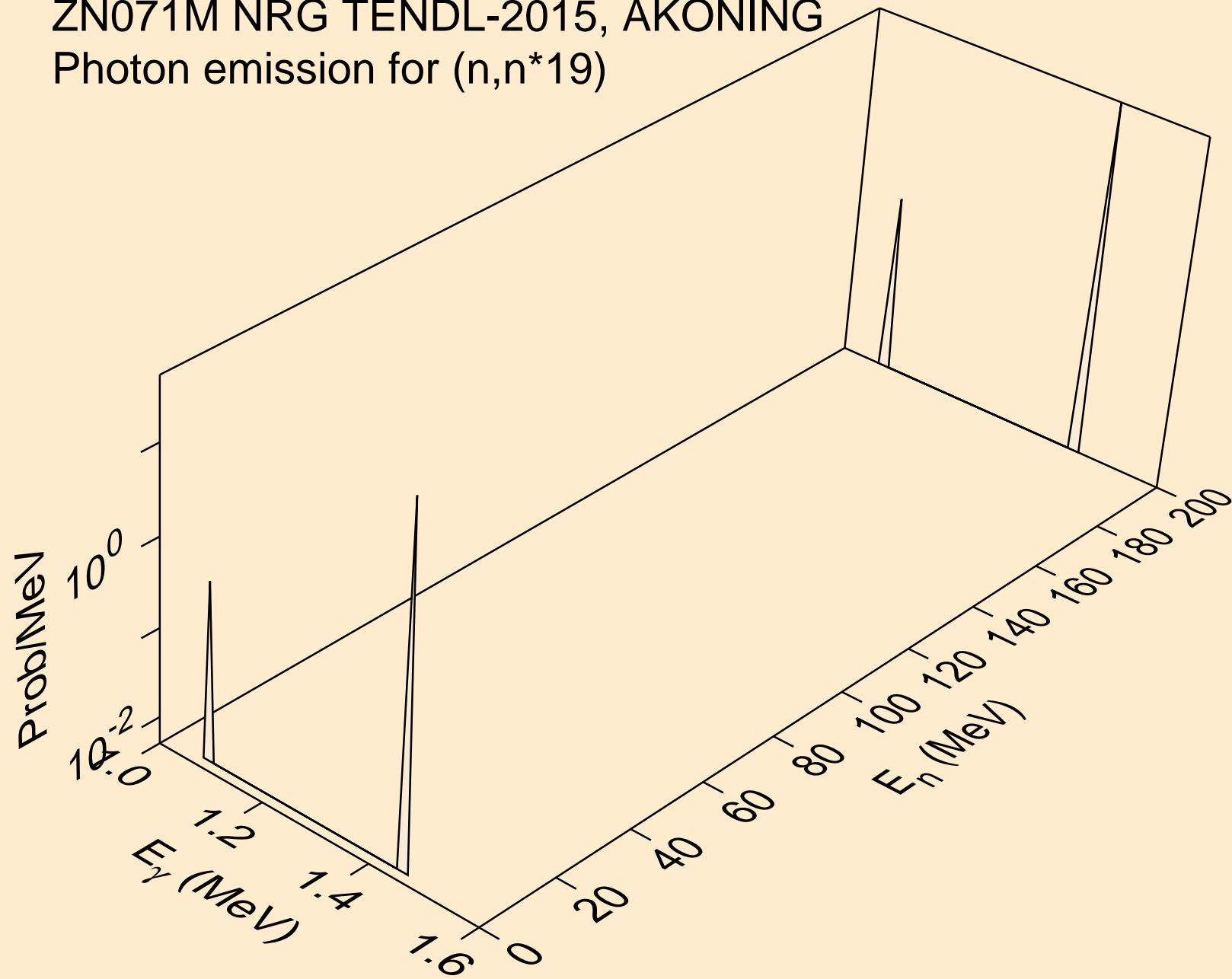

ZN071M NRG TENDL-2015, AKONING
Photon emission for (n,n*20)

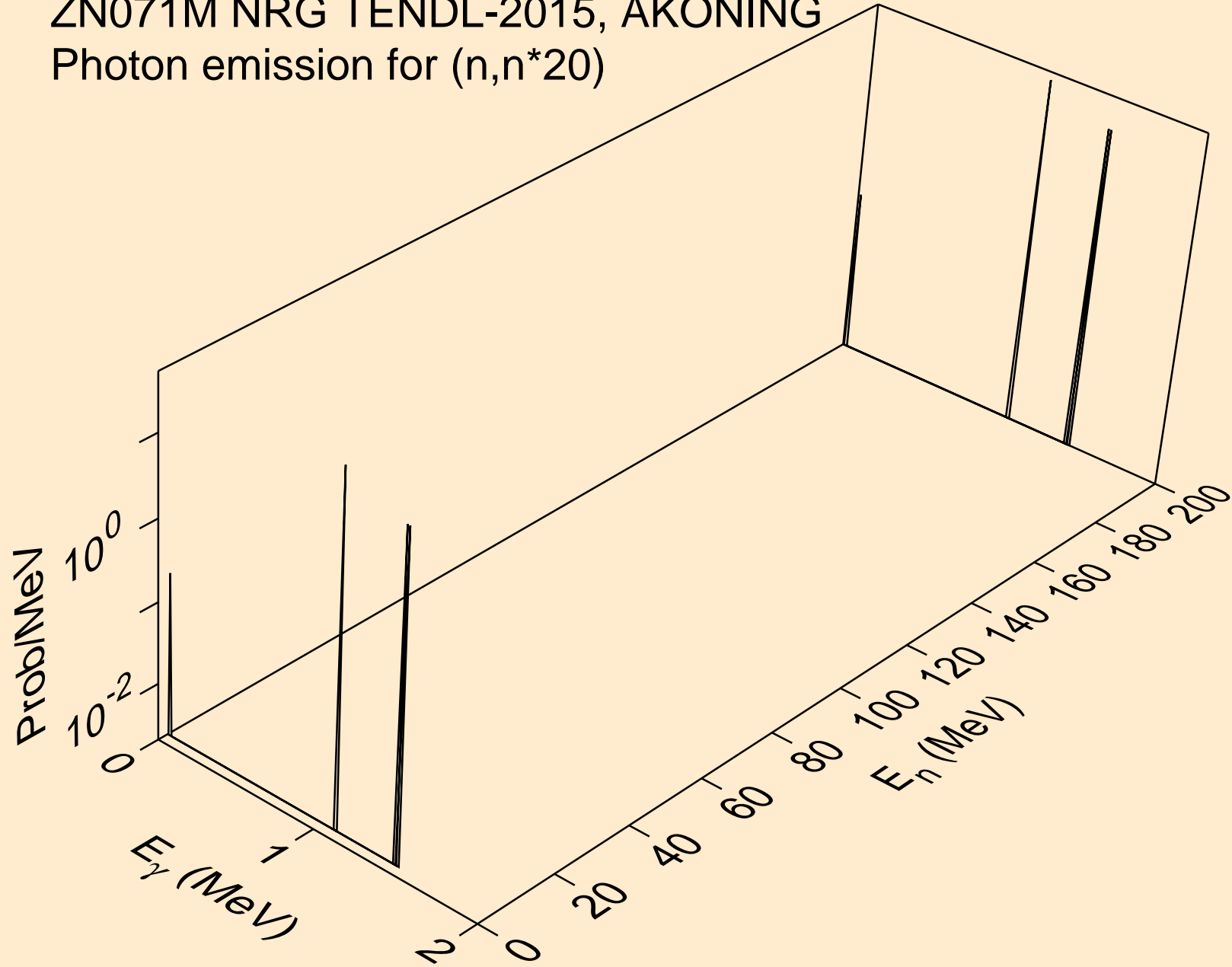

ZN071M NRG TENDL-2015, AKONING
Photon emission for (n,n*21)

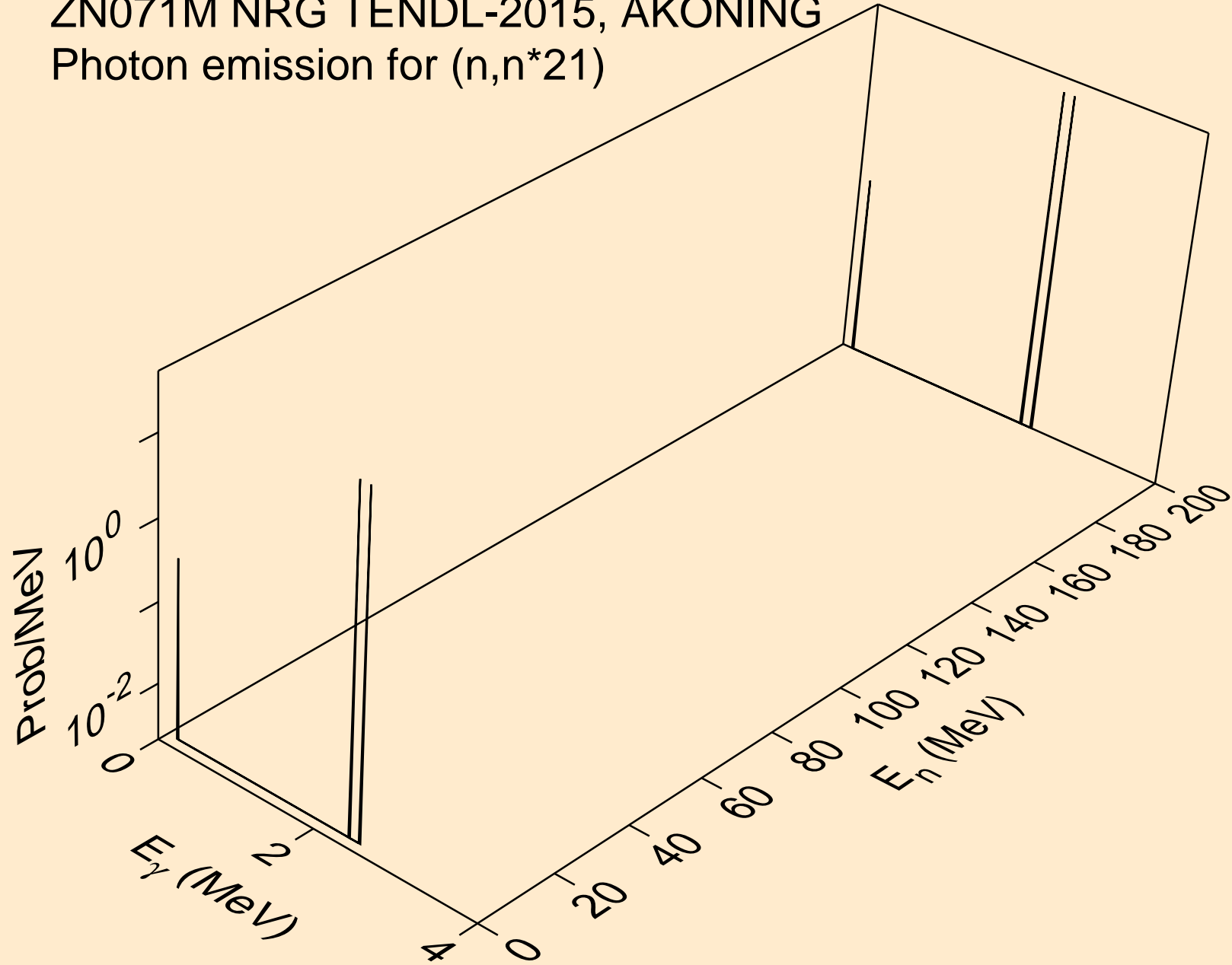

ZN071M NRG TENDL-2015, AKONING
Photon emission for (n,n*22)

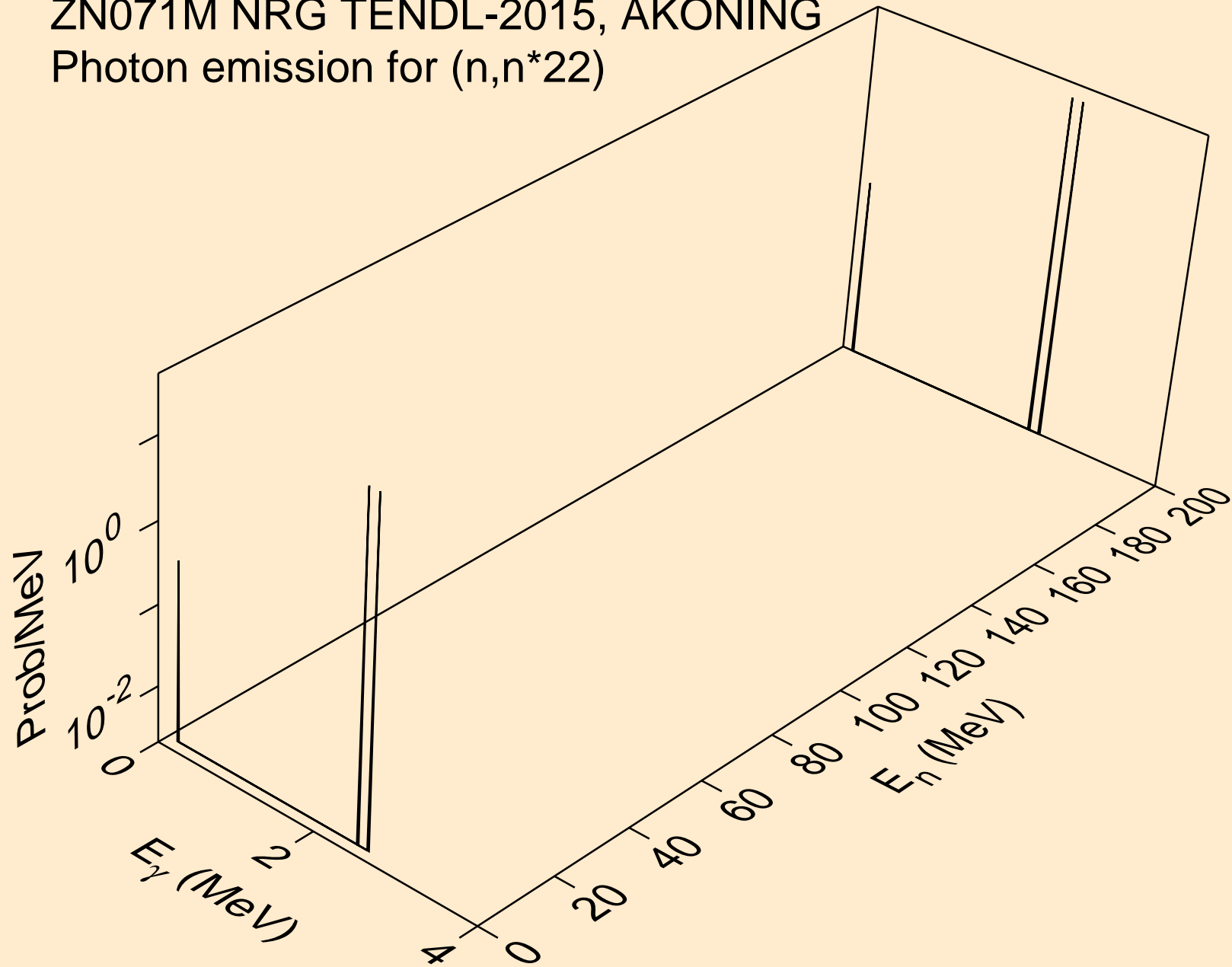

ZN071M NRG TENDL-2015, AKONING
Photon emission for (n,n*23)

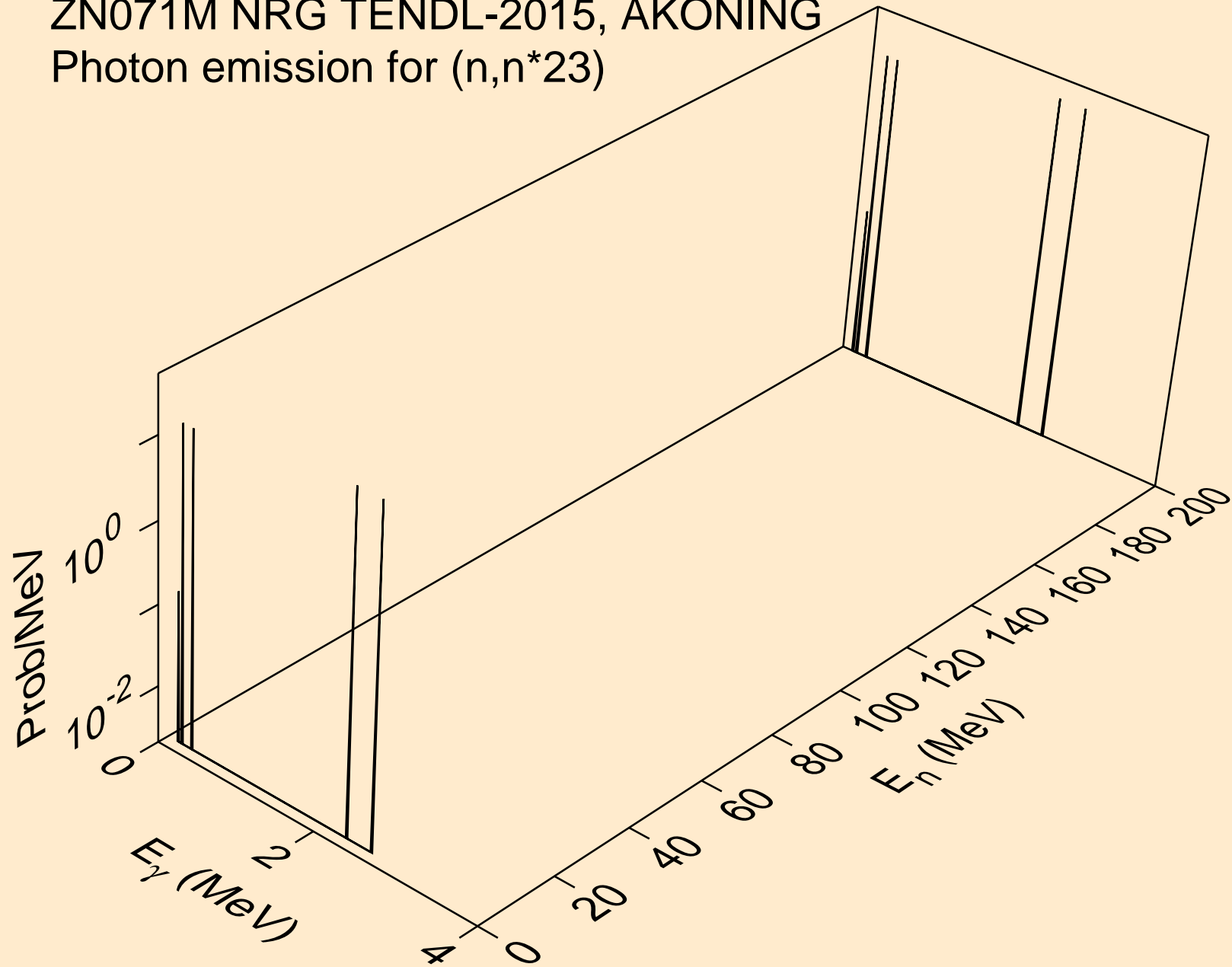

ZN071M NRG TENDL-2015, AKONING
Photon emission for (n,n*24)

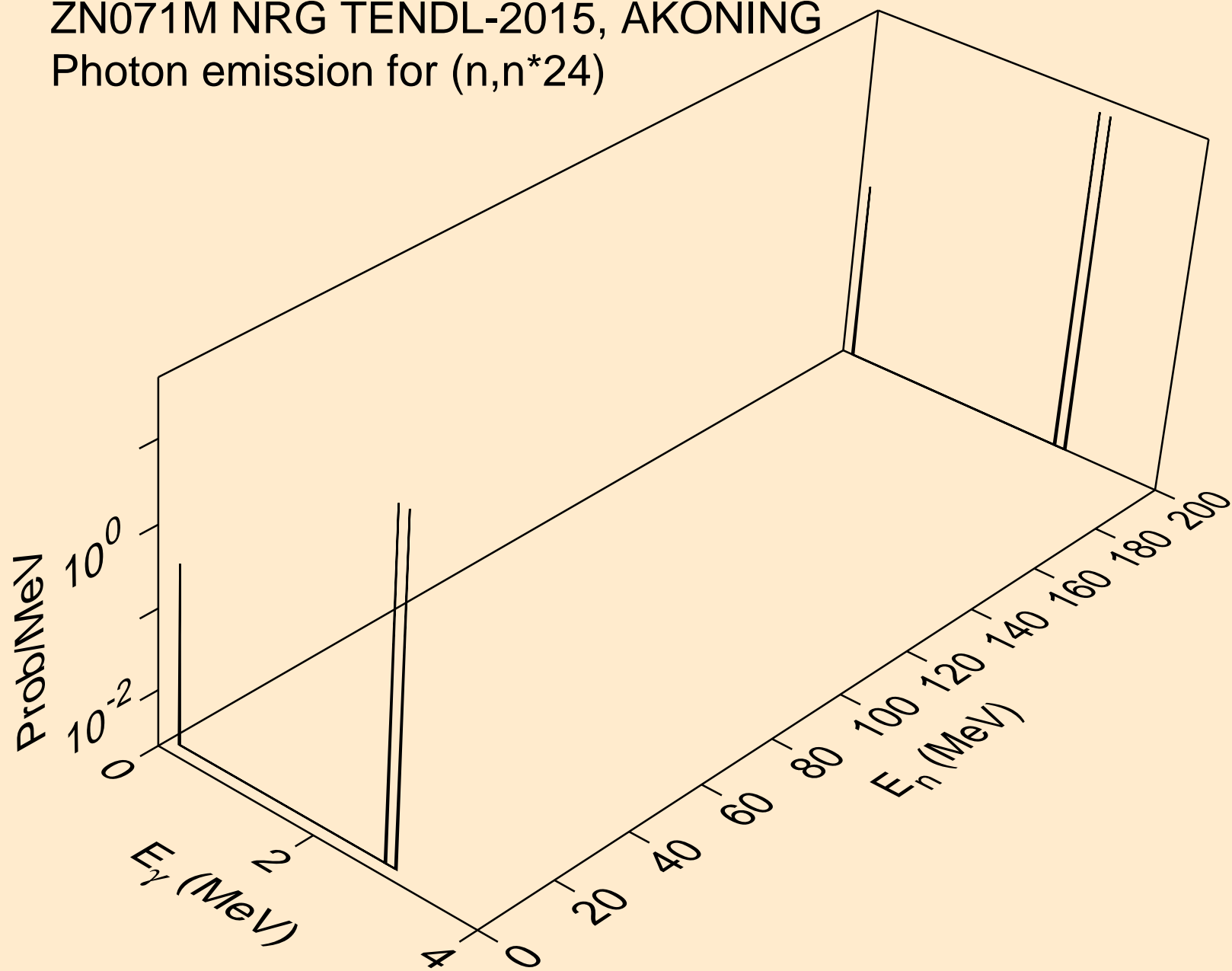

ZN071M NRG TENDL-2015, AKONING
Photon emission for (n,n*25)

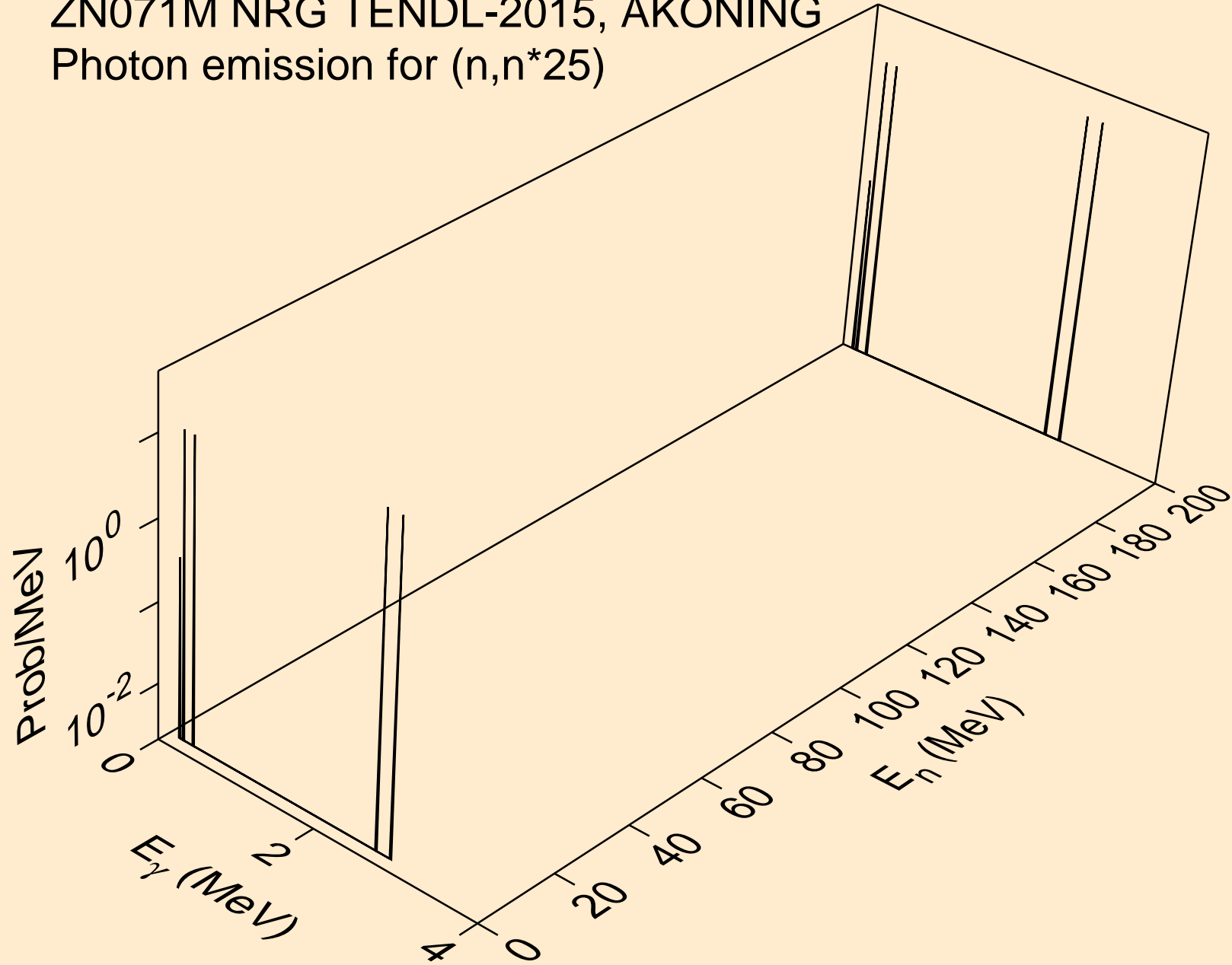

ZN071M NRG TENDL-2015, AKONING
Photon emission for (n,n*26)

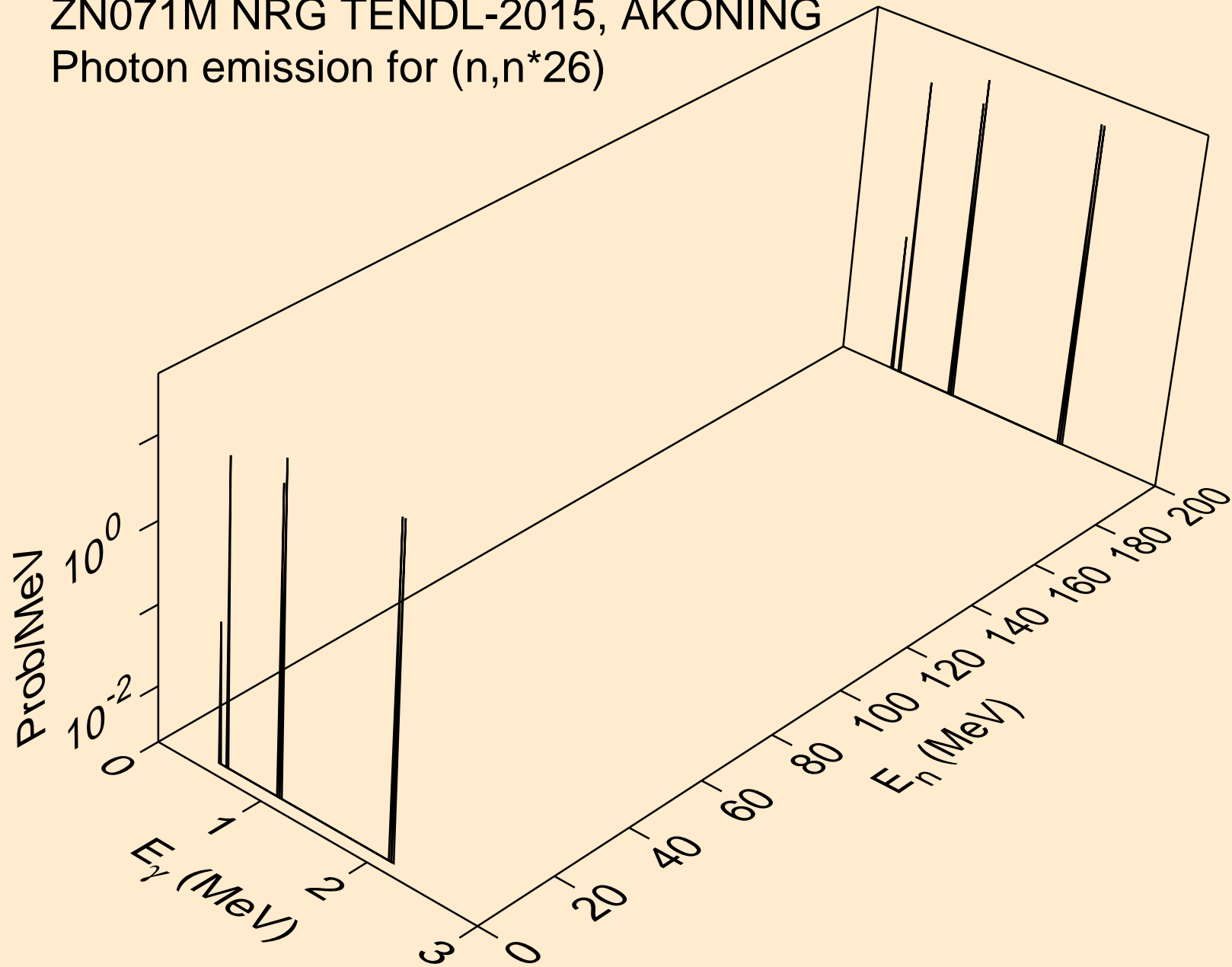

ZN071M NRG TENDL-2015, AKONING
Photon emission for (n,n*c)

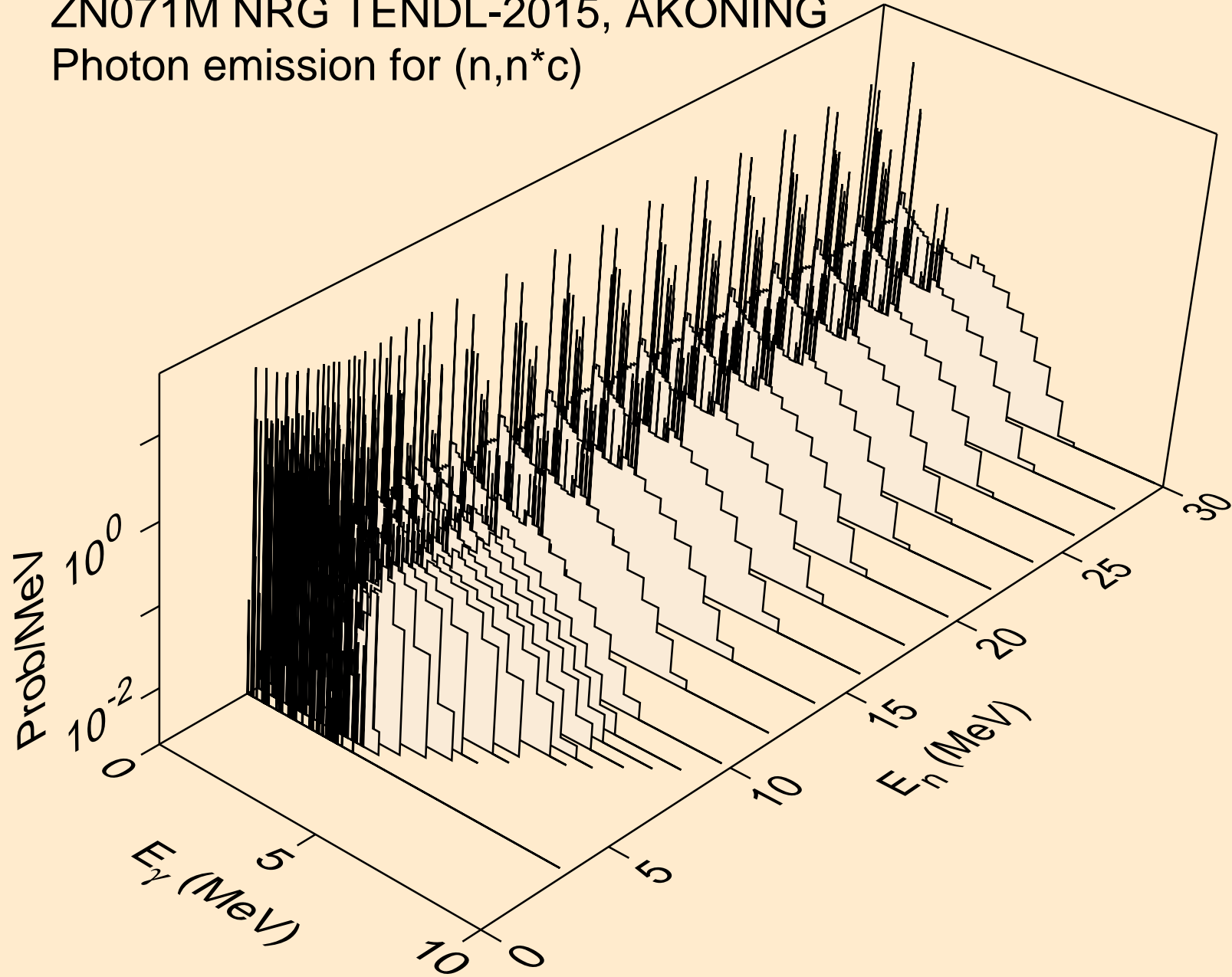

ZN071M NRG TENDL-2015, AKONING
Photon emission for (n,gma)

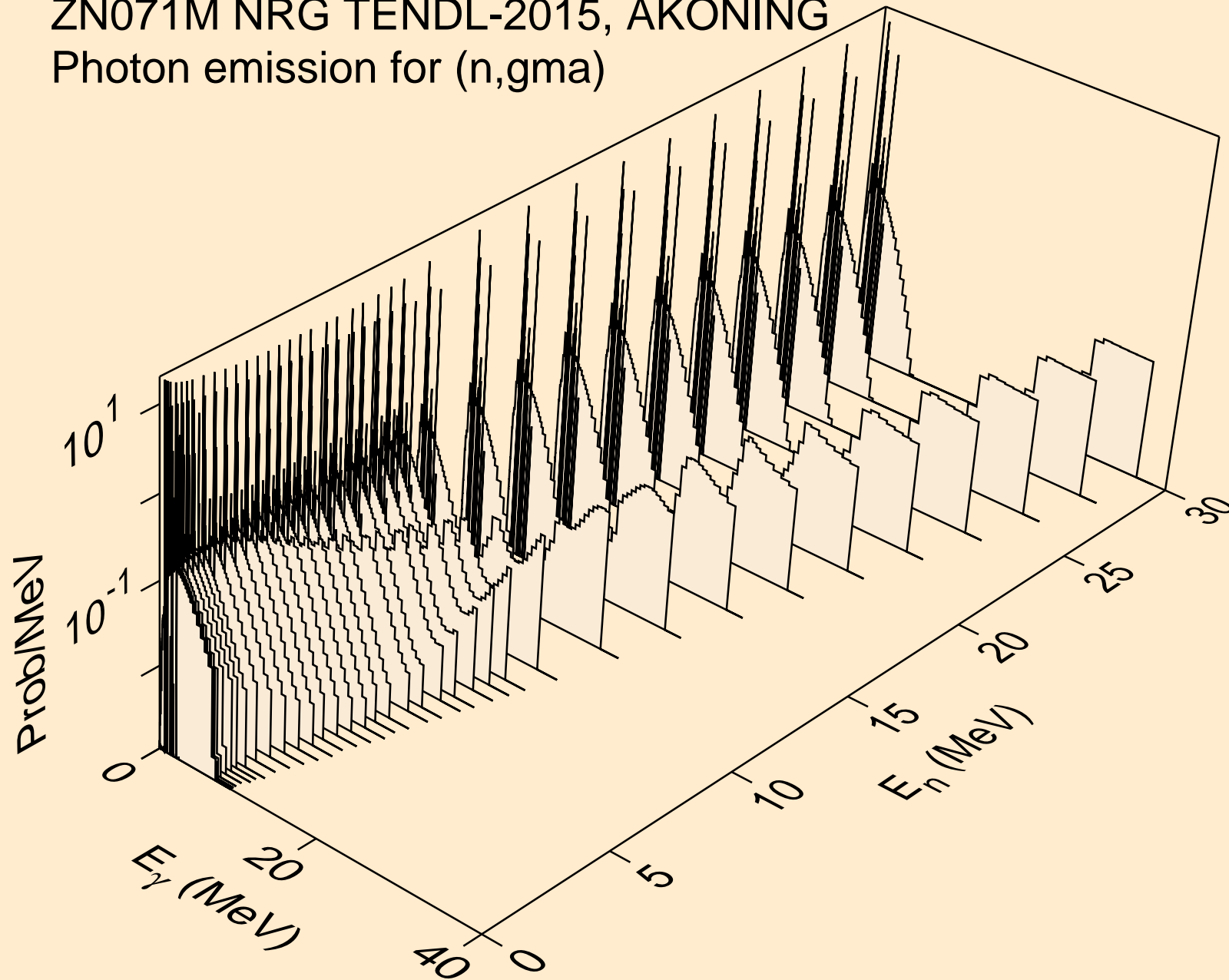

ZN071M NRG TENDL-2015, AKONING
Photon emission for (n,p)

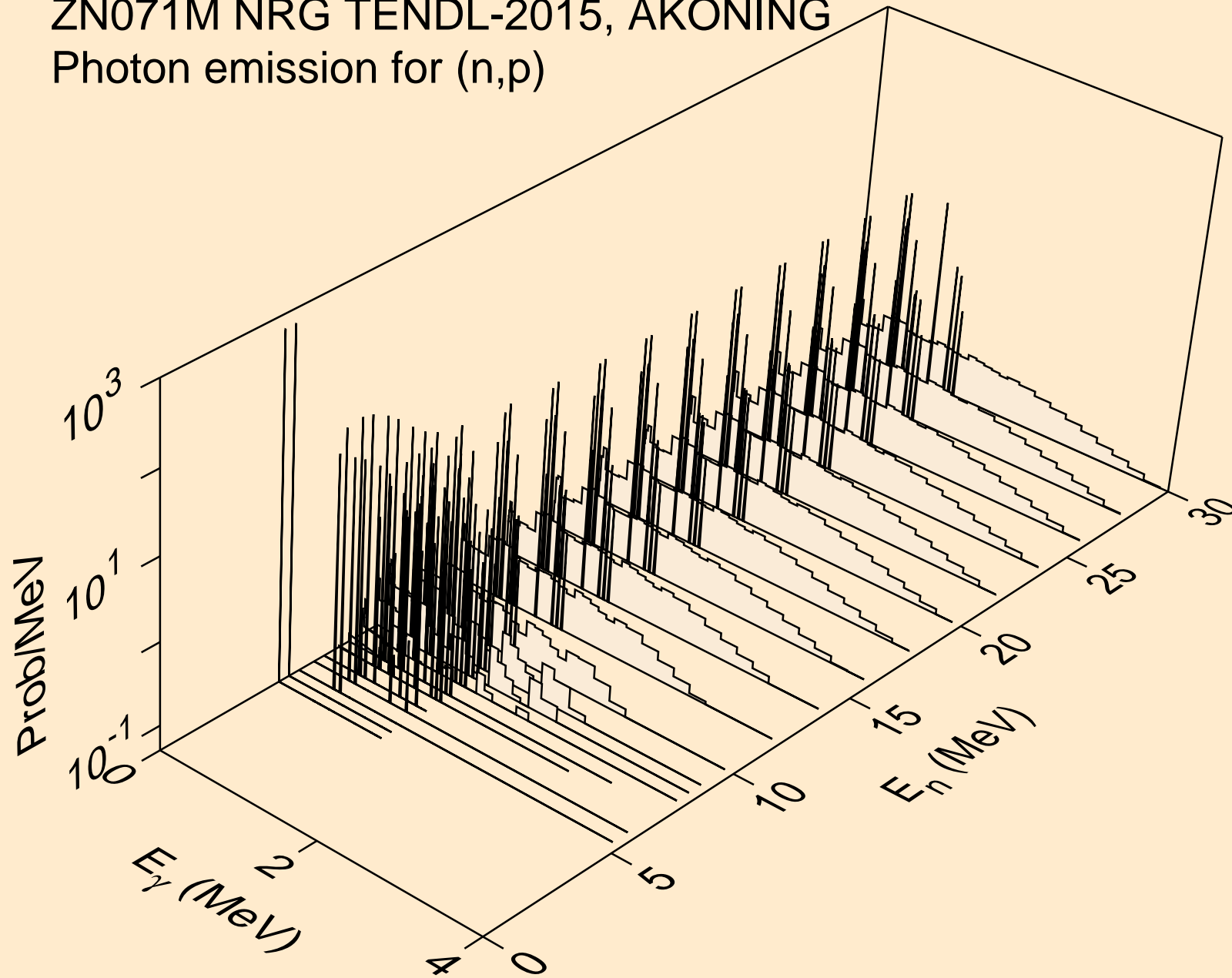

ZN071M NRG TENDL-2015, AKONING
Photon emission for (n,d)

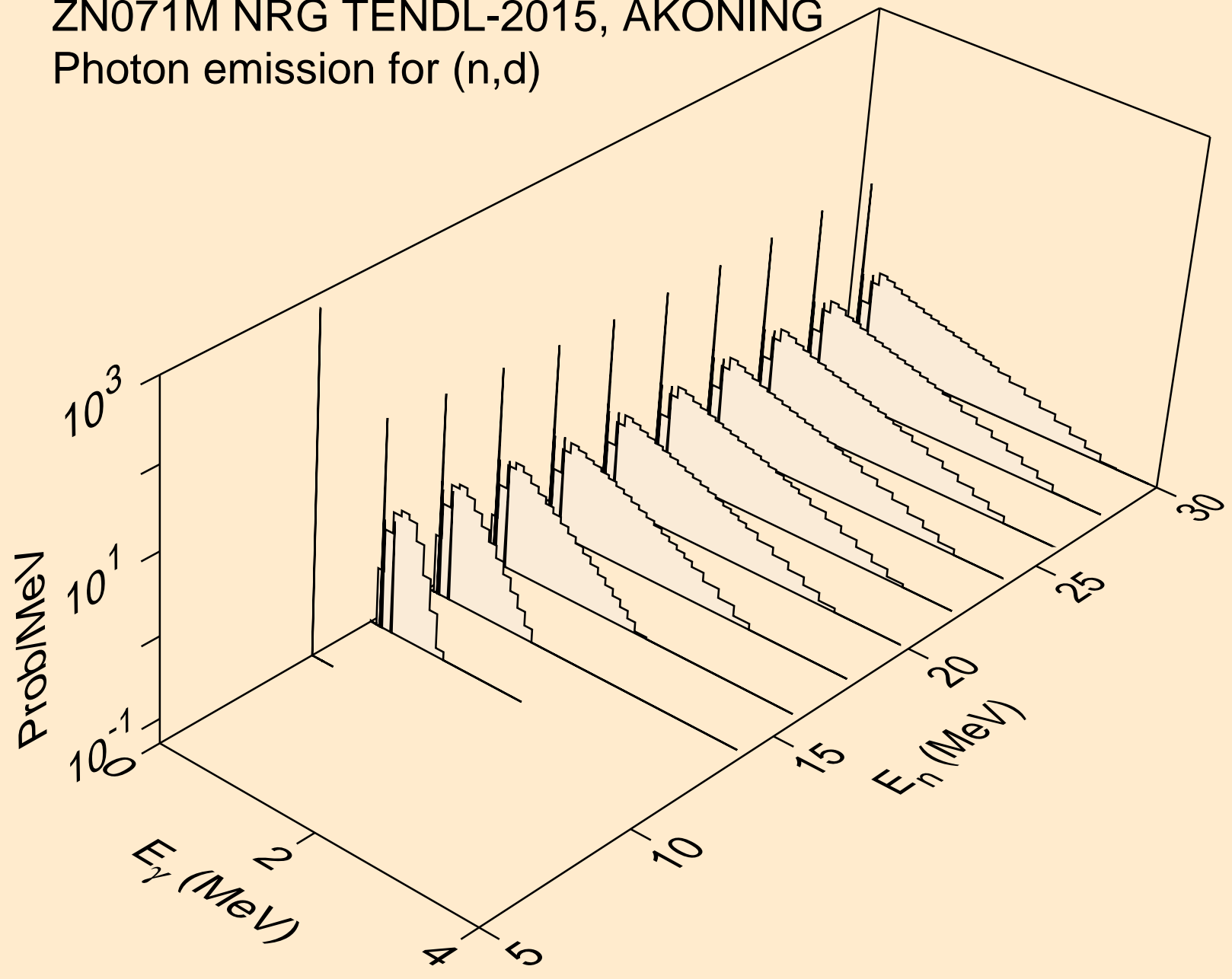

ZN071M NRG TENDL-2015, AKONING
Photon emission for (n,t)

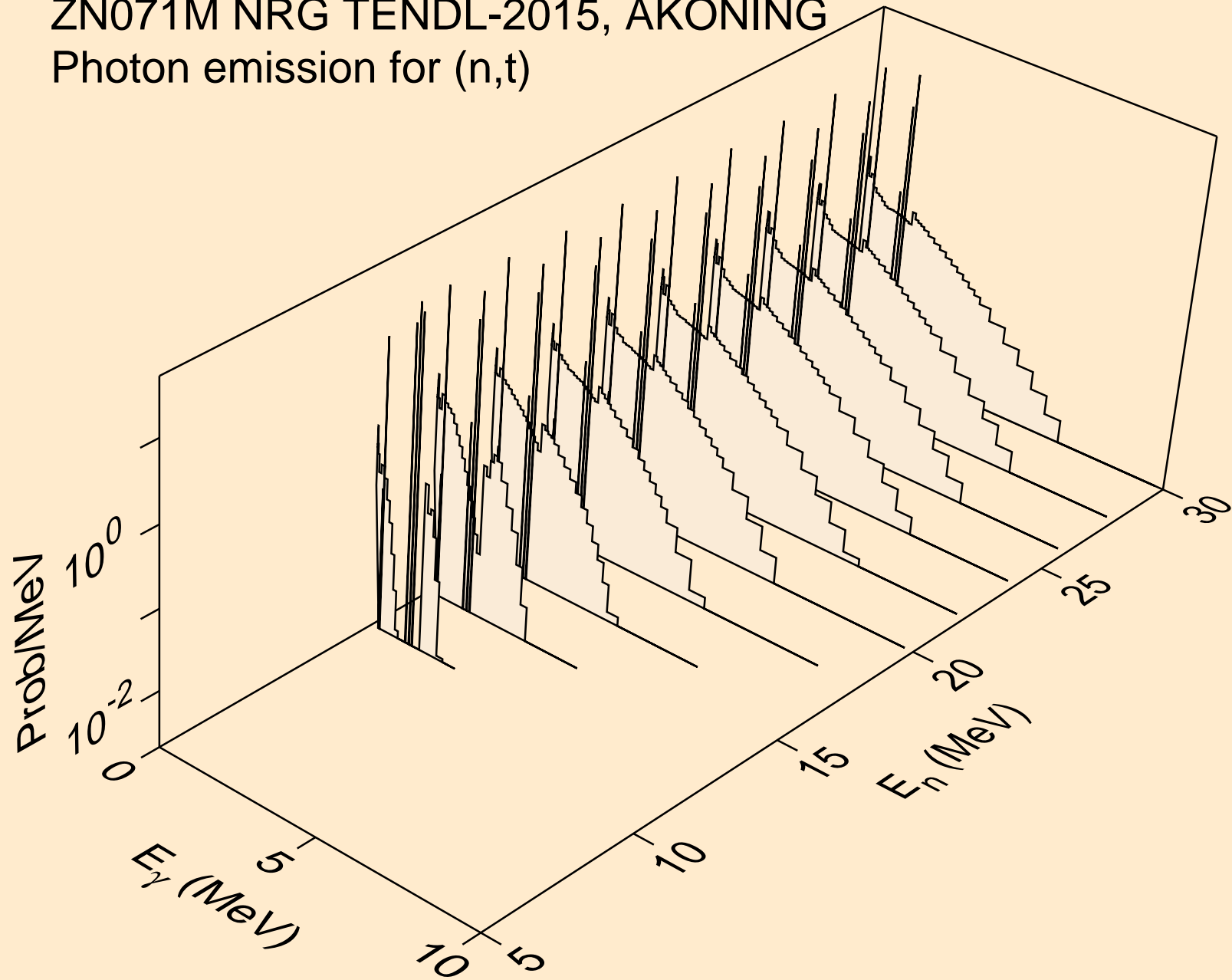

ZN071M NRG TENDL-2015, AKONING
Photon emission for (n,he3)

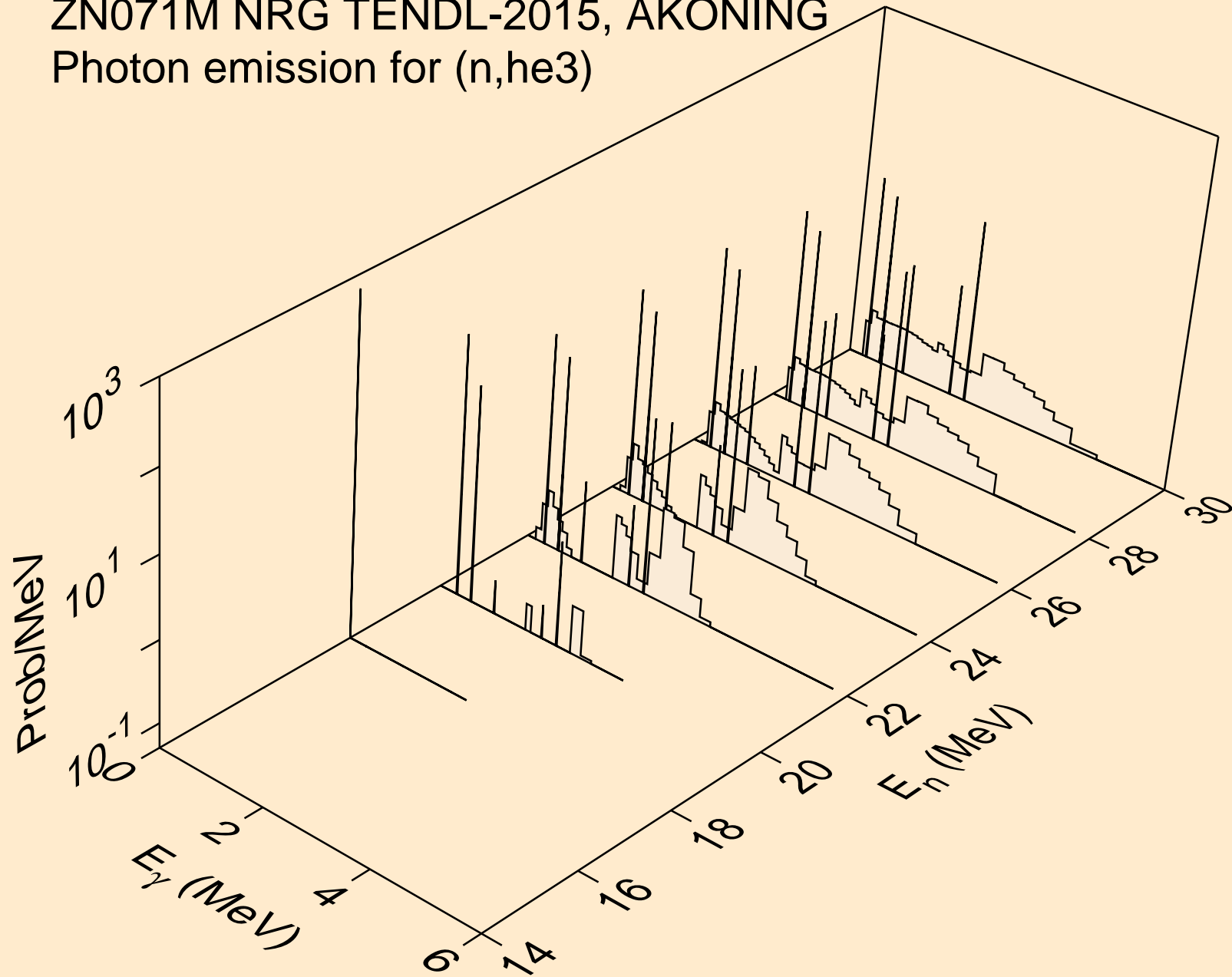

ZN071M NRG TENDL-2015, AKONING
Photon emission for (n,a)

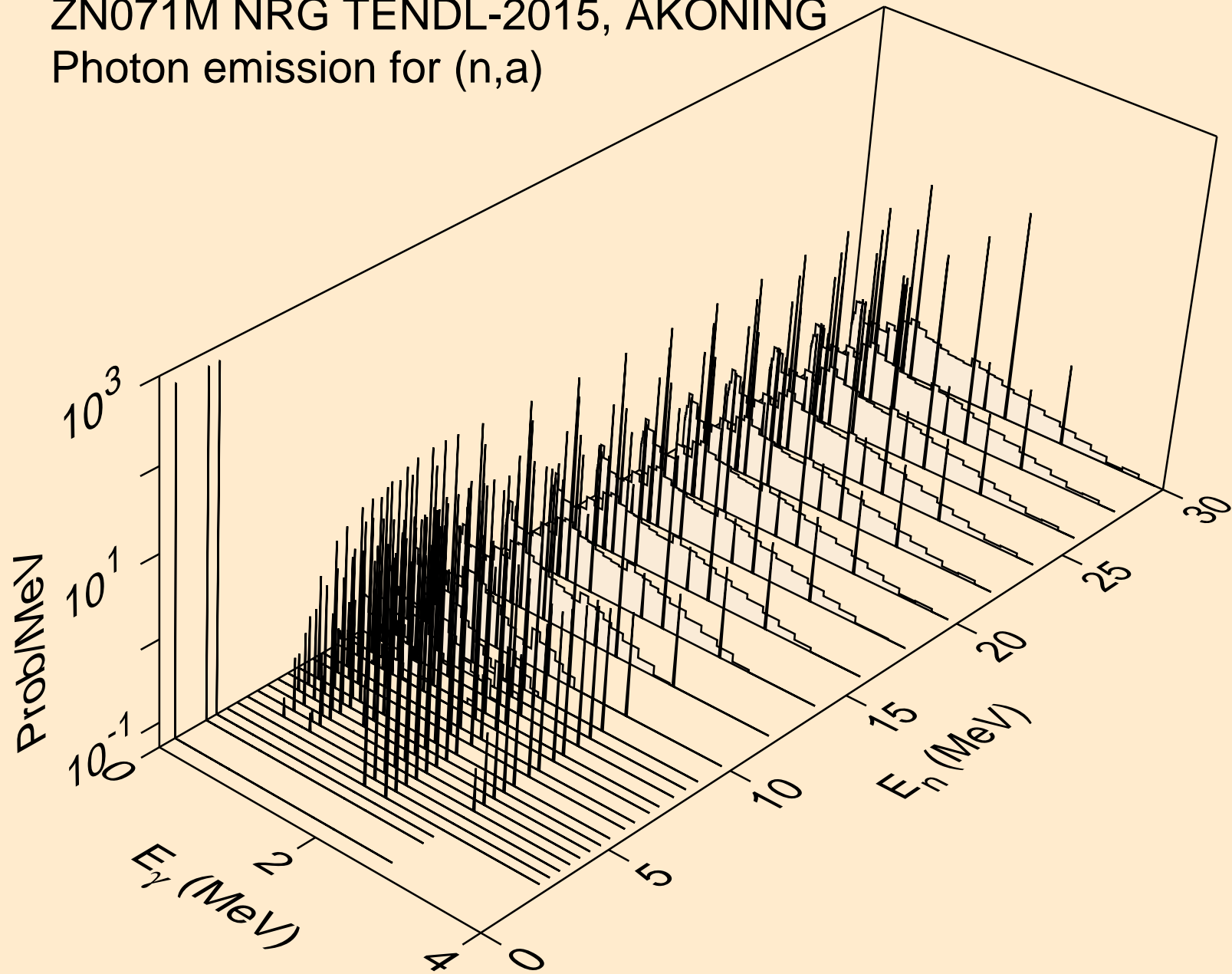

ZN071M NRG TENDL-2015, AKONING
Photon emission for (n,2a)

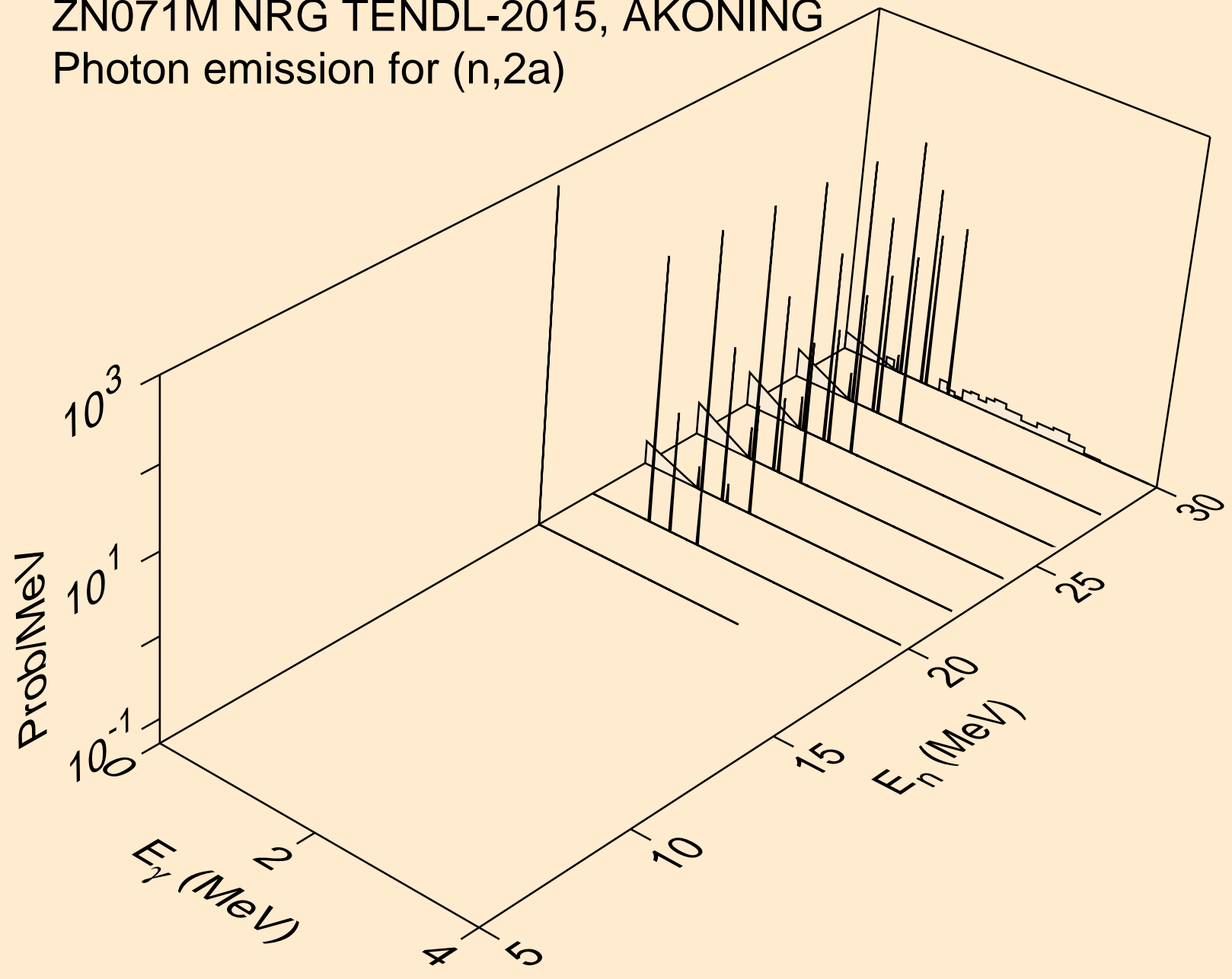

ZN071M NRG TENDL-2015, AKONING
Photon emission for (n,2p)

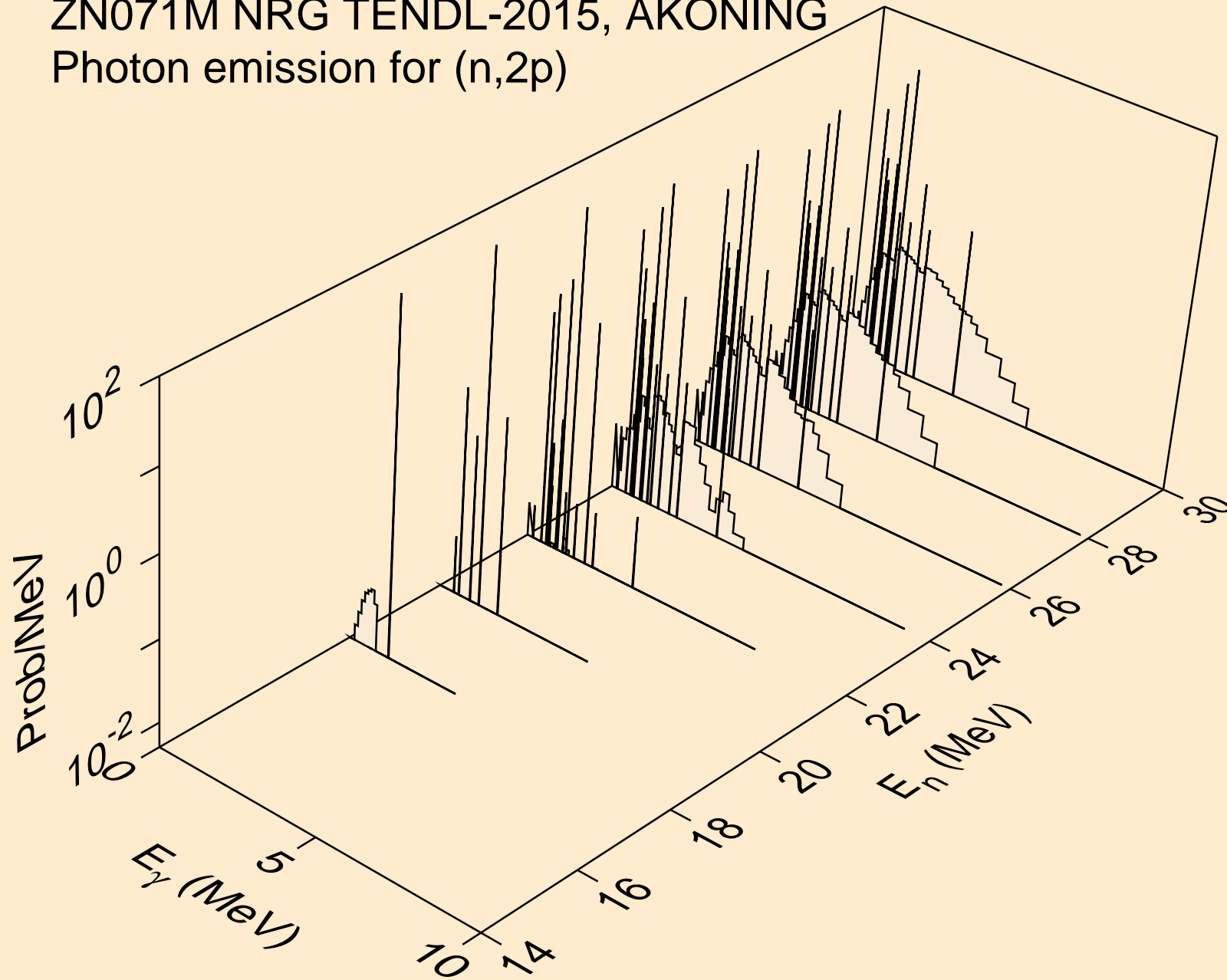

ZN071M NRG TENDL-2015, AKONING
Photon emission for (n,p α)

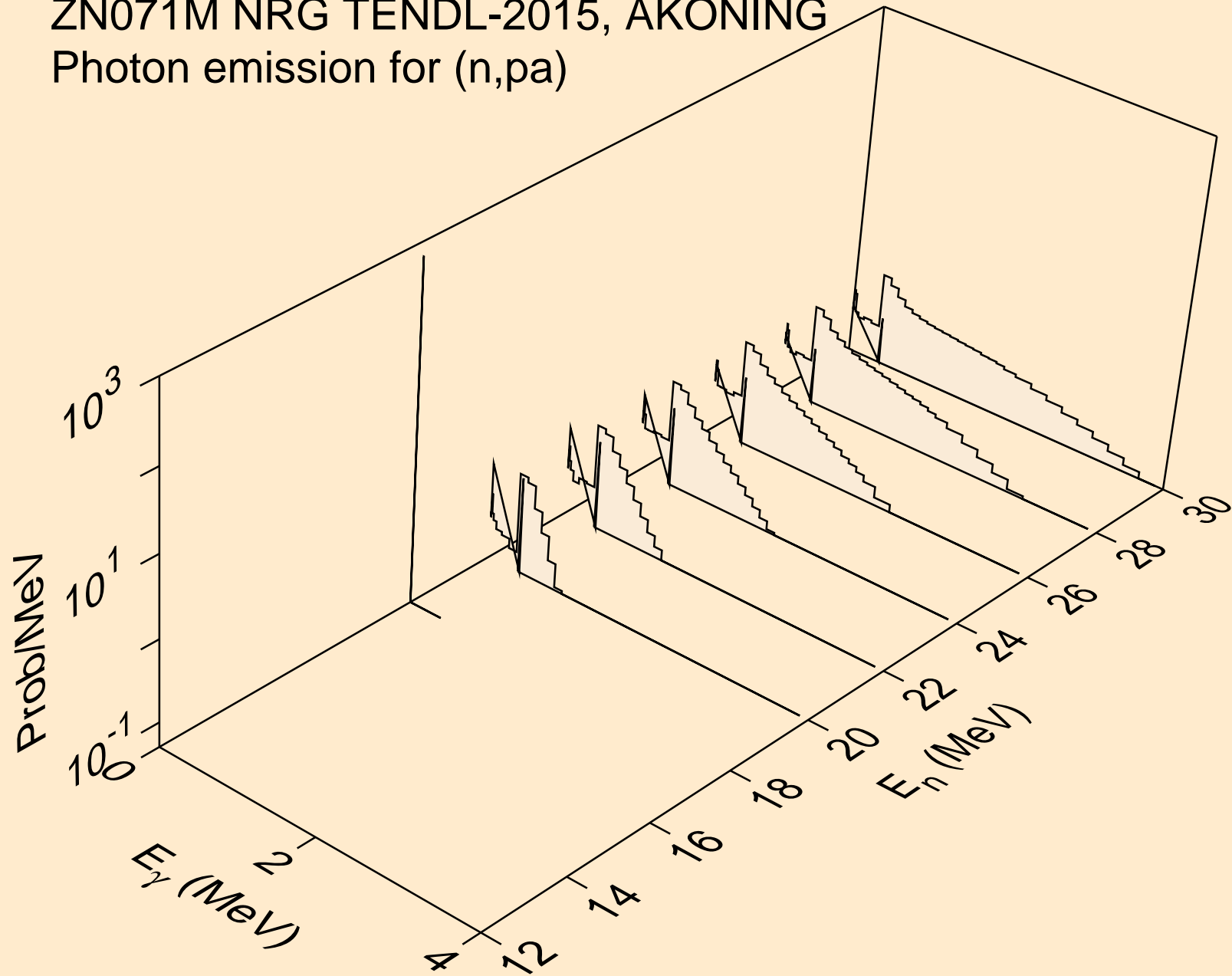

ZN071M NRG TENDL-2015, AKONING
Photon emission for (n,pd)

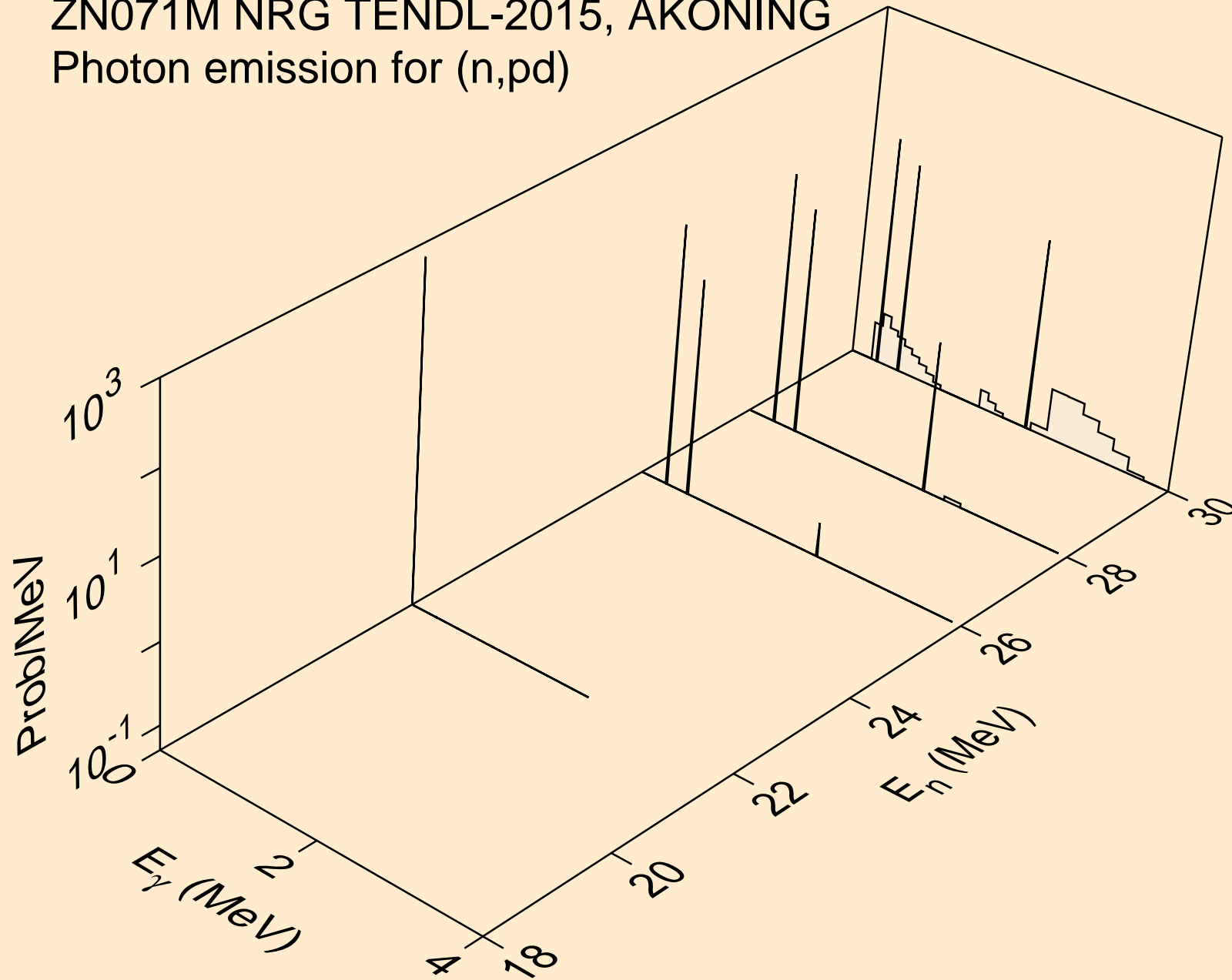

ZN071M NRG TENDL-2015, AKONING
Photon emission for (n,pt)

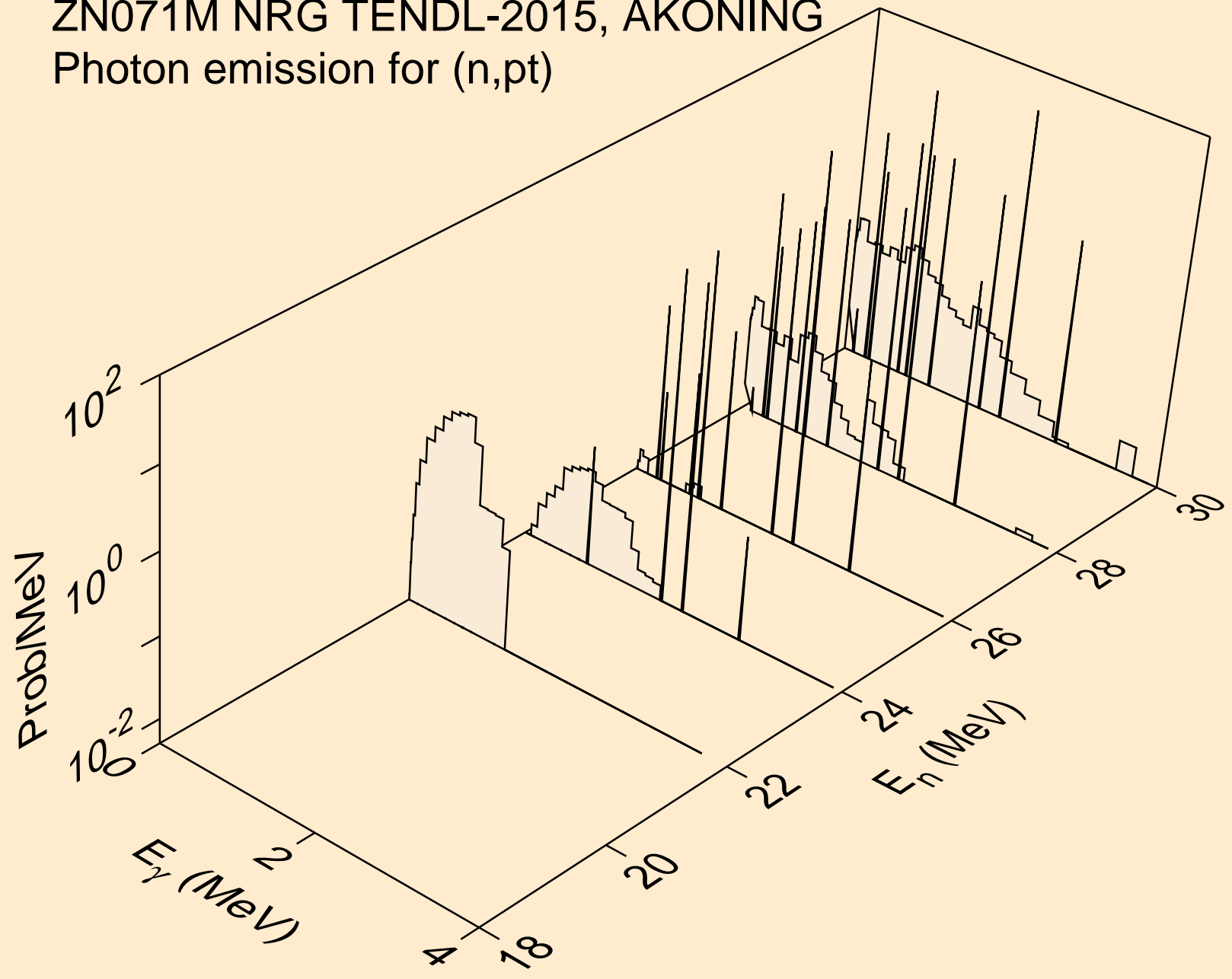

ZN071M NRG TENDL-2015, AKONING
thermal capture photon spectrum

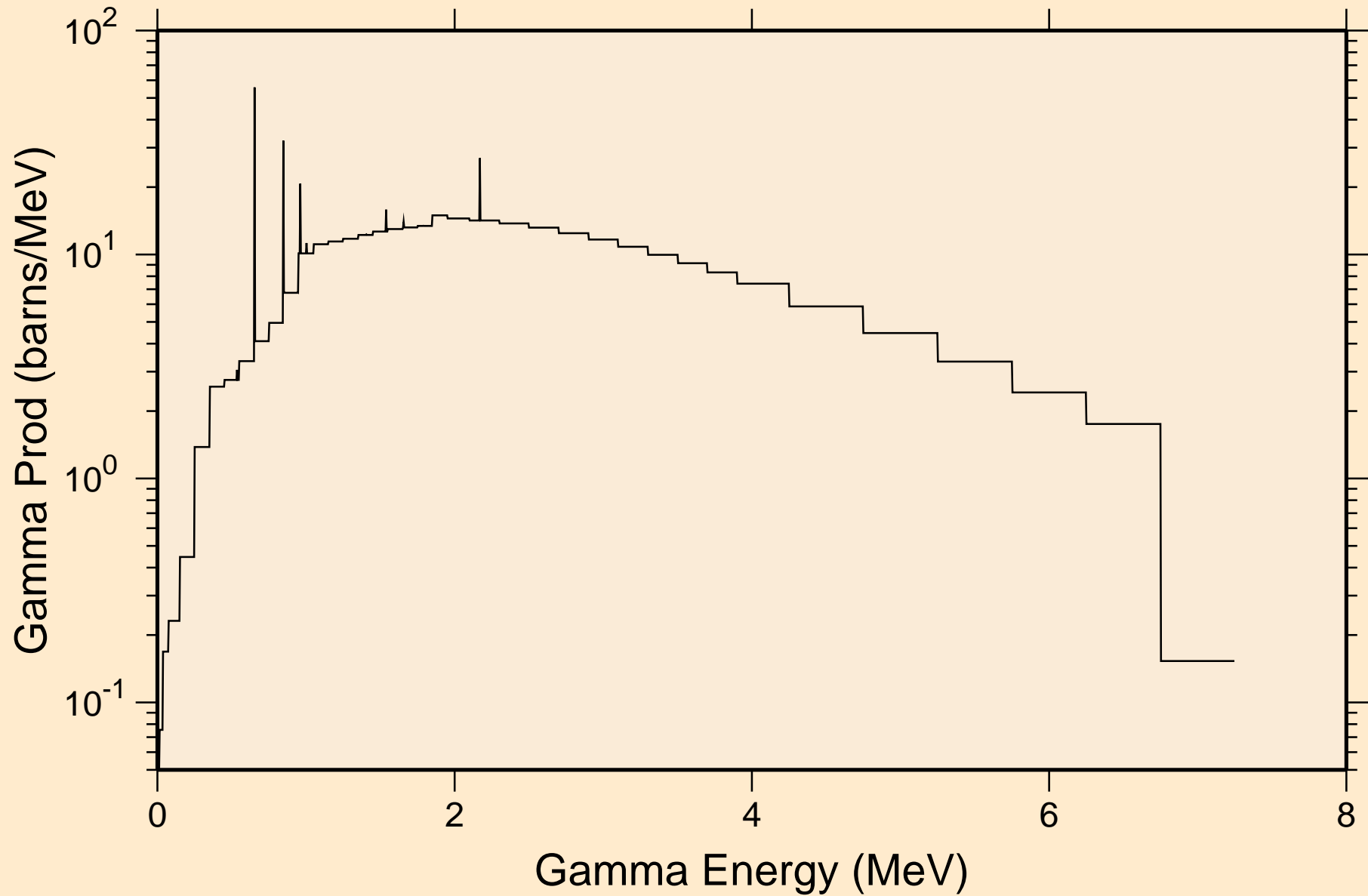

ZN071M NRG TENDL-2015, AKONING
14 MeV photon spectrum

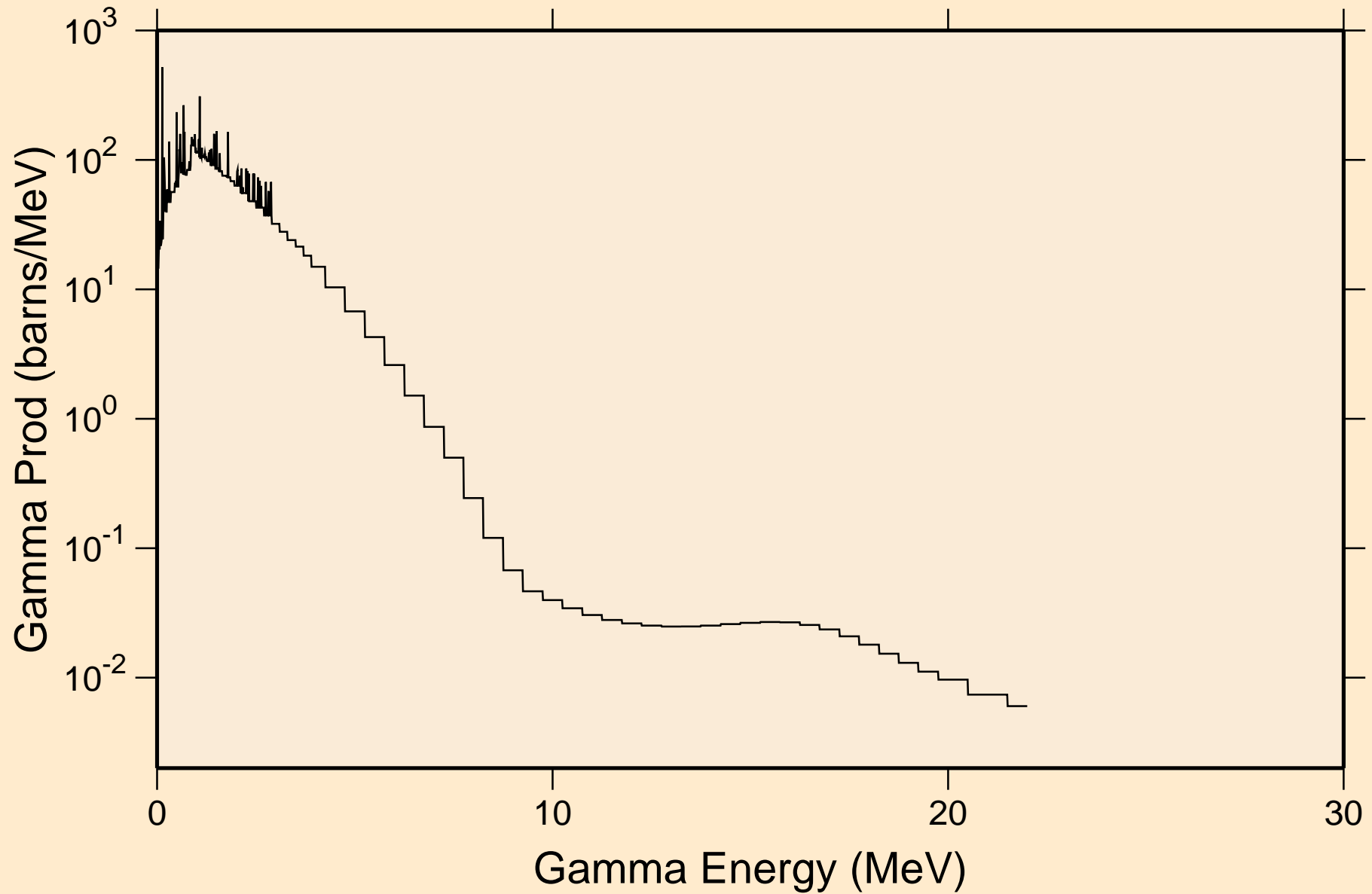

ZN071M NRG TENDL-2015, AKONING

Particle heating contributions

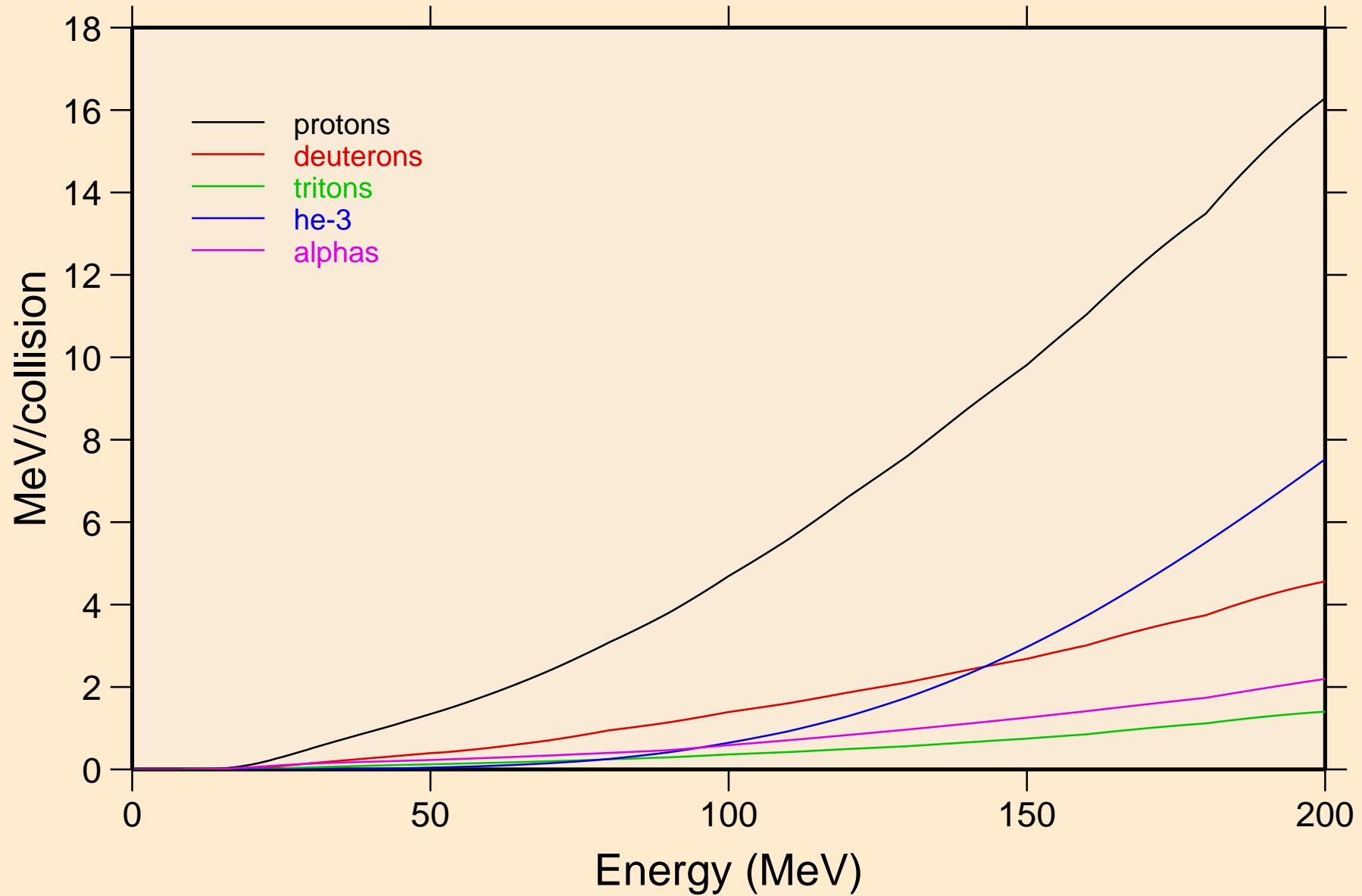

ZN071M NRG TENDL-2015, AKONING

Recoil Heating

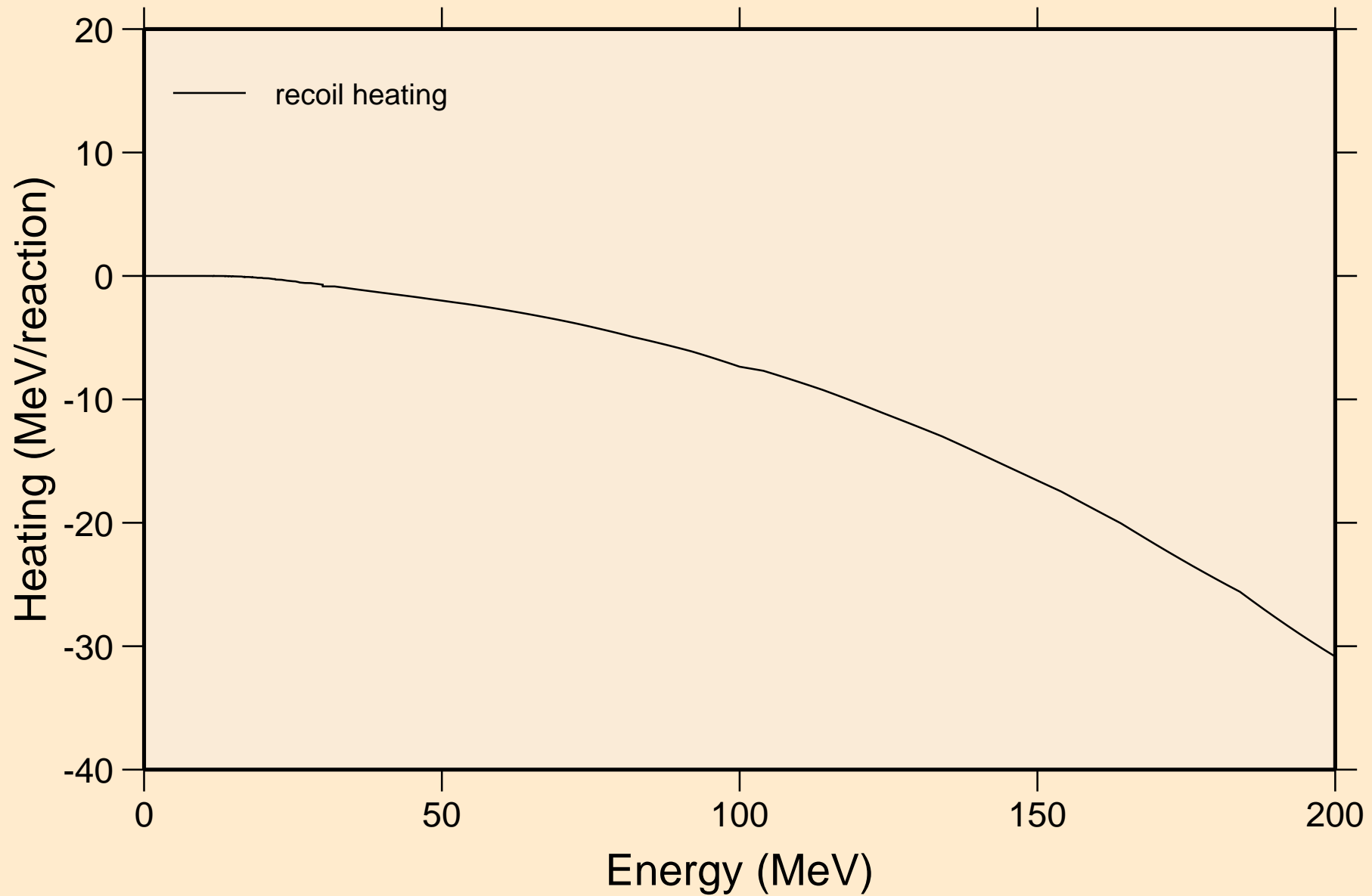

ZN071M NRG TENDL-2015, AKONING

Particle production cross sections

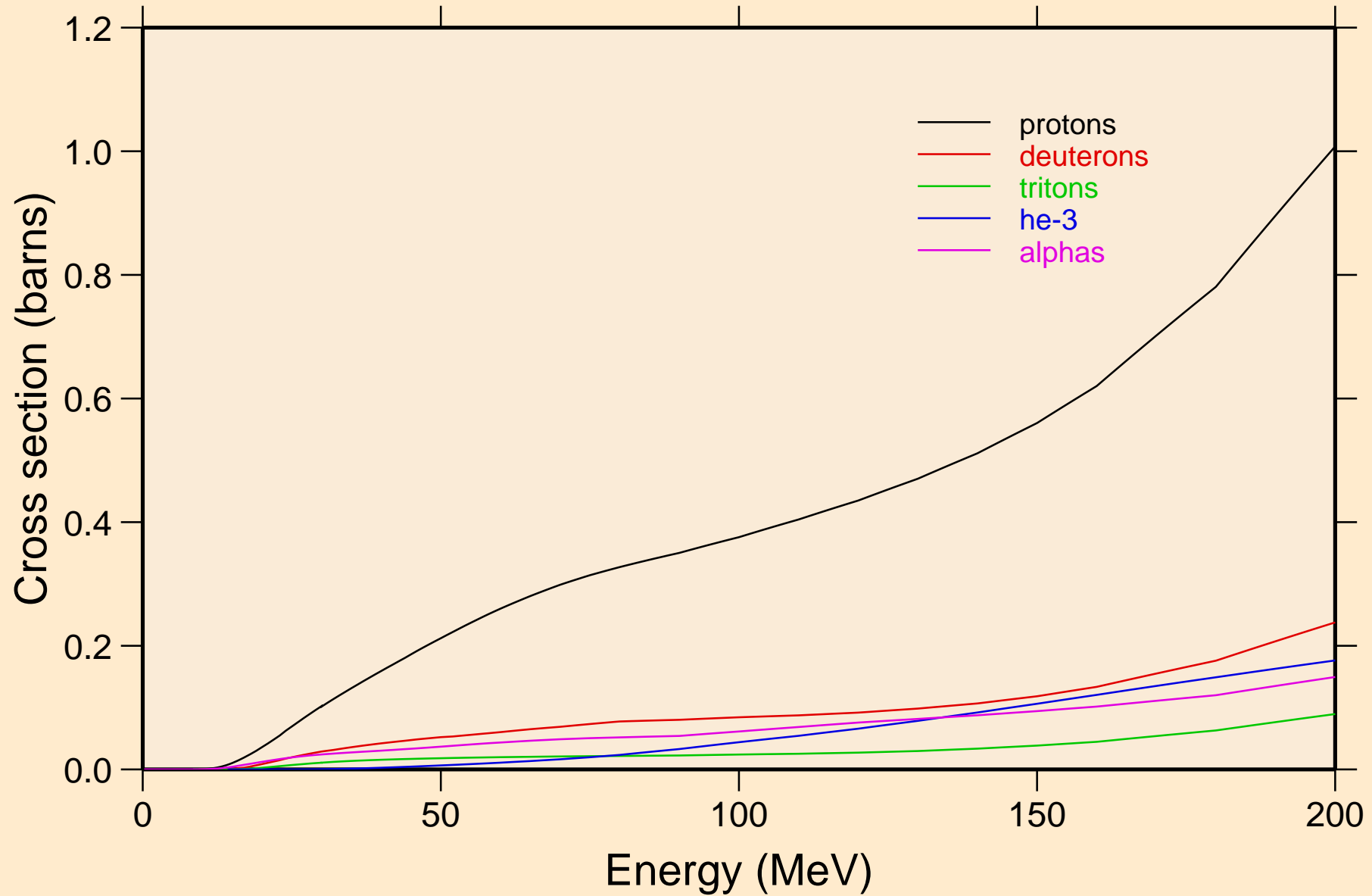

ZN071M NRG TENDL-2015, AKONING
protons from (n,x)

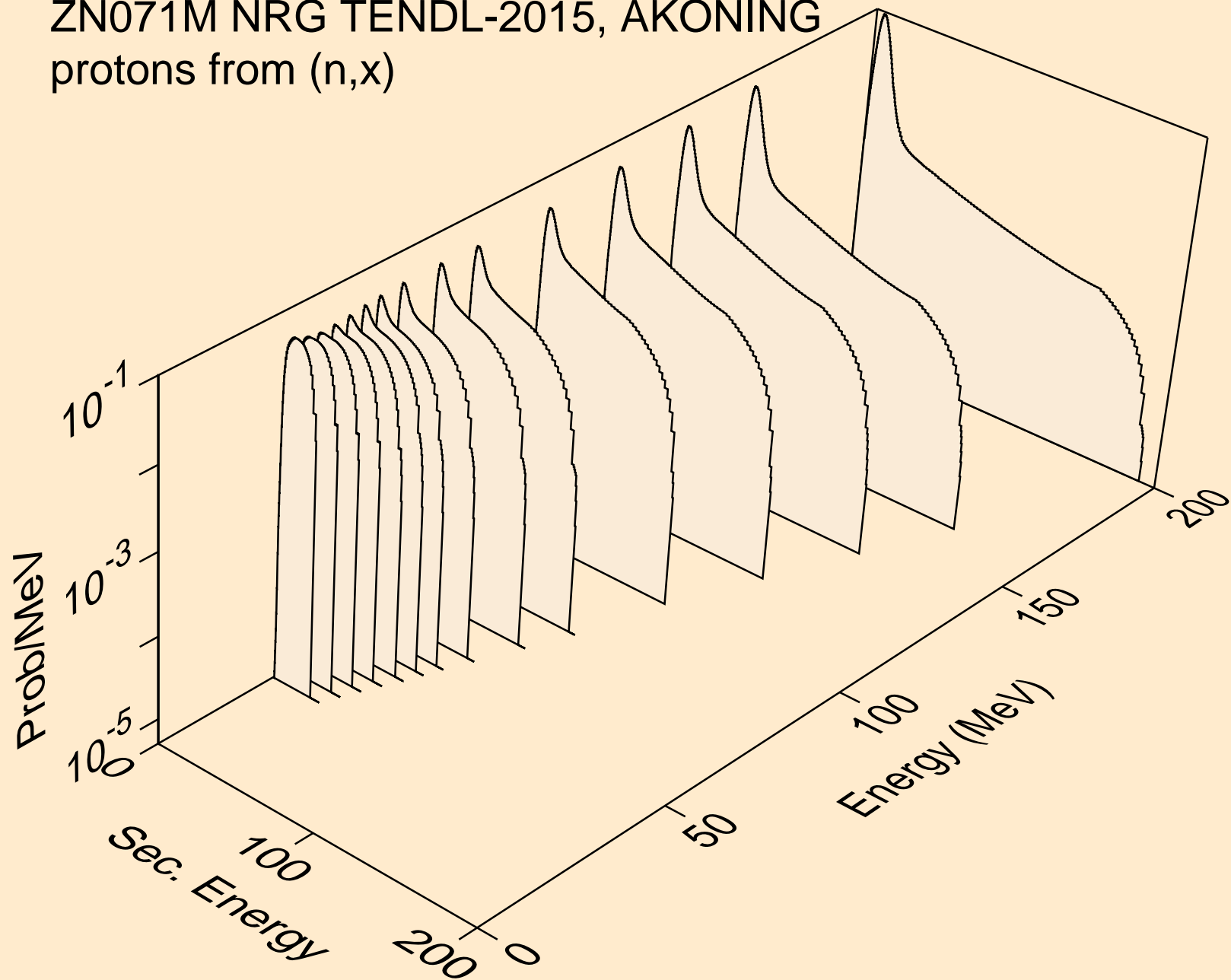

ZN071M NRG TENDL-2015, AKONING
protons from (n,n*)p

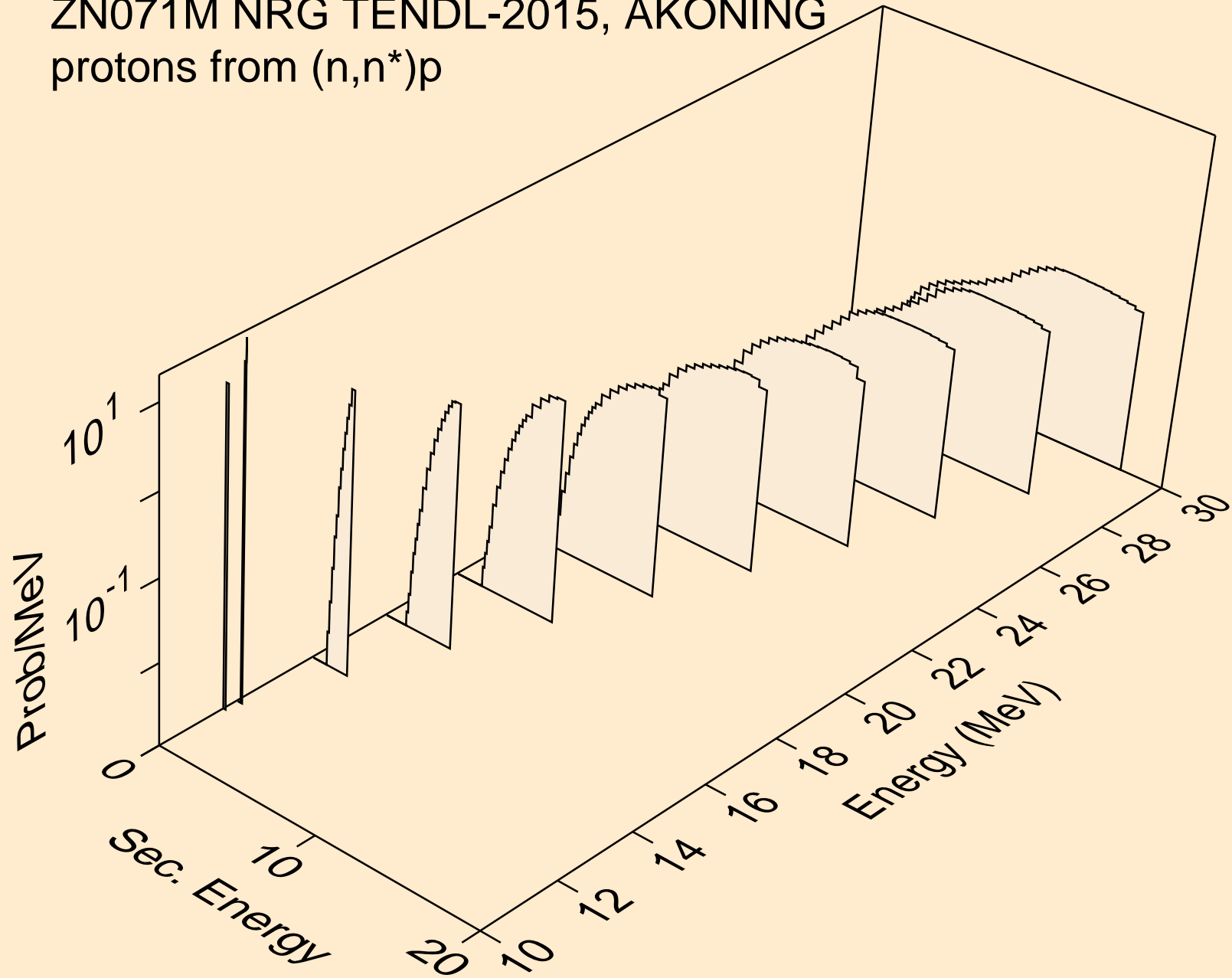

ZN071M NRG TENDL-2015, AKONING
protons from (n,2np)

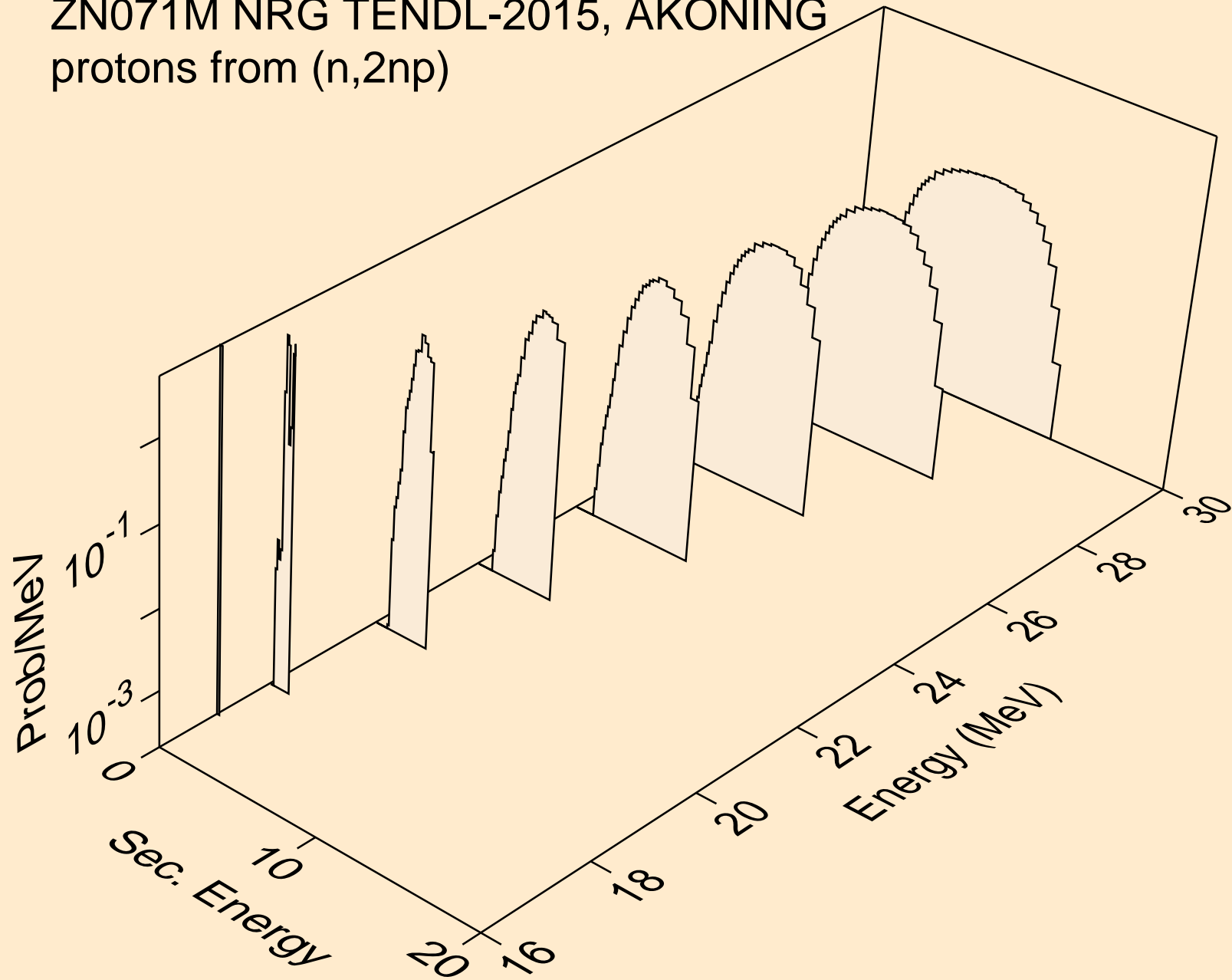

ZN071M NRG TENDL-2015, AKONING
protons from (n,3np)

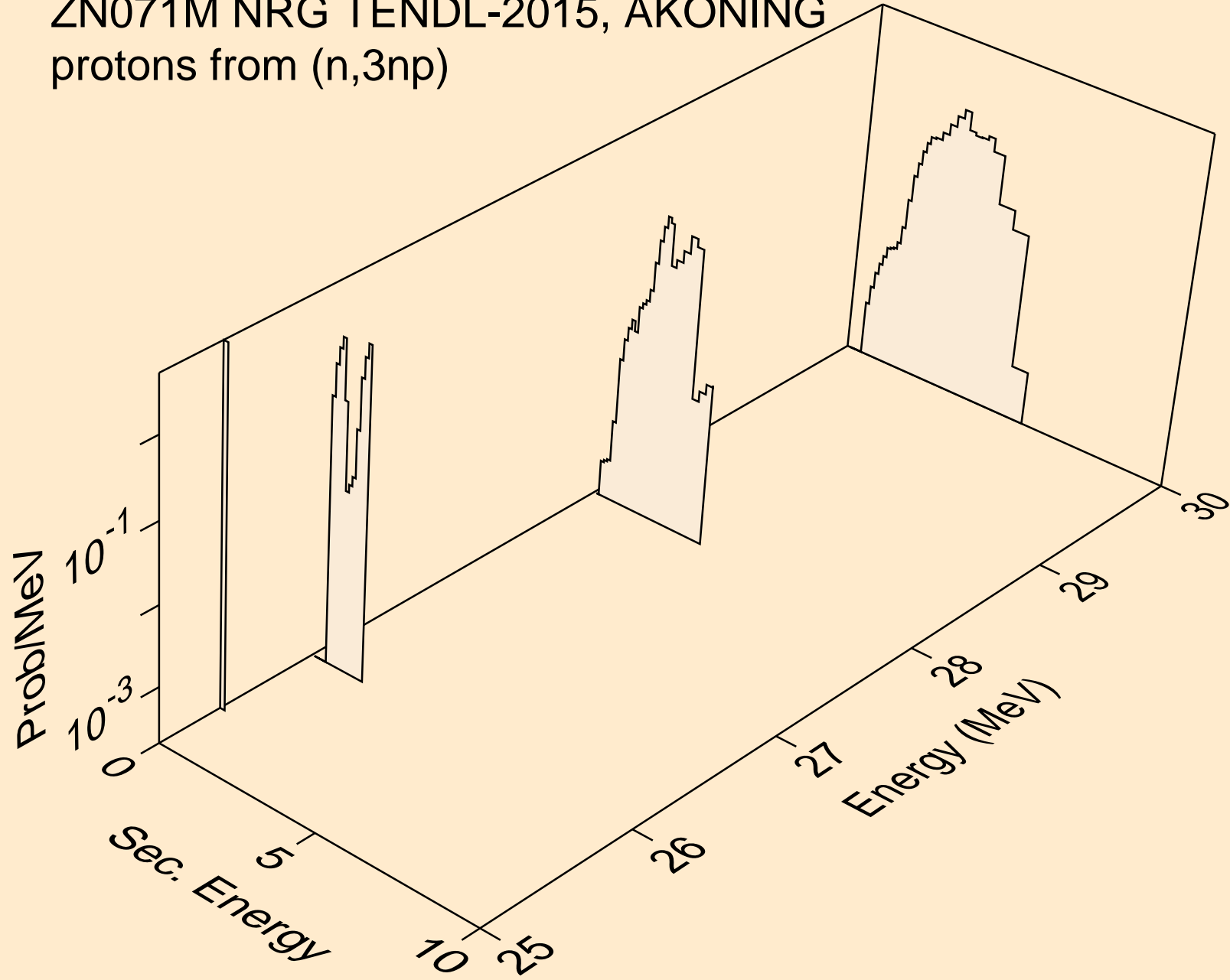

ZN071M NRG TENDL-2015, AKONING
protons from (n,2np)

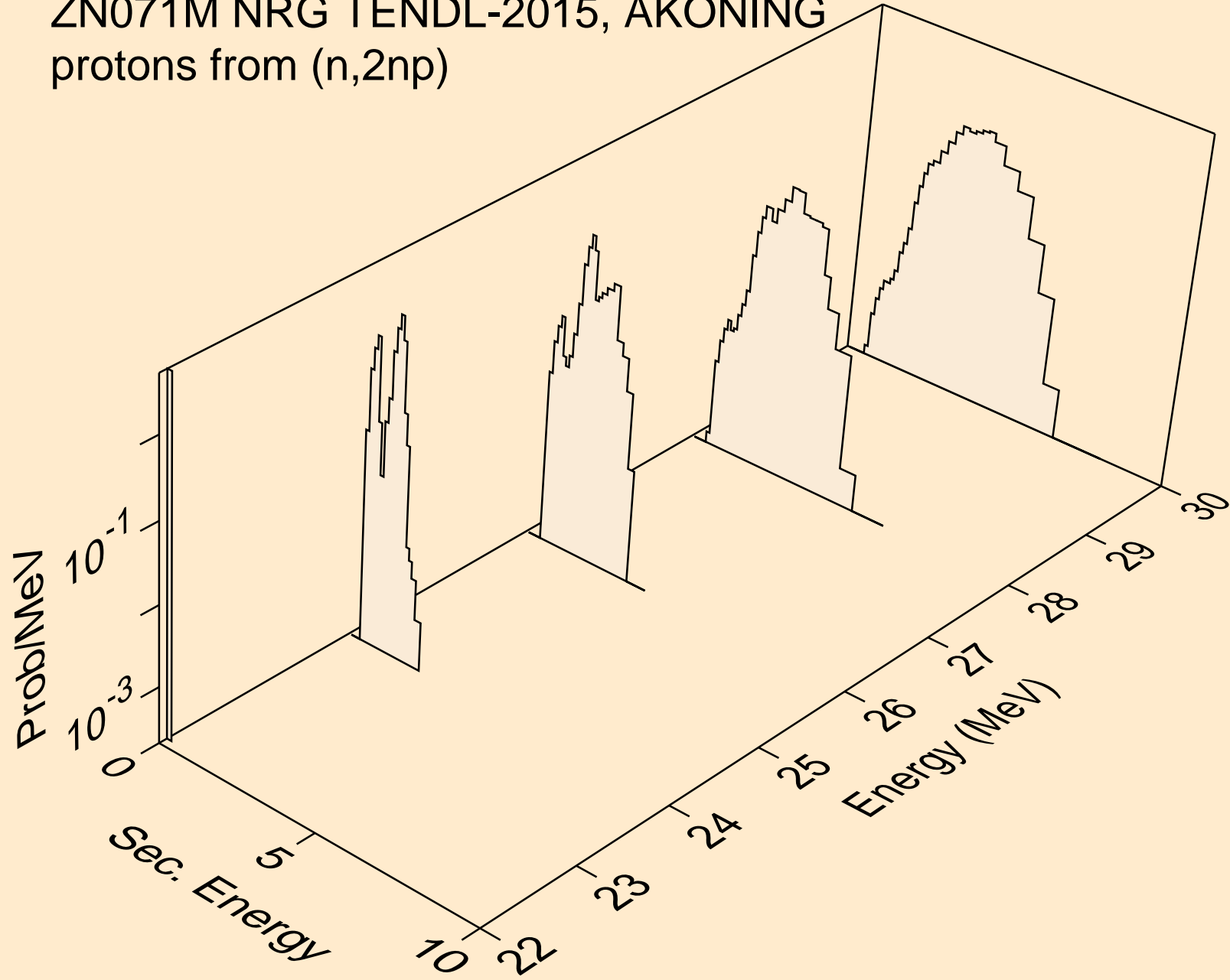

ZN071M NRG TENDL-2015, AKONING
protons from (n,p)

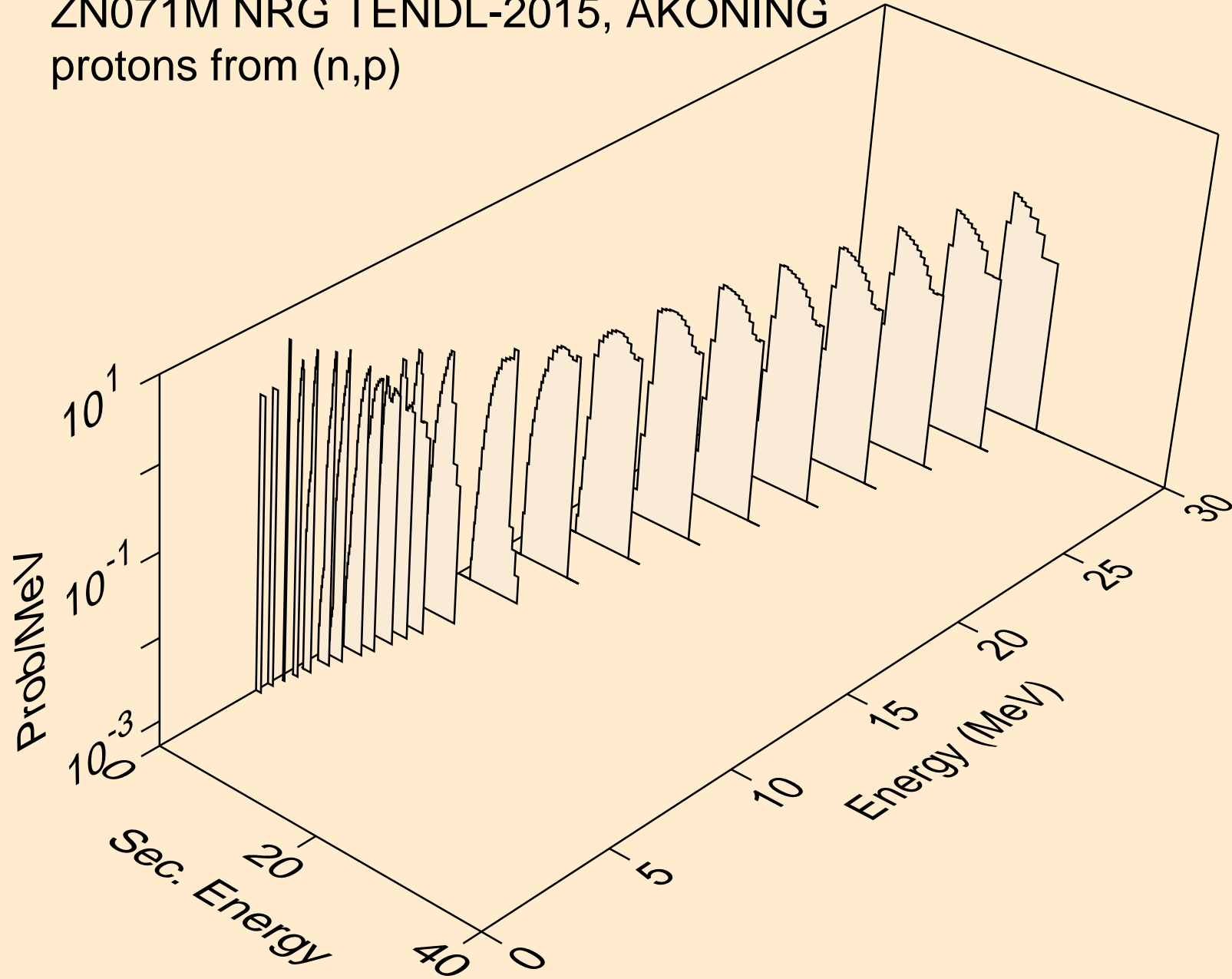

ZN071M NRG TENDL-2015, AKONING
protons from (n,2p)

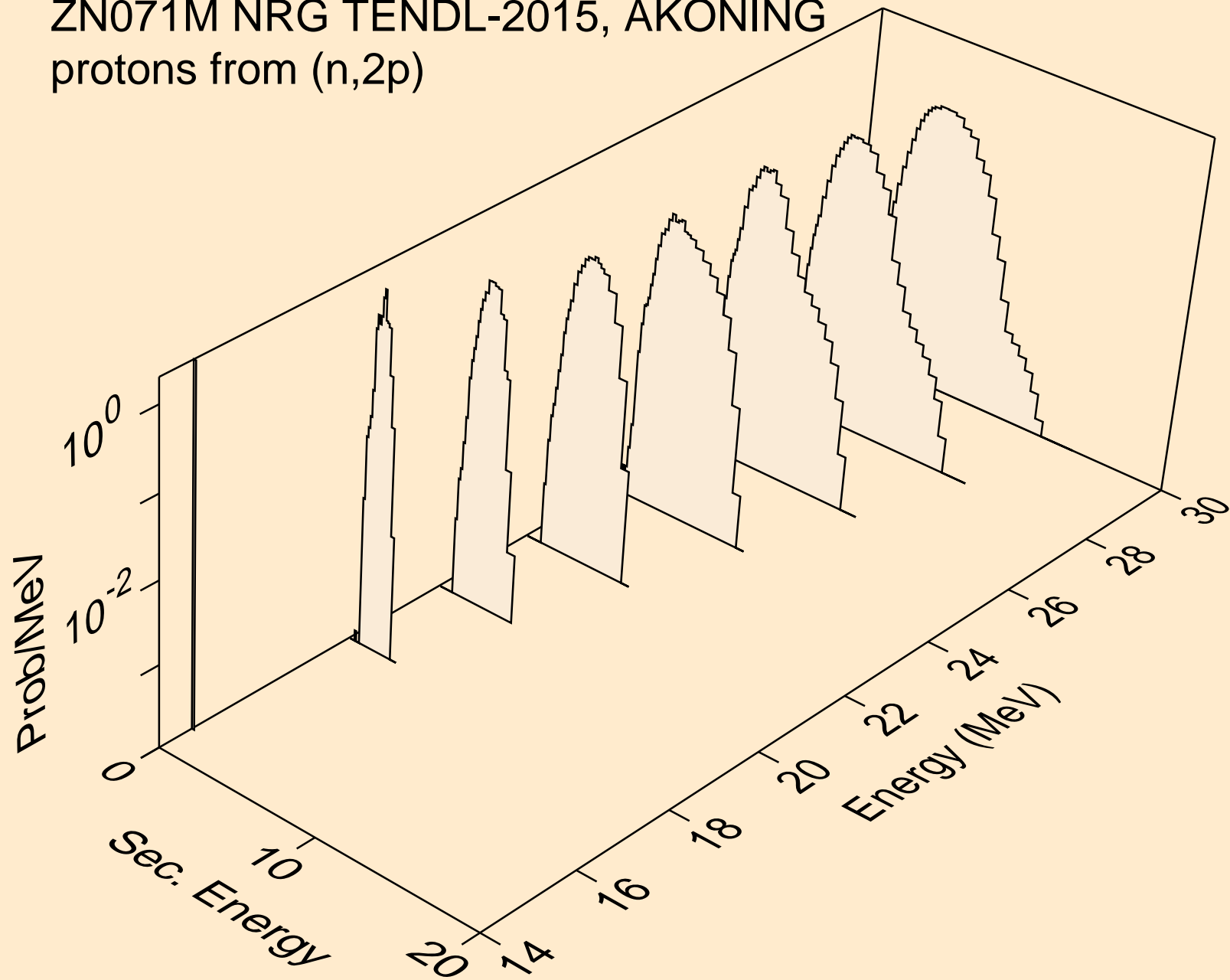

ZN071M NRG TENDL-2015, AKONING
protons from (n,p)

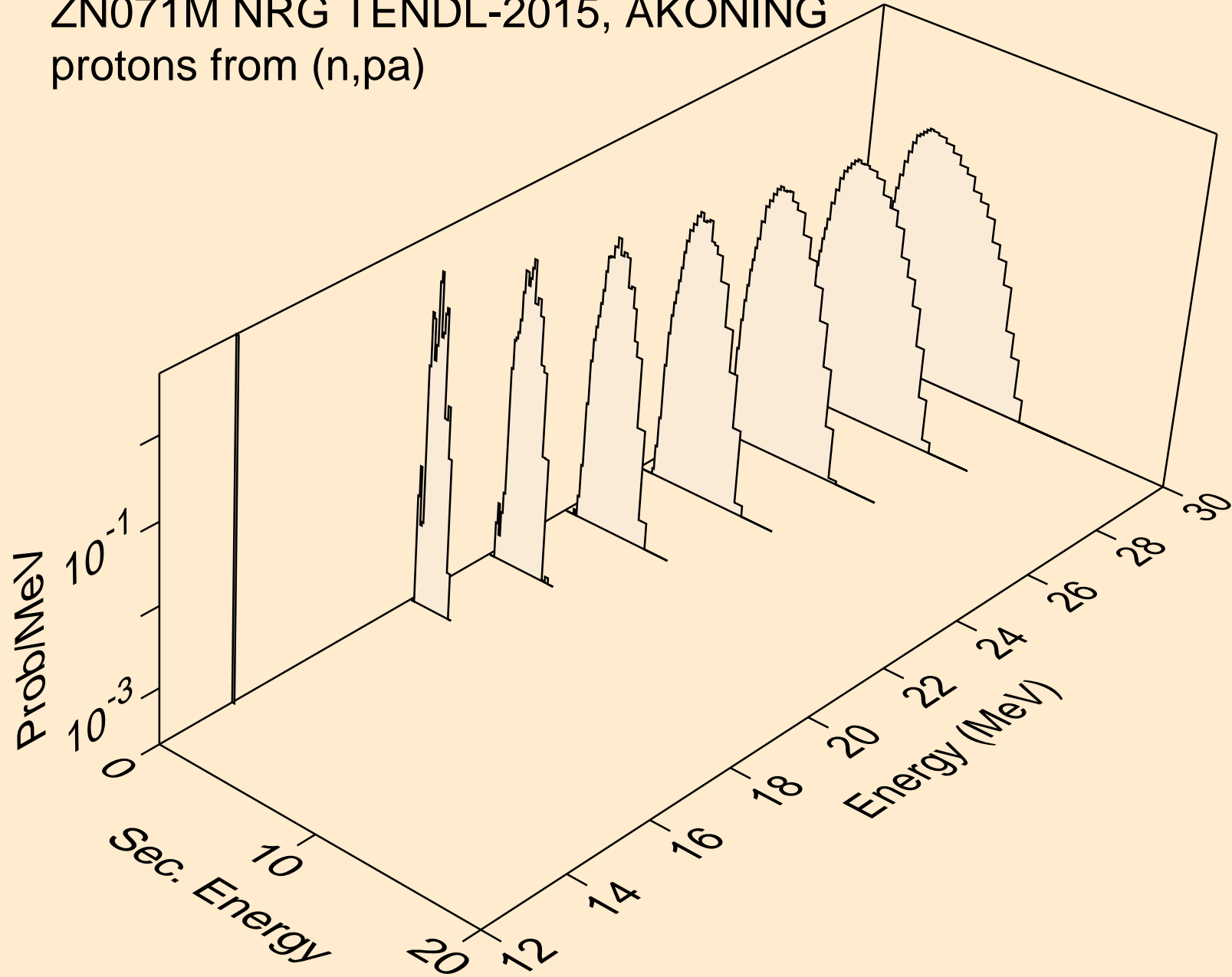

ZN071M NRG TENDL-2015, AKONING
protons from (n,pd)

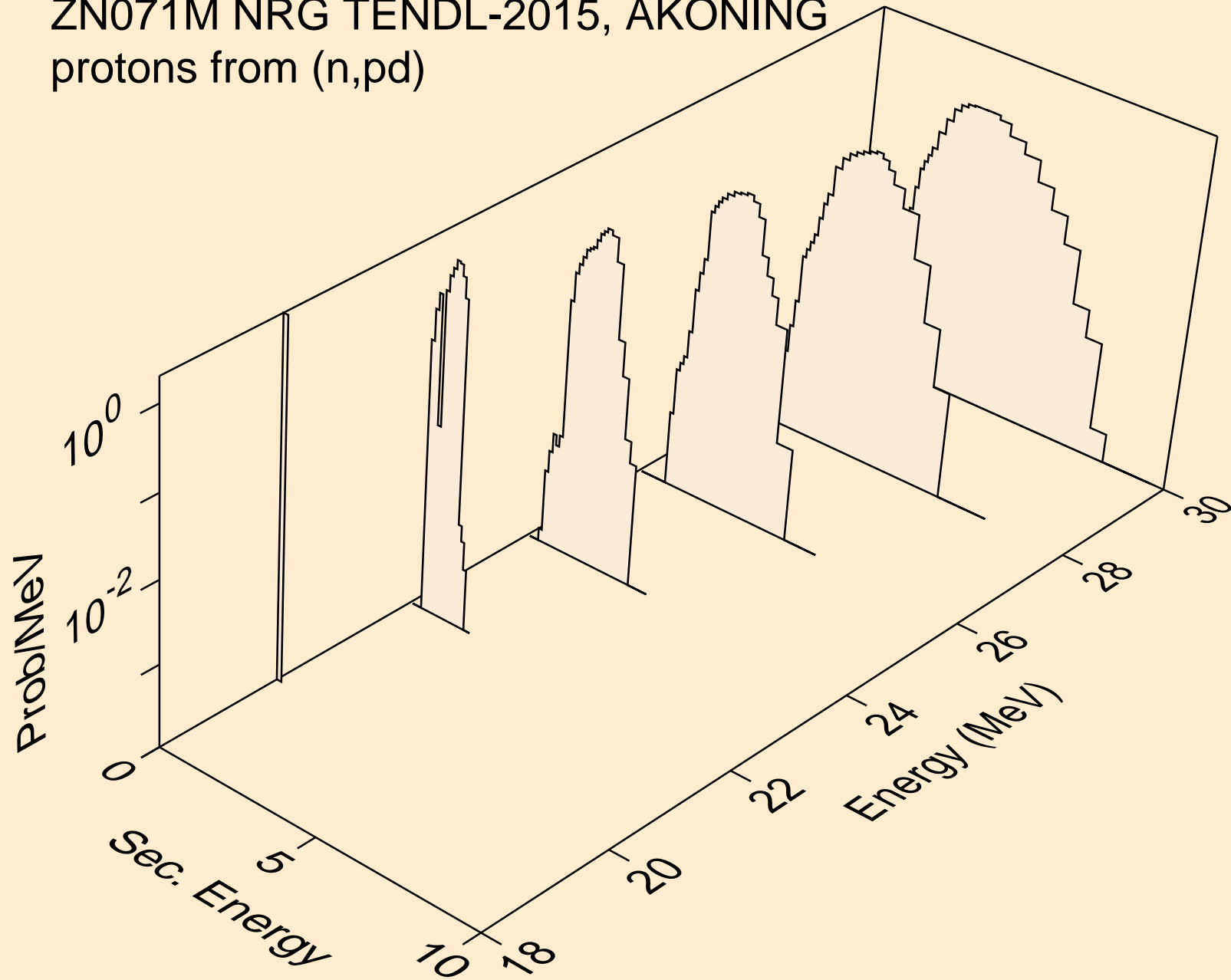

ZN071M NRG TENDL-2015, AKONING
protons from (n,pt)

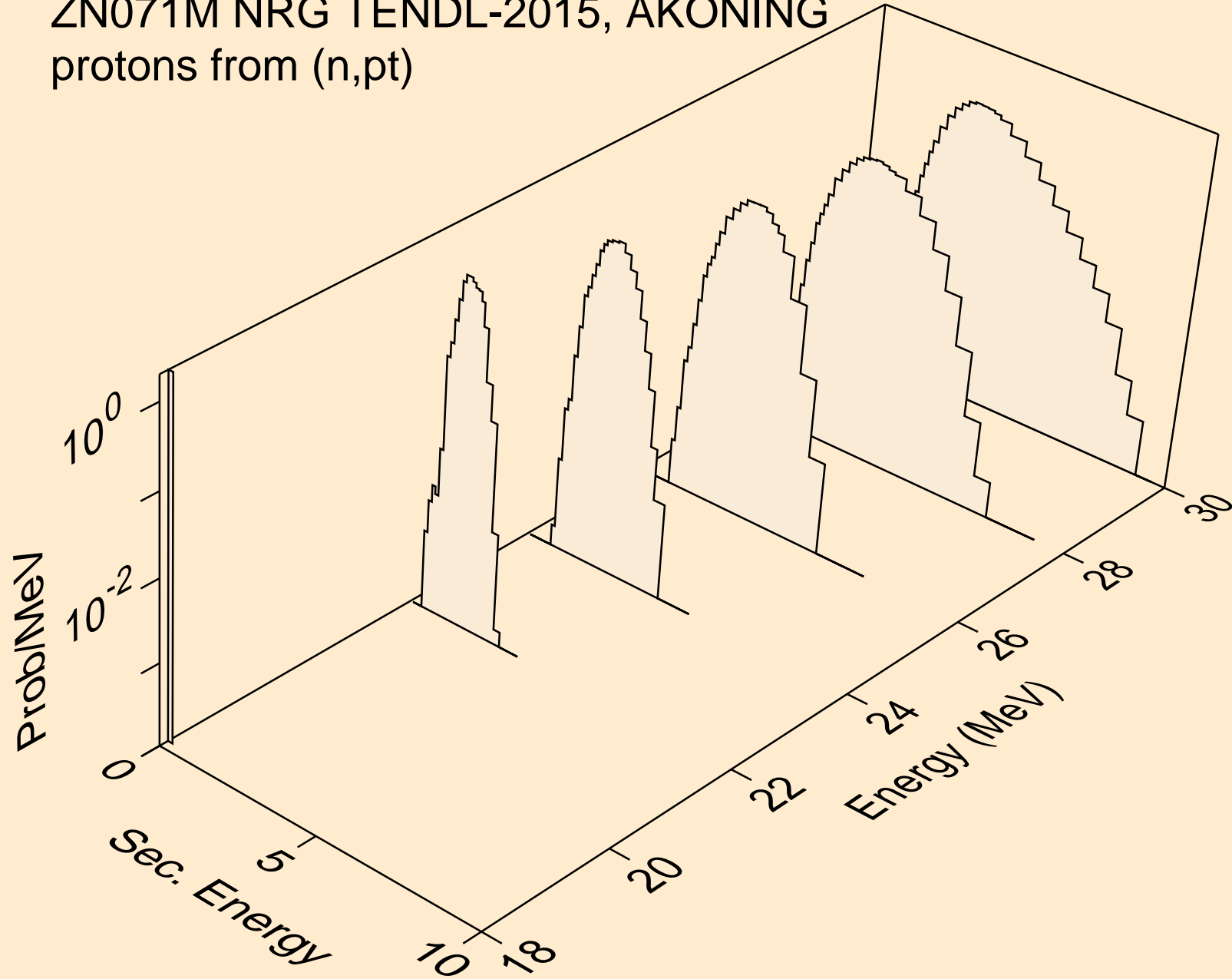

ZN071M NRG TENDL-2015, AKONING
deuterons from (n,x)

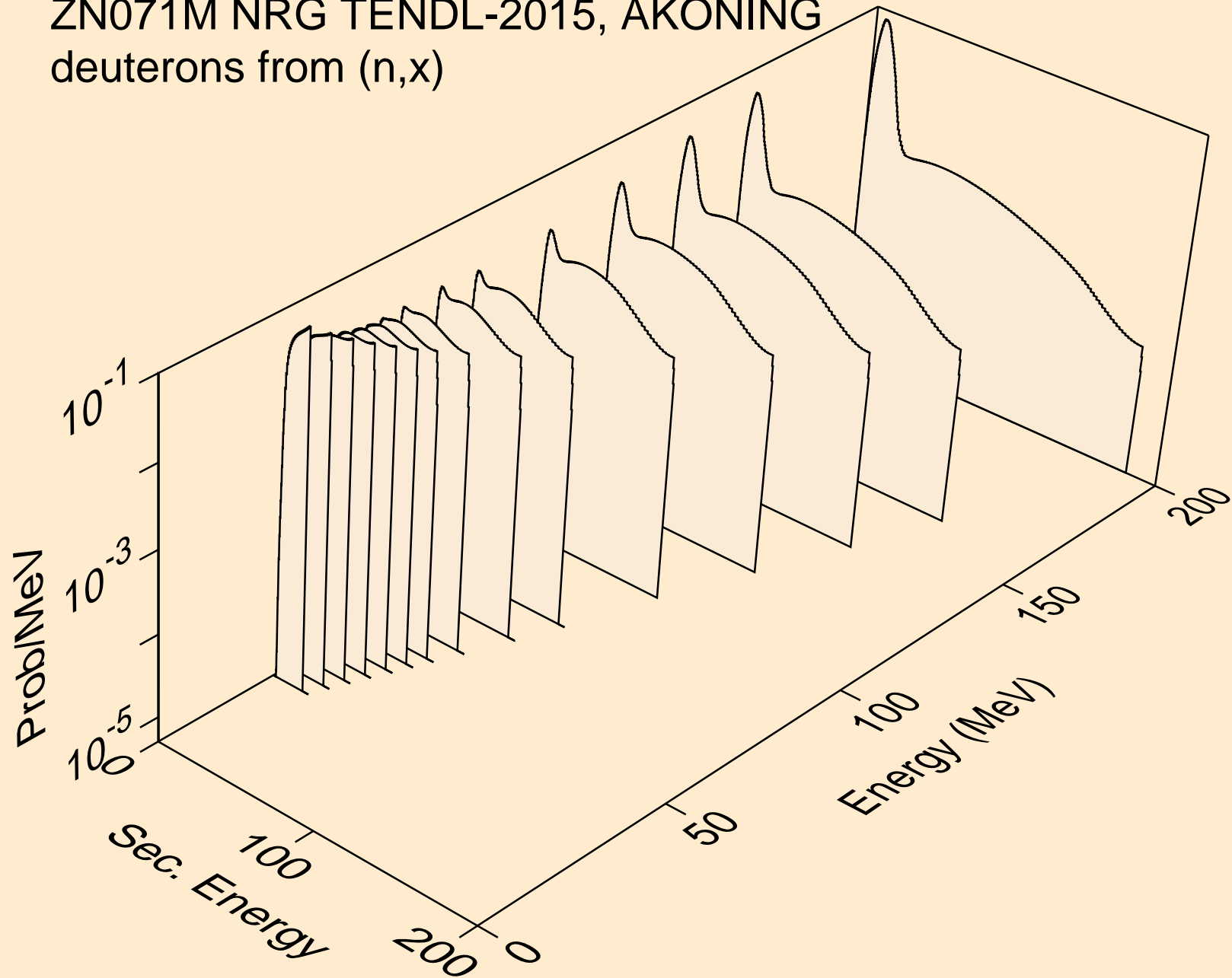

ZN071M NRG TENDL-2015, AKONING
deuterons from (n,2nd)

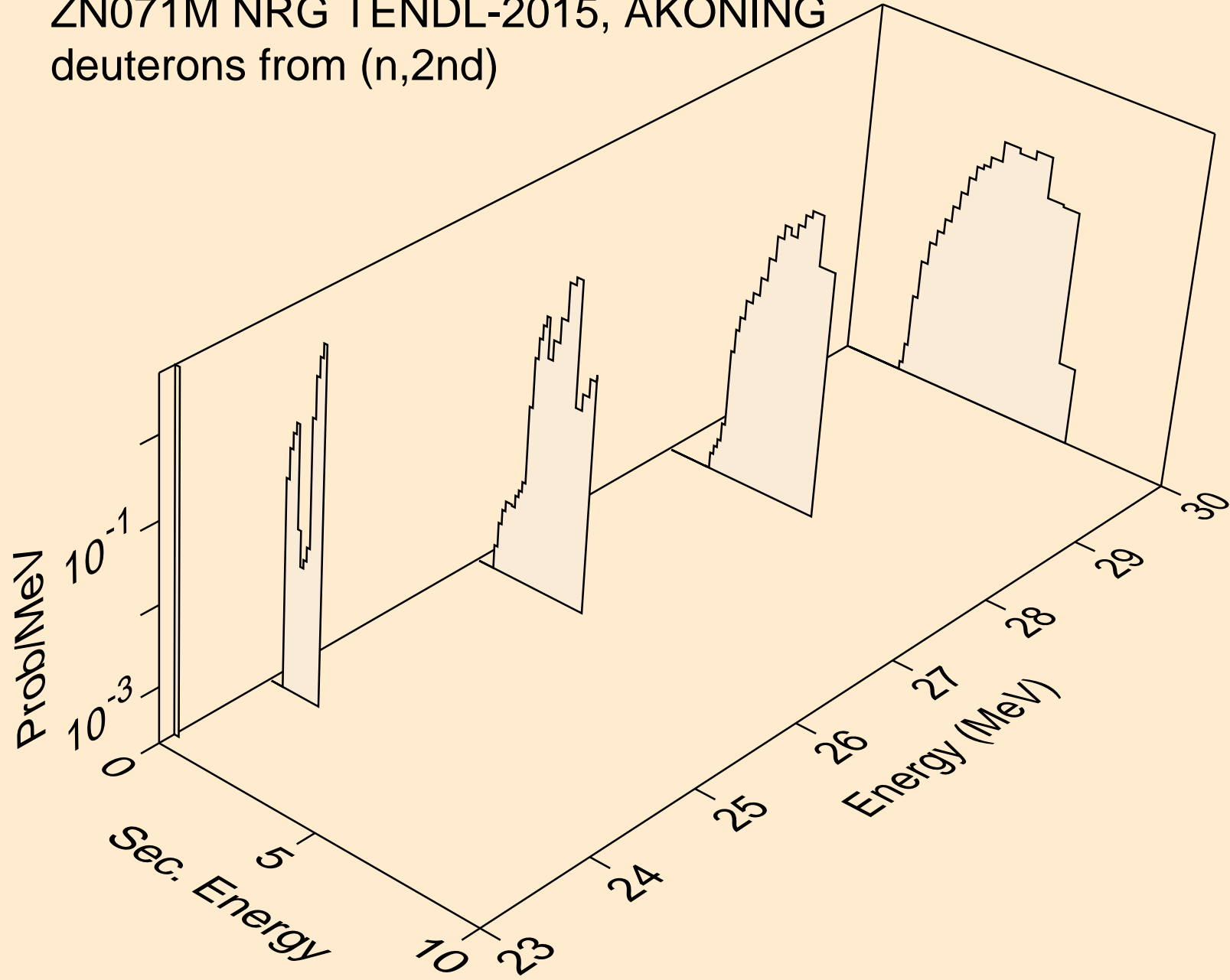

ZN071M NRG TENDL-2015, AKONING
deuterons from (n,n*)d

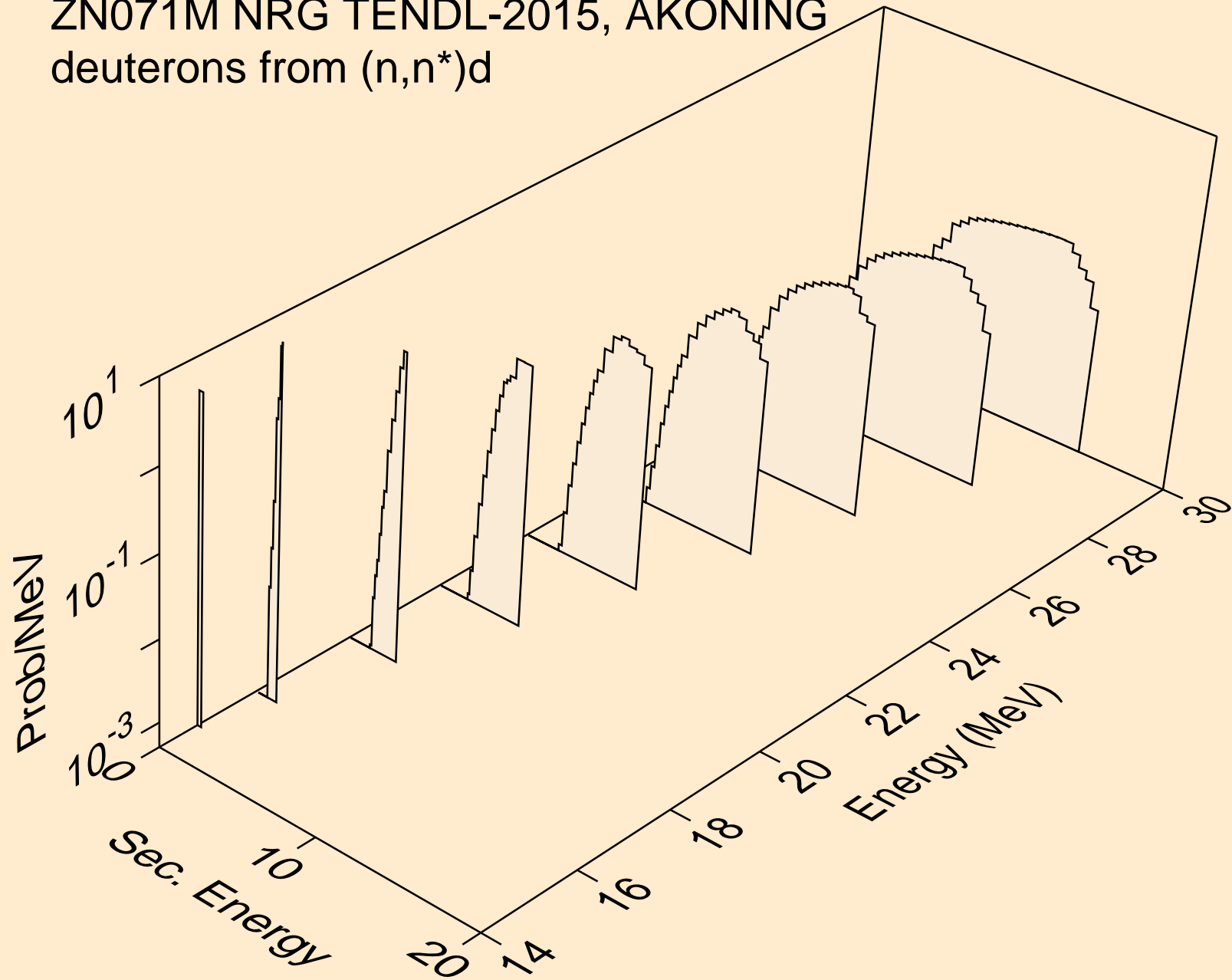

ZN071M NRG TENDL-2015, AKONING
deuterons from (n,d)

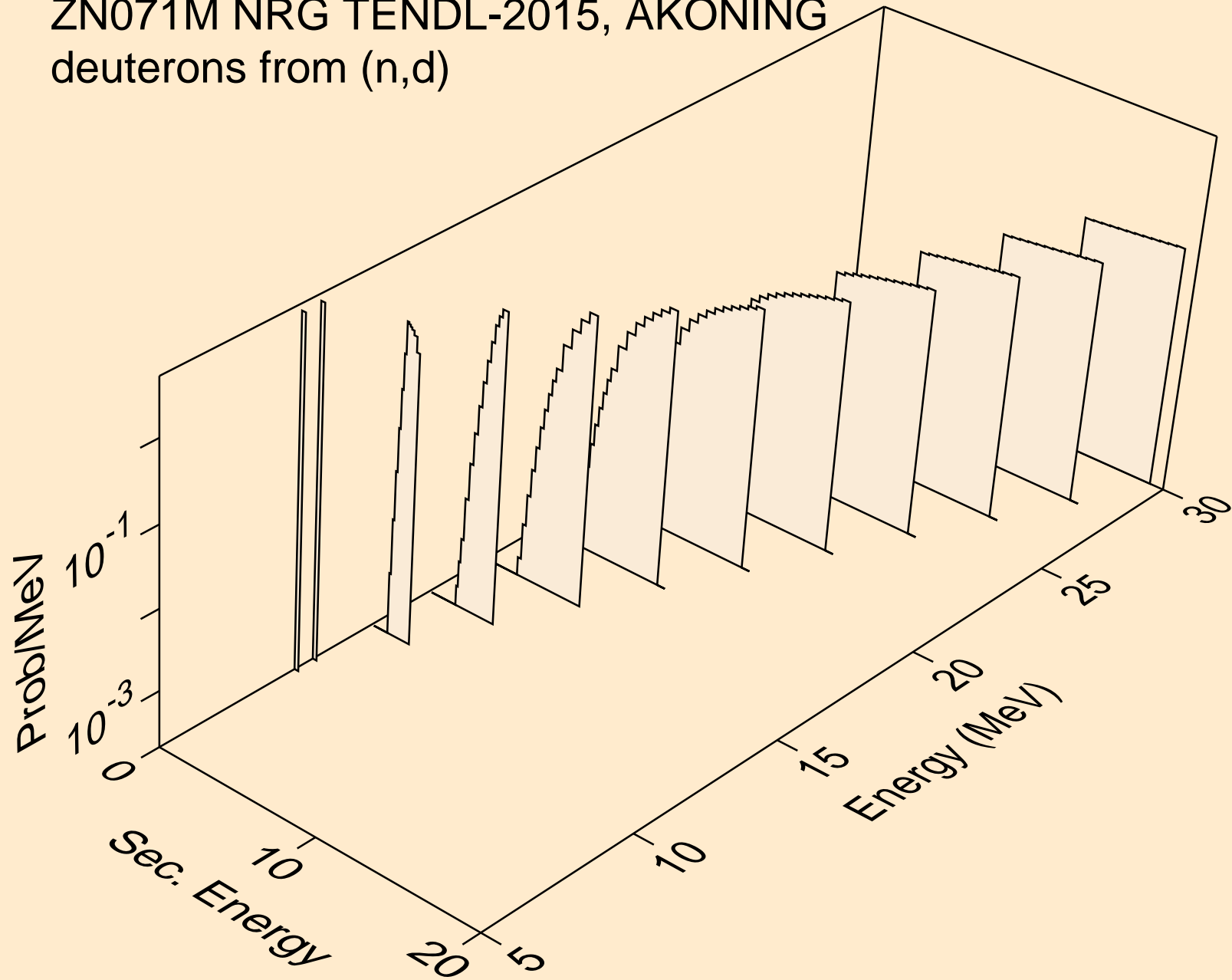

ZN071M NRG TENDL-2015, AKONING
deuterons from (n,pd)

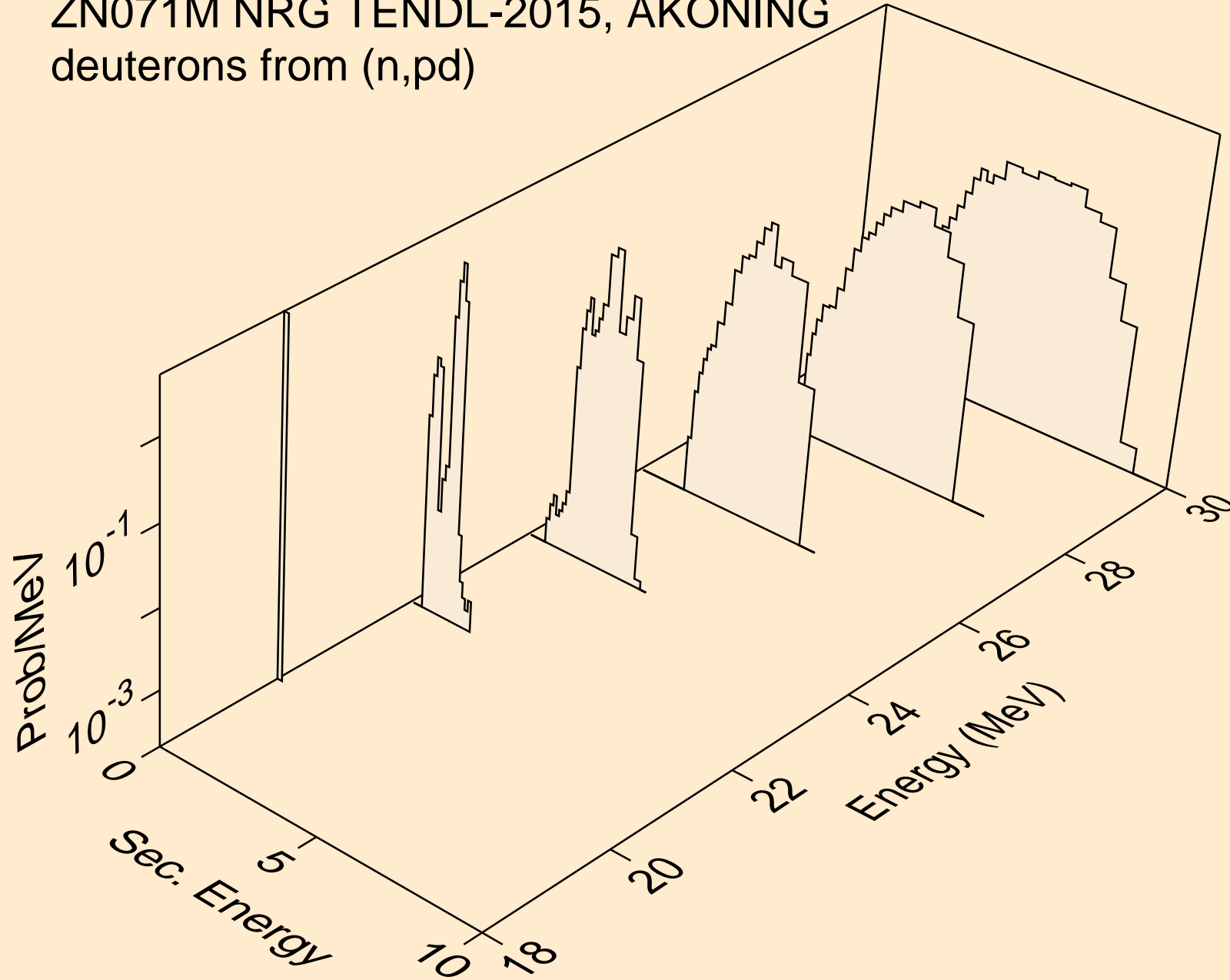

ZN071M NRG TENDL-2015, AKONING
tritons from (n,x)

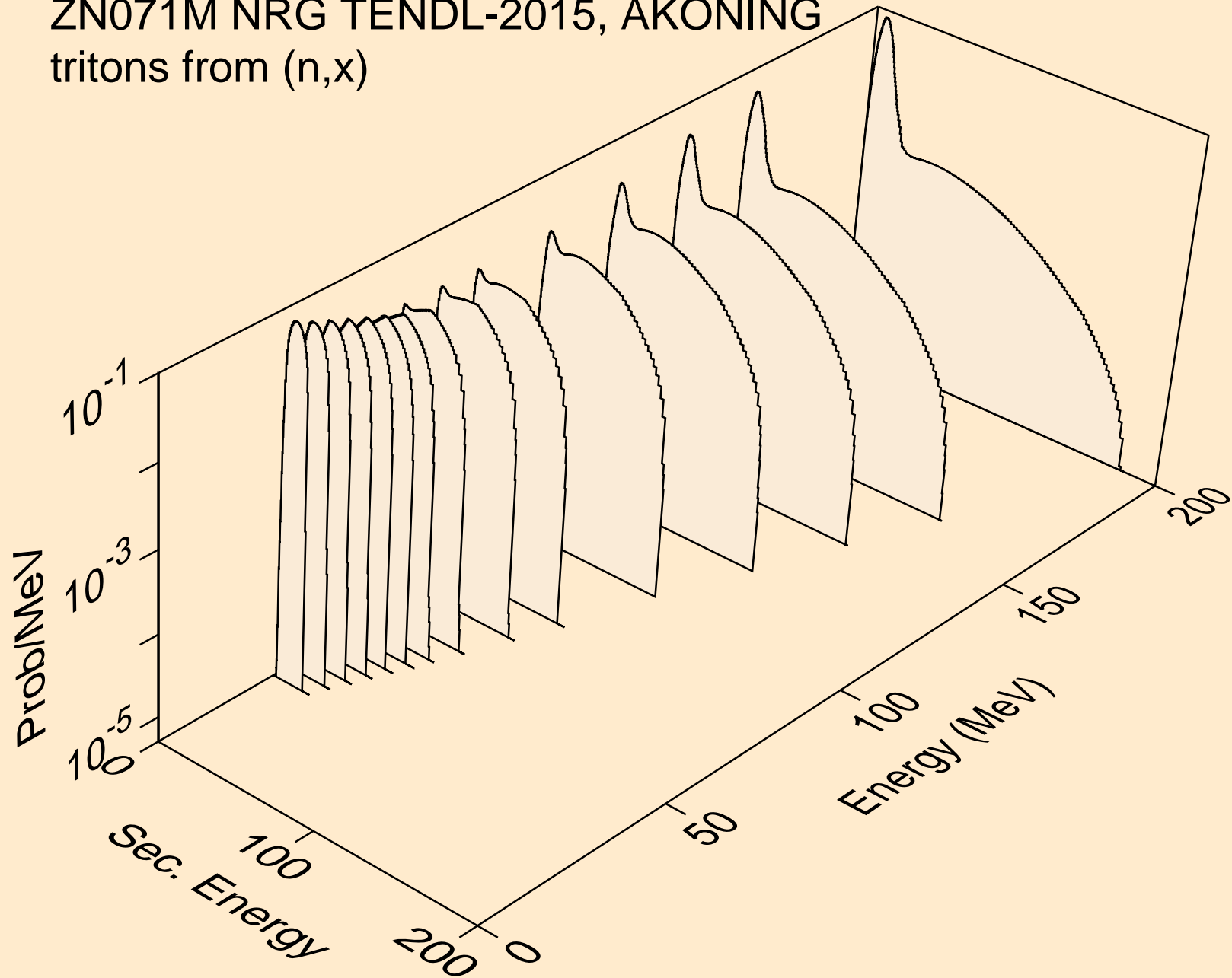

ZN071M NRG TENDL-2015, AKONING
tritons from (n,n*)t

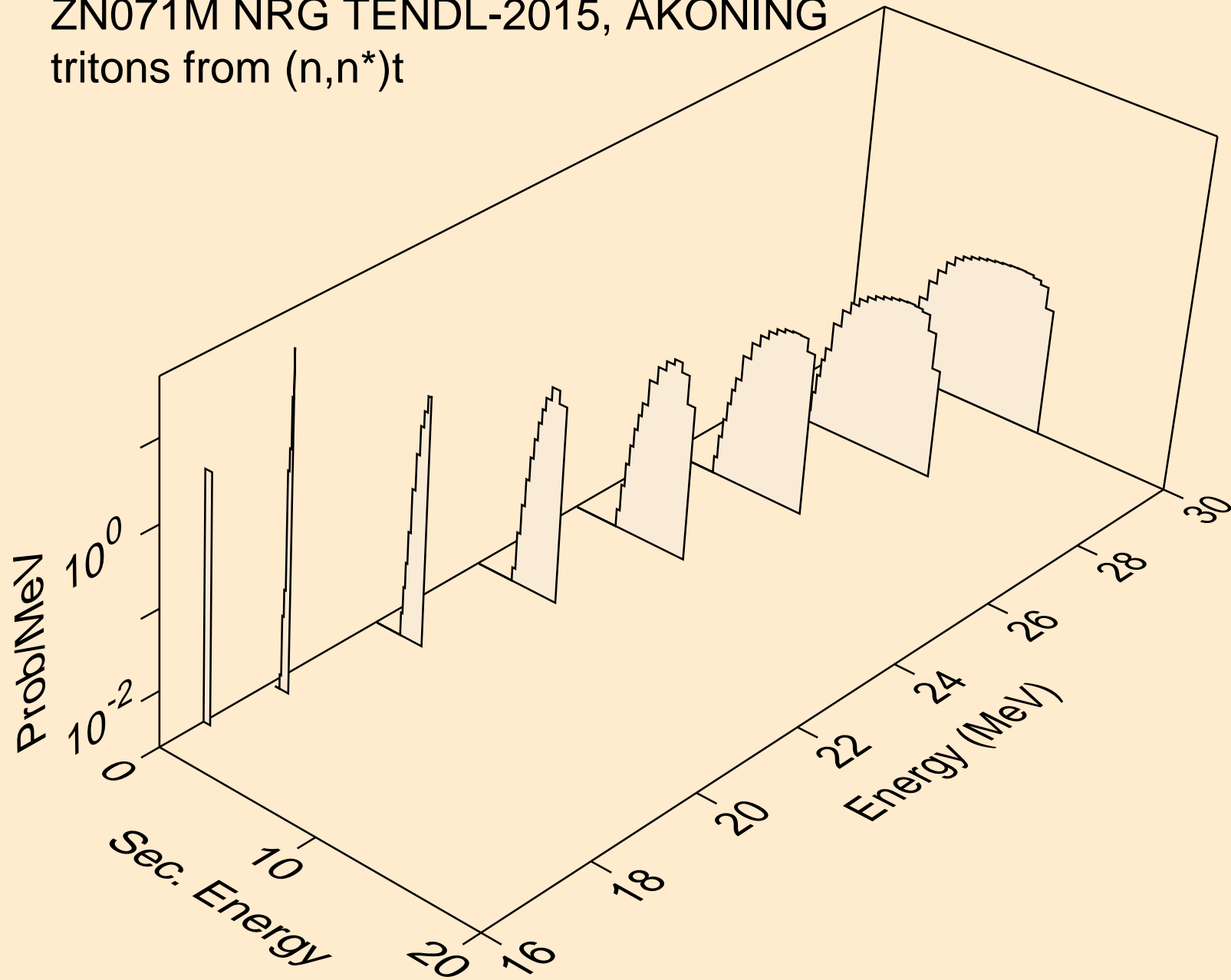

ZN071M NRG TENDL-2015, AKONING
tritons from (n,t)

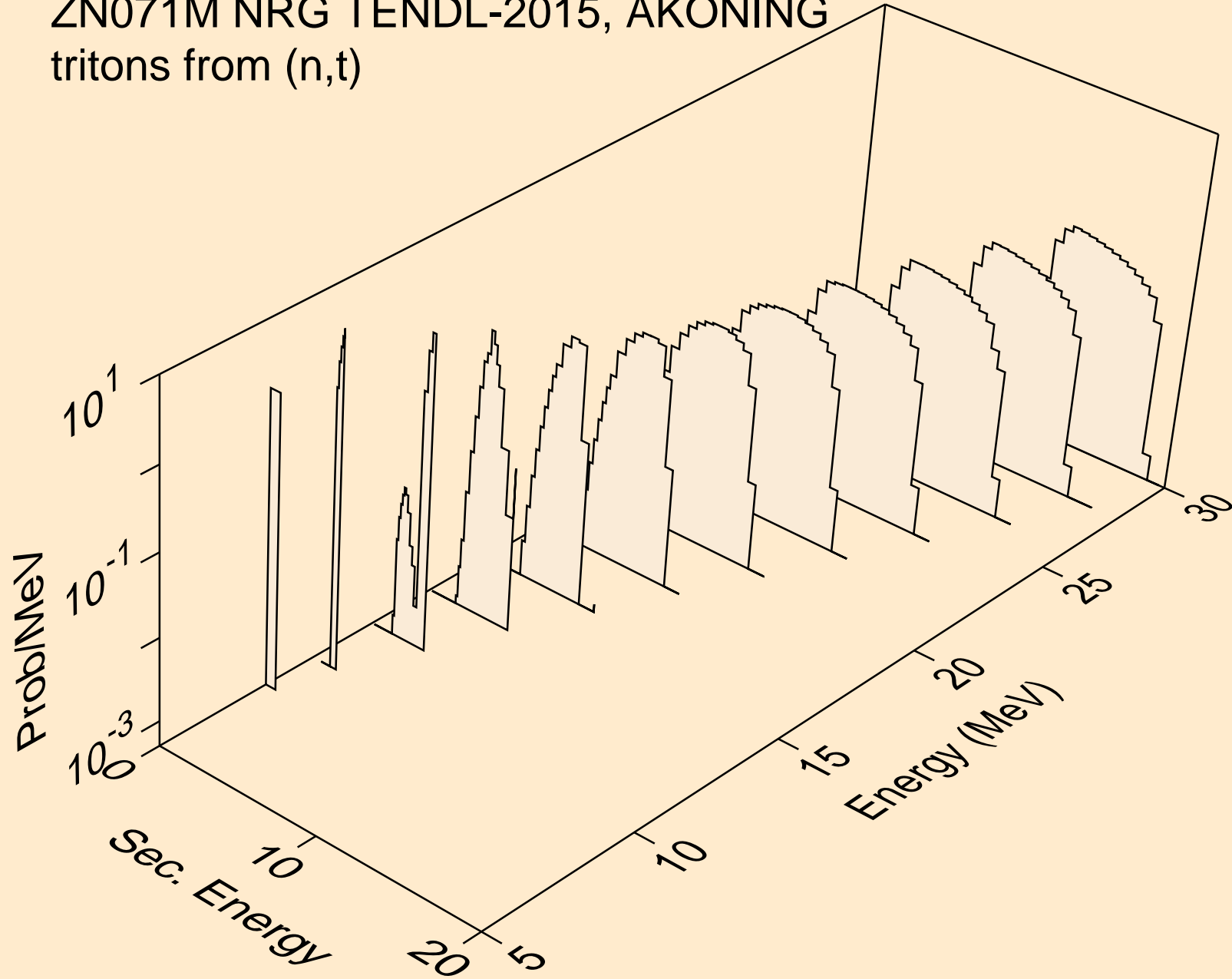

ZN071M NRG TENDL-2015, AKONING
tritons from (n,pt)

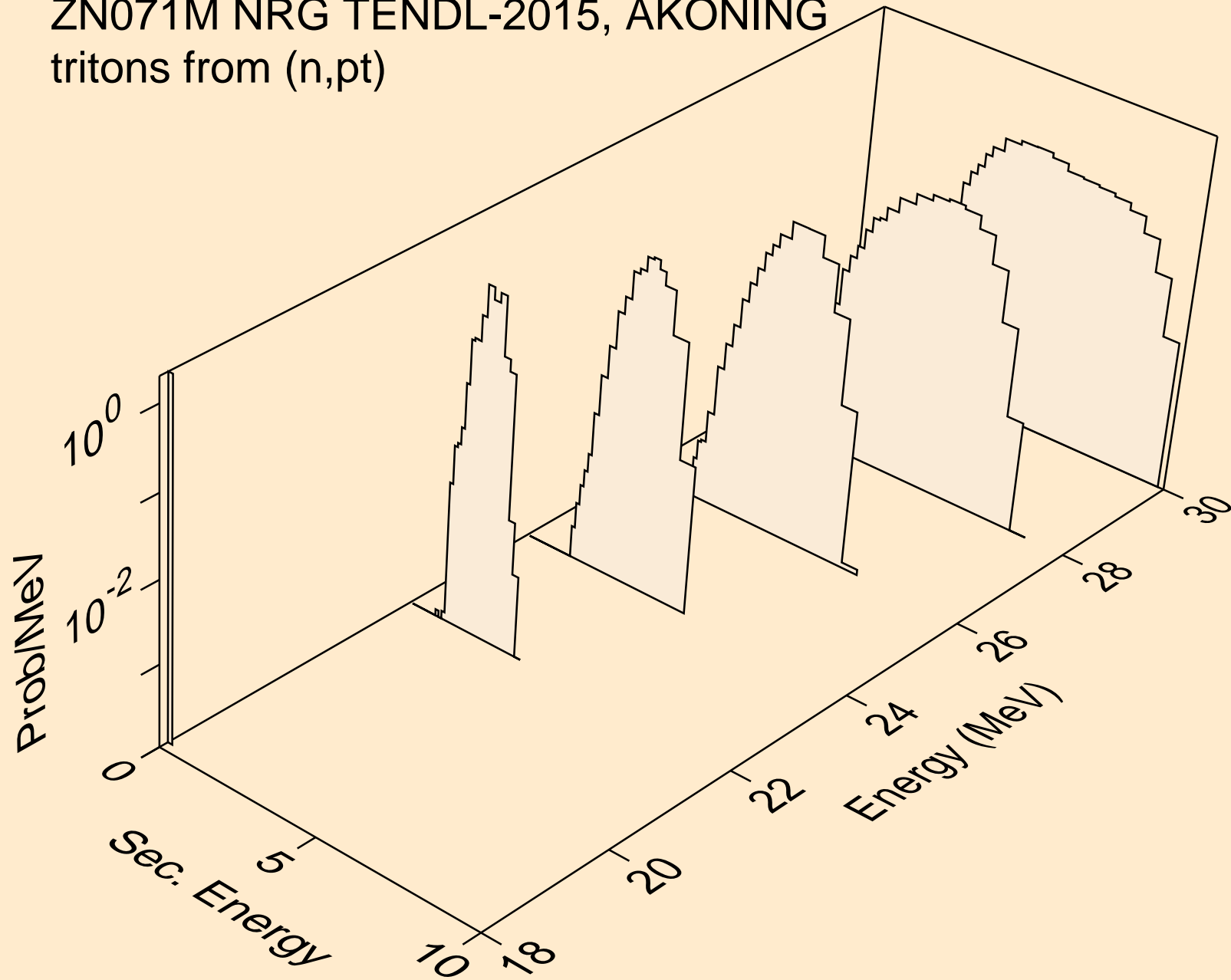

ZN071M NRG TENDL-2015, AKONING
he3s from (n,x)

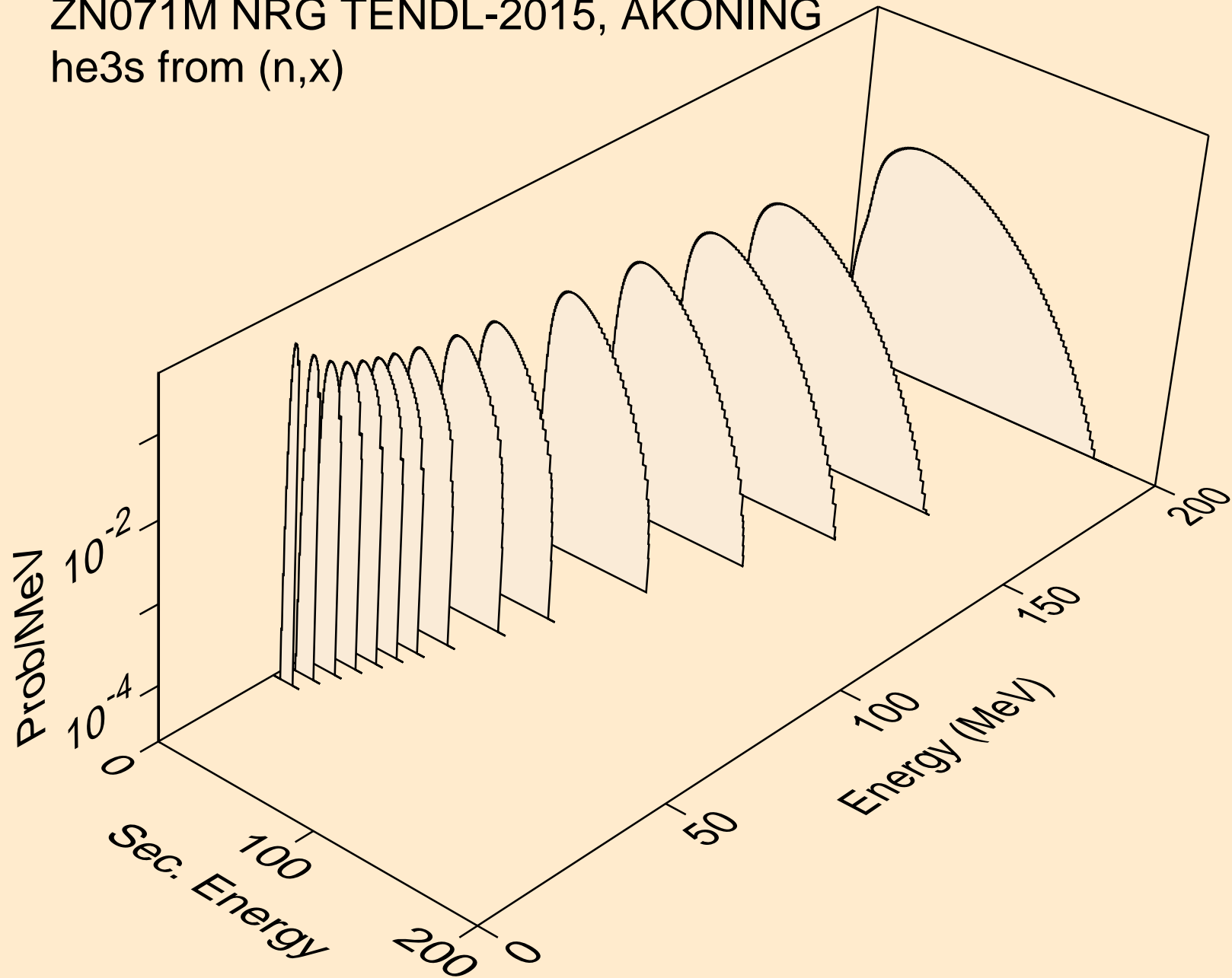

ZN071M NRG TENDL-2015, AKONING
he3s from (n,n*)he3

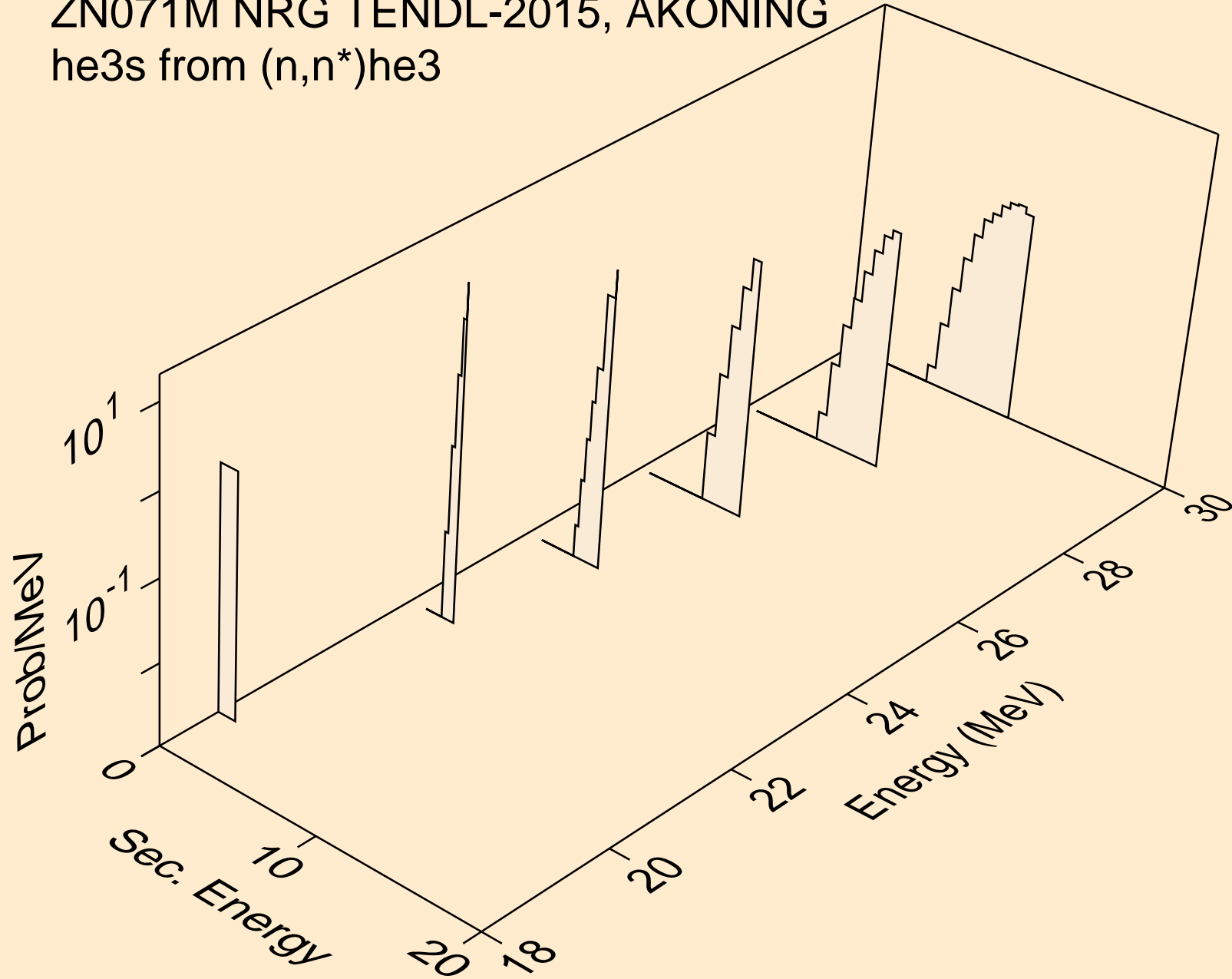

ZN071M NRG TENDL-2015, AKONING
he3s from (n,he3)

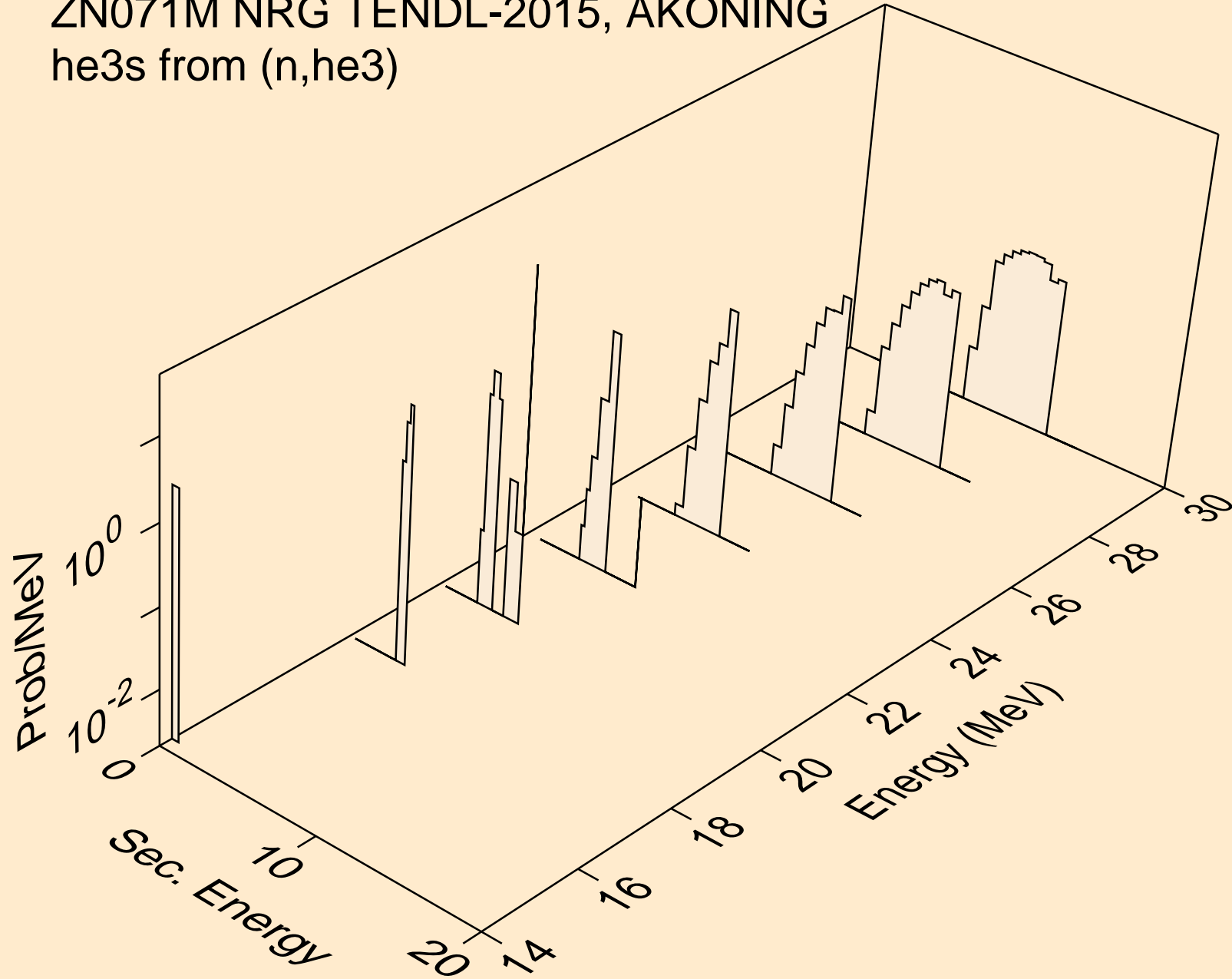

ZN071M NRG TENDL-2015, AKONING
alphas from (n,x)

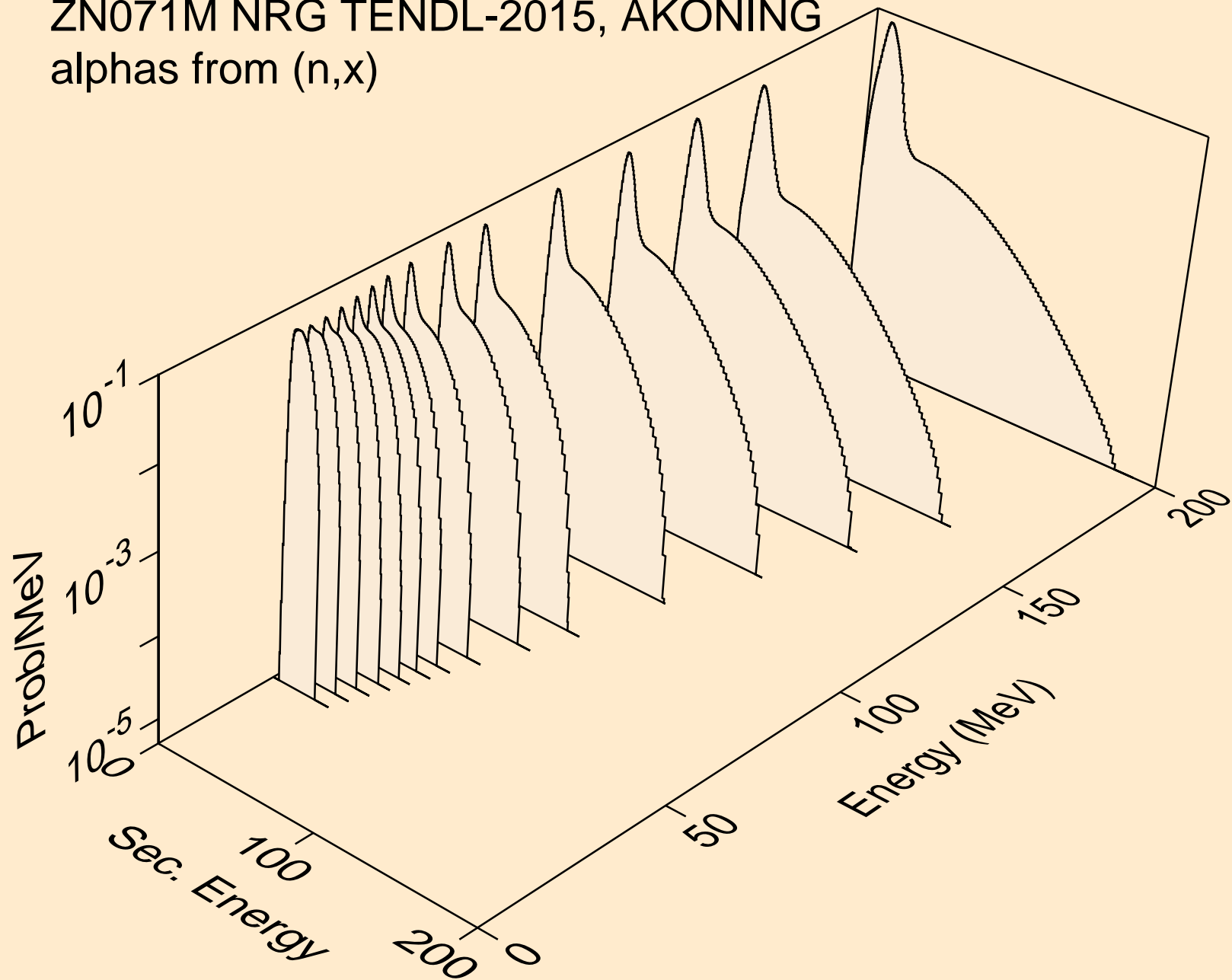

ZN071M NRG TENDL-2015, AKONING
alphas from (n,n*)a

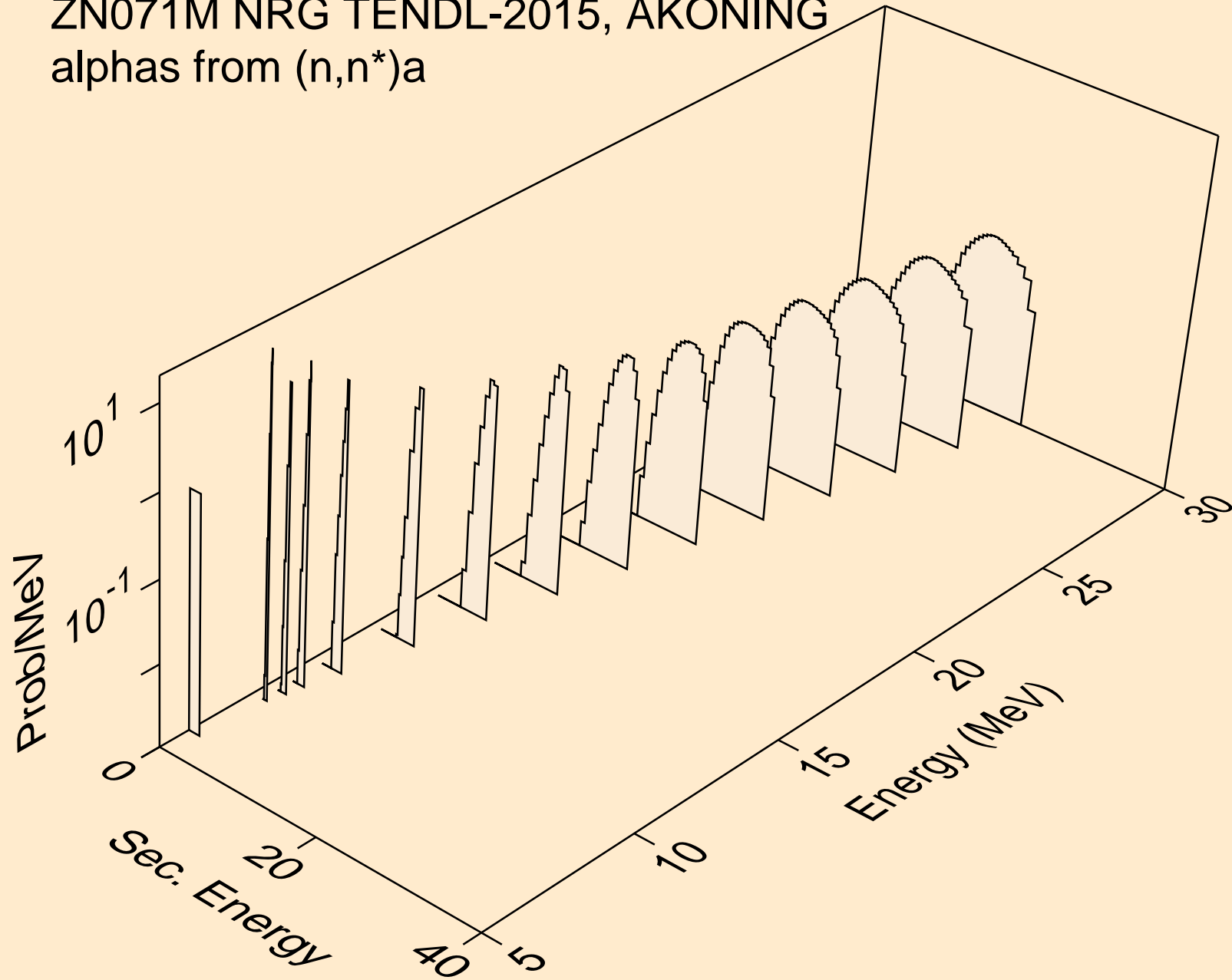

ZN071M NRG TENDL-2015, AKONING
alphas from (n,2n)a

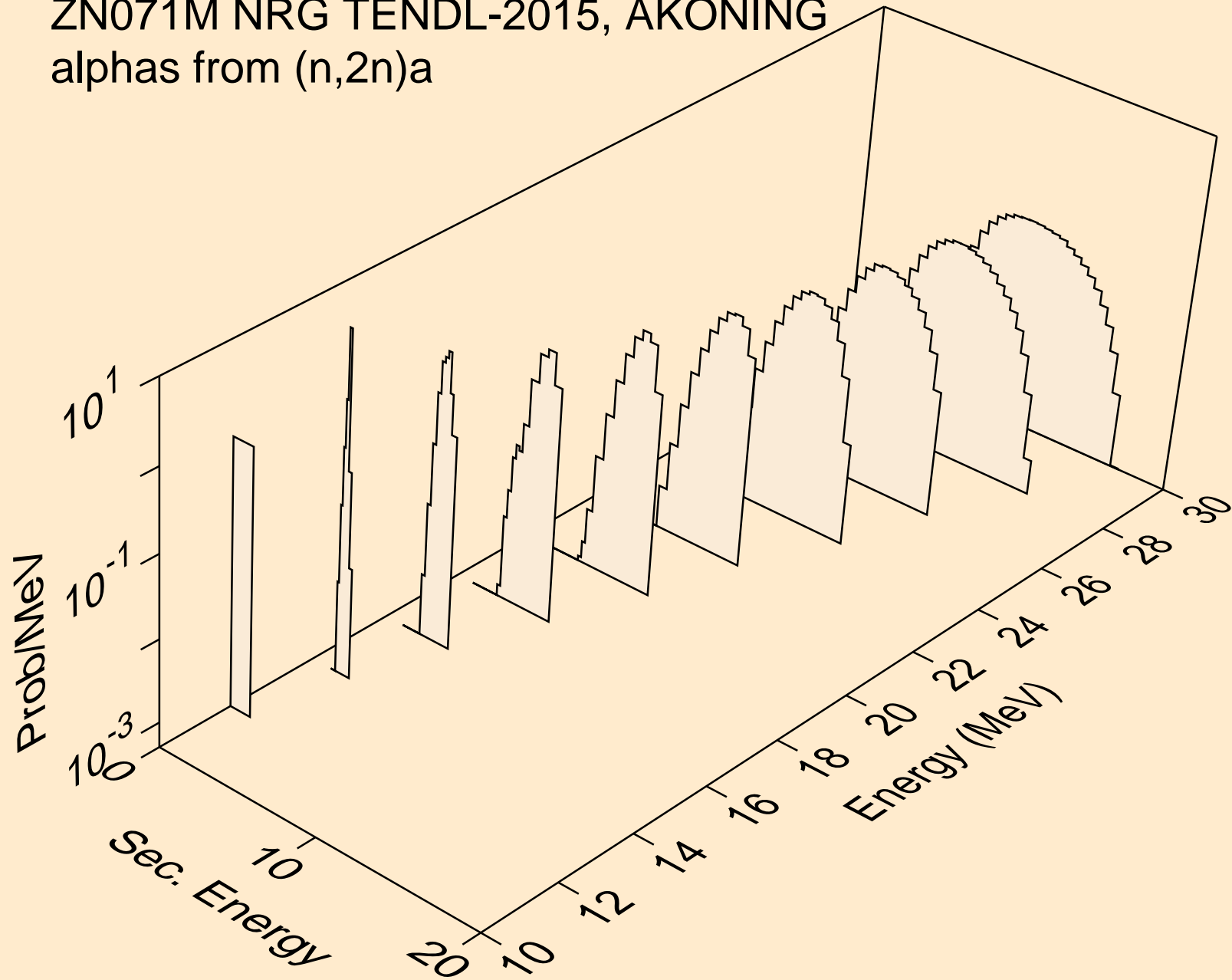

ZN071M NRG TENDL-2015, AKONING
alphas from (n,3n)a

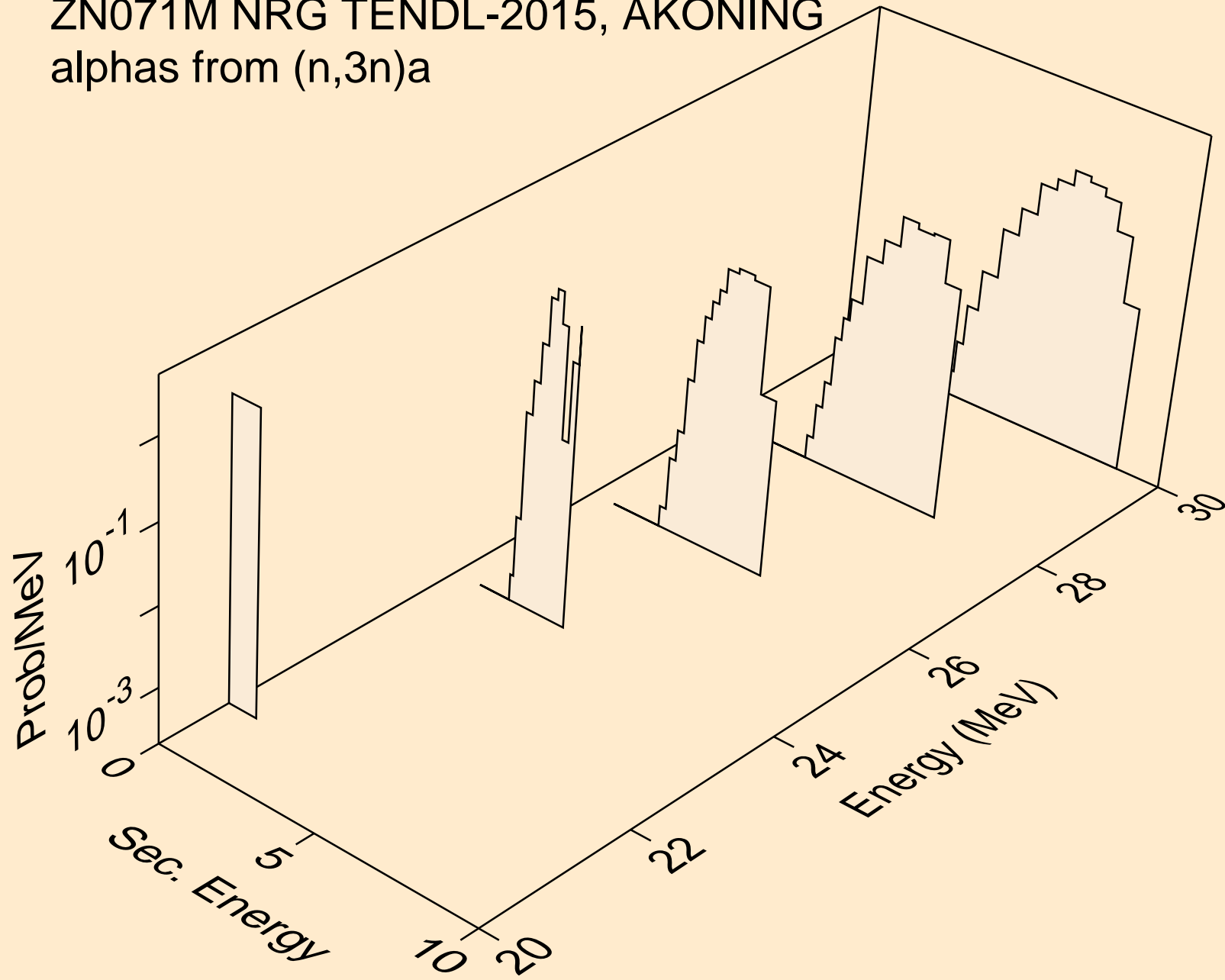

ZN071M NRG TENDL-2015, AKONING
alphas from (n,a)

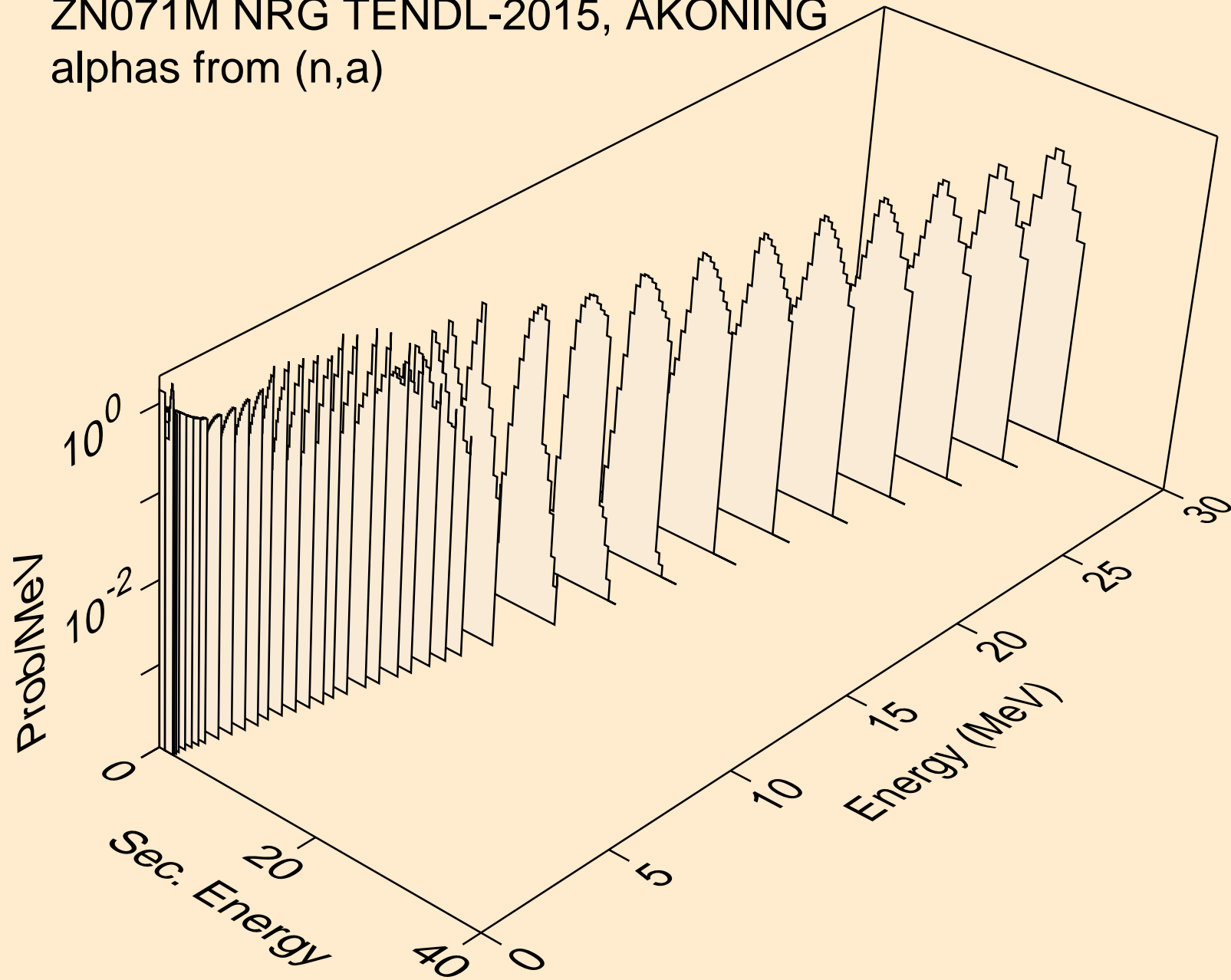

ZN071M NRG TENDL-2015, AKONING
alphas from (n,2a)

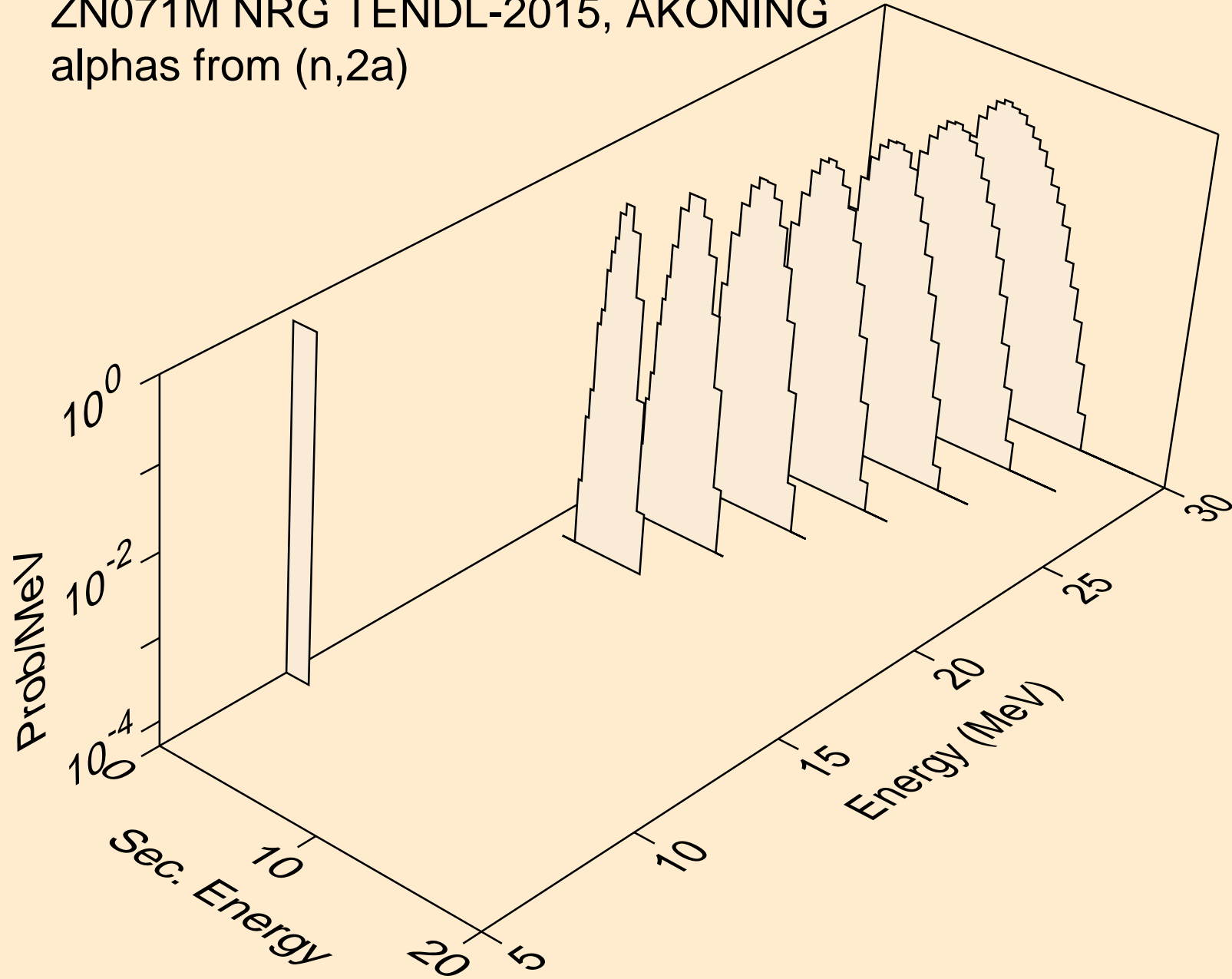

ZN071M NRG TENDL-2015, AKONING
alphas from (n,pa)

