

N-AC230 NRG TENDL-2017, AKONING

Principal cross sections

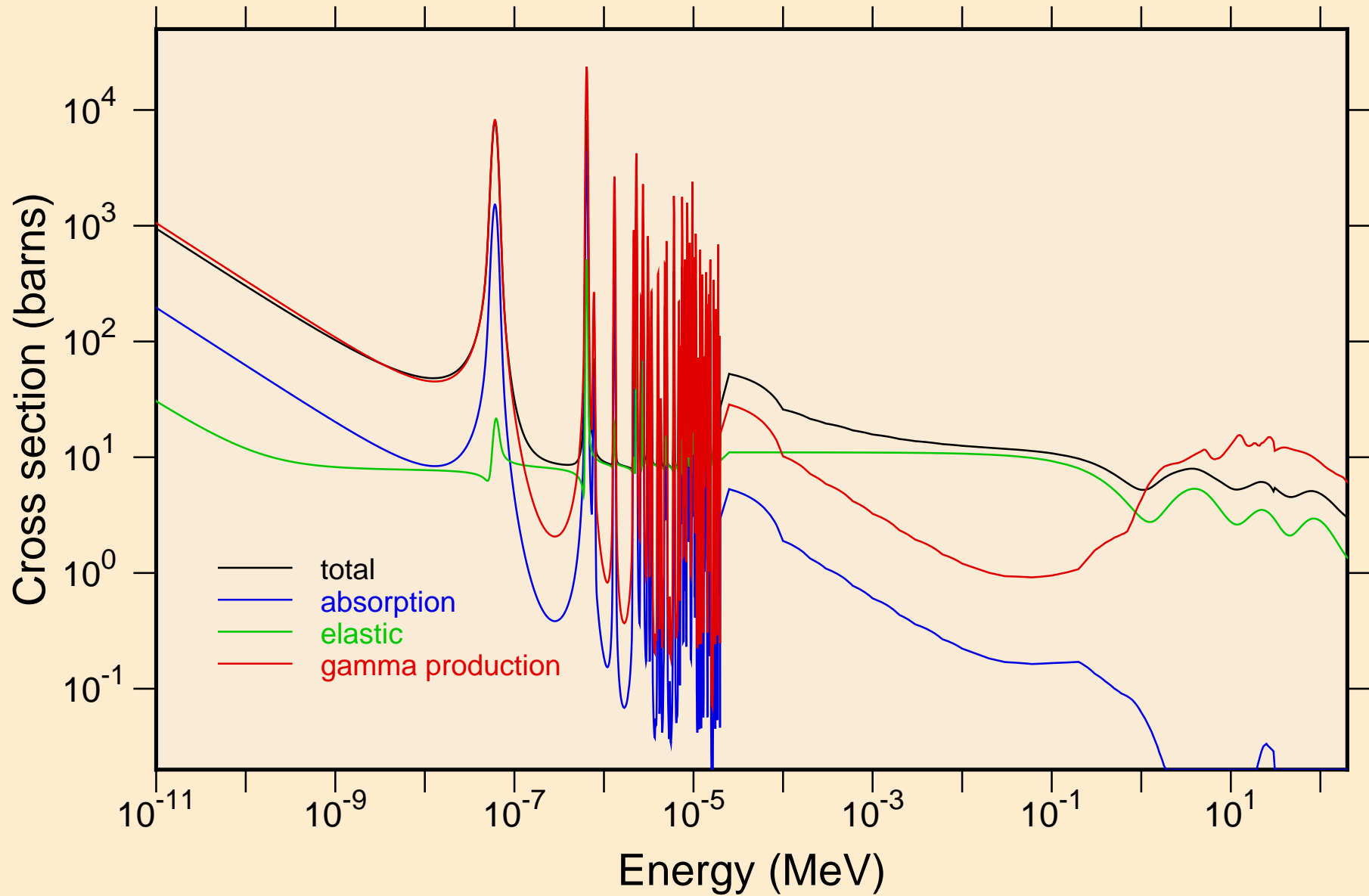

N-AC230 NRG TENDL-2017, AKONING
resonance total cross section

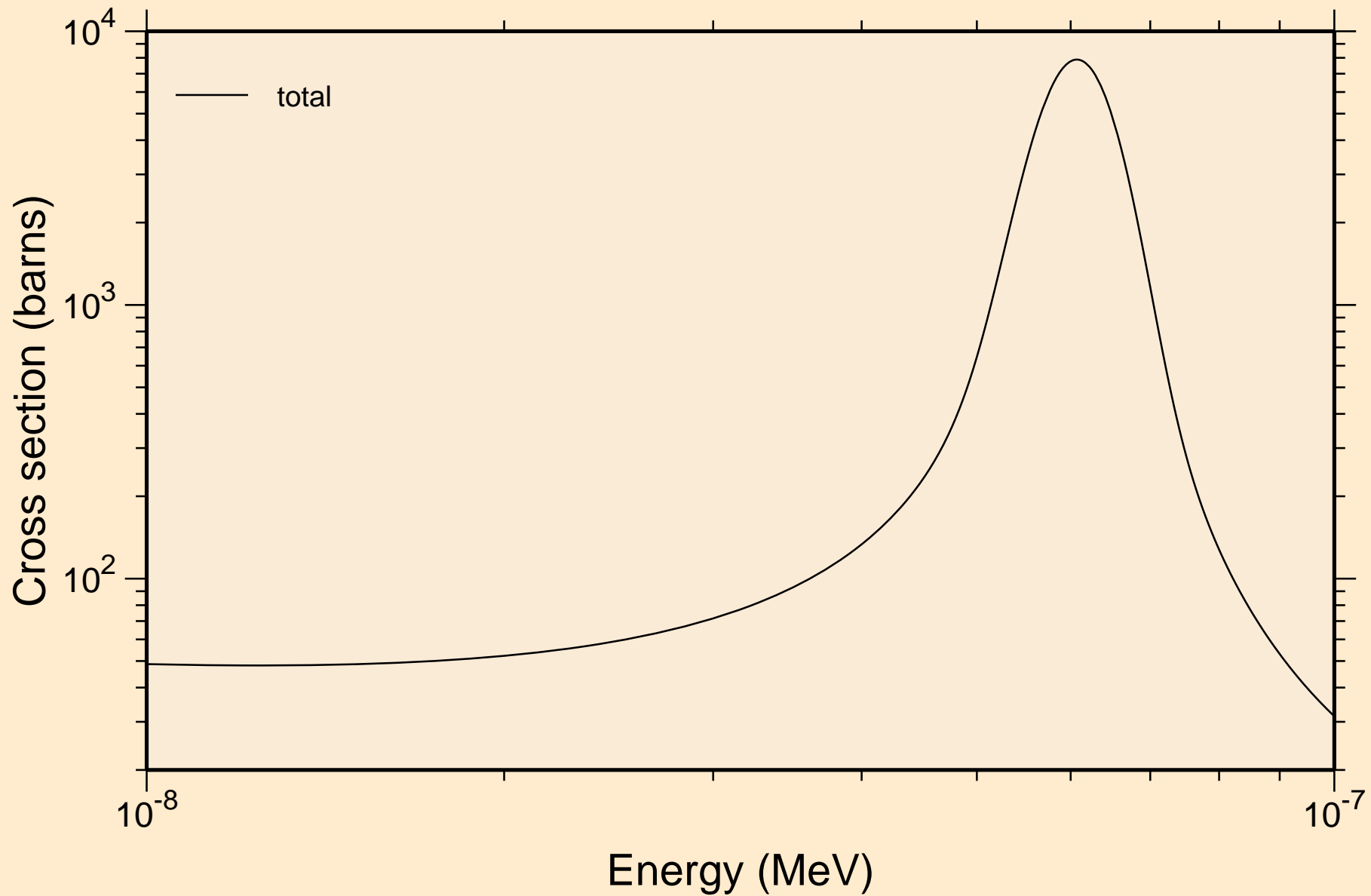

N-AC230 NRG TENDL-2017, AKONING
resonance total cross section

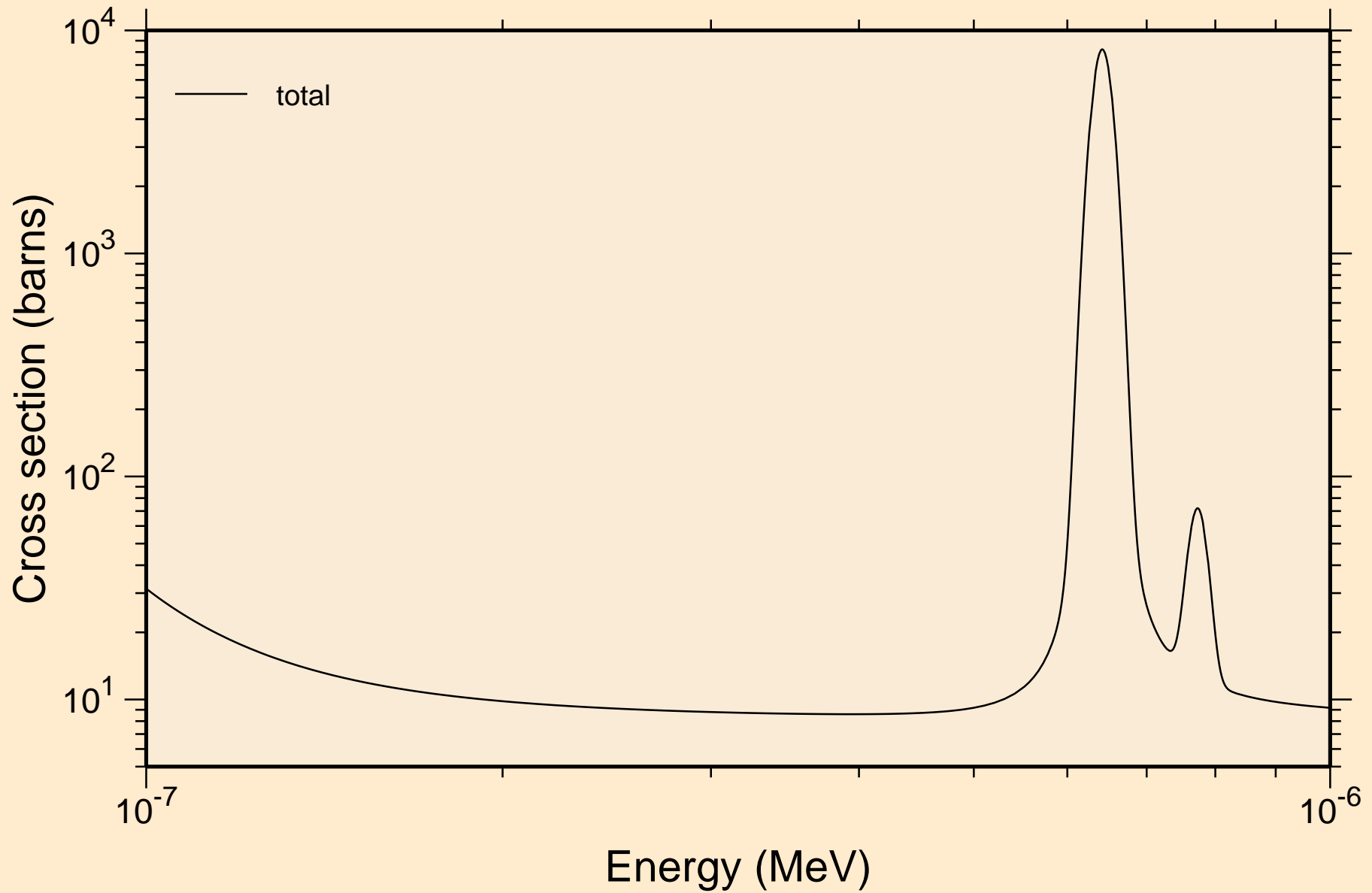

N-AC230 NRG TENDL-2017, AKONING
resonance total cross section

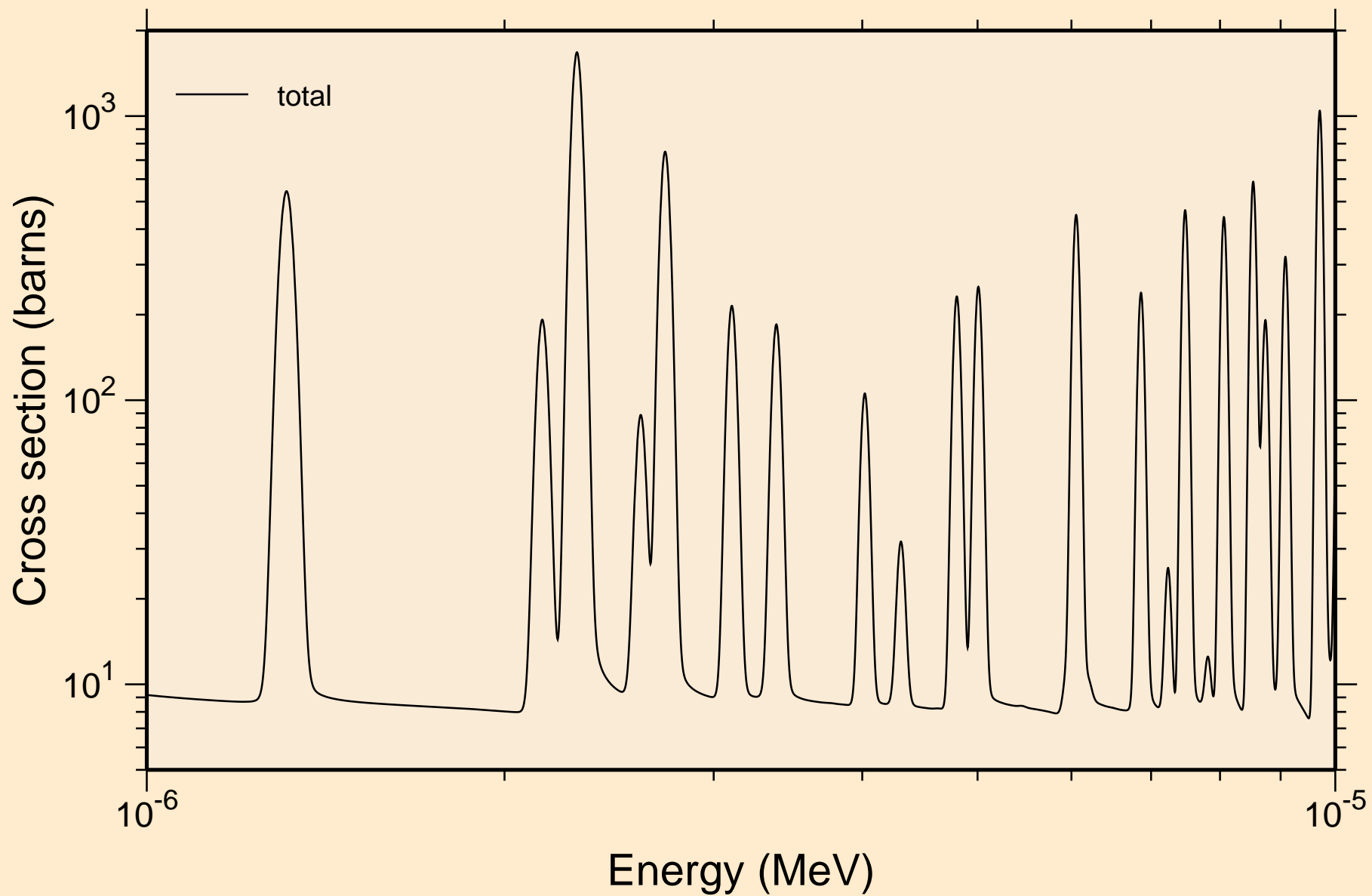

N-AC230 NRG TENDL-2017, AKONING
resonance total cross section

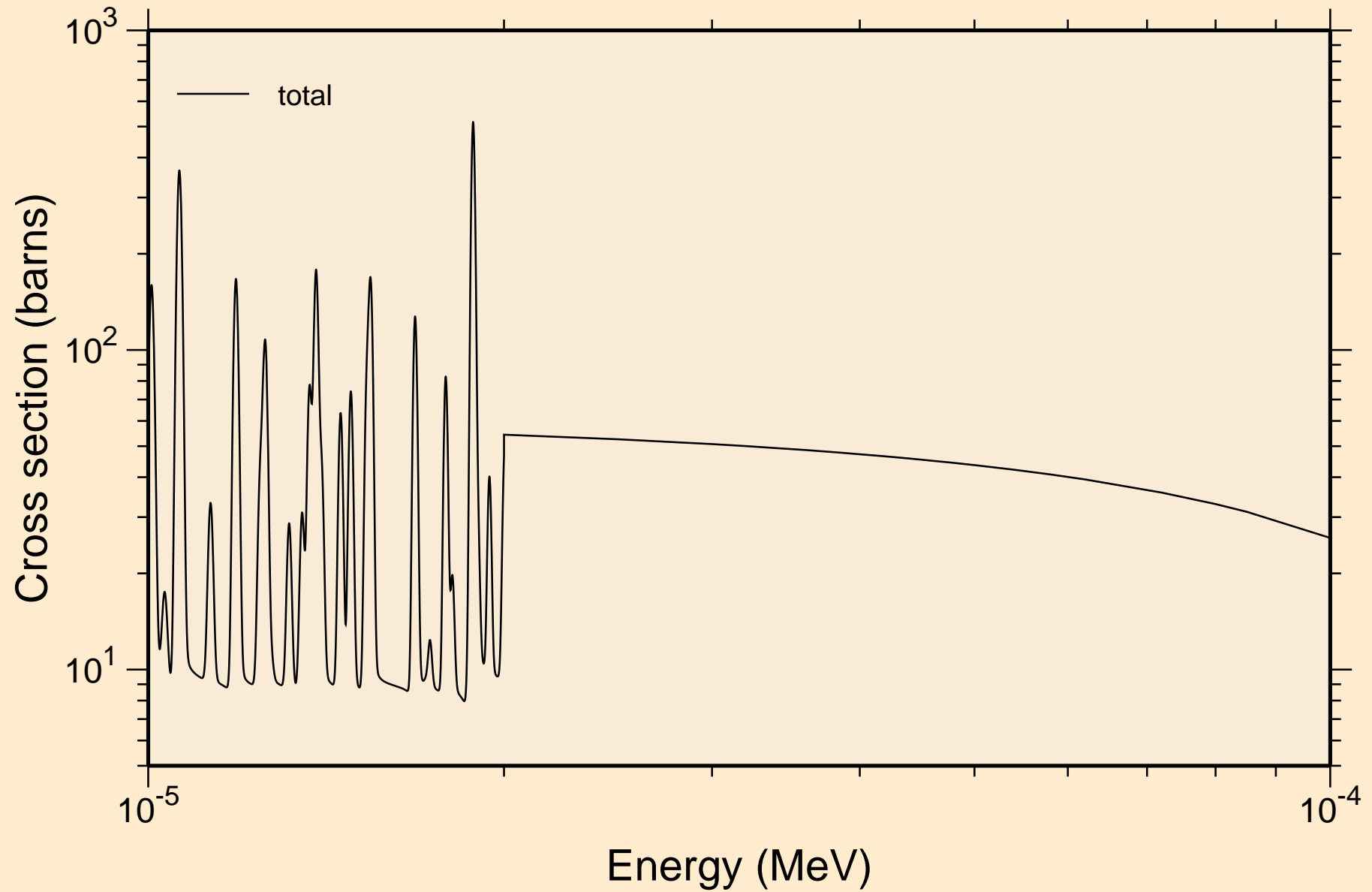

N-AC230 NRG TENDL-2017, AKONING
resonance total cross section

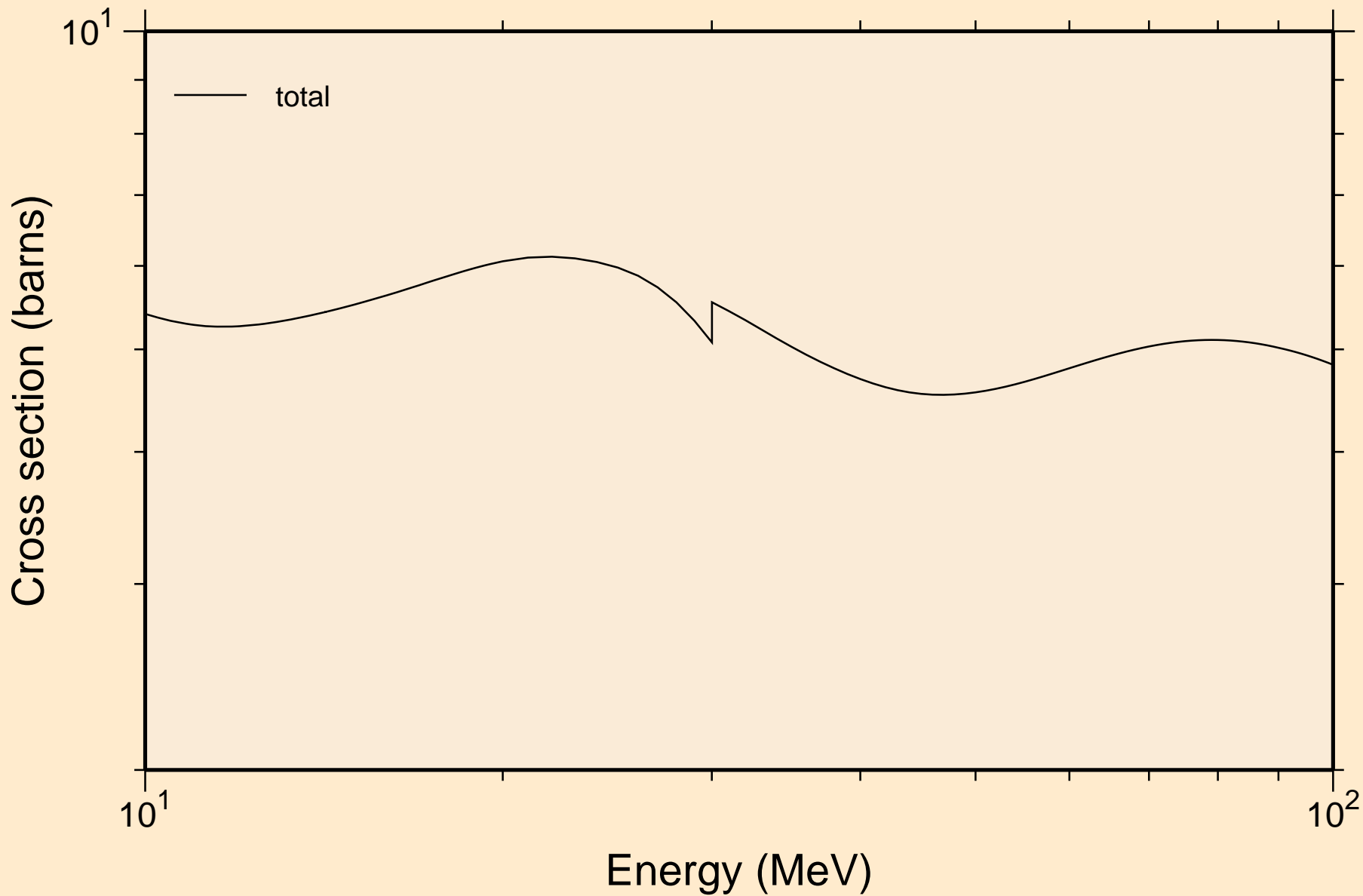

N-AC230 NRG TENDL-2017, AKONING
resonance absorption cross sections

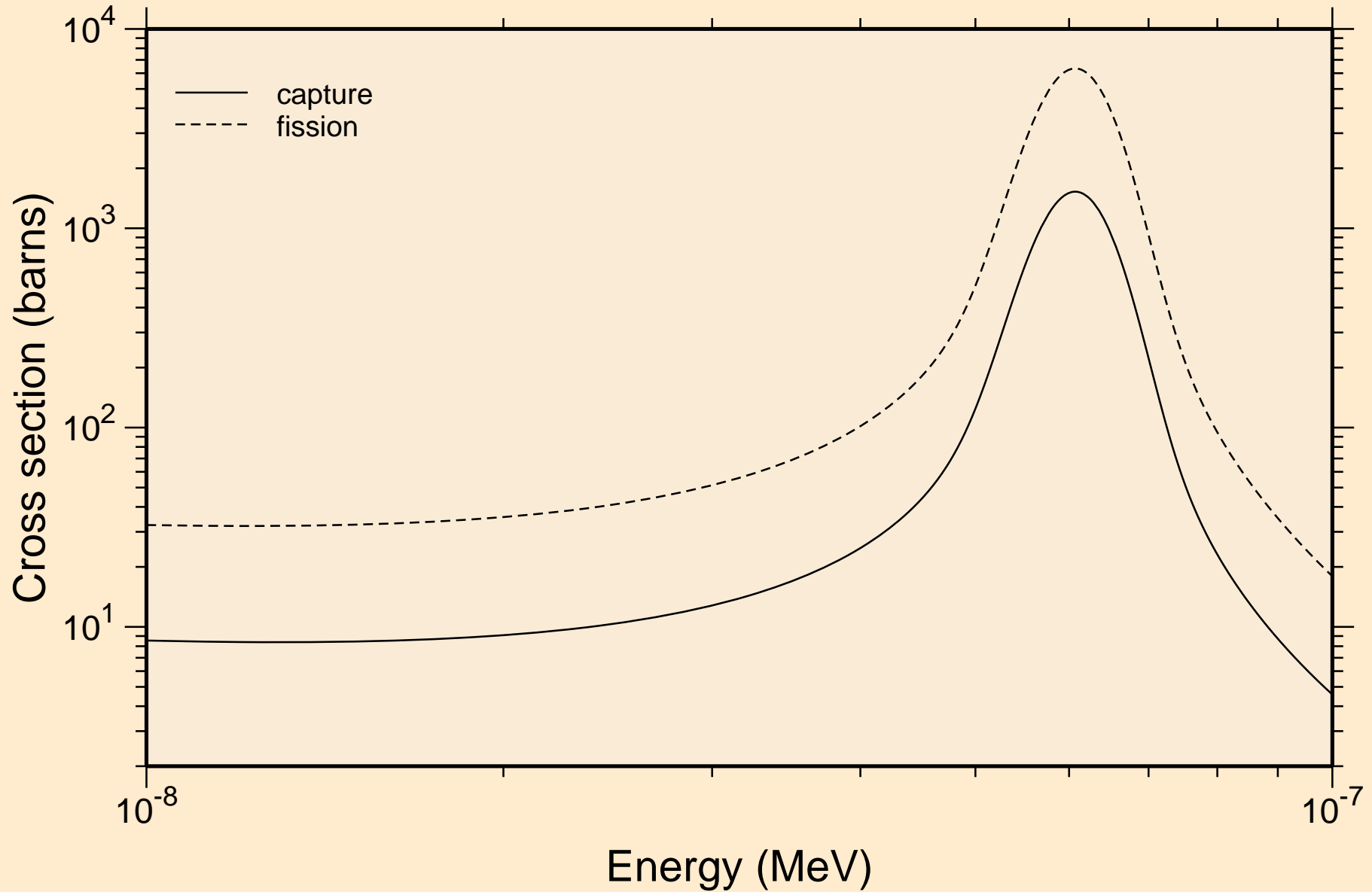

N-AC230 NRG TENDL-2017, AKONING resonance absorption cross sections

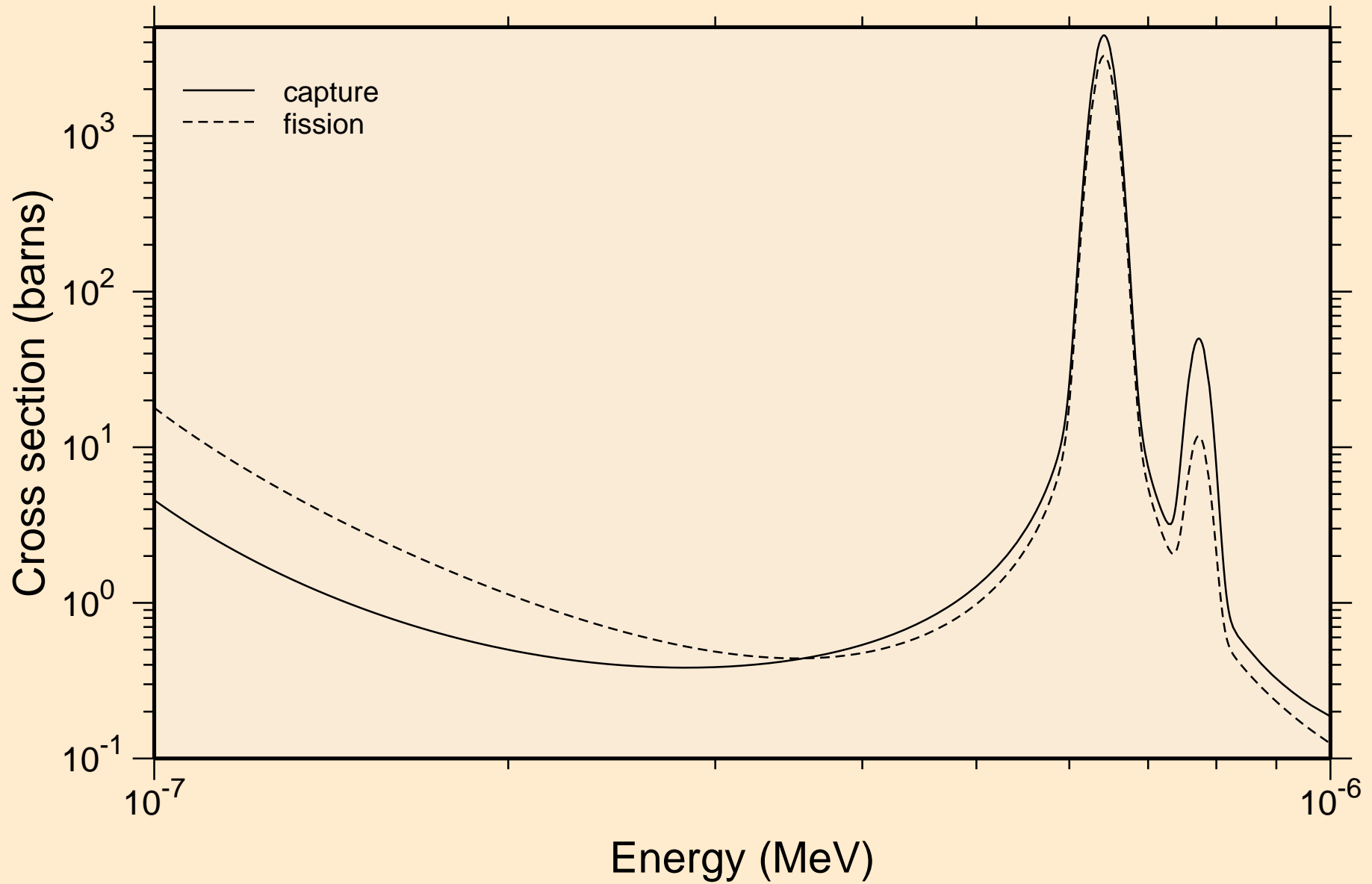

N-AC230 NRG TENDL-2017, AKONING resonance absorption cross sections

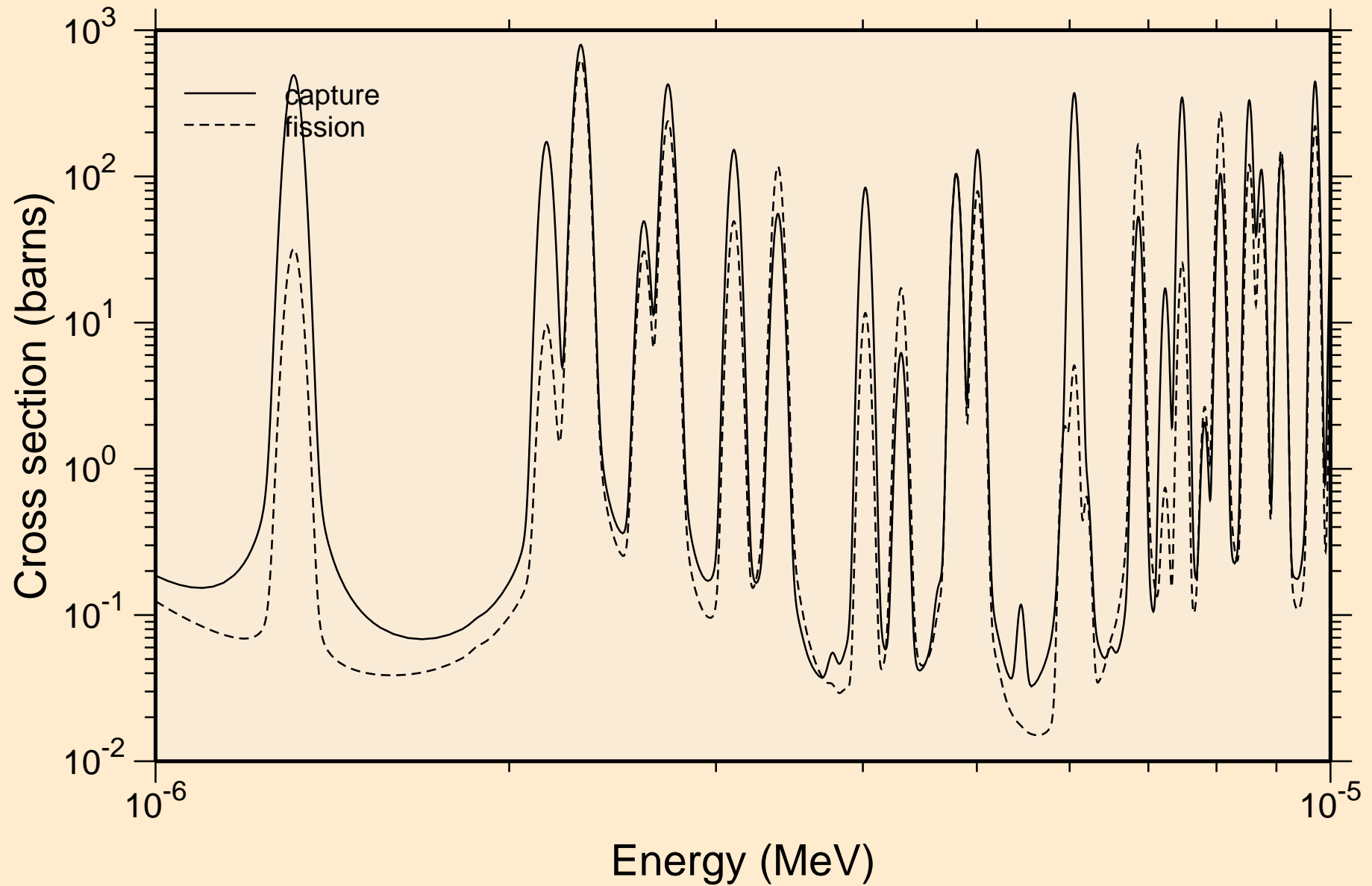

N-AC230 NRG TENDL-2017, AKONING resonance absorption cross sections

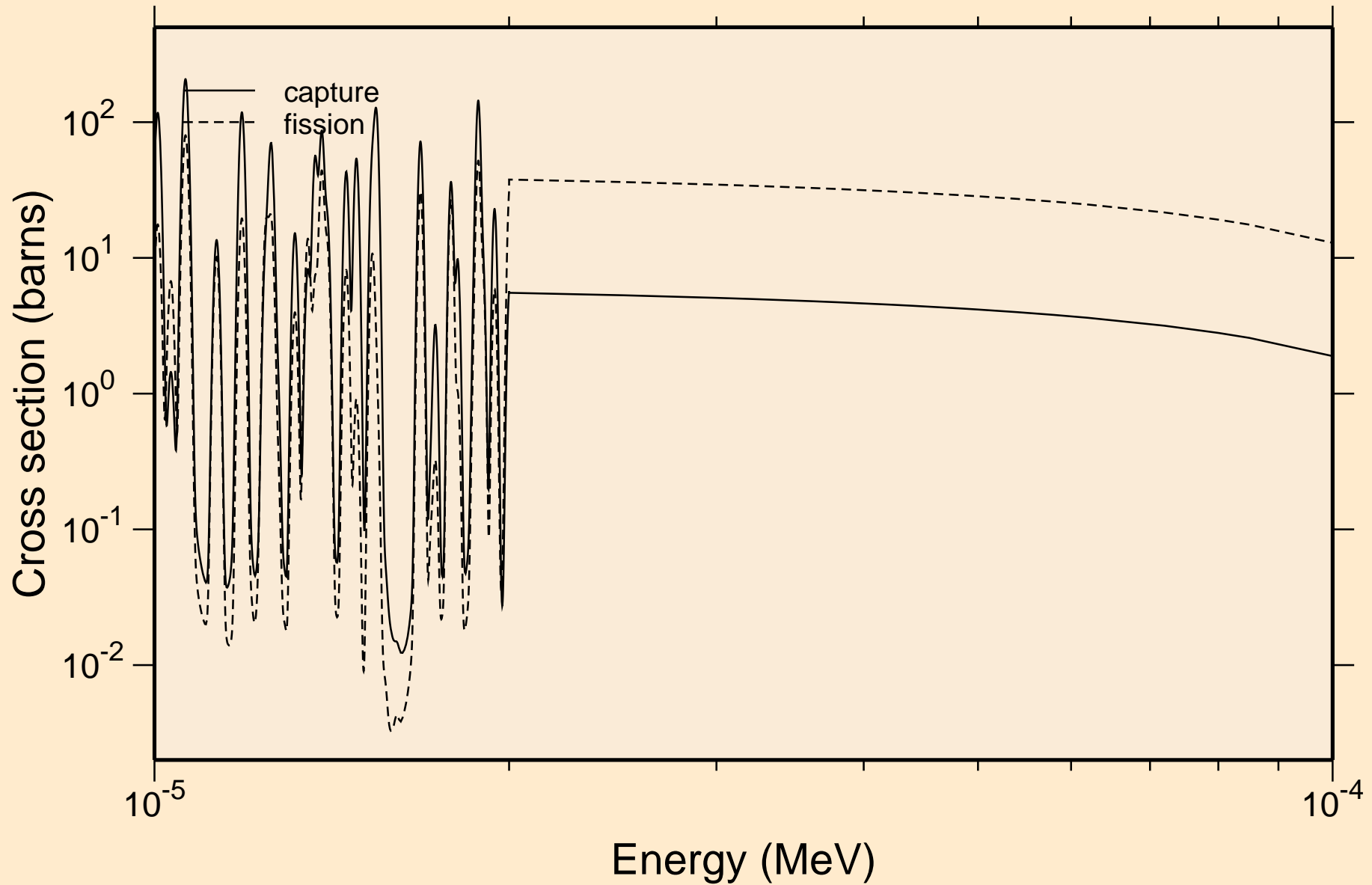

N-AC230 NRG TENDL-2017, AKONING resonance absorption cross sections

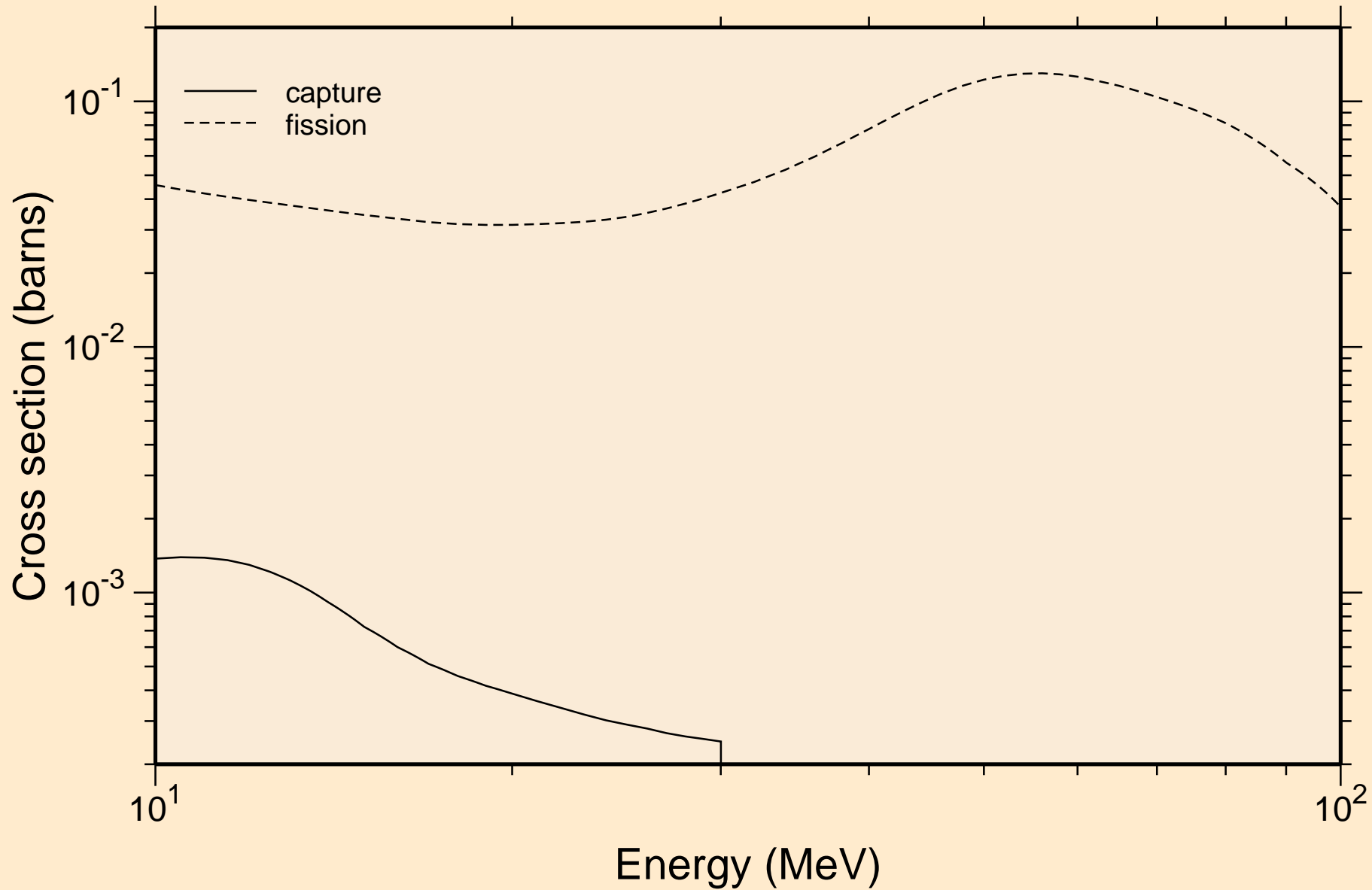

N-AC230 NRG TENDL-2017, AKONING

Non-threshold reactions

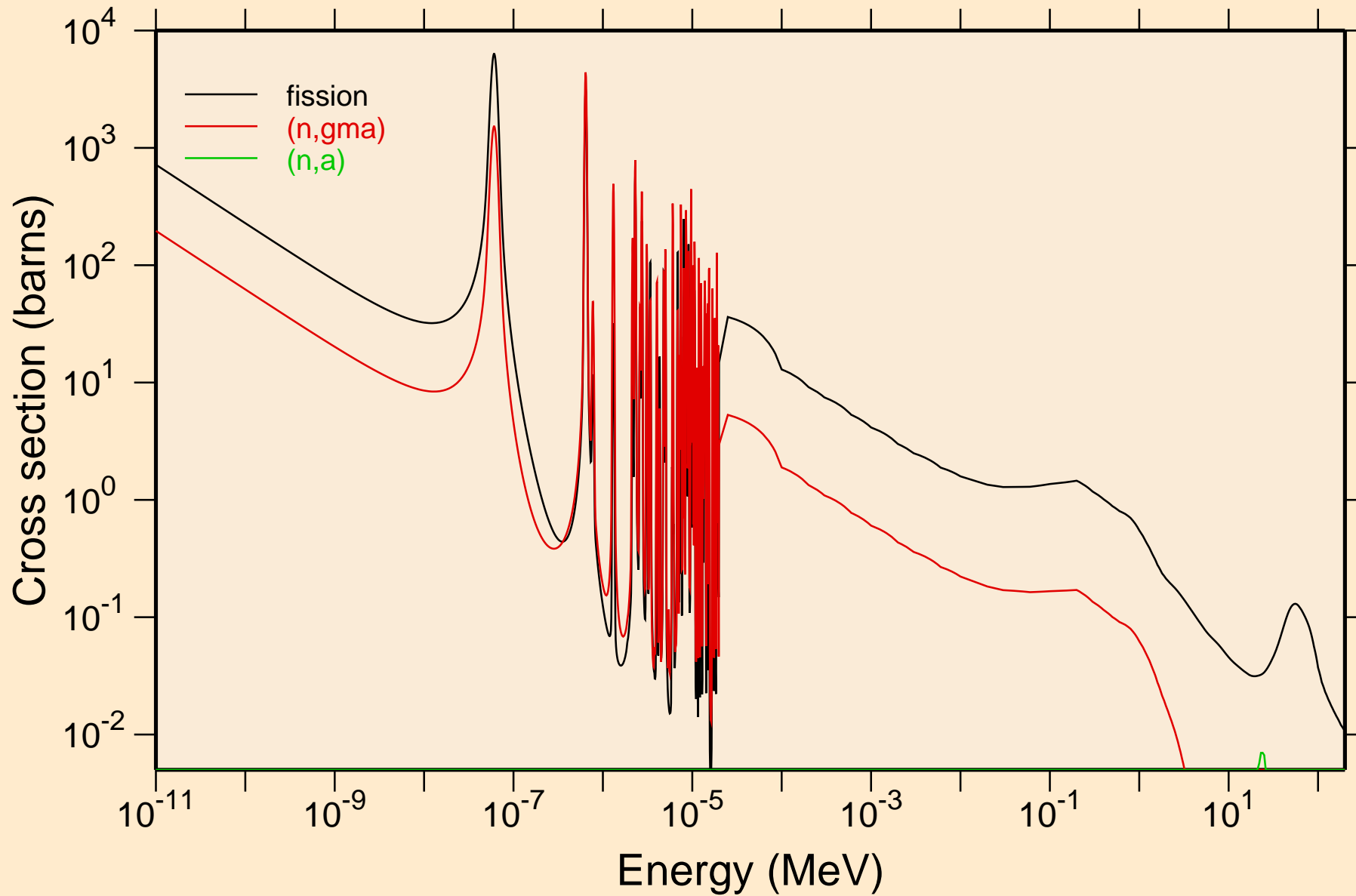

N-AC230 NRG TENDL-2017, AKONING

Principal cross sections

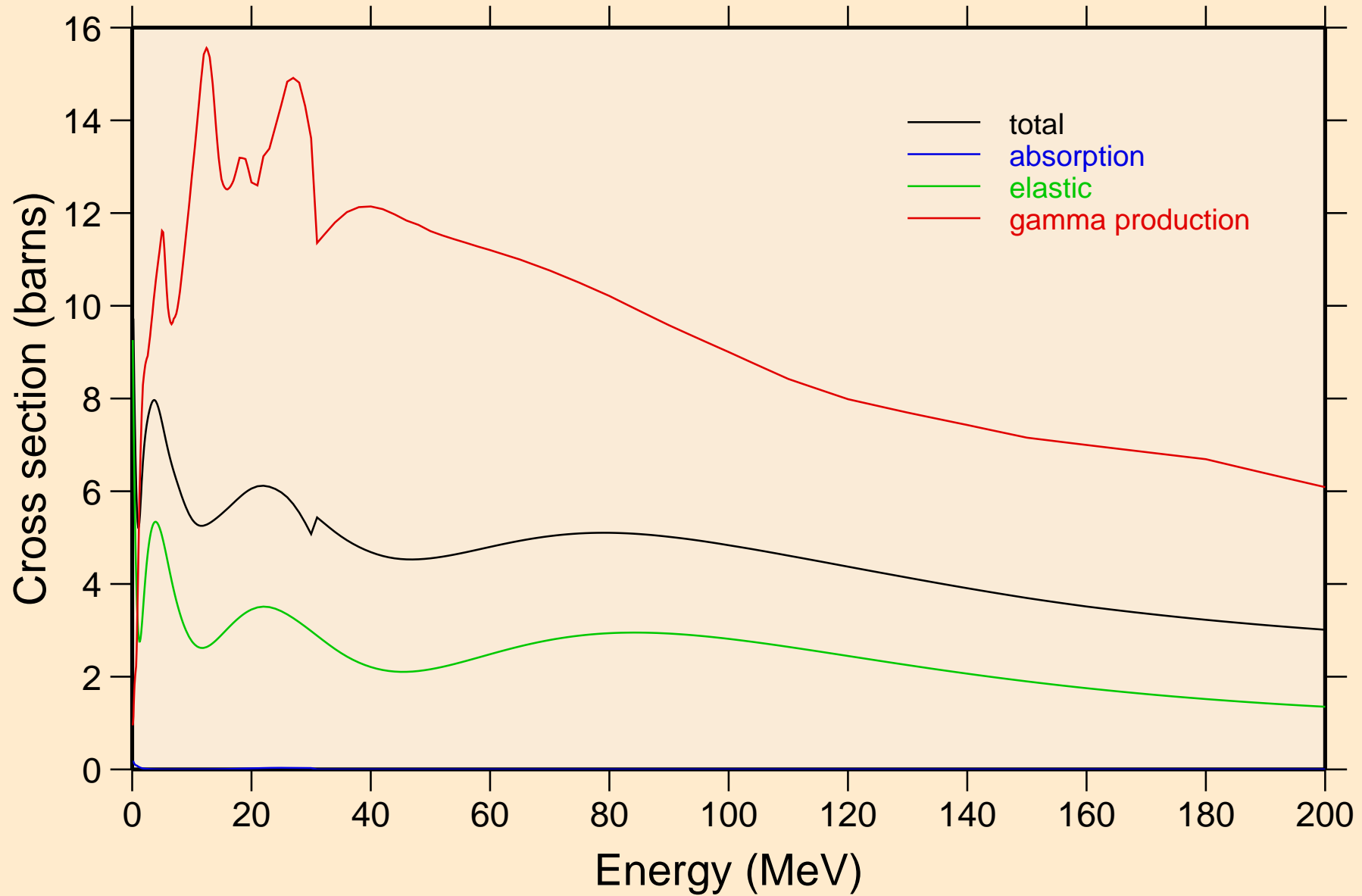

N-AC230 NRG TENDL-2017, AKONING

Non-threshold reactions

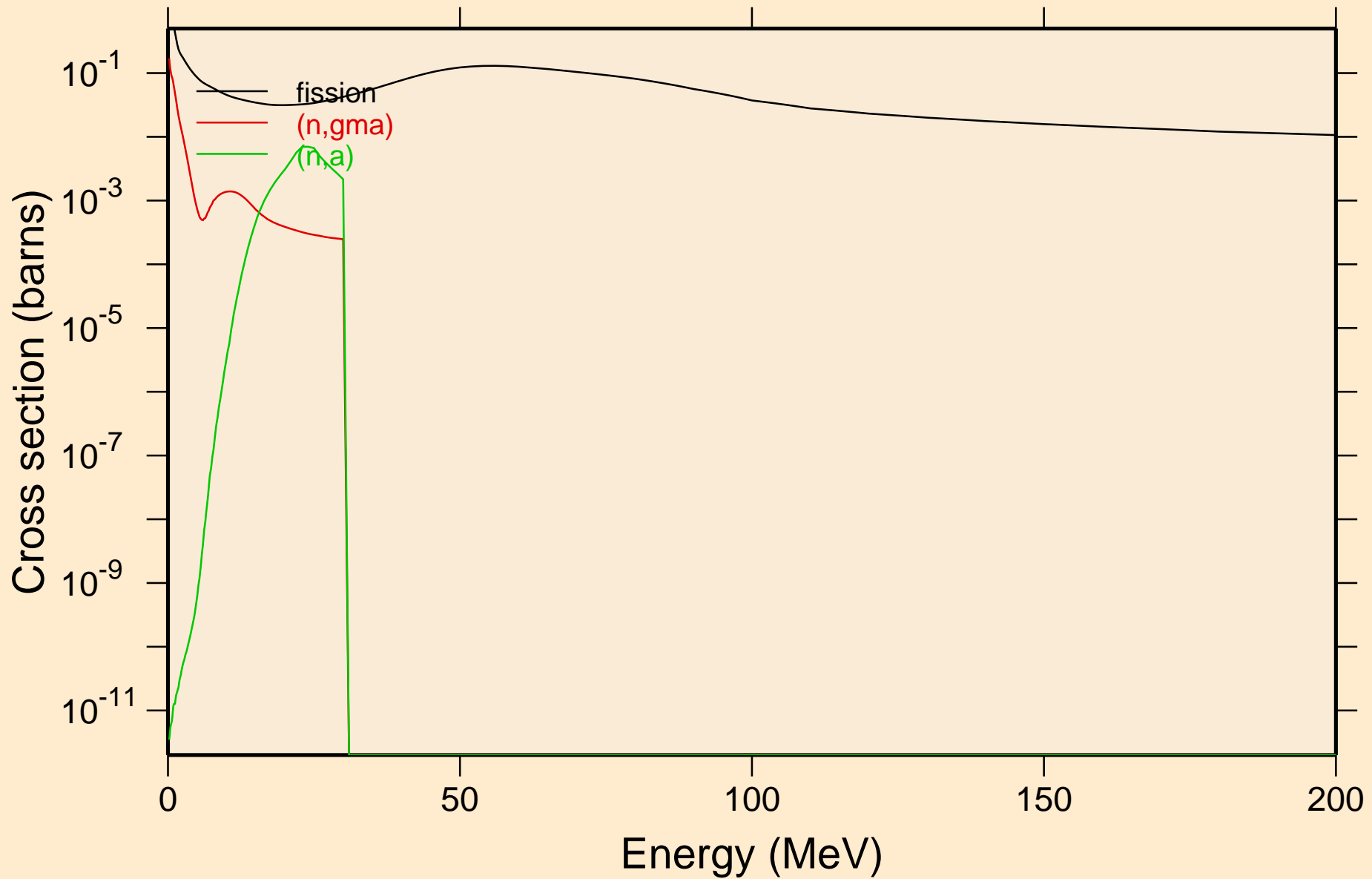

N-AC230 NRG TENDL-2017, AKONING

Inelastic levels

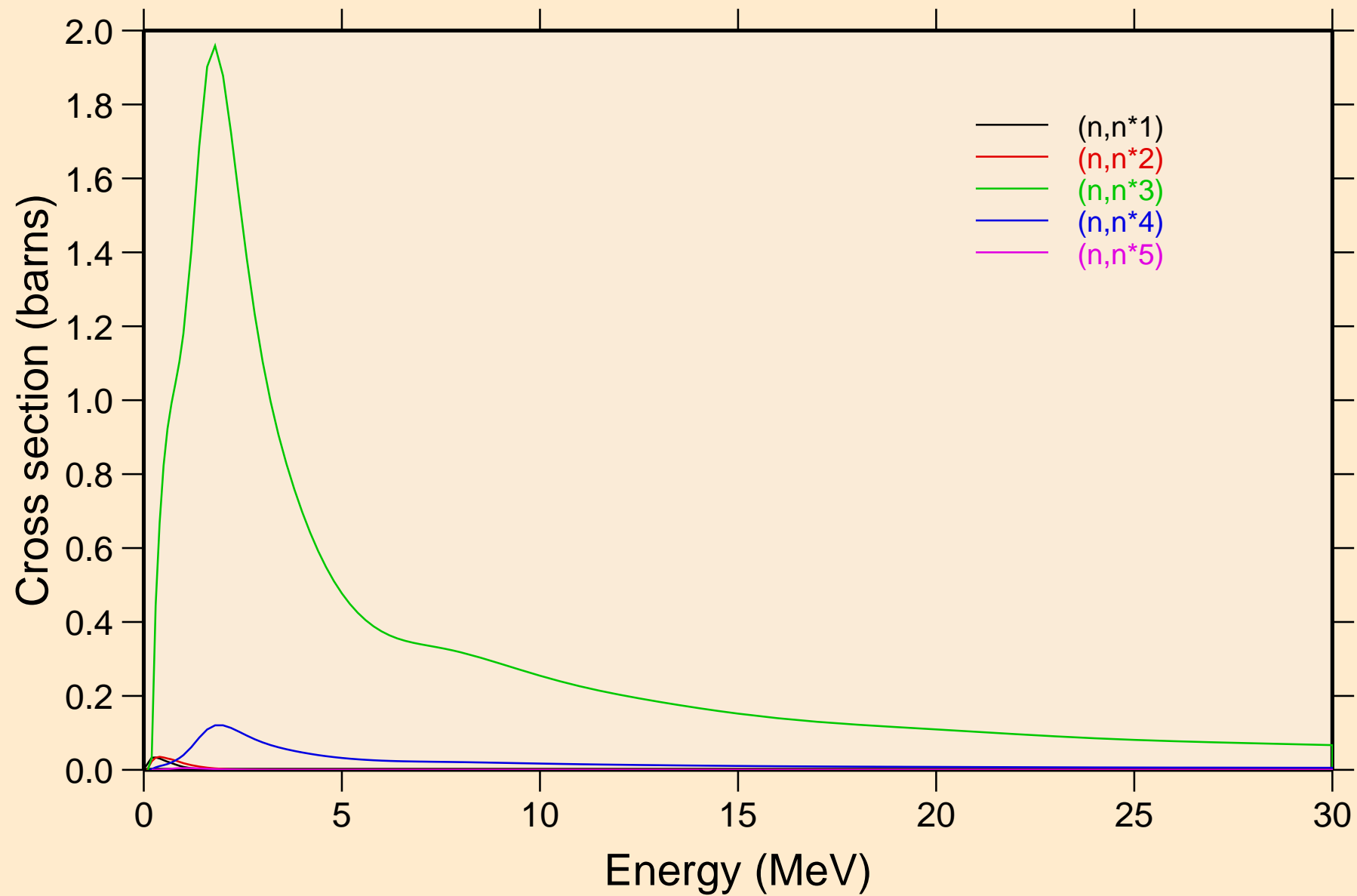

N-AC230 NRG TENDL-2017, AKONING

Inelastic levels

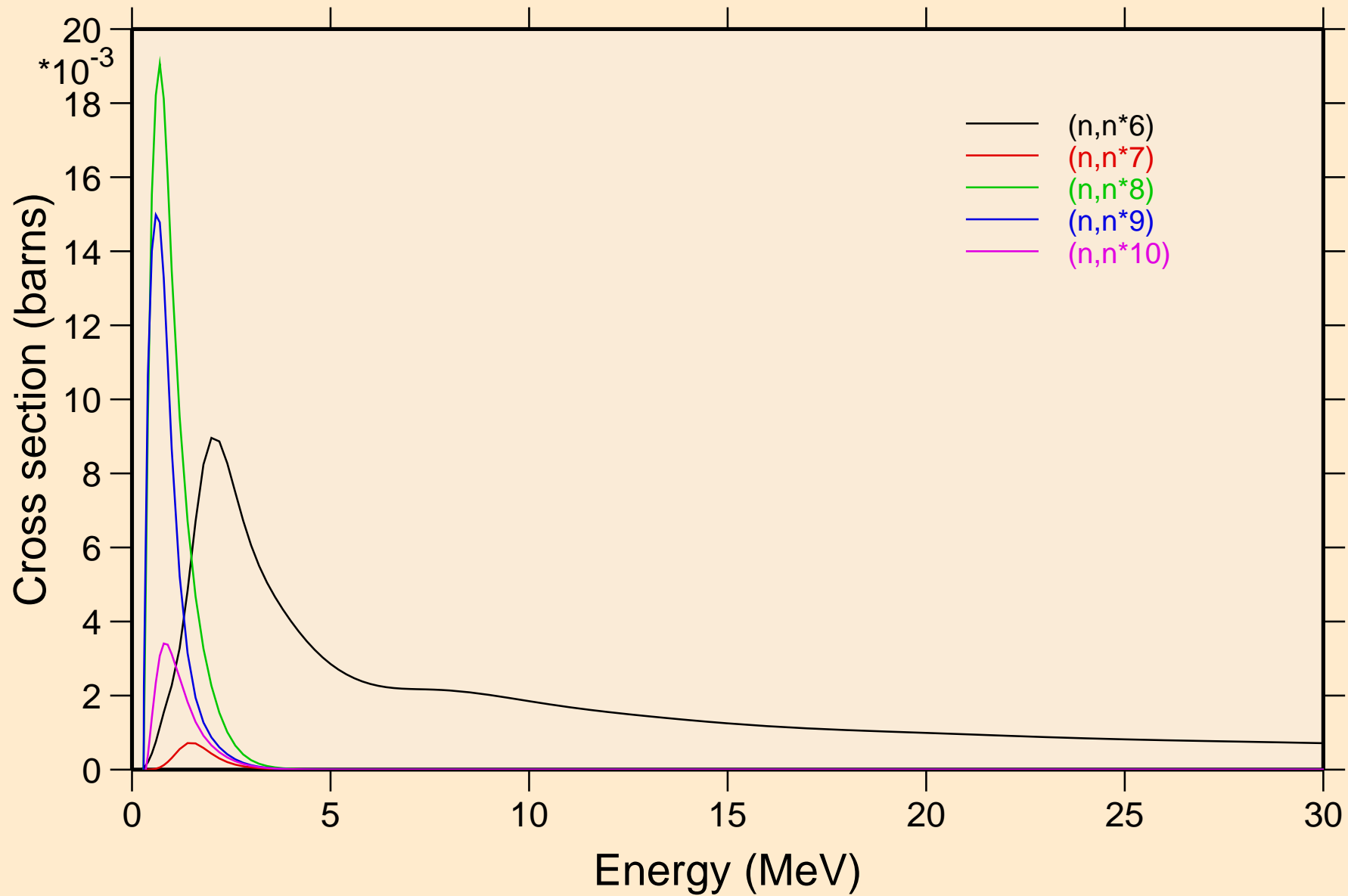

N-AC230 NRG TENDL-2017, AKONING

Inelastic levels

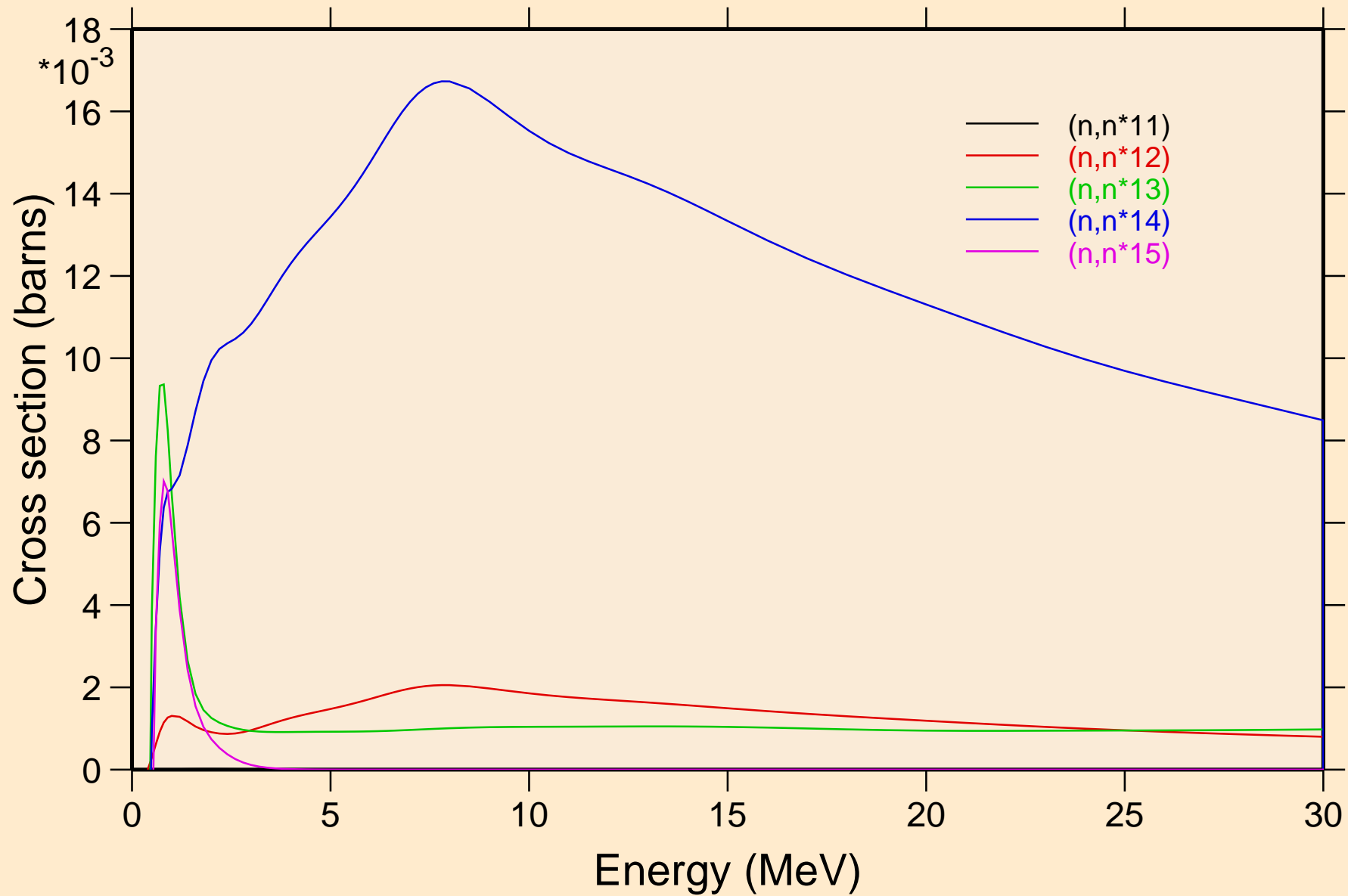

N-AC230 NRG TENDL-2017, AKONING

Inelastic levels

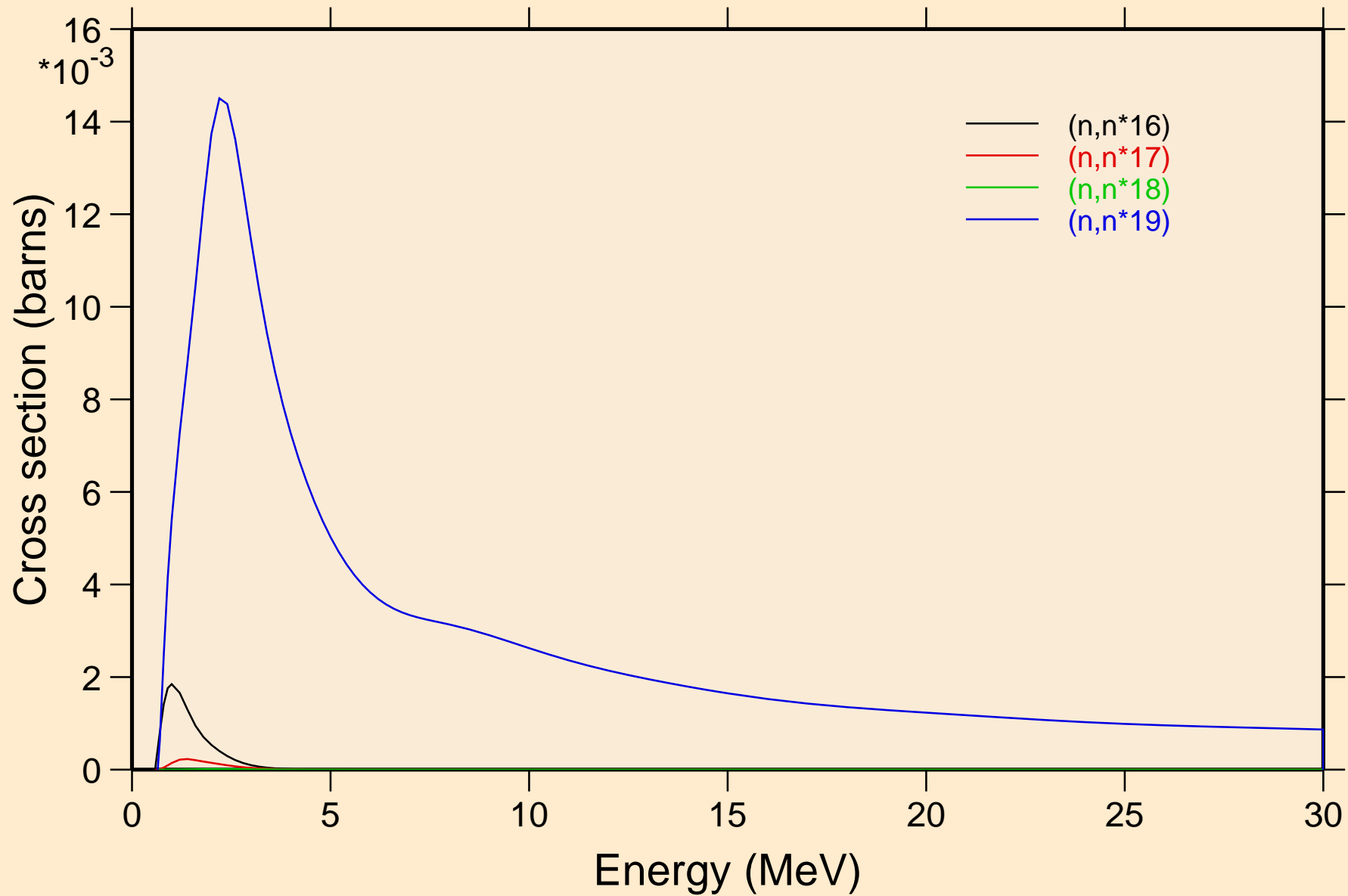

N-AC230 NRG TENDL-2017, AKONING

Threshold reactions

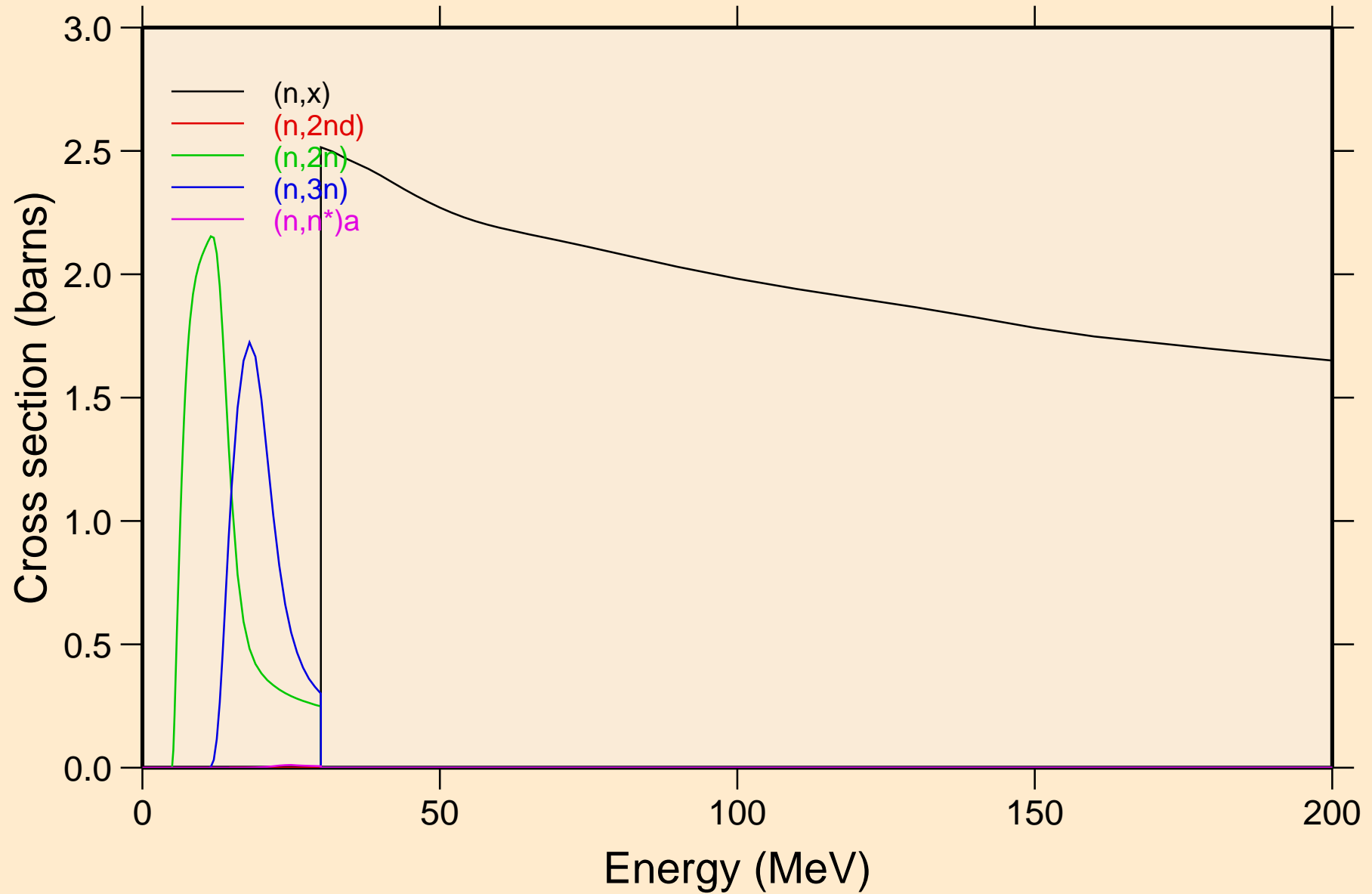

N-AC230 NRG TENDL-2017, AKONING

Threshold reactions

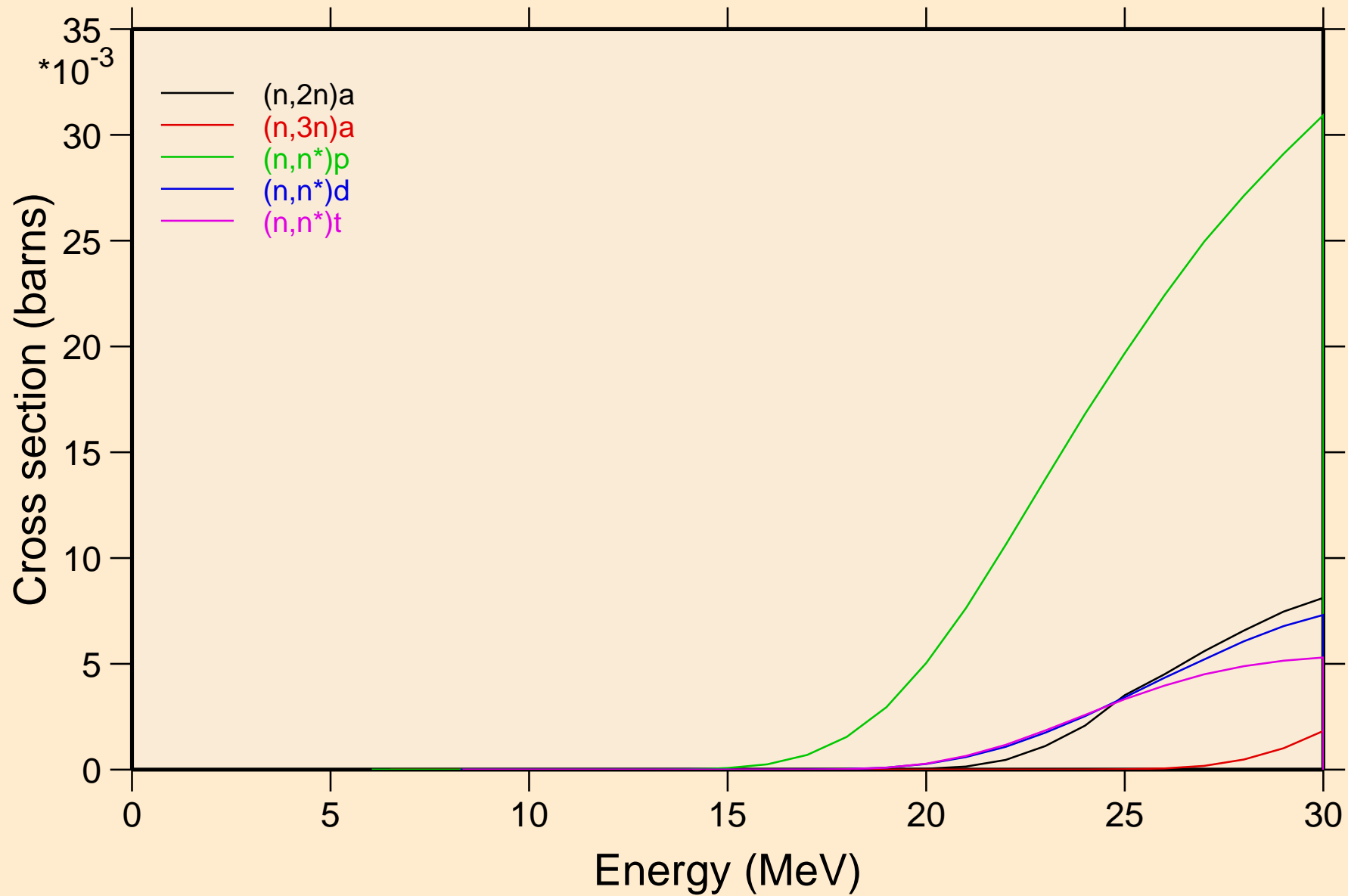

N-AC230 NRG TENDL-2017, AKONING

Threshold reactions

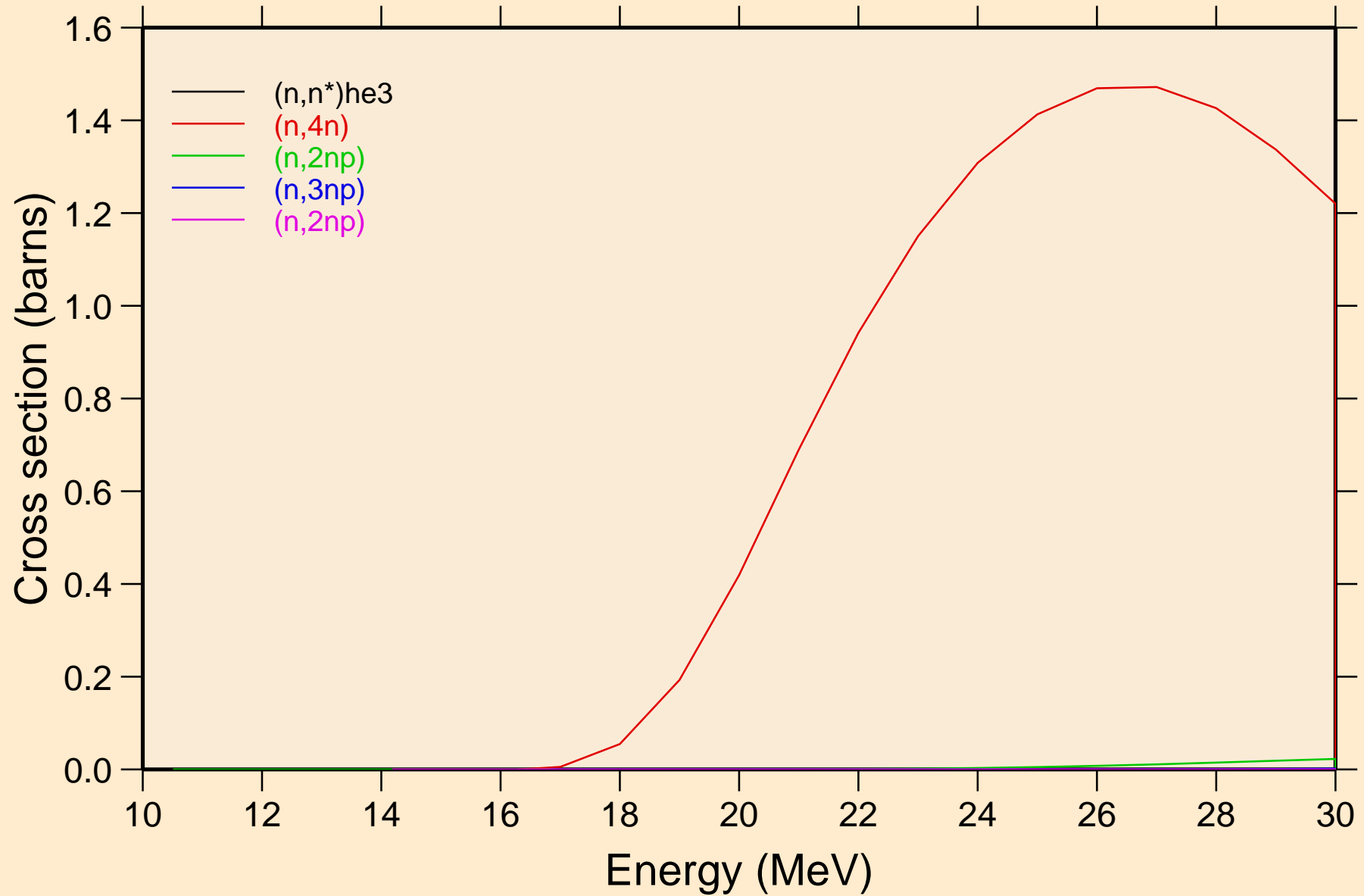

N-AC230 NRG TENDL-2017, AKONING

Threshold reactions

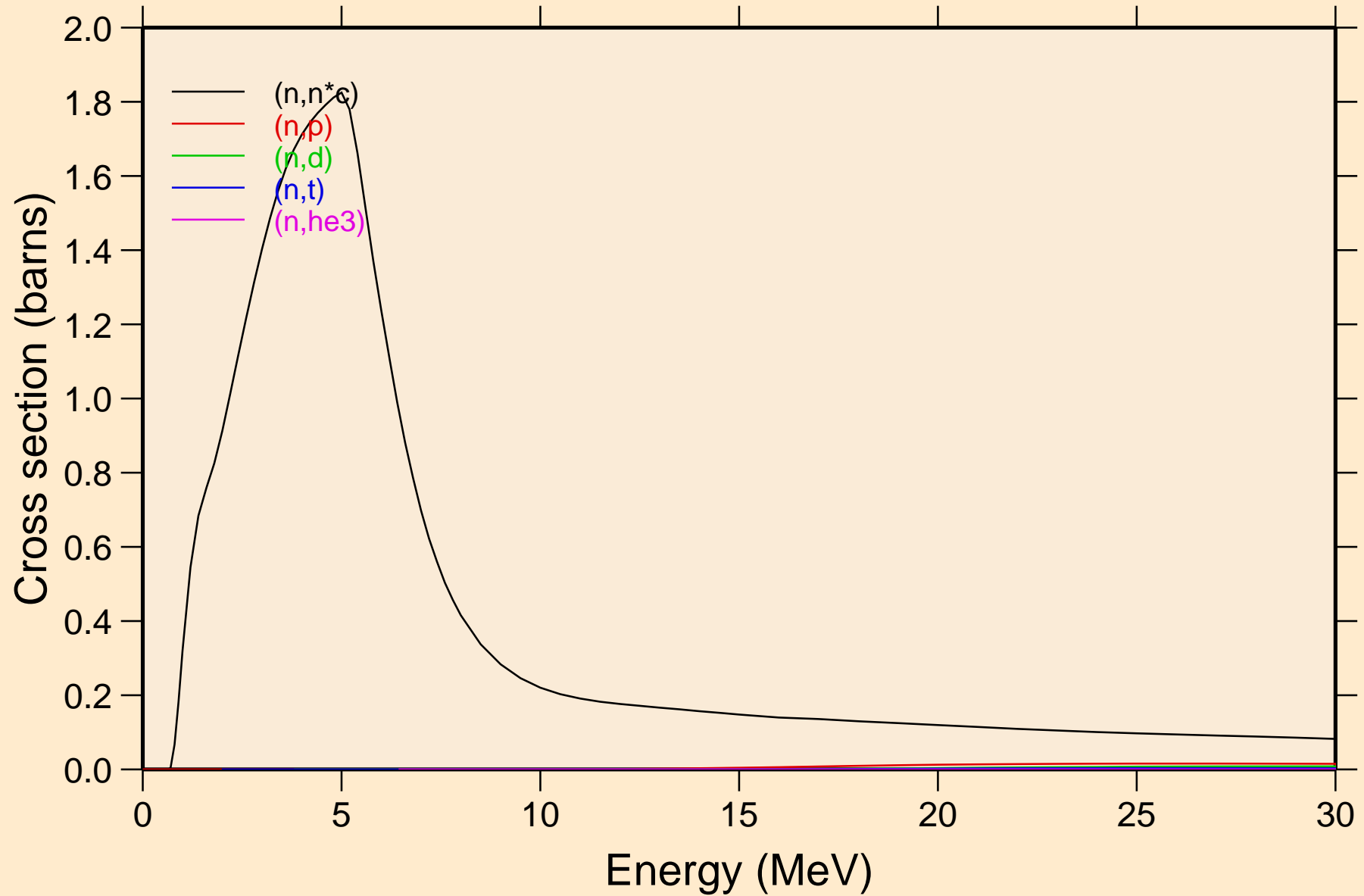

N-AC230 NRG TENDL-2017, AKONING

Threshold reactions

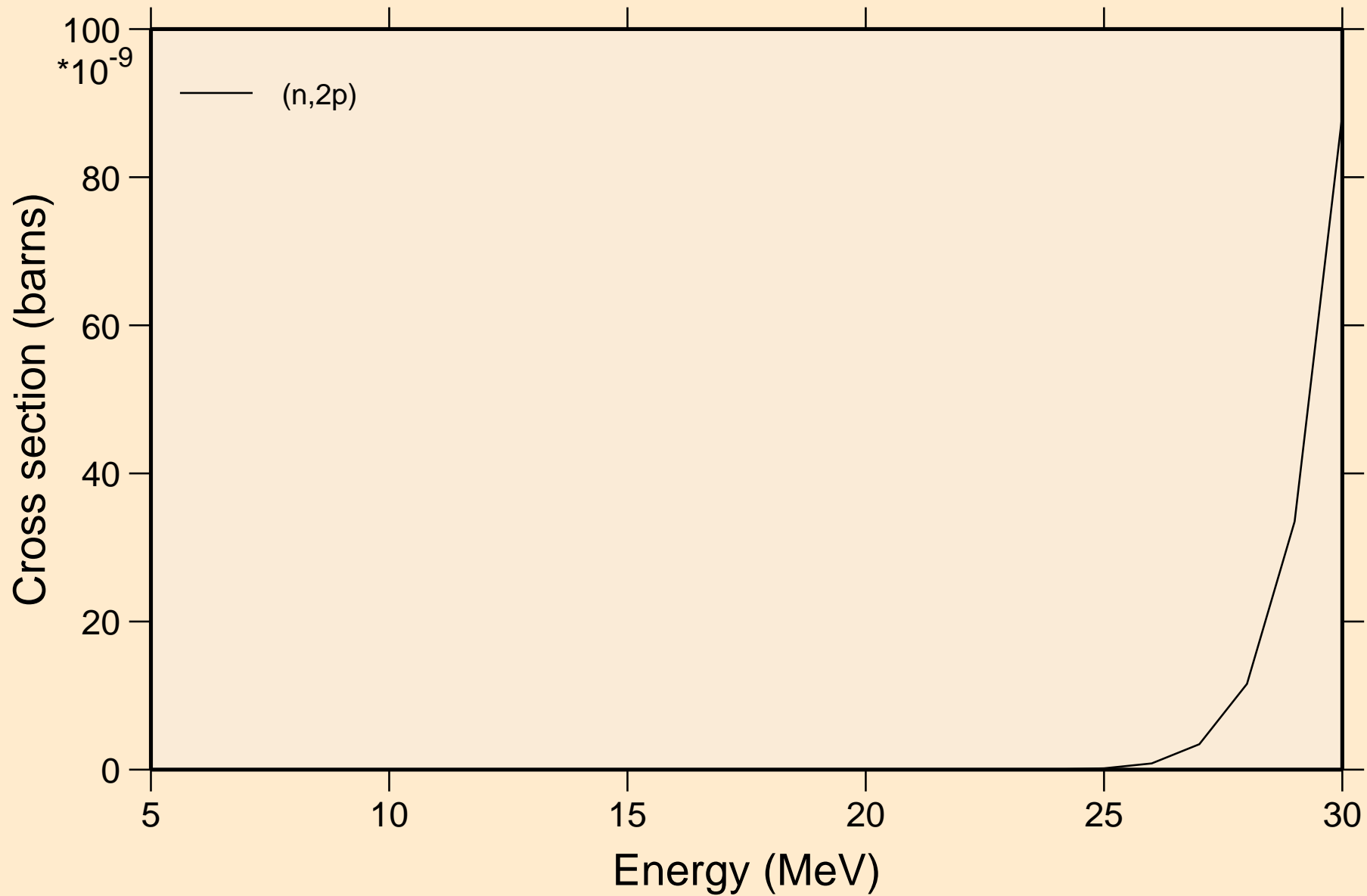

N-AC230 NRG TENDL-2017, AKONING
angular distribution for elastic

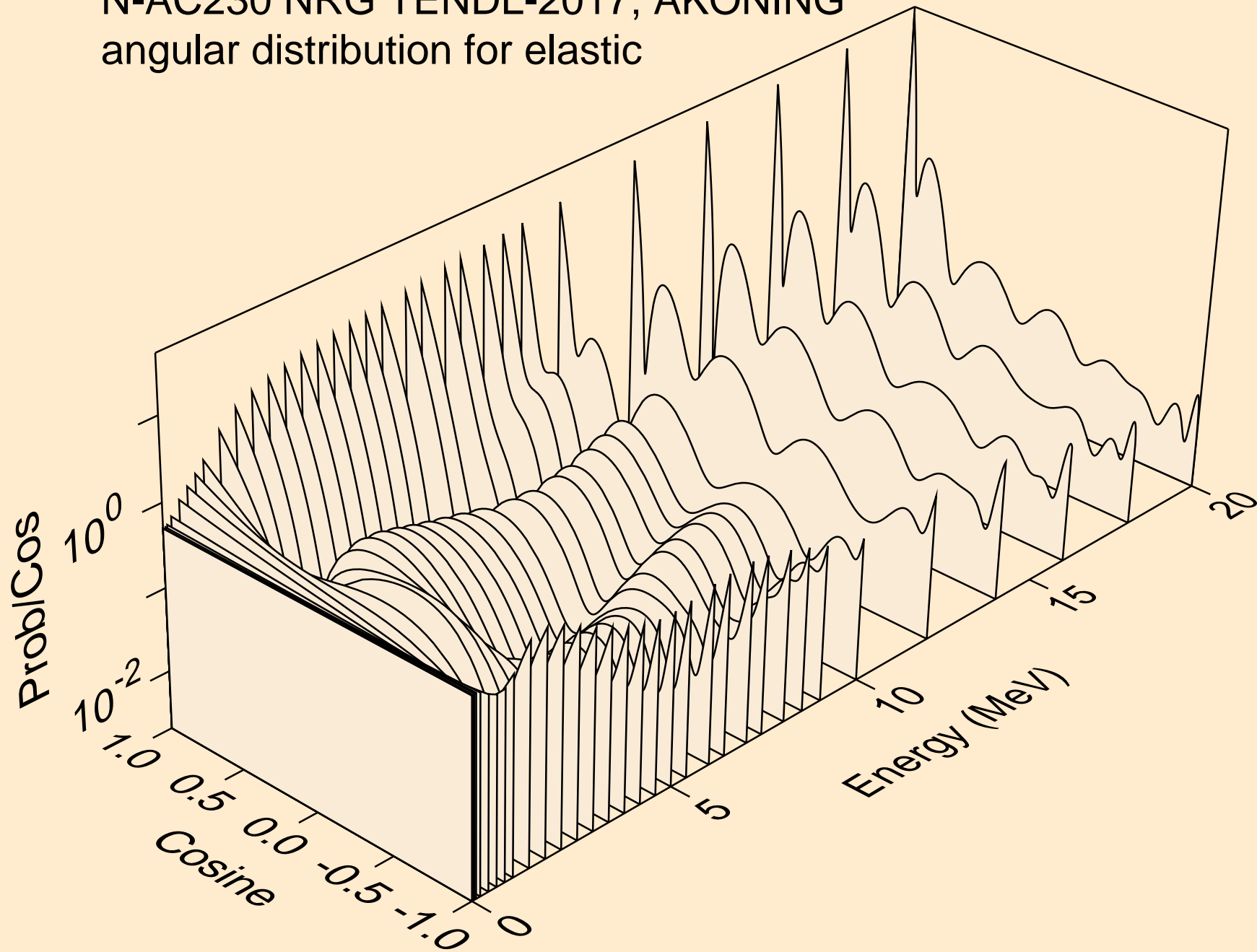

N-AC230 NRG TENDL-2017, AKONING
angular distribution for elastic

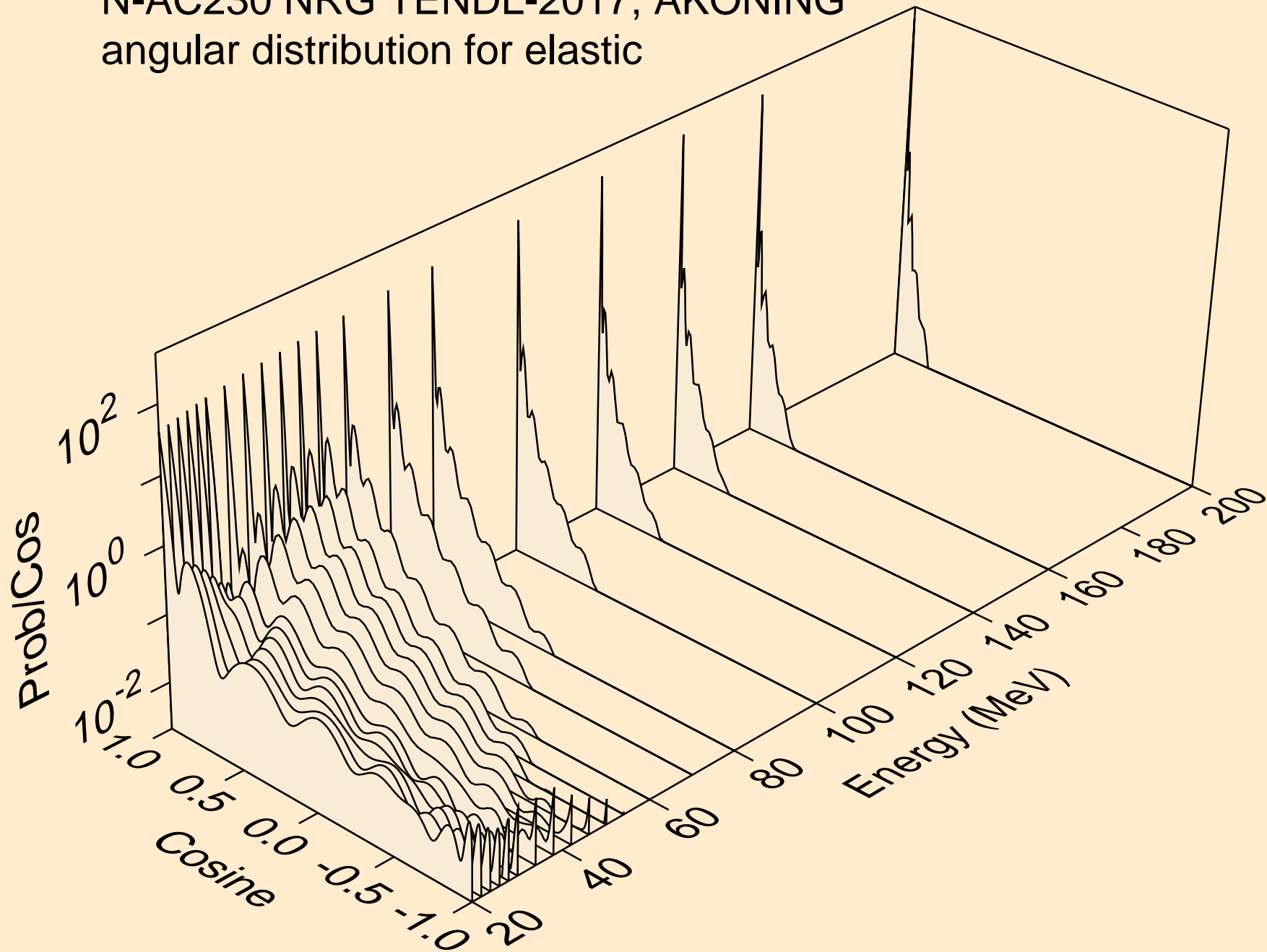

N-AC230 NRG TENDL-2017, AKONING
angular distribution for (n,n*1)

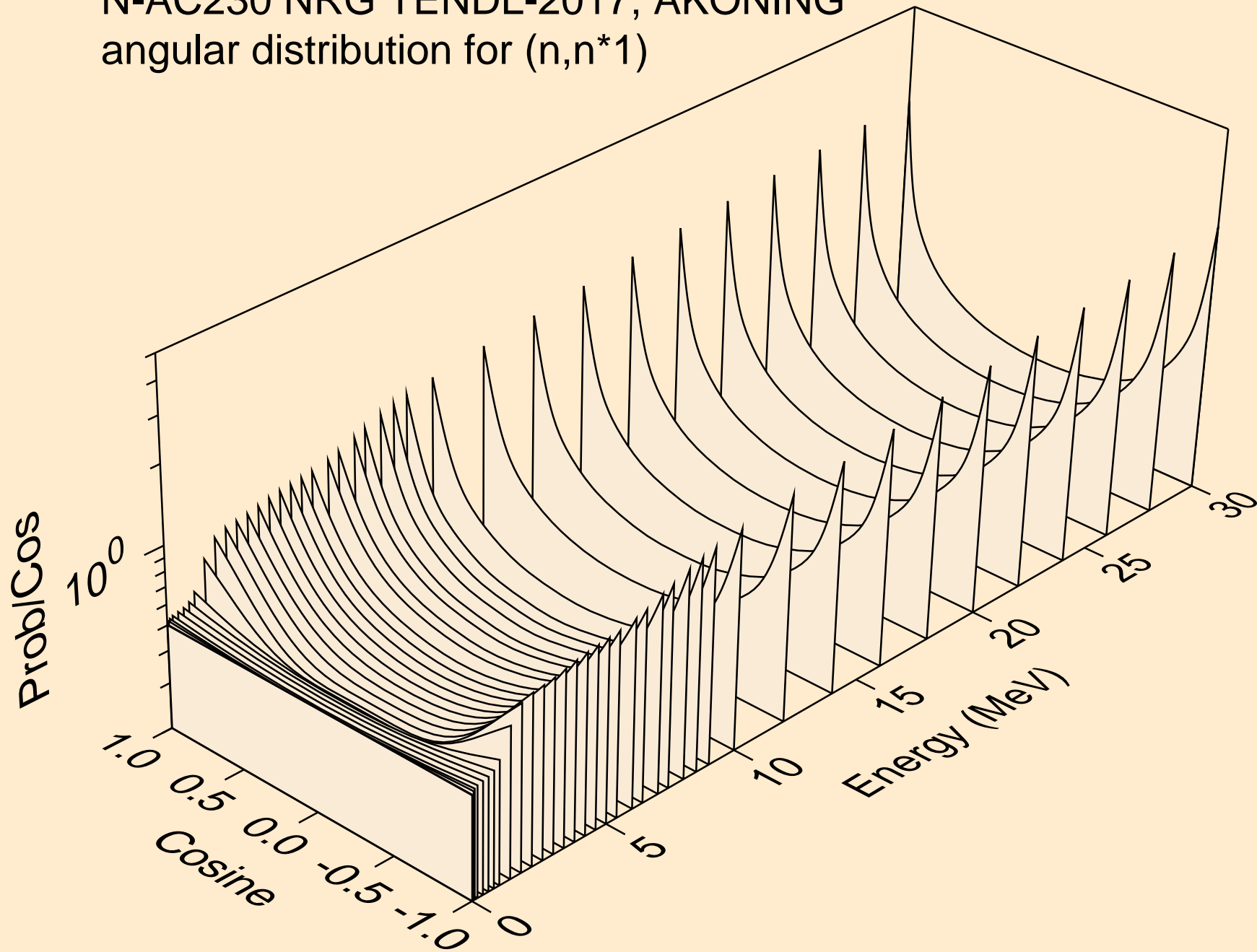

N-AC230 NRG TENDL-2017, AKONING
angular distribution for (n,n*2)

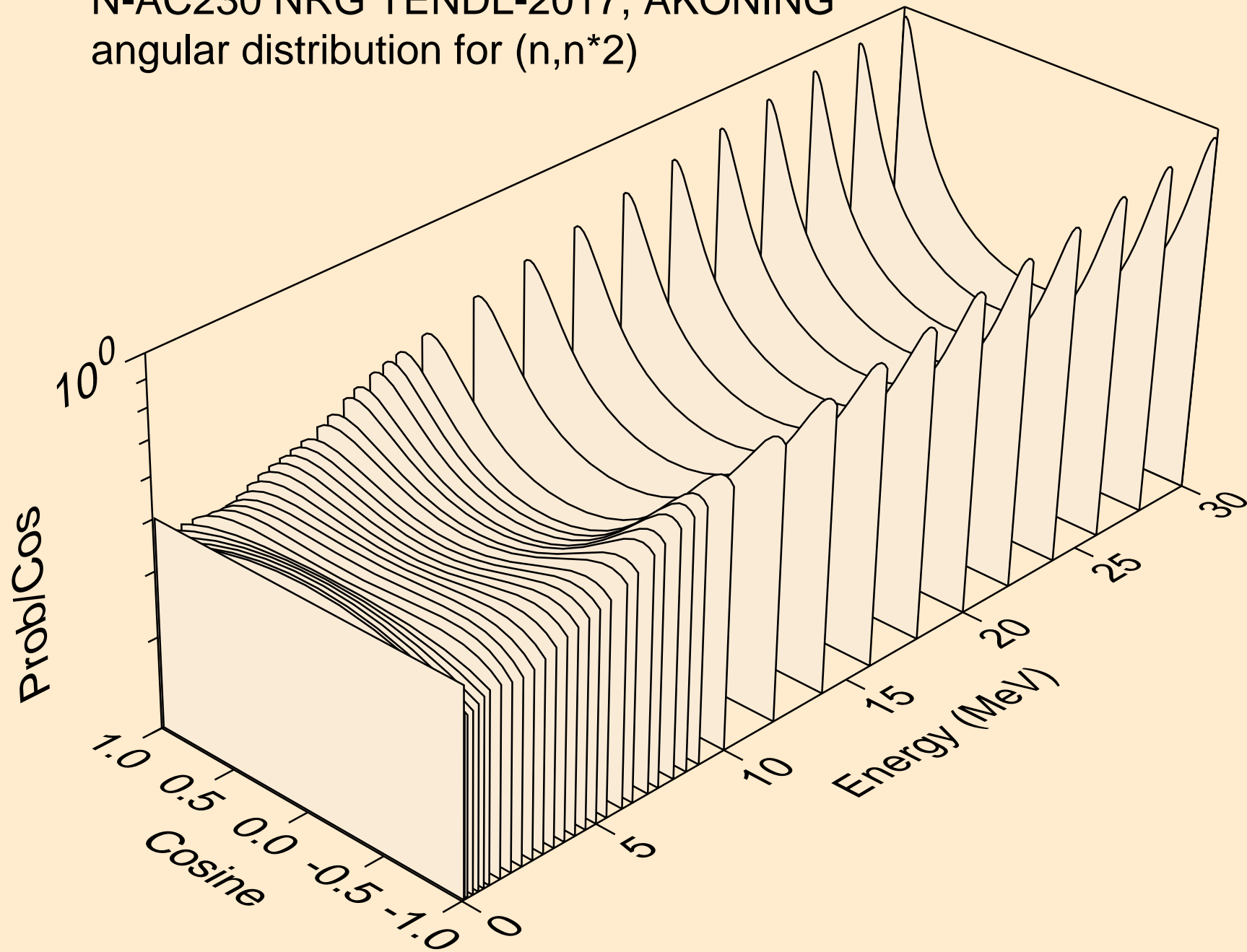

N-AC230 NRG TENDL-2017, AKONING
angular distribution for (n,n*3)

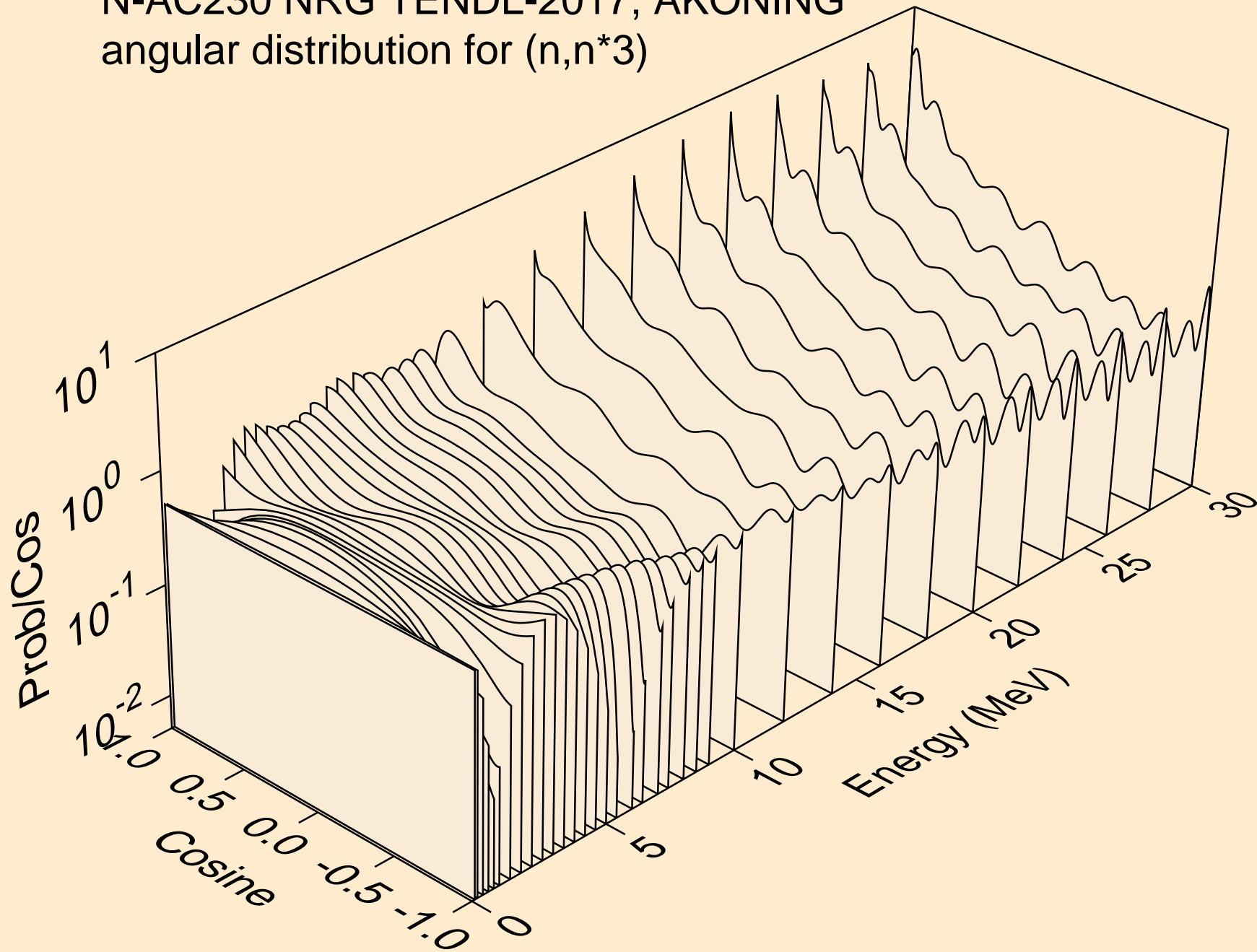

N-AC230 NRG TENDL-2017, AKONING
angular distribution for (n,n*4)

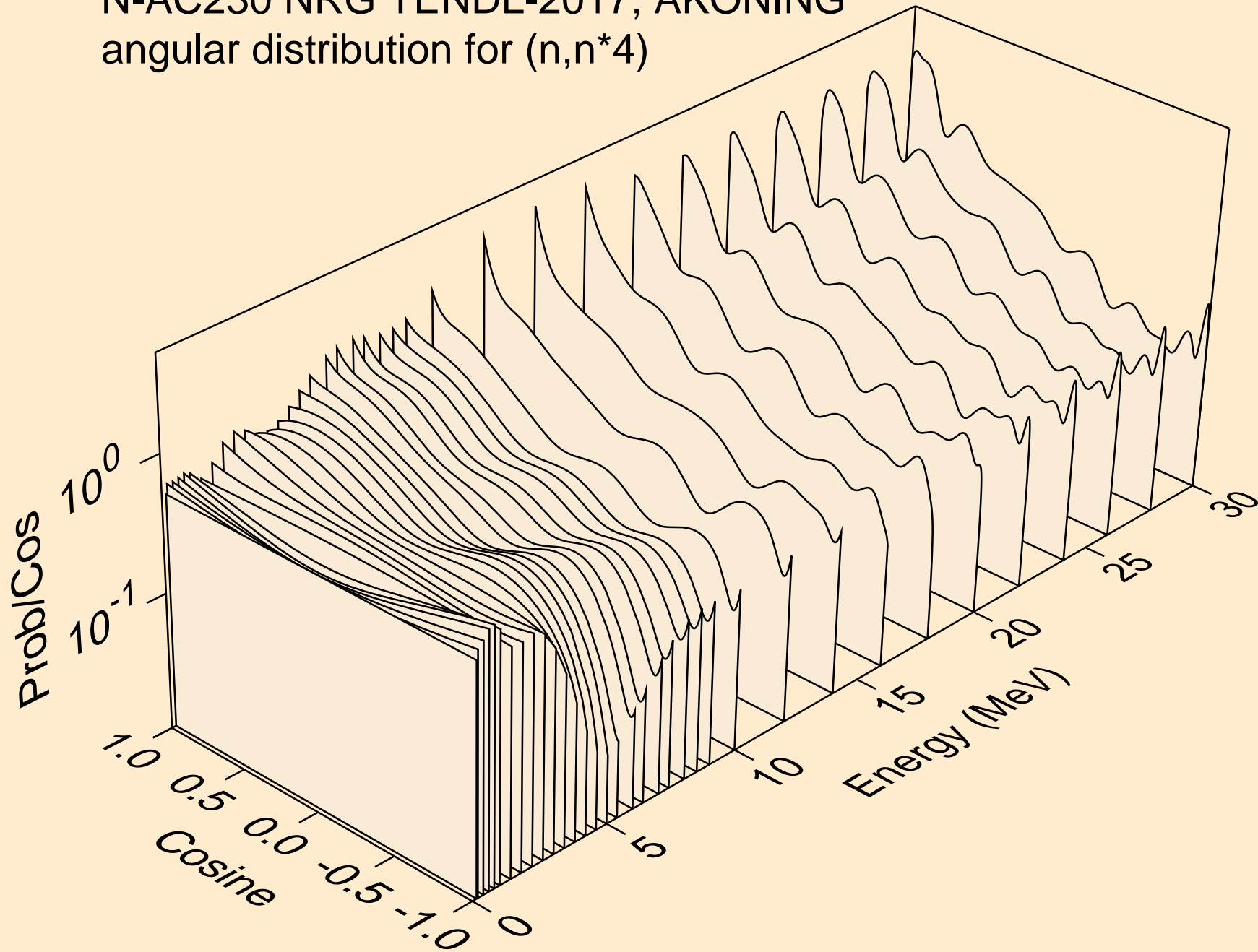

N-AC230 NRG TENDL-2017, AKONING
angular distribution for (n,n*5)

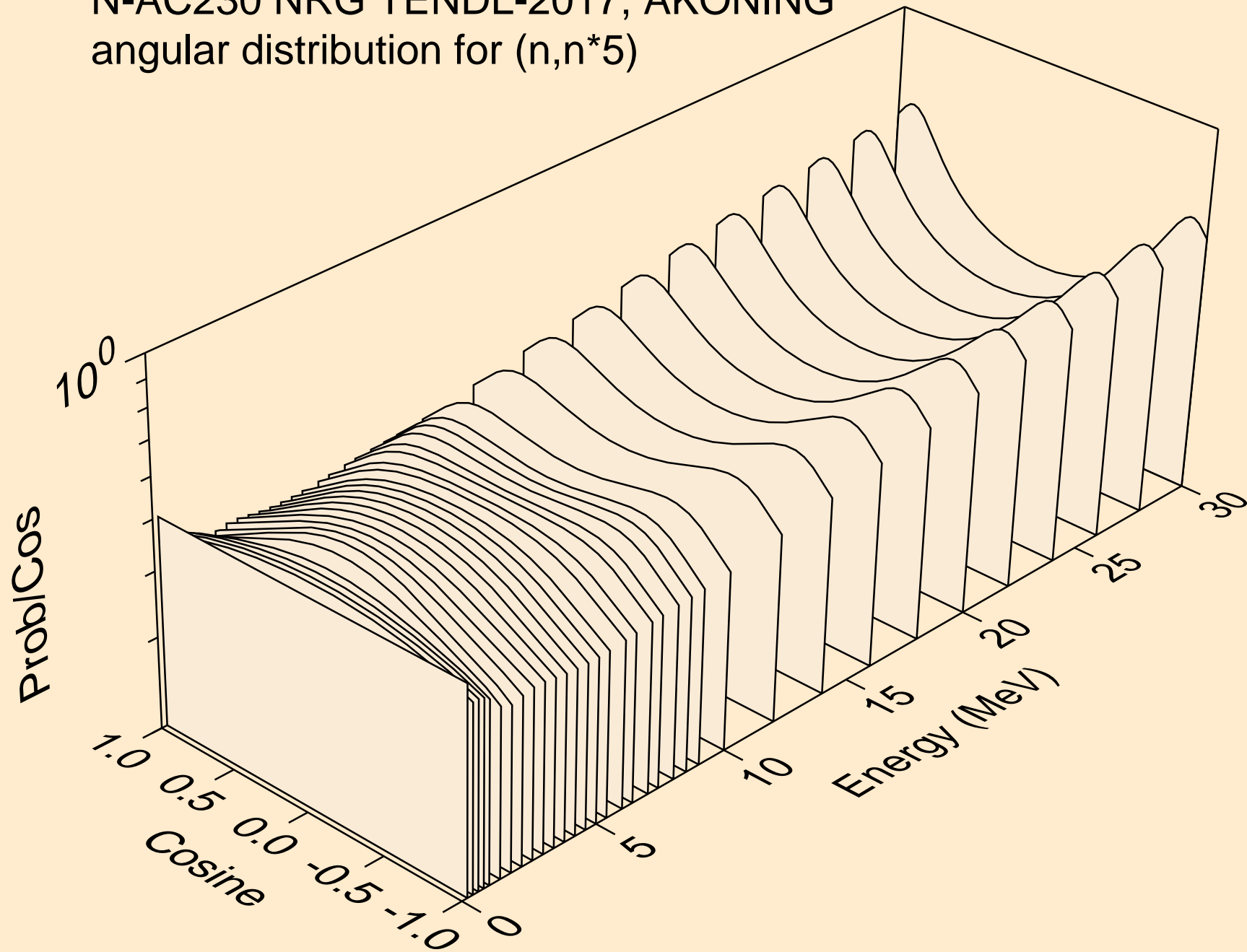

N-AC230 NRG TENDL-2017, AKONING
angular distribution for (n,n*6)

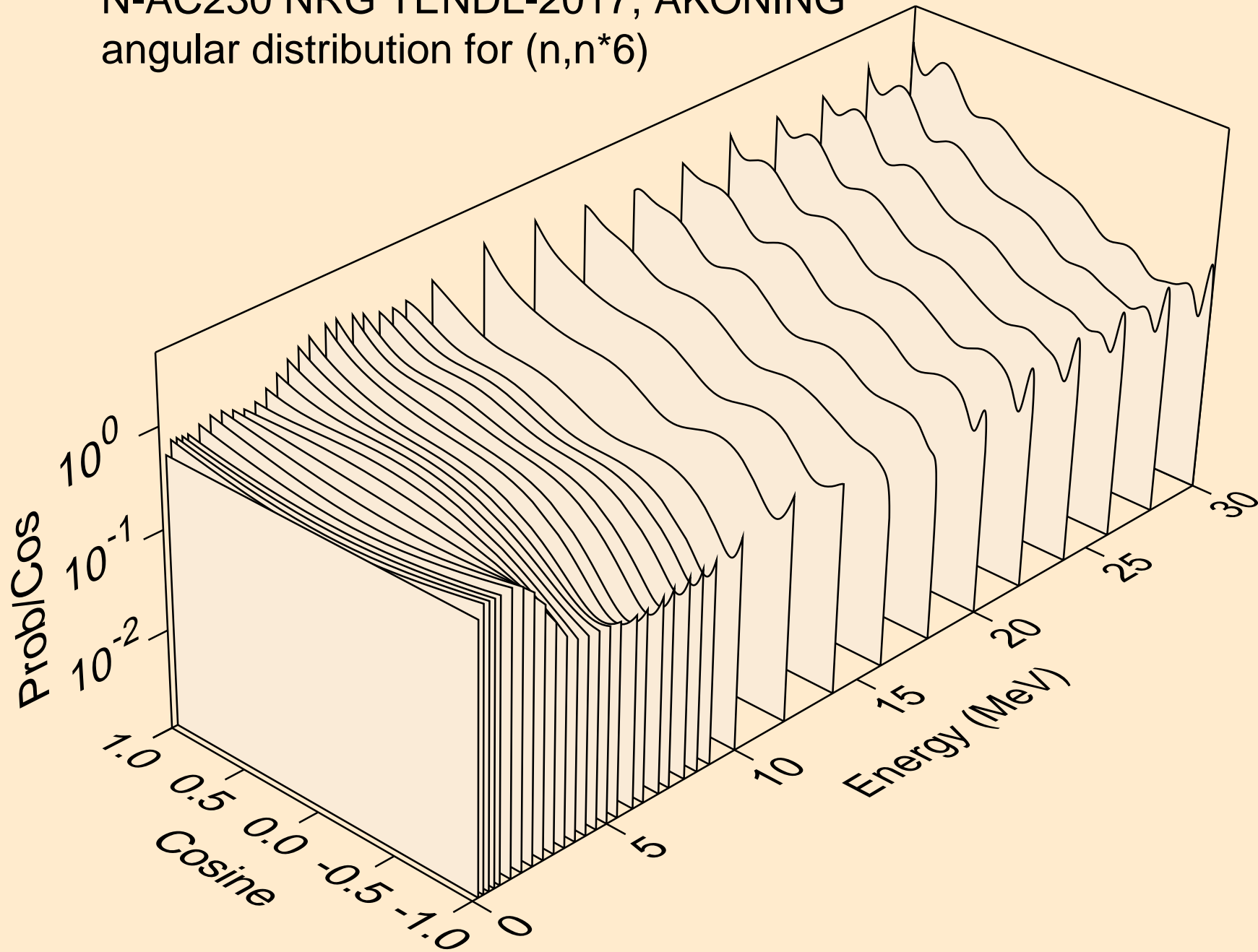

N-AC230 NRG TENDL-2017, AKONING
angular distribution for (n,n*7)

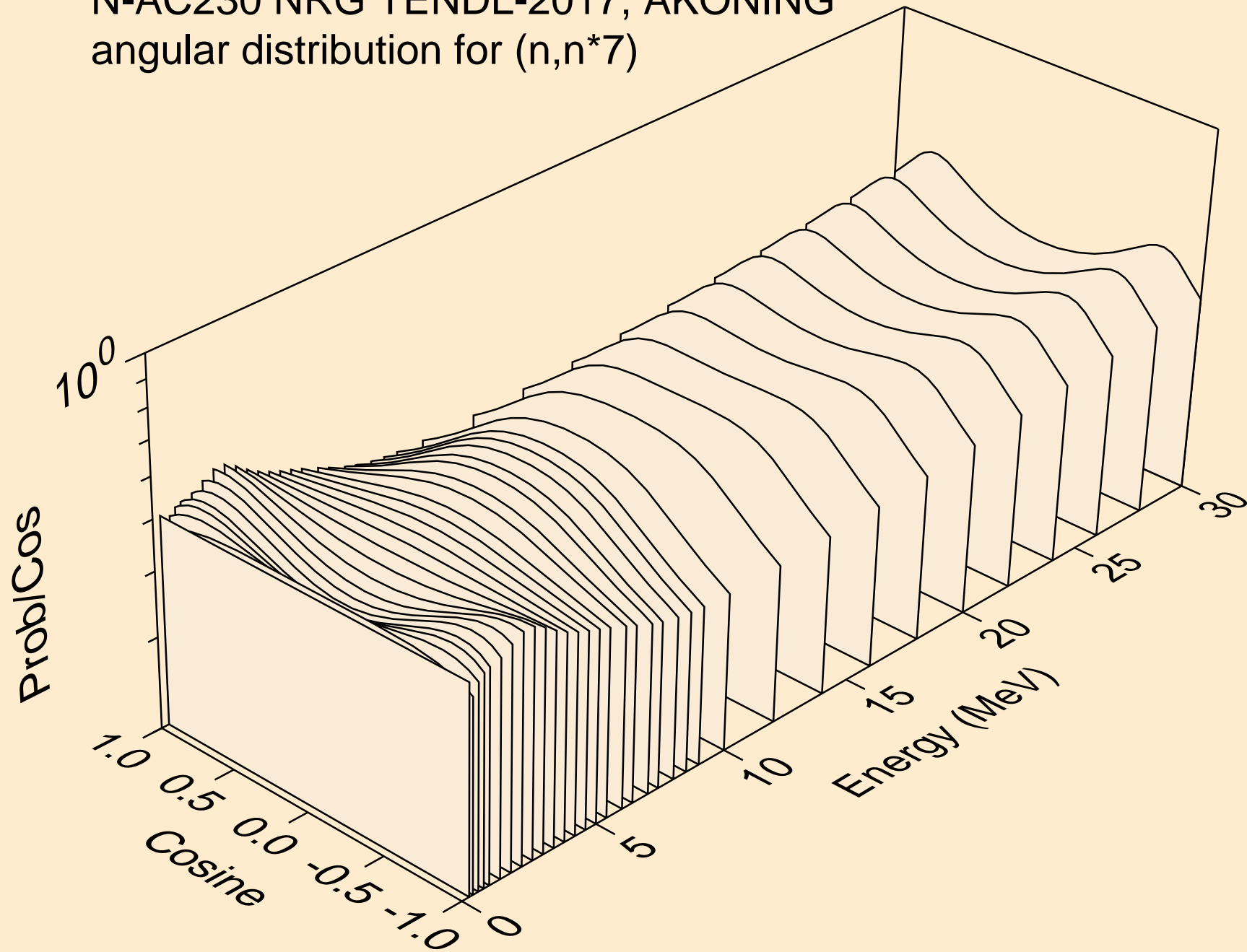

N-AC230 NRG TENDL-2017, AKONING
angular distribution for (n,n*8)

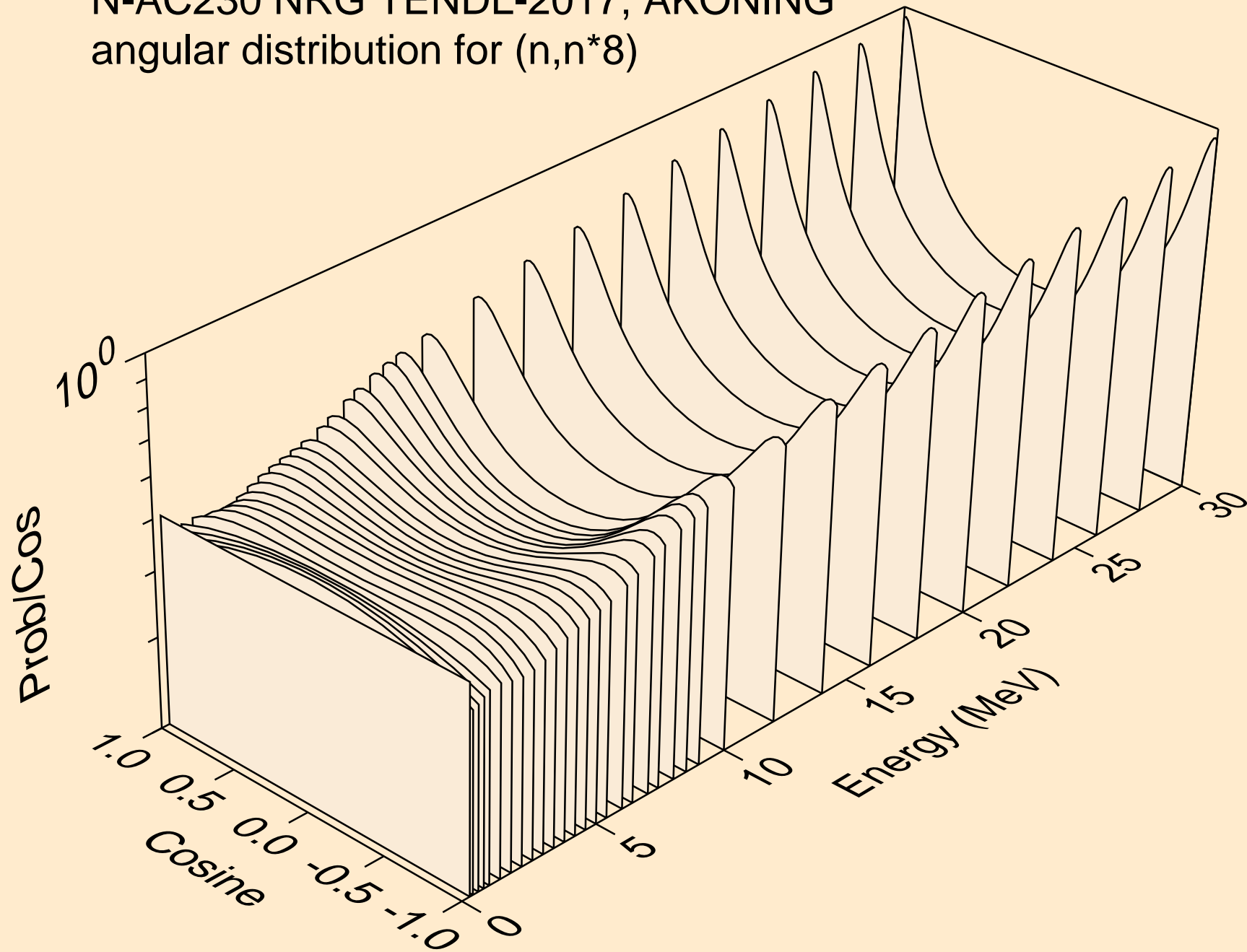

N-AC230 NRG TENDL-2017, AKONING
angular distribution for (n,n*9)

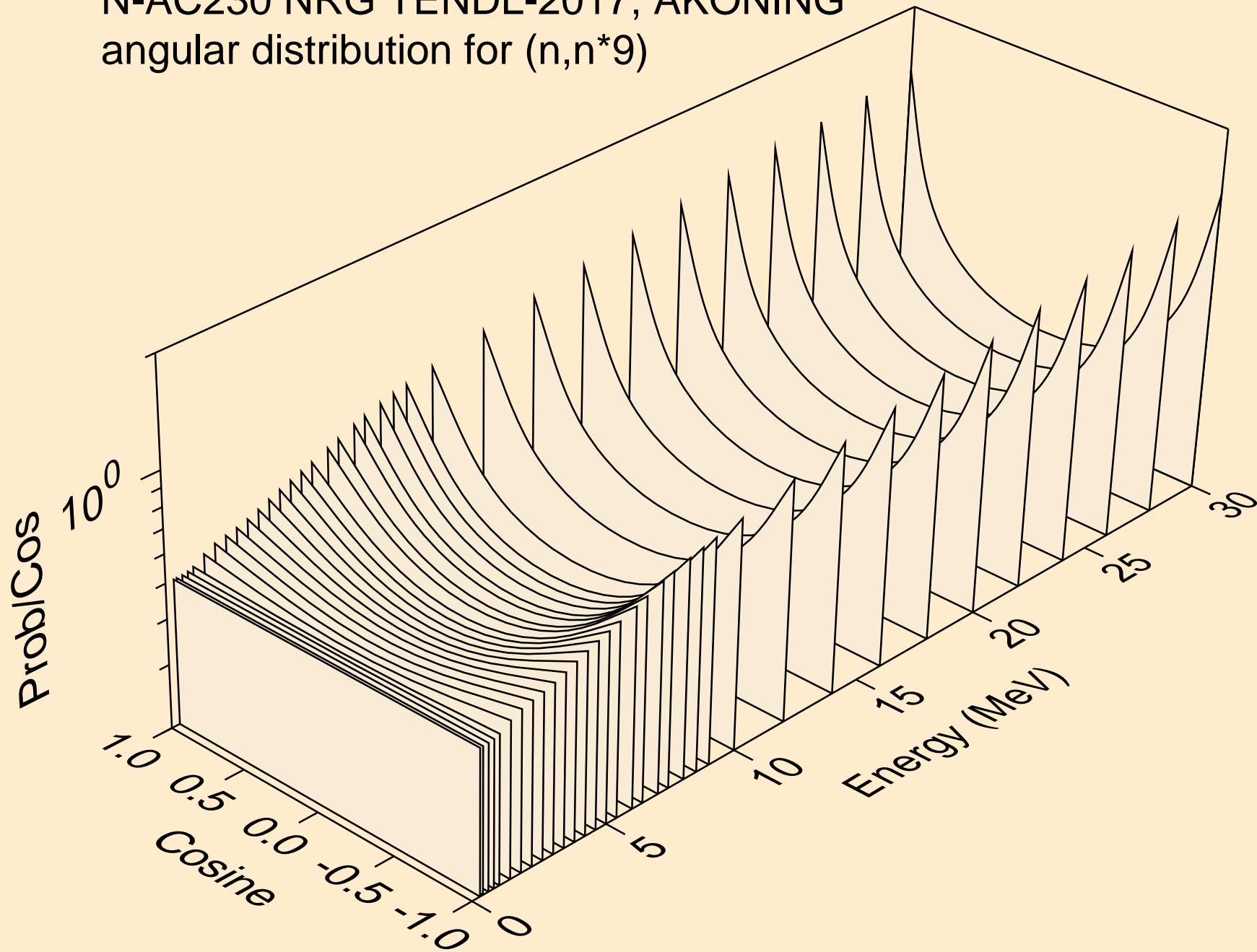

N-AC230 NRG TENDL-2017, AKONING
angular distribution for (n,n*10)

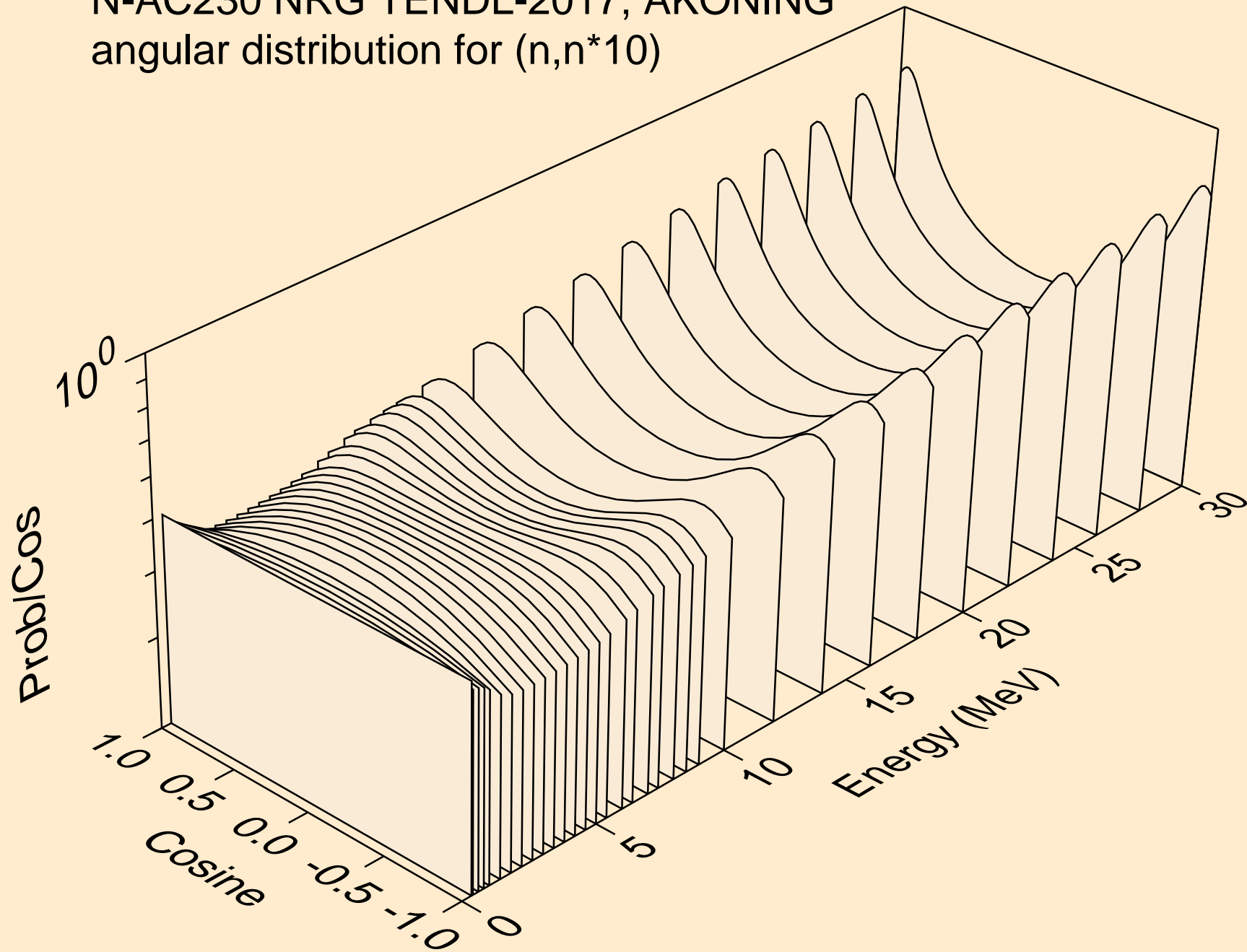

N-AC230 NRG TENDL-2017, AKONING
angular distribution for (n,n*11)

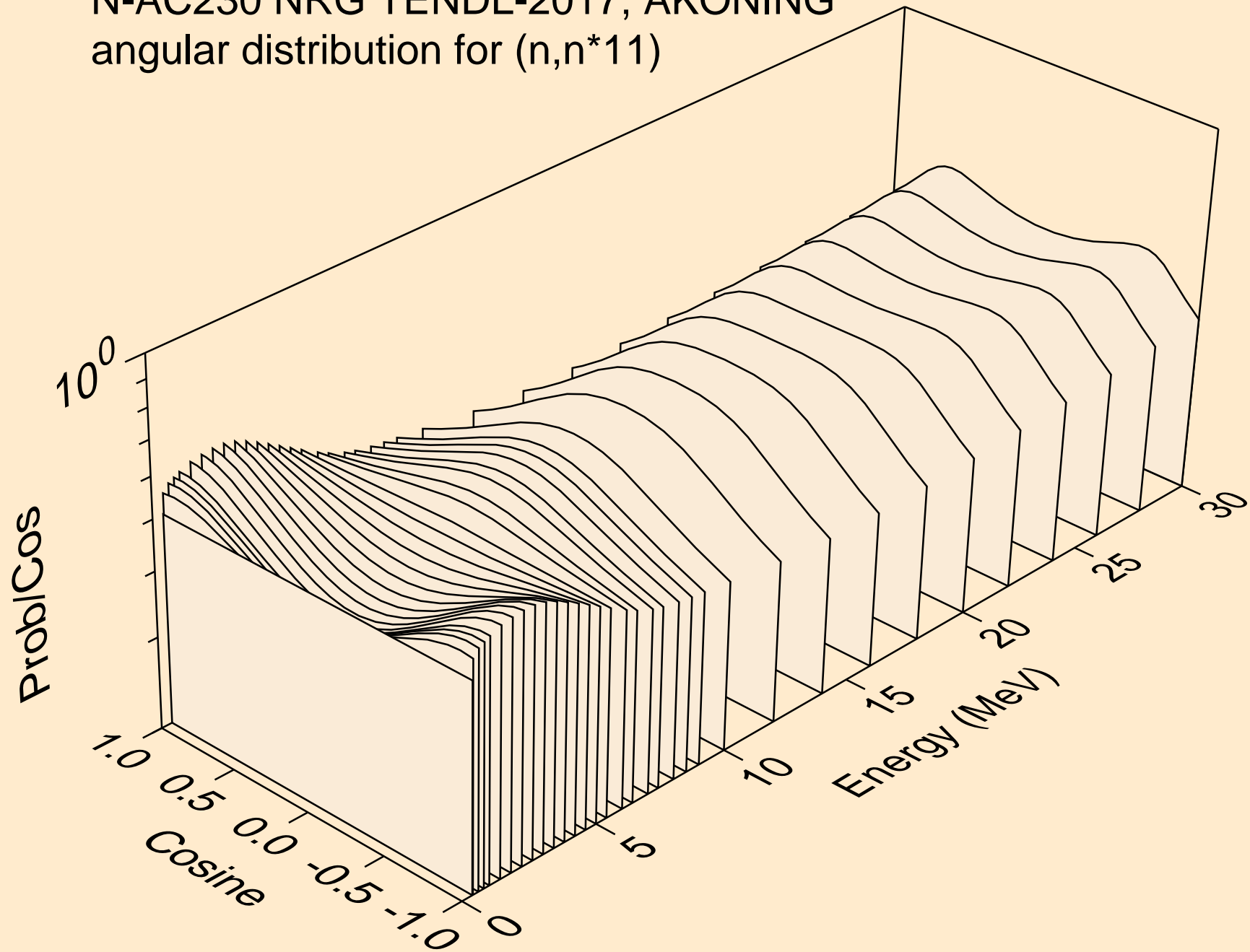

N-AC230 NRG TENDL-2017, AKONING
angular distribution for (n,n*12)

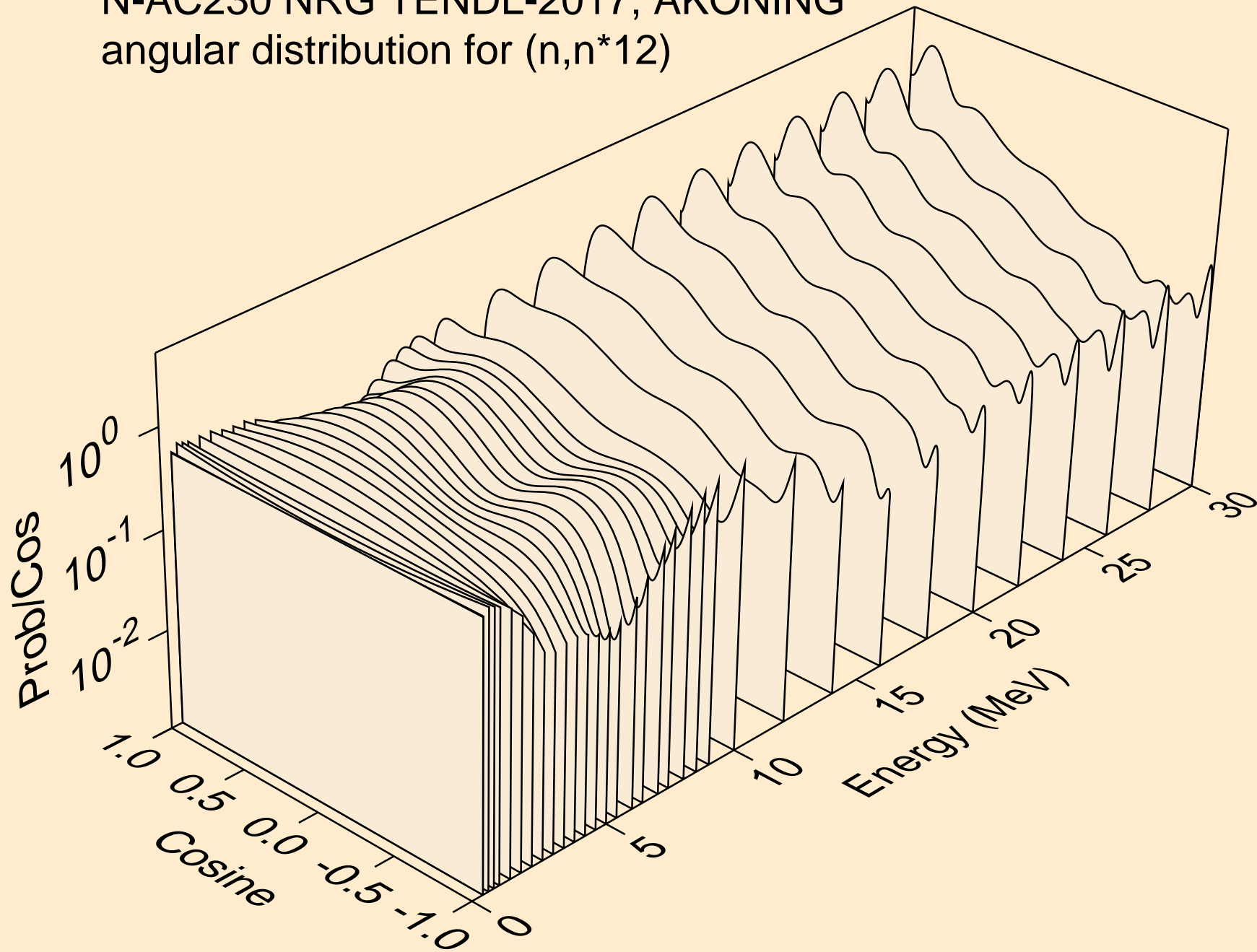

N-AC230 NRG TENDL-2017, AKONING
angular distribution for (n,n*13)

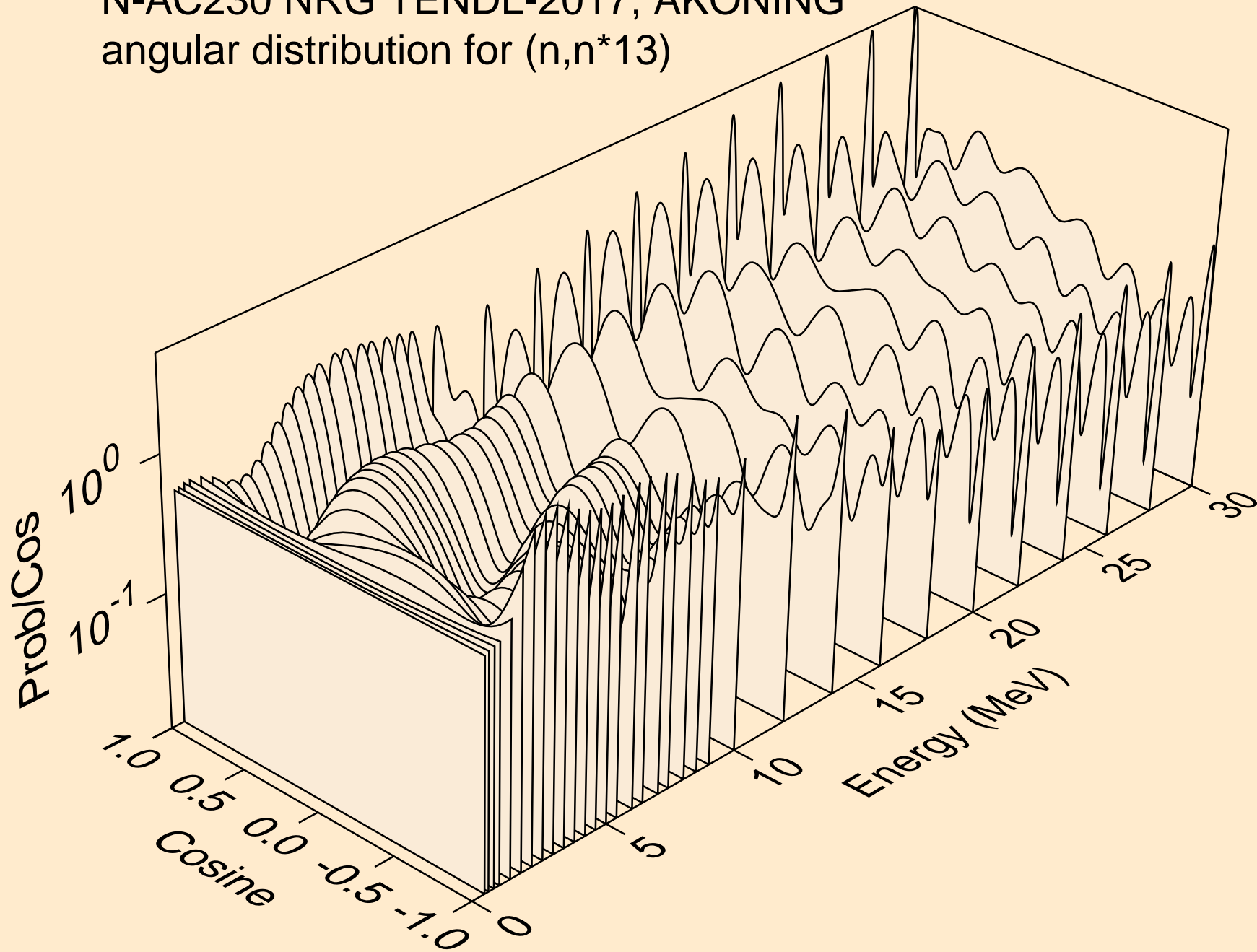

N-AC230 NRG TENDL-2017, AKONING
angular distribution for (n,n*14)

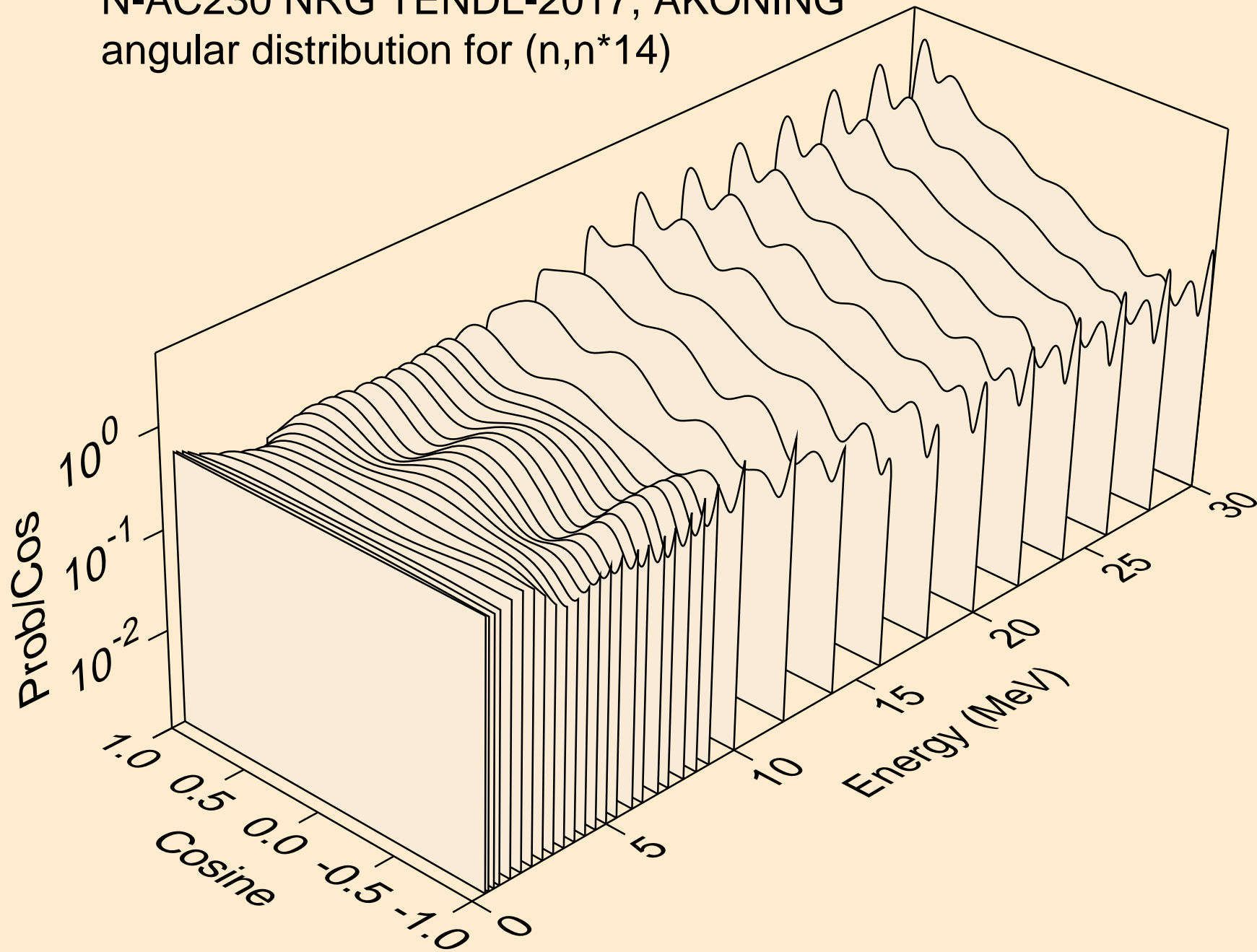

N-AC230 NRG TENDL-2017, AKONING
angular distribution for (n,n*15)

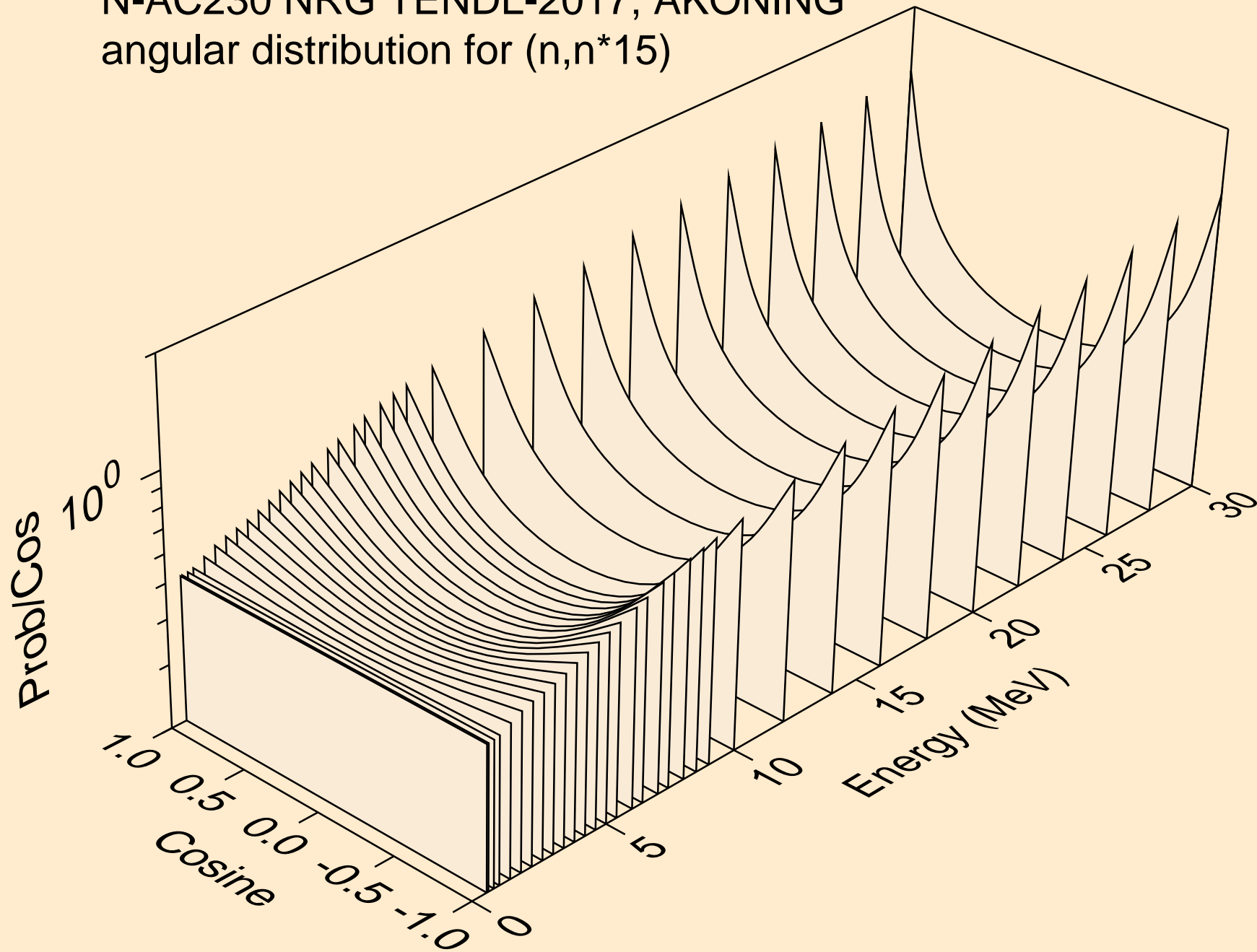

N-AC230 NRG TENDL-2017, AKONING
angular distribution for (n,n*16)

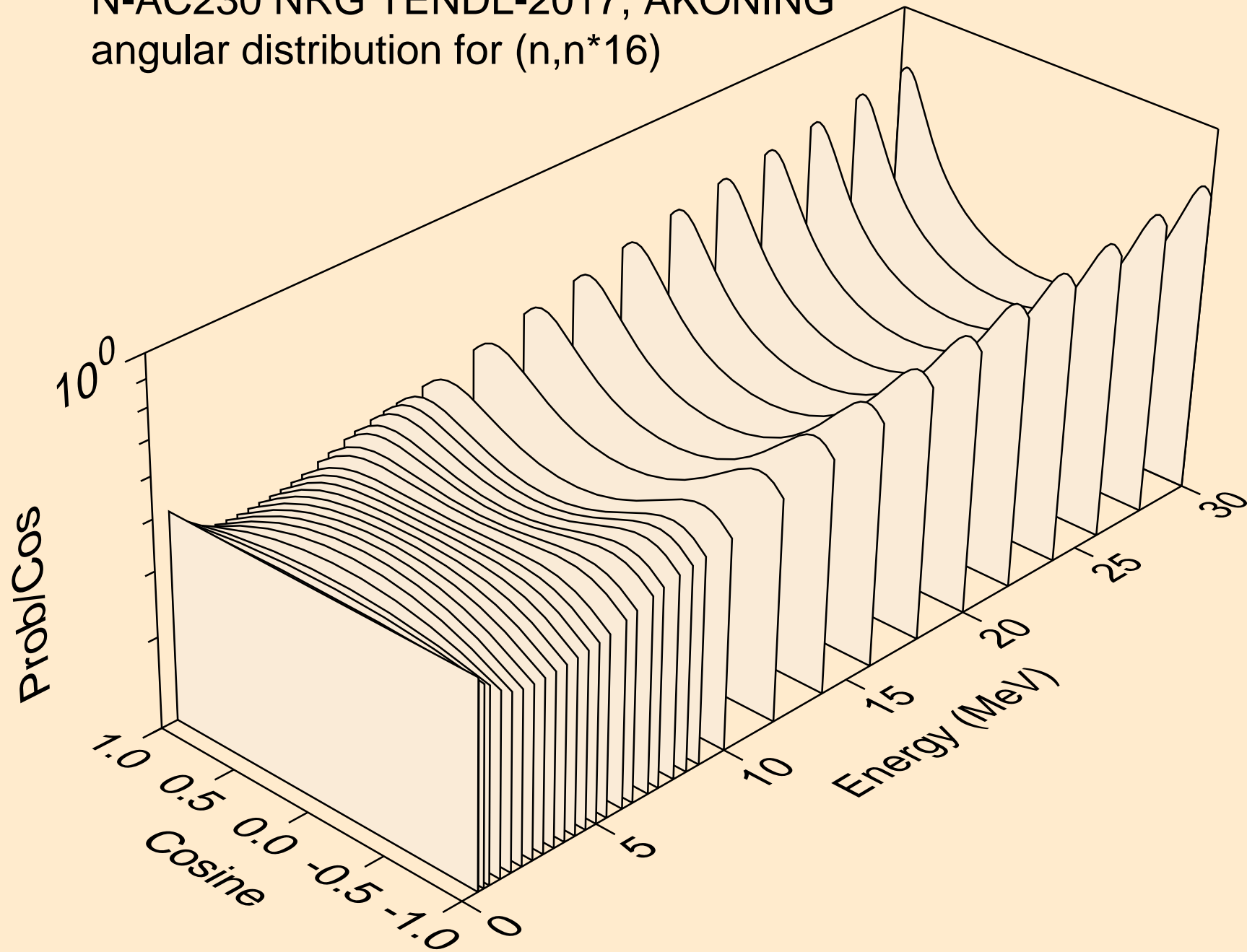

N-AC230 NRG TENDL-2017, AKONING
angular distribution for (n,n*17)

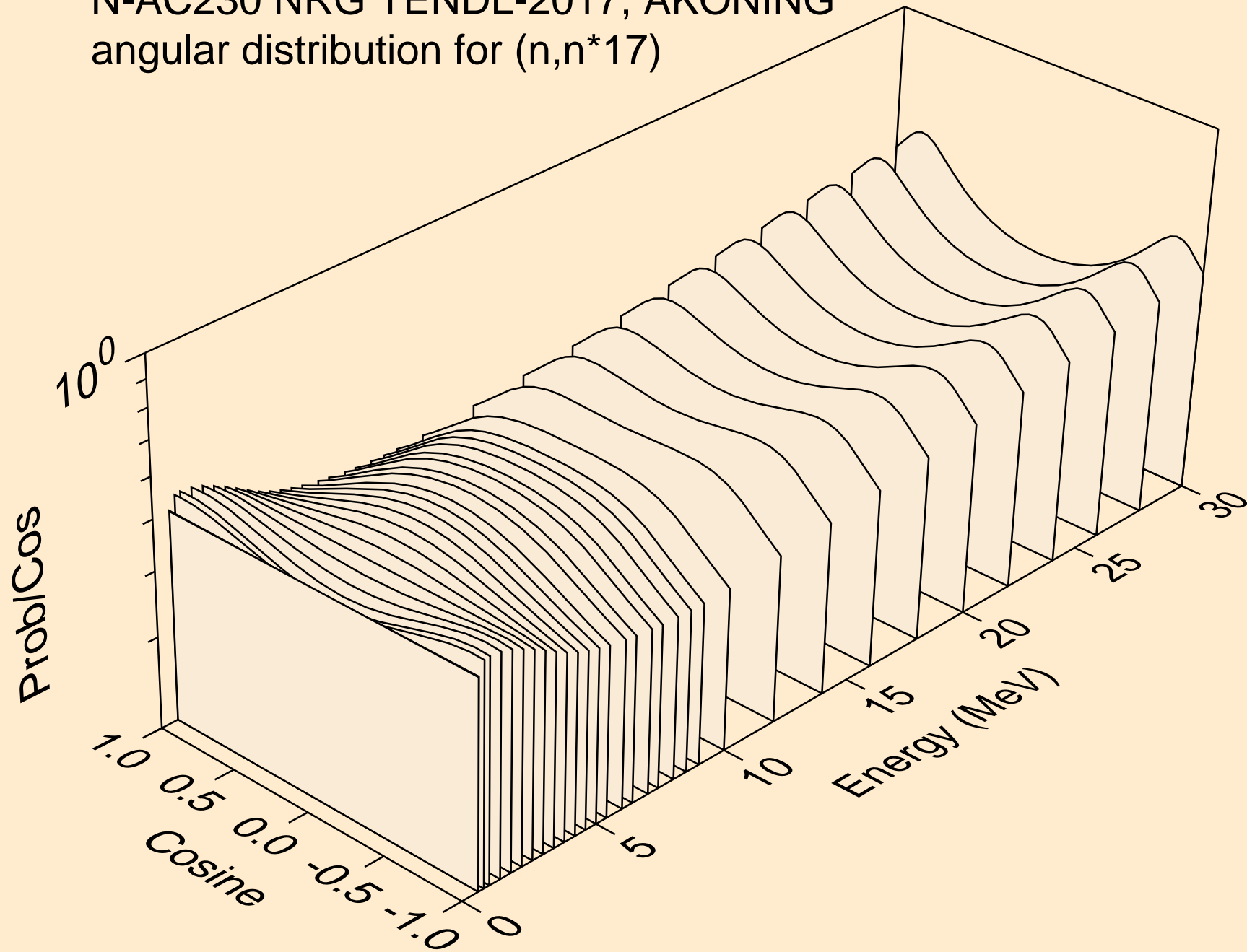

N-AC230 NRG TENDL-2017, AKONING
angular distribution for (n,n*18)

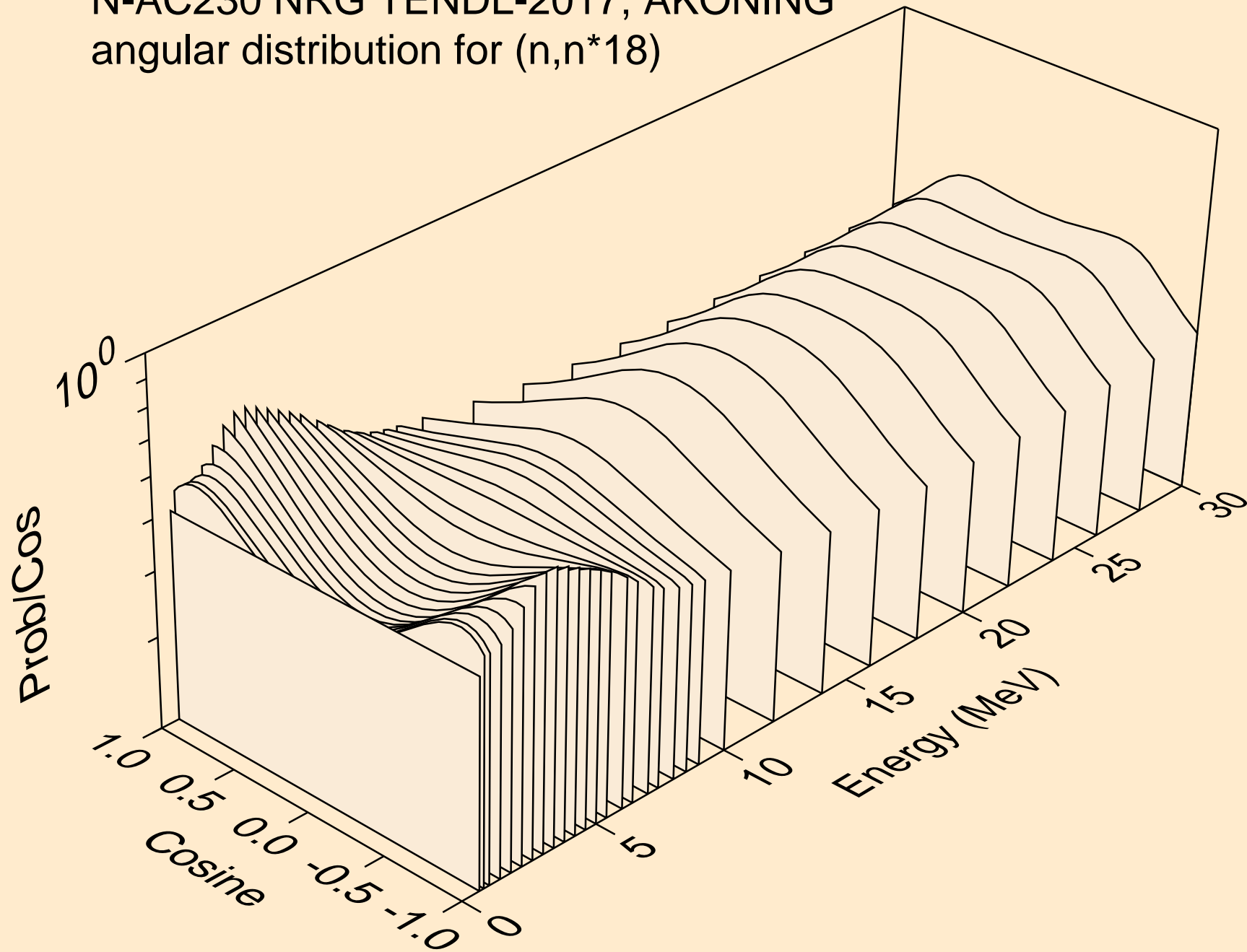

N-AC230 NRG TENDL-2017, AKONING
angular distribution for (n,n*19)

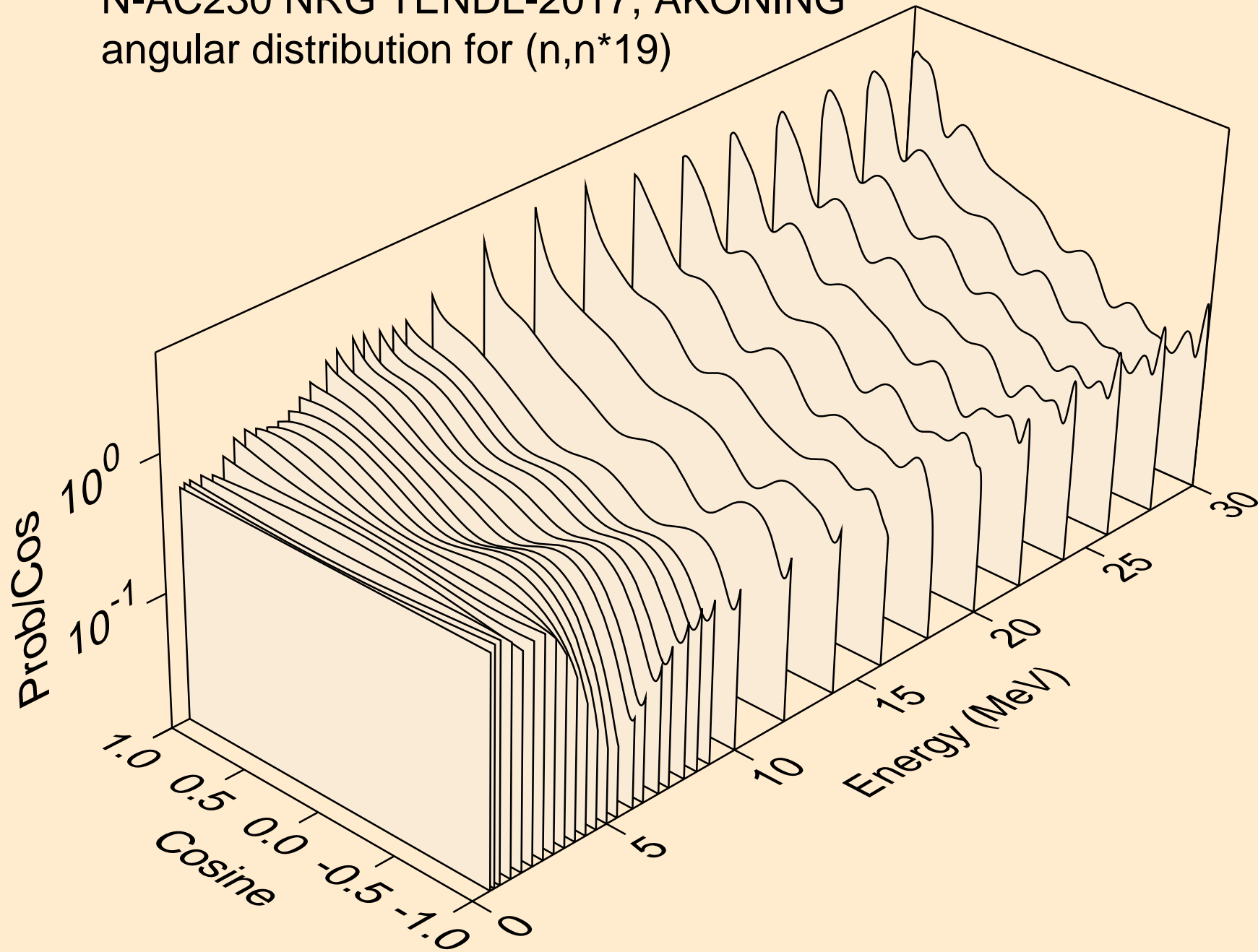

N-AC230 NRG TENDL-2017, AKONING

Total fission nubar

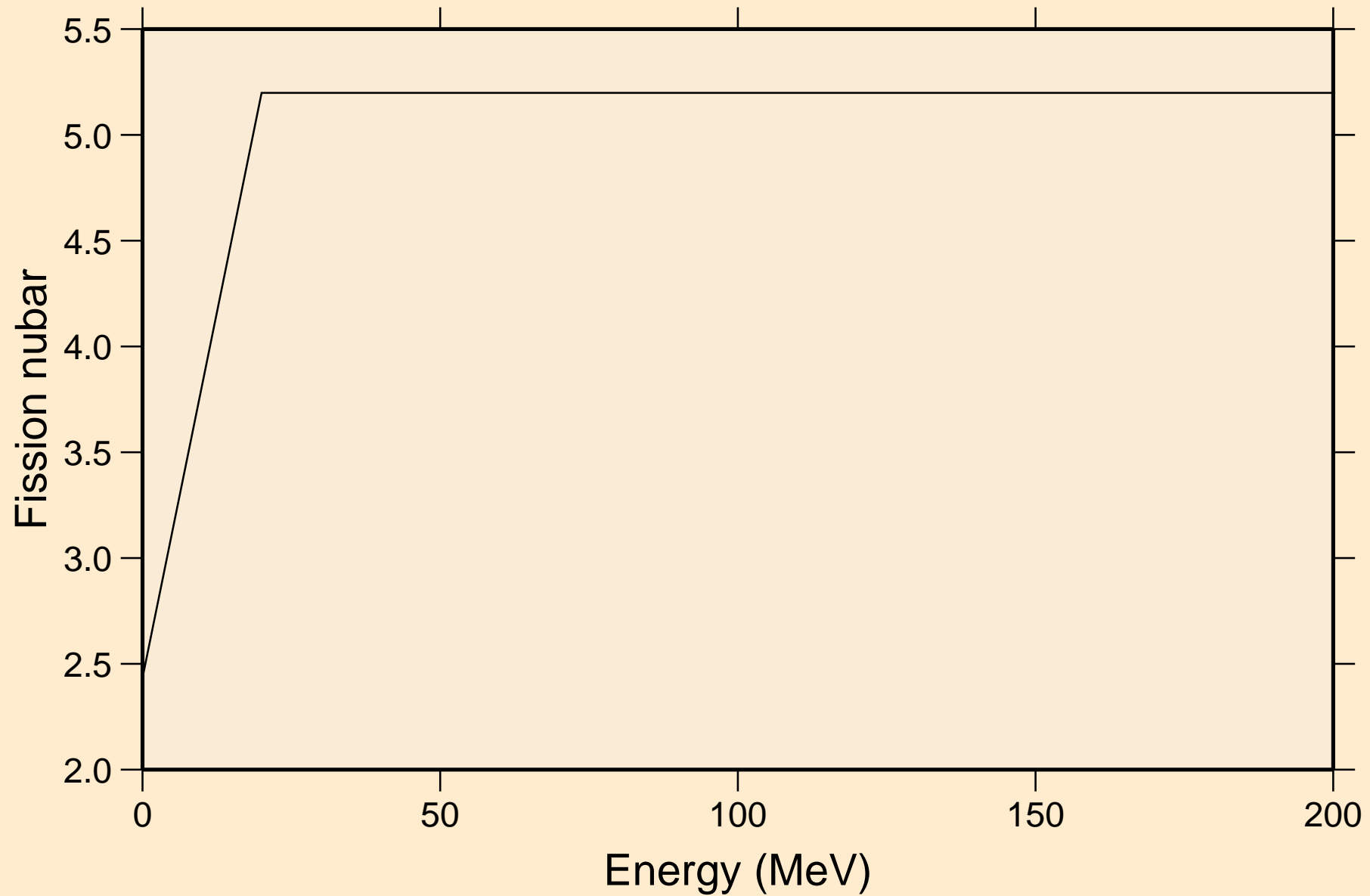

N-AC230 NRG TENDL-2017, AKONING
Neutron emission for (n,x)

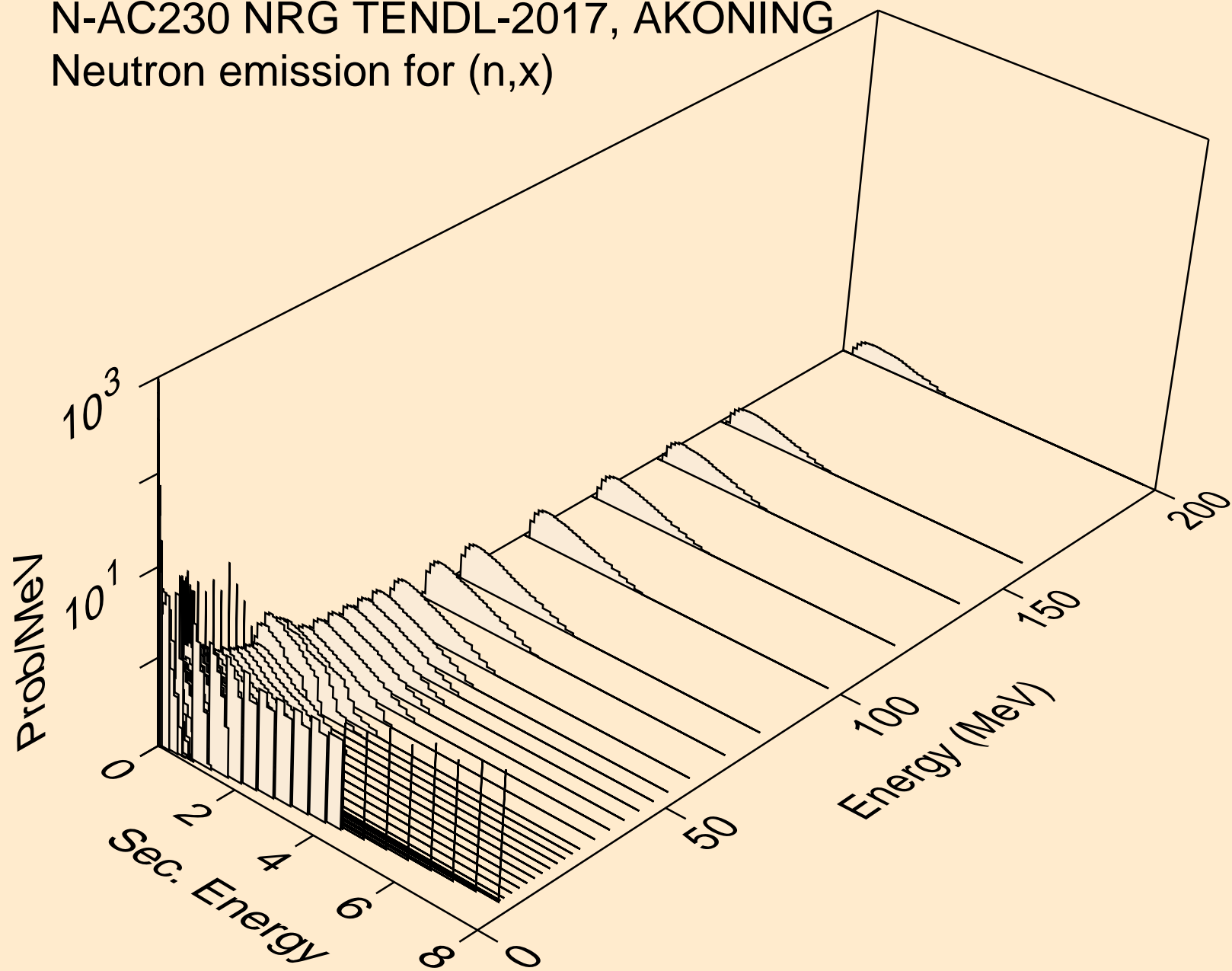

N-AC230 NRG TENDL-2017, AKONING
Neutron emission for (n,2nd)

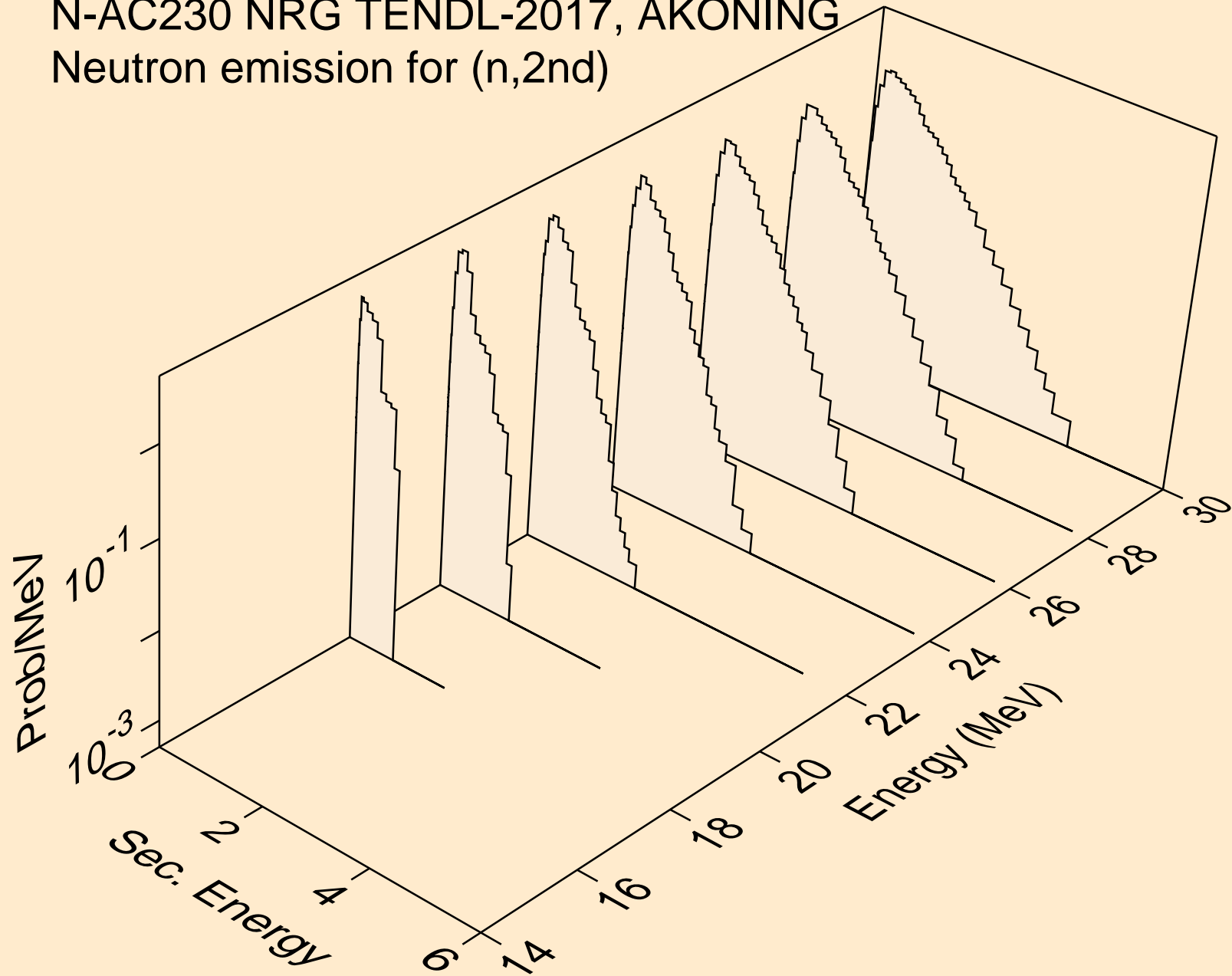

N-AC230 NRG TENDL-2017, AKONING
Neutron emission for (n,2n)

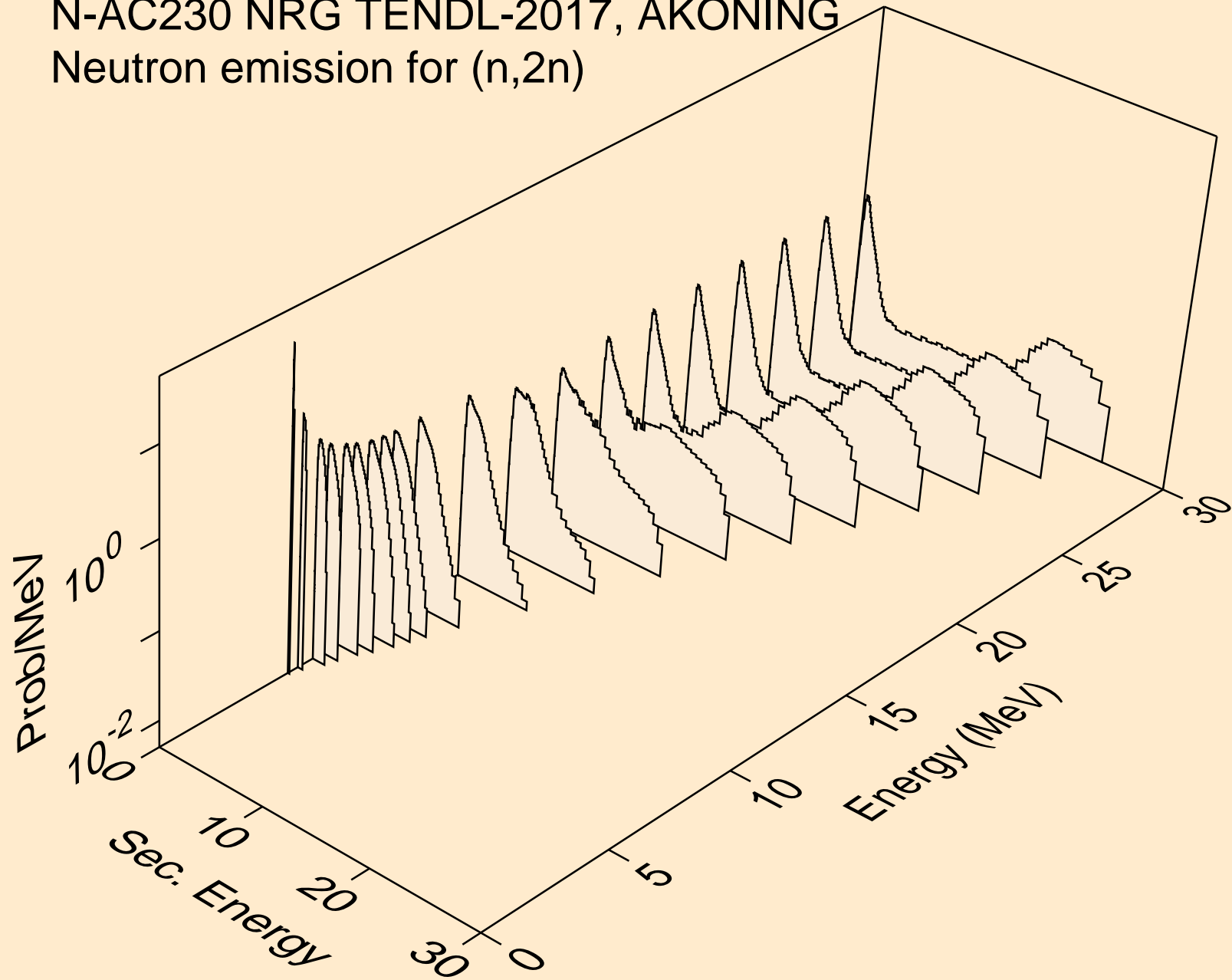

N-AC230 NRG TENDL-2017, AKONING
Neutron emission for (n,3n)

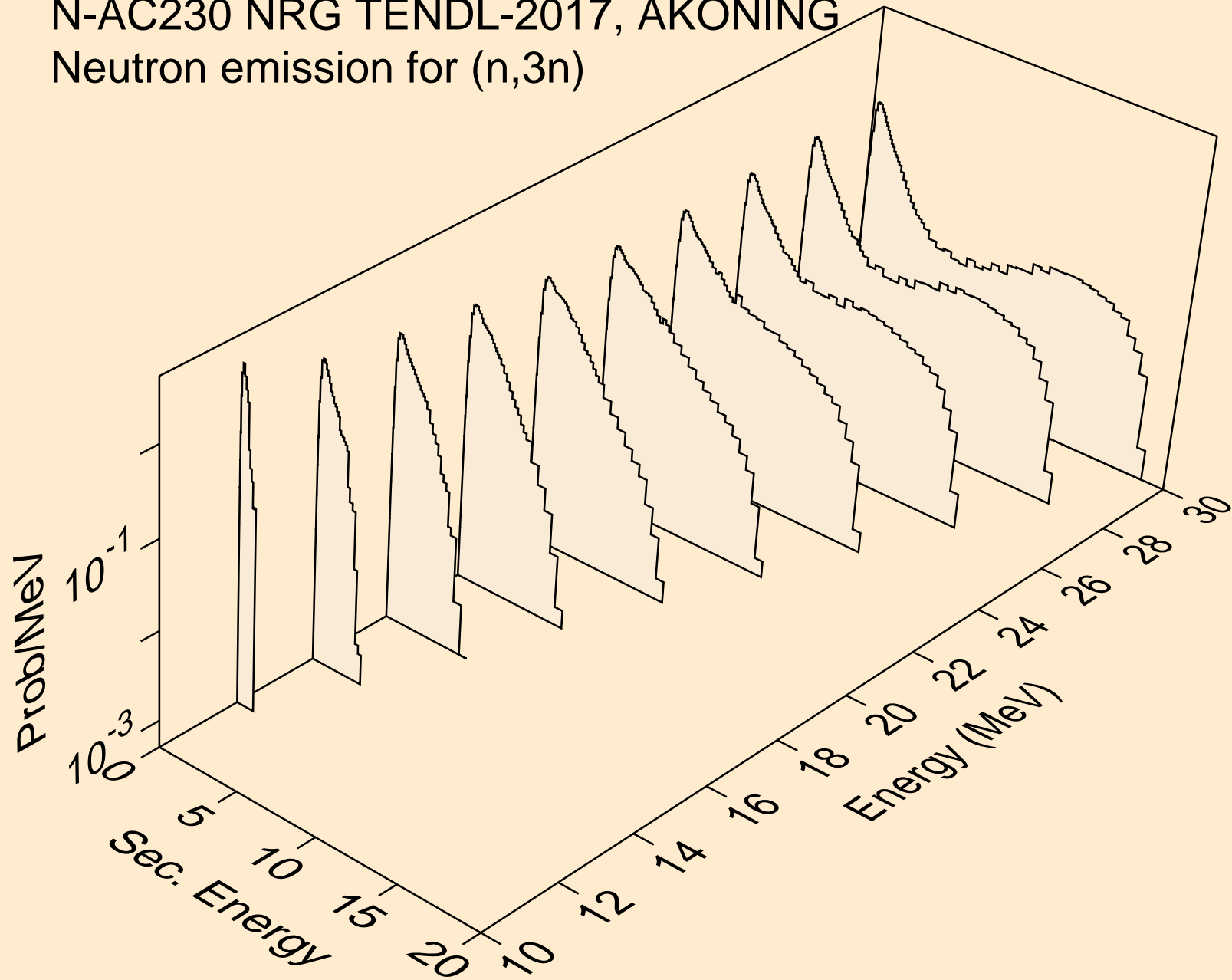

N-AC230 NRG TENDL-2017, AKONING
Neutron emission for fission

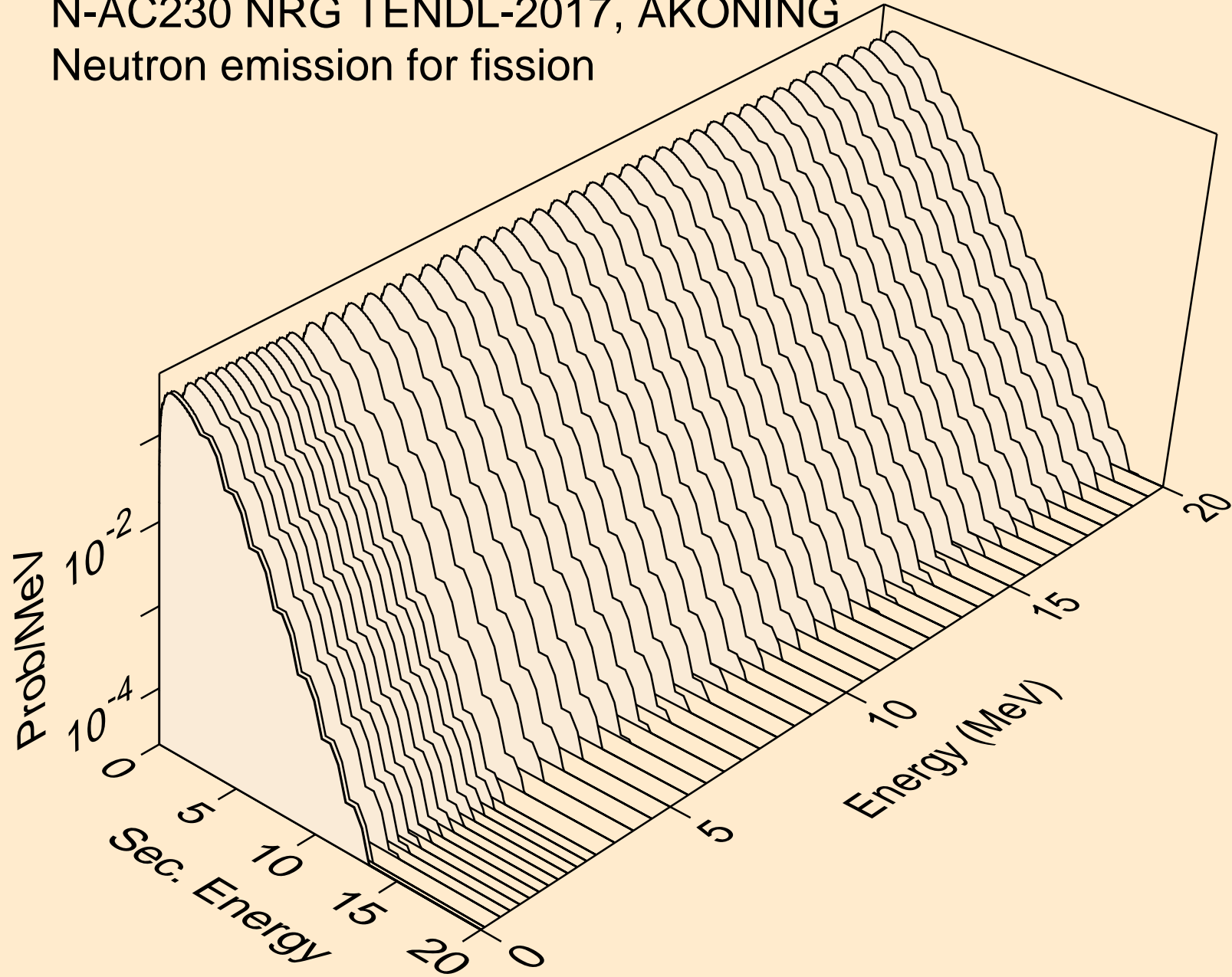

N-AC230 NRG TENDL-2017, AKONING
Neutron emission for (n,n*)a

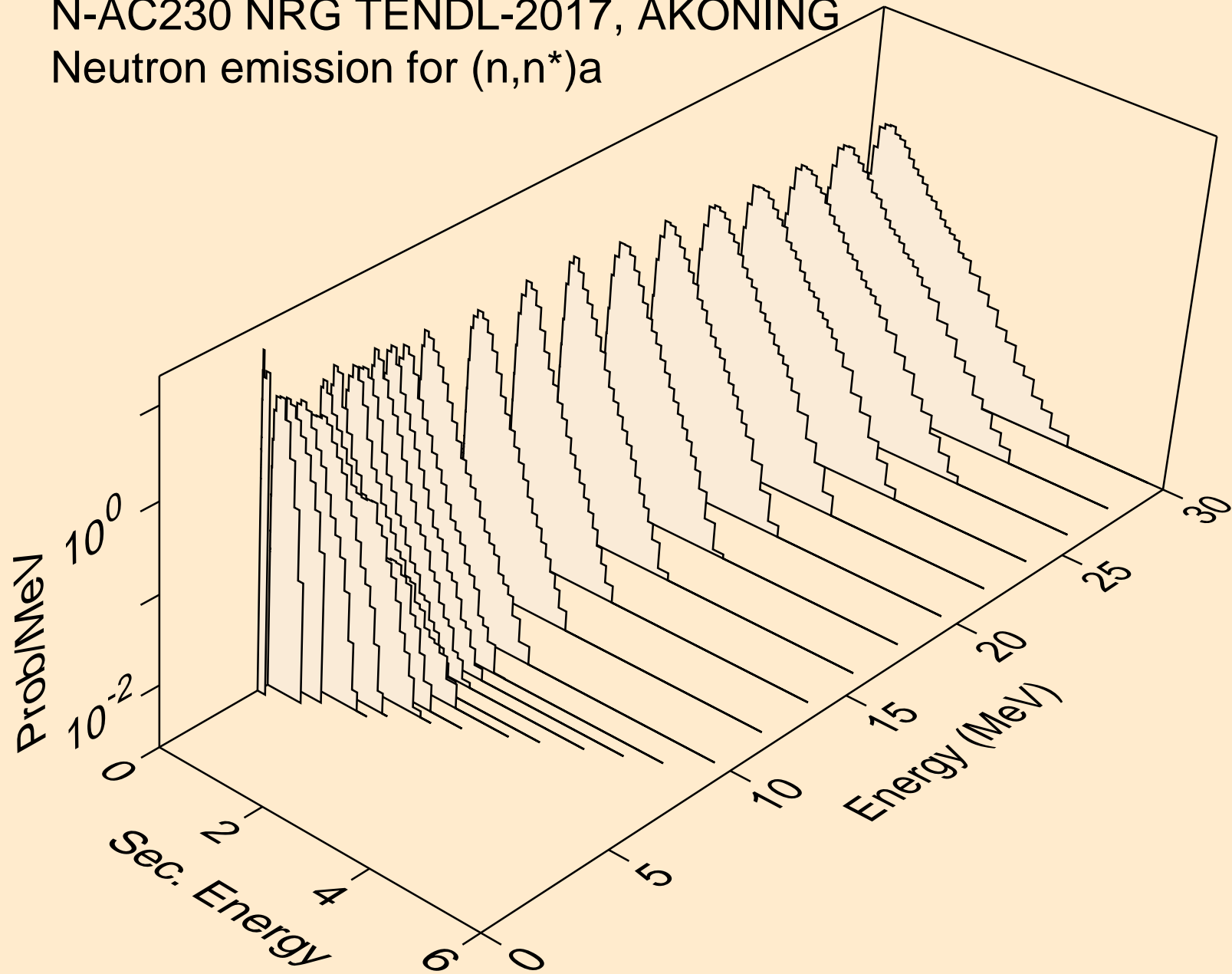

N-AC230 NRG TENDL-2017, AKONING
Neutron emission for (n,2n)_a

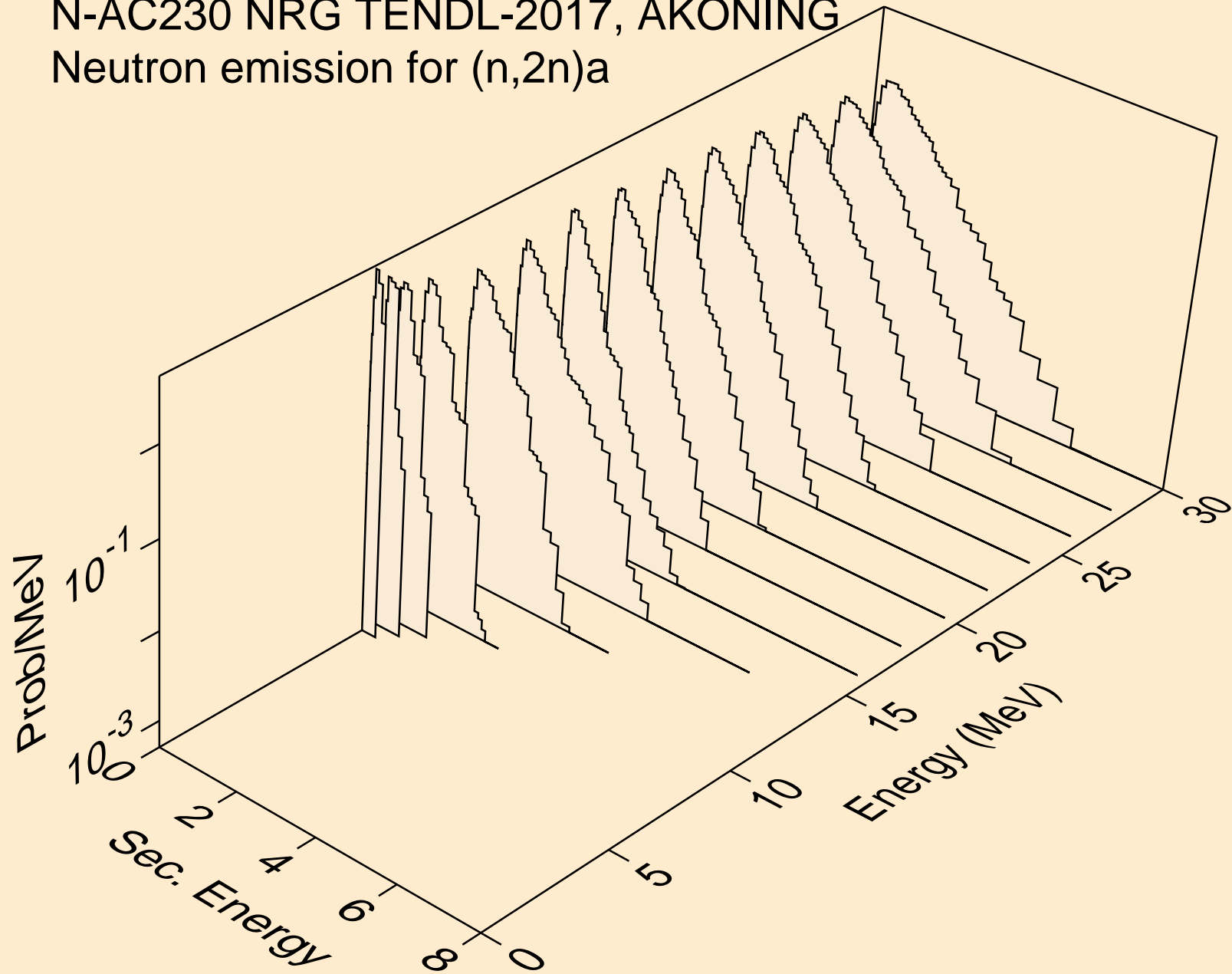

N-AC230 NRG TENDL-2017, AKONING
Neutron emission for (n,3n)a

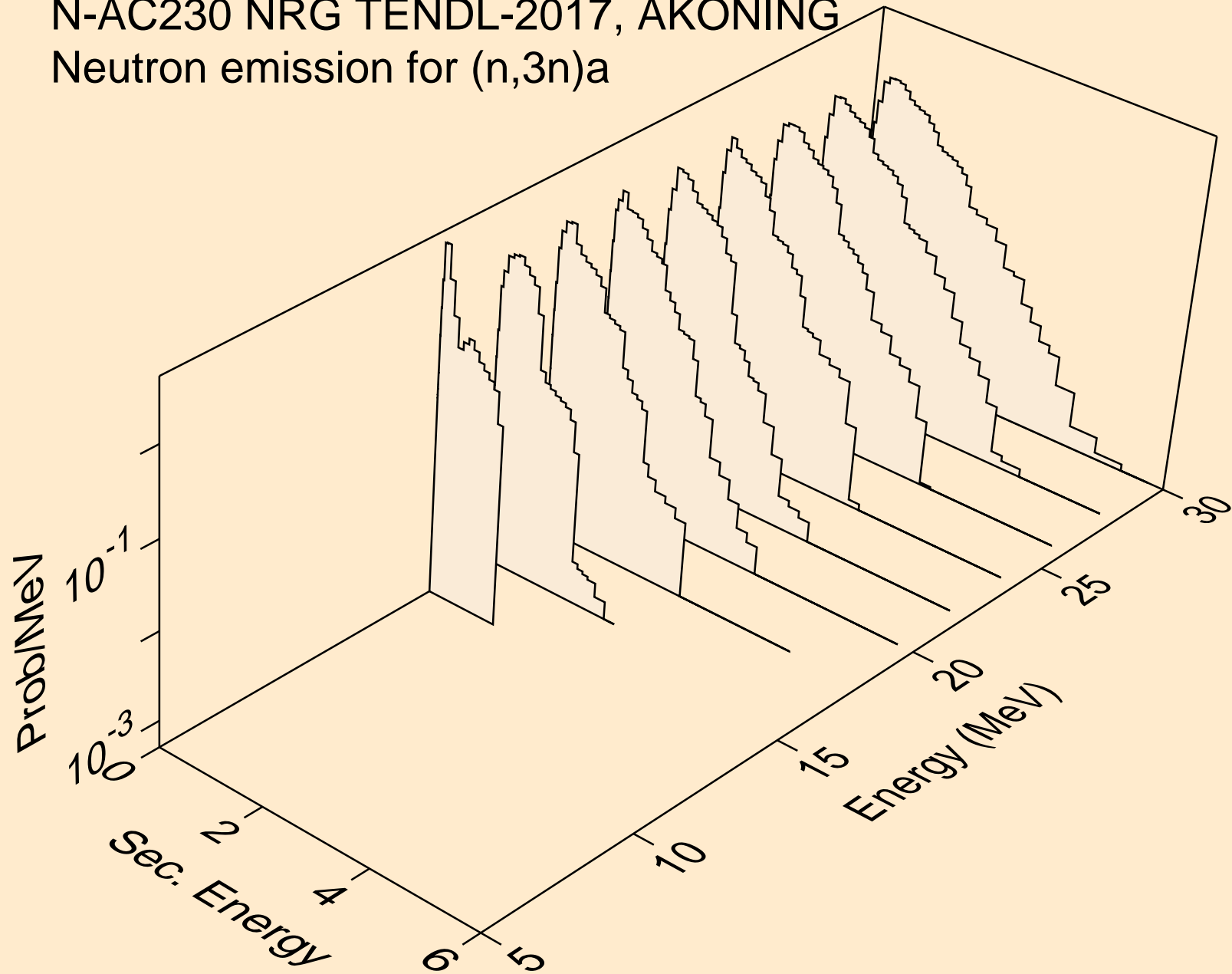

N-AC230 NRG TENDL-2017, AKONING
Neutron emission for (n,n*)p

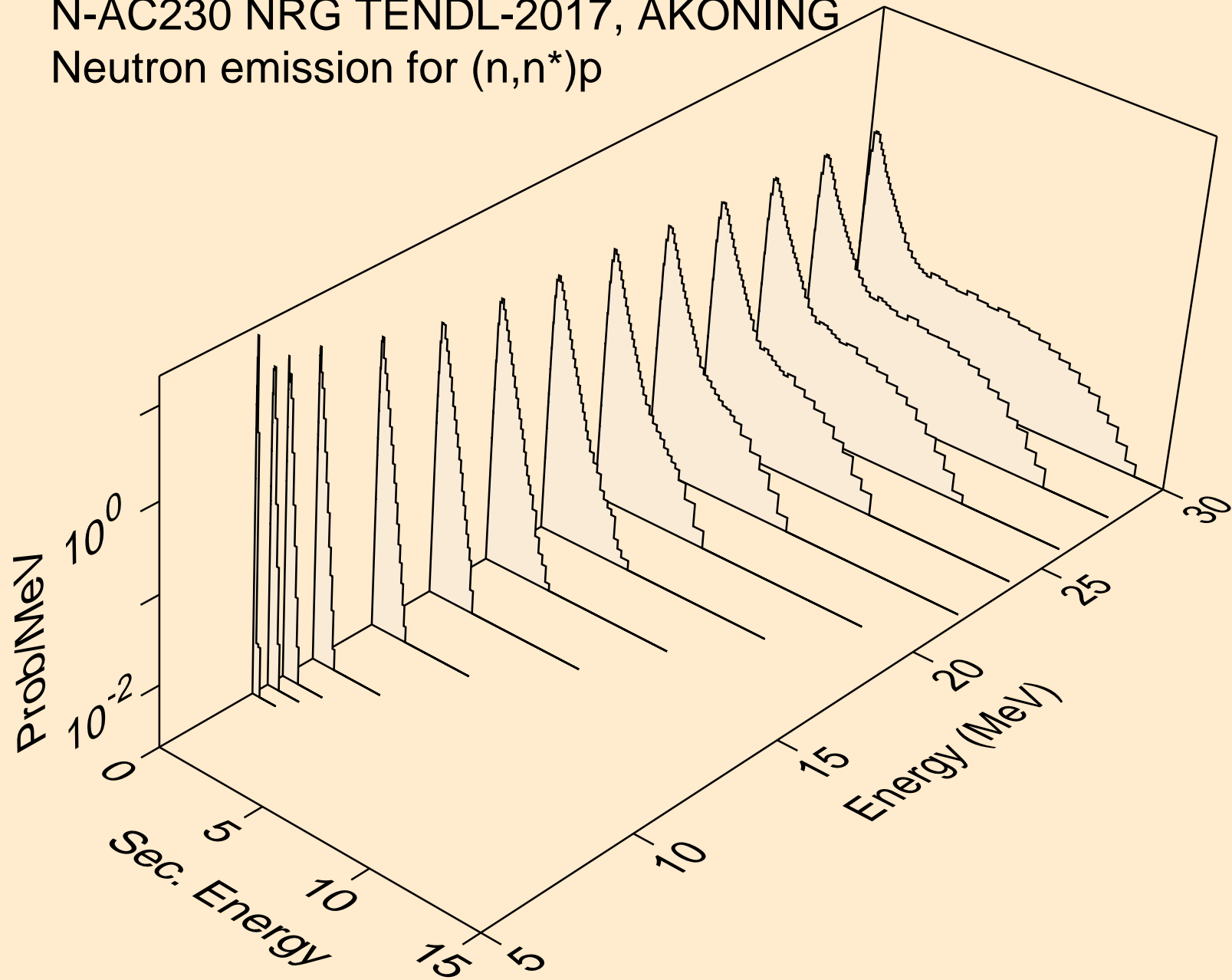

N-AC230 NRG TENDL-2017, AKONING
Neutron emission for (n,n*)d

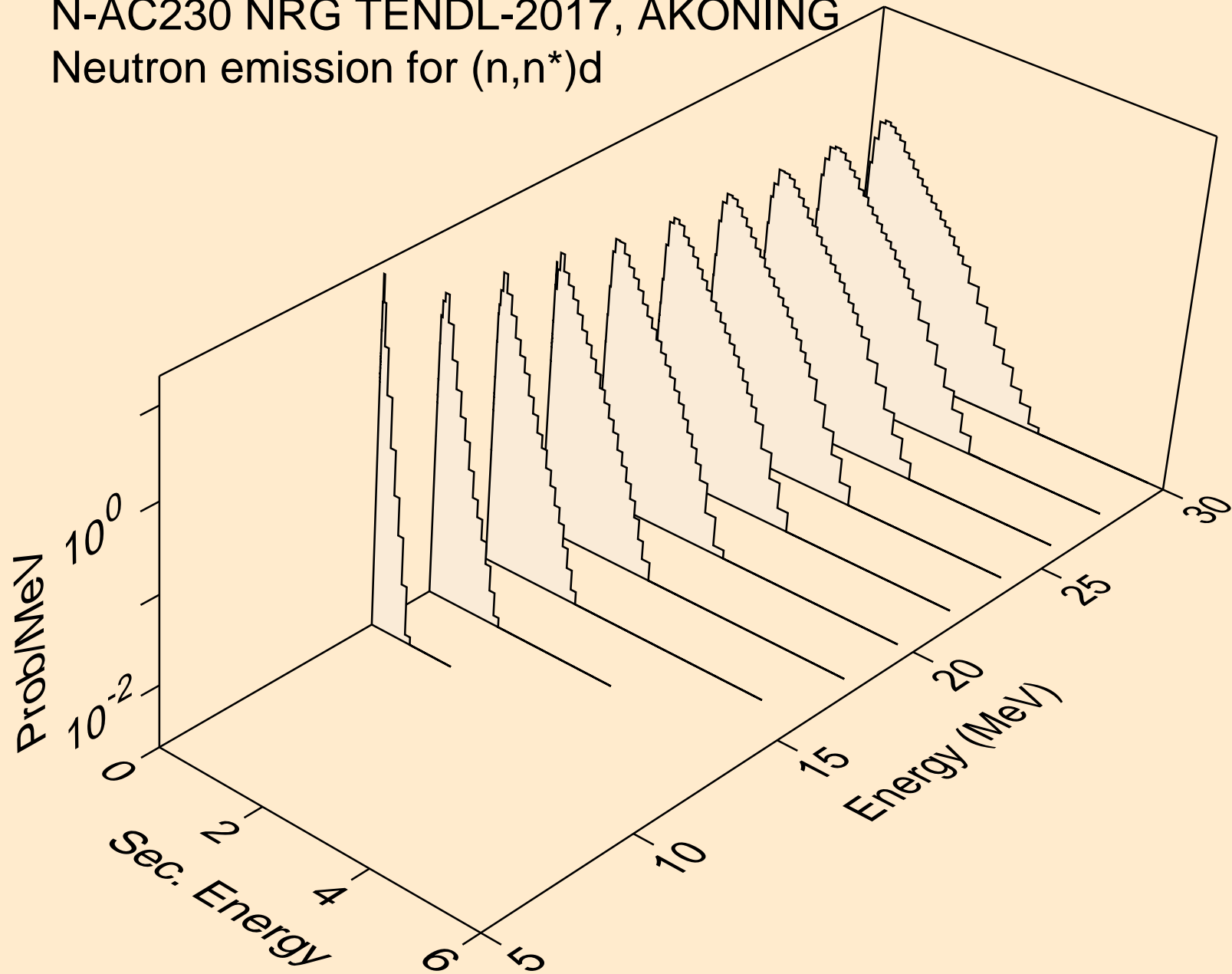

N-AC230 NRG TENDL-2017, AKONING
Neutron emission for (n,n*)t

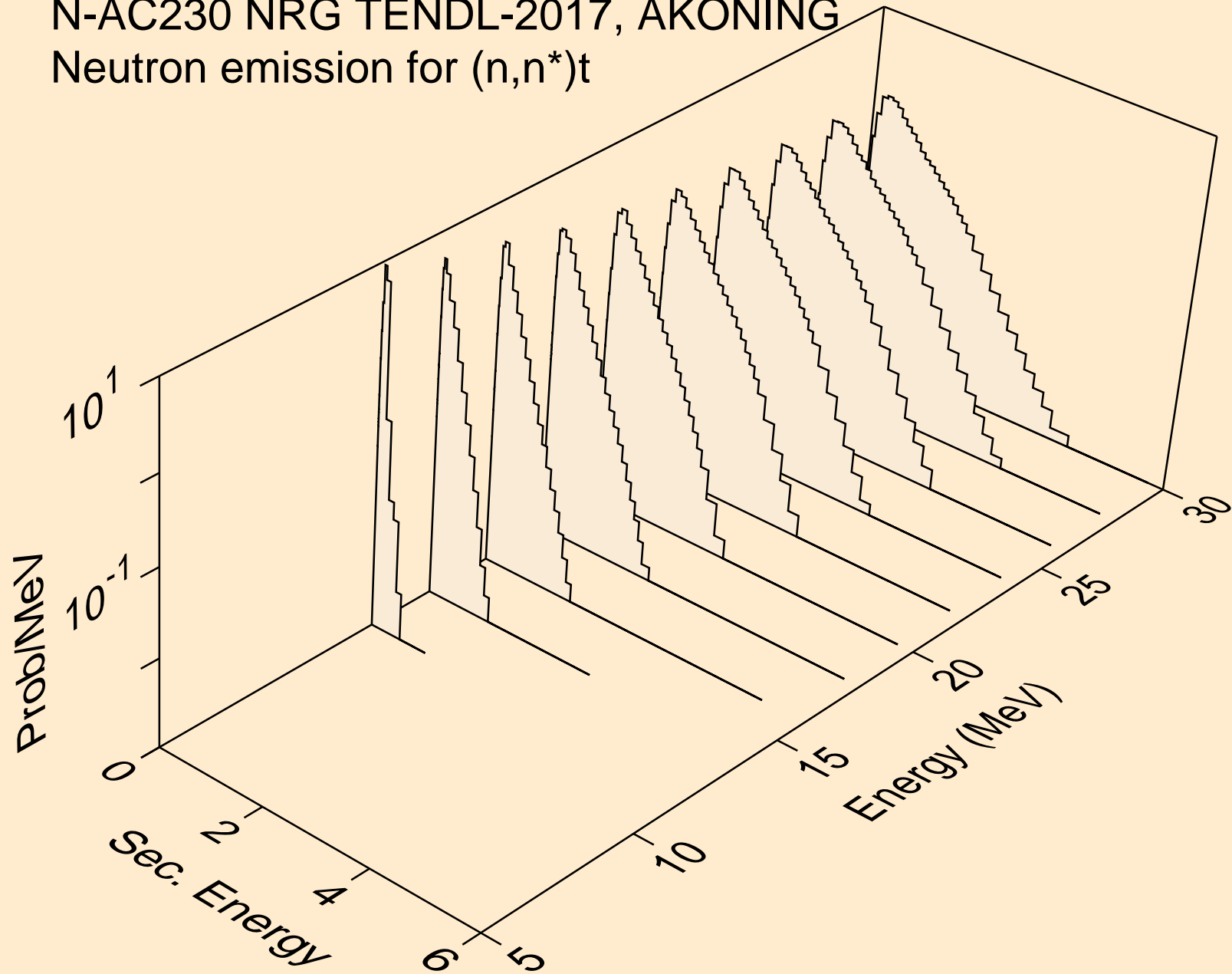

N-AC230 NRG TENDL-2017, AKONING
Neutron emission for (n,n*)he3

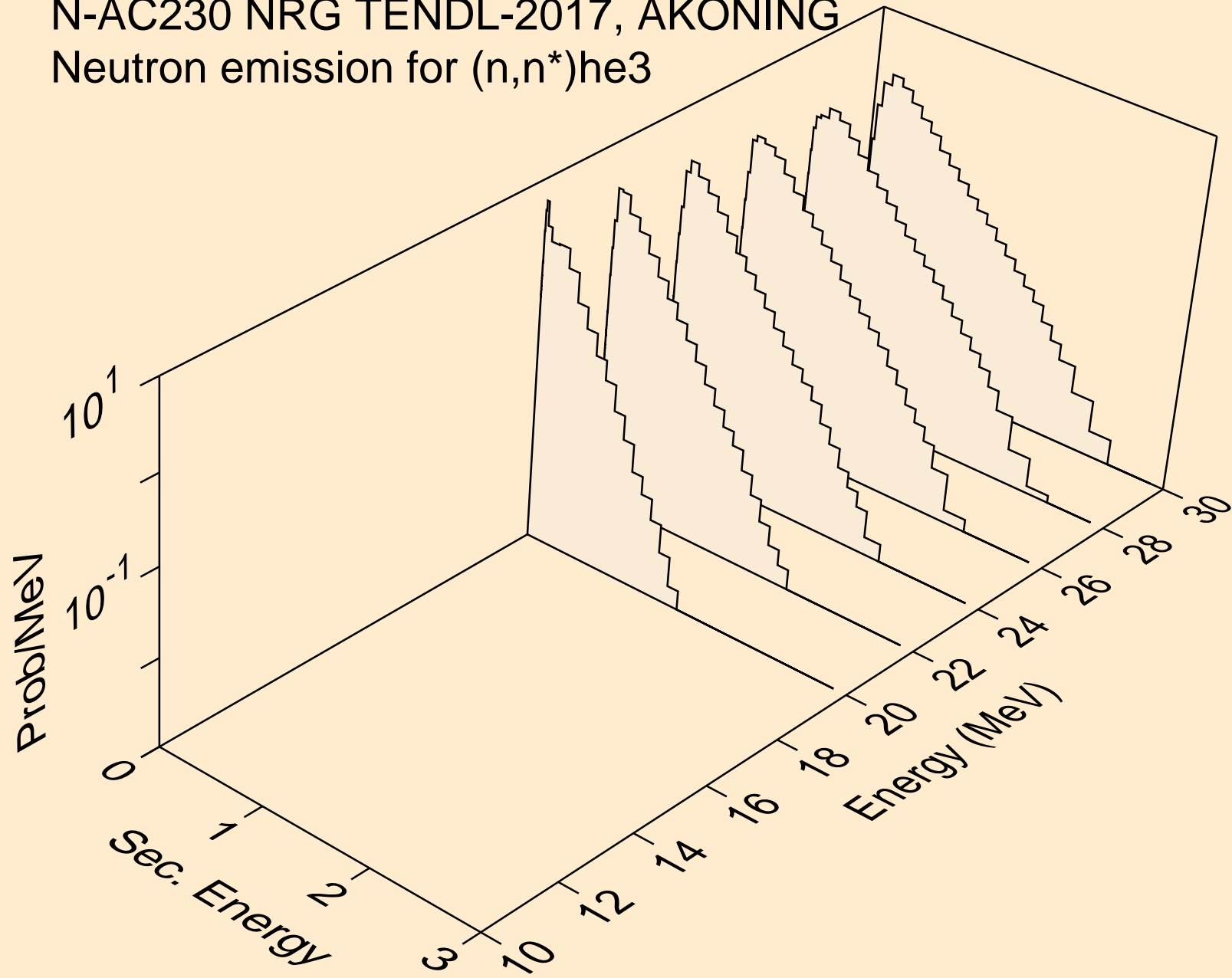

N-AC230 NRG TENDL-2017, AKONING
Neutron emission for (n,4n)

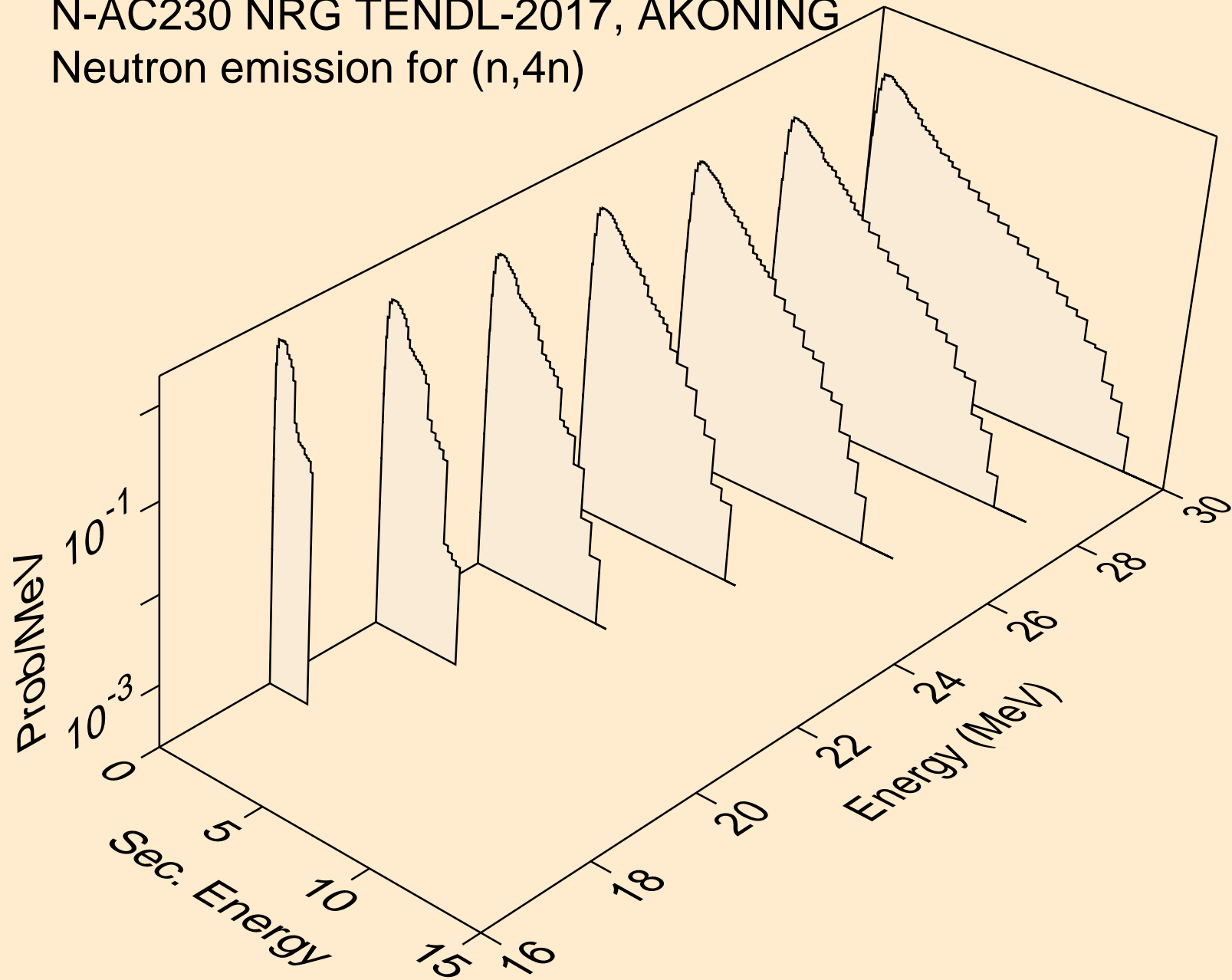

N-AC230 NRG TENDL-2017, AKONING
Neutron emission for (n,2np)

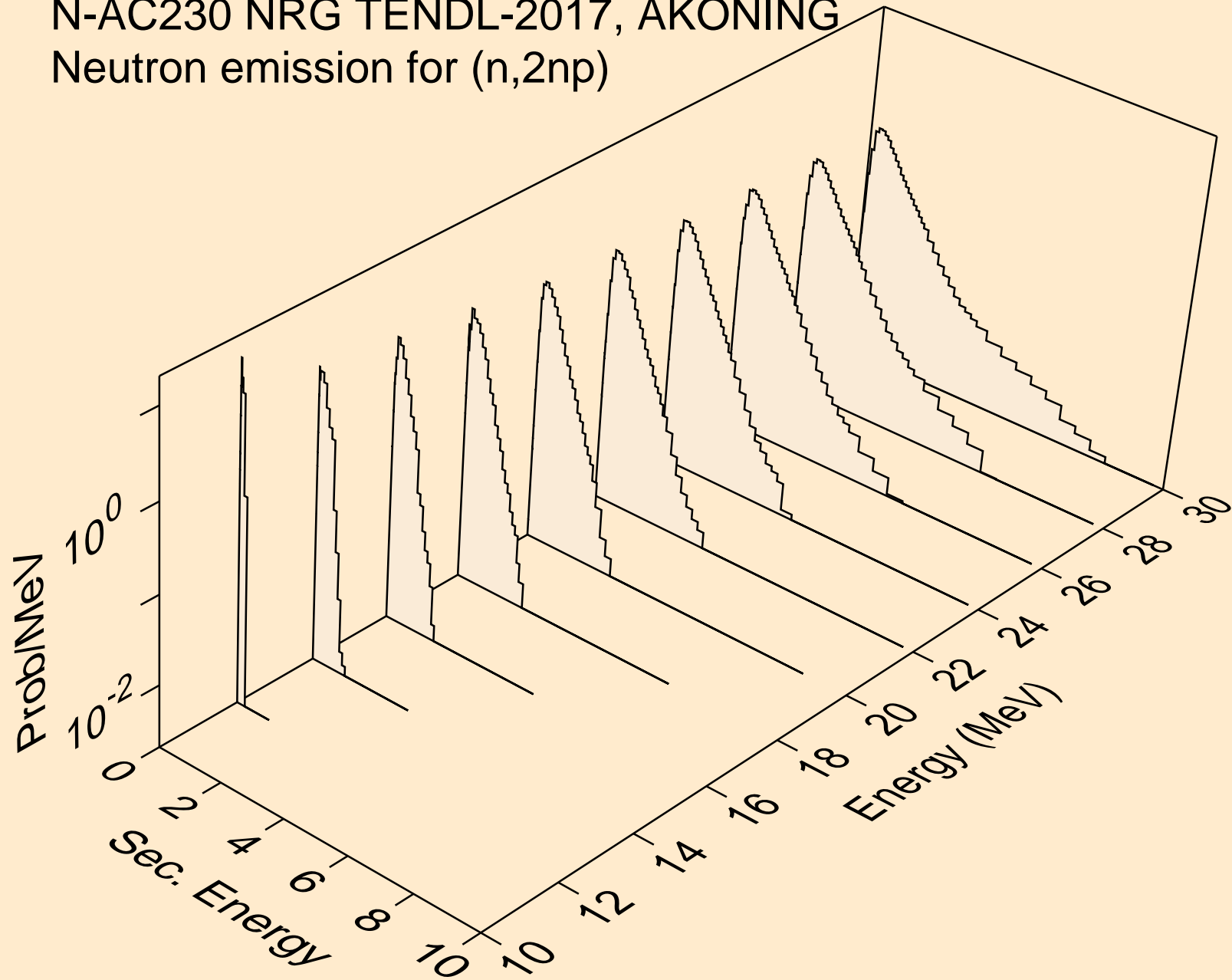

N-AC230 NRG TENDL-2017, AKONING
Neutron emission for (n,3np)

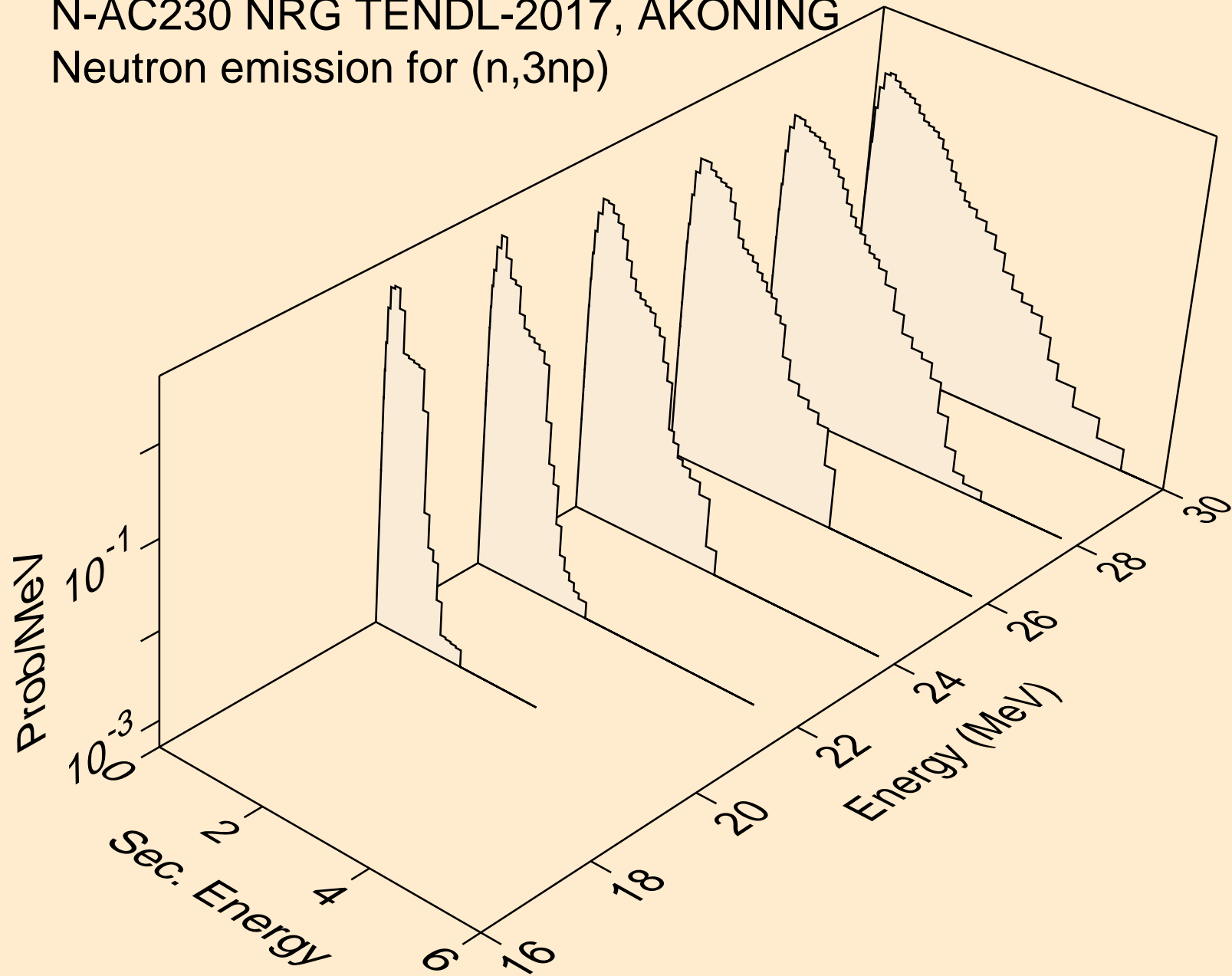

N-AC230 NRG TENDL-2017, AKONING
Neutron emission for (n,2np)

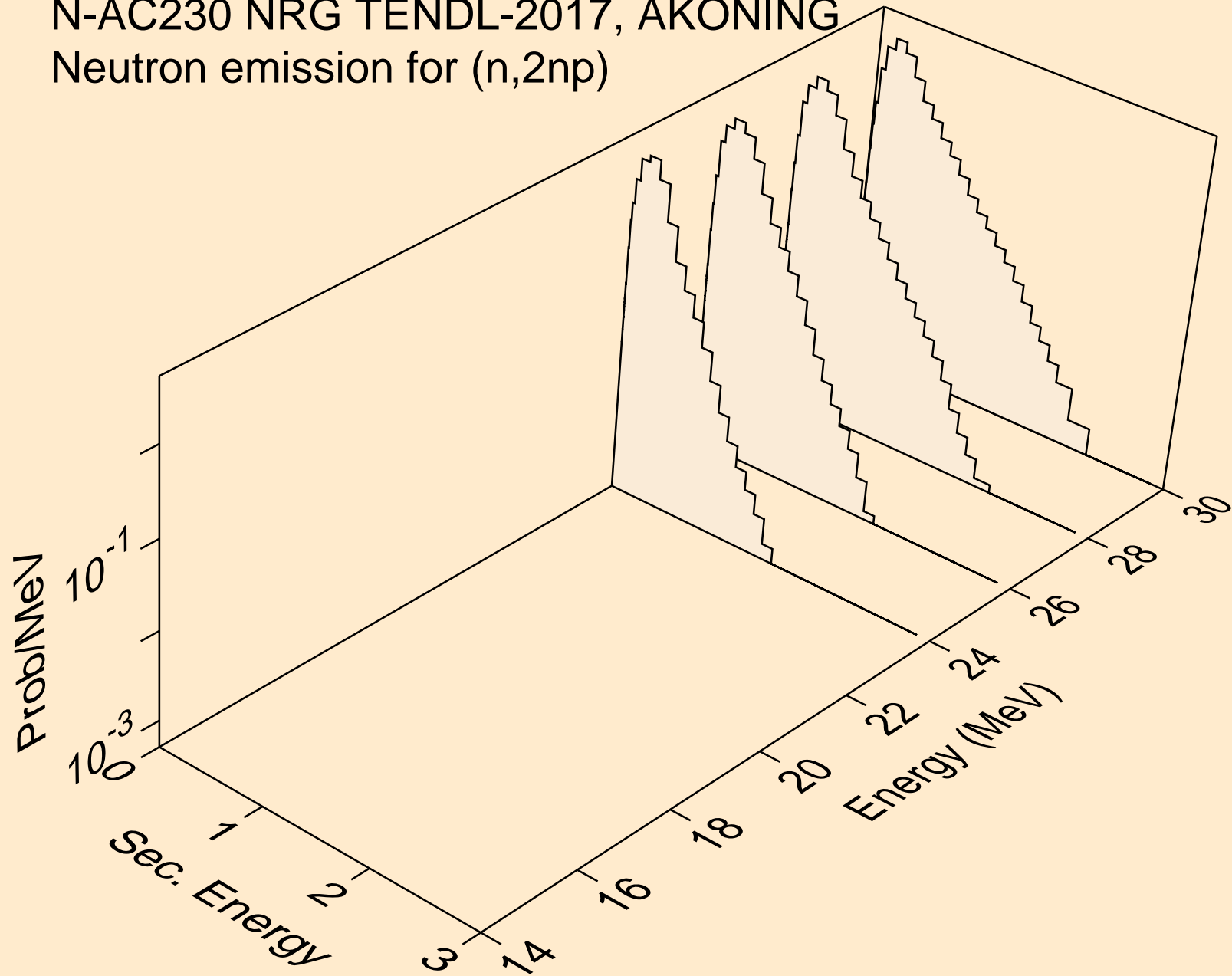

N-AC230 NRG TENDL-2017, AKONING
Neutron emission for (n,n*c)

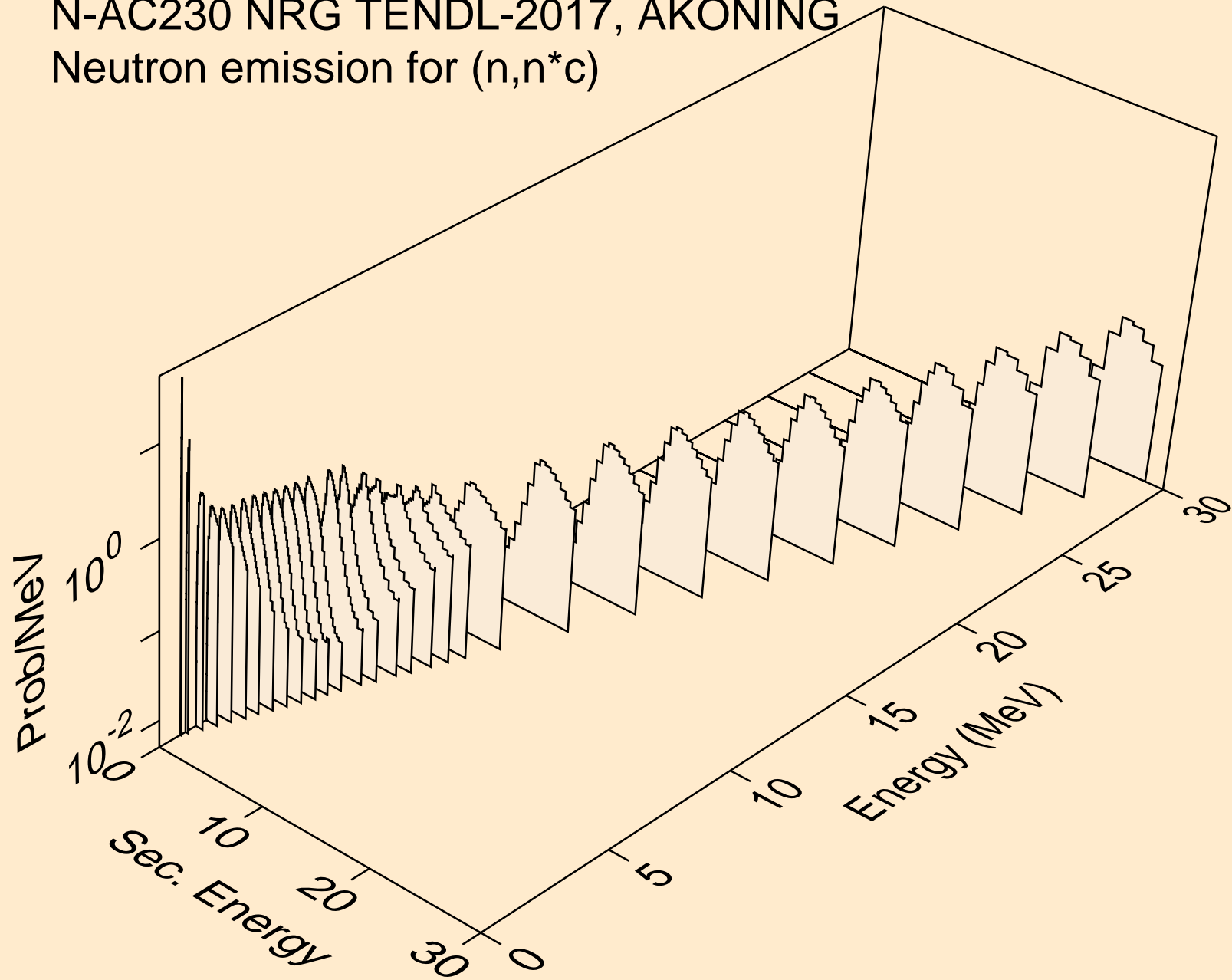

N-AC230 NRG TENDL-2017, AKONING

Delayed nubar

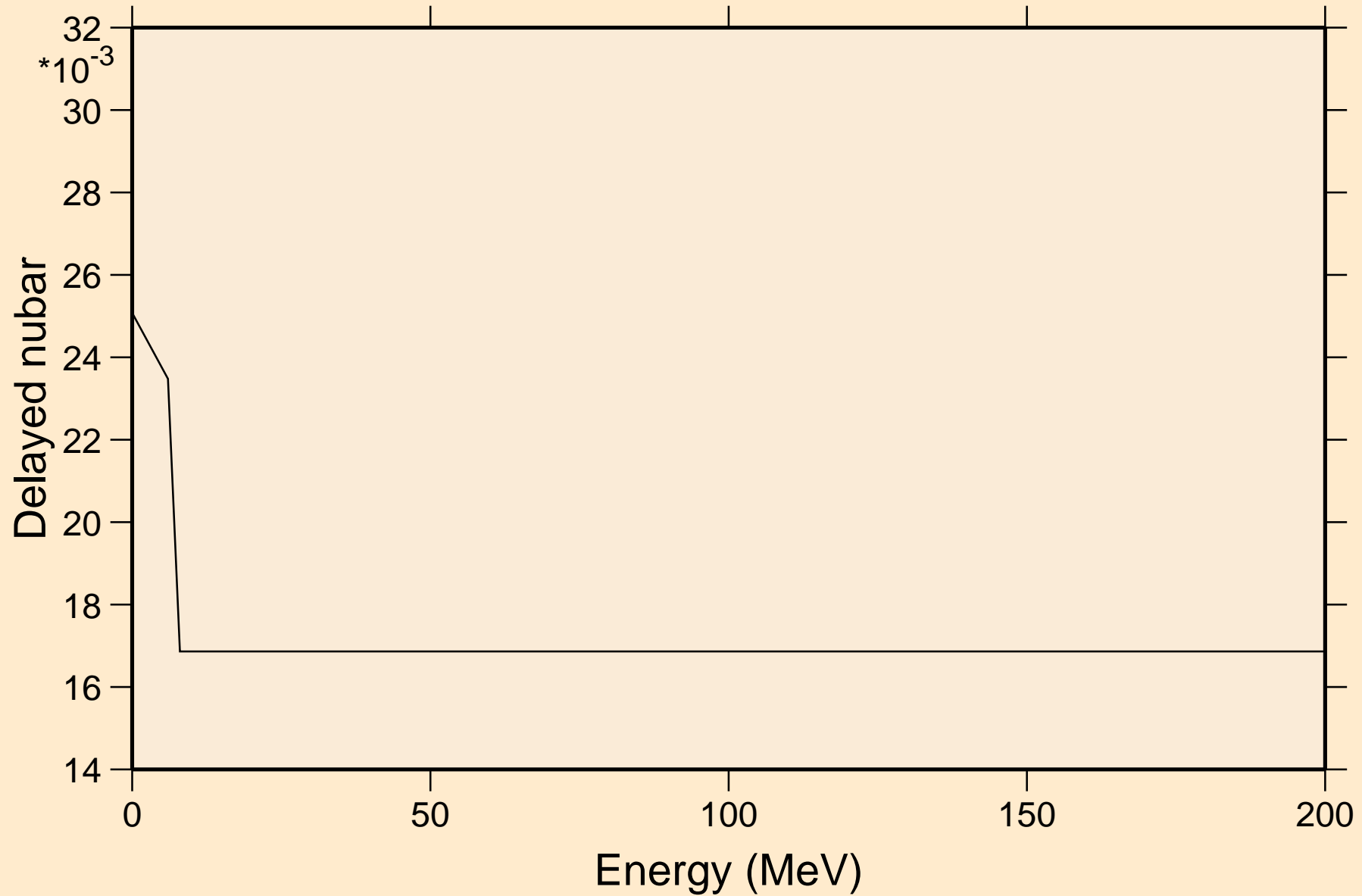

N-AC230 NRG TENDL-2017, AKONING

Delayed neutron spectra

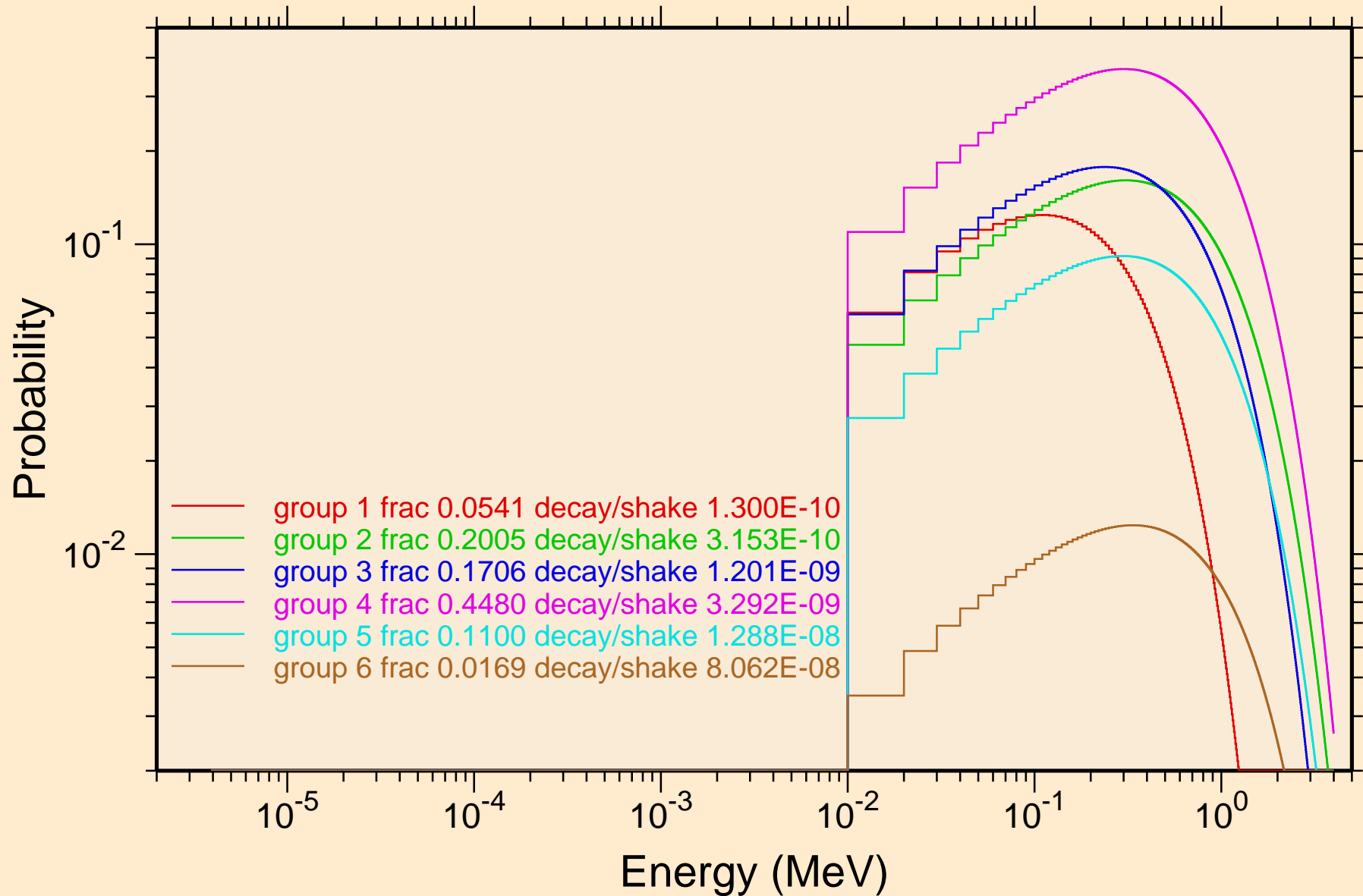

N-AC230 NRG TENDL-2017, AKONING
Photon emission for (n,x)

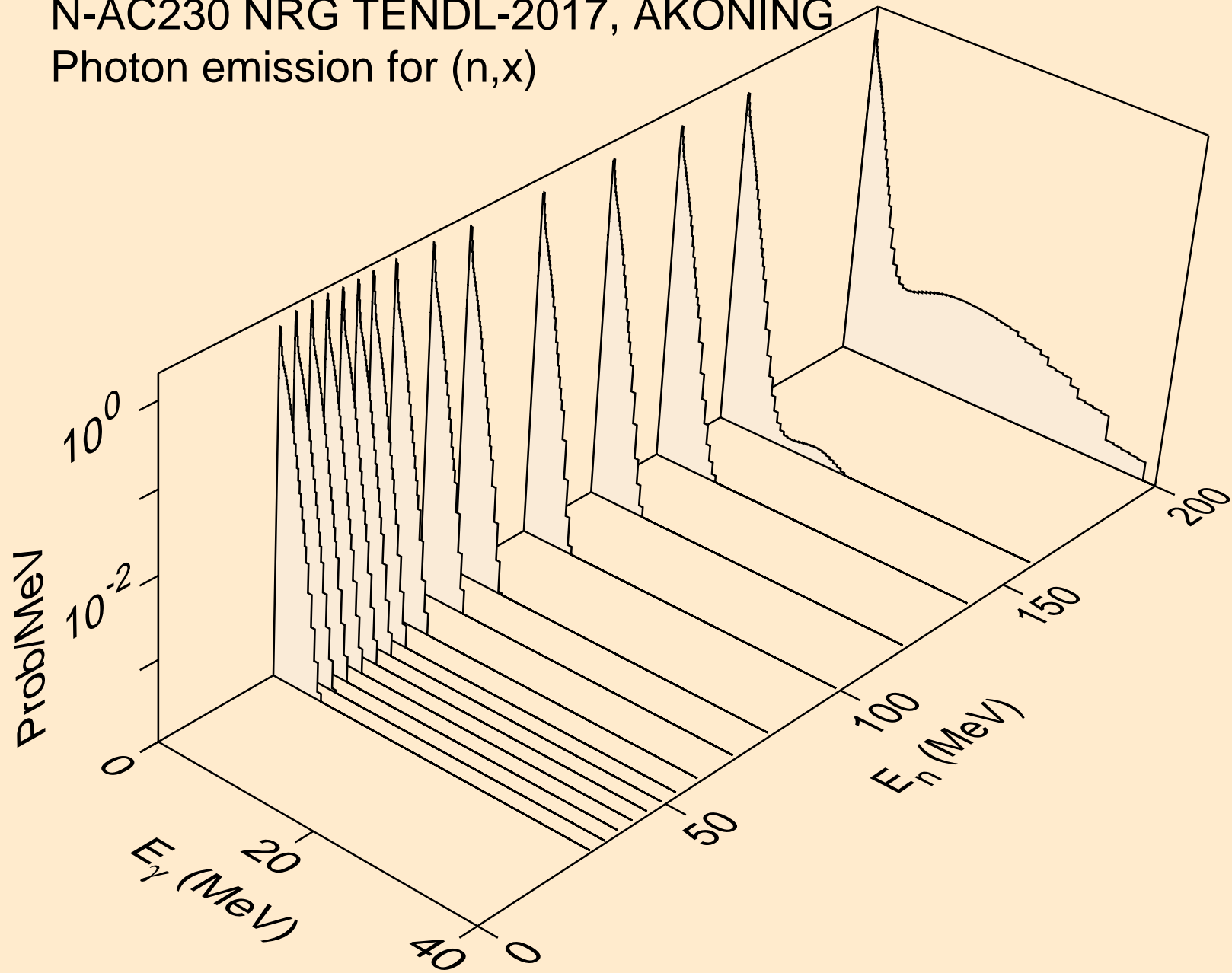

N-AC230 NRG TENDL-2017, AKONING
Photon emission for (n,2nd)

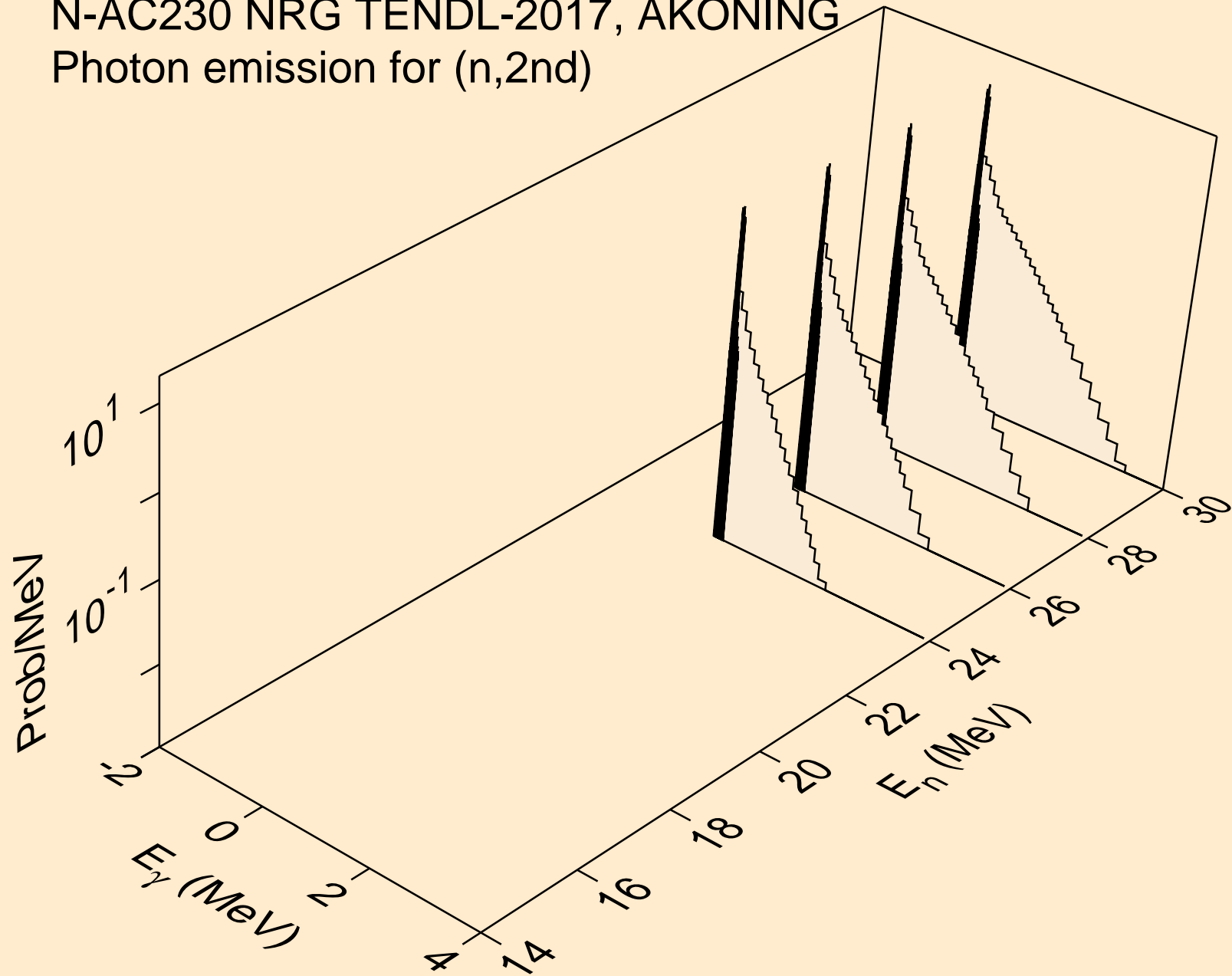

N-AC230 NRG TENDL-2017, AKONING
Photon emission for (n,2n)

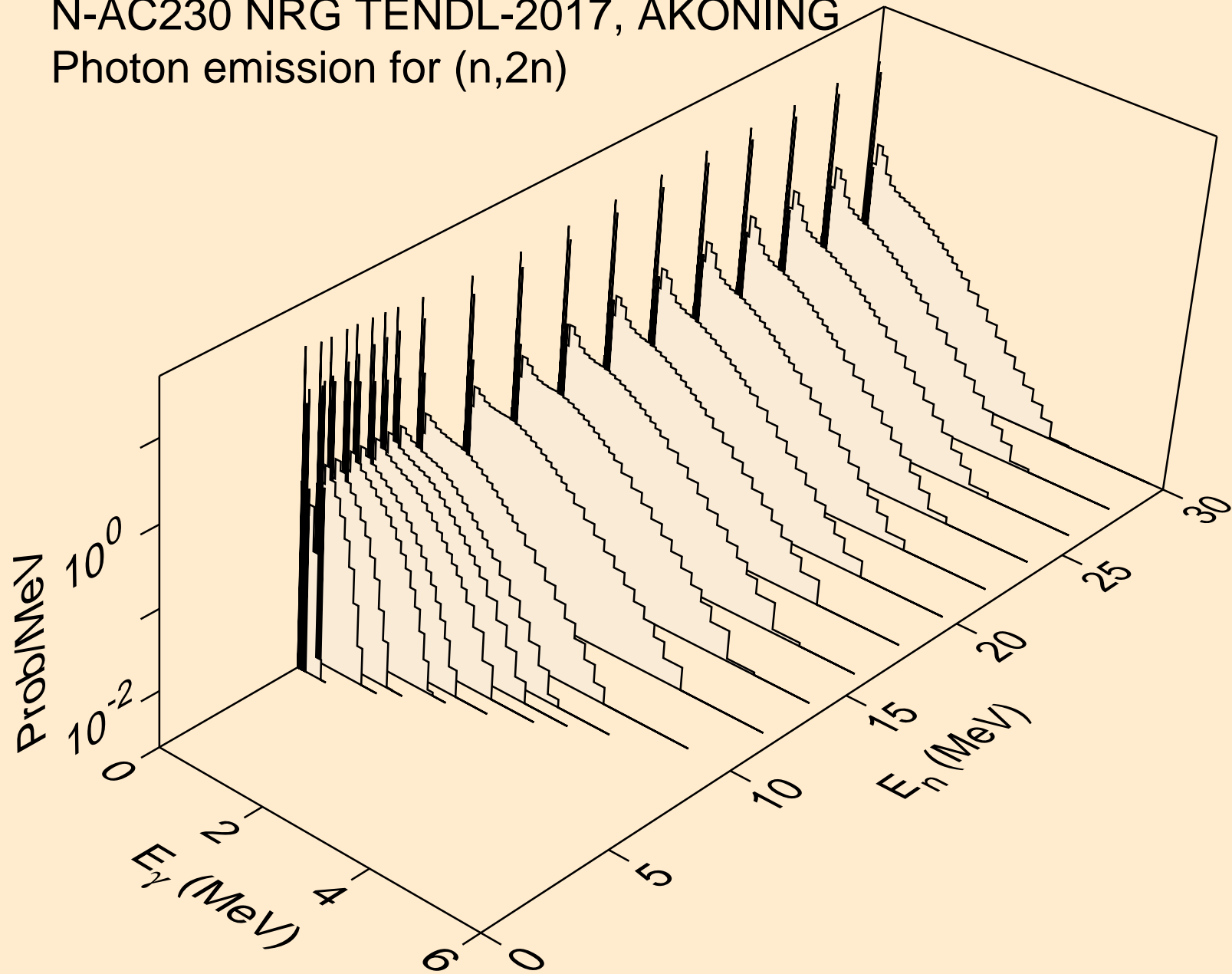

N-AC230 NRG TENDL-2017, AKONING
Photon emission for (n,3n)

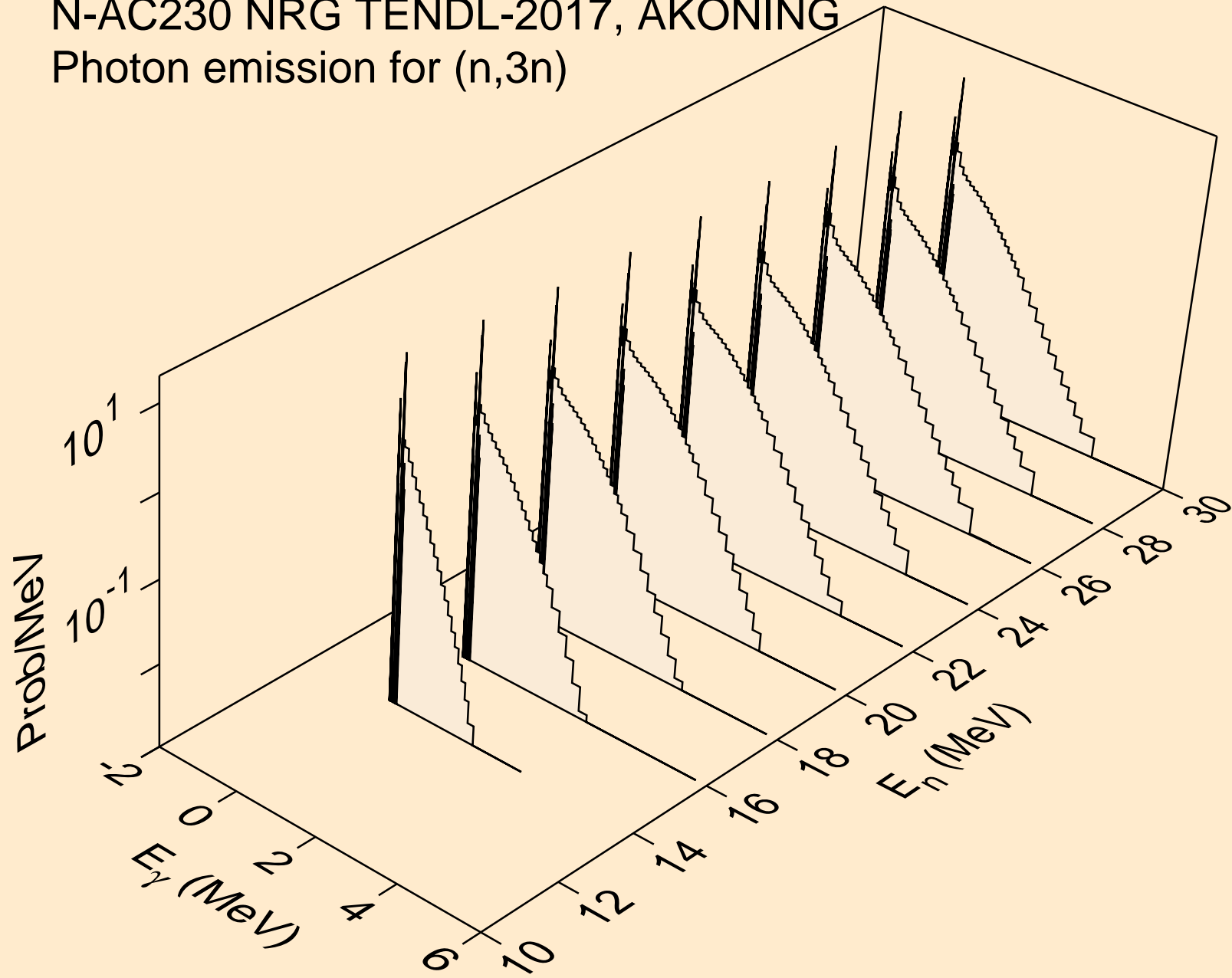

N-AC230 NRG TENDL-2017, AKONING
Photon emission for (n,n*)a

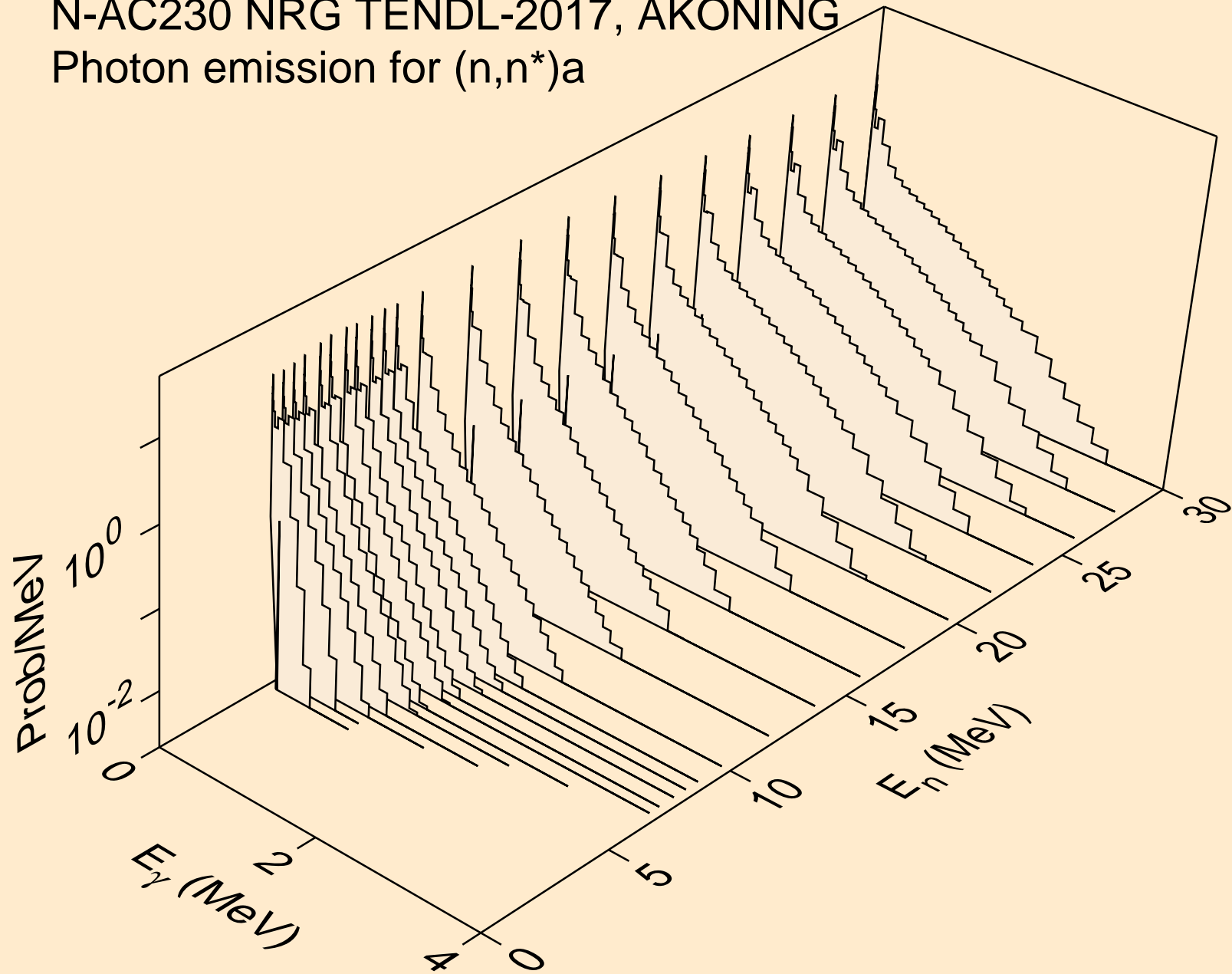

N-AC230 NRG TENDL-2017, AKONING
Photon emission for (n,2n)a

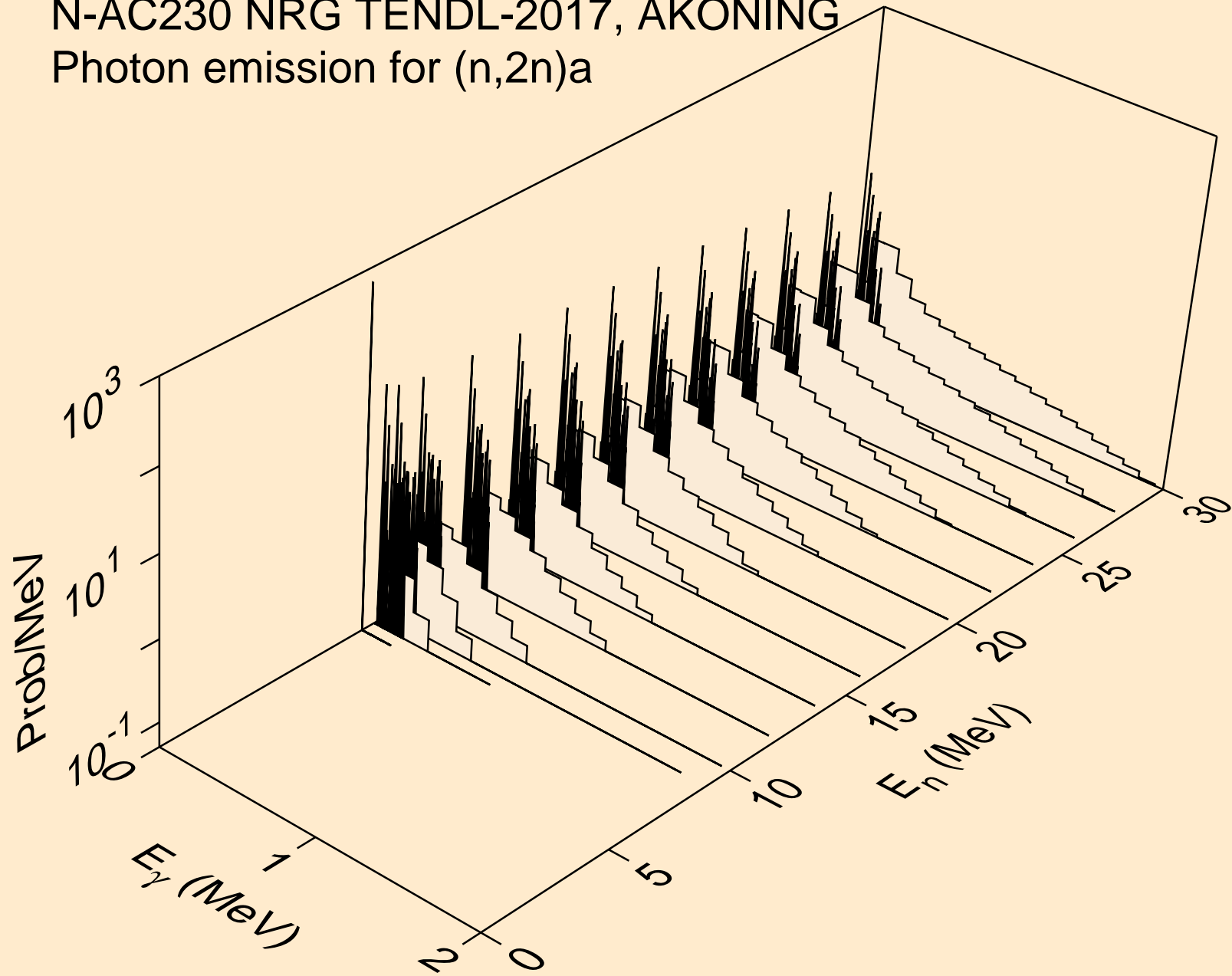

N-AC230 NRG TENDL-2017, AKONING
Photon emission for (n,3n)a

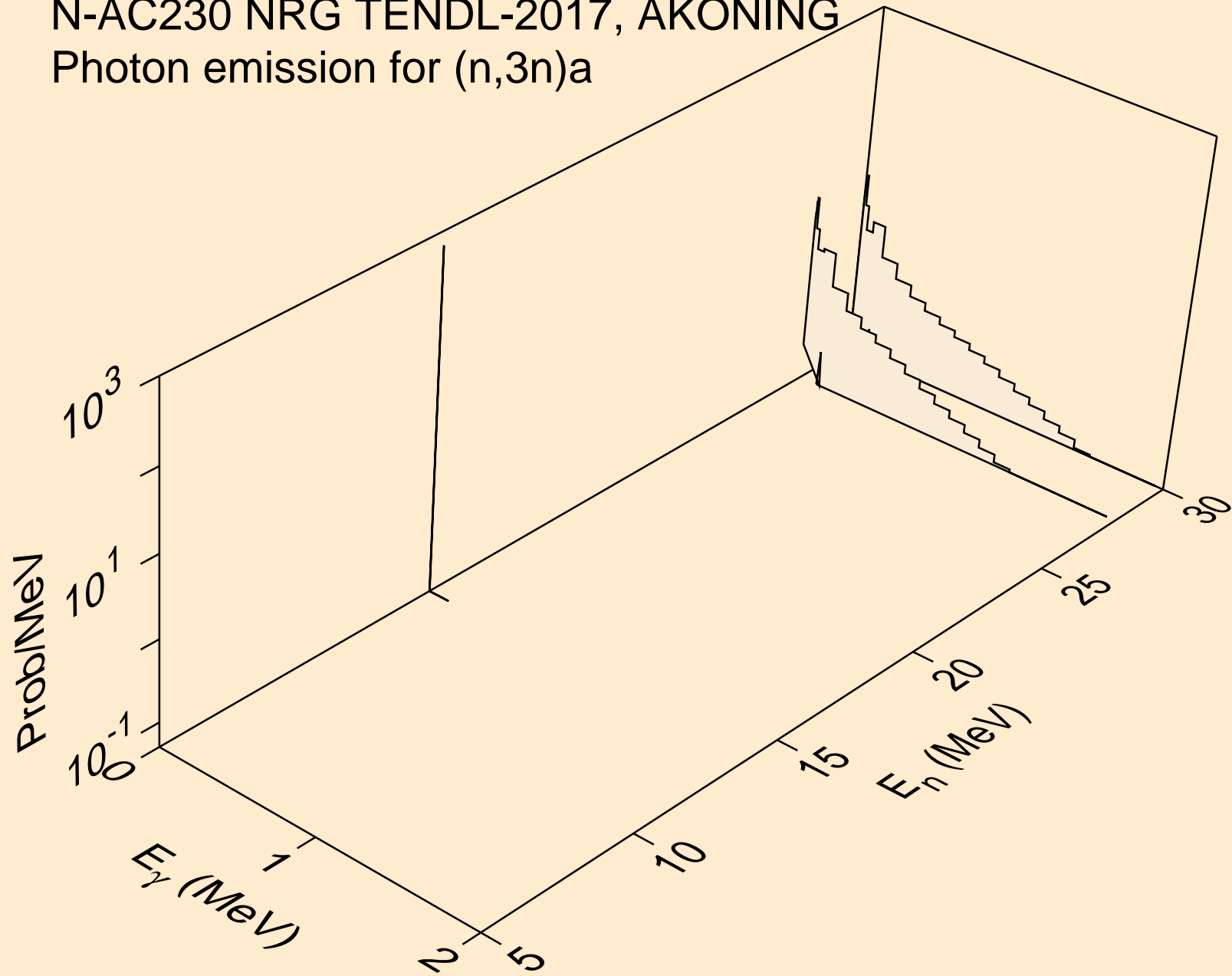

N-AC230 NRG TENDL-2017, AKONING
Photon emission for (n,n*)p

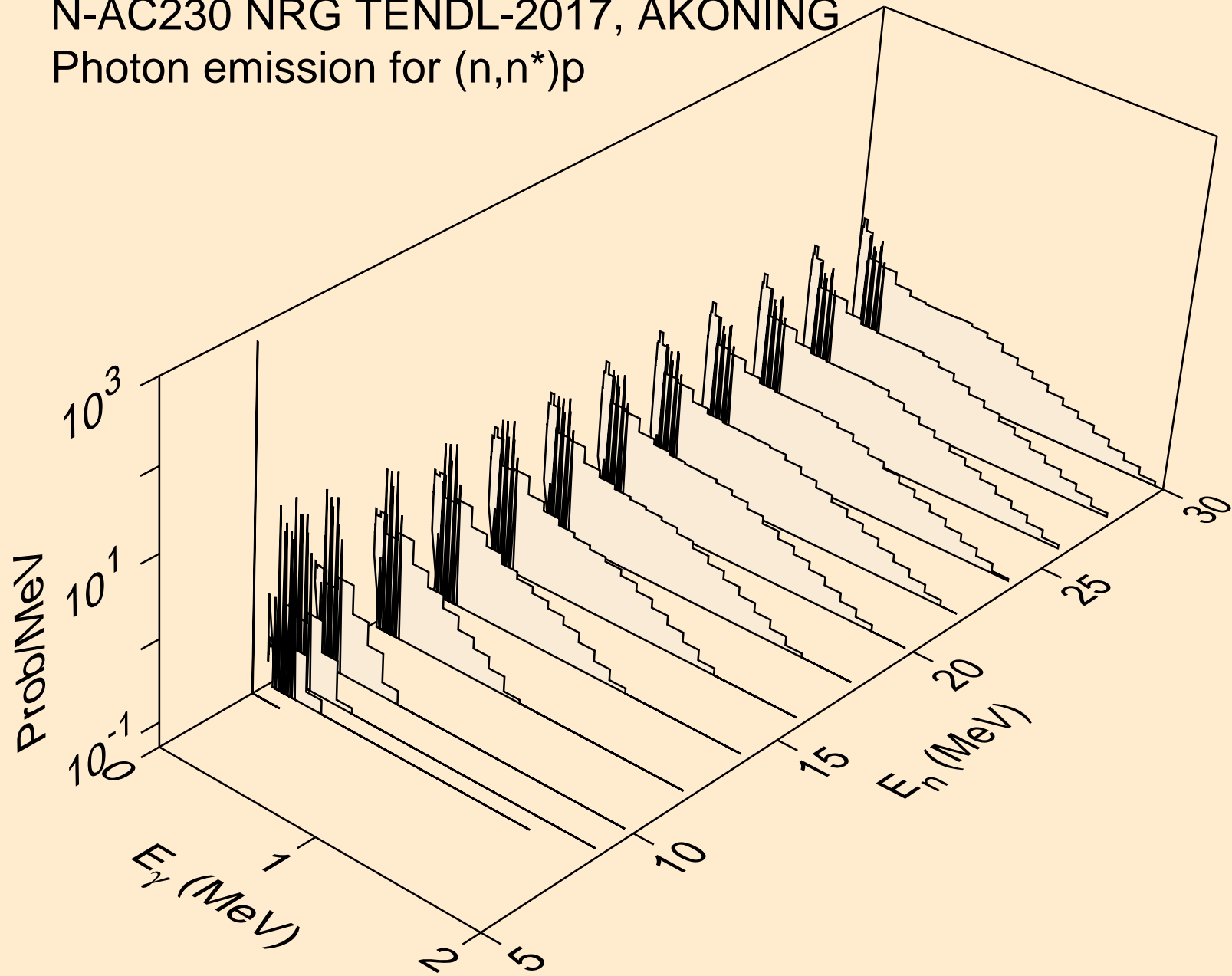

N-AC230 NRG TENDL-2017, AKONING
Photon emission for (n,n*)d

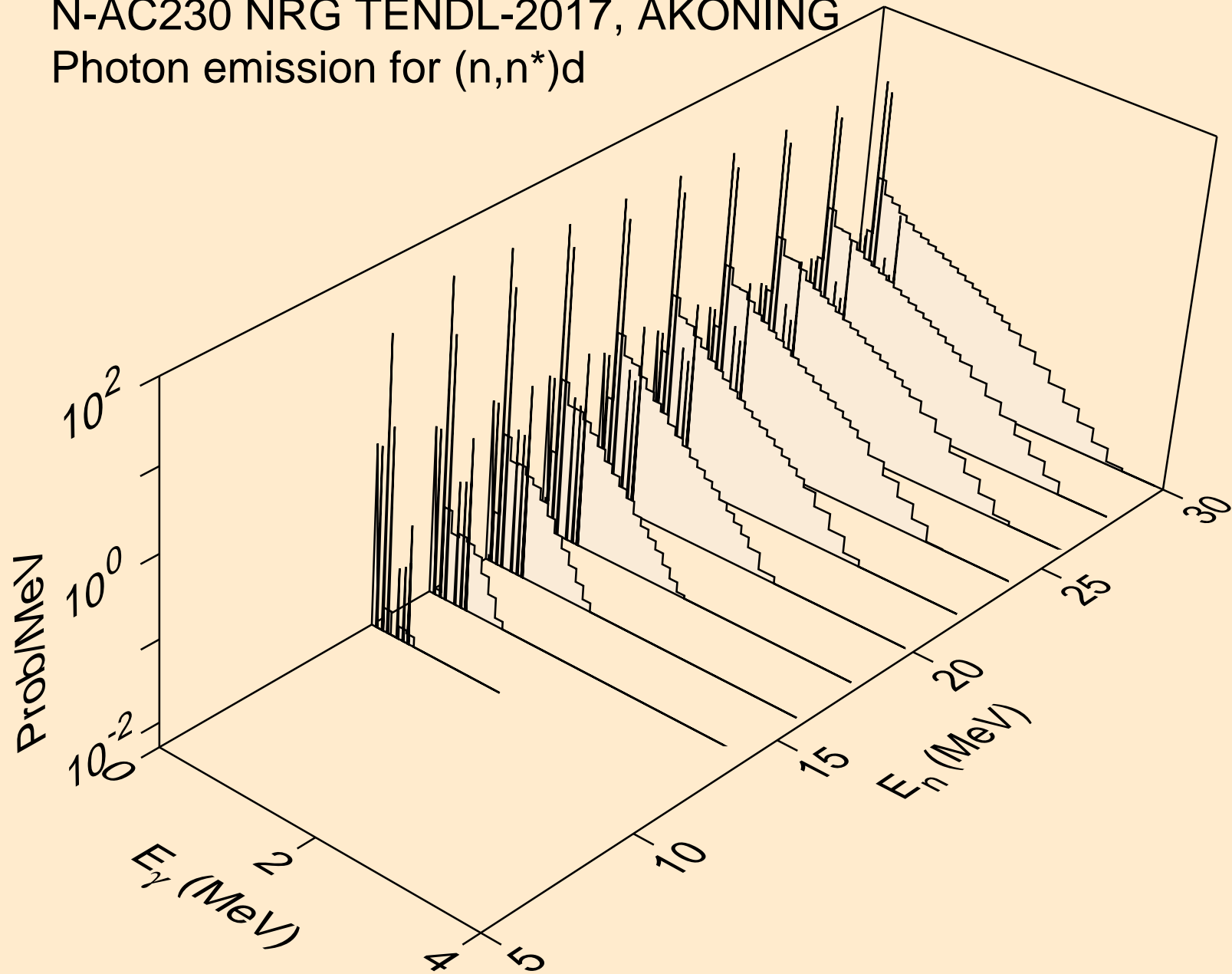

N-AC230 NRG TENDL-2017, AKONING
Photon emission for (n,n*)t

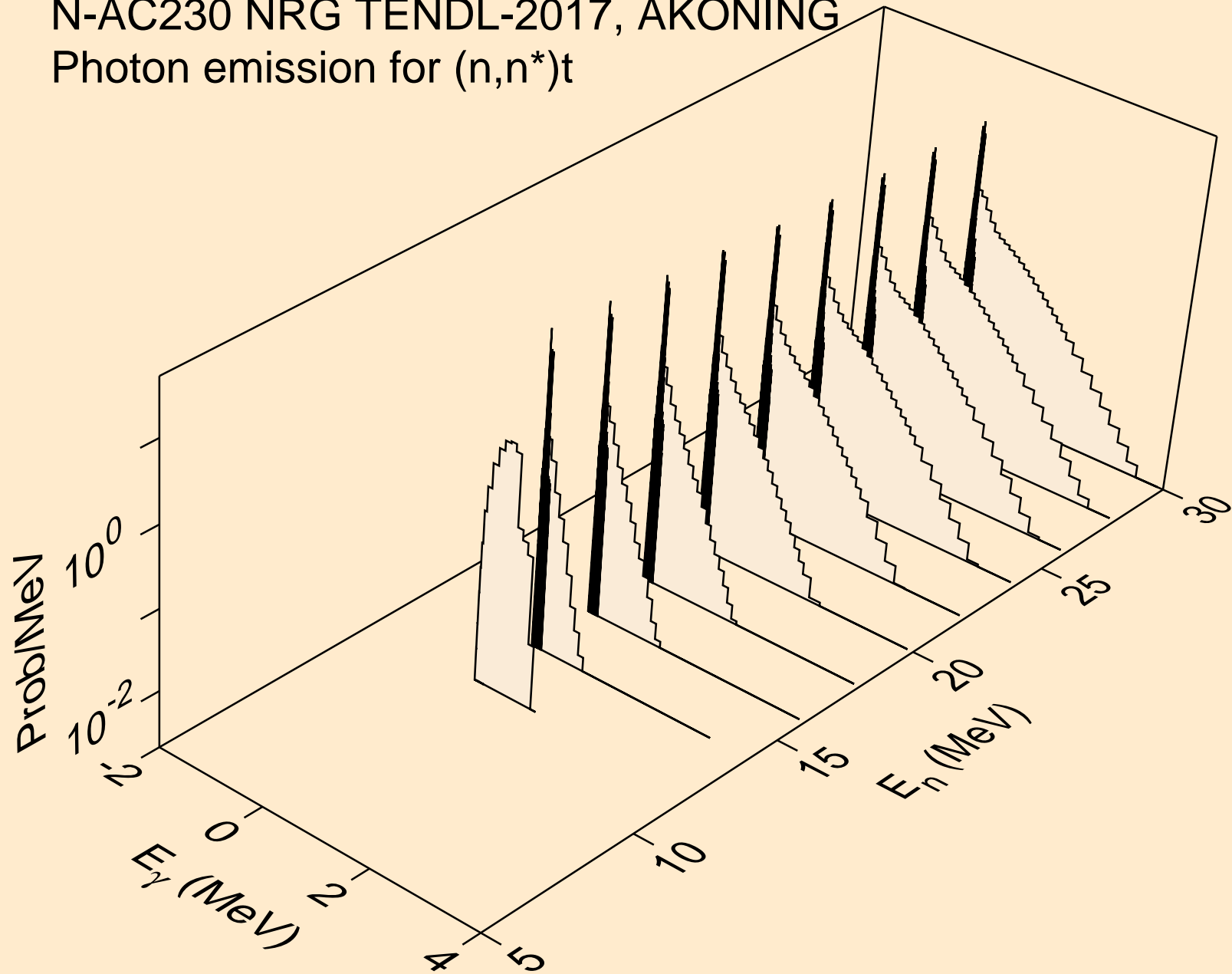

N-AC230 NRG TENDL-2017, AKONING
Photon emission for (n,n*)he3

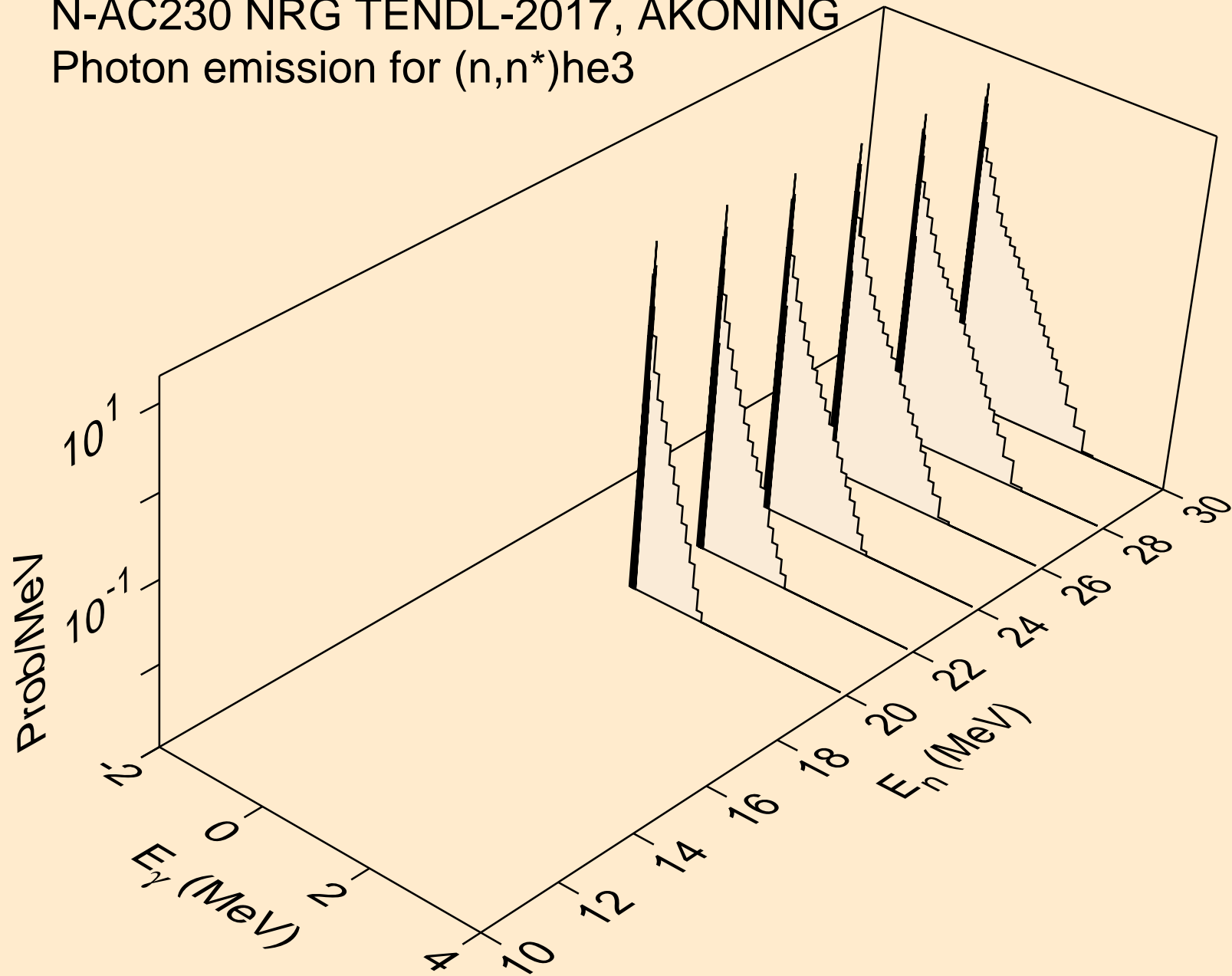

N-AC230 NRG TENDL-2017, AKONING
Photon emission for (n,4n)

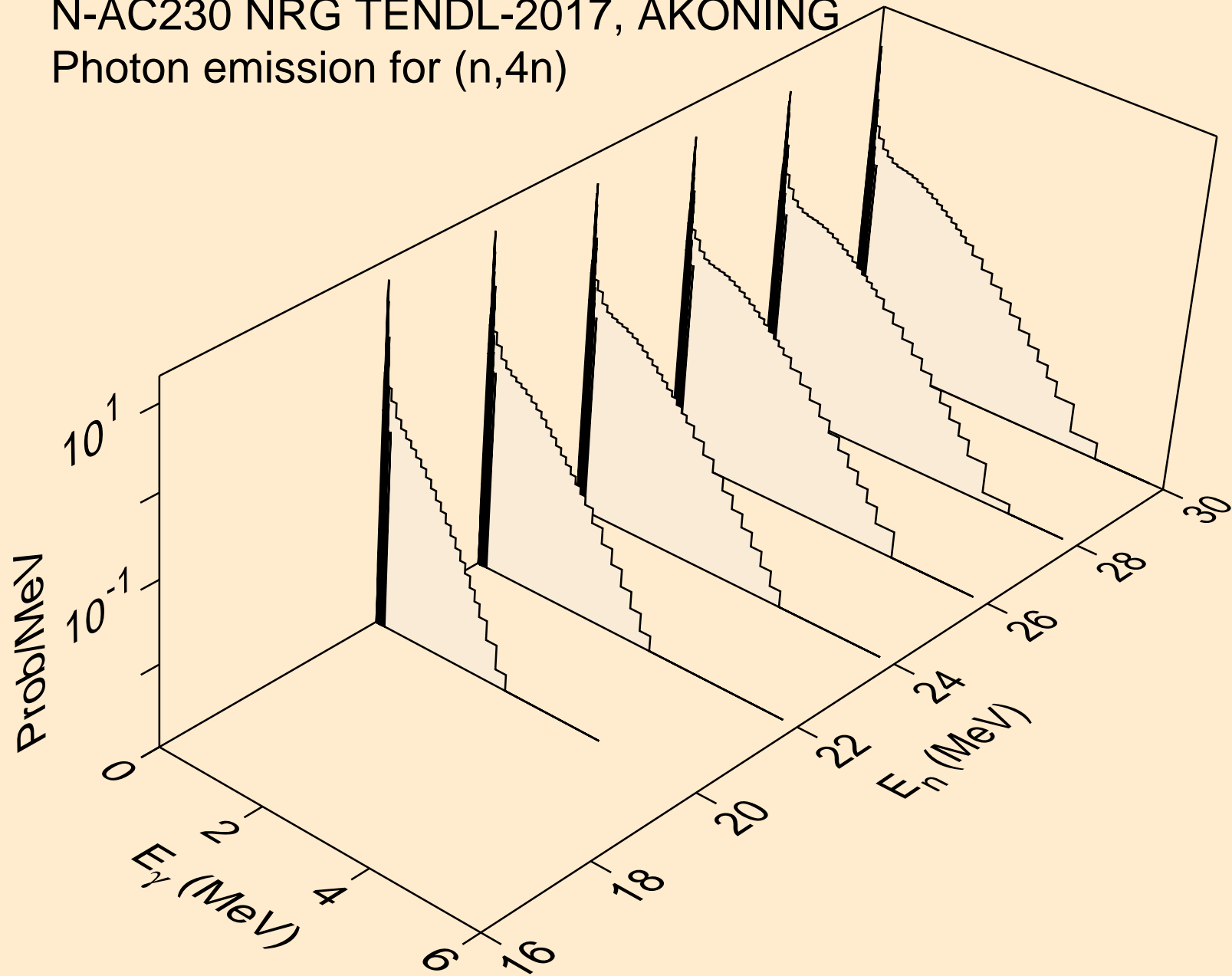

N-AC230 NRG TENDL-2017, AKONING
Photon emission for (n,2np)

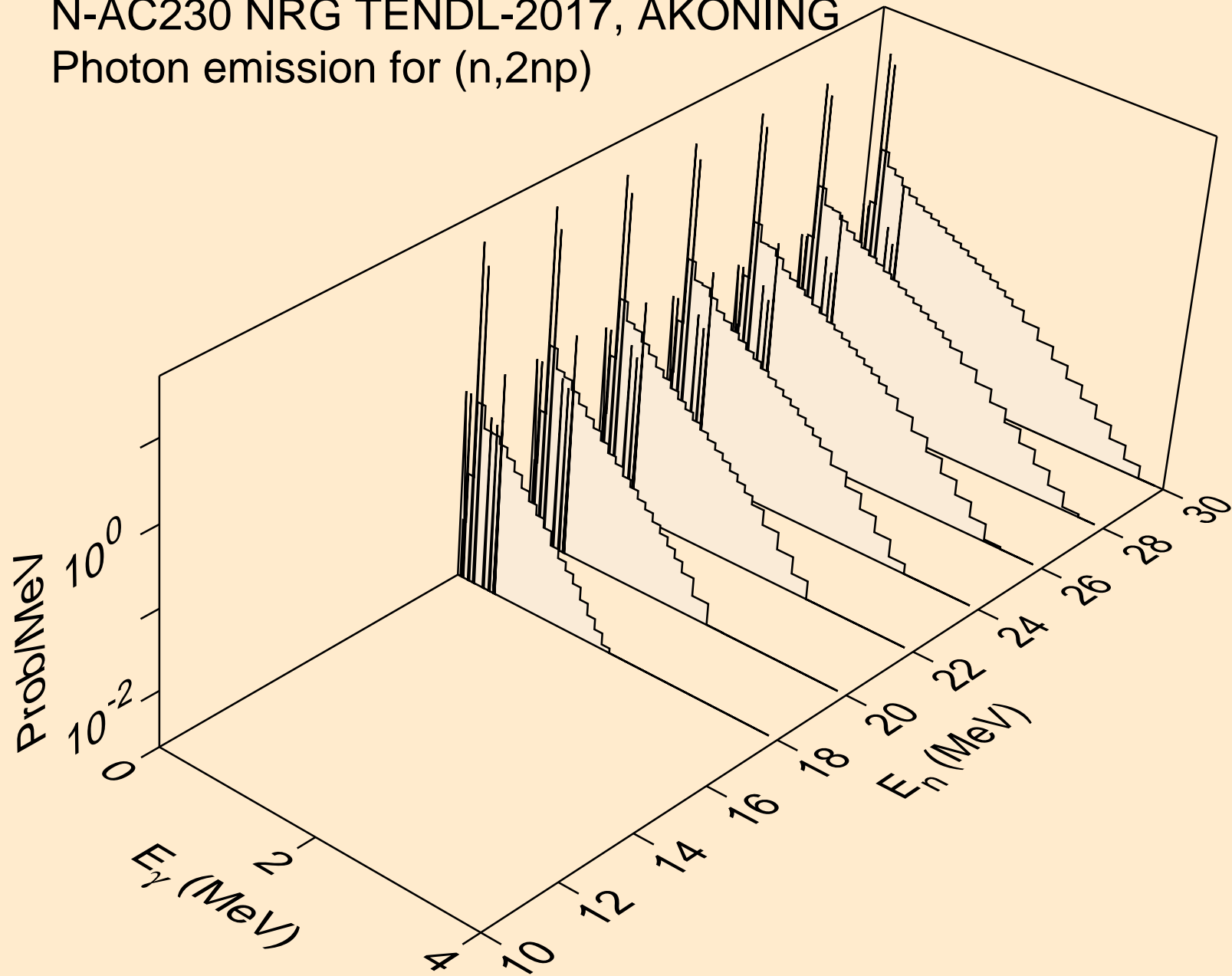

N-AC230 NRG TENDL-2017, AKONING
Photon emission for (n,3np)

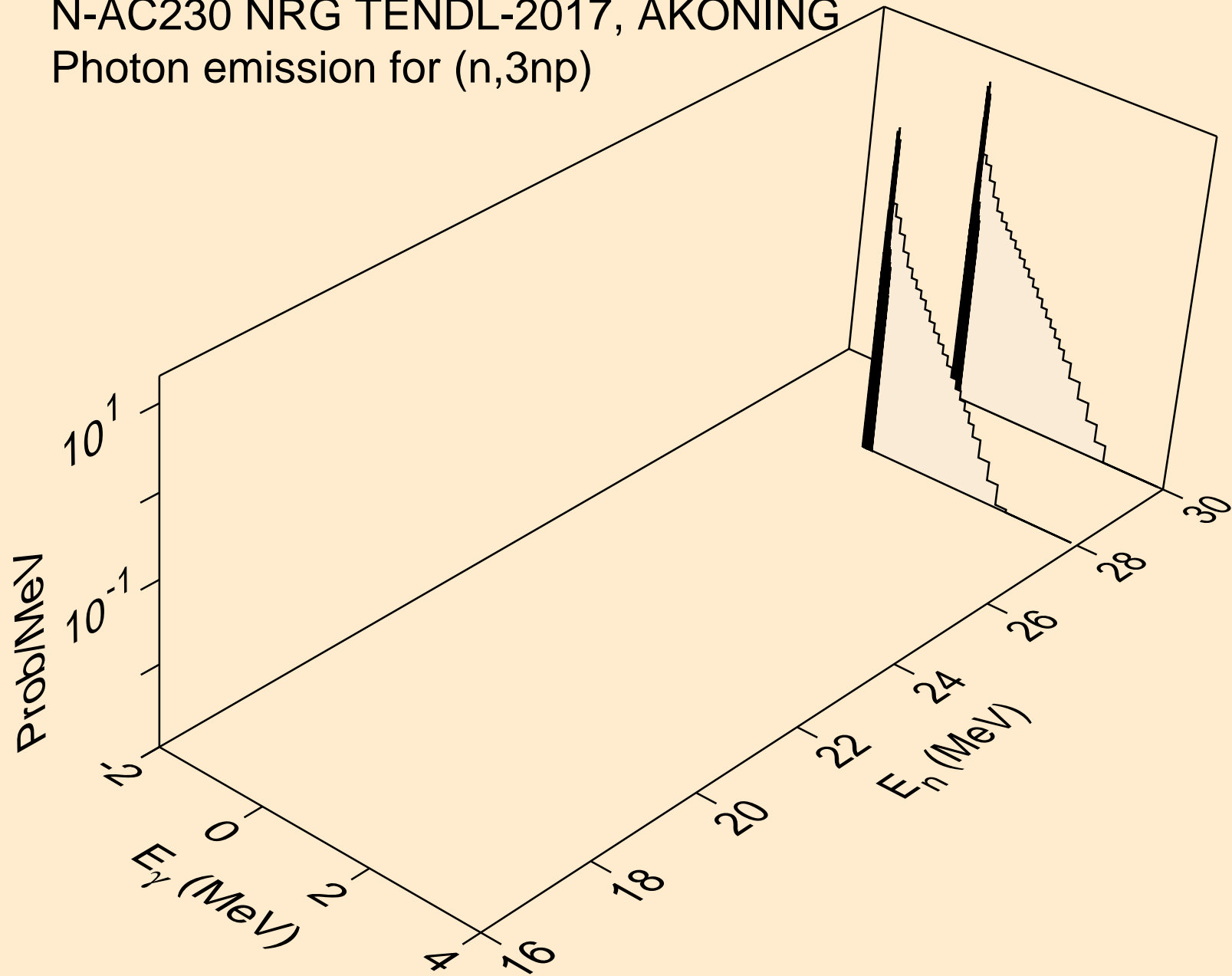

N-AC230 NRG TENDL-2017, AKONING
Photon emission for (n,2np)

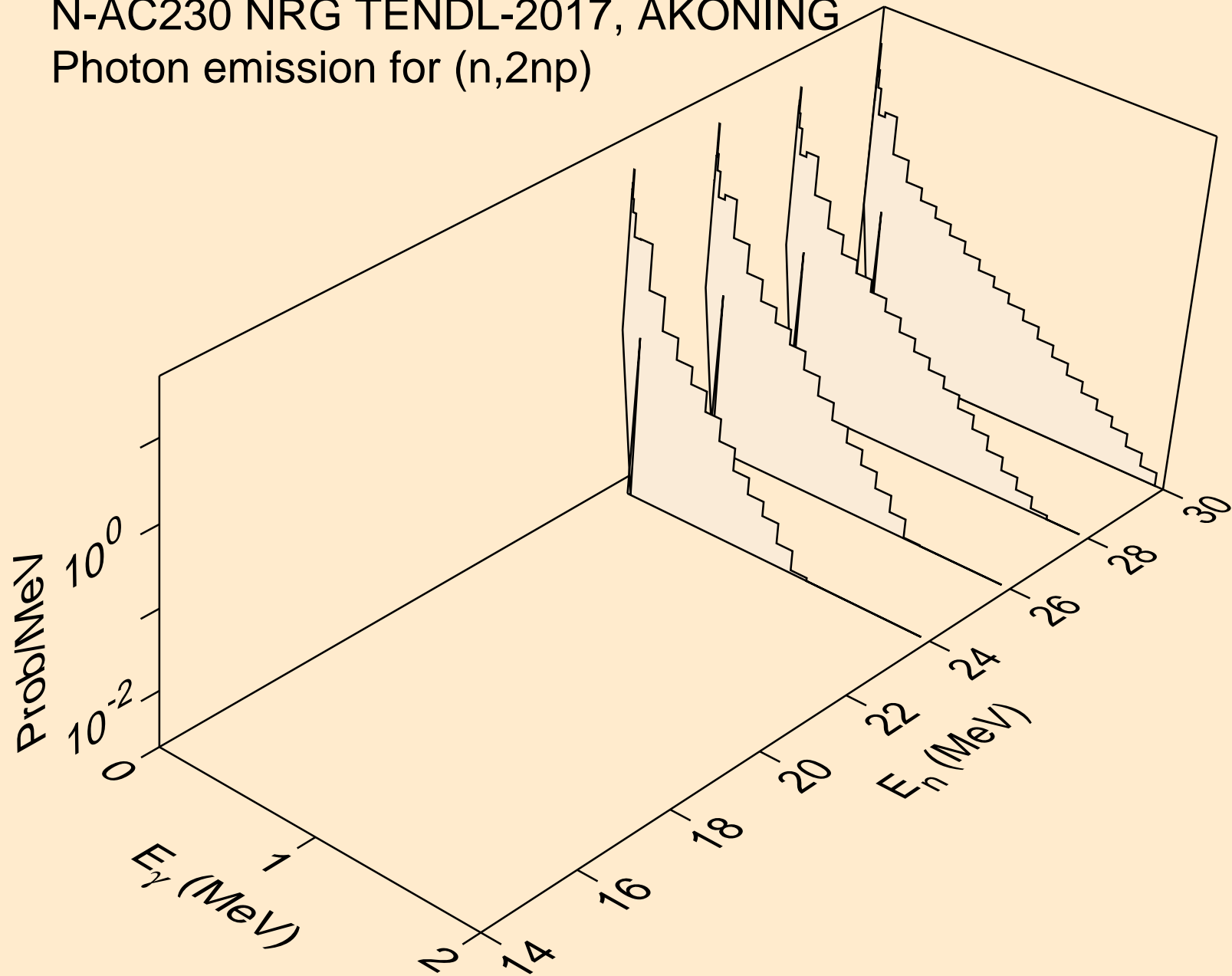

N-AC230 NRG TENDL-2017, AKONING
Photon emission for (n,n*c)

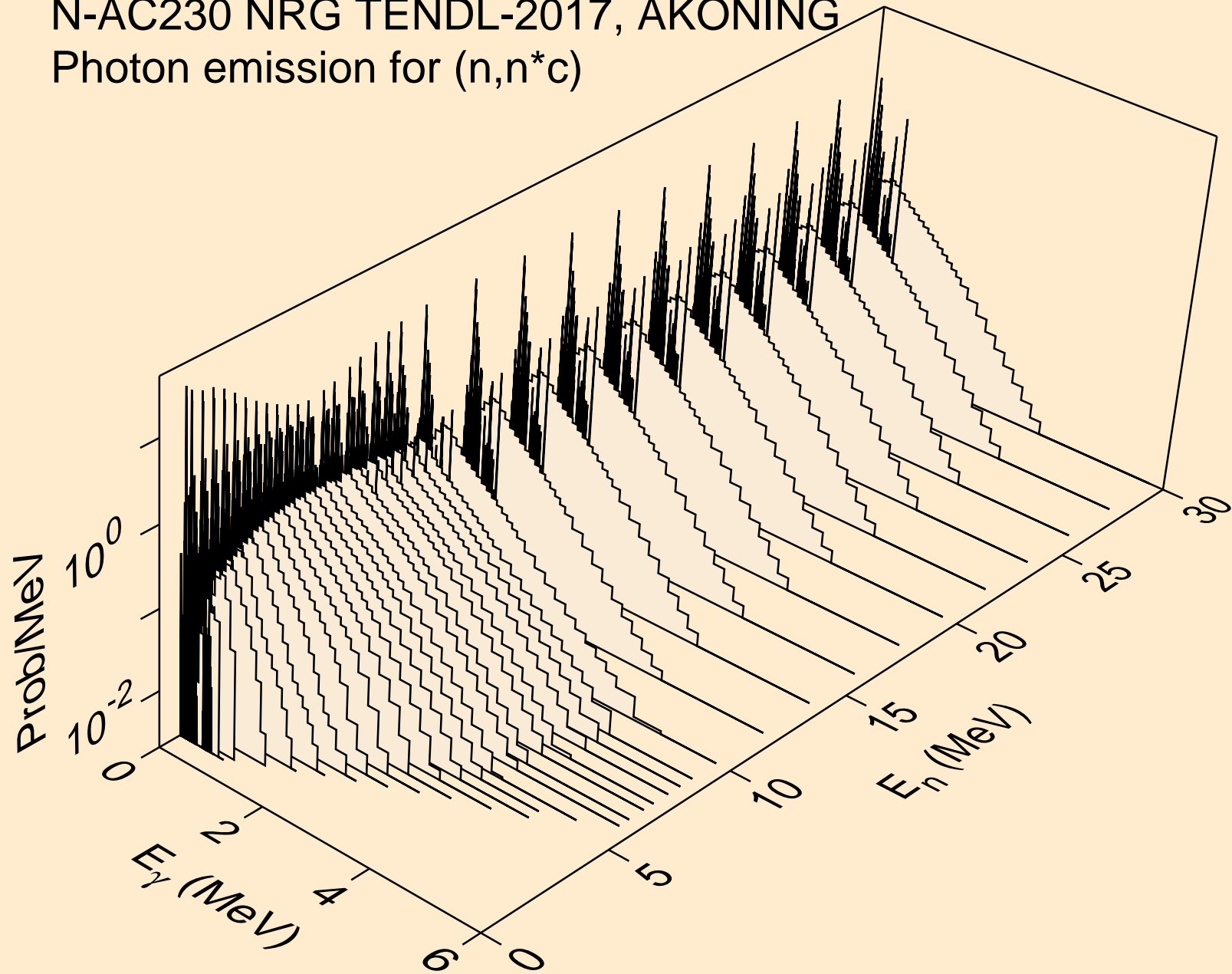

N-AC230 NRG TENDL-2017, AKONING
Photon emission for (n,gma)

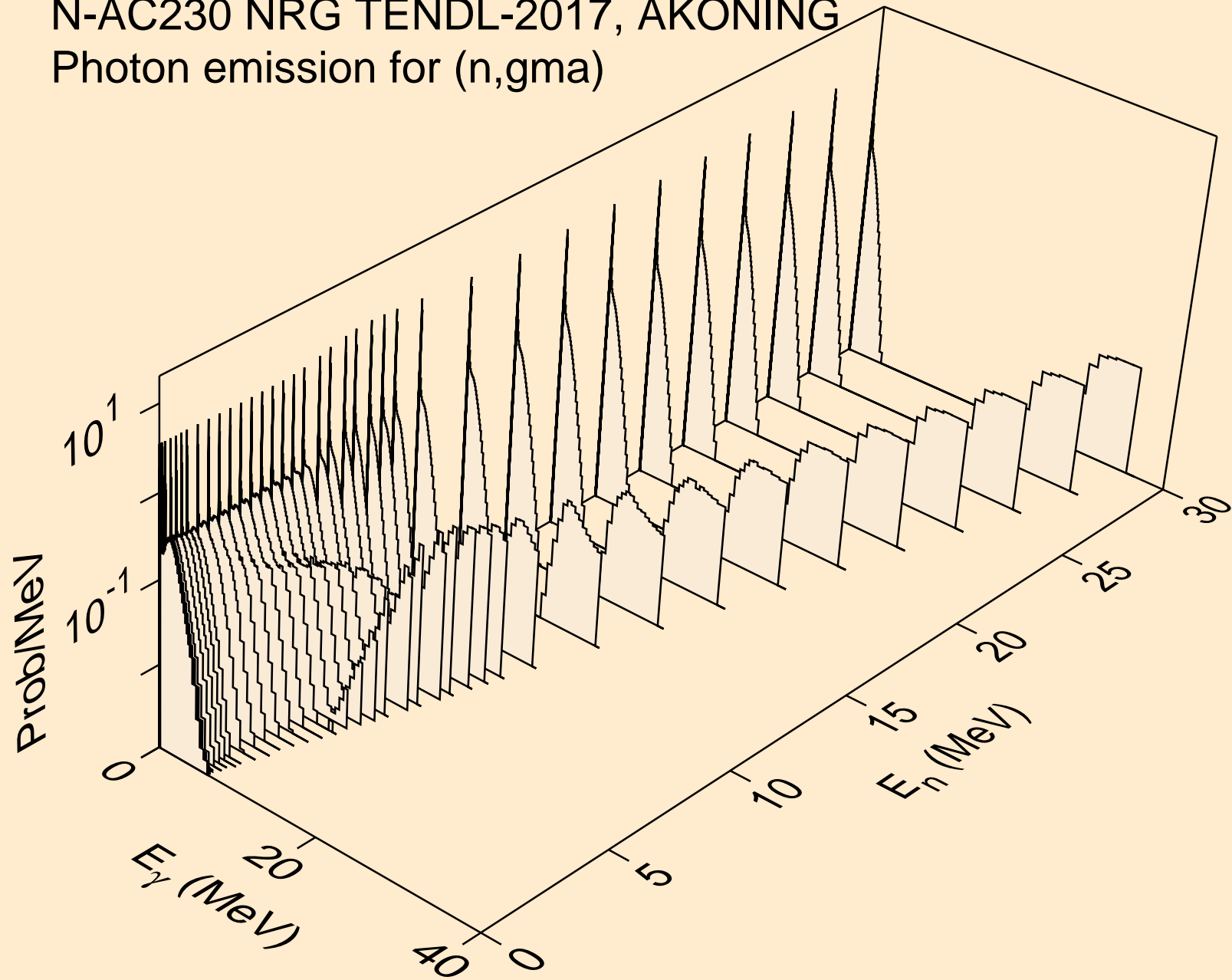

N-AC230 NRG TENDL-2017, AKONING
Photon emission for (n,p)

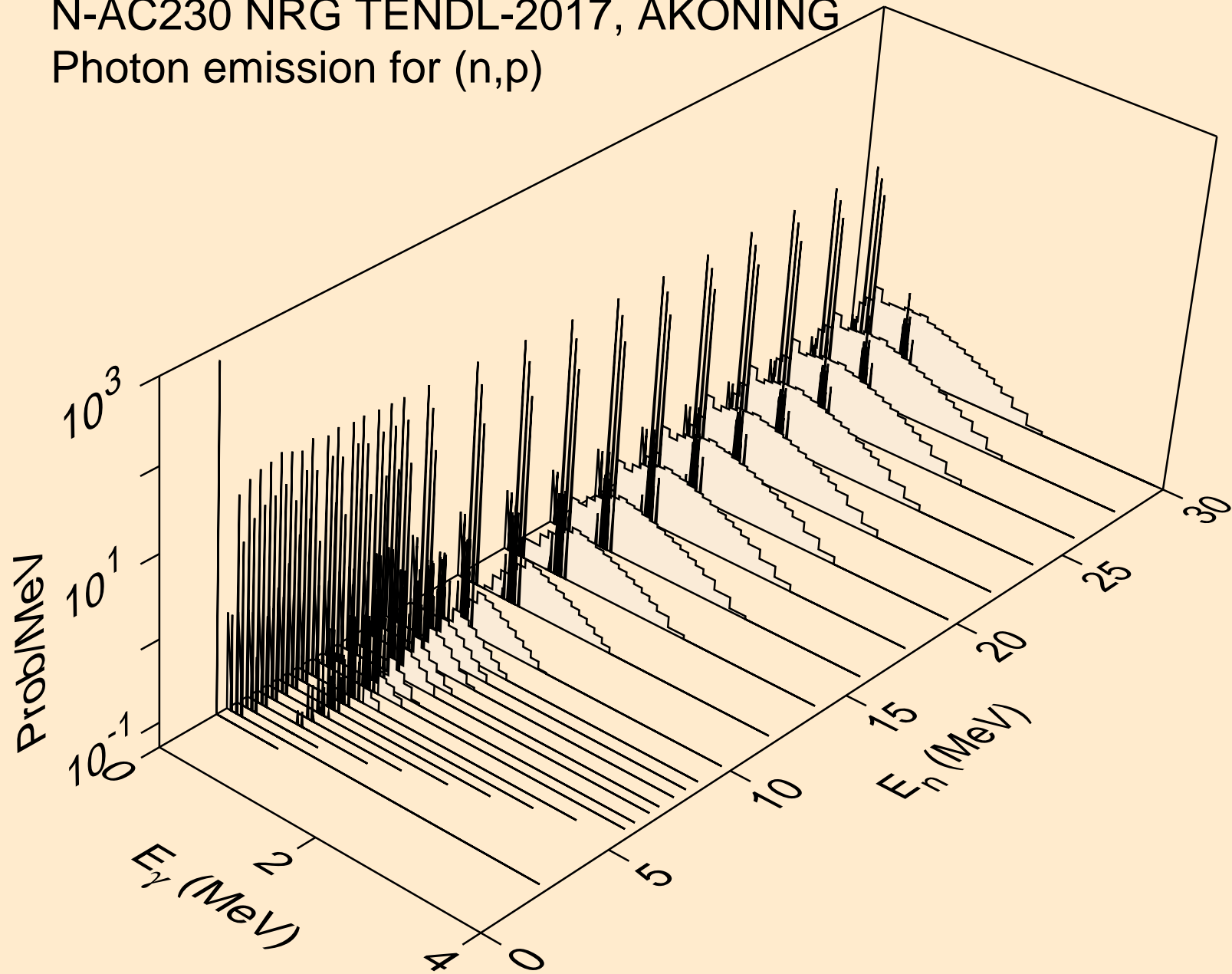

N-AC230 NRG TENDL-2017, AKONING
Photon emission for (n,d)

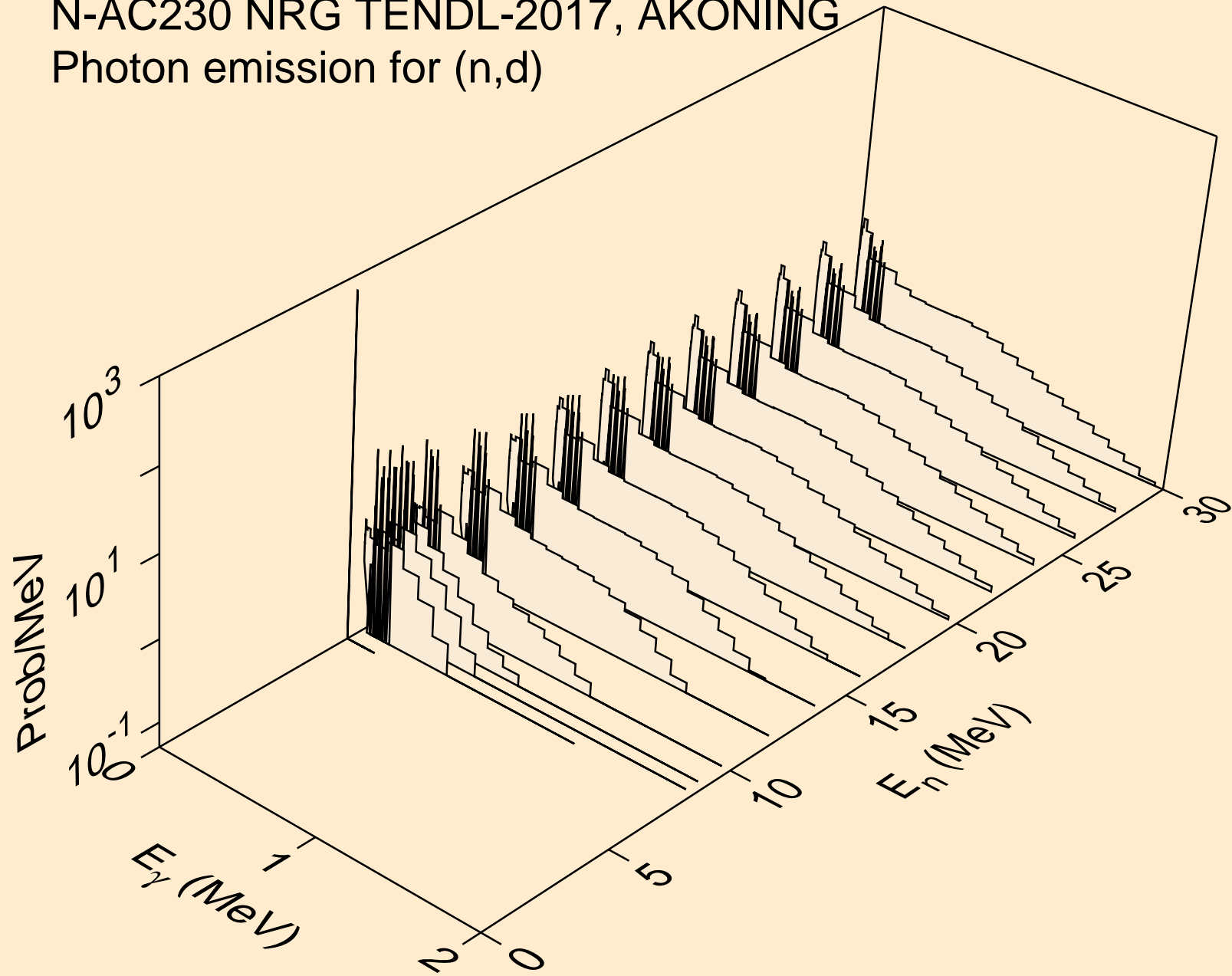

N-AC230 NRG TENDL-2017, AKONING
Photon emission for (n,t)

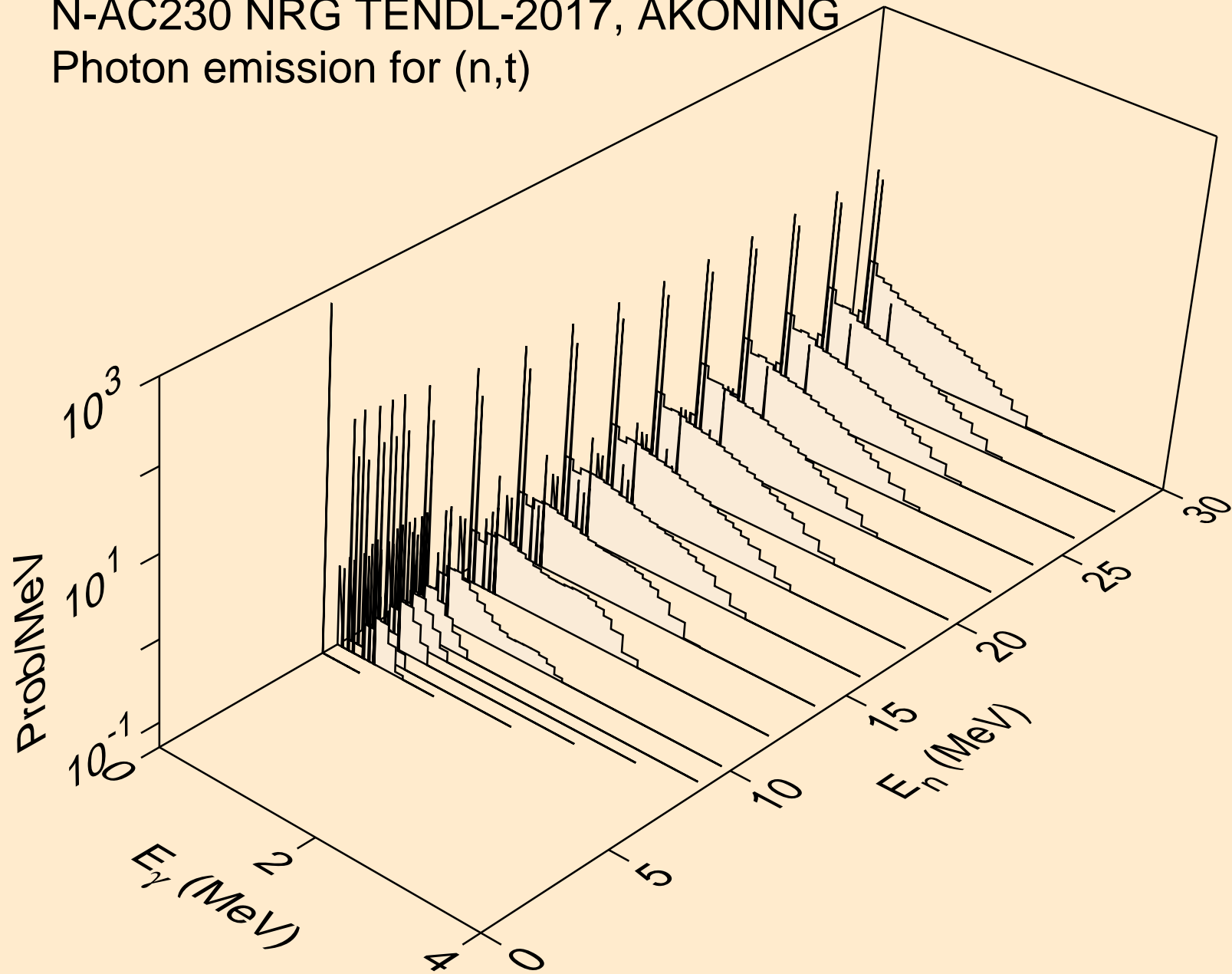

N-AC230 NRG TENDL-2017, AKONING
Photon emission for (n,he3)

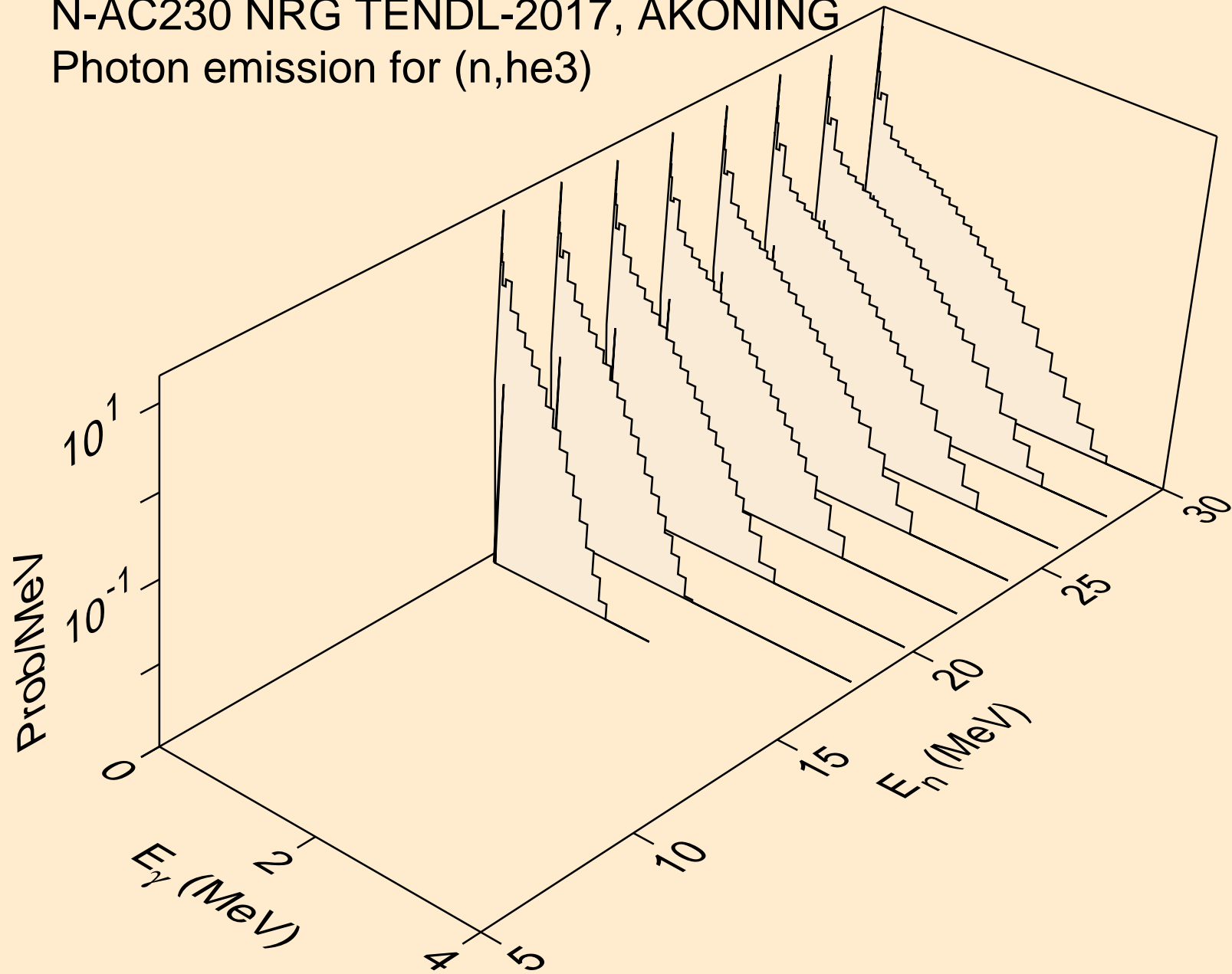

N-AC230 NRG TENDL-2017, AKONING
Photon emission for (n,a)

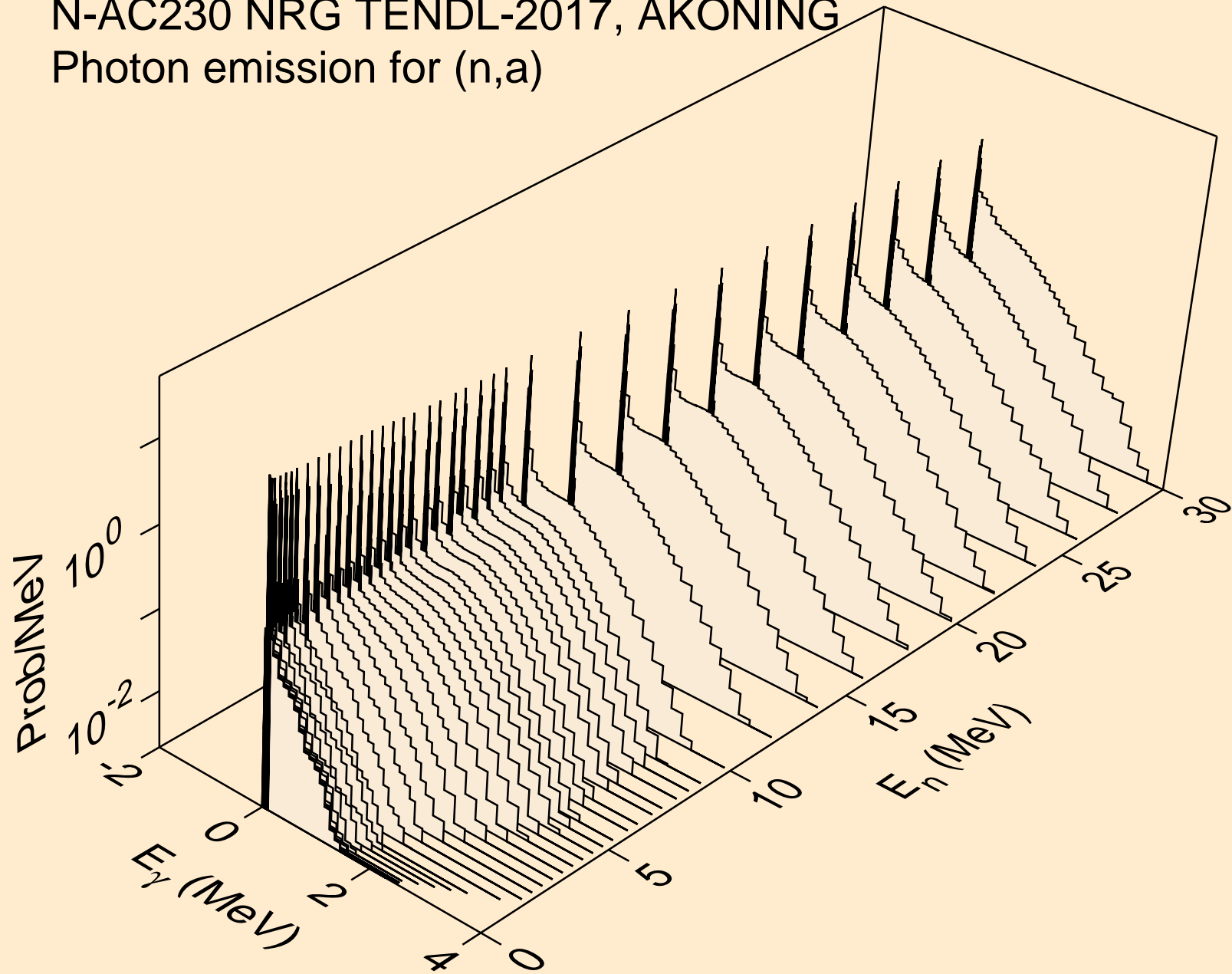

N-AC230 NRG TENDL-2017, AKONING
Photon emission for (n,2p)

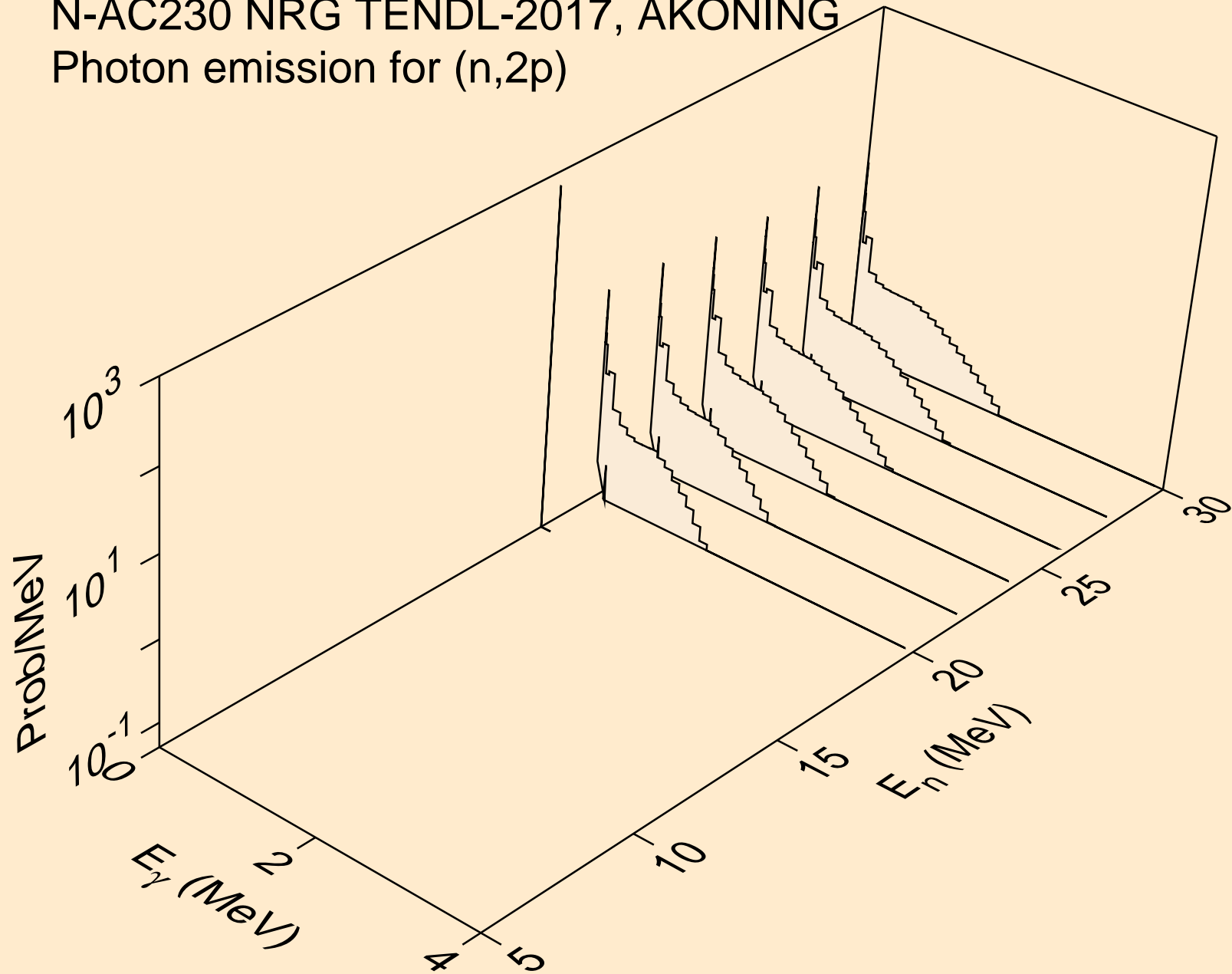

N-AC230 NRG TENDL-2017, AKONING
thermal capture photon spectrum

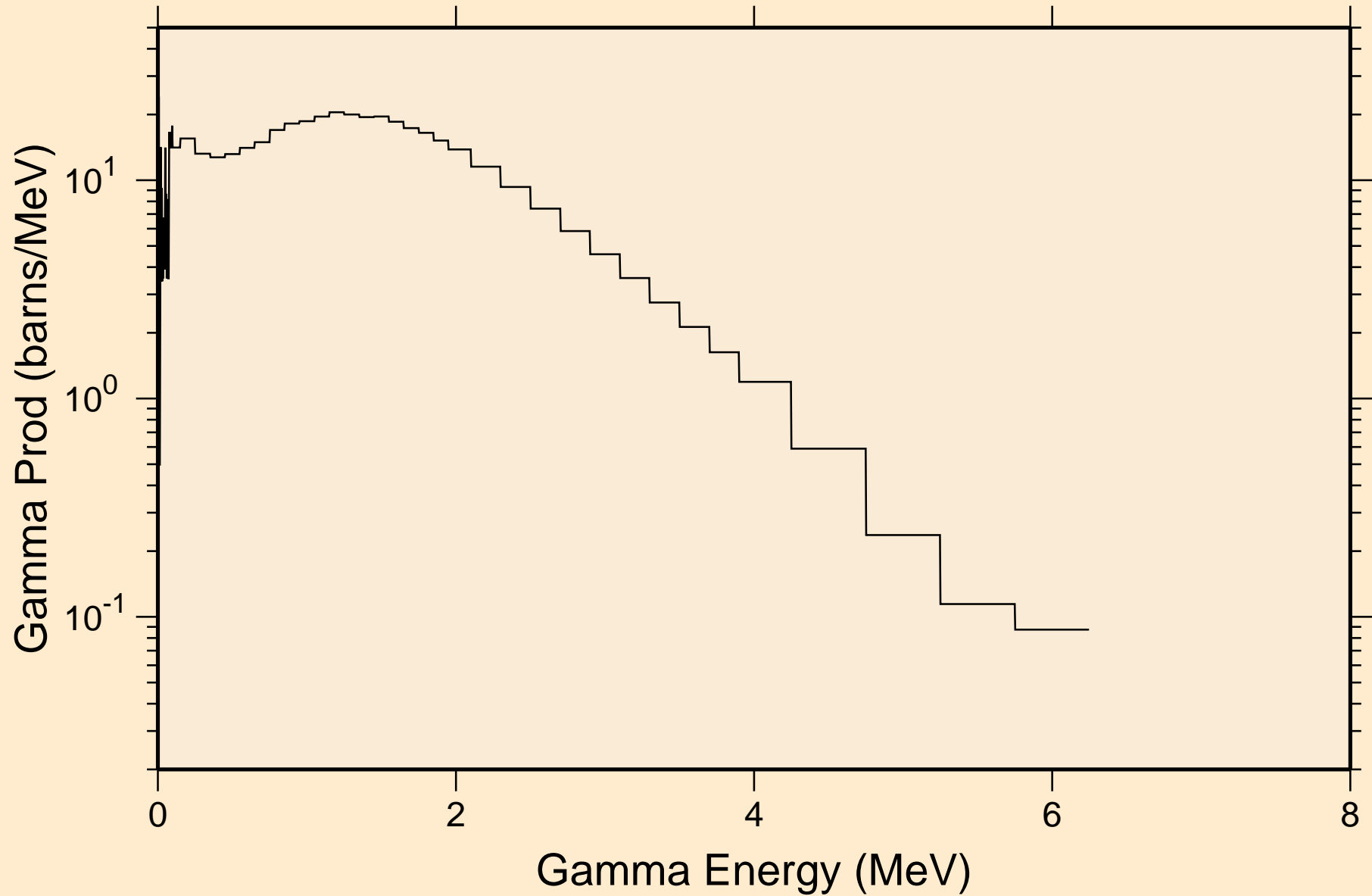

N-AC230 NRG TENDL-2017, AKONING
14 MeV photon spectrum

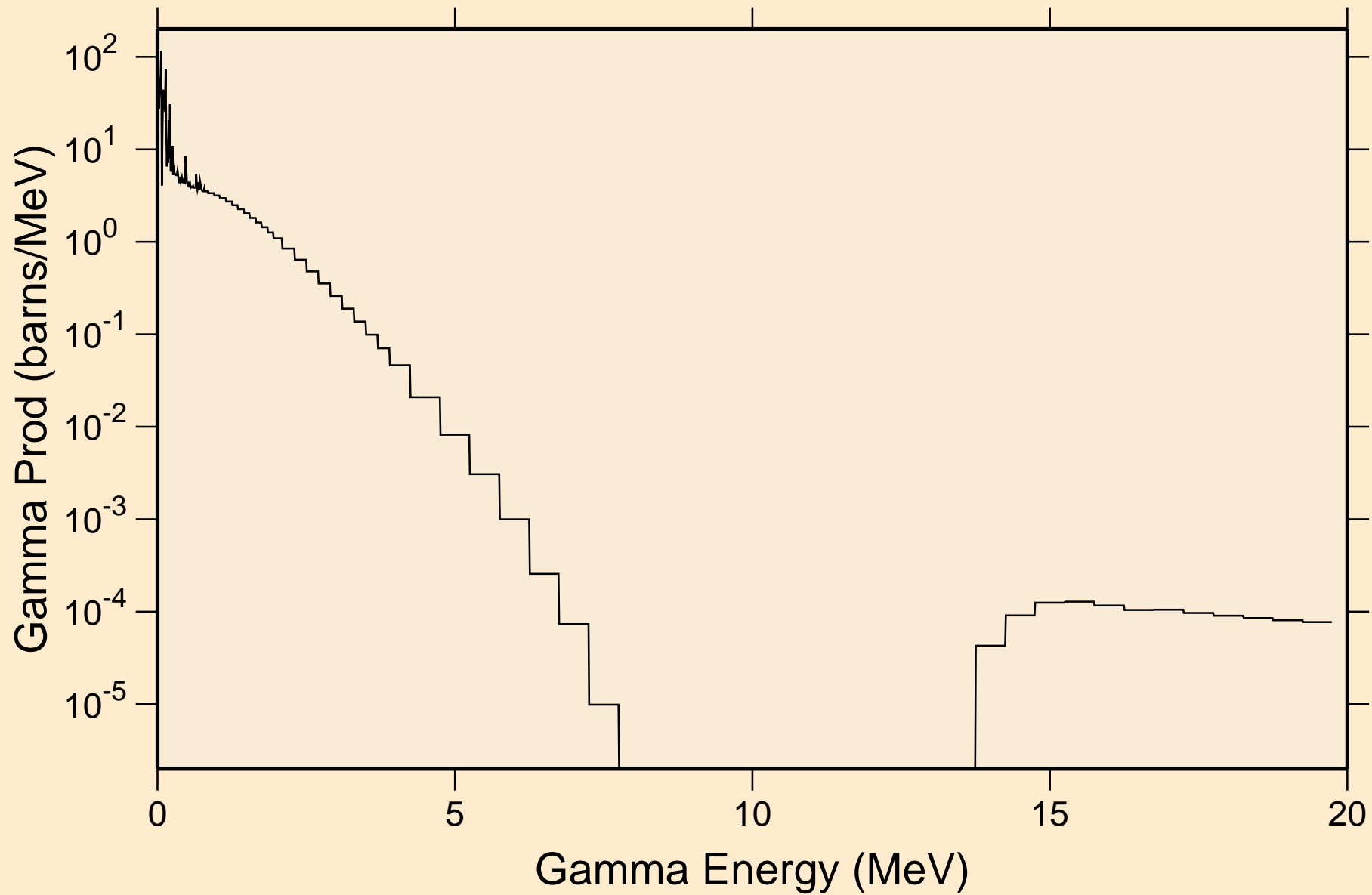

N-AC230 NRG TENDL-2017, AKONING

Particle heating contributions

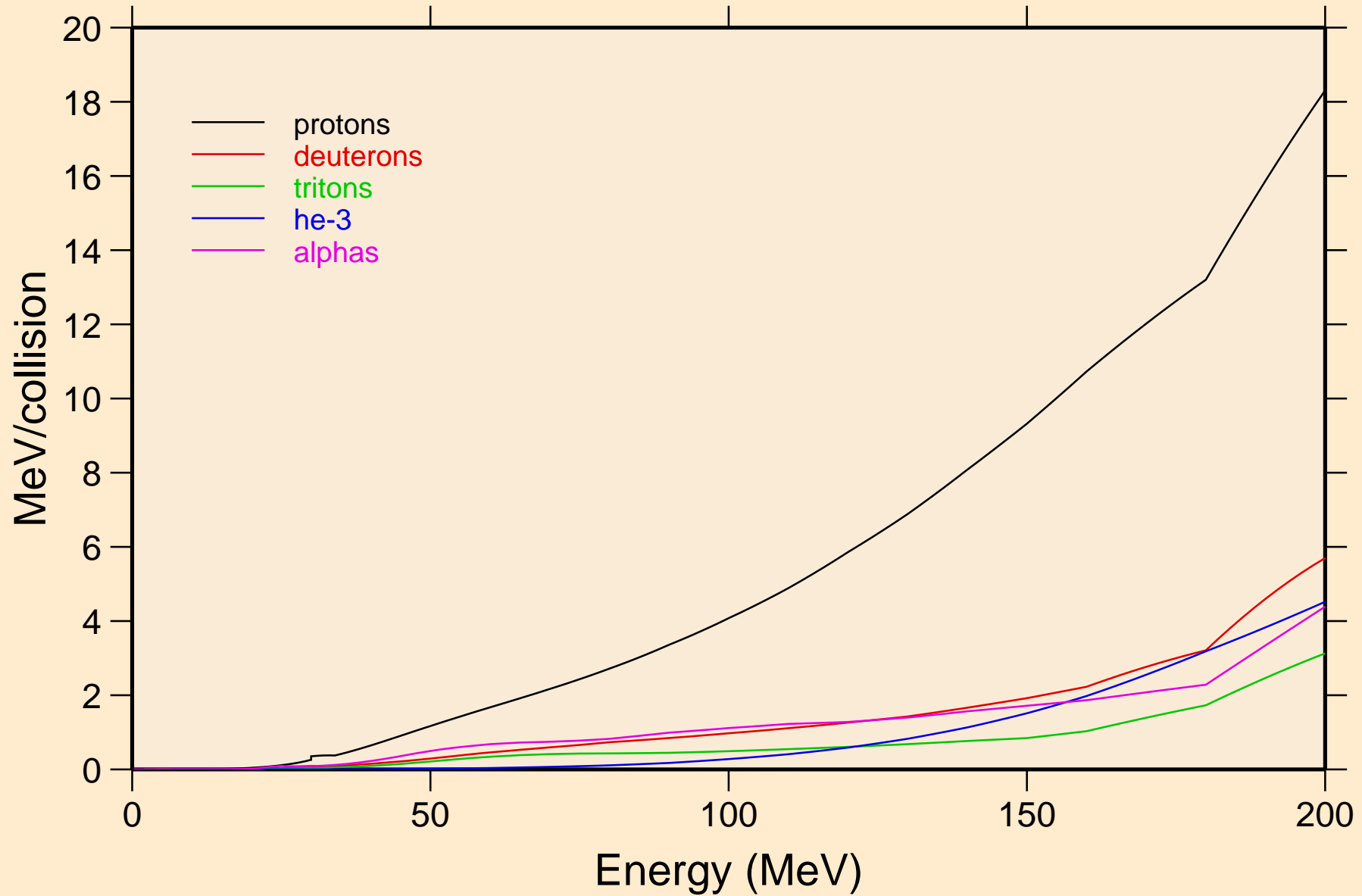

N-AC230 NRG TENDL-2017, AKONING

Recoil Heating

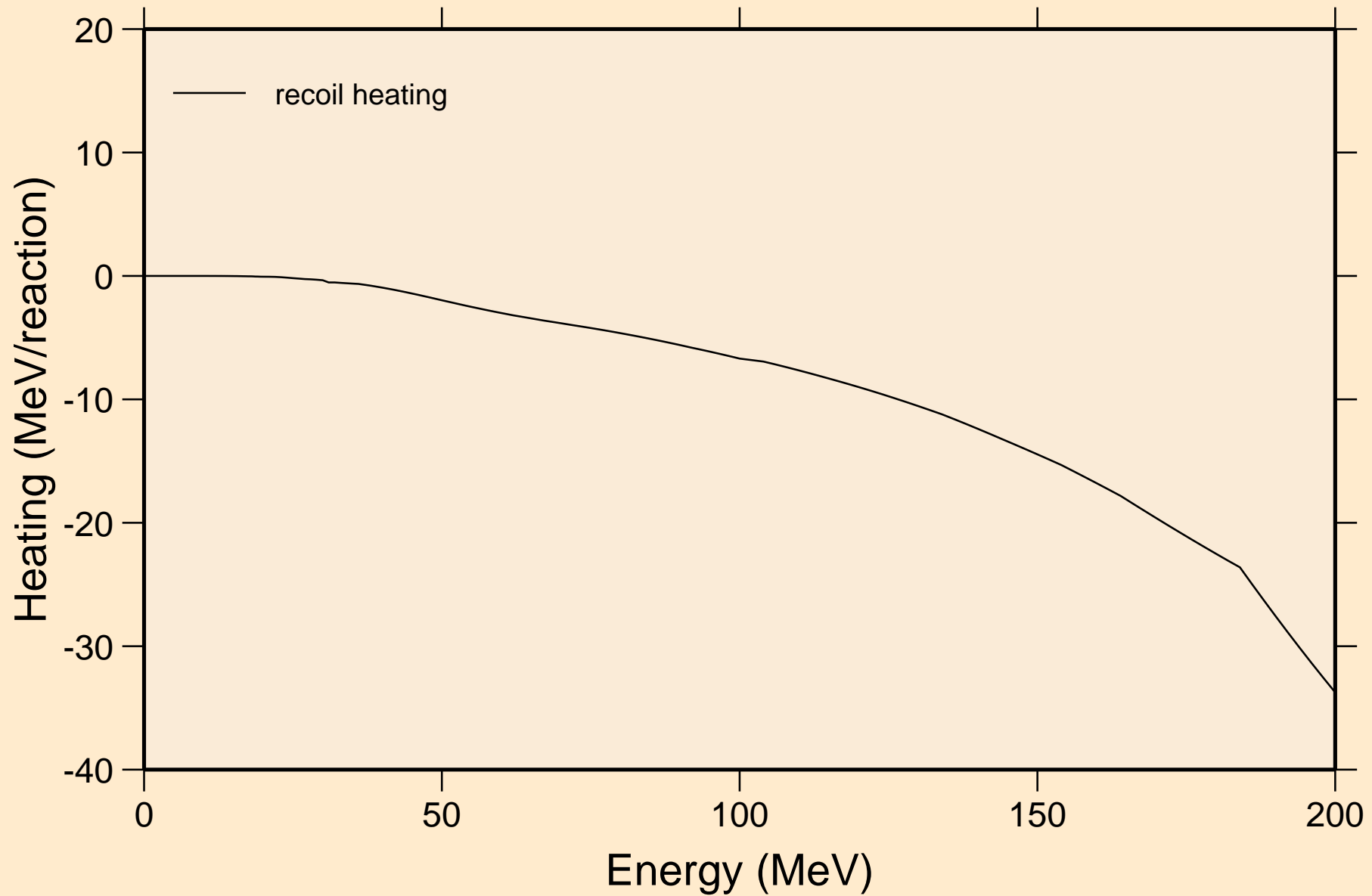

N-AC230 NRG TENDL-2017, AKONING

Particle production cross sections

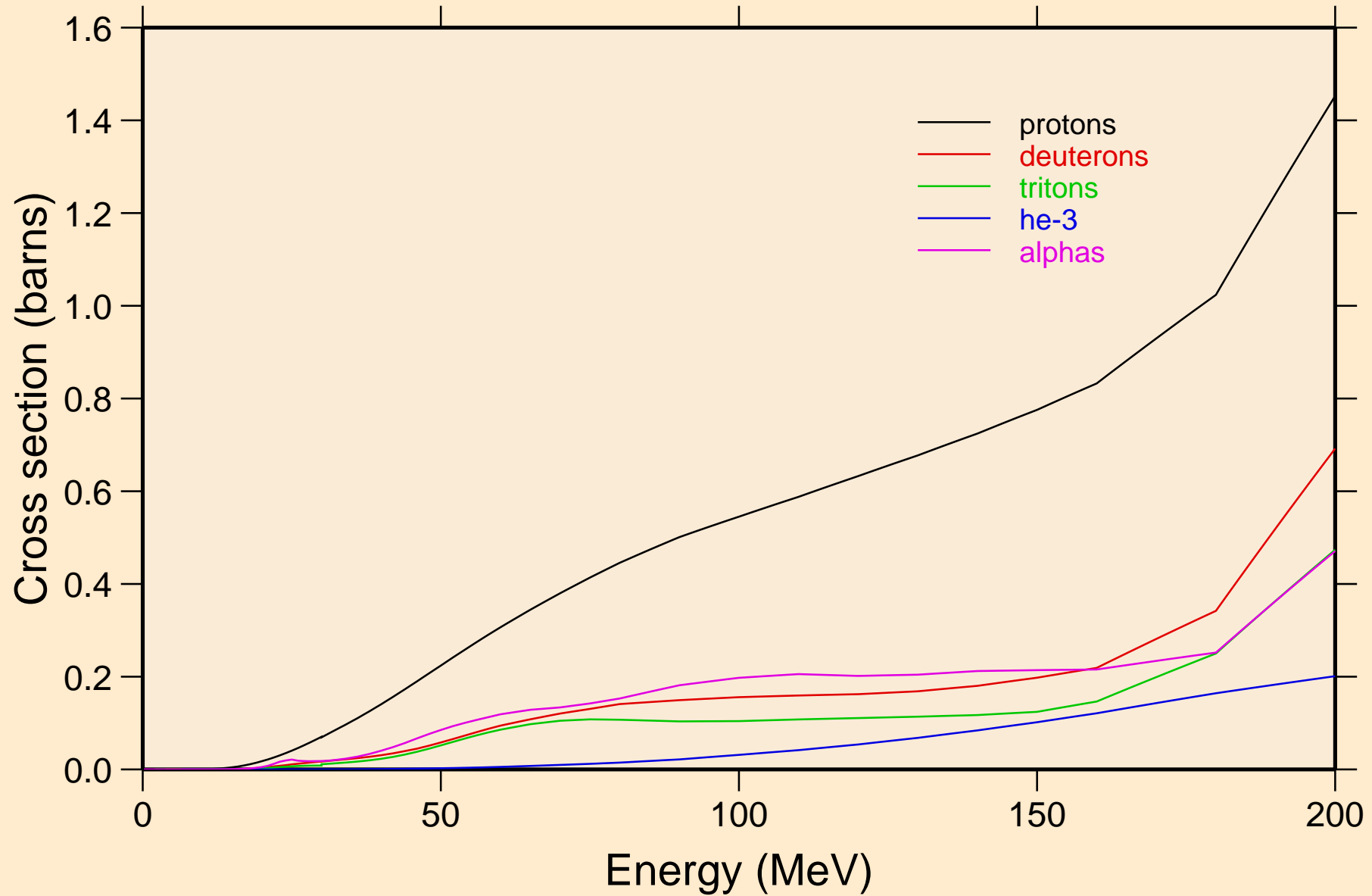

N-AC230 NRG TENDL-2017, AKONING
protons from (n,x)

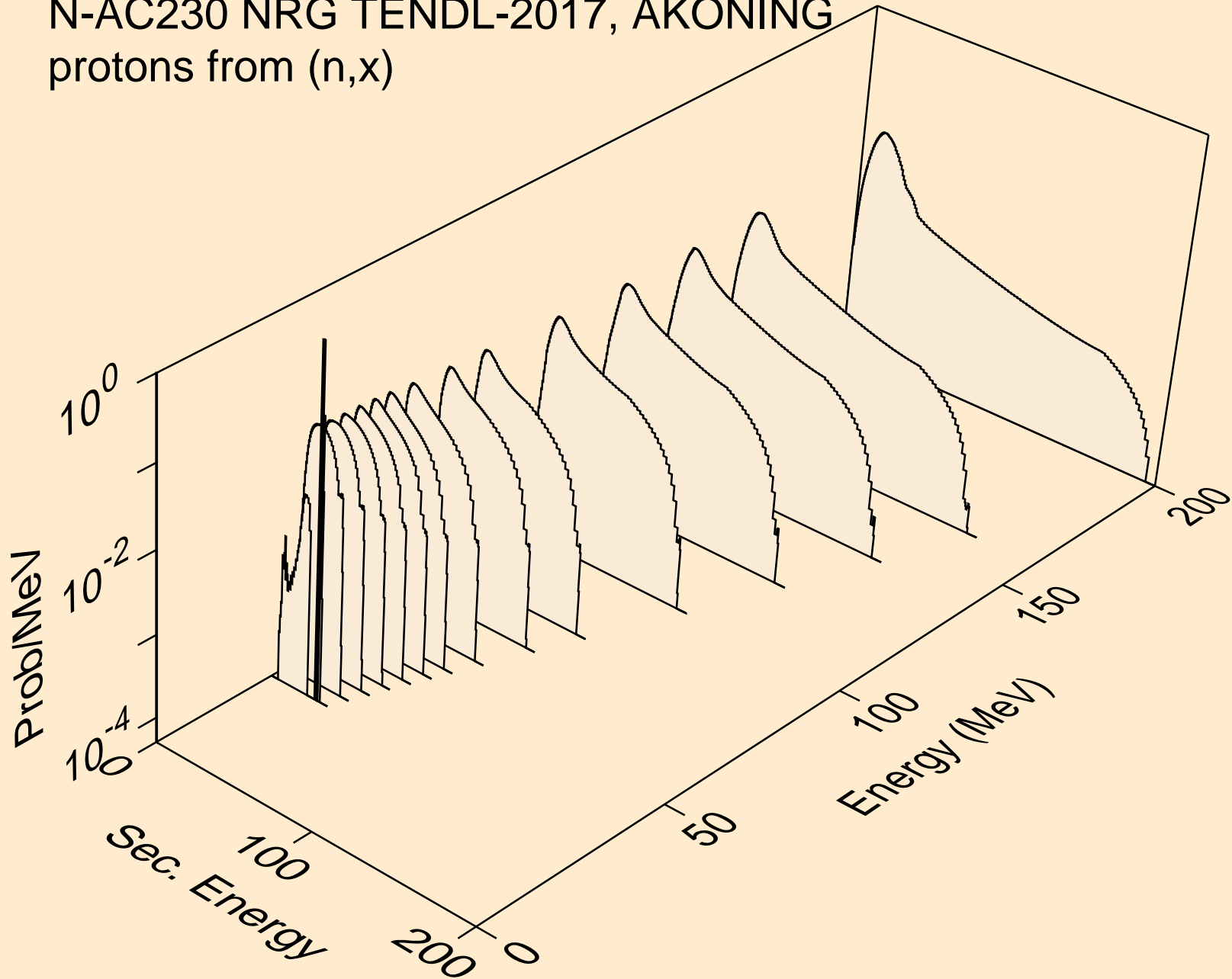

N-AC230 NRG TENDL-2017, AKONING
protons from (n,n*)p

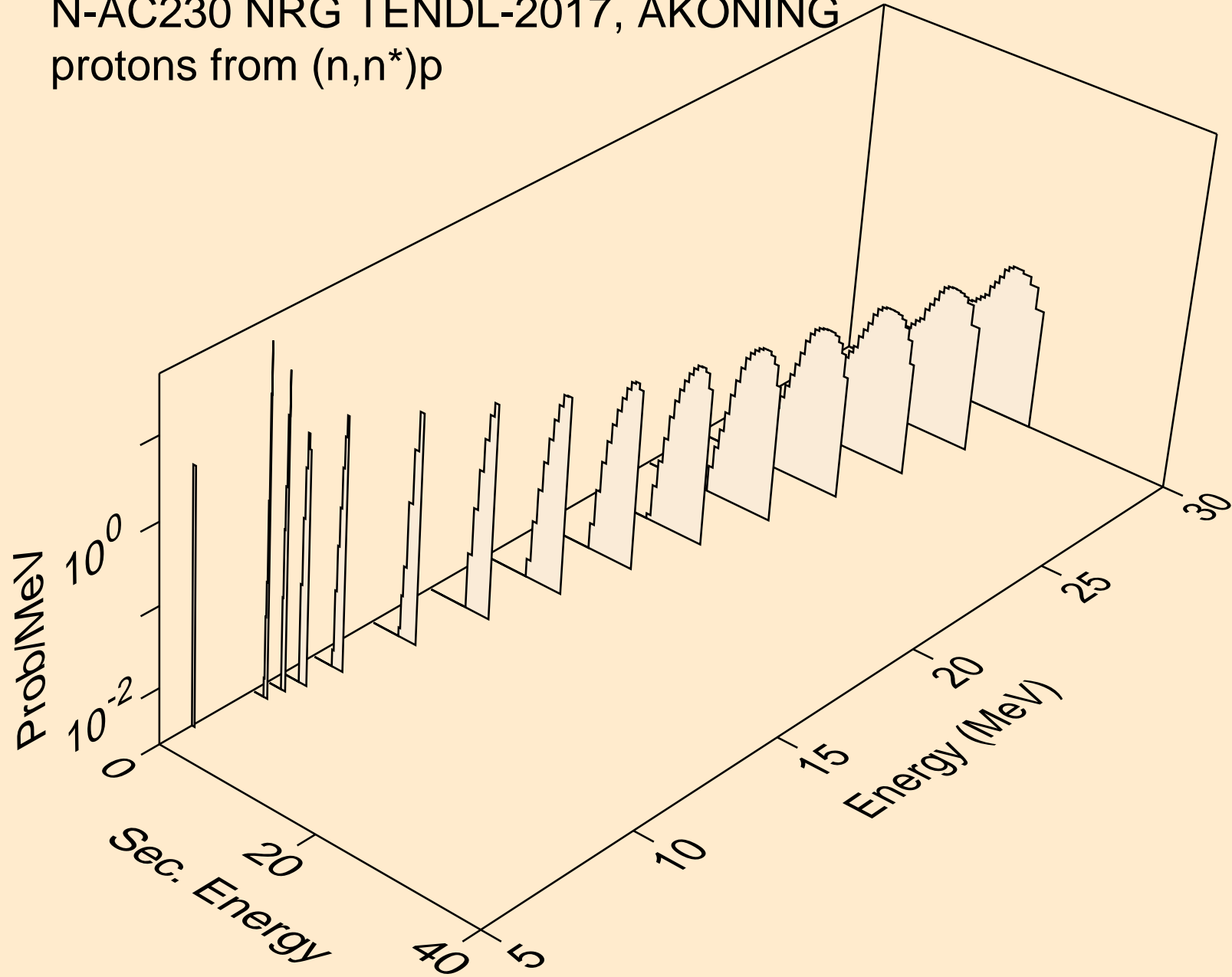

N-AC230 NRG TENDL-2017, AKONING
protons from (n,2np)

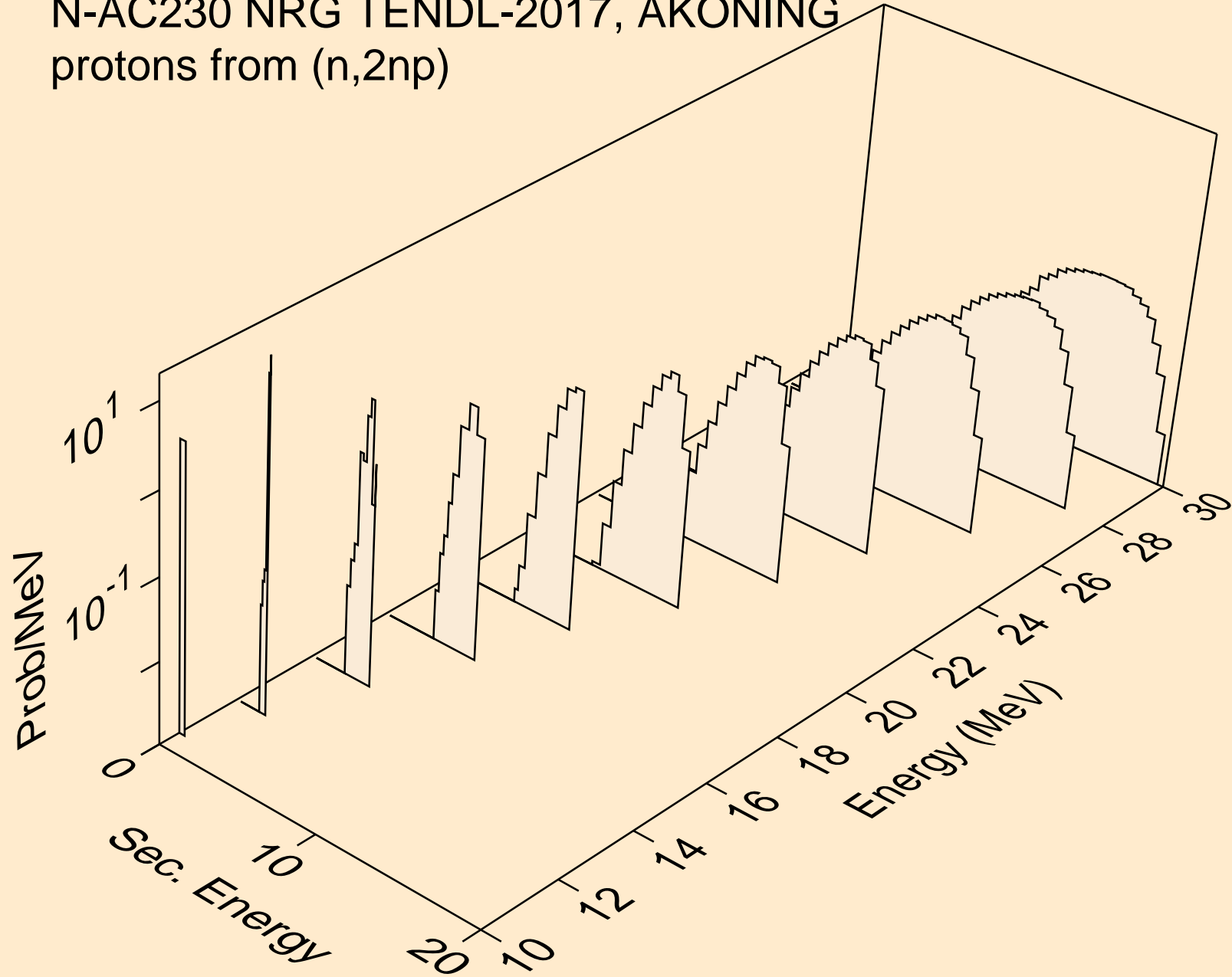

N-AC230 NRG TENDL-2017, AKONING
protons from (n,3np)

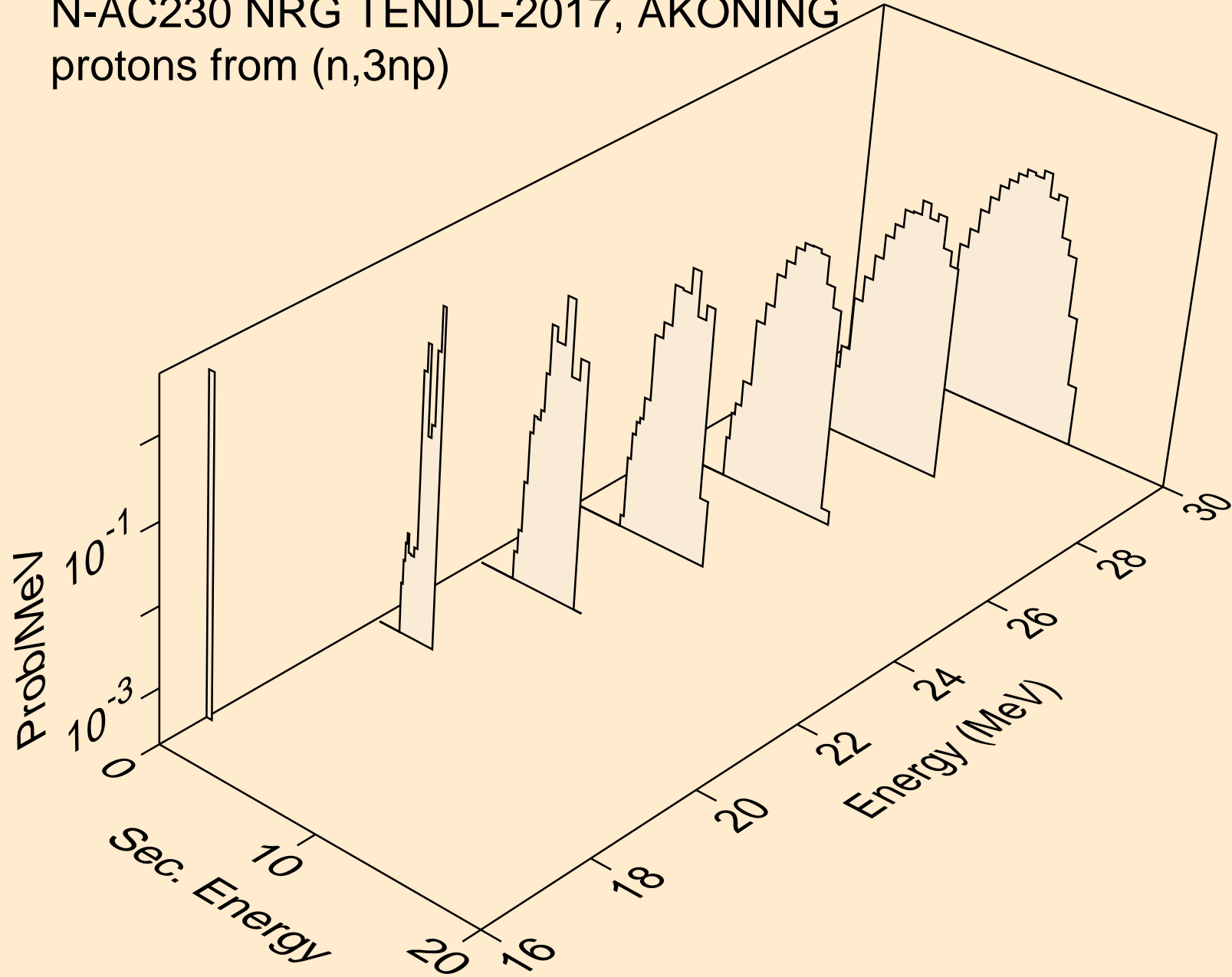

N-AC230 NRG TENDL-2017, AKONING
protons from (n,2np)

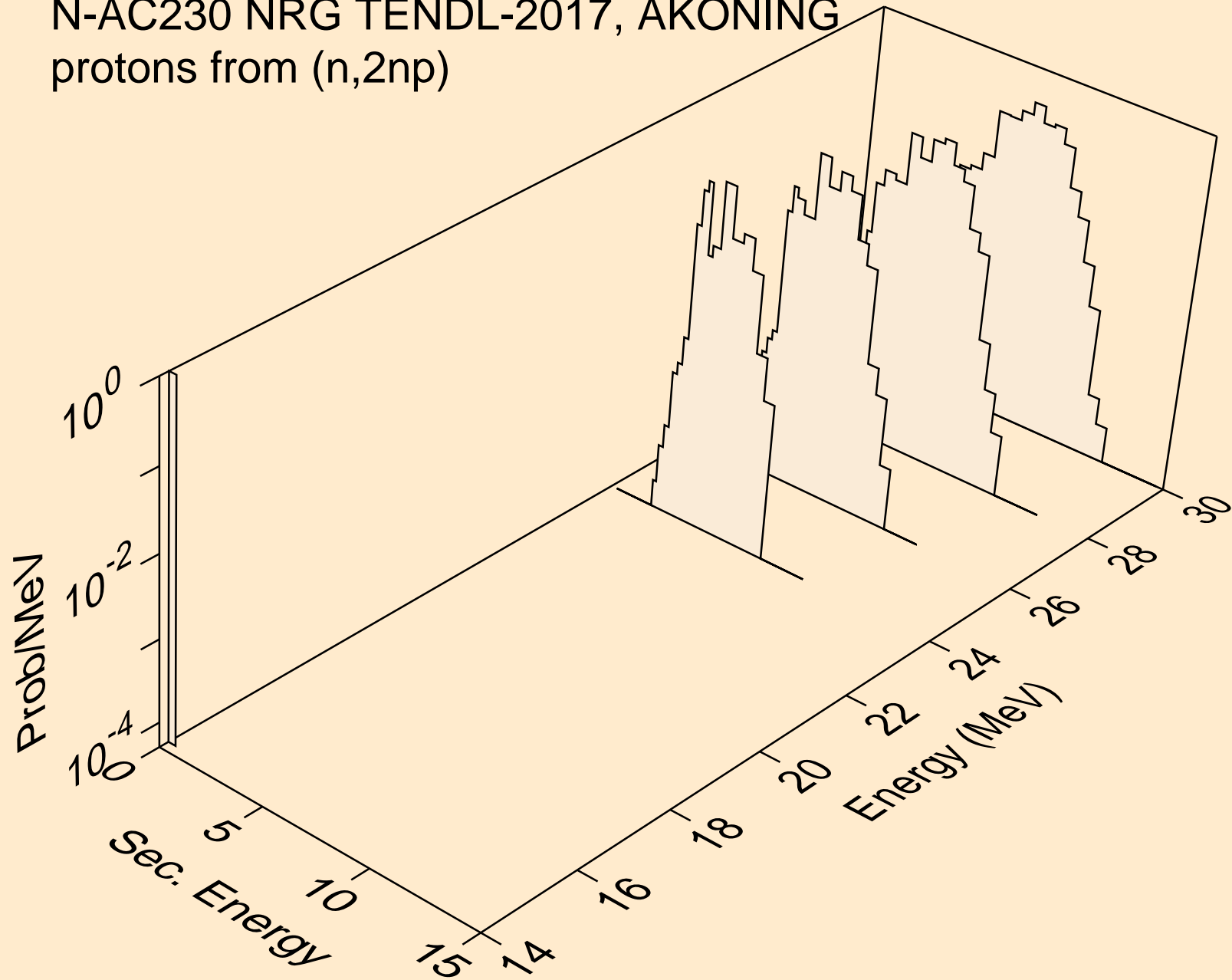

N-AC230 NRG TENDL-2017, AKONING
protons from (n,p)

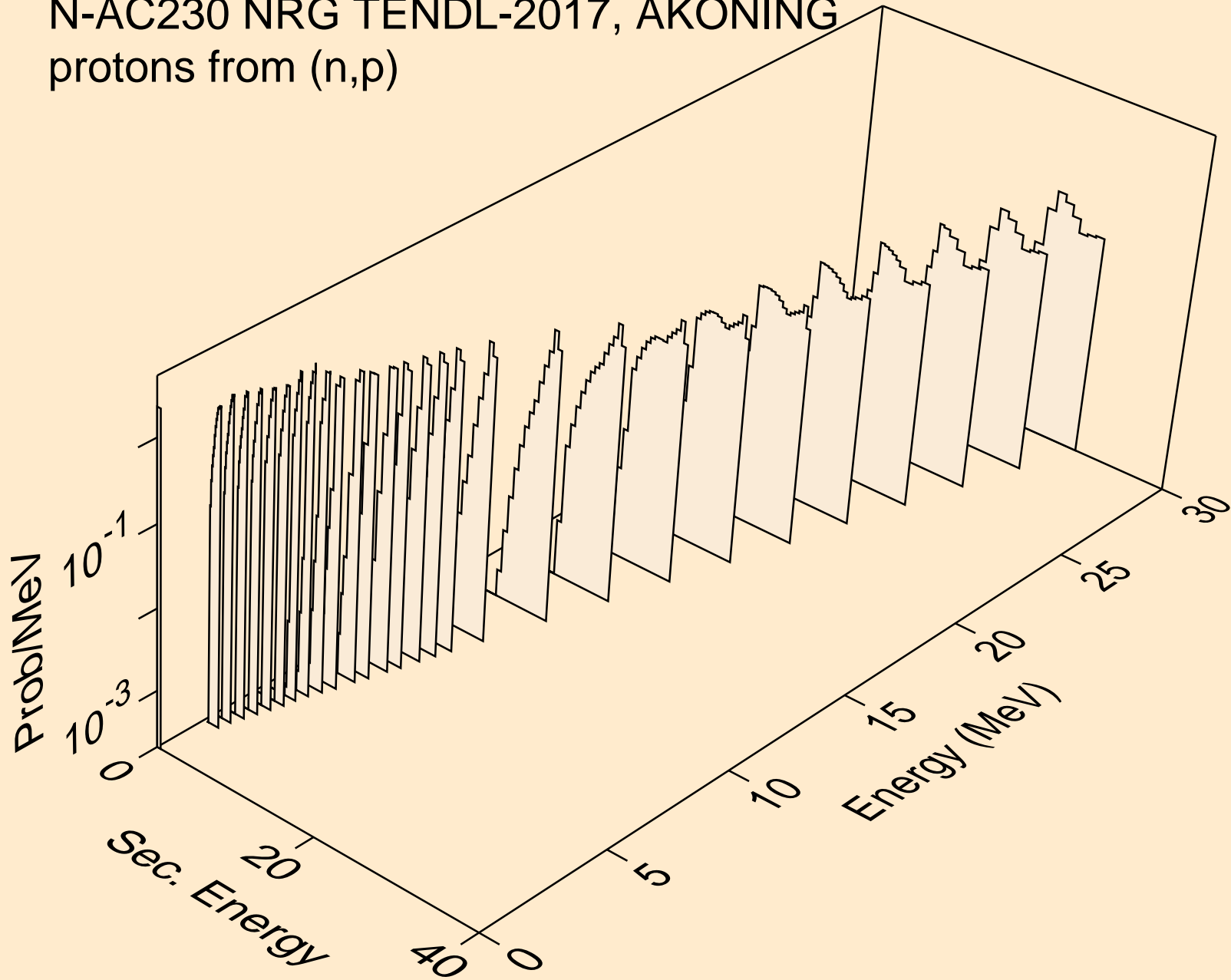

N-AC230 NRG TENDL-2017, AKONING
protons from (n,2p)

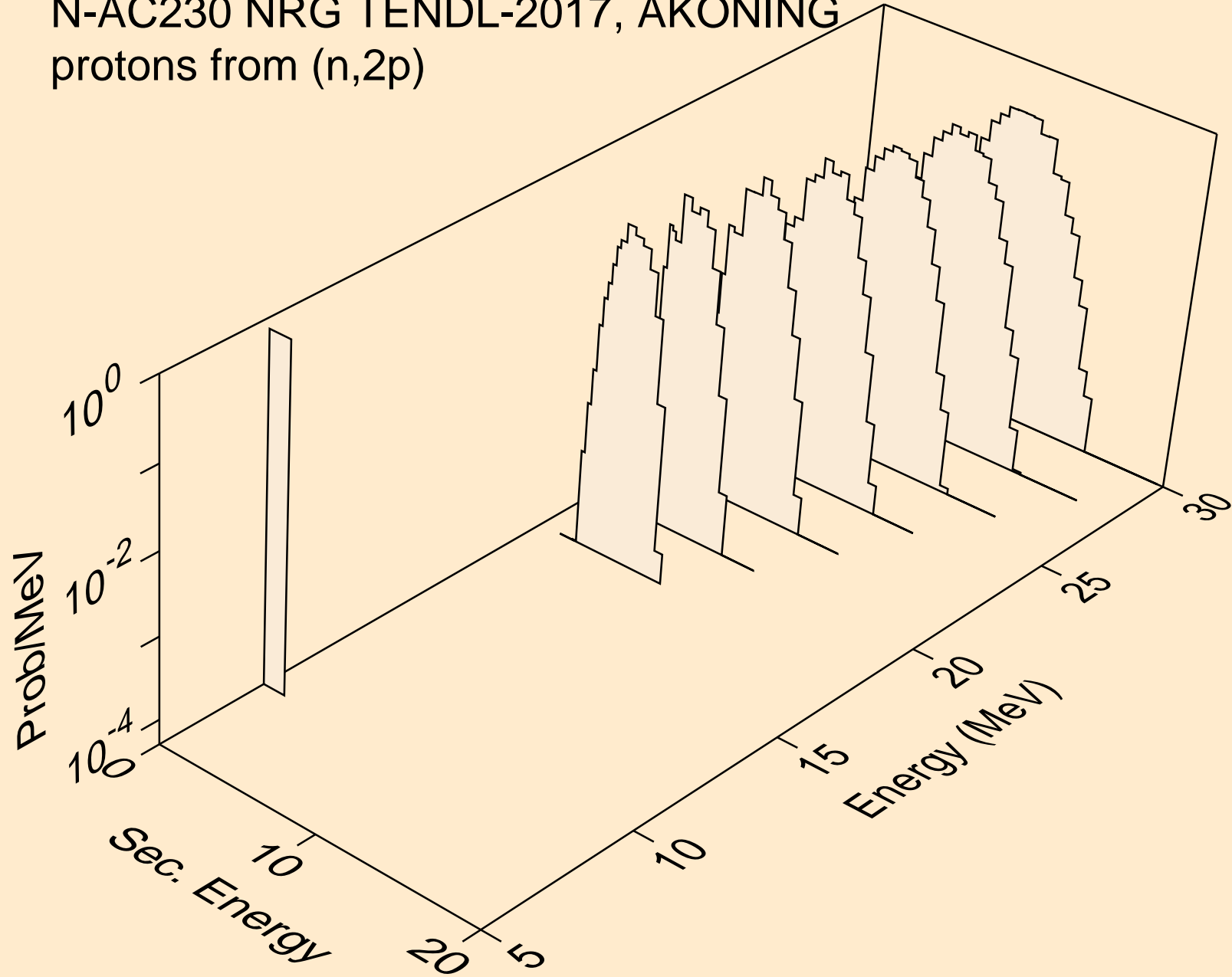

N-AC230 NRG TENDL-2017, AKONING
deuterons from (n,x)

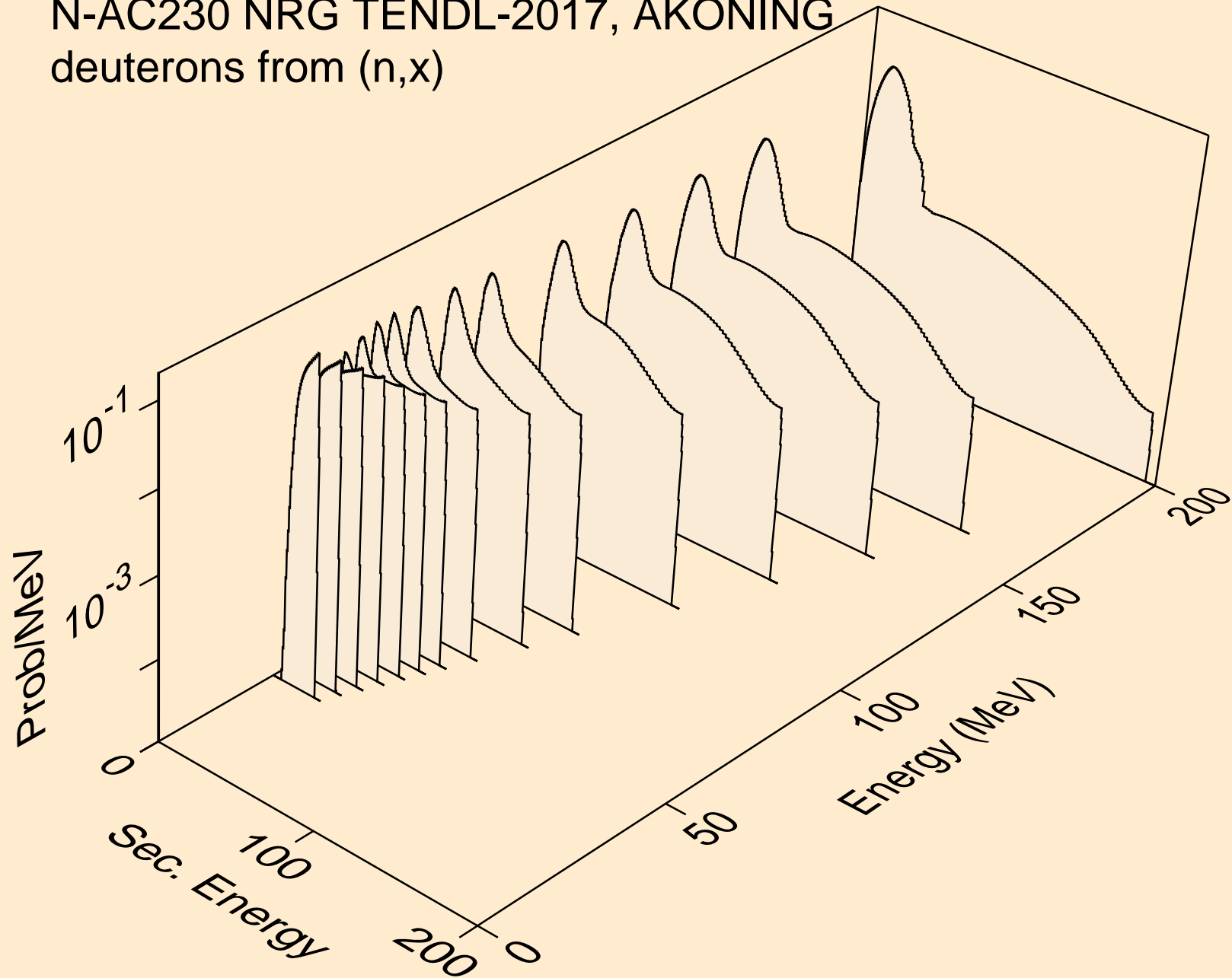

N-AC230 NRG TENDL-2017, AKONING
deuterons from (n,2nd)

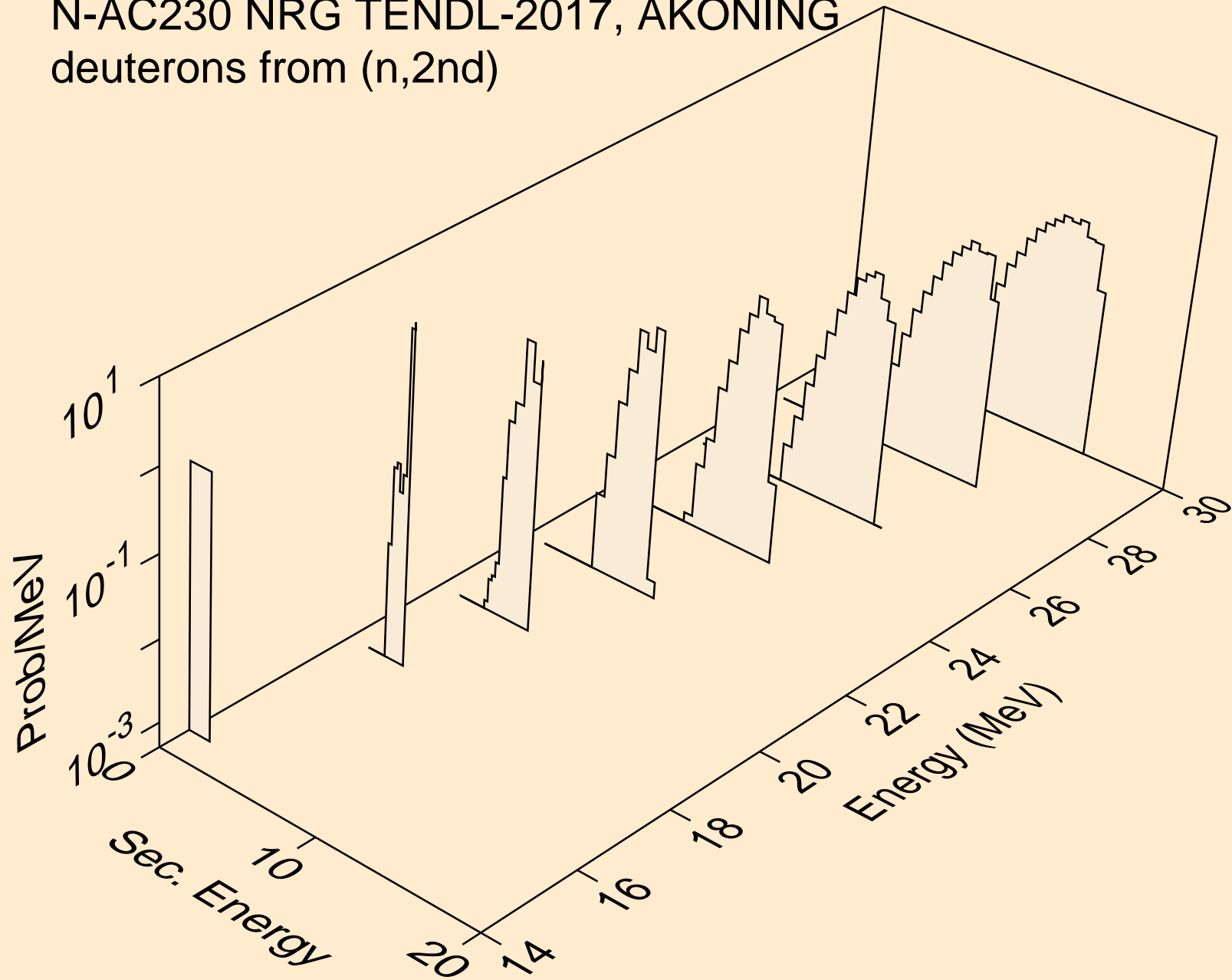

N-AC230 NRG TENDL-2017, AKONING
deuterons from (n,n*)d

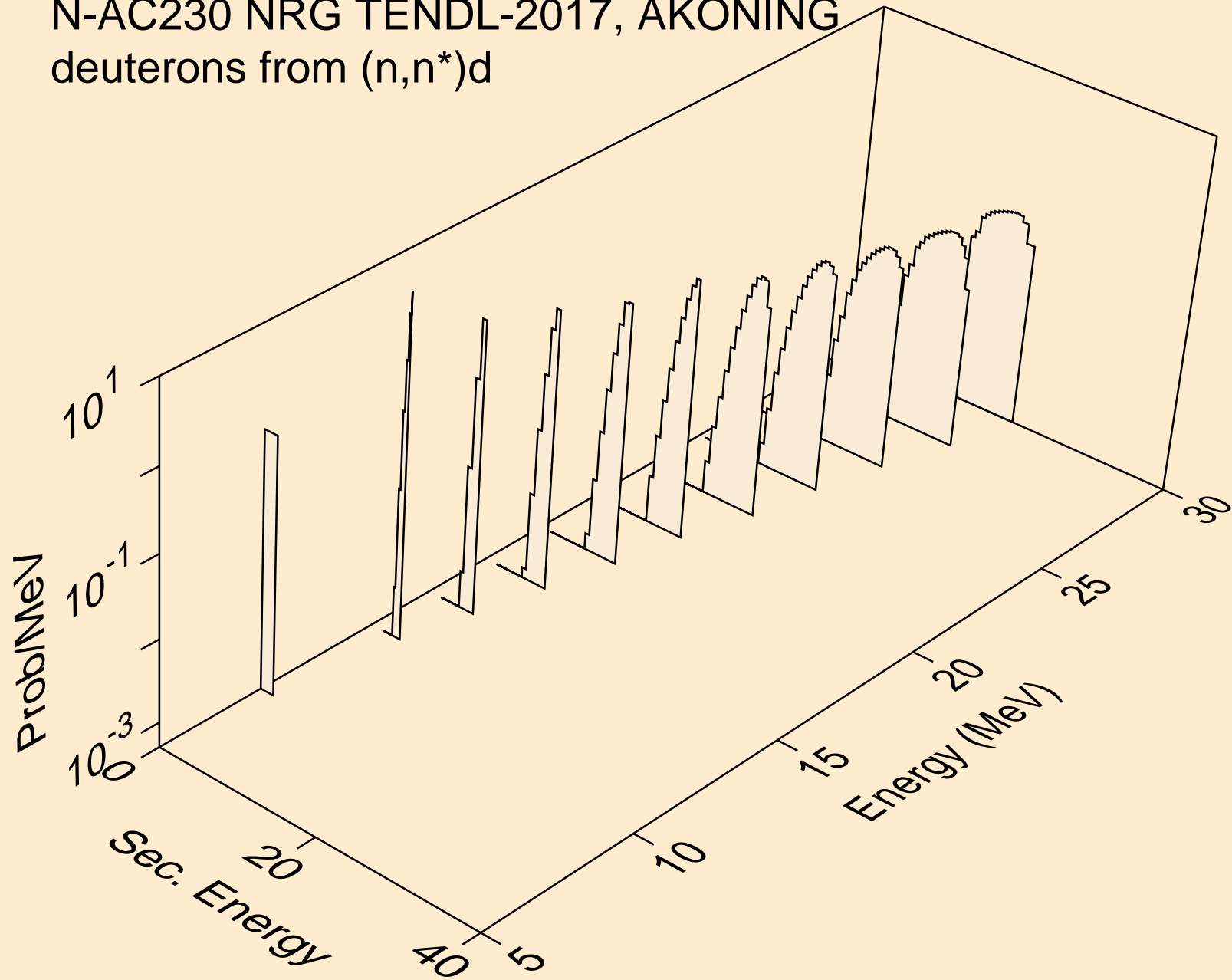

N-AC230 NRG TENDL-2017, AKONING
deuterons from (n,d)

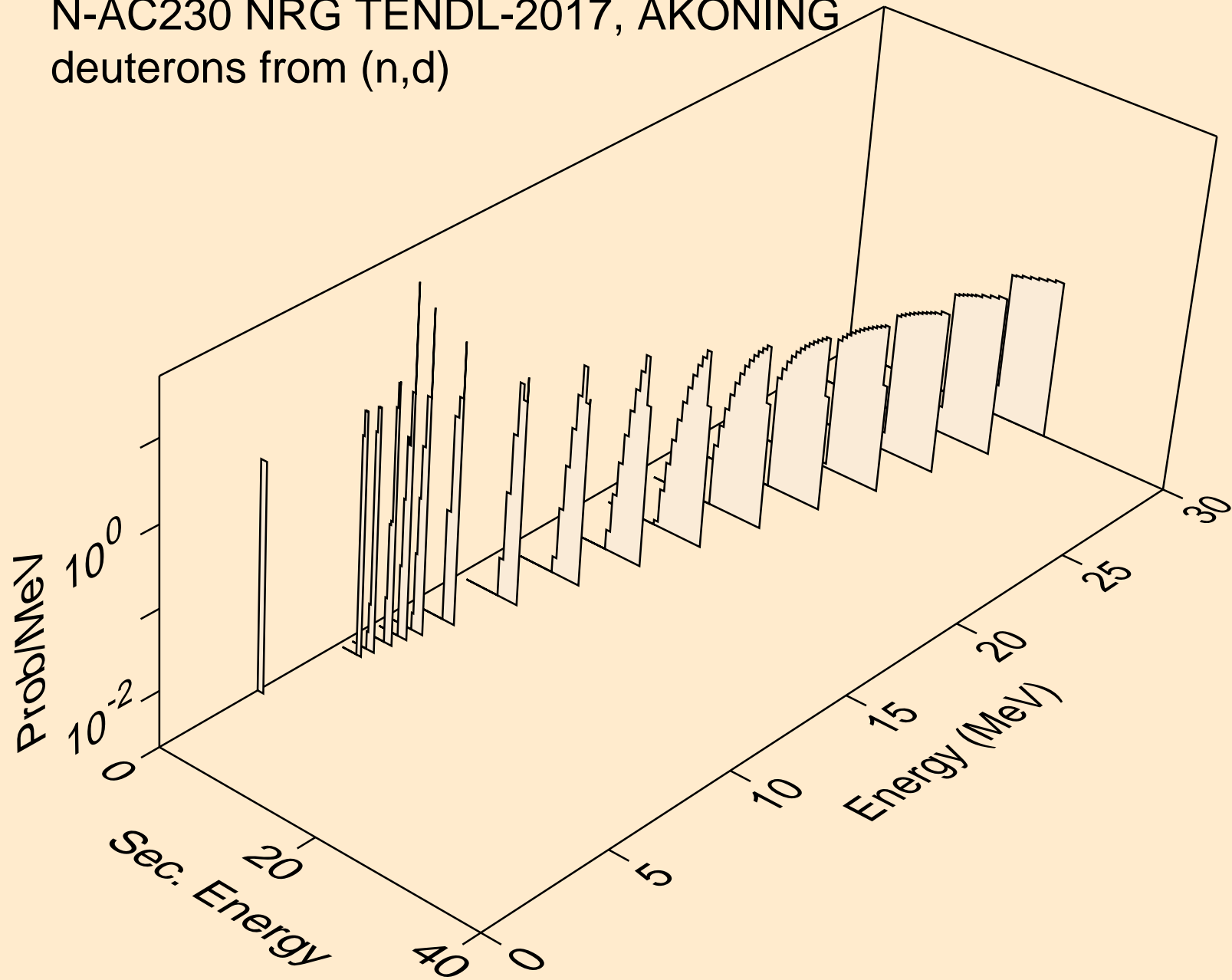

N-AC230 NRG TENDL-2017, AKONING
tritons from (n,x)

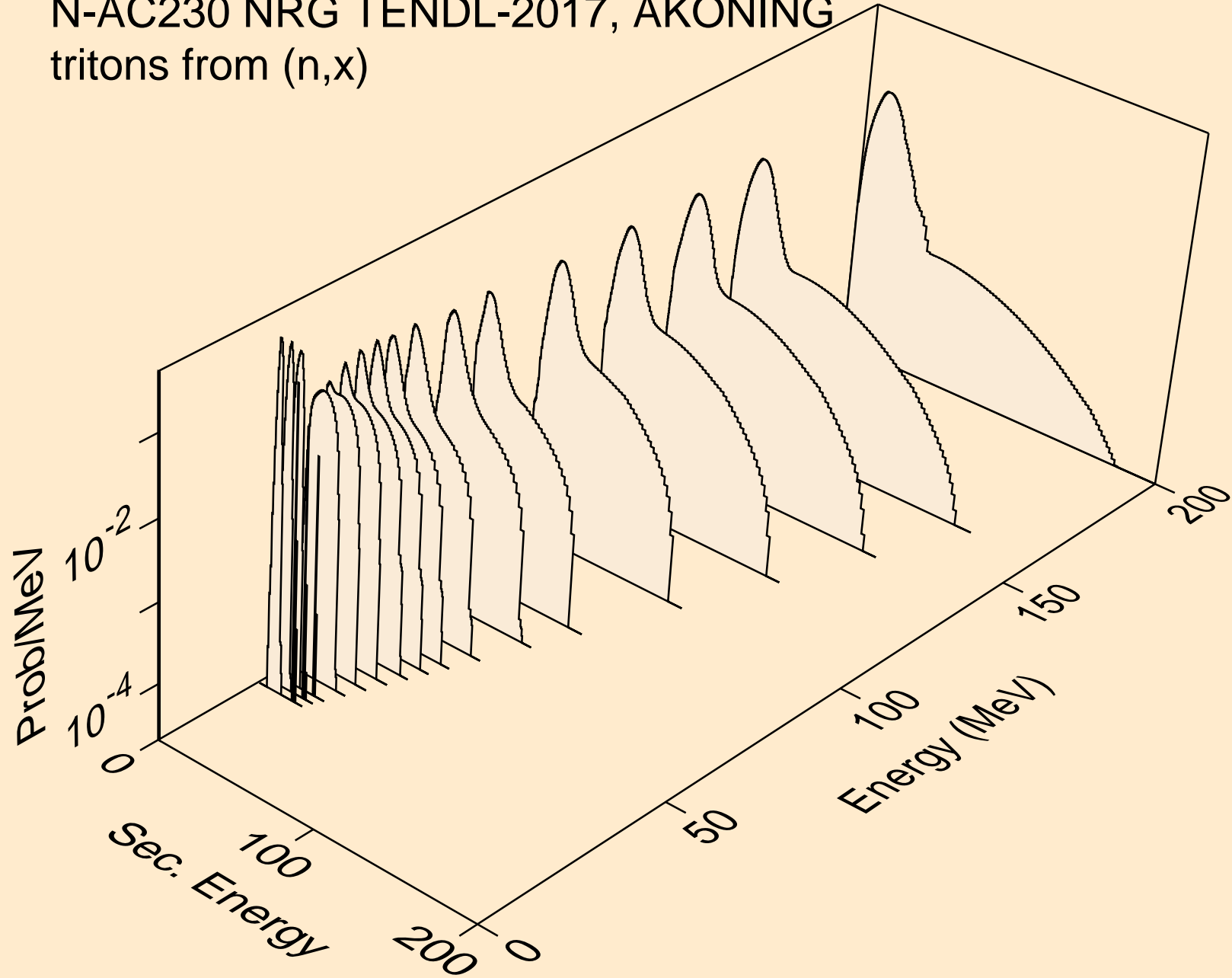

N-AC230 NRG TENDL-2017, AKONING
tritons from (n,n*)t

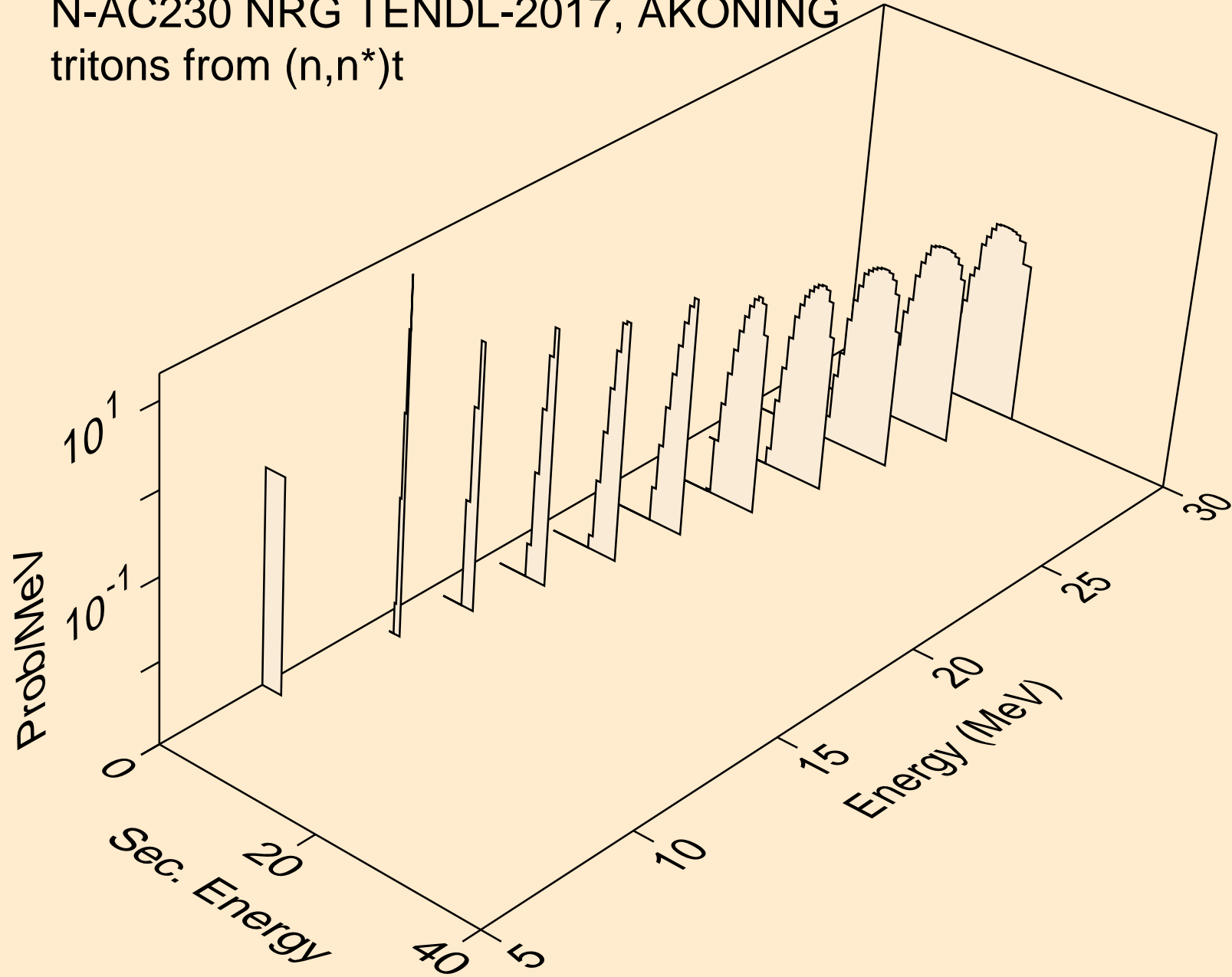

N-AC230 NRG TENDL-2017, AKONING
tritons from (n,t)

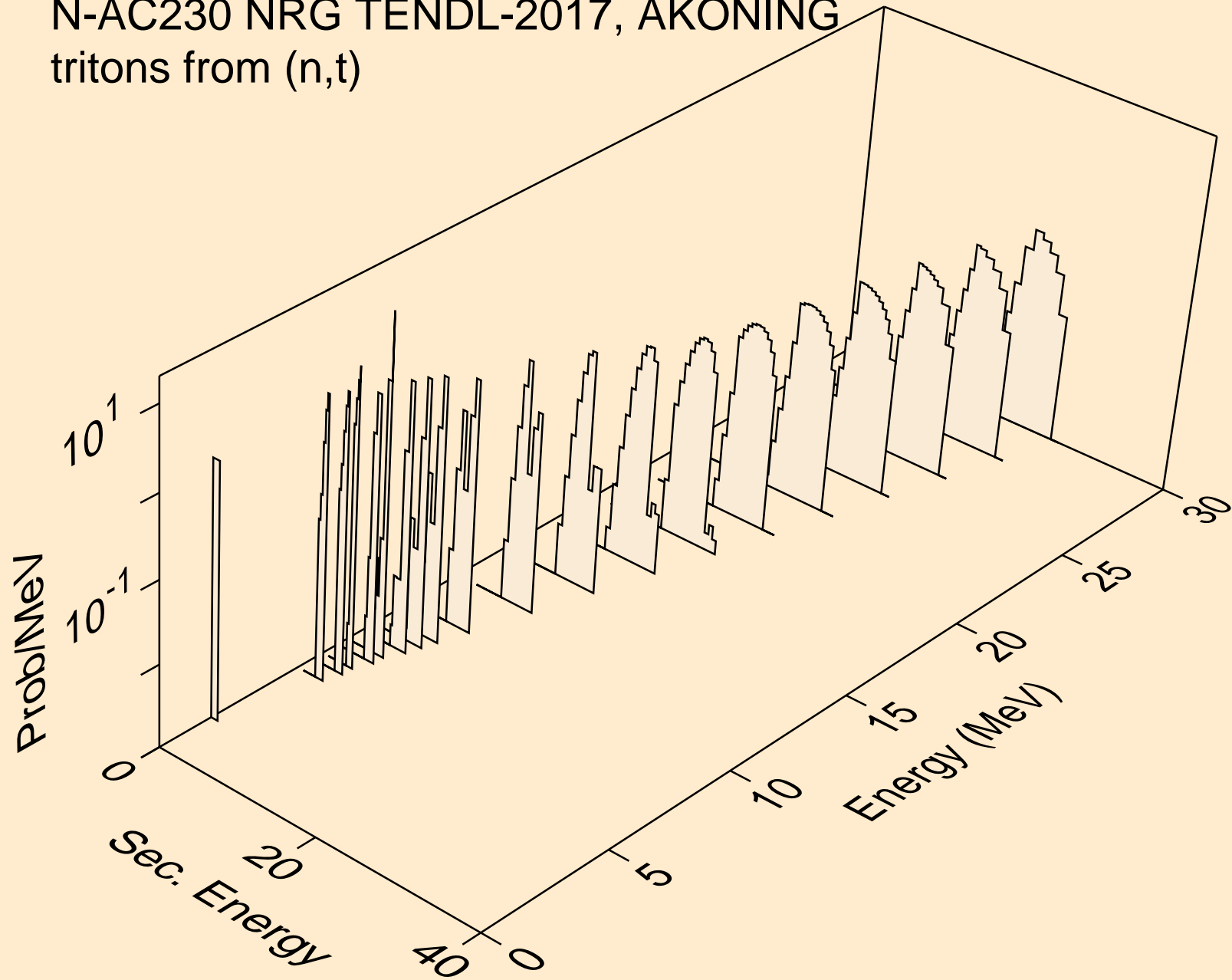

N-AC230 NRG TENDL-2017, AKONING
he3s from (n,x)

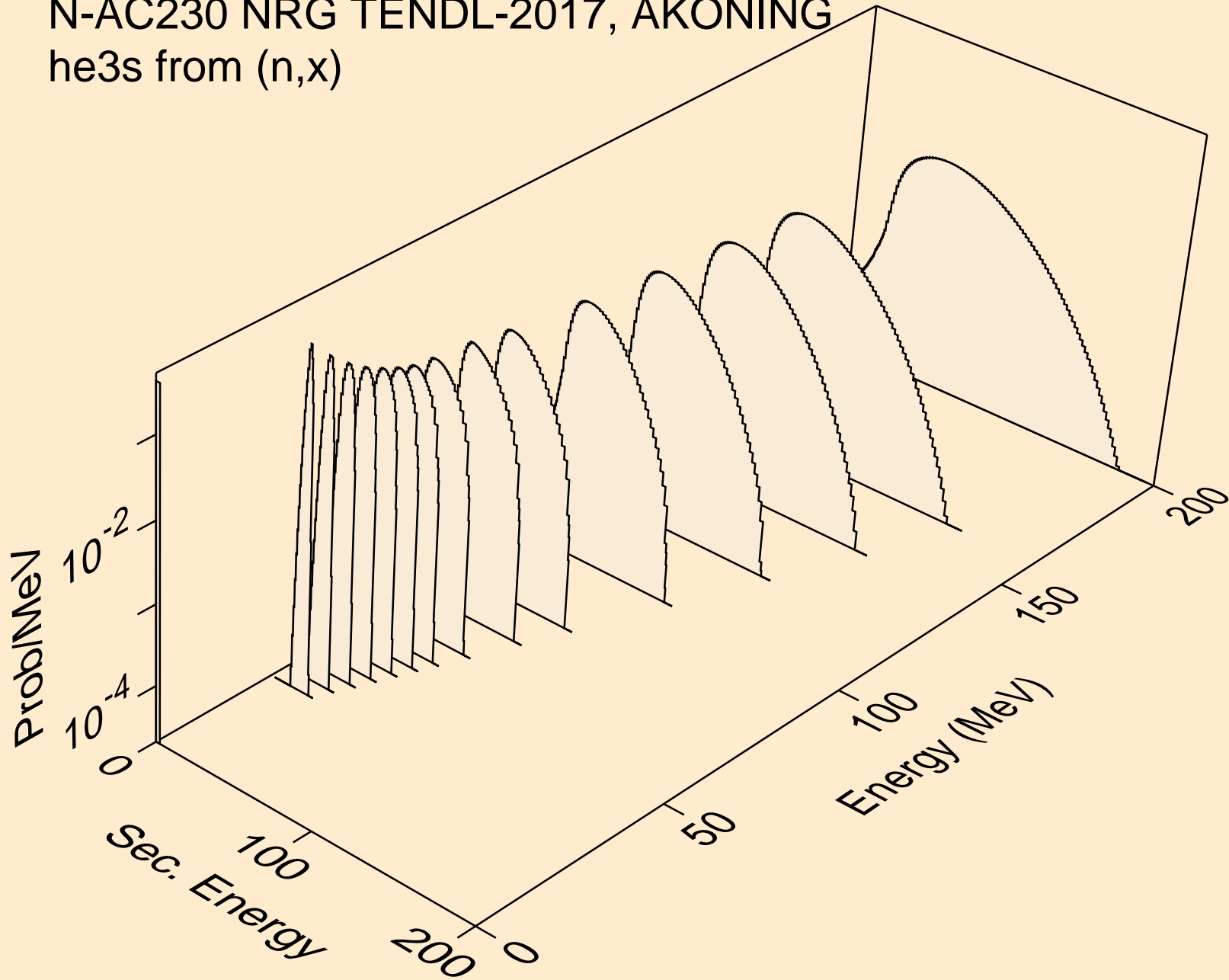

N-AC230 NRG TENDL-2017, AKONING
he3s from (n,n*)he3

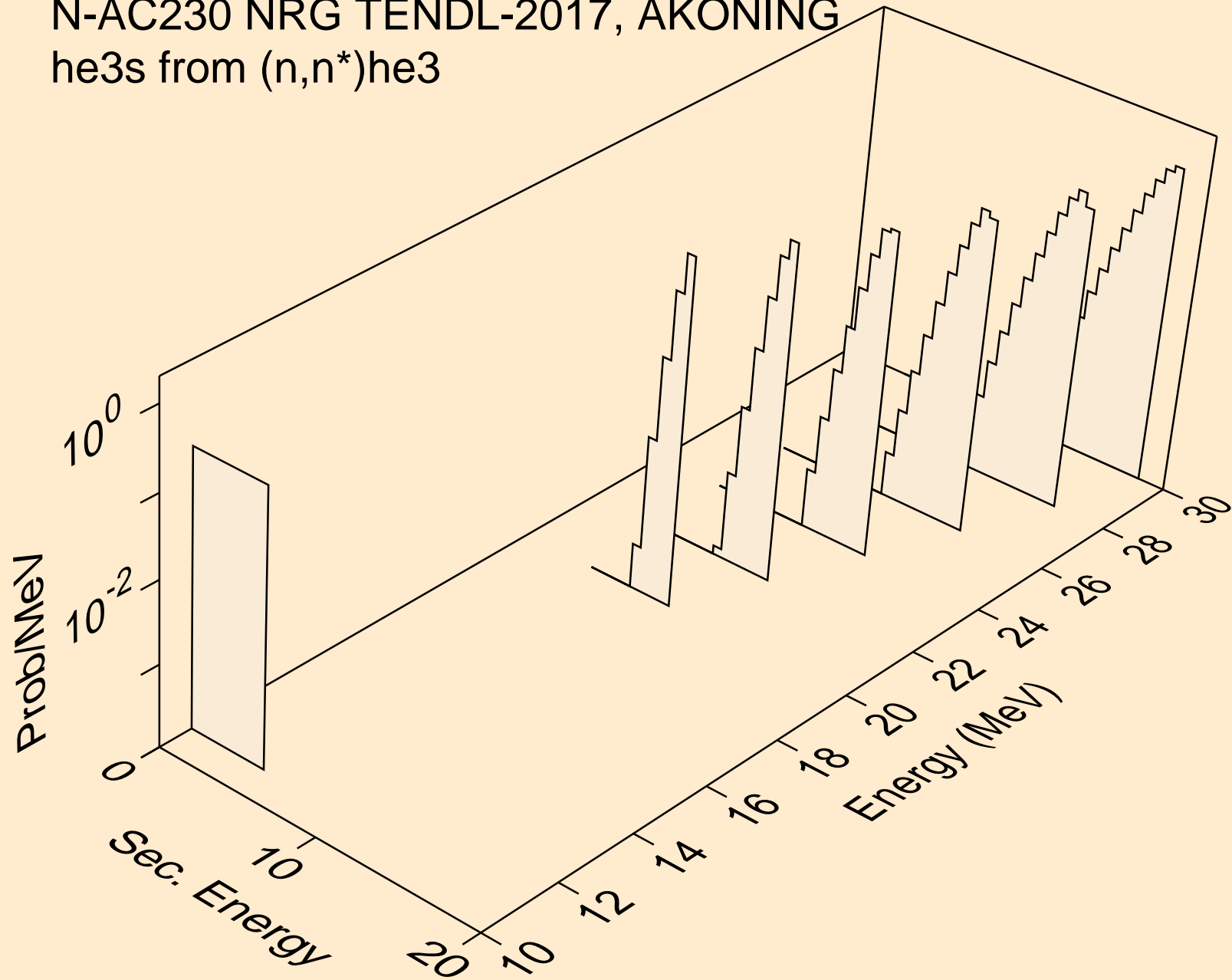

N-AC230 NRG TENDL-2017, AKONING
he3s from (n,he3)

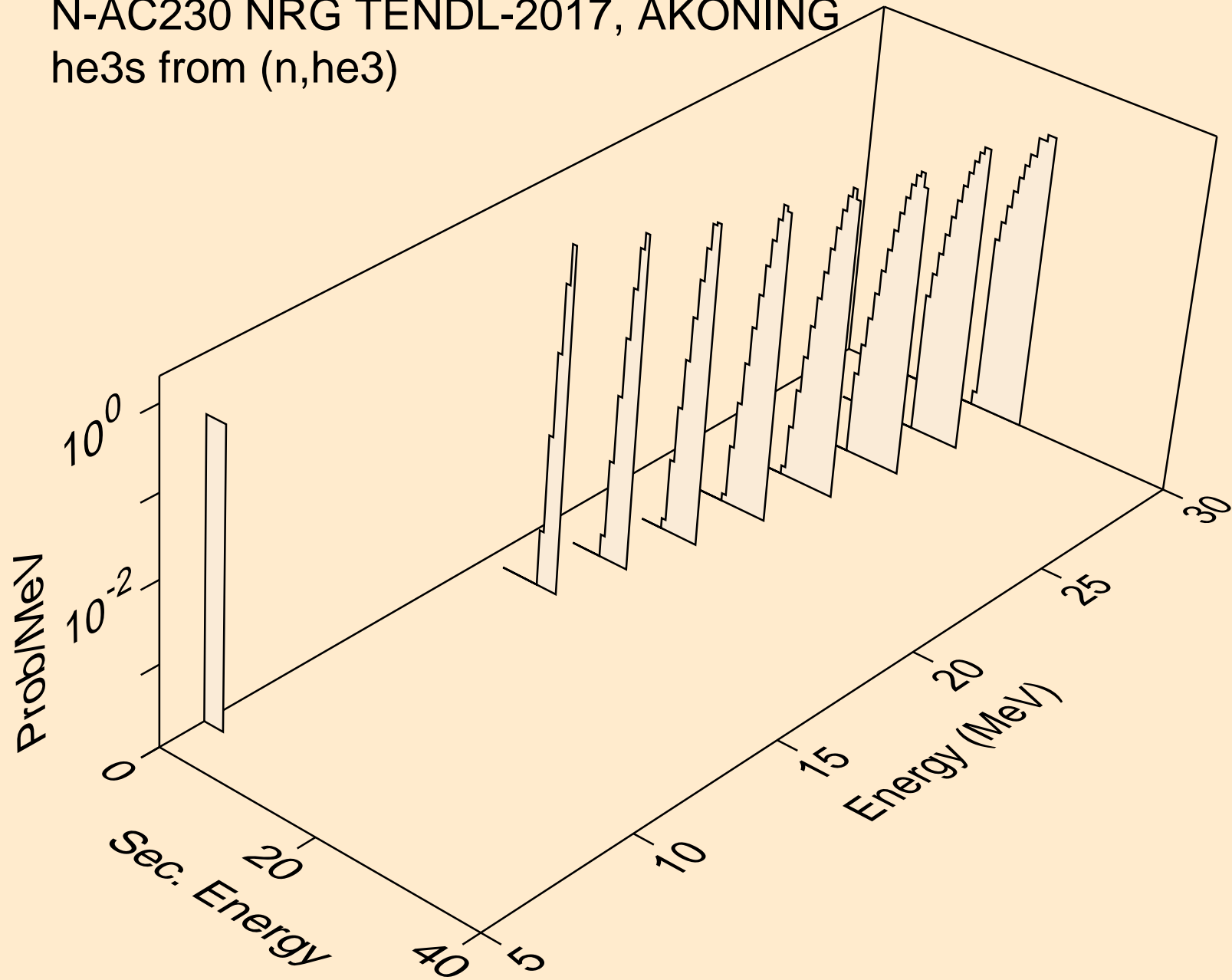

N-AC230 NRG TENDL-2017, AKONING
alphas from (n,x)

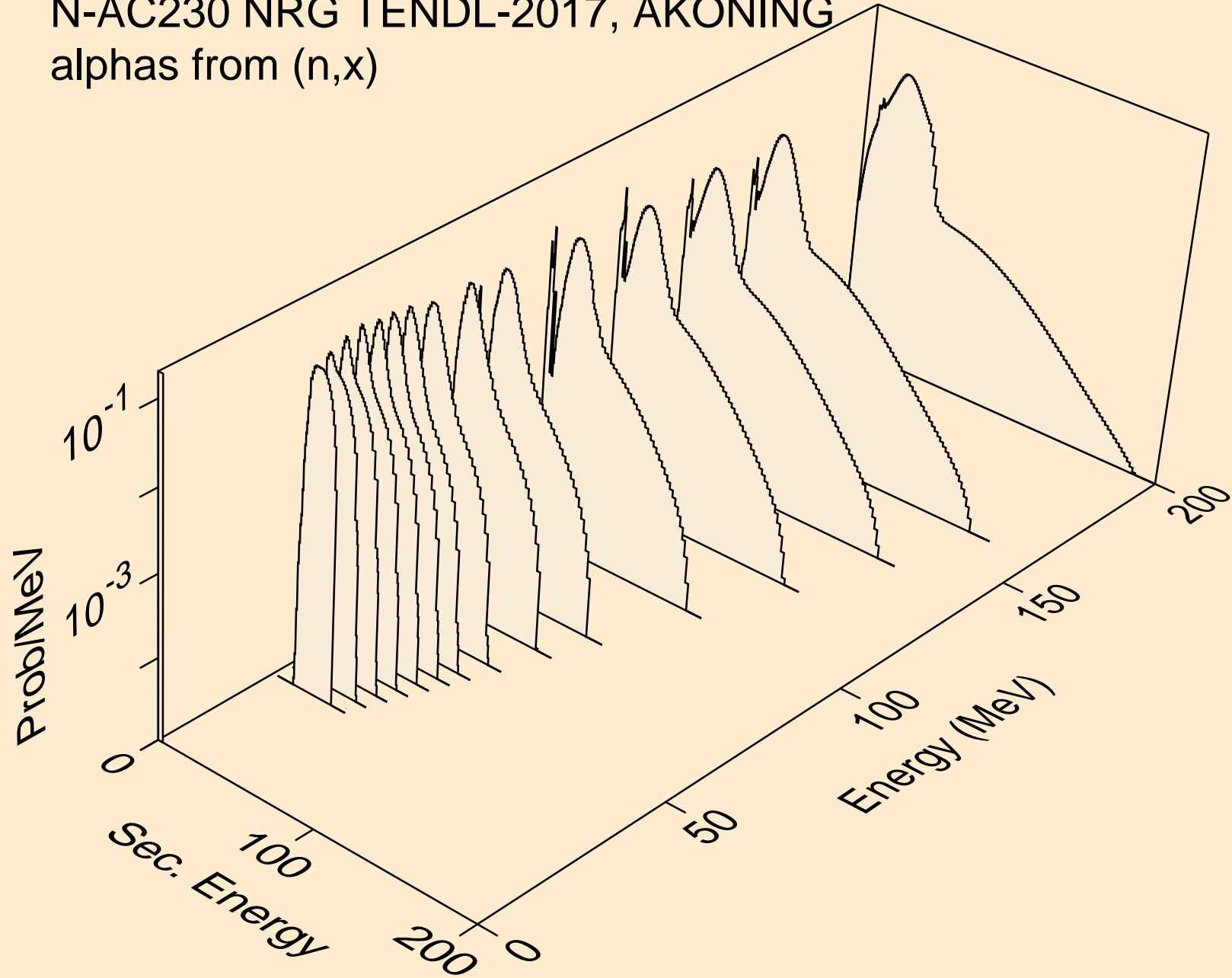

N-AC230 NRG TENDL-2017, AKONING
alphas from (n,n*)a

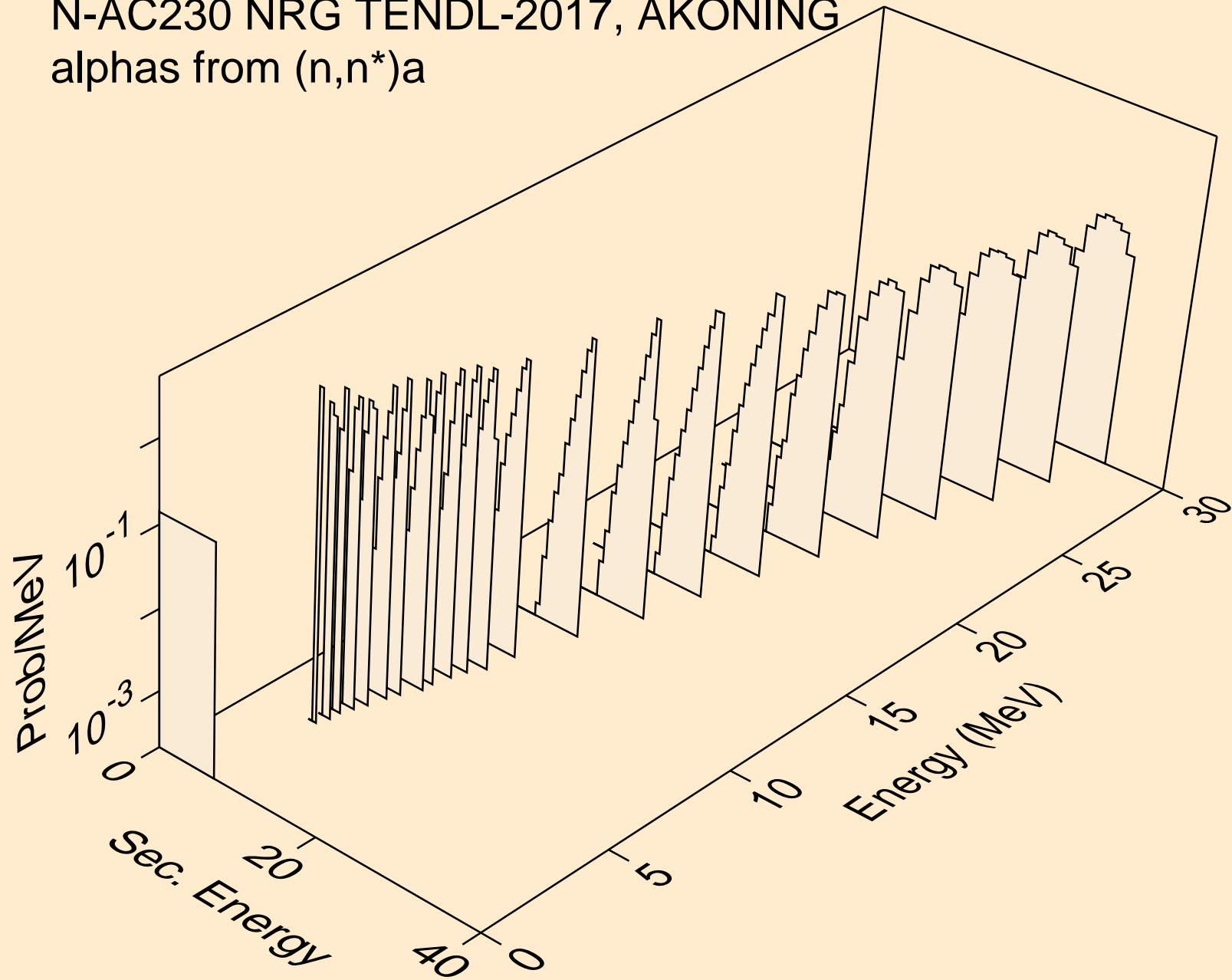

N-AC230 NRG TENDL-2017, AKONING
alphas from (n,2n)a

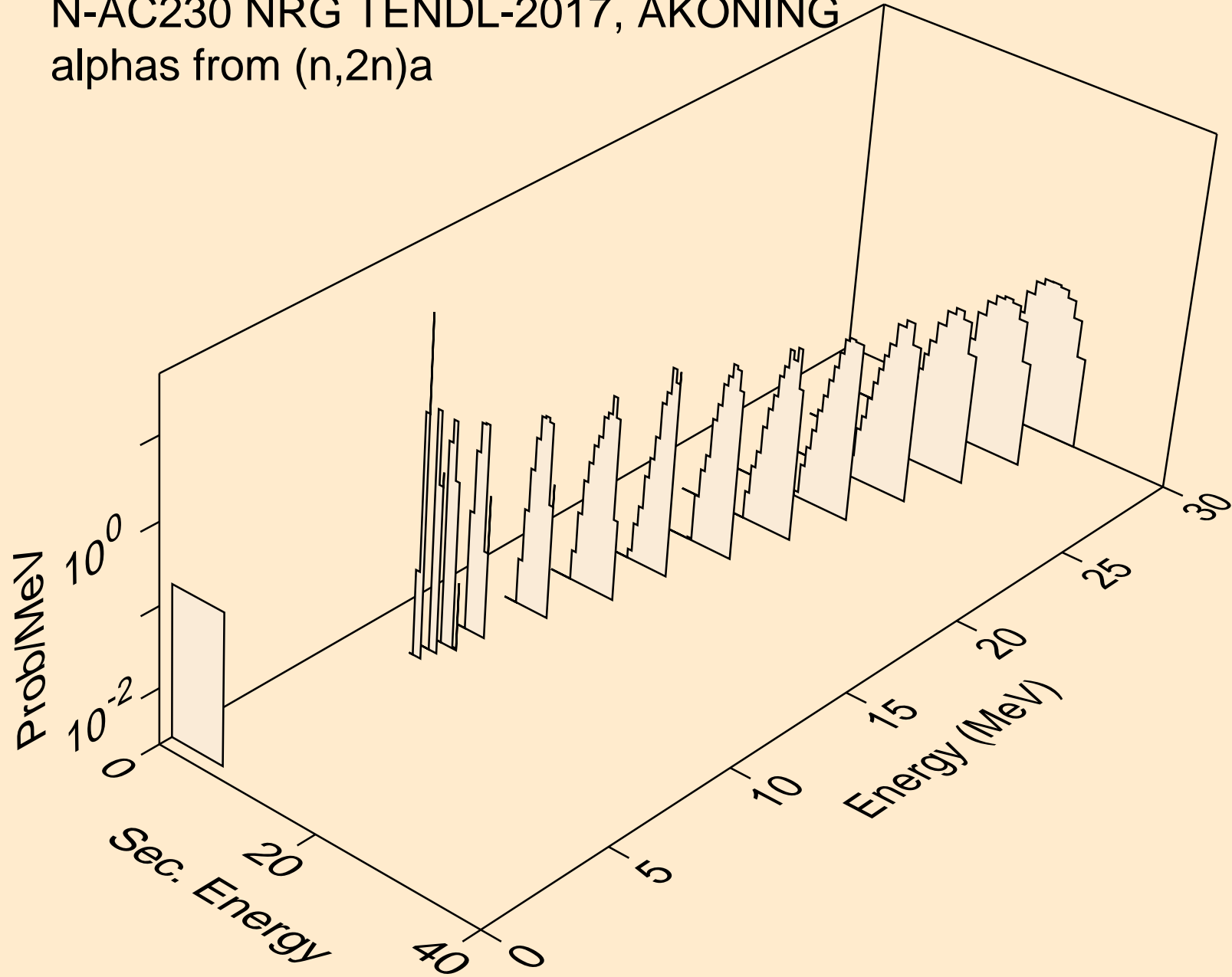

N-AC230 NRG TENDL-2017, AKONING
alphas from (n,3n)a

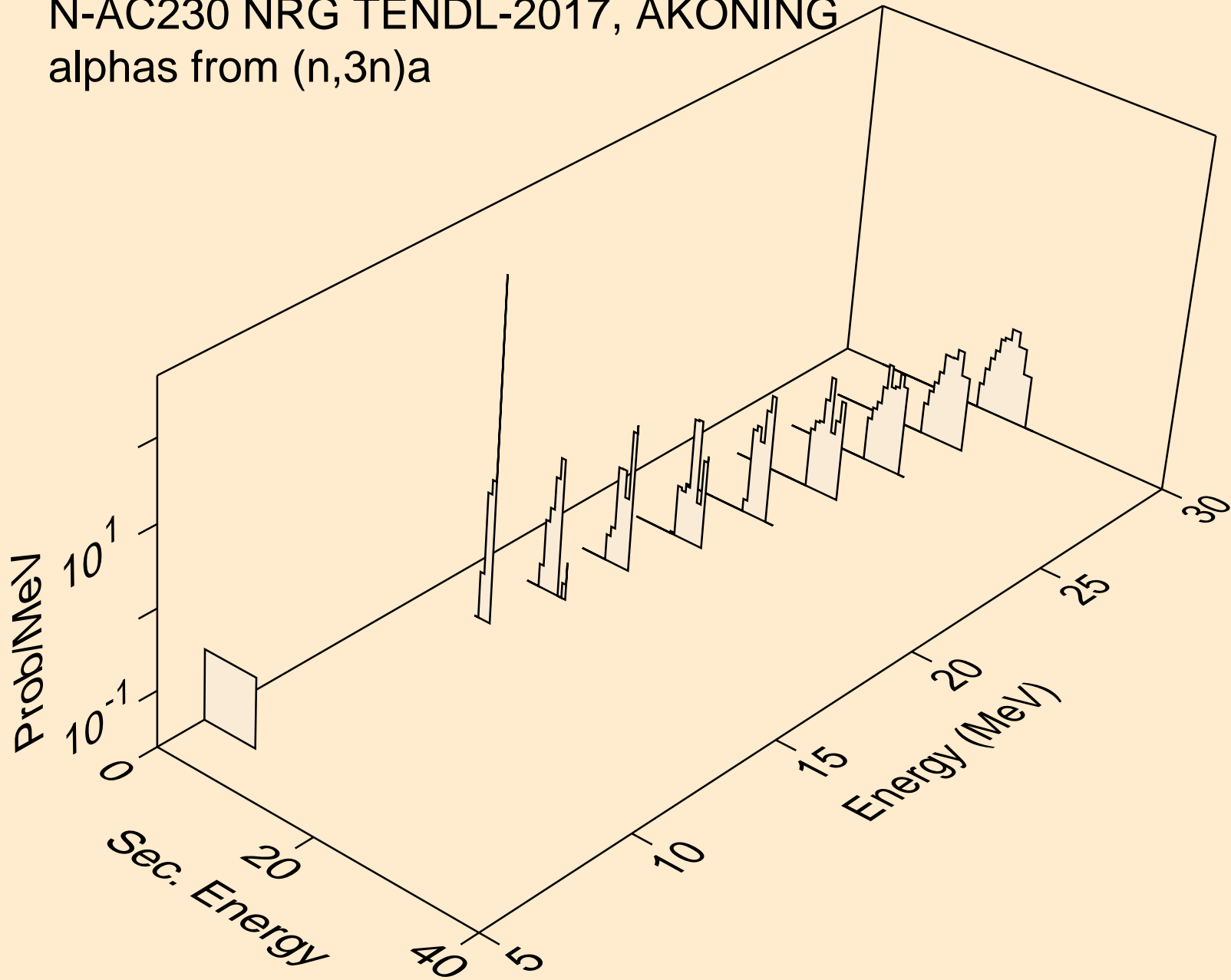

N-AC230 NRG TENDL-2017, AKONING
alphas from (n,a)

