

N-AM231 NRG TENDL-2017, AKONING

Principal cross sections

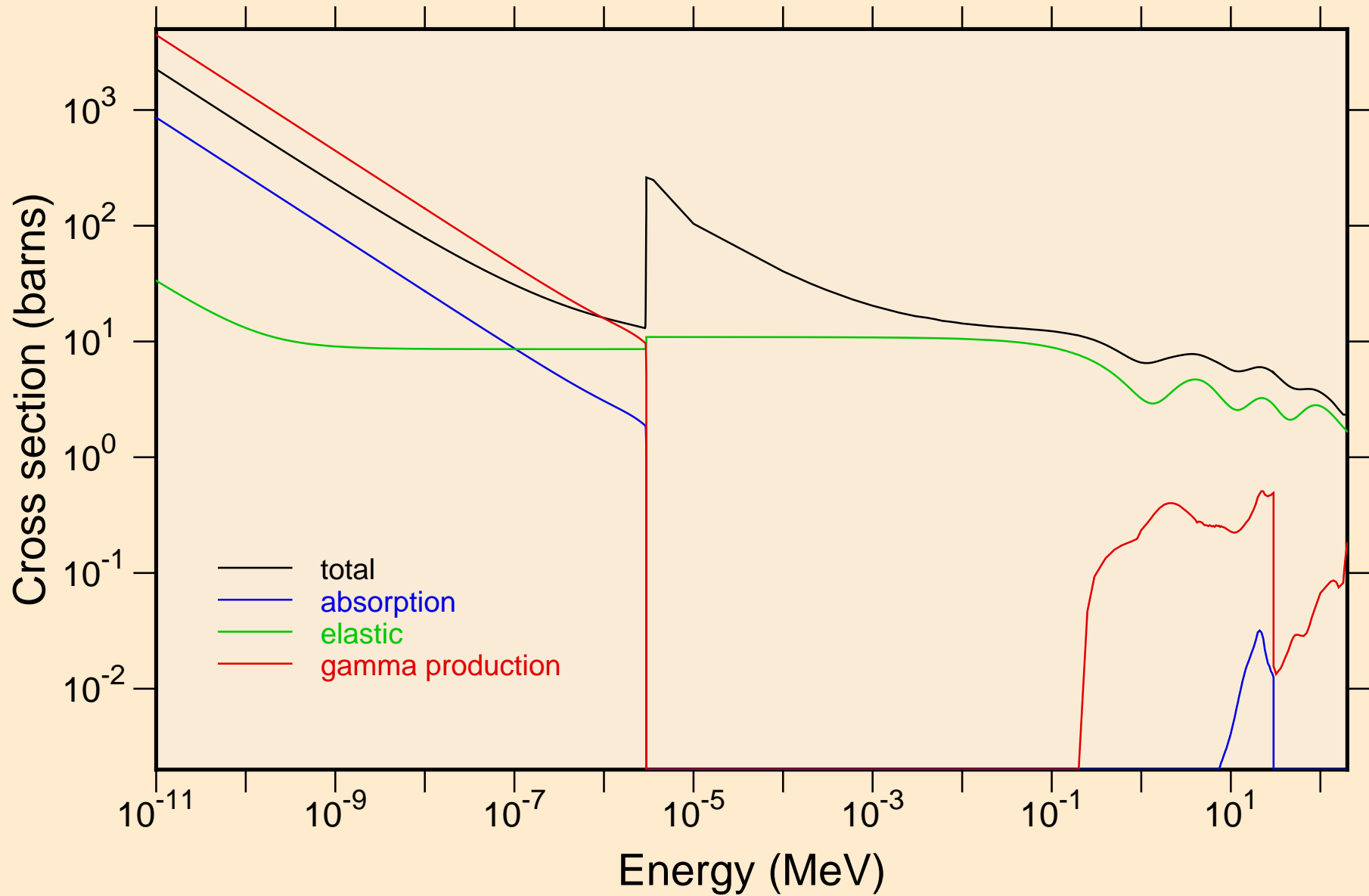

N-AM231 NRG TENDL-2017, AKONING

Non-threshold reactions

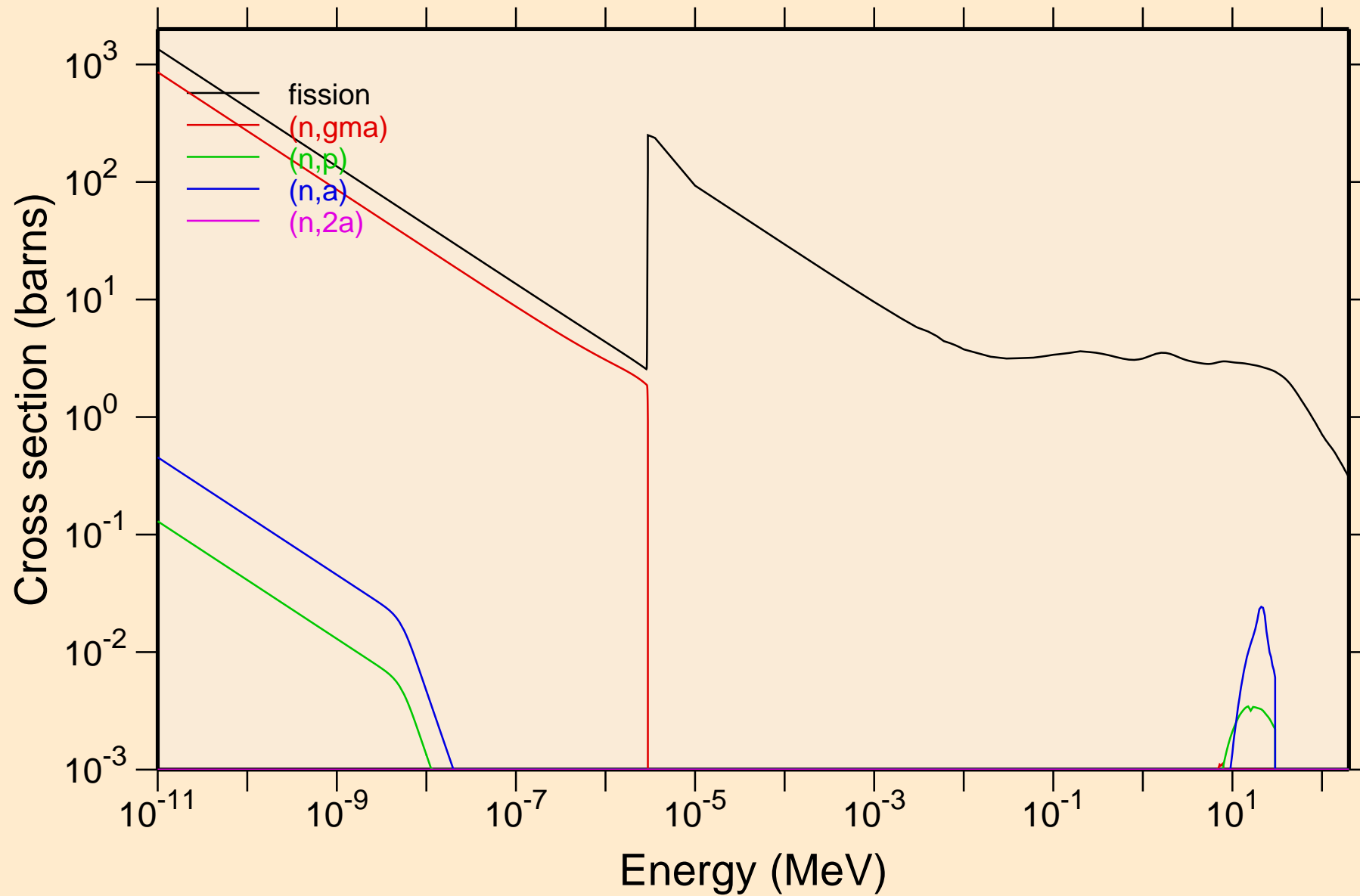

N-AM231 NRG TENDL-2017, AKONING
Non-threshold reactions

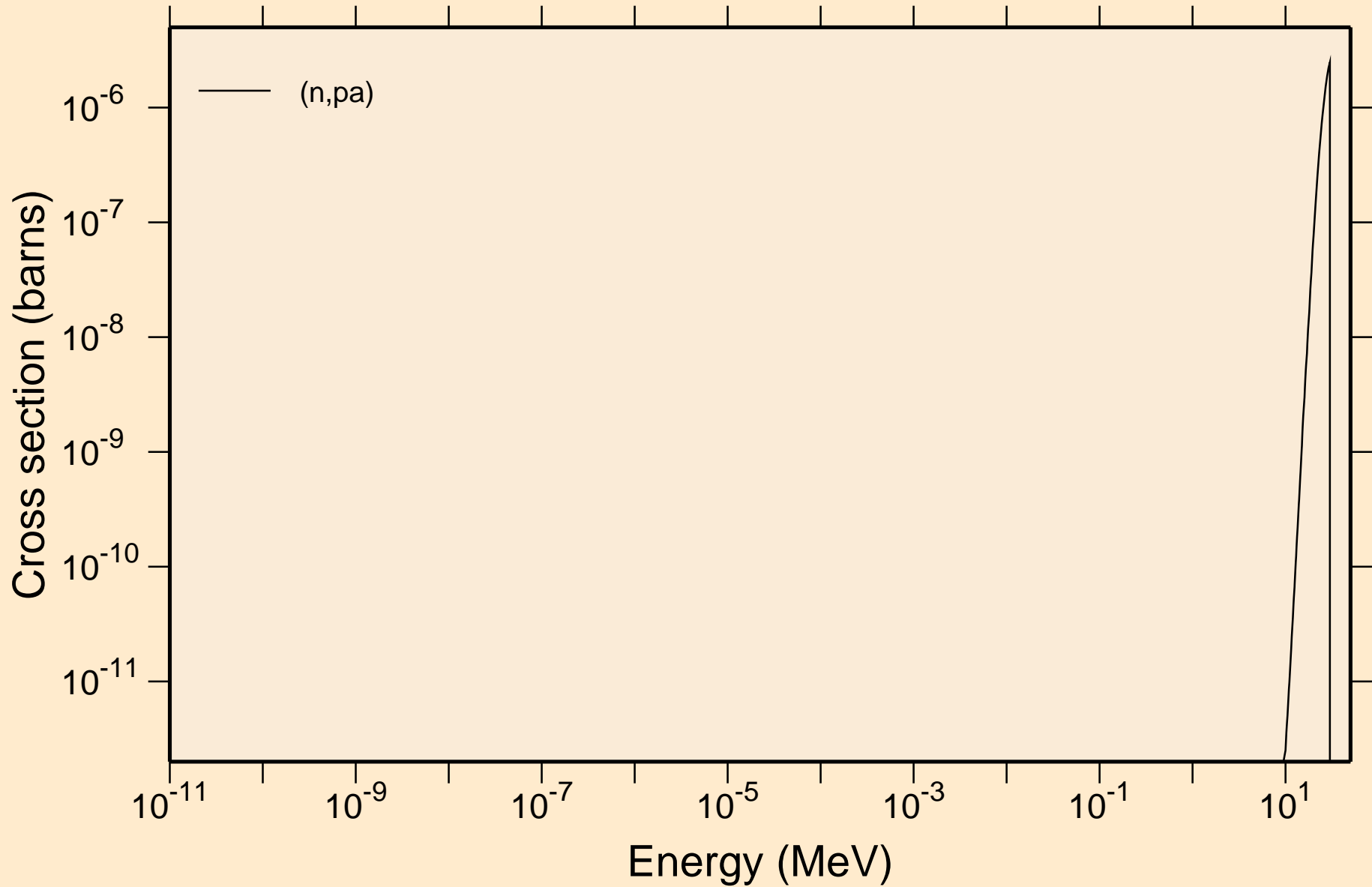

N-AM231 NRG TENDL-2017, AKONING

Principal cross sections

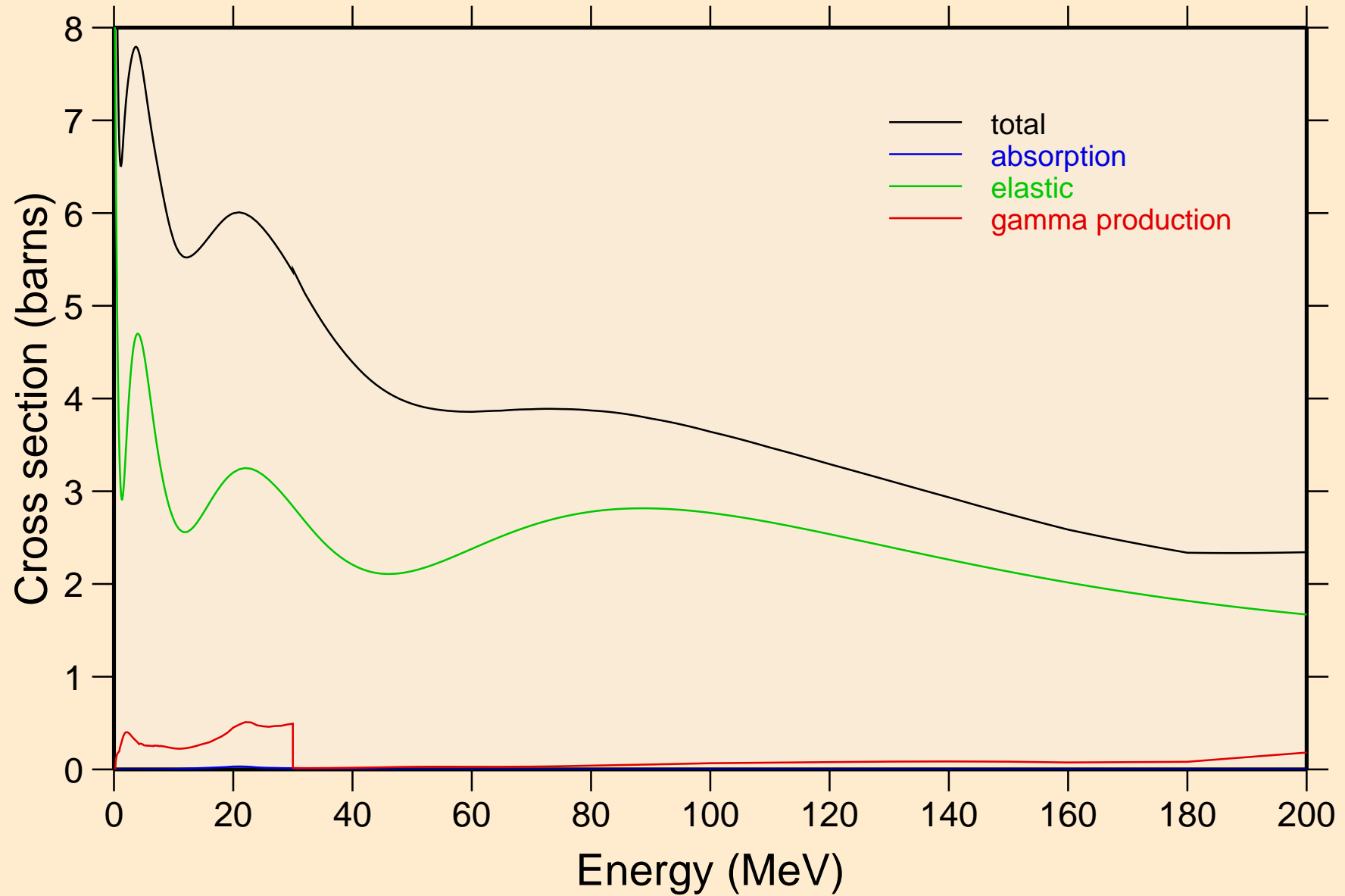

N-AM231 NRG TENDL-2017, AKONING

Non-threshold reactions

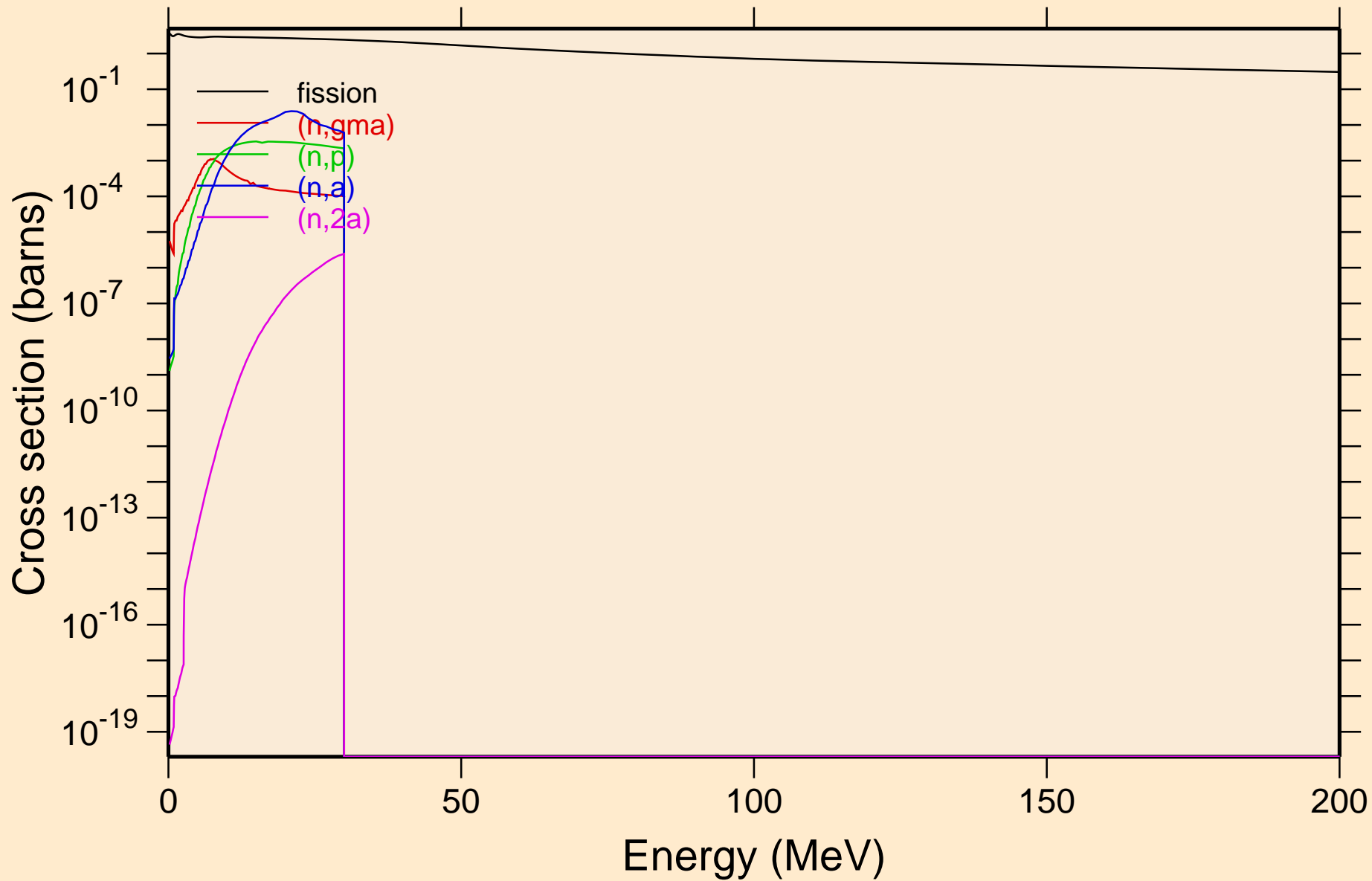

N-AM231 NRG TENDL-2017, AKONING
Non-threshold reactions

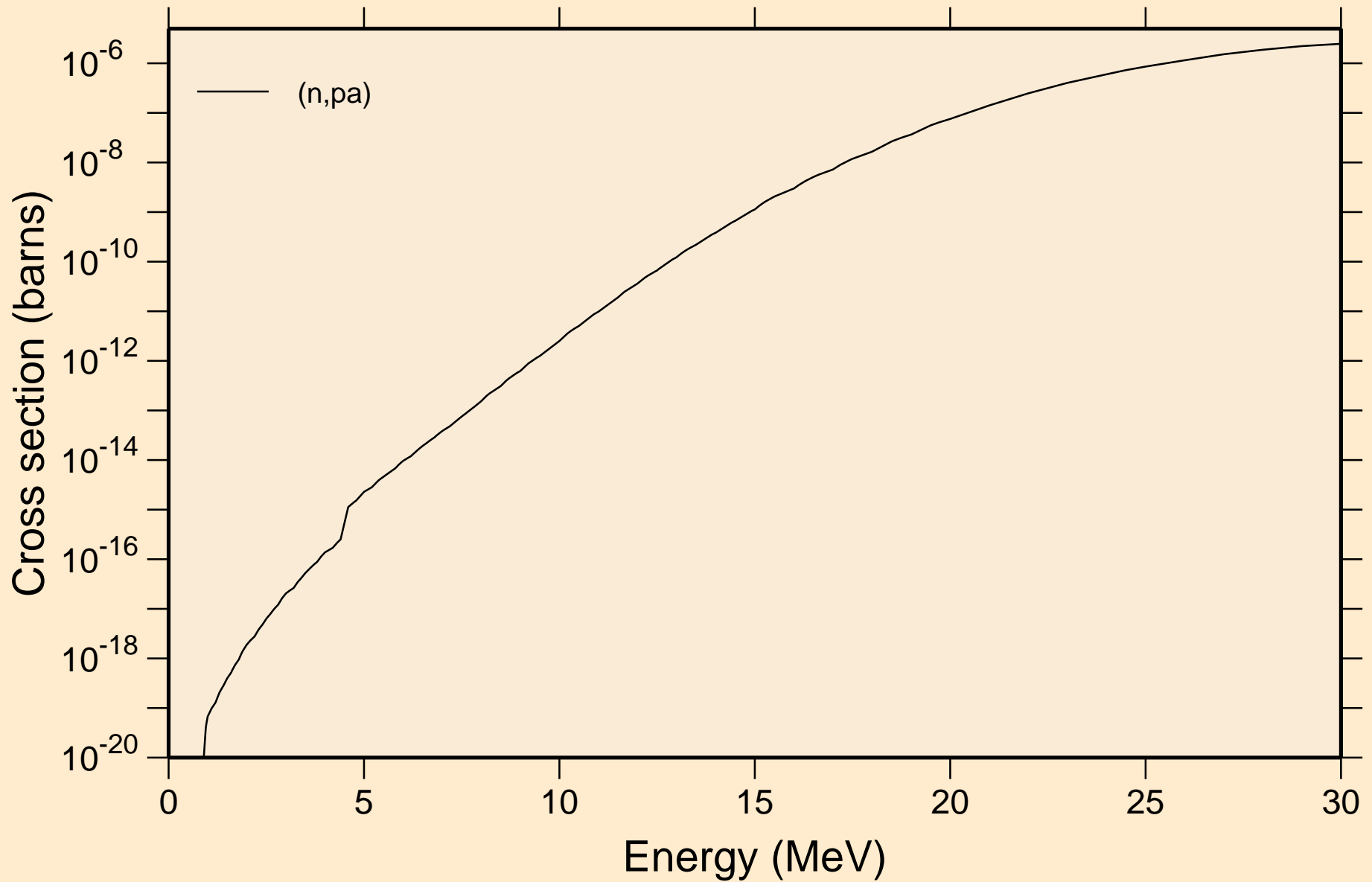

N-AM231 NRG TENDL-2017, AKONING
Inelastic levels

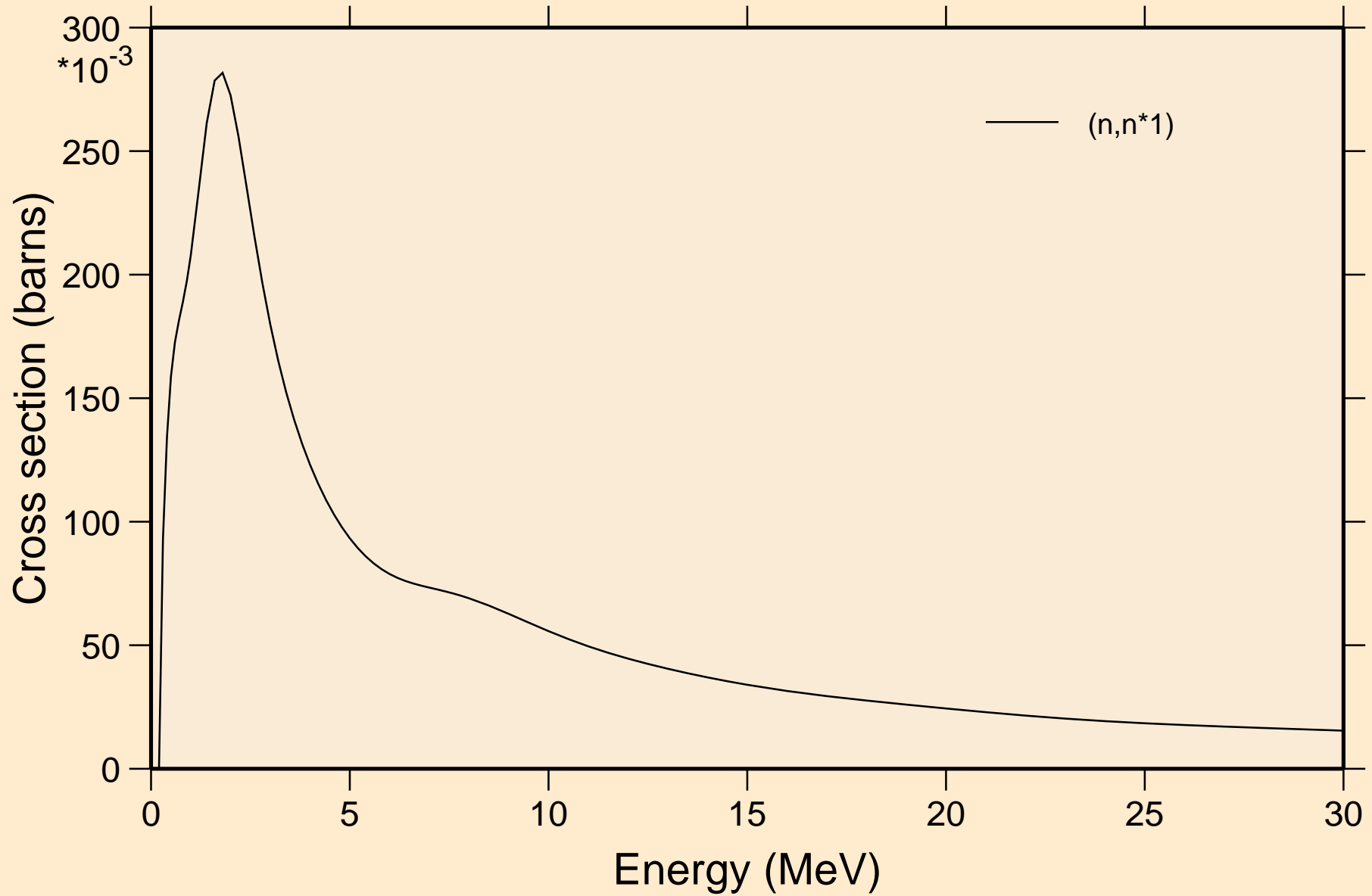

N-AM231 NRG TENDL-2017, AKONING

Threshold reactions

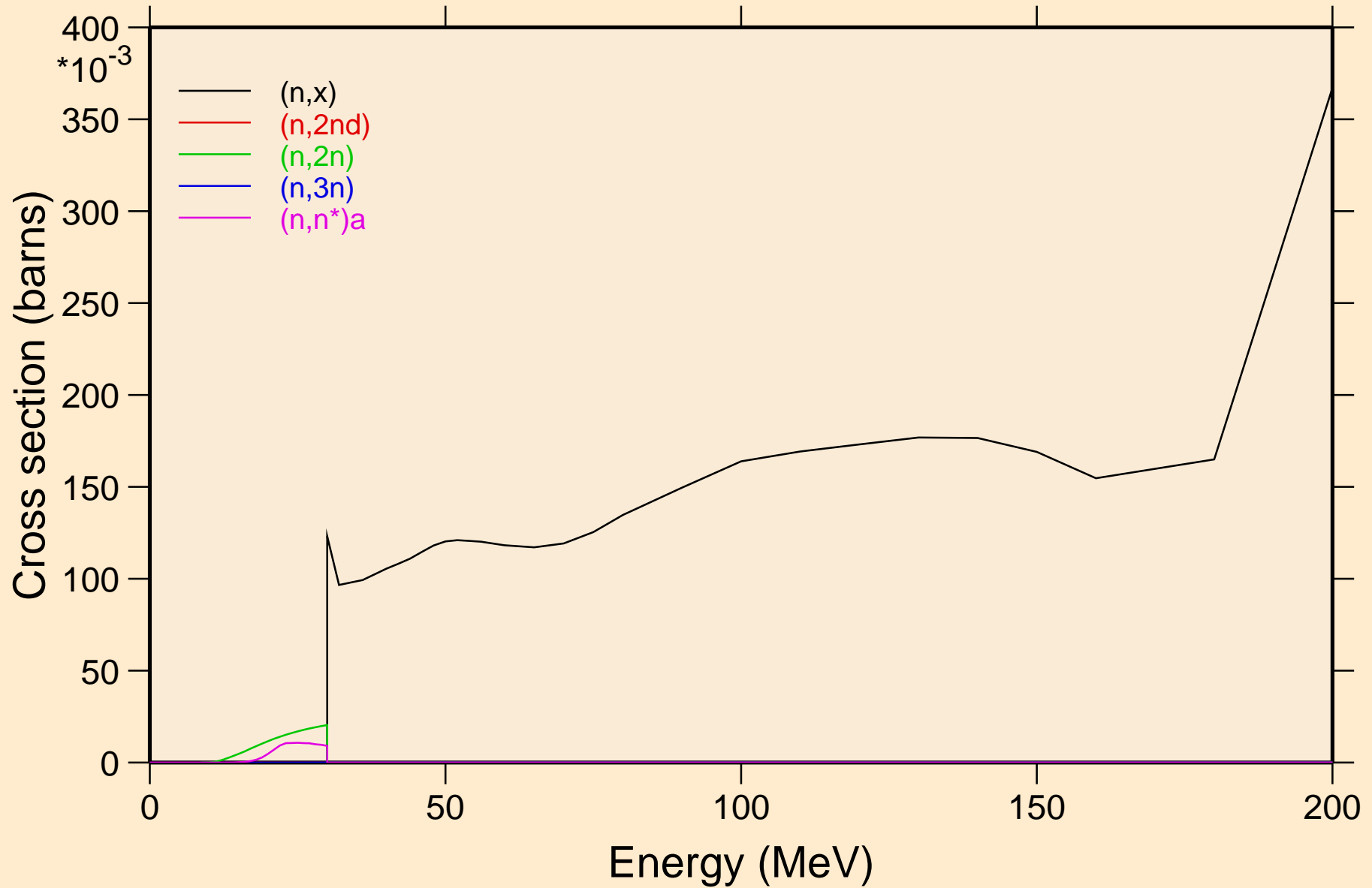

N-AM231 NRG TENDL-2017, AKONING

Threshold reactions

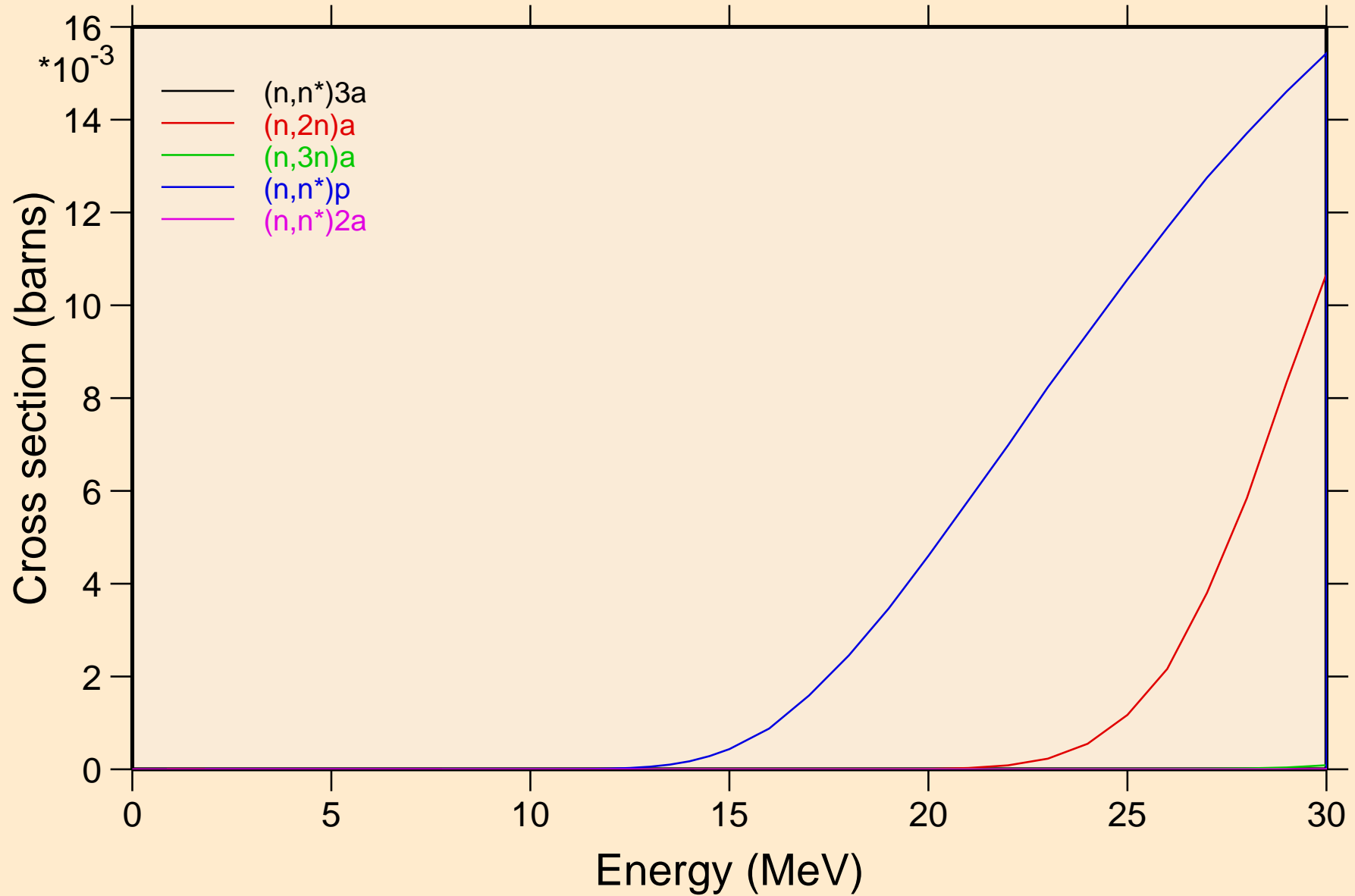

N-AM231 NRG TENDL-2017, AKONING

Threshold reactions

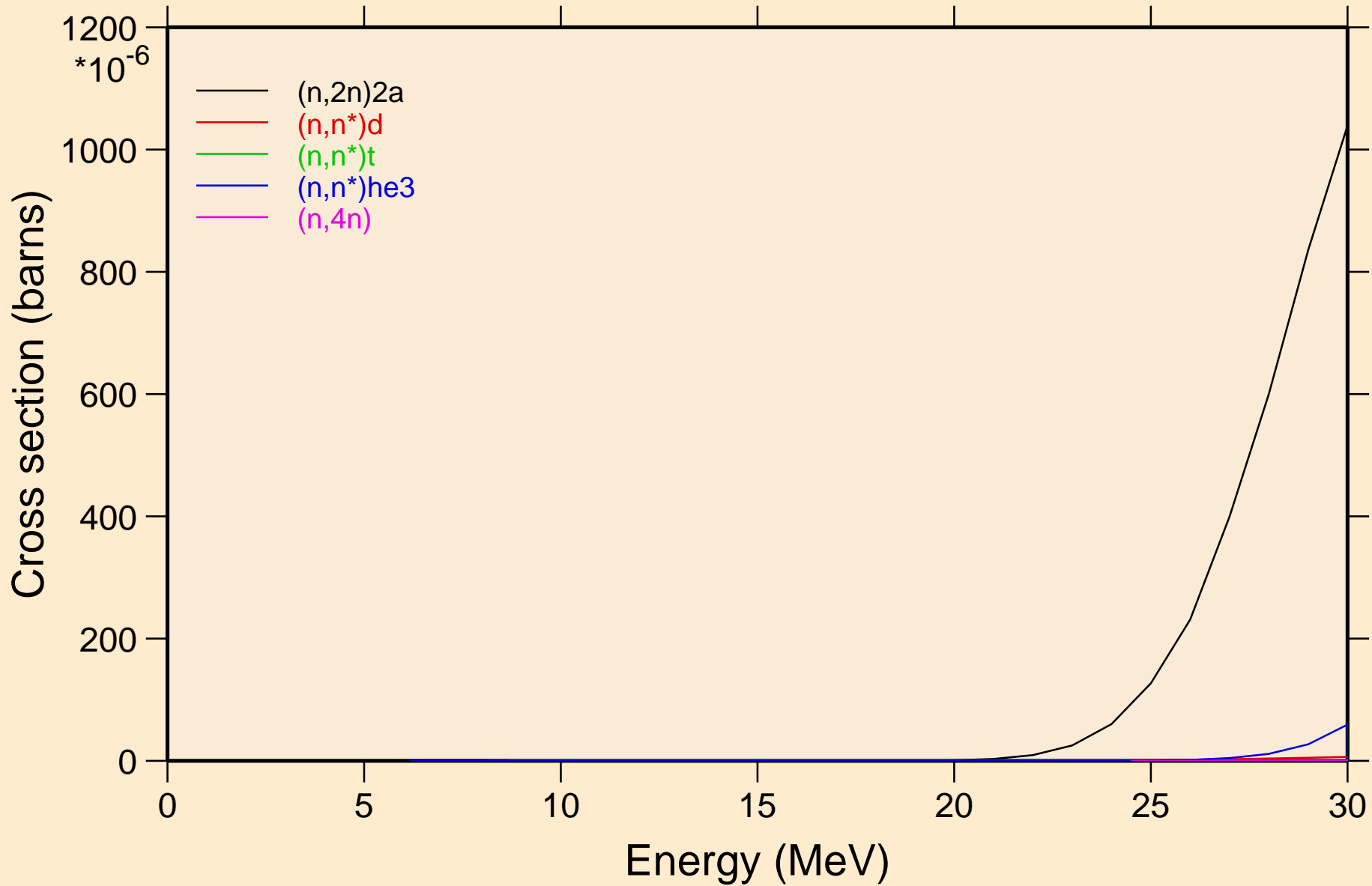

N-AM231 NRG TENDL-2017, AKONING

Threshold reactions

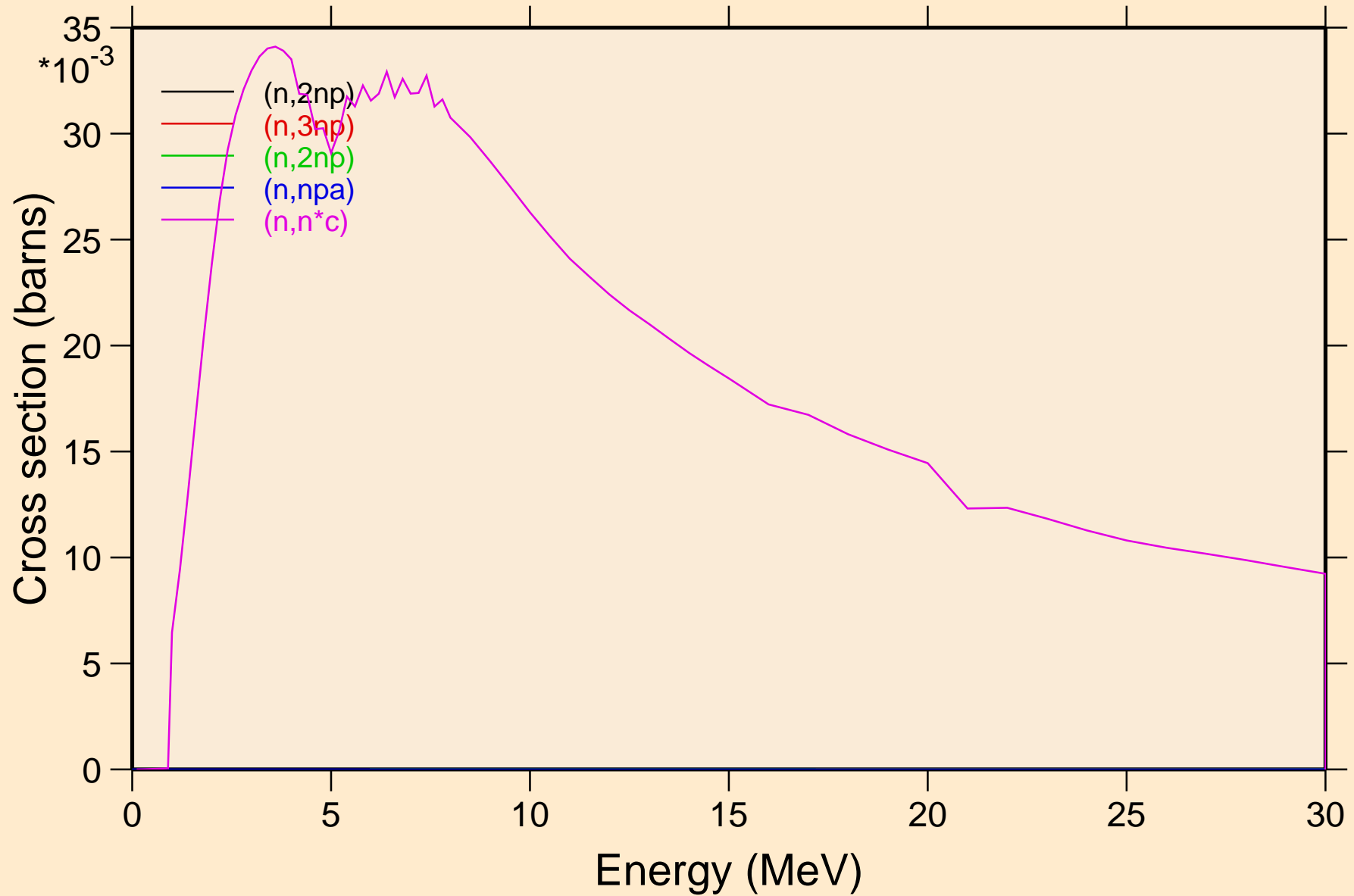

N-AM231 NRG TENDL-2017, AKONING

Threshold reactions

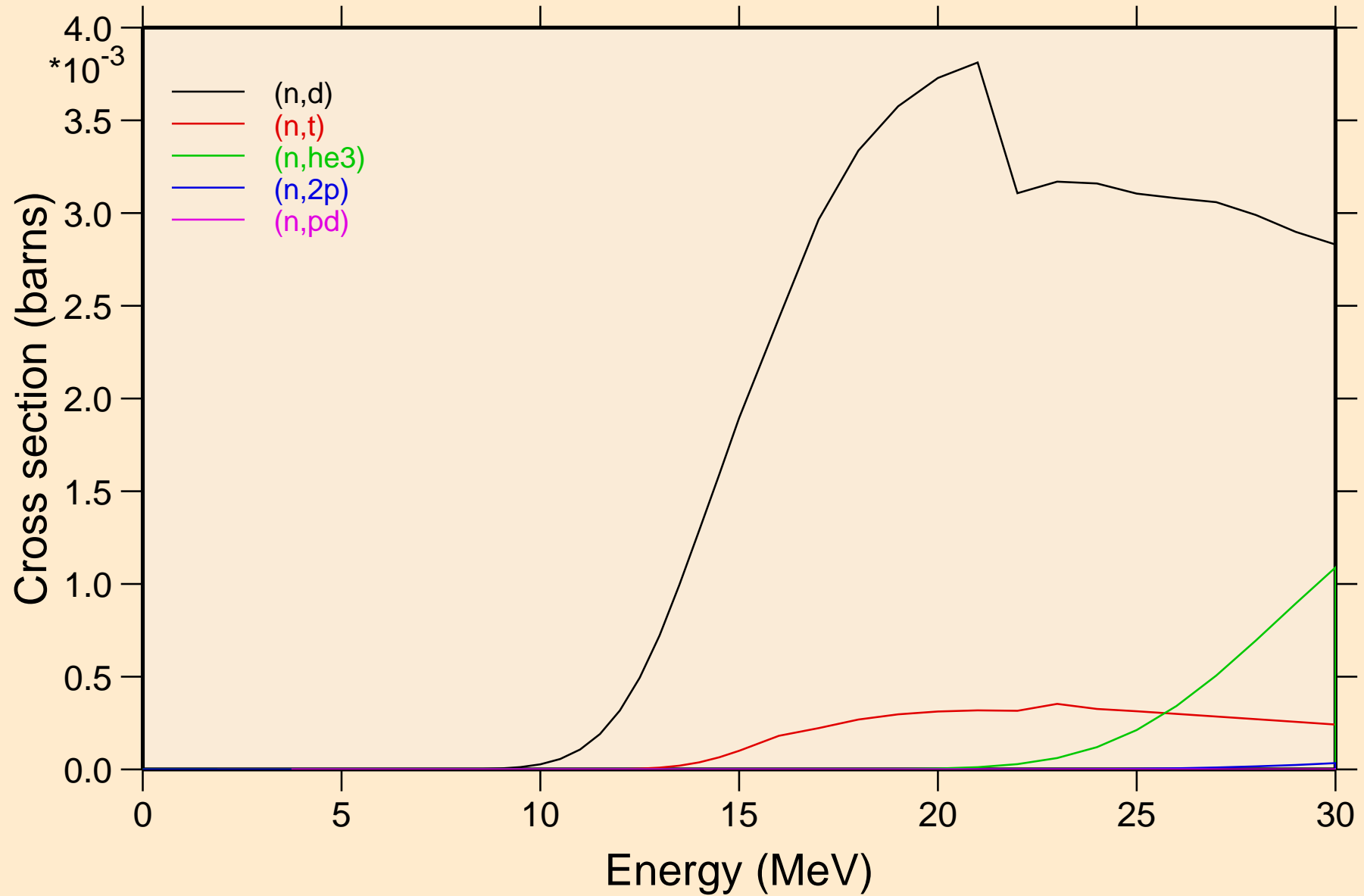

N-AM231 NRG TENDL-2017, AKONING

Threshold reactions

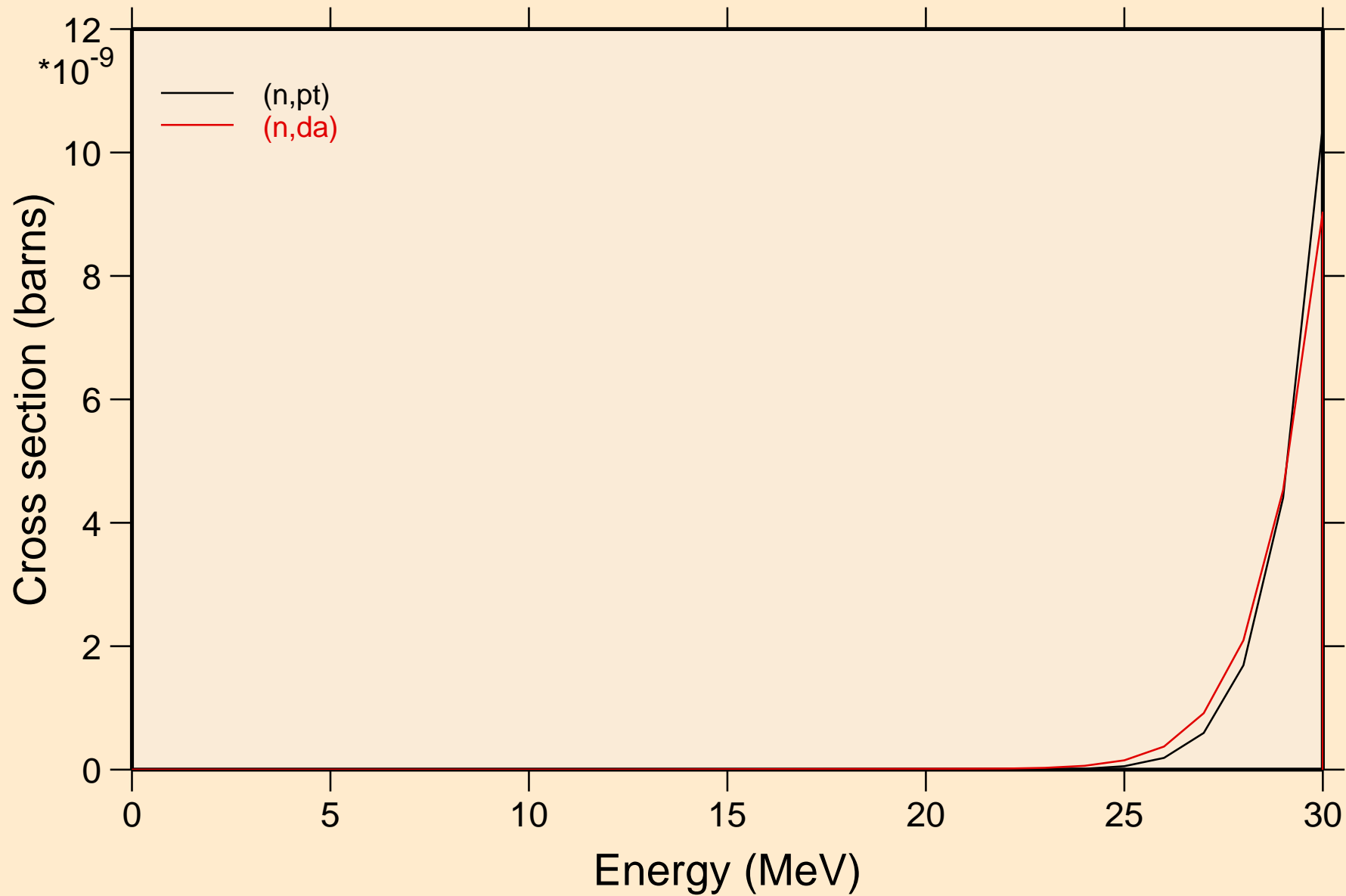

N-AM231 NRG TENDL-2017, AKONING
angular distribution for elastic

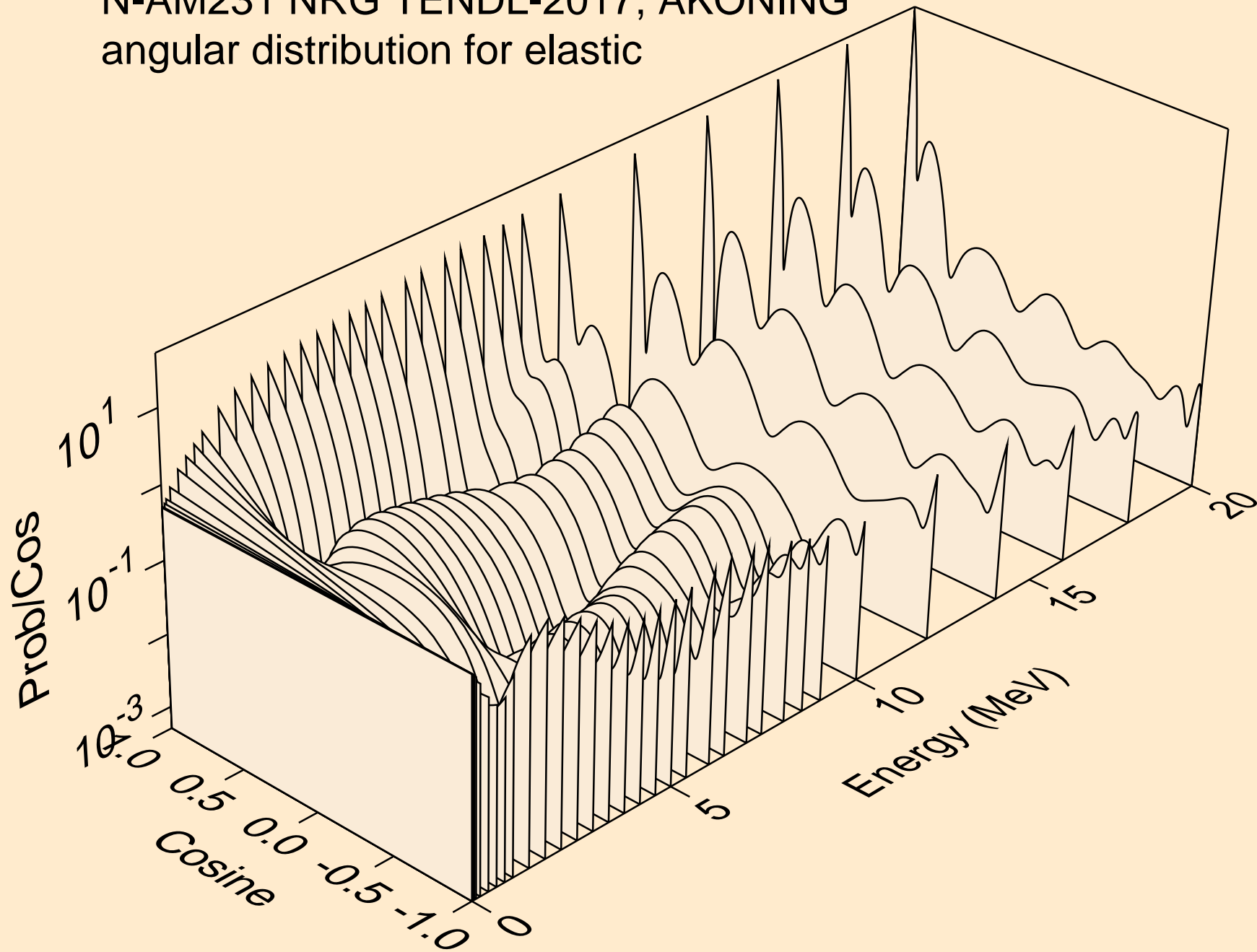

N-AM231 NRG TENDL-2017, AKONING
angular distribution for elastic

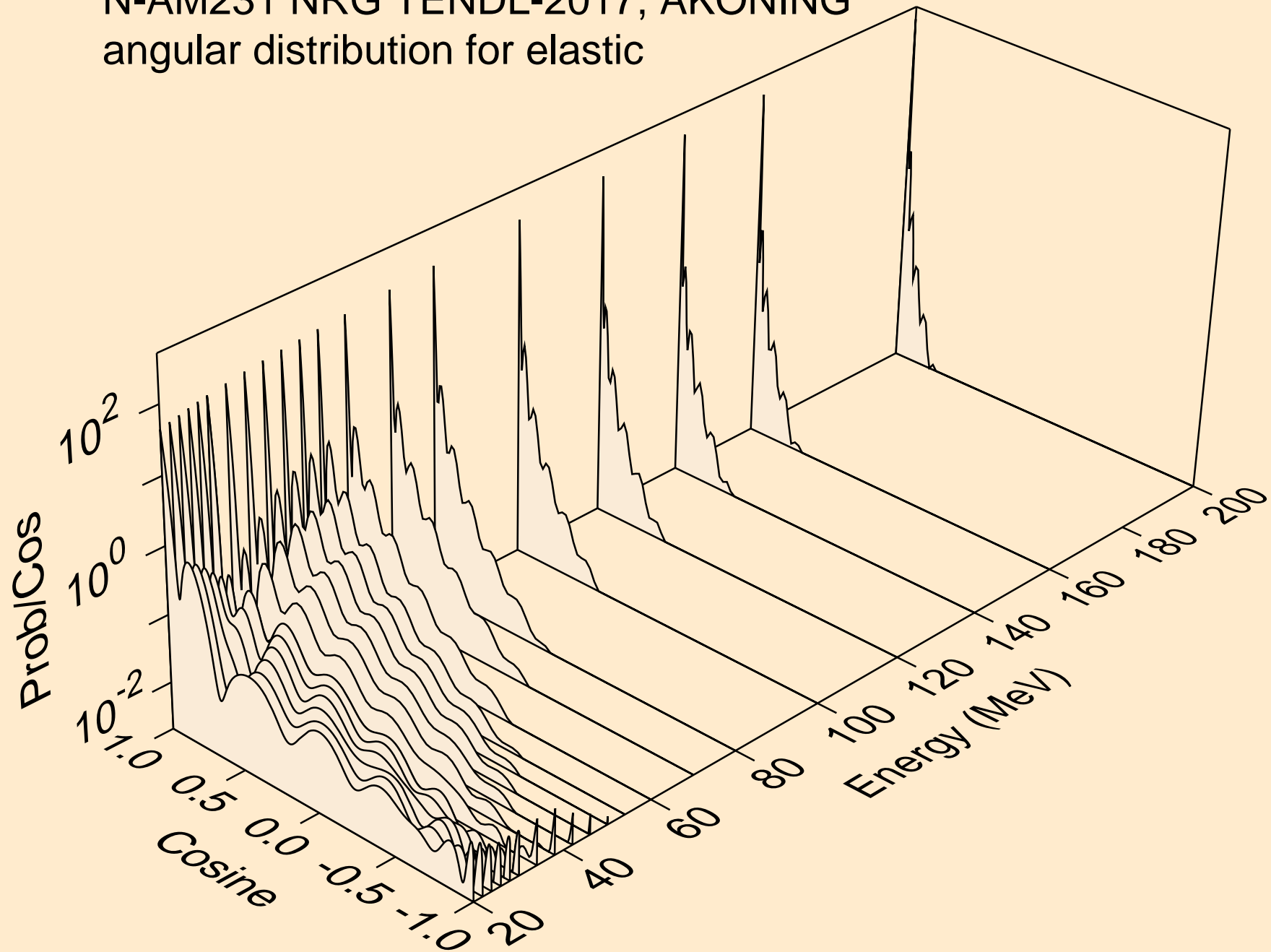

N-AM231 NRG TENDL-2017, AKONING
angular distribution for (n,n*1)

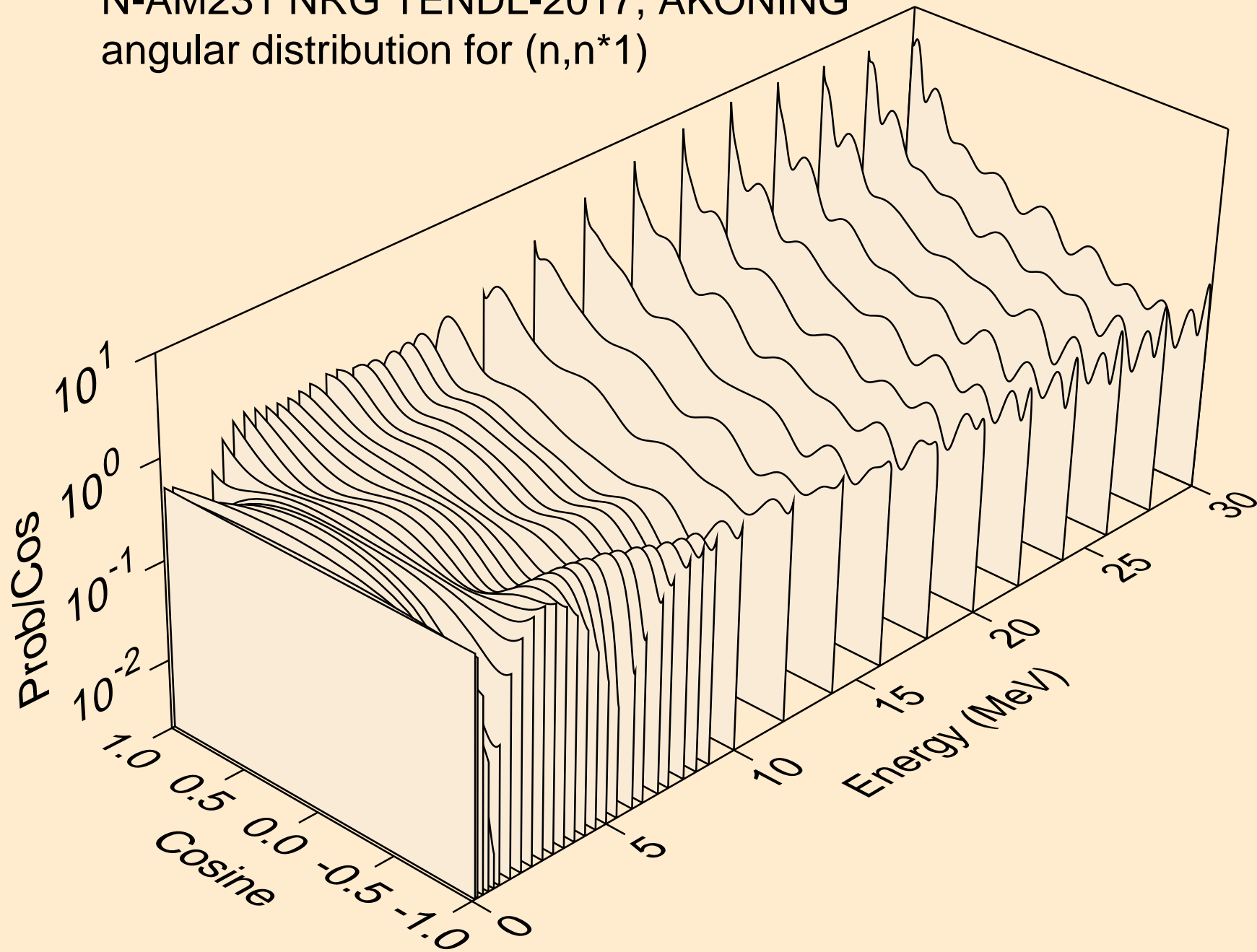

N-AM231 NRG TENDL-2017, AKONING

Total fission nubar

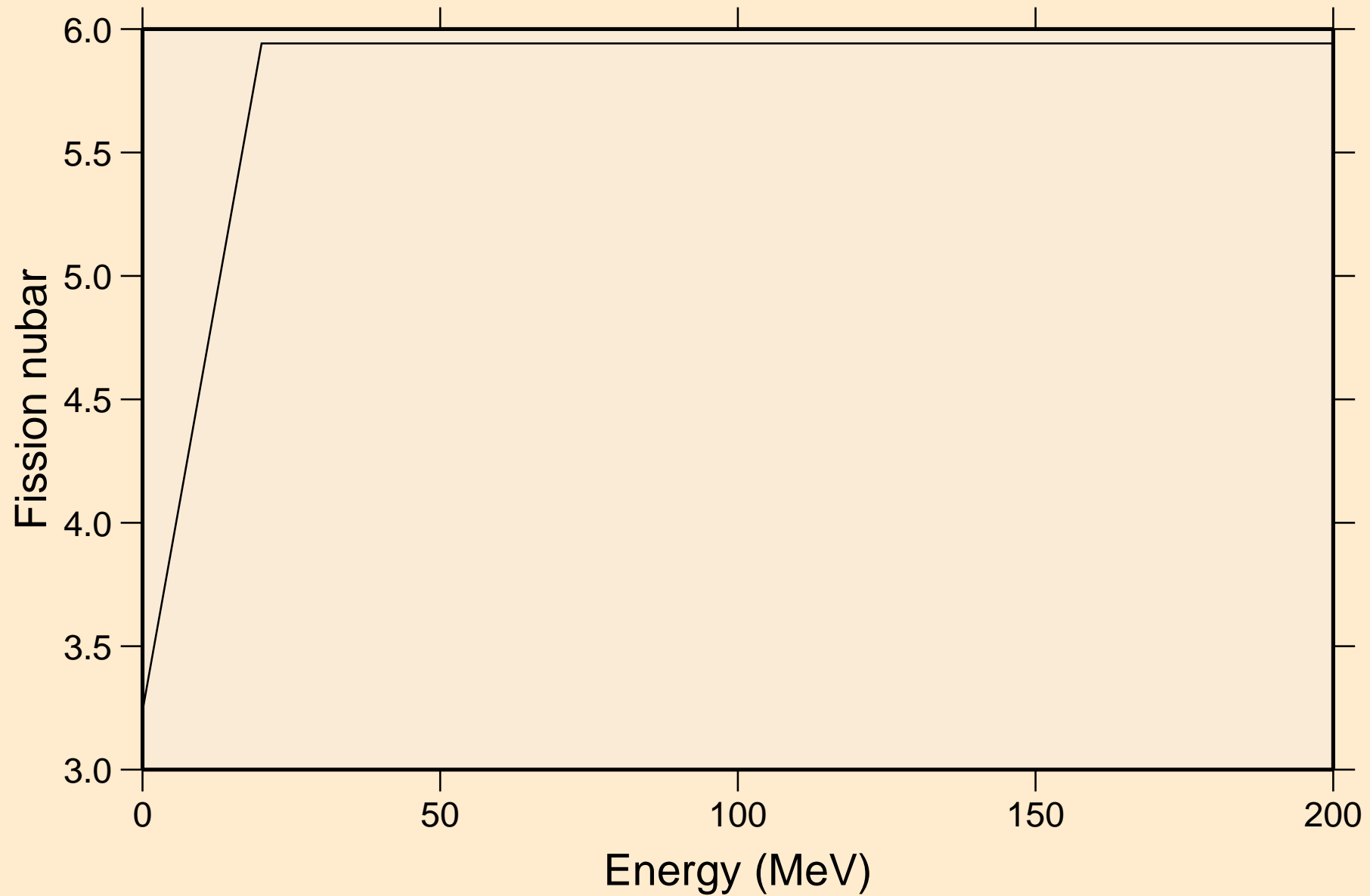

N-AM231 NRG TENDL-2017, AKONING
Neutron emission for (n,x)

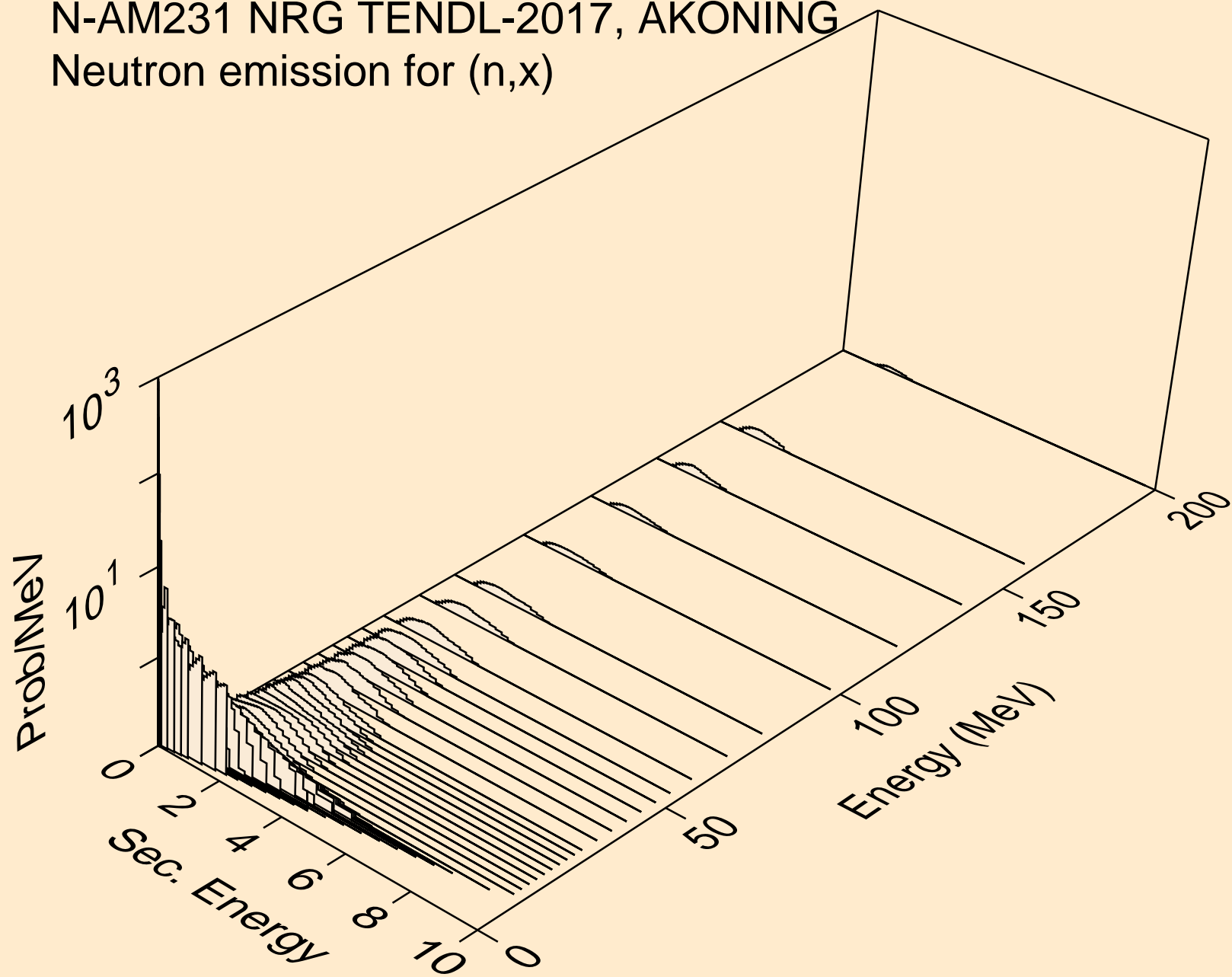

N-AM231 NRG TENDL-2017, AKONING
Neutron emission for (n,2nd)

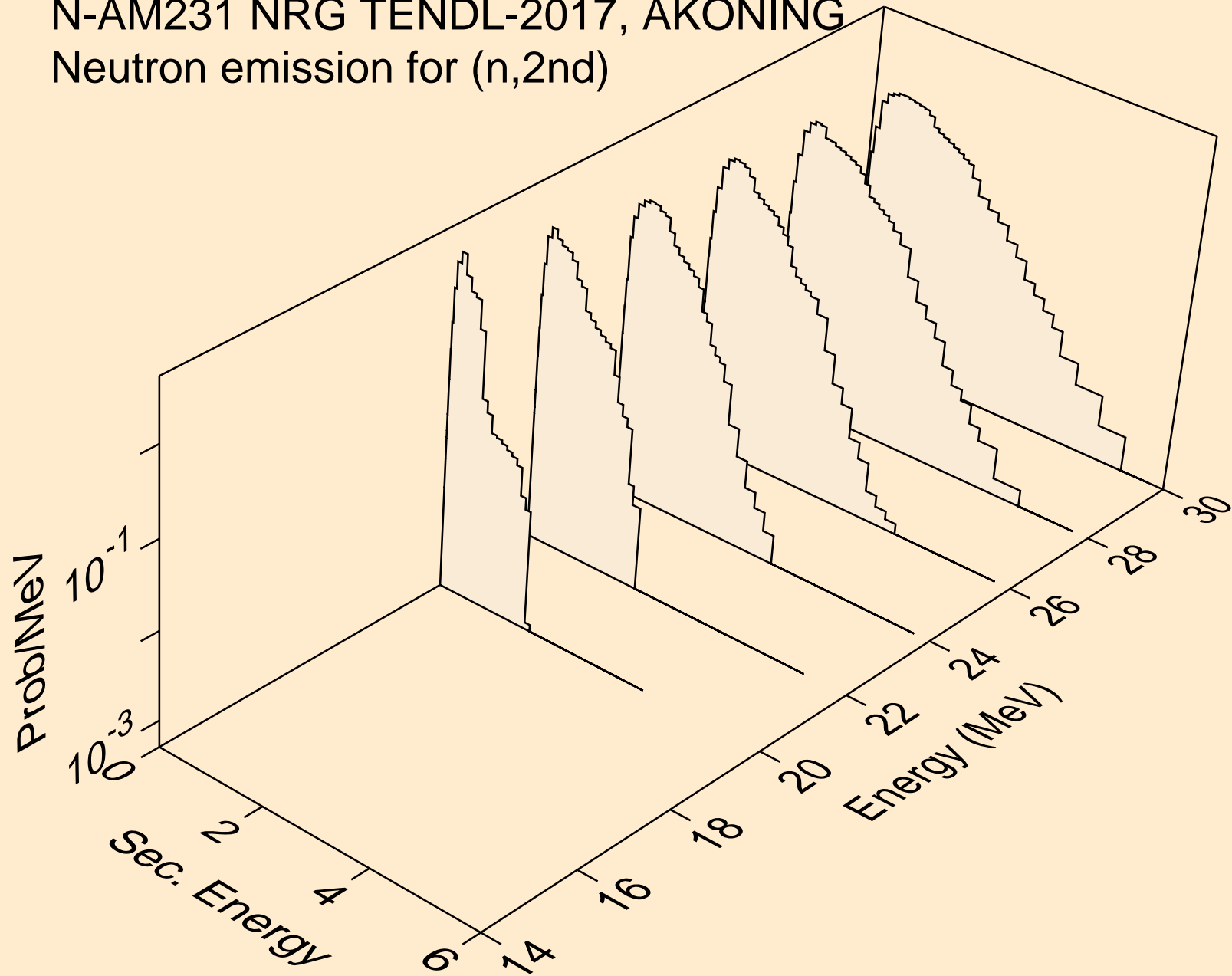

N-AM231 NRG TENDL-2017, AKONING
Neutron emission for (n,2n)

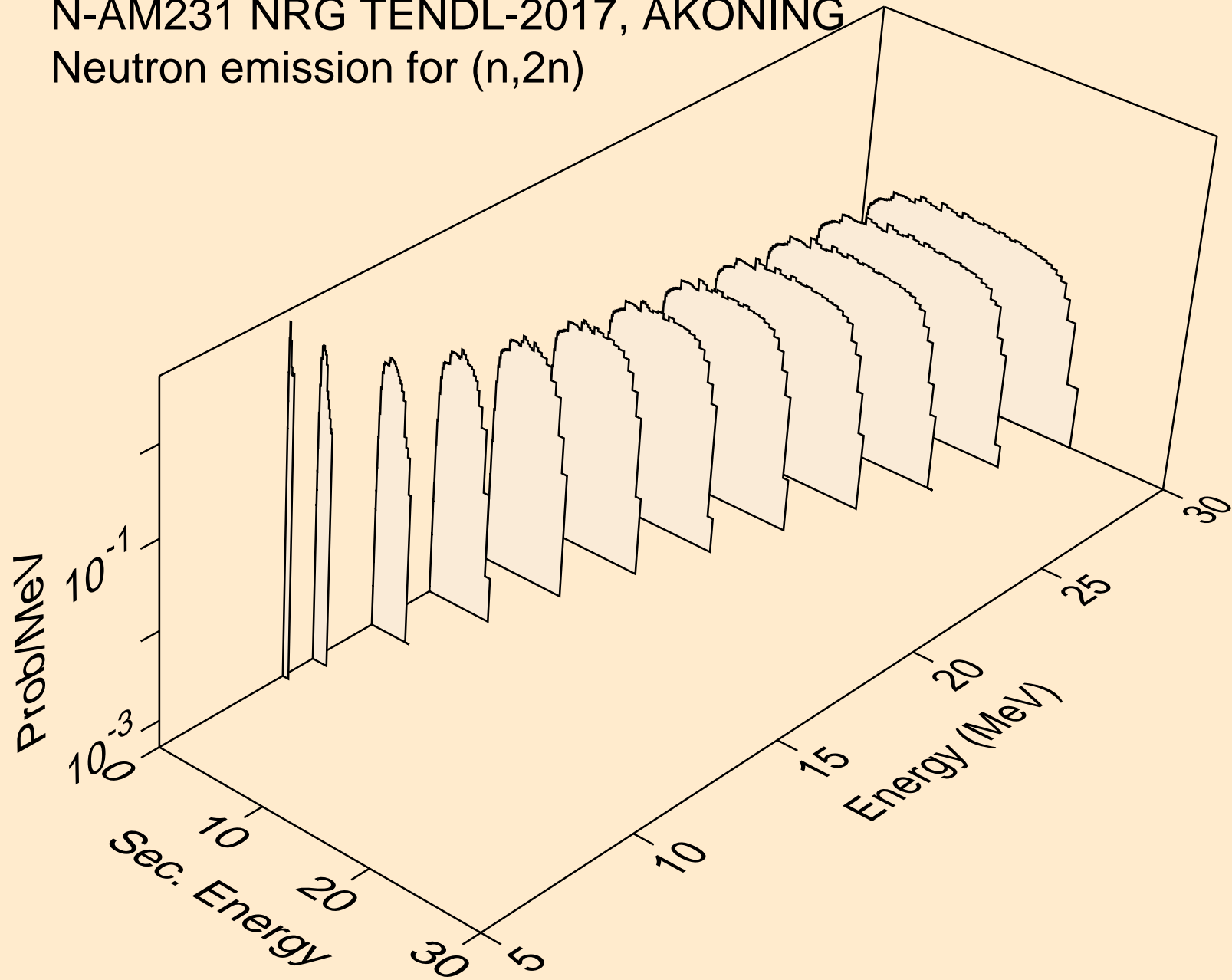

N-AM231 NRG TENDL-2017, AKONING
Neutron emission for (n,3n)

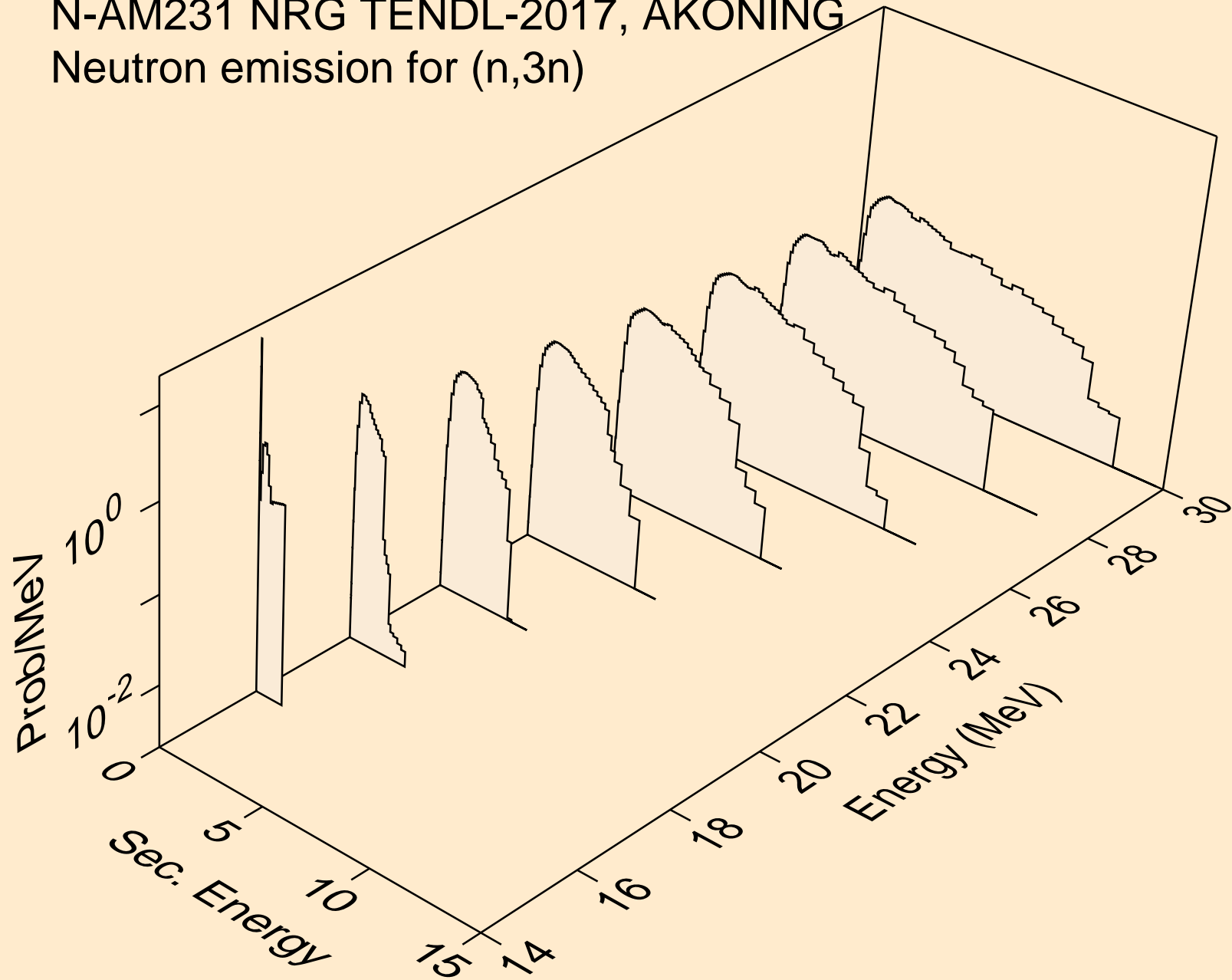

N-AM231 NRG TENDL-2017, AKONING
Neutron emission for fission

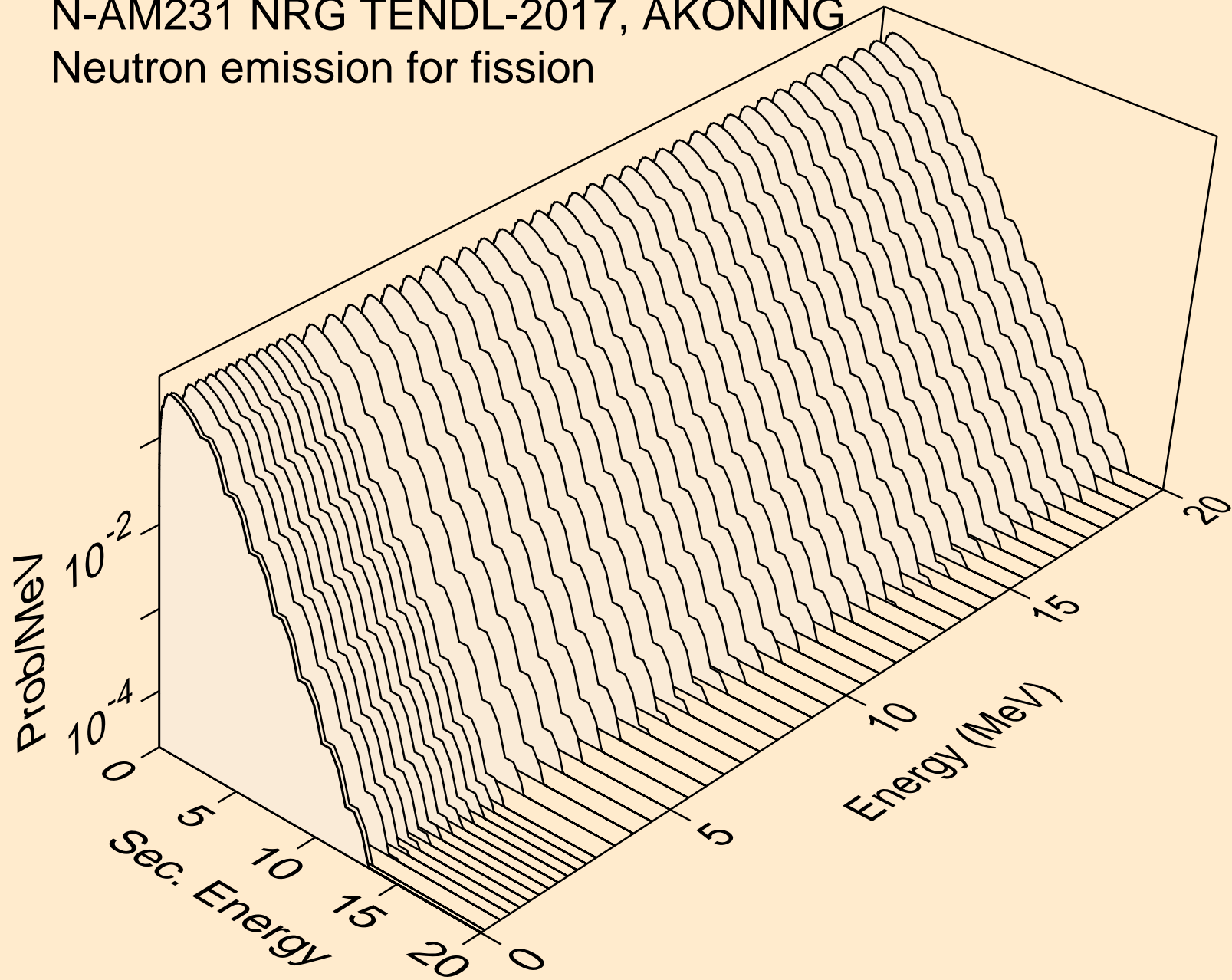

N-AM231 NRG TENDL-2017, AKONING
Neutron emission for (n,n*)a

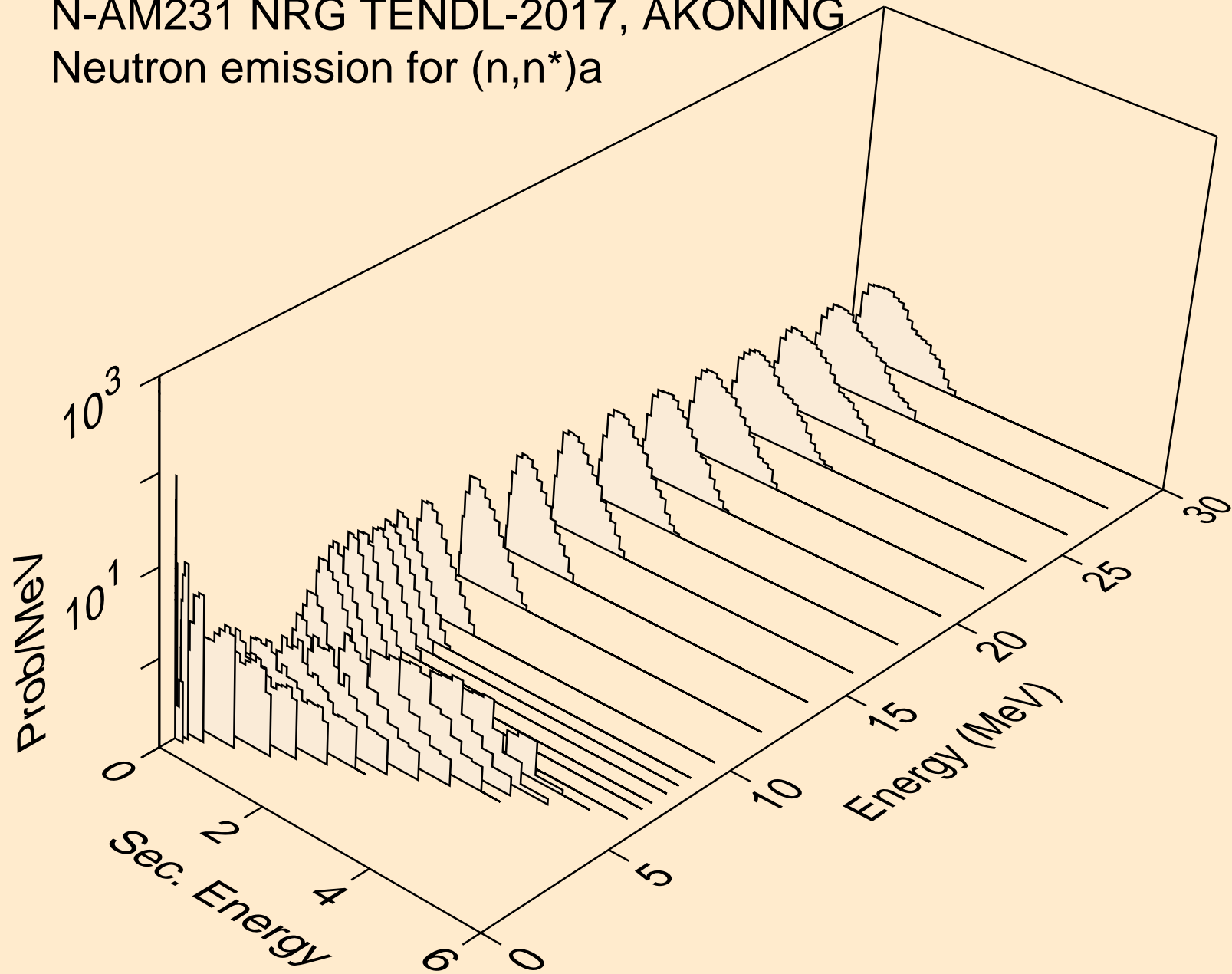

N-AM231 NRG TENDL-2017, AKONING
Neutron emission for (n,n*)3a

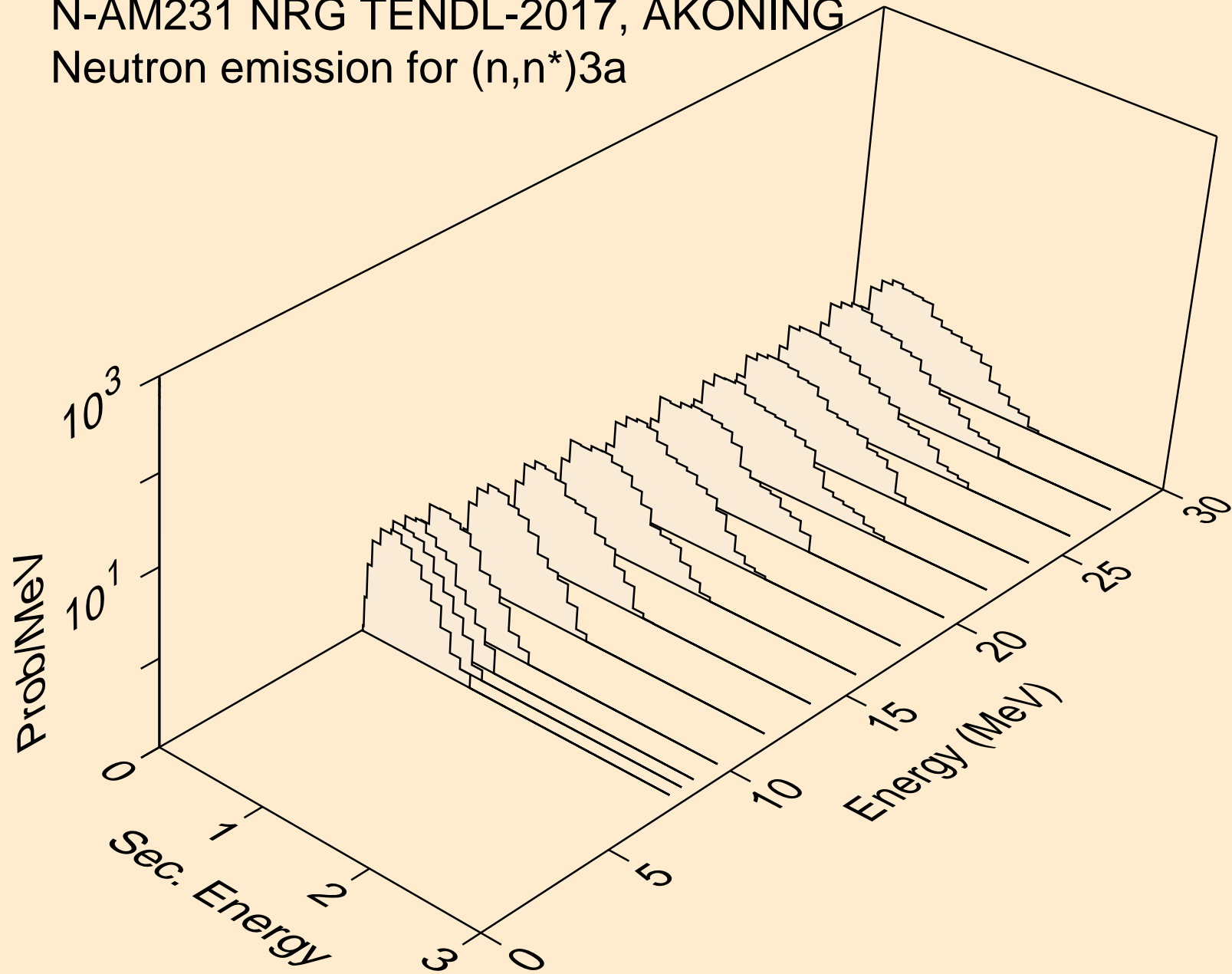

N-AM231 NRG TENDL-2017, AKONING
Neutron emission for (n,2n)a

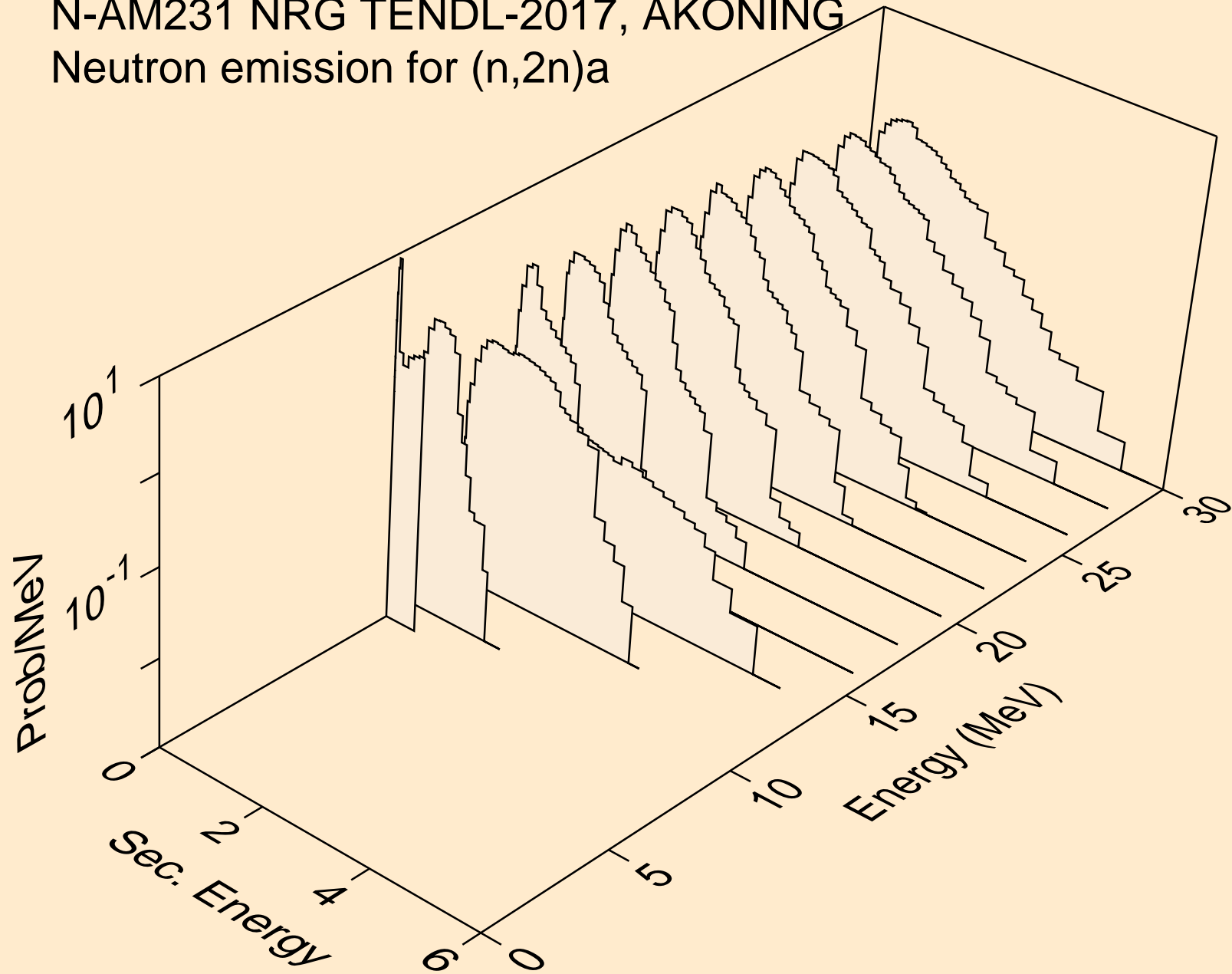

N-AM231 NRG TENDL-2017, AKONING
Neutron emission for (n,3n)a

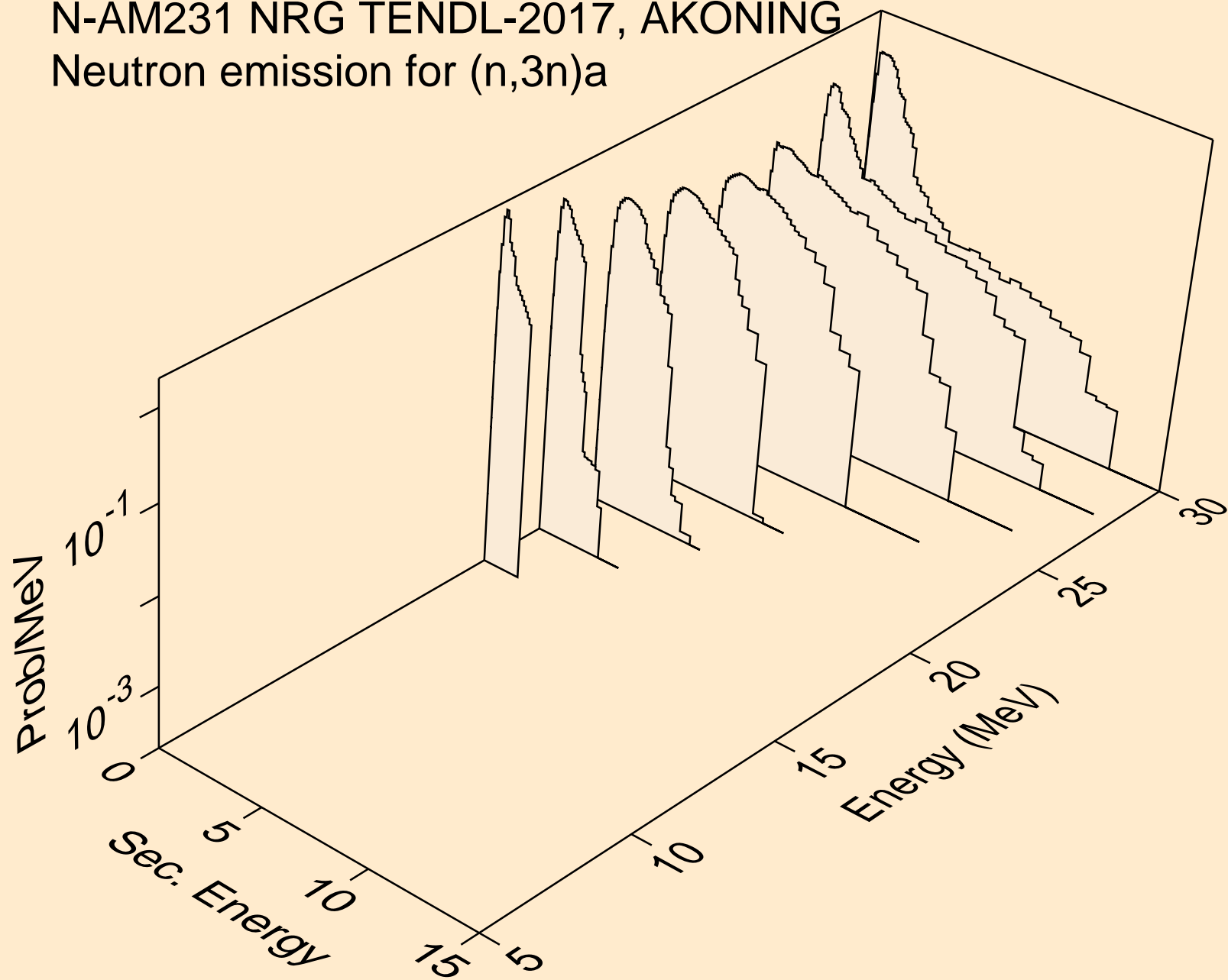

N-AM231 NRG TENDL-2017, AKONING
Neutron emission for (n,n*)p

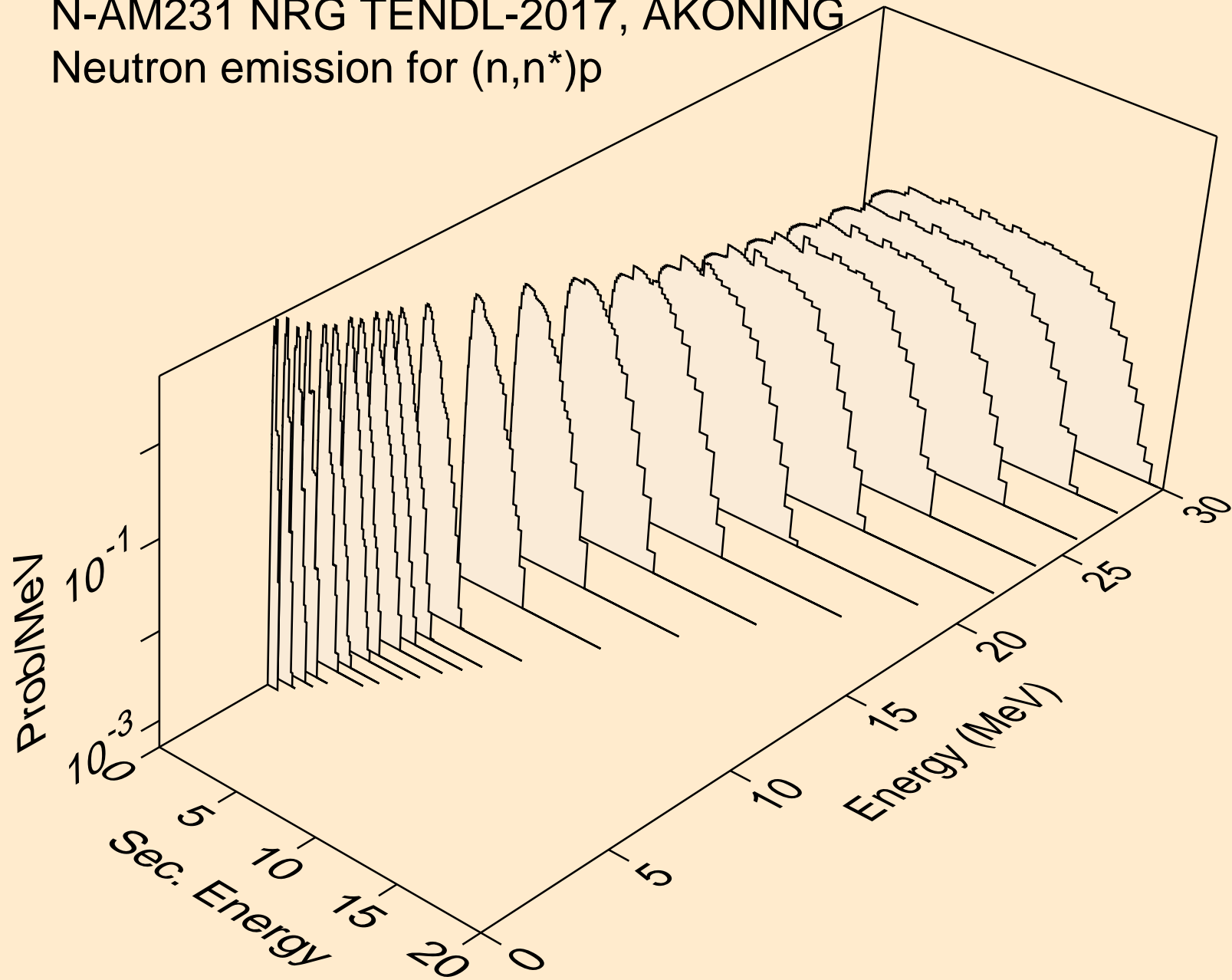

N-AM231 NRG TENDL-2017, AKONING
Neutron emission for (n,n*)2a

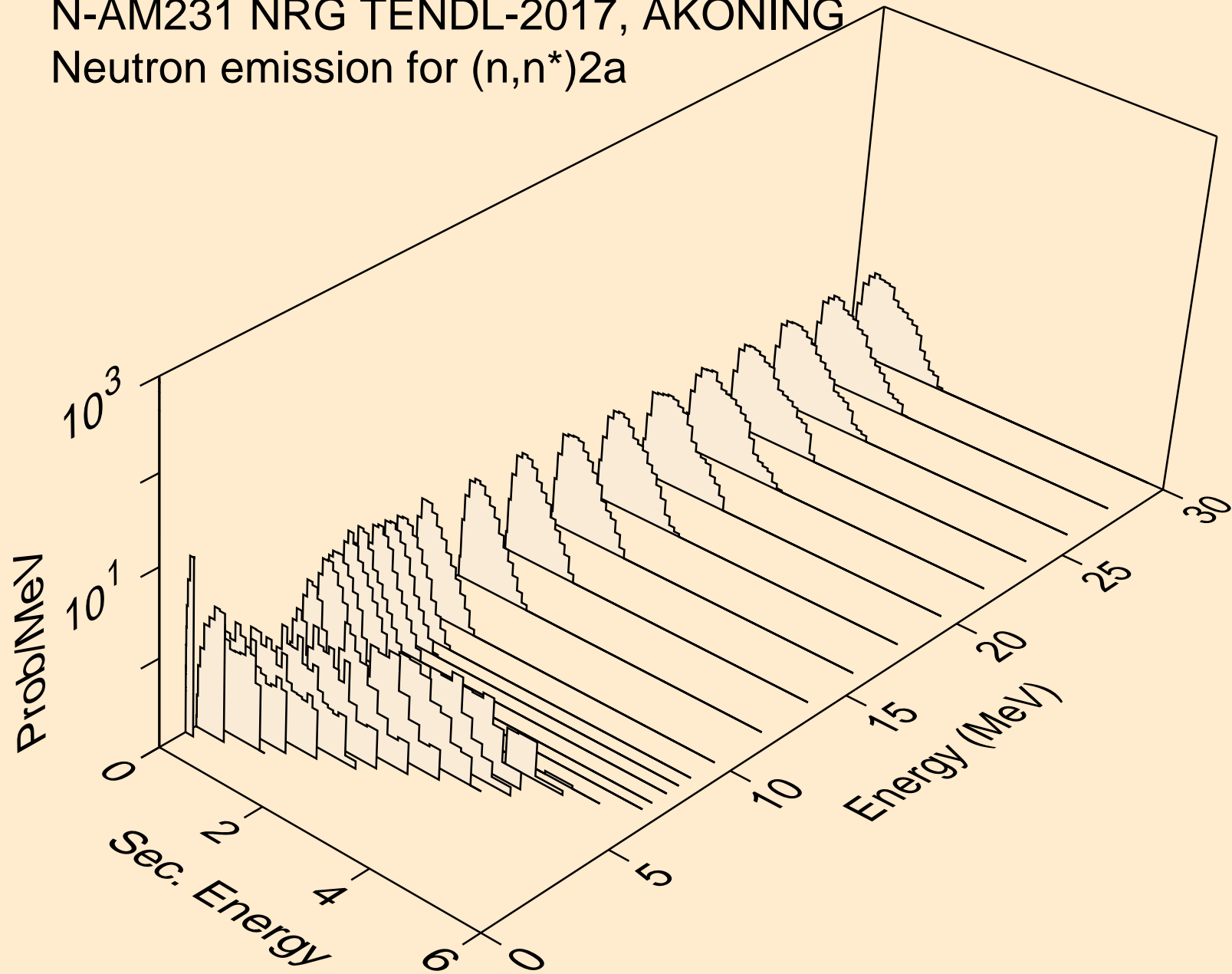

N-AM231 NRG TENDL-2017, AKONING
Neutron emission for (n,2n)2a

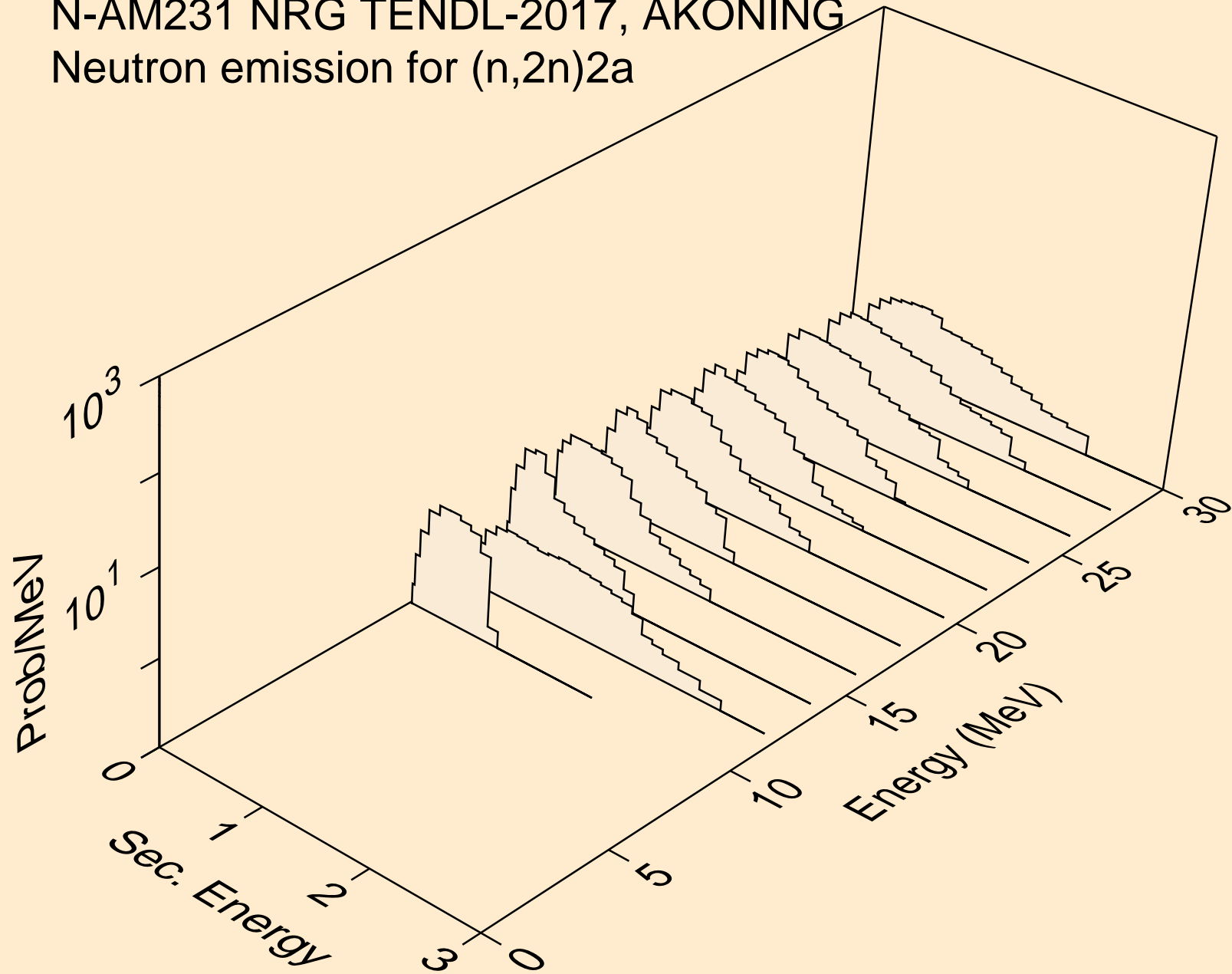

N-AM231 NRG TENDL-2017, AKONING
Neutron emission for (n,n*)d

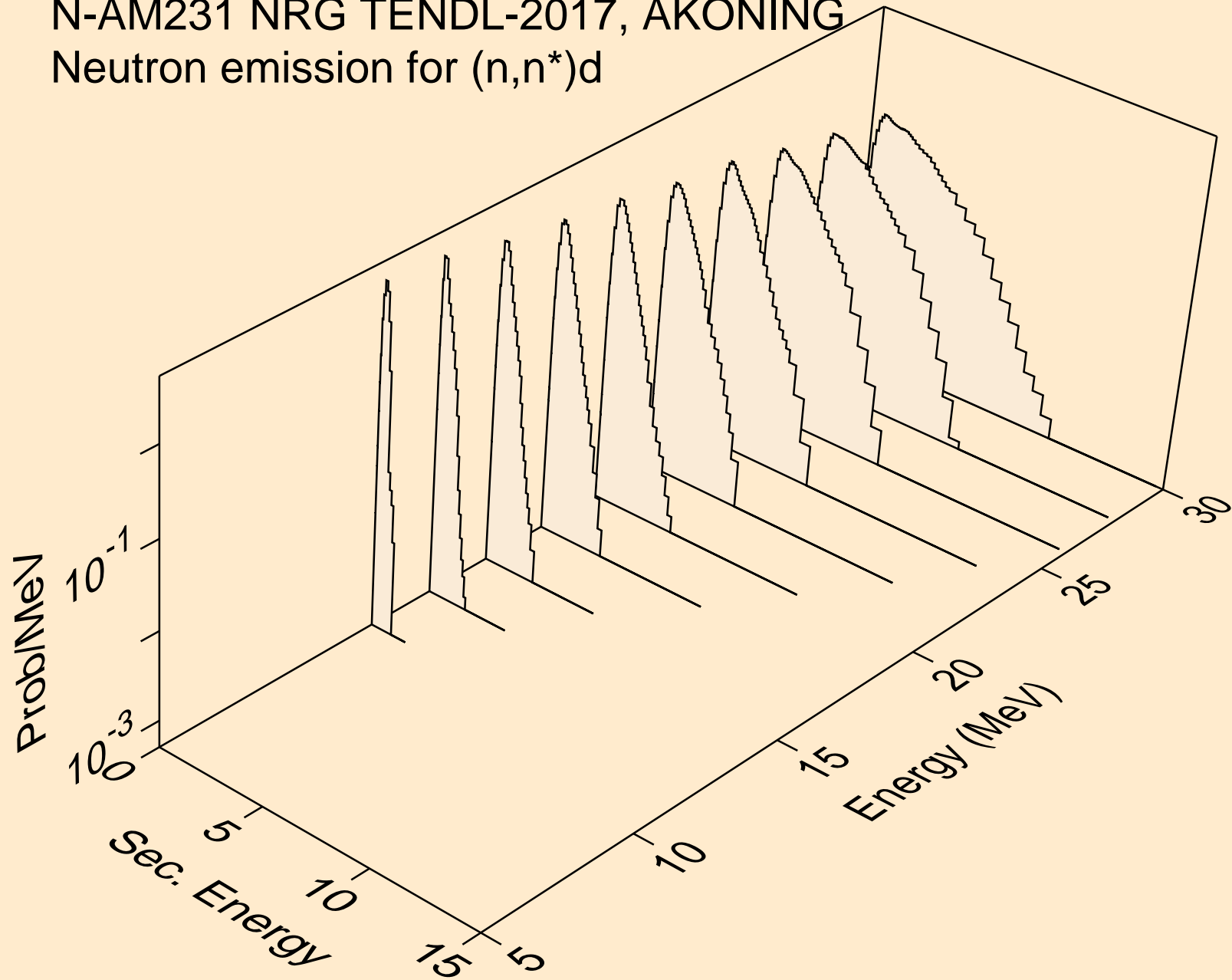

N-AM231 NRG TENDL-2017, AKONING
Neutron emission for (n,n*)t

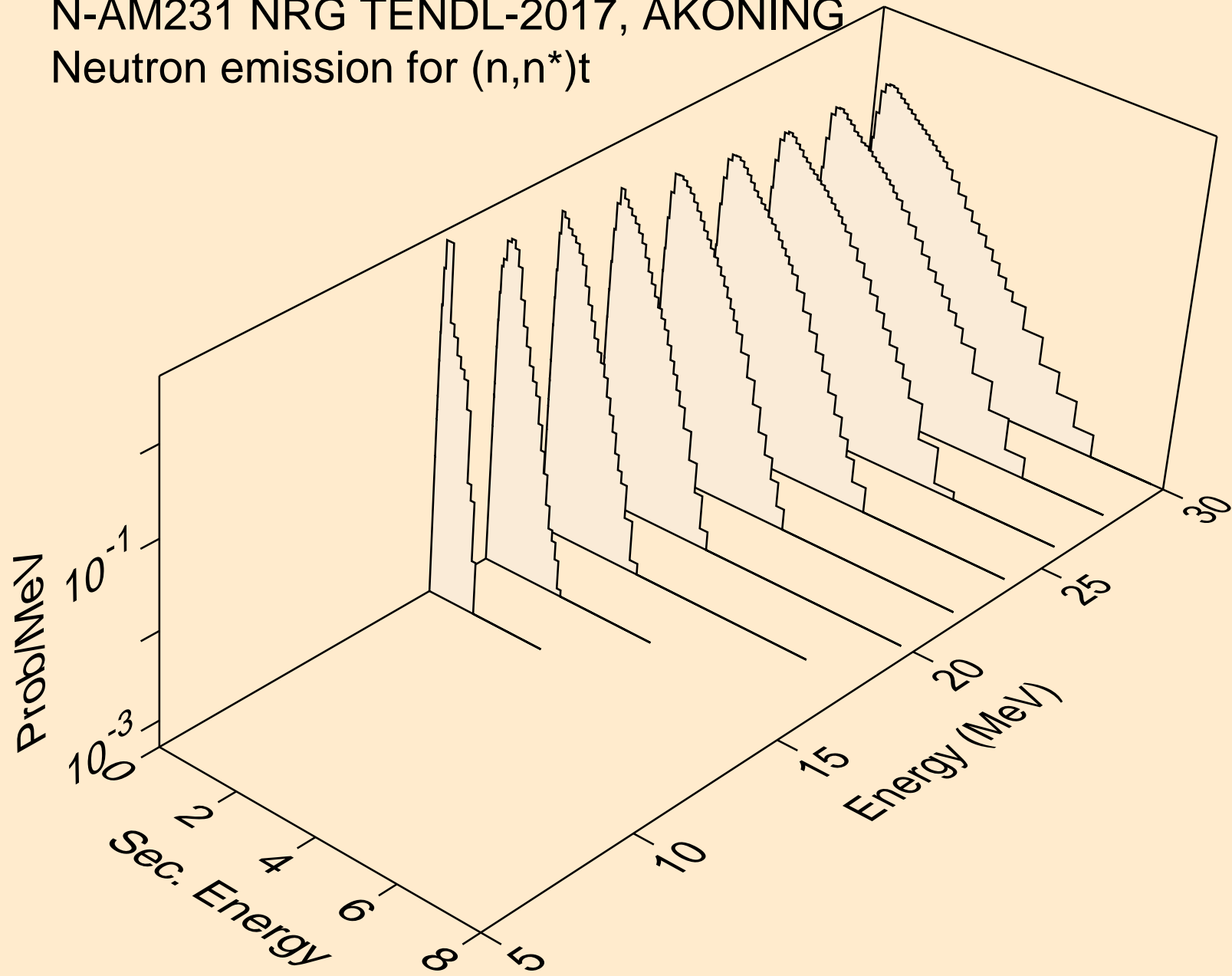

N-AM231 NRG TENDL-2017, AKONING
Neutron emission for (n,n*)he3

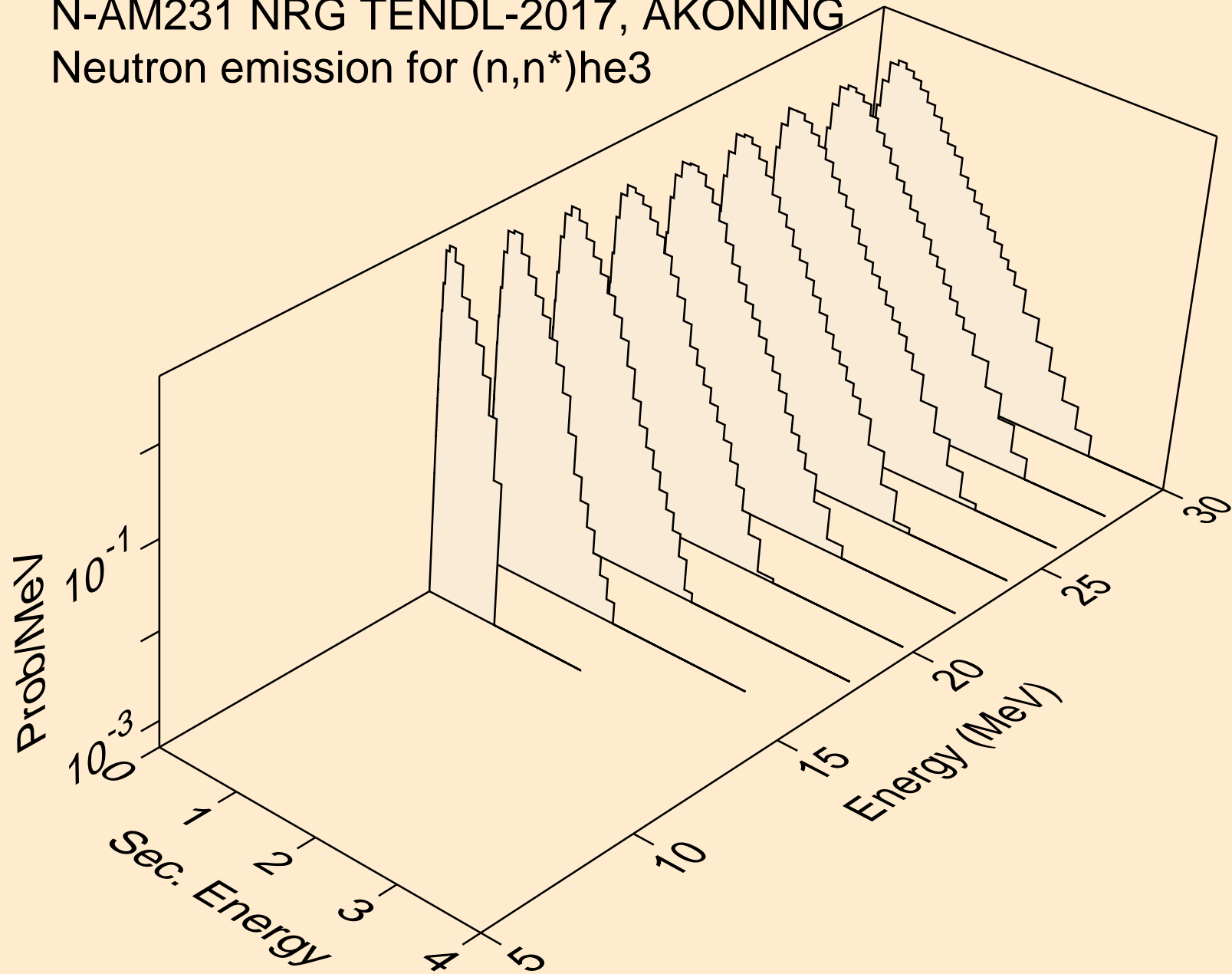

N-AM231 NRG TENDL-2017, AKONING
Neutron emission for (n,4n)

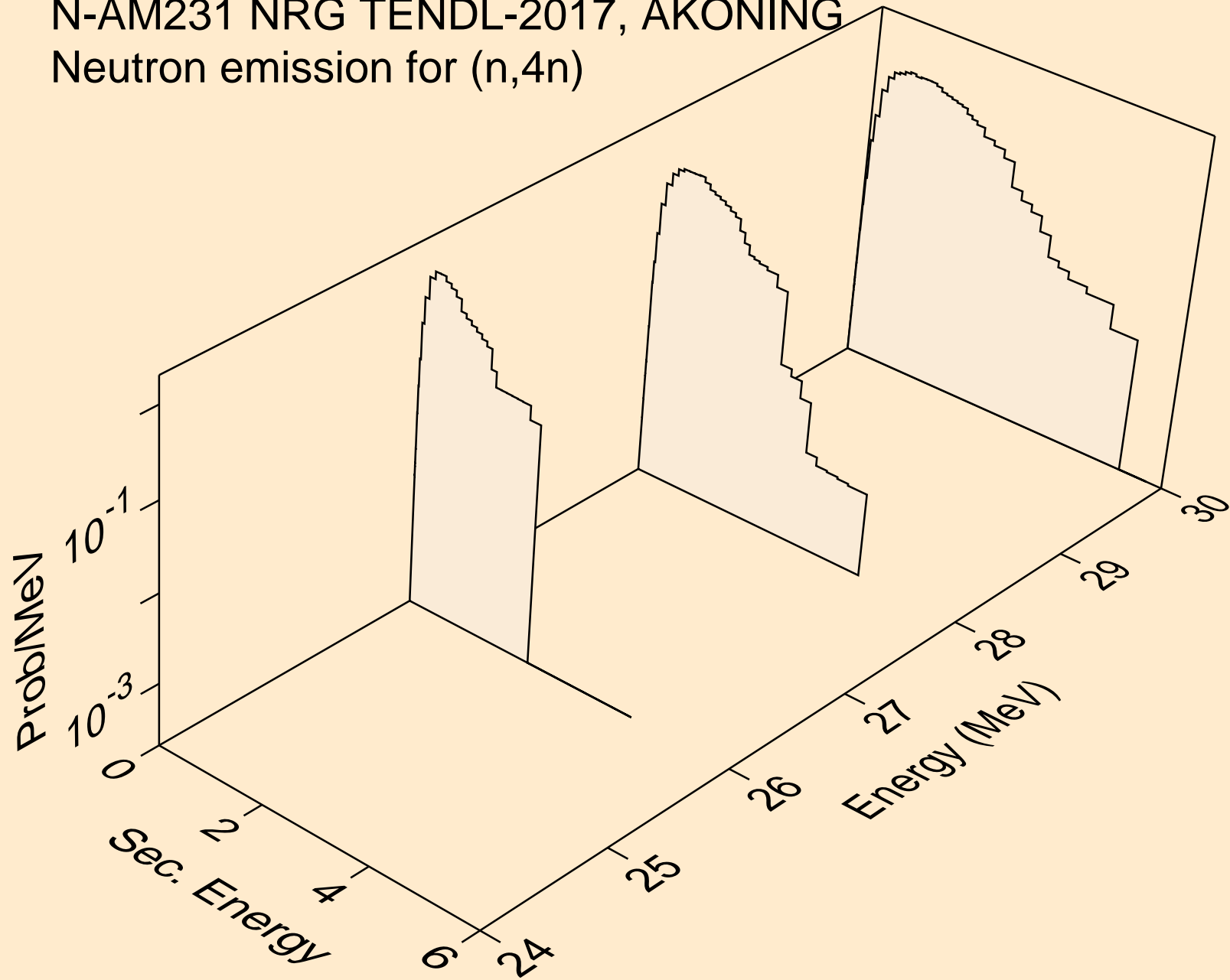

N-AM231 NRG TENDL-2017, AKONING
Neutron emission for (n,2np)

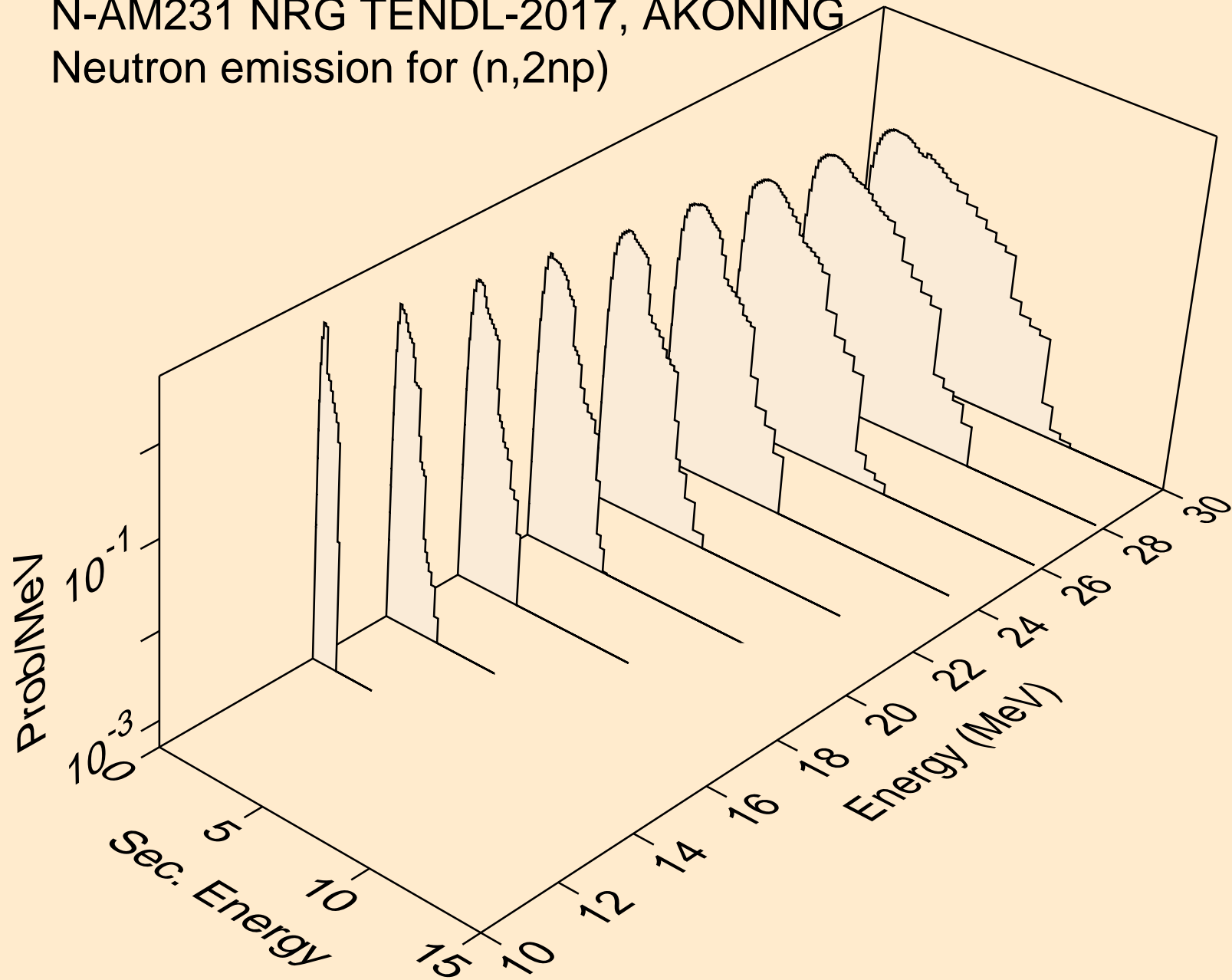

N-AM231 NRG TENDL-2017, AKONING
Neutron emission for (n,3np)

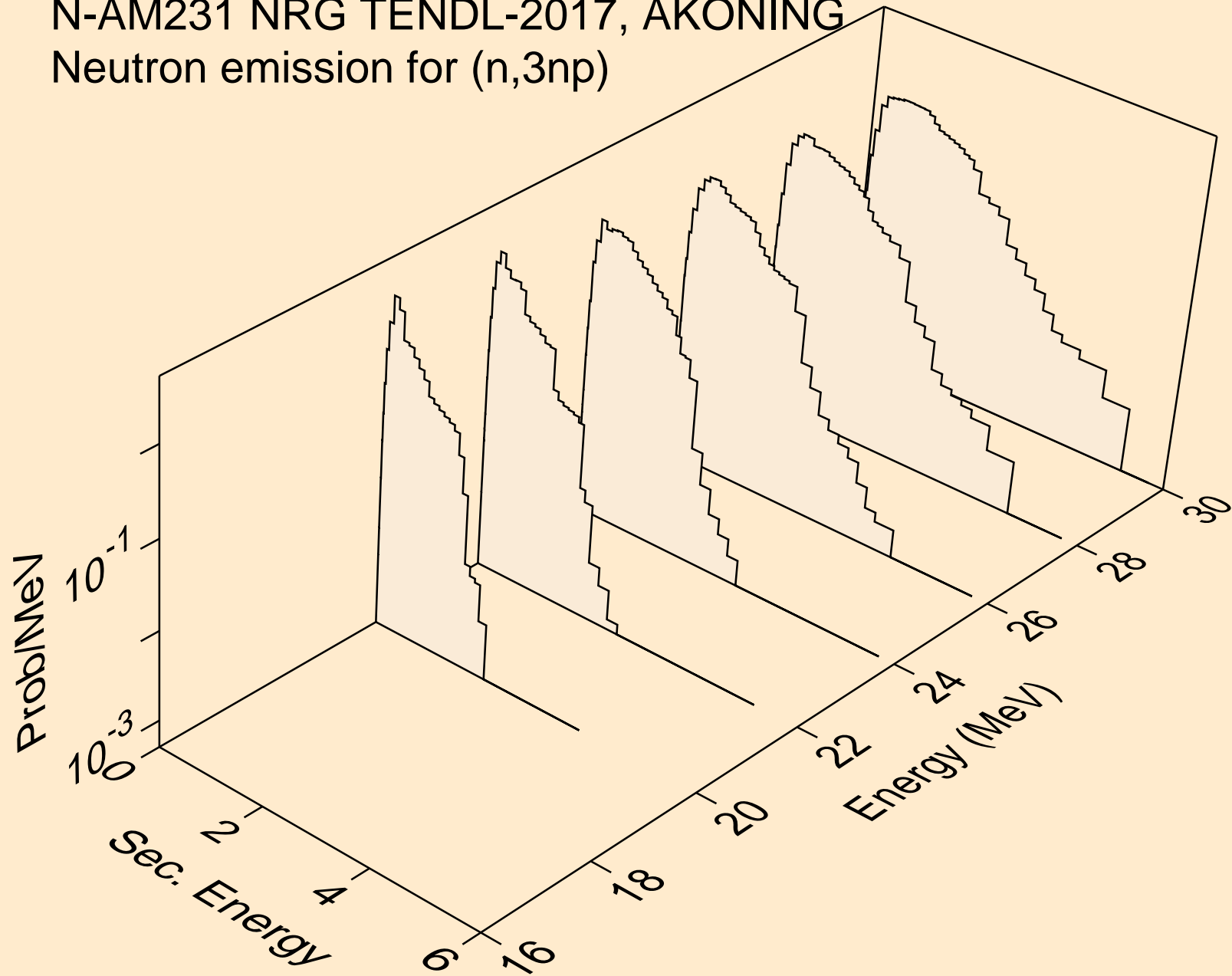

N-AM231 NRG TENDL-2017, AKONING
Neutron emission for (n,2np)

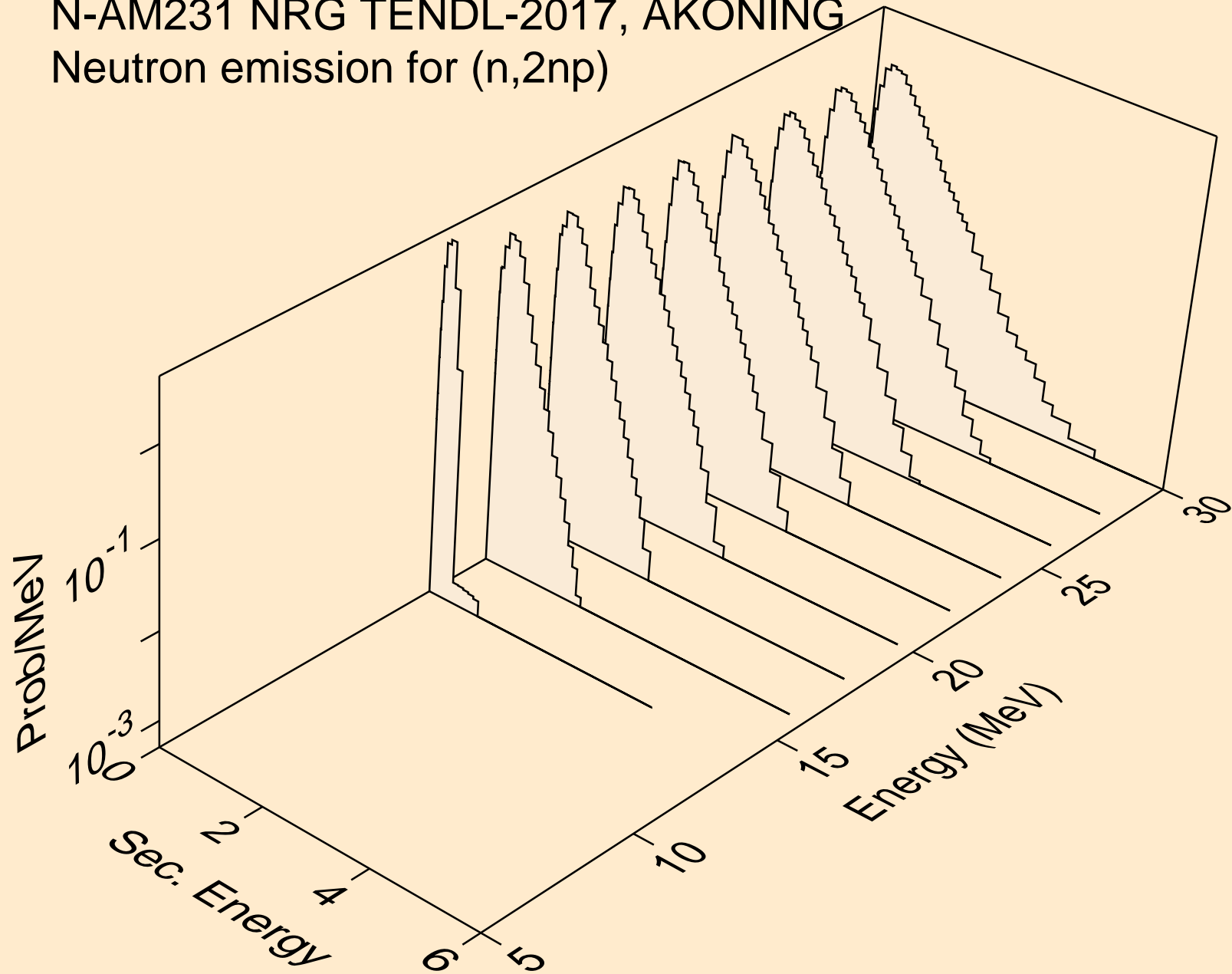

N-AM231 NRG TENDL-2017, AKONING
Neutron emission for (n,npa)

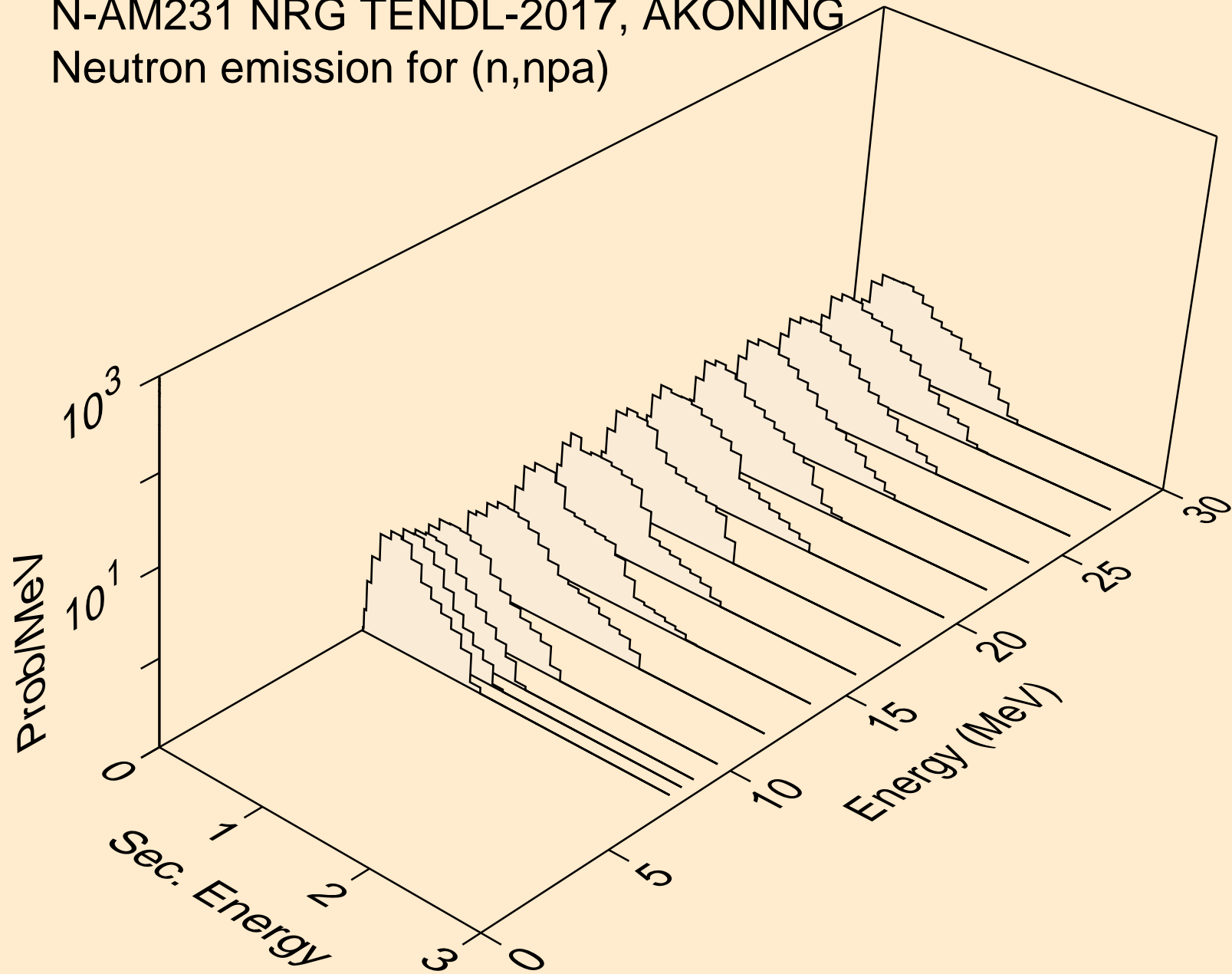

N-AM231 NRG TENDL-2017, AKONING
Neutron emission for (n,n*c)

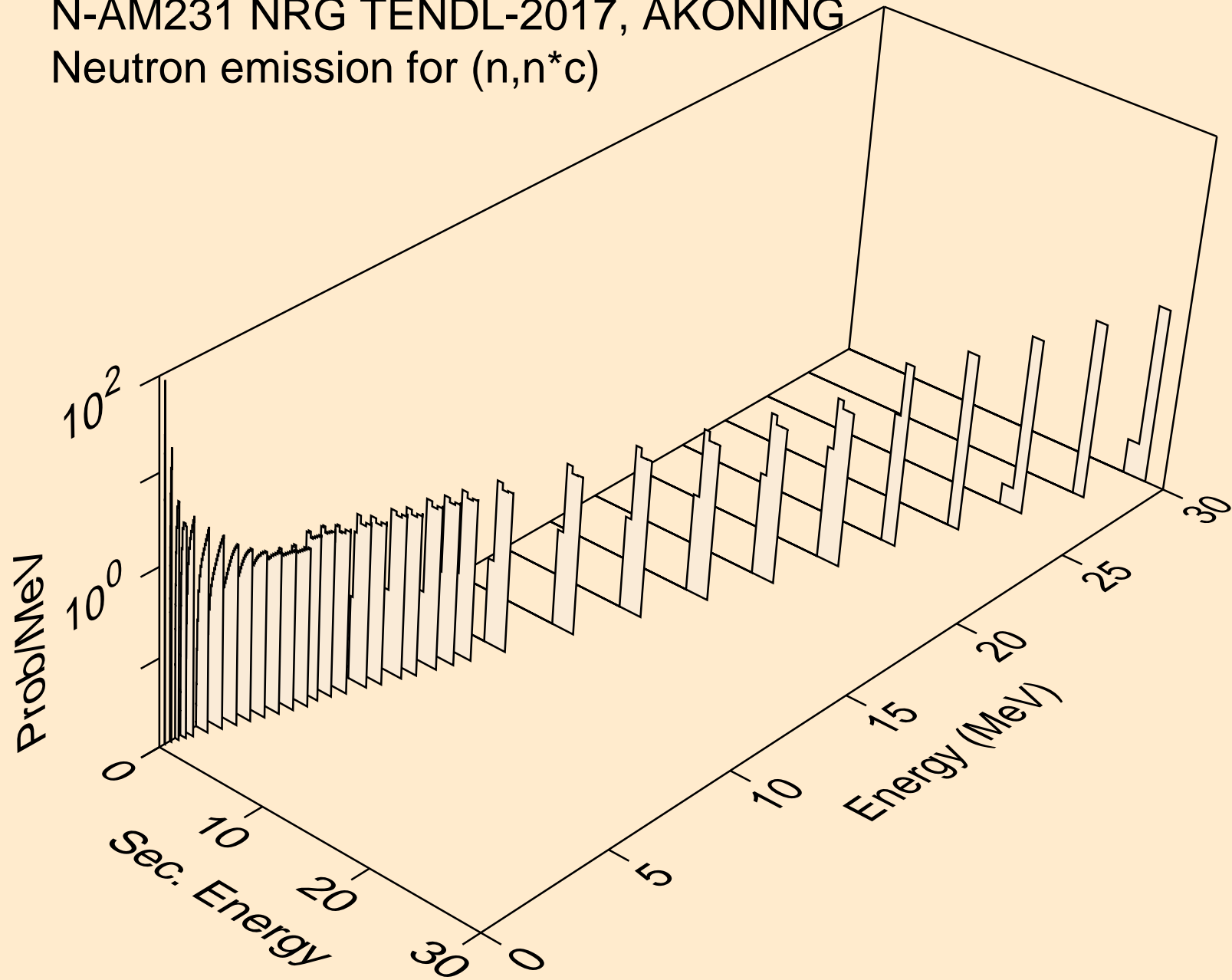

N-AM231 NRG TENDL-2017, AKONING

Delayed nubar

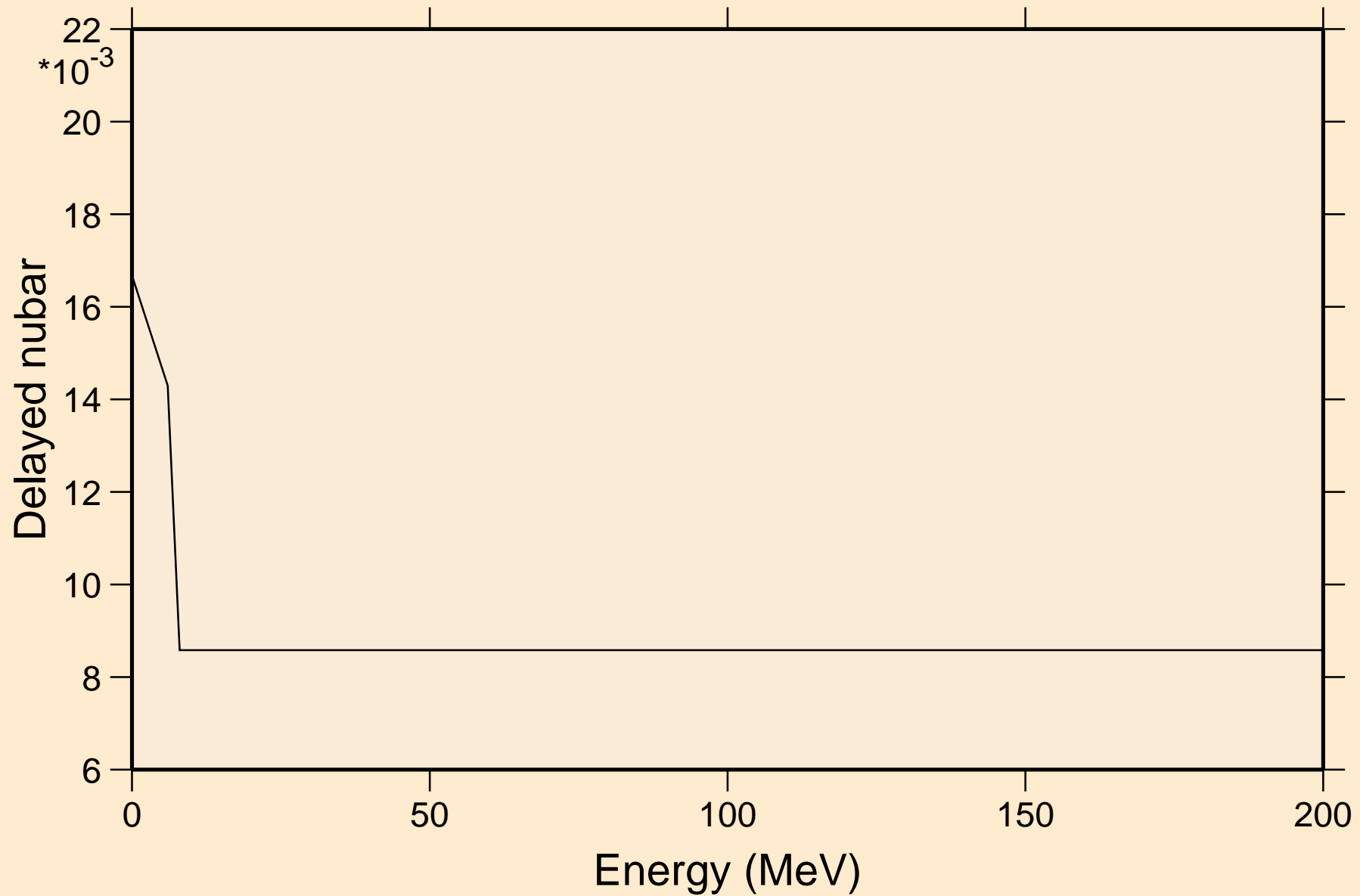

N-AM231 NRG TENDL-2017, AKONING

Delayed neutron spectra

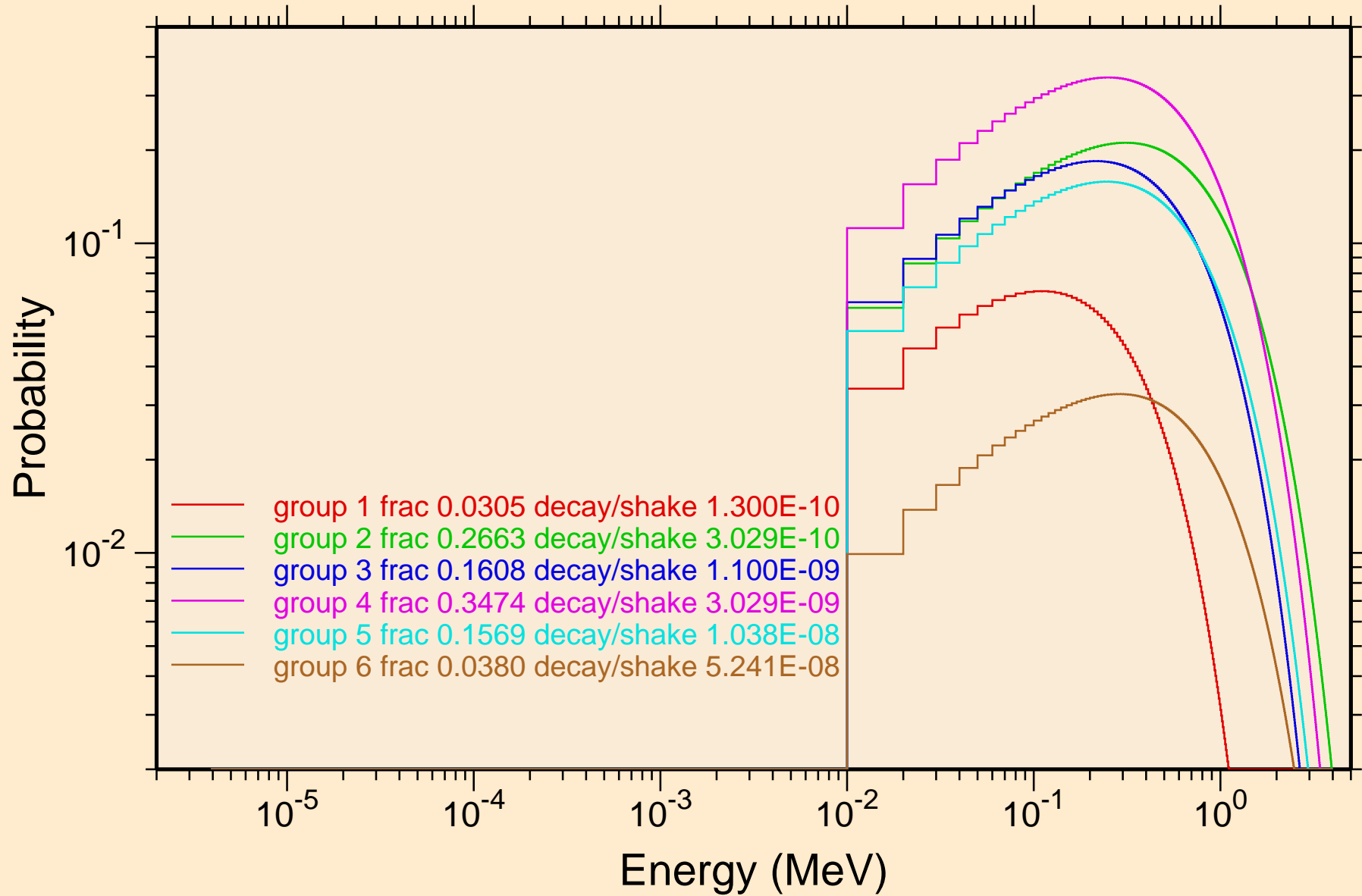

N-AM231 NRG TENDL-2017, AKONING
Photon emission for (n,x)

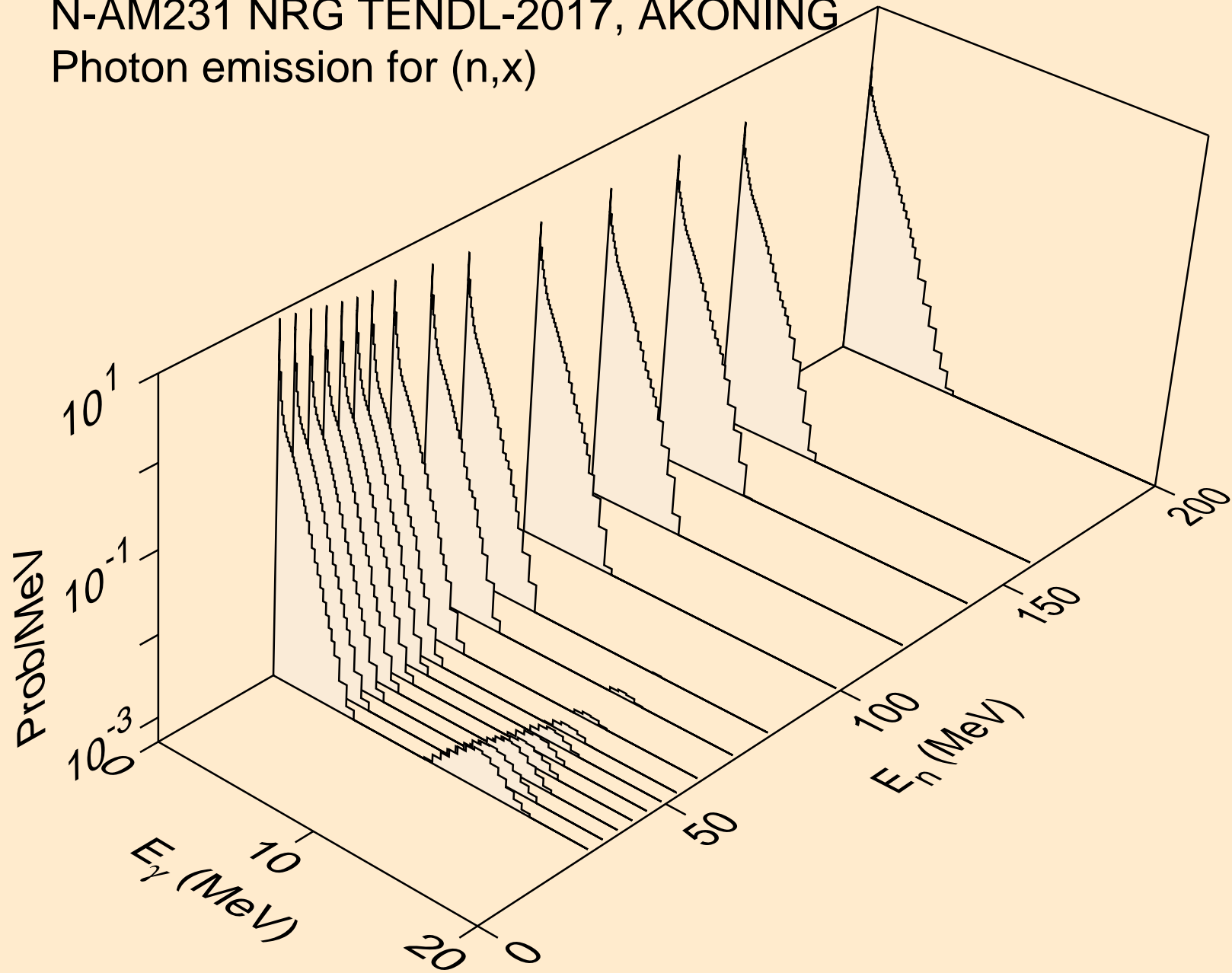

N-AM231 NRG TENDL-2017, AKONING
Photon emission for (n,2nd)

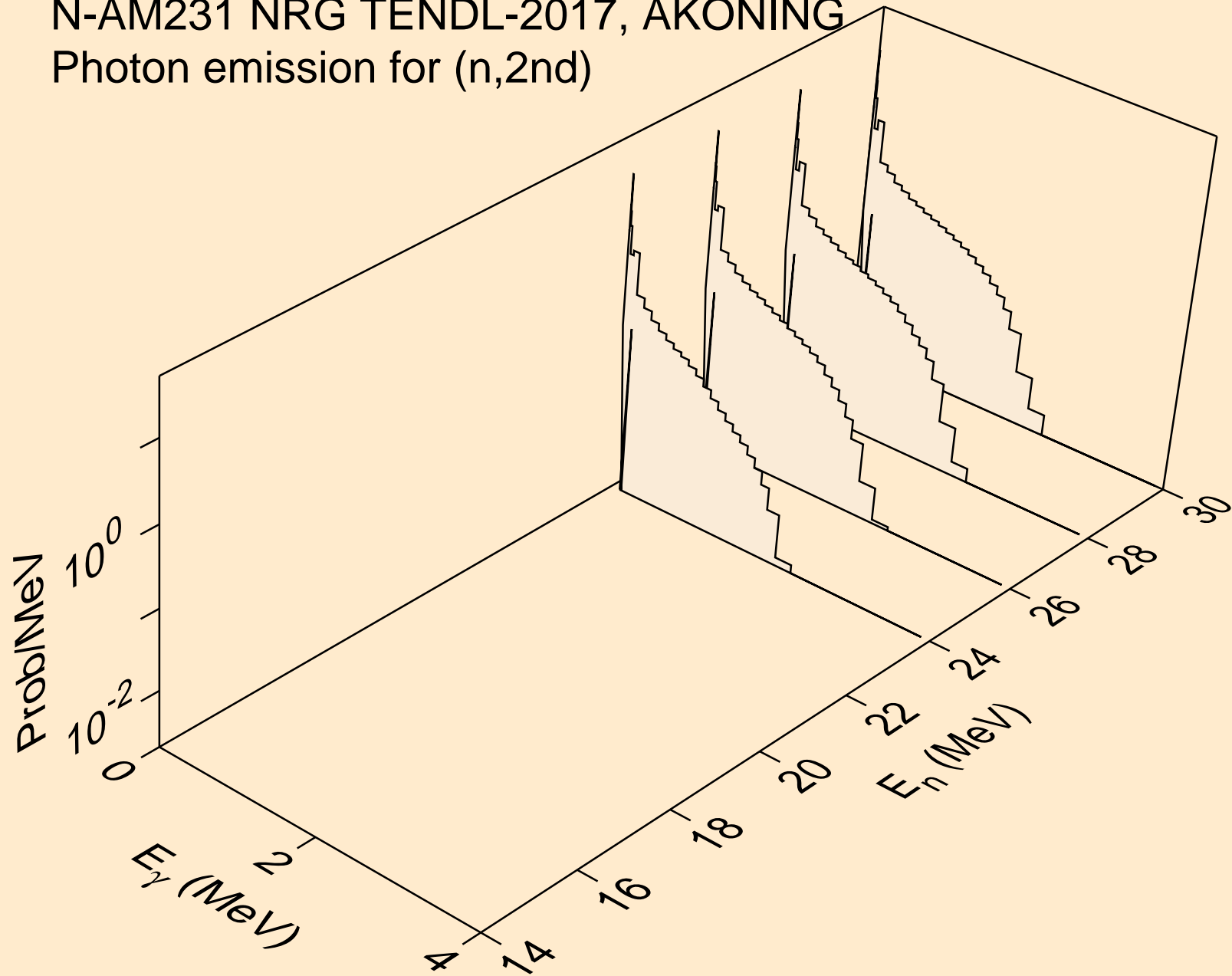

N-AM231 NRG TENDL-2017, AKONING
Photon emission for (n,2n)

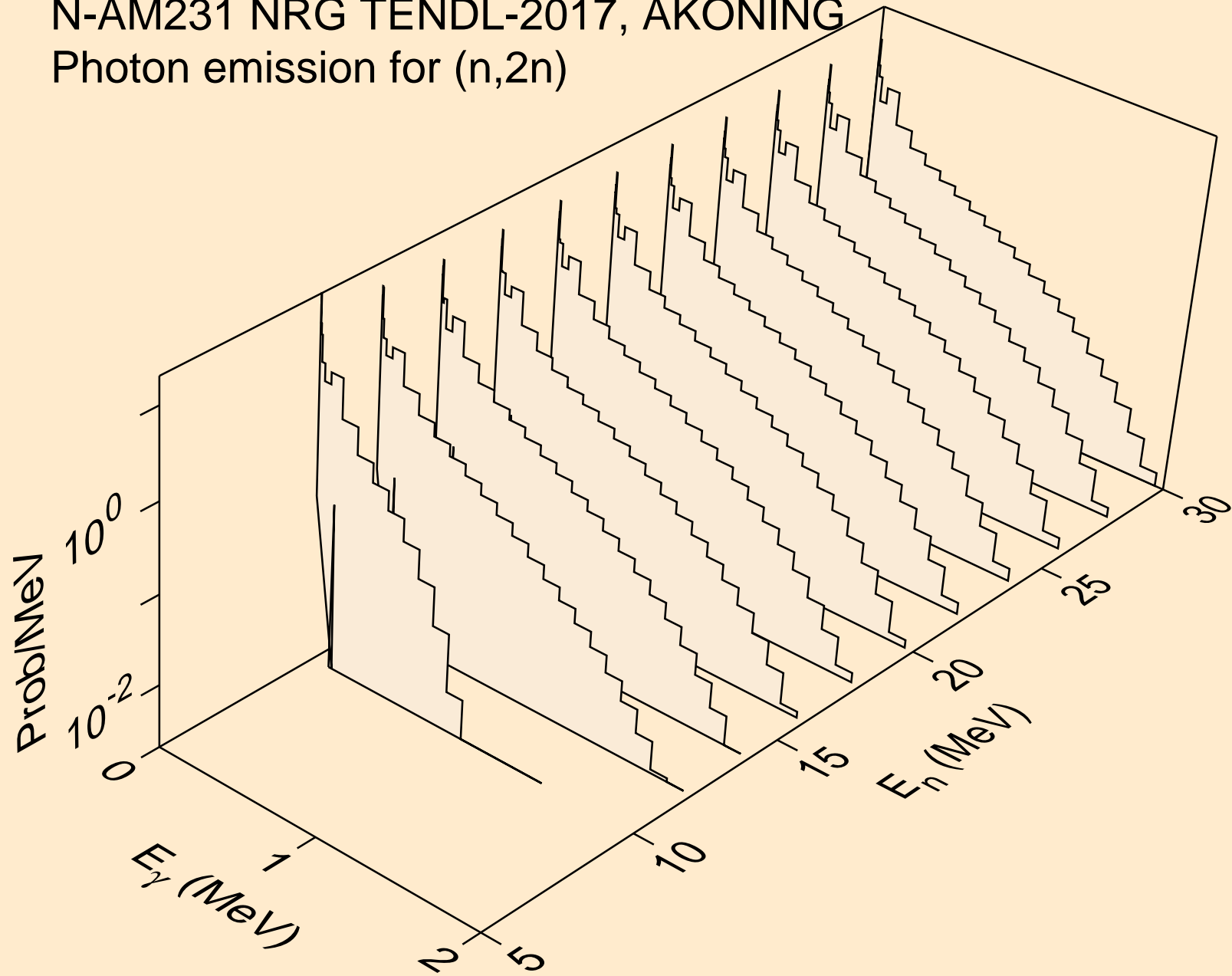

N-AM231 NRG TENDL-2017, AKONING
Photon emission for (n,3n)

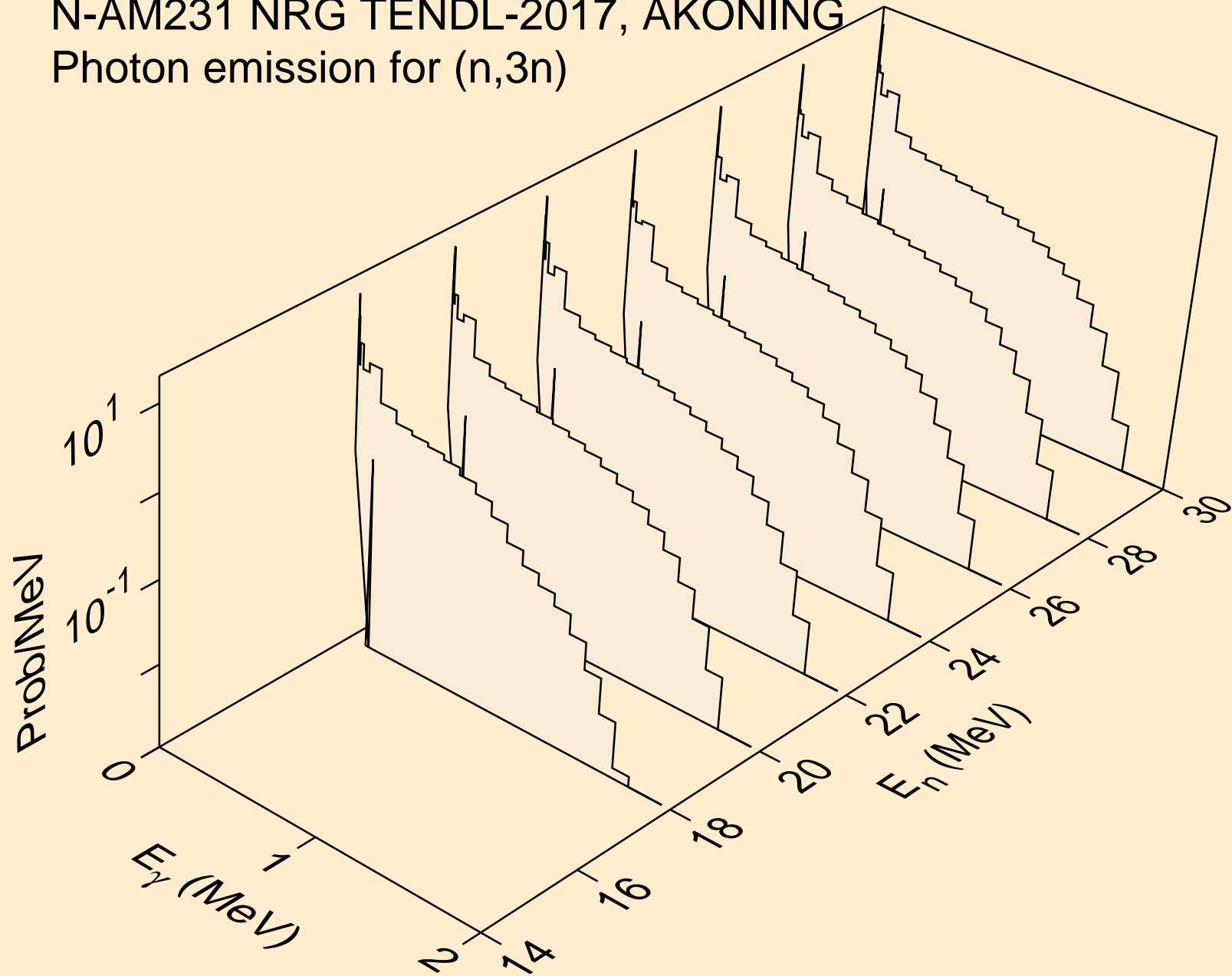

N-AM231 NRG TENDL-2017, AKONING
Photon emission for (n,n*)a

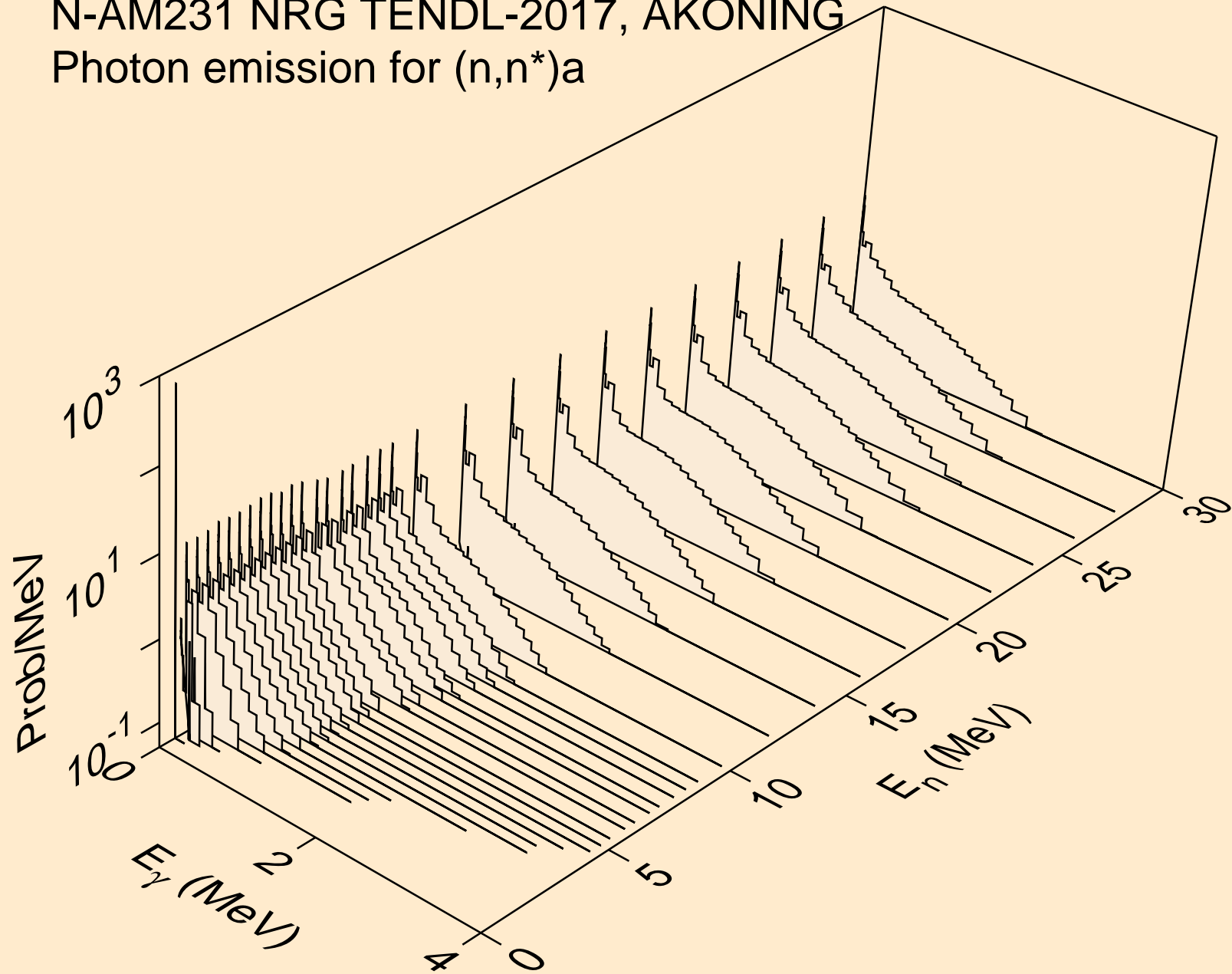

N-AM231 NRG TENDL-2017, AKONING
Photon emission for (n,n*)3a

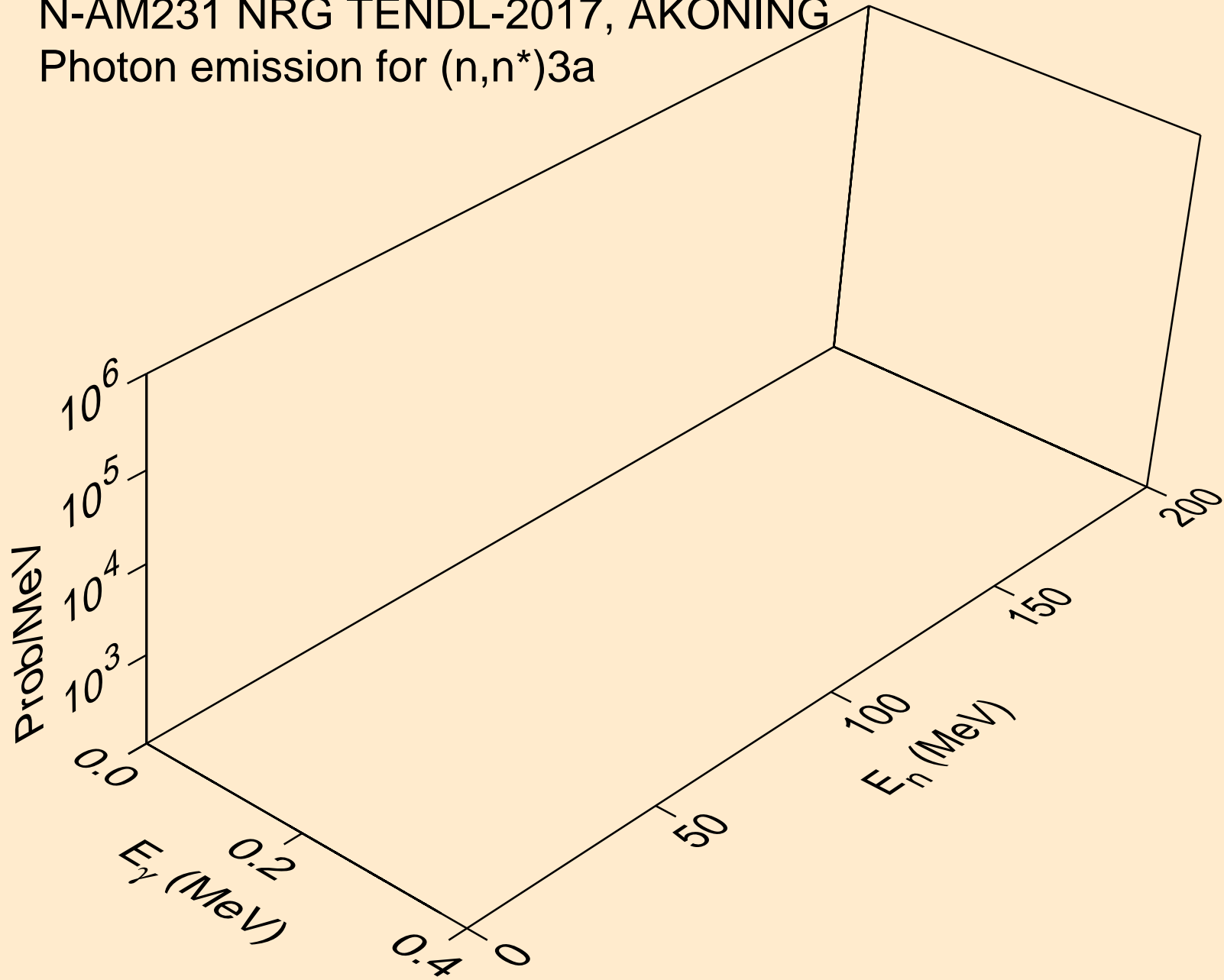

N-AM231 NRG TENDL-2017, AKONING
Photon emission for (n,2n)a

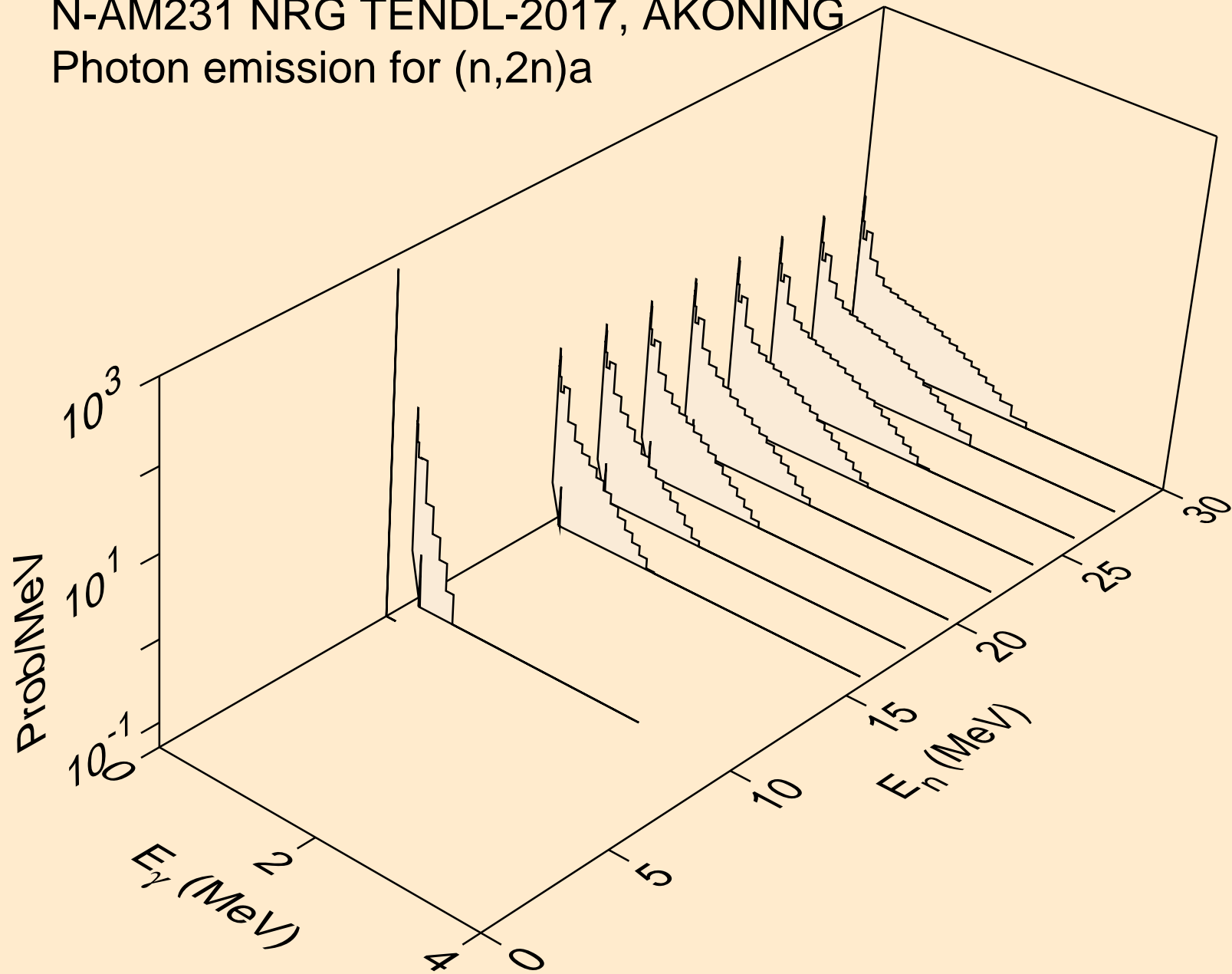

N-AM231 NRG TENDL-2017, AKONING
Photon emission for (n,3n)a

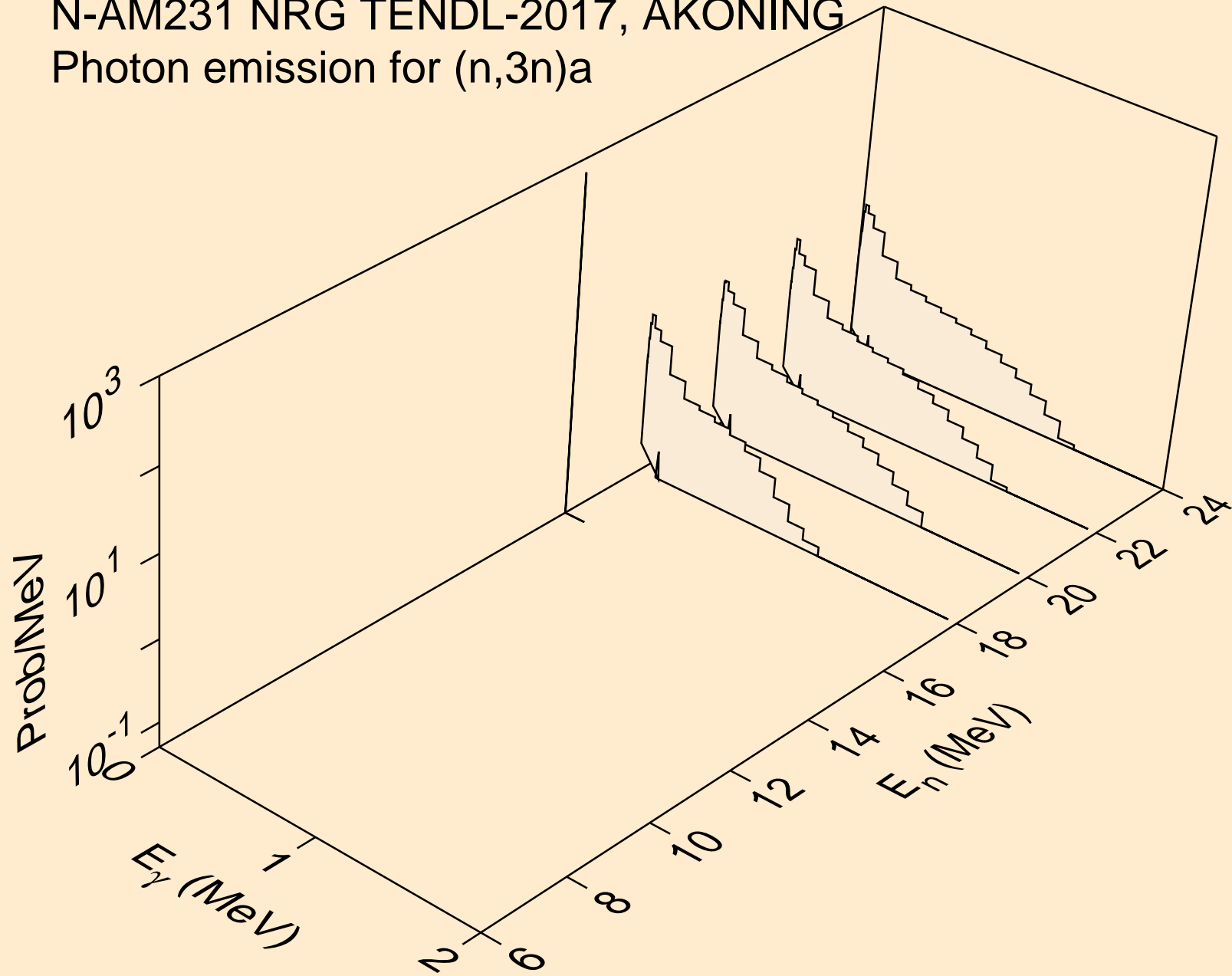

N-AM231 NRG TENDL-2017, AKONING
Photon emission for (n,n*)p

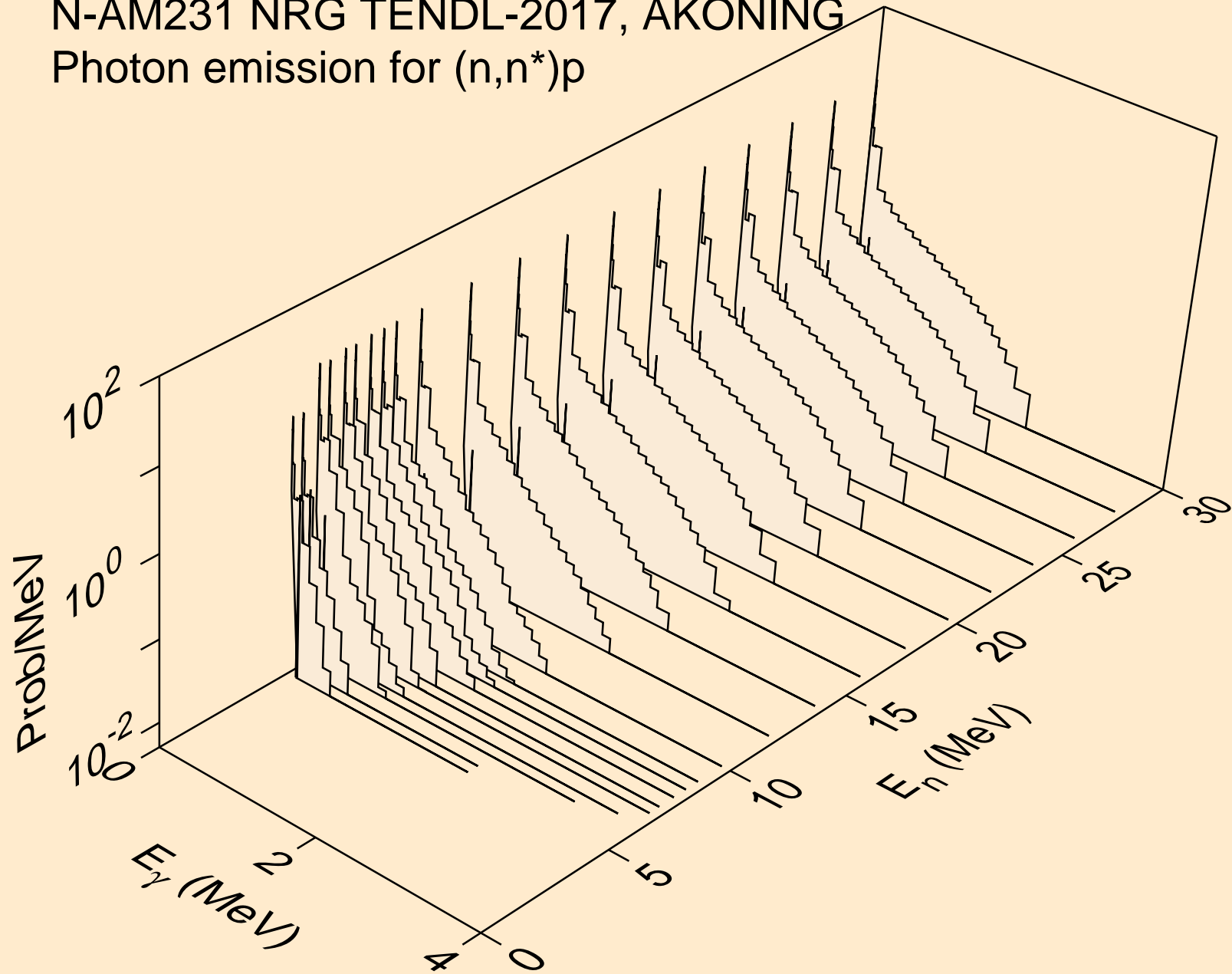

N-AM231 NRG TENDL-2017, AKONING
Photon emission for (n,n*)2a

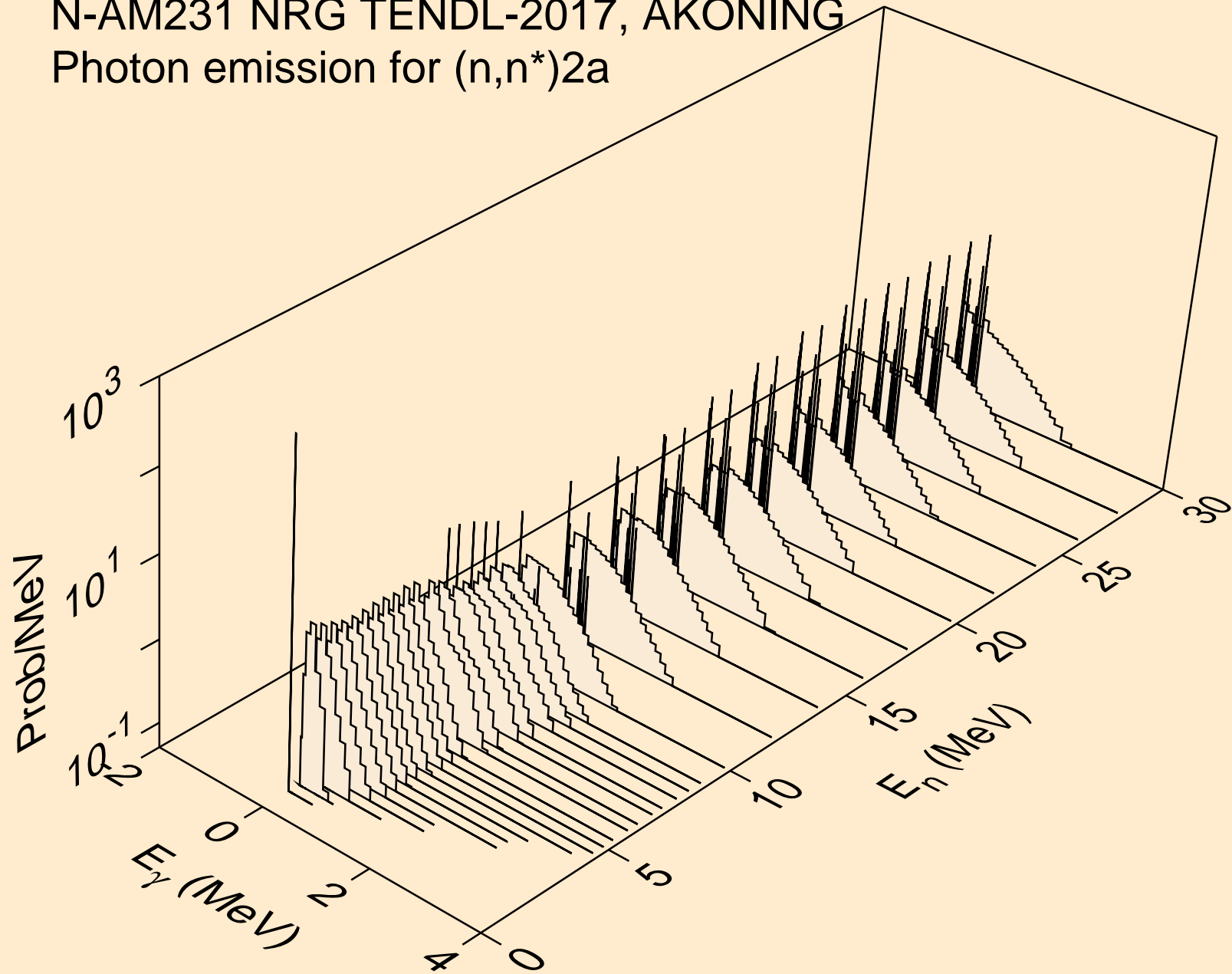

N-AM231 NRG TENDL-2017, AKONING
Photon emission for (n,2n)2a

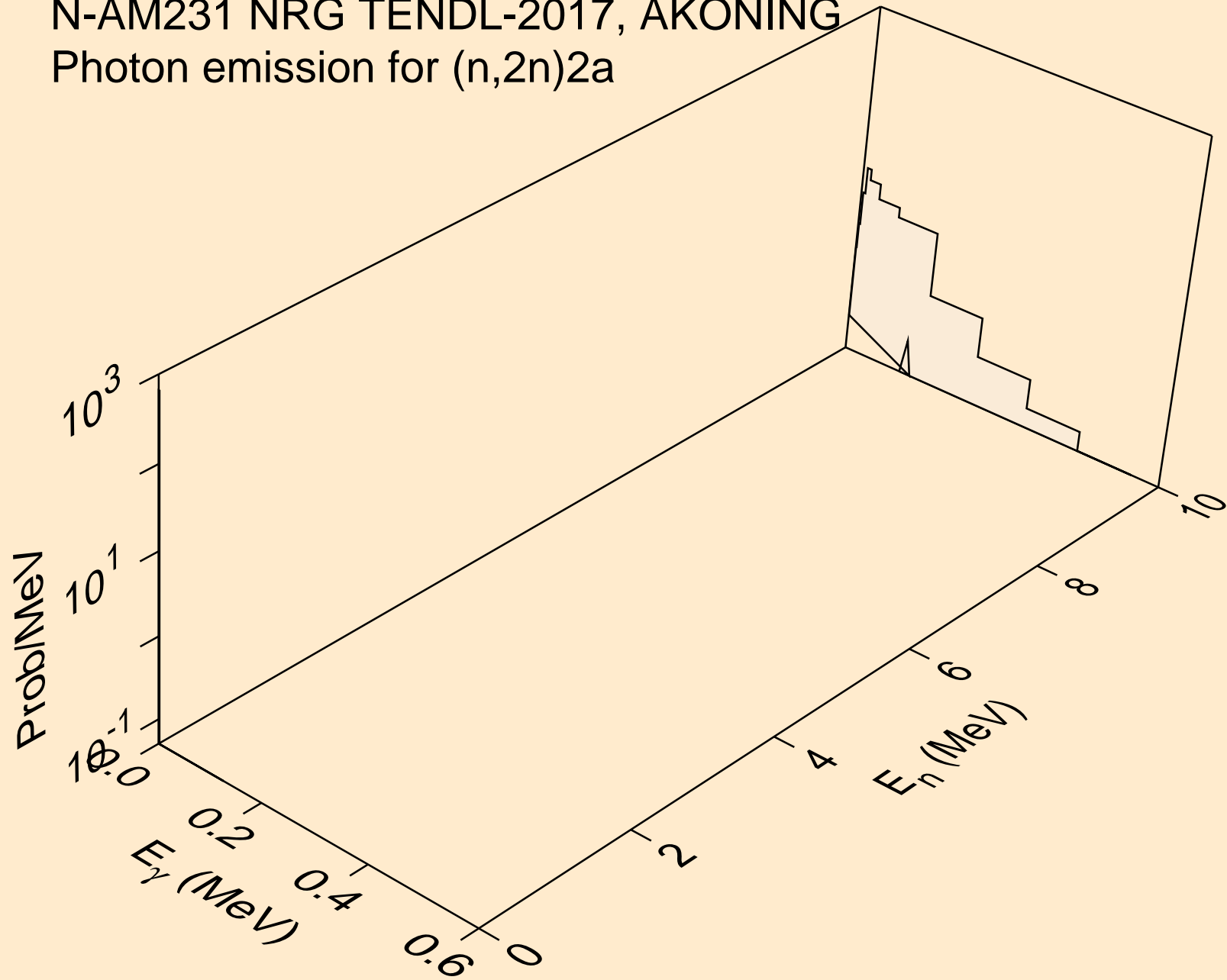

N-AM231 NRG TENDL-2017, AKONING
Photon emission for (n,n*)d

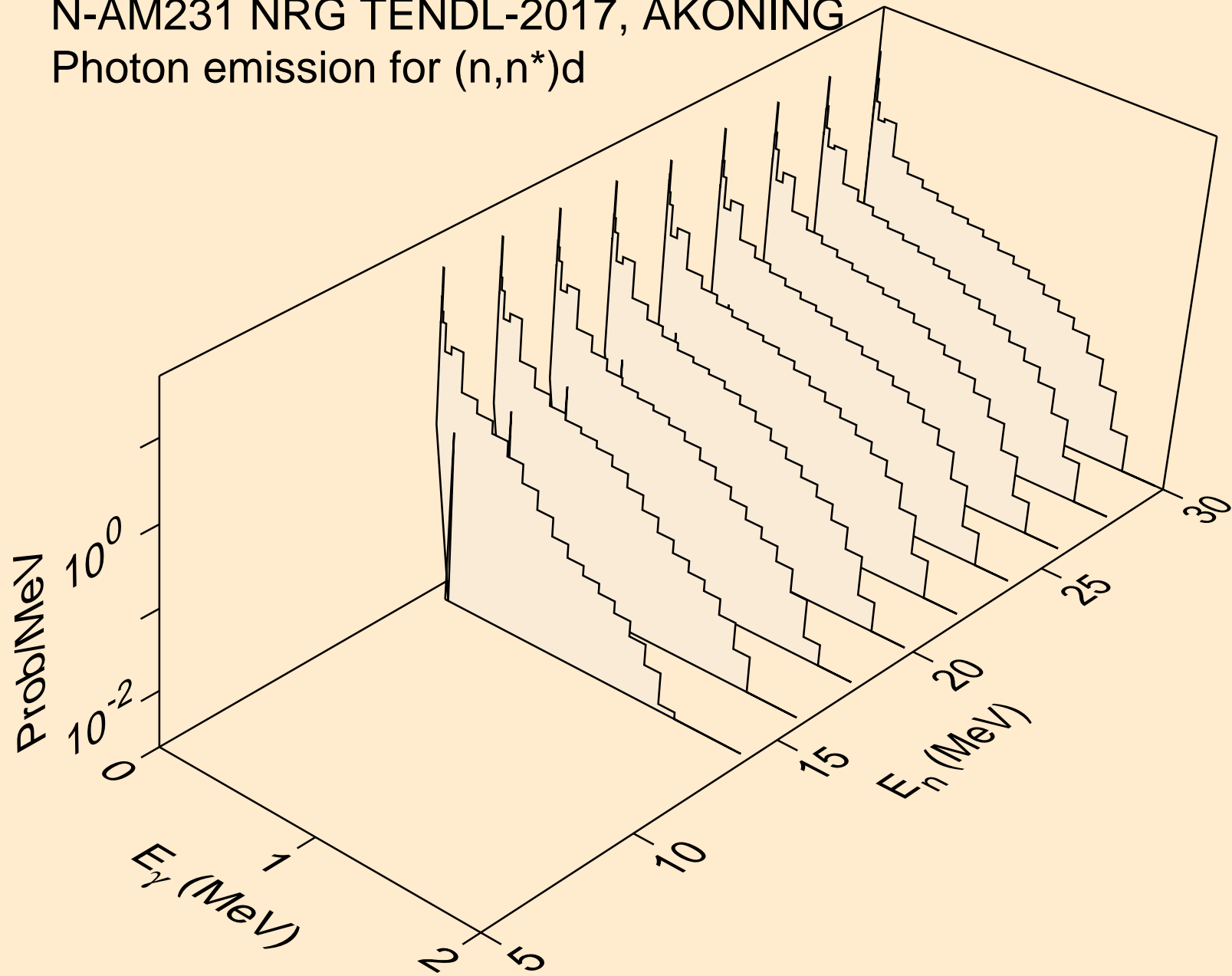

N-AM231 NRG TENDL-2017, AKONING
Photon emission for (n,n*)t

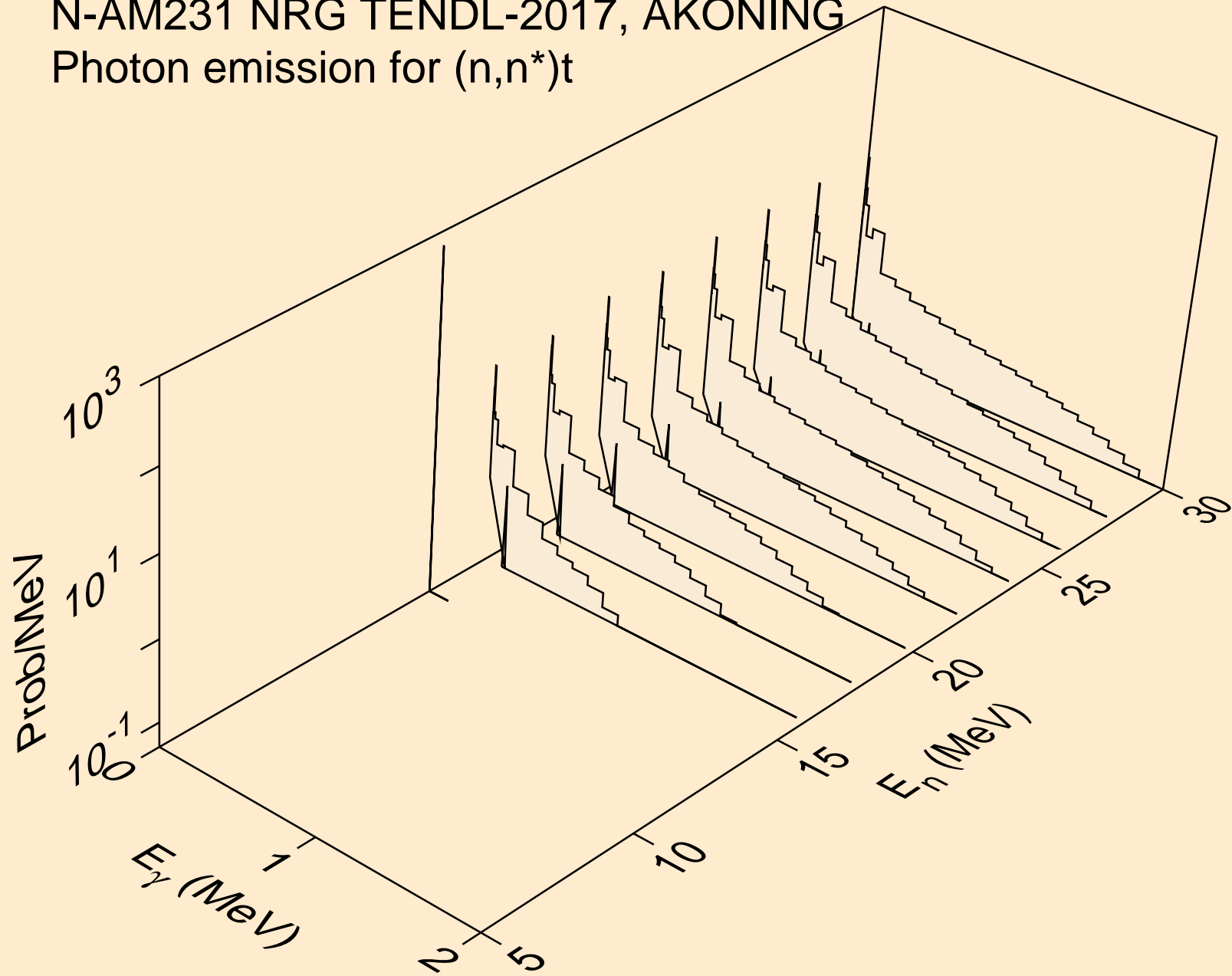

N-AM231 NRG TENDL-2017, AKONING
Photon emission for (n,n*)he3

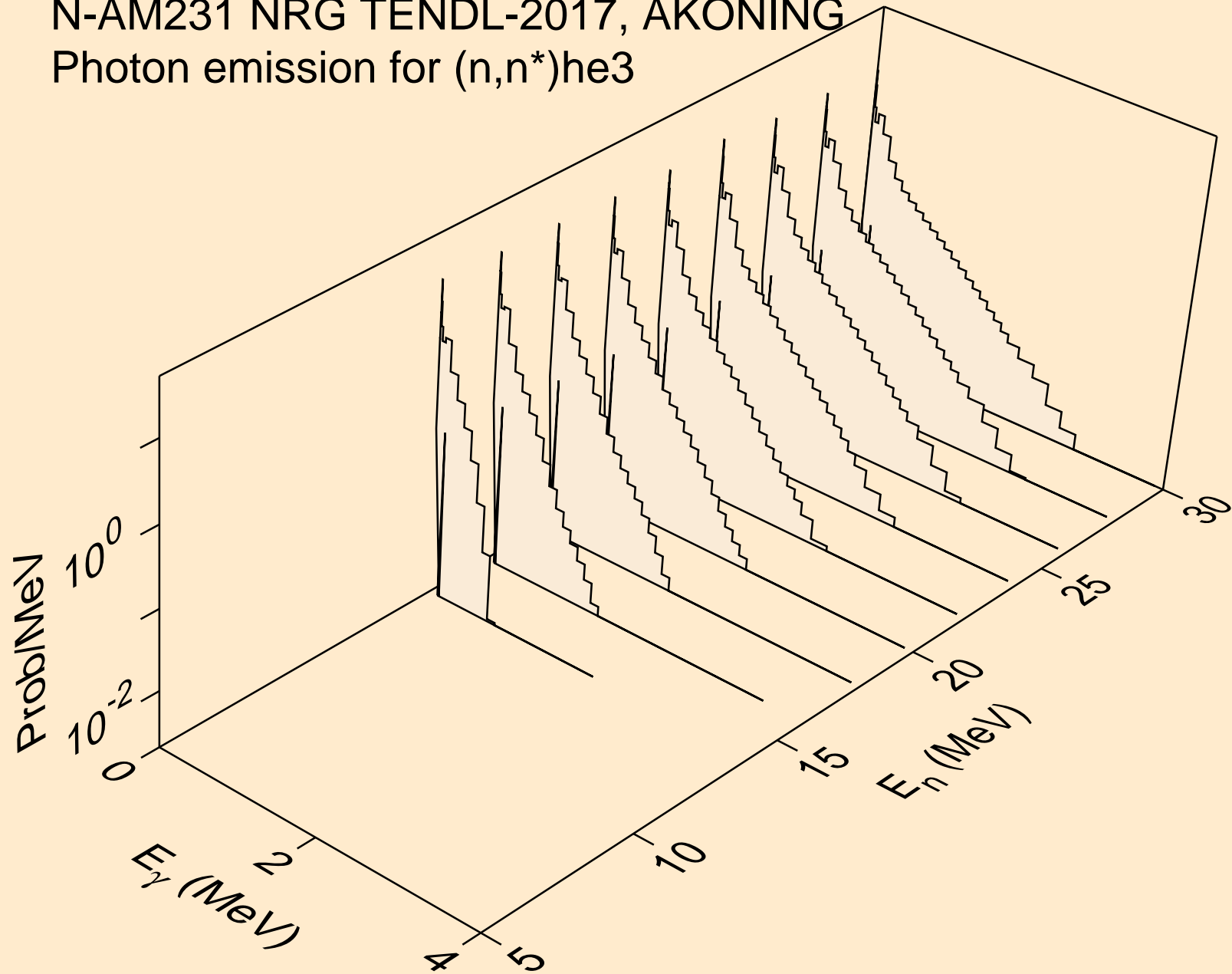

N-AM231 NRG TENDL-2017, AKONING
Photon emission for (n,4n)

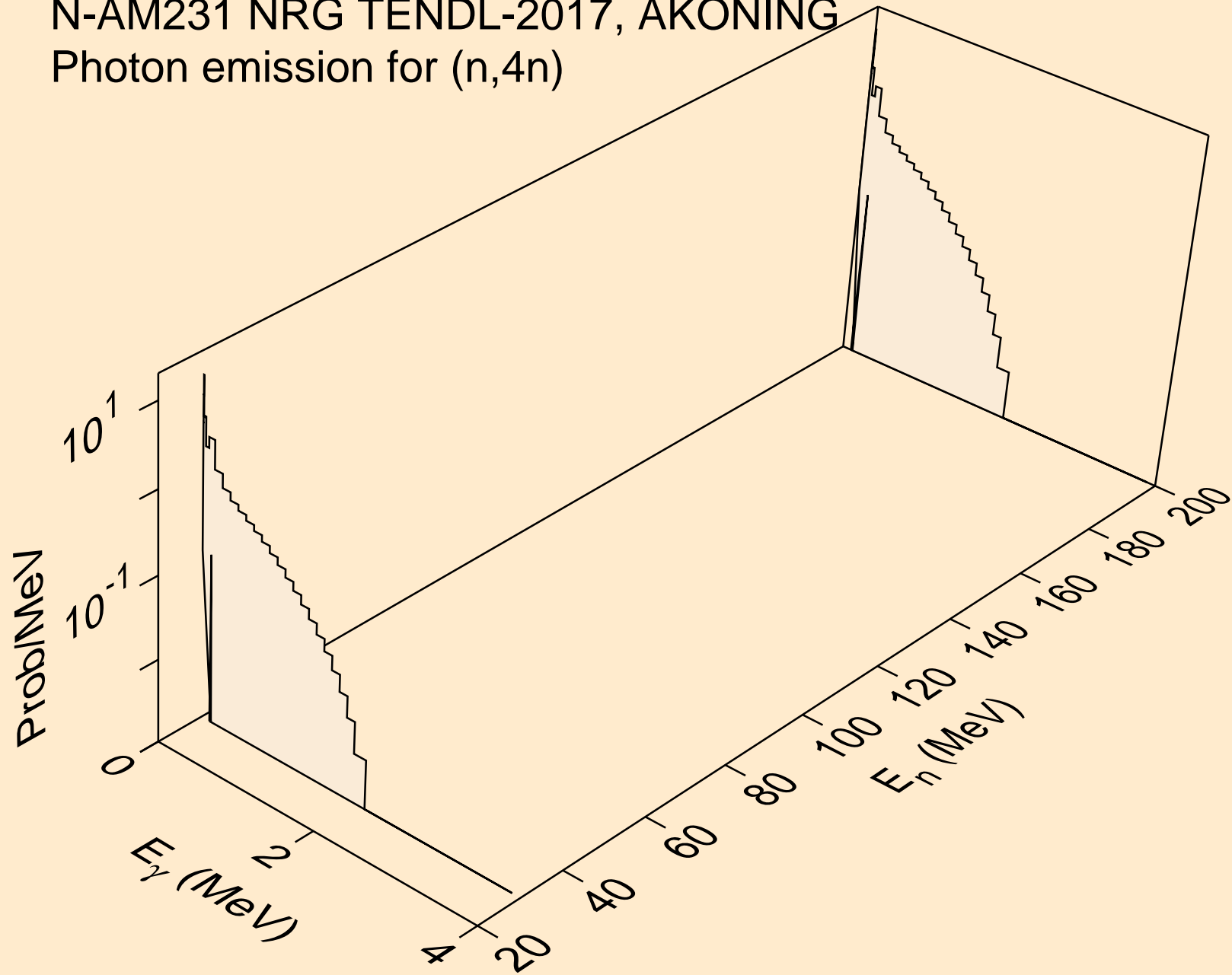

N-AM231 NRG TENDL-2017, AKONING
Photon emission for (n,2np)

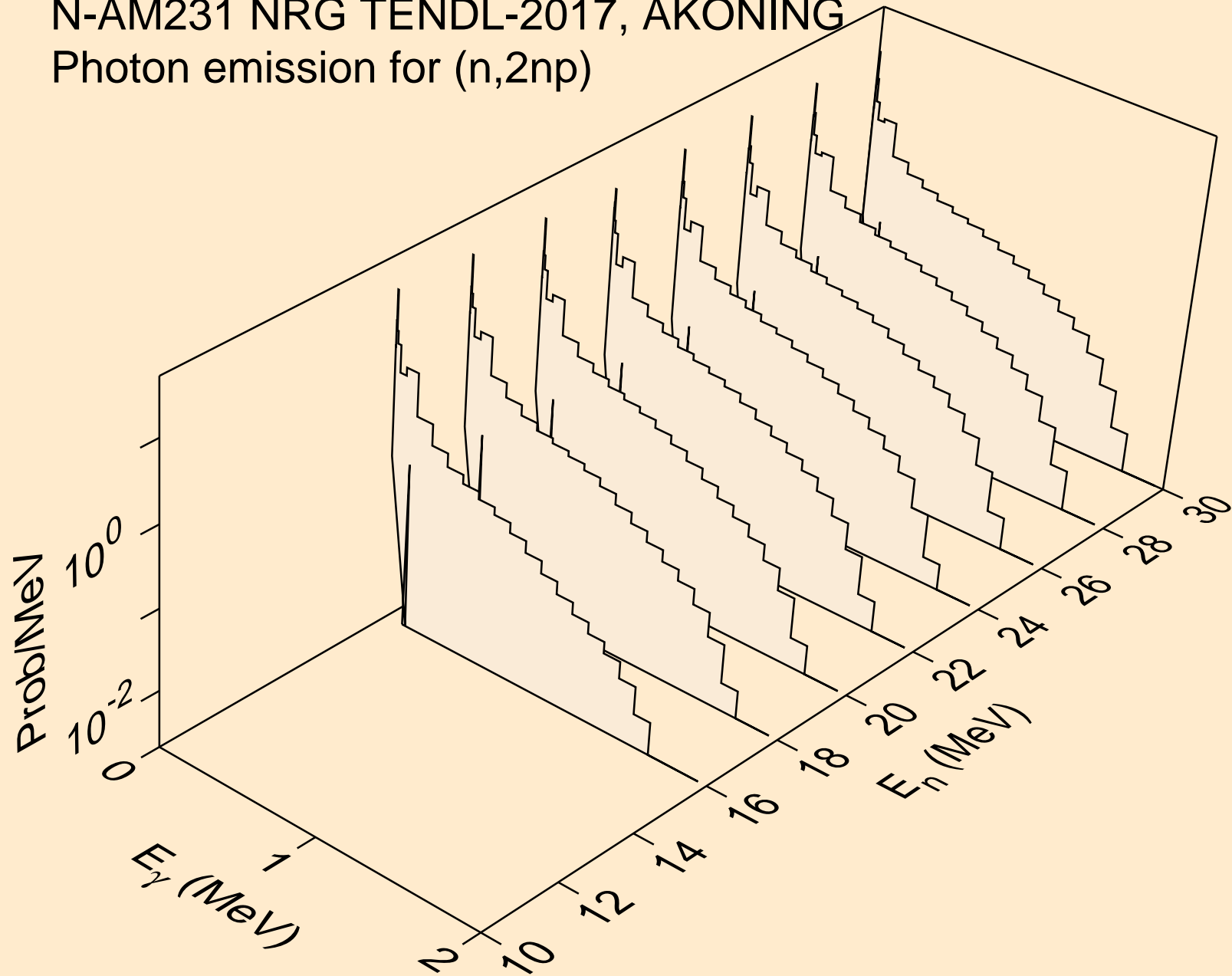

N-AM231 NRG TENDL-2017, AKONING
Photon emission for (n,3np)

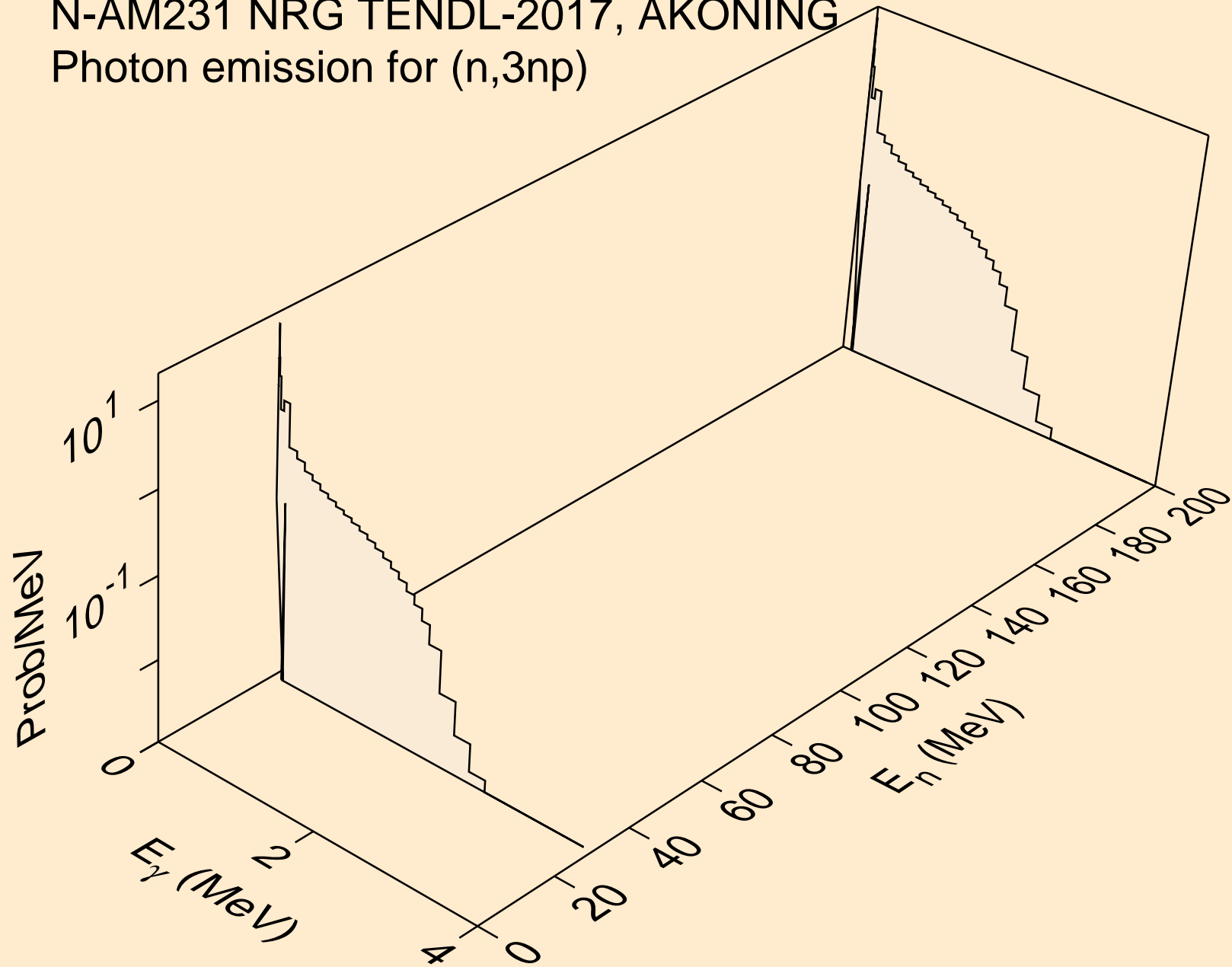

N-AM231 NRG TENDL-2017, AKONING
Photon emission for (n,2np)

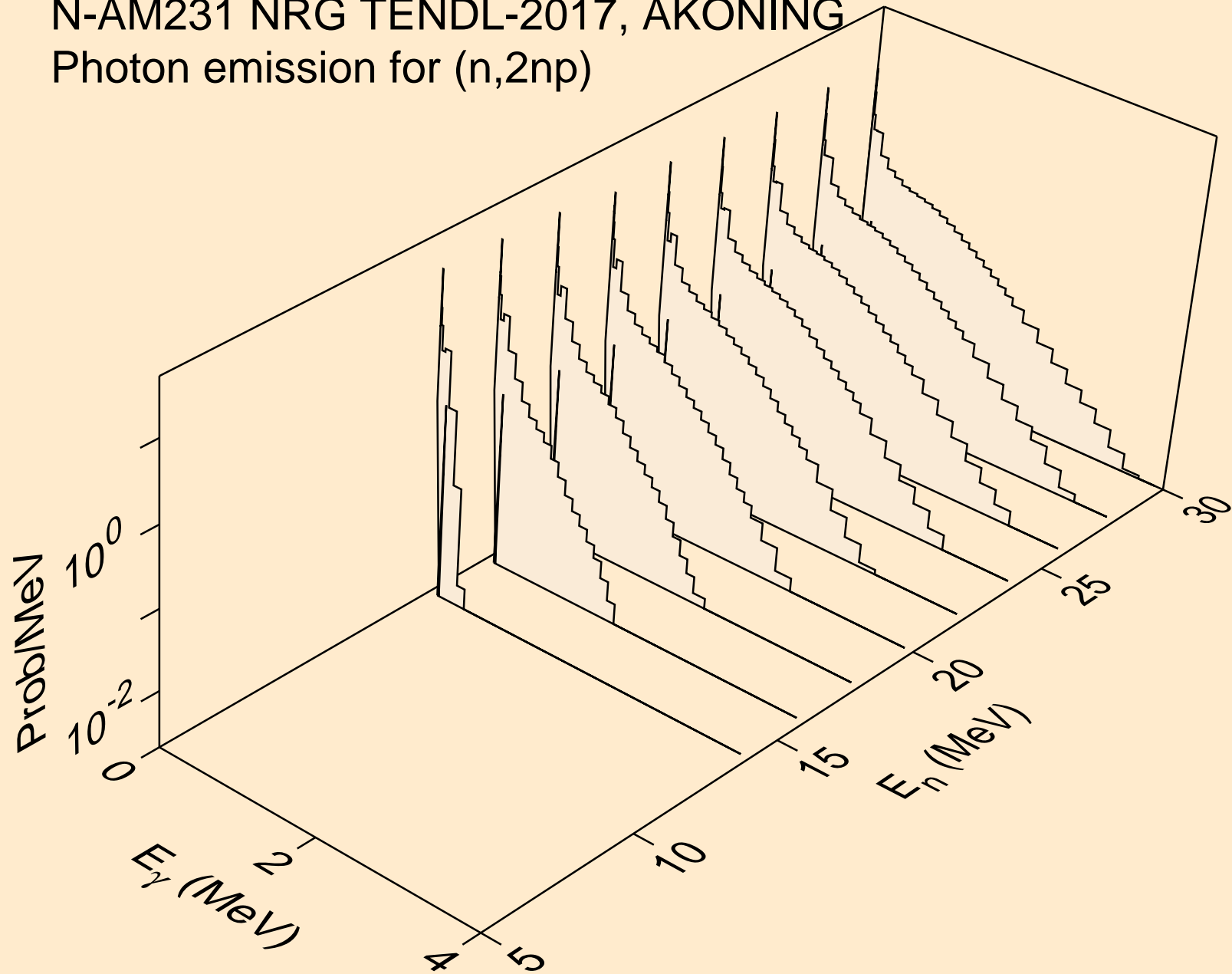

N-AM231 NRG TENDL-2017, AKONING
Photon emission for (n,npa)

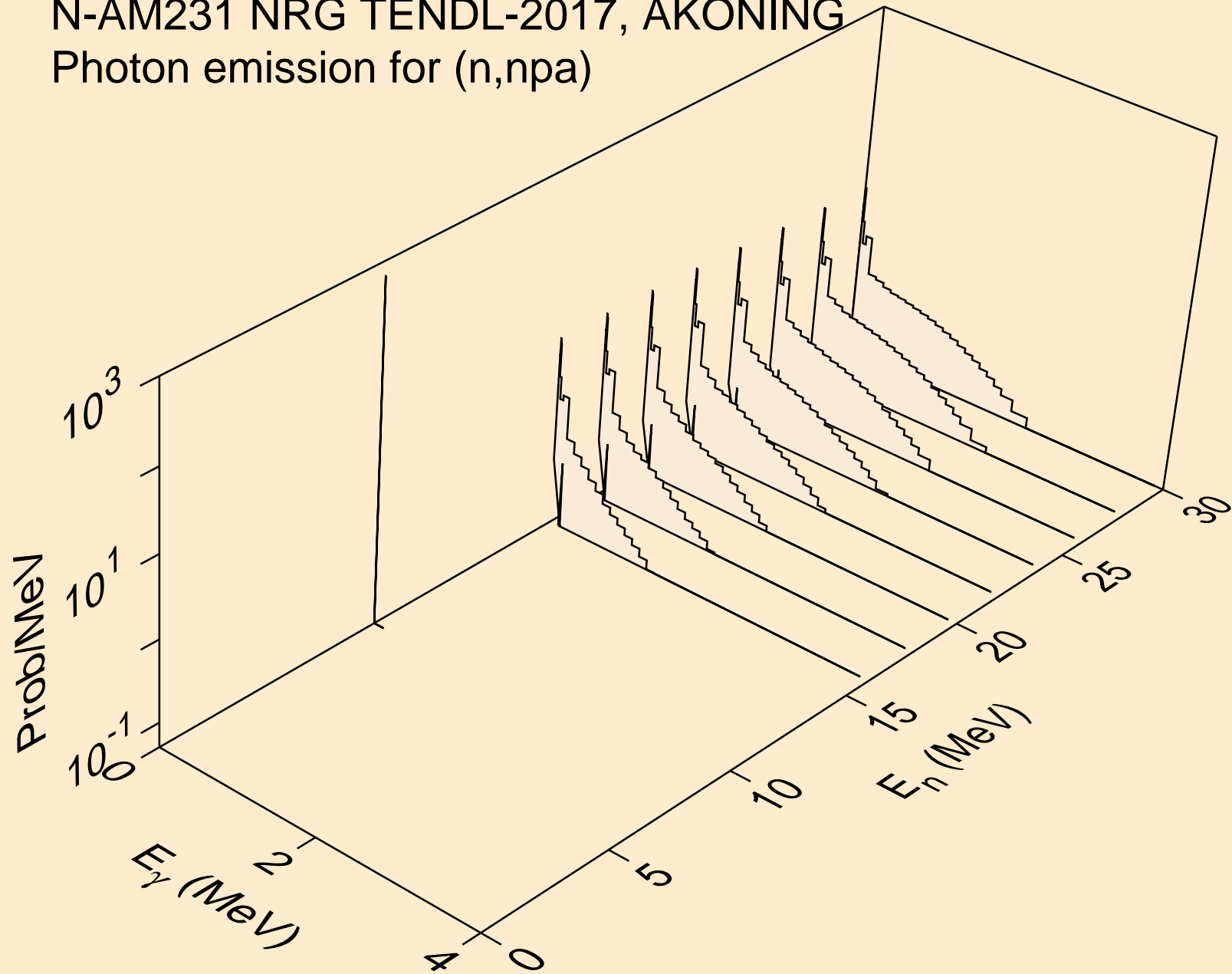

N-AM231 NRG TENDL-2017, AKONING
Photon emission for (n,n*c)

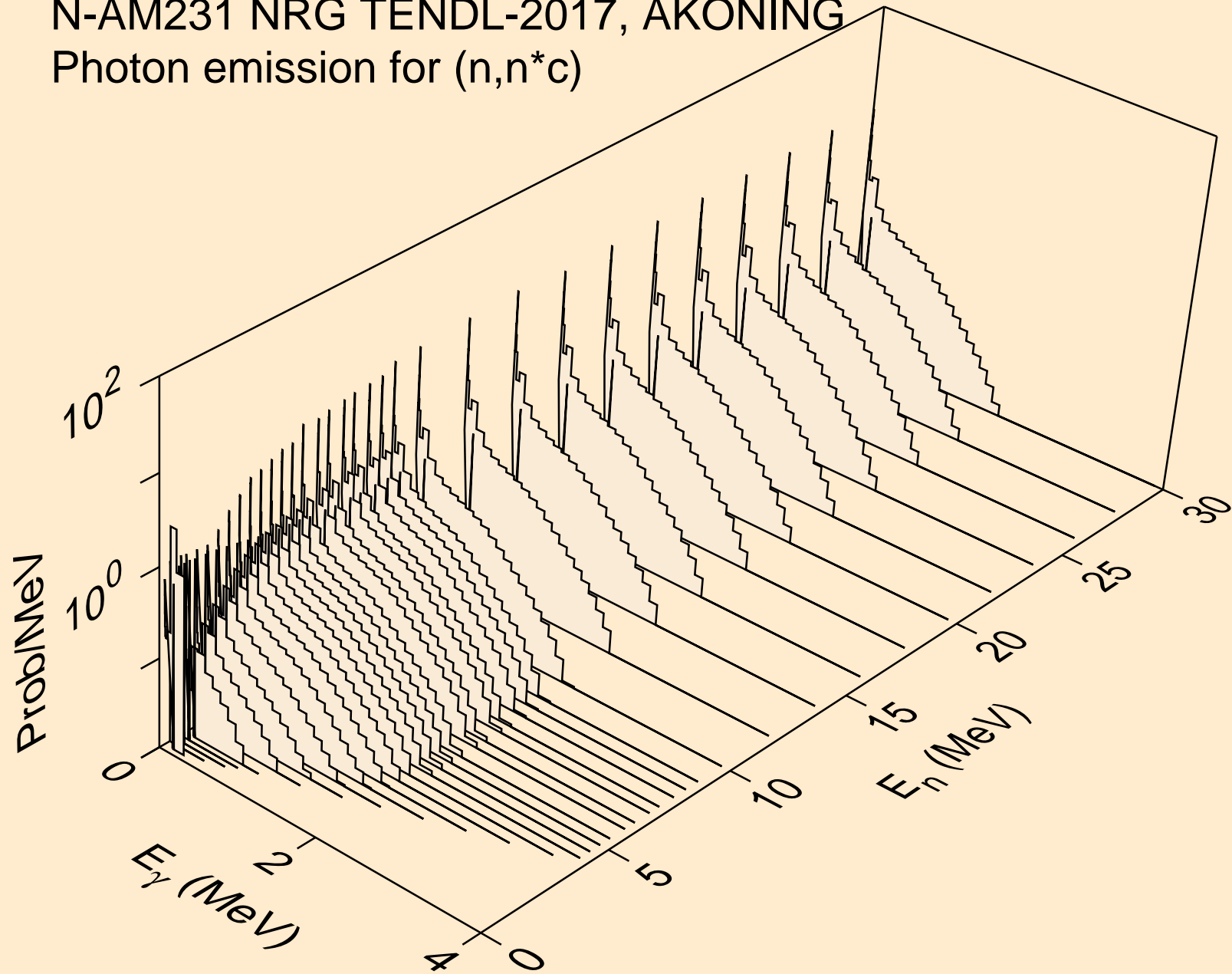

N-AM231 NRG TENDL-2017, AKONING
Photon emission for (n,gma)

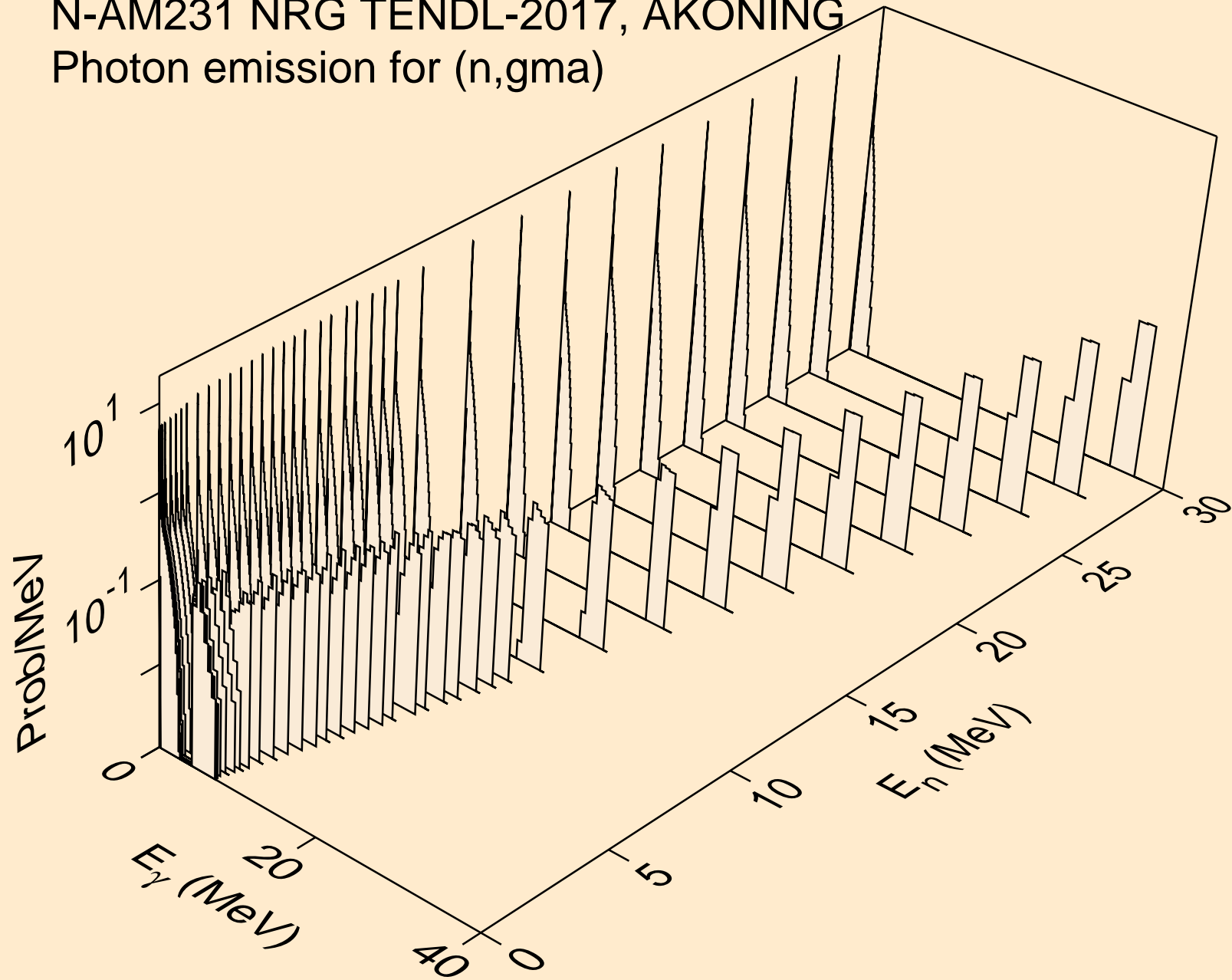

N-AM231 NRG TENDL-2017, AKONING
Photon emission for (n,p)

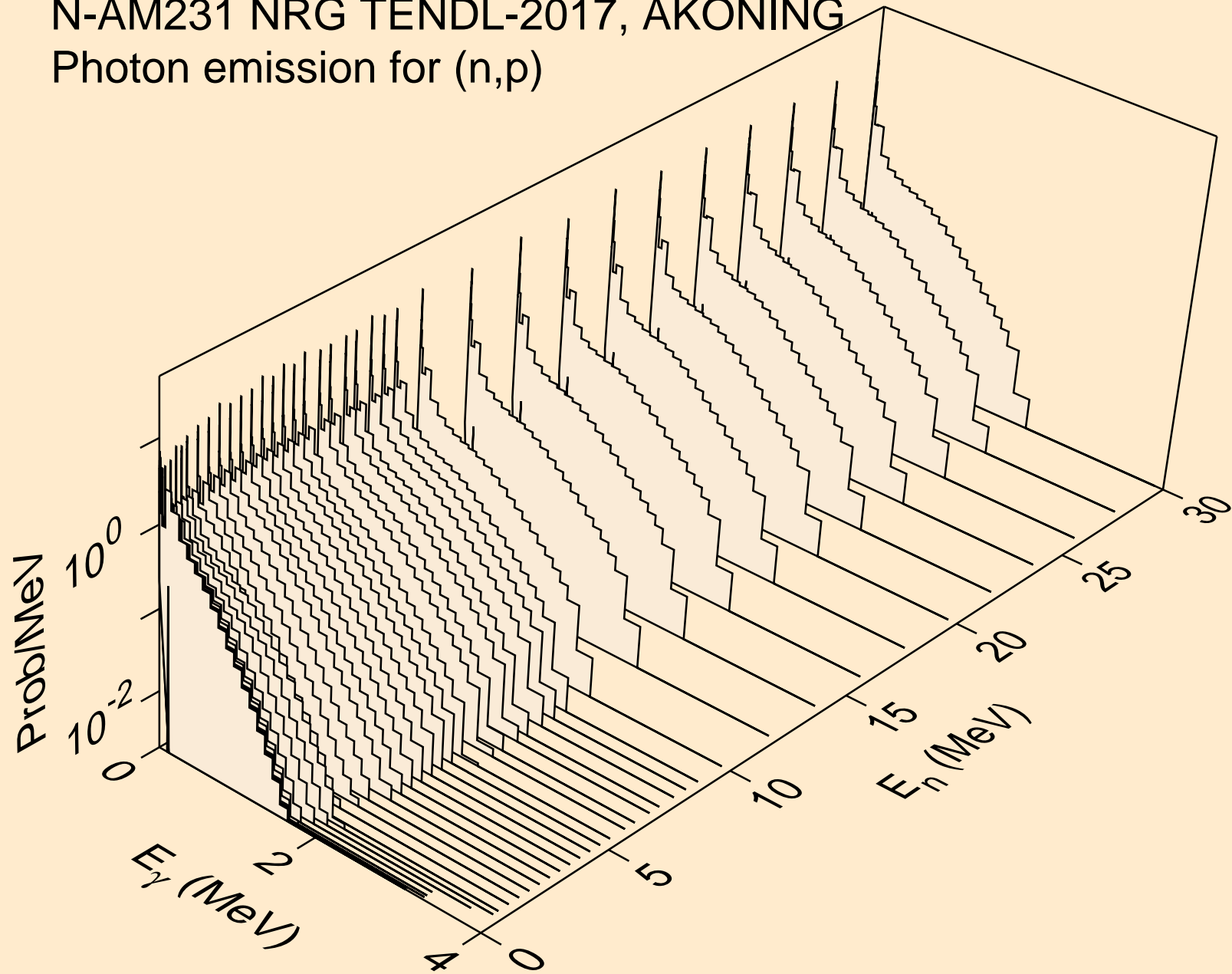

N-AM231 NRG TENDL-2017, AKONING
Photon emission for (n,d)

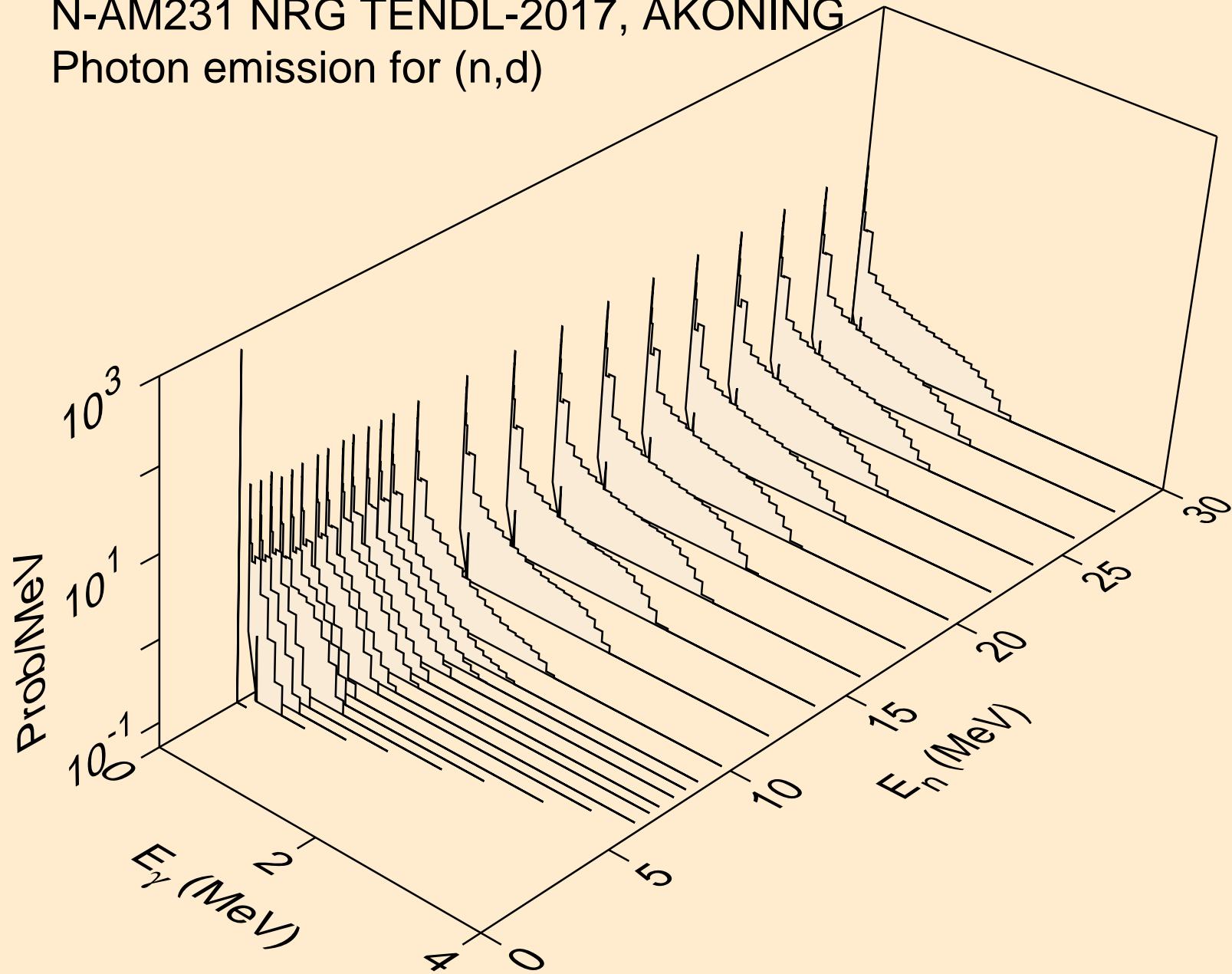

N-AM231 NRG TENDL-2017, AKONING
Photon emission for (n,t)

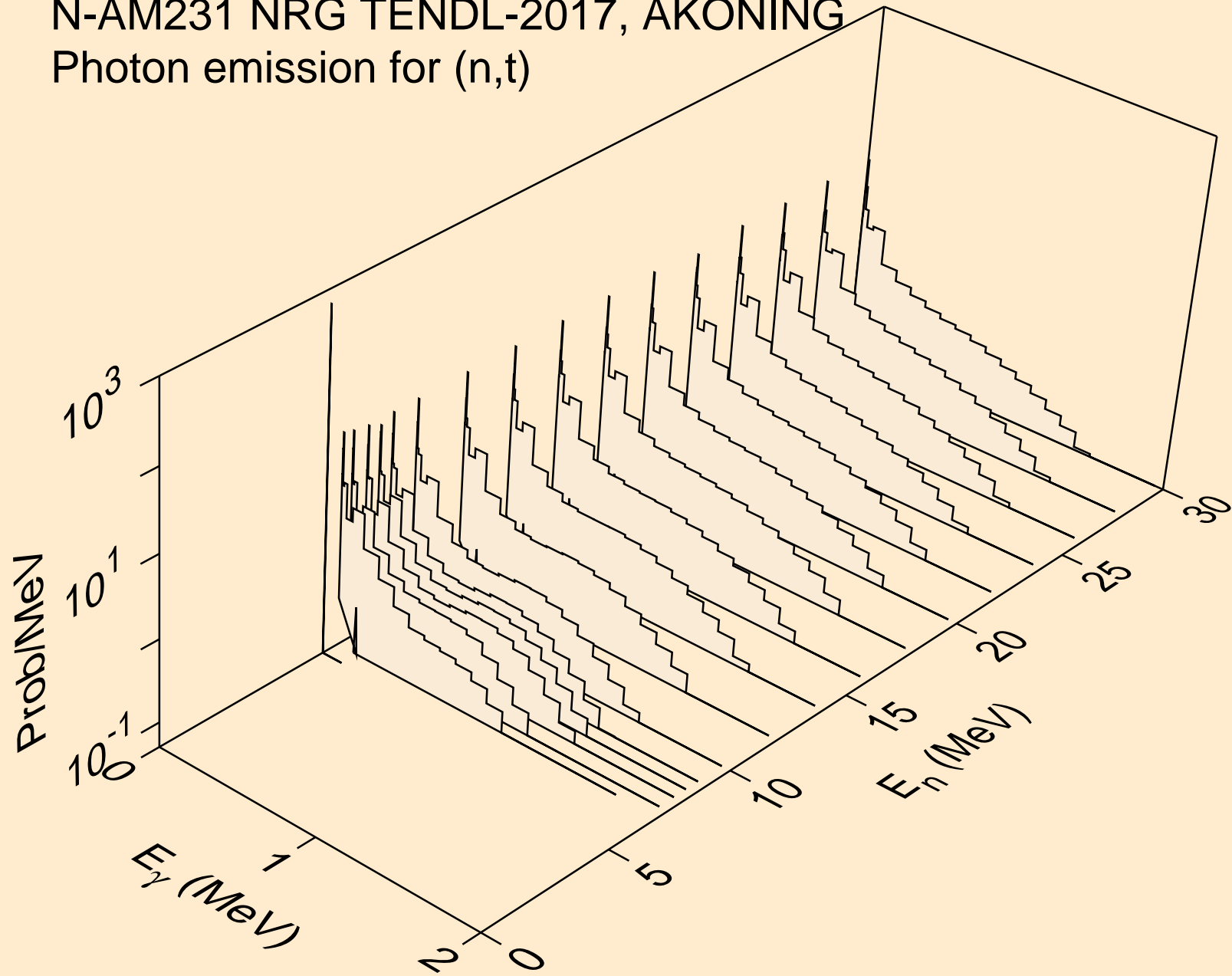

N-AM231 NRG TENDL-2017, AKONING
Photon emission for (n,he3)

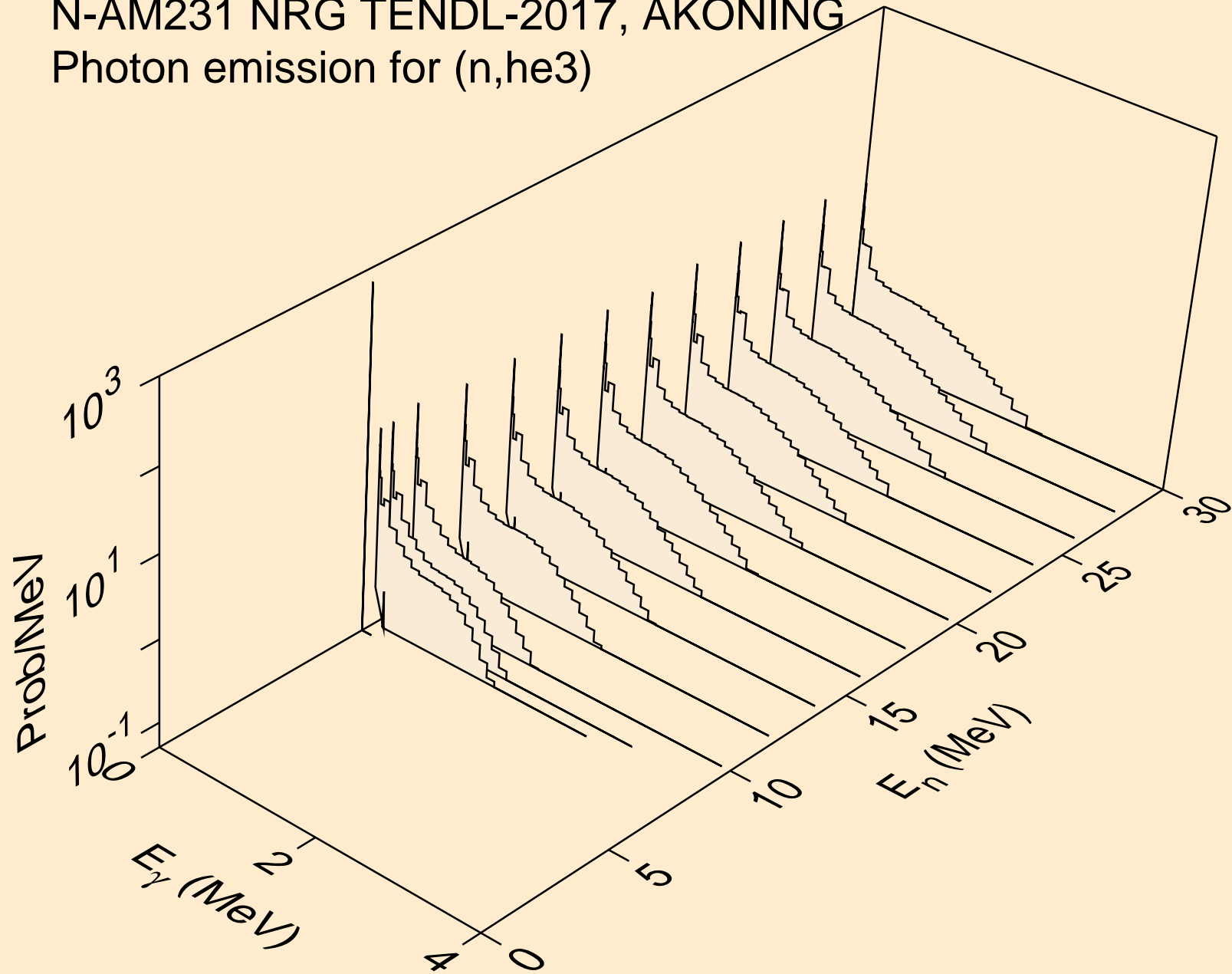

N-AM231 NRG TENDL-2017, AKONING
Photon emission for (n,a)

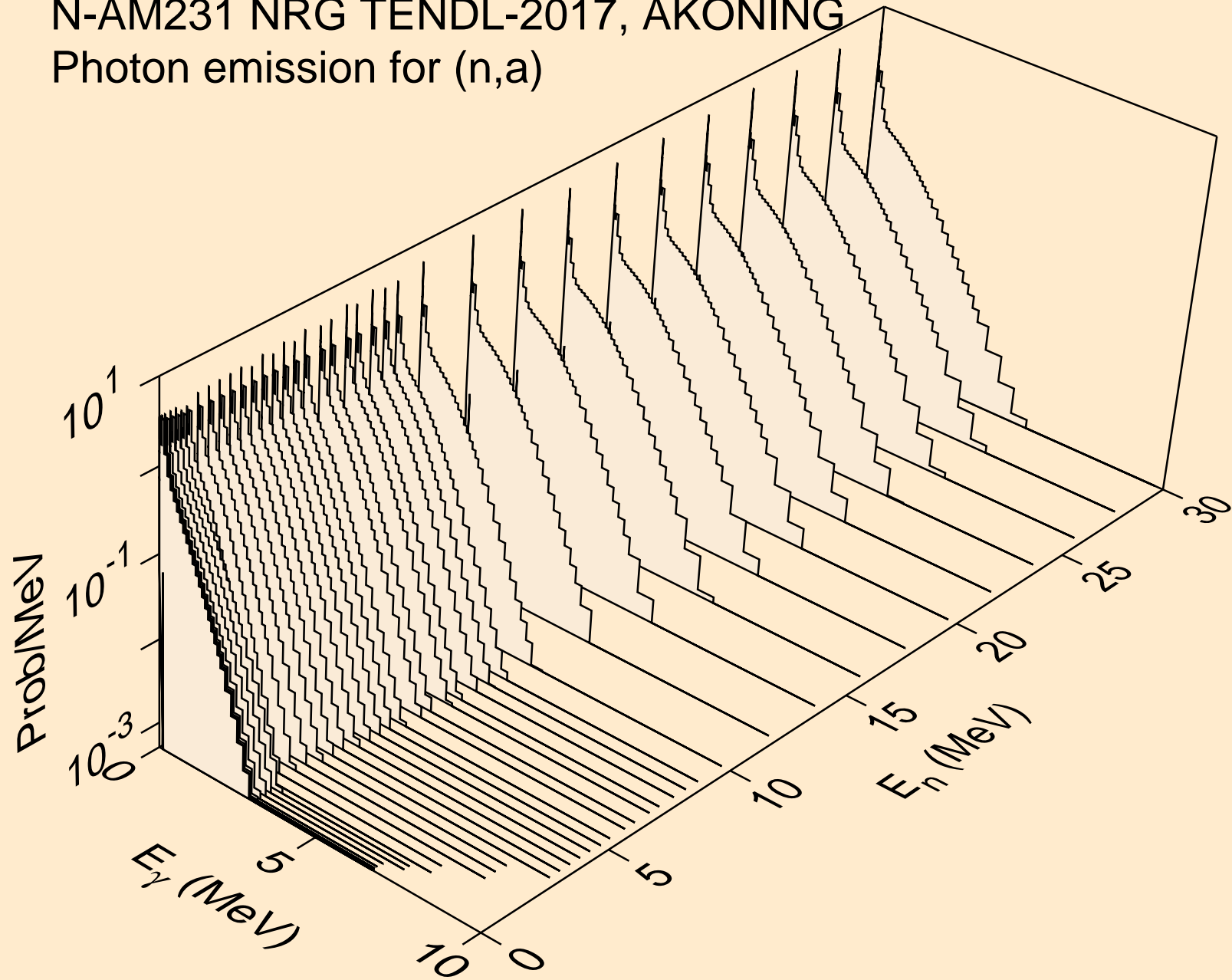

N-AM231 NRG TENDL-2017, AKONING
Photon emission for (n,2a)

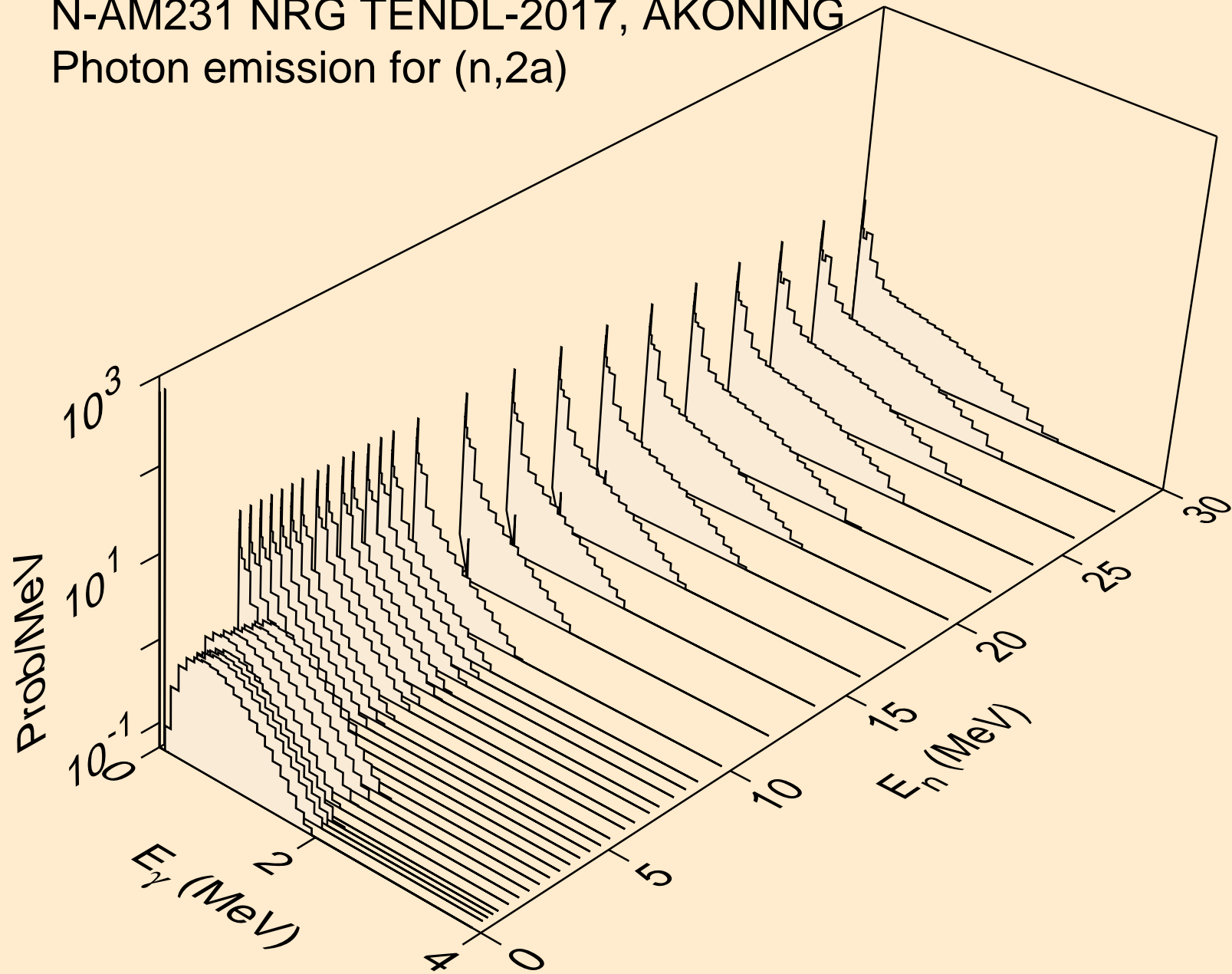

N-AM231 NRG TENDL-2017, AKONING
Photon emission for (n,2p)

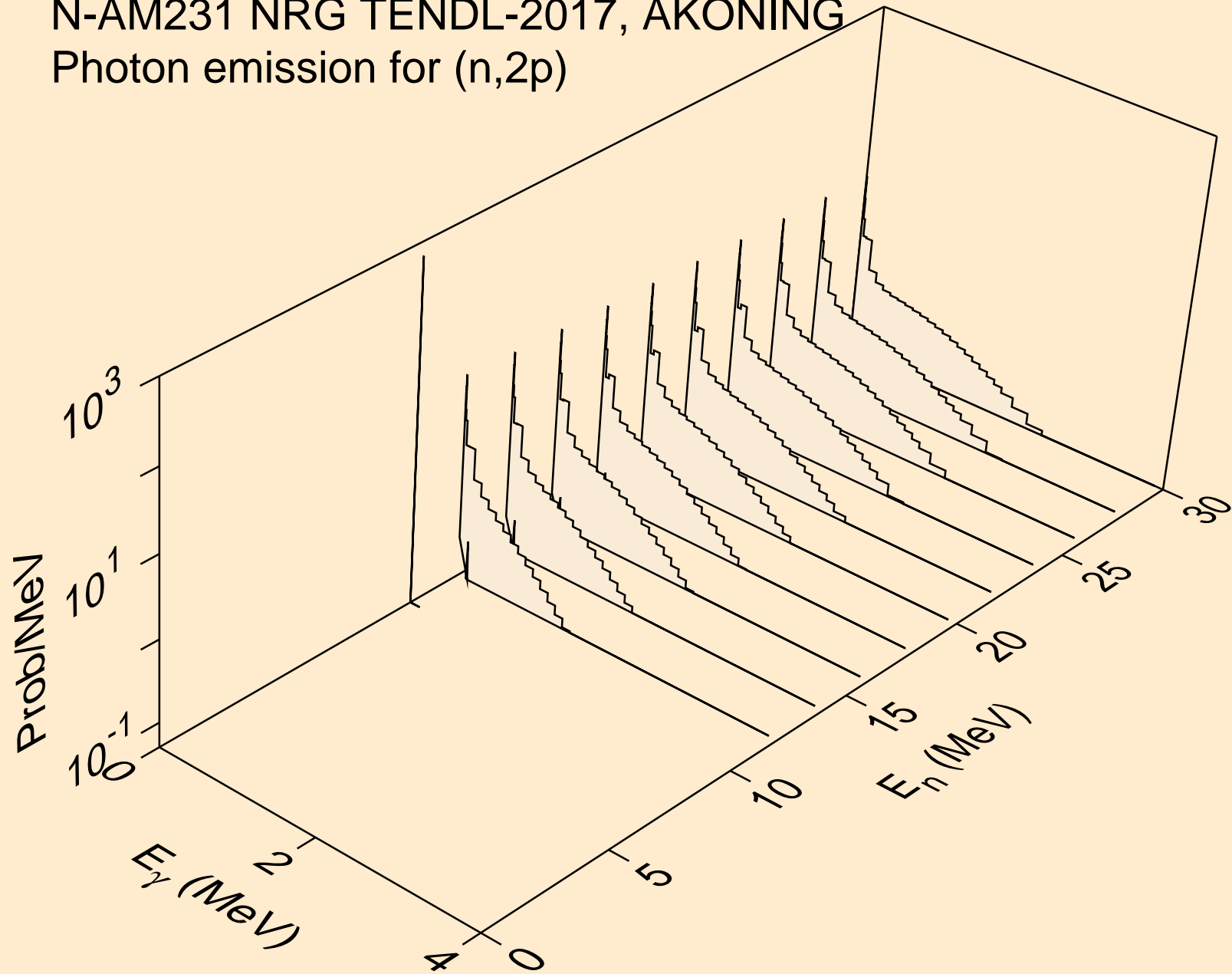

N-AM231 NRG TENDL-2017, AKONING
Photon emission for (n,p α)

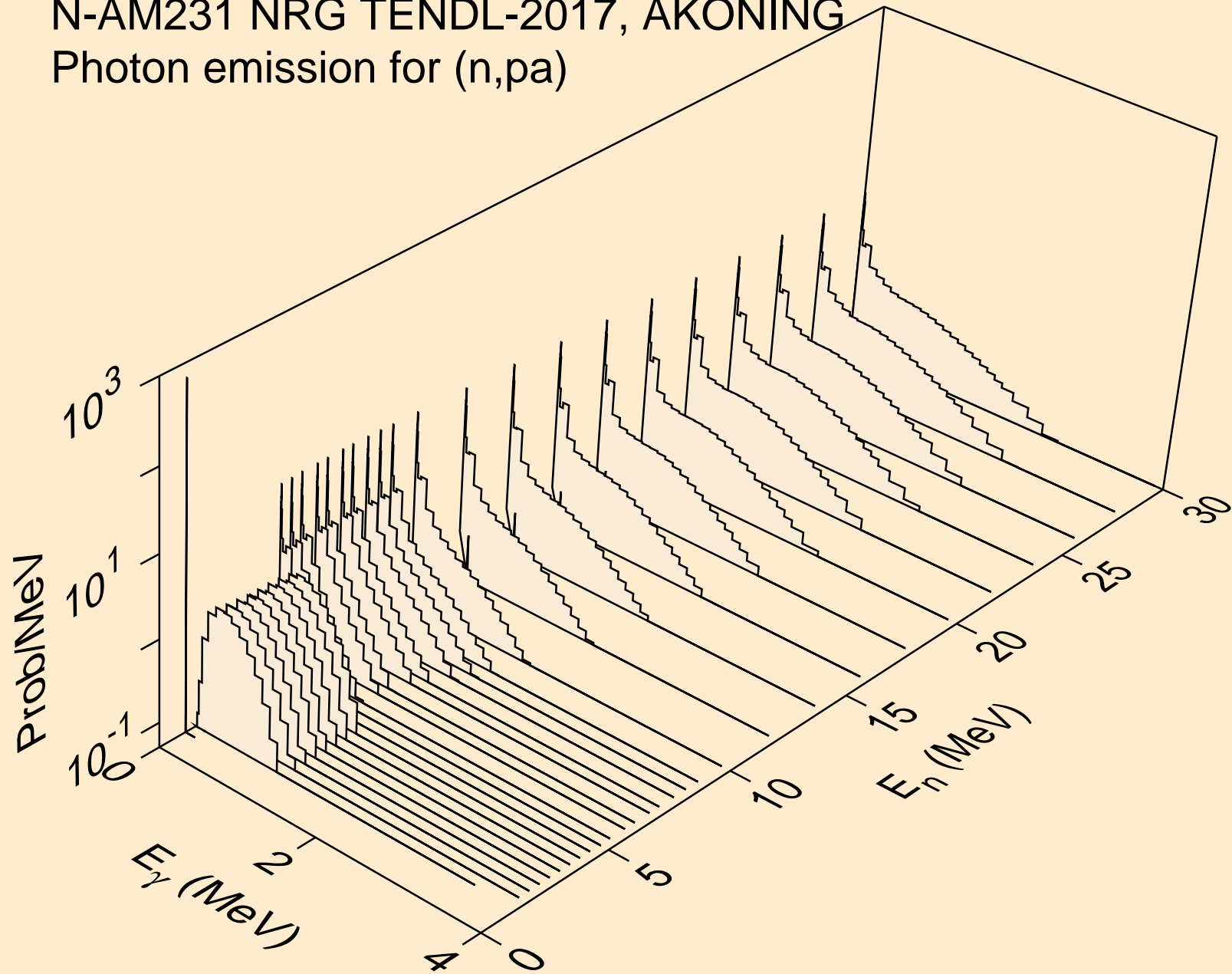

N-AM231 NRG TENDL-2017, AKONING
Photon emission for (n,pd)

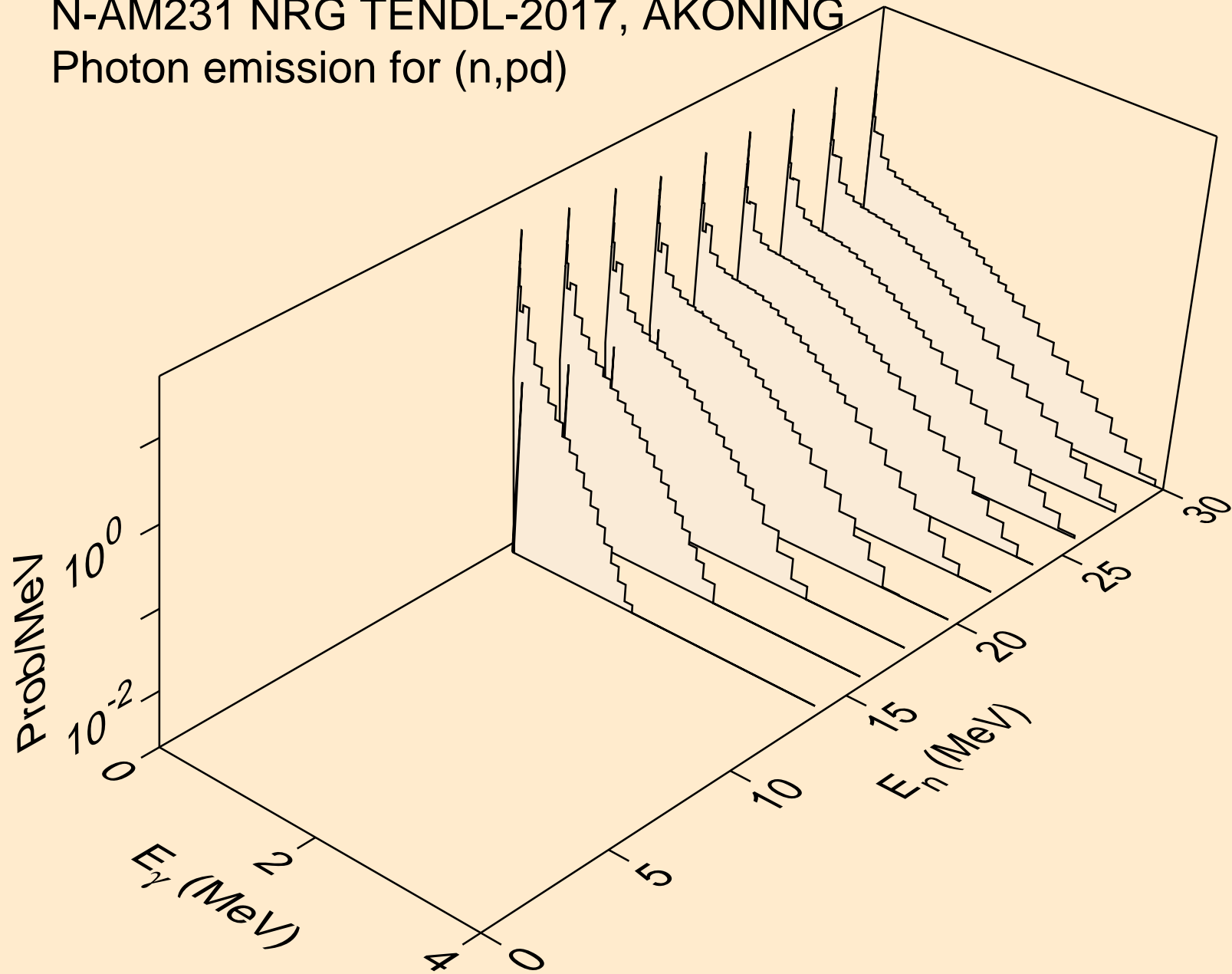

N-AM231 NRG TENDL-2017, AKONING
Photon emission for (n,pt)

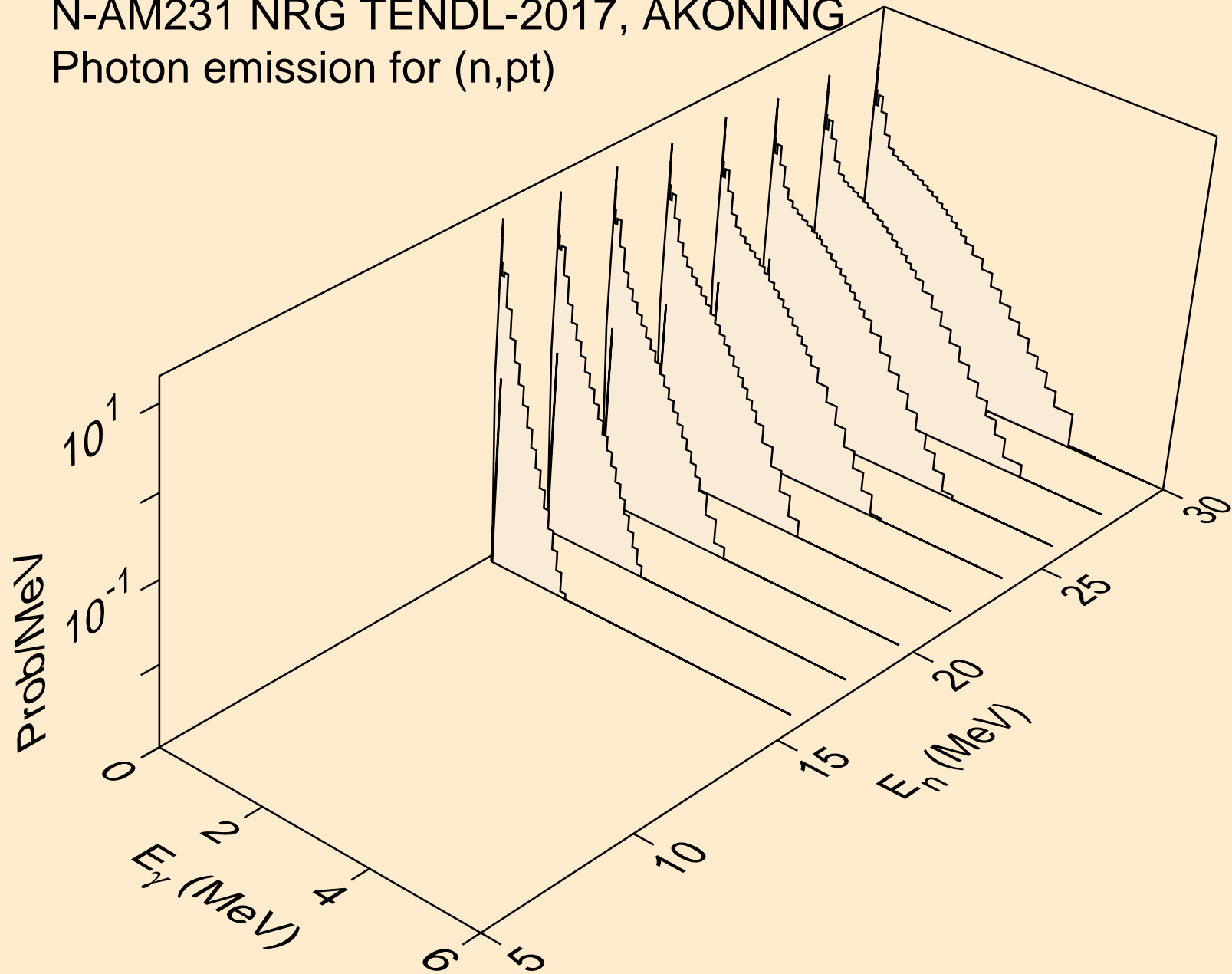

N-AM231 NRG TENDL-2017, AKONING
Photon emission for (n,da)

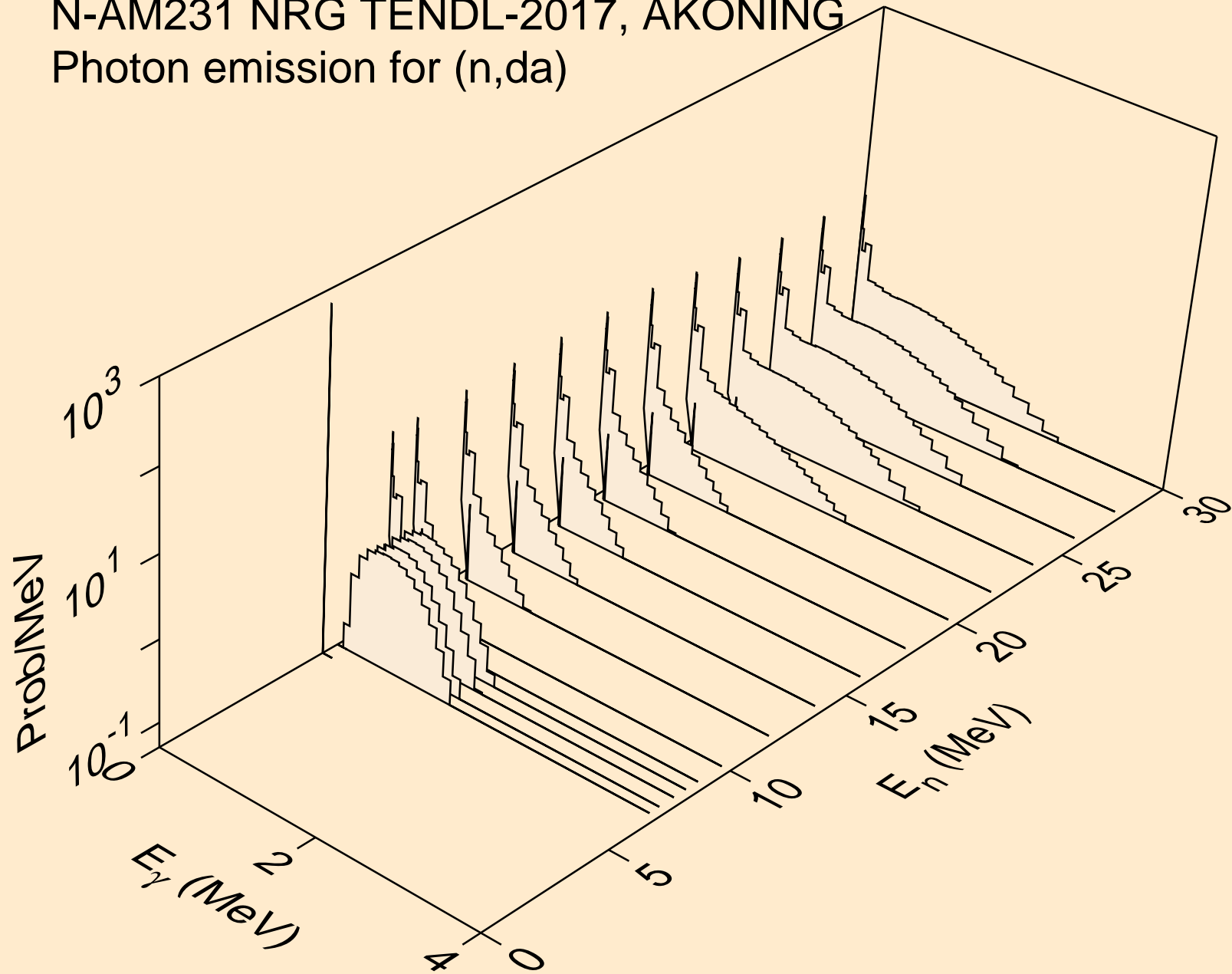

N-AM231 NRG TENDL-2017, AKONING
thermal capture photon spectrum

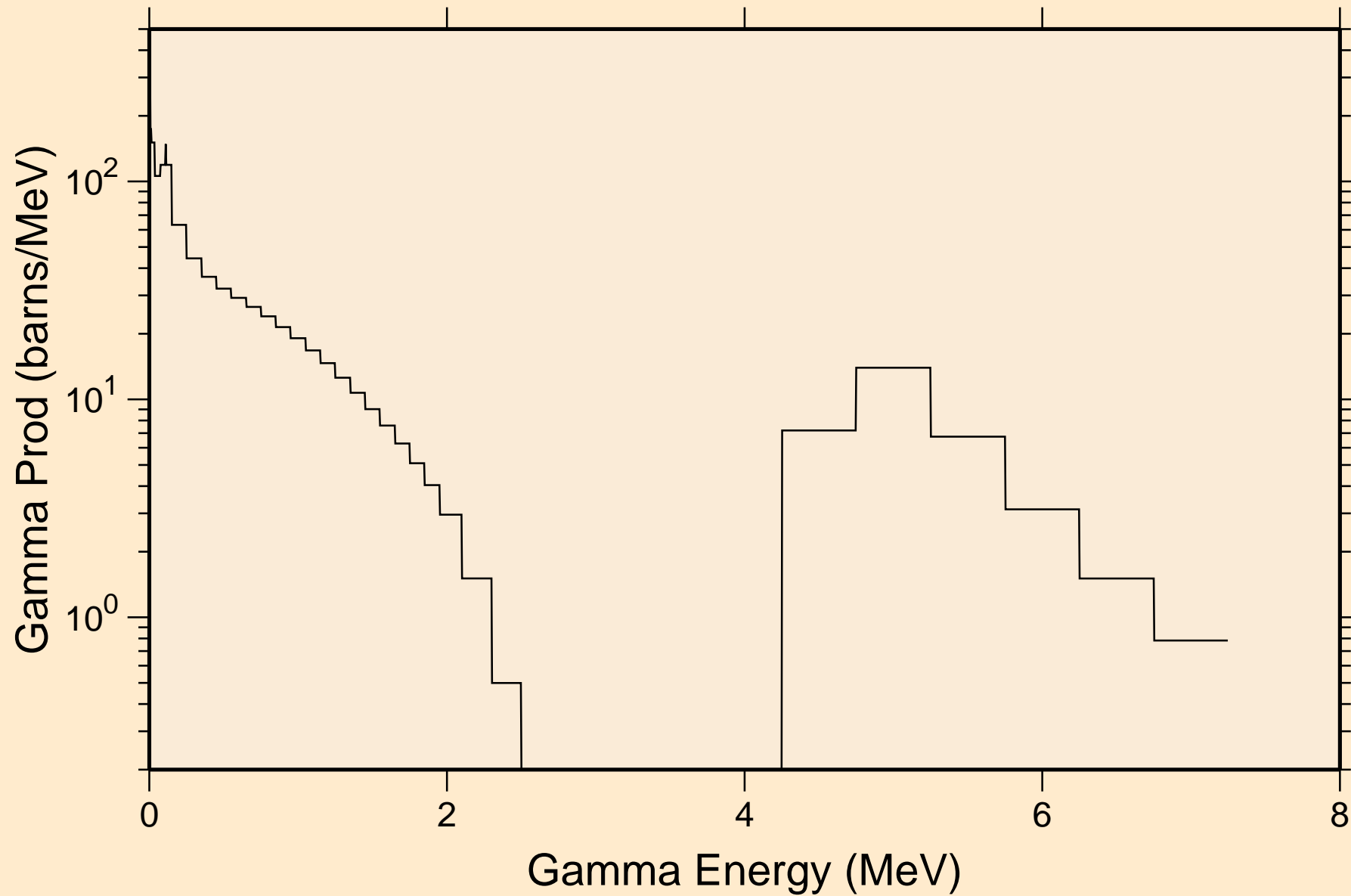

N-AM231 NRG TENDL-2017, AKONING
14 MeV photon spectrum

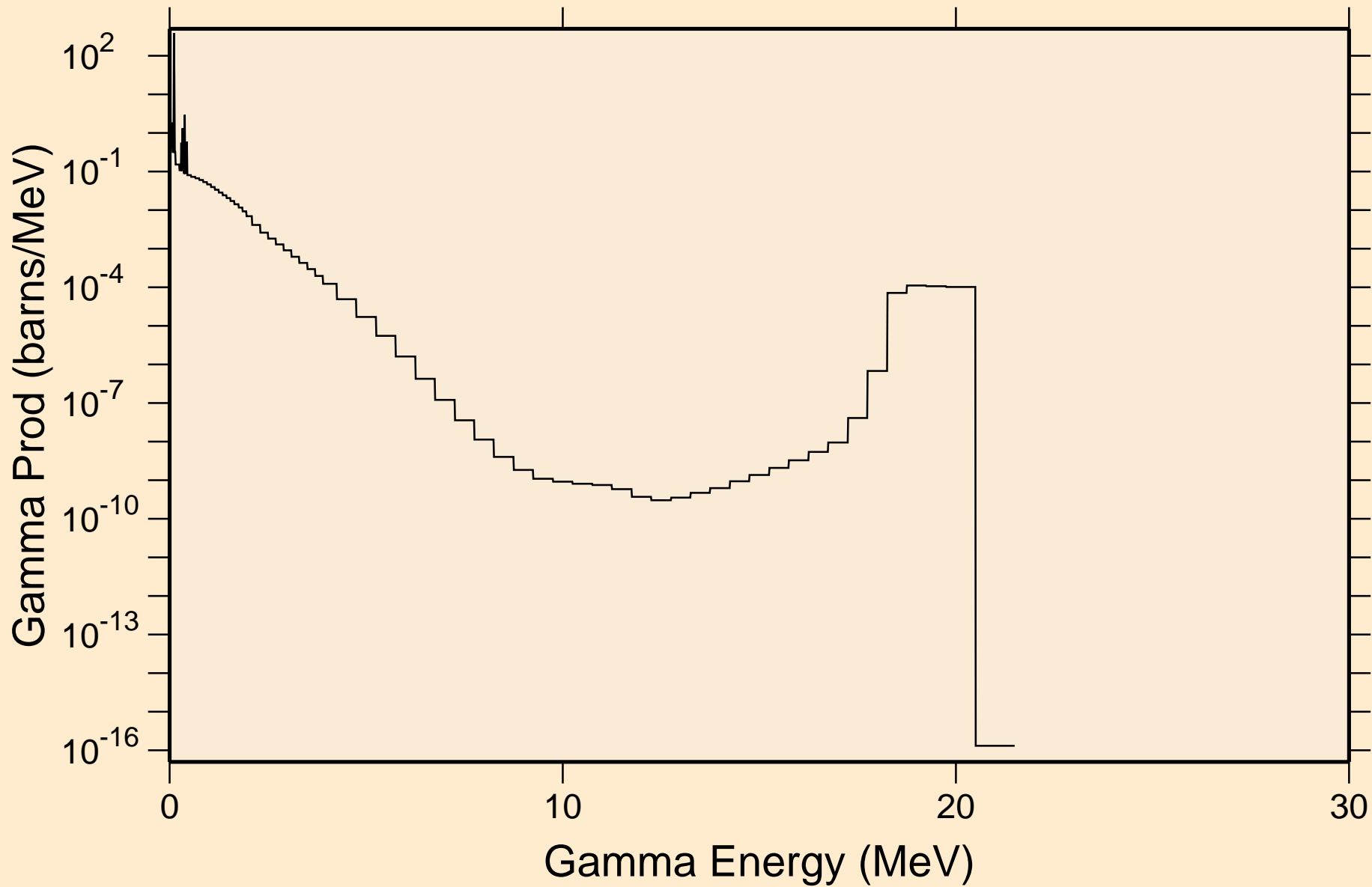

N-AM231 NRG TENDL-2017, AKONING

Particle heating contributions

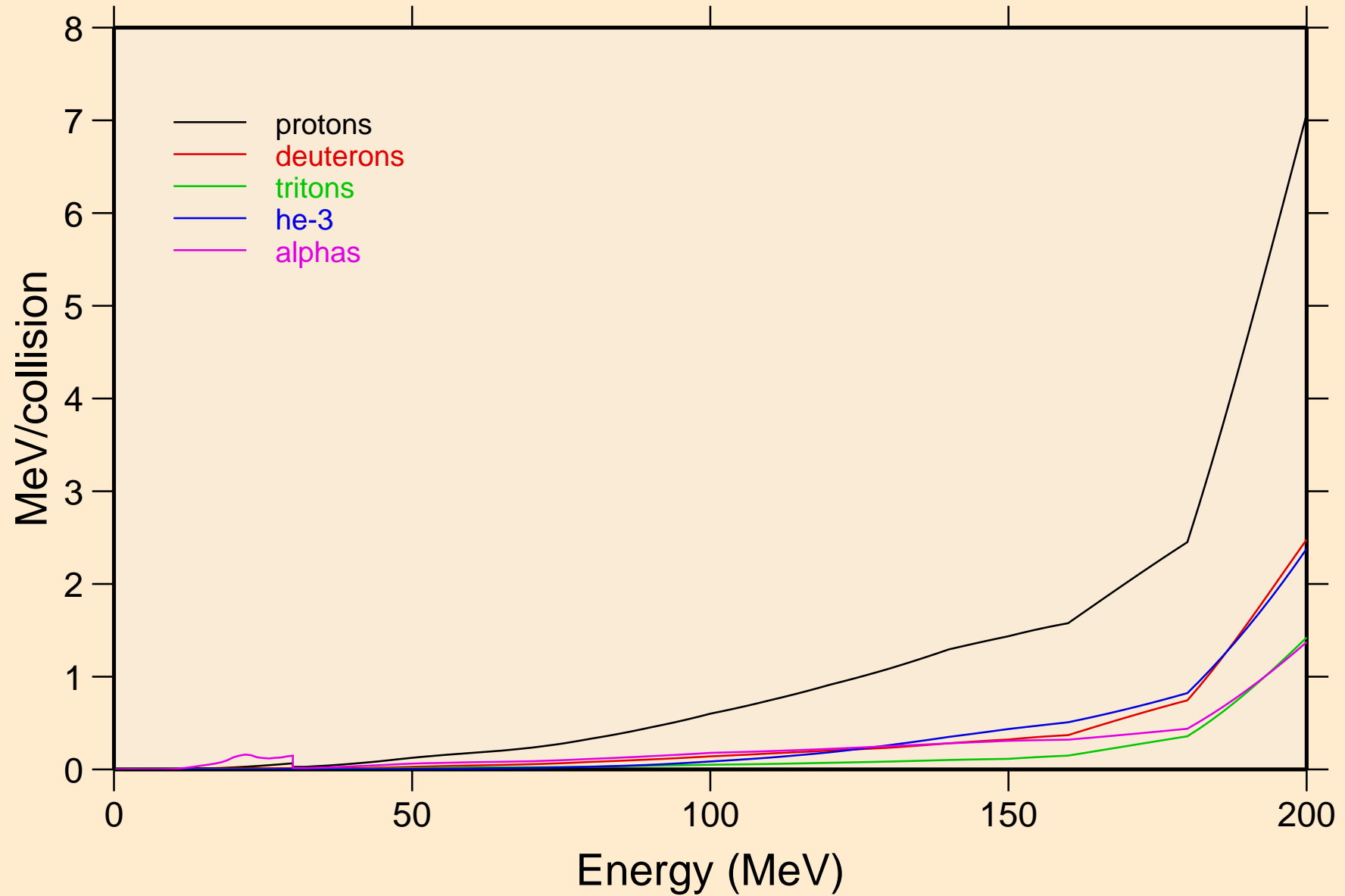

N-AM231 NRG TENDL-2017, AKONING

Recoil Heating

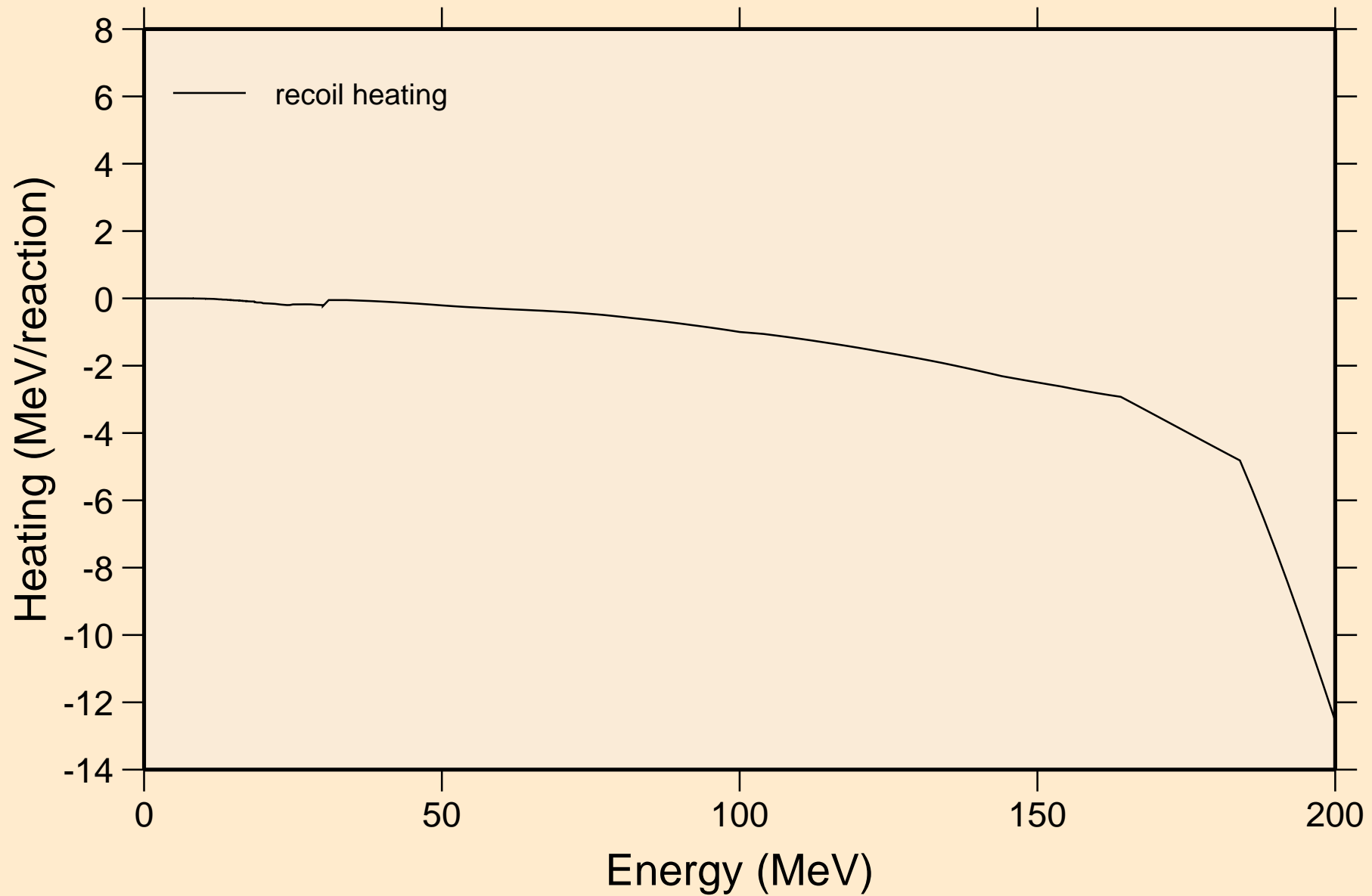

N-AM231 NRG TENDL-2017, AKONING

Particle production cross sections

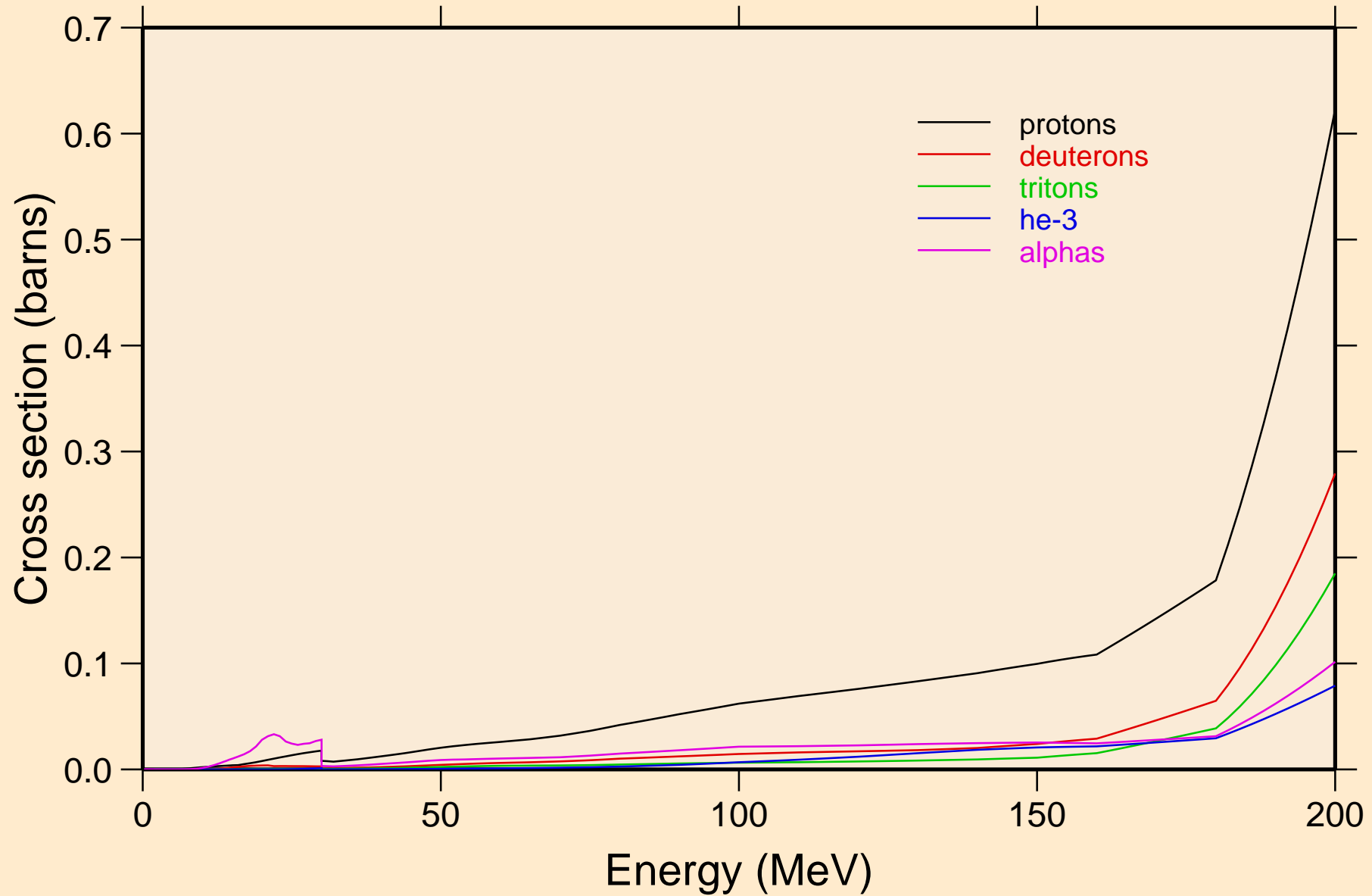

N-AM231 NRG TENDL-2017, AKONING
protons from (n,x)

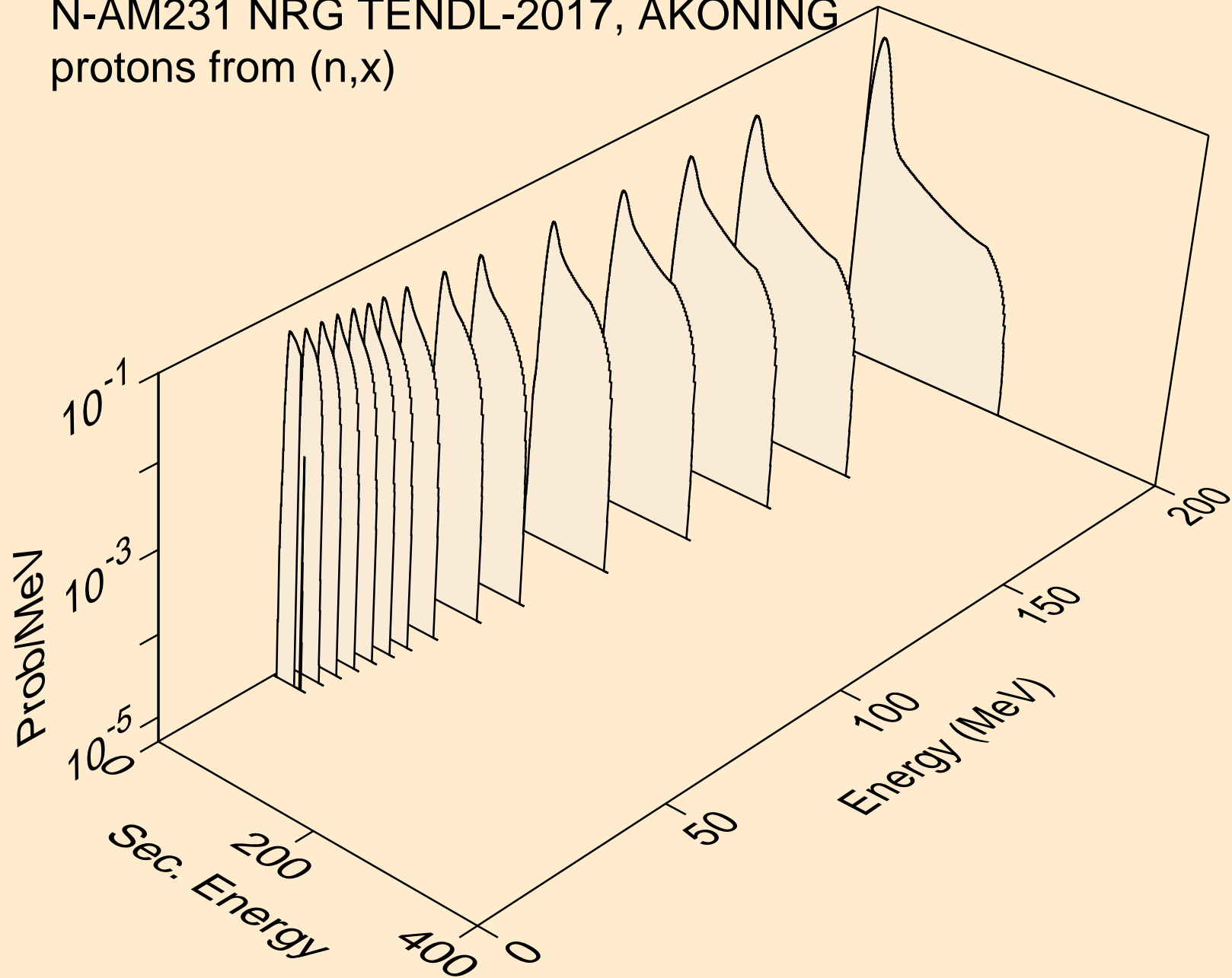

N-AM231 NRG TENDL-2017, AKONING
protons from (n,n*)p

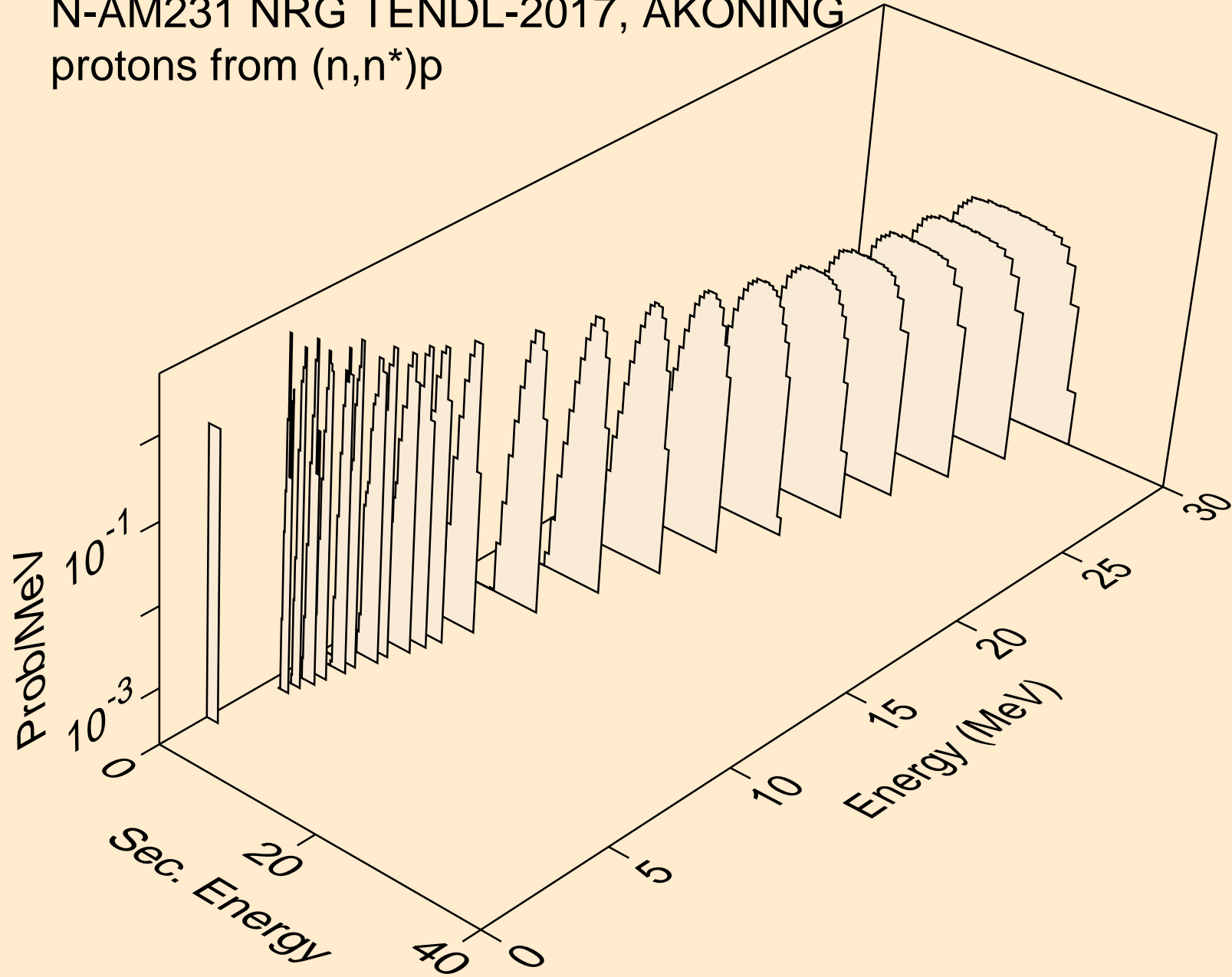

N-AM231 NRG TENDL-2017, AKONING
protons from (n,2np)

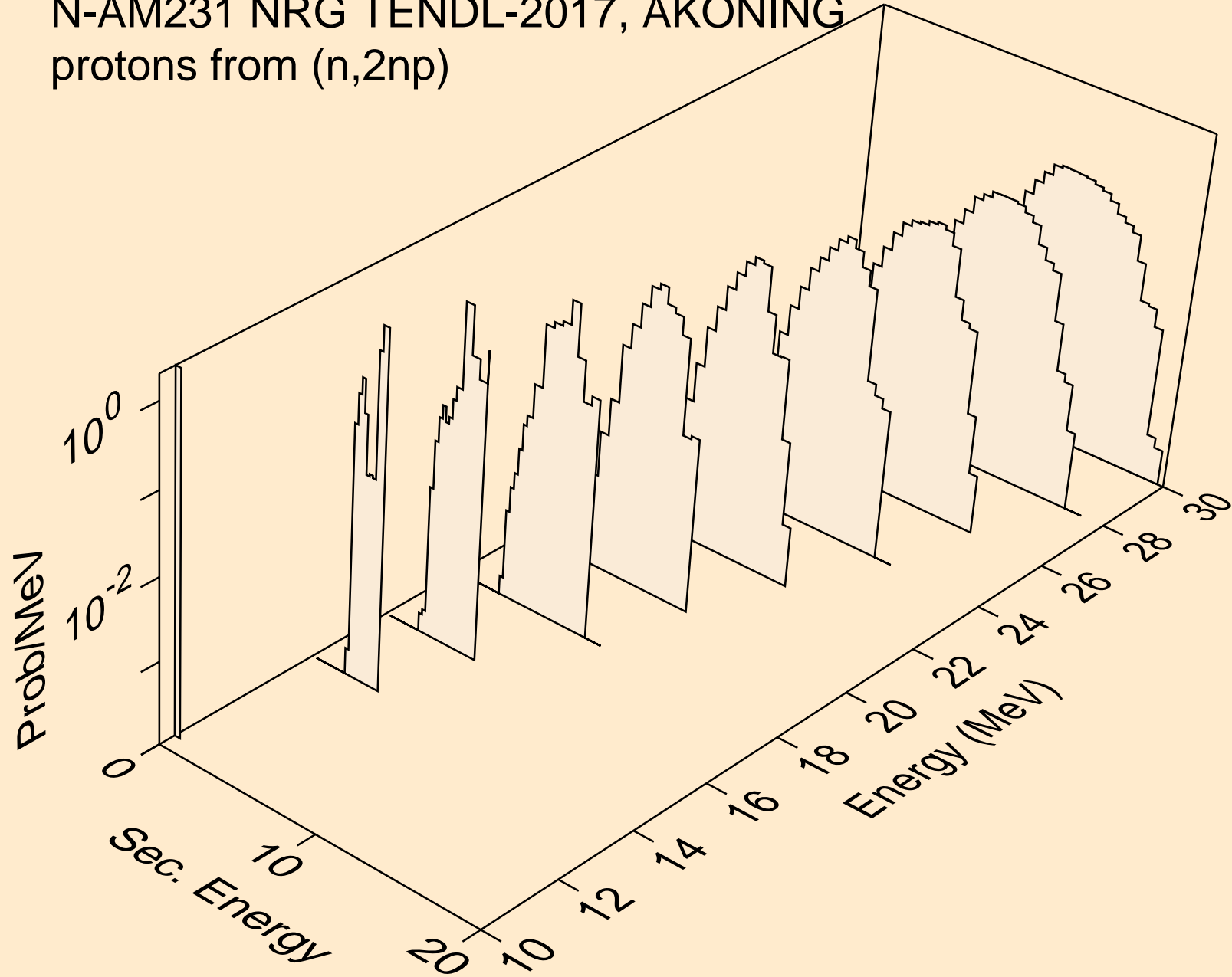

N-AM231 NRG TENDL-2017, AKONING
protons from (n,3np)

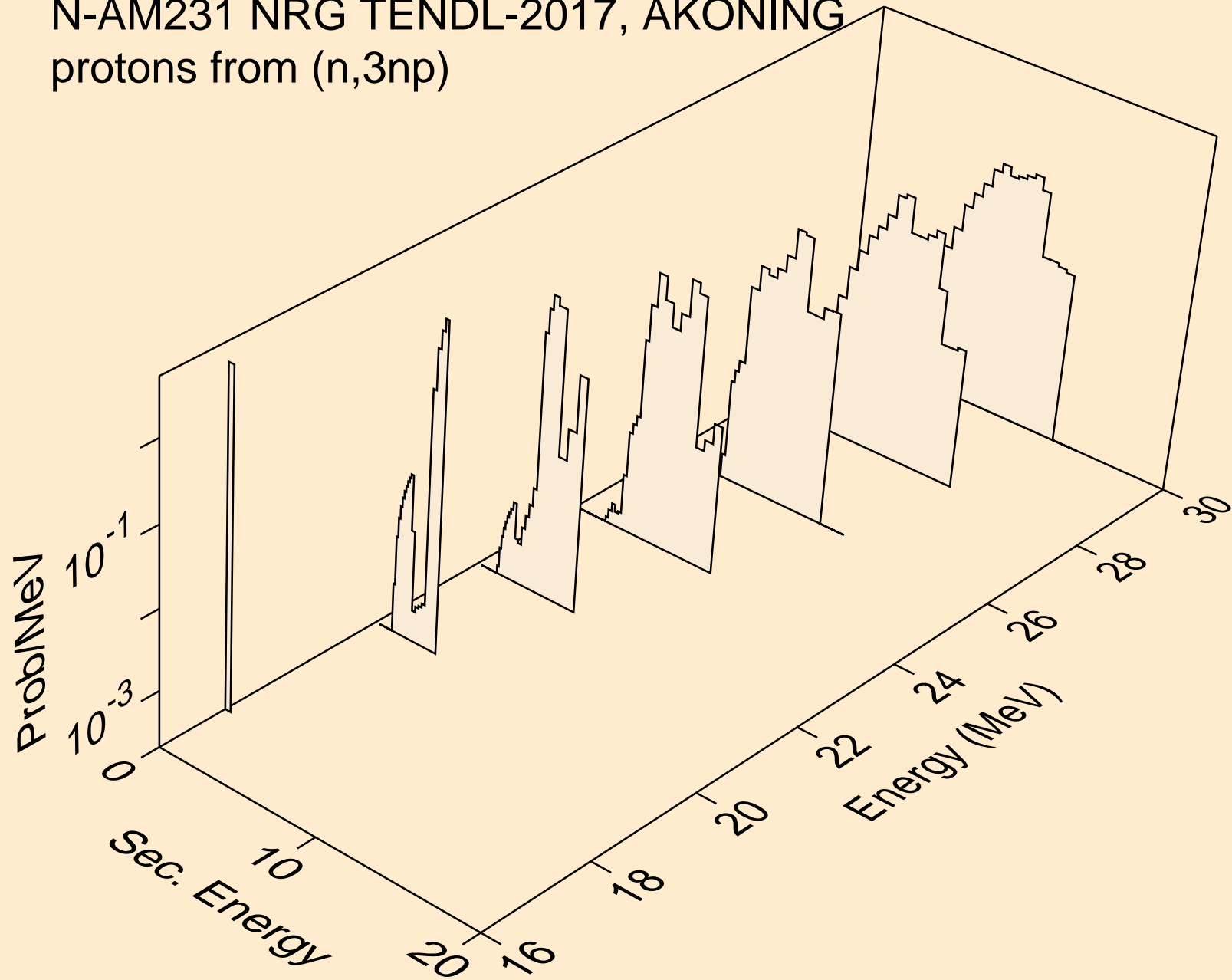

N-AM231 NRG TENDL-2017, AKONING
protons from (n,2np)

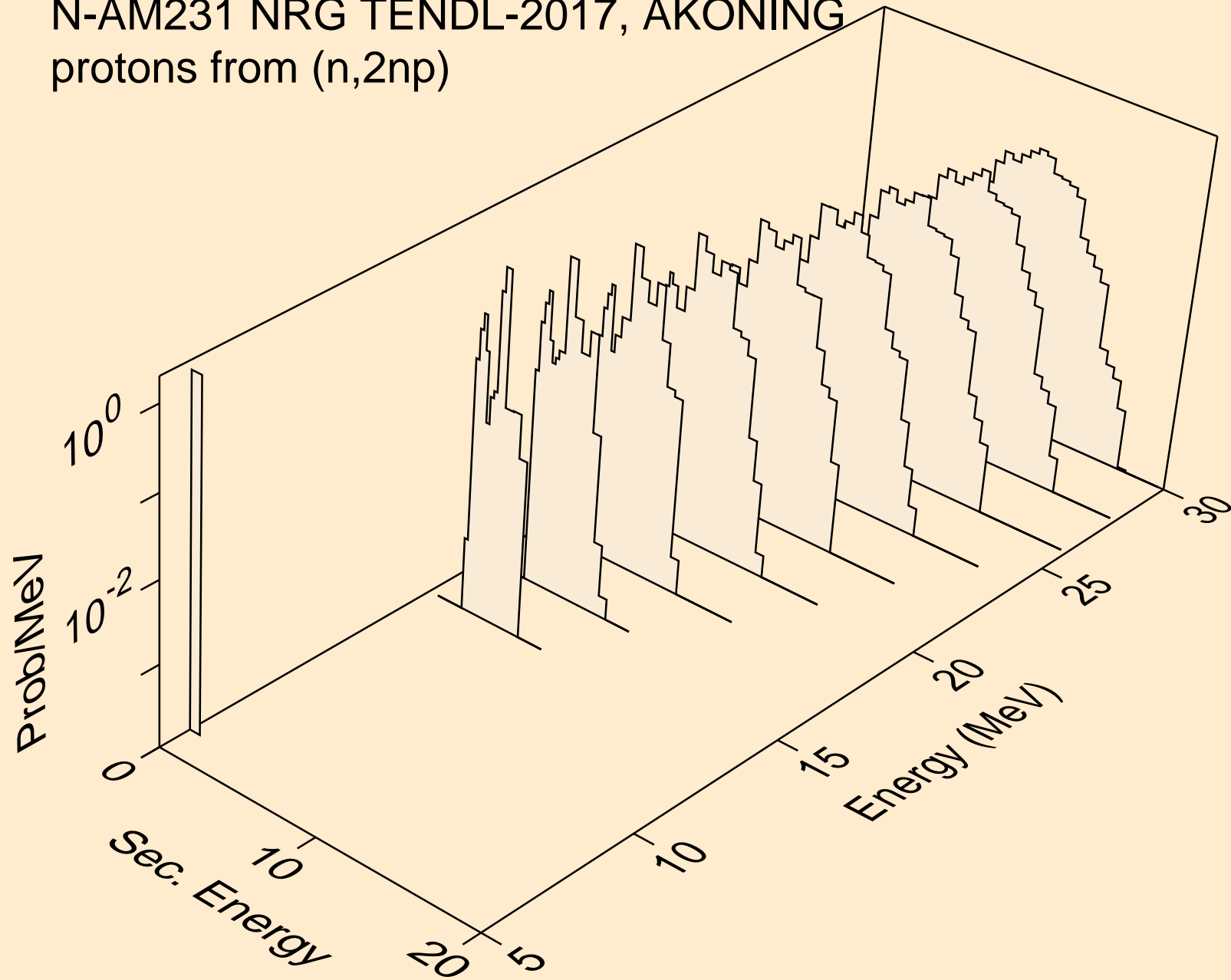

N-AM231 NRG TENDL-2017, AKONING
protons from (n,npa)

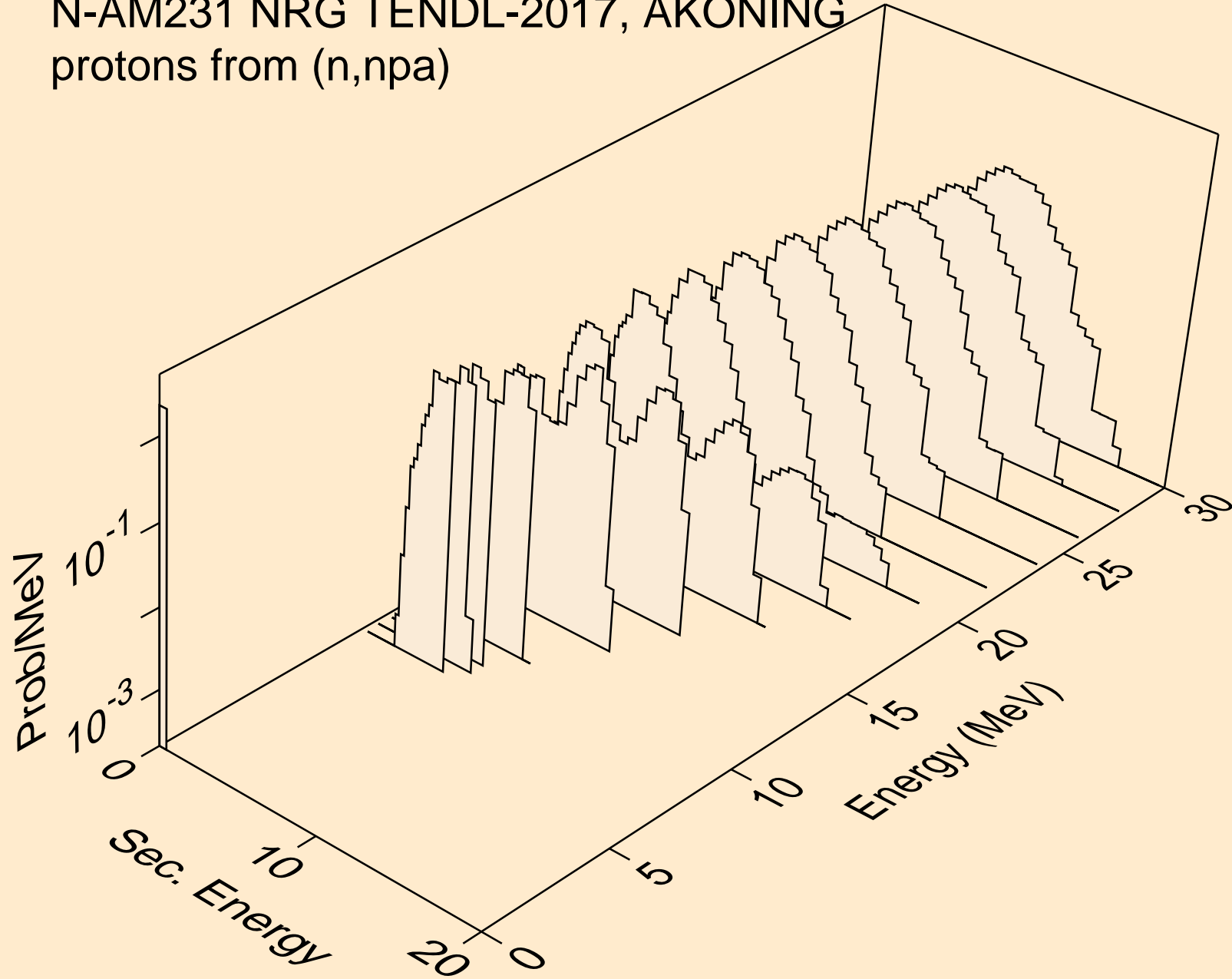

N-AM231 NRG TENDL-2017, AKONING
protons from (n,p)

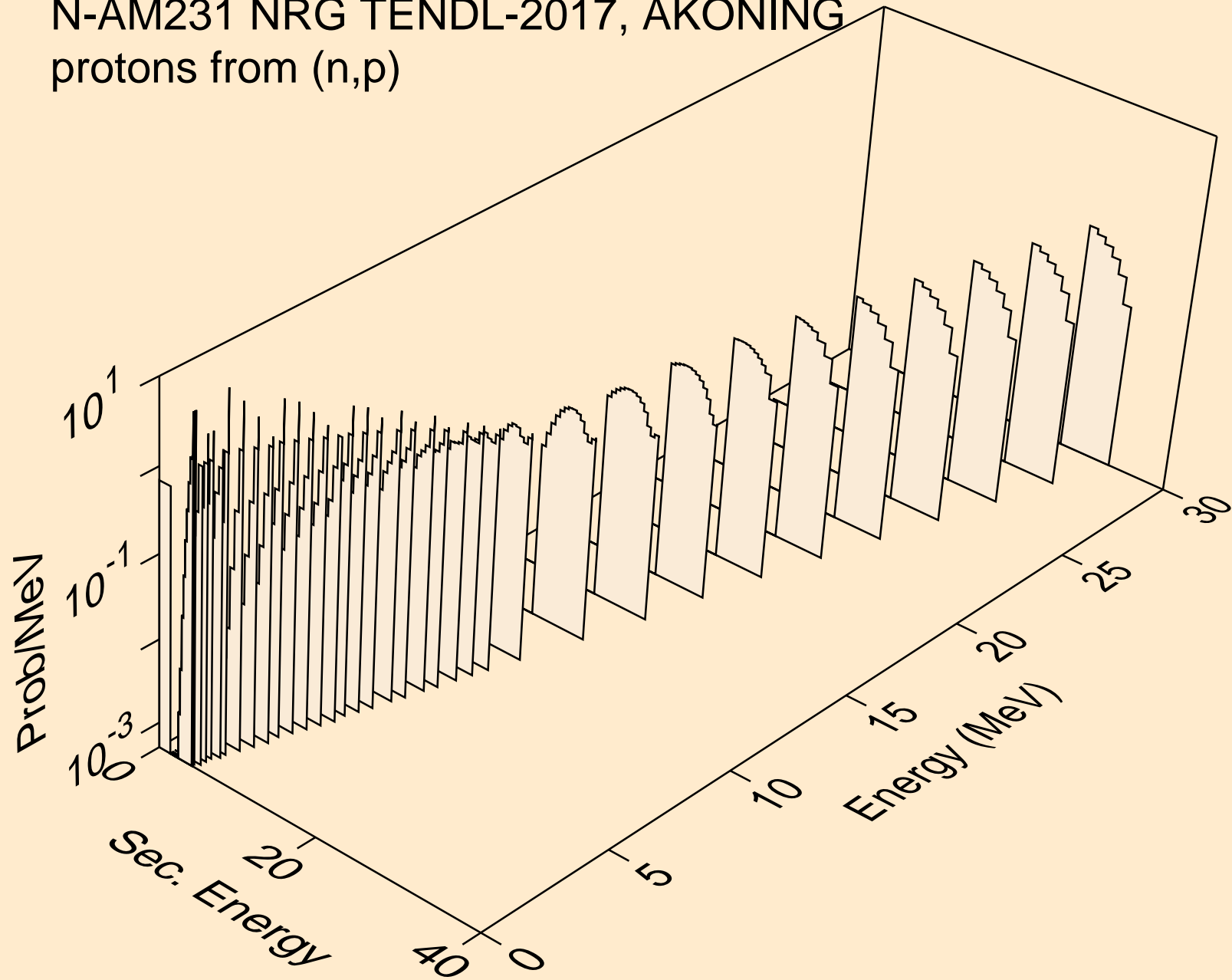

N-AM231 NRG TENDL-2017, AKONING
protons from (n,2p)

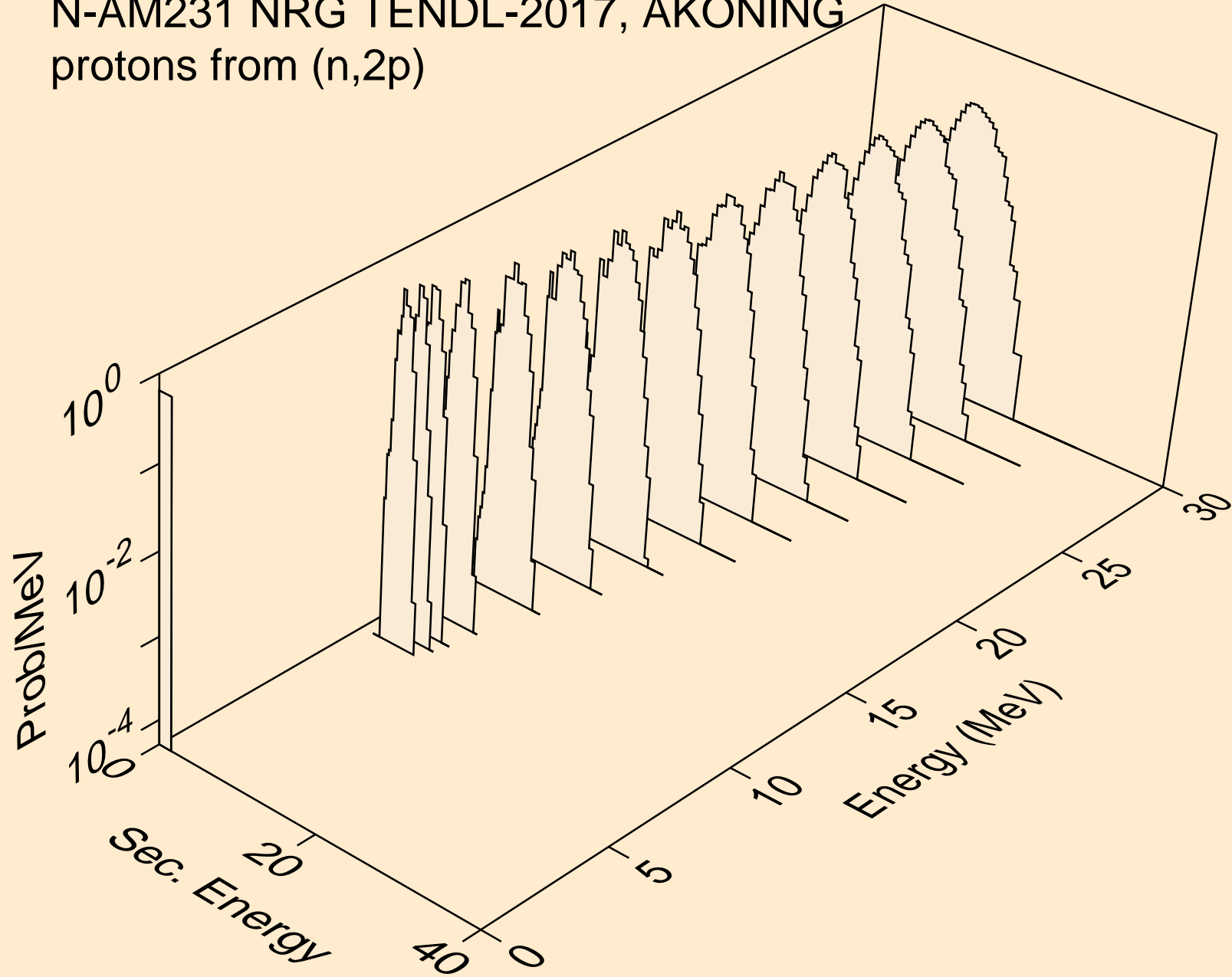

N-AM231 NRG TENDL-2017, AKONING
protons from (n,pa)

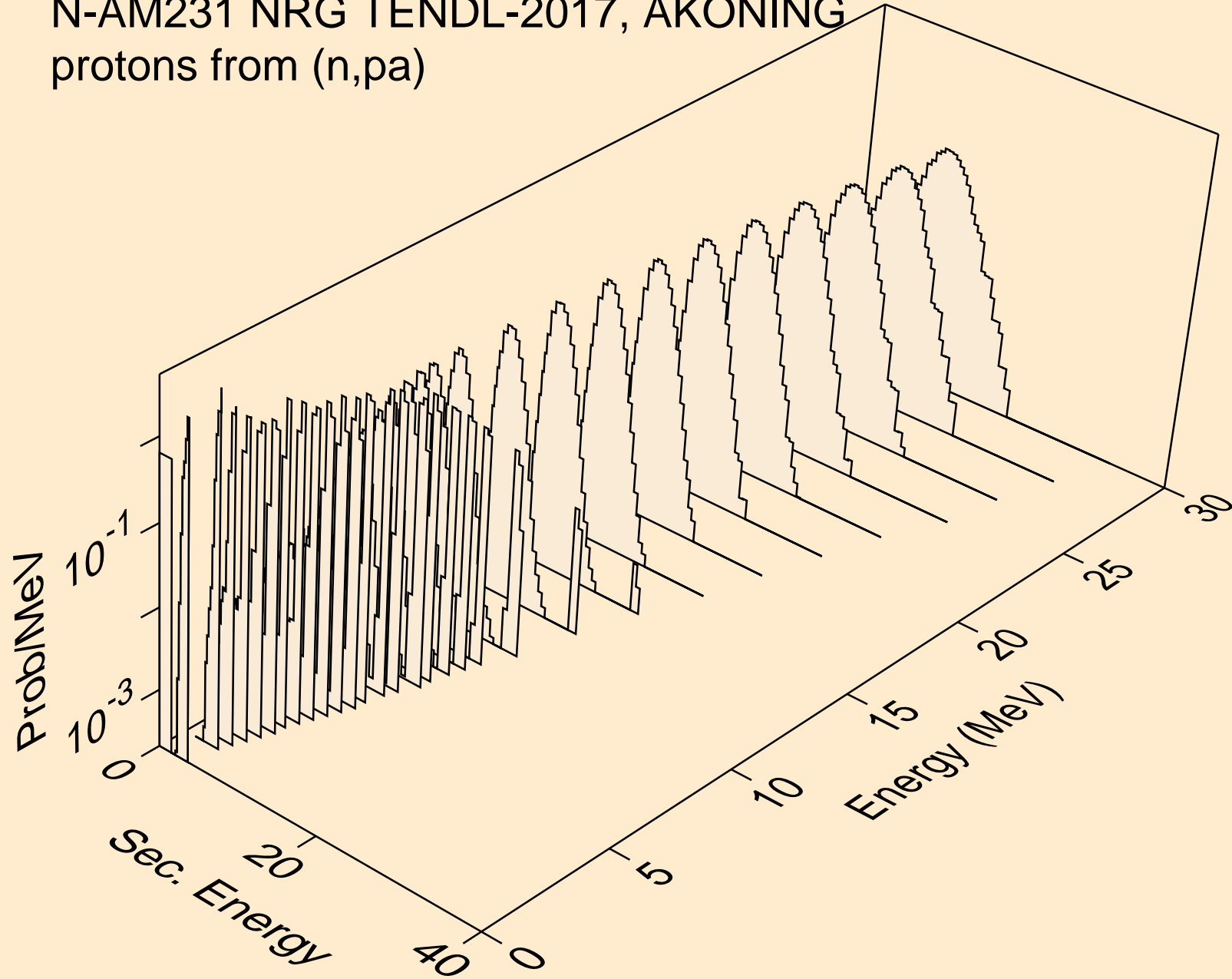

N-AM231 NRG TENDL-2017, AKONING
protons from (n,pd)

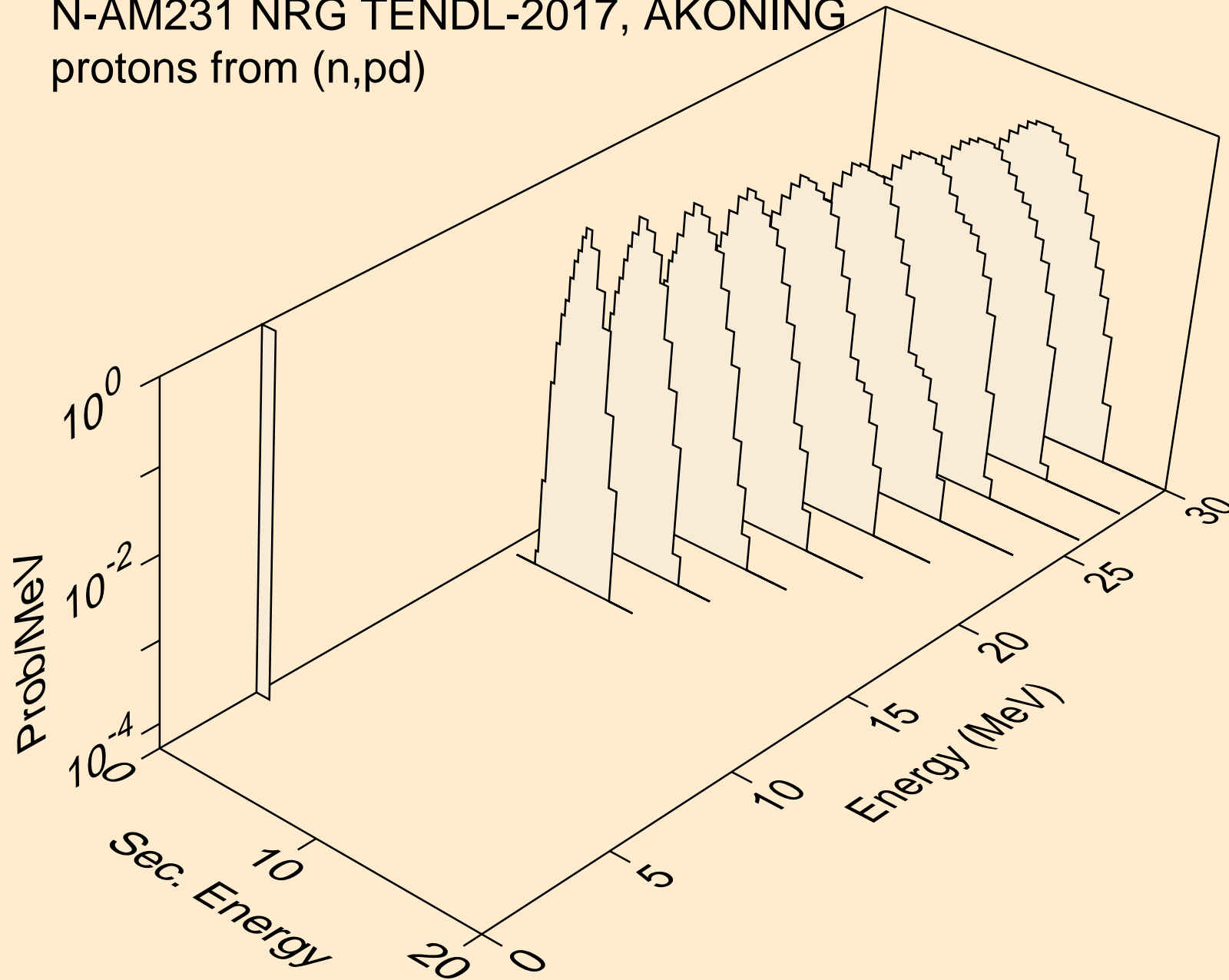

N-AM231 NRG TENDL-2017, AKONING
protons from (n,pt)

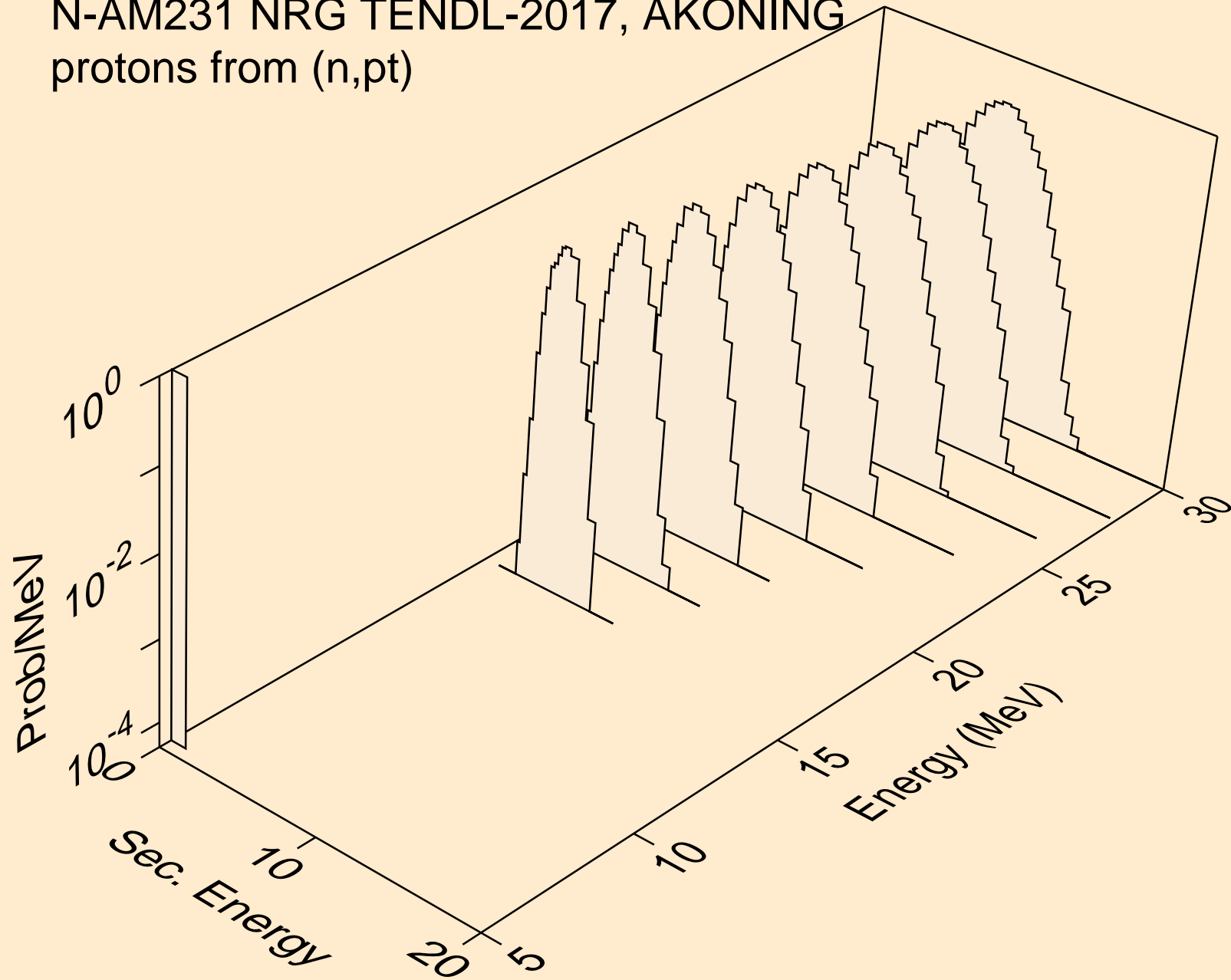

N-AM231 NRG TENDL-2017, AKONING
deuterons from (n,x)

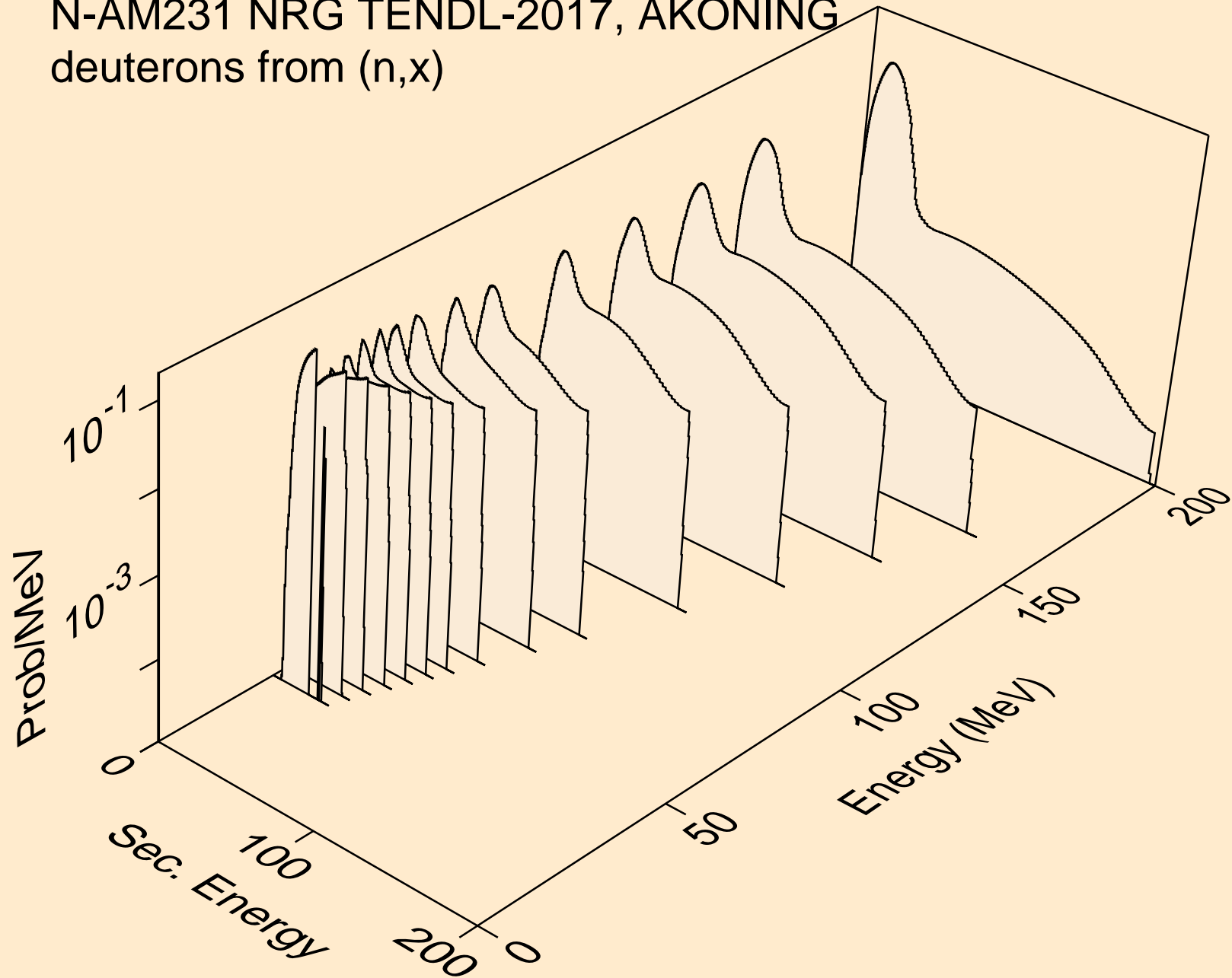

N-AM231 NRG TENDL-2017, AKONING
deuterons from (n,2nd)

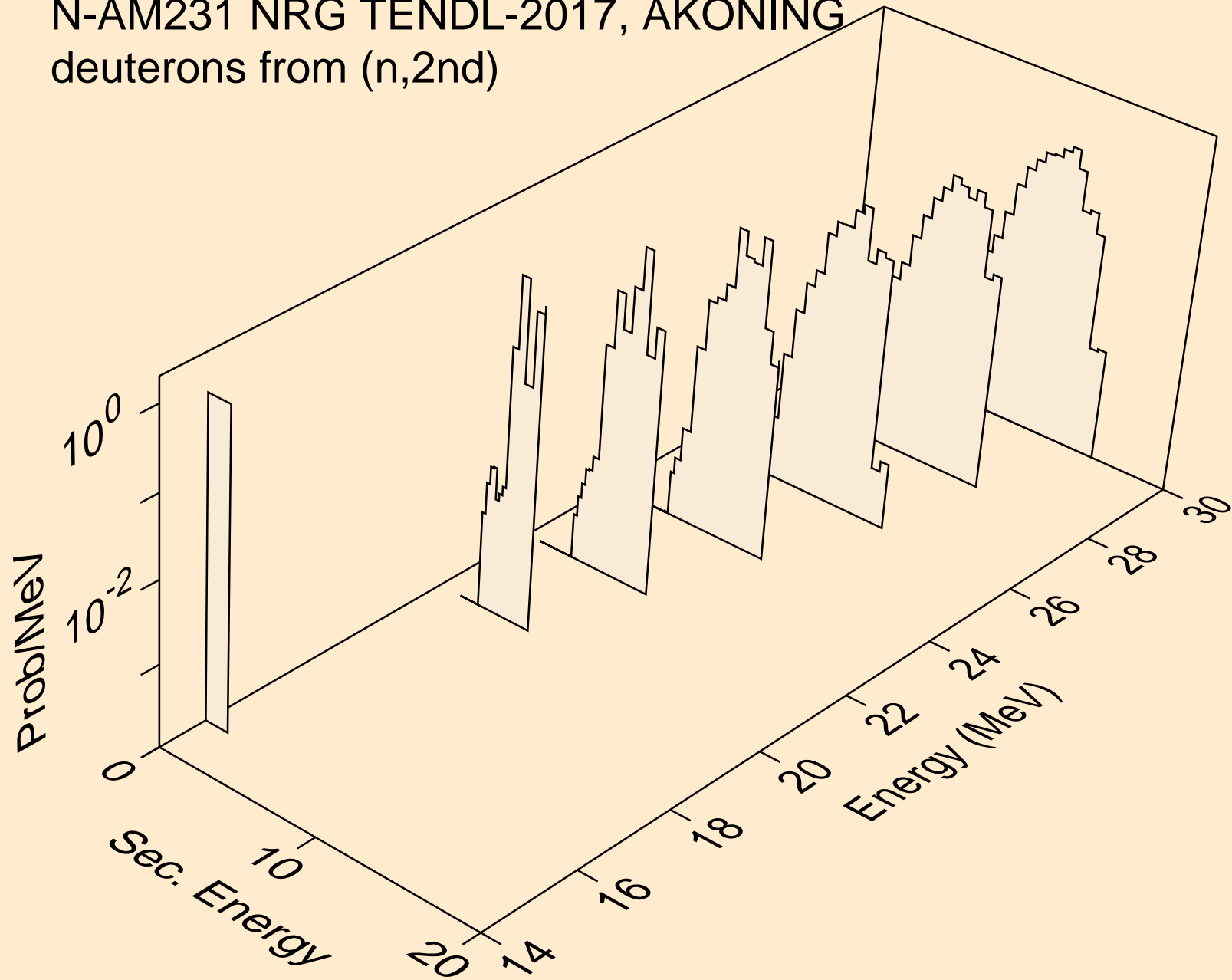

N-AM231 NRG TENDL-2017, AKONING
deuterons from (n,n*)d

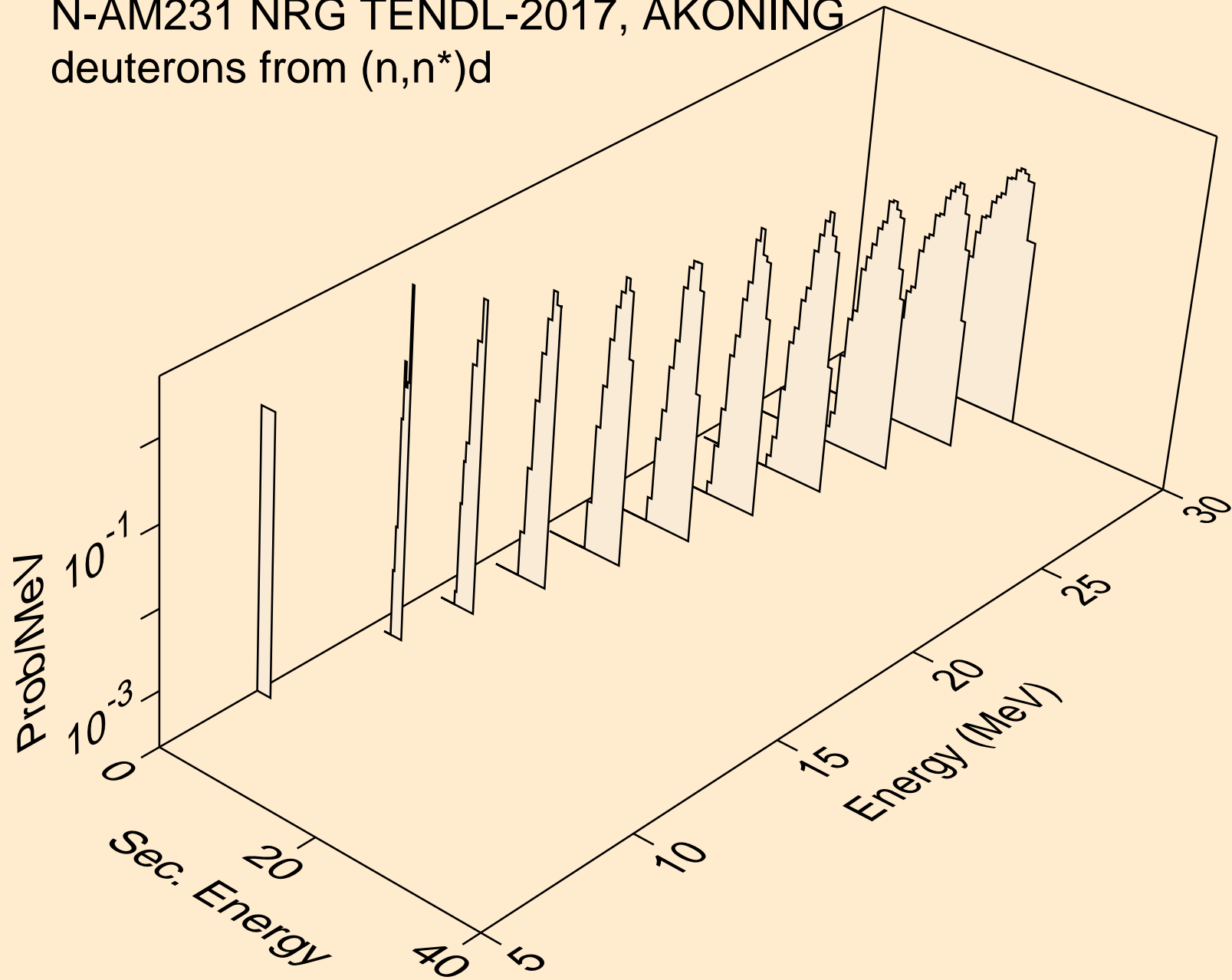

N-AM231 NRG TENDL-2017, AKONING
deuterons from (n,d)

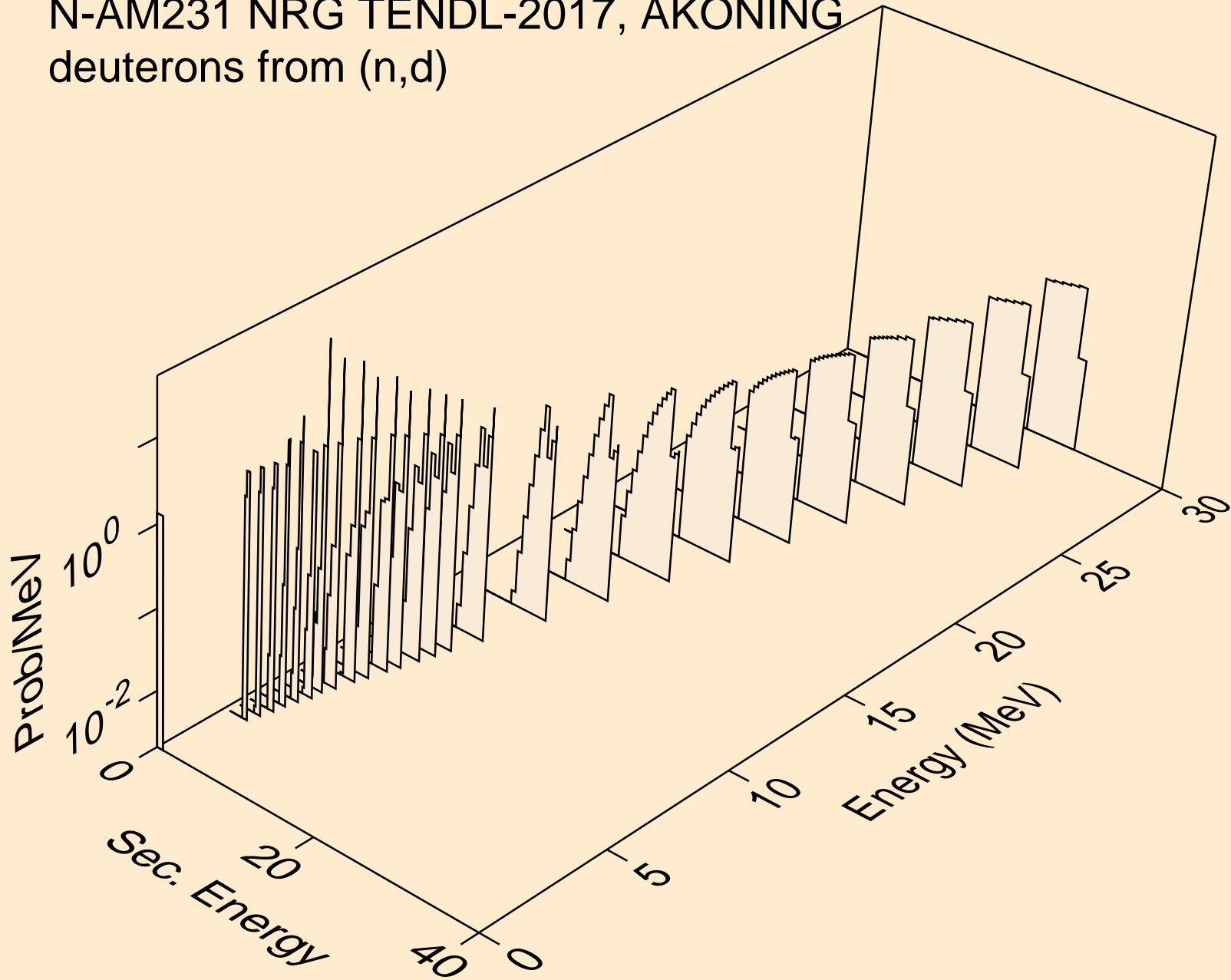

N-AM231 NRG TENDL-2017, AKONING
deuterons from (n,pd)

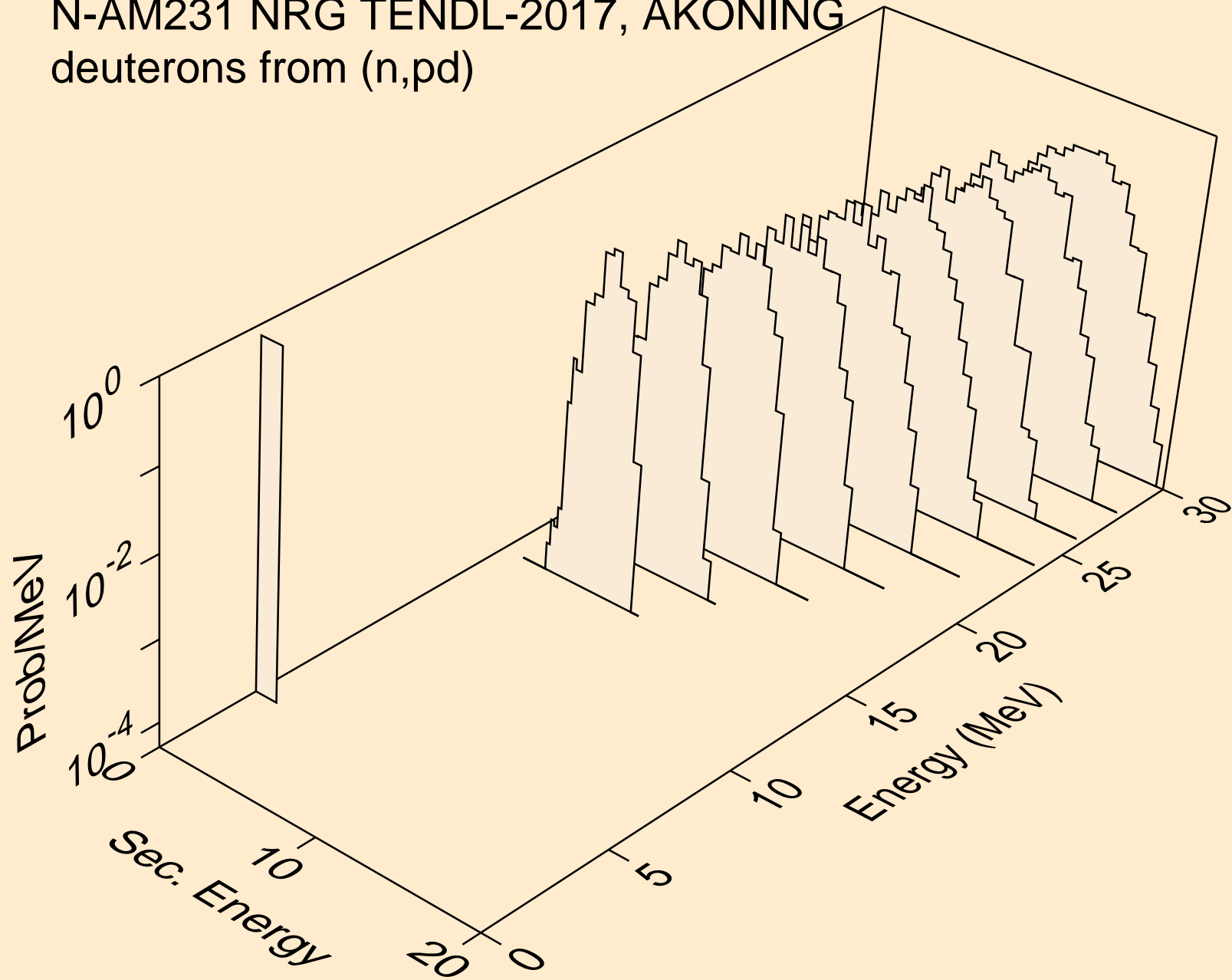

N-AM231 NRG TENDL-2017, AKONING
deuterons from (n,da)

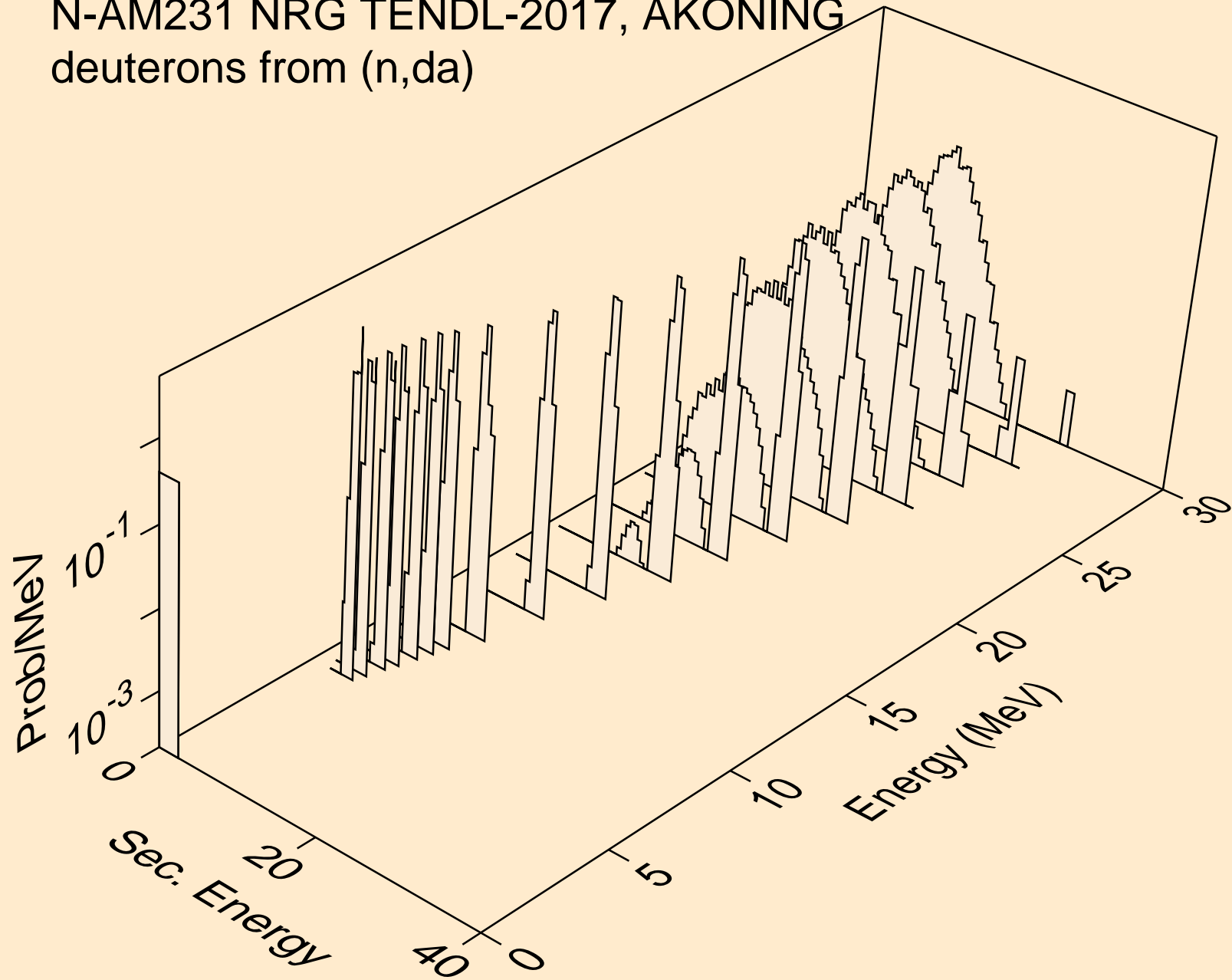

N-AM231 NRG TENDL-2017, AKONING
tritons from (n,x)

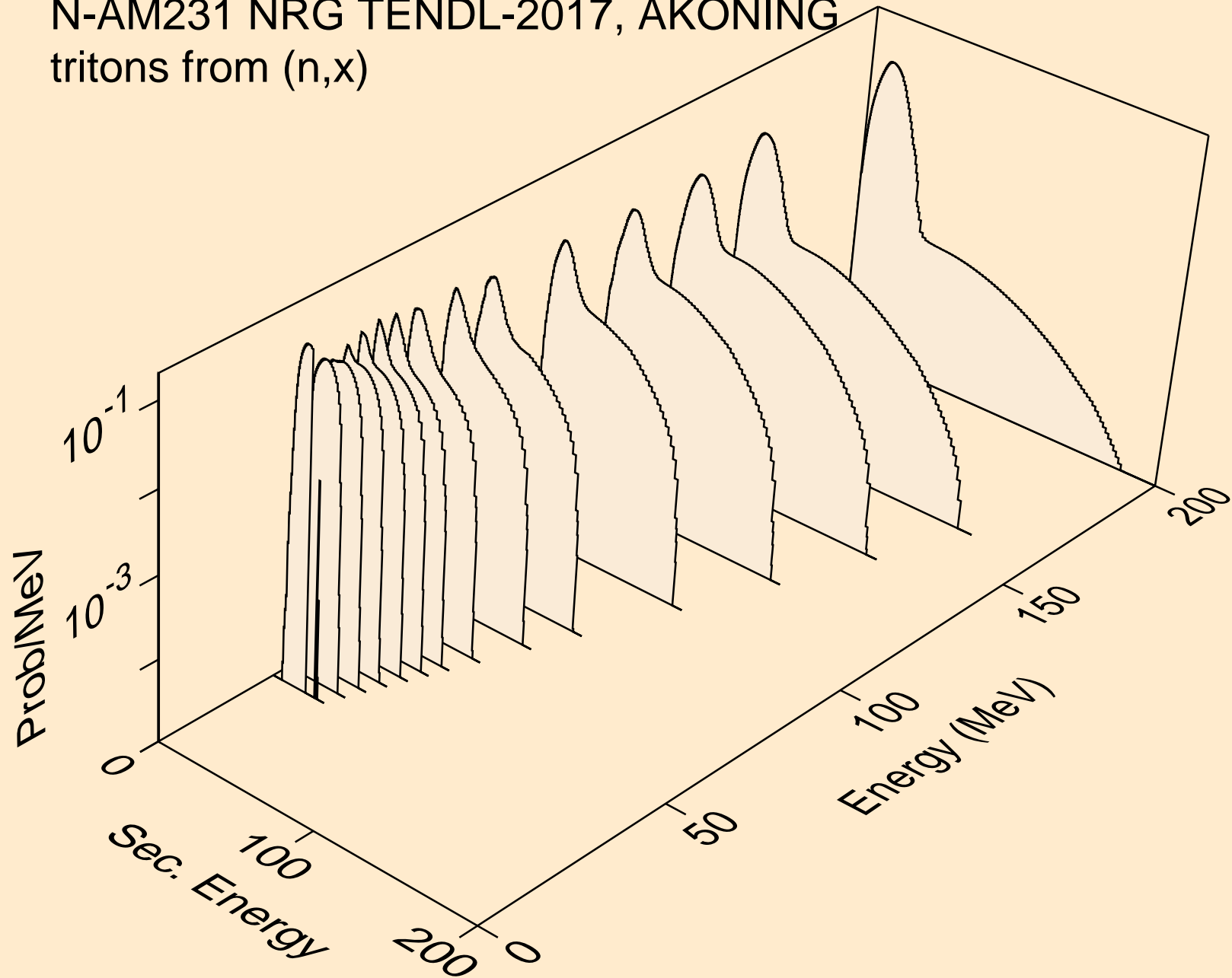

N-AM231 NRG TENDL-2017, AKONING
tritons from (n,n*)t

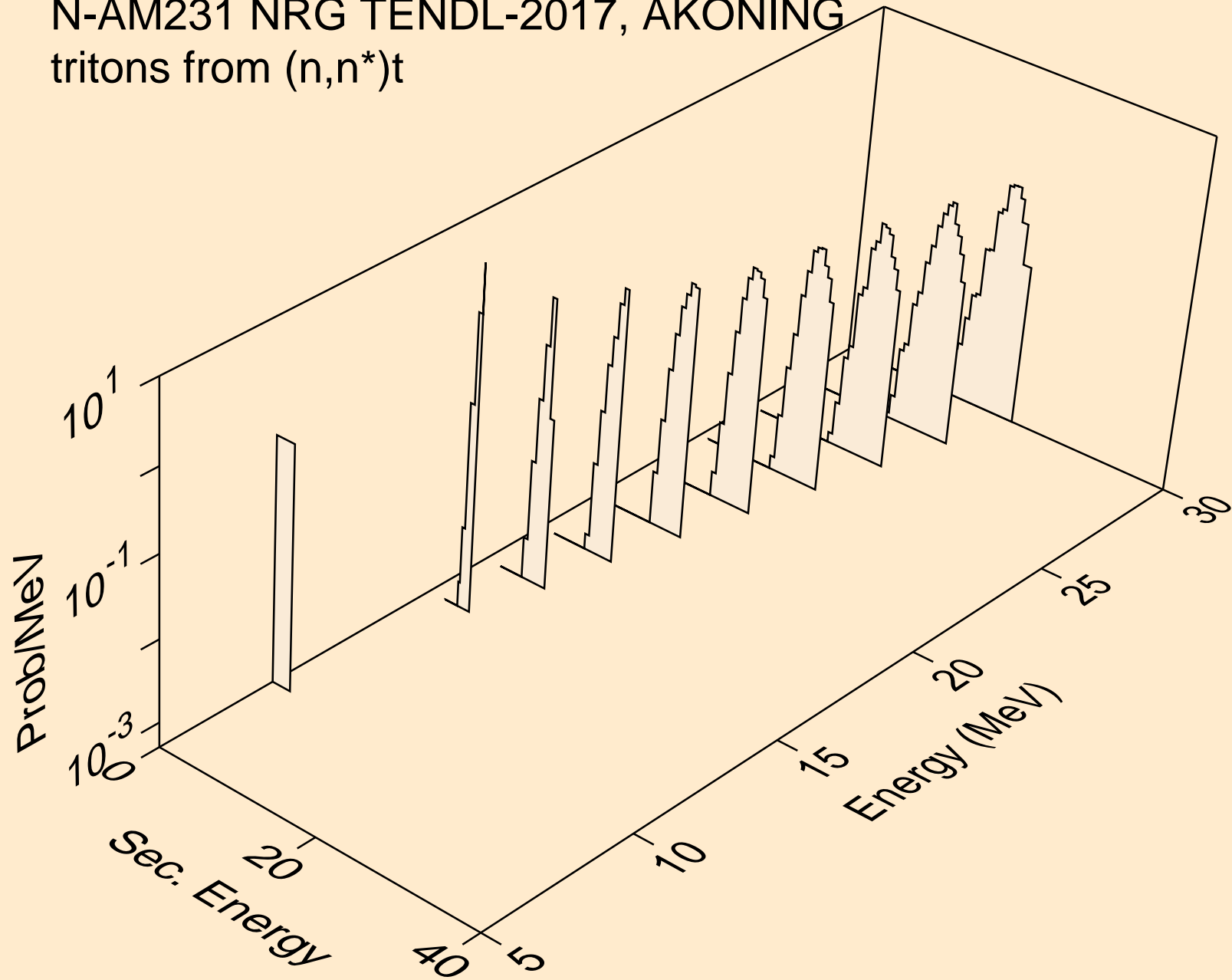

N-AM231 NRG TENDL-2017, AKONING
tritons from (n,t)

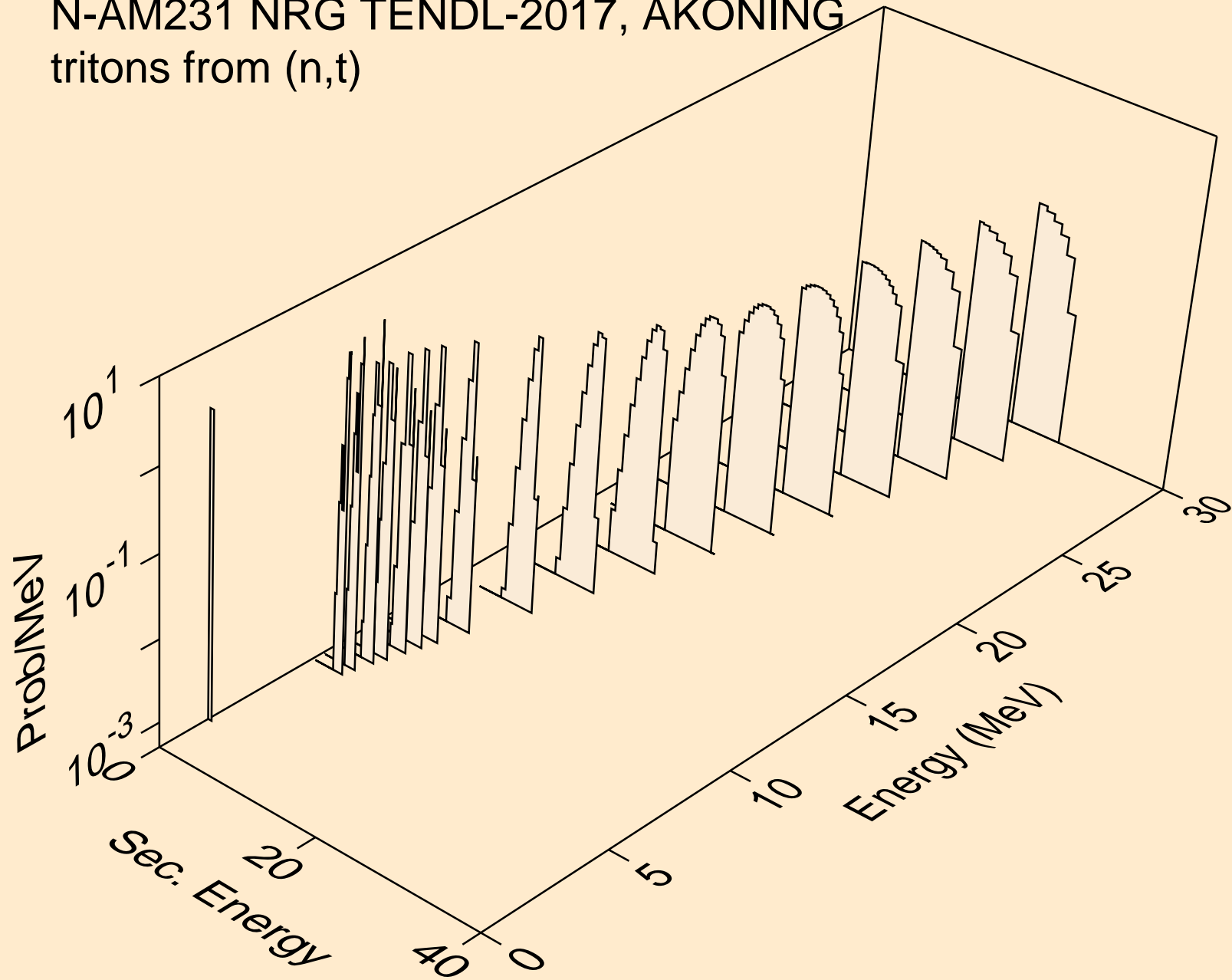

N-AM231 NRG TENDL-2017, AKONING
tritons from (n,pt)

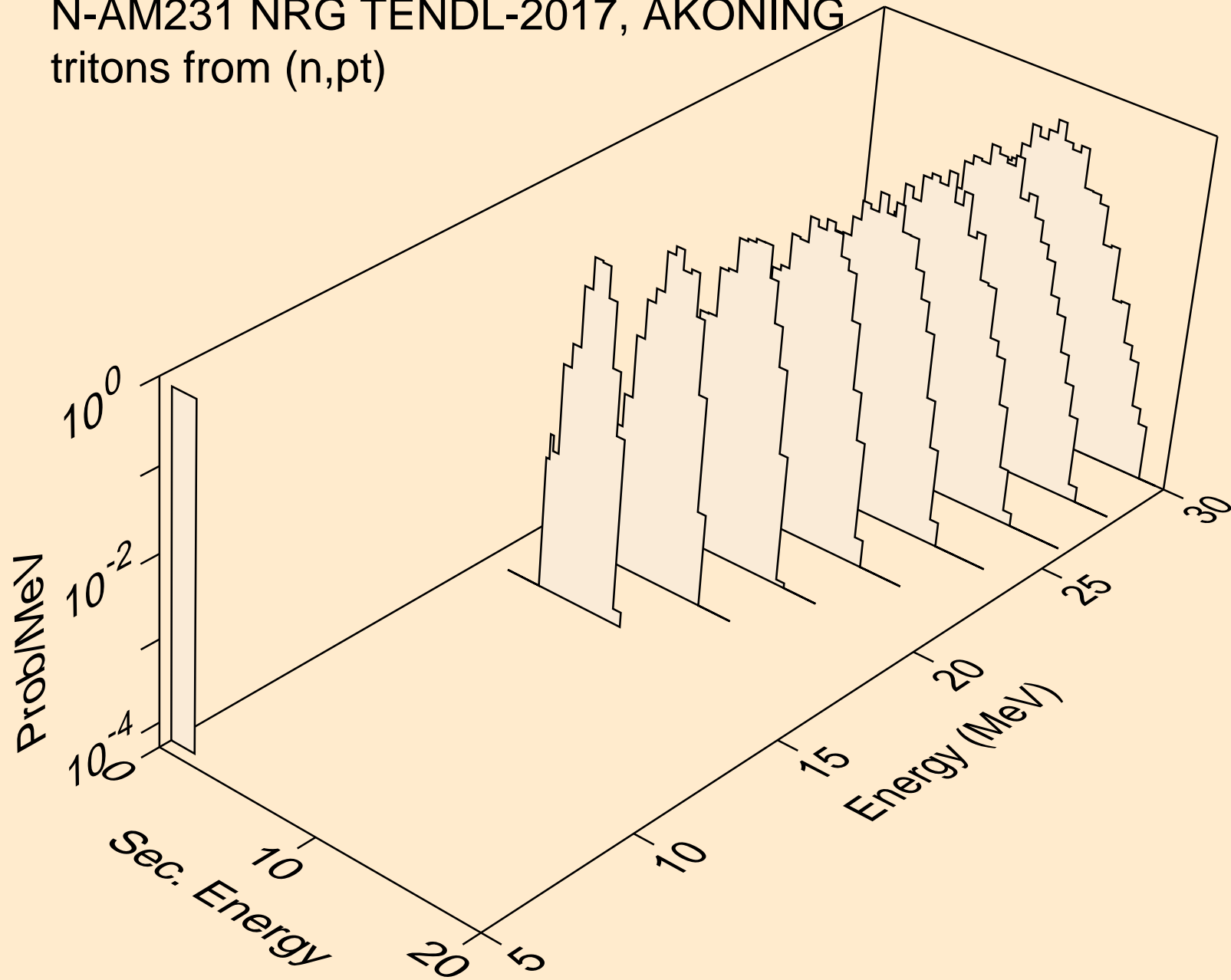

N-AM231 NRG TENDL-2017, AKONING
he3s from (n,x)

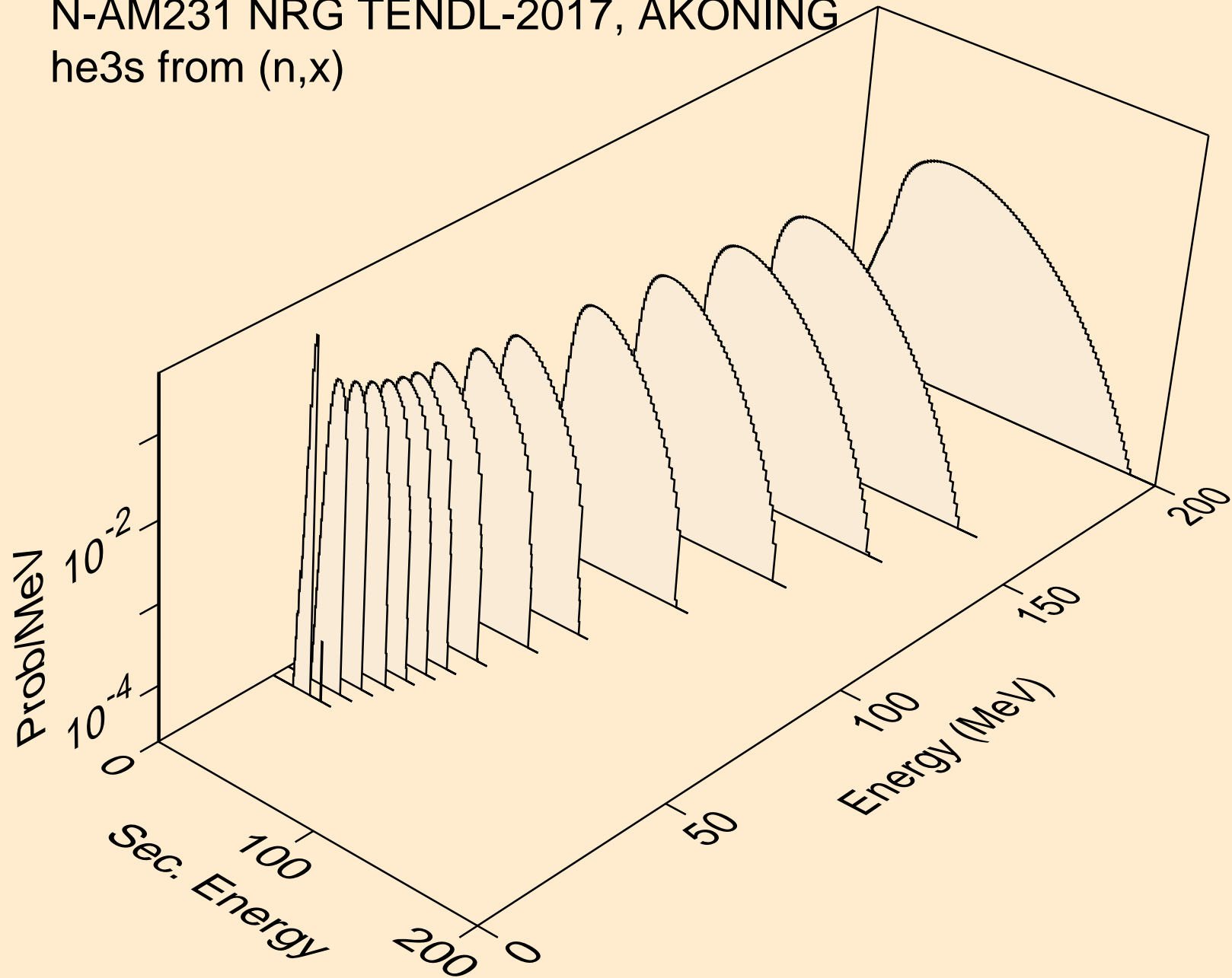

N-AM231 NRG TENDL-2017, AKONING
he3s from (n,n*)he3

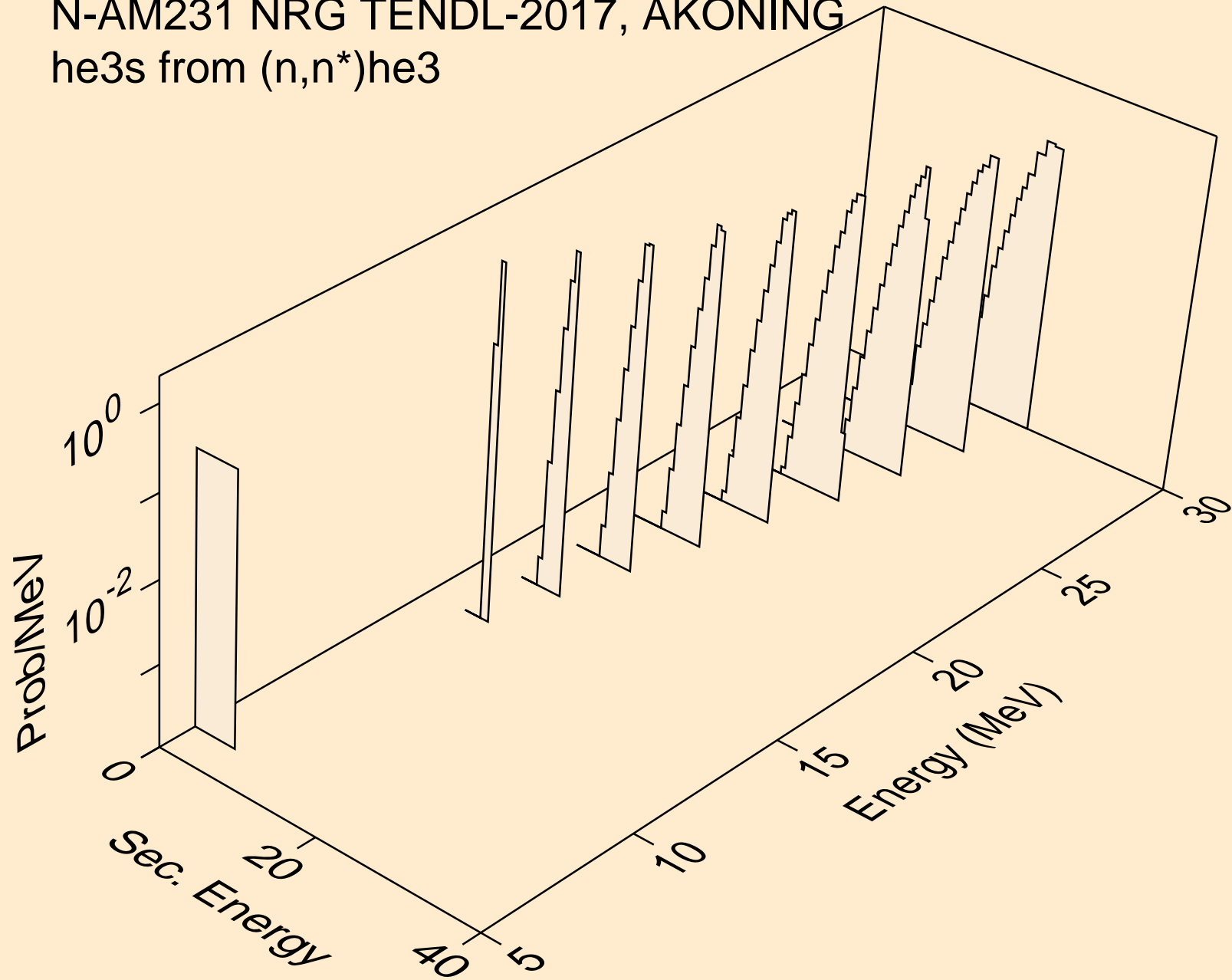

N-AM231 NRG TENDL-2017, AKONING
he3s from (n,he3)

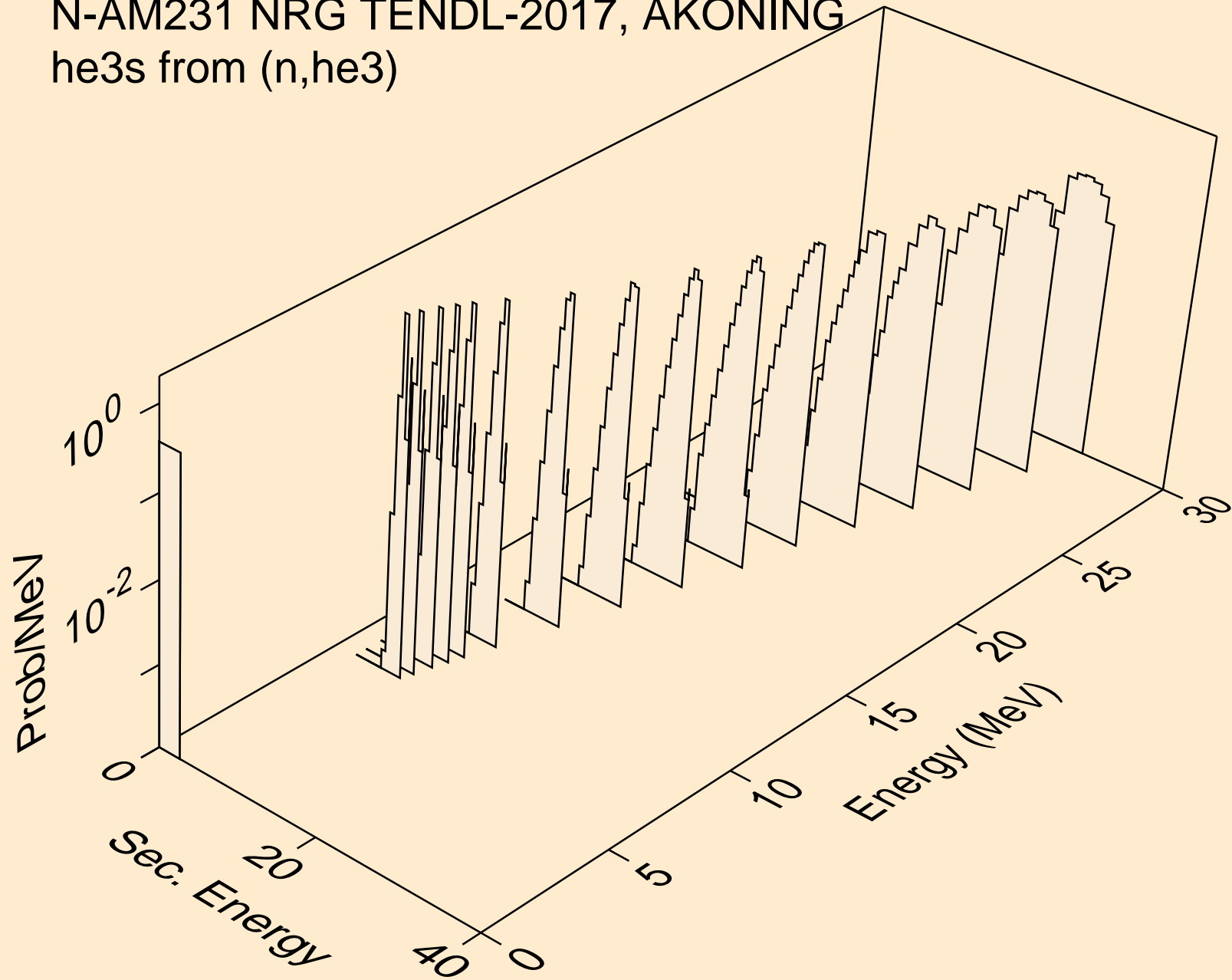

N-AM231 NRG TENDL-2017, AKONING
alphas from (n,x)

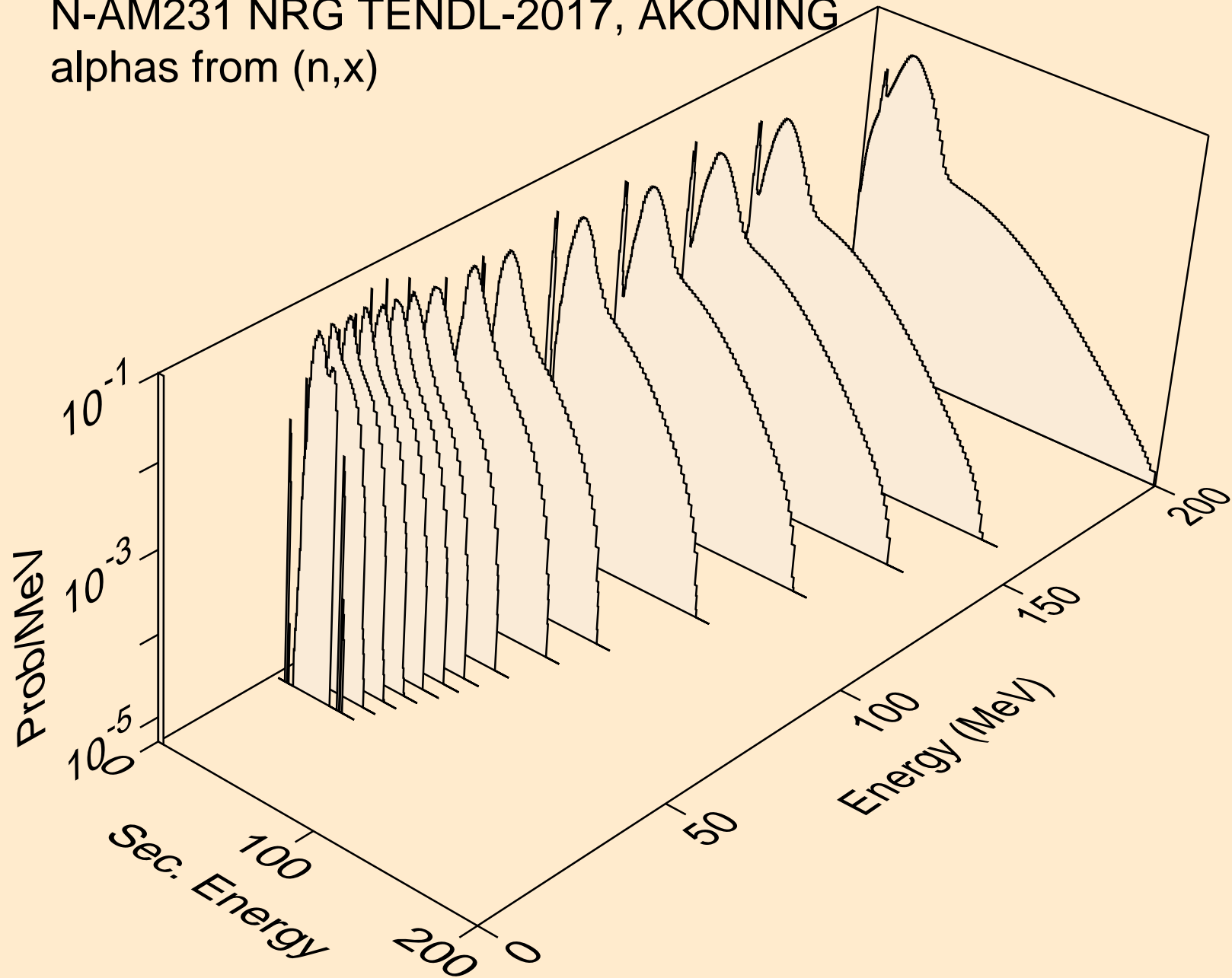

N-AM231 NRG TENDL-2017, AKONING
alphas from (n,n*)a

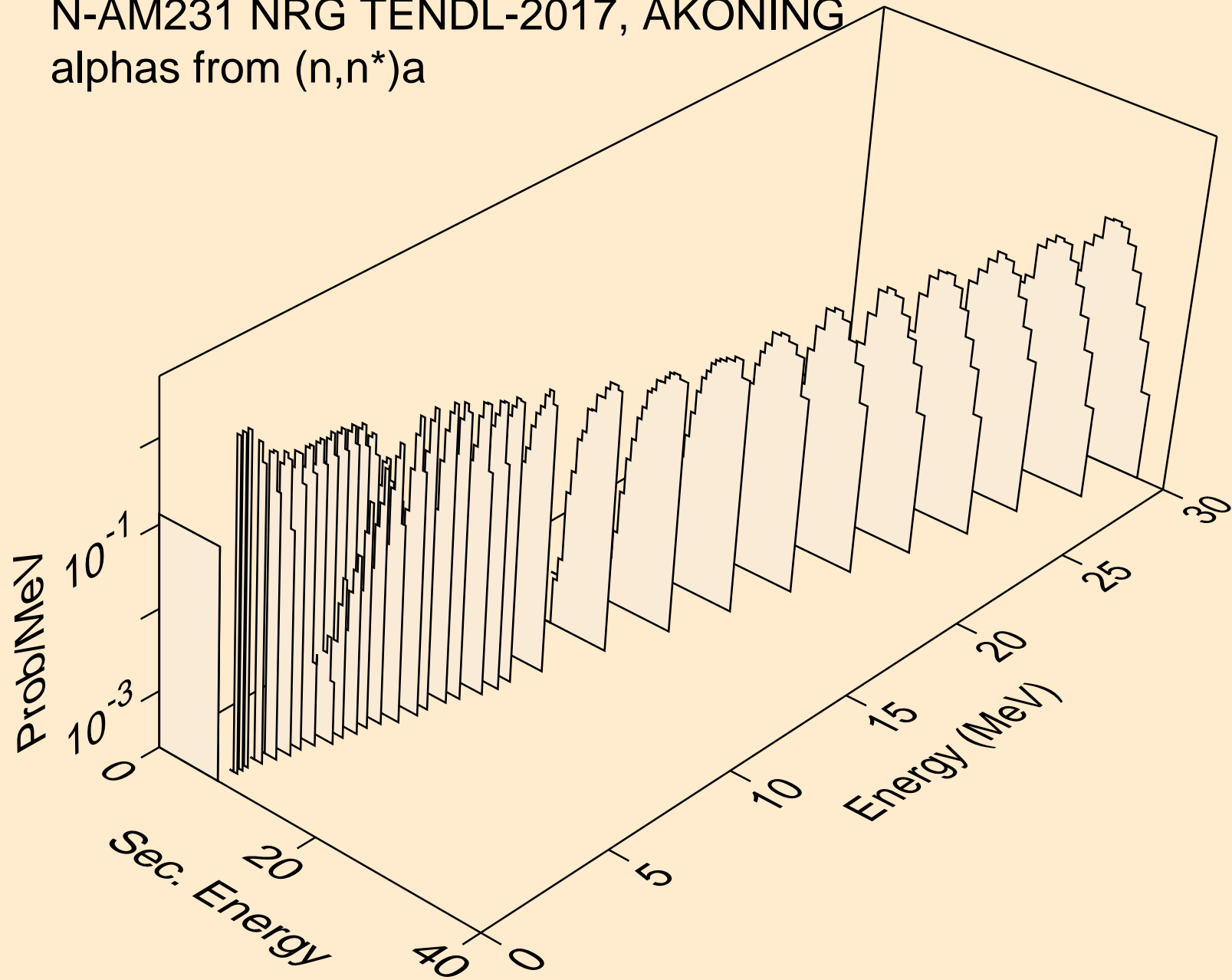

N-AM231 NRG TENDL-2017, AKONING
alphas from (n,n*)3a

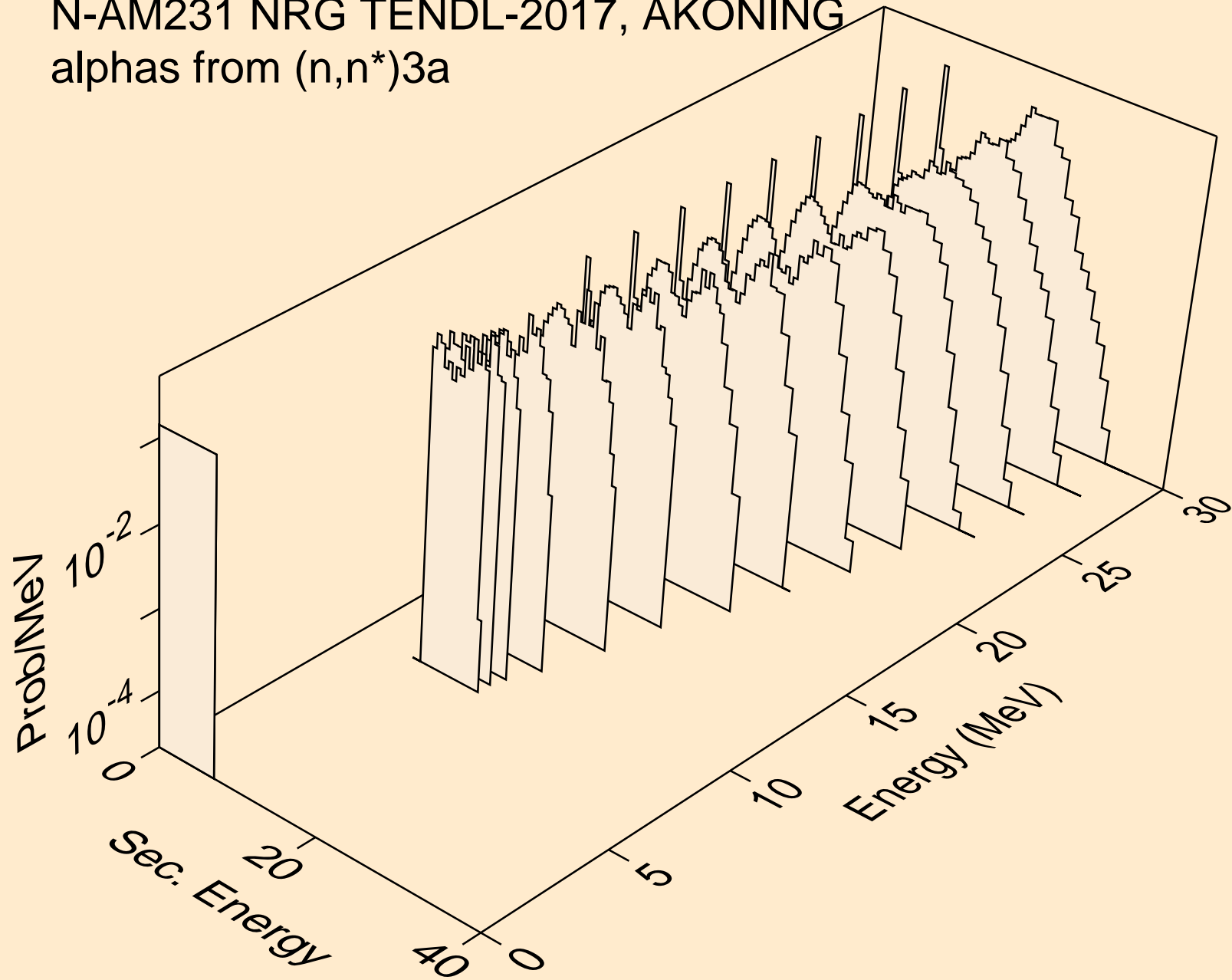

N-AM231 NRG TENDL-2017, AKONING
alphas from (n,2n)a

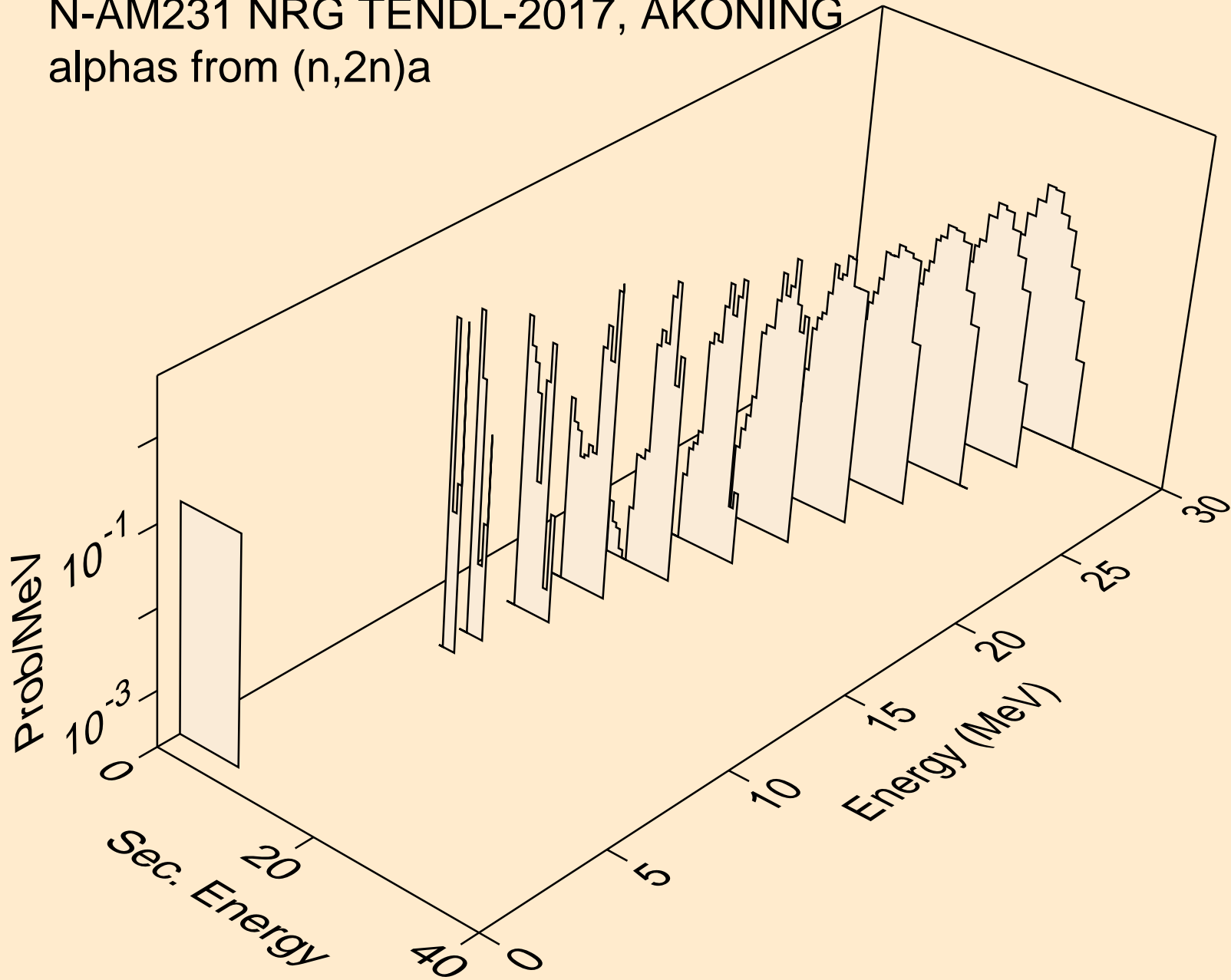

N-AM231 NRG TENDL-2017, AKONING
alphas from (n,3n)a

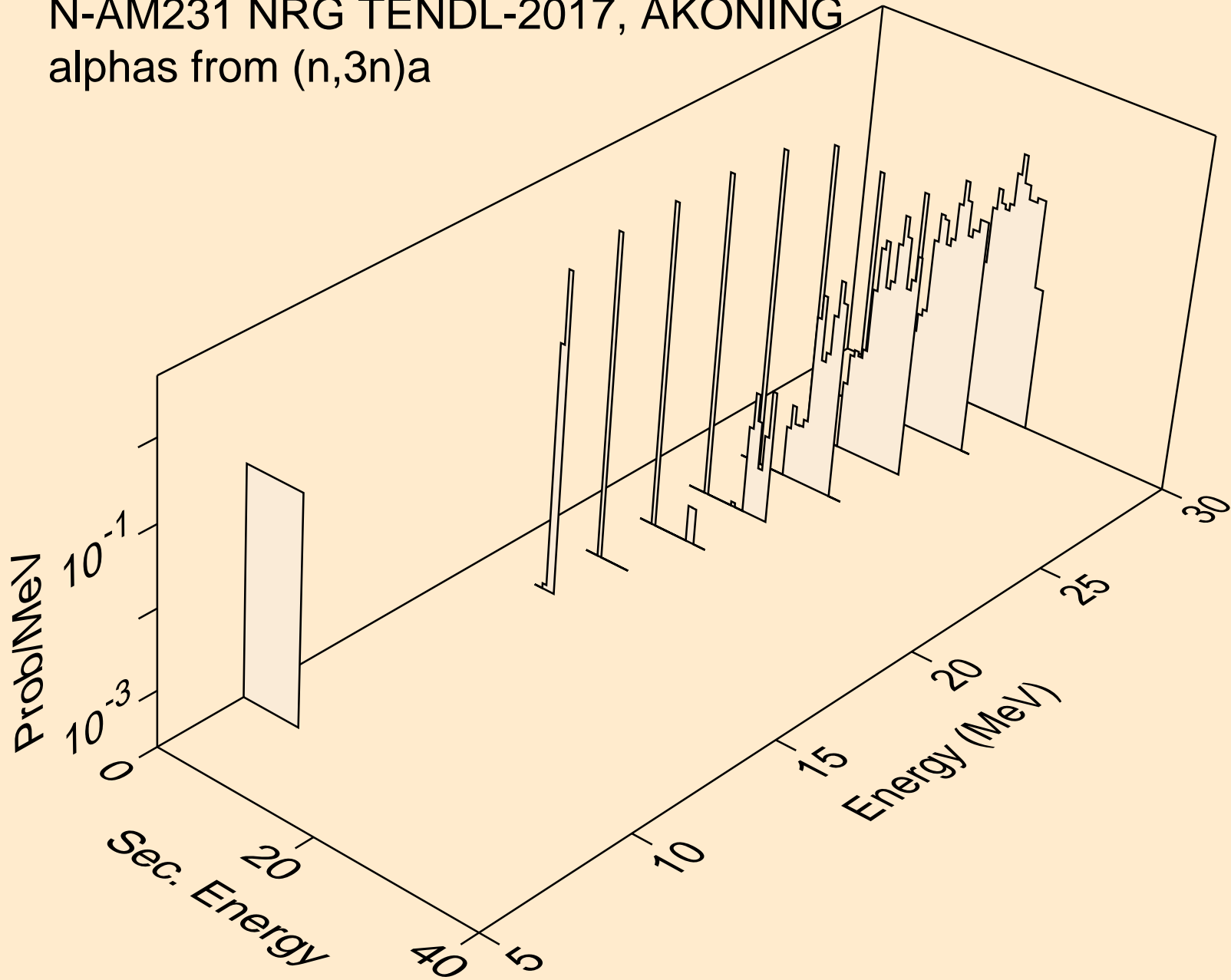

N-AM231 NRG TENDL-2017, AKONING
alphas from (n,n*)2a

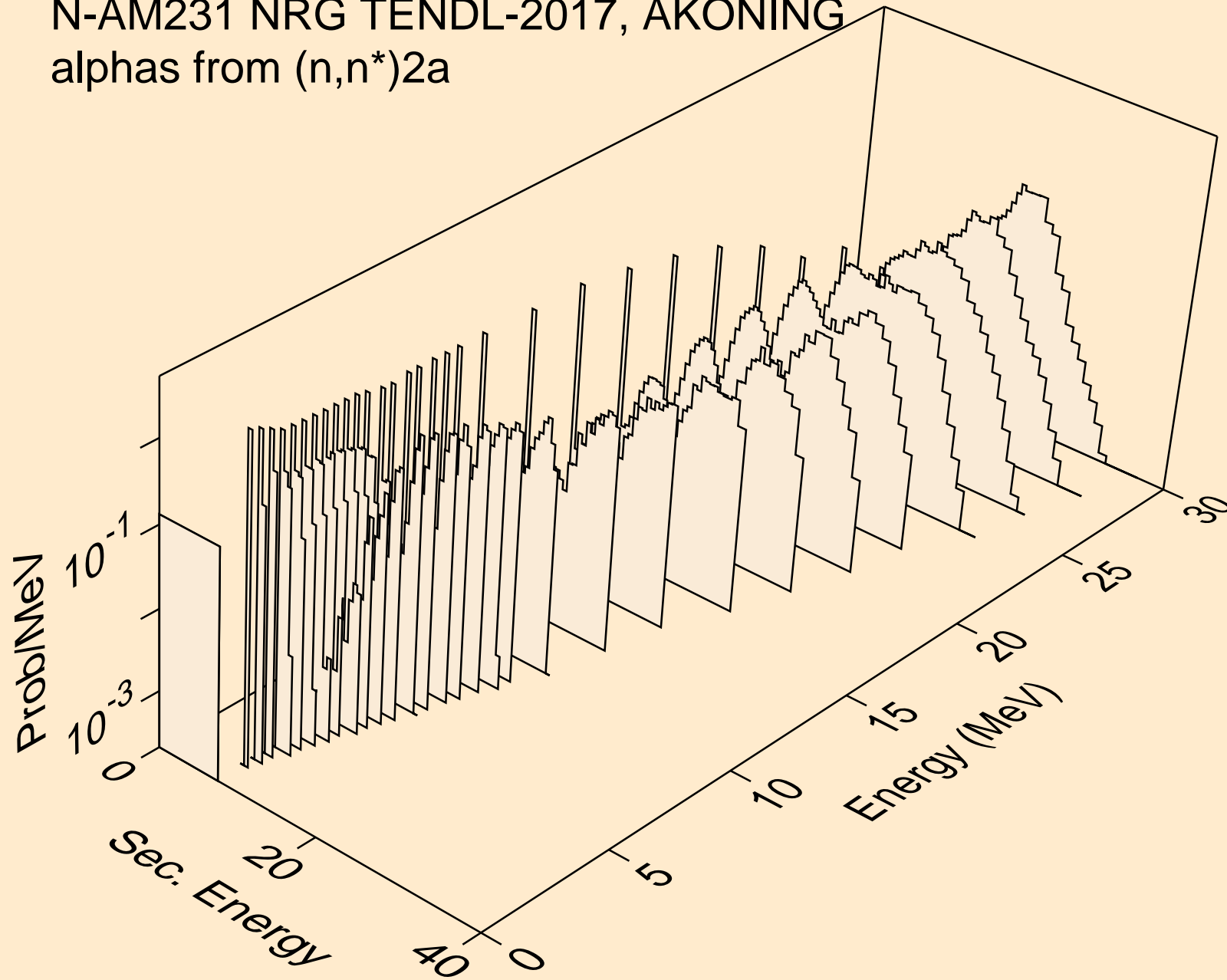

N-AM231 NRG TENDL-2017, AKONING
alphas from (n,2n)2a

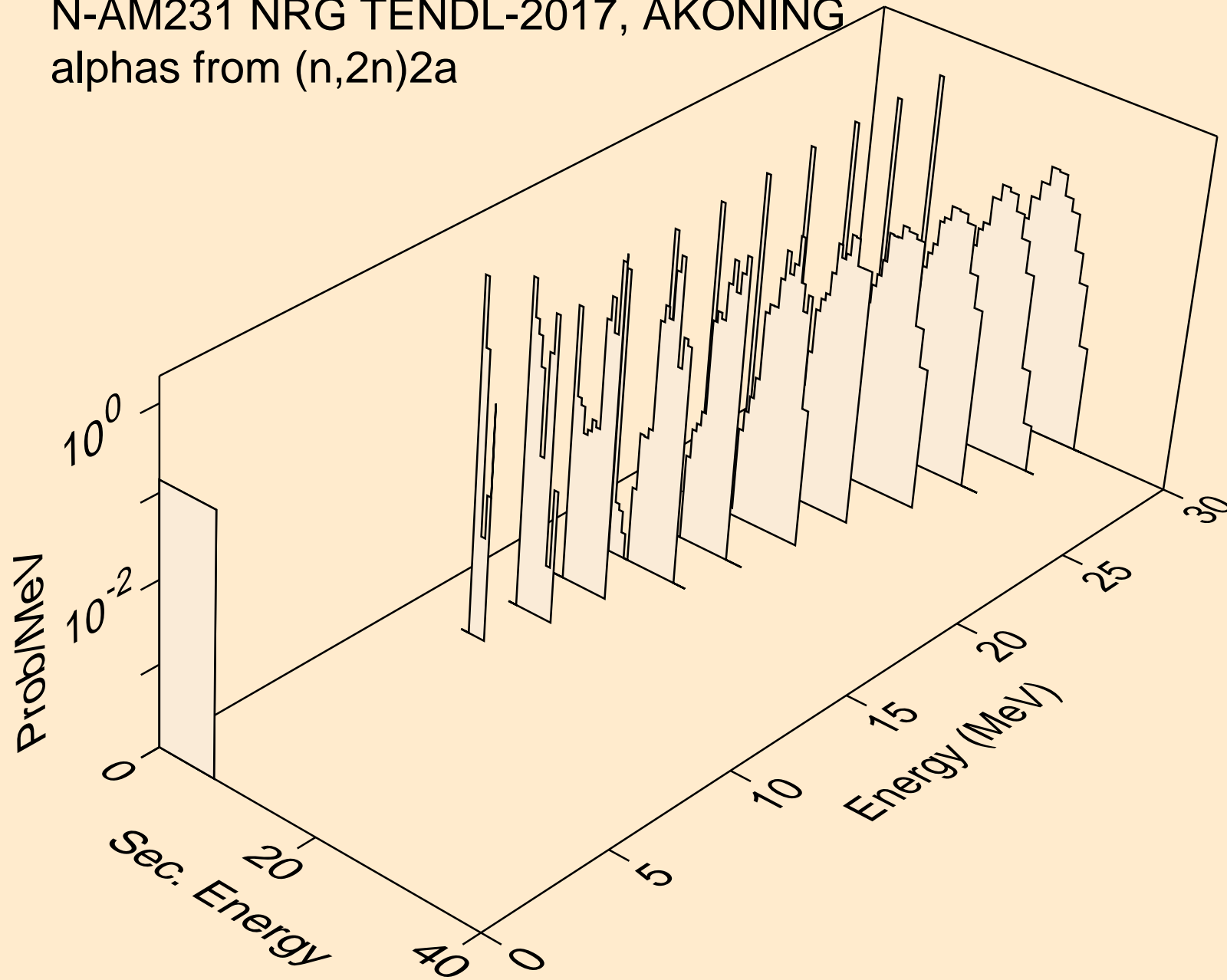

N-AM231 NRG TENDL-2017, AKONING
alphas from (n,npa)

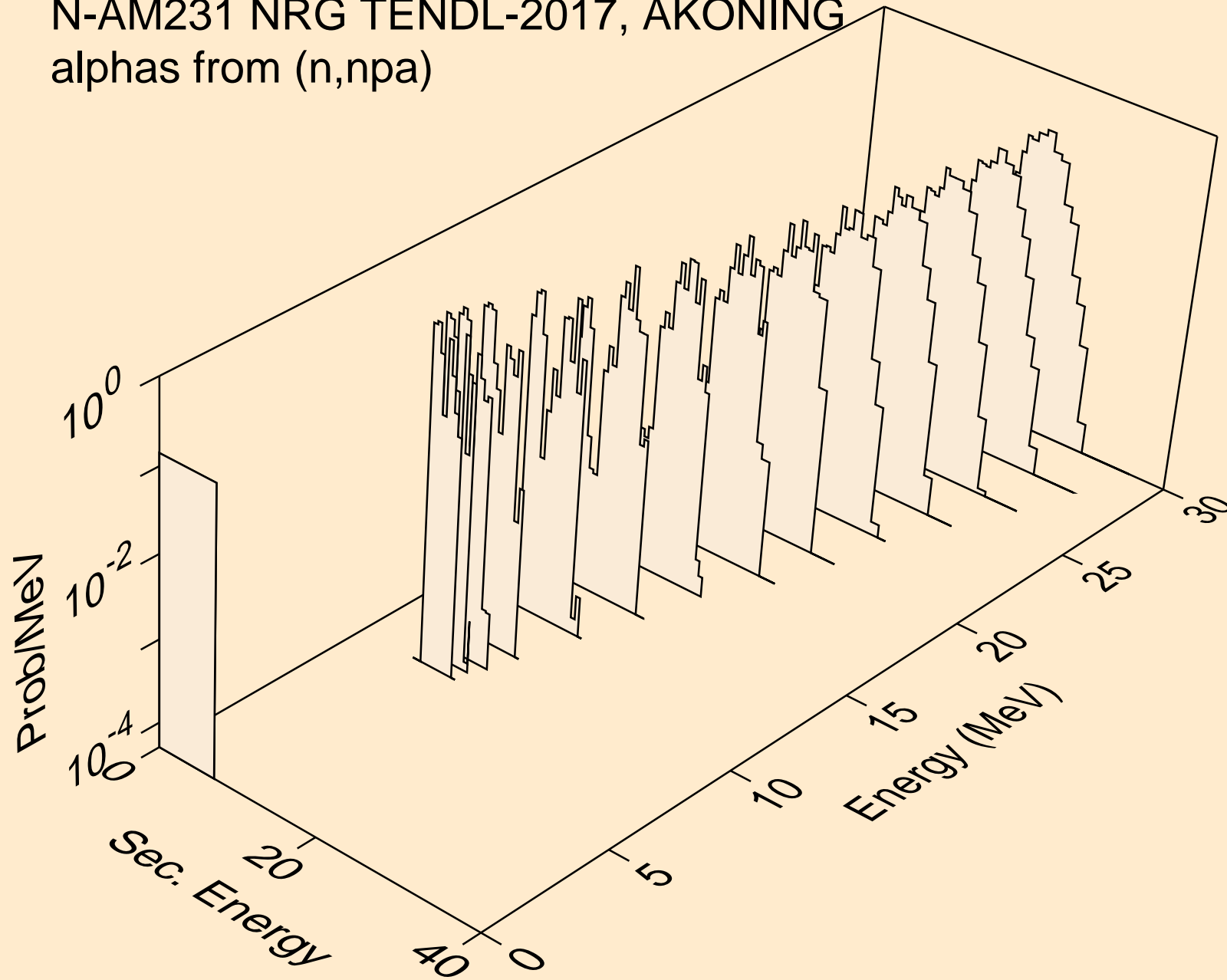

N-AM231 NRG TENDL-2017, AKONING
alphas from (n,a)

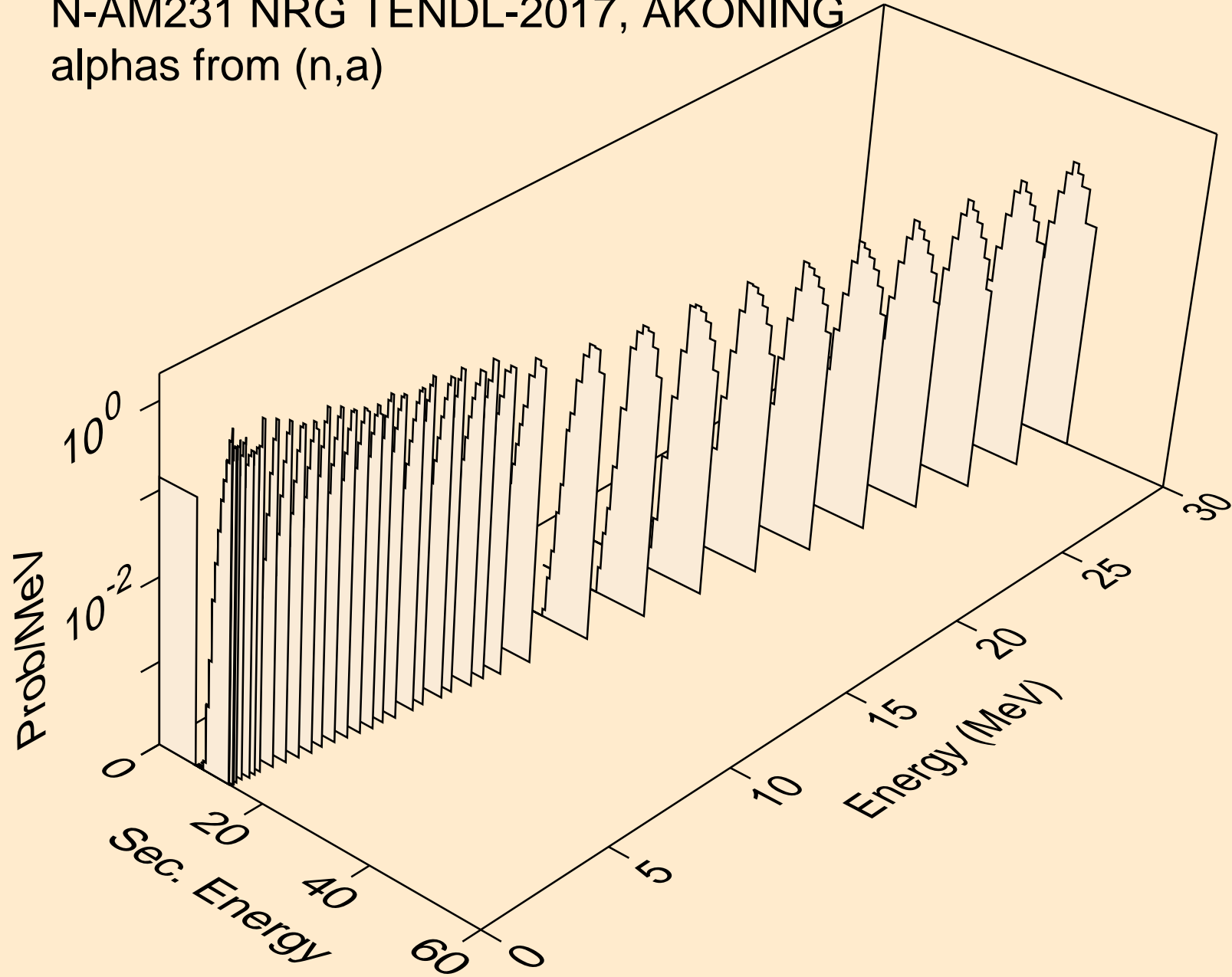

N-AM231 NRG TENDL-2017, AKONING
alphas from (n,2a)

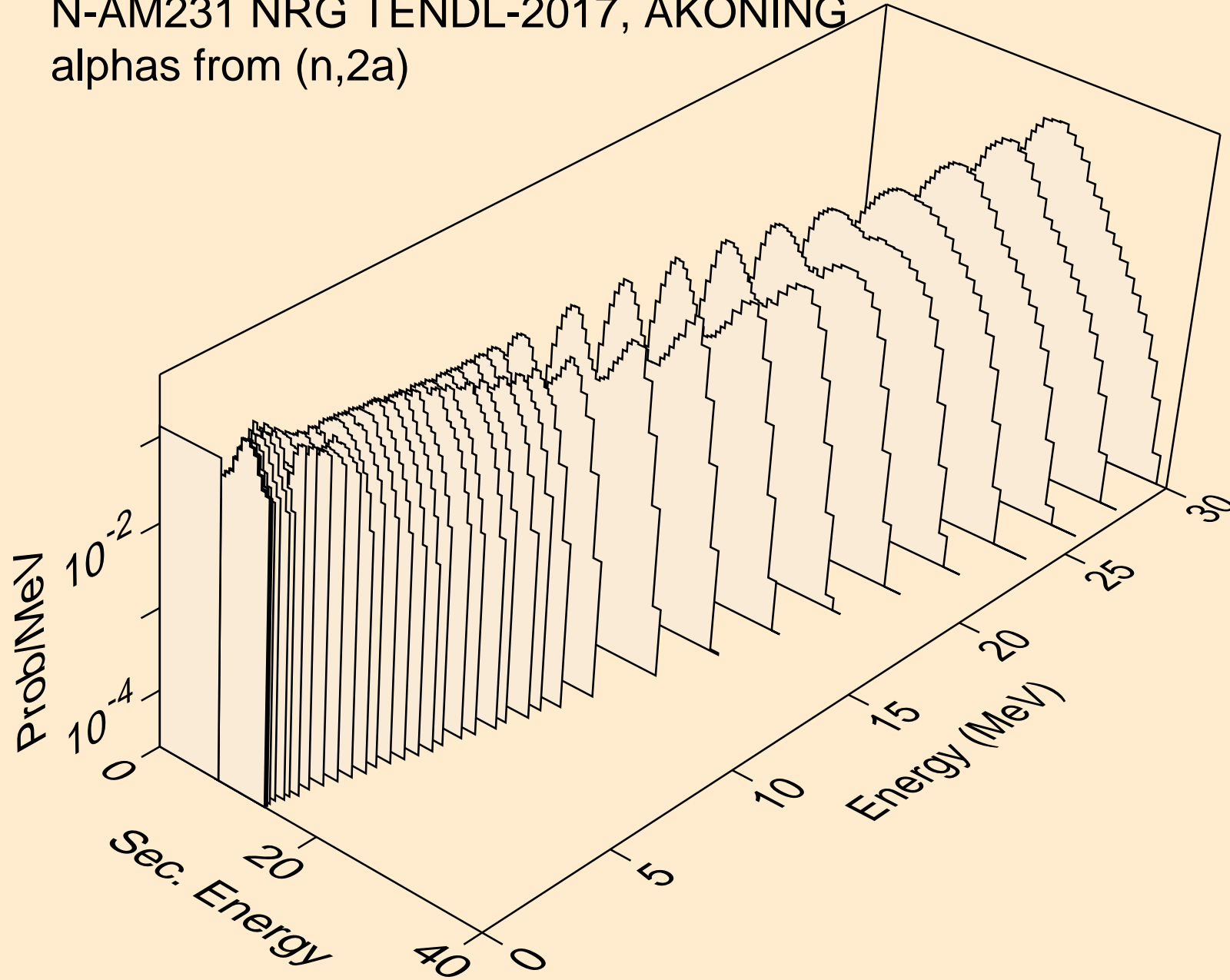

N-AM231 NRG TENDL-2017, AKONING
alphas from (n,pa)

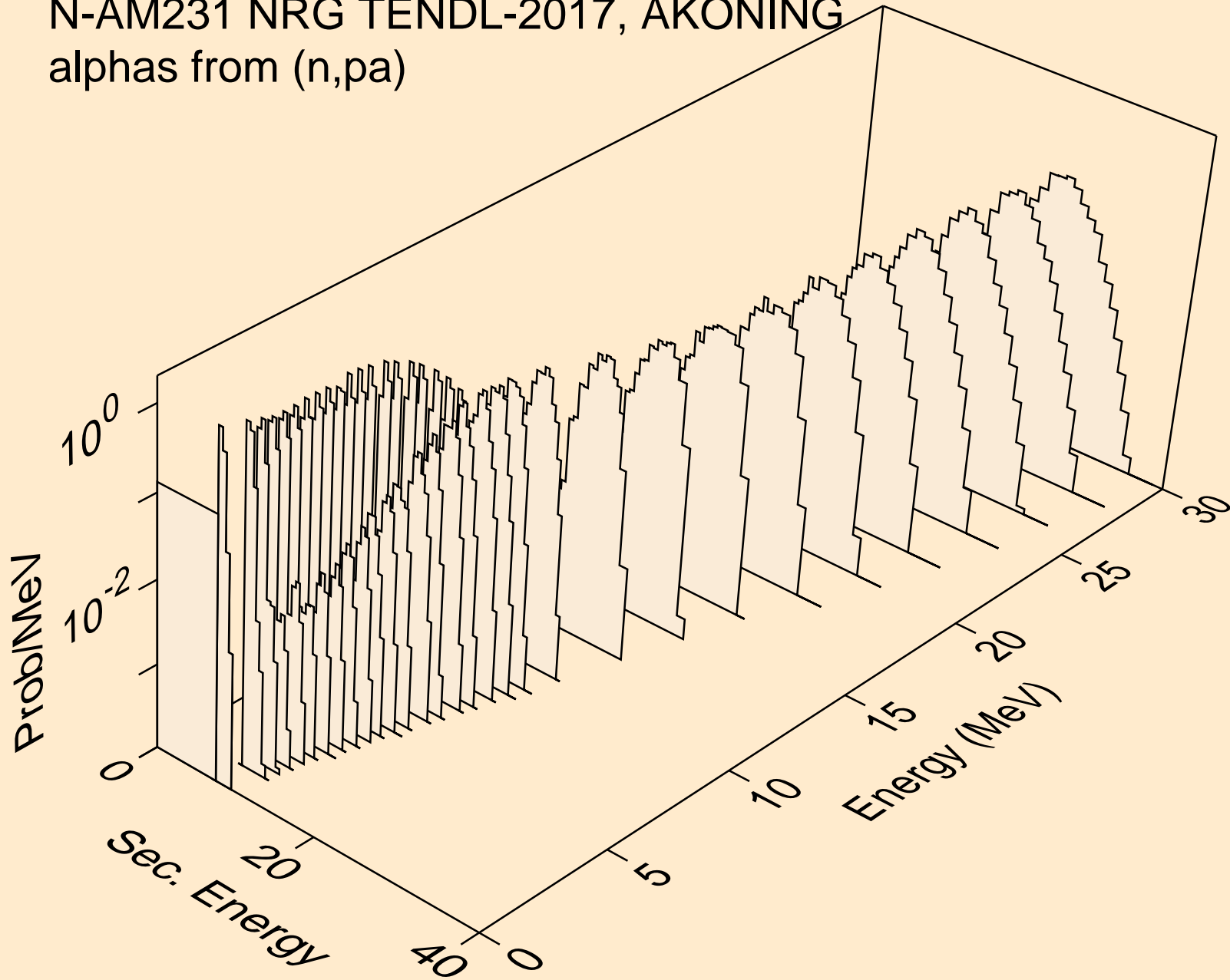

N-AM231 NRG TENDL-2017, AKONING
alphas from (n,da)

