

Program EVALPLOT
(Version 2017-1)

by

Dermott E. Cullen
(Present Contact Information)

Dermott E. Cullen
1466 Hudson Way
Livermore, CA 94550
U.S.A.

Tele: 925-443-1911

E.Mail:redcullen1@comcast.net

Web:redcullen1.net/HOMEPAGE.NEW

Press Mouse Button to Start

MAT 5549

Major
293 Kelvin Cross Sections

55-Cs-141

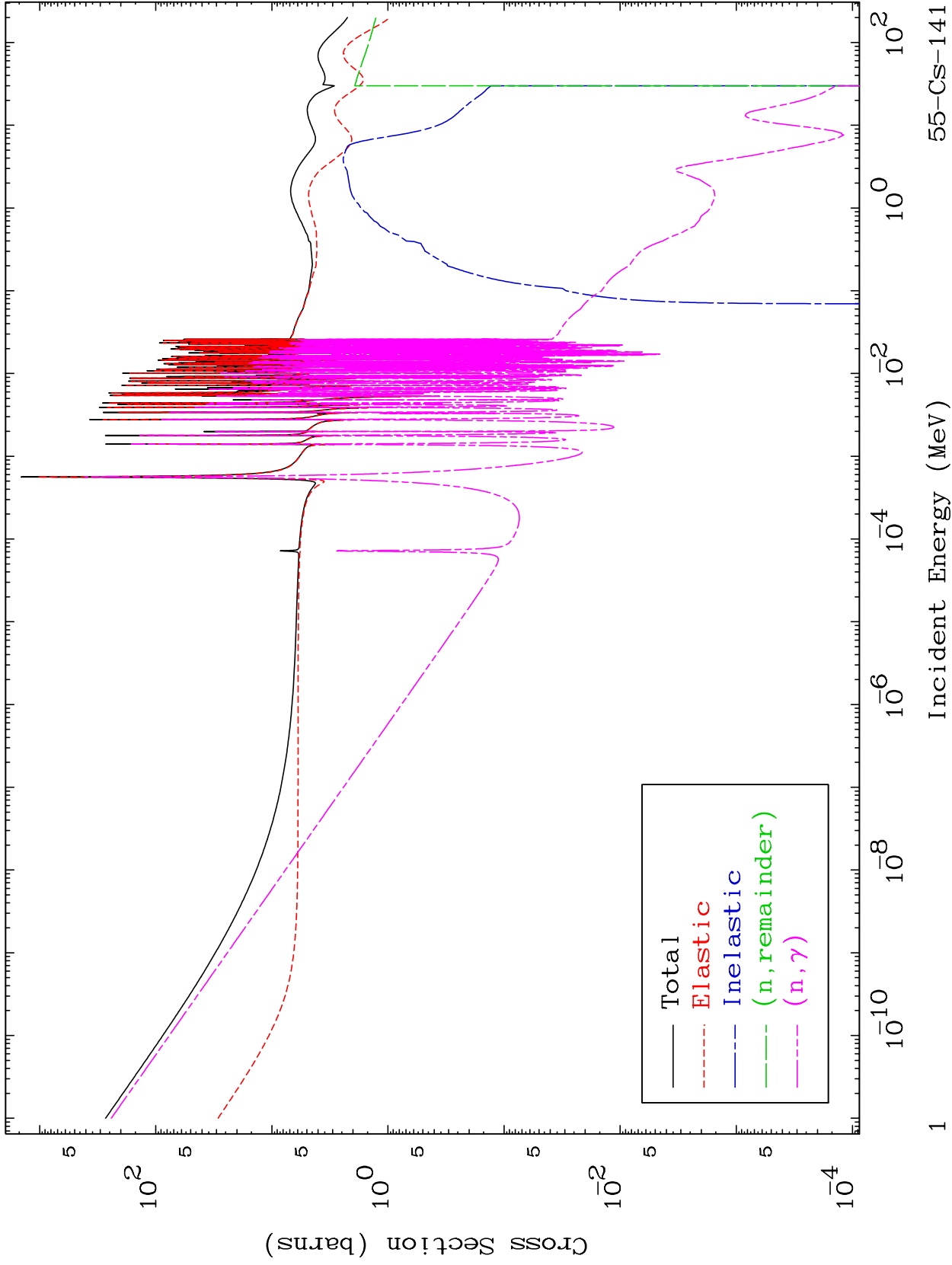

MAT 5549

Neutron Production
293 Kelvin Cross Sections

55-Cs-141

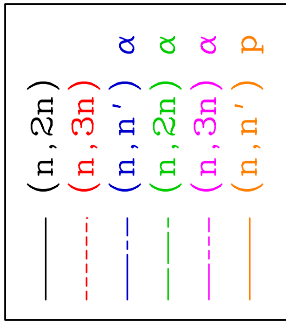
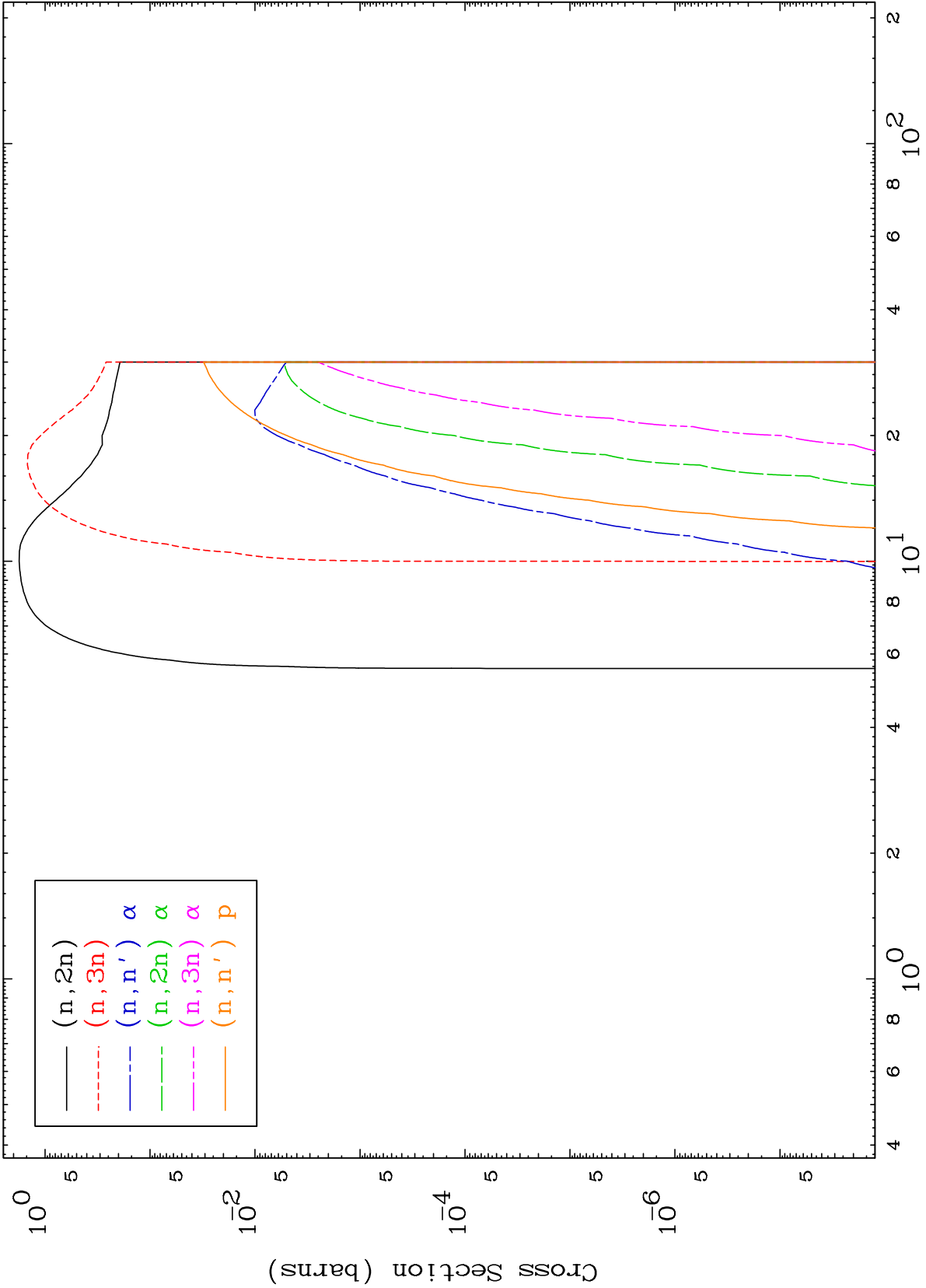

2

Incident Energy (MeV)

55-Cs-141

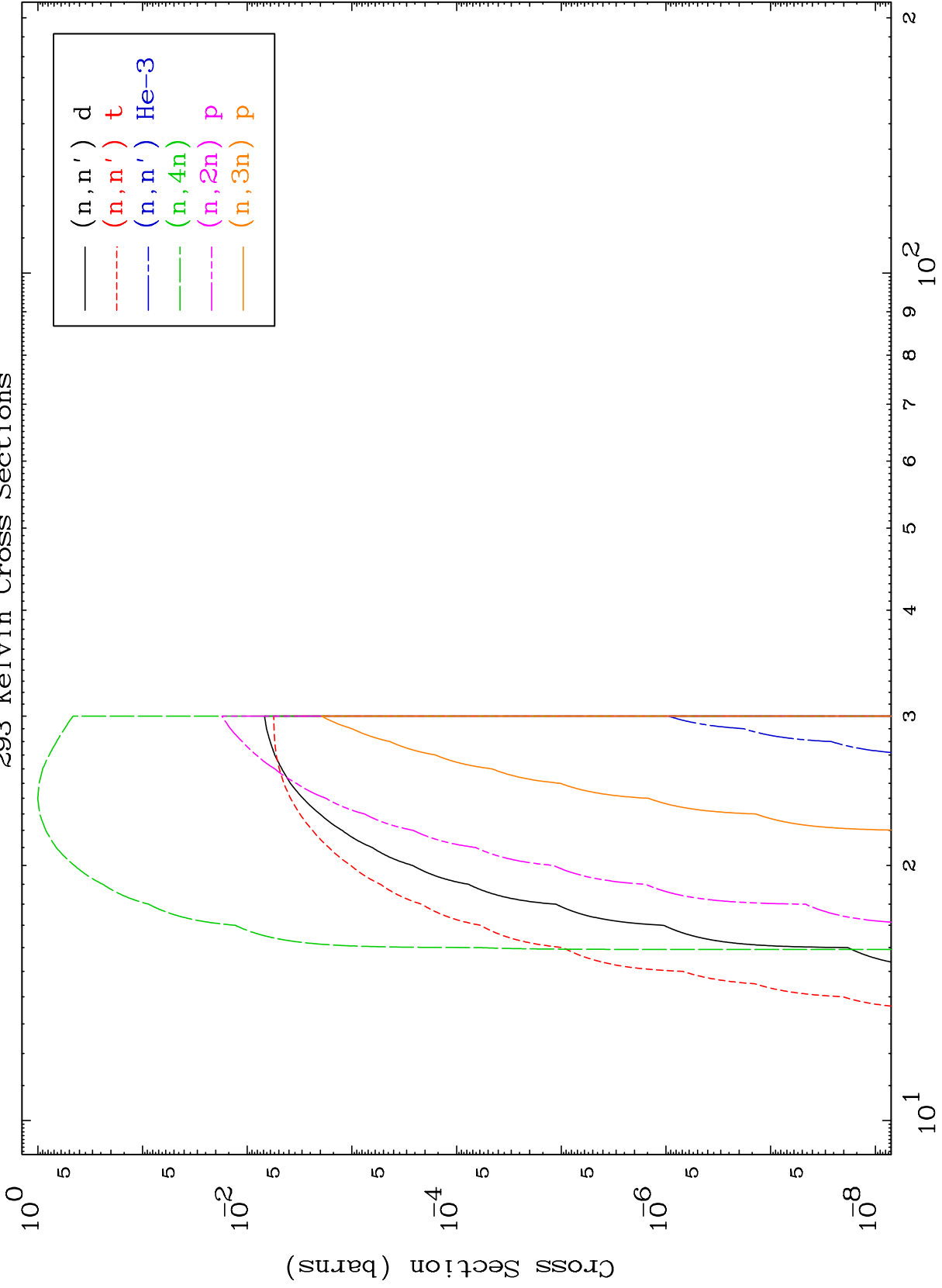

MAT 5549

Charged Particle
293 Kelvin Cross Sections

55-Cs-141

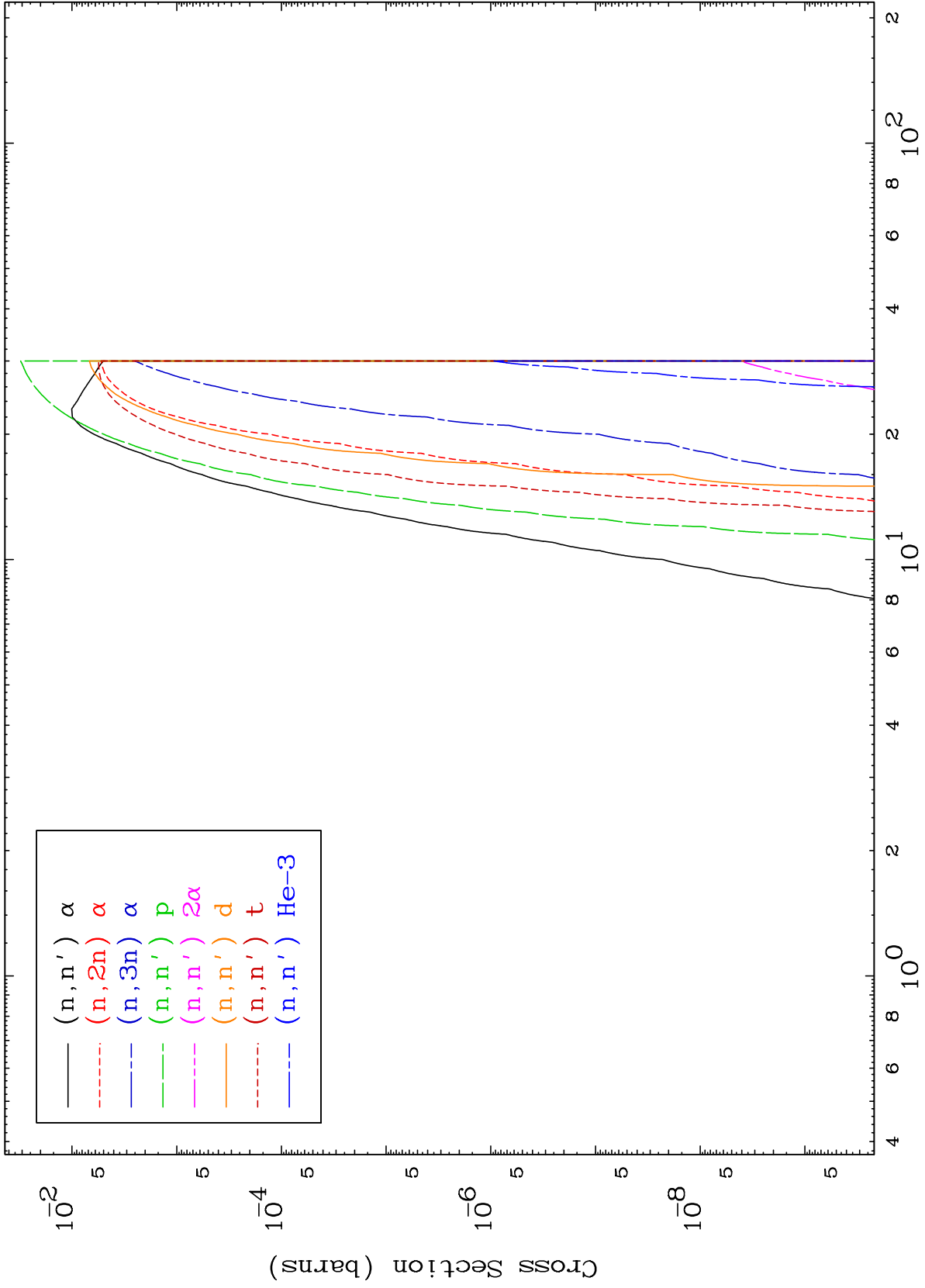

4

Incident Energy (MeV)

55-Cs-141

MAT 5549

Charged Particle
293 Kelvin Cross Sections

55-Cs-141

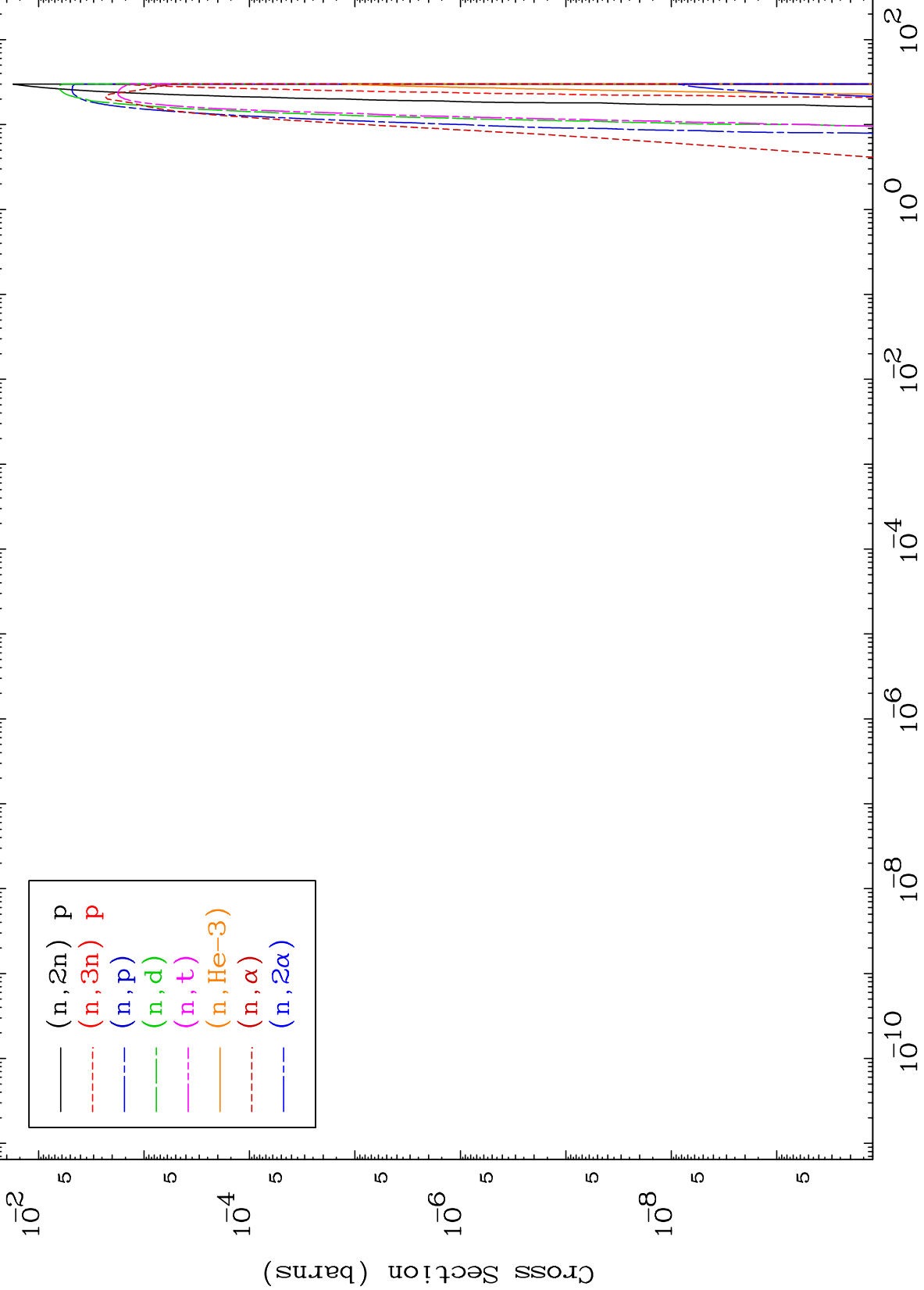

MAT 5549

Particle Production
293 Kelvin Cross Sections

55-Cs-141

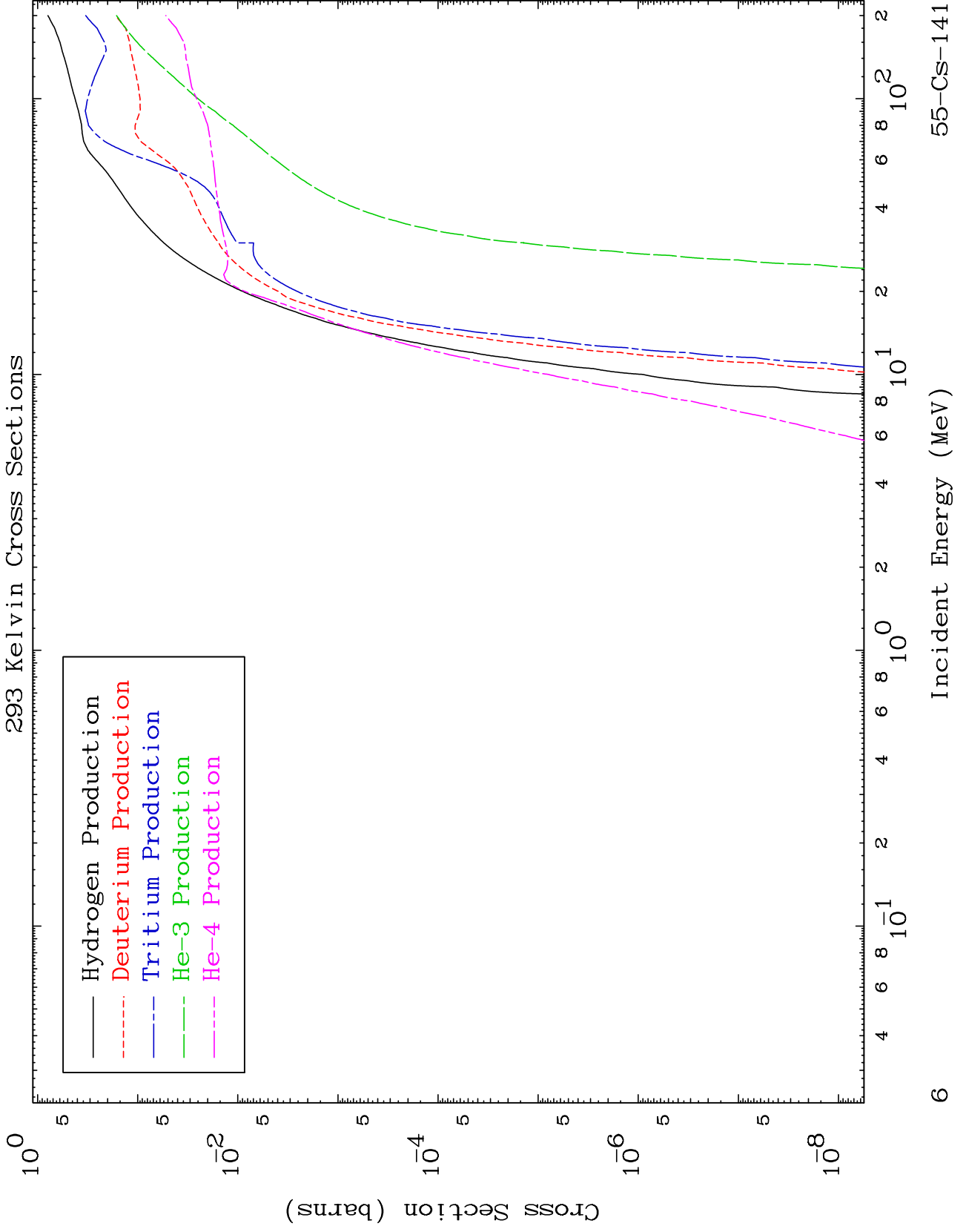

293 Kelvin Cross Sections

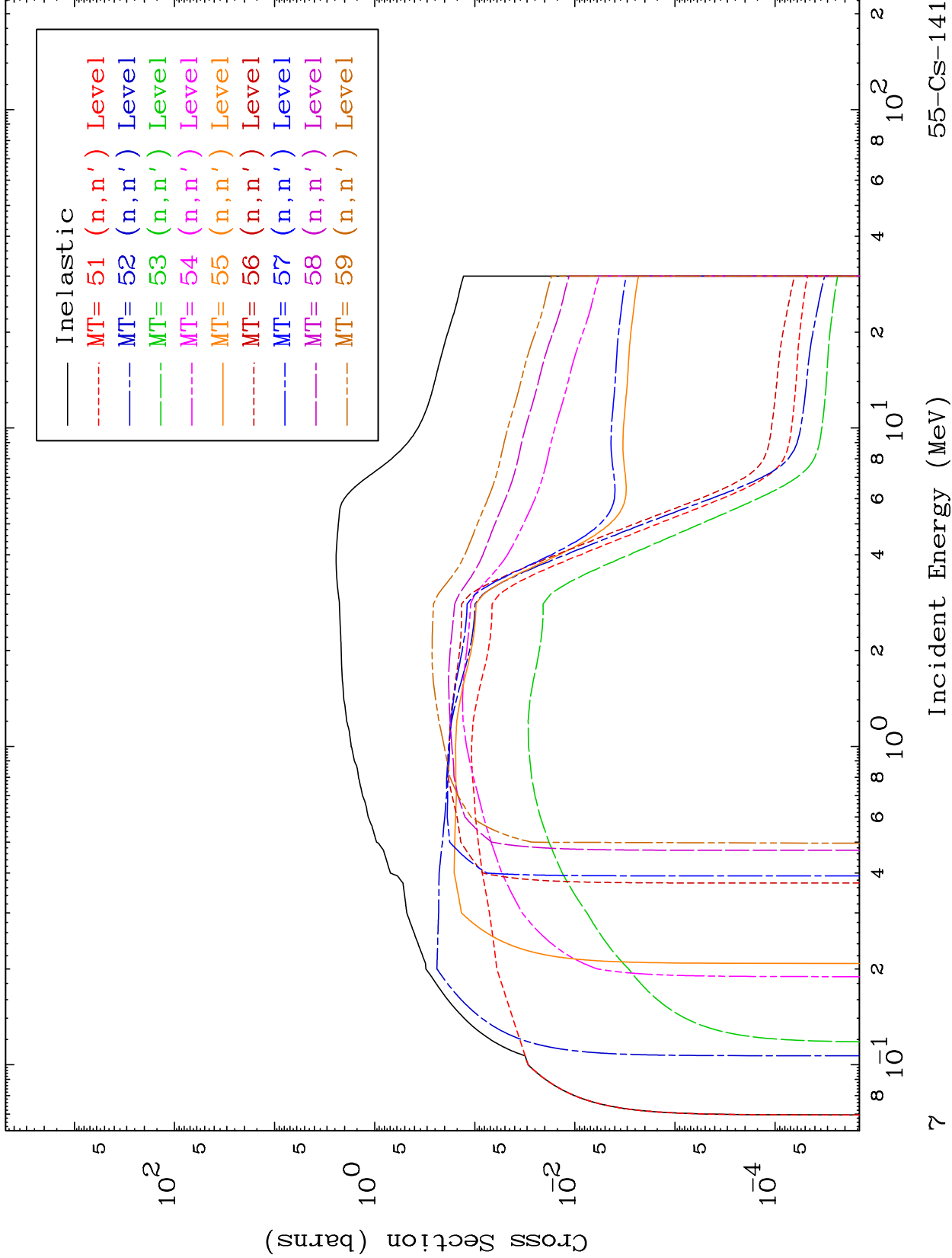

MAT 5549

(n,n') Level

293 Kelvin Cross Sections

55-Cs-141

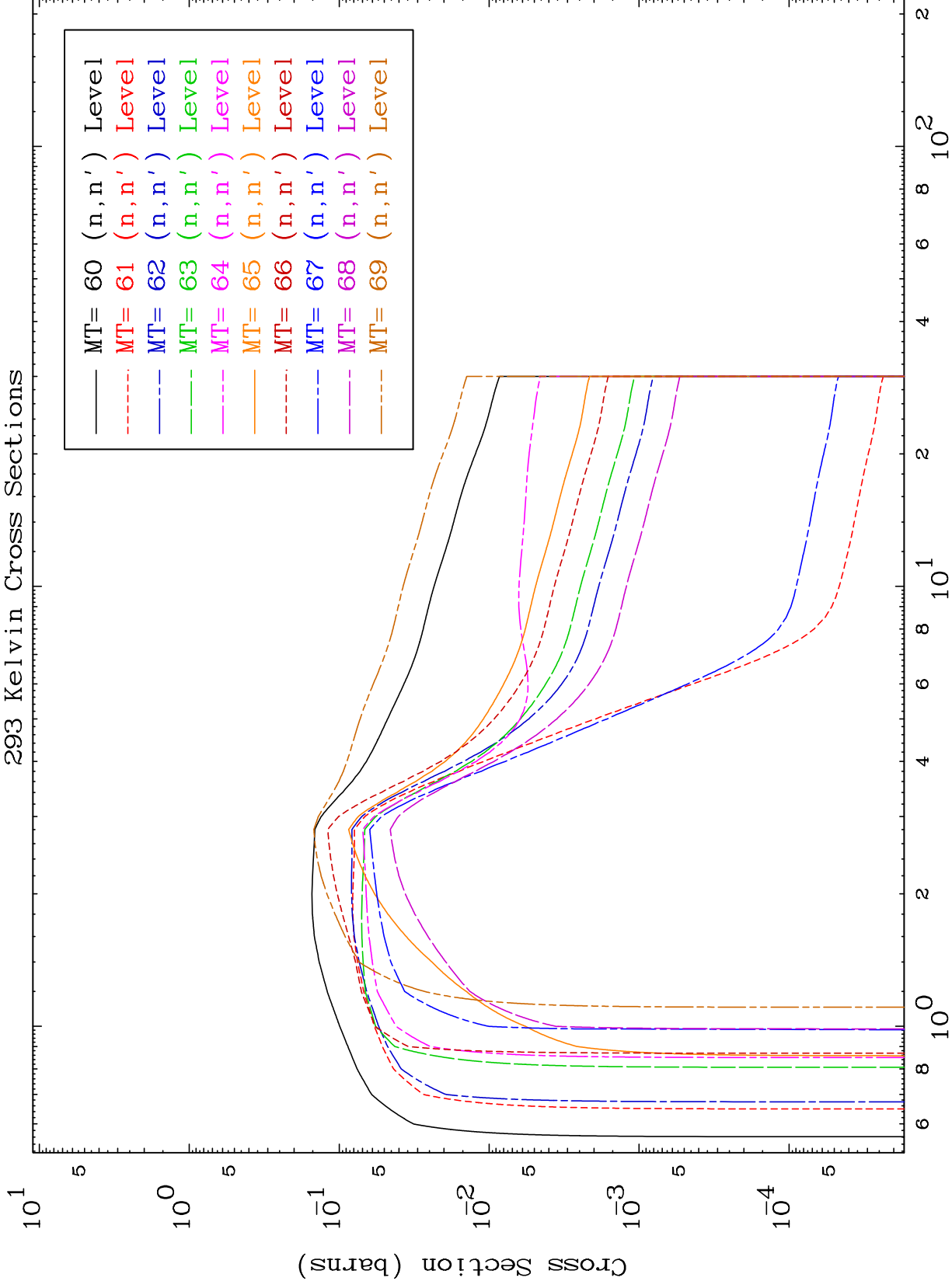

8

Incident Energy (MeV)

55-Cs-141

293 Kelvin Cross Sections

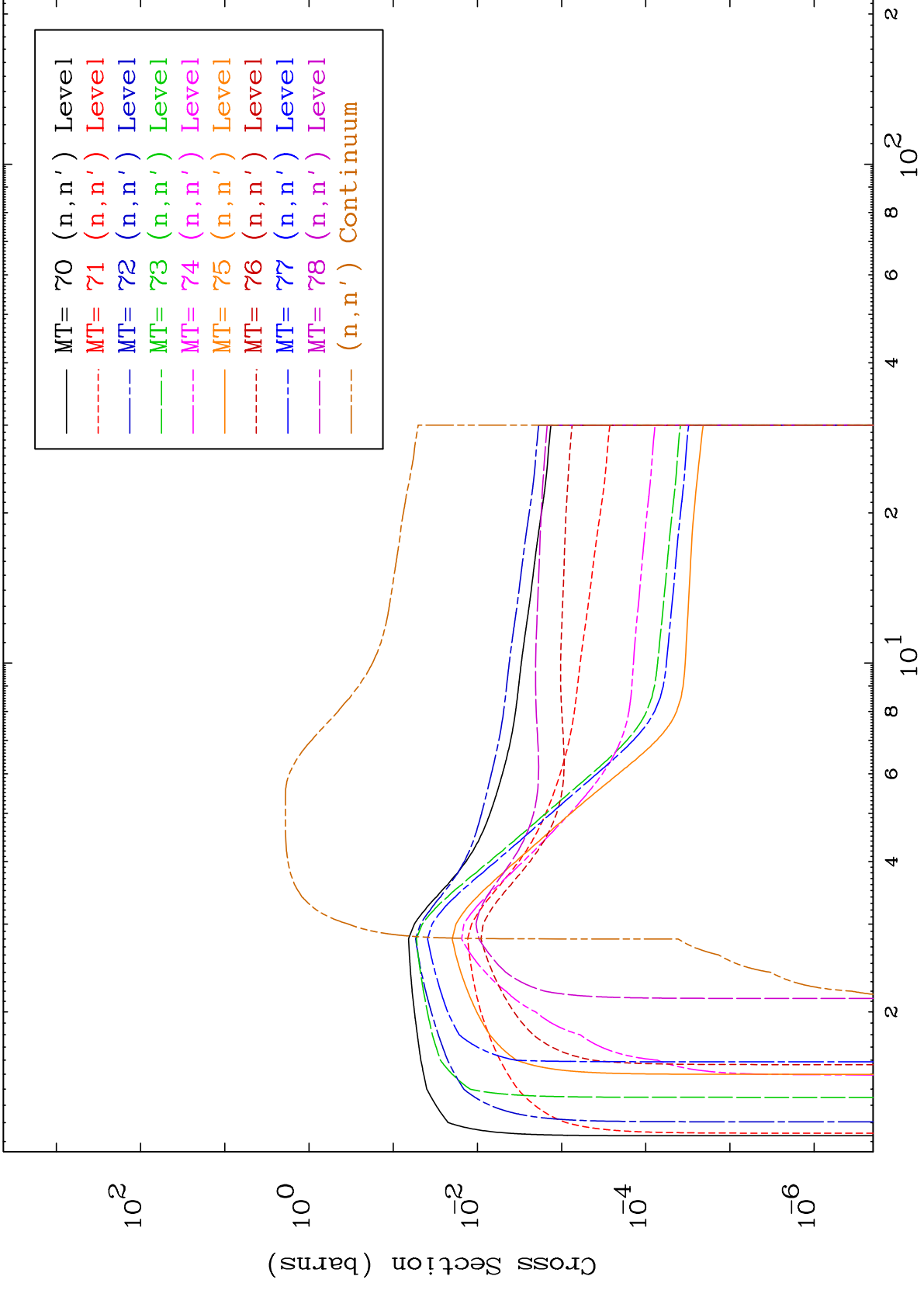

MAT 5549

(n,p) Levels
293 Kelvin Cross Sections

55-Cs-141

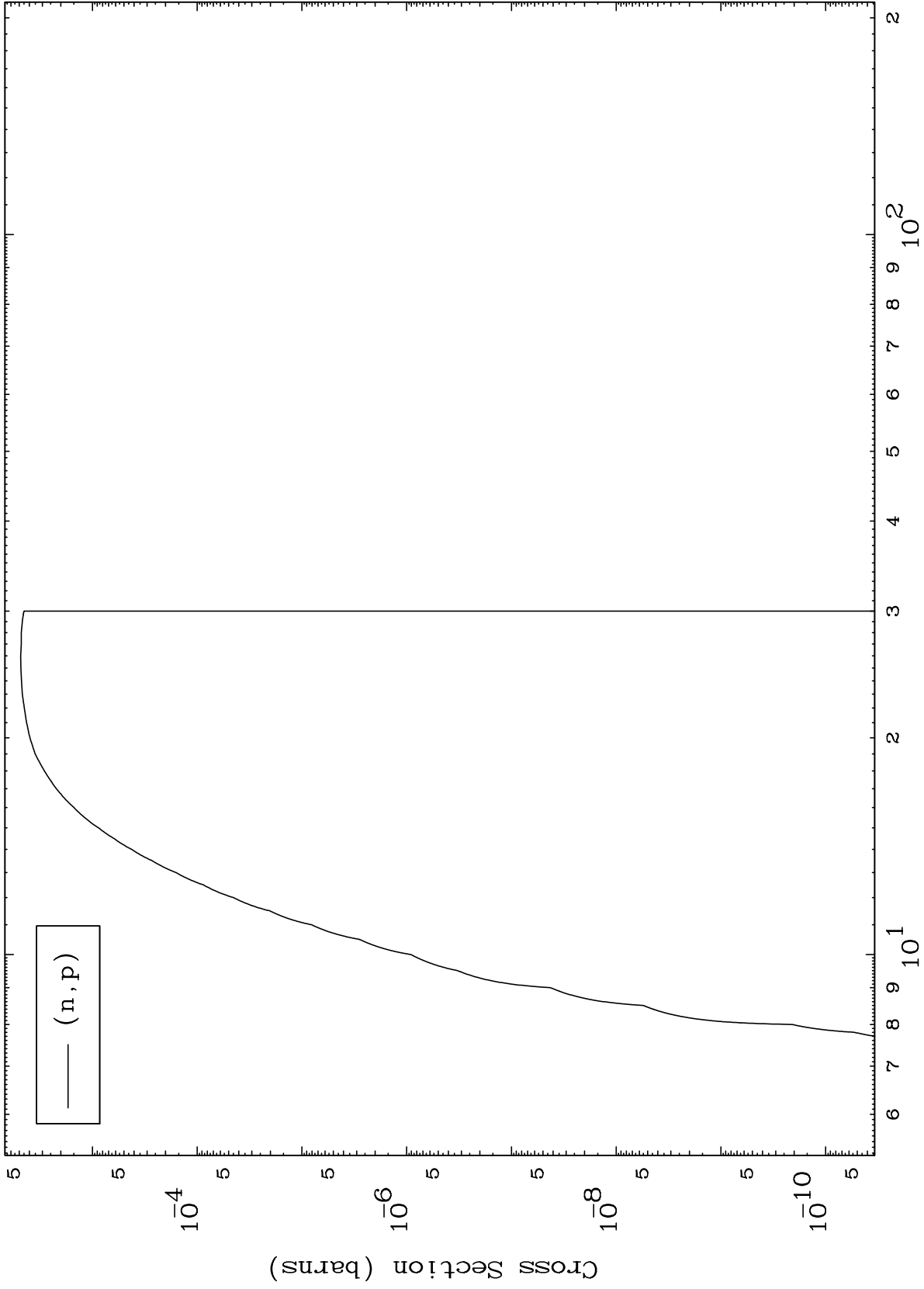

10

Incident Energy (MeV)

55-Cs-141

MAT 5549

(n,d) Levels
293 Kelvin Cross Sections

55-Cs-141

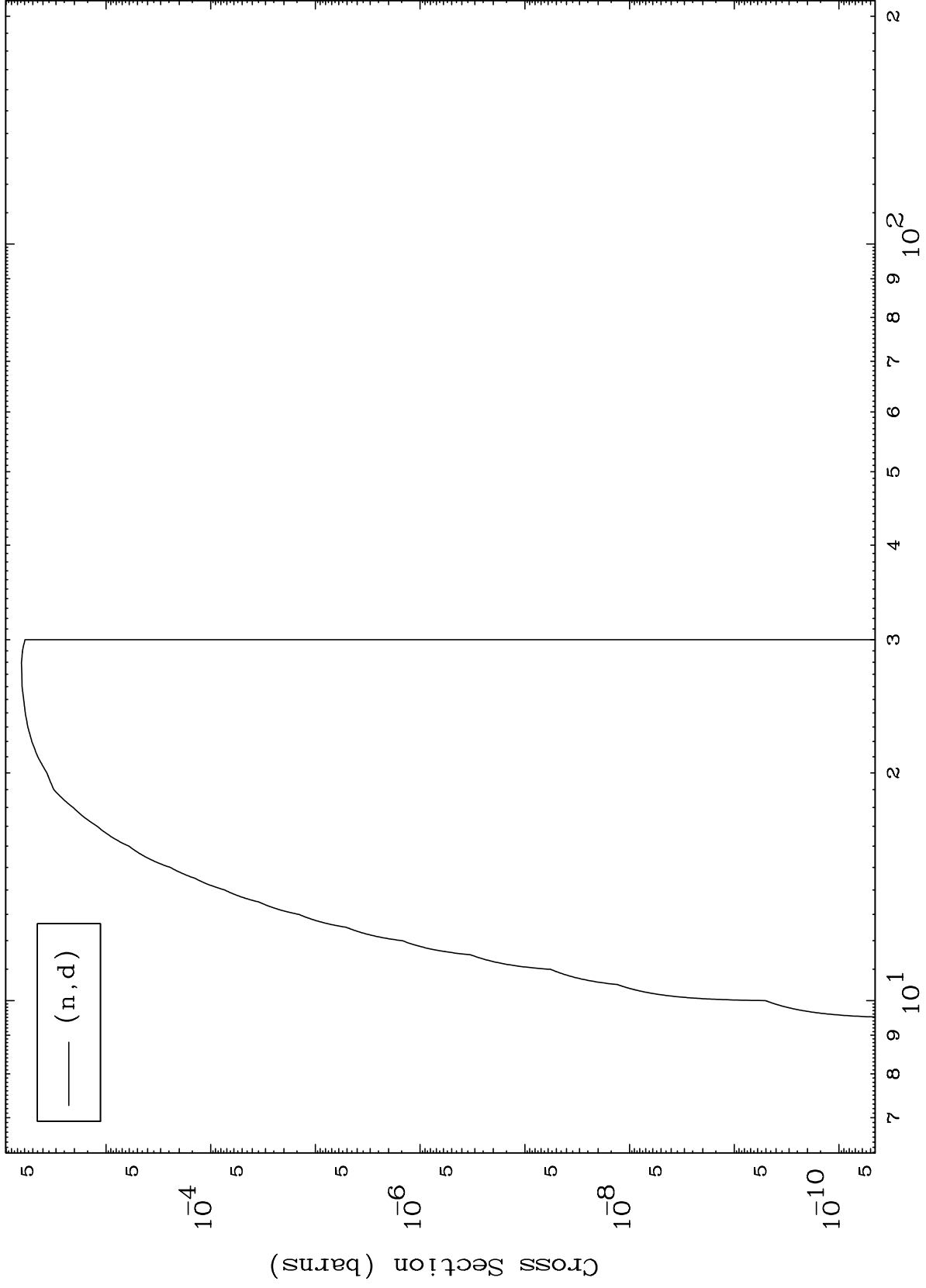

11

Incident Energy (MeV)

55-Cs-141

MAT 5549

(n,t) Levels
293 Kelvin Cross Sections

55-Cs-141

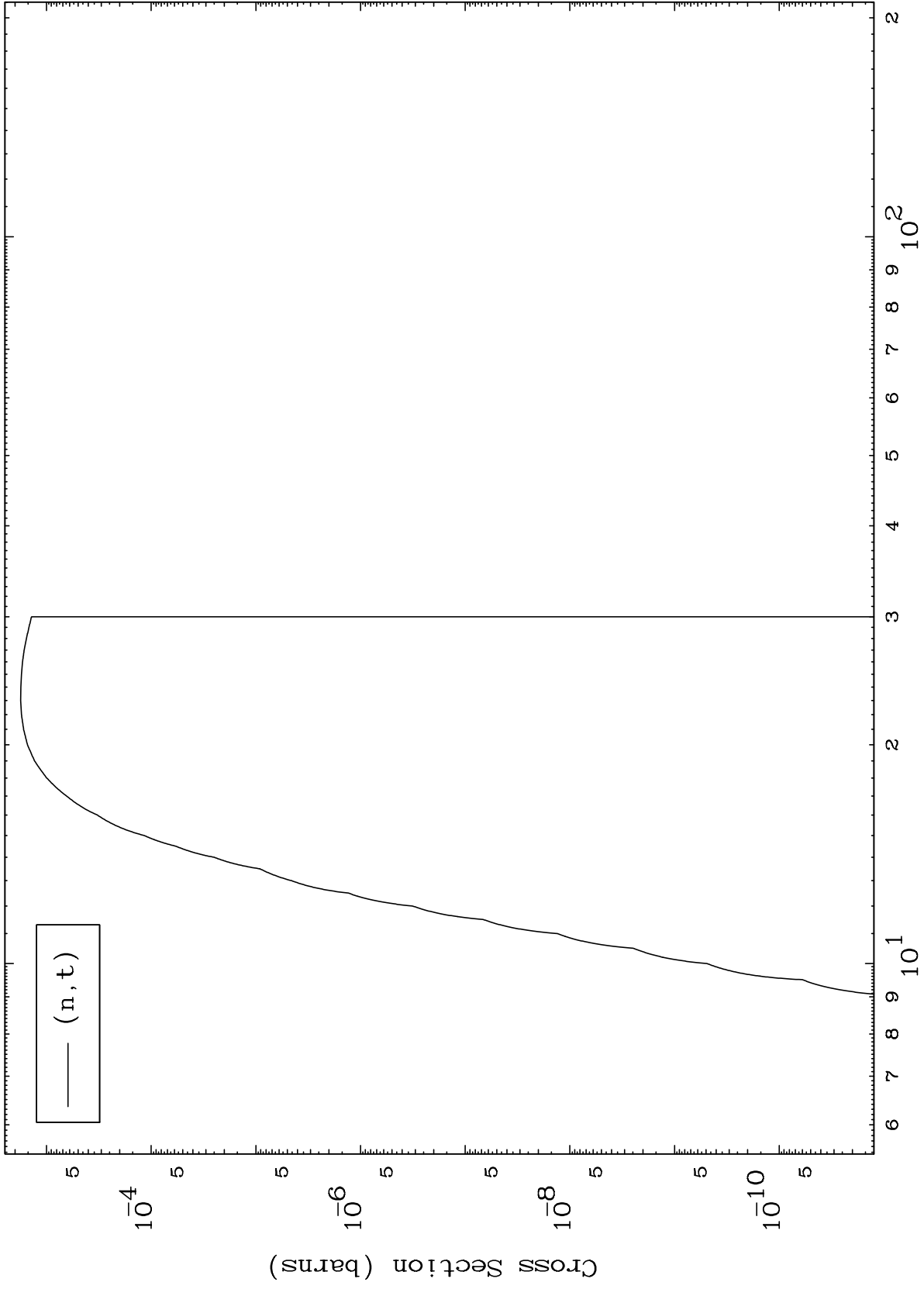

12

Incident Energy (MeV)

55-Cs-141

MAT 5549

(n,He3) Levels
293 Kelvin Cross Sections

55-Cs-141

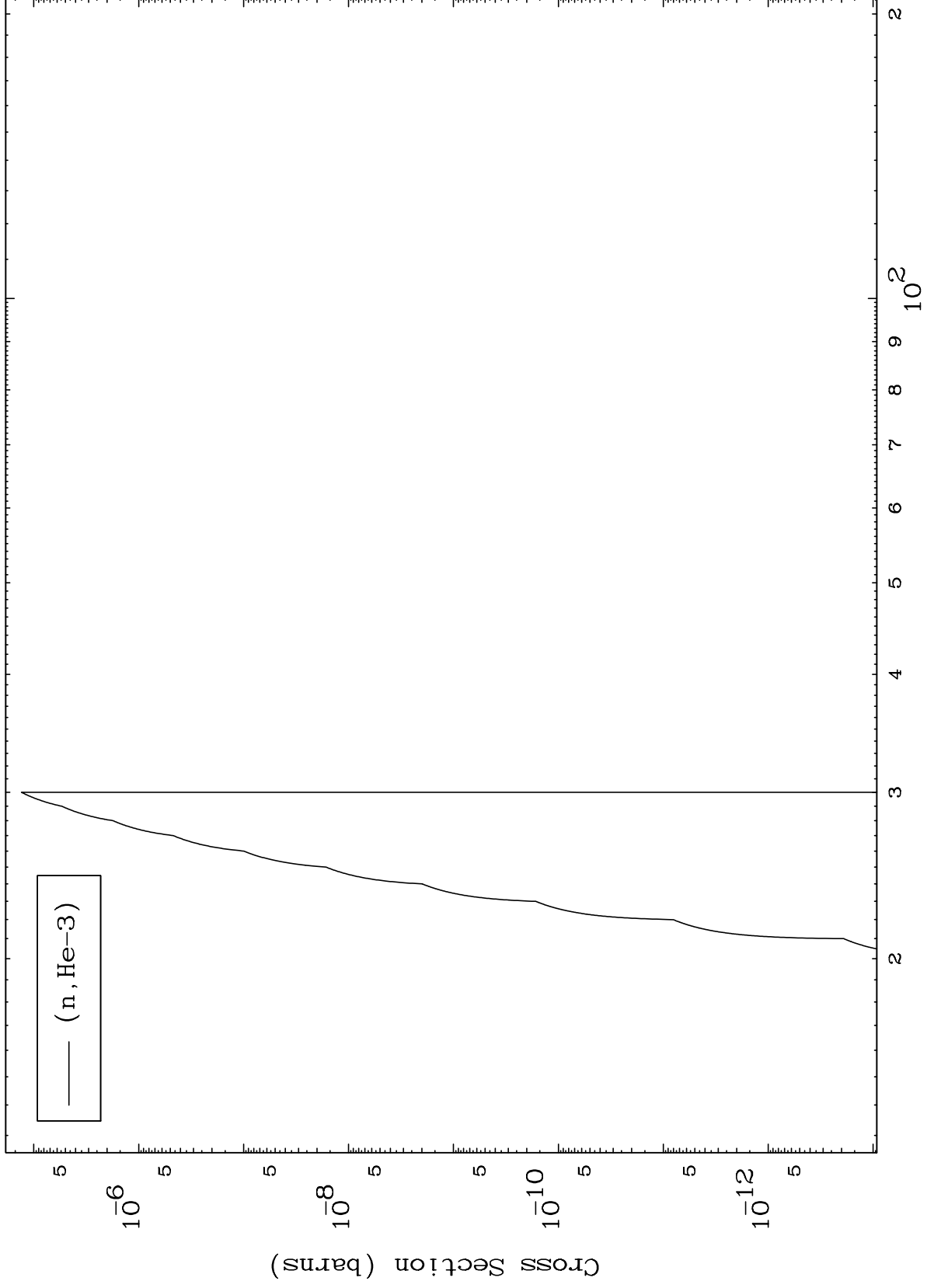

MAT 5549

(n, α) Levels
293 Kelvin Cross Sections

55-Cs-141

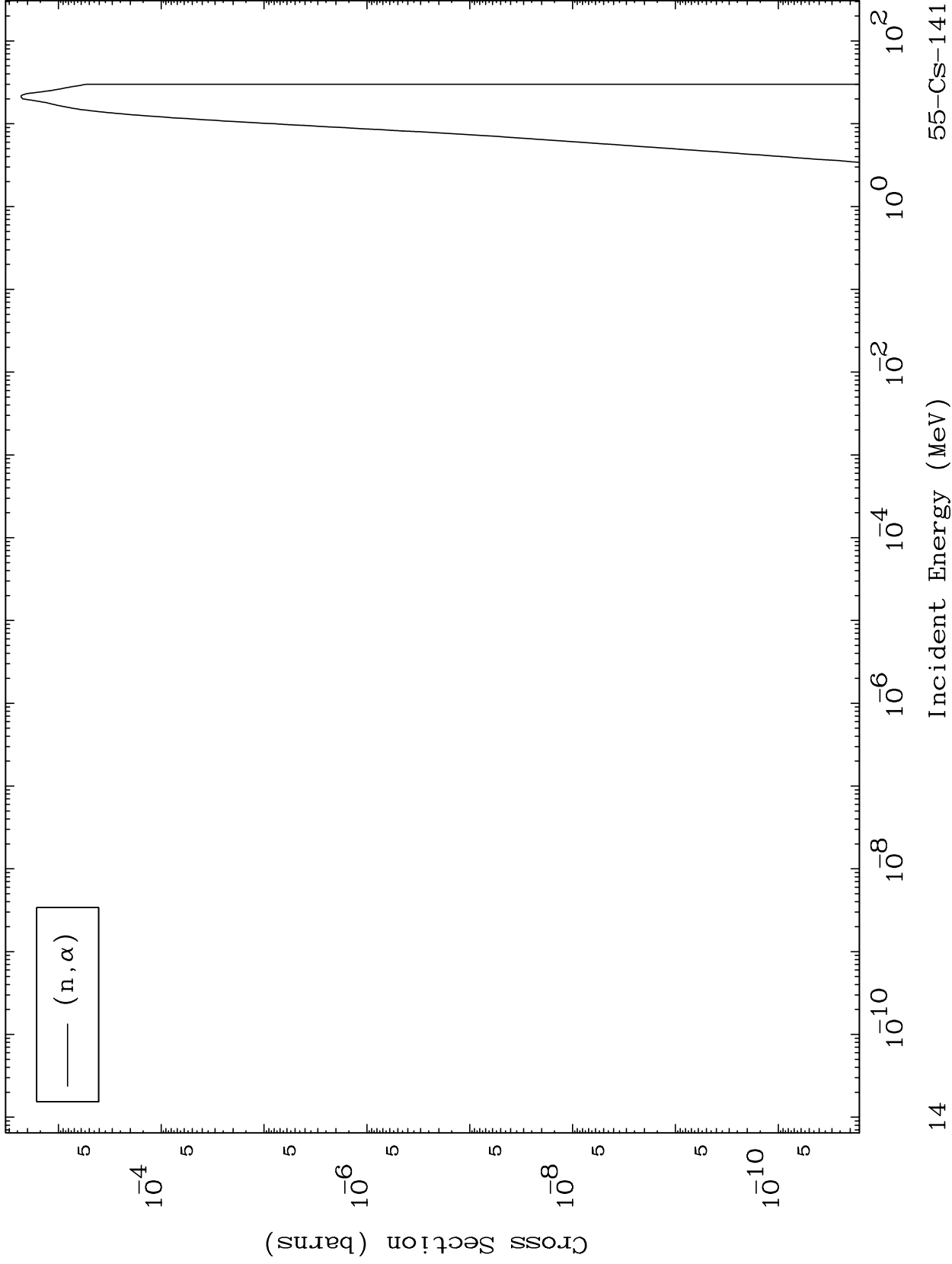

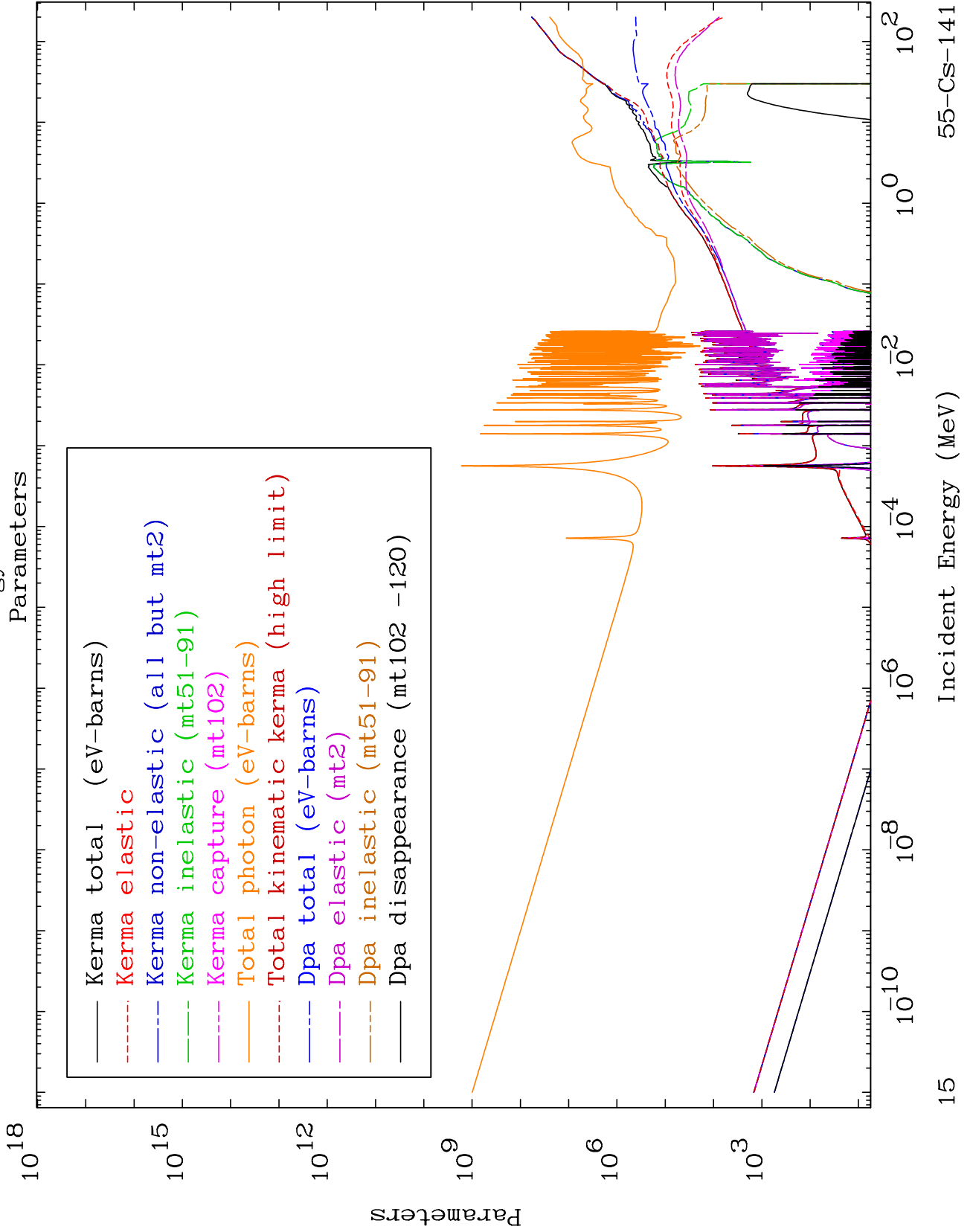

MAT 5549

55-Cs-141

Elastic Legendre Coefficients

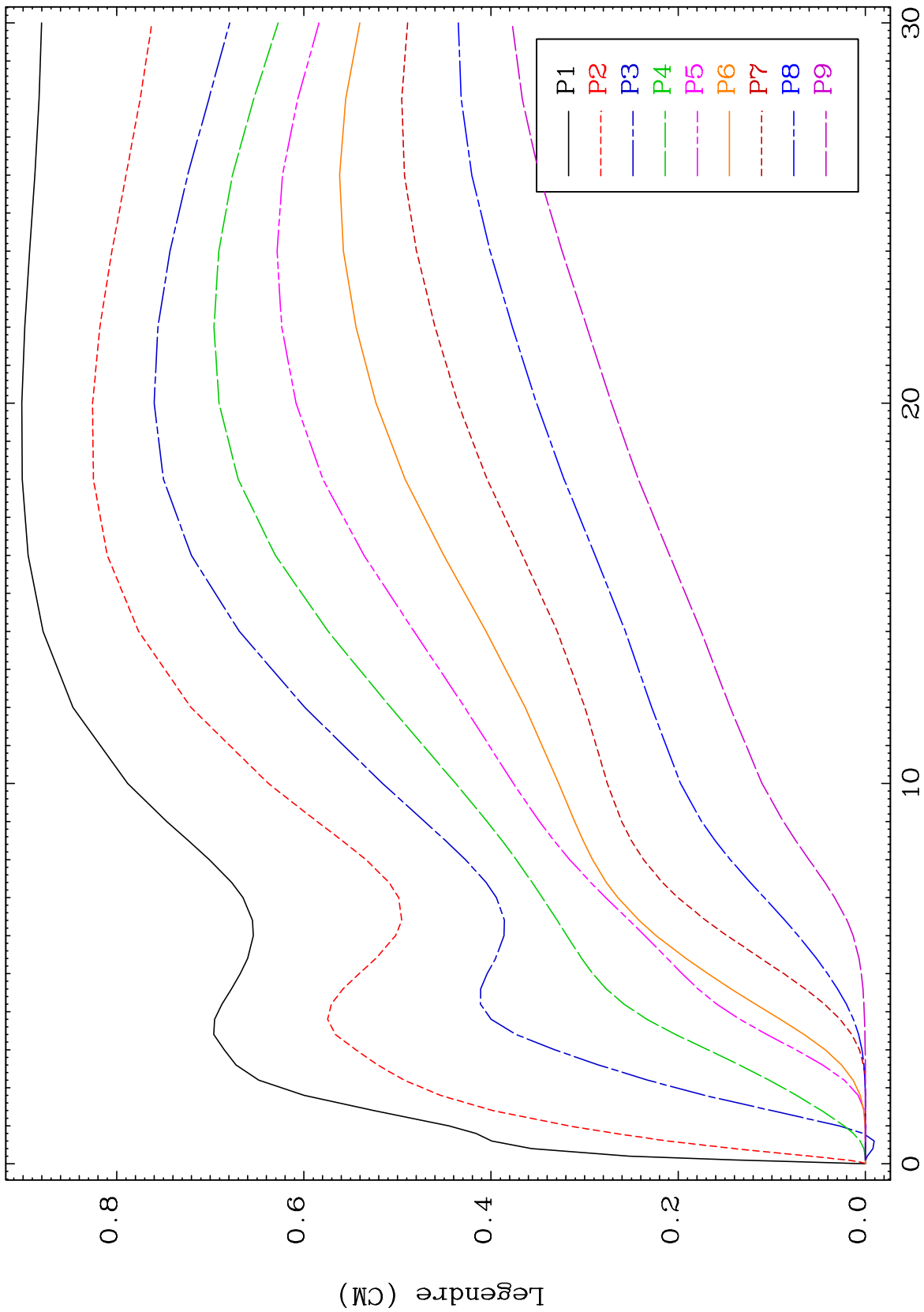

16

Incident Energy (MeV)

55-Cs-141

MAT 5549

Elastic Legendre Coefficients

55-Cs-141

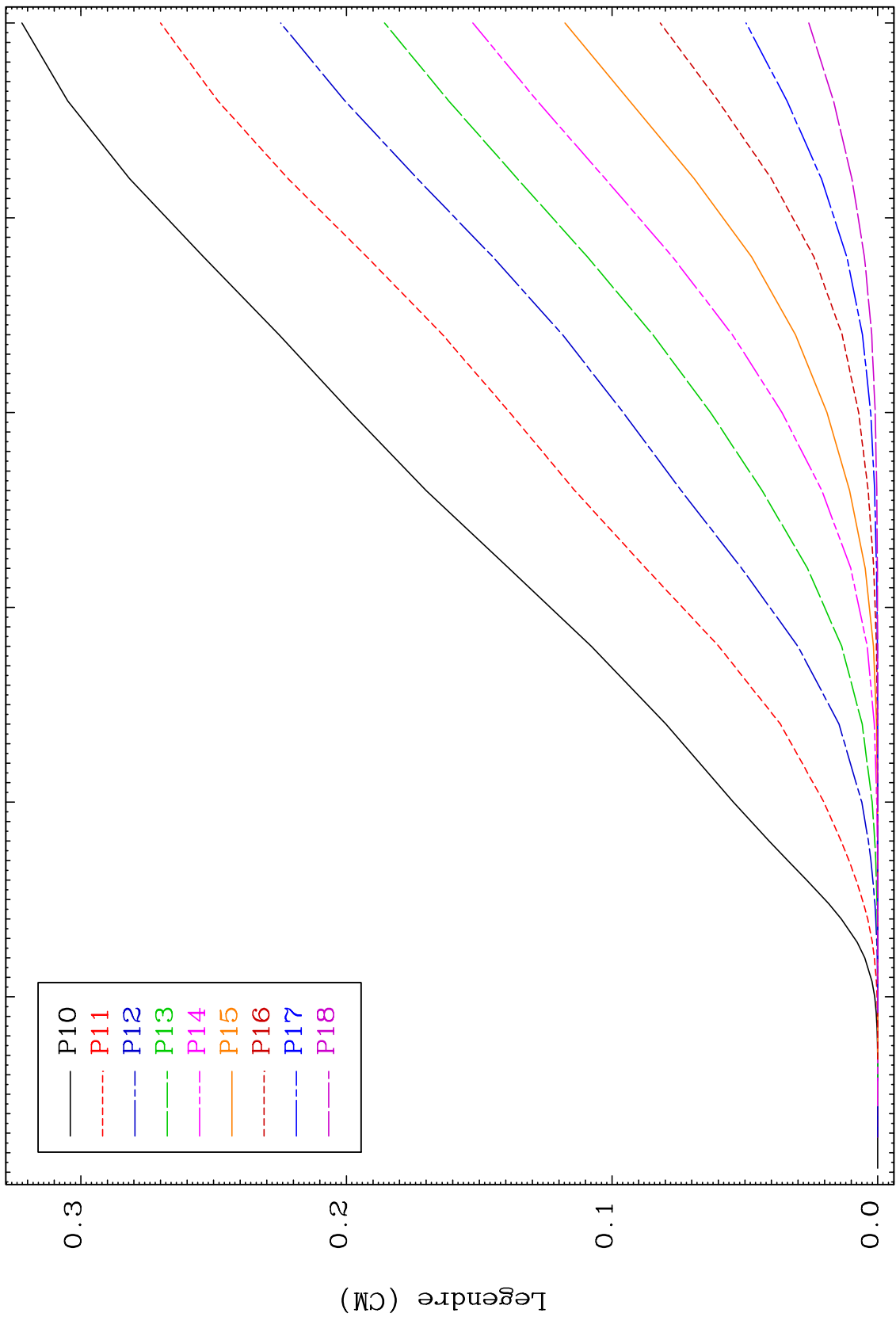

17

55-Cs-141

Incident Energy (MeV)

MAT 5549

Elastic Legendre Coefficients

55-Cs-141

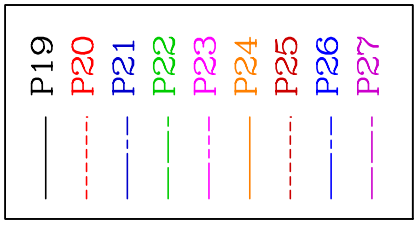
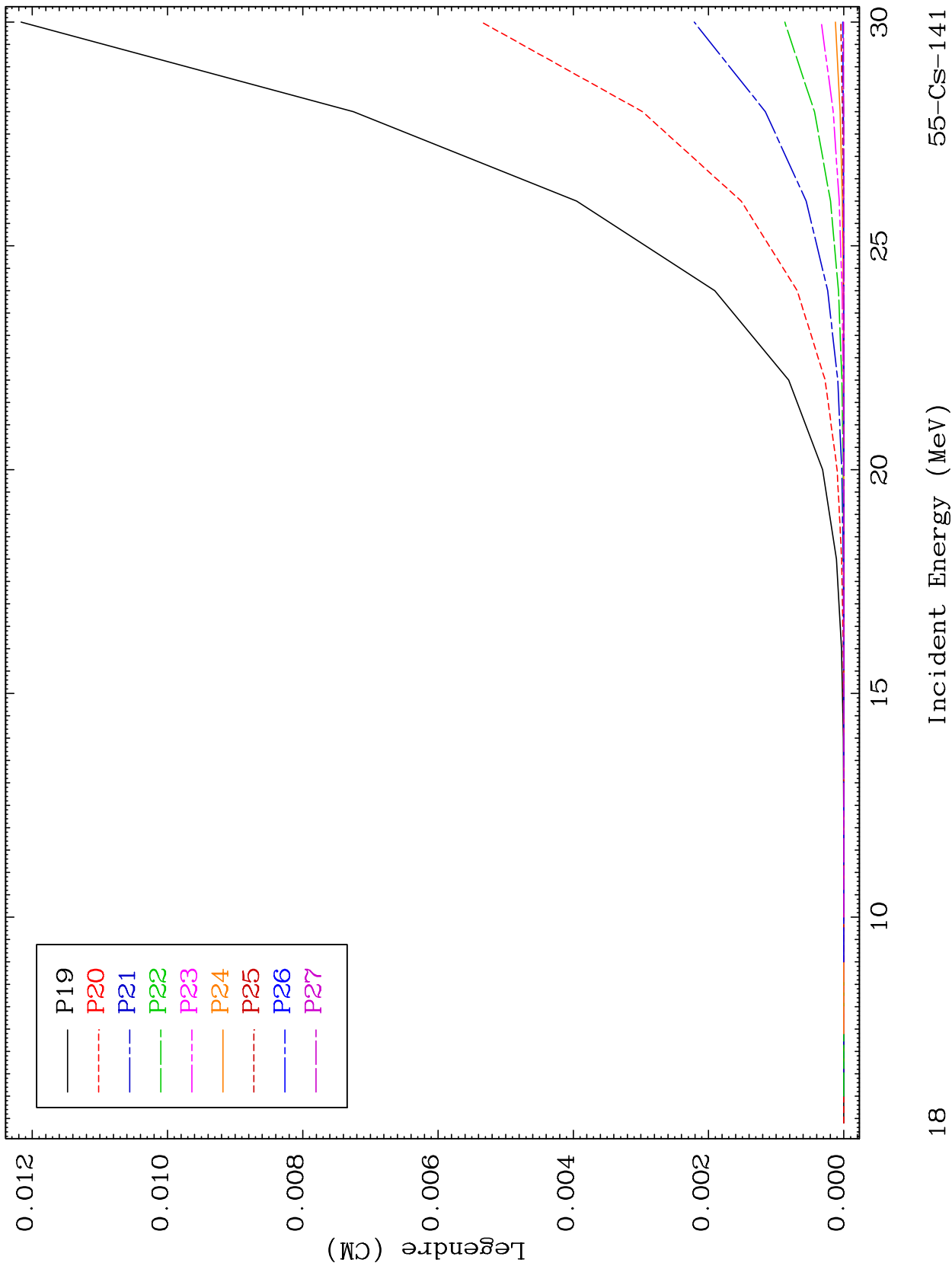

MAT 5549

Elastic Legendre Coefficients

55-Cs-141

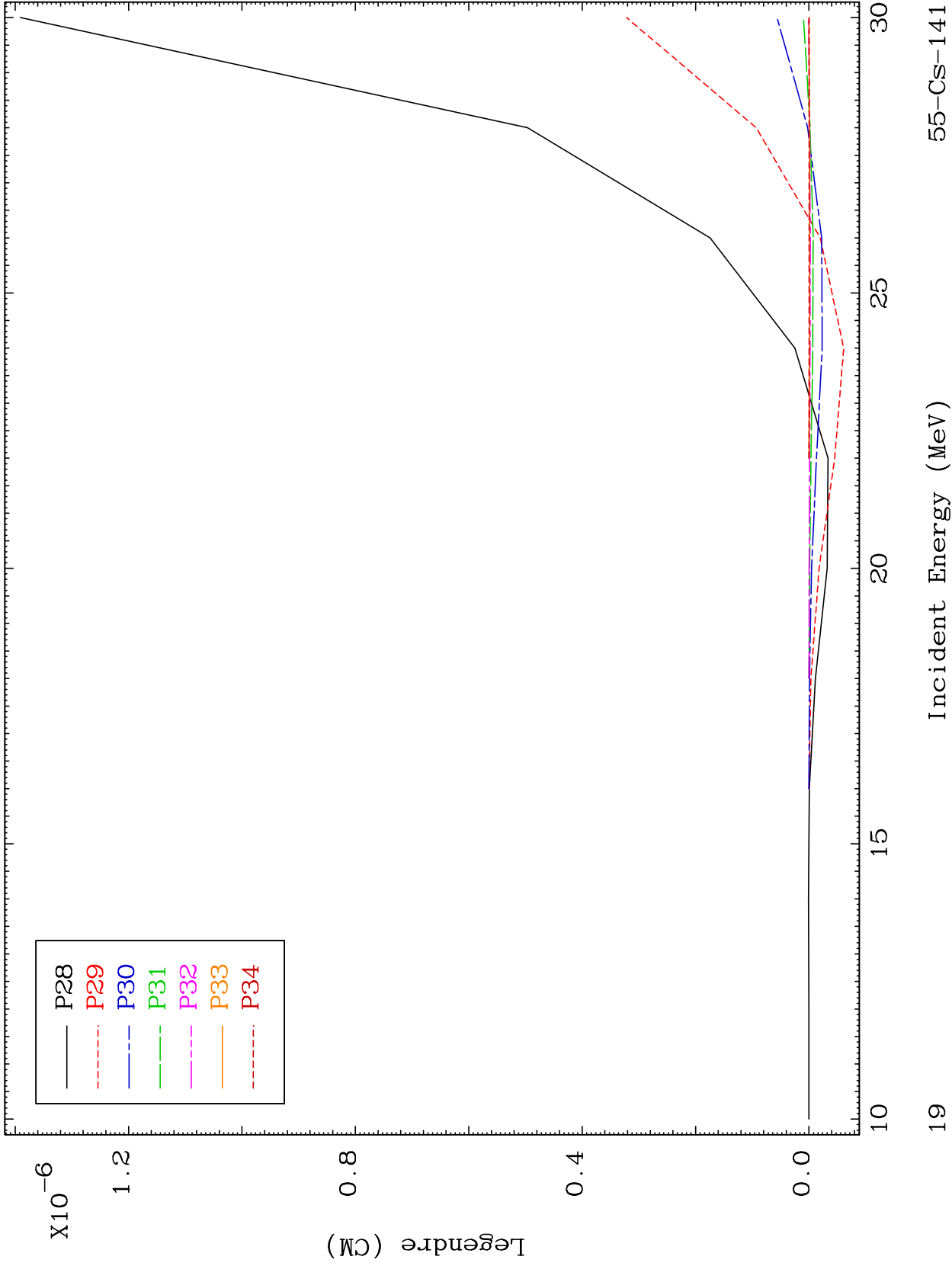

19

Incident Energy (MeV)

55-Cs-141

MAT 5549

MT= 51 (n,n') Level
Legendre Coefficients

55-Cs-141

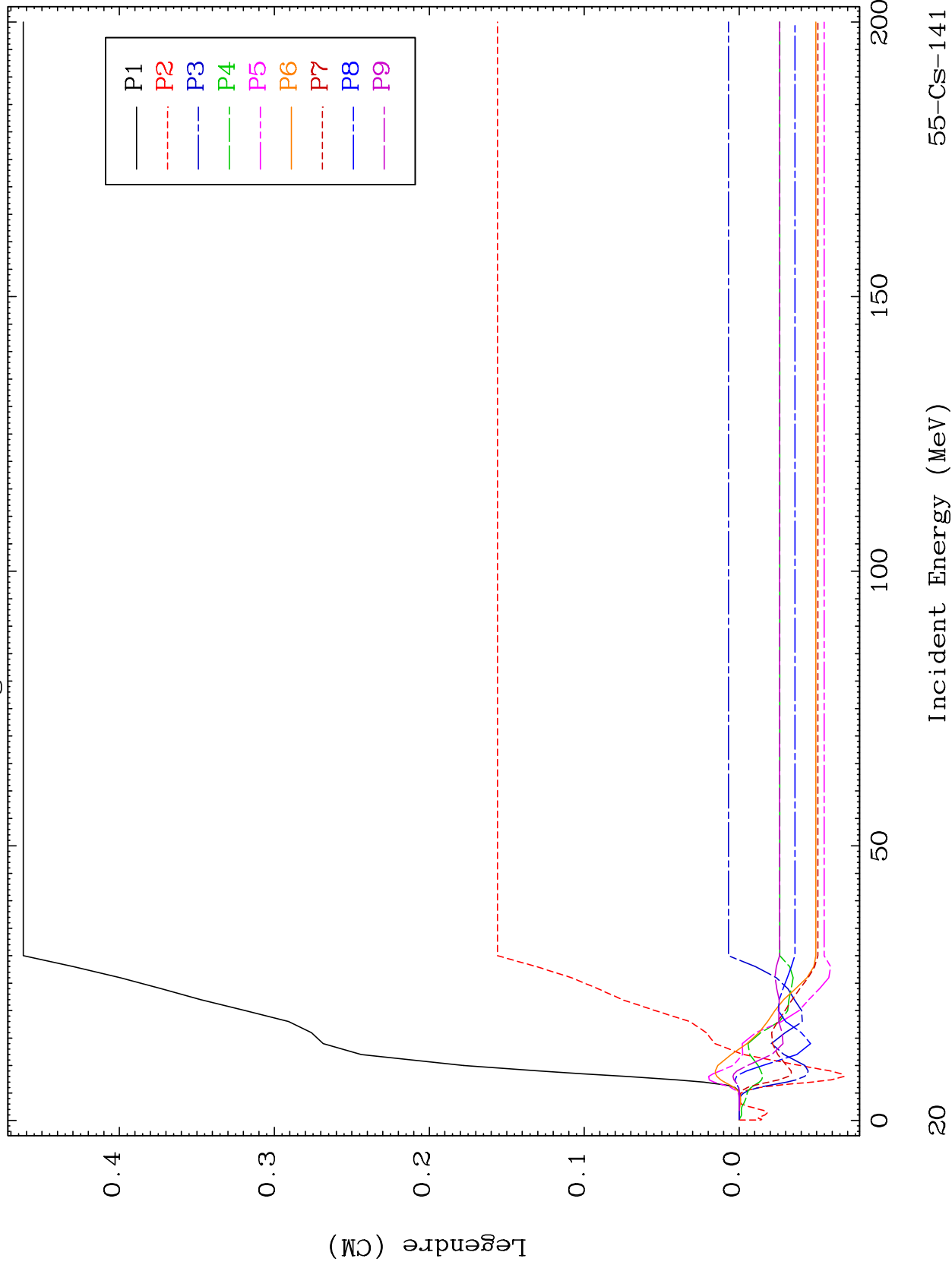

55-Cs-141

Incident Energy (MeV)

0

MAT 5549

MT= 51 (n,n') Level
Legendre Coefficients

55-Cs-141

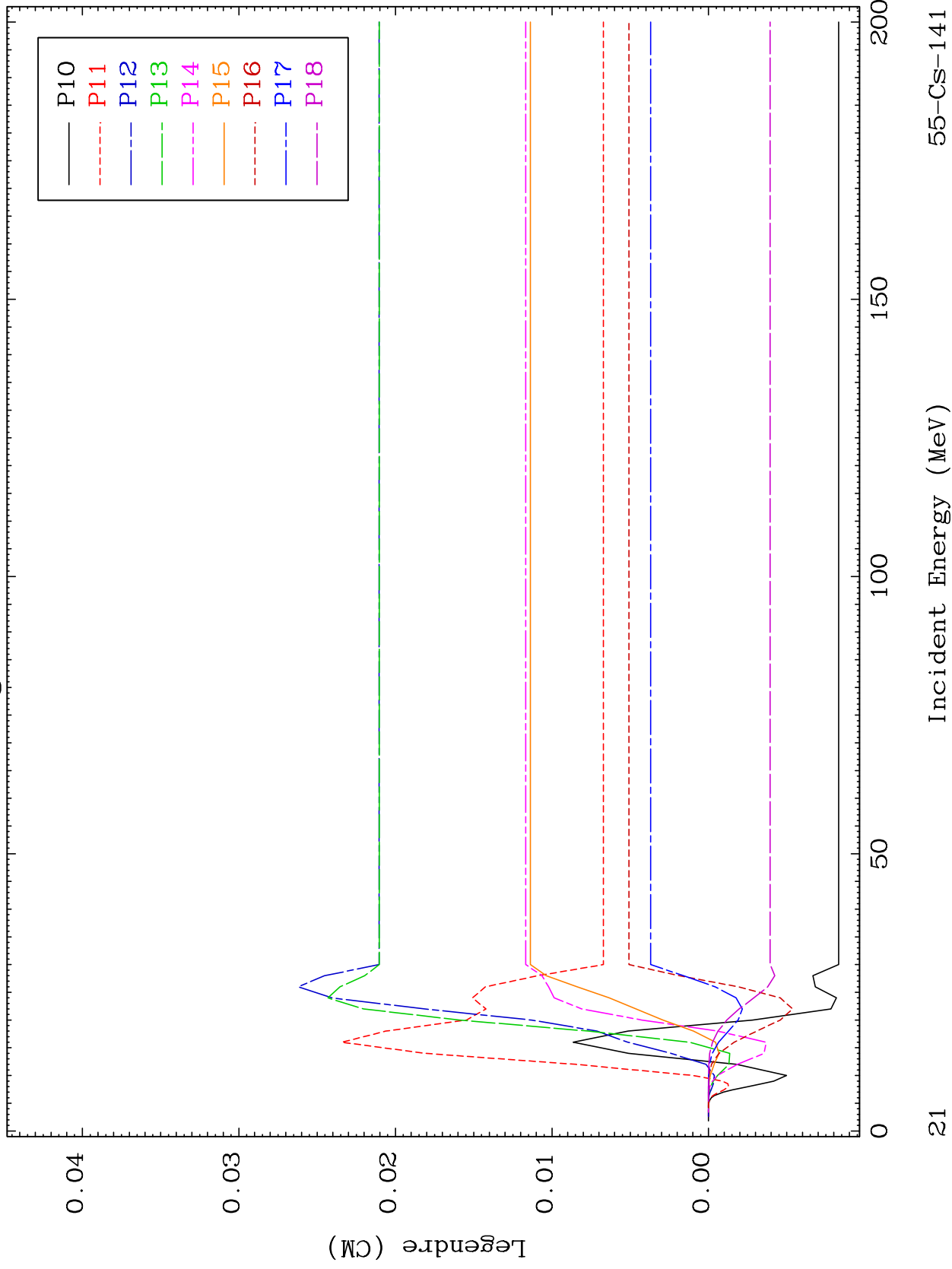

21

Incident Energy (MeV)

55-Cs-141

MAT 5549

MT= 51 (n,n') Level
Legendre Coefficients

55-Cs-141

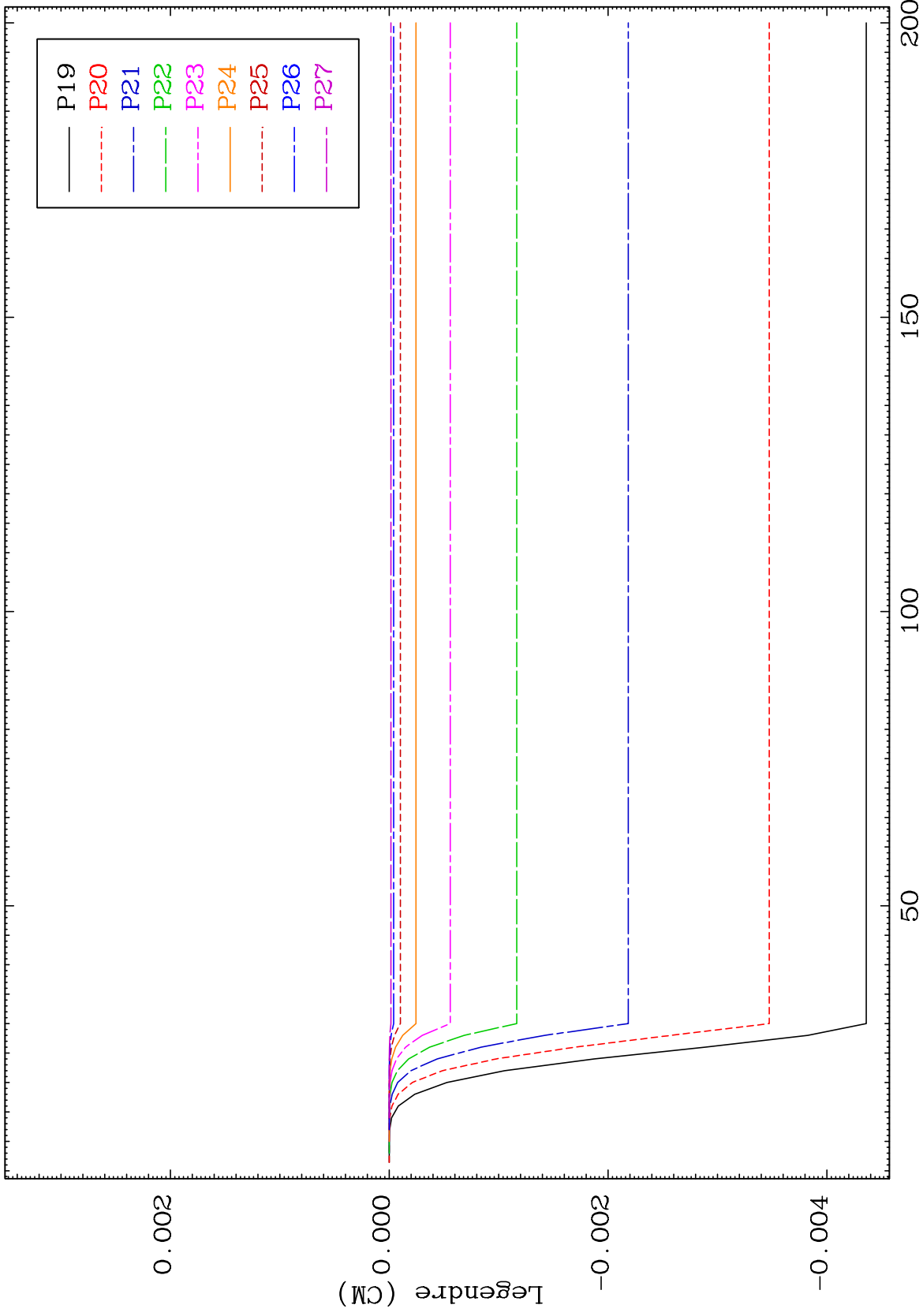

22

Incident Energy (MeV)

55-Cs-141

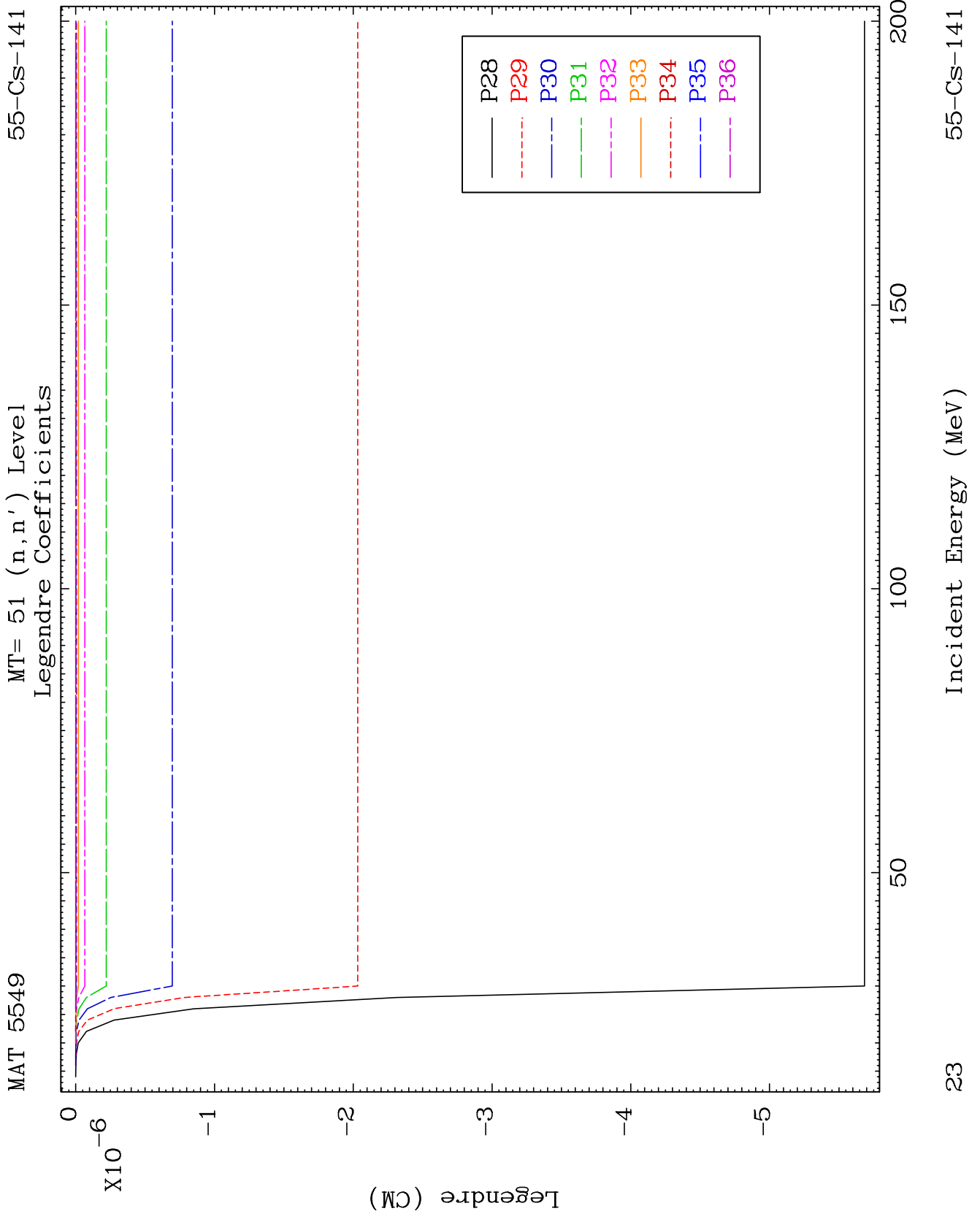

MAT 5549

MT= 52 (n,n') Level
Legendre Coefficients

55-Cs-141

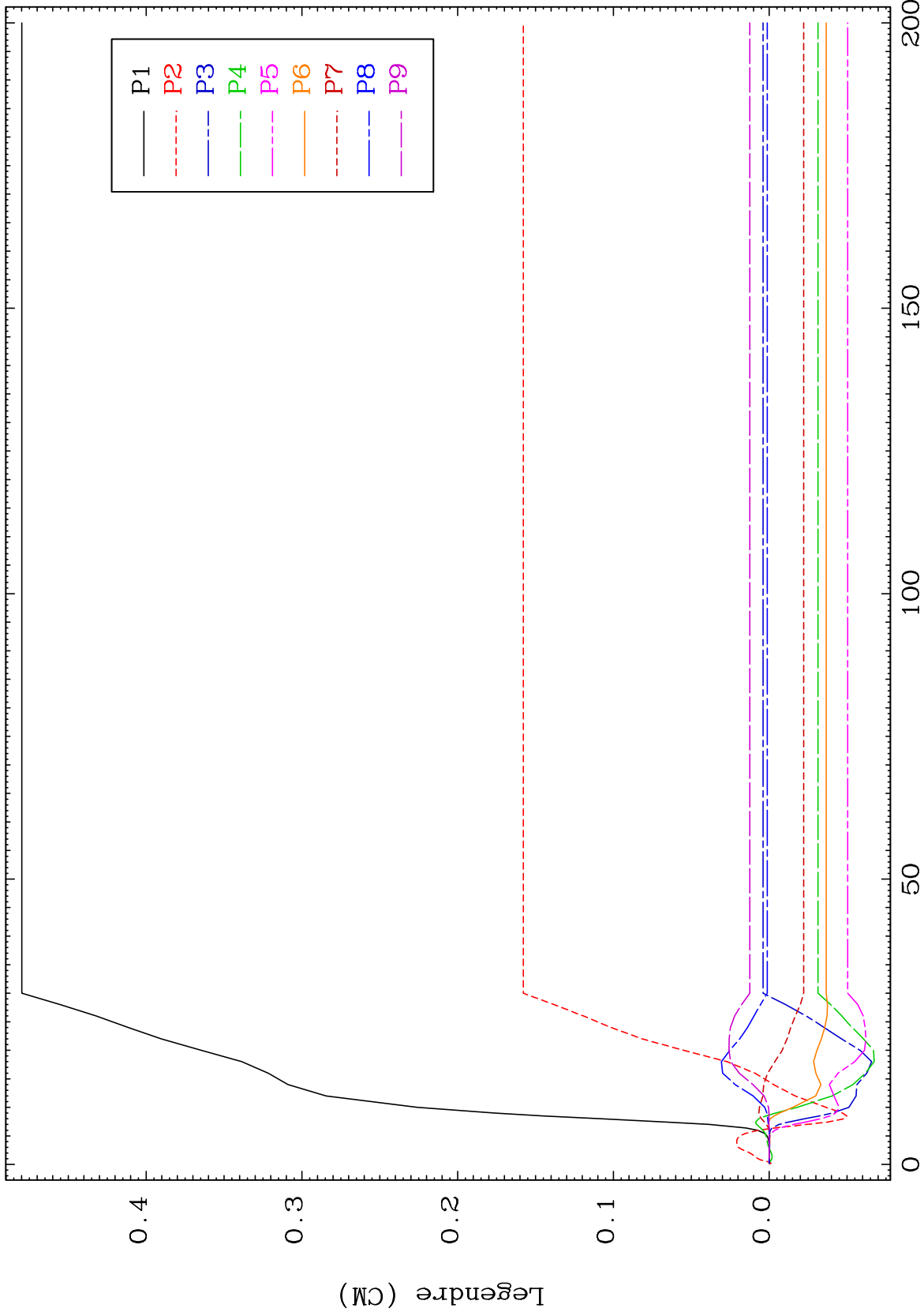

55-Cs-141

Incident Energy (MeV)

24

MAT 5549

MT= 52 (n,n') Level
Legendre Coefficients

55-Cs-141

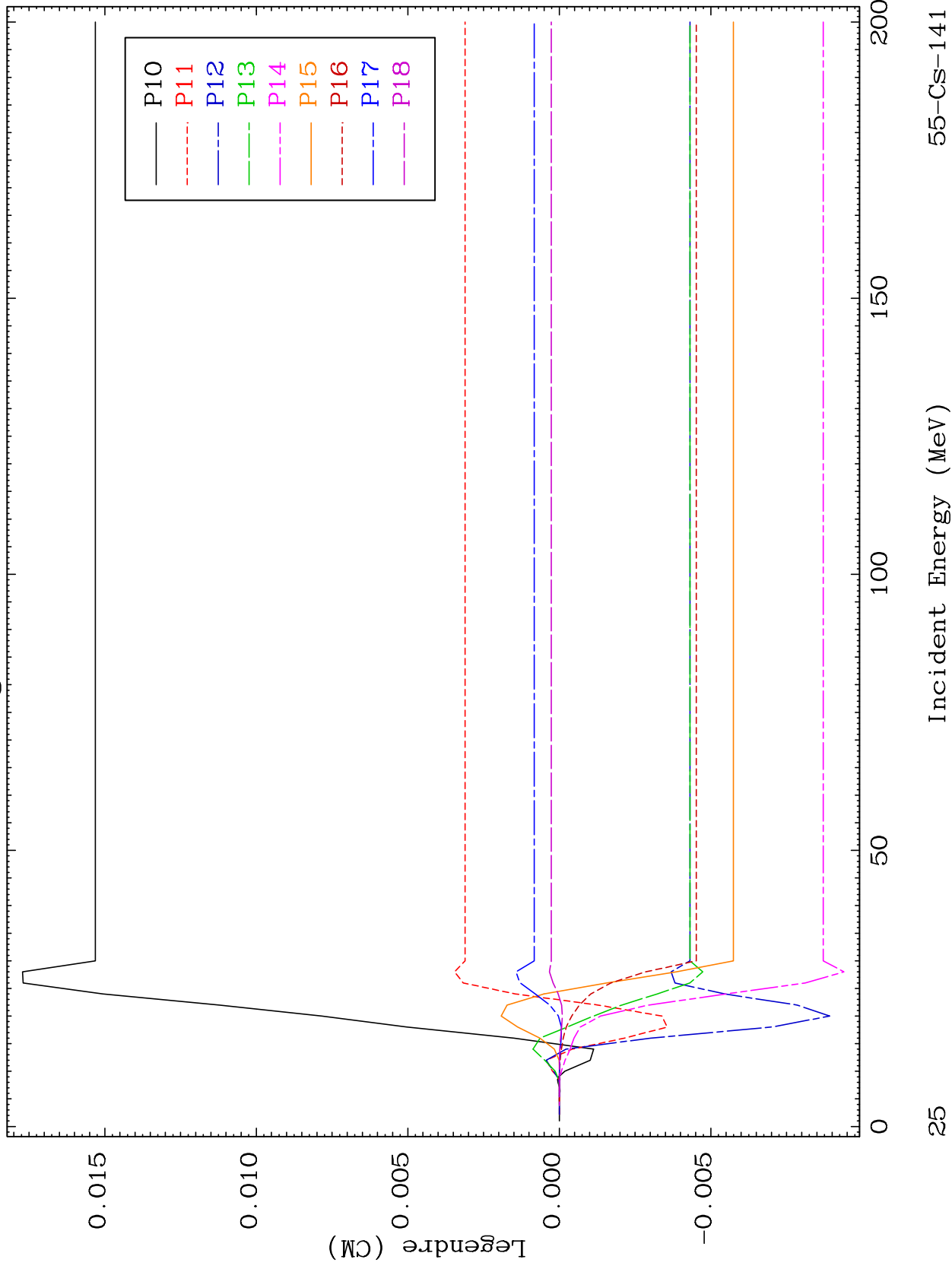

55-Cs-141

Incident Energy (MeV)

25

MAT 5549

MT= 52 (n,n') Level
Legendre Coefficients

55-Cs-141

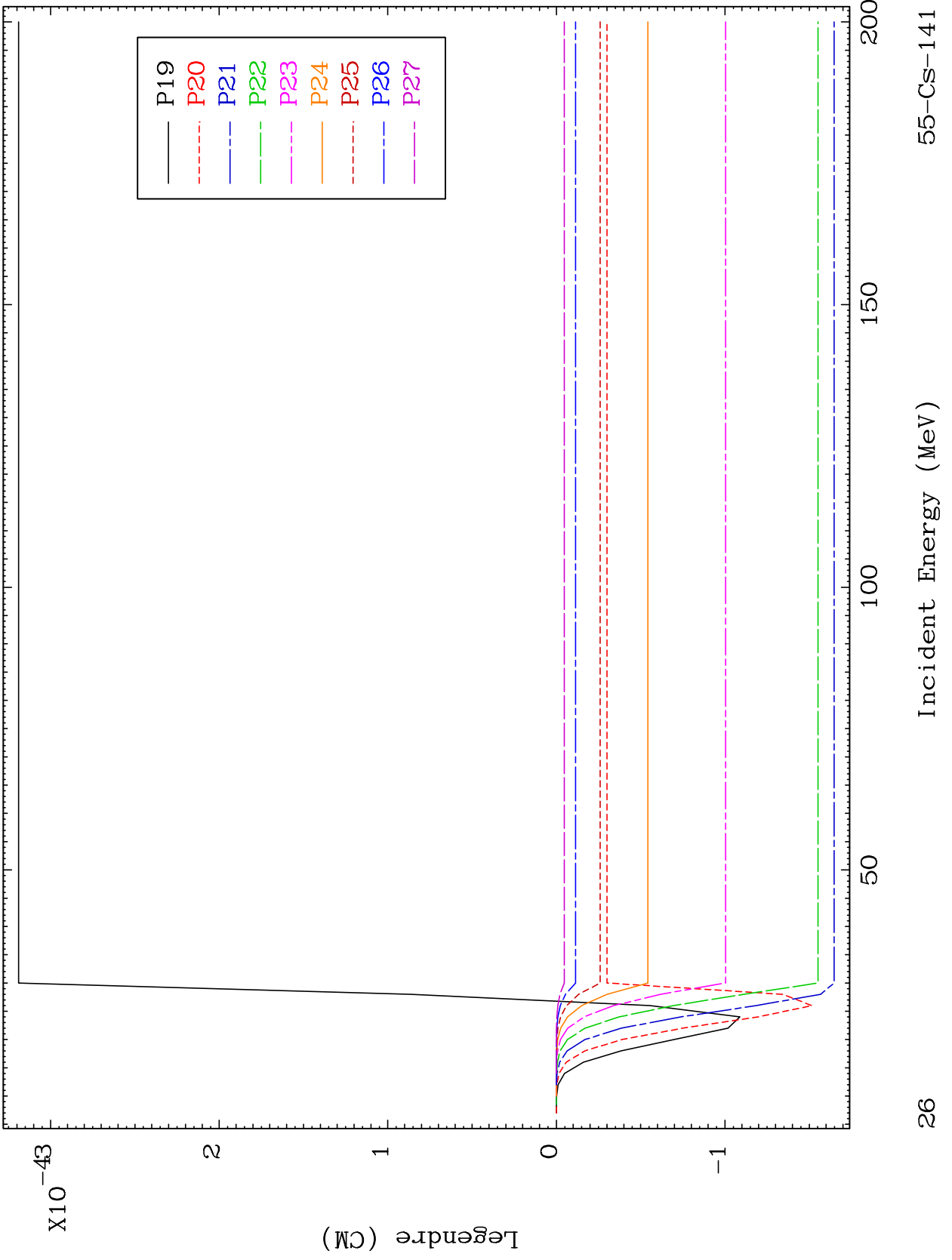

26

Incident Energy (MeV)

55-Cs-141

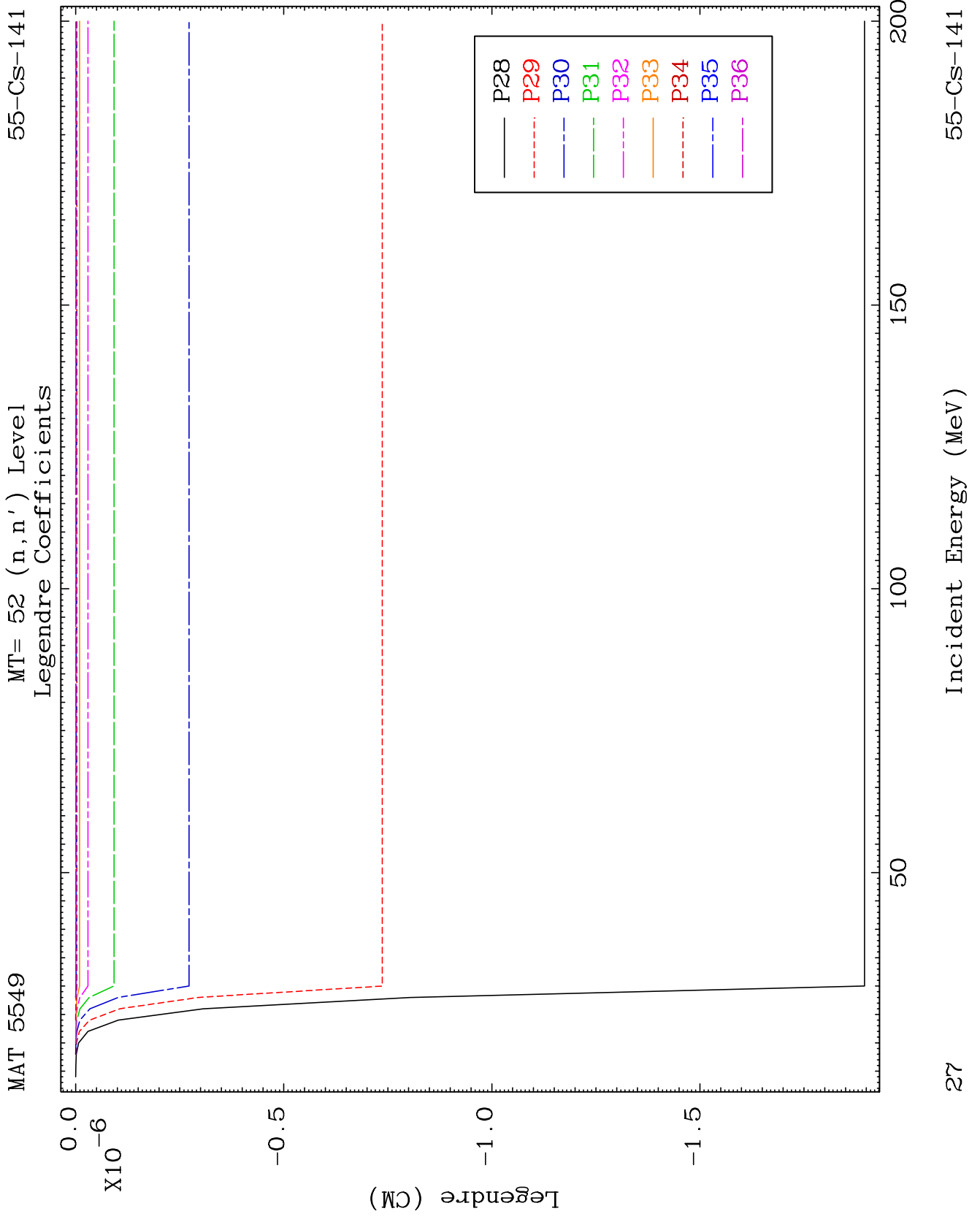

MAT 5549

MT= 53 (n,n') Level
Legendre Coefficients

55-Cs-141

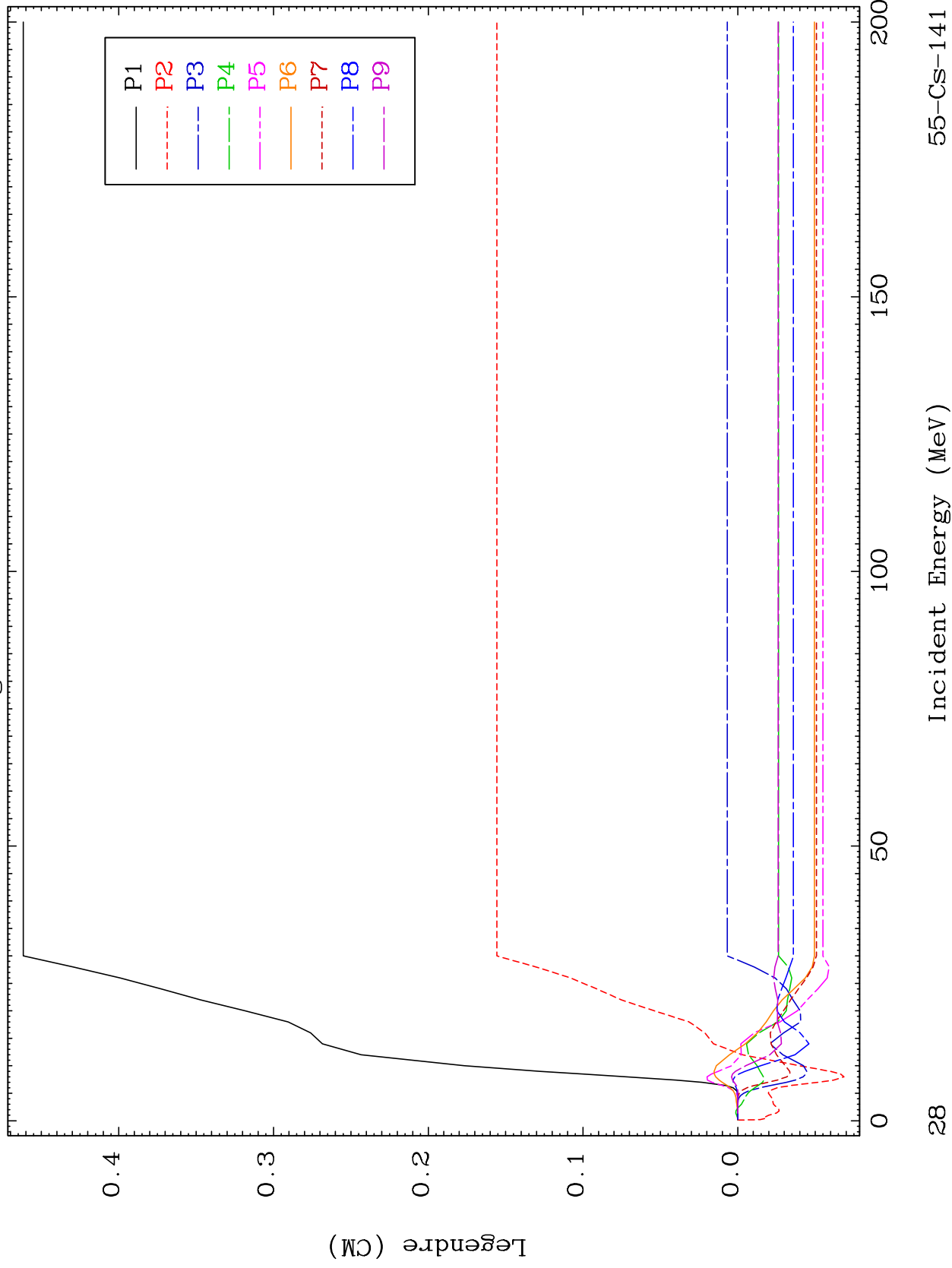

55-Cs-141

Incident Energy (MeV)

28

MAT 5549

MT= 53 (n,n') Level
Legendre Coefficients

55-Cs-141

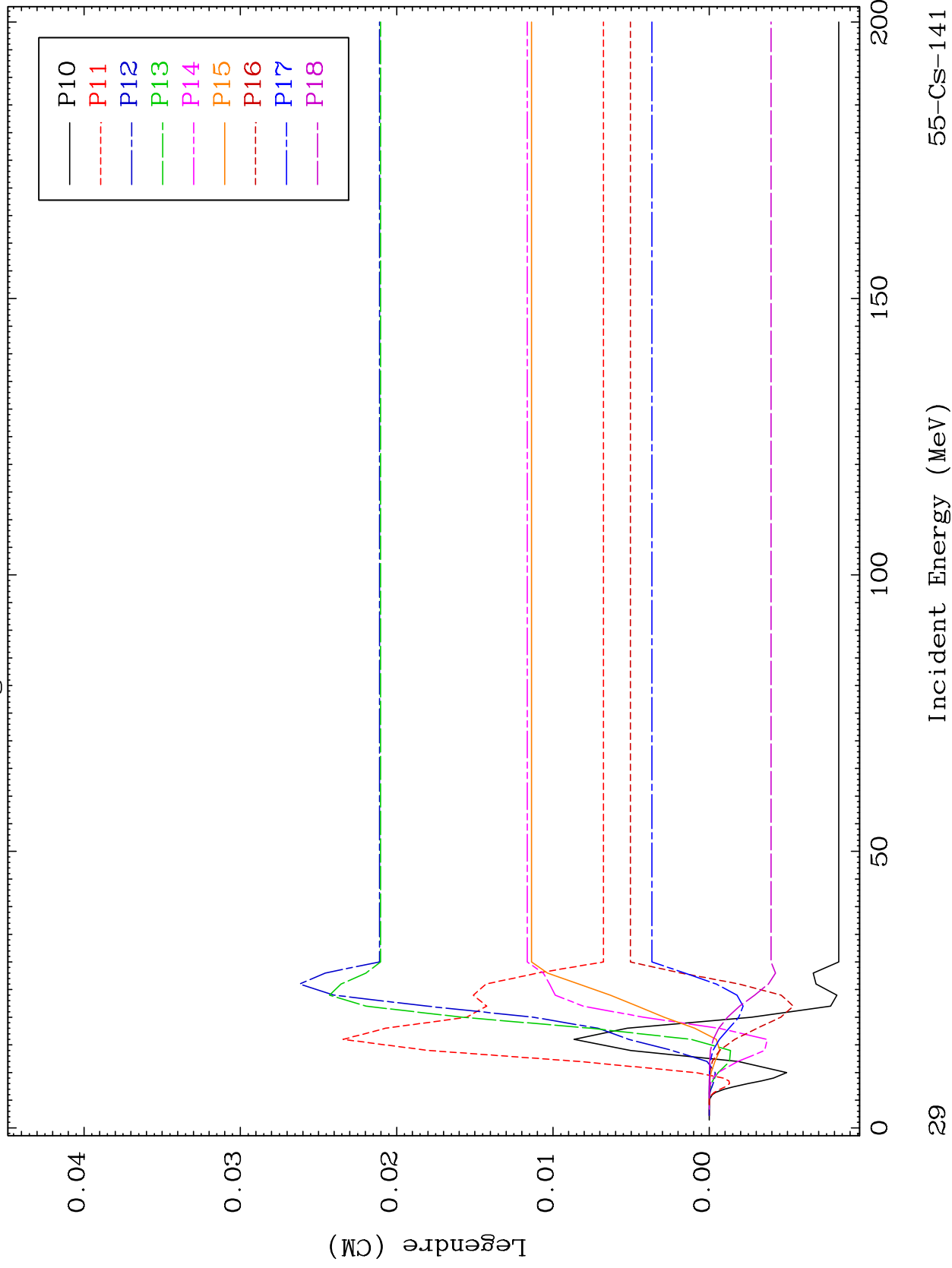

29

Incident Energy (MeV)

55-Cs-141

MAT 5549

MT= 53 (n,n') Level
Legendre Coefficients

55-Cs-141

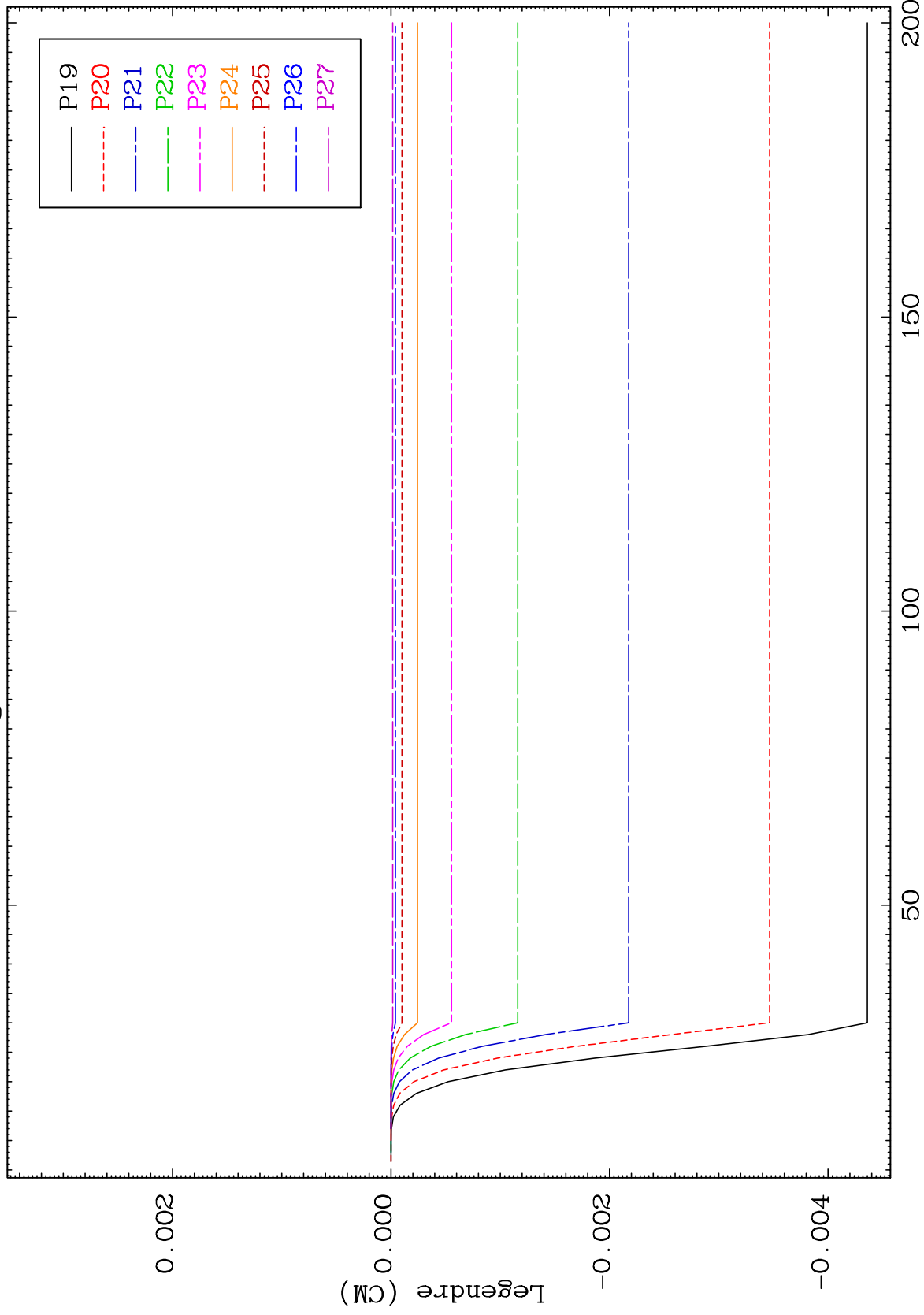

30

Incident Energy (MeV)

55-Cs-141

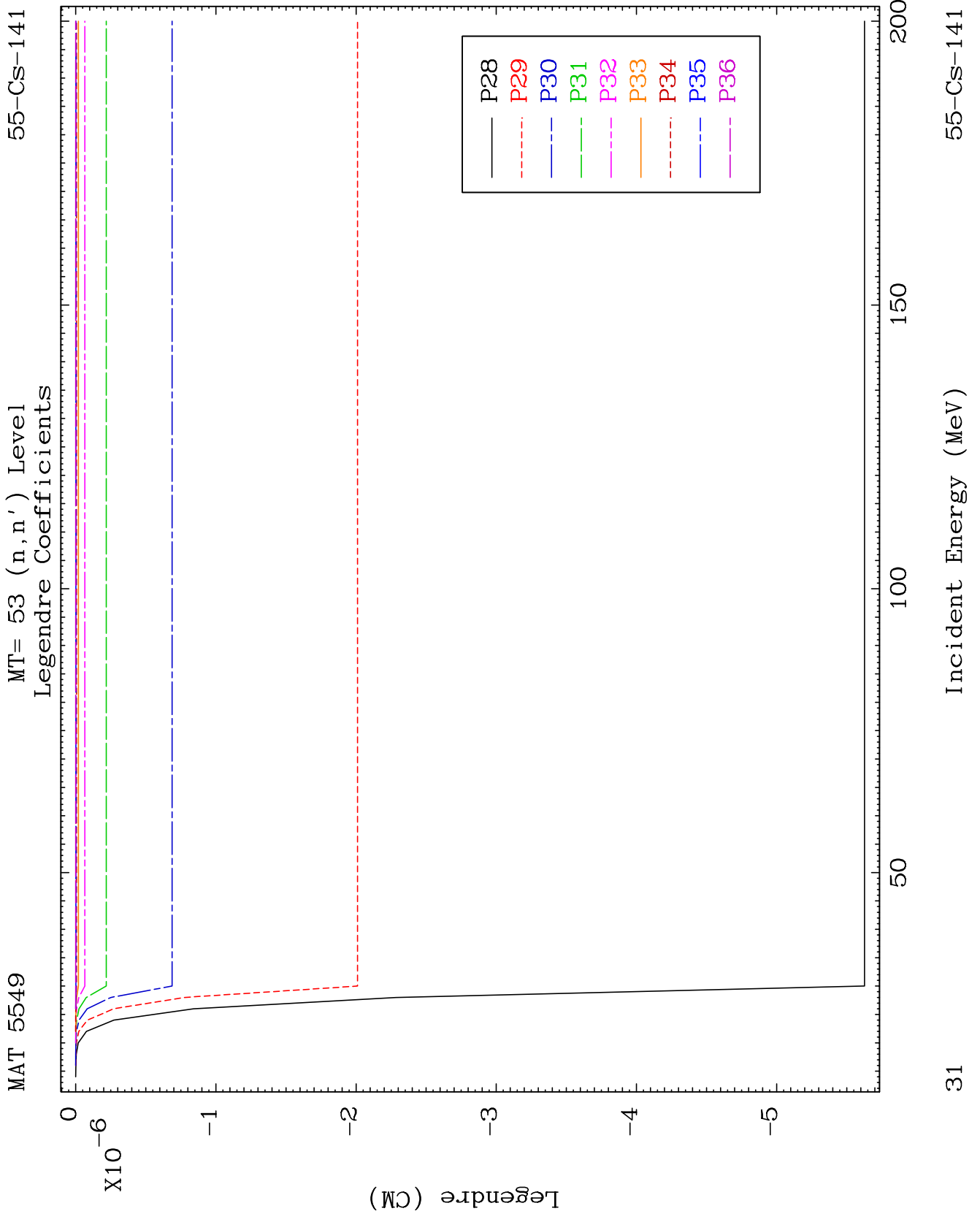

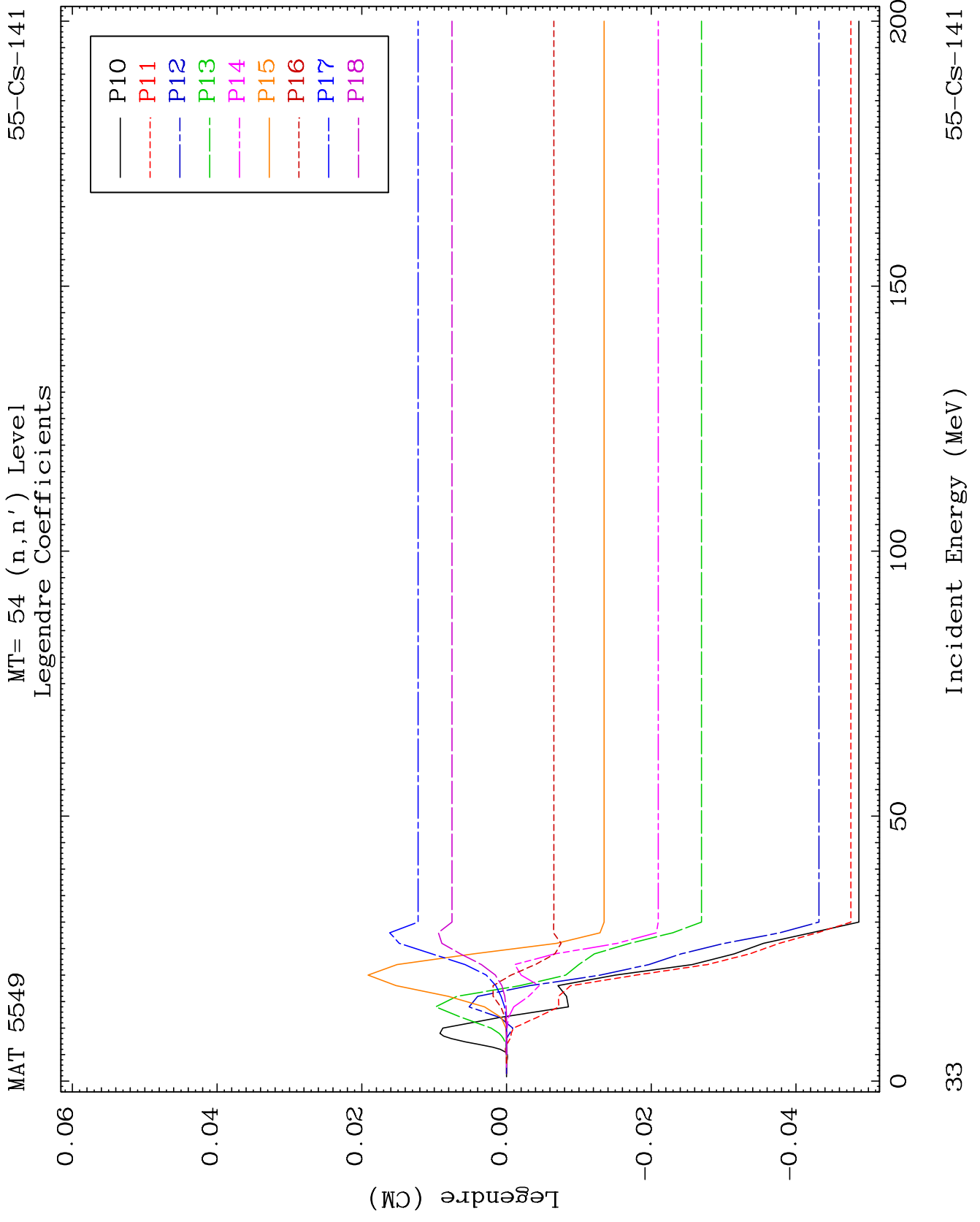

MAT 5549

MT= 54 (n,n') Level
Legendre Coefficients

55-Cs-141

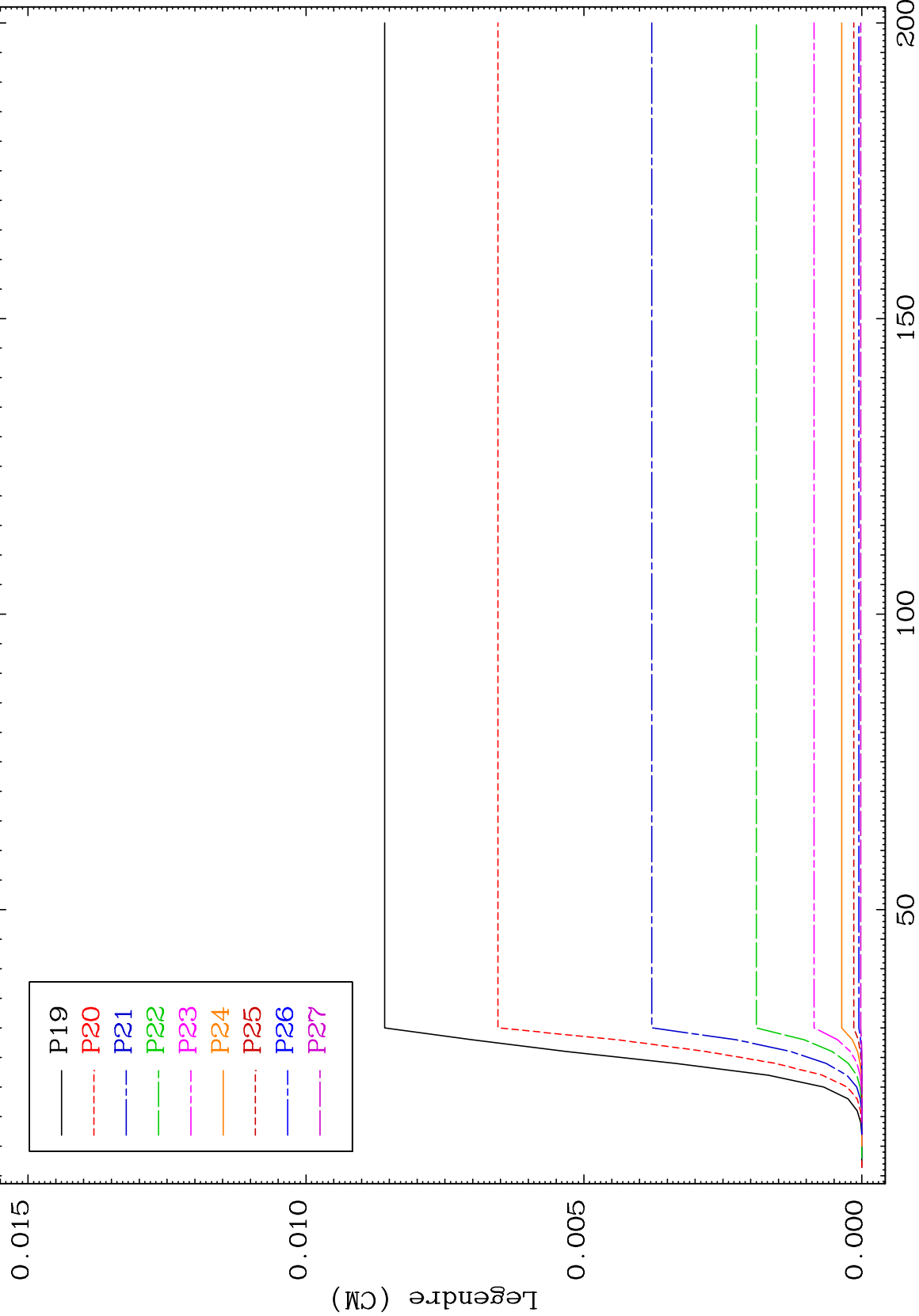

34

Incident Energy (MeV)

55-Cs-141

MAT 5549

MT= 54 (n,n') Level
Legendre Coefficients

55-Cs-141

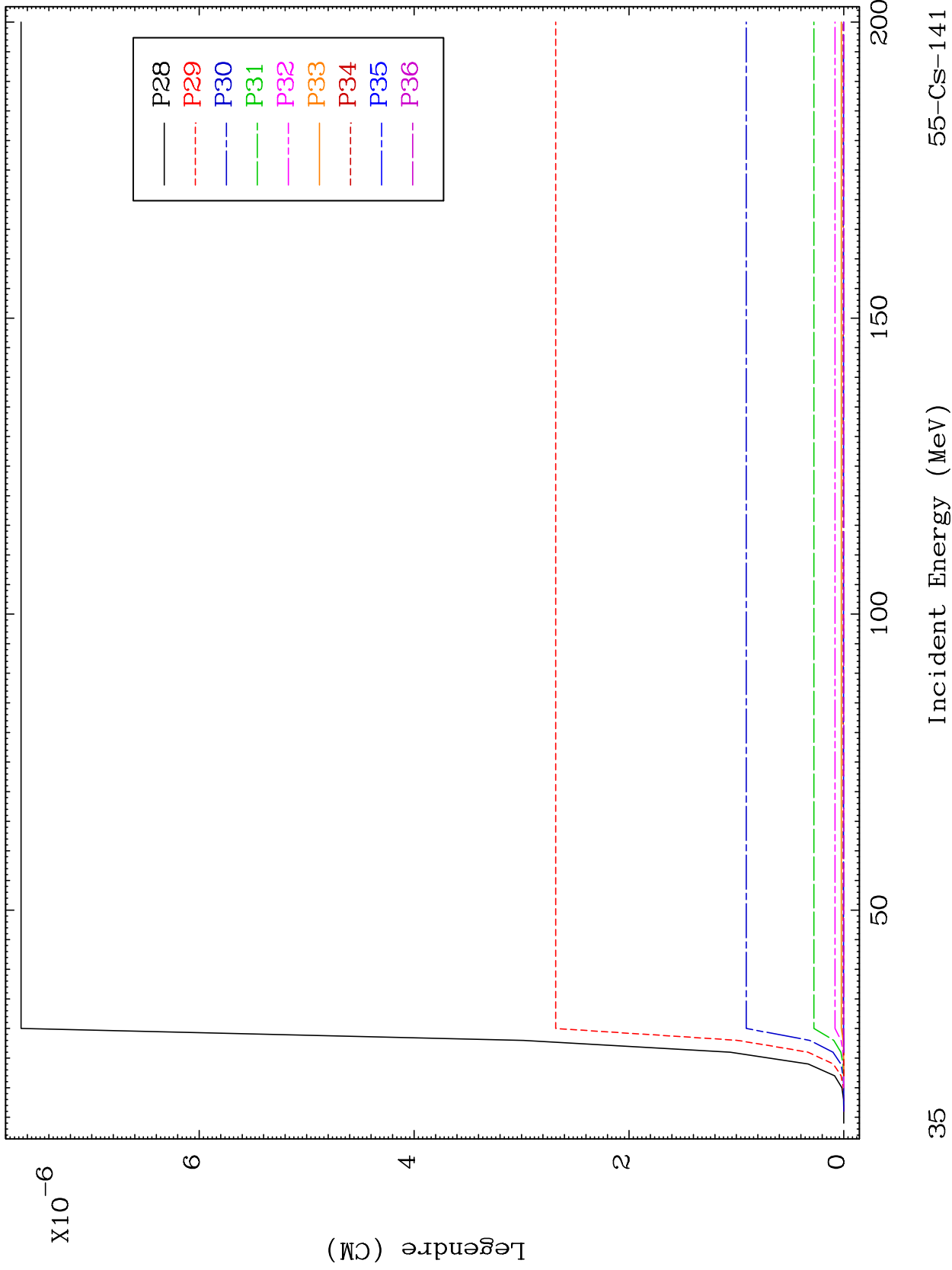

MAT 5549

MT= 55 (n,n') Level
Legendre Coefficients

55-Cs-141

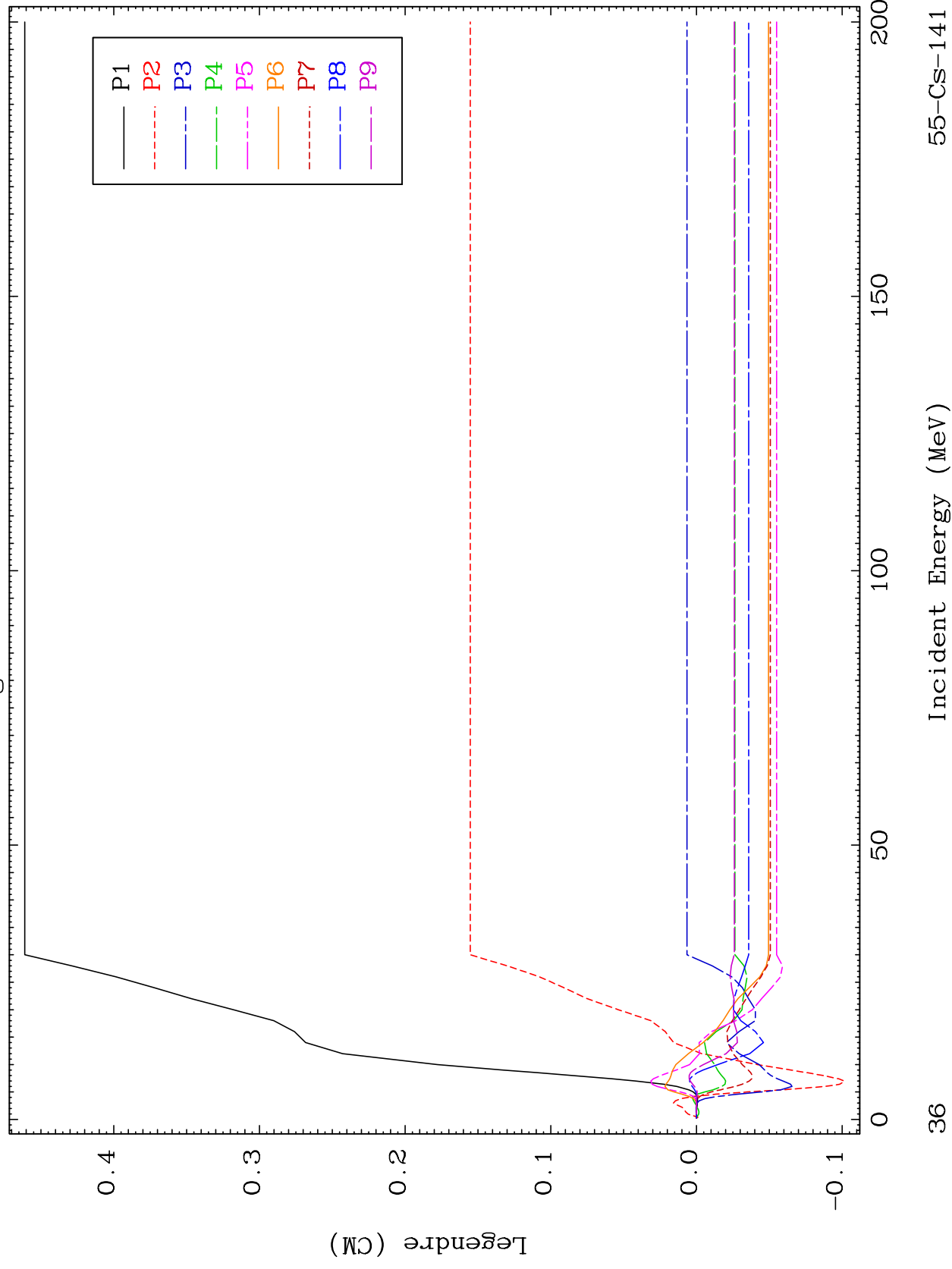

55-Cs-141

Incident Energy (MeV)

36

MAT 5549

MT= 55 (n,n') Level
Legendre Coefficients

55-Cs-141

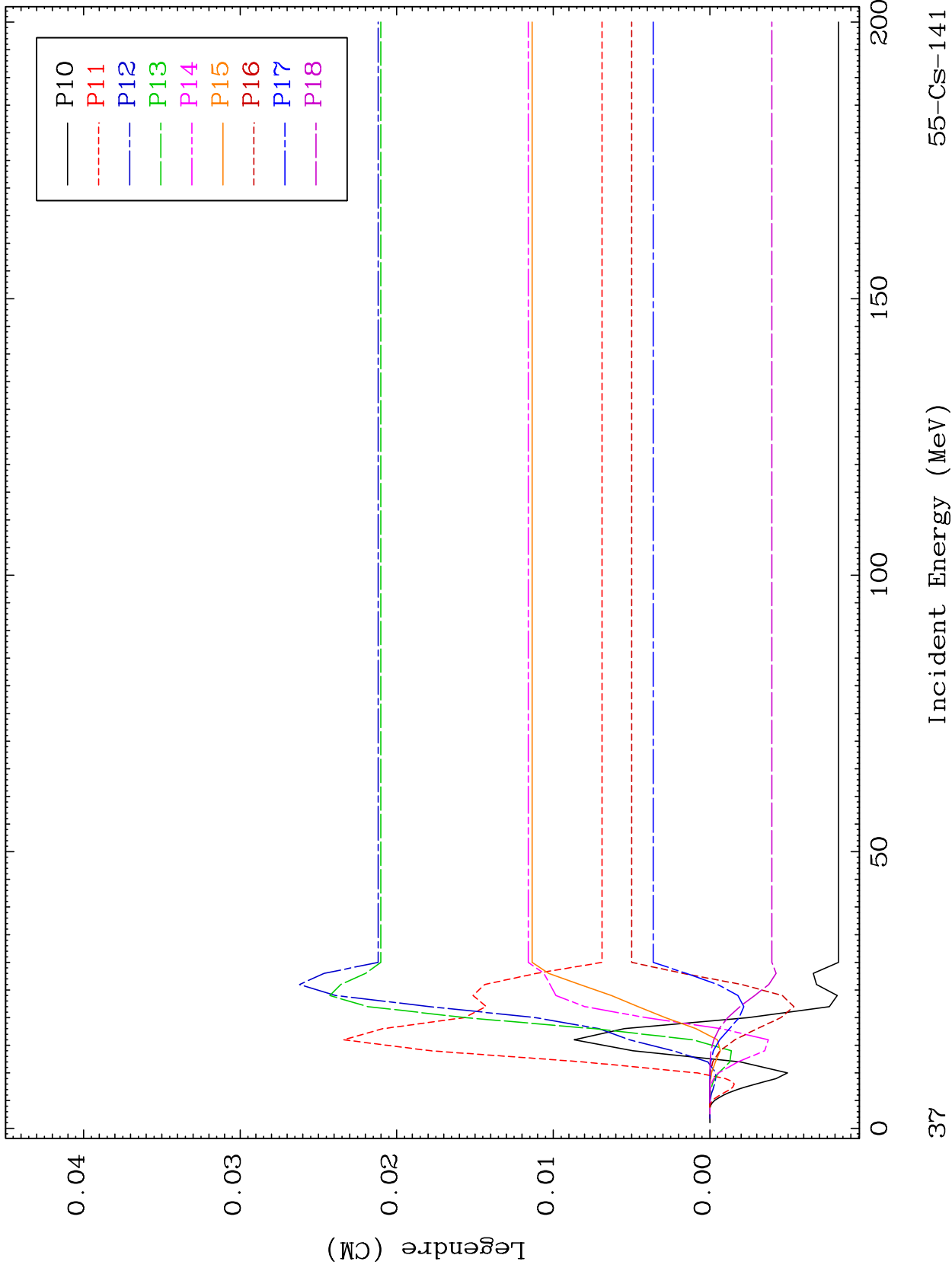

37

55-Cs-141

MAT 5549

MT= 55 (n,n') Level
Legendre Coefficients

55-Cs-141

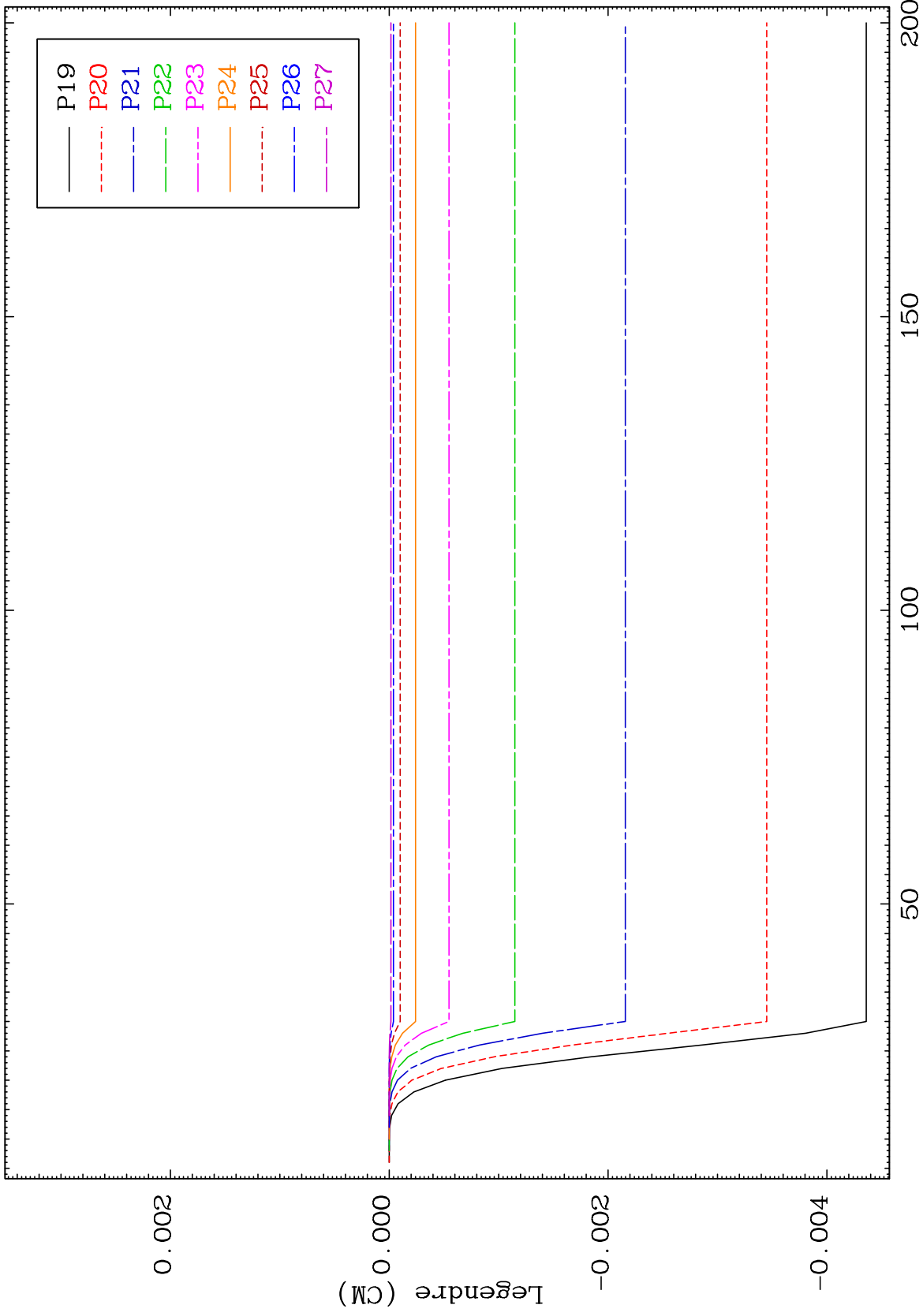

38

Incident Energy (MeV)

55-Cs-141

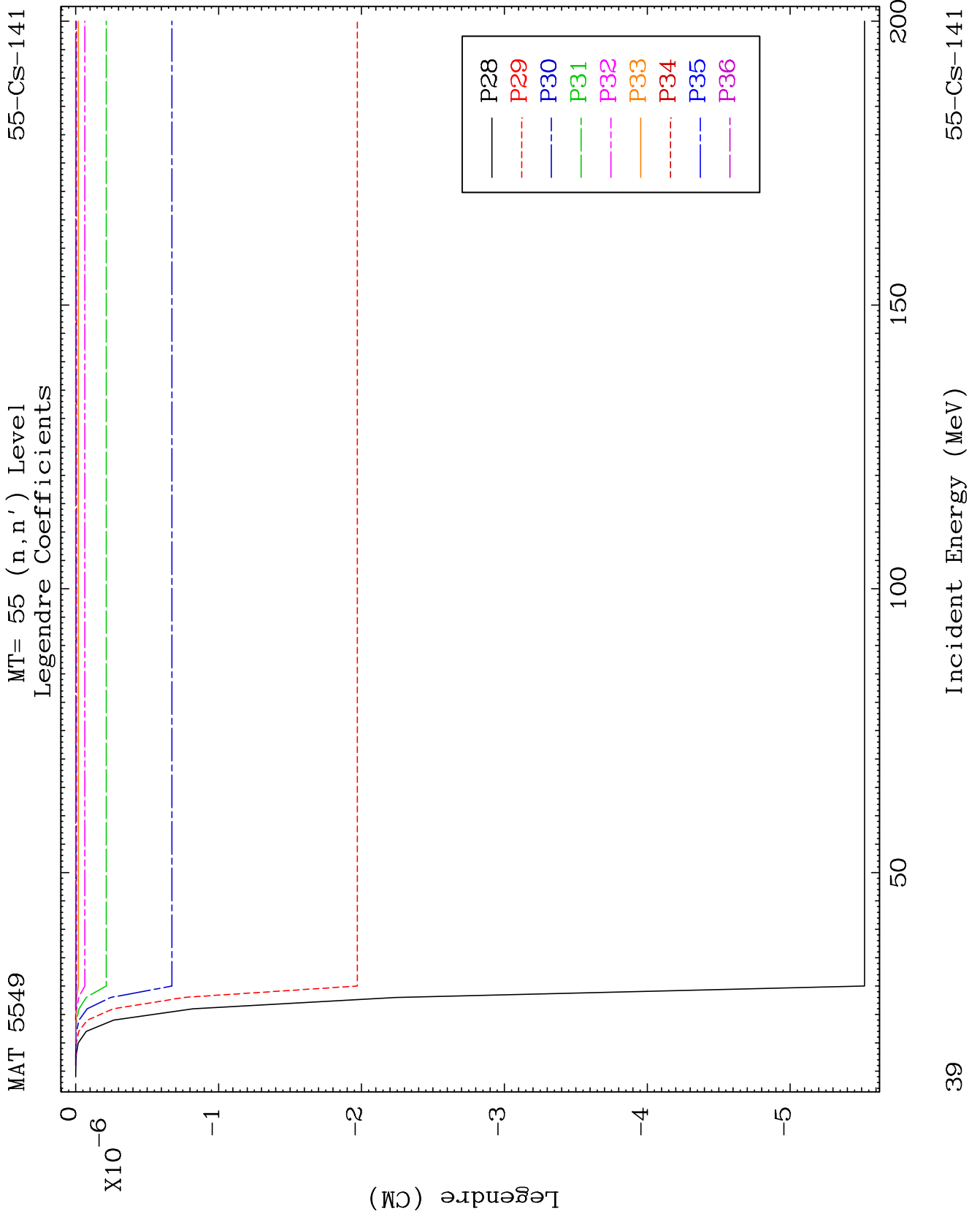

MAT 5549

MT= 56 (n,n') Level
Legendre Coefficients

55-Cs-141

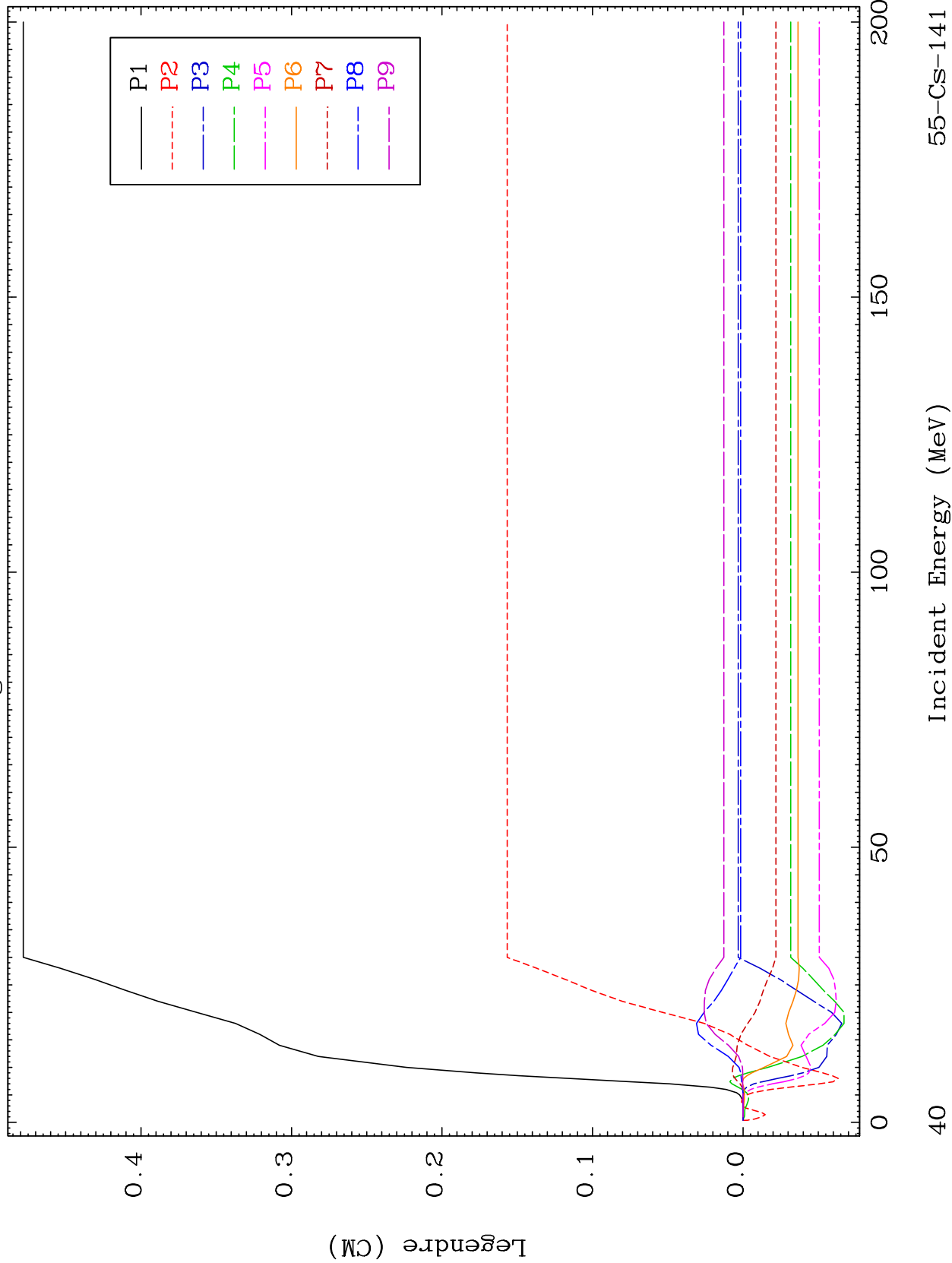

55-Cs-141

MAT 5549

MT= 56 (n,n') Level
Legendre Coefficients

55-Cs-141

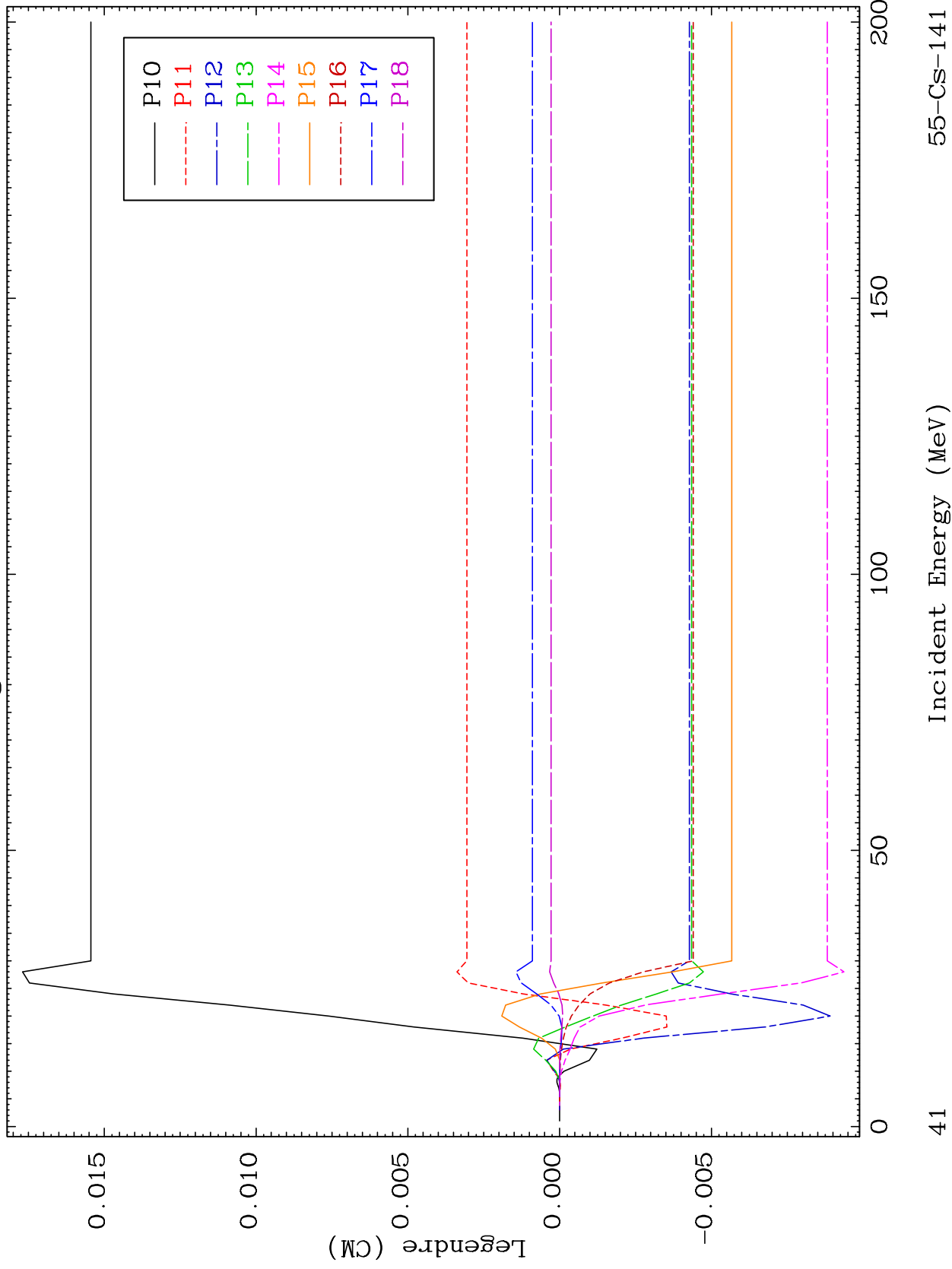

41

Incident Energy (MeV)

55-Cs-141

MAT 5549

MT= 56 (n,n') Level
Legendre Coefficients

55-Cs-141

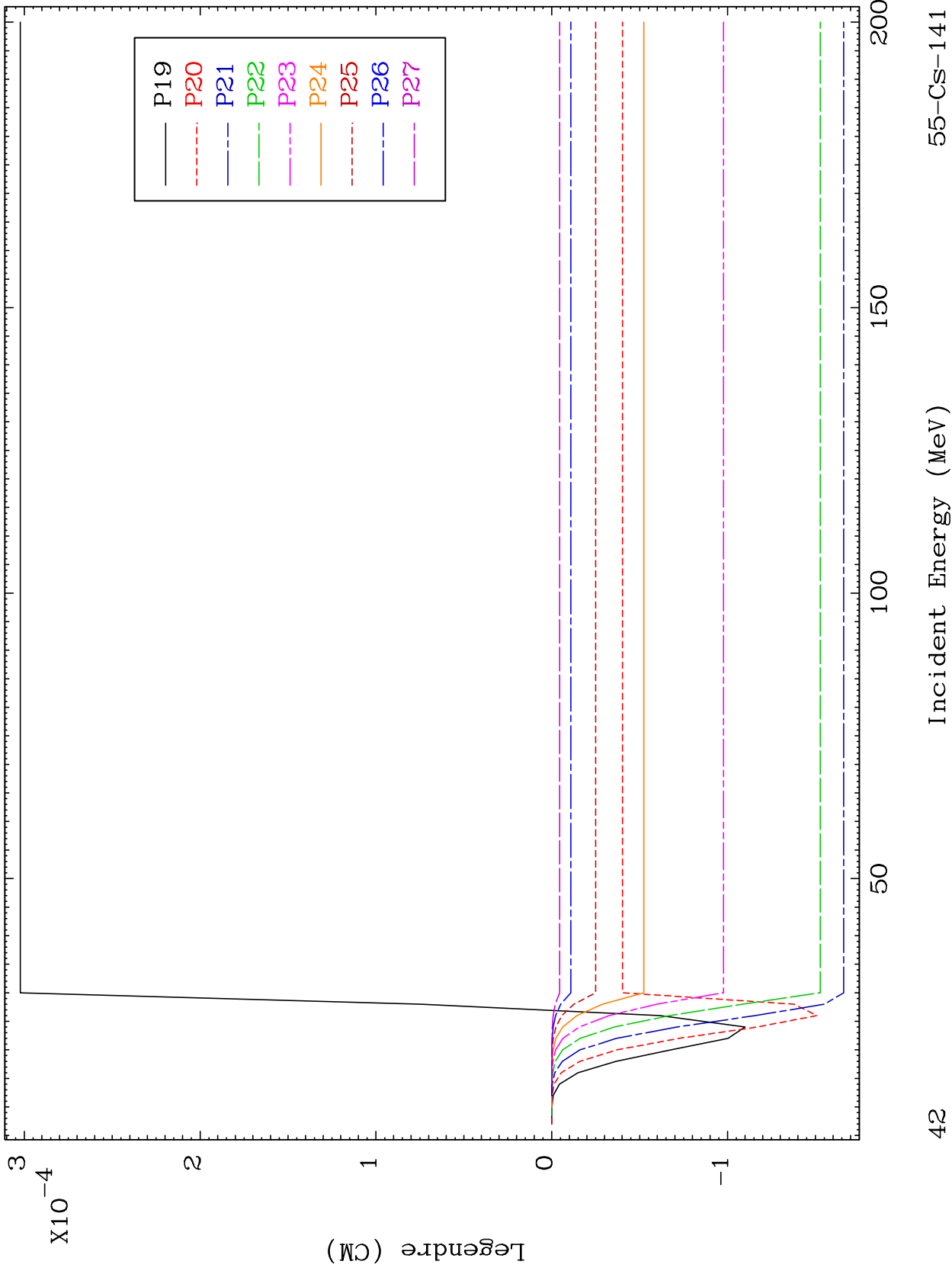

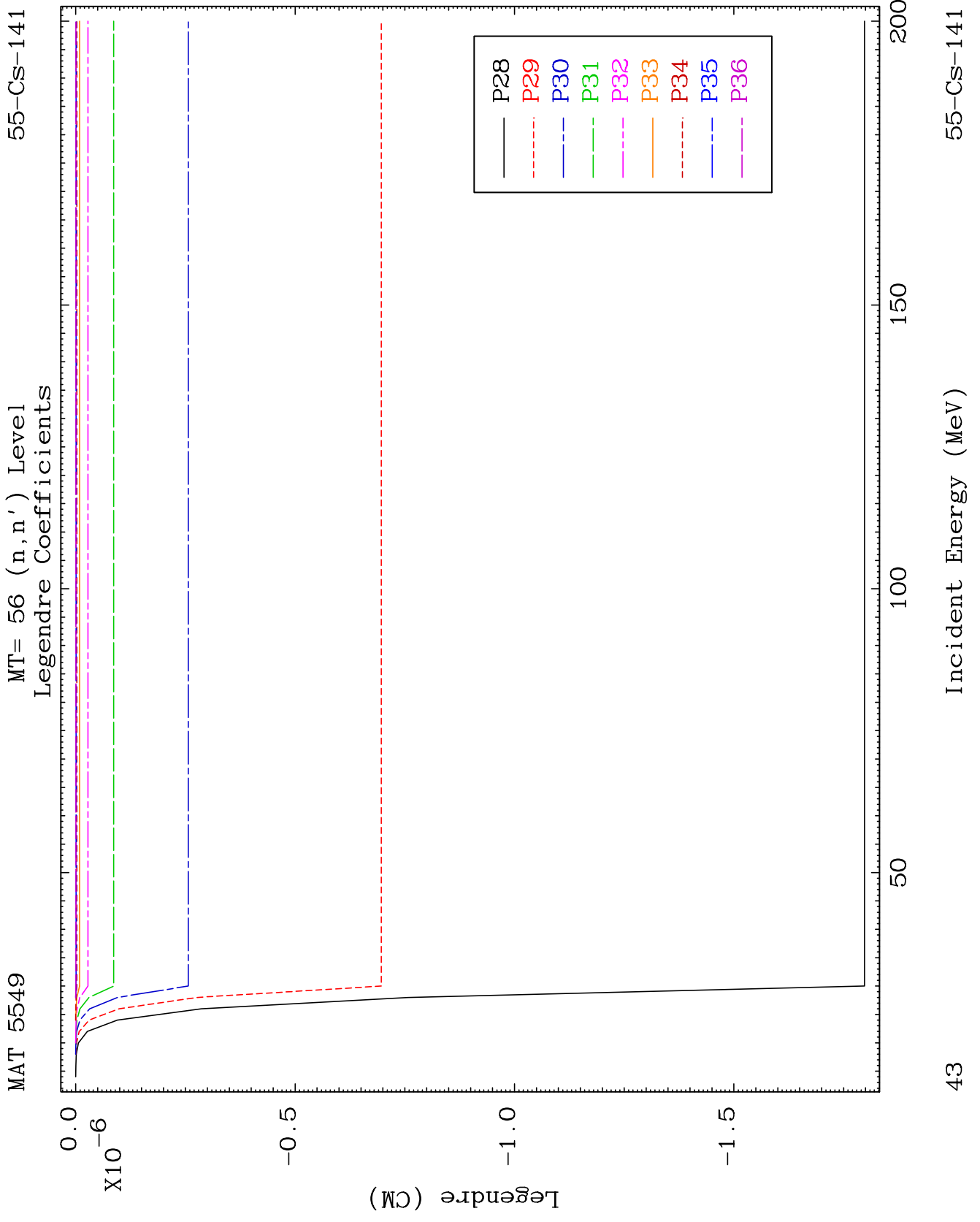

MAT 5549

MT= 57 (n,n') Level
Legendre Coefficients

55-Cs-141

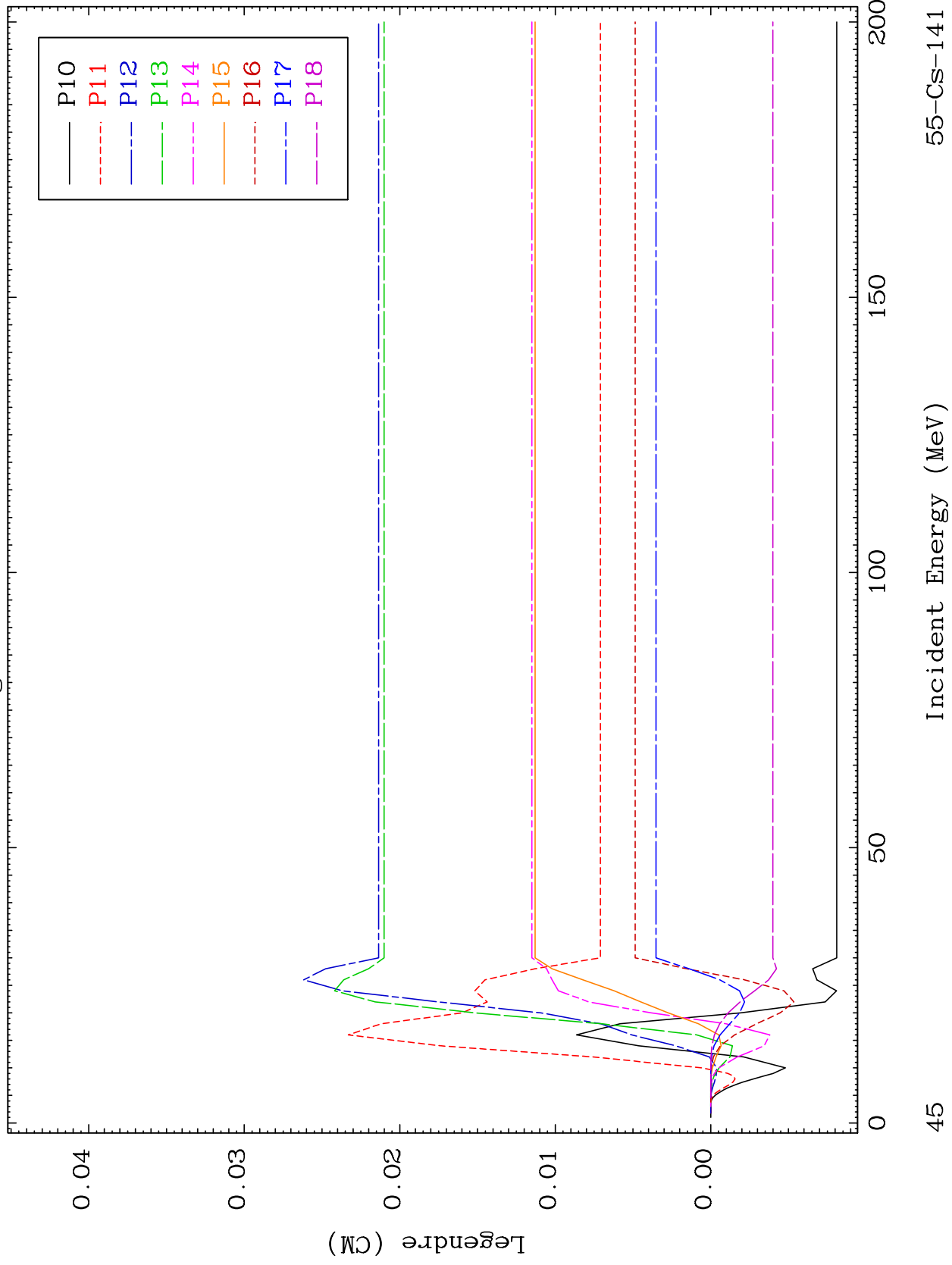

55-Cs-141

Incident Energy (MeV)

45

MAT 5549

MT= 57 (n,n') Level
Legendre Coefficients

55-Cs-141

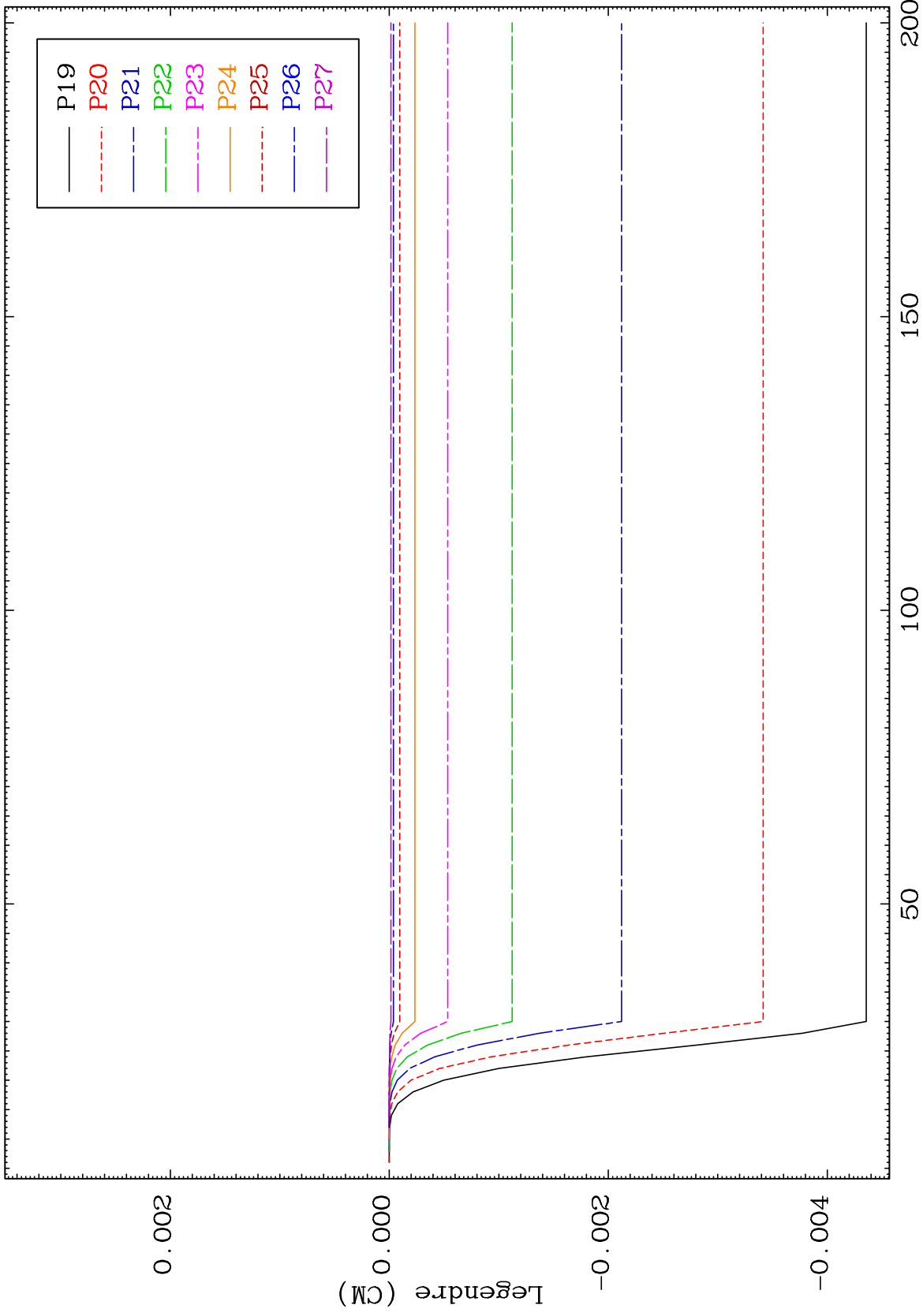

46

Incident Energy (MeV)

55-Cs-141

MAT 5549

MT= 58 (n,n') Level
Legendre Coefficients

55-Cs-141

55-Cs-141

Incident Energy (MeV)

48

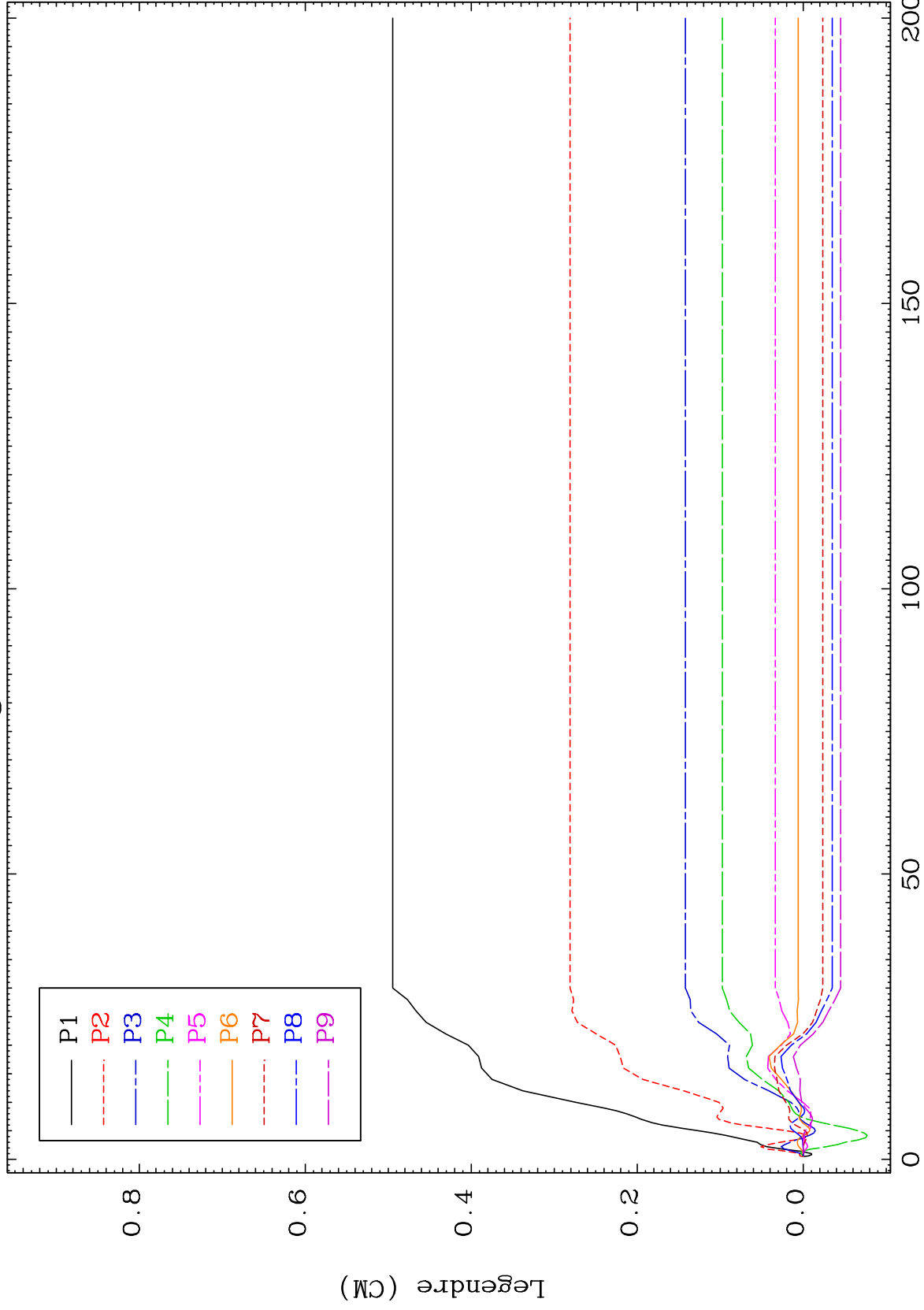

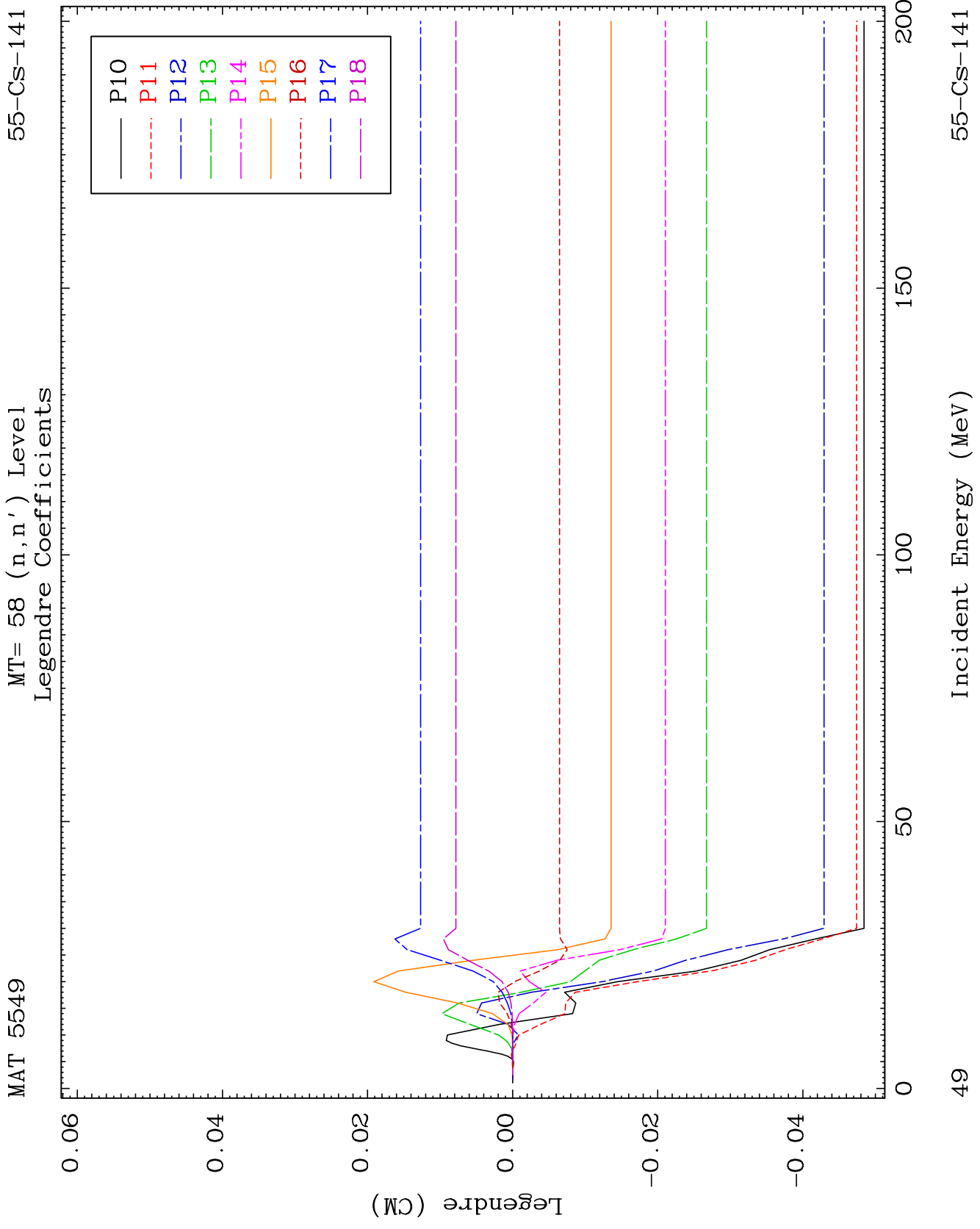

MAT 5549

MT= 58 (n,n') Level
Legendre Coefficients

55-Cs-141

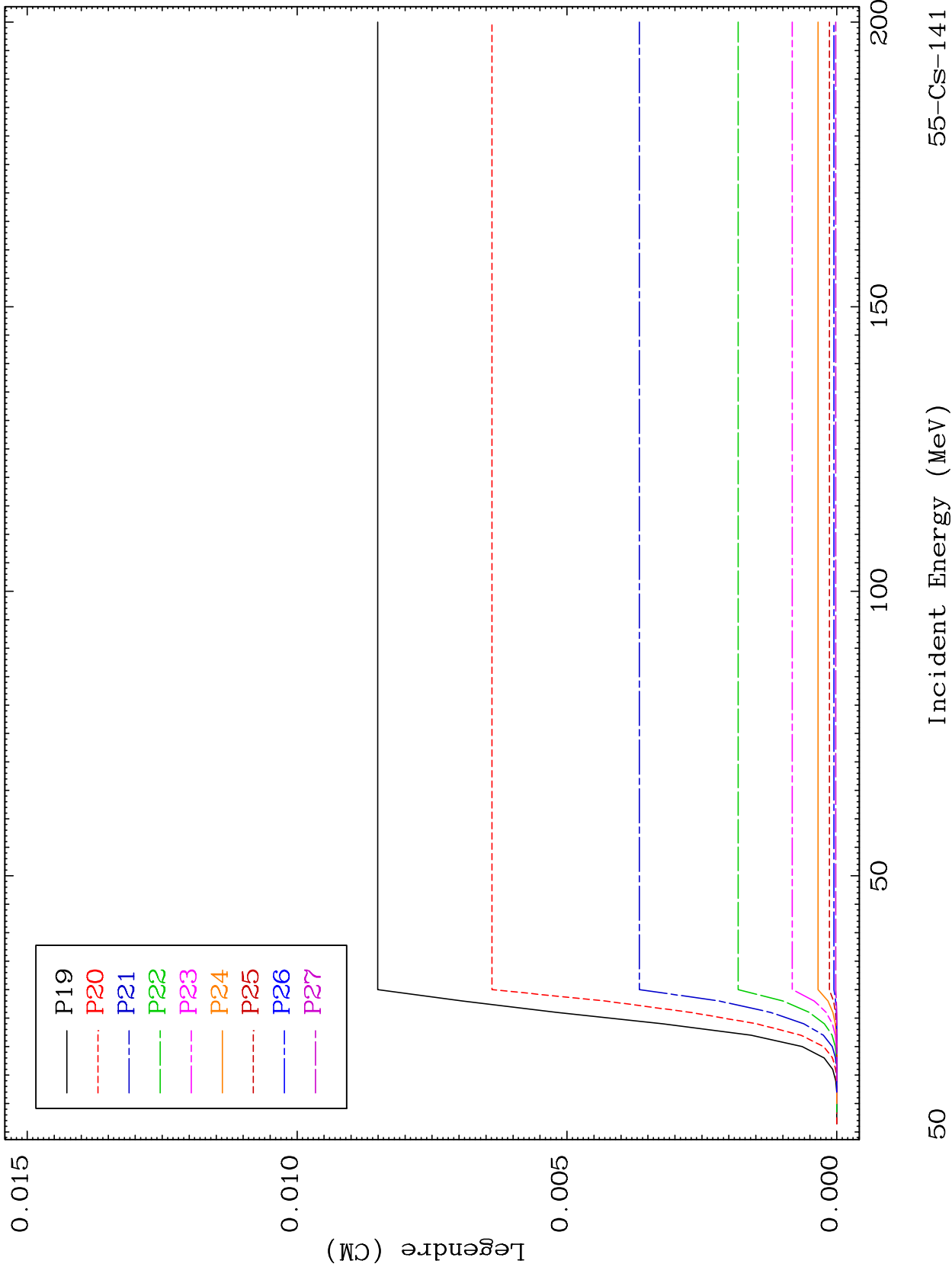

55-Cs-141

Incident Energy (MeV)

50

MAT 5549

MT= 58 (n,n') Level
Legendre Coefficients

55-Cs-141

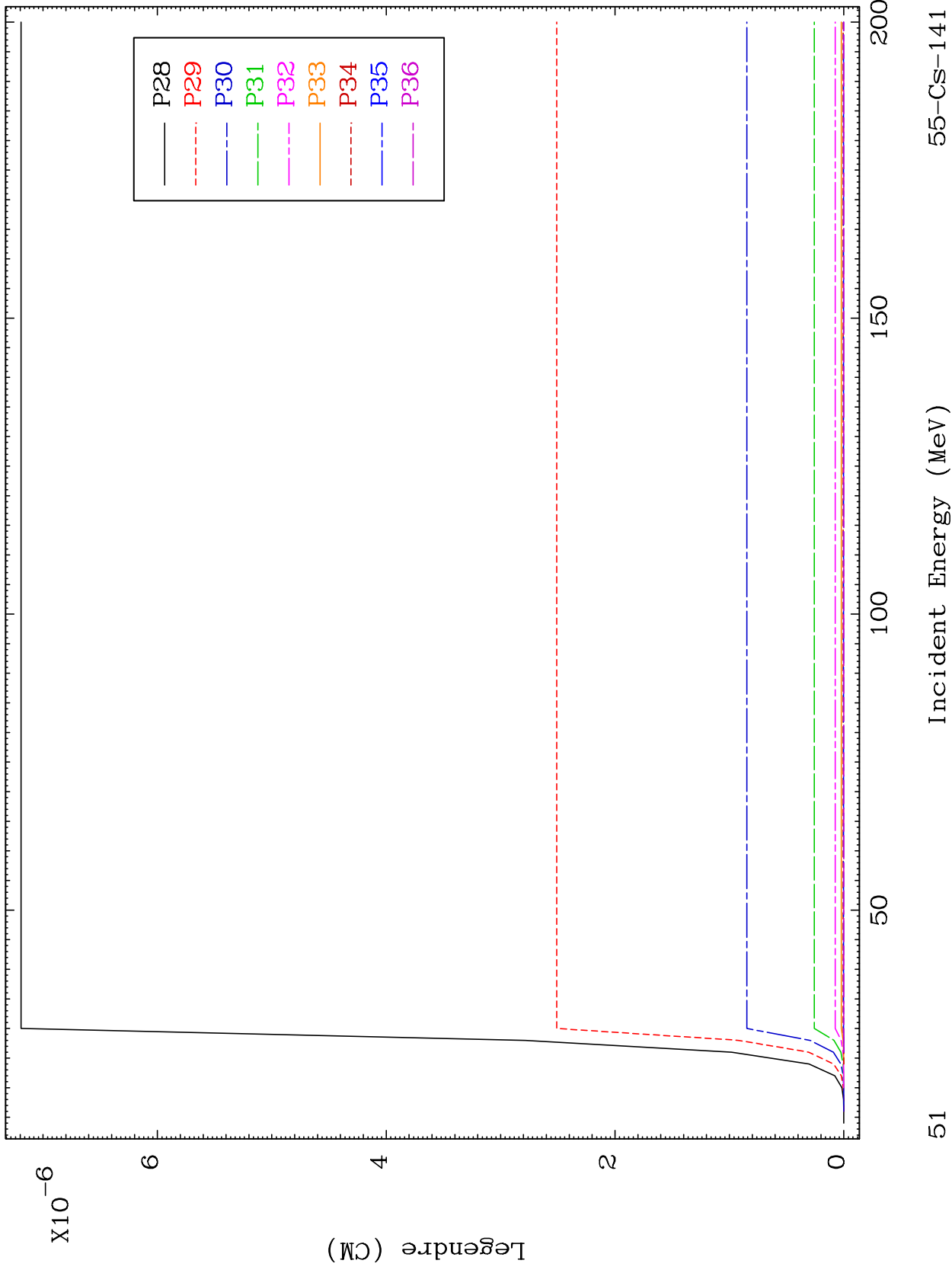

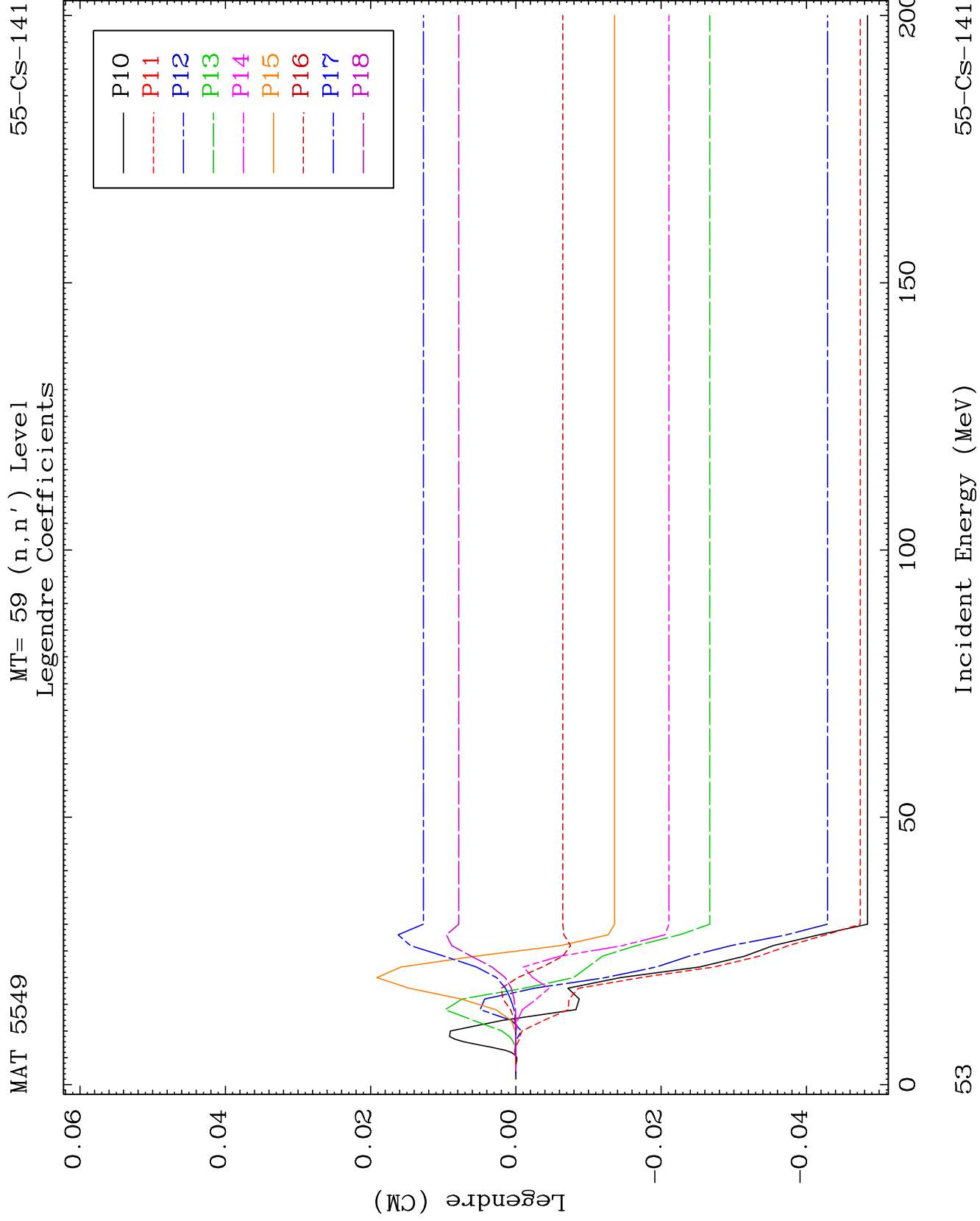

MAT 5549

MT= 59 (n,n') Level
Legendre Coefficients

55-Cs-141

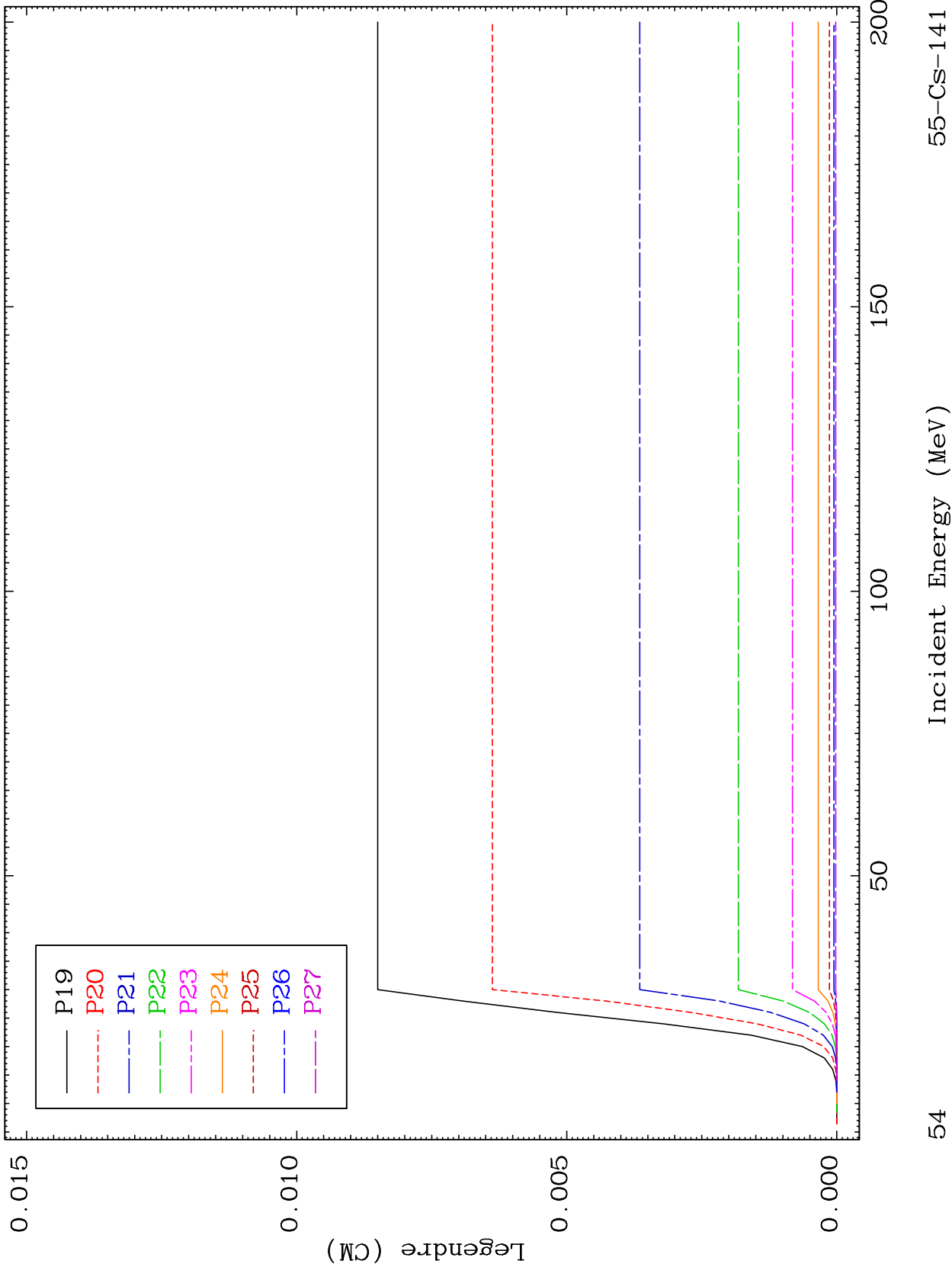

54

Incident Energy (MeV)

55-Cs-141

MAT 5549

MT= 59 (n,n') Level
Legendre Coefficients

55-Cs-141

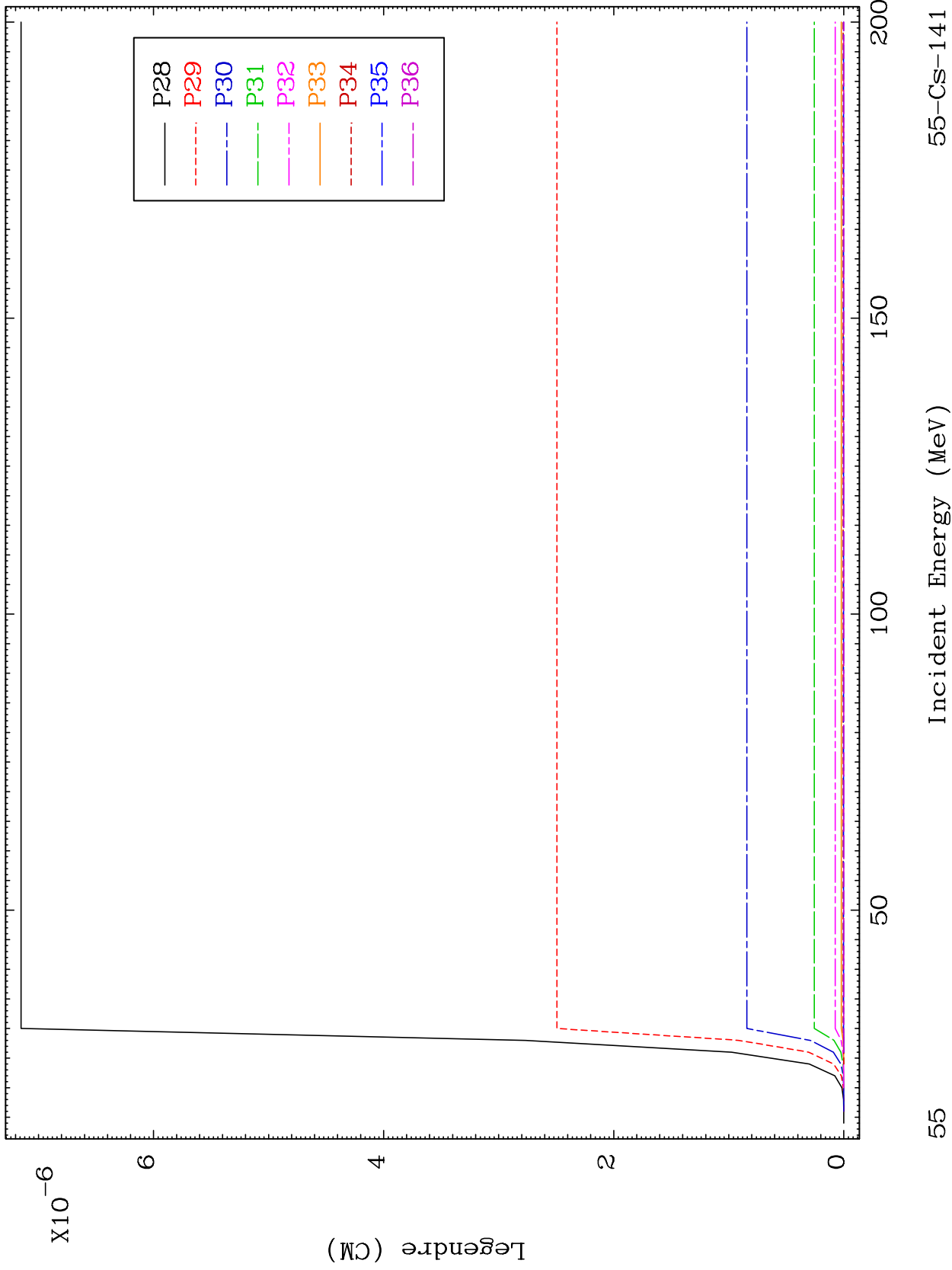

MAT 5549

MT= 60 (n,n') Level
Legendre Coefficients

55-Cs-141

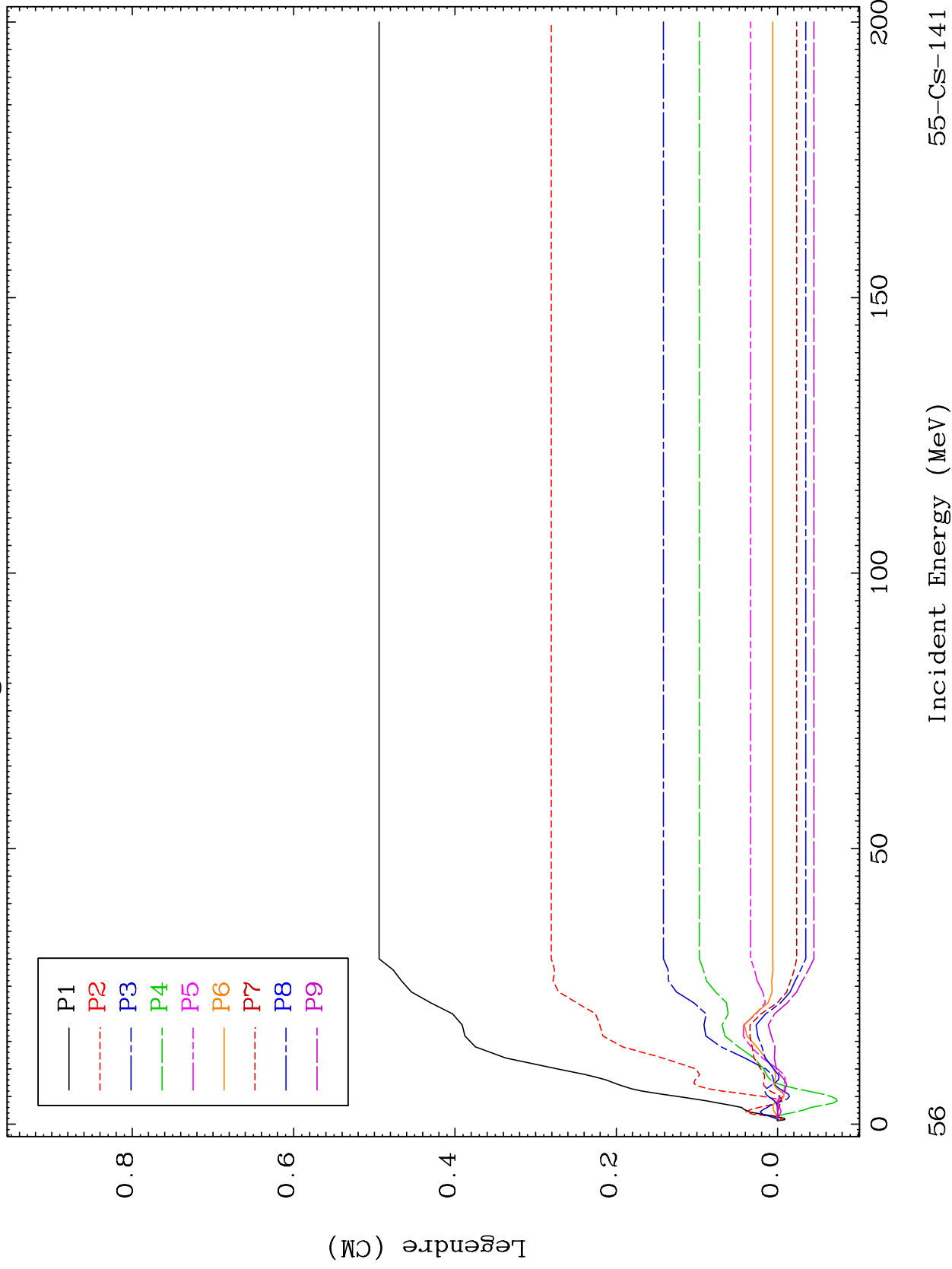

56

Incident Energy (MeV)

55-Cs-141

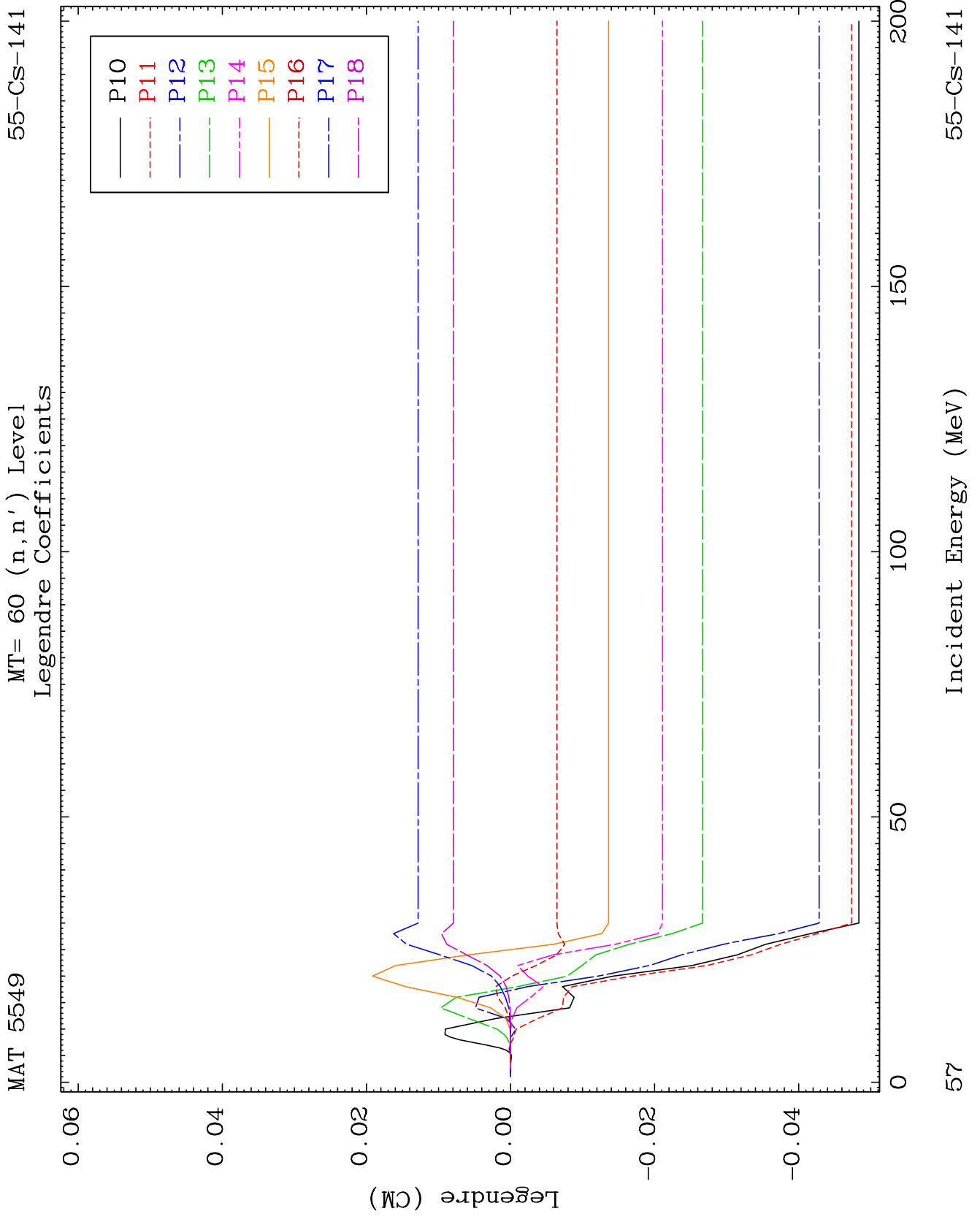

MAT 5549

MT= 60 (n,n') Level
Legendre Coefficients

55-Cs-141

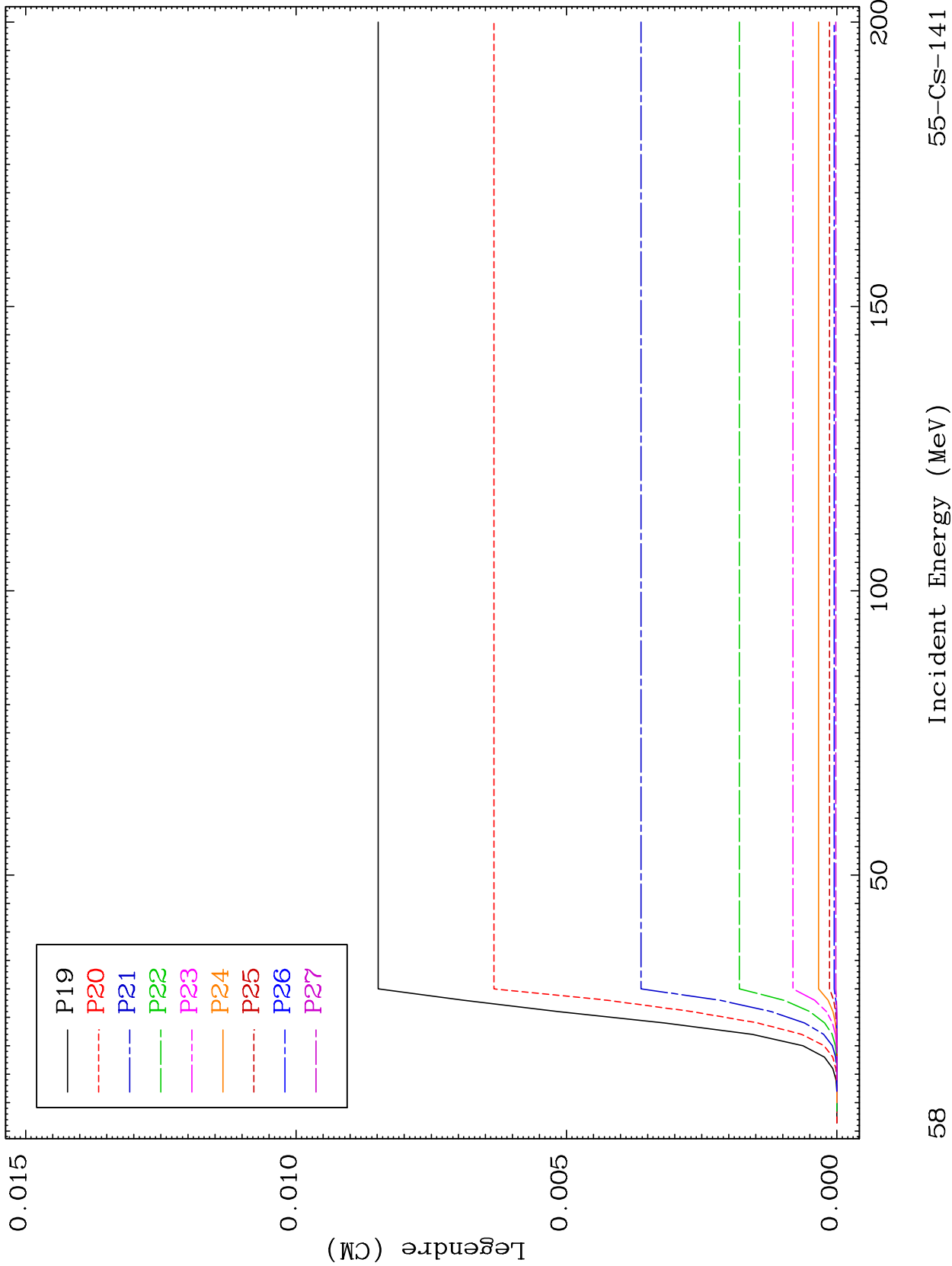

58

55-Cs-141

Incident Energy (MeV)

MAT 5549

MT= 60 (n,n') Level
Legendre Coefficients

55-Cs-141

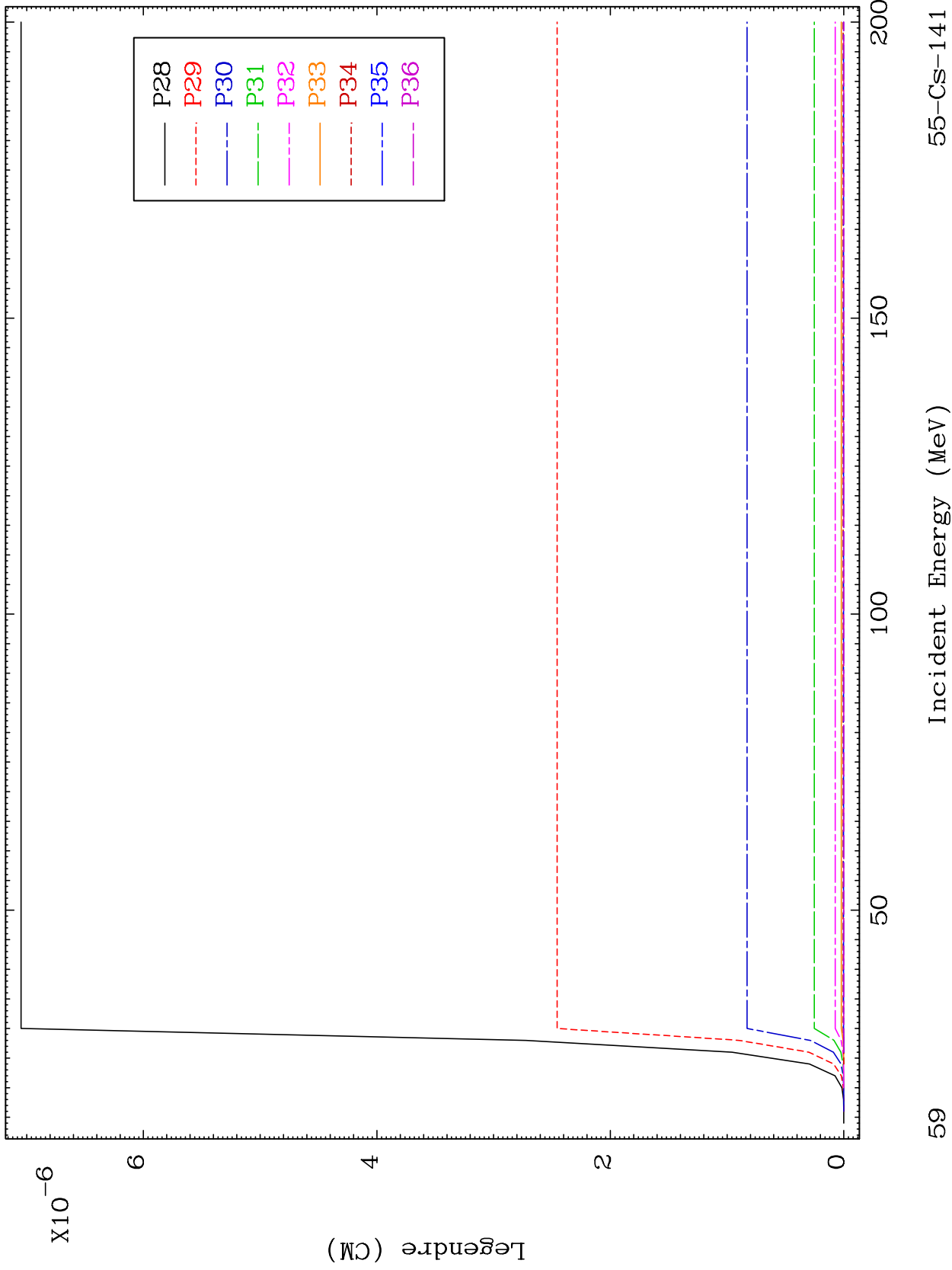

59

Incident Energy (MeV)

55-Cs-141

MAT 5549

MT= 61 (n,n') Level
Legendre Coefficients

55-Cs-141

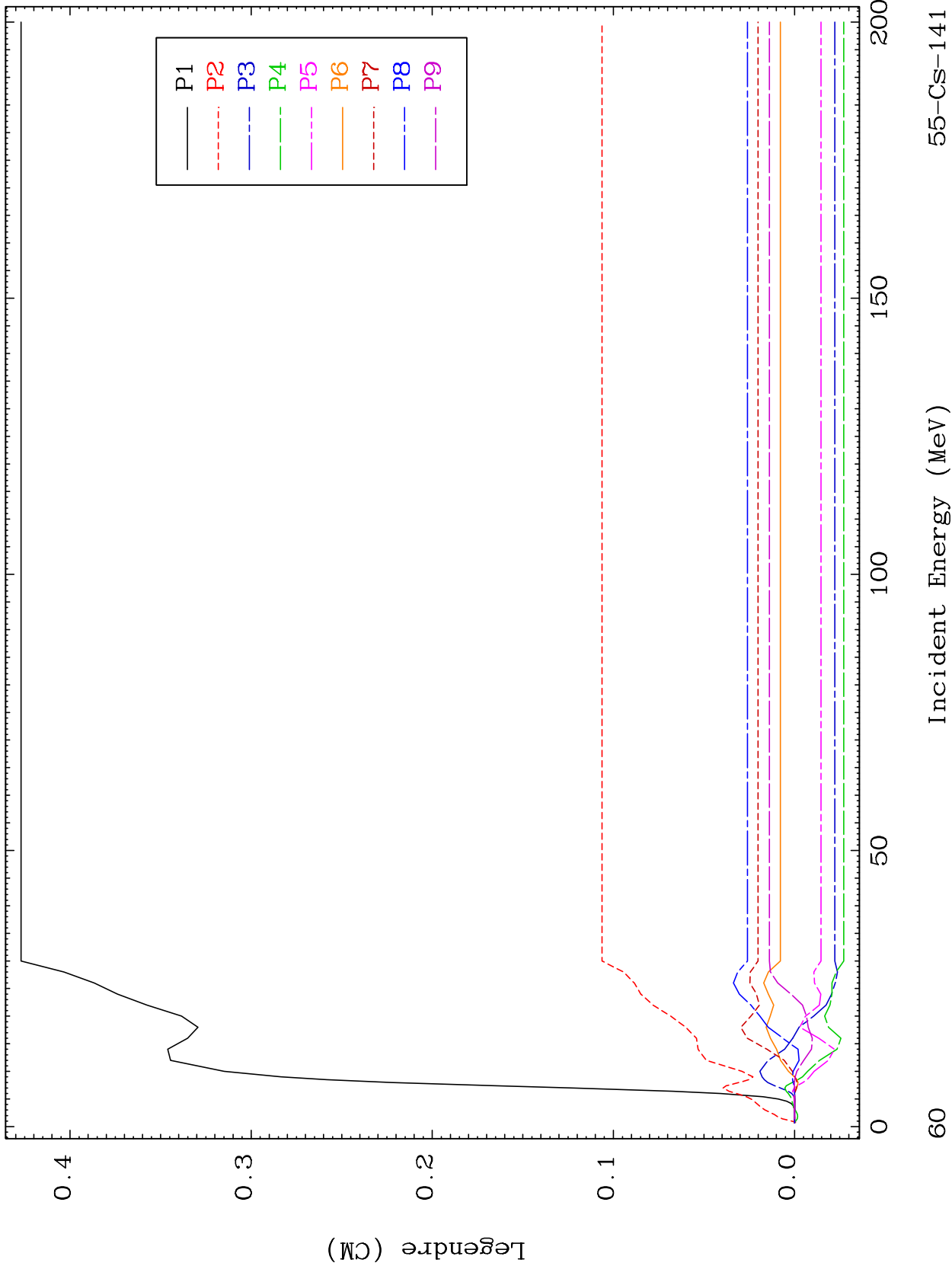

55-Cs-141

MAT 5549

MT= 61 (n,n') Level
Legendre Coefficients

55-Cs-141

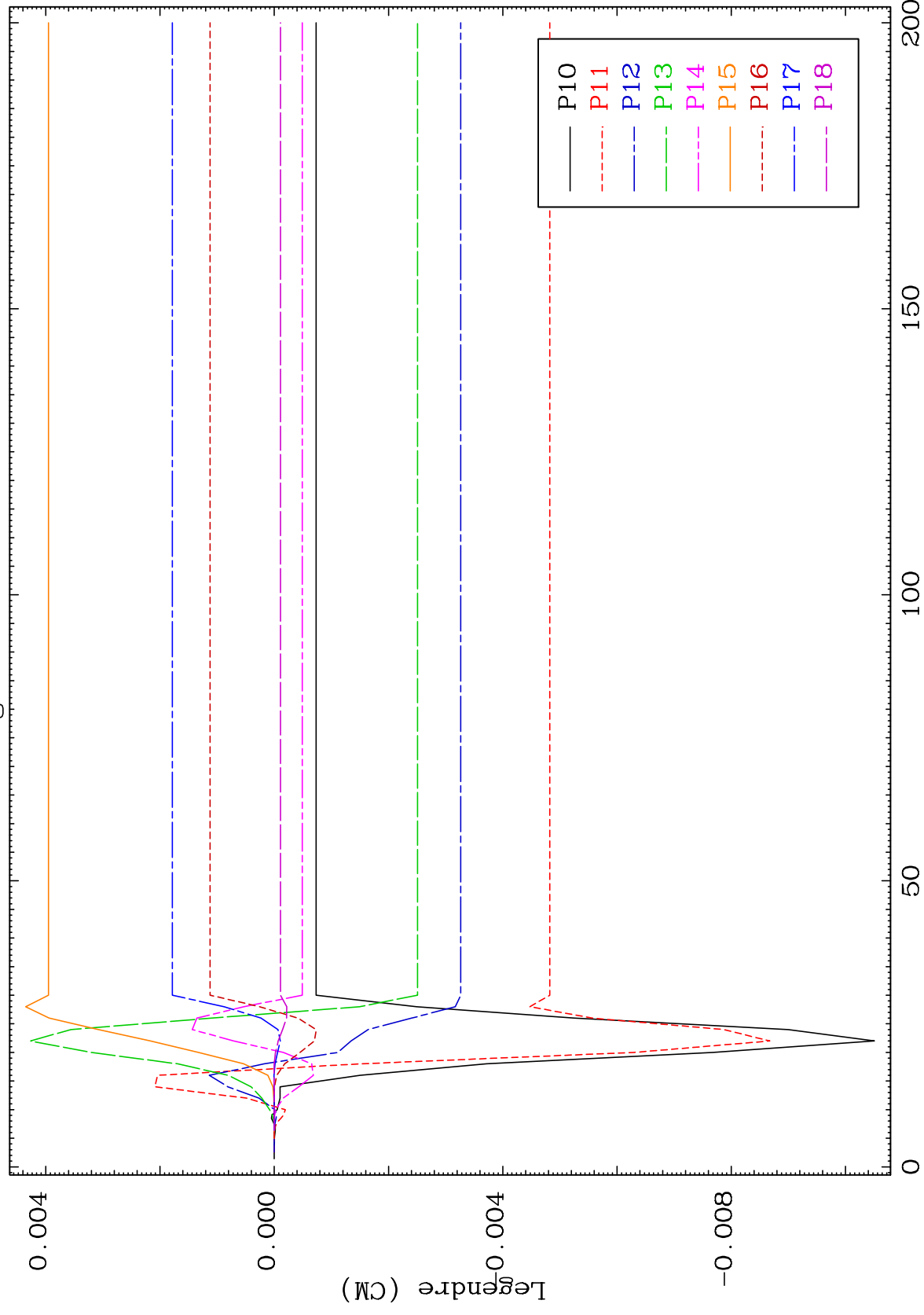

55-Cs-141

Incident Energy (MeV)

61

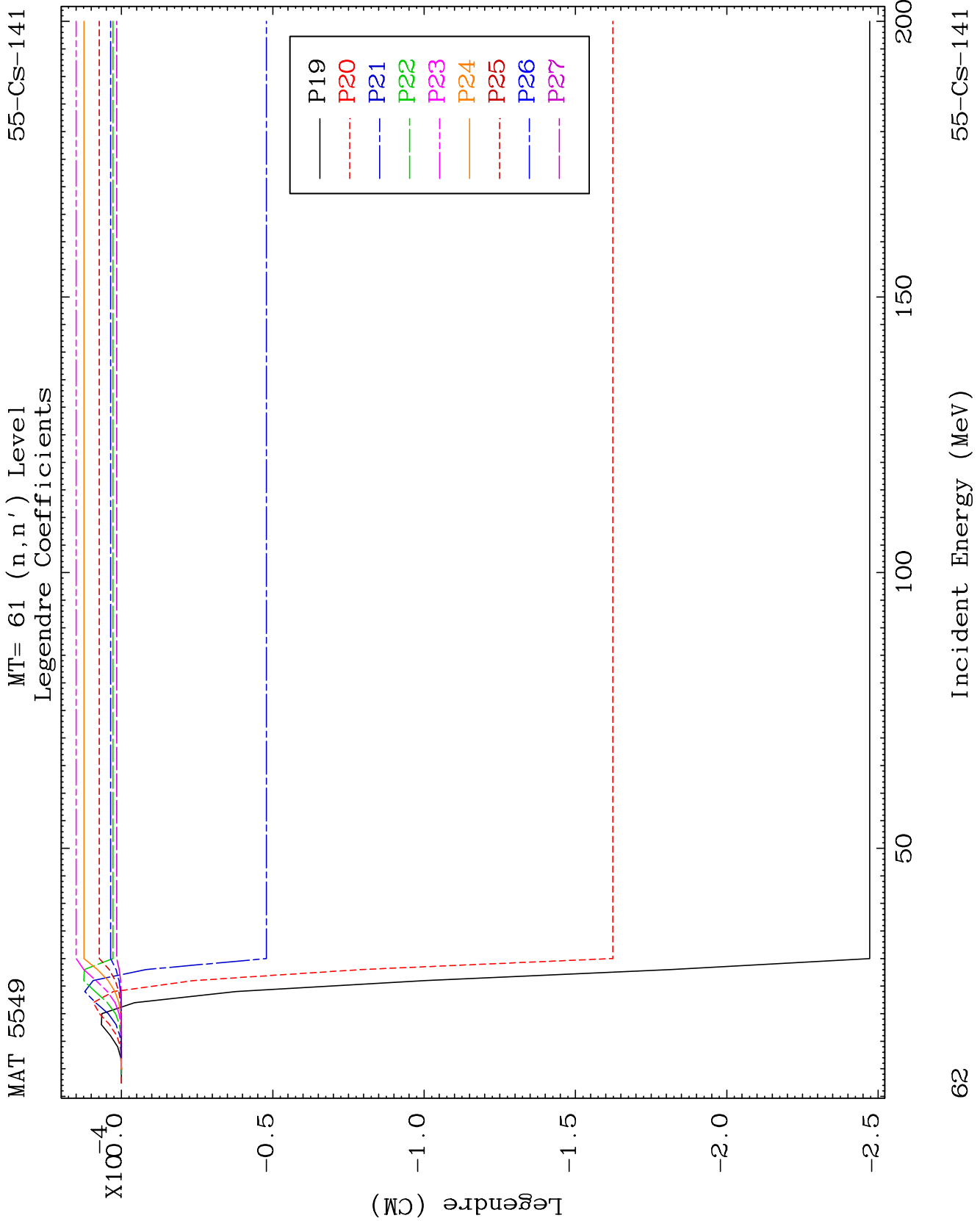

MAT 5549

MT= 61 (n,n') Level
Legendre Coefficients

55-Cs-141

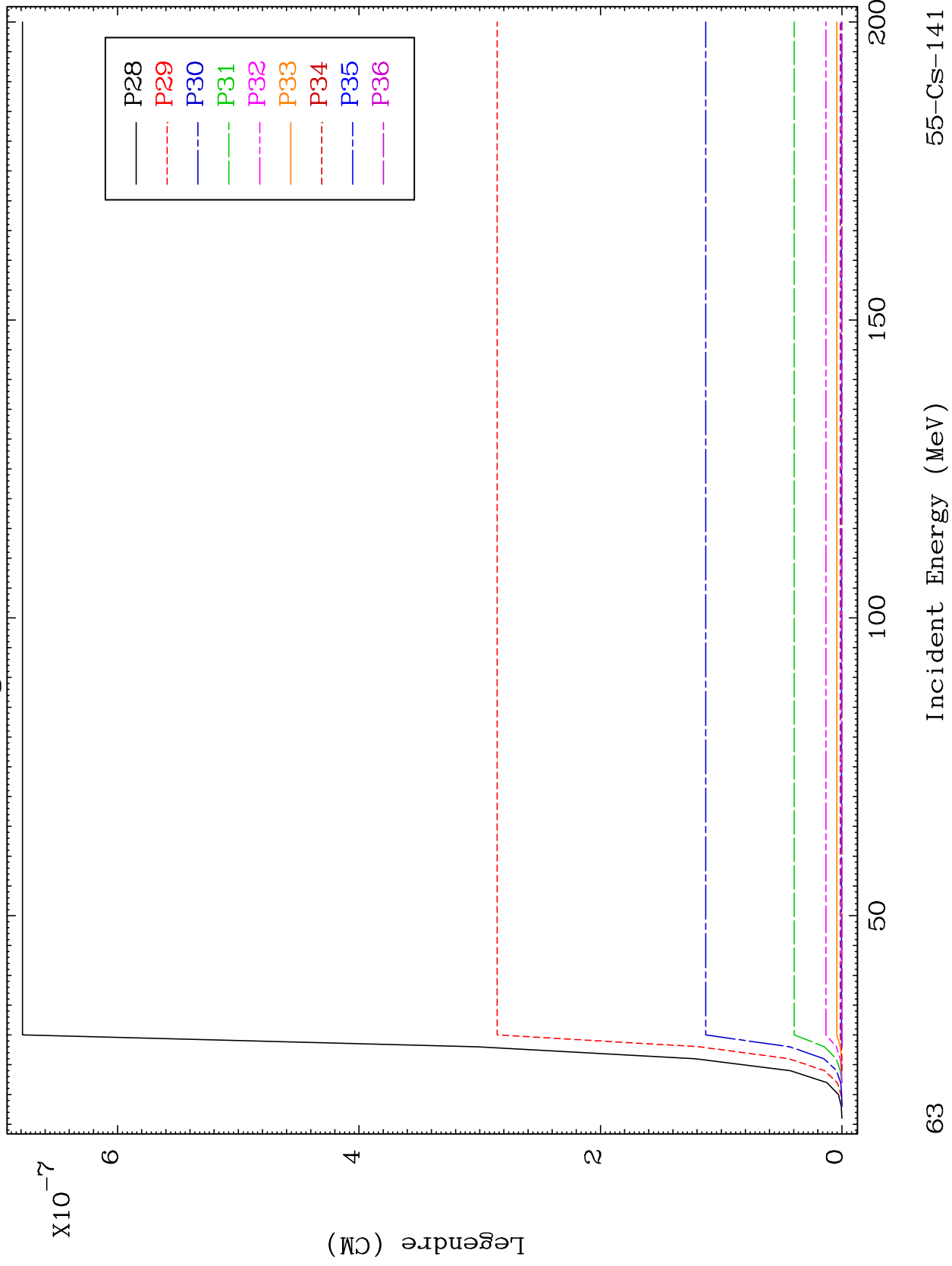

MAT 5549

MT= 62 (n,n') Level
Legendre Coefficients

55-Cs-141

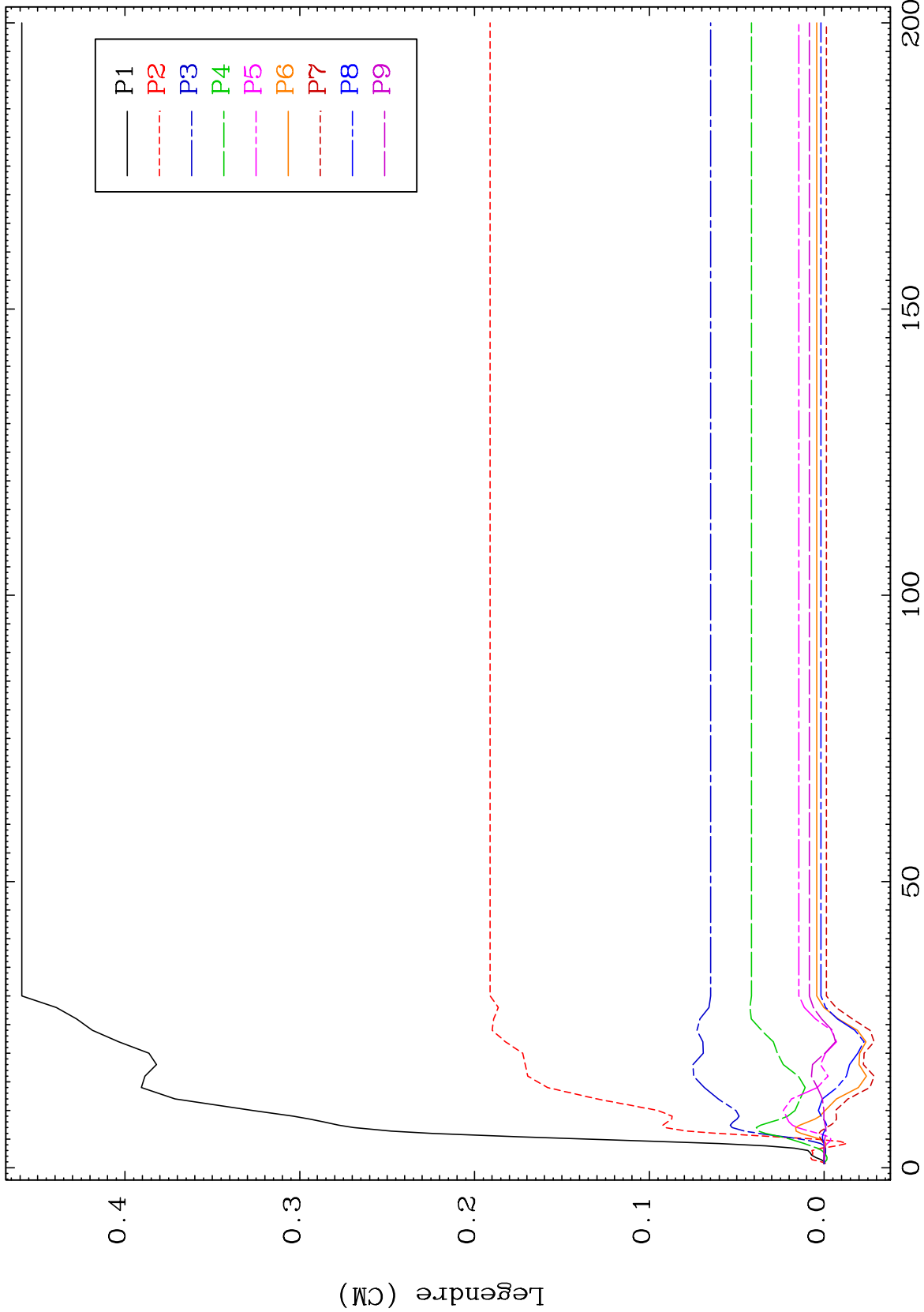

64

Incident Energy (MeV)

55-Cs-141

MAT 5549

MT= 62 (n,n') Level
Legendre Coefficients

55-Cs-141

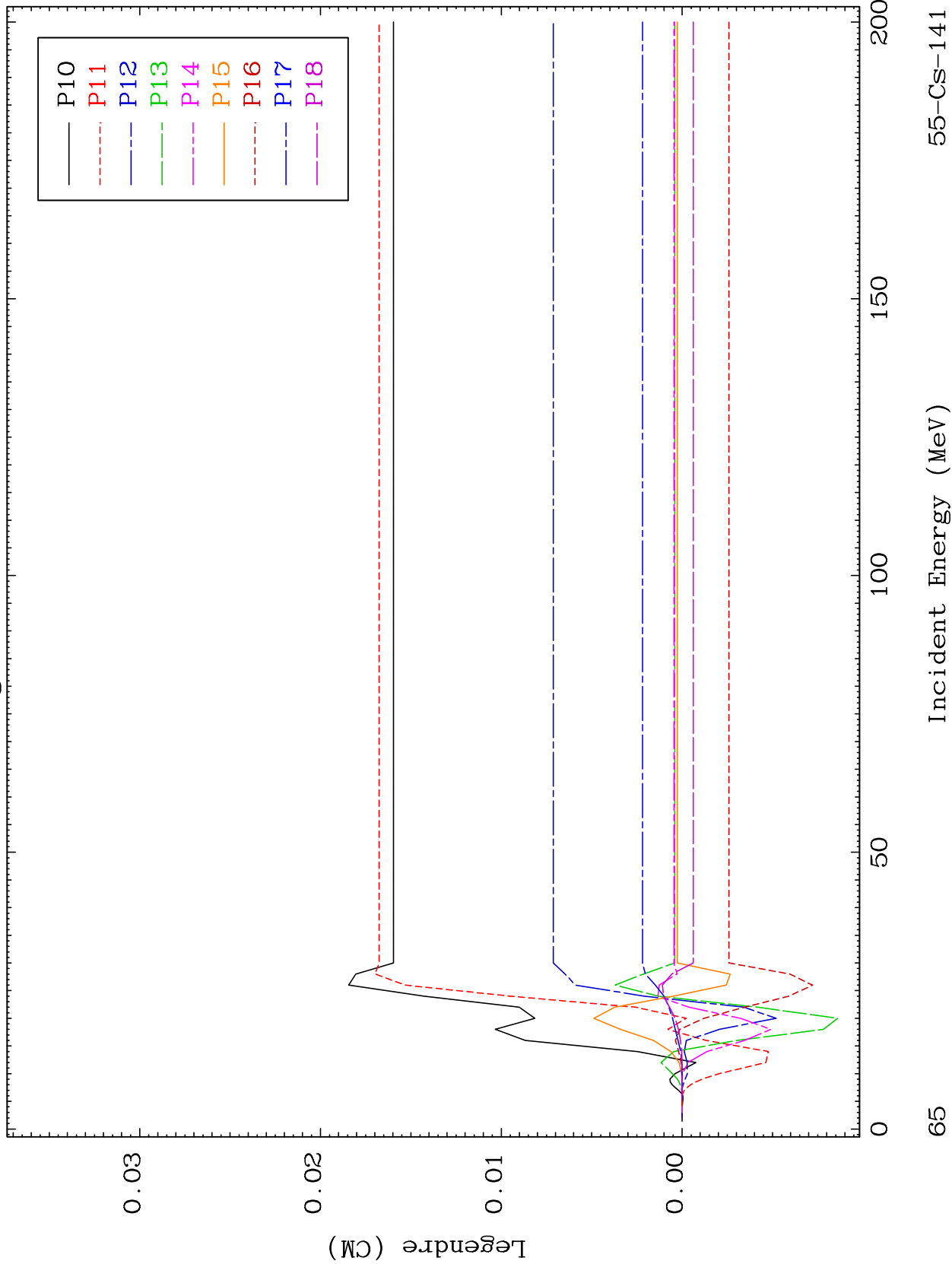

55-Cs-141

Incident Energy (MeV)

65

MAT 5549

MT= 62 (n,n') Level
Legendre Coefficients

55-Cs-141

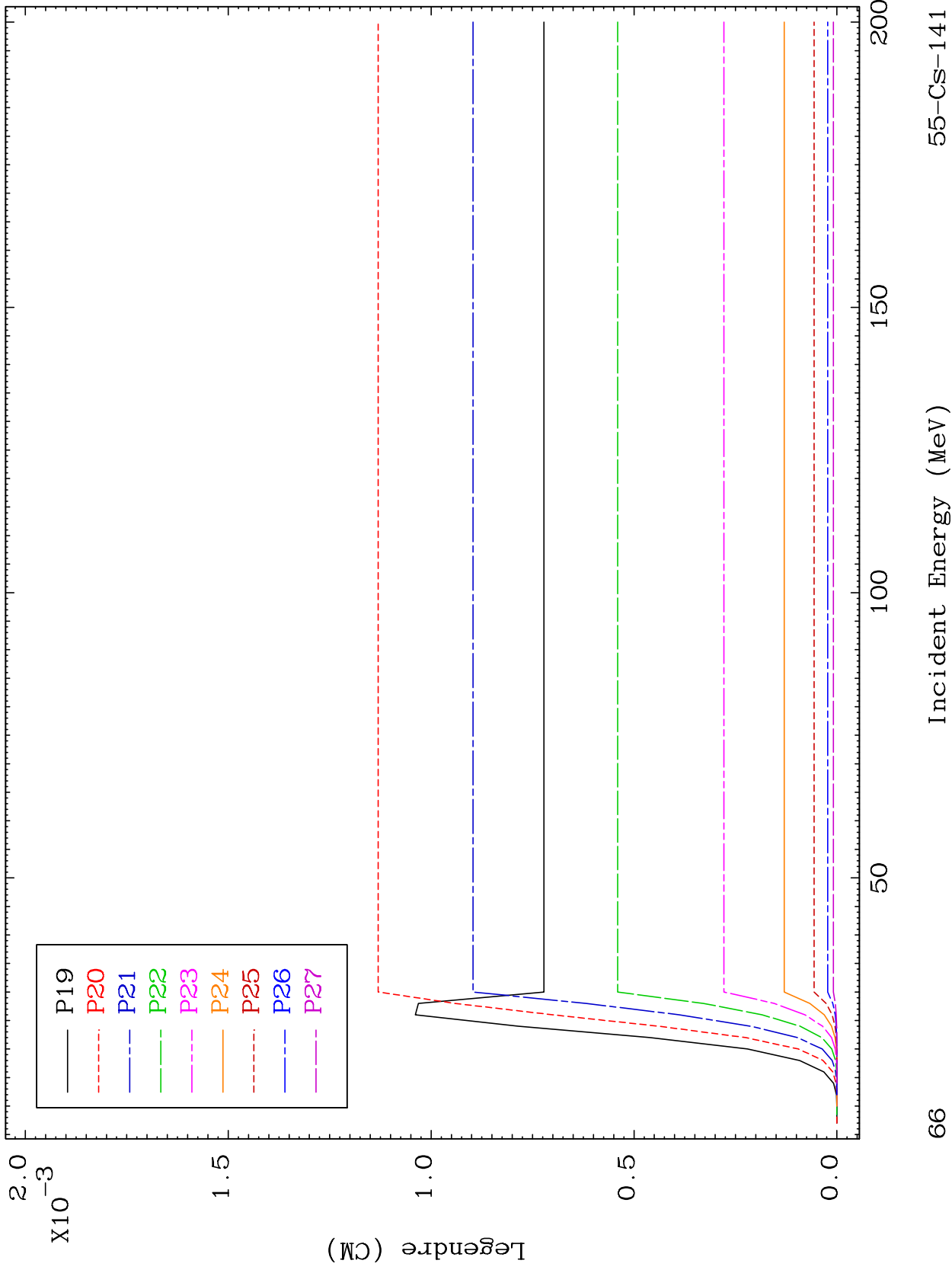

MAT 5549

MT= 62 (n,n') Level
Legendre Coefficients

55-Cs-141

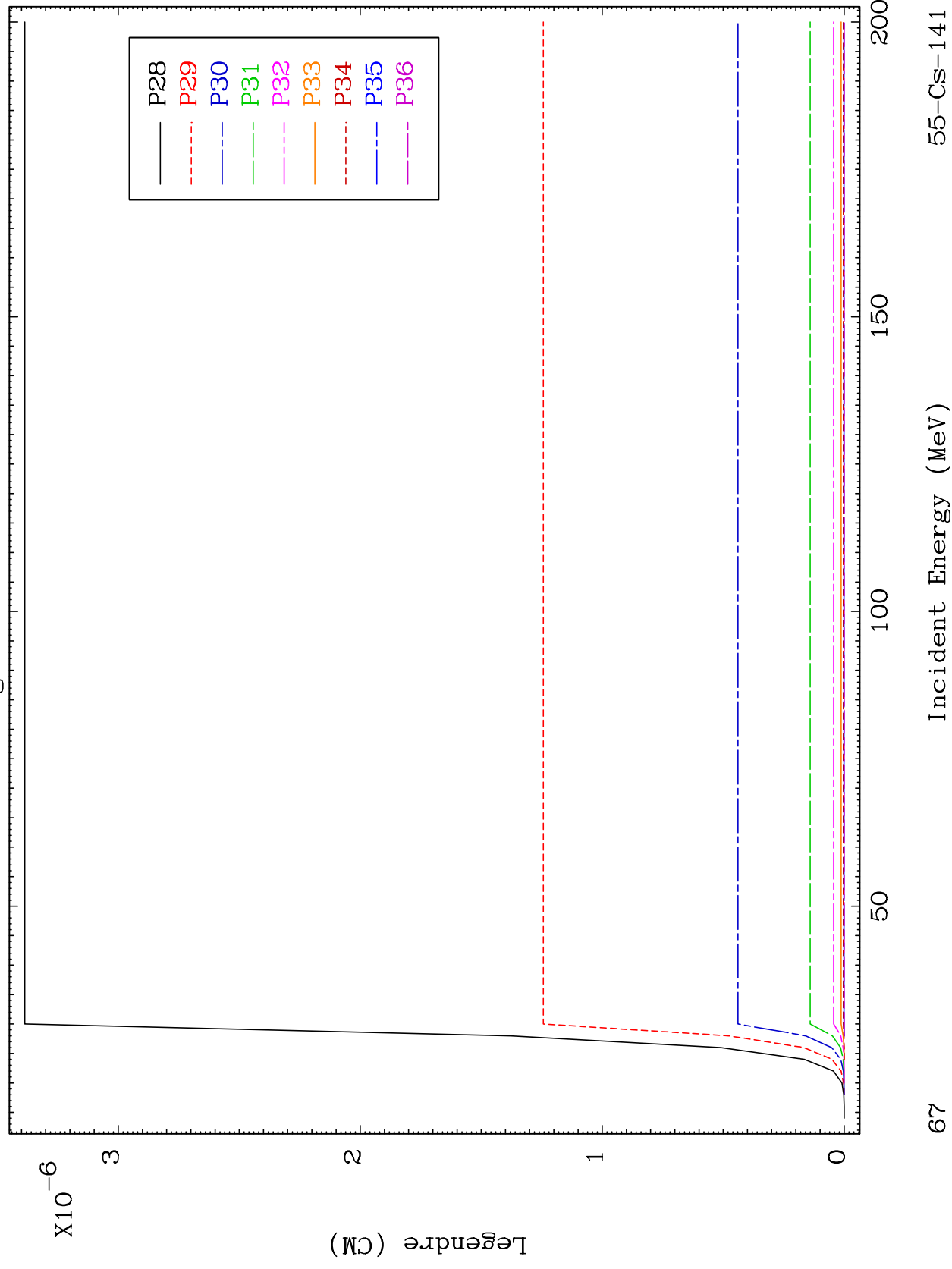

MAT 5549

MT= 63 (n,n') Level
Legendre Coefficients

55-Cs-141

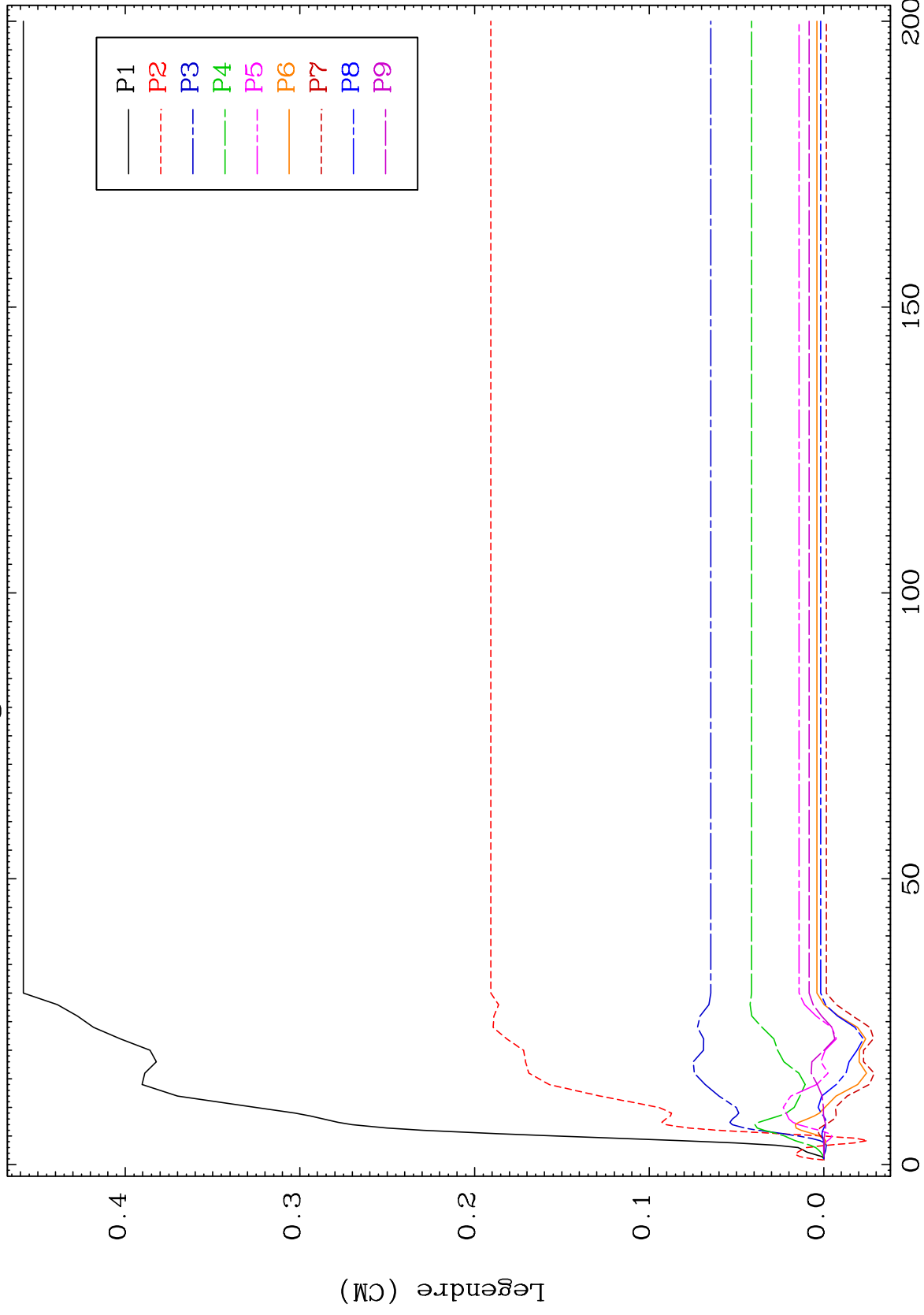

68

Incident Energy (MeV)

55-Cs-141

MAT 5549

MT= 63 (n,n') Level
Legendre Coefficients

55-Cs-141

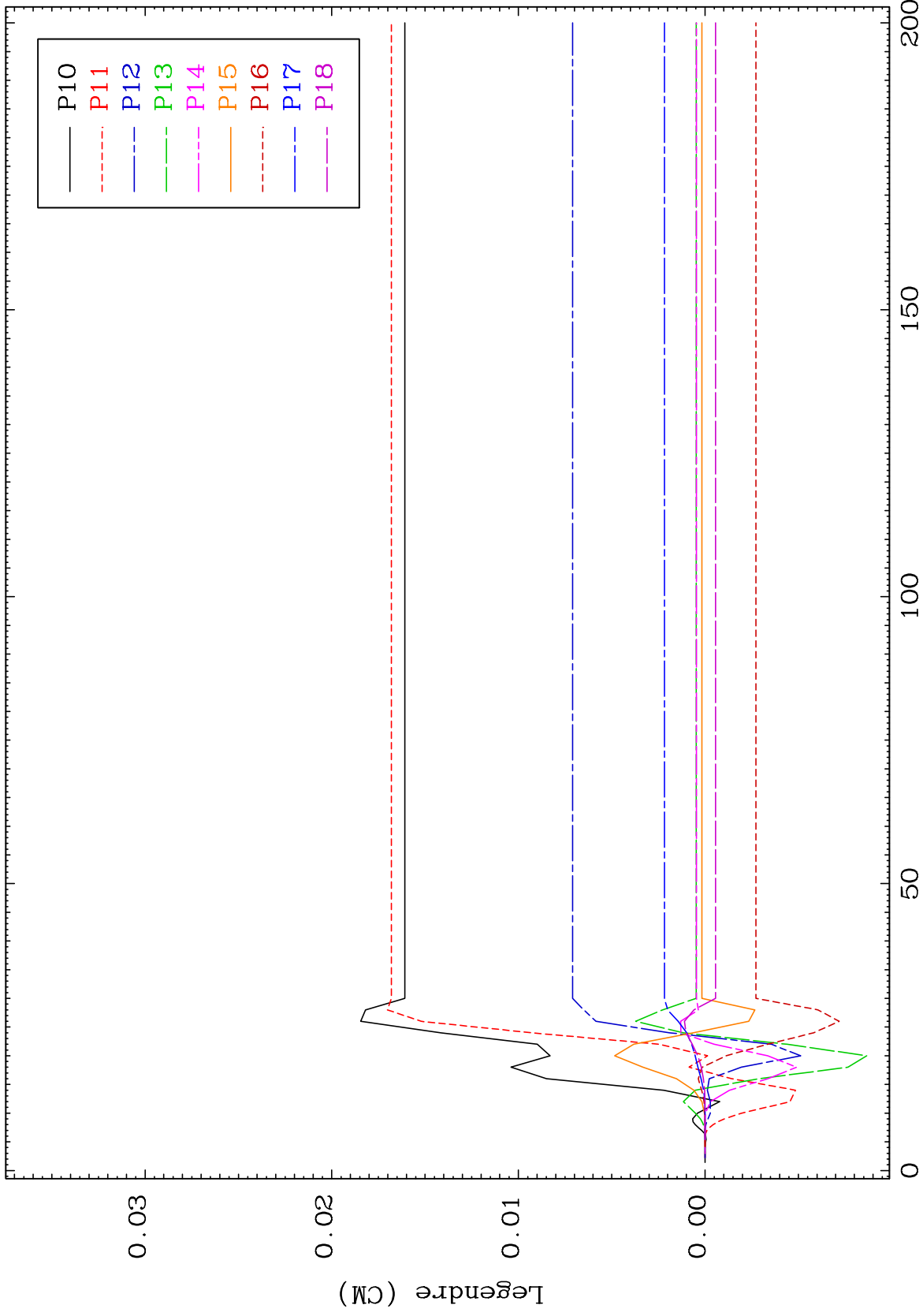

69

55-Cs-141

55-Cs-141

MAT 5549

MT= 63 (n,n') Level
Legendre Coefficients

55-Cs-141

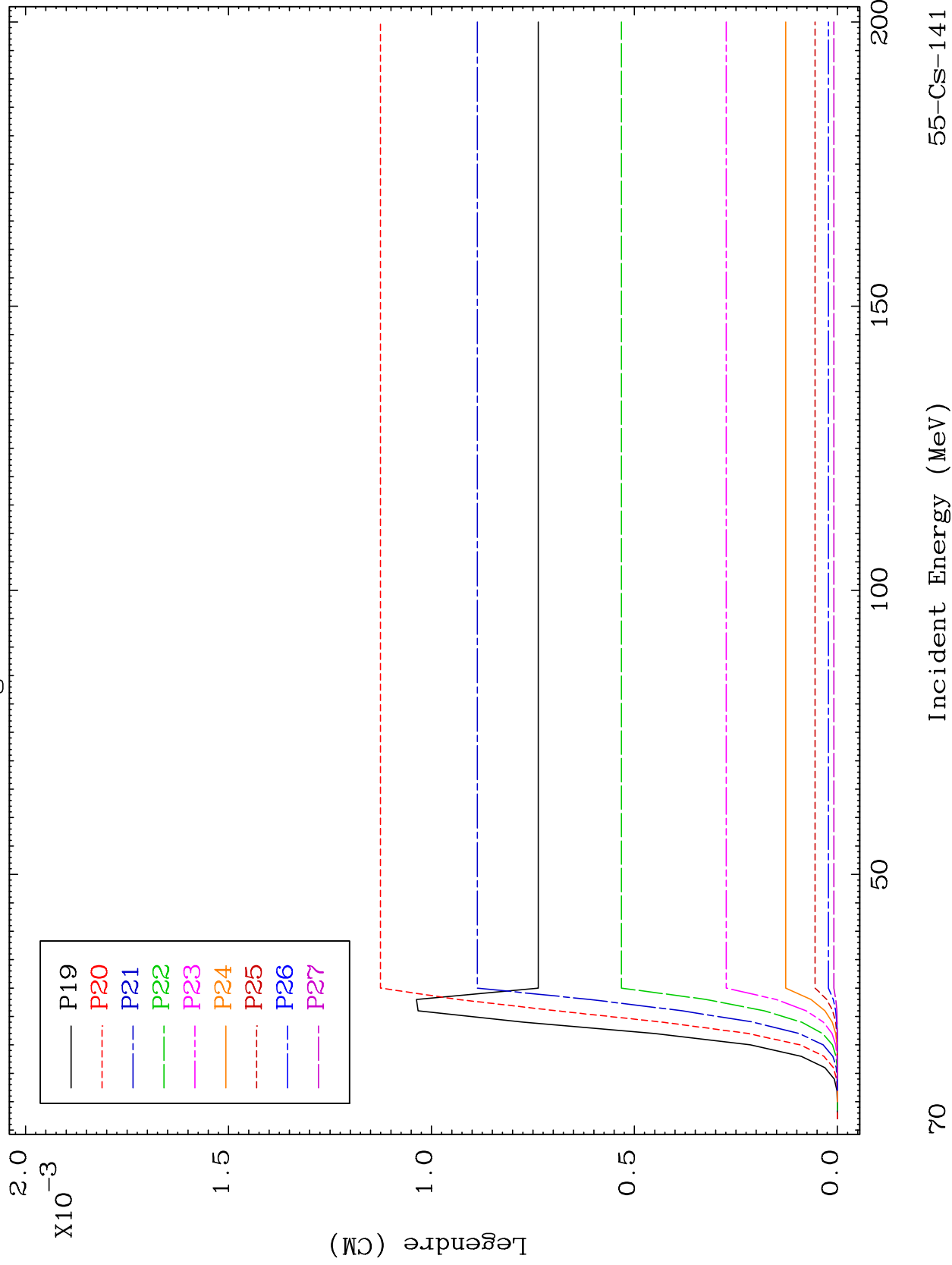

MAT 5549

MT= 63 (n,n') Level
Legendre Coefficients

55-Cs-141

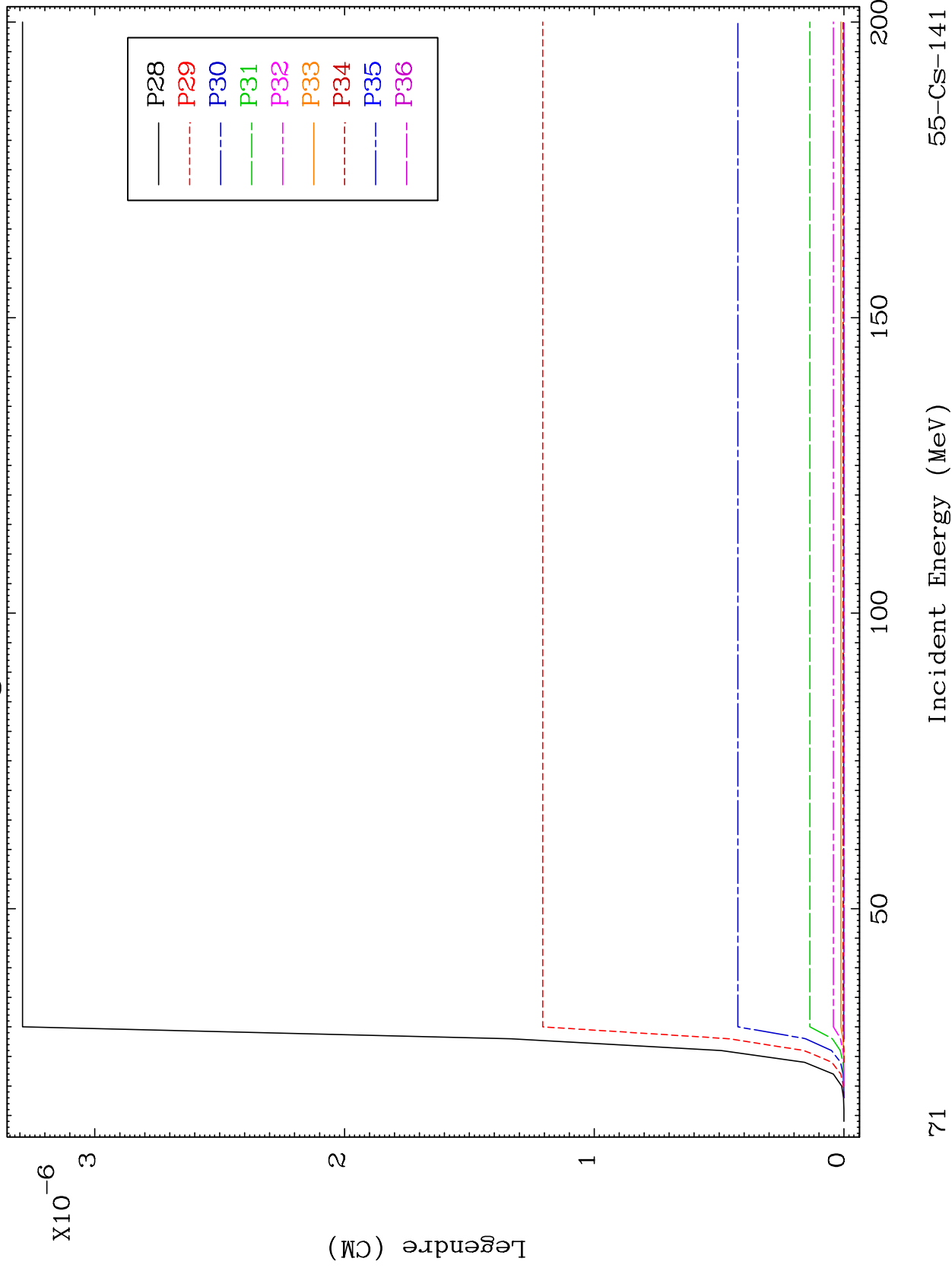

MAT 5549

MT= 64 (n,n') Level
Legendre Coefficients

55-Cs-141

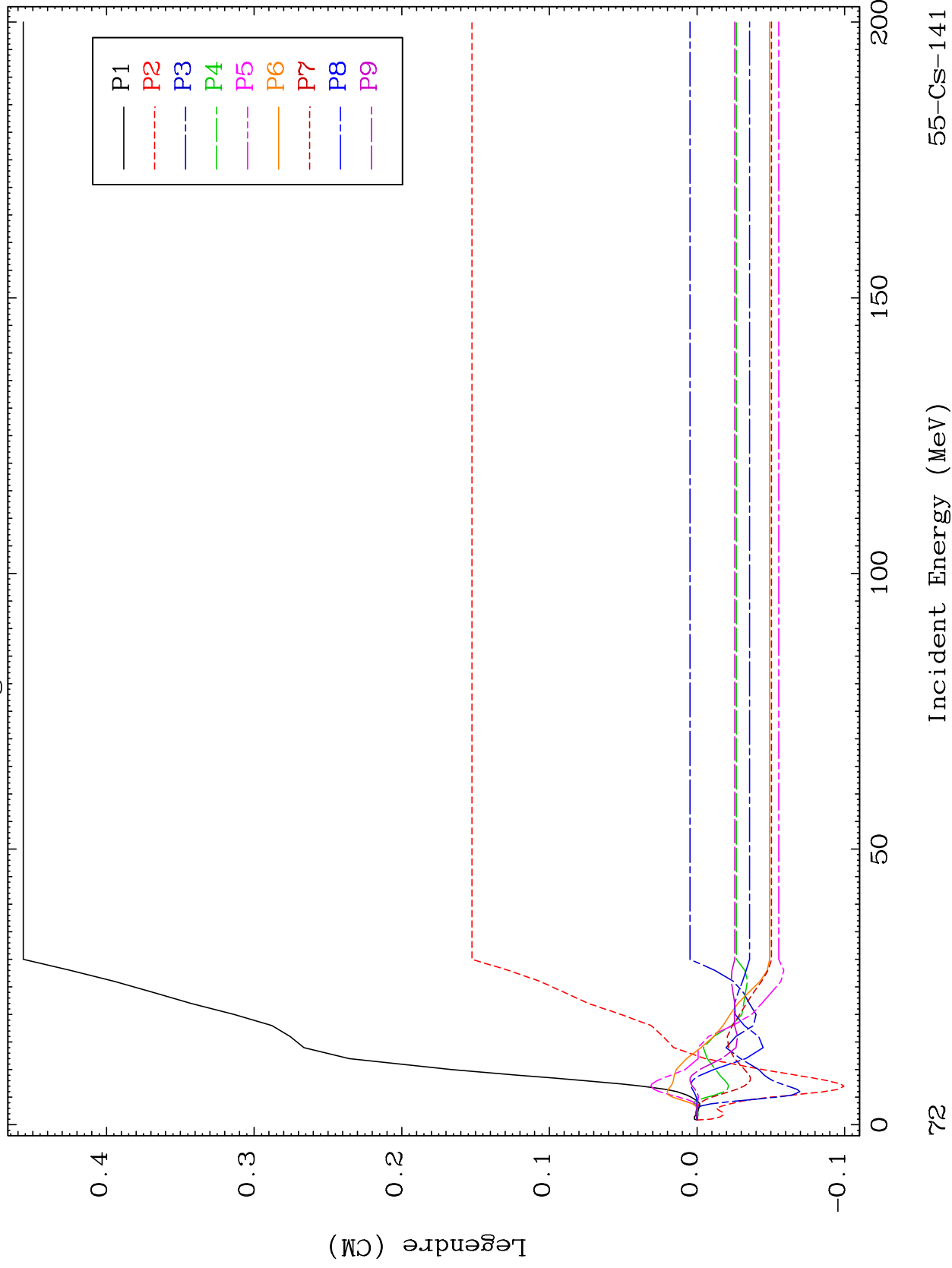

55-Cs-141

Incident Energy (MeV)

72

MAT 5549

MT= 64 (n,n') Level
Legendre Coefficients

55-Cs-141

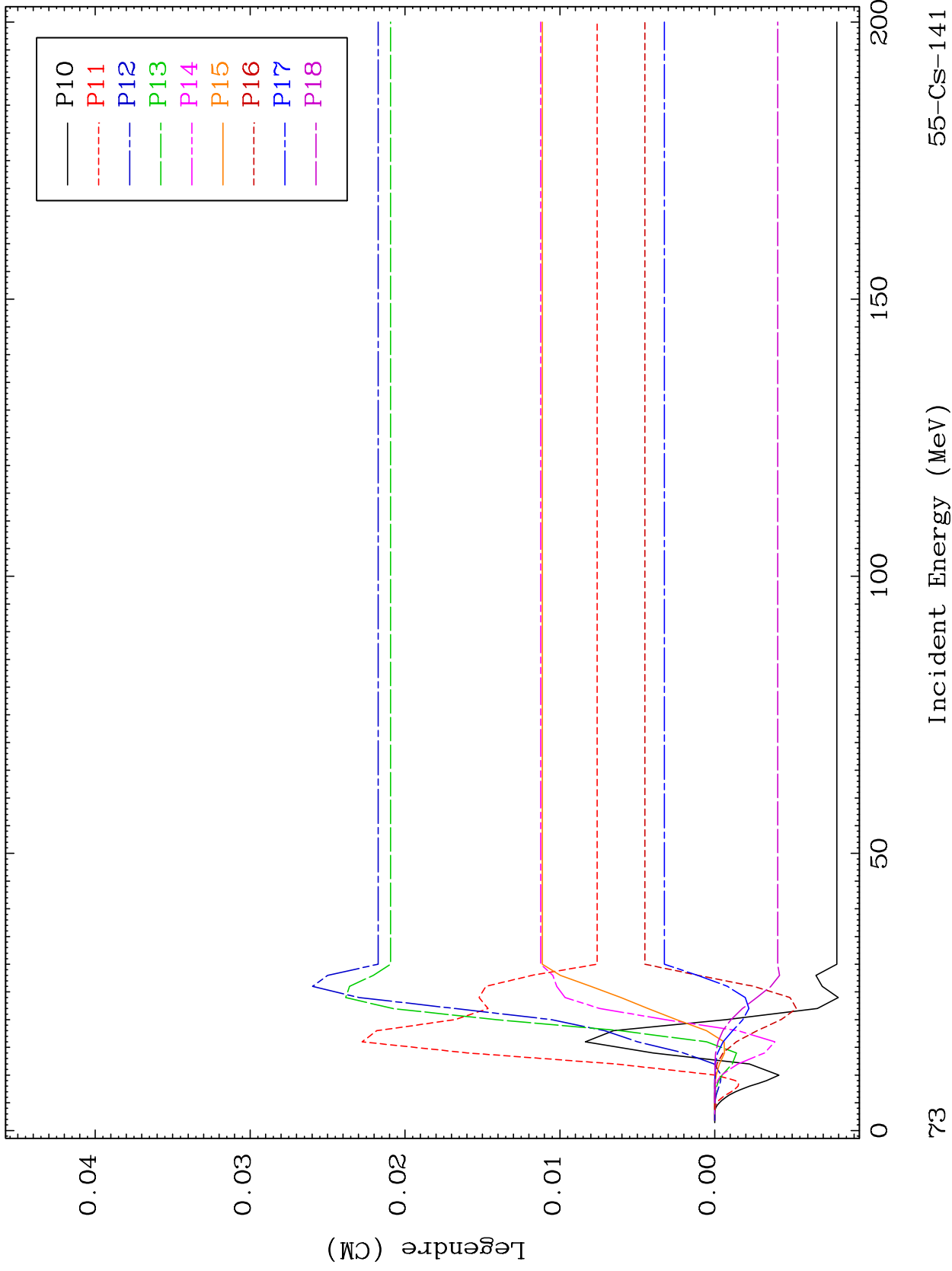

73

Incident Energy (MeV)

55-Cs-141

MAT 5549

MT= 64 (n,n') Level
Legendre Coefficients

55-Cs-141

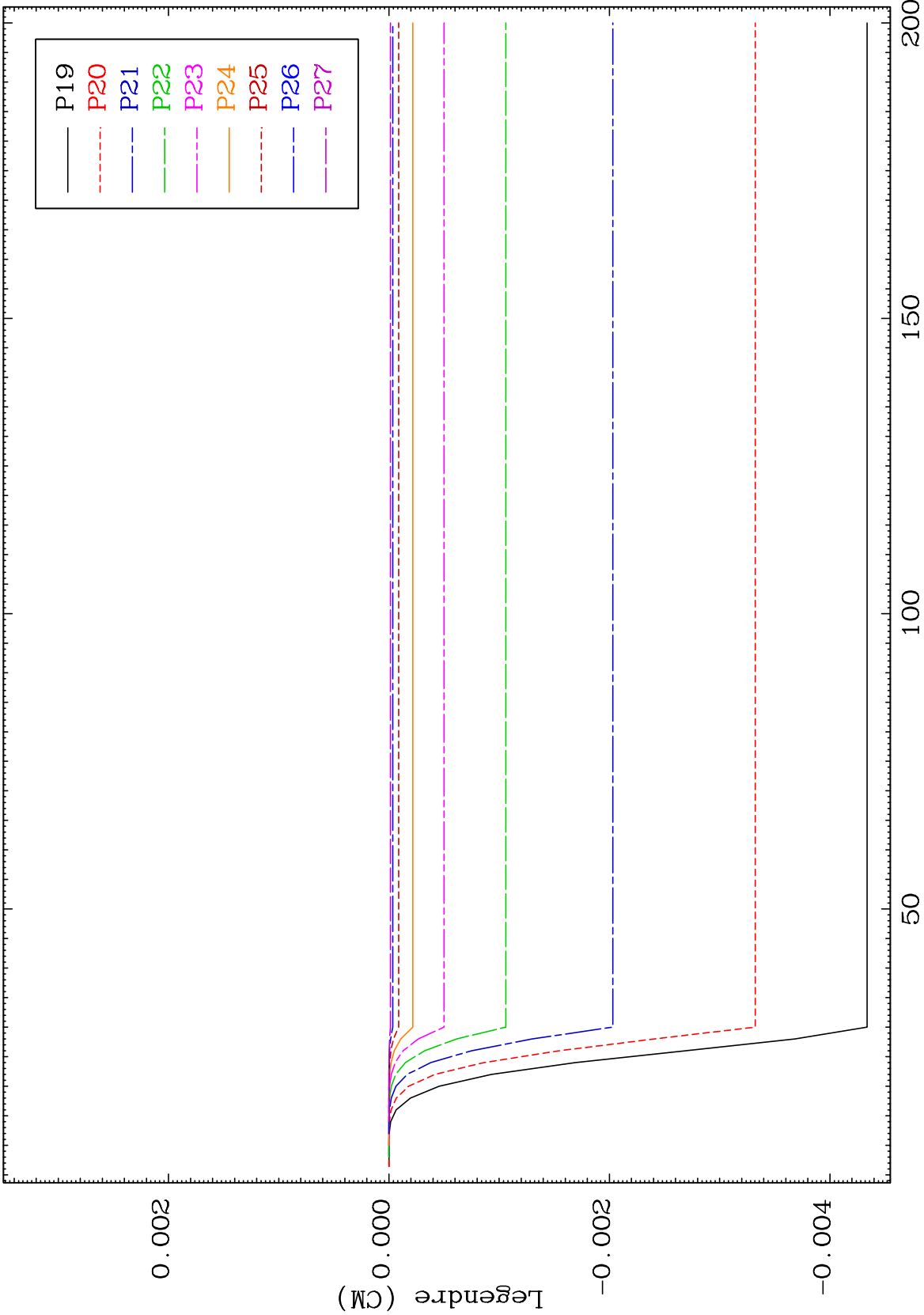

74

Incident Energy (MeV)

55-Cs-141

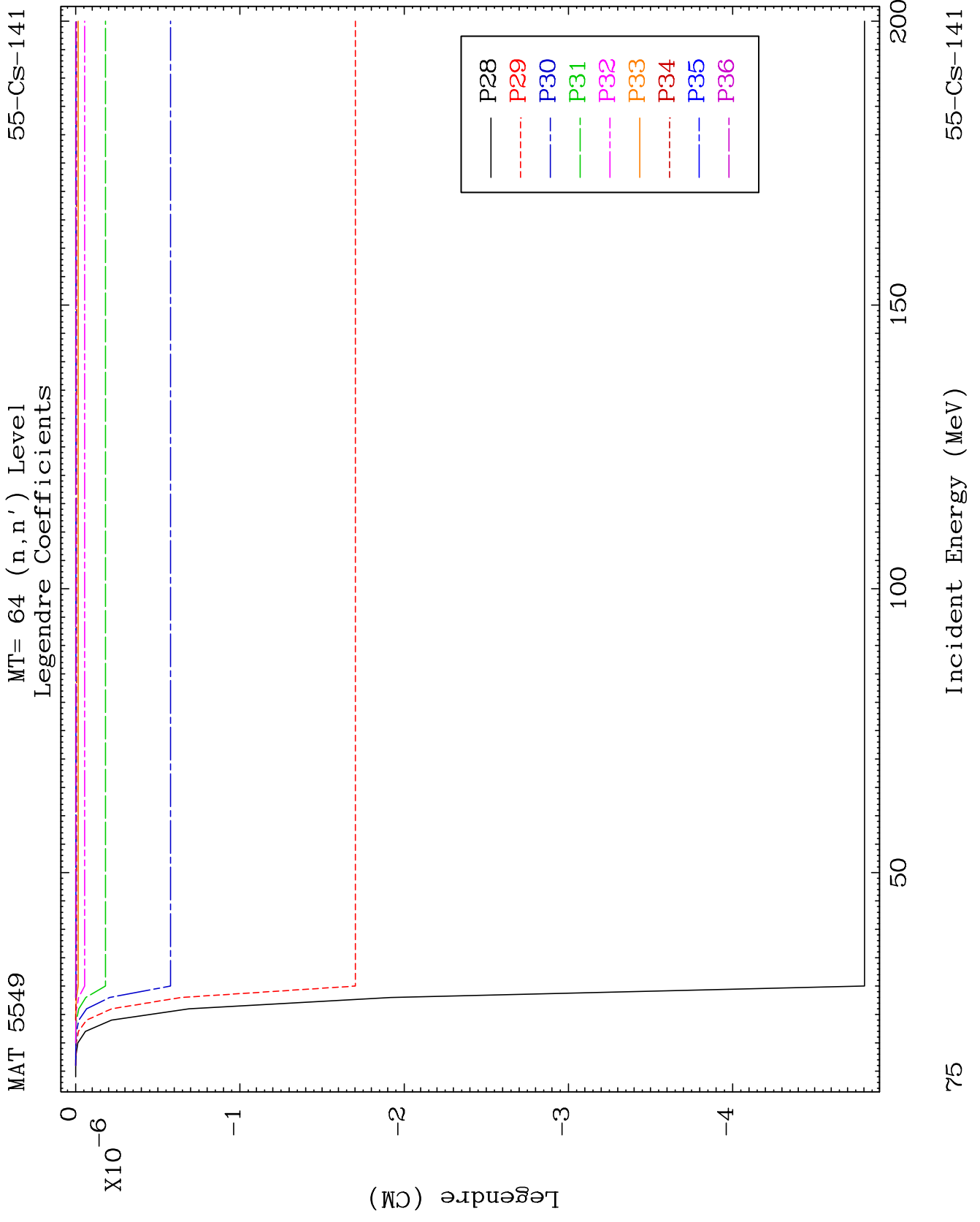

MAT 5549

MT= 65 (n,n') Level
Legendre Coefficients

55-Cs-141

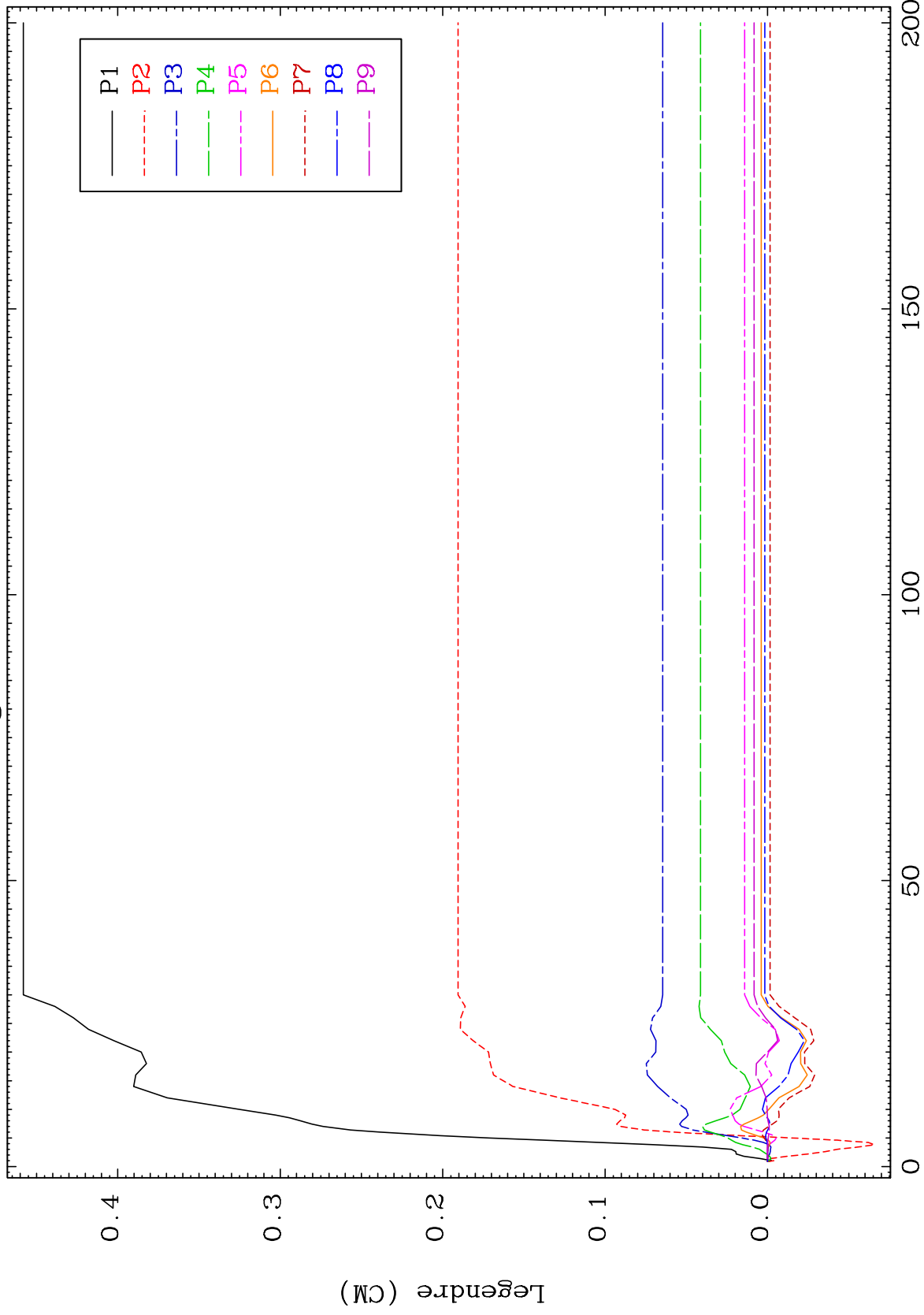

76

55-Cs-141

55-Cs-141

MAT 5549

MT= 65 (n,n') Level
Legendre Coefficients

55-Cs-141

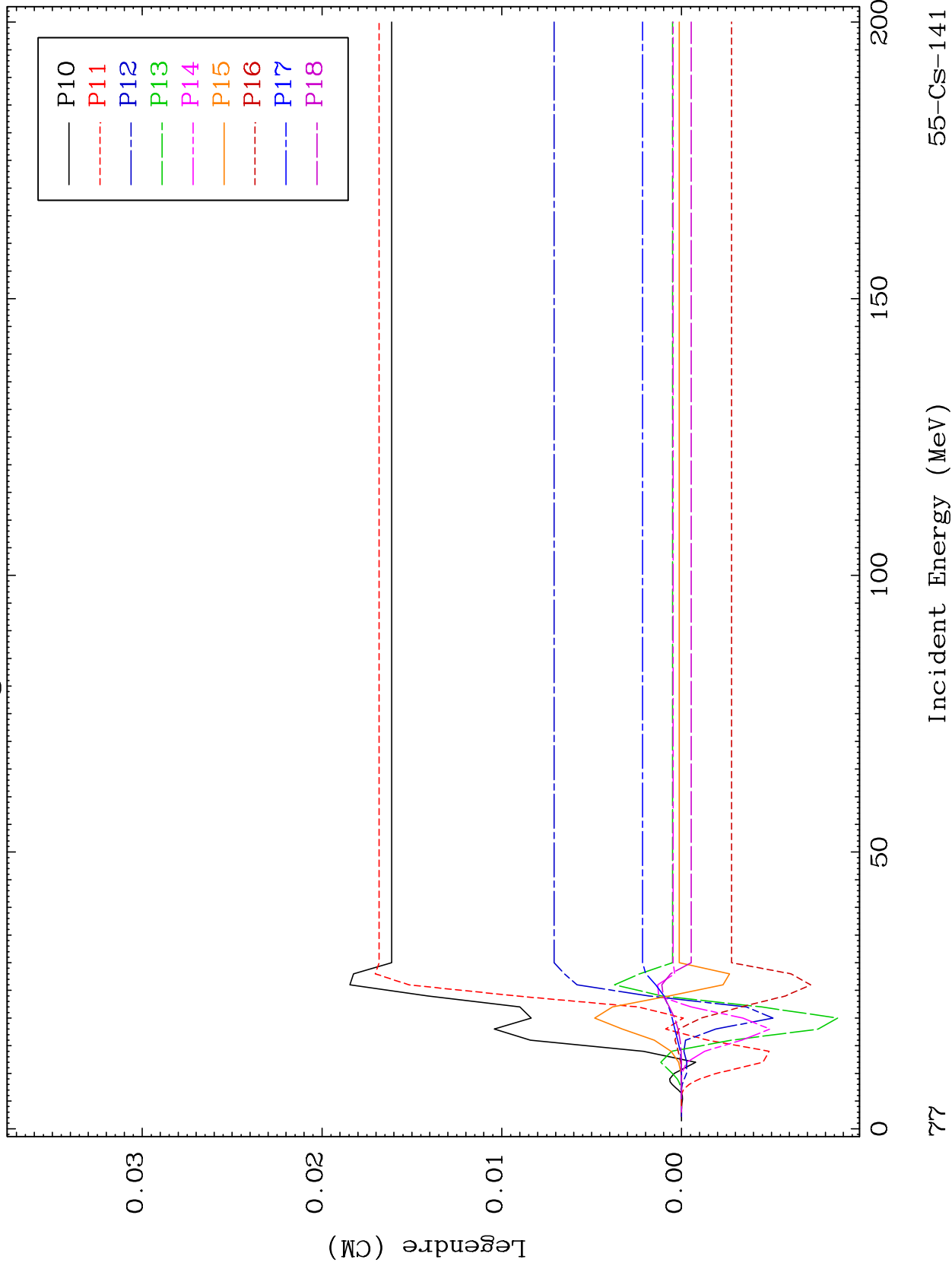

55-Cs-141

Incident Energy (MeV)

77

MAT 5549

MT= 65 (n,n') Level
Legendre Coefficients

55-Cs-141

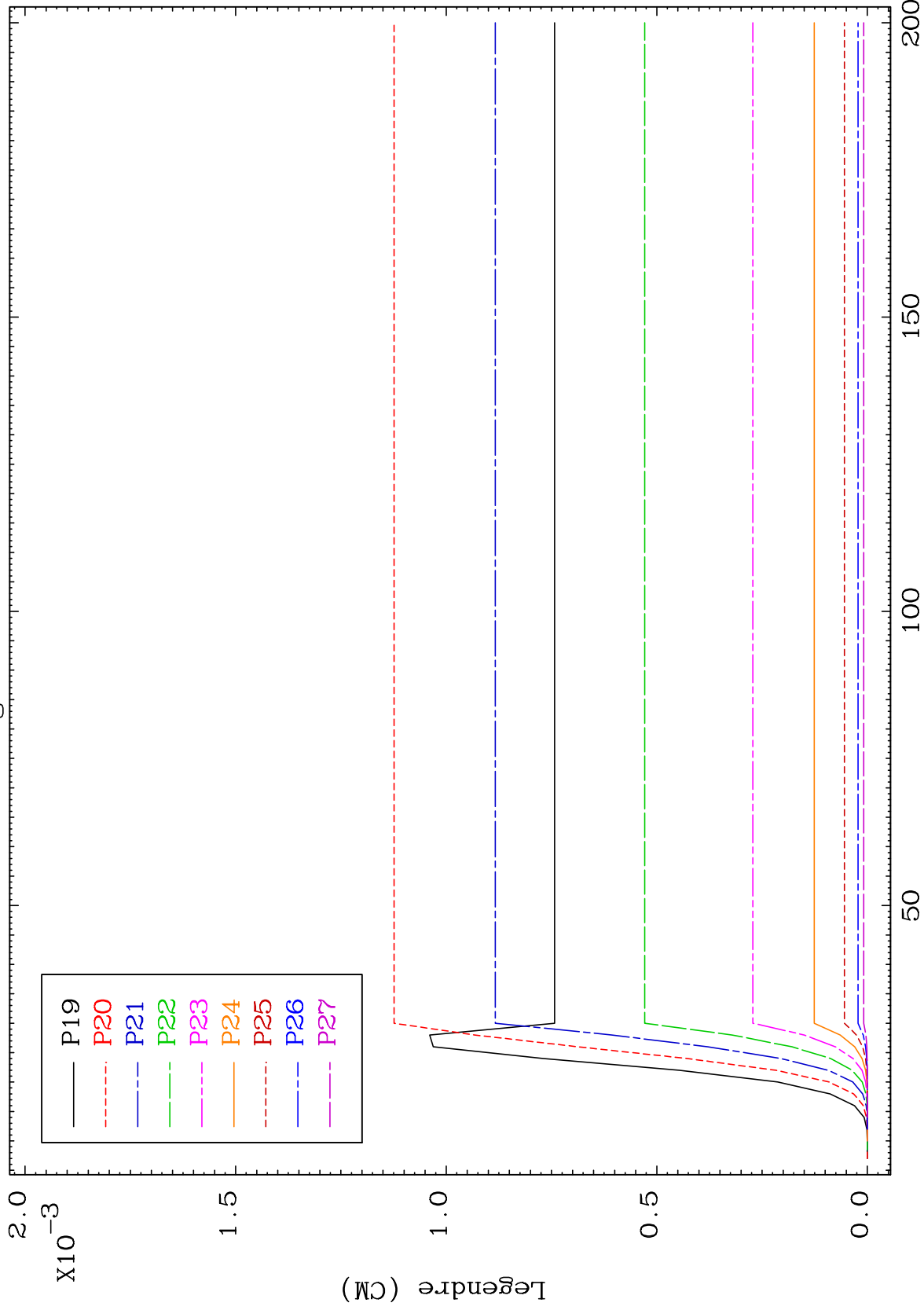

78

Incident Energy (MeV)

55-Cs-141

200

150

100

50

MAT 5549

MT= 65 (n,n') Level
Legendre Coefficients

55-Cs-141

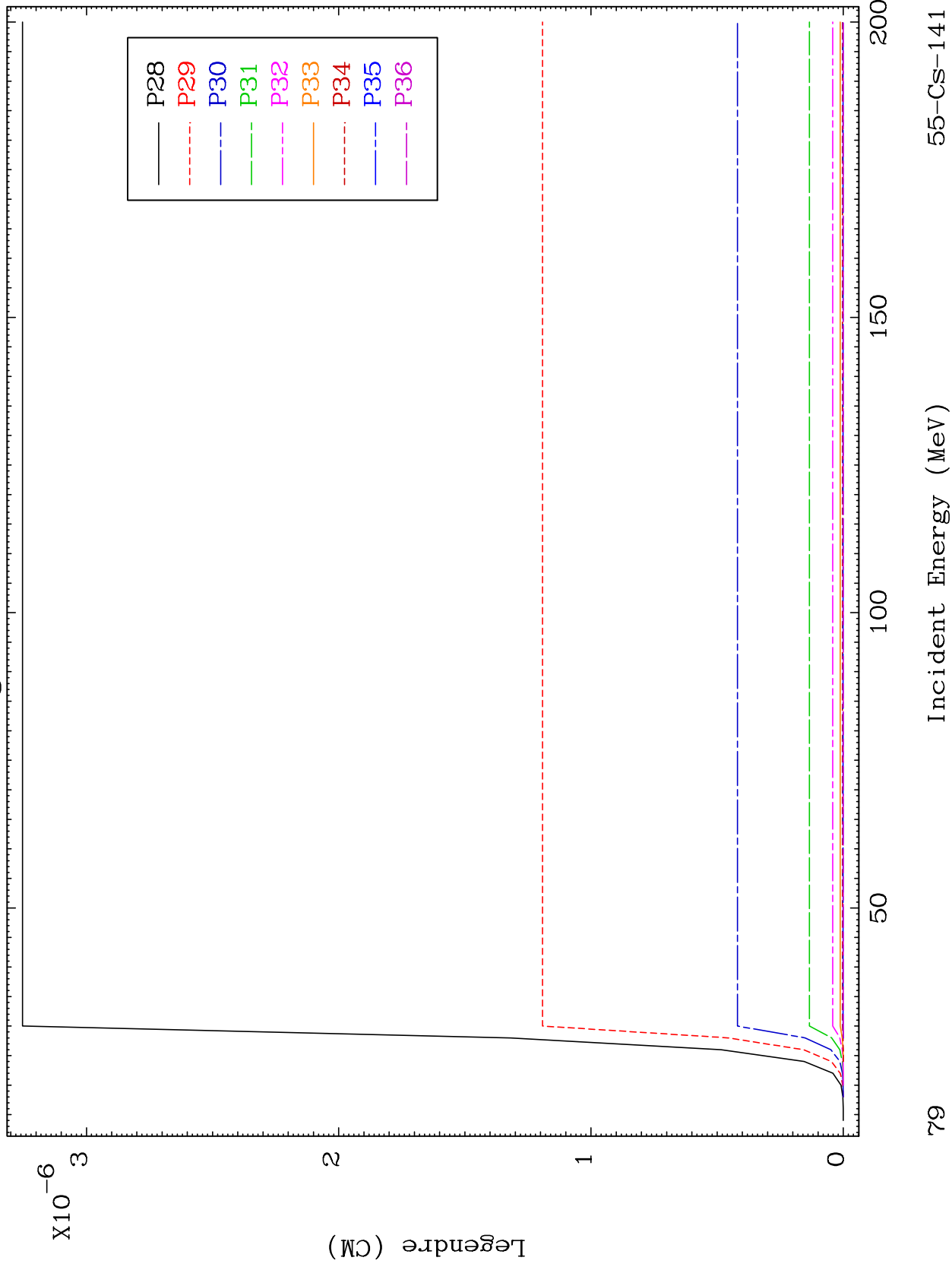

79

55-Cs-141

MAT 5549

MT= 66 (n,n') Level
Legendre Coefficients

55-Cs-141

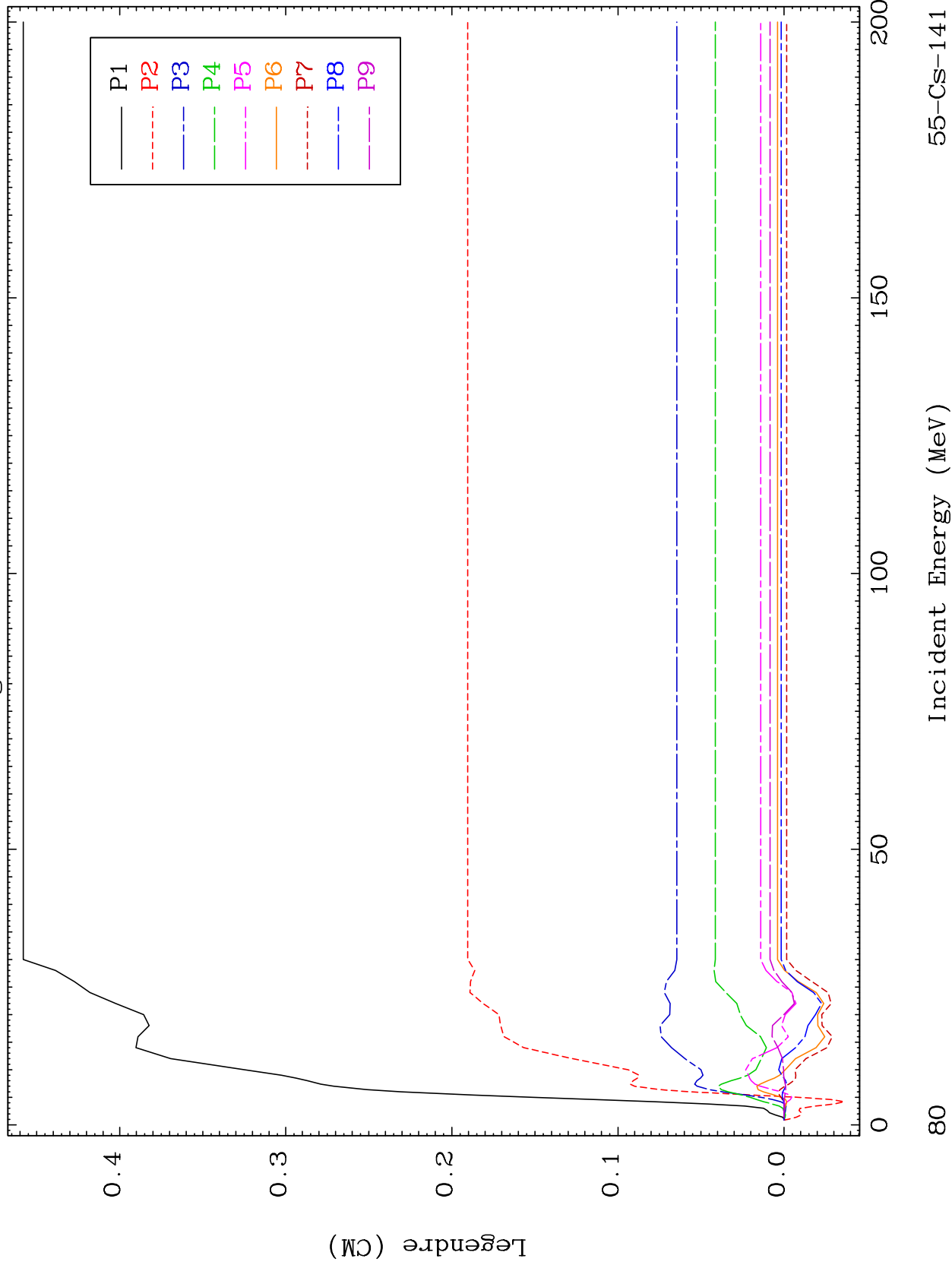

MAT 5549

MT= 66 (n,n') Level Legendre Coefficients

55-Cs-141

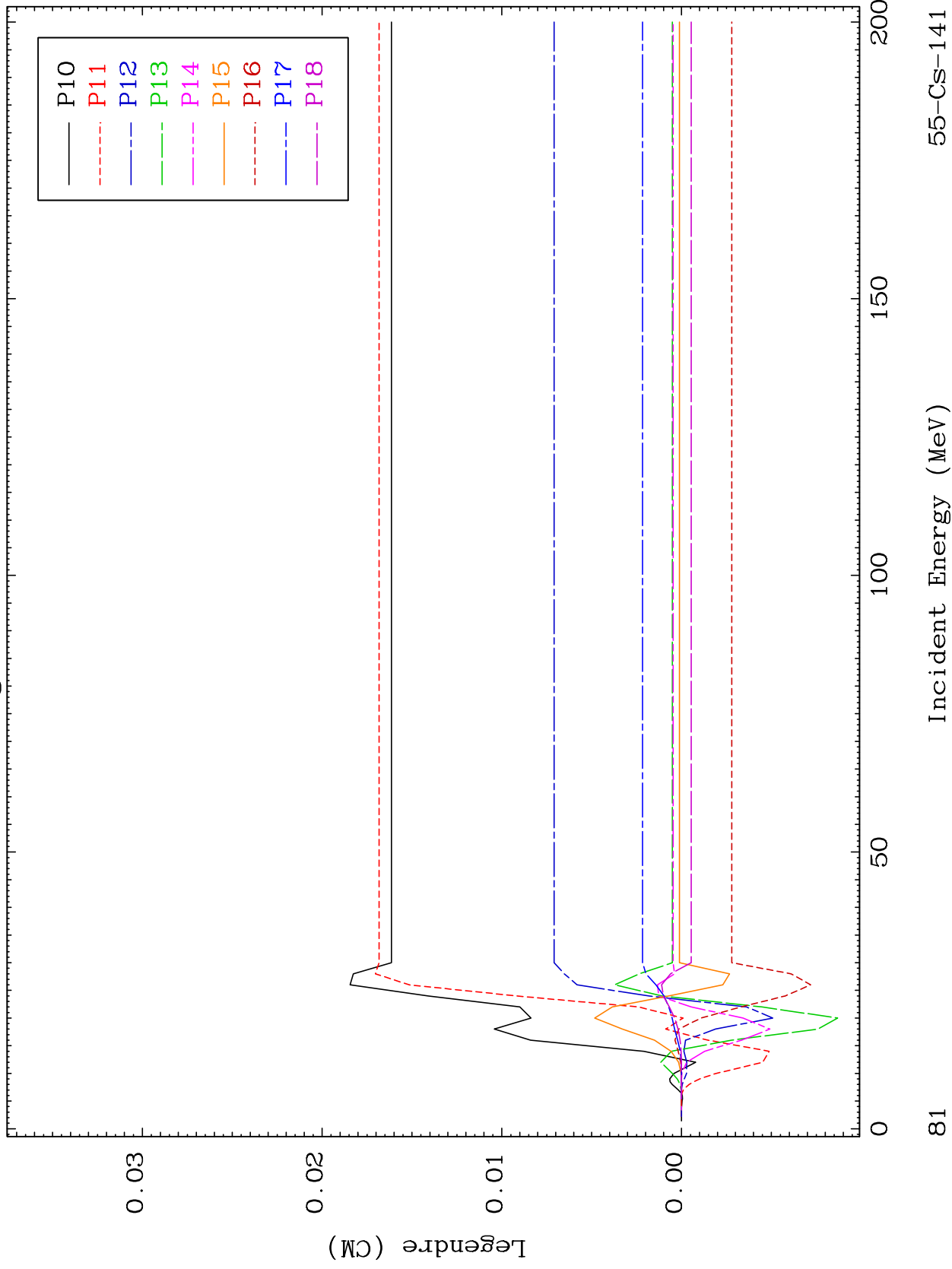

81

Incident Energy (MeV)

55-Cs-141

MAT 5549

MT= 66 (n,n') Level
Legendre Coefficients

55-Cs-141

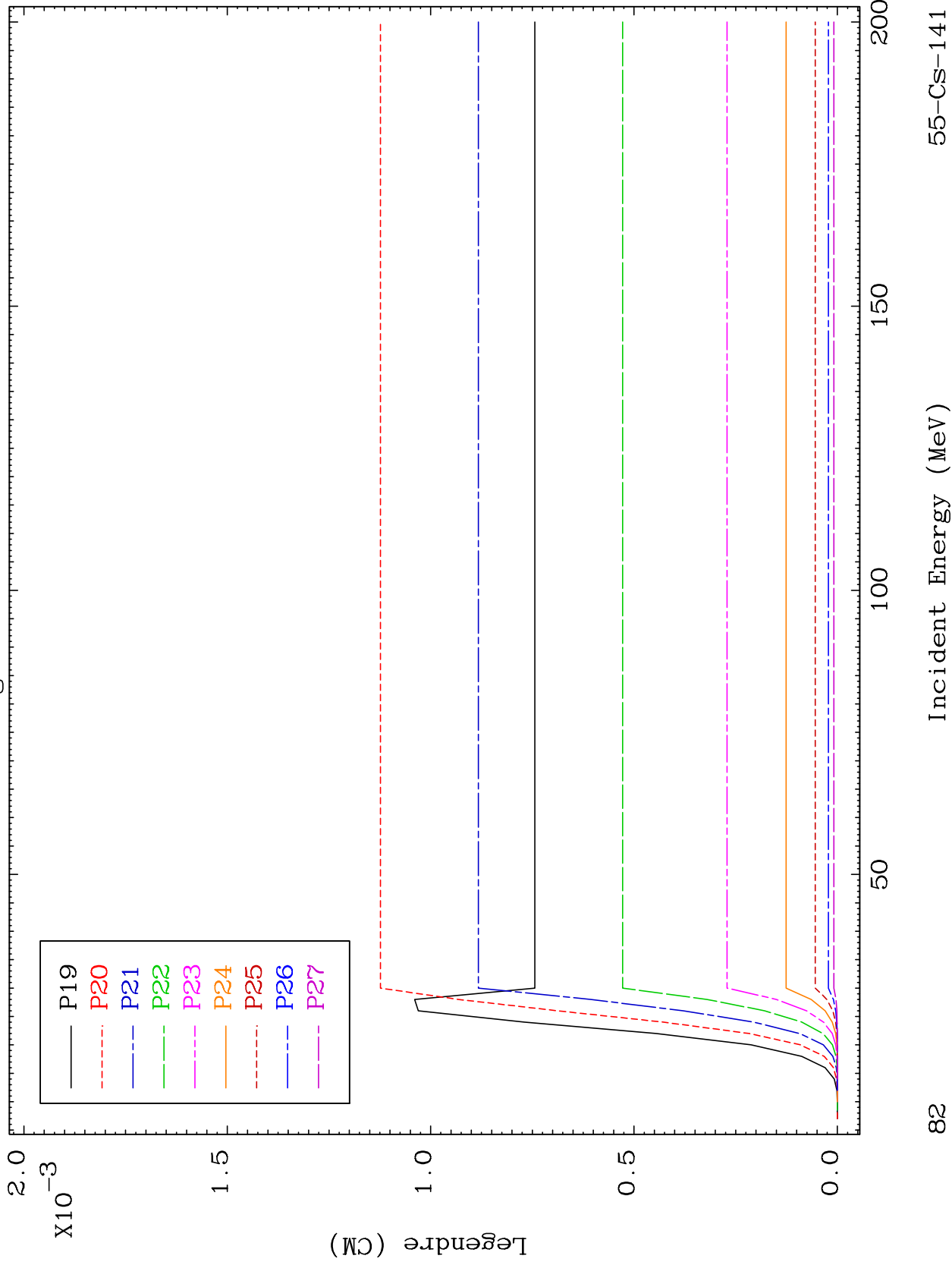

MAT 5549

MT= 66 (n,n') Level
Legendre Coefficients

55-Cs-141

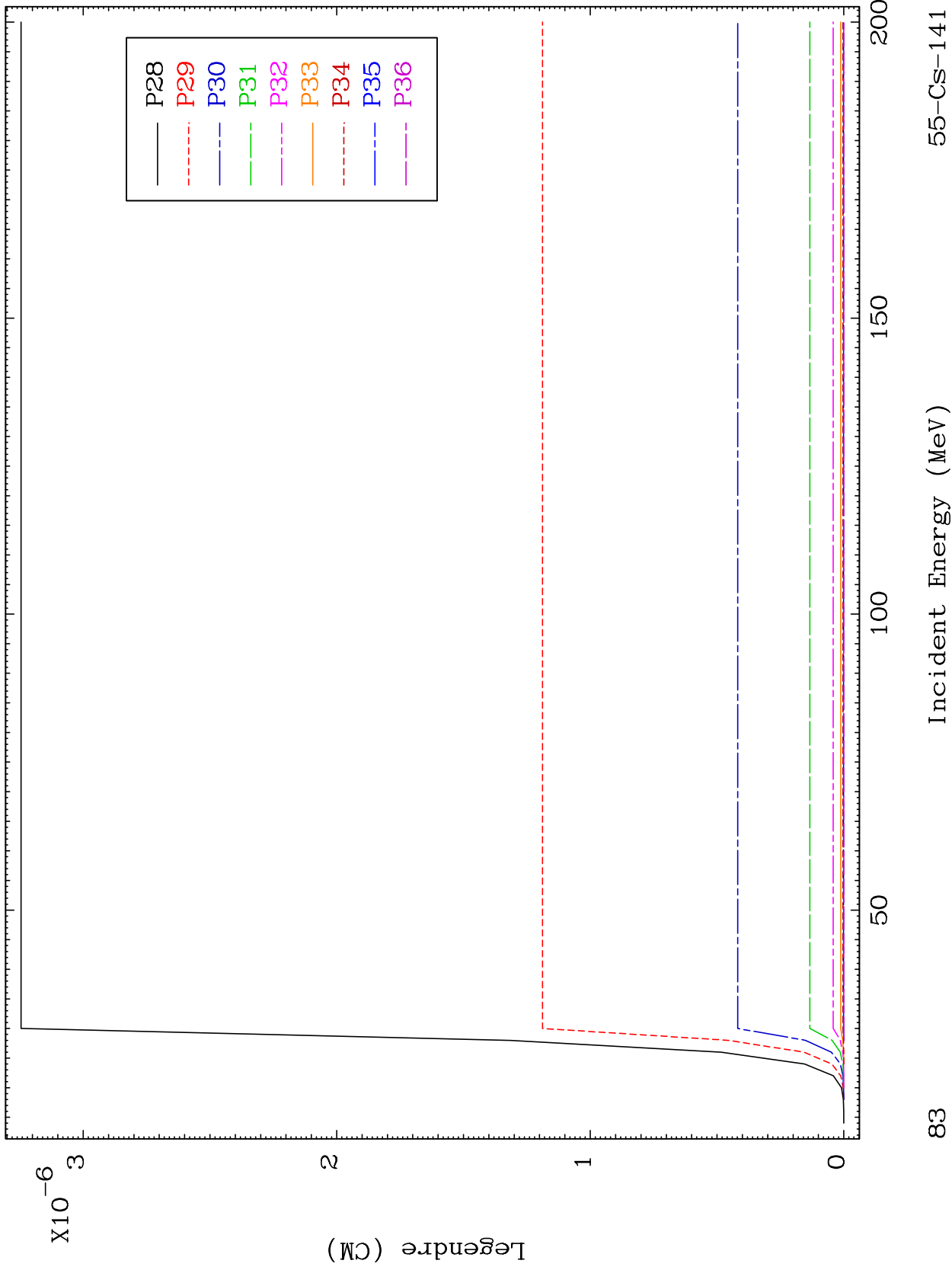

MAT 5549

MT= 67 (n,n') Level
Legendre Coefficients

55-Cs-141

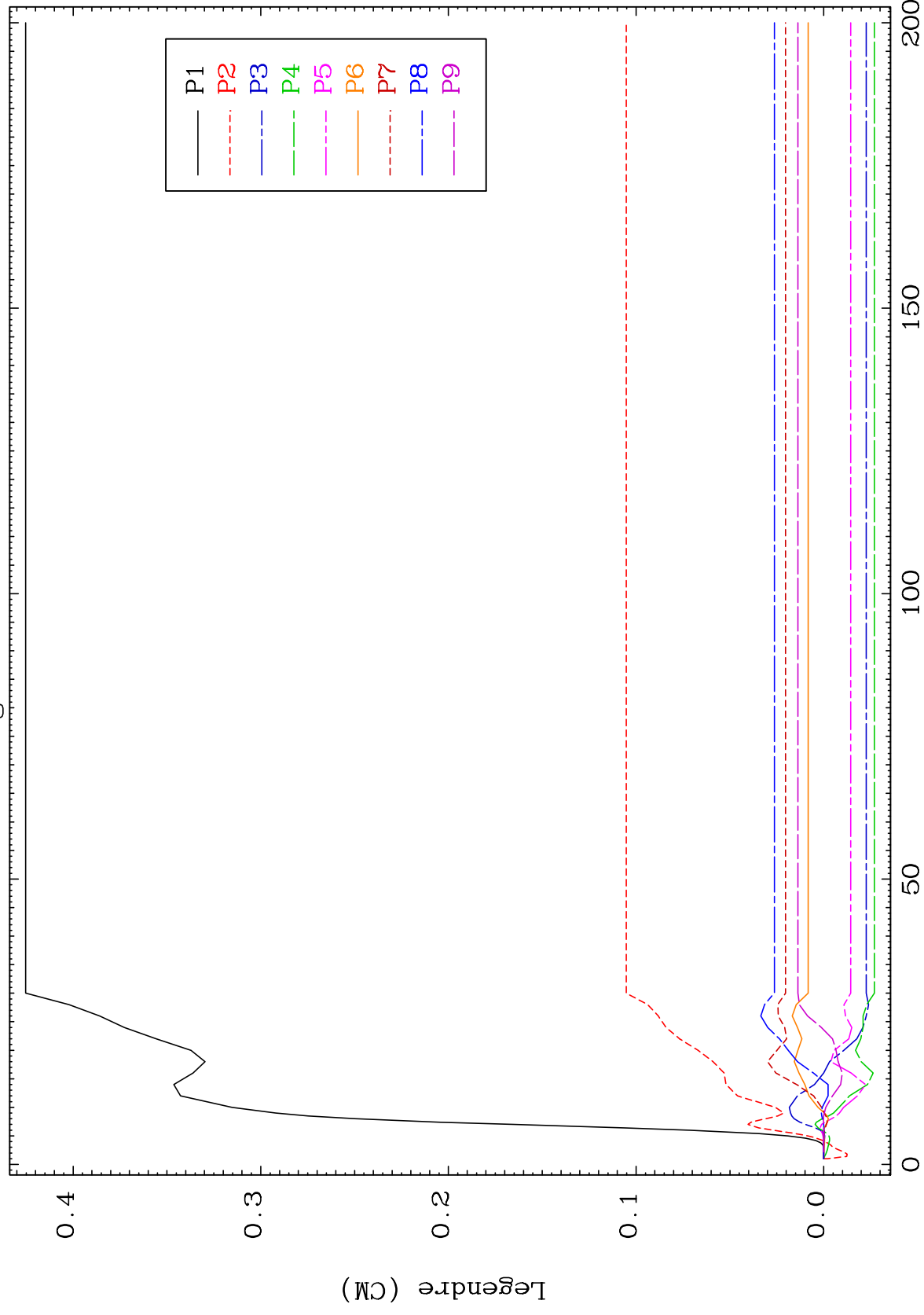

84

Incident Energy (MeV)

55-Cs-141

MAT 5549

55-Cs-141

MT= 67 (n,n') Level
Legendre Coefficients

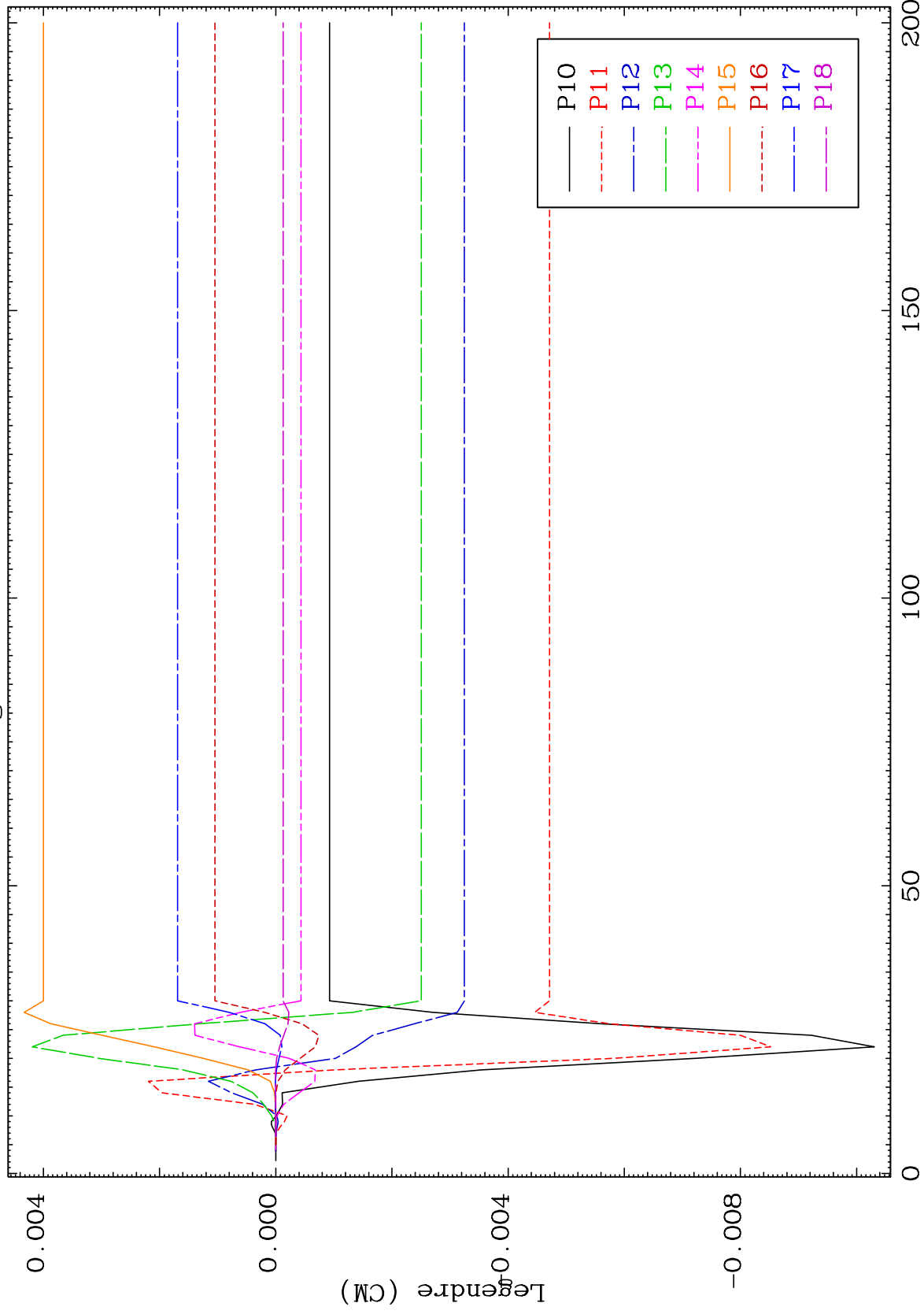

85

Incident Energy (MeV)

55-Cs-141

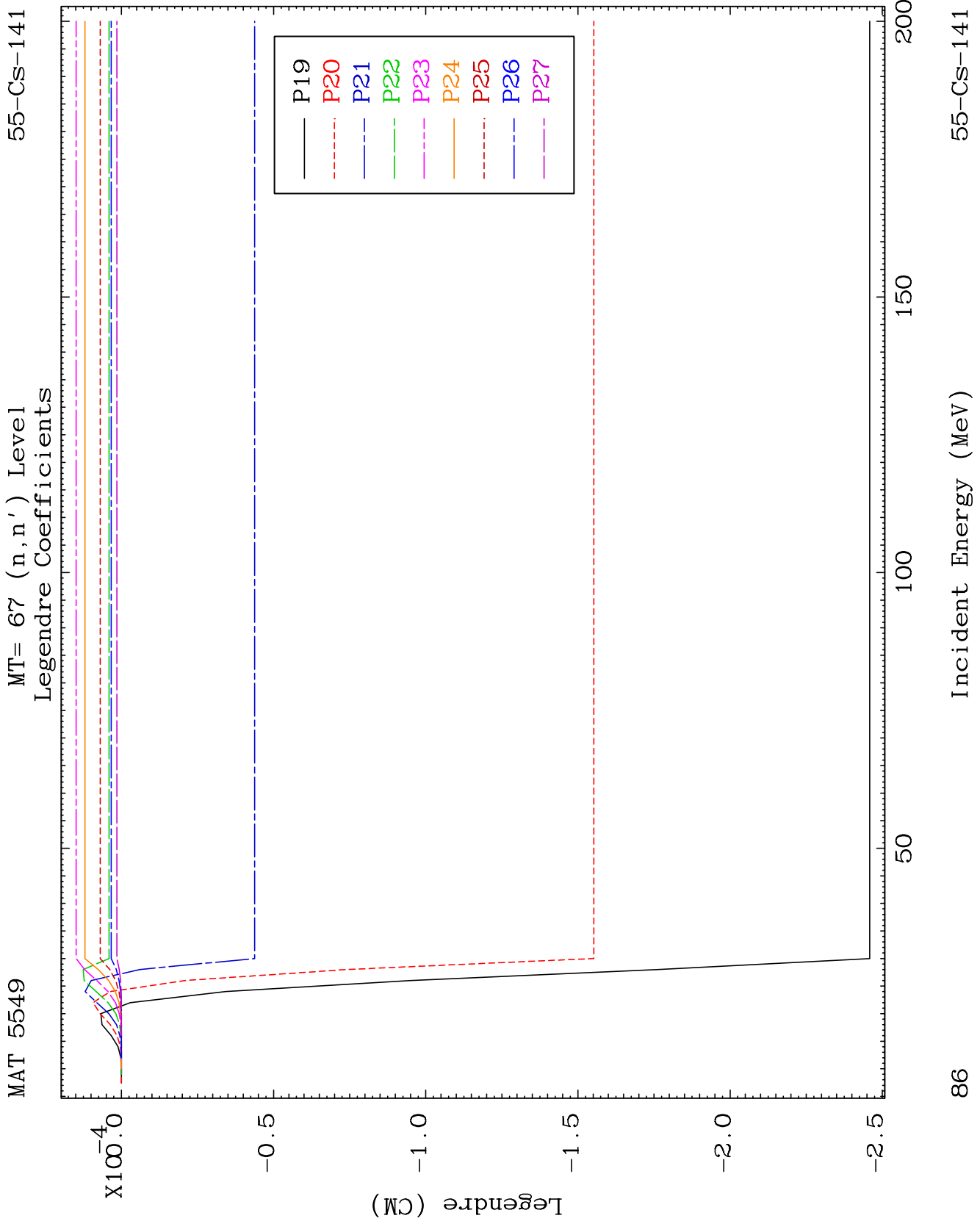

MAT 5549

MT= 67 (n,n') Level
Legendre Coefficients

55-Cs-141

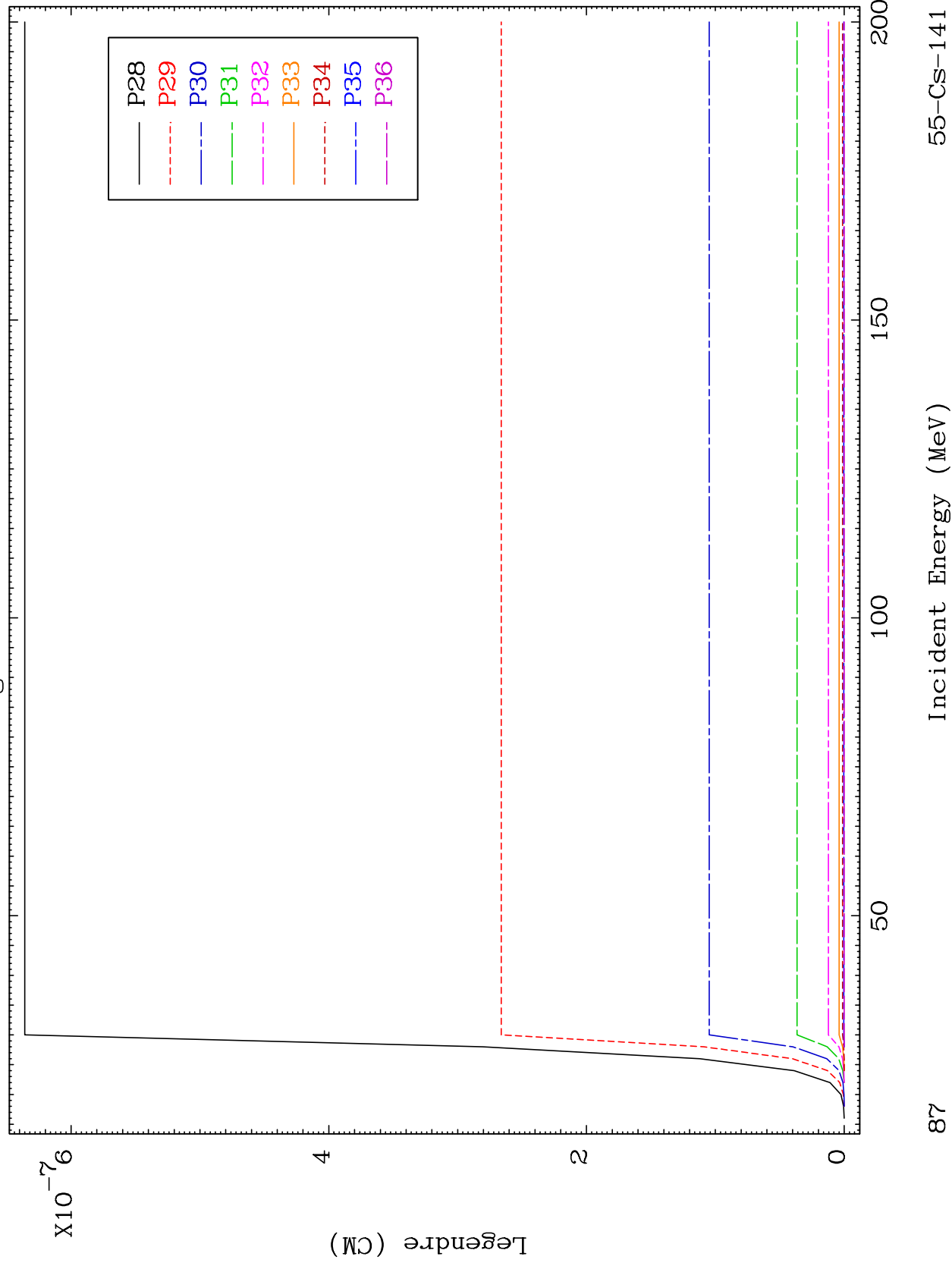

MAT 5549

MT= 68 (n,n') Level
Legendre Coefficients

55-Cs-141

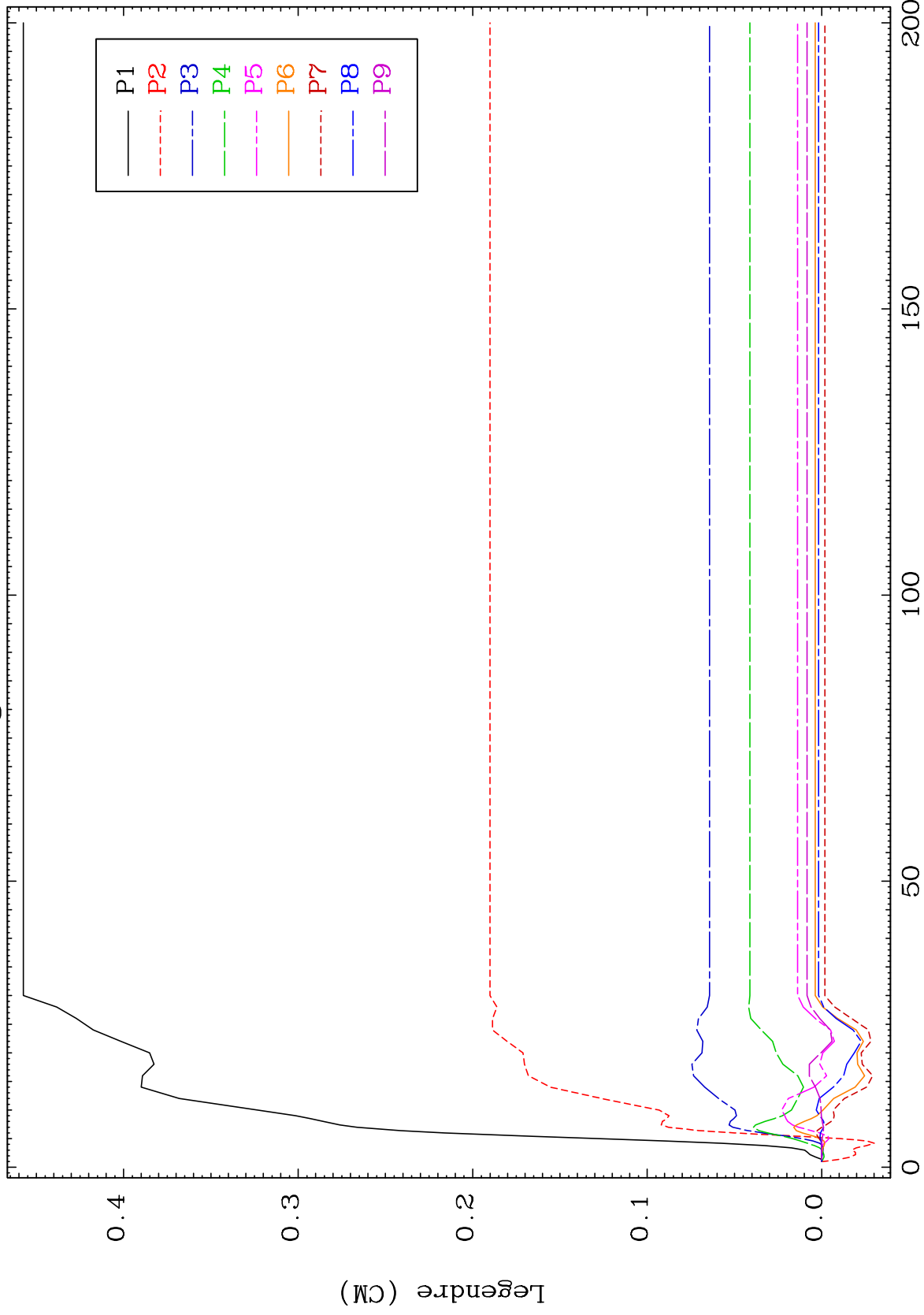

55-Cs-141

Incident Energy (MeV)

88

MAT 5549

MT= 68 (n,n') Level
Legendre Coefficients

55-Cs-141

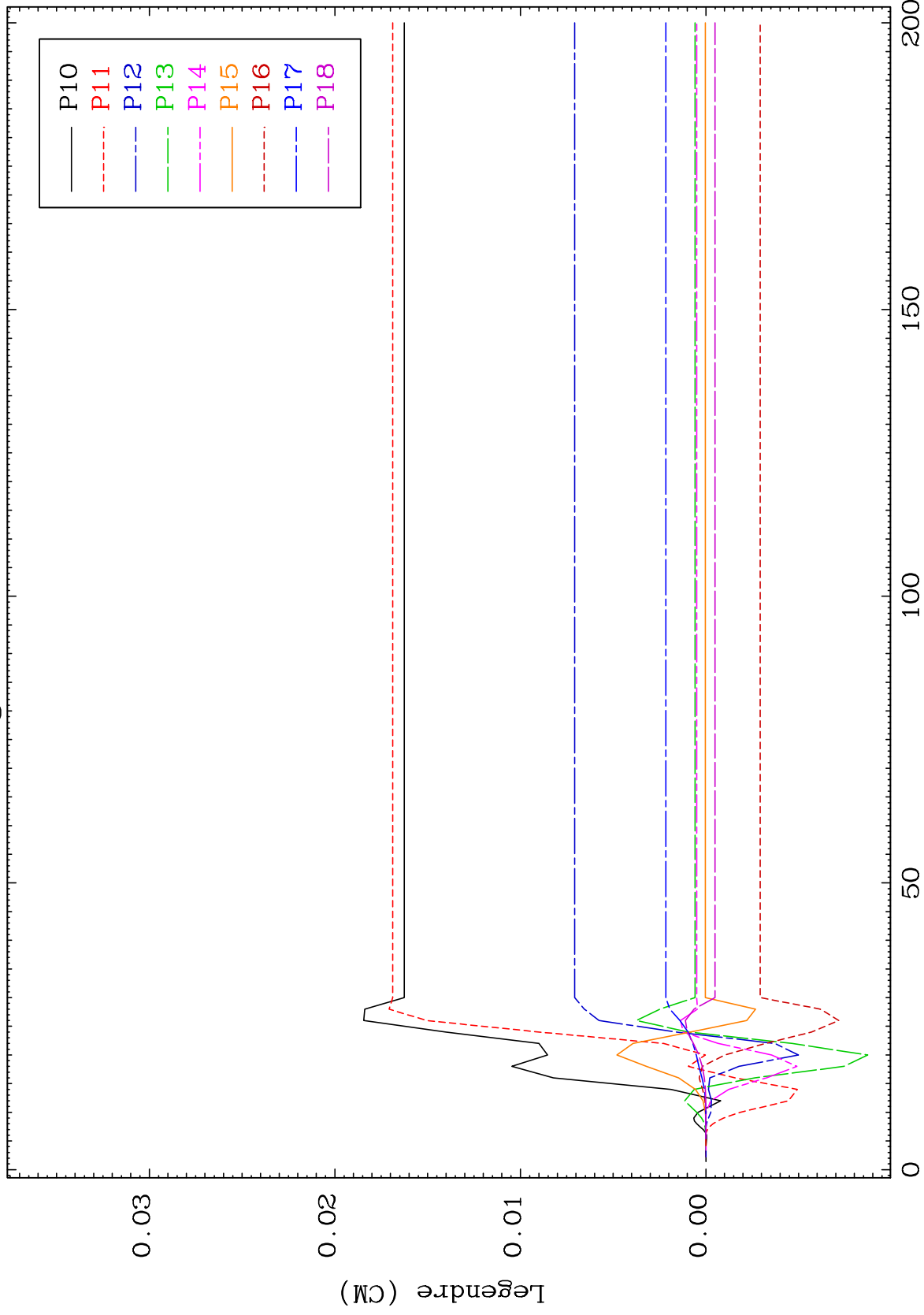

89

Incident Energy (MeV)

55-Cs-141

MAT 5549

MT= 68 (n,n') Level
Legendre Coefficients

55-Cs-141

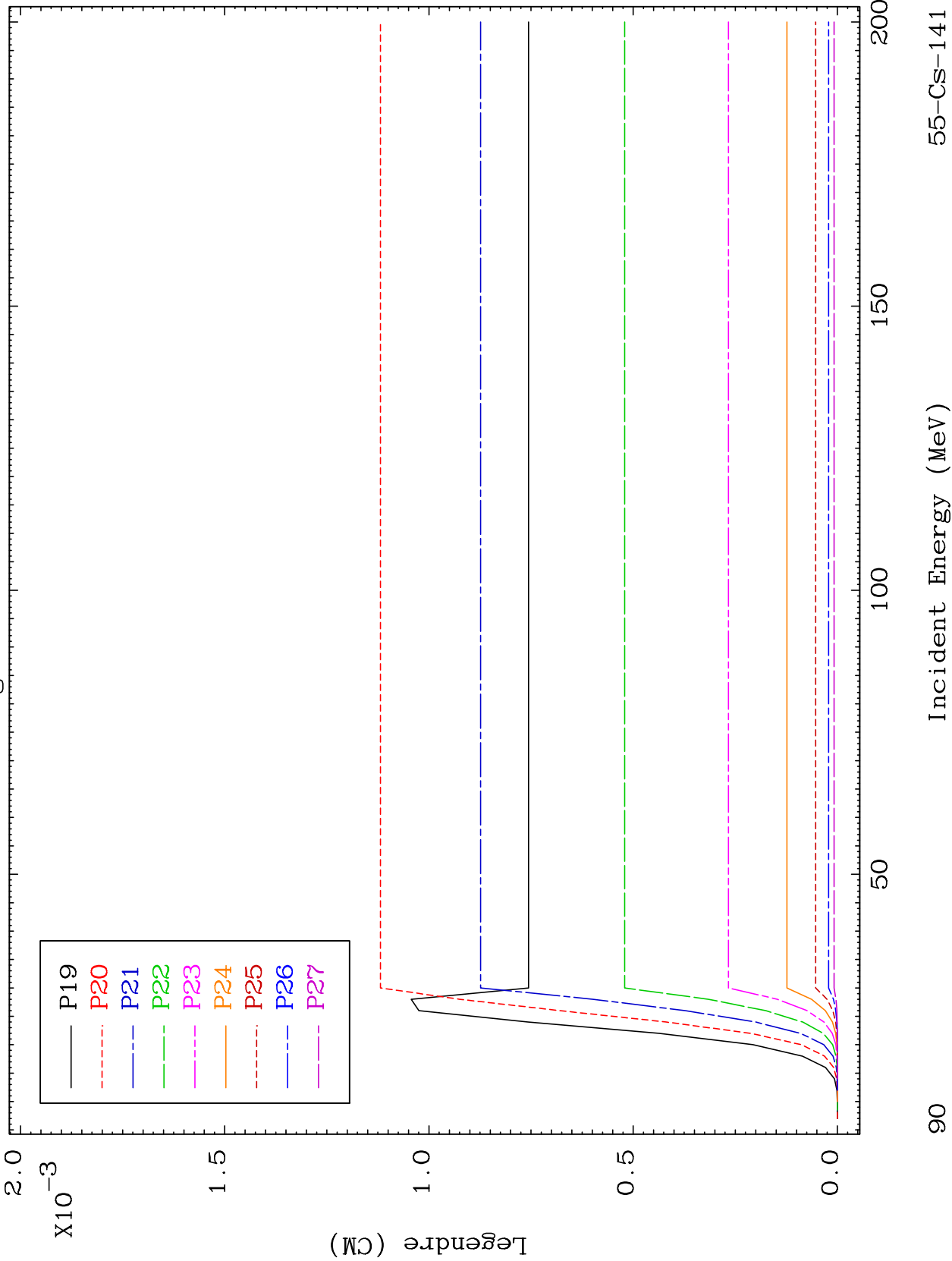

MAT 5549

MT= 68 (n,n') Level
Legendre Coefficients

55-Cs-141

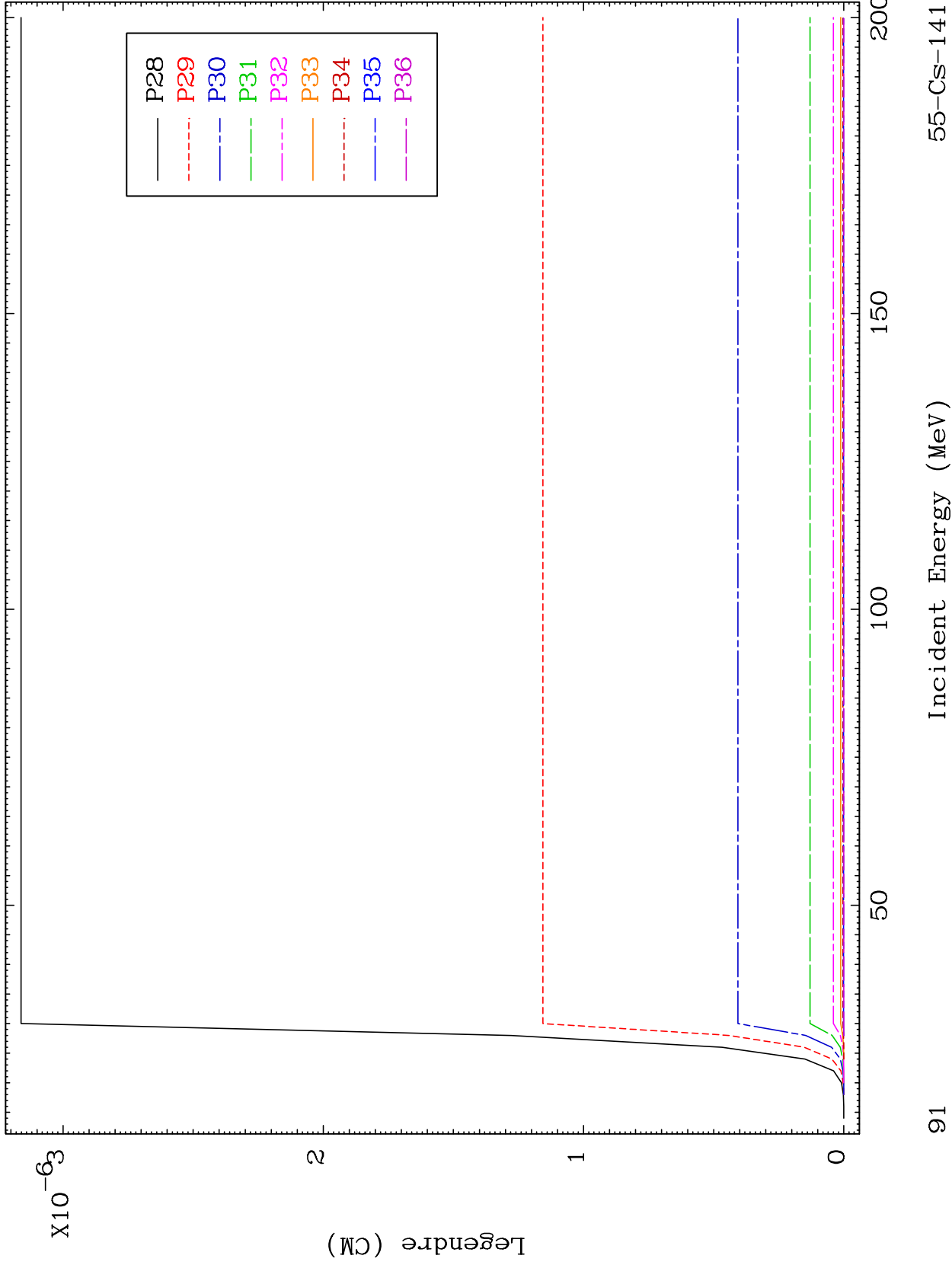

91

Incident Energy (MeV)

55-Cs-141

MAT 5549

MT= 69 (n,n') Level
Legendre Coefficients

55-Cs-141

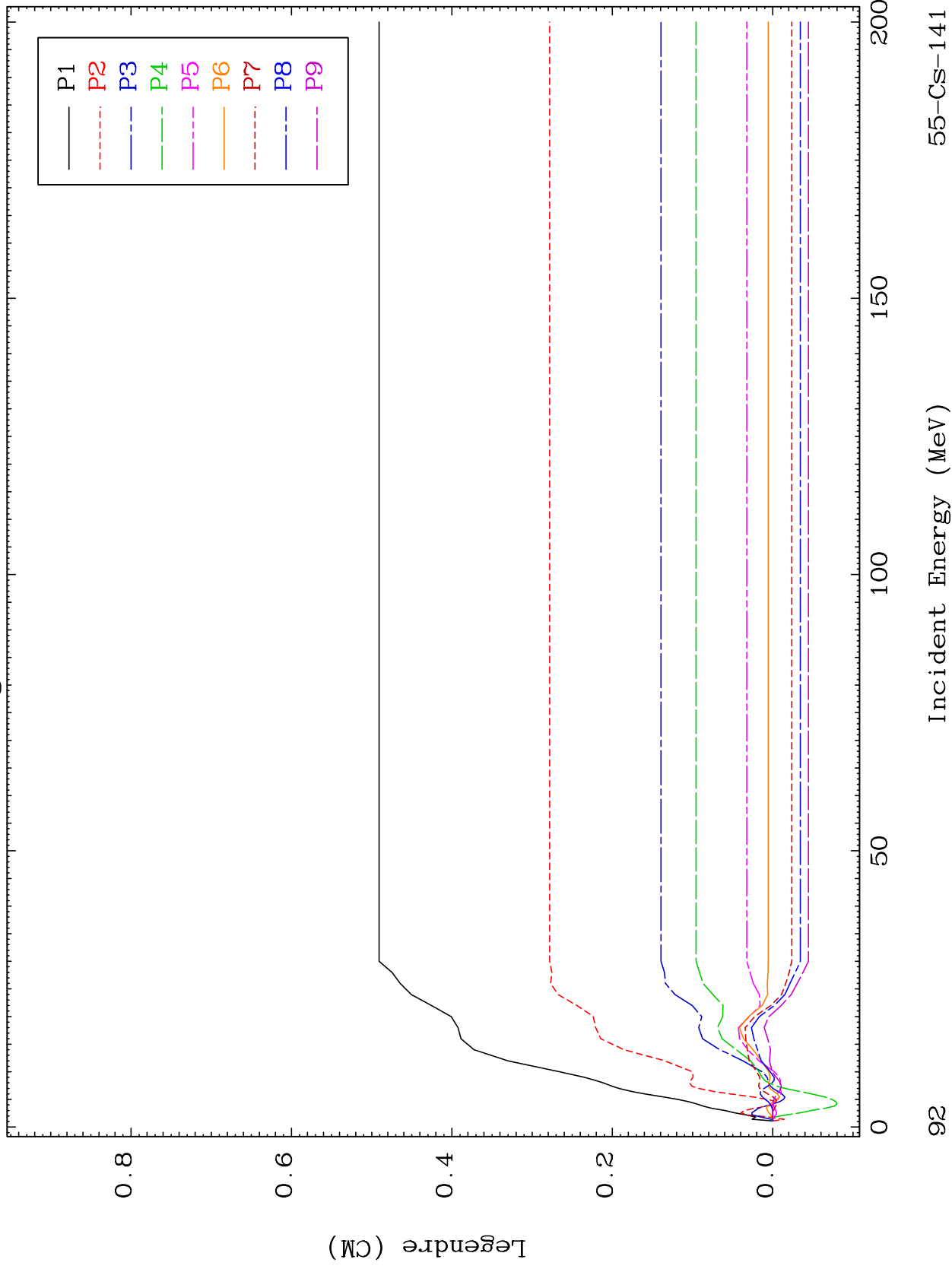

55-Cs-141

Incident Energy (MeV)

92

MAT 5549

MT= 69 (n,n') Level
Legendre Coefficients

55-Cs-141

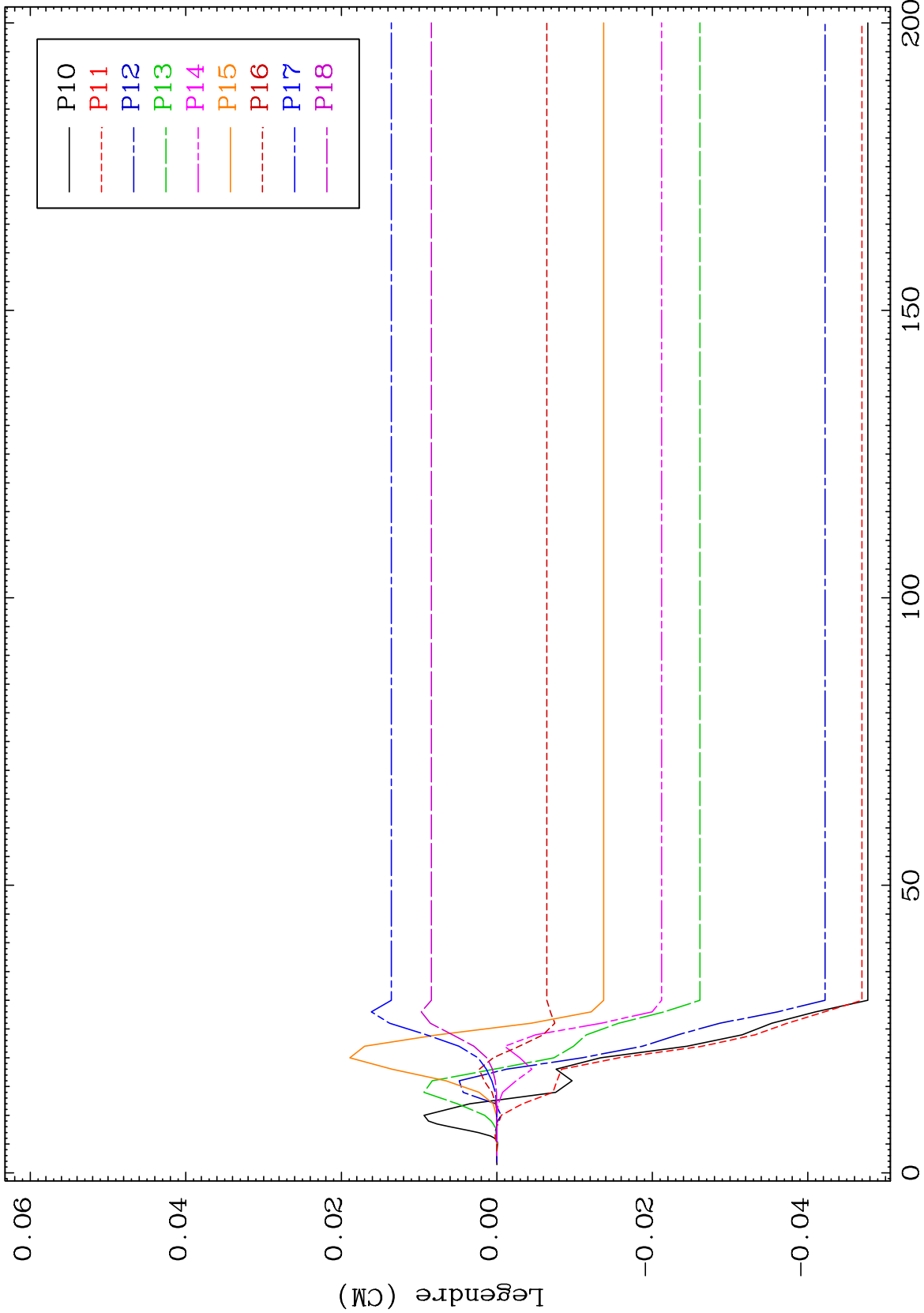

93

Incident Energy (MeV)

55-Cs-141

MAT 5549

MT= 69 (n,n') Level
Legendre Coefficients

55-Cs-141

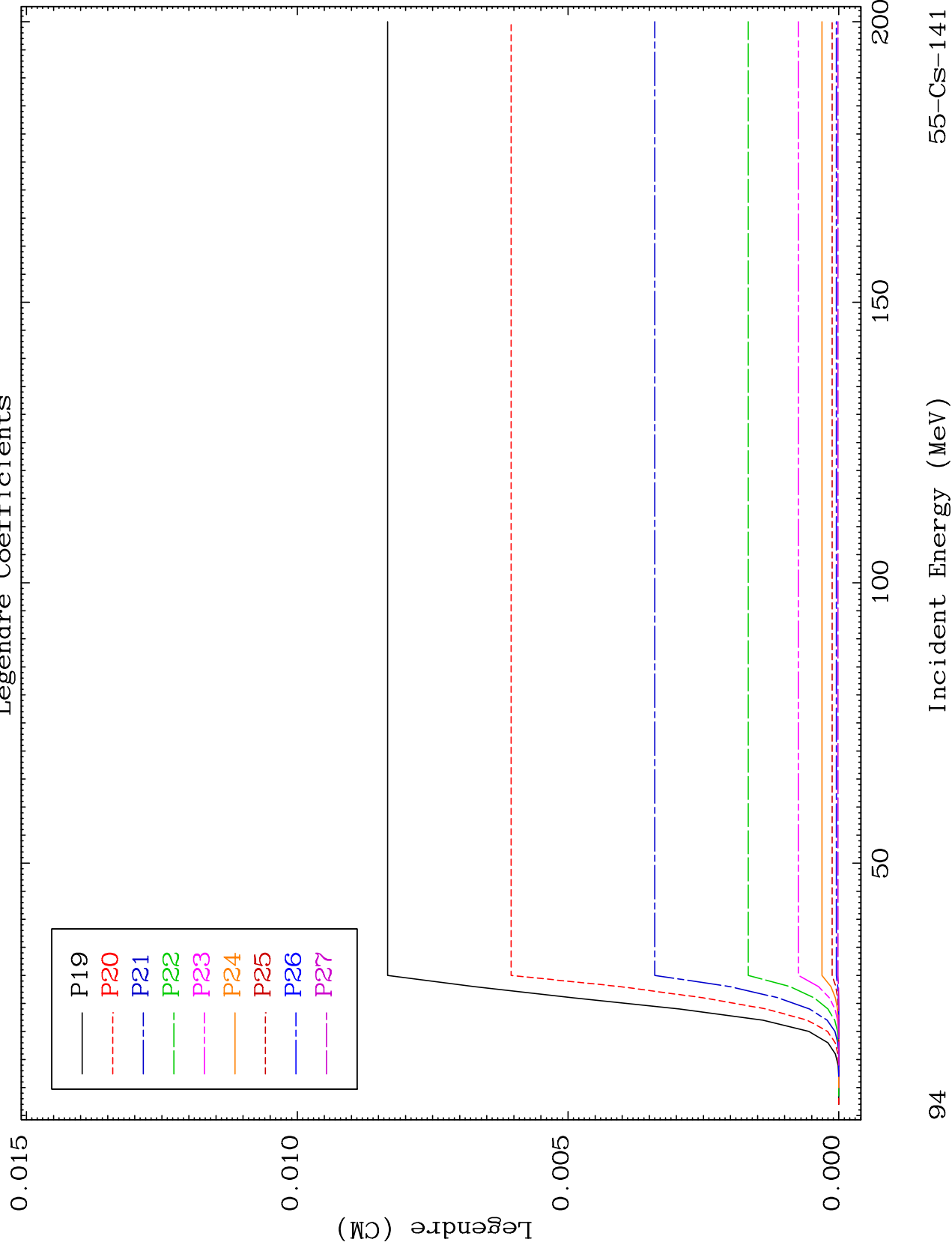

94

55-Cs-141

Incident Energy (MeV)

MAT 5549

MT= 69 (n,n') Level
Legendre Coefficients

55-Cs-141

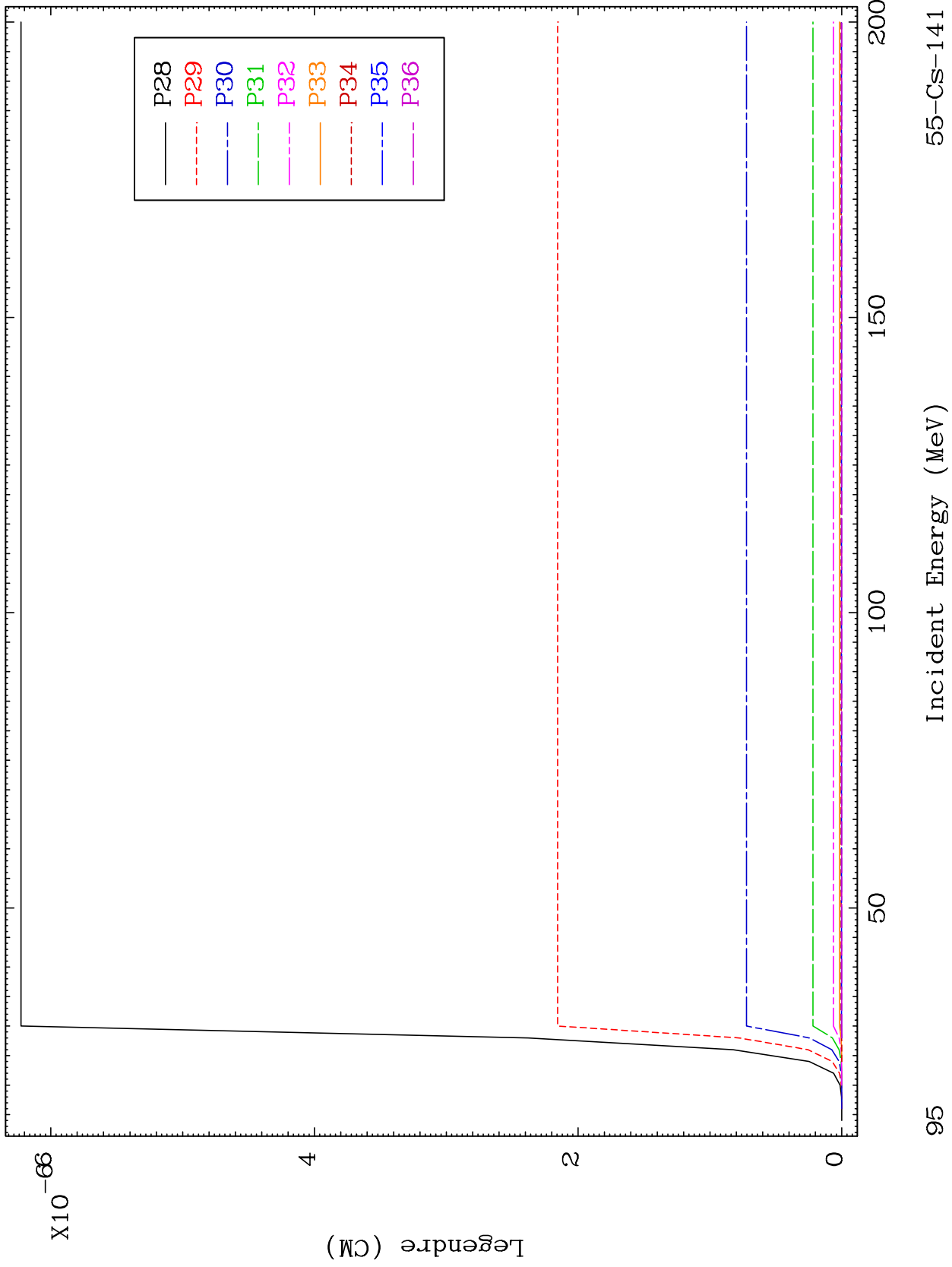

95

Incident Energy (MeV)

55-Cs-141

200

150

100

50

MAT 5549

MT= 70 (n,n') Level
Legendre Coefficients

55-Cs-141

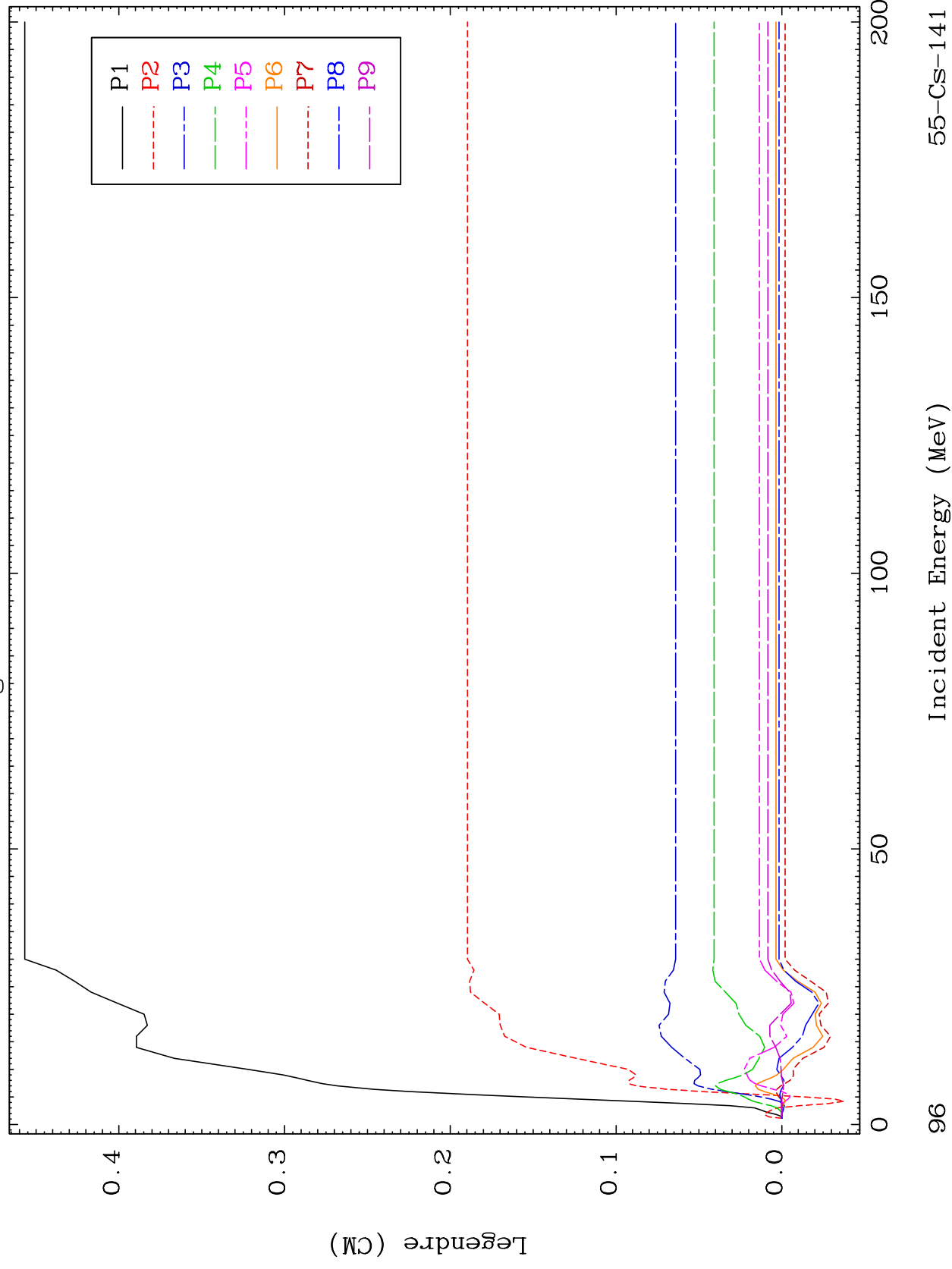

55-Cs-141

Incident Energy (MeV)

96

MAT 5549

MT= 70 (n,n') Level
Legendre Coefficients

55-Cs-141

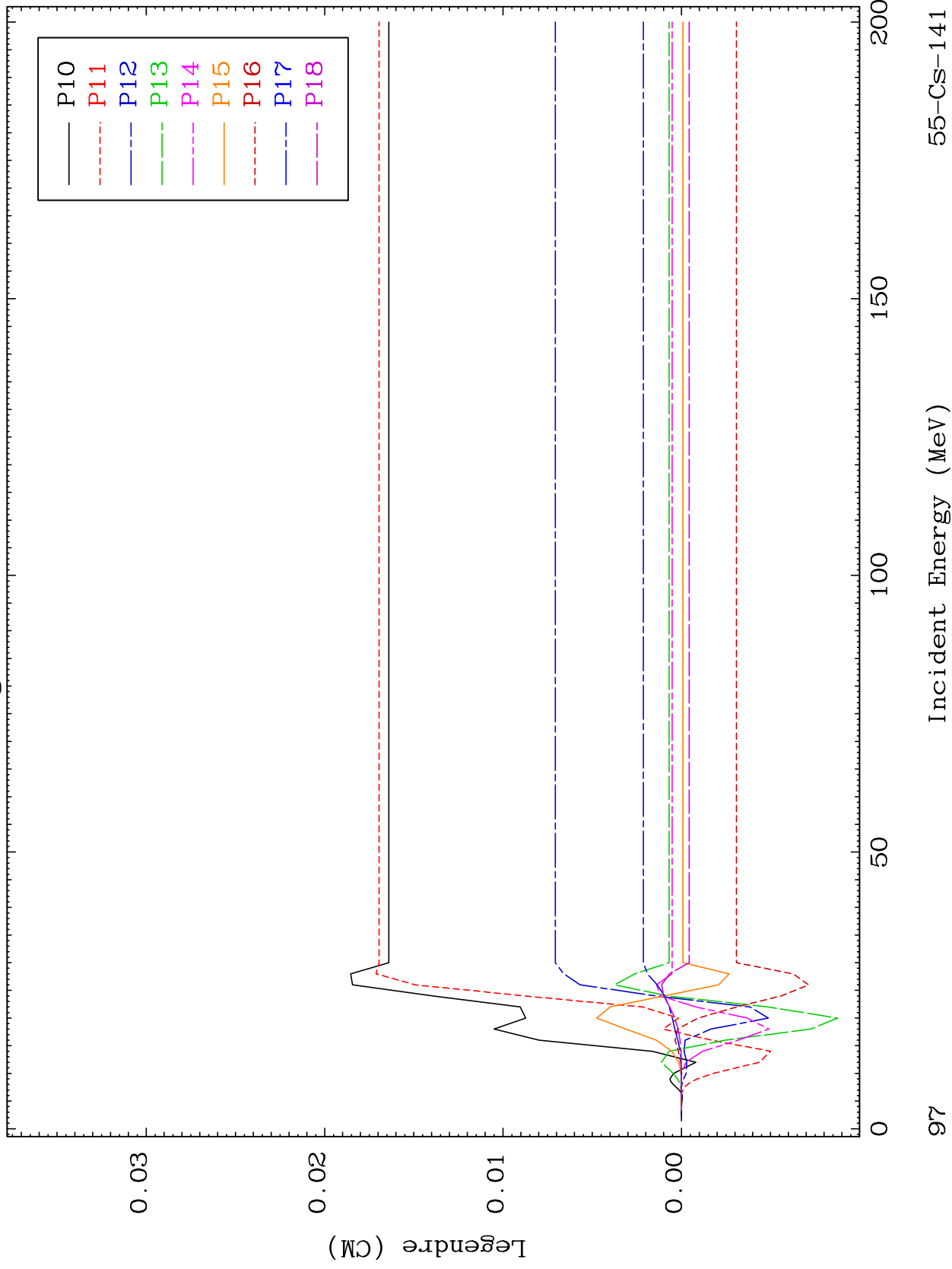

97

Incident Energy (MeV)

55-Cs-141

MAT 5549

MT= 70 (n,n') Level
Legendre Coefficients

55-Cs-141

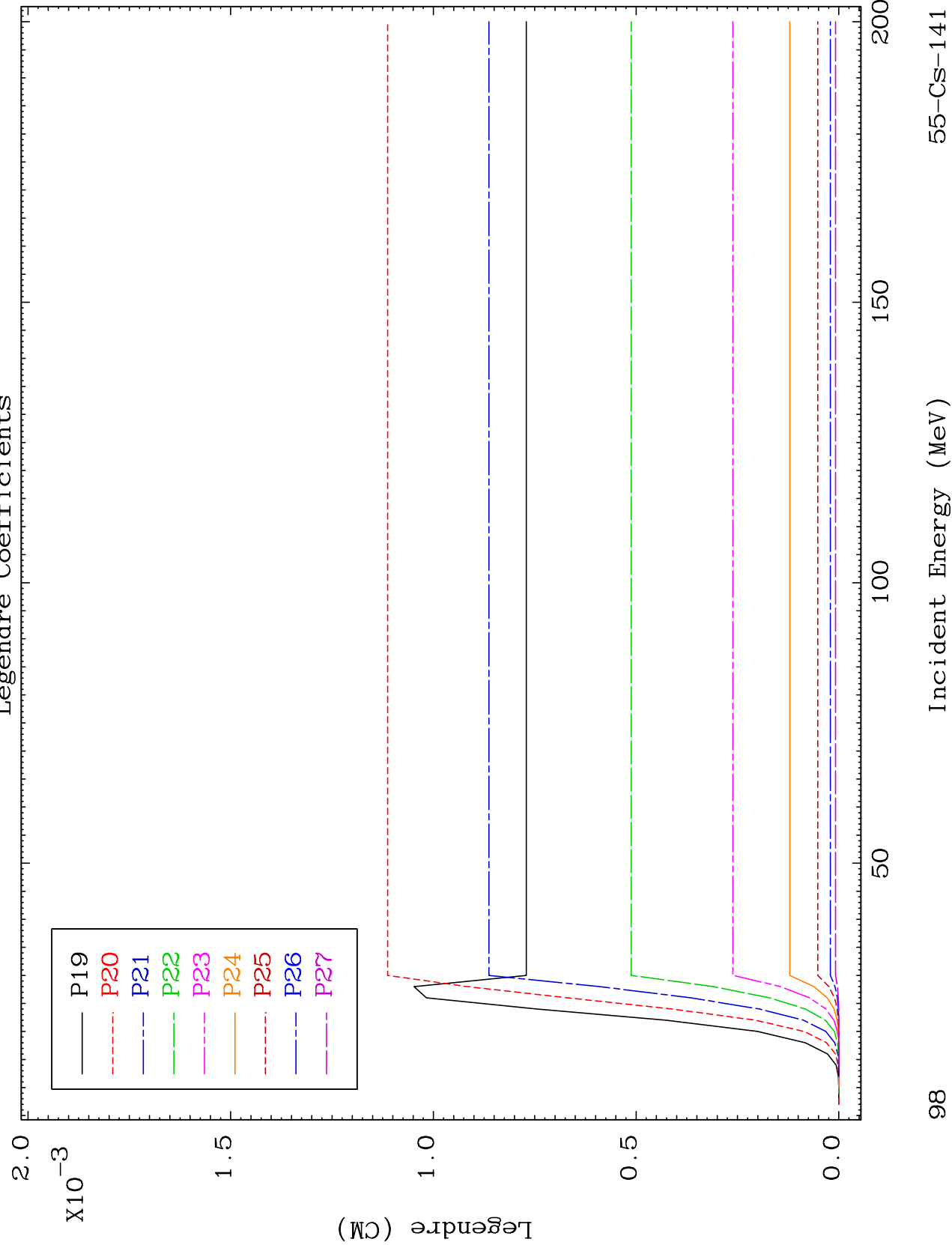

98

55-Cs-141

MAT 5549

MT= 70 (n,n') Level
Legendre Coefficients

55-Cs-141

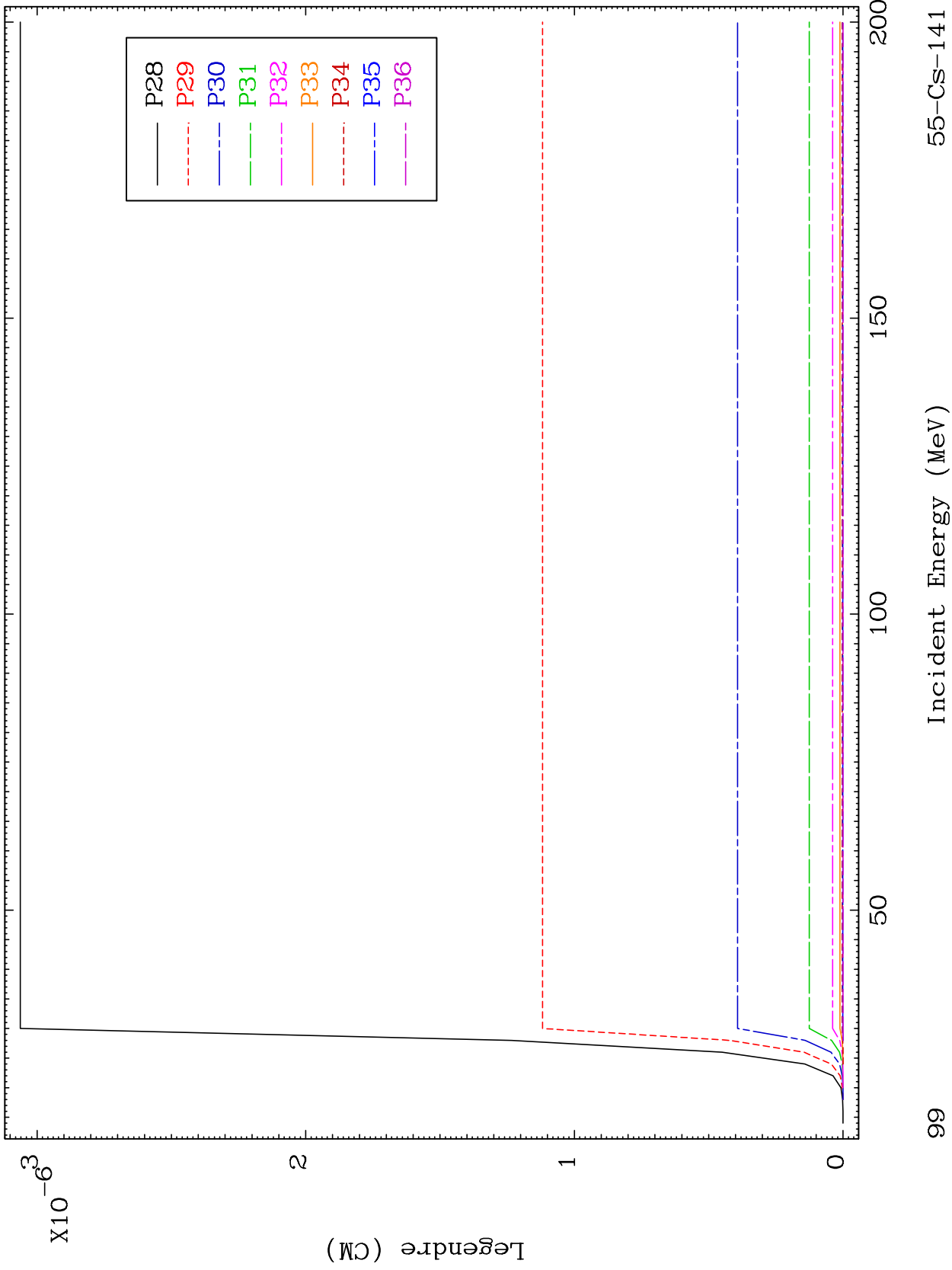

MAT 5549

MT= 71 (n,n') Level
Legendre Coefficients

55-Cs-141

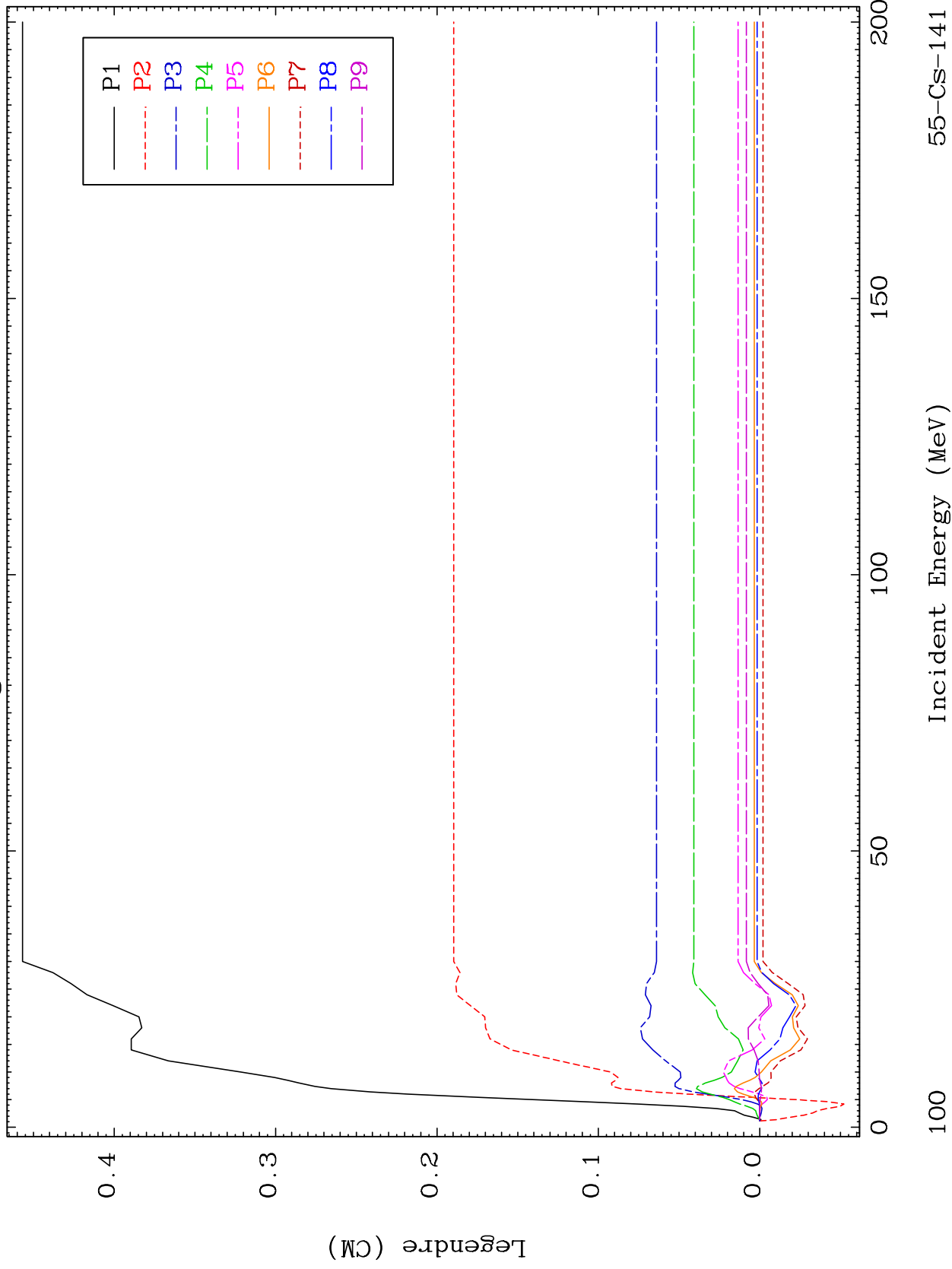

55-Cs-141

MAT 5549

MT= 71 (n,n') Level
Legendre Coefficients

55-Cs-141

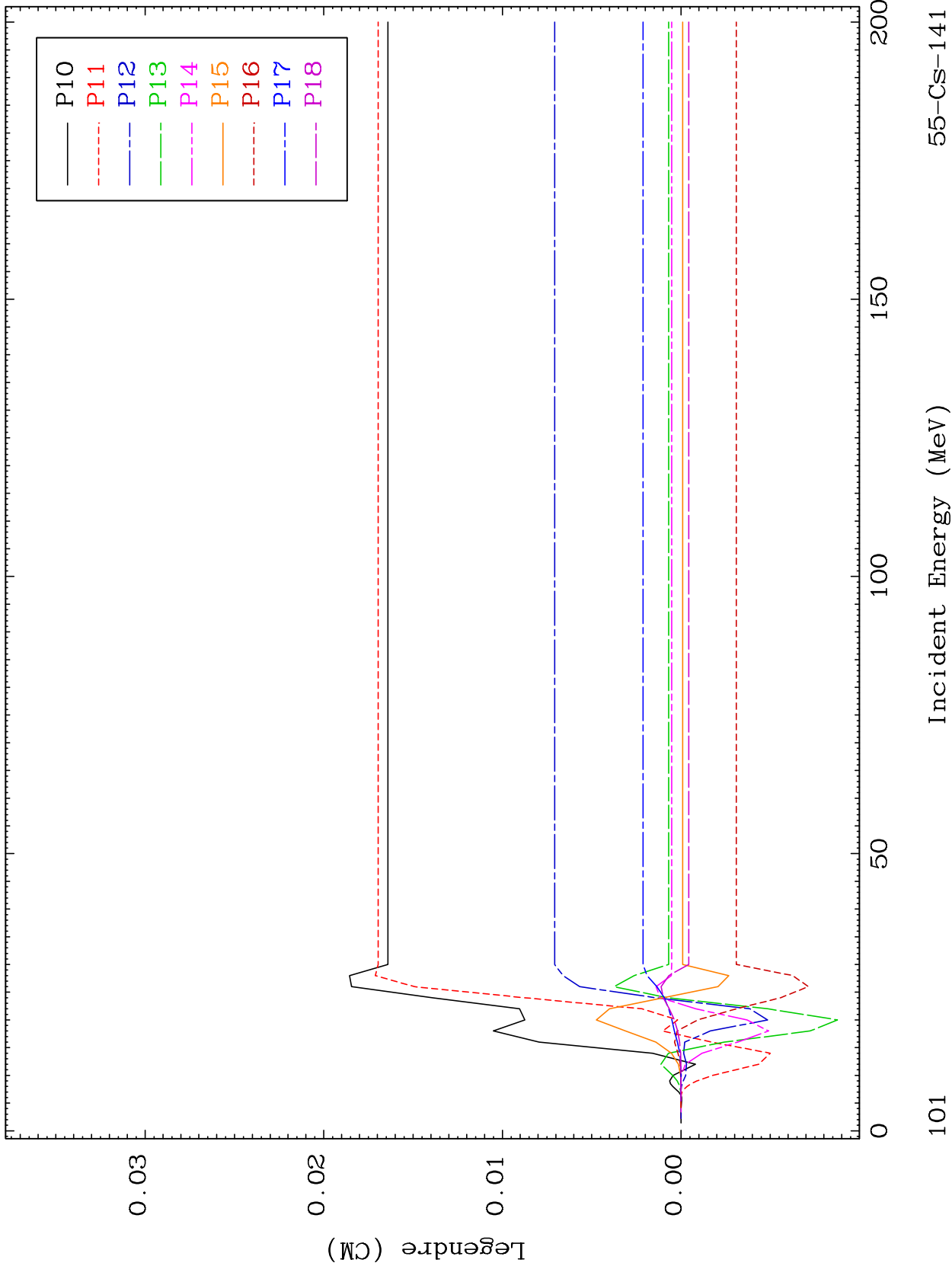

55-Cs-141

Incident Energy (MeV)

101

MAT 5549

MT= 71 (n,n') Level
Legendre Coefficients

55-Cs-141

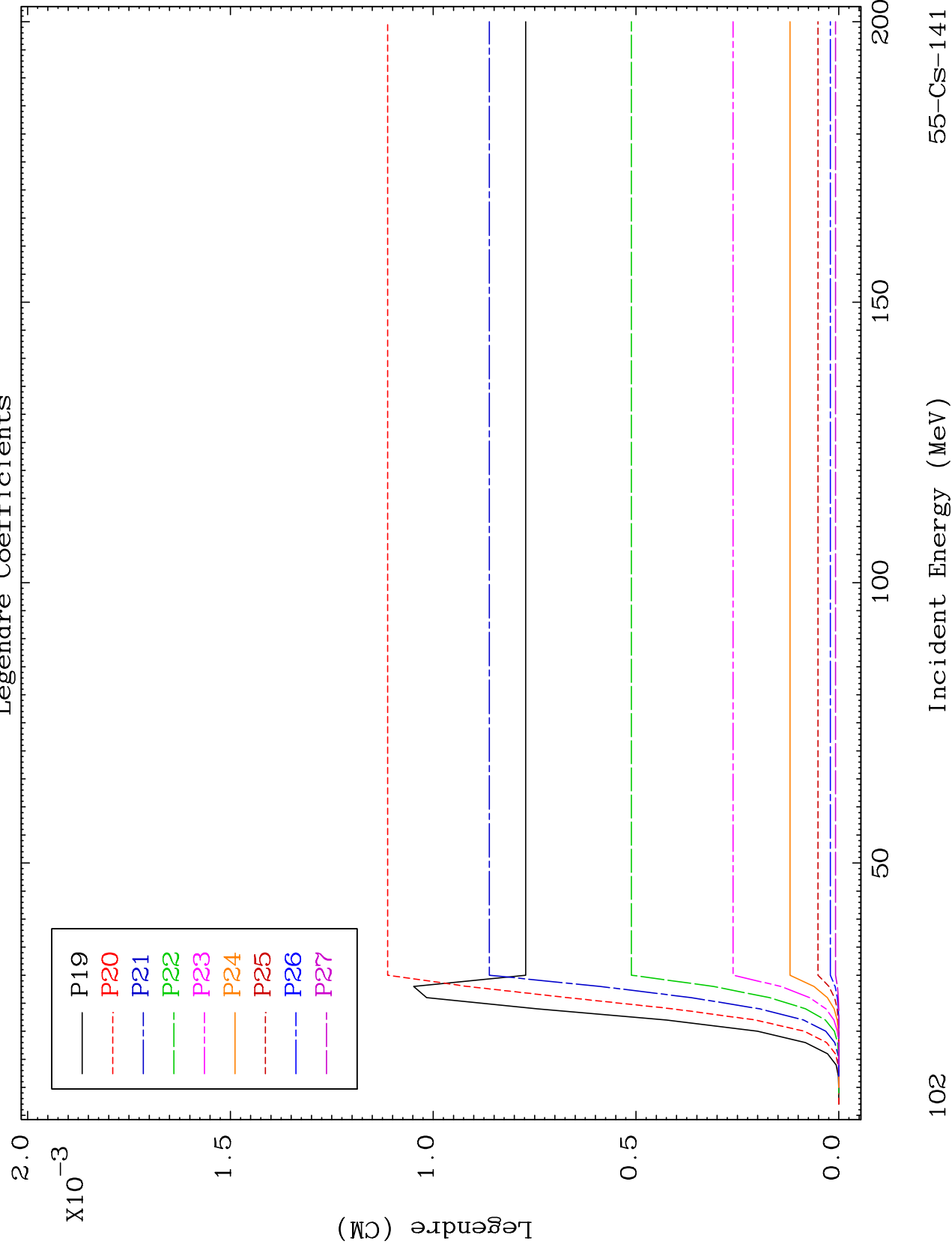

102

Incident Energy (MeV)

55-Cs-141

MAT 5549

MT= 71 (n,n') Level
Legendre Coefficients

55-Cs-141

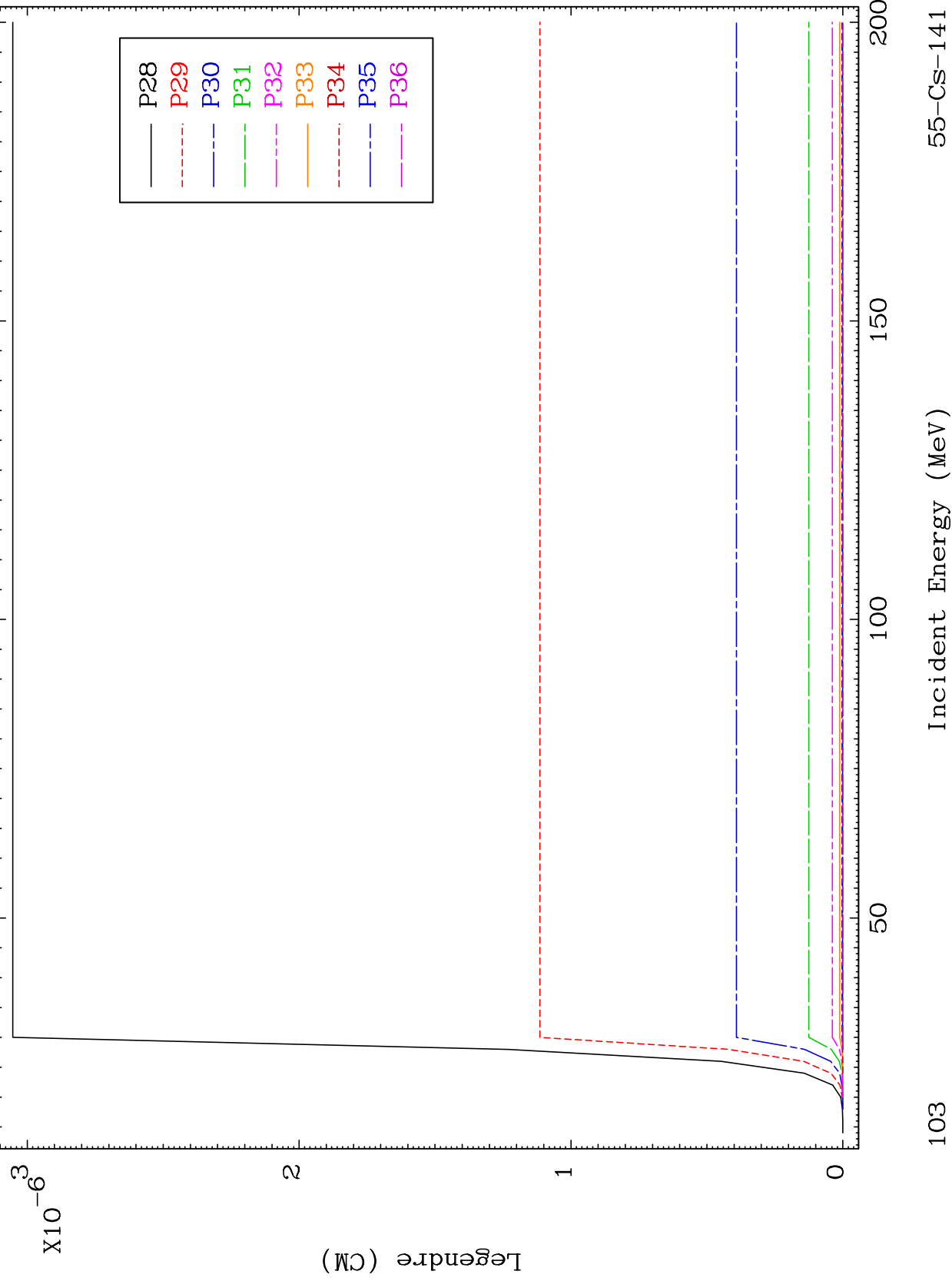

103

Incident Energy (MeV)

55-Cs-141

MAT 5549

MT= 72 (n,n') Level
Legendre Coefficients

55-Cs-141

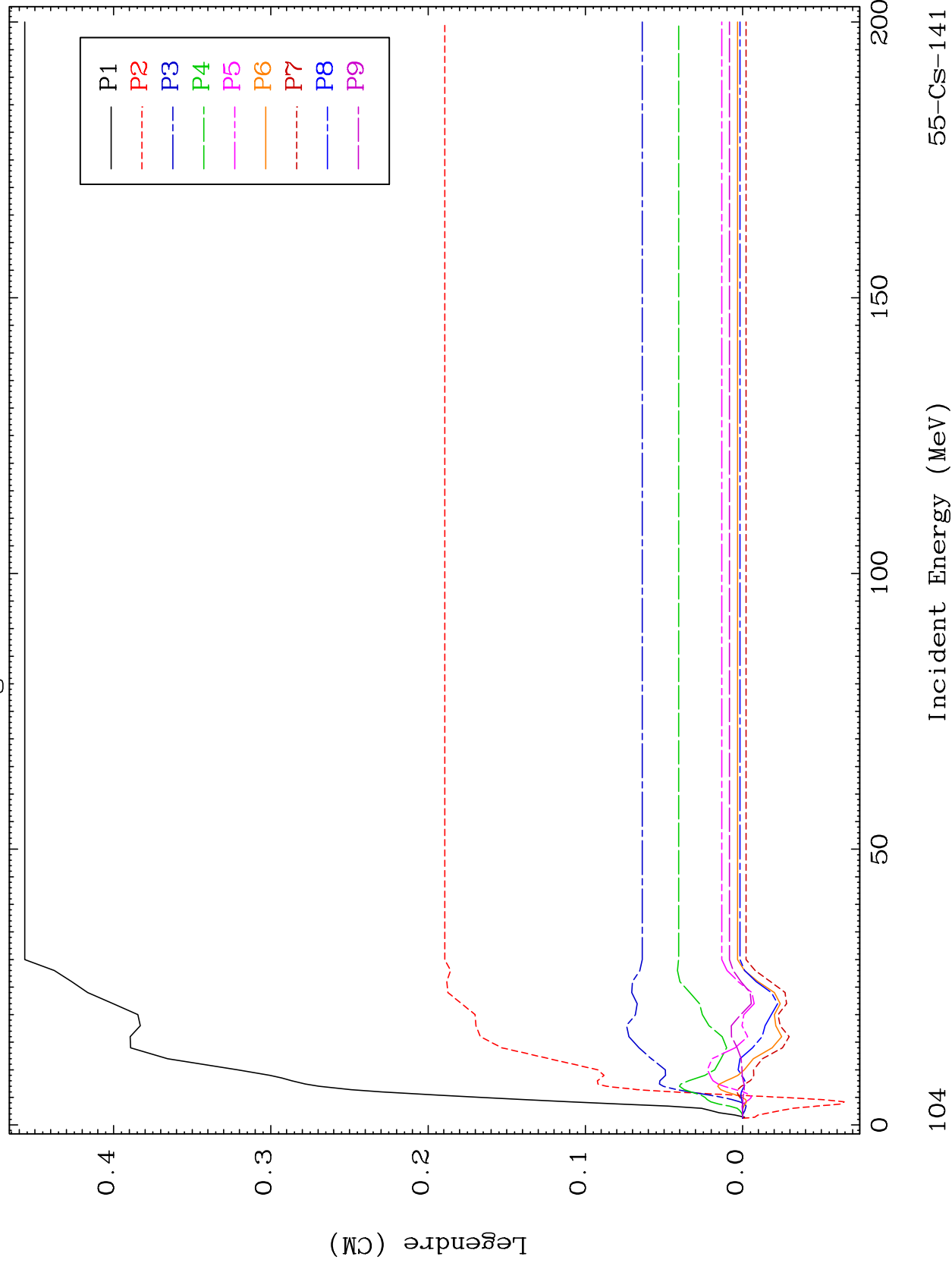

MAT 5549

MT= 72 (n,n') Level
Legendre Coefficients

55-Cs-141

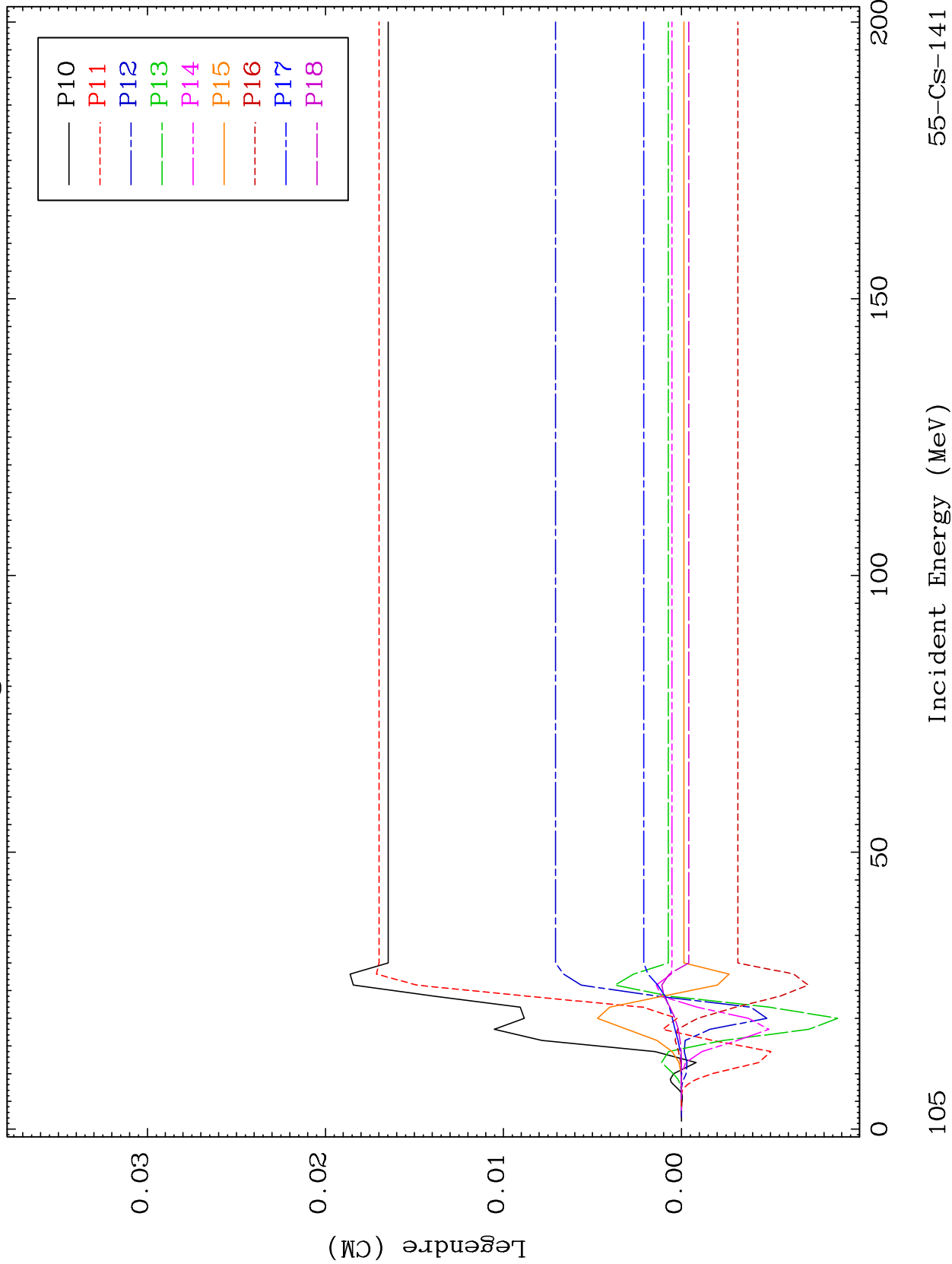

55-Cs-141

Incident Energy (MeV)

105

MAT 5549

MT= 72 (n,n') Level
Legendre Coefficients

55-Cs-141

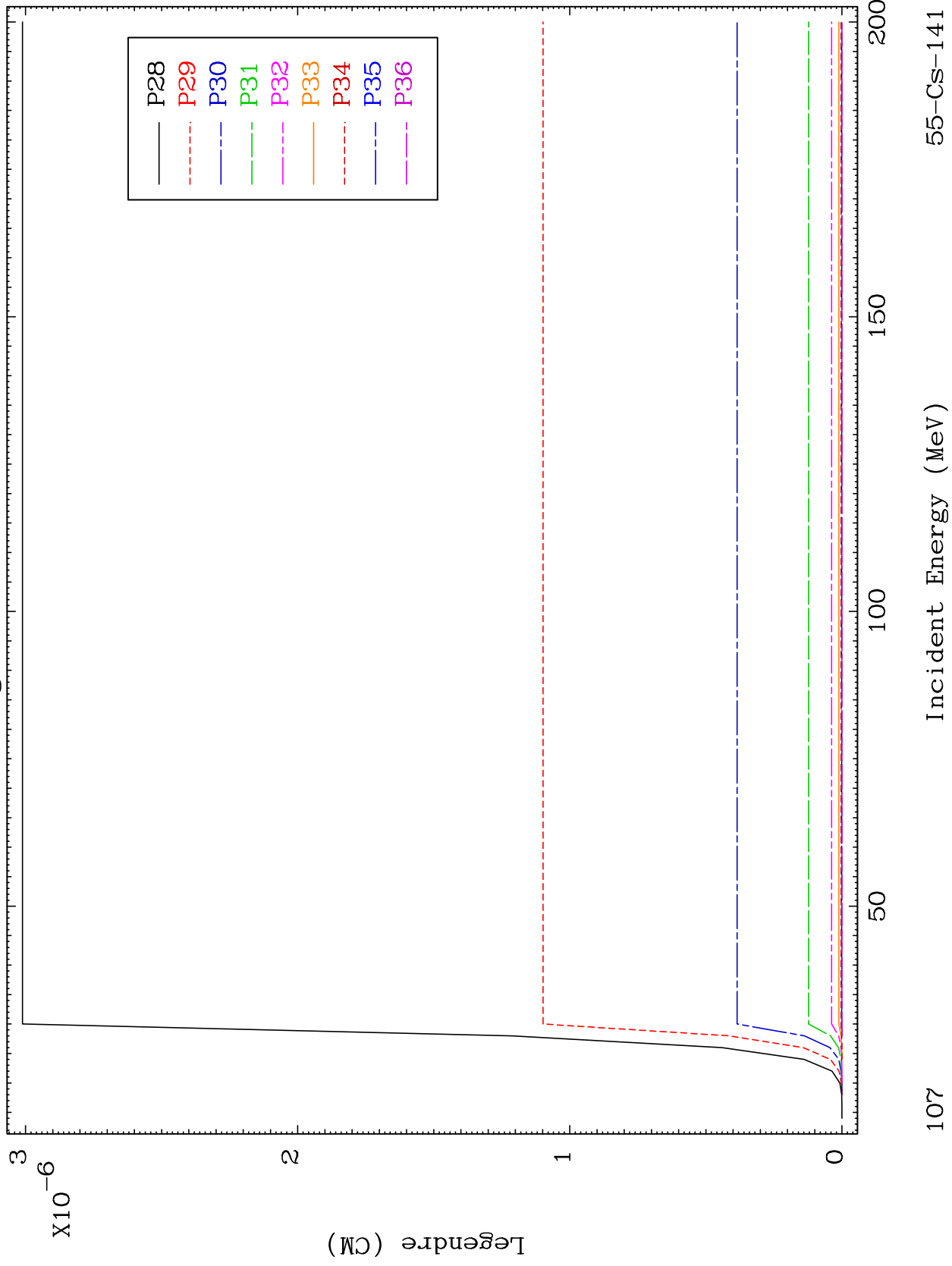

107

MAT 5549

MT= 73 (n,n') Level
Legendre Coefficients

55-Cs-141

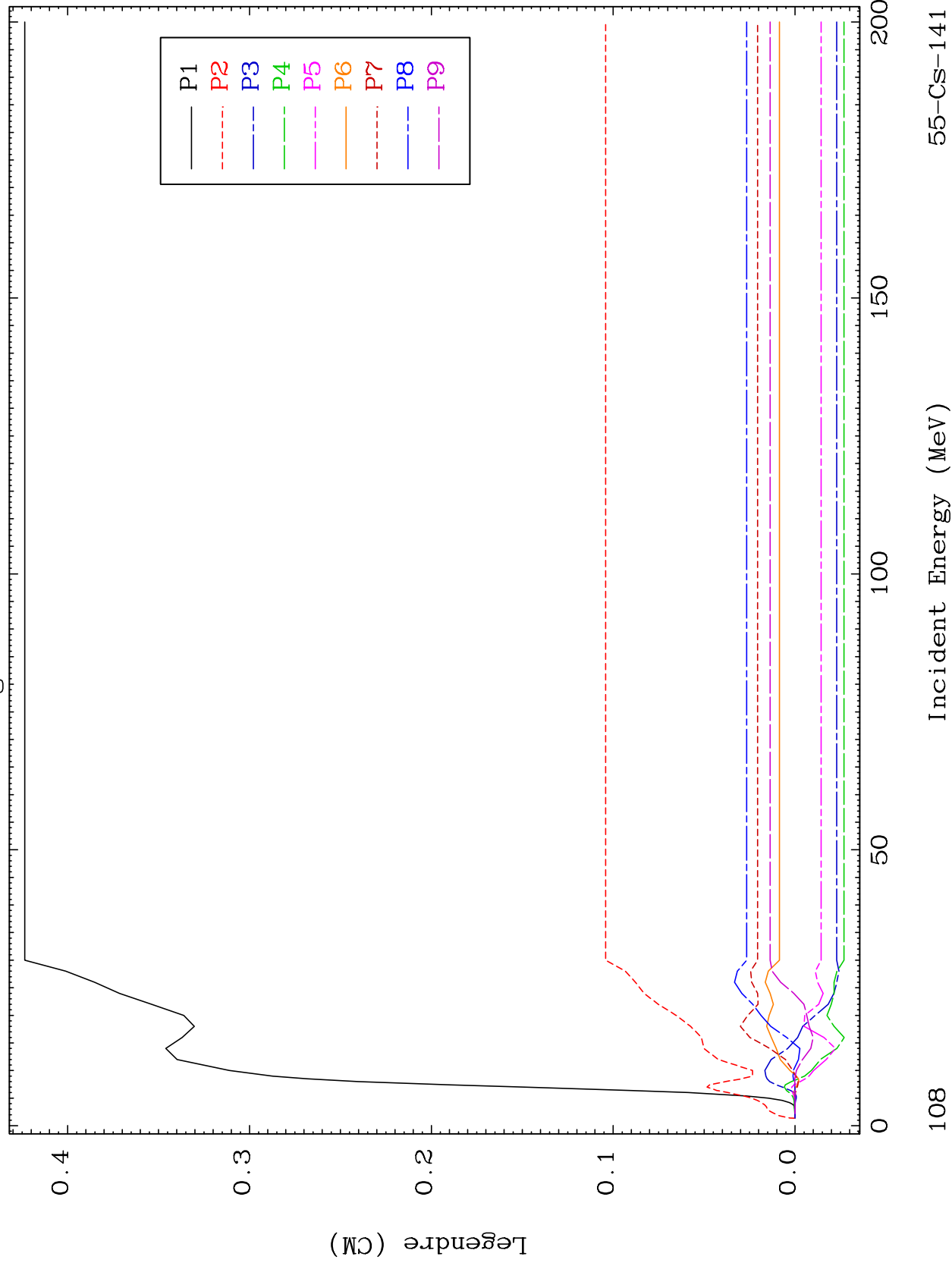

55-Cs-141

Incident Energy (MeV)

108

MAT 5549

MT= 73 (n,n') Level
Legendre Coefficients

55-Cs-141

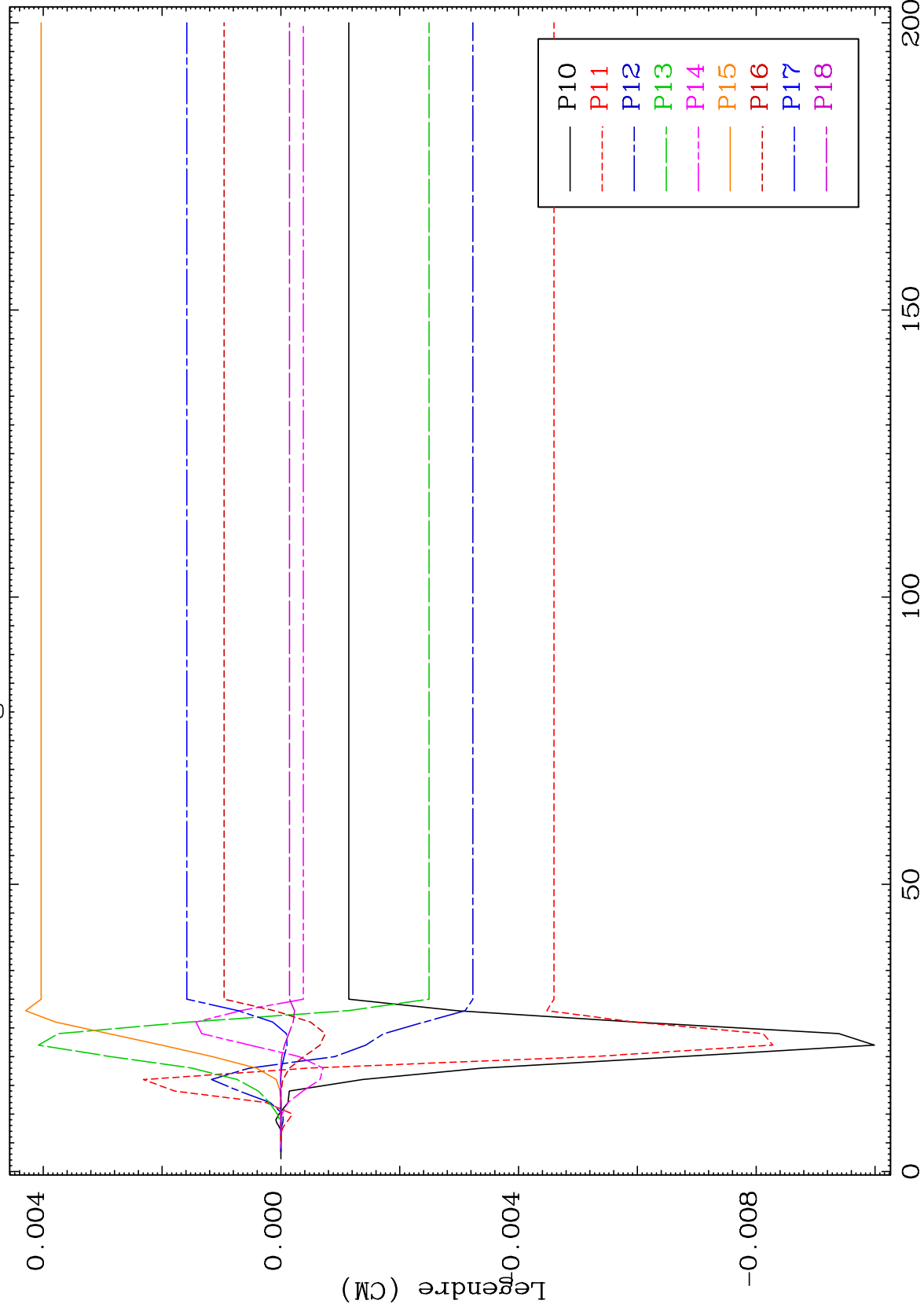

109

55-Cs-141

55-Cs-141

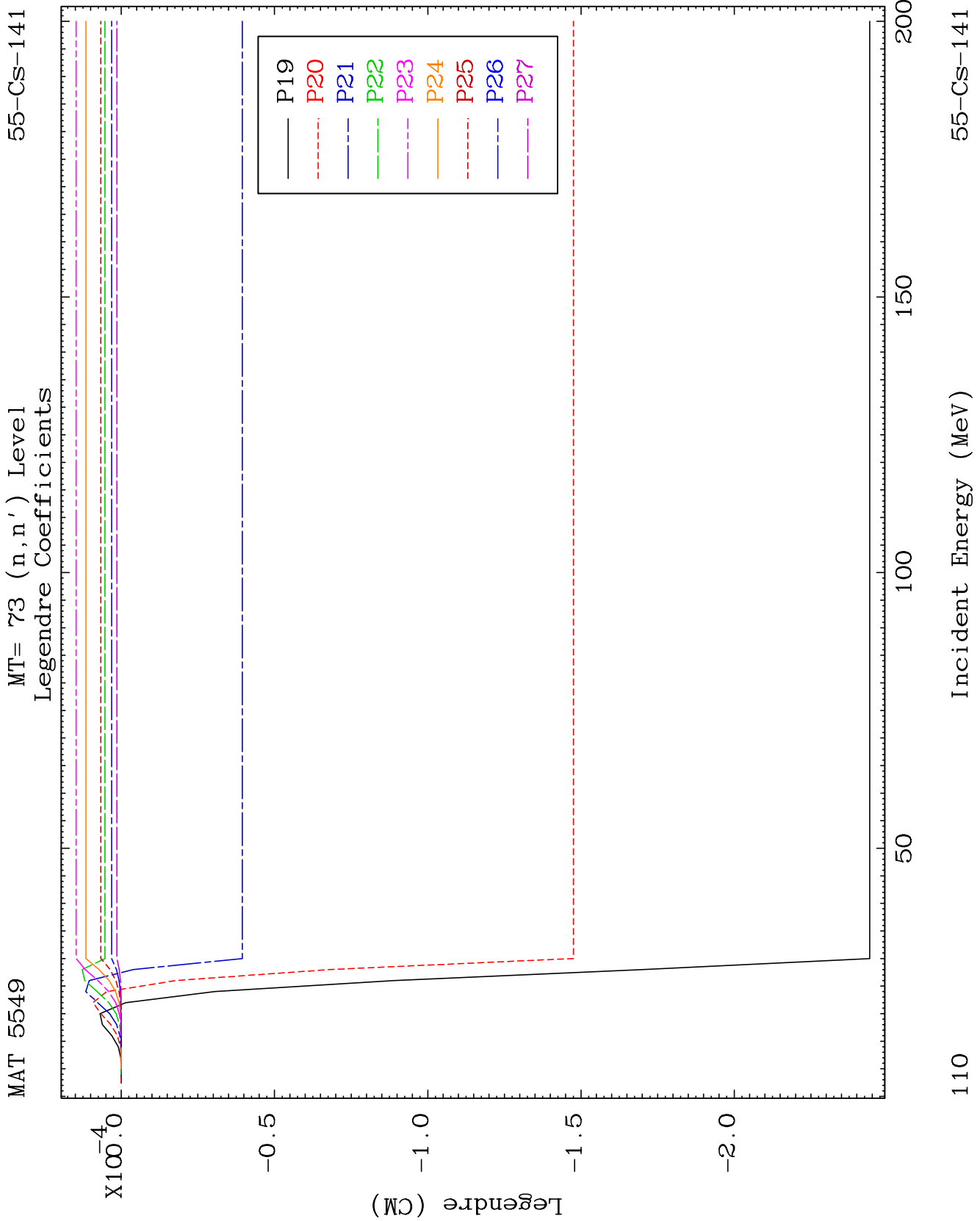

MAT 5549

MT= 73 (n,n') Level
Legendre Coefficients

55-Cs-141

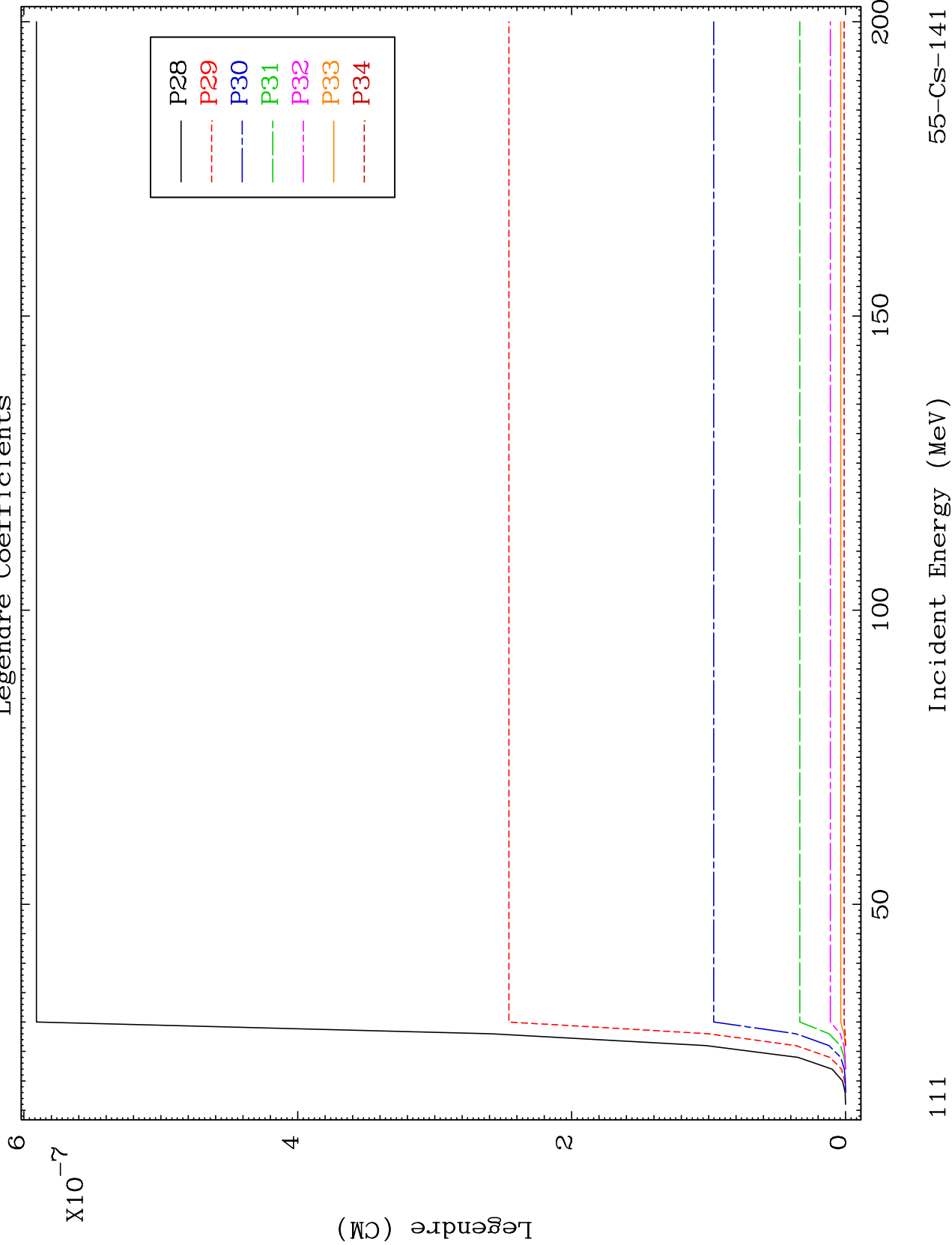

MAT 5549

MT= 74 (n,n') Level
Legendre Coefficients

55-Cs-141

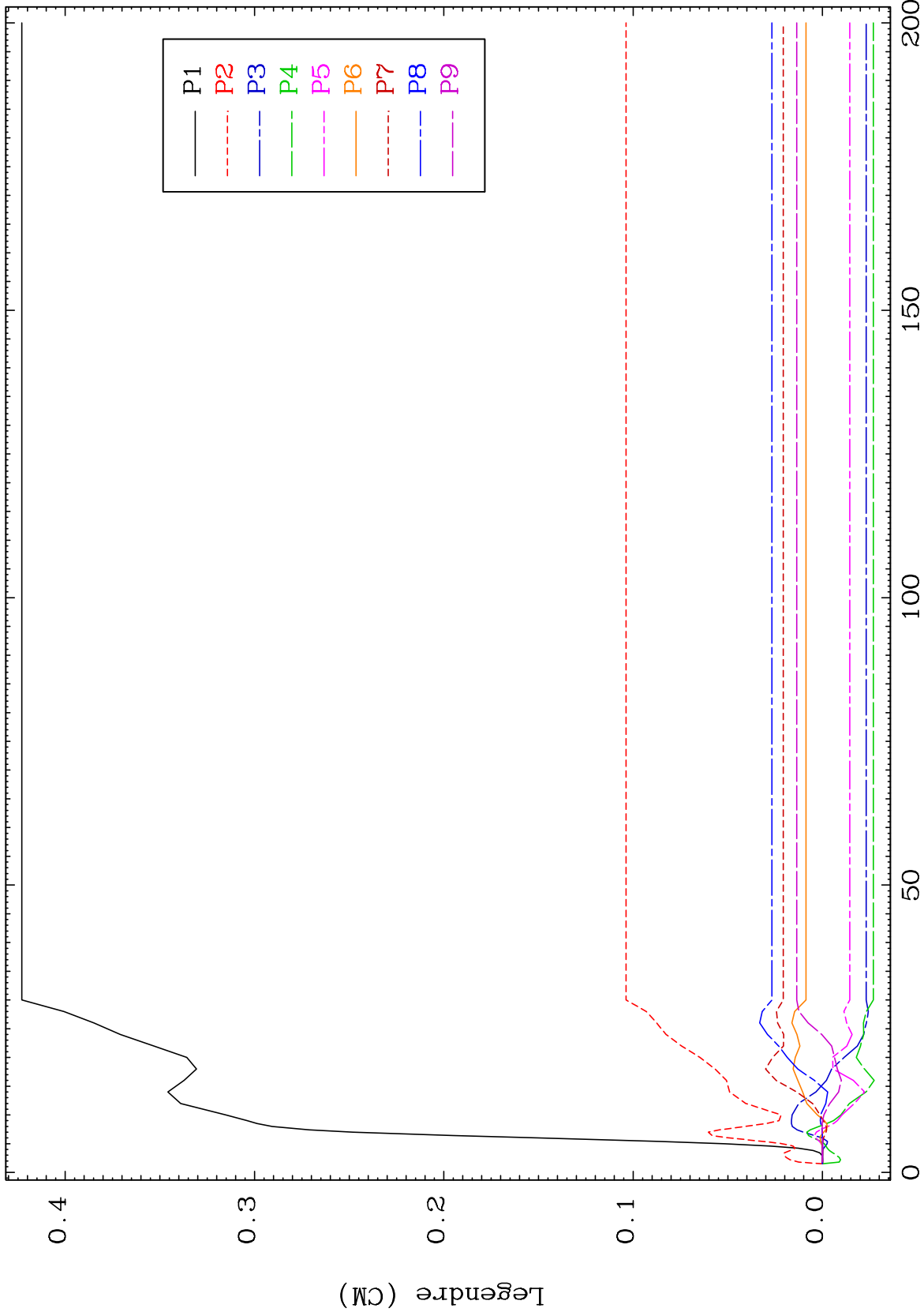

55-Cs-141

Incident Energy (MeV)

112

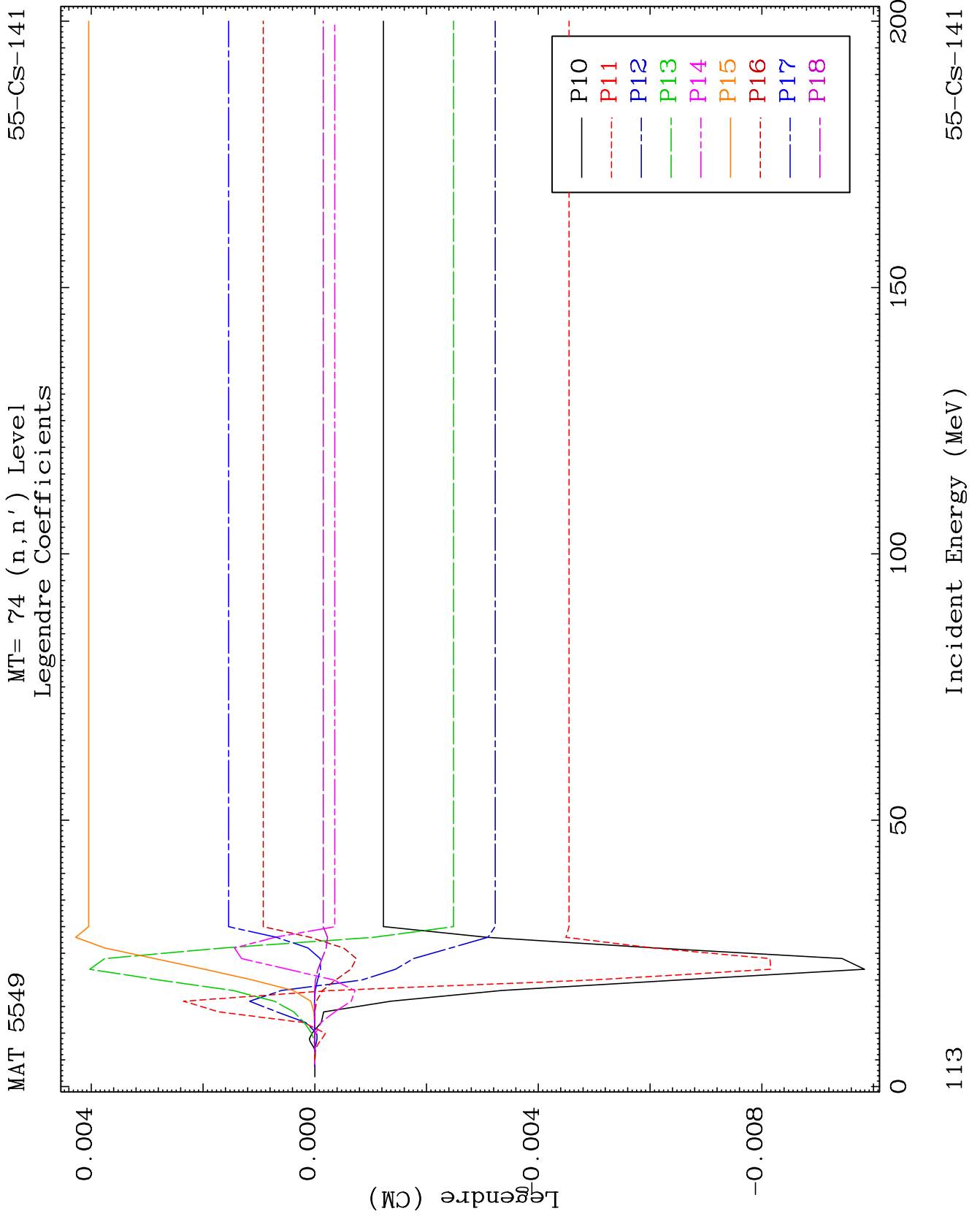

MAT 5549

MT= 74 (n,n') Level
Legendre Coefficients

55-Cs-141

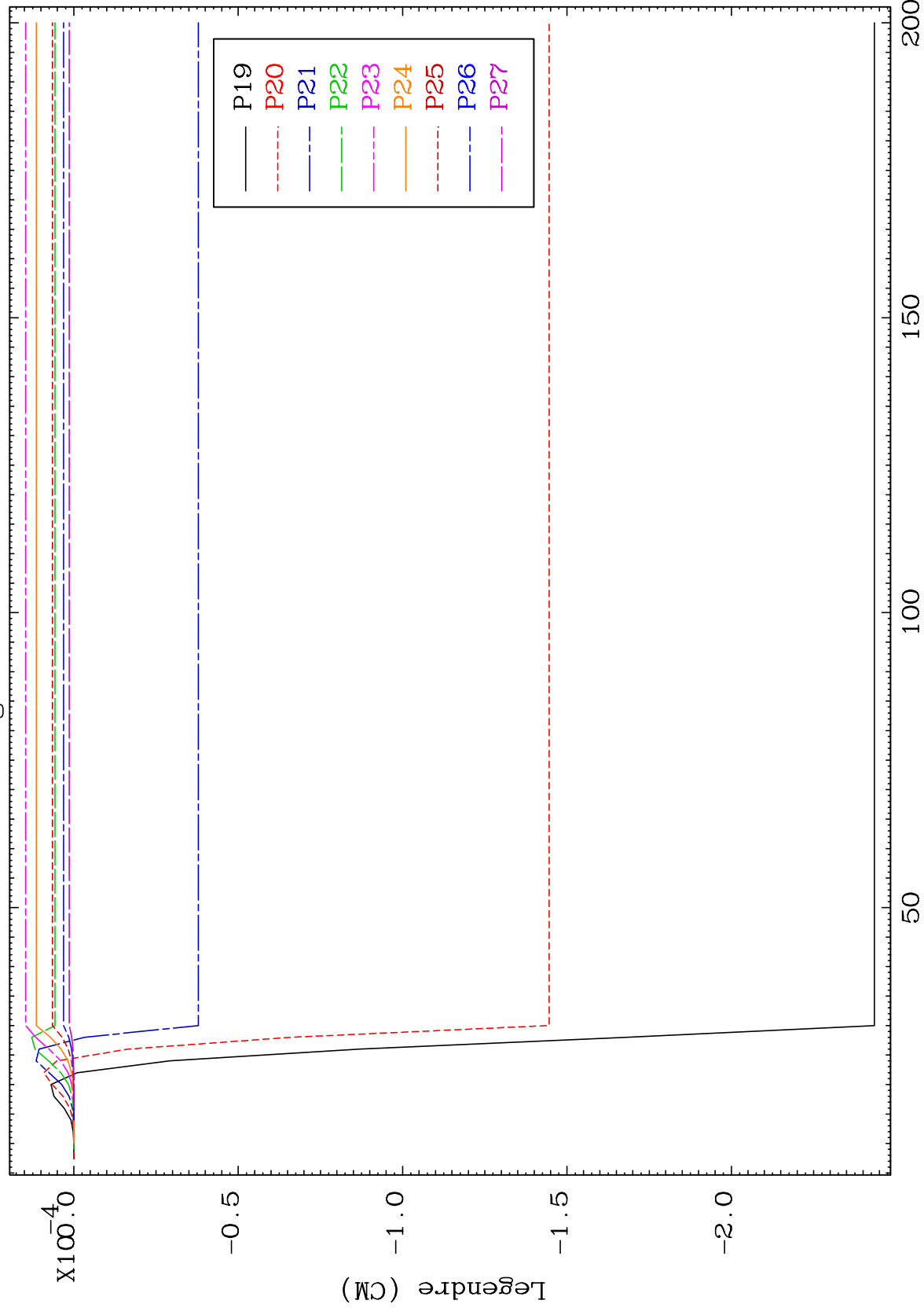

114

Incident Energy (MeV)

55-Cs-141

MAT 5549

MT= 74 (n,n') Level
Legendre Coefficients

55-Cs-141

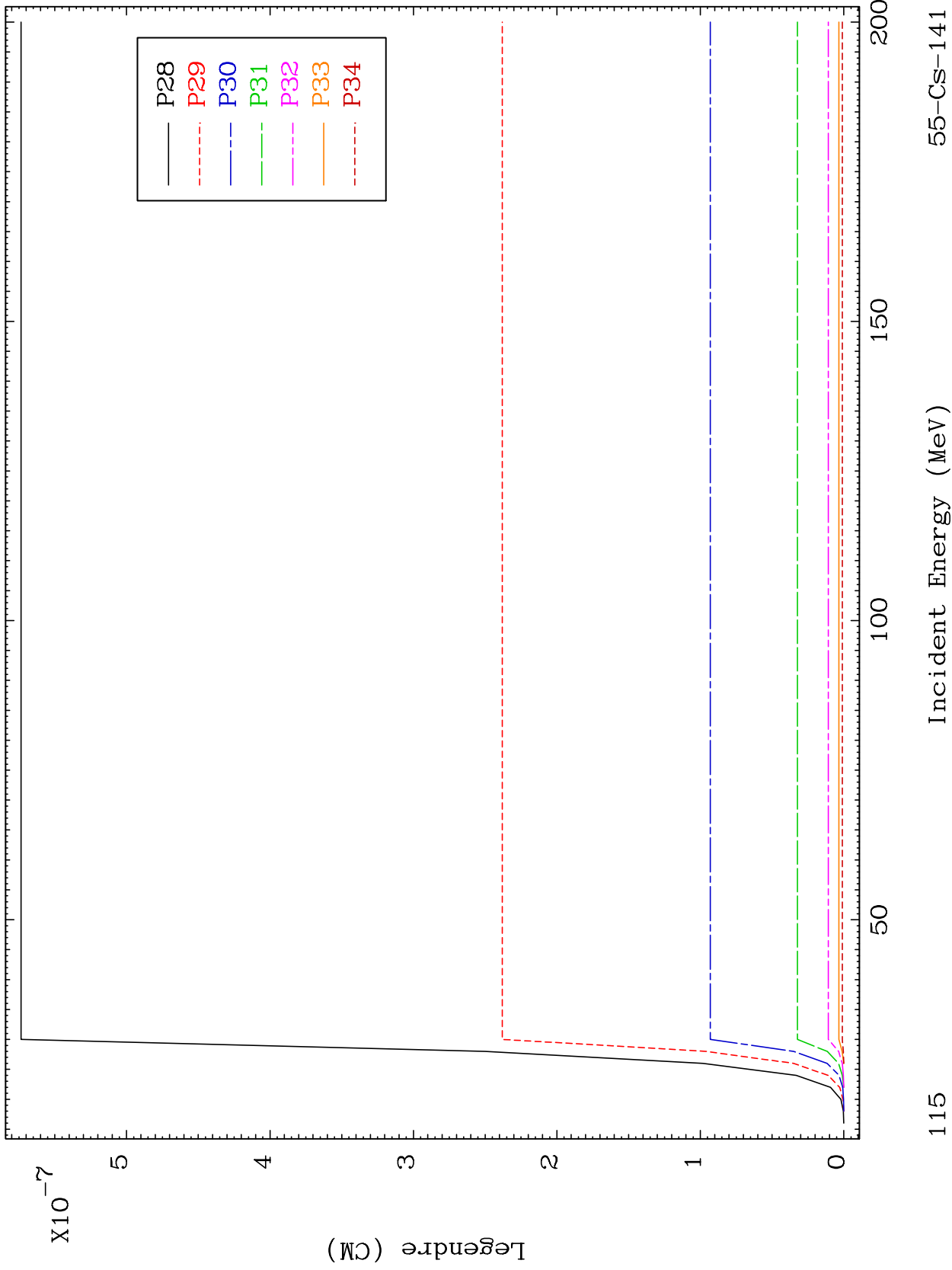

115

Incident Energy (MeV)

55-Cs-141

MAT 5549

MT= 75 (n,n') Level
Legendre Coefficients

55-Cs-141

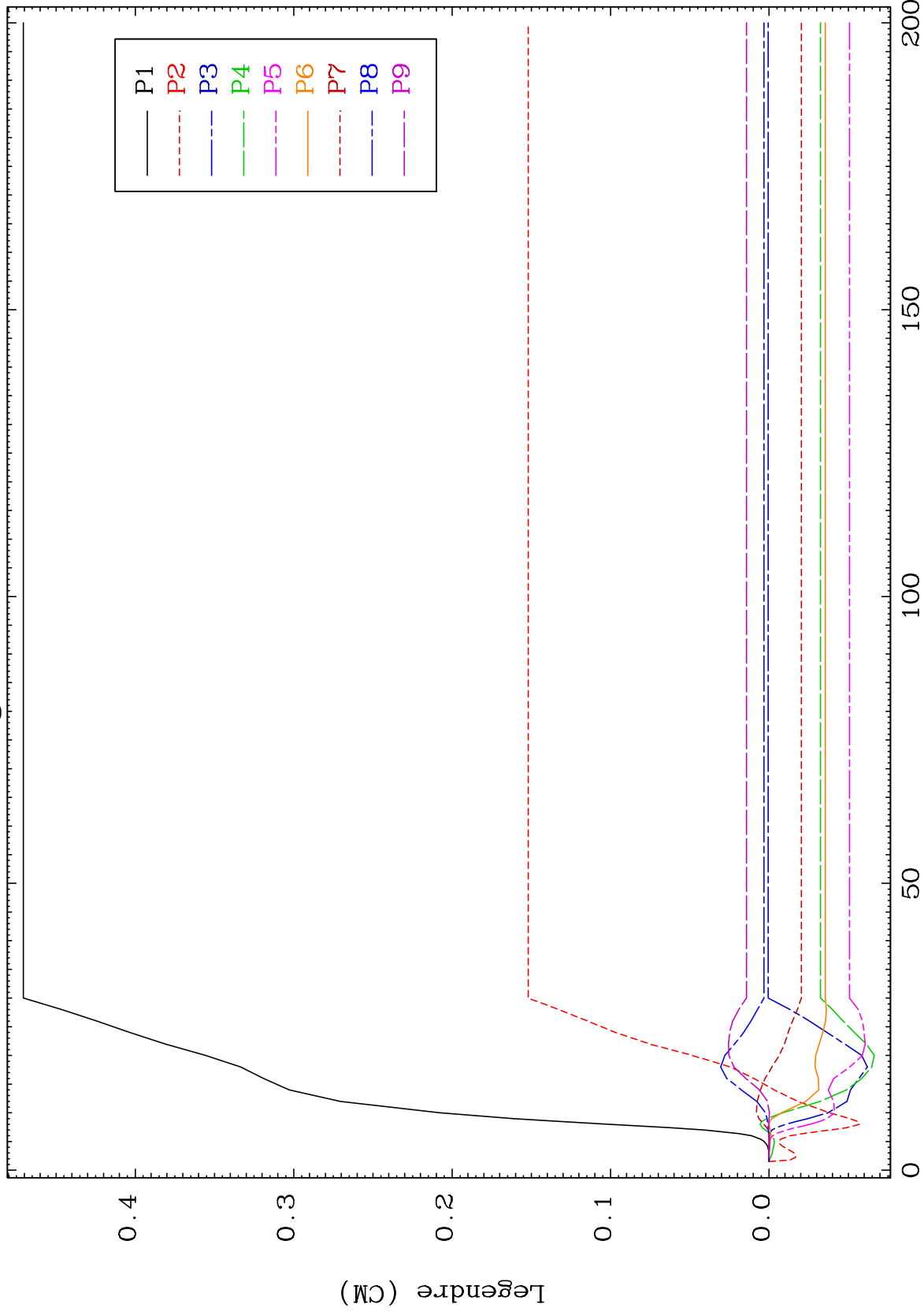

116

55-Cs-141

MAT 5549

MT= 75 (n,n') Level
Legendre Coefficients

55-Cs-141

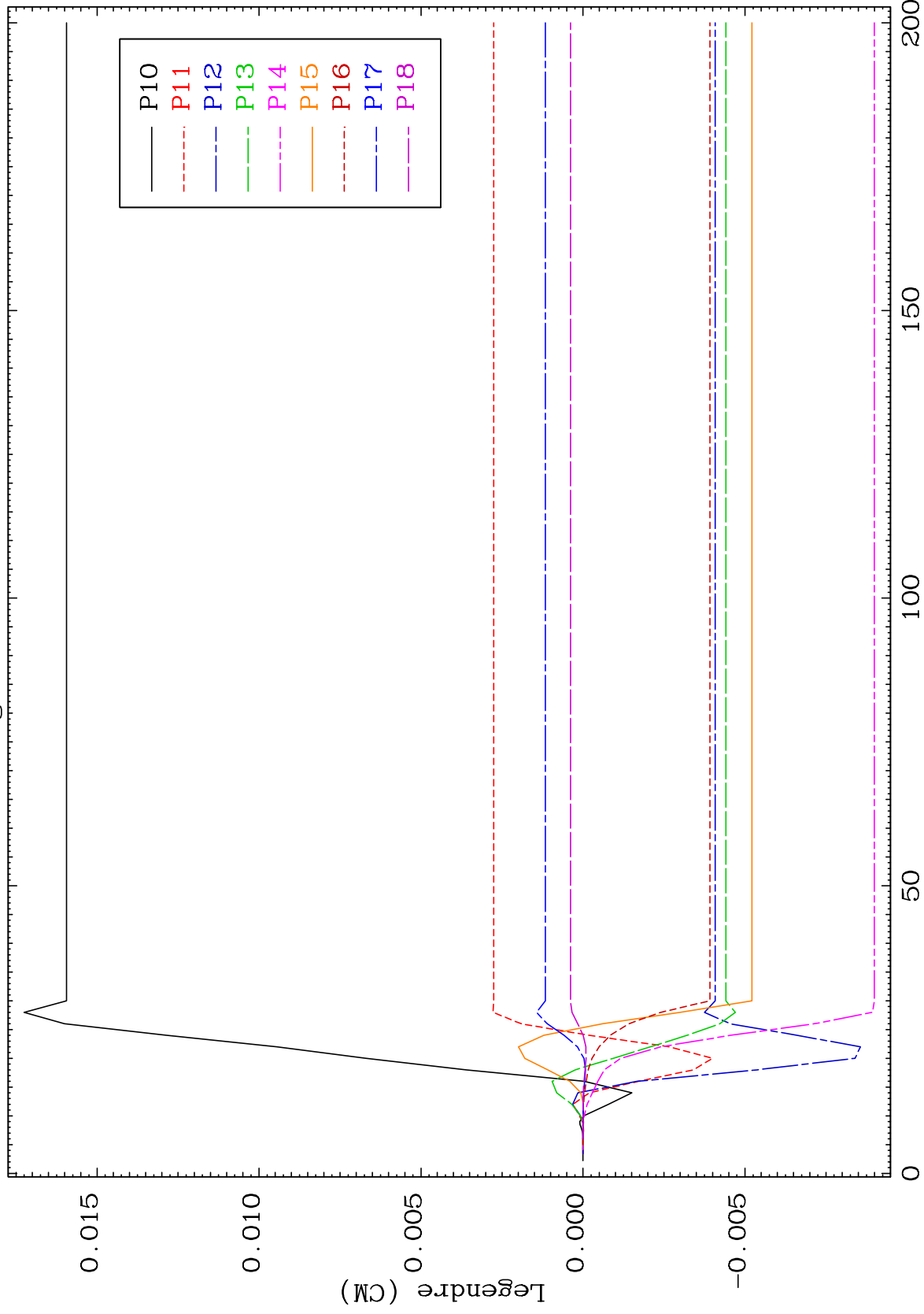

117

Incident Energy (MeV)

55-Cs-141

MAT 5549

MT= 75 (n,n') Level
Legendre Coefficients

55-Cs-141

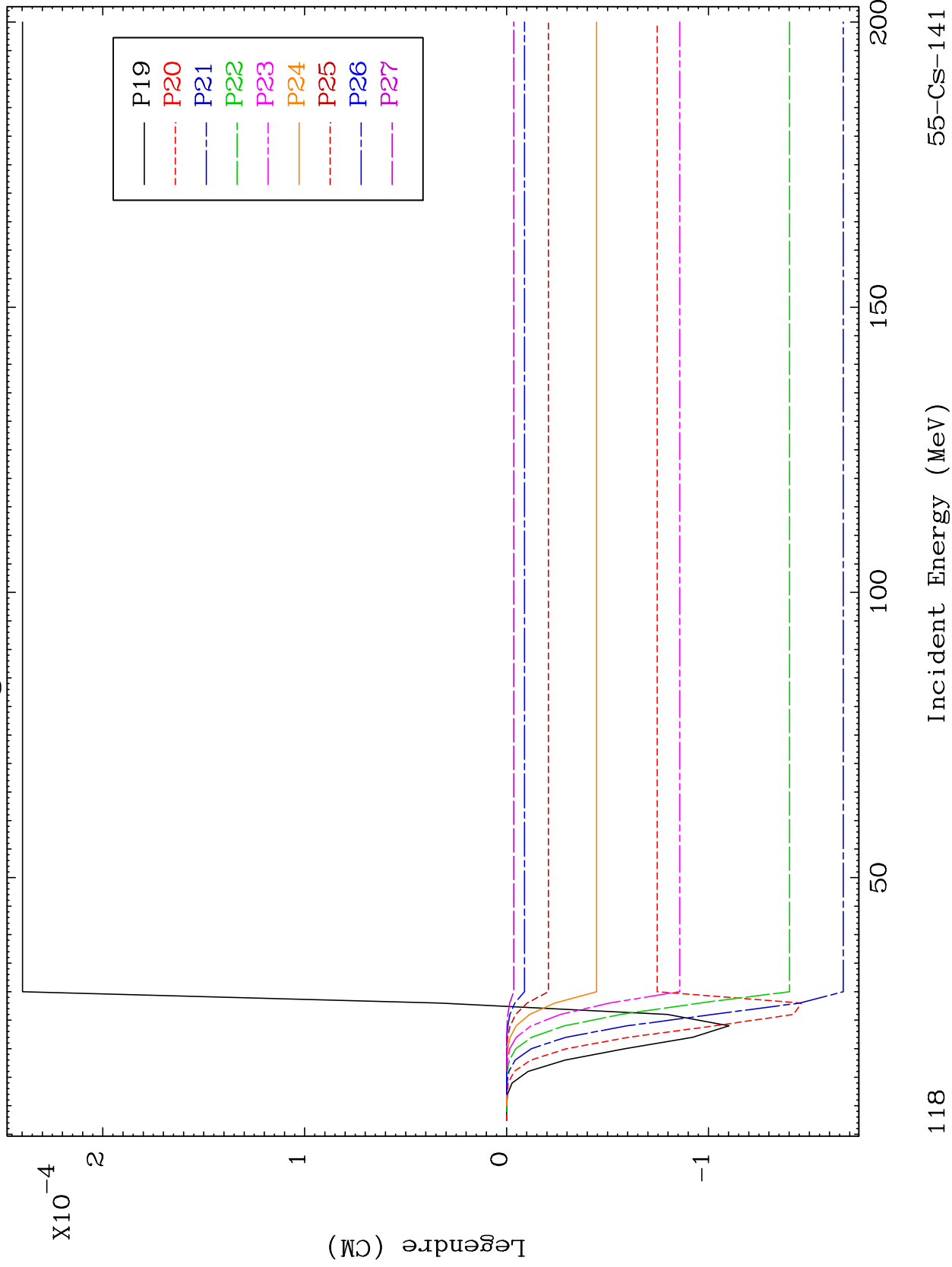

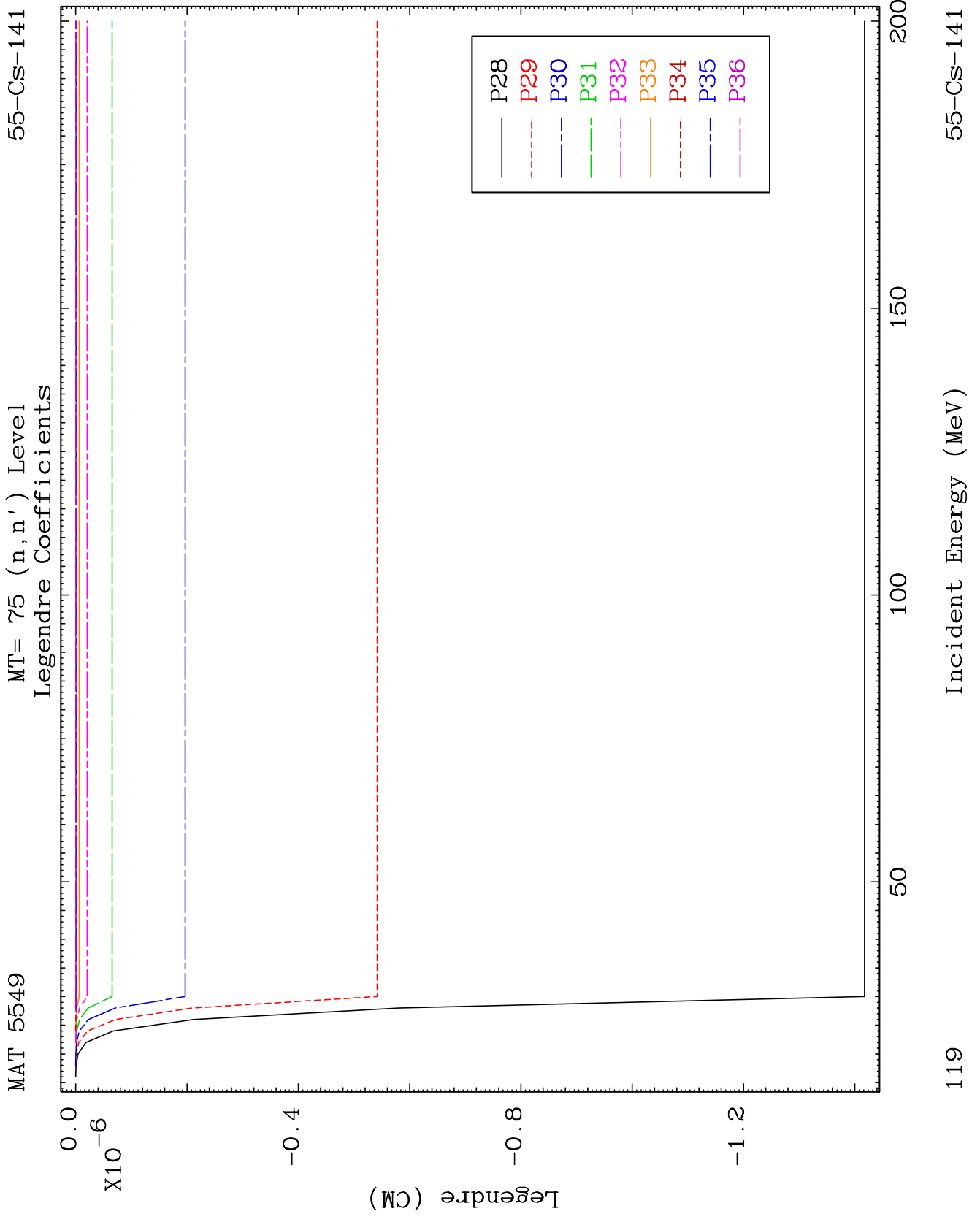

MAT 5549

MT= 76 (n,n') Level
Legendre Coefficients

55-Cs-141

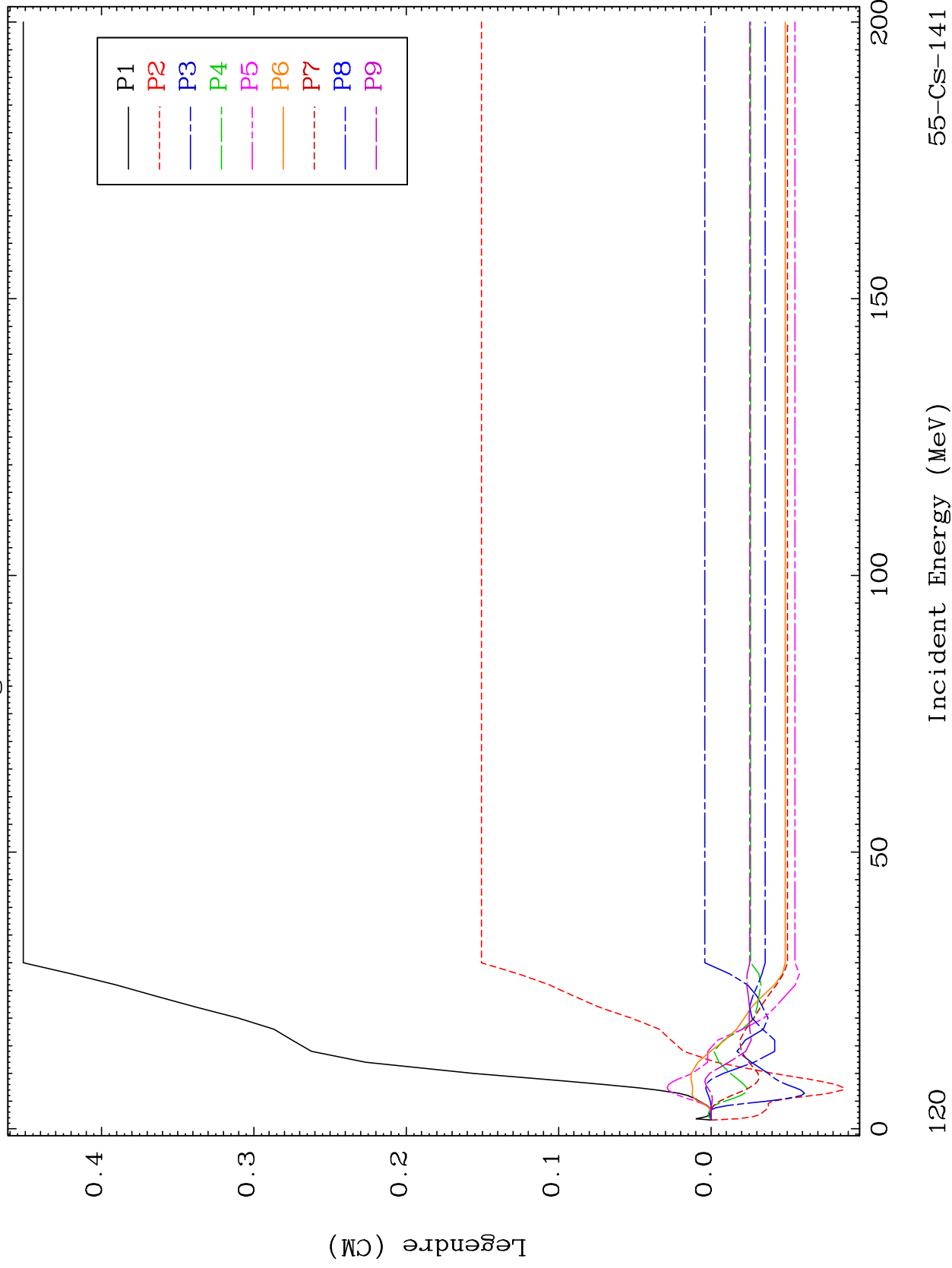

55-Cs-141

Incident Energy (MeV)

120

MAT 5549

MT= 76 (n,n') Level
Legendre Coefficients

55-Cs-141

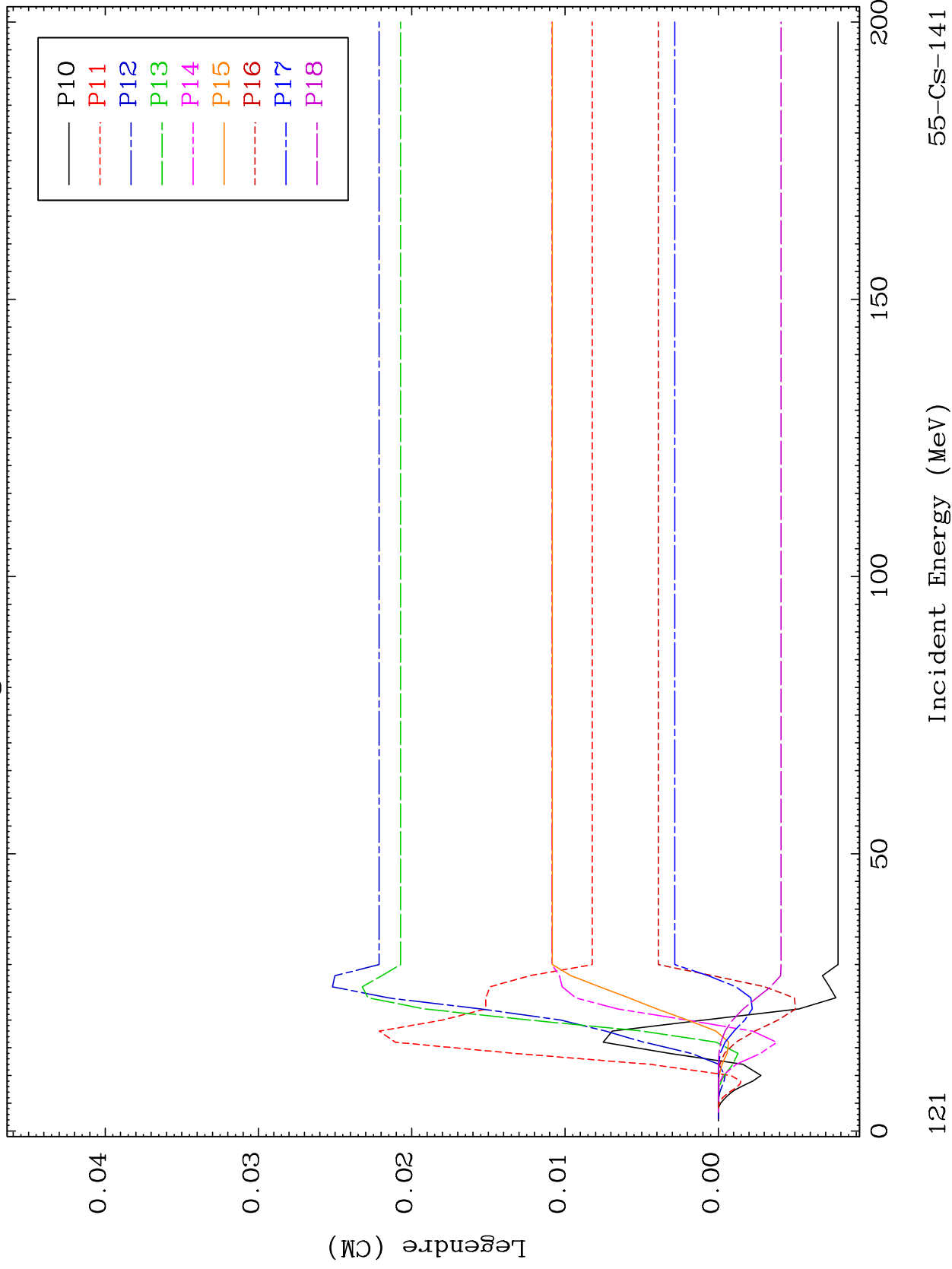

MAT 5549

MT= 76 (n,n') Level
Legendre Coefficients

55-Cs-141

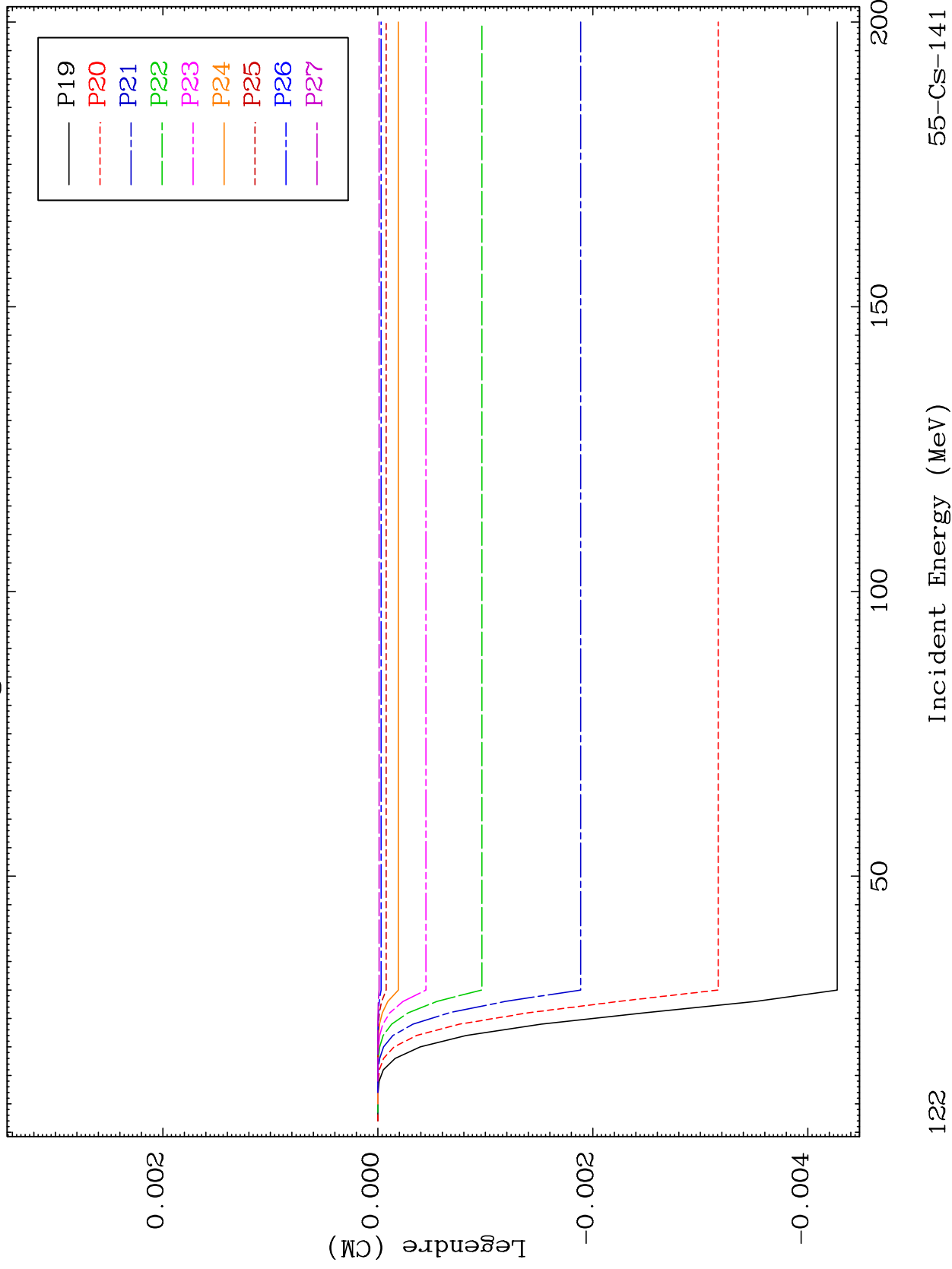

122

Incident Energy (MeV)

55-Cs-141

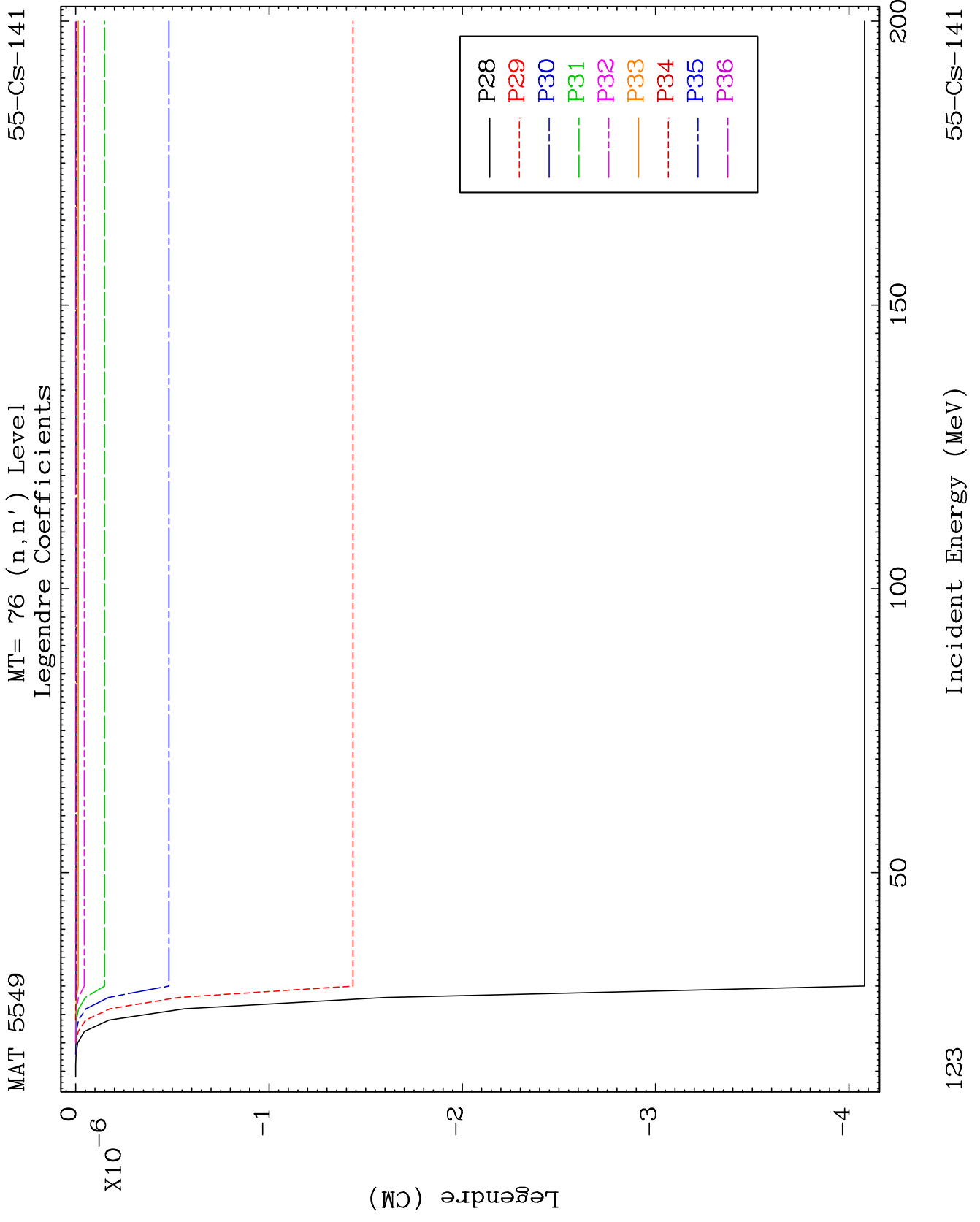

MAT 5549

MT= 77 (n,n') Level
Legendre Coefficients

55-Cs-141

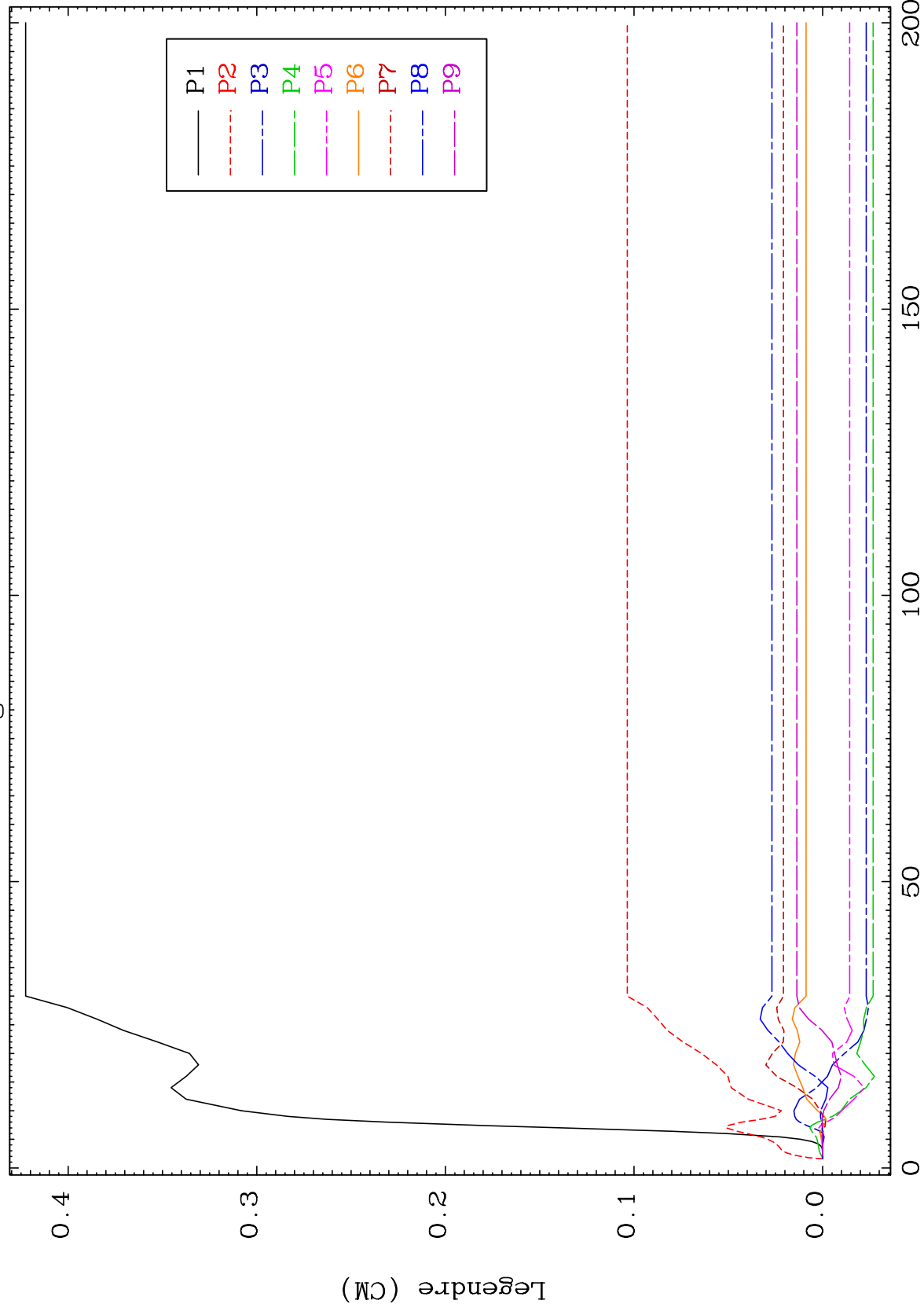

124

Incident Energy (MeV)

55-Cs-141

MAT 5549

MT= 77 (n,n') Level
Legendre Coefficients

55-Cs-141

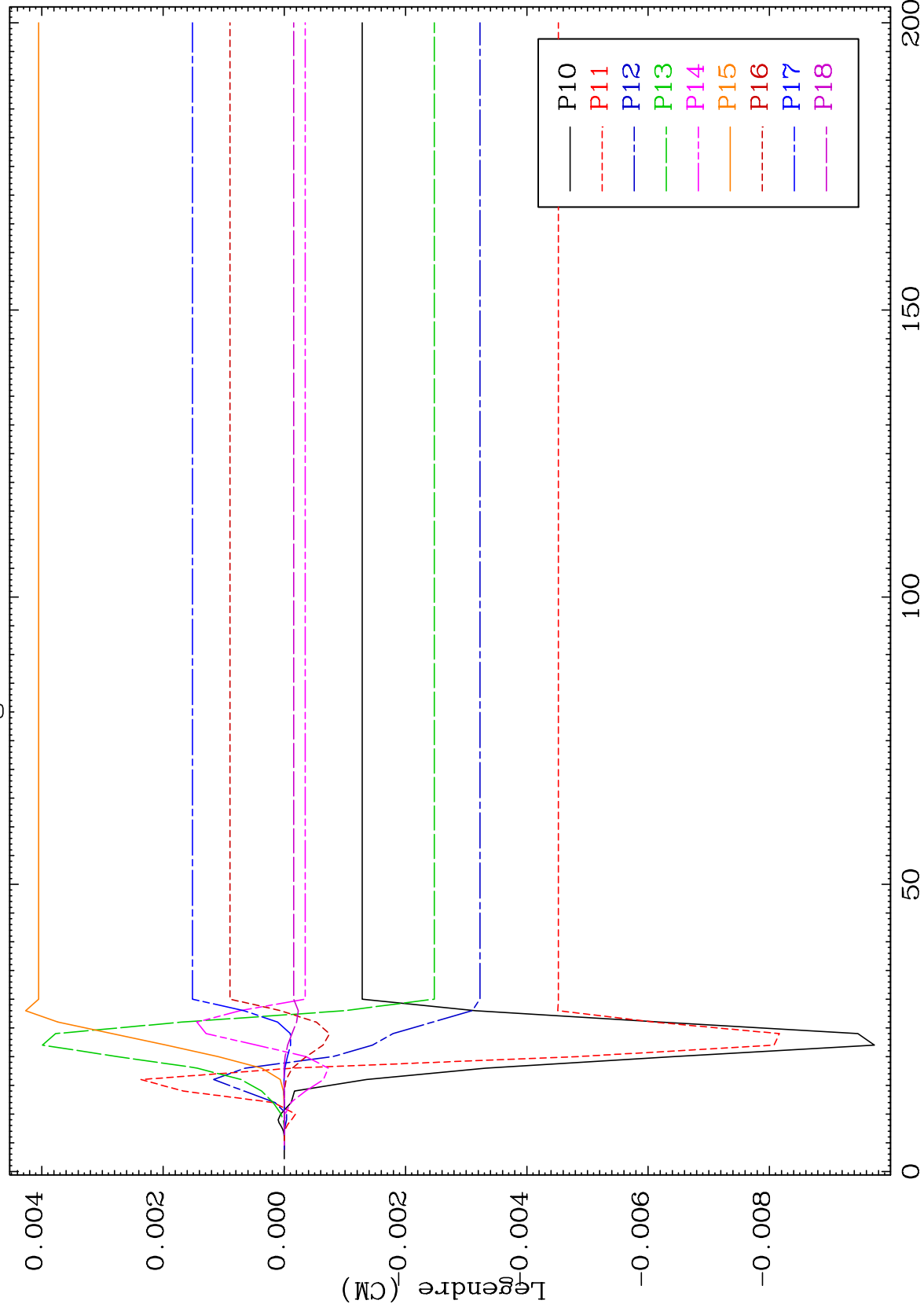

55-Cs-141

Incident Energy (MeV)

125

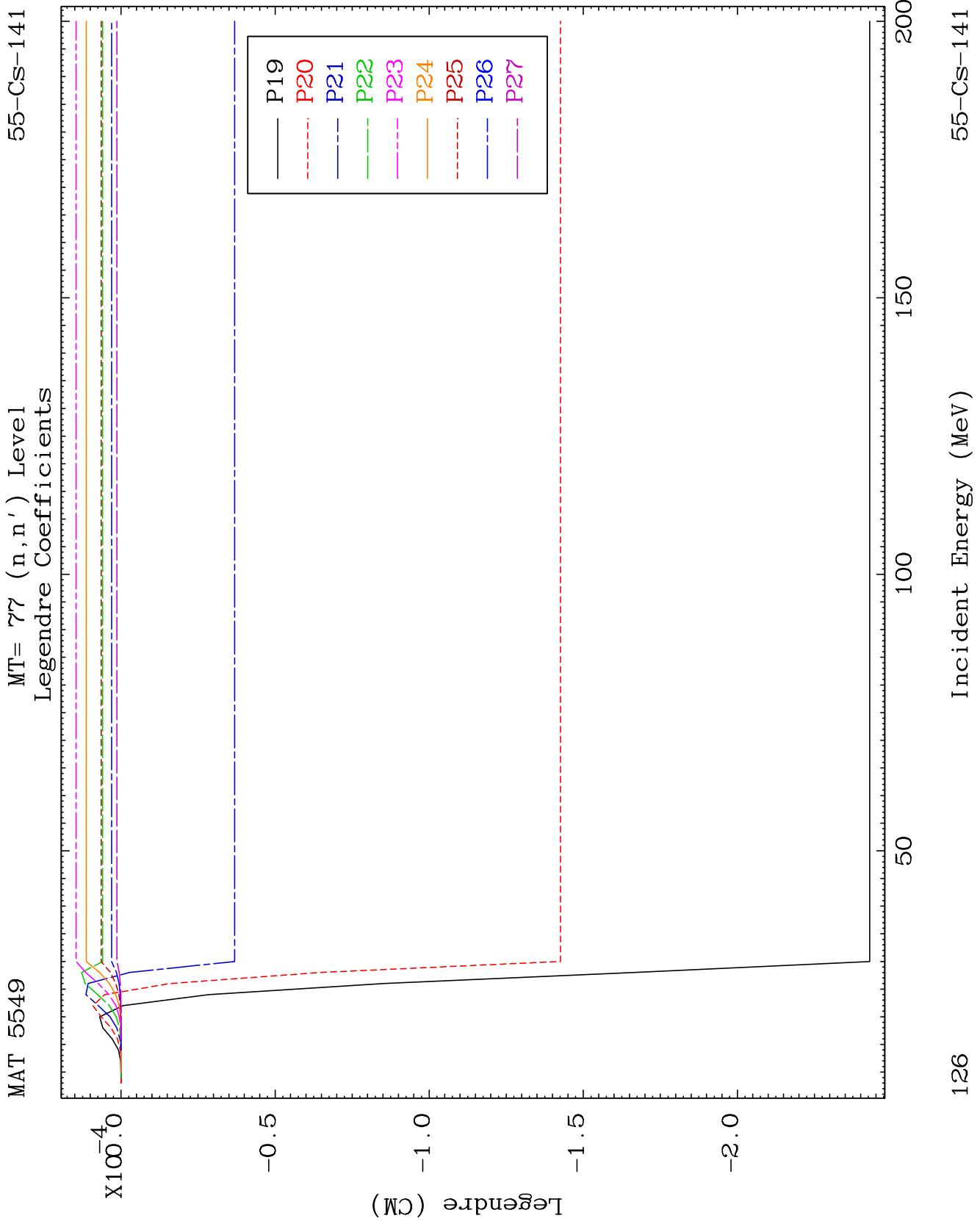

MAT 5549

MT= 77 (n,n') Level
Legendre Coefficients

55-Cs-141

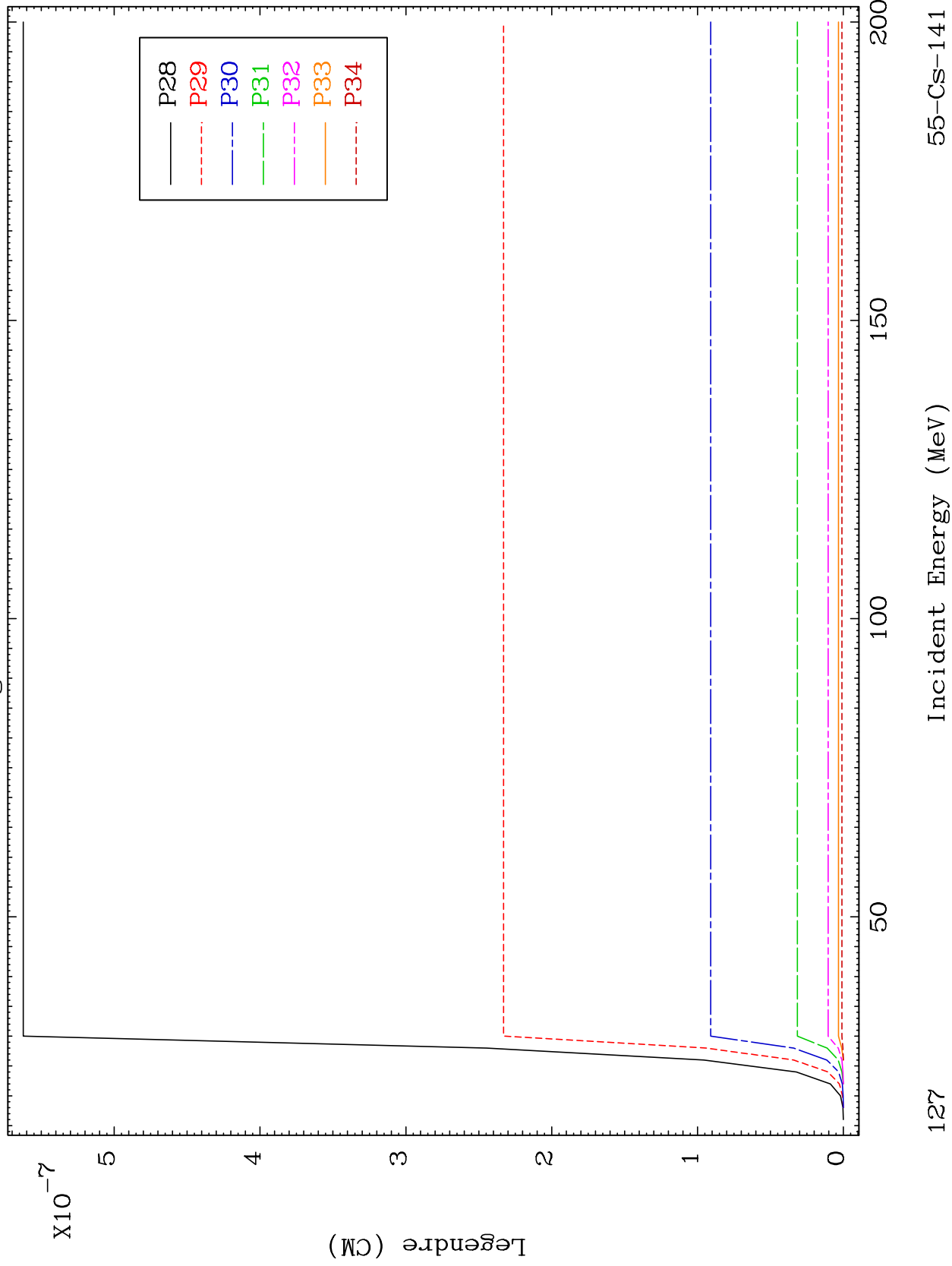

MAT 5549

MT= 78 (n,n') Level
Legendre Coefficients

55-Cs-141

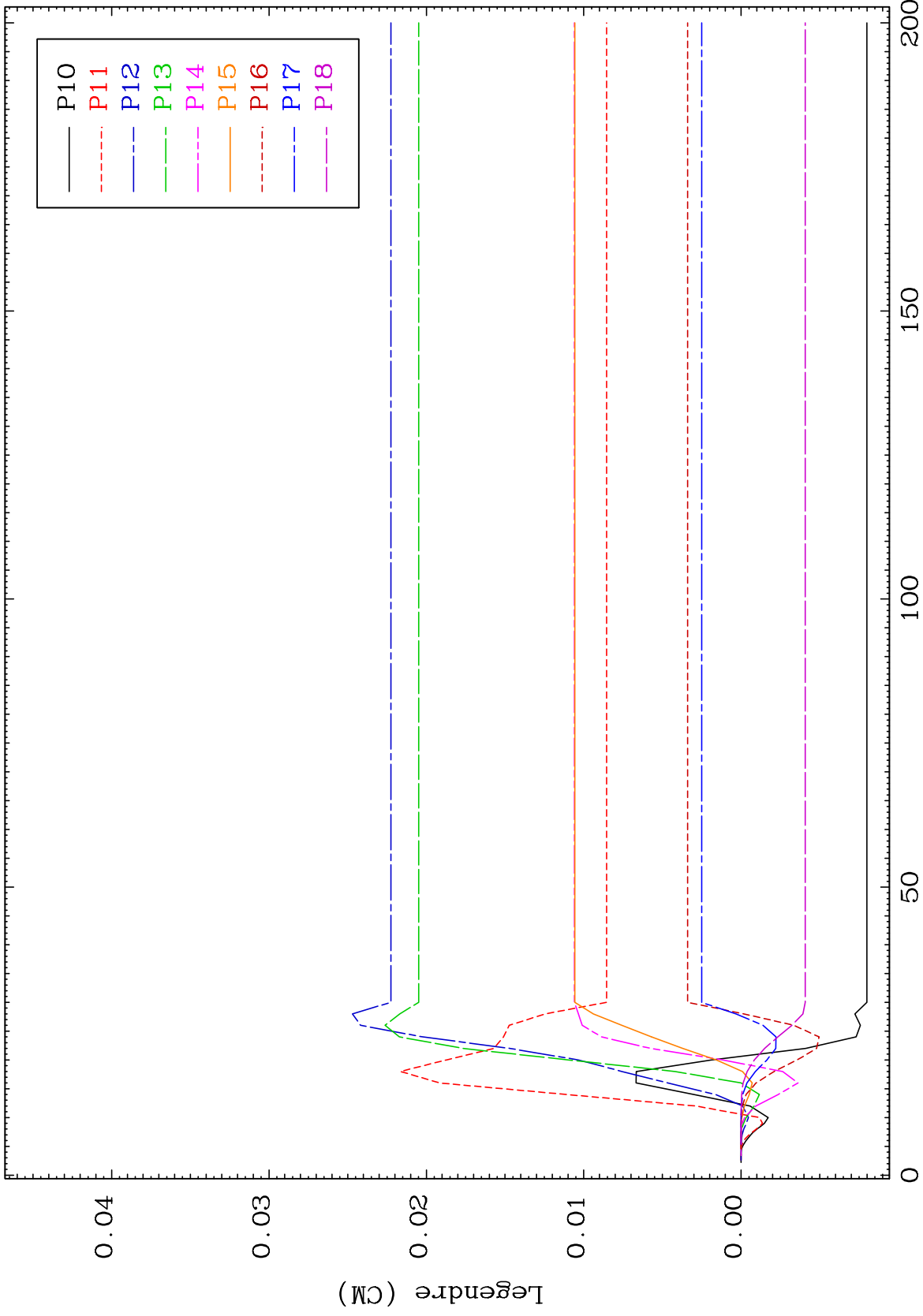

129

Incident Energy (MeV)

55-Cs-141

MAT 5549

MT= 78 (n,n') Level
Legendre Coefficients

55-Cs-141

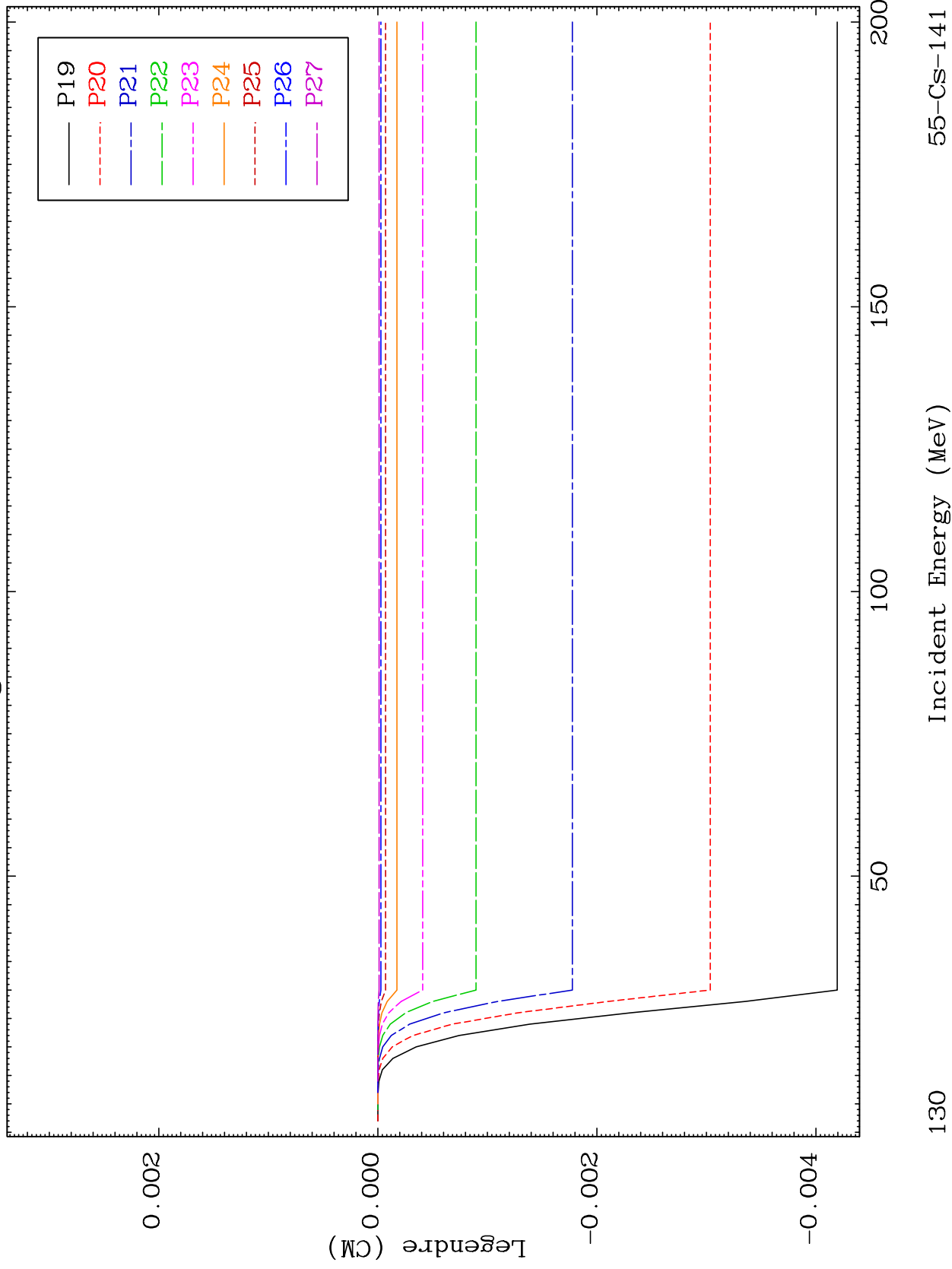

130

Incident Energy (MeV)

55-Cs-141

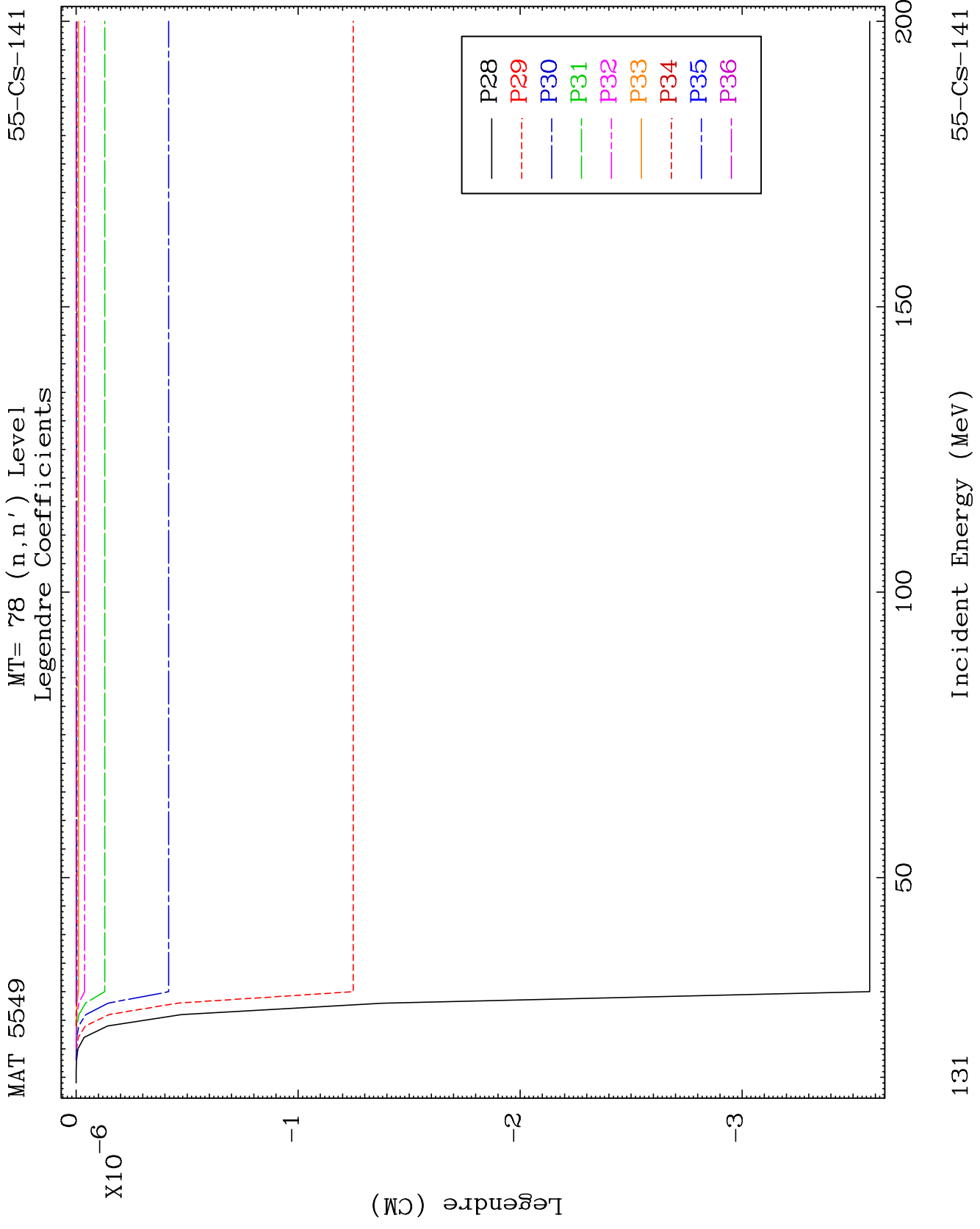

MAT 5549

(n,2n) α

55-Cs-141

Radionuclide Production Cross Section

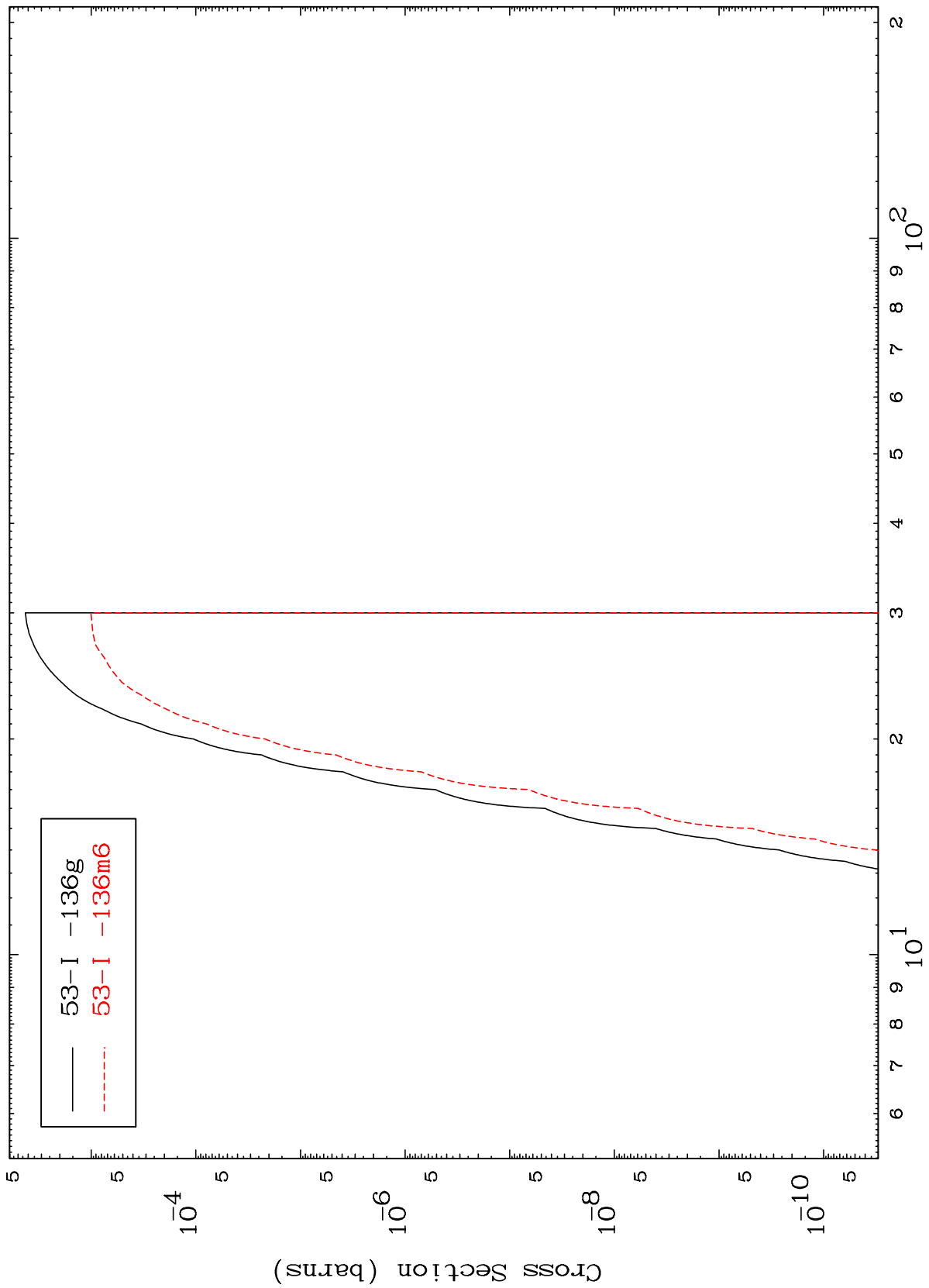

132

Incident Energy (MeV)

55-Cs-141

MAT 5549

(n,4n)

55-Cs-141

Radionuclide Production Cross Section

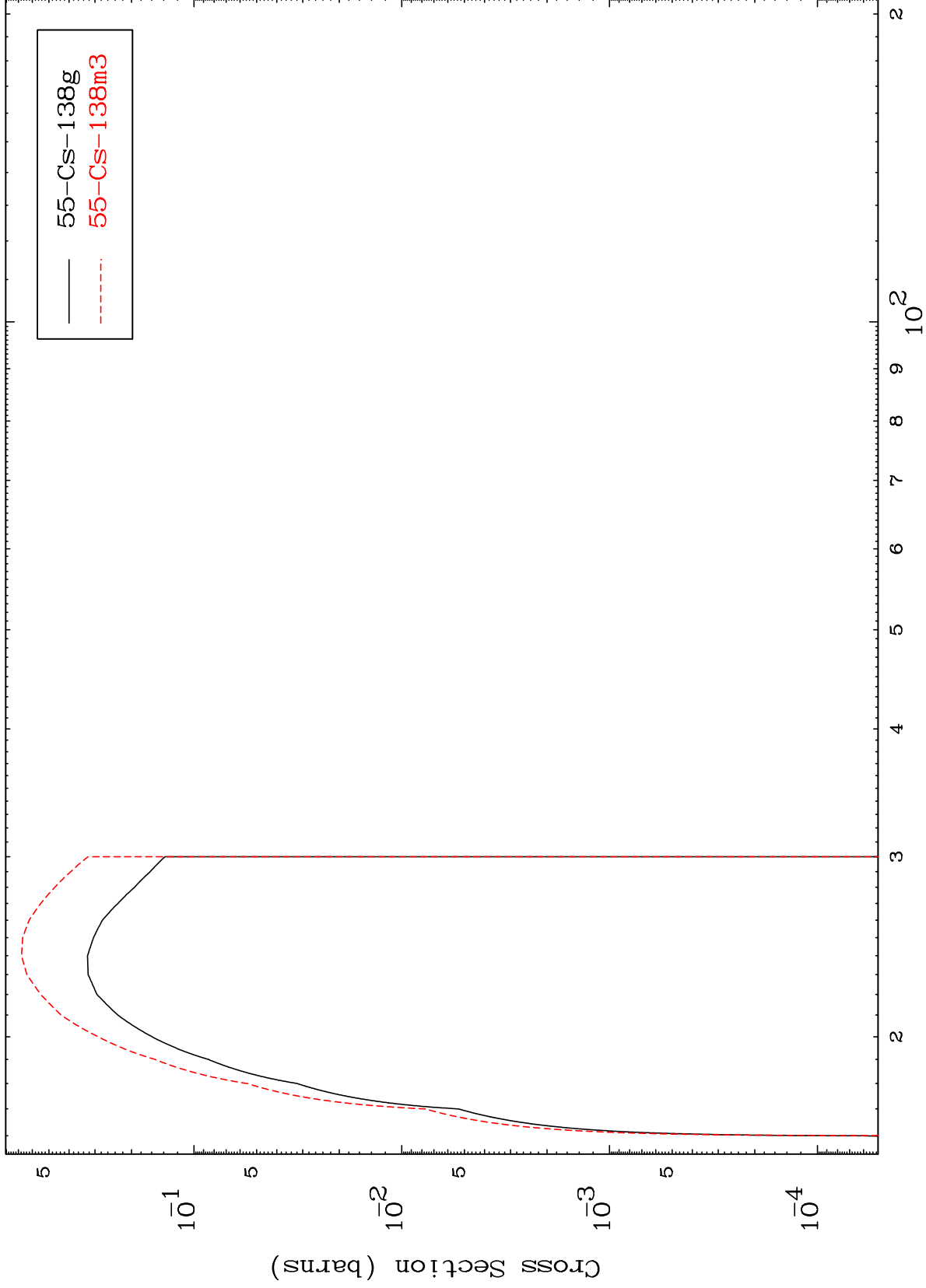

133

Incident Energy (MeV)

55-Cs-141

MAT 5549

(n,2α)

55-Cs-141

Radionuclide Production Cross Section

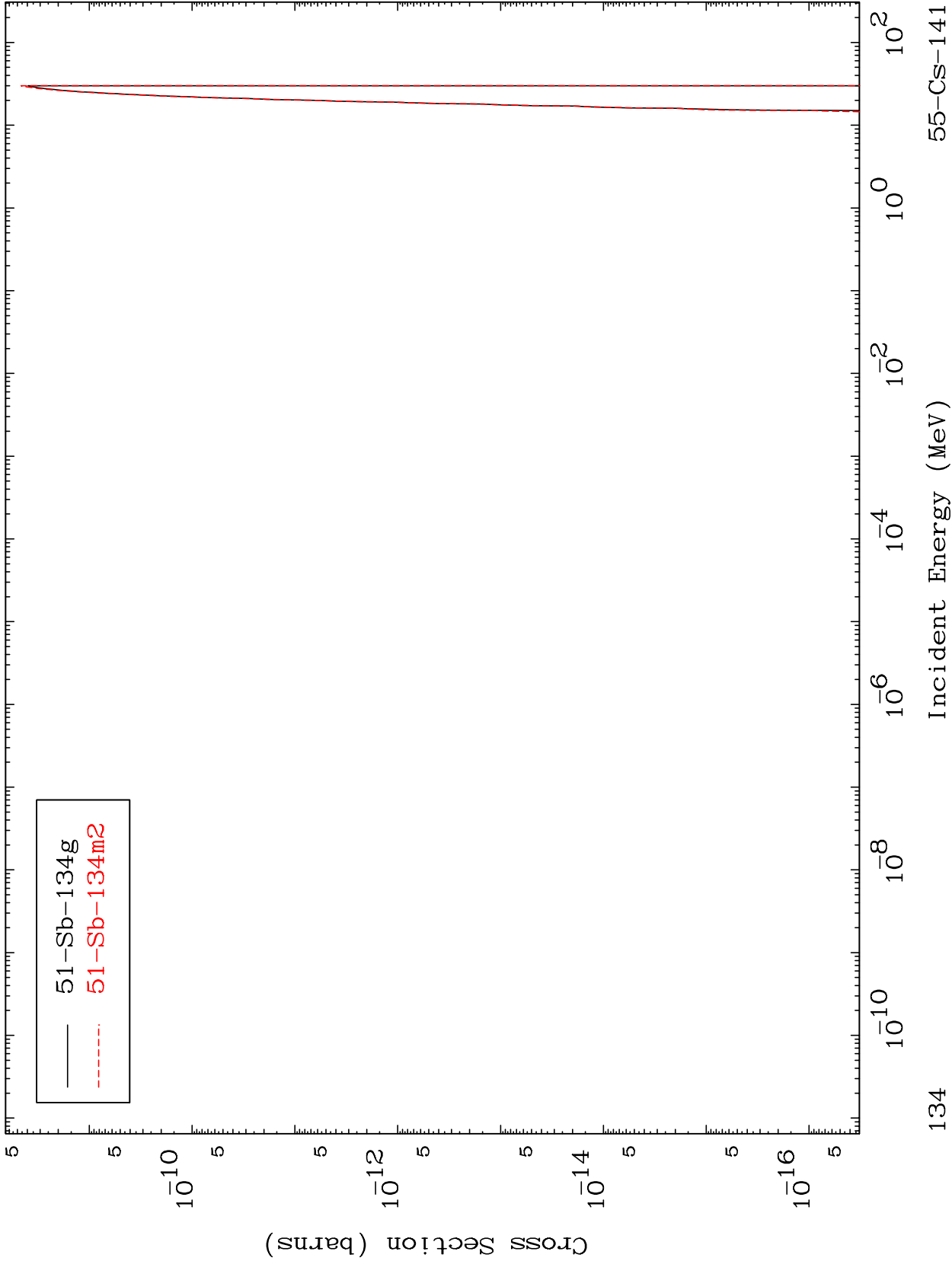

134

55-Cs-141