

# N-DY142 NRG TENDL-2017, AKONING

## Principal cross sections

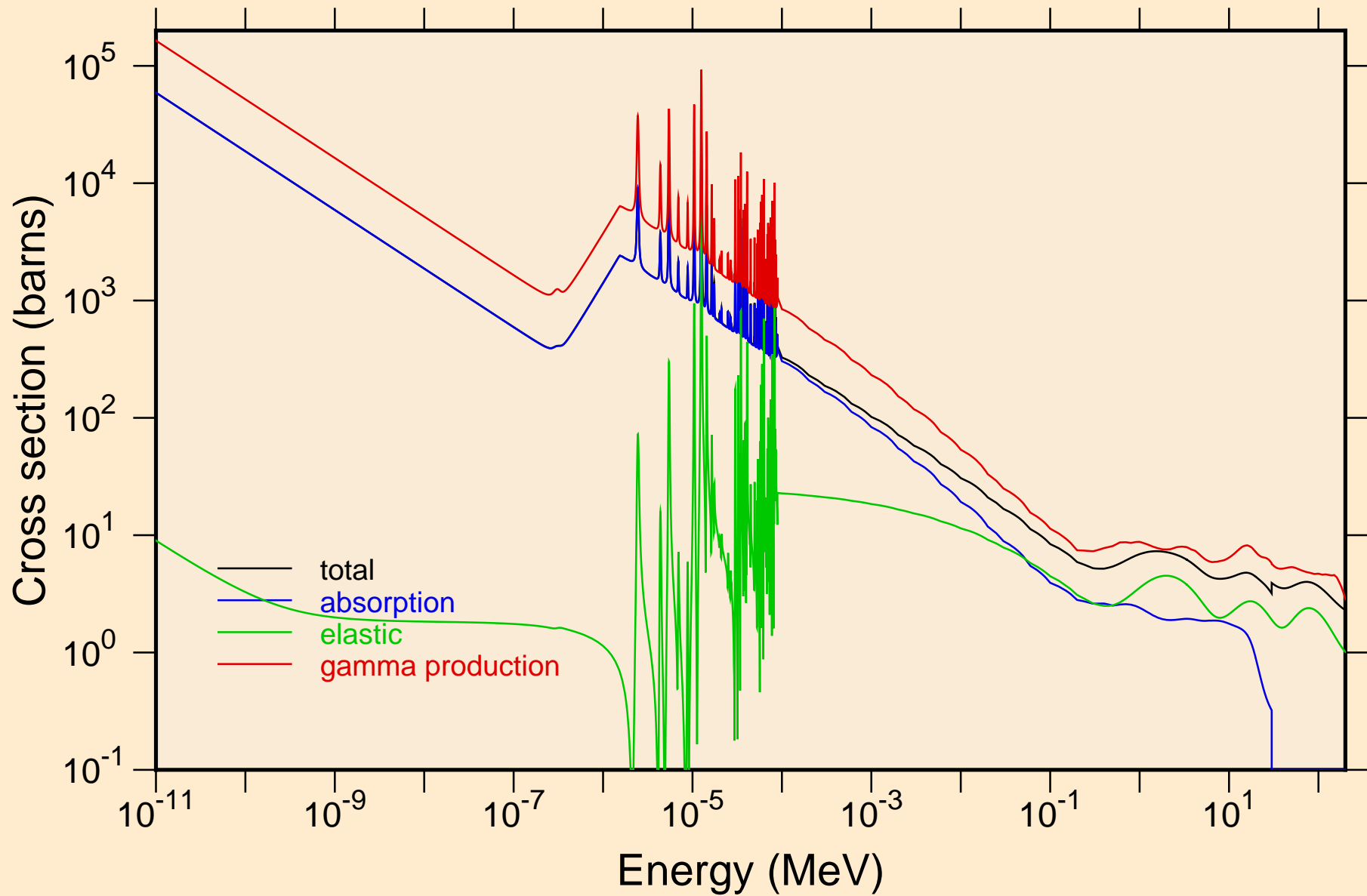

N-DY142 NRG TENDL-2017, AKONING  
resonance total cross section

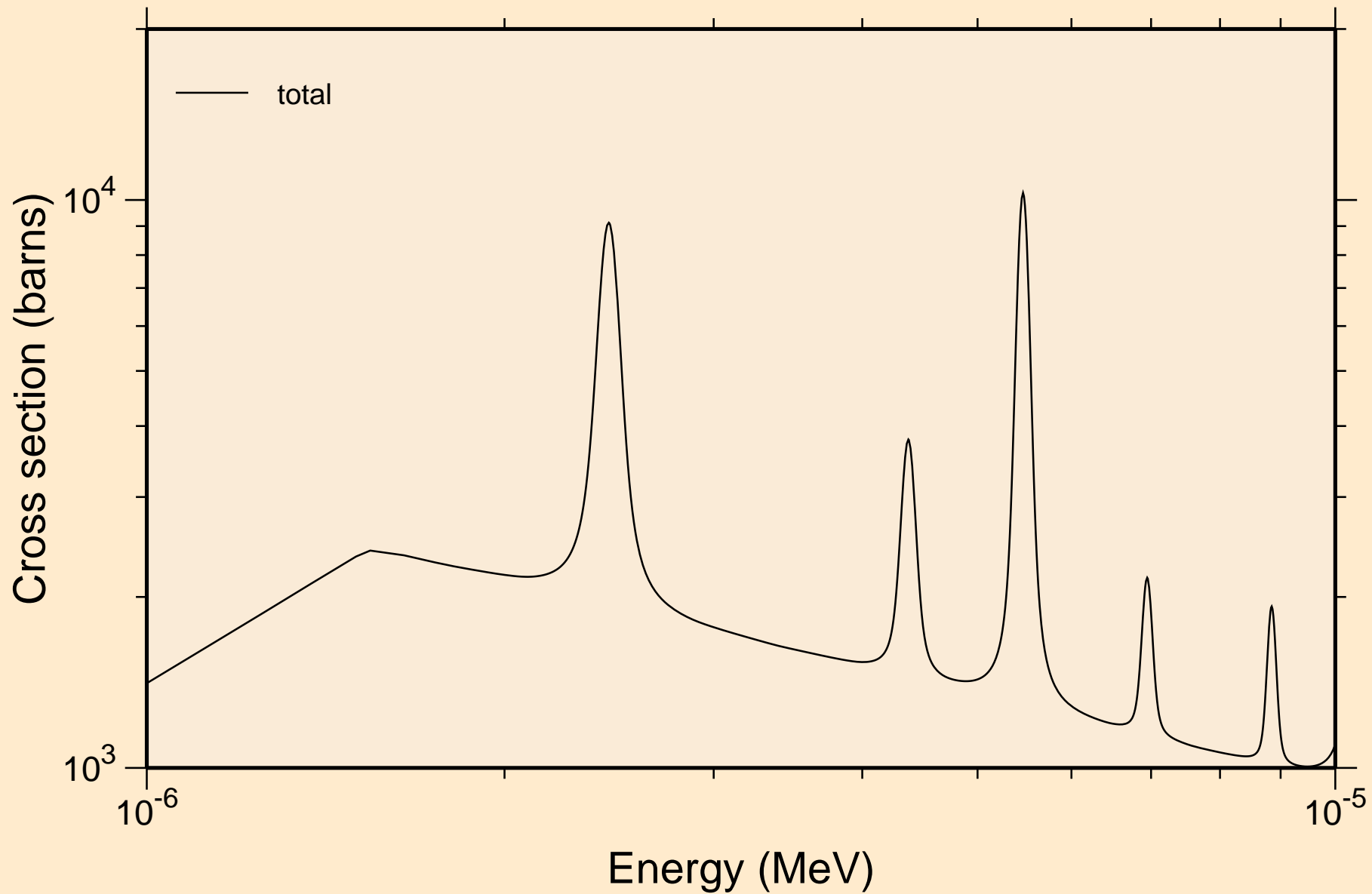

N-DY142 NRG TENDL-2017, AKONING  
resonance total cross section

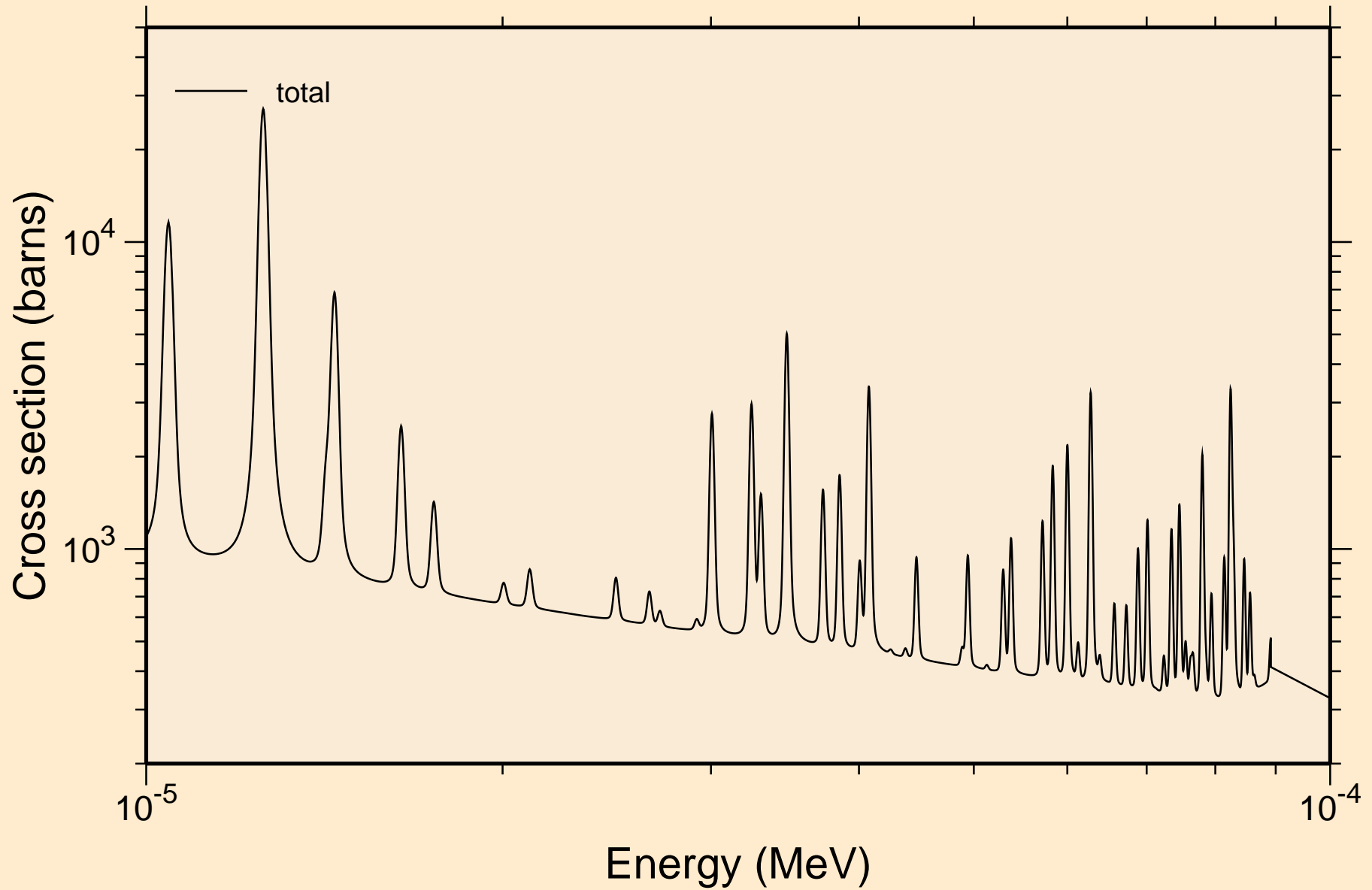

N-DY142 NRG TENDL-2017, AKONING  
resonance total cross section

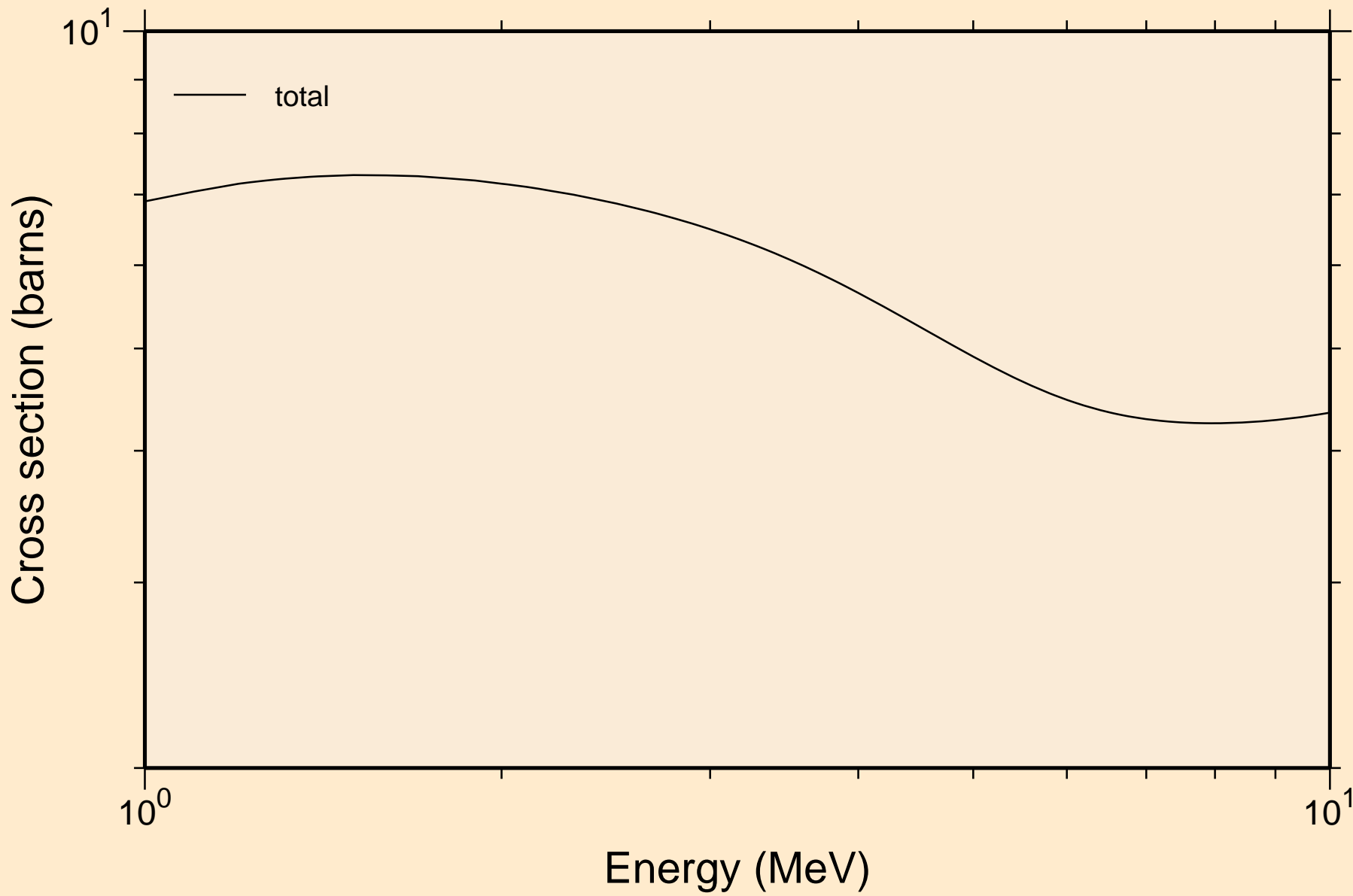

# N-DY142 NRG TENDL-2017, AKONING resonance absorption cross sections

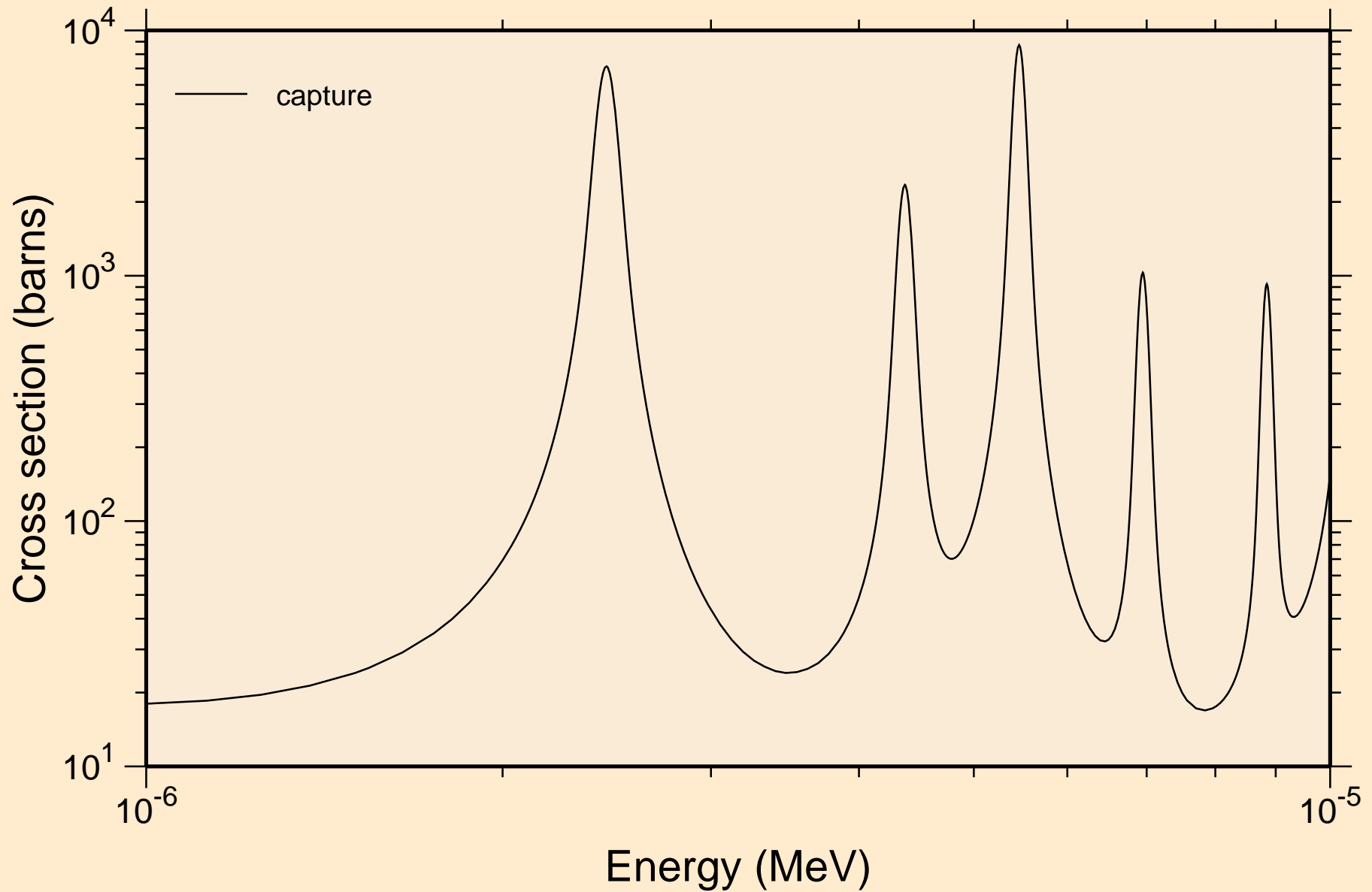

# N-DY142 NRG TENDL-2017, AKONING resonance absorption cross sections

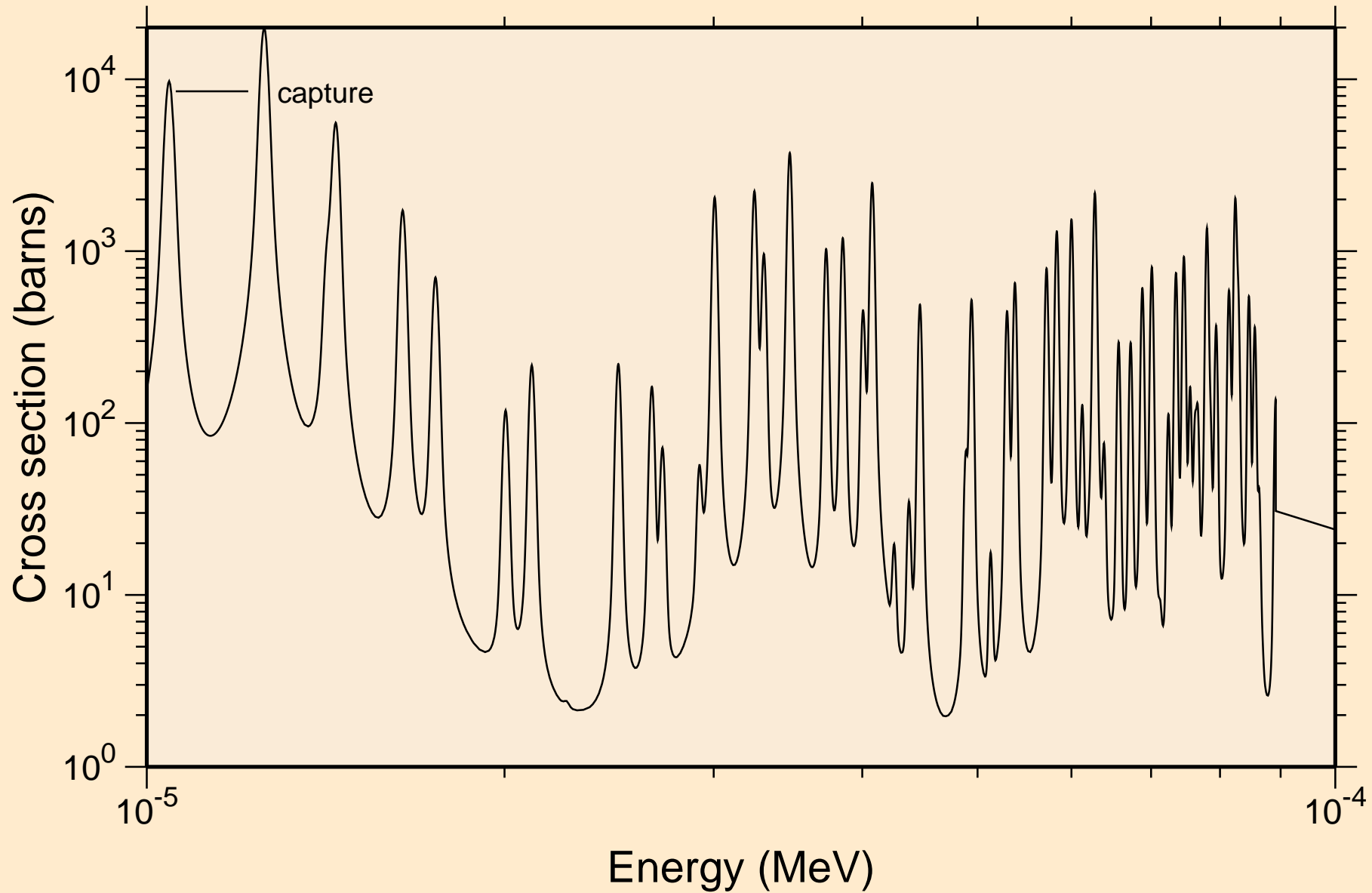

N-DY142 NRG TENDL-2017, AKONING  
resonance absorption cross sections

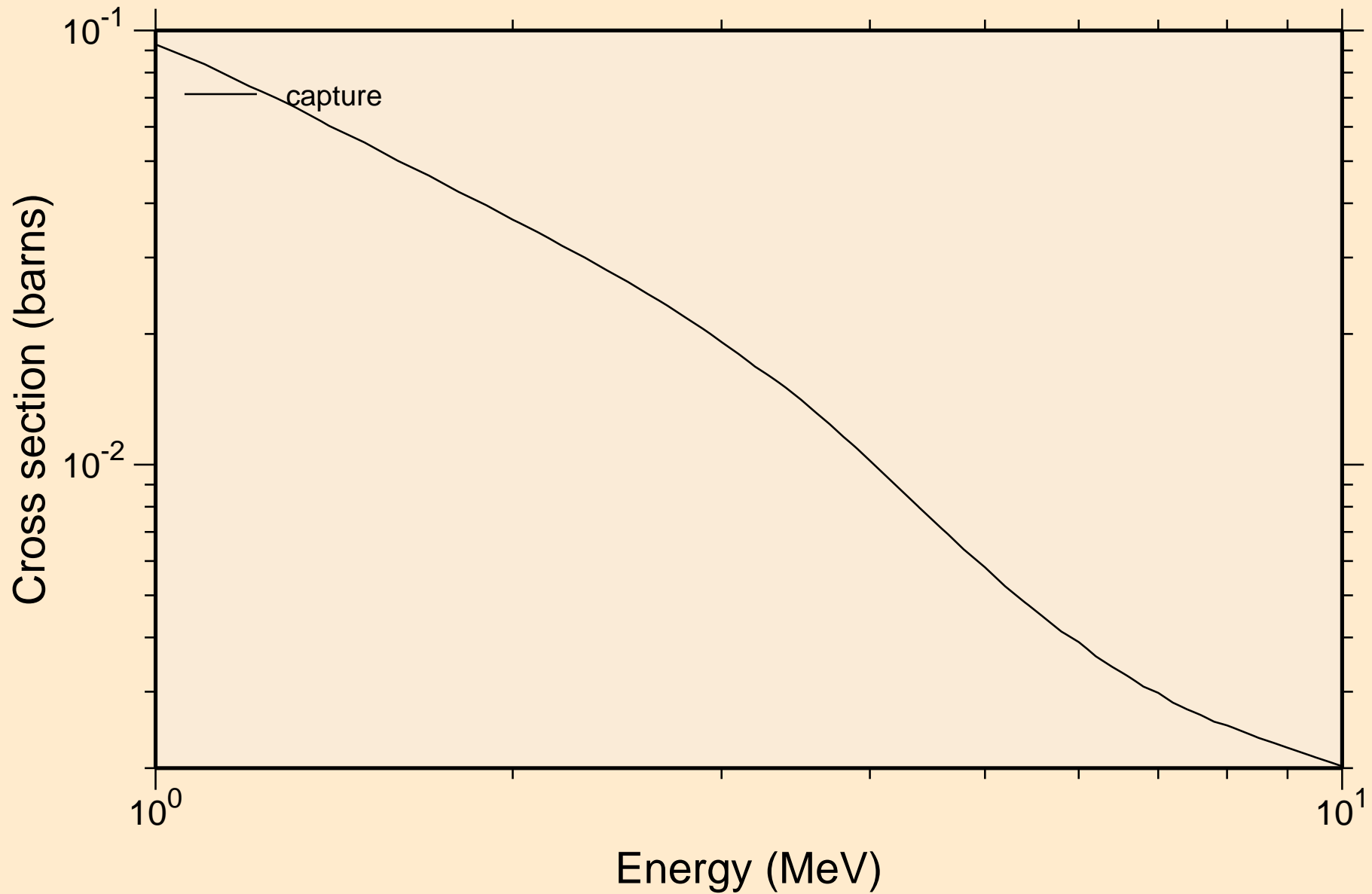

# N-DY142 NRG TENDL-2017, AKONING

## Non-threshold reactions

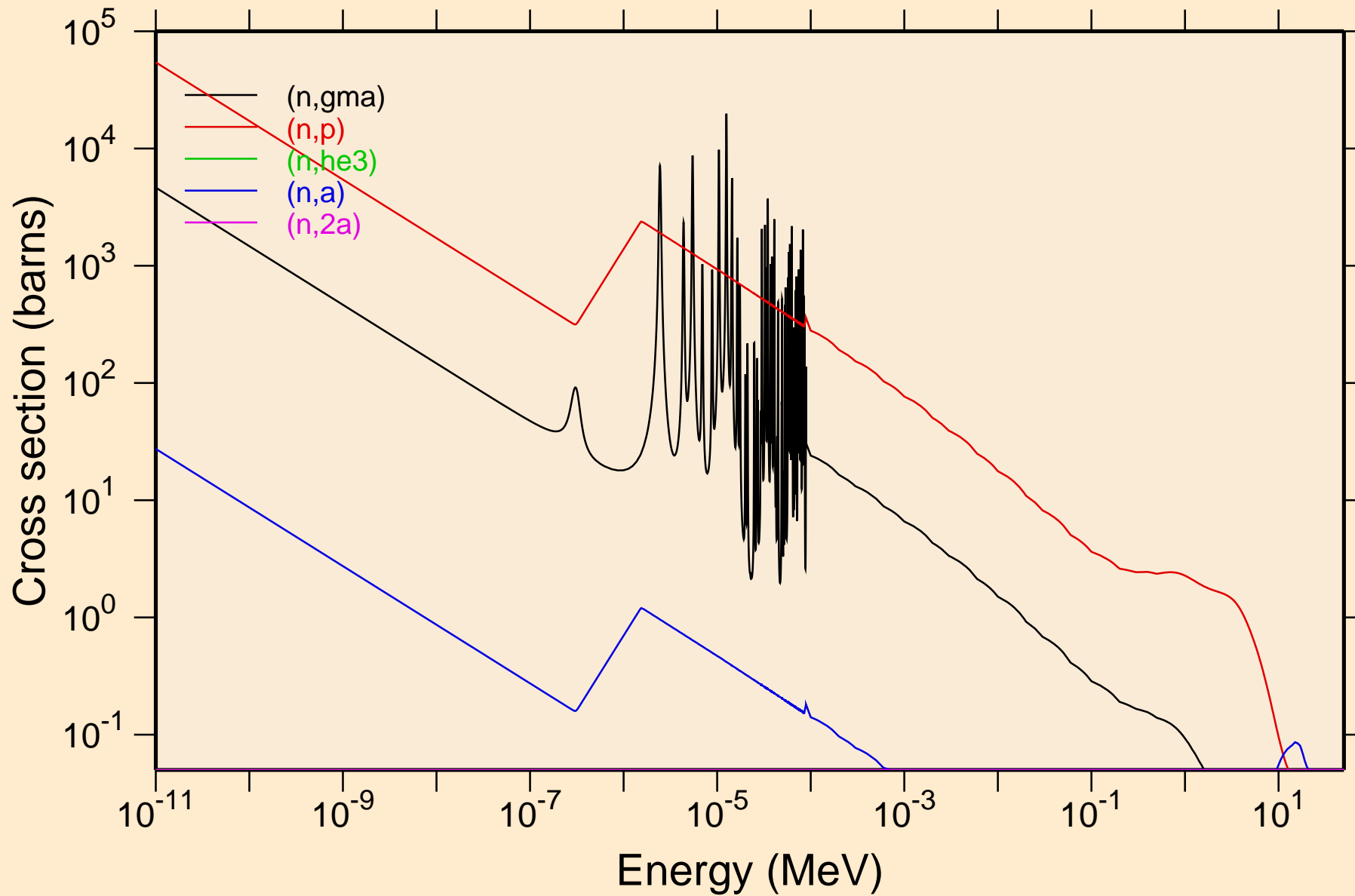



N-DY142 NRG TENDL-2017, AKONING  
Non-threshold reactions

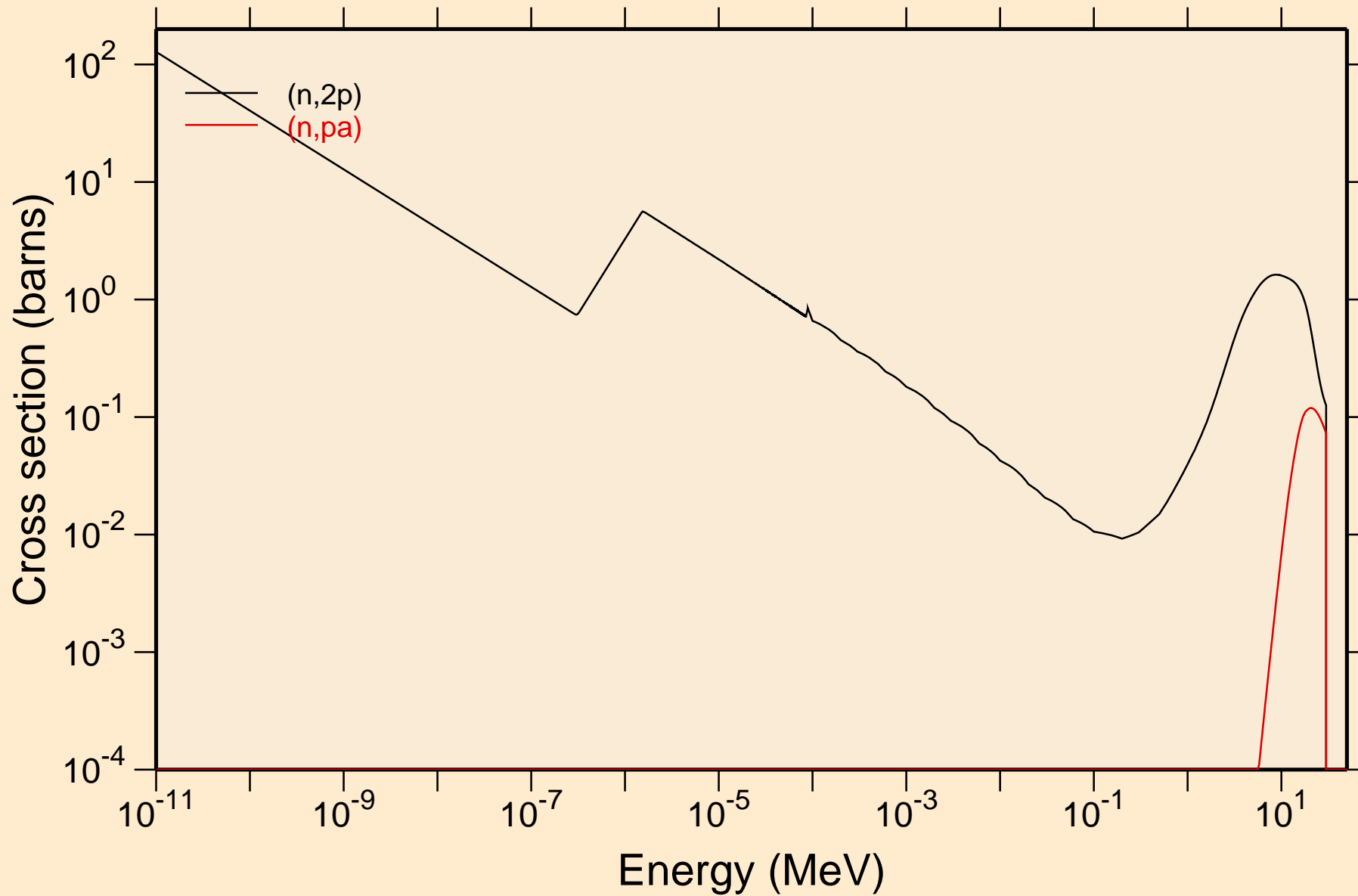

# N-DY142 NRG TENDL-2017, AKONING

## Principal cross sections

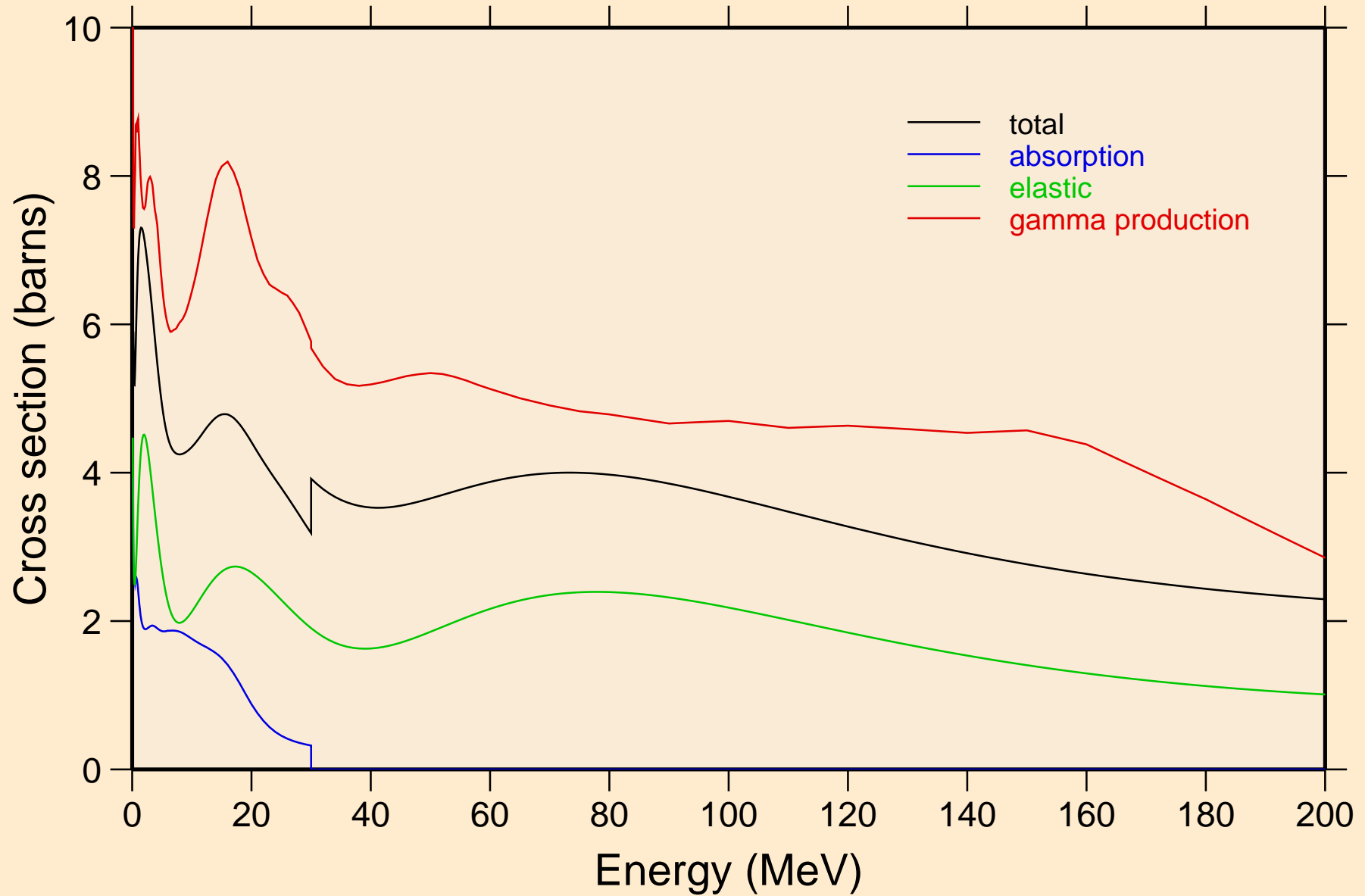

# N-DY142 NRG TENDL-2017, AKONING

## Non-threshold reactions

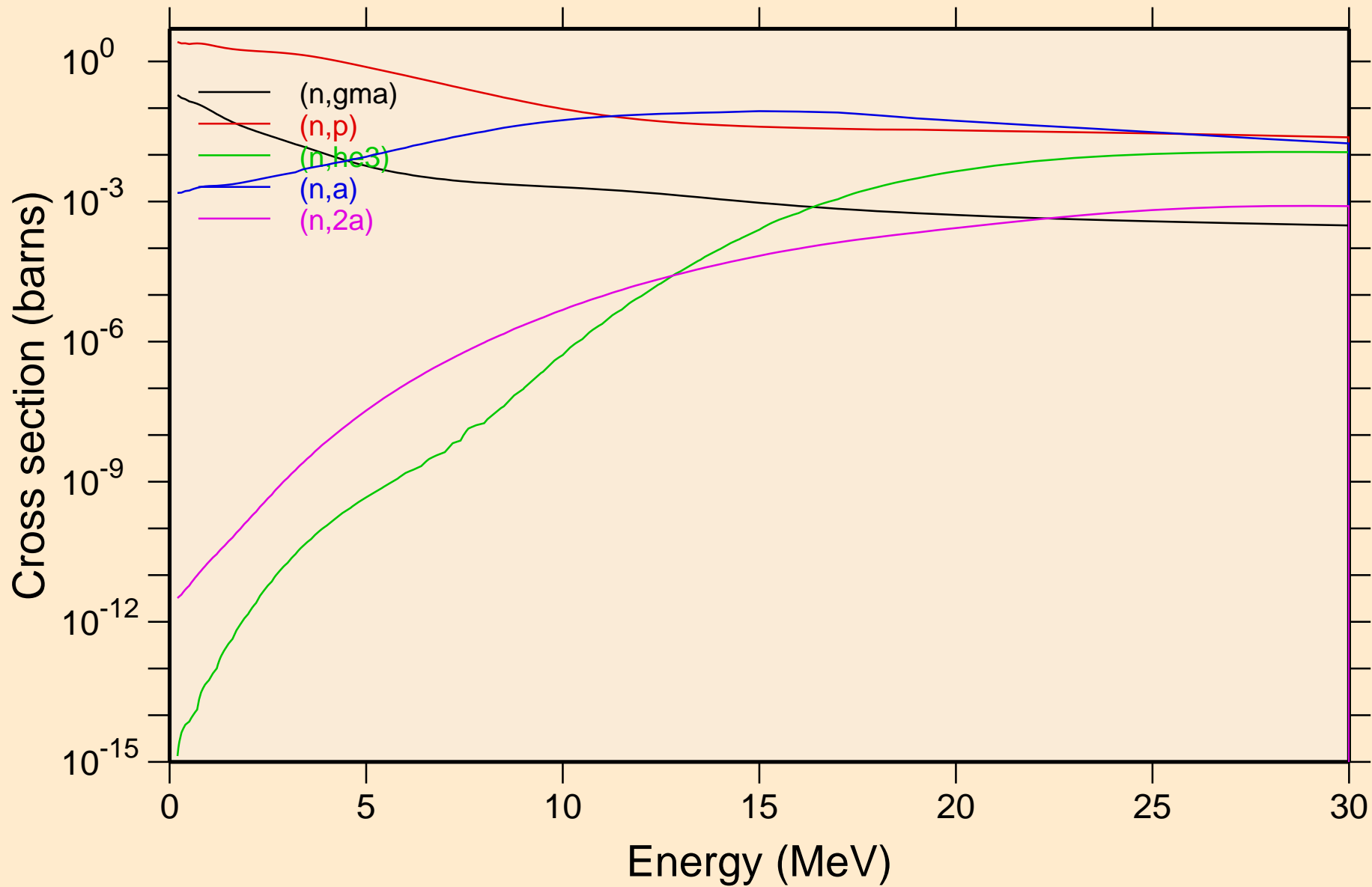

N-DY142 NRG TENDL-2017, AKONING  
Non-threshold reactions

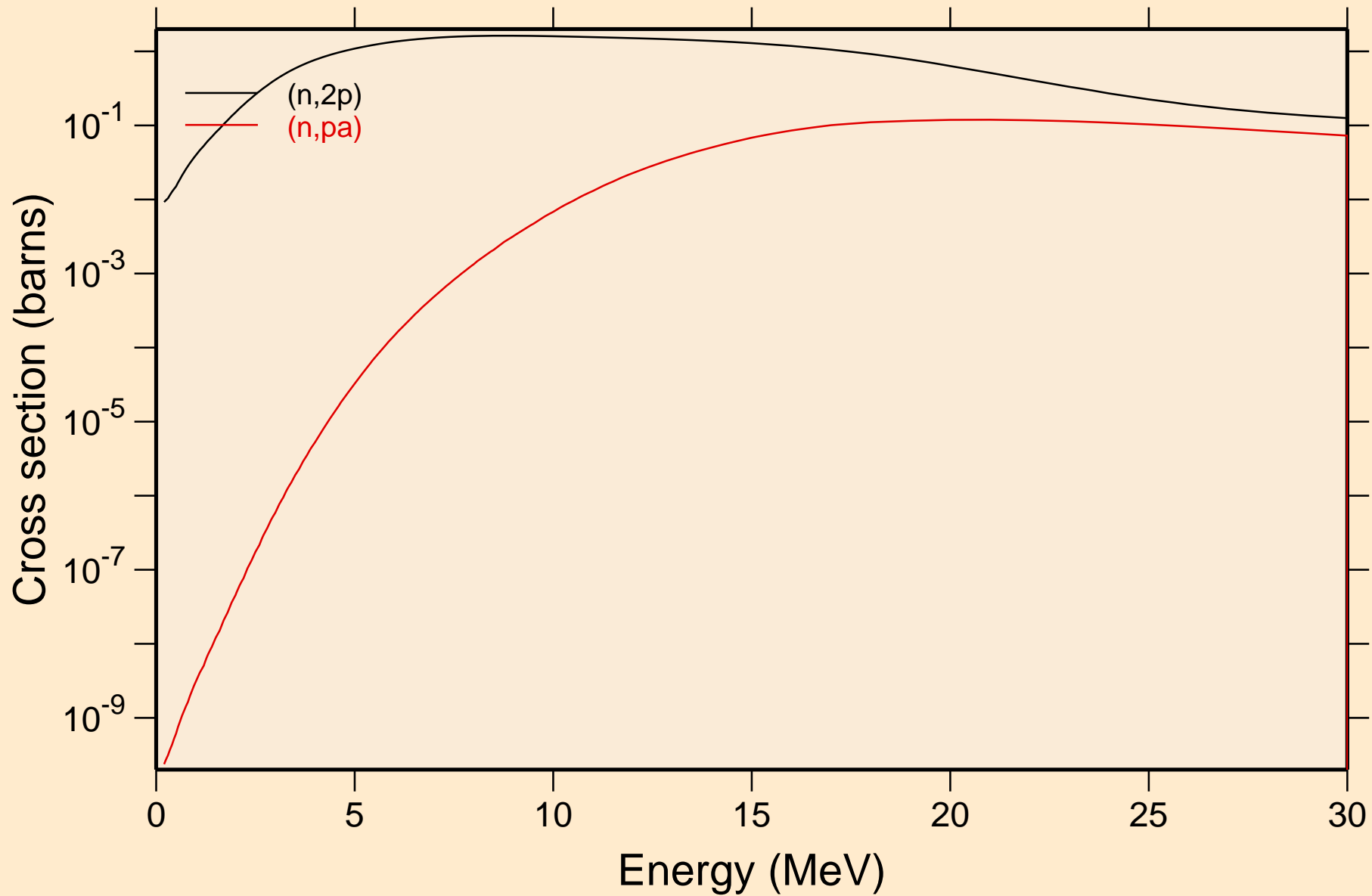

# N-DY142 NRG TENDL-2017, AKONING

## Inelastic levels

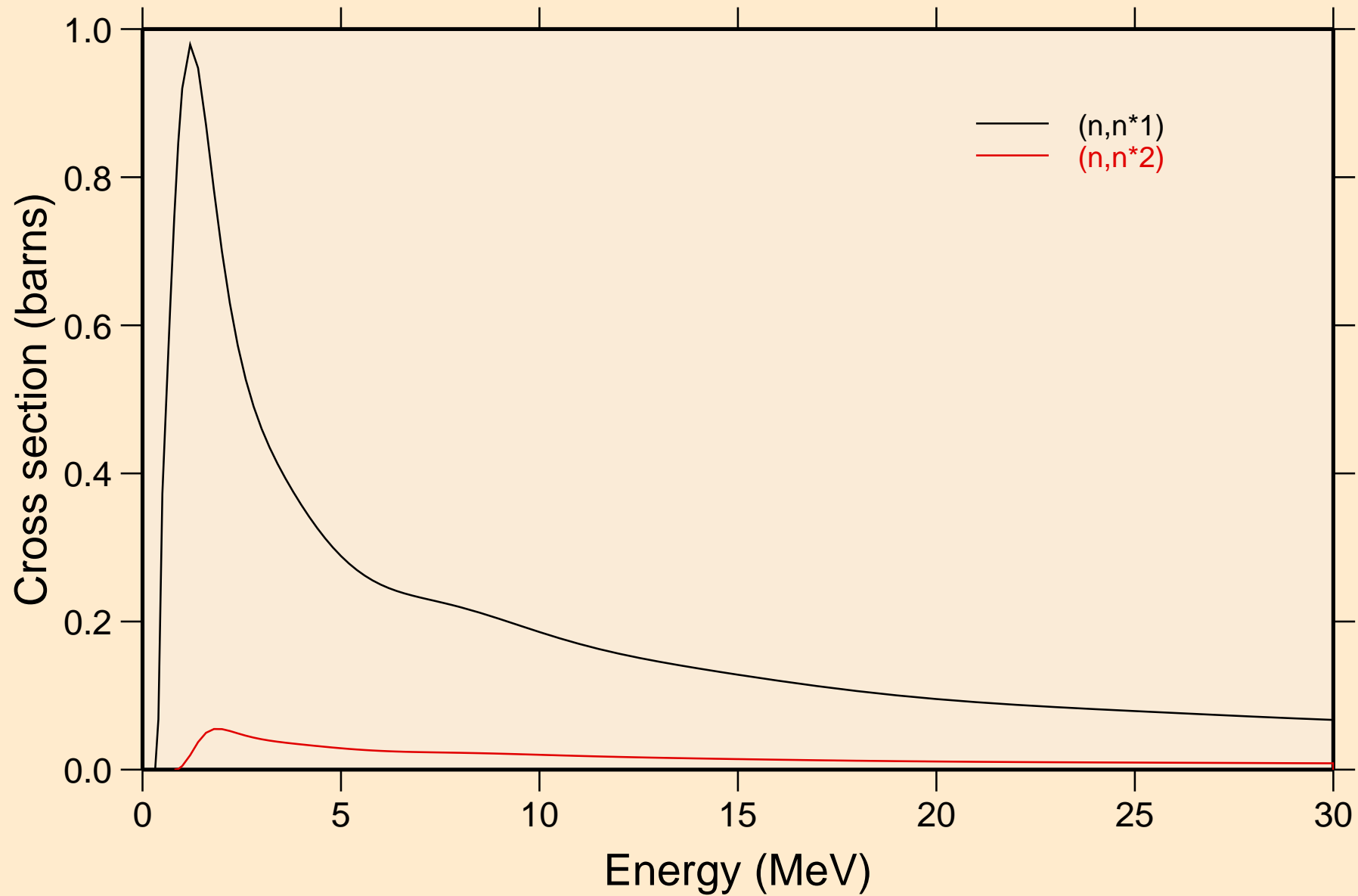

# N-DY142 NRG TENDL-2017, AKONING

## Threshold reactions

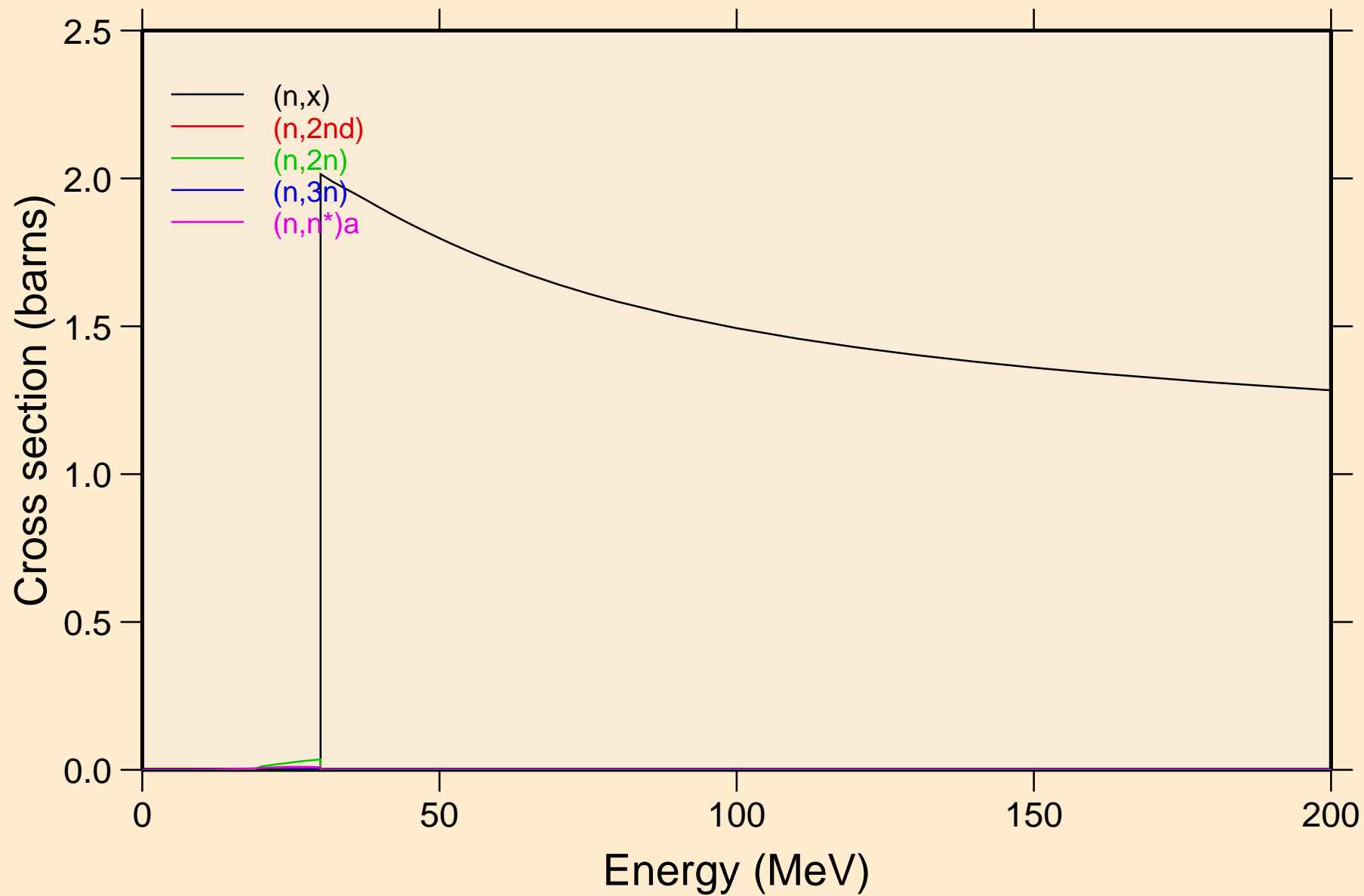

# N-DY142 NRG TENDL-2017, AKONING

## Threshold reactions

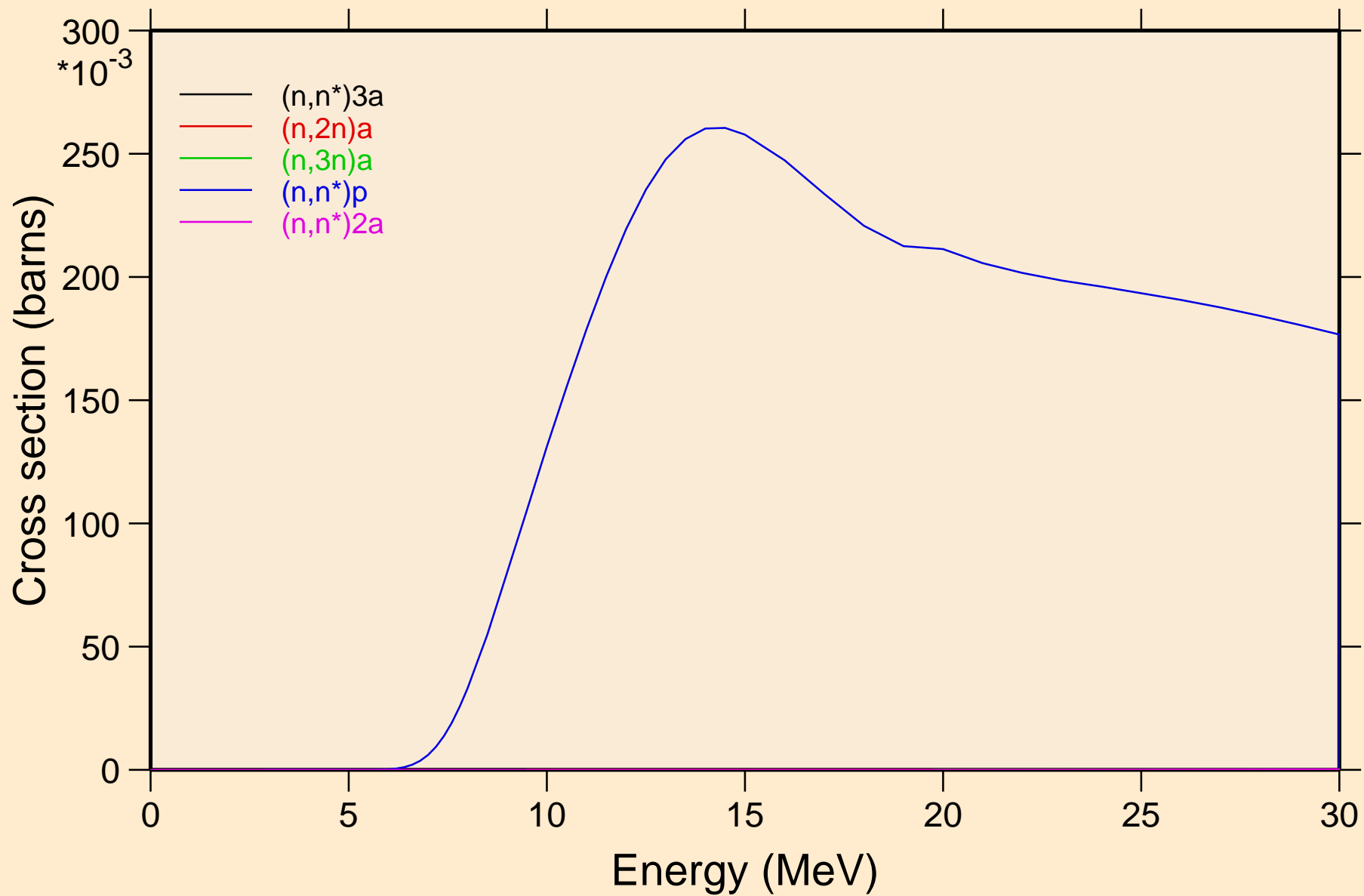

# N-DY142 NRG TENDL-2017, AKONING

## Threshold reactions

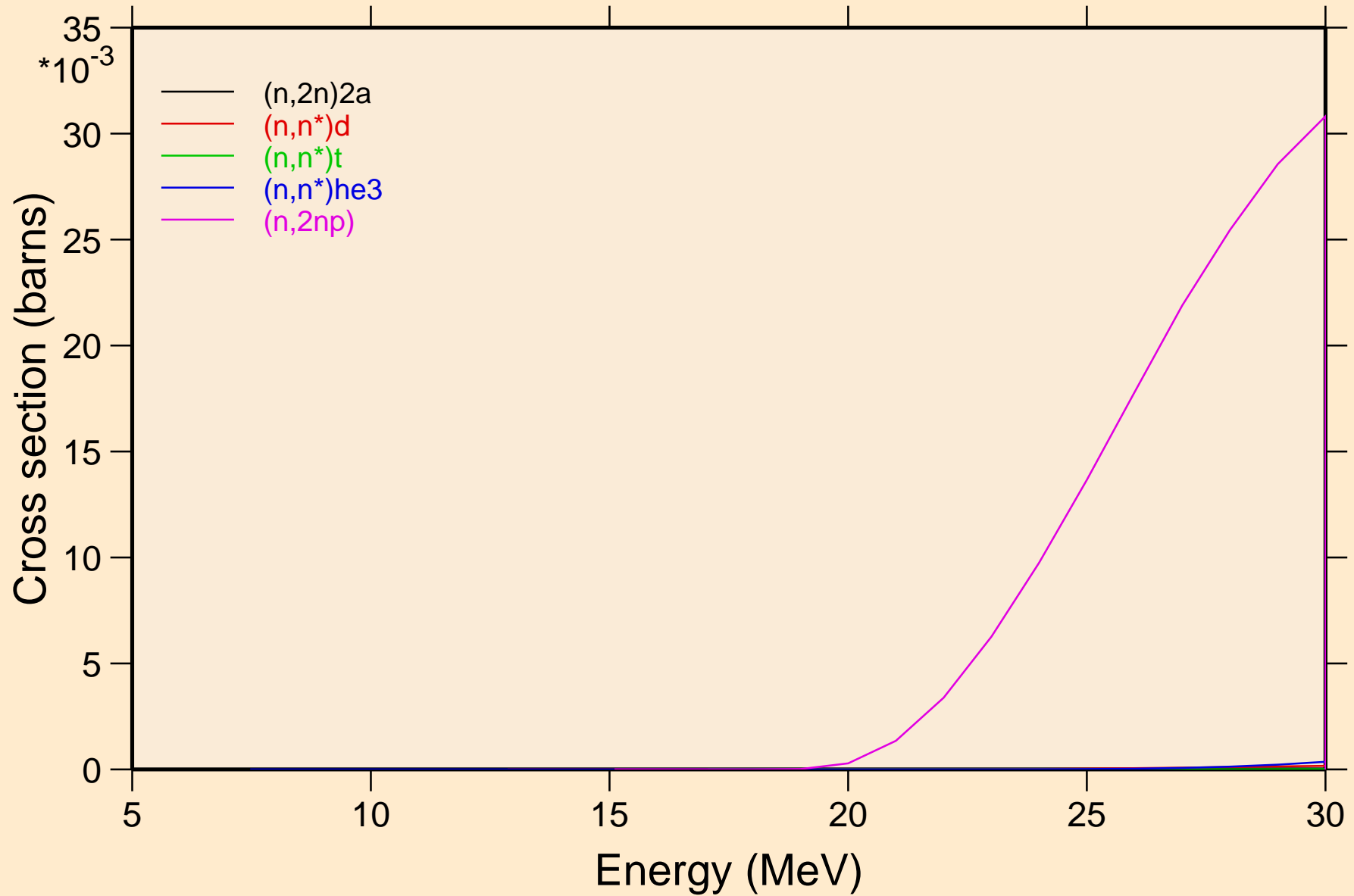



# N-DY142 NRG TENDL-2017, AKONING

## Threshold reactions

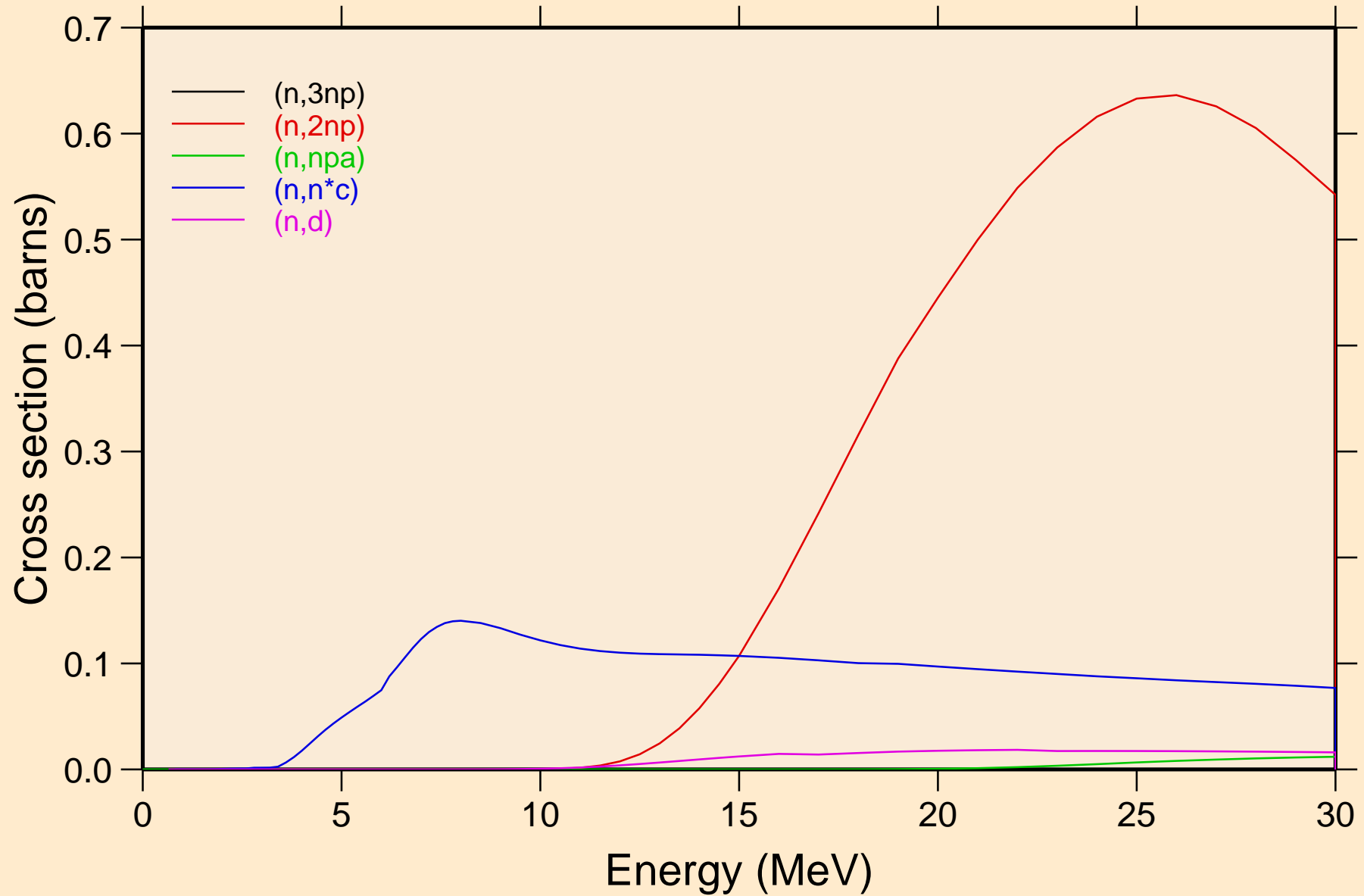

# N-DY142 NRG TENDL-2017, AKONING

## Threshold reactions

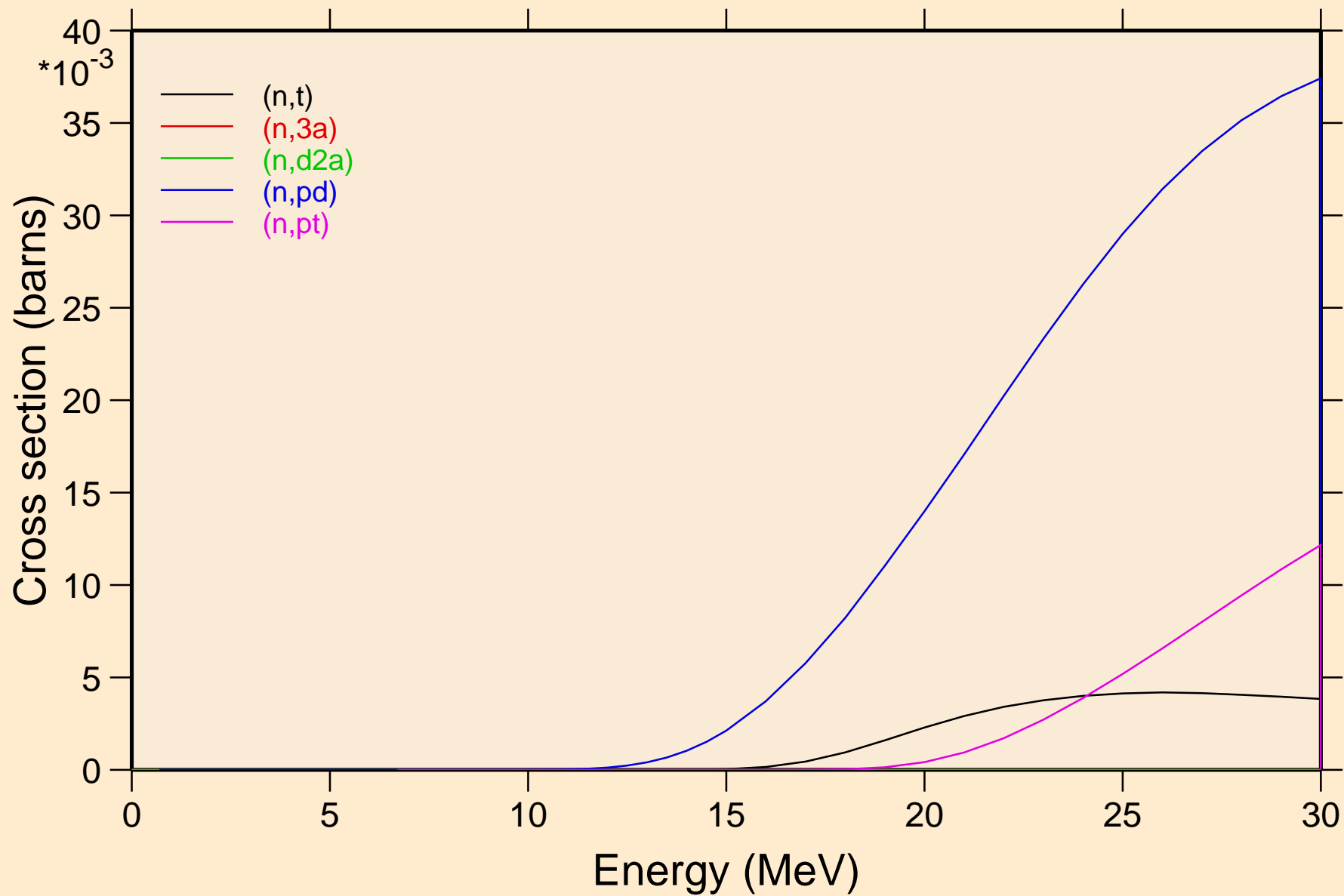

# N-DY142 NRG TENDL-2017, AKONING

## Threshold reactions

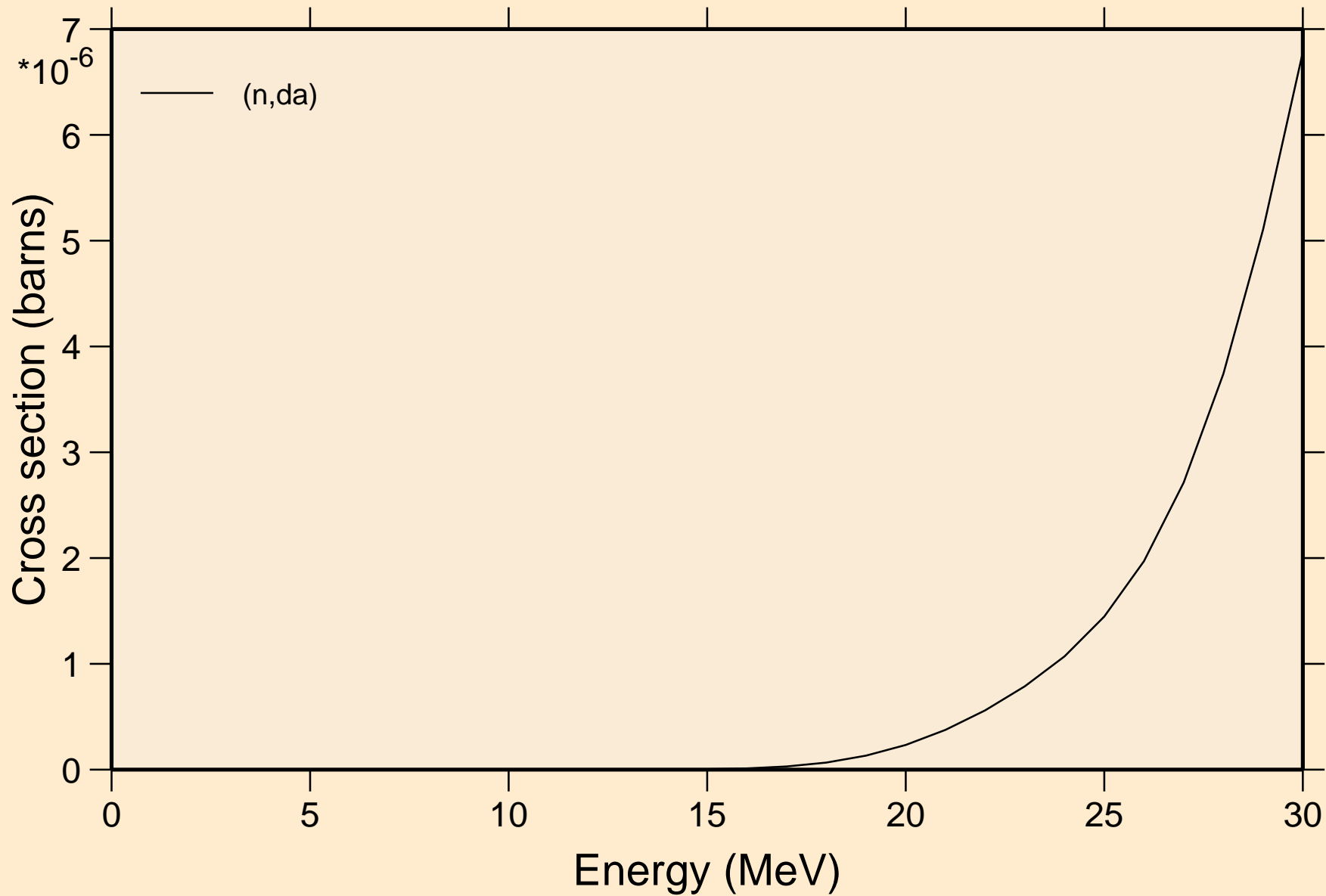

N-DY142 NRG TENDL-2017, AKONING  
angular distribution for elastic

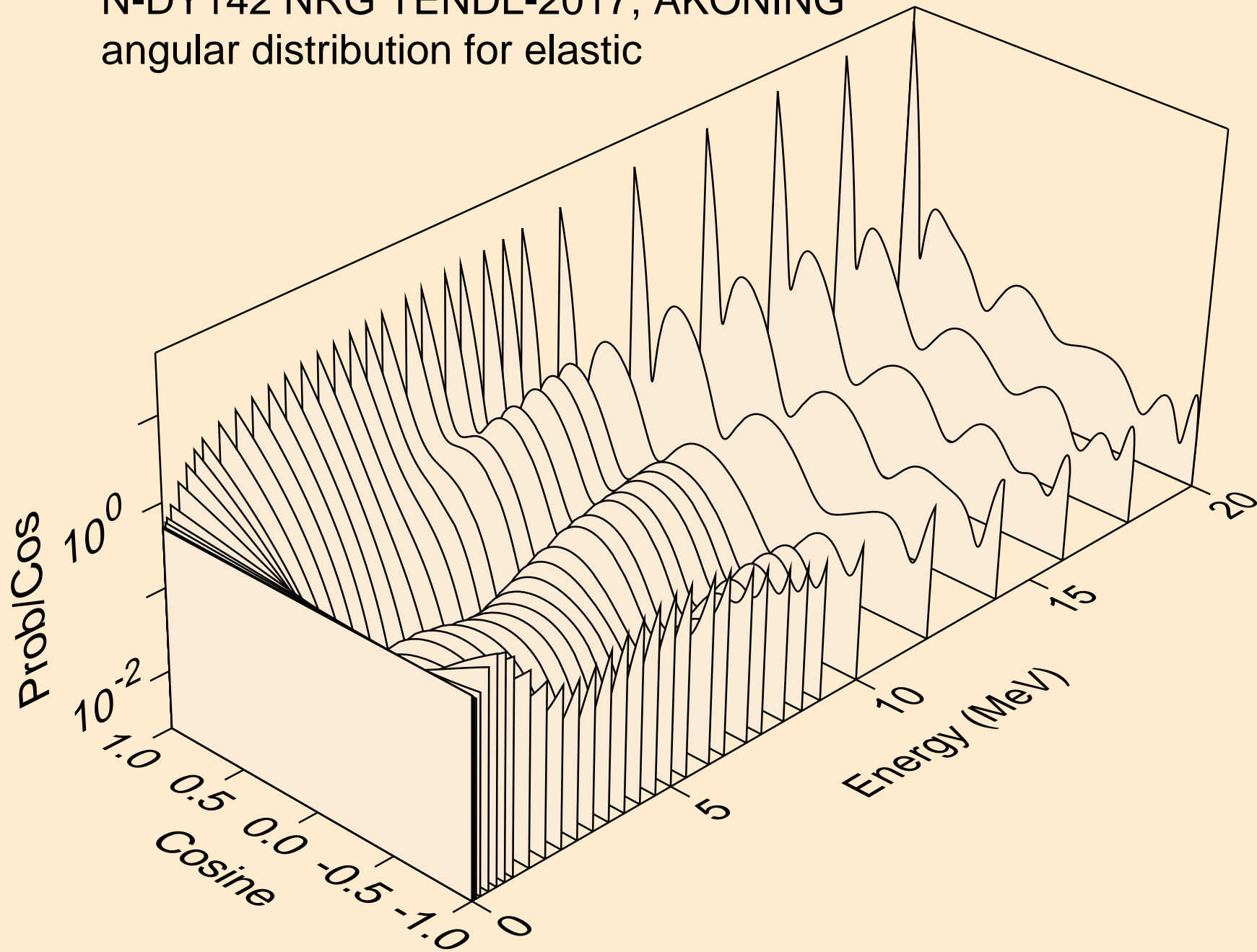

N-DY142 NRG TENDL-2017, AKONING  
angular distribution for elastic

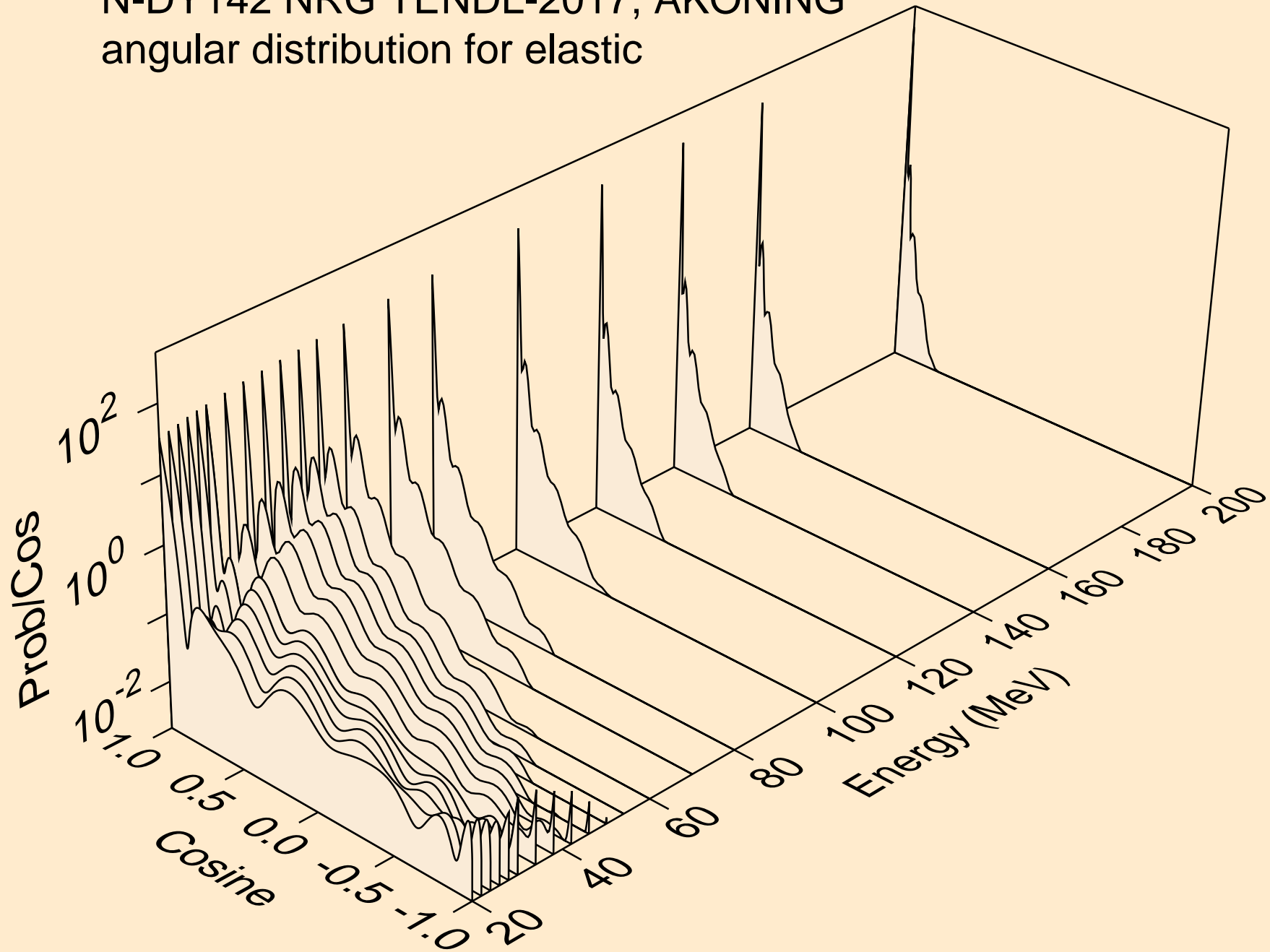

N-DY142 NRG TENDL-2017, AKONING  
angular distribution for (n,n\*1)

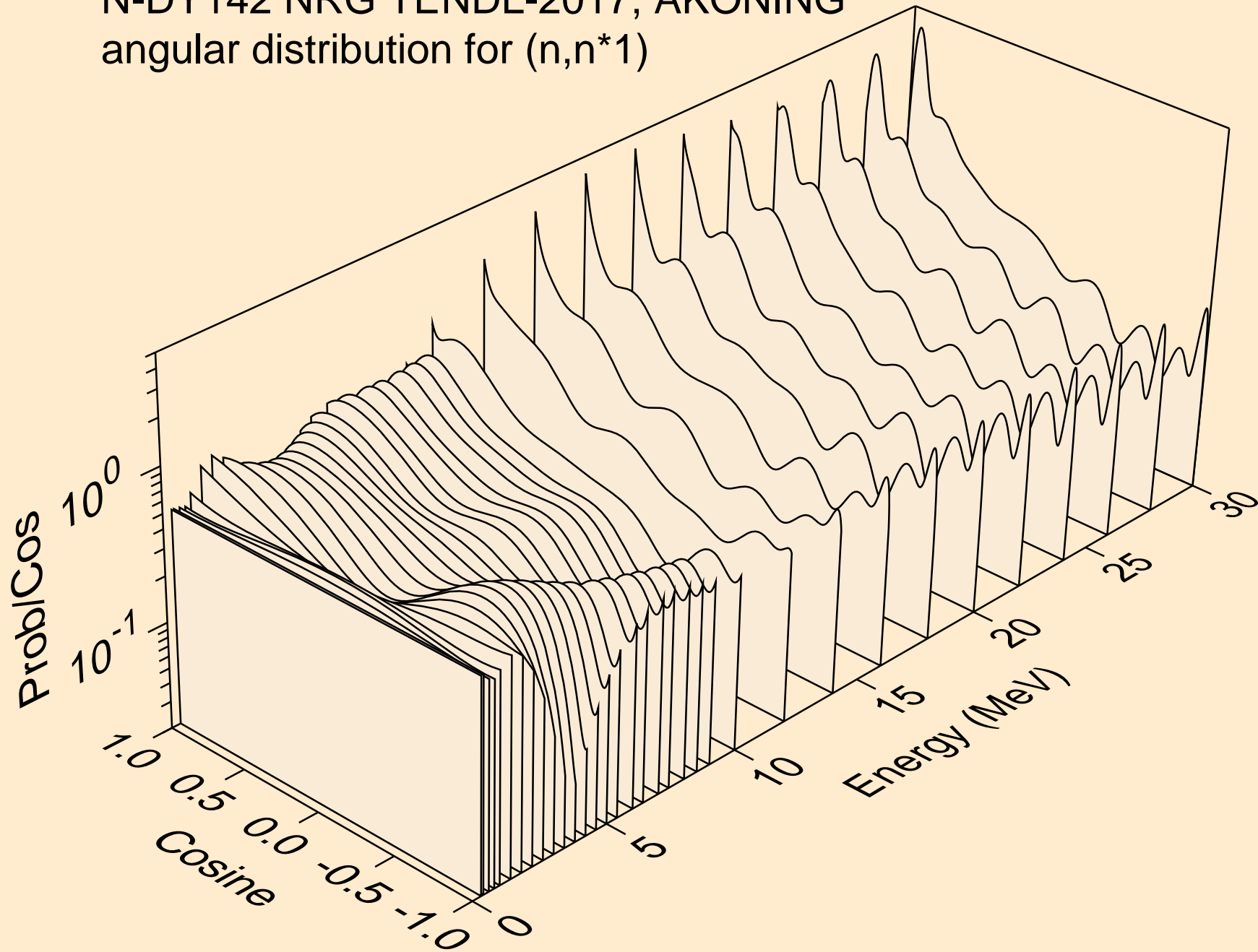

N-DY142 NRG TENDL-2017, AKONING  
angular distribution for (n,n\*2)

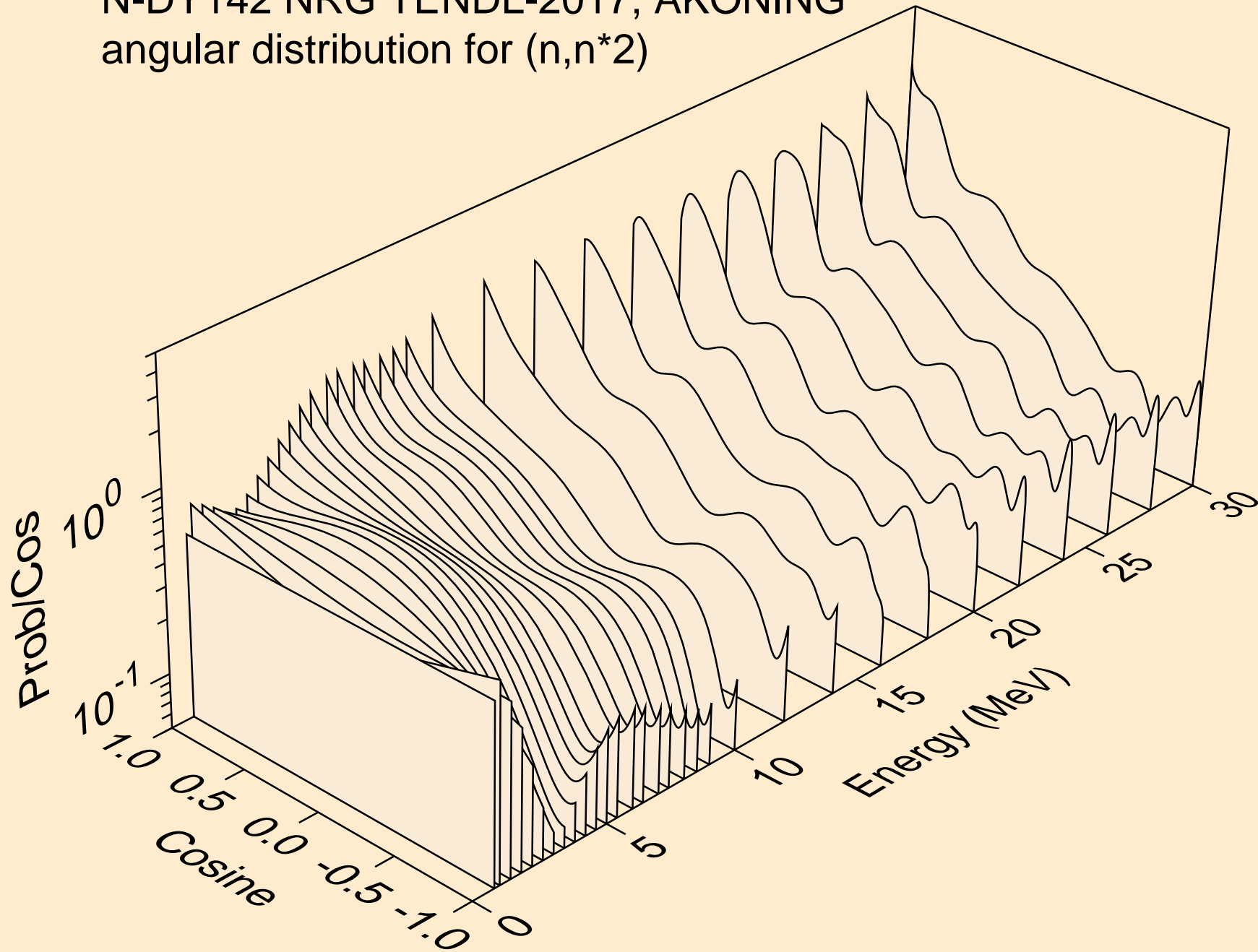

N-DY142 NRG TENDL-2017, AKONING  
Neutron emission for (n,x)

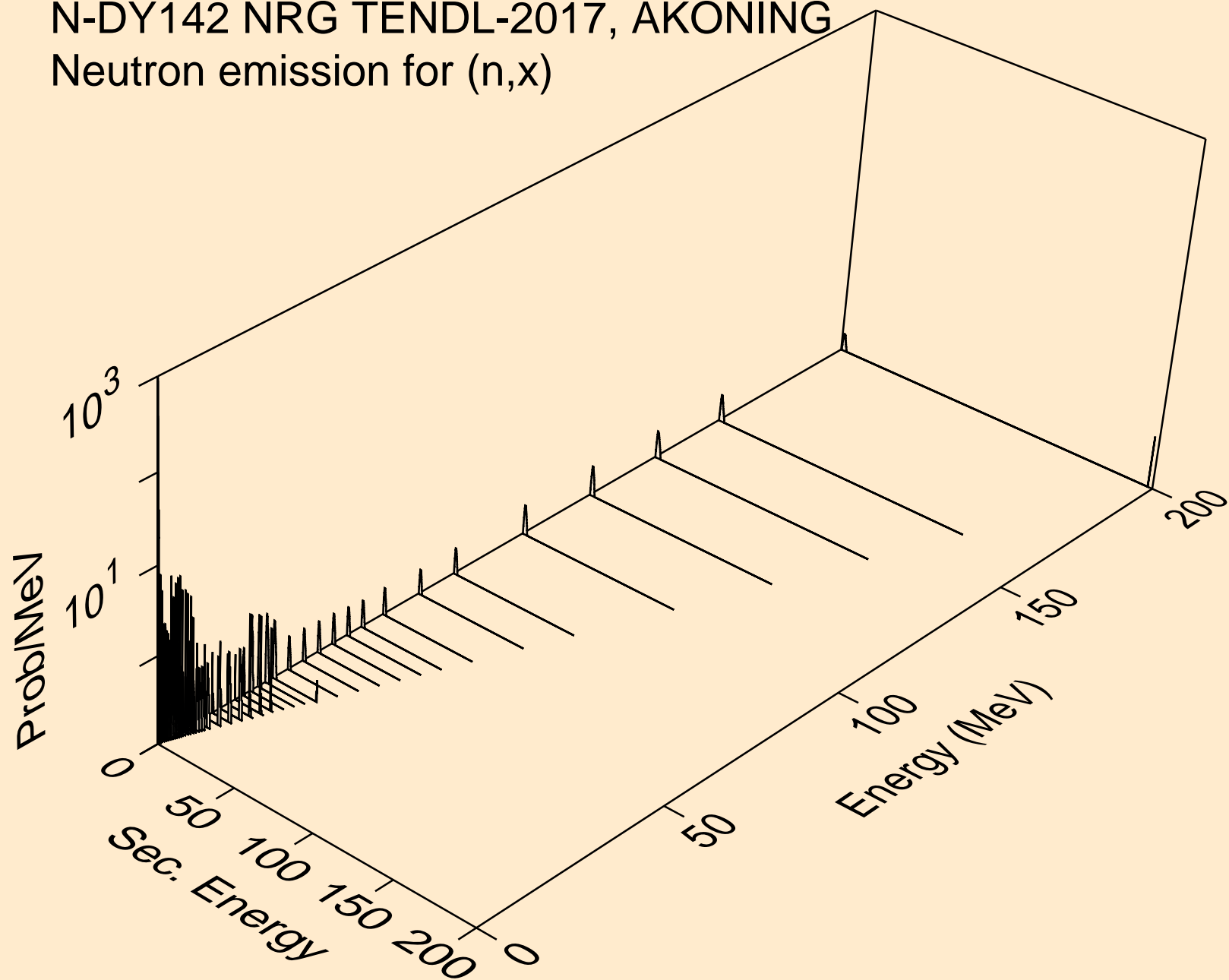



N-DY142 NRG TENDL-2017, AKONING  
Neutron emission for (n,2nd)

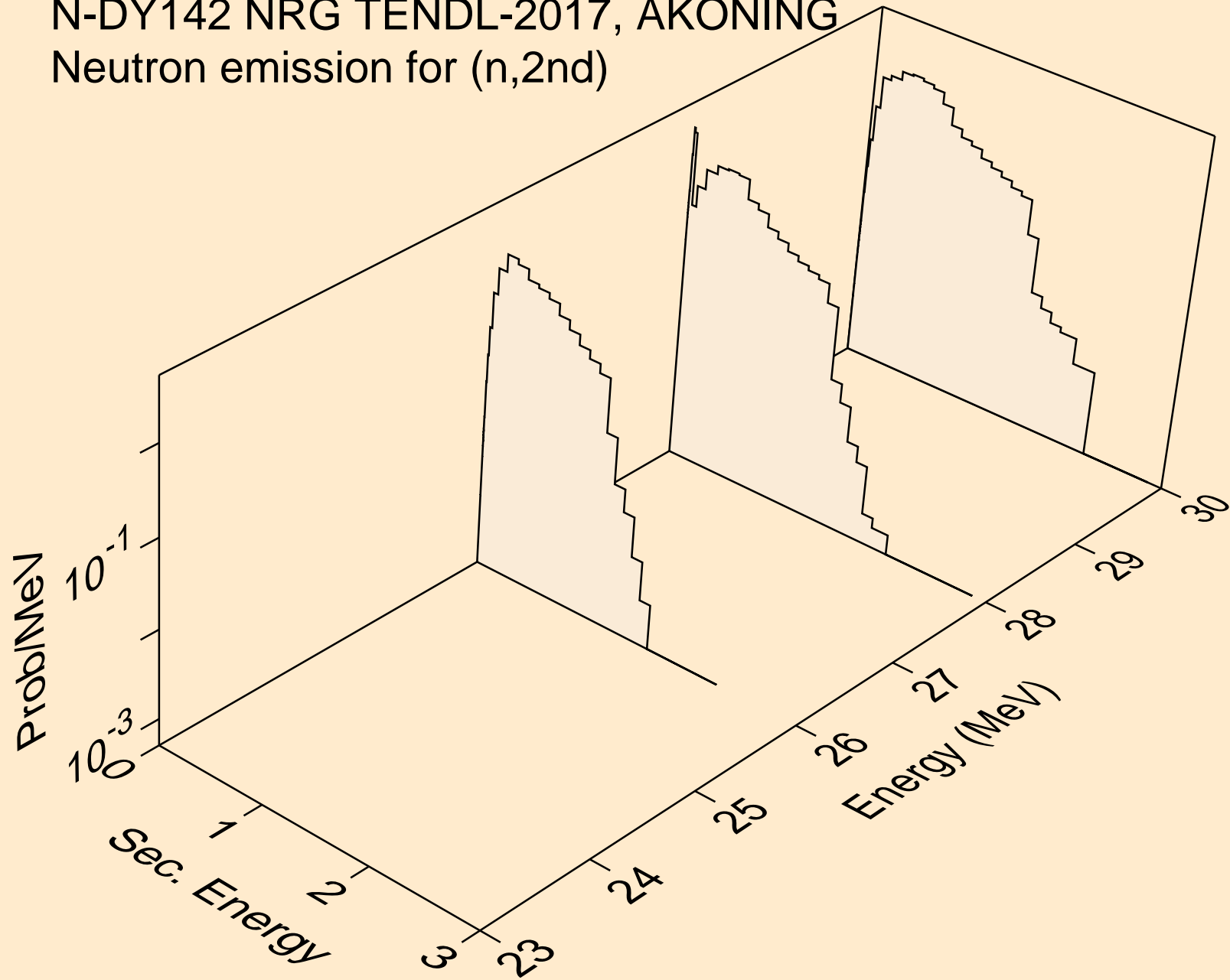

N-DY142 NRG TENDL-2017, AKONING  
Neutron emission for (n,2n)

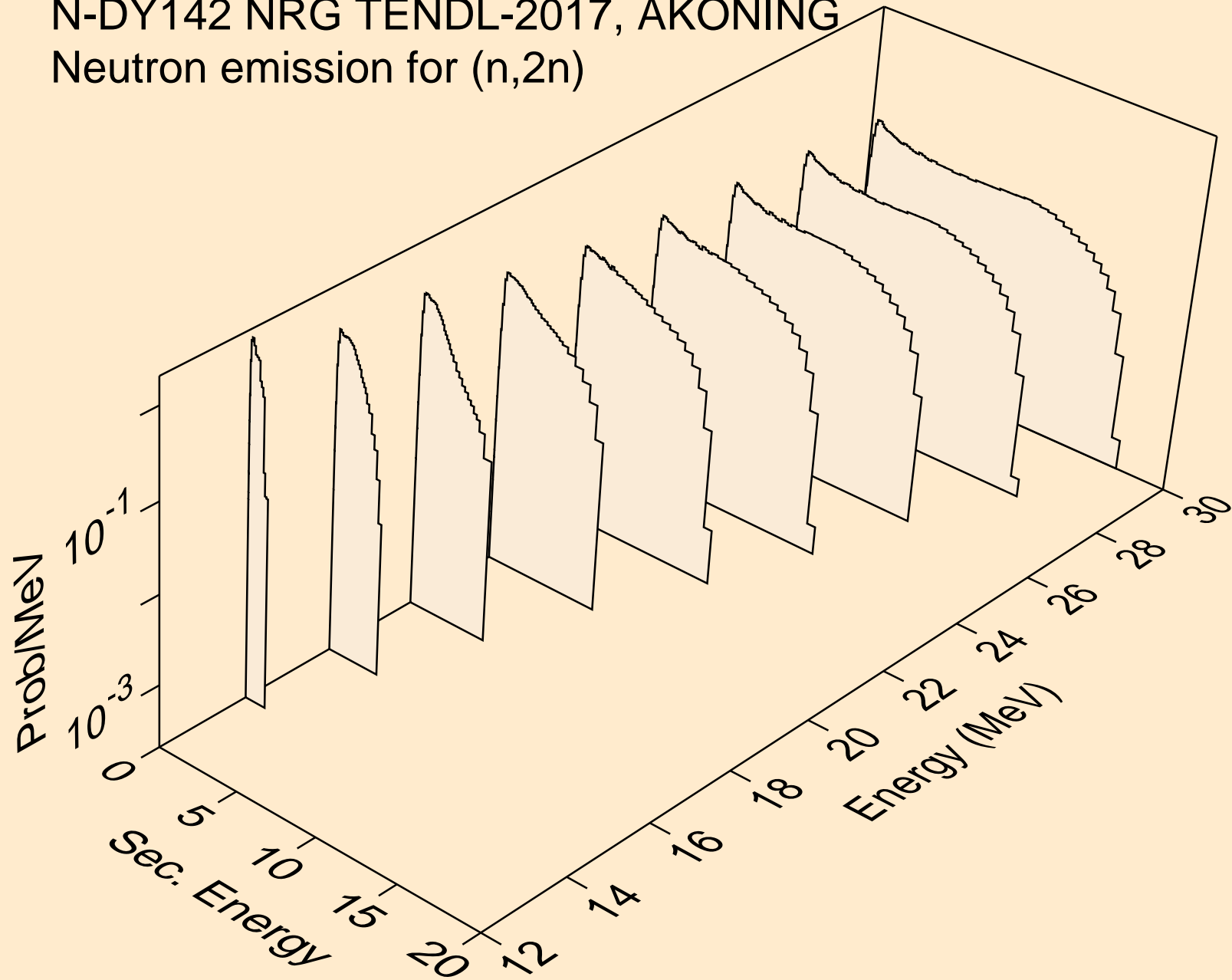

N-DY142 NRG TENDL-2017, AKONING  
Neutron emission for (n,3n)

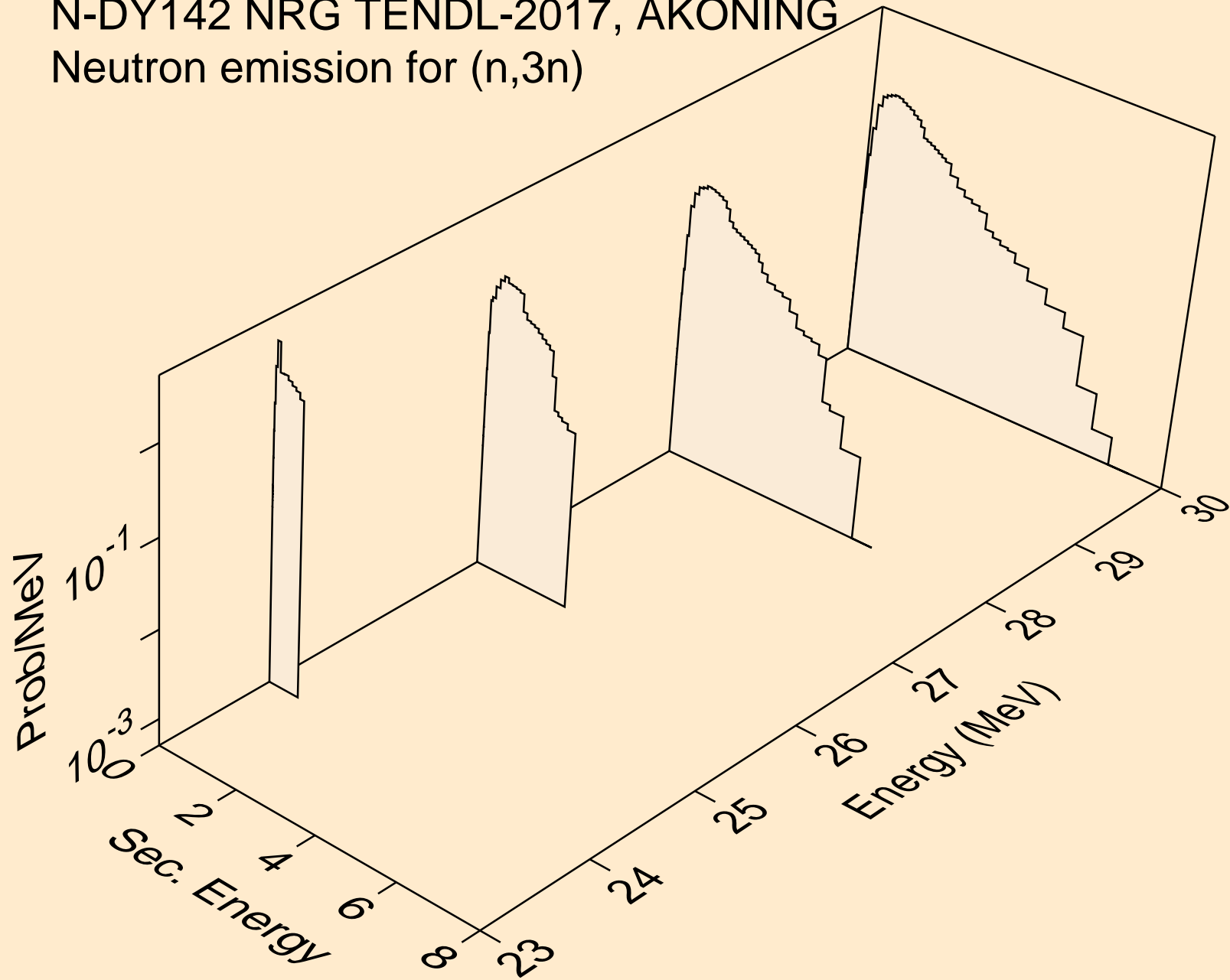

N-DY142 NRG TENDL-2017, AKONING  
Neutron emission for (n,n\*)a

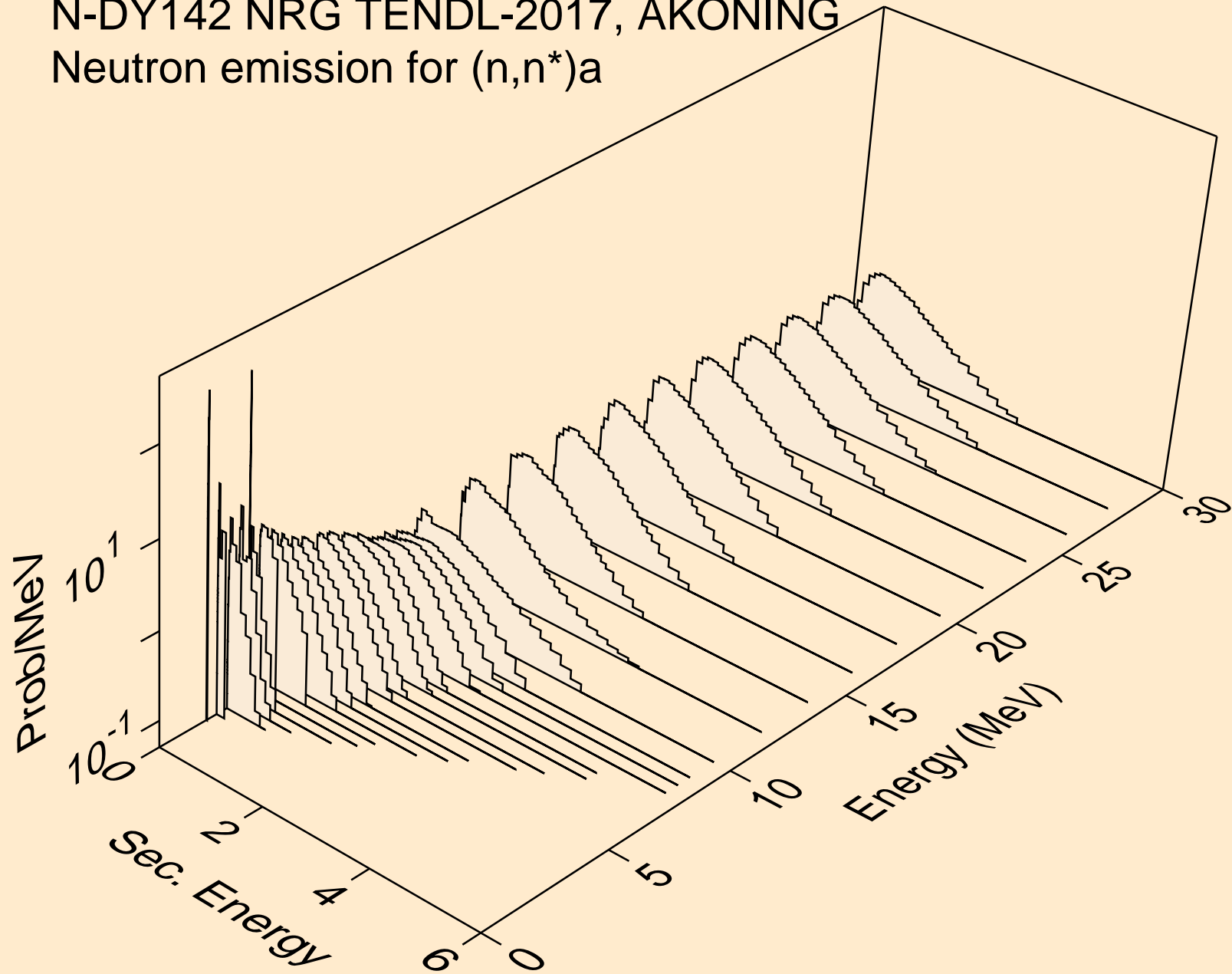

N-DY142 NRG TENDL-2017, AKONING  
Neutron emission for (n,n\*)3a

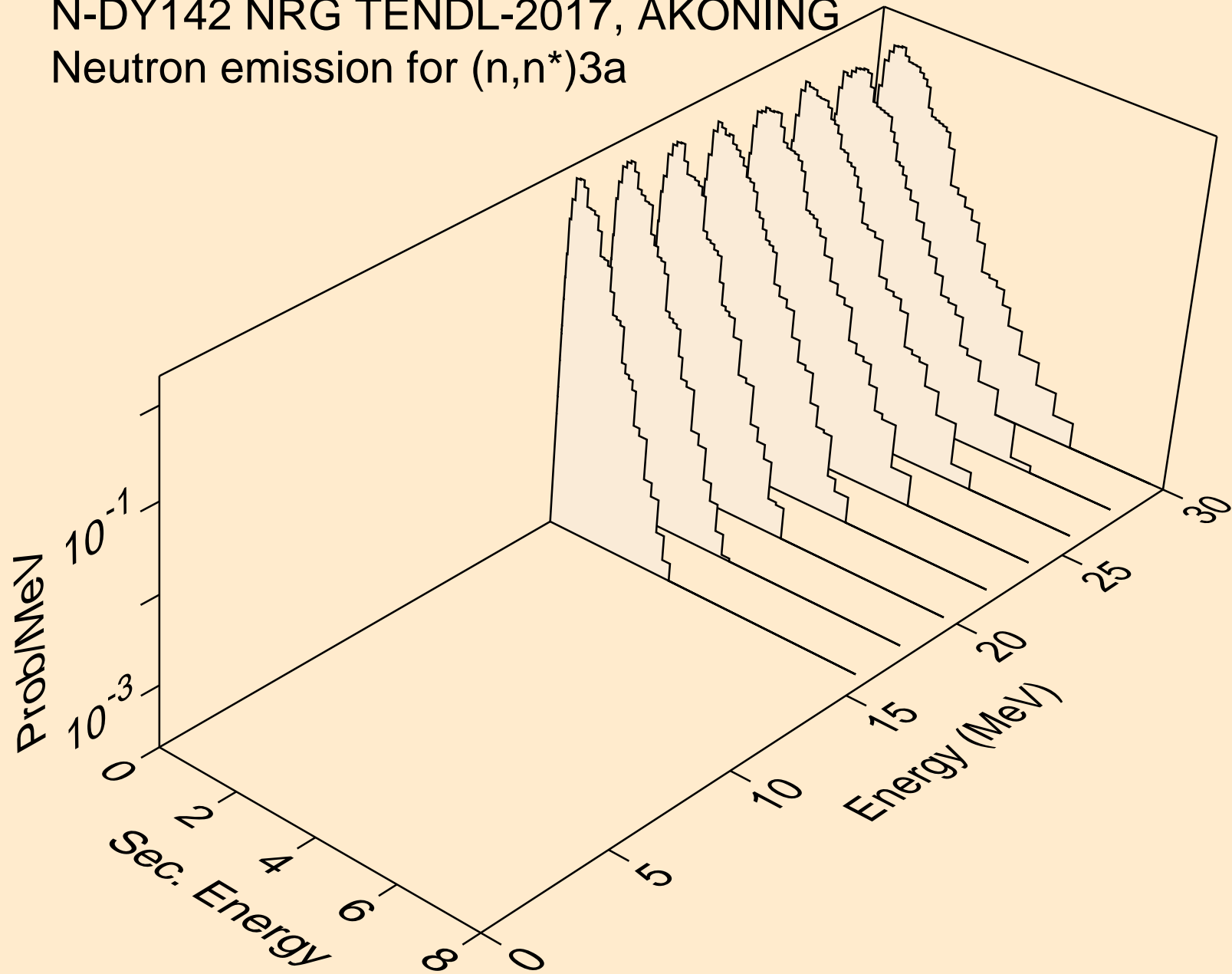

N-DY142 NRG TENDL-2017, AKONING  
Neutron emission for (n,2n)<sub>a</sub>

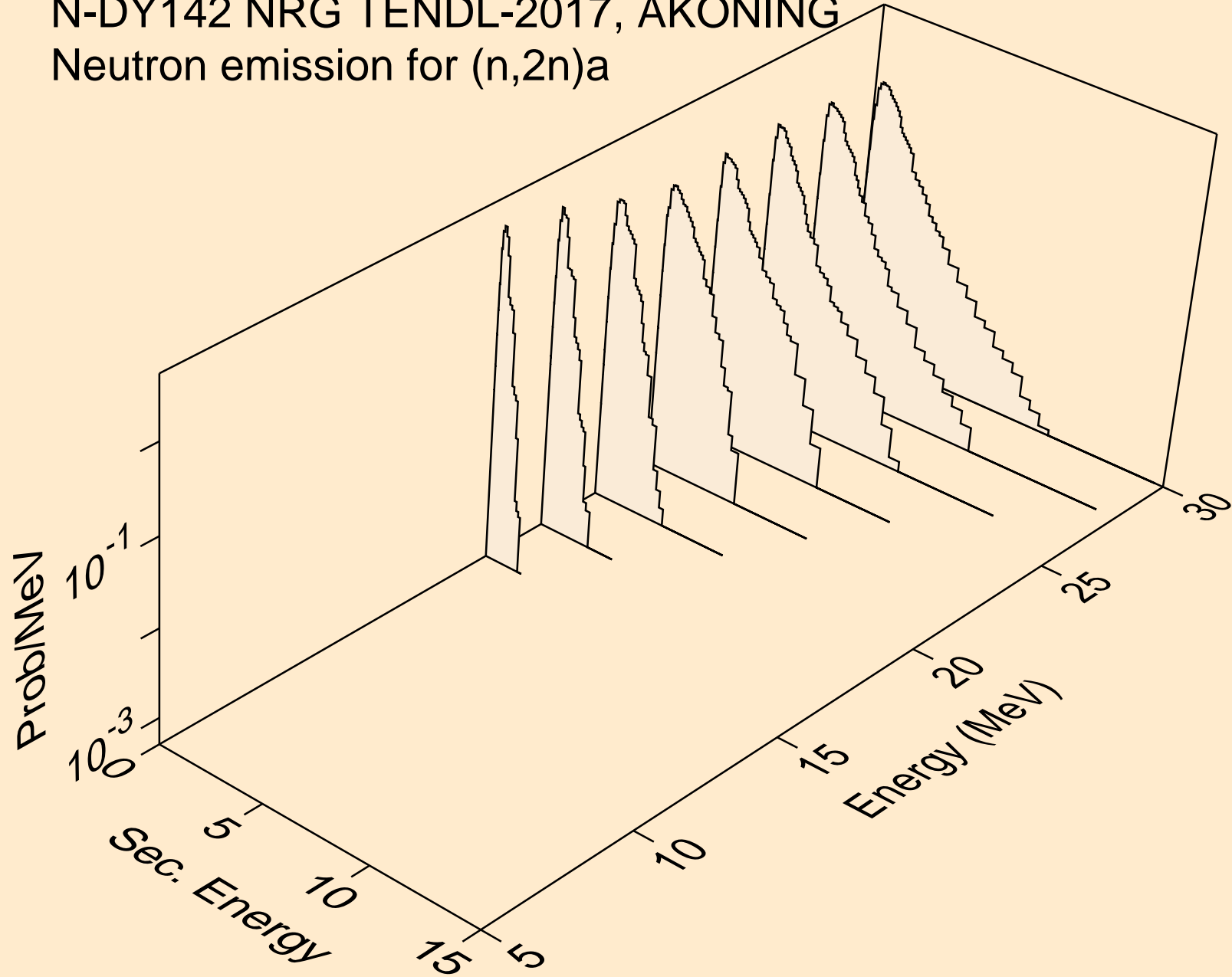

N-DY142 NRG TENDL-2017, AKONING  
Neutron emission for (n,3n)a

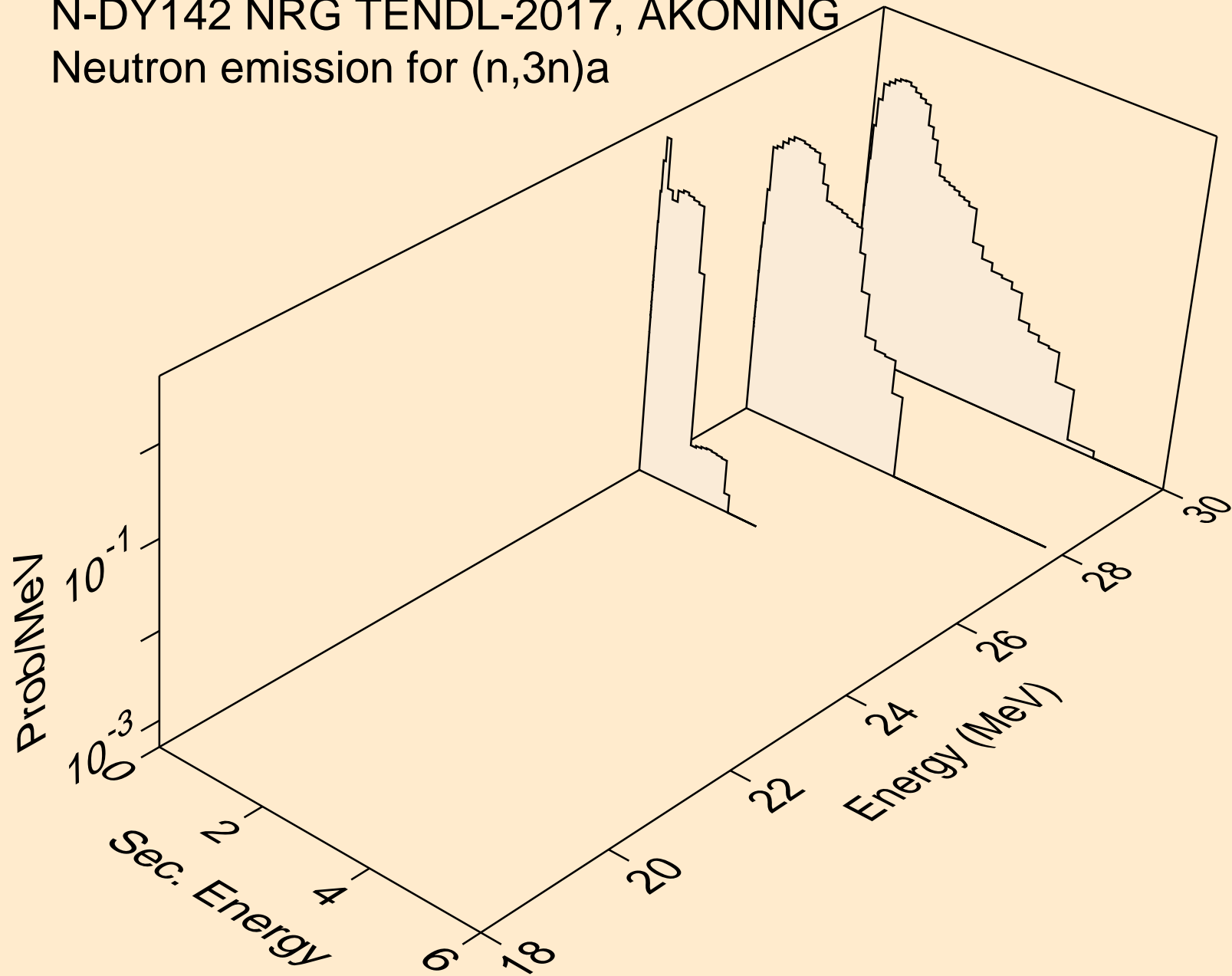

N-DY142 NRG TENDL-2017, AKONING  
Neutron emission for (n,n\*)p

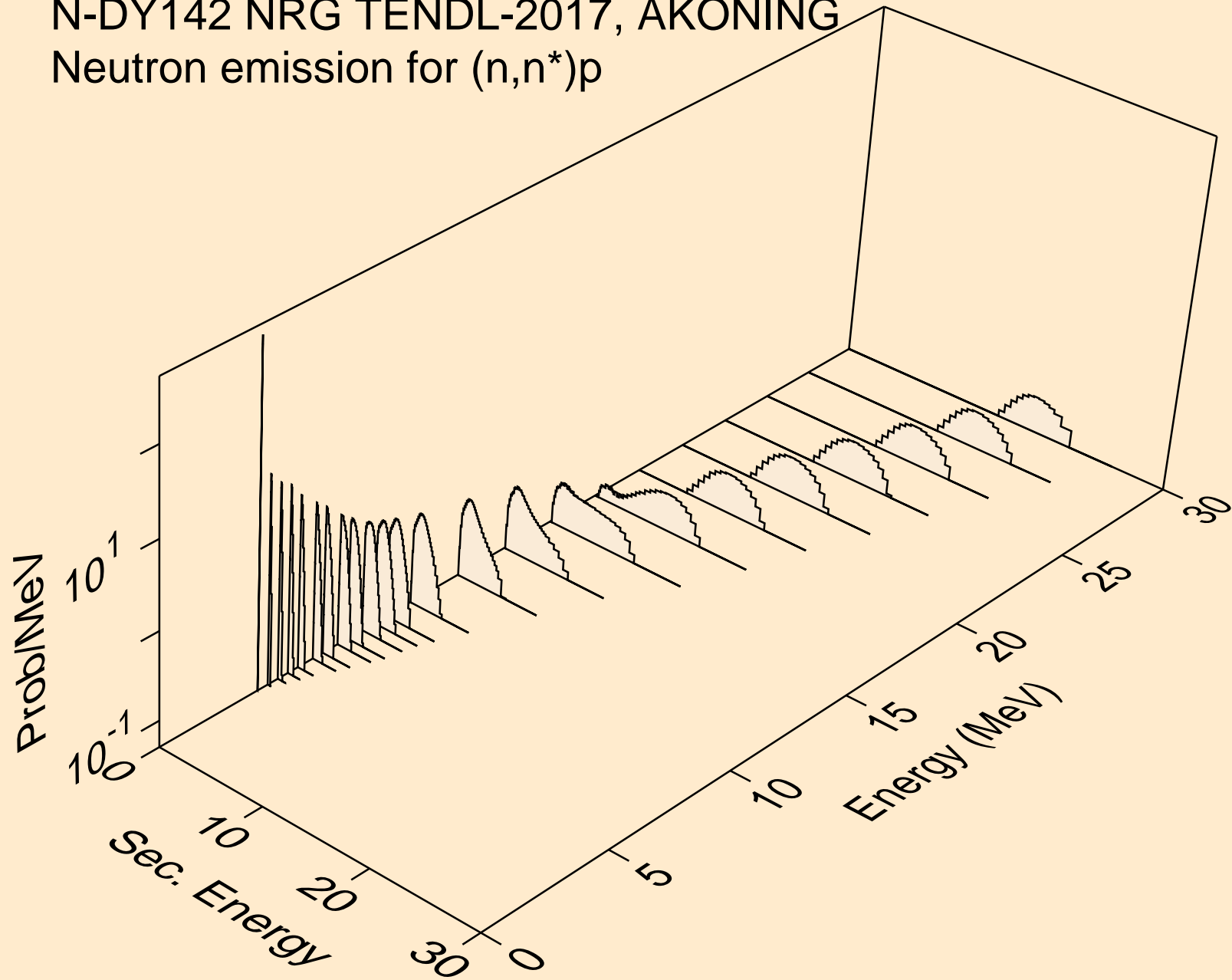



N-DY142 NRG TENDL-2017, AKONING  
Neutron emission for (n,n\*)2a

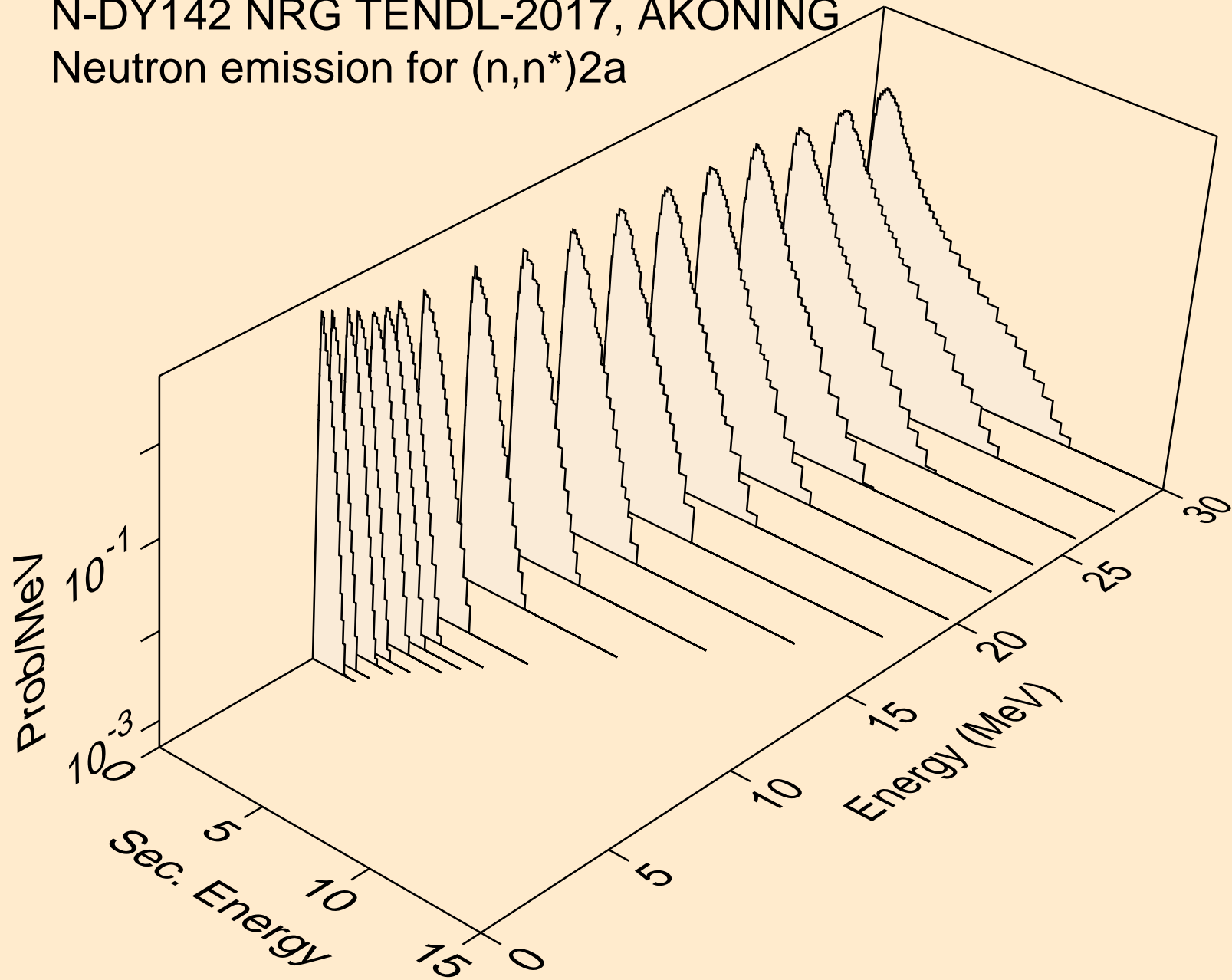

N-DY142 NRG TENDL-2017, AKONING  
Neutron emission for (n,2n)2a

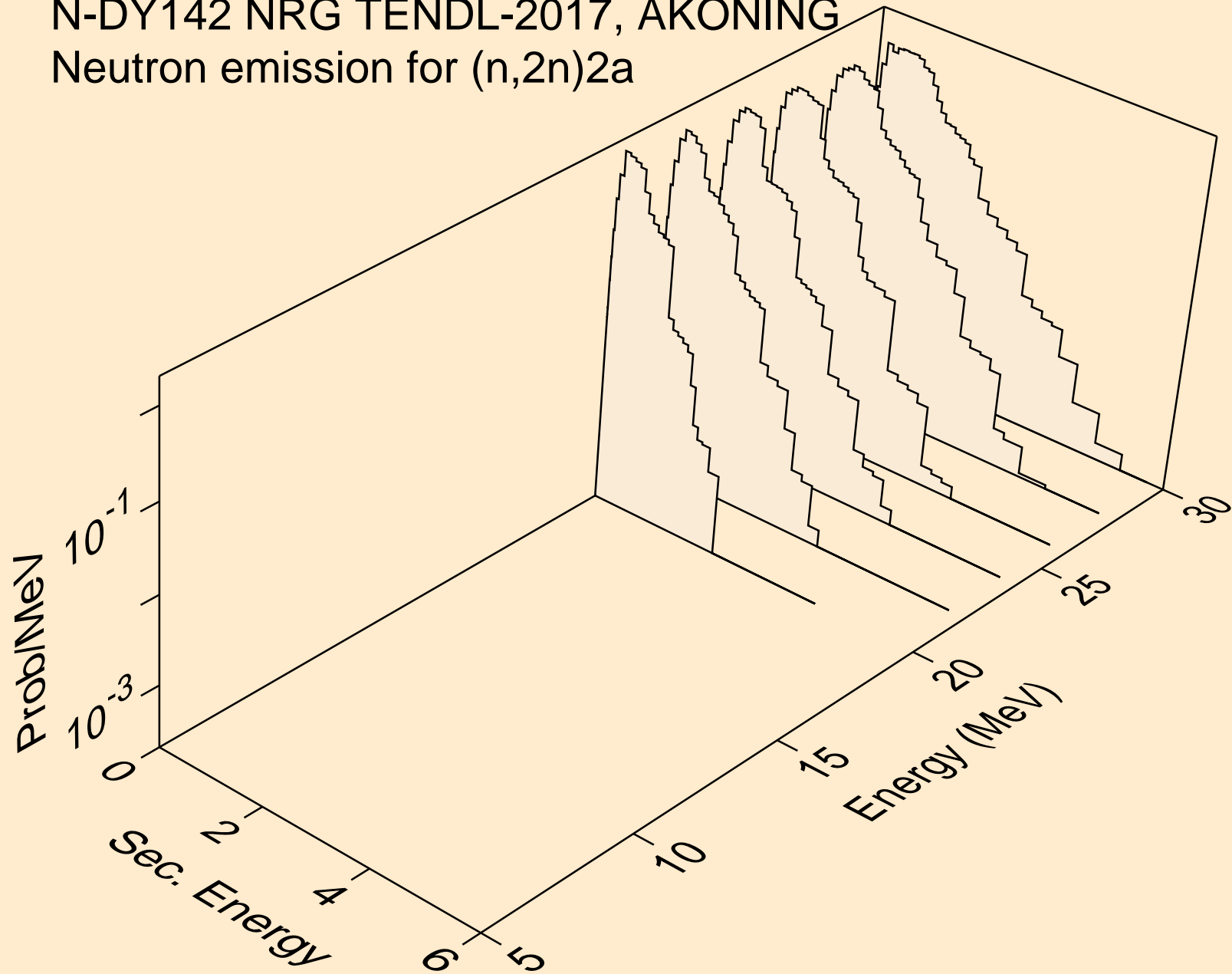

N-DY142 NRG TENDL-2017, AKONING  
Neutron emission for (n,n\*)d

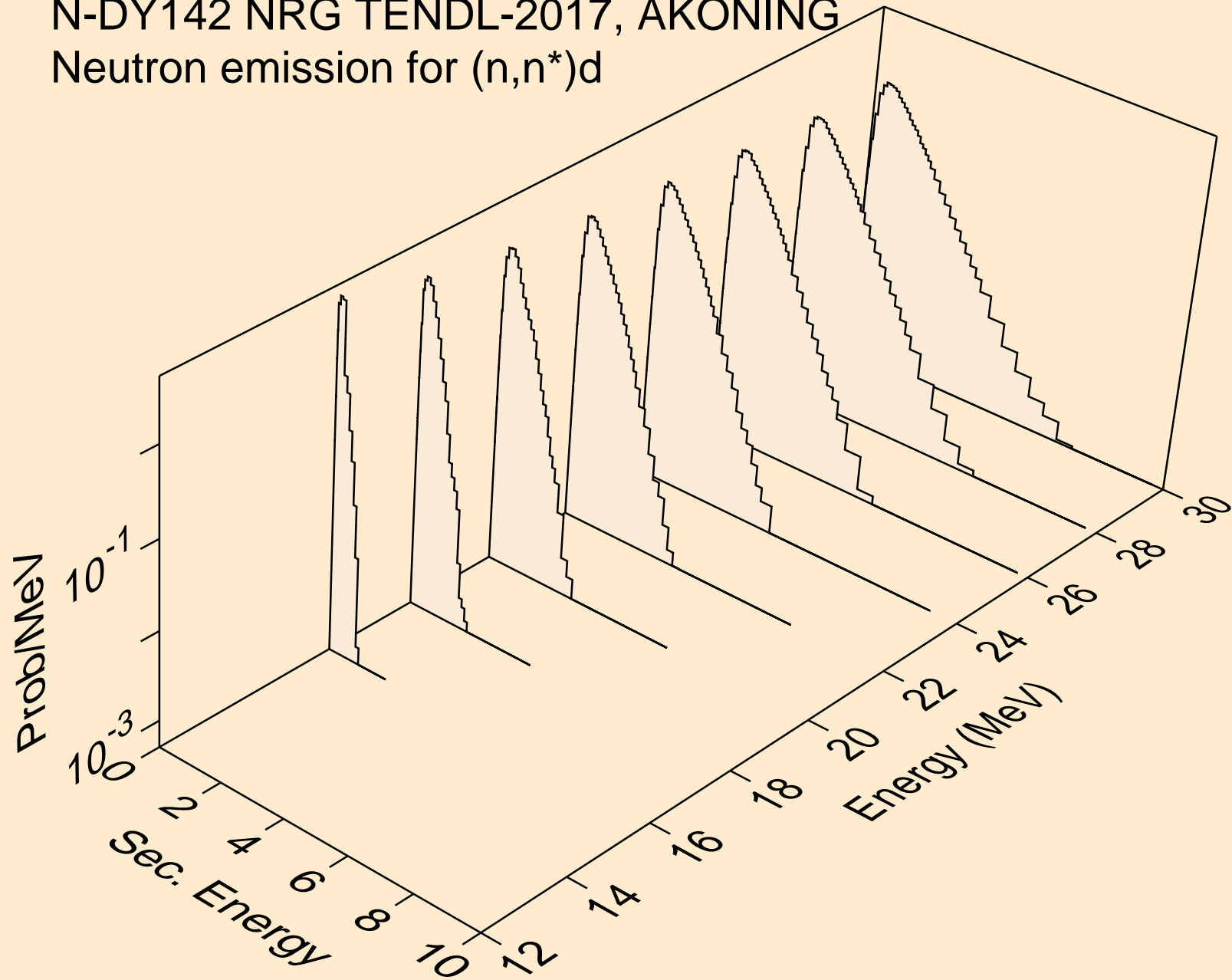

N-DY142 NRG TENDL-2017, AKONING  
Neutron emission for (n,n\*)t

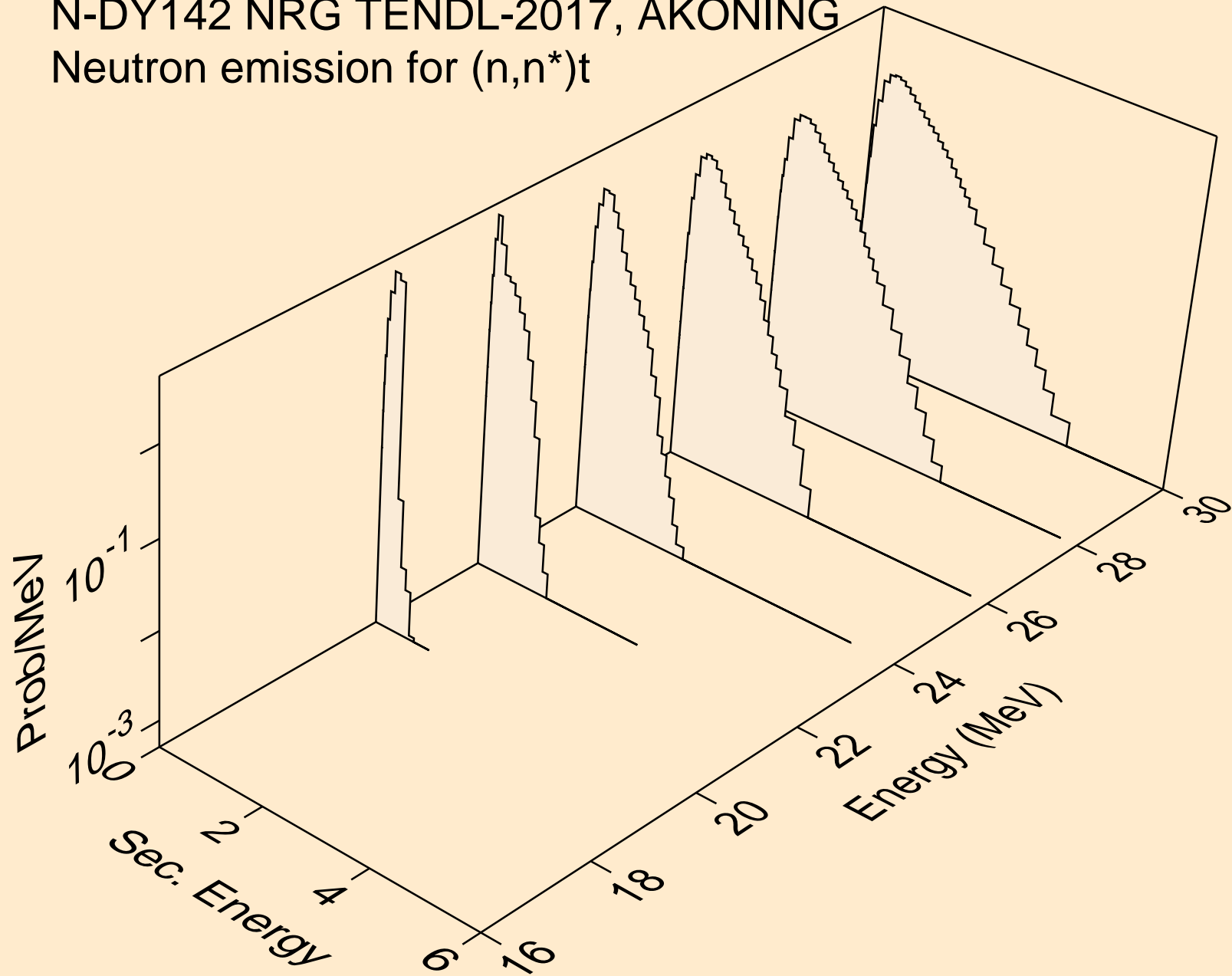

N-DY142 NRG TENDL-2017, AKONING  
Neutron emission for (n,n\*)he3

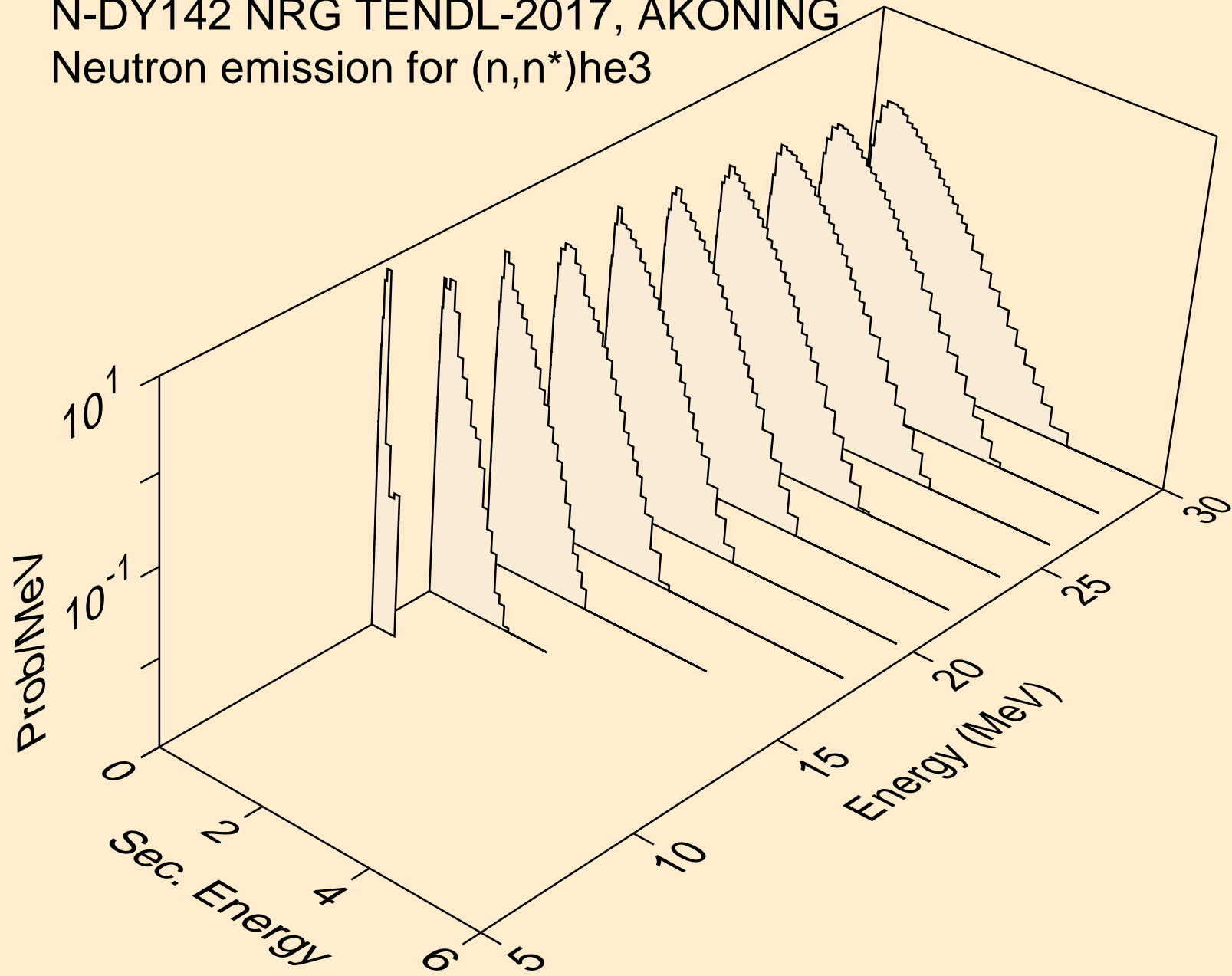

N-DY142 NRG TENDL-2017, AKONING  
Neutron emission for (n,2np)

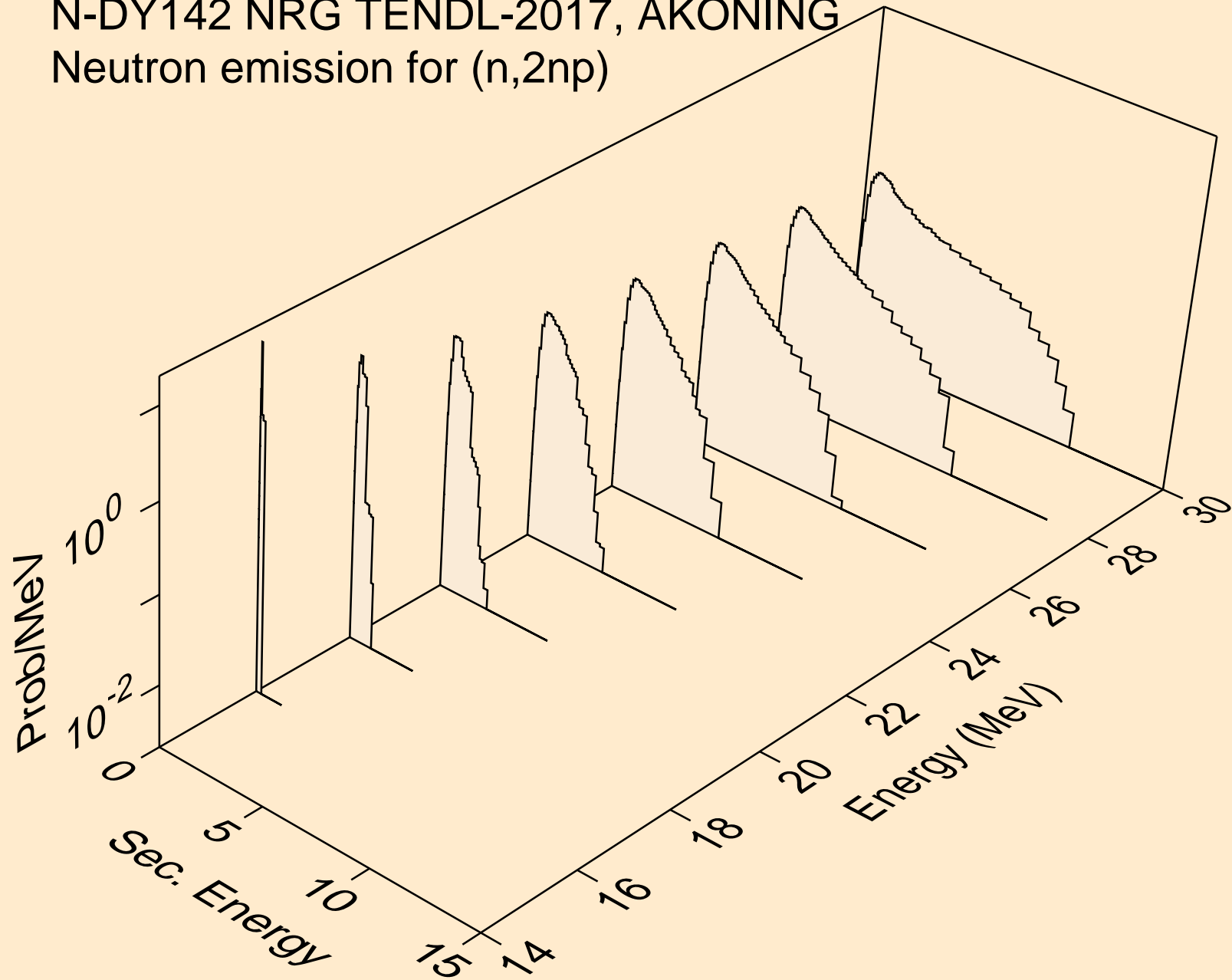

N-DY142 NRG TENDL-2017, AKONING  
Neutron emission for (n,3np)

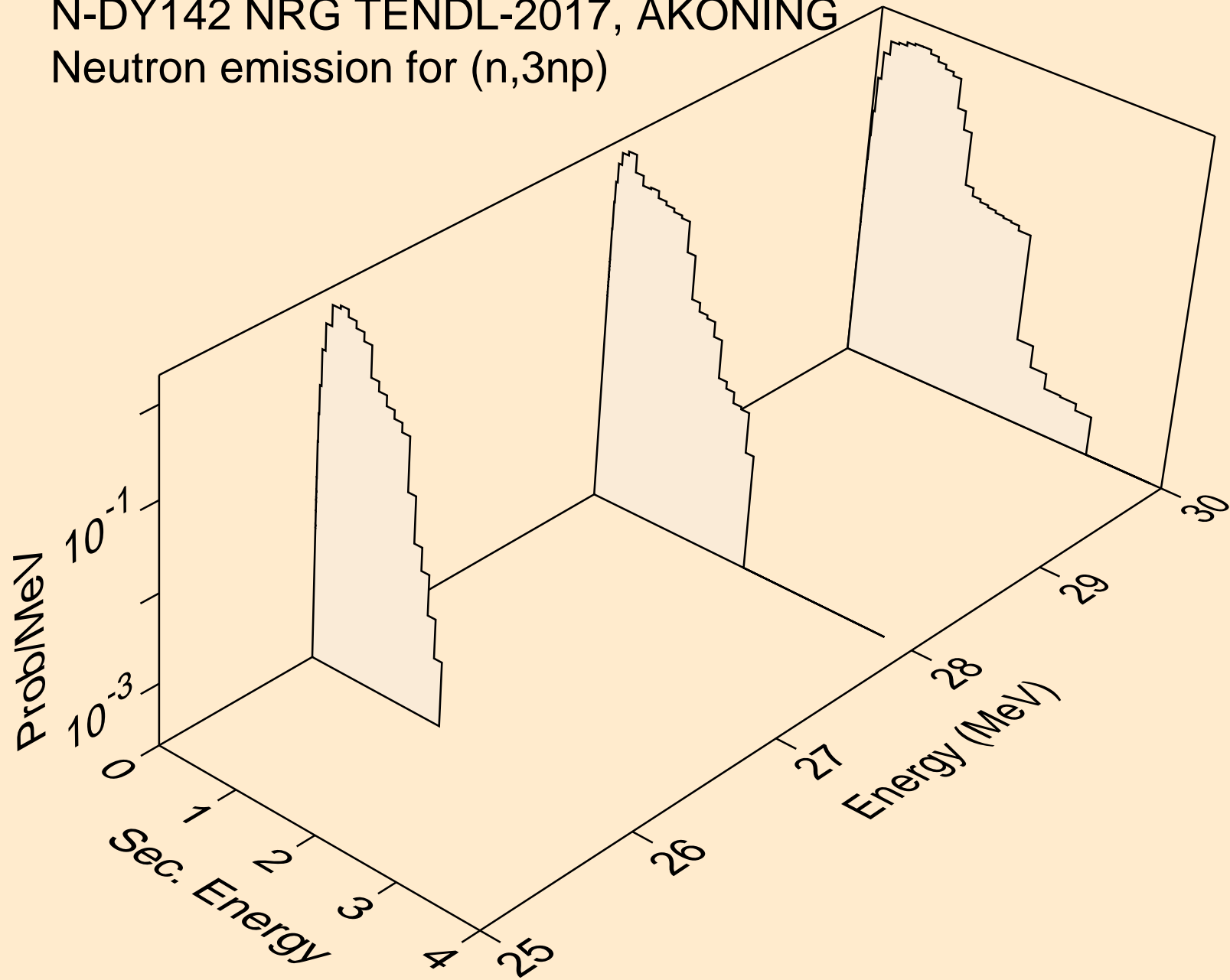

N-DY142 NRG TENDL-2017, AKONING  
Neutron emission for (n,2np)

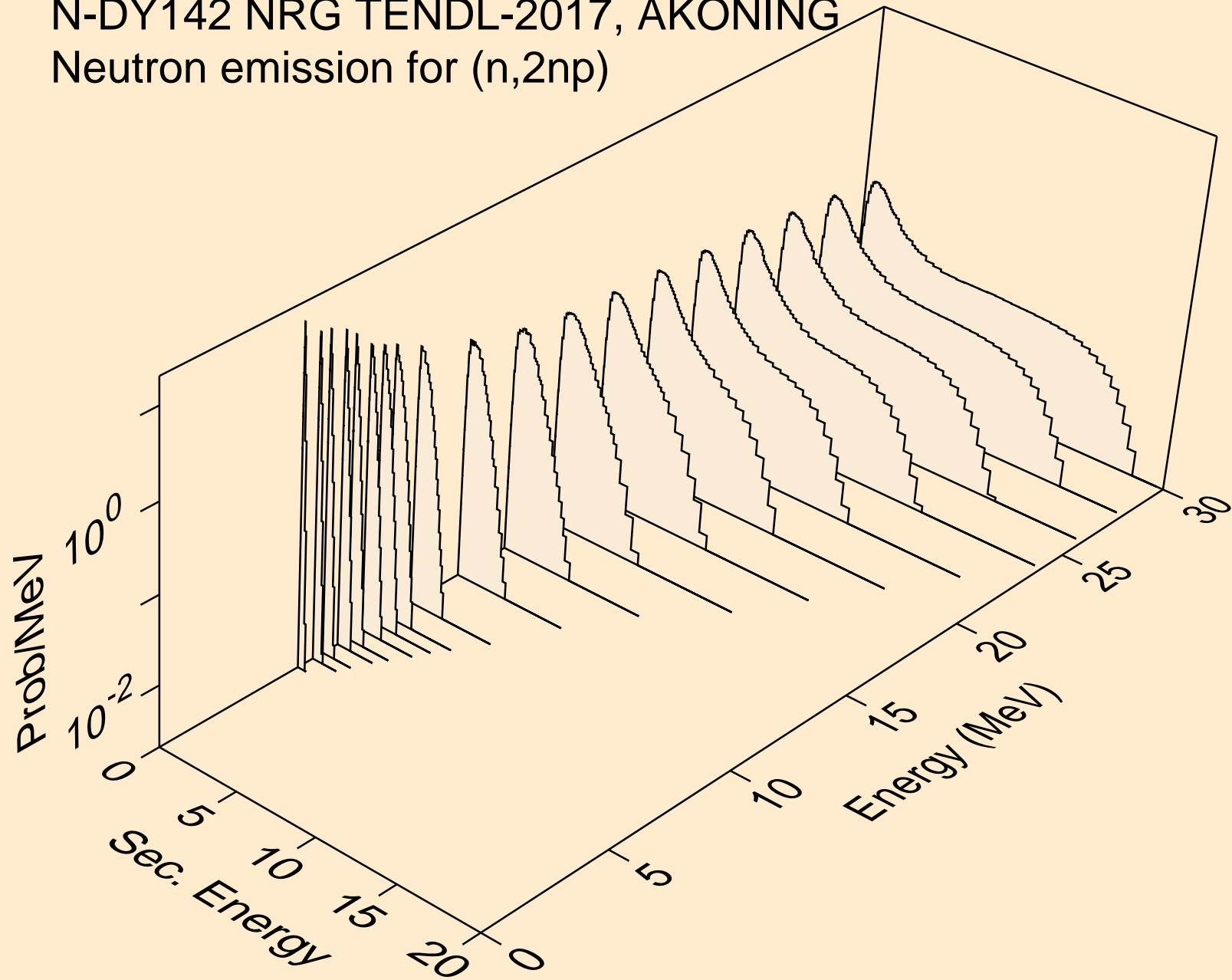



N-DY142 NRG TENDL-2017, AKONING  
Neutron emission for (n,npa)

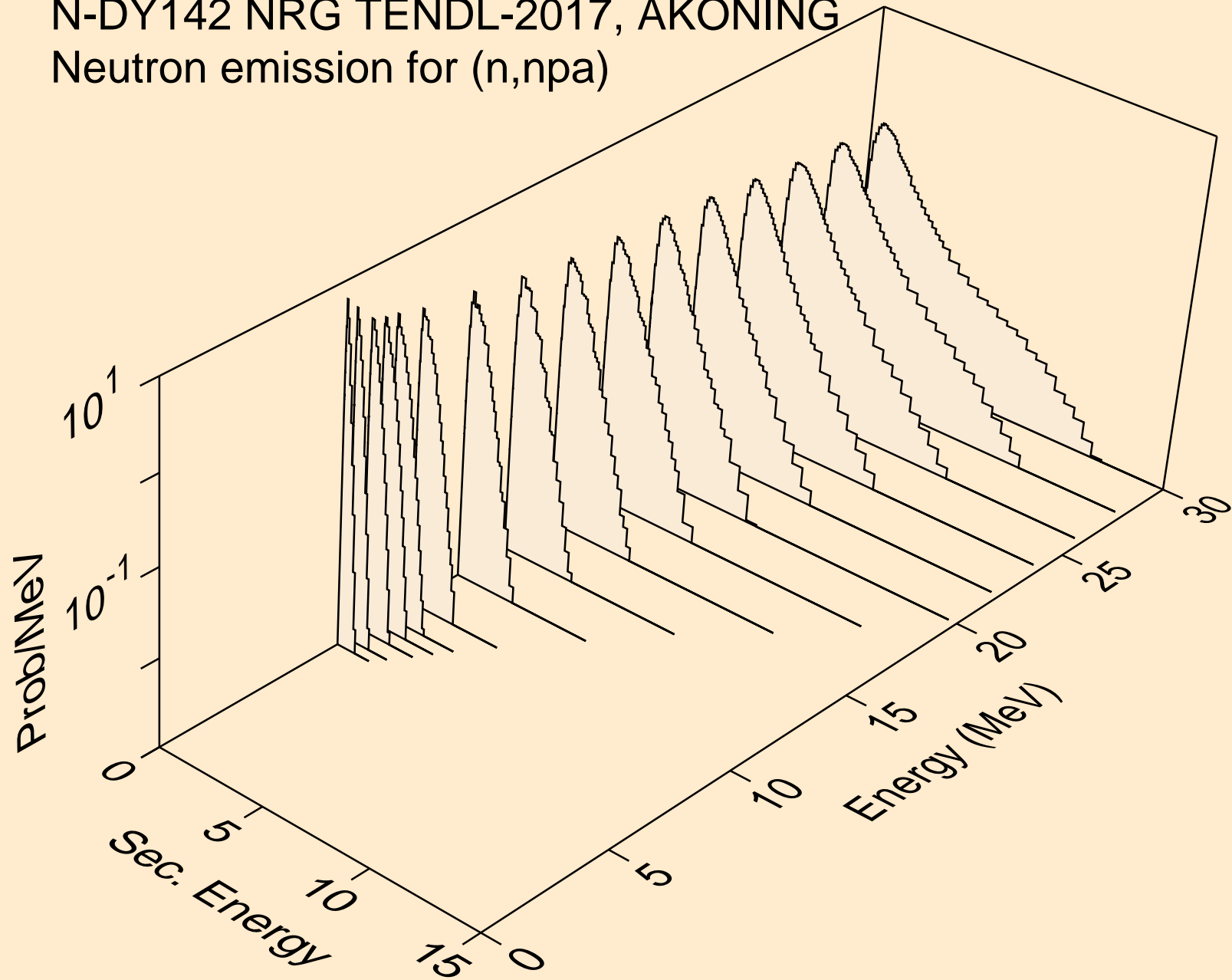

N-DY142 NRG TENDL-2017, AKONING  
Neutron emission for (n,n\*c)

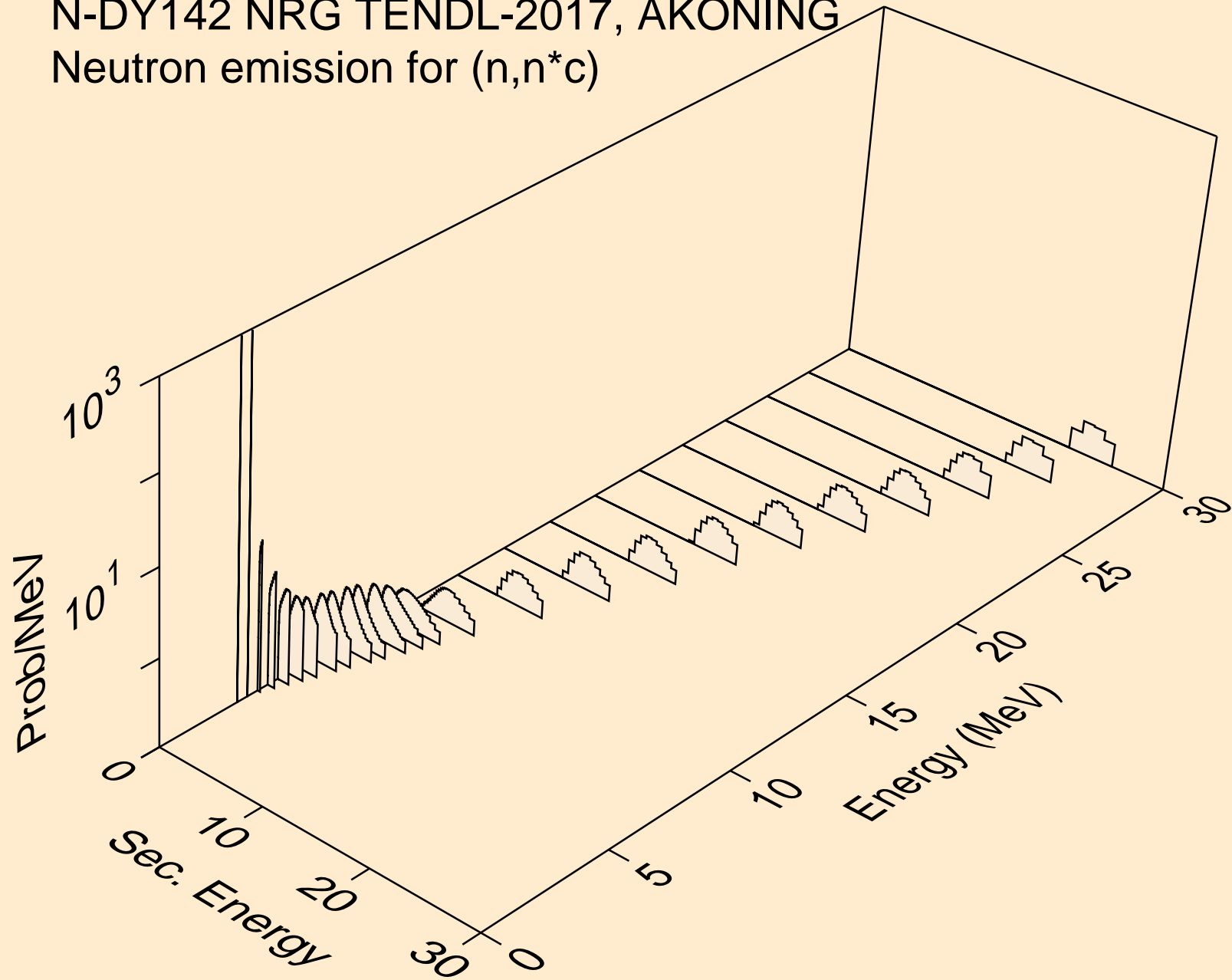

N-DY142 NRG TENDL-2017, AKONING  
Photon emission for (n,x)

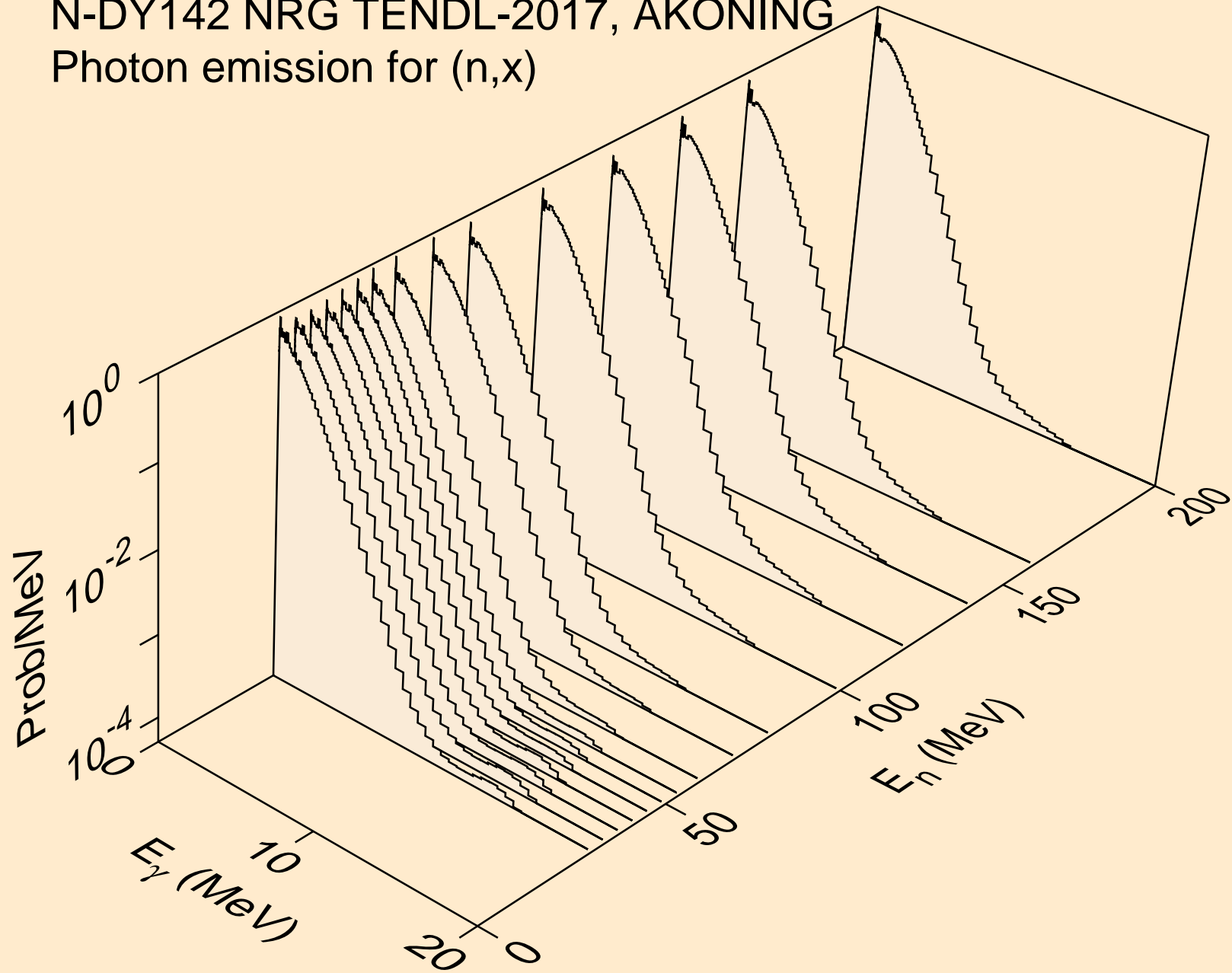

N-DY142 NRG TENDL-2017, AKONING  
Photon emission for (n,2nd)

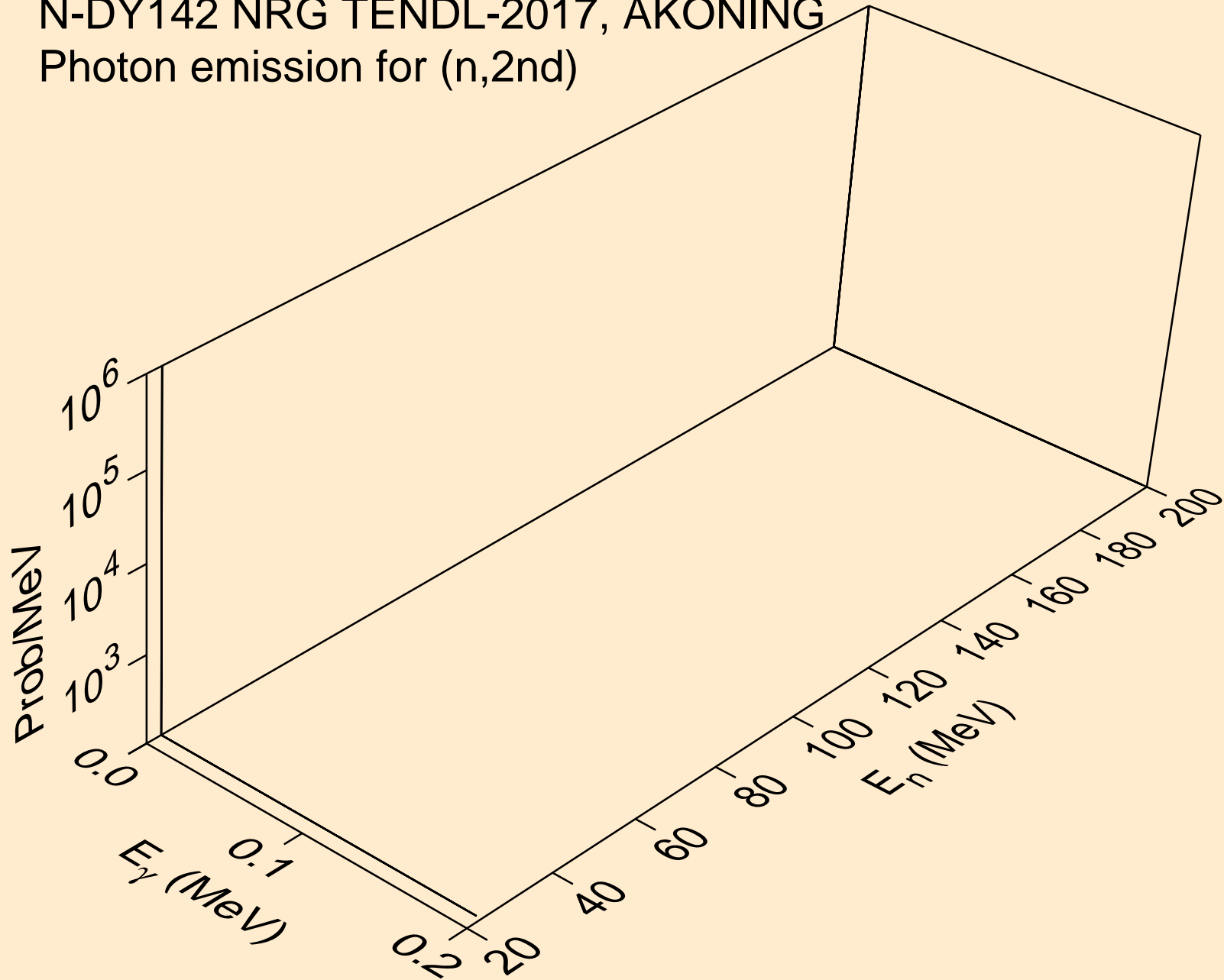

N-DY142 NRG TENDL-2017, AKONING  
Photon emission for (n,2n)

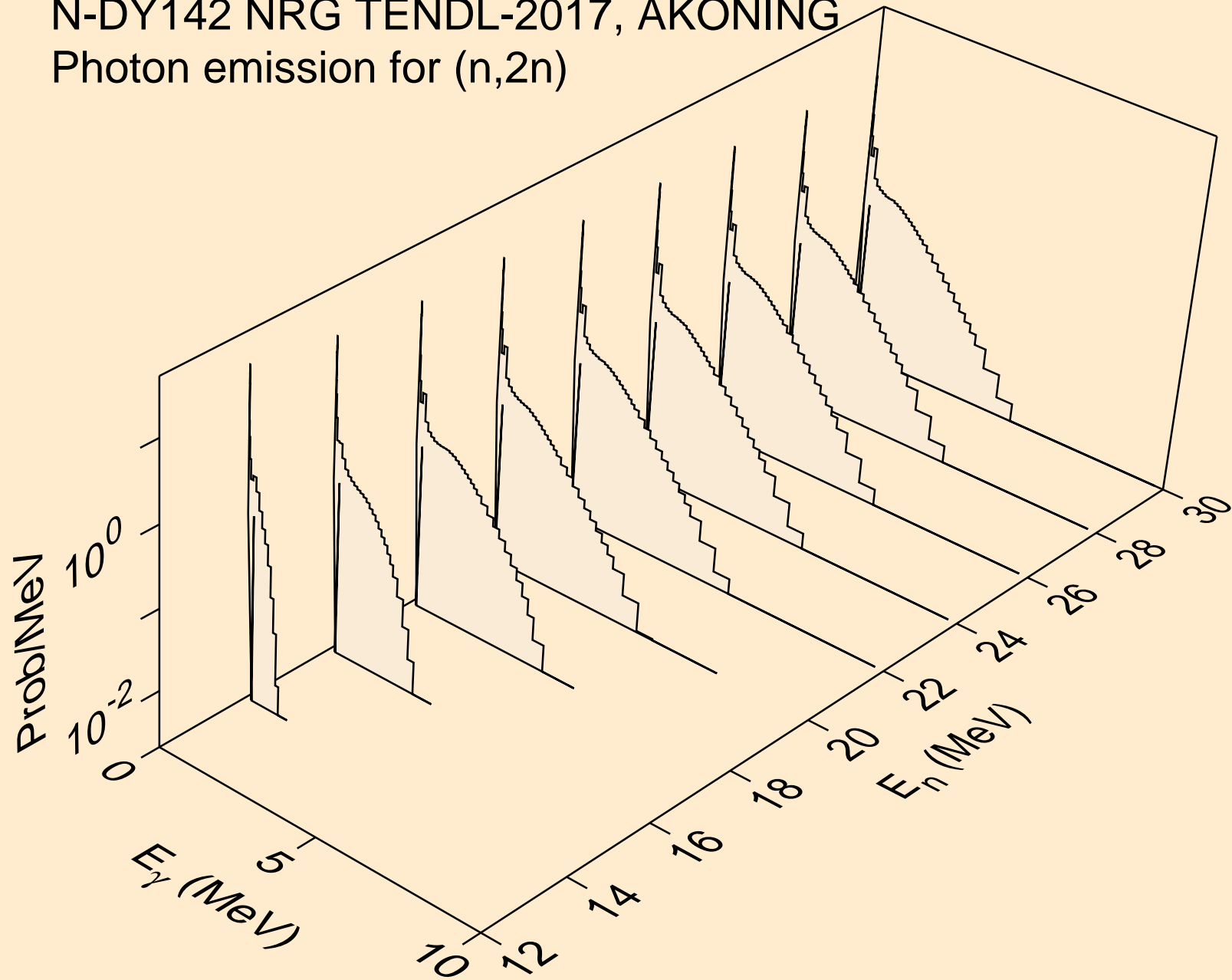

N-DY142 NRG TENDL-2017, AKONING  
Photon emission for (n,3n)

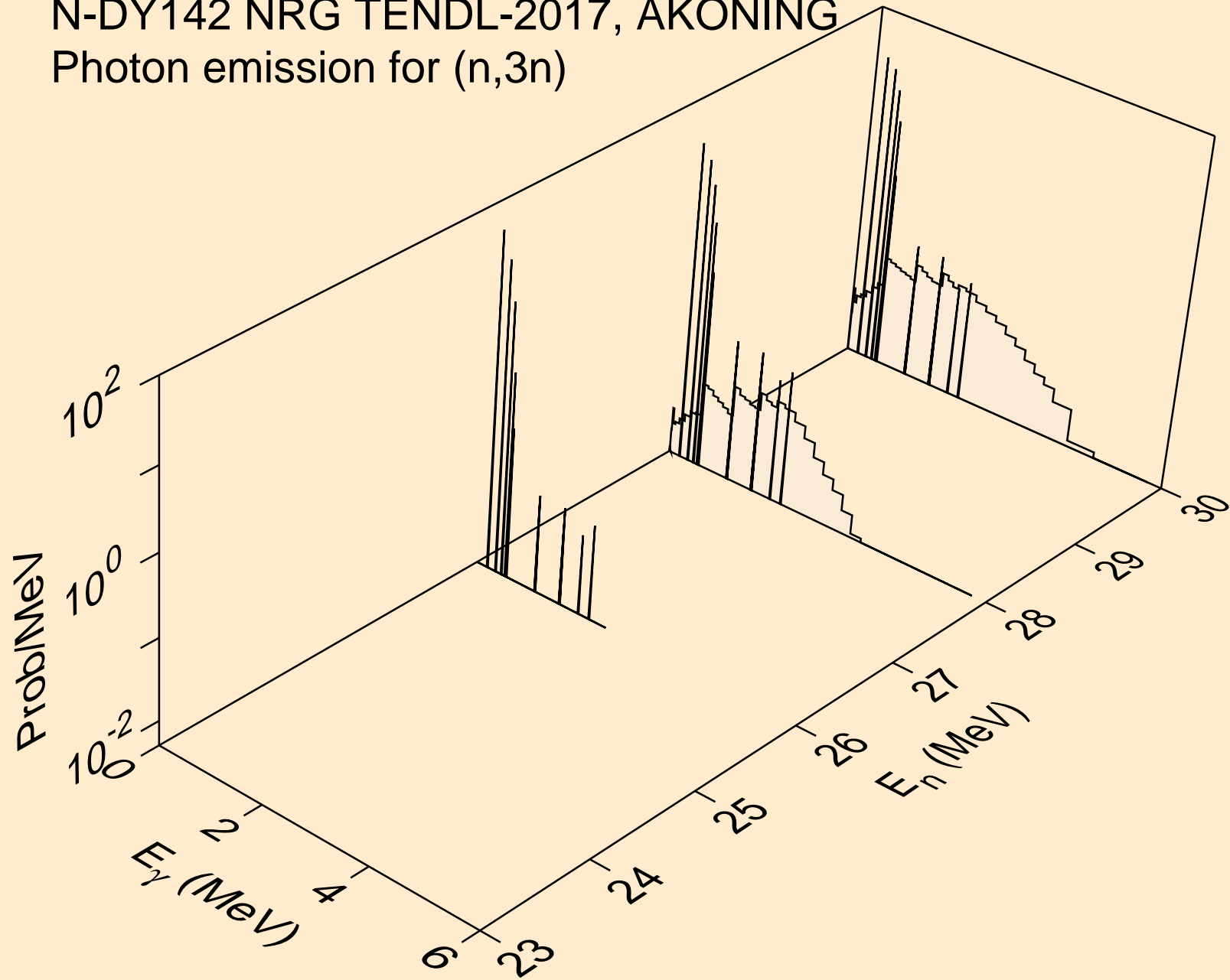

N-DY142 NRG TENDL-2017, AKONING  
Photon emission for (n,n\*)a

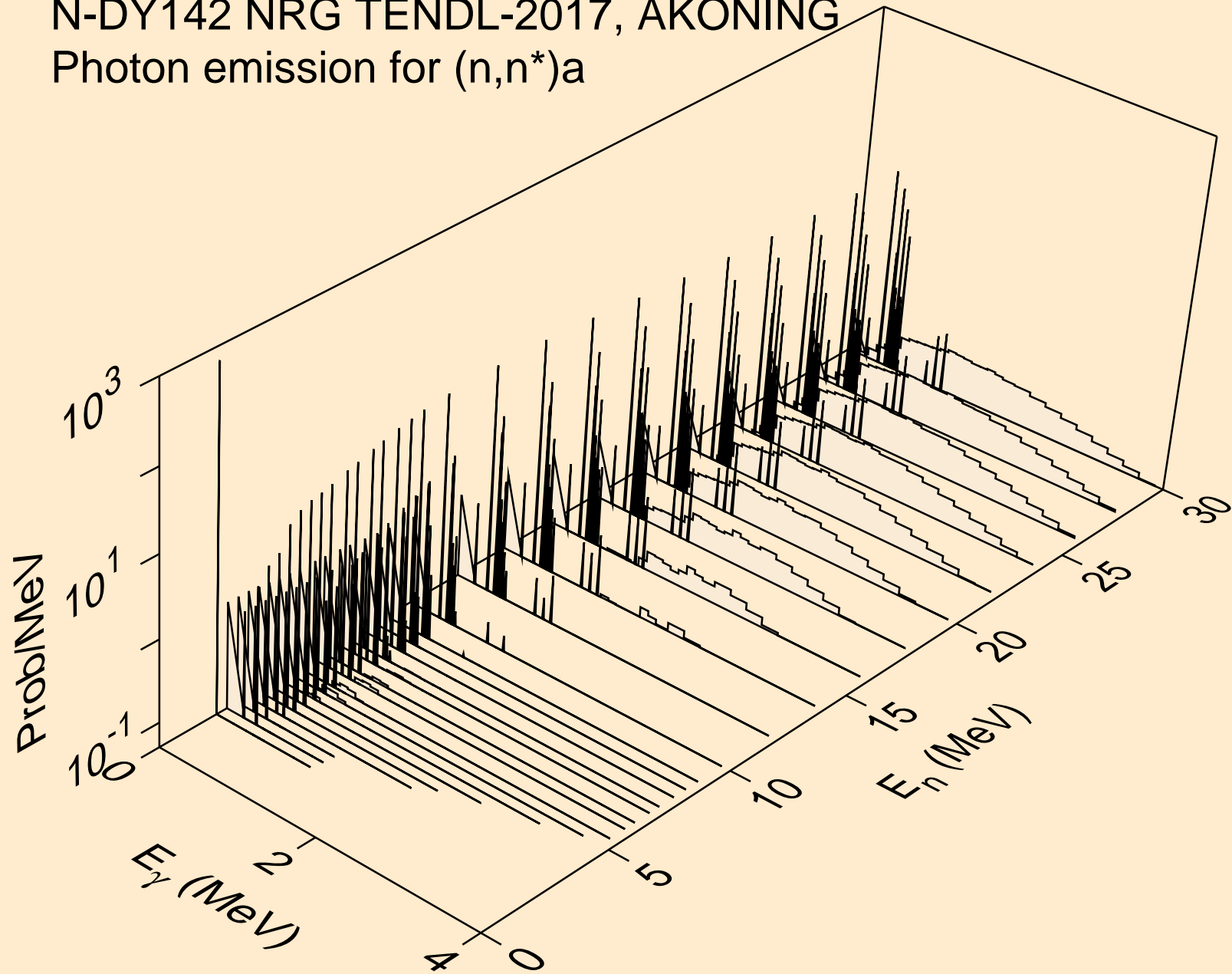

N-DY142 NRG TENDL-2017, AKONING  
Photon emission for (n,n\*)3a

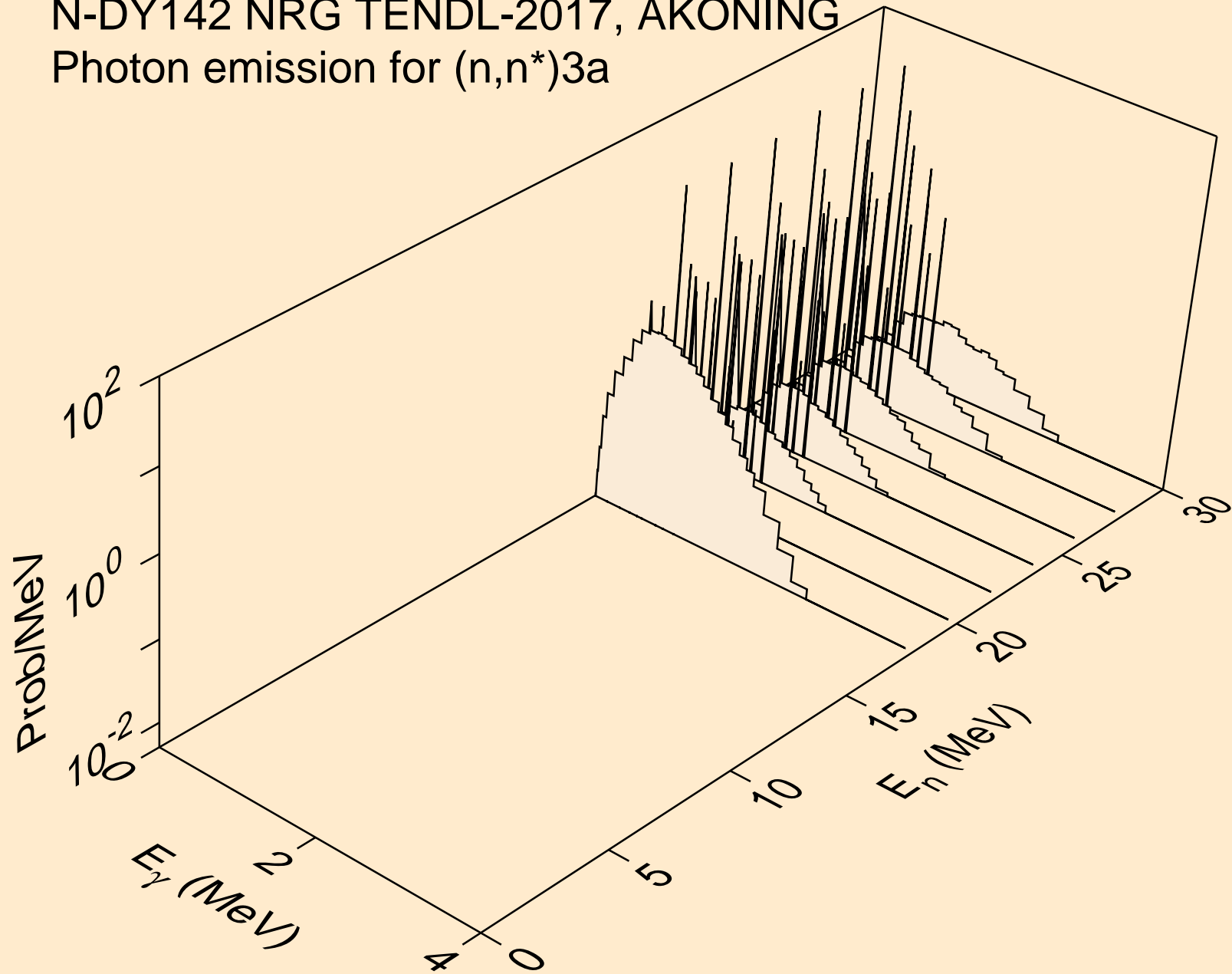



N-DY142 NRG TENDL-2017, AKONING  
Photon emission for (n,2n)a

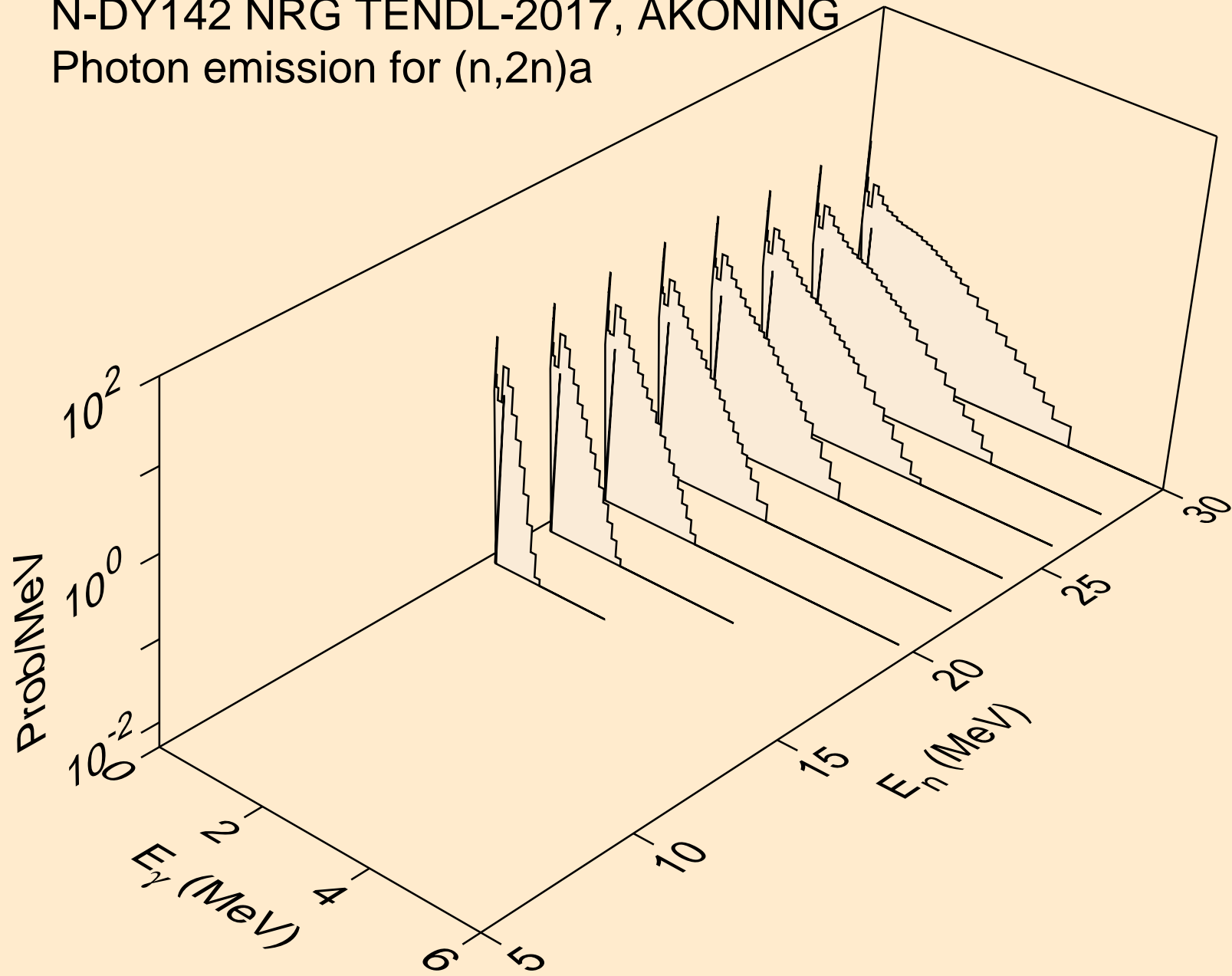

N-DY142 NRG TENDL-2017, AKONING  
Photon emission for (n,3n)a

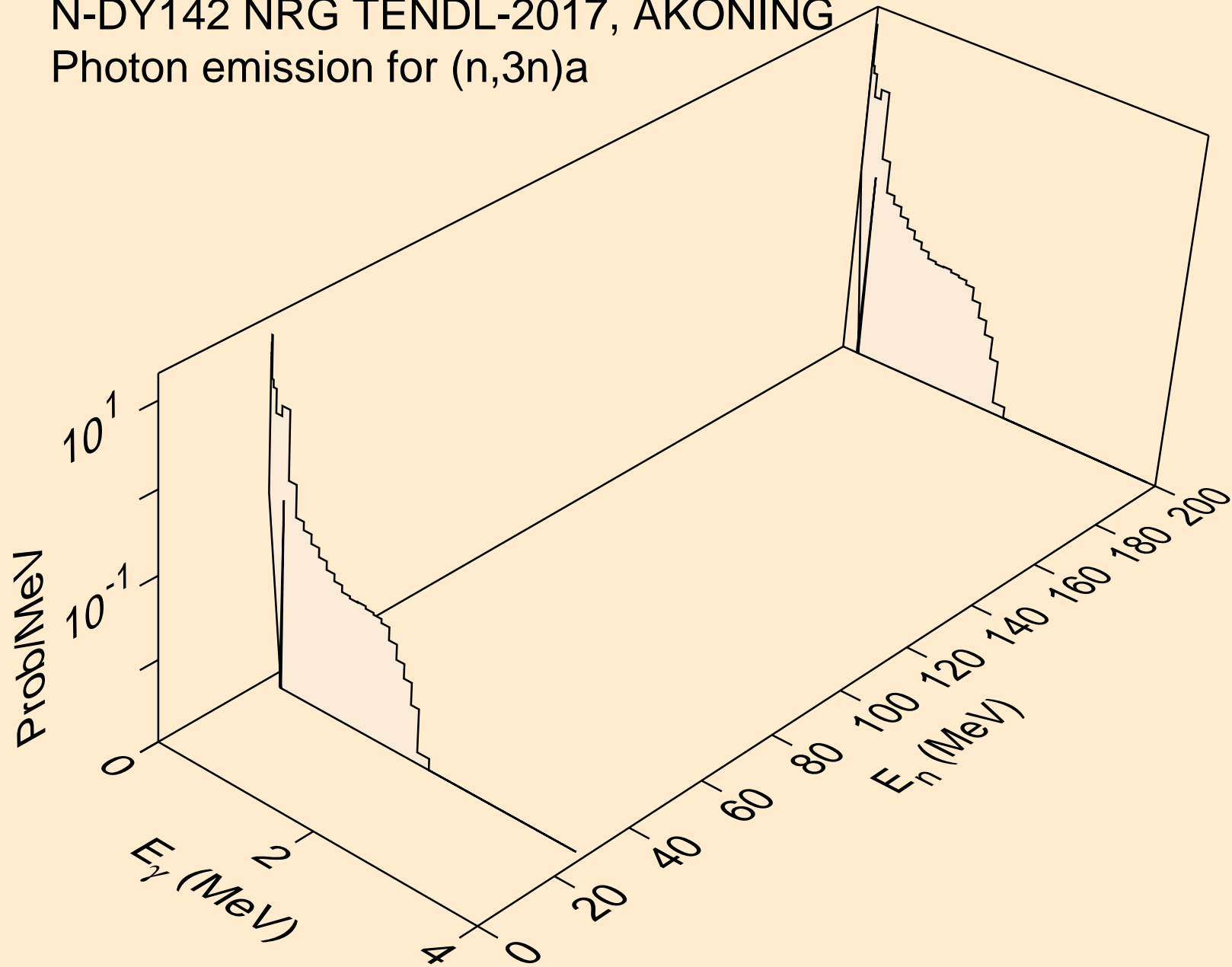

N-DY142 NRG TENDL-2017, AKONING  
Photon emission for (n,n\*)p

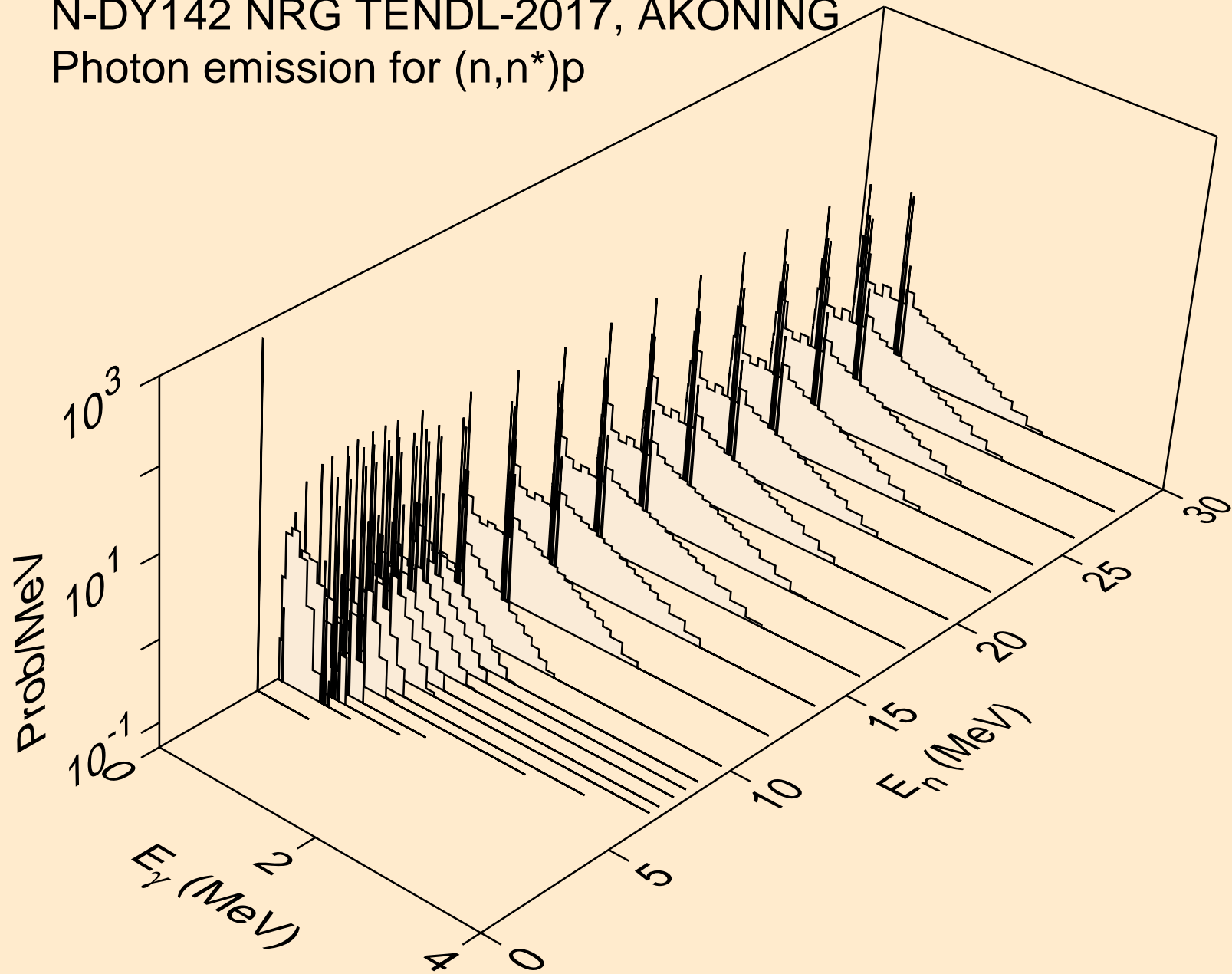

N-DY142 NRG TENDL-2017, AKONING  
Photon emission for (n,n\*)2a

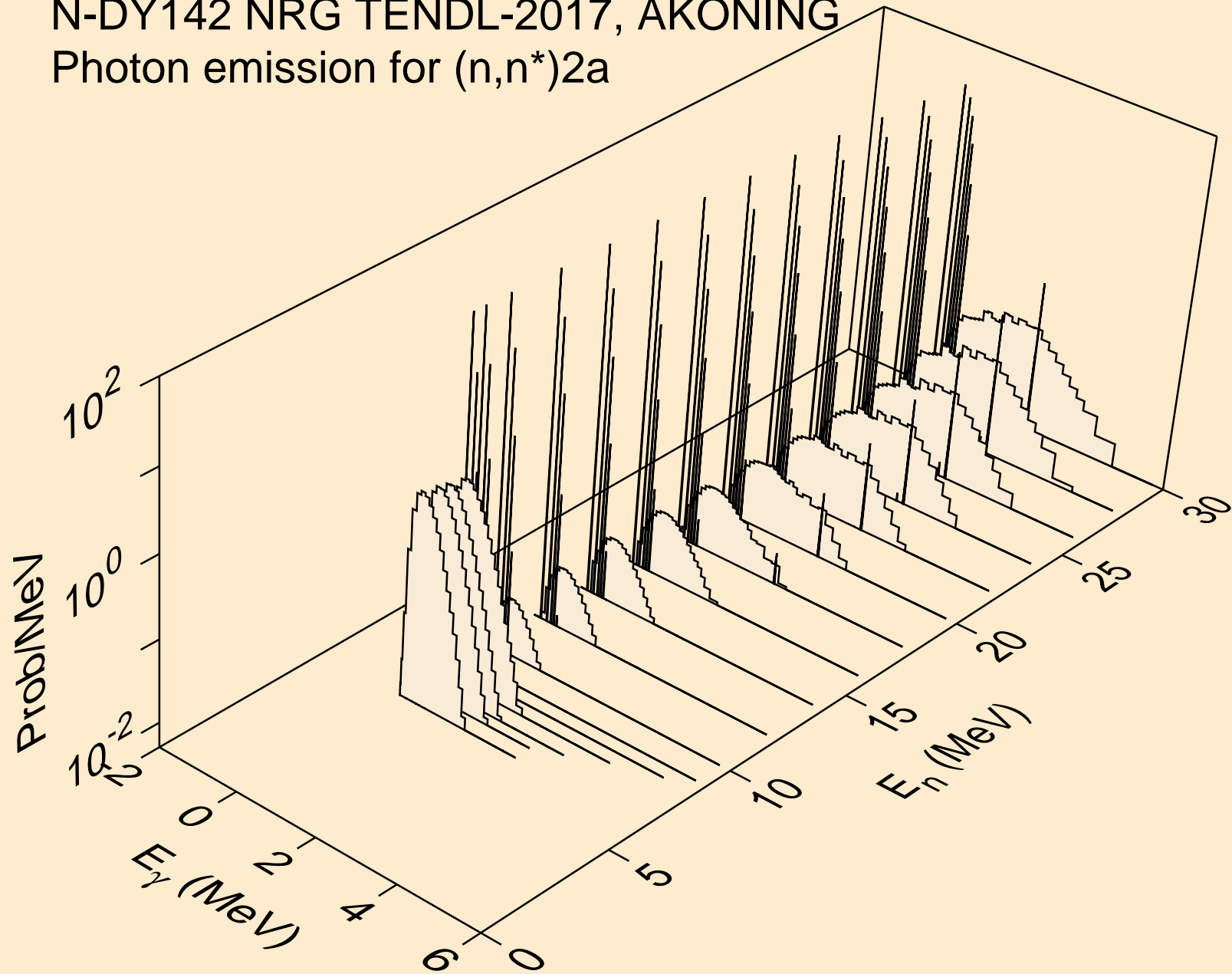

N-DY142 NRG TENDL-2017, AKONING  
Photon emission for (n,2n)2a

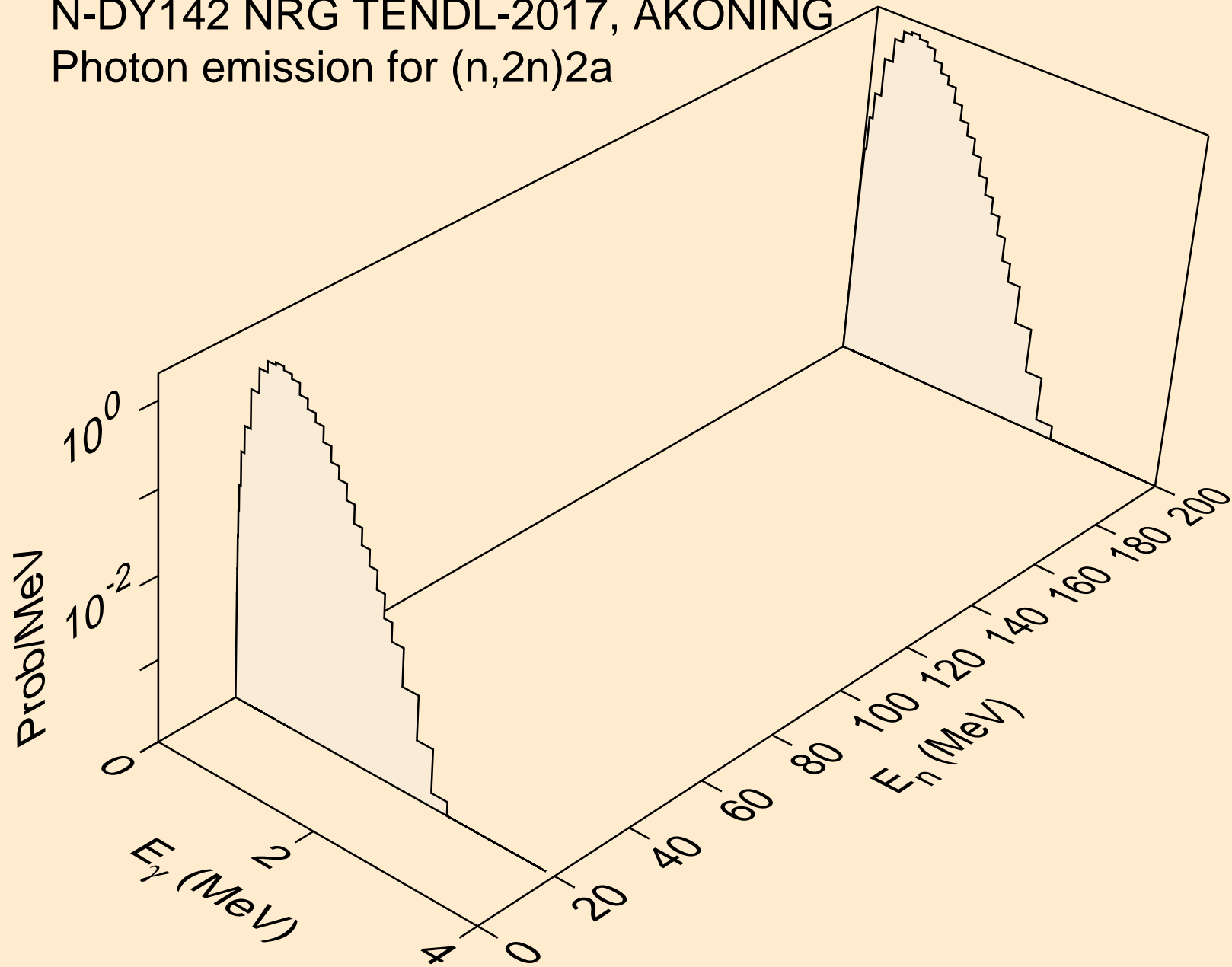

N-DY142 NRG TENDL-2017, AKONING  
Photon emission for (n,n\*)d

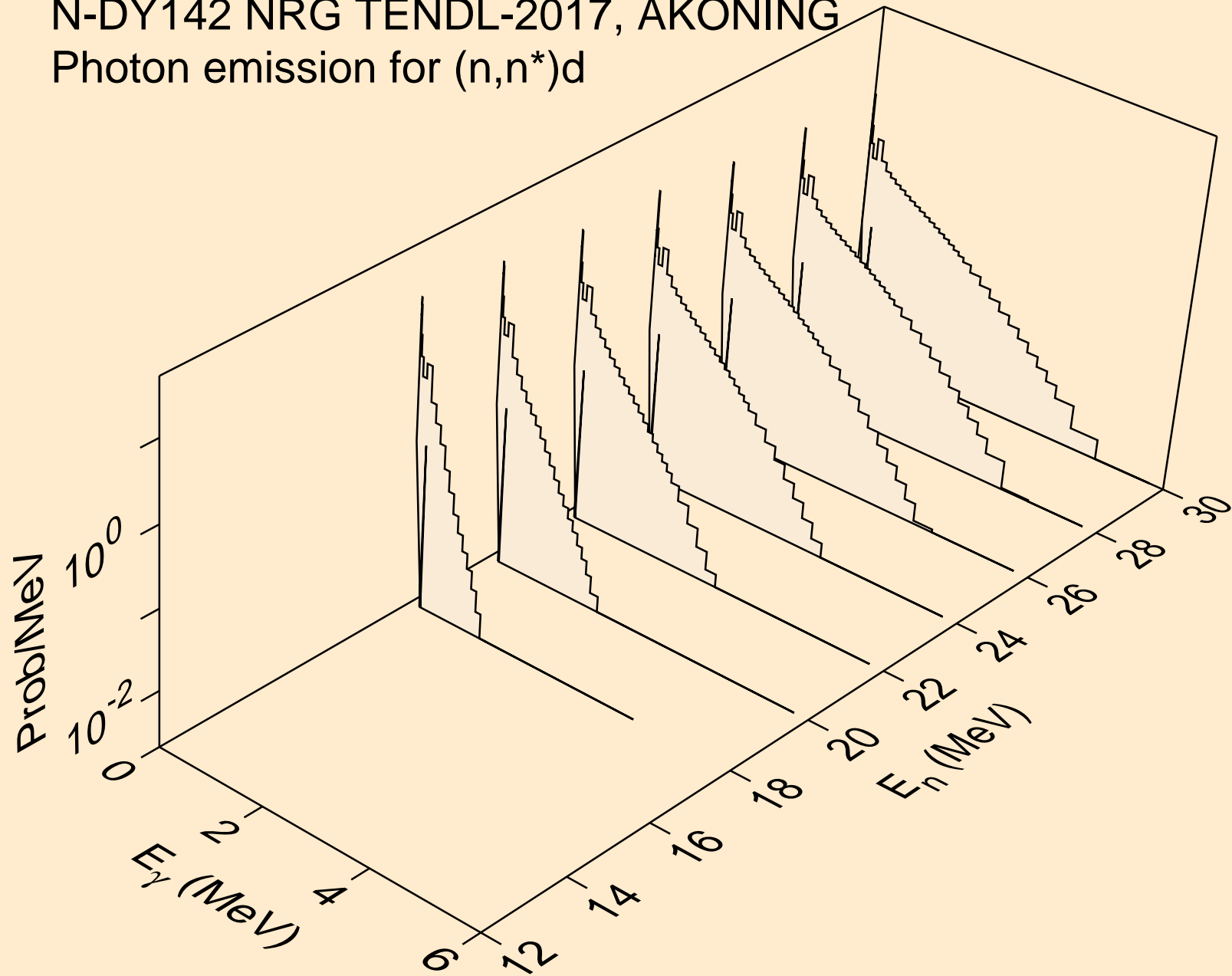

N-DY142 NRG TENDL-2017, AKONING  
Photon emission for (n,n\*)t

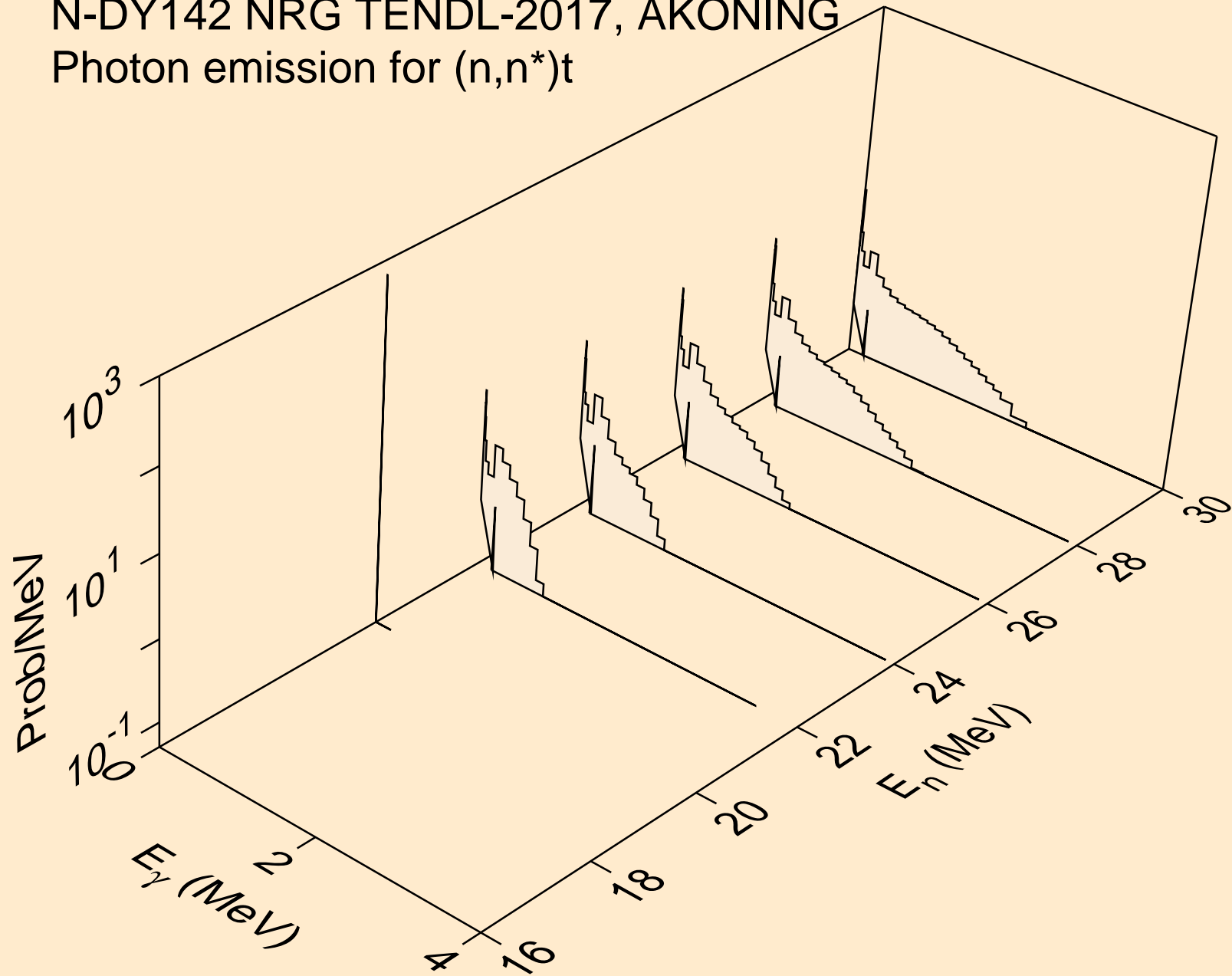

N-DY142 NRG TENDL-2017, AKONING  
Photon emission for (n,n\*)he3

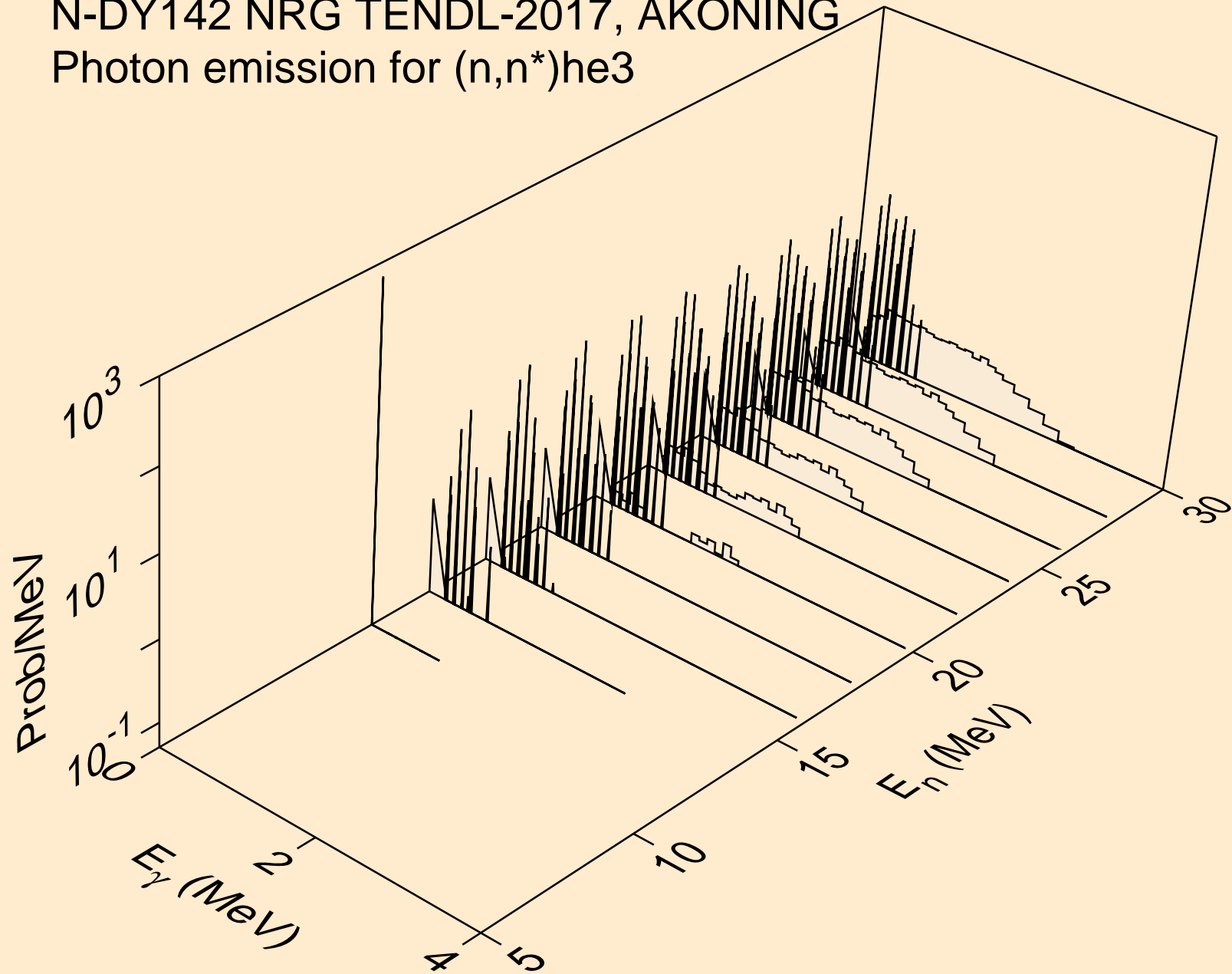



N-DY142 NRG TENDL-2017, AKONING  
Photon emission for (n,2np)

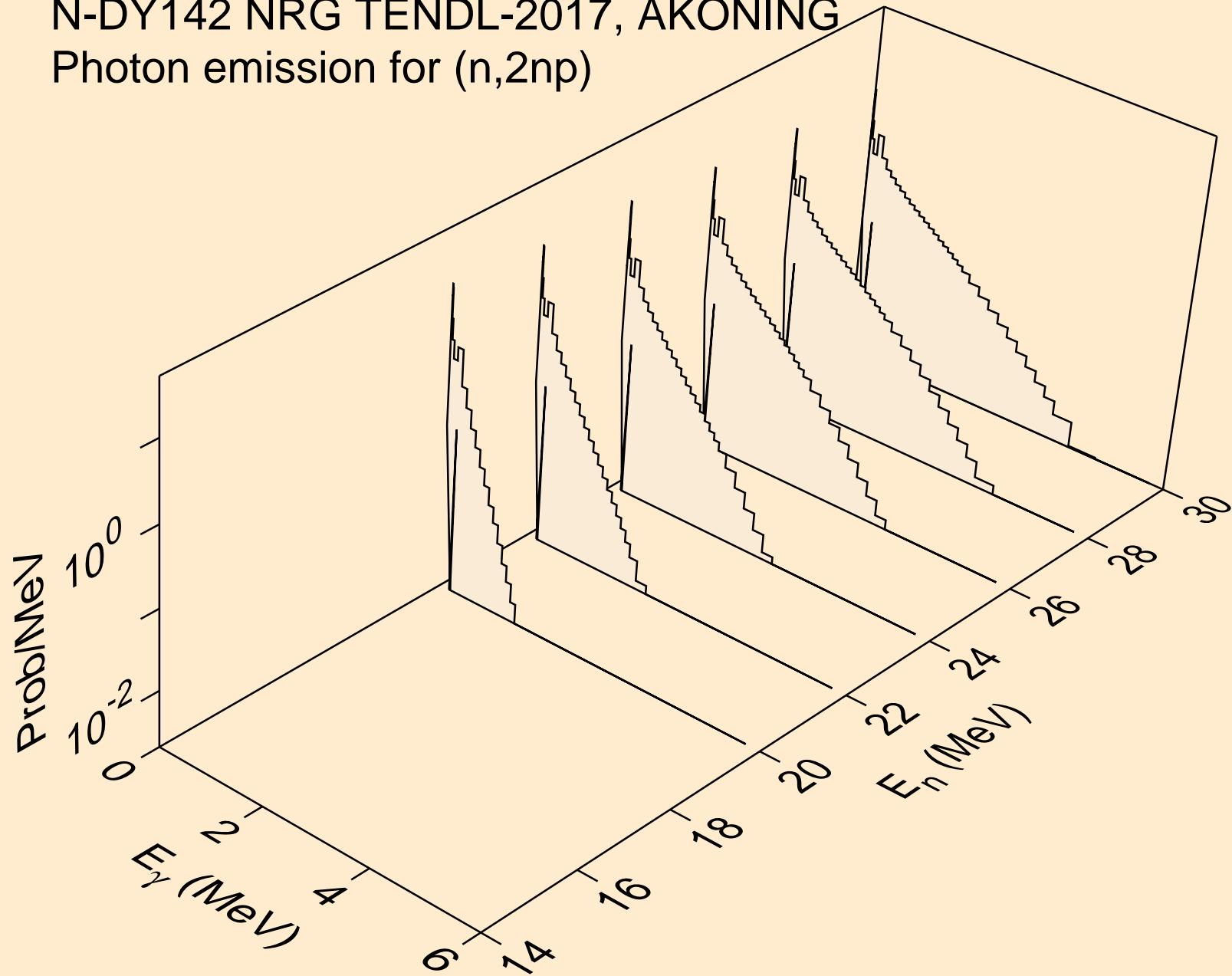

N-DY142 NRG TENDL-2017, AKONING  
Photon emission for (n,3np)

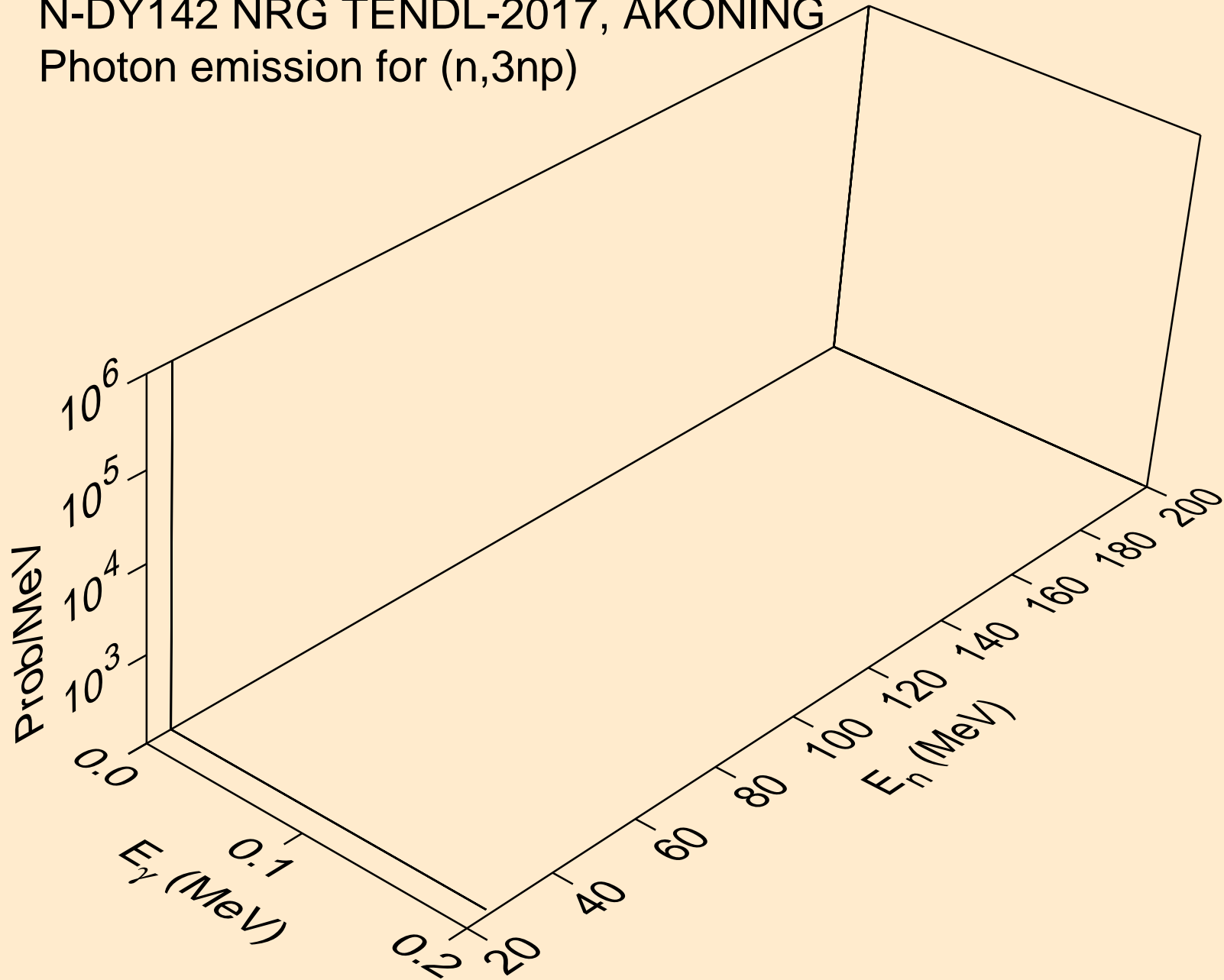

N-DY142 NRG TENDL-2017, AKONING  
Photon emission for (n,2np)

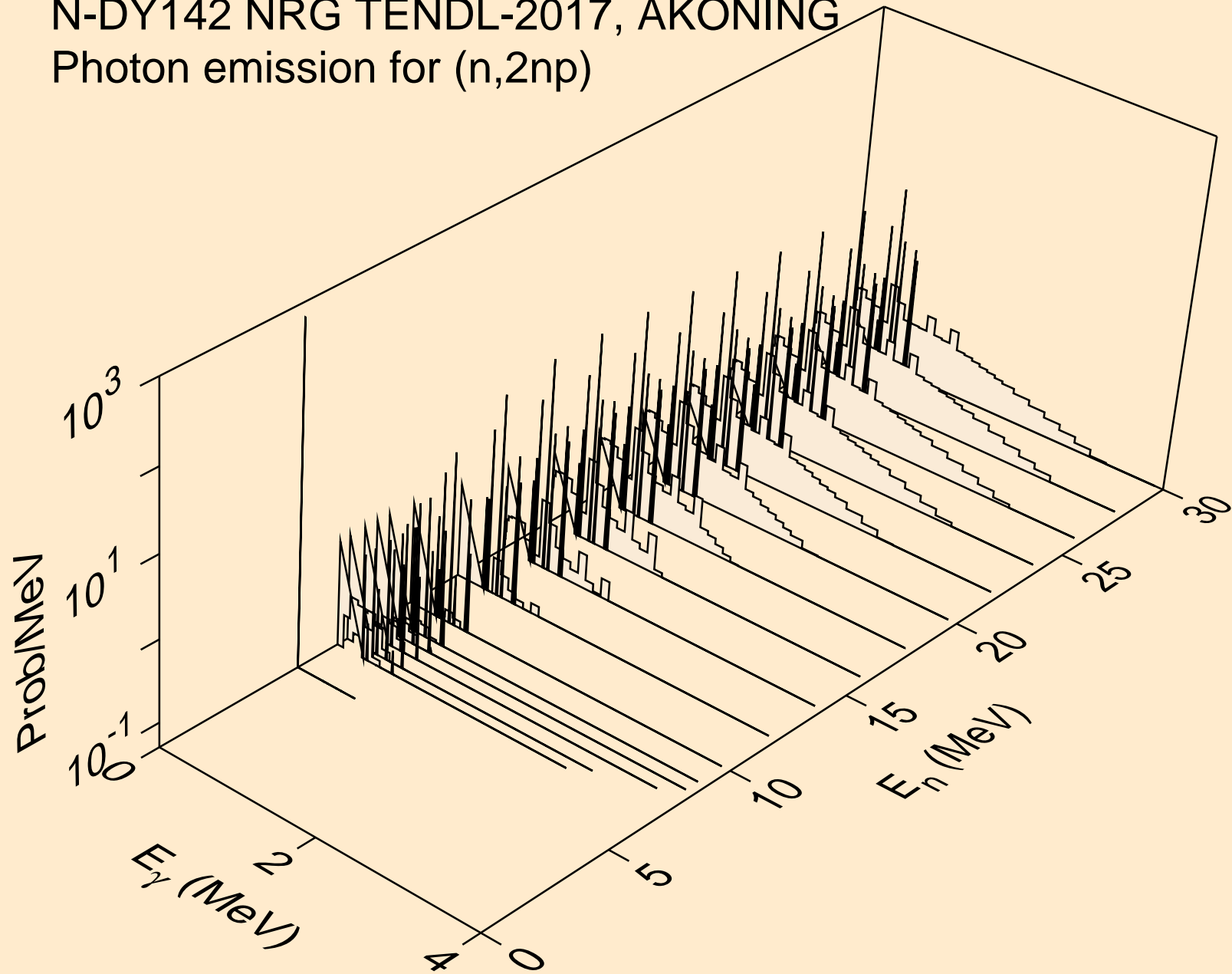

N-DY142 NRG TENDL-2017, AKONING  
Photon emission for (n,npa)

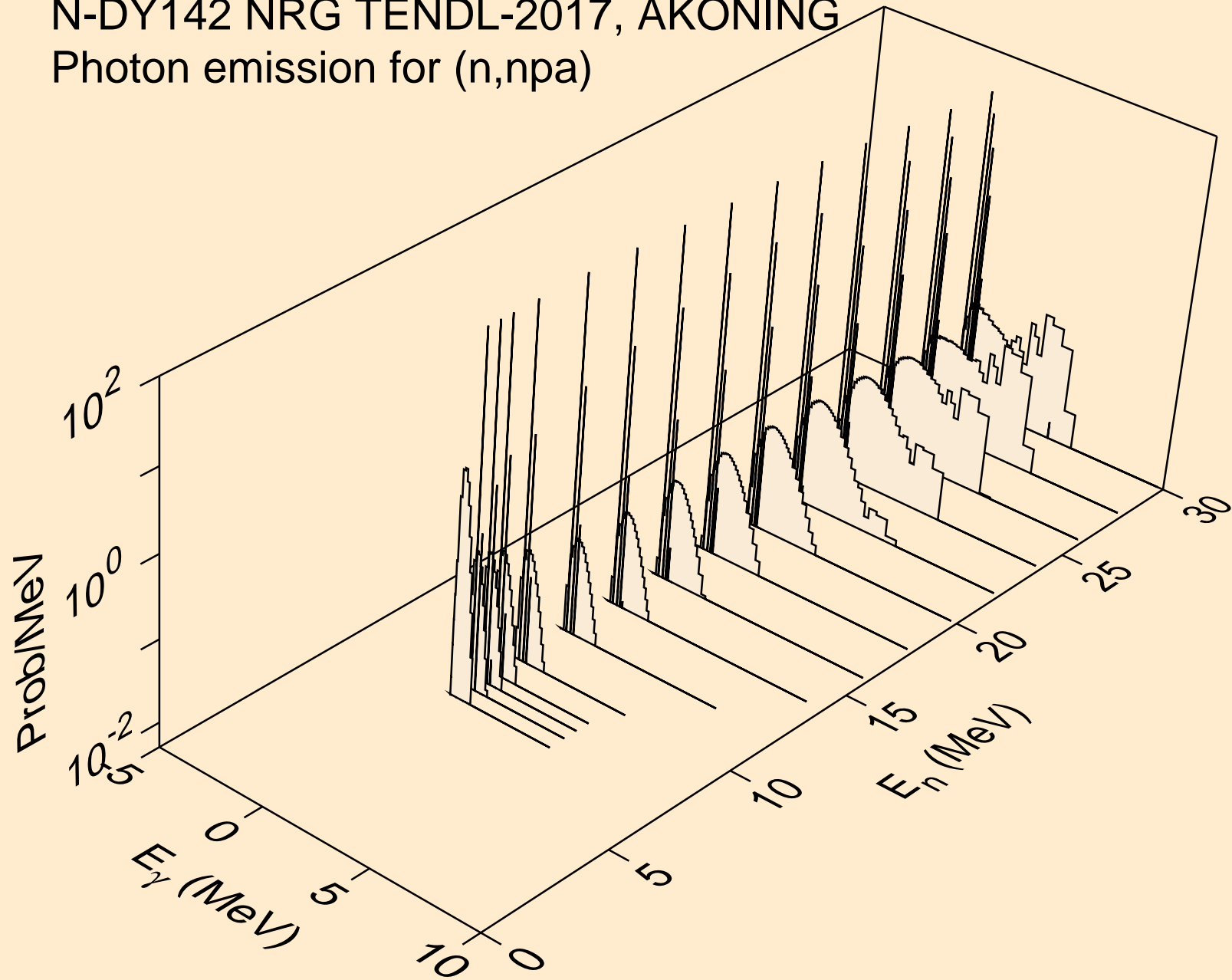

N-DY142 NRG TENDL-2017, AKONING  
Photon emission for (n,n\*c)

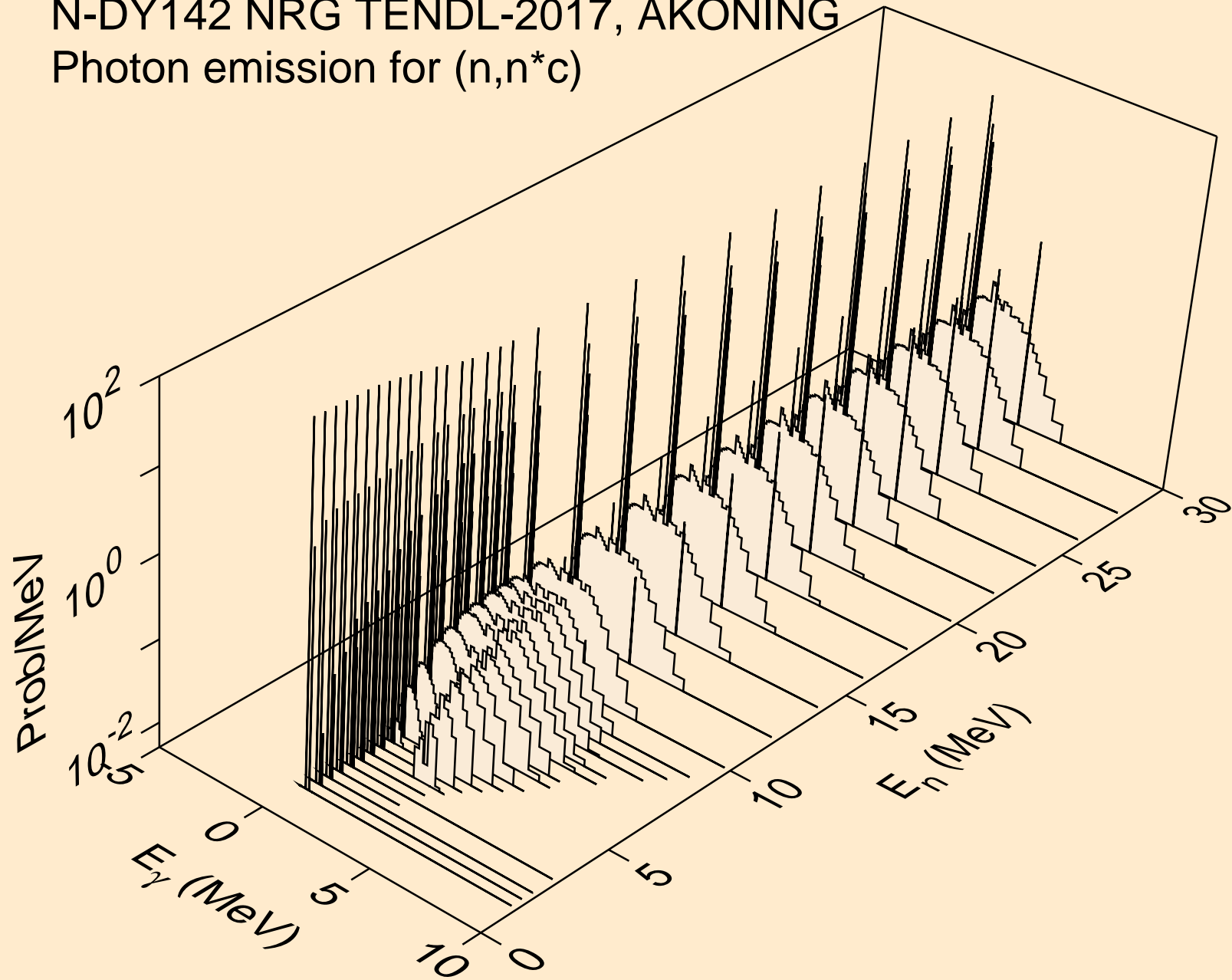

N-DY142 NRG TENDL-2017, AKONING  
Photon emission for (n,gma)

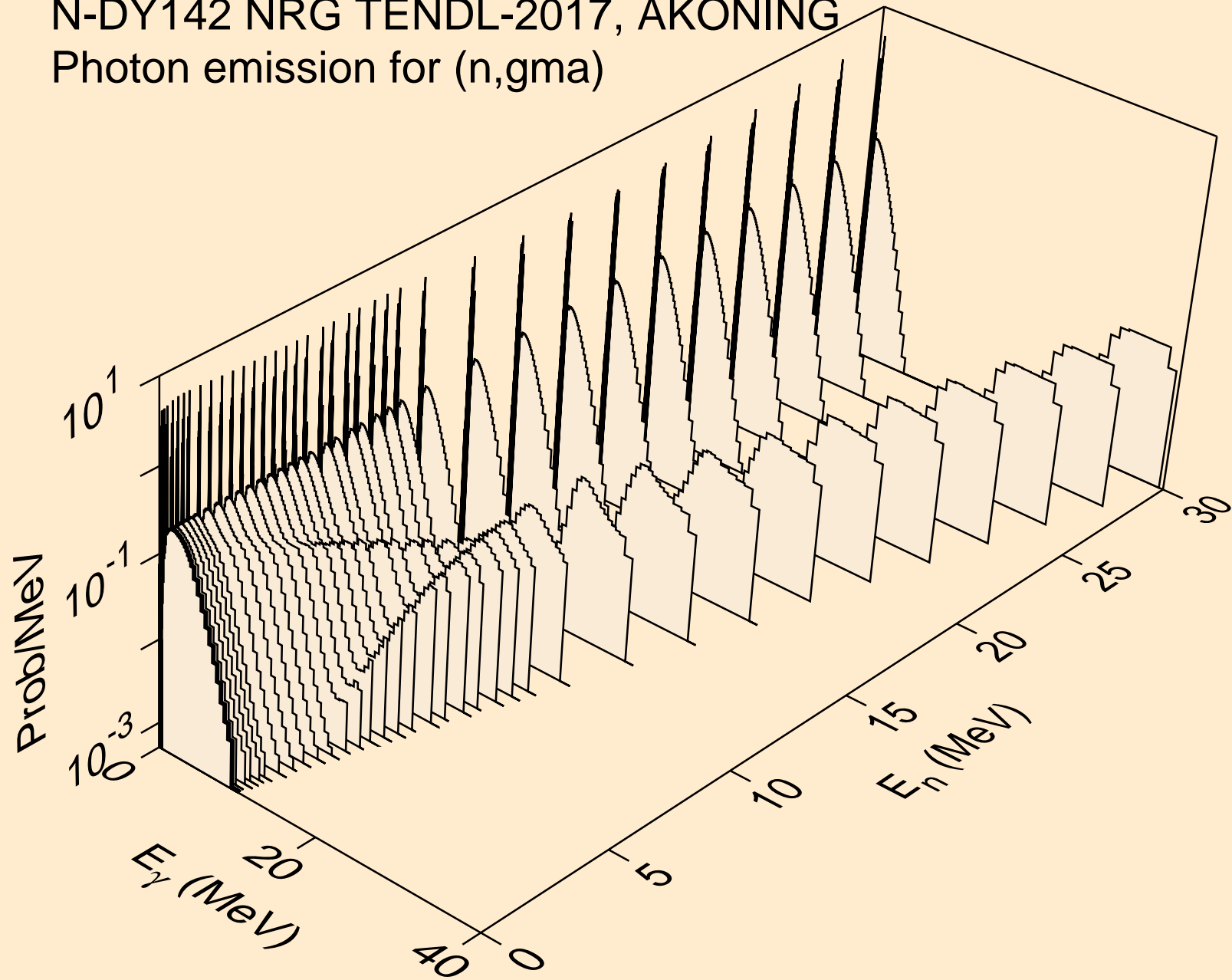

N-DY142 NRG TENDL-2017, AKONING  
Photon emission for (n,p)

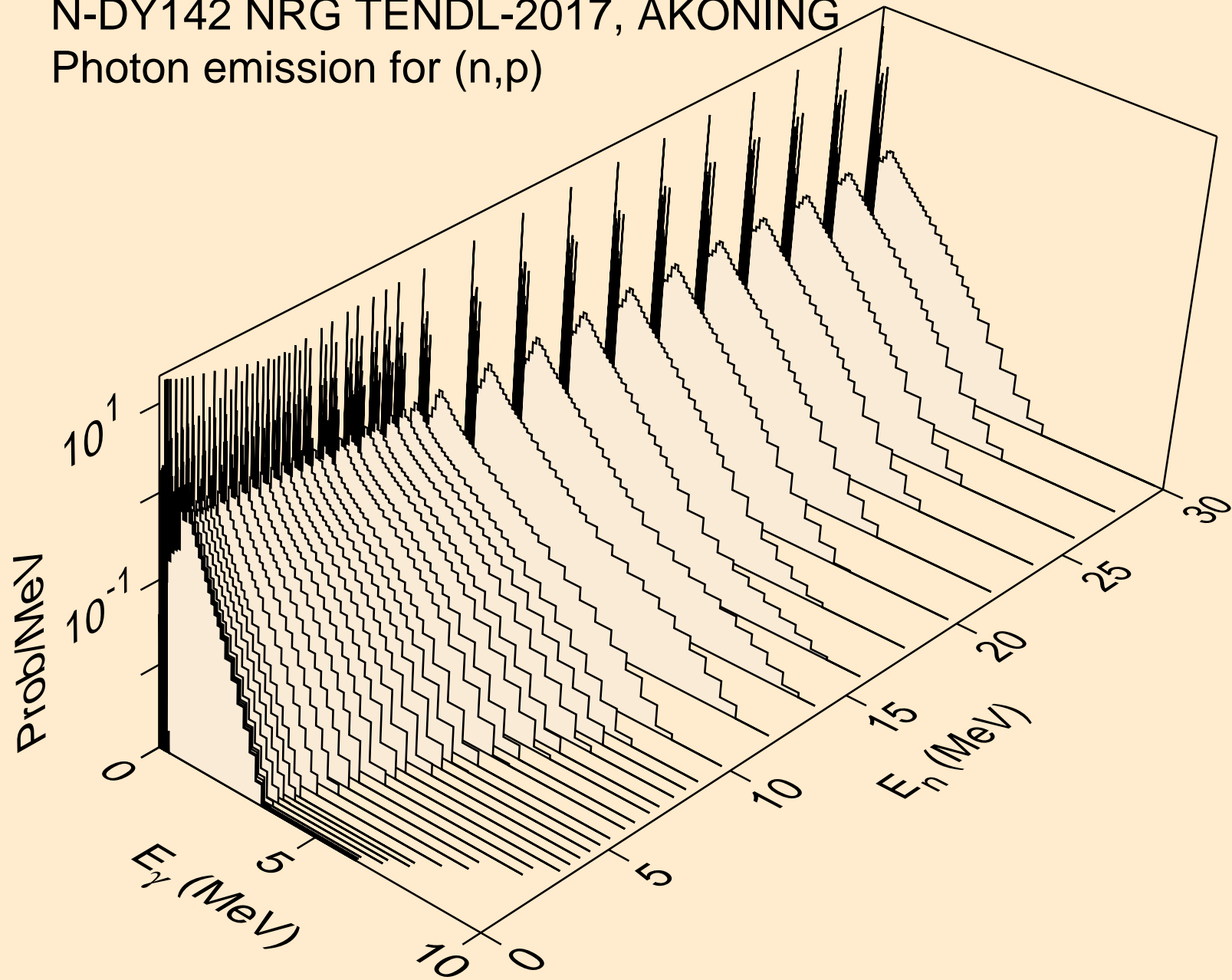

N-DY142 NRG TENDL-2017, AKONING  
Photon emission for (n,d)

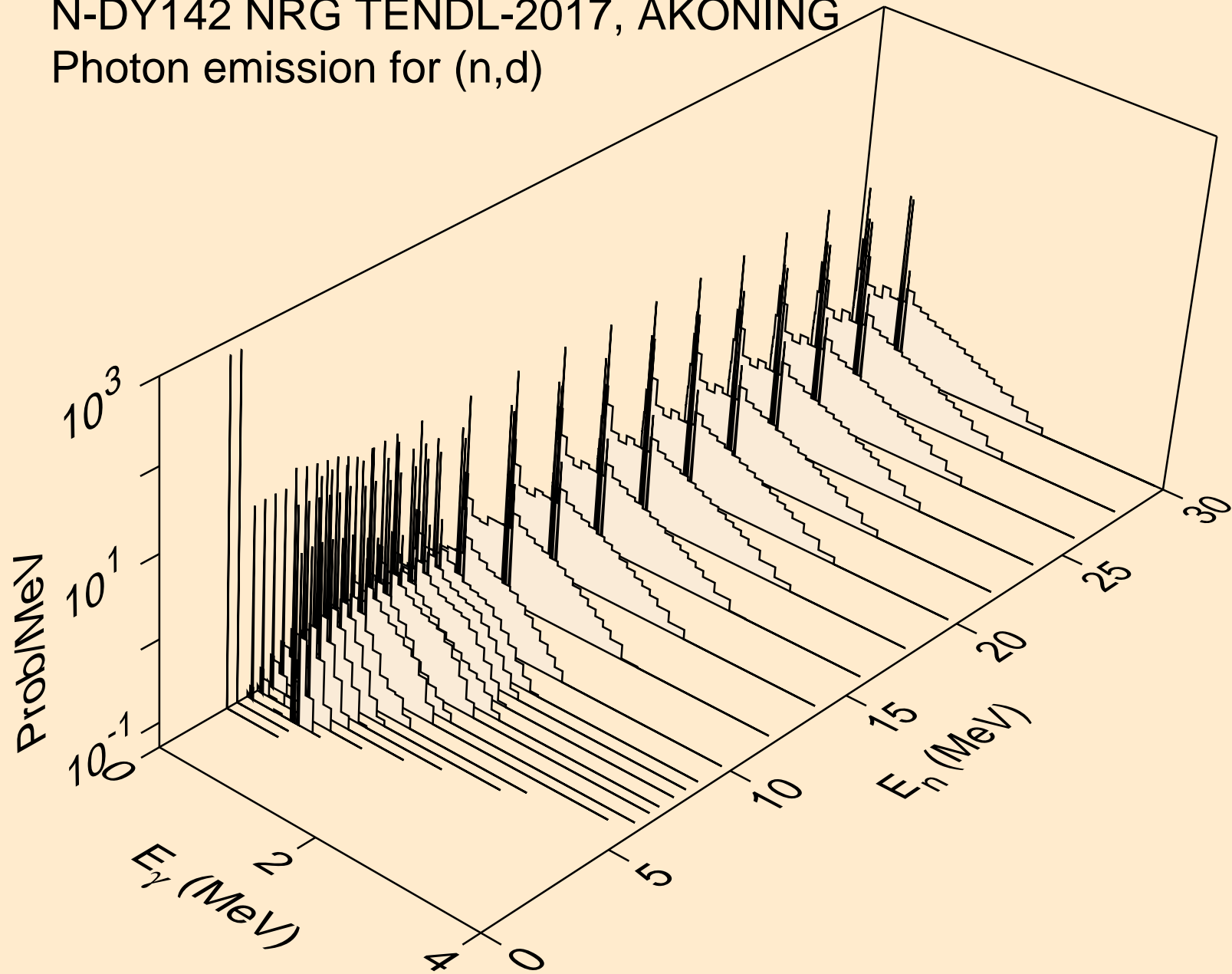



N-DY142 NRG TENDL-2017, AKONING  
Photon emission for (n,t)

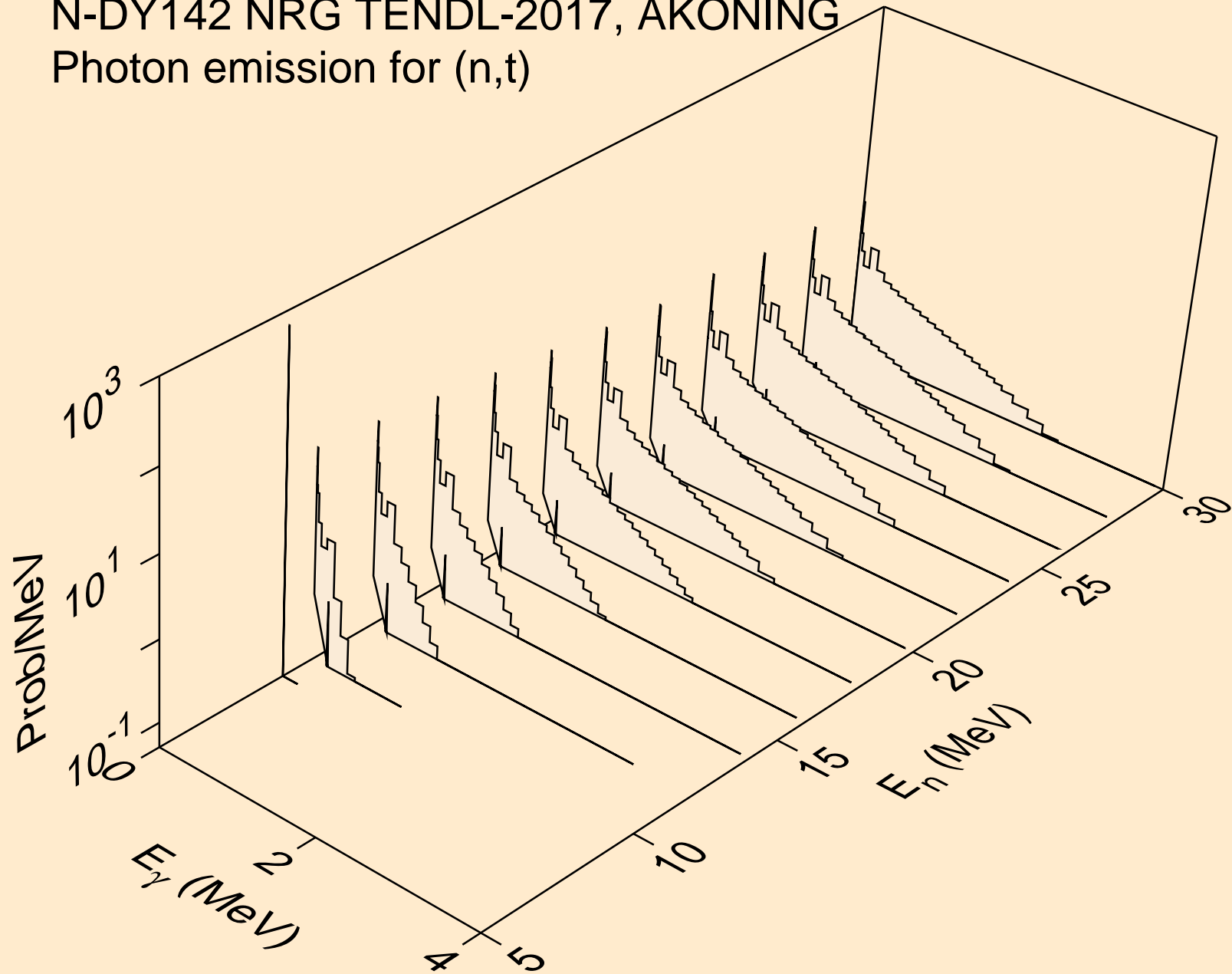

N-DY142 NRG TENDL-2017, AKONING  
Photon emission for (n,he3)

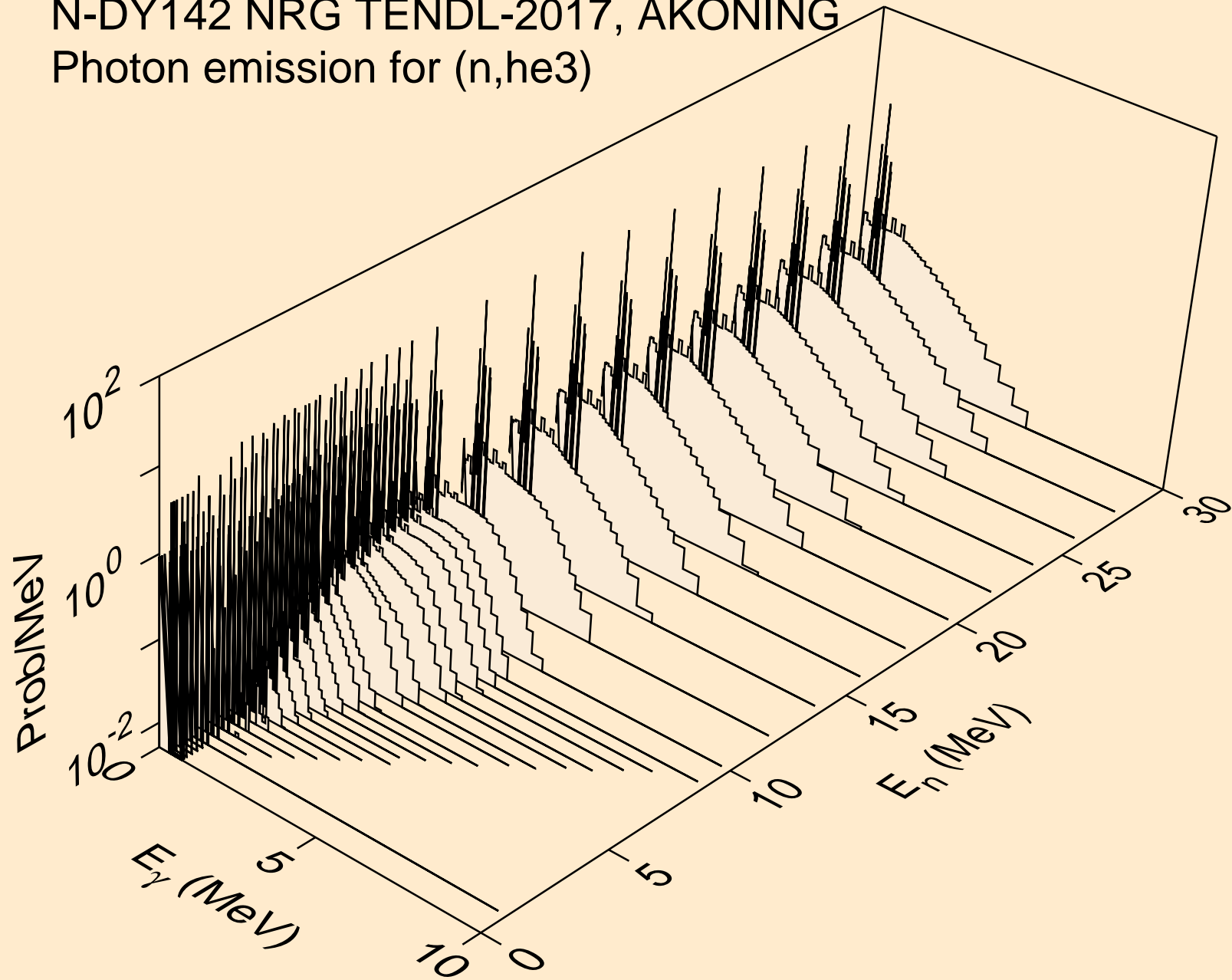

N-DY142 NRG TENDL-2017, AKONING  
Photon emission for (n,a)

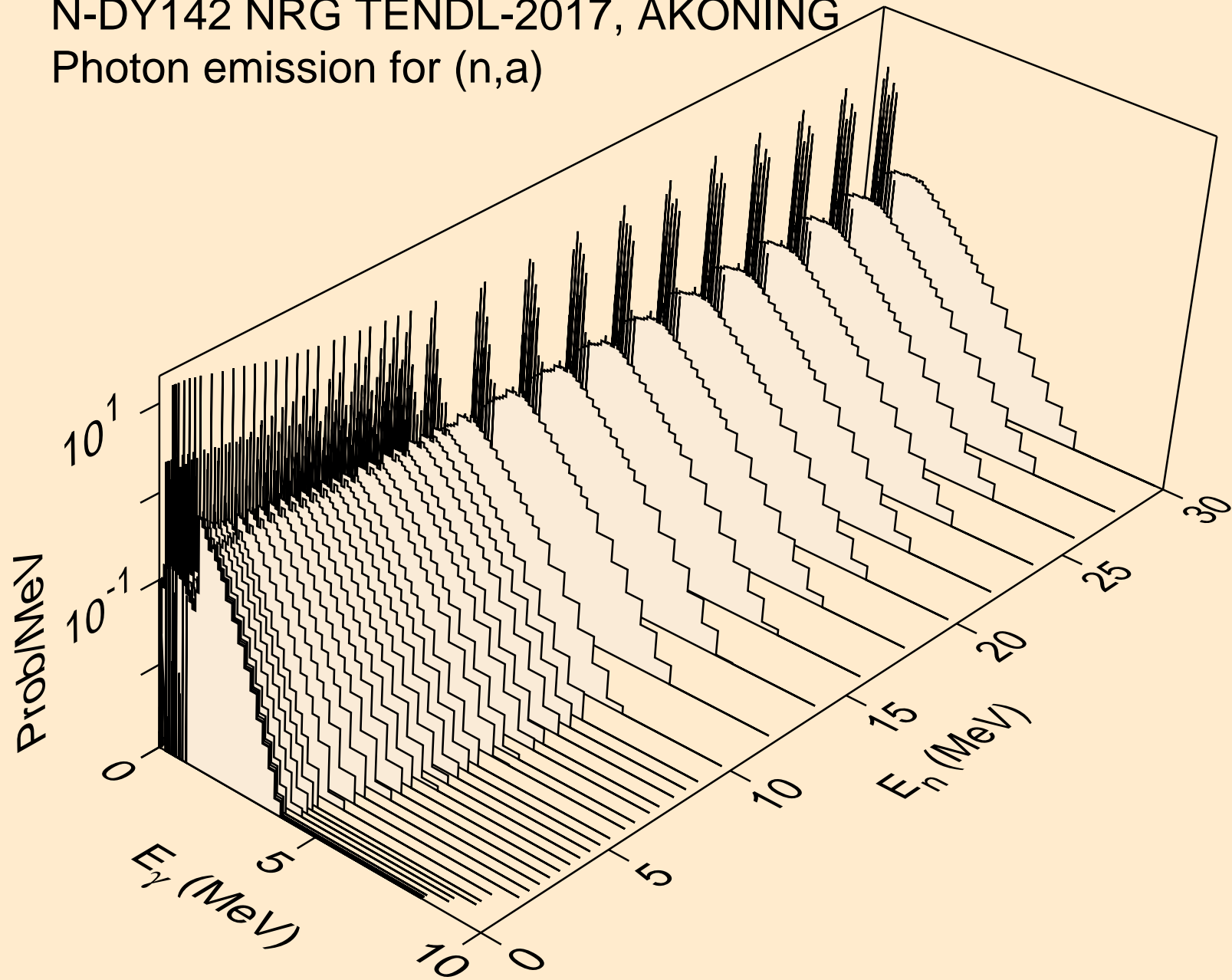

N-DY142 NRG TENDL-2017, AKONING  
Photon emission for (n,2a)

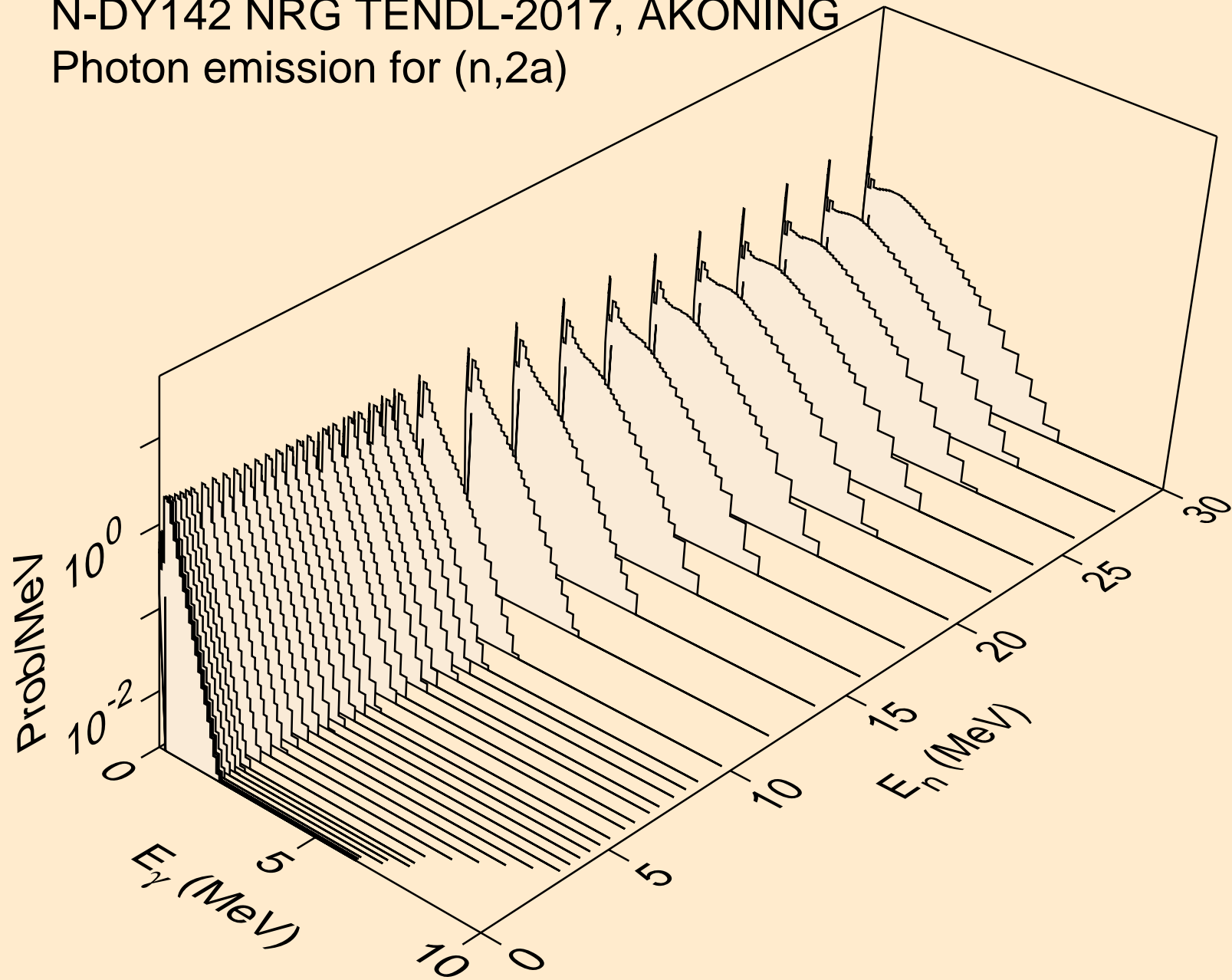

N-DY142 NRG TENDL-2017, AKONING  
Photon emission for (n,3a)

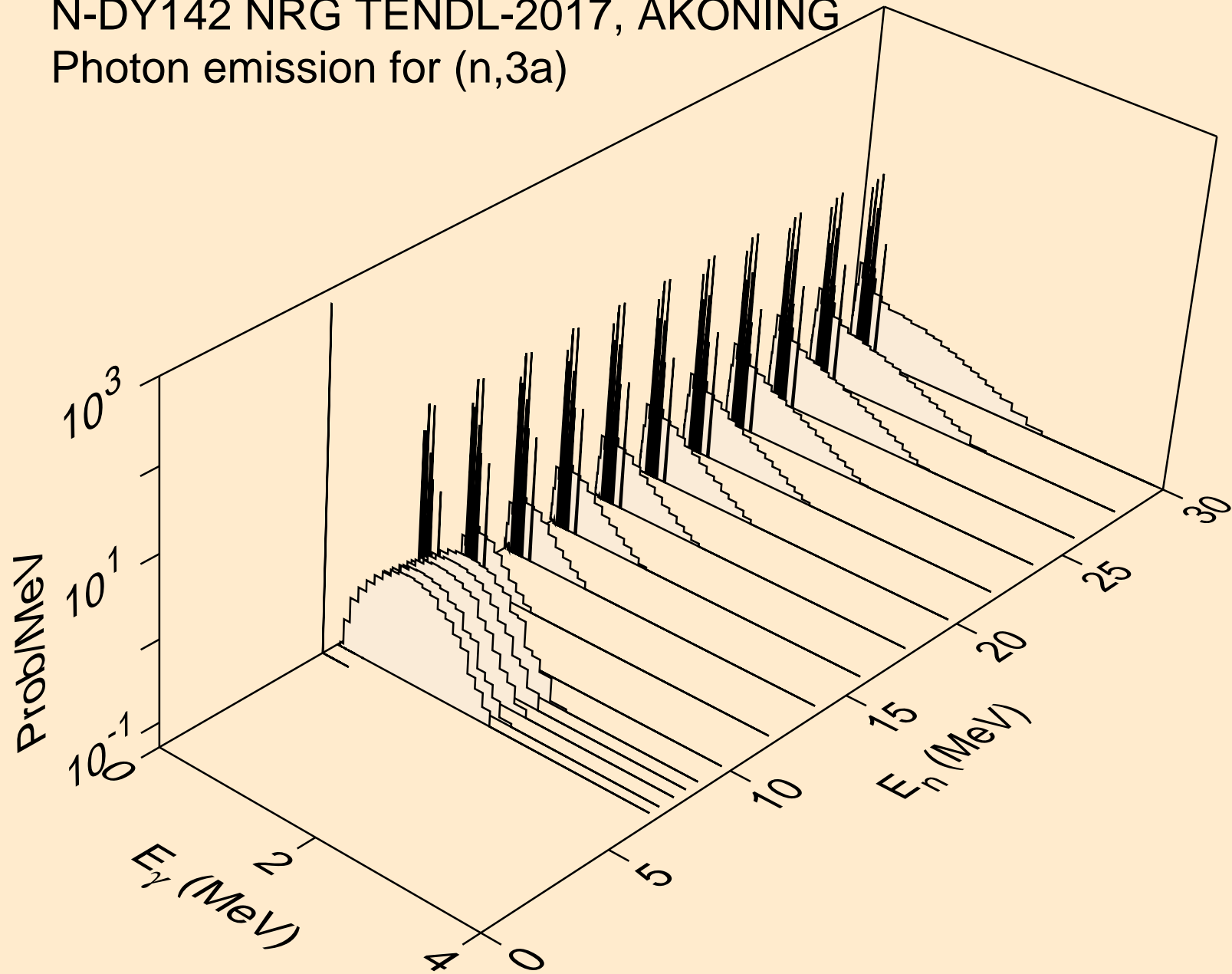

N-DY142 NRG TENDL-2017, AKONING  
Photon emission for (n,2p)

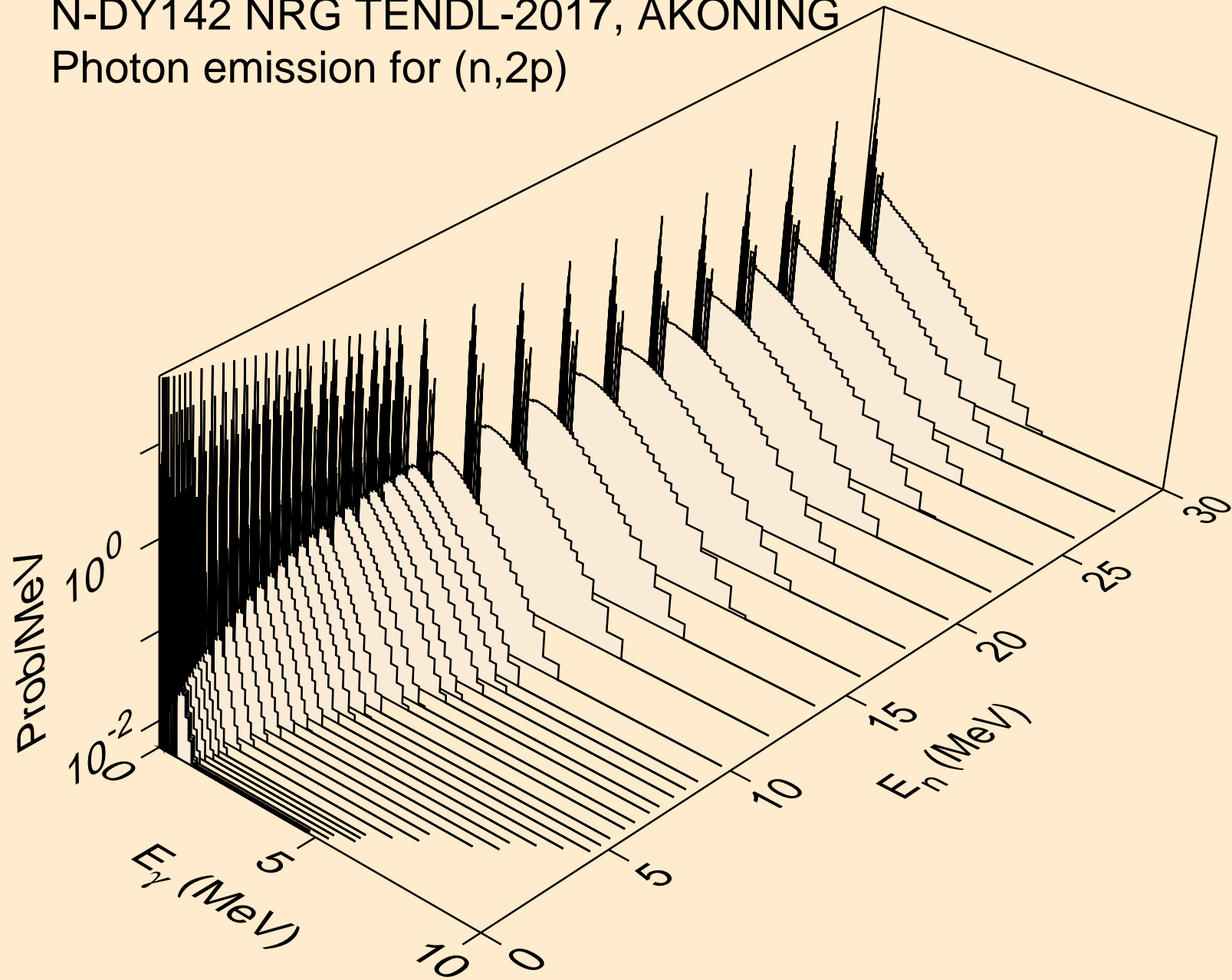

N-DY142 NRG TENDL-2017, AKONING  
Photon emission for (n,pa)

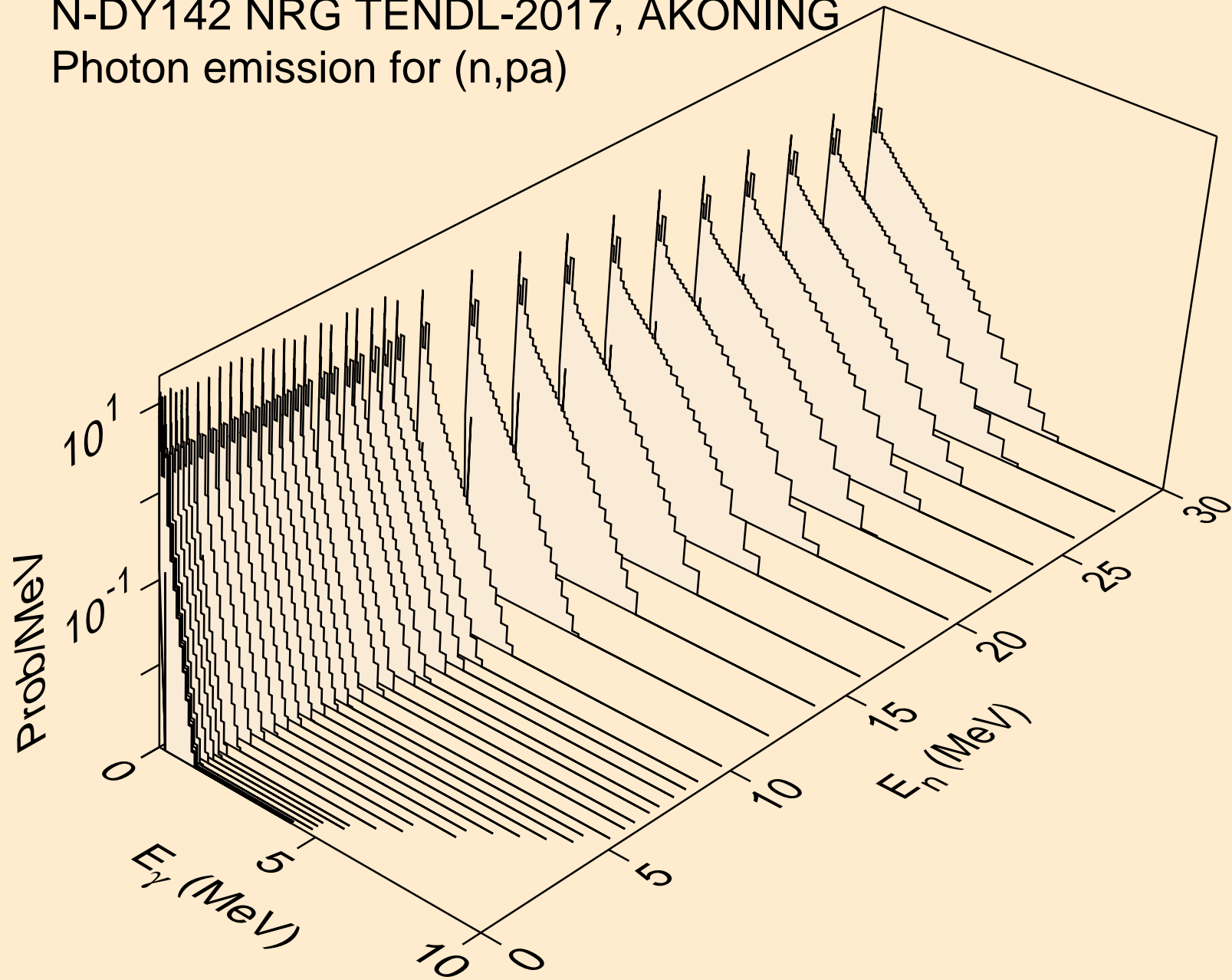

N-DY142 NRG TENDL-2017, AKONING  
Photon emission for (n,d2a)

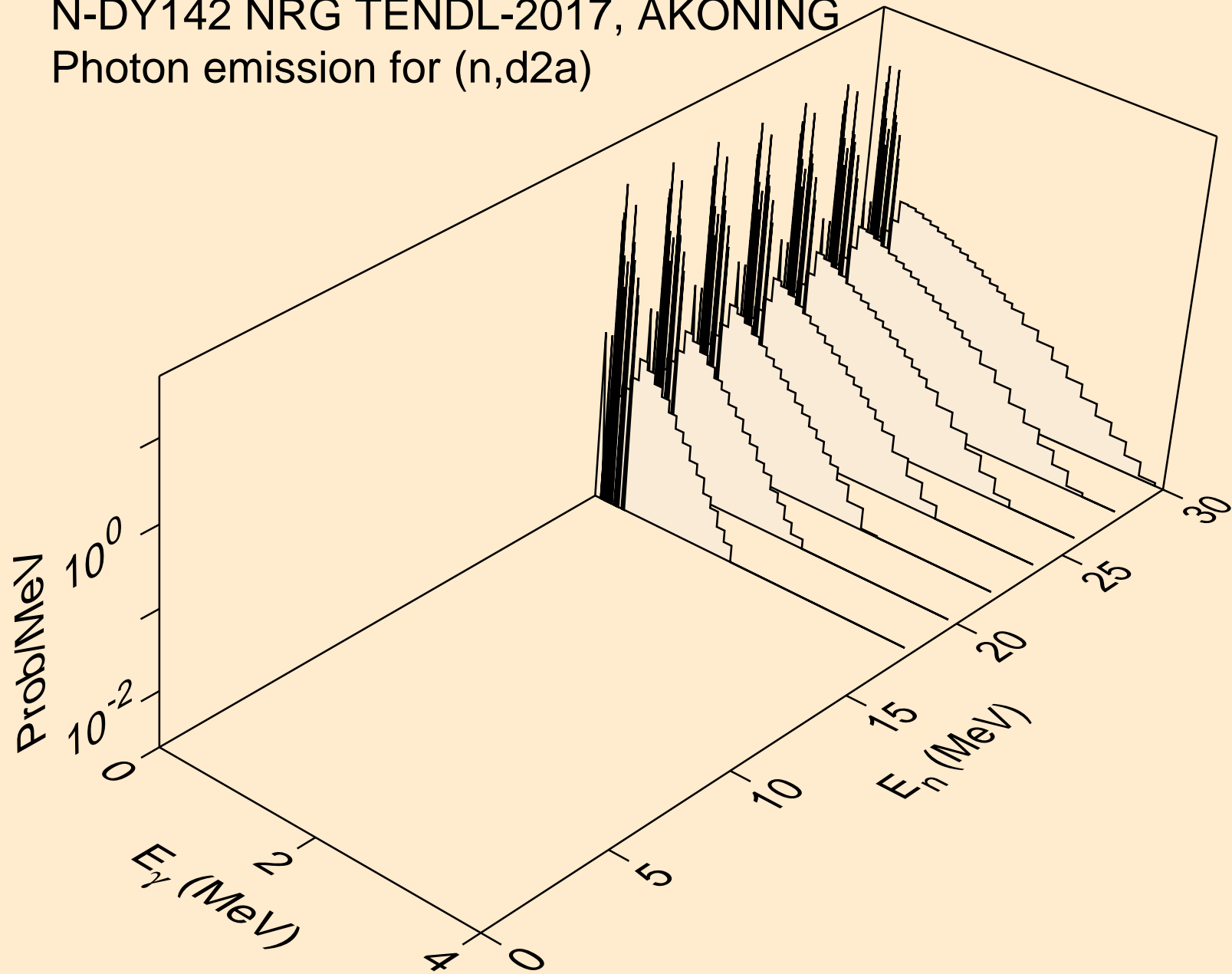



N-DY142 NRG TENDL-2017, AKONING  
Photon emission for (n,pd)

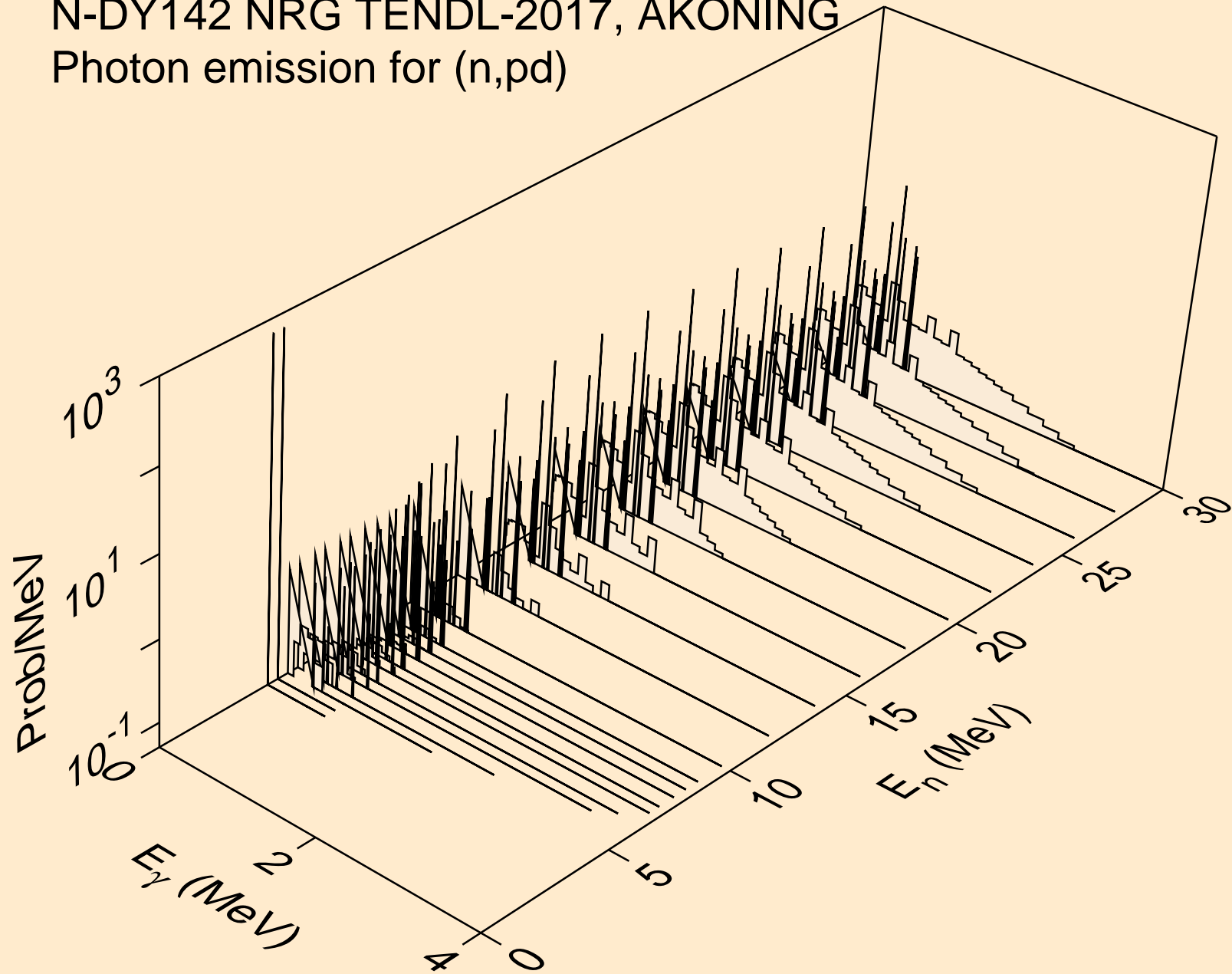

N-DY142 NRG TENDL-2017, AKONING  
Photon emission for (n,pt)

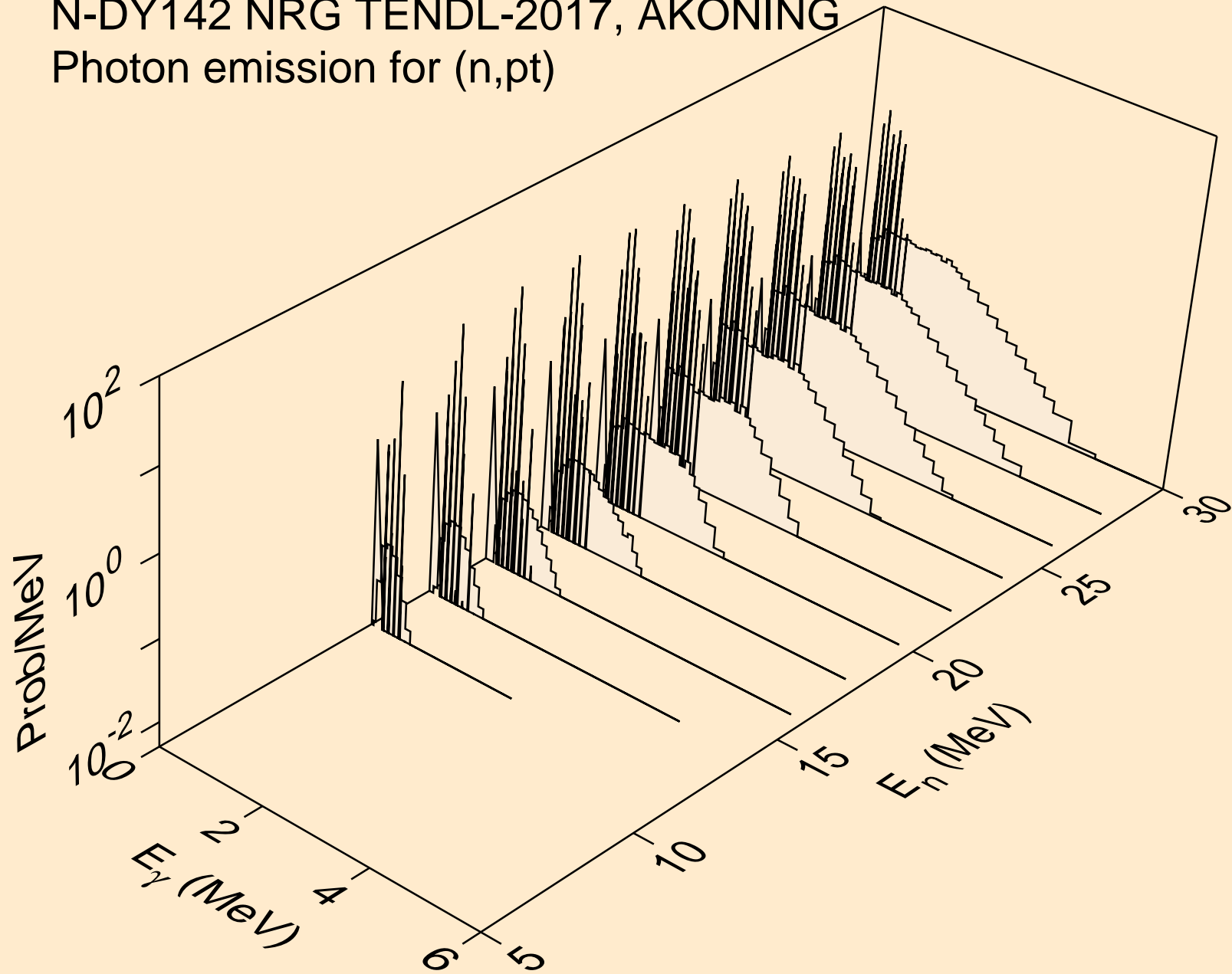

N-DY142 NRG TENDL-2017, AKONING  
Photon emission for (n,da)

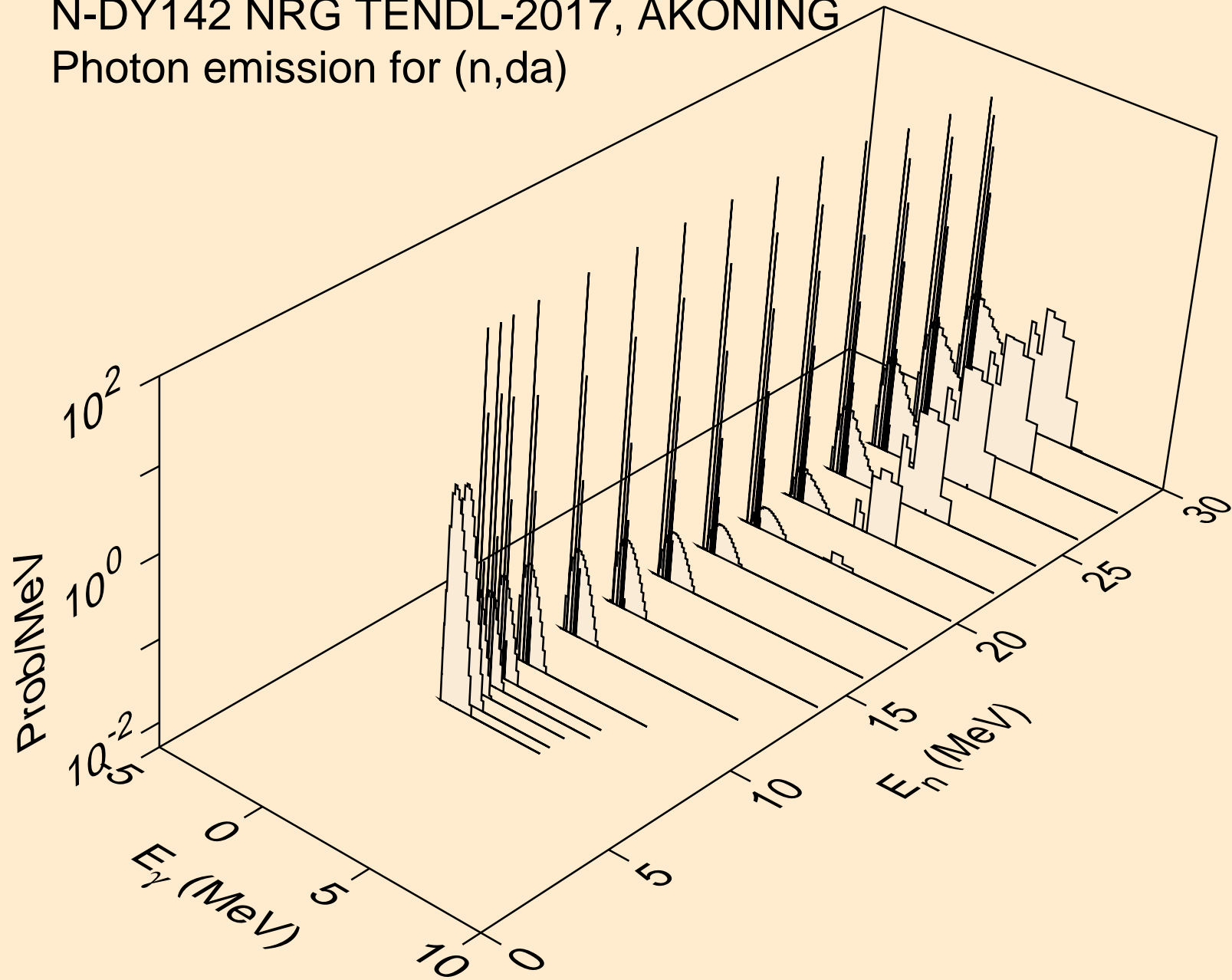

N-DY142 NRG TENDL-2017, AKONING  
thermal capture photon spectrum

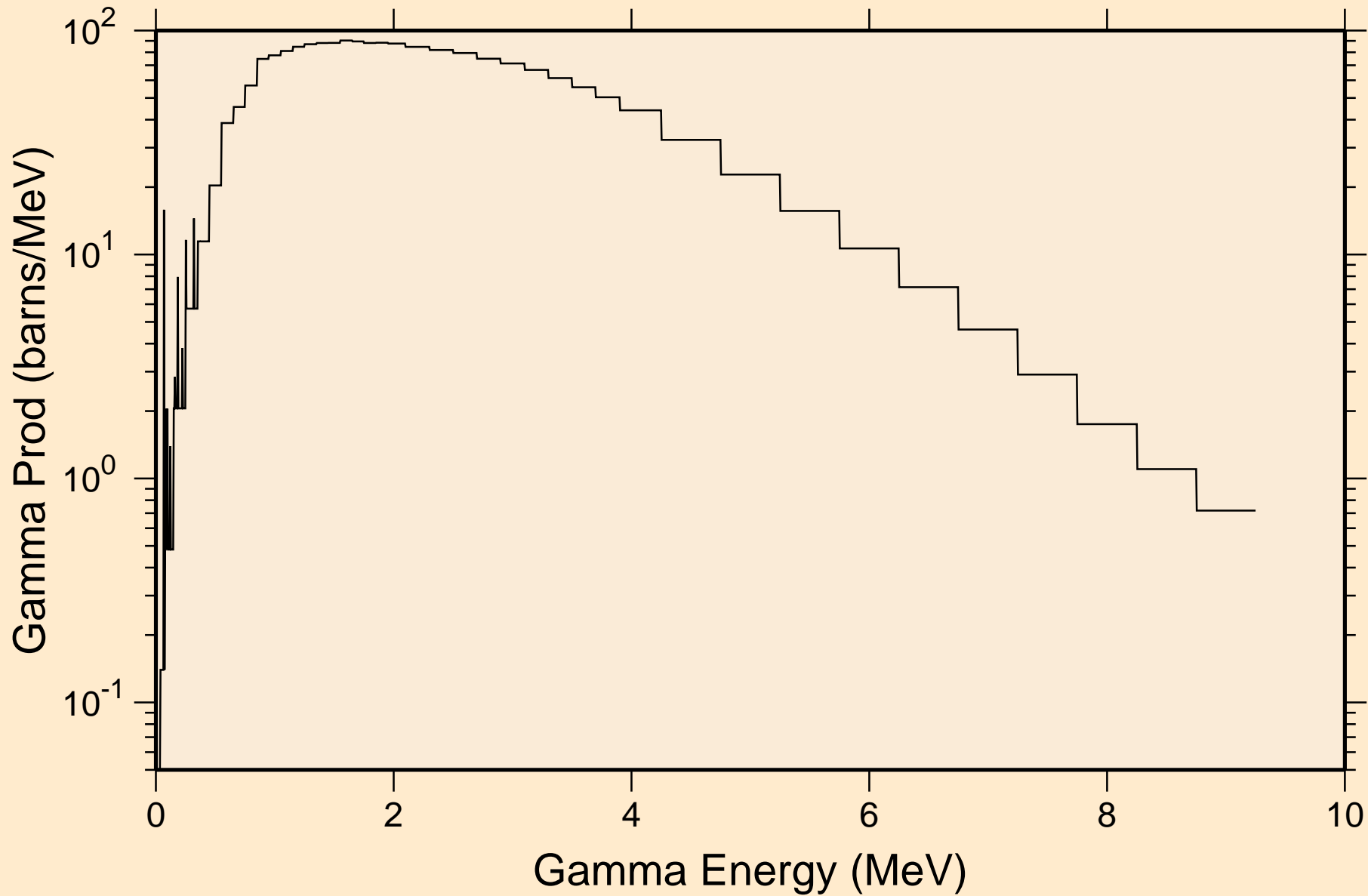

N-DY142 NRG TENDL-2017, AKONING  
14 MeV photon spectrum

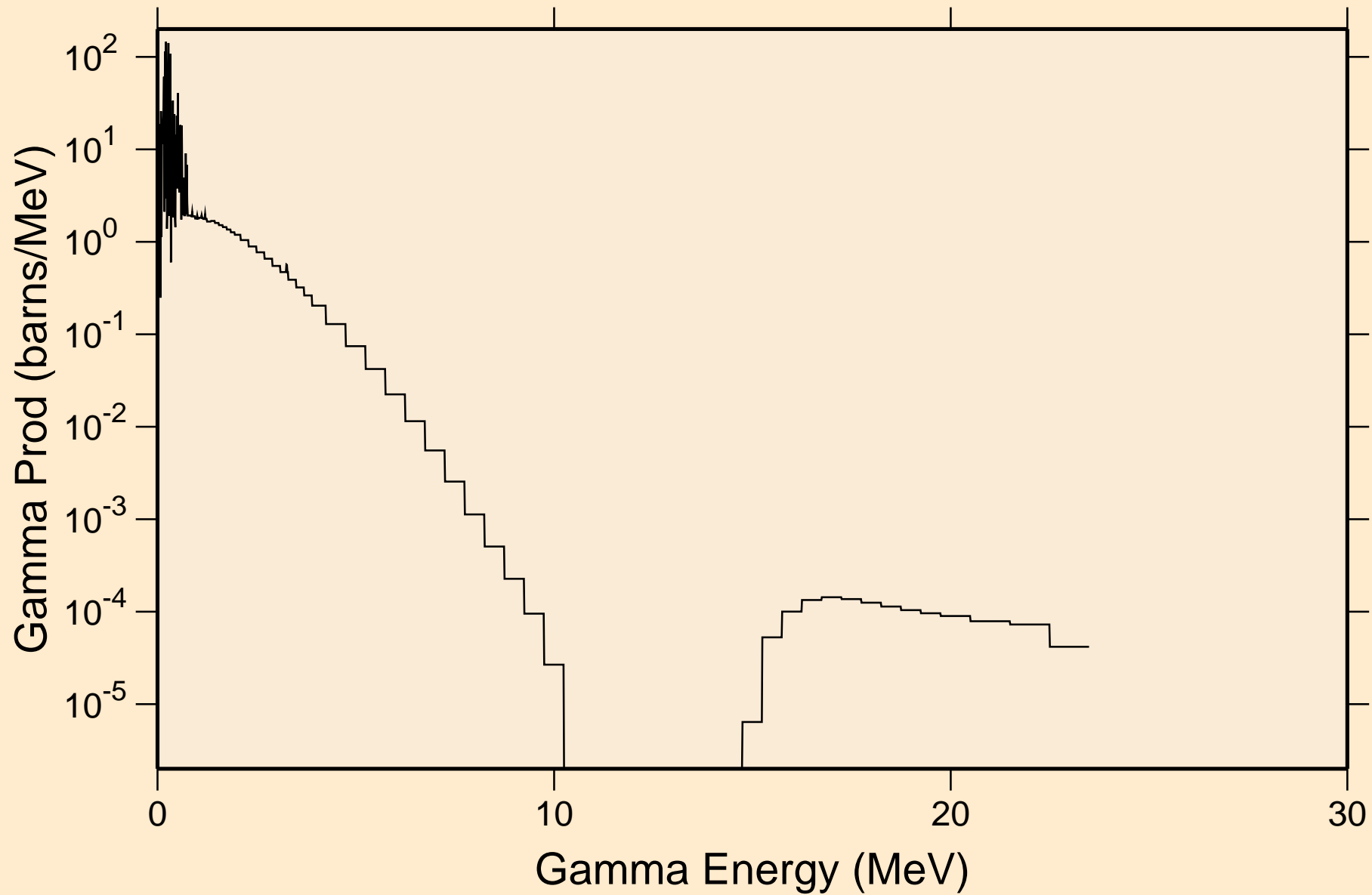

# N-DY142 NRG TENDL-2017, AKONING

## Particle heating contributions

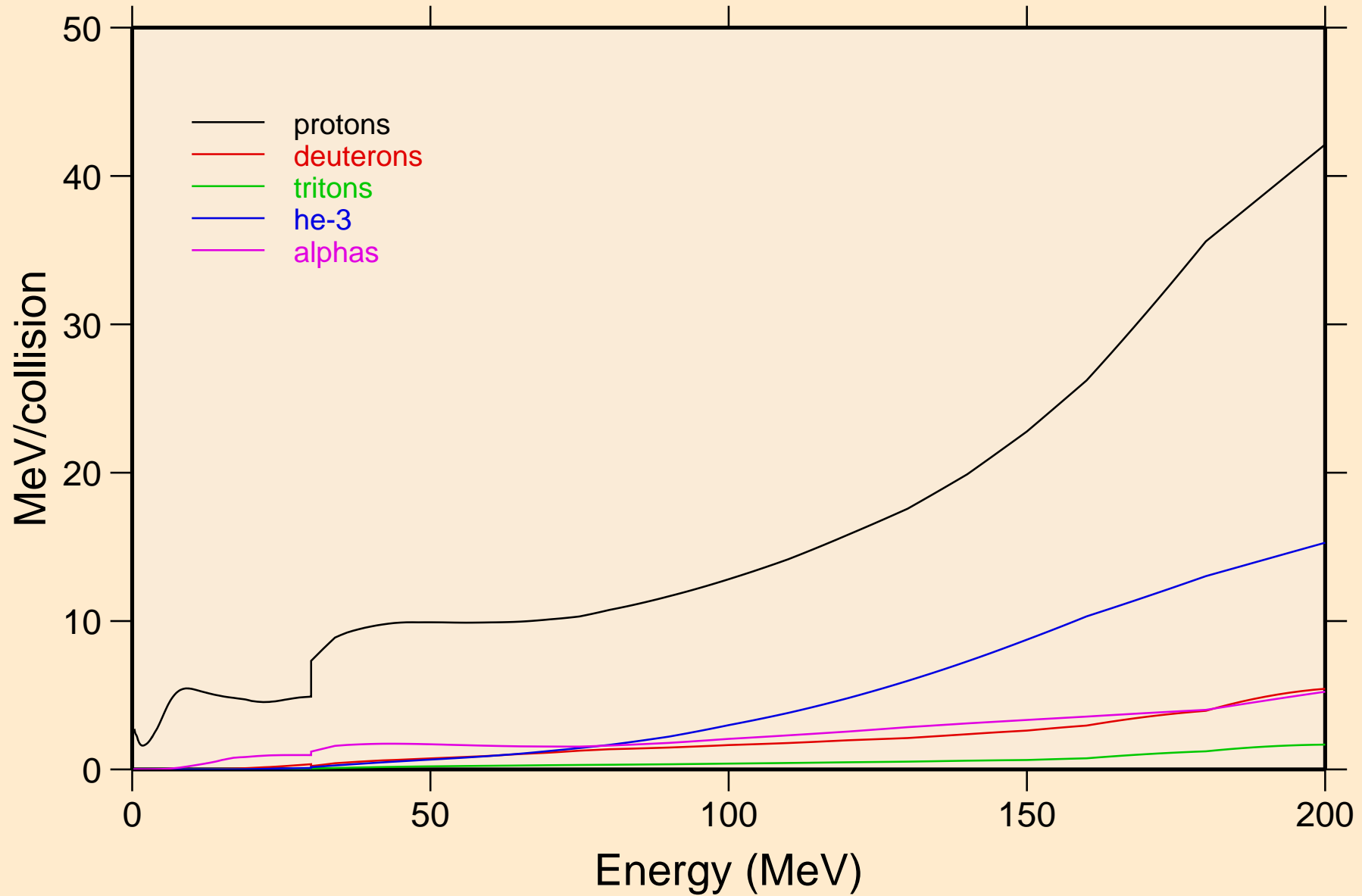

# N-DY142 NRG TENDL-2017, AKONING

## Recoil Heating

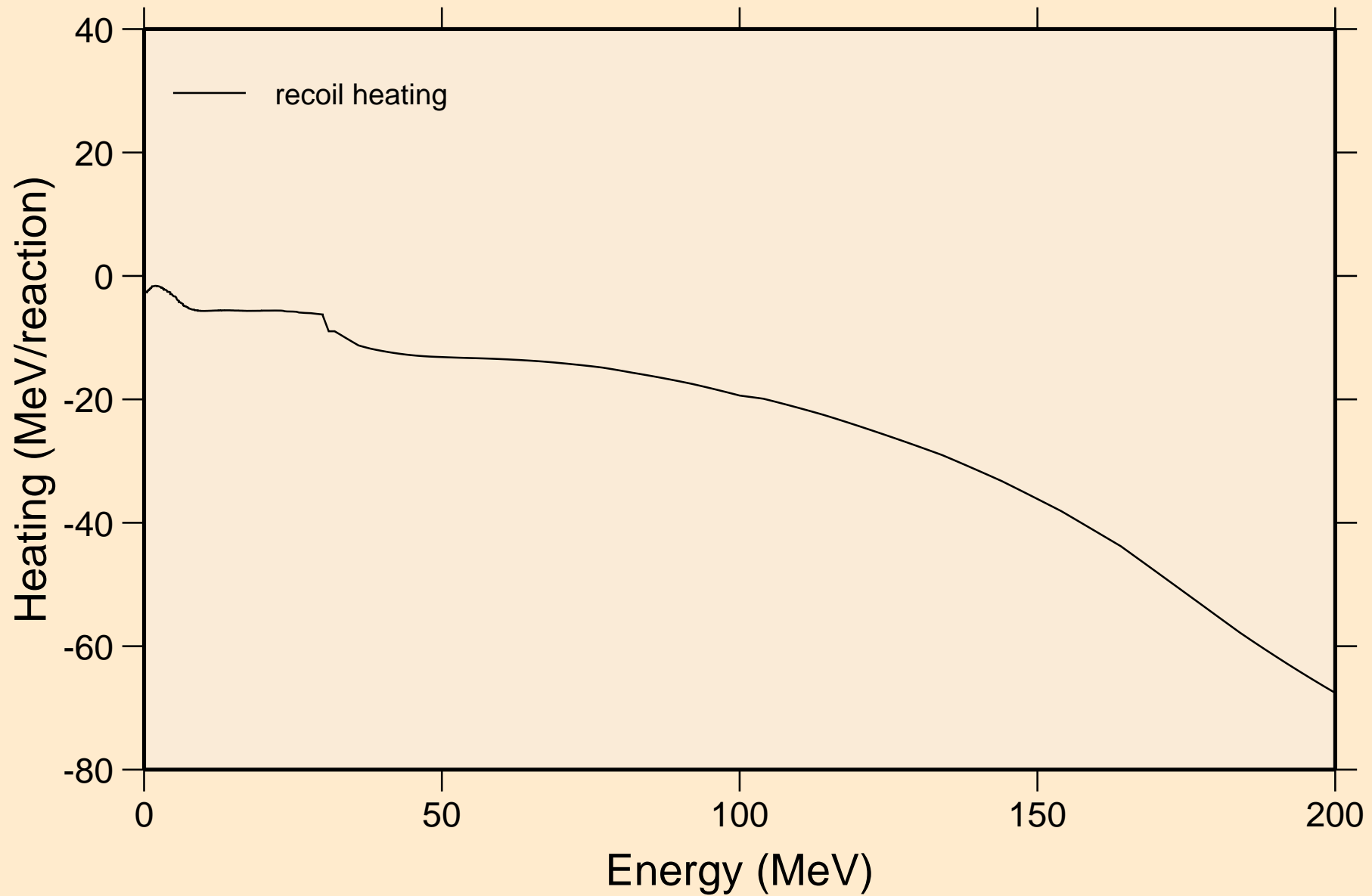

# N-DY142 NRG TENDL-2017, AKONING

## Particle production cross sections

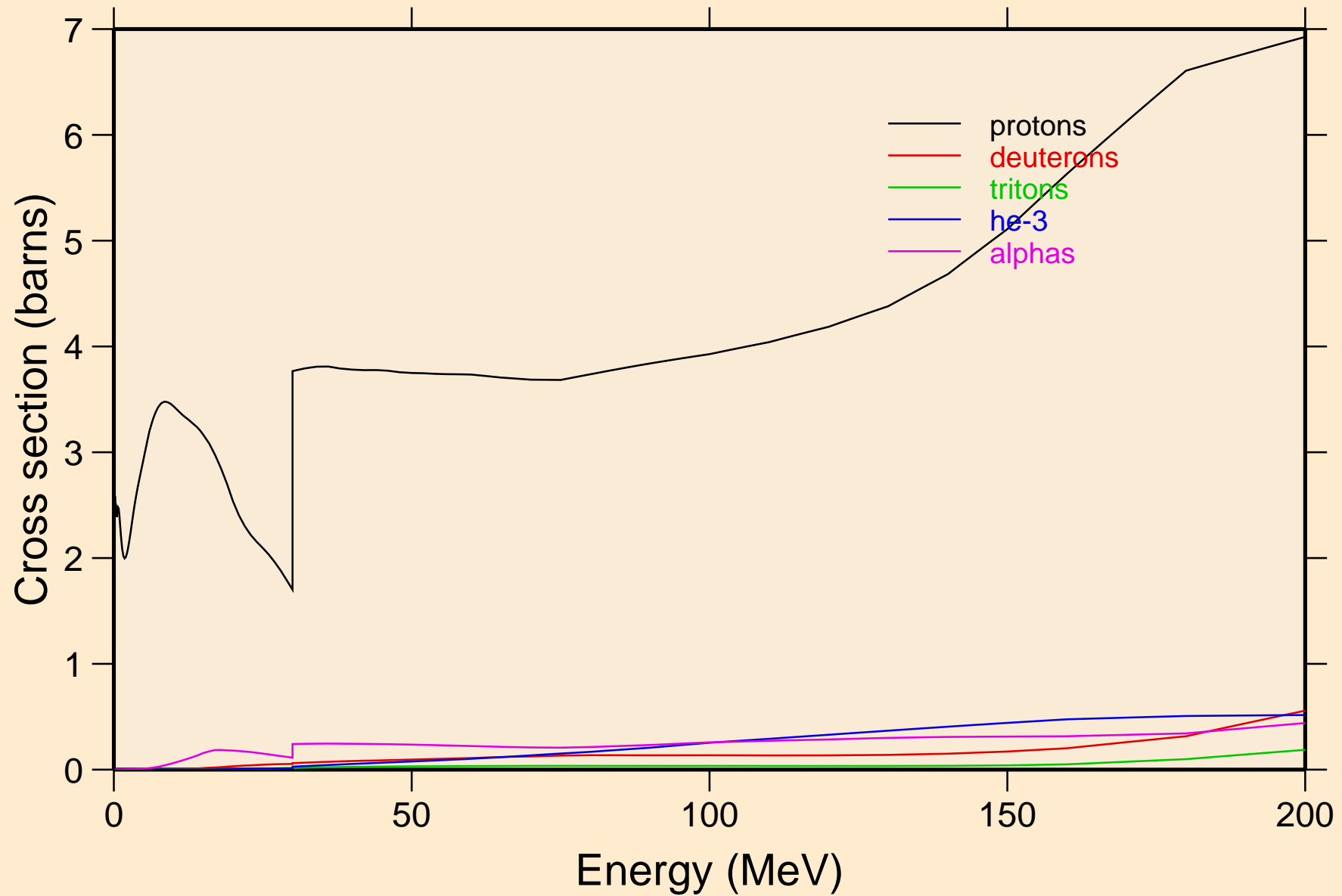



N-DY142 NRG TENDL-2017, AKONING  
protons from (n,x)

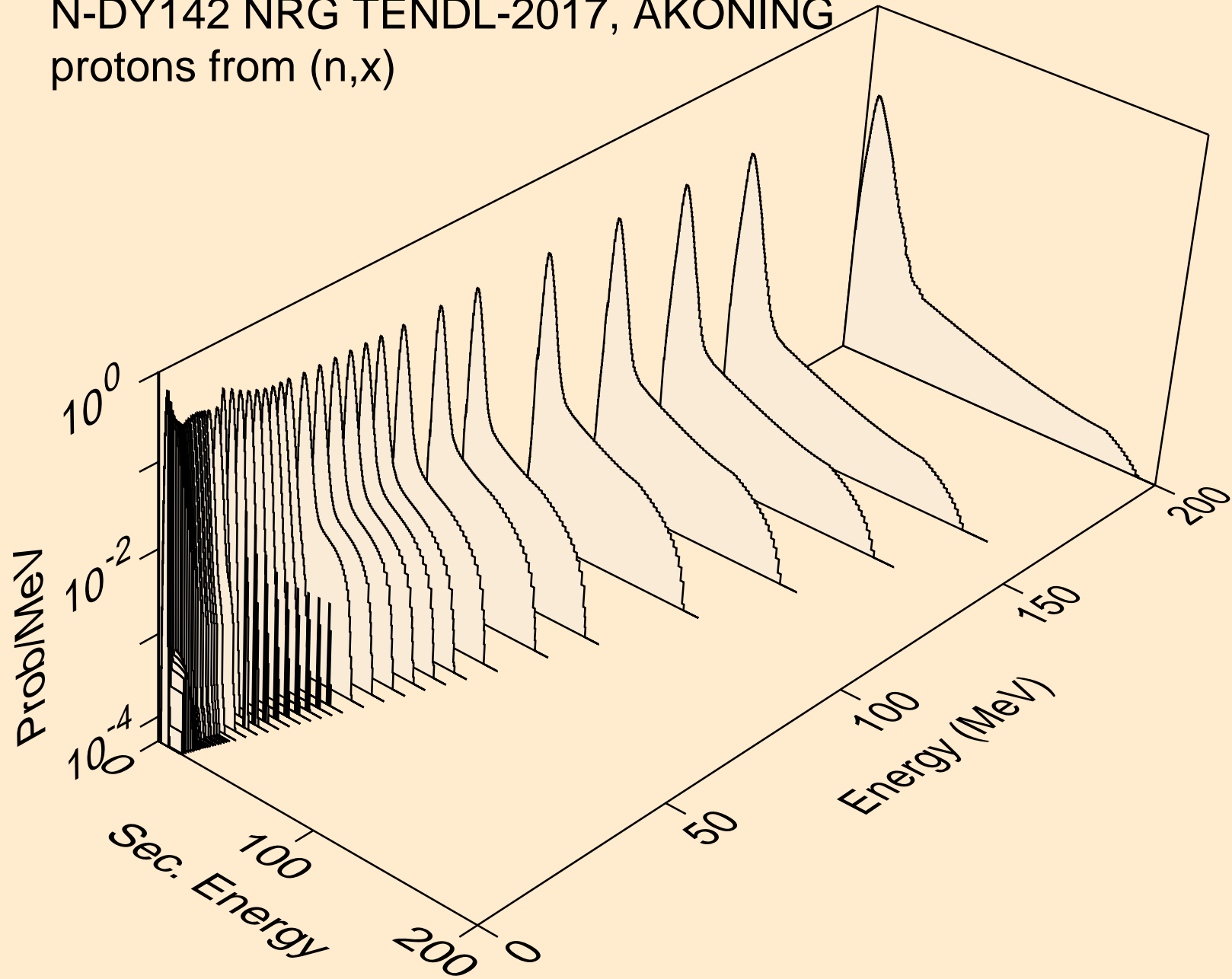

N-DY142 NRG TENDL-2017, AKONING  
protons from (n,n\*)p

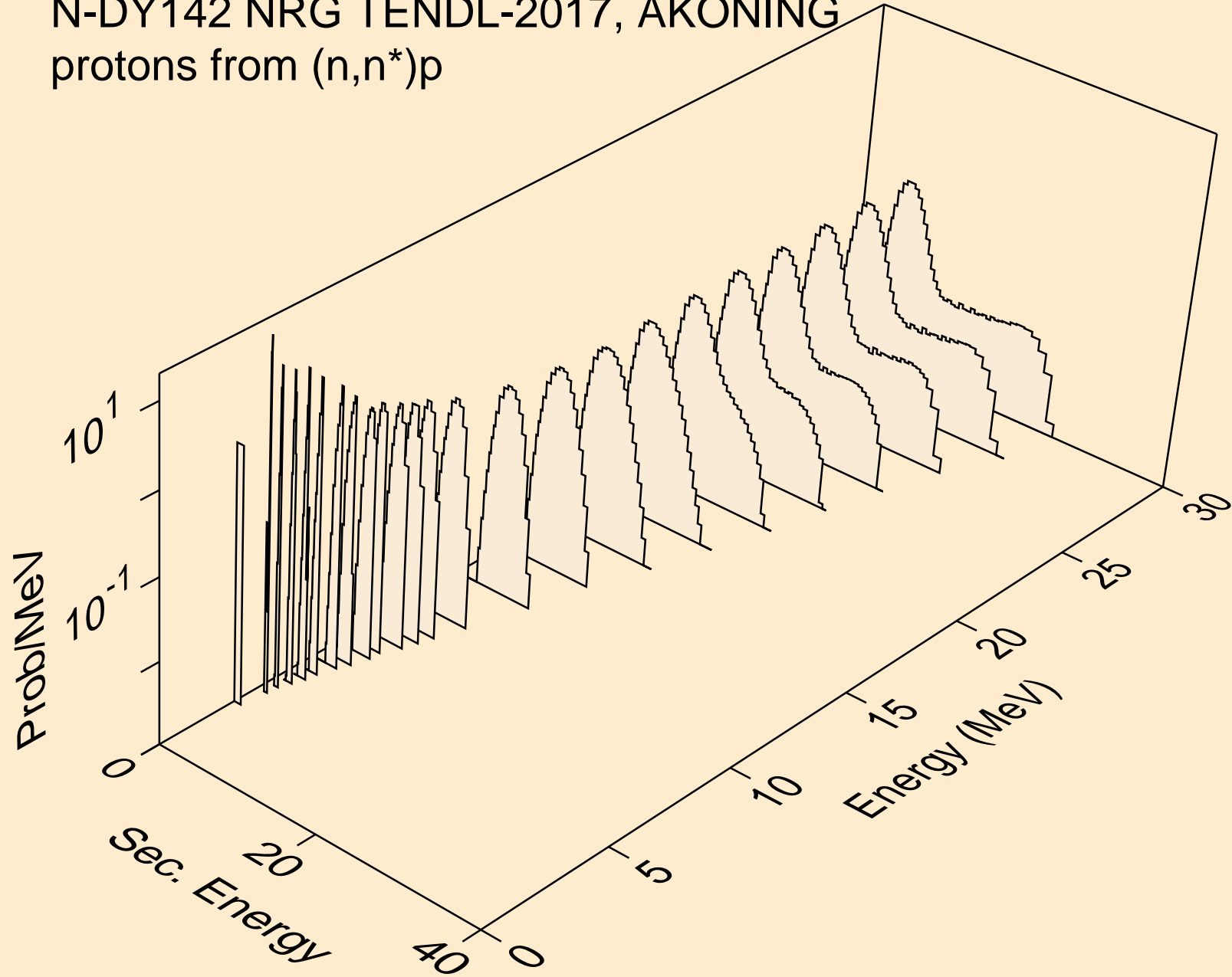

N-DY142 NRG TENDL-2017, AKONING  
protons from (n,2np)

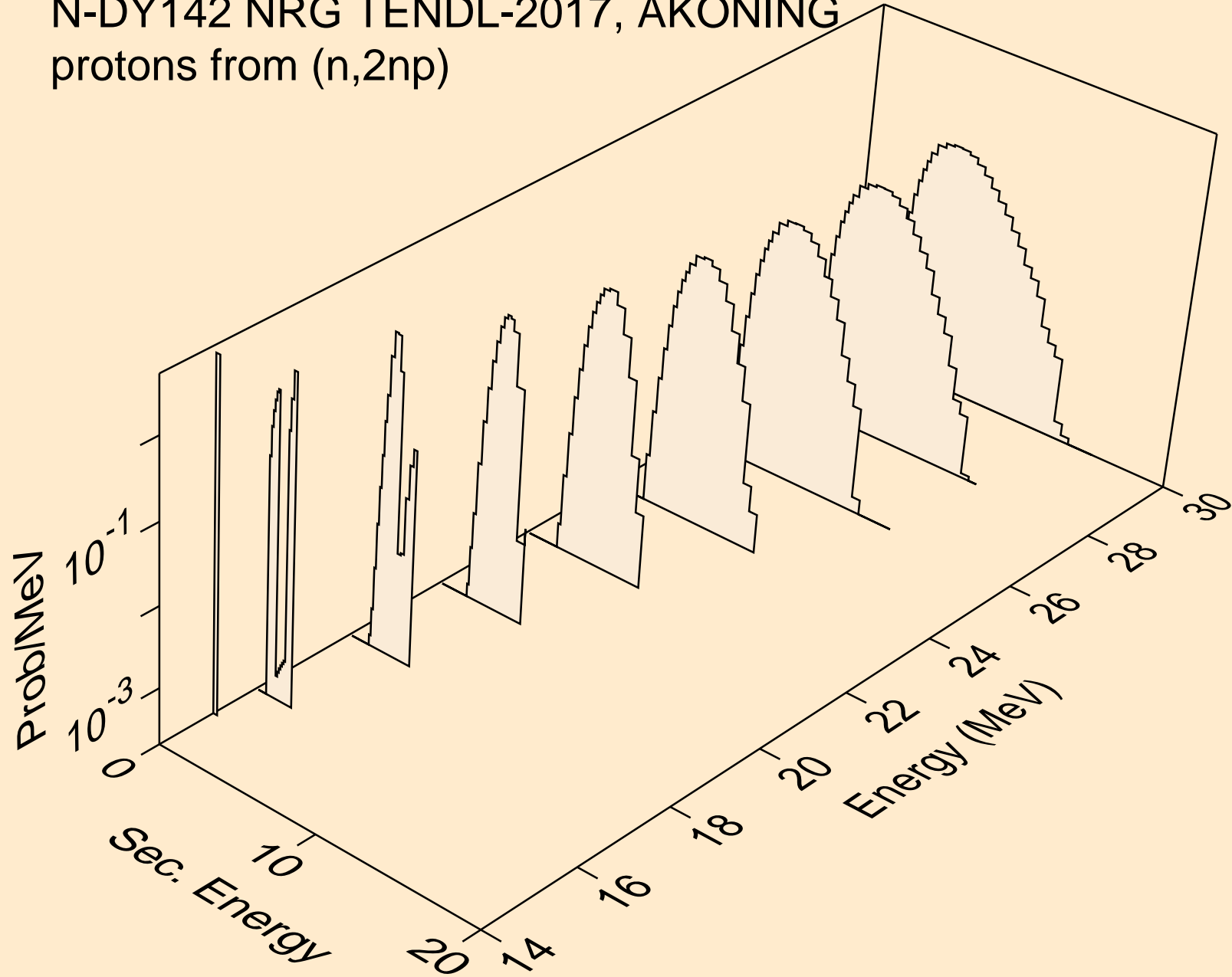

N-DY142 NRG TENDL-2017, AKONING  
protons from (n,3np)

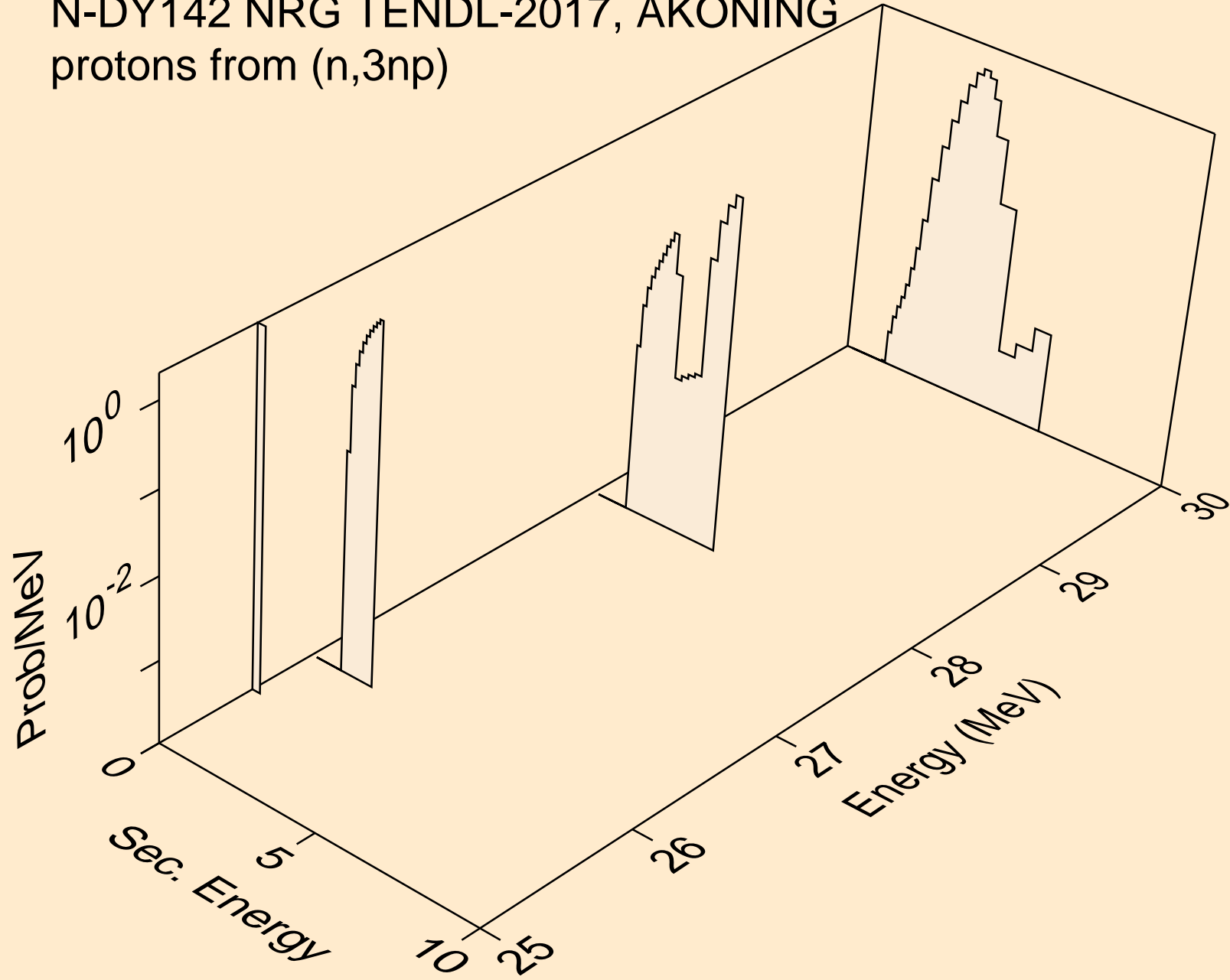

N-DY142 NRG TENDL-2017, AKONING  
protons from (n,2np)

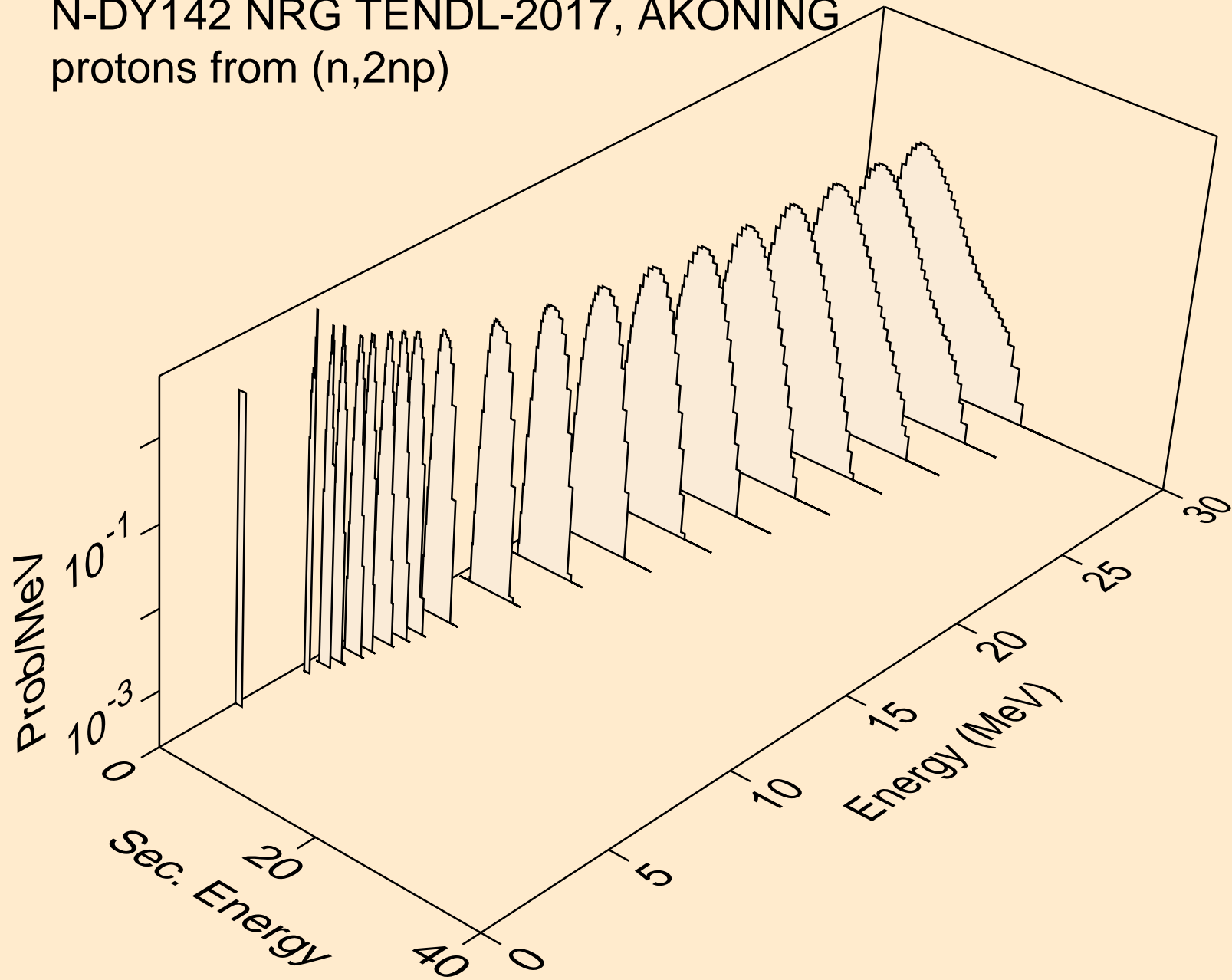

N-DY142 NRG TENDL-2017, AKONING  
protons from (n,npa)

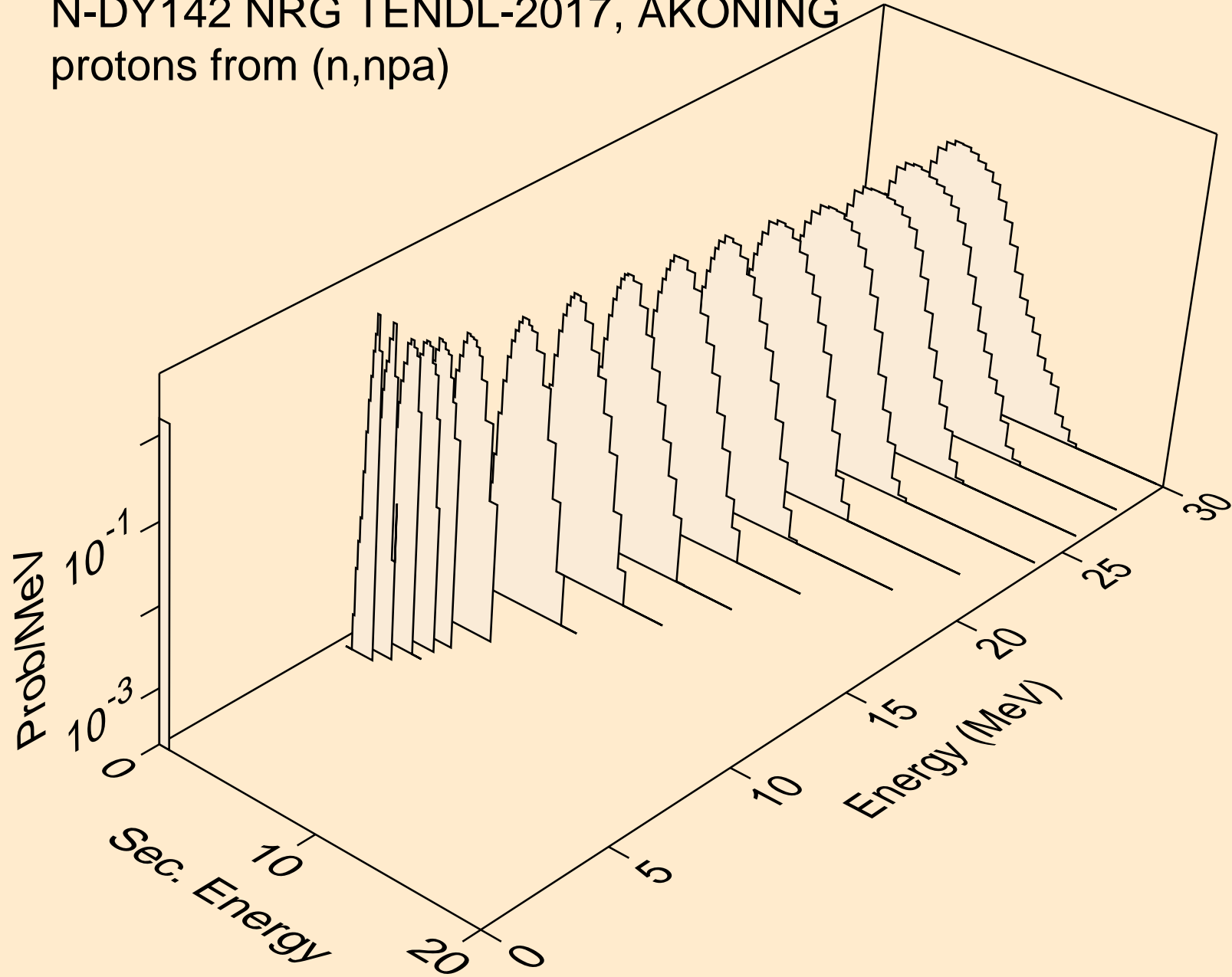

N-DY142 NRG TENDL-2017, AKONING  
protons from (n,p)

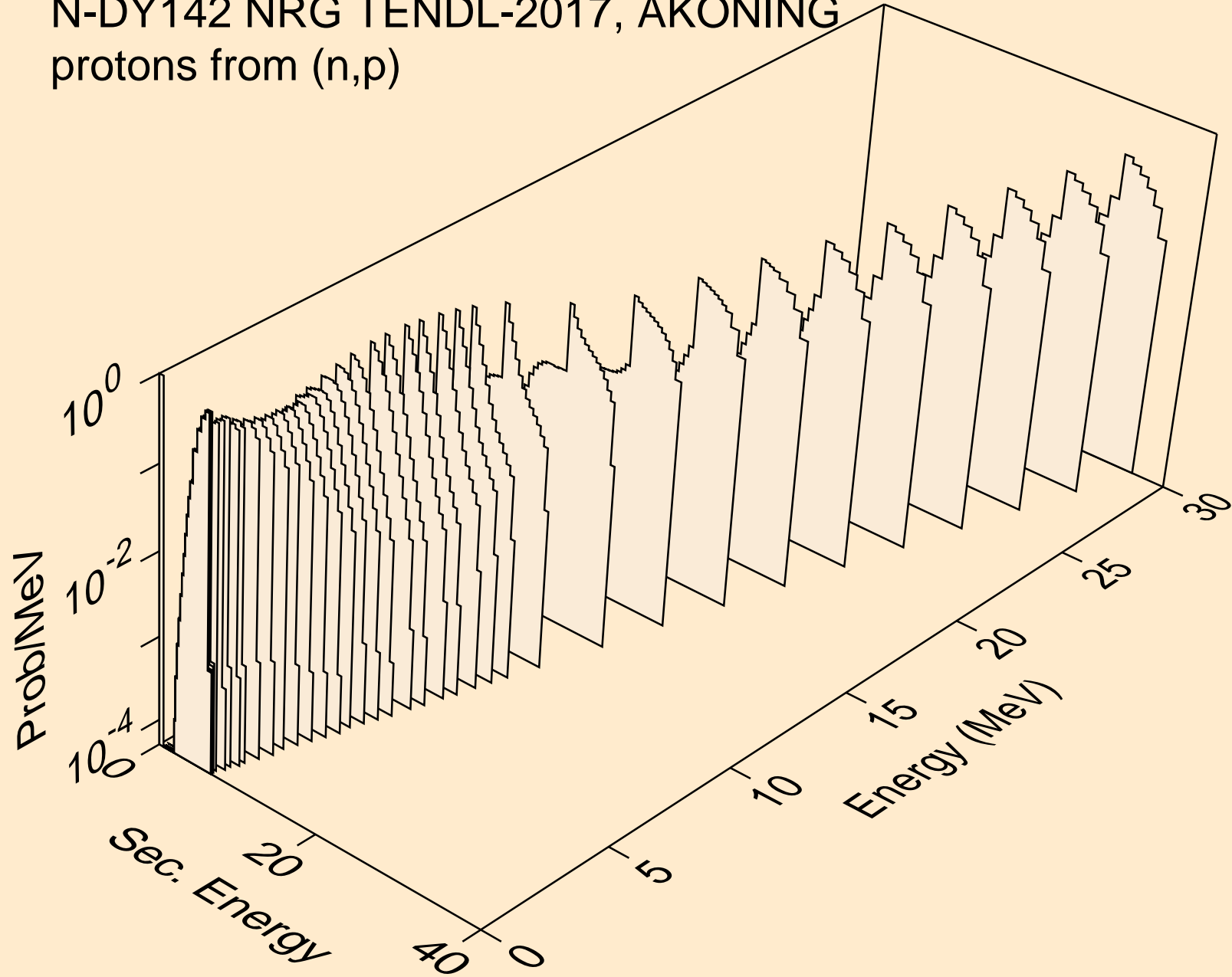

N-DY142 NRG TENDL-2017, AKONING  
protons from (n,2p)

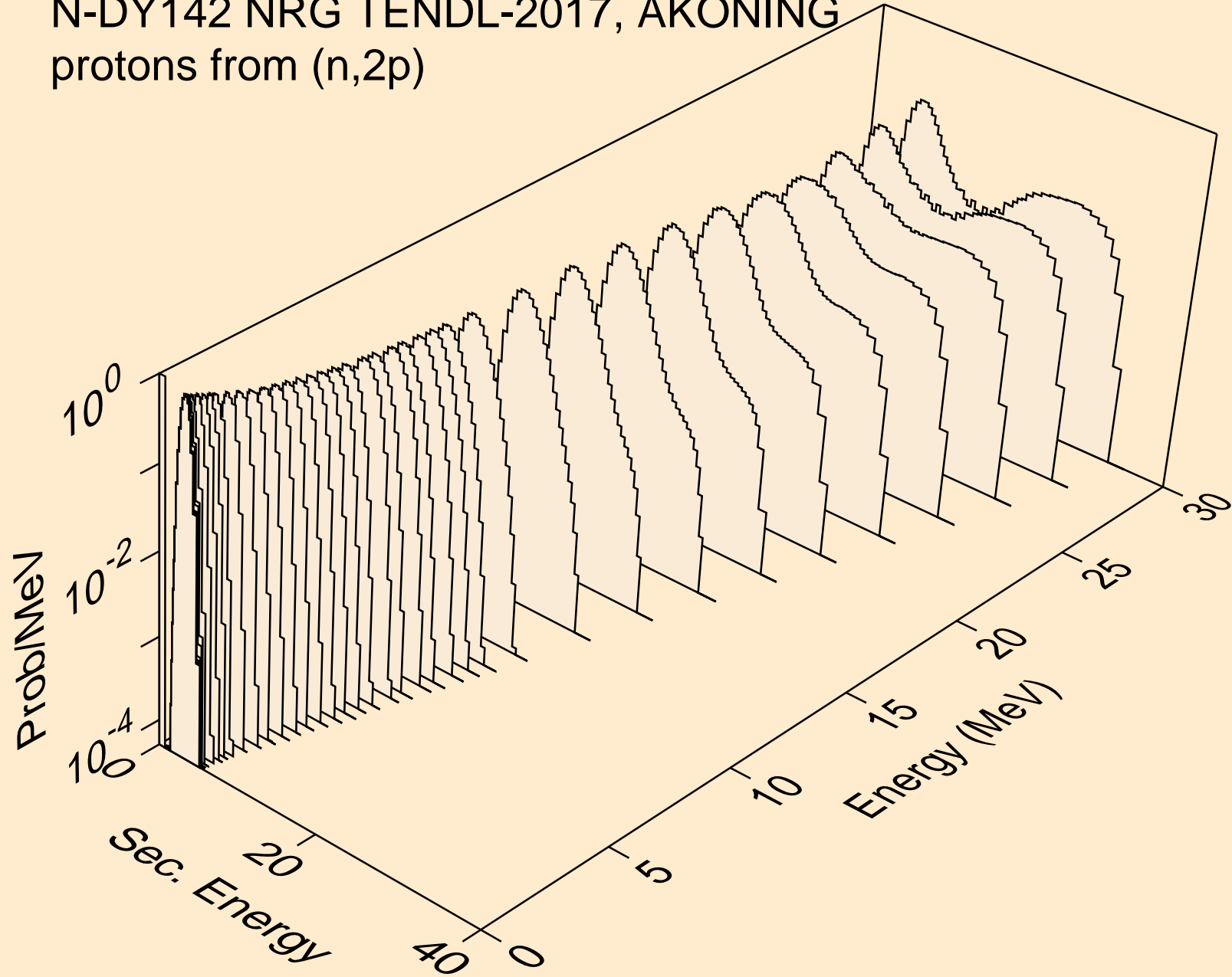



N-DY142 NRG TENDL-2017, AKONING  
protons from (n,pa)

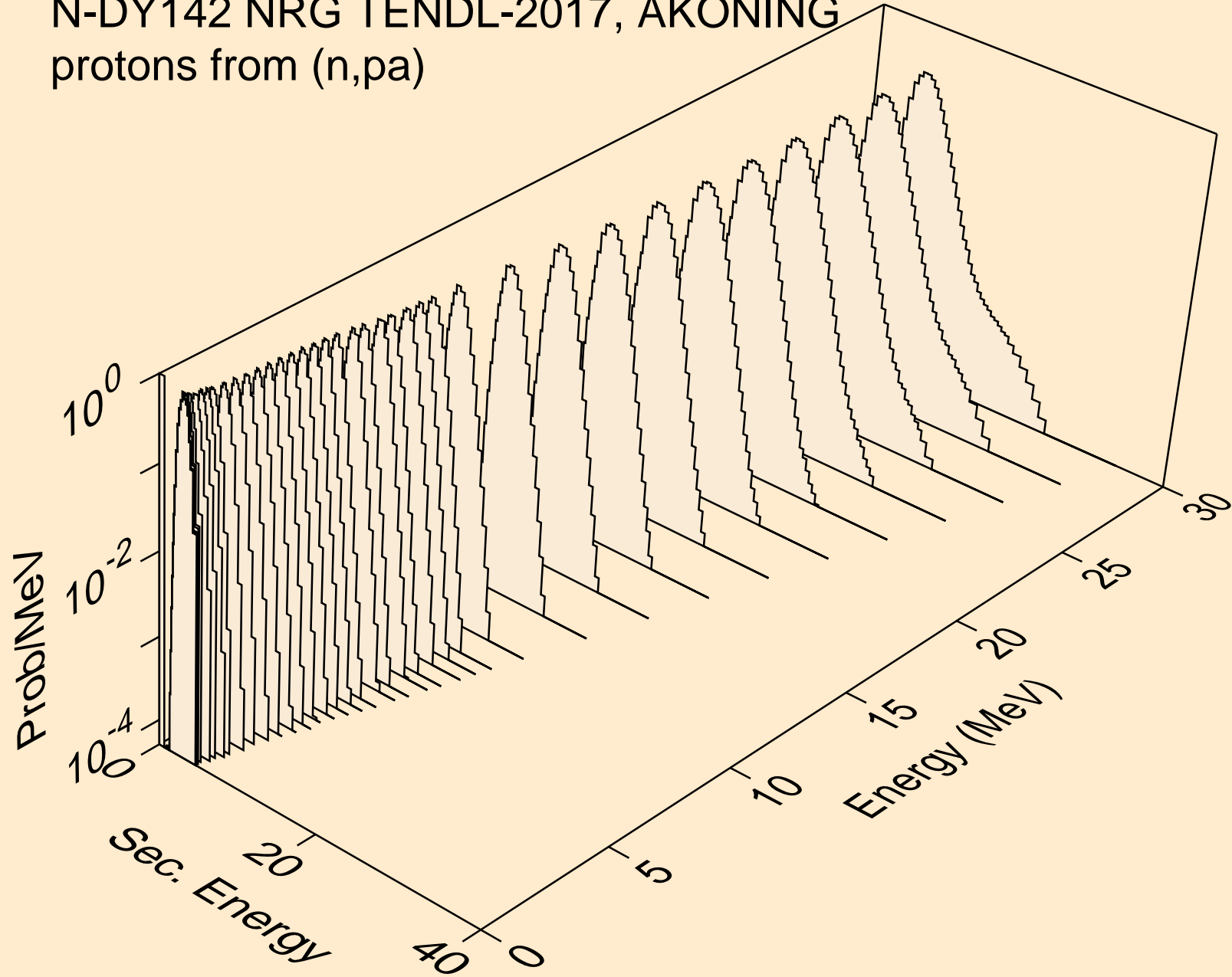

N-DY142 NRG TENDL-2017, AKONING  
protons from (n,pd)

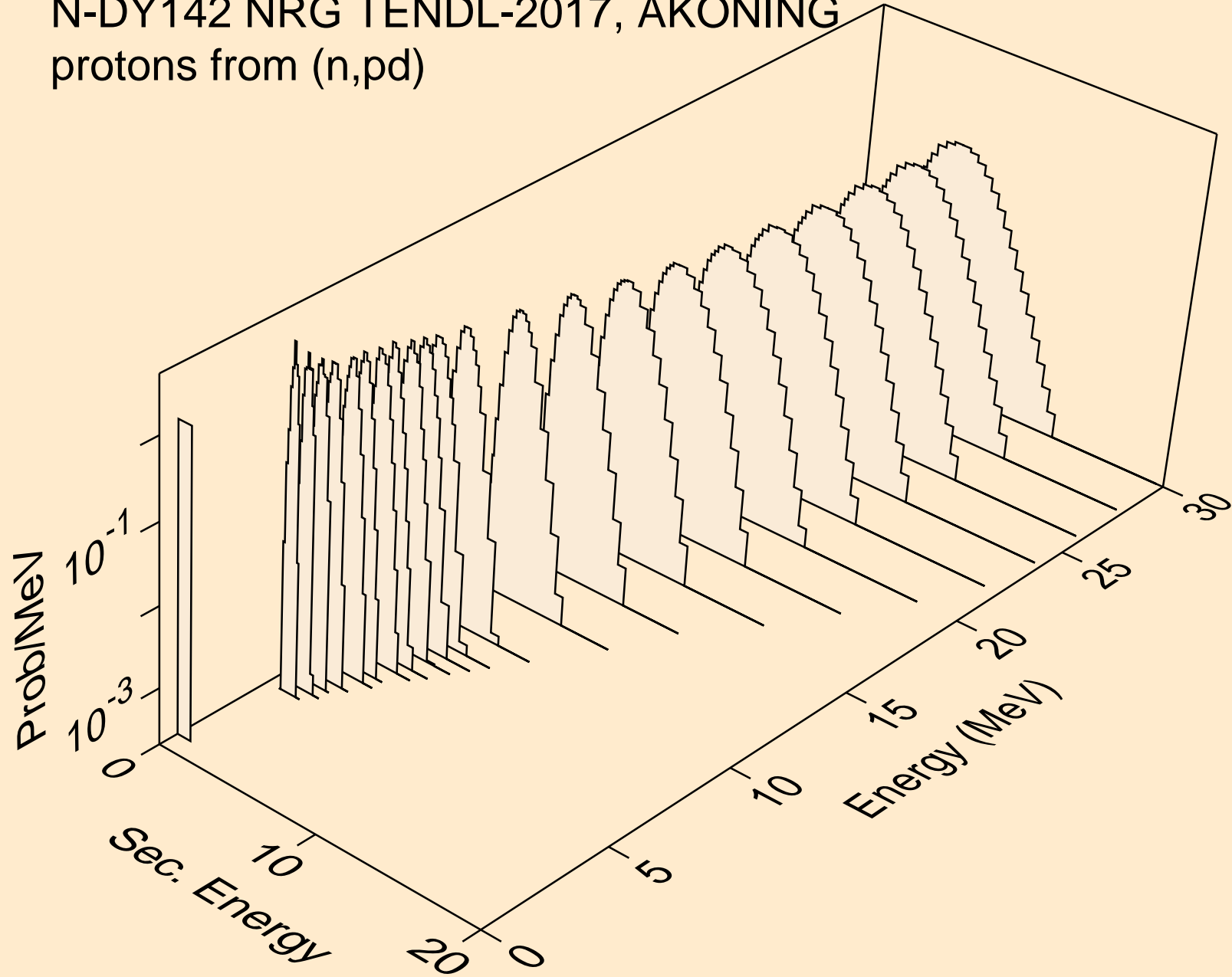

N-DY142 NRG TENDL-2017, AKONING  
protons from (n,pt)

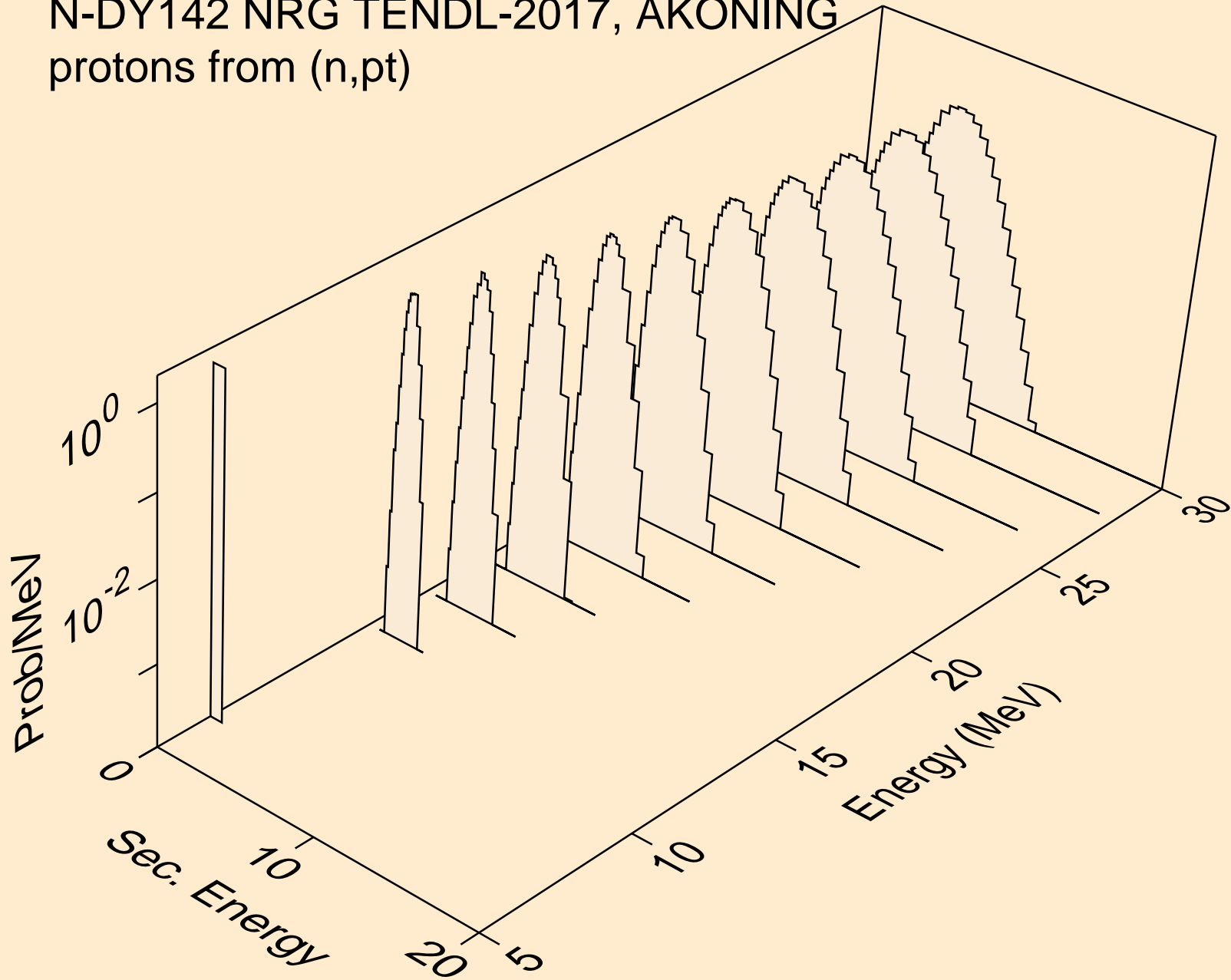

N-DY142 NRG TENDL-2017, AKONING  
deuterons from (n,x)

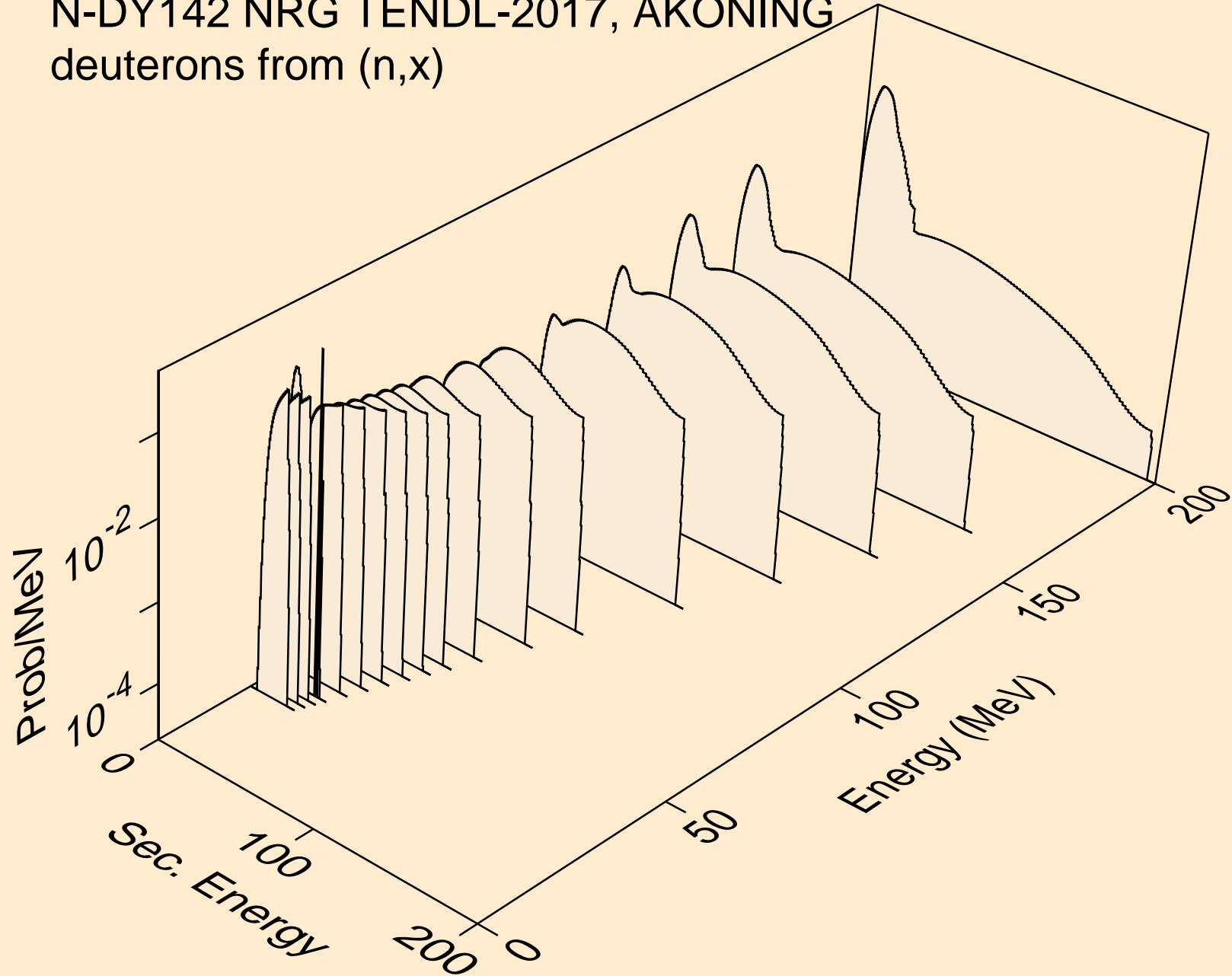

N-DY142 NRG TENDL-2017, AKONING  
deuterons from (n,2nd)

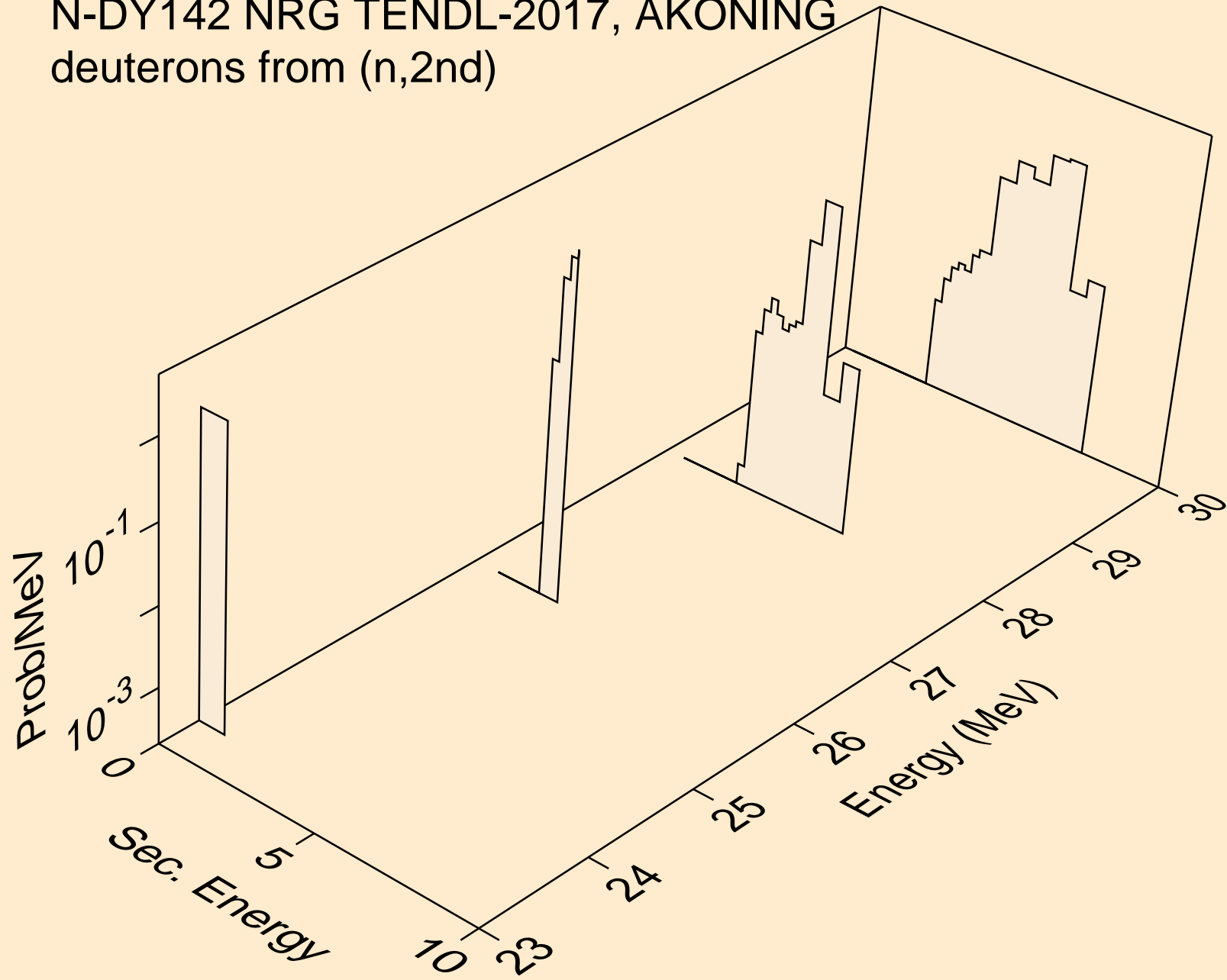

N-DY142 NRG TENDL-2017, AKONING  
deuterons from (n,n\*)d

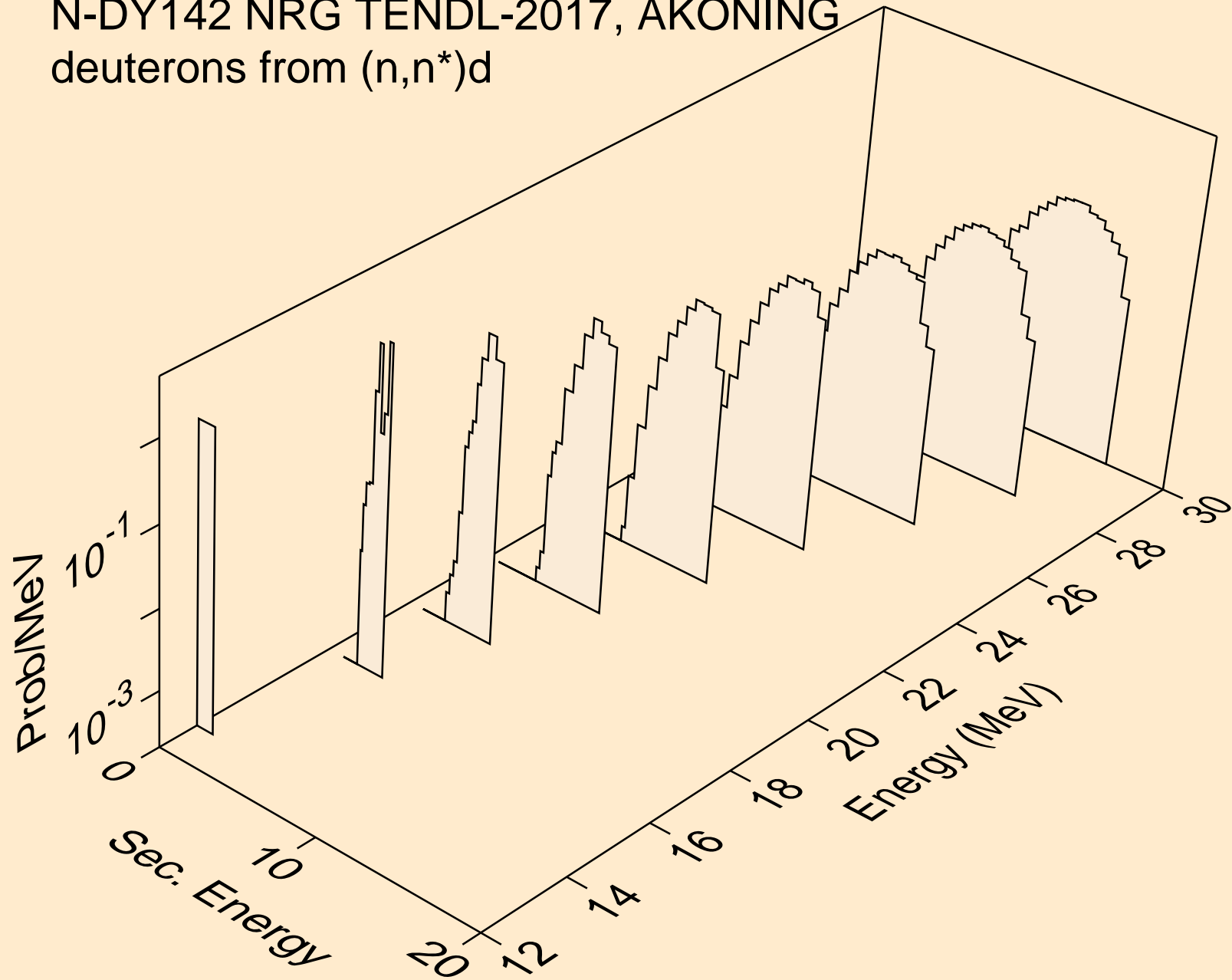

N-DY142 NRG TENDL-2017, AKONING  
deuterons from (n,d)

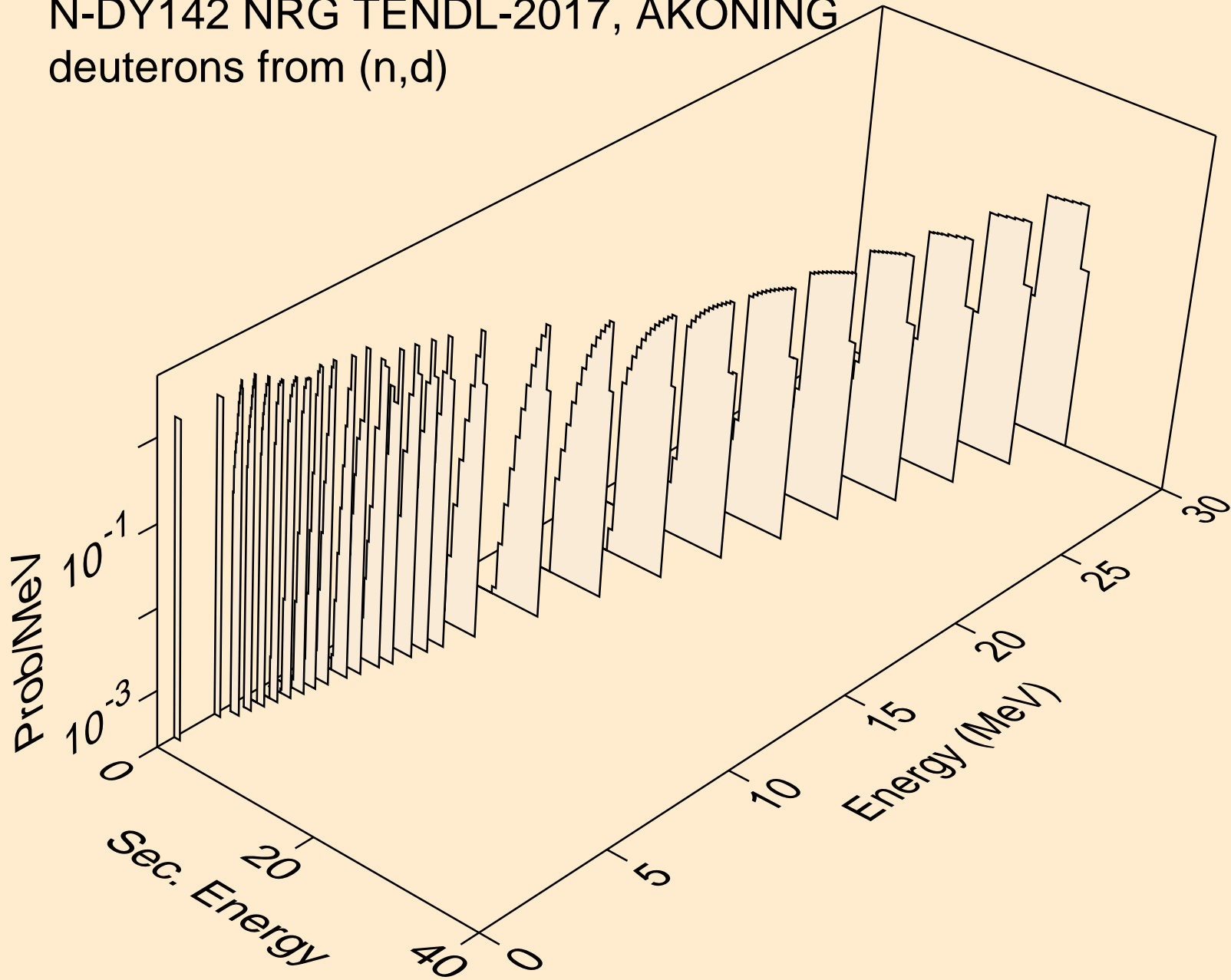

N-DY142 NRG TENDL-2017, AKONING  
deuterons from (n,d2a)

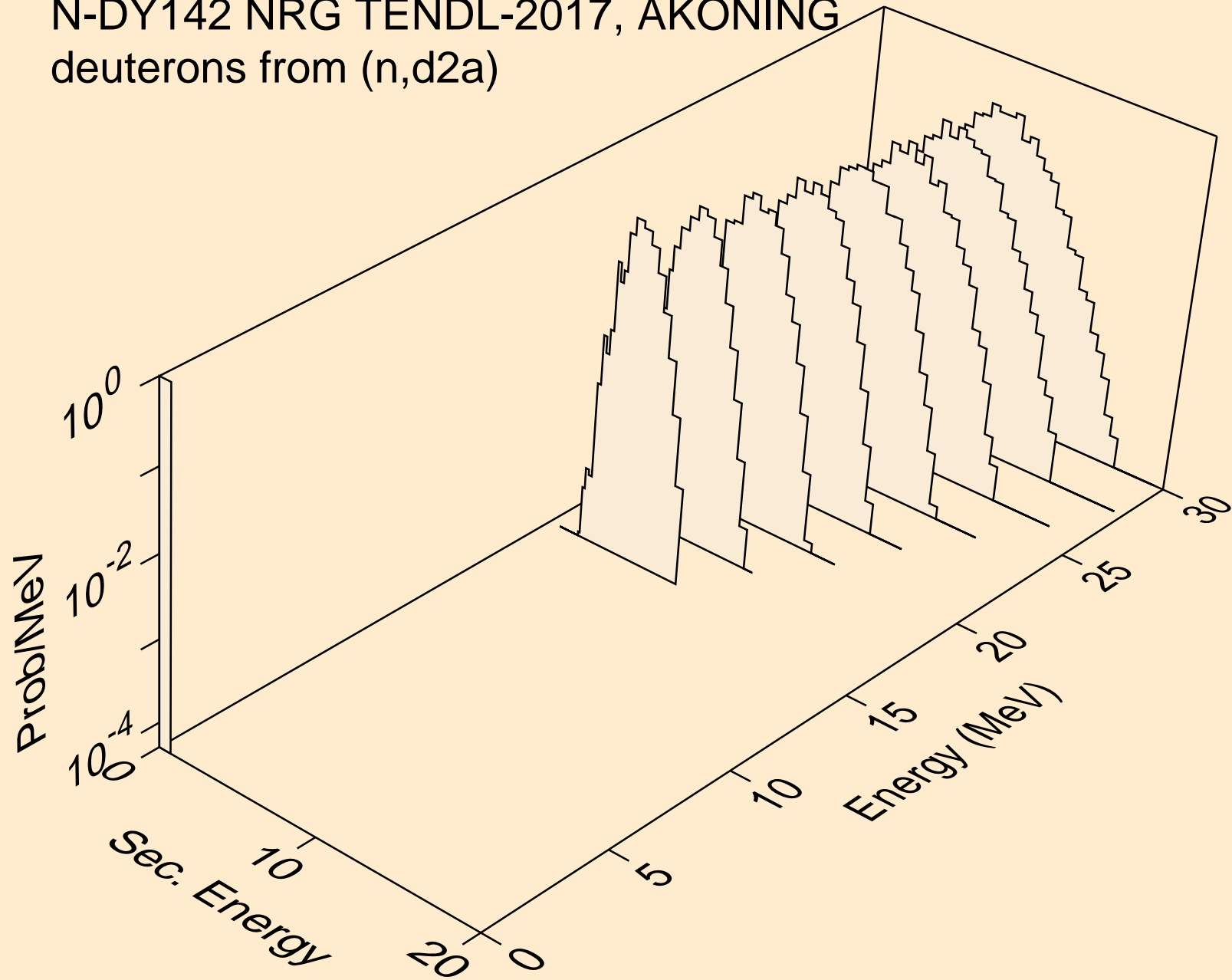



N-DY142 NRG TENDL-2017, AKONING  
deuterons from (n,pd)

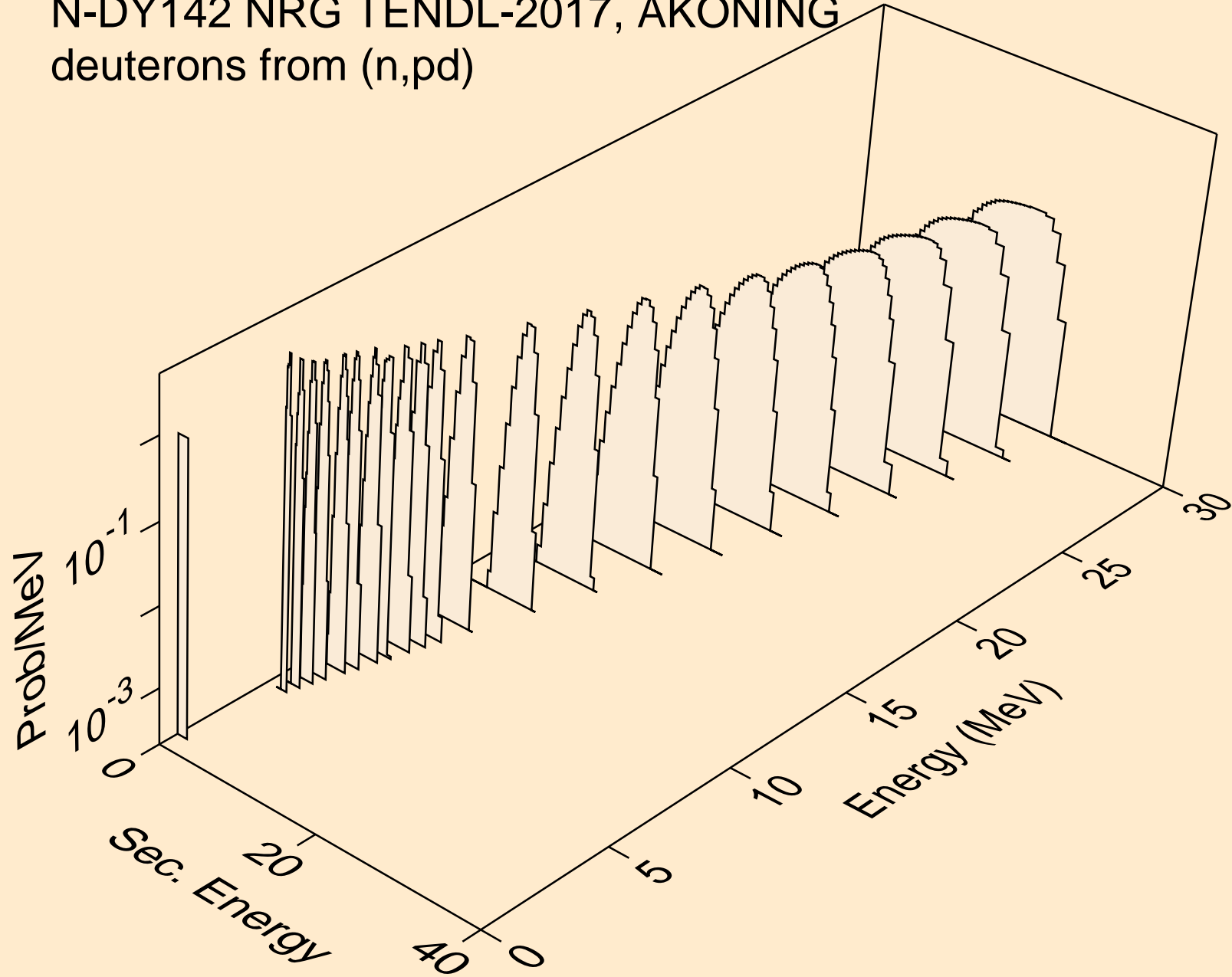

N-DY142 NRG TENDL-2017, AKONING  
deuterons from (n,da)

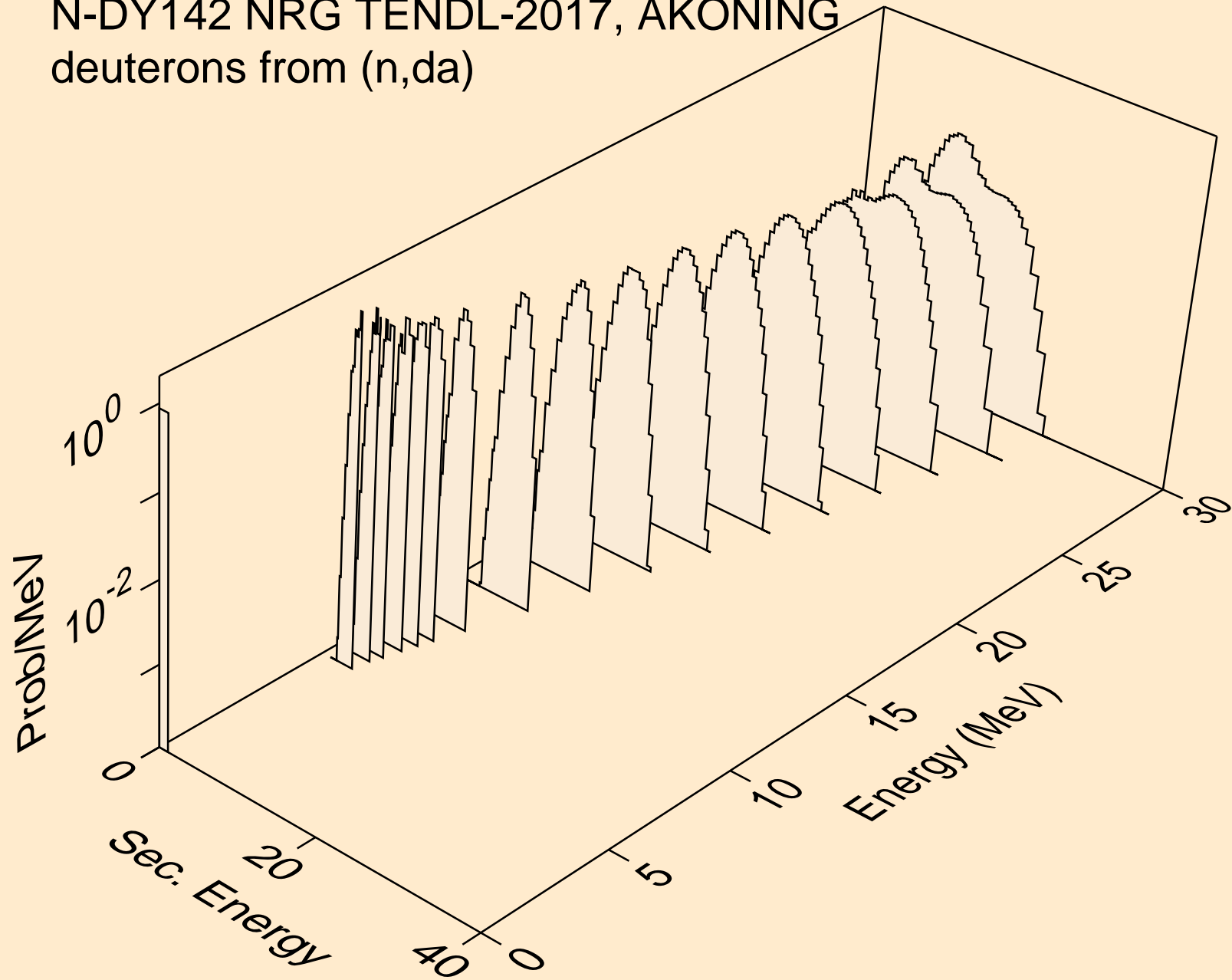

N-DY142 NRG TENDL-2017, AKONING  
tritons from (n,x)

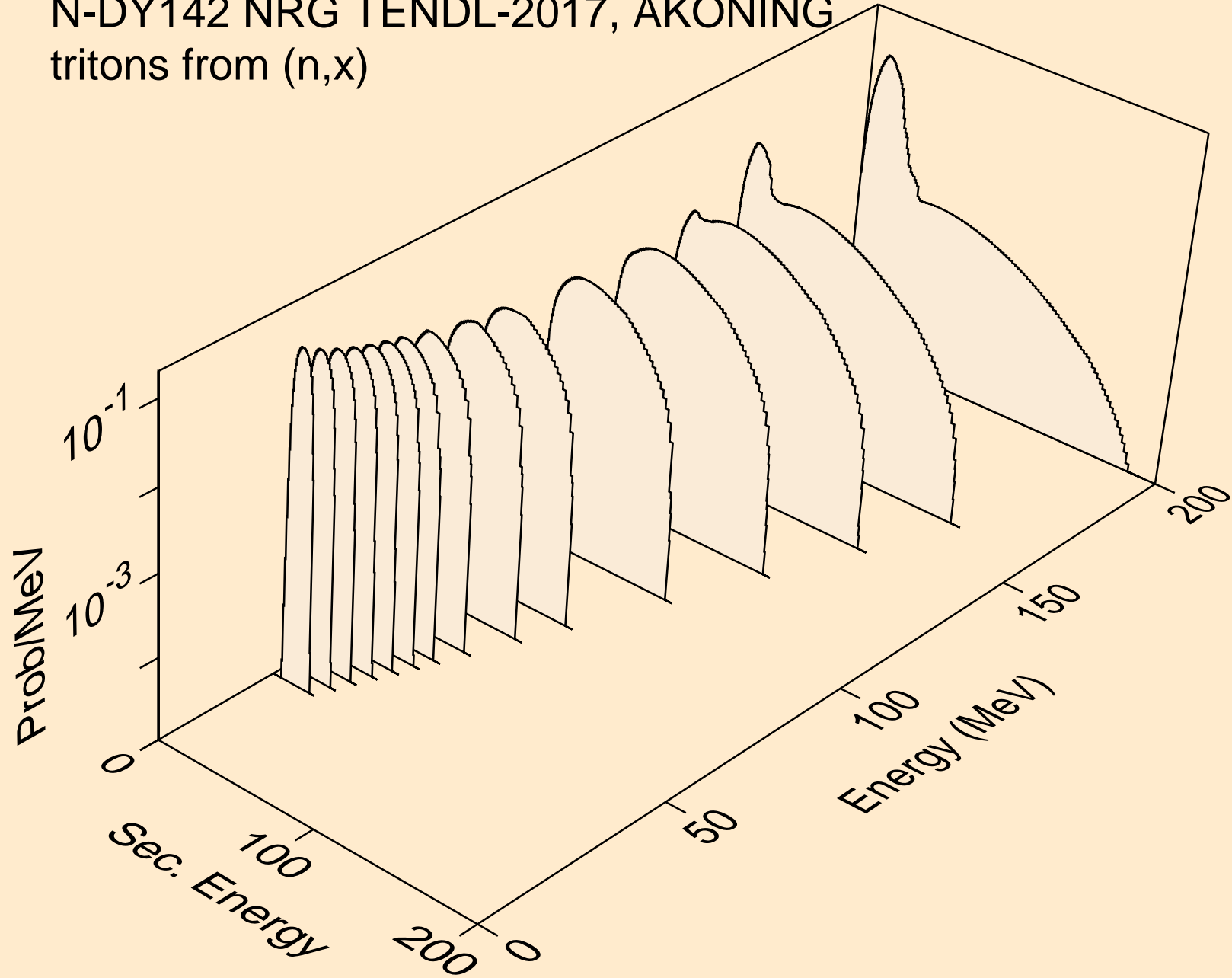

N-DY142 NRG TENDL-2017, AKONING  
tritons from (n,n\*)t

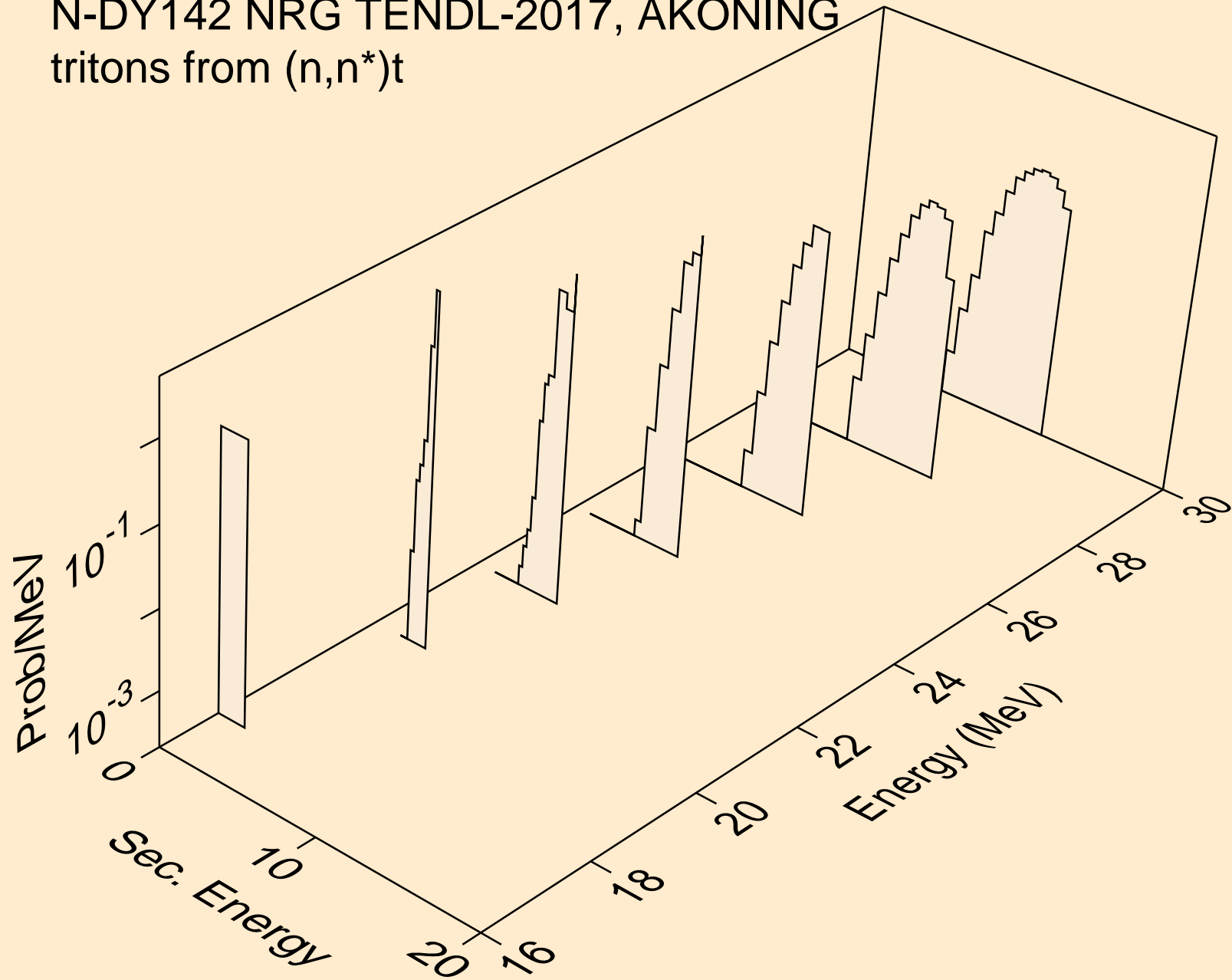

N-DY142 NRG TENDL-2017, AKONING  
tritons from (n,t)

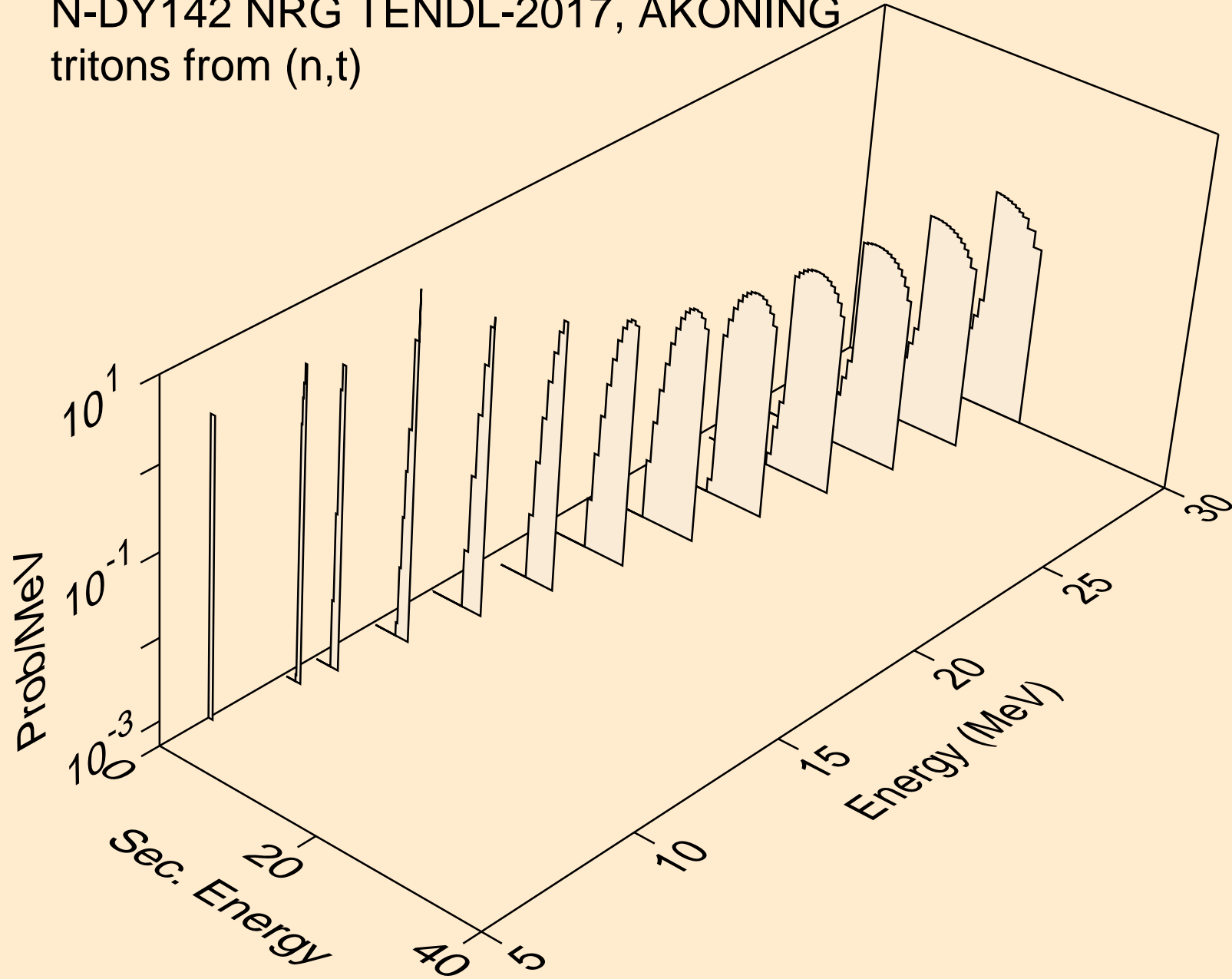

N-DY142 NRG TENDL-2017, AKONING  
tritons from (n,pt)

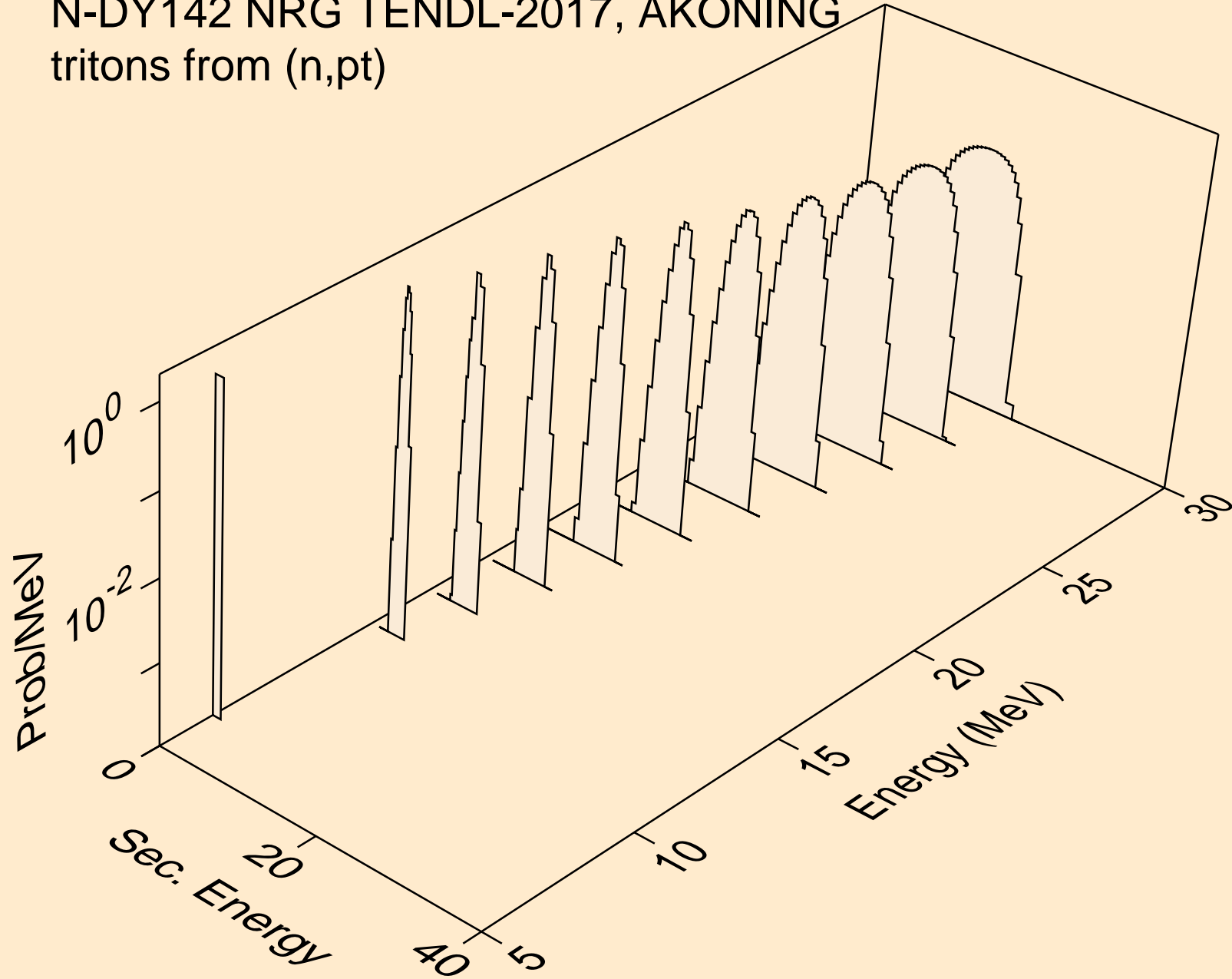

N-DY142 NRG TENDL-2017, AKONING  
he3s from (n,x)

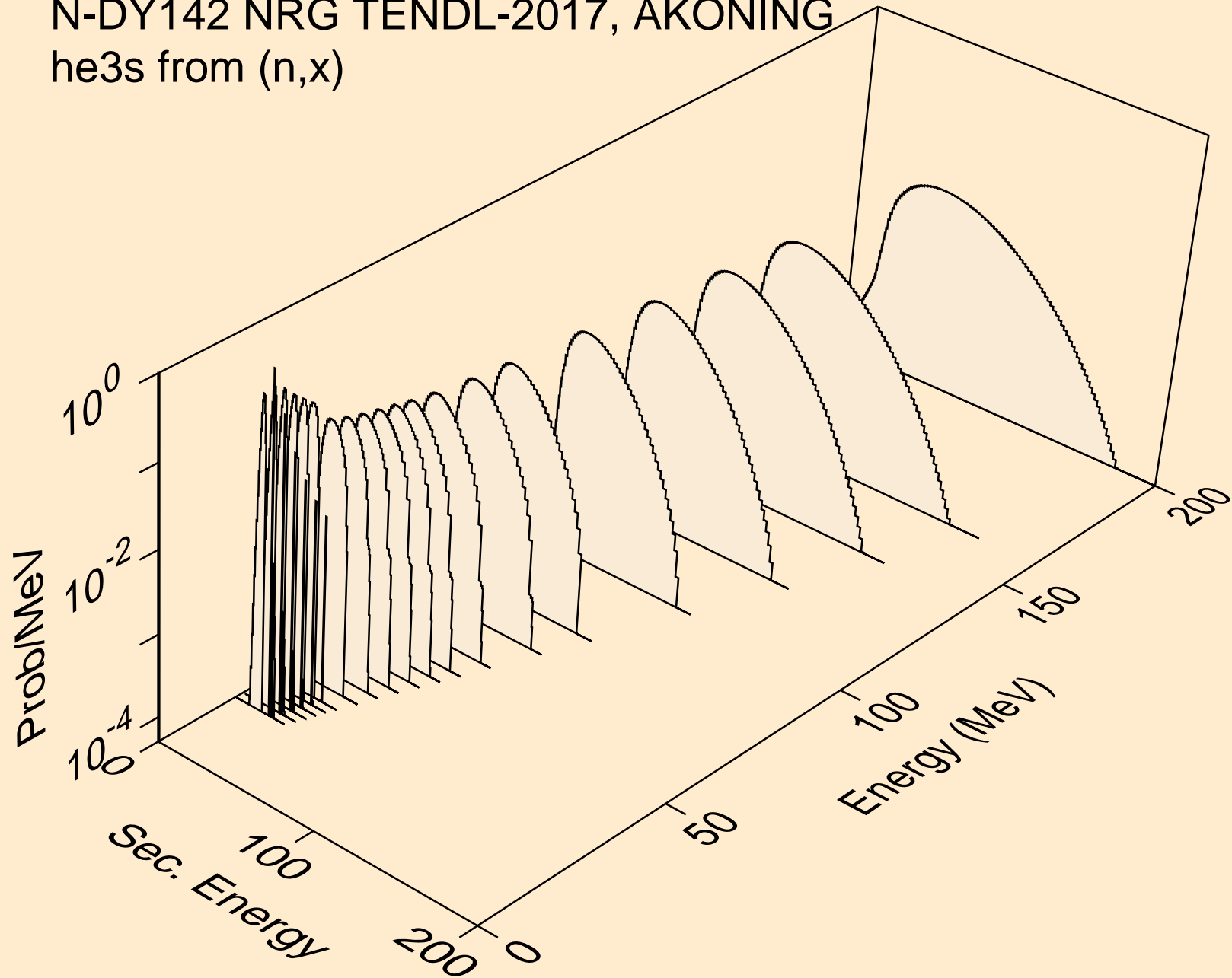

N-DY142 NRG TENDL-2017, AKONING  
he3s from (n,n\*)he3

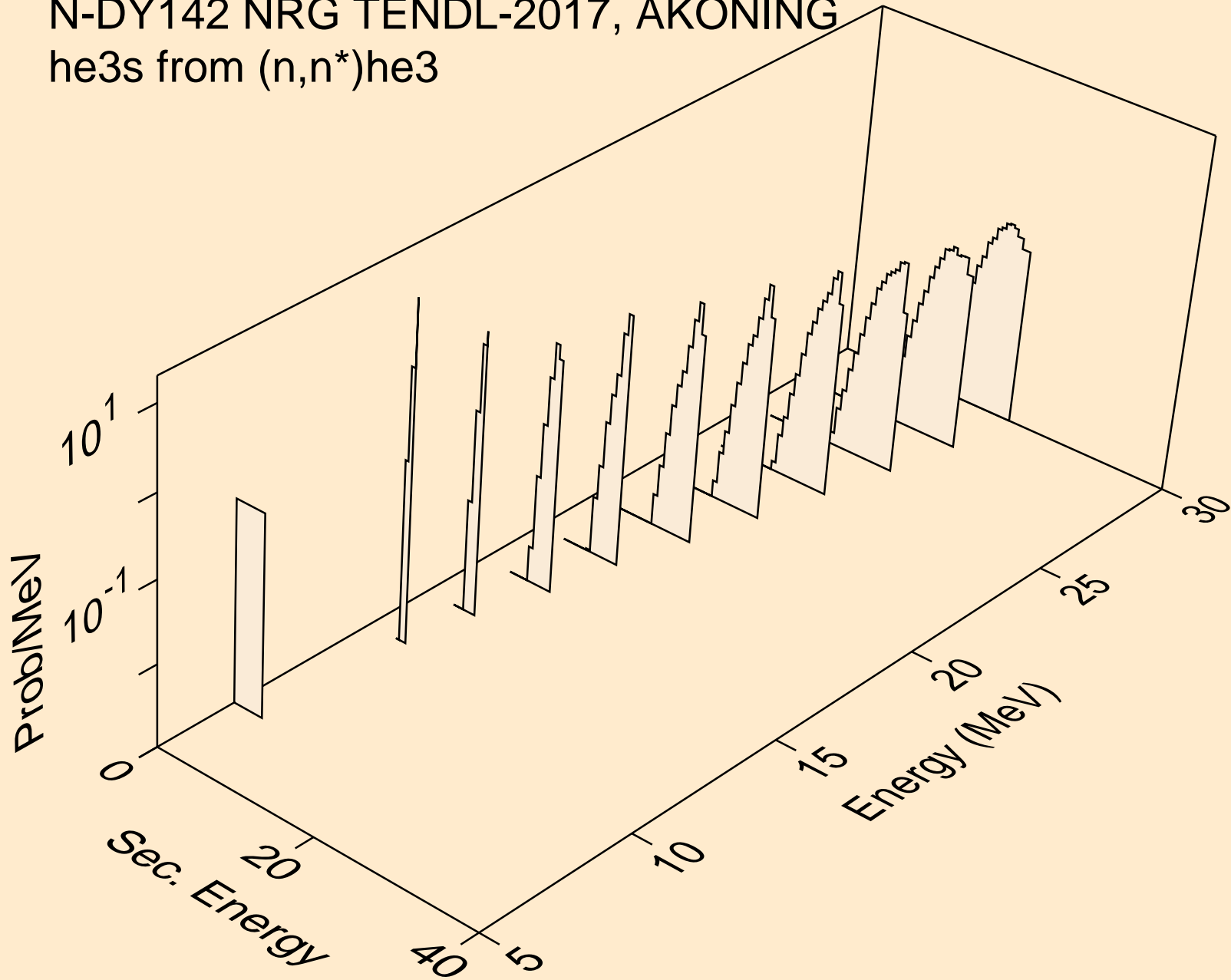



N-DY142 NRG TENDL-2017, AKONING  
he3s from (n,he3)

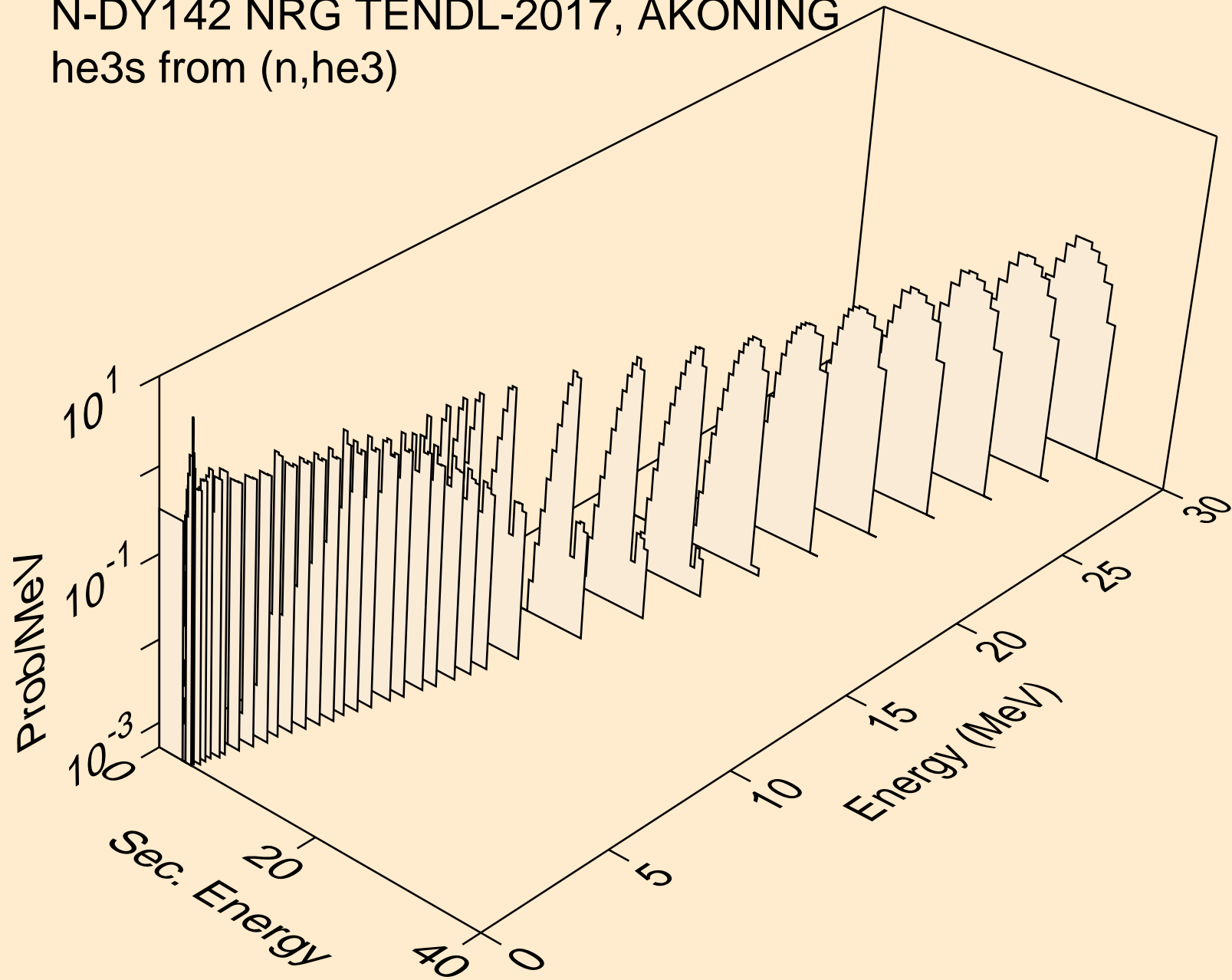

N-DY142 NRG TENDL-2017, AKONING  
alphas from (n,x)

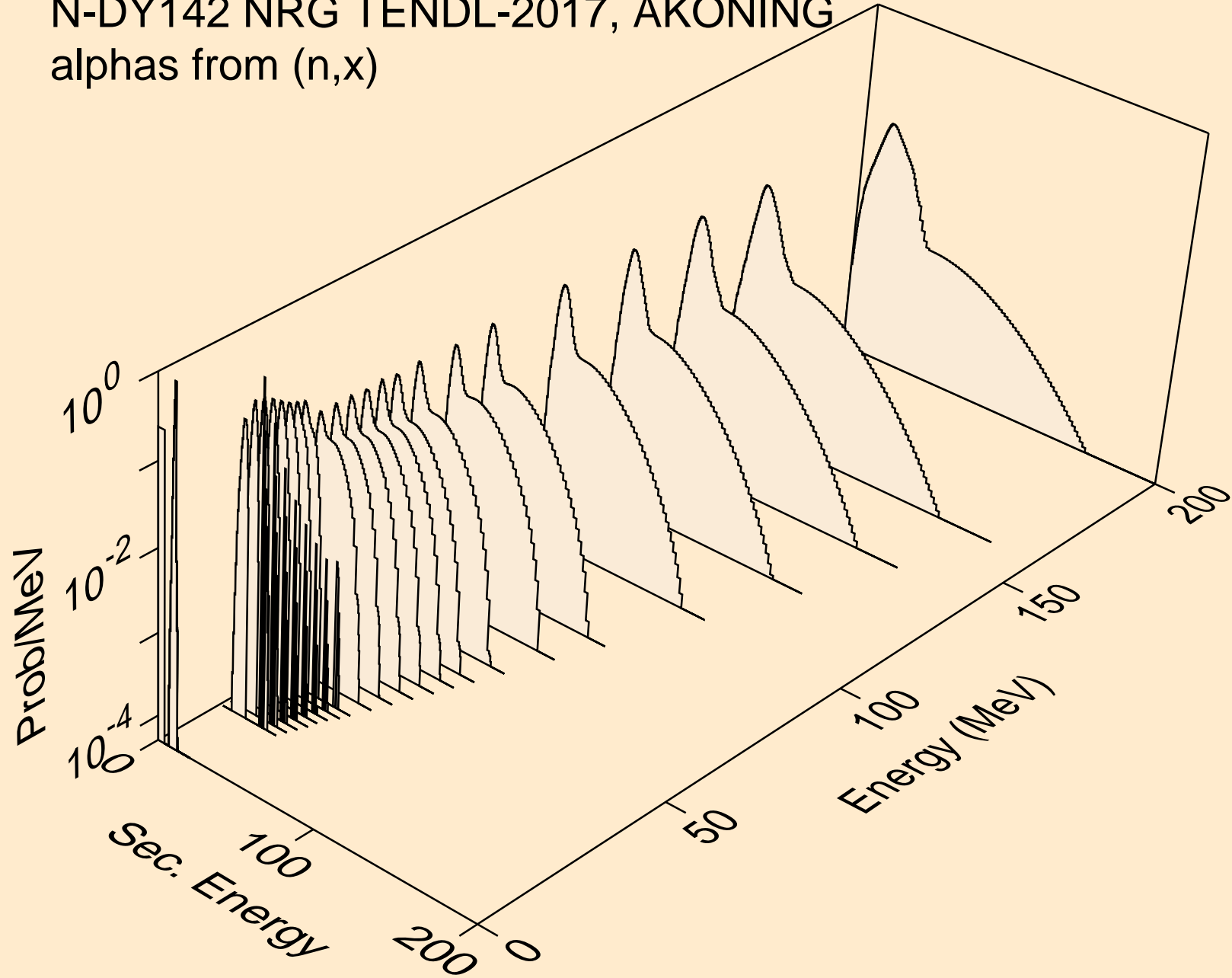

N-DY142 NRG TENDL-2017, AKONING  
alphas from (n,n\*)a

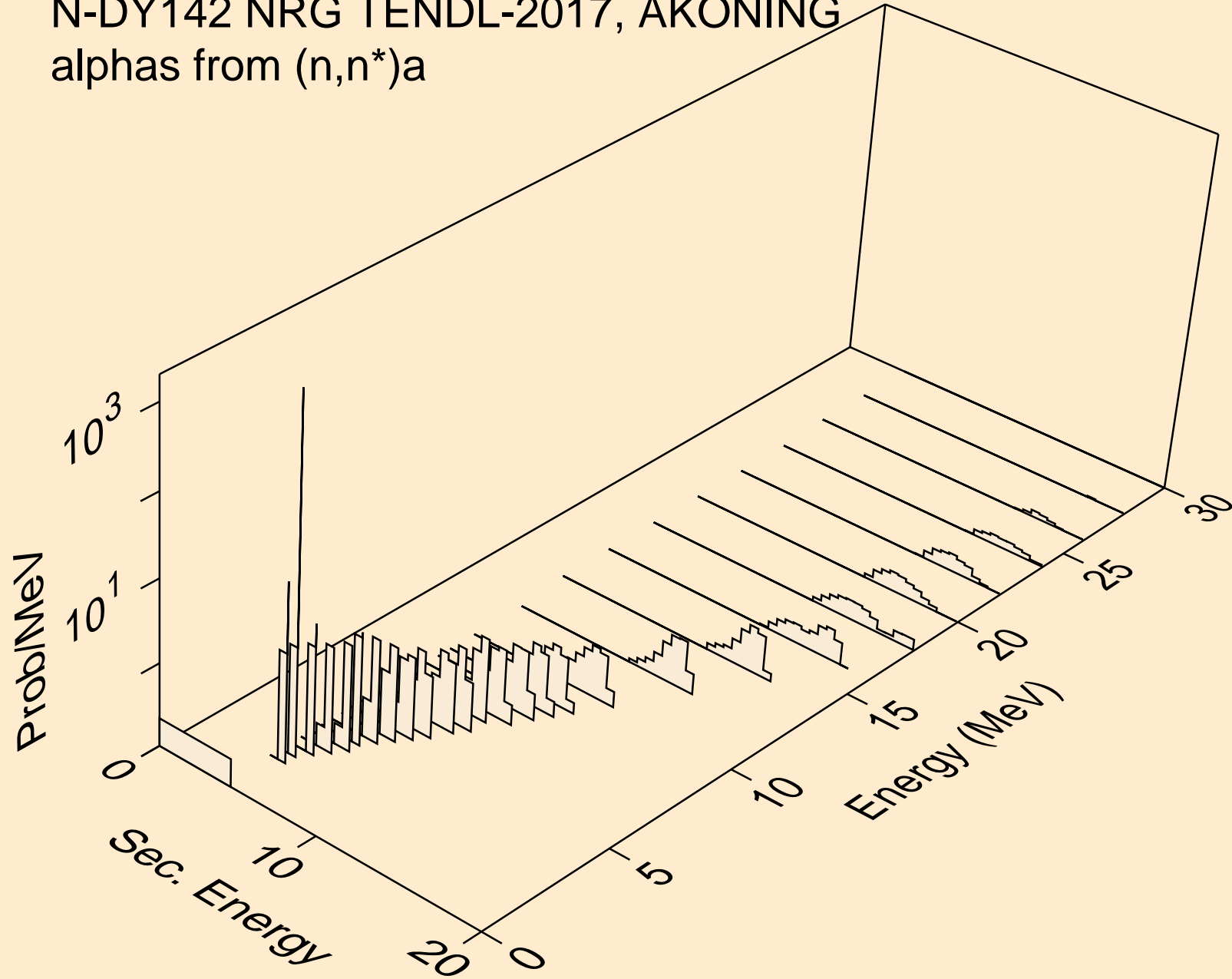

N-DY142 NRG TENDL-2017, AKONING  
alphas from (n,n\*)3a

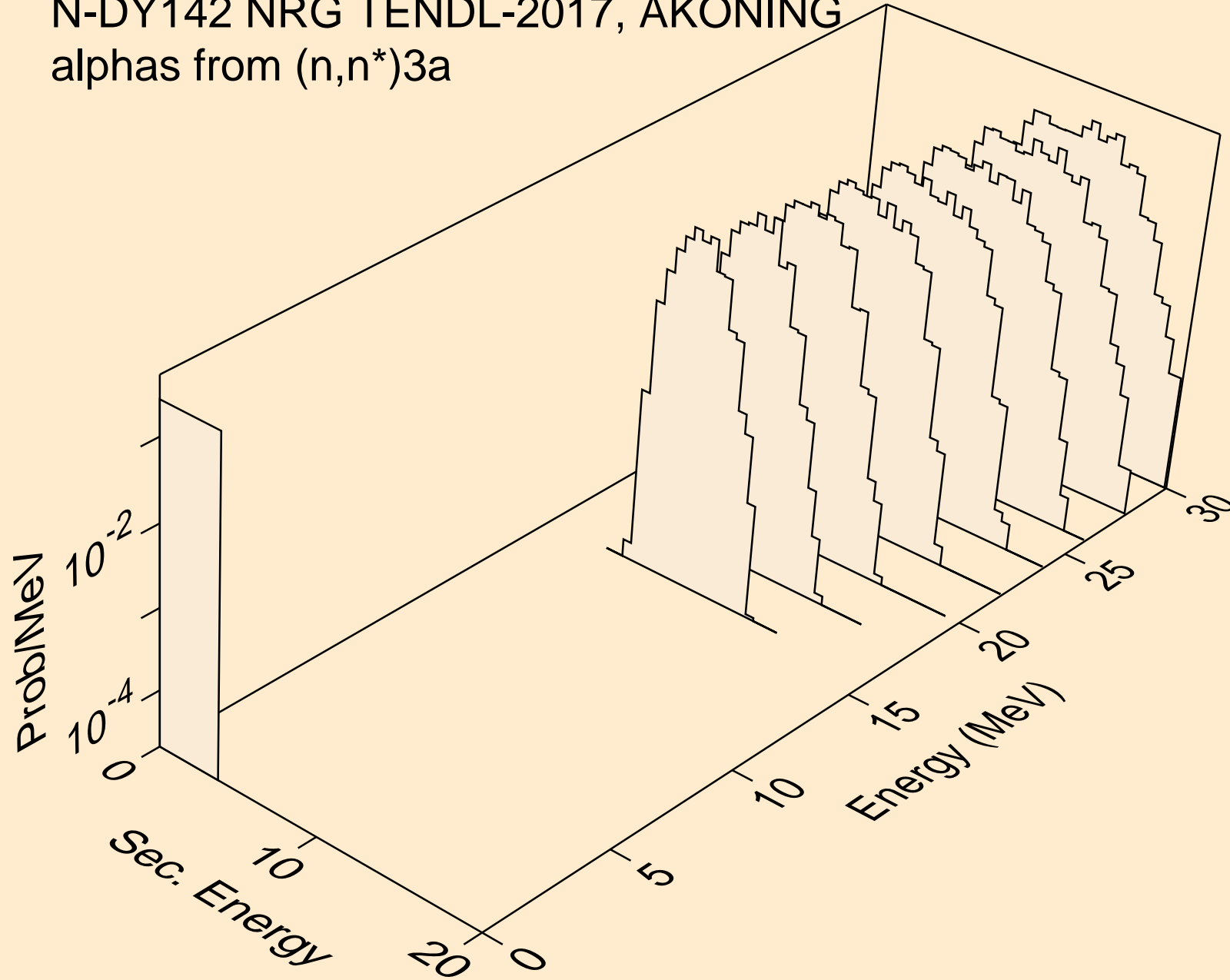

N-DY142 NRG TENDL-2017, AKONING  
alphas from (n,2n)a

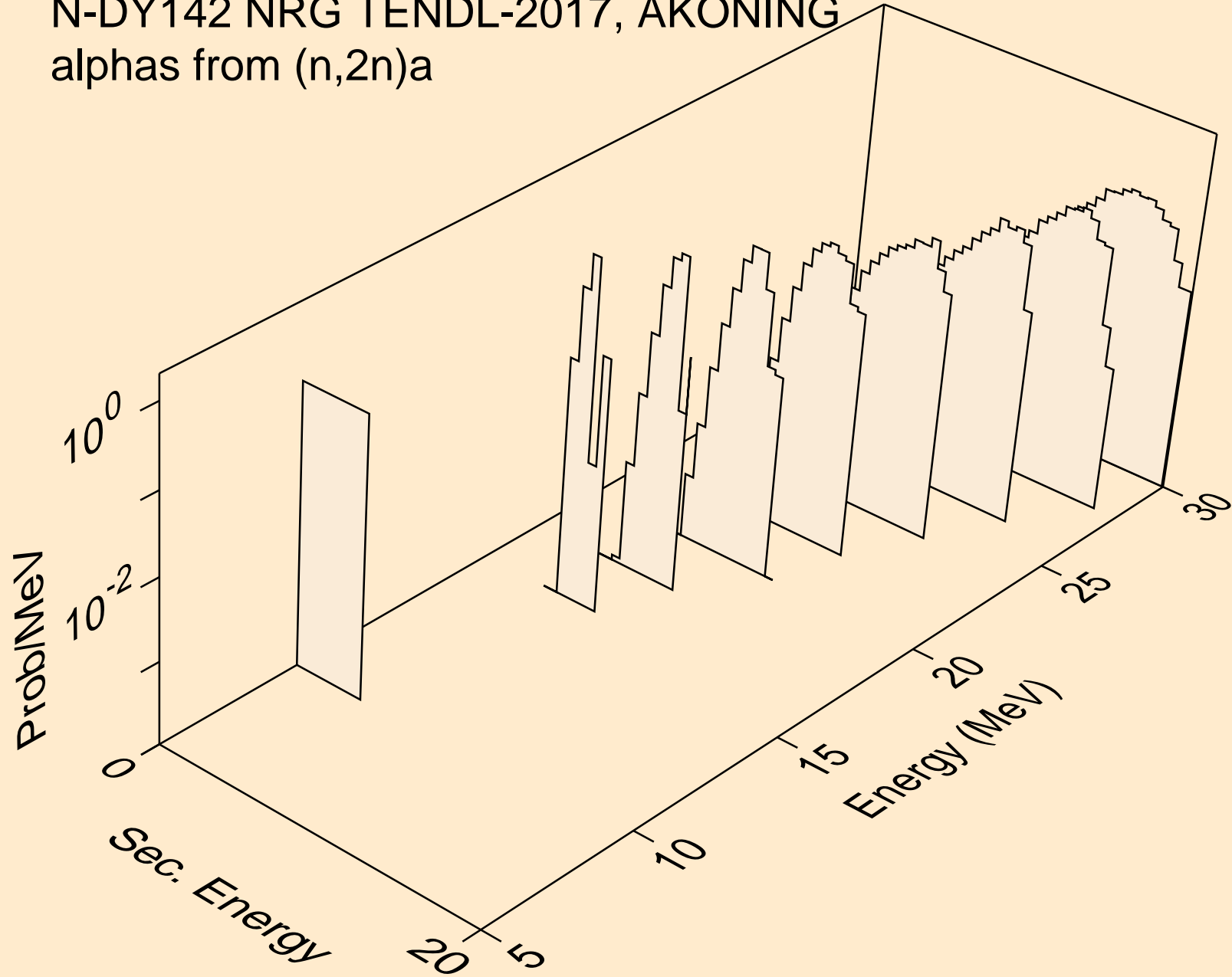

N-DY142 NRG TENDL-2017, AKONING  
alphas from (n,3n)a

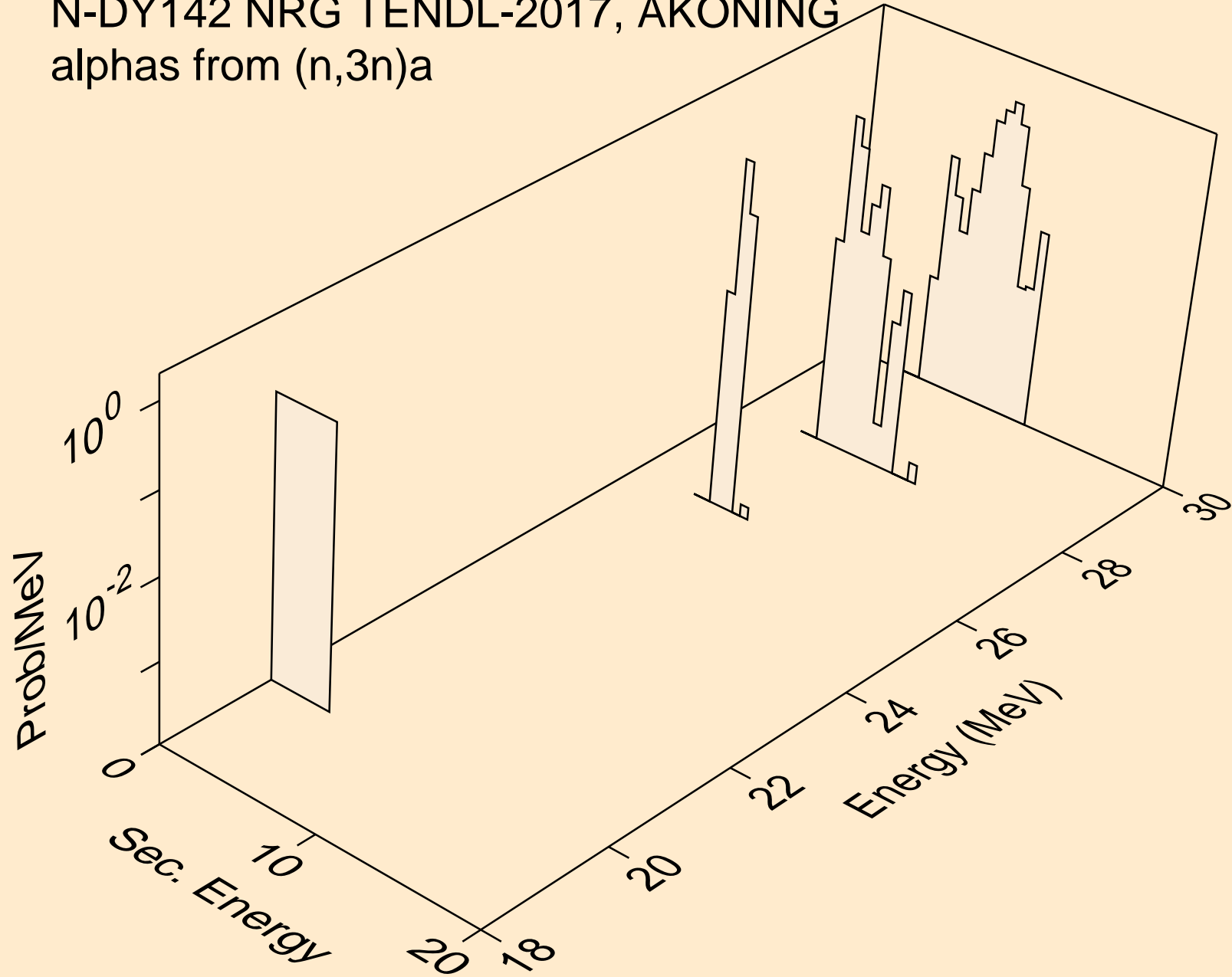

N-DY142 NRG TENDL-2017, AKONING  
alphas from (n,n\*)2a

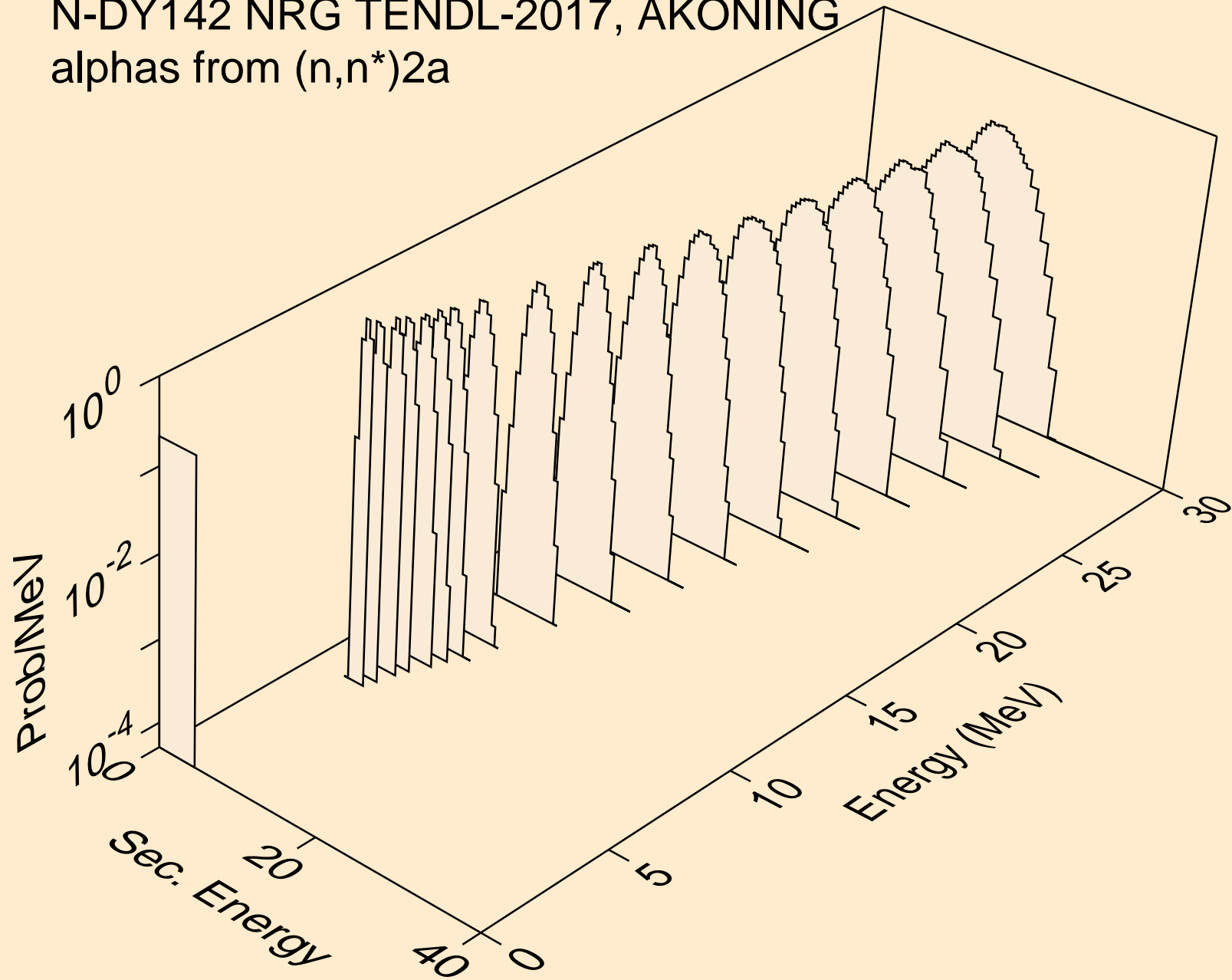

N-DY142 NRG TENDL-2017, AKONING  
alphas from (n,2n)2a

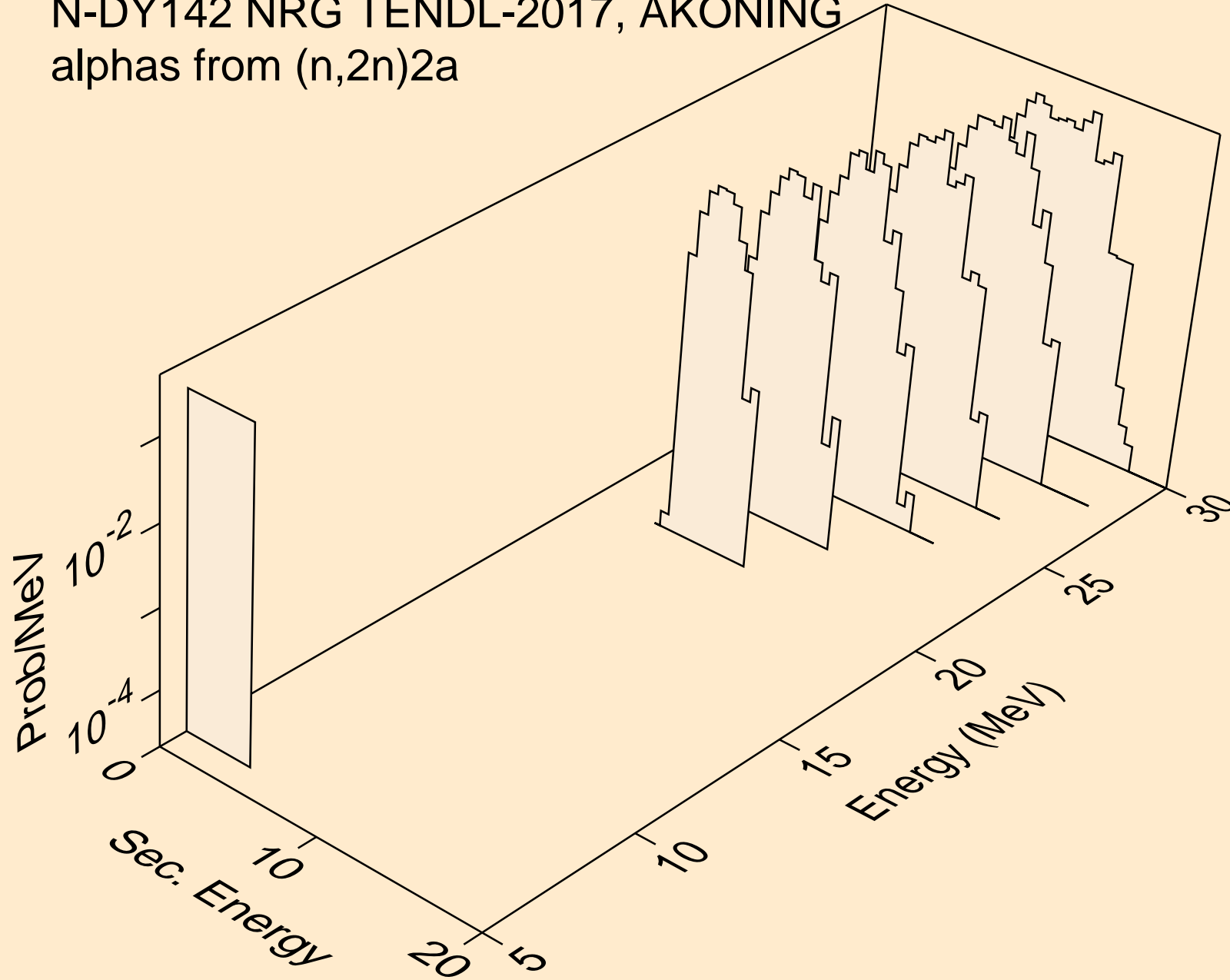



N-DY142 NRG TENDL-2017, AKONING  
alphas from (n,npa)

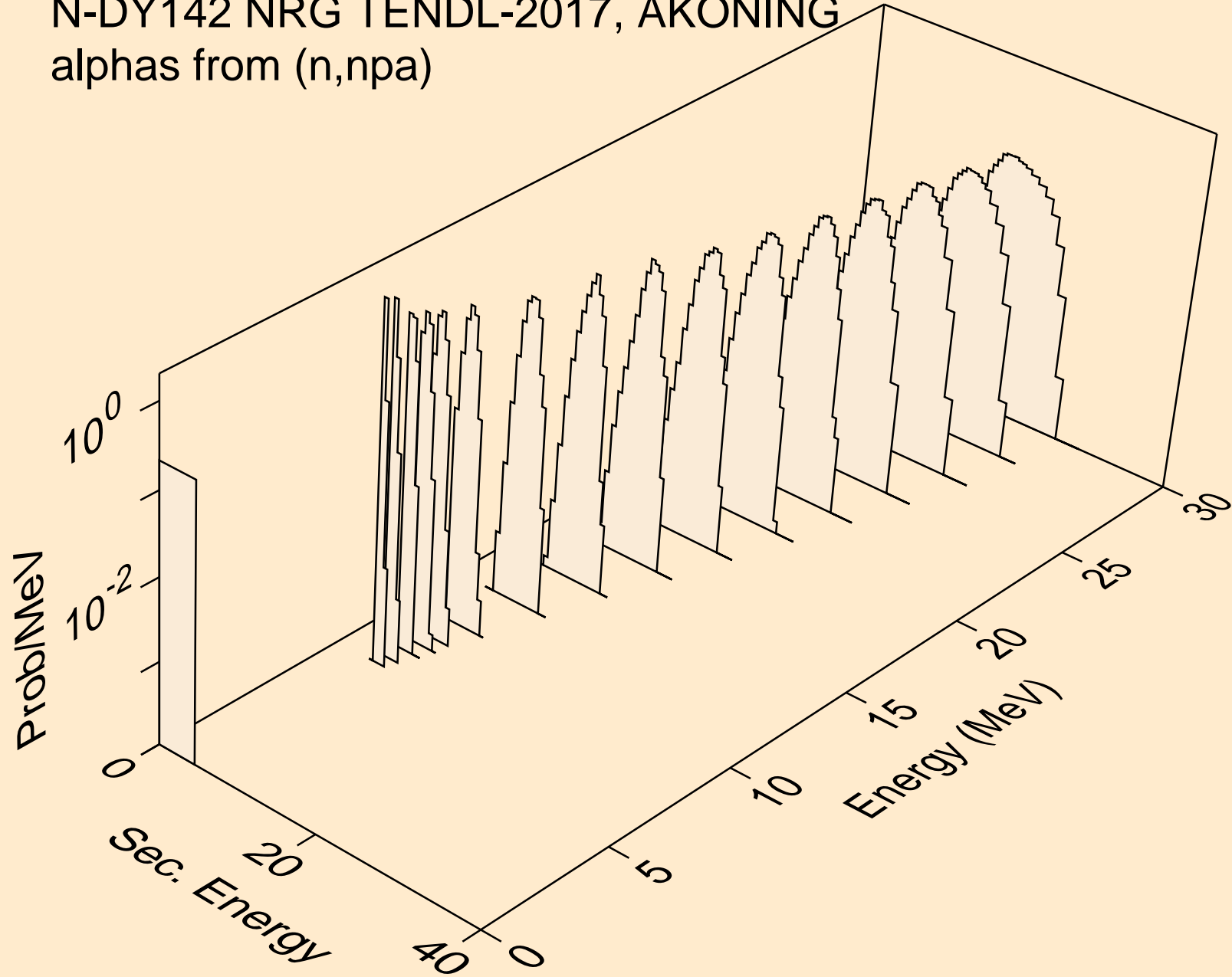

N-DY142 NRG TENDL-2017, AKONING  
alphas from (n,a)

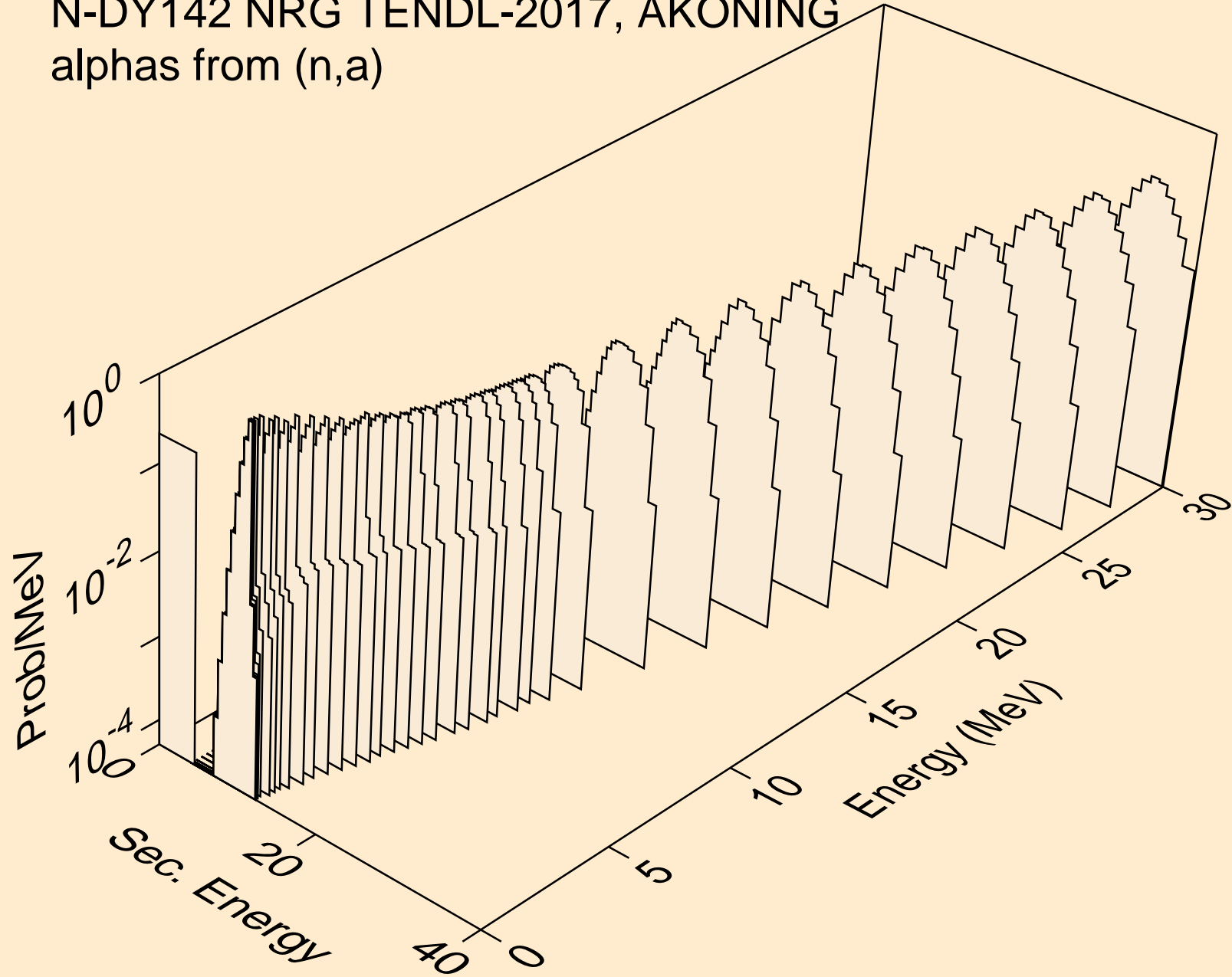

N-DY142 NRG TENDL-2017, AKONING  
alphas from (n,2a)

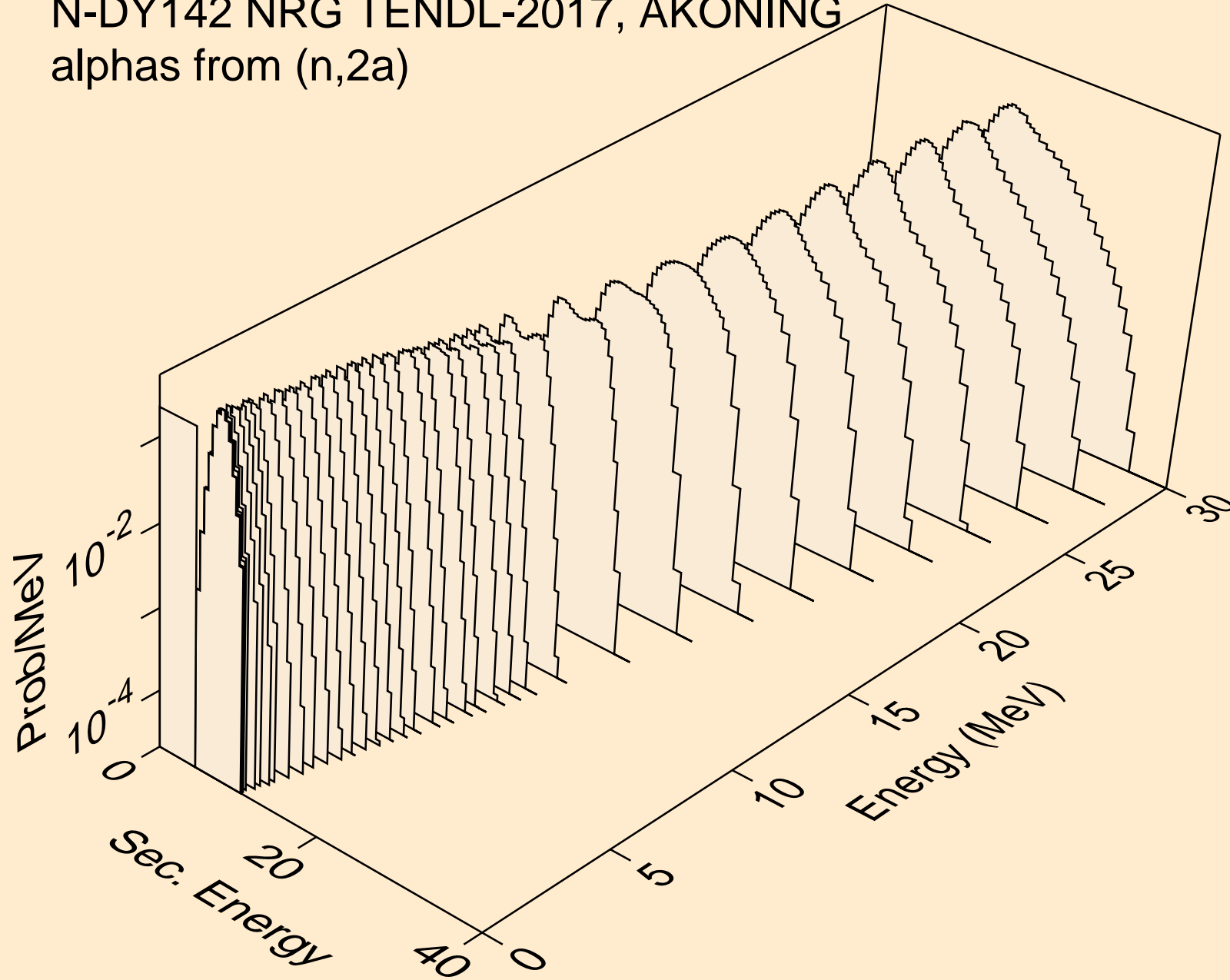

N-DY142 NRG TENDL-2017, AKONING  
alphas from (n,3a)

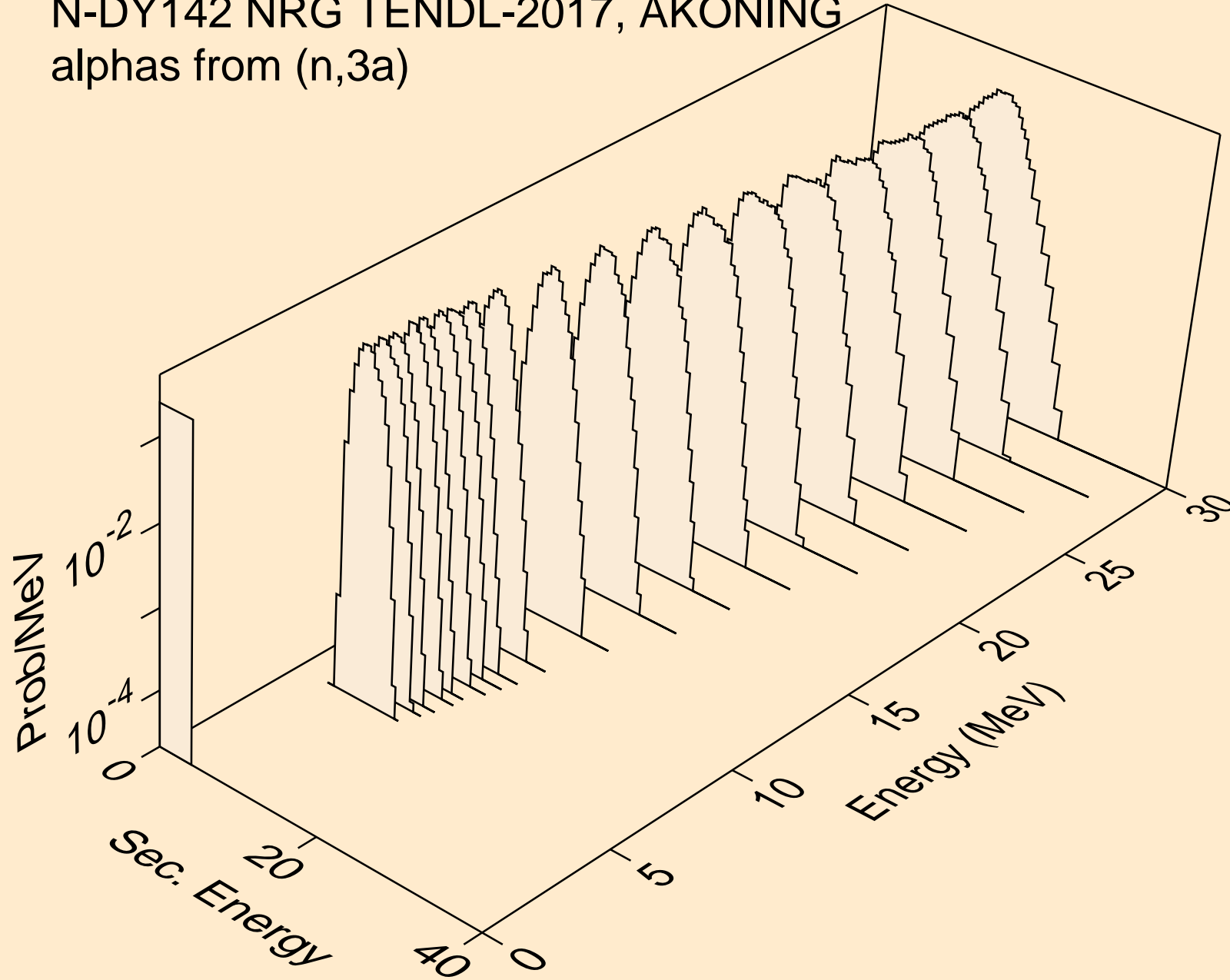

N-DY142 NRG TENDL-2017, AKONING  
alphas from (n,pa)

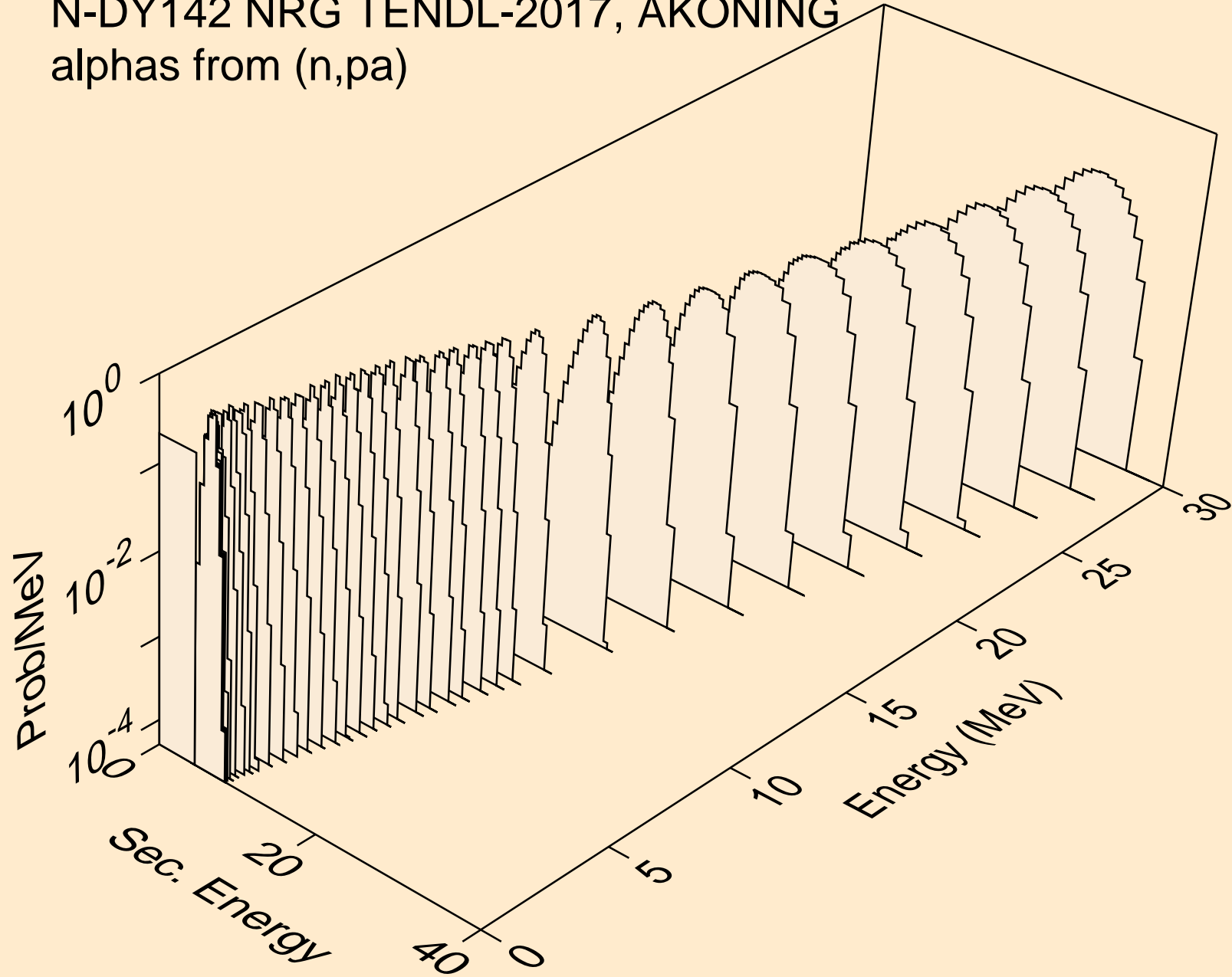

N-DY142 NRG TENDL-2017, AKONING  
alphas from (n,d2a)

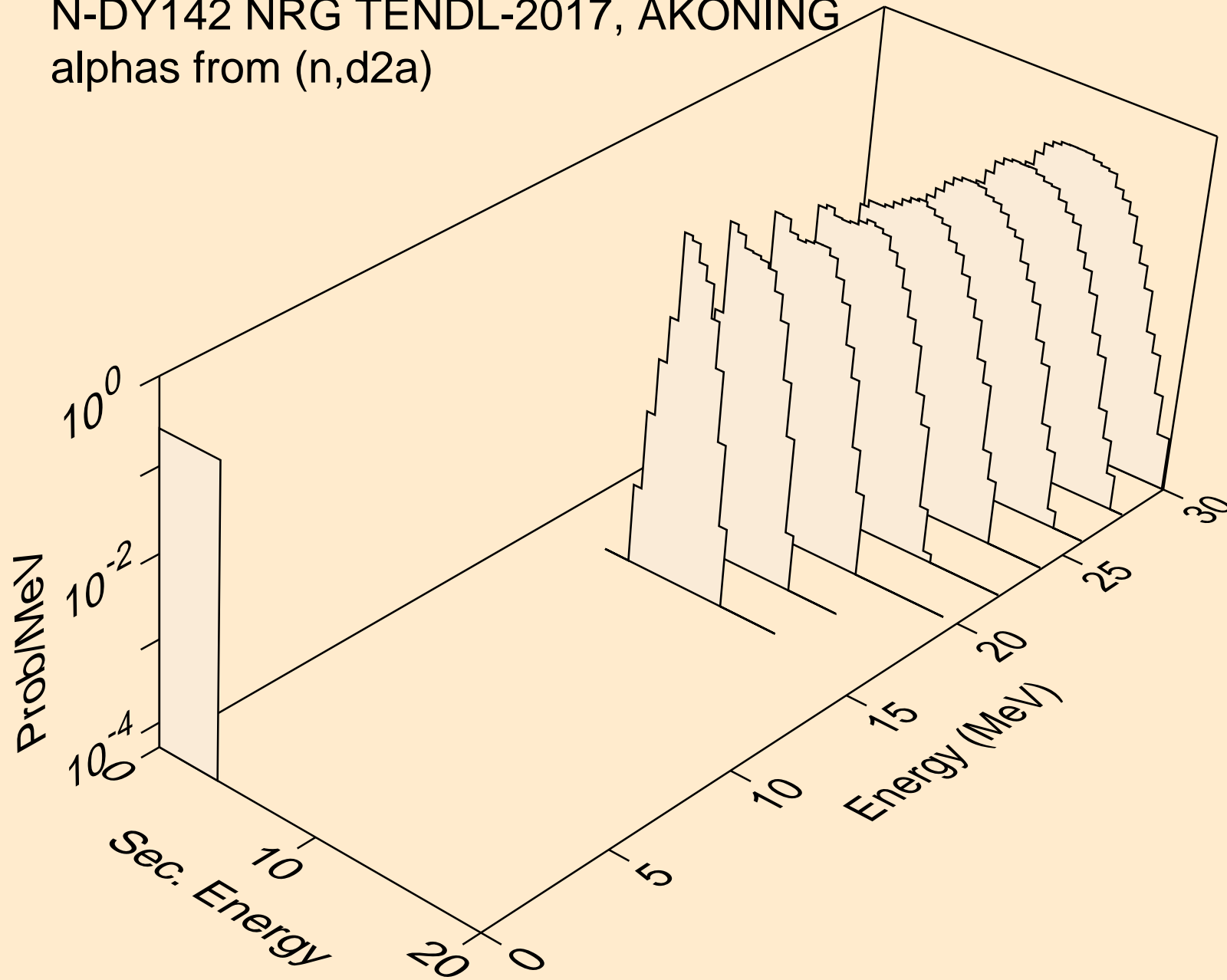

N-DY142 NRG TENDL-2017, AKONING  
alphas from (n,da)

