

N-DY156 NRG TENDL-2018, AKONING

Principal cross sections

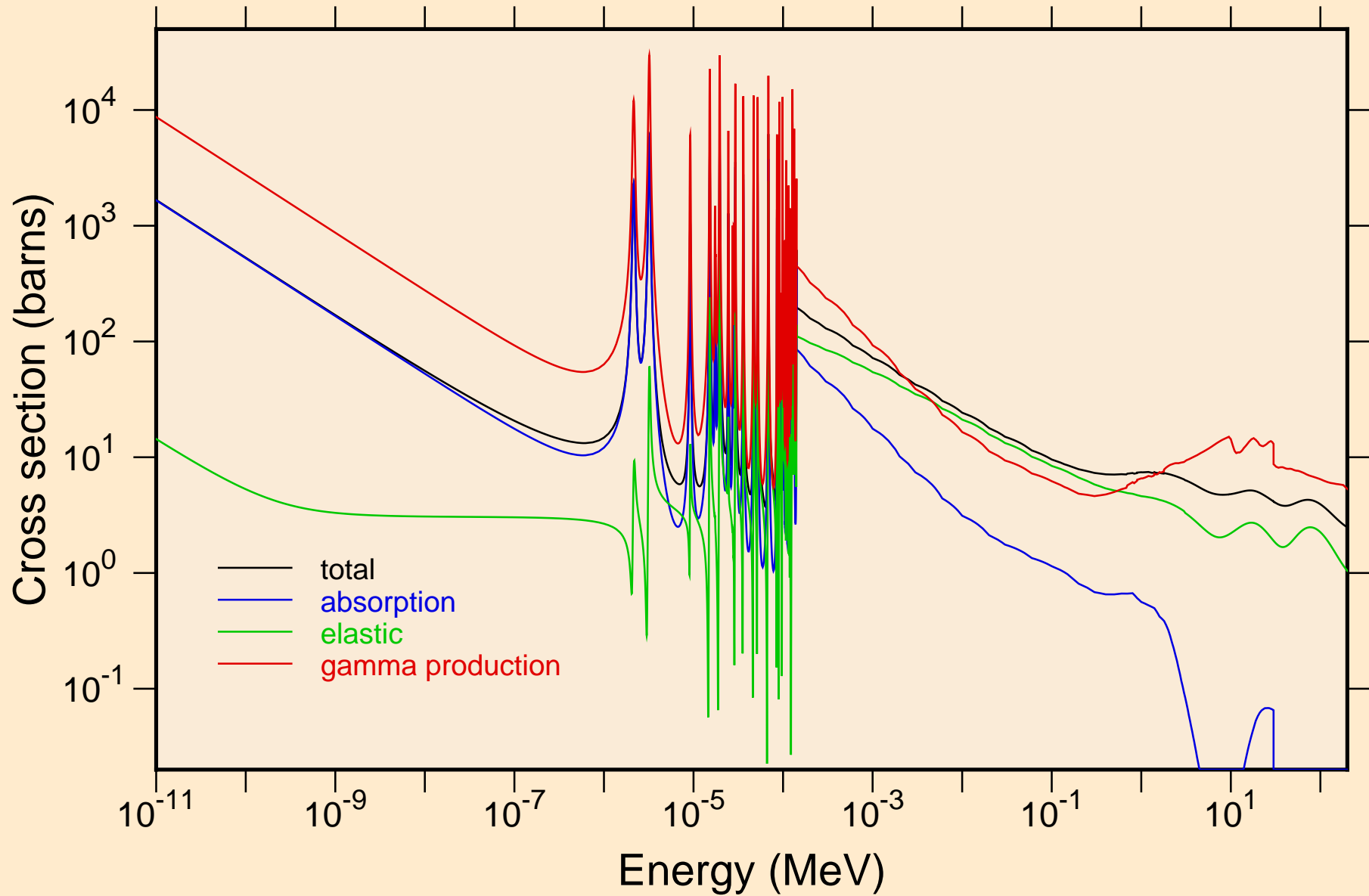

N-DY156 NRG TENDL-2018, AKONING
resonance total cross section

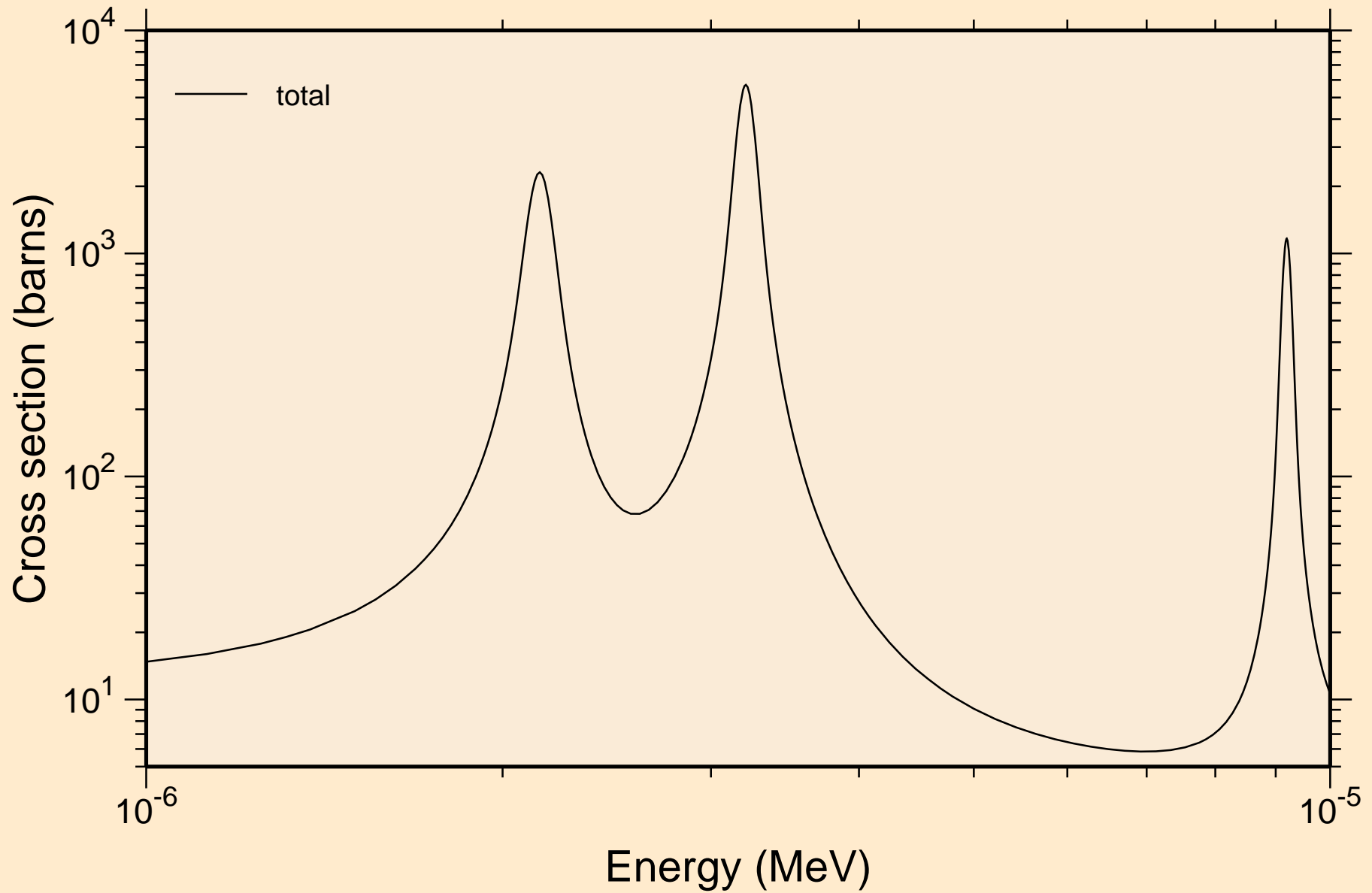

N-DY156 NRG TENDL-2018, AKONING
resonance total cross section

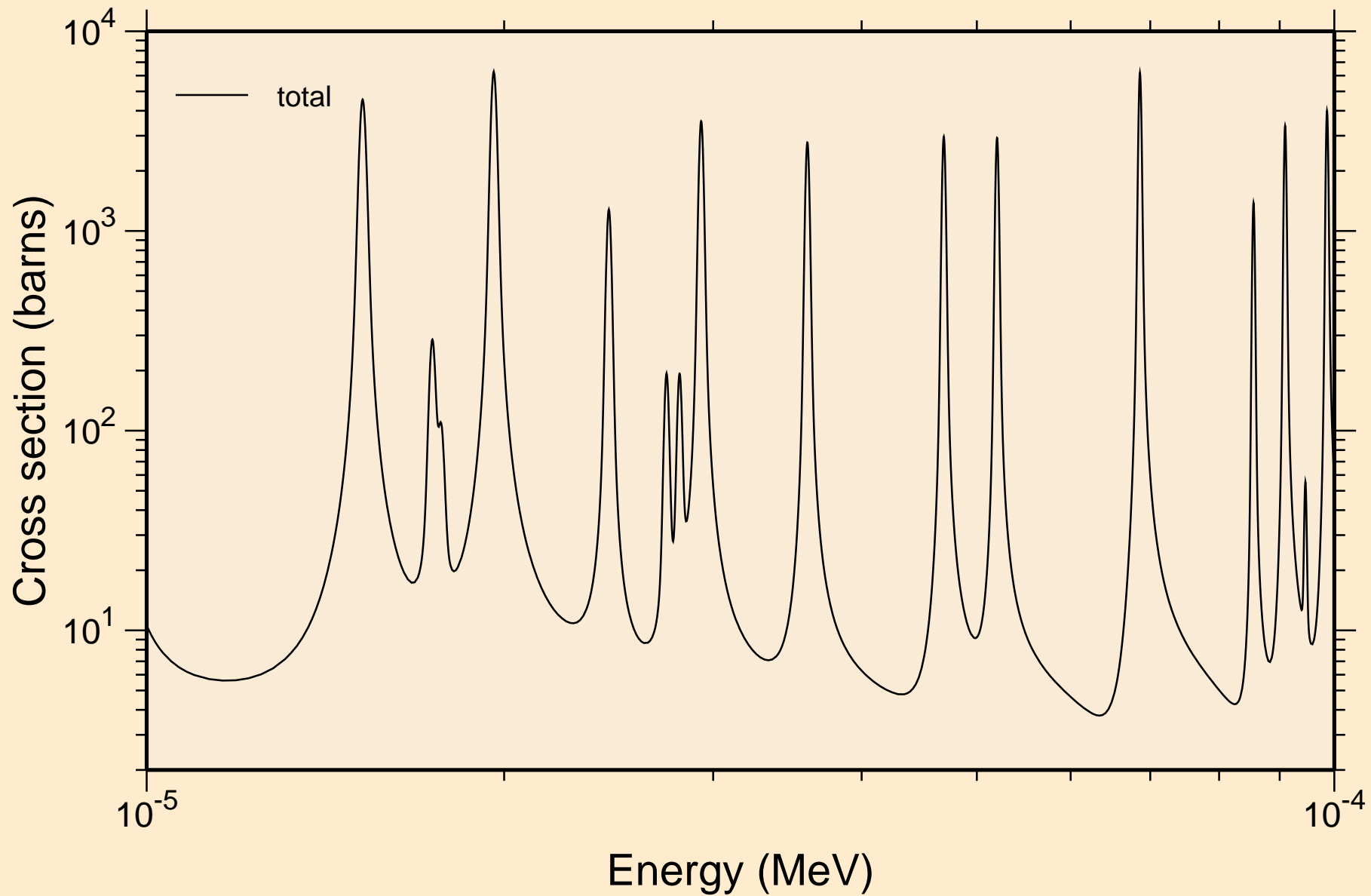

N-DY156 NRG TENDL-2018, AKONING
resonance total cross section

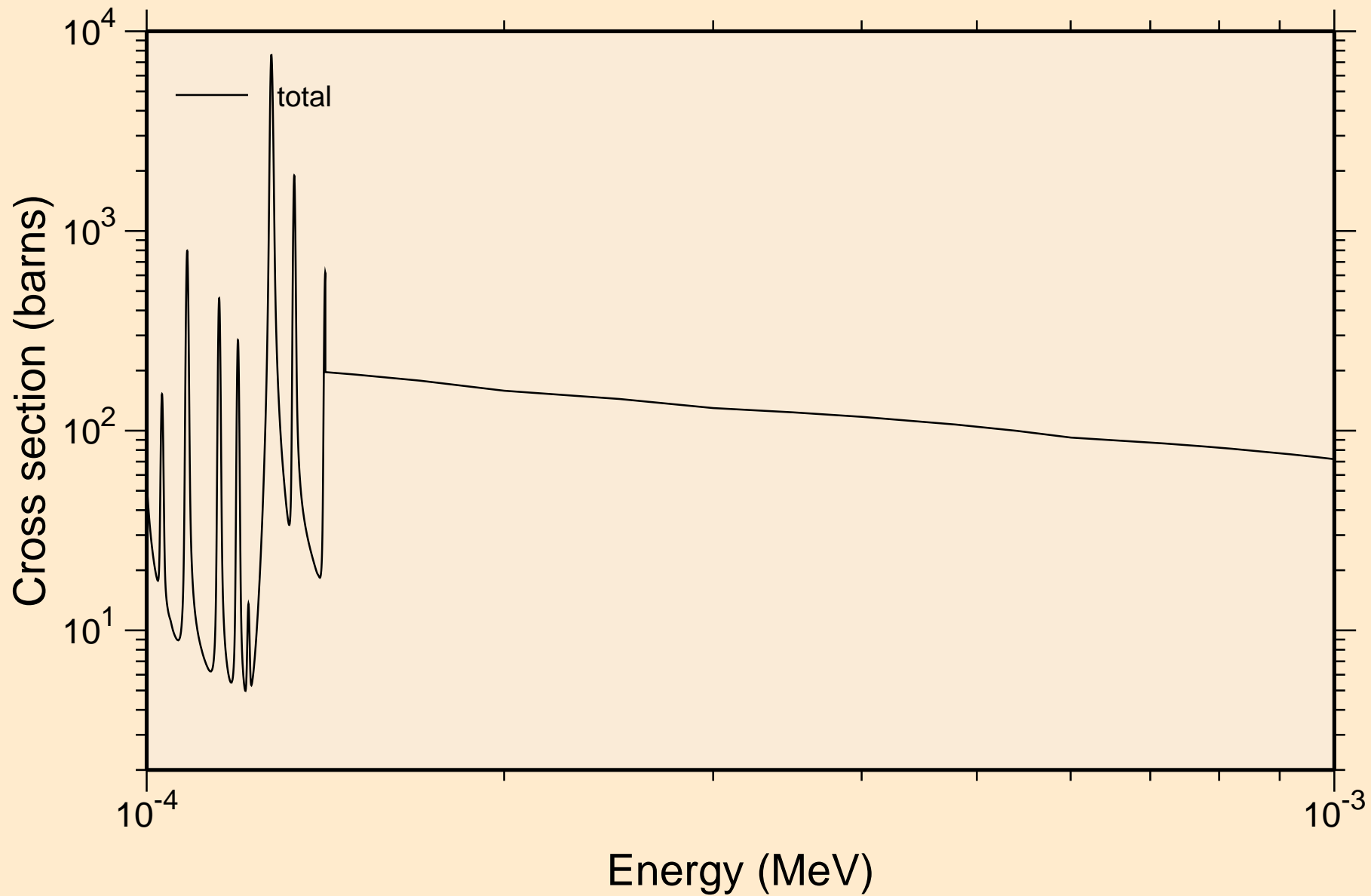

N-DY156 NRG TENDL-2018, AKONING
resonance total cross section

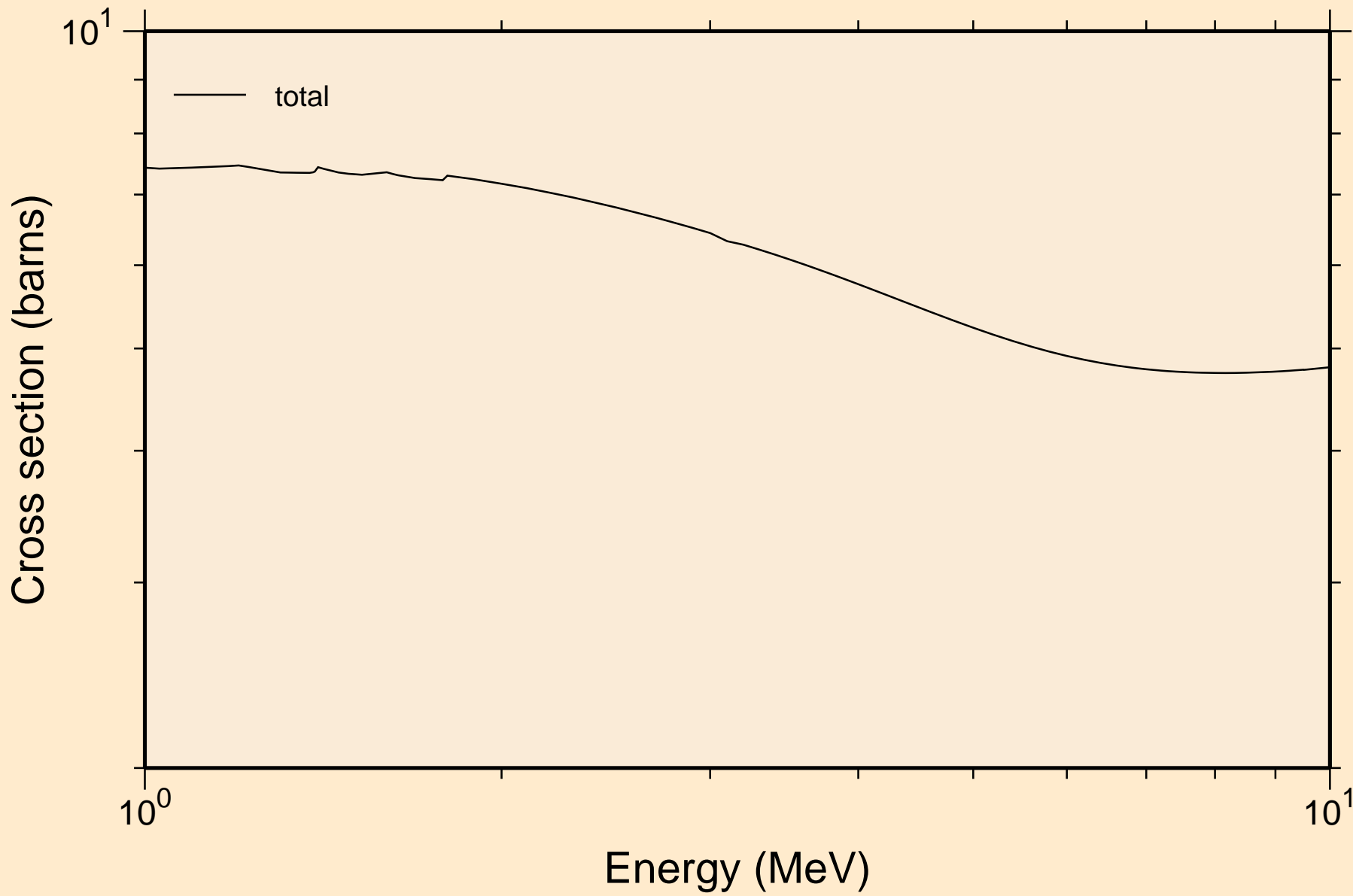

N-DY156 NRG TENDL-2018, AKONING
resonance absorption cross sections

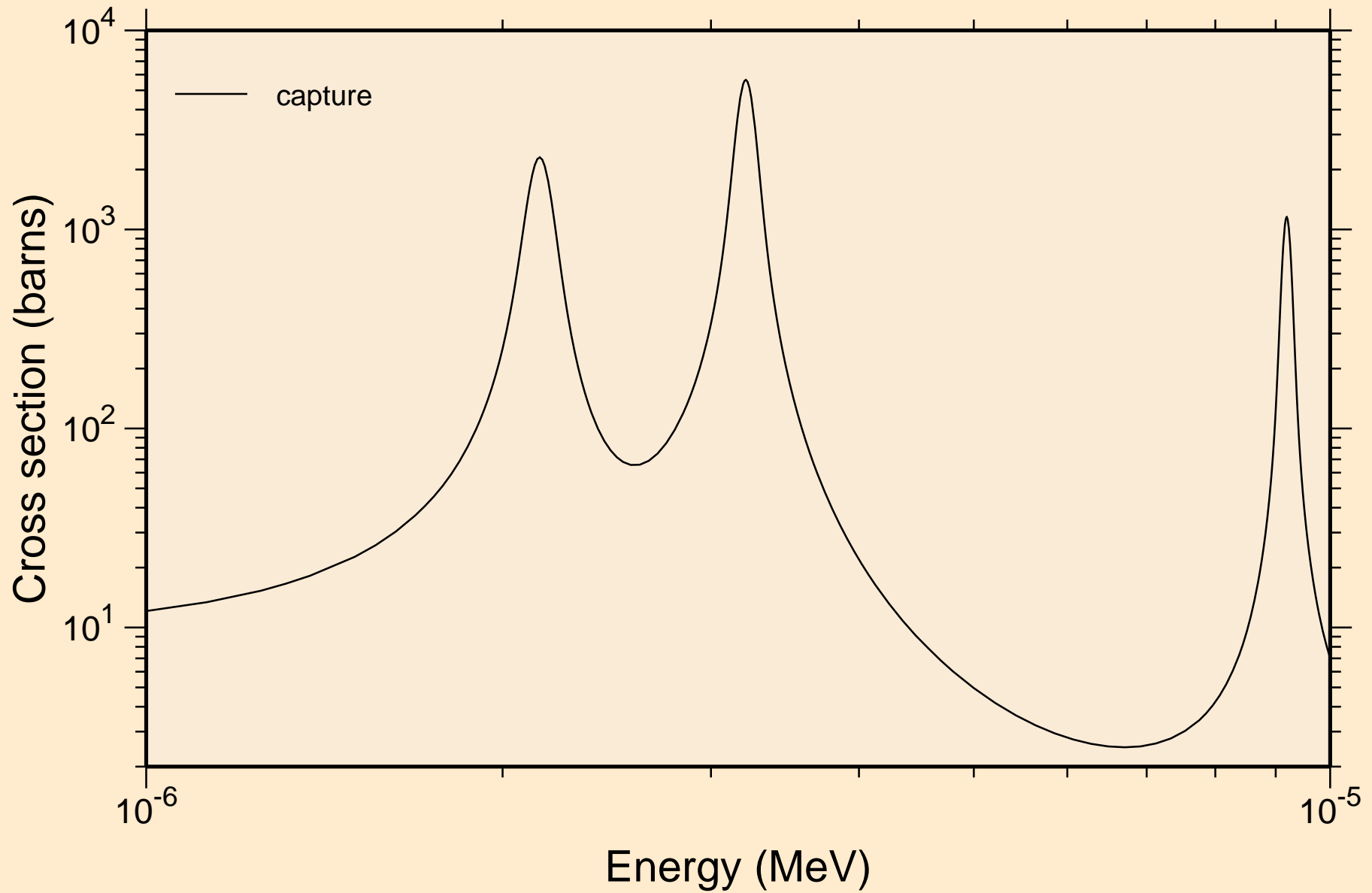

N-DY156 NRG TENDL-2018, AKONING resonance absorption cross sections

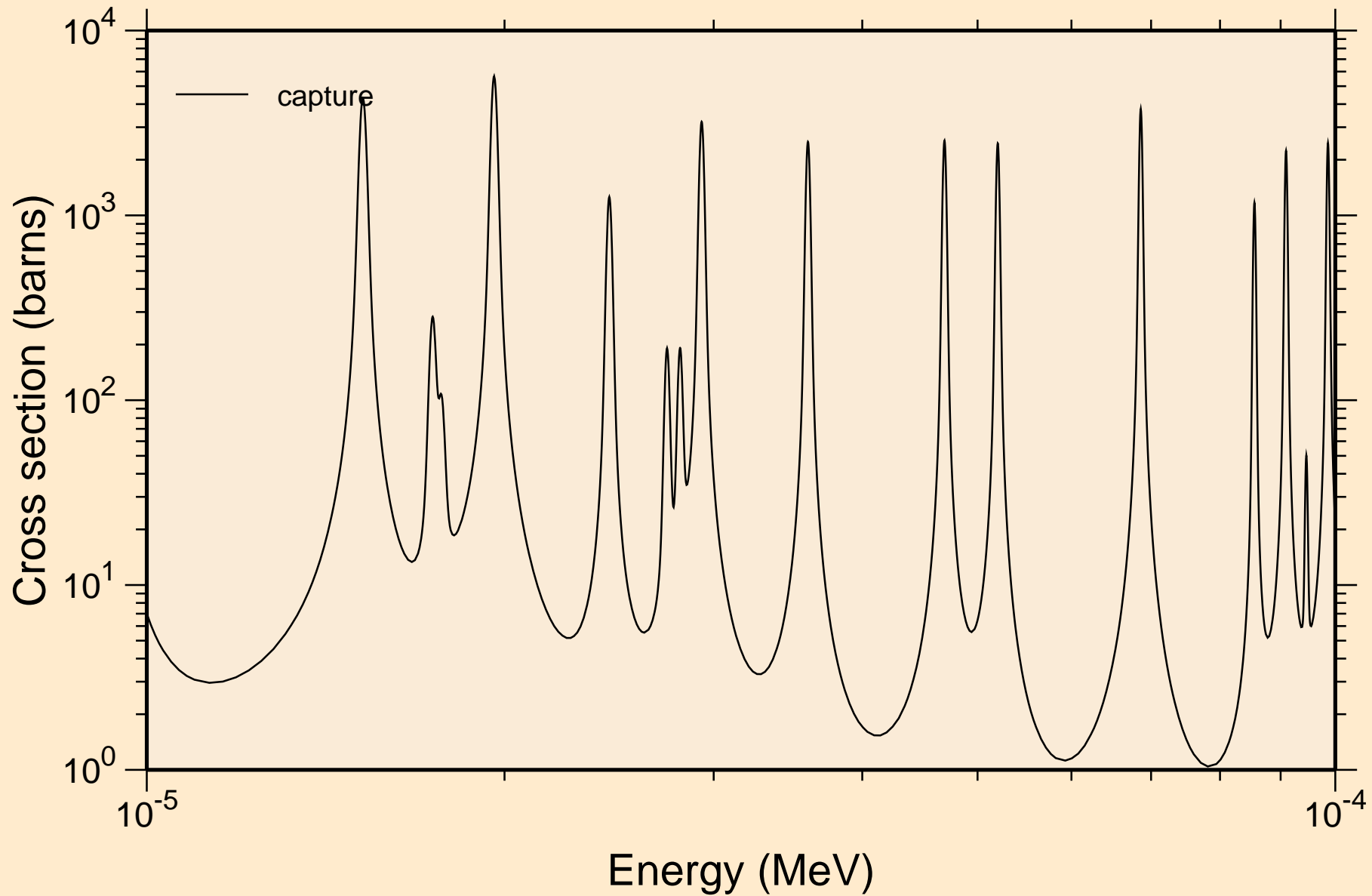

N-DY156 NRG TENDL-2018, AKONING resonance absorption cross sections

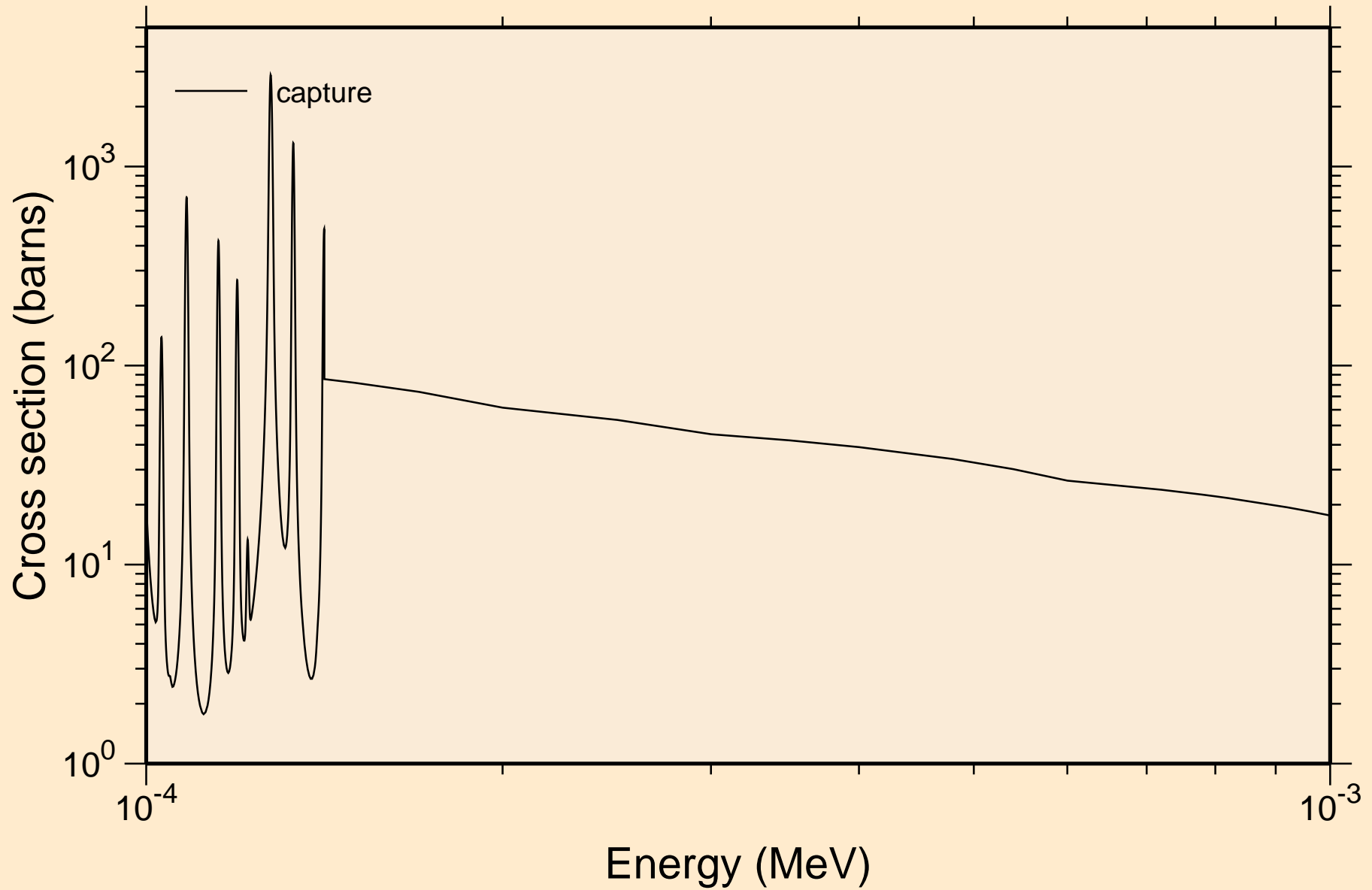

N-DY156 NRG TENDL-2018, AKONING
resonance absorption cross sections

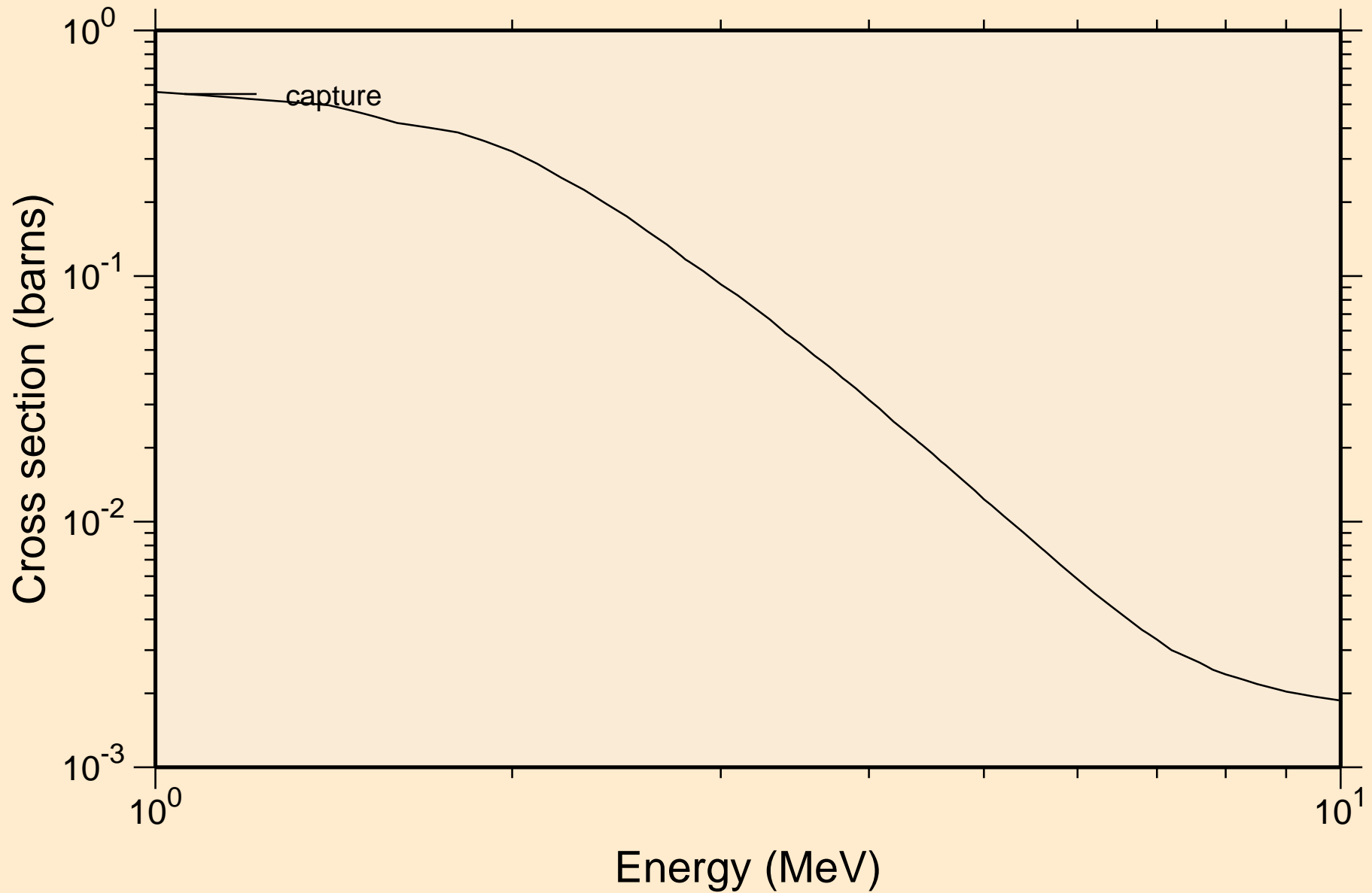

N-DY156 NRG TENDL-2018, AKONING

Non-threshold reactions

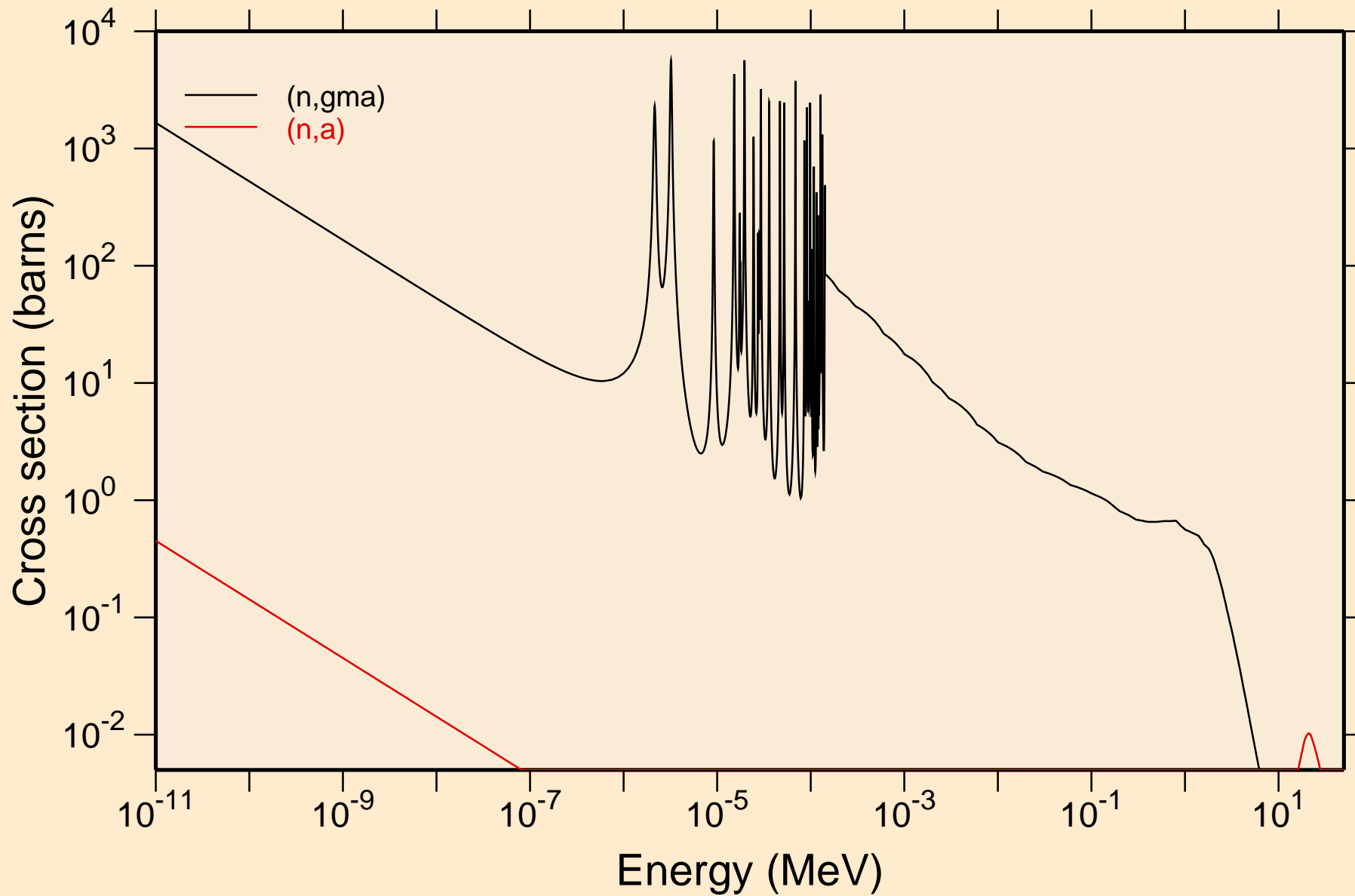

N-DY156 NRG TENDL-2018, AKONING

Principal cross sections

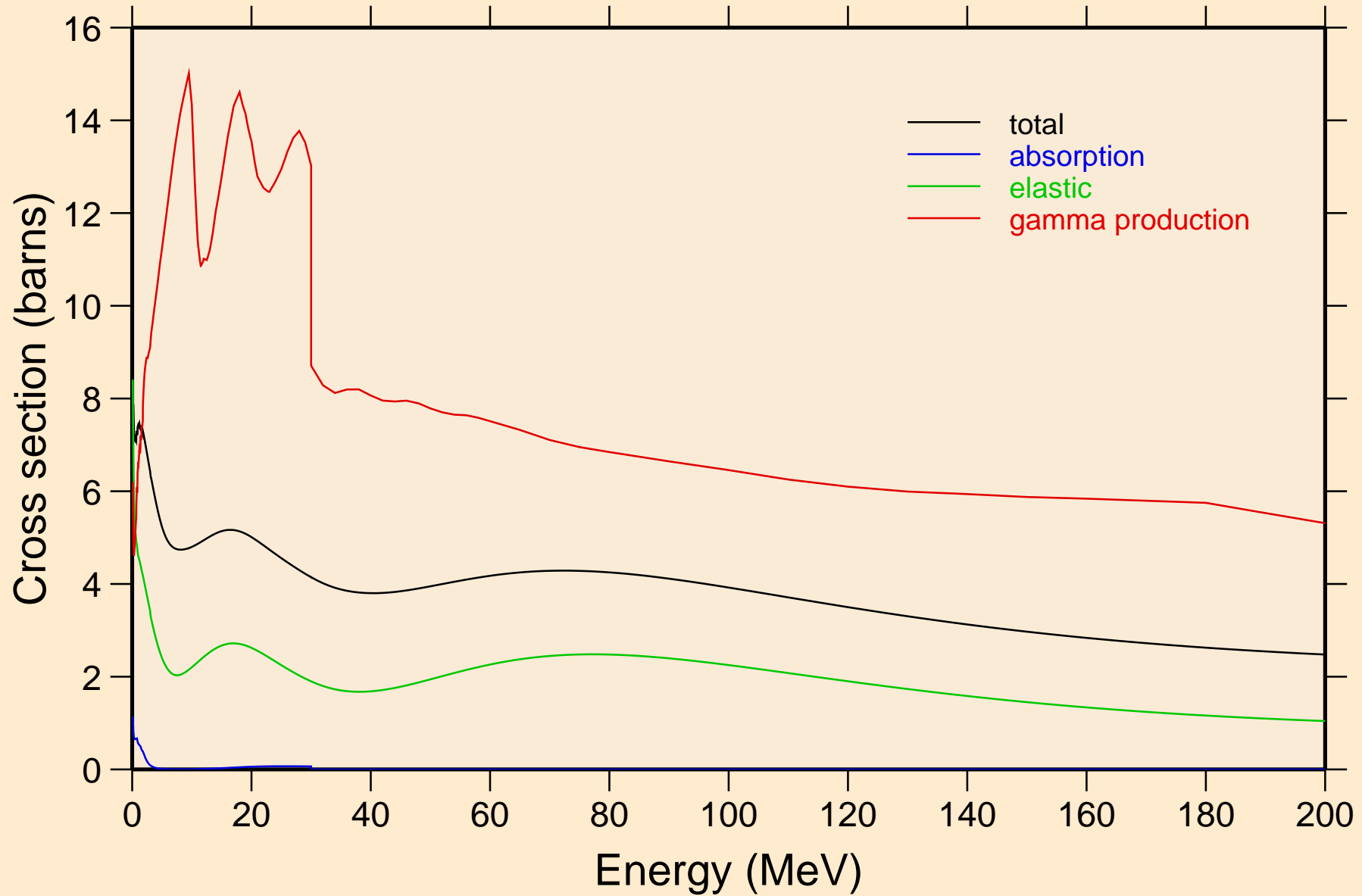

N-DY156 NRG TENDL-2018, AKONING

Non-threshold reactions

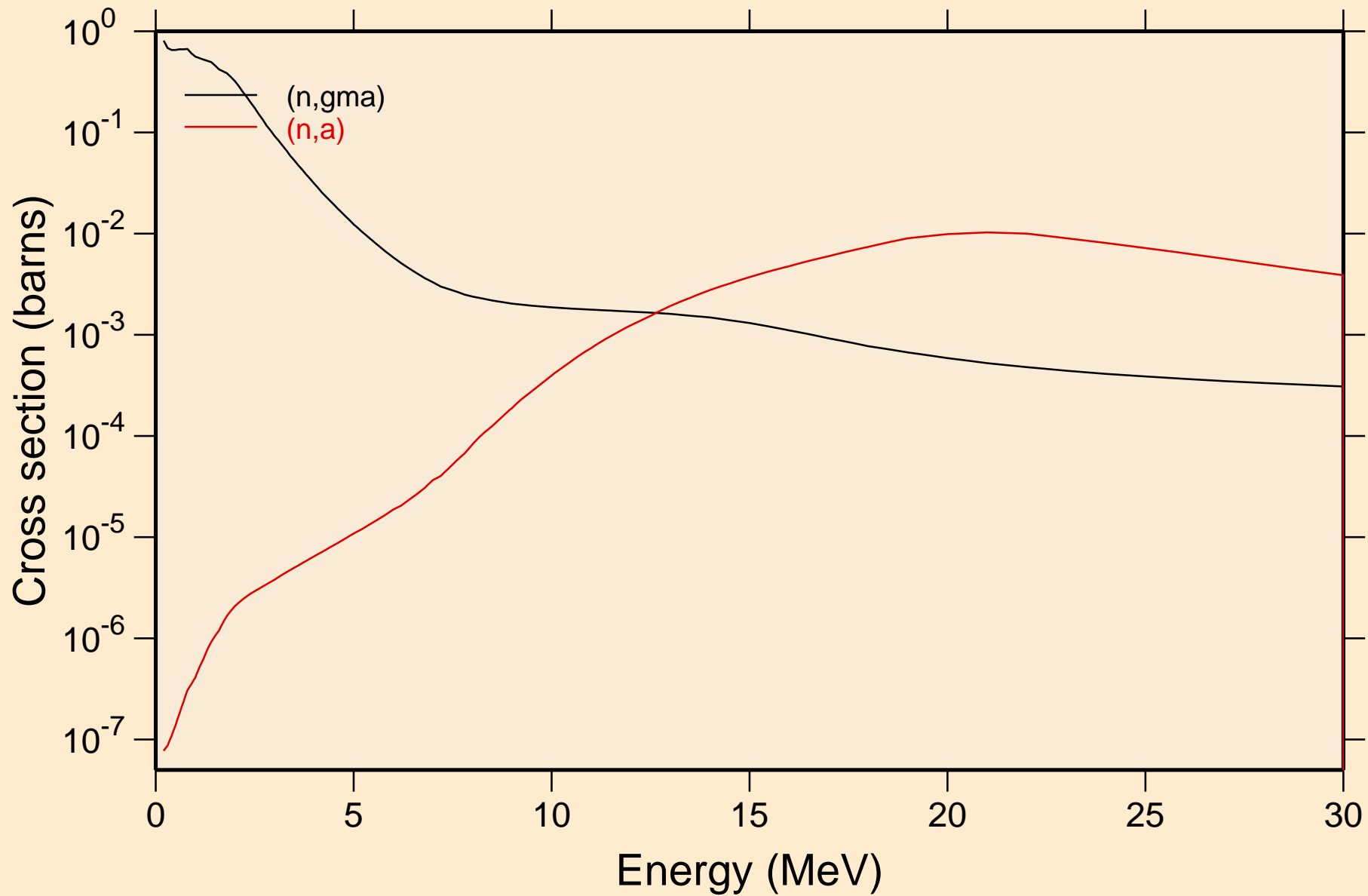

N-DY156 NRG TENDL-2018, AKONING

Inelastic levels

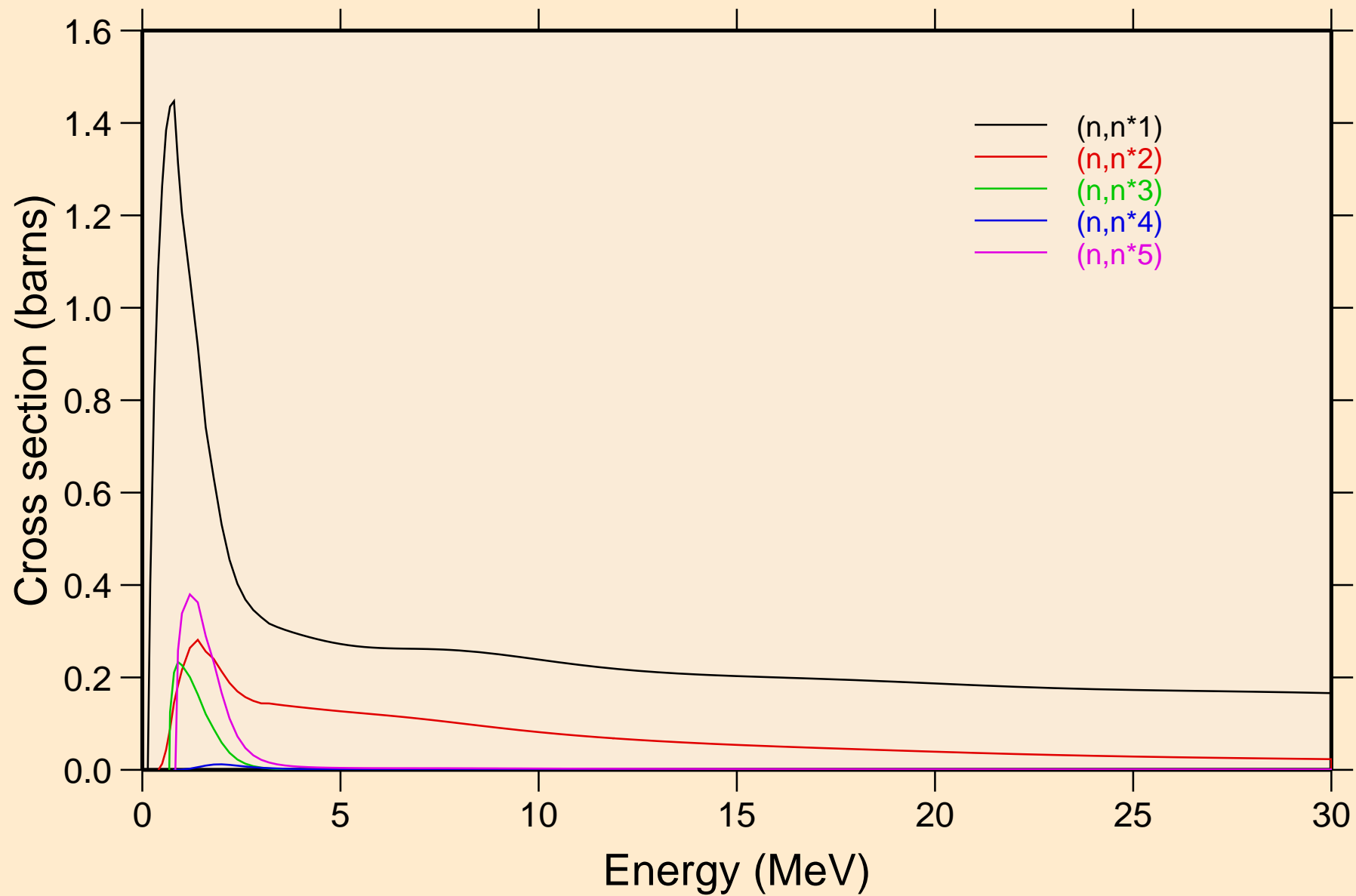

N-DY156 NRG TENDL-2018, AKONING

Inelastic levels

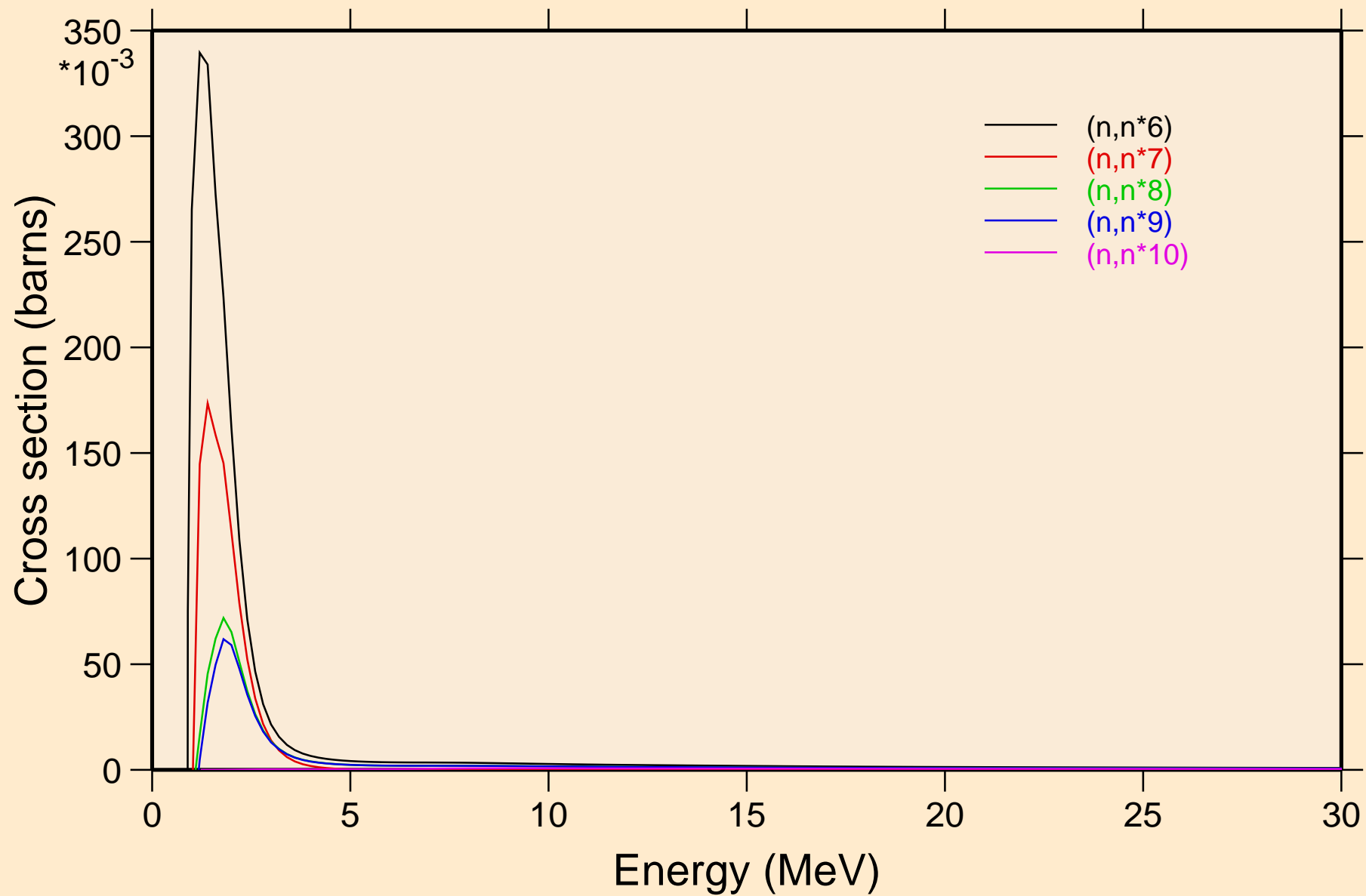

N-DY156 NRG TENDL-2018, AKONING

Inelastic levels

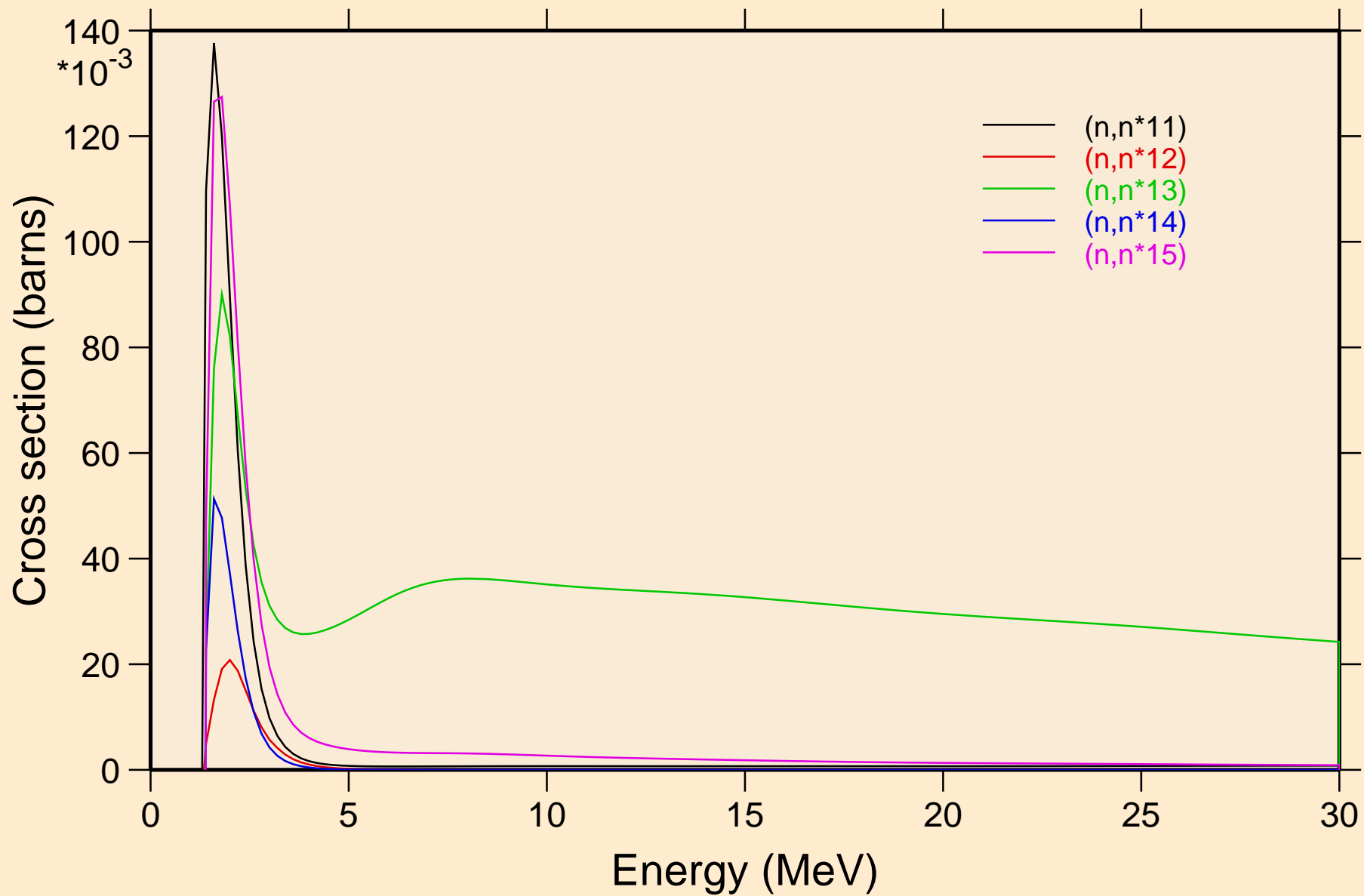

N-DY156 NRG TENDL-2018, AKONING

Inelastic levels

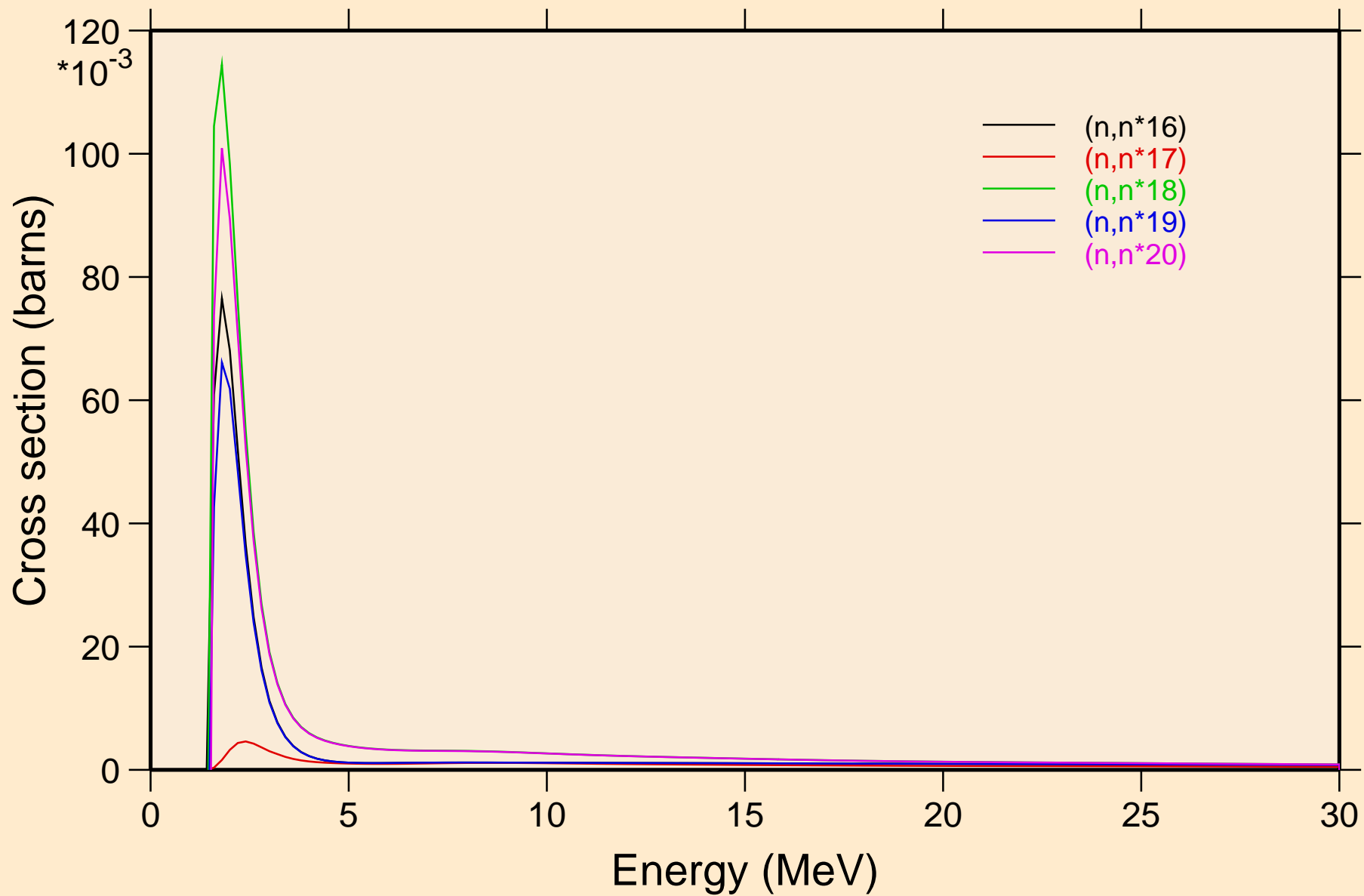

N-DY156 NRG TENDL-2018, AKONING

Inelastic levels

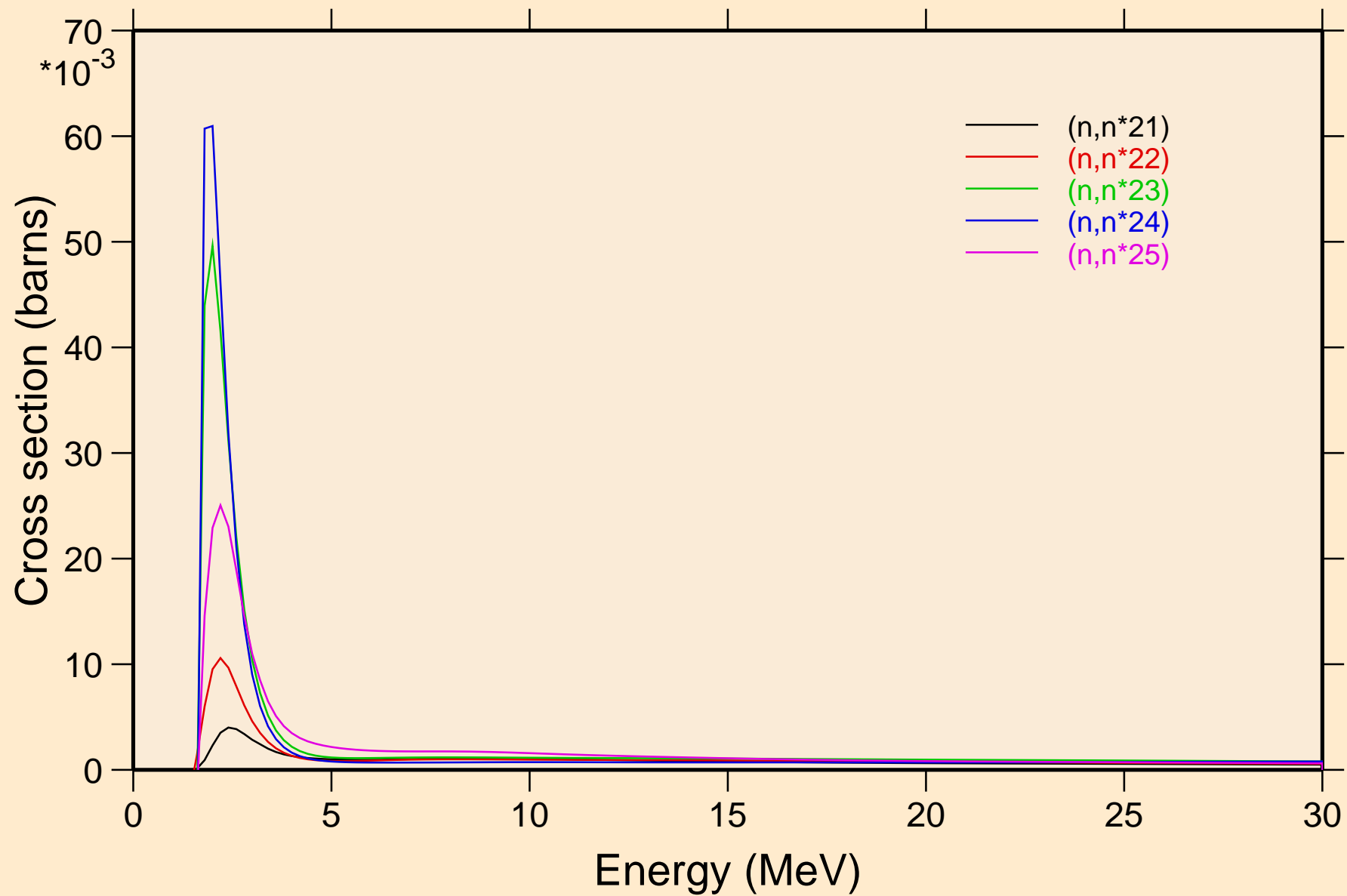

N-DY156 NRG TENDL-2018, AKONING

Inelastic levels

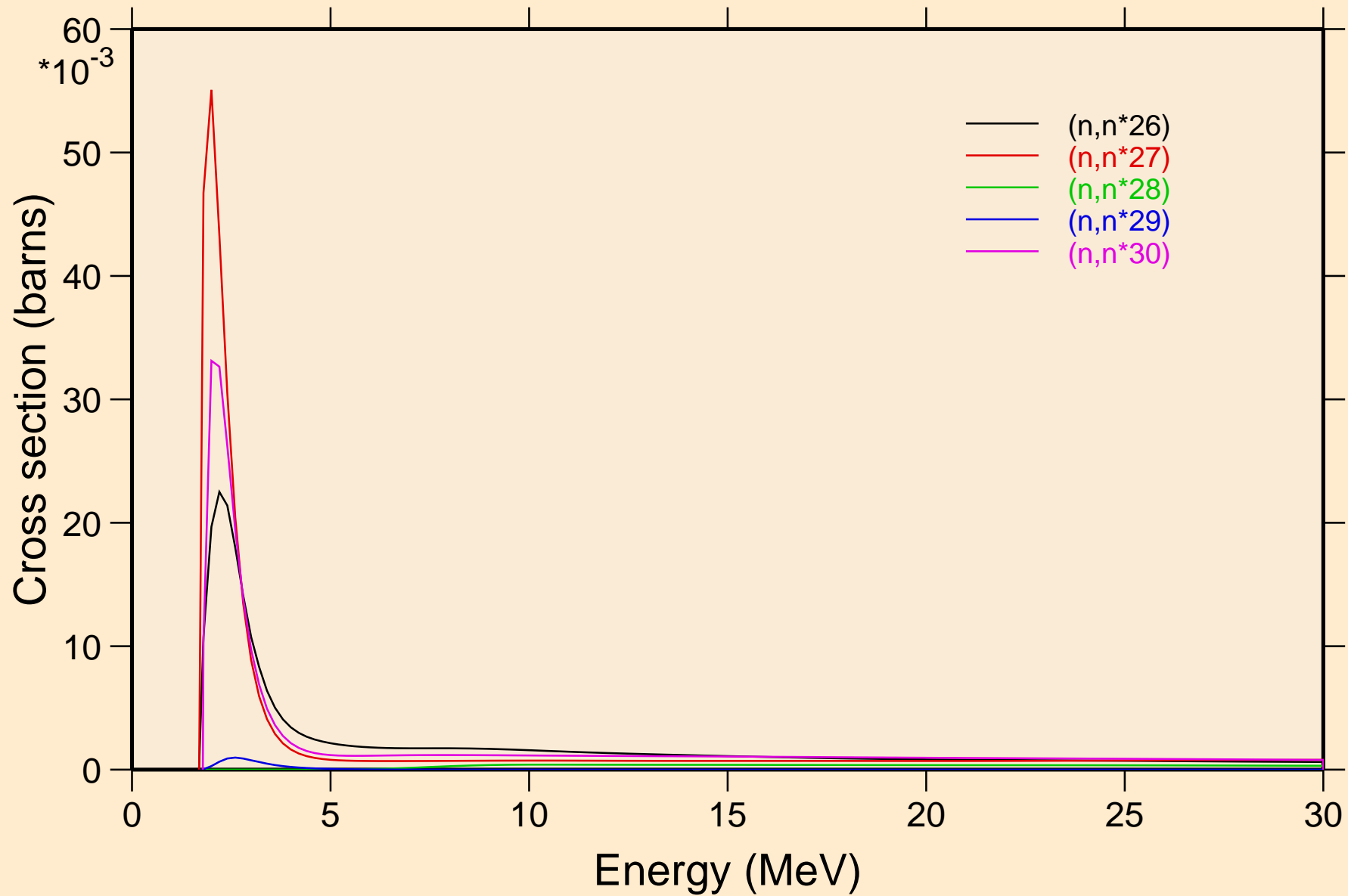

N-DY156 NRG TENDL-2018, AKONING

Threshold reactions

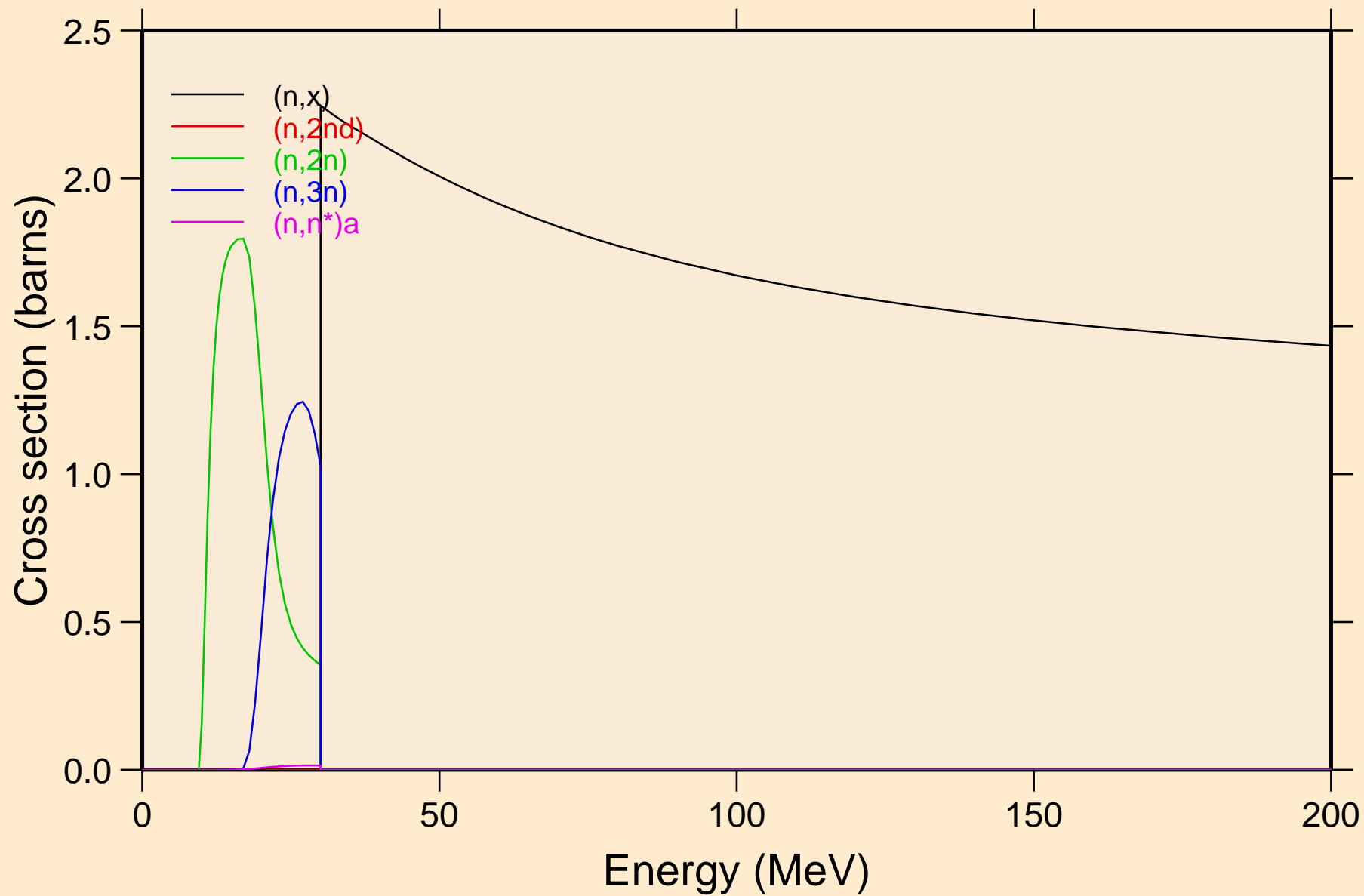

N-DY156 NRG TENDL-2018, AKONING

Threshold reactions

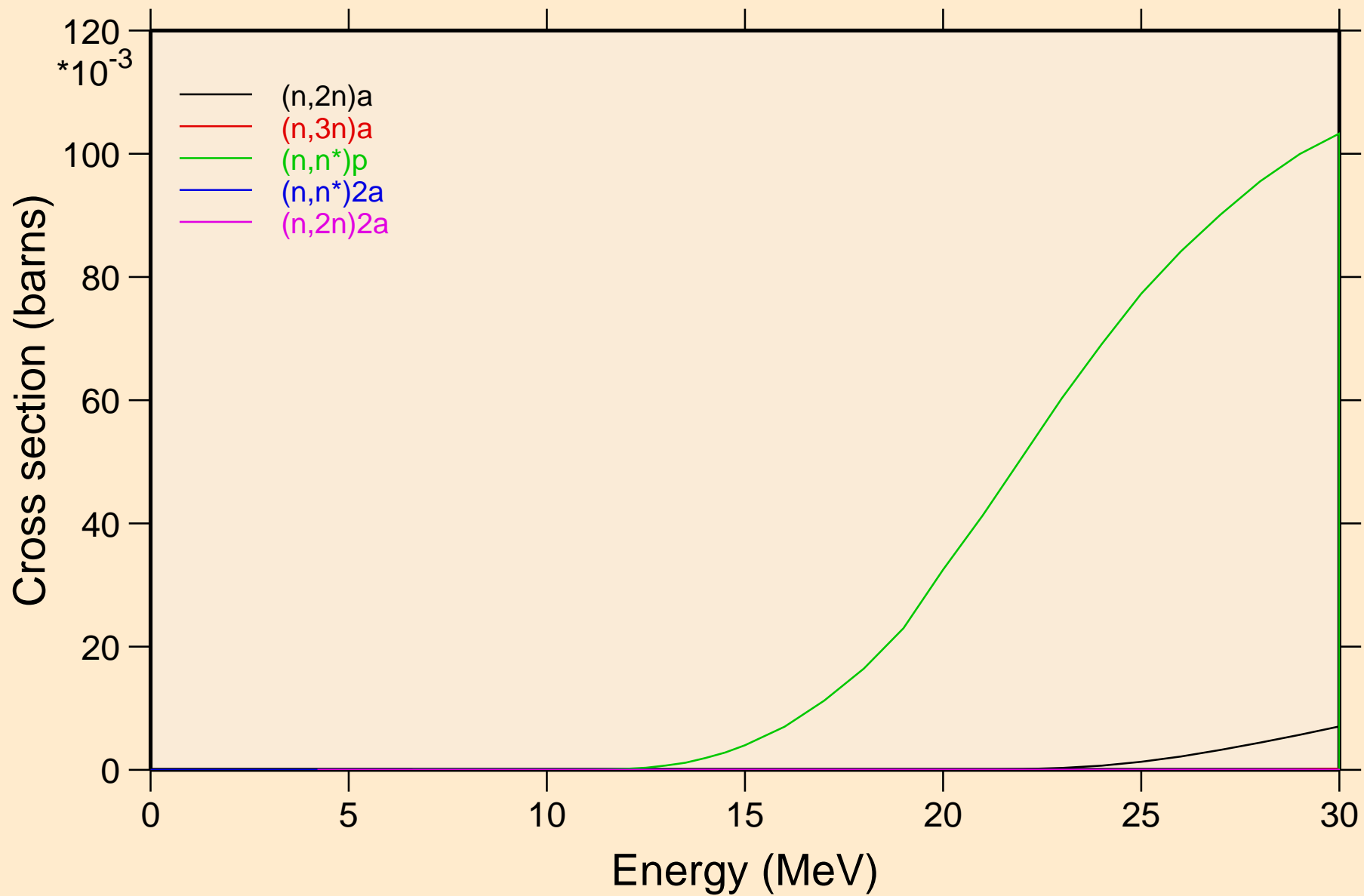

N-DY156 NRG TENDL-2018, AKONING

Threshold reactions

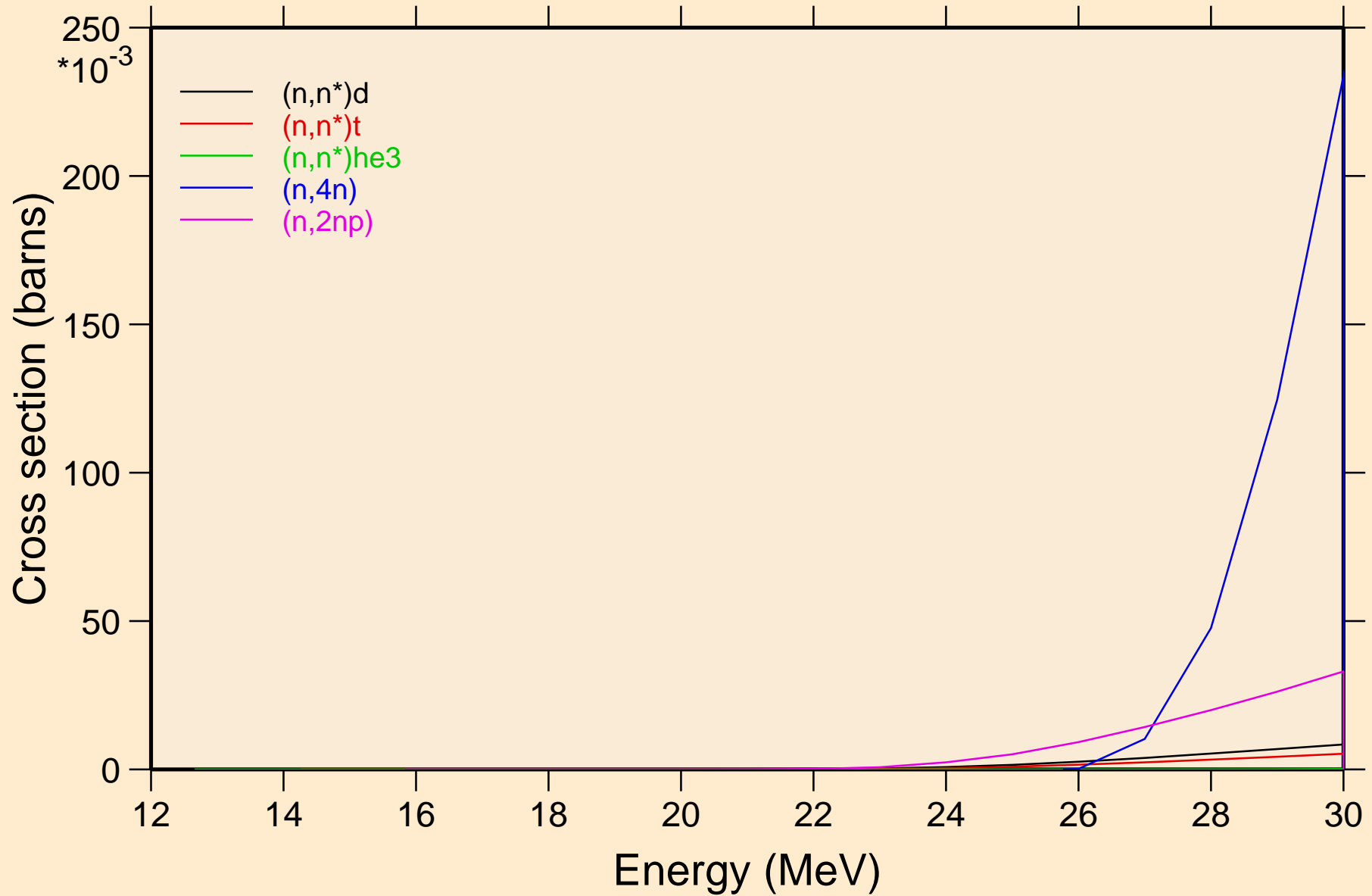

N-DY156 NRG TENDL-2018, AKONING

Threshold reactions

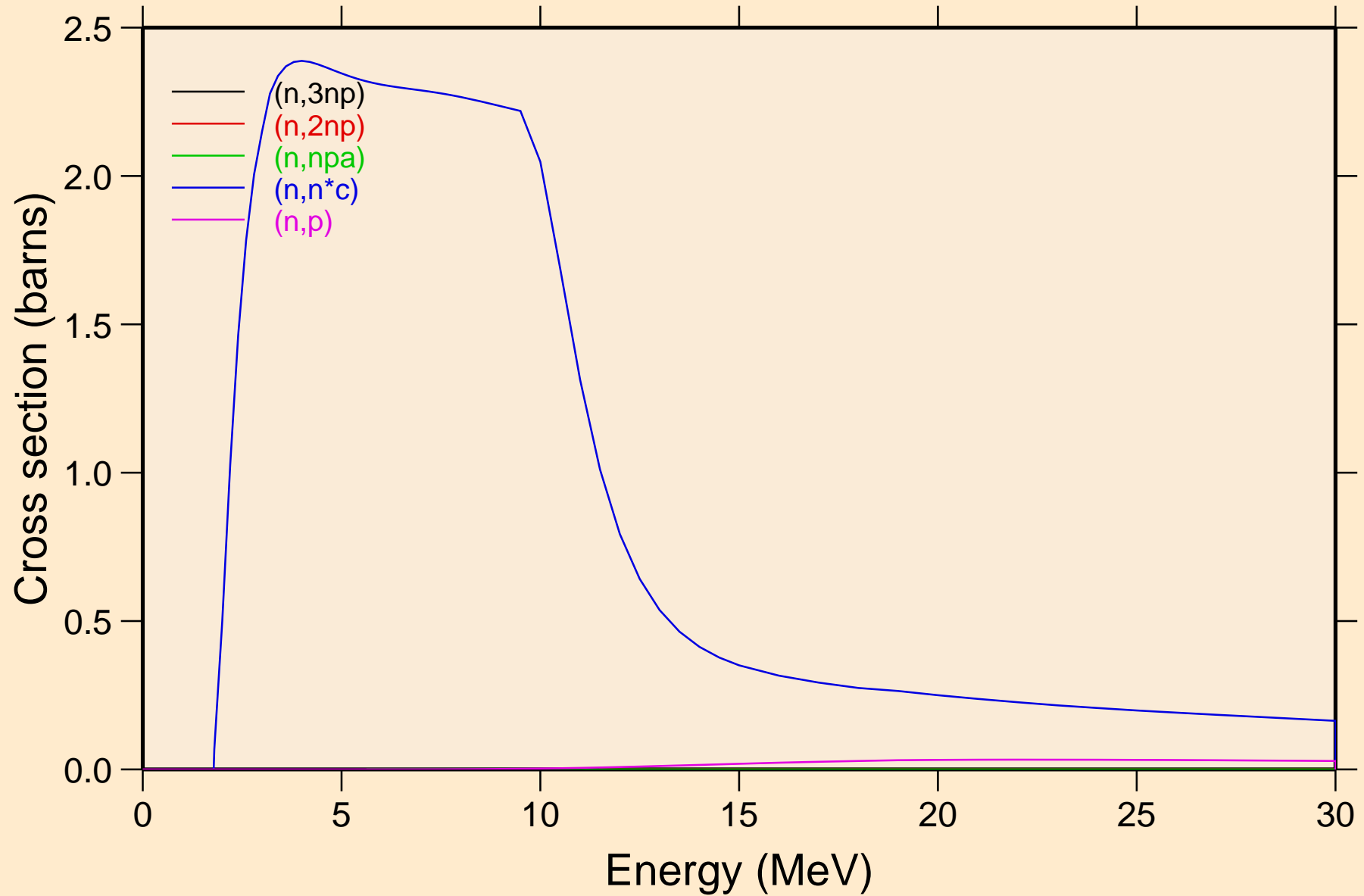

N-DY156 NRG TENDL-2018, AKONING

Threshold reactions

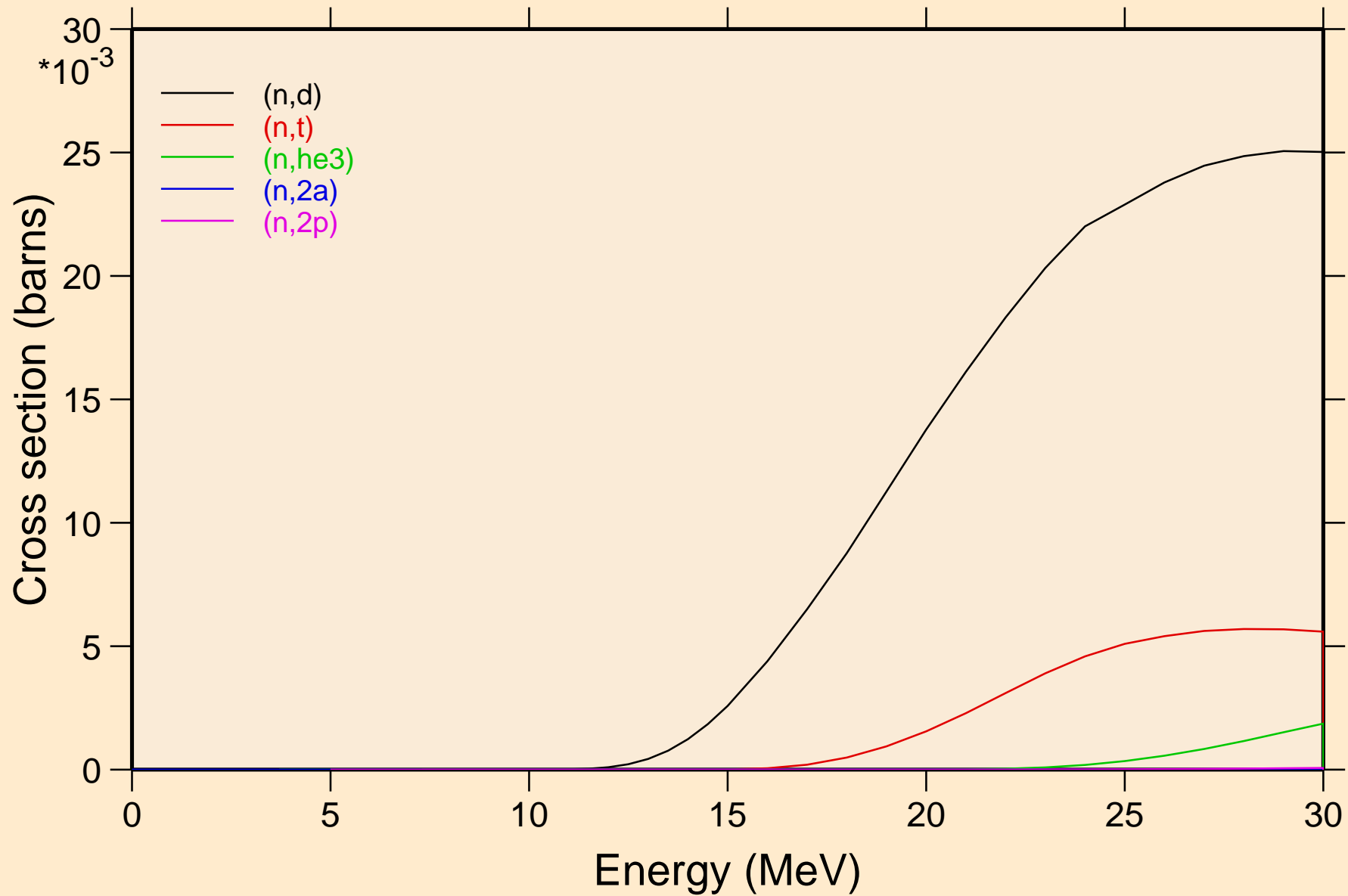

N-DY156 NRG TENDL-2018, AKONING

Threshold reactions

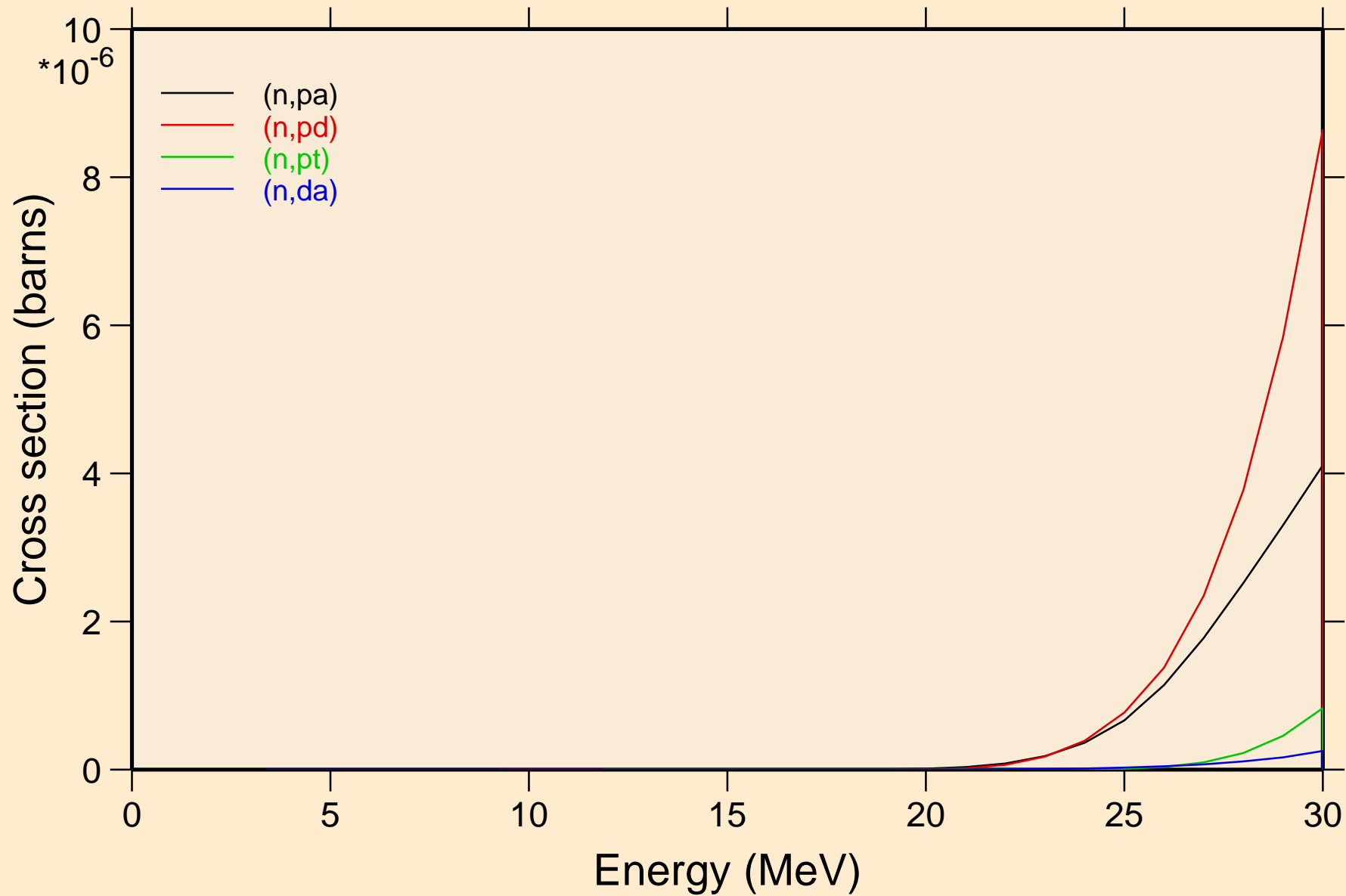

N-DY156 NRG TENDL-2018, AKONING
angular distribution for elastic

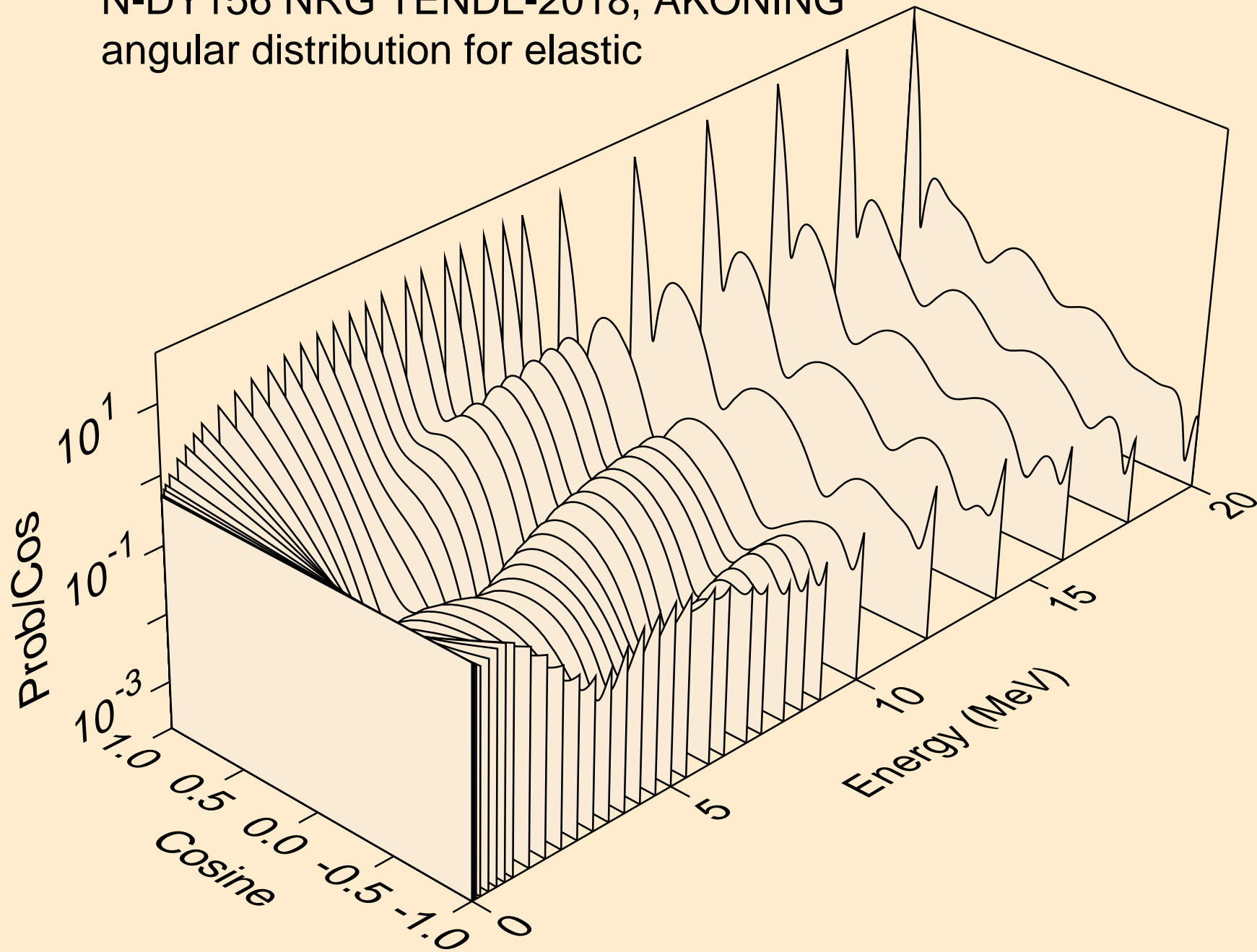

N-DY156 NRG TENDL-2018, AKONING
angular distribution for elastic

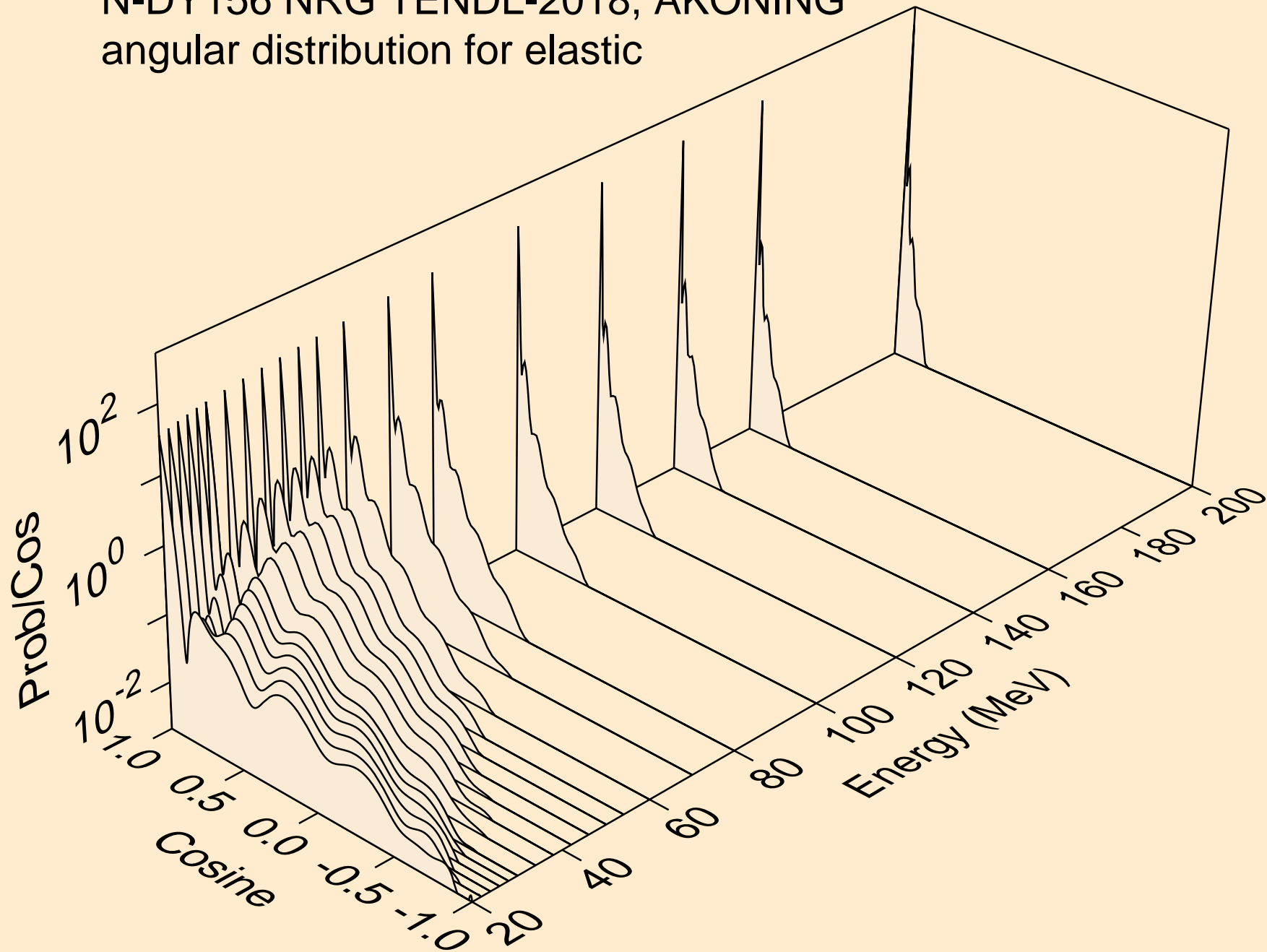

N-DY156 NRG TENDL-2018, AKONING
angular distribution for (n,n*1)

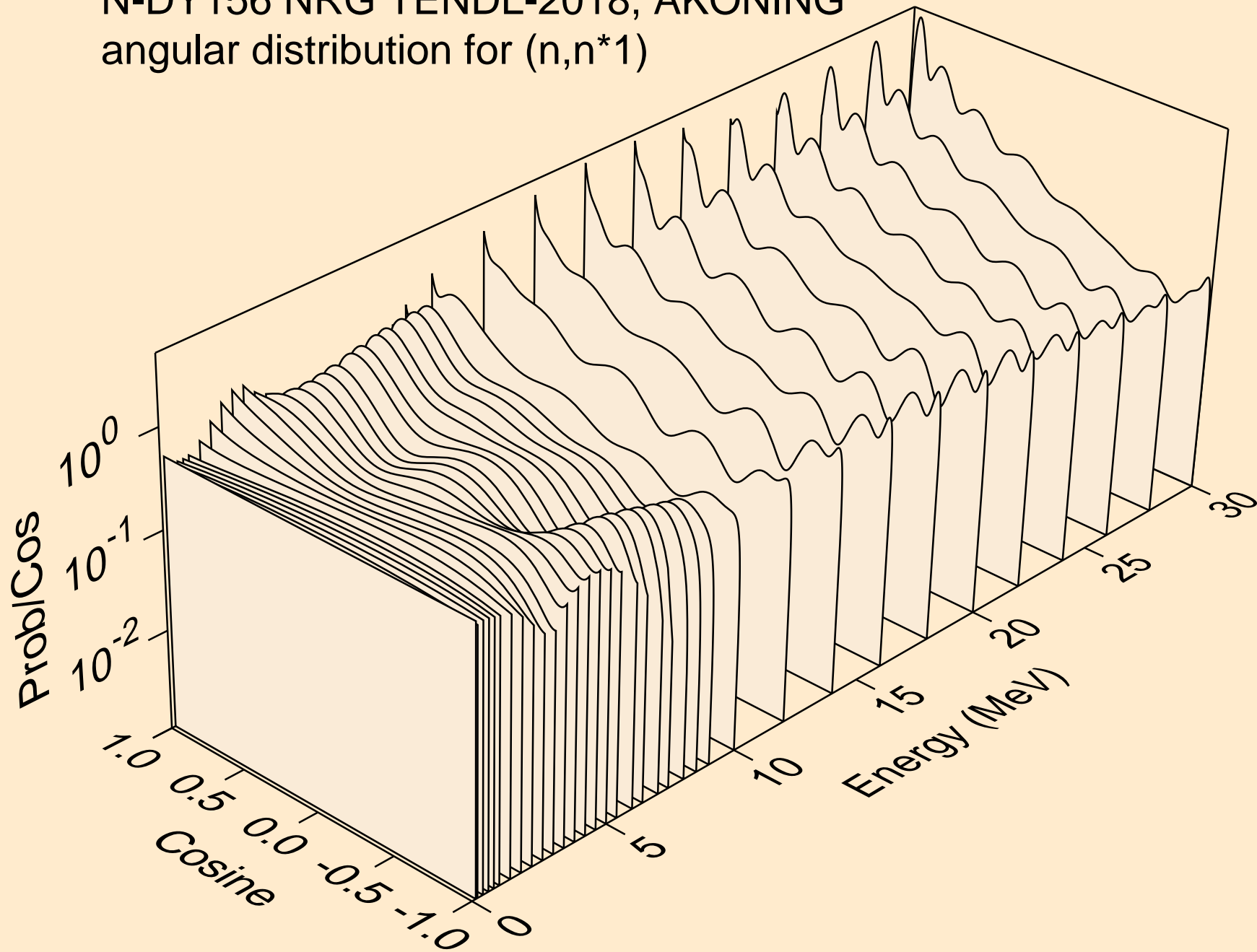

N-DY156 NRG TENDL-2018, AKONING
angular distribution for (n,n*2)

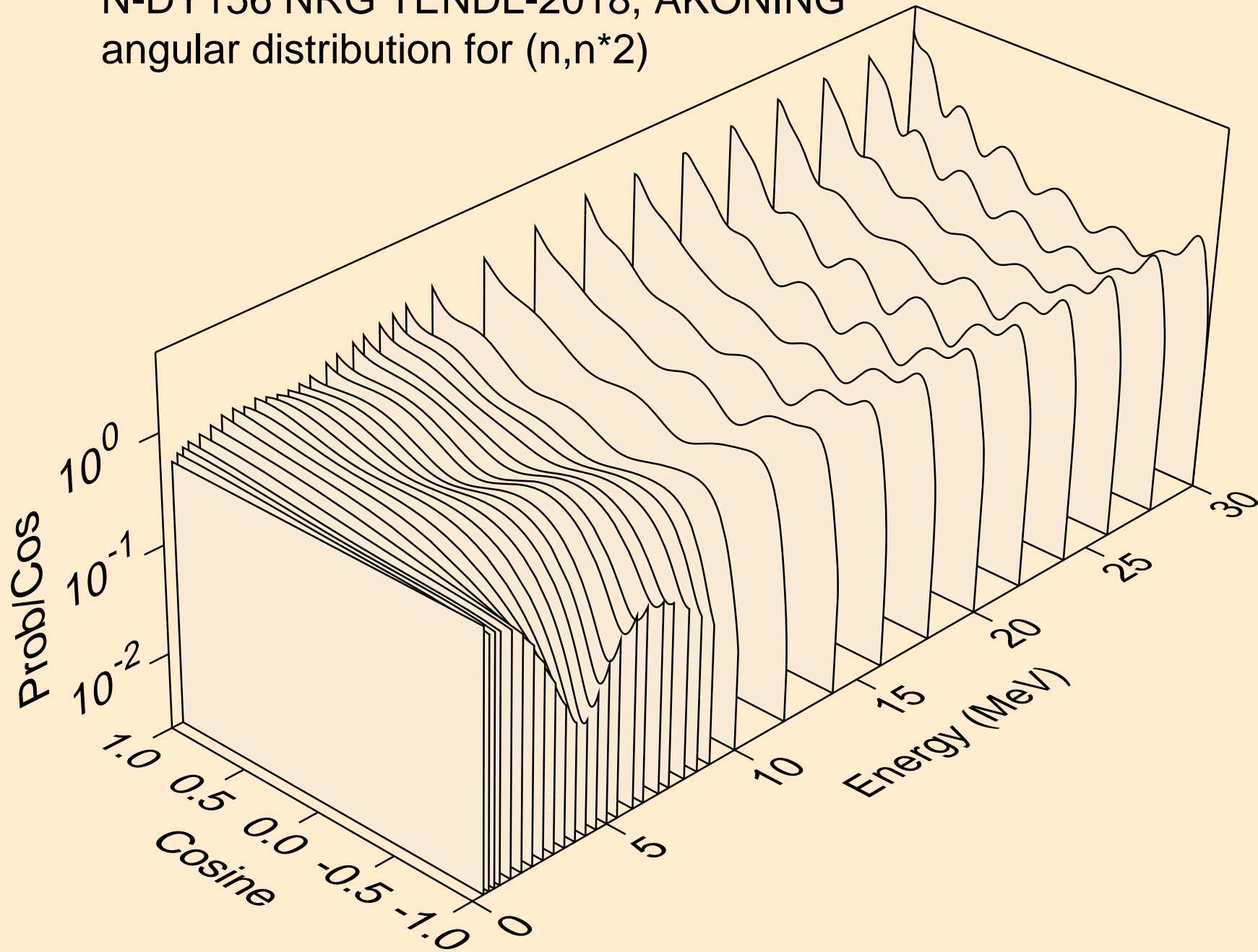

N-DY156 NRG TENDL-2018, AKONING
angular distribution for (n,n*3)

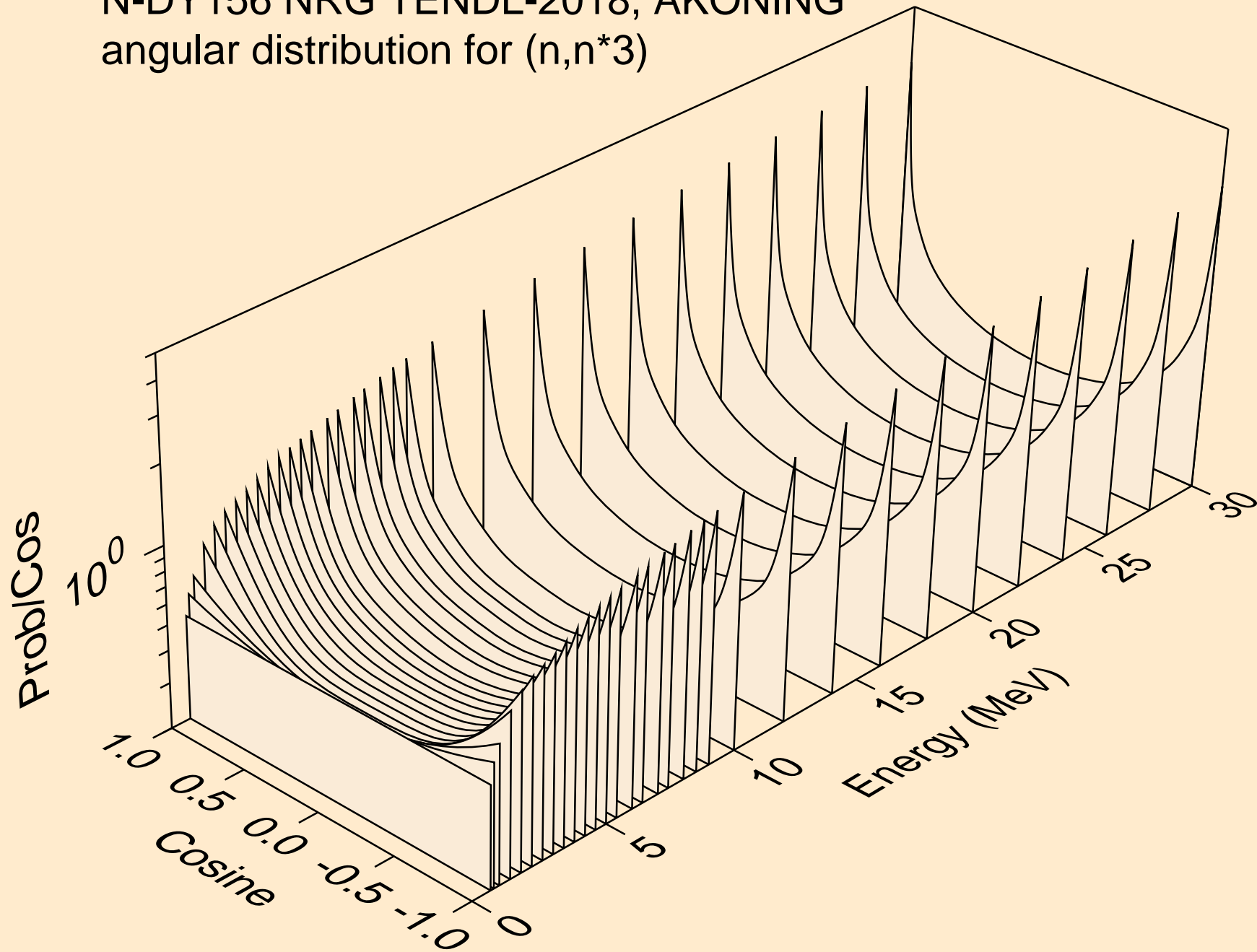

N-DY156 NRG TENDL-2018, AKONING
angular distribution for (n,n*4)

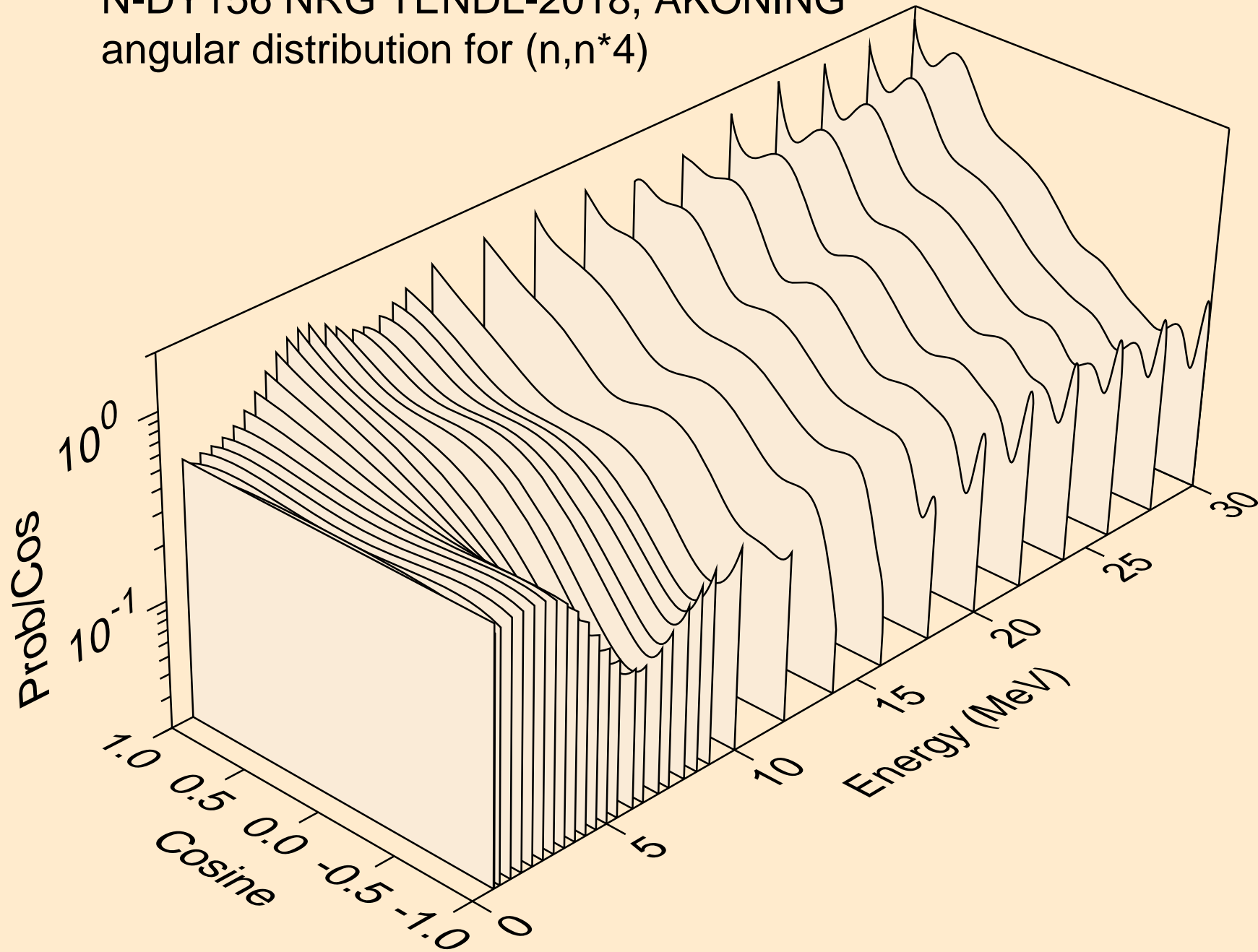

N-DY156 NRG TENDL-2018, AKONING
angular distribution for (n,n*5)

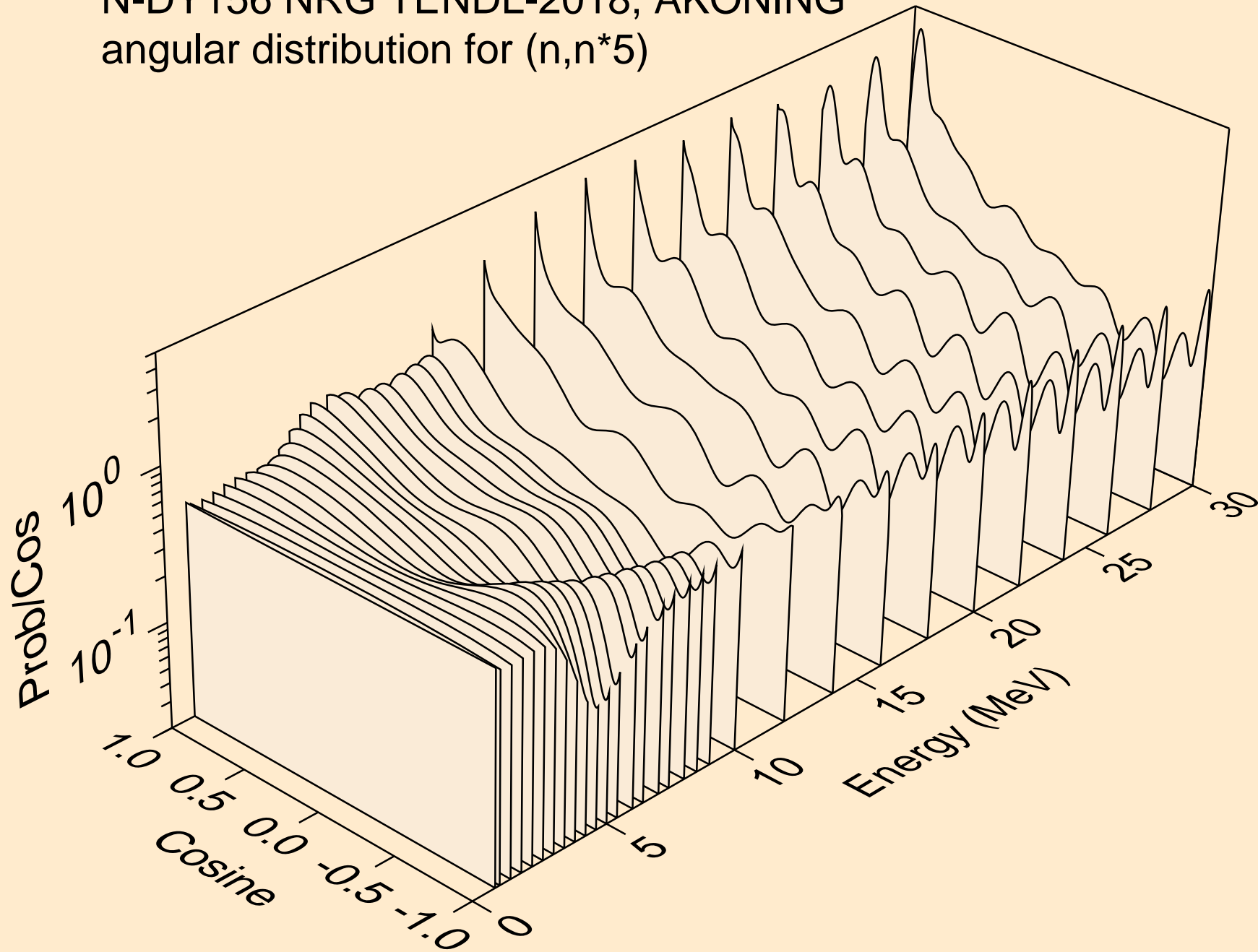

N-DY156 NRG TENDL-2018, AKONING
angular distribution for (n,n*6)

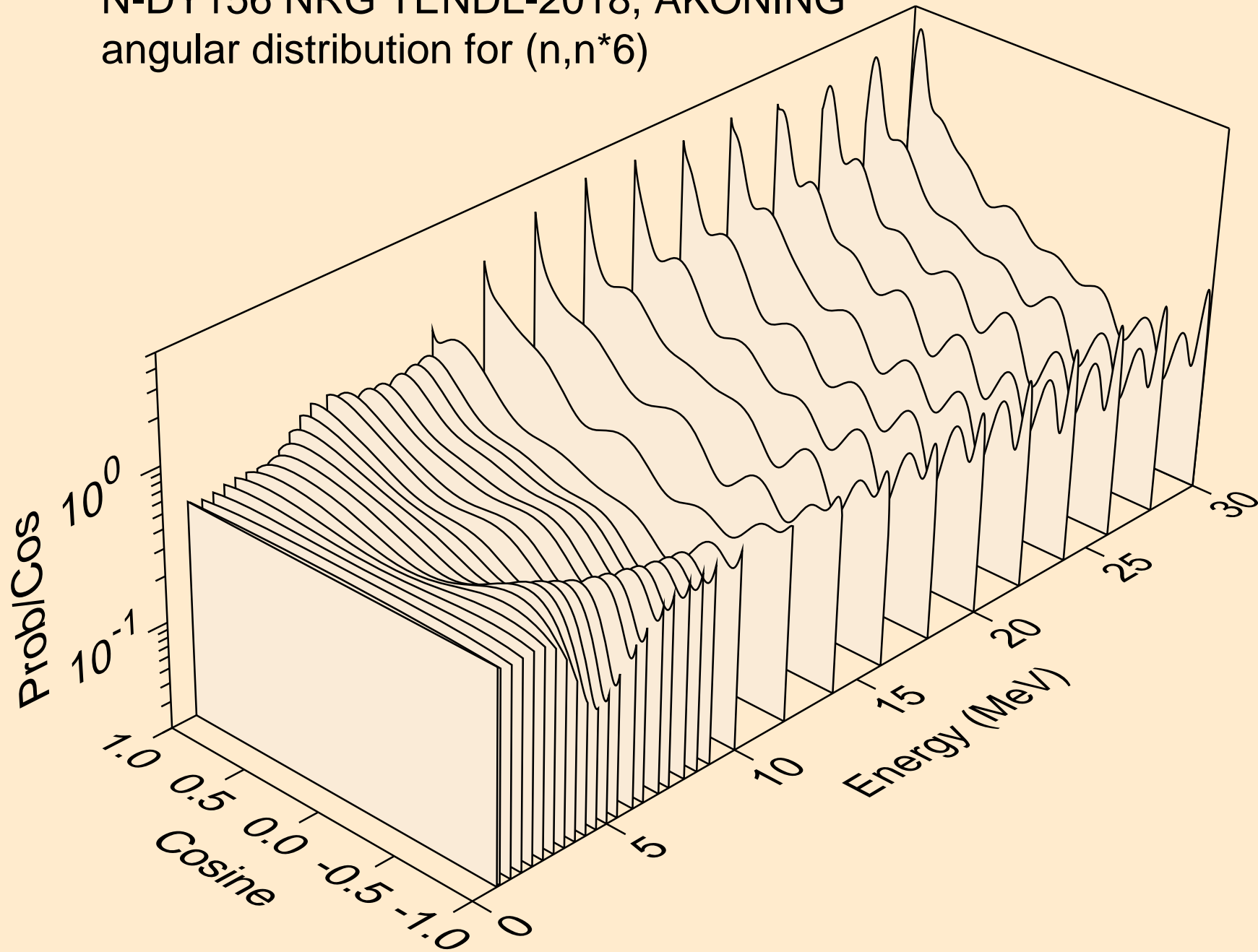

N-DY156 NRG TENDL-2018, AKONING
angular distribution for (n,n*7)

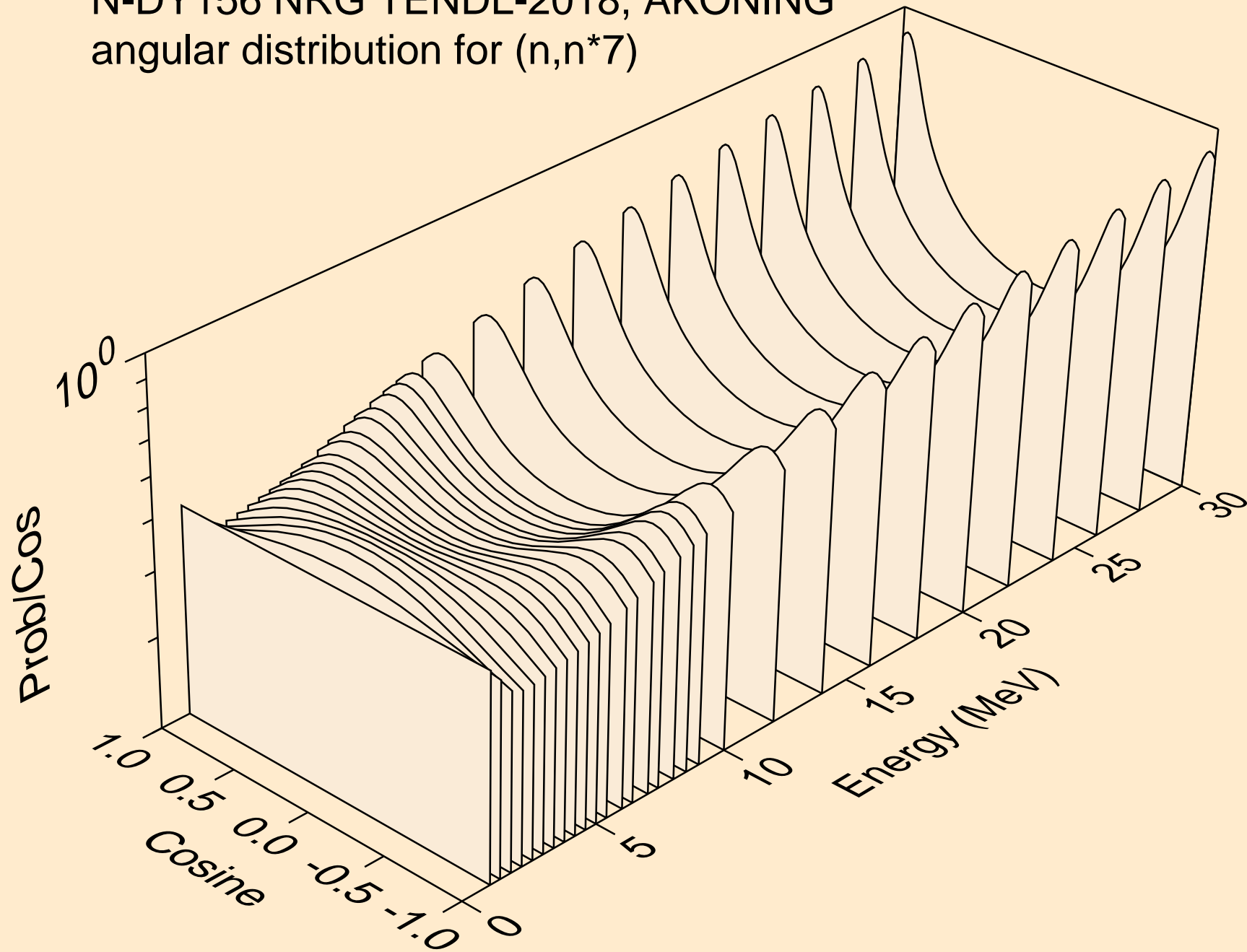

N-DY156 NRG TENDL-2018, AKONING
angular distribution for (n,n*8)

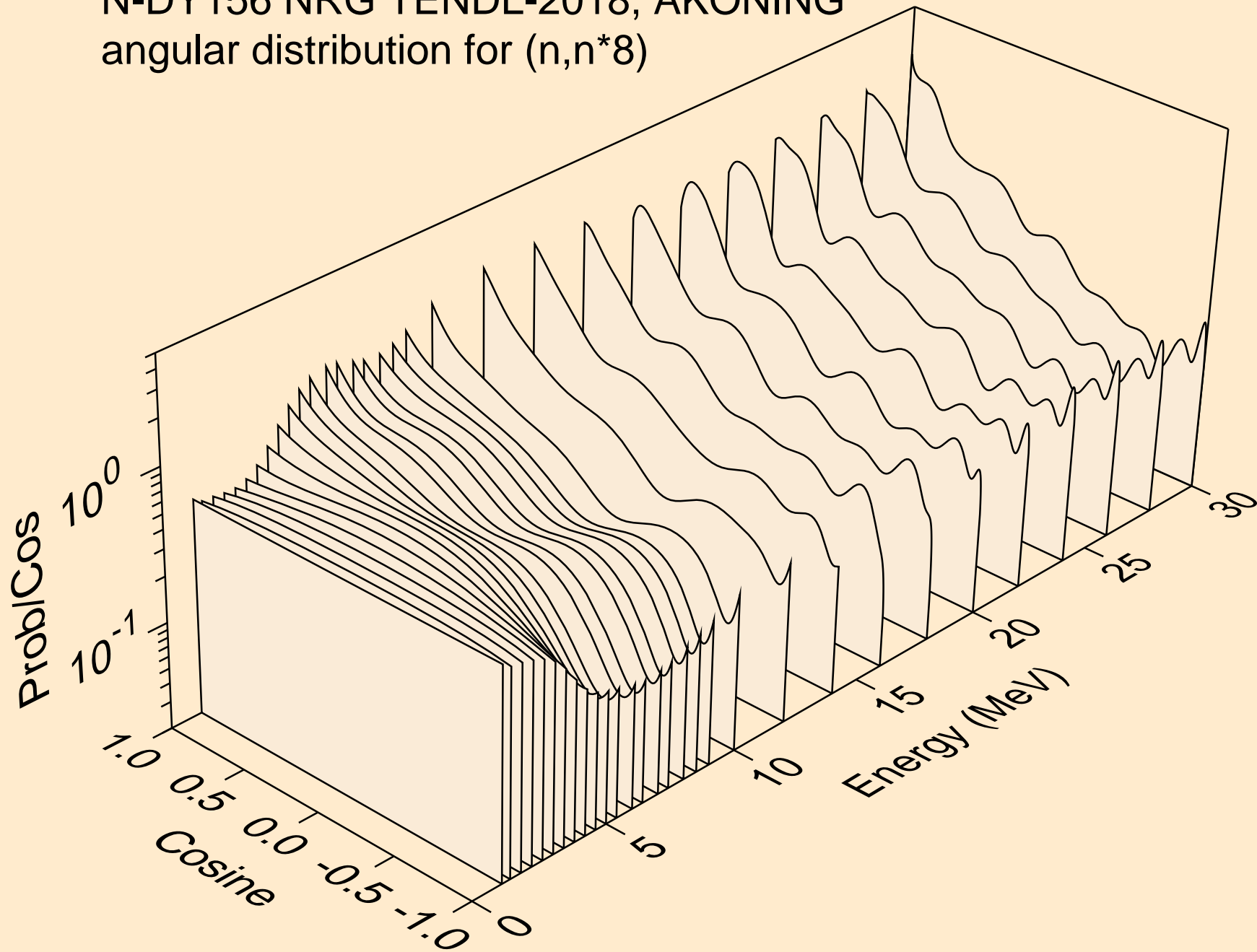

N-DY156 NRG TENDL-2018, AKONING
angular distribution for (n,n*9)

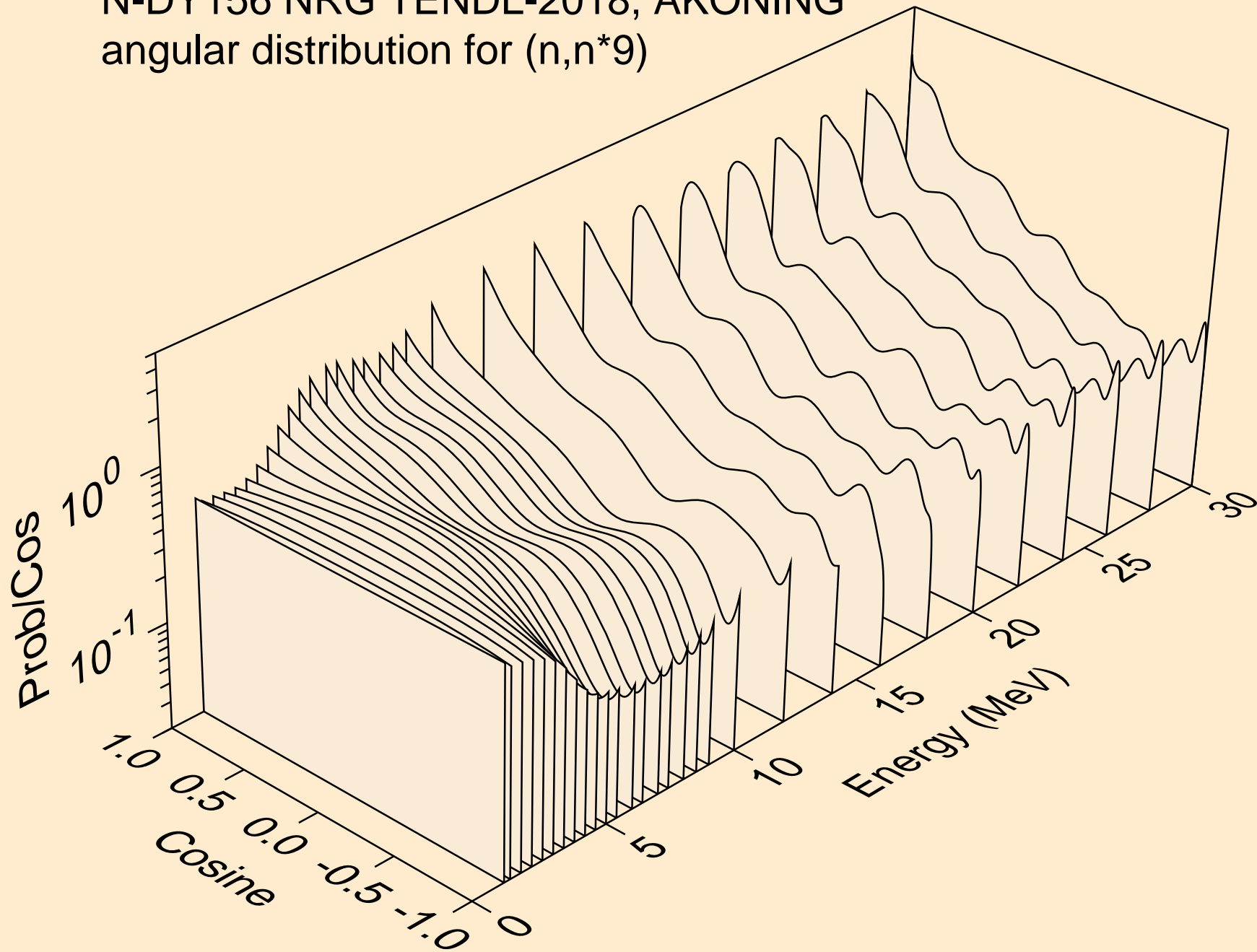

N-DY156 NRG TENDL-2018, AKONING
angular distribution for (n,n*10)

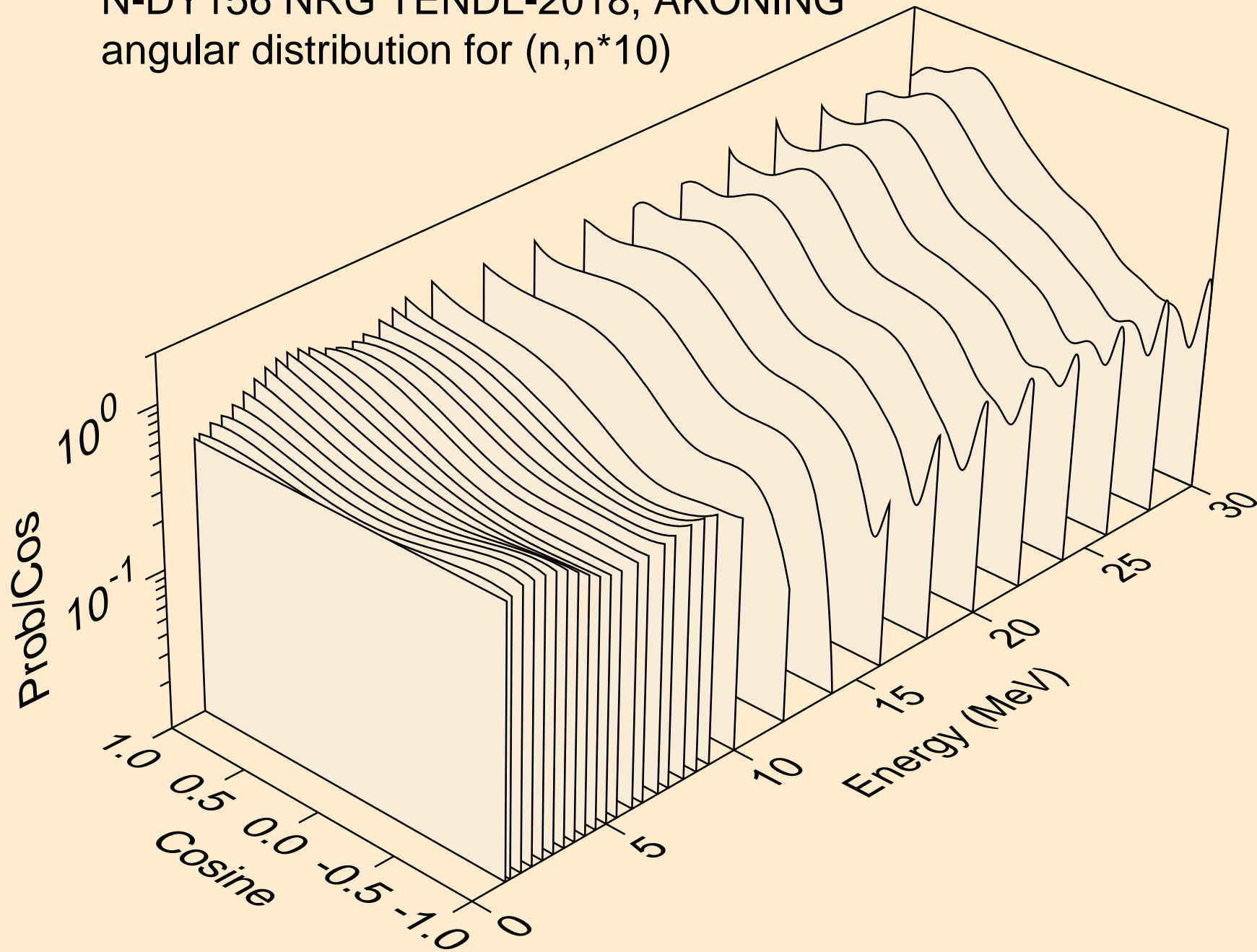

N-DY156 NRG TENDL-2018, AKONING
angular distribution for (n,n*11)

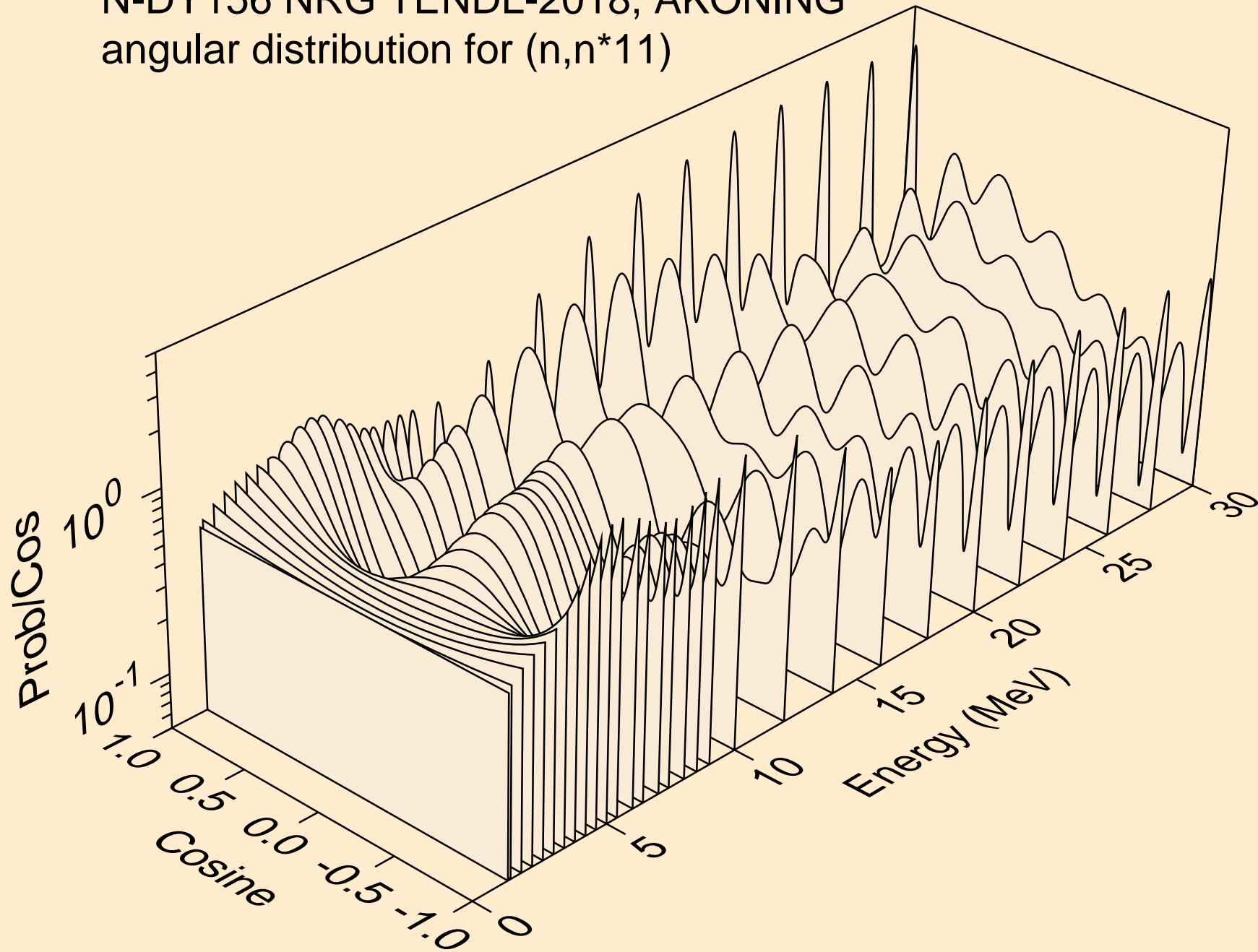

N-DY156 NRG TENDL-2018, AKONING
angular distribution for (n,n*12)

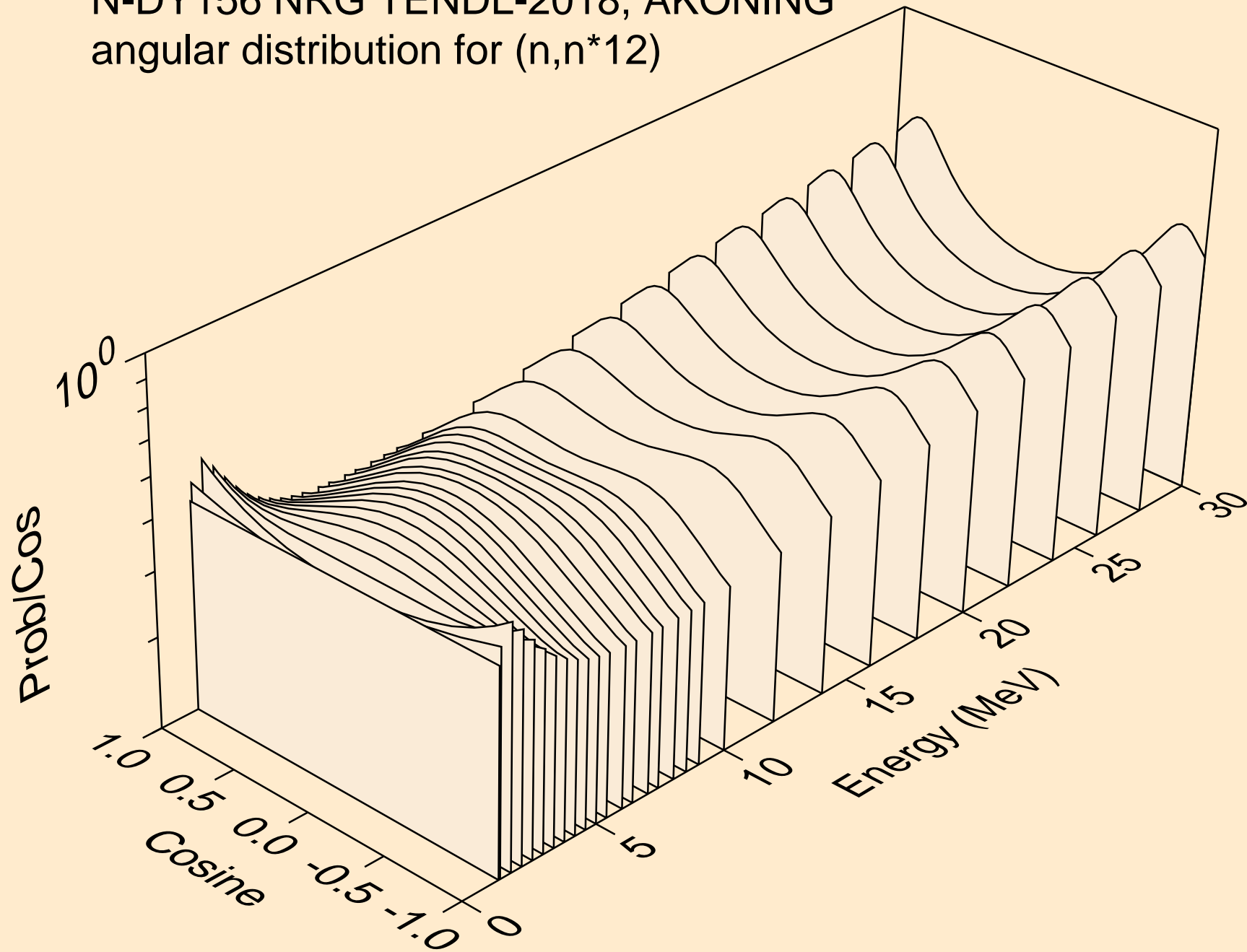

N-DY156 NRG TENDL-2018, AKONING
angular distribution for (n,n*13)

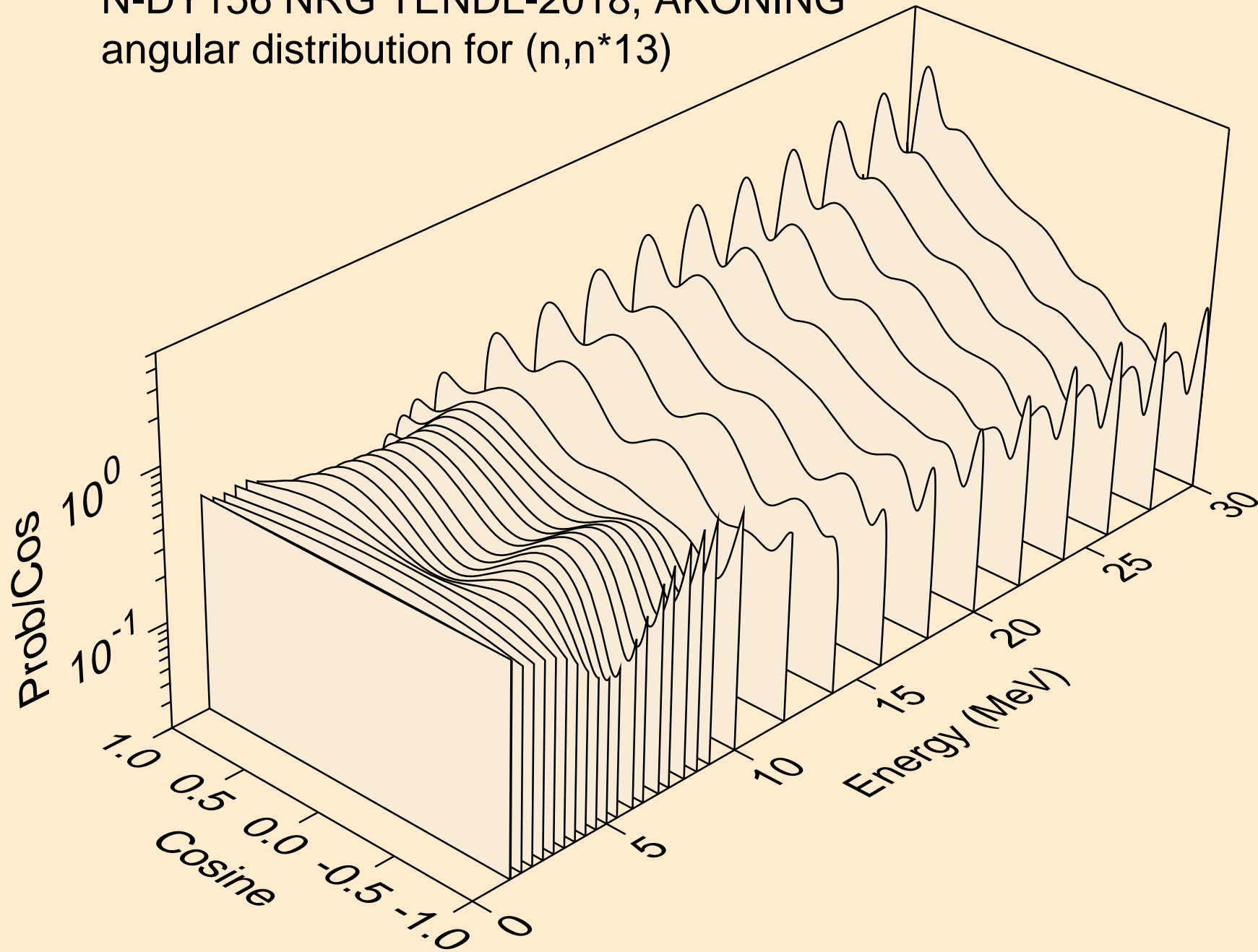

N-DY156 NRG TENDL-2018, AKONING
angular distribution for (n,n*14)

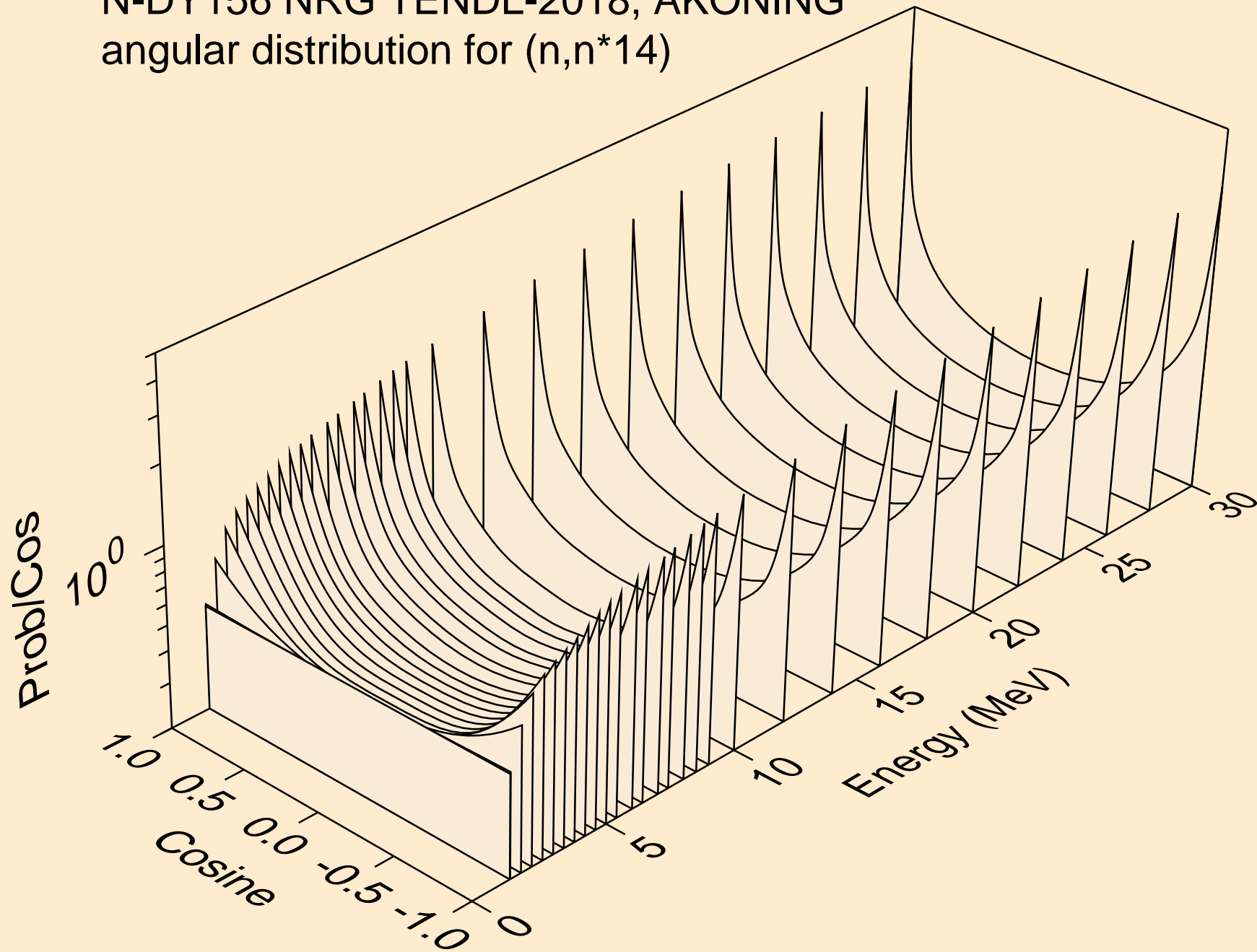

N-DY156 NRG TENDL-2018, AKONING
angular distribution for (n,n*15)

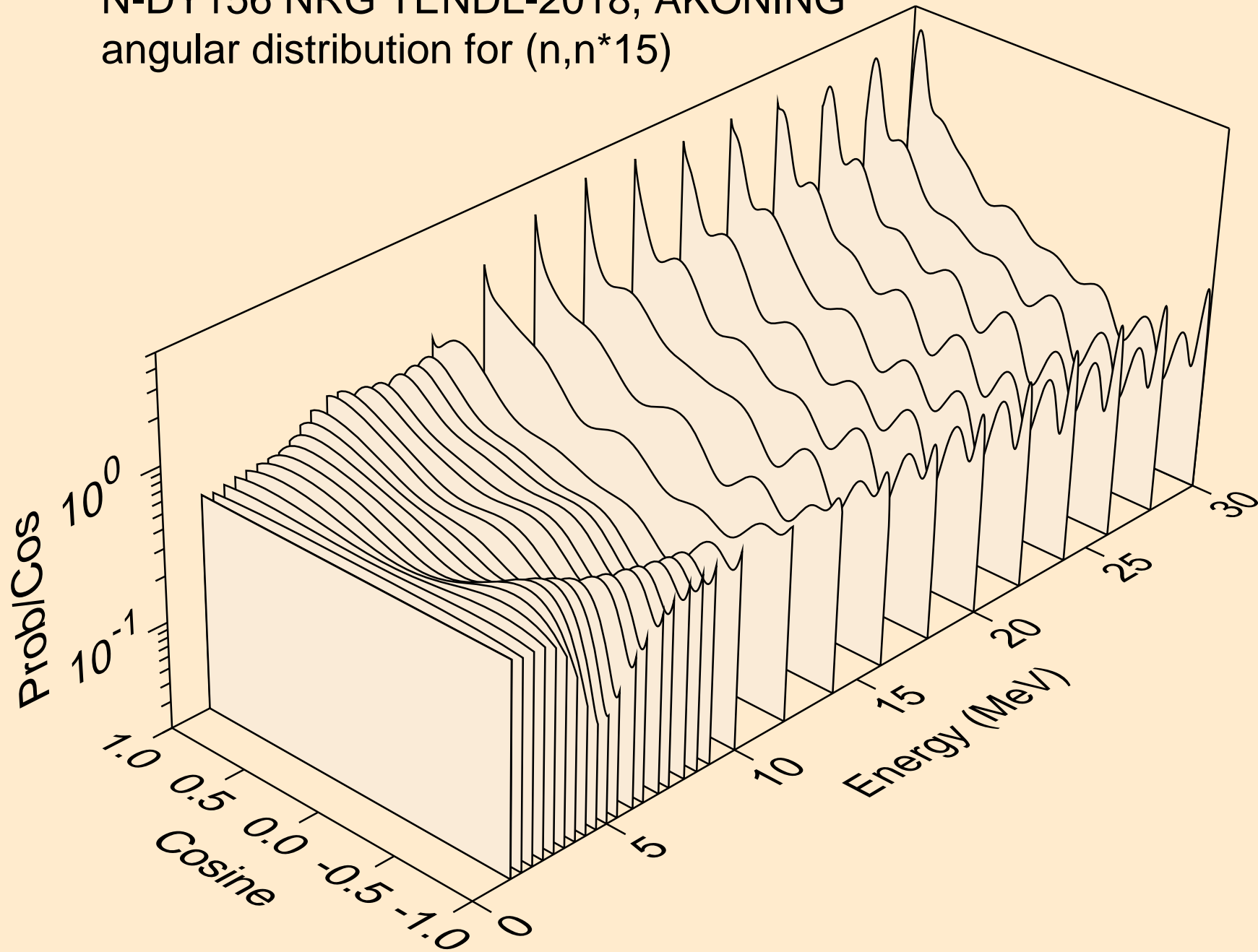

N-DY156 NRG TENDL-2018, AKONING
angular distribution for (n,n*16)

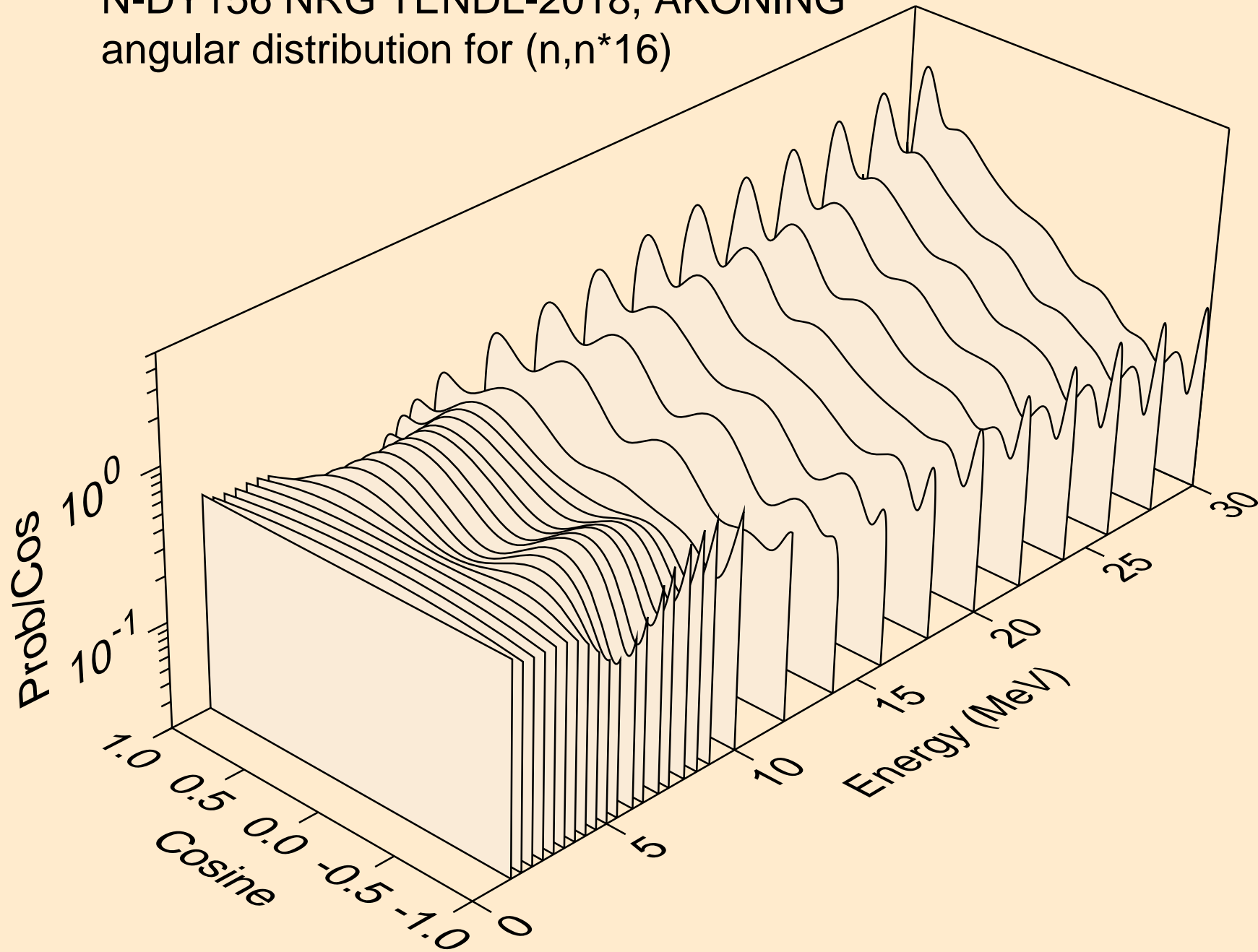

N-DY156 NRG TENDL-2018, AKONING
angular distribution for (n,n*17)

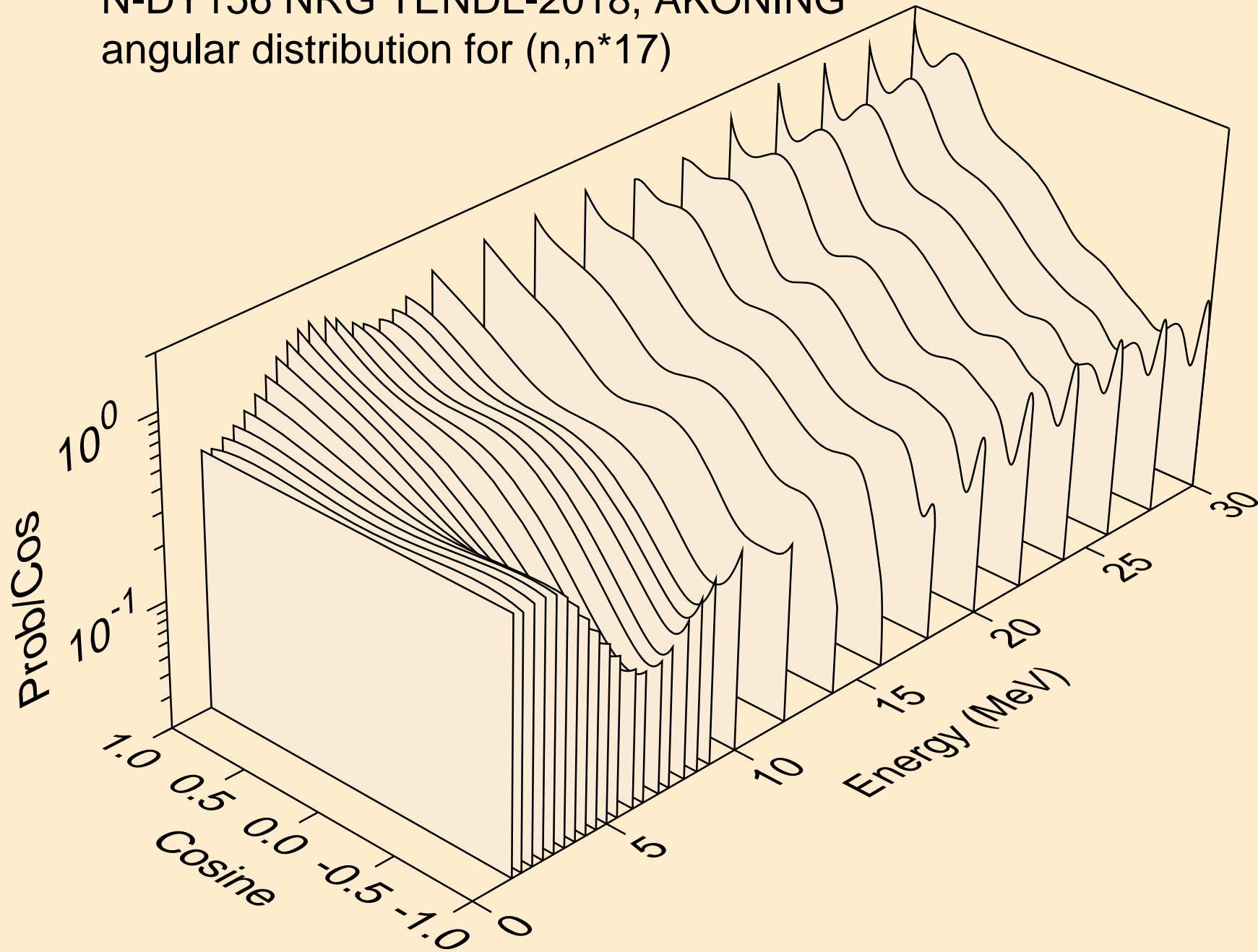

N-DY156 NRG TENDL-2018, AKONING
angular distribution for (n,n*18)

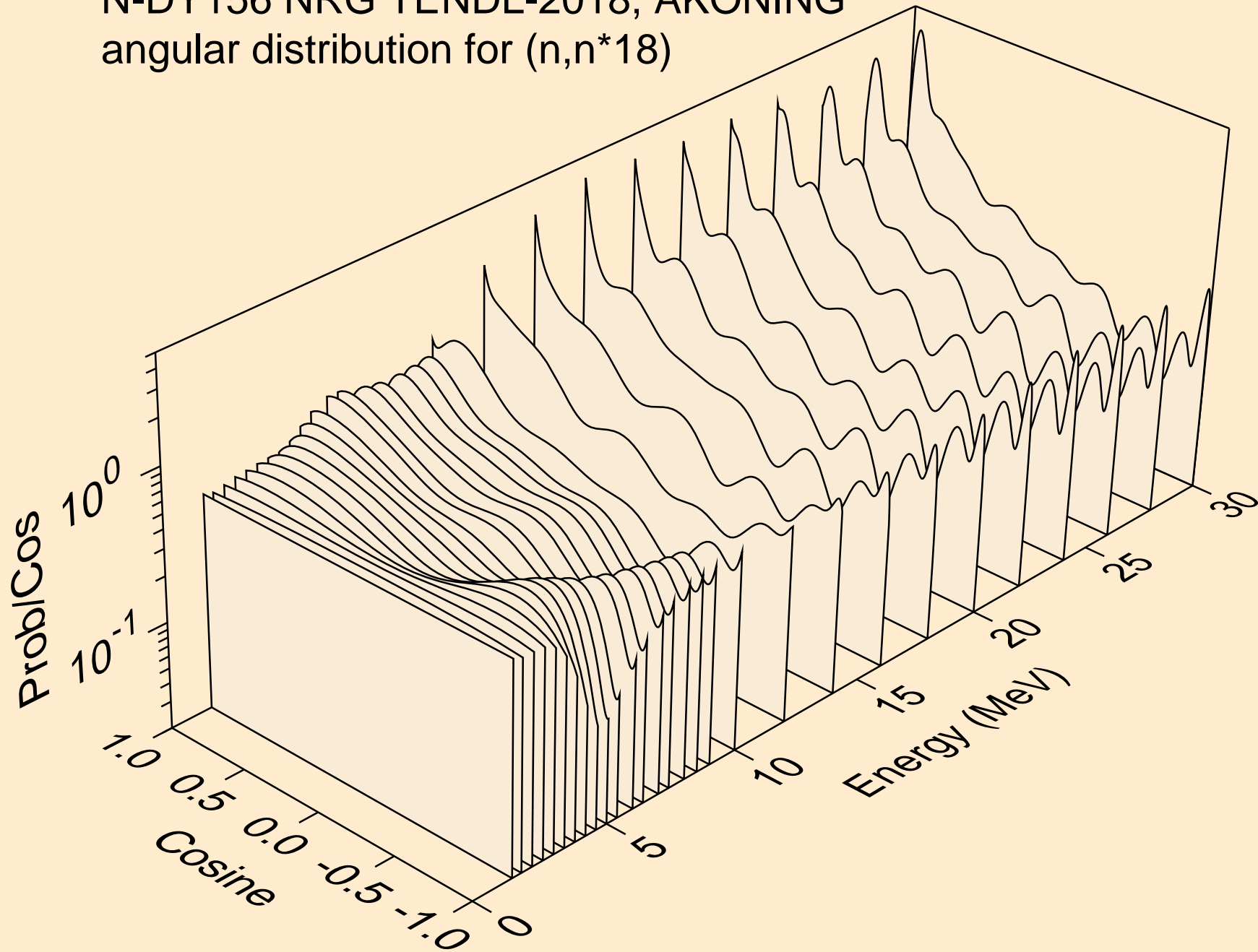

N-DY156 NRG TENDL-2018, AKONING
angular distribution for (n,n*19)

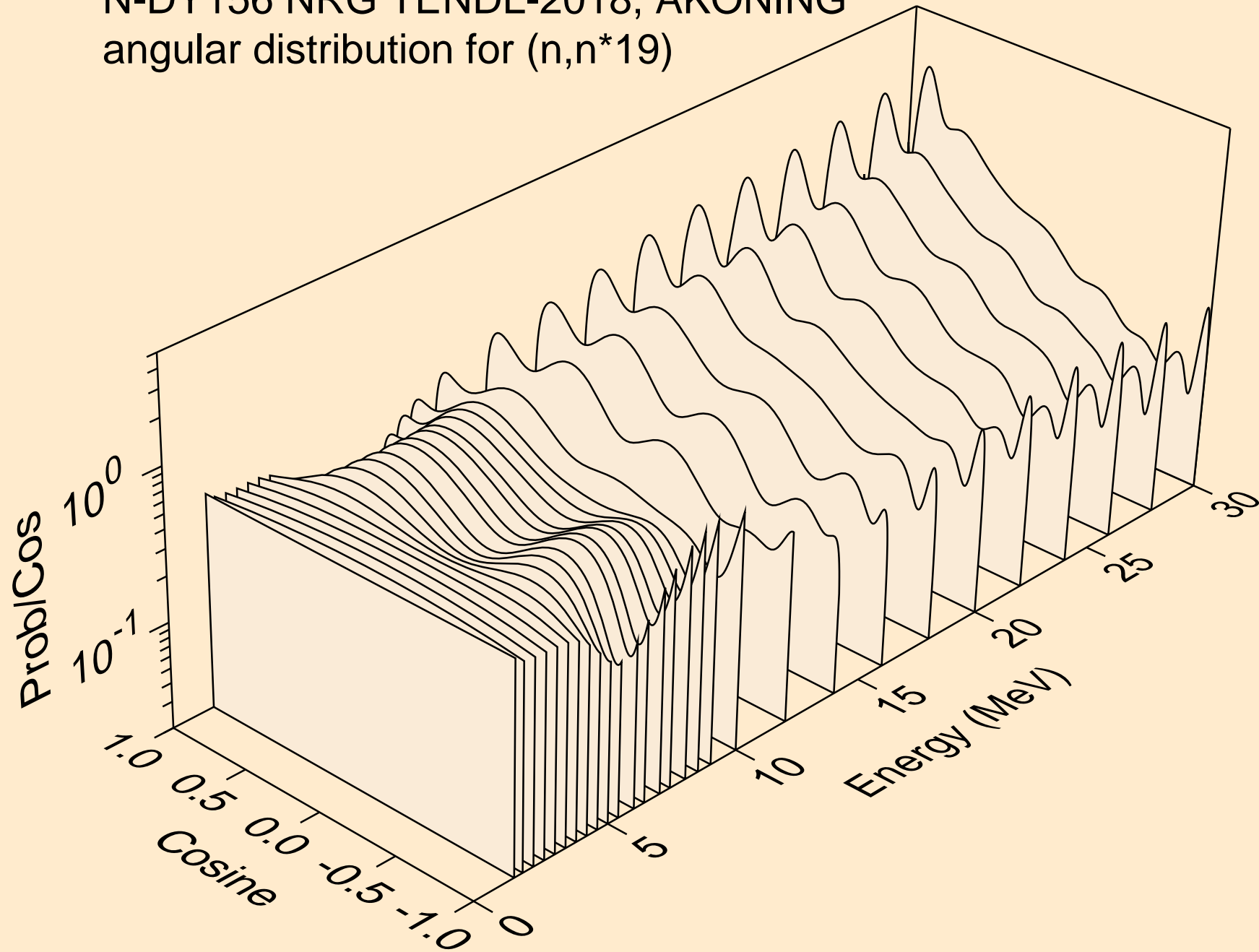

N-DY156 NRG TENDL-2018, AKONING
angular distribution for (n,n*20)

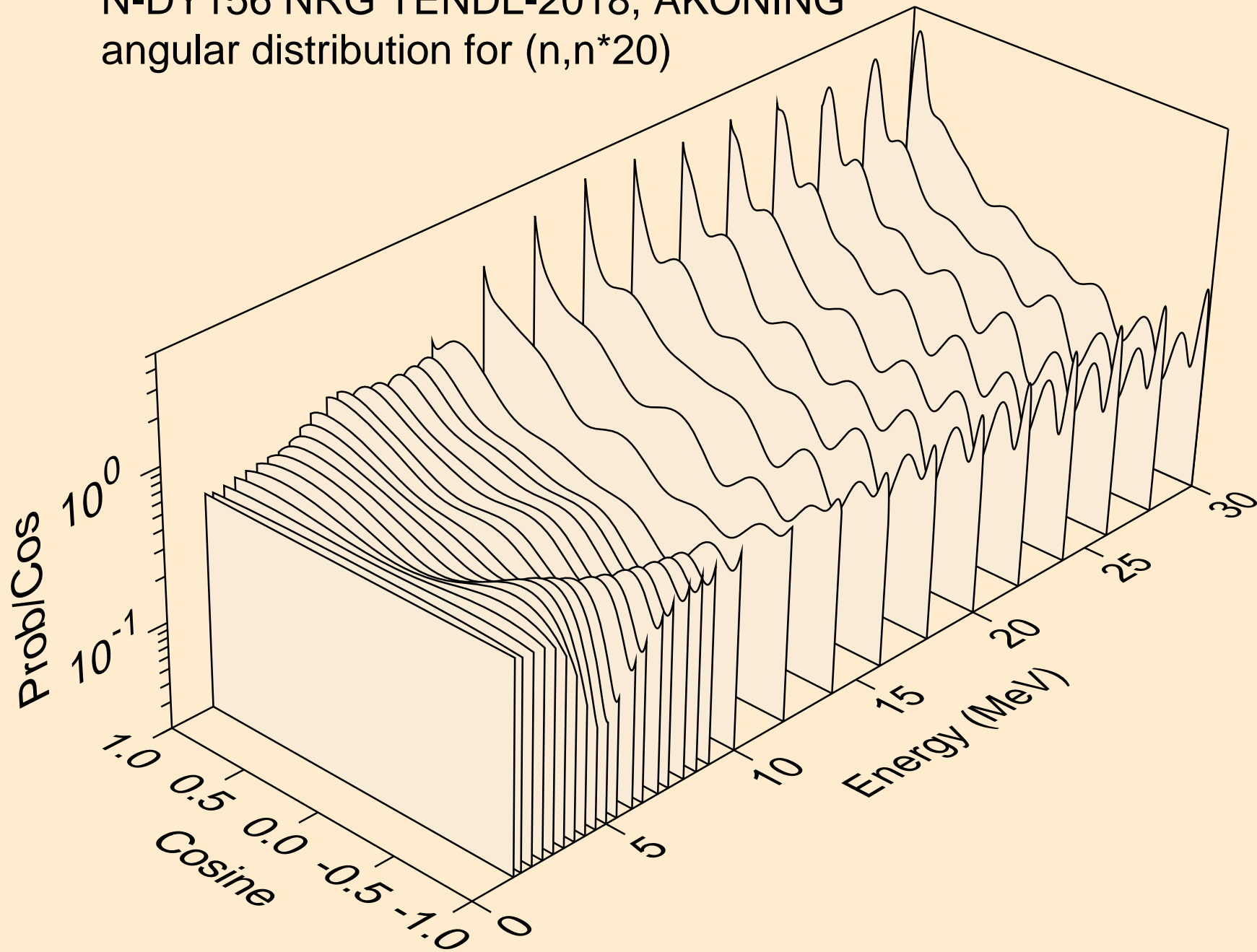

N-DY156 NRG TENDL-2018, AKONING
angular distribution for (n,n*21)

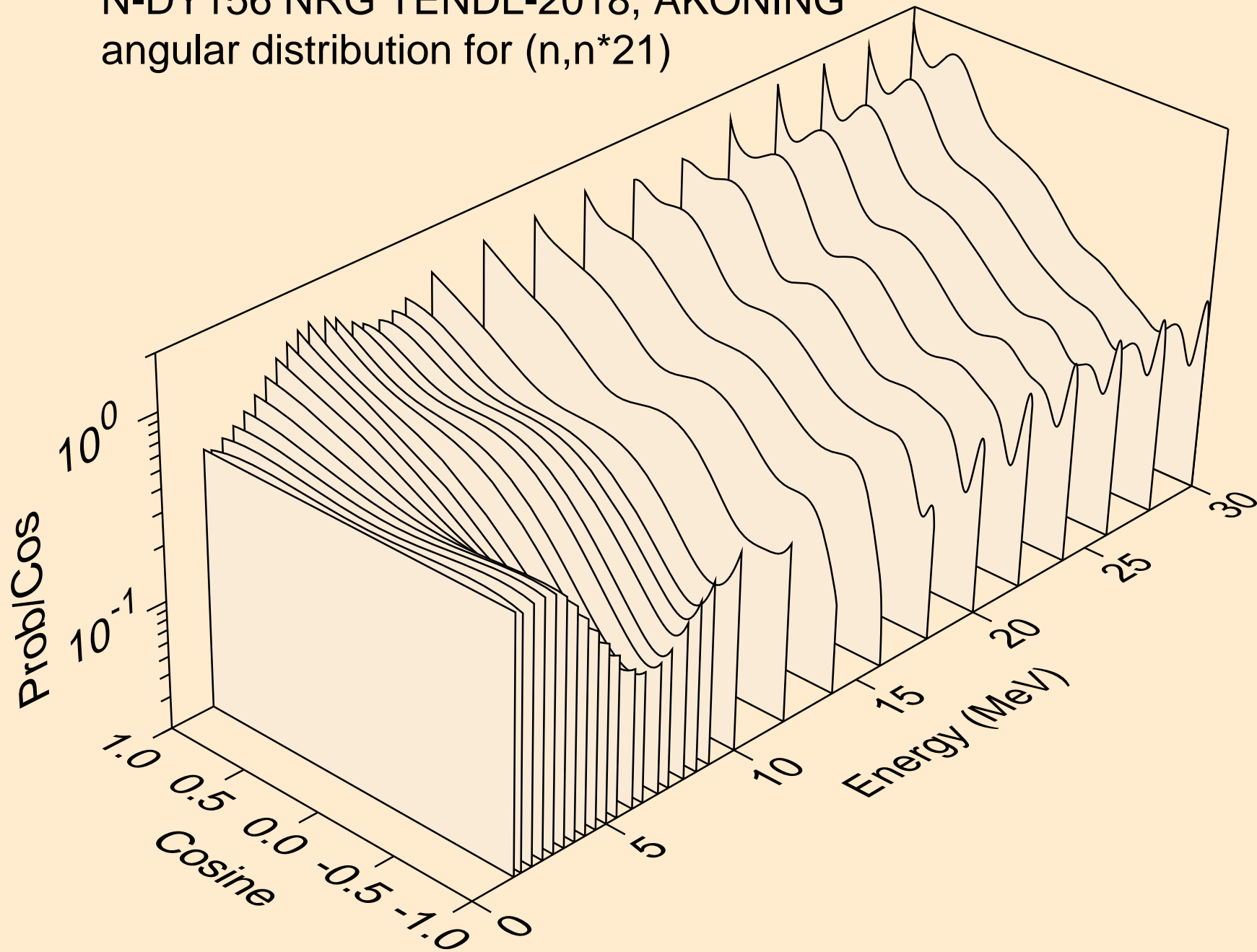

N-DY156 NRG TENDL-2018, AKONING
angular distribution for (n,n*22)

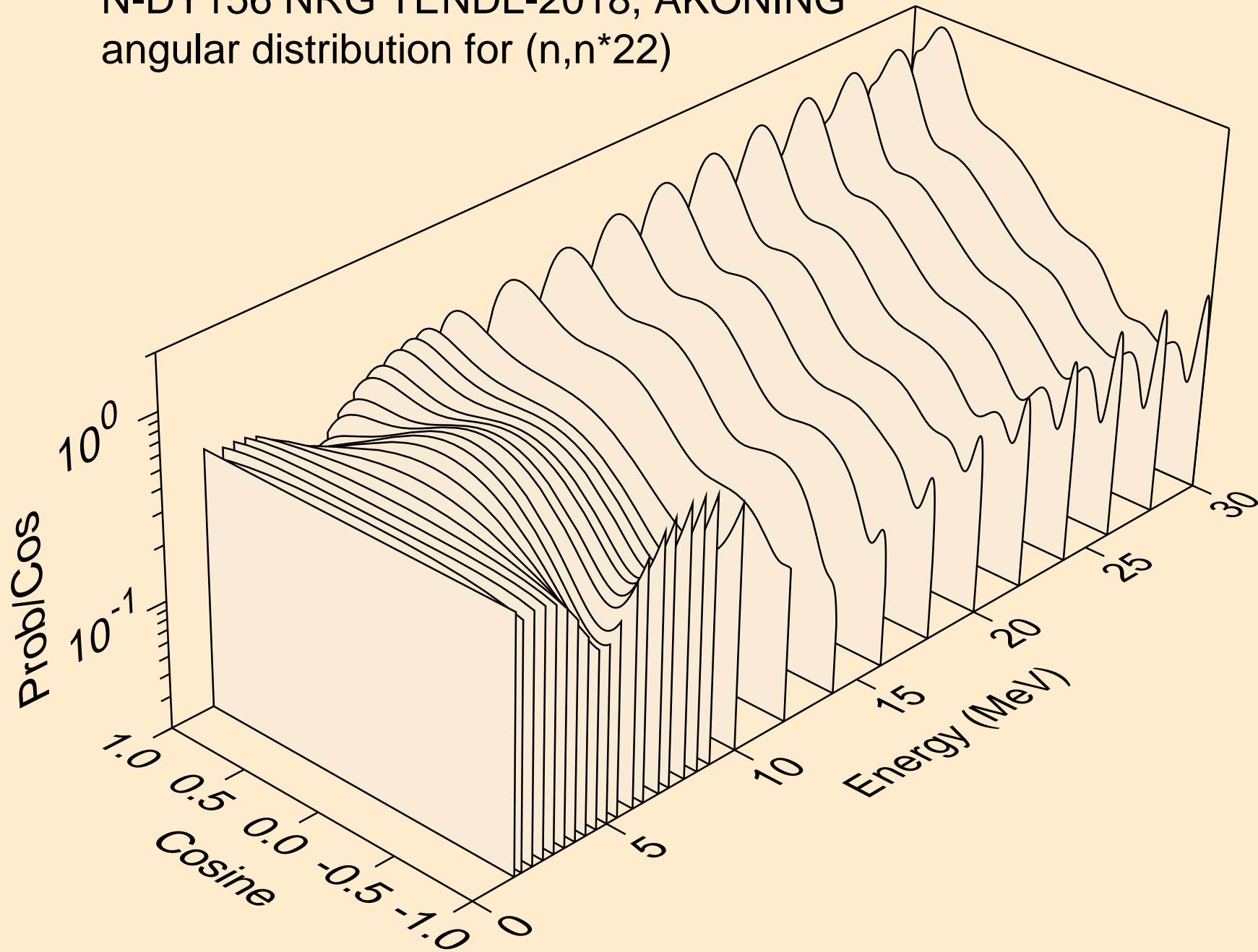

N-DY156 NRG TENDL-2018, AKONING
angular distribution for (n,n*23)

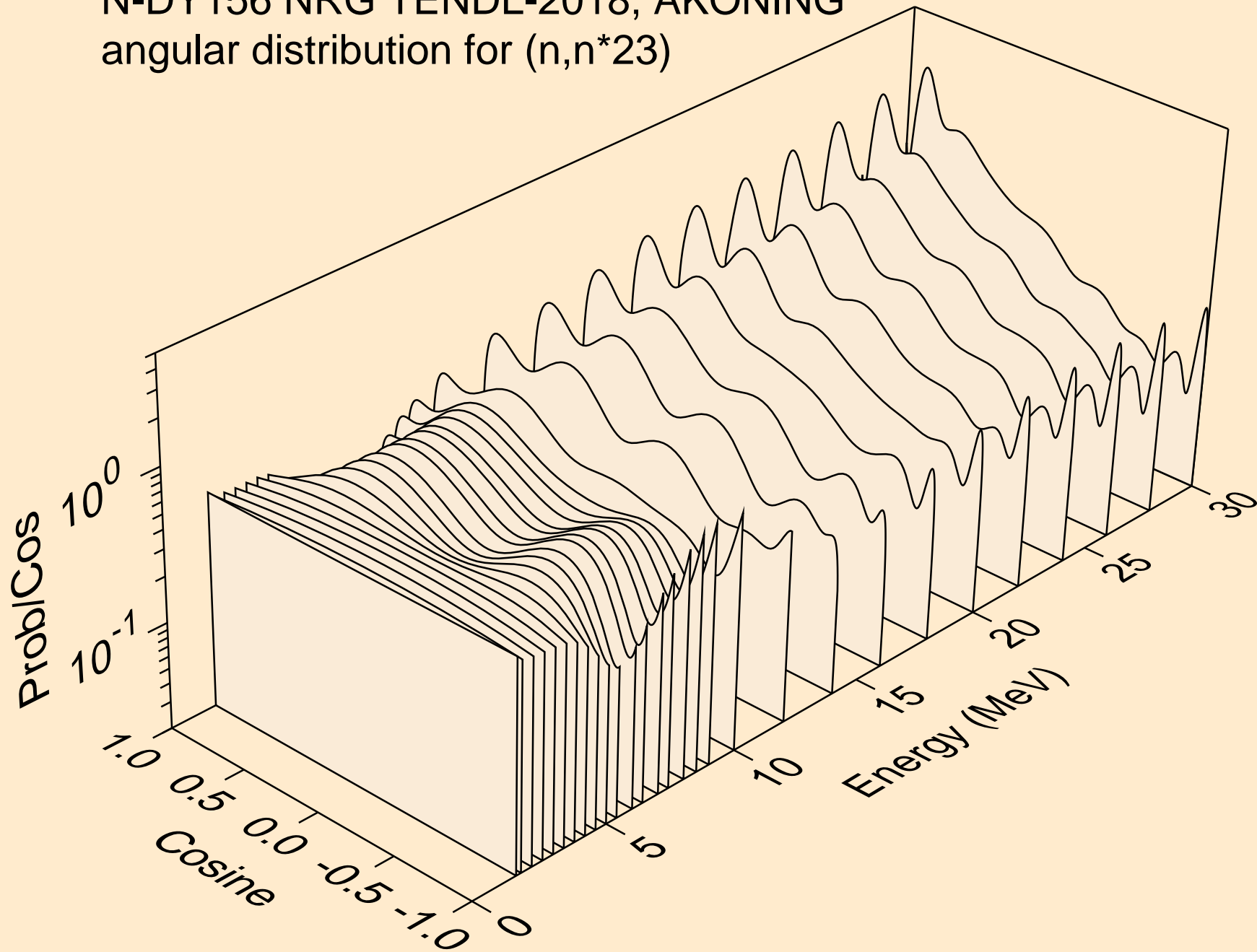

N-DY156 NRG TENDL-2018, AKONING
angular distribution for (n,n*24)

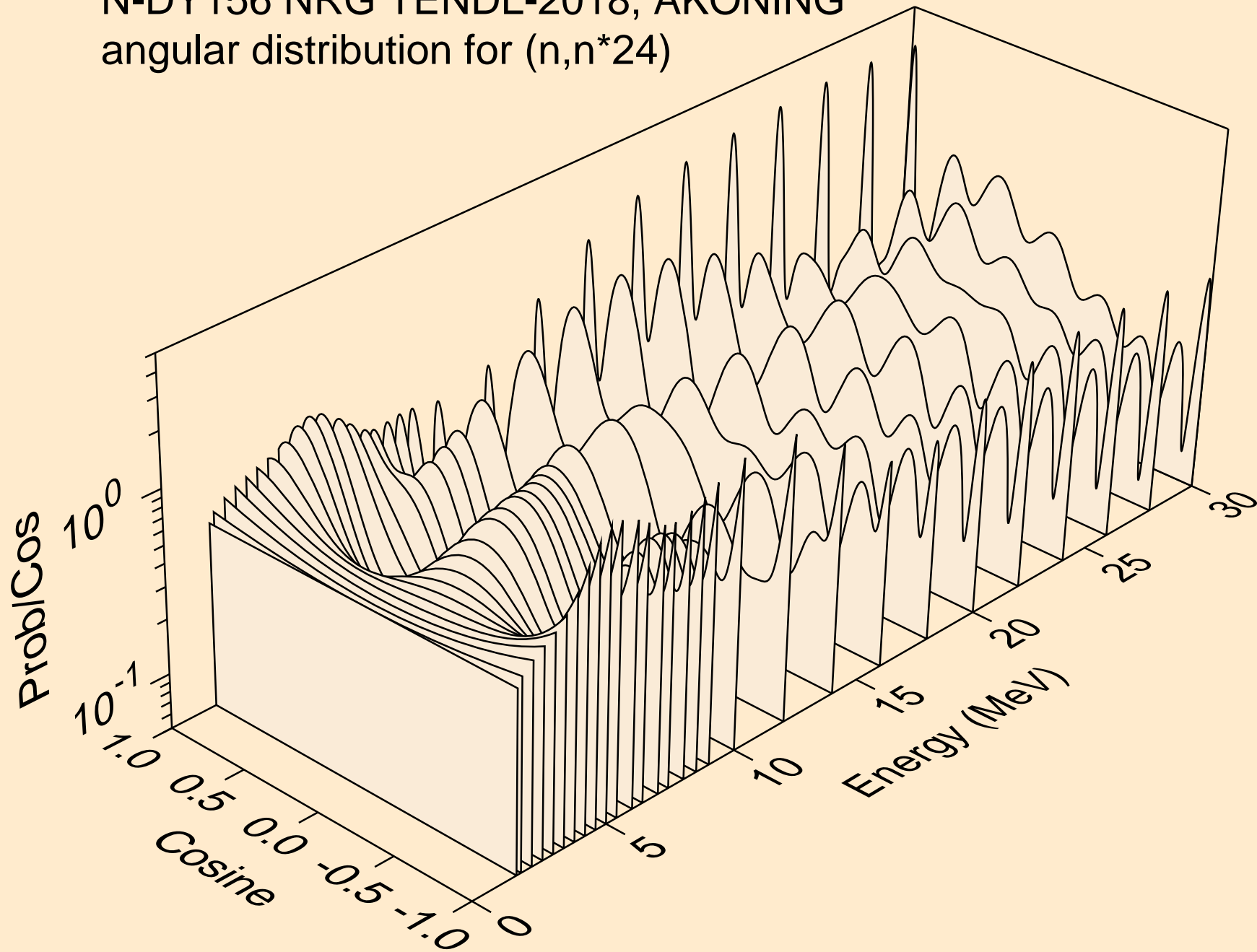

N-DY156 NRG TENDL-2018, AKONING
angular distribution for (n,n*25)

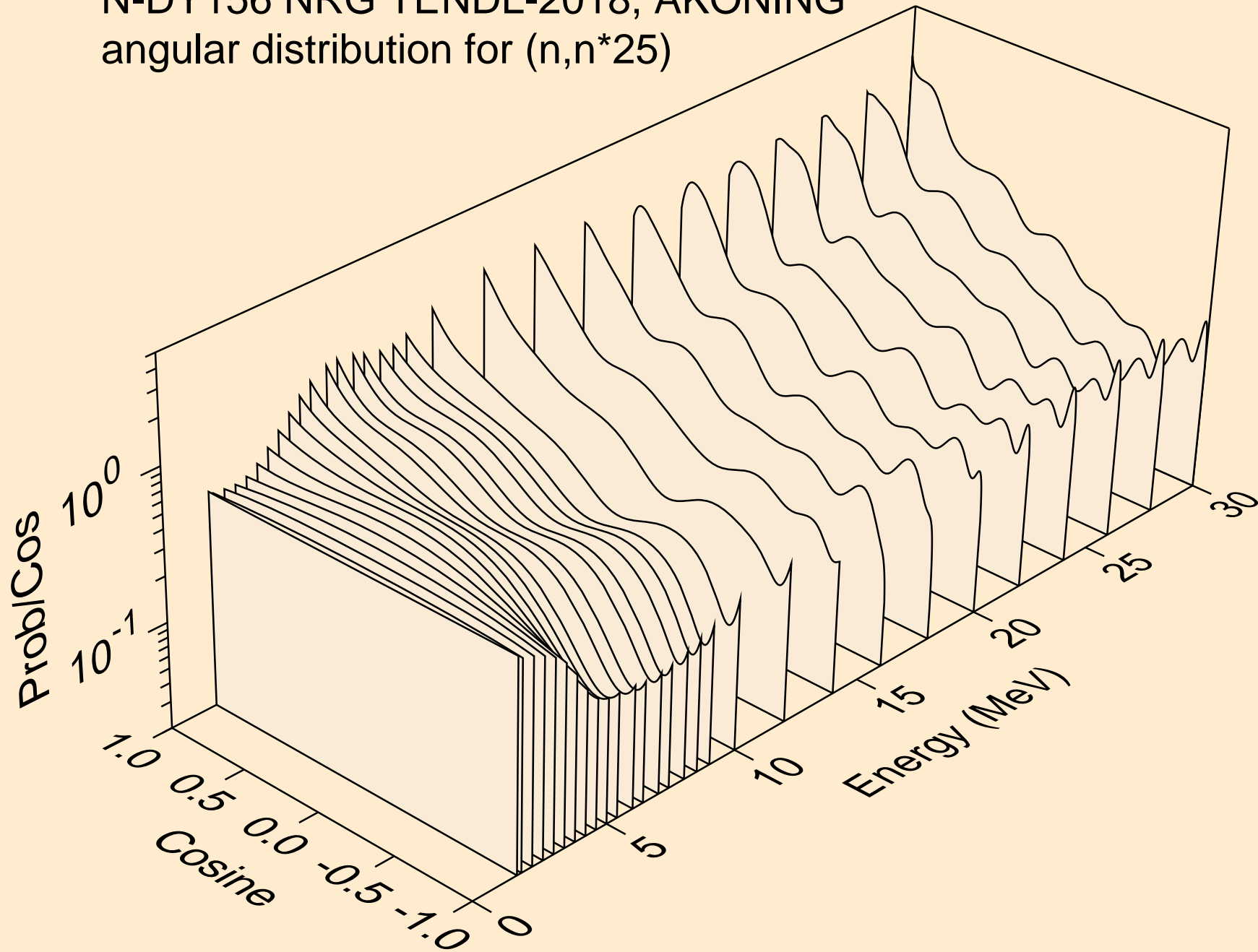

N-DY156 NRG TENDL-2018, AKONING
angular distribution for (n,n*26)

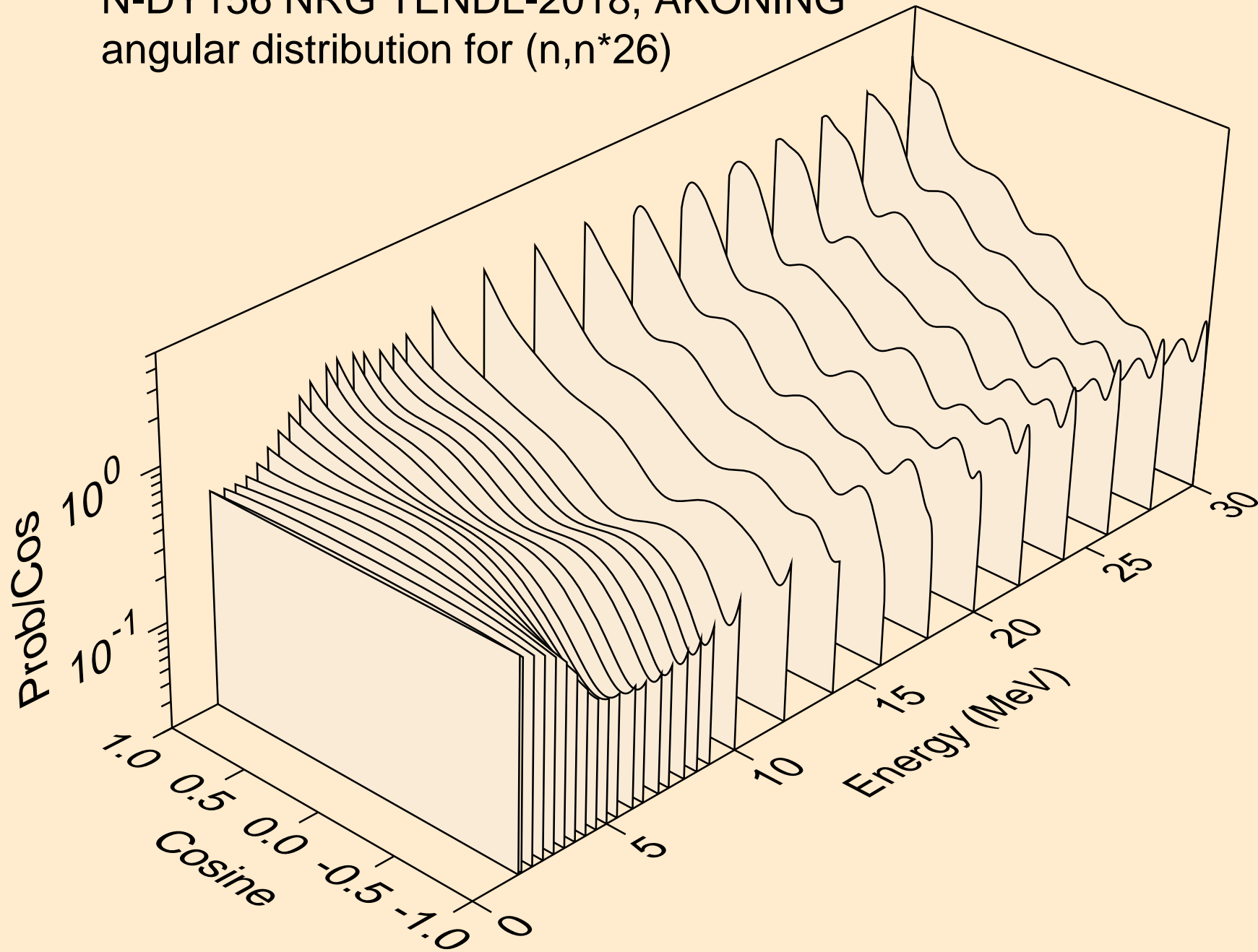

N-DY156 NRG TENDL-2018, AKONING
angular distribution for (n,n*27)

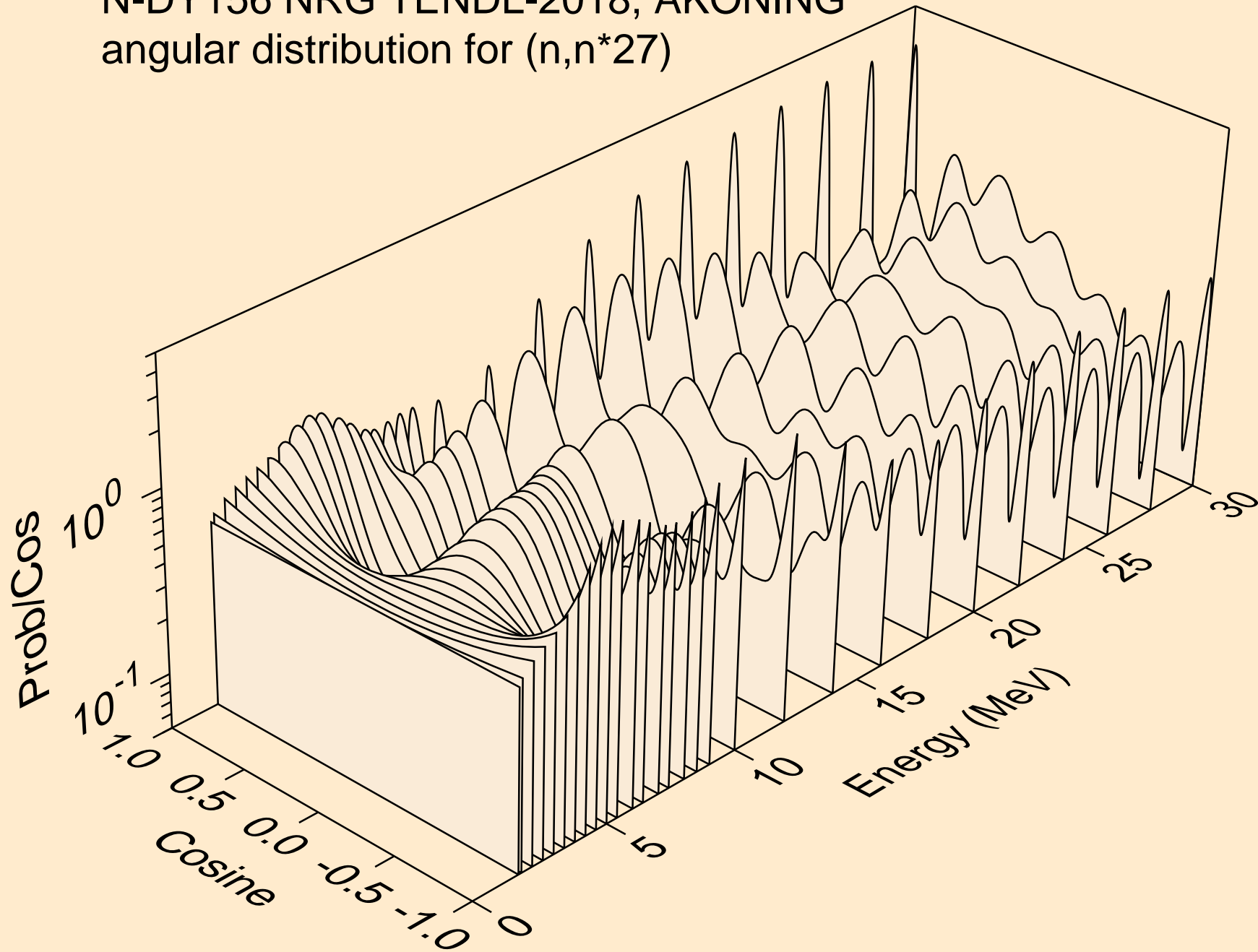

N-DY156 NRG TENDL-2018, AKONING
angular distribution for (n,n*28)

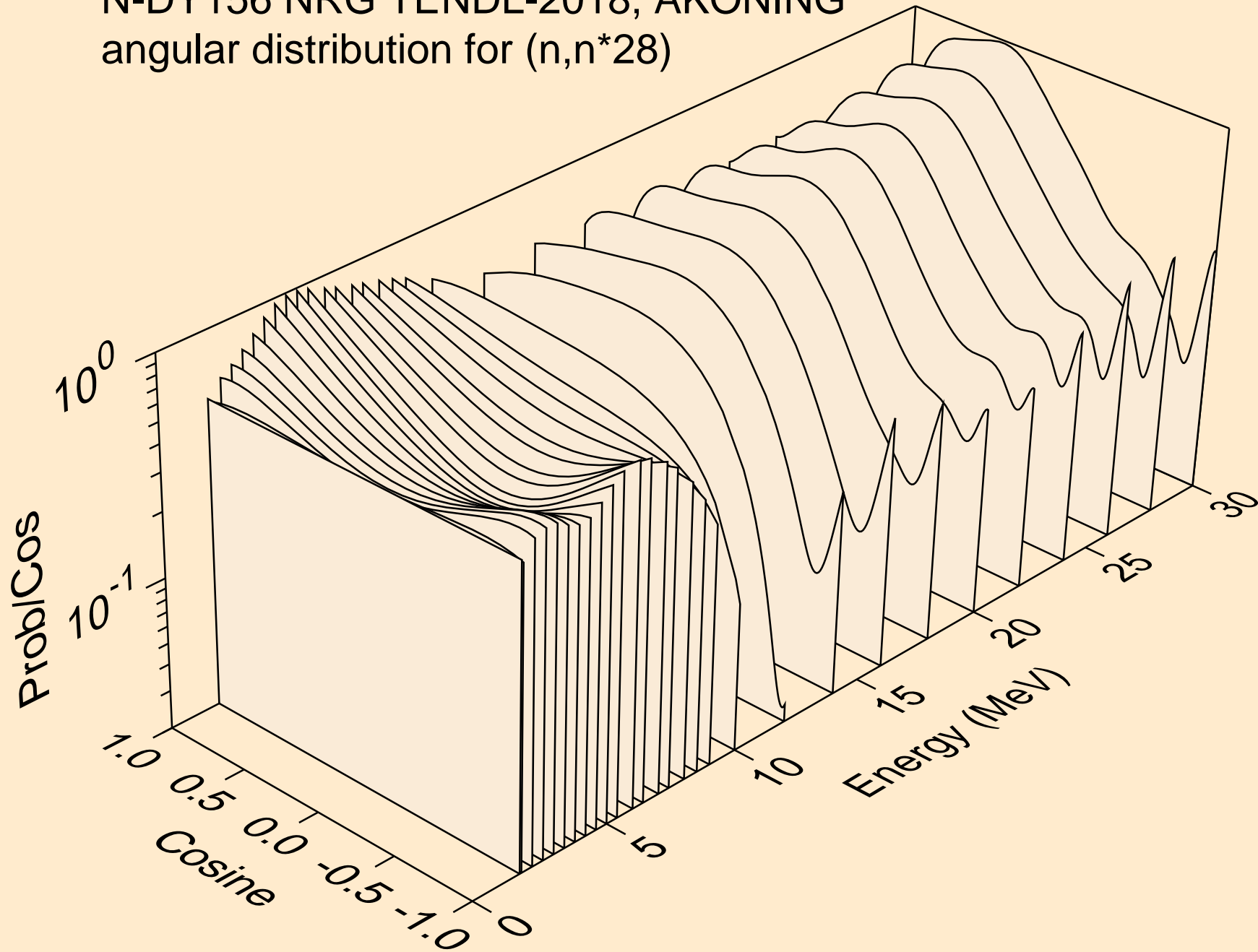

N-DY156 NRG TENDL-2018, AKONING
angular distribution for (n,n*29)

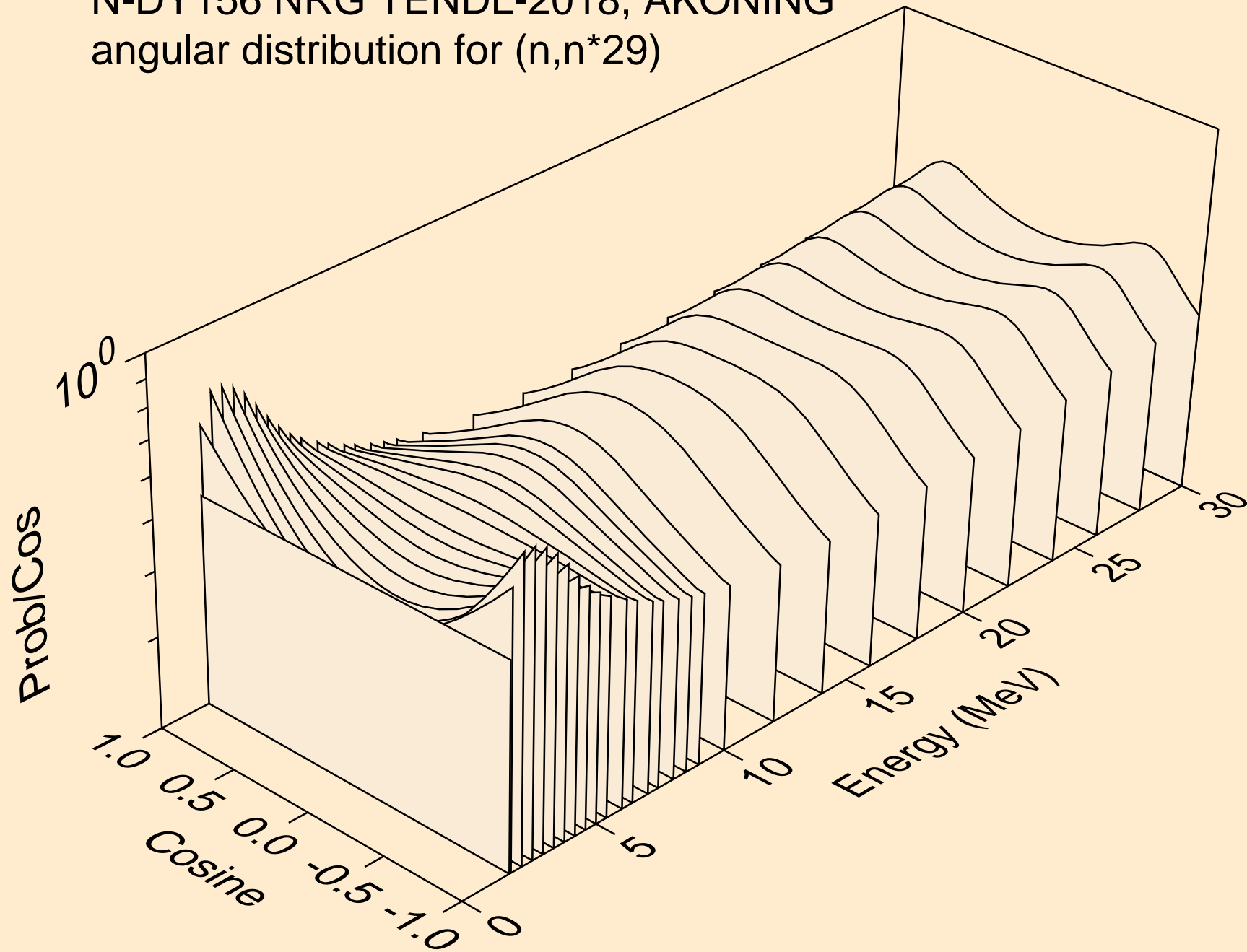

N-DY156 NRG TENDL-2018, AKONING
angular distribution for (n,n*30)

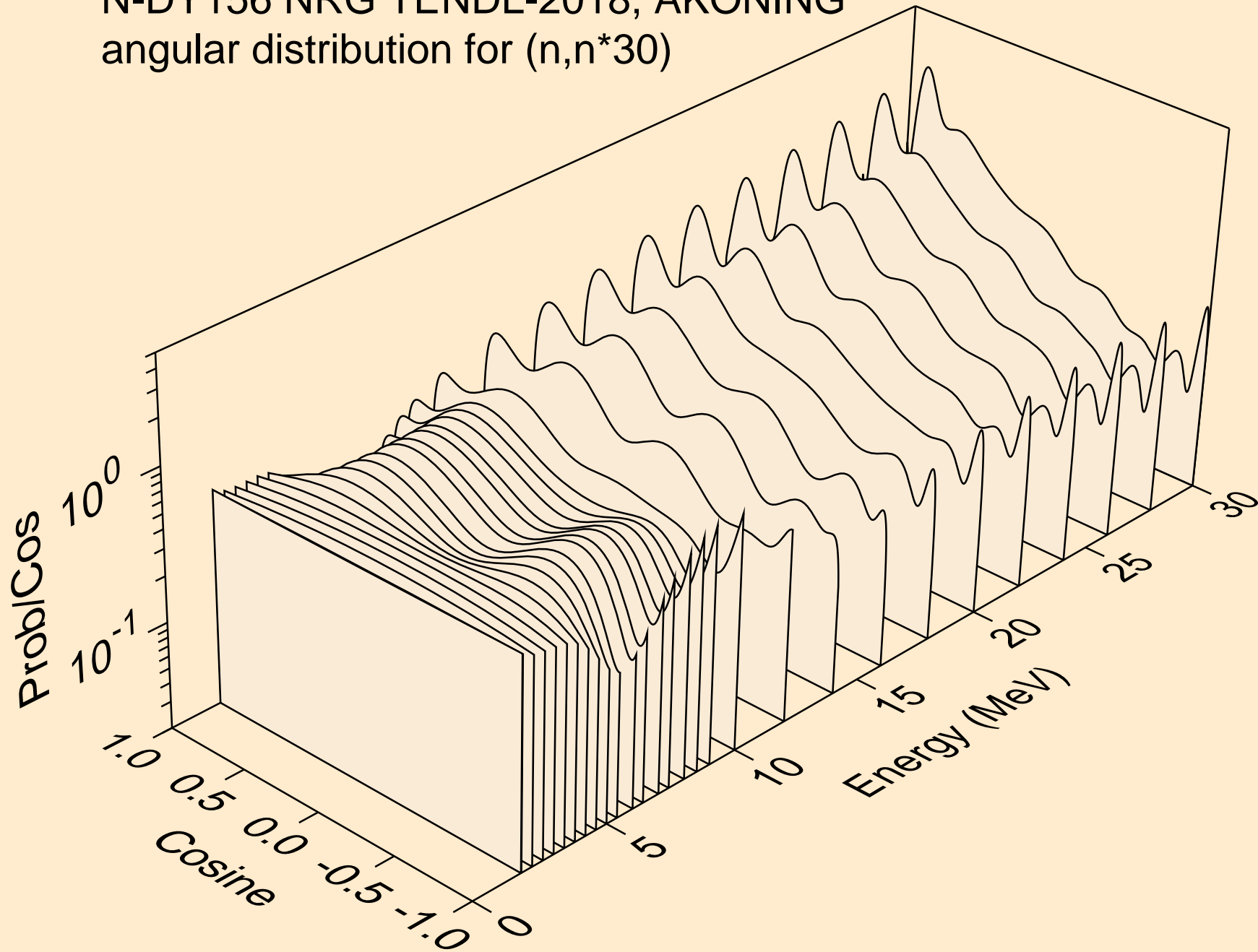

N-DY156 NRG TENDL-2018, AKONING
Neutron emission for (n,x)

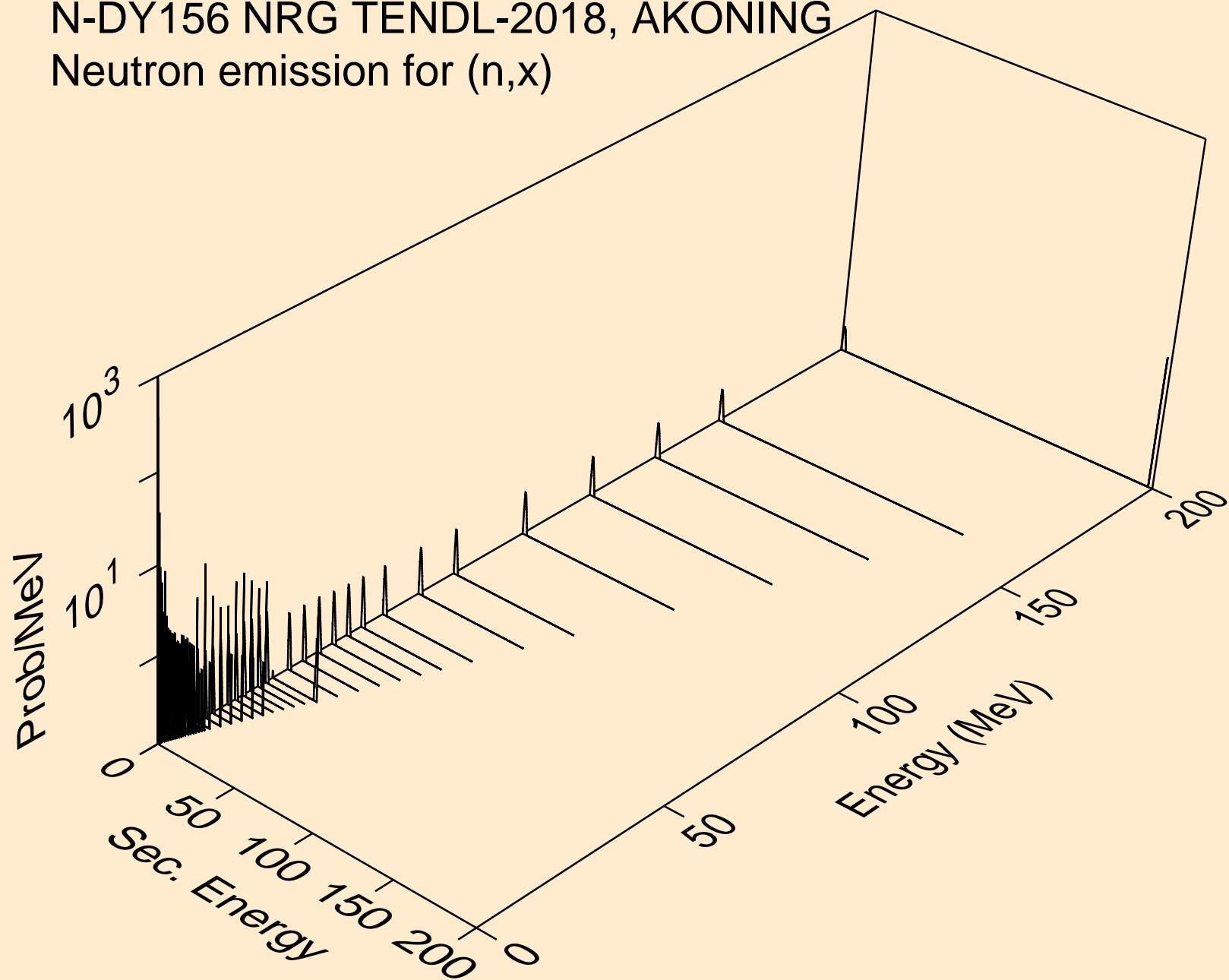

N-DY156 NRG TENDL-2018, AKONING
Neutron emission for (n,2nd)

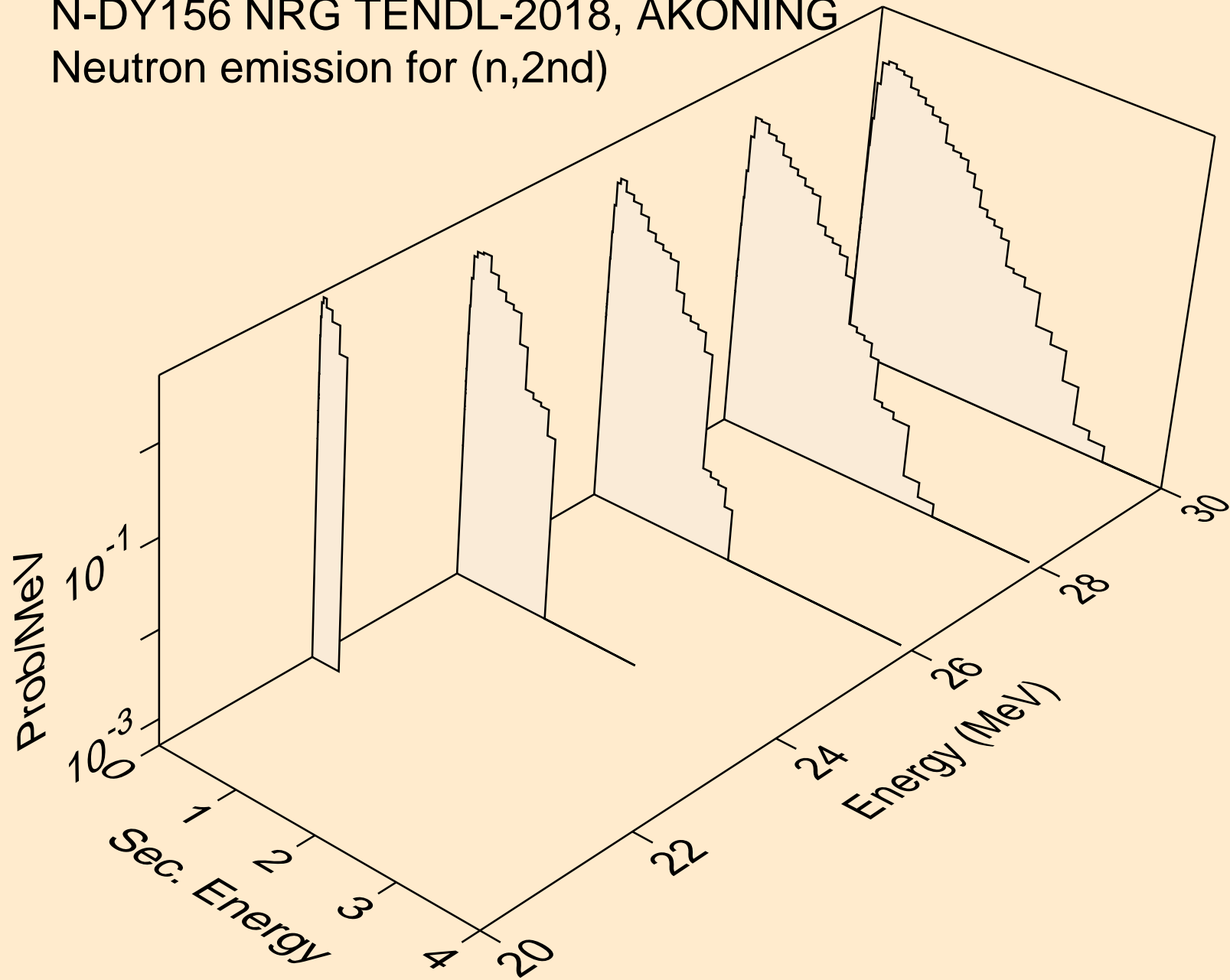

N-DY156 NRG TENDL-2018, AKONING
Neutron emission for (n,2n)

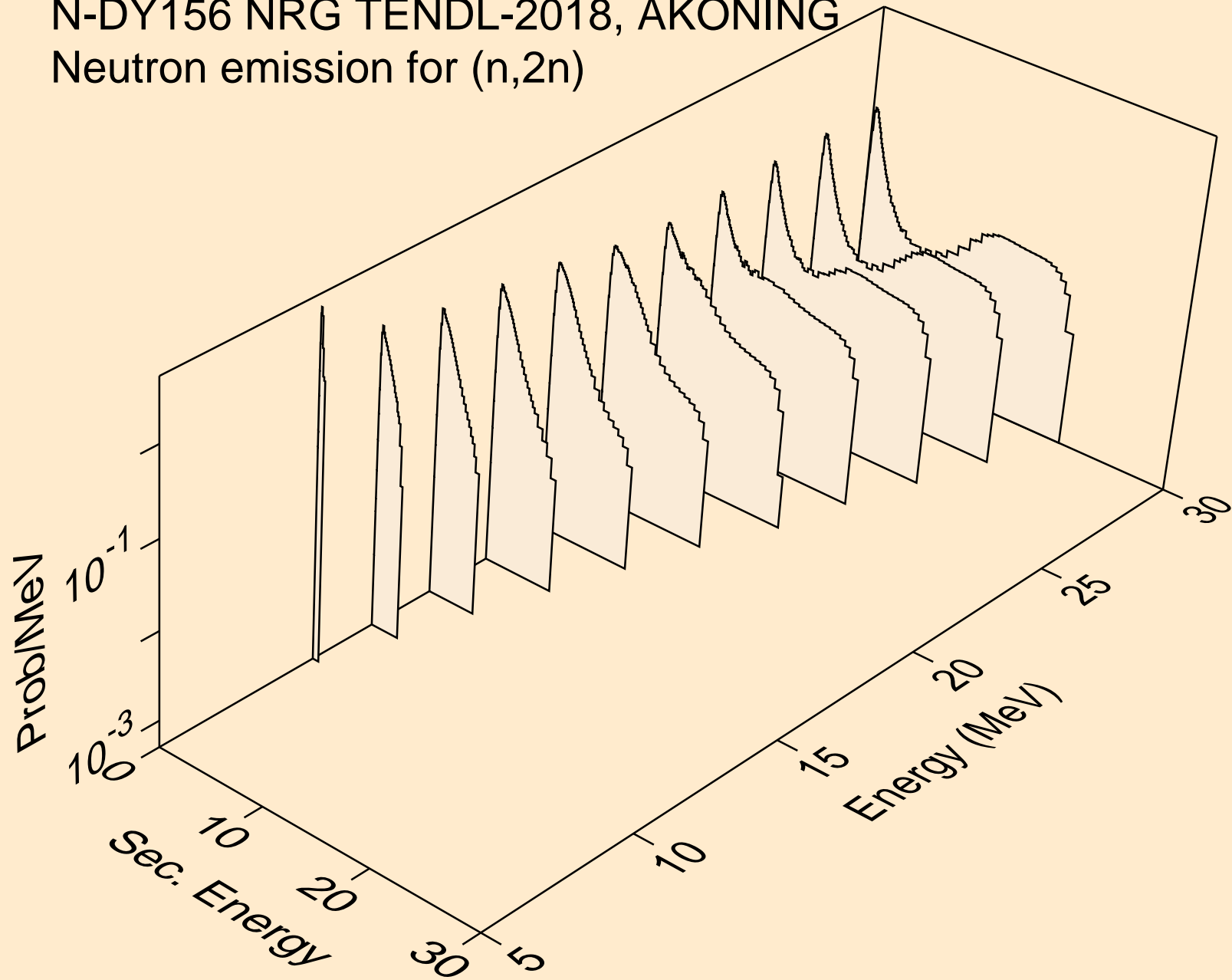

N-DY156 NRG TENDL-2018, AKONING
Neutron emission for (n,3n)

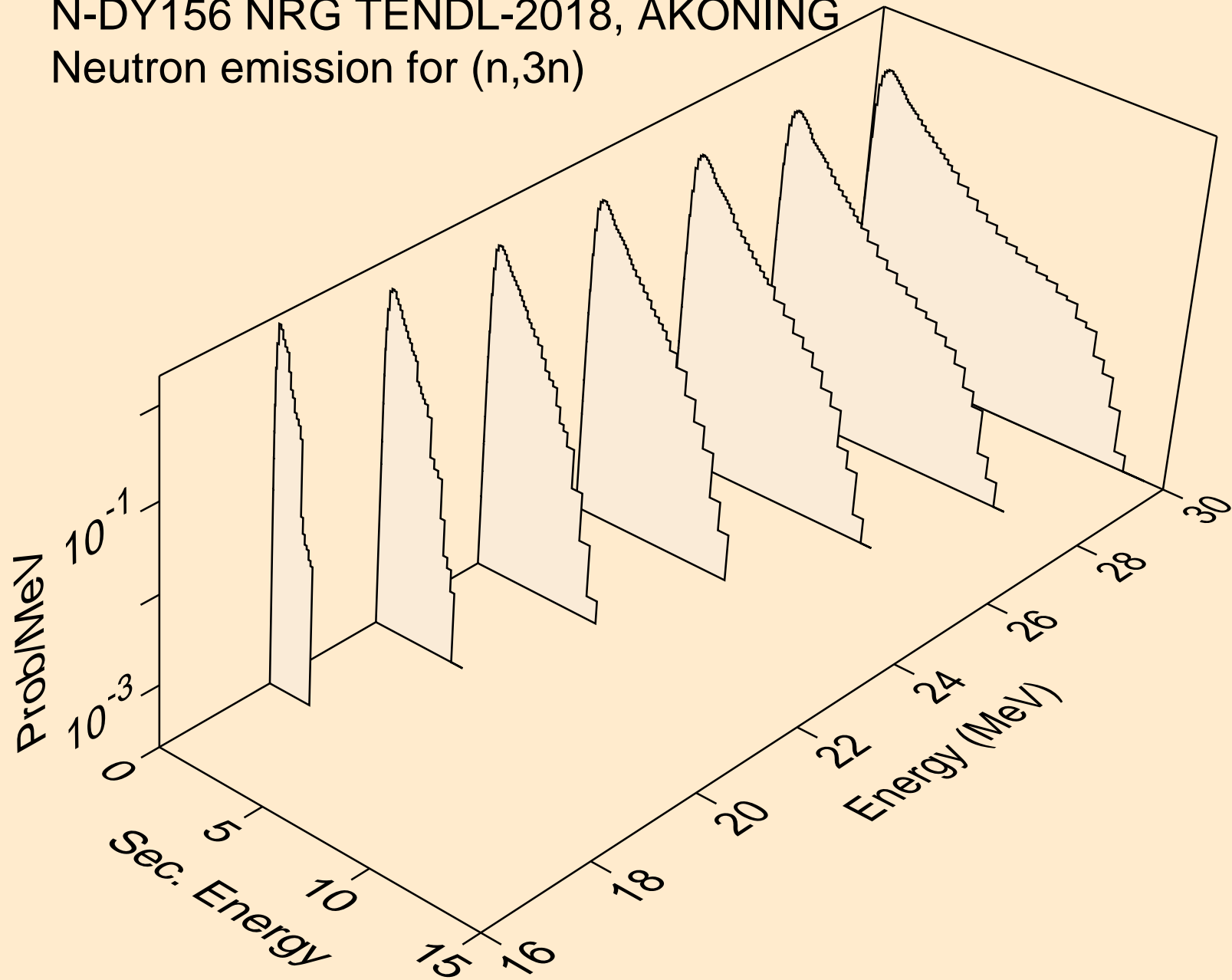

N-DY156 NRG TENDL-2018, AKONING
Neutron emission for (n,n*)a

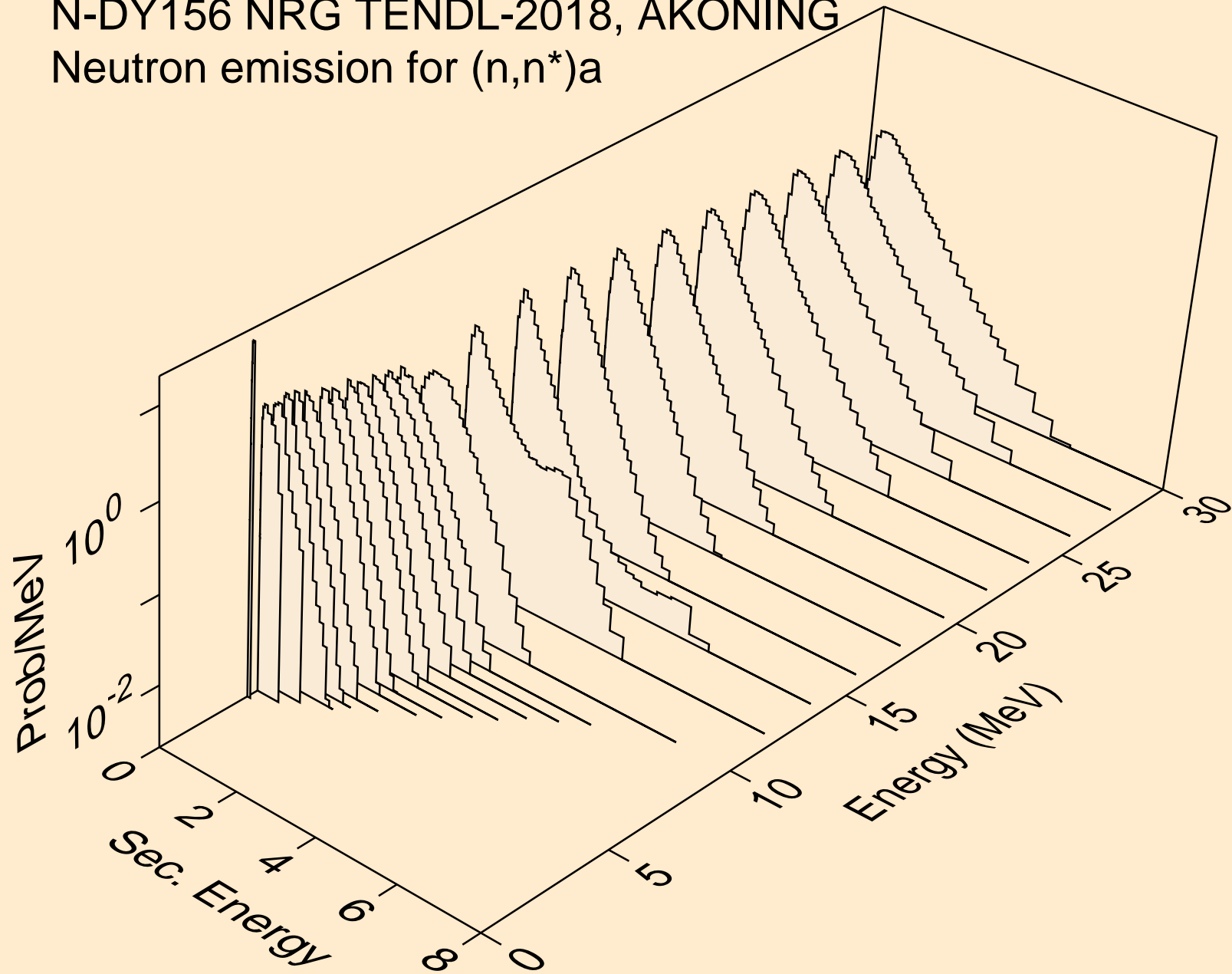

N-DY156 NRG TENDL-2018, AKONING
Neutron emission for (n,2n)a

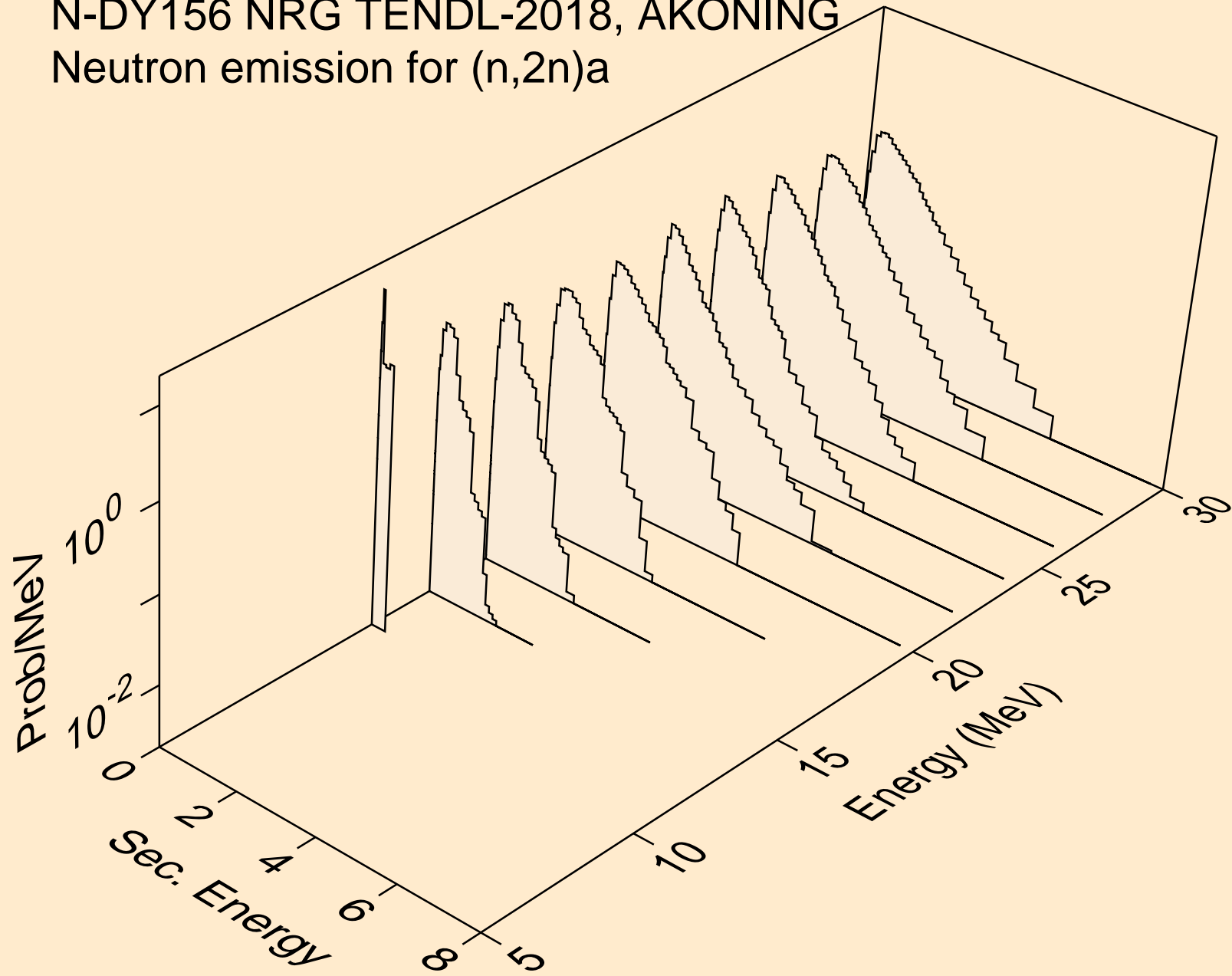

N-DY156 NRG TENDL-2018, AKONING
Neutron emission for (n,3n)a

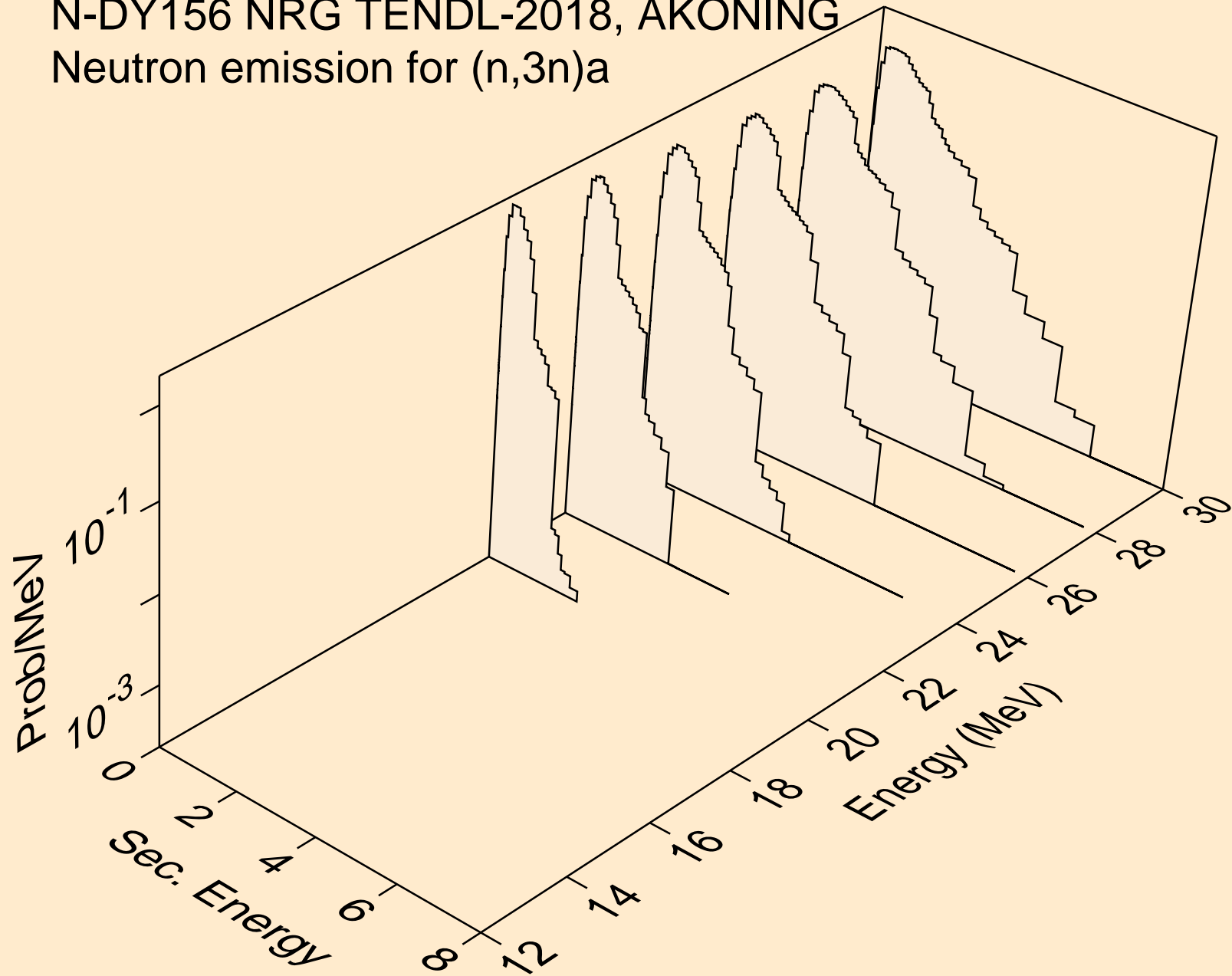

N-DY156 NRG TENDL-2018, AKONING
Neutron emission for (n,n*)p

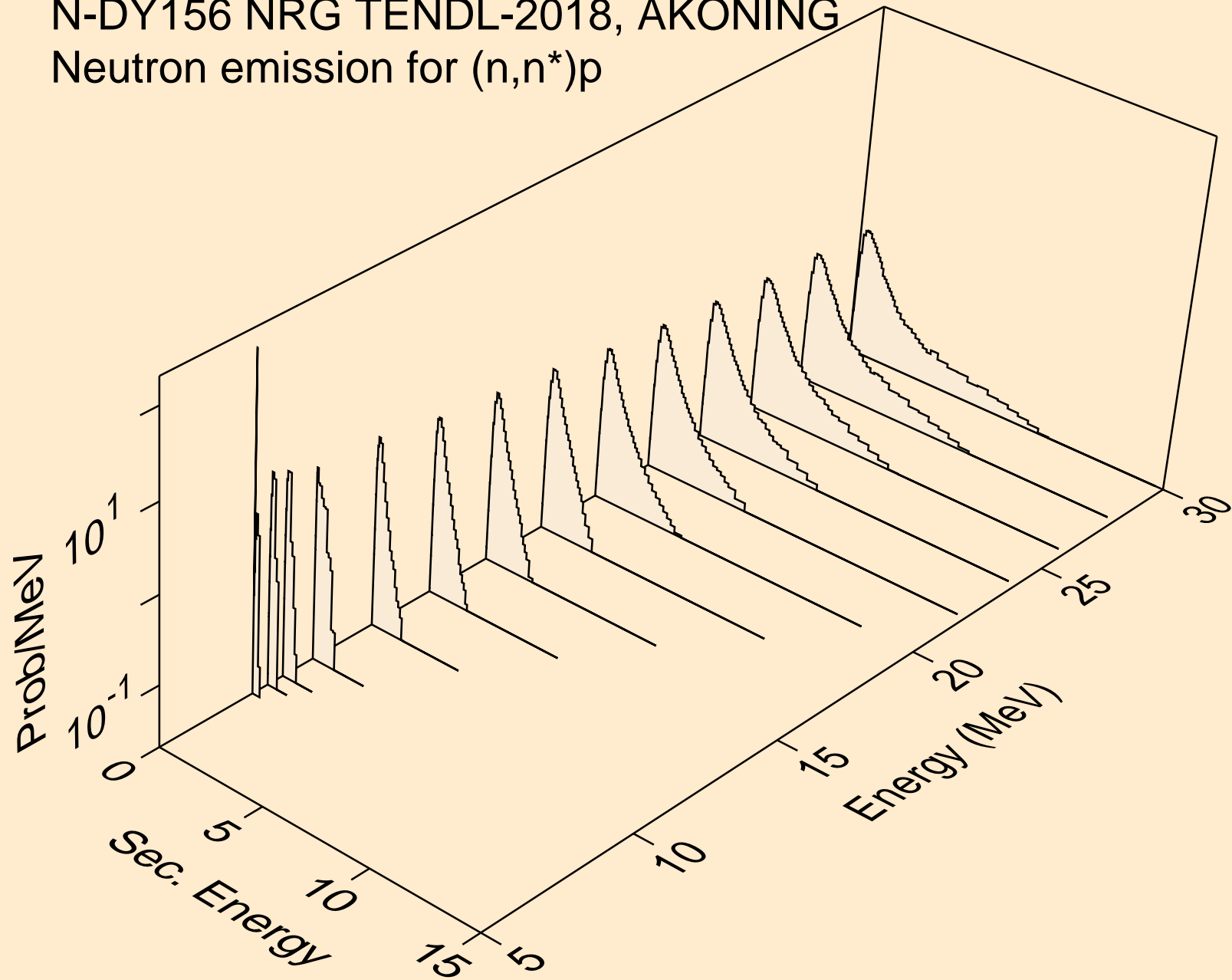

N-DY156 NRG TENDL-2018, AKONING
Neutron emission for (n,n*)2a

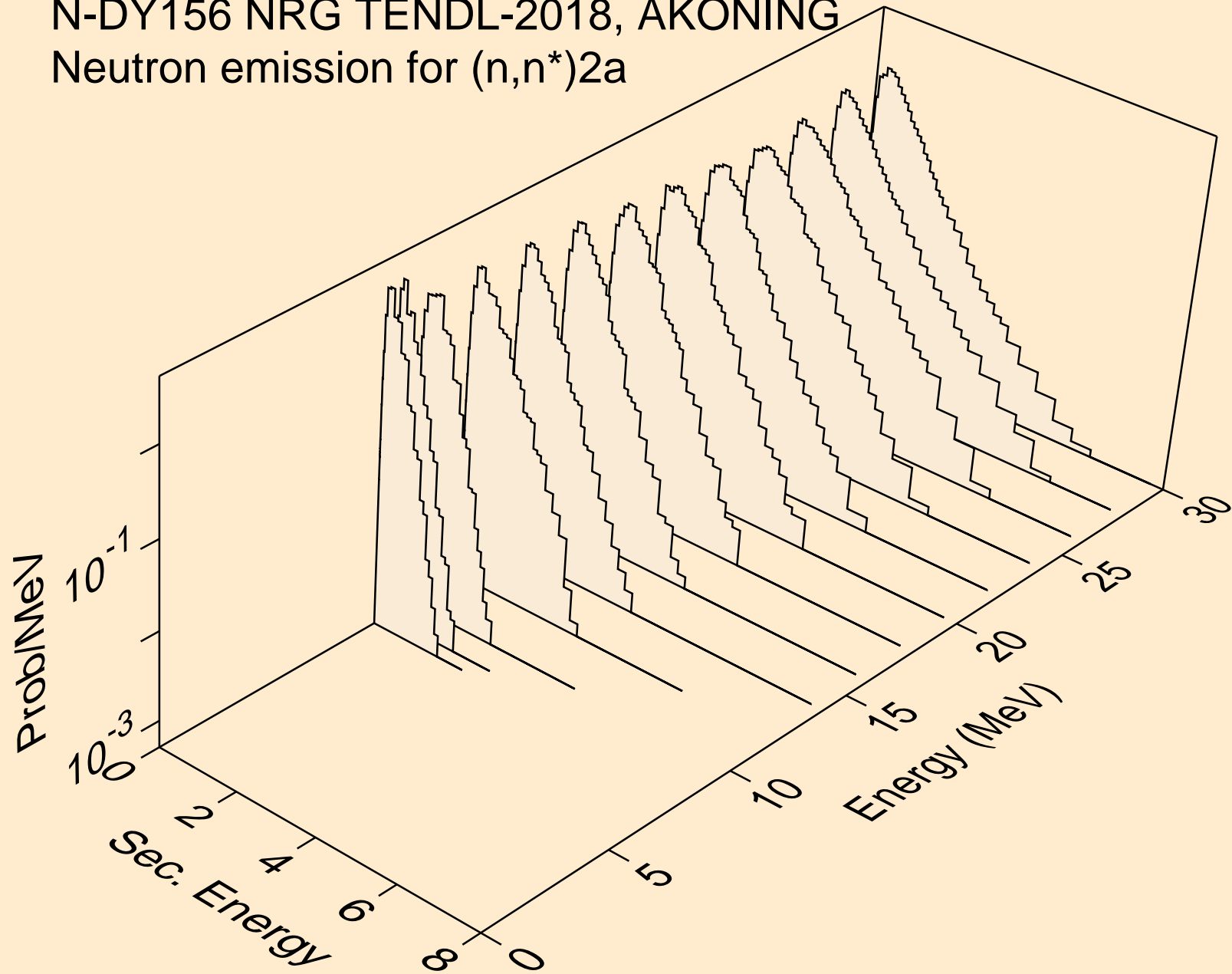

N-DY156 NRG TENDL-2018, AKONING
Neutron emission for (n,2n)2a

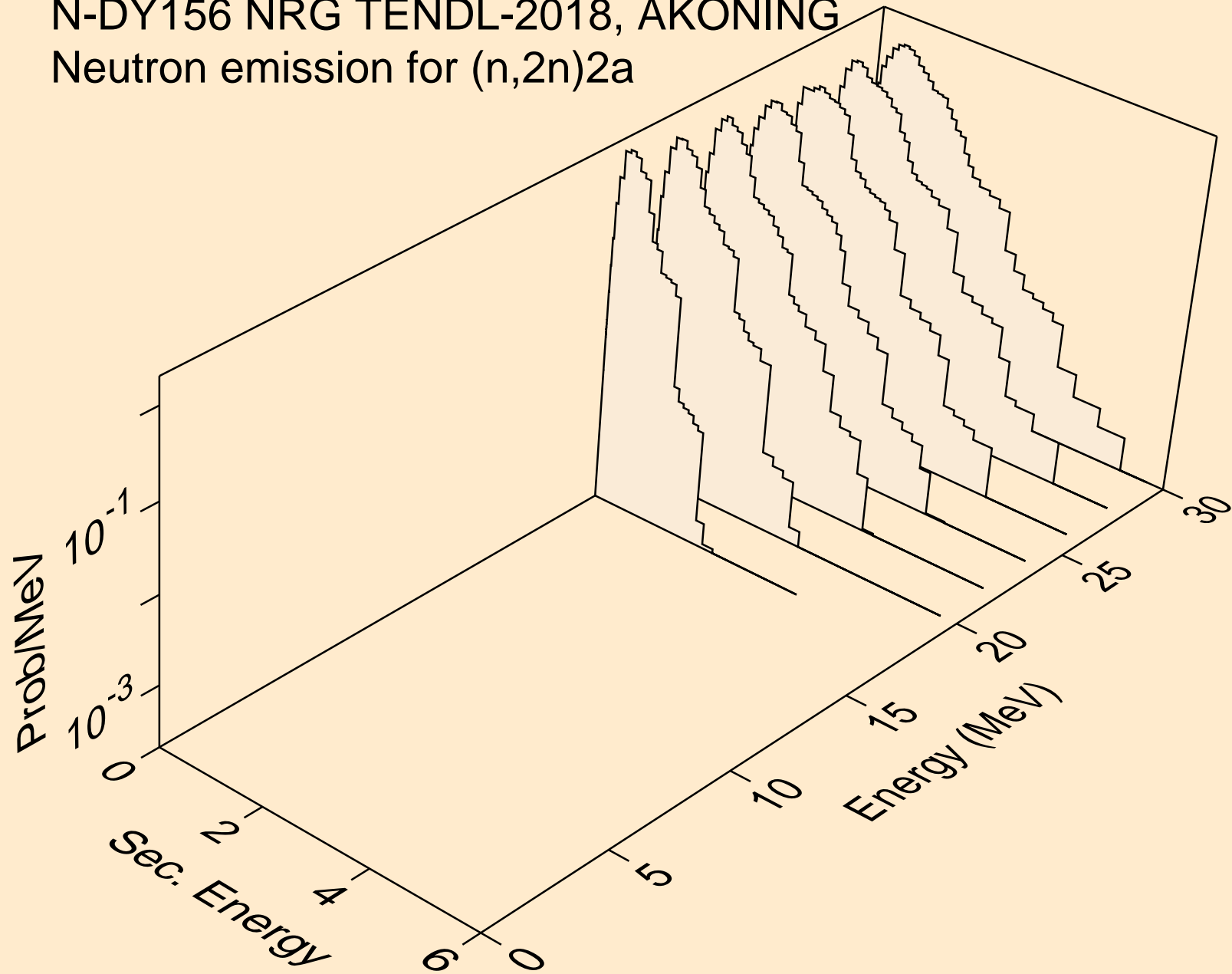

N-DY156 NRG TENDL-2018, AKONING
Neutron emission for (n,n*)d

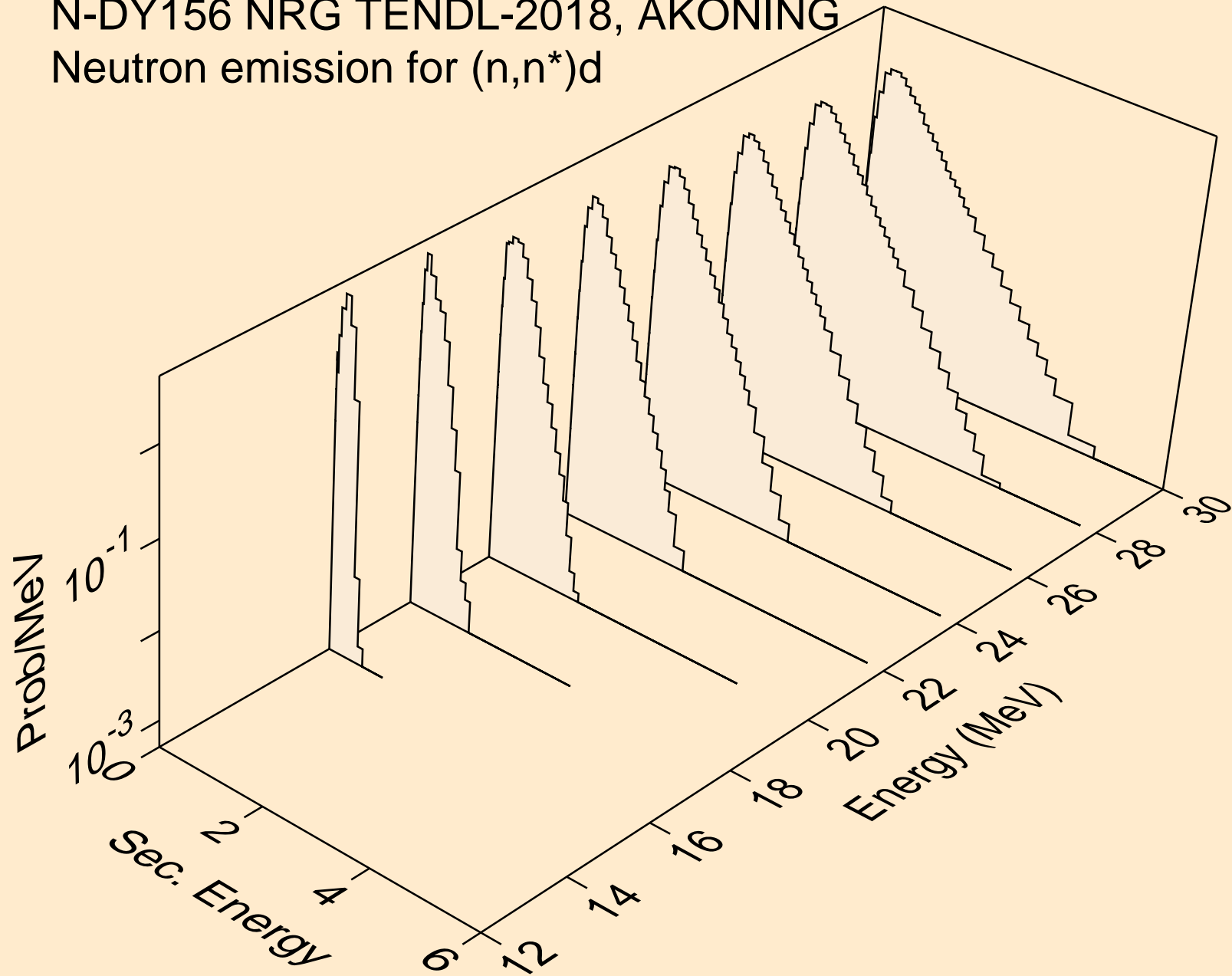

N-DY156 NRG TENDL-2018, AKONING
Neutron emission for (n,n*)t

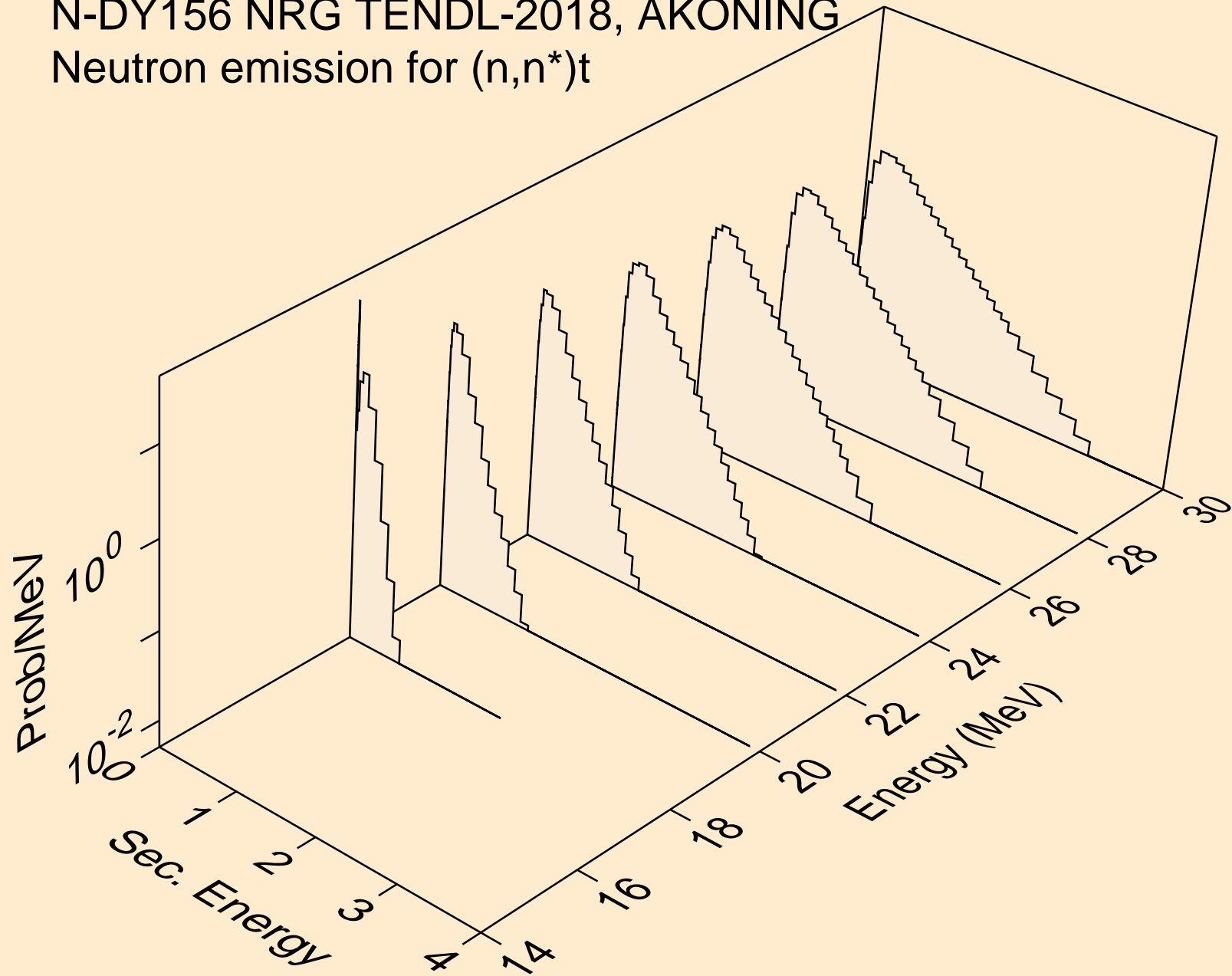

N-DY156 NRG TENDL-2018, AKONING
Neutron emission for (n,n*)he3

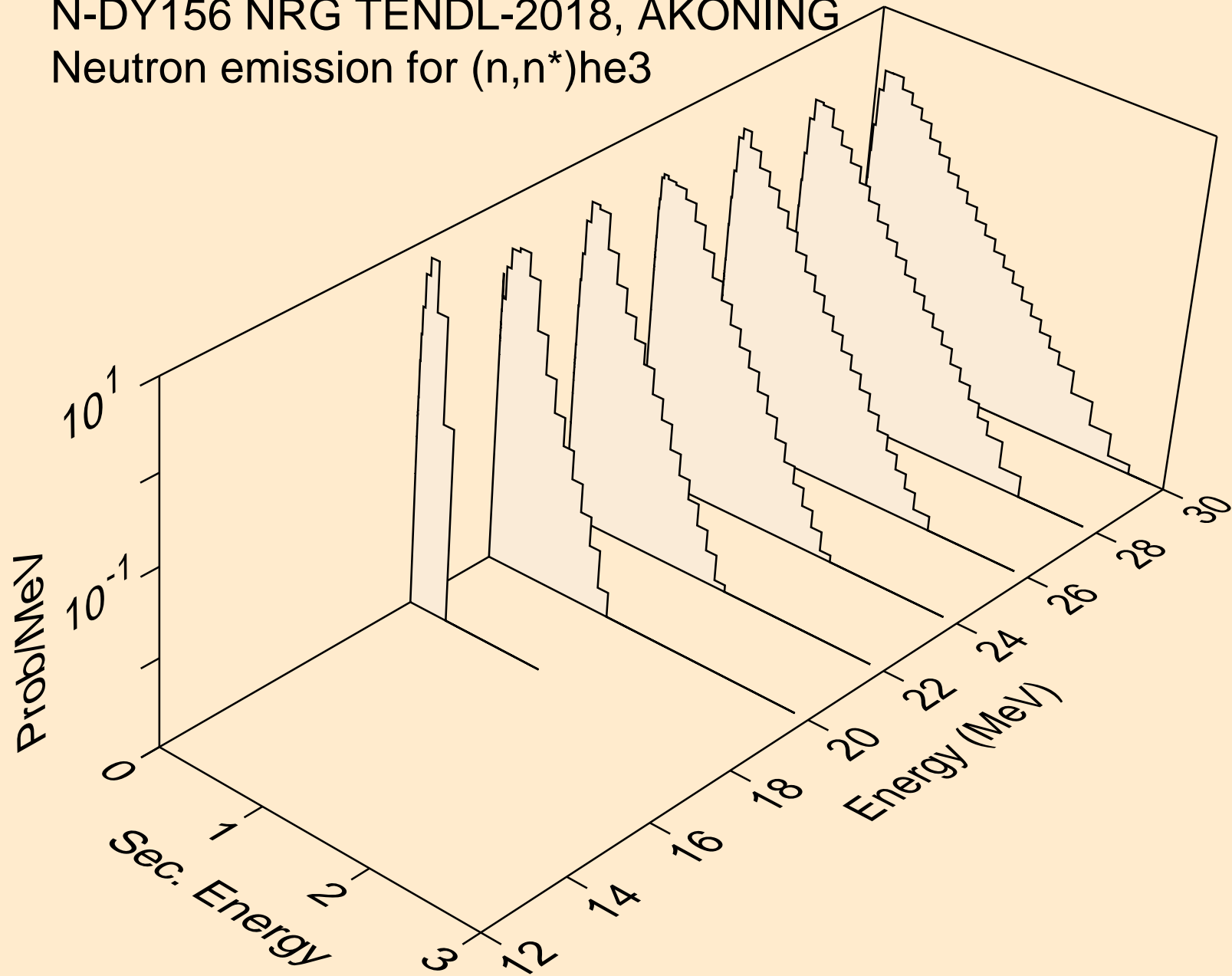

N-DY156 NRG TENDL-2018, AKONING
Neutron emission for (n,4n)

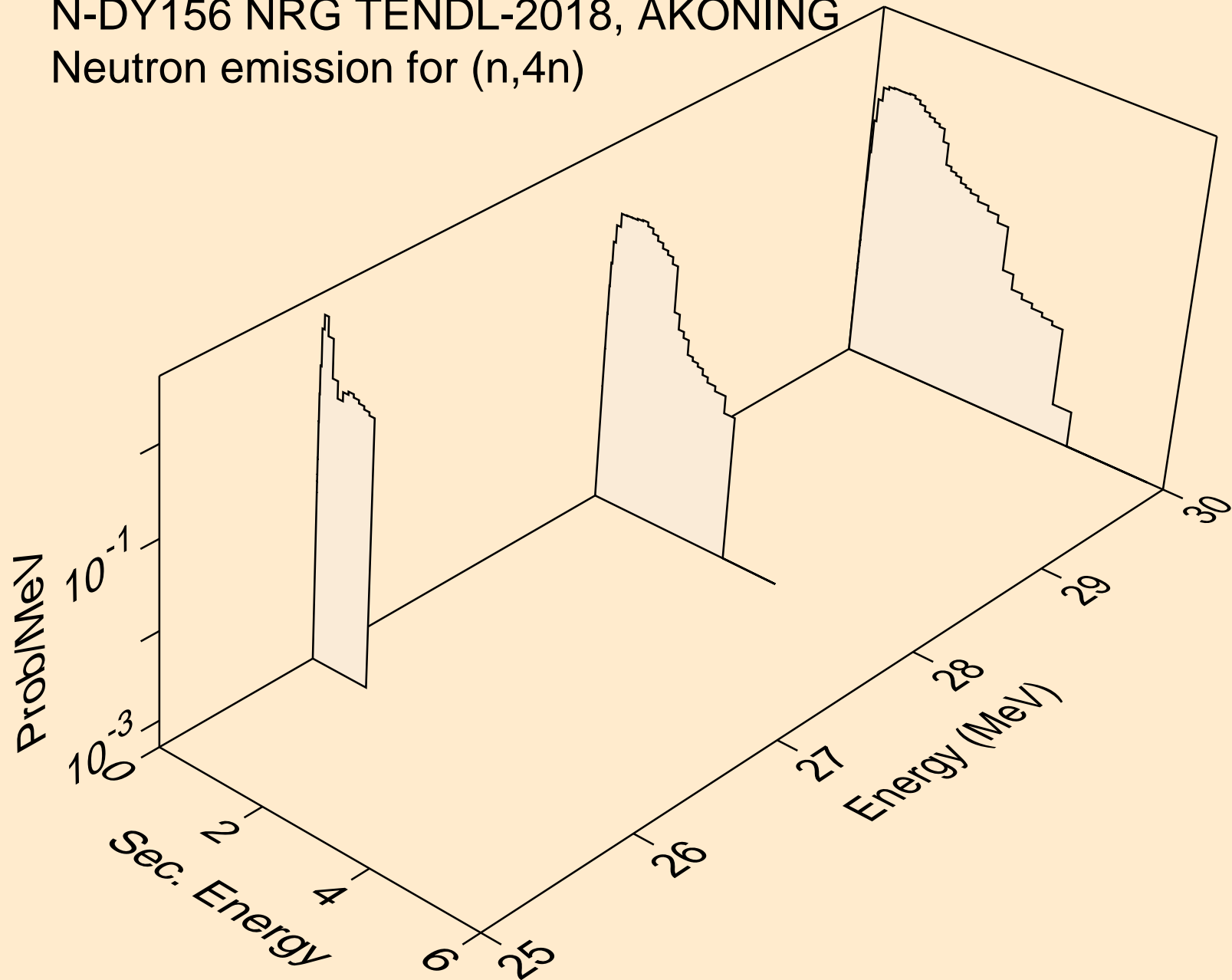

N-DY156 NRG TENDL-2018, AKONING
Neutron emission for (n,2np)

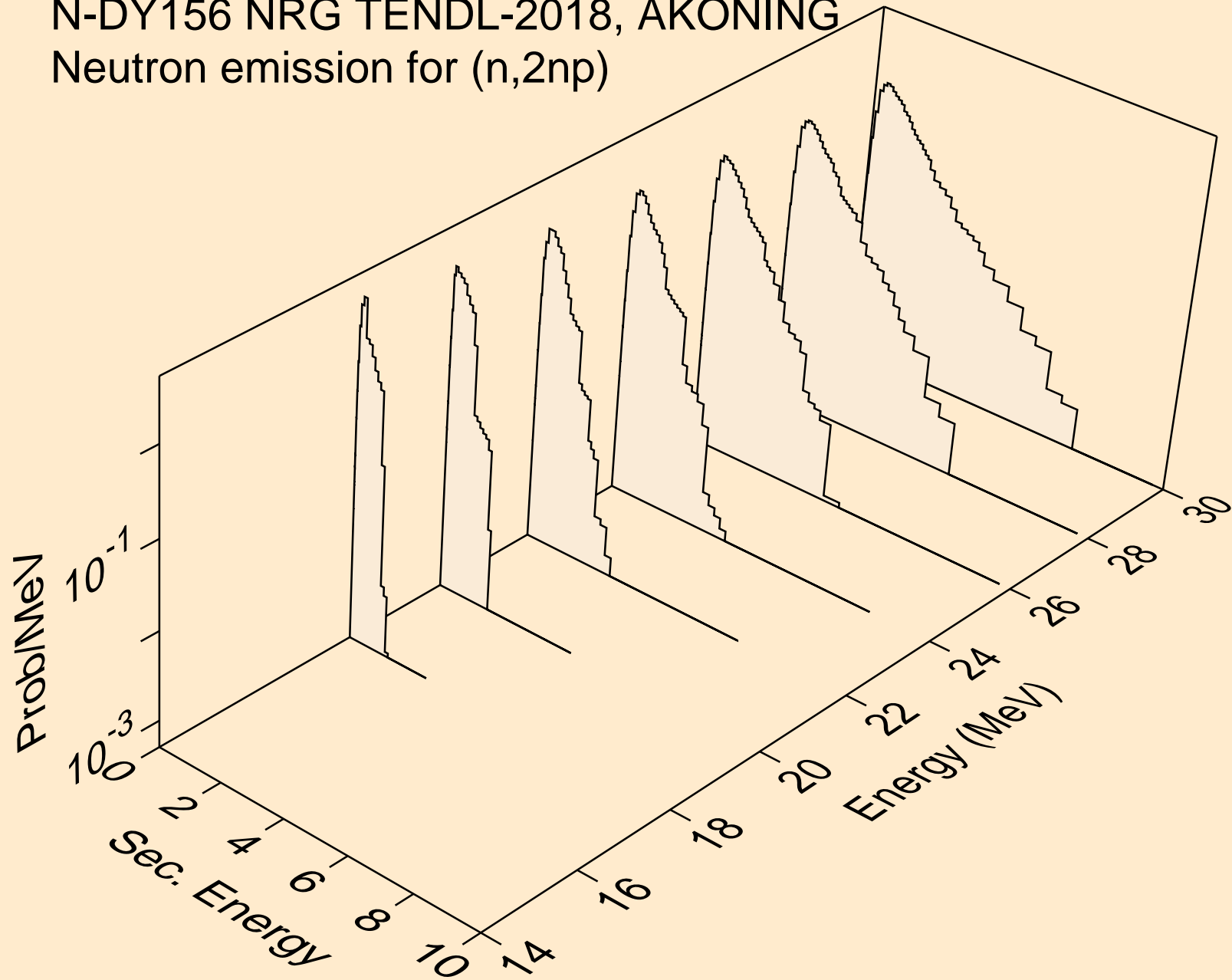

N-DY156 NRG TENDL-2018, AKONING
Neutron emission for (n,3np)

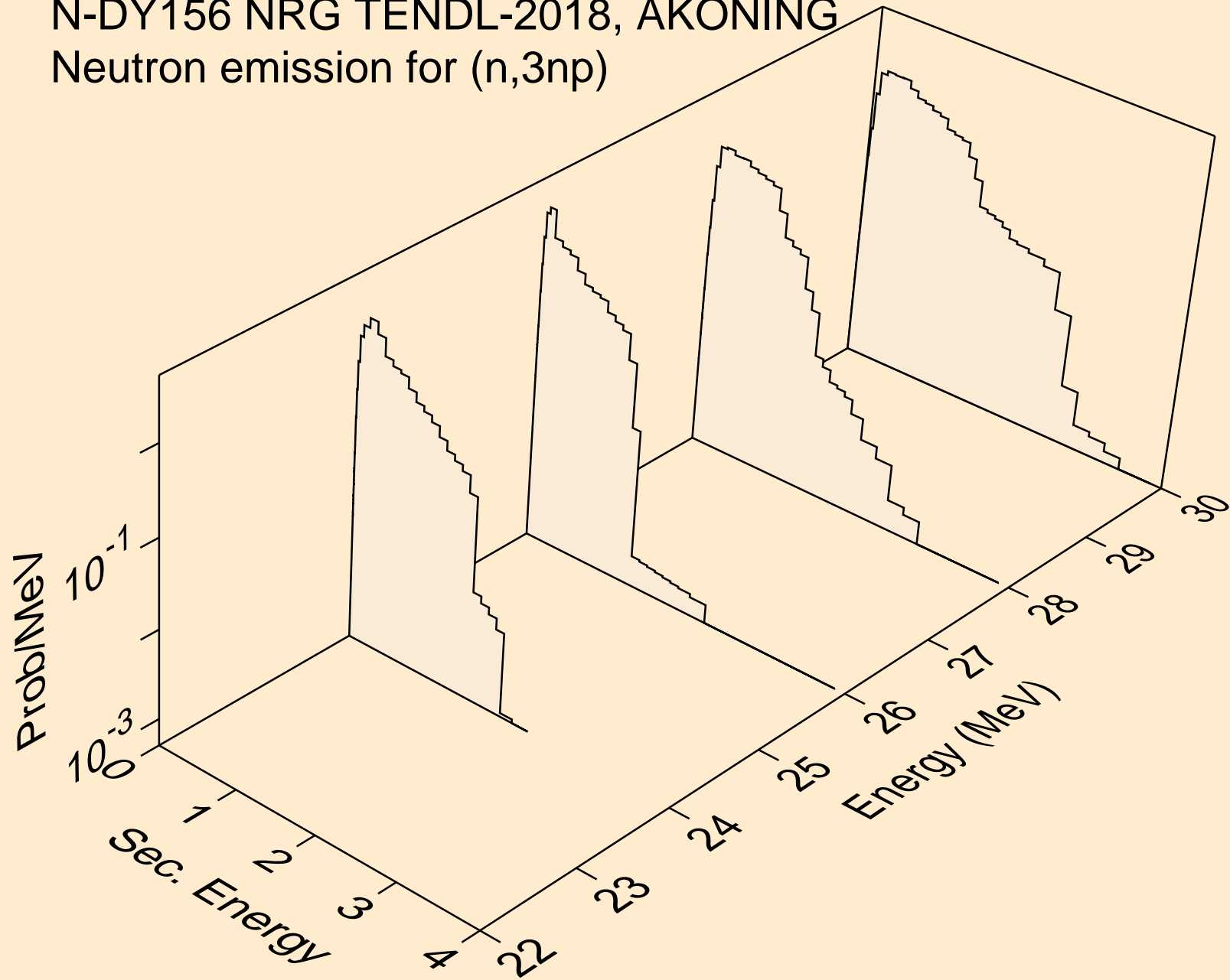

N-DY156 NRG TENDL-2018, AKONING
Neutron emission for (n,2np)

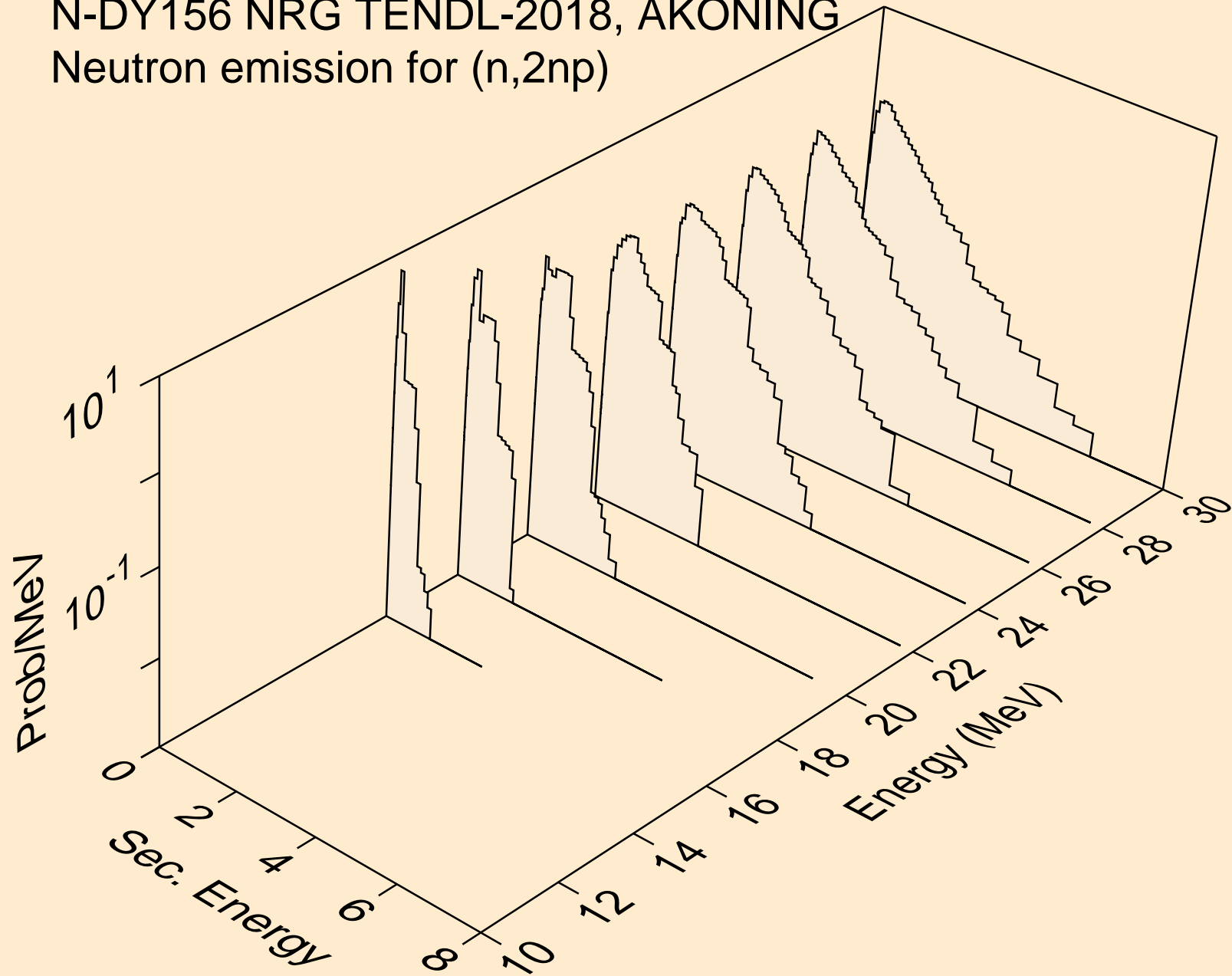

N-DY156 NRG TENDL-2018, AKONING
Neutron emission for (n,npa)

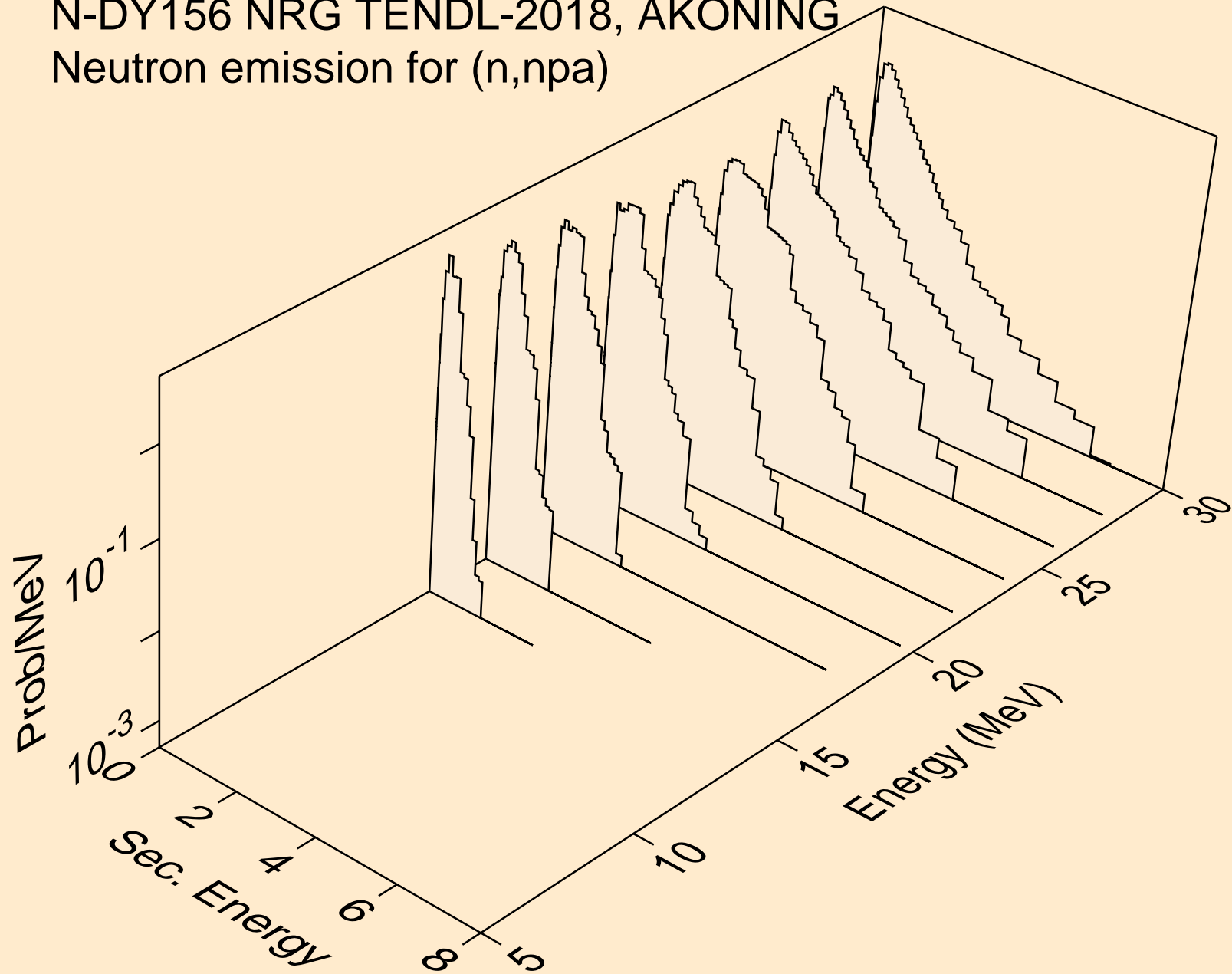

N-DY156 NRG TENDL-2018, AKONING
Neutron emission for (n,n*c)

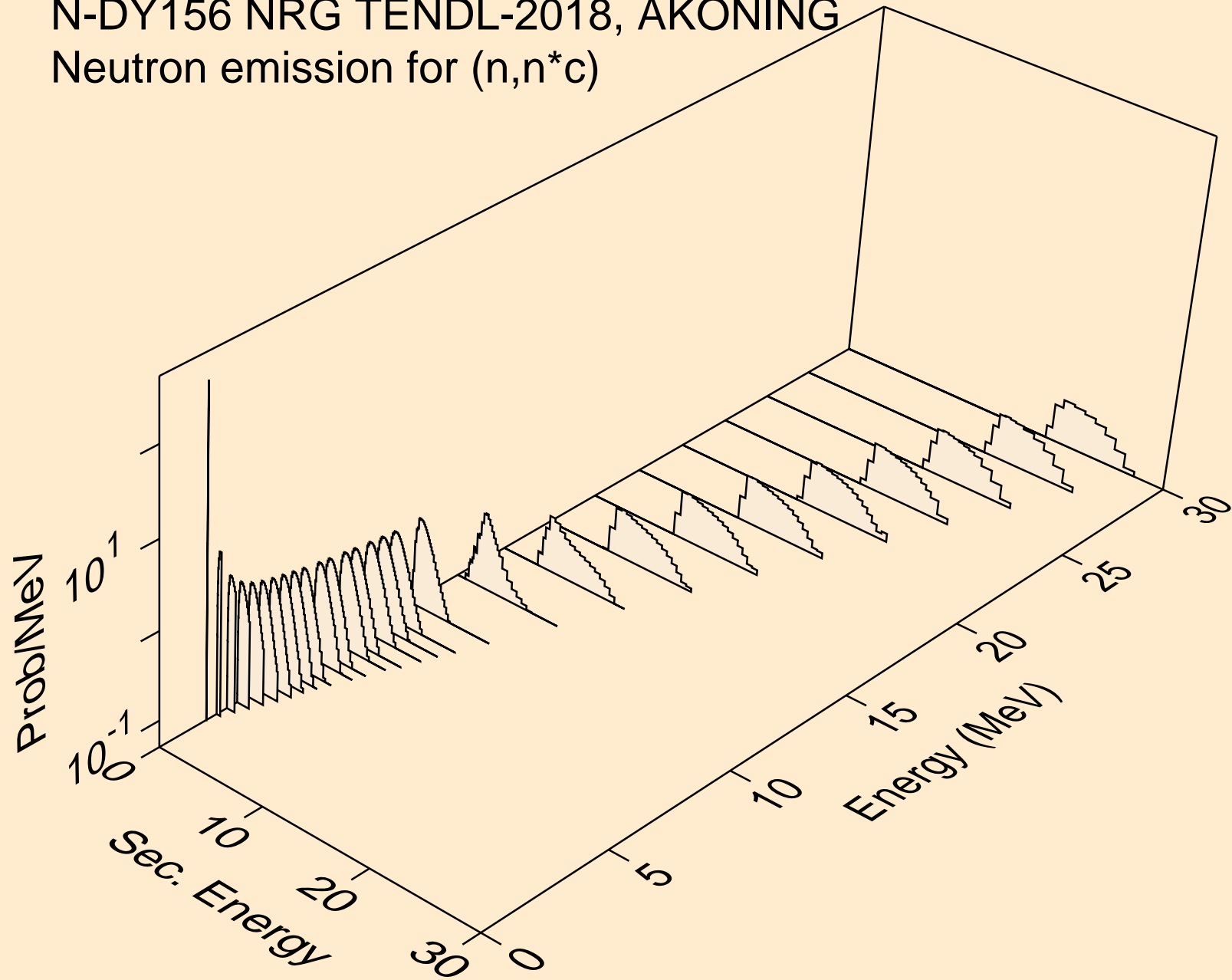

N-DY156 NRG TENDL-2018, AKONING
Photon emission for (n,x)

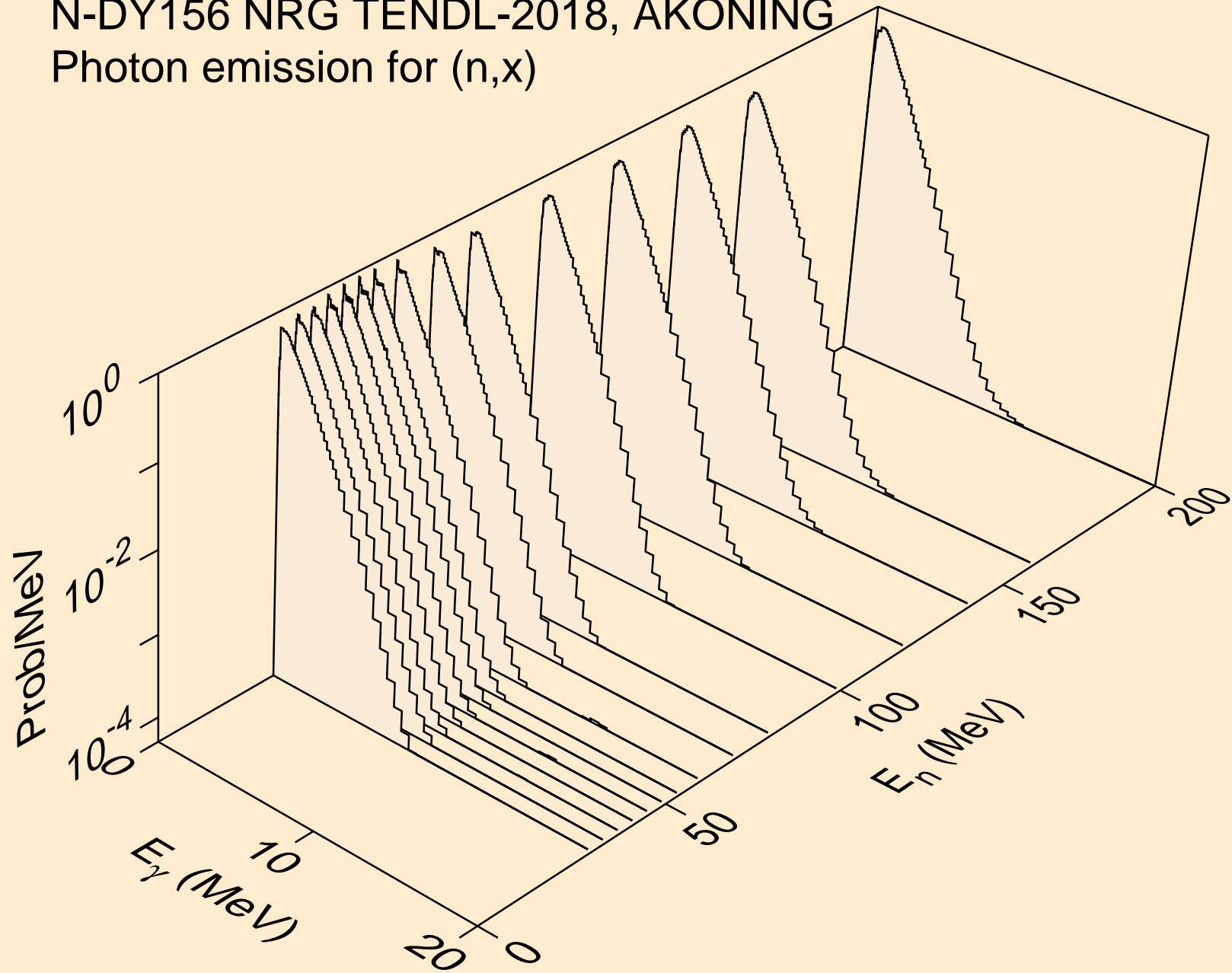

N-DY156 NRG TENDL-2018, AKONING
Photon emission for (n,2nd)

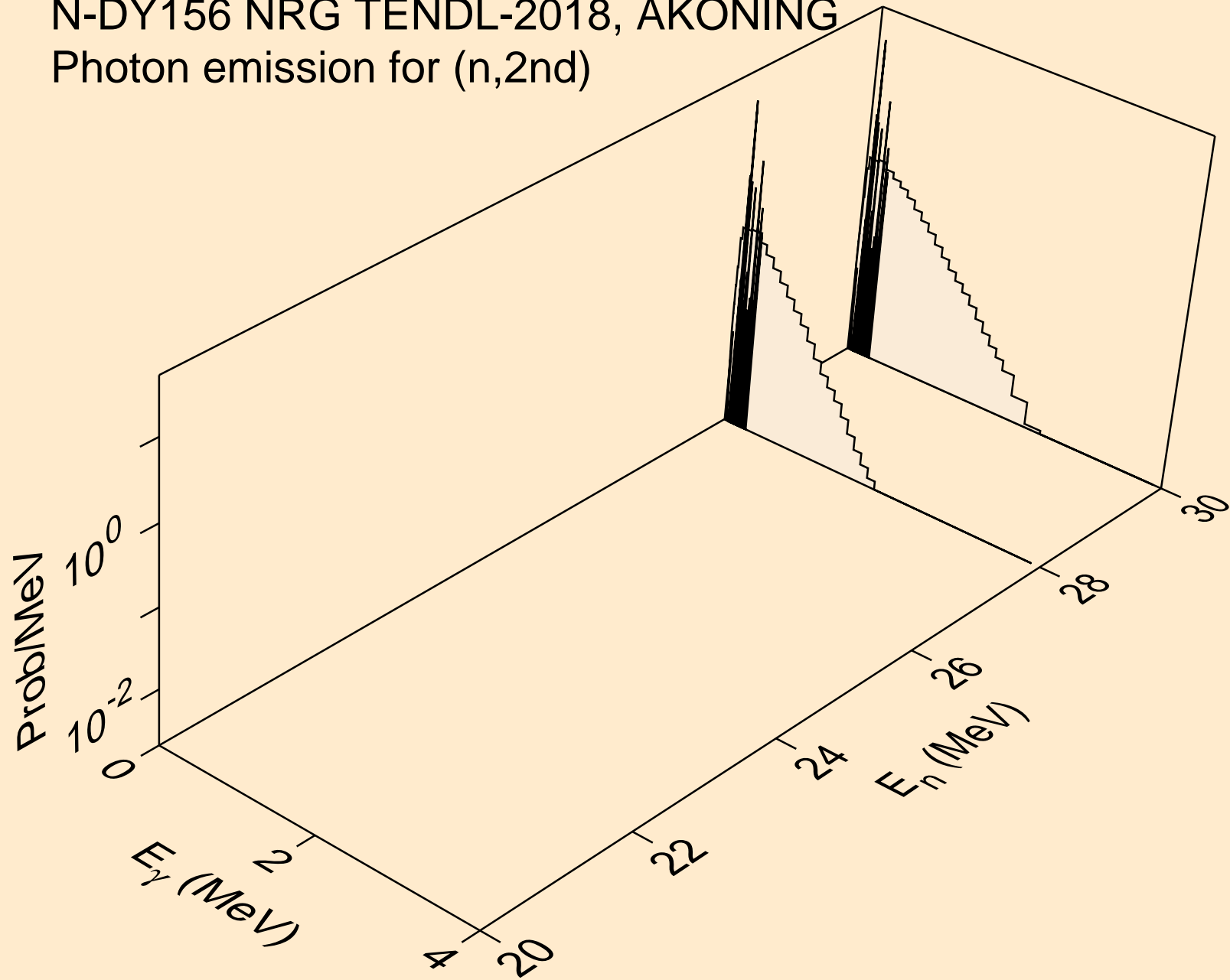

N-DY156 NRG TENDL-2018, AKONING
Photon emission for (n,2n)

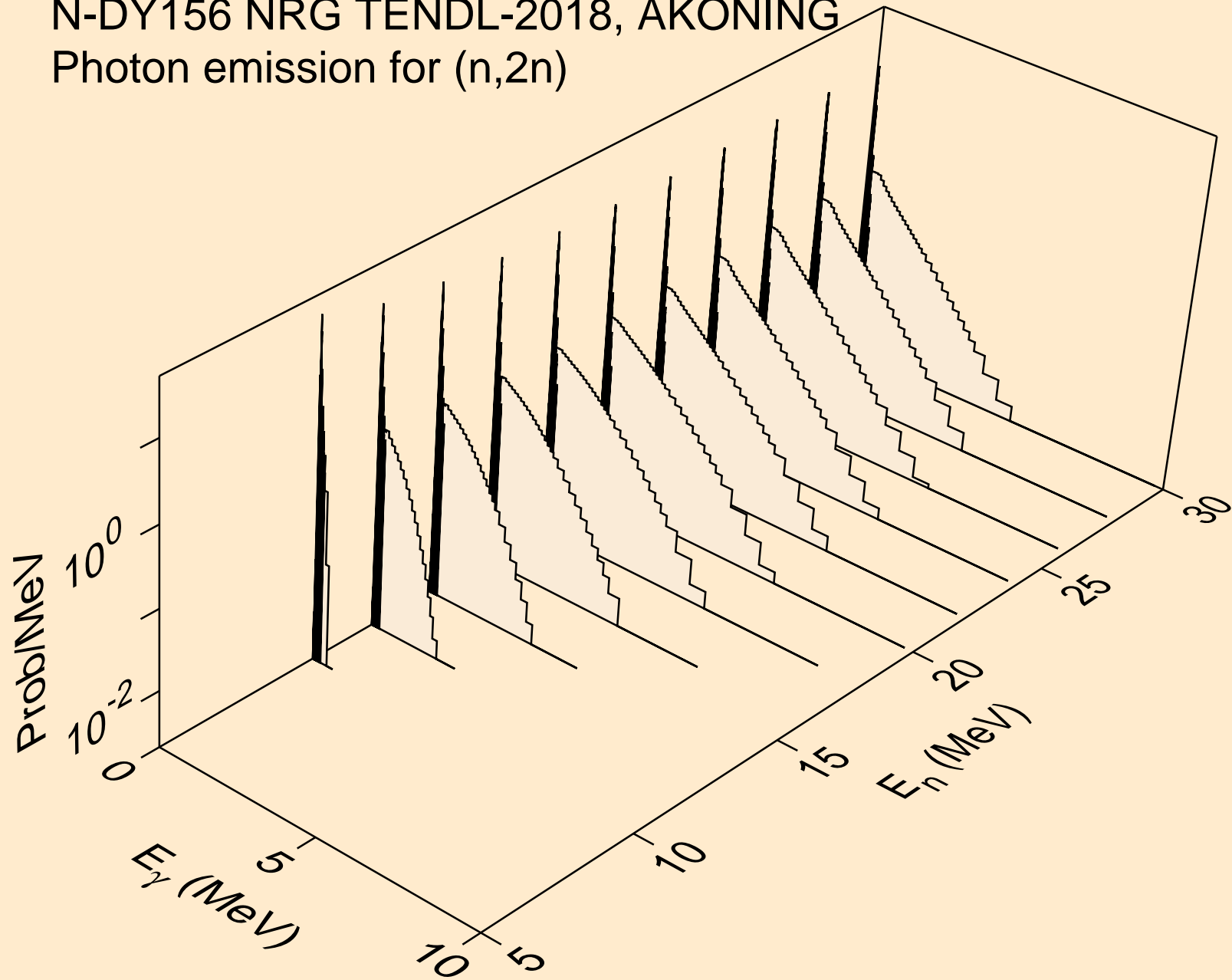

N-DY156 NRG TENDL-2018, AKONING
Photon emission for (n,3n)

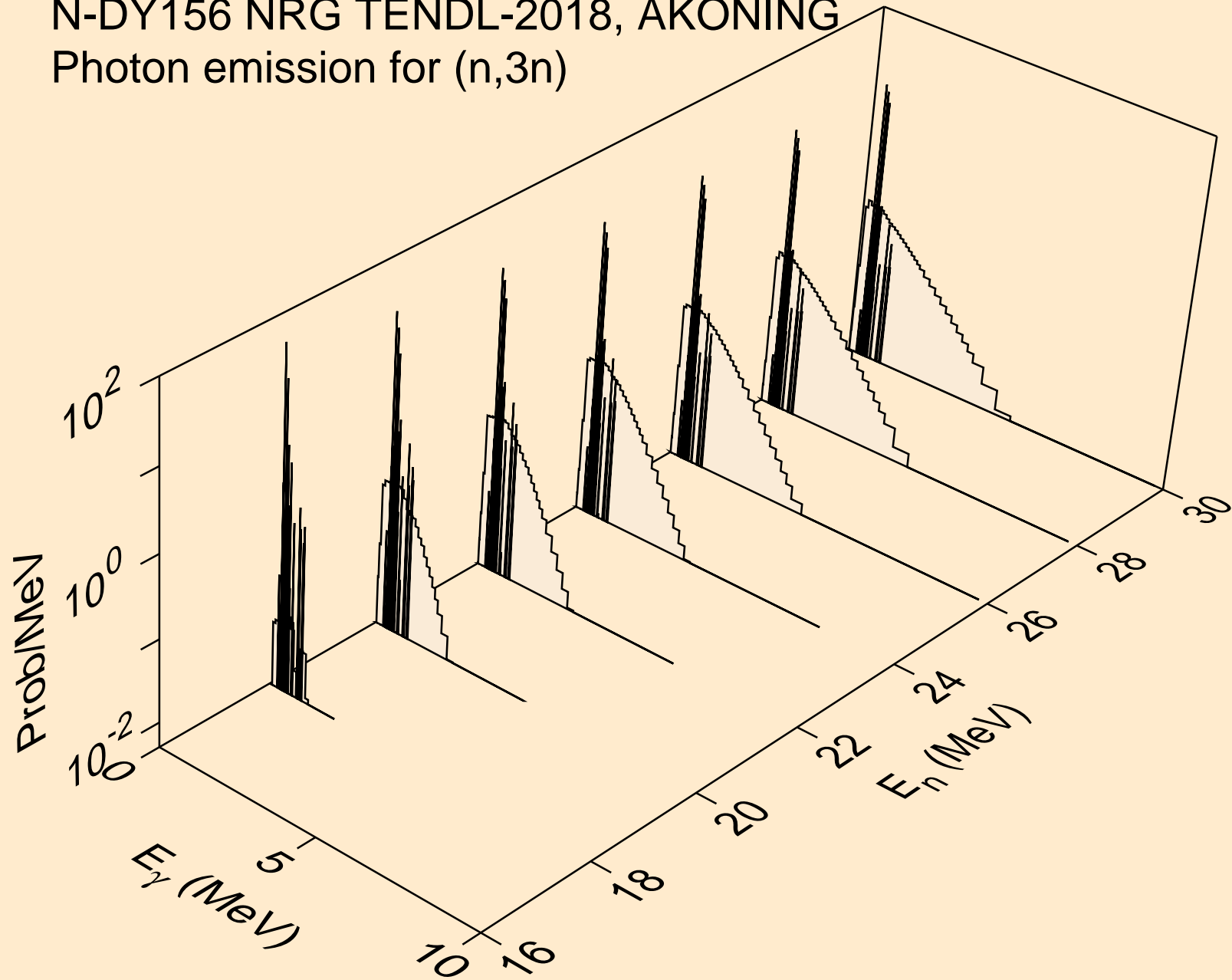

N-DY156 NRG TENDL-2018, AKONING
Photon emission for (n,n*)a

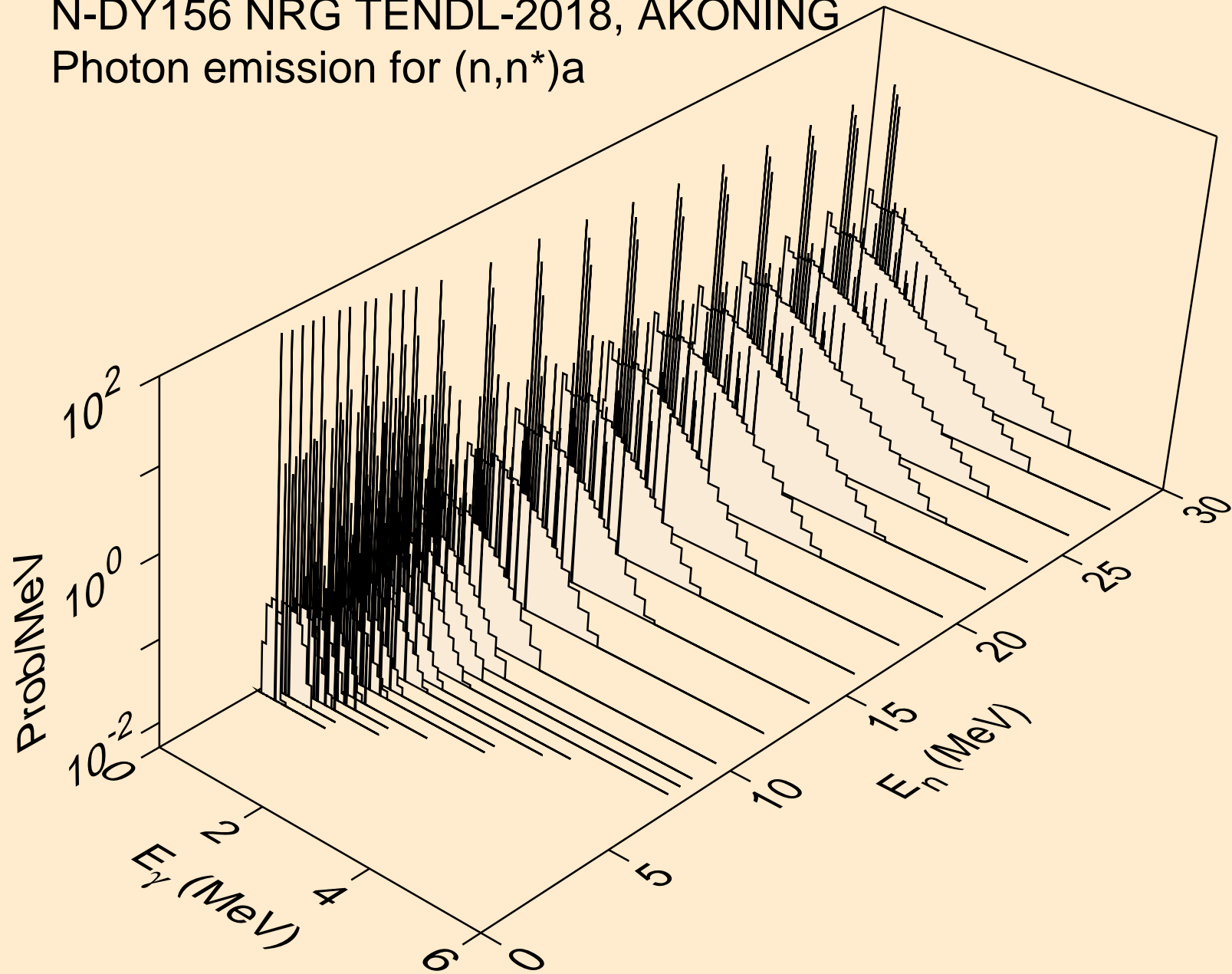

N-DY156 NRG TENDL-2018, AKONING
Photon emission for (n,2n)a

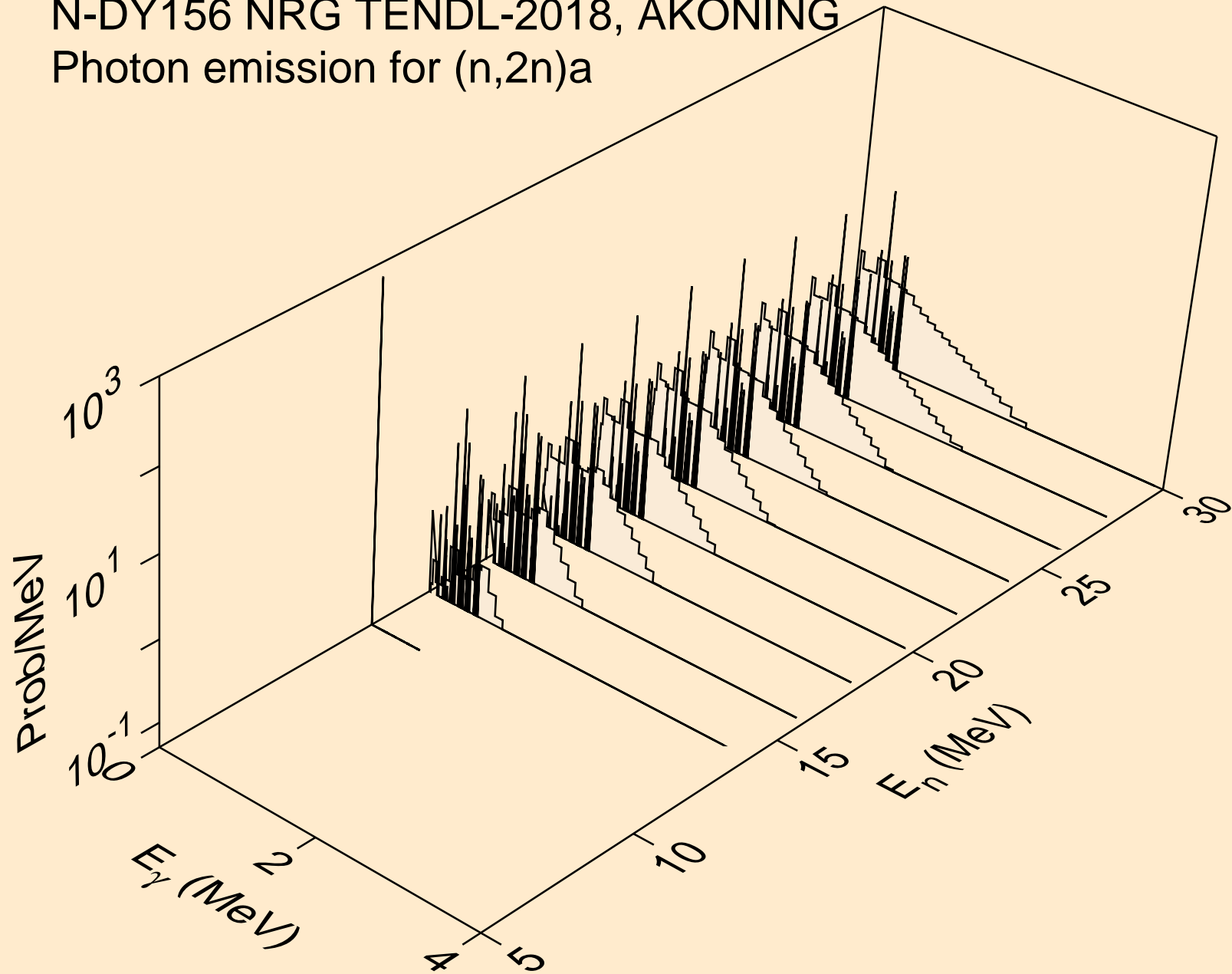

N-DY156 NRG TENDL-2018, AKONING
Photon emission for (n,3n)a

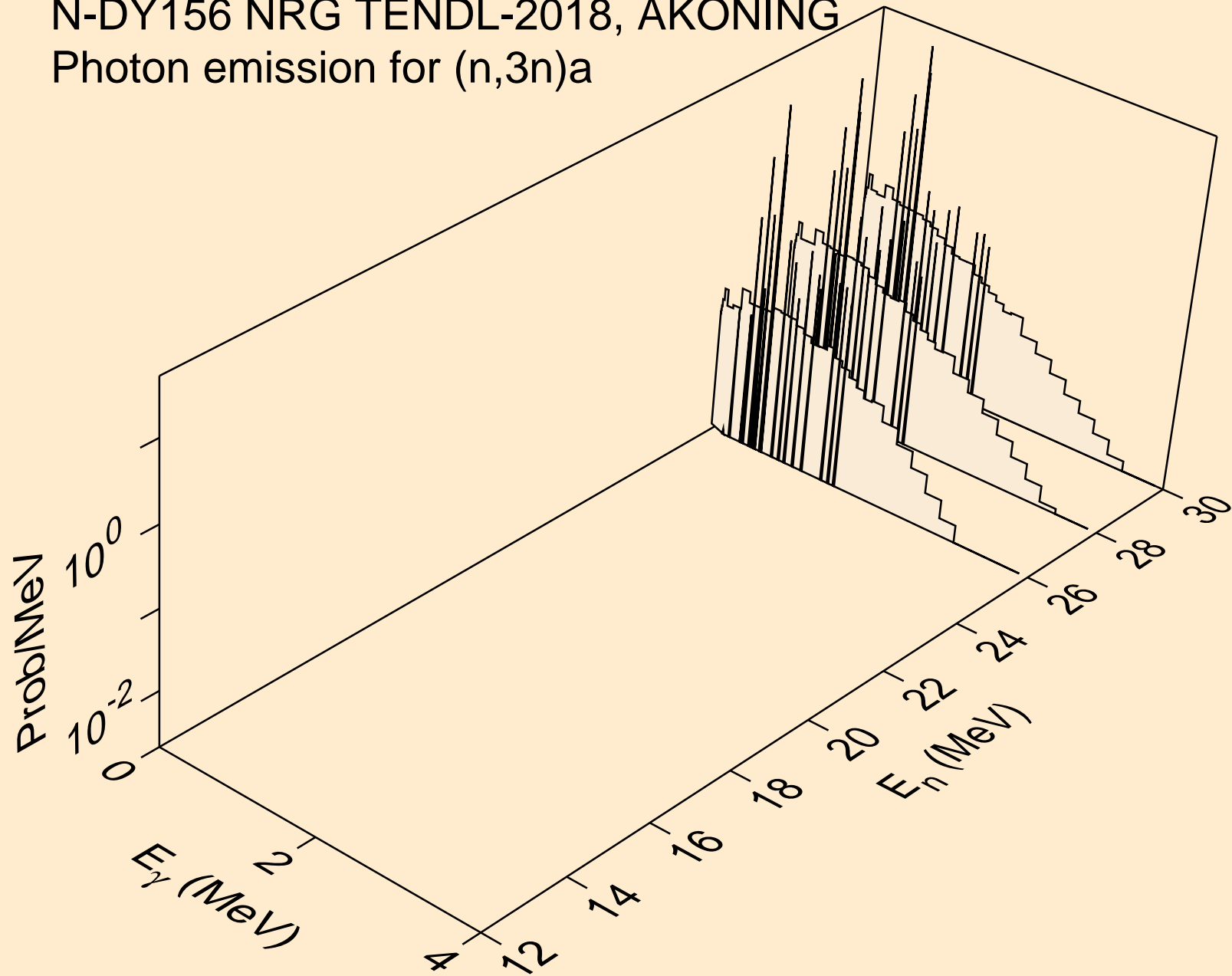

N-DY156 NRG TENDL-2018, AKONING
Photon emission for (n,n*)p

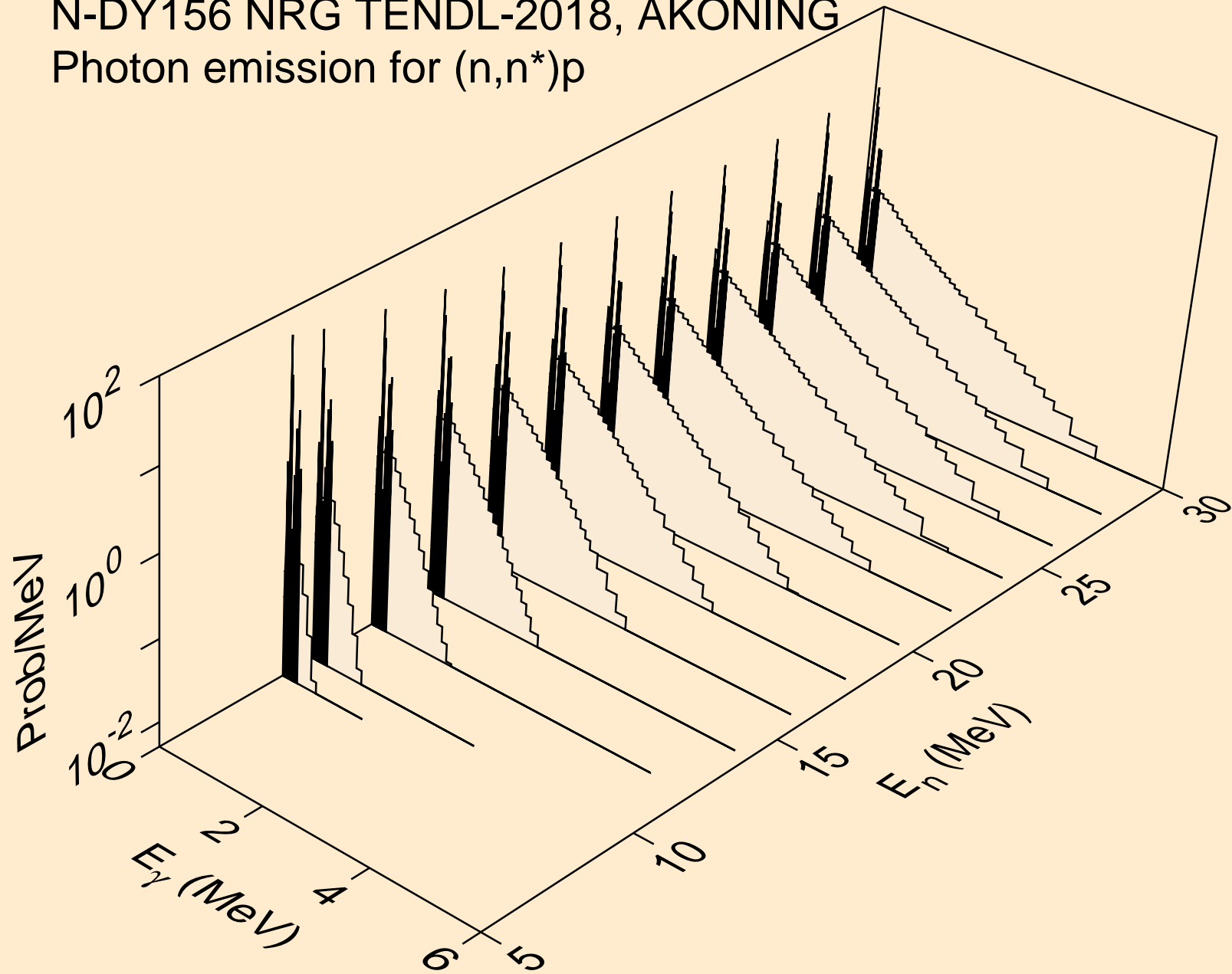

N-DY156 NRG TENDL-2018, AKONING
Photon emission for (n,n*)2a

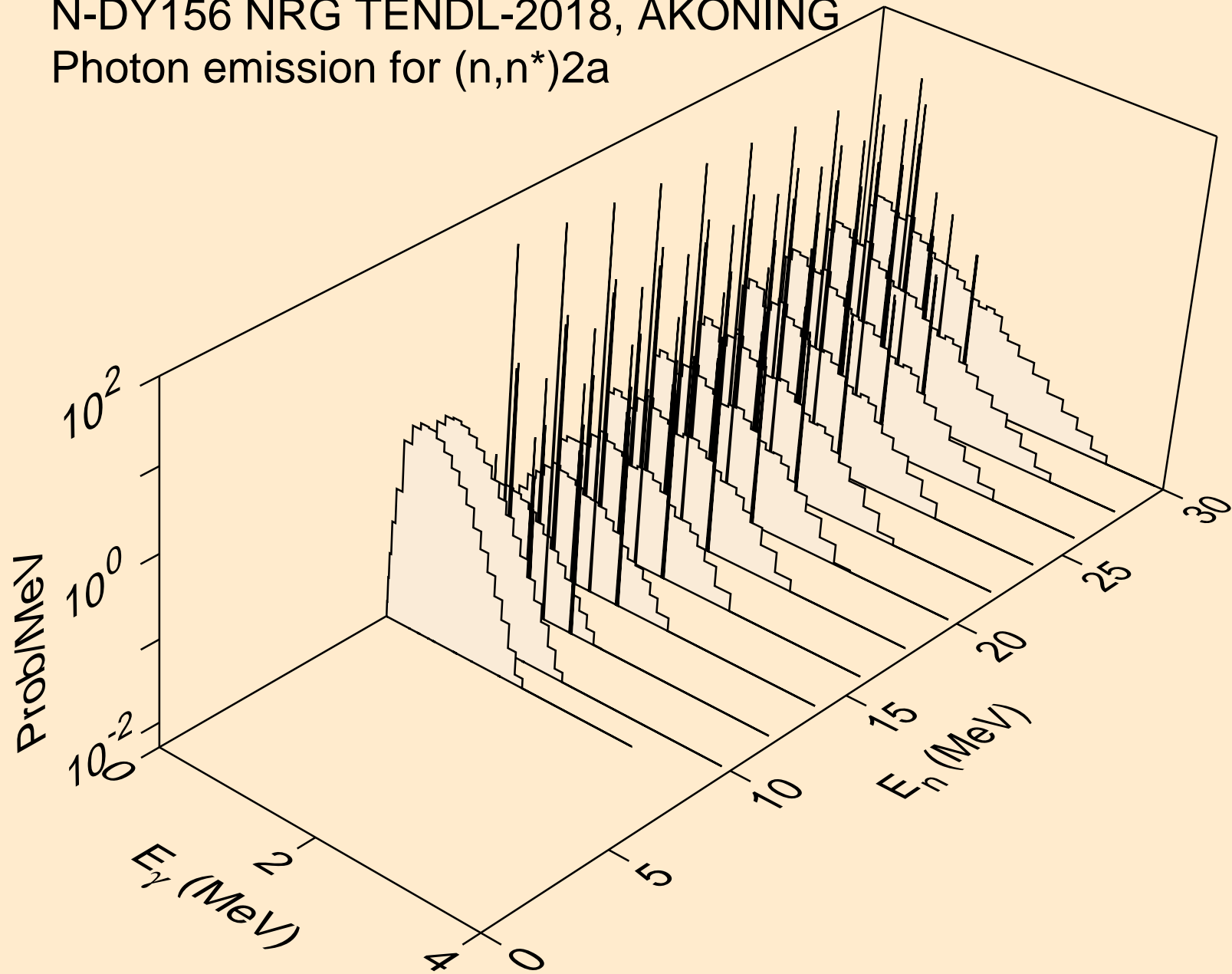

N-DY156 NRG TENDL-2018, AKONING
Photon emission for (n,2n)2a

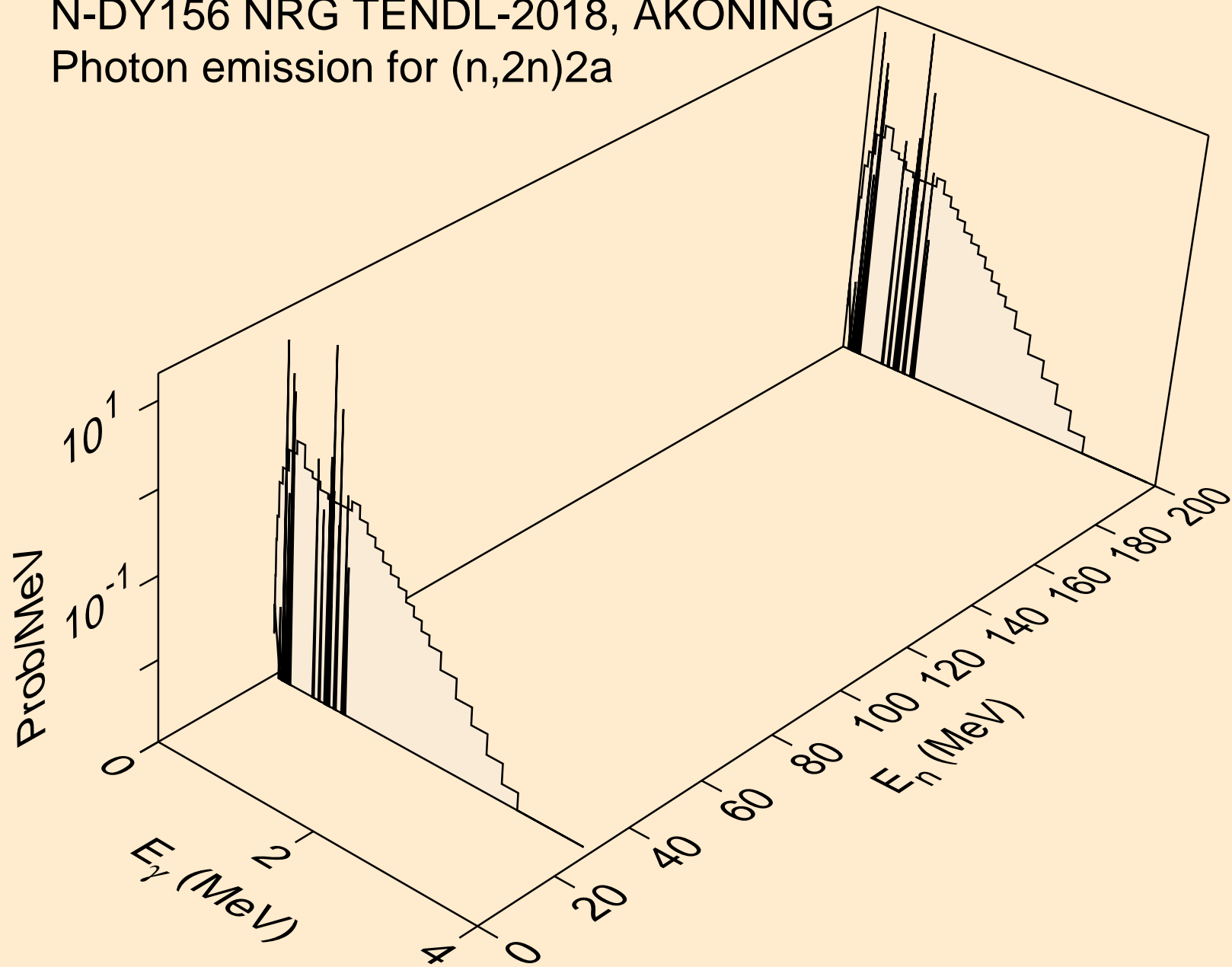

N-DY156 NRG TENDL-2018, AKONING
Photon emission for (n,n*)d

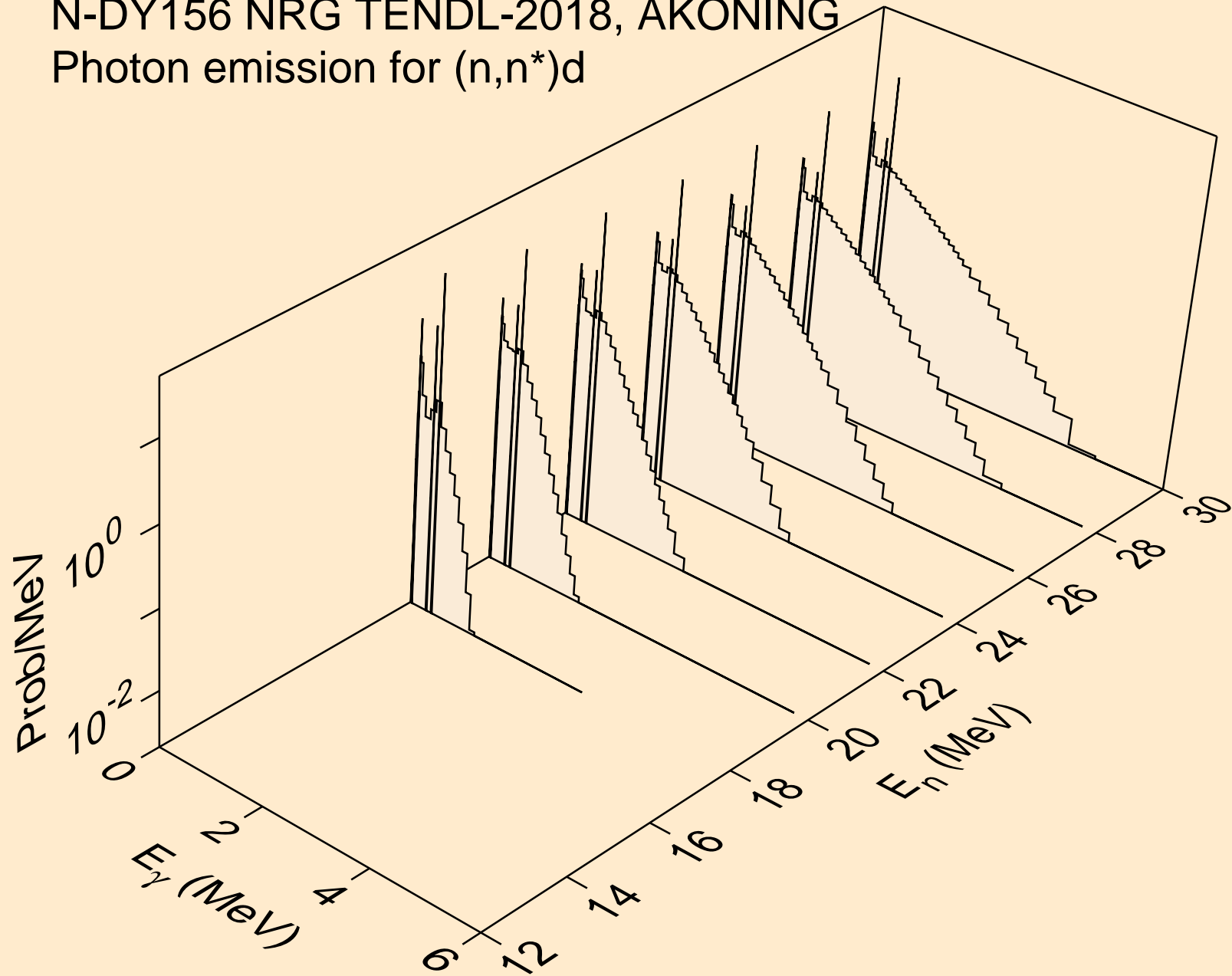

N-DY156 NRG TENDL-2018, AKONING
Photon emission for (n,n*)t

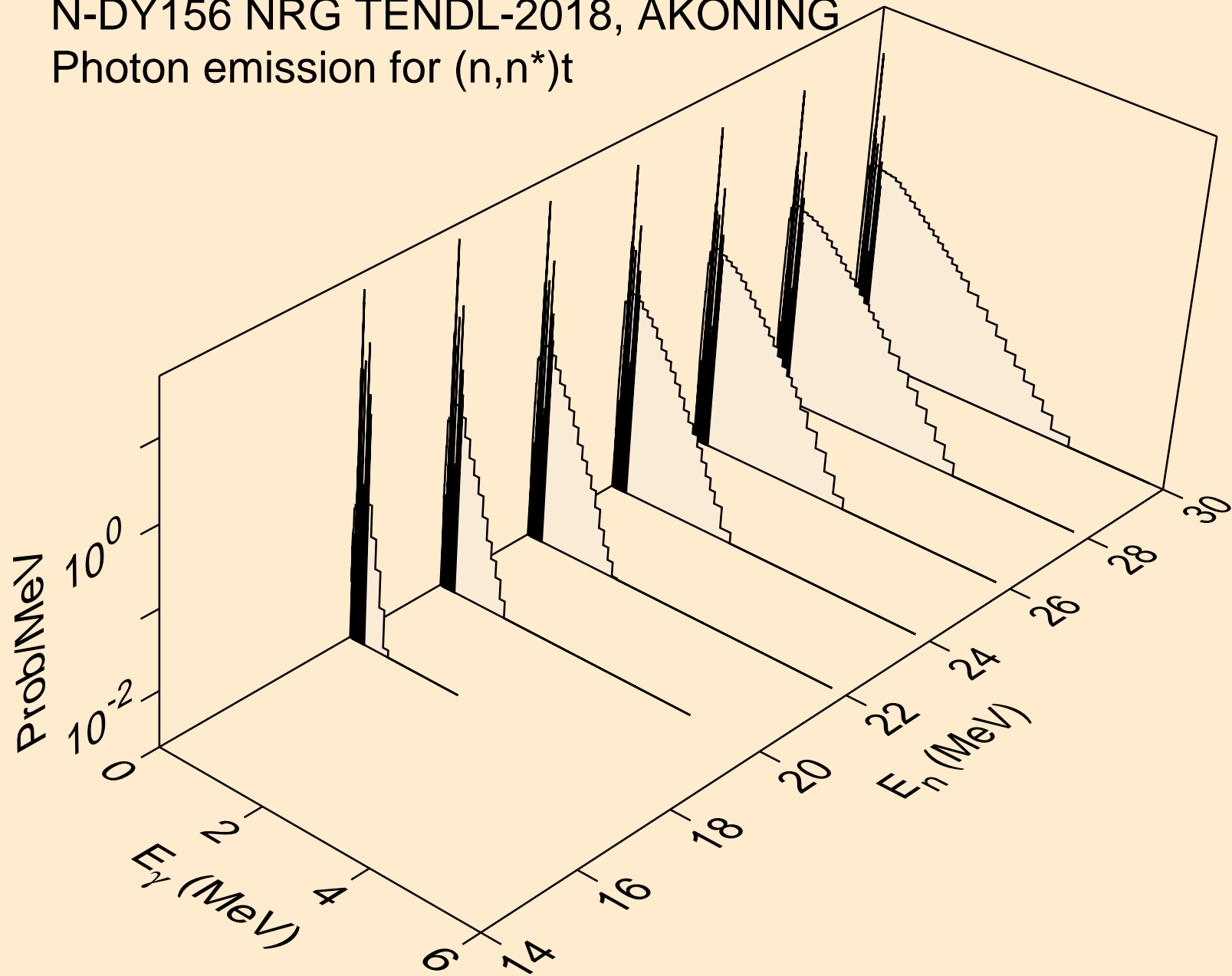

N-DY156 NRG TENDL-2018, AKONING
Photon emission for (n,n*)he3

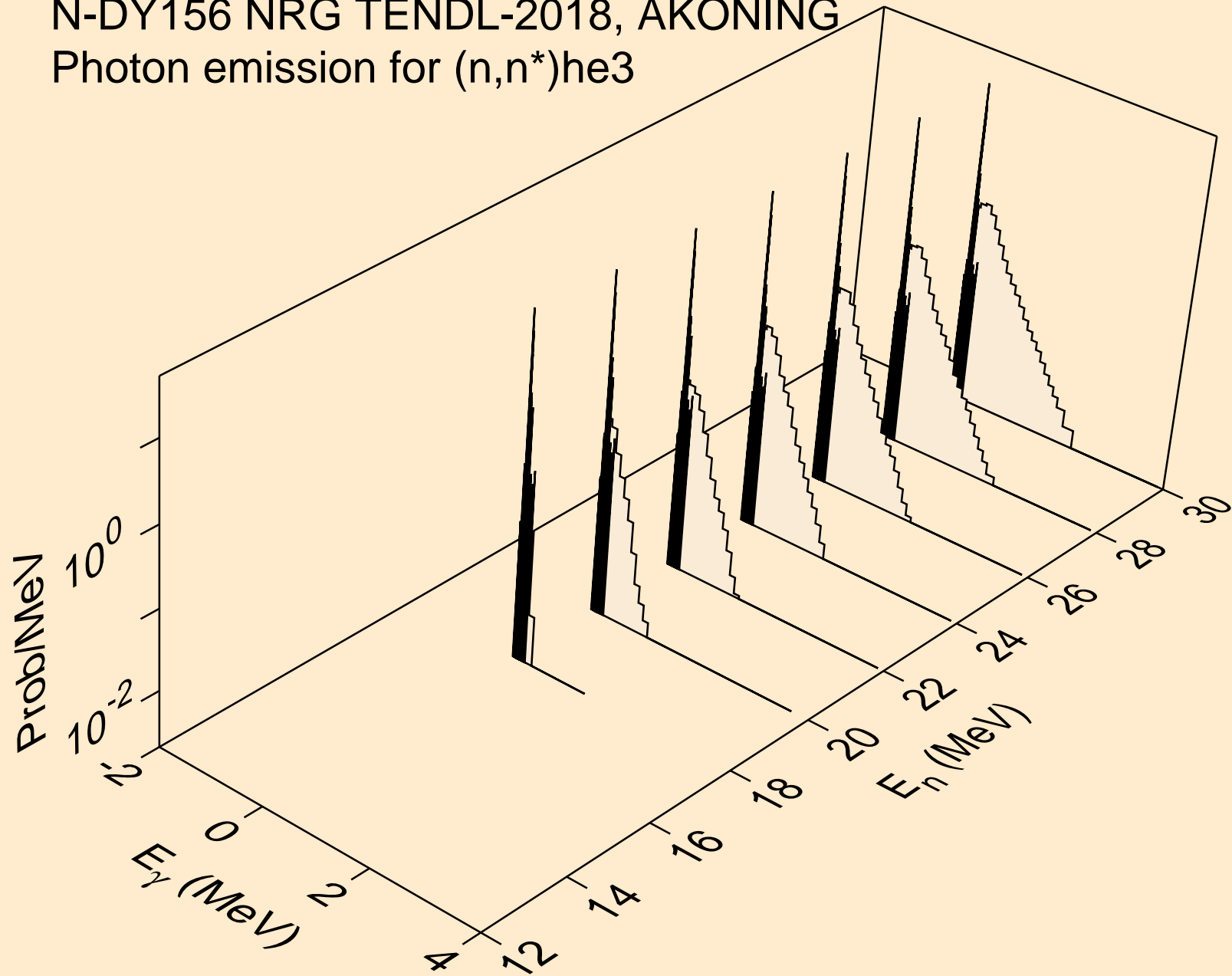

N-DY156 NRG TENDL-2018, AKONING
Photon emission for (n,4n)

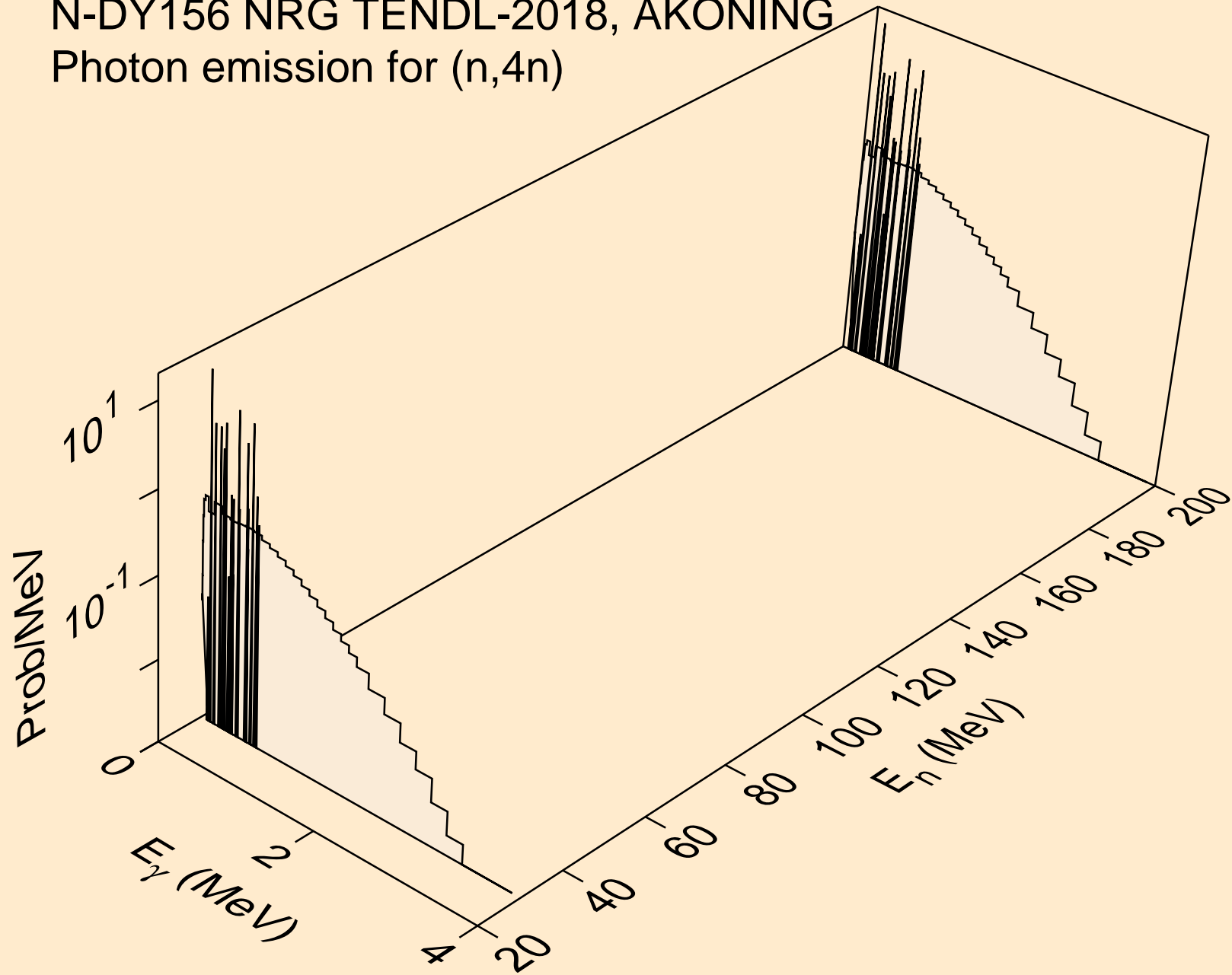

N-DY156 NRG TENDL-2018, AKONING
Photon emission for (n,2np)

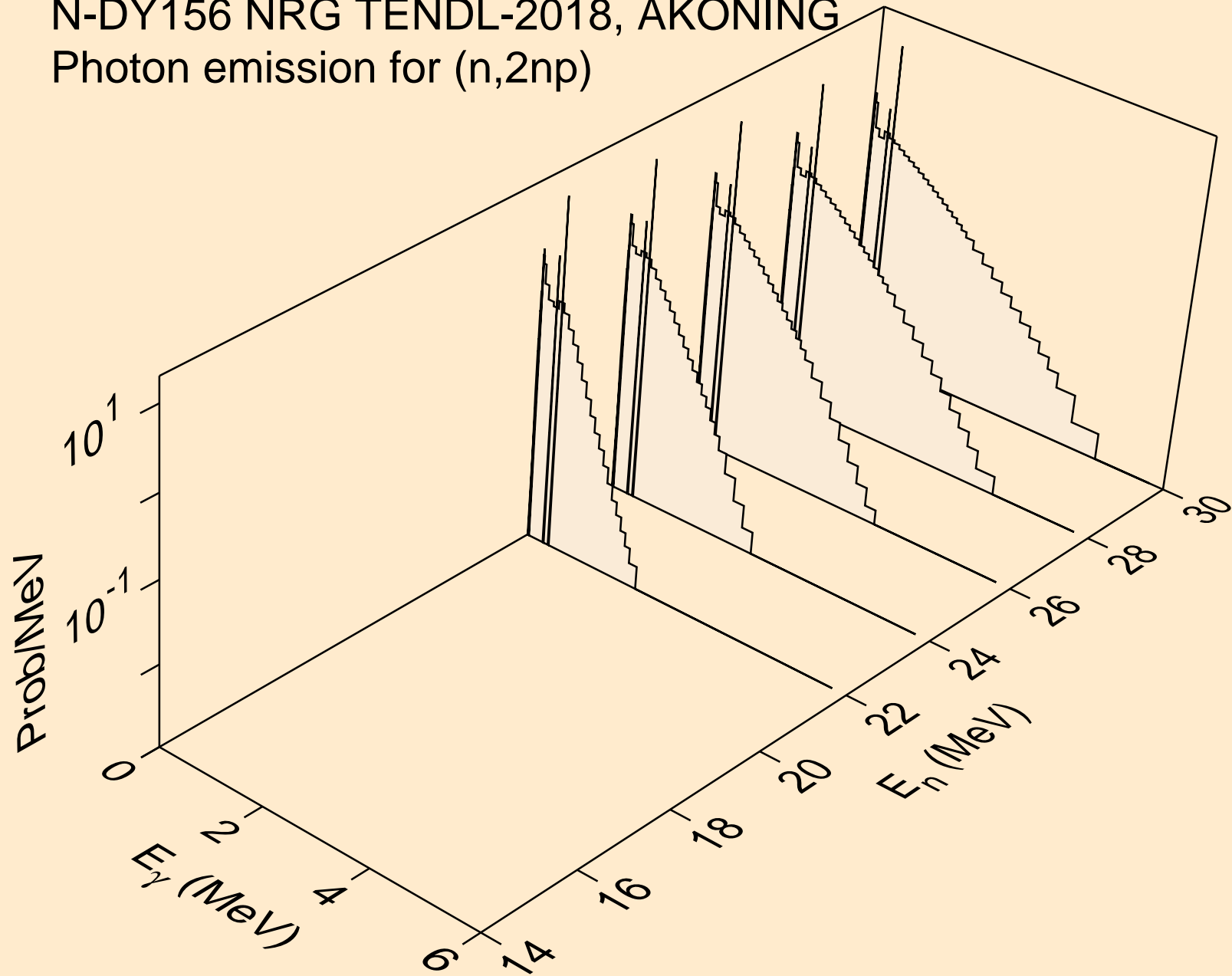

N-DY156 NRG TENDL-2018, AKONING
Photon emission for (n,3np)

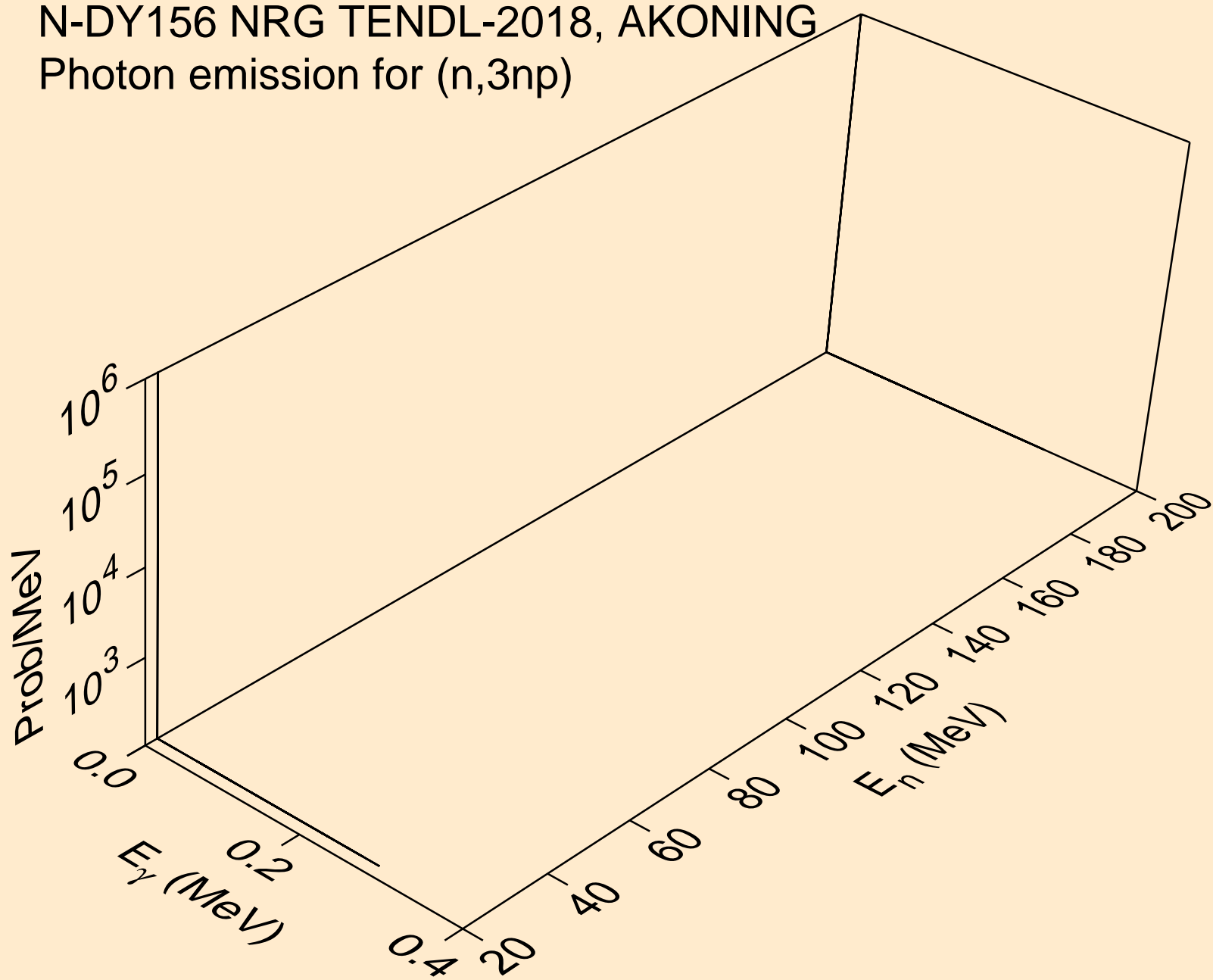

N-DY156 NRG TENDL-2018, AKONING
Photon emission for (n,2np)

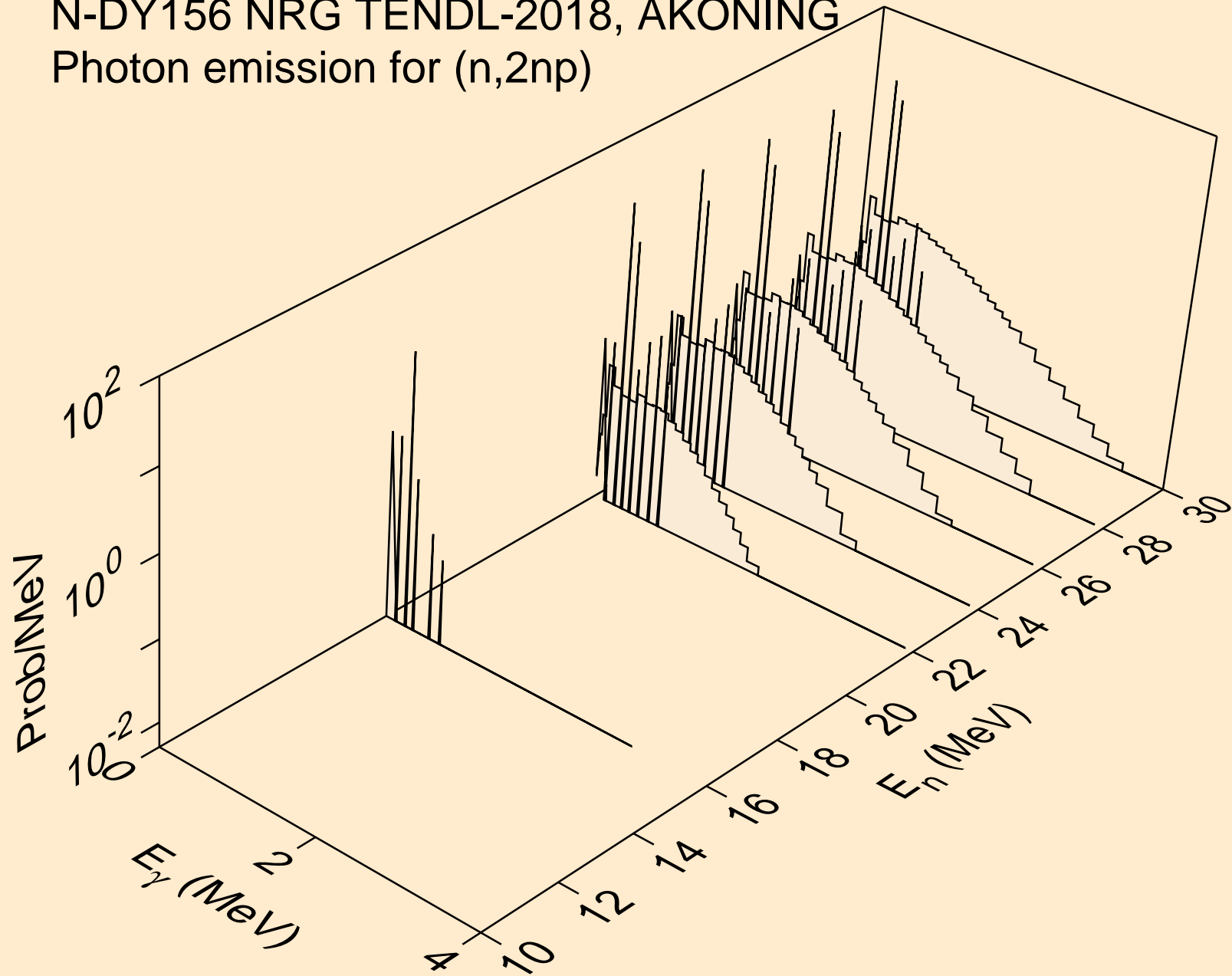

N-DY156 NRG TENDL-2018, AKONING
Photon emission for (n,npa)

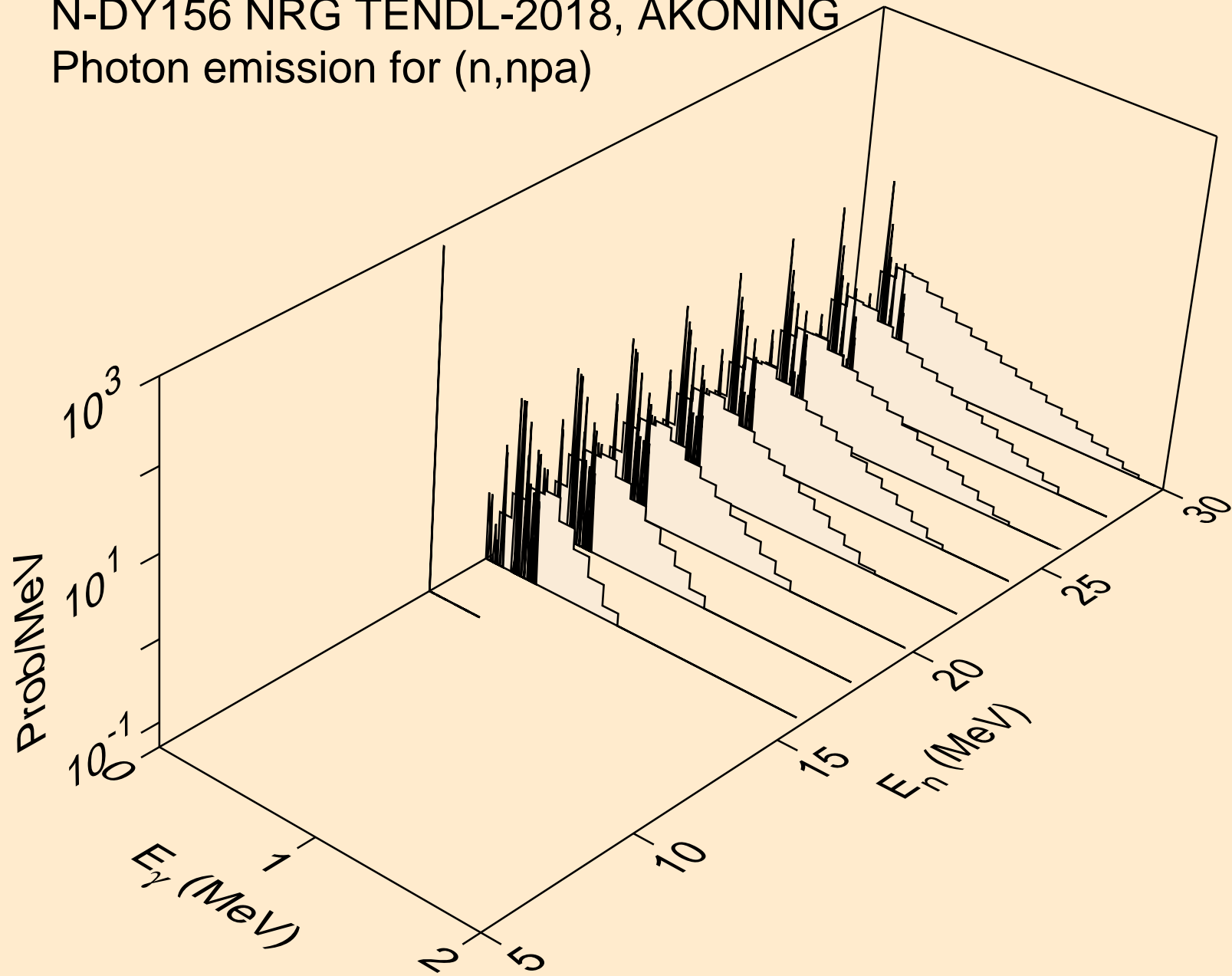

N-DY156 NRG TENDL-2018, AKONING
Photon emission for (n,n*c)

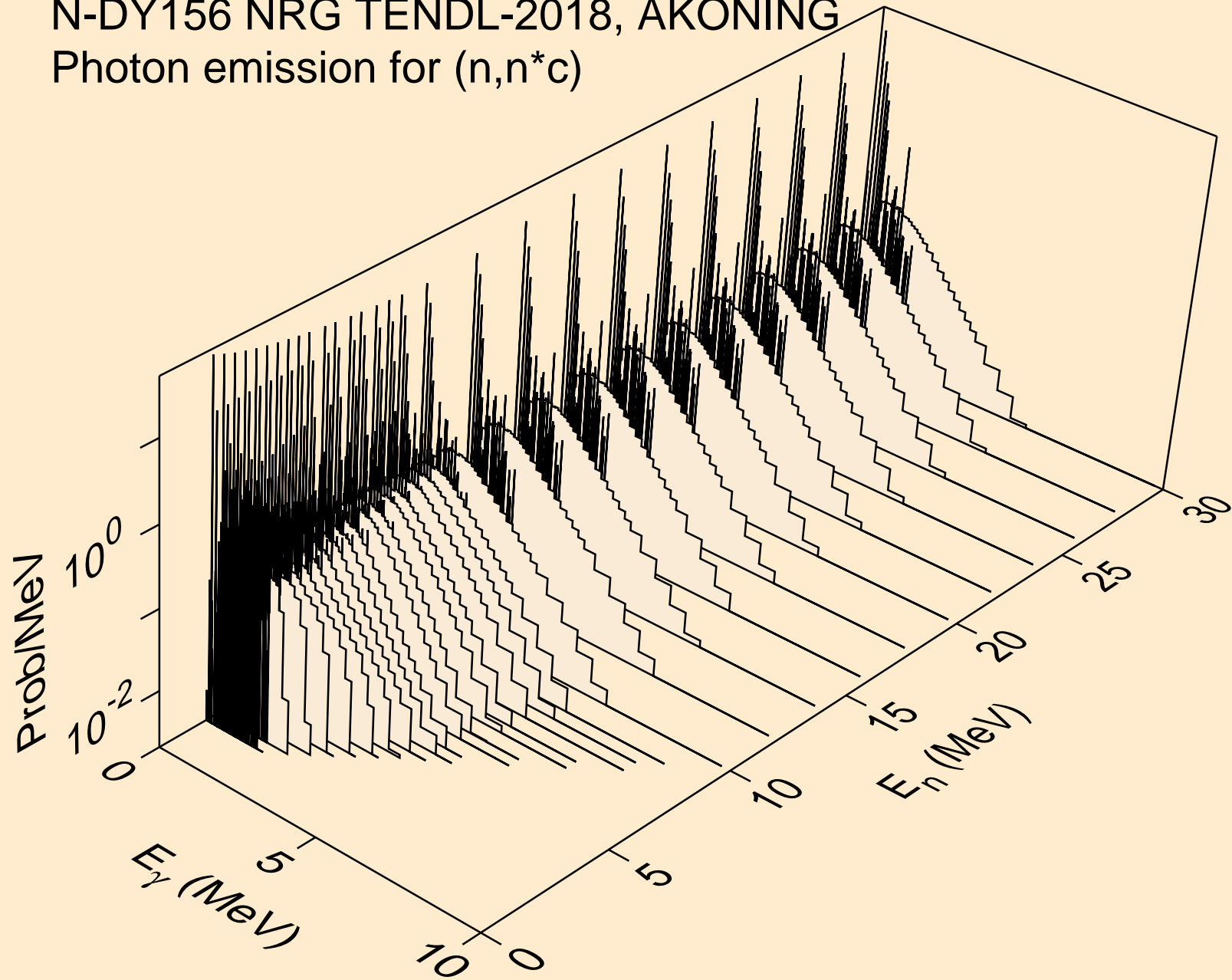

N-DY156 NRG TENDL-2018, AKONING
Photon emission for (n,gma)

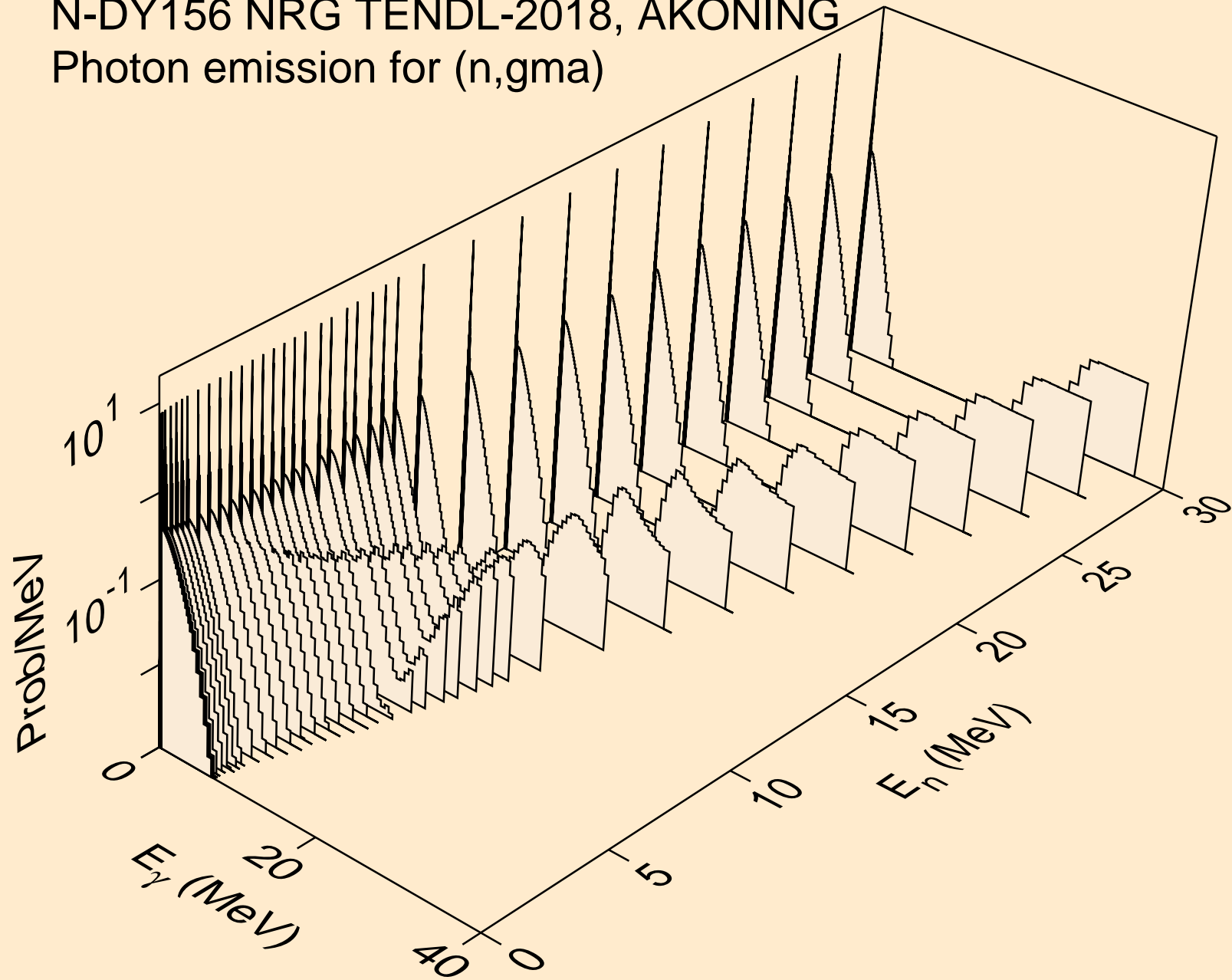

N-DY156 NRG TENDL-2018, AKONING
Photon emission for (n,p)

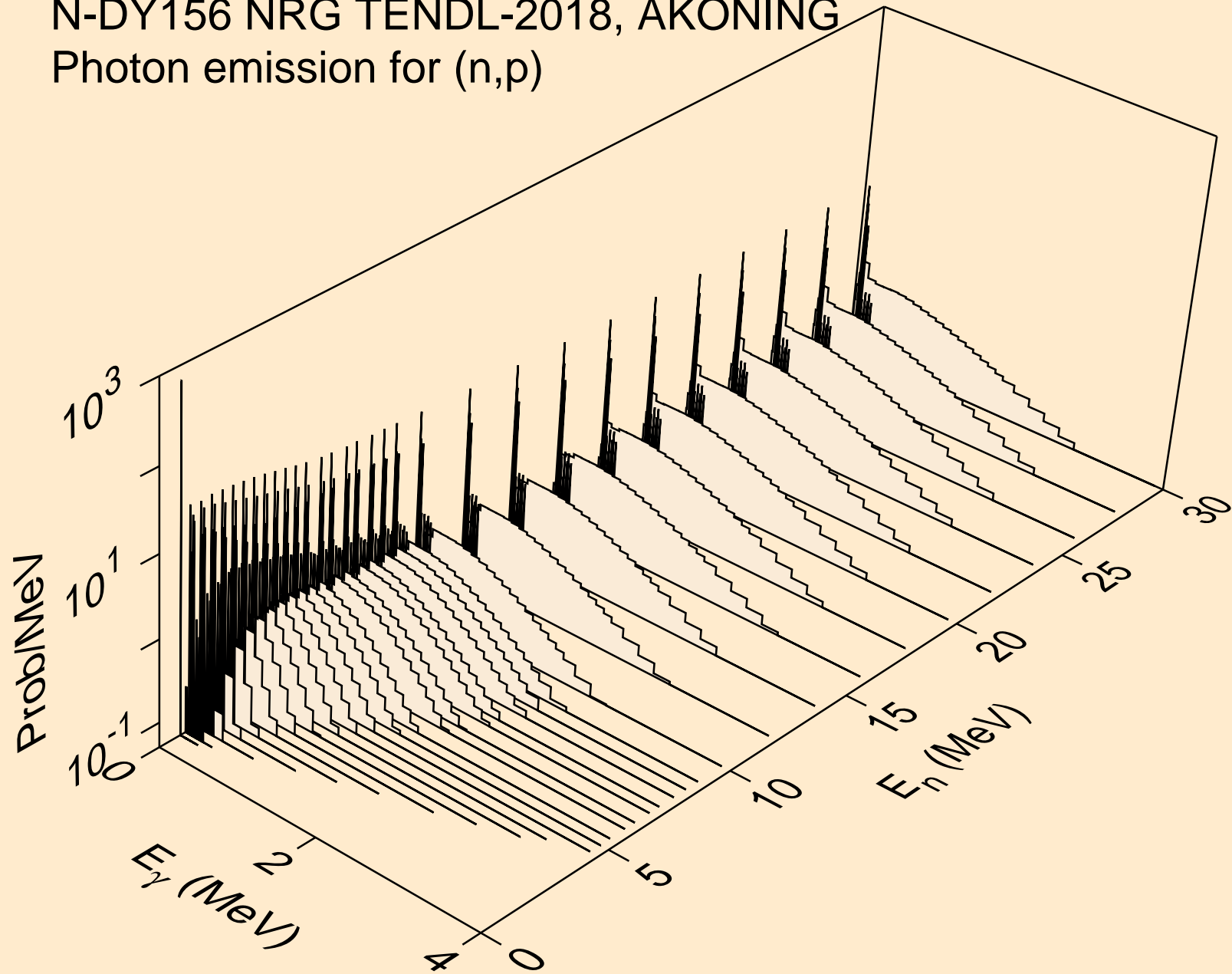

N-DY156 NRG TENDL-2018, AKONING
Photon emission for (n,d)

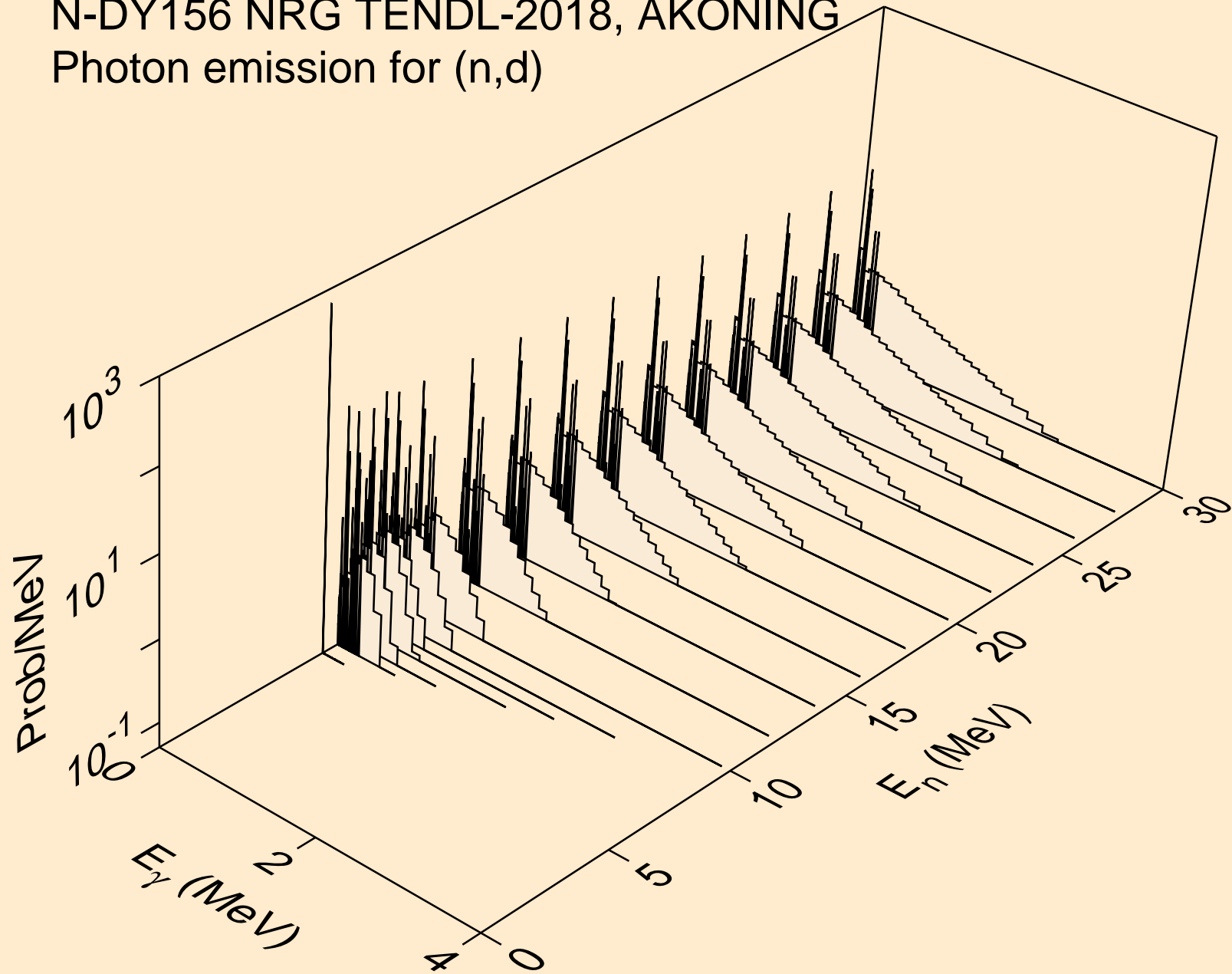

N-DY156 NRG TENDL-2018, AKONING
Photon emission for (n,t)

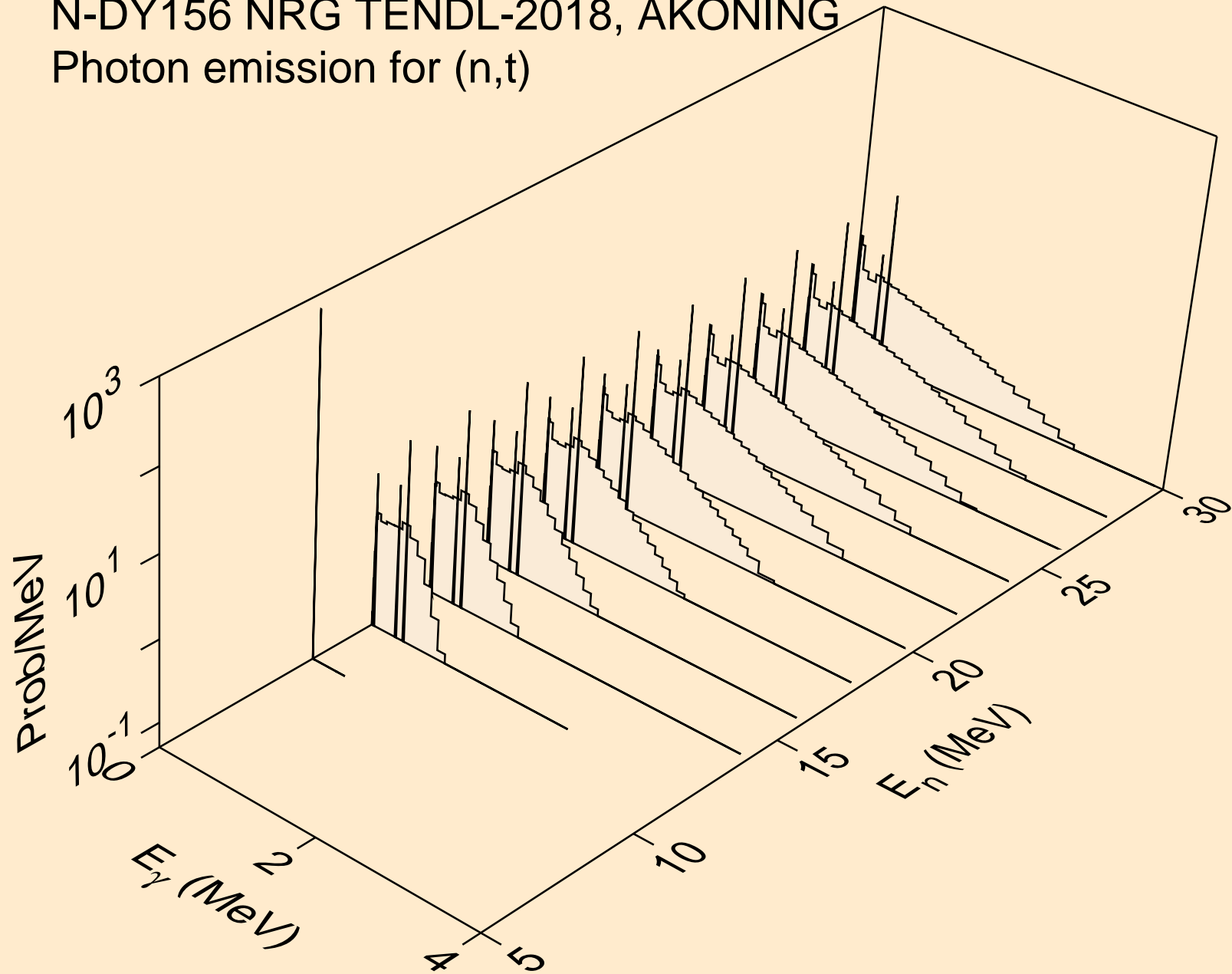

N-DY156 NRG TENDL-2018, AKONING
Photon emission for (n,he3)

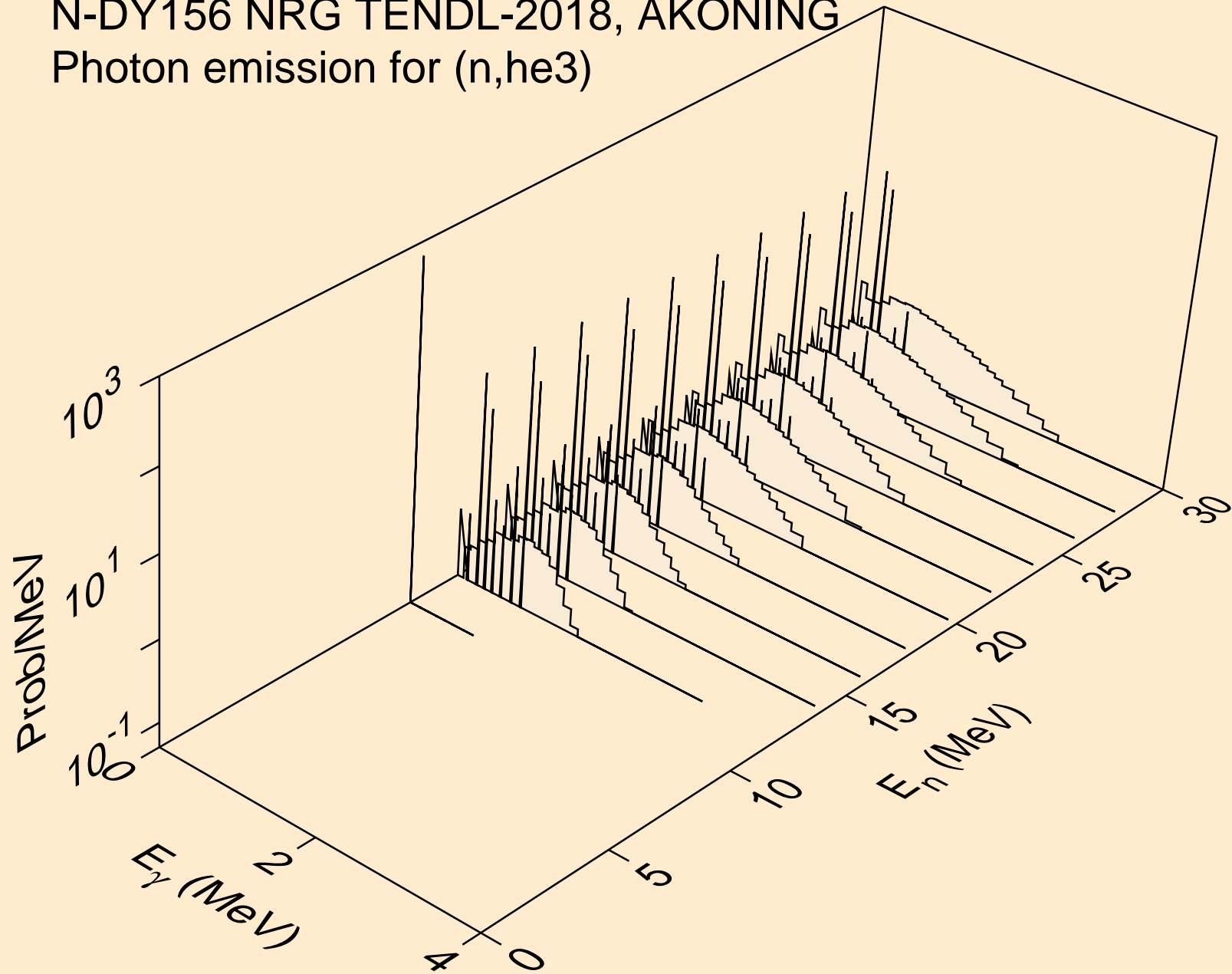

N-DY156 NRG TENDL-2018, AKONING
Photon emission for (n,a)

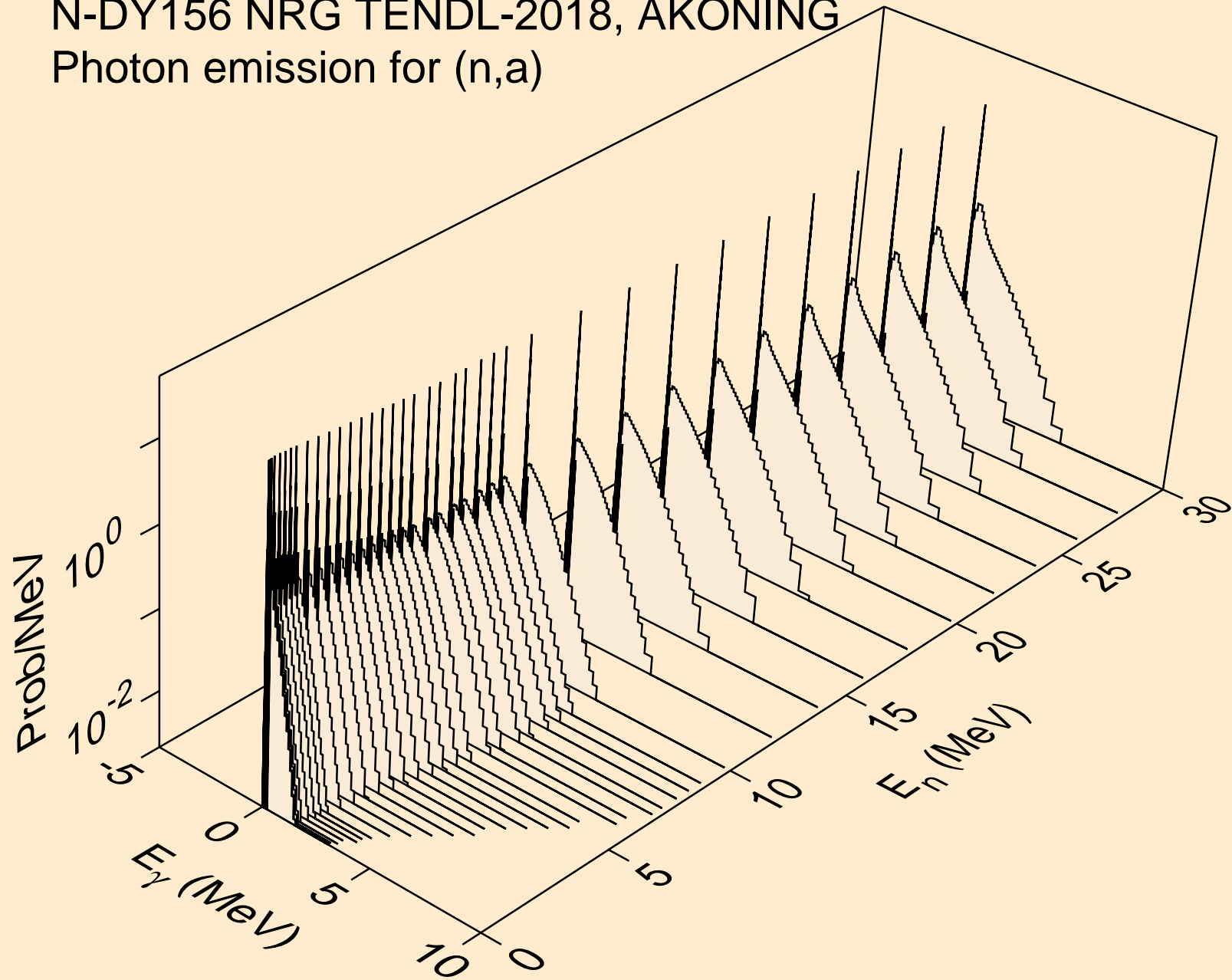

N-DY156 NRG TENDL-2018, AKONING
Photon emission for (n,2a)

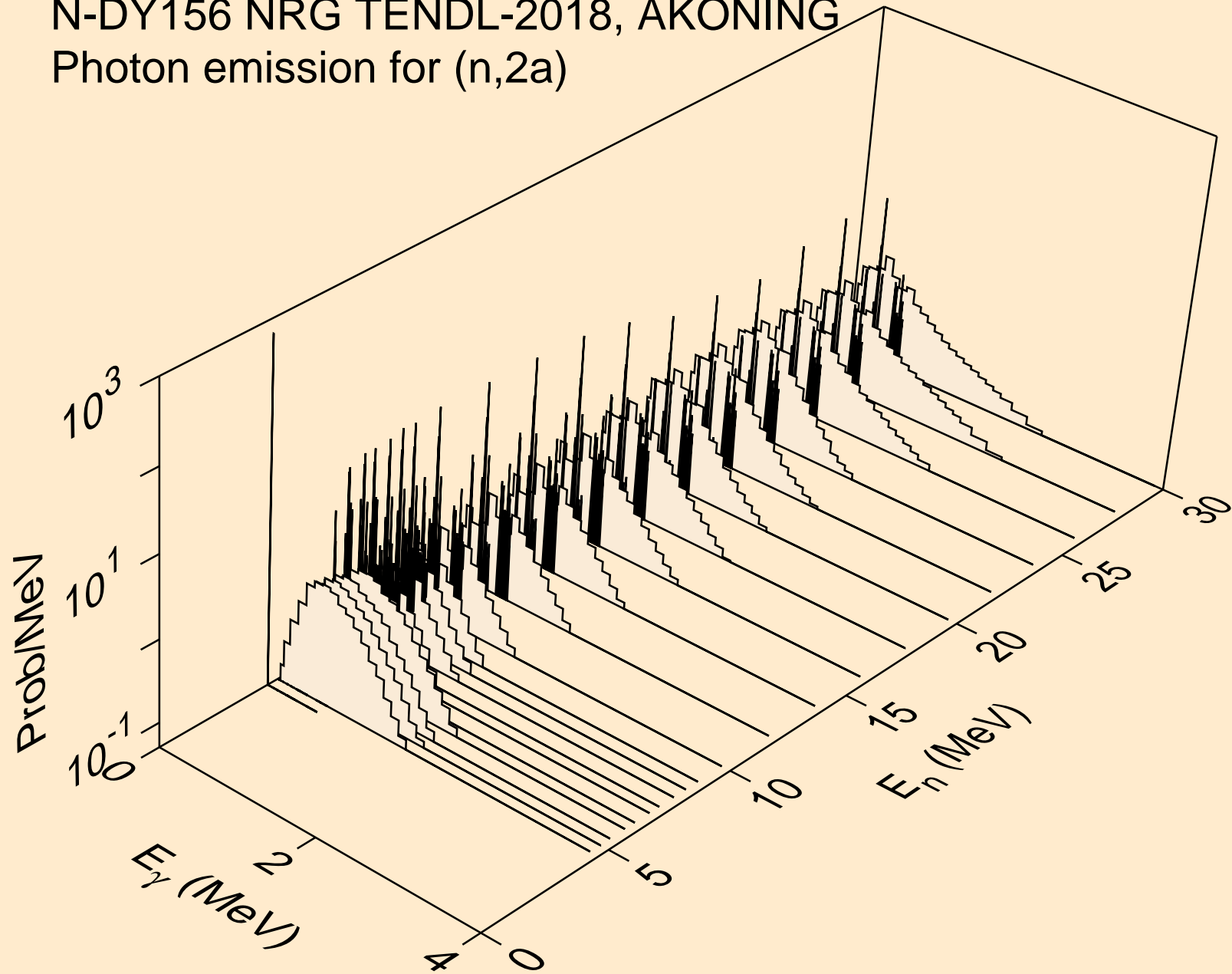

N-DY156 NRG TENDL-2018, AKONING
Photon emission for (n,2p)

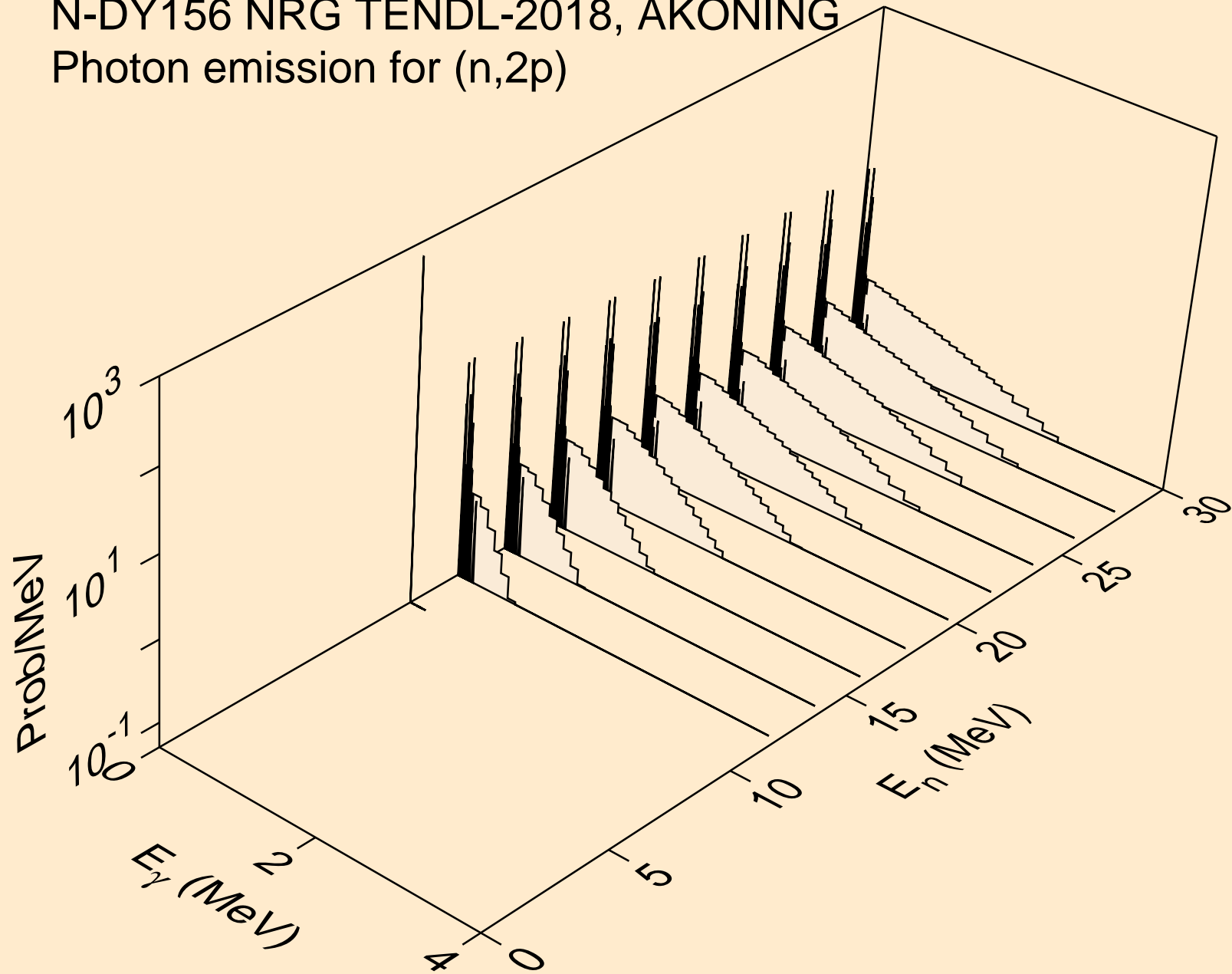

N-DY156 NRG TENDL-2018, AKONING
Photon emission for (n,pa)

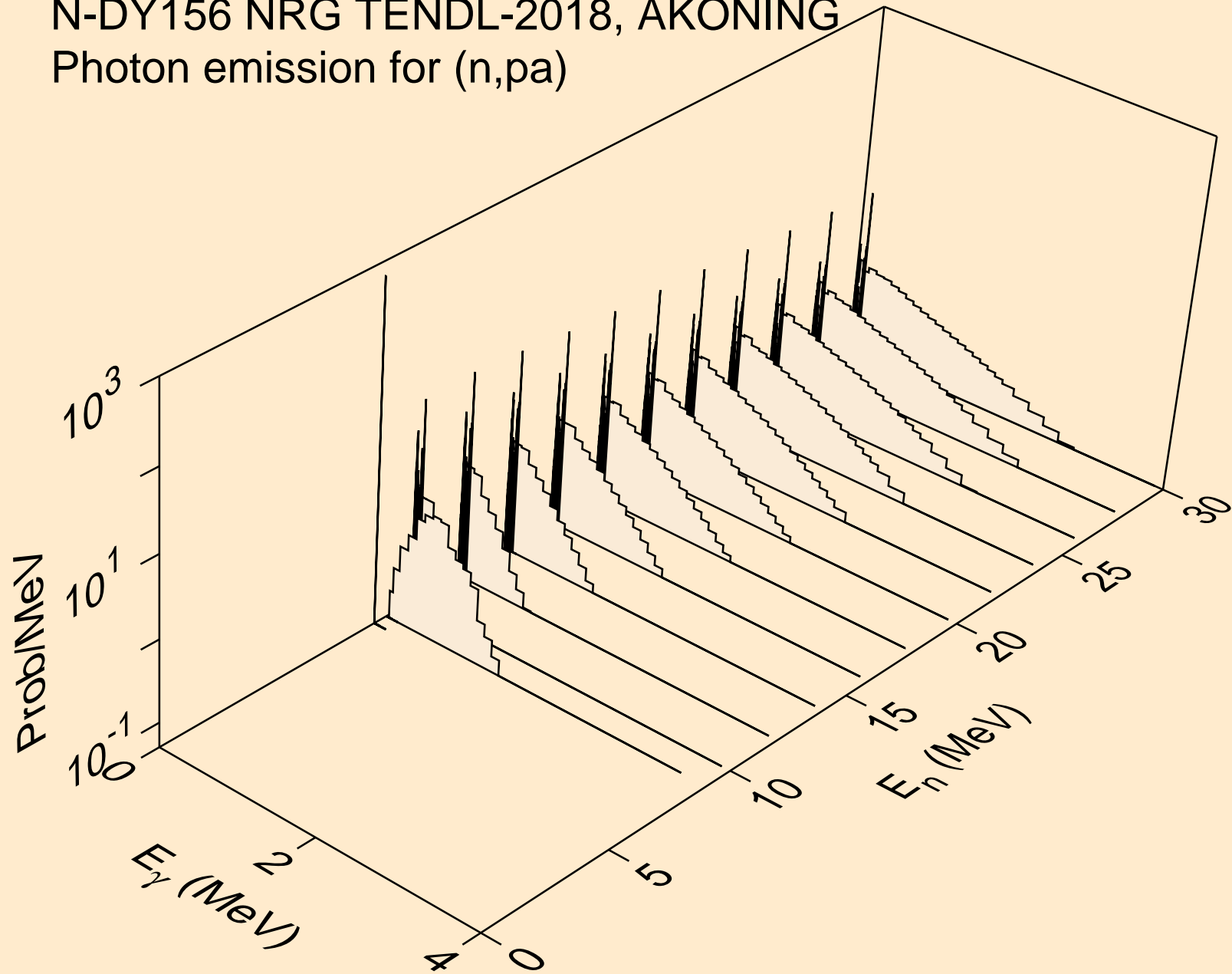

N-DY156 NRG TENDL-2018, AKONING
Photon emission for (n,pd)

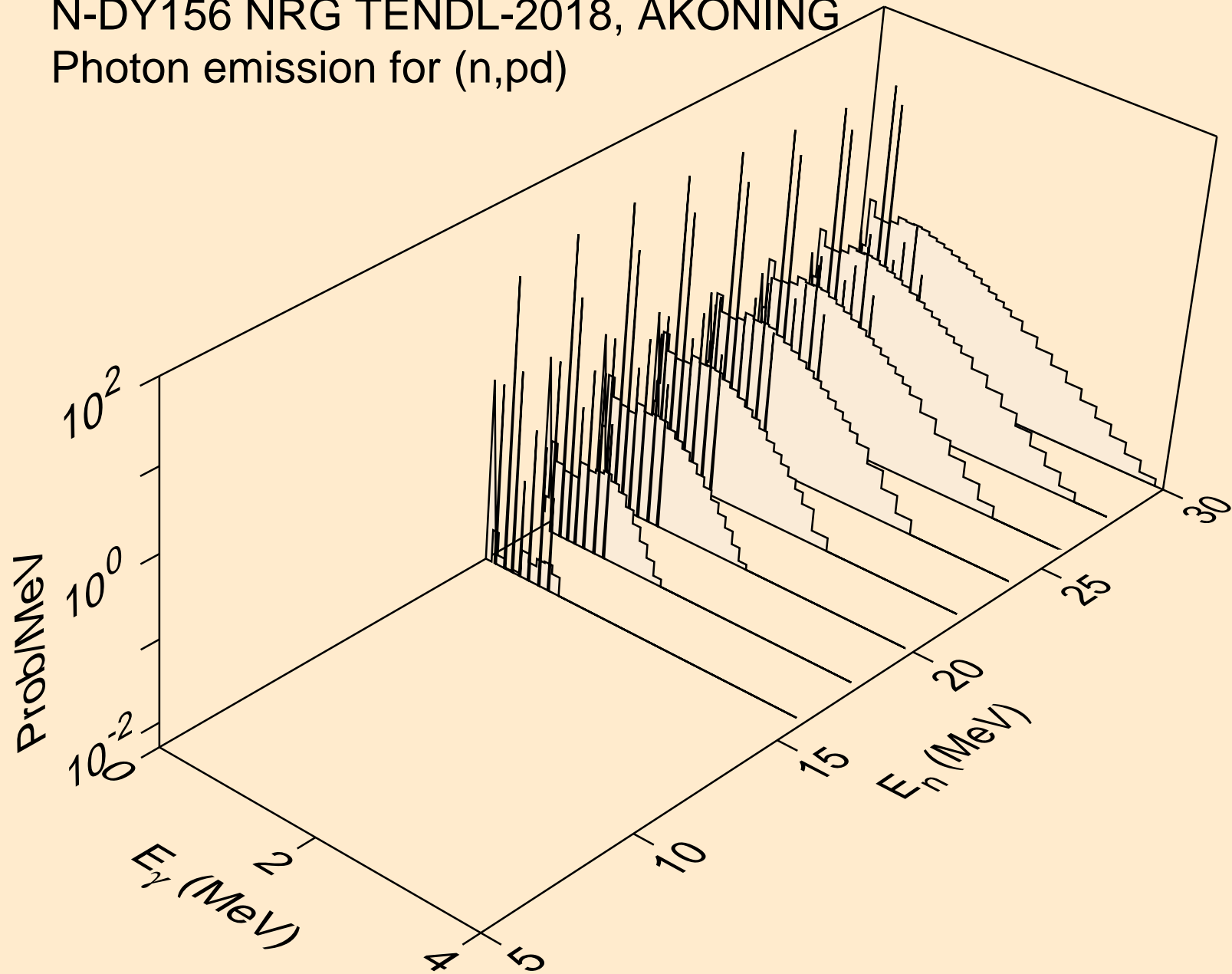

N-DY156 NRG TENDL-2018, AKONING
Photon emission for (n,pt)

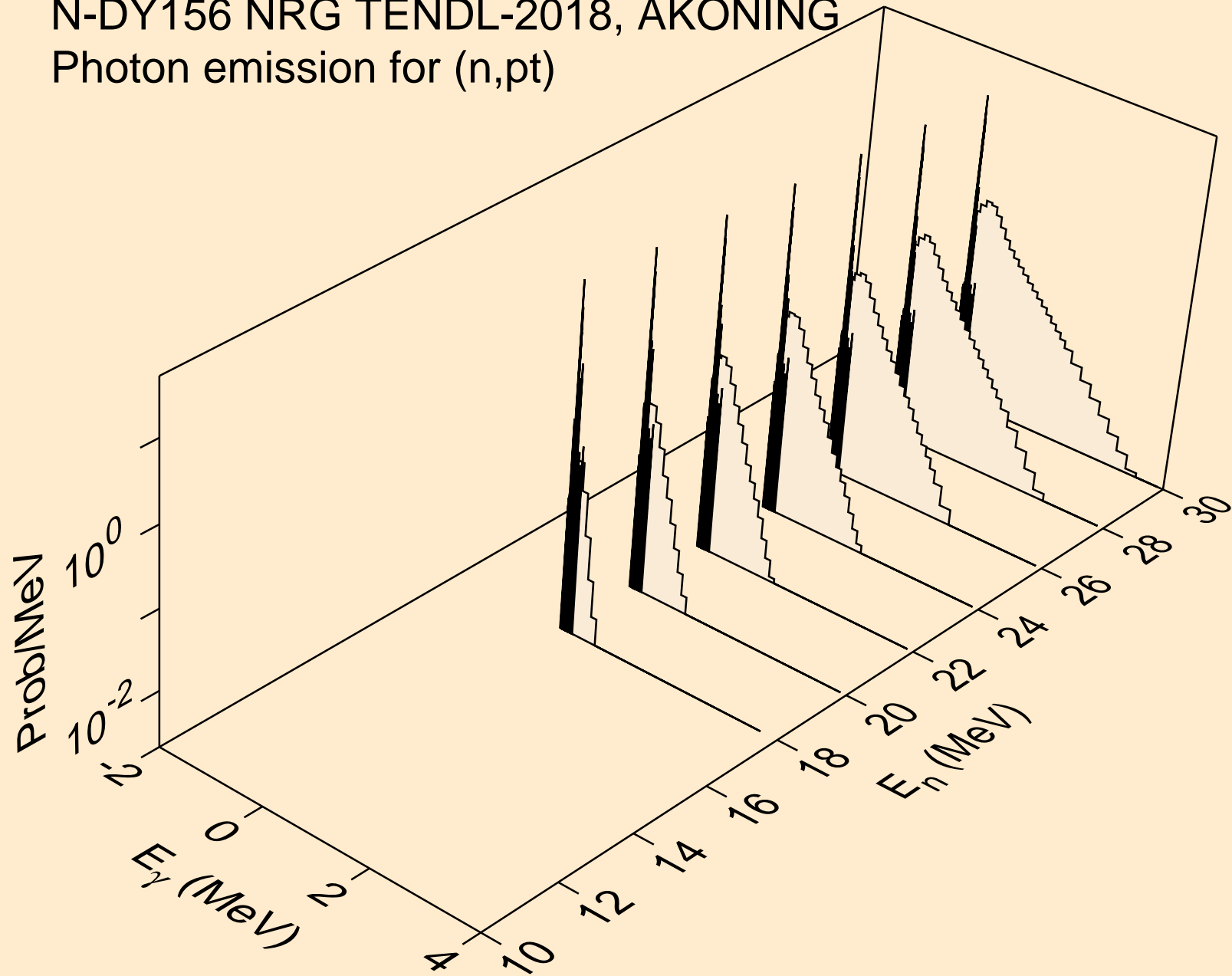

N-DY156 NRG TENDL-2018, AKONING
Photon emission for (n,da)

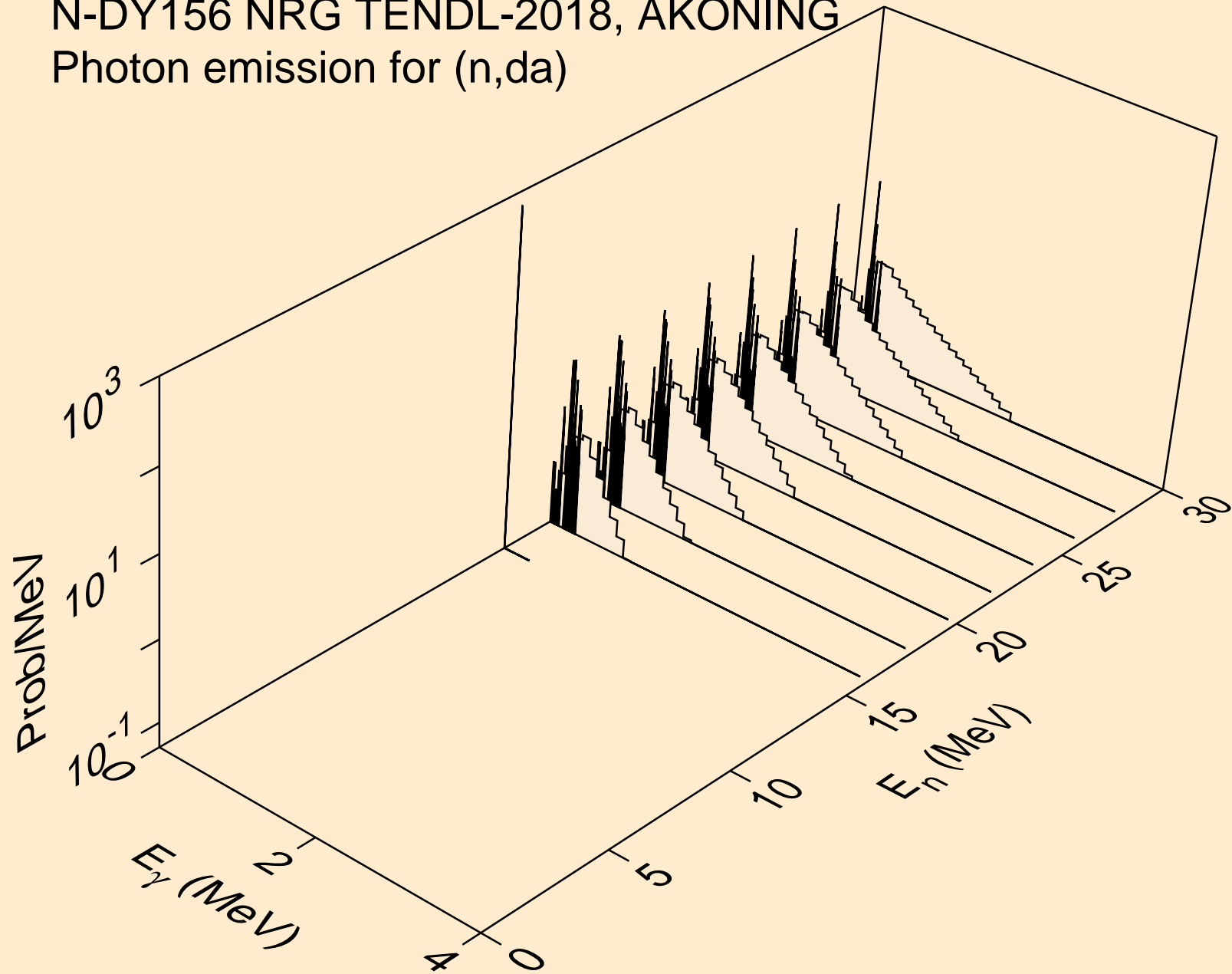

N-DY156 NRG TENDL-2018, AKONING
thermal capture photon spectrum

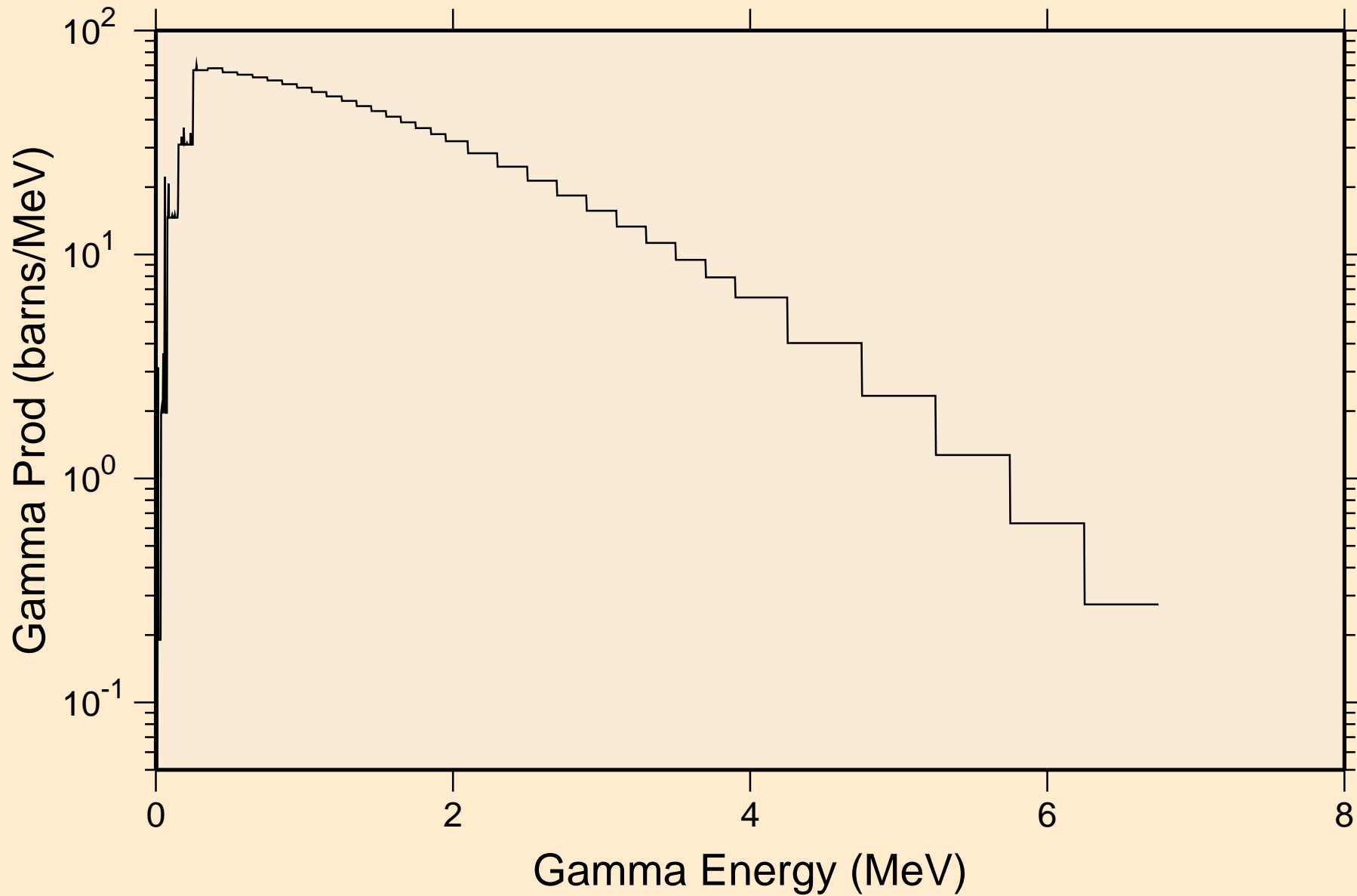

N-DY156 NRG TENDL-2018, AKONING
14 MeV photon spectrum

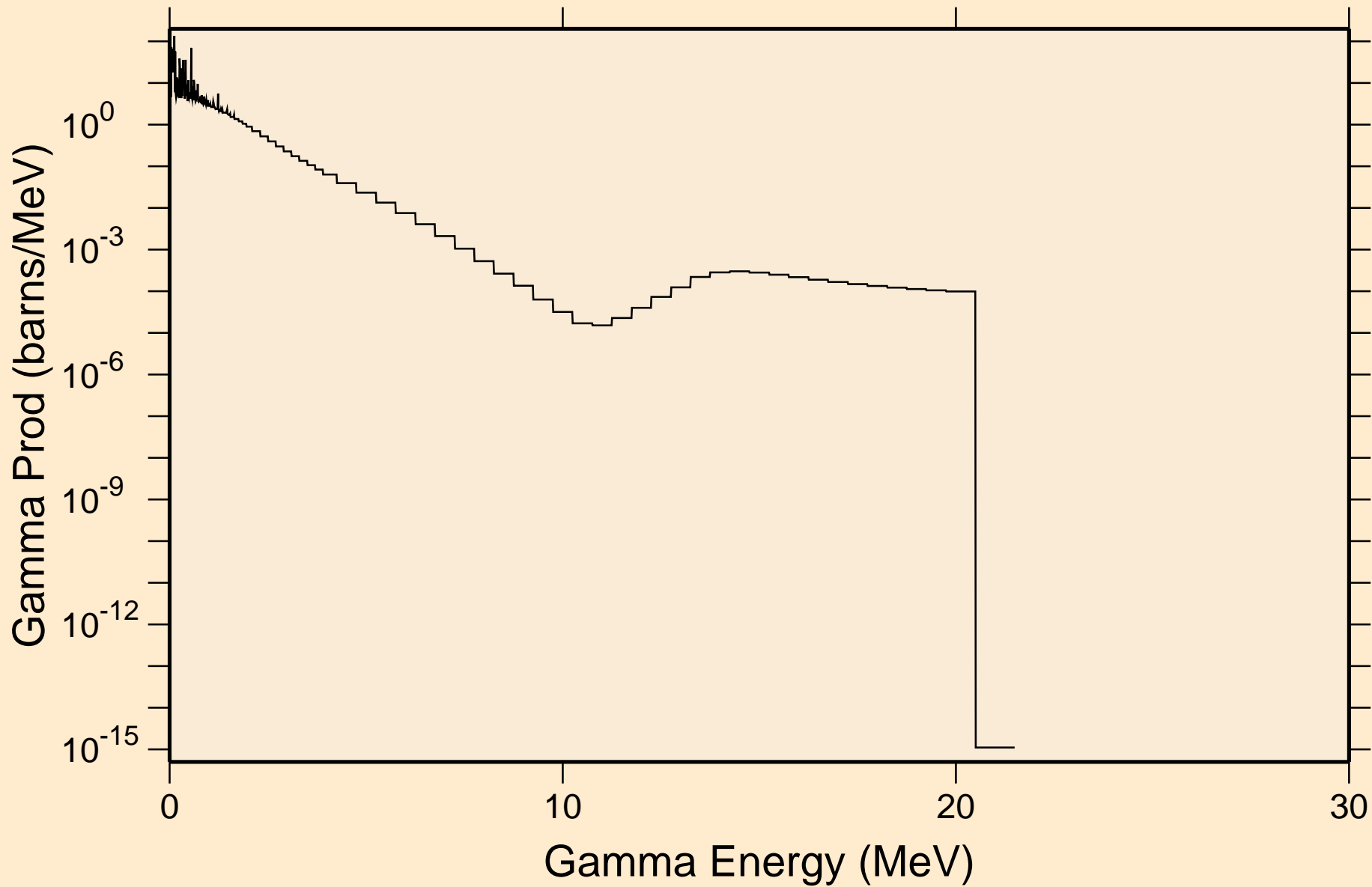

N-DY156 NRG TENDL-2018, AKONING

Particle heating contributions

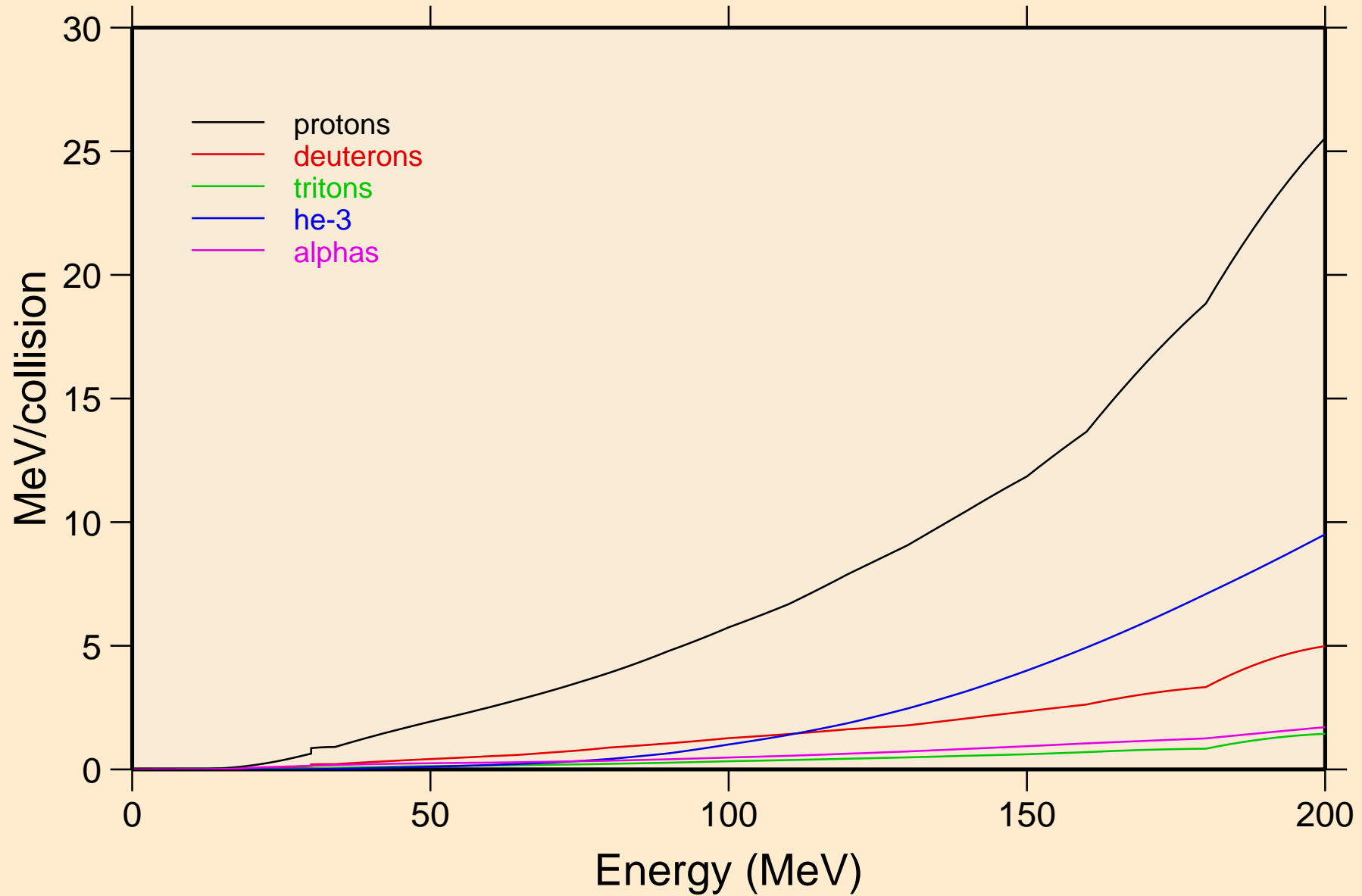

N-DY156 NRG TENDL-2018, AKONING

Recoil Heating

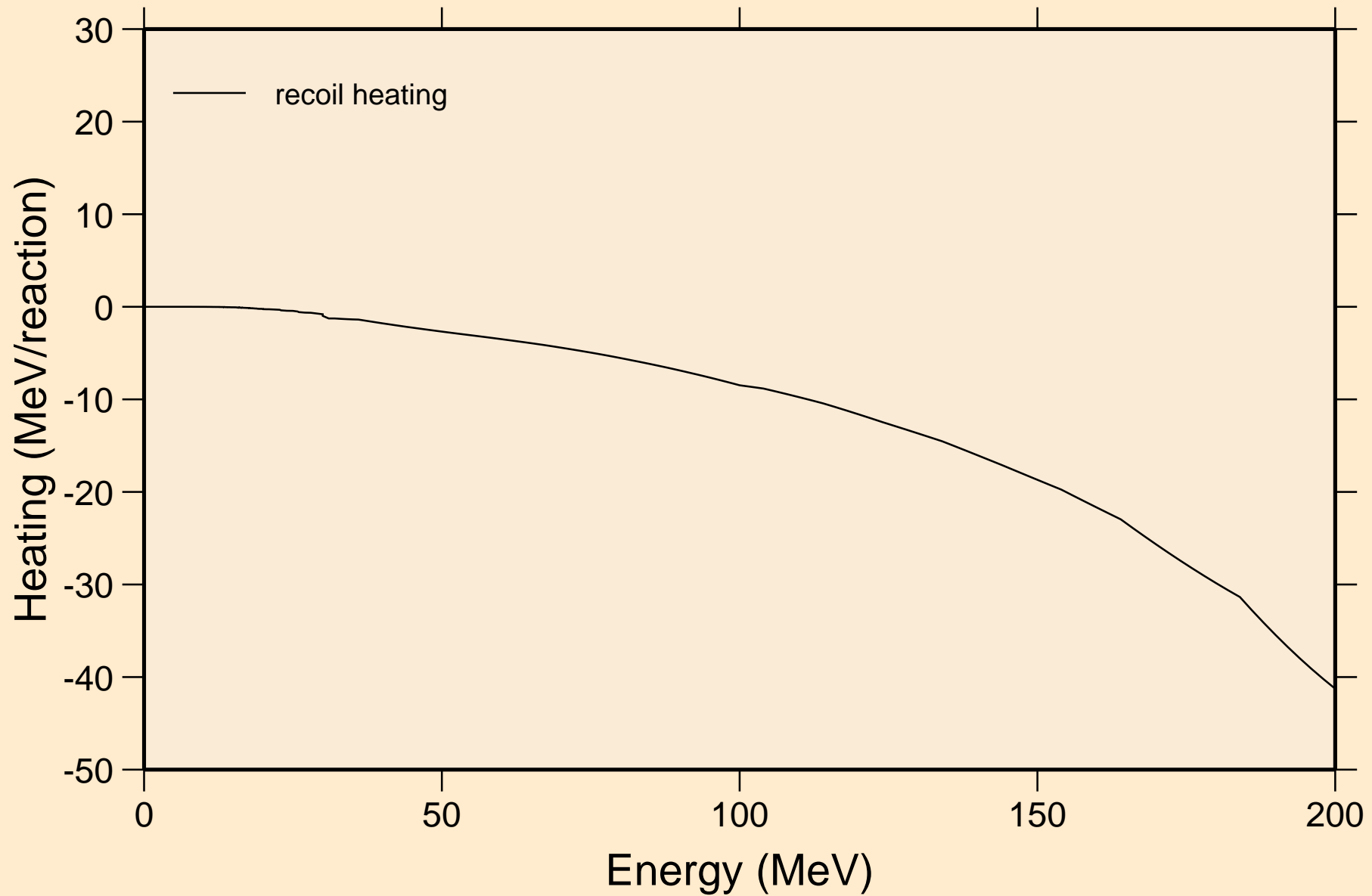

N-DY156 NRG TENDL-2018, AKONING

Particle production cross sections

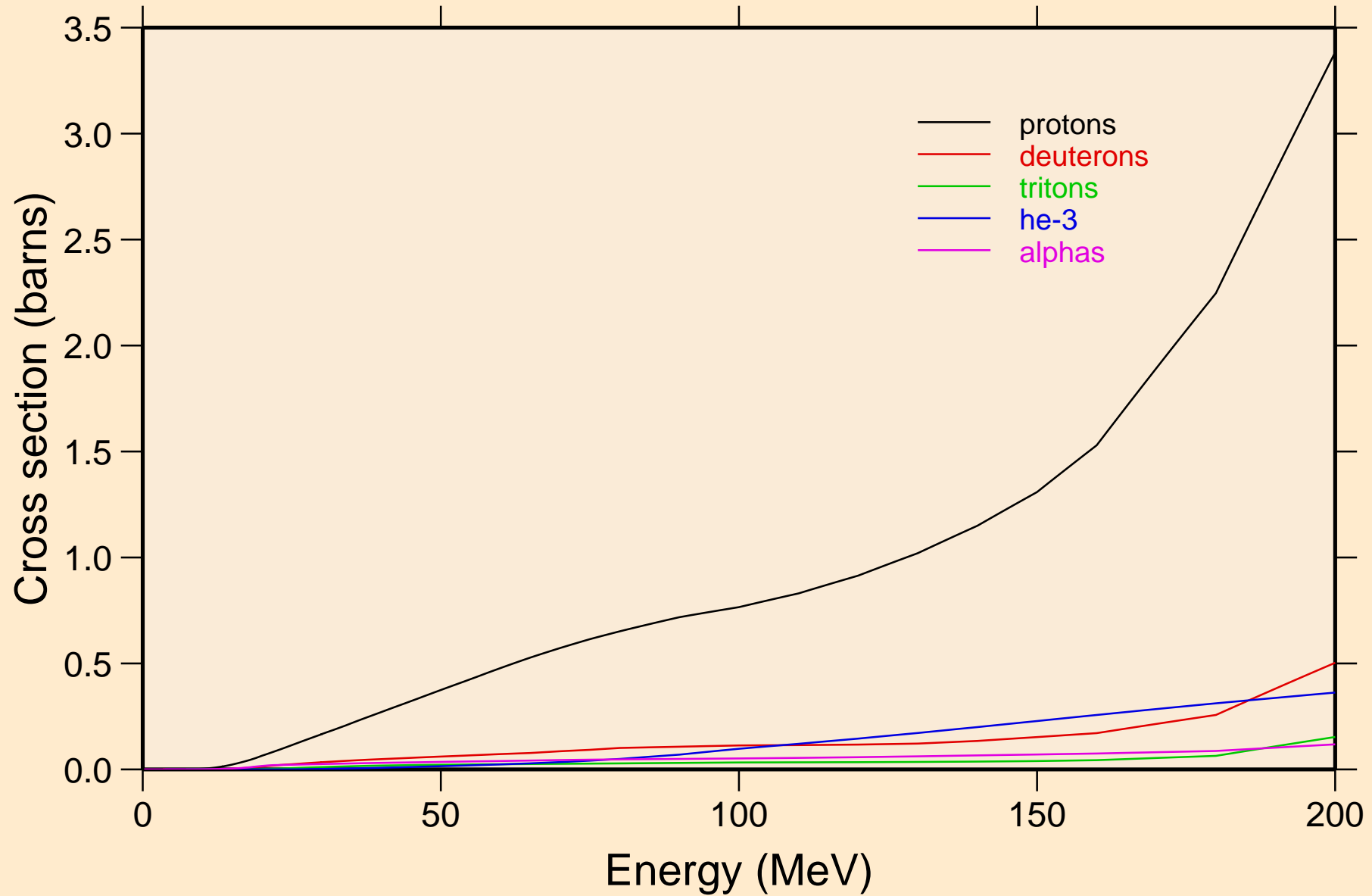

N-DY156 NRG TENDL-2018, AKONING
protons from (n,x)

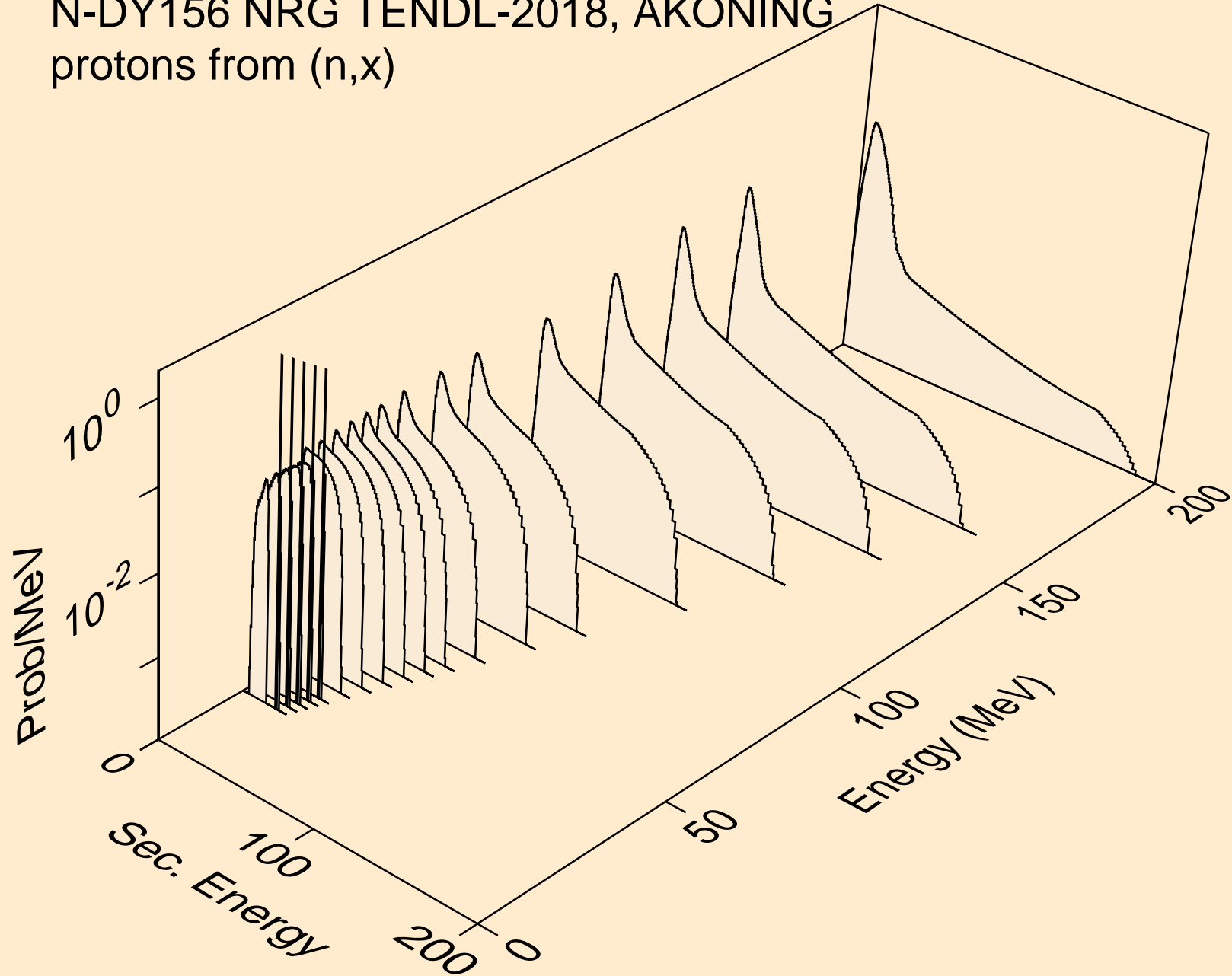

N-DY156 NRG TENDL-2018, AKONING
protons from (n,n*)p

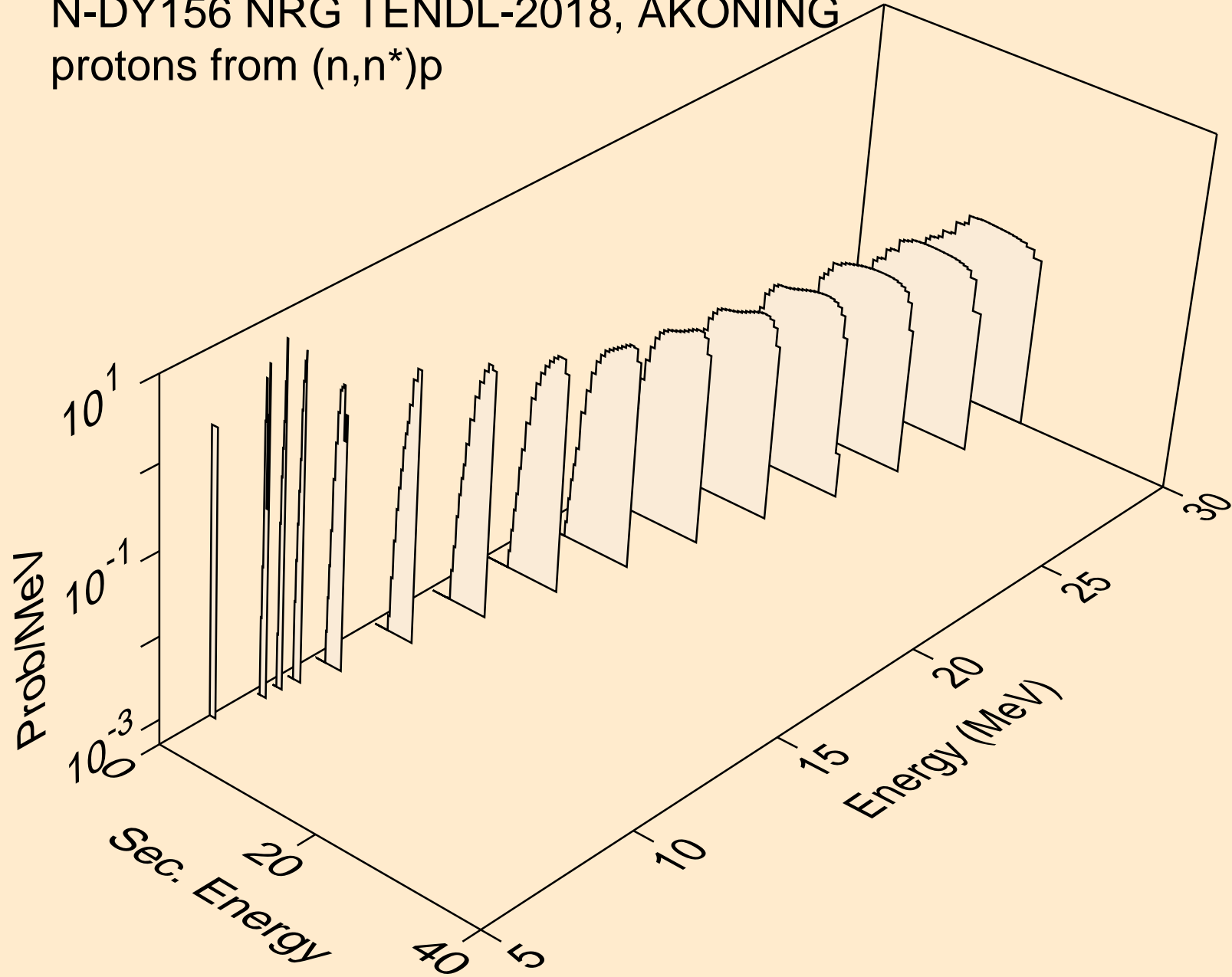

N-DY156 NRG TENDL-2018, AKONING
protons from (n,2np)

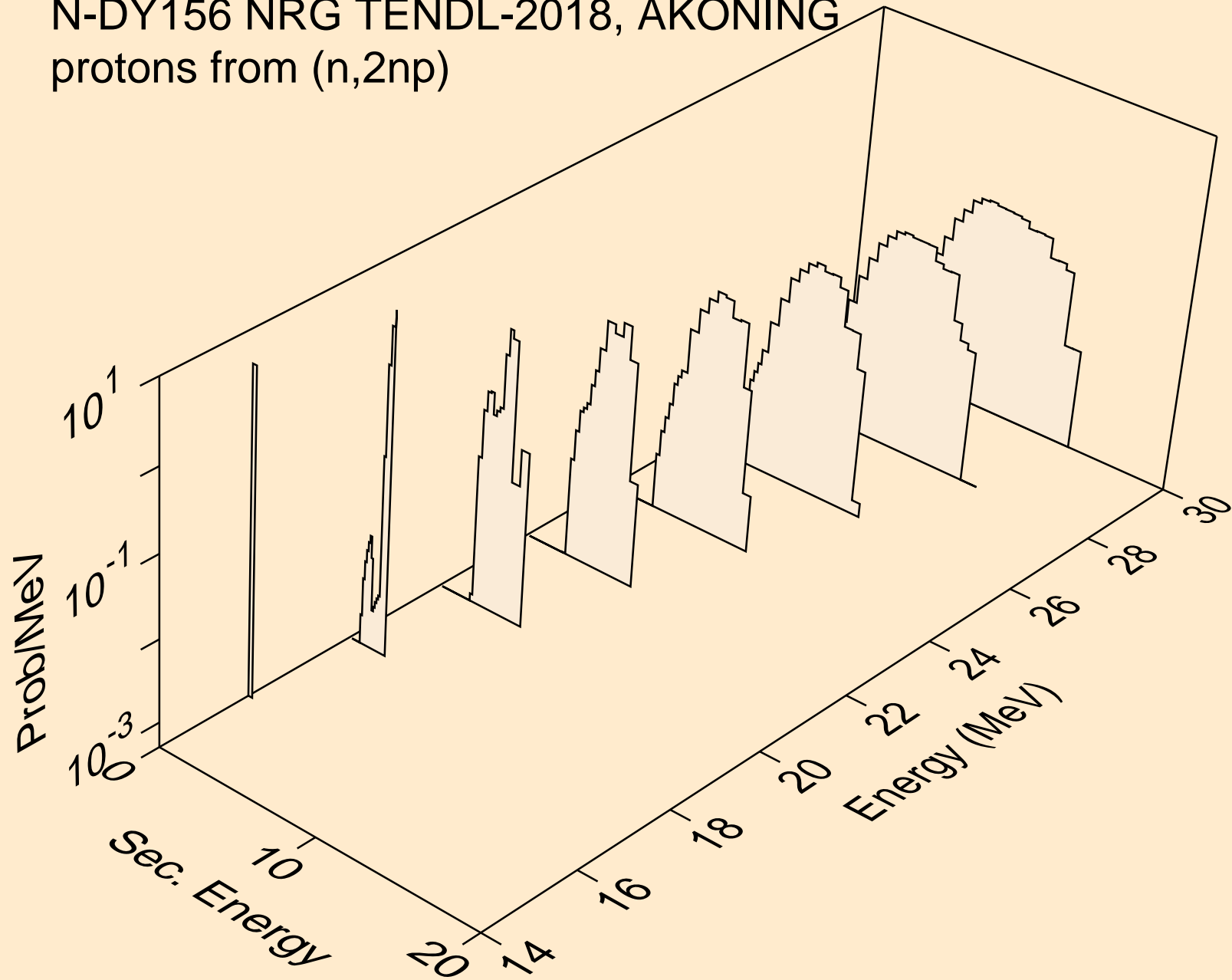

N-DY156 NRG TENDL-2018, AKONING
protons from (n,3np)

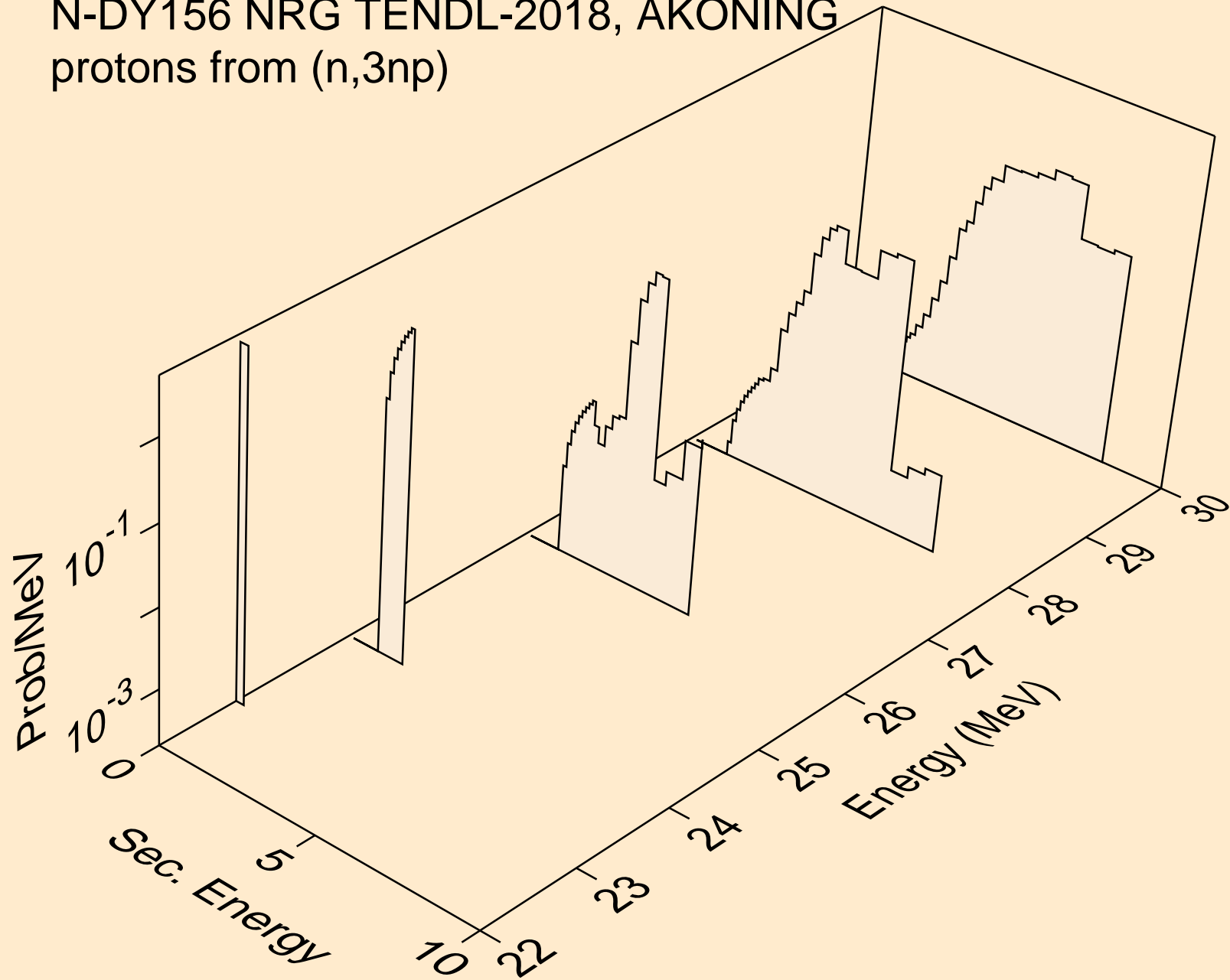

N-DY156 NRG TENDL-2018, AKONING
protons from (n,2np)

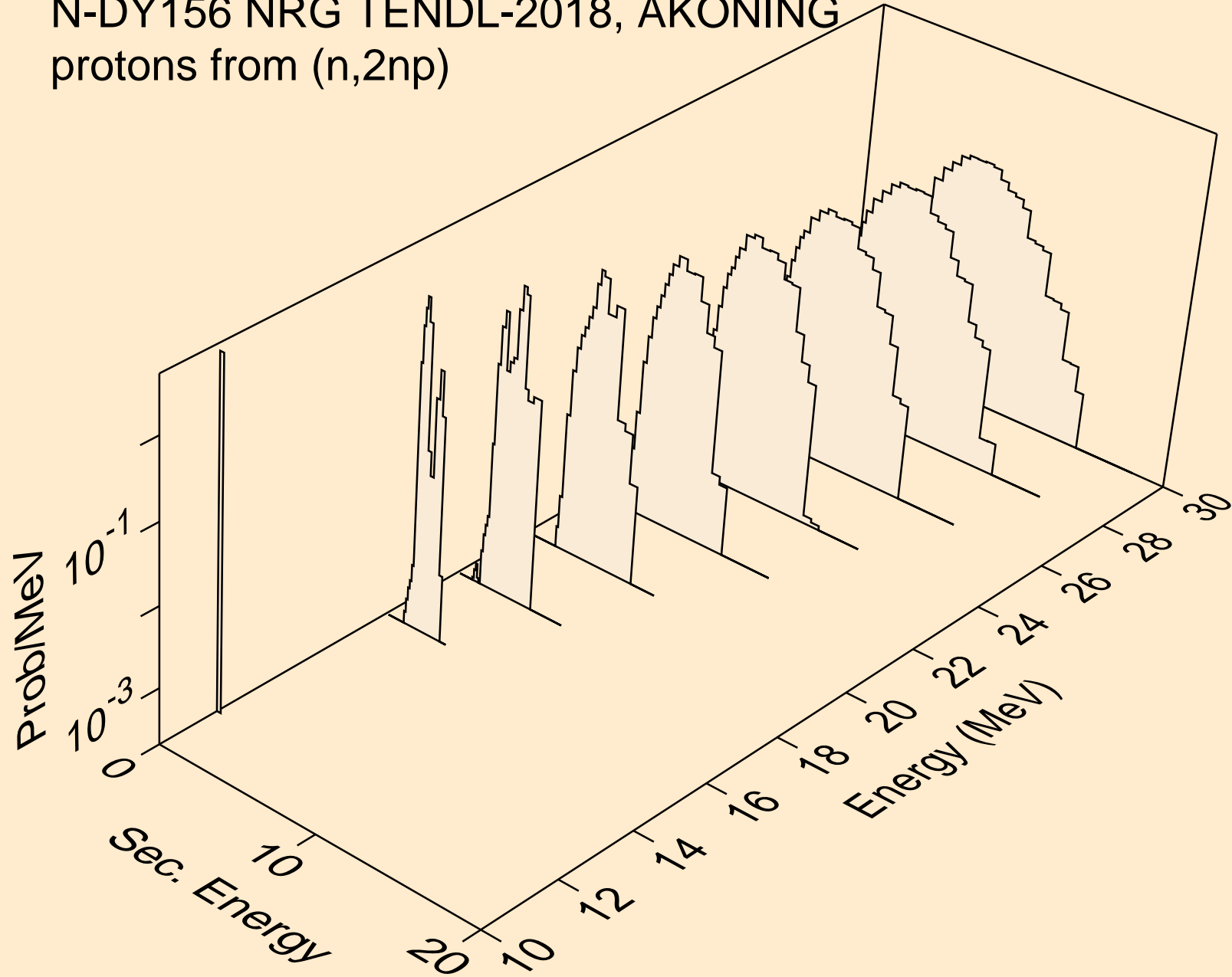

N-DY156 NRG TENDL-2018, AKONING
protons from (n,npa)

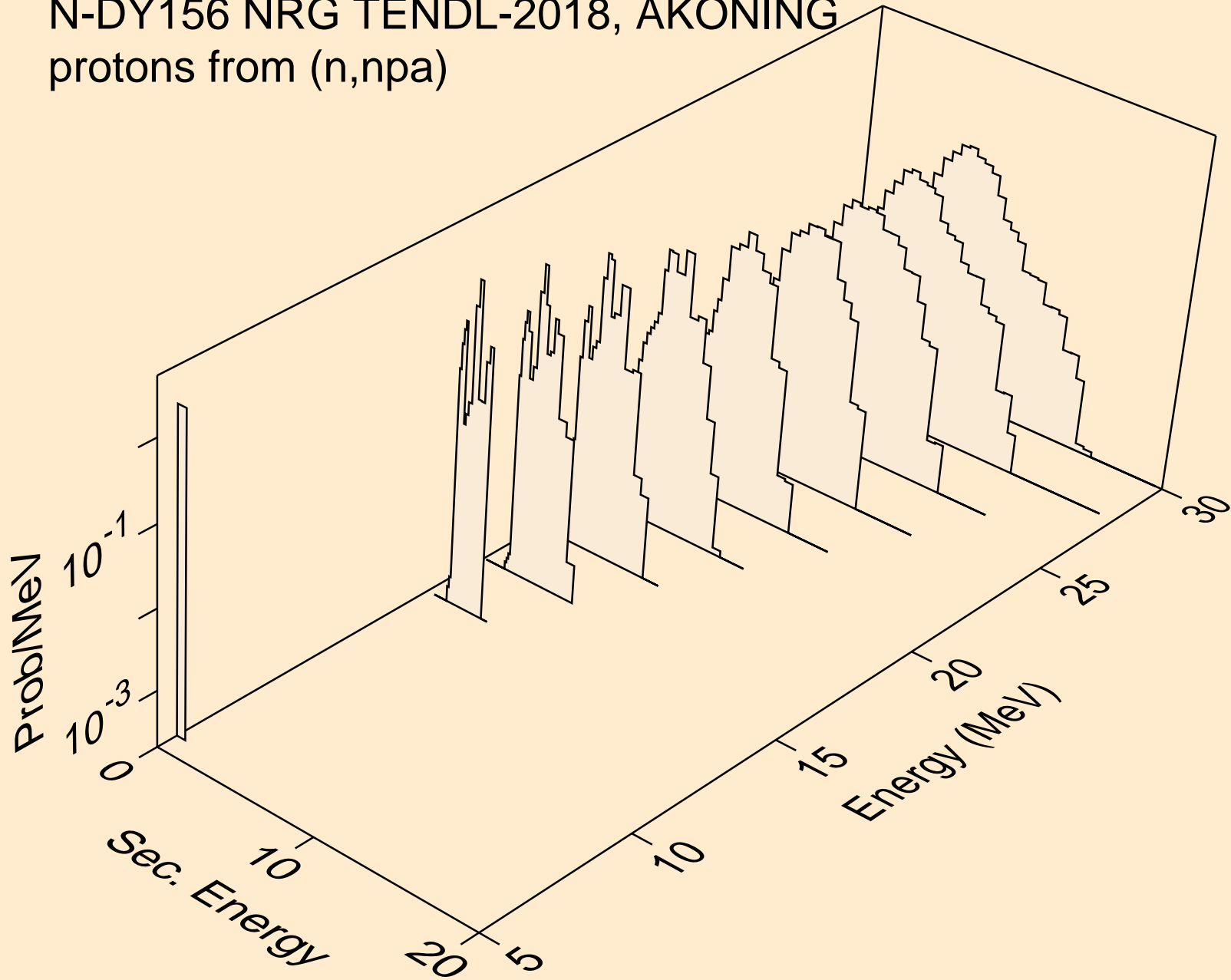

N-DY156 NRG TENDL-2018, AKONING
protons from (n,p)

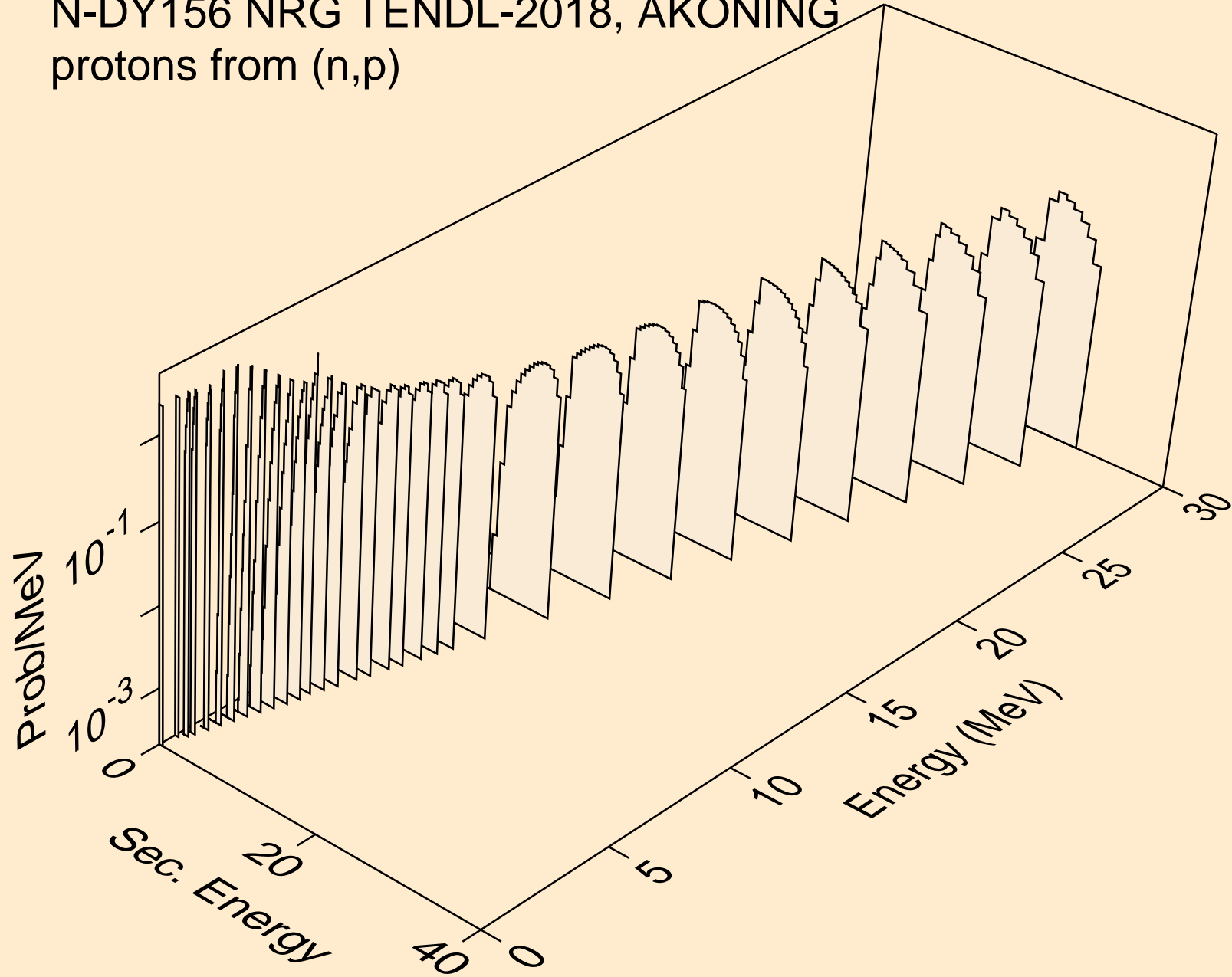

N-DY156 NRG TENDL-2018, AKONING
protons from (n,2p)

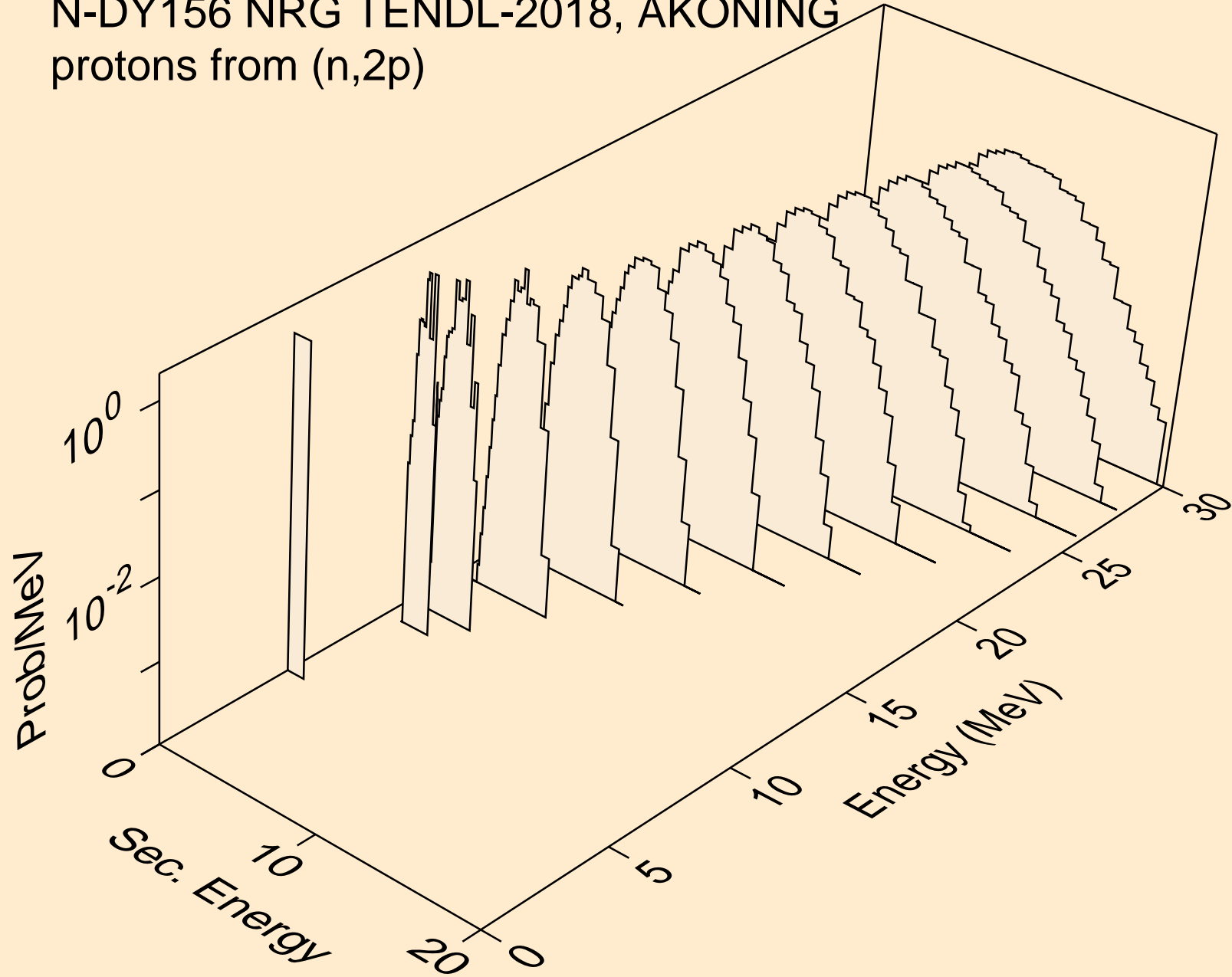

N-DY156 NRG TENDL-2018, AKONING
protons from (n,pa)

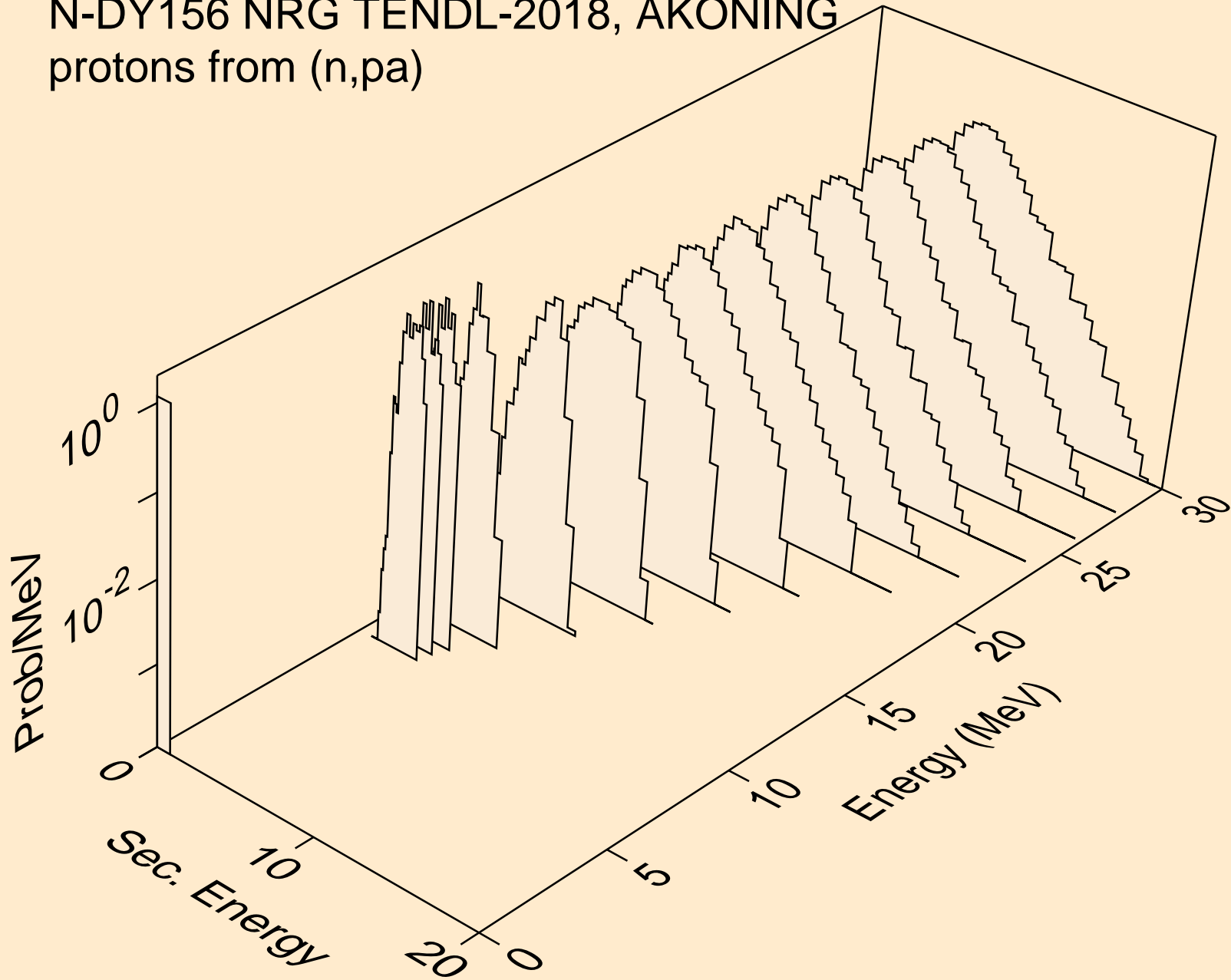

N-DY156 NRG TENDL-2018, AKONING
protons from (n,pd)

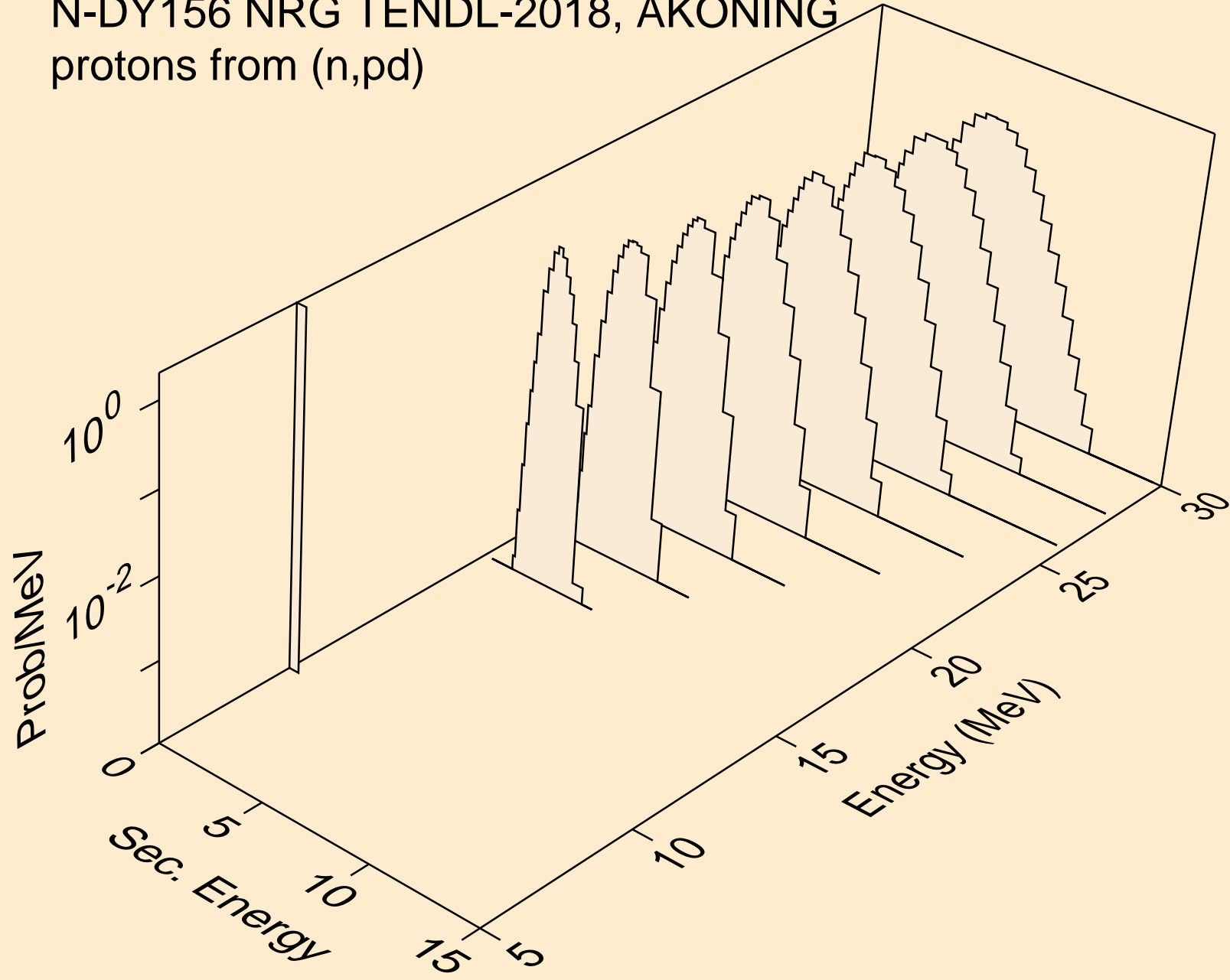

N-DY156 NRG TENDL-2018, AKONING
protons from (n,pt)

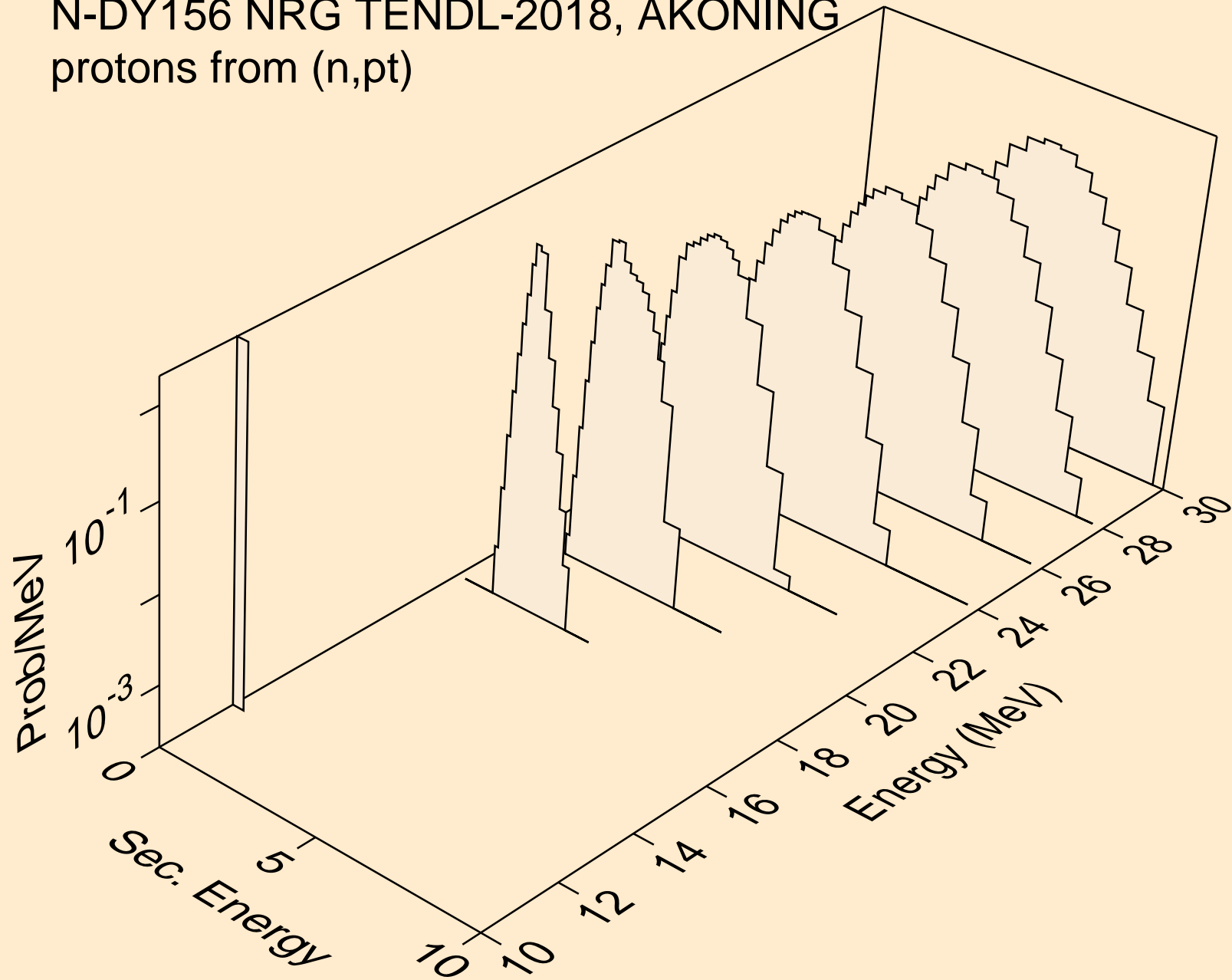

N-DY156 NRG TENDL-2018, AKONING
deuterons from (n,x)

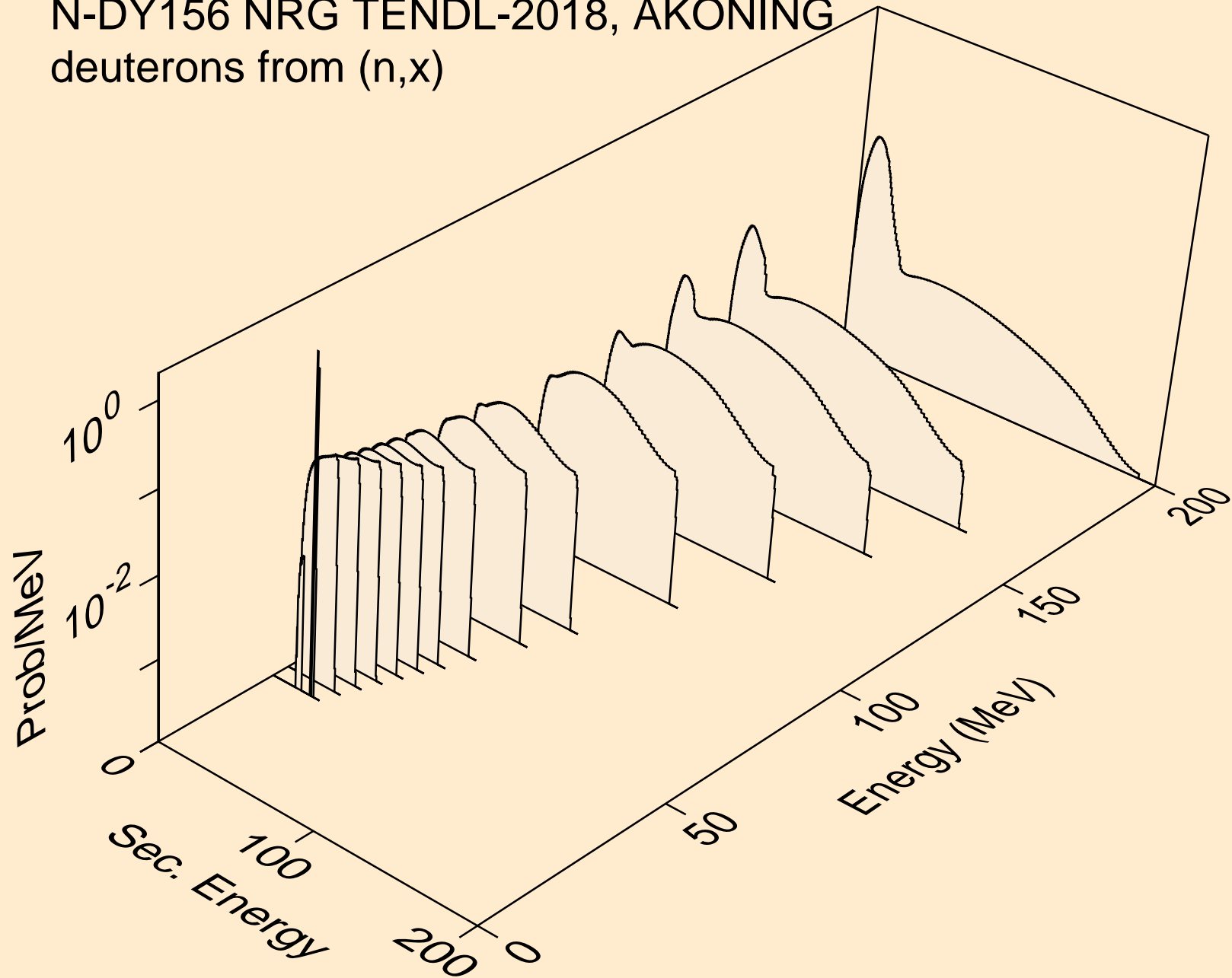

N-DY156 NRG TENDL-2018, AKONING
deuterons from (n,2nd)

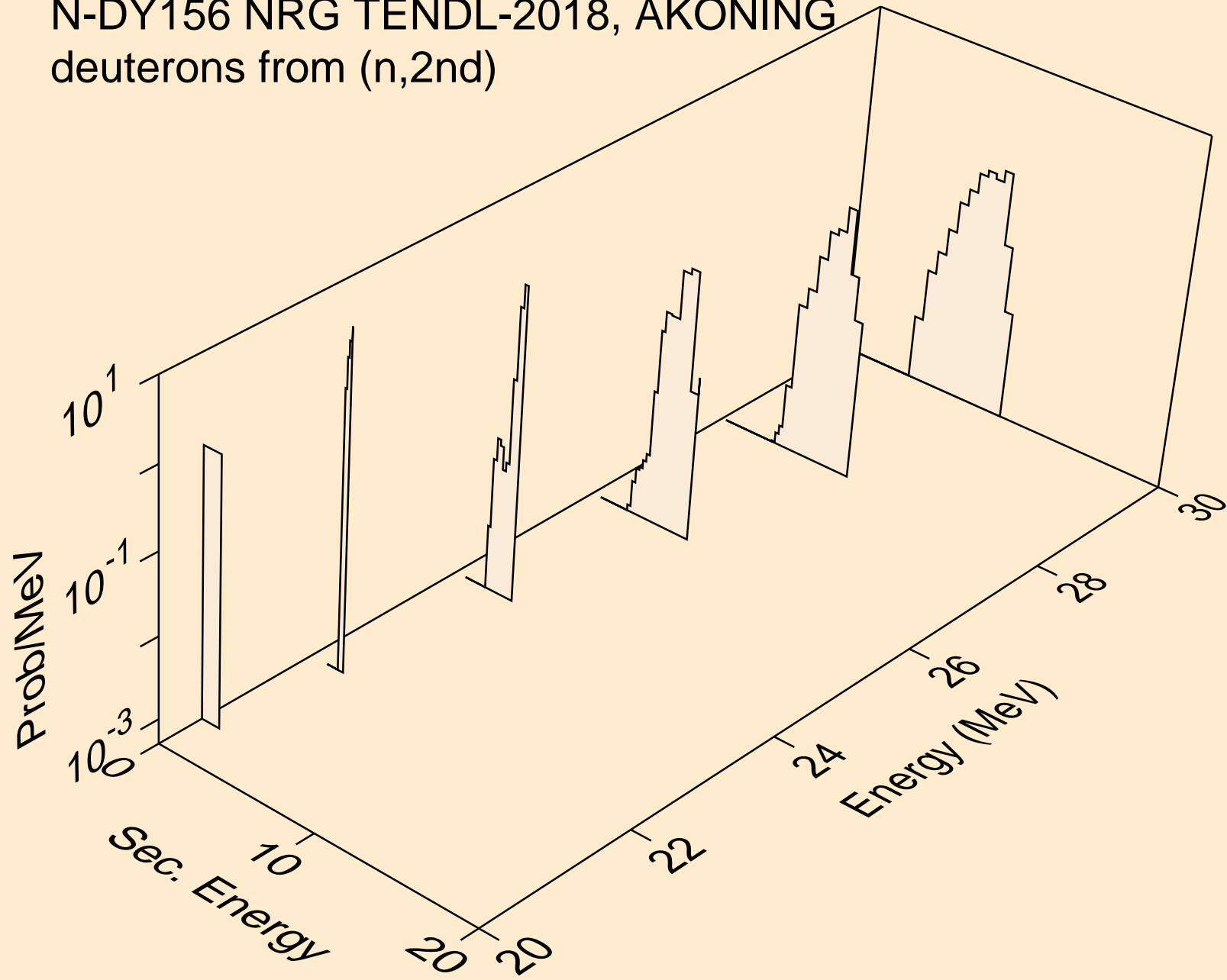

N-DY156 NRG TENDL-2018, AKONING
deuterons from (n,n*)d

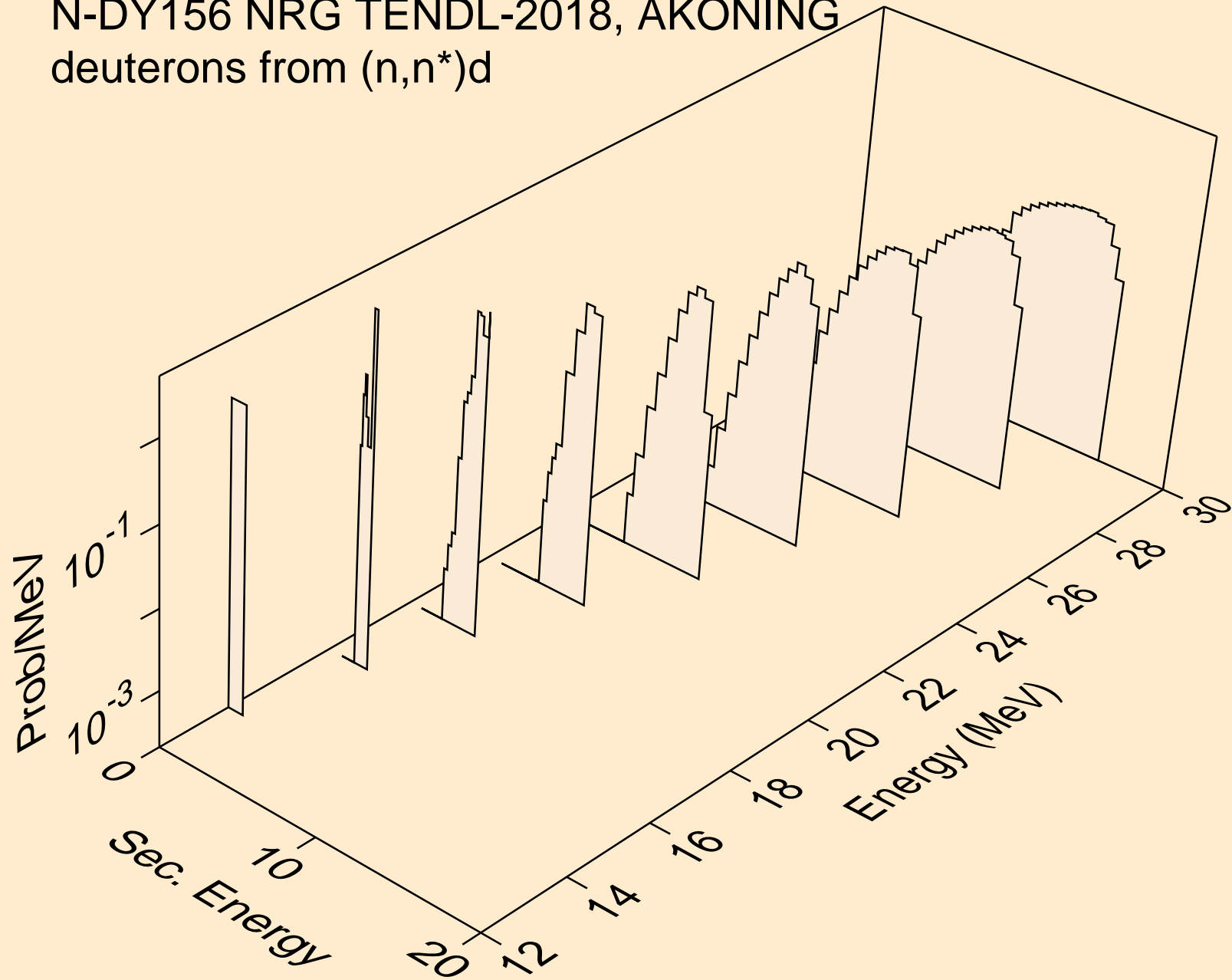

N-DY156 NRG TENDL-2018, AKONING
deuterons from (n,d)

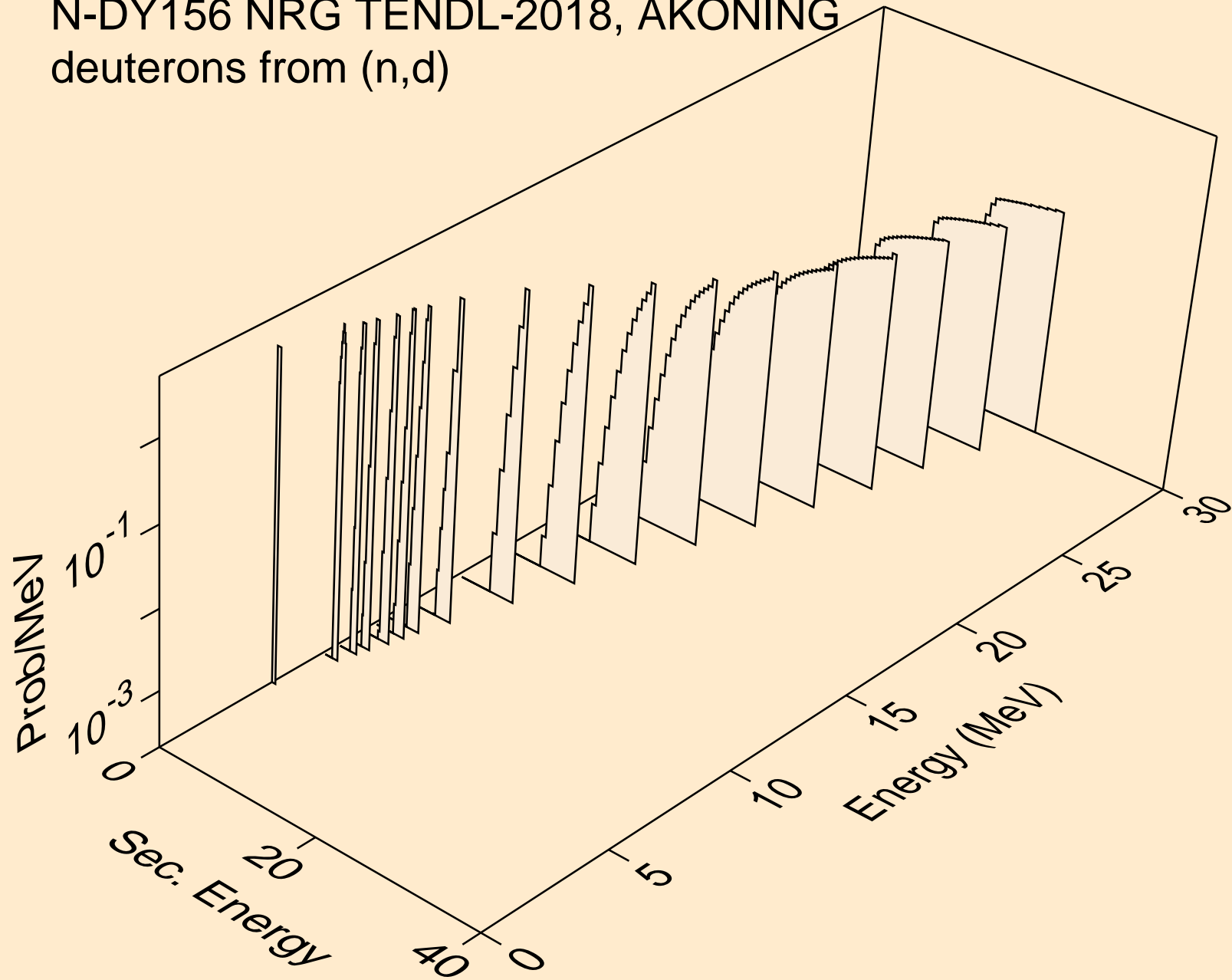

N-DY156 NRG TENDL-2018, AKONING
deuterons from (n,pd)

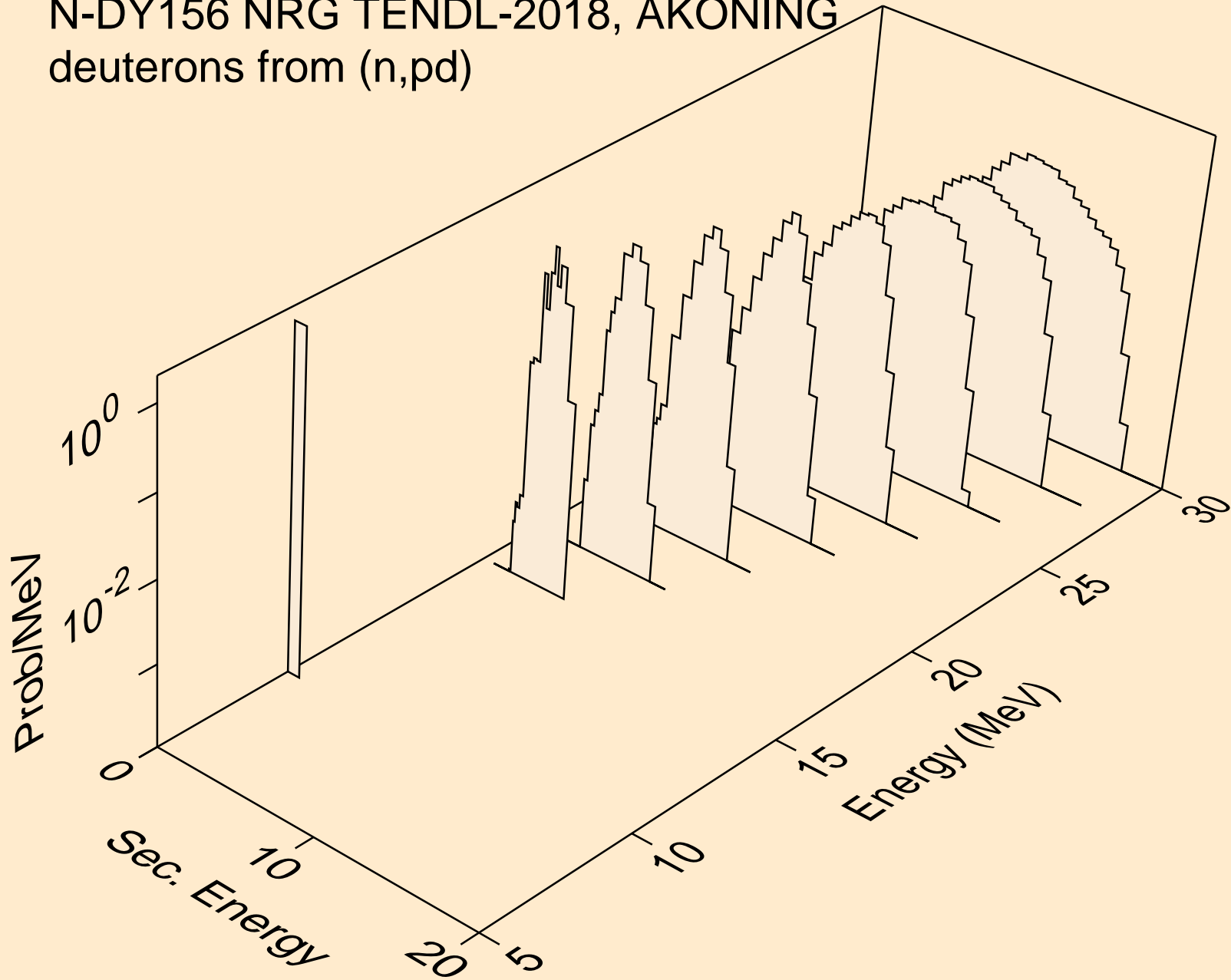

N-DY156 NRG TENDL-2018, AKONING
deuterons from (n,da)

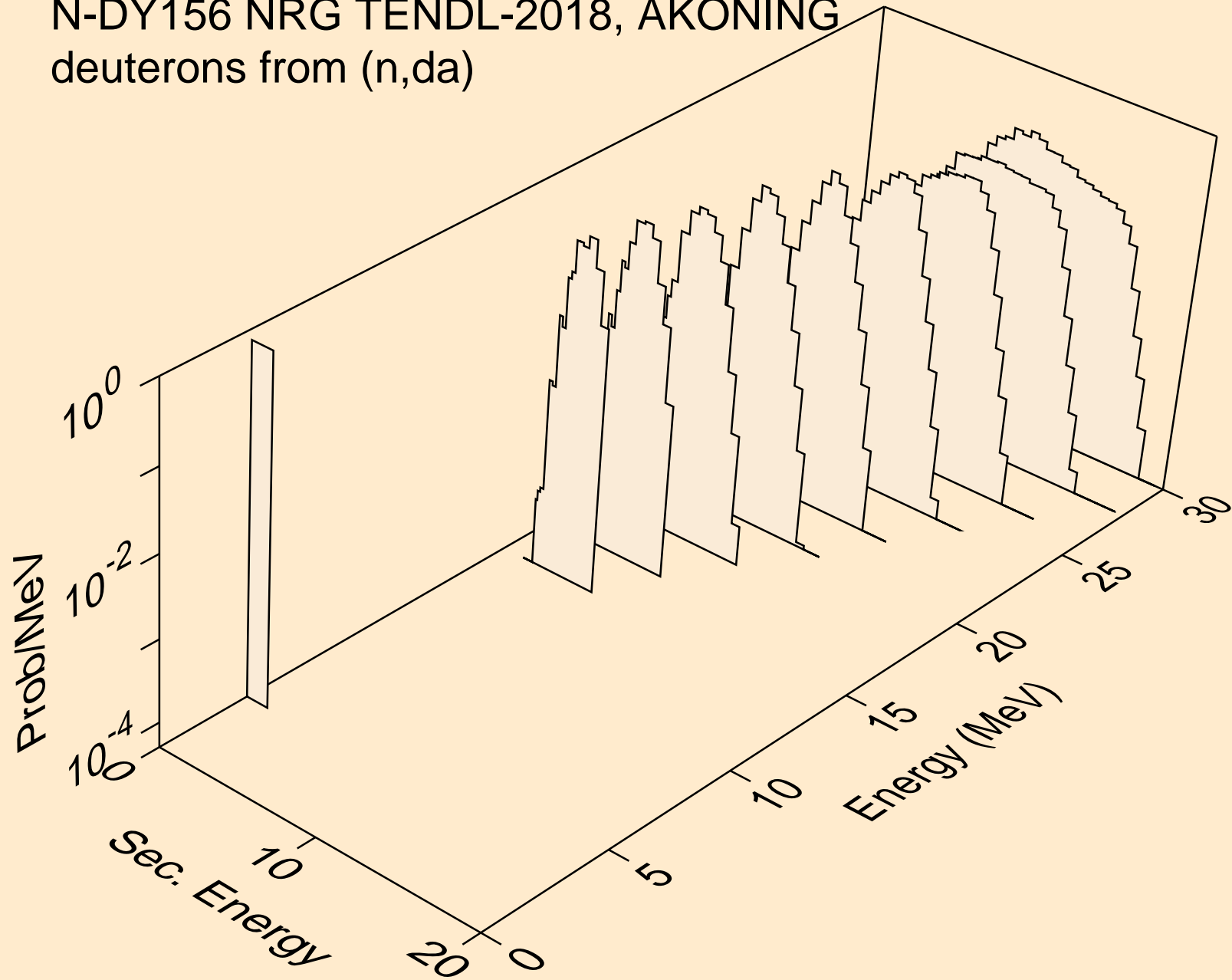

N-DY156 NRG TENDL-2018, AKONING
tritons from (n,x)

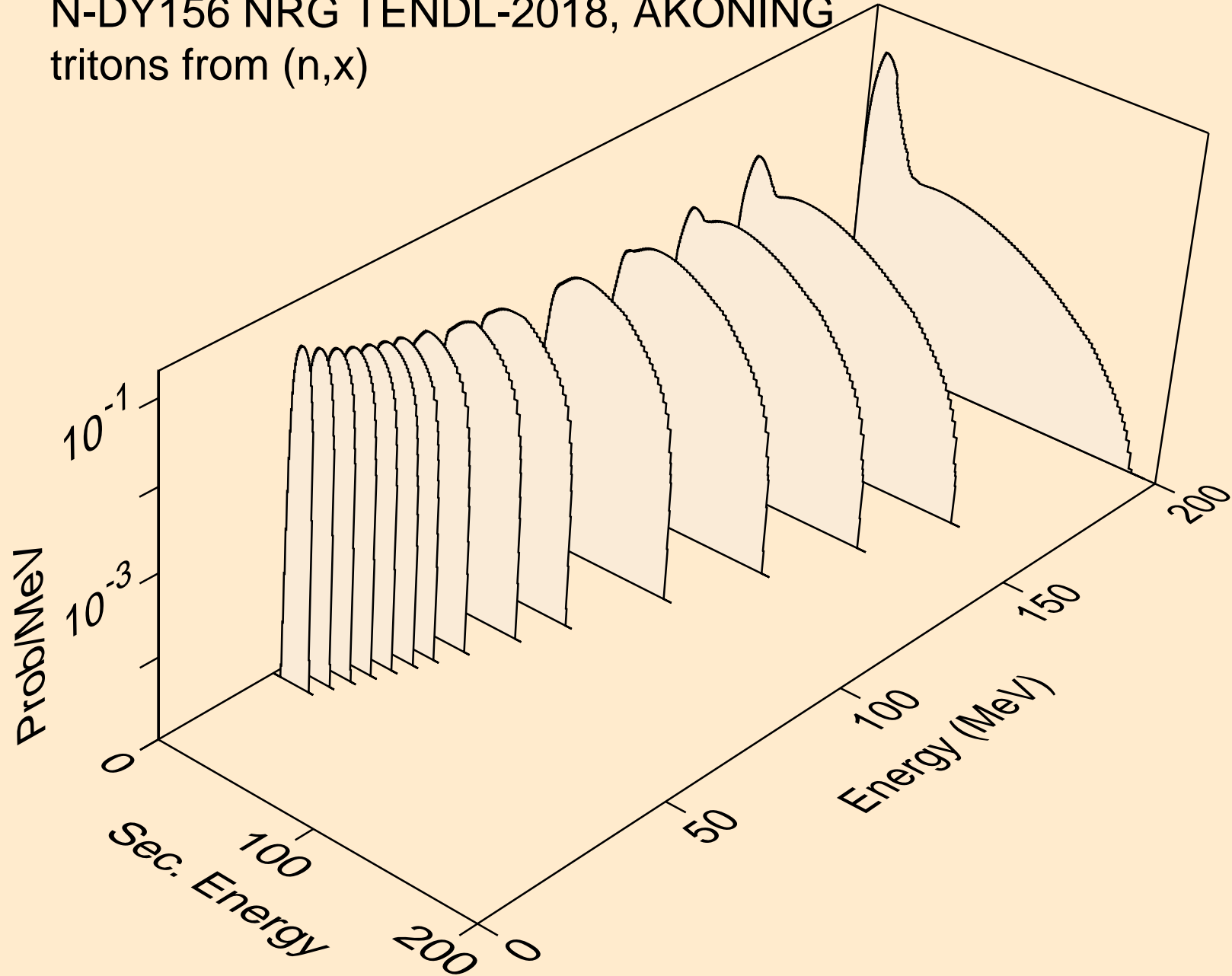

N-DY156 NRG TENDL-2018, AKONING
tritons from (n,n*)t

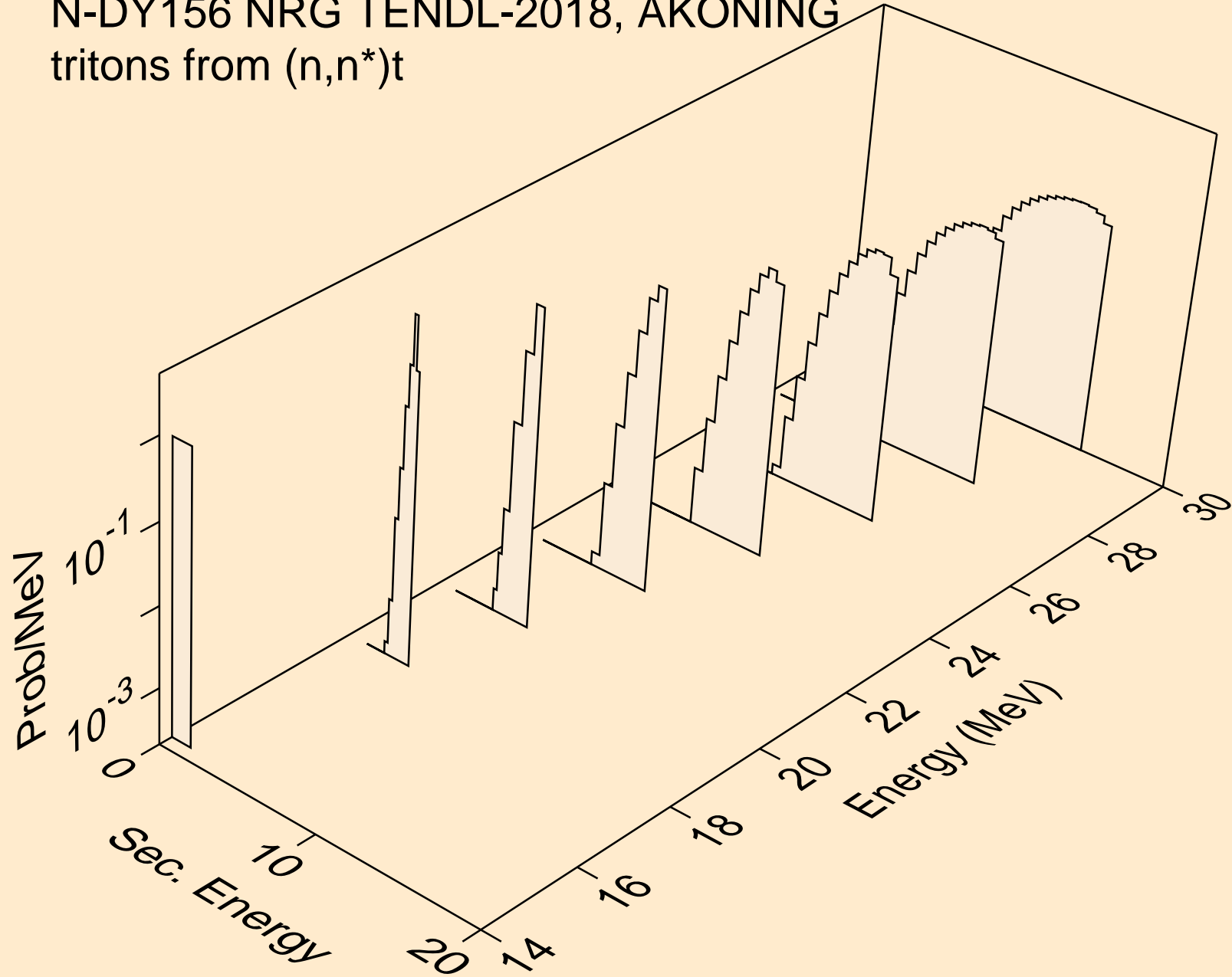

N-DY156 NRG TENDL-2018, AKONING
tritons from (n,t)

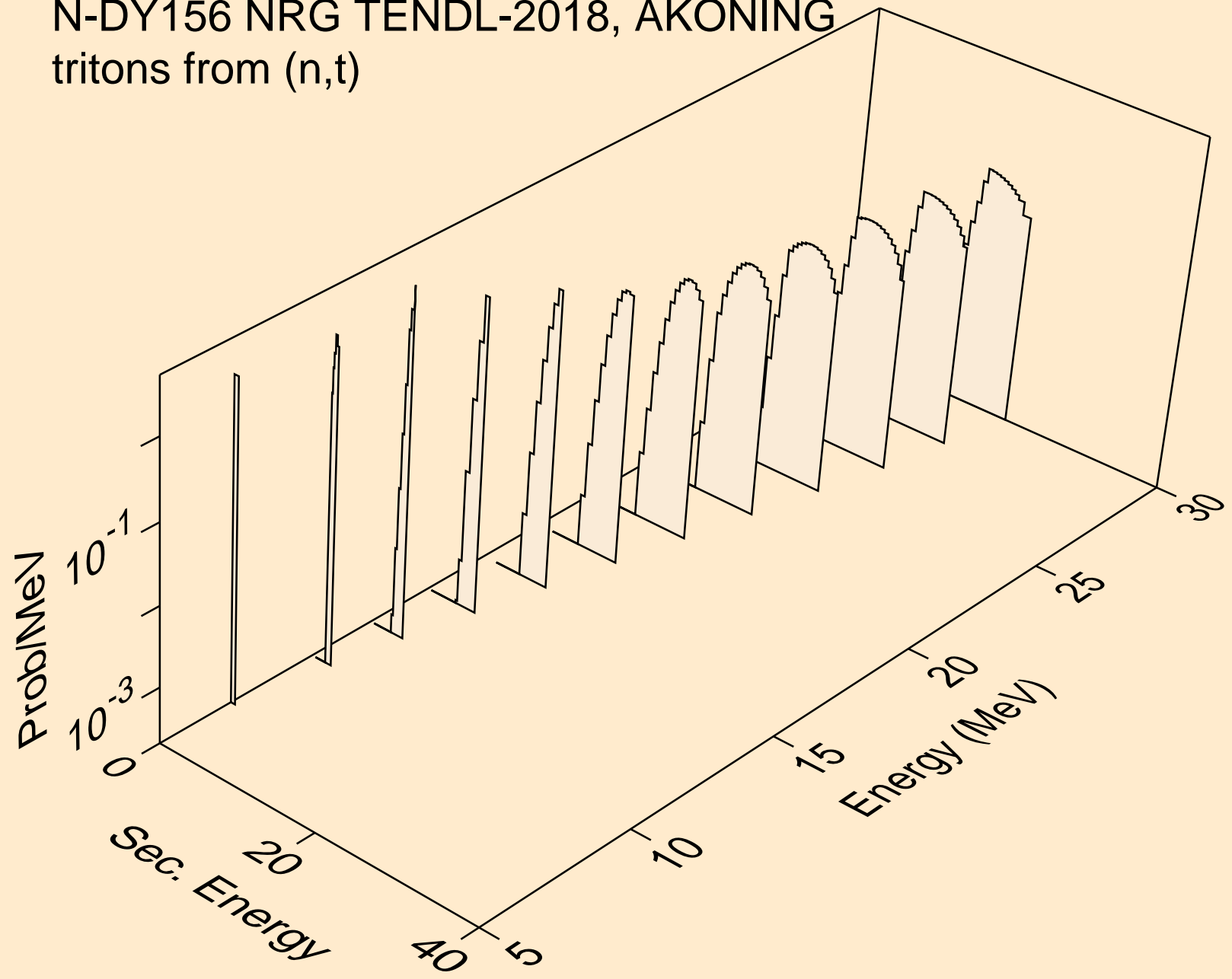

N-DY156 NRG TENDL-2018, AKONING
tritons from (n,pt)

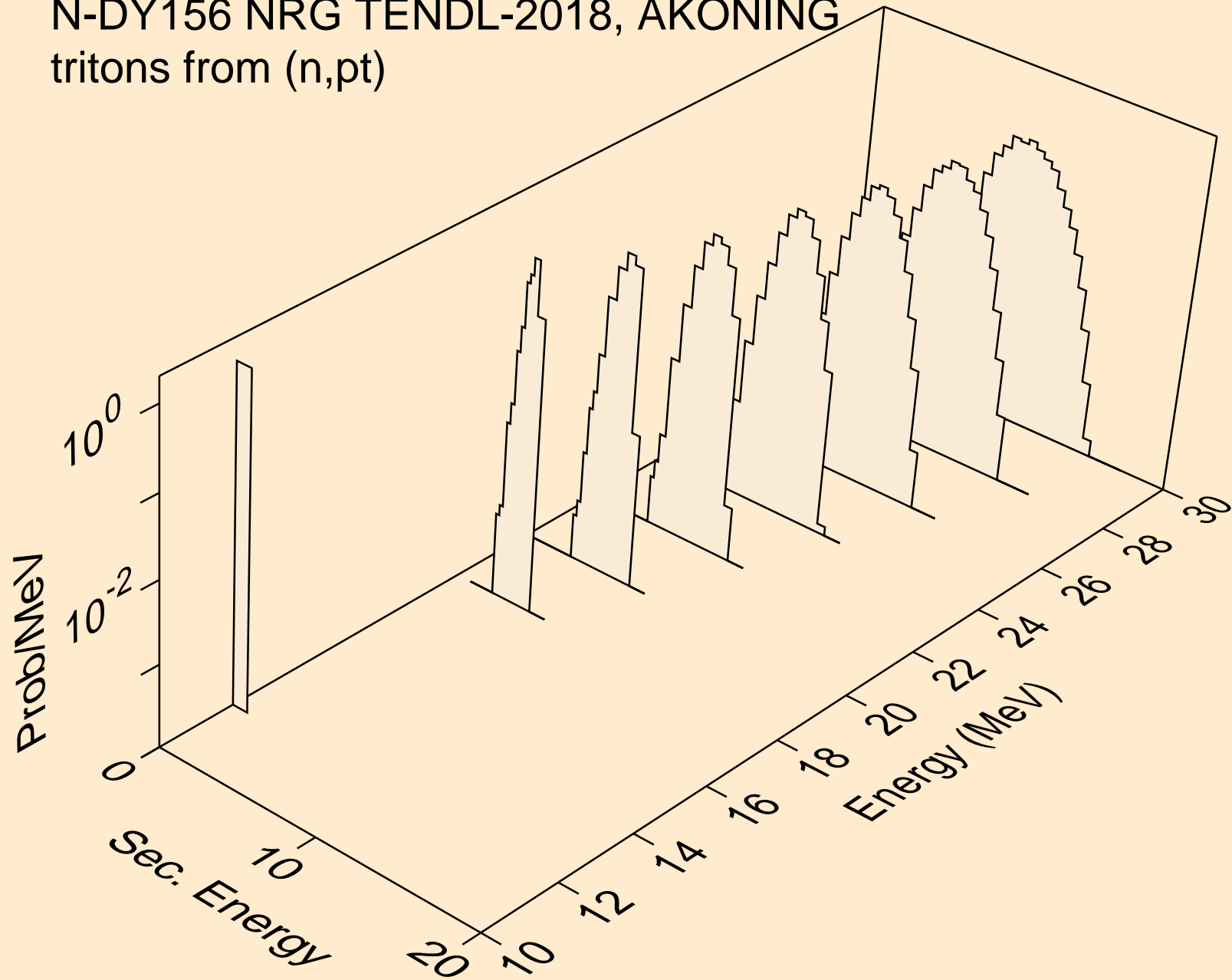

N-DY156 NRG TENDL-2018, AKONING
he3s from (n,x)

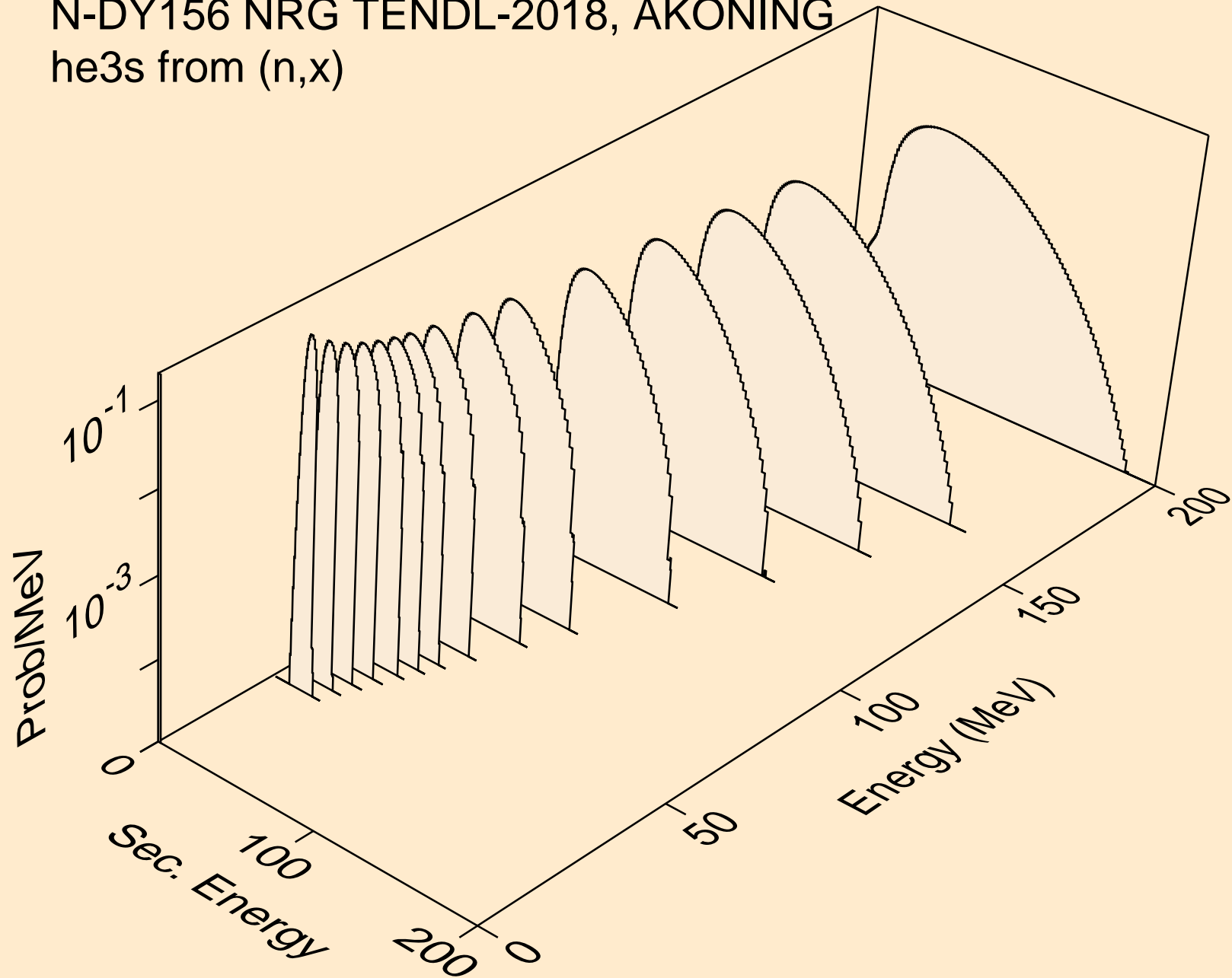

N-DY156 NRG TENDL-2018, AKONING
he3s from (n,n*)he3

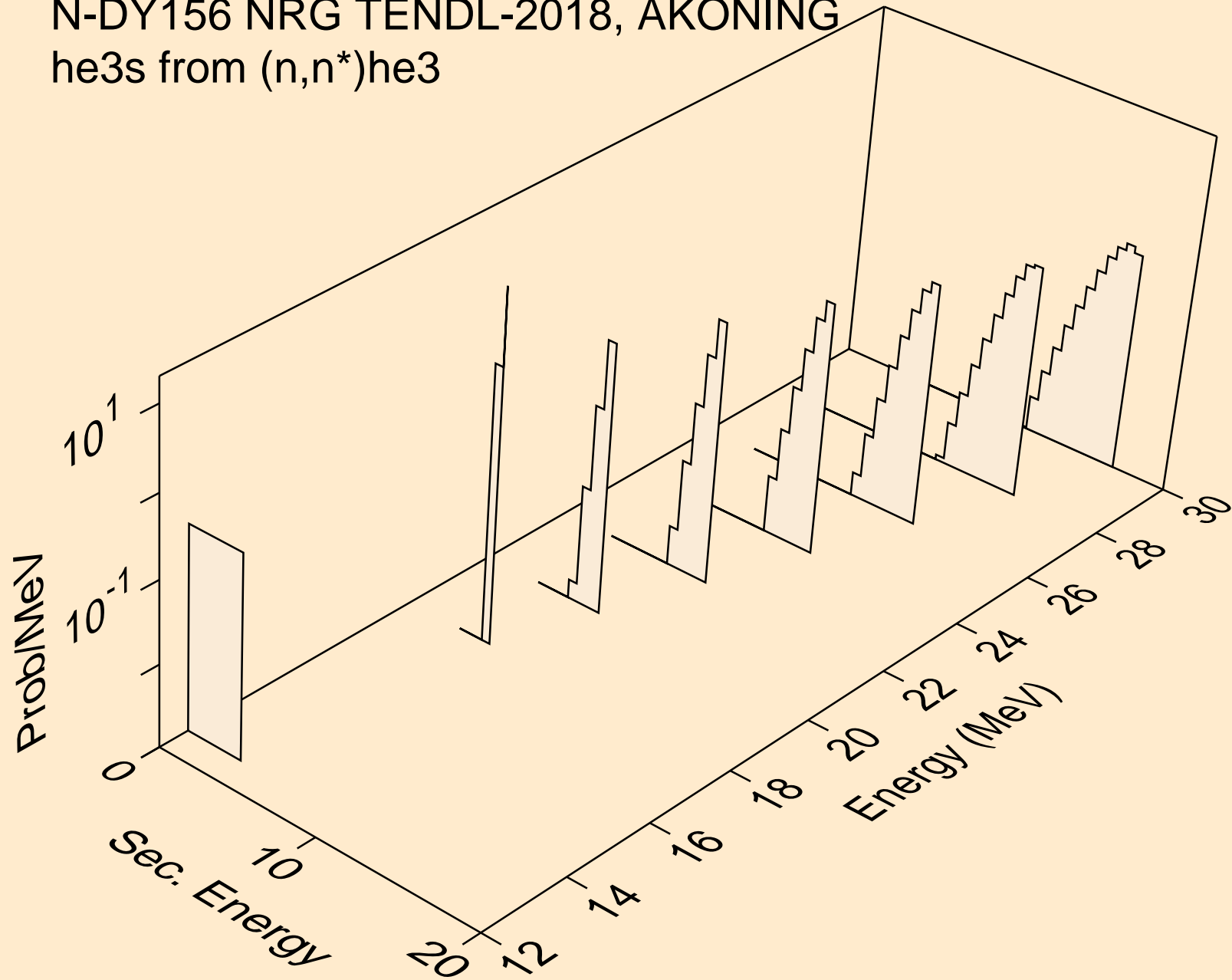

N-DY156 NRG TENDL-2018, AKONING
he3s from (n,he3)

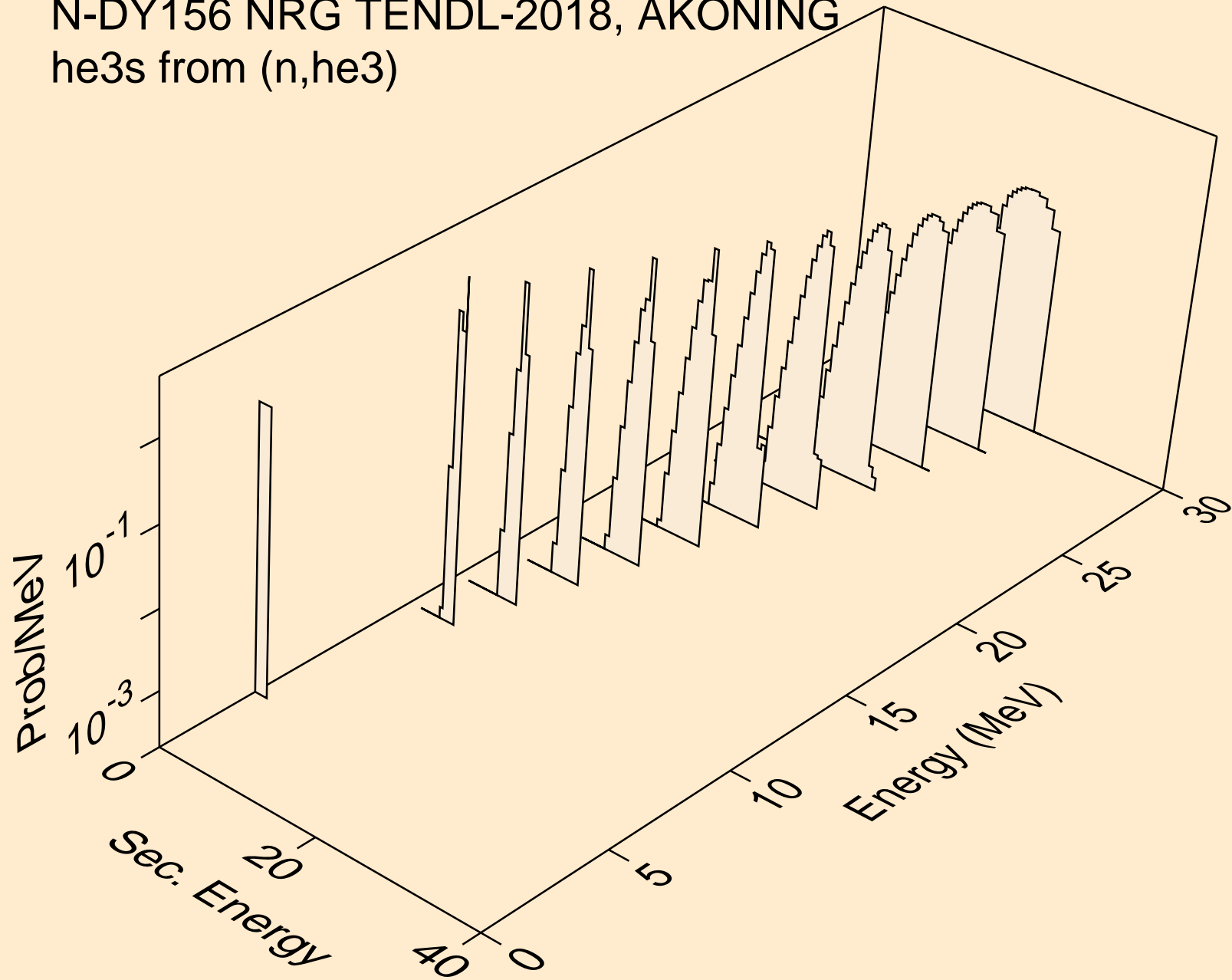

N-DY156 NRG TENDL-2018, AKONING
alphas from (n,x)

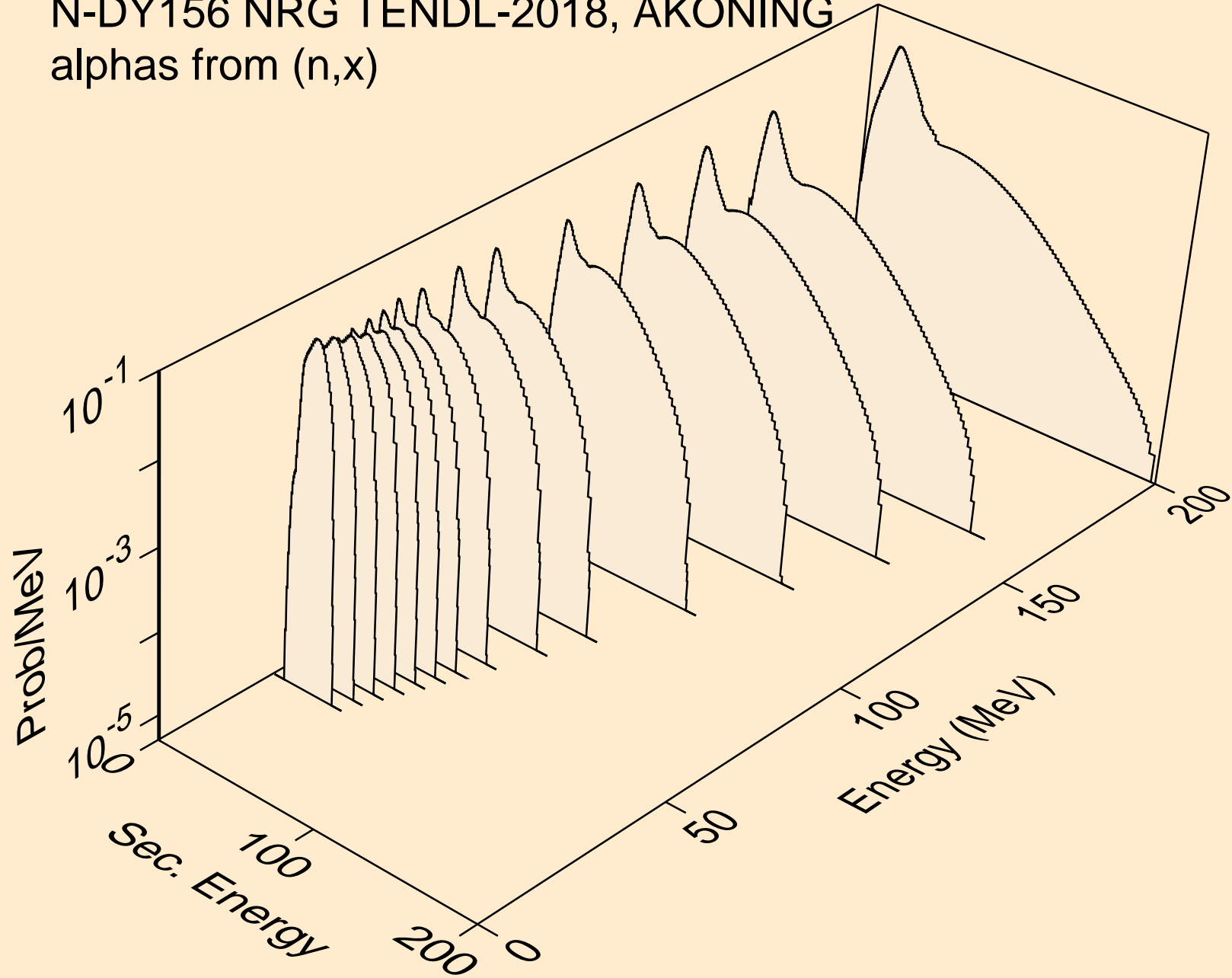

N-DY156 NRG TENDL-2018, AKONING
alphas from (n,n*)a

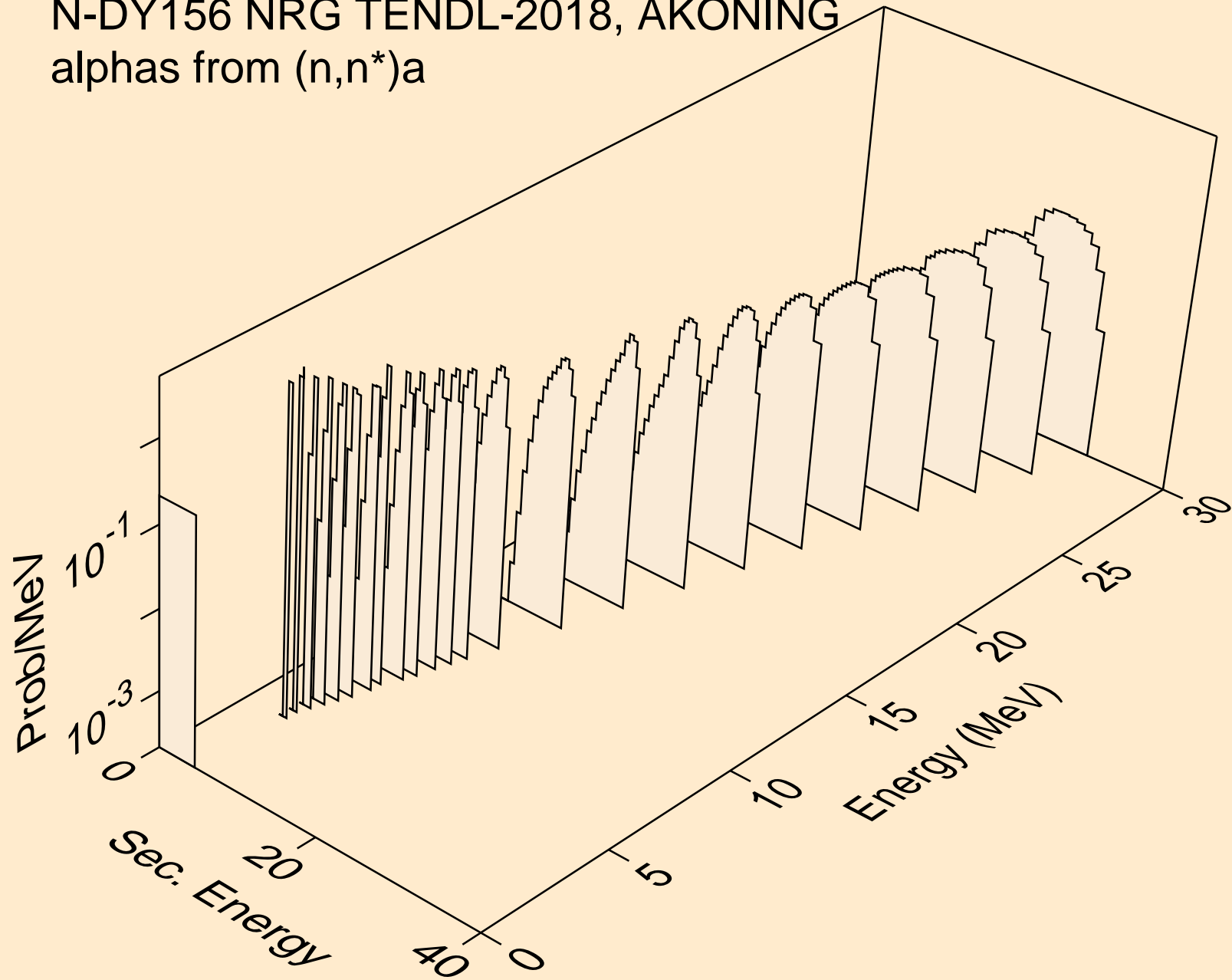

N-DY156 NRG TENDL-2018, AKONING
alphas from (n,2n)a

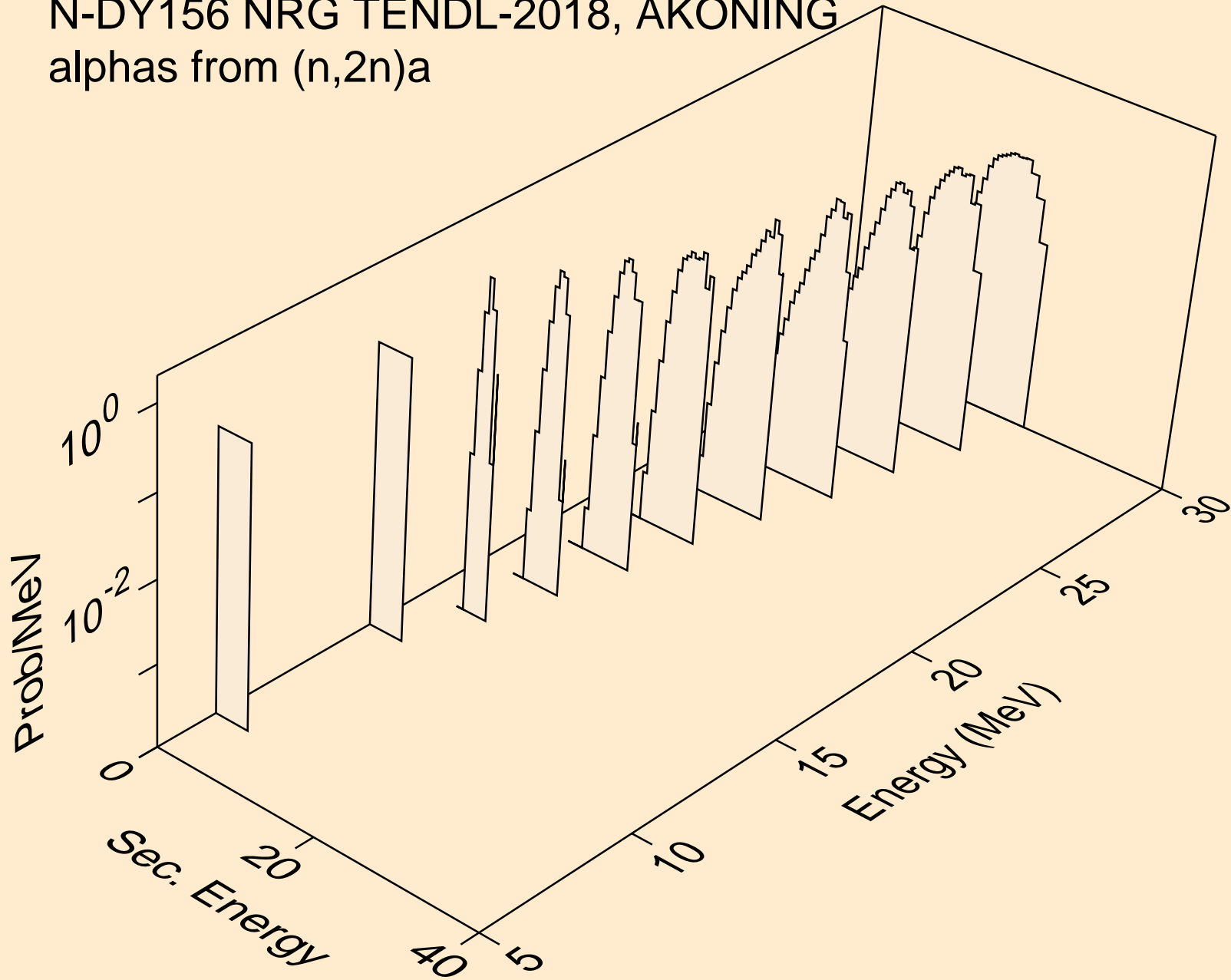

N-DY156 NRG TENDL-2018, AKONING
alphas from (n,3n)a

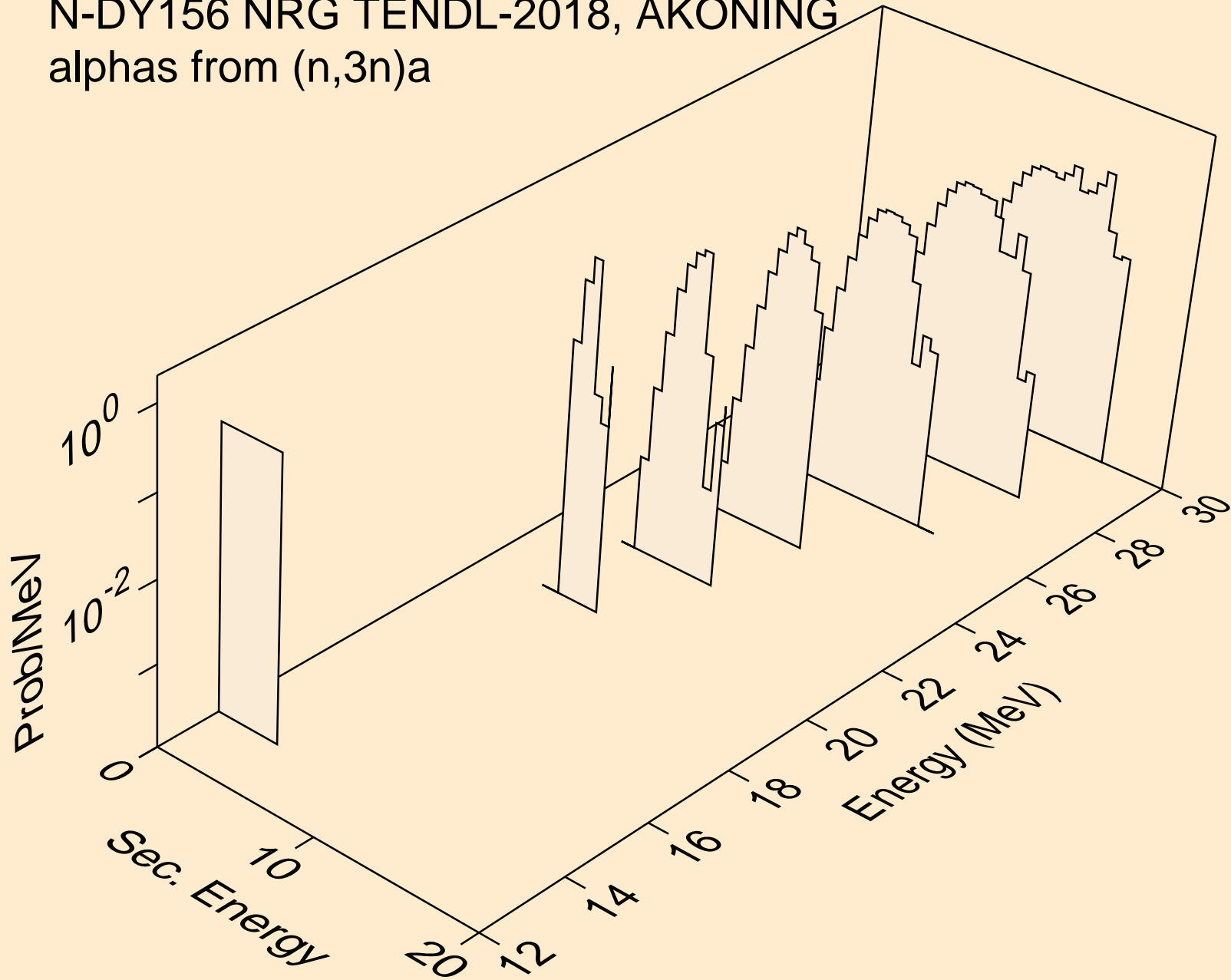

N-DY156 NRG TENDL-2018, AKONING
alphas from (n,n*)2a

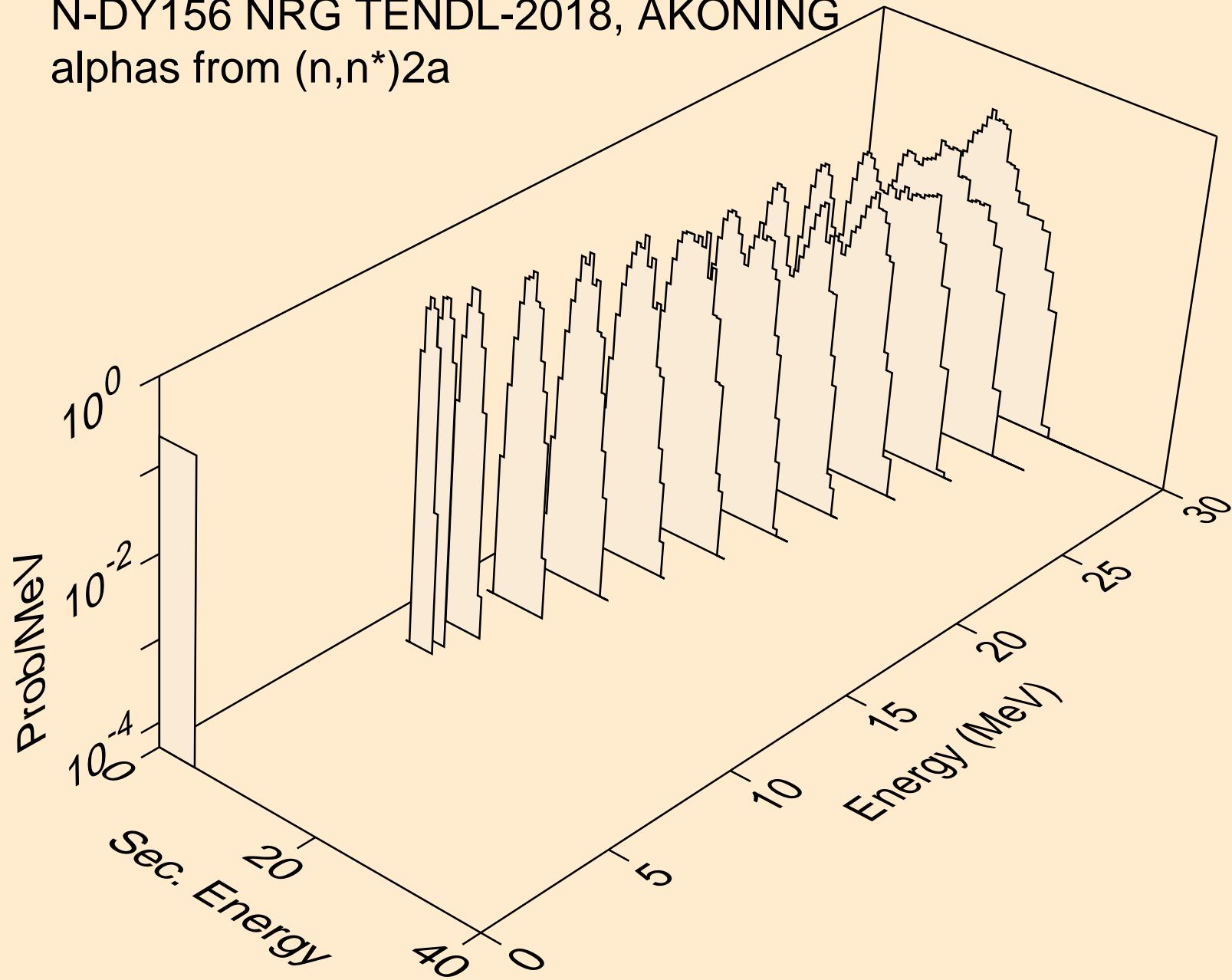

N-DY156 NRG TENDL-2018, AKONING
alphas from (n,2n)2a

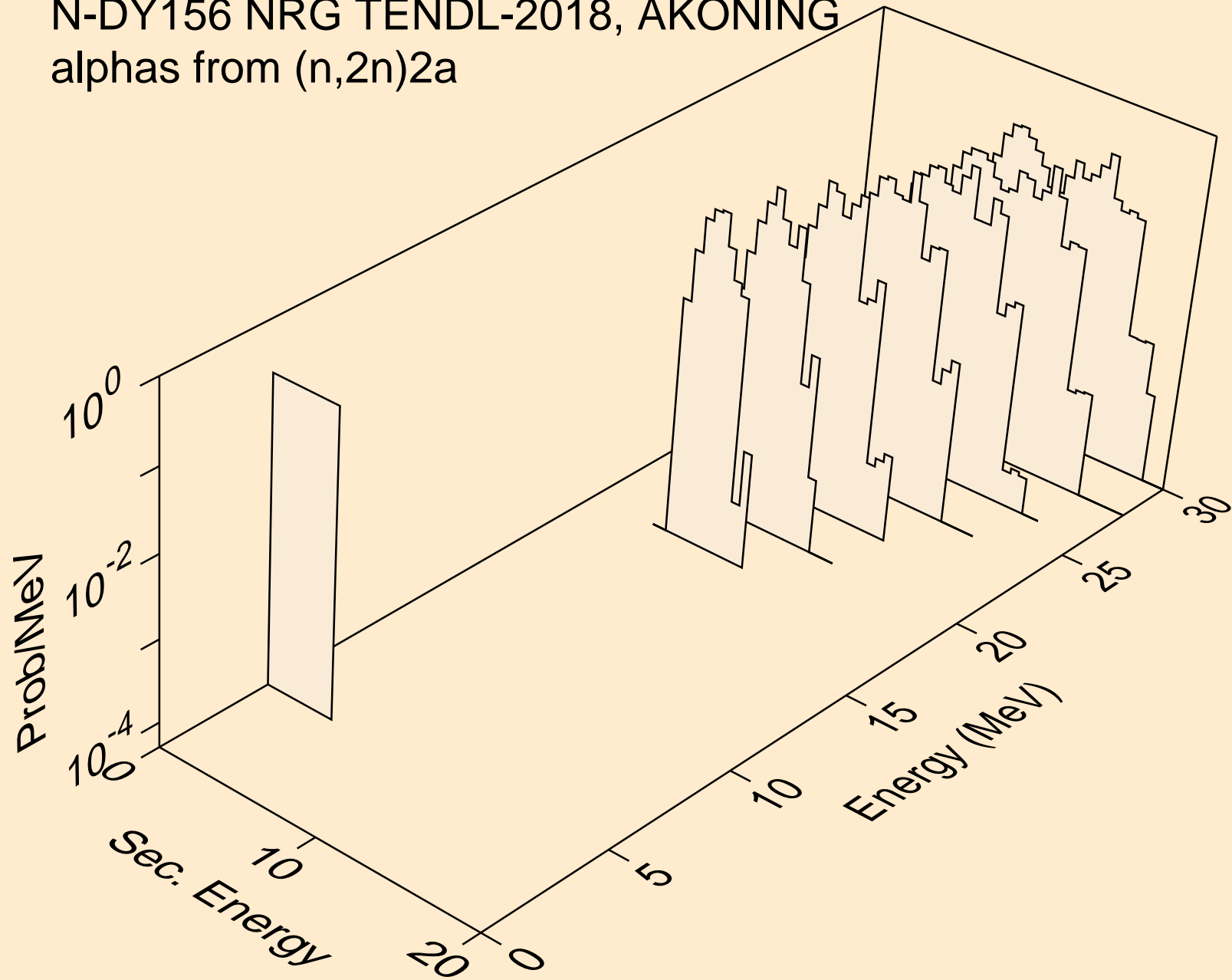

N-DY156 NRG TENDL-2018, AKONING
alphas from (n,npa)

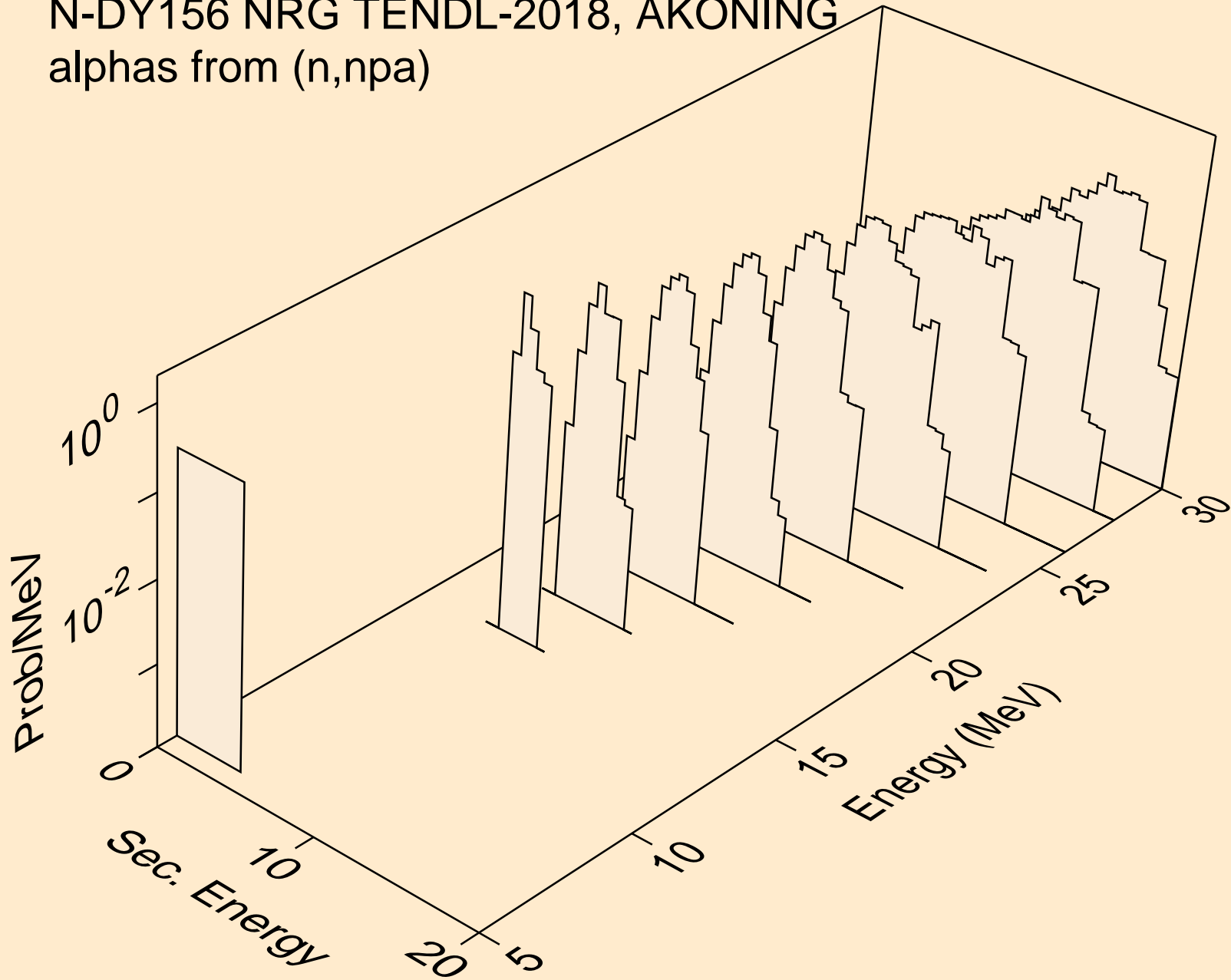

N-DY156 NRG TENDL-2018, AKONING
alphas from (n,a)

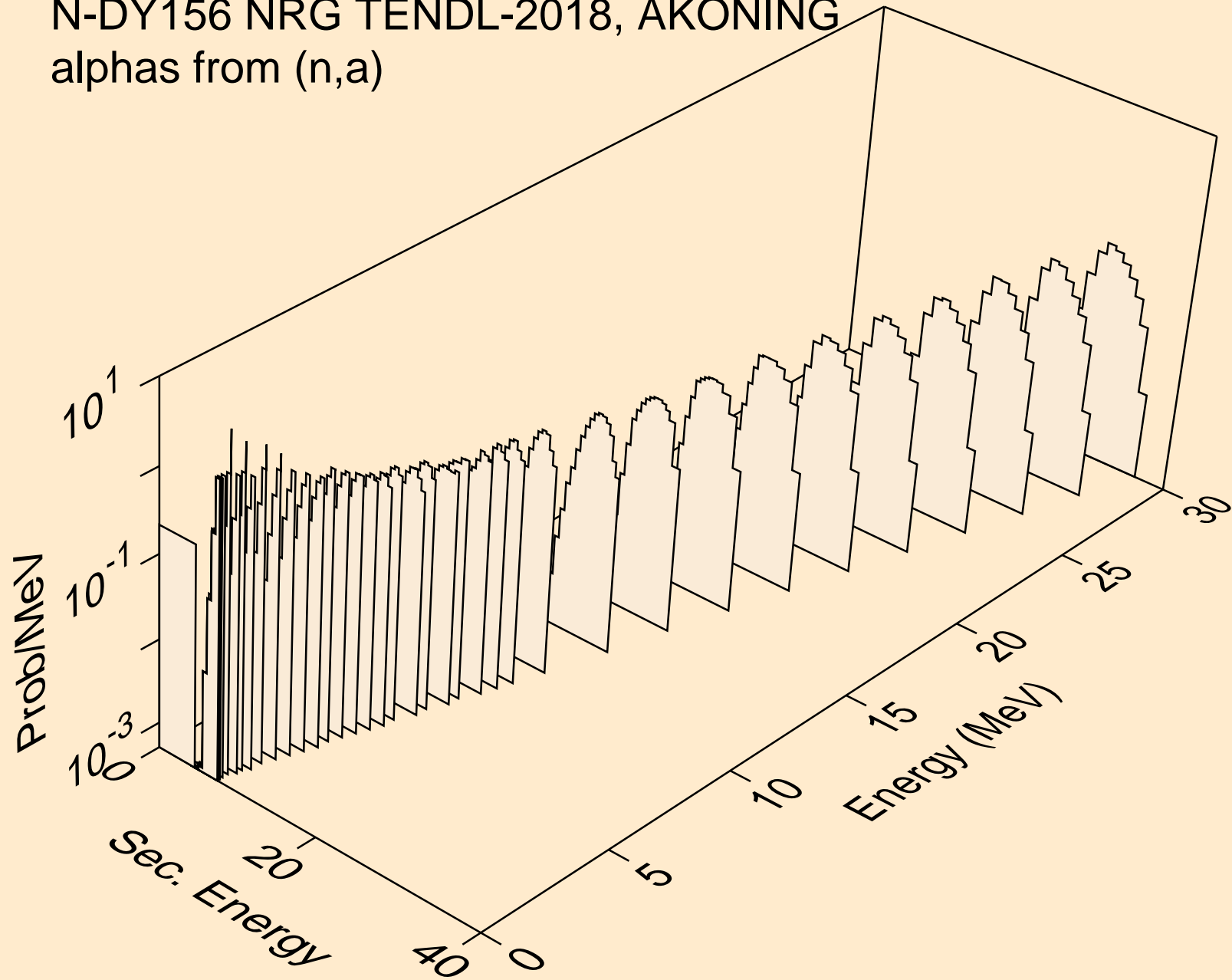

N-DY156 NRG TENDL-2018, AKONING
alphas from (n,2a)

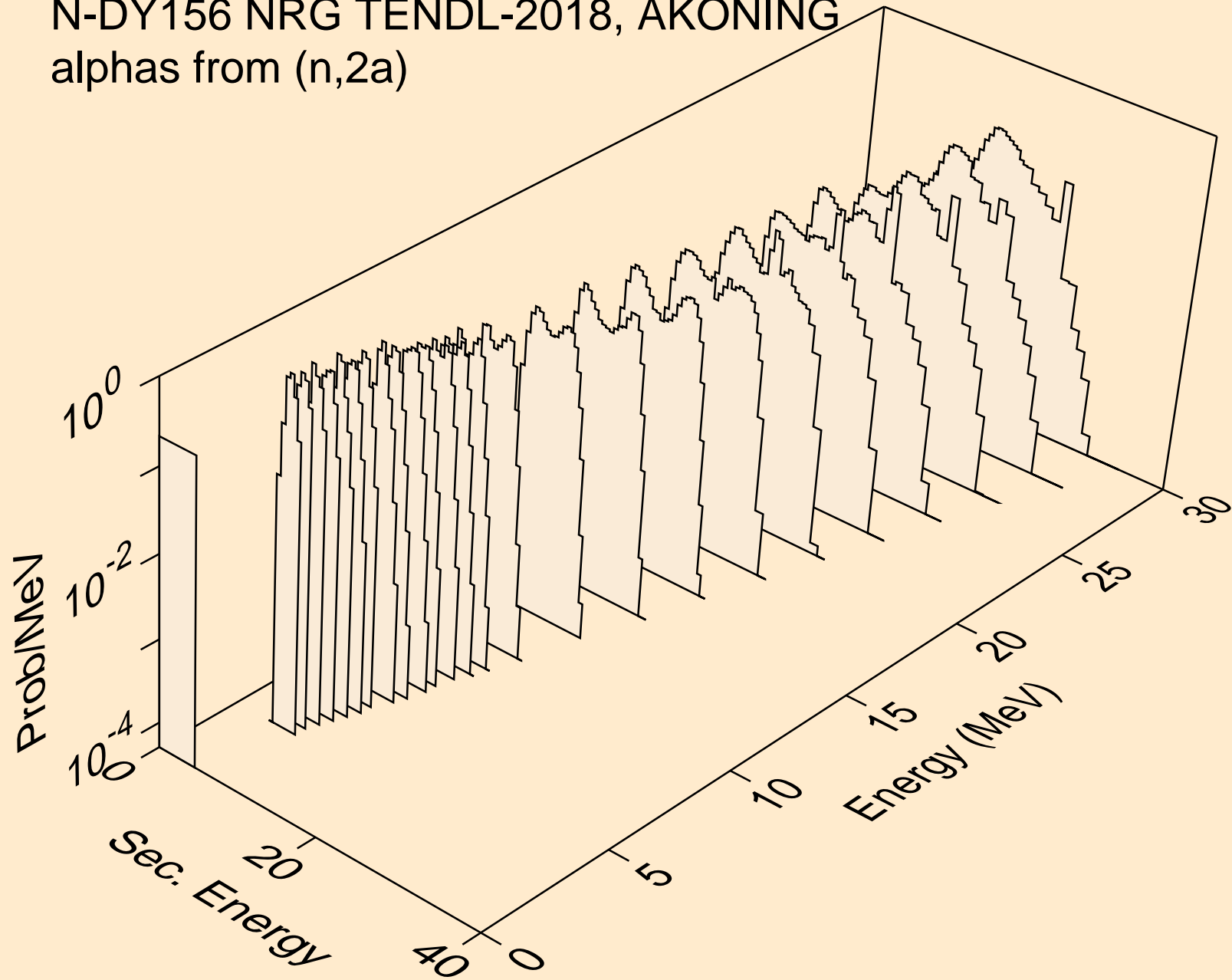

N-DY156 NRG TENDL-2018, AKONING
alphas from (n,pa)

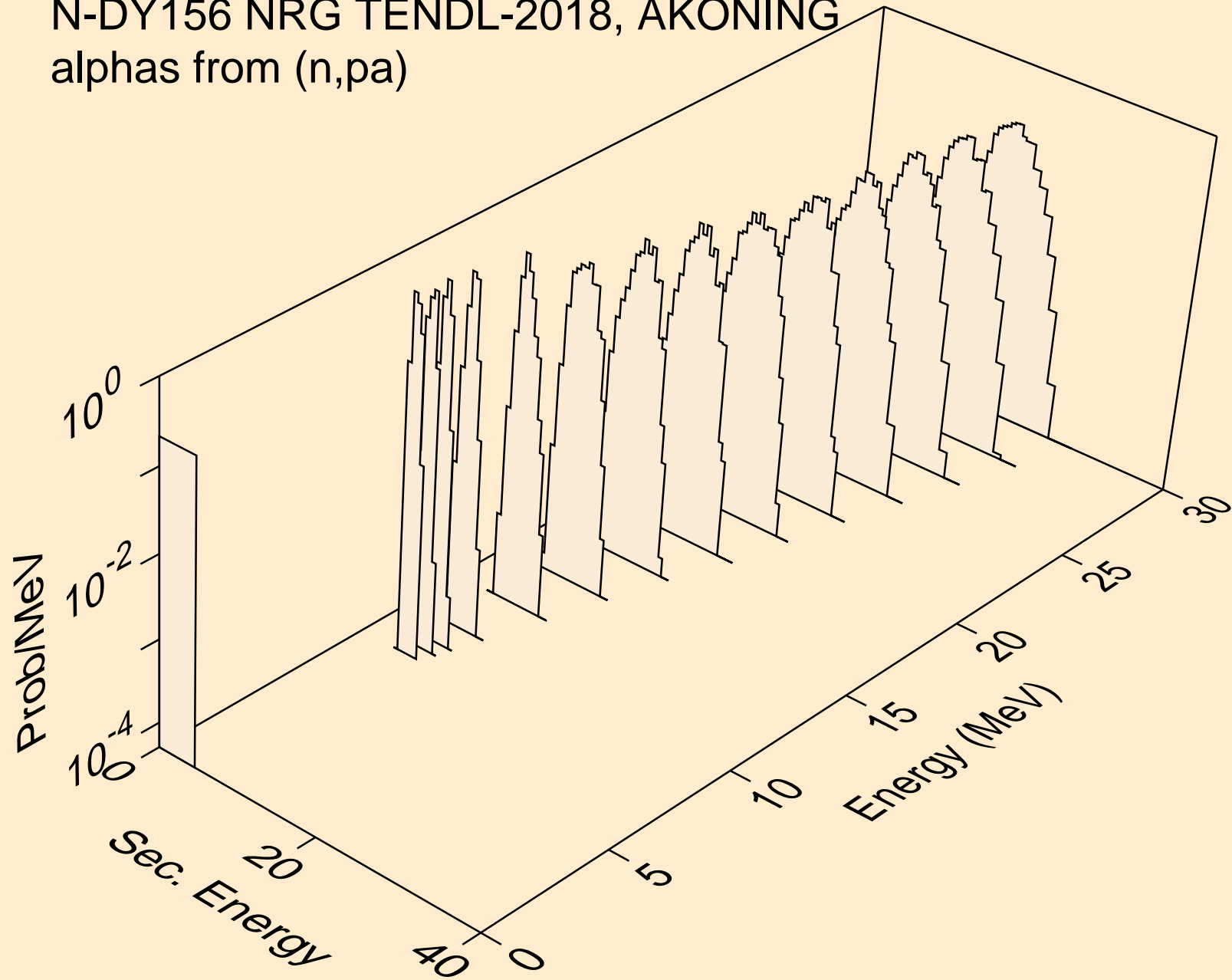

N-DY156 NRG TENDL-2018, AKONING
alphas from (n,da)

