

Program EVALPLOT
(Version 2017-1)

by

Dermott E. Cullen
(Present Contact Information)

Dermott E. Cullen
1466 Hudson Way
Livermore, CA 94550
U.S.A.

Tele: 925-443-1911

E.Mail:redcullen1@comcast.net

Web:redcullen1.net/HOMEPAGE.NEW

Press Mouse Button to Start

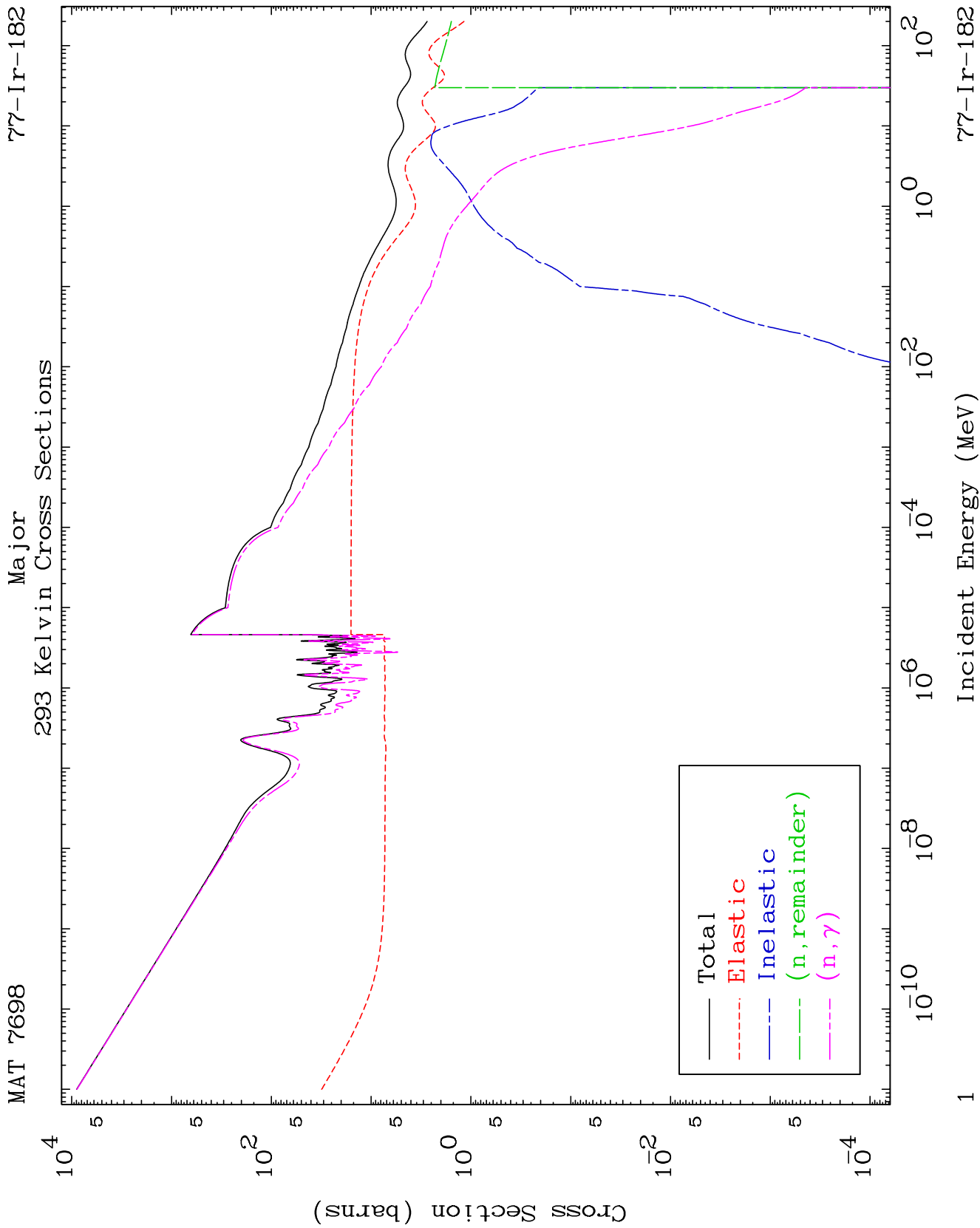

MAT 7698

Neutron Production
293 Kelvin Cross Sections

77-Ir-182

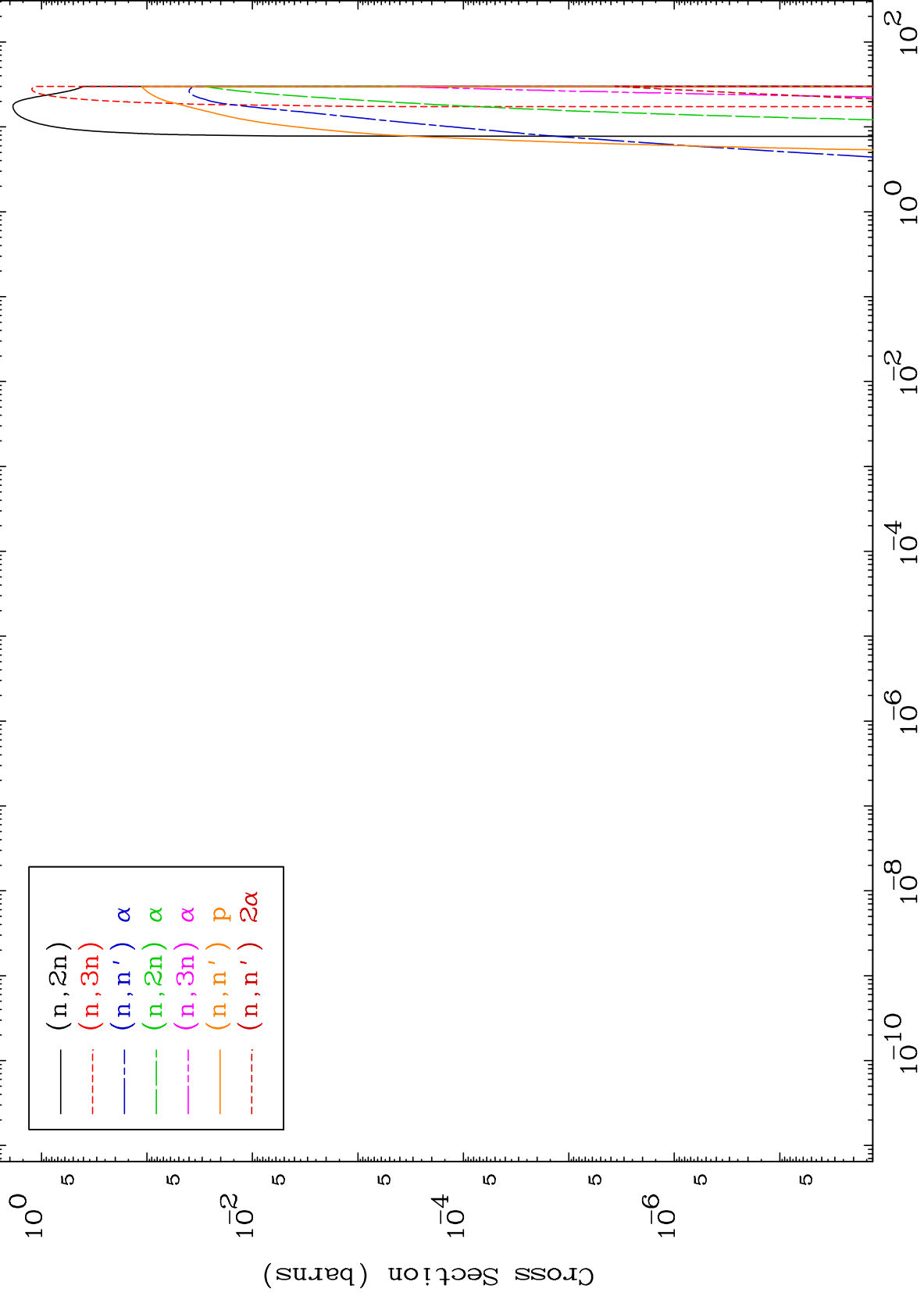

77-Ir-182

Incident Energy (MeV)

MAT 7698

Neutron Production
293 Kelvin Cross Sections

77-Ir-182

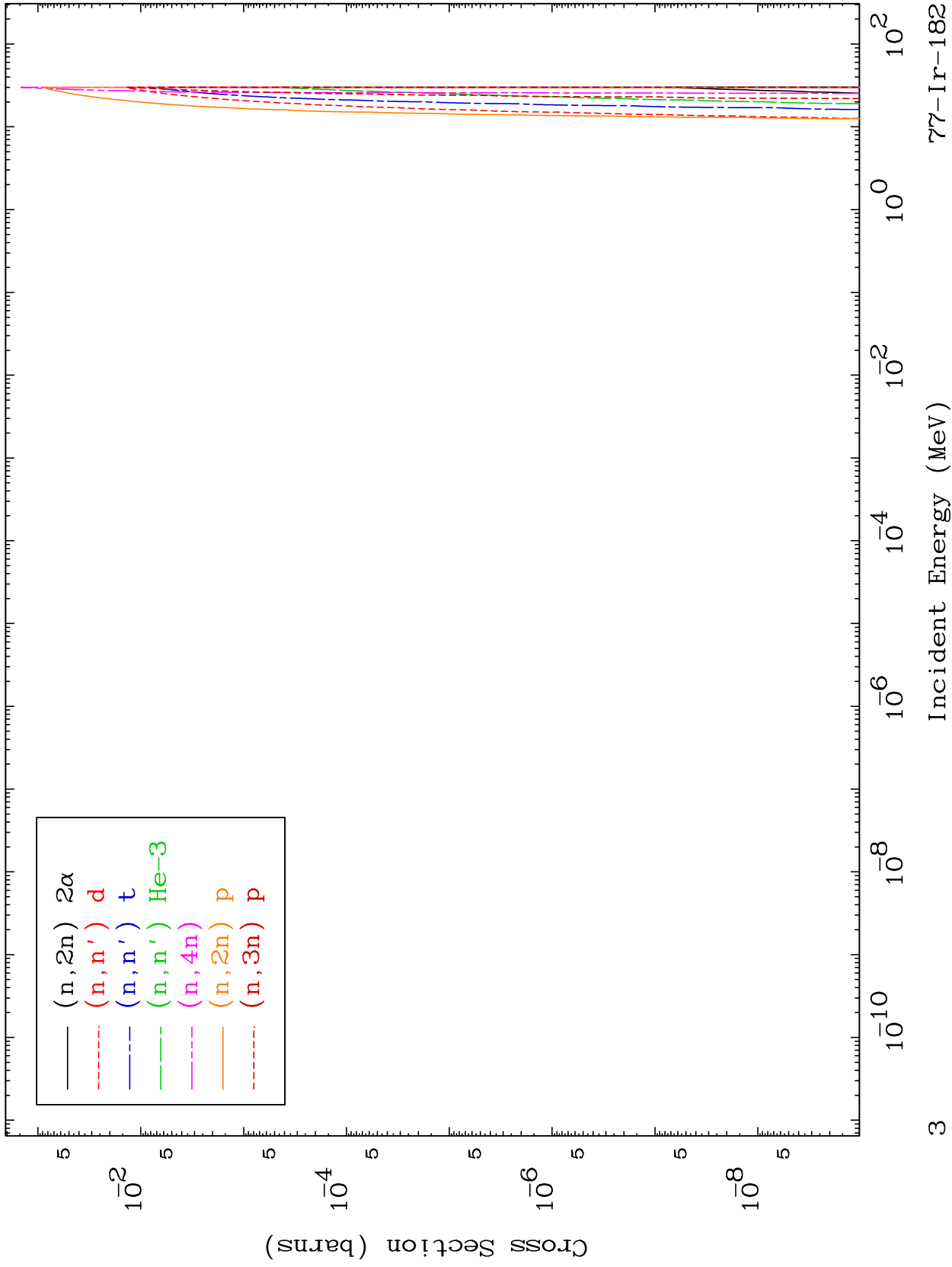

MAT 7698

Charged Particle
293 Kelvin Cross Sections

77-Ir-182

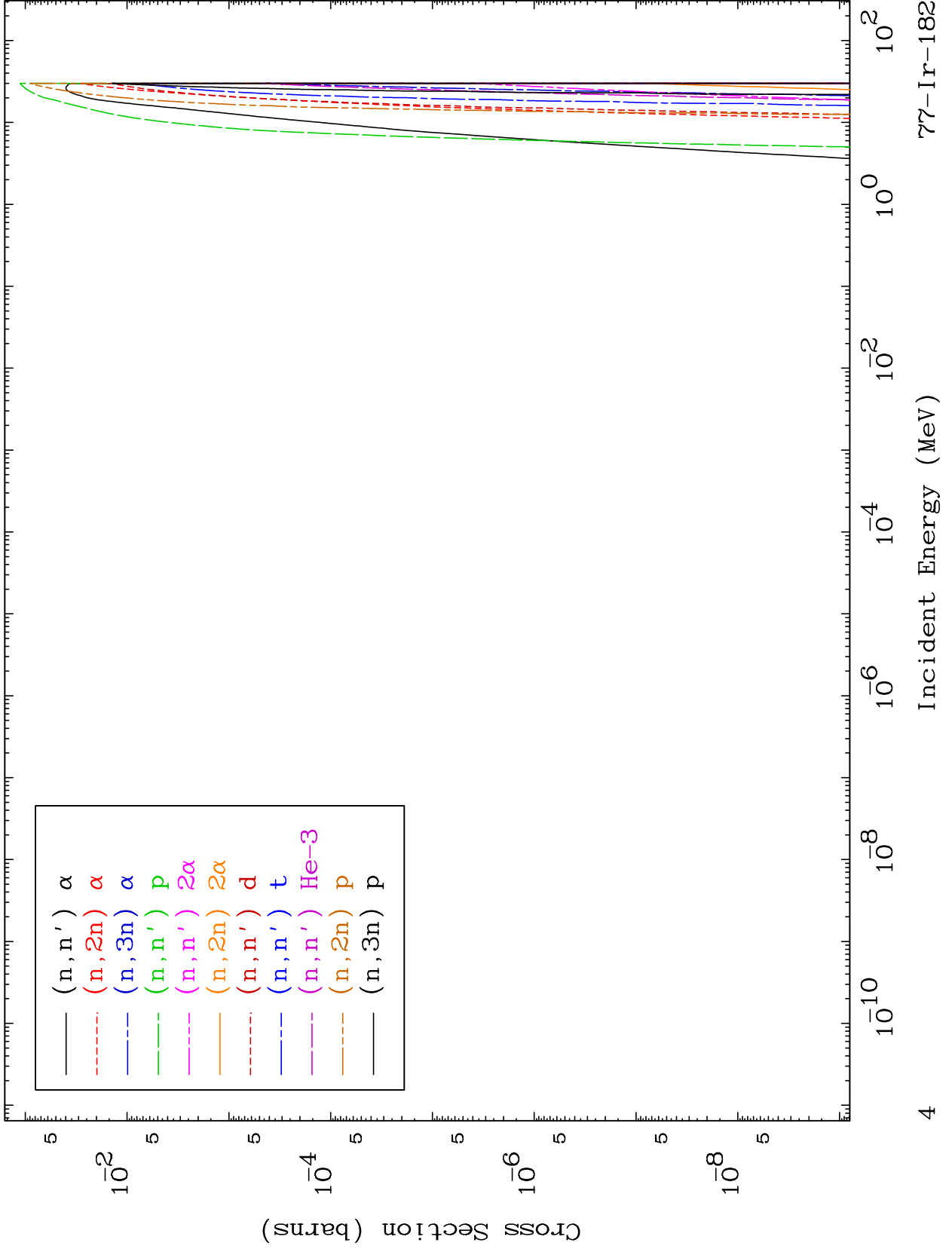

MAT 7698

Charged Particle
293 Kelvin Cross Sections

77-Ir-182

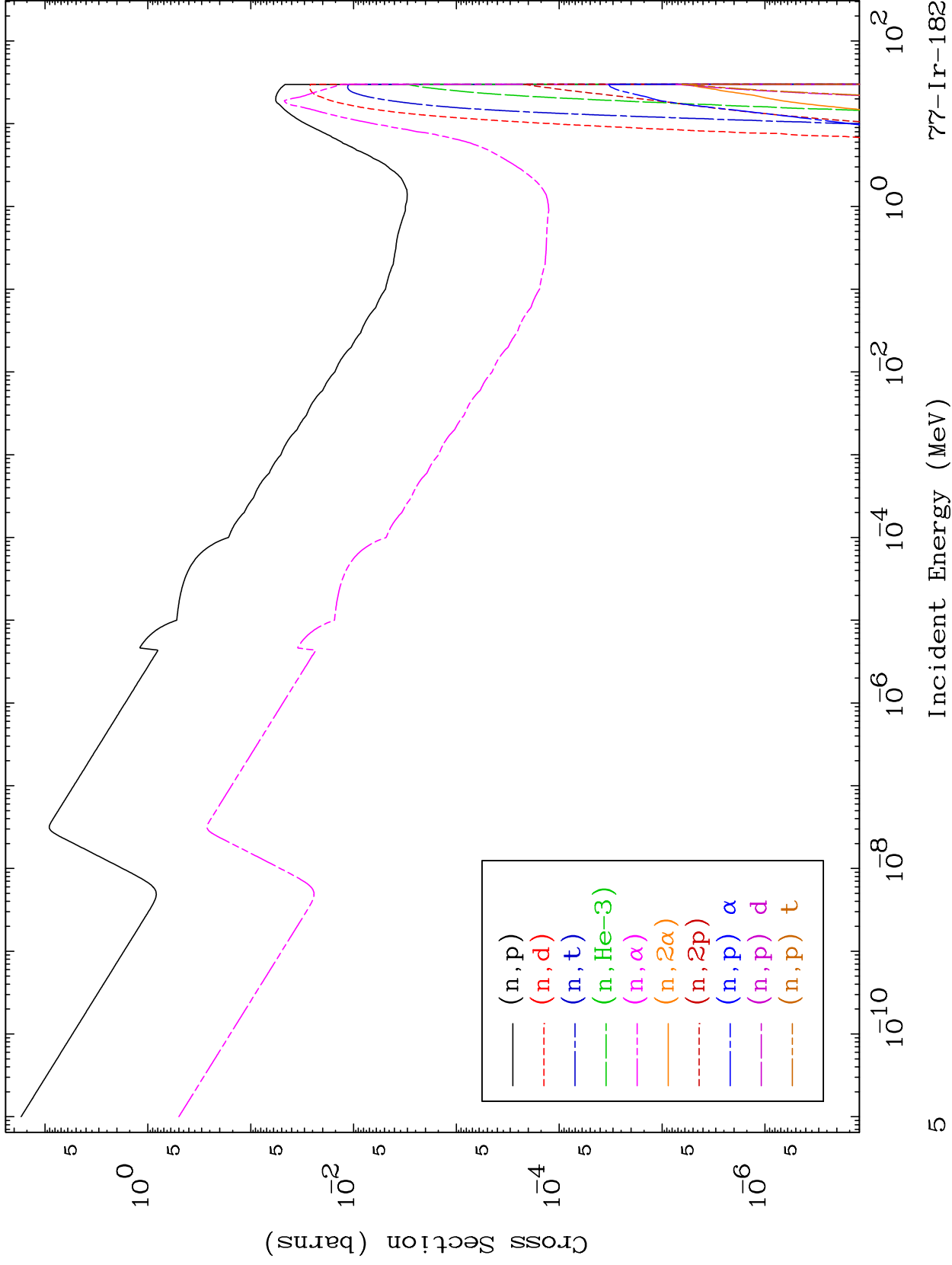

MAT 7698

Particle Production
293 Kelvin Cross Sections

77-Ir-182

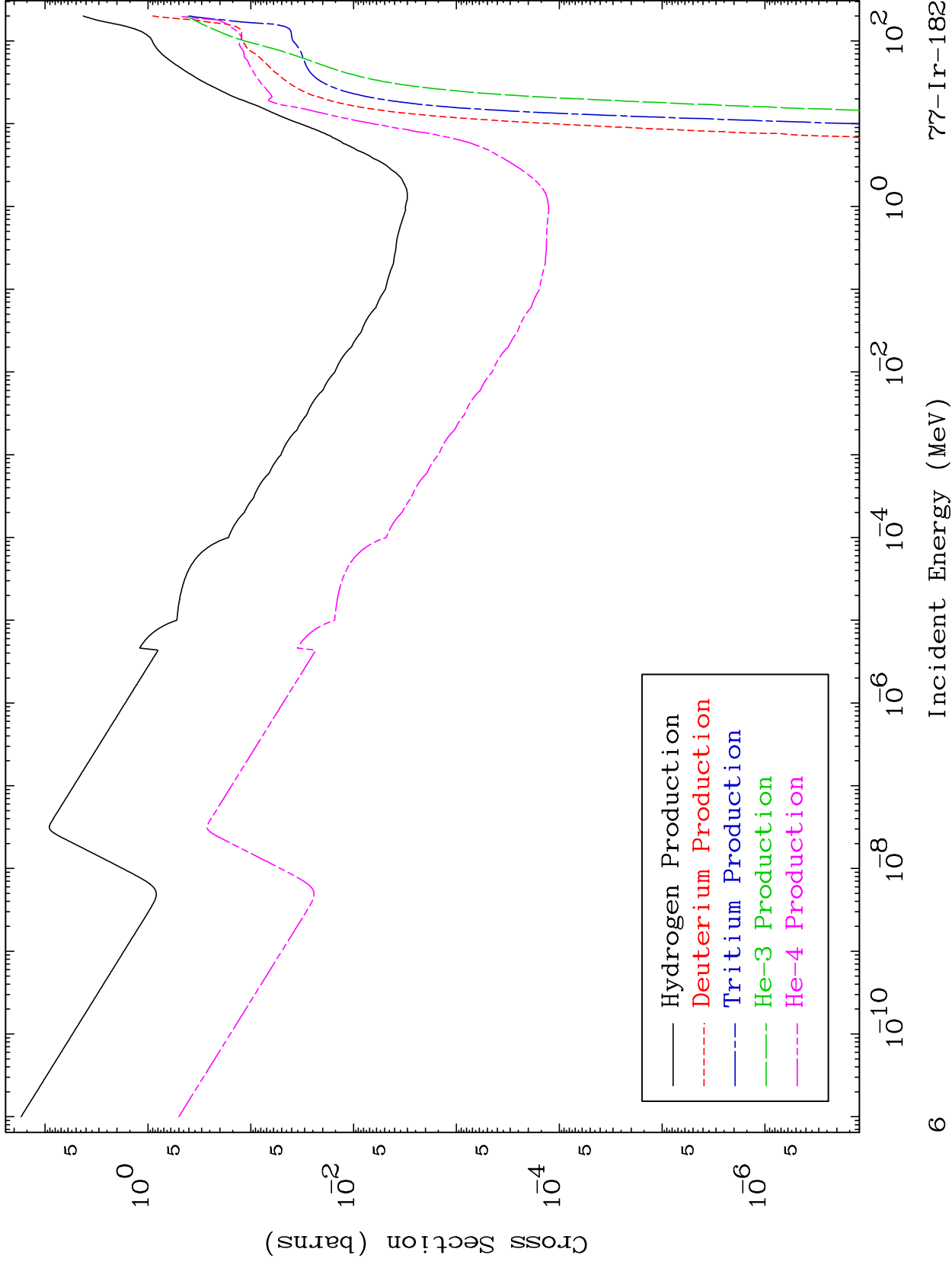

MAT 7698

(n,n') Level
293 Kelvin Cross Sections

77-Ir-182

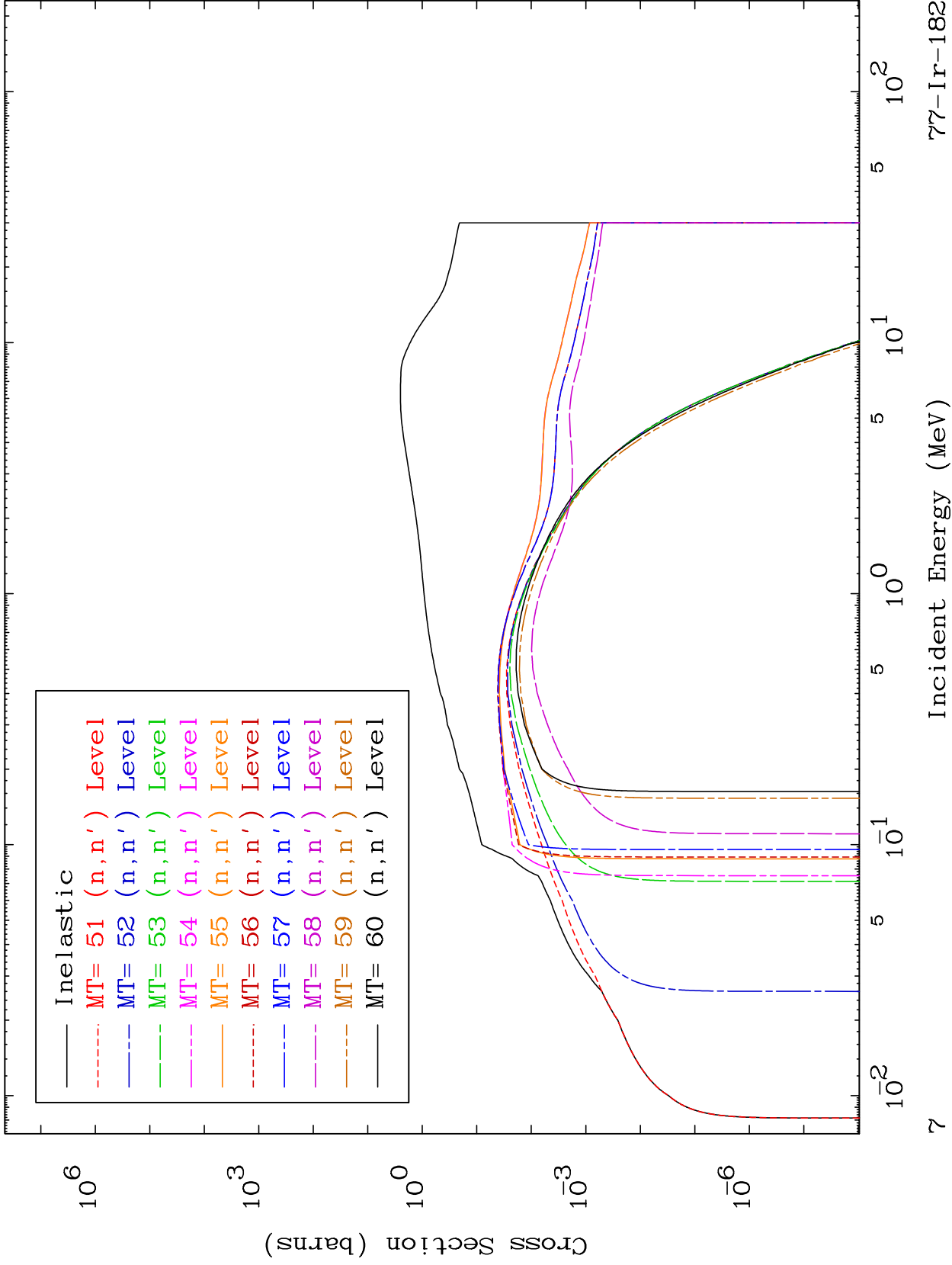

MAT 7698

(n,n') Level

293 Kelvin Cross Sections

77-Ir-182

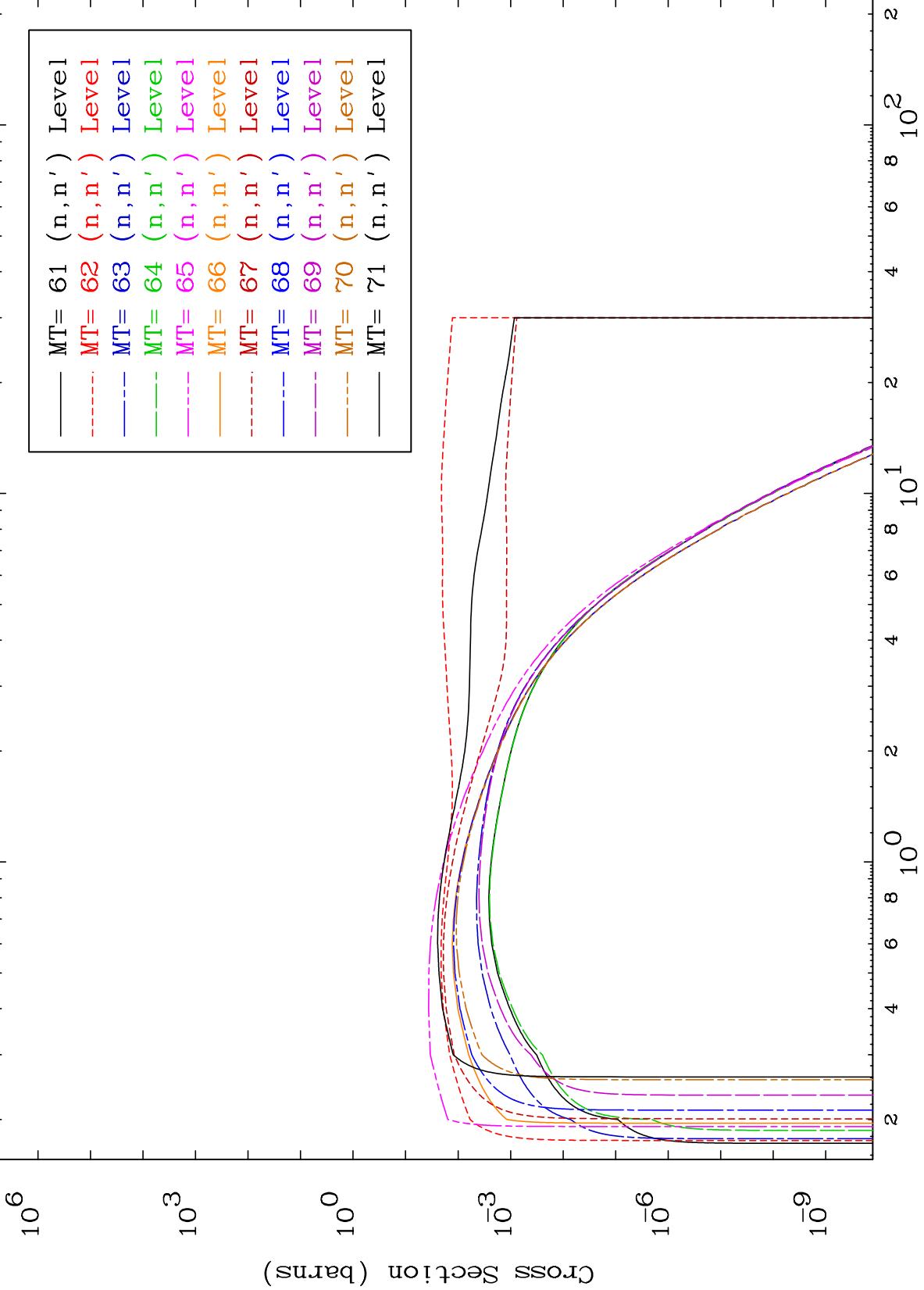

8

Incident Energy (MeV)

77-Ir-182

293 Kelvin Cross Sections

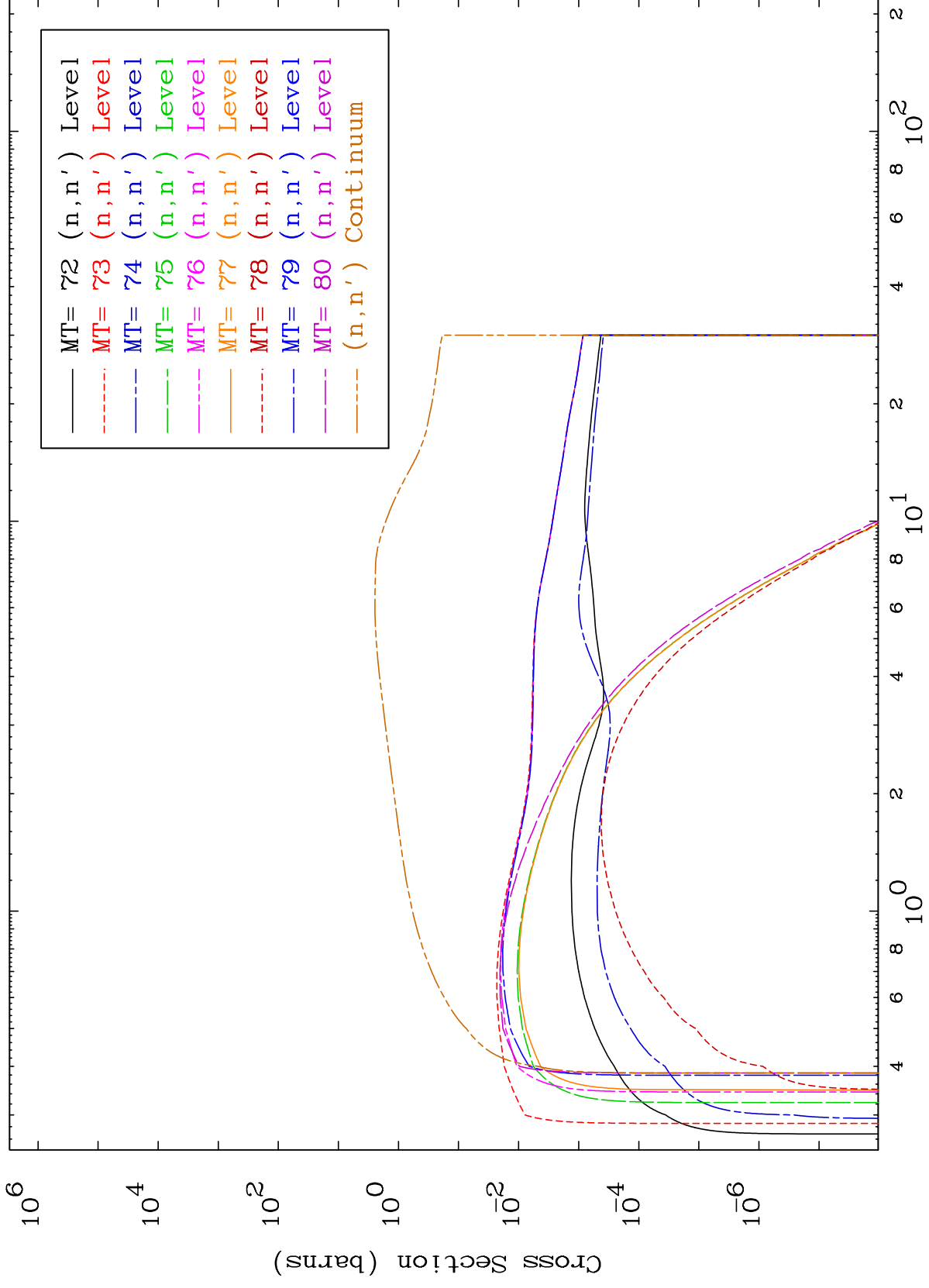

MAT 7698

(n,p) Levels
293 Kelvin Cross Sections

77-Ir-182

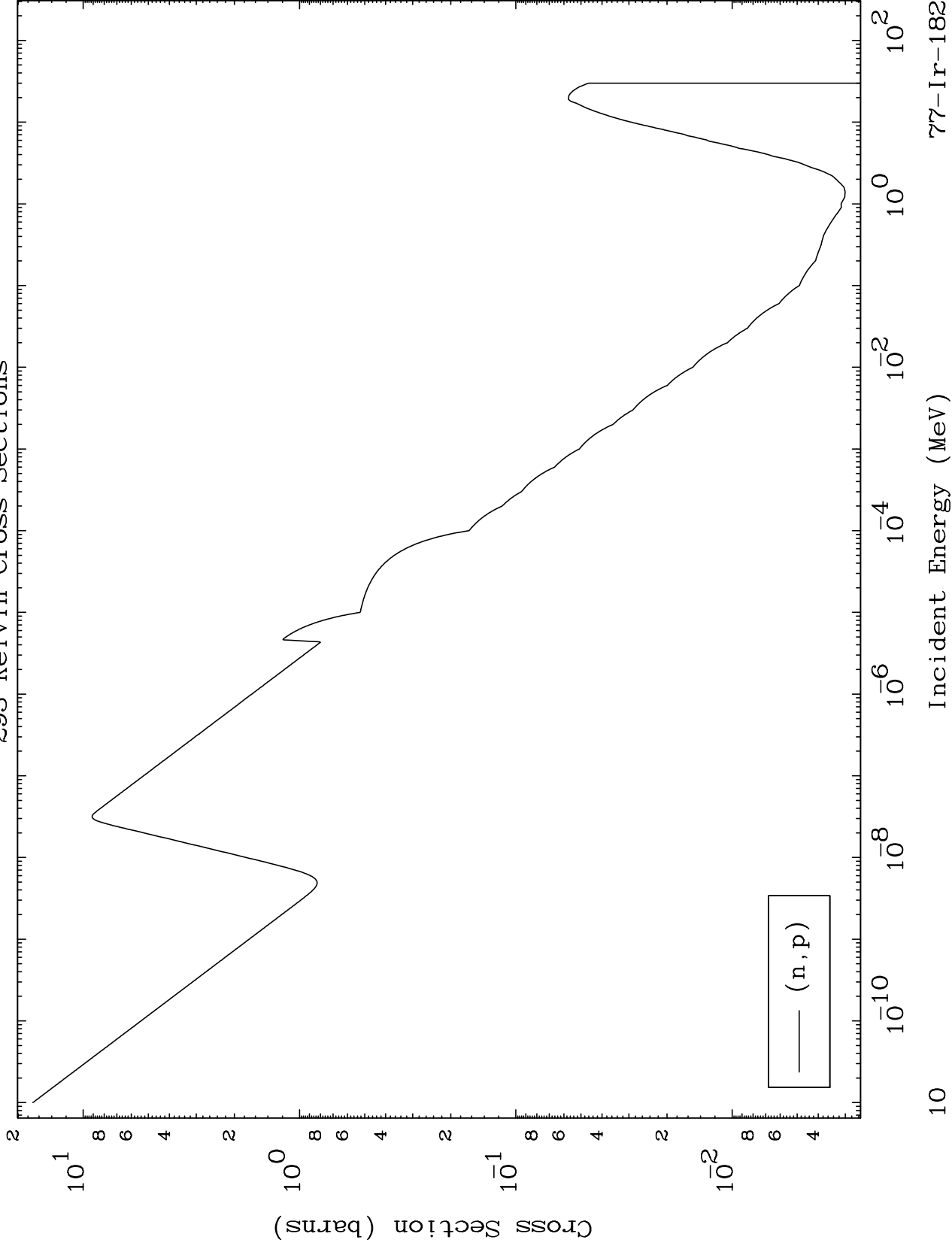

10

Incident Energy (MeV)

77-Ir-182

MAT 7698

(n,d) Levels
293 Kelvin Cross Sections

77-Ir-182

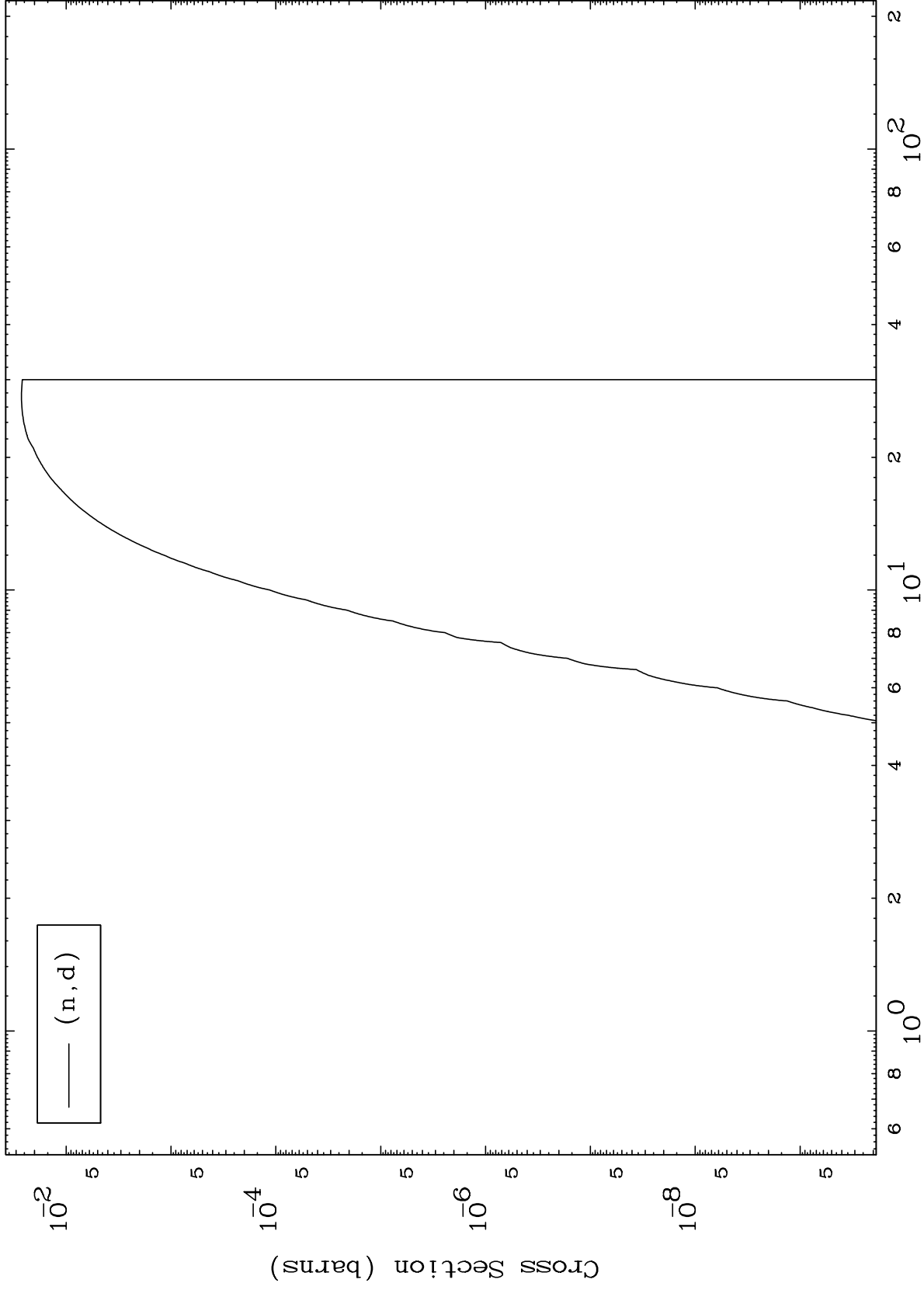

MAT 7698

(n,t) Levels
293 Kelvin Cross Sections

77-Ir-182

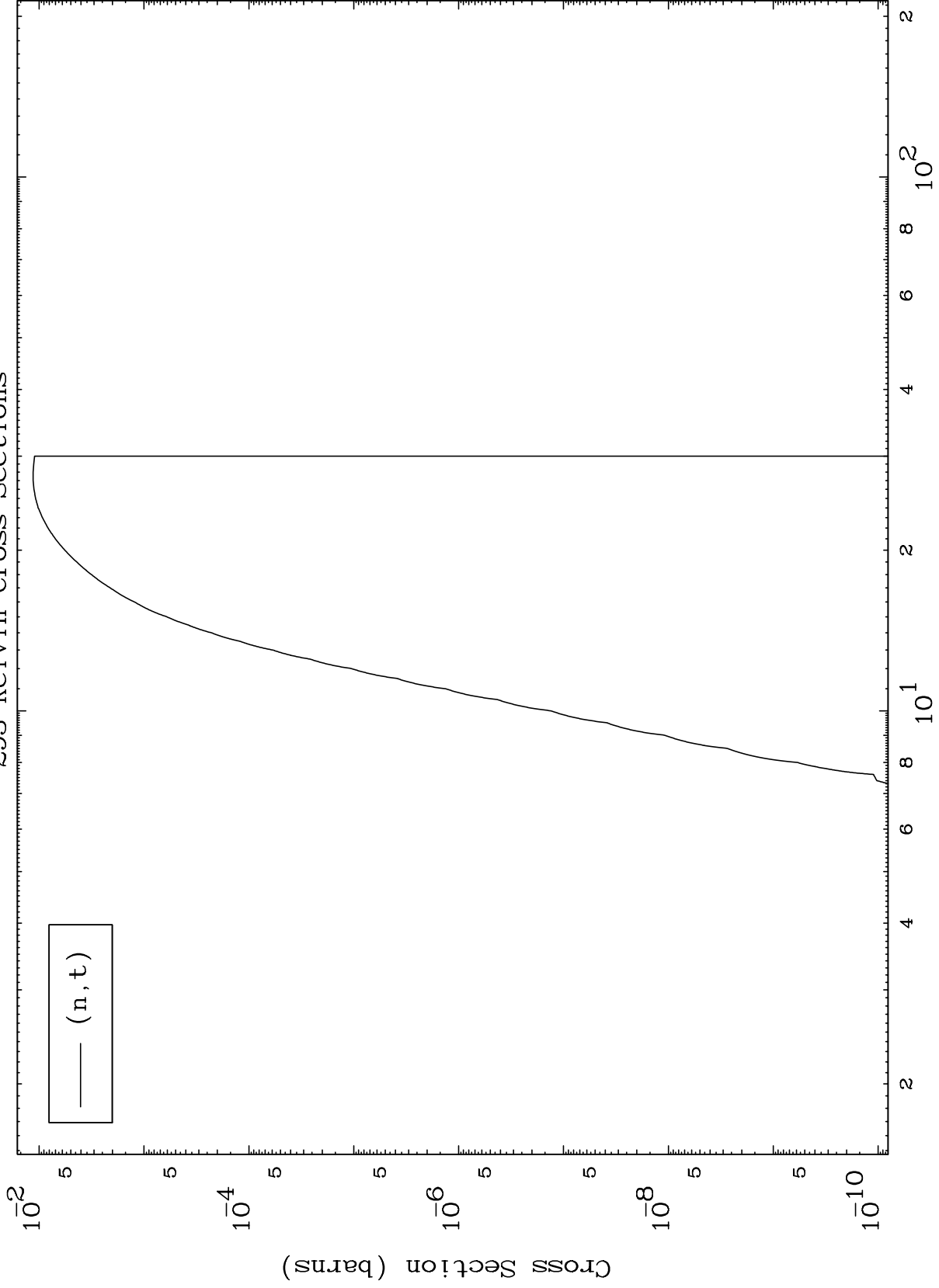

12

Incident Energy (MeV)

77-Ir-182

MAT 7698

(n,He3) Levels
293 Kelvin Cross Sections

77-Ir-182

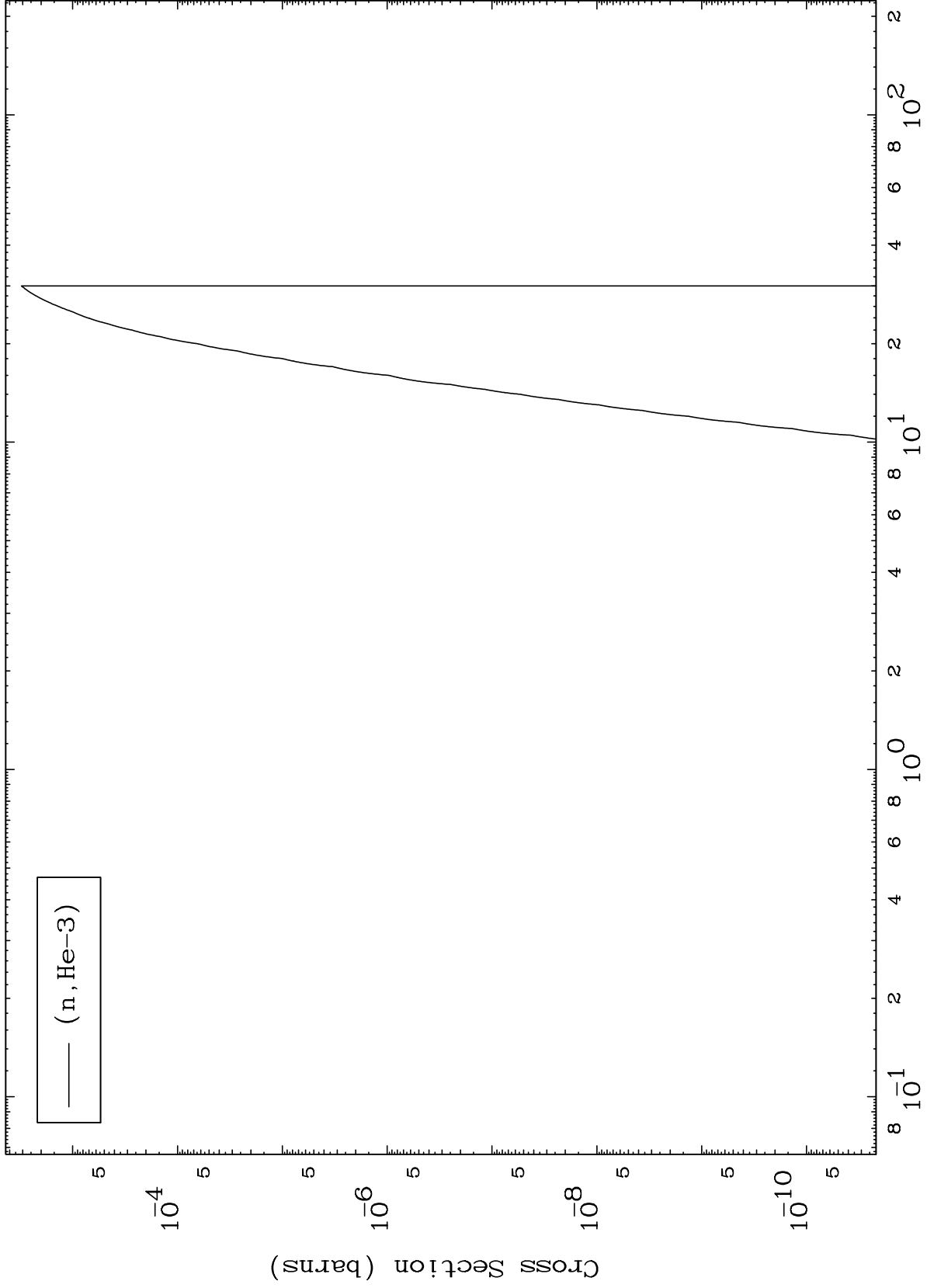

13

Incident Energy (MeV)

77-Ir-182

MAT 7698

(n,α) Levels
293 Kelvin Cross Sections

77-Ir-182

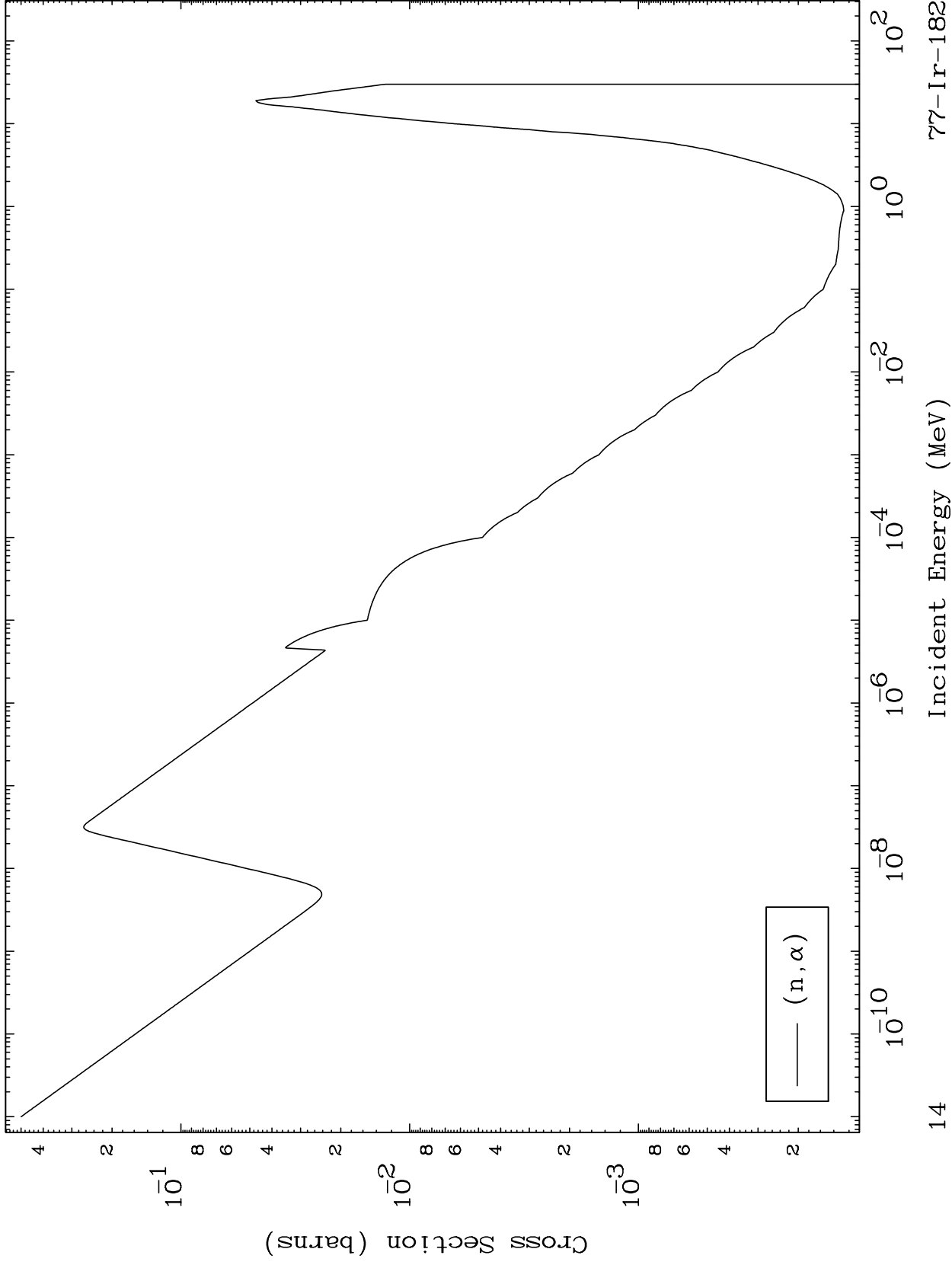

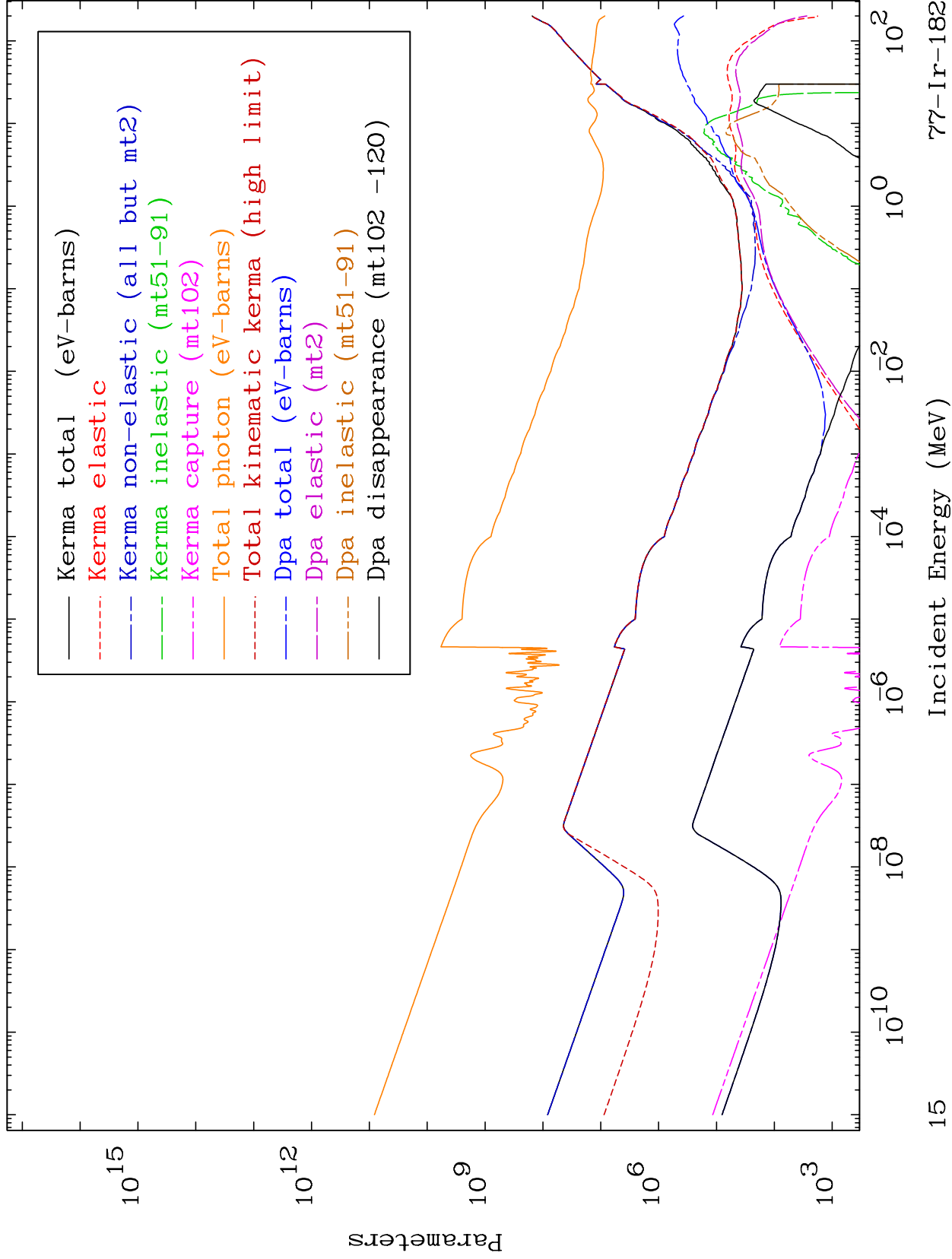

MAT 7698

Elastic Legendre Coefficients

77-Ir-182

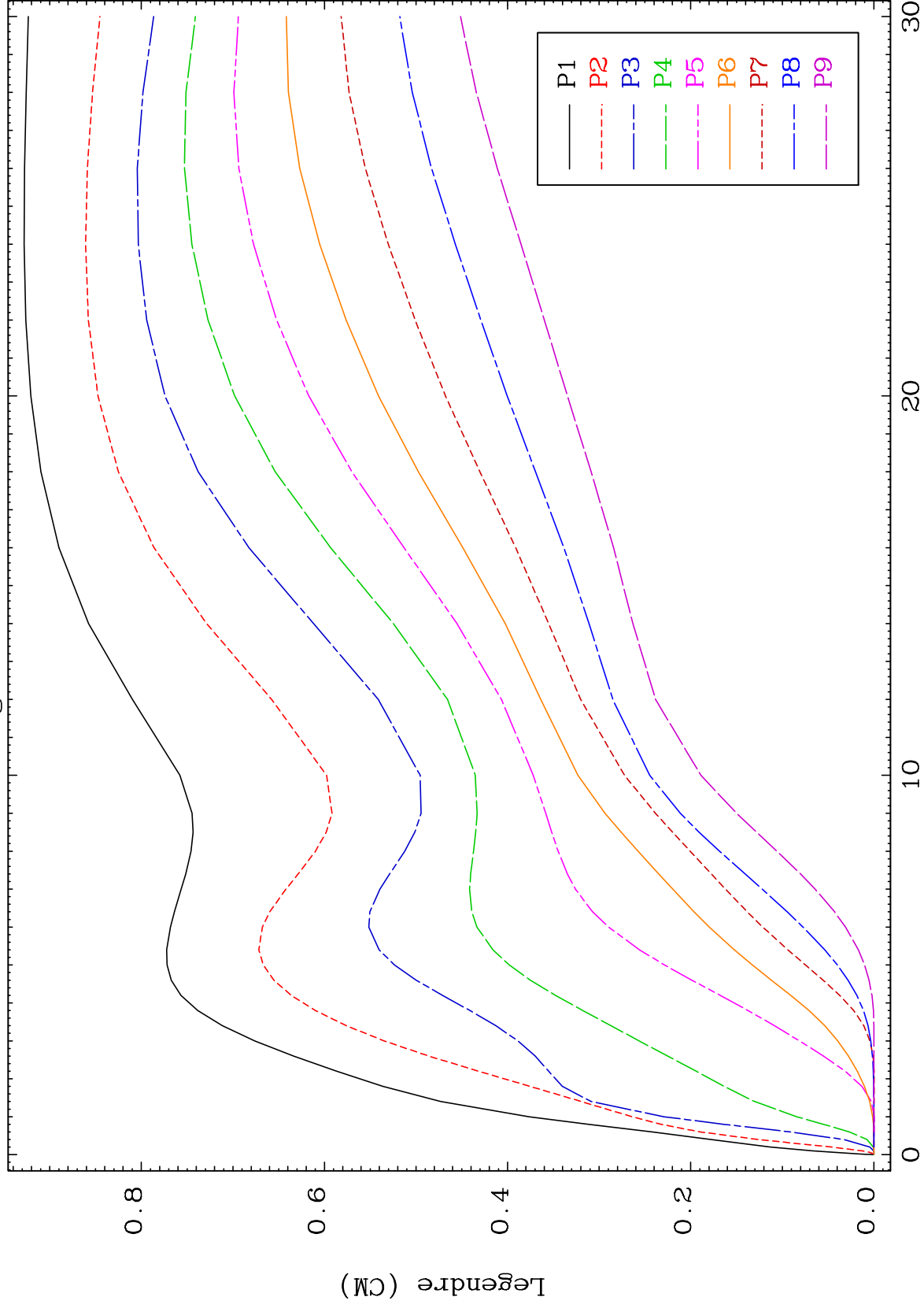

16

Incident Energy (MeV)

77-Ir-182

MAT 7698

Elastic Legendre Coefficients

⁷⁷Ir-182

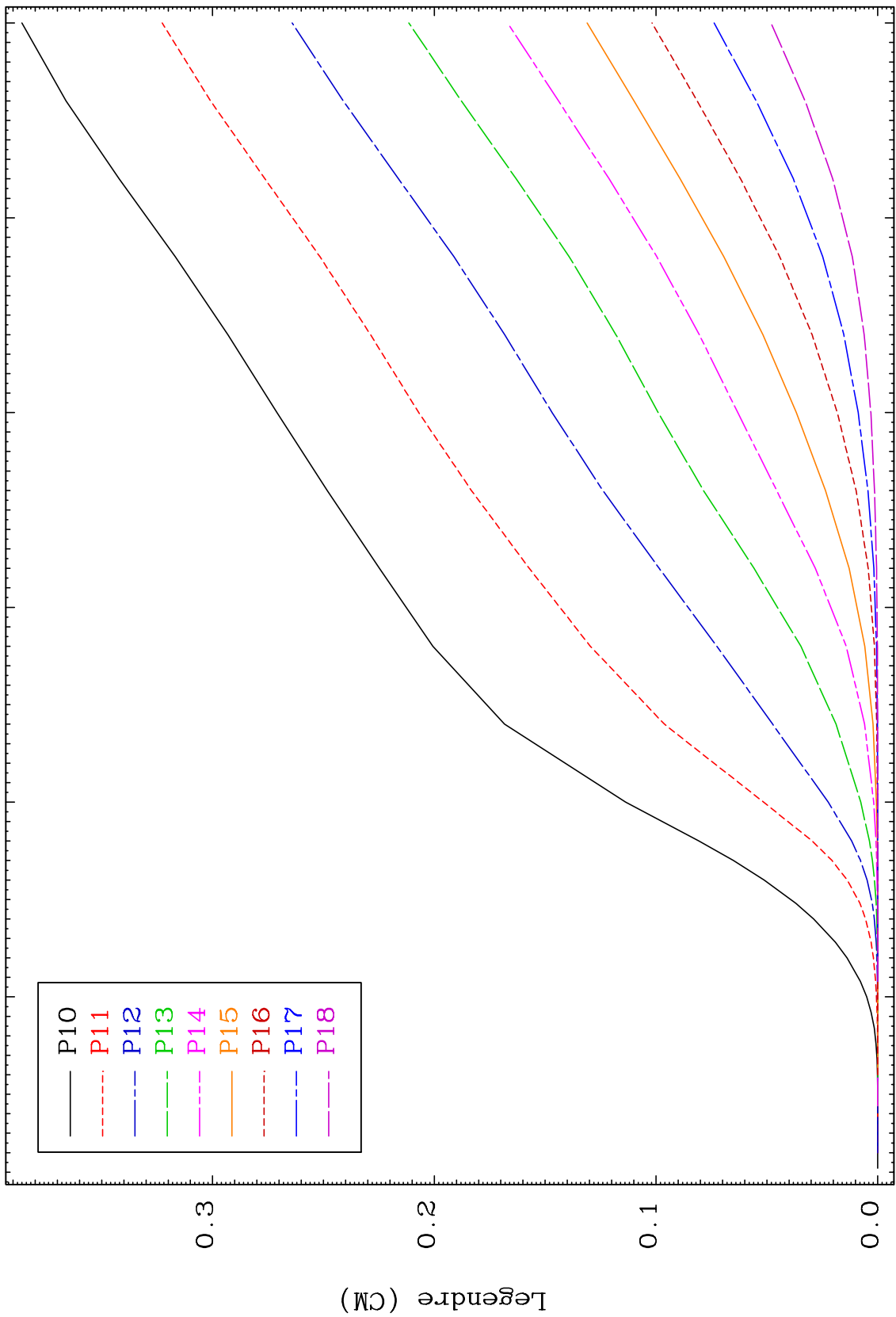

17

Incident Energy (MeV)

⁷⁷Ir-182

MAT 7698

Elastic Legendre Coefficients

77-Ir-182

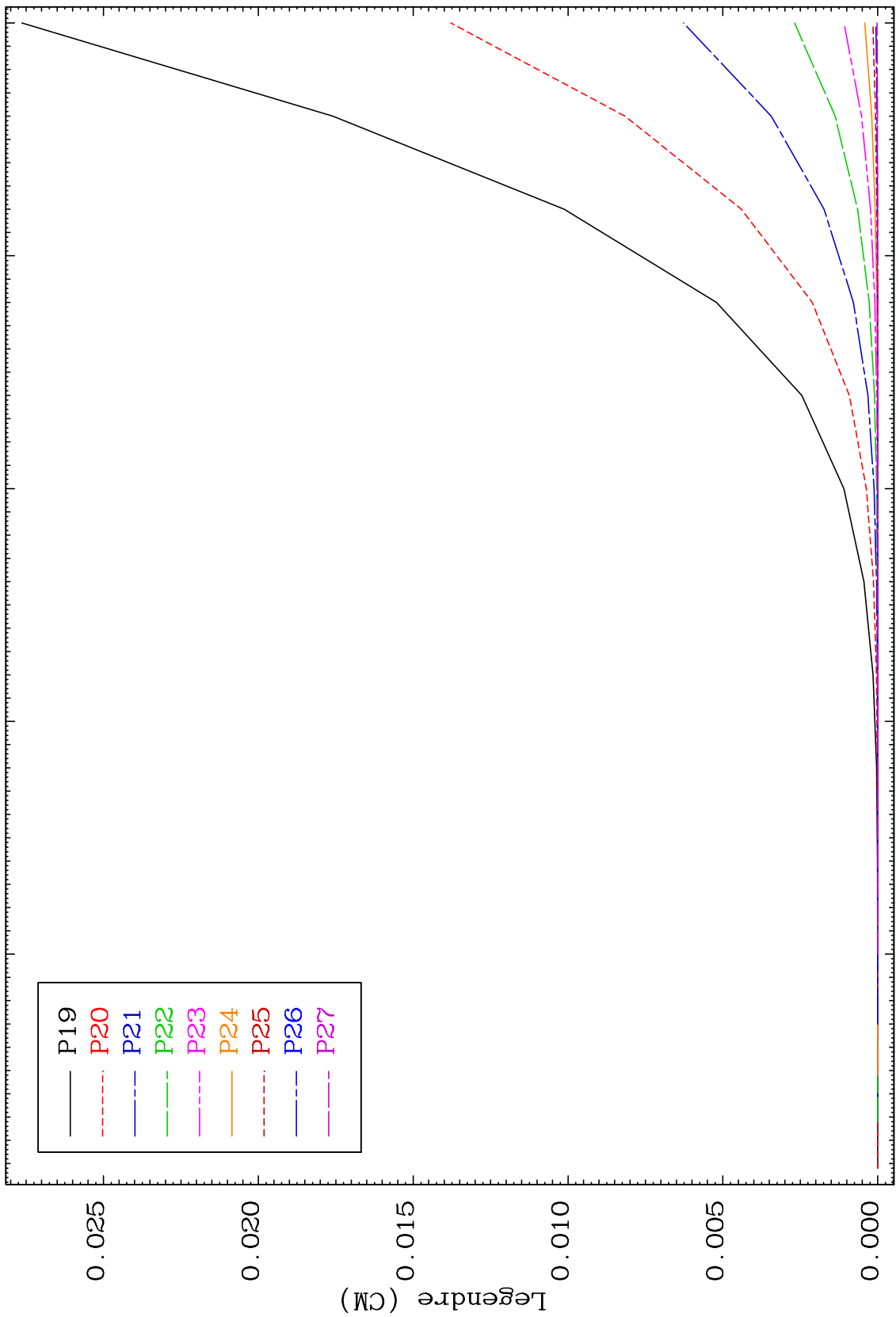

18

Incident Energy (MeV)

77-Ir-182

MAT 7698

Elastic Legendre Coefficients

⁷⁷Ir-182

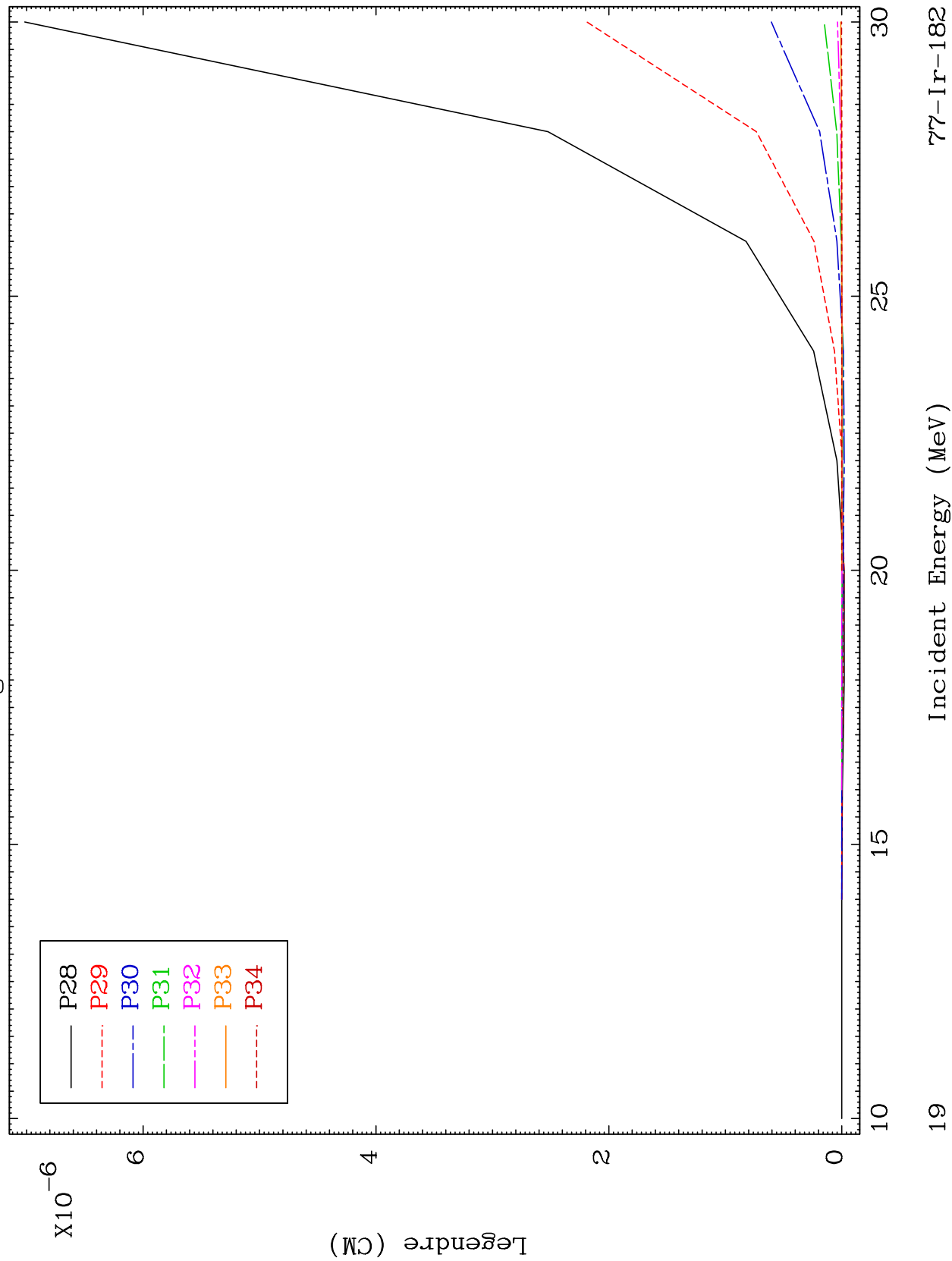

19

Incident Energy (MeV)

⁷⁷Ir-182

MAT 7698

MT= 51 (n,n') Level
Legendre Coefficients

77-Ir-182

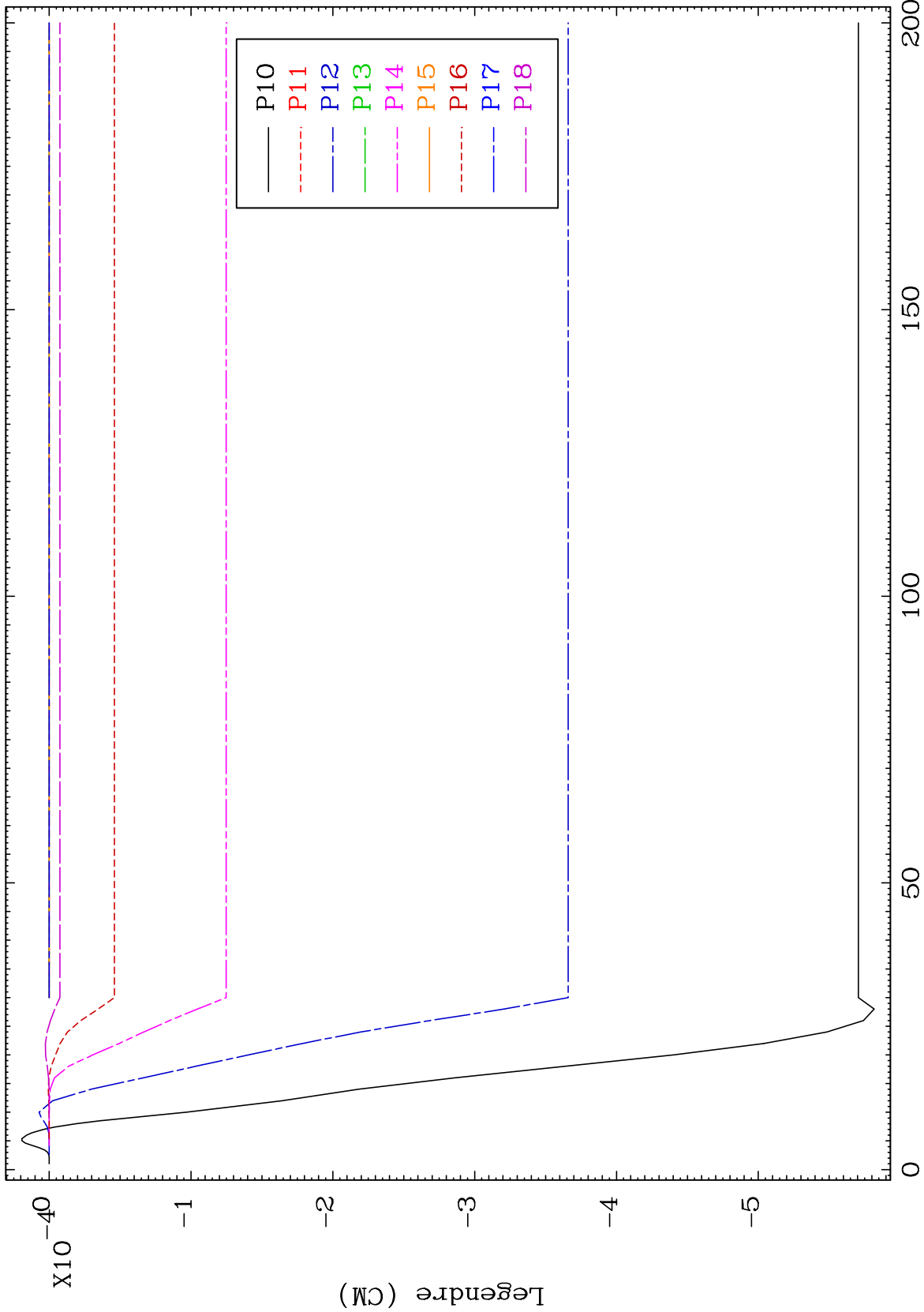

21

Incident Energy (MeV)

77-Ir-182

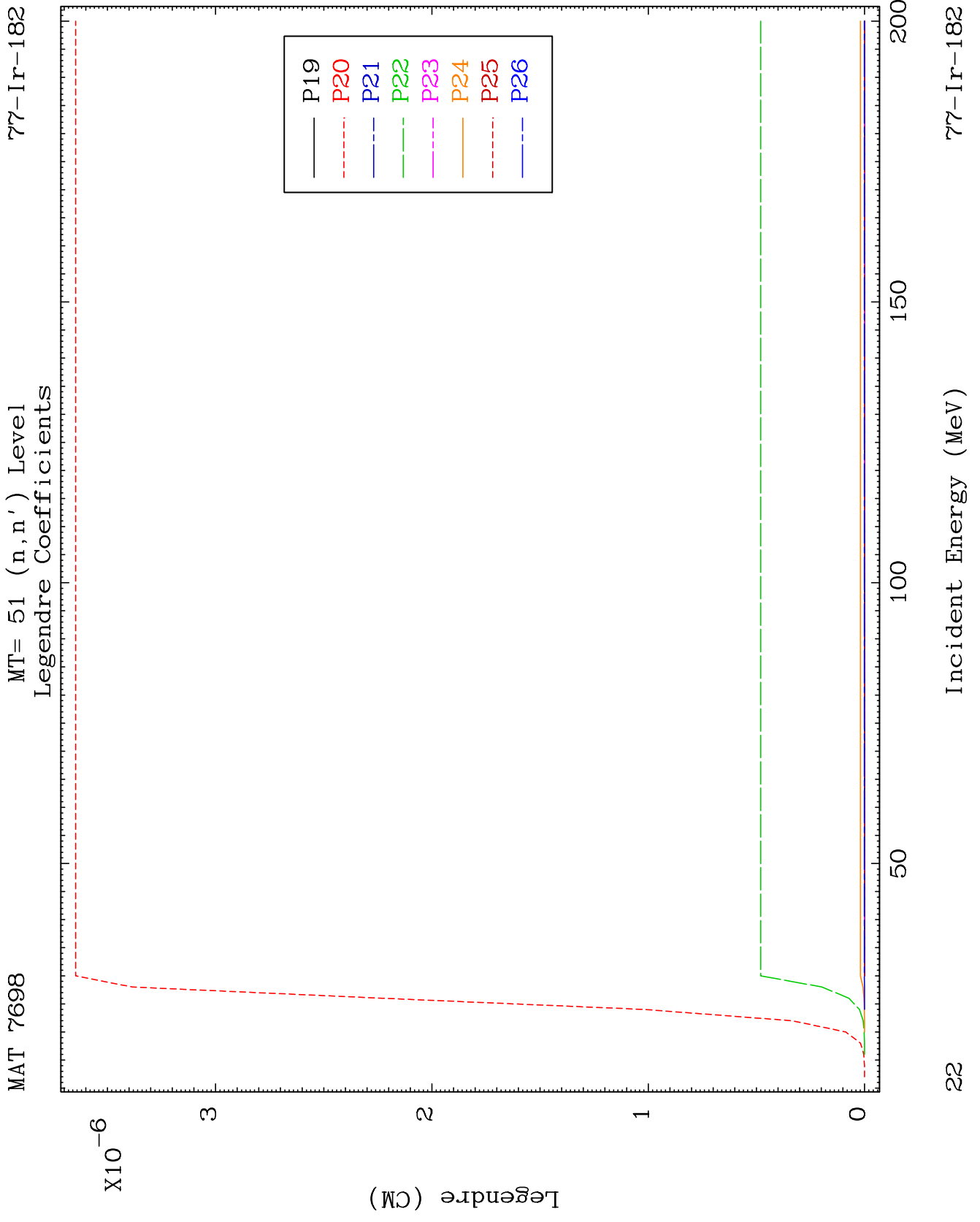

MAT 7698

MT= 52 (n,n') Level
Legendre Coefficients

77-Ir-182

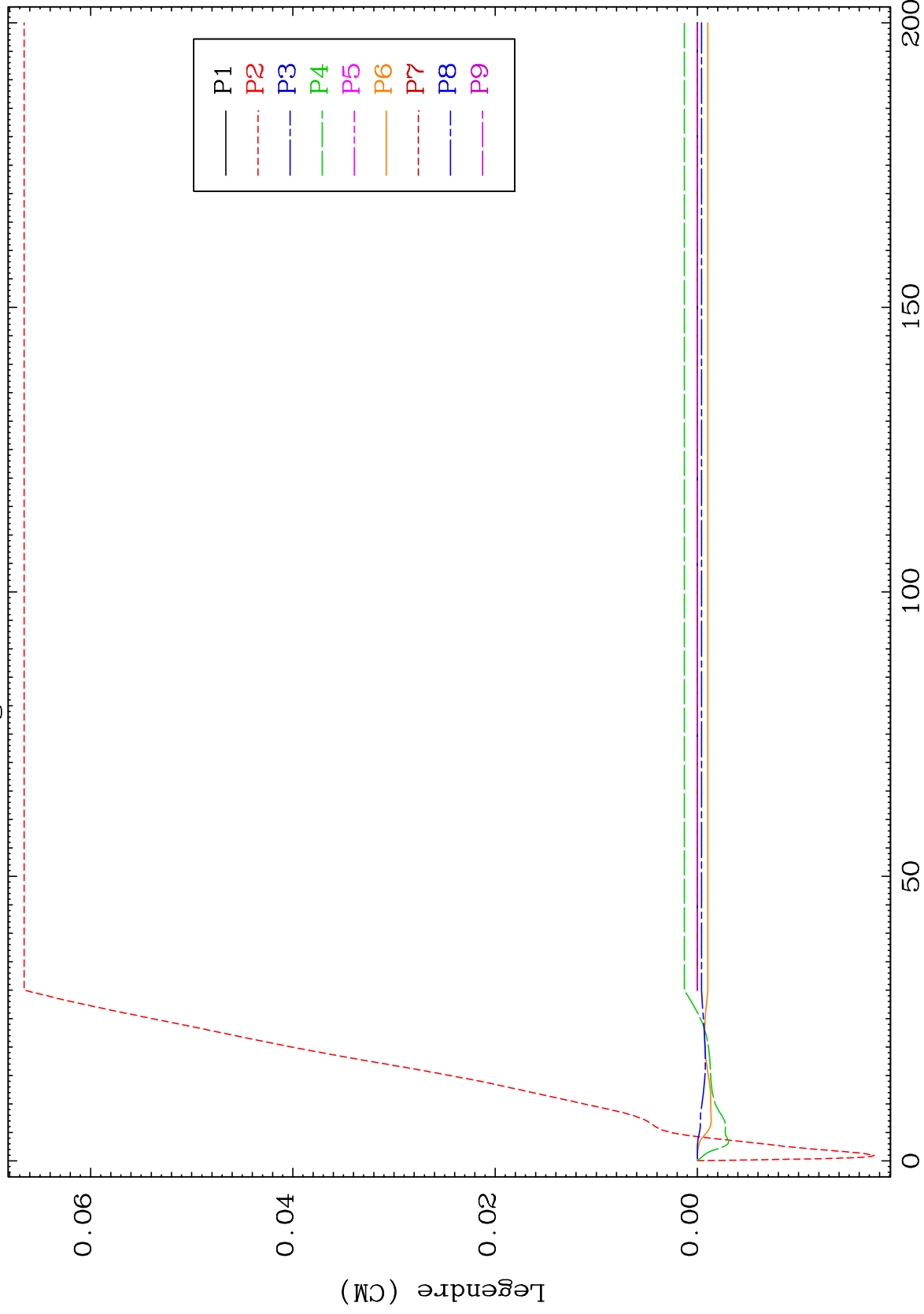

23

Incident Energy (MeV)

77-Ir-182

MAT 7698

MT= 52 (n,n') Level
Legendre Coefficients

77-Ir-182

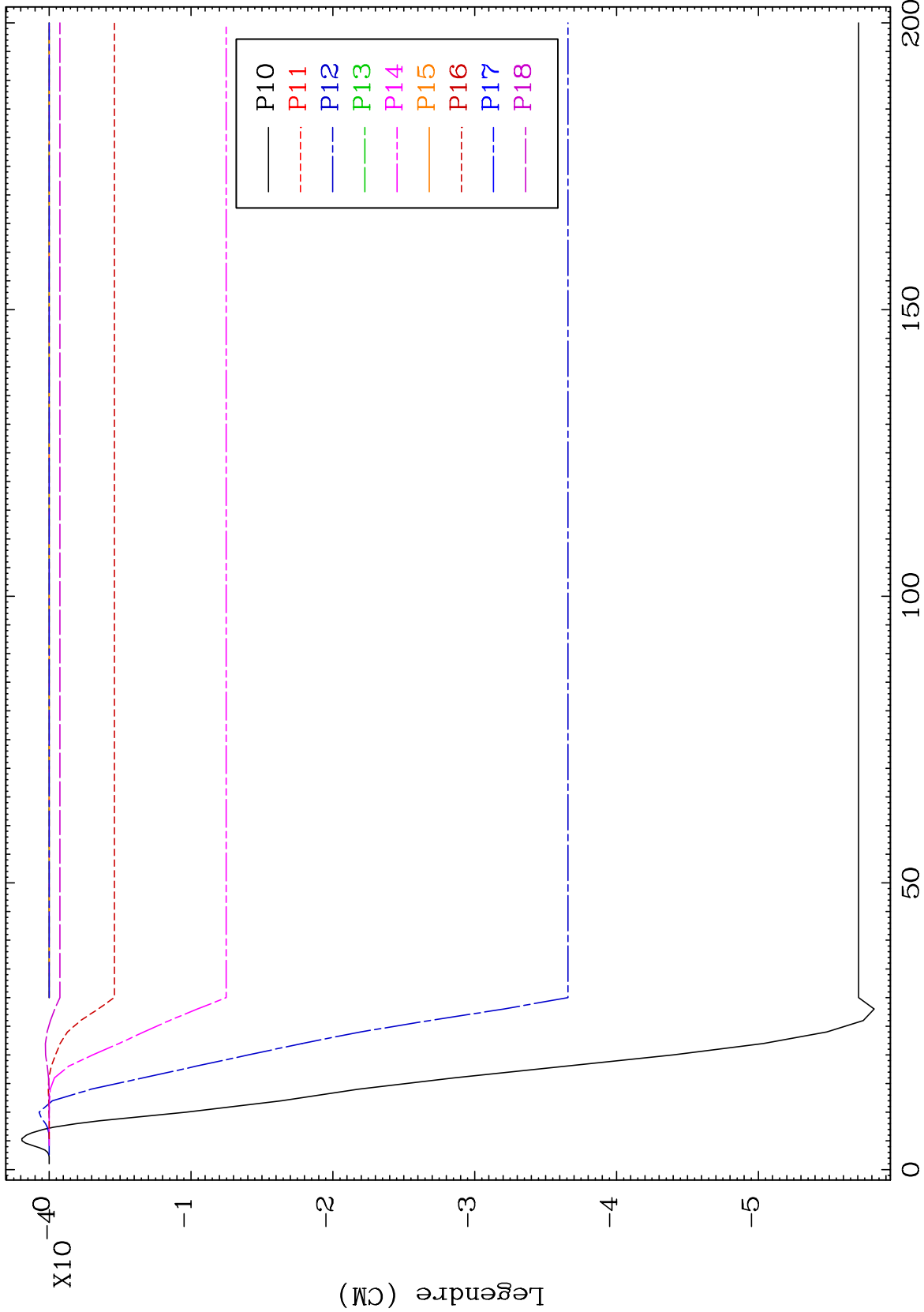

24

Incident Energy (MeV)

77-Ir-182

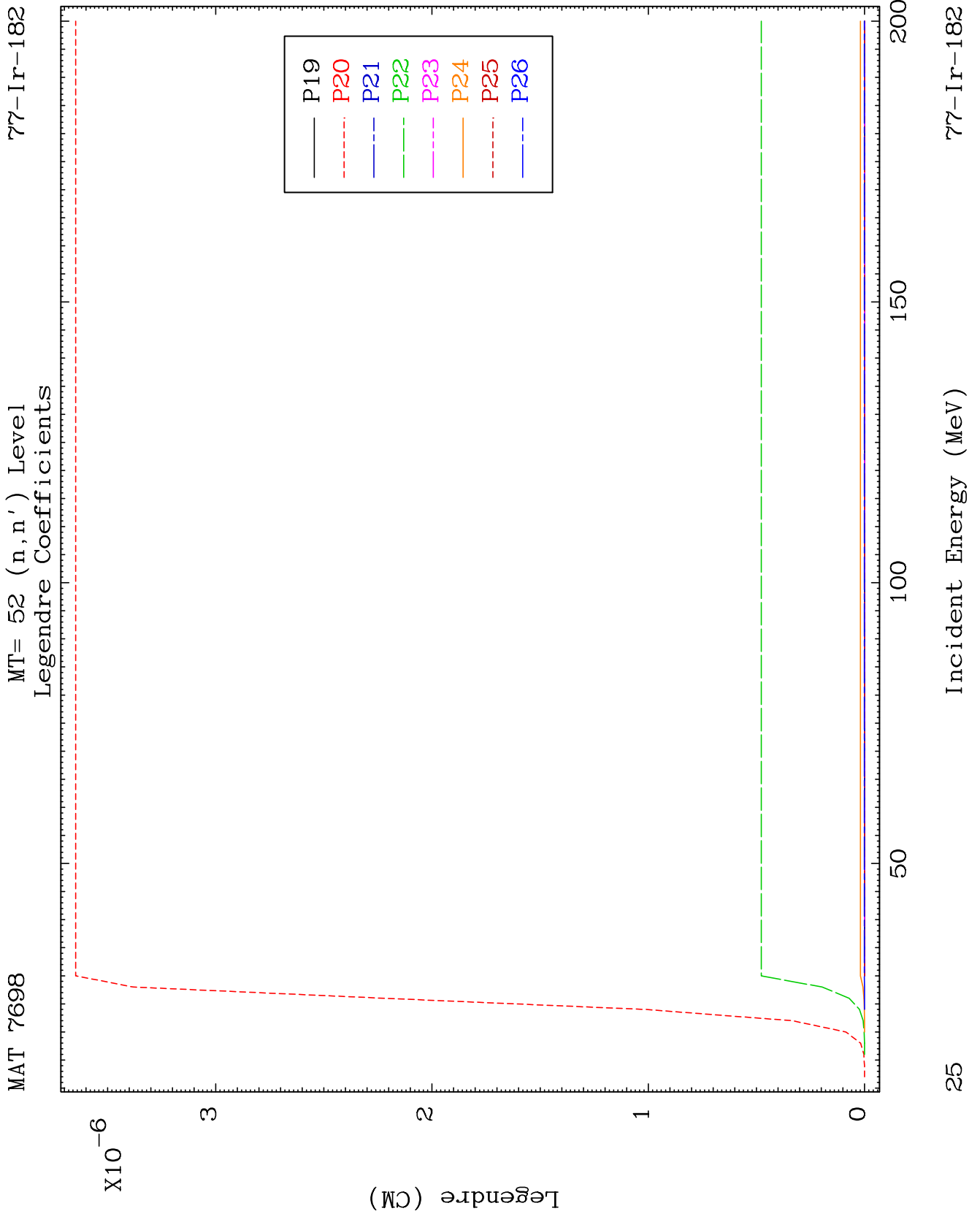

MAT 7698

MT= 53 (n,n') Level
Legendre Coefficients

77-Ir-182

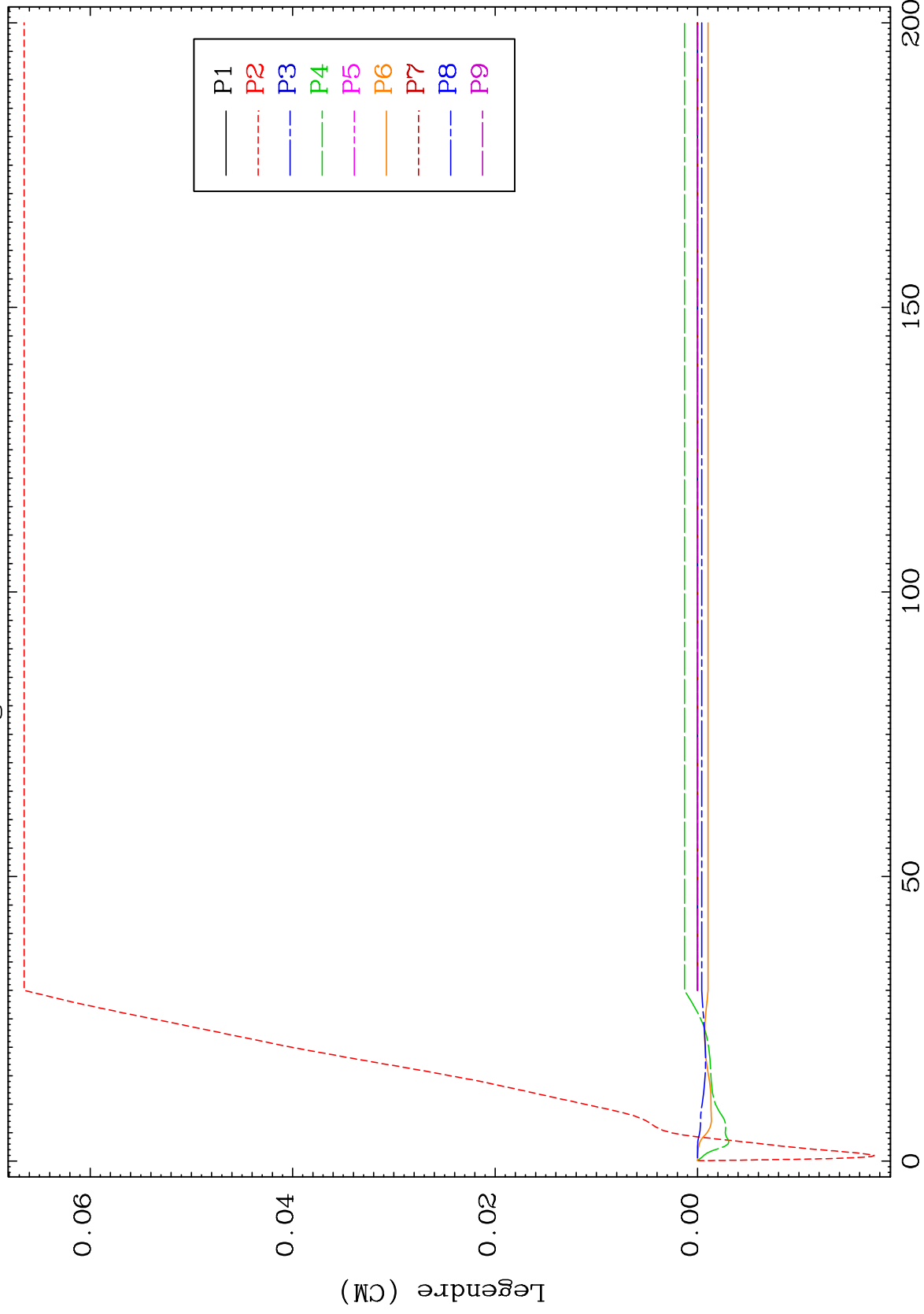

26

Incident Energy (MeV)

77-Ir-182

MAT 7698

MT= 53 (n,n') Level
Legendre Coefficients

77-Ir-182

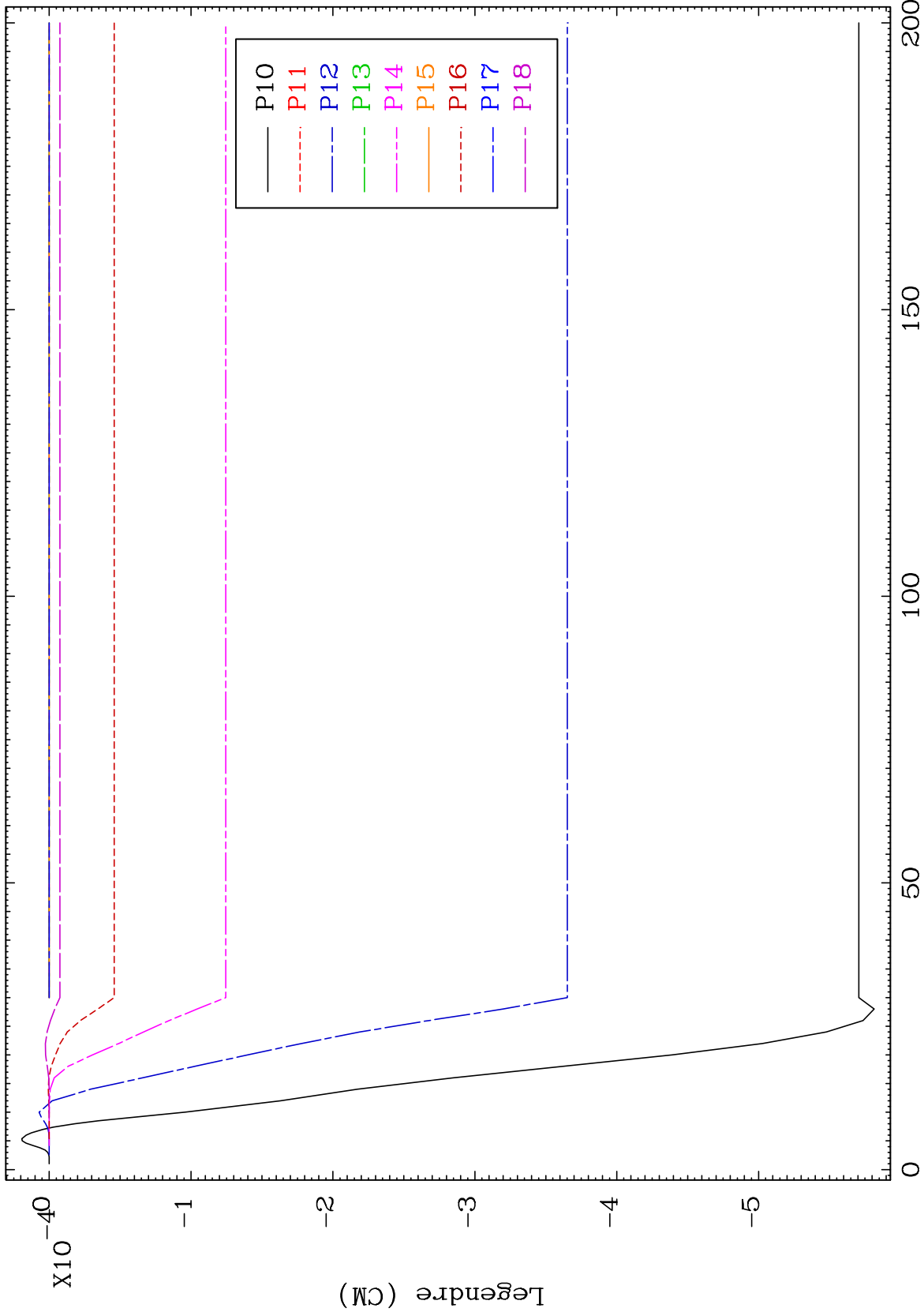

27

Incident Energy (MeV)

77-Ir-182

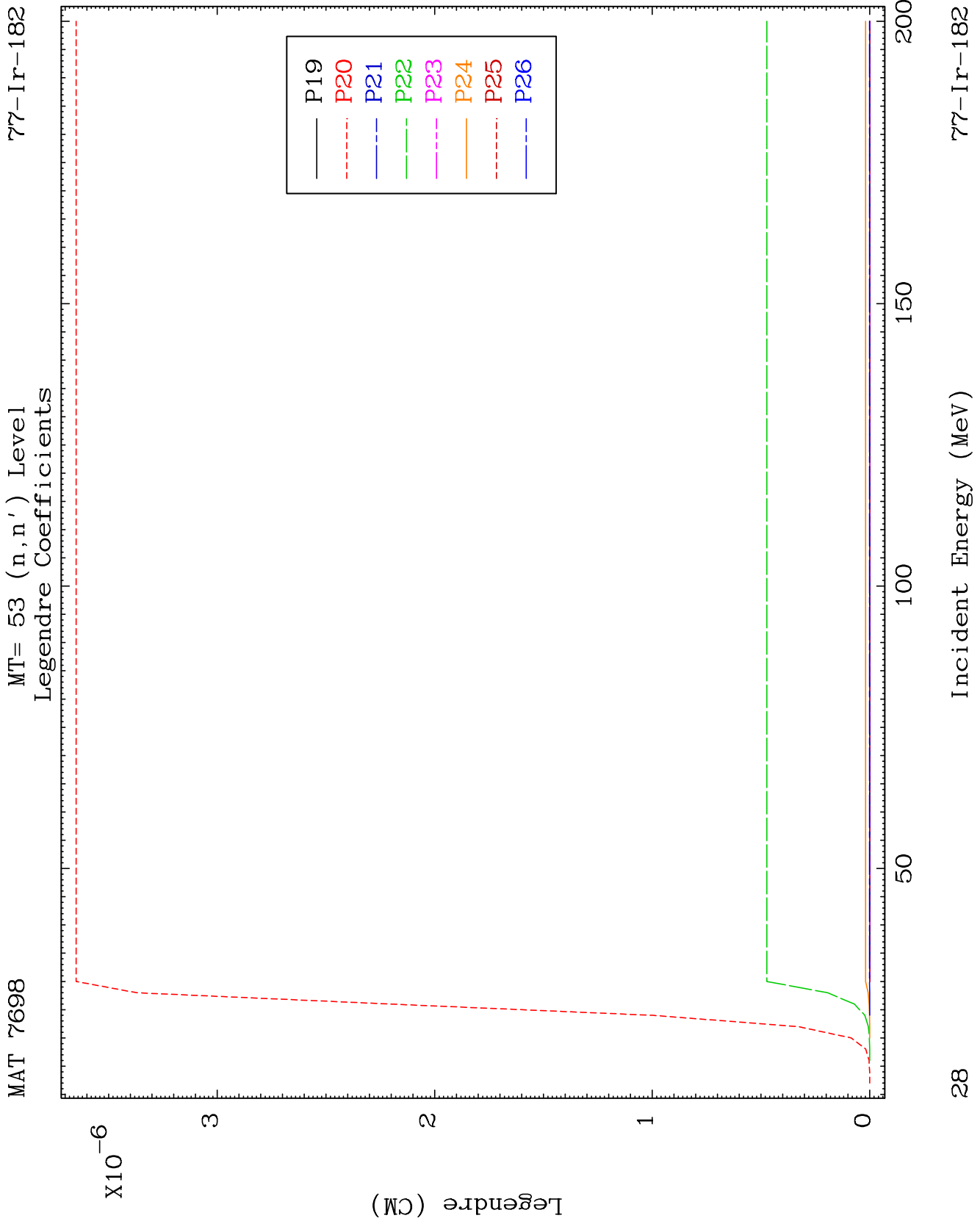

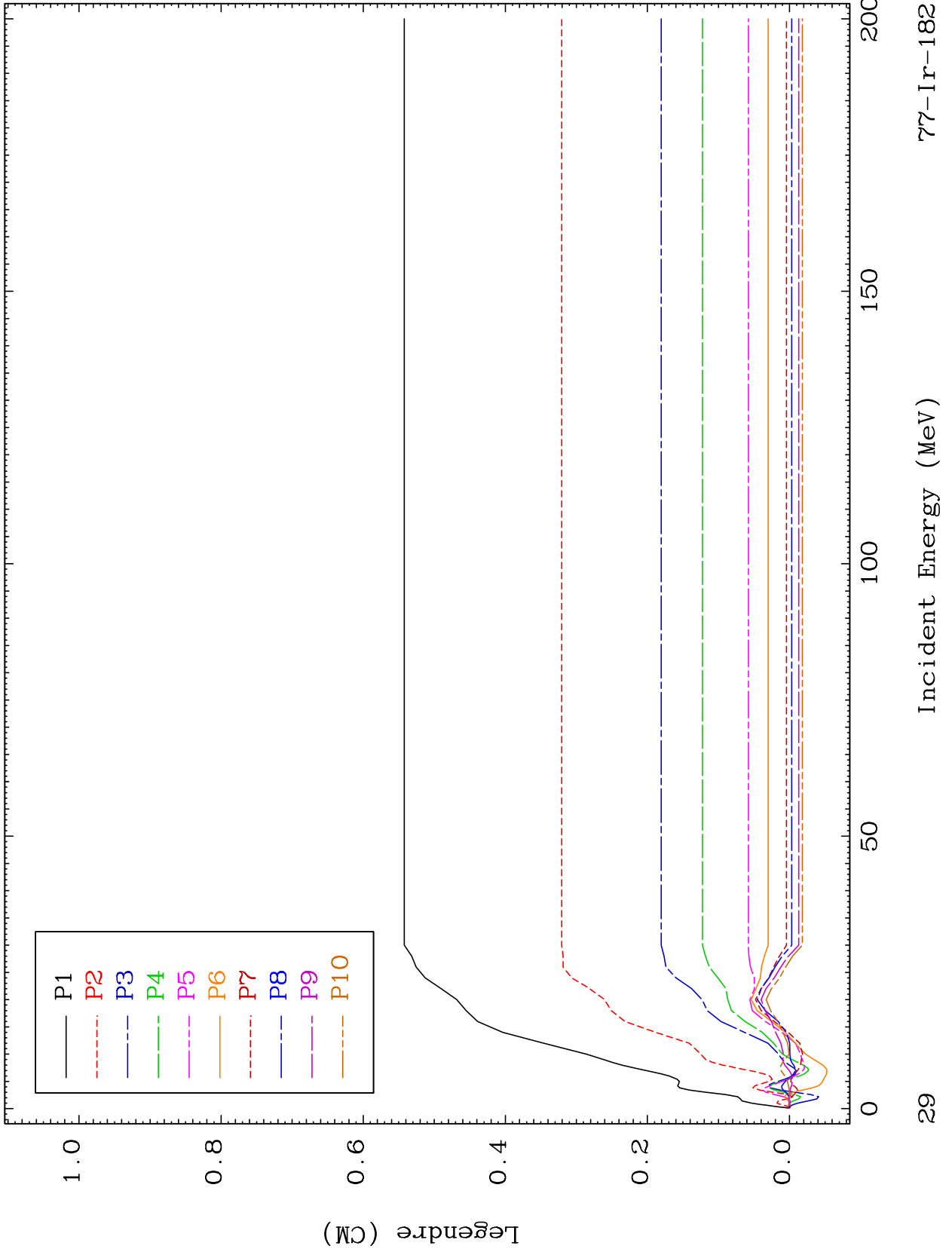

MAT 7698

MT= 54 (n,n') Level
Legendre Coefficients

77-Ir-182

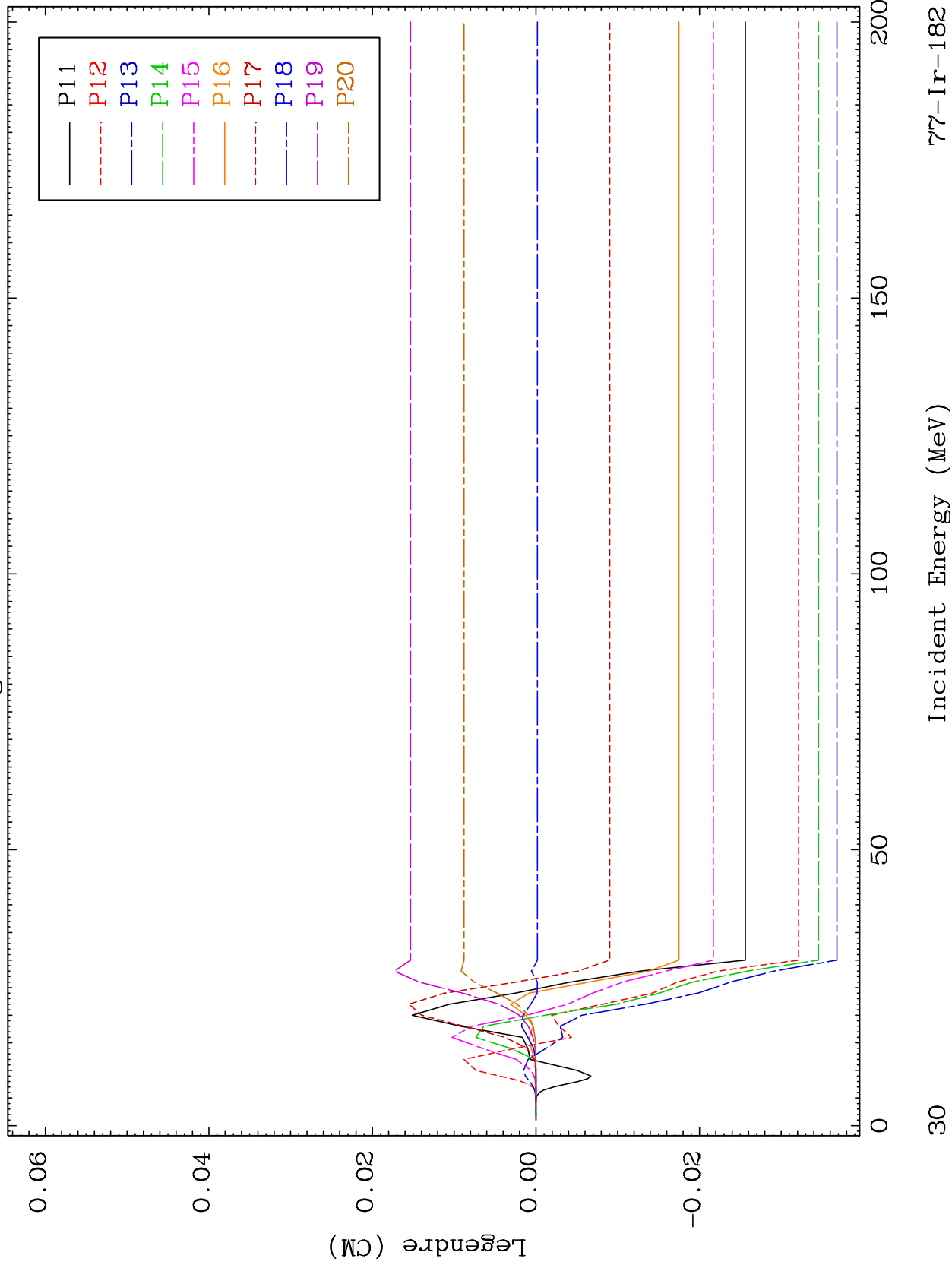

77-Ir-182

Incident Energy (MeV)

30

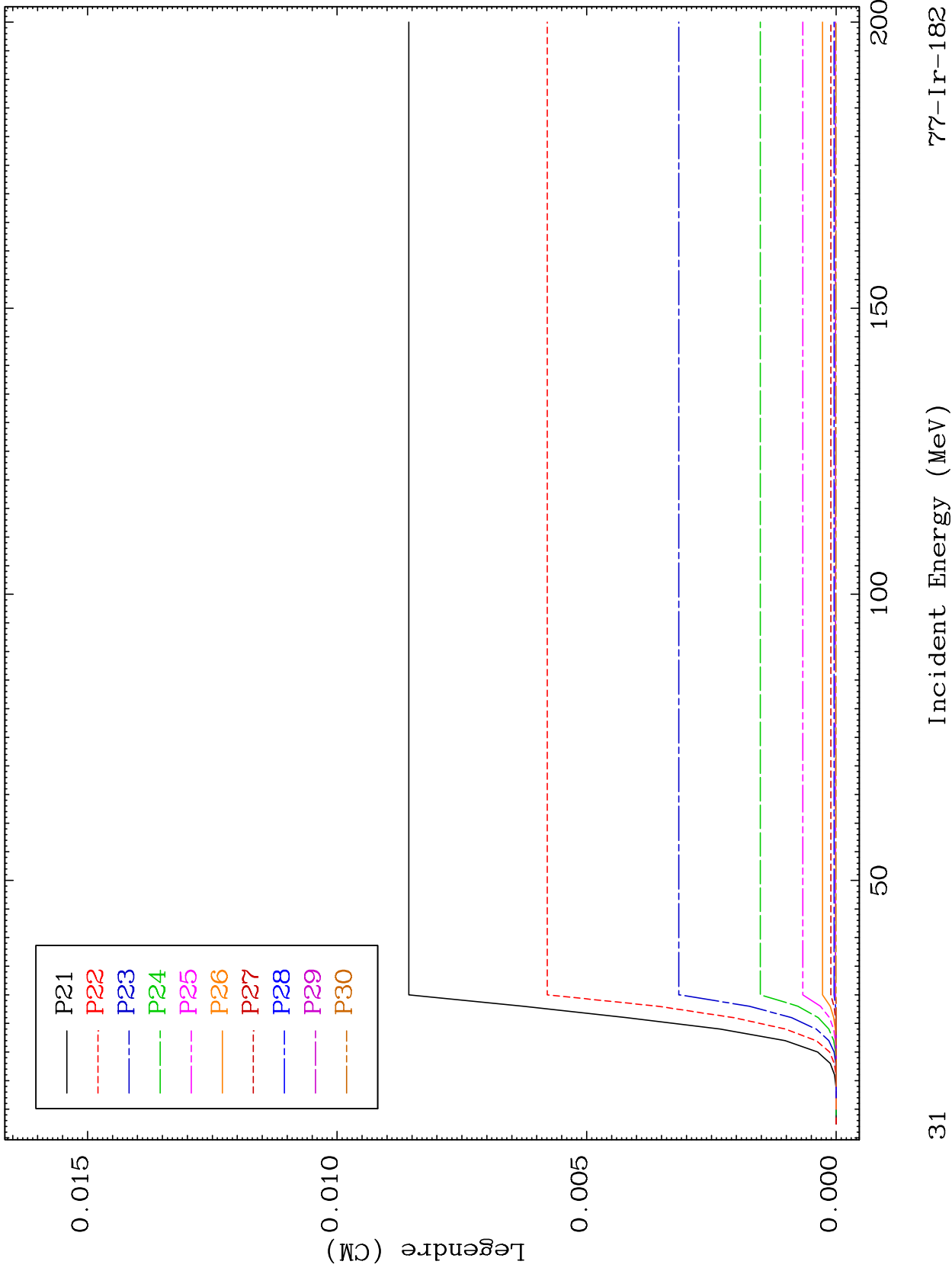

MAT 7698

MT= 54 (n,n') Level
Legendre Coefficients

77-Ir-182

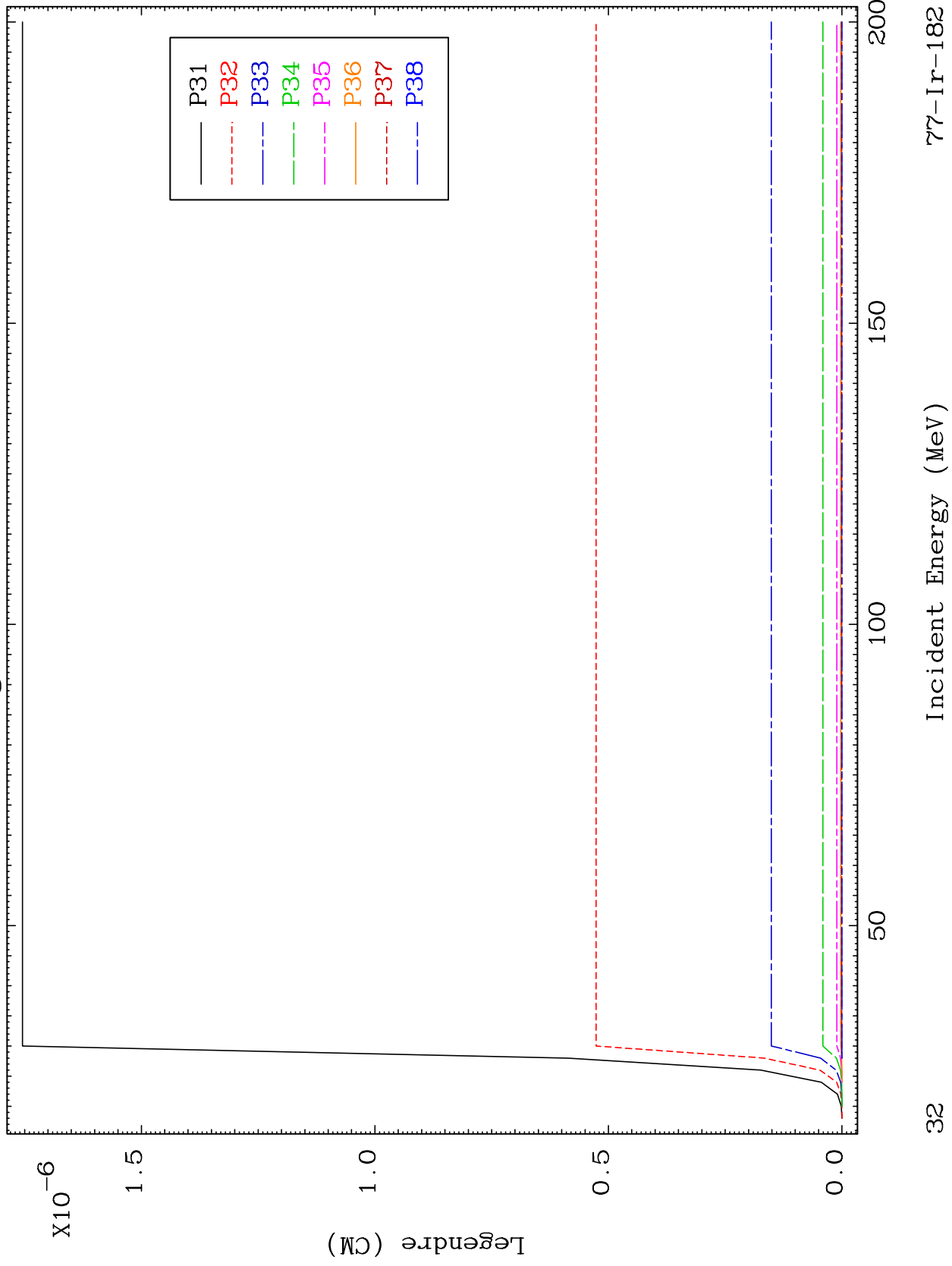

32

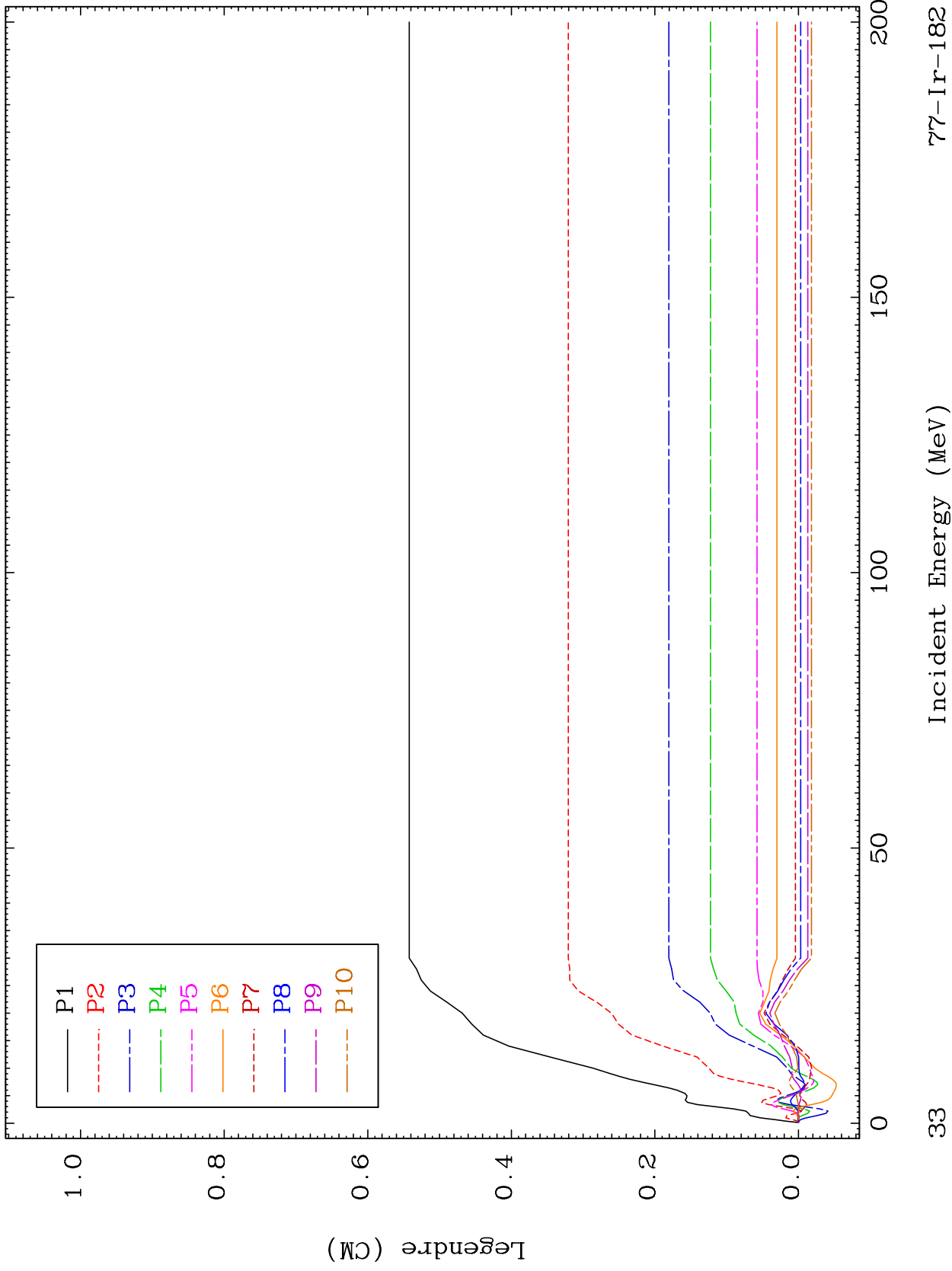

MAT 7698

MT= 55 (n,n') Level
Legendre Coefficients

77-Ir-182

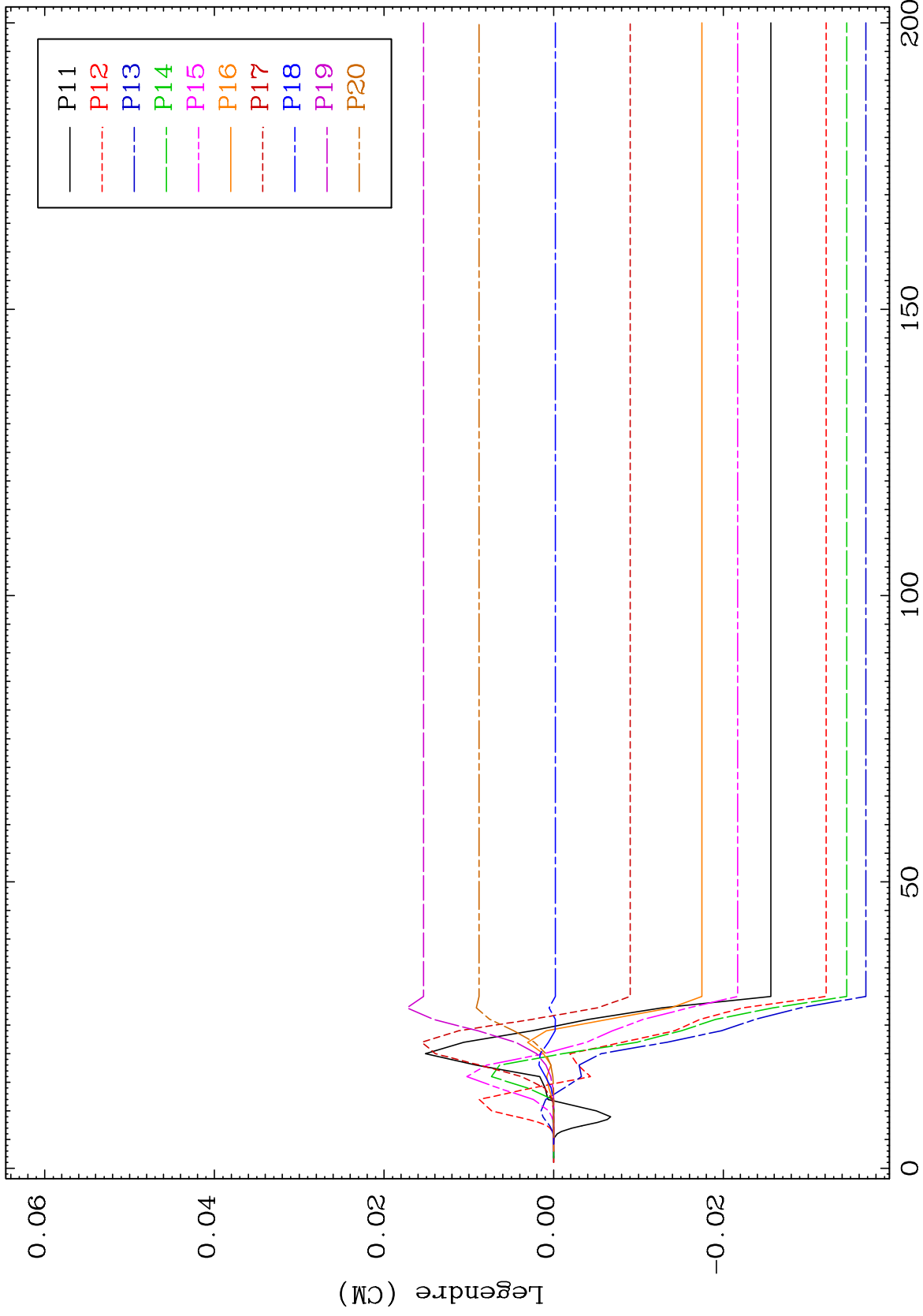

34

77-Ir-182

MAT 7698

MT= 55 (n,n') Level
Legendre Coefficients

77-Ir-182

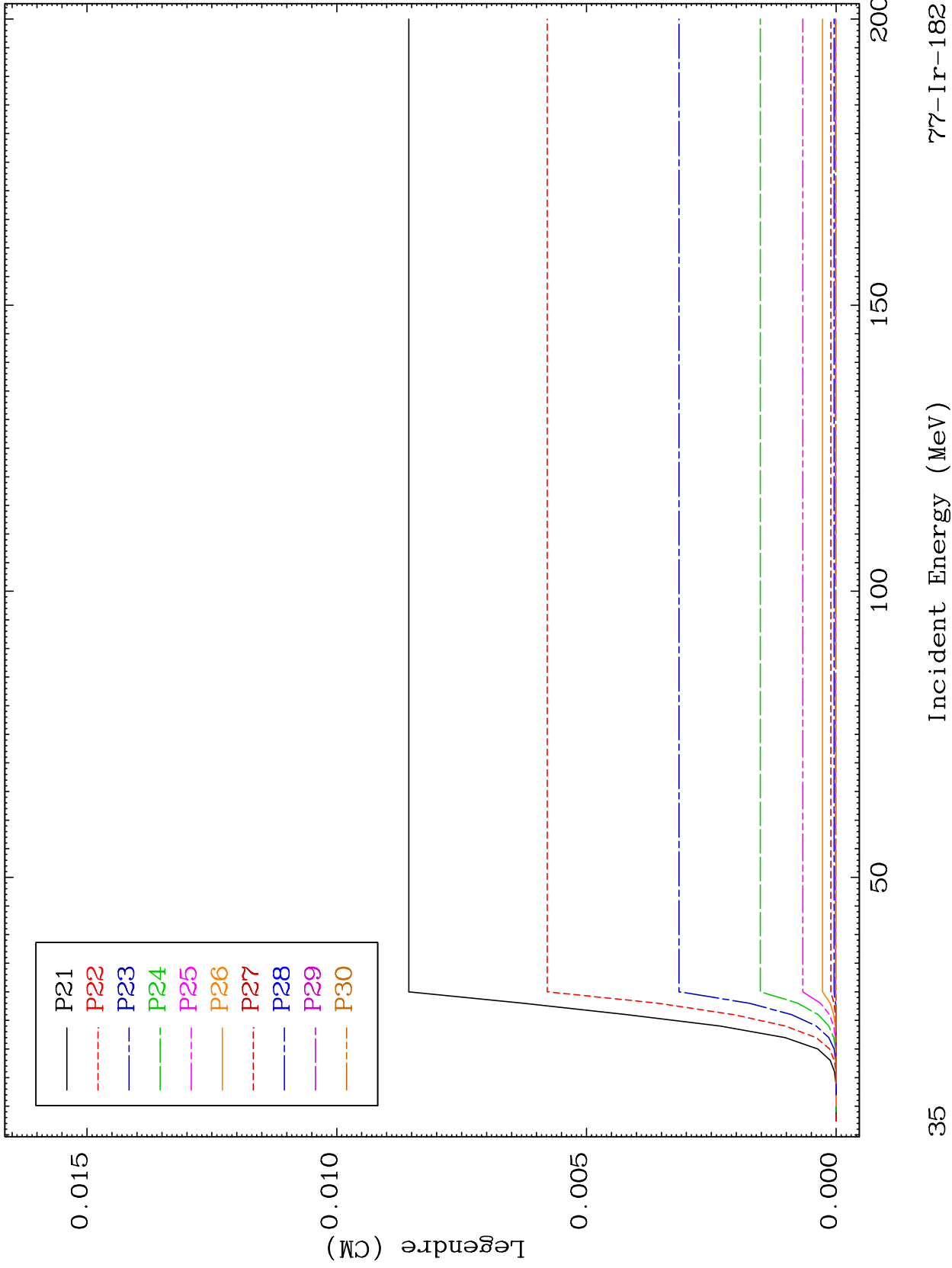

35

Incident Energy (MeV)

77-Ir-182

MAT 7698

MT= 55 (n,n') Level
Legendre Coefficients

77-Ir-182

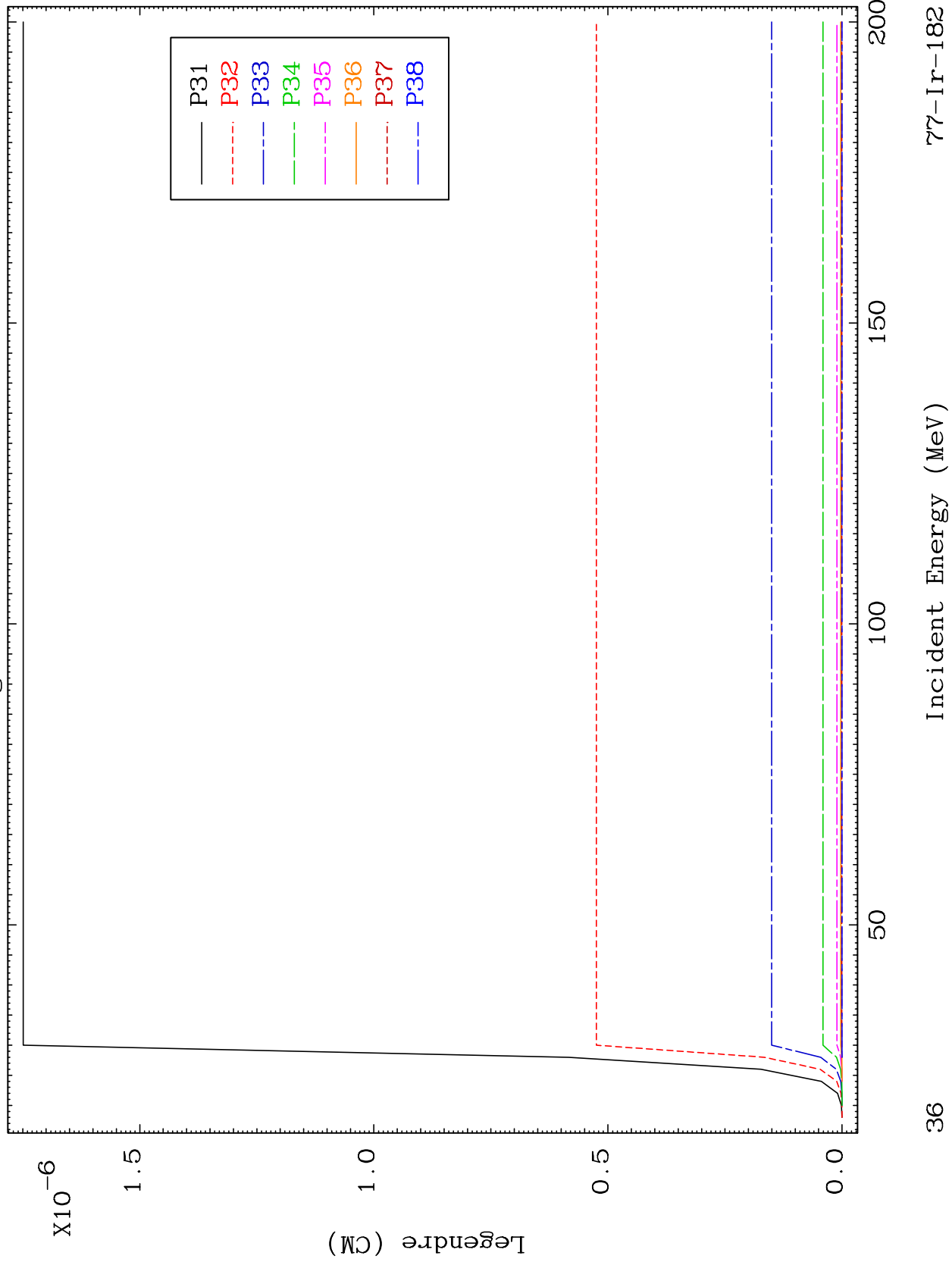

36

Incident Energy (MeV)

77-Ir-182

MAT 7698

MT= 56 (n,n') Level
Legendre Coefficients

⁷⁷Ir-182

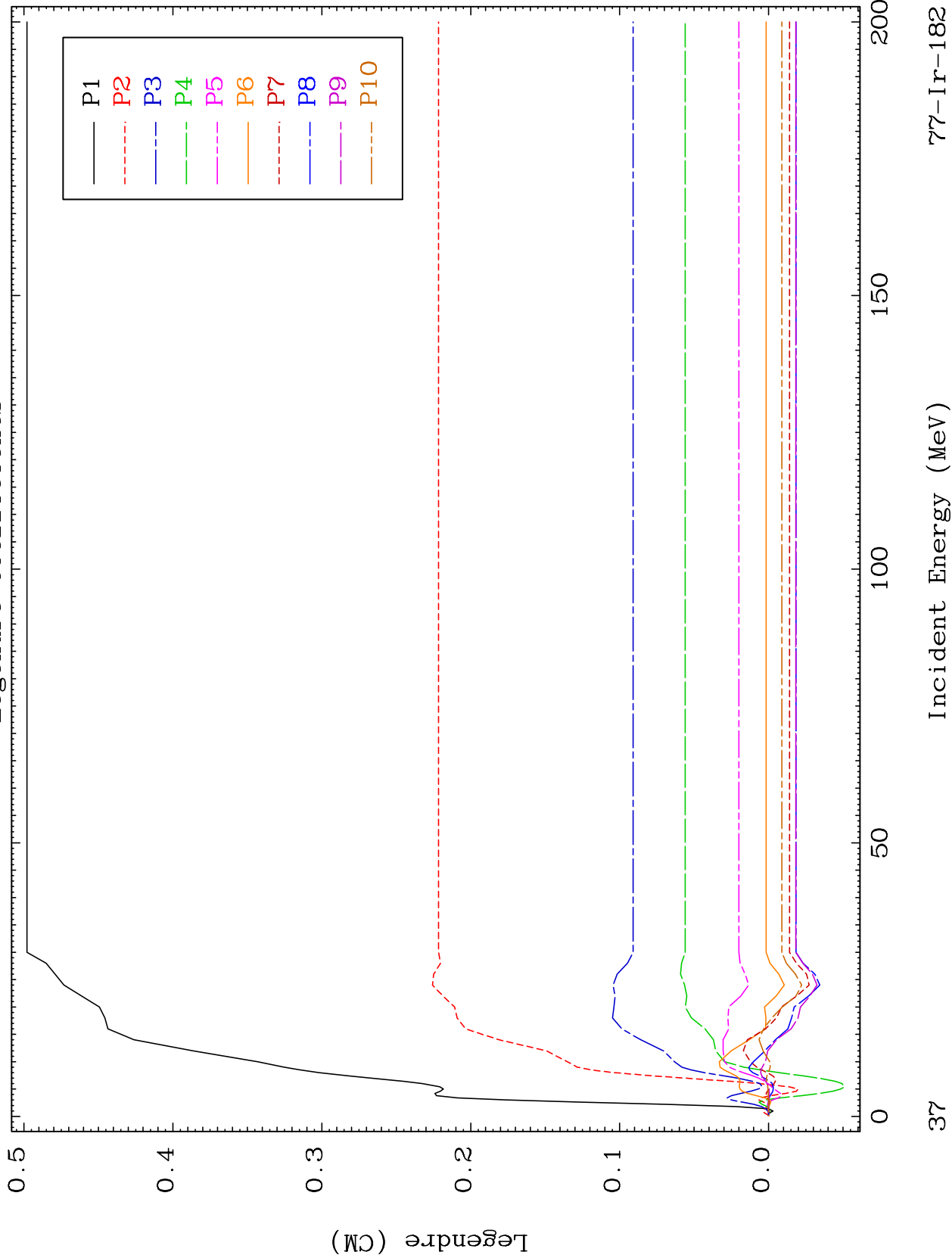

⁷⁷Ir-182

Incident Energy (MeV)

37

MAT 7698

MT= 56 (n,n') Level

77-Ir-182

Legendre Coefficients

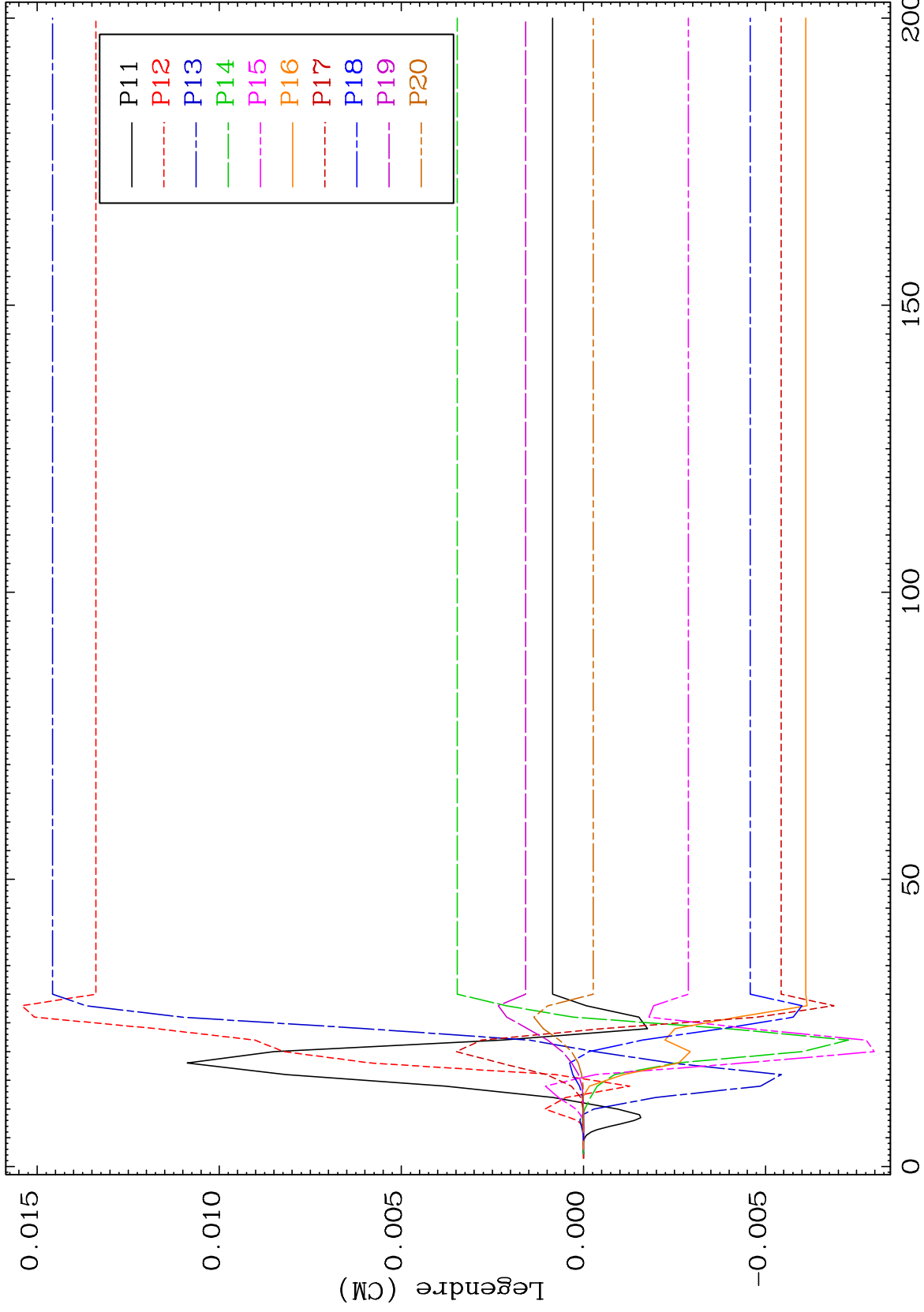

38

Incident Energy (MeV)

77-Ir-182

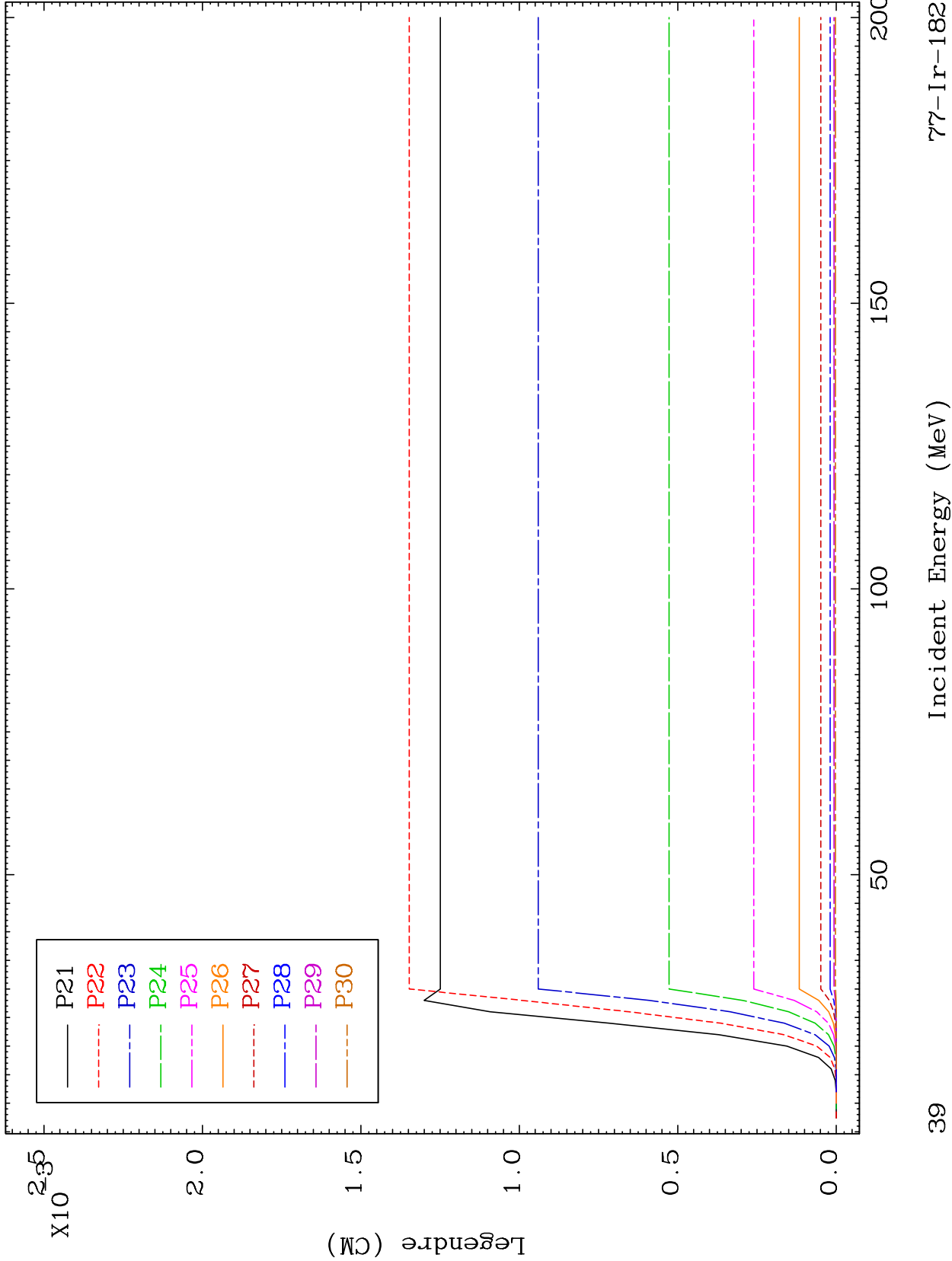

MAT 7698

MT= 56 (n,n') Level
Legendre Coefficients

77-Ir-182

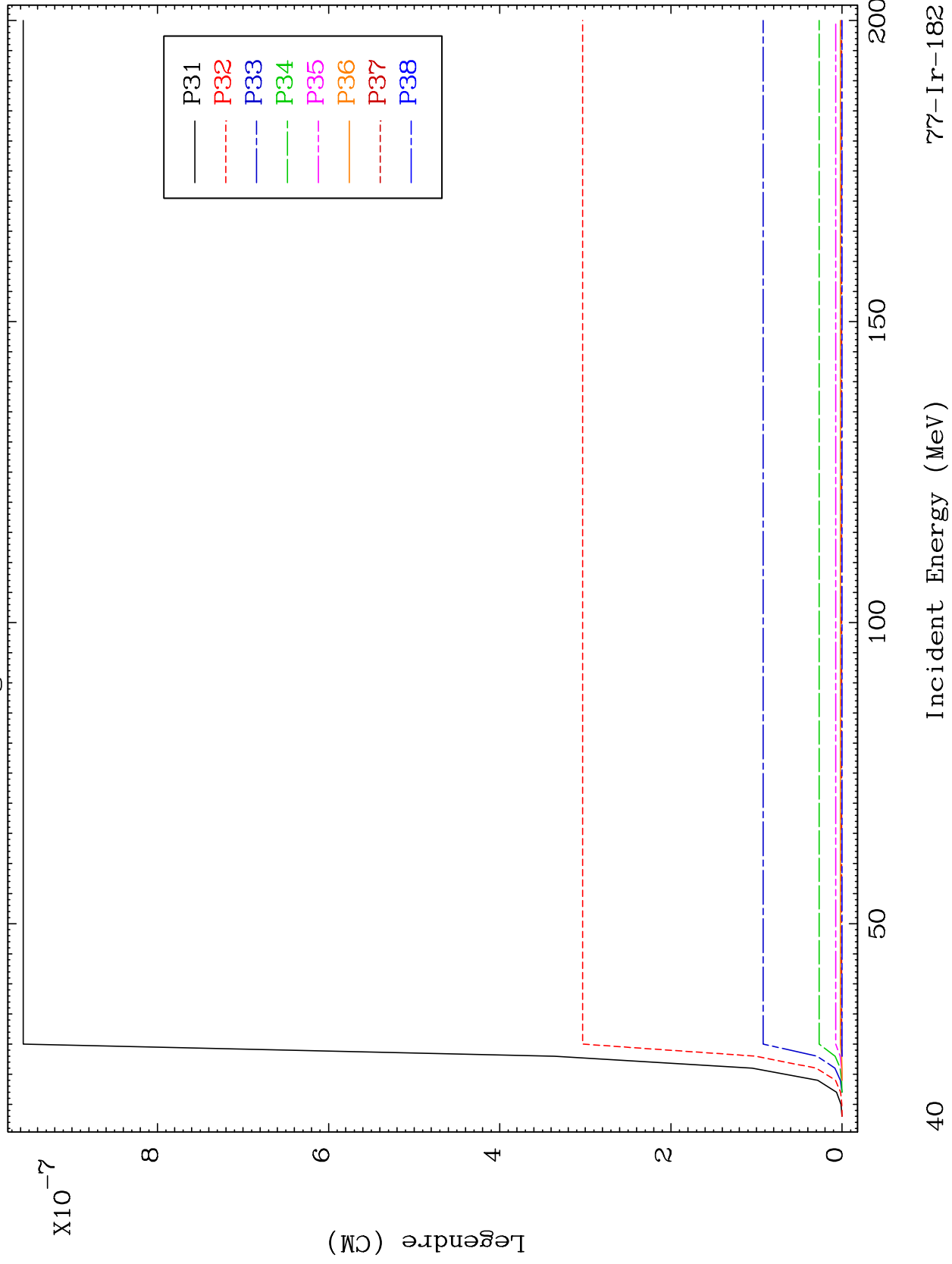

77-Ir-182

MAT 7698

MT= 57 (n,n') Level
Legendre Coefficients

77-Ir-182

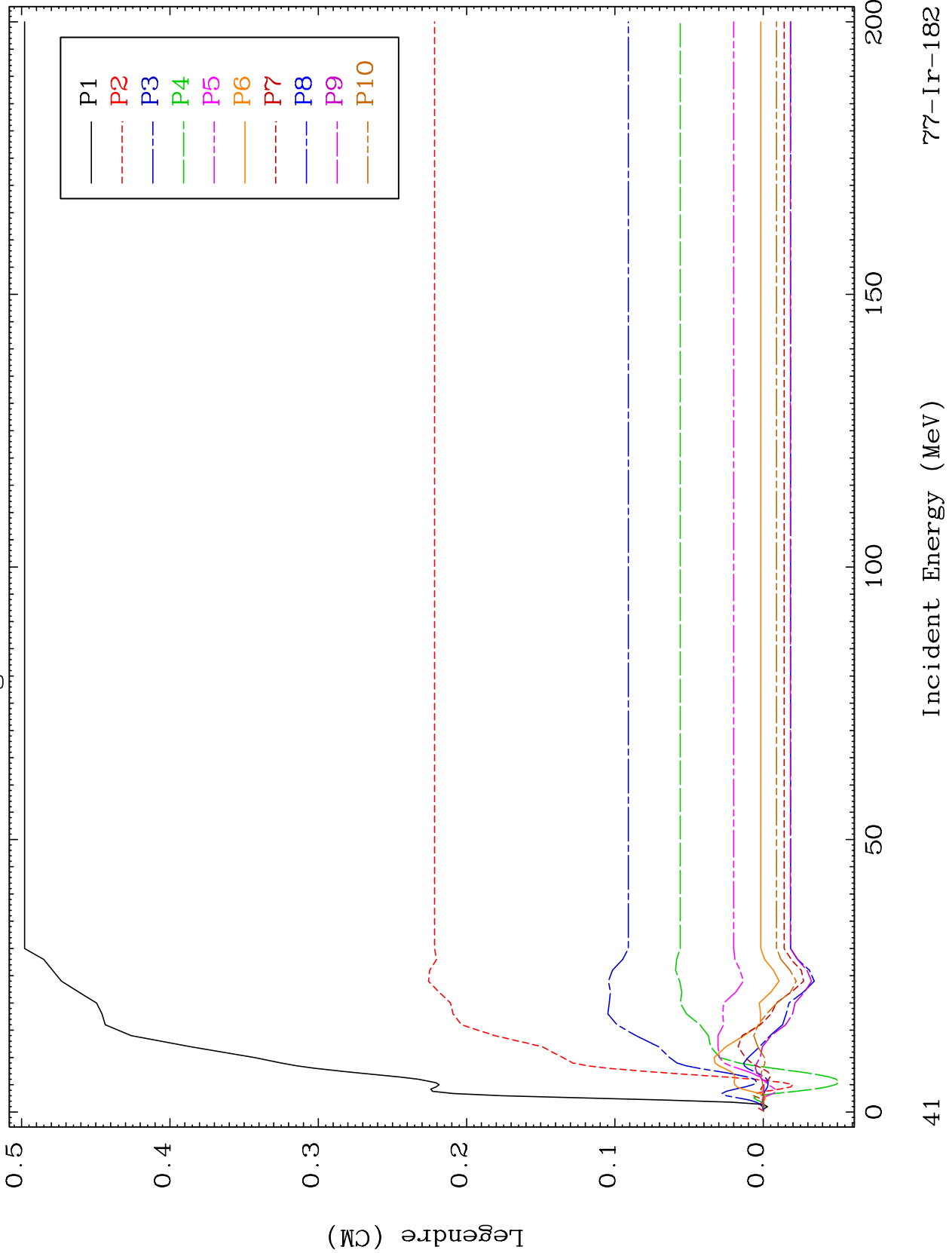

MAT 7698

MT= 57 (n,n') Level

77-Ir-182

Legendre Coefficients

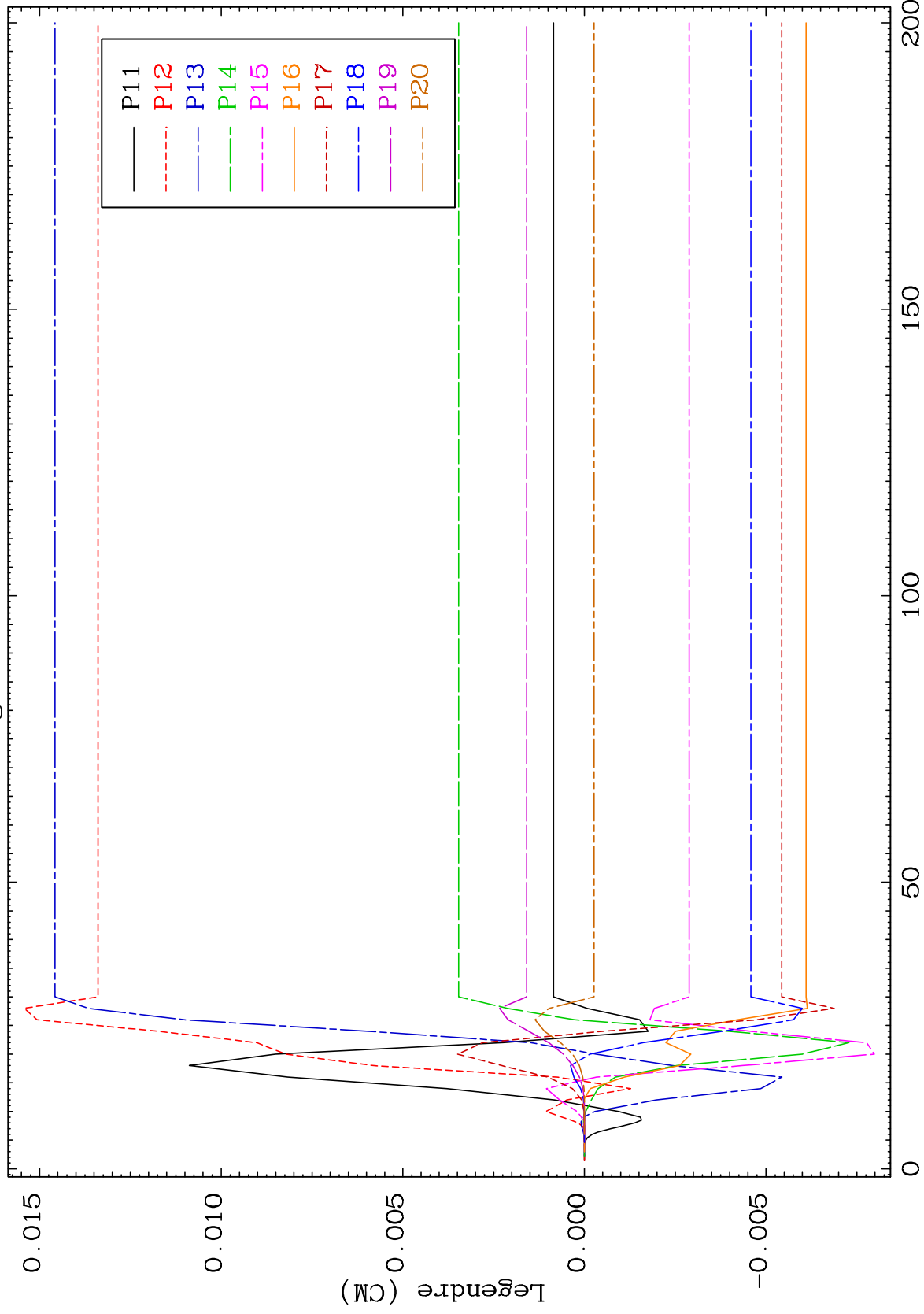

42

Incident Energy (MeV)

77-Ir-182

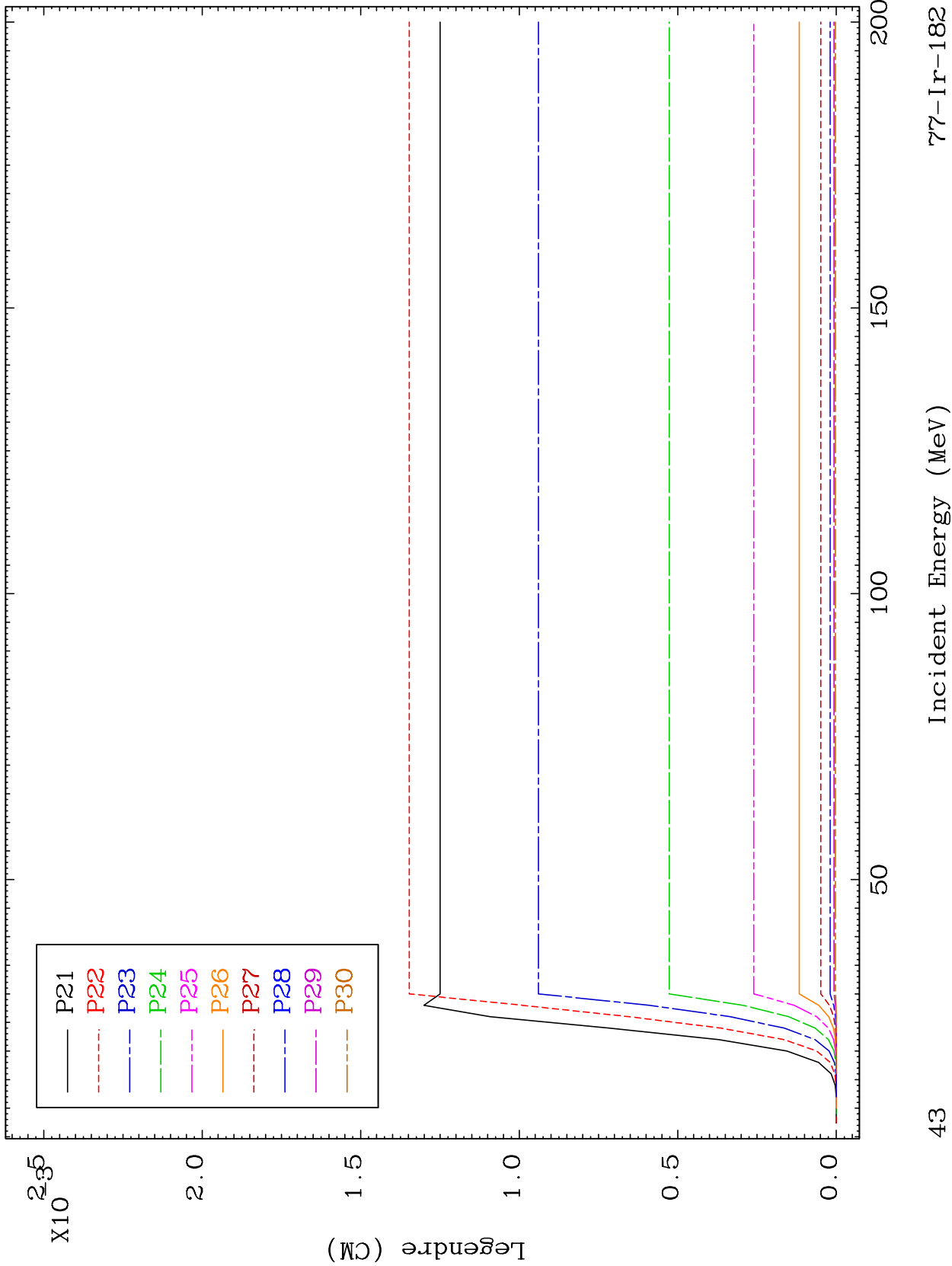

MAT 7698

MT= 57 (n,n') Level
Legendre Coefficients

77-Ir-182

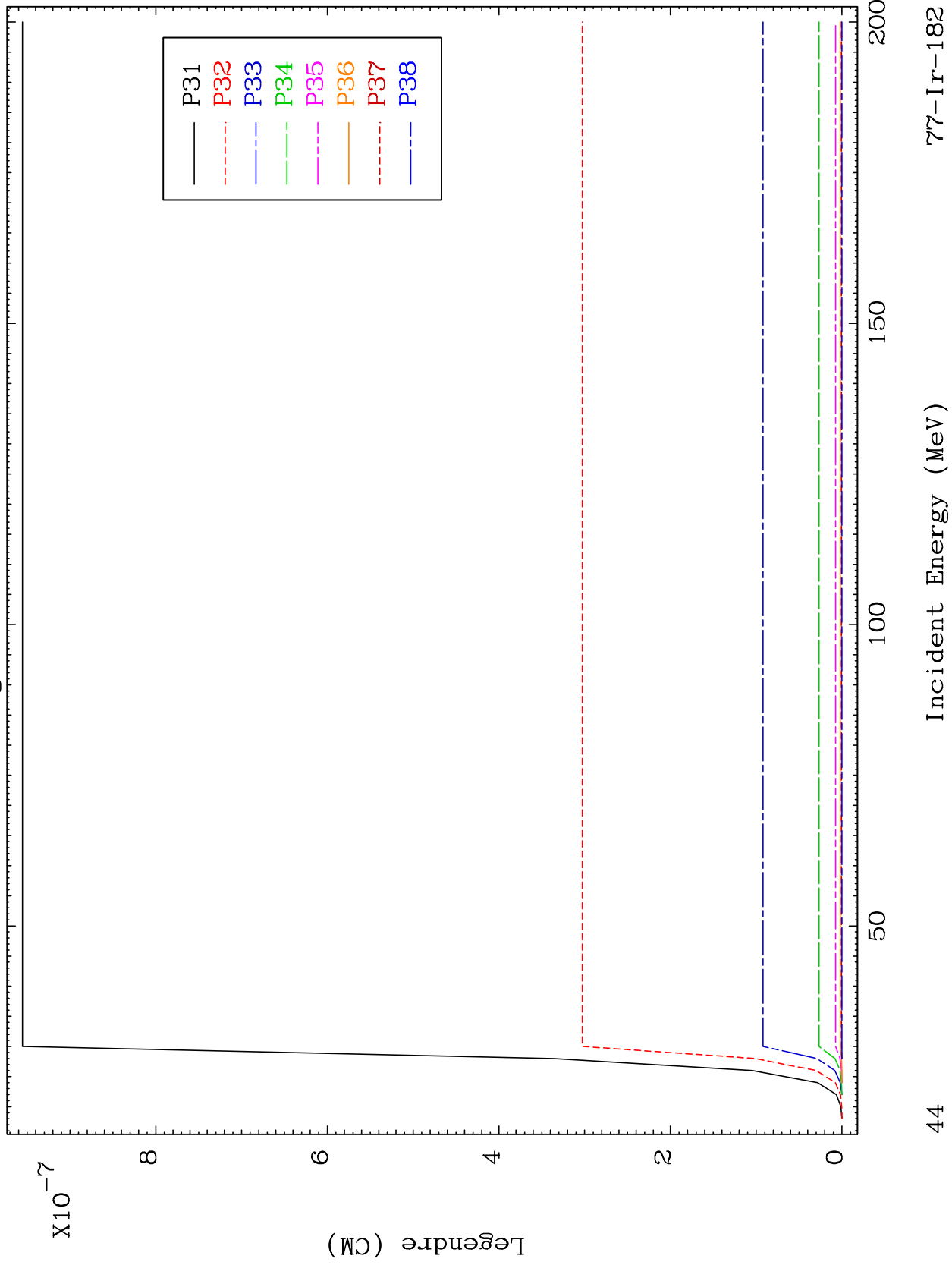

44

Incident Energy (MeV)

77-Ir-182

MAT 7698

MT= 58 (n,n') Level
Legendre Coefficients

77-Ir-182

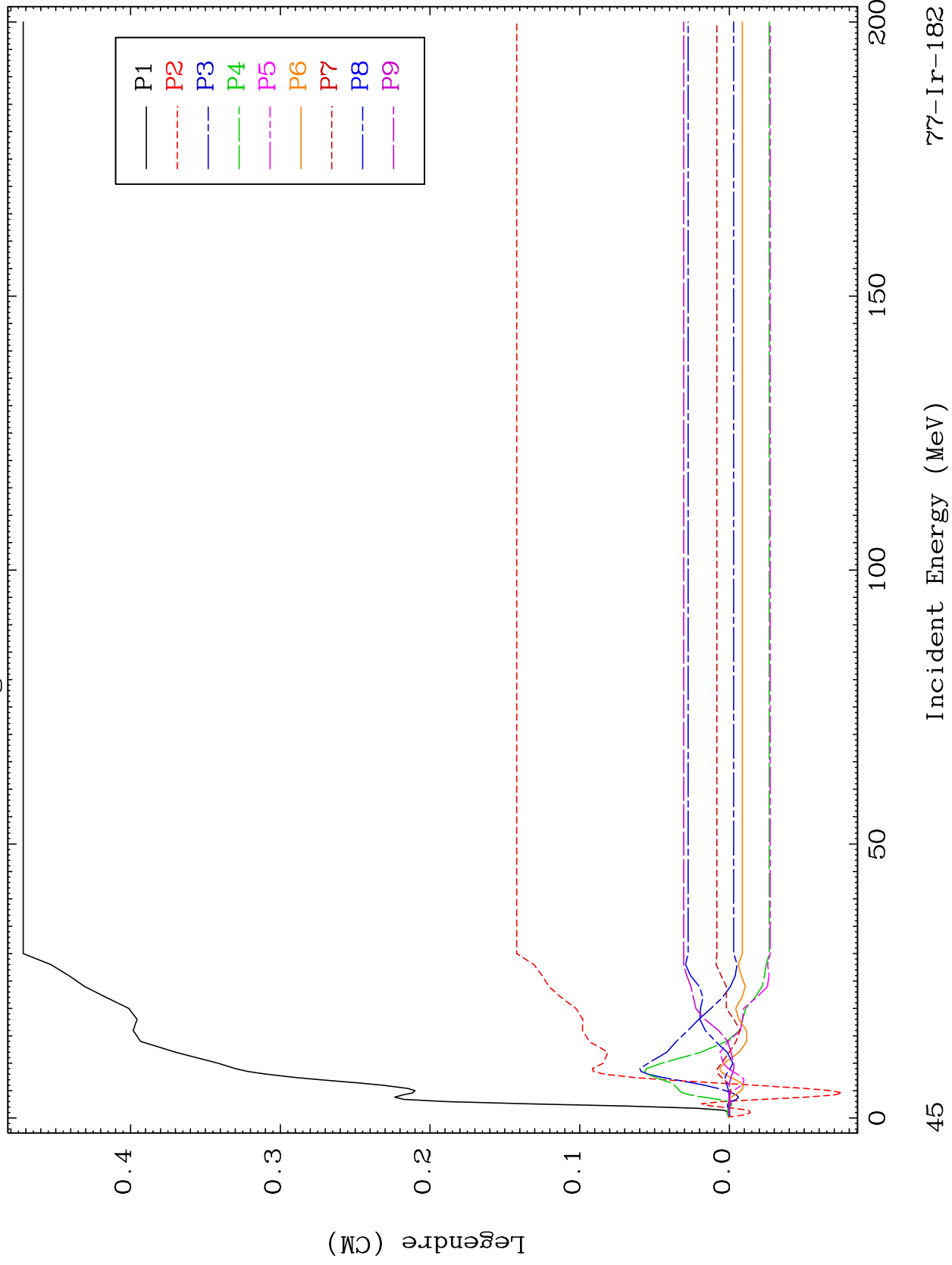

77-Ir-182

Incident Energy (MeV)

45

MAT 7698

MT= 58 (n,n') Level
Legendre Coefficients

77-Ir-182

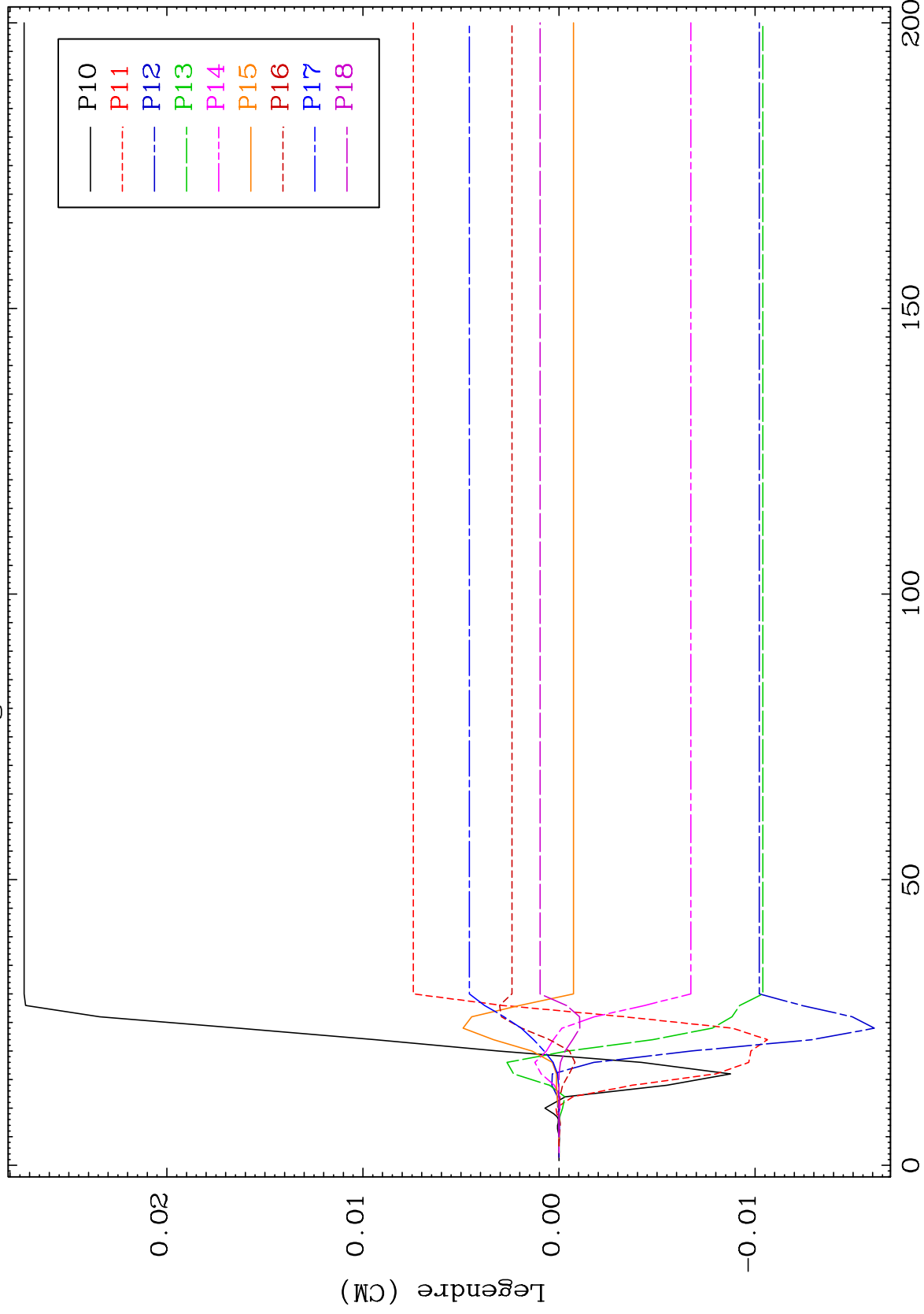

46

Incident Energy (MeV)

77-Ir-182

MAT 7698

MT= 58 (n,n') Level
Legendre Coefficients

77-Ir-182

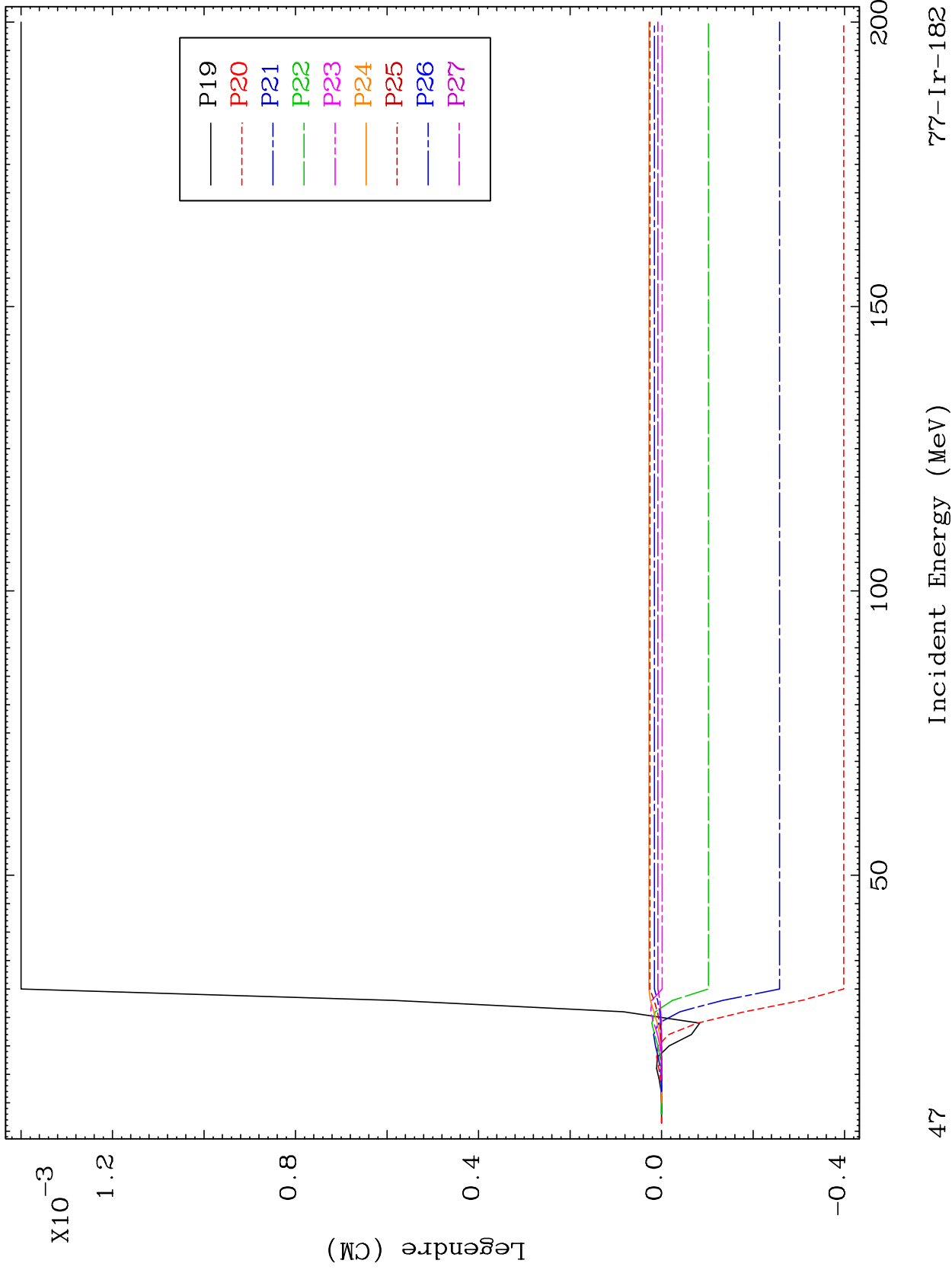

47

Incident Energy (MeV)

77-Ir-182

MAT 7698

MT= 58 (n,n') Level
Legendre Coefficients

77-Ir-182

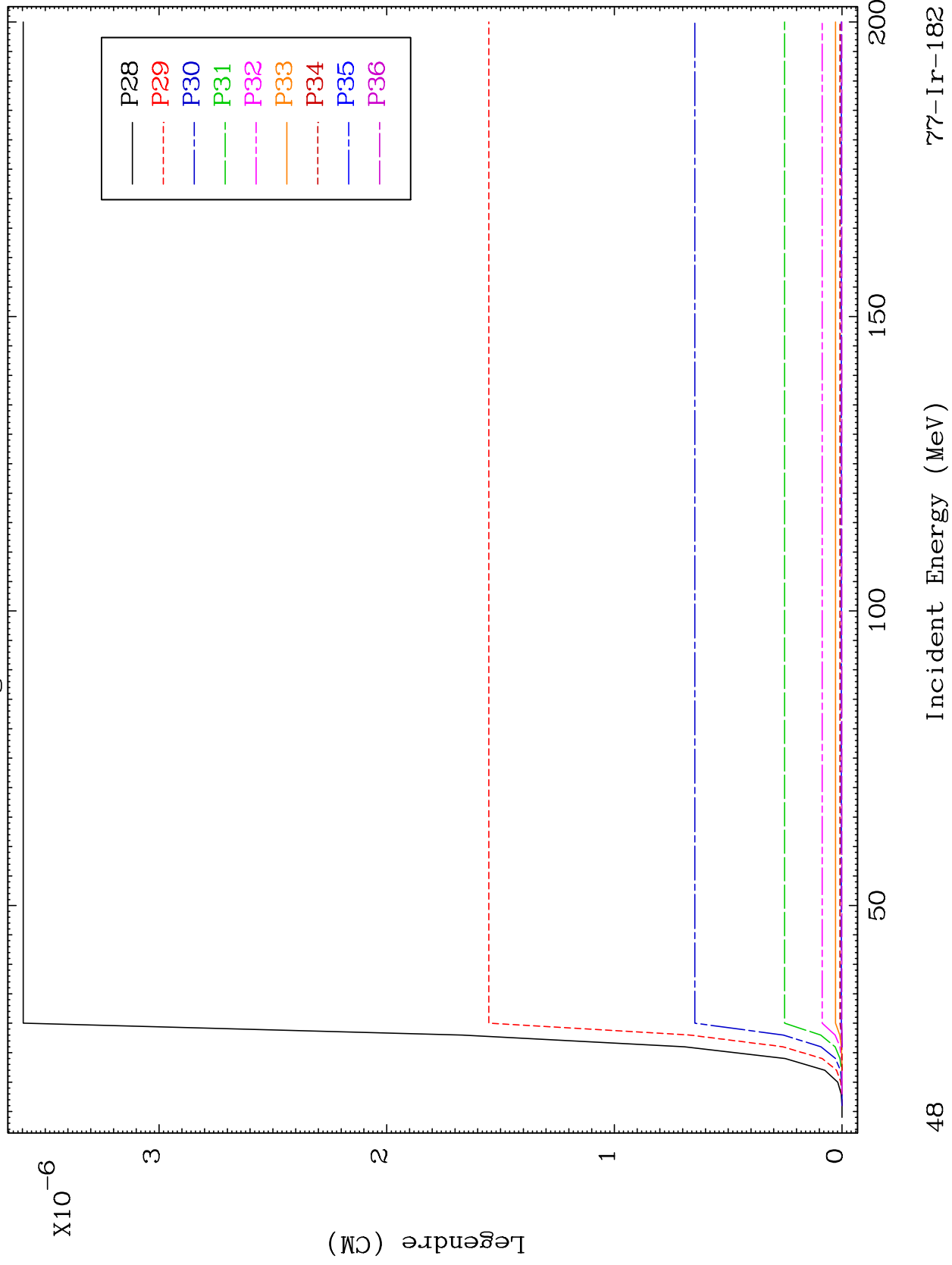

48

Incident Energy (MeV)

77-Ir-182

MAT 7698

MT= 59 (n,n') Level
Legendre Coefficients

77-Ir-182

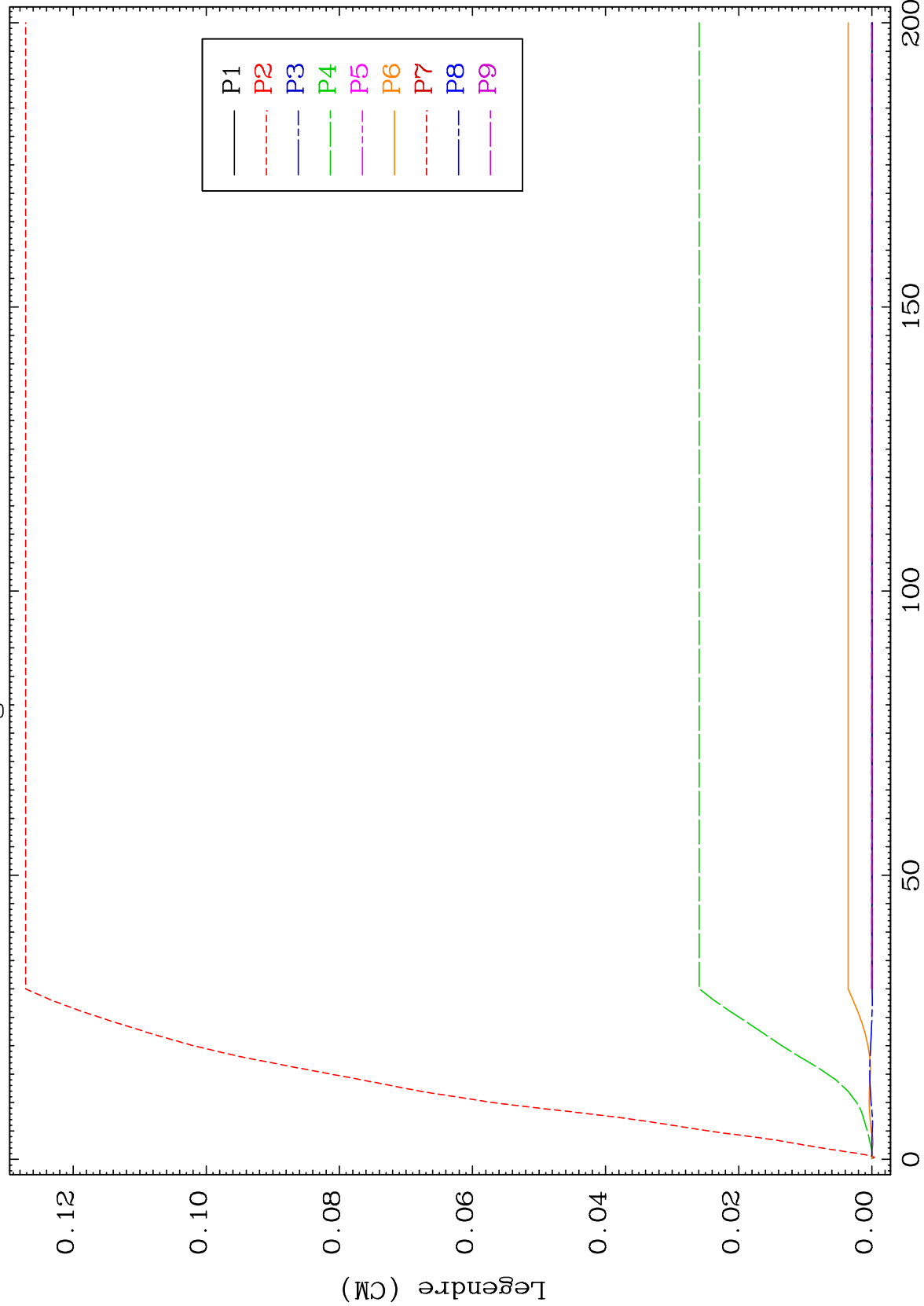

49

Incident Energy (MeV)

77-Ir-182

MAT 7698

MT= 59 (n,n') Level
Legendre Coefficients

77-Ir-182

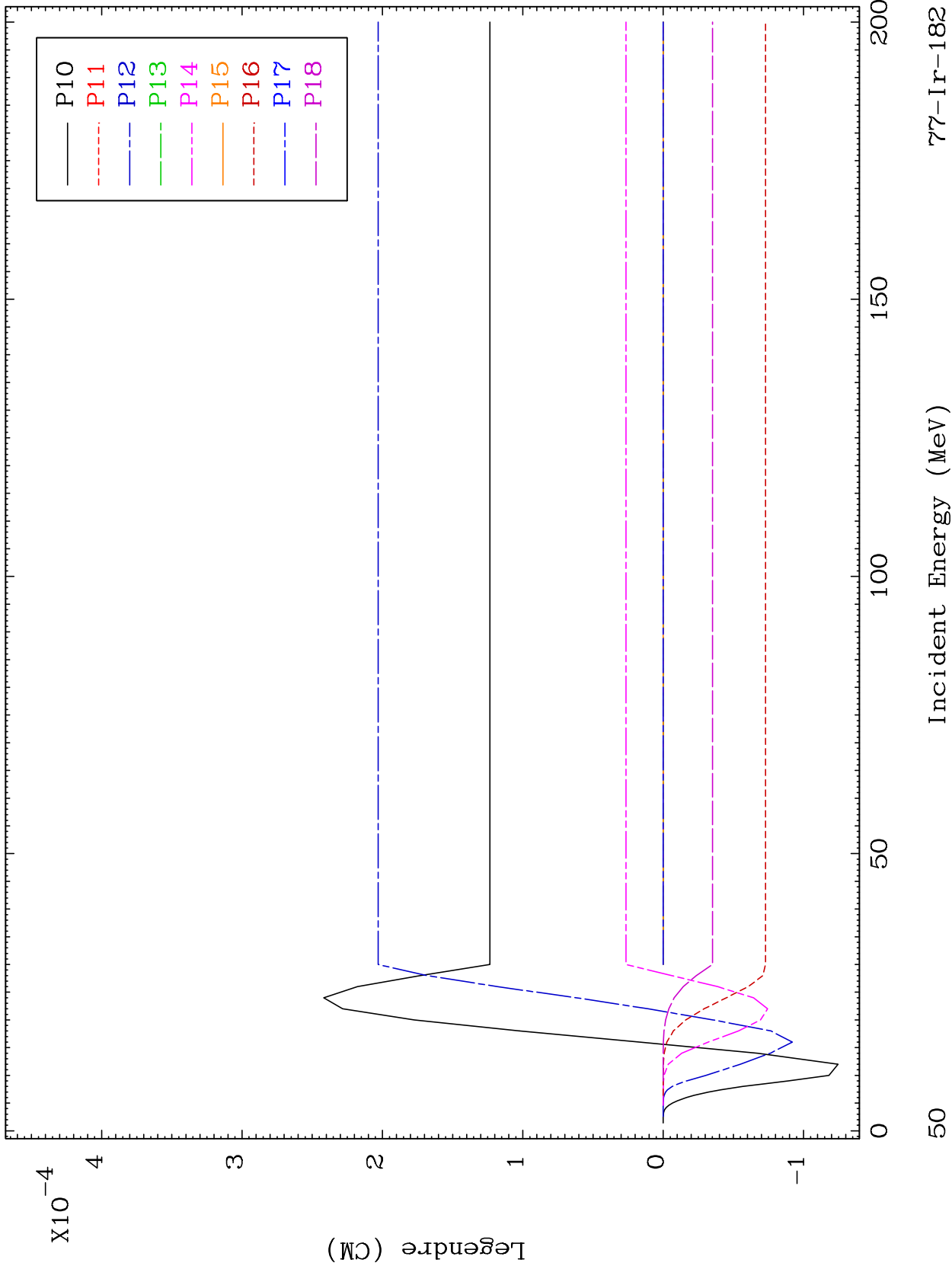

77-Ir-182

MAT 7698

MT= 59 (n,n') Level
Legendre Coefficients

77-Ir-182

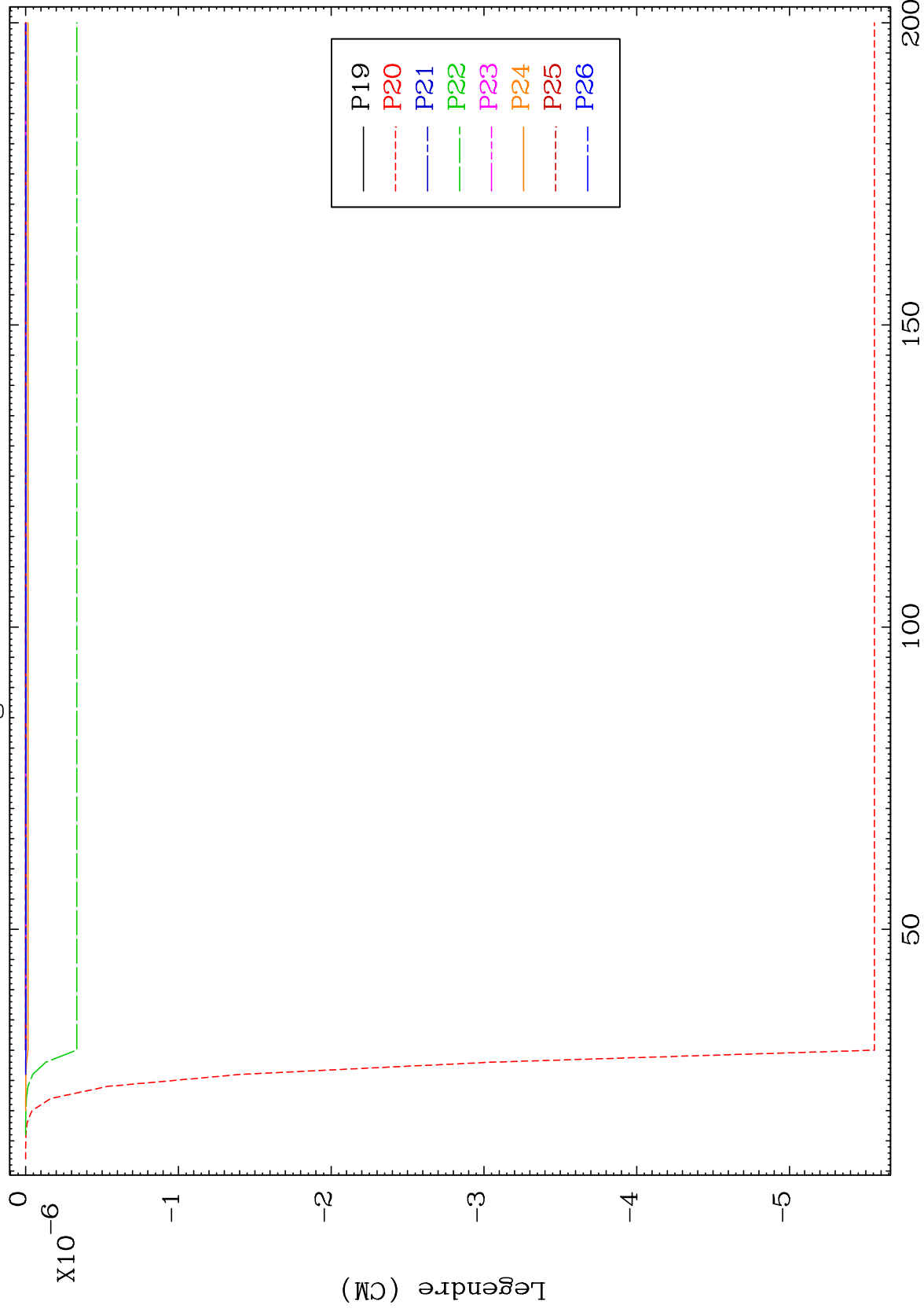

51

Incident Energy (MeV)

77-Ir-182

MAT 7698

MT= 60 (n,n') Level
Legendre Coefficients

77-Ir-182

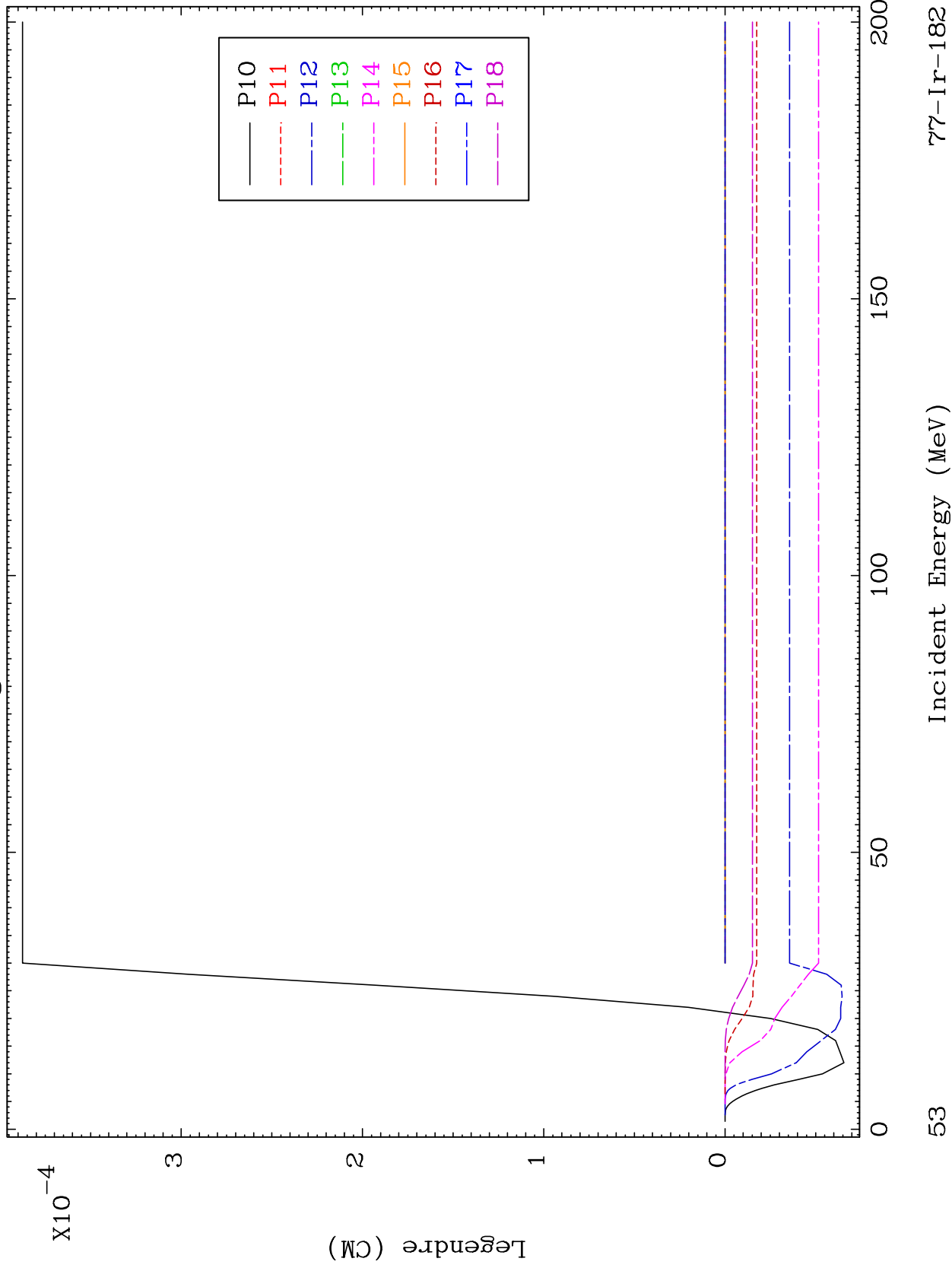

53

Incident Energy (MeV)

77-Ir-182

MAT 7698

MT= 60 (n,n') Level
Legendre Coefficients

77-Ir-182

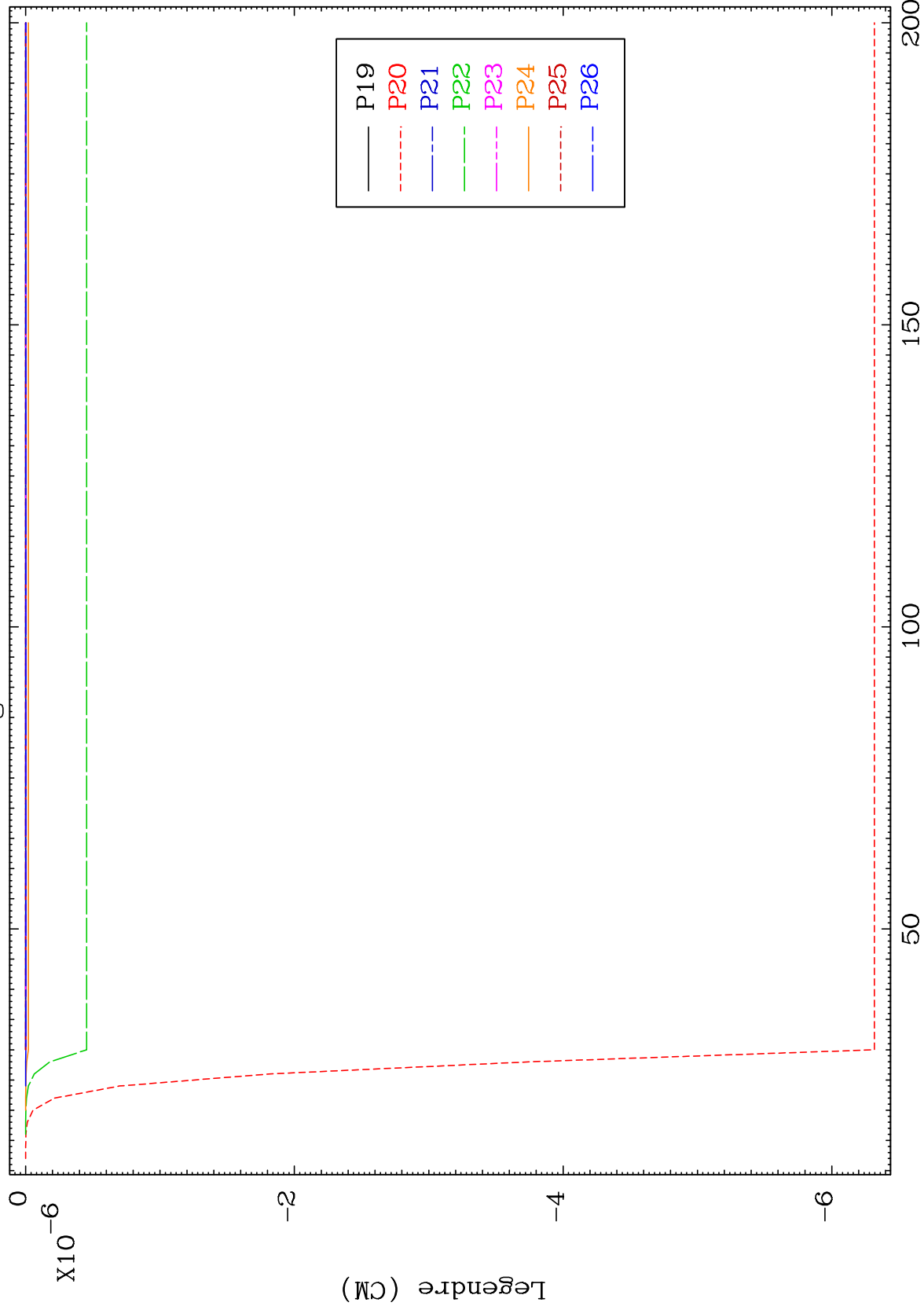

54

Incident Energy (MeV)

77-Ir-182

MAT 7698

MT= 61 (n,n') Level
Legendre Coefficients

77-Ir-182

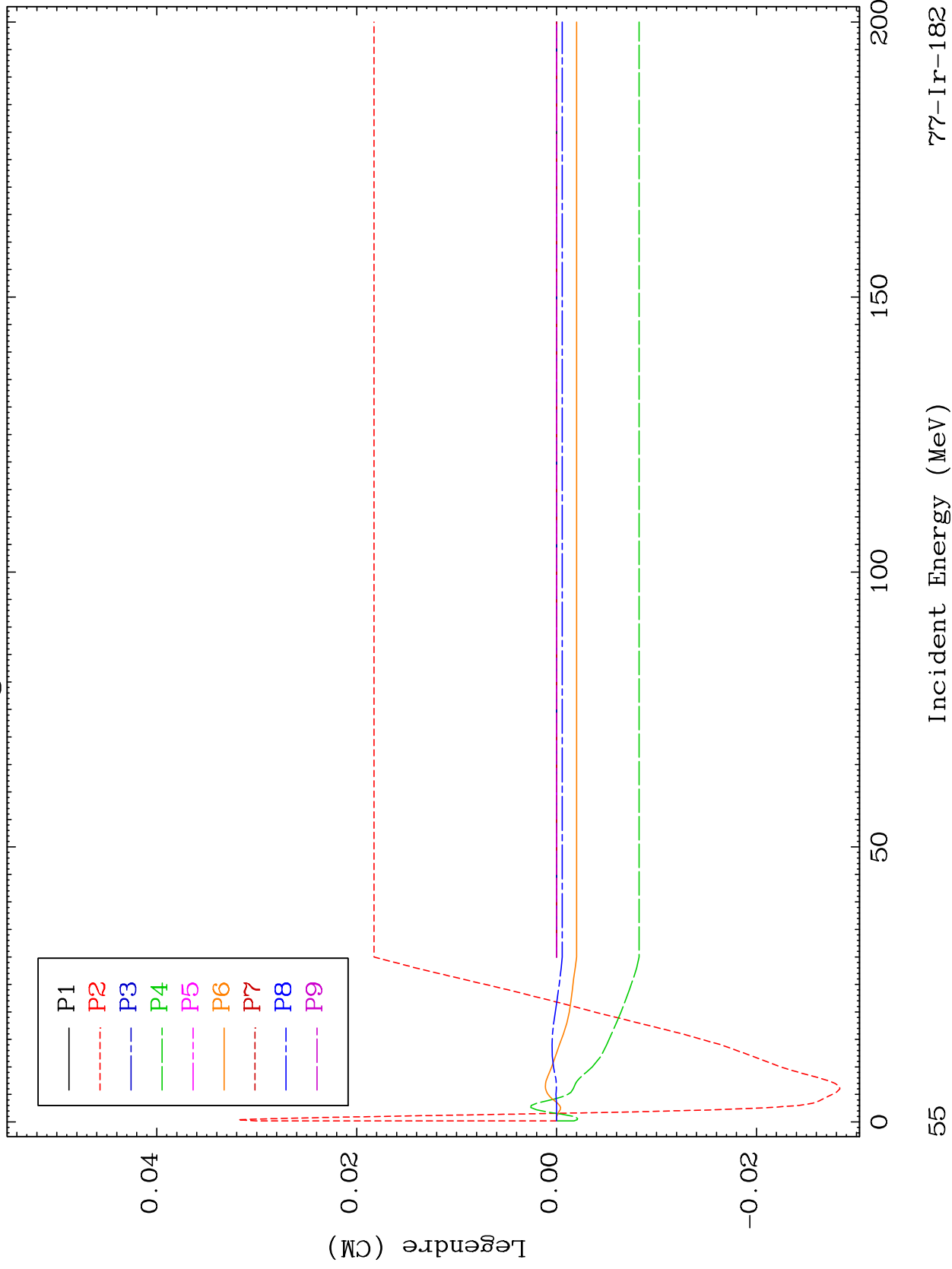

77-Ir-182

Incident Energy (MeV)

55

MAT 7698

MT= 61 (n,n') Level
Legendre Coefficients

77-Ir-182

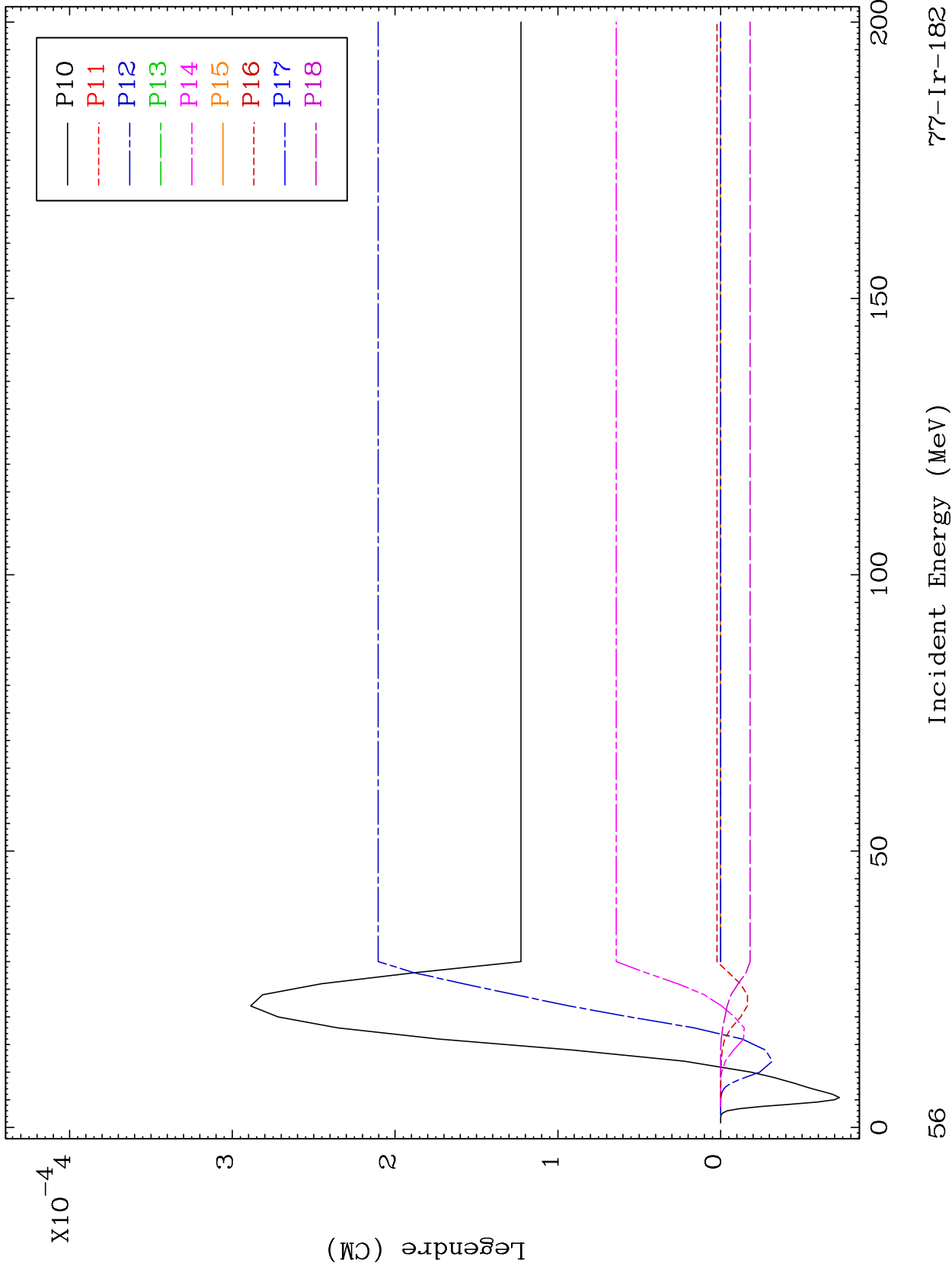

56

77-Ir-182

MAT 7698

MT= 61 (n,n') Level
Legendre Coefficients

77-Ir-182

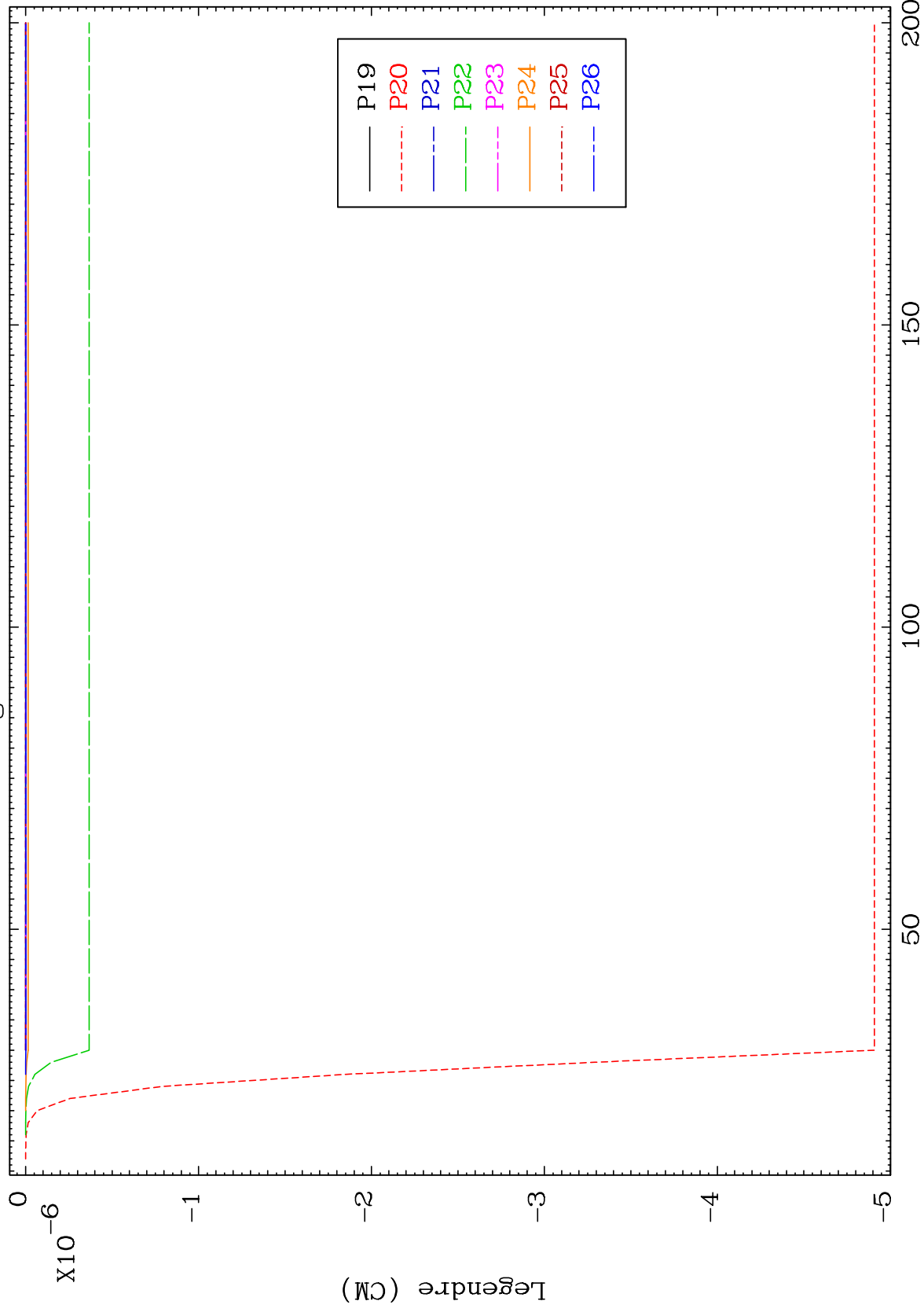

MAT 7698

MT= 62 (n,n') Level
Legendre Coefficients

77-Ir-182

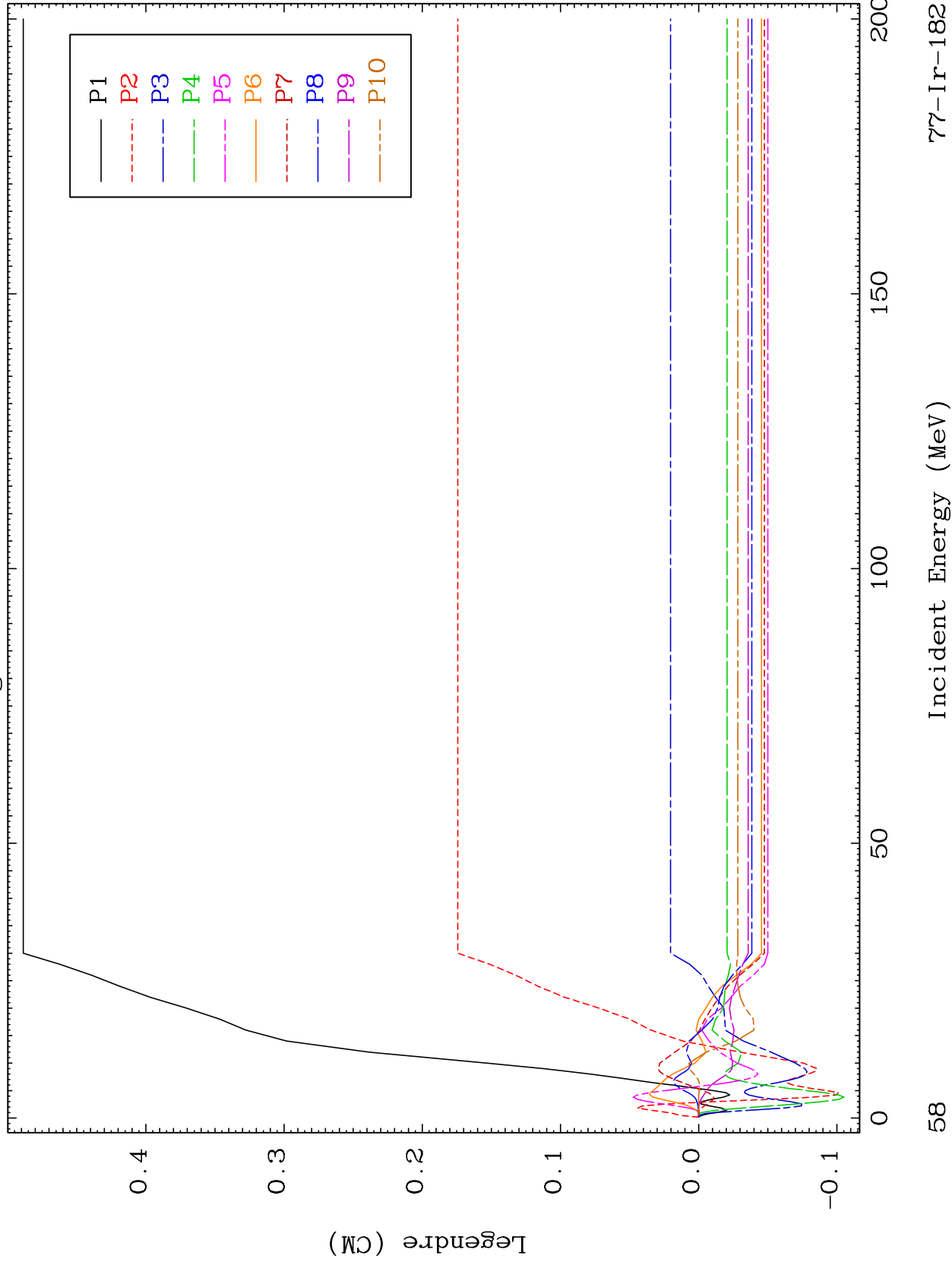

77-Ir-182

Incident Energy (MeV)

58

MAT 7698

MT= 62 (n,n') Level
Legendre Coefficients

77-Ir-182

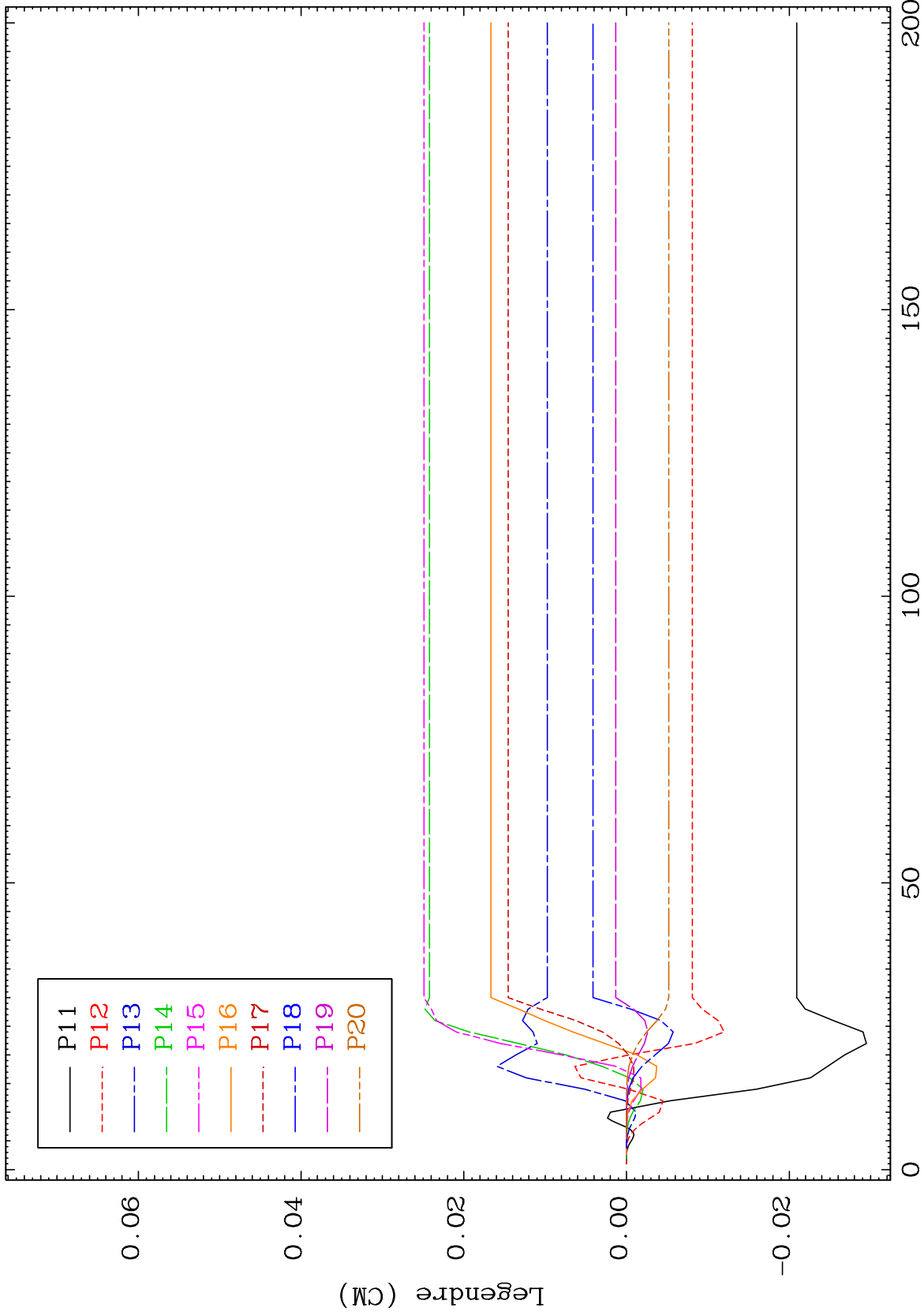

59

Incident Energy (MeV)

77-Ir-182

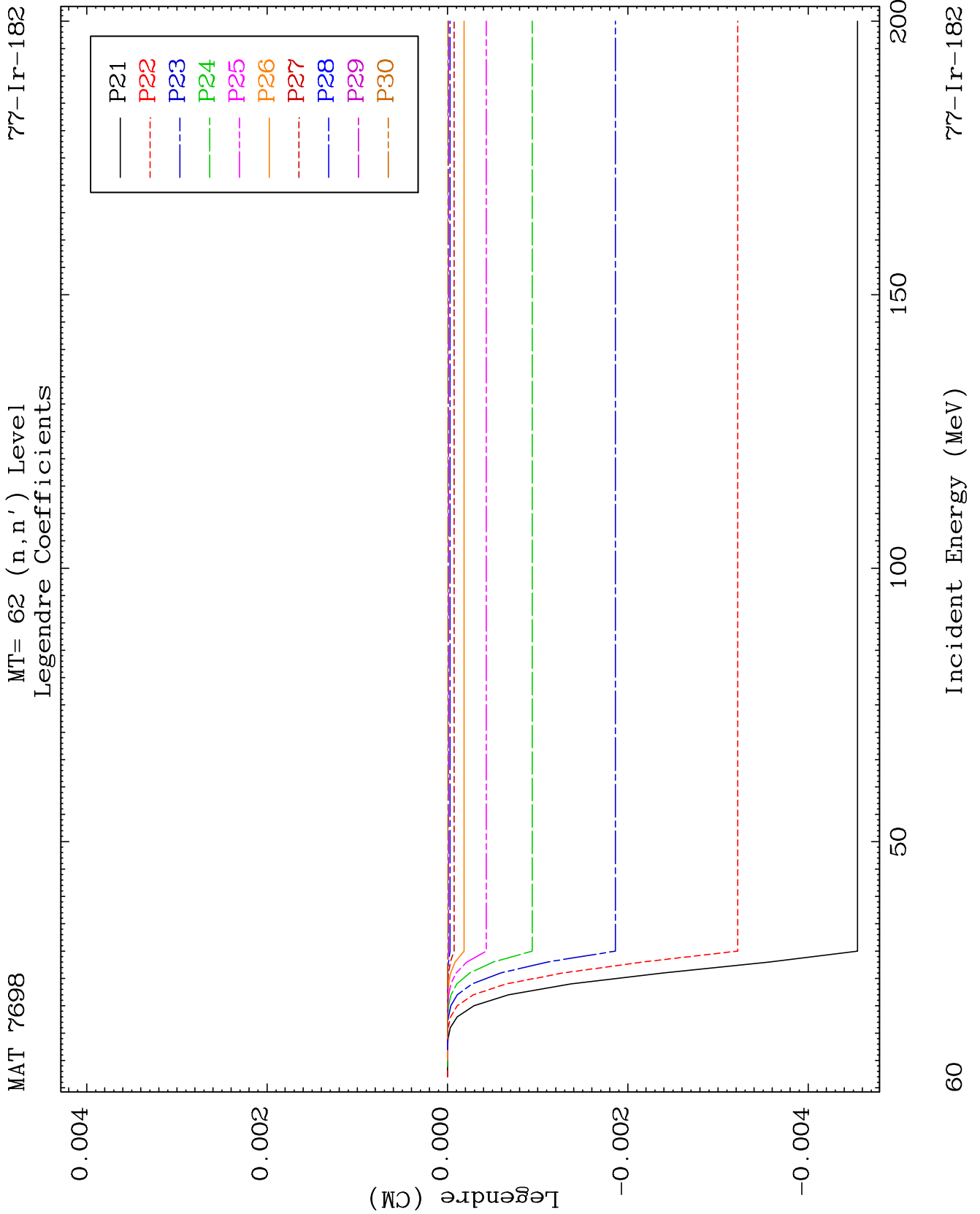

MAT 7698

MT= 62 (n,n') Level

77-Ir-182

Legendre Coefficients

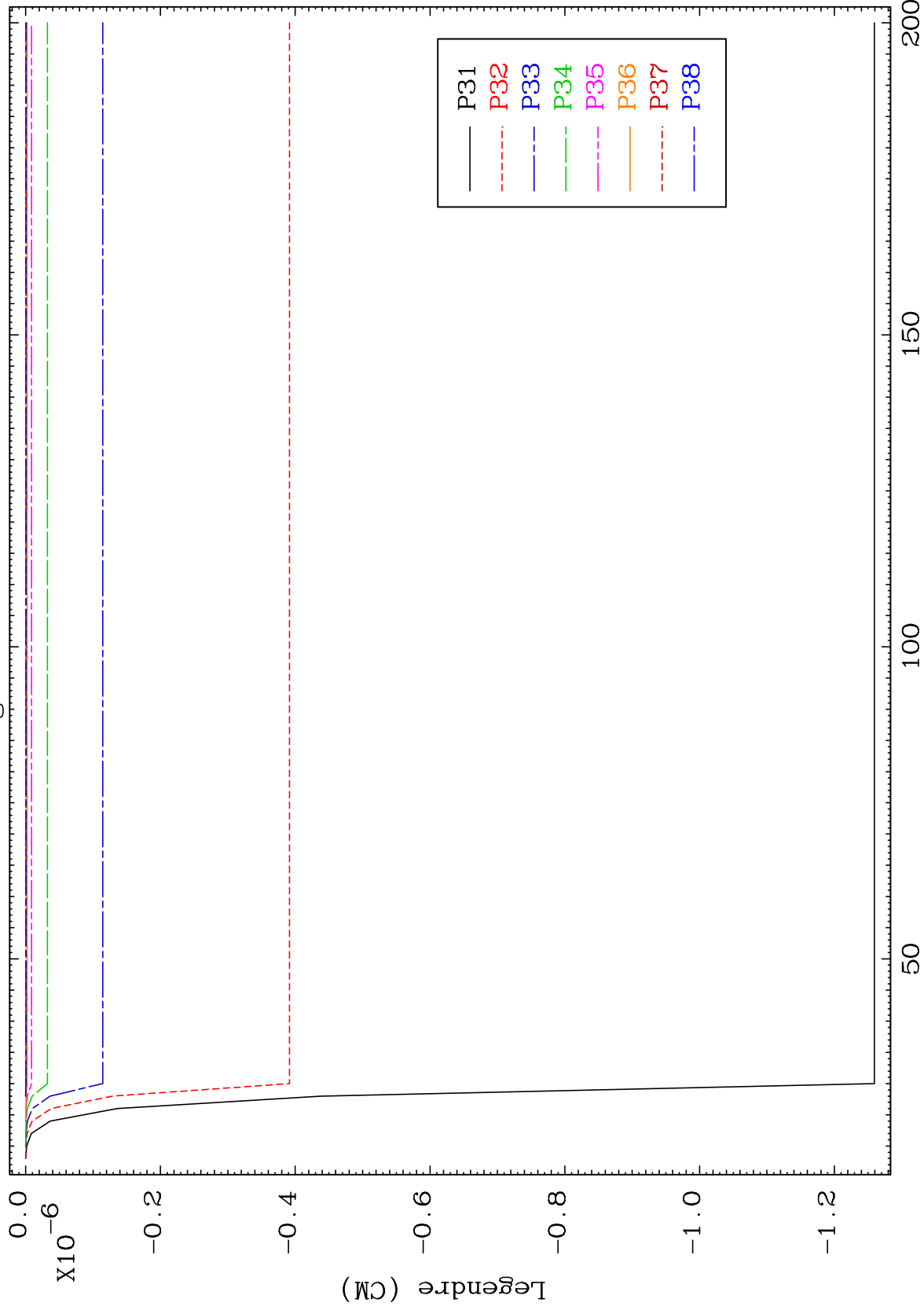

61

Incident Energy (MeV)

77-Ir-182

MAT 7698

MT= 63 (n,n') Level
Legendre Coefficients

77-Ir-182

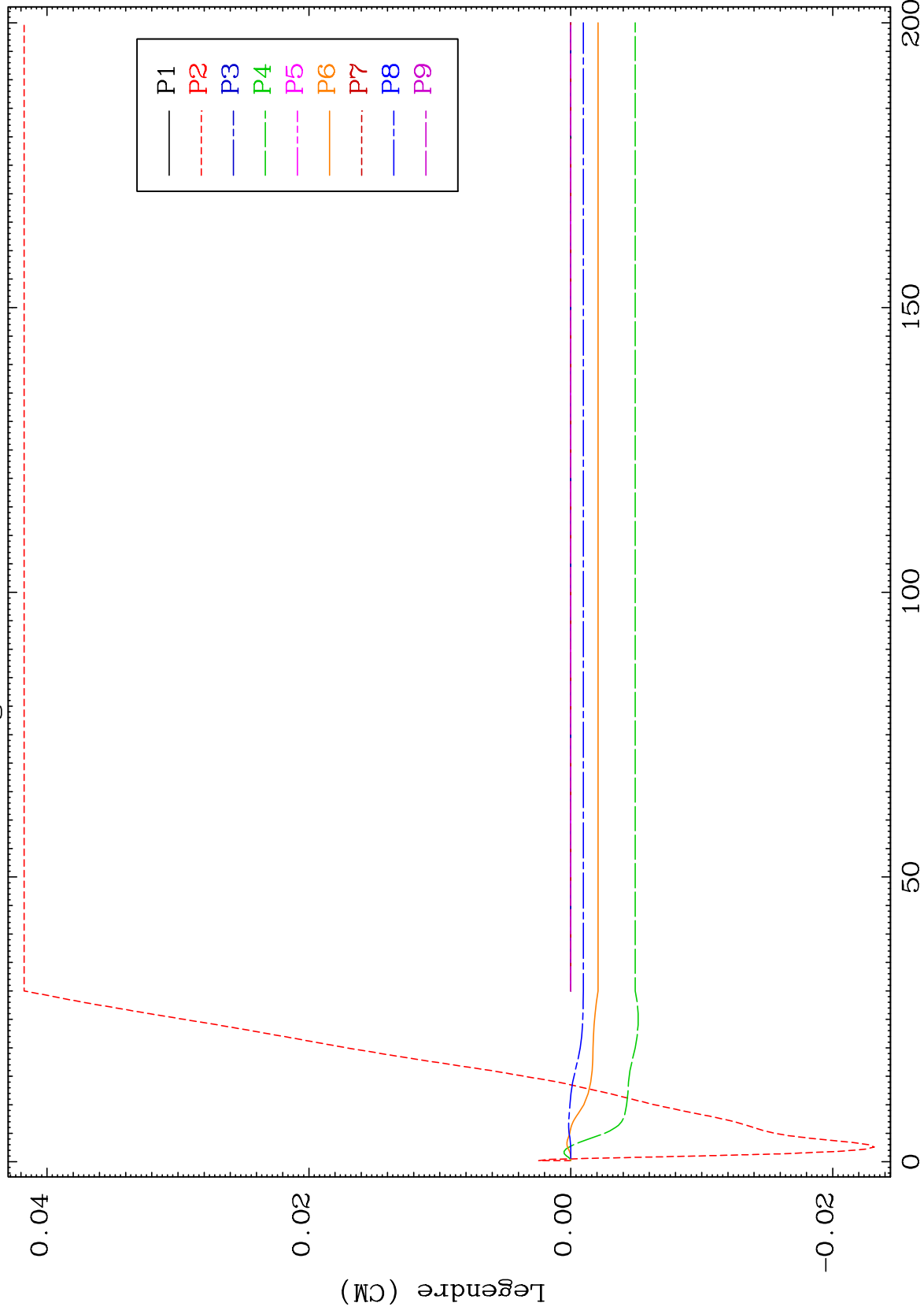

62

Incident Energy (MeV)

77-Ir-182

MAT 7698

MT= 63 (n,n') Level
Legendre Coefficients

77-Ir-182

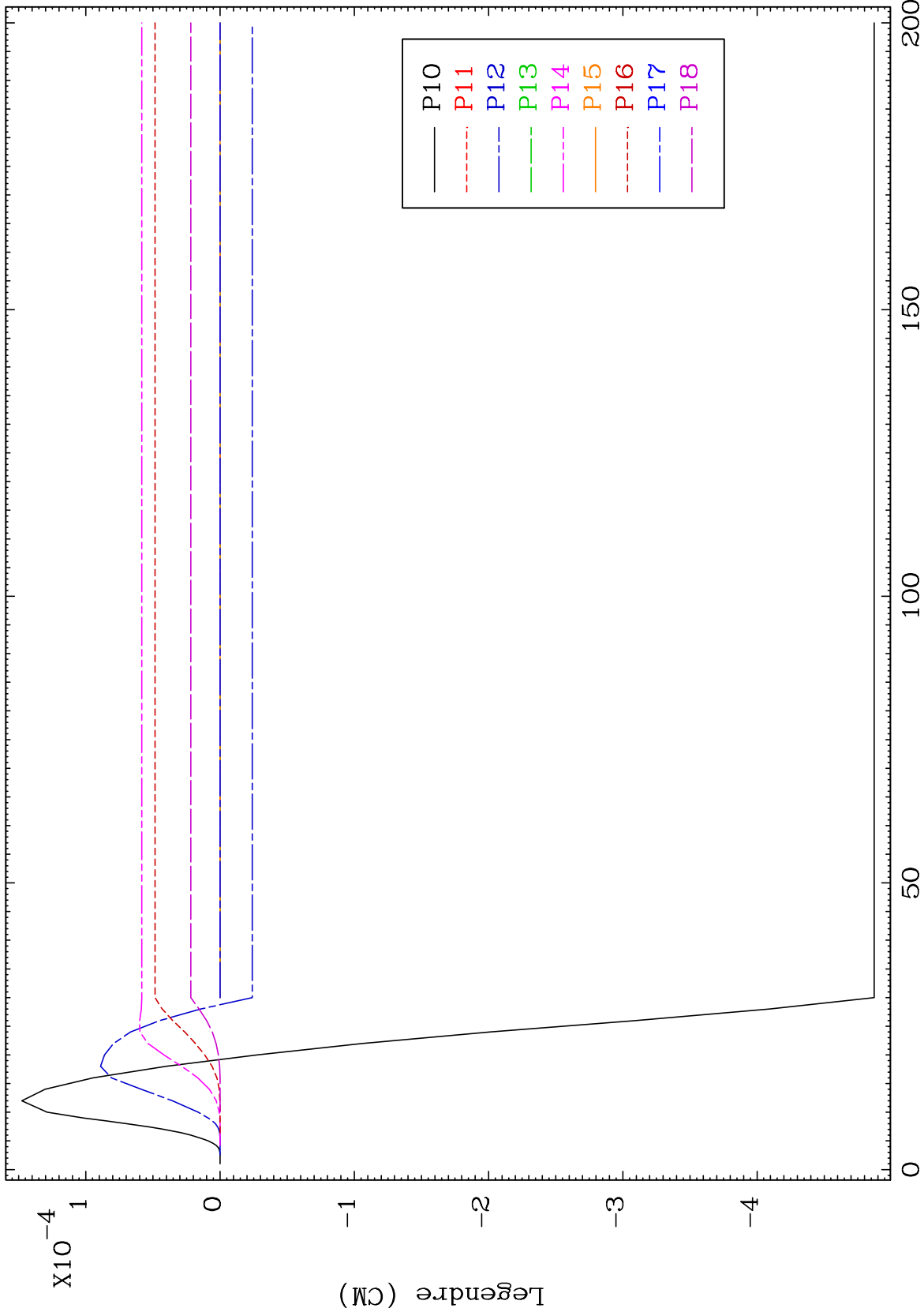

63

Incident Energy (MeV)

77-Ir-182

MAT 7698

MT= 63 (n,n') Level
Legendre Coefficients

77-Ir-182

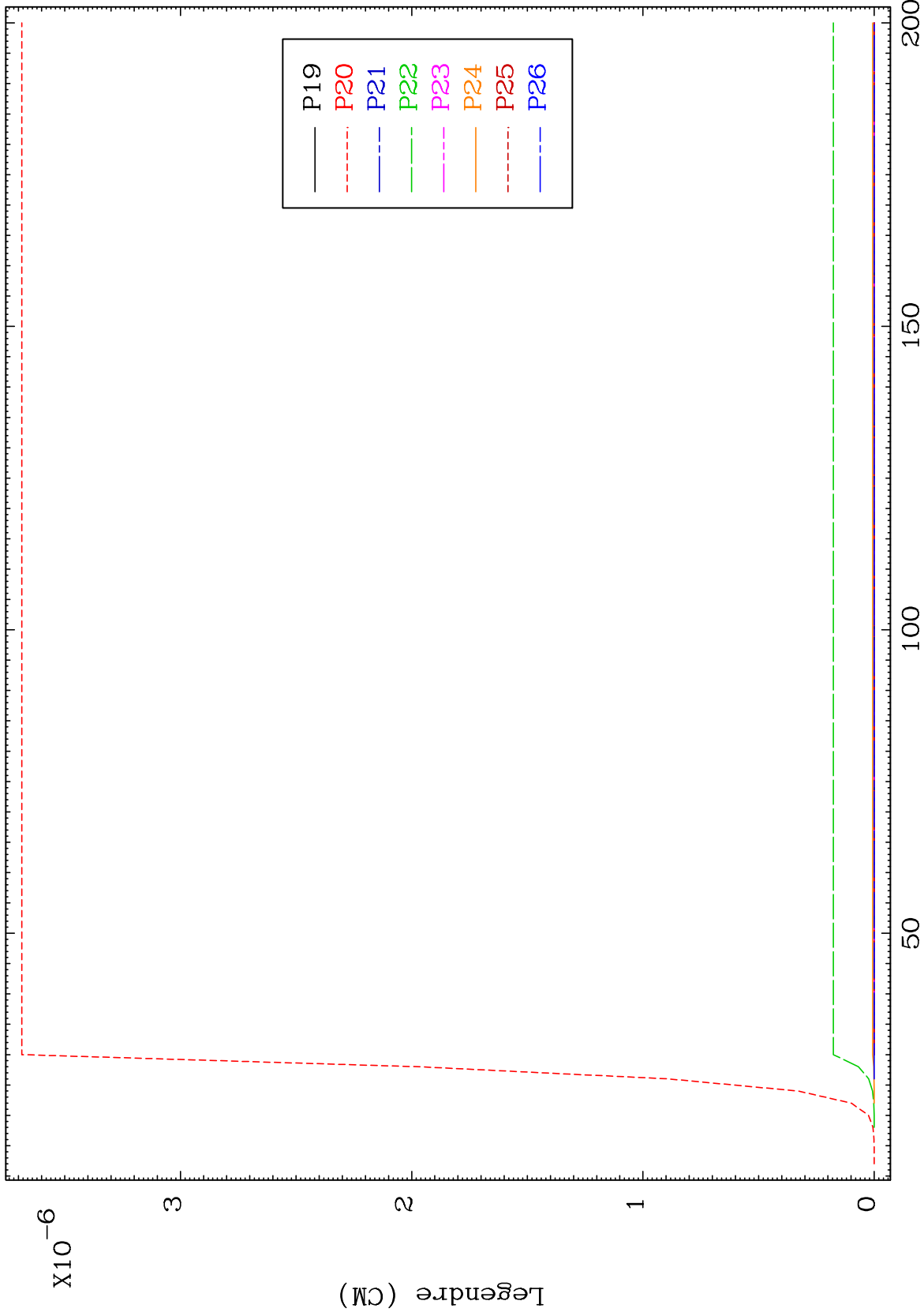

64

Incident Energy (MeV)

77-Ir-182

MAT 7698

MT= 64 (n,n') Level
Legendre Coefficients

77-Ir-182

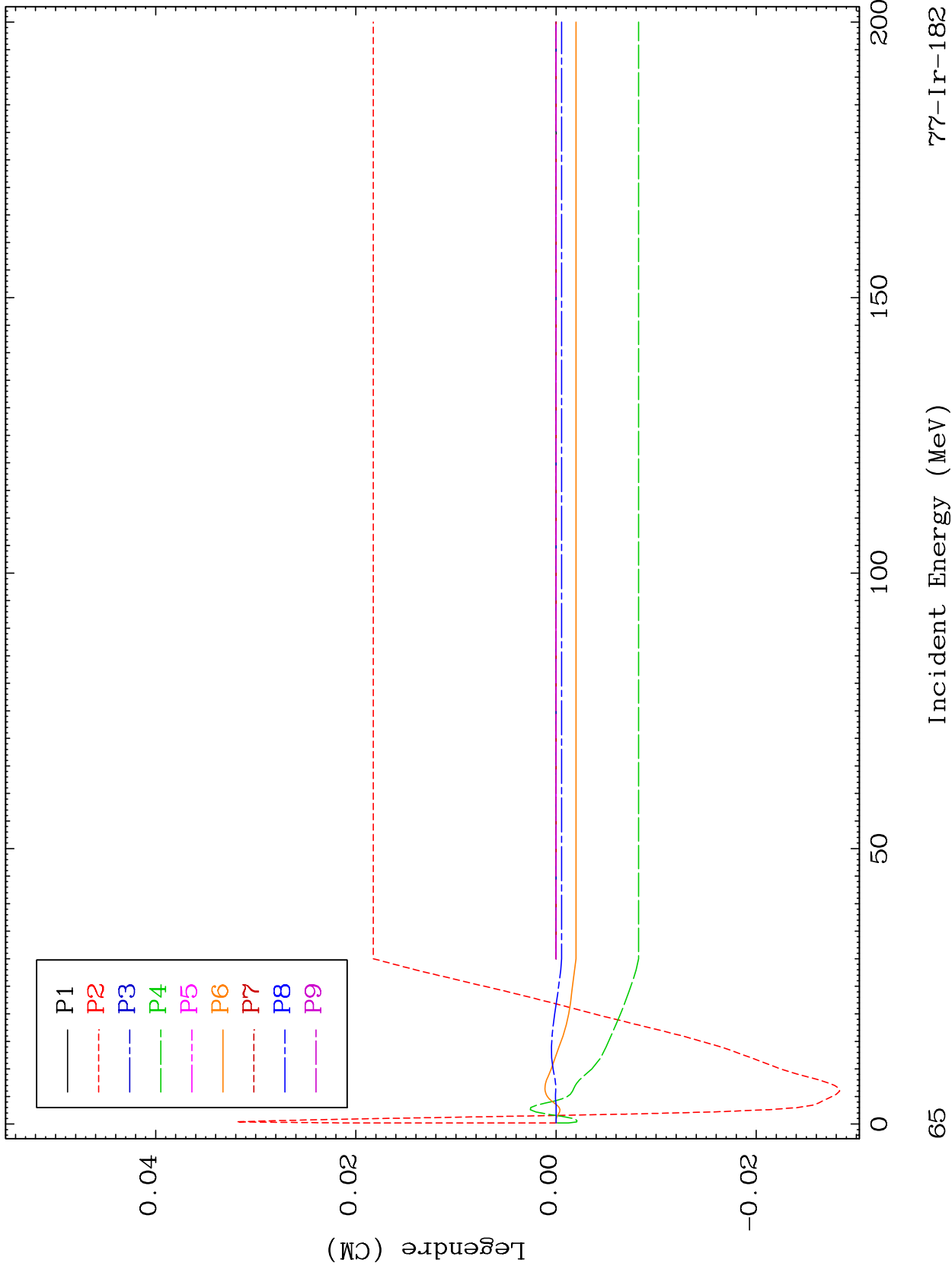

77-Ir-182

Incident Energy (MeV)

65

MAT 7698

MT= 64 (n,n') Level
Legendre Coefficients

77-Ir-182

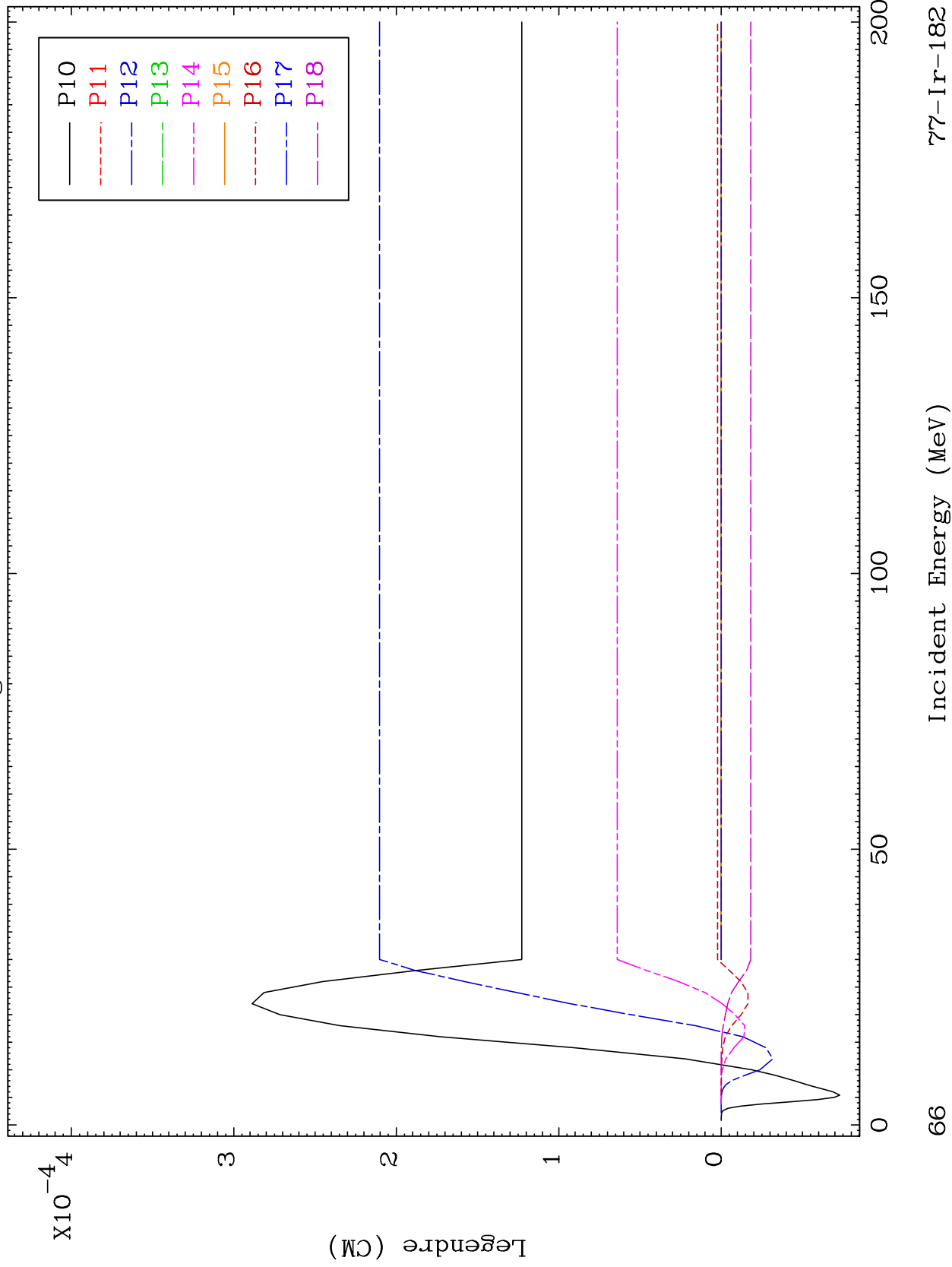

66

Incident Energy (MeV)

77-Ir-182

MAT 7698

MT= 64 (n,n') Level
Legendre Coefficients

77-Ir-182

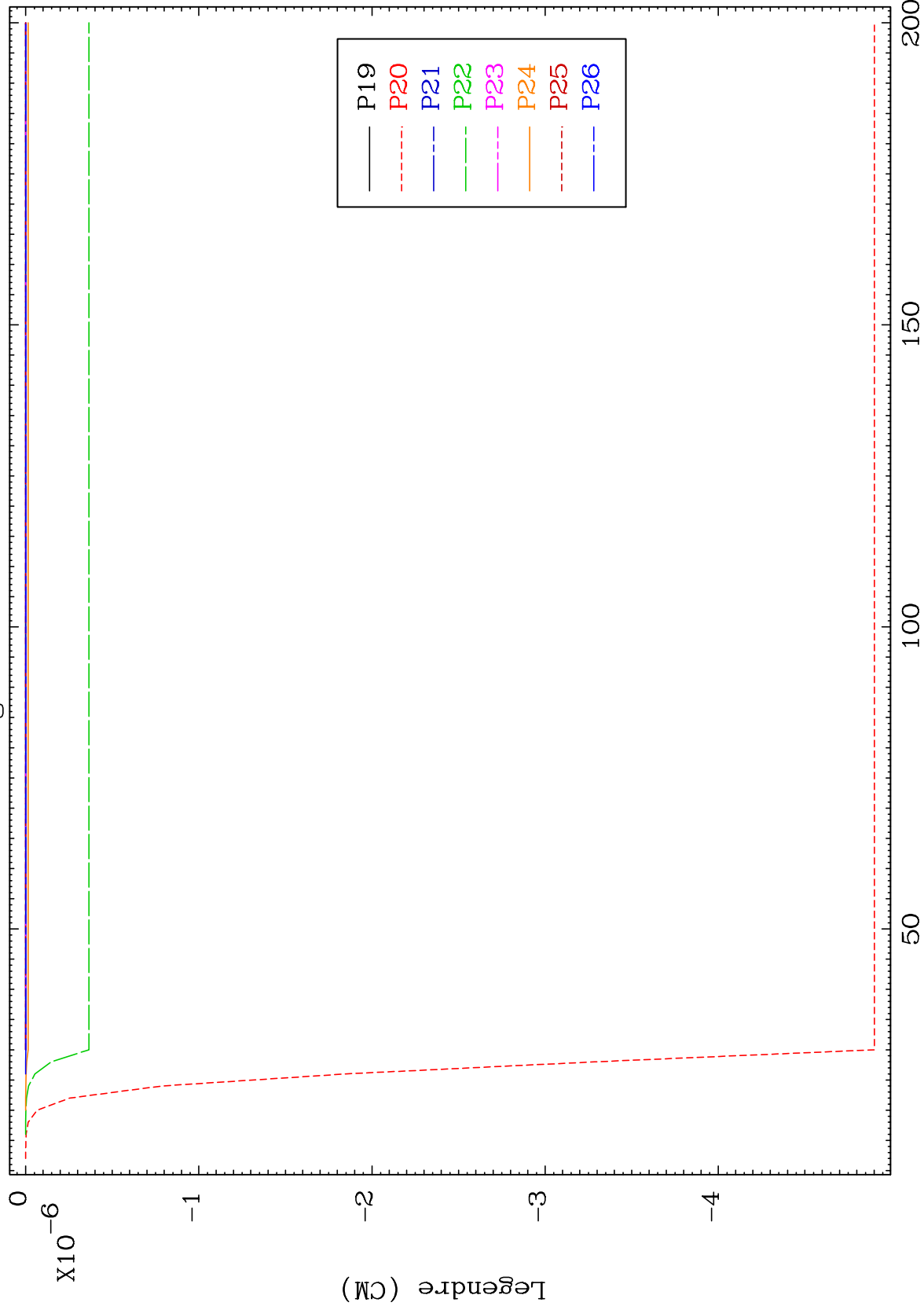

67

Incident Energy (MeV)

77-Ir-182

MAT 7698

MT= 65 (n,n') Level
Legendre Coefficients

77-Ir-182

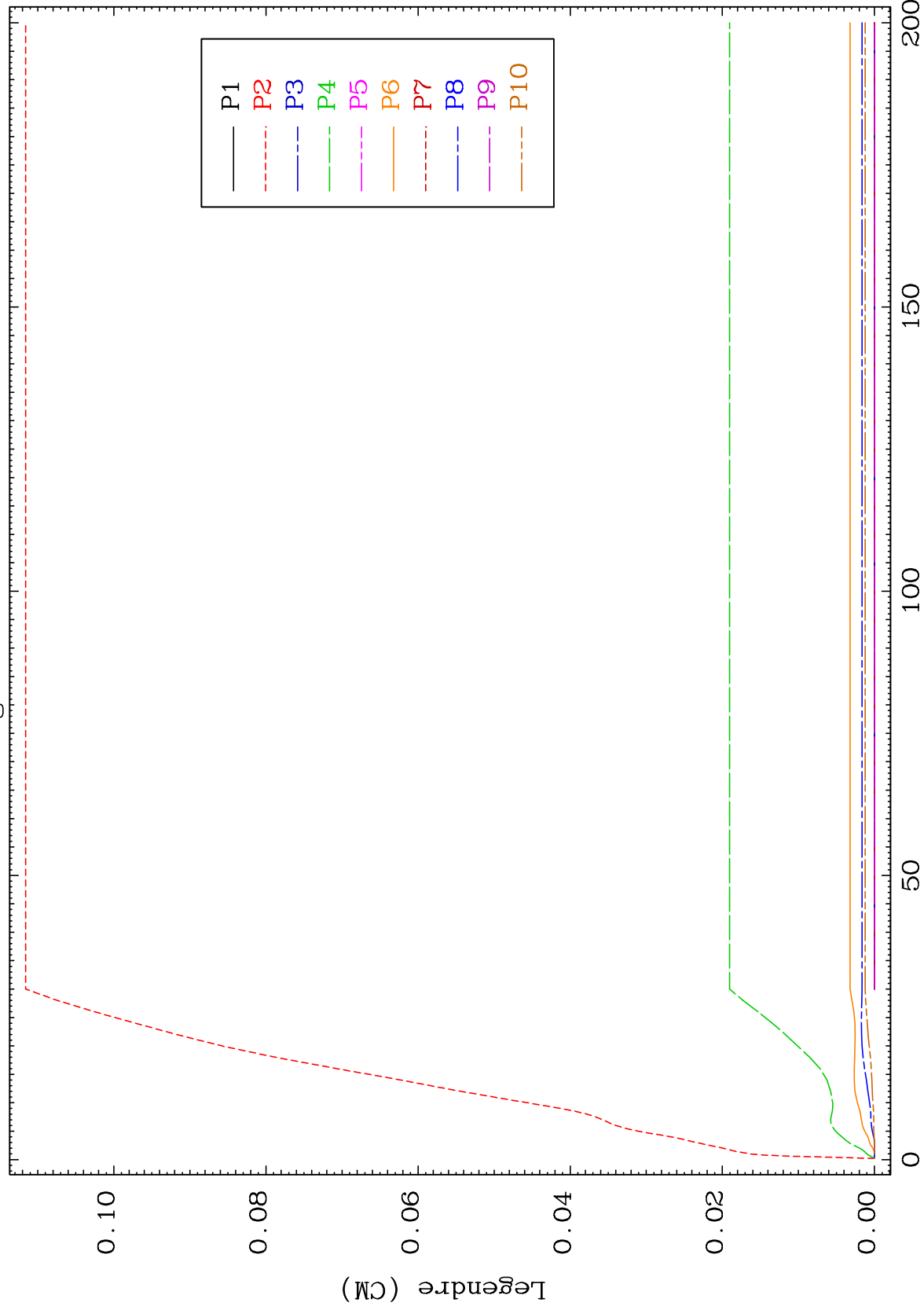

68

Incident Energy (MeV)

77-Ir-182

MAT 7698

MT= 65 (n,n') Level
Legendre Coefficients

77-Ir-182

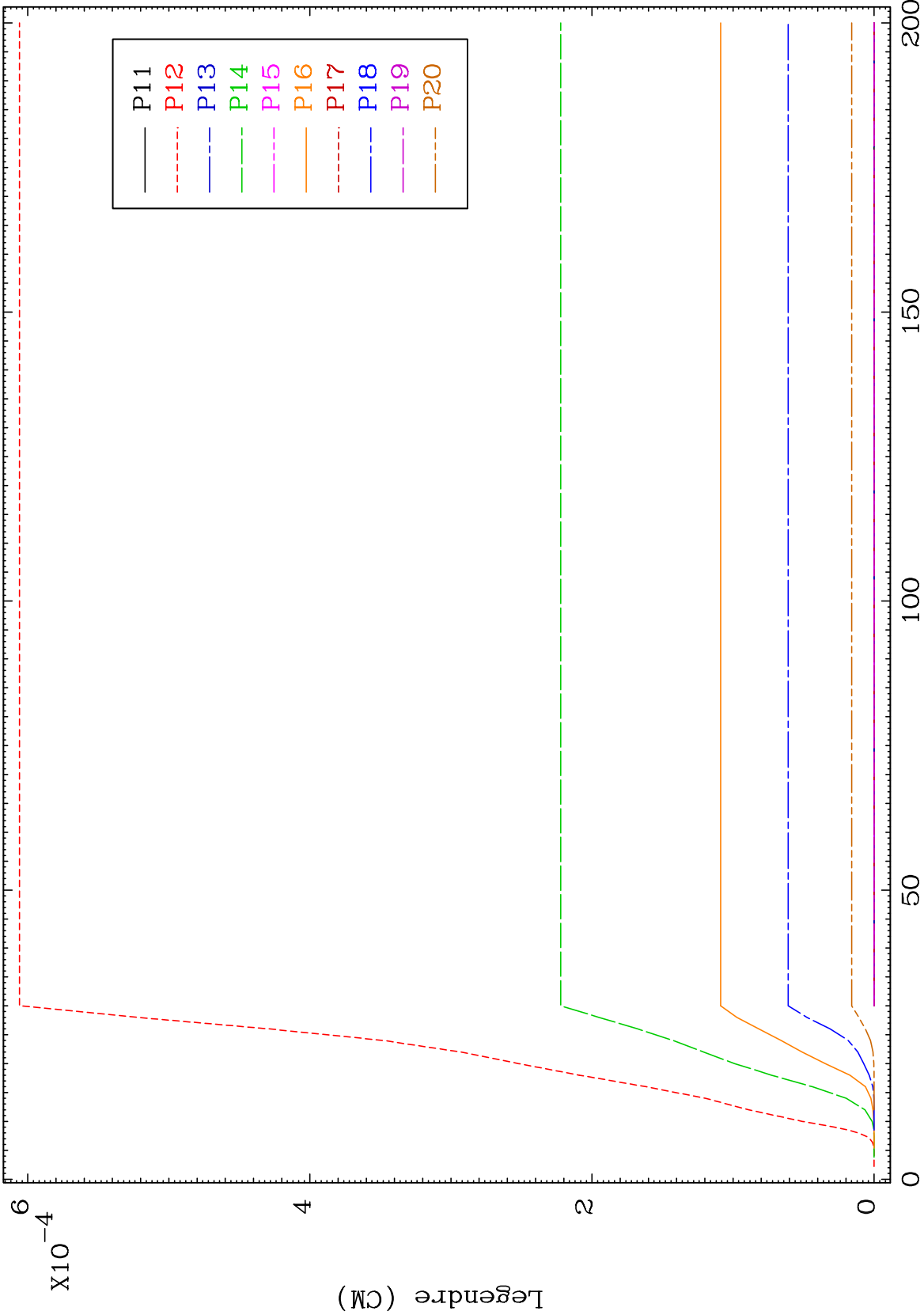

69

Incident Energy (MeV)

77-Ir-182

MAT 7698

MT= 65 (n,n') Level
Legendre Coefficients

77-Ir-182

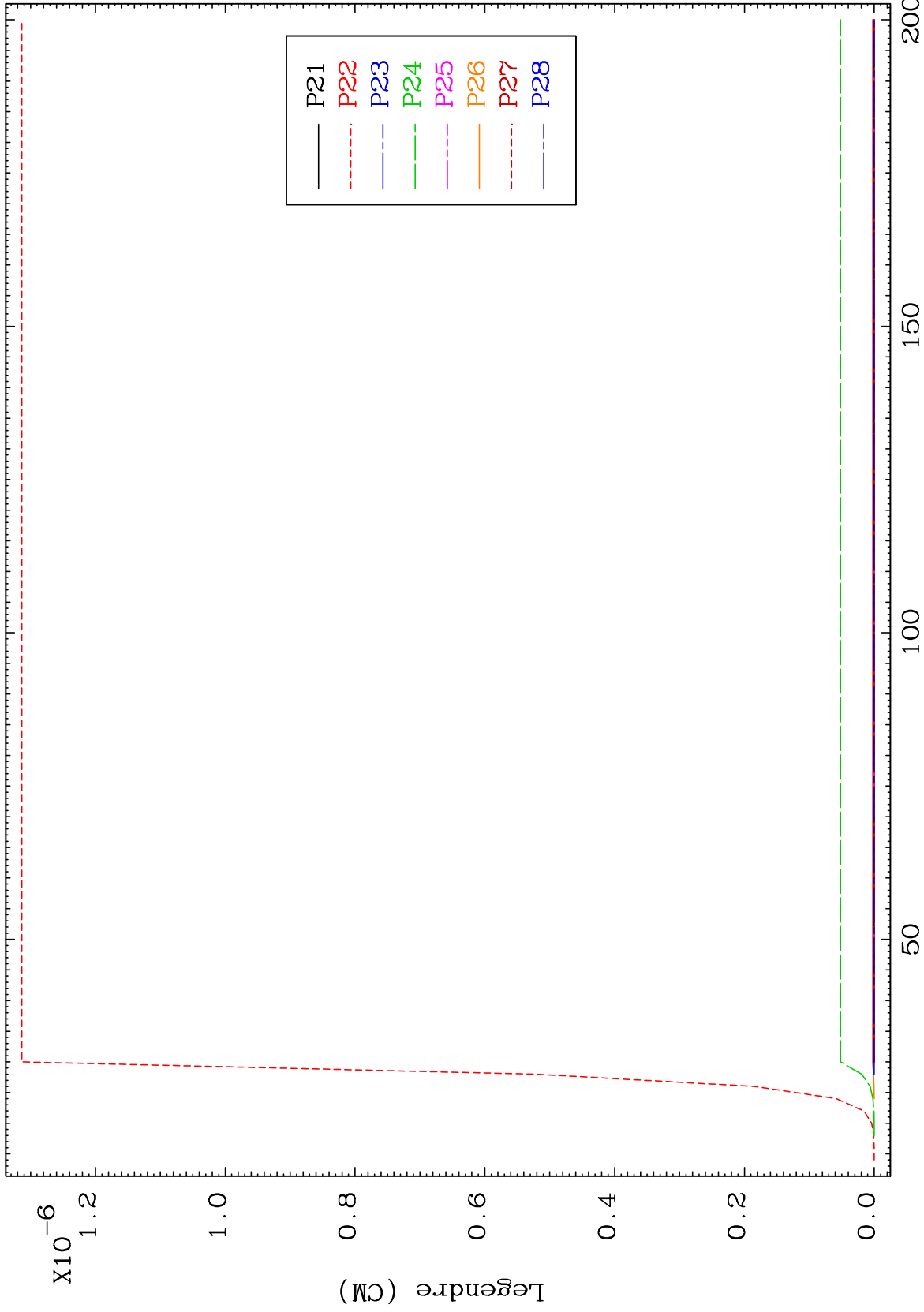

70

Incident Energy (MeV)

77-Ir-182

MAT 7698

MT= 66 (n,n') Level
Legendre Coefficients

77-Ir-182

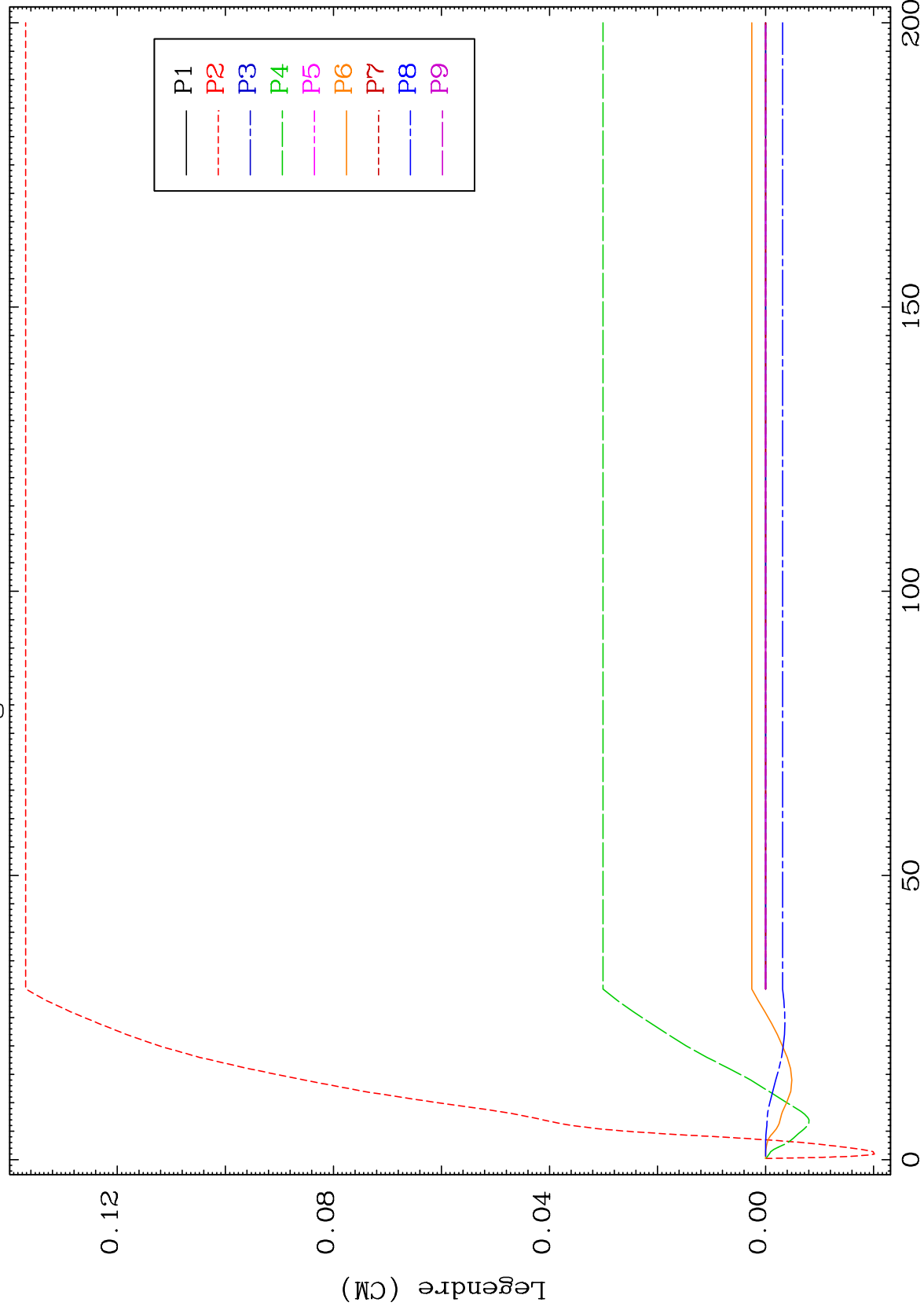

71

Incident Energy (MeV)

77-Ir-182

MAT 7698

MT= 66 (n,n') Level
Legendre Coefficients

77-Ir-182

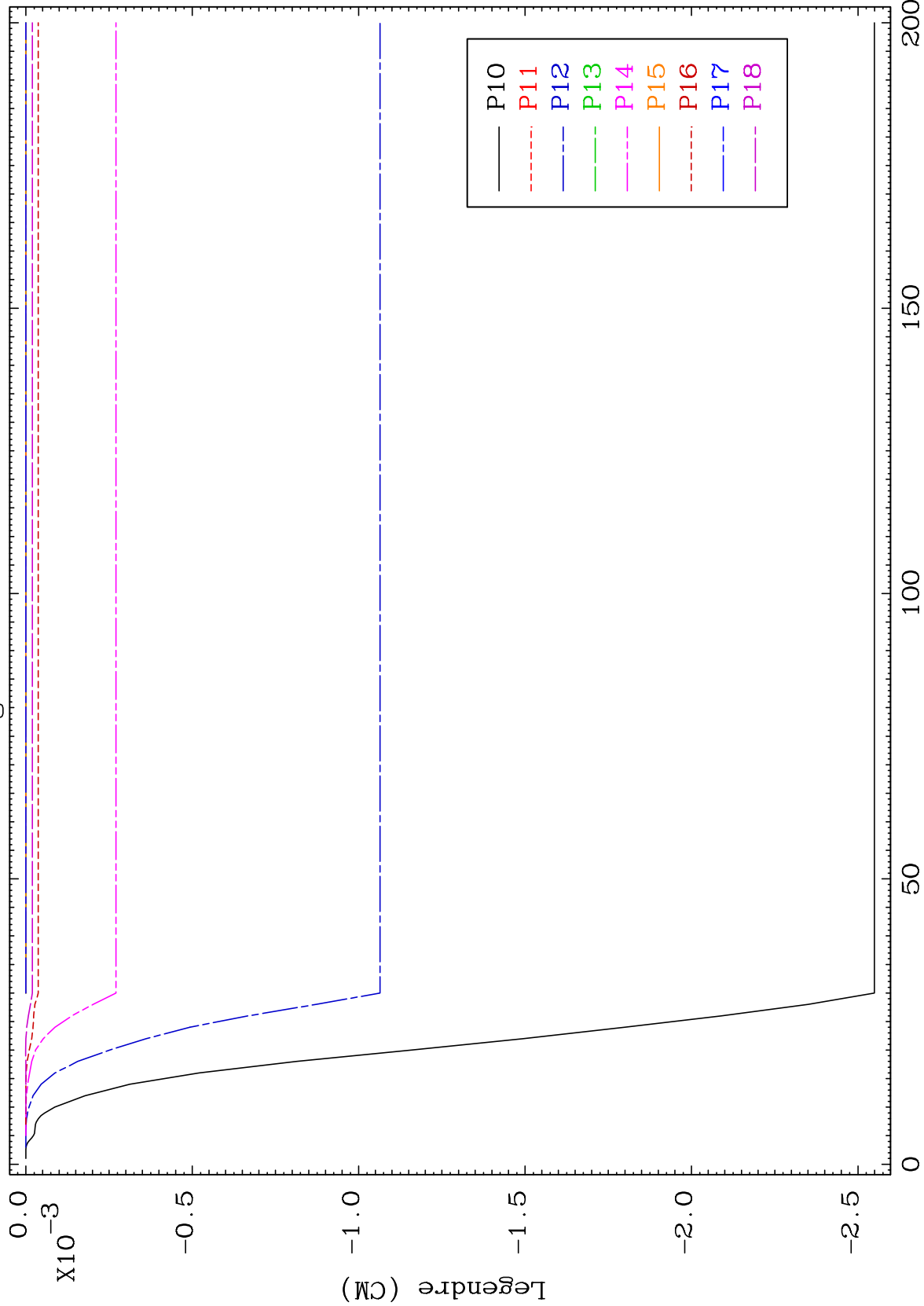

72

Incident Energy (MeV)

77-Ir-182

MAT 7698

MT= 66 (n,n') Level
Legendre Coefficients

77-Ir-182

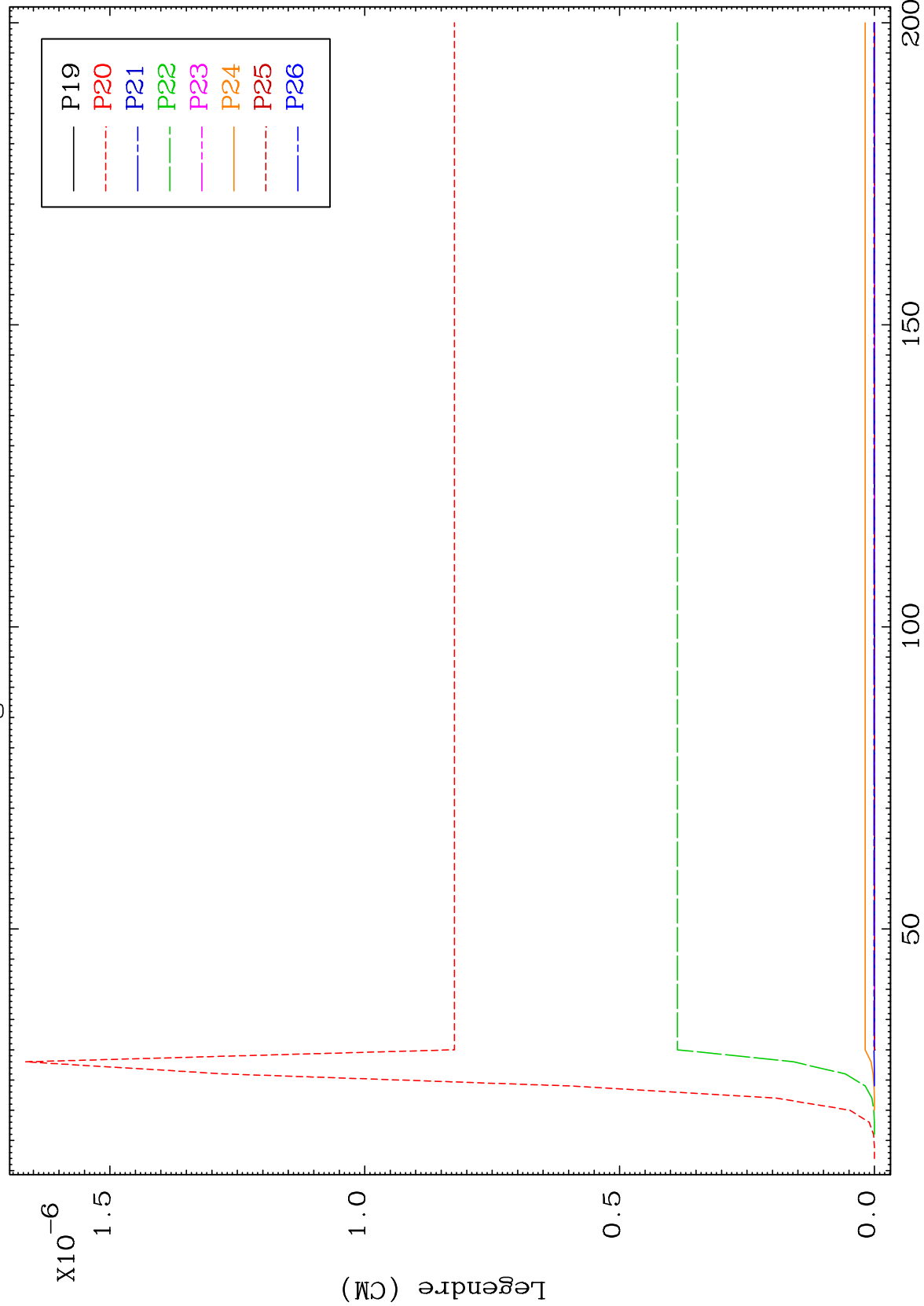

73

Incident Energy (MeV)

77-Ir-182

MAT 7698

MT= 67 (n,n') Level
Legendre Coefficients

77-Ir-182

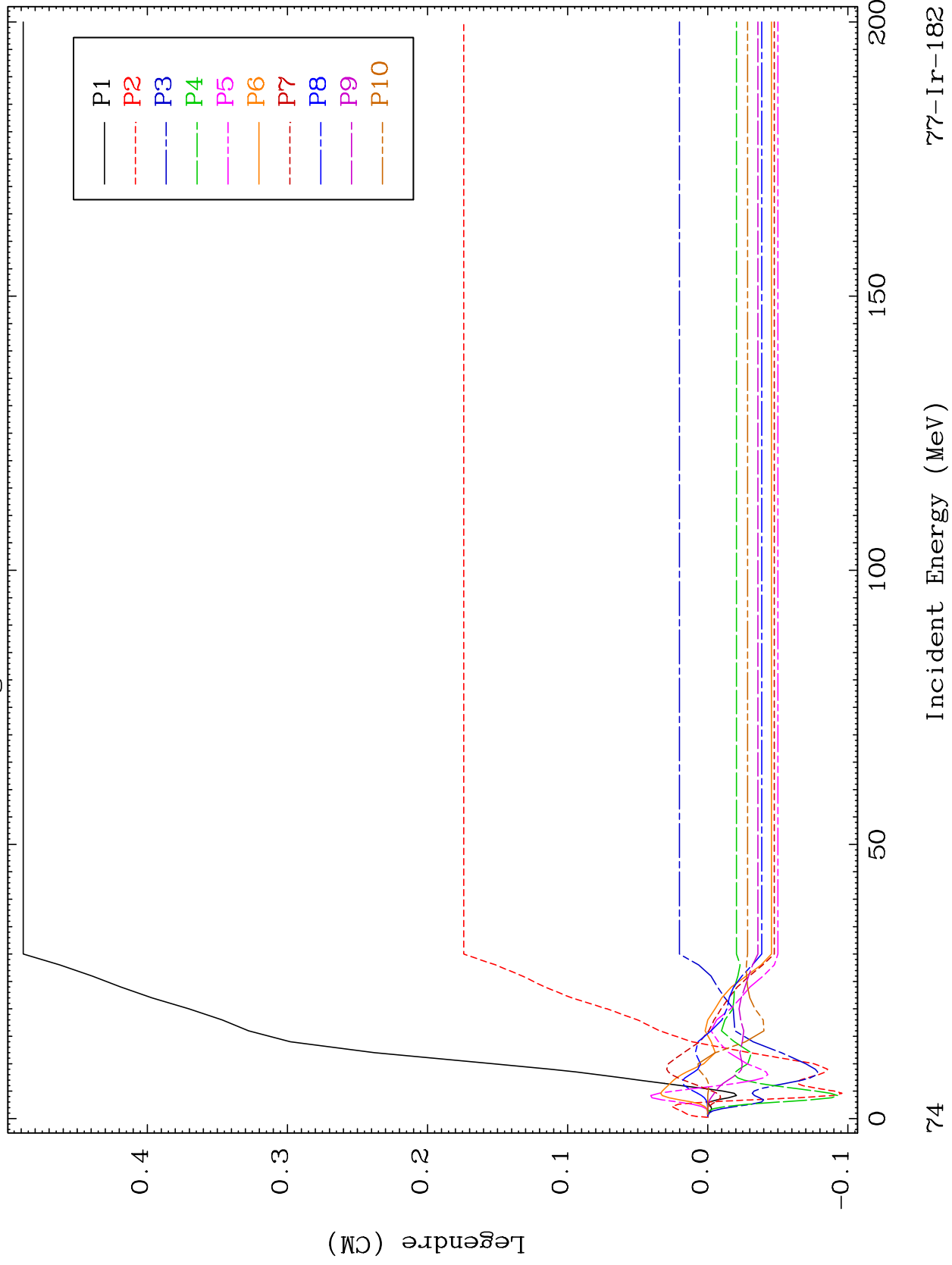

77-Ir-182

Incident Energy (MeV)

74

MAT 7698

MT= 67 (n,n') Level
Legendre Coefficients

77-Ir-182

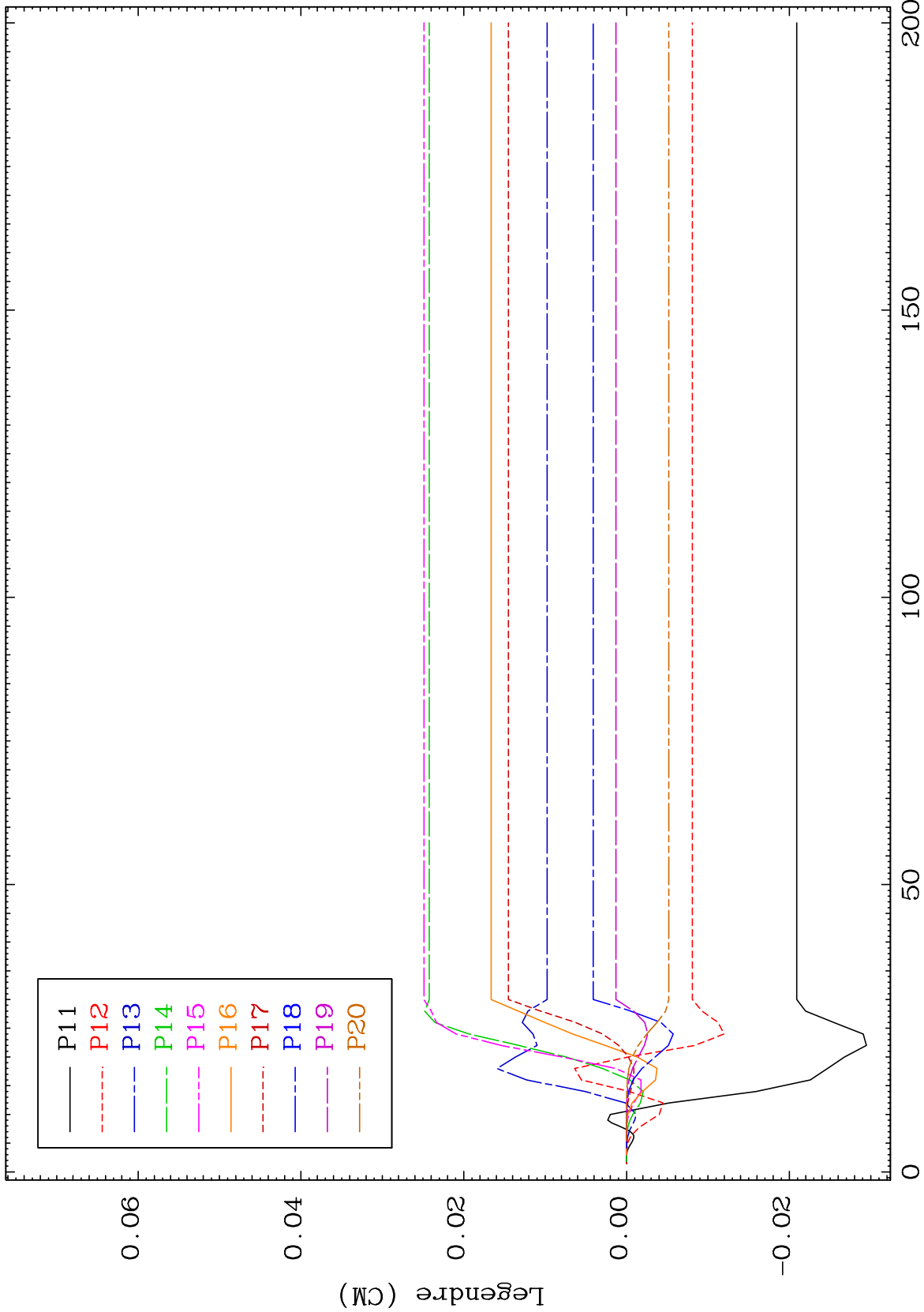

75

Incident Energy (MeV)

77-Ir-182

MAT 7698

MT= 67 (n,n') Level
Legendre Coefficients

77-Ir-182

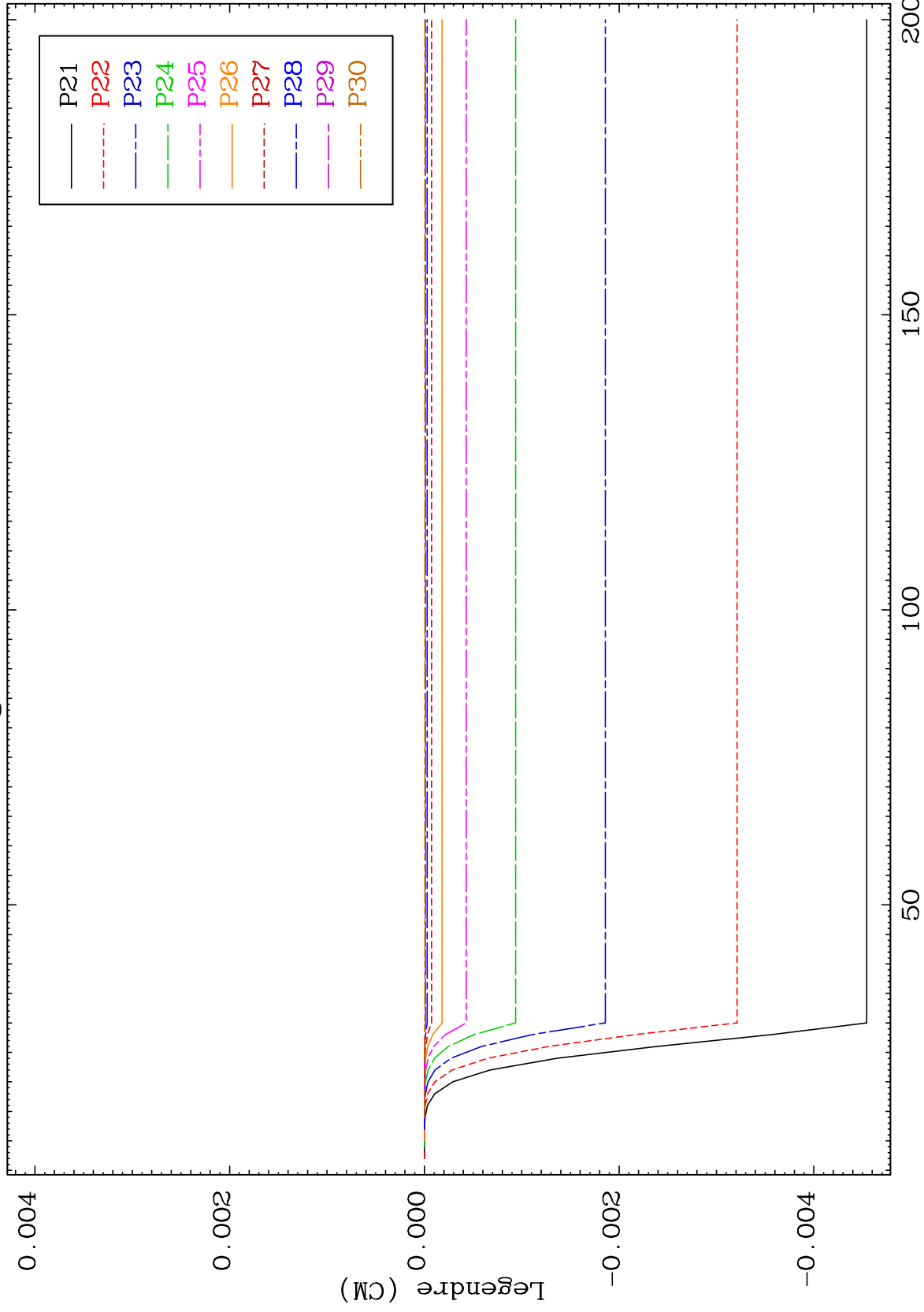

76

Incident Energy (MeV)

77-Ir-182

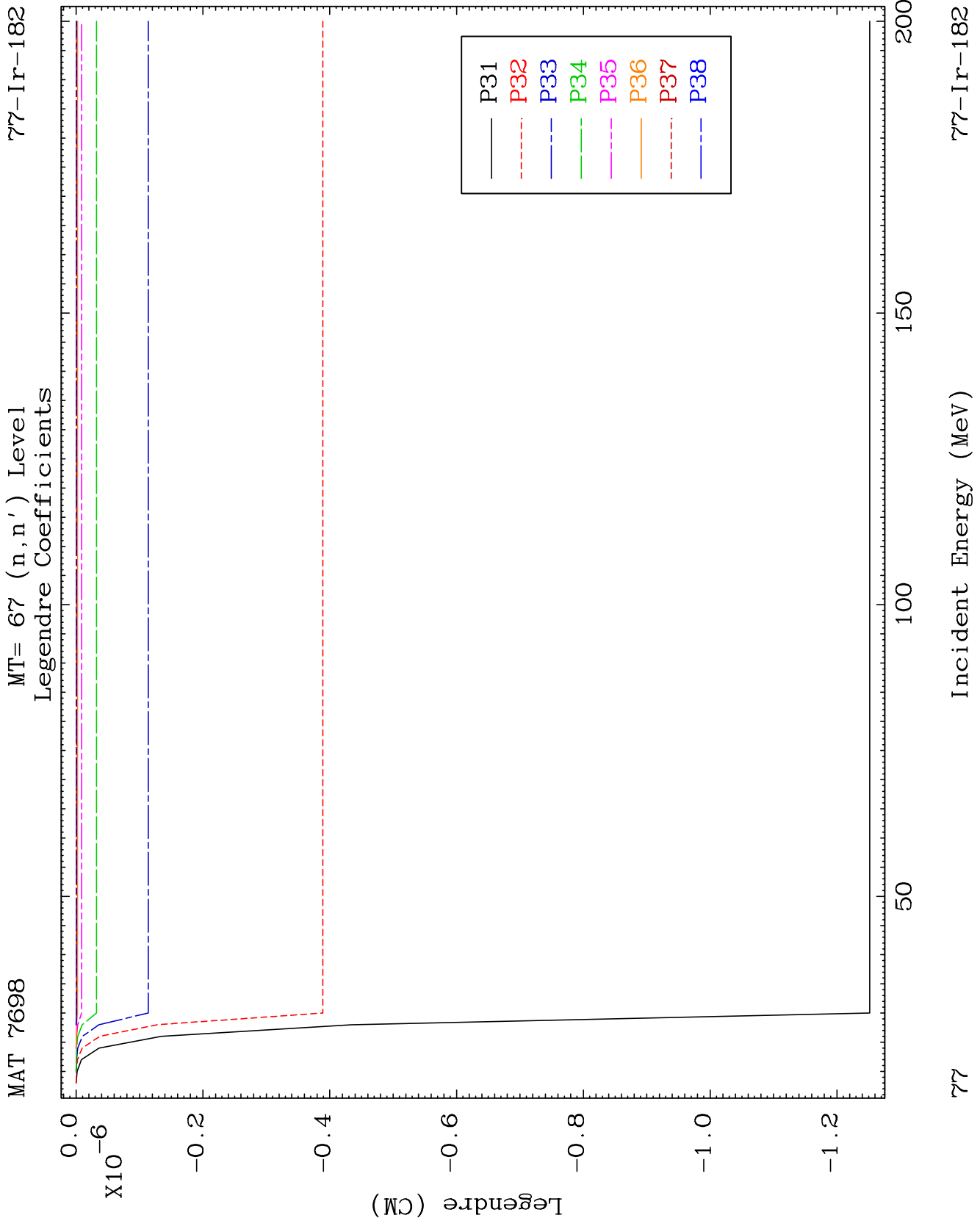

MAT 7698

MT= 68 (n,n') Level
Legendre Coefficients

77-Ir-182

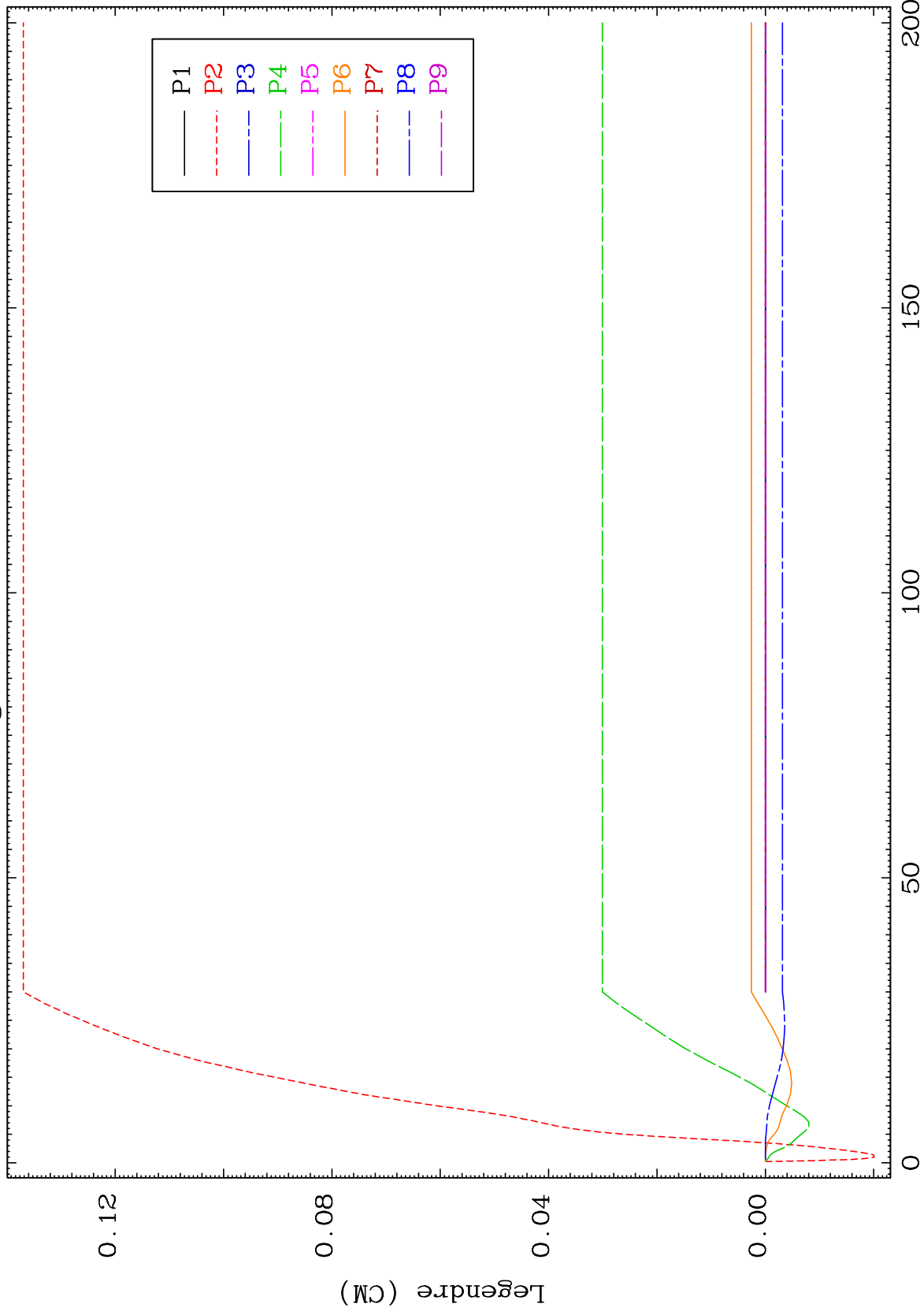

78

Incident Energy (MeV)

77-Ir-182

MAT 7698

MT= 68 (n,n') Level

77-Ir-182

Legendre Coefficients

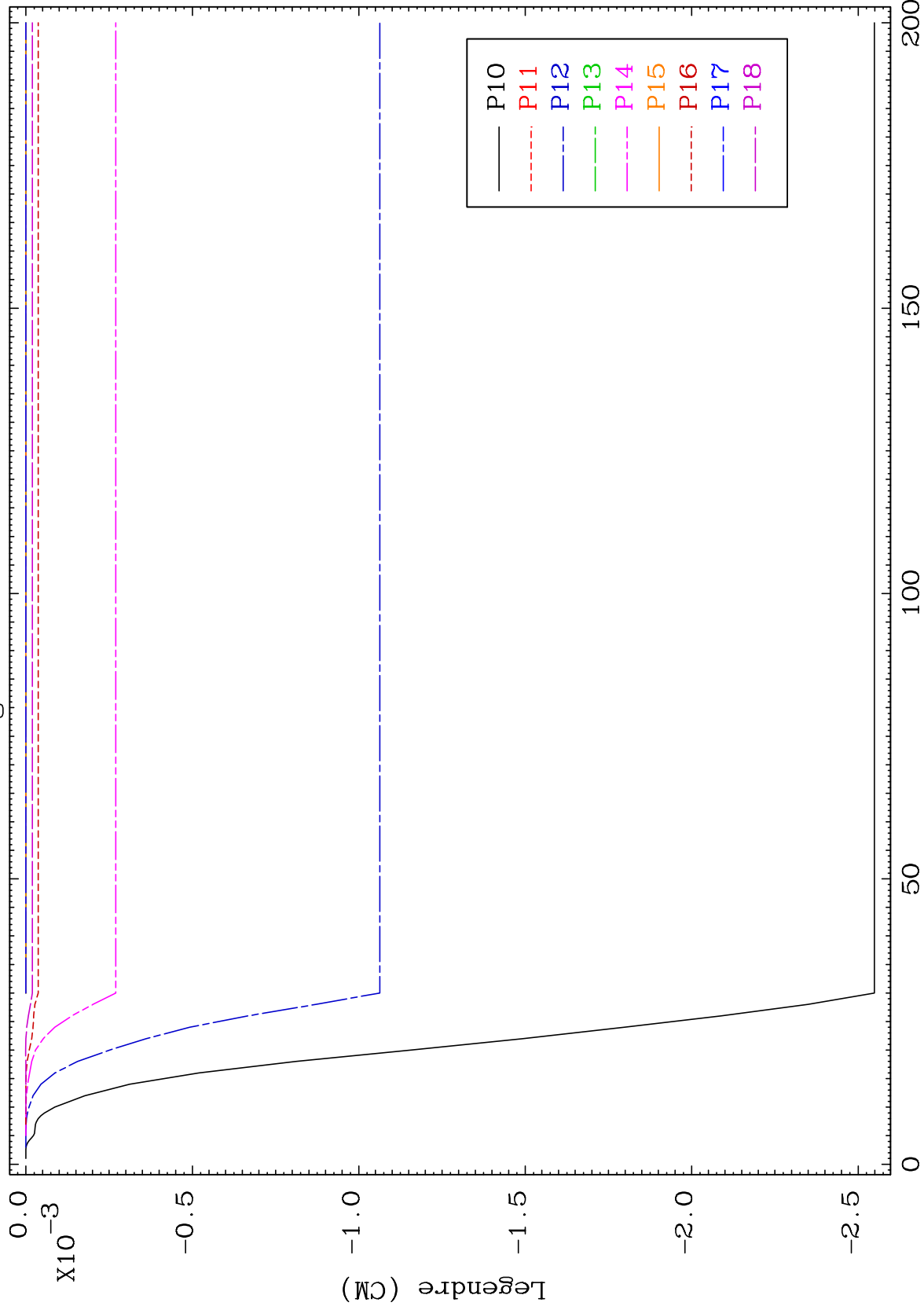

79

Incident Energy (MeV)

77-Ir-182

MAT 7698

MT= 68 (n,n') Level
Legendre Coefficients

77-Ir-182

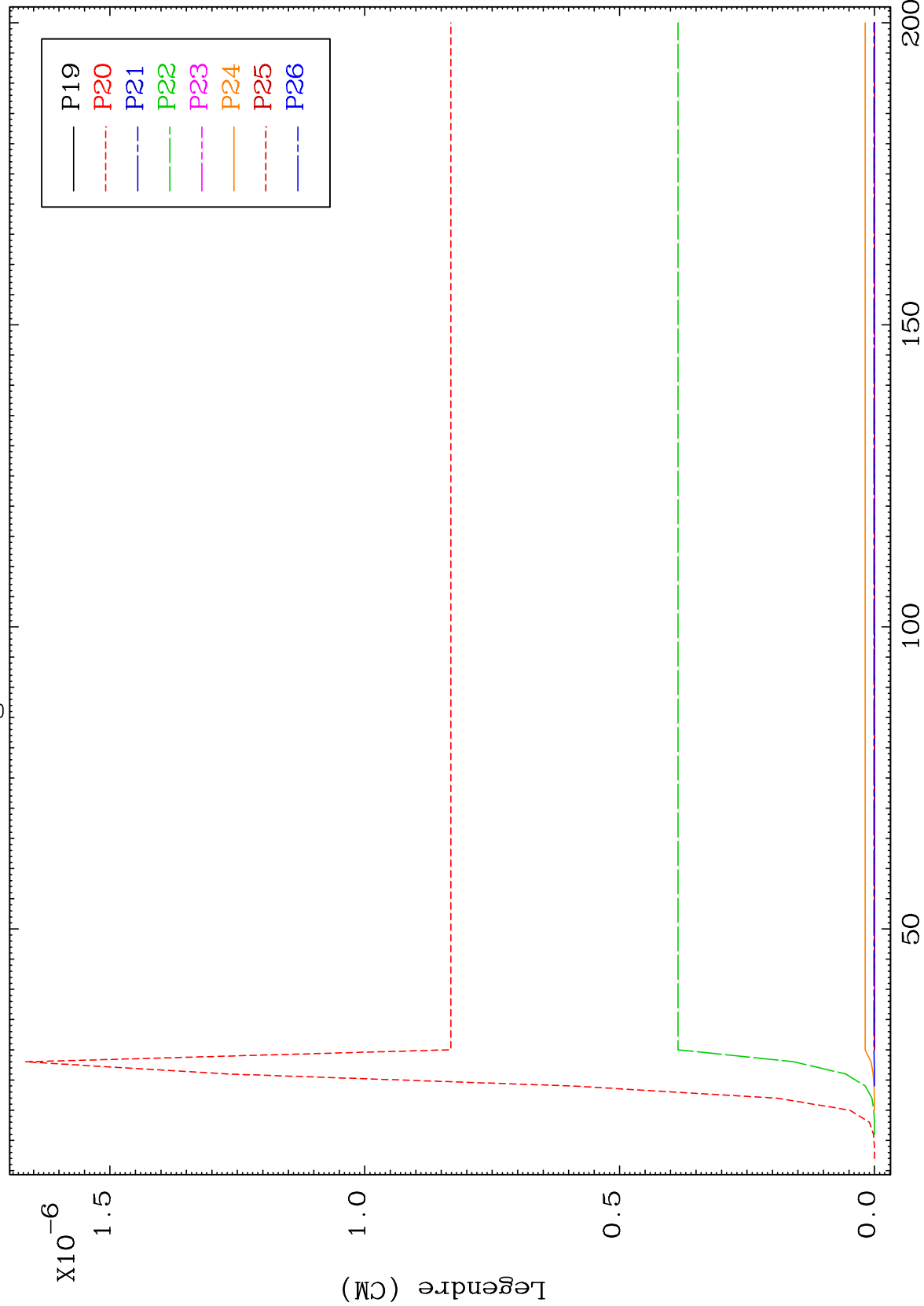

80

Incident Energy (MeV)

77-Ir-182

MAT 7698

MT= 69 (n,n') Level
Legendre Coefficients

77-Ir-182

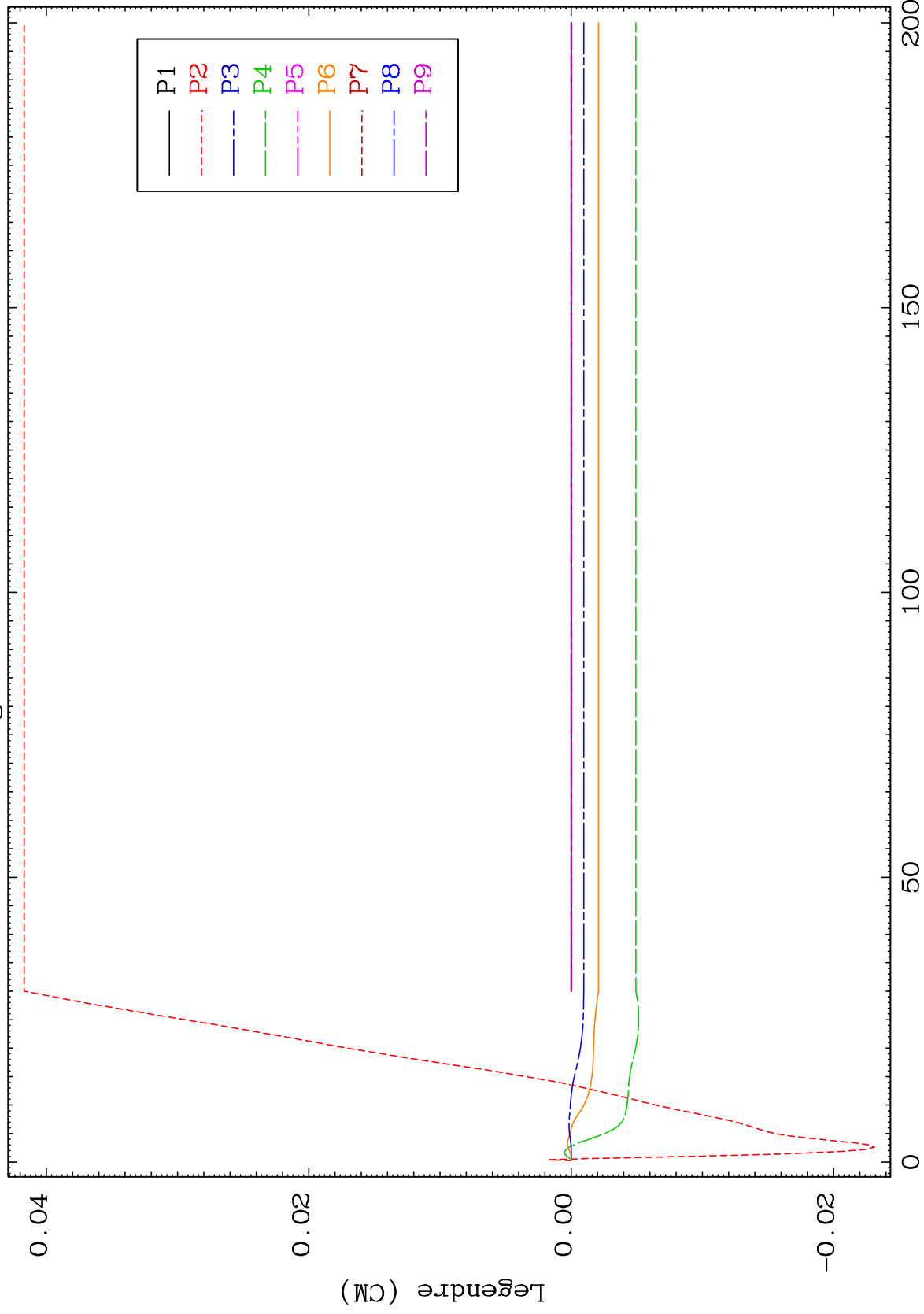

81

Incident Energy (MeV)

77-Ir-182

MAT 7698

MT= 69 (n,n') Level
Legendre Coefficients

77-Ir-182

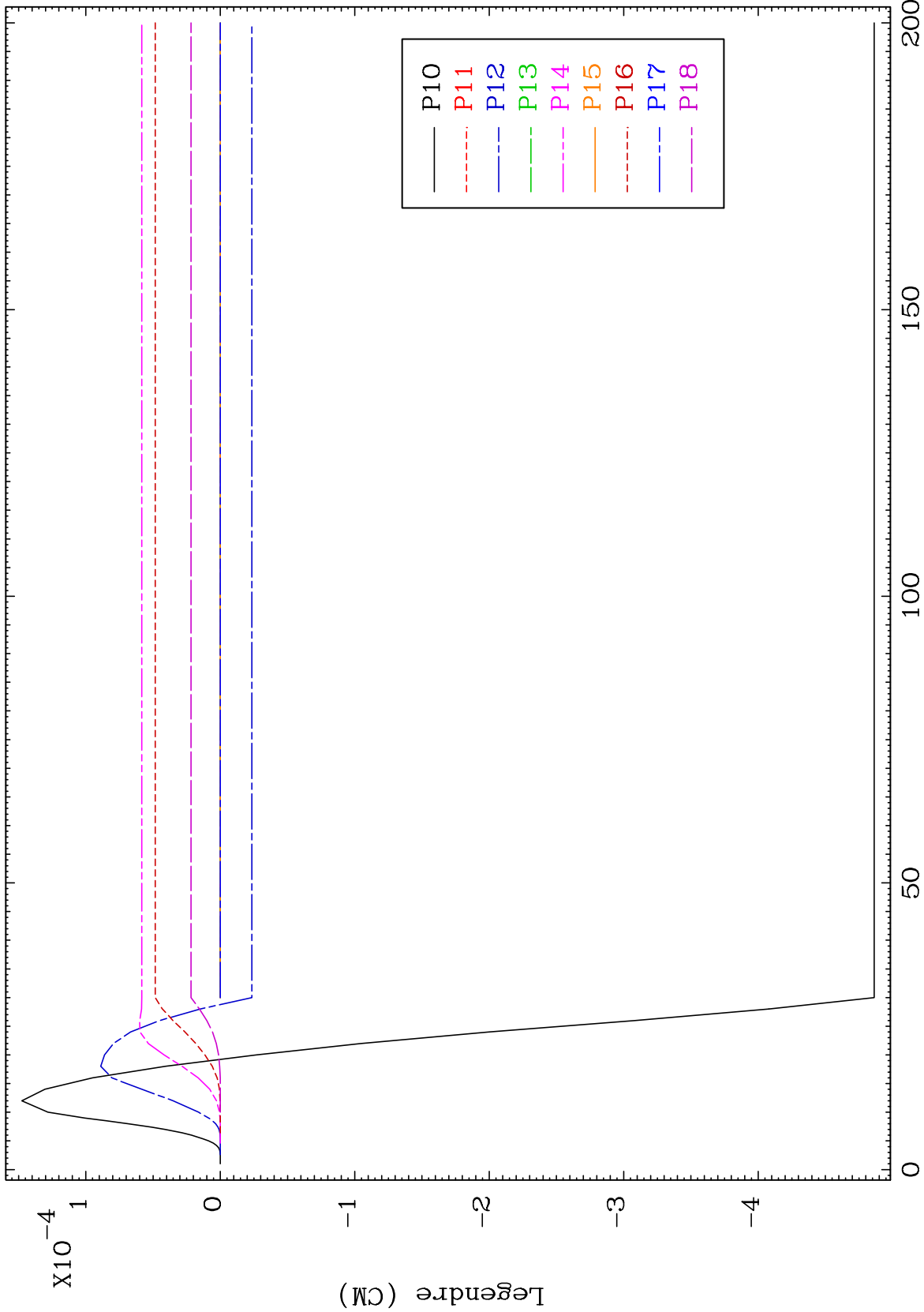

82

Incident Energy (MeV)

77-Ir-182

MAT 7698

MT= 69 (n,n') Level
Legendre Coefficients

77-Ir-182

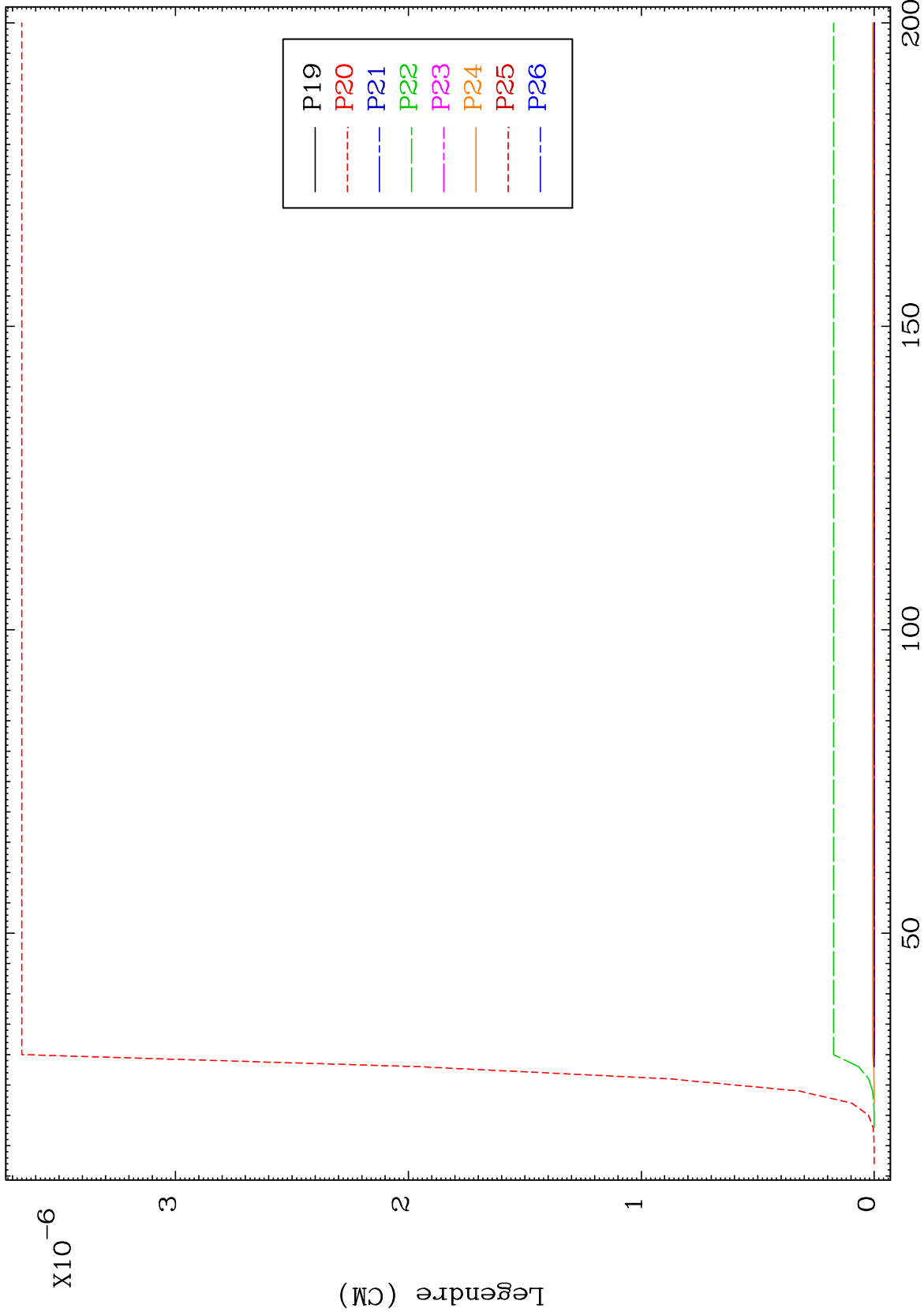

83

Incident Energy (MeV)

77-Ir-182

MAT 7698

MT= 70 (n,n') Level
Legendre Coefficients

77-Ir-182

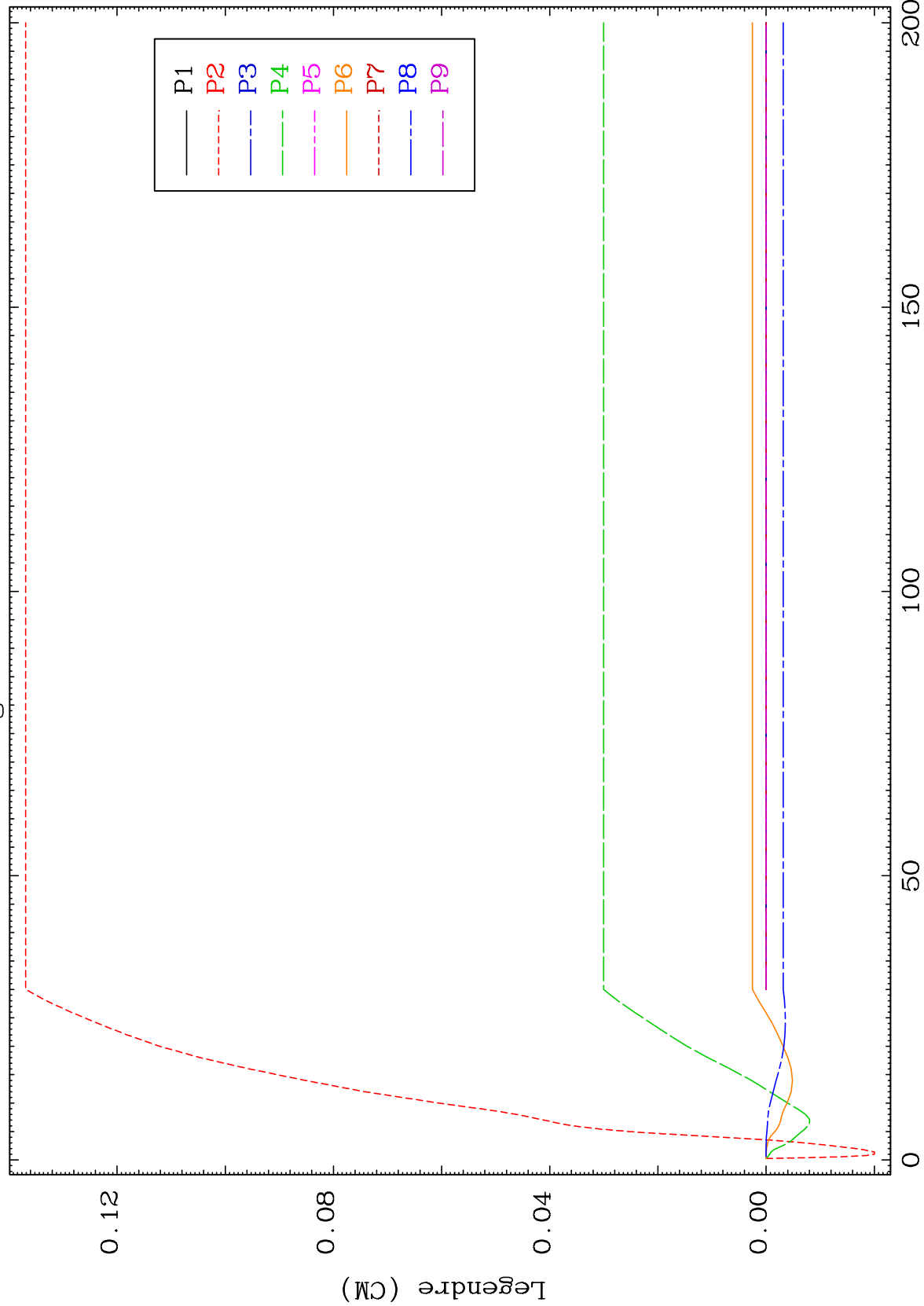

84

Incident Energy (MeV)

77-Ir-182

MAT 7698

MT= 70 (n,n') Level
Legendre Coefficients

77-Ir-182

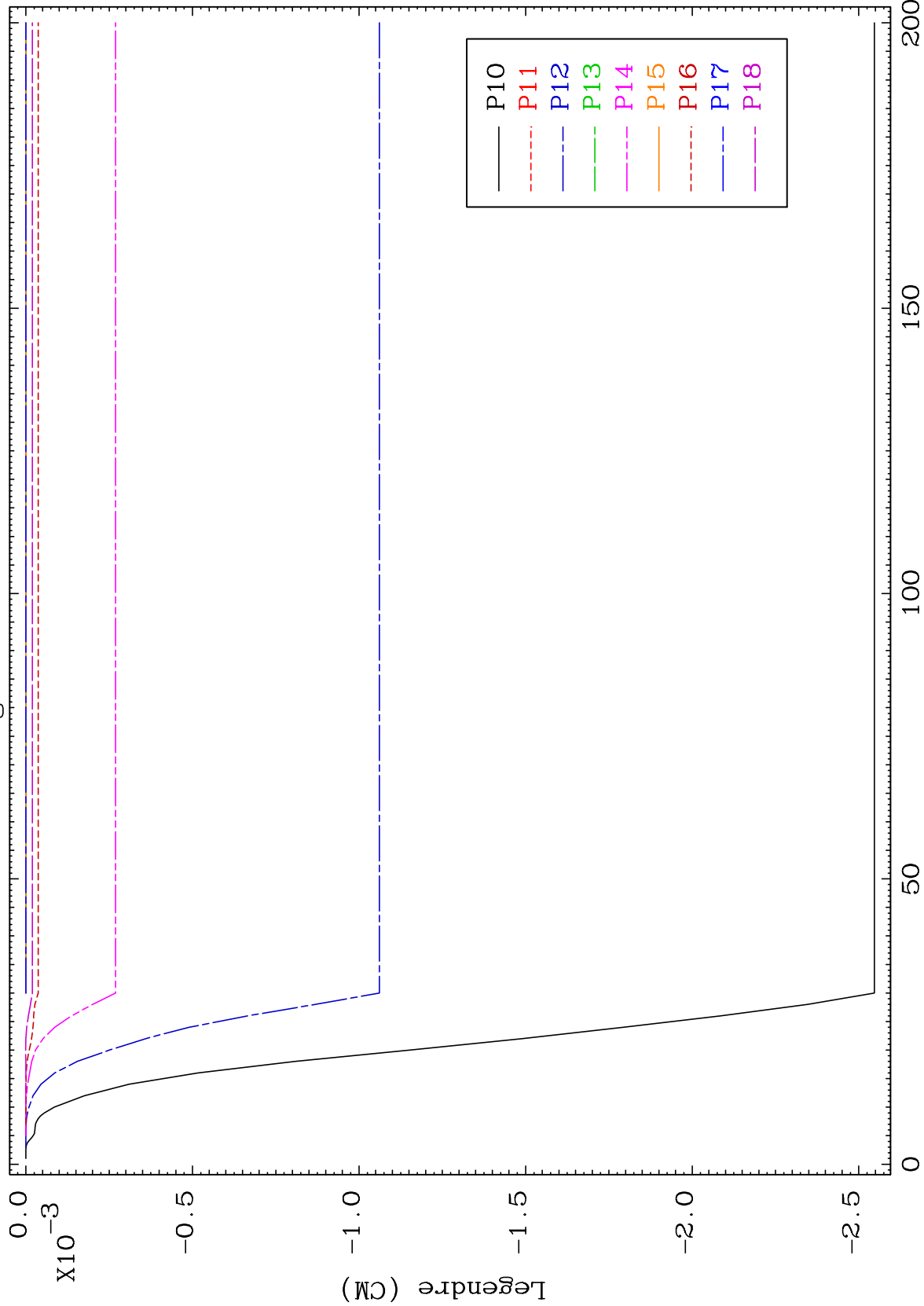

85

Incident Energy (MeV)

77-Ir-182

MAT 7698

MT= 70 (n,n') Level
Legendre Coefficients

77-Ir-182

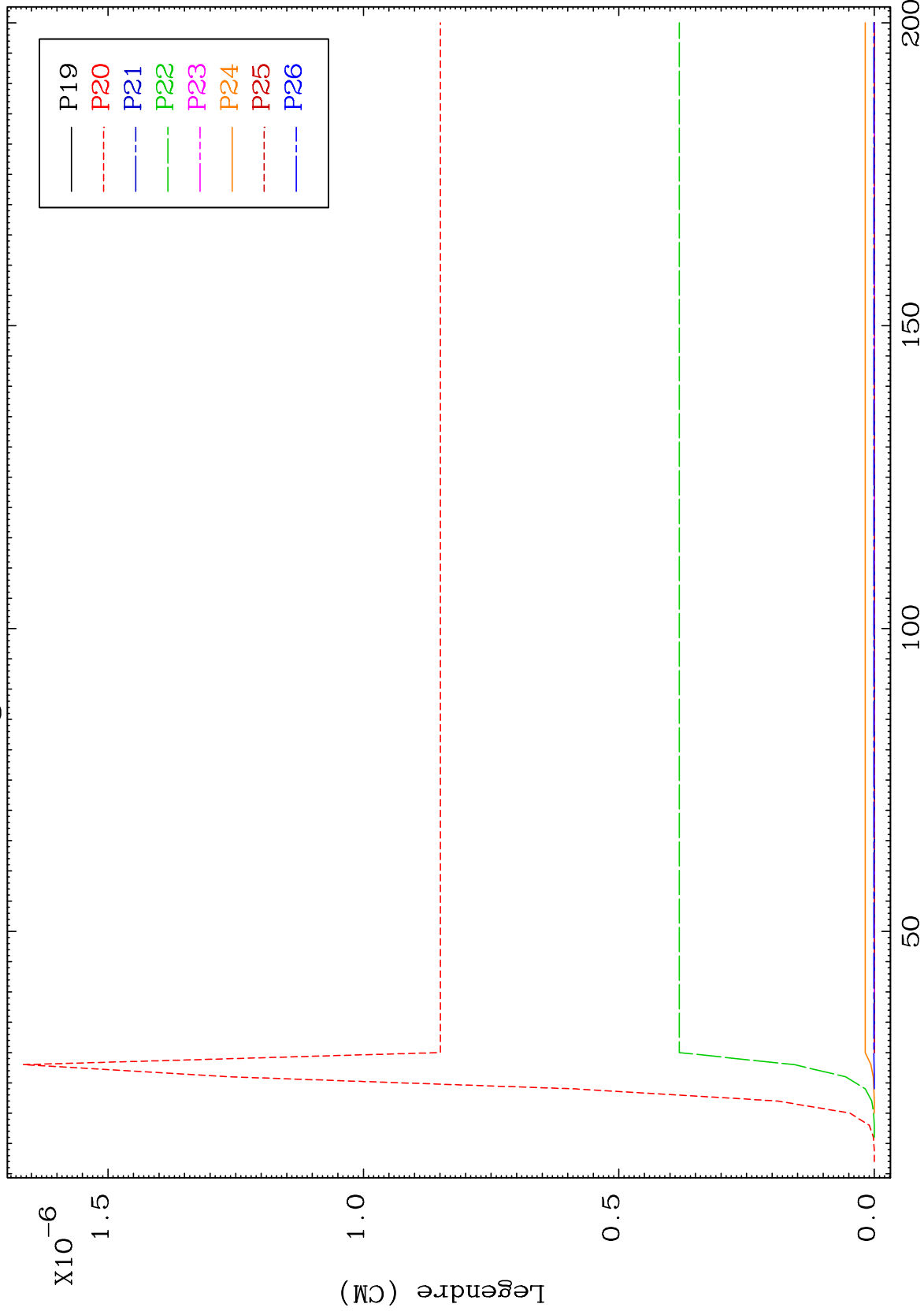

86

Incident Energy (MeV)

77-Ir-182

MAT 7698

MT= 71 (n,n') Level
Legendre Coefficients

77-Ir-182

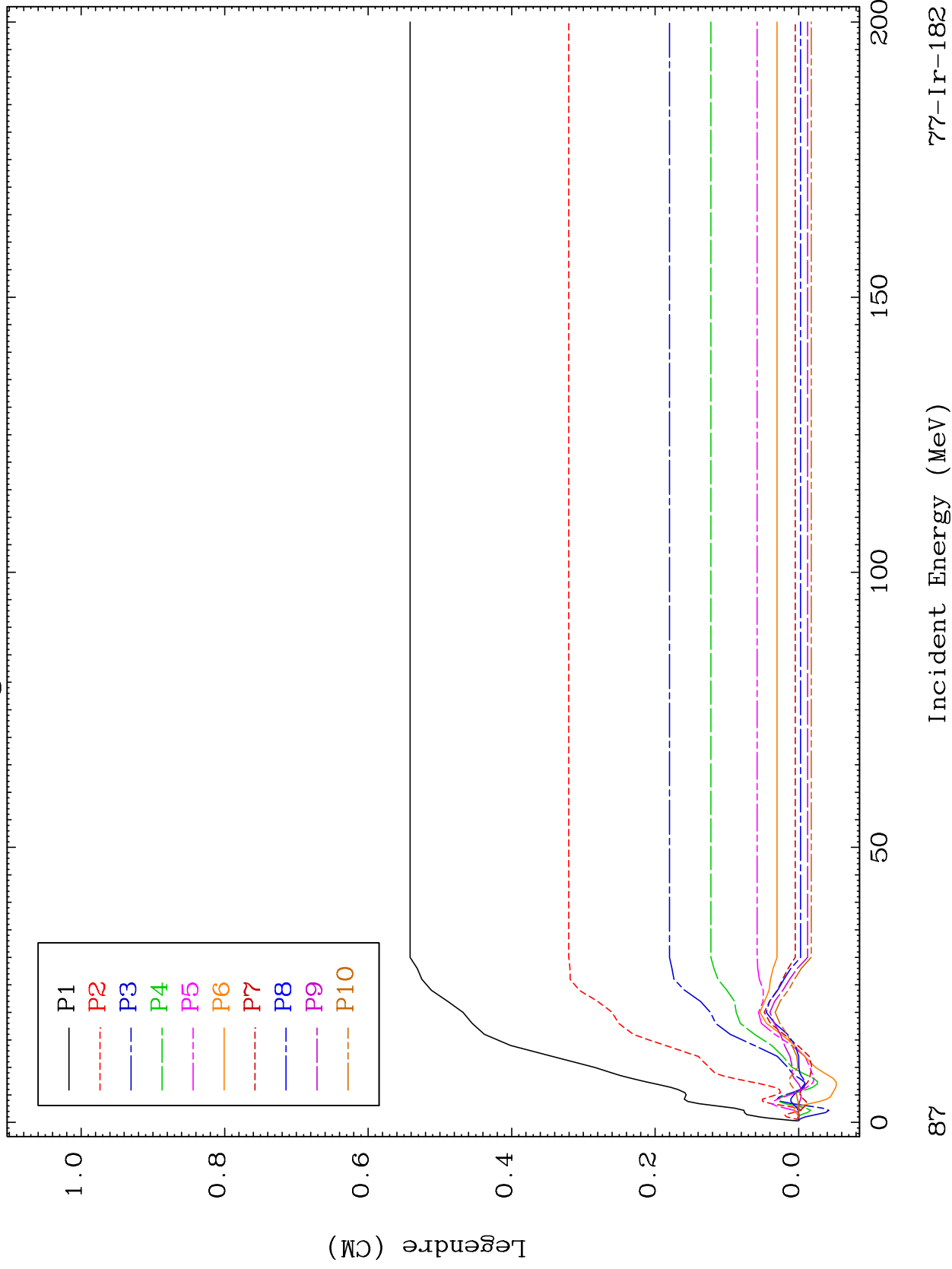

77-Ir-182

Incident Energy (MeV)

87

MAT 7698

MT= 71 (n,n') Level
Legendre Coefficients

77-Ir-182

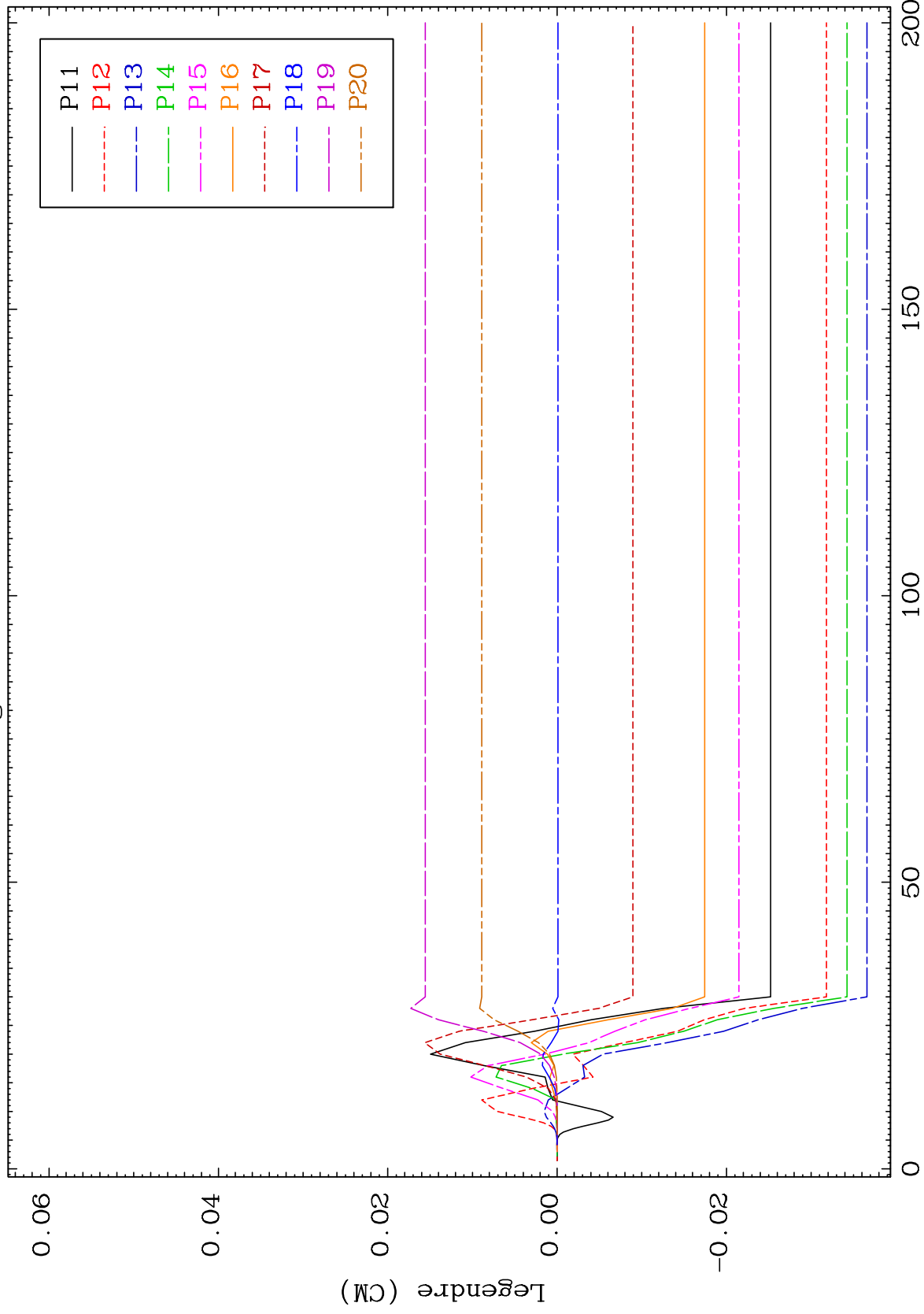

88

77-Ir-182

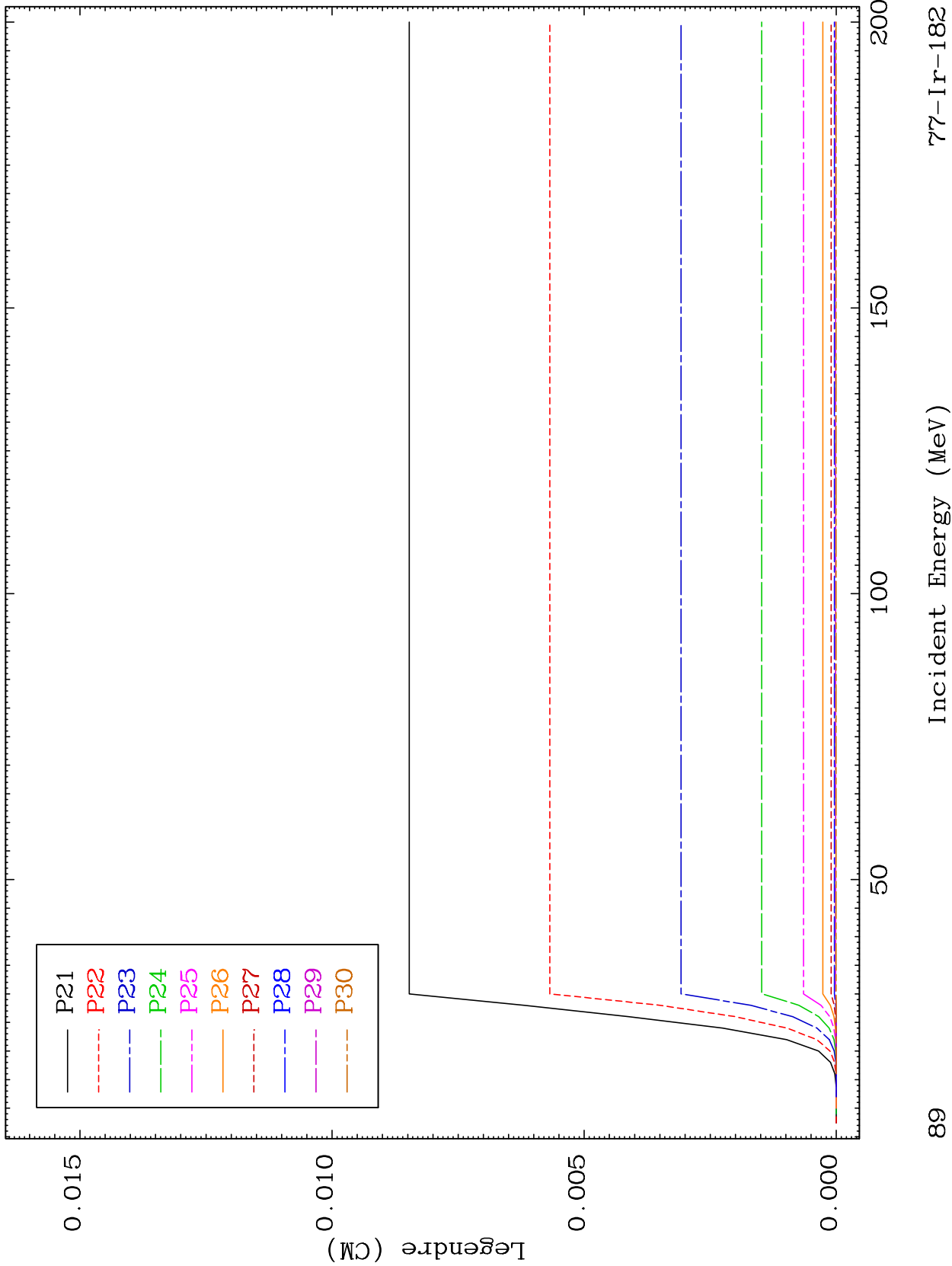

MAT 7698

MT= 71 (n,n') Level
Legendre Coefficients

77-Ir-182

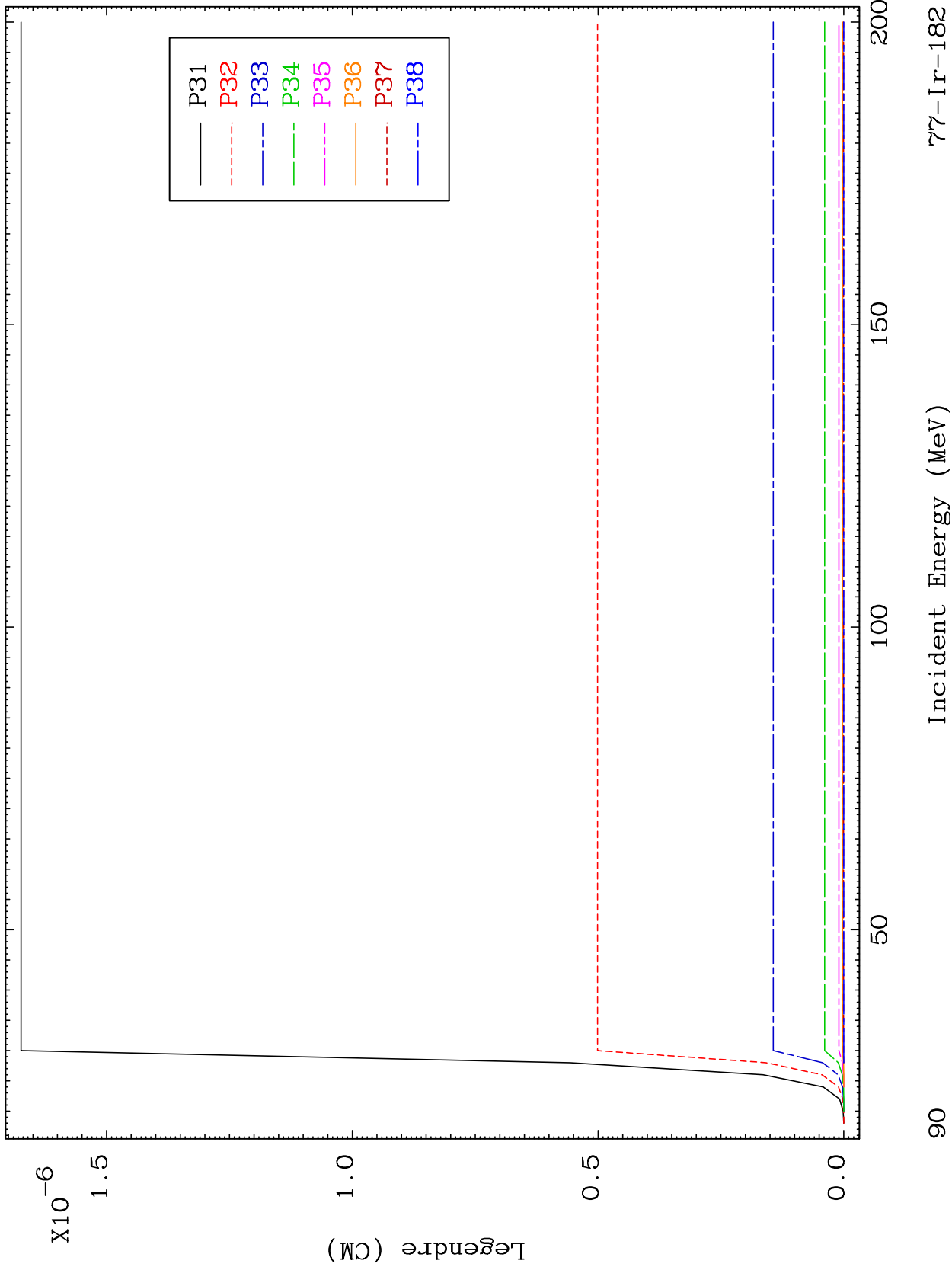

90

Incident Energy (MeV)

77-Ir-182

MAT 7698

MT= 72 (n,n') Level
Legendre Coefficients

77-Ir-182

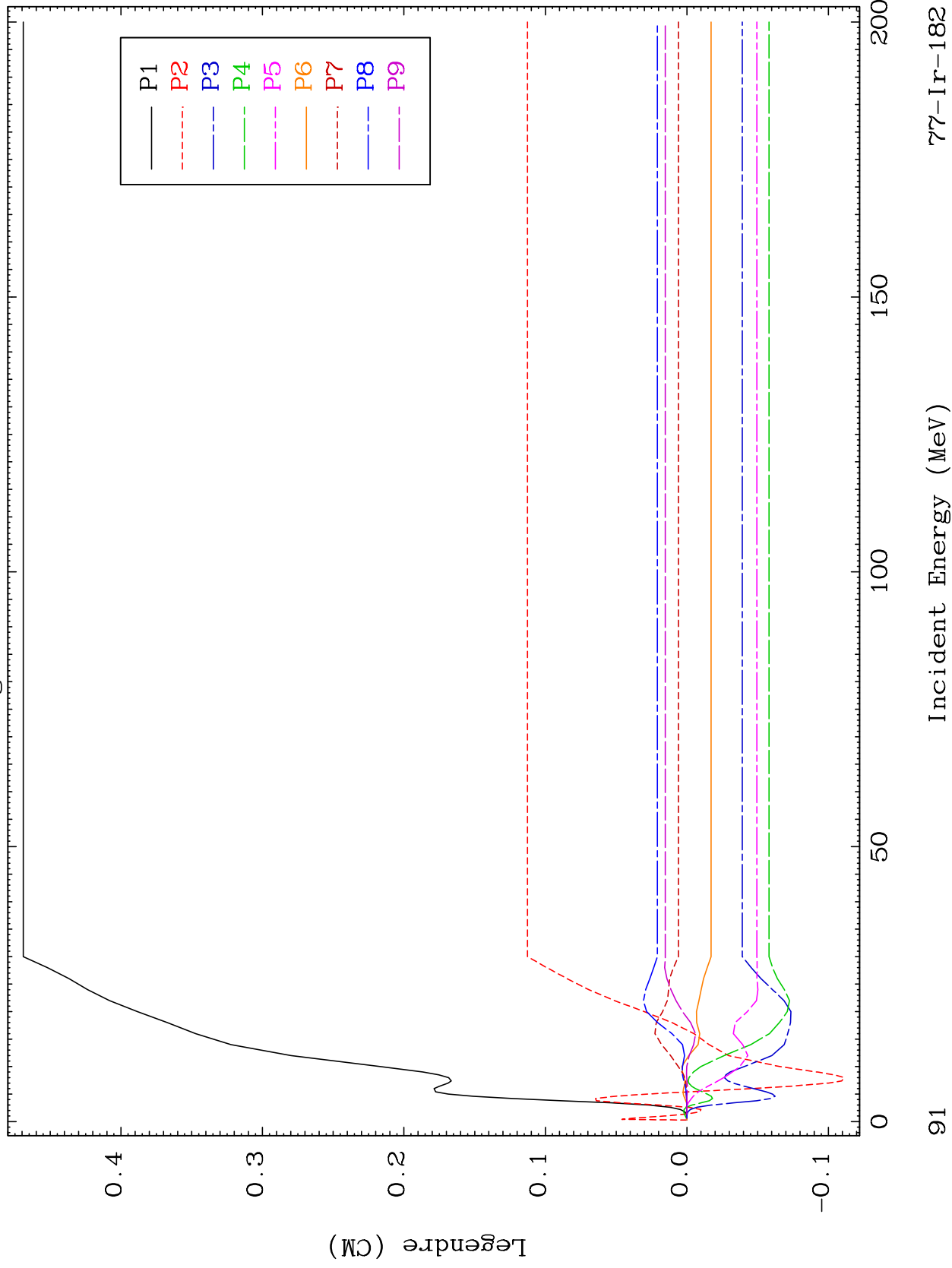

77-Ir-182

Incident Energy (MeV)

91

MAT 7698

MT= 72 (n,n') Level
Legendre Coefficients

77-Ir-182

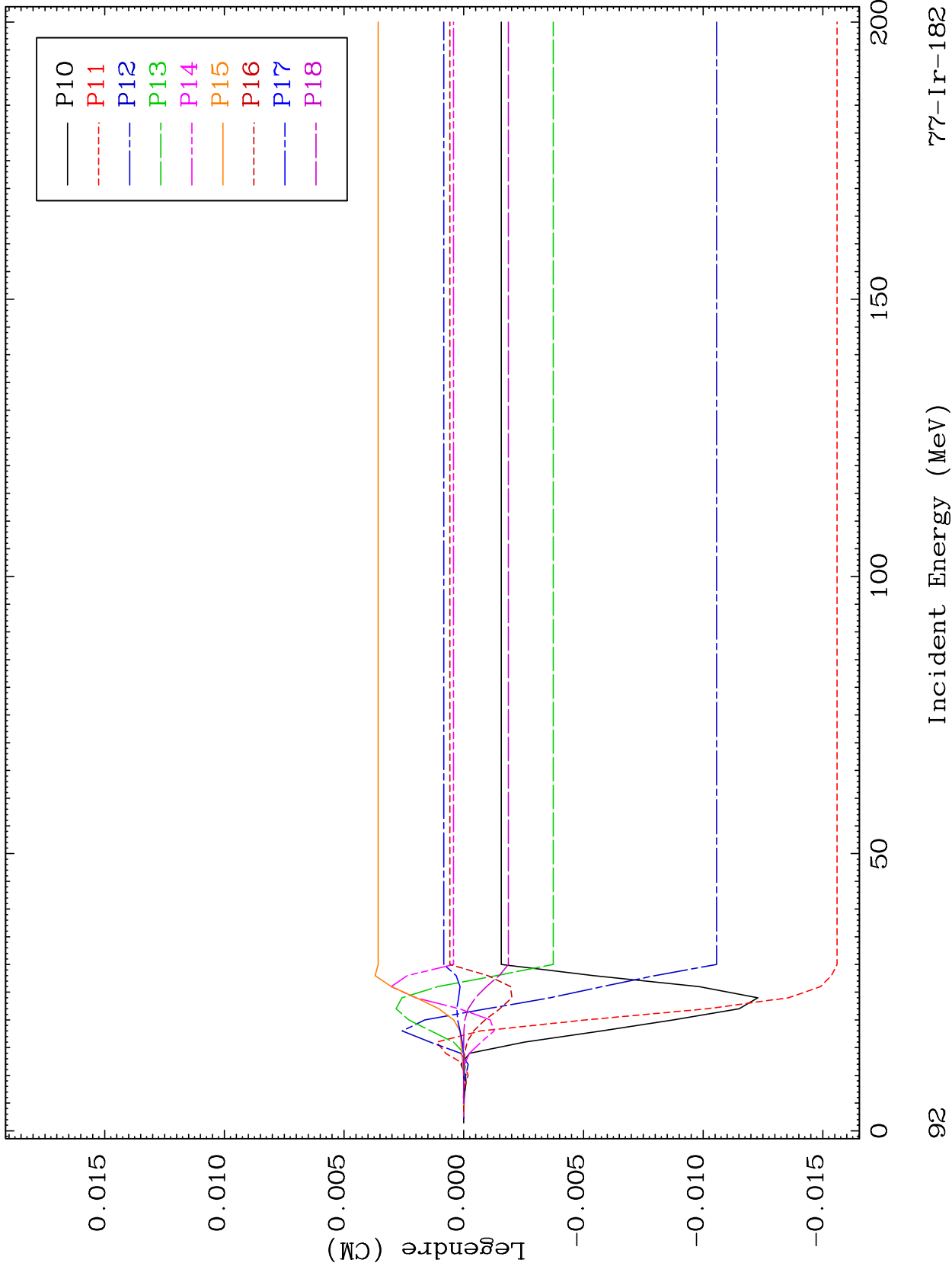

77-Ir-182

Incident Energy (MeV)

92

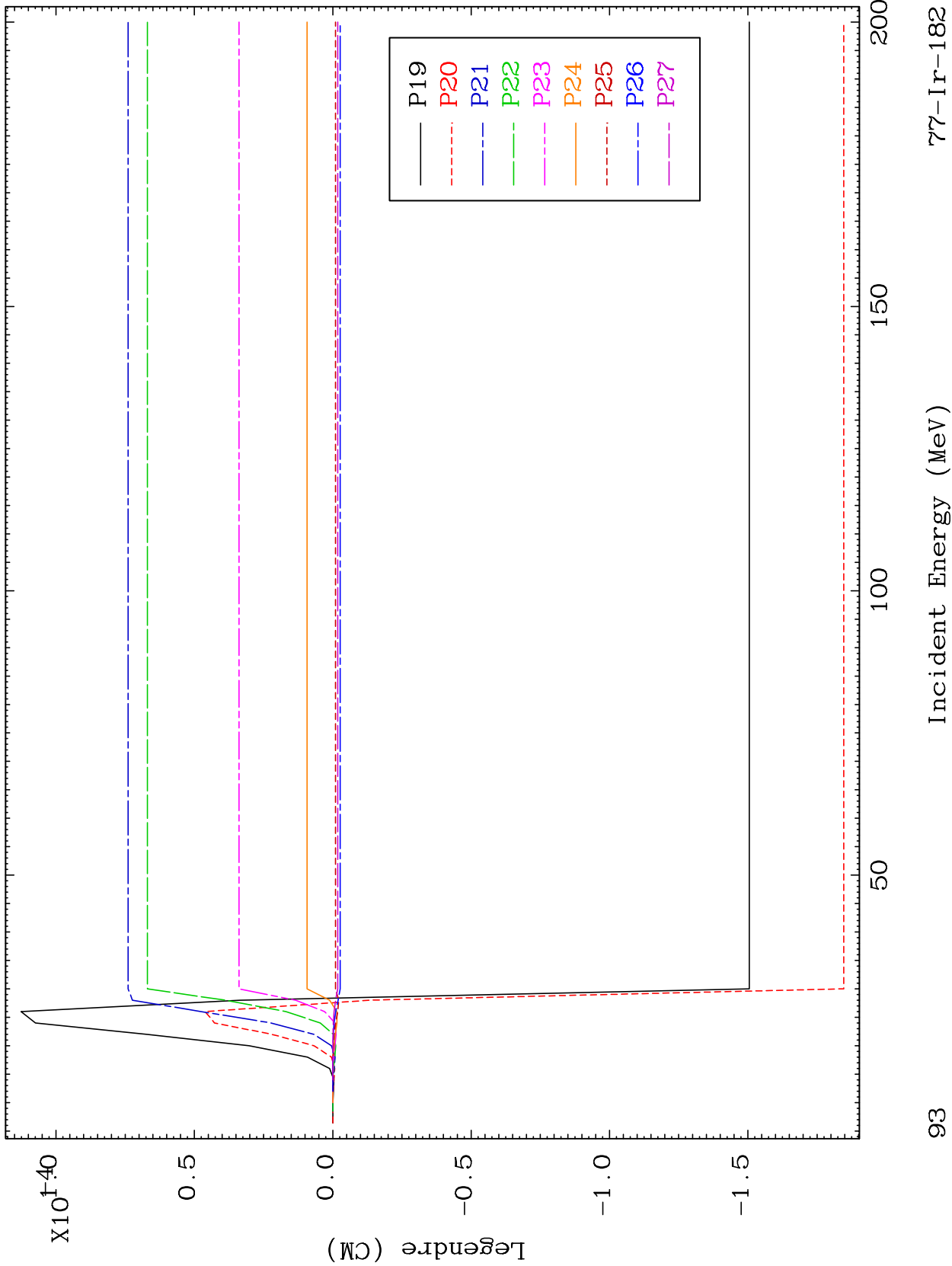

MAT 7698

MT= 72 (n,n') Level
Legendre Coefficients

77-Ir-182

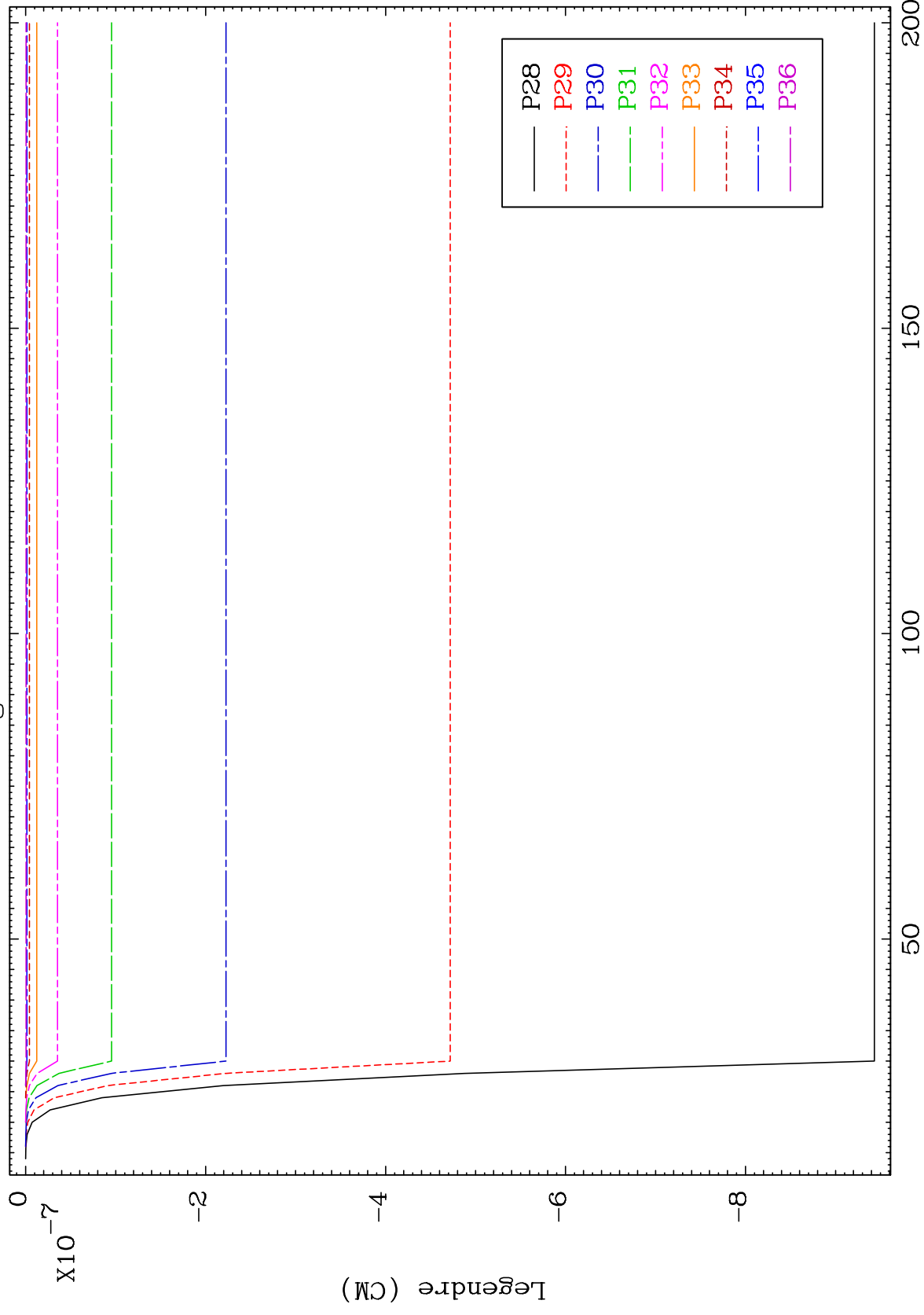

94

Incident Energy (MeV)

77-Ir-182

MAT 7698

MT= 73 (n,n') Level
Legendre Coefficients

77-Ir-182

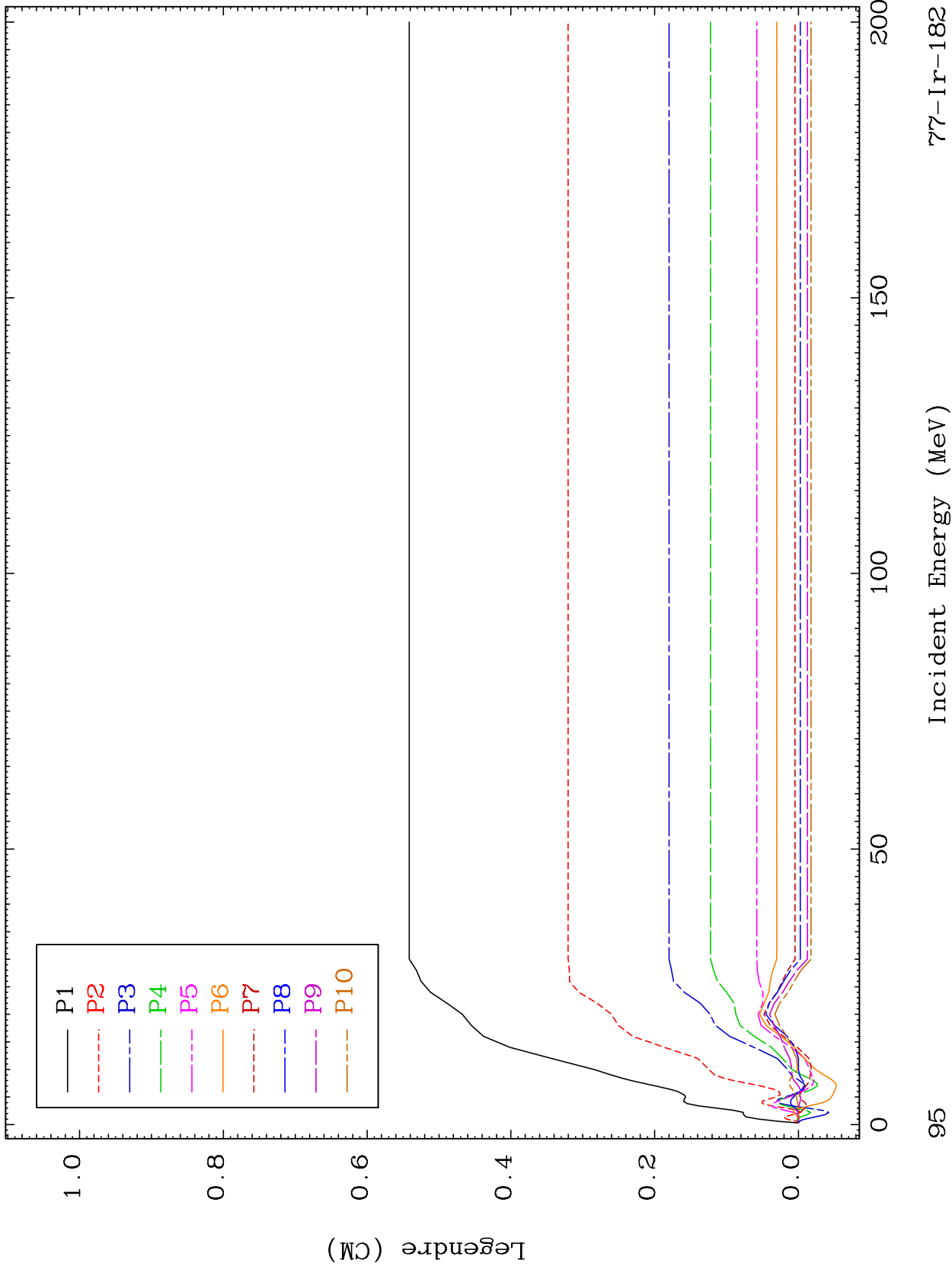

MAT 7698

MT= 73 (n,n') Level
Legendre Coefficients

77-Ir-182

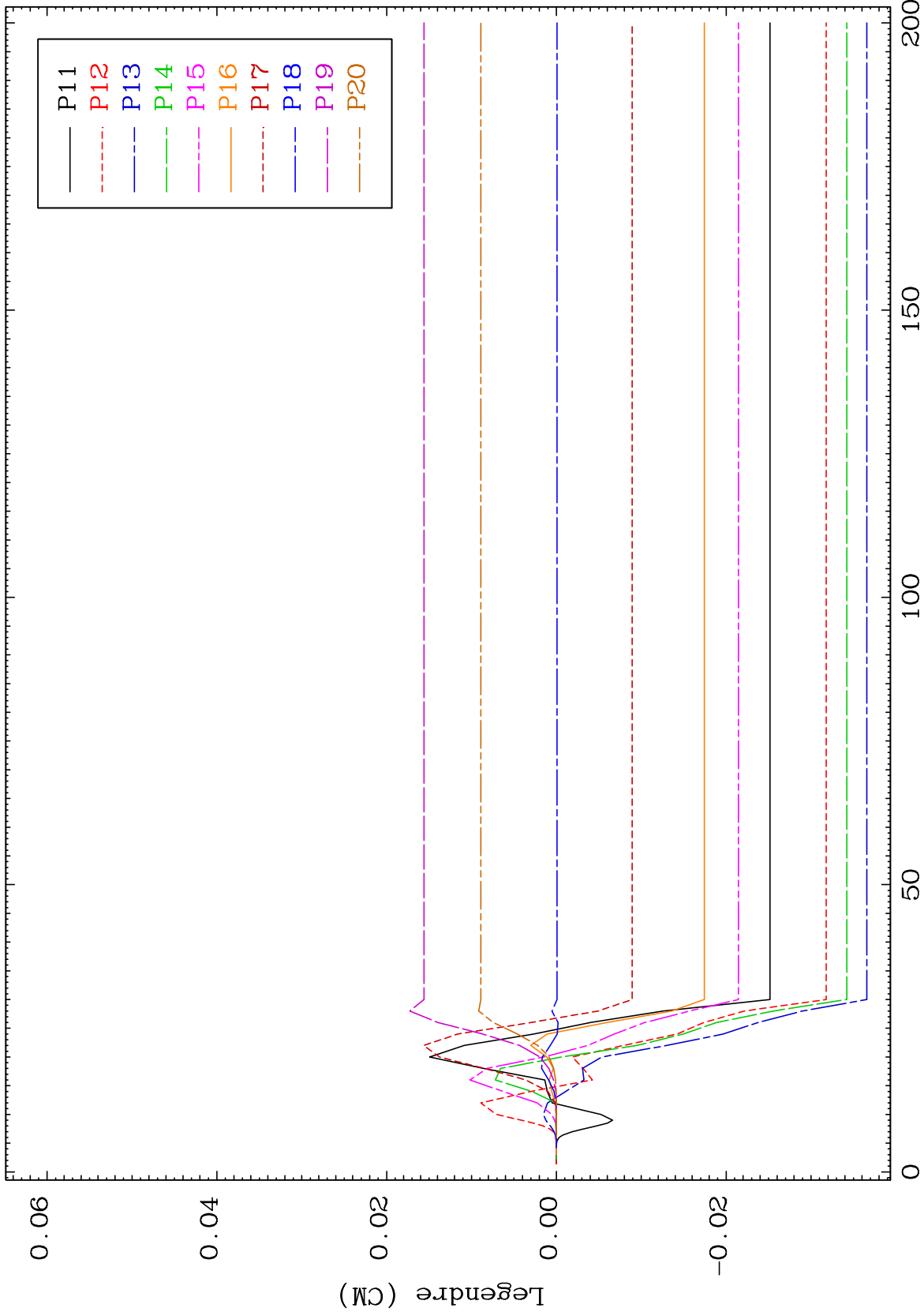

96

Incident Energy (MeV)

77-Ir-182

MAT 7698

MT= 73 (n,n') Level
Legendre Coefficients

77-Ir-182

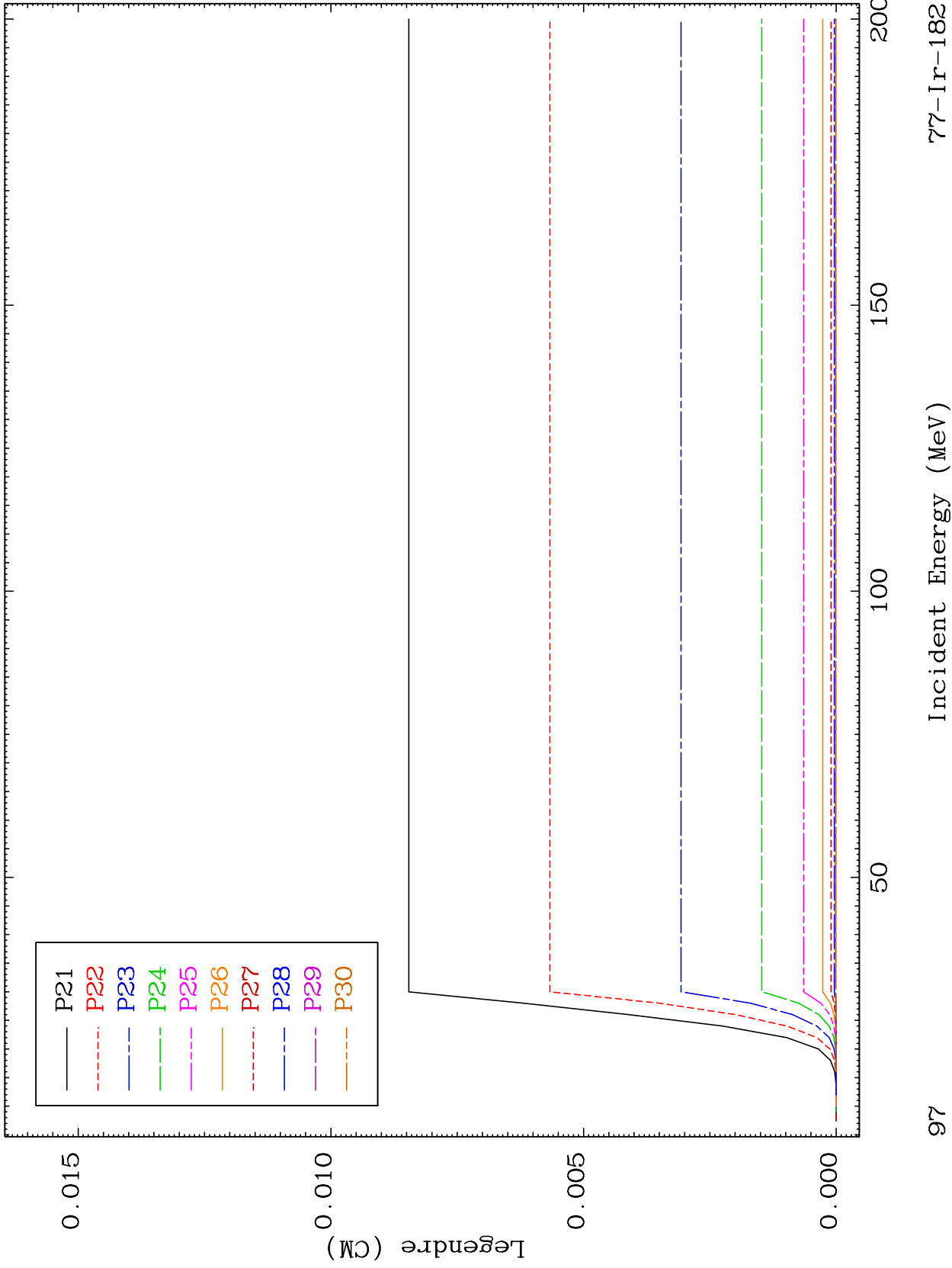

97

Incident Energy (MeV)

77-Ir-182

MAT 7698

MT= 73 (n,n') Level
Legendre Coefficients

77-Ir-182

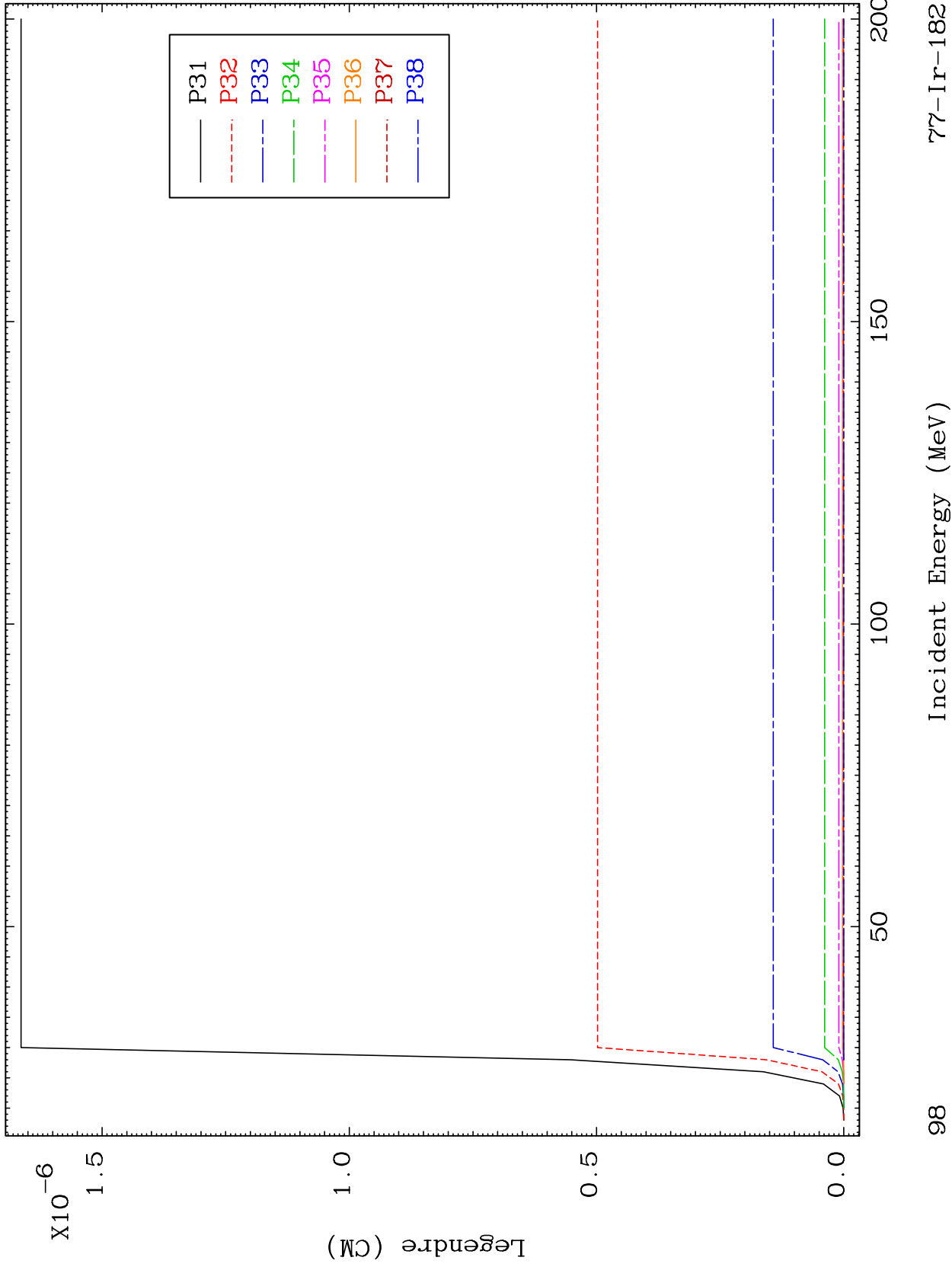

MAT 7698

MT= 74 (n,n') Level
Legendre Coefficients

77-Ir-182

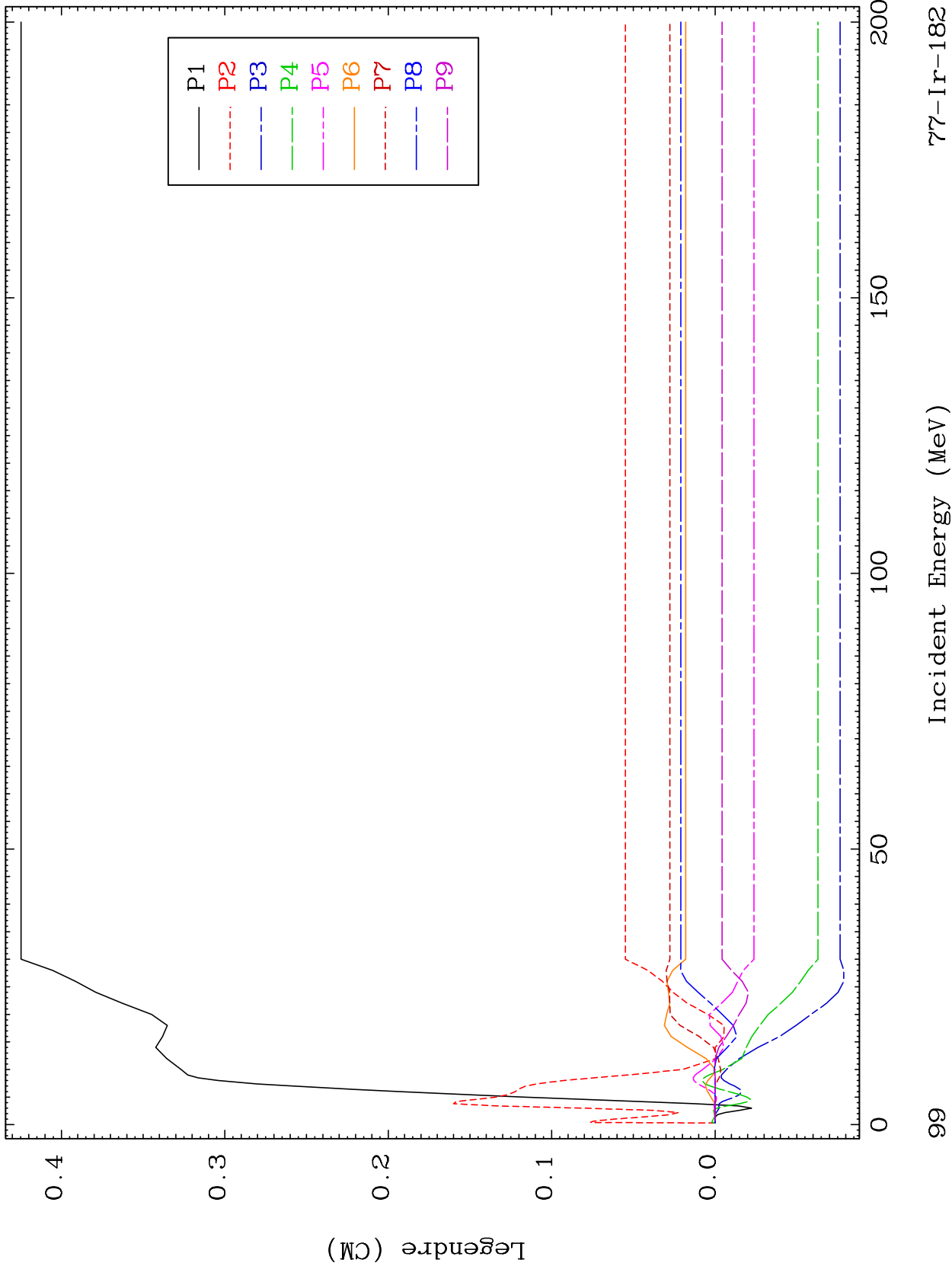

MAT 7698

MT= 74 (n,n') Level
Legendre Coefficients

77-Ir-182

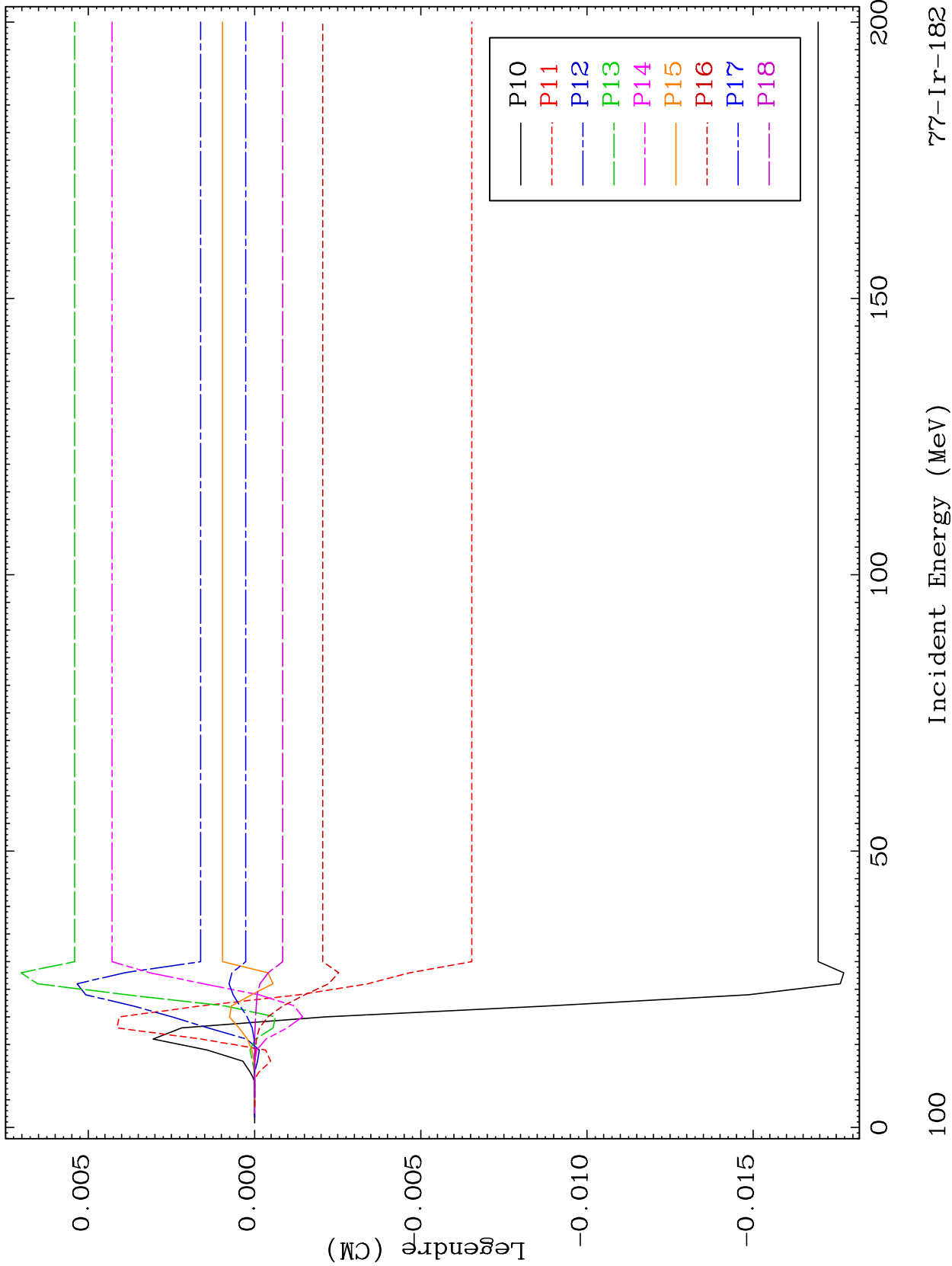

MAT 7698

MT= 74 (n,n') Level
Legendre Coefficients

⁷⁷Ir-182

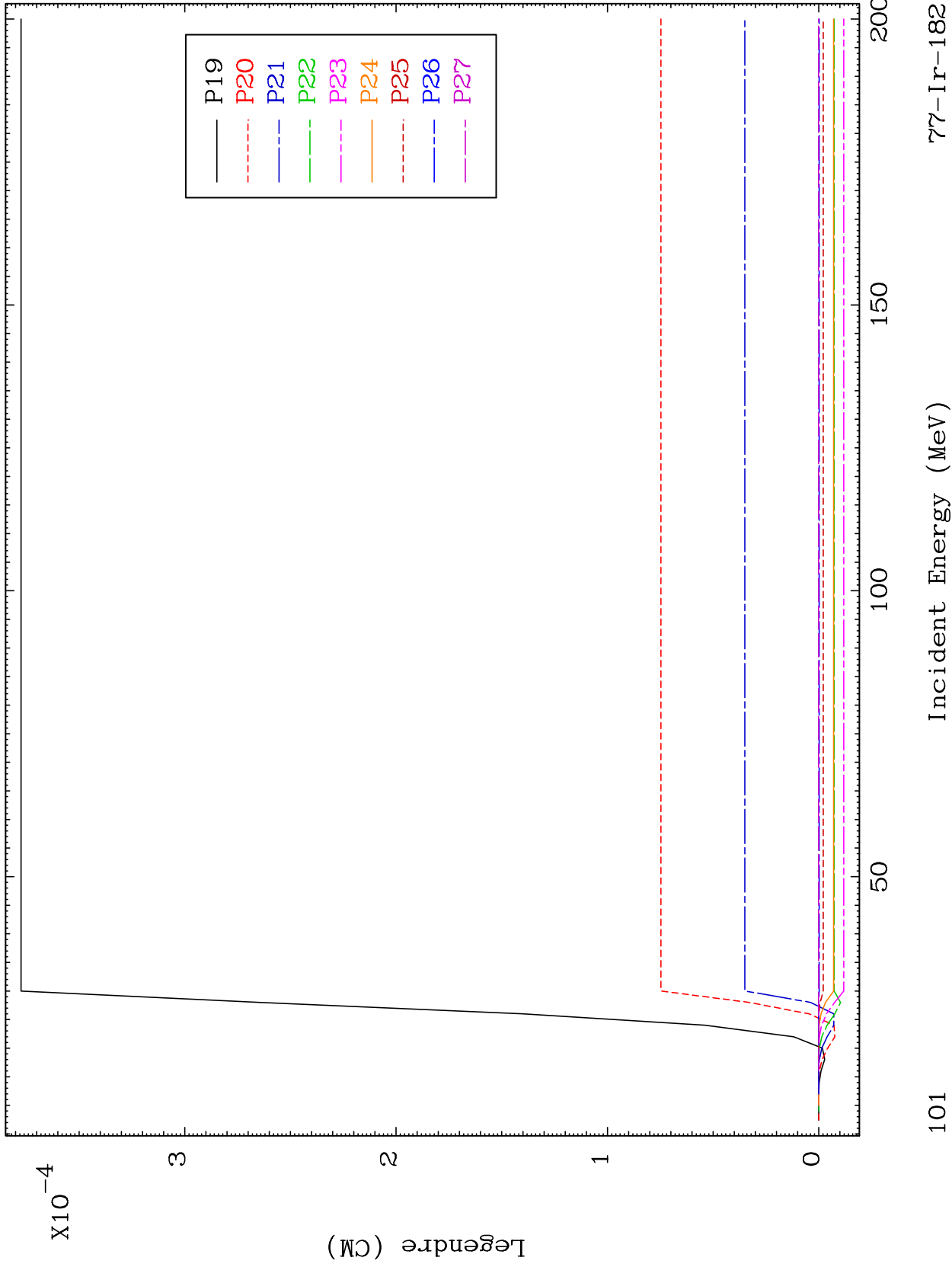

101

Incident Energy (MeV)

⁷⁷Ir-182

MAT 7698

MT= 74 (n,n') Level
Legendre Coefficients

⁷⁷Ir-182

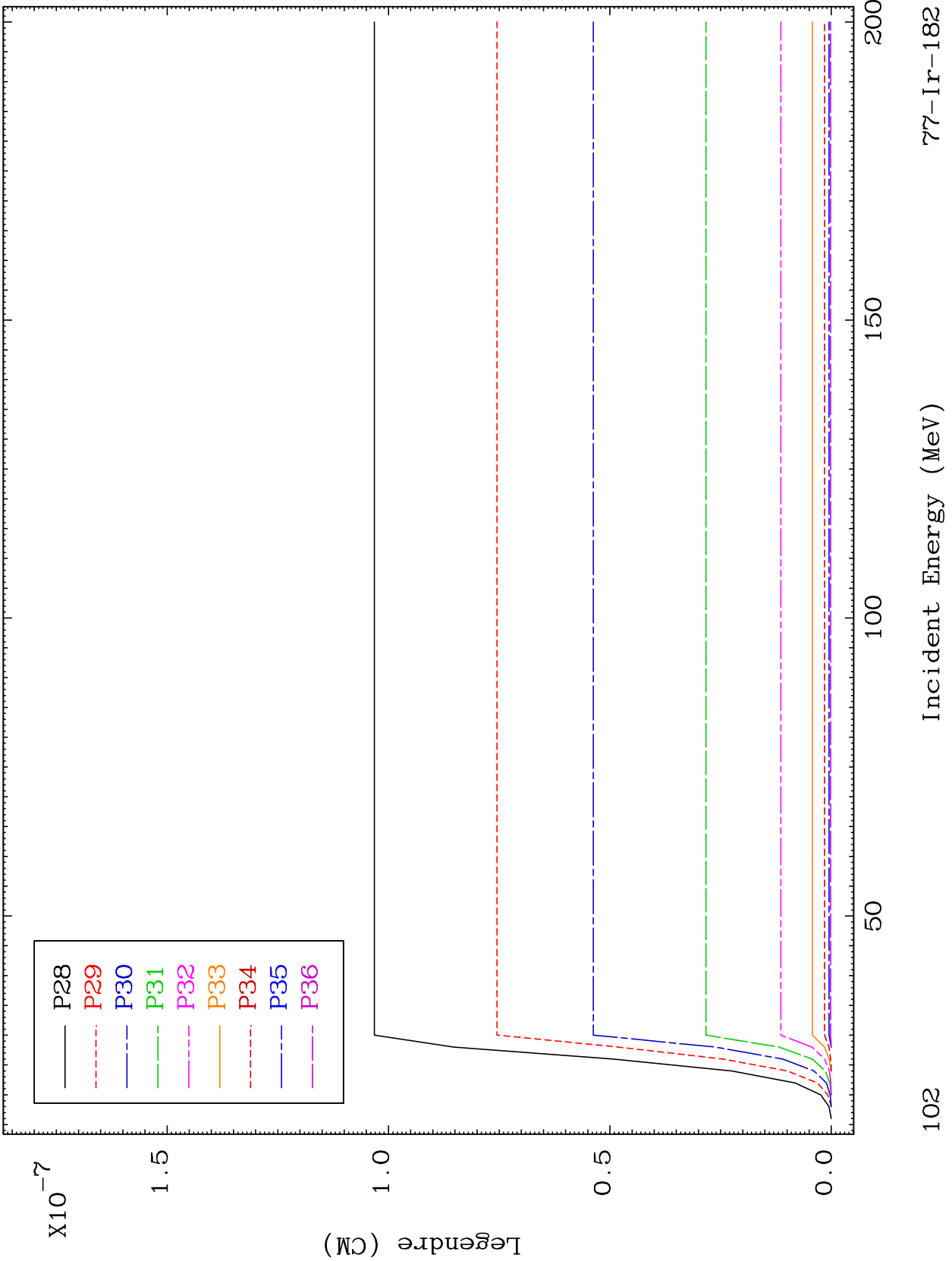

102

Incident Energy (MeV)

⁷⁷Ir-182

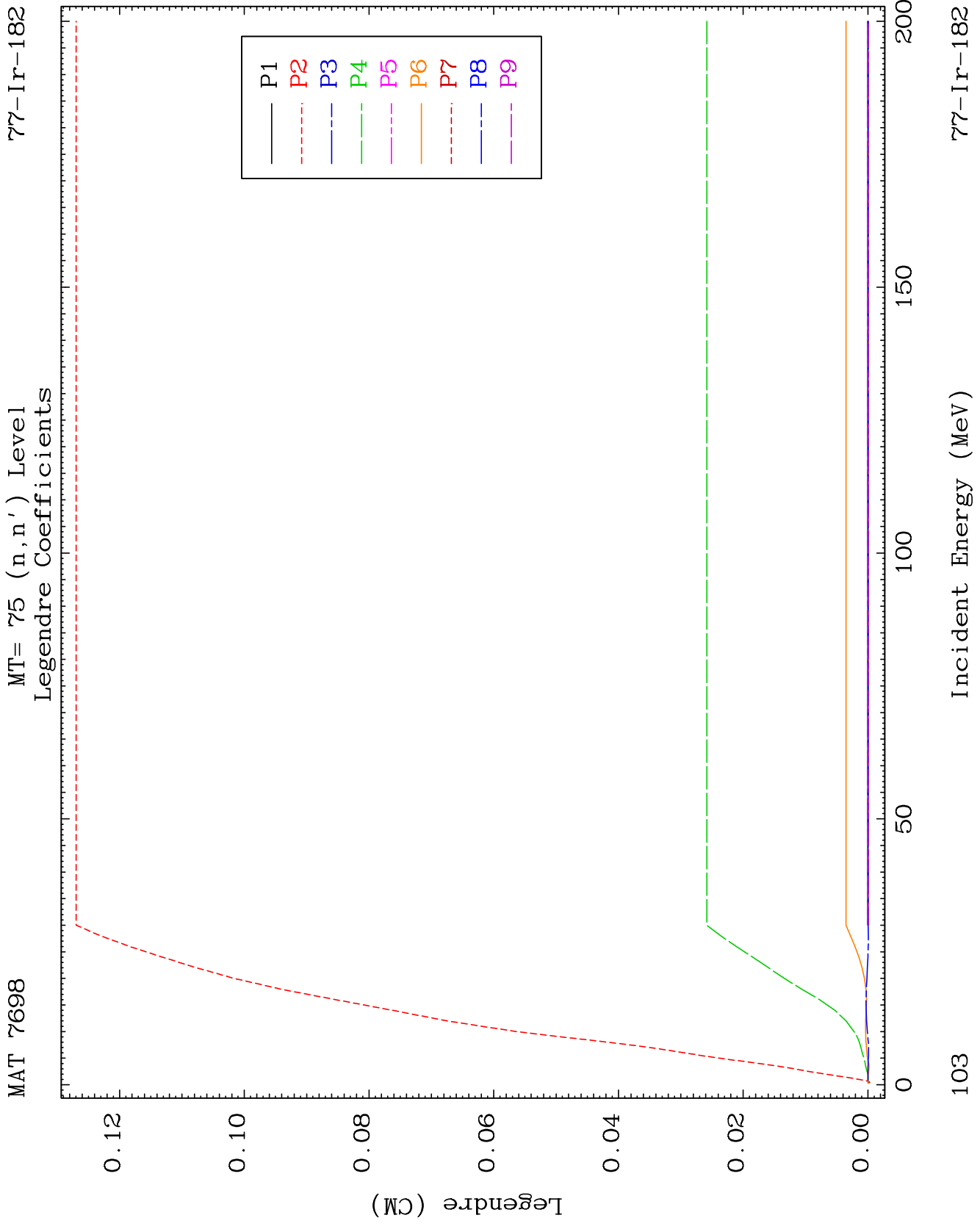

MAT 7698

MT= 75 (n,n') Level
Legendre Coefficients

77-Ir-182

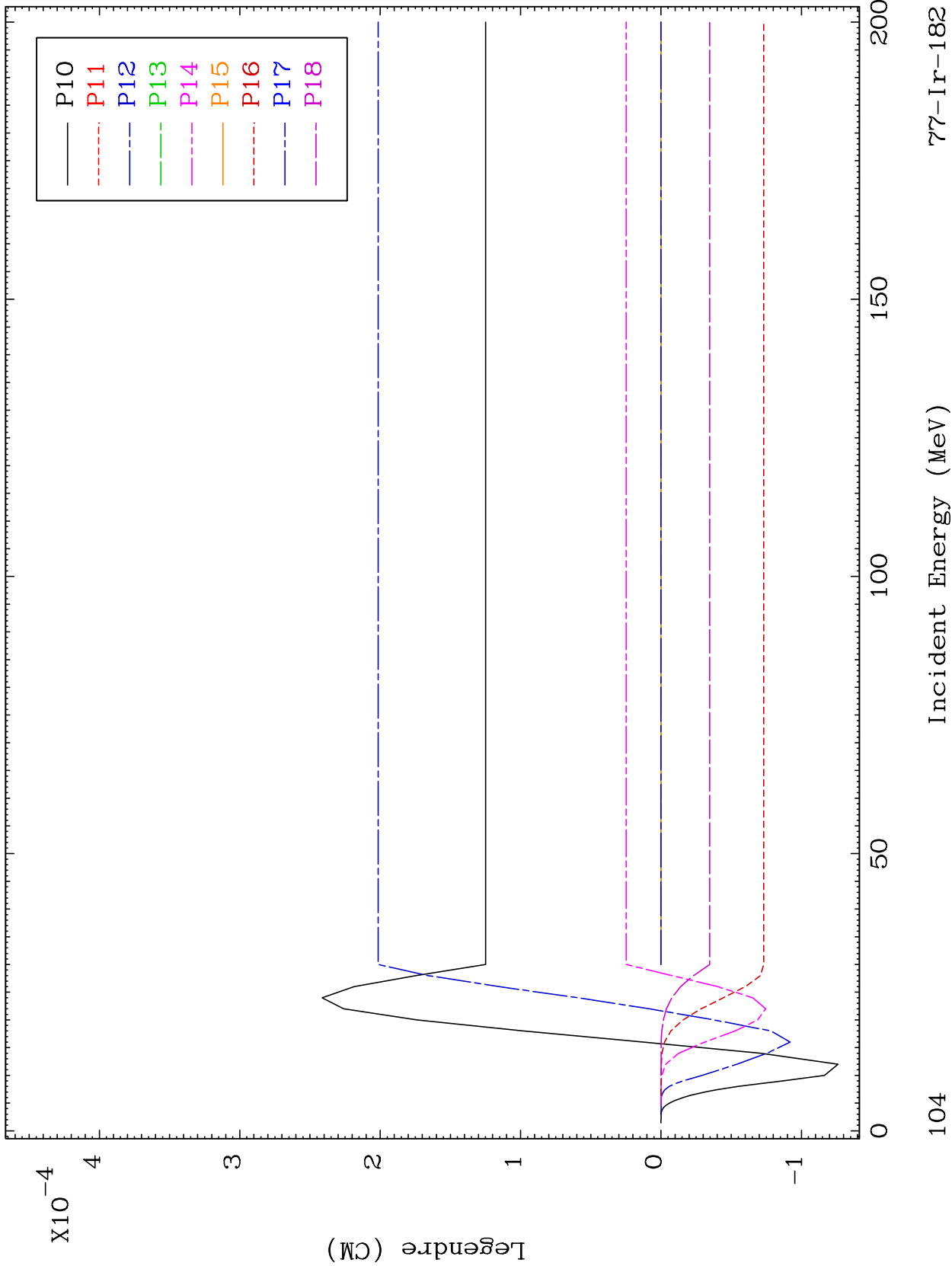

104

77-Ir-182

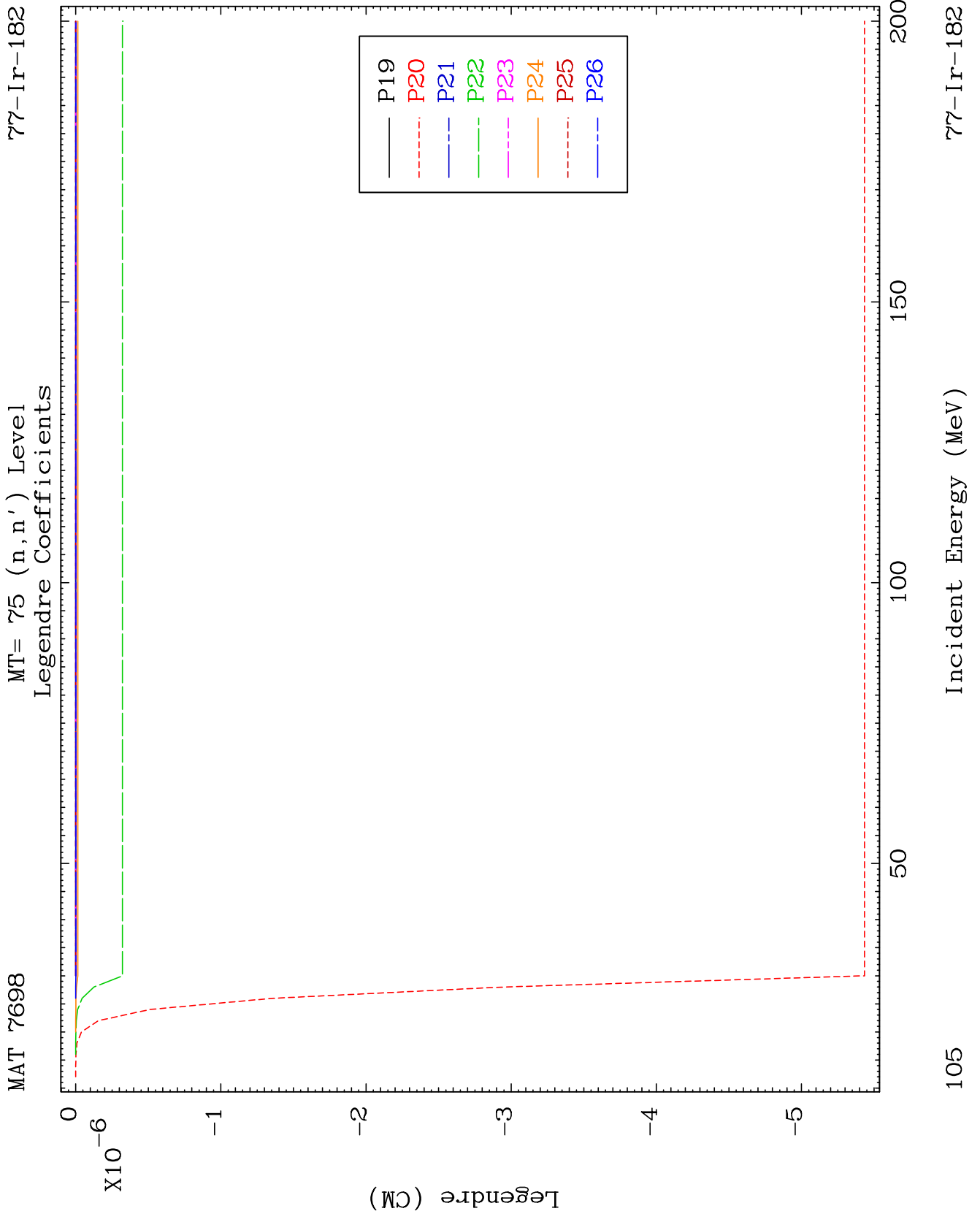

MAT 7698

MT= 76 (n,n') Level
Legendre Coefficients

77-Ir-182

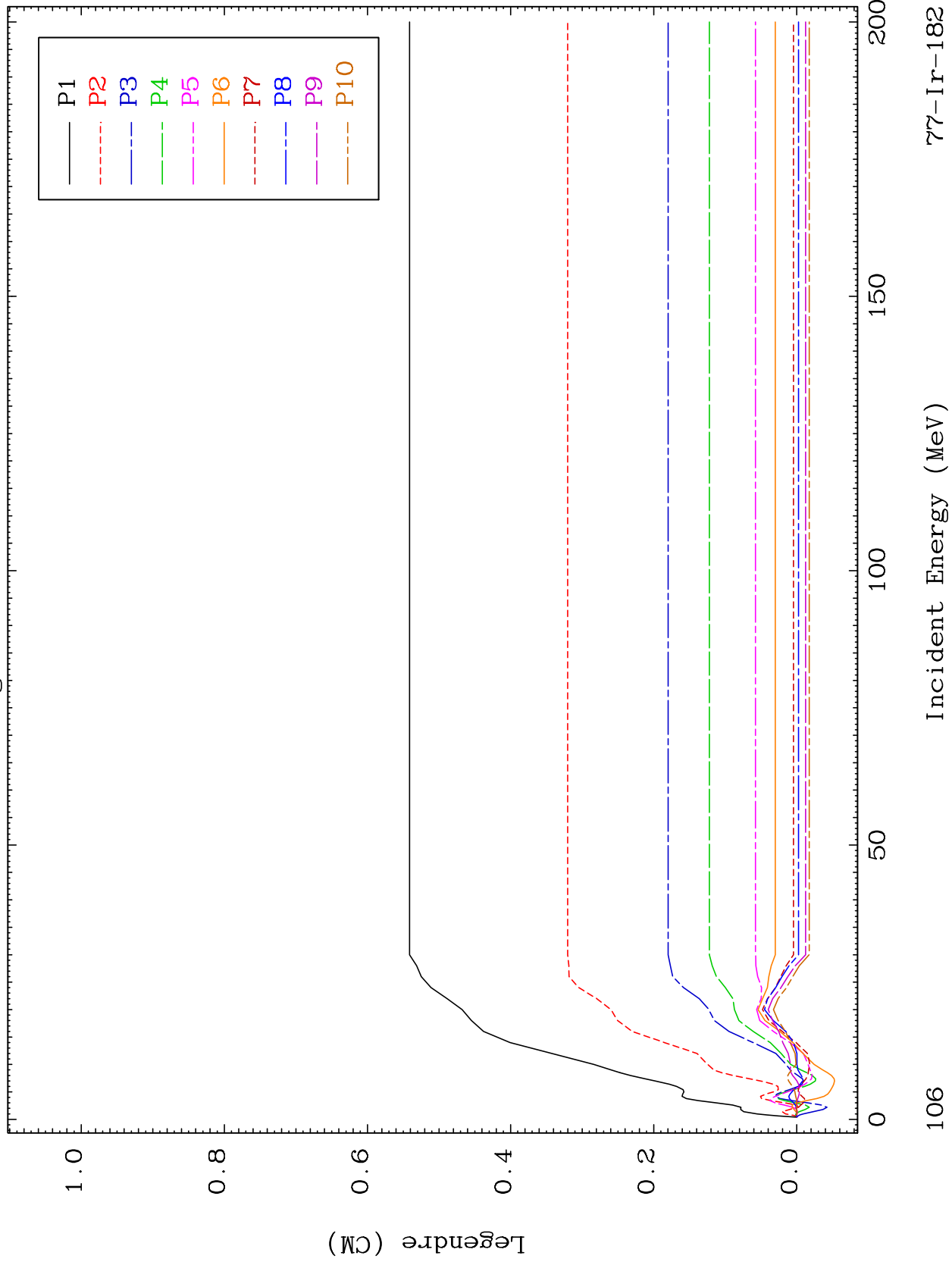

77-Ir-182

Incident Energy (MeV)

106

MAT 7698

MT= 76 (n,n') Level
Legendre Coefficients

77-Ir-182

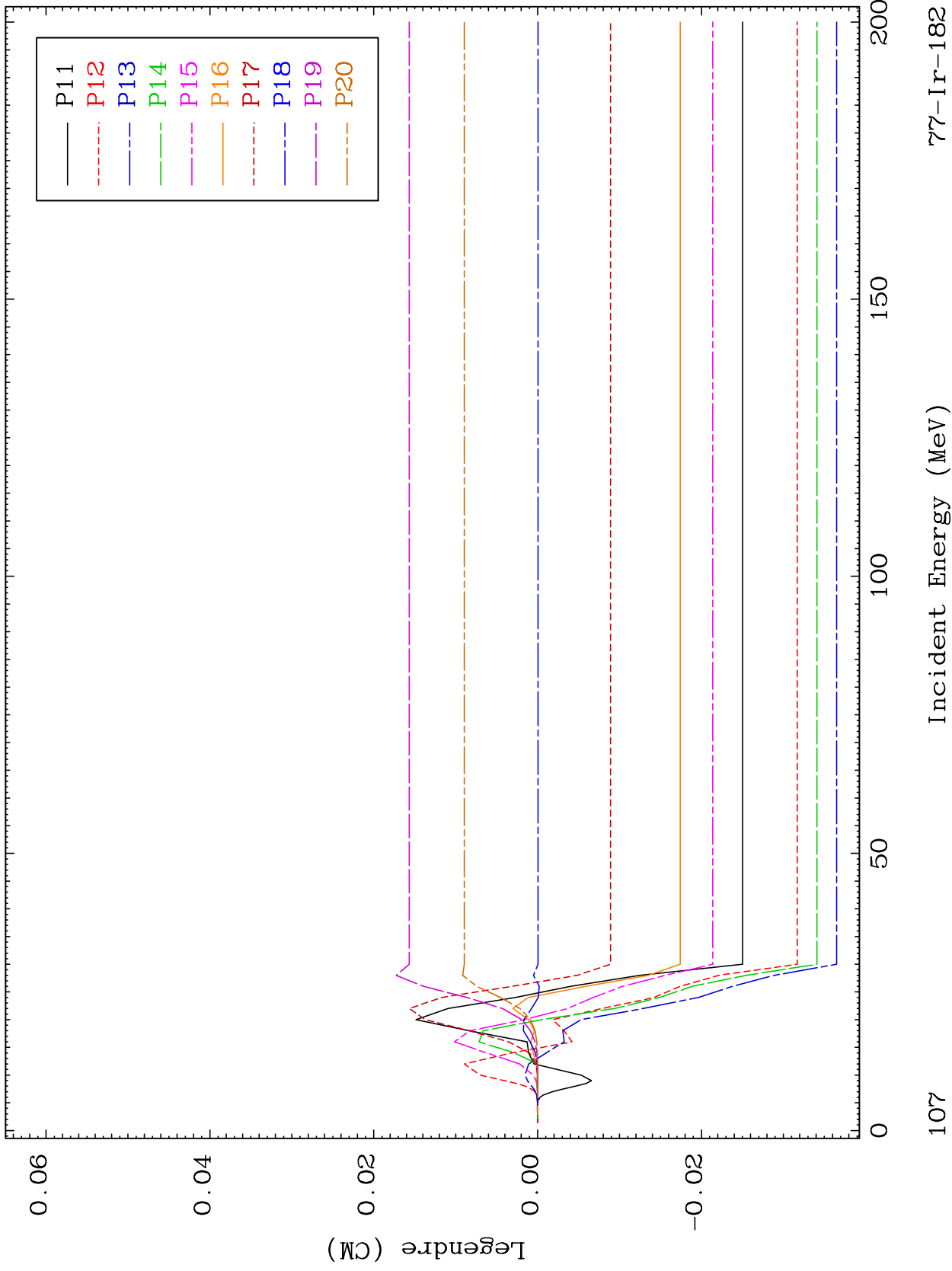

77-Ir-182

Incident Energy (MeV)

107

MAT 7698

MT= 76 (n,n') Level
Legendre Coefficients

77-Ir-182

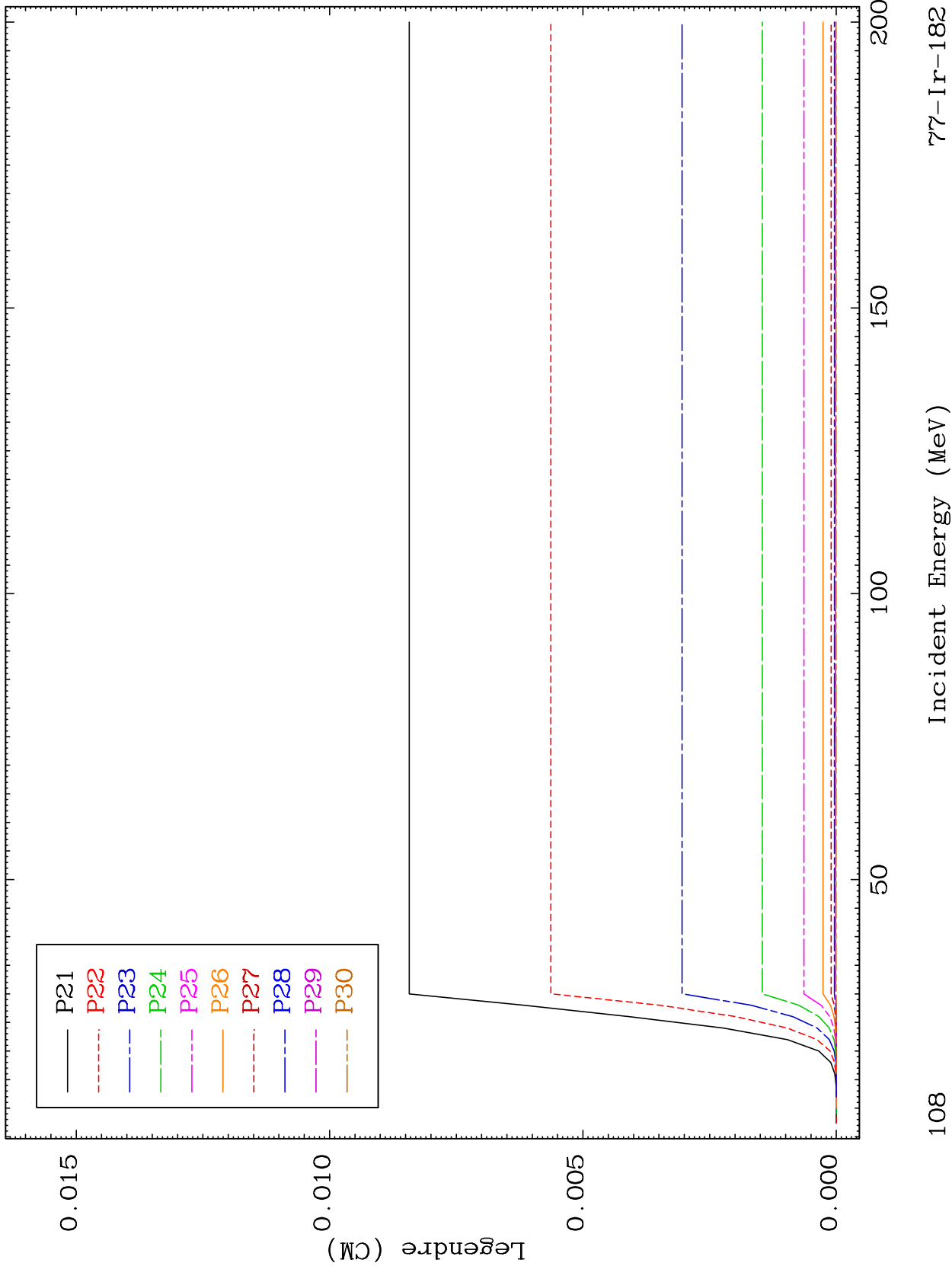

108

Incident Energy (MeV)

77-Ir-182

MAT 7698

MT= 76 (n,n') Level
Legendre Coefficients

77-Ir-182

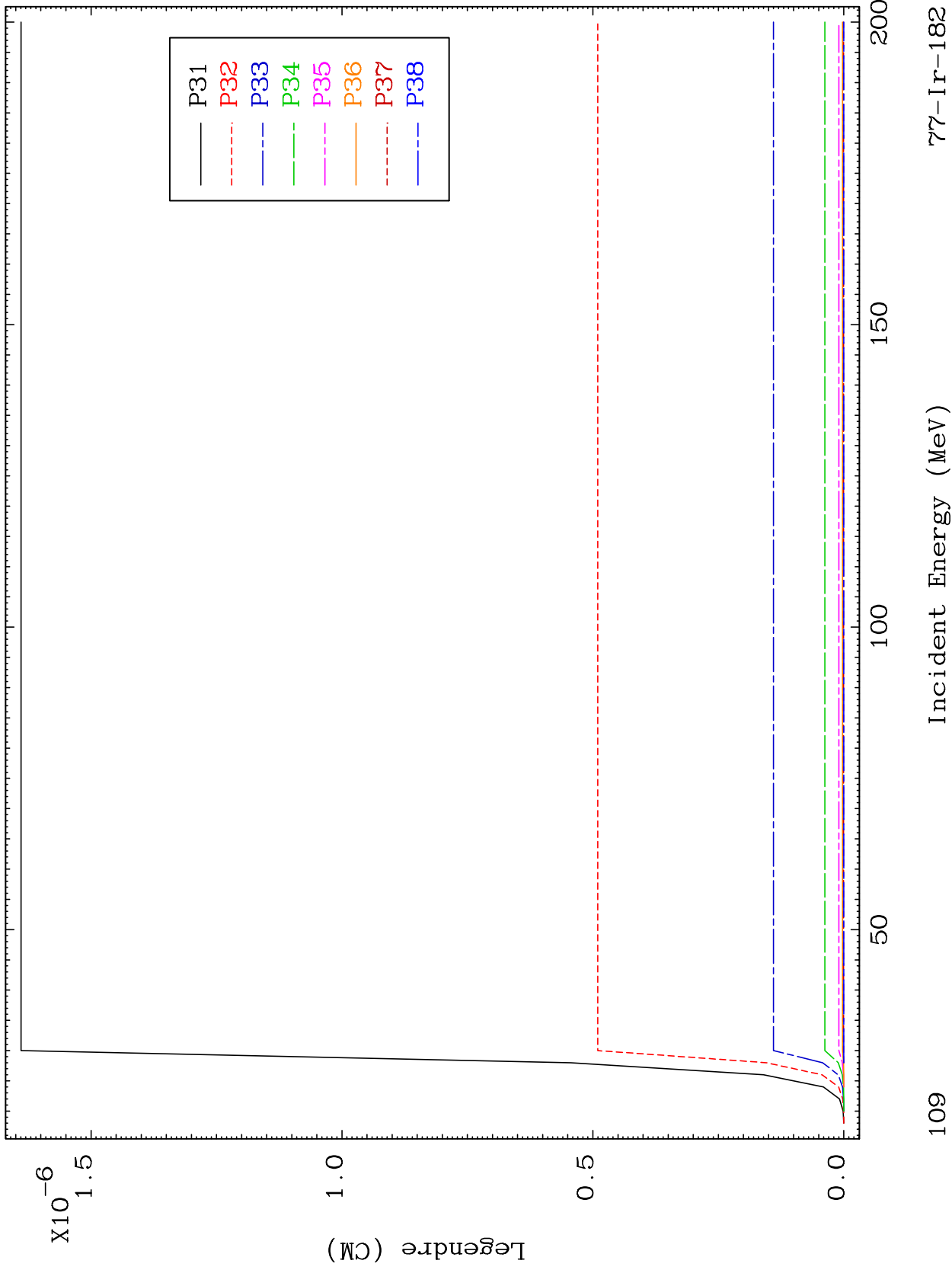

109

Incident Energy (MeV)

77-Ir-182

MAT 7698

MT= 77 (n,n') Level Legendre Coefficients

77-Ir-182

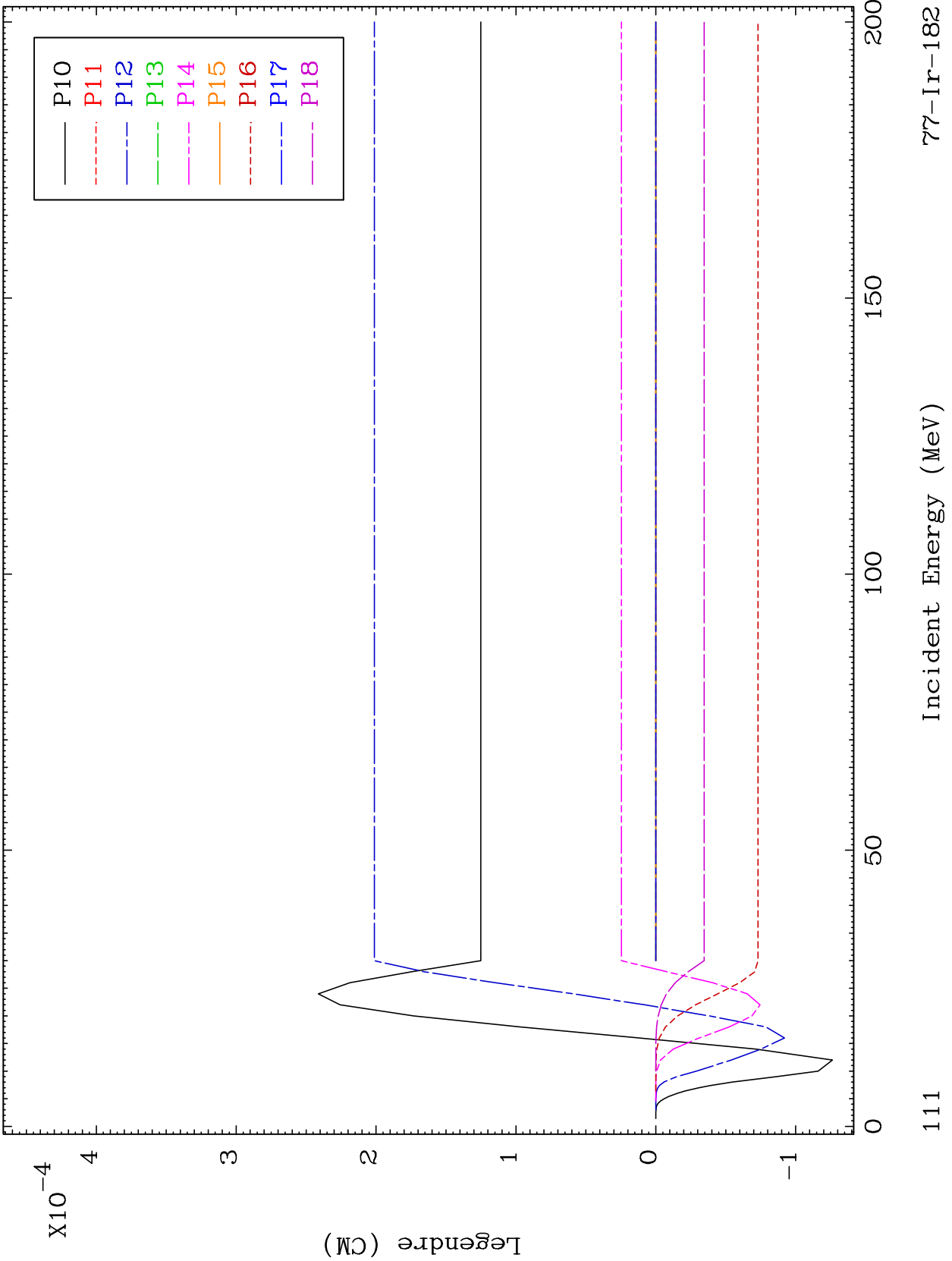

111

77-Ir-182

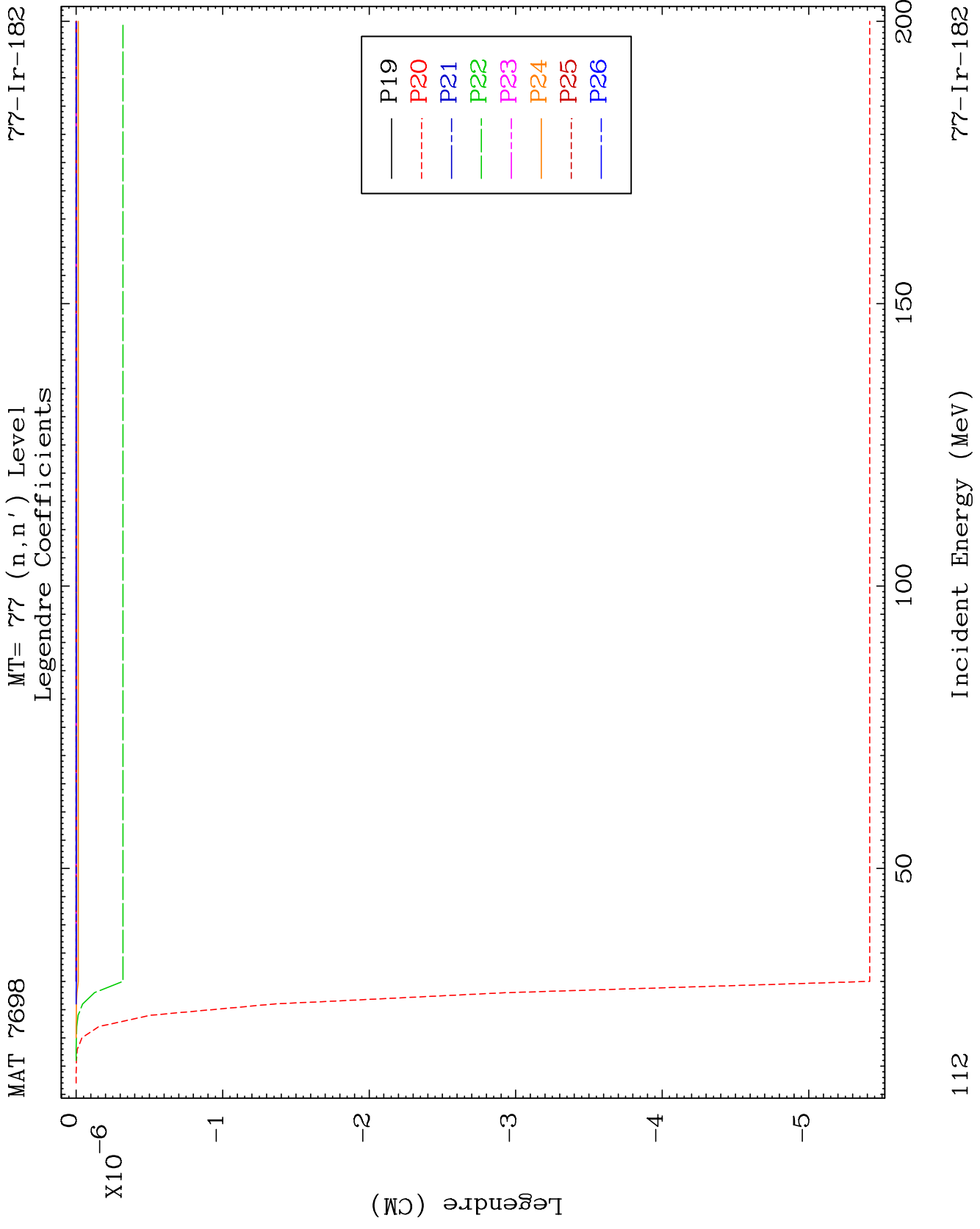

MAT 7698

MT= 78 (n,n') Level
Legendre Coefficients

77-Ir-182

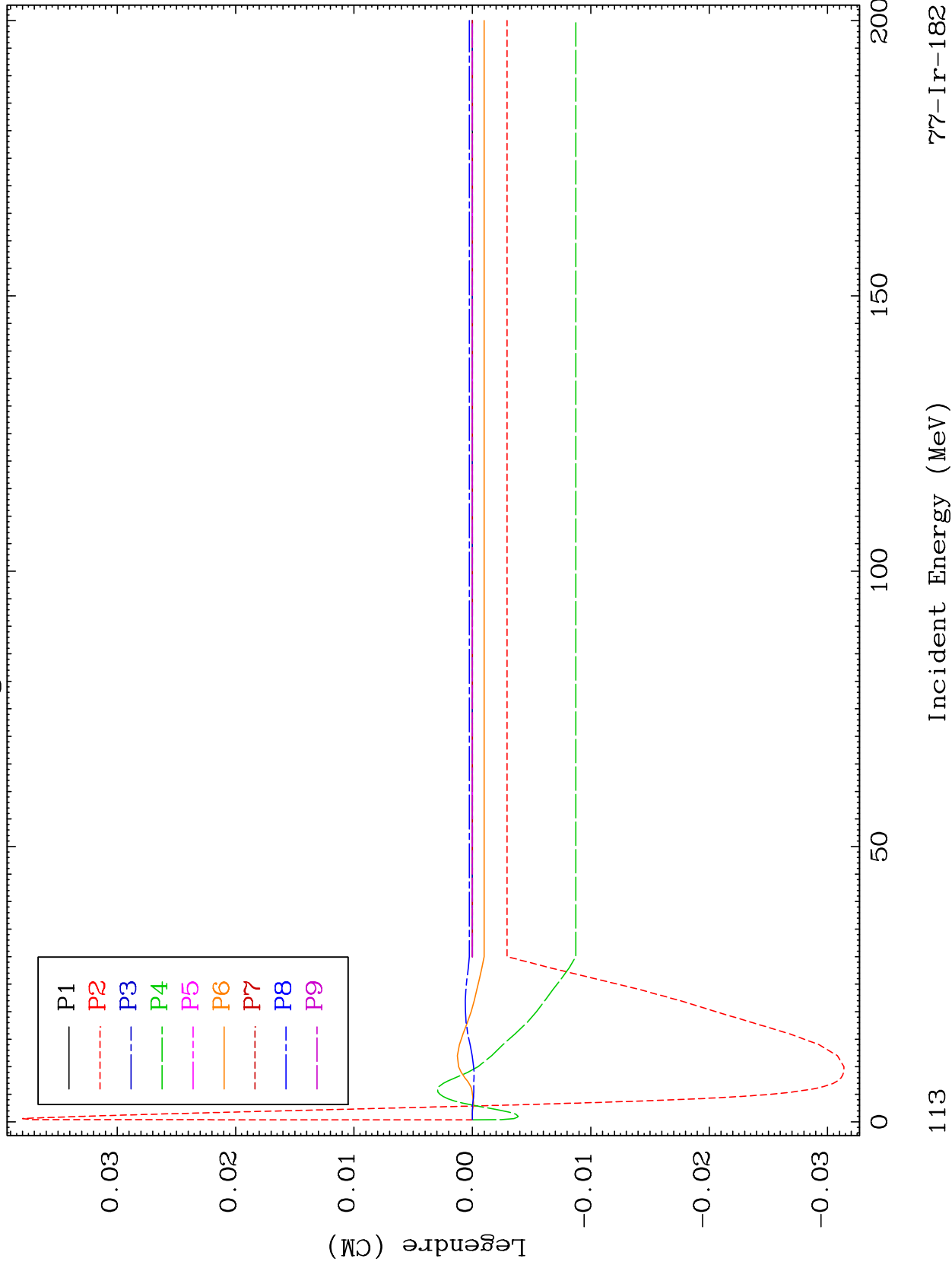

113

Incident Energy (MeV)

77-Ir-182

MAT 7698

MT= 78 (n,n') Level
Legendre Coefficients

77-Ir-182

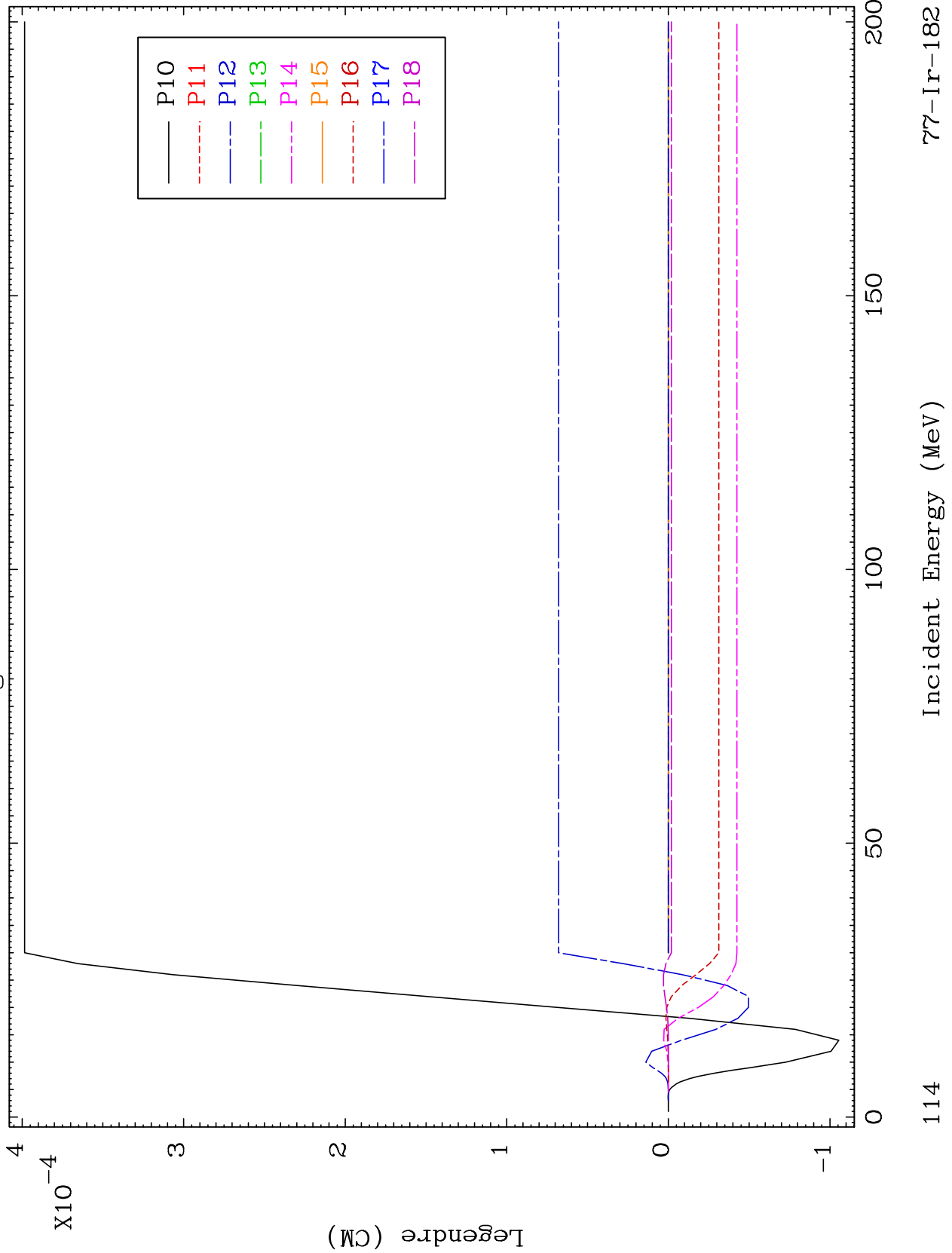

77-Ir-182

Incident Energy (MeV)

114

MAT 7698

MT= 79 (n,n') Level
Legendre Coefficients

⁷⁷Ir-182

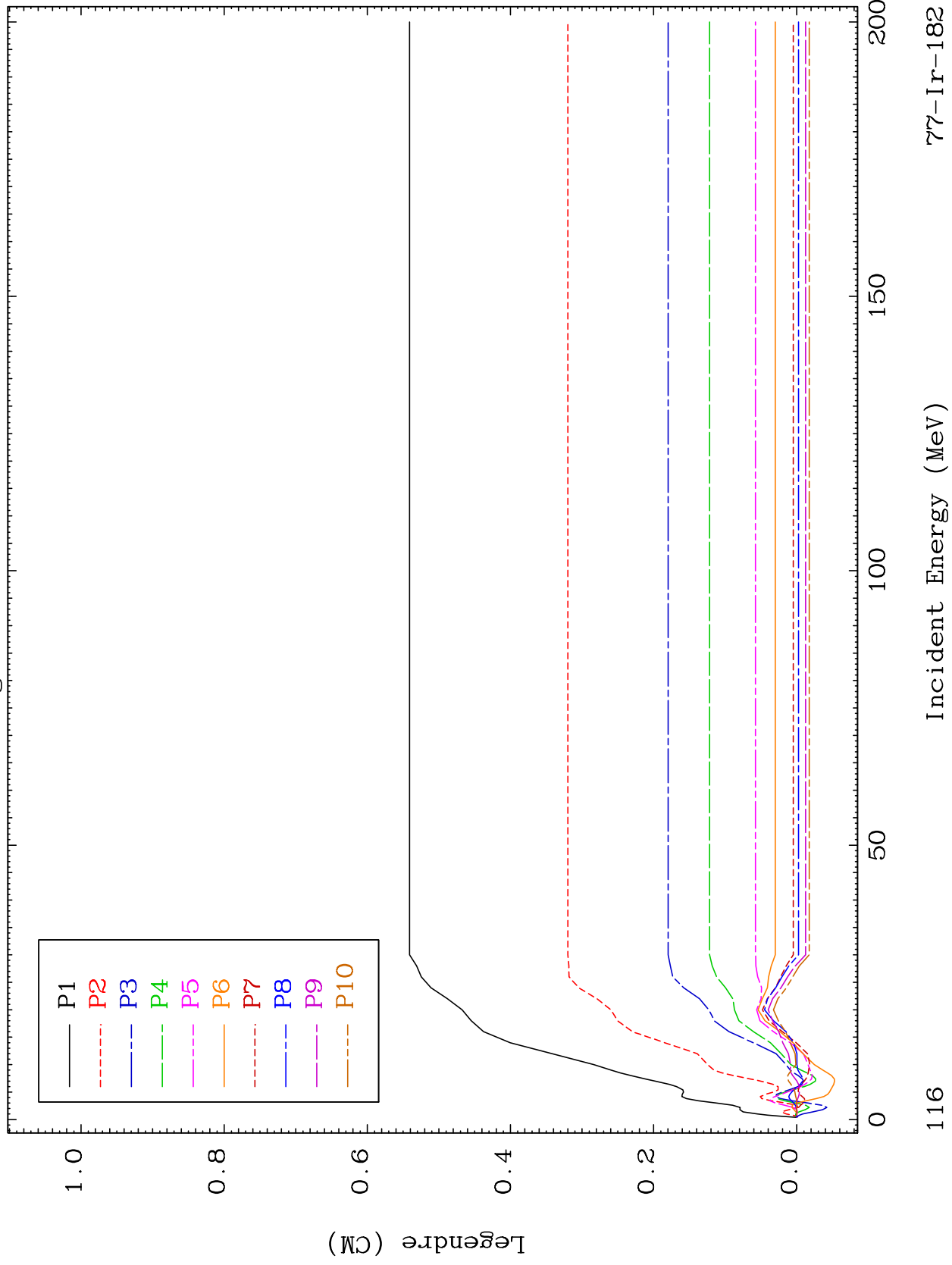

MAT 7698

MT= 79 (n,n') Level
Legendre Coefficients

77-Ir-182

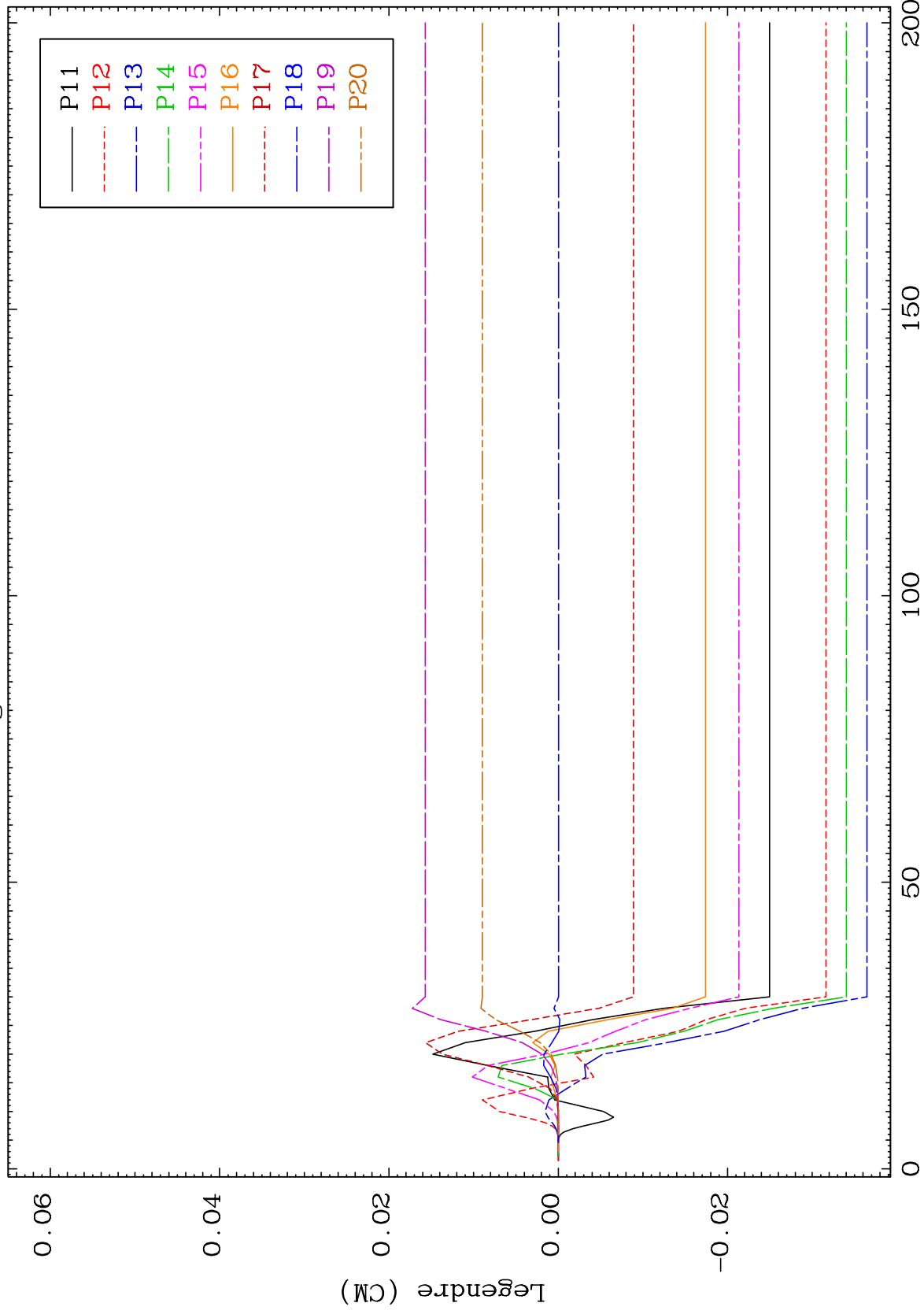

117

Incident Energy (MeV)

77-Ir-182

MAT 7698

MT= 79 (n,n') Level
Legendre Coefficients

77-Ir-182

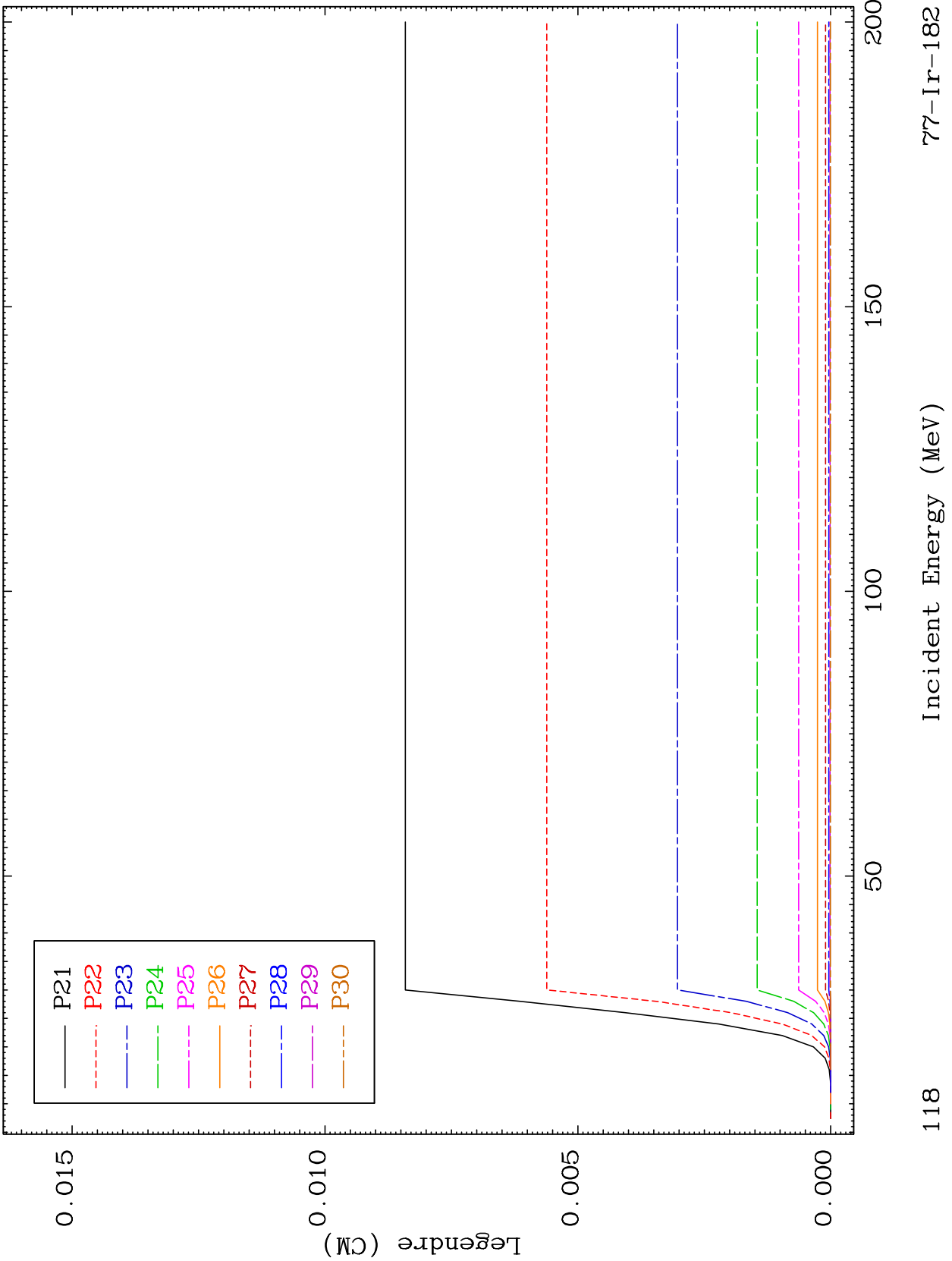

118

Incident Energy (MeV)

77-Ir-182

MAT 7698

MT= 79 (n,n') Level
Legendre Coefficients

77-Ir-182

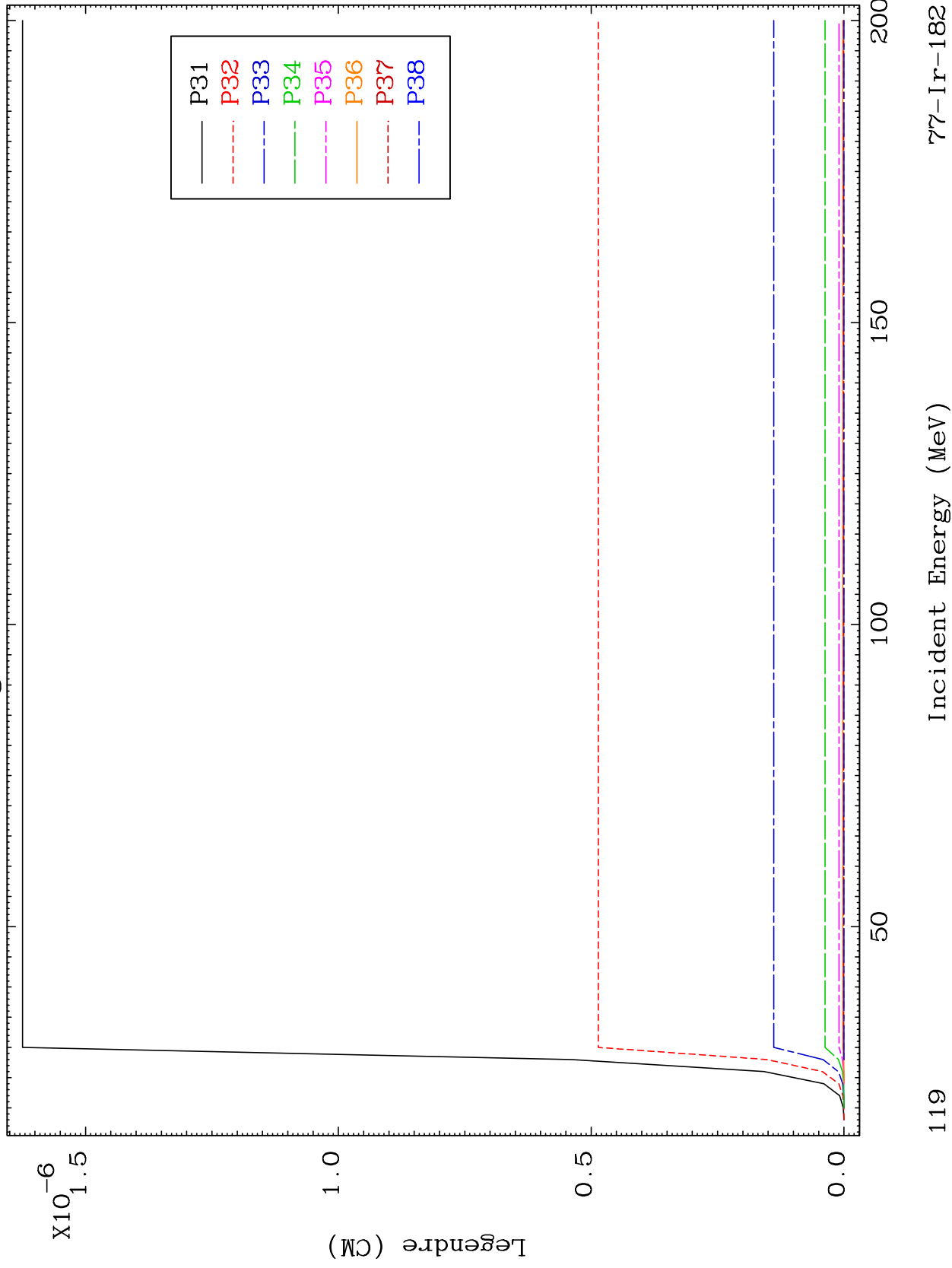

119

Incident Energy (MeV)

77-Ir-182

MAT 7698

MT= 80 (n,n') Level
Legendre Coefficients

77-Ir-182

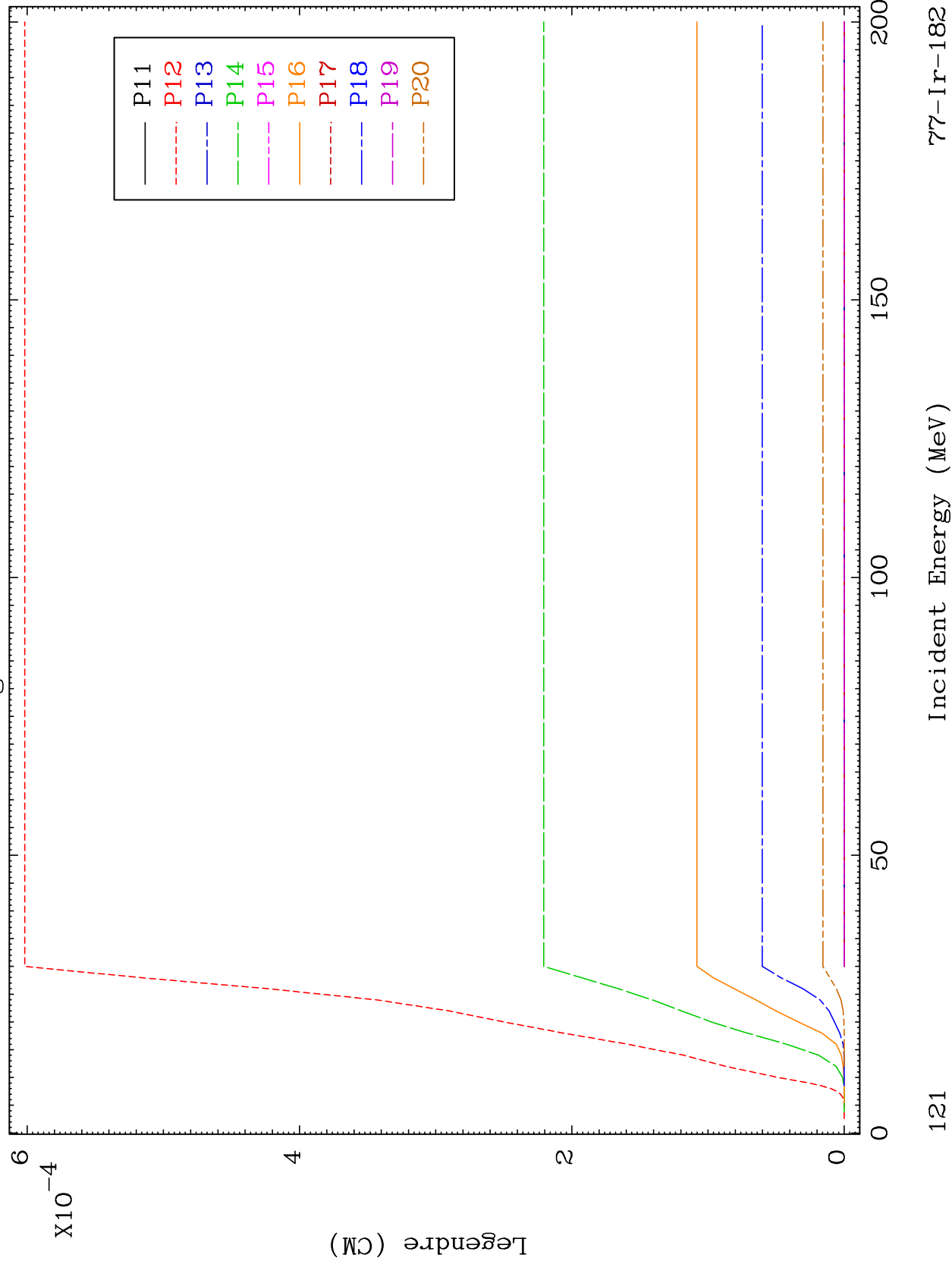

121

Incident Energy (MeV)

77-Ir-182

MAT 7698

Fission

⁷⁷Ir-182

Radionuclide Production Cross Section

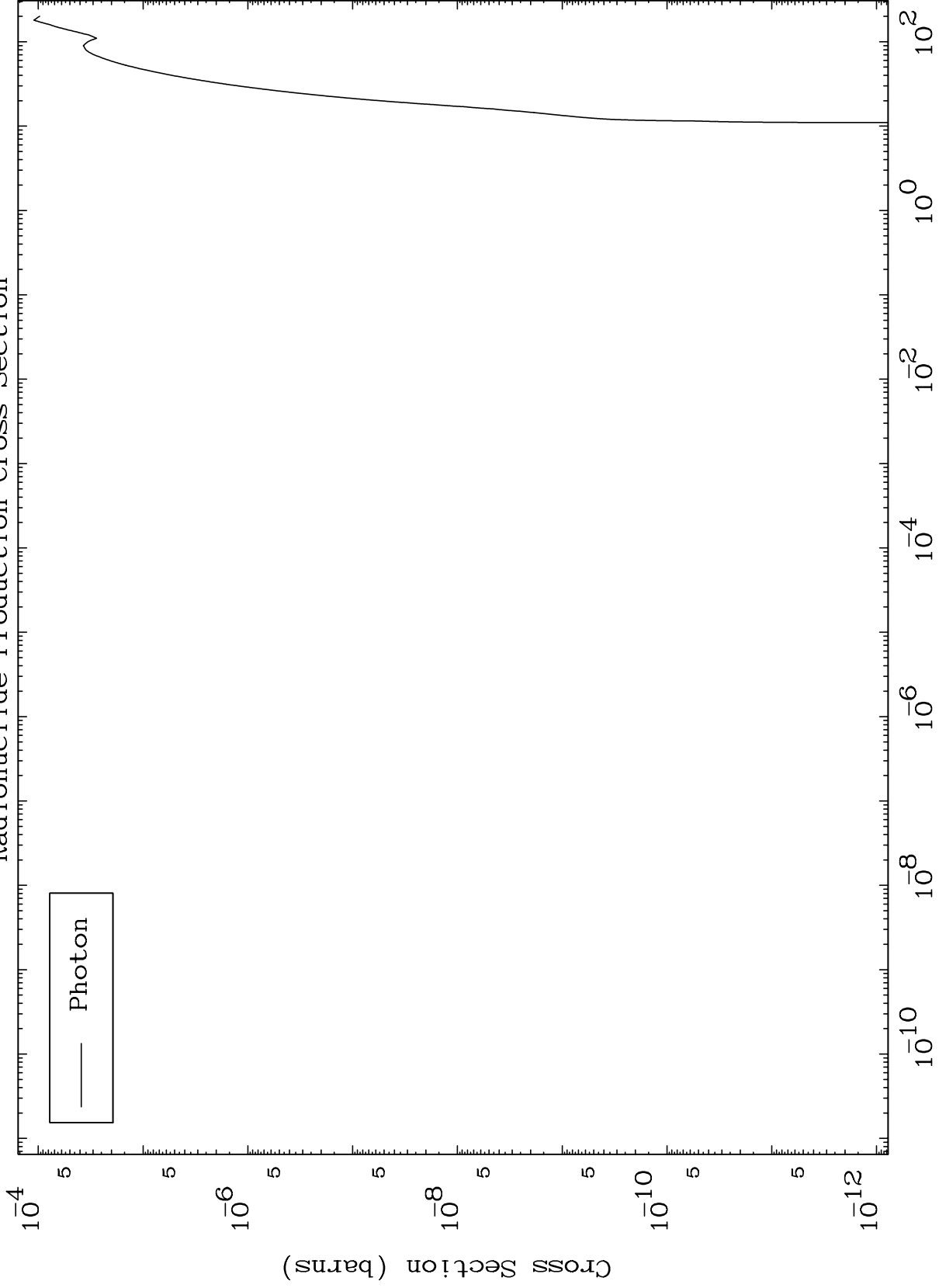

MAT 7698

77-Ir-182

(n,n') p
Radionuclide Production Cross Section

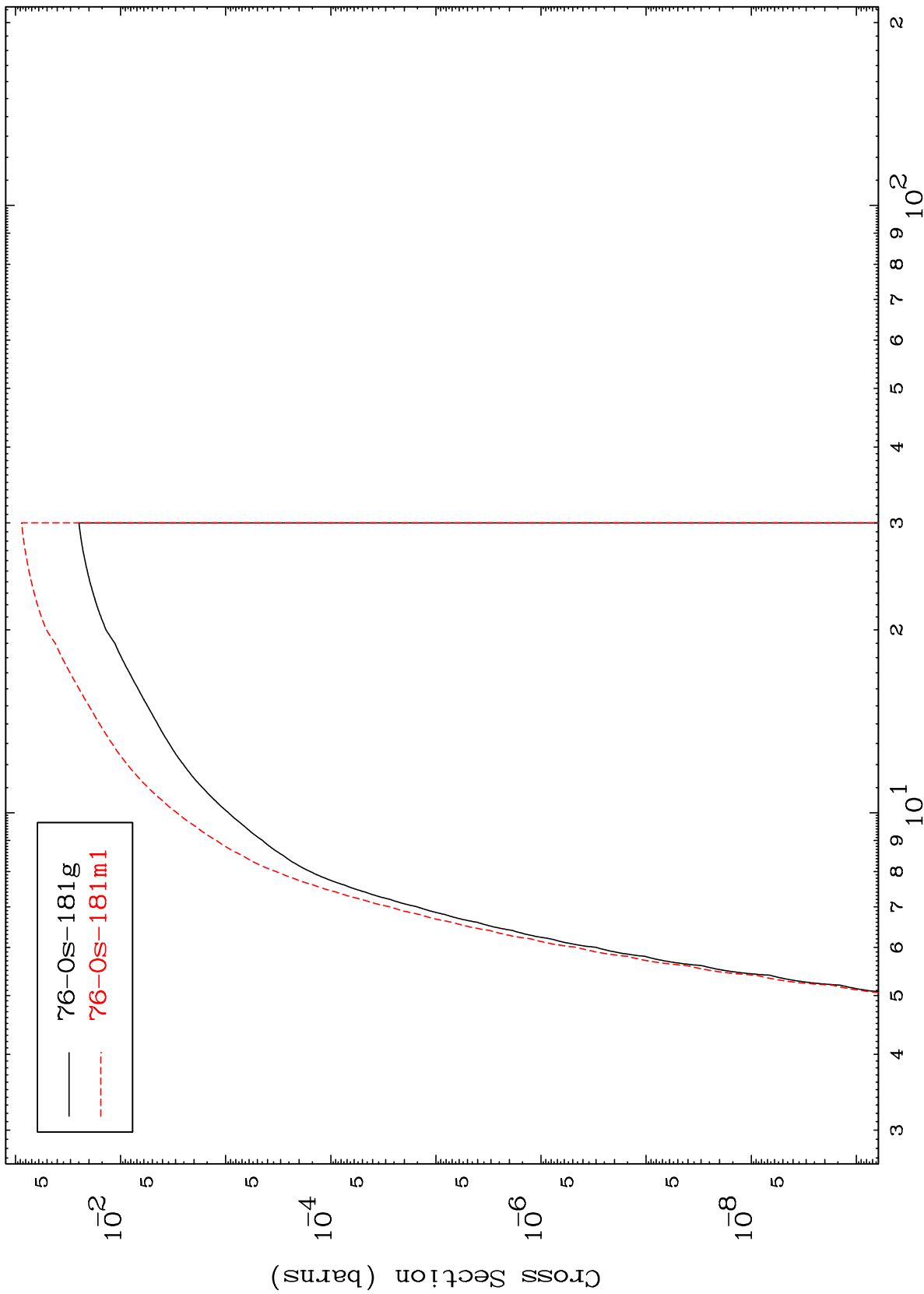

77-Ir-182

Incident Energy (MeV)

124

MAT 7698

(n,d)

⁷⁷Ir-182

Radionuclide Production Cross Section

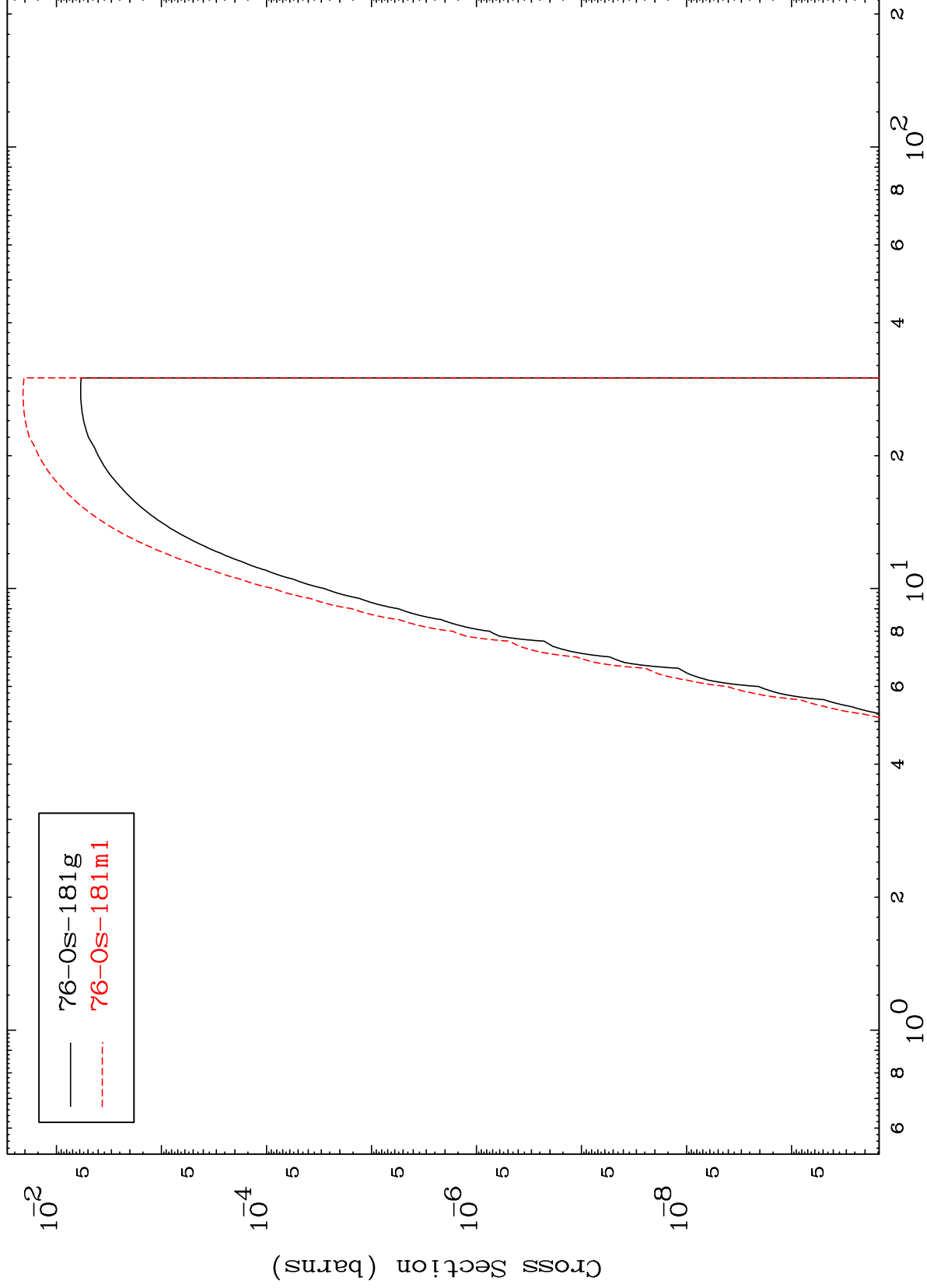

125

Incident Energy (MeV)

⁷⁷Ir-182