

# N-SN132 NRG TENDL-2017, AKONING

## Principal cross sections

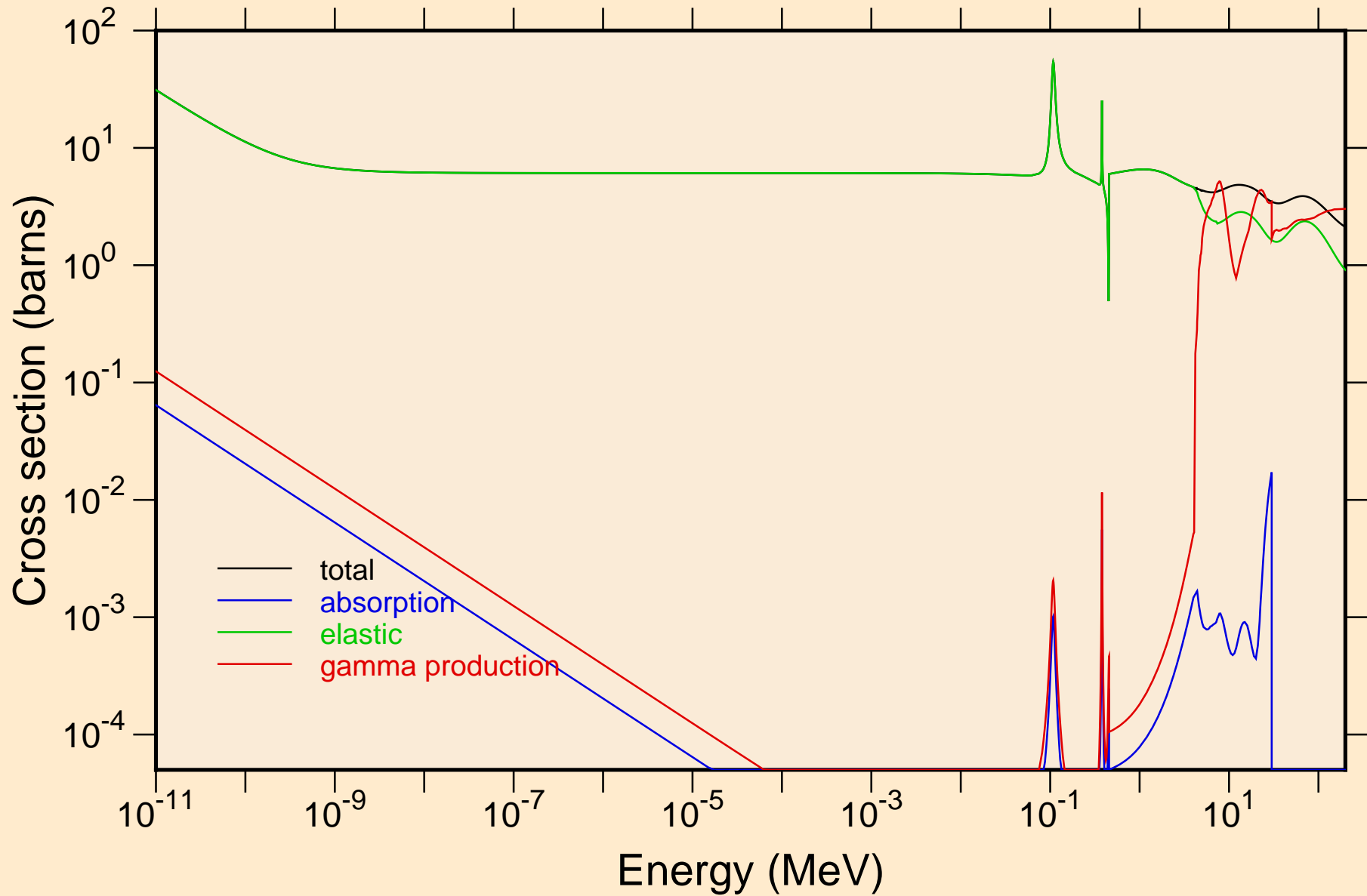

# N-SN132 NRG TENDL-2017, AKONING

## Non-threshold reactions

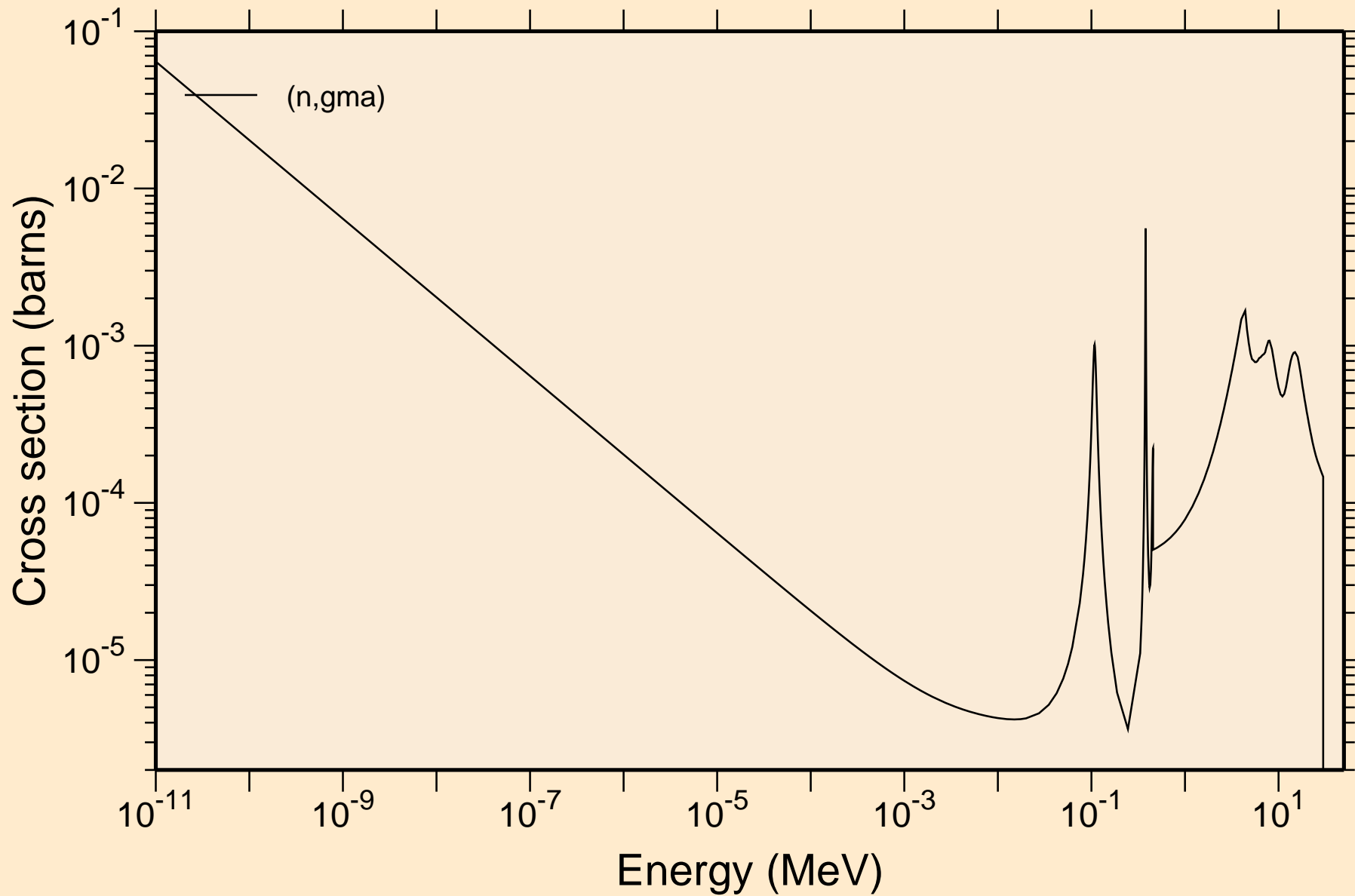

# N-SN132 NRG TENDL-2017, AKONING

## Principal cross sections

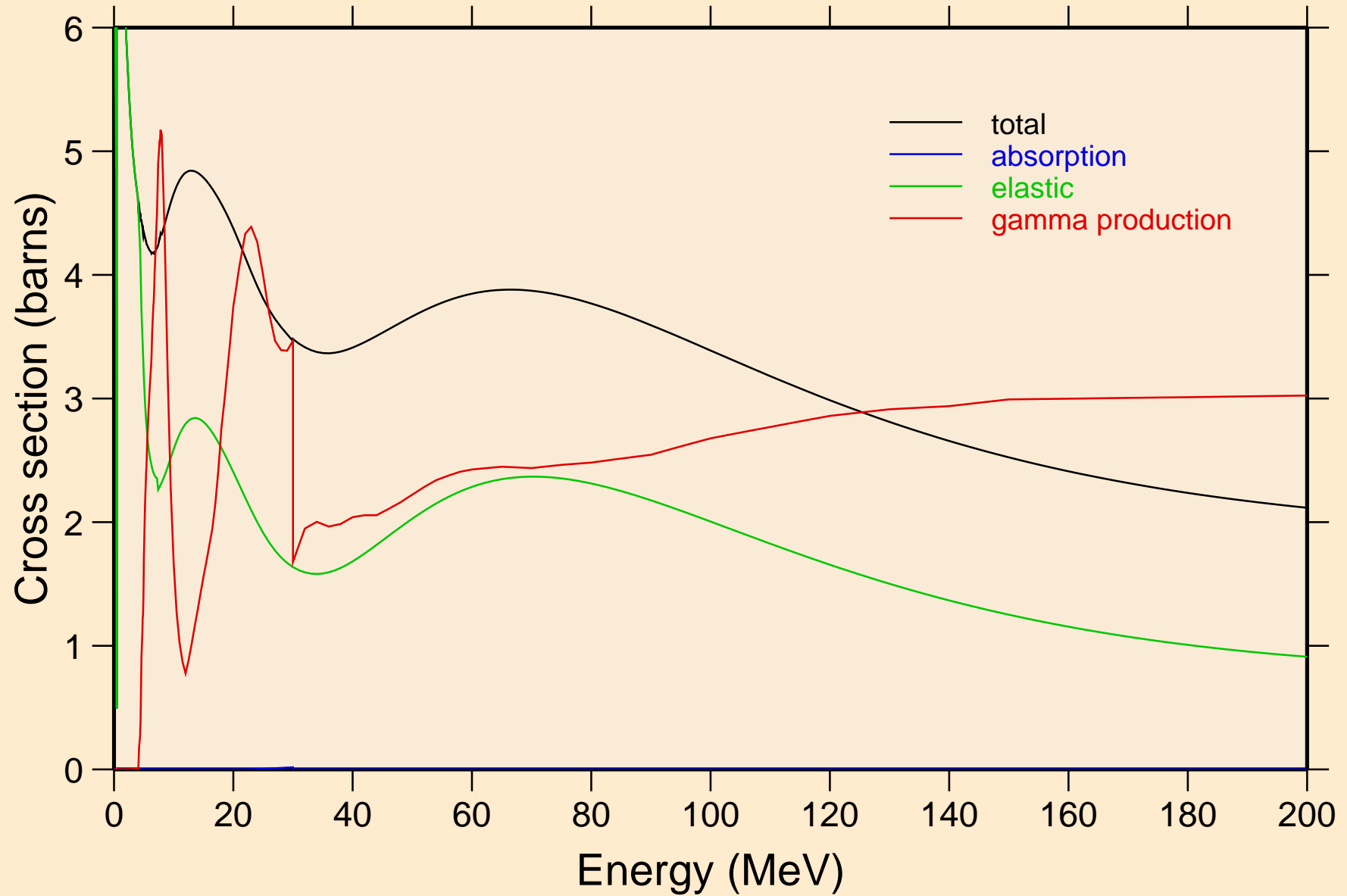

N-SN132 NRG TENDL-2017, AKONING  
Non-threshold reactions

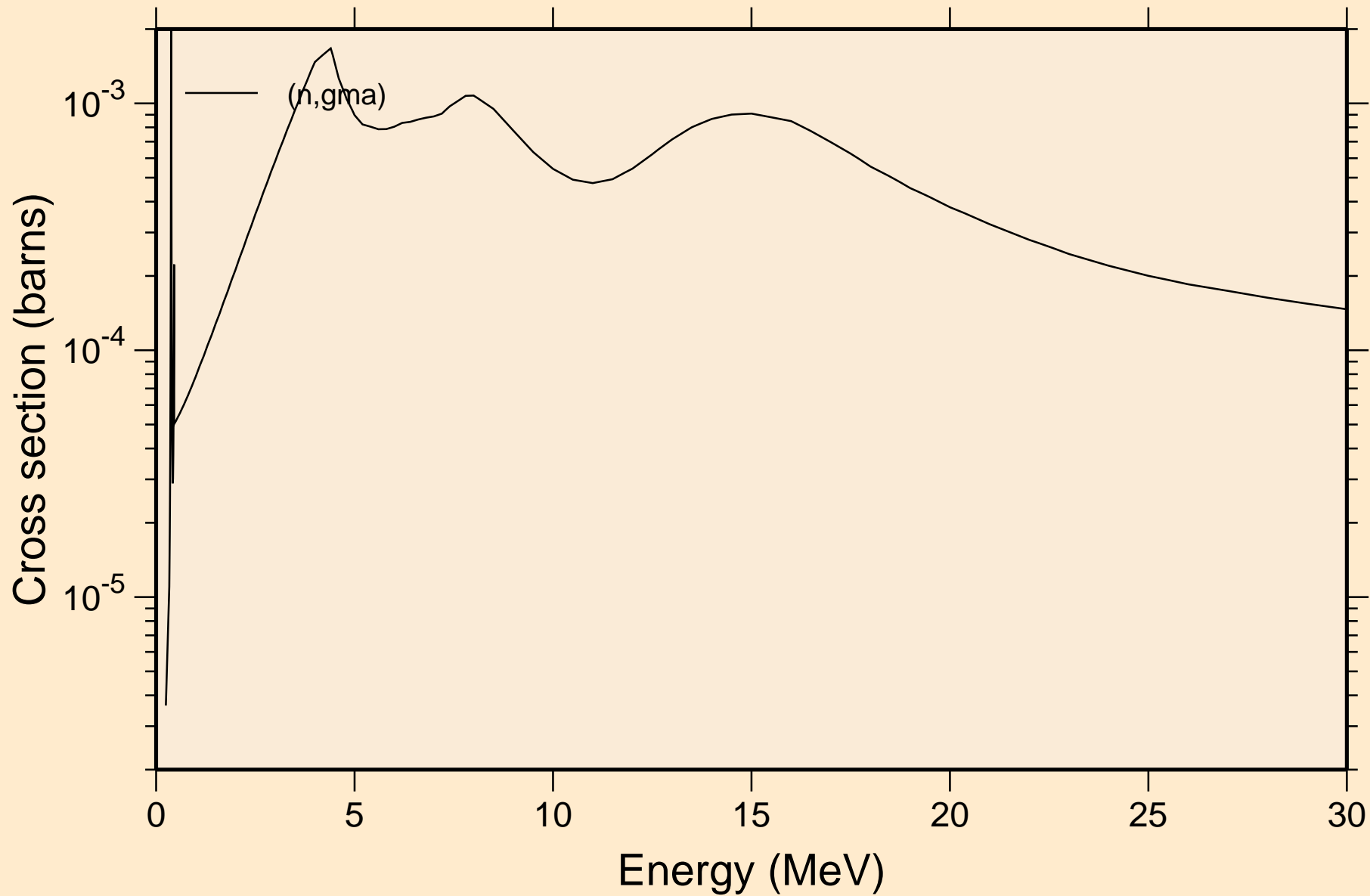

# N-SN132 NRG TENDL-2017, AKONING

## Inelastic levels

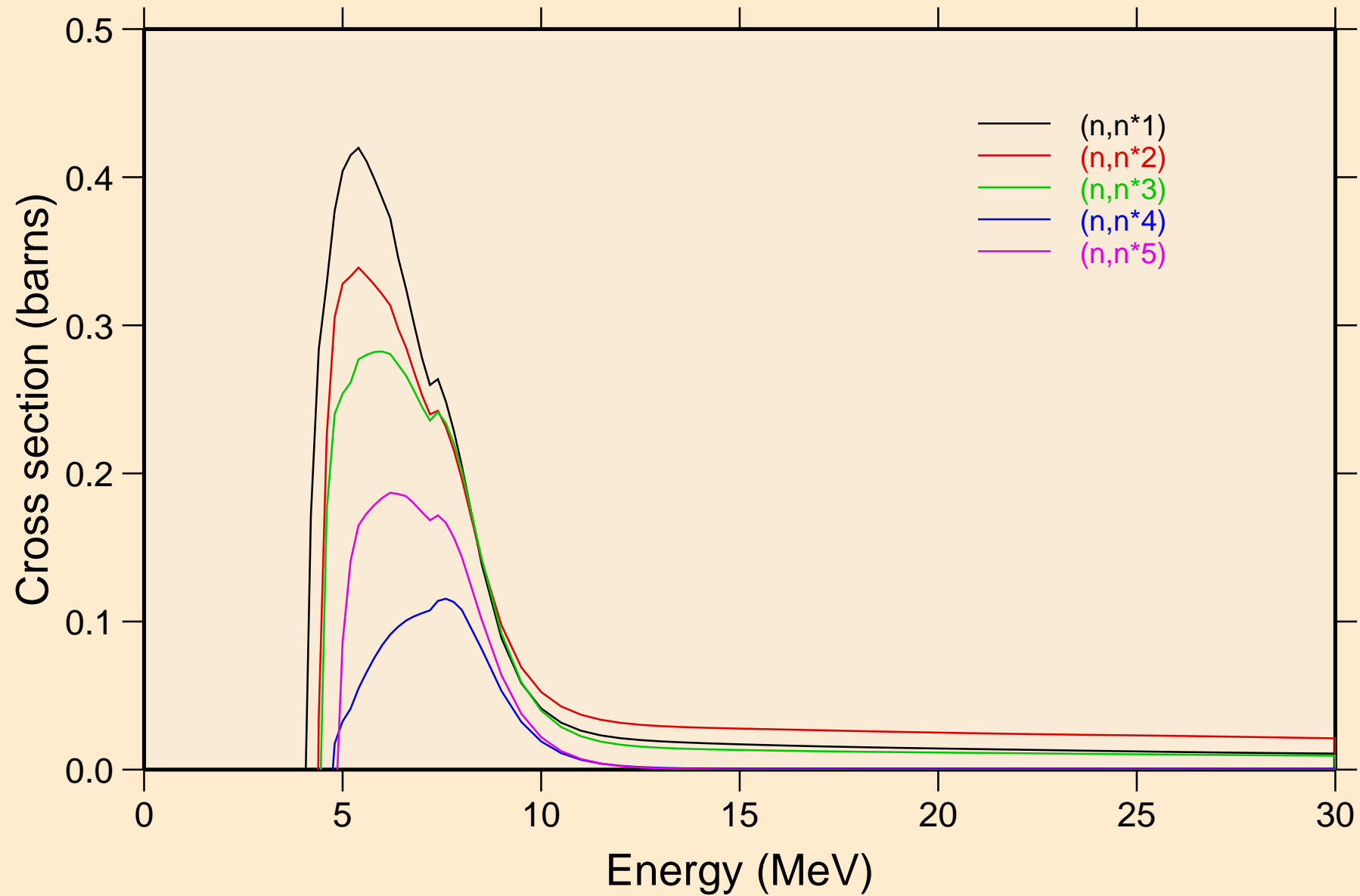

# N-SN132 NRG TENDL-2017, AKONING

## Inelastic levels

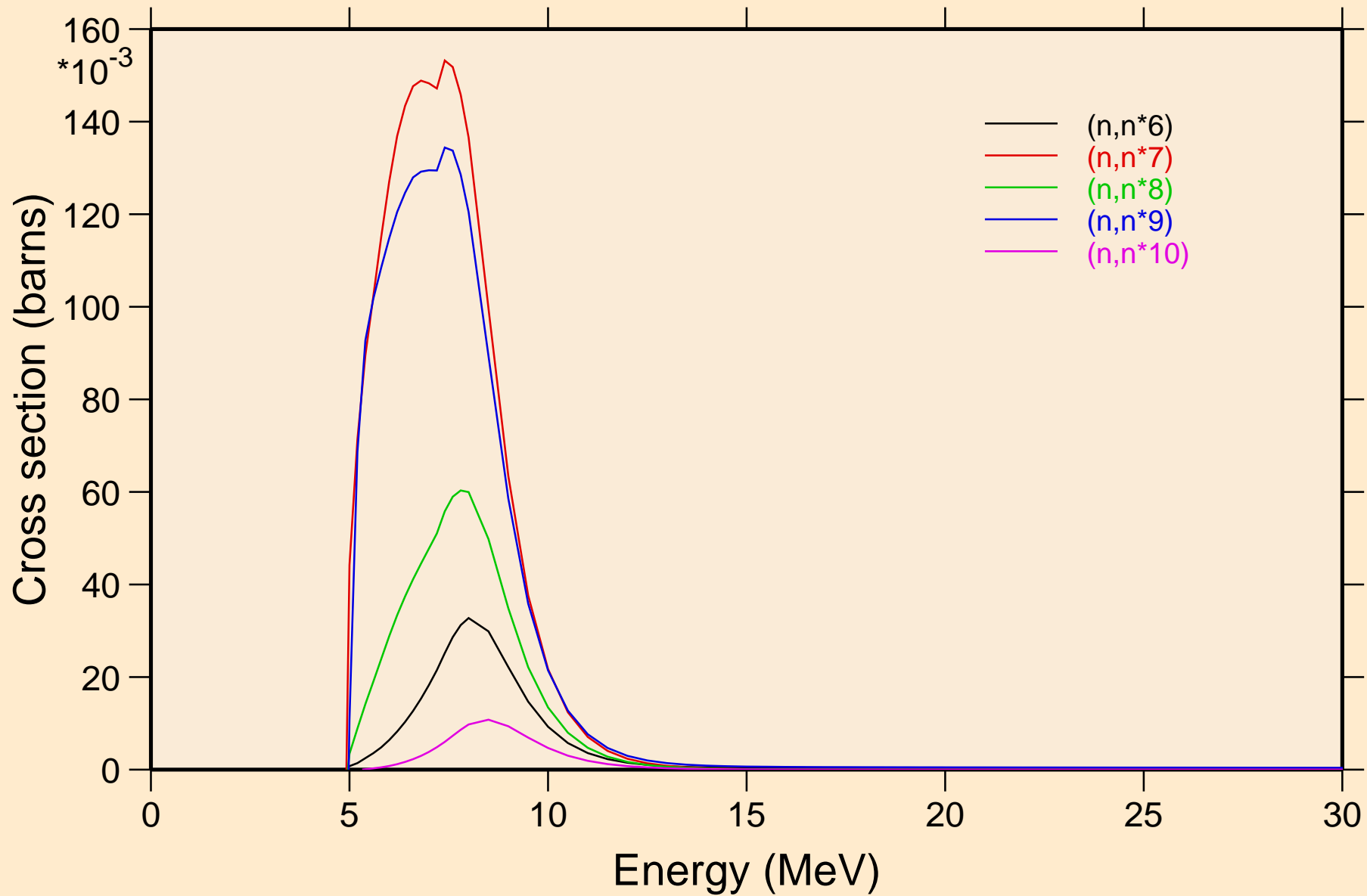

# N-SN132 NRG TENDL-2017, AKONING

## Inelastic levels

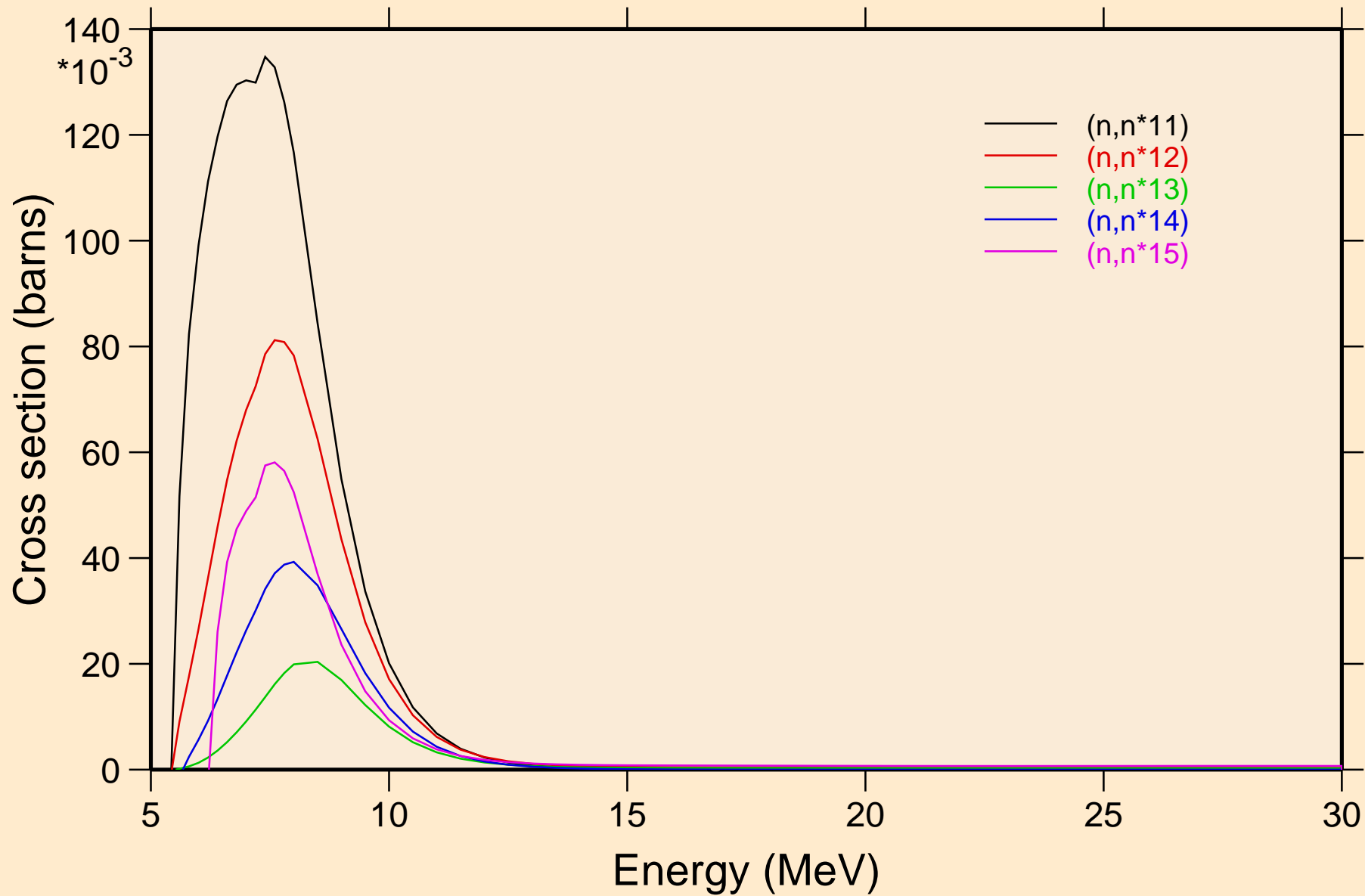

# N-SN132 NRG TENDL-2017, AKONING

## Inelastic levels

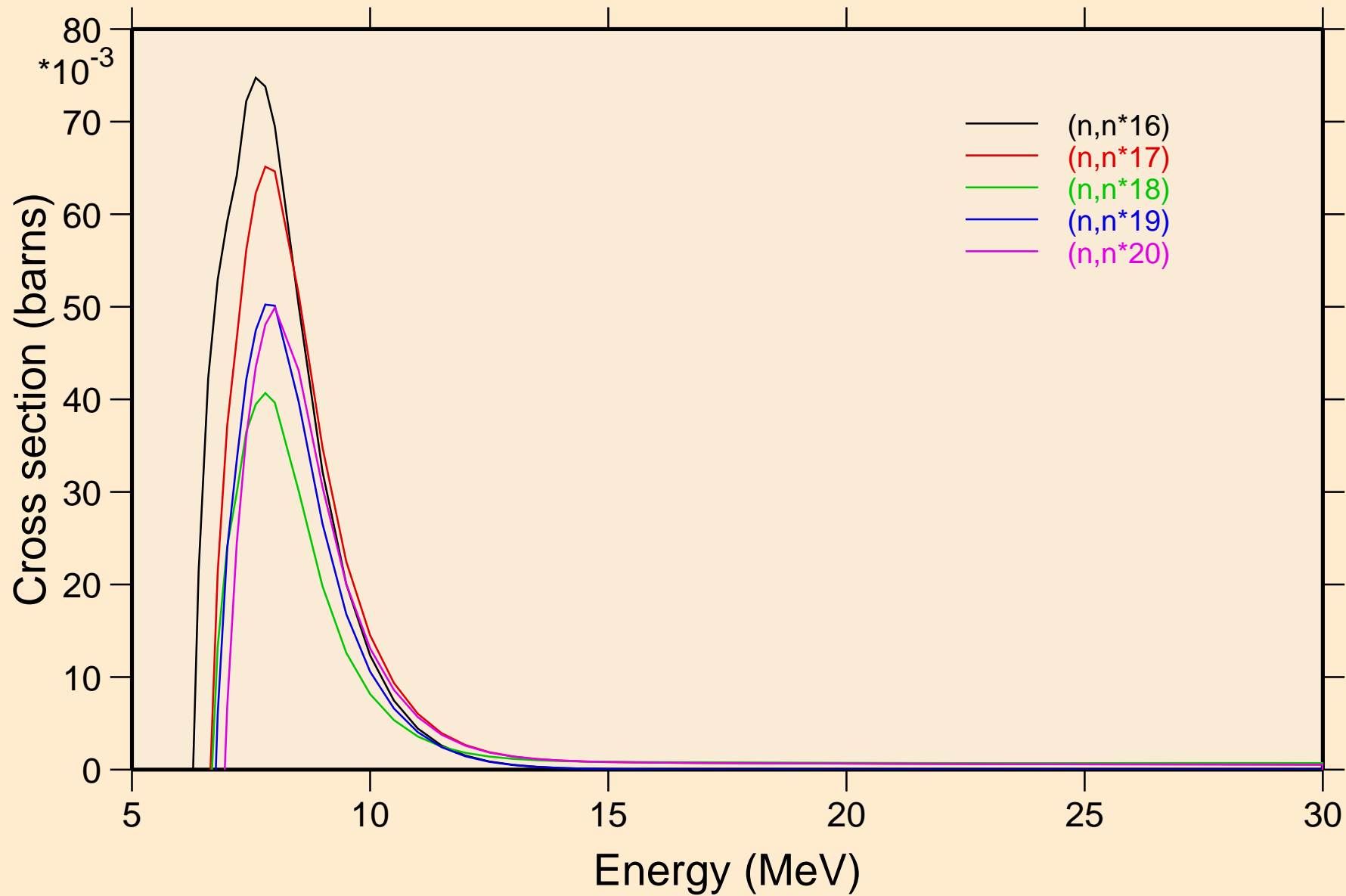



# N-SN132 NRG TENDL-2017, AKONING

## Inelastic levels

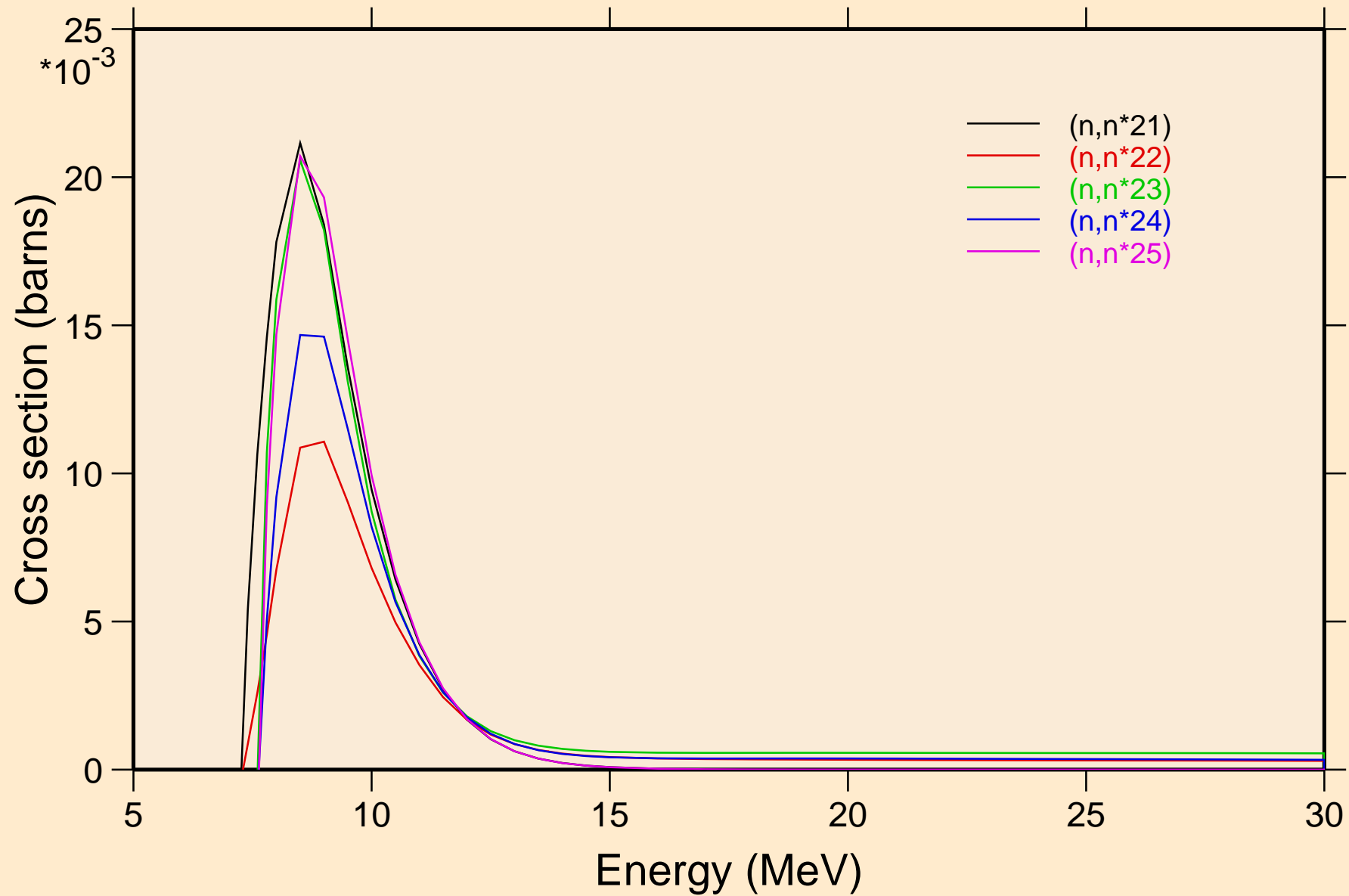

# N-SN132 NRG TENDL-2017, AKONING

## Inelastic levels

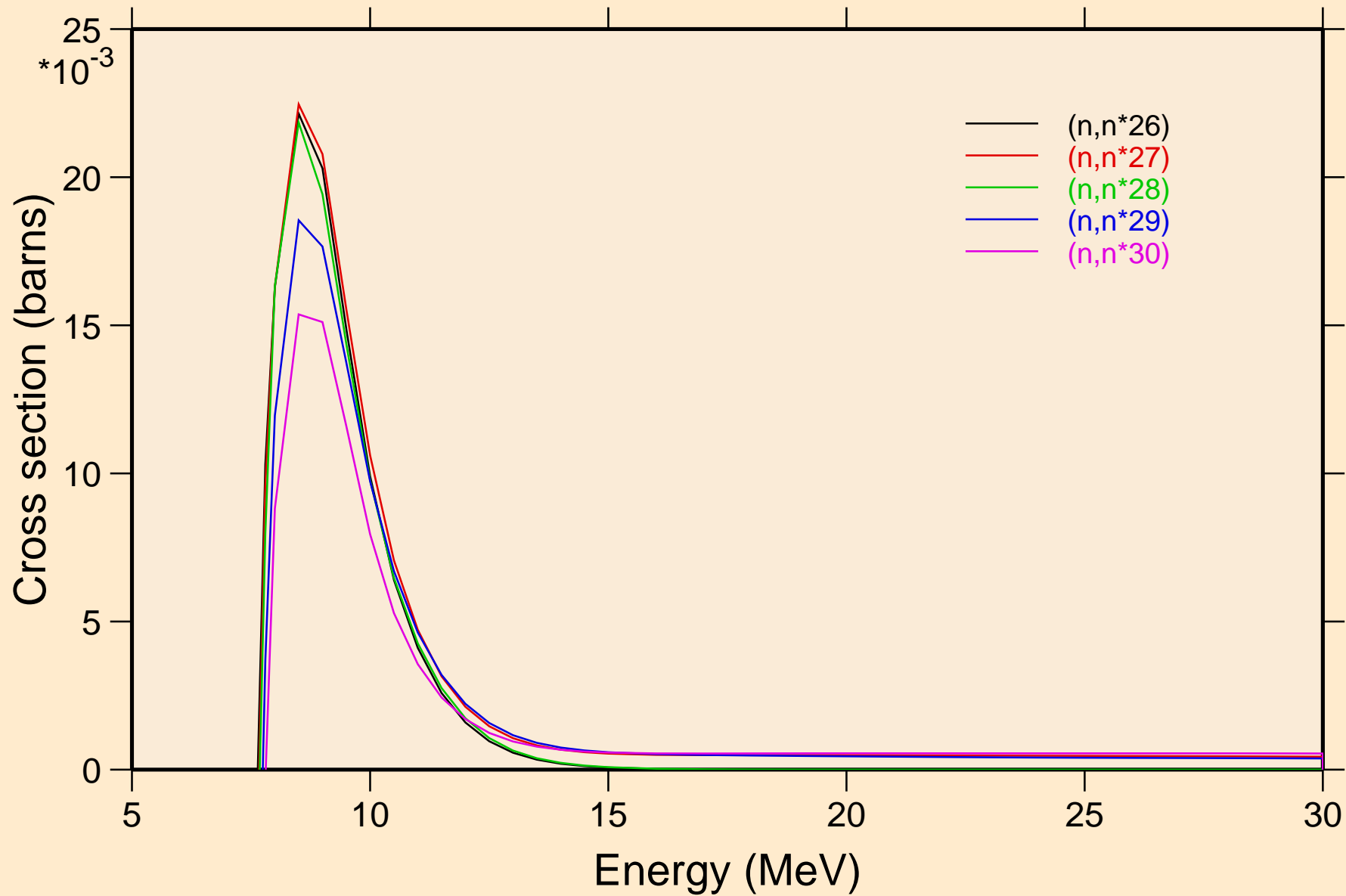

# N-SN132 NRG TENDL-2017, AKONING

## Threshold reactions

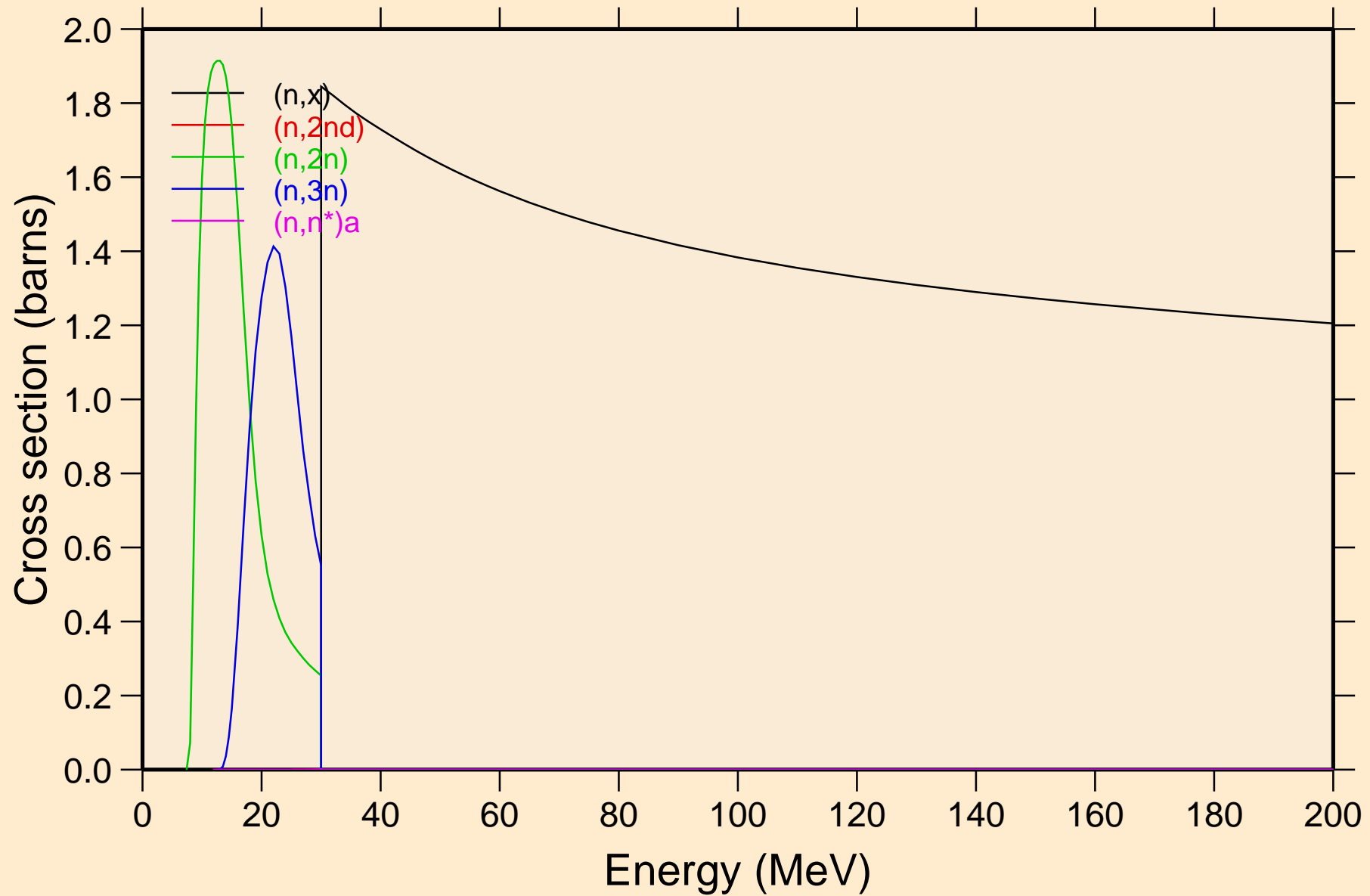

# N-SN132 NRG TENDL-2017, AKONING

## Threshold reactions

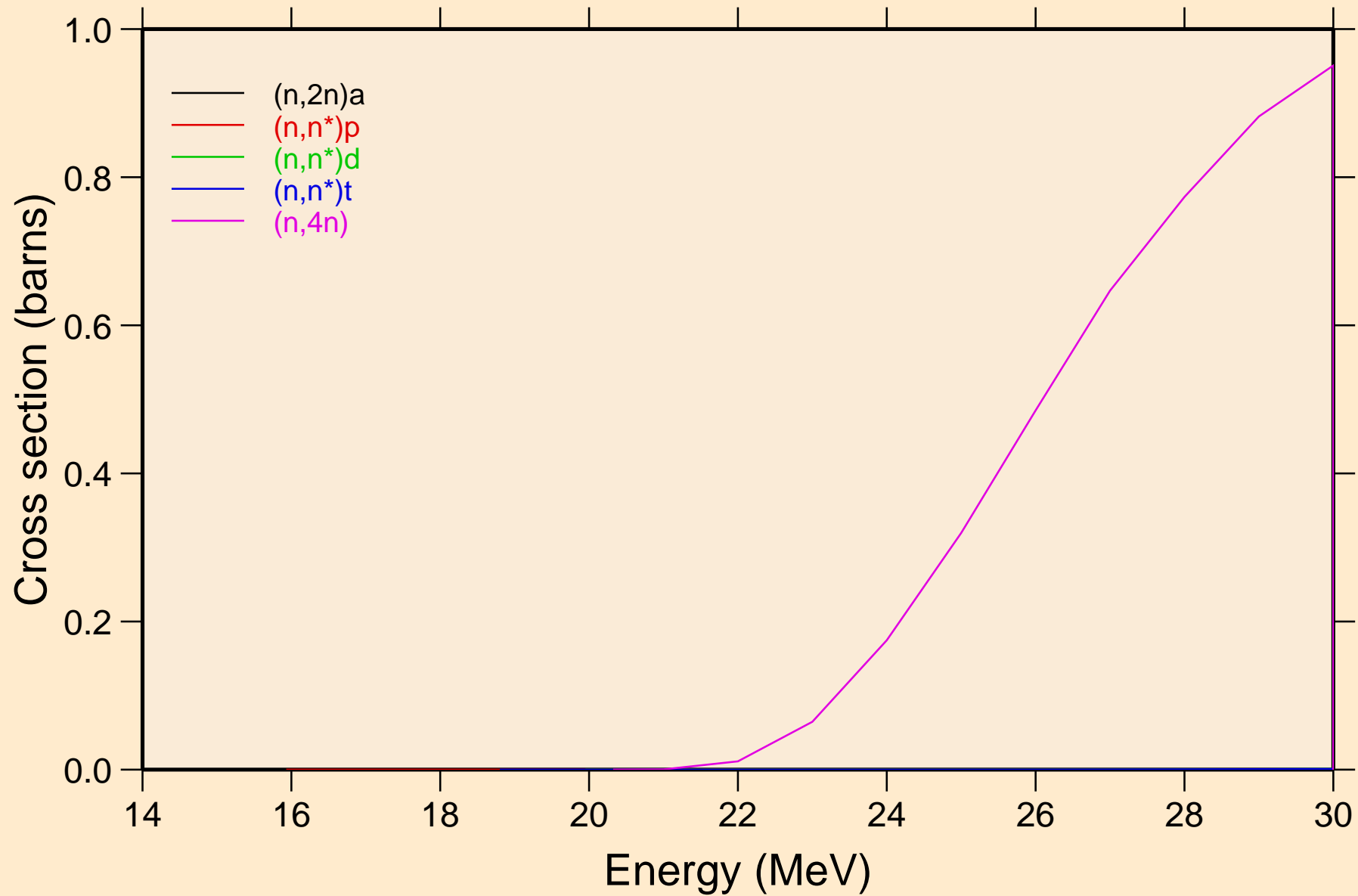

# N-SN132 NRG TENDL-2017, AKONING

## Threshold reactions

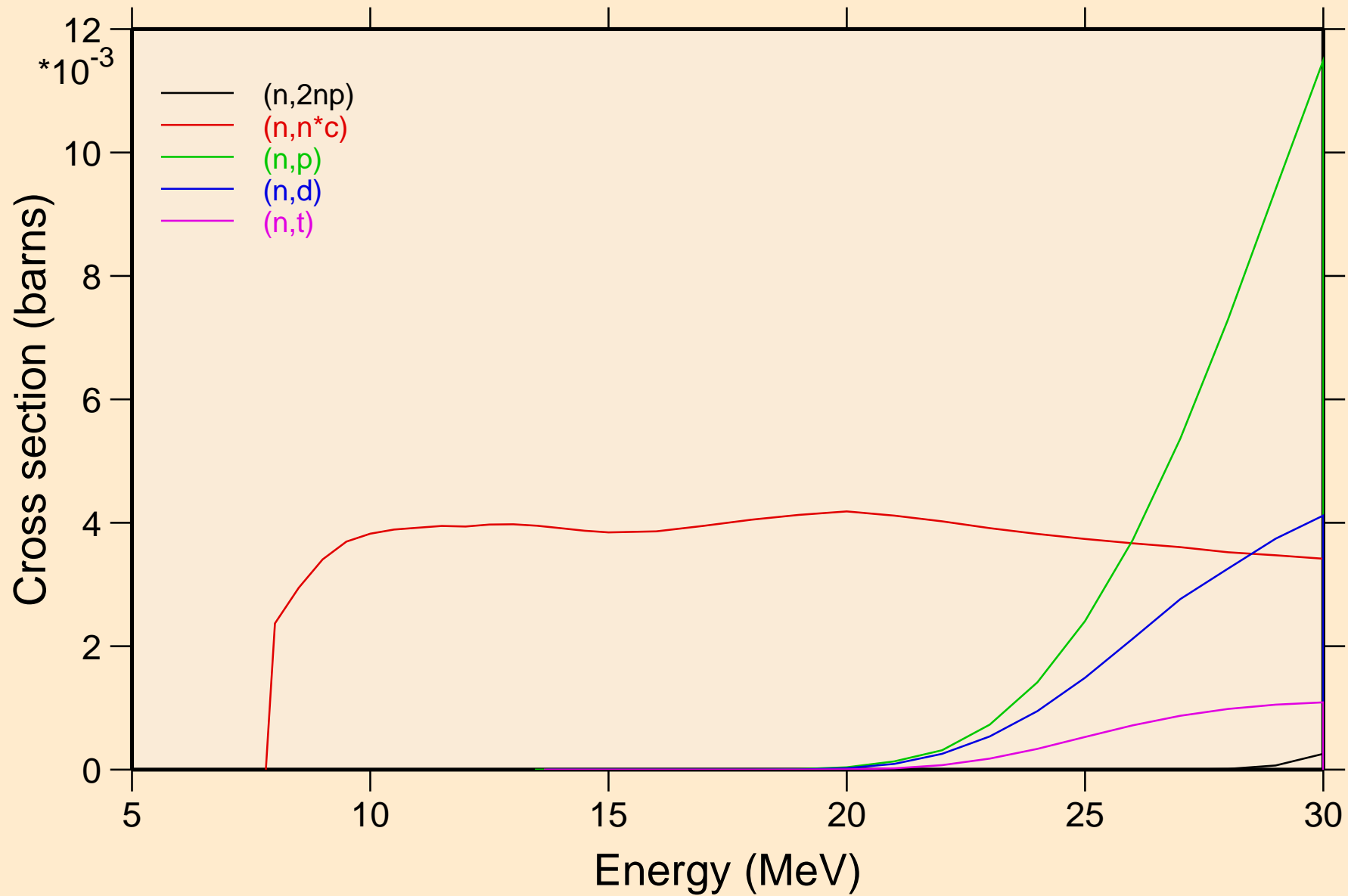

# N-SN132 NRG TENDL-2017, AKONING

## Threshold reactions

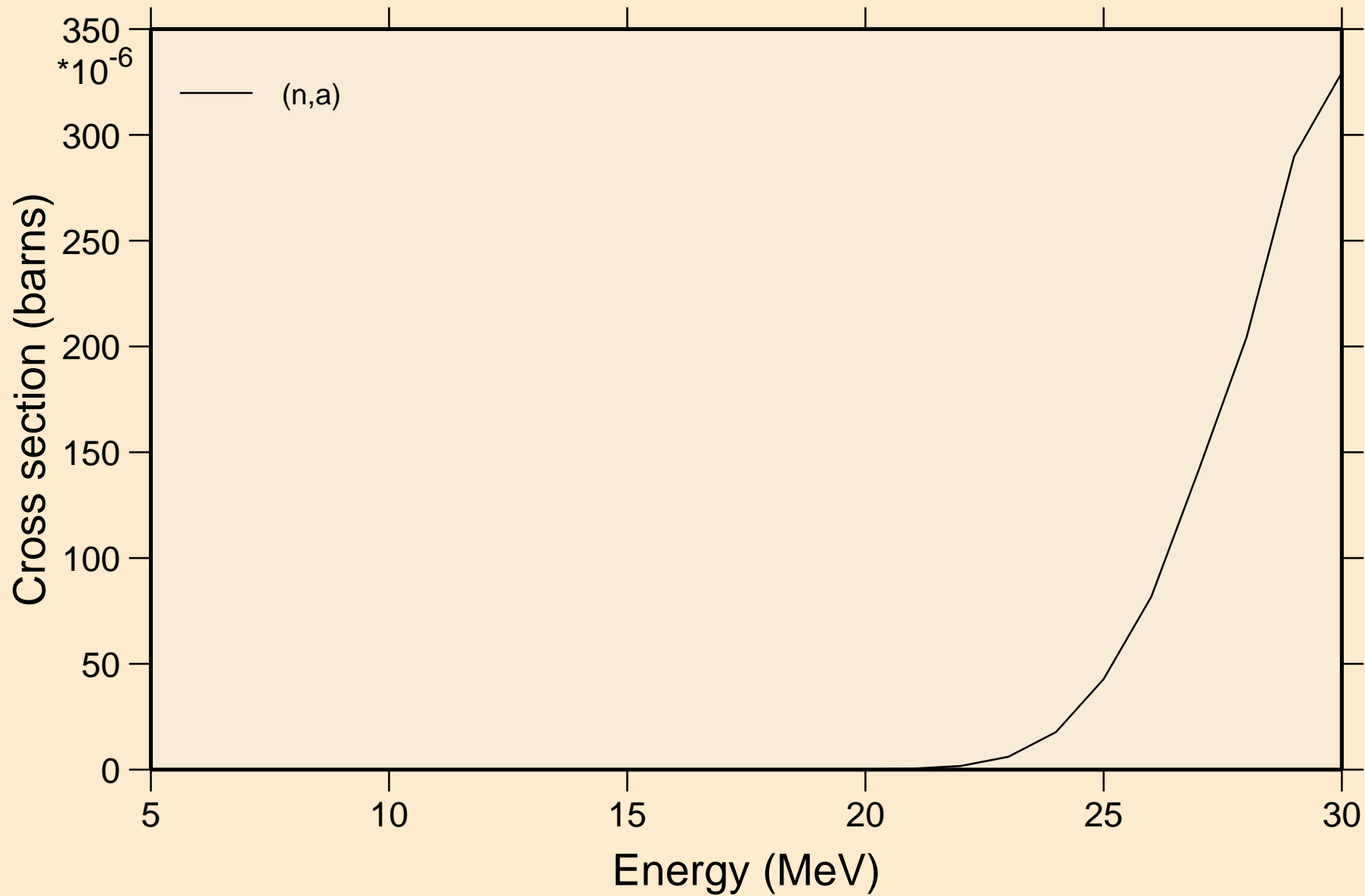

N-SN132 NRG TENDL-2017, AKONING  
angular distribution for elastic

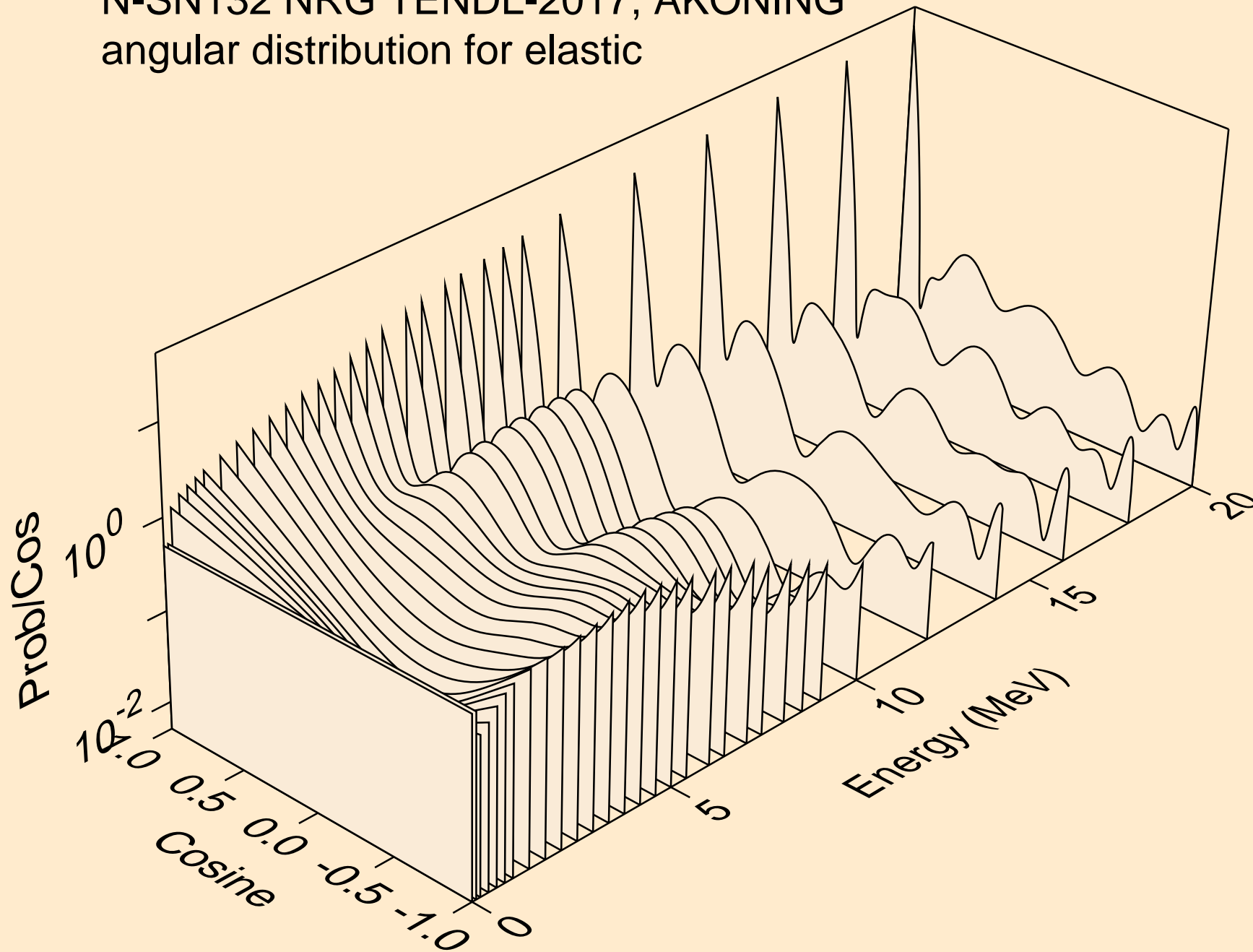

N-SN132 NRG TENDL-2017, AKONING  
angular distribution for elastic

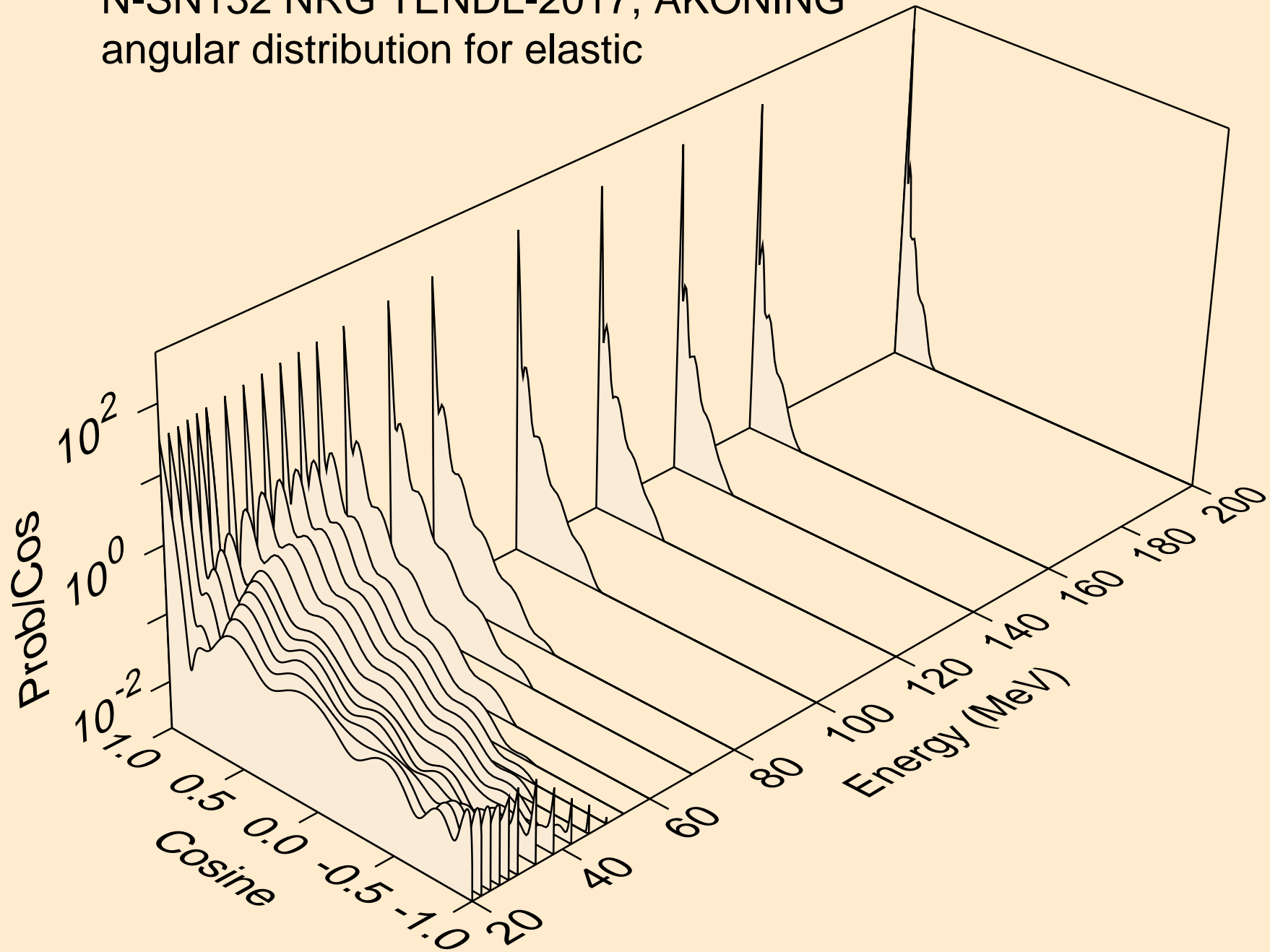



N-SN132 NRG TENDL-2017, AKONING  
angular distribution for (n,n\*1)

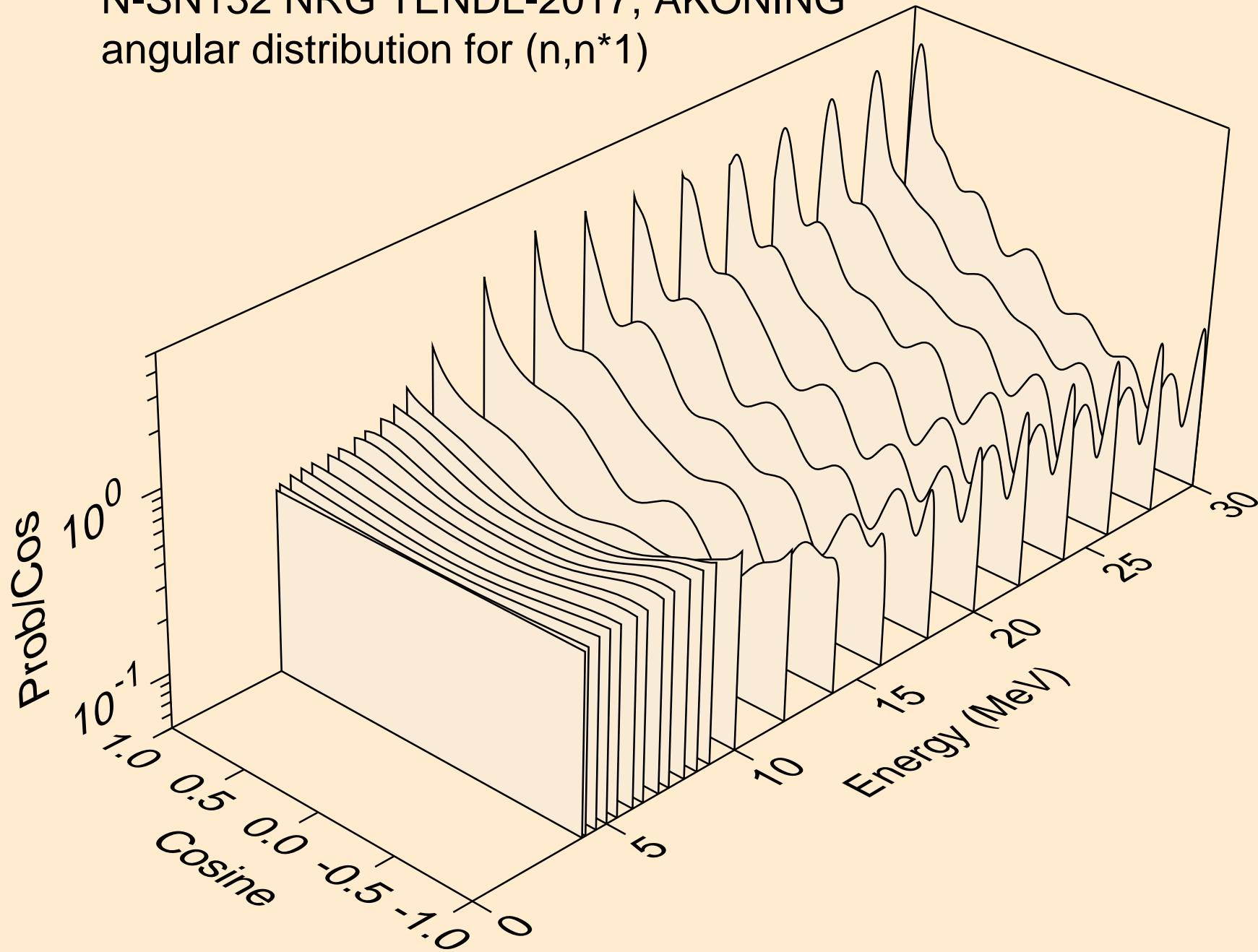

N-SN132 NRG TENDL-2017, AKONING  
angular distribution for (n,n\*2)

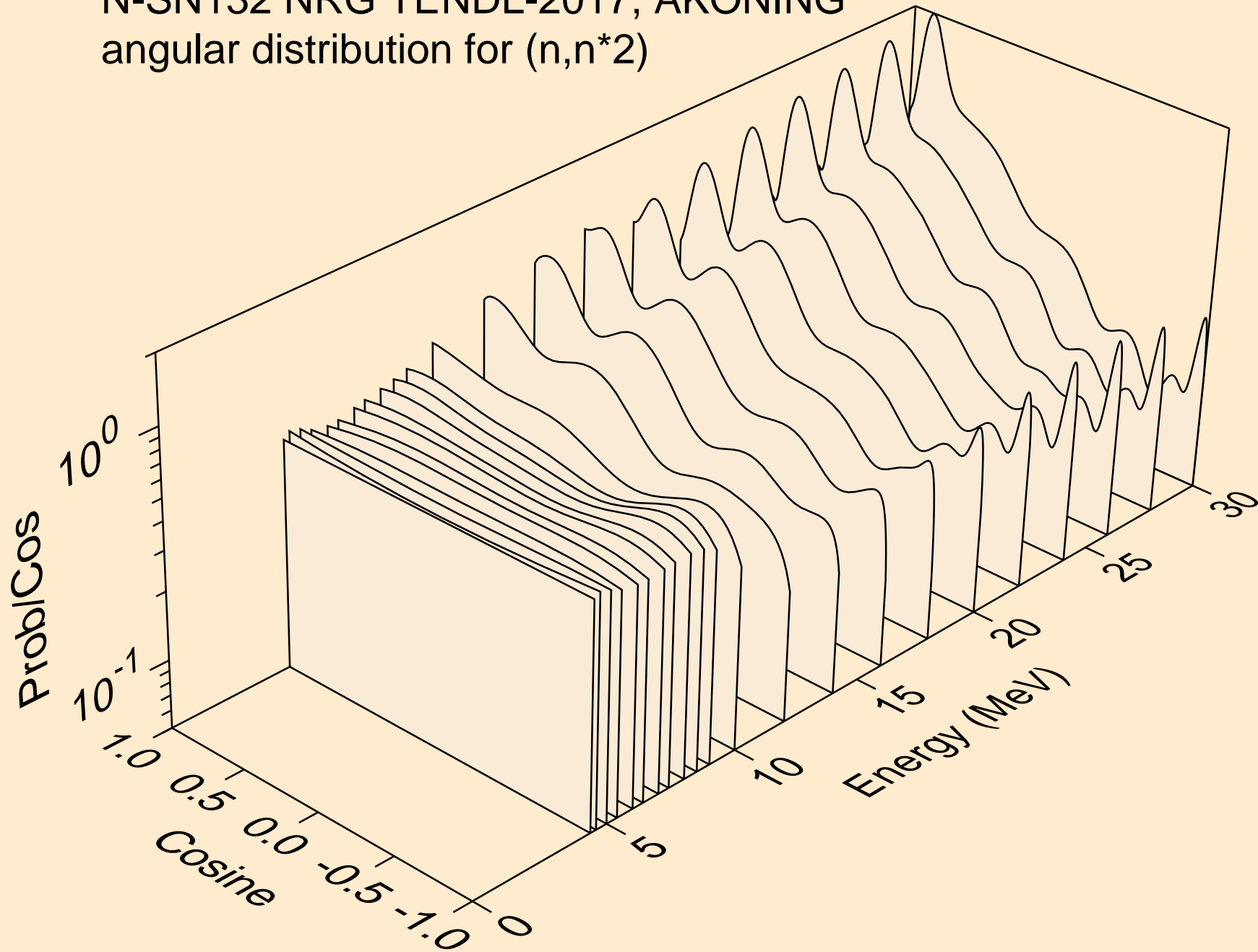

N-SN132 NRG TENDL-2017, AKONING  
angular distribution for (n,n\*3)

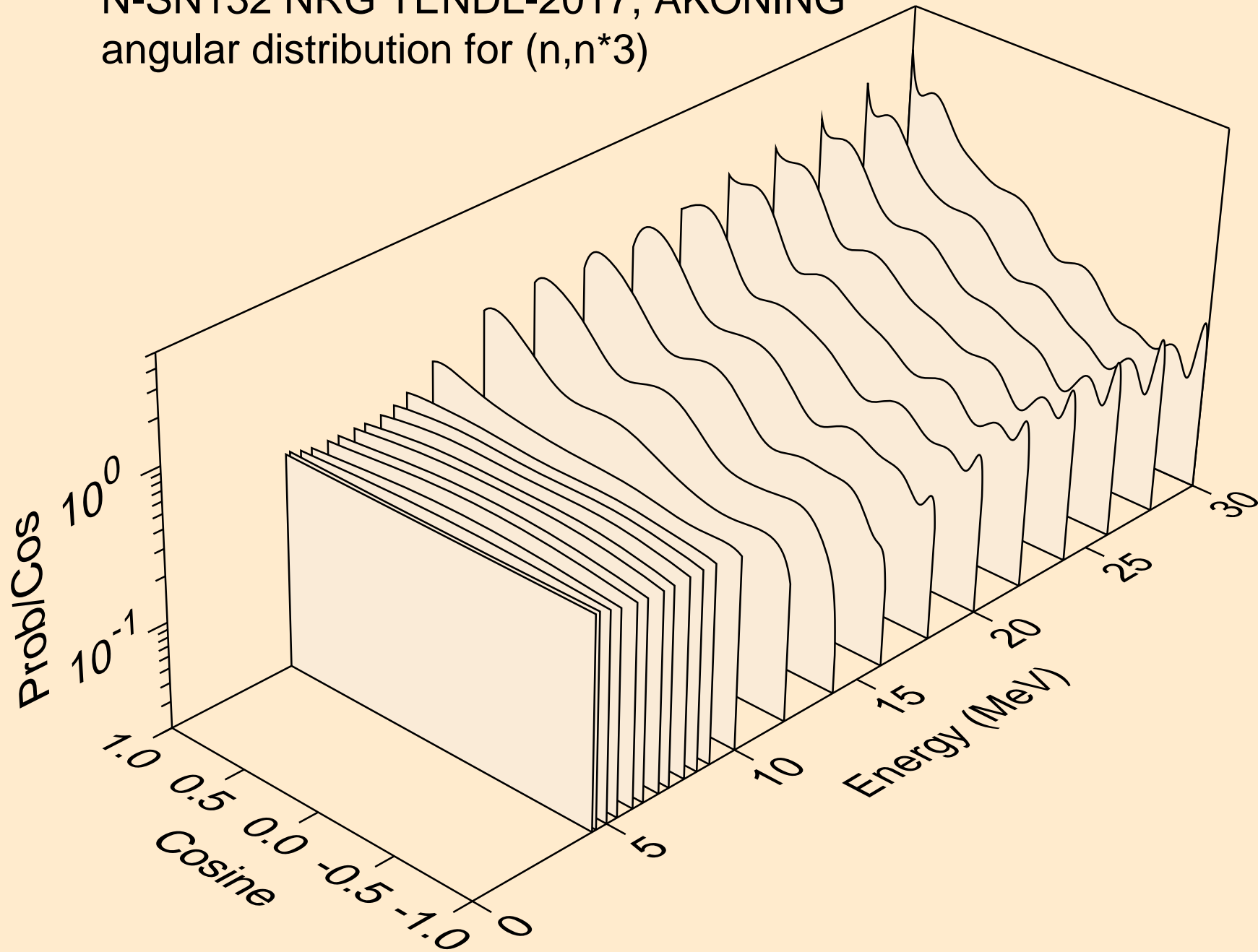

N-SN132 NRG TENDL-2017, AKONING  
angular distribution for (n,n\*4)

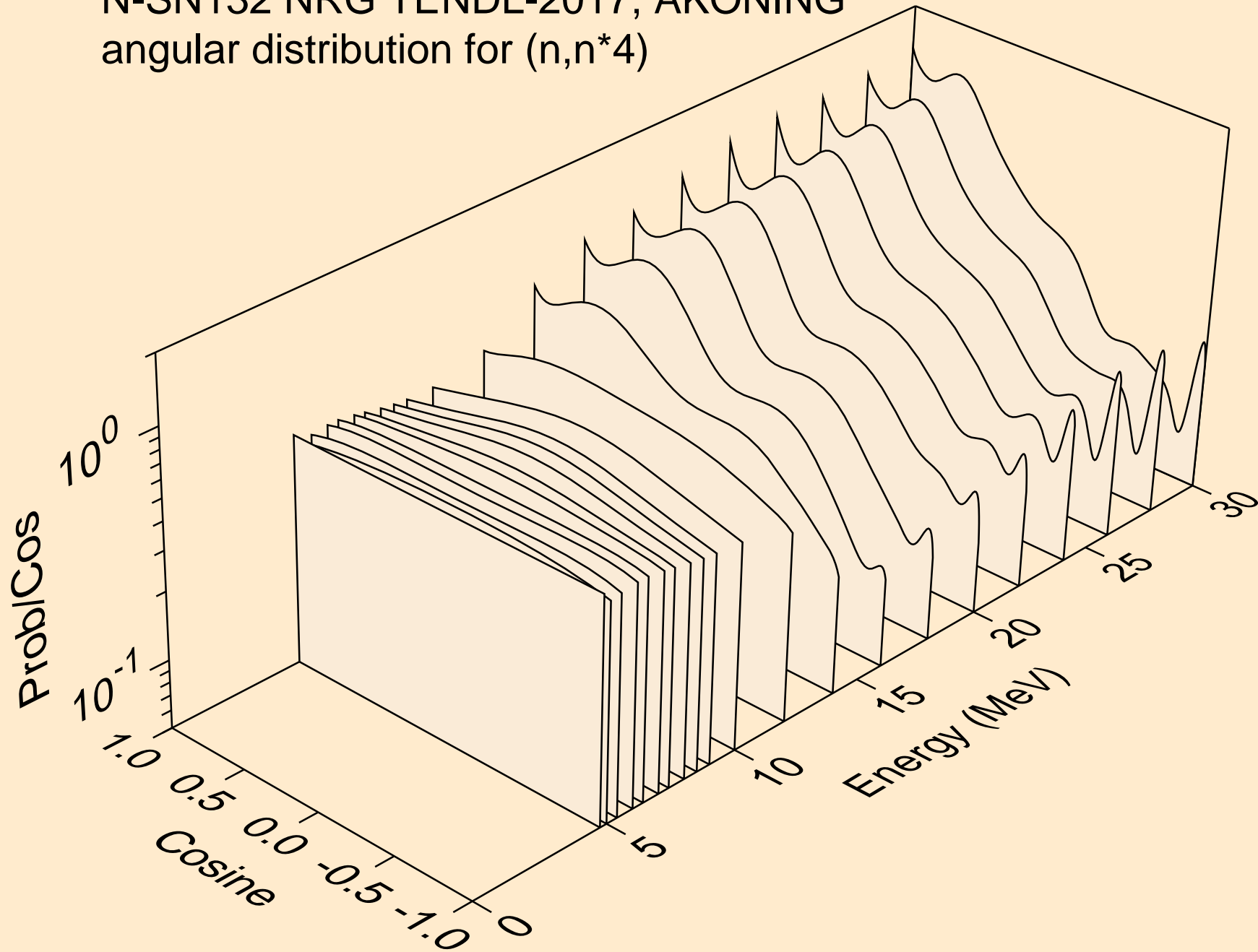

N-SN132 NRG TENDL-2017, AKONING  
angular distribution for (n,n\*5)

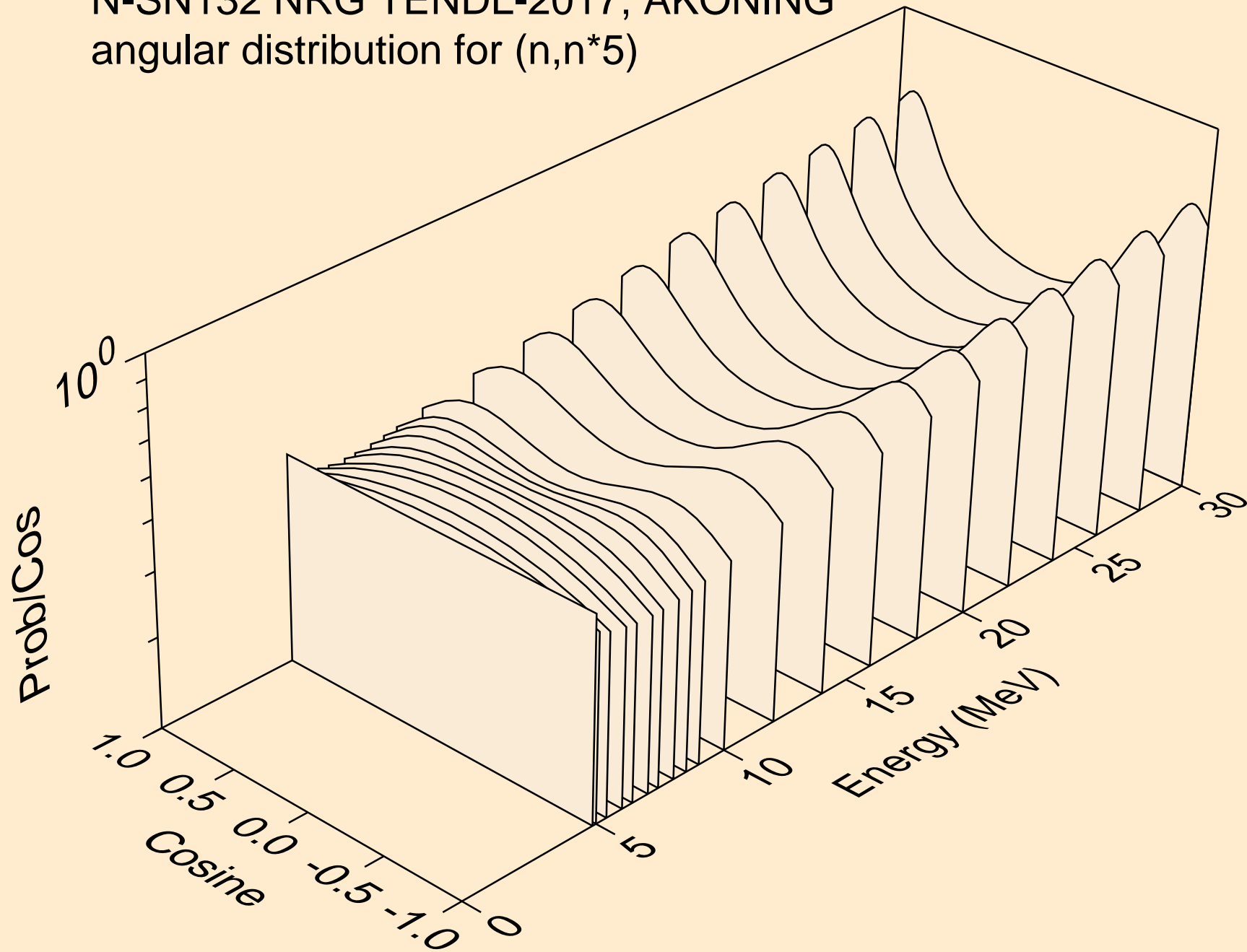

N-SN132 NRG TENDL-2017, AKONING  
angular distribution for (n,n\*6)

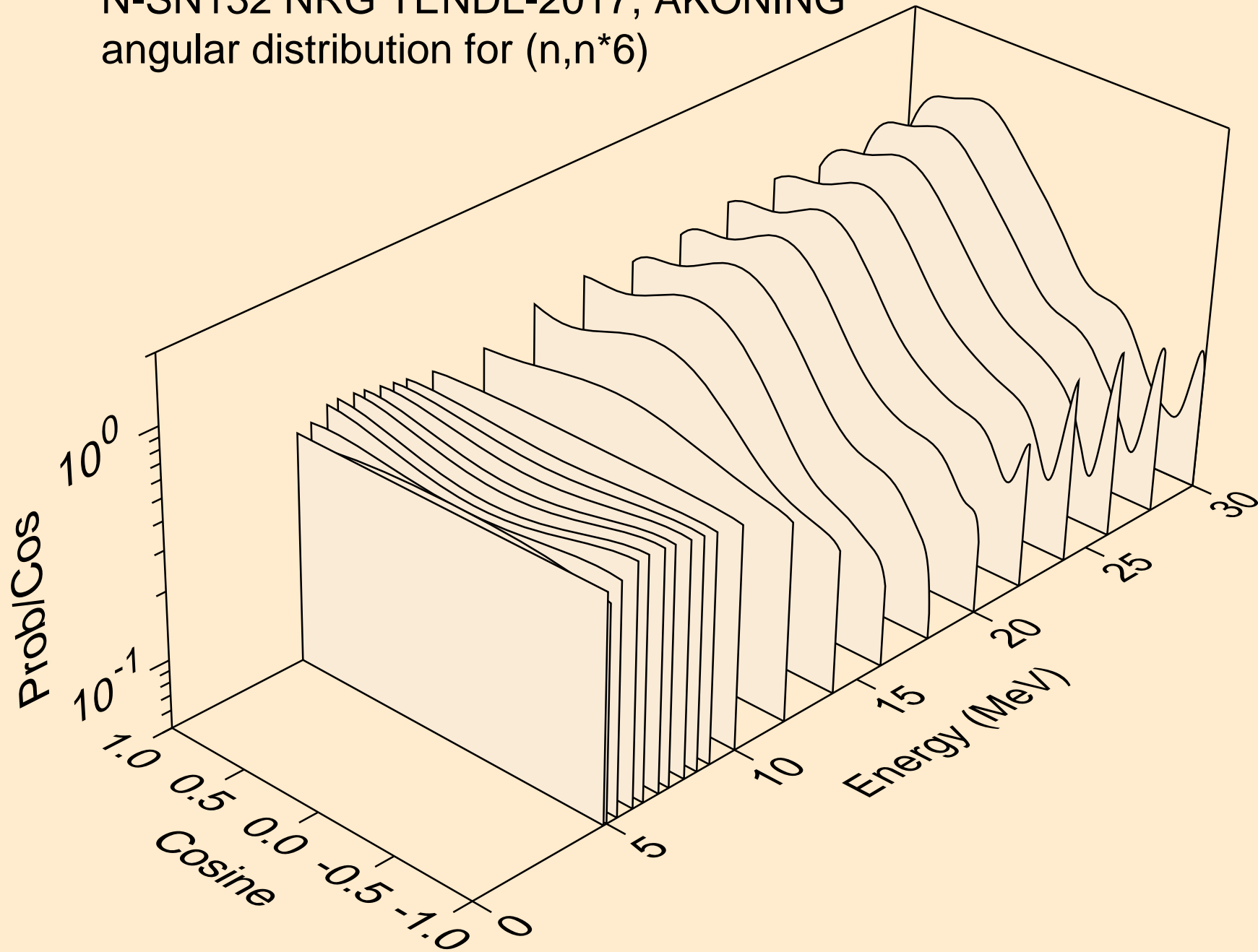

N-SN132 NRG TENDL-2017, AKONING  
angular distribution for (n,n\*7)

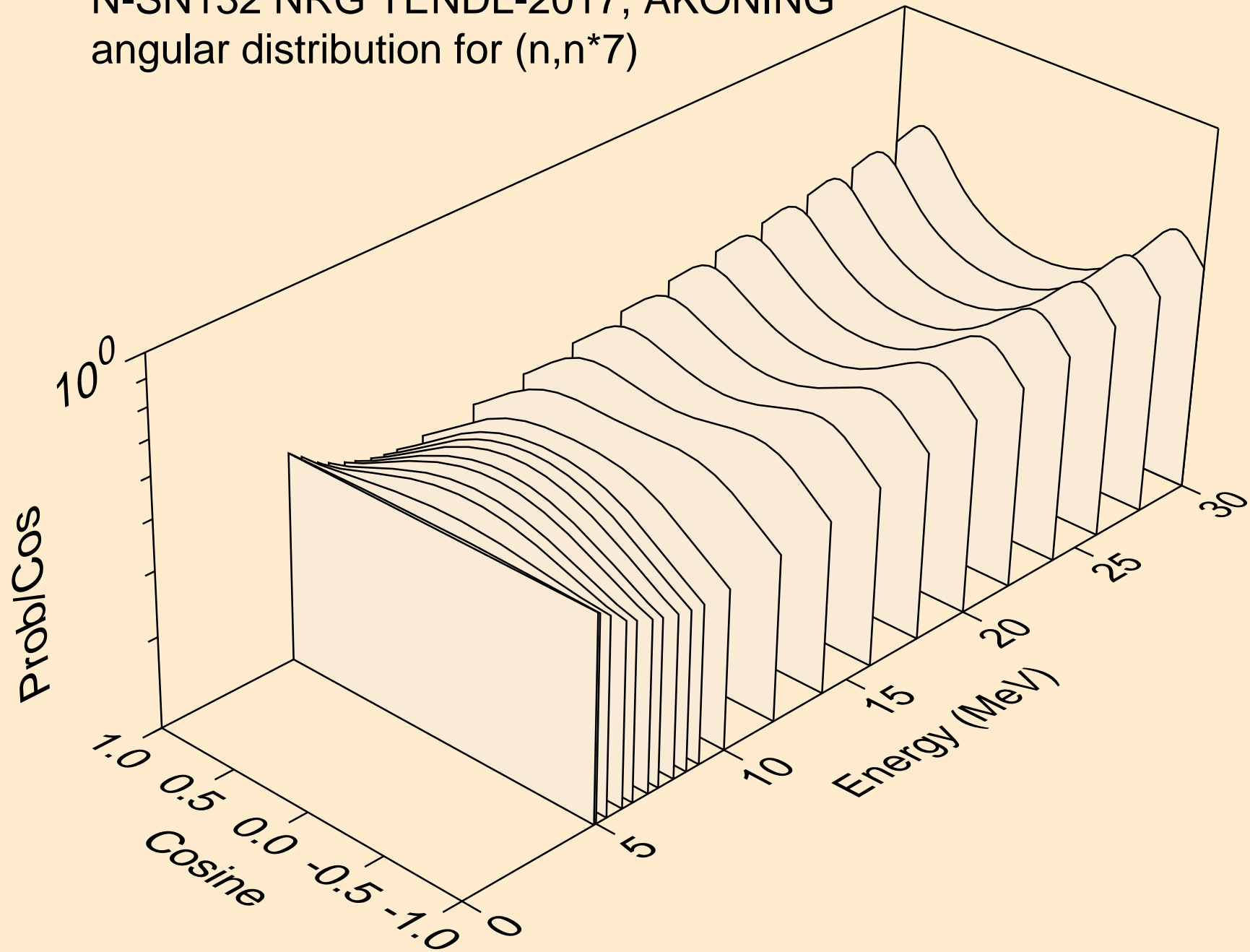

N-SN132 NRG TENDL-2017, AKONING  
angular distribution for (n,n\*8)

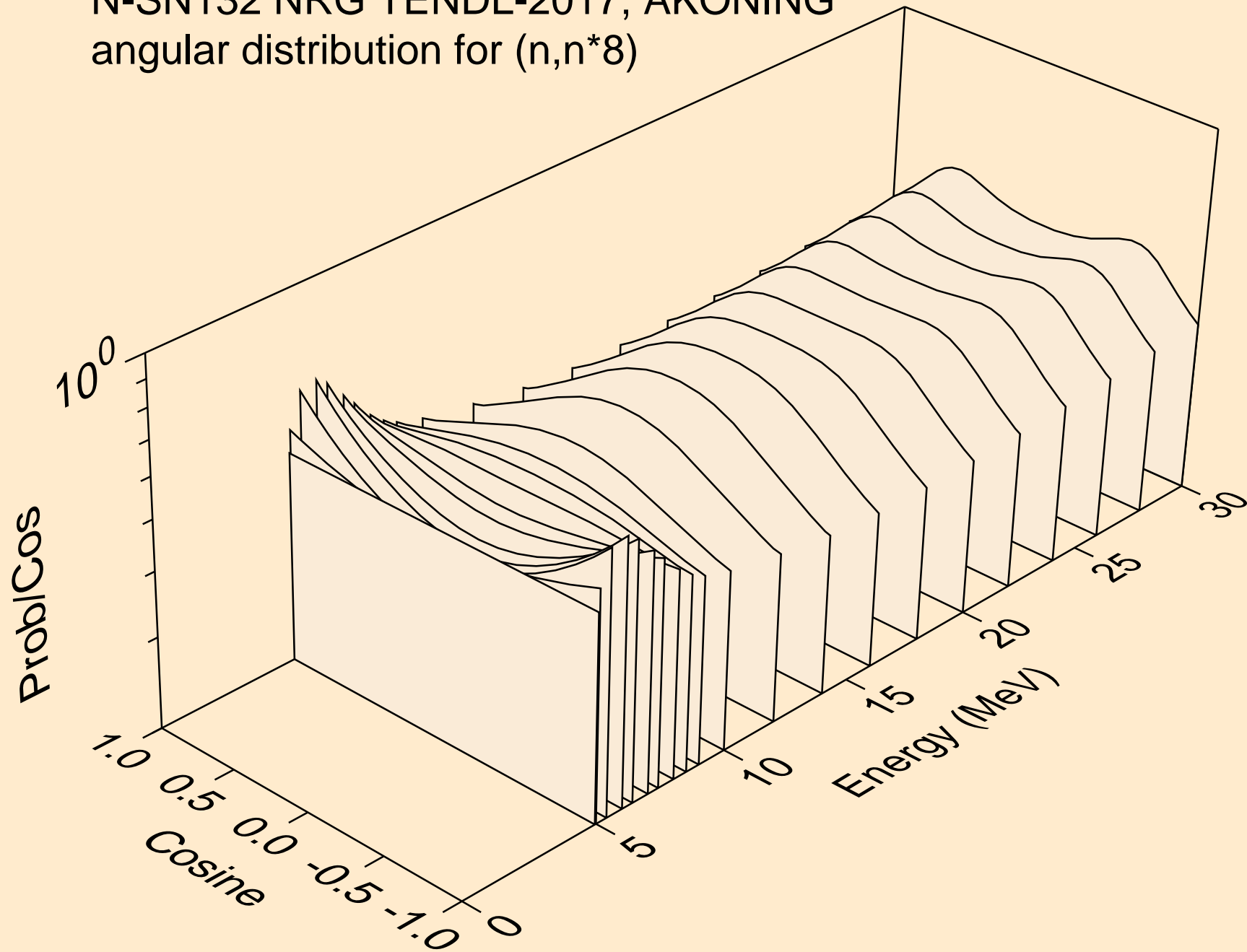



N-SN132 NRG TENDL-2017, AKONING  
angular distribution for (n,n\*9)

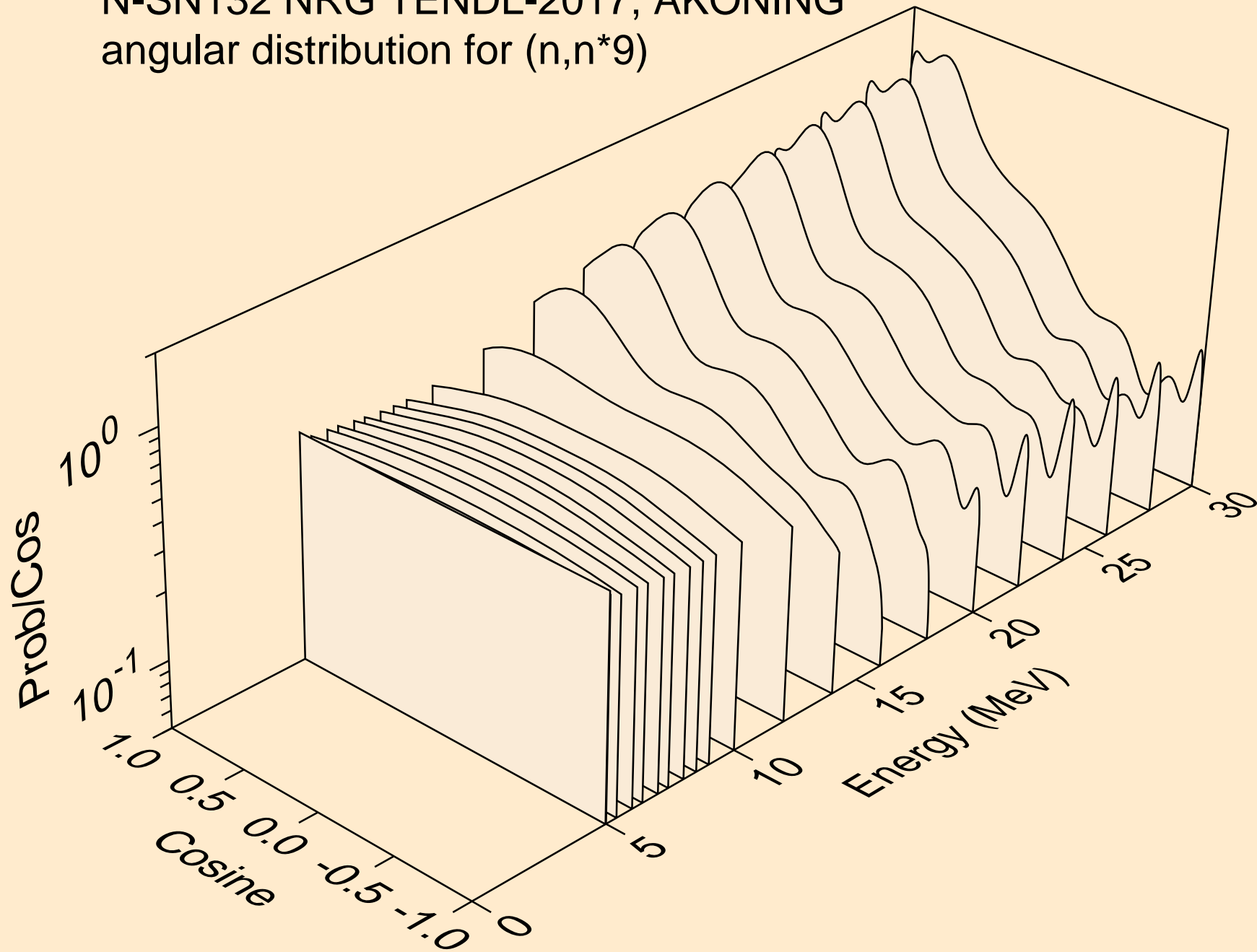

N-SN132 NRG TENDL-2017, AKONING  
angular distribution for (n,n\*10)

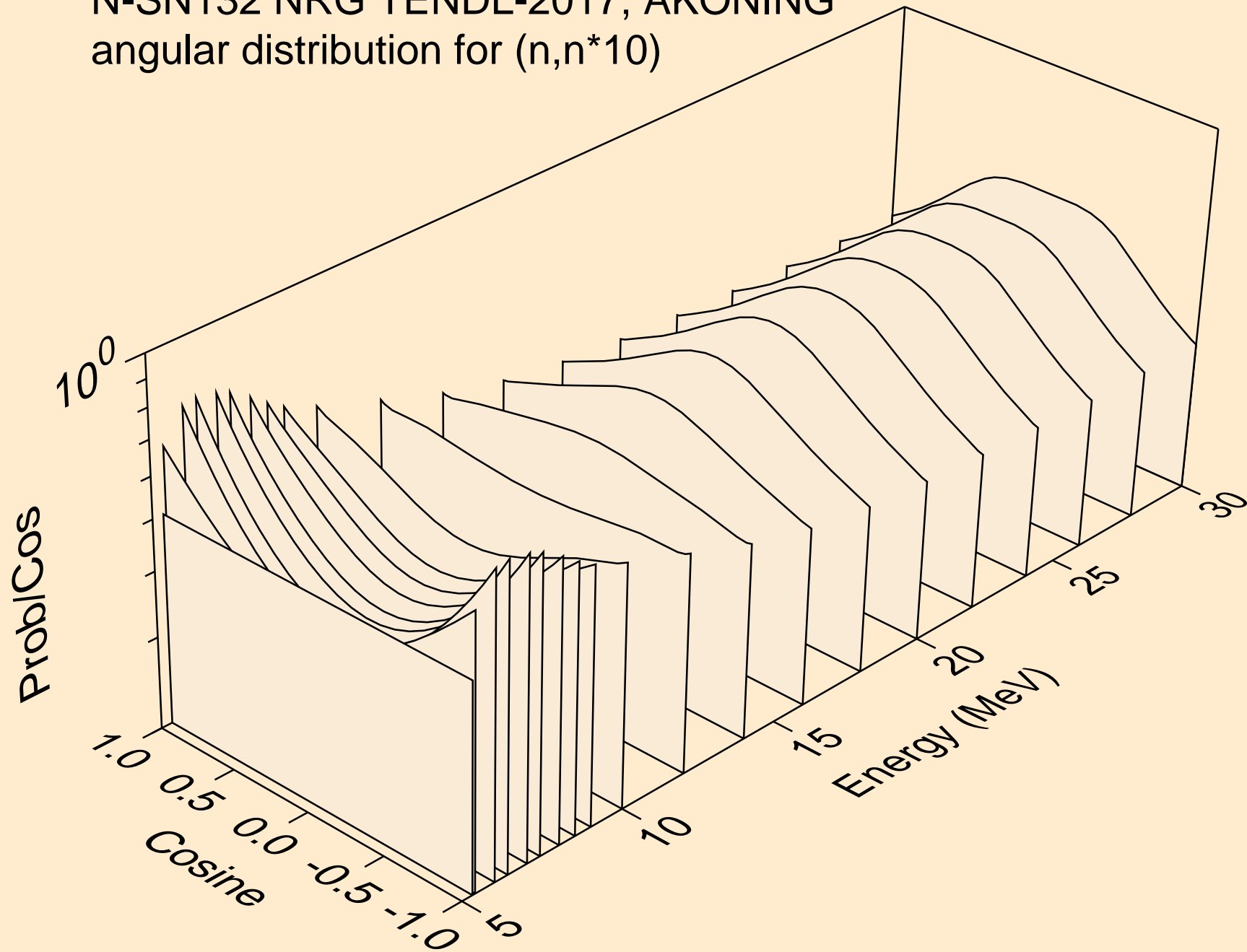

N-SN132 NRG TENDL-2017, AKONING  
angular distribution for (n,n\*11)

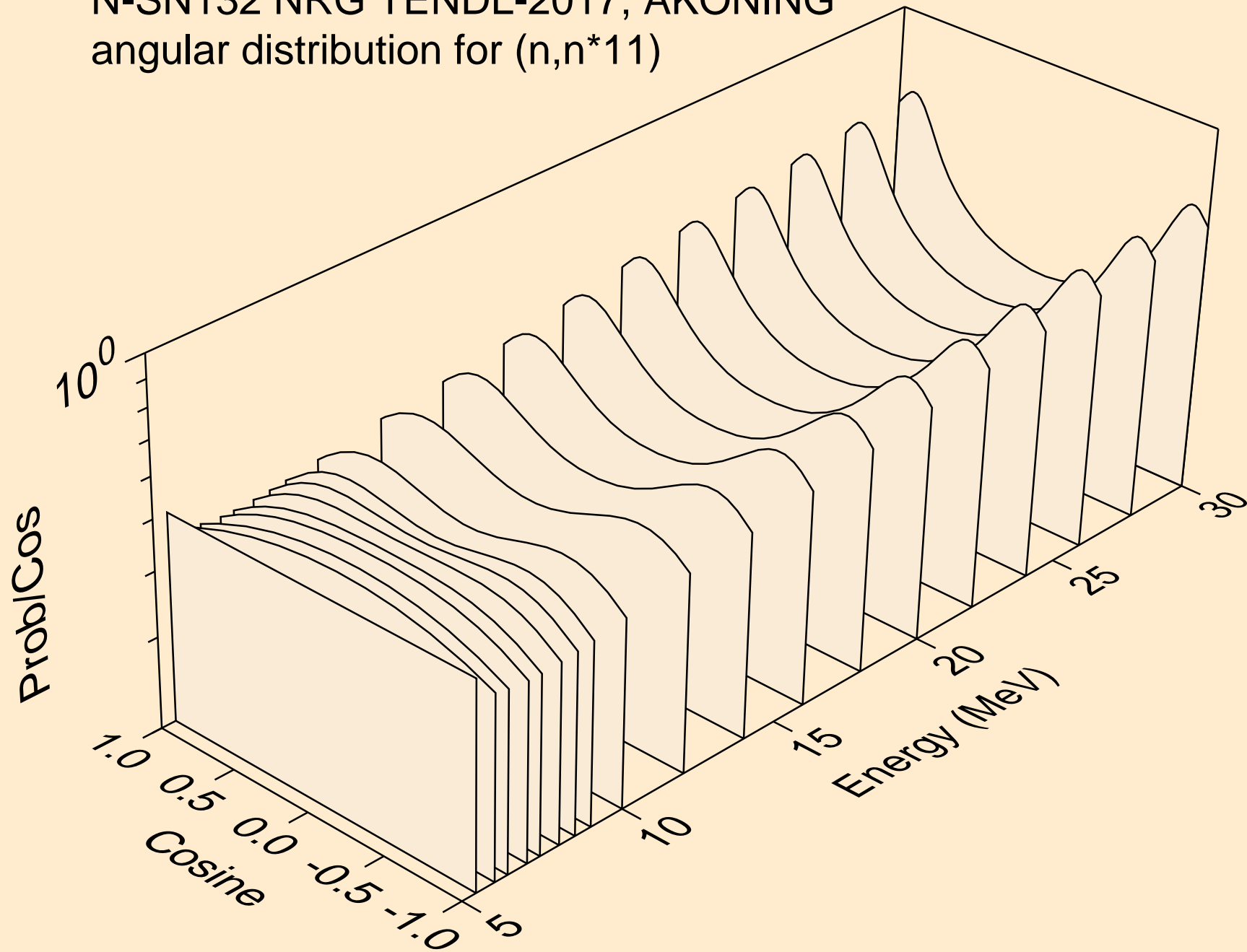

N-SN132 NRG TENDL-2017, AKONING  
angular distribution for (n,n\*12)

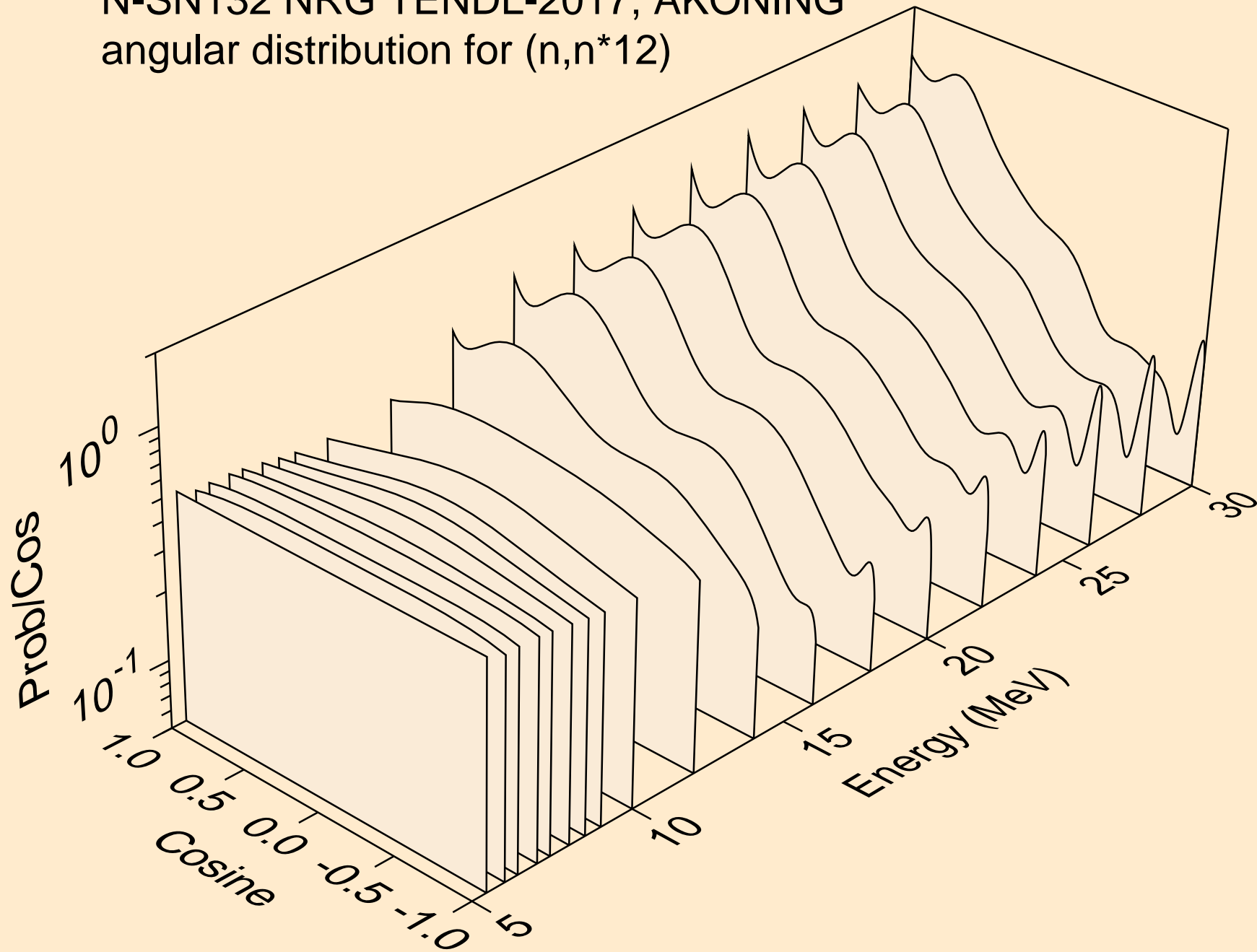

N-SN132 NRG TENDL-2017, AKONING  
angular distribution for (n,n\*13)

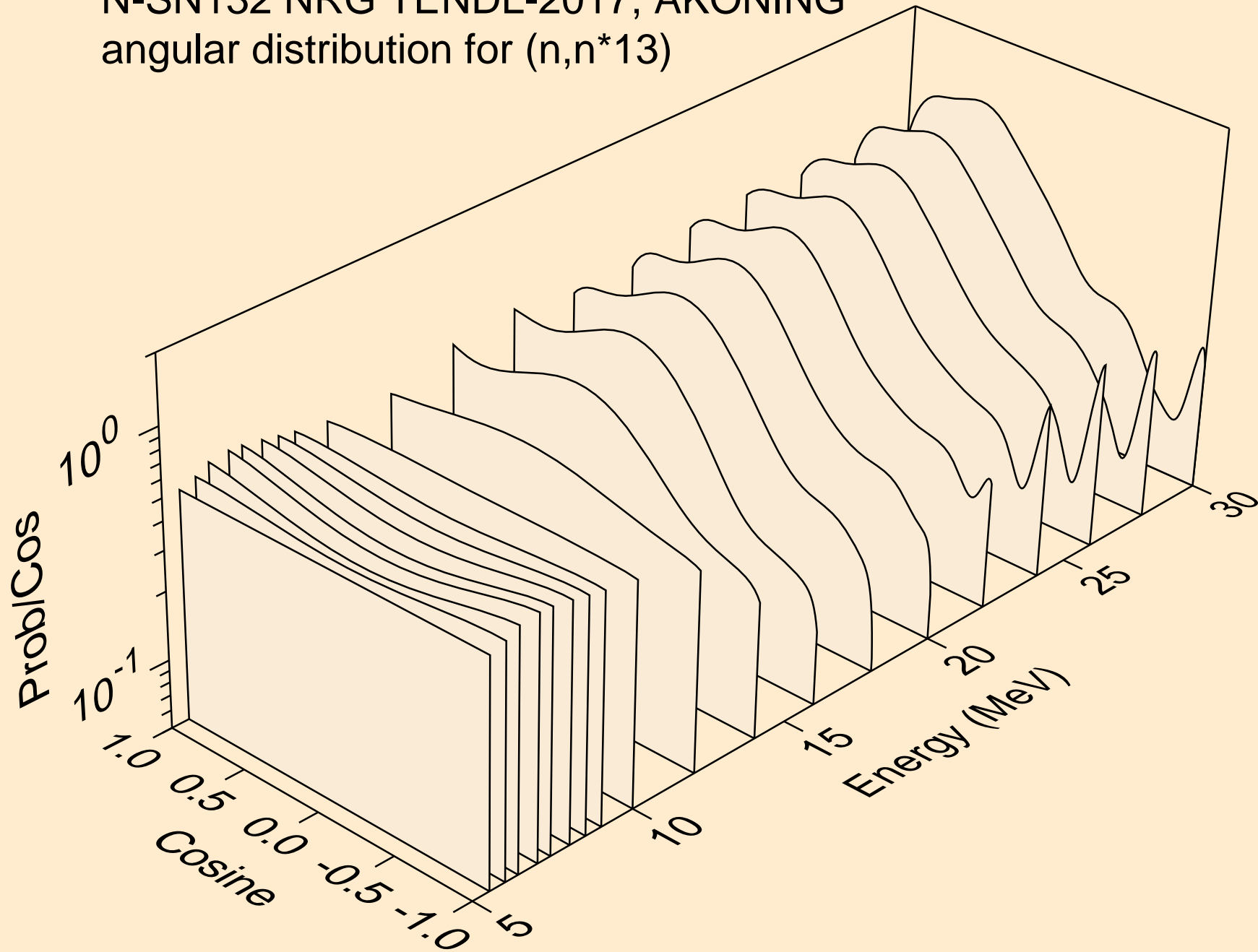

N-SN132 NRG TENDL-2017, AKONING  
angular distribution for (n,n\*14)

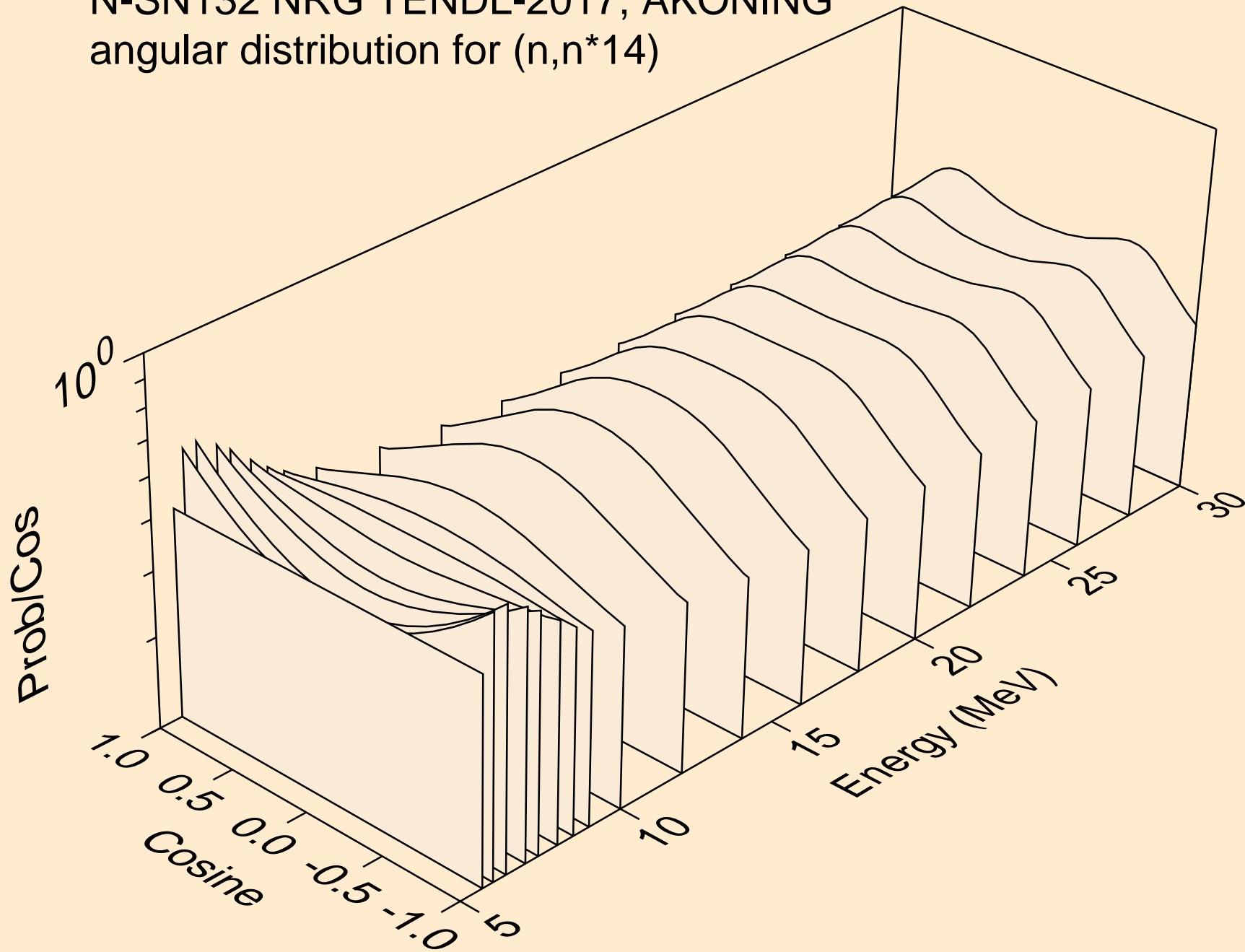

N-SN132 NRG TENDL-2017, AKONING  
angular distribution for (n,n\*15)

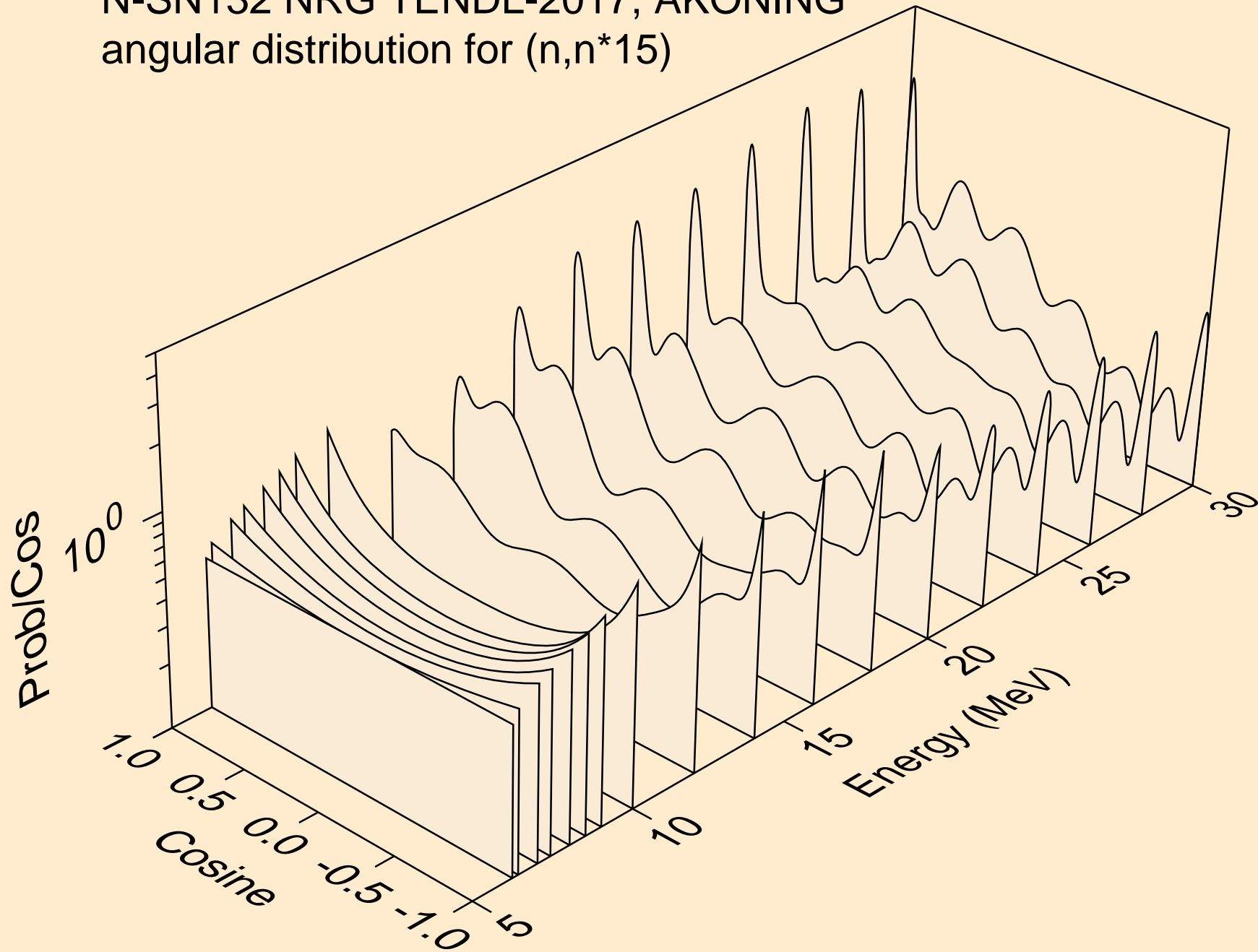

N-SN132 NRG TENDL-2017, AKONING  
angular distribution for (n,n\*16)

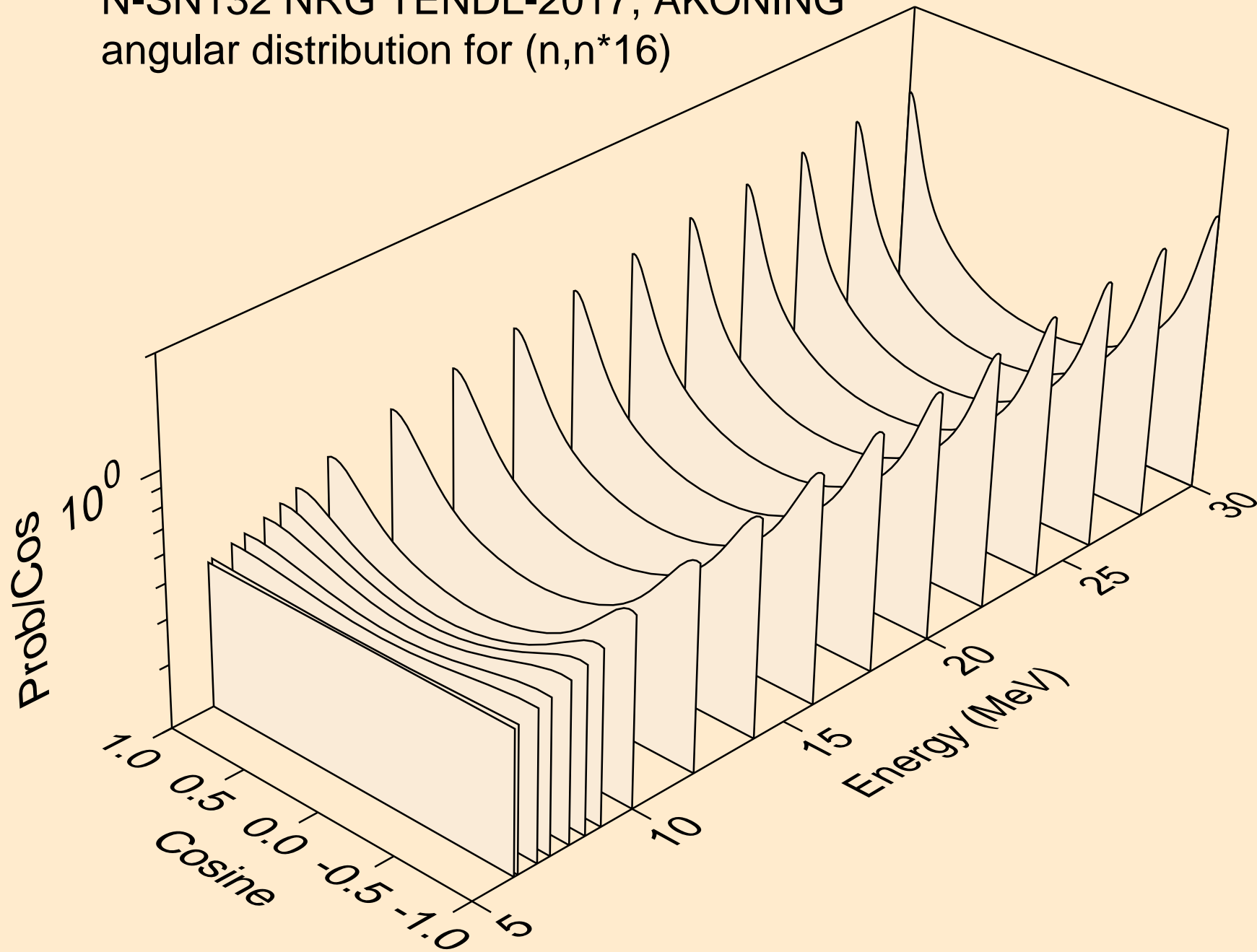



N-SN132 NRG TENDL-2017, AKONING  
angular distribution for (n,n\*17)

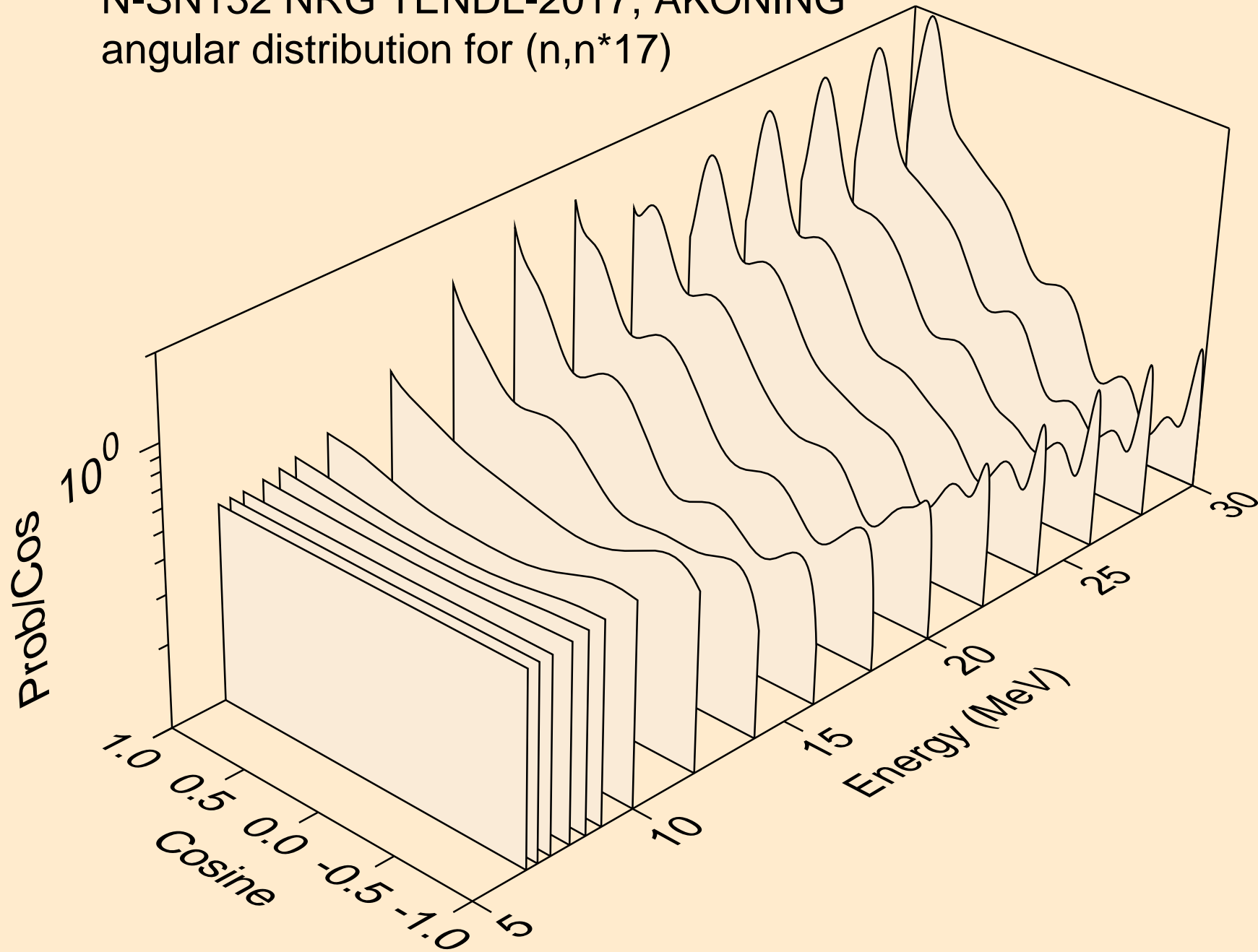

N-SN132 NRG TENDL-2017, AKONING  
angular distribution for (n,n\*18)

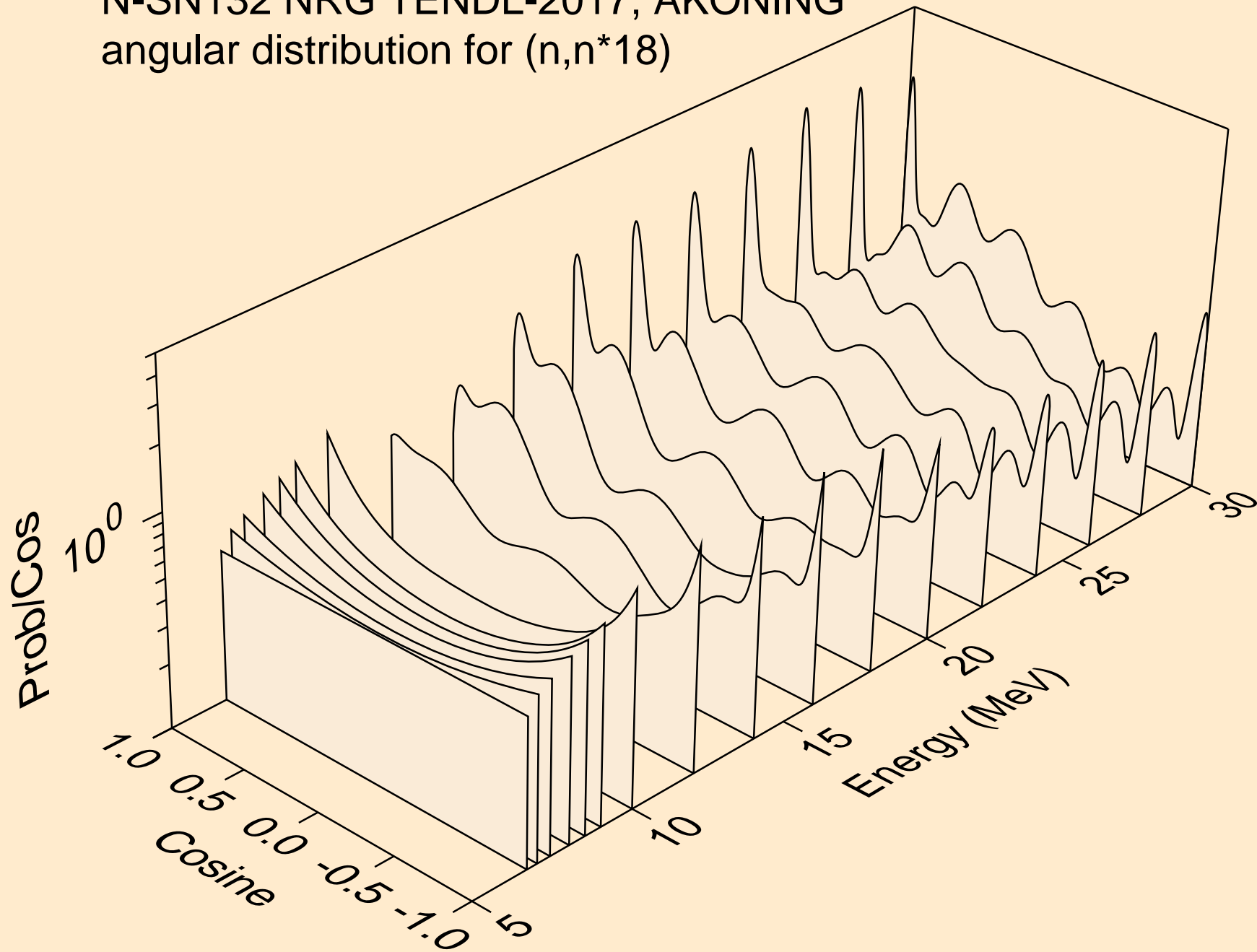

N-SN132 NRG TENDL-2017, AKONING  
angular distribution for (n,n\*19)

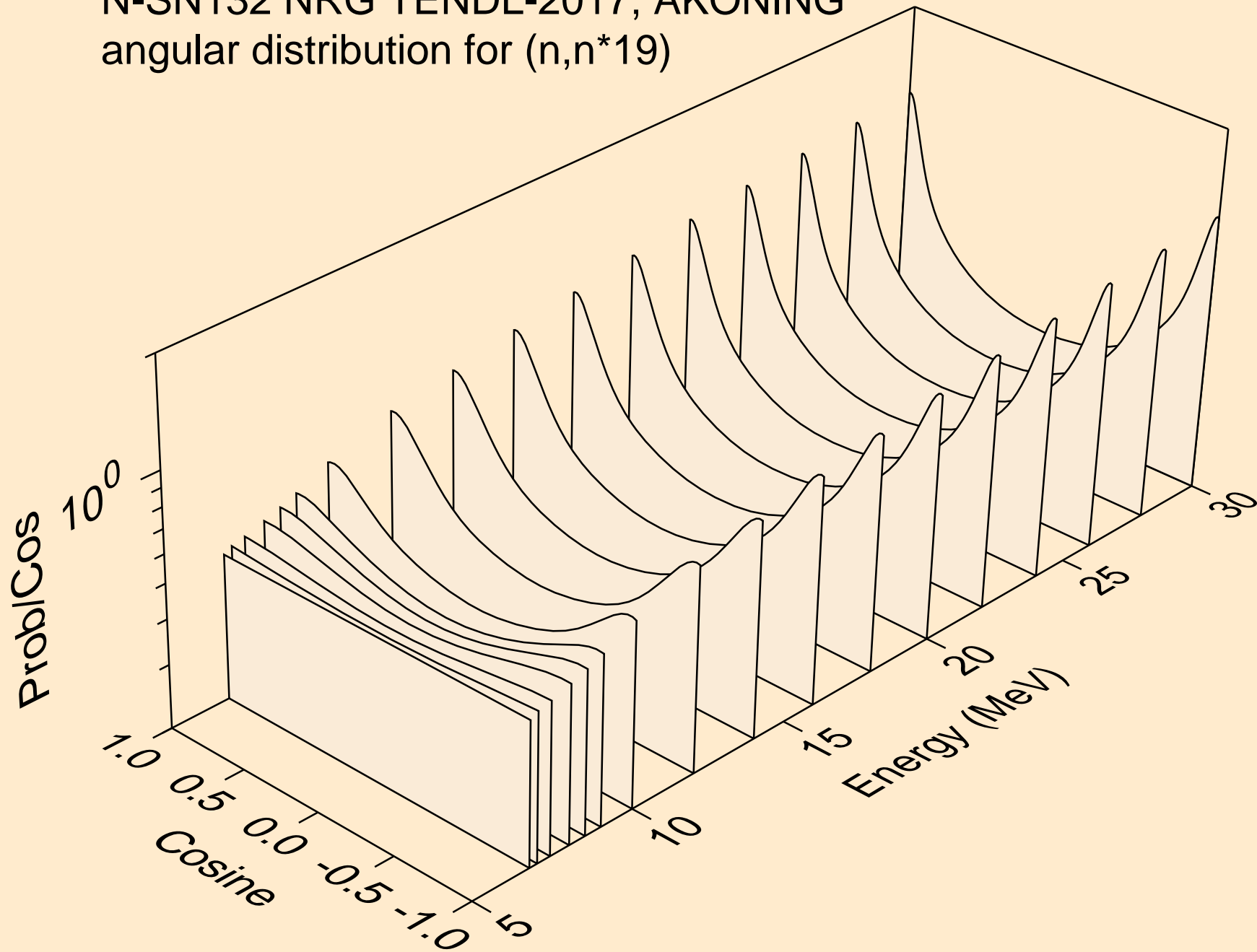

N-SN132 NRG TENDL-2017, AKONING  
angular distribution for (n,n\*20)

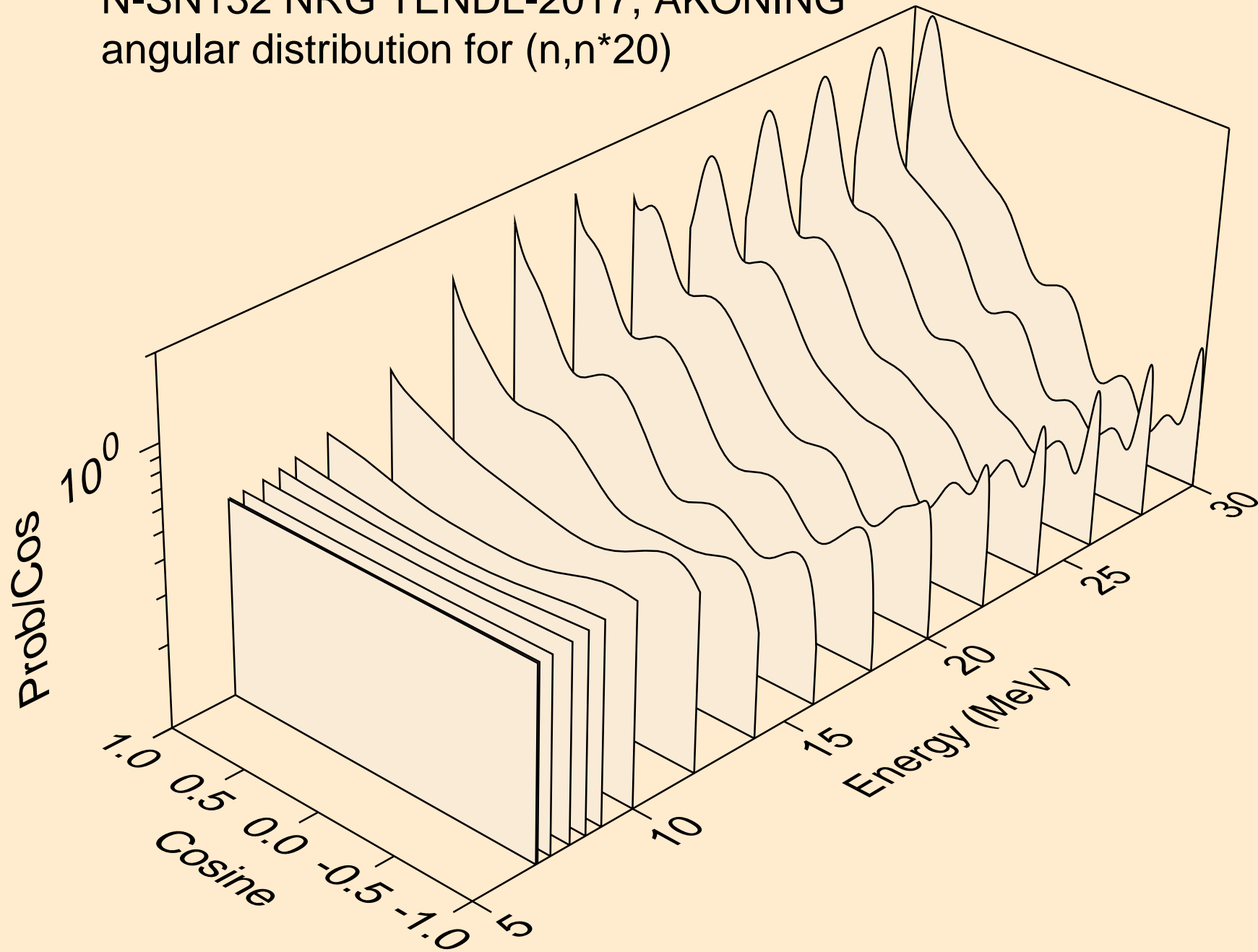

N-SN132 NRG TENDL-2017, AKONING  
angular distribution for (n,n\*21)

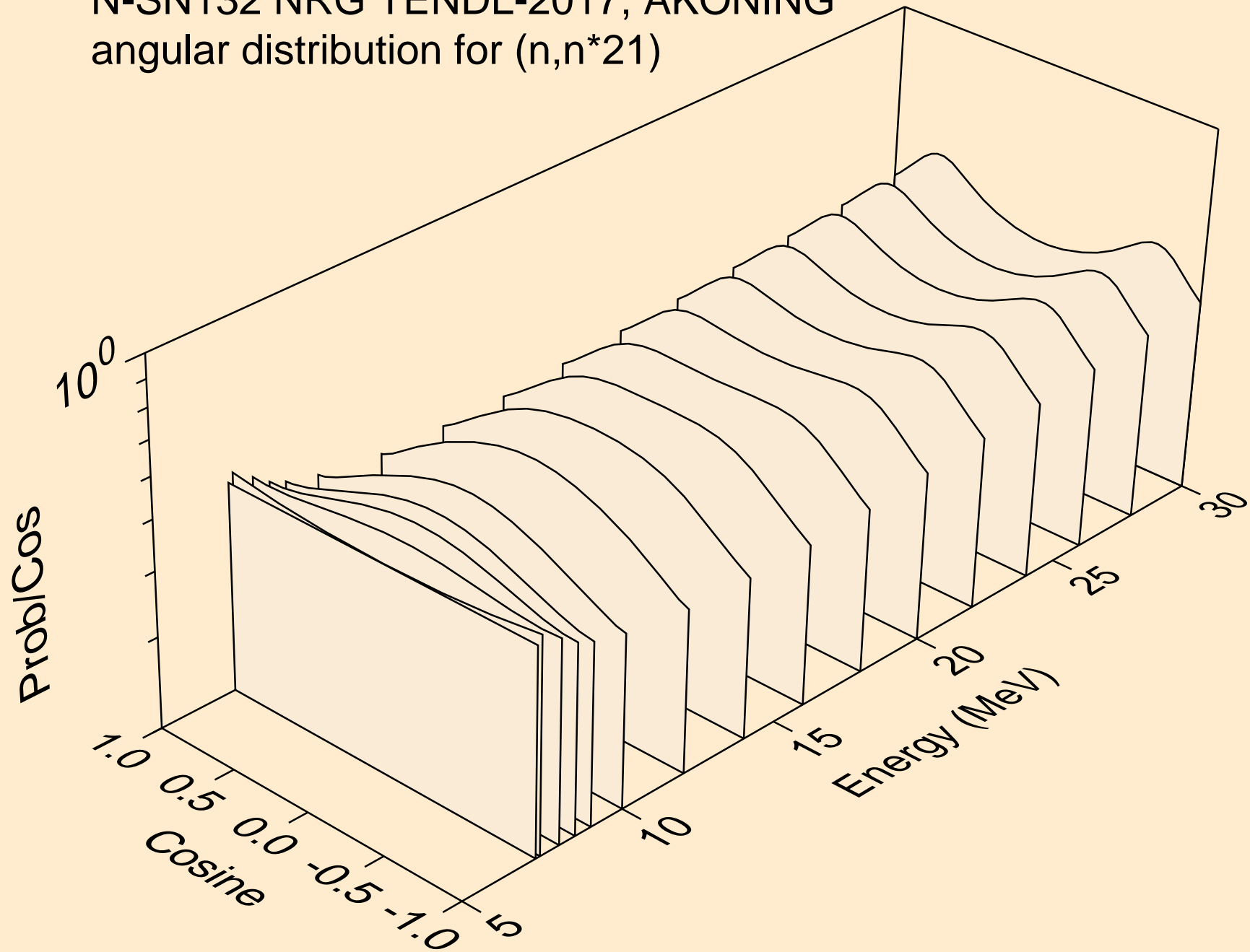

N-SN132 NRG TENDL-2017, AKONING  
angular distribution for (n,n\*22)

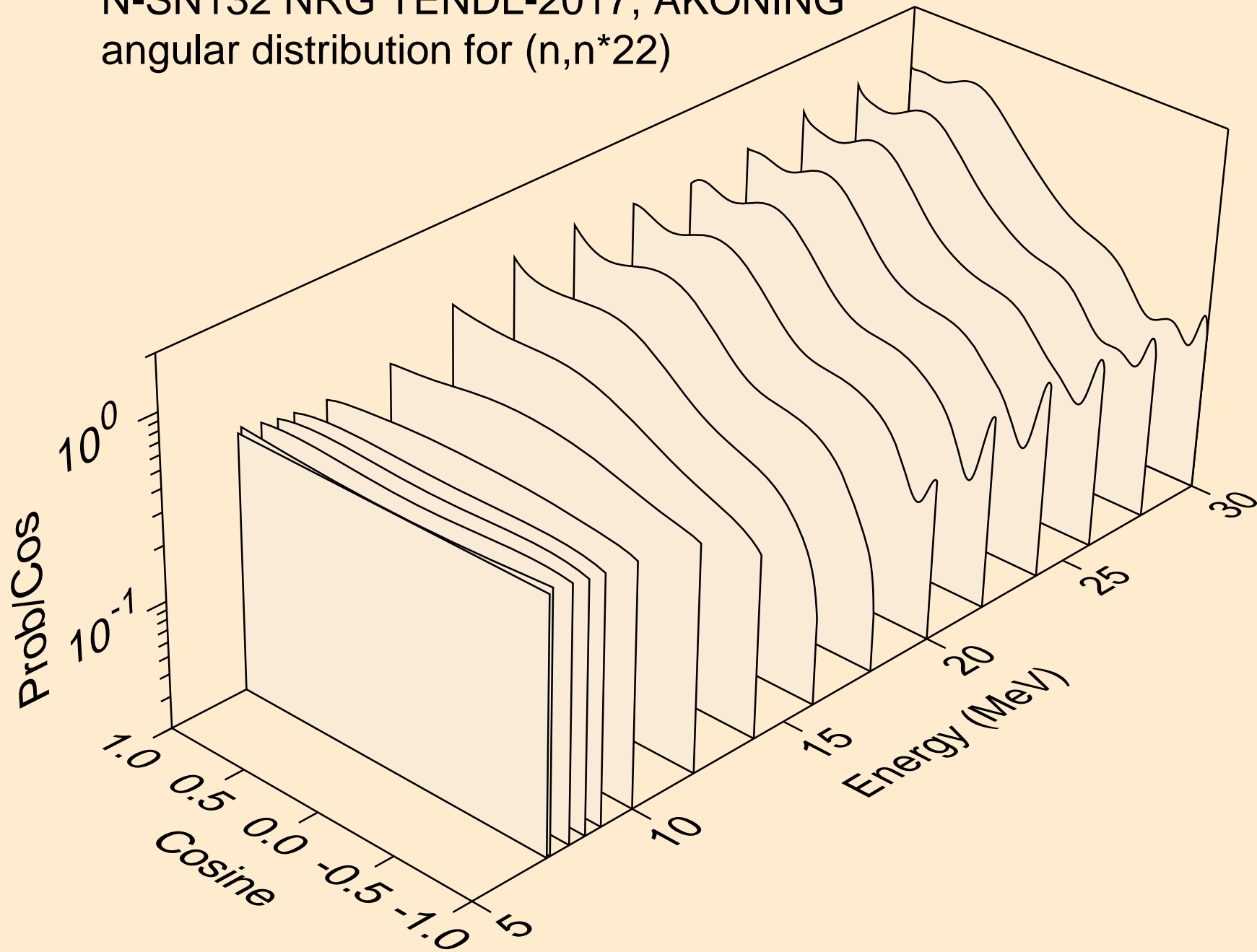

N-SN132 NRG TENDL-2017, AKONING  
angular distribution for (n,n\*23)

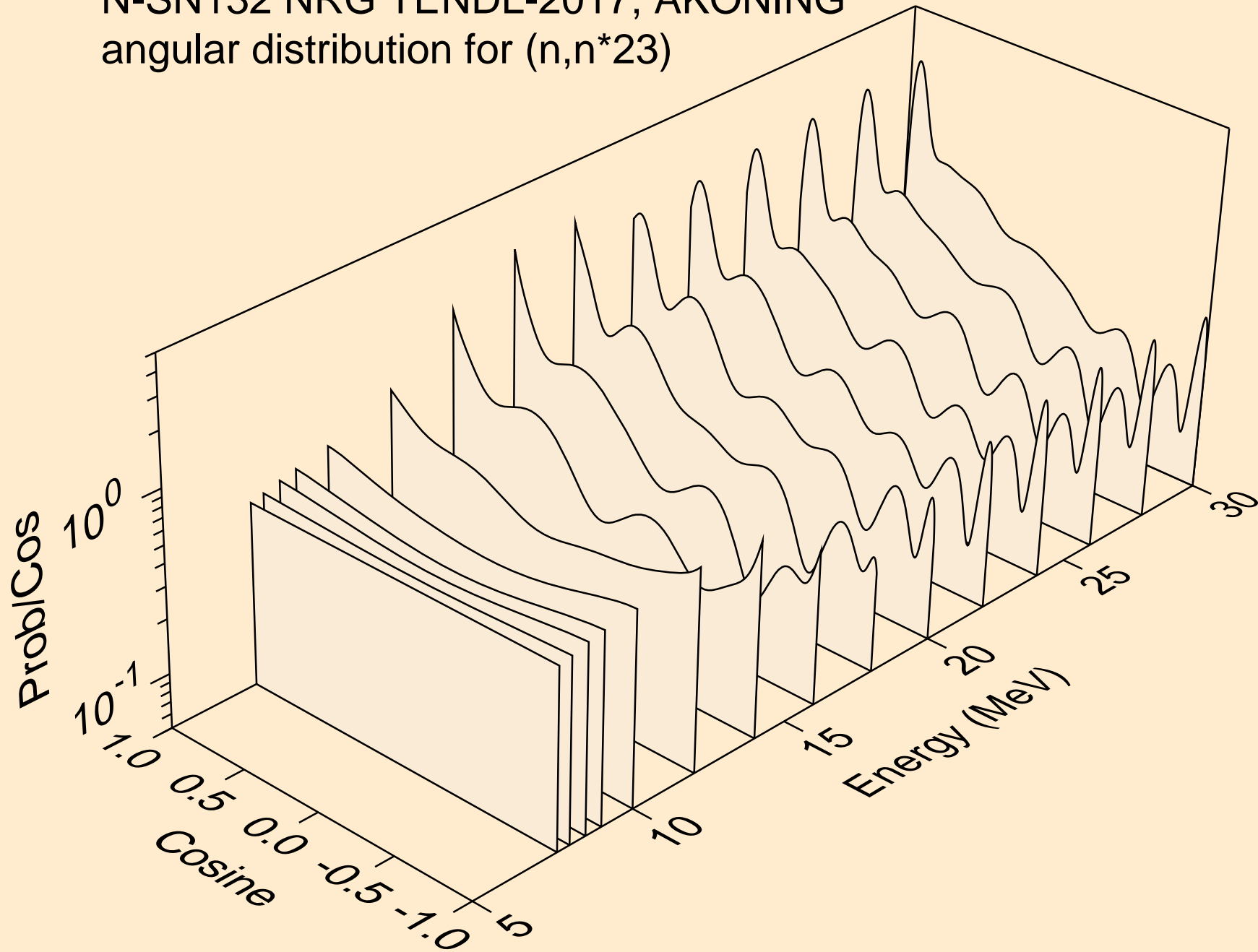

N-SN132 NRG TENDL-2017, AKONING  
angular distribution for (n,n\*24)

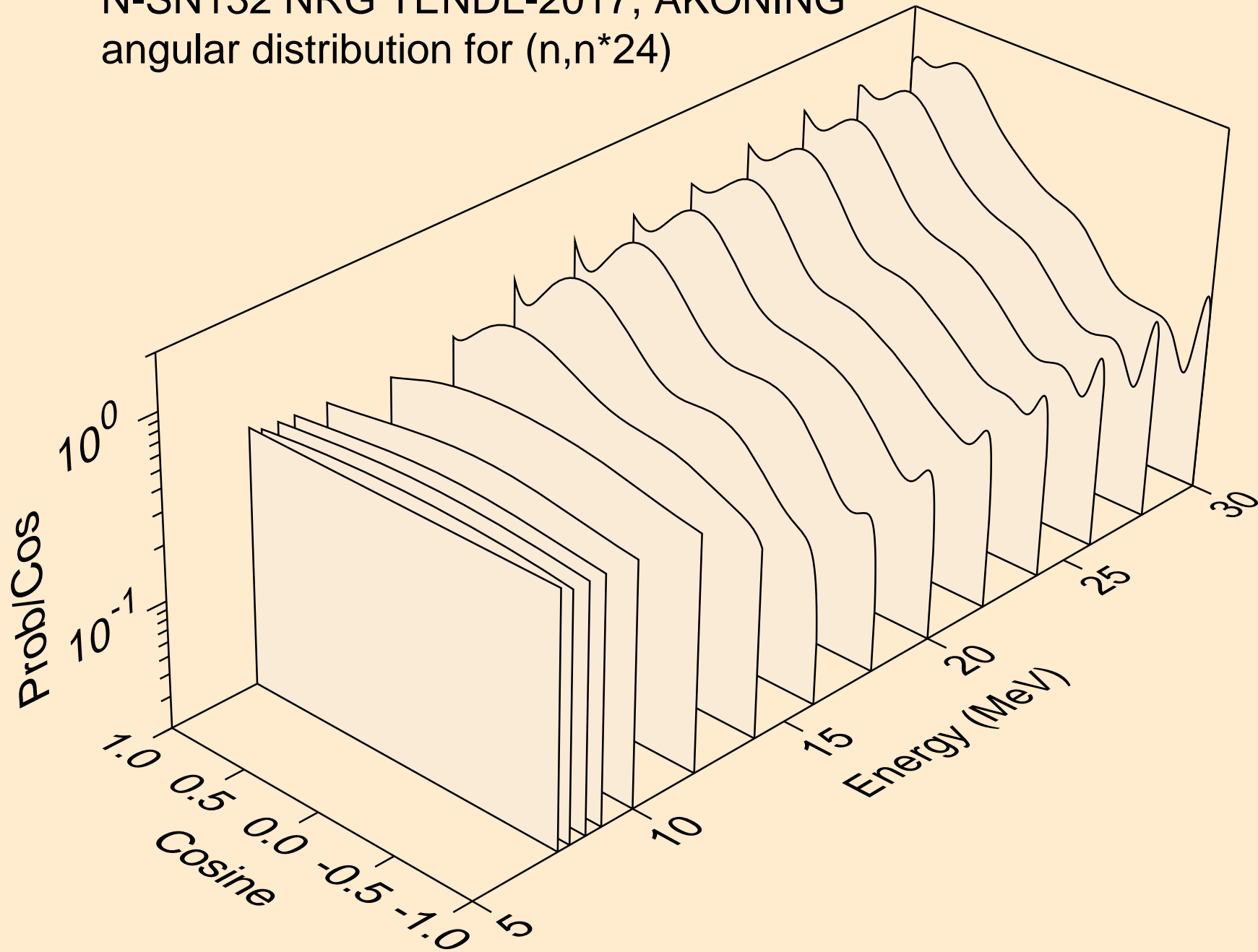



N-SN132 NRG TENDL-2017, AKONING  
angular distribution for (n,n\*25)

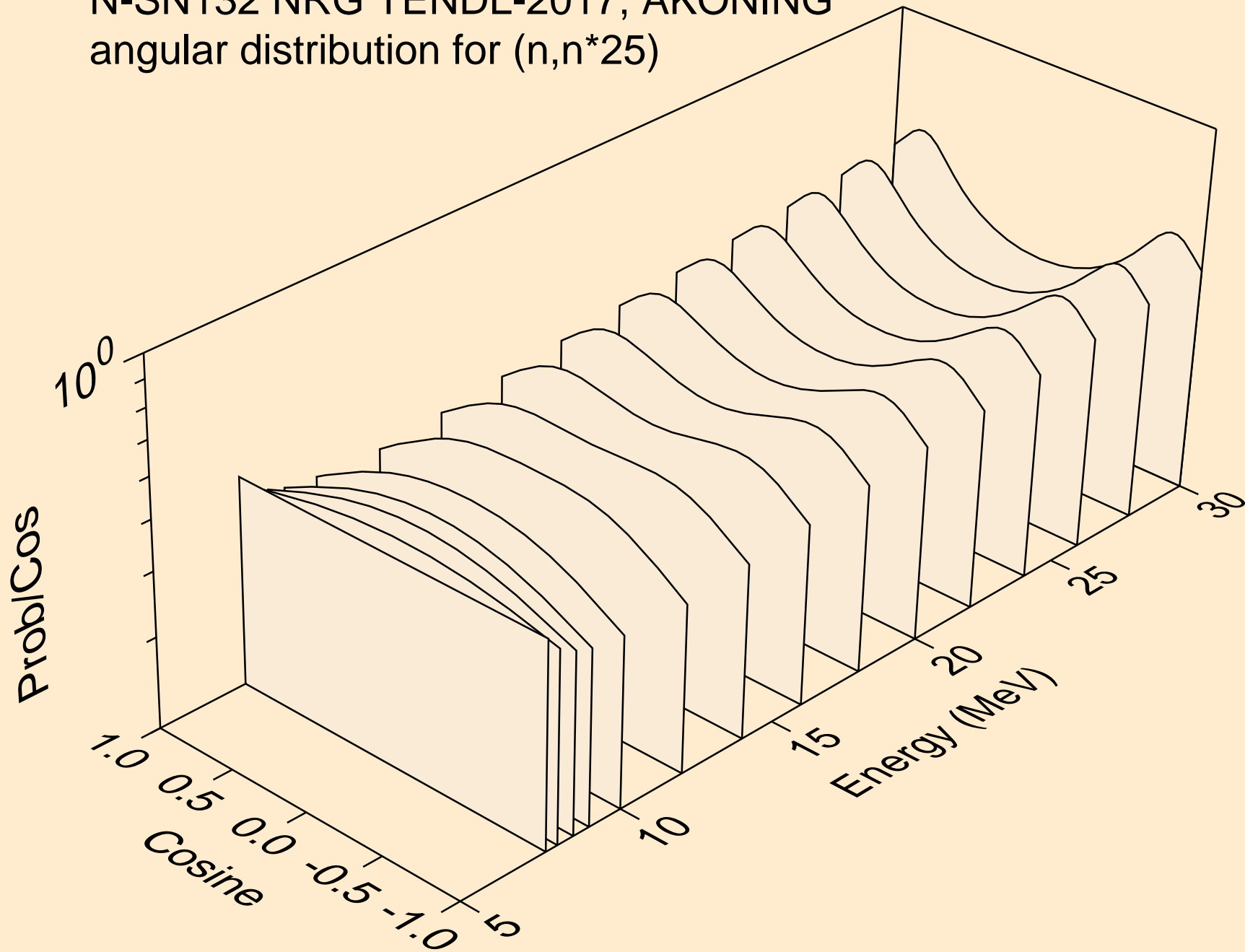

N-SN132 NRG TENDL-2017, AKONING  
angular distribution for (n,n\*26)

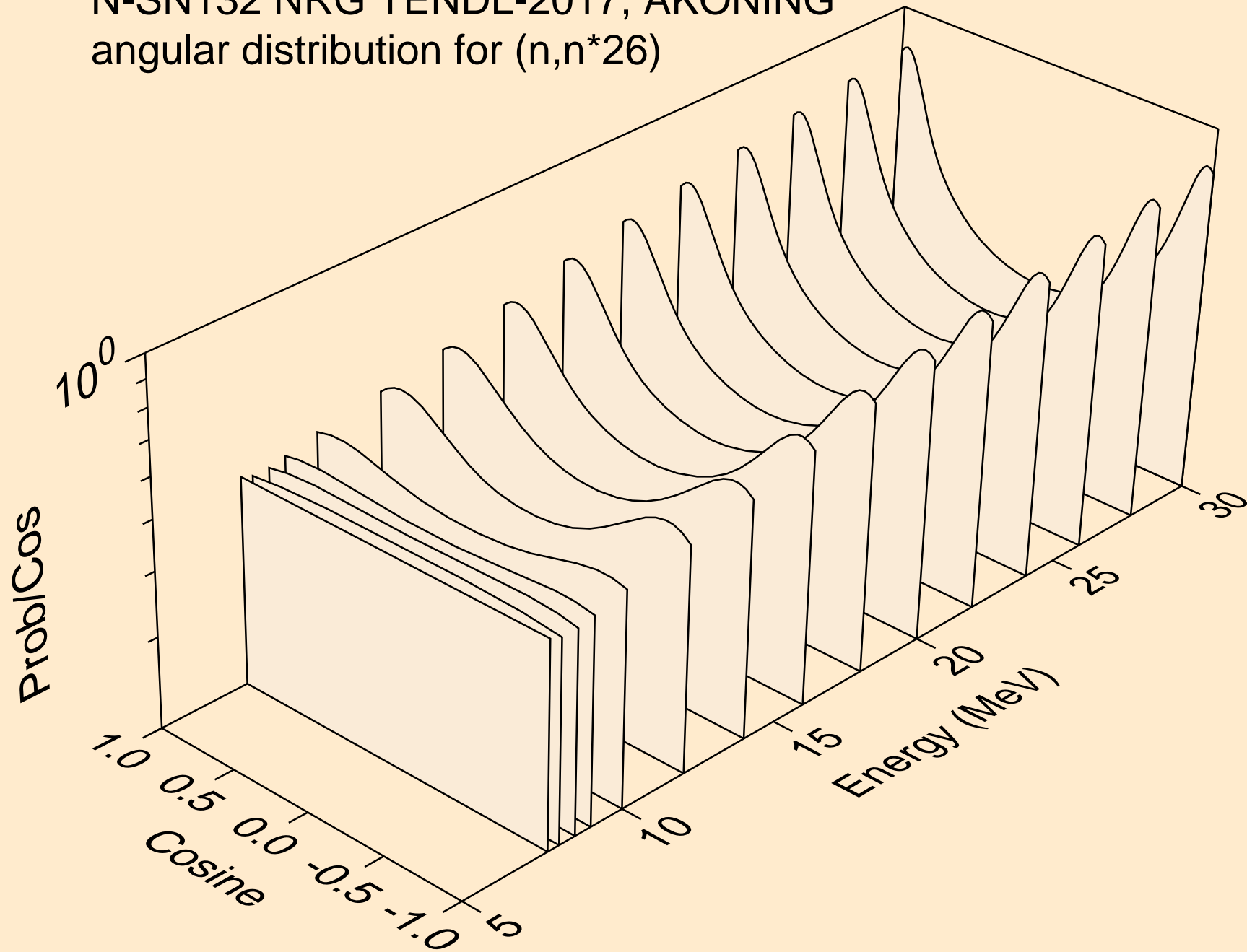

N-SN132 NRG TENDL-2017, AKONING  
angular distribution for (n,n\*27)

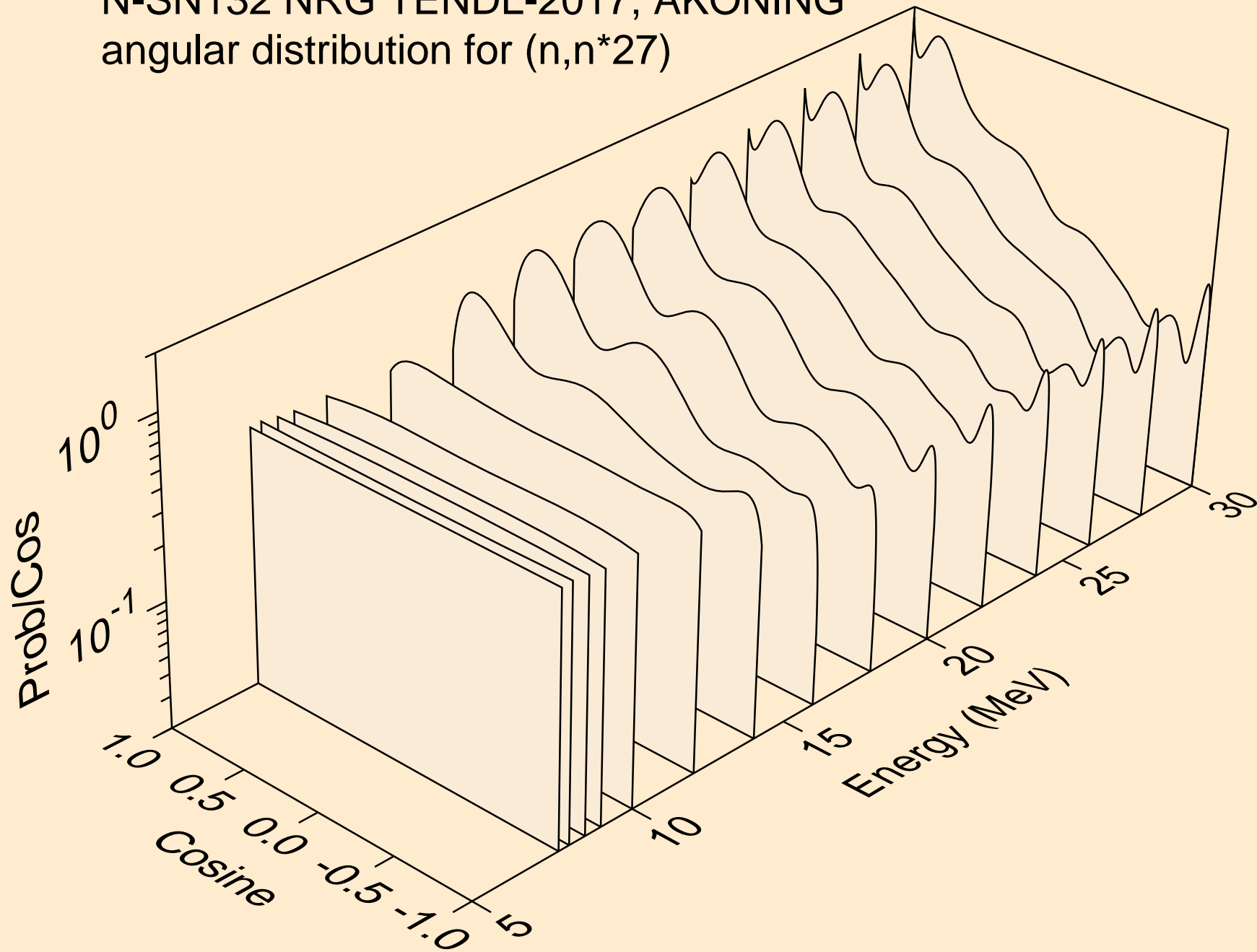

N-SN132 NRG TENDL-2017, AKONING  
angular distribution for (n,n\*28)

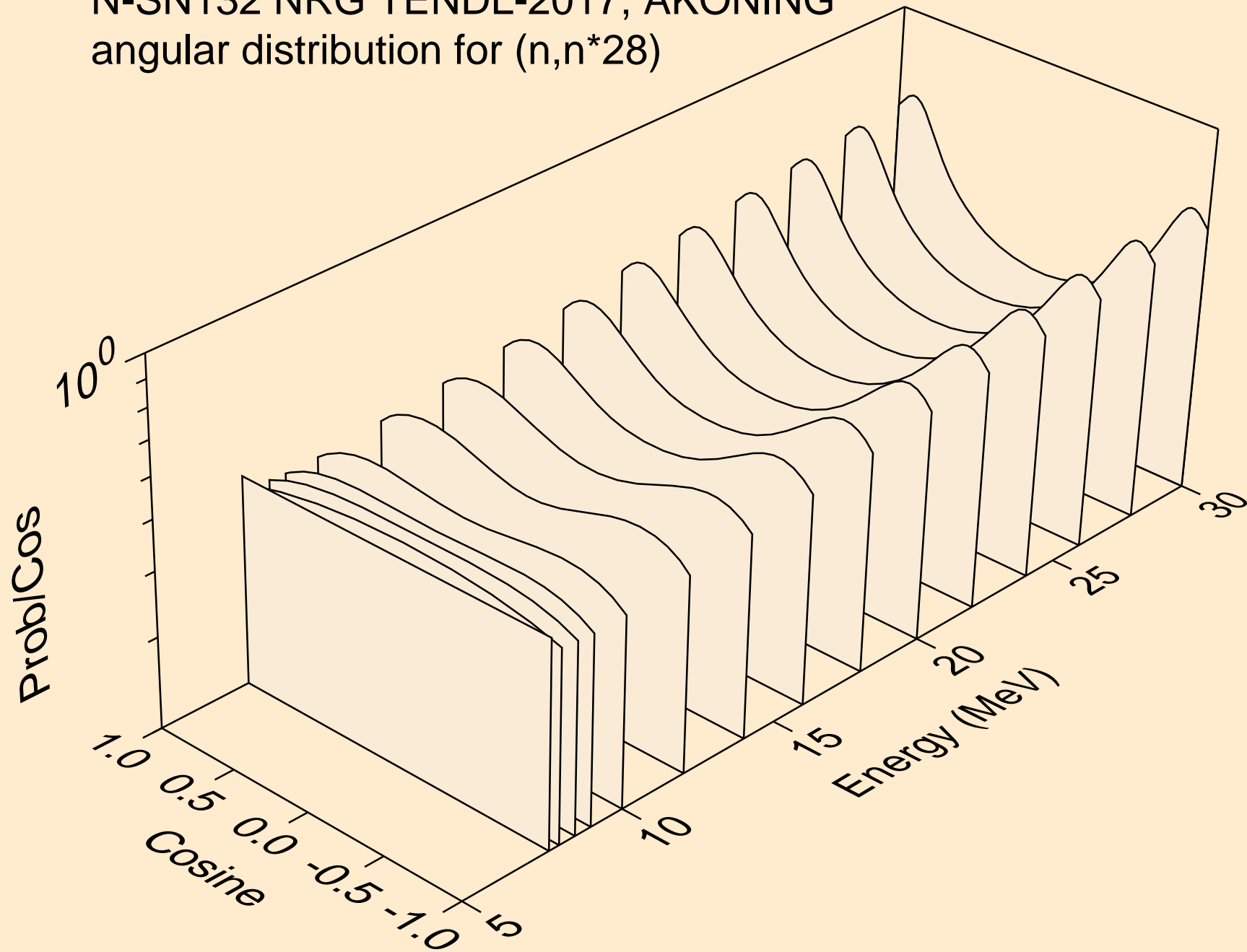

N-SN132 NRG TENDL-2017, AKONING  
angular distribution for (n,n\*29)

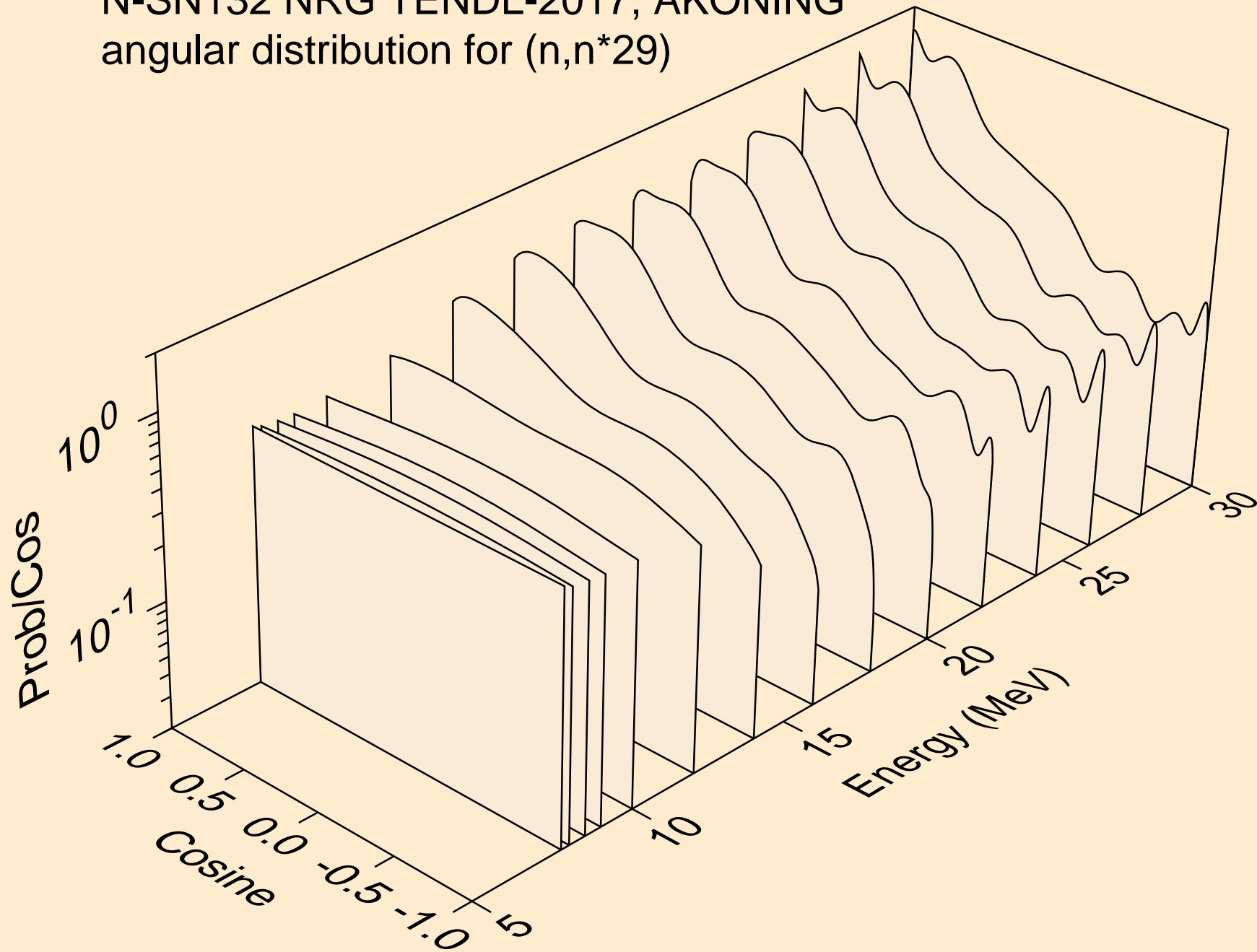

N-SN132 NRG TENDL-2017, AKONING  
angular distribution for (n,n\*30)

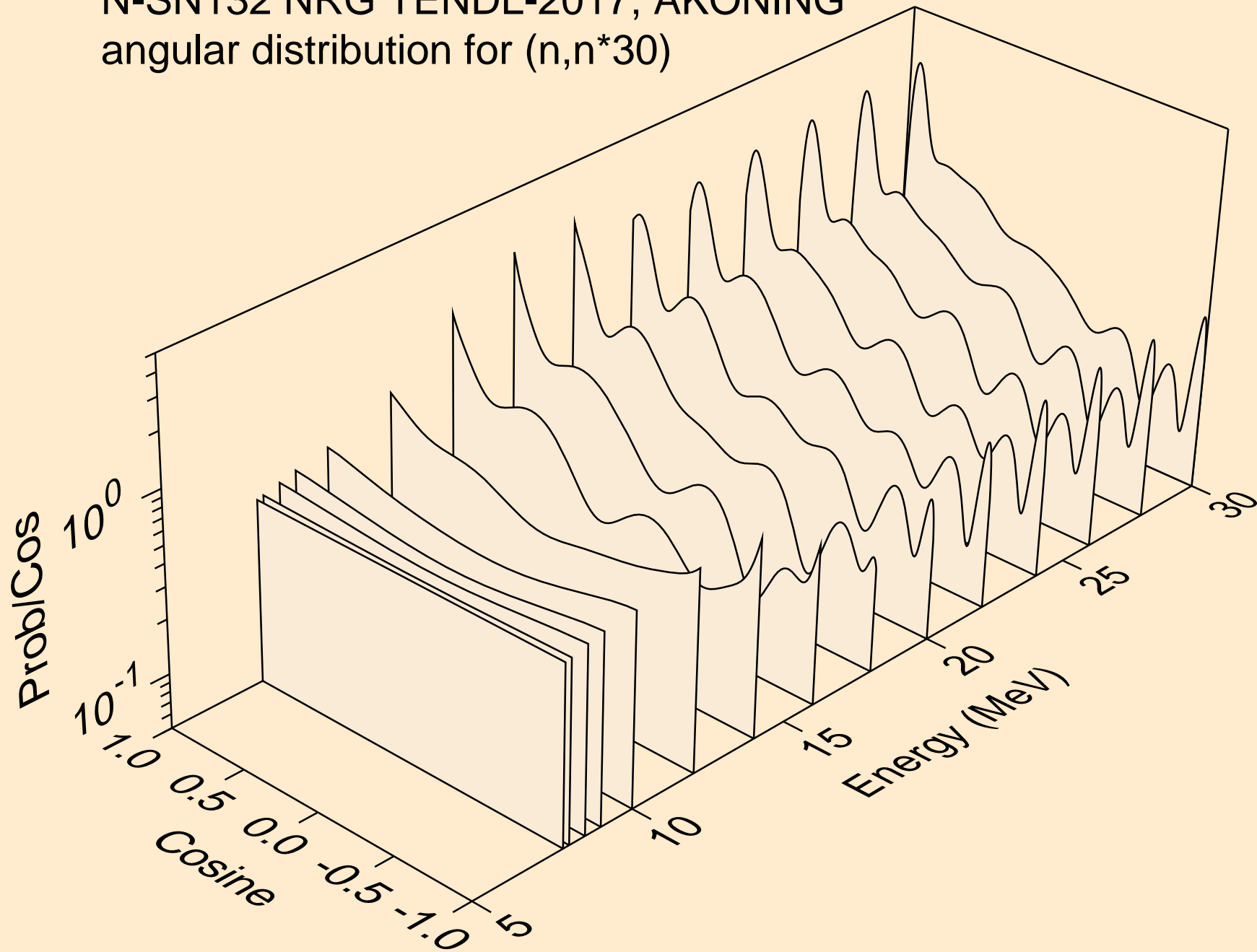

N-SN132 NRG TENDL-2017, AKONING  
Neutron emission for (n,x)

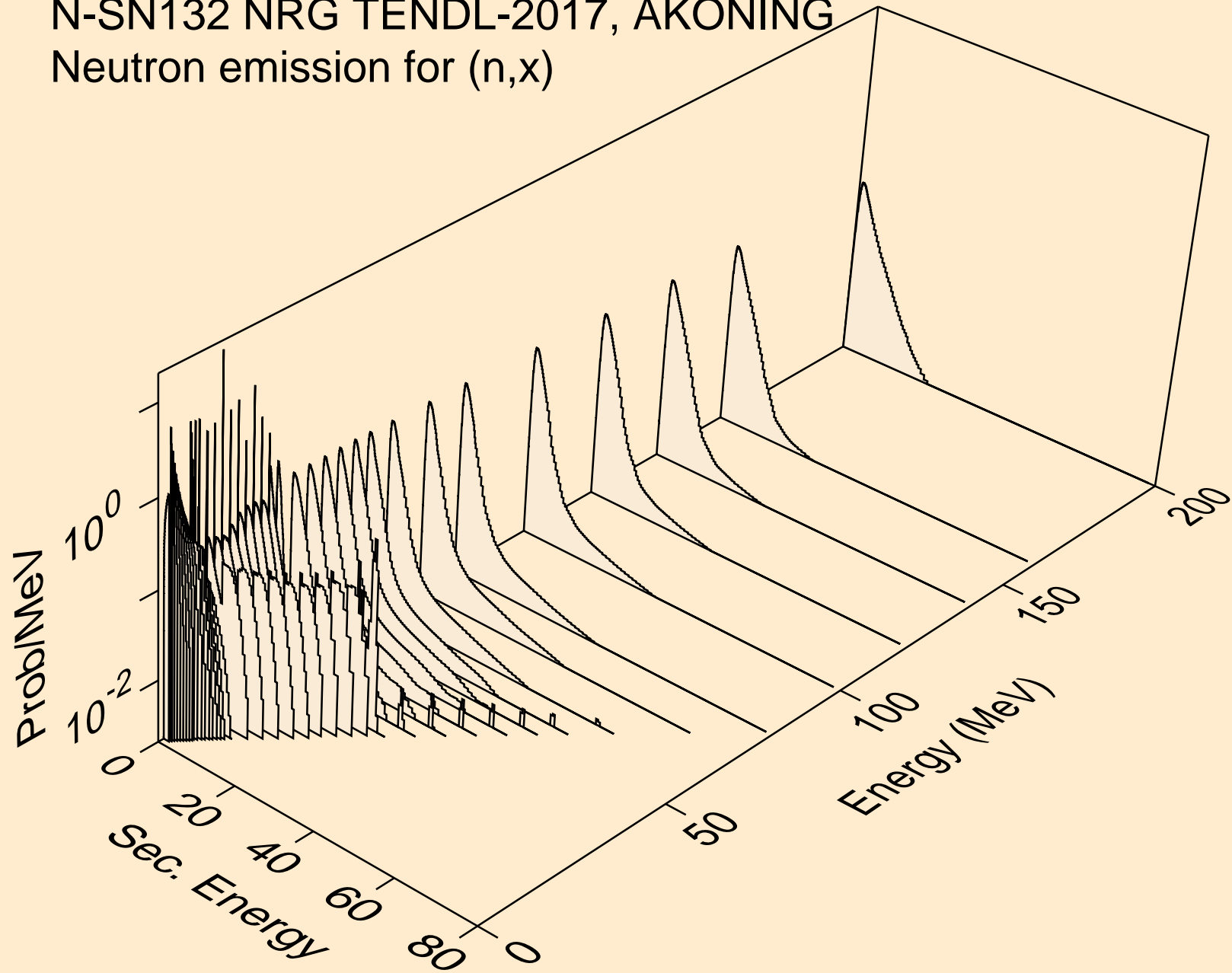

N-SN132 NRG TENDL-2017, AKONING  
Neutron emission for (n,2nd)

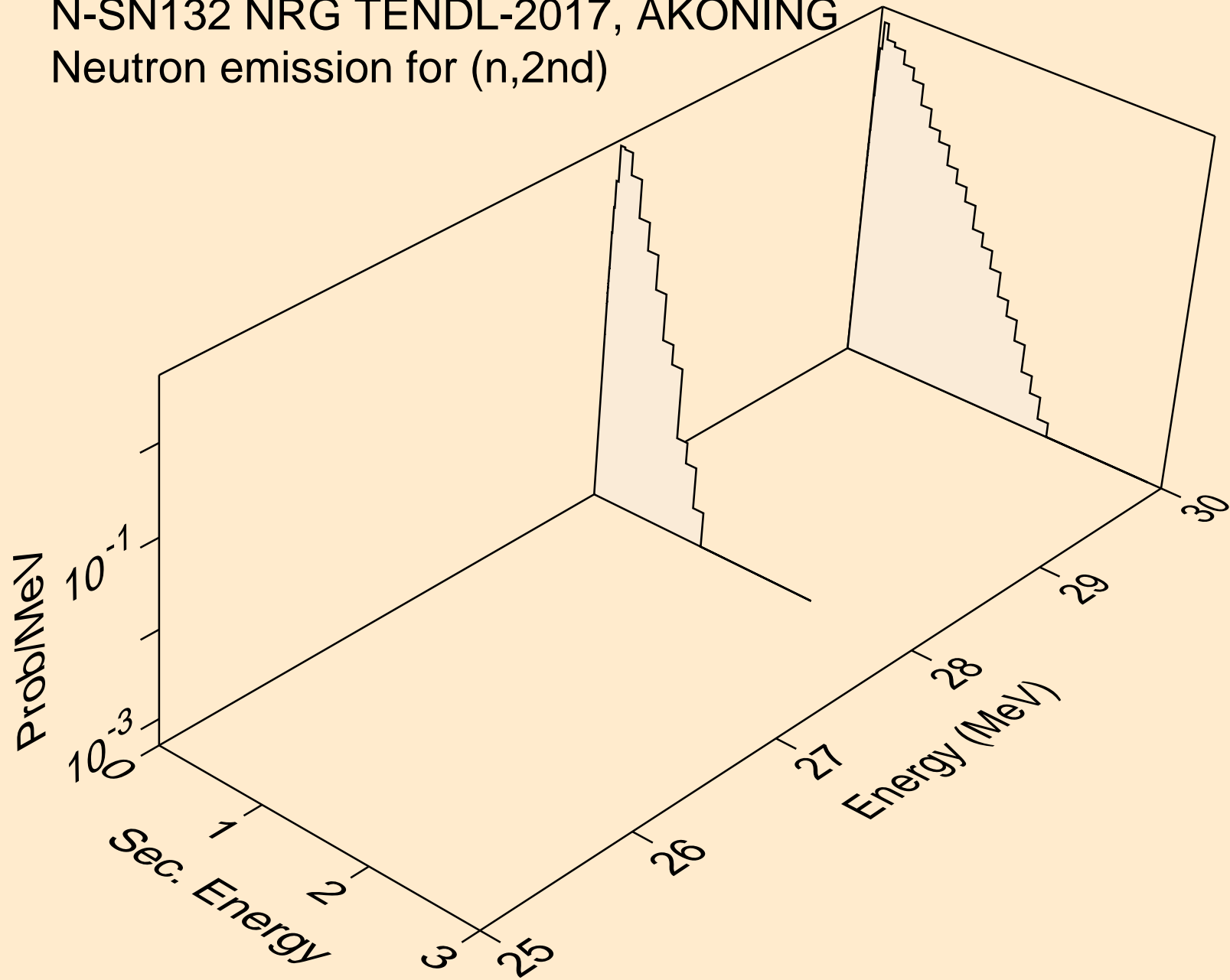



N-SN132 NRG TENDL-2017, AKONING  
Neutron emission for (n,2n)

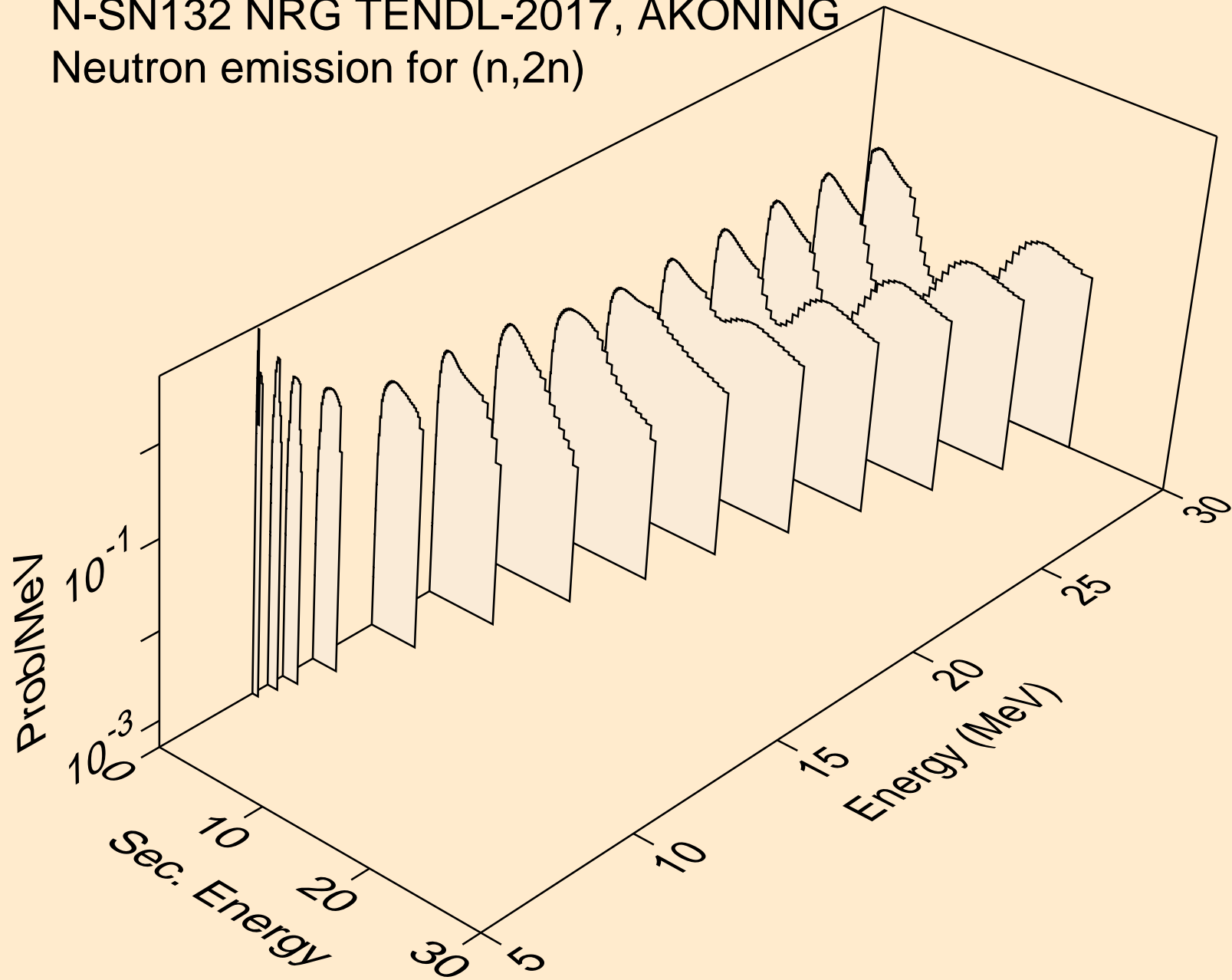

N-SN132 NRG TENDL-2017, AKONING  
Neutron emission for (n,3n)

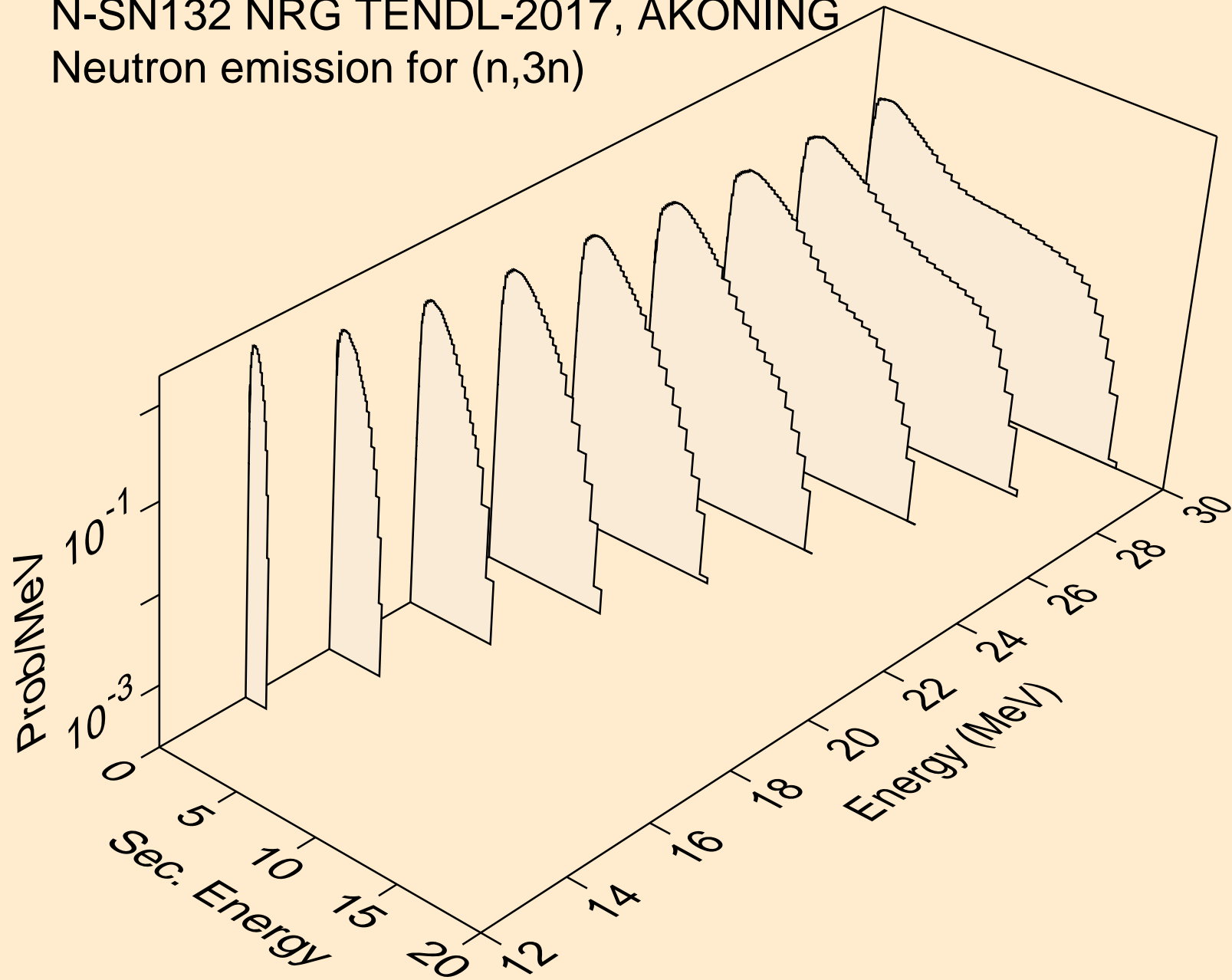

N-SN132 NRG TENDL-2017, AKONING  
Neutron emission for (n,n\*)a

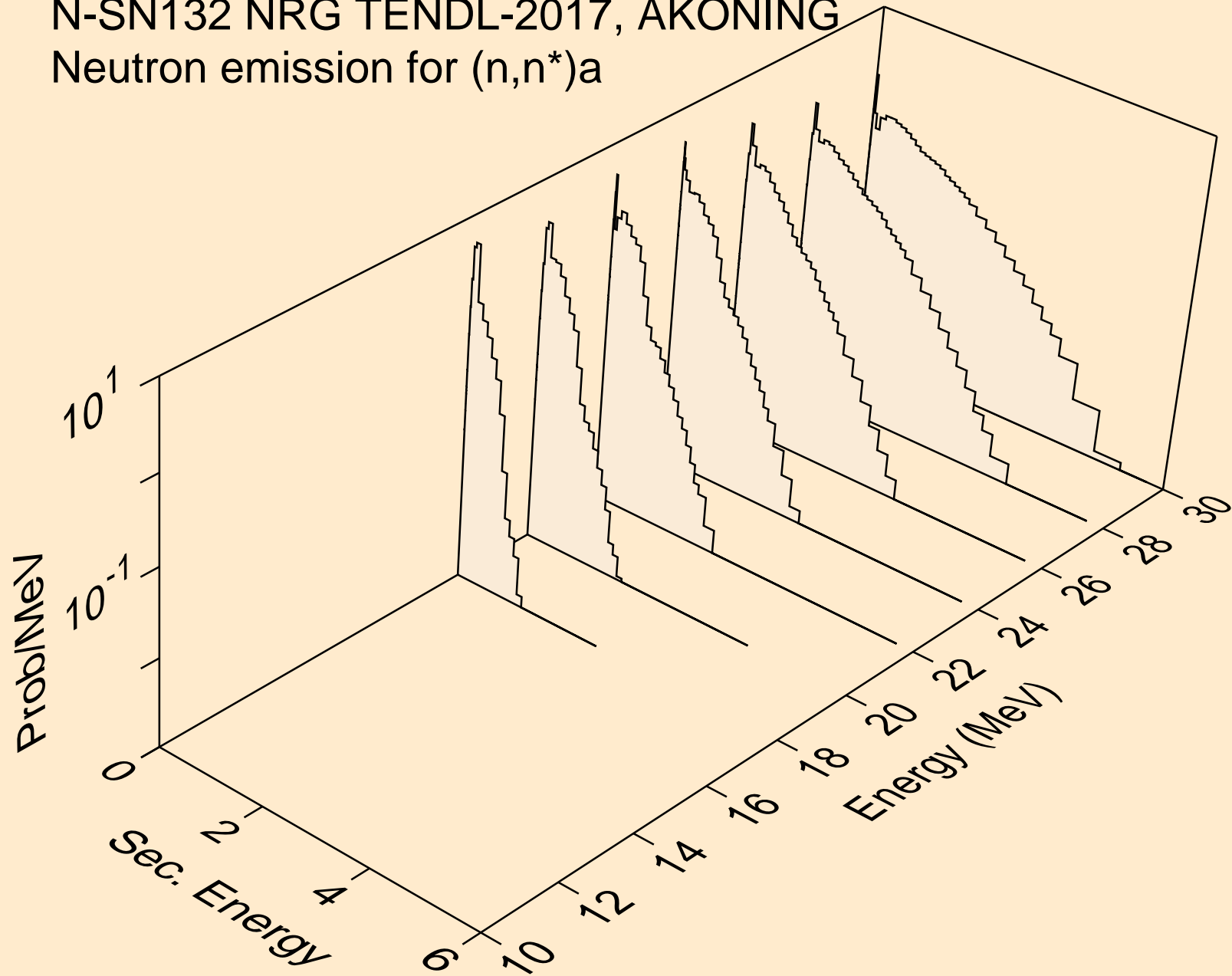

N-SN132 NRG TENDL-2017, AKONING  
Neutron emission for (n,2n)a

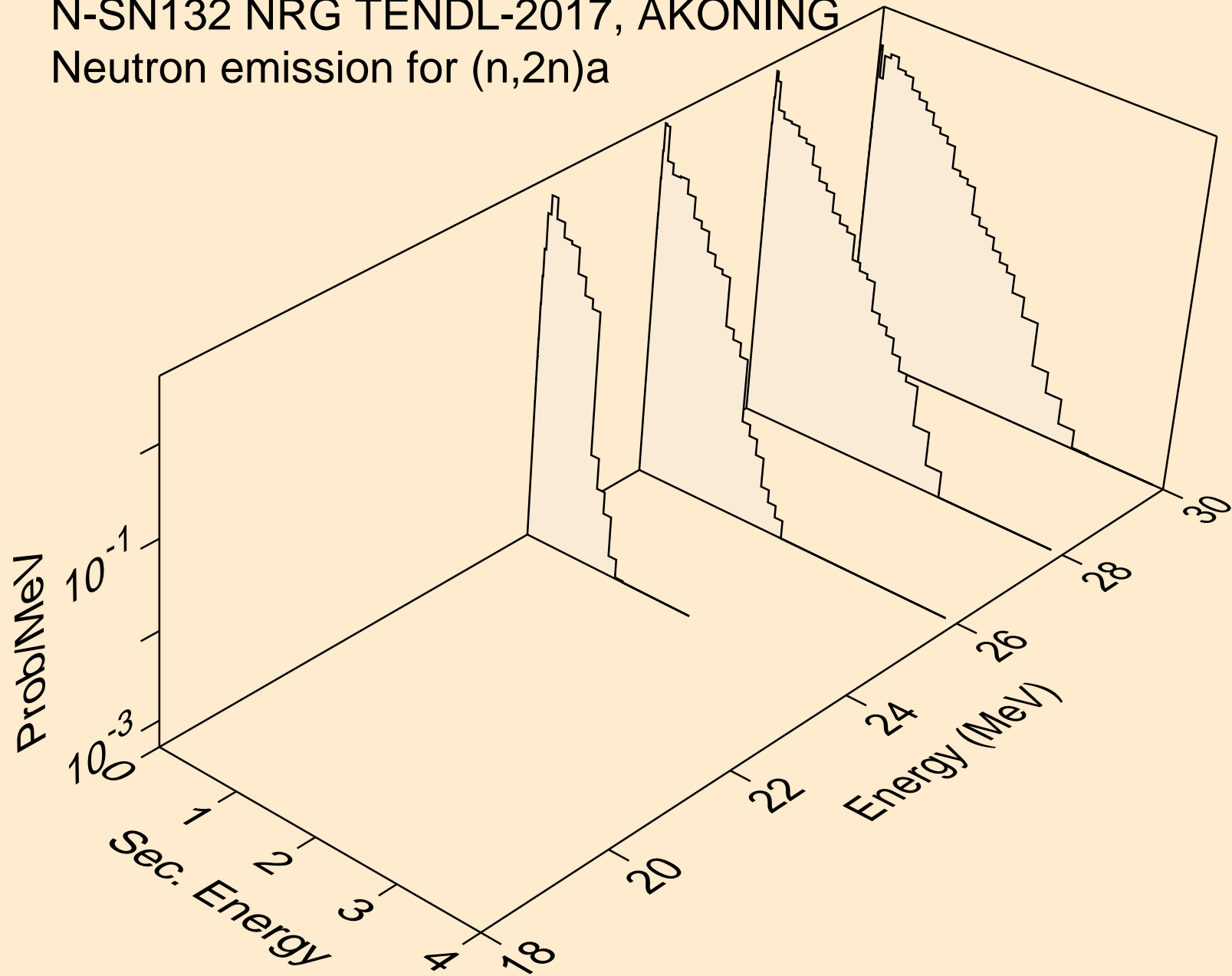

N-SN132 NRG TENDL-2017, AKONING  
Neutron emission for (n,n\*)p

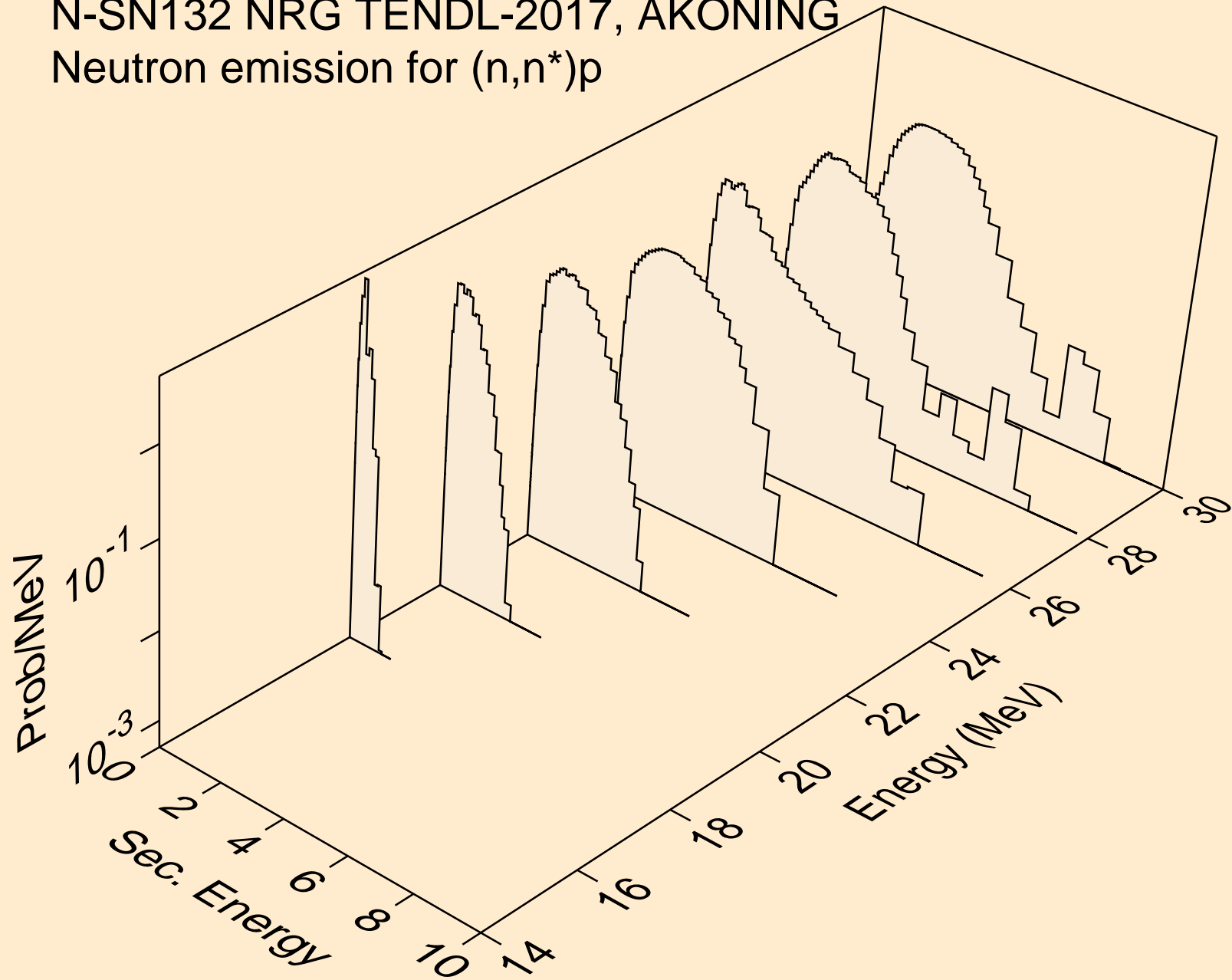

N-SN132 NRG TENDL-2017, AKONING  
Neutron emission for (n,n\*)d

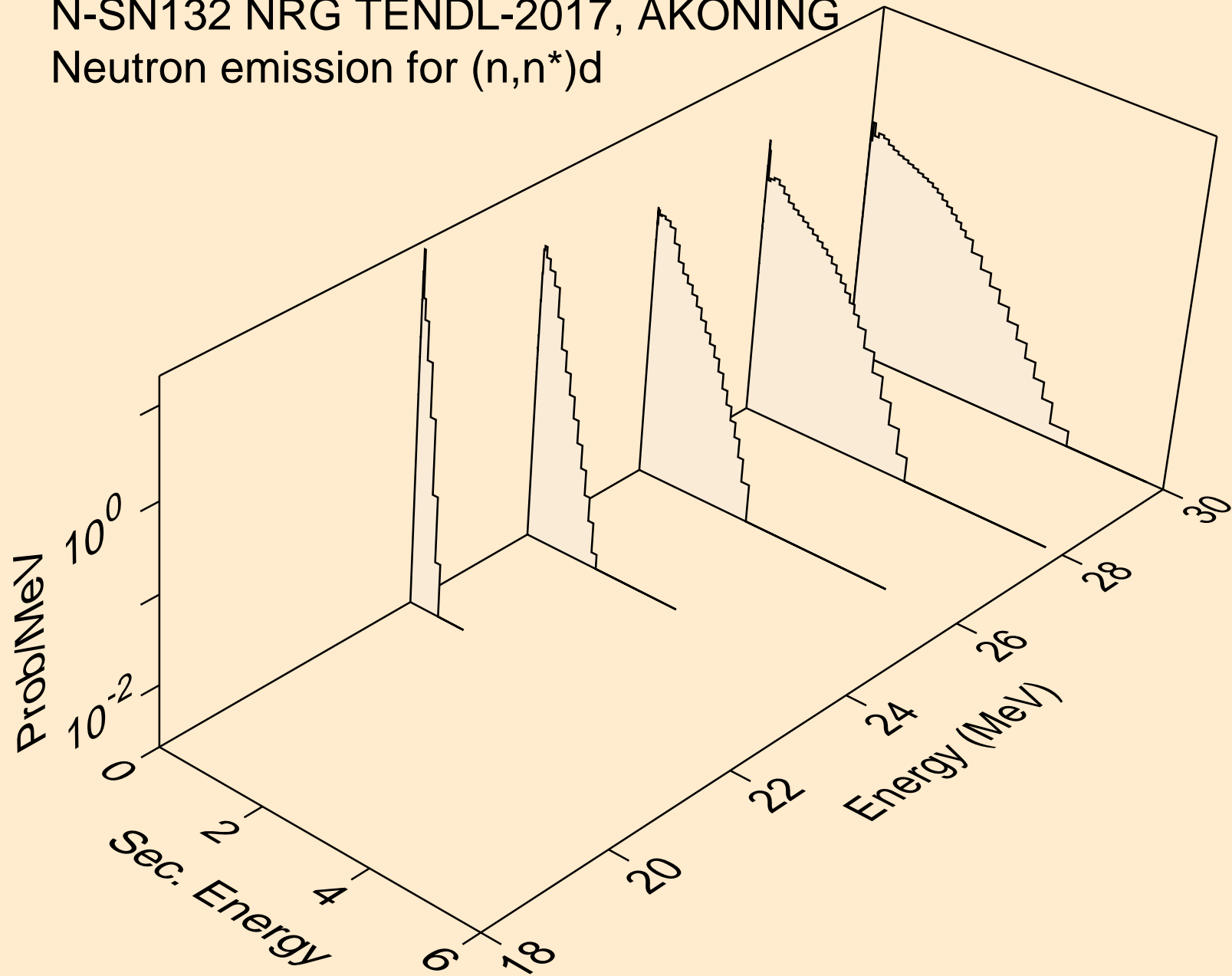

N-SN132 NRG TENDL-2017, AKONING  
Neutron emission for (n,n\*)t

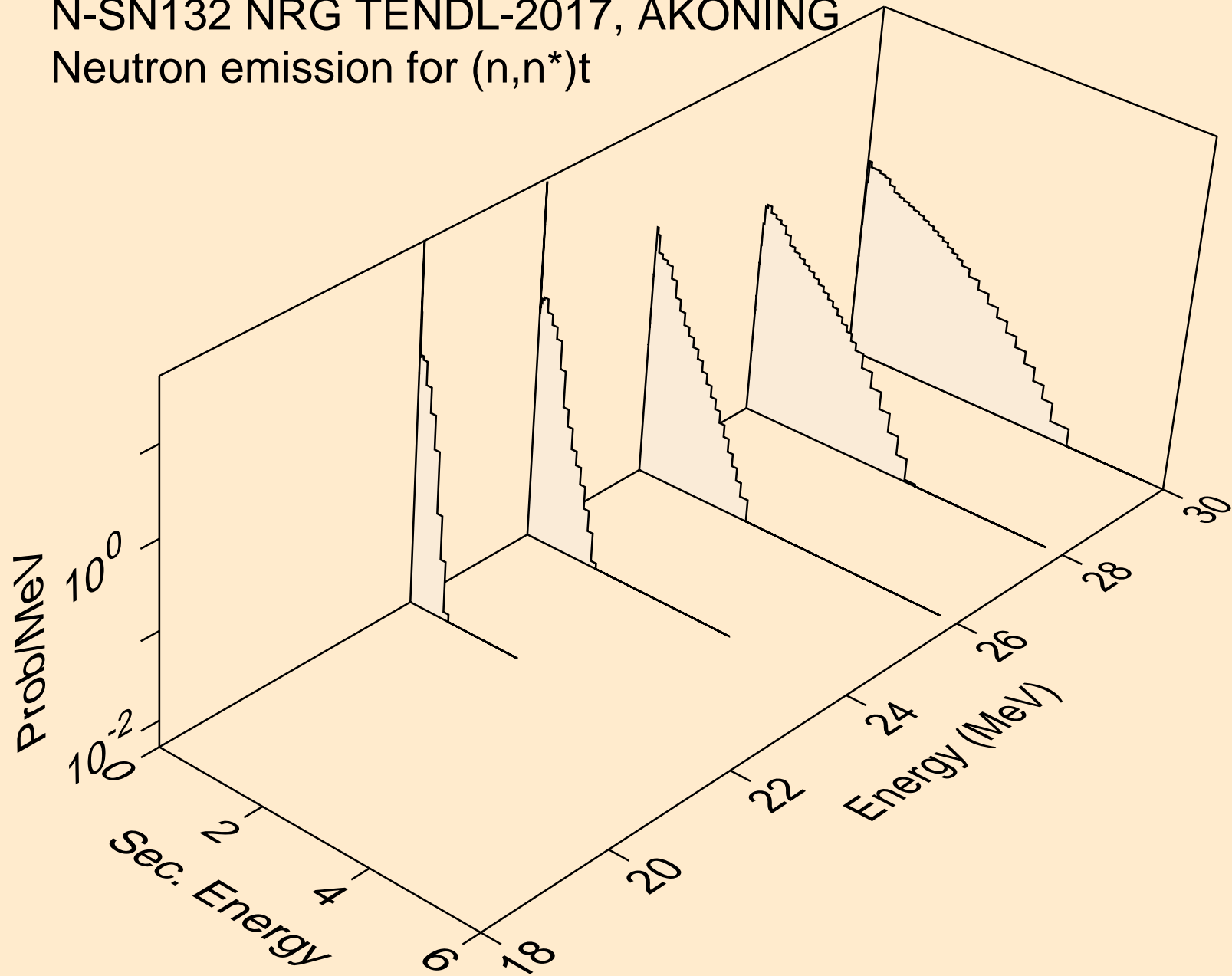

N-SN132 NRG TENDL-2017, AKONING  
Neutron emission for (n,4n)

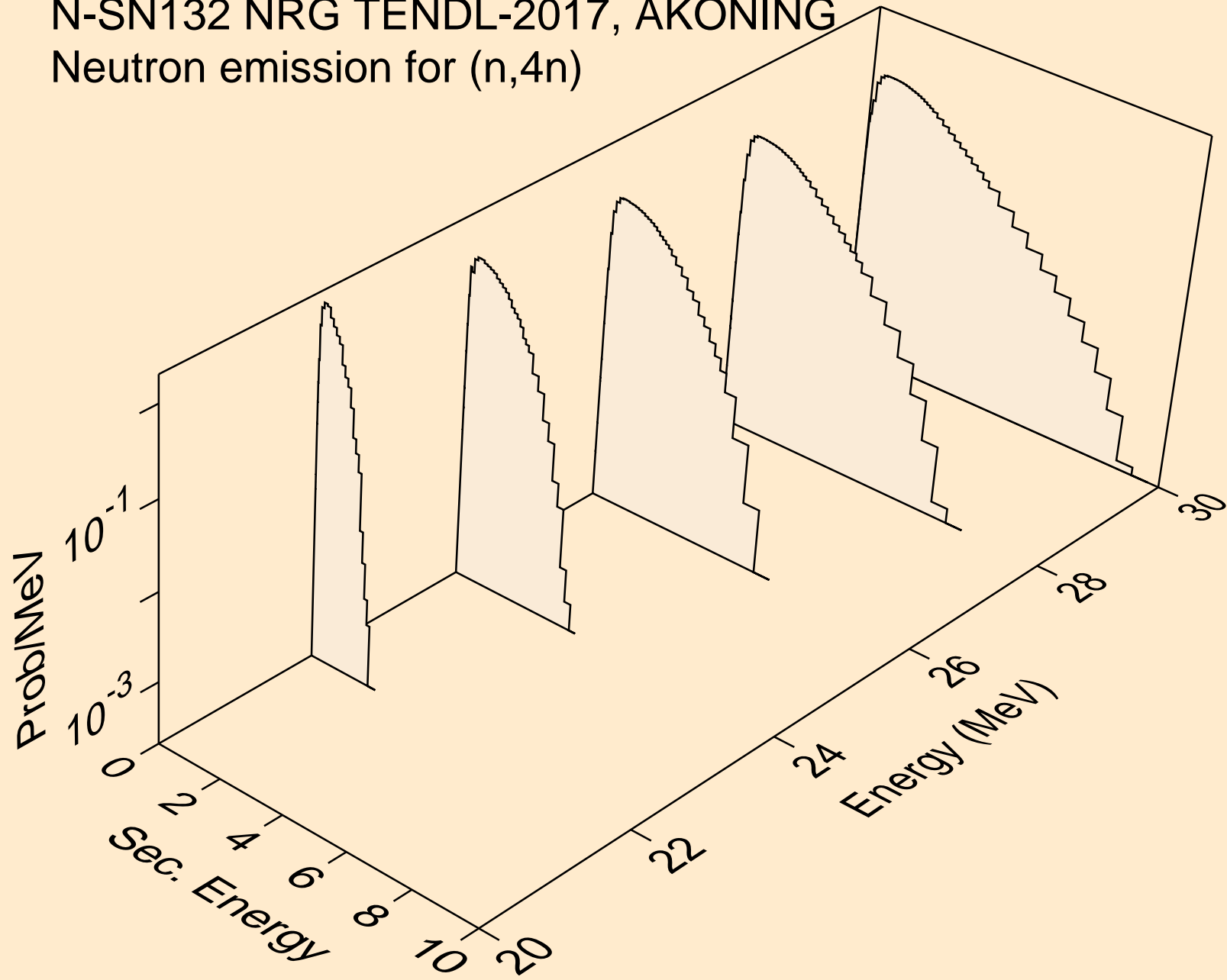



N-SN132 NRG TENDL-2017, AKONING  
Neutron emission for (n,2np)

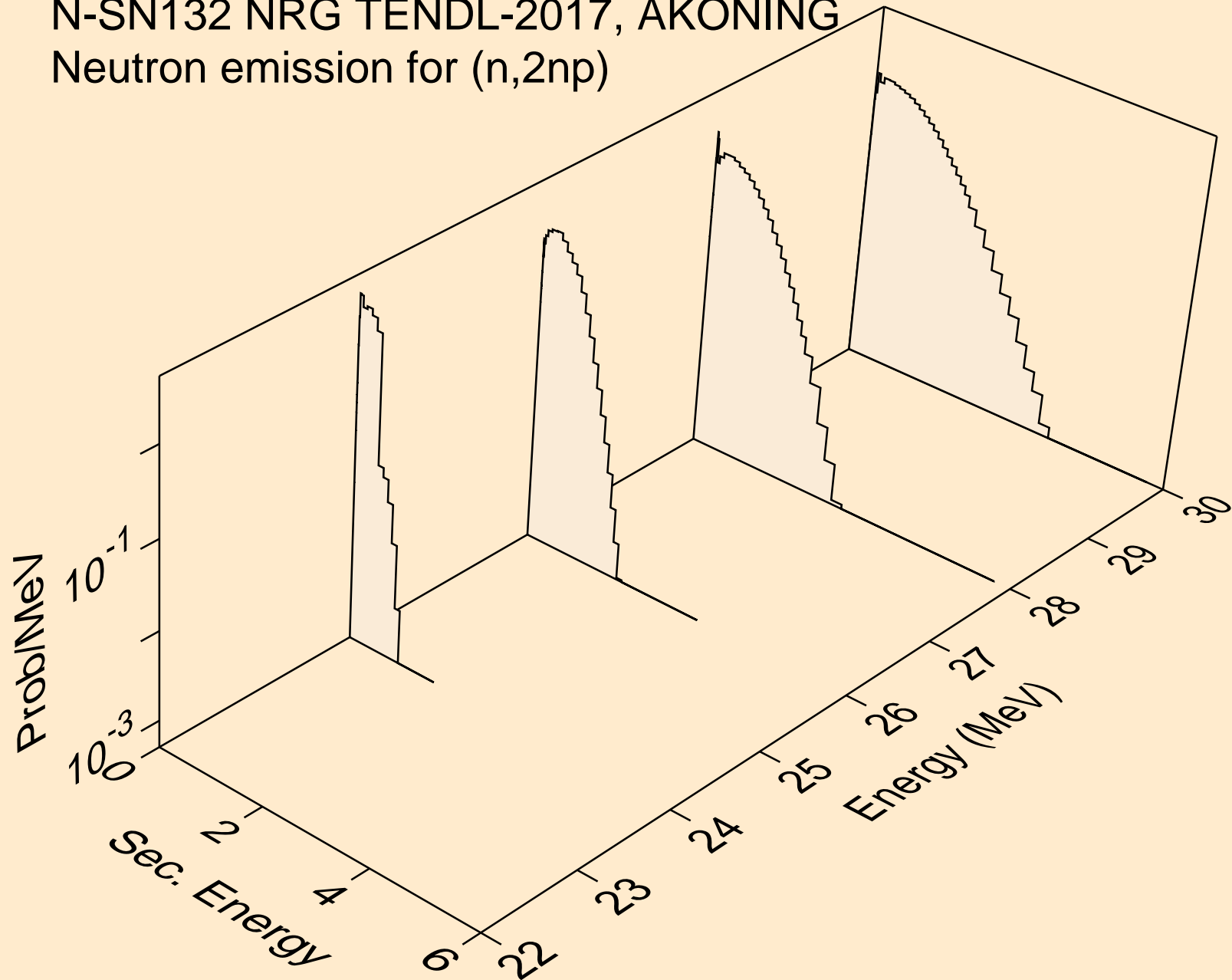

N-SN132 NRG TENDL-2017, AKONING  
Neutron emission for (n,n\*c)

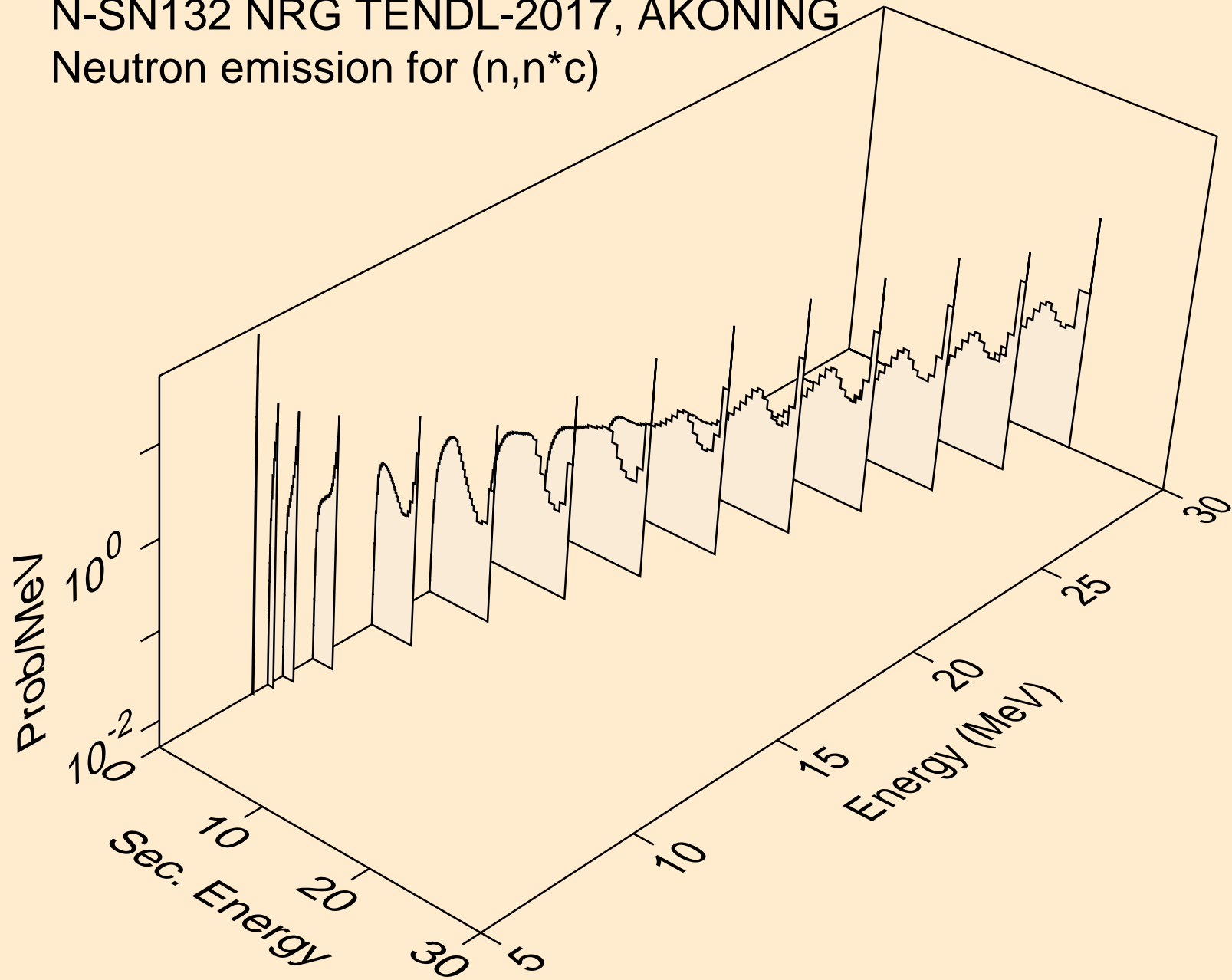

N-SN132 NRG TENDL-2017, AKONING  
Photon emission for (n,x)

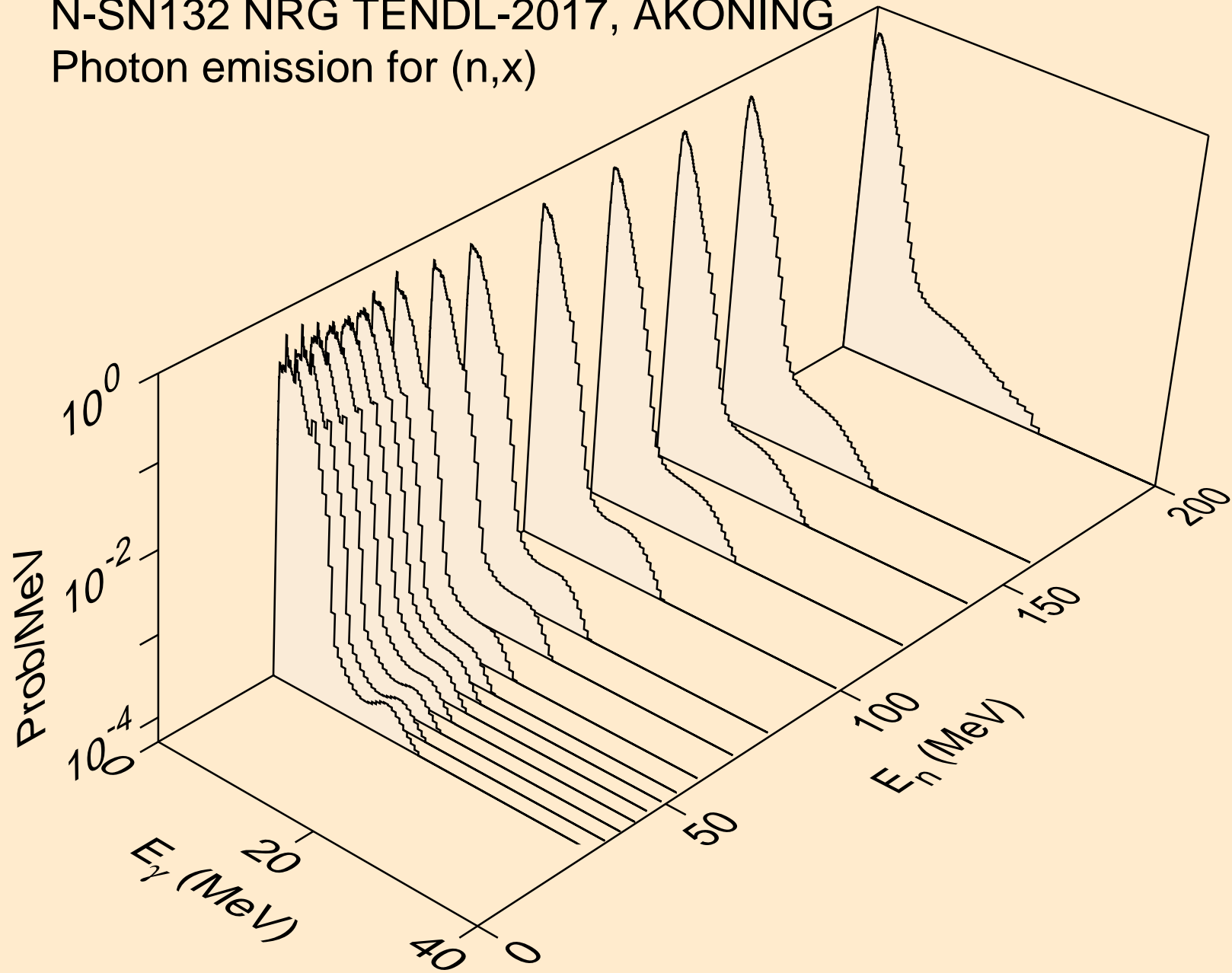

N-SN132 NRG TENDL-2017, AKONING  
Photon emission for (n,2nd)

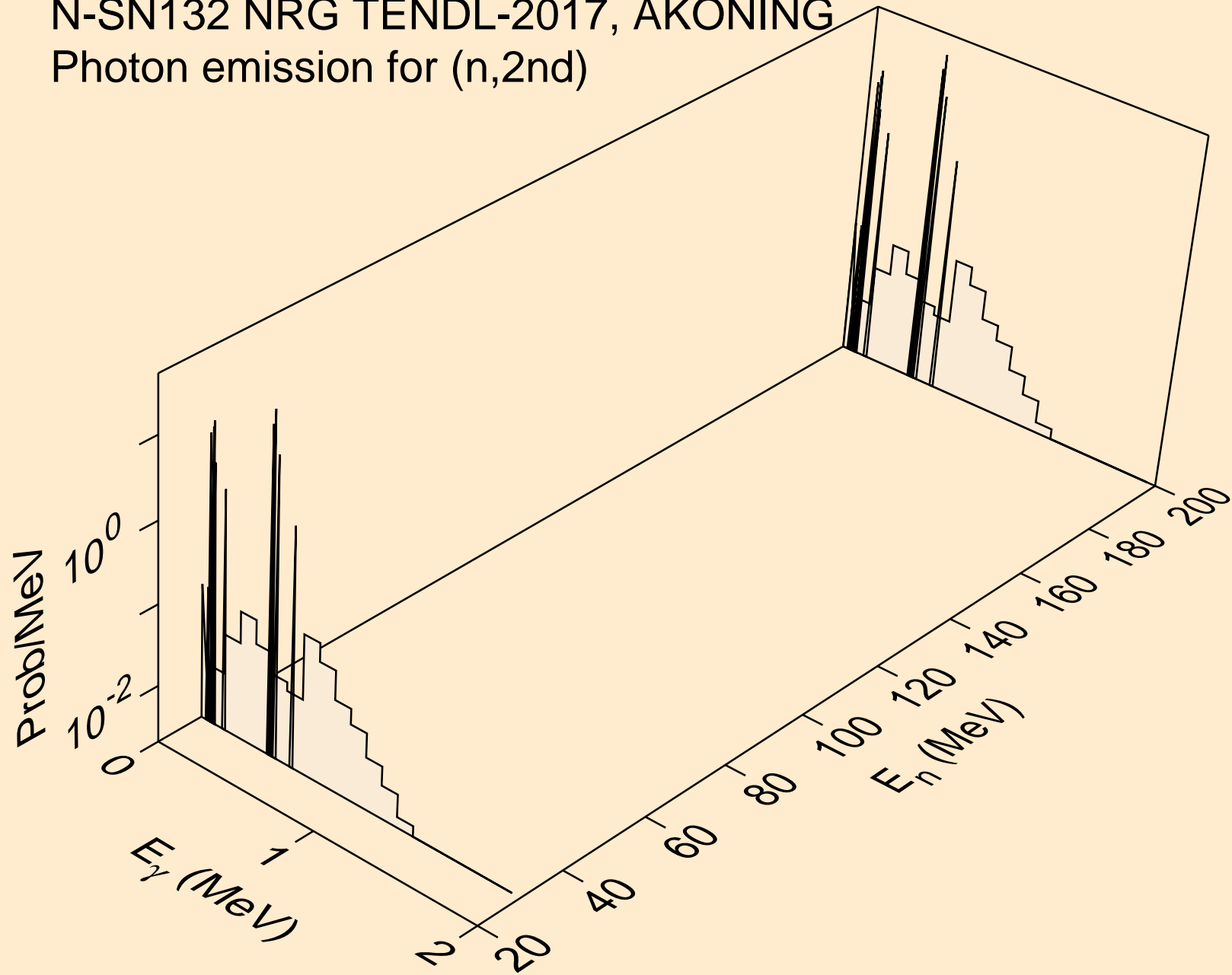

N-SN132 NRG TENDL-2017, AKONING  
Photon emission for (n,2n)

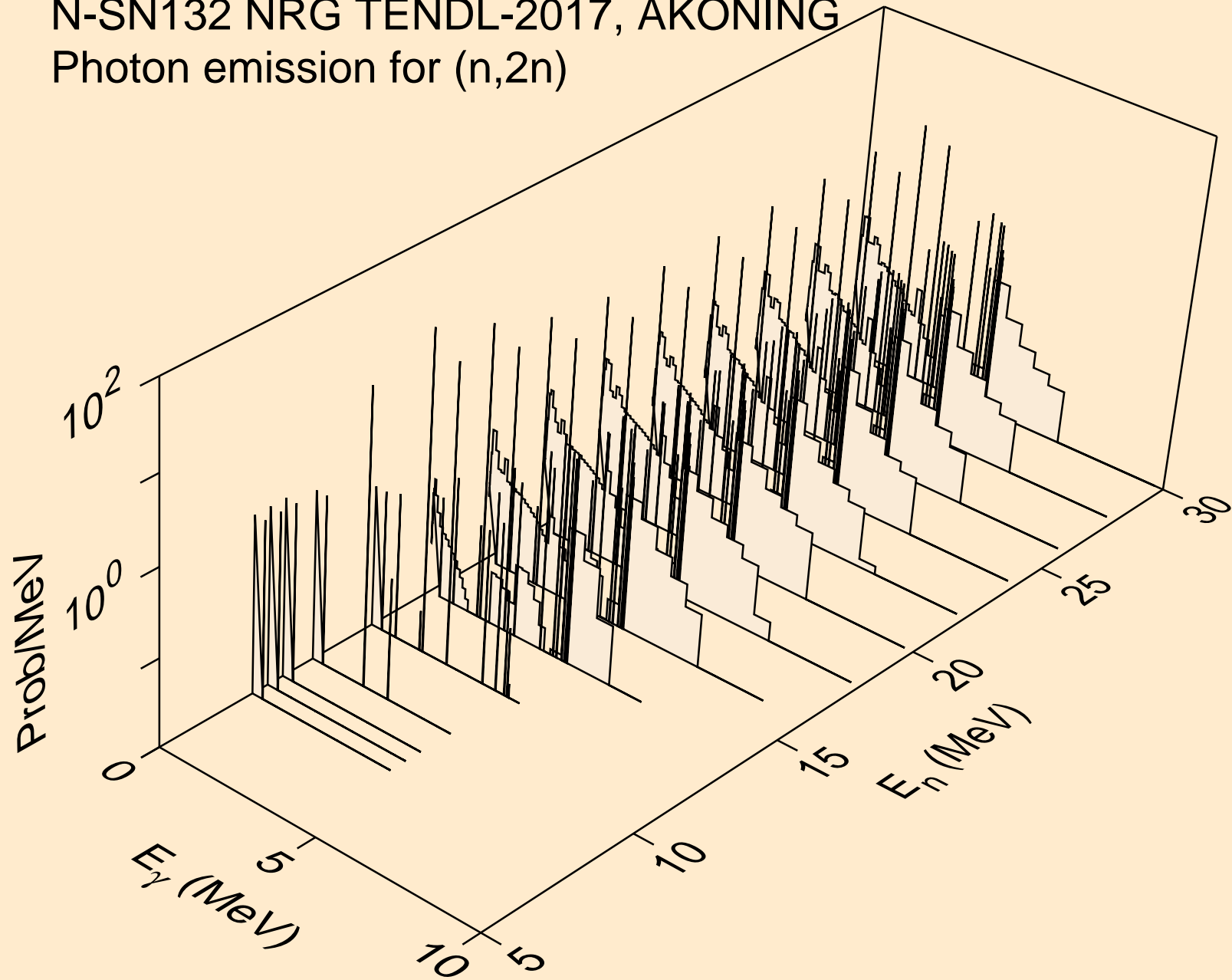

N-SN132 NRG TENDL-2017, AKONING  
Photon emission for (n,3n)

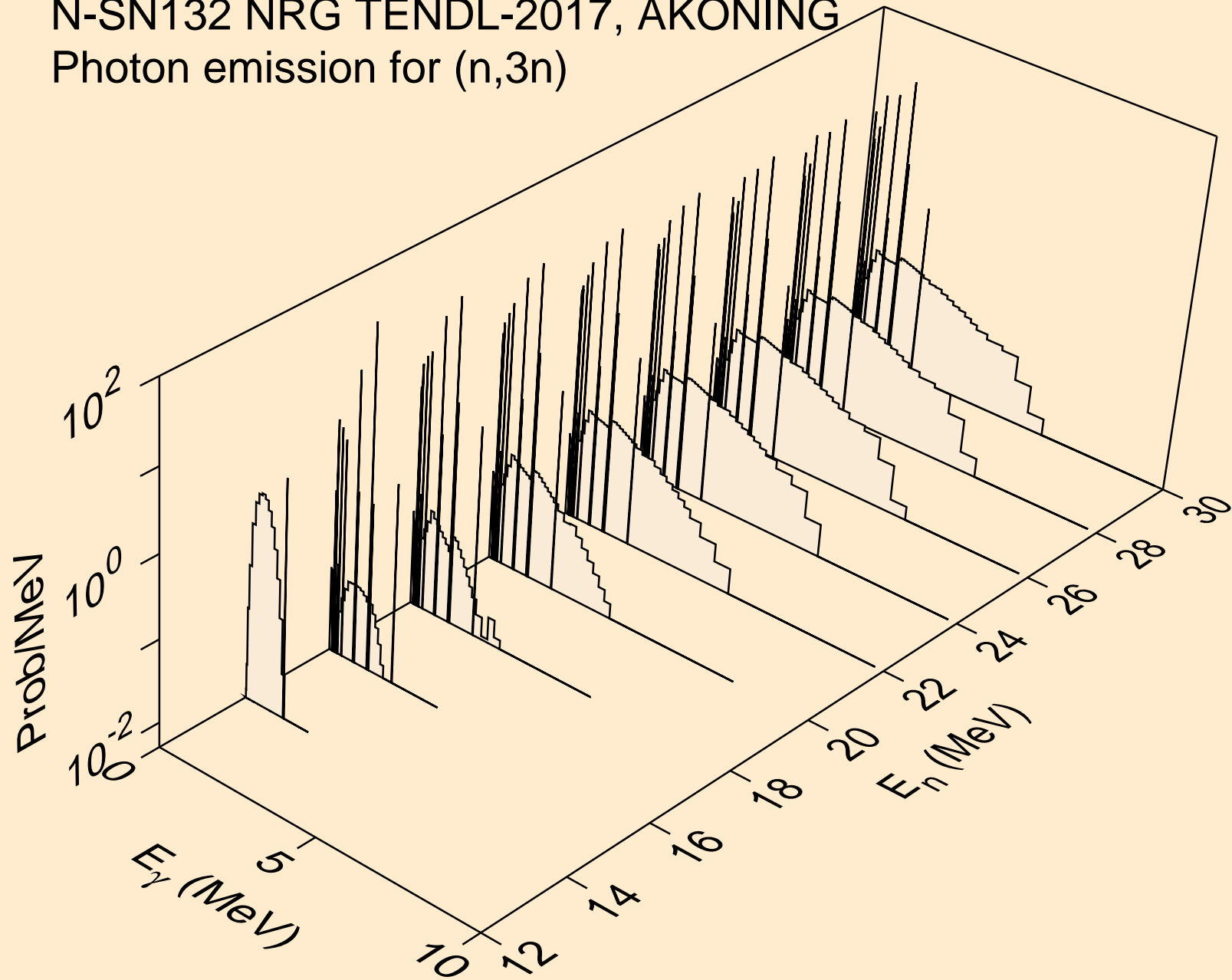

N-SN132 NRG TENDL-2017, AKONING  
Photon emission for (n,n\*)a

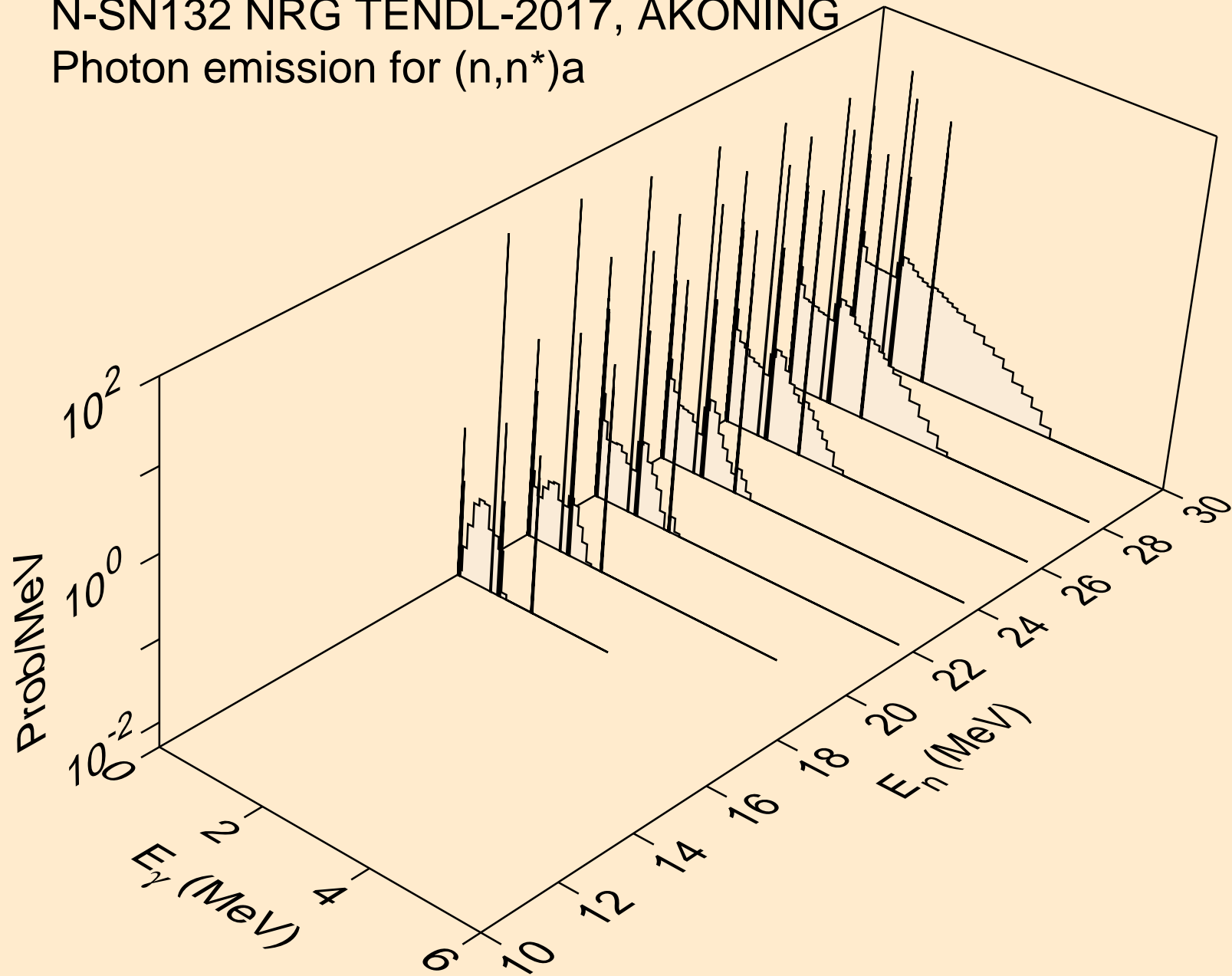

N-SN132 NRG TENDL-2017, AKONING  
Photon emission for (n,2n)a

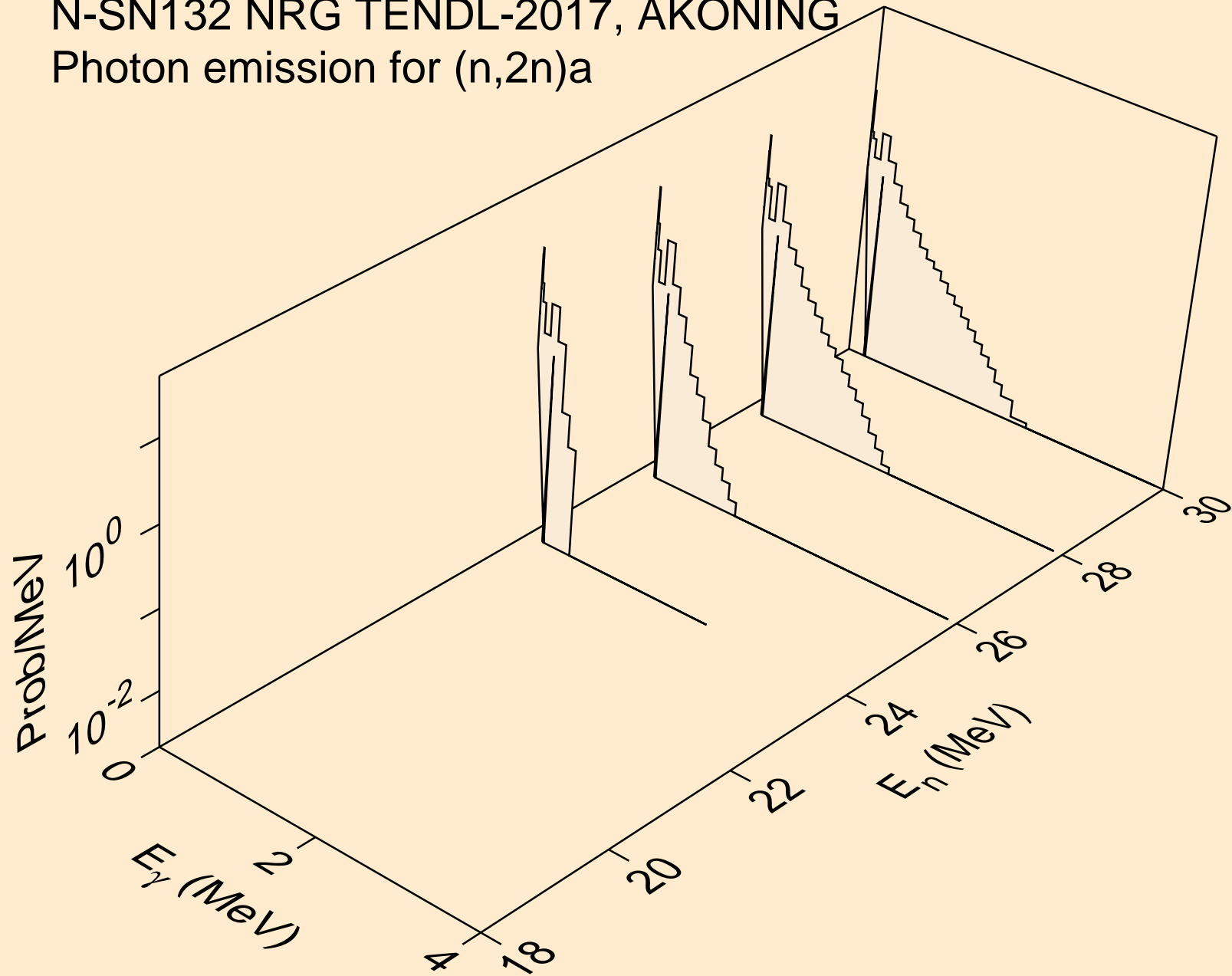



N-SN132 NRG TENDL-2017, AKONING  
Photon emission for (n,n\*)p

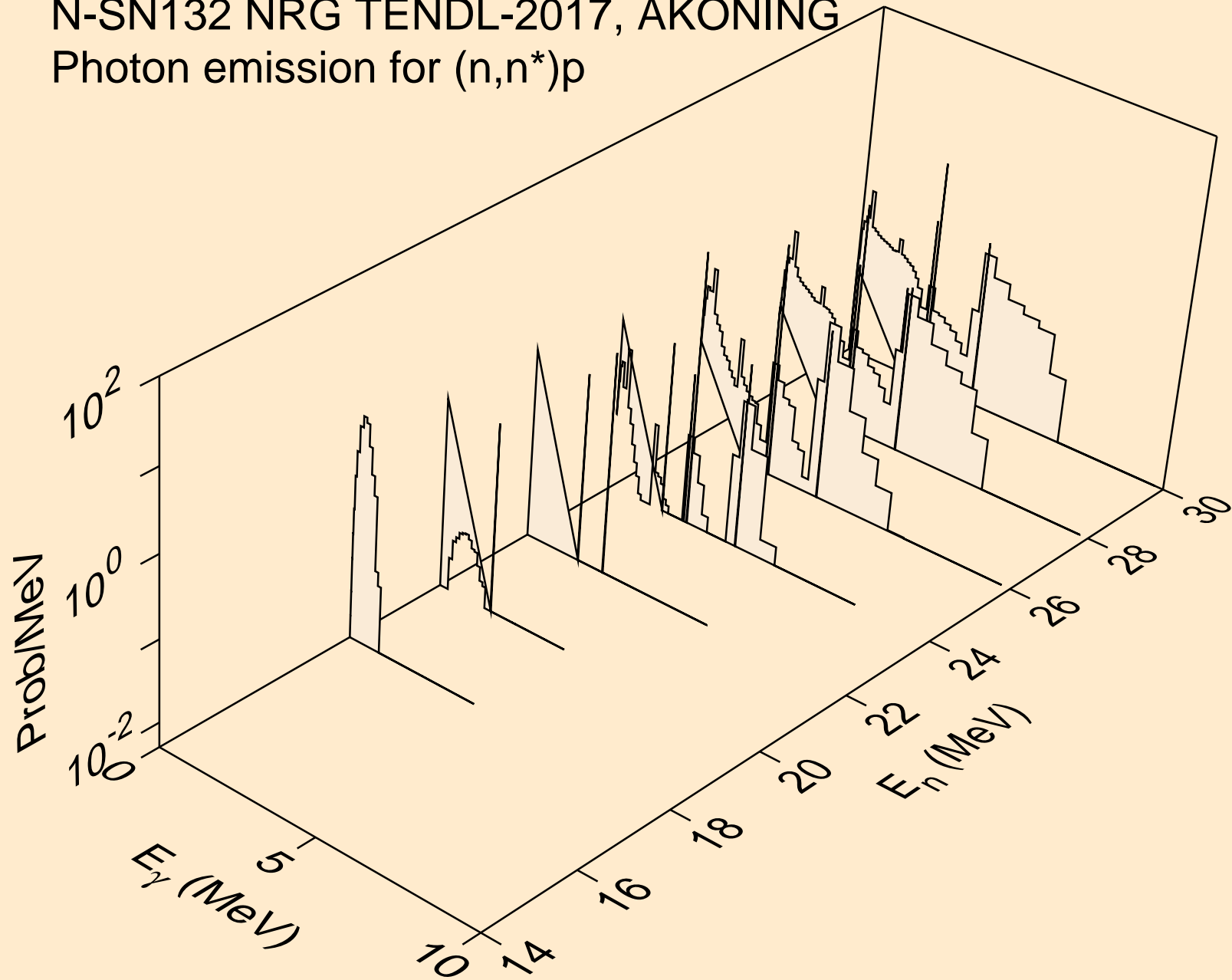

N-SN132 NRG TENDL-2017, AKONING  
Photon emission for (n,n\*)d

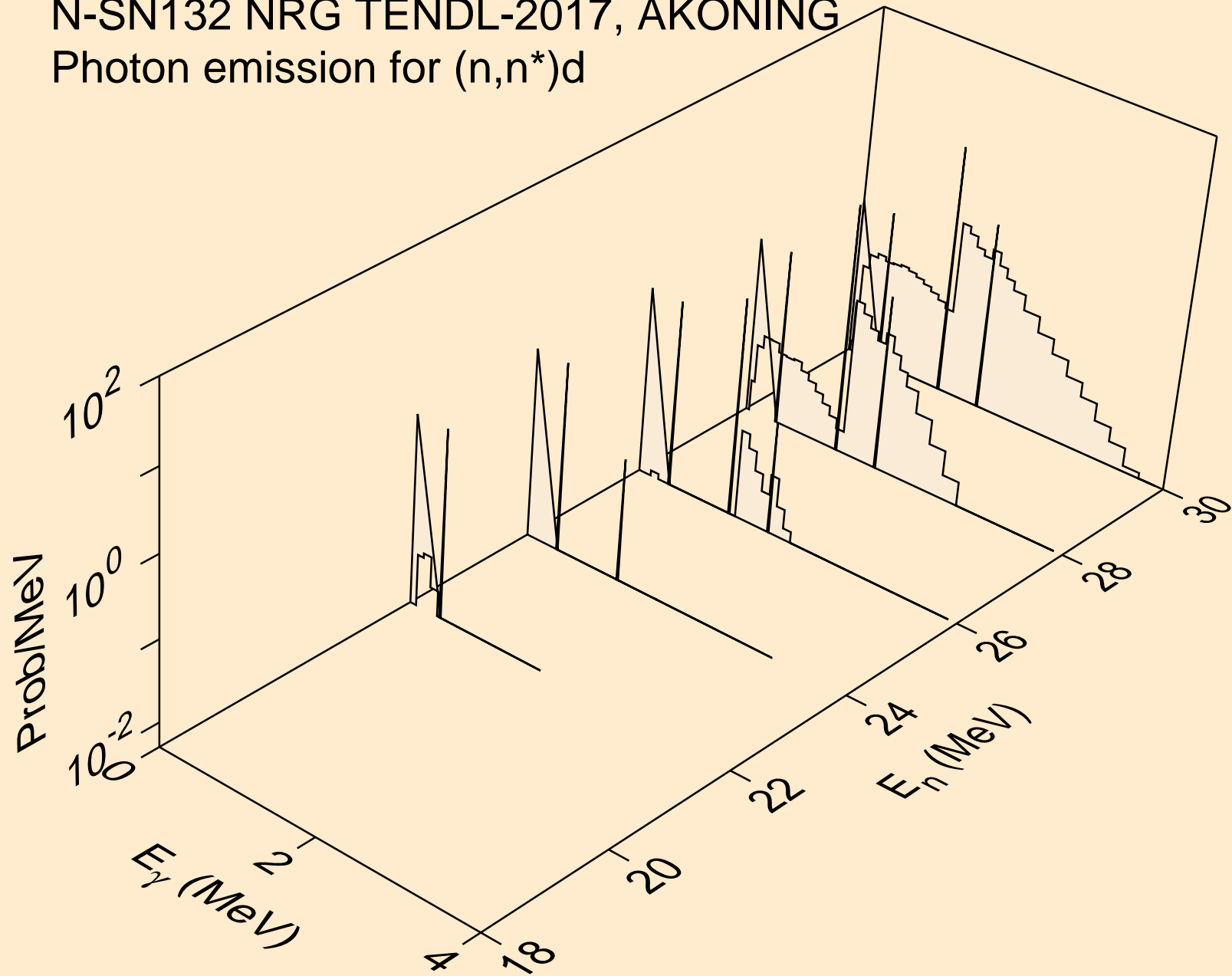

N-SN132 NRG TENDL-2017, AKONING  
Photon emission for (n,n\*)t

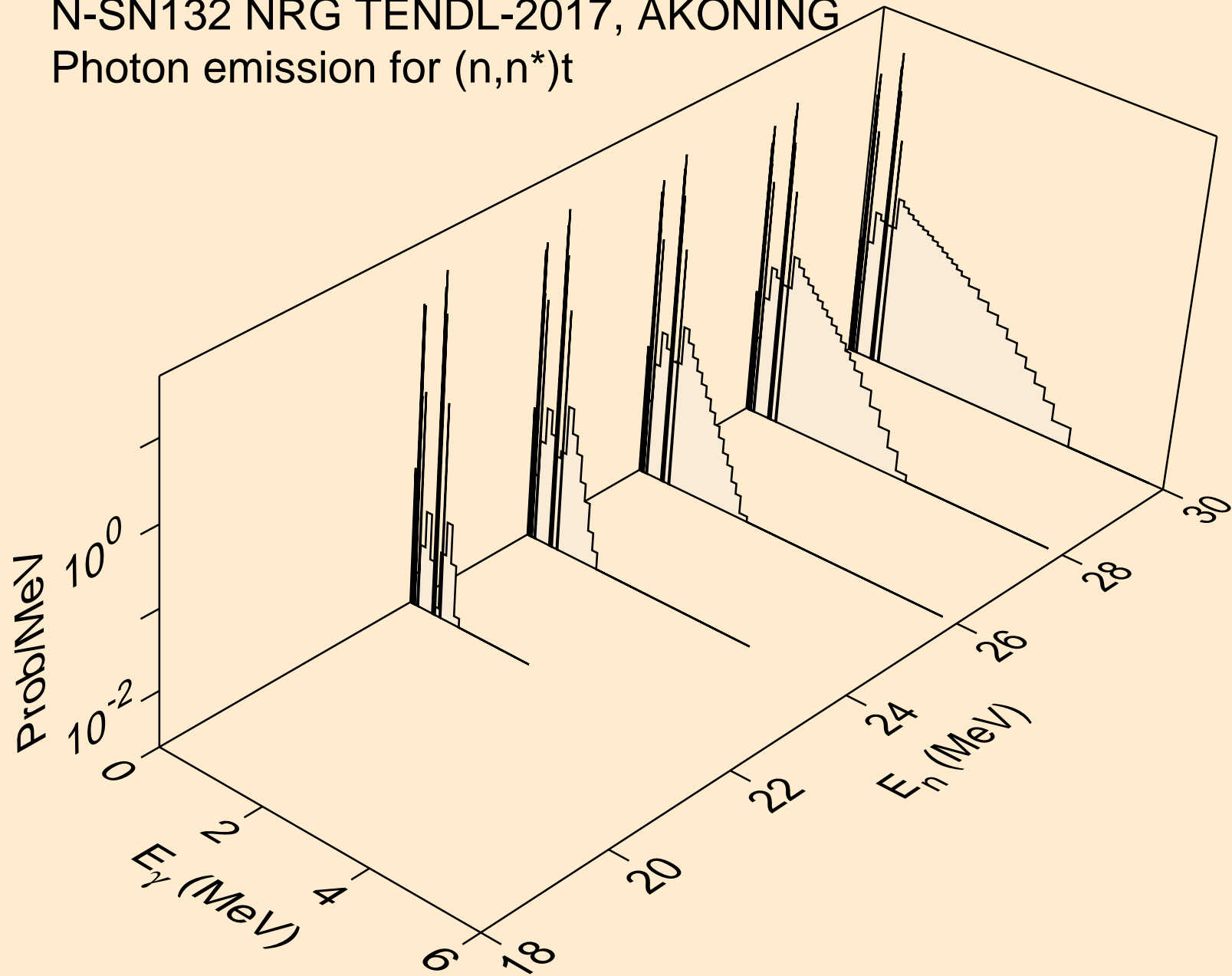

N-SN132 NRG TENDL-2017, AKONING  
Photon emission for (n,4n)

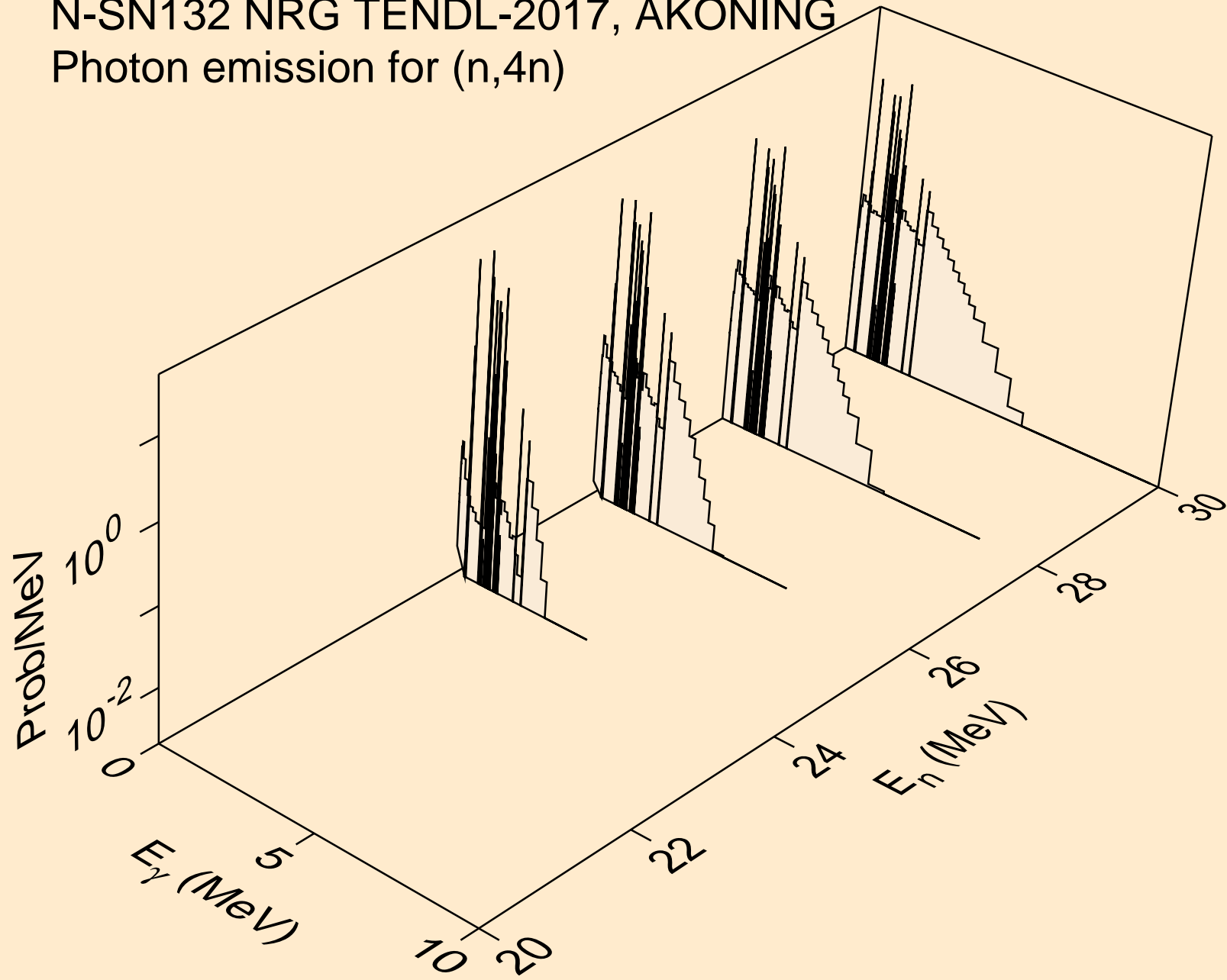

N-SN132 NRG TENDL-2017, AKONING  
Photon emission for (n,2np)

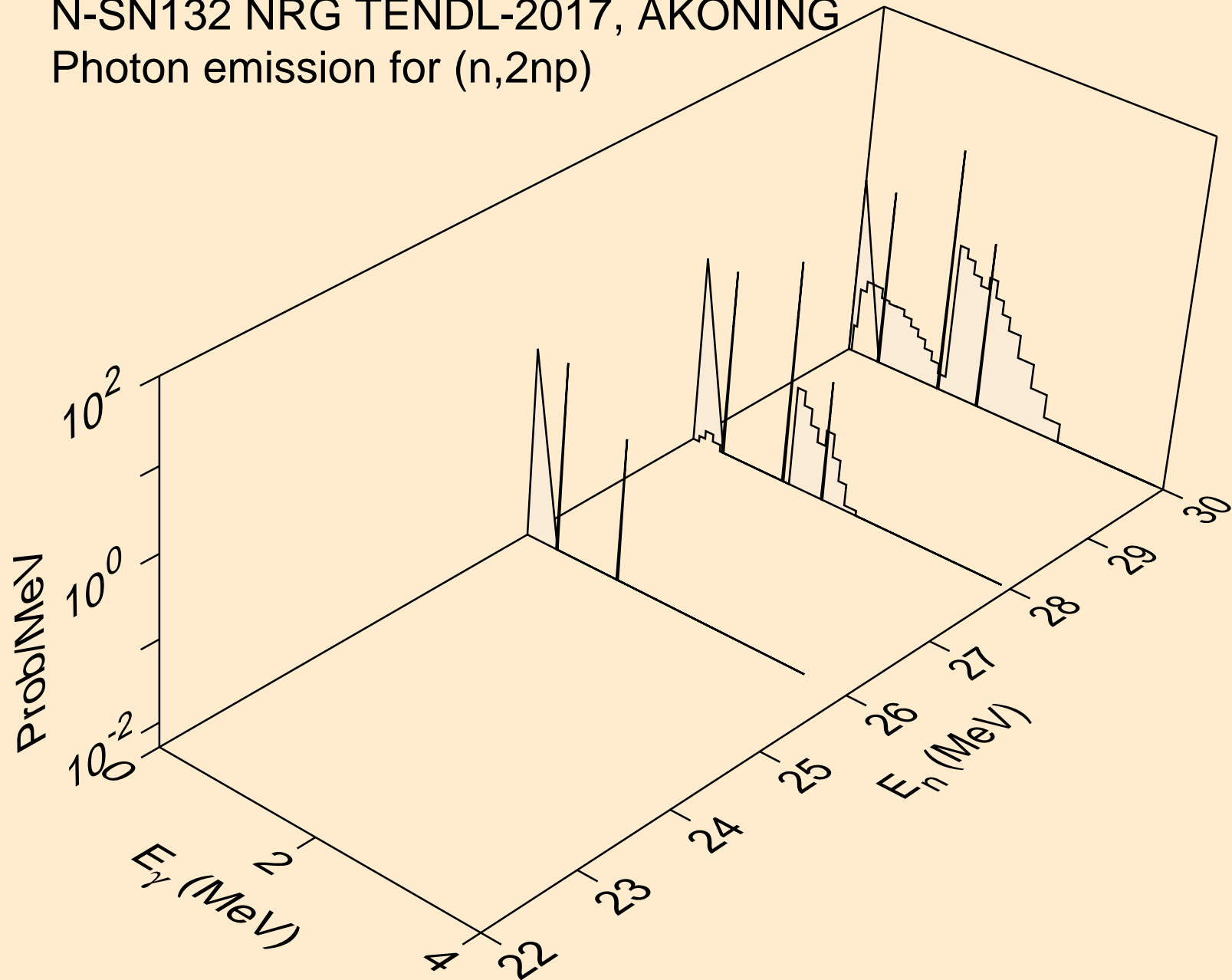

N-SN132 NRG TENDL-2017, AKONING  
Photon emission for (n,n\*c)

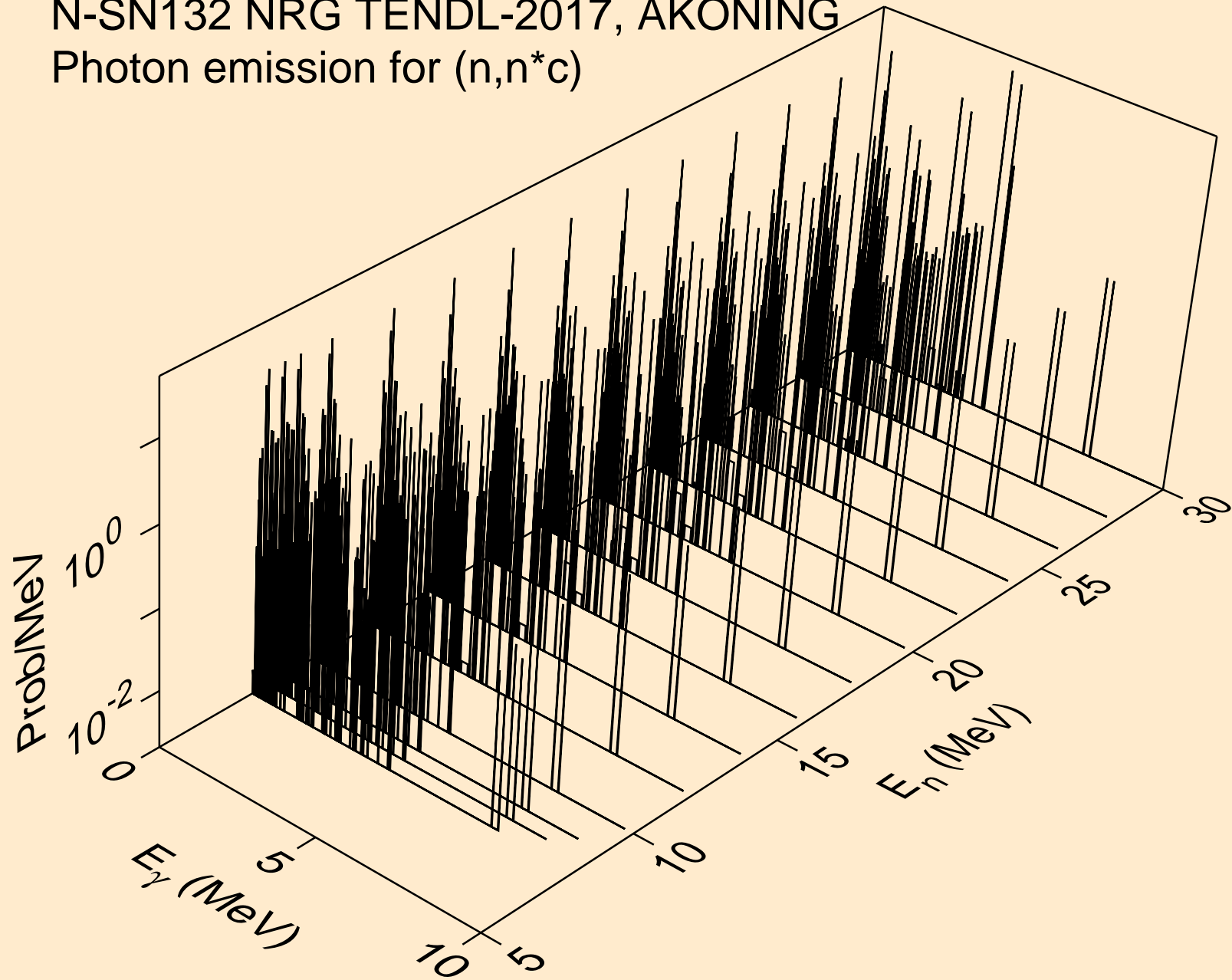

N-SN132 NRG TENDL-2017, AKONING  
Photon emission for (n,gma)

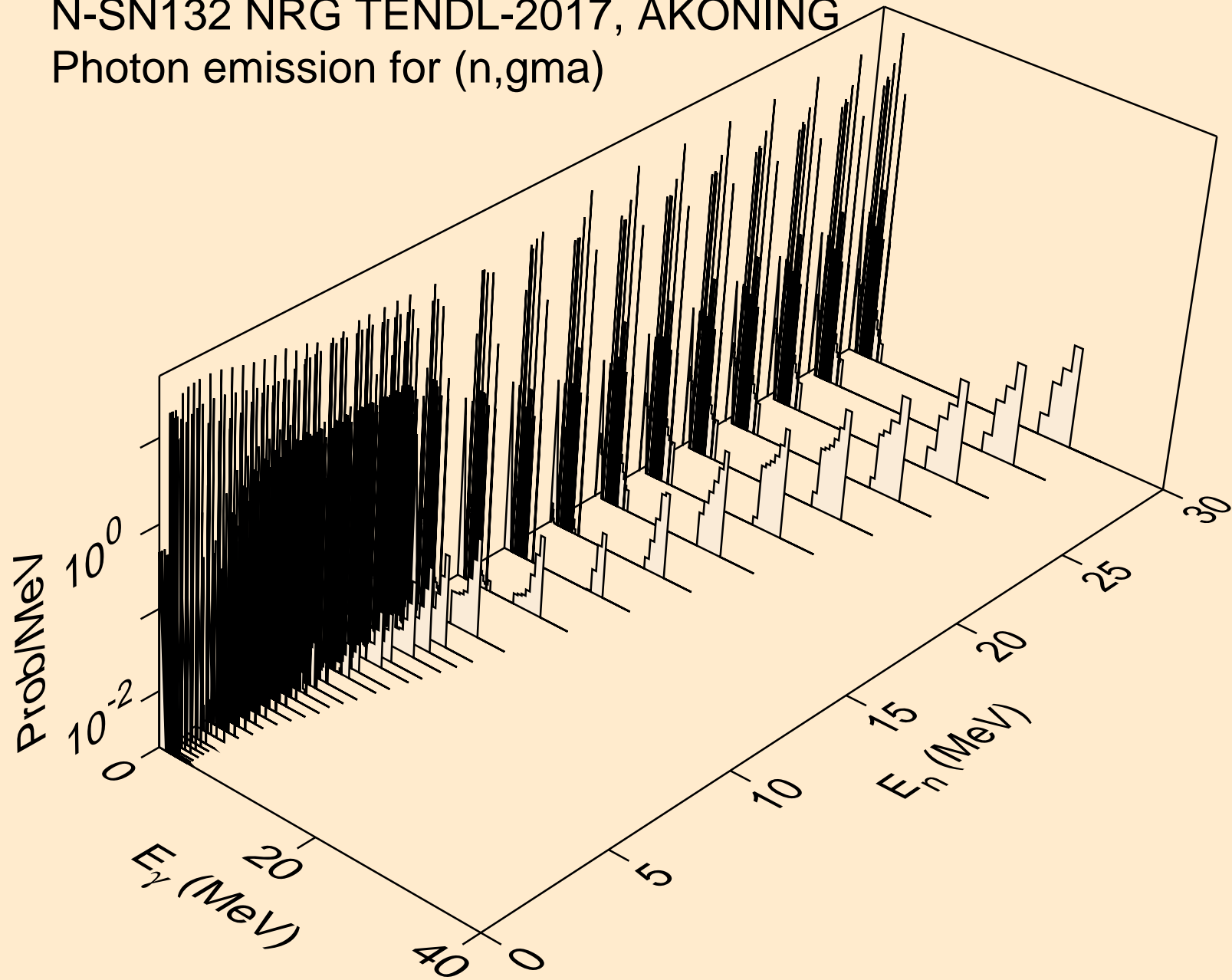

N-SN132 NRG TENDL-2017, AKONING  
Photon emission for (n,p)

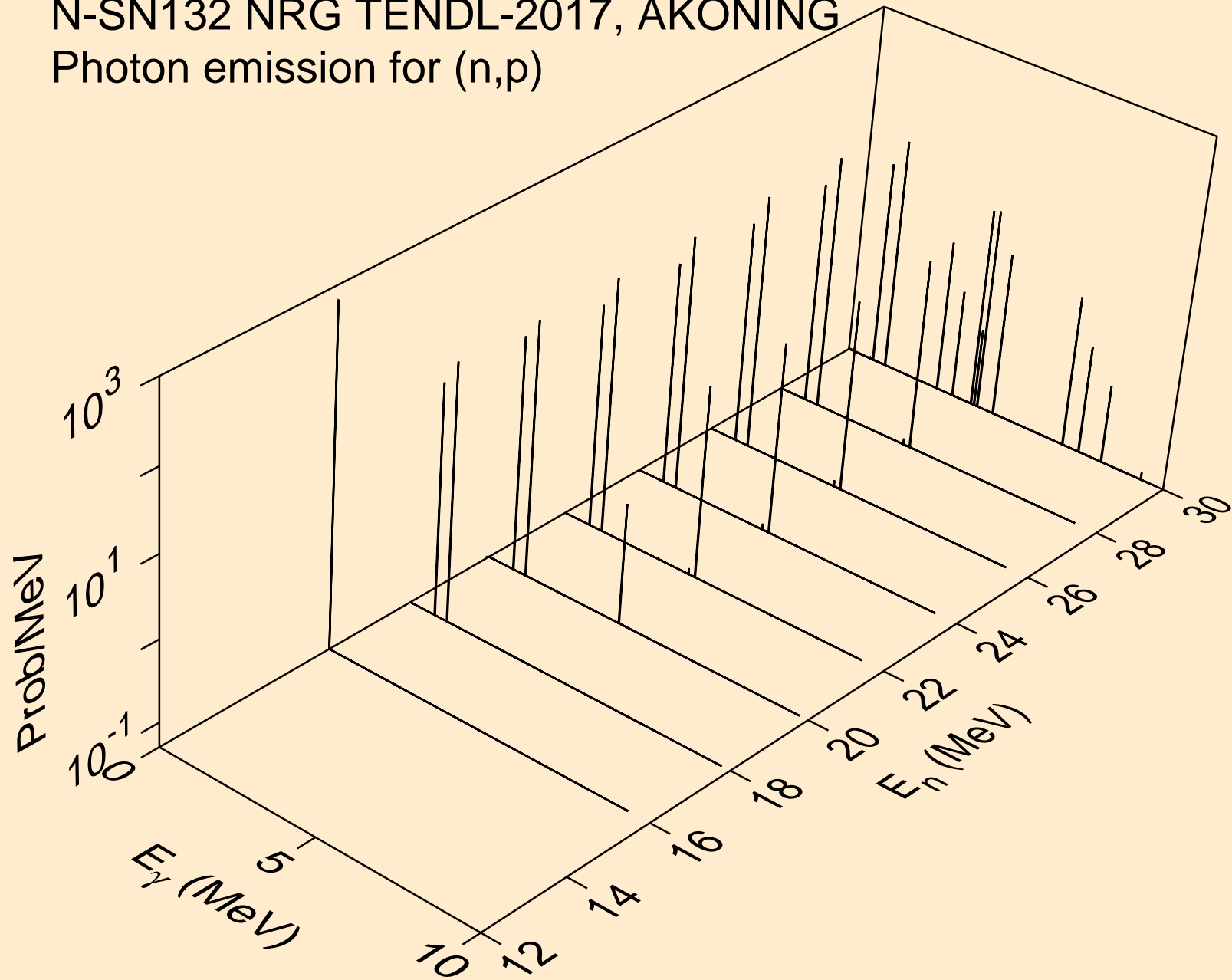



N-SN132 NRG TENDL-2017, AKONING  
Photon emission for (n,d)

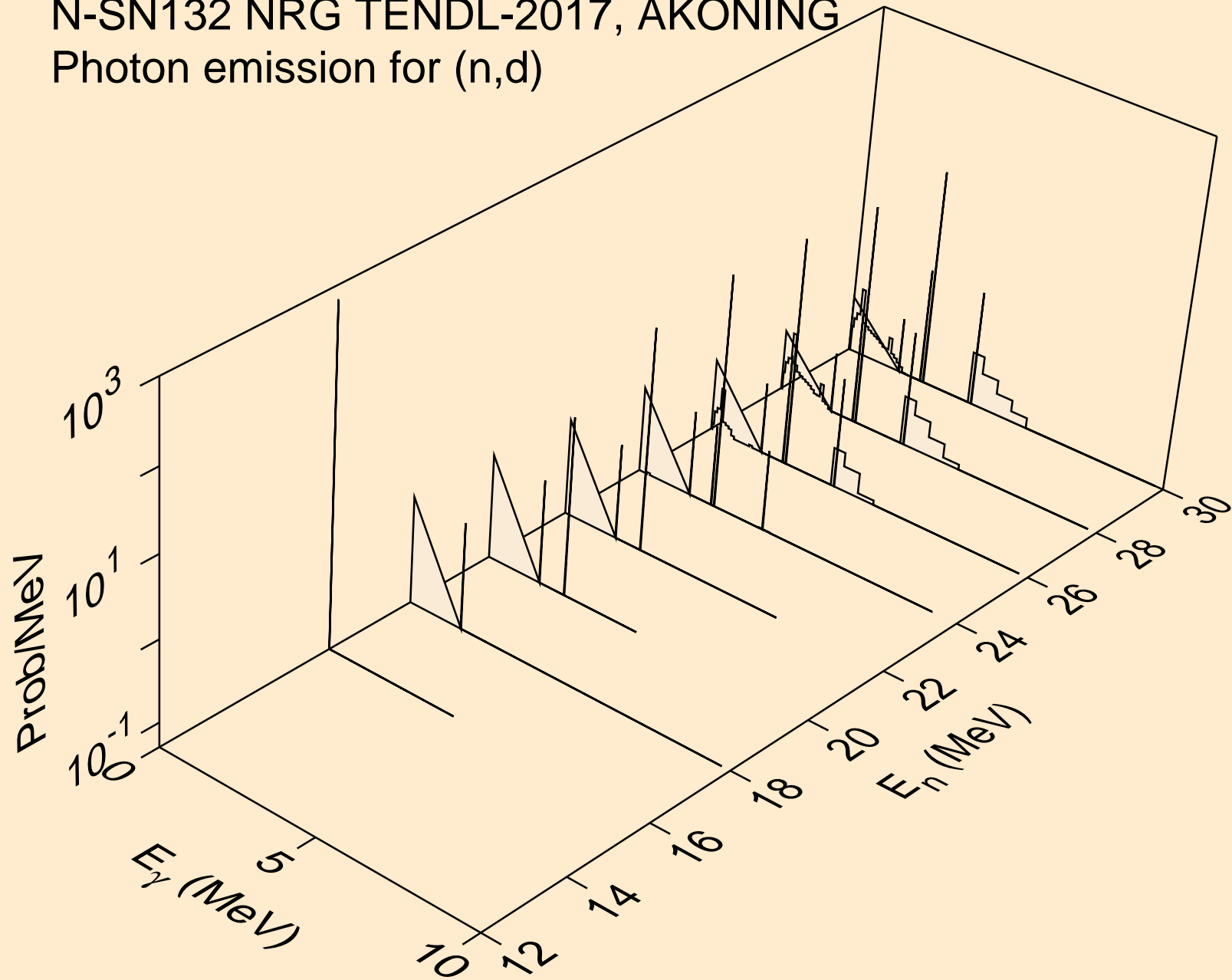

N-SN132 NRG TENDL-2017, AKONING  
Photon emission for (n,t)

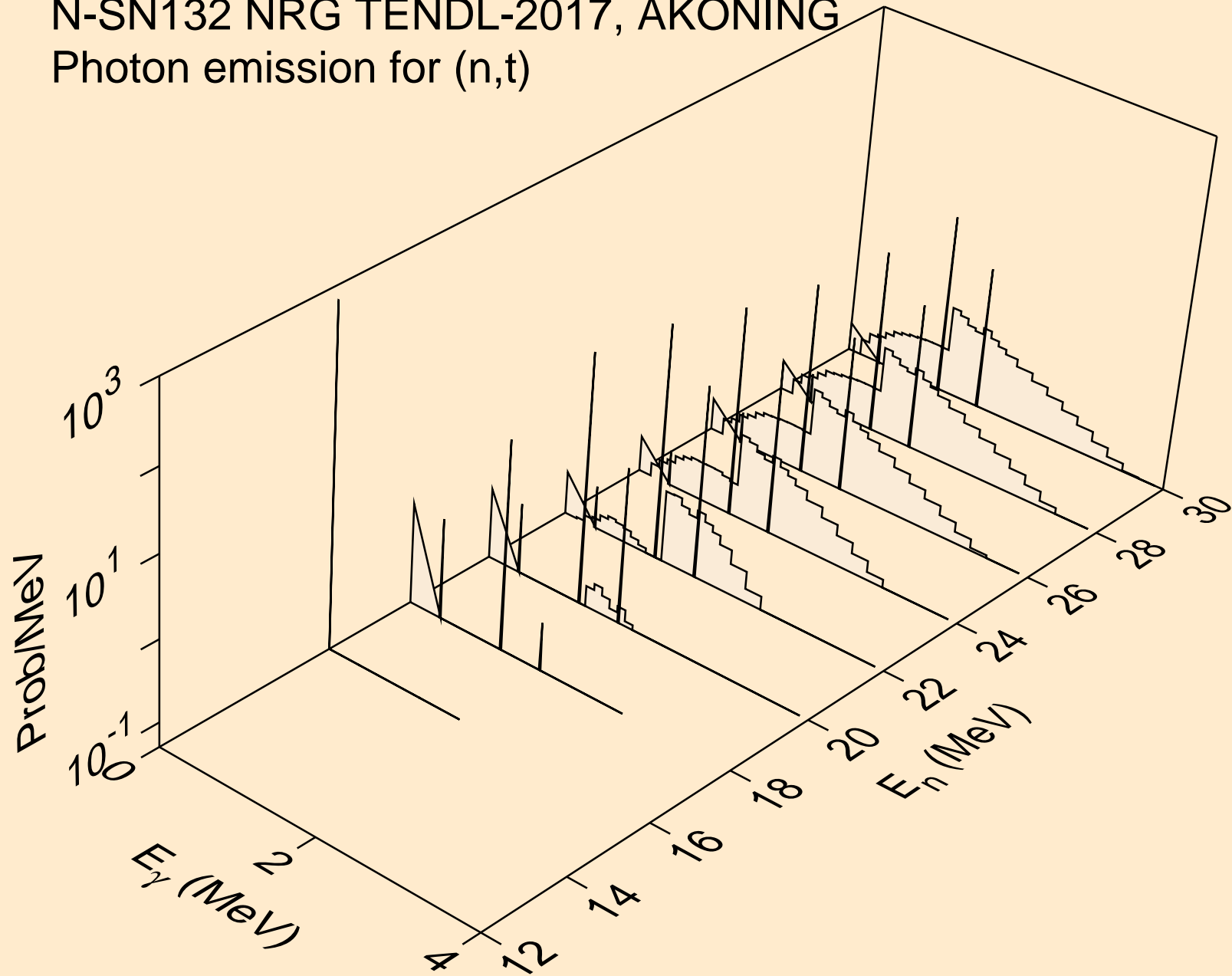

N-SN132 NRG TENDL-2017, AKONING  
Photon emission for (n,a)

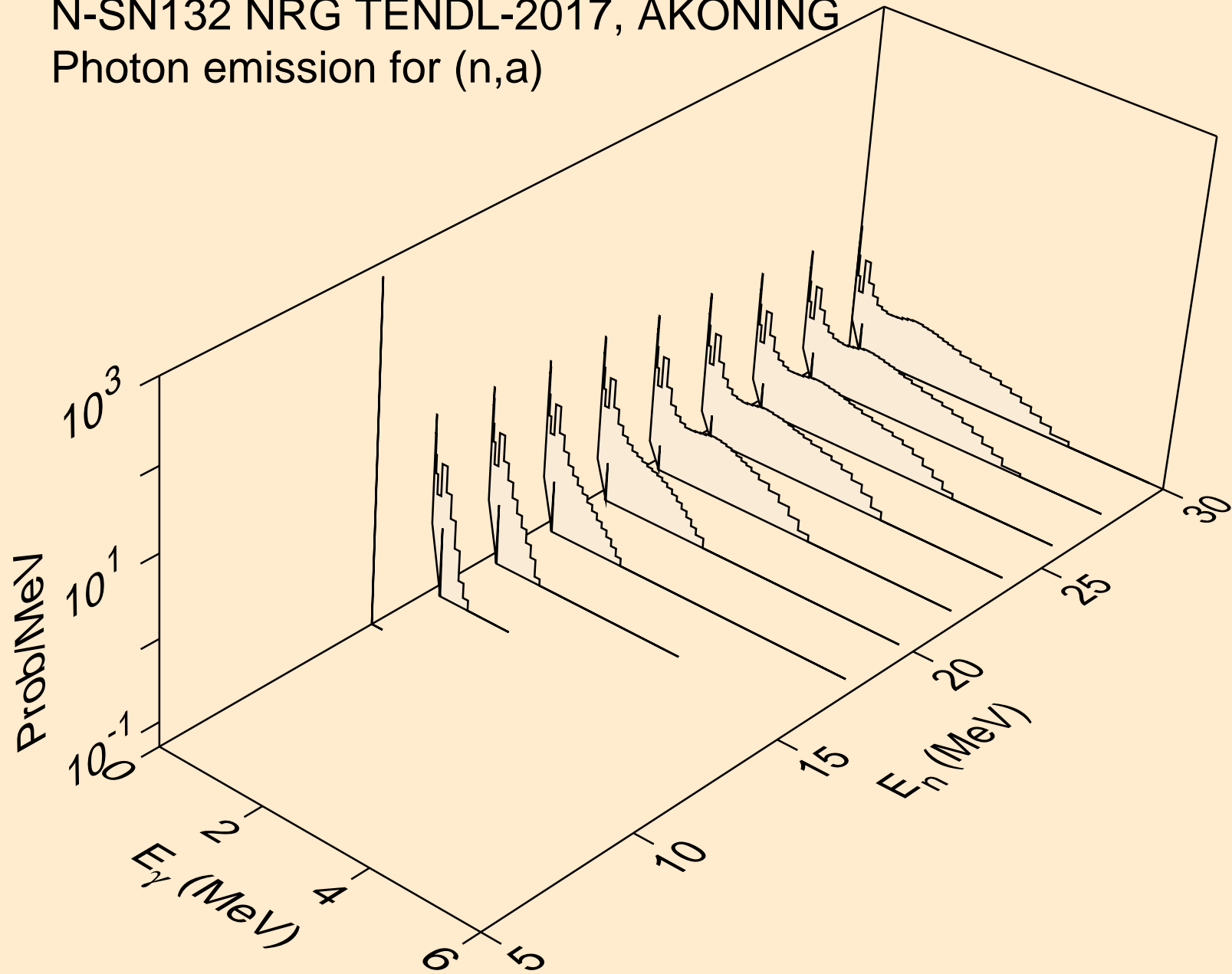

N-SN132 NRG TENDL-2017, AKONING  
thermal capture photon spectrum

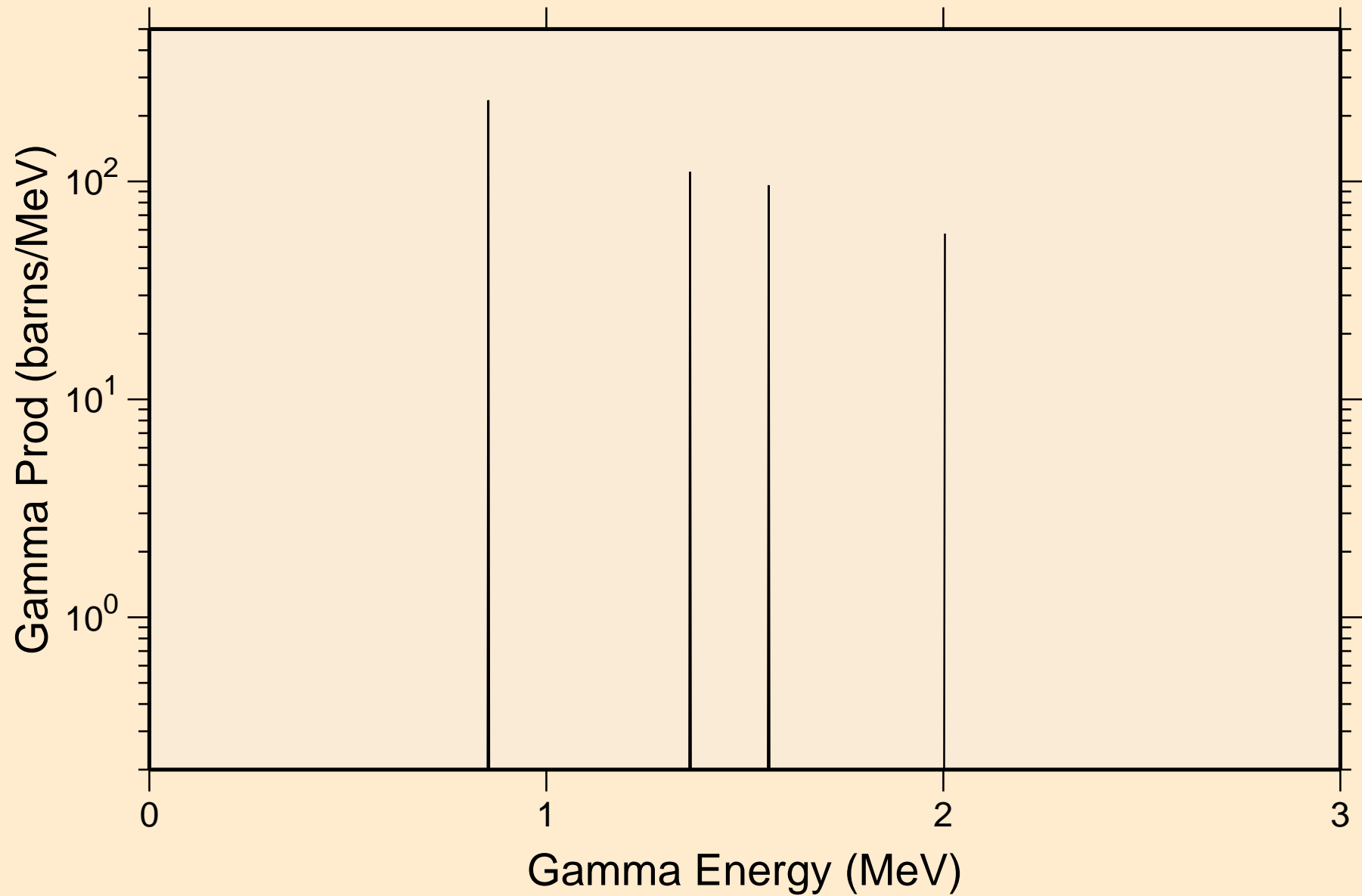

N-SN132 NRG TENDL-2017, AKONING  
14 MeV photon spectrum

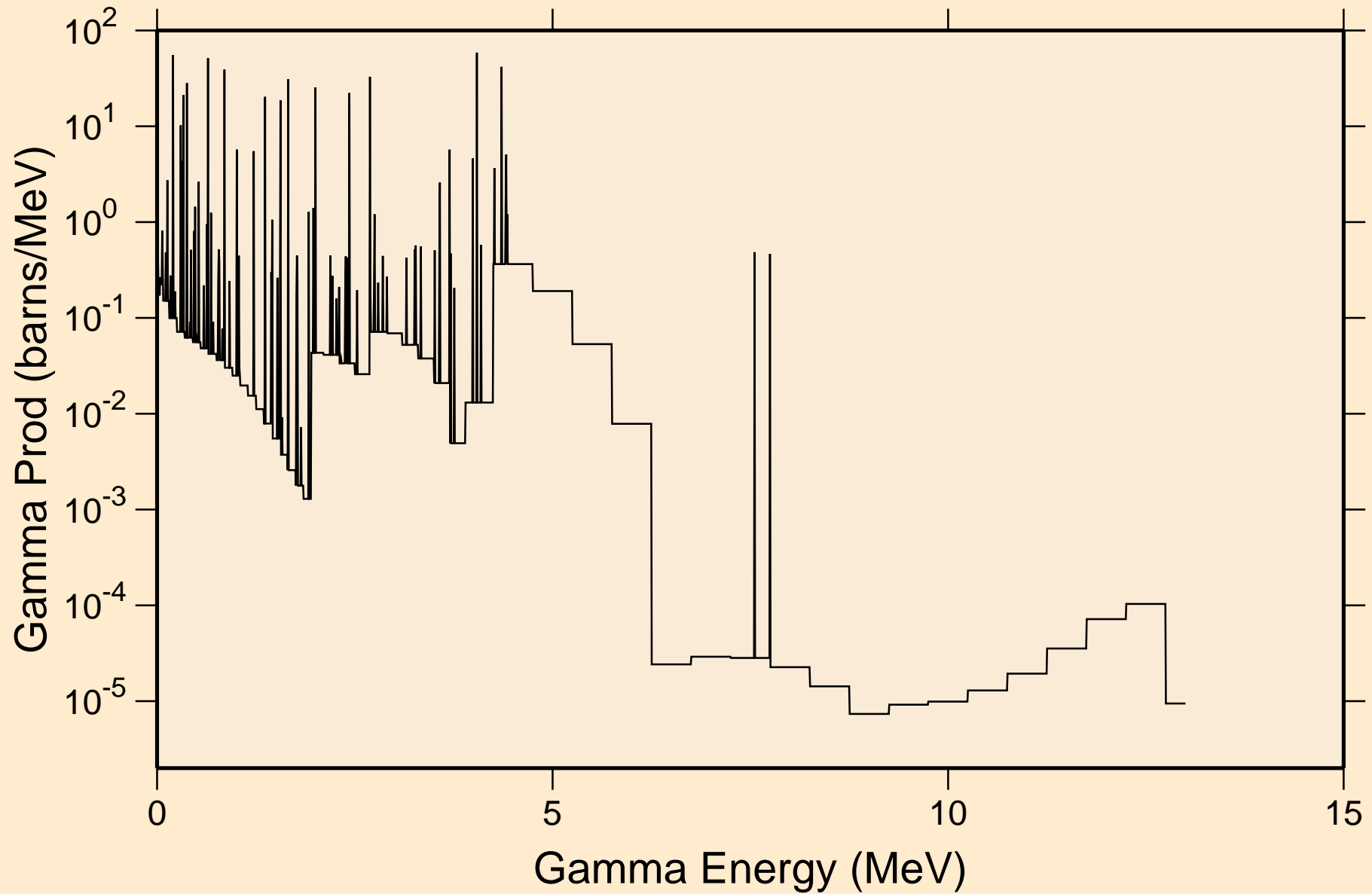

# N-SN132 NRG TENDL-2017, AKONING

## Particle heating contributions

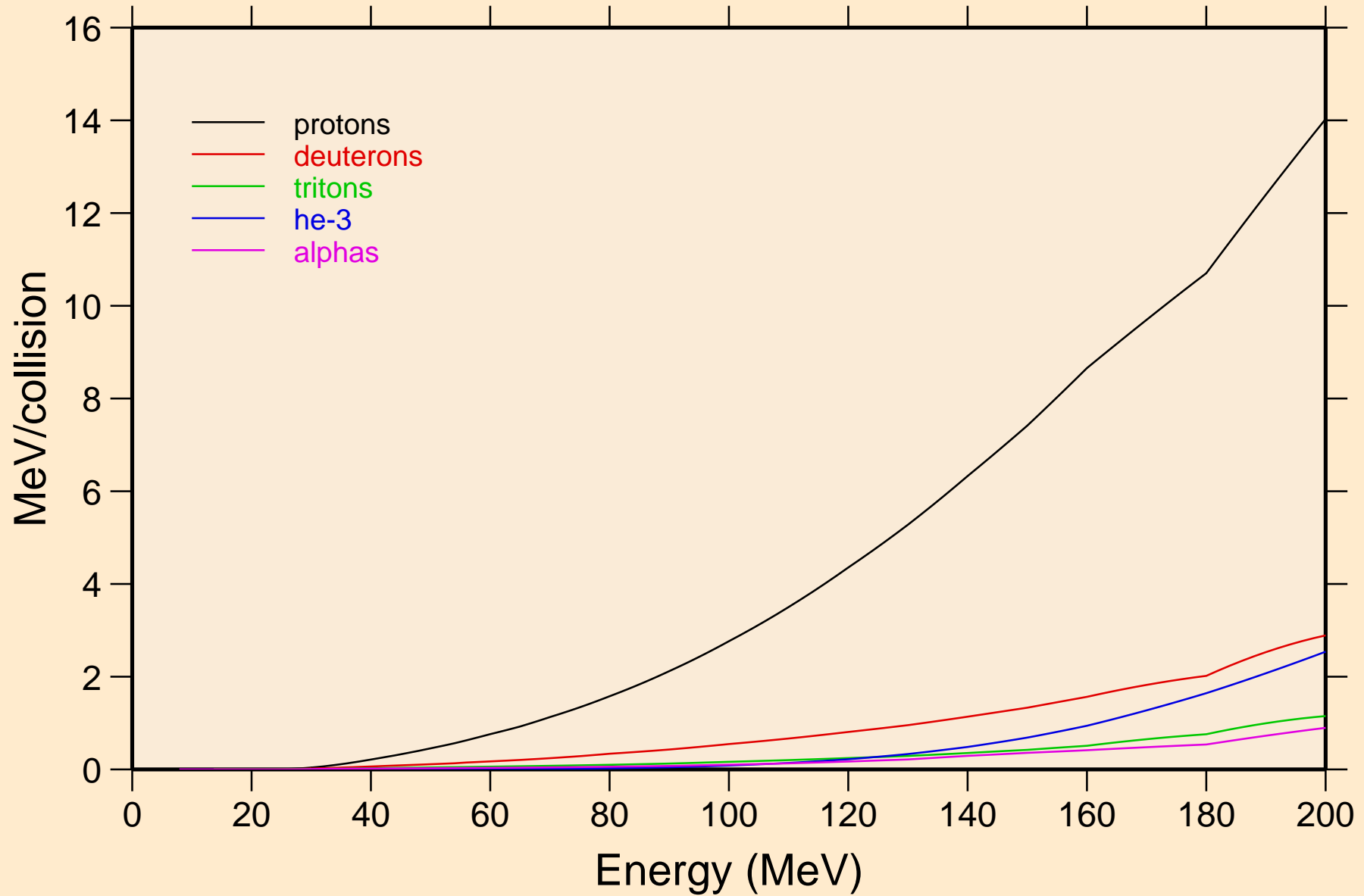

# N-SN132 NRG TENDL-2017, AKONING

## Recoil Heating

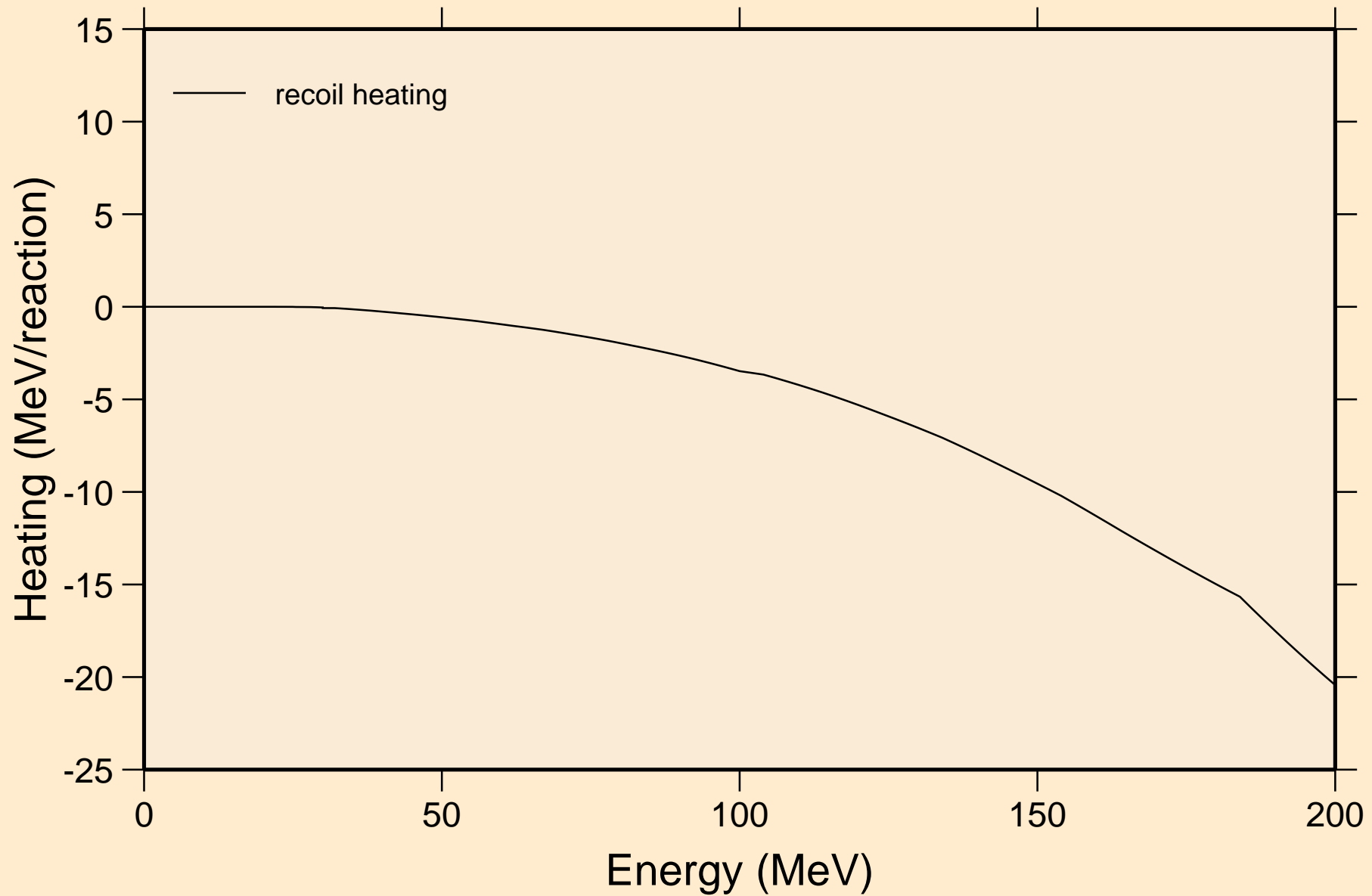

# N-SN132 NRG TENDL-2017, AKONING

## Particle production cross sections

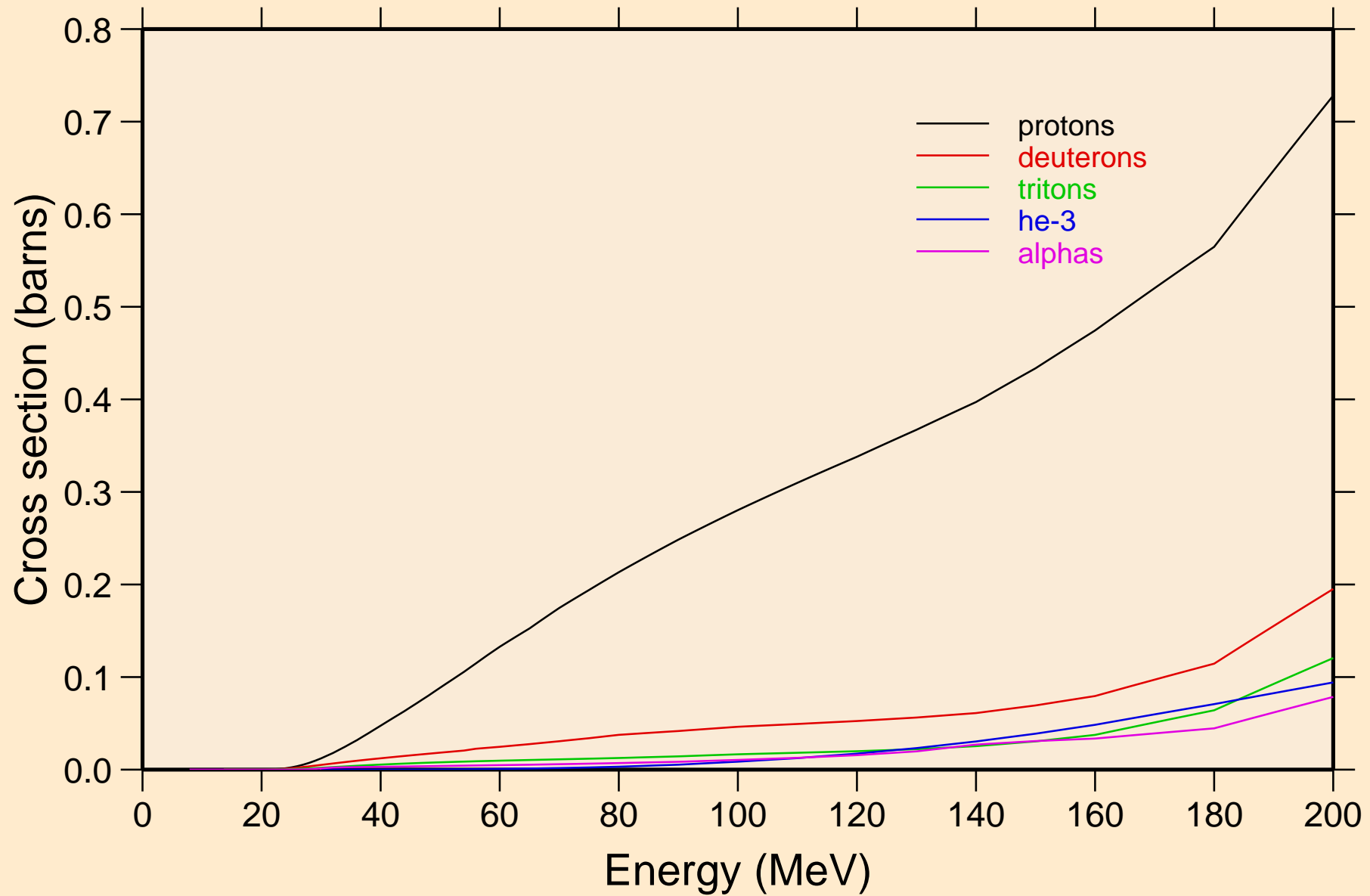



N-SN132 NRG TENDL-2017, AKONING  
protons from (n,x)

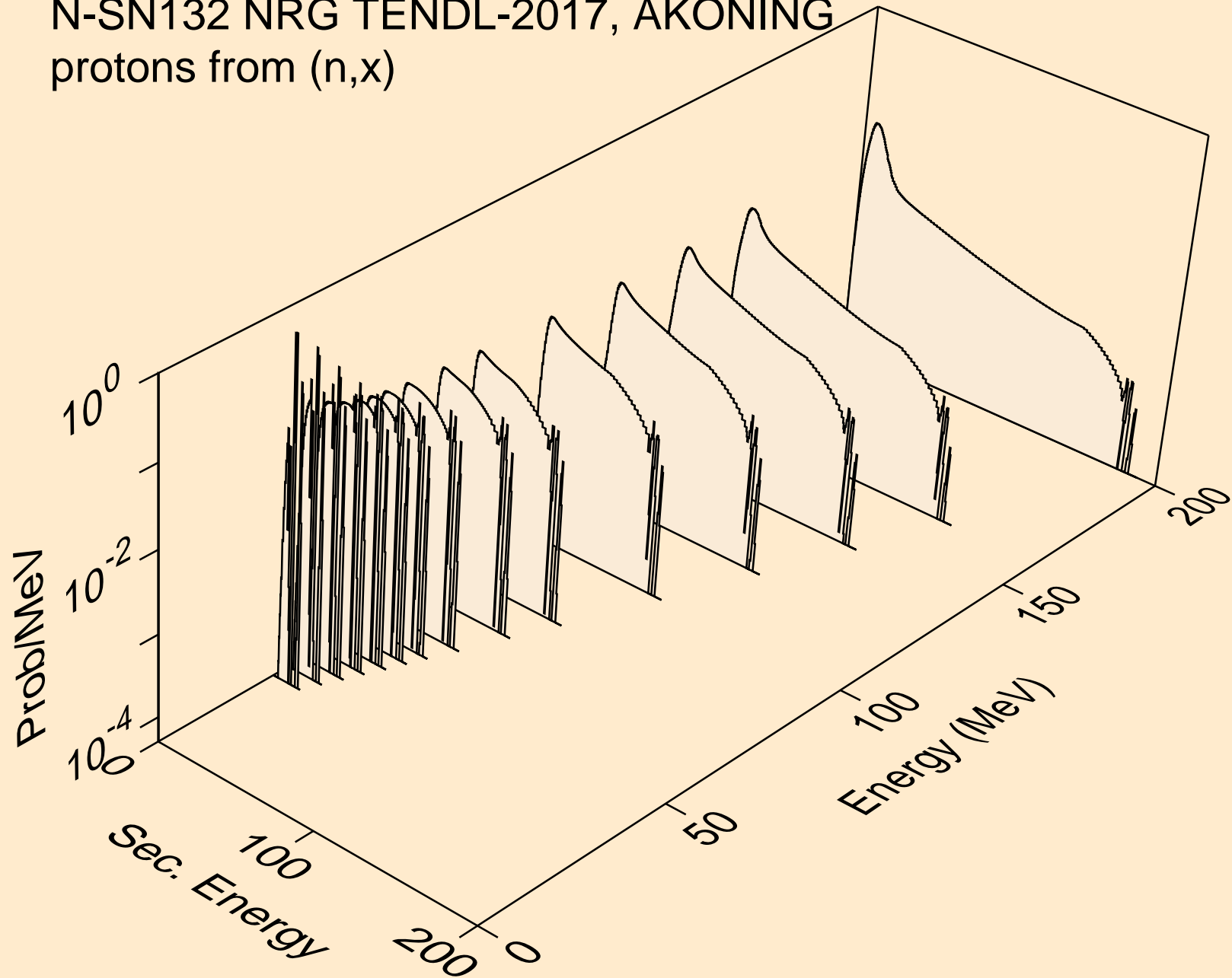

N-SN132 NRG TENDL-2017, AKONING  
protons from (n,n\*)p

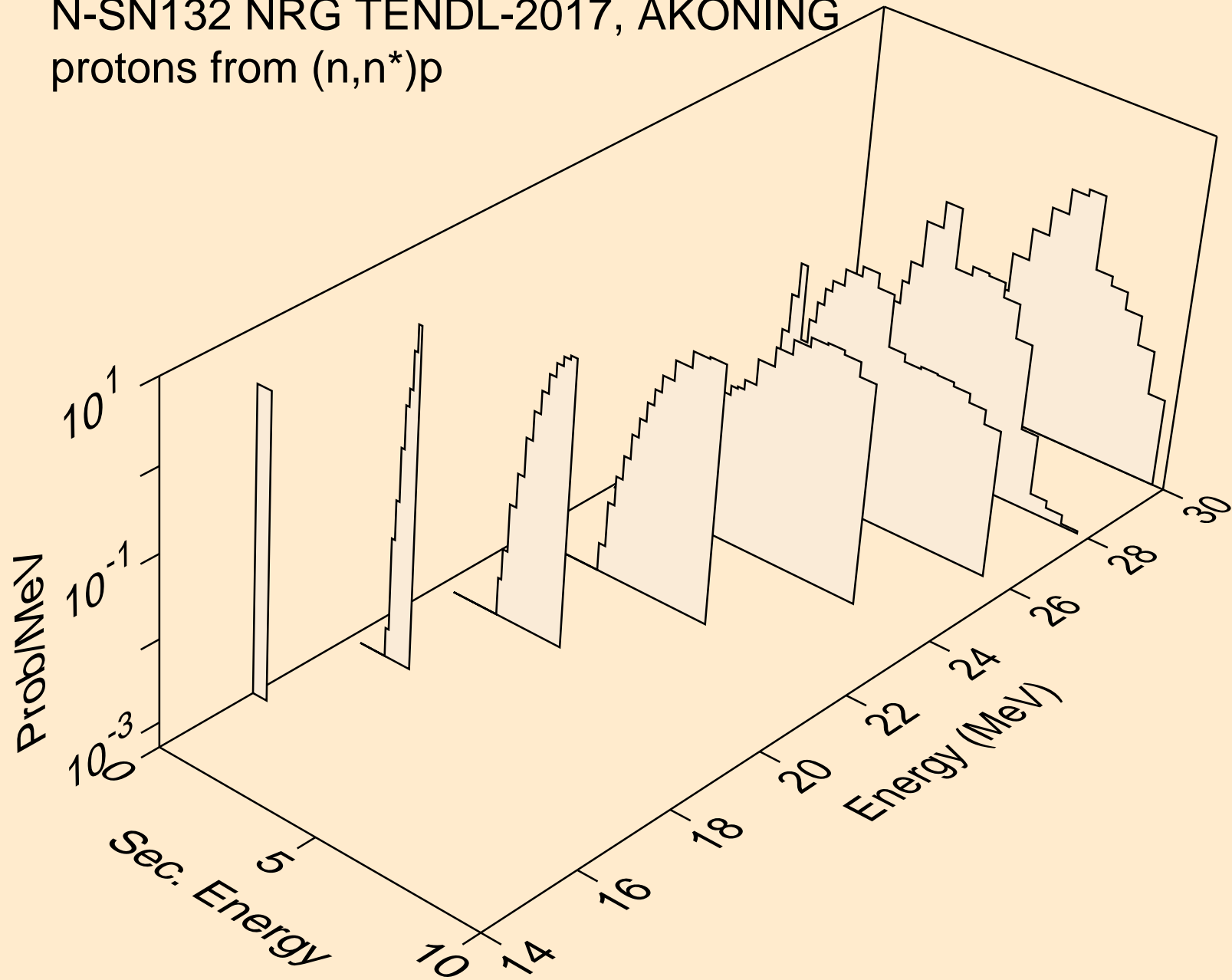

N-SN132 NRG TENDL-2017, AKONING  
protons from (n,2np)

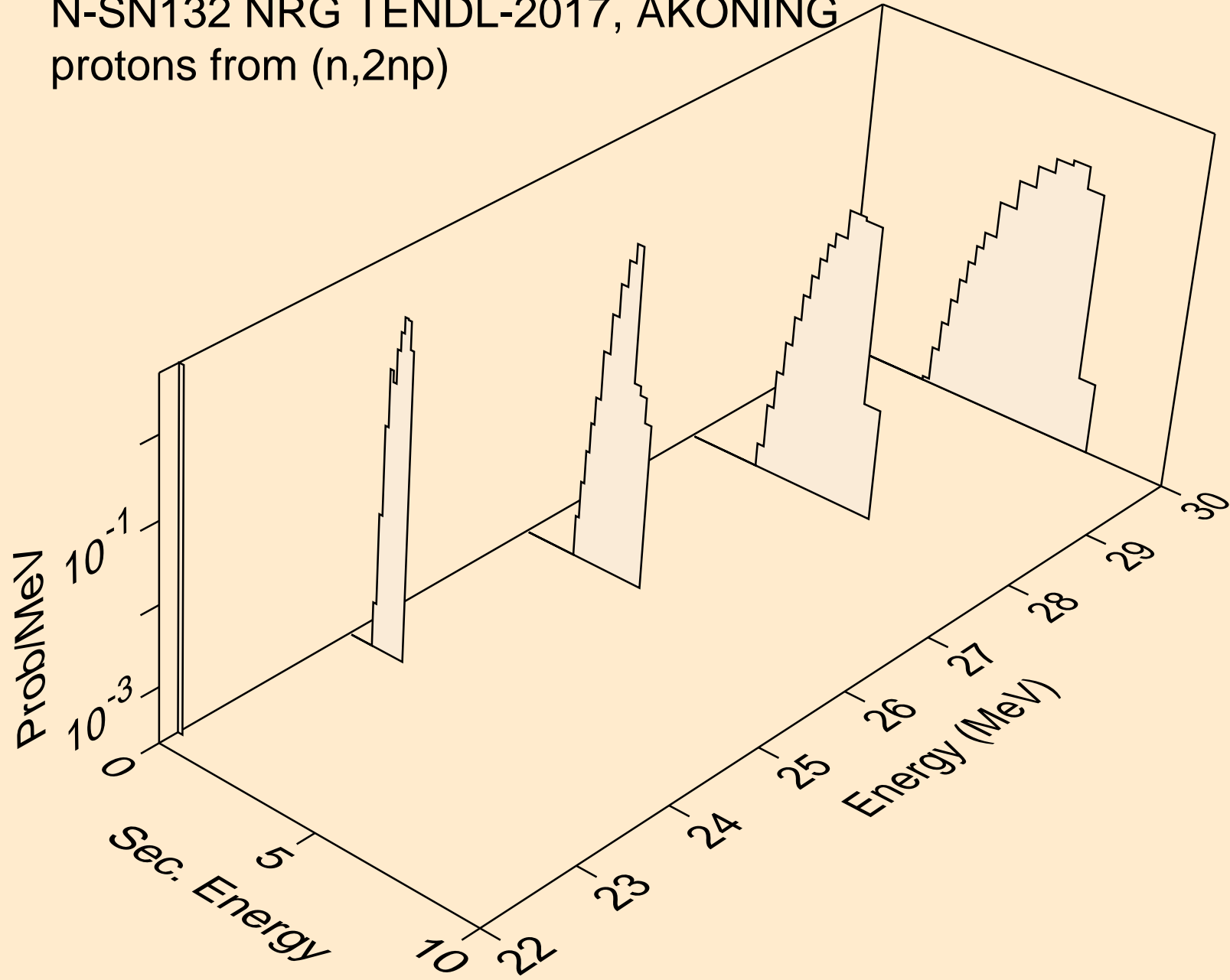

N-SN132 NRG TENDL-2017, AKONING  
protons from (n,p)

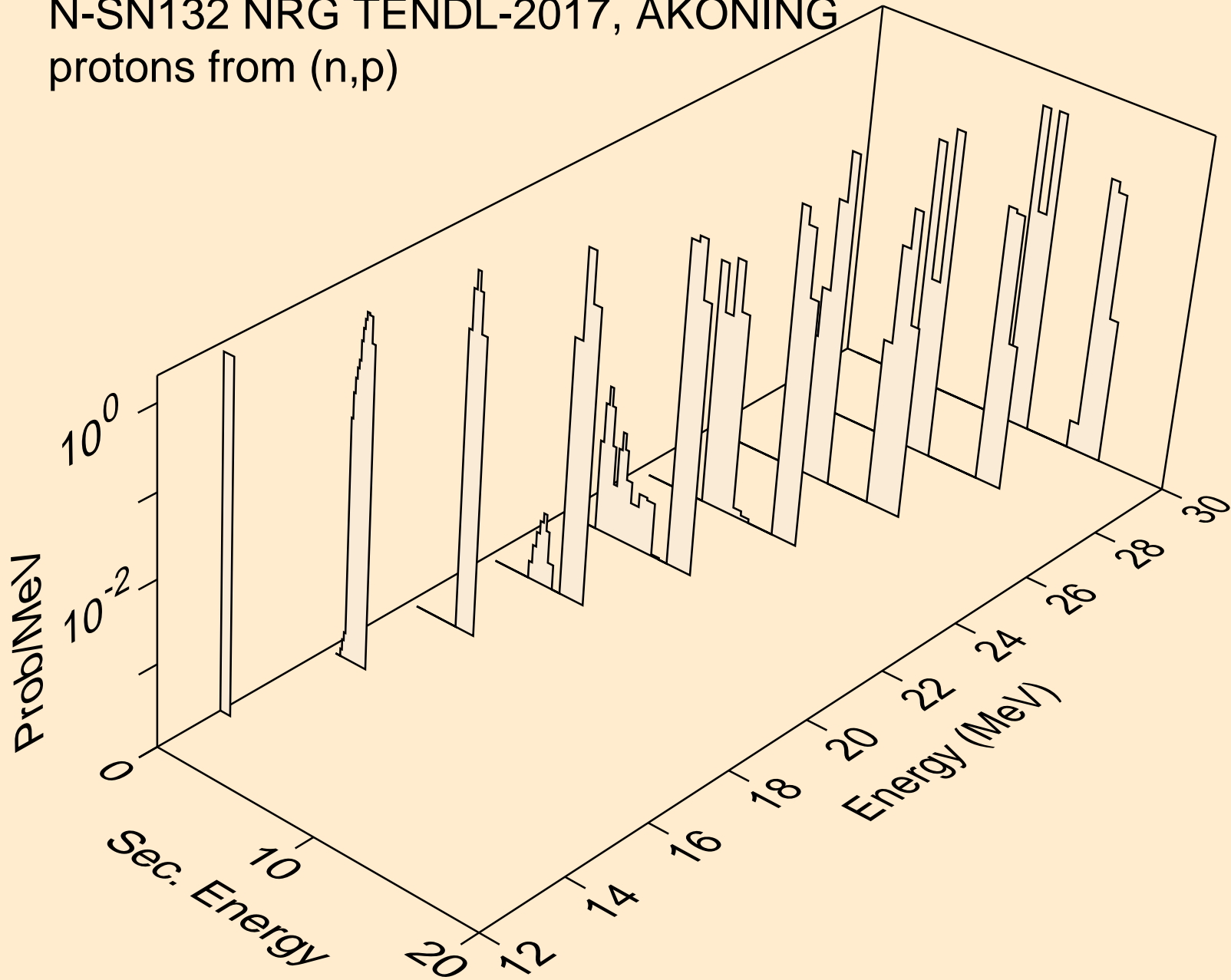

N-SN132 NRG TENDL-2017, AKONING  
deuterons from (n,x)

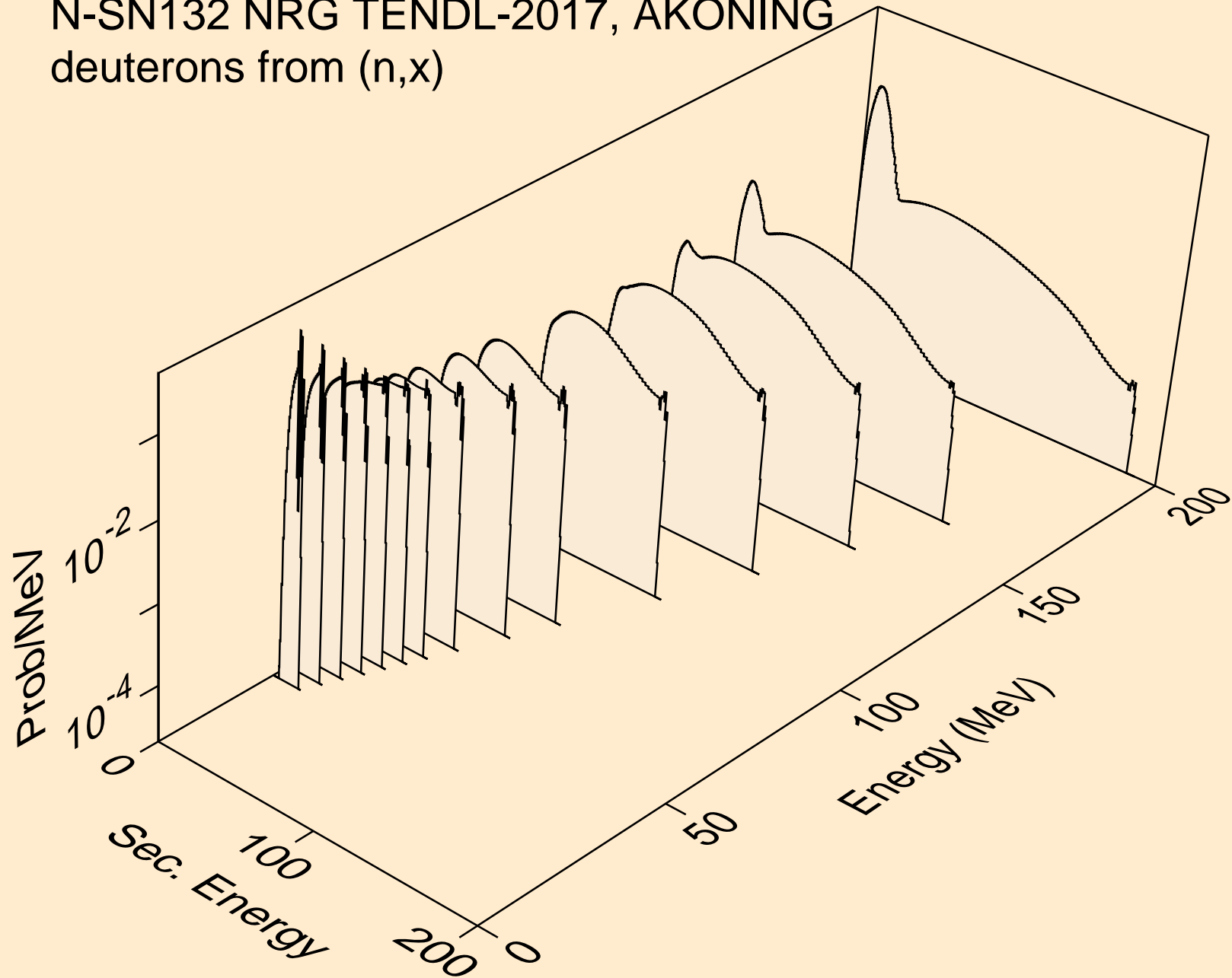

N-SN132 NRG TENDL-2017, AKONING  
deuterons from (n,2nd)

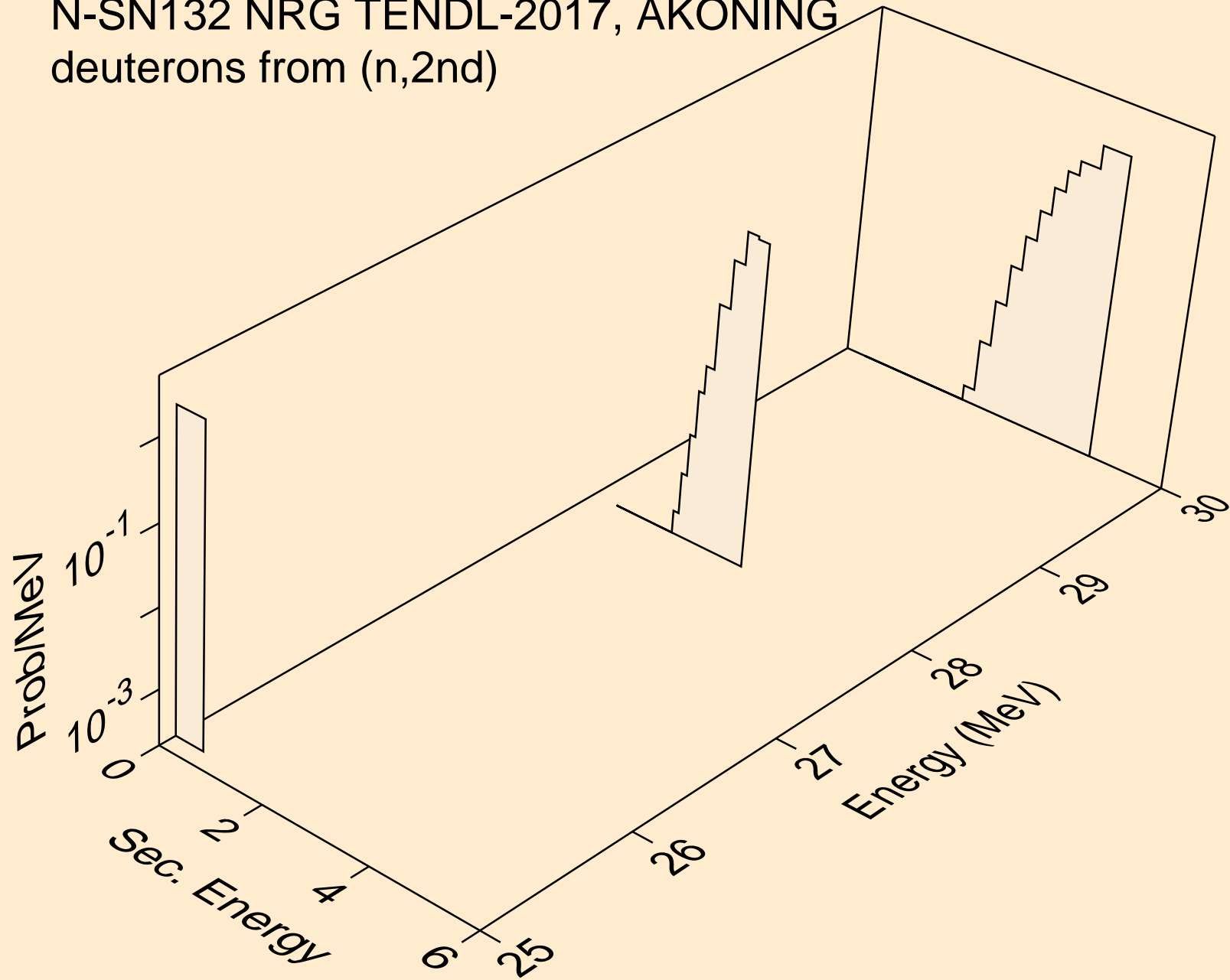

N-SN132 NRG TENDL-2017, AKONING  
deuterons from (n,n\*)d

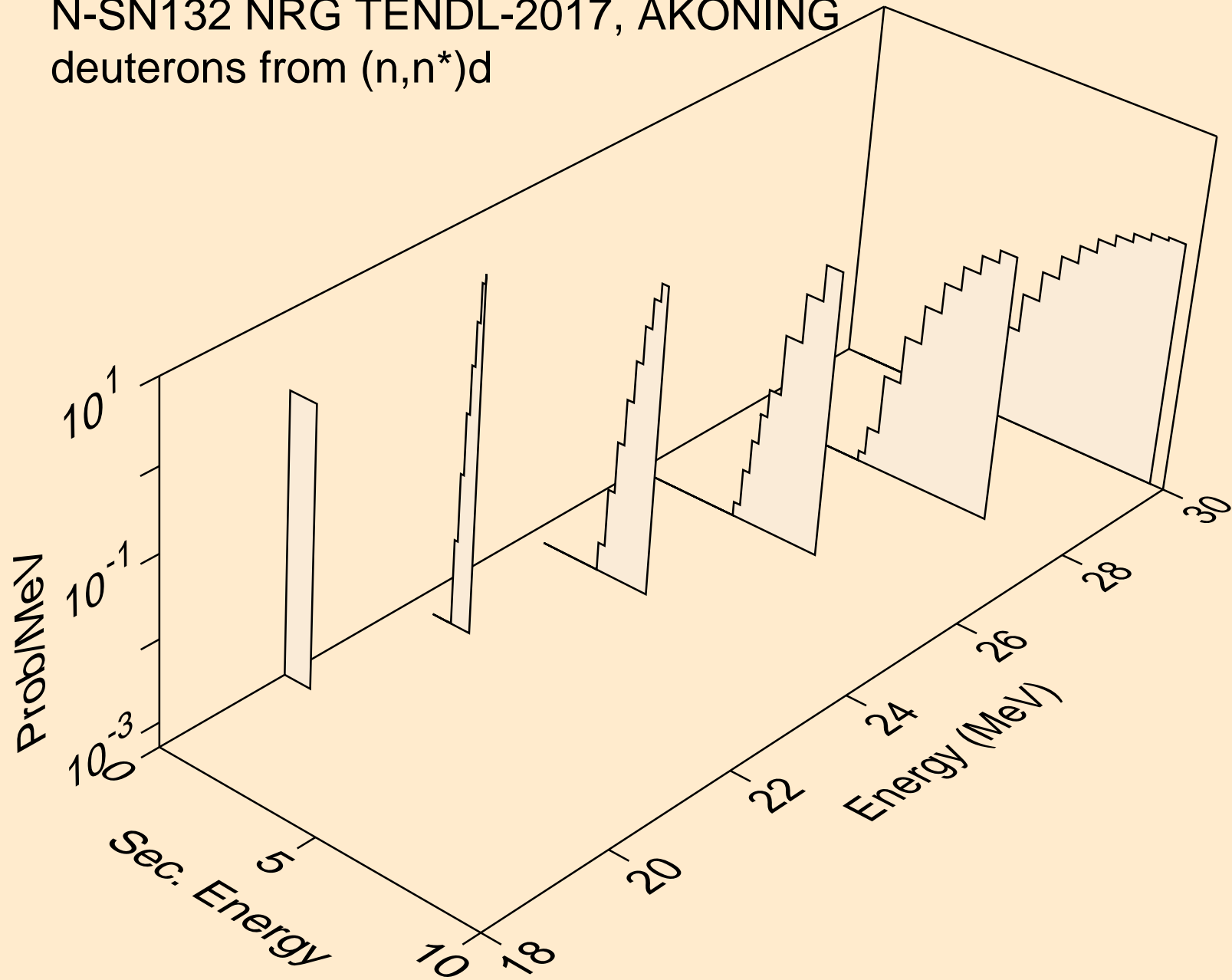

N-SN132 NRG TENDL-2017, AKONING  
deuterons from (n,d)

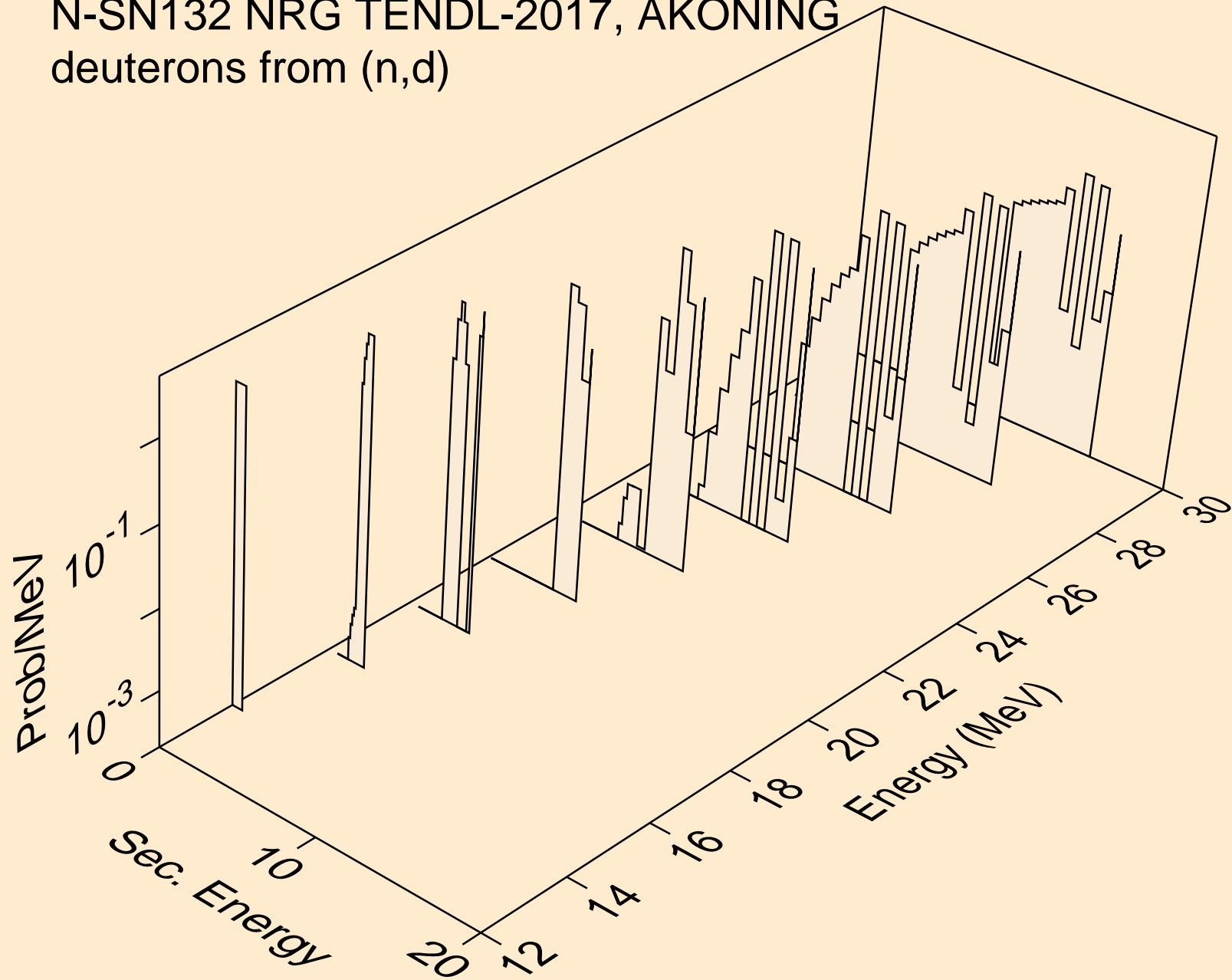



N-SN132 NRG TENDL-2017, AKONING  
tritons from (n,x)

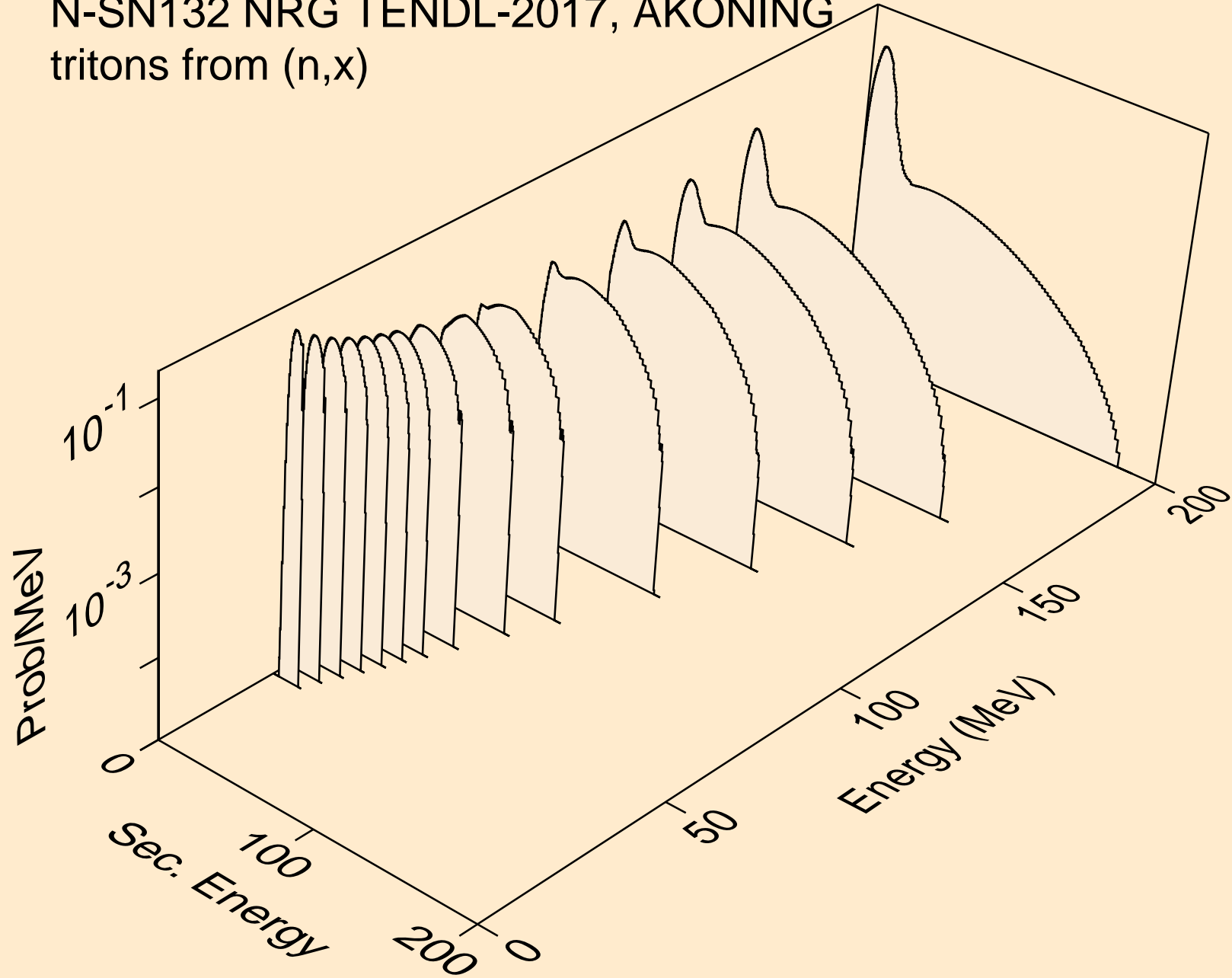

N-SN132 NRG TENDL-2017, AKONING  
tritons from (n,n\*)t

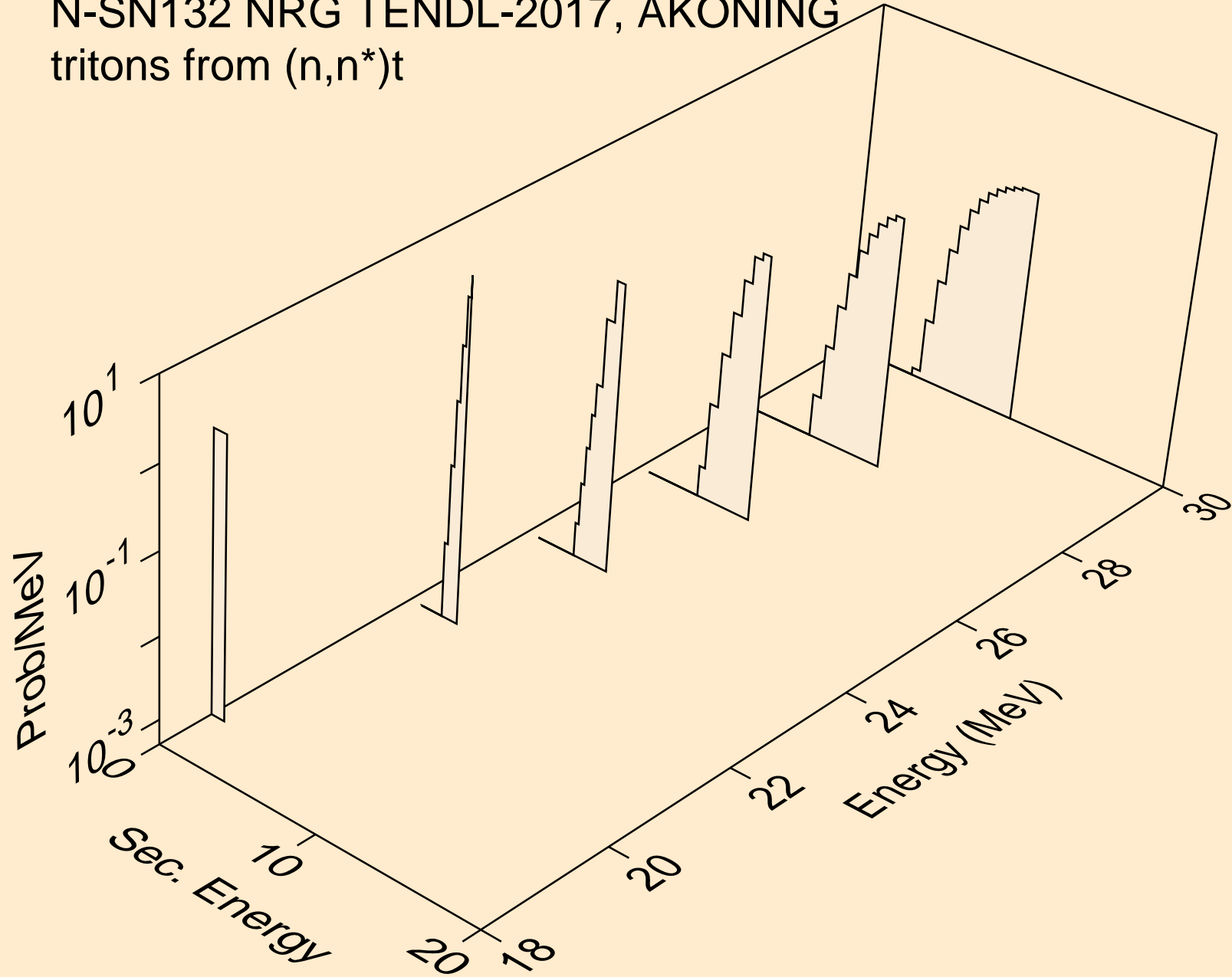

N-SN132 NRG TENDL-2017, AKONING  
tritons from (n,t)

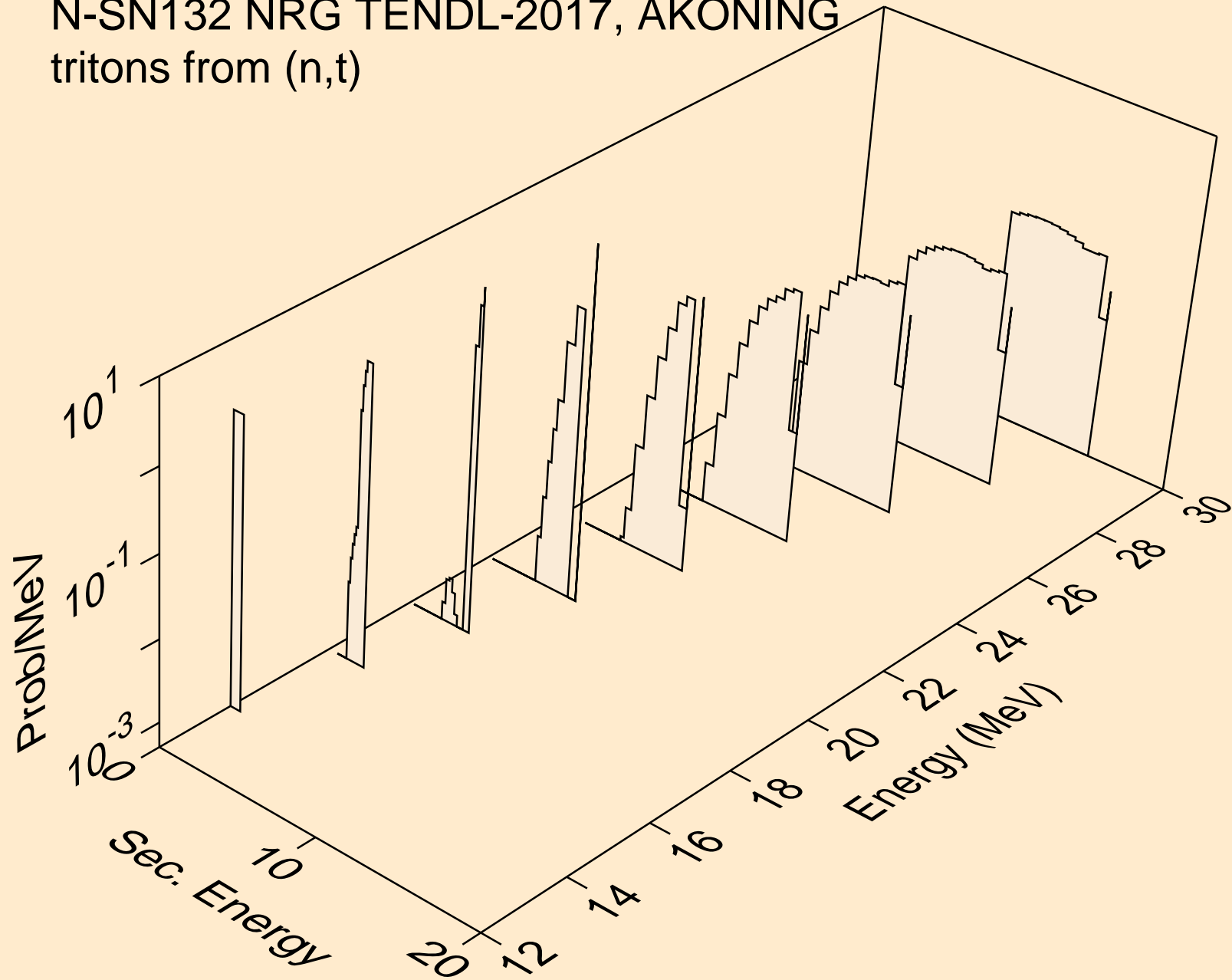

N-SN132 NRG TENDL-2017, AKONING  
he3s from (n,x)

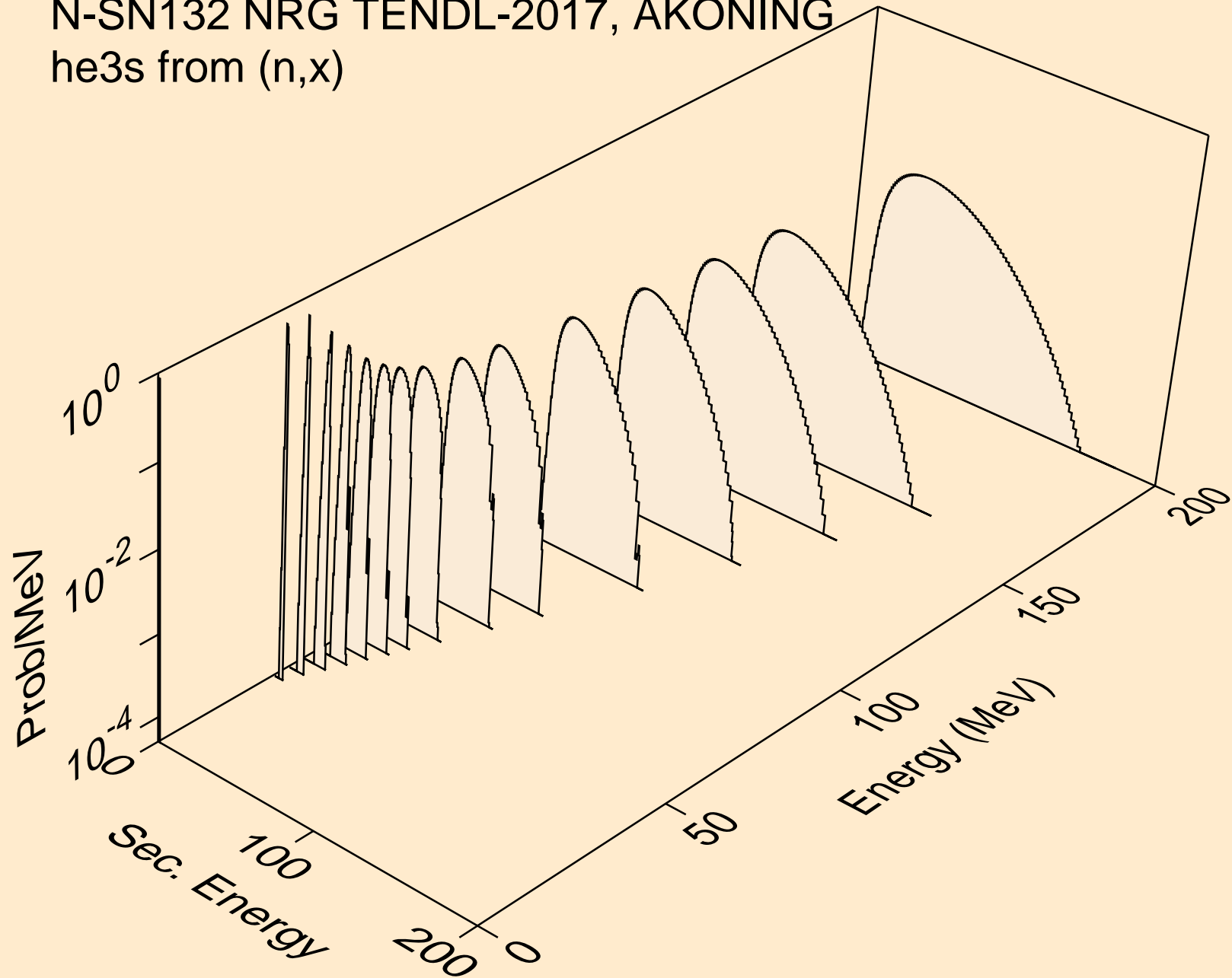

N-SN132 NRG TENDL-2017, AKONING  
alphas from (n,x)

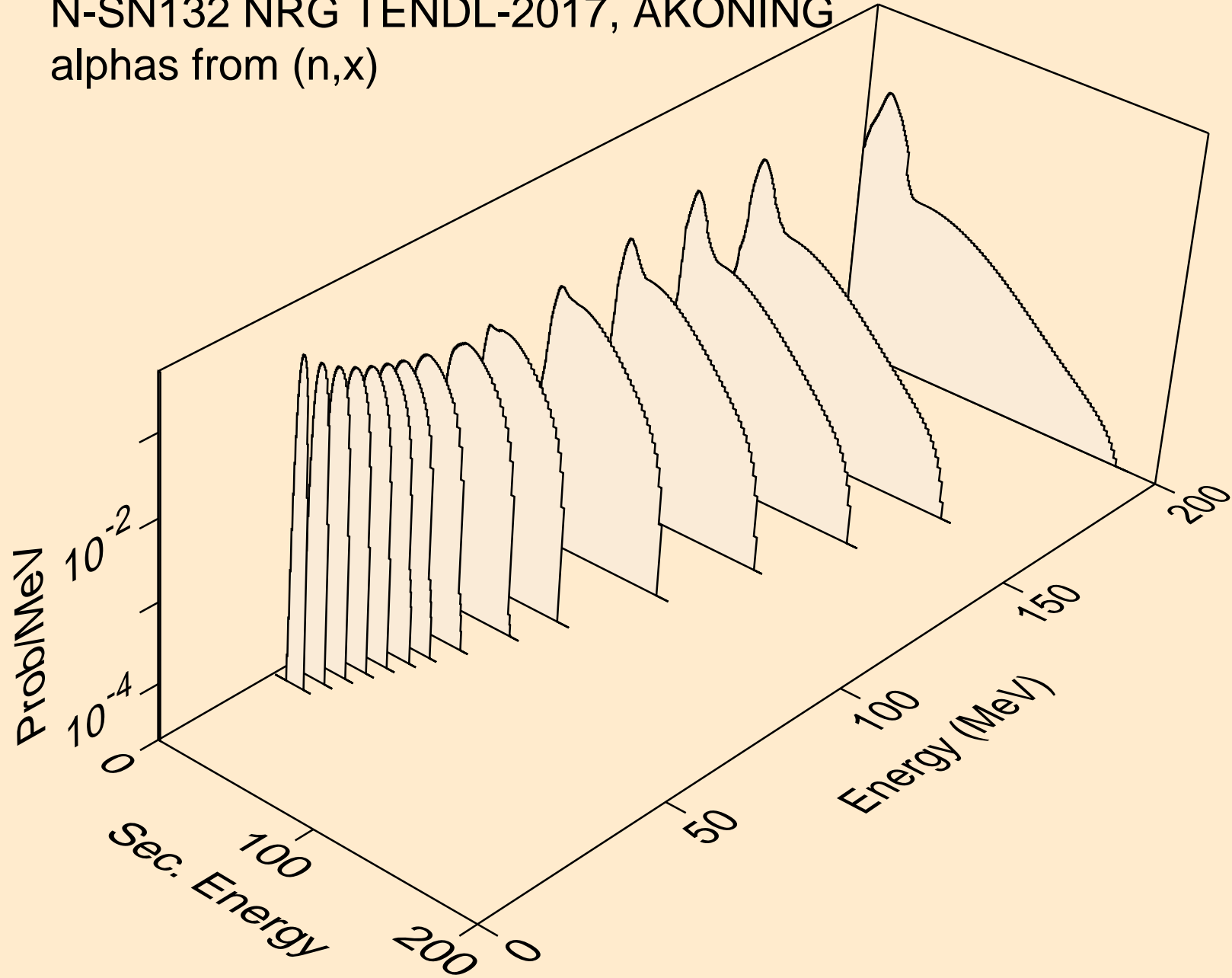

N-SN132 NRG TENDL-2017, AKONING  
alphas from (n,n\*)a

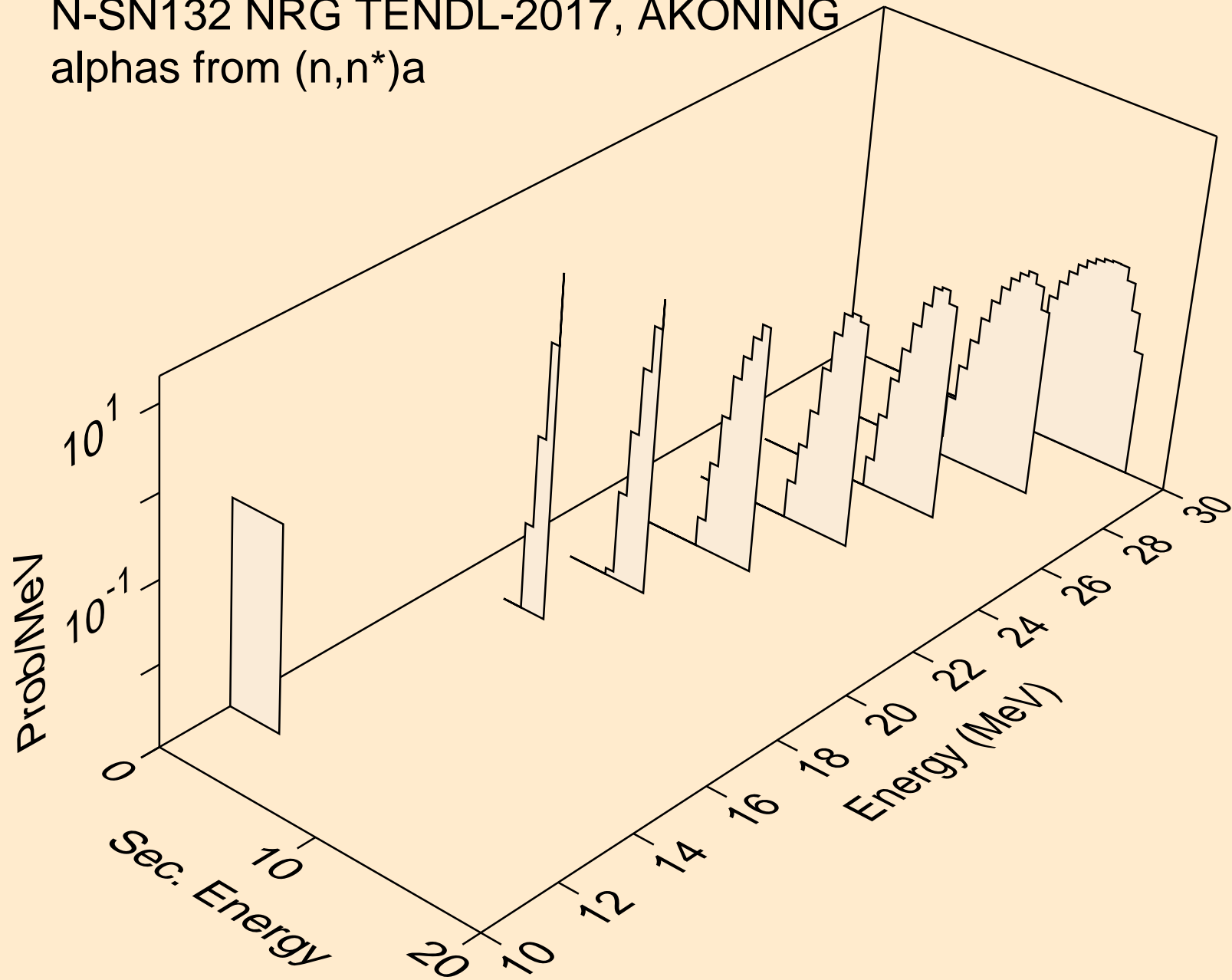

N-SN132 NRG TENDL-2017, AKONING  
alphas from (n,2n)a

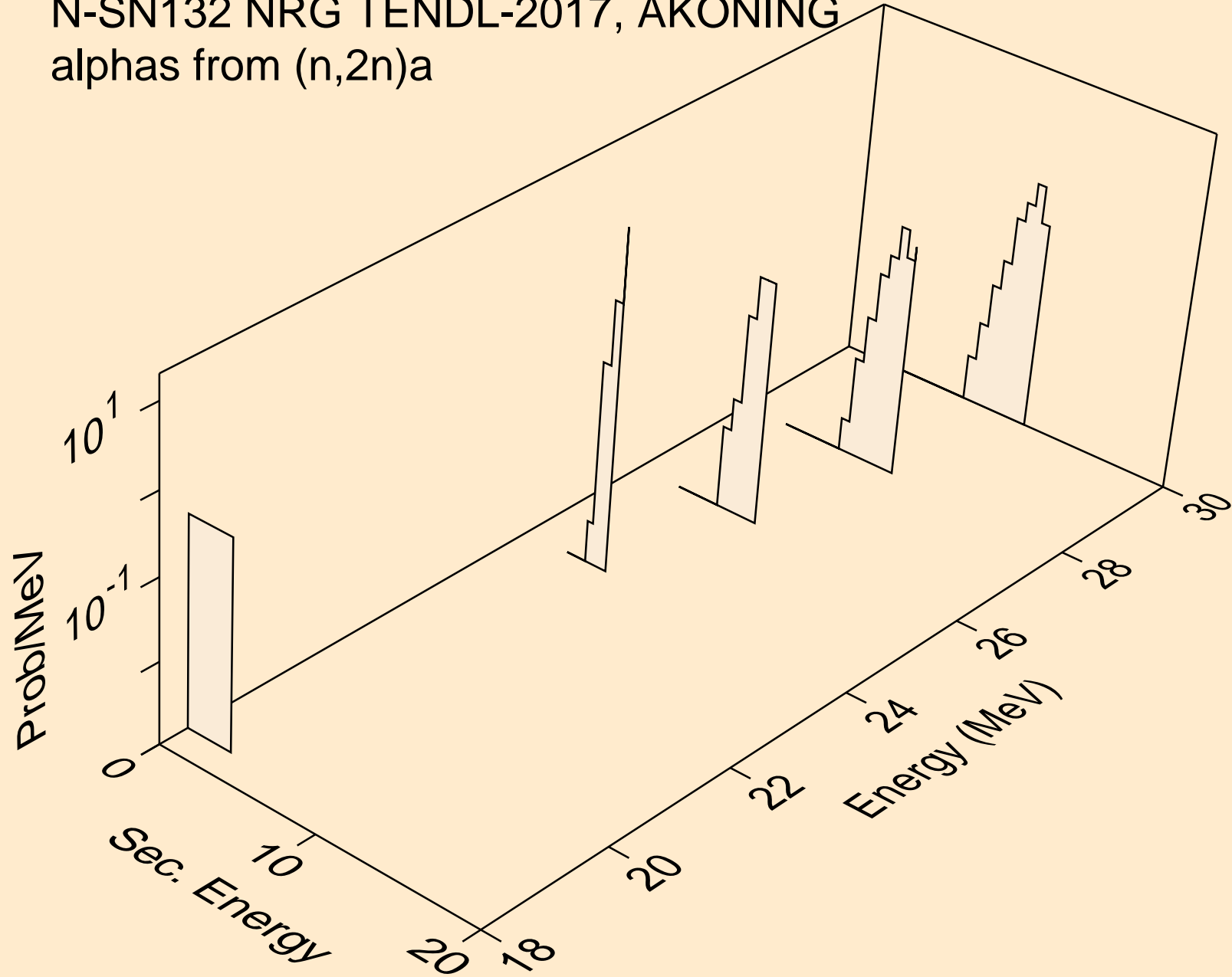

N-SN132 NRG TENDL-2017, AKONING  
alphas from (n,a)

