

AG100M NEUTRON ACER TENDL-2019 LIBRARY; T=293.16K
Principal cross sections

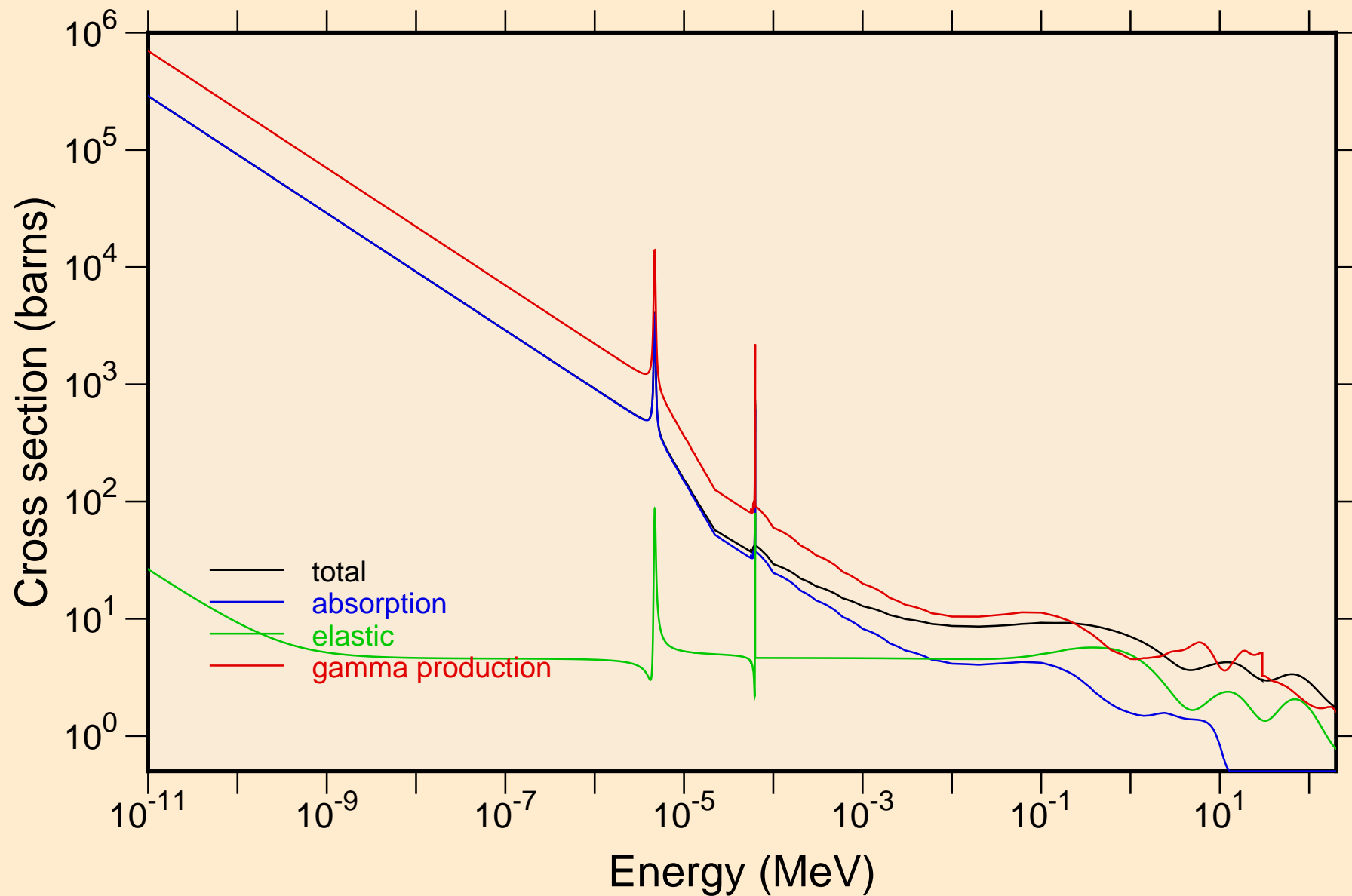

AG100M NEUTRON ACER TENDL-2019 LIBRARY; T=293.16K
resonance total cross section

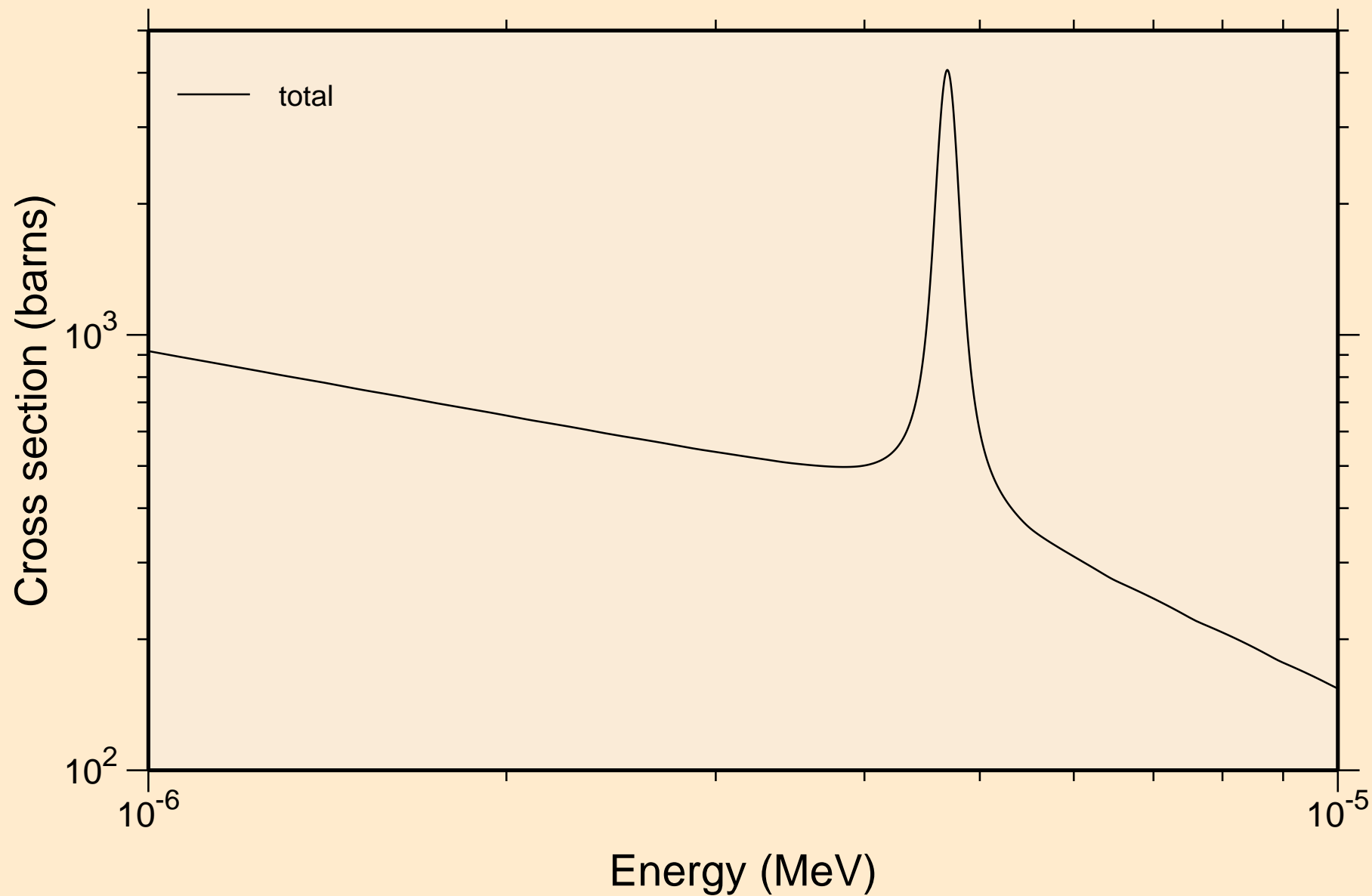

AG100M NEUTRON ACER TENDL-2019 LIBRARY; T=293.16K
resonance total cross section

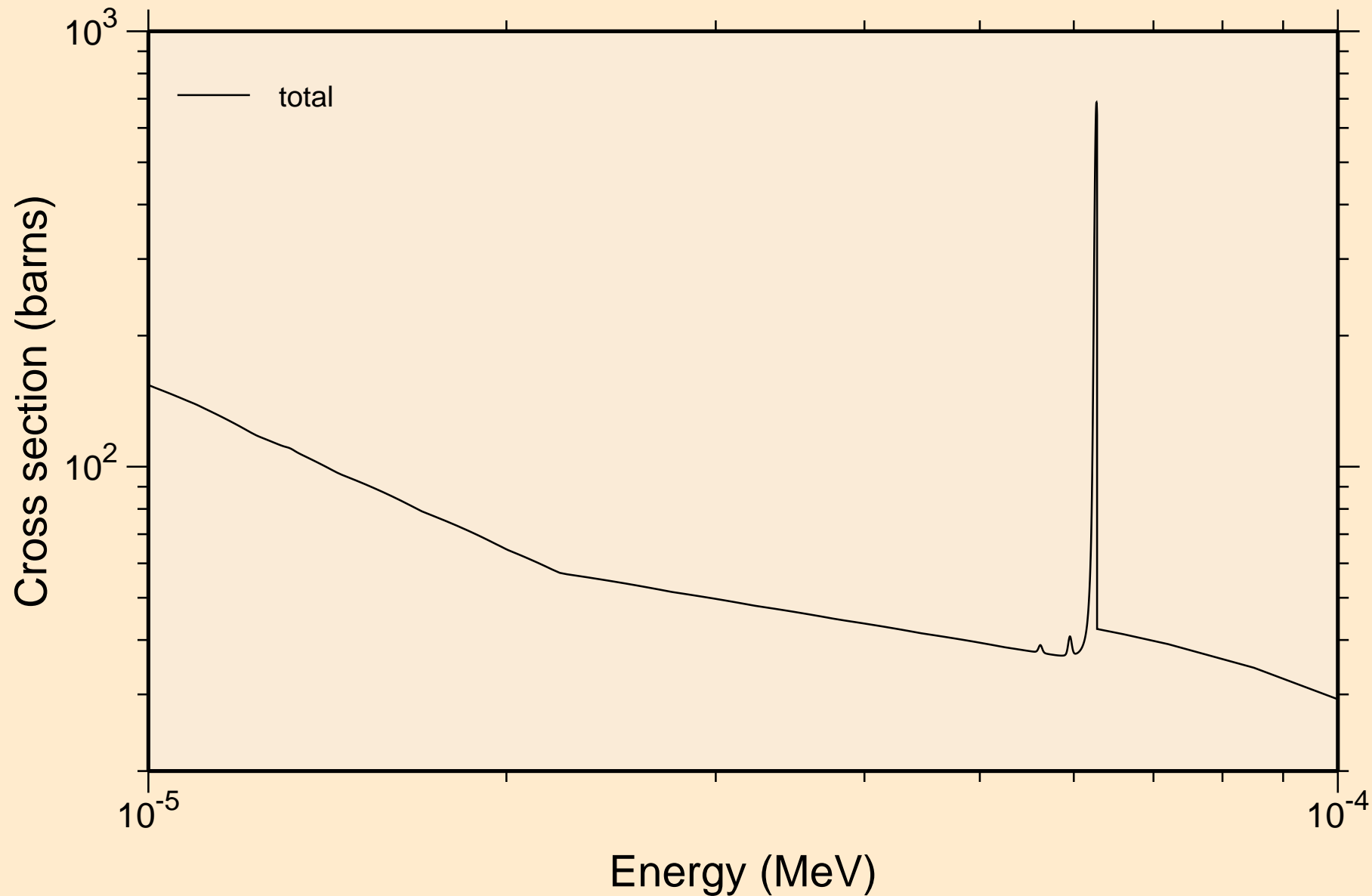

AG100M NEUTRON ACER TENDL-2019 LIBRARY; T=293.16K
resonance total cross section

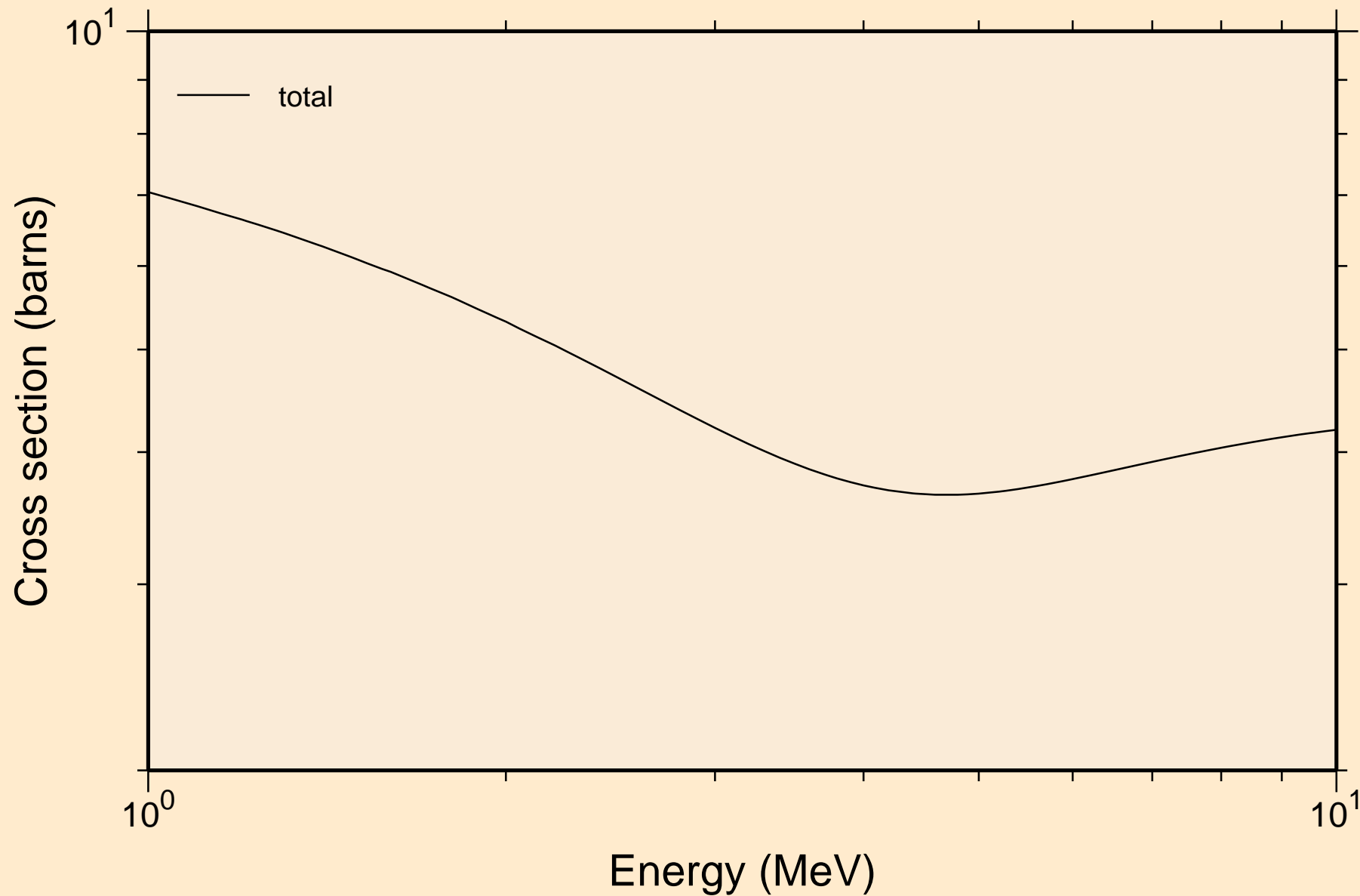

AG100M NEUTRON ACER TENDL-2019 LIBRARY; T=293.16K
resonance absorption cross sections

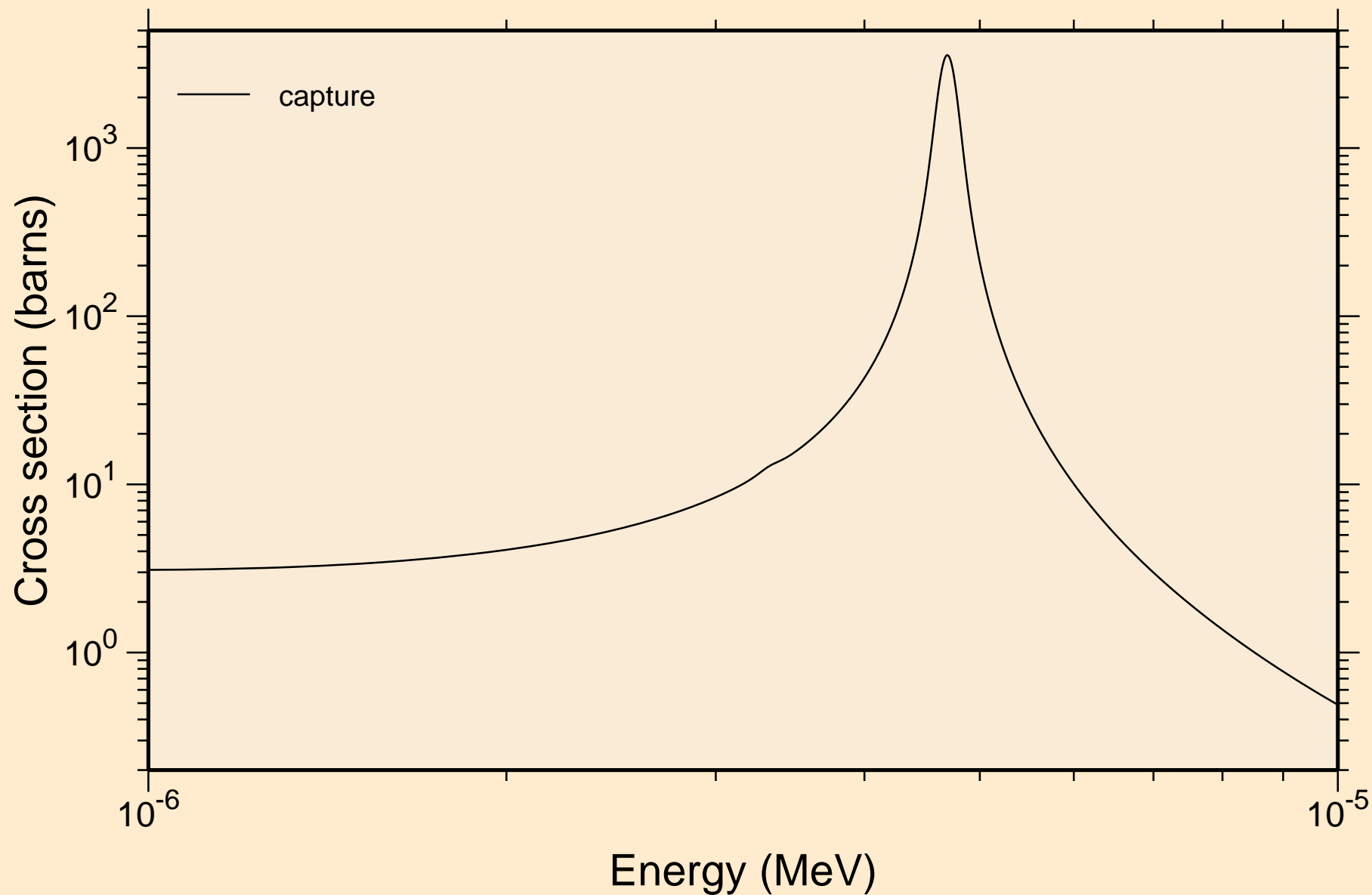

AG100M NEUTRON ACER TENDL-2019 LIBRARY; T=293.16K
resonance absorption cross sections

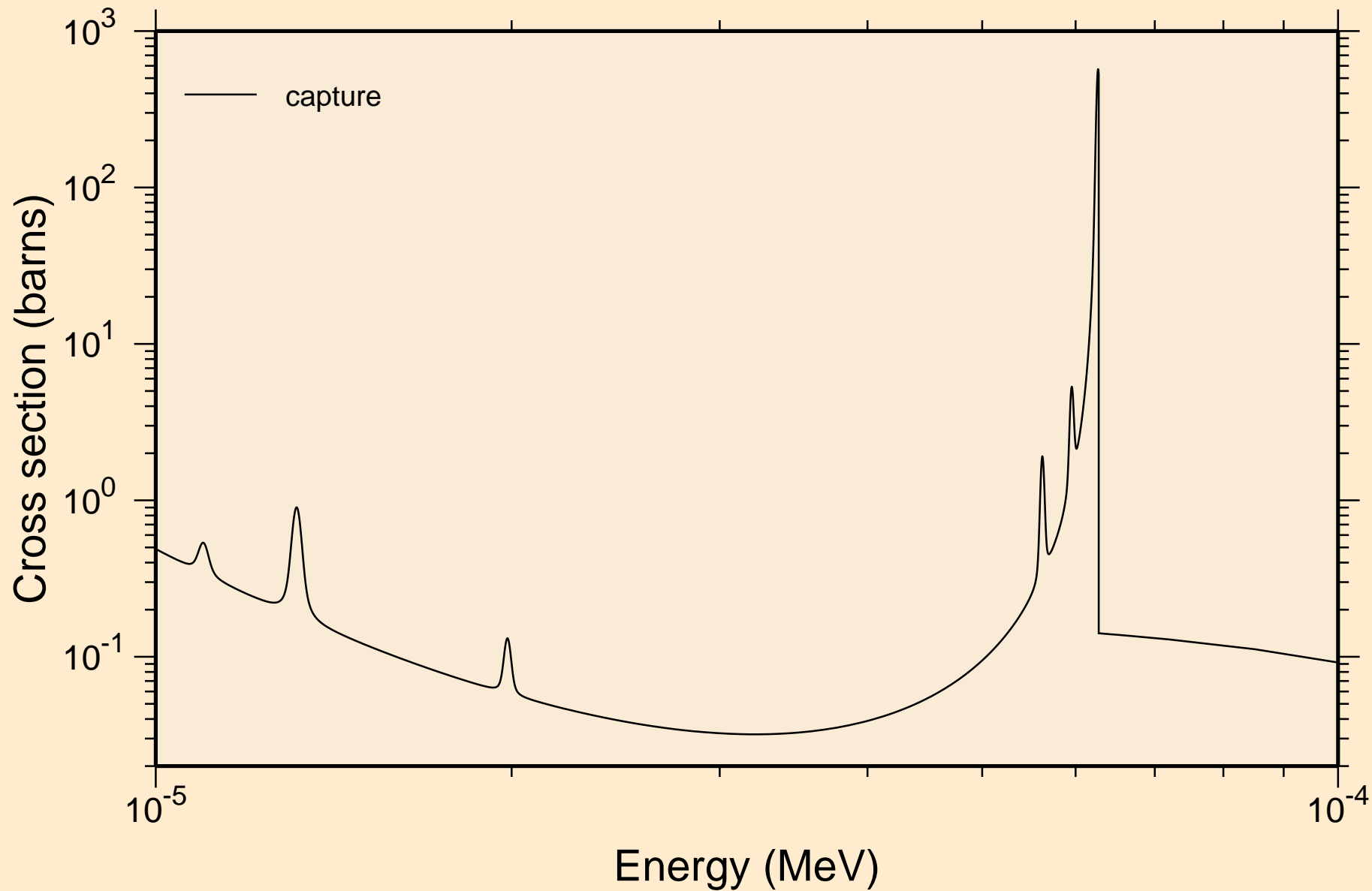

AG100M NEUTRON ACER TENDL-2019 LIBRARY; T=293.16K
resonance absorption cross sections

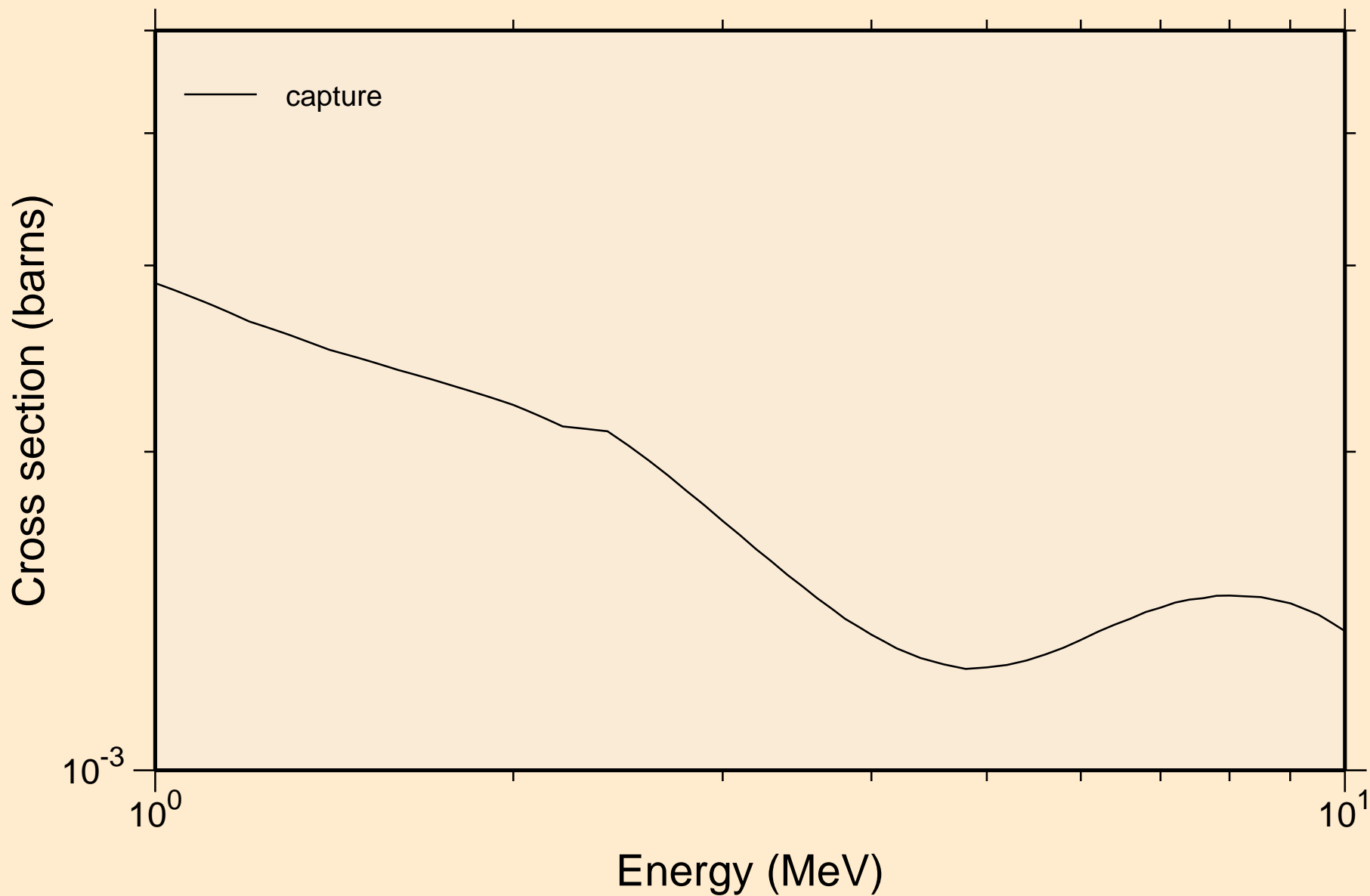

AG100M NEUTRON ACER TENDL-2019 LIBRARY; T=293.16K
Heating

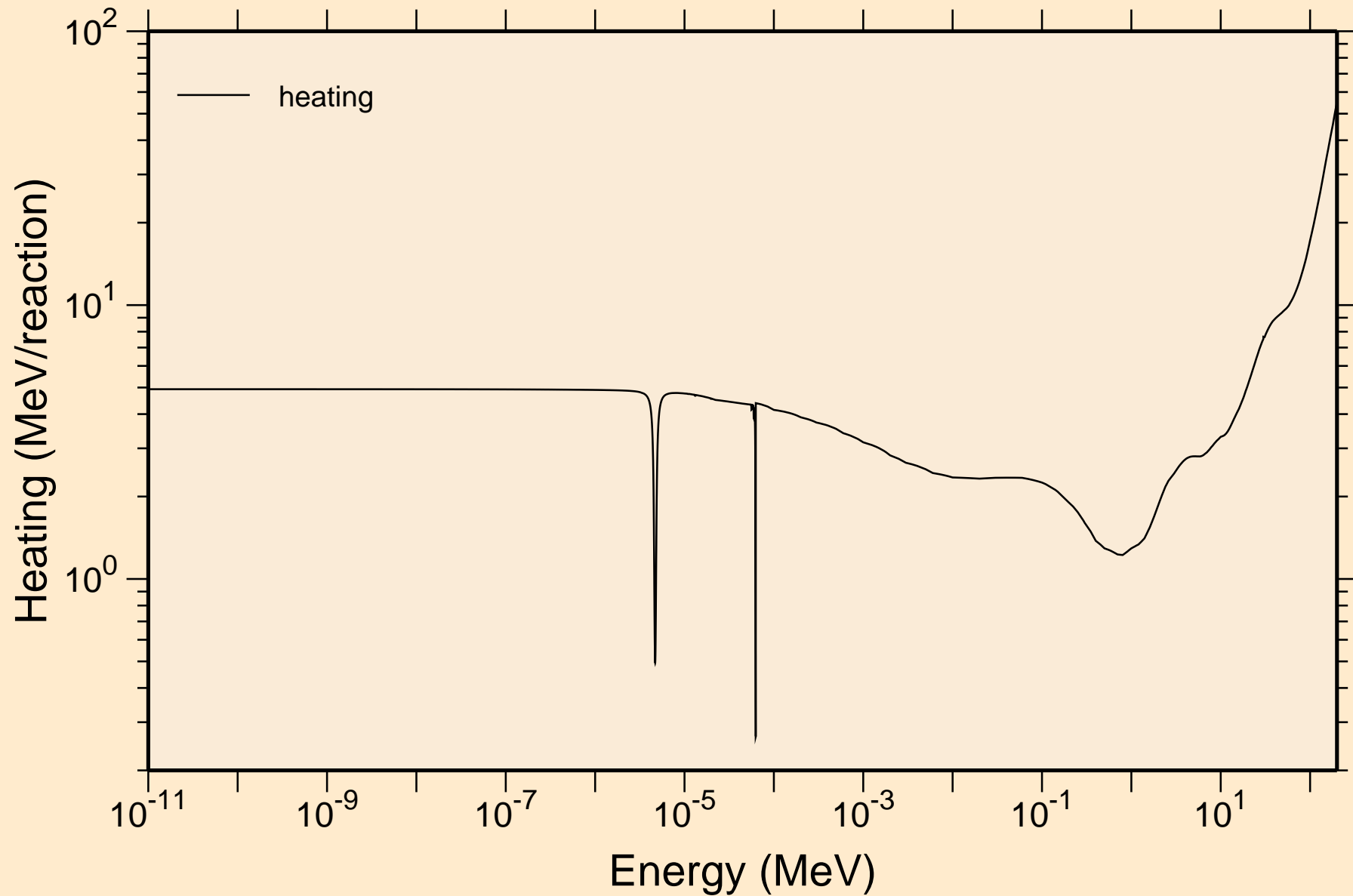

AG100M NEUTRON ACER TENDL-2019 LIBRARY; T=293.16K
Damage

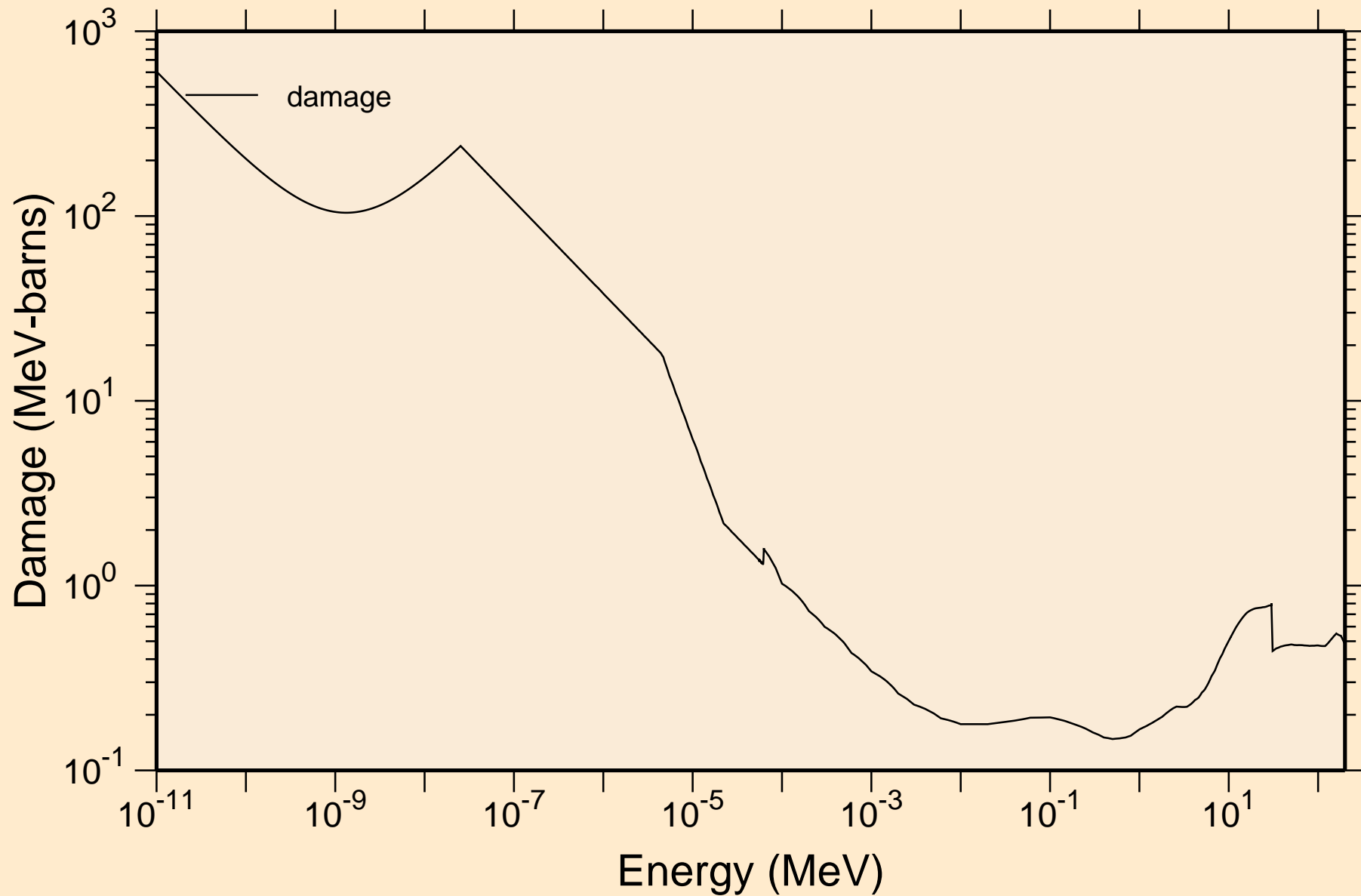

AG100M NEUTRON ACER TENDL-2019 LIBRARY; T=293.16K
Non-threshold reactions

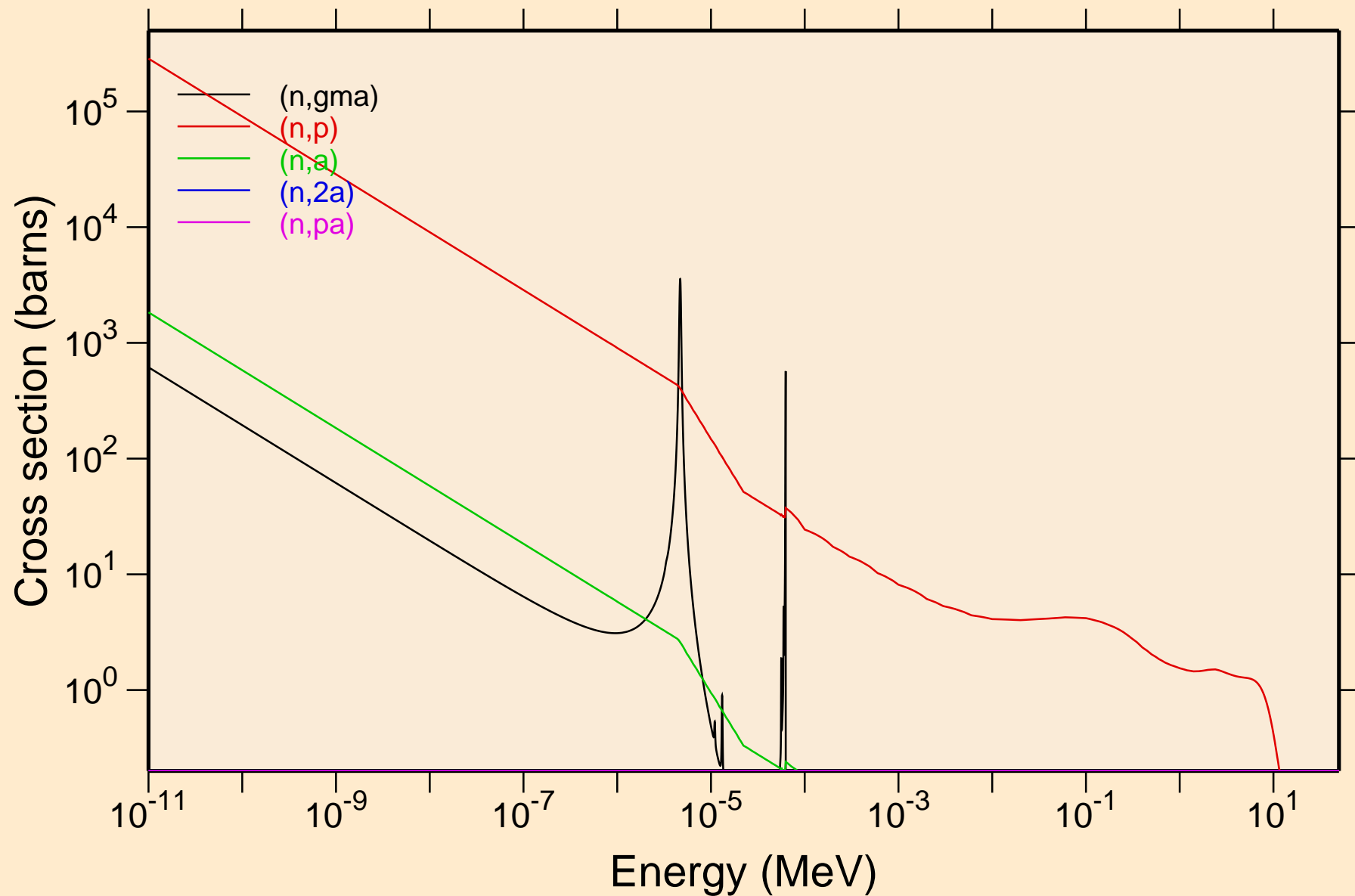

AG100M NEUTRON ACER TENDL-2019 LIBRARY; T=293.16K
Non-threshold reactions

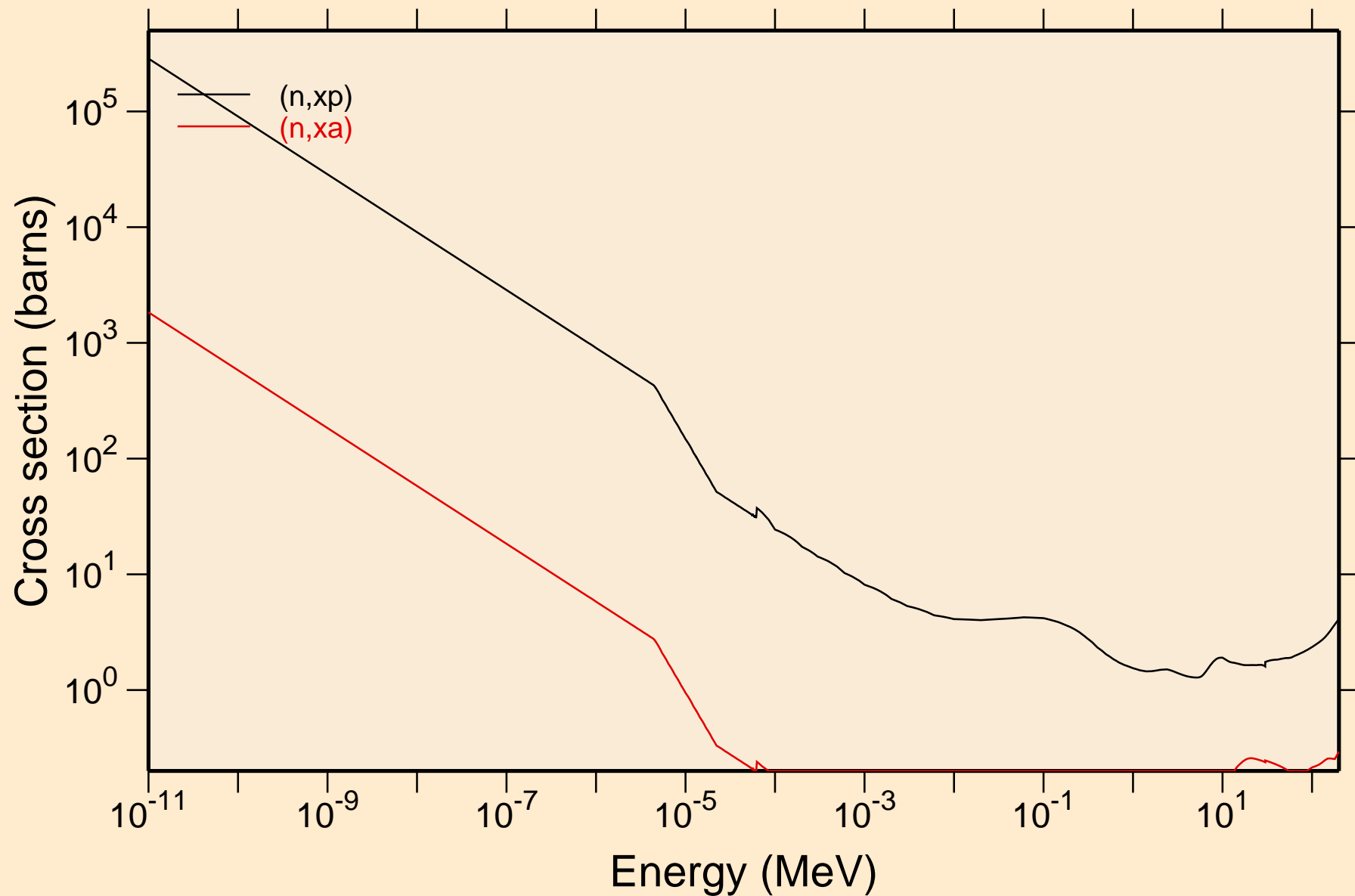

AG100M NEUTRON ACER TENDL-2019 LIBRARY; T=293.16K
Principal cross sections

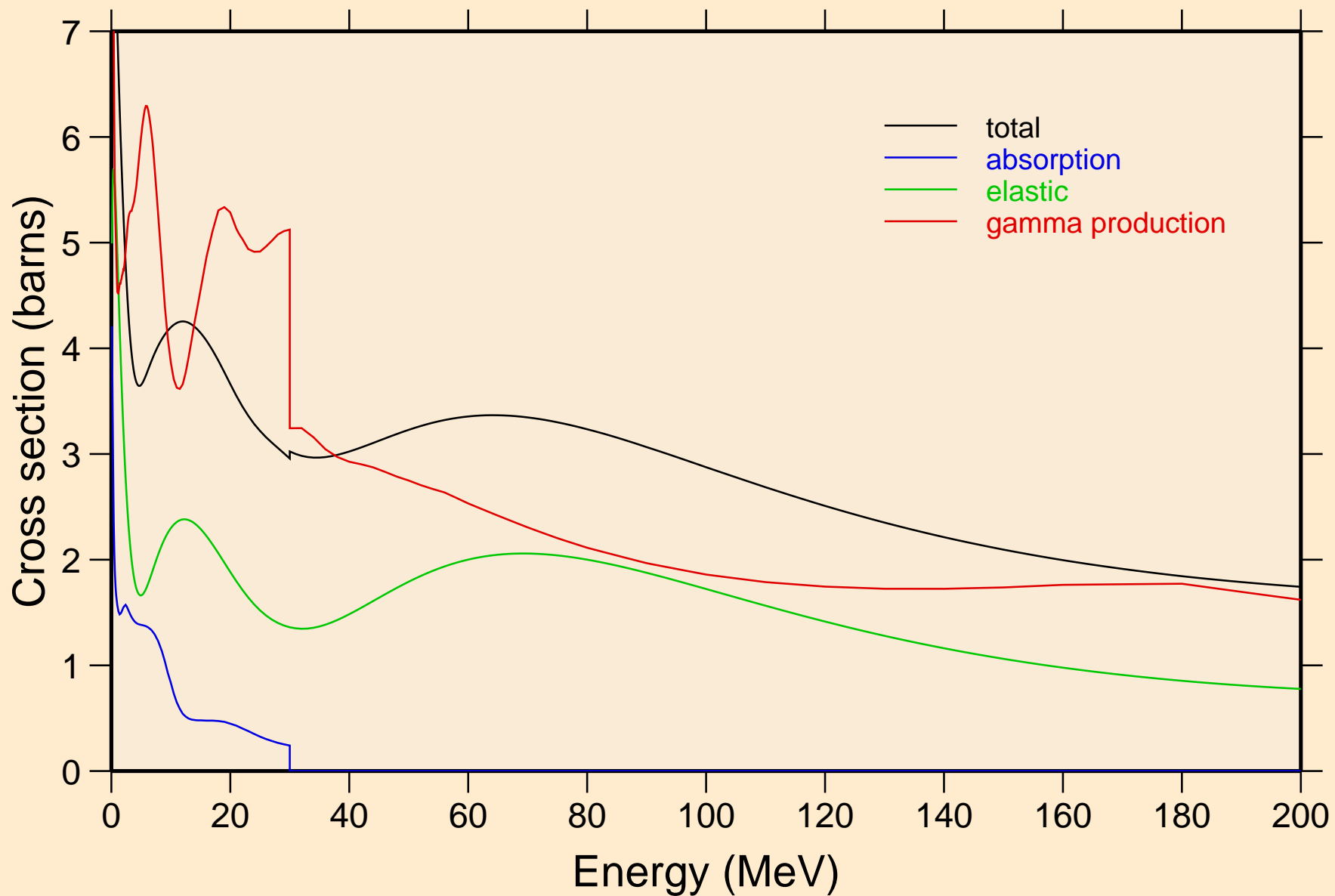

AG100M NEUTRON ACER TENDL-2019 LIBRARY; T=293.16K
Heating

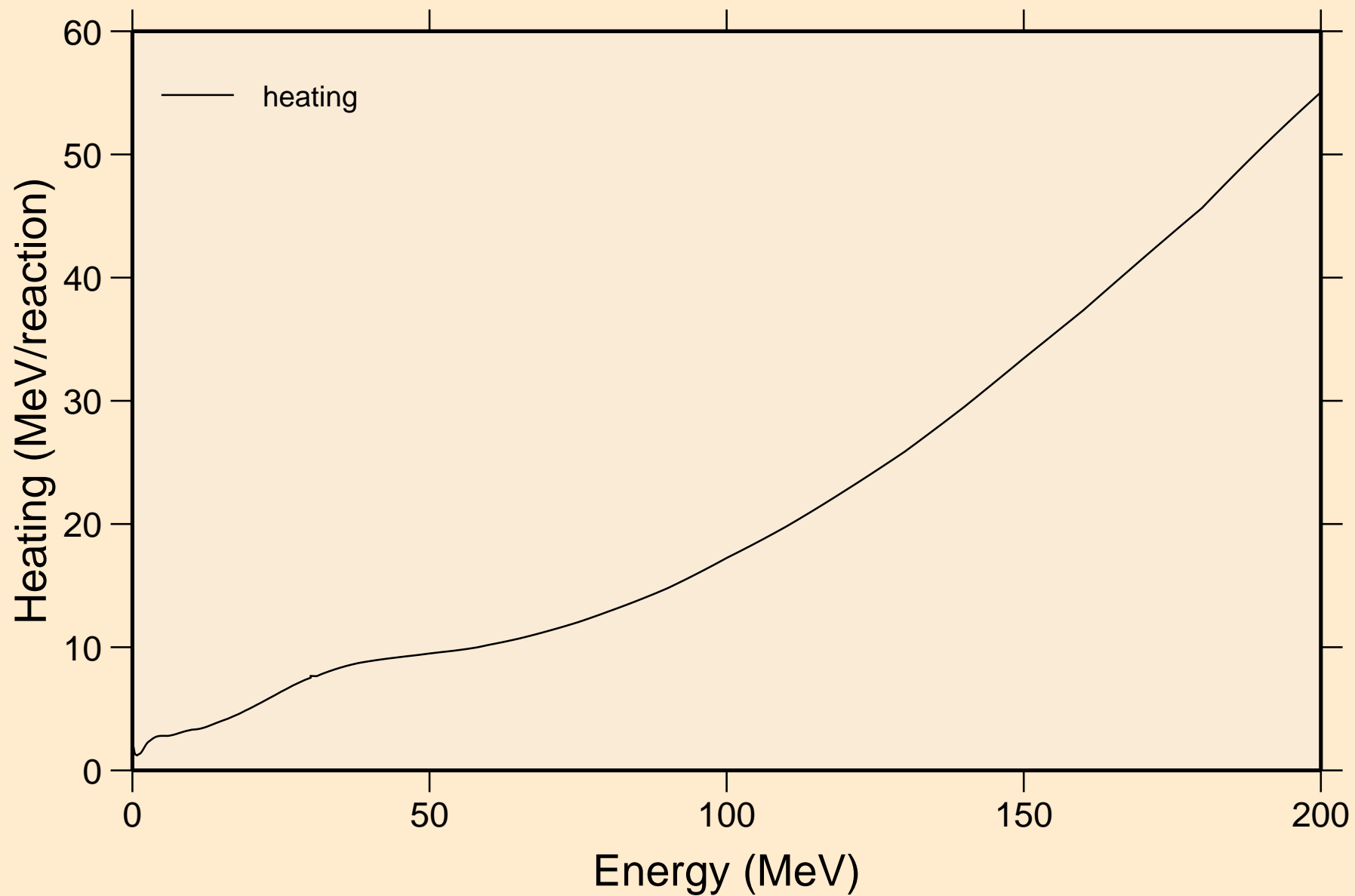

AG100M NEUTRON ACER TENDL-2019 LIBRARY; T=293.16K Damage

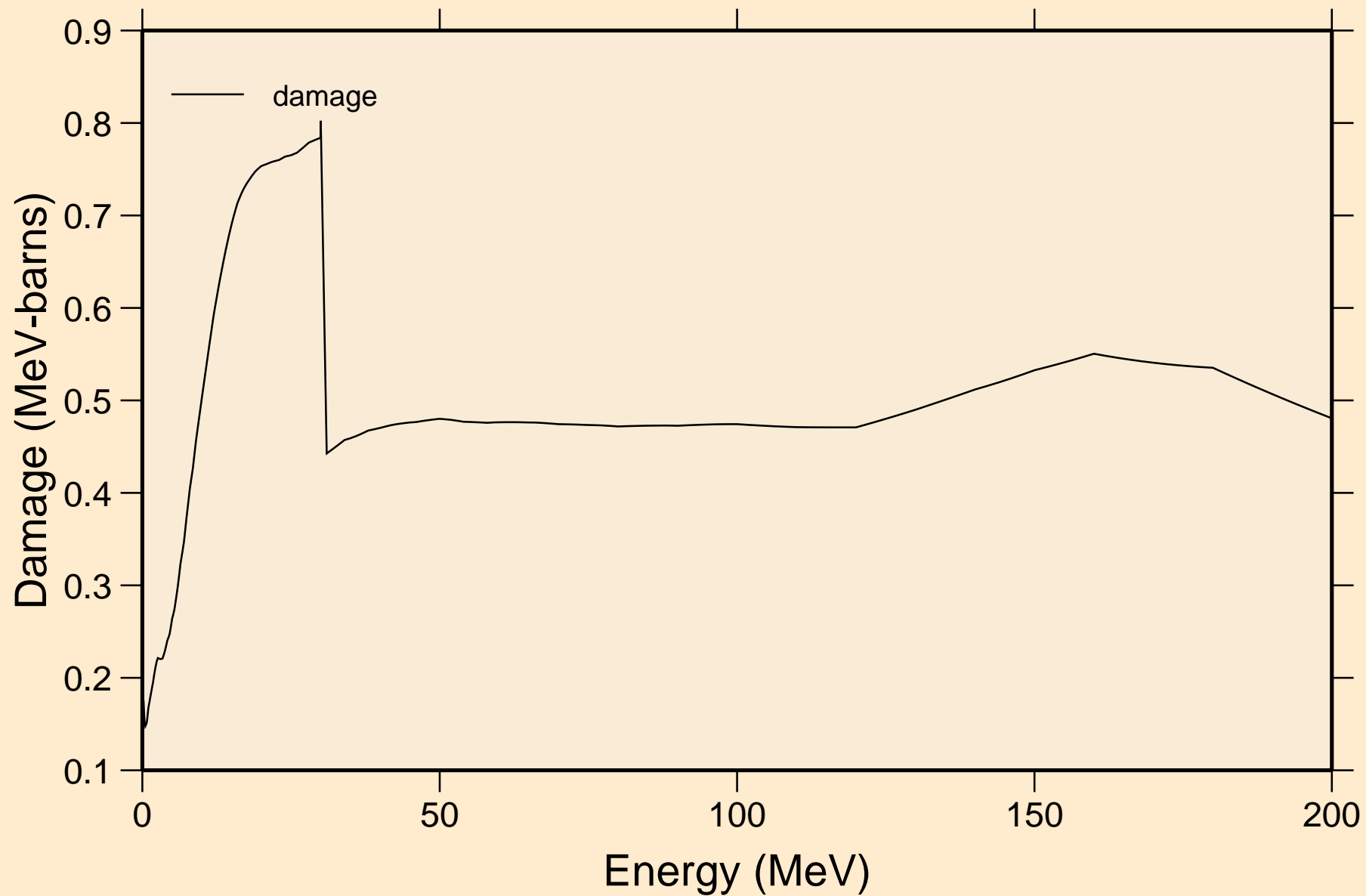

AG100M NEUTRON ACER TENDL-2019 LIBRARY; T=293.16K
Non-threshold reactions

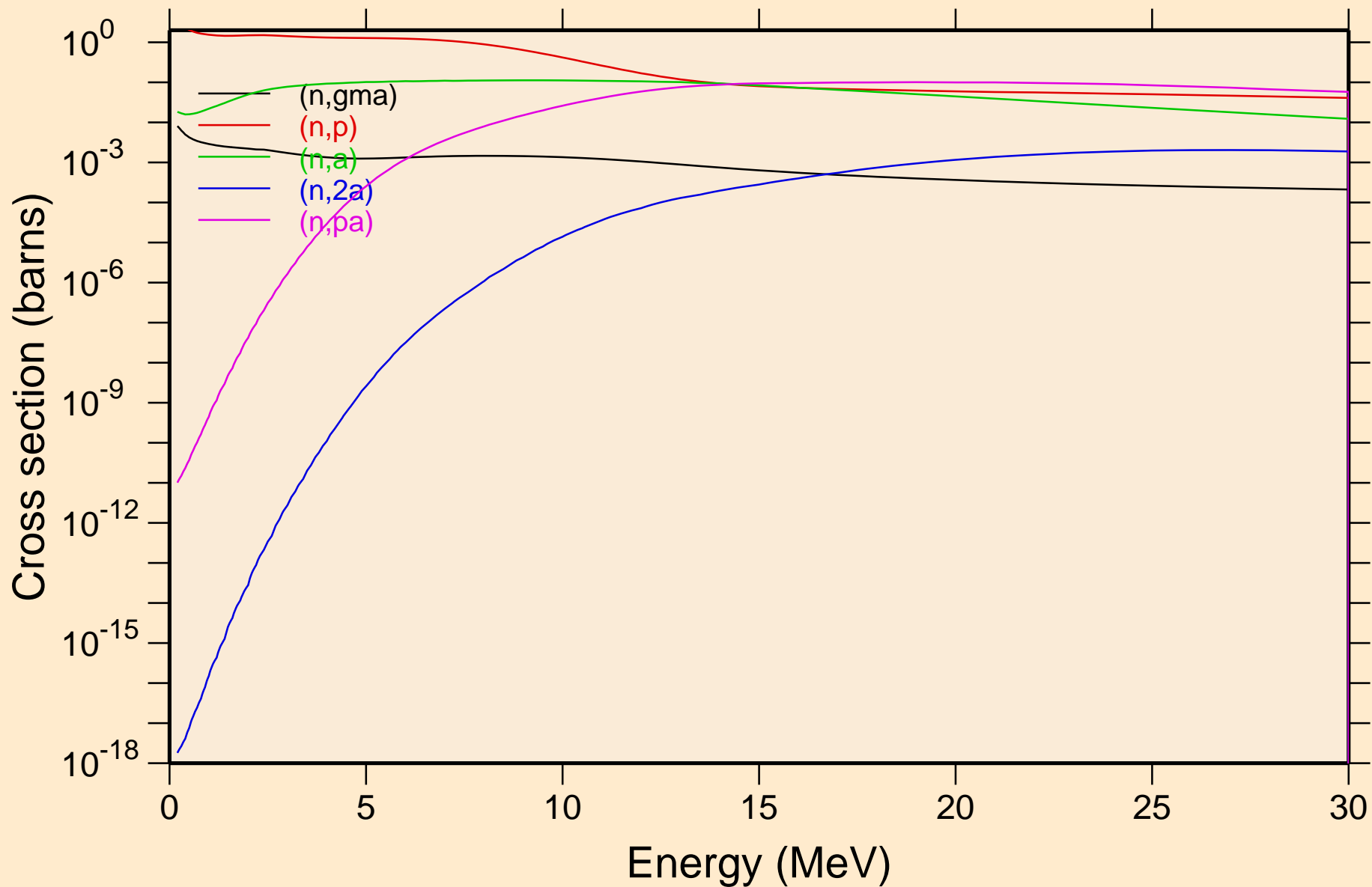

AG100M NEUTRON ACER TENDL-2019 LIBRARY; T=293.16K
Non-threshold reactions

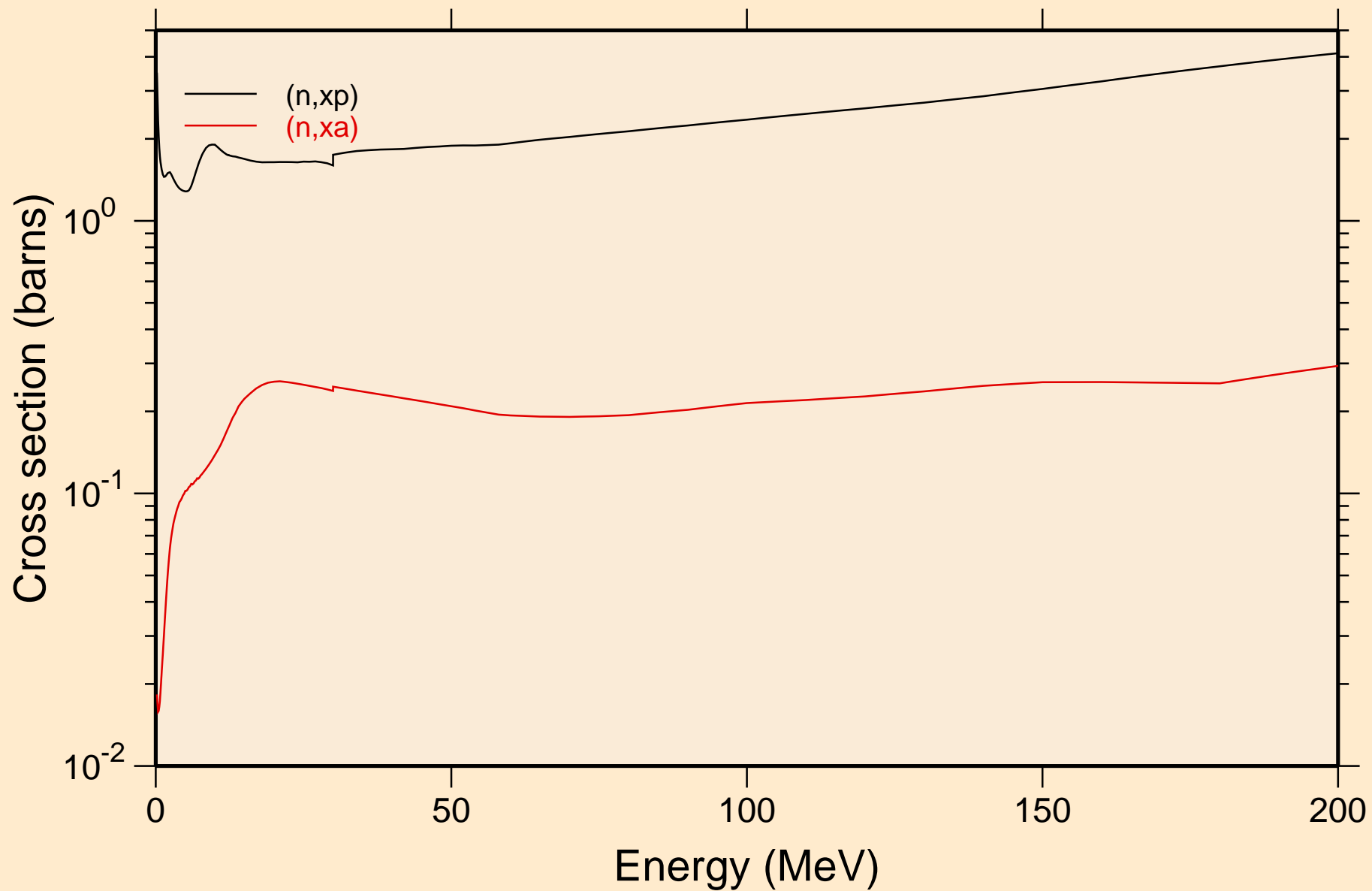

AG100M NEUTRON ACER TENDL-2019 LIBRARY; T=293.16K
Inelastic levels

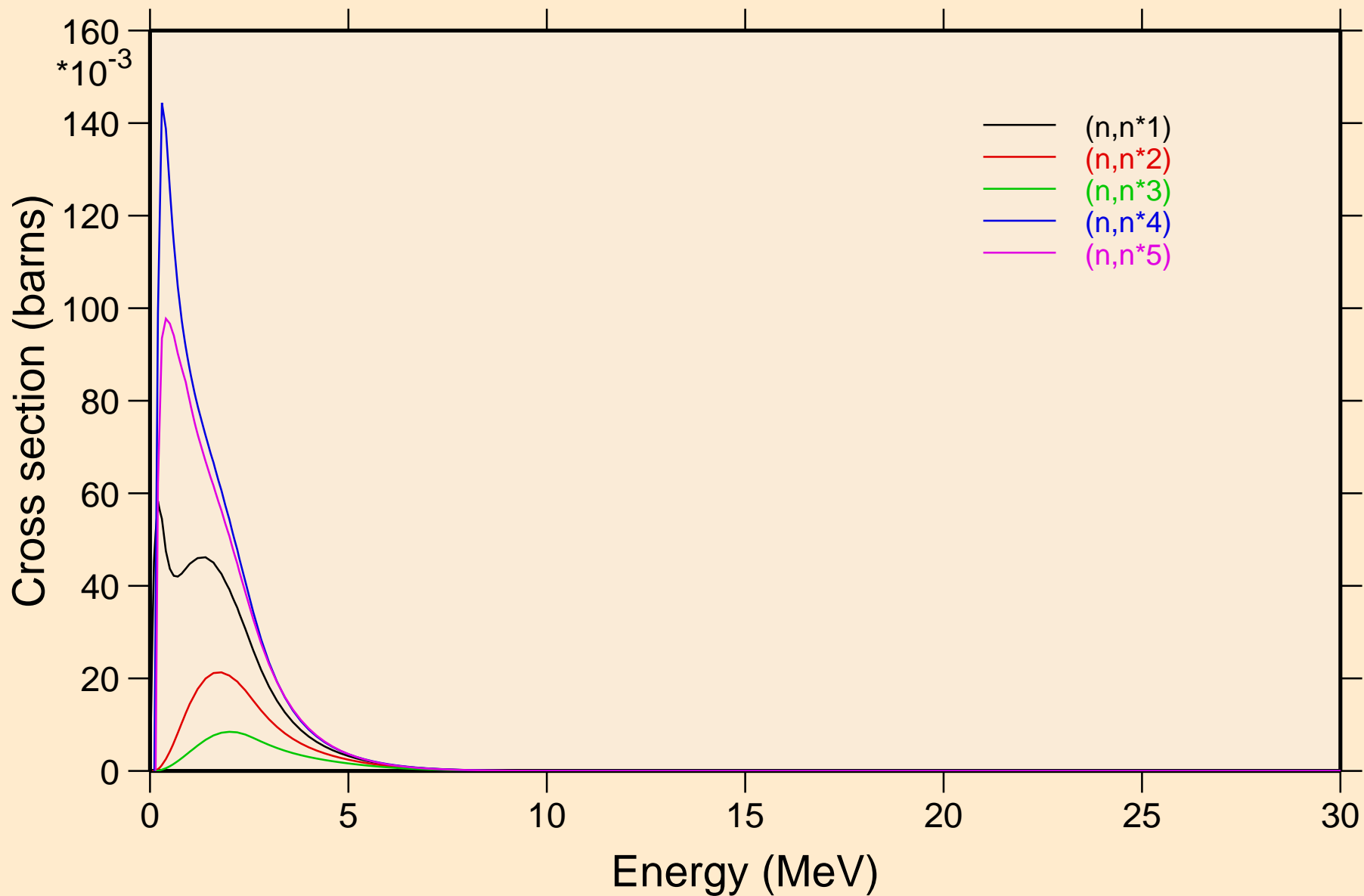

AG100M NEUTRON ACER TENDL-2019 LIBRARY; T=293.16K
Inelastic levels

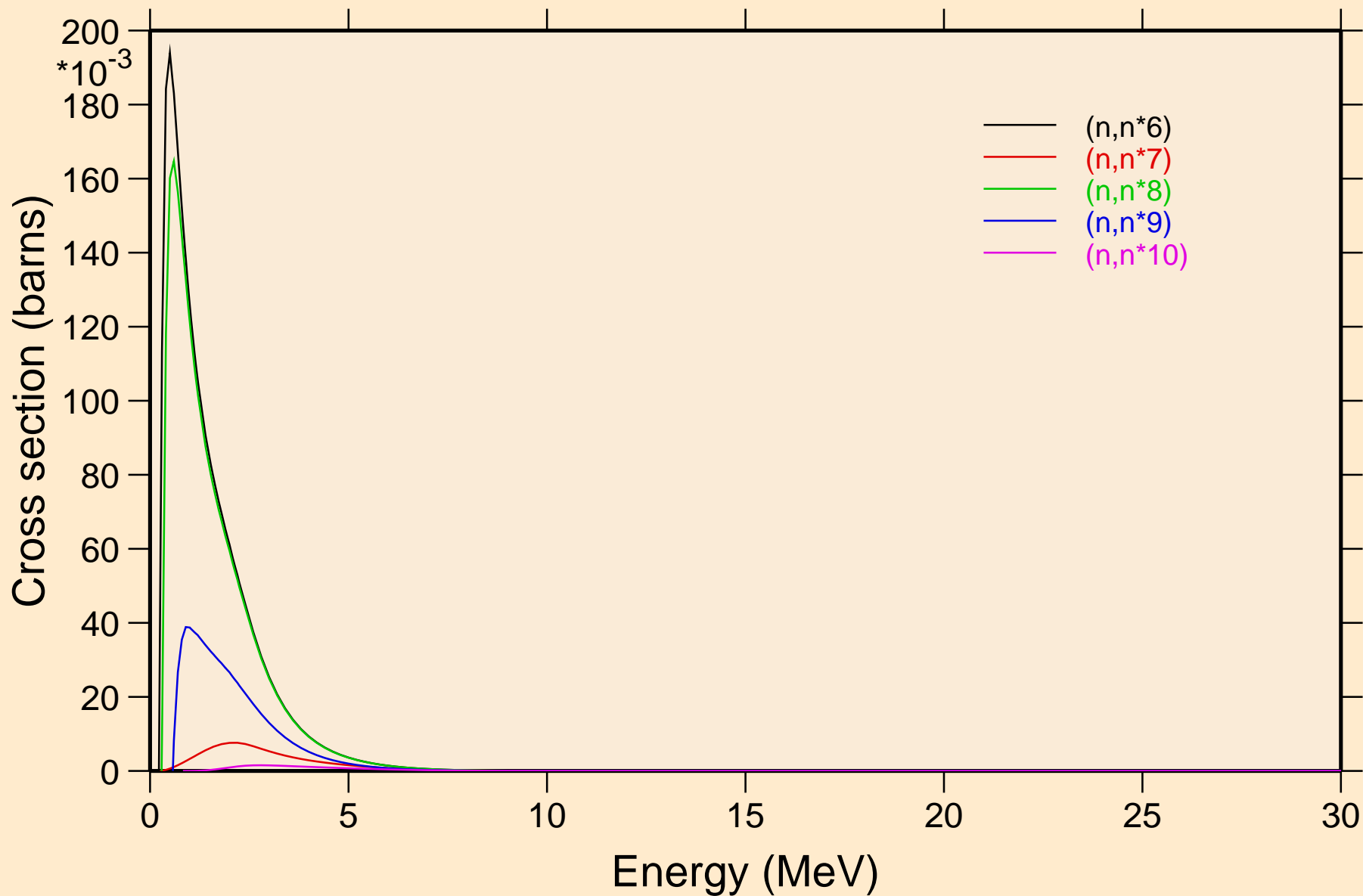

AG100M NEUTRON ACER TENDL-2019 LIBRARY; T=293.16K
Inelastic levels

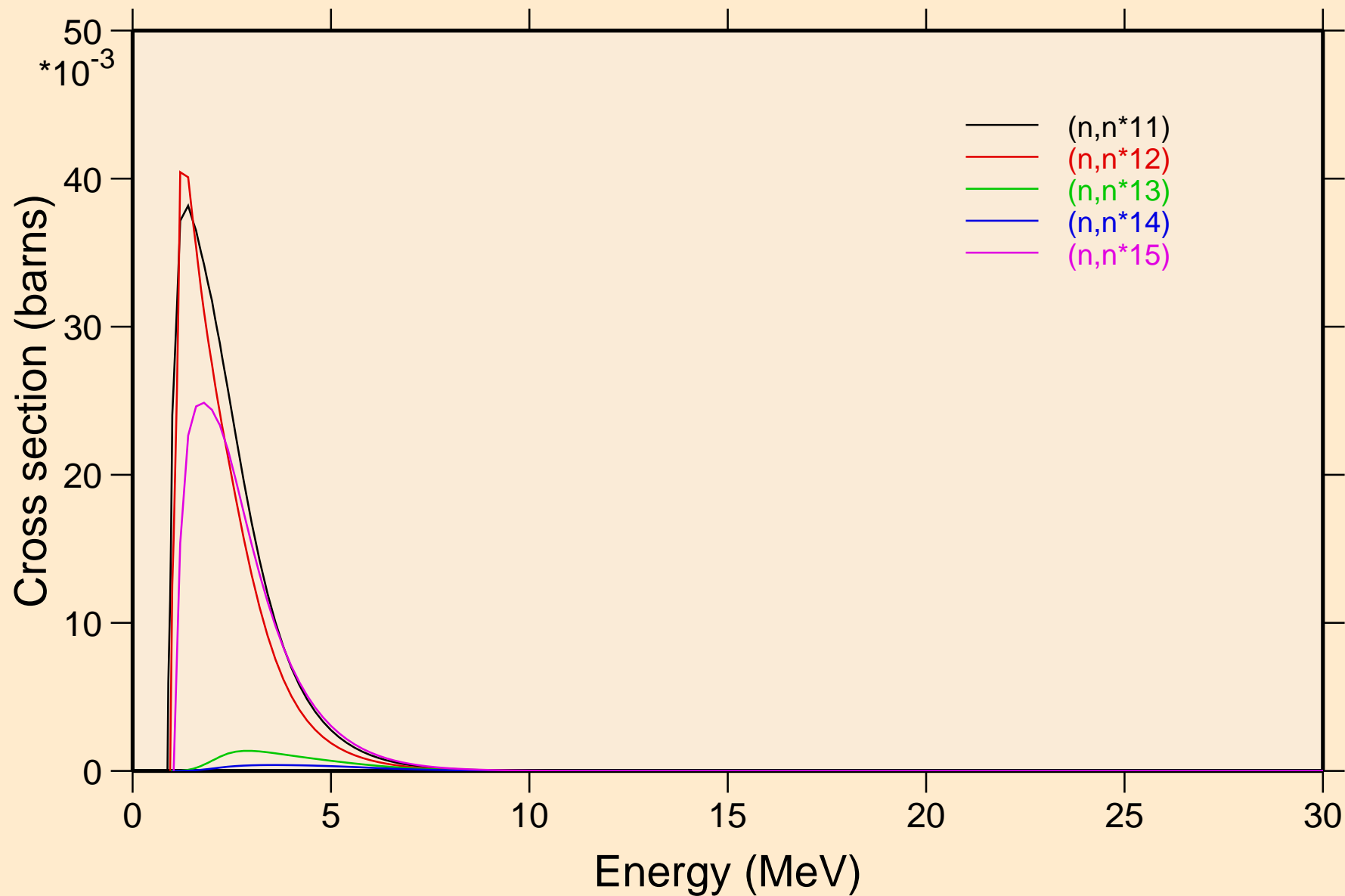

AG100M NEUTRON ACER TENDL-2019 LIBRARY; T=293.16K
Inelastic levels

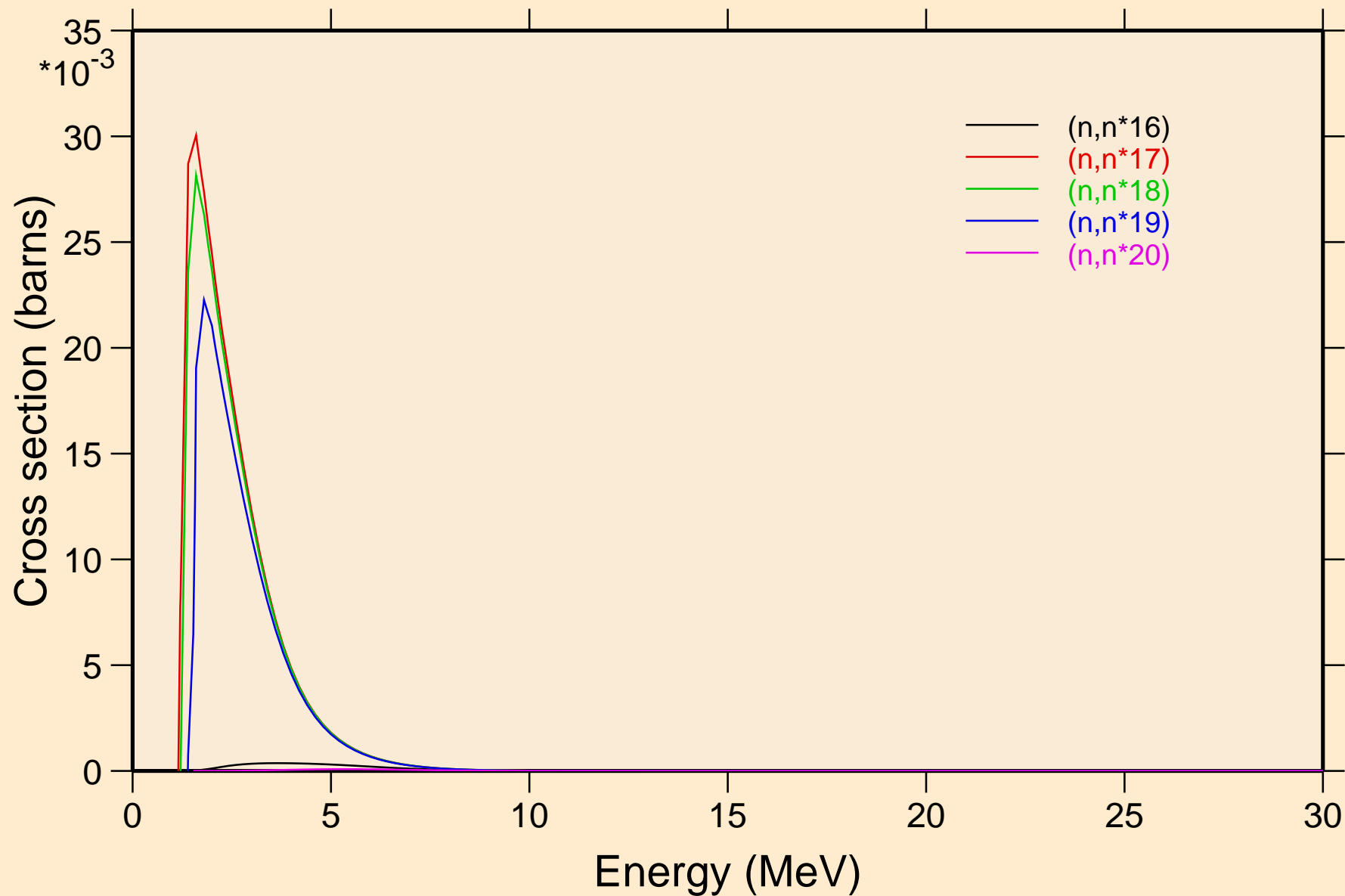

AG100M NEUTRON ACER TENDL-2019 LIBRARY; T=293.16K
Inelastic levels

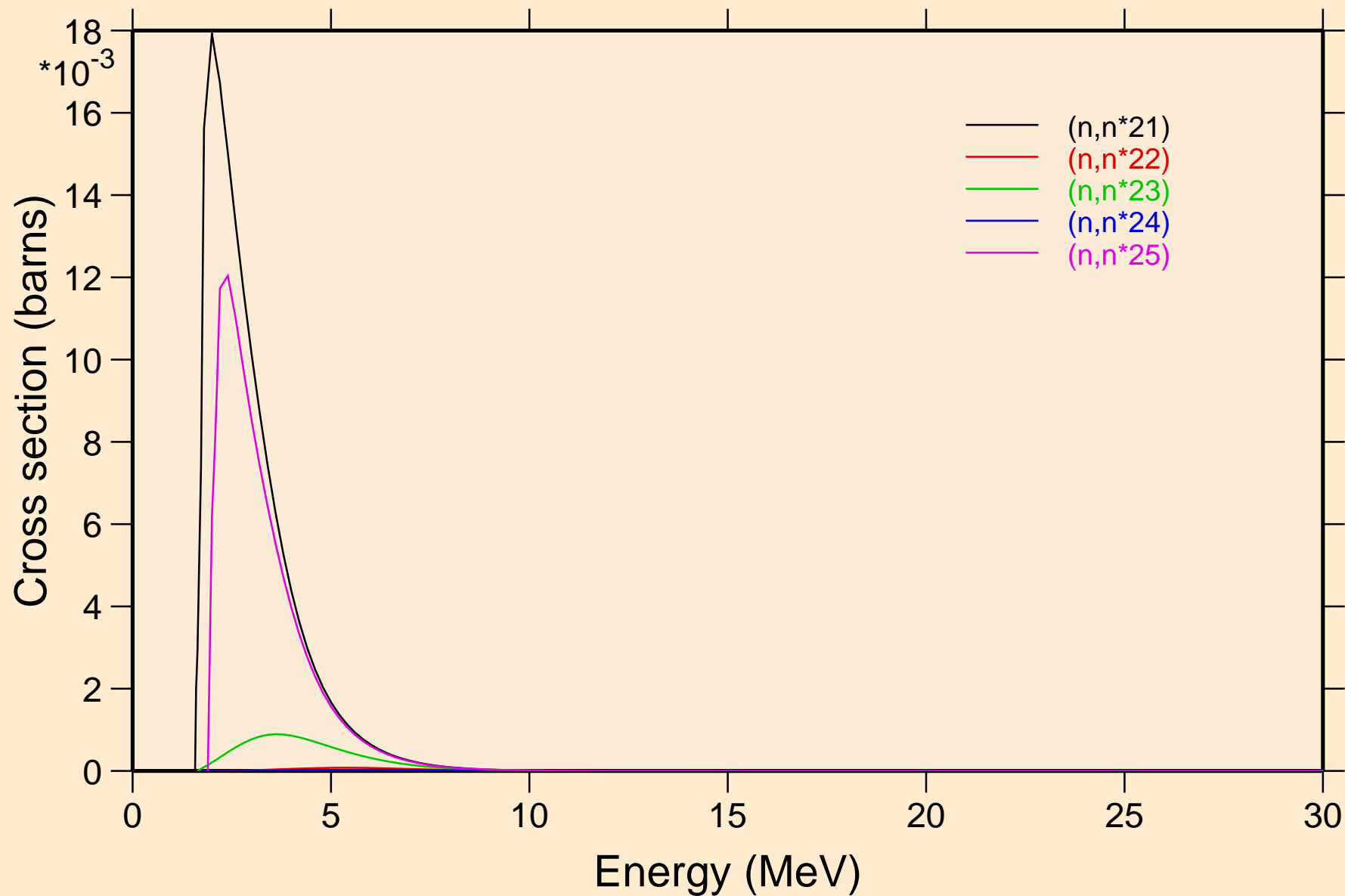

AG100M NEUTRON ACER TENDL-2019 LIBRARY; T=293.16K
Inelastic levels

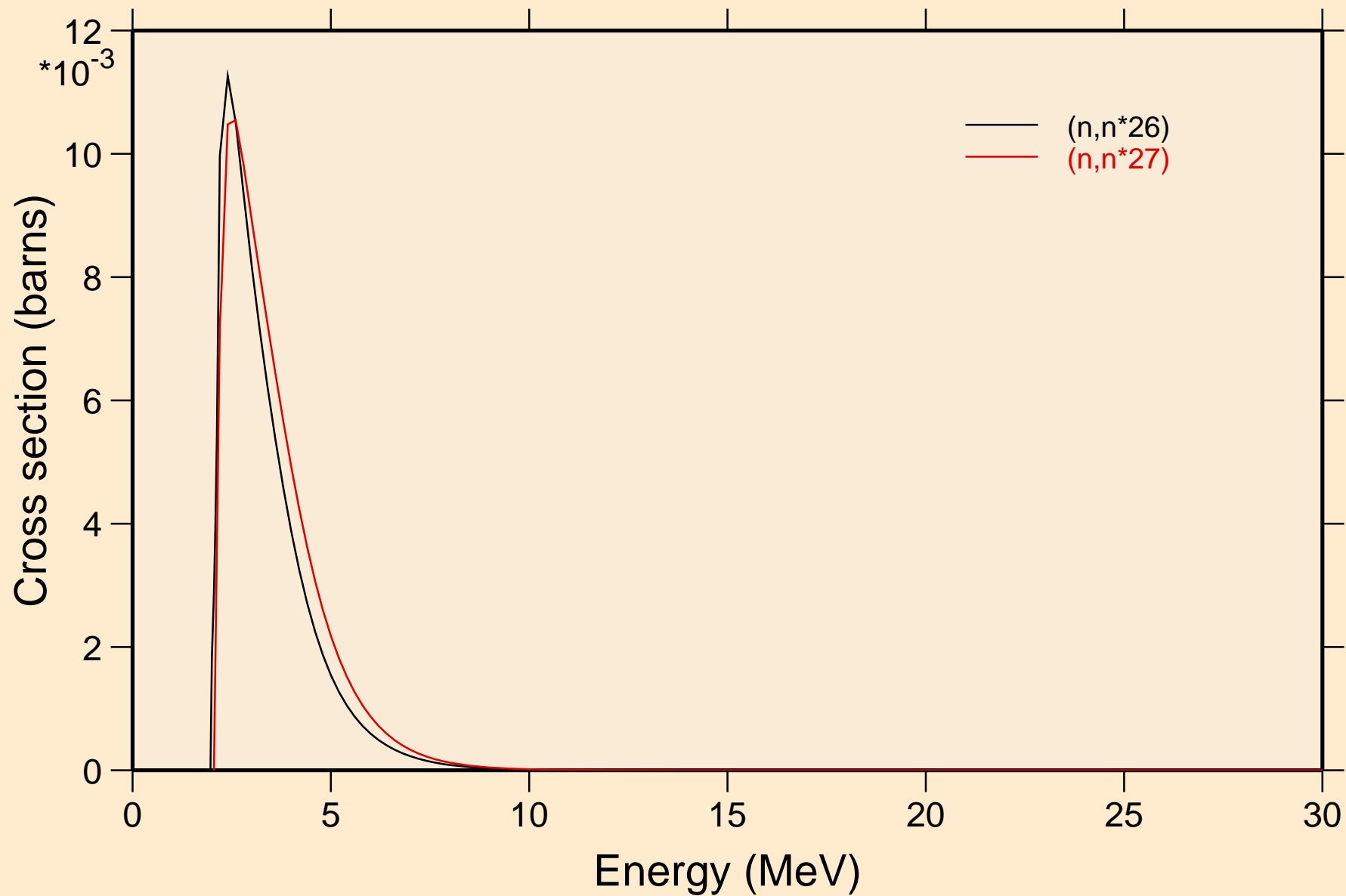

AG100M NEUTRON ACER TENDL-2019 LIBRARY; T=293.16K
Threshold reactions

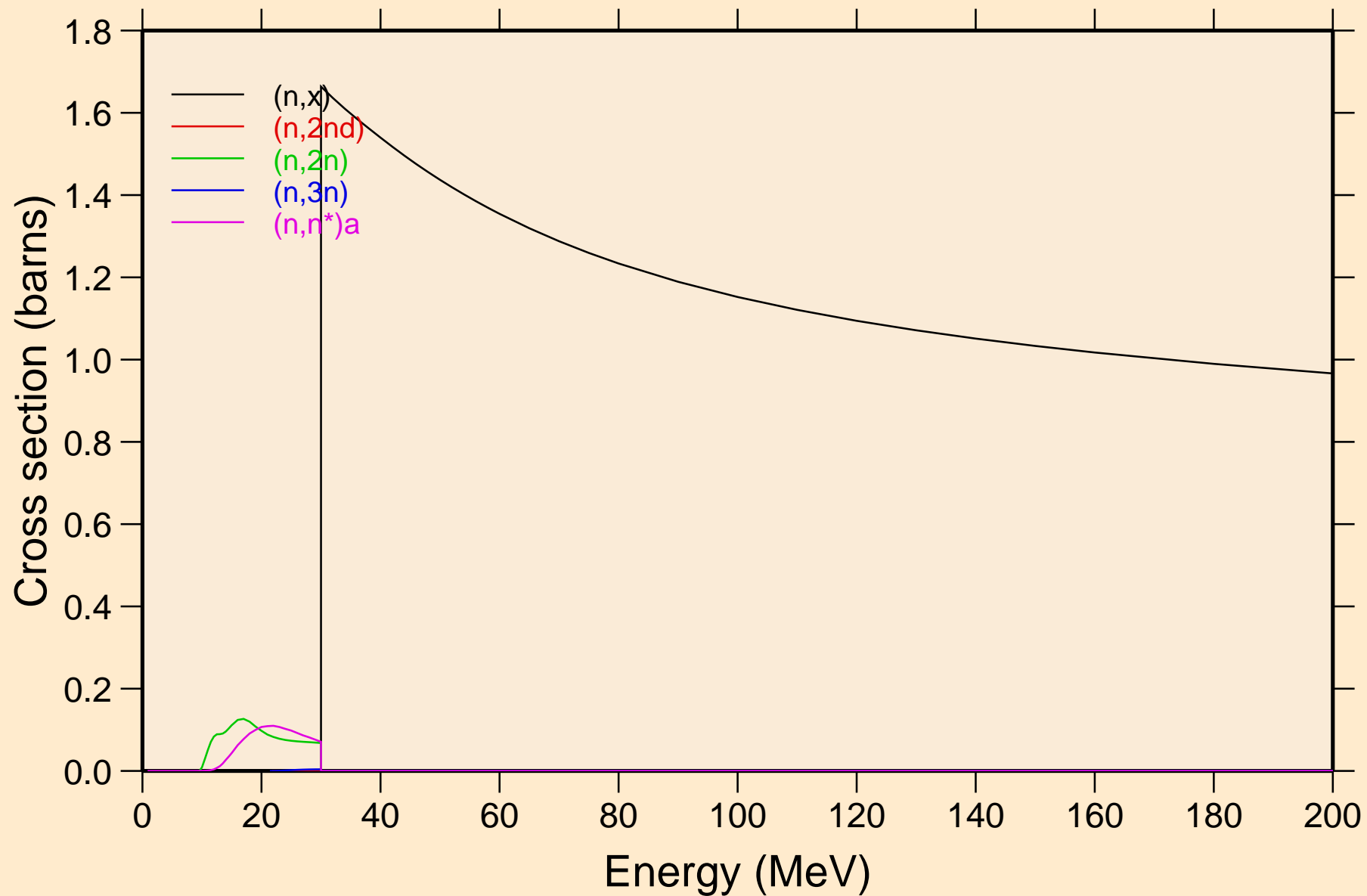

AG100M NEUTRON ACER TENDL-2019 LIBRARY; T=293.16K
Threshold reactions

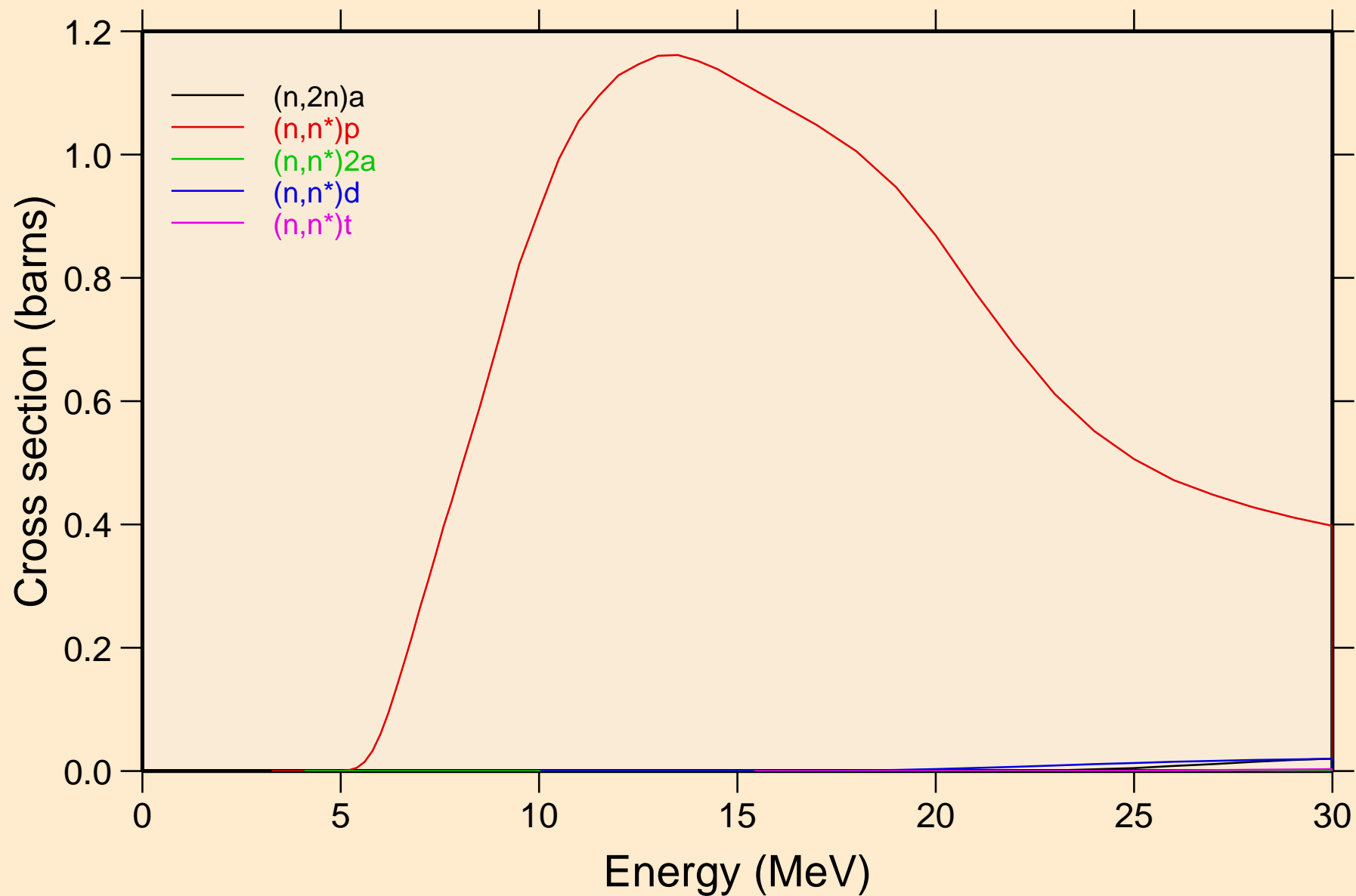

AG100M NEUTRON ACER TENDL-2019 LIBRARY; T=293.16K
Threshold reactions

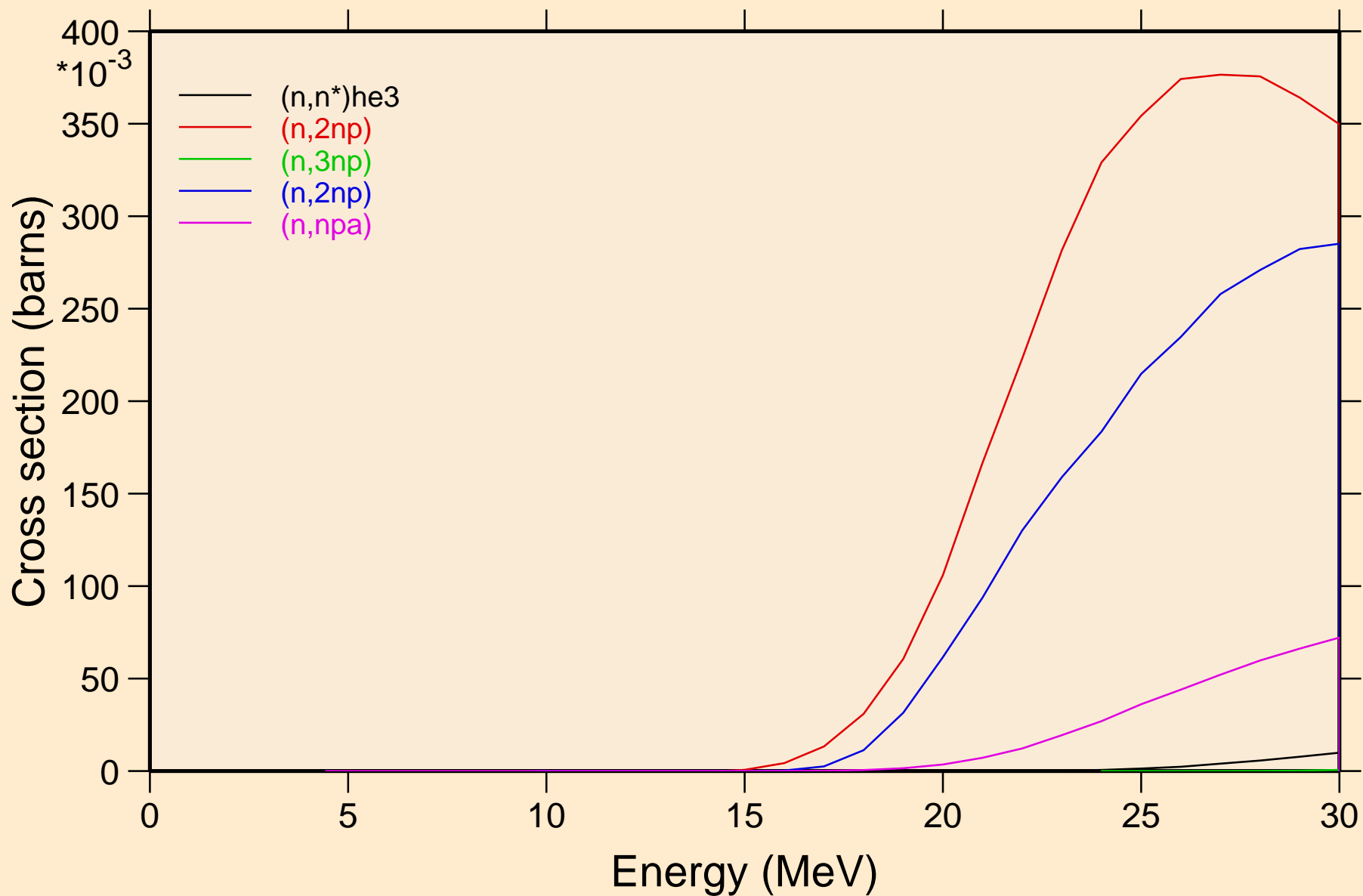

AG100M NEUTRON ACER TENDL-2019 LIBRARY; T=293.16K
Threshold reactions

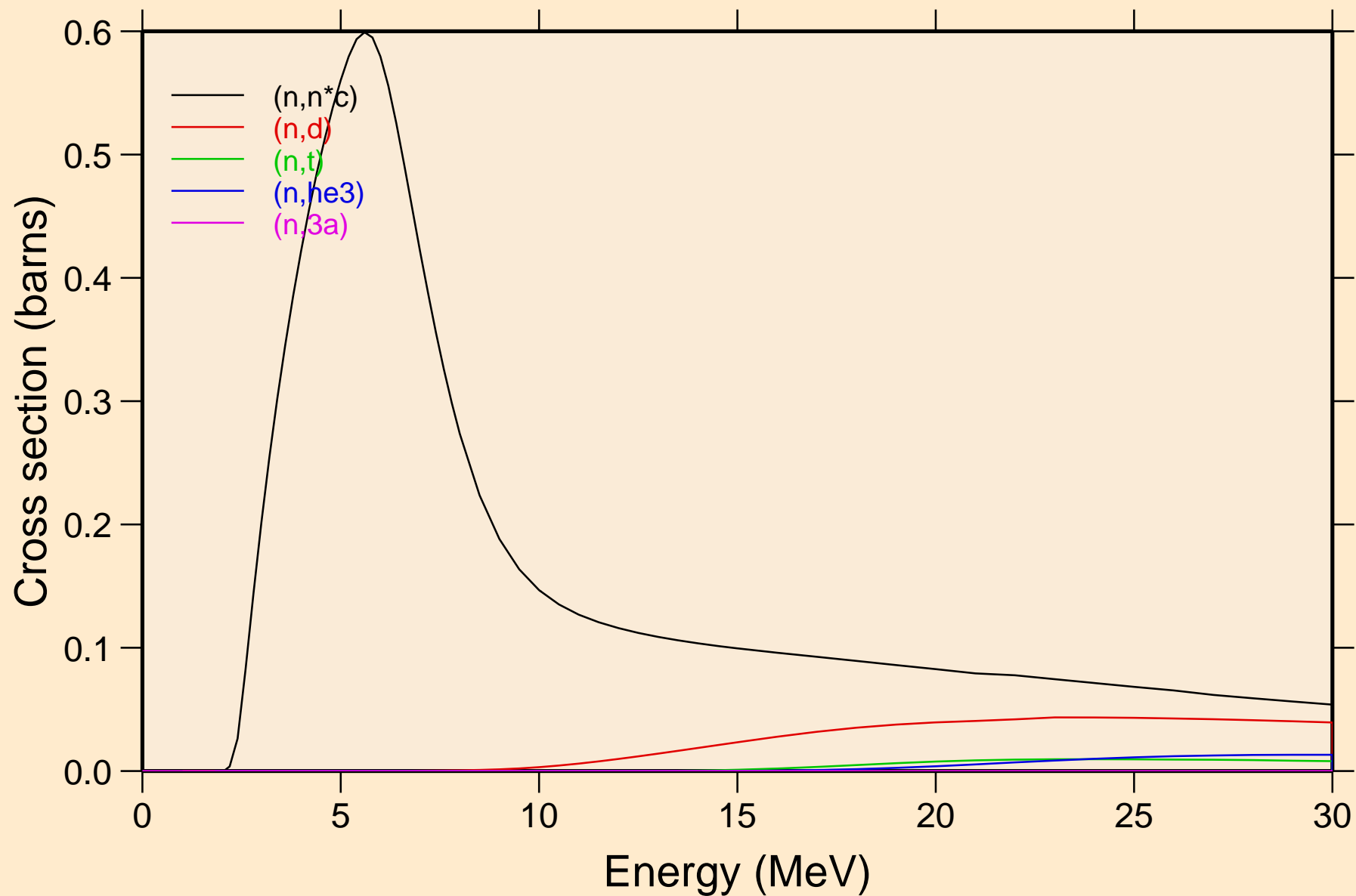

AG100M NEUTRON ACER TENDL-2019 LIBRARY; T=293.16K
Threshold reactions

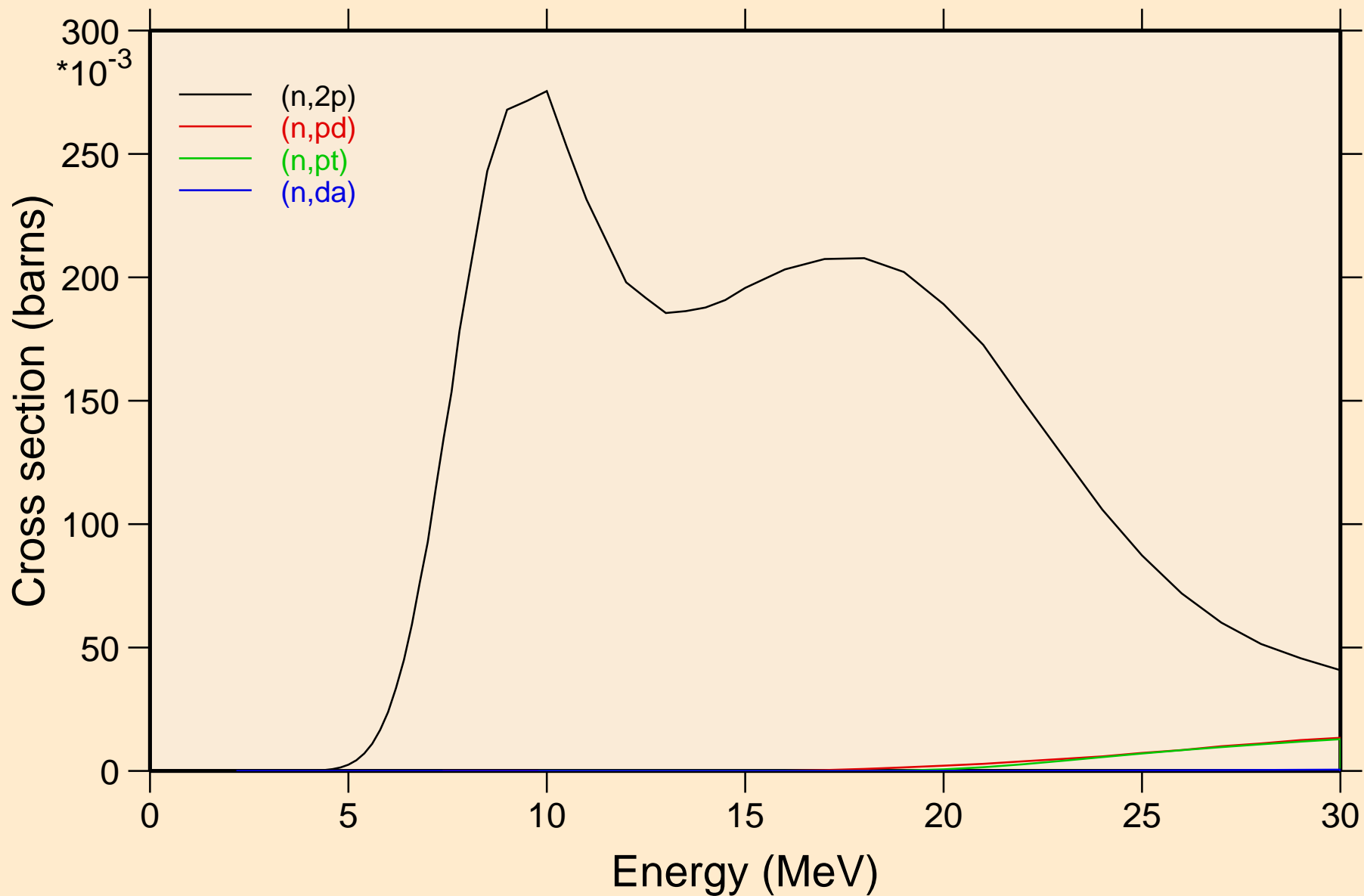

AG100M NEUTRON ACER TENDL-2019 LIBRARY; T=293.16K
Threshold reactions

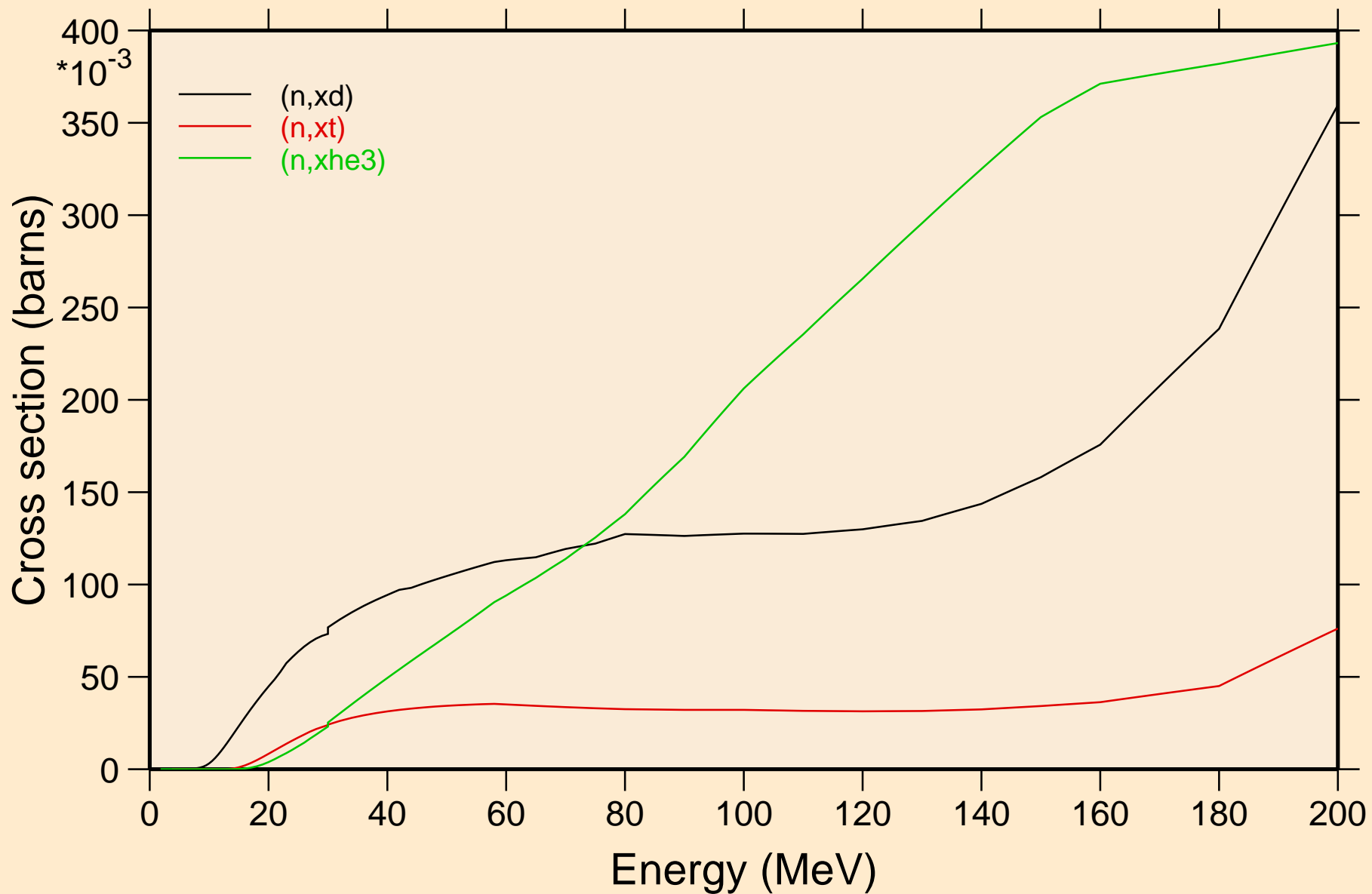

AG100M NEUTRON ACER TENDL-2019 LIBRARY; T=293.16K
angular distribution for elastic

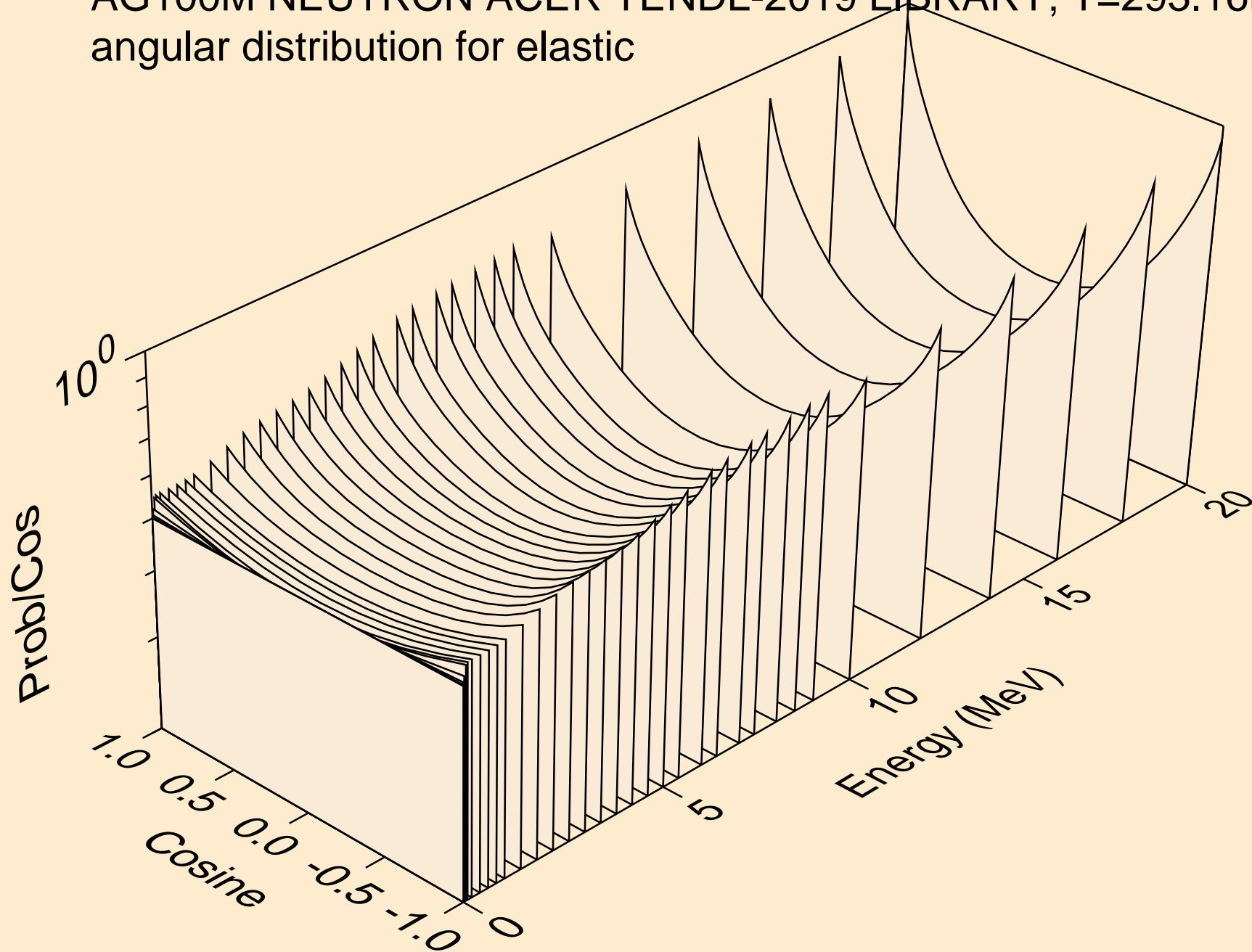

AG100M NEUTRON ACER TENDL-2019 LIBRARY; T=293.16K
angular distribution for elastic

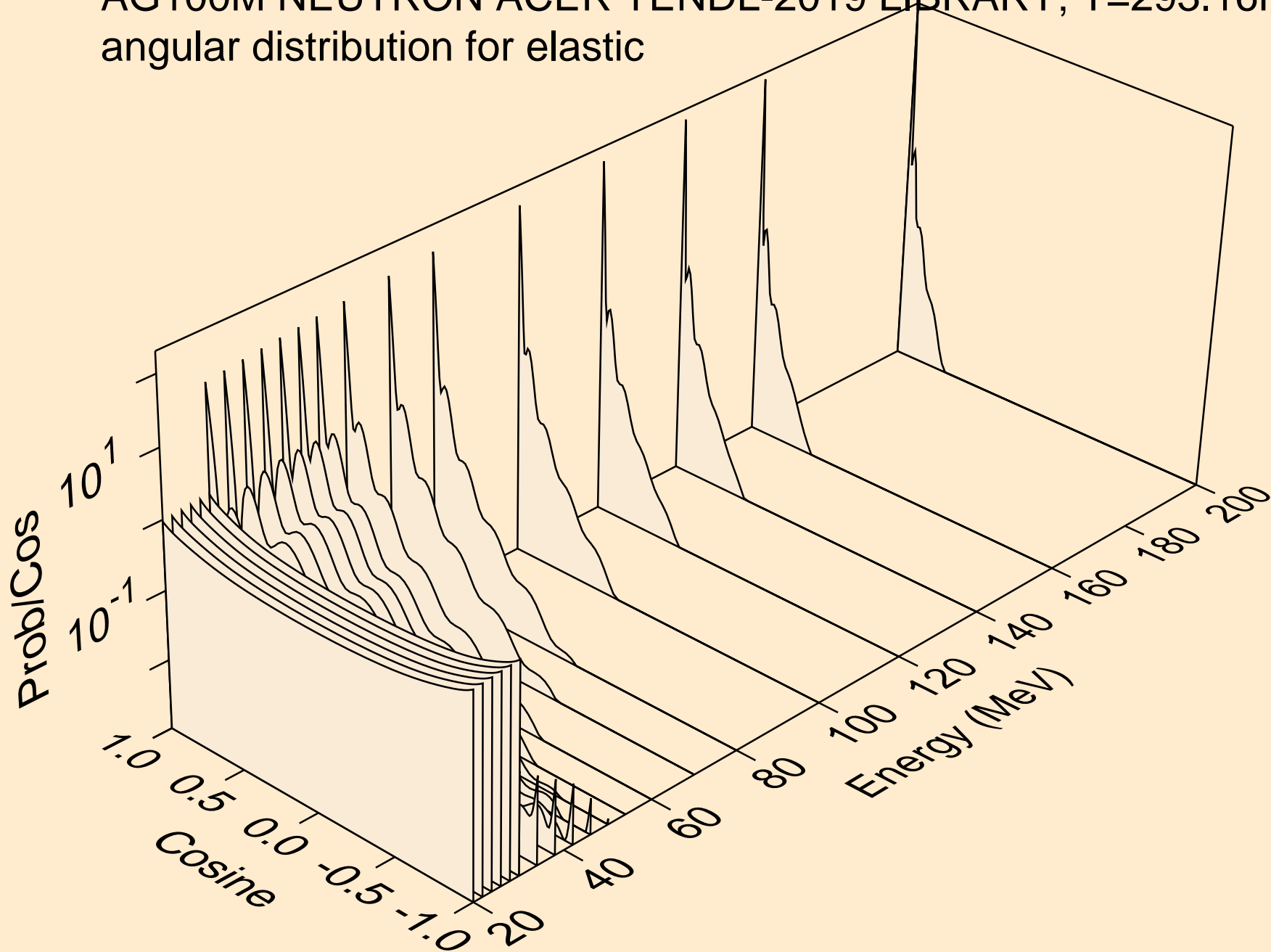

AG100M NEUTRON ACER TENDL-2019 LIBRARY; T=293.16K
angular distribution for (n,n*1)

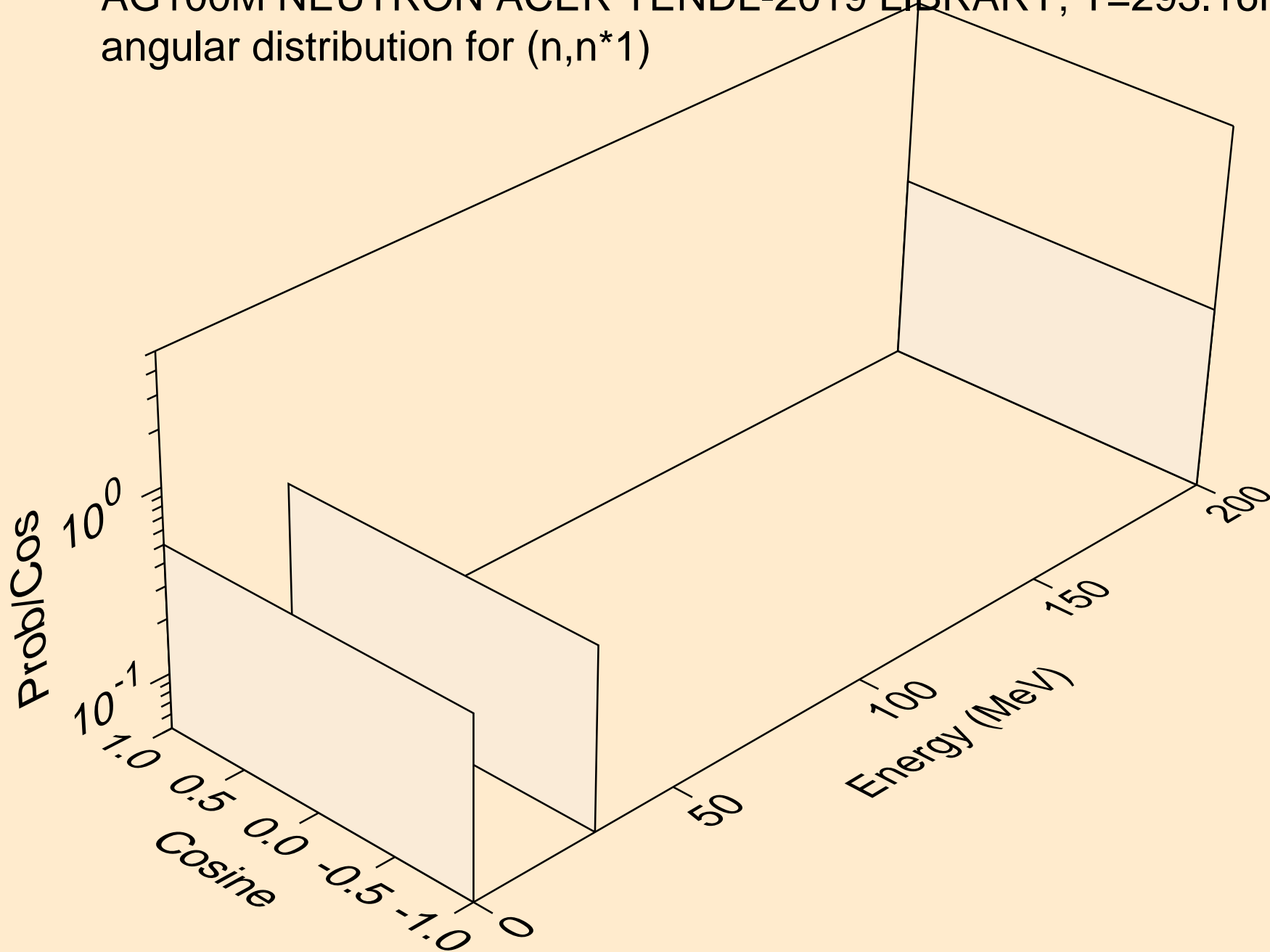

AG100M NEUTRON ACER TENDL-2019 LIBRARY; T=293.16K
angular distribution for (n,n*2)

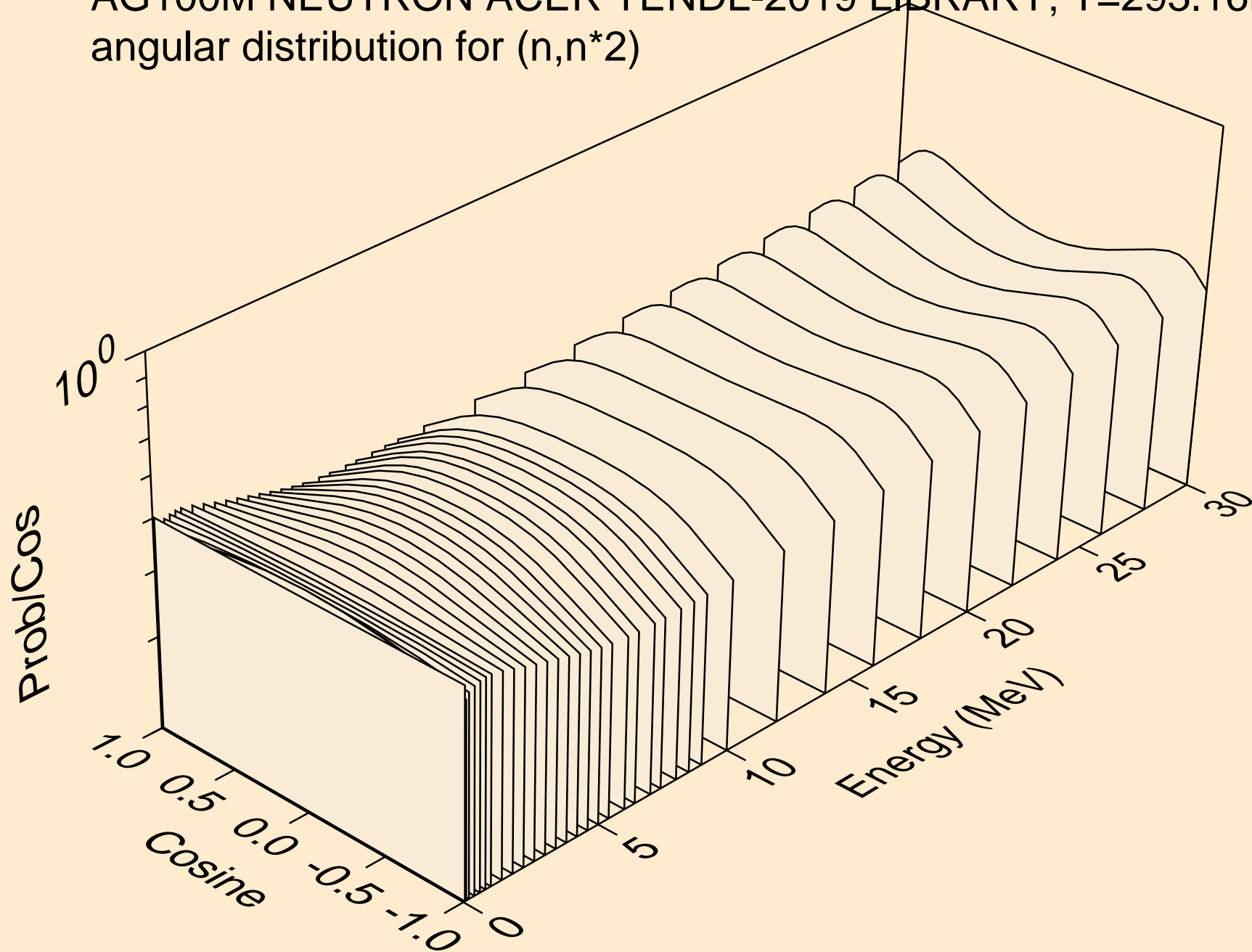

AG100M NEUTRON ACER TENDL-2019 LIBRARY; T=293.16K
angular distribution for (n,n*3)

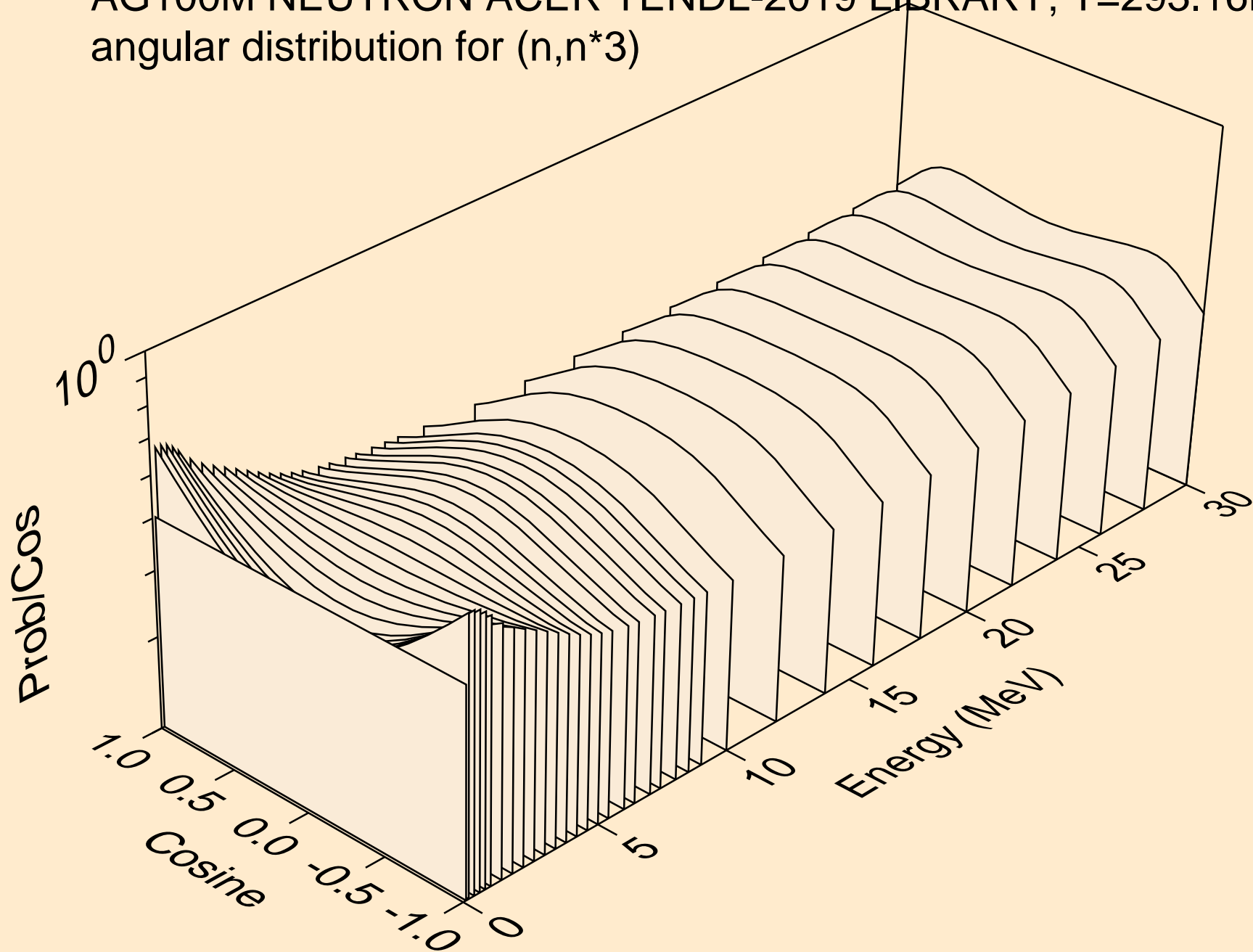

AG100M NEUTRON ACER TENDL-2019 LIBRARY; T=293.16K
angular distribution for (n,n*4)

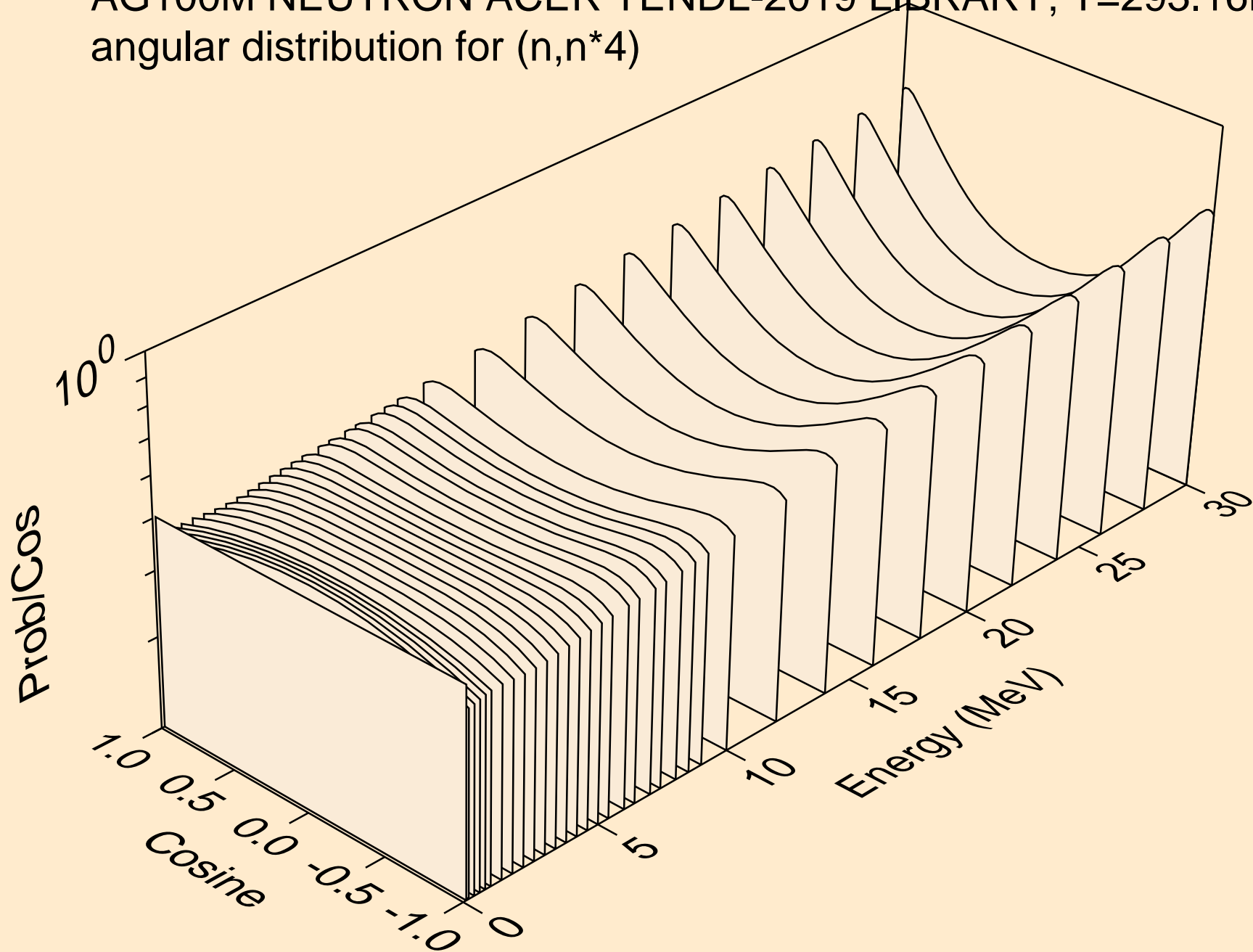

AG100M NEUTRON ACER TENDL-2019 LIBRARY; T=293.16K
angular distribution for (n,n*5)

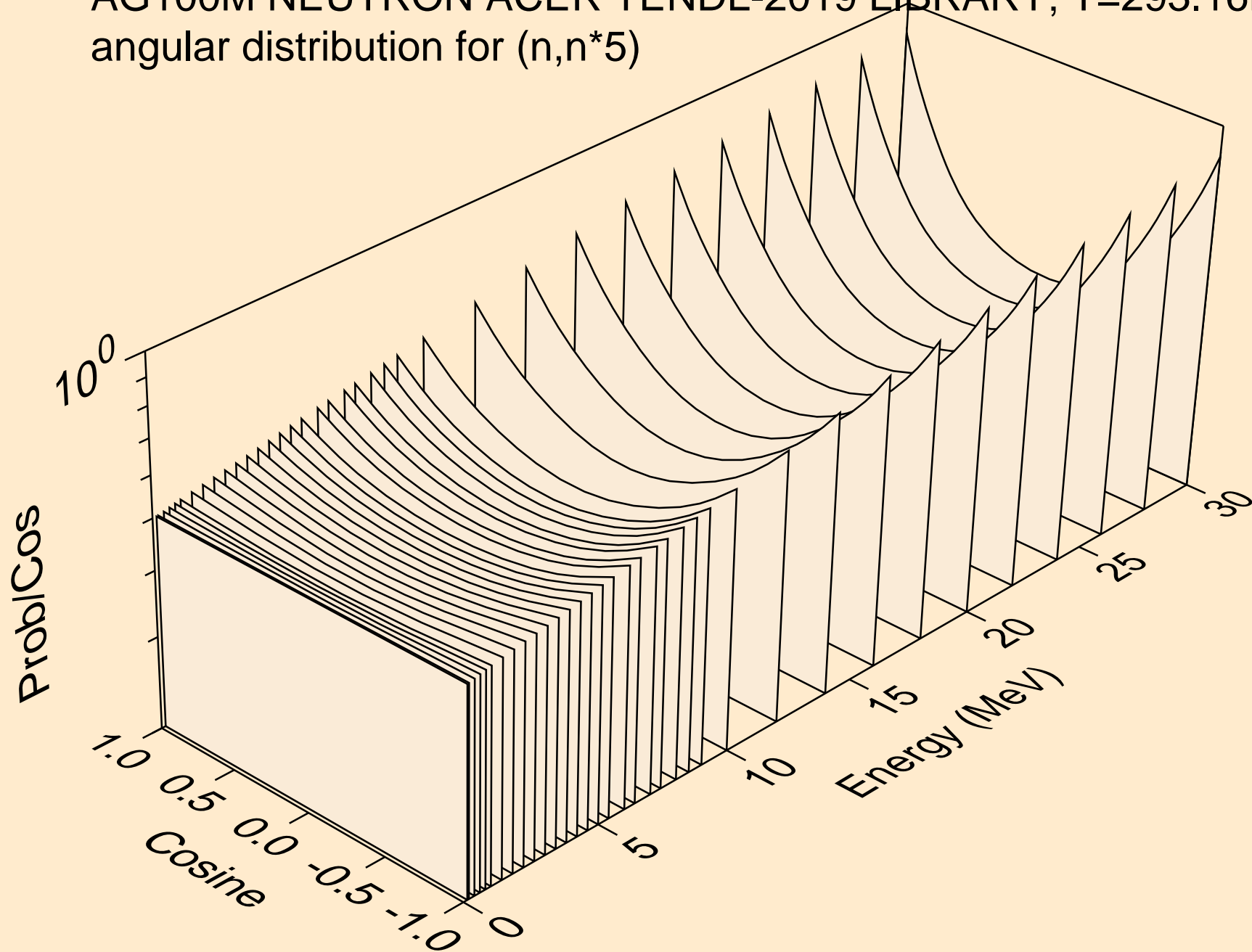

AG100M NEUTRON ACER TENDL-2019 LIBRARY; T=293.16K
angular distribution for (n,n*6)

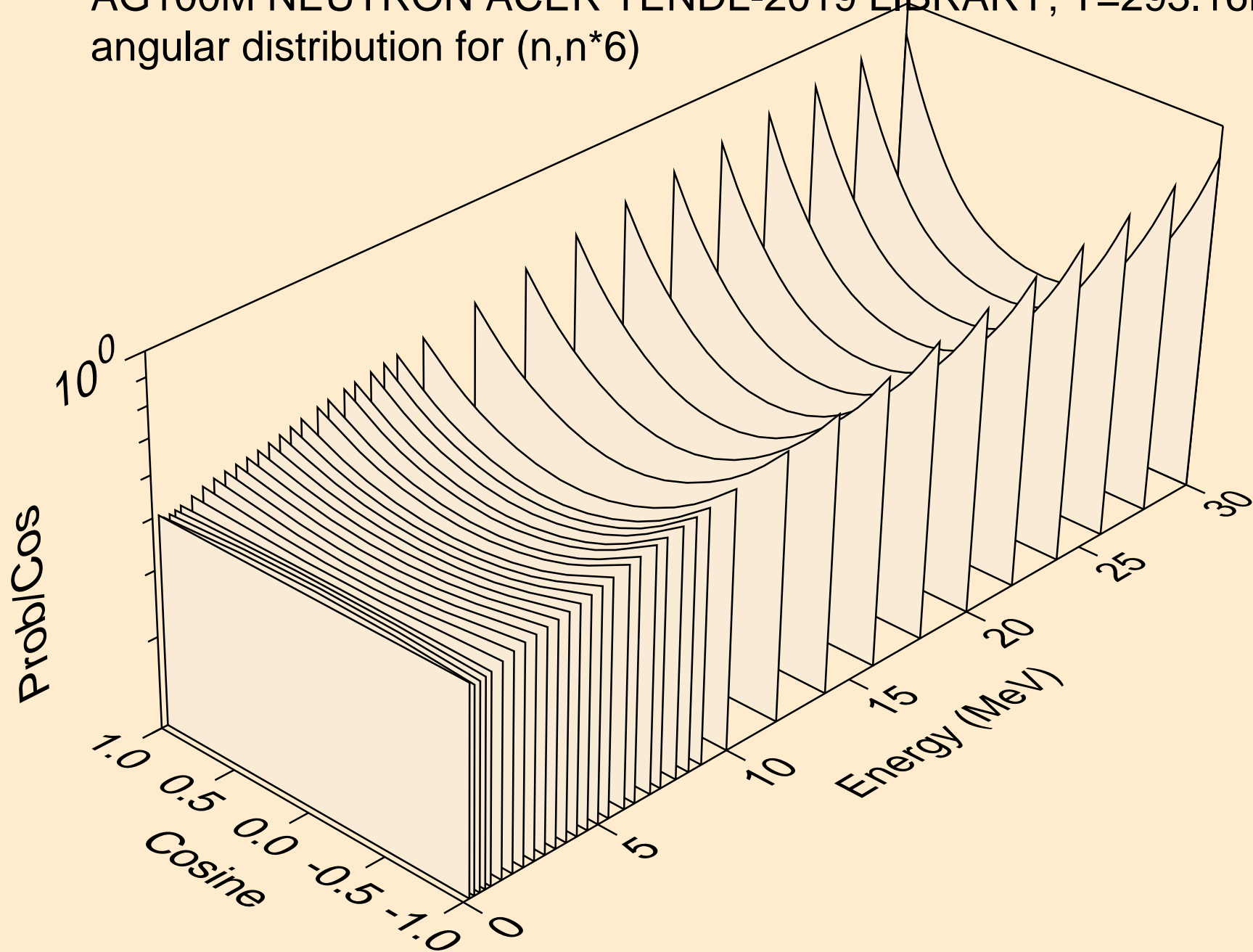

AG100M NEUTRON ACER TENDL-2019 LIBRARY; T=293.16K
angular distribution for (n,n*7)

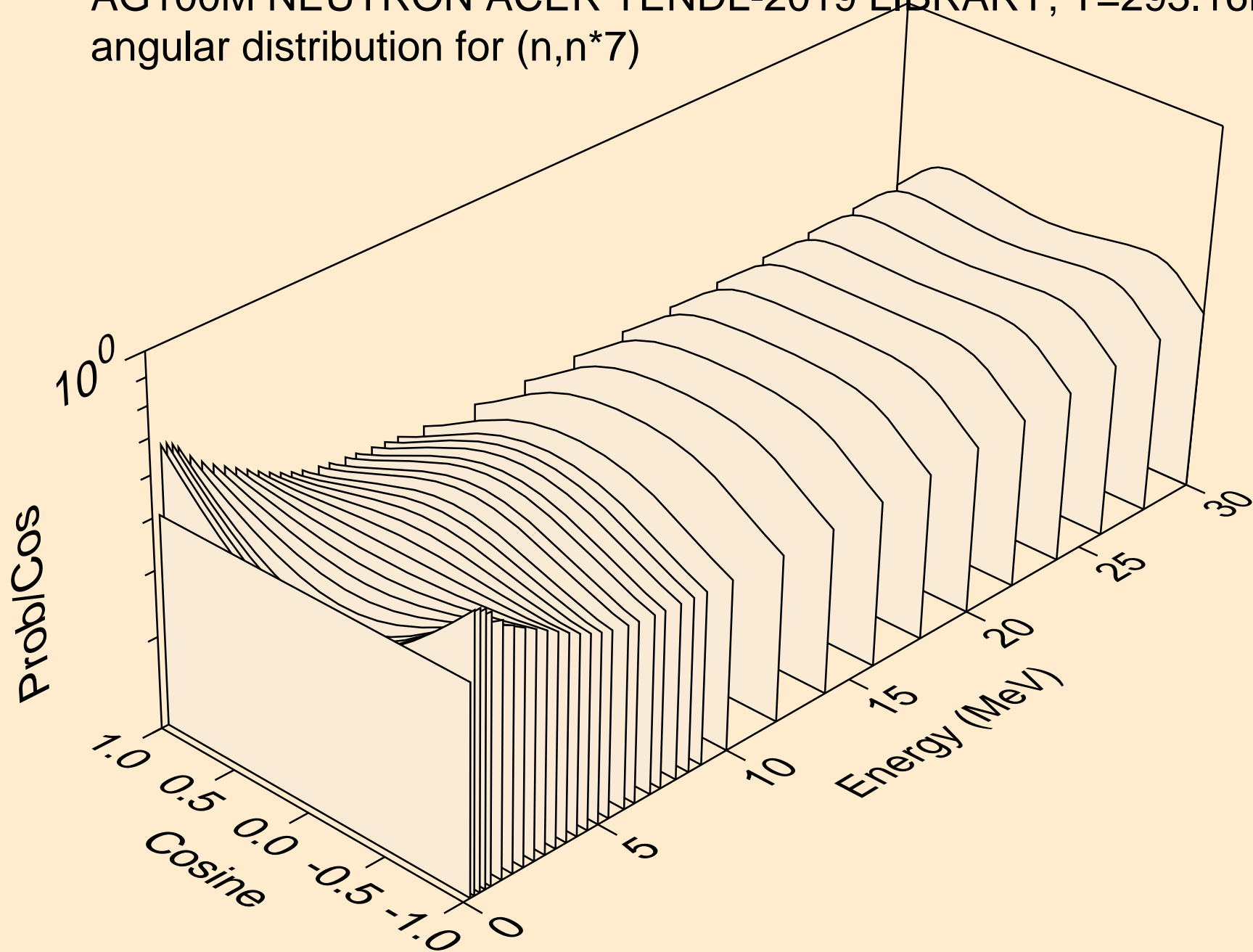

AG100M NEUTRON ACER TENDL-2019 LIBRARY; T=293.16K
angular distribution for (n,n*8)

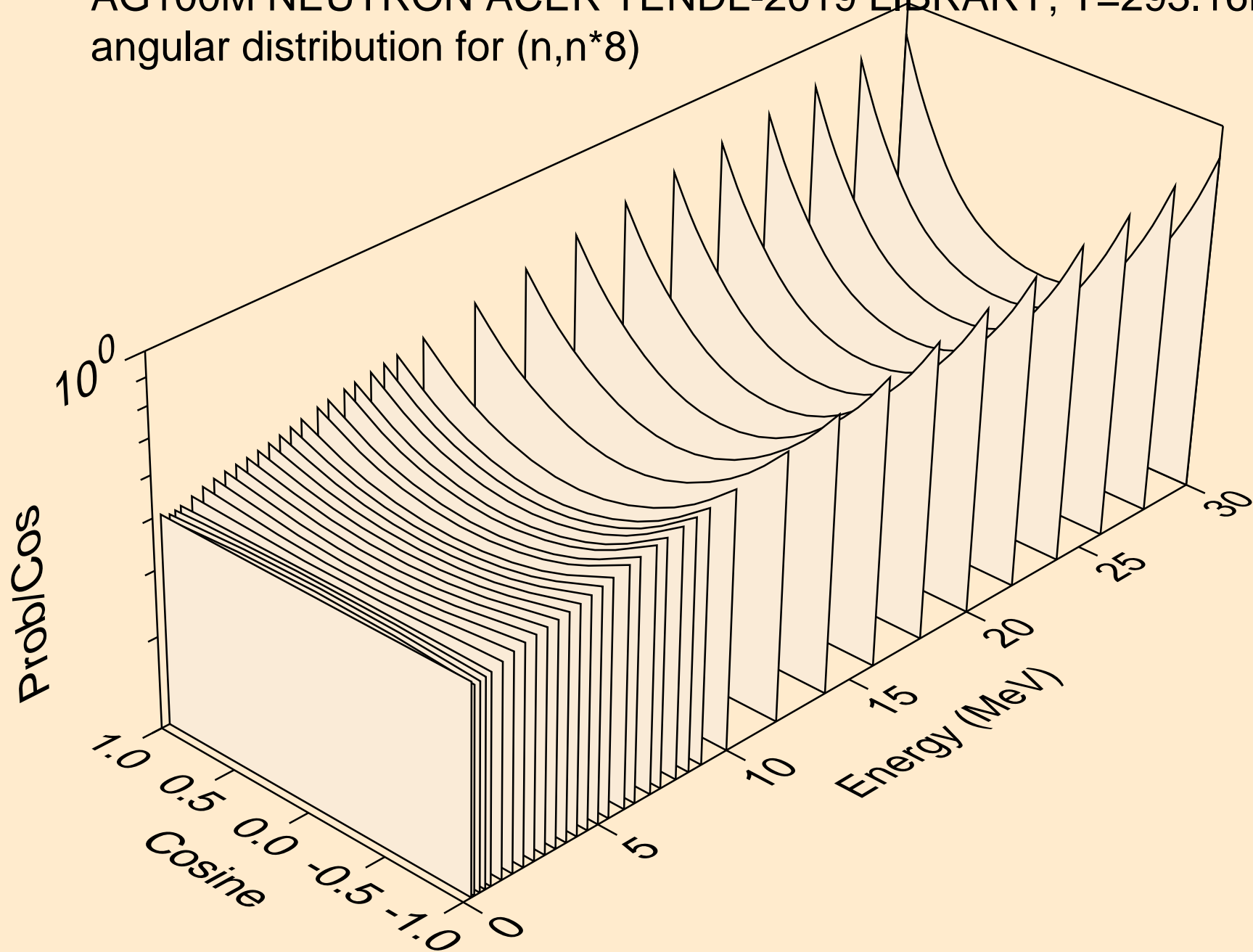

AG100M NEUTRON ACER TENDL-2019 LIBRARY; T=293.16K
angular distribution for (n,n*9)

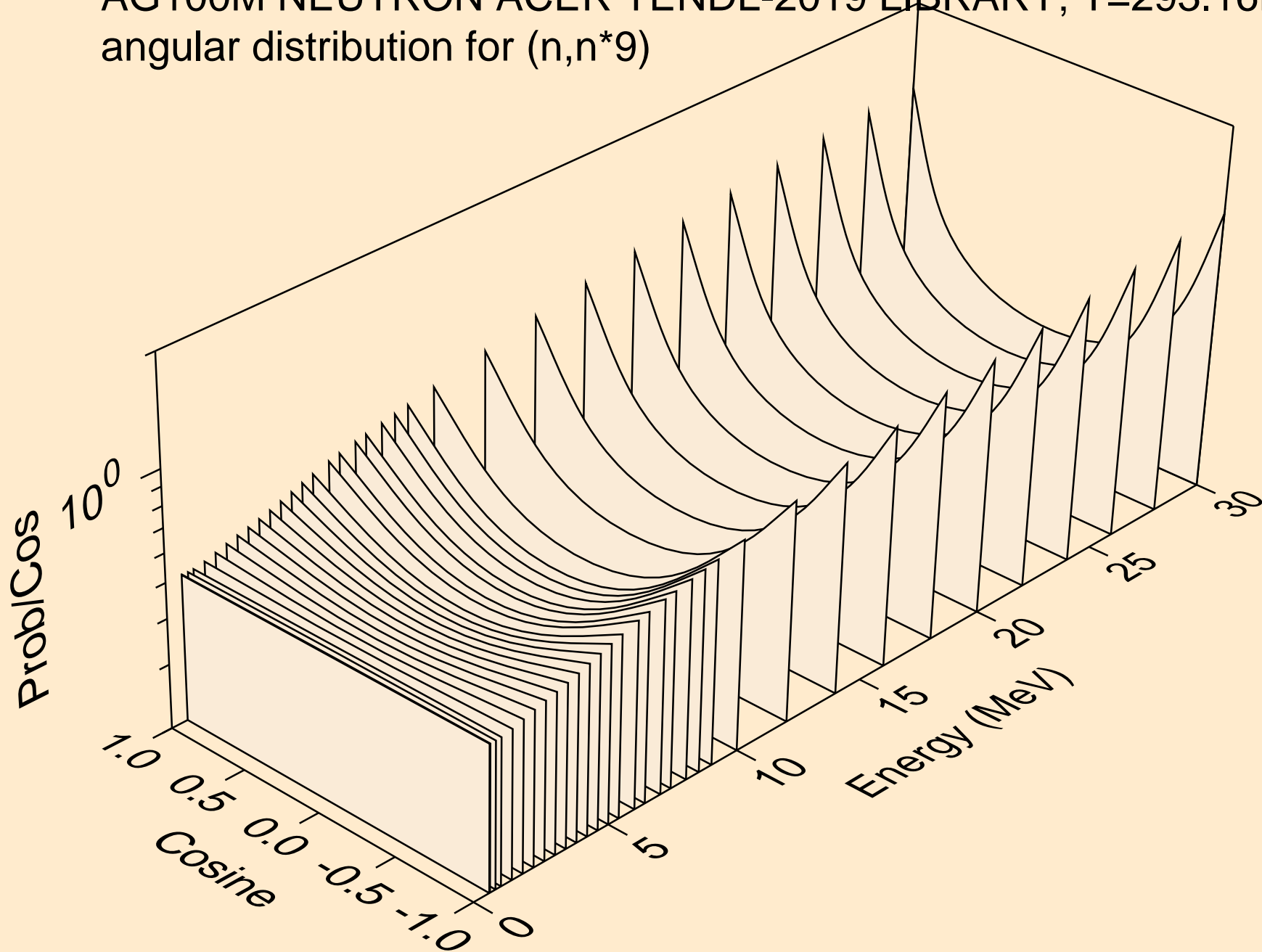

AG100M NEUTRON ACER TENDL-2019 LIBRARY; T=293.16K
angular distribution for (n,n*10)

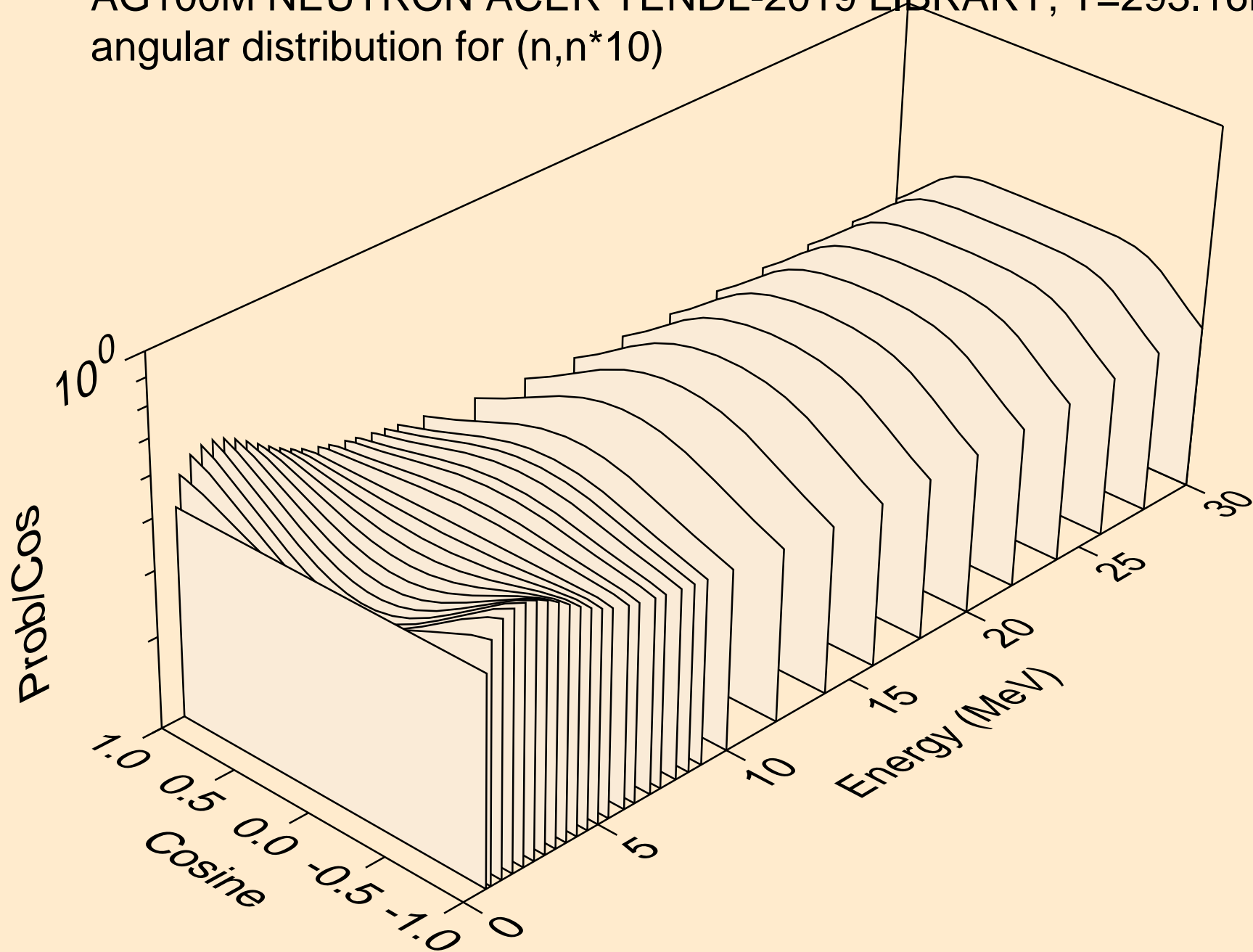

AG100M NEUTRON ACER TENDL-2019 LIBRARY; T=293.16K
angular distribution for (n,n*11)

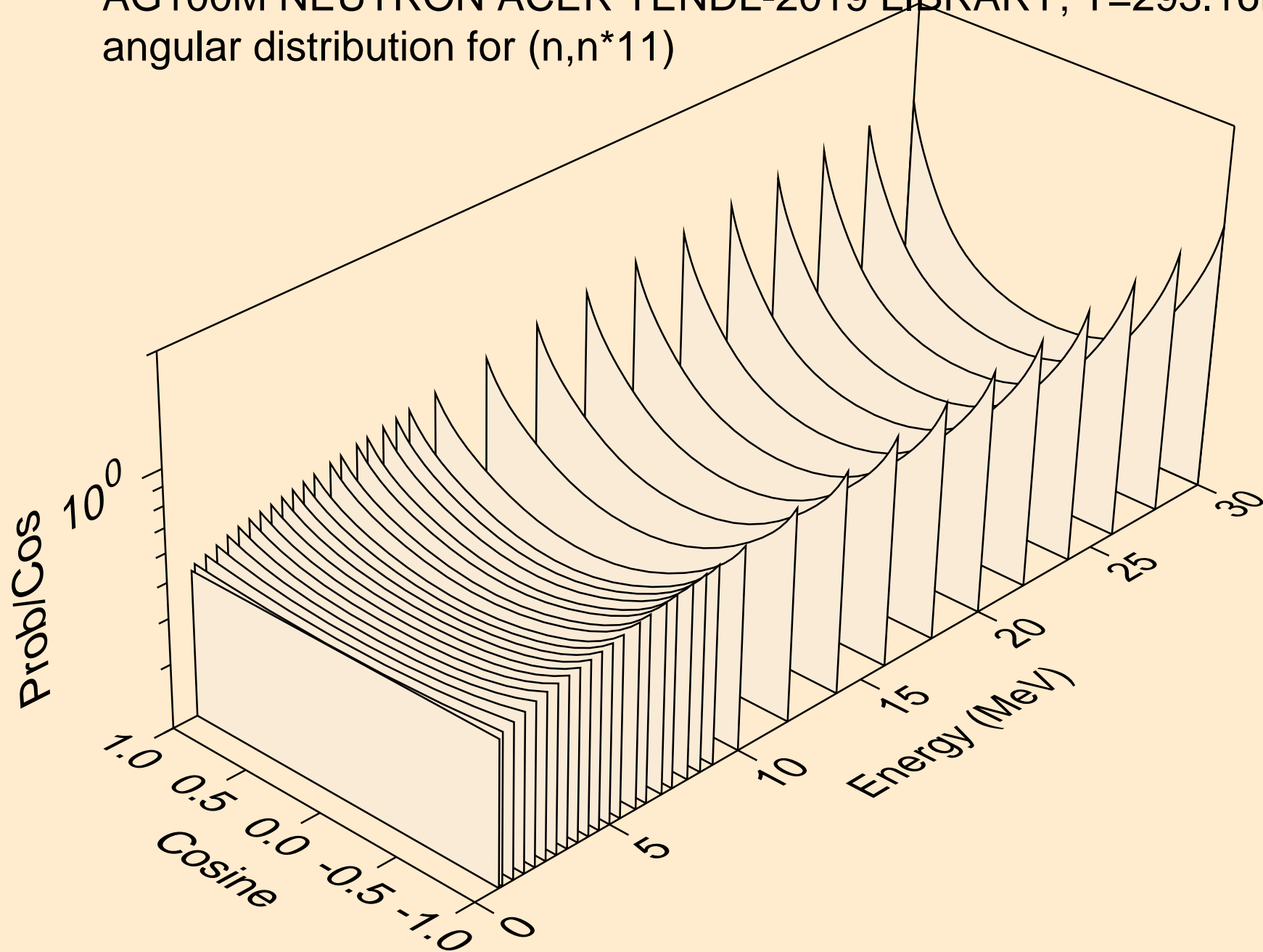

AG100M NEUTRON ACER TENDL-2019 LIBRARY; T=293.16K
angular distribution for (n,n*12)

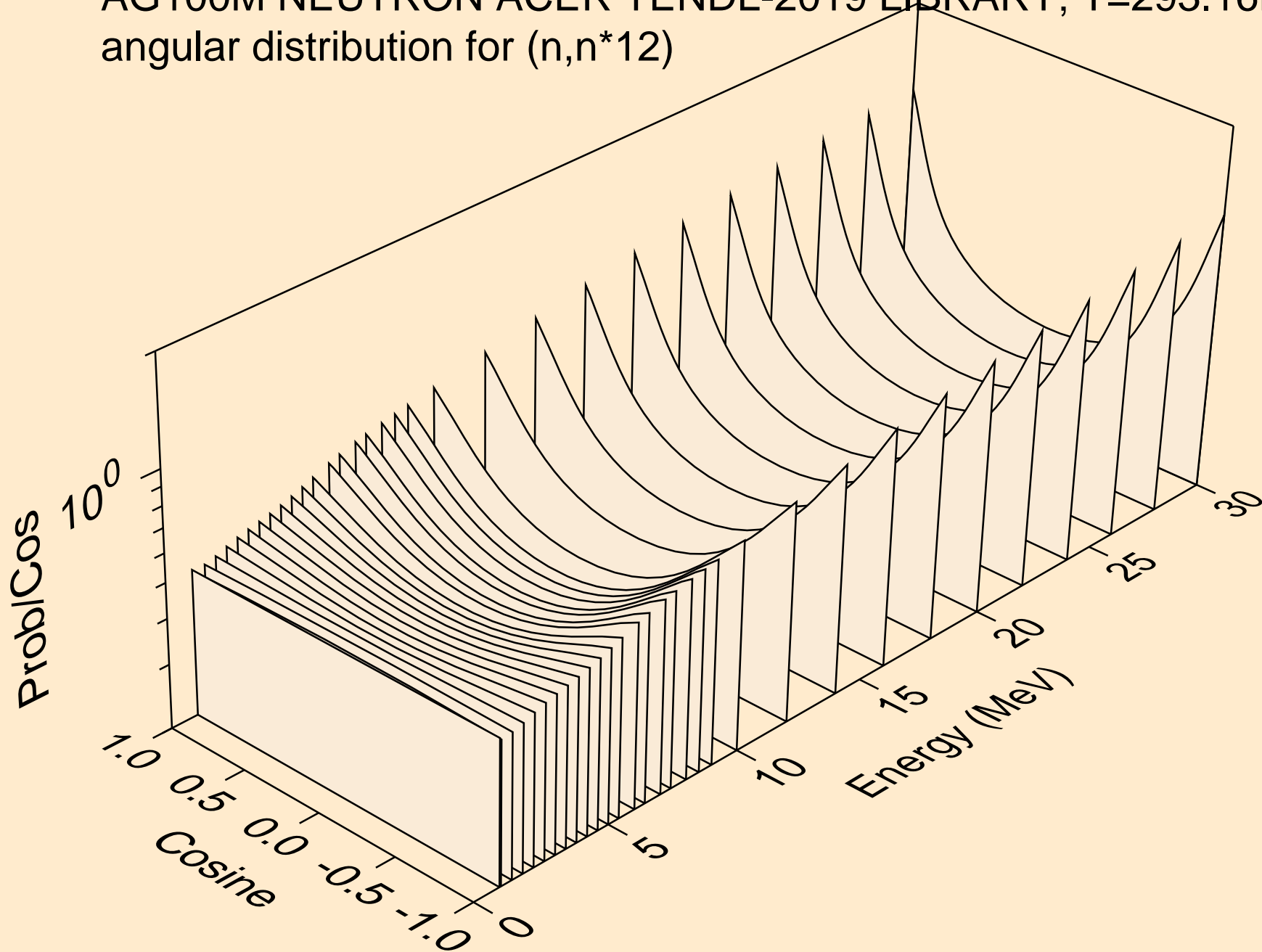

AG100M NEUTRON ACER TENDL-2019 LIBRARY; T=293.16K
angular distribution for (n,n*13)

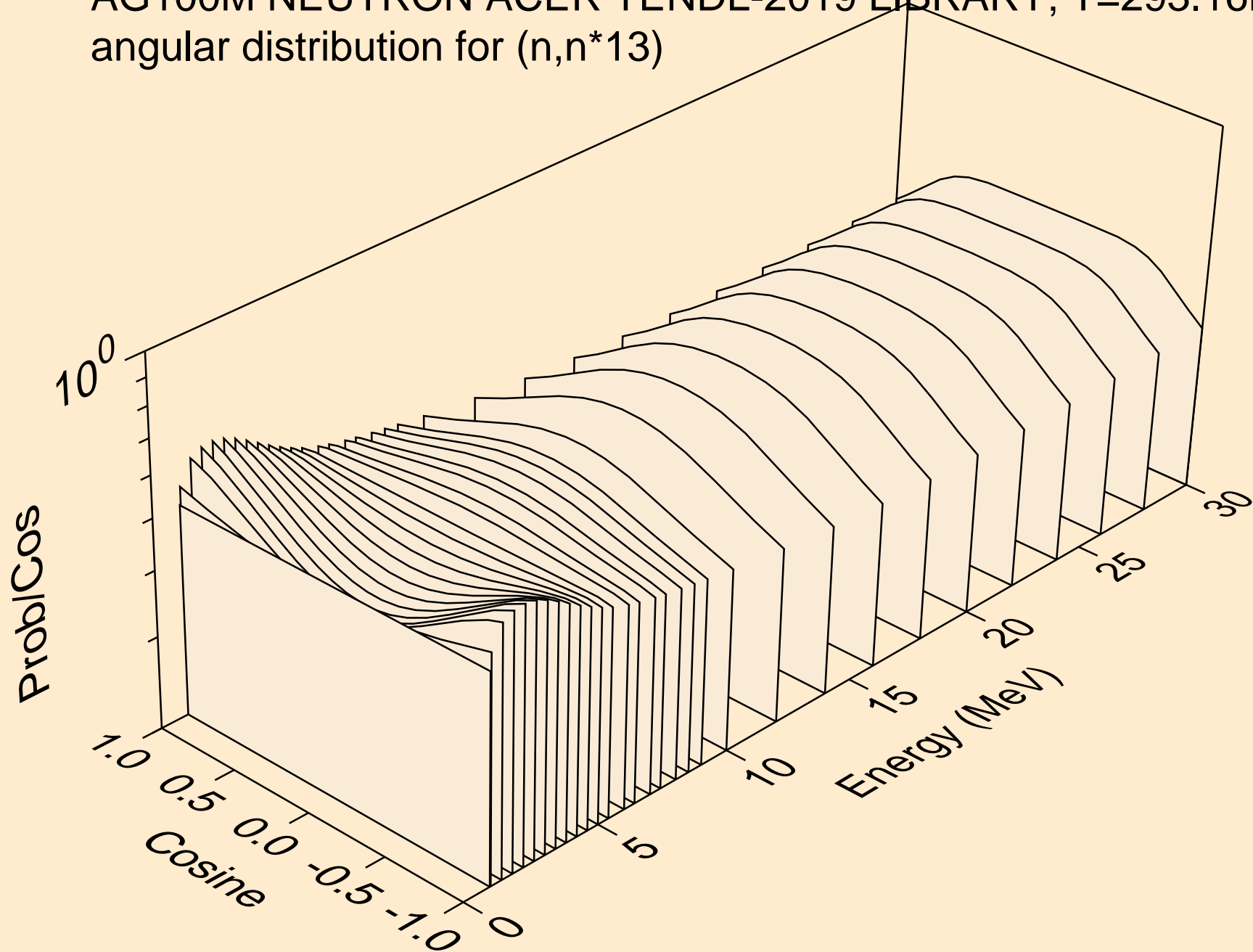

AG100M NEUTRON ACER TENDL-2019 LIBRARY; T=293.16K
angular distribution for (n,n*14)

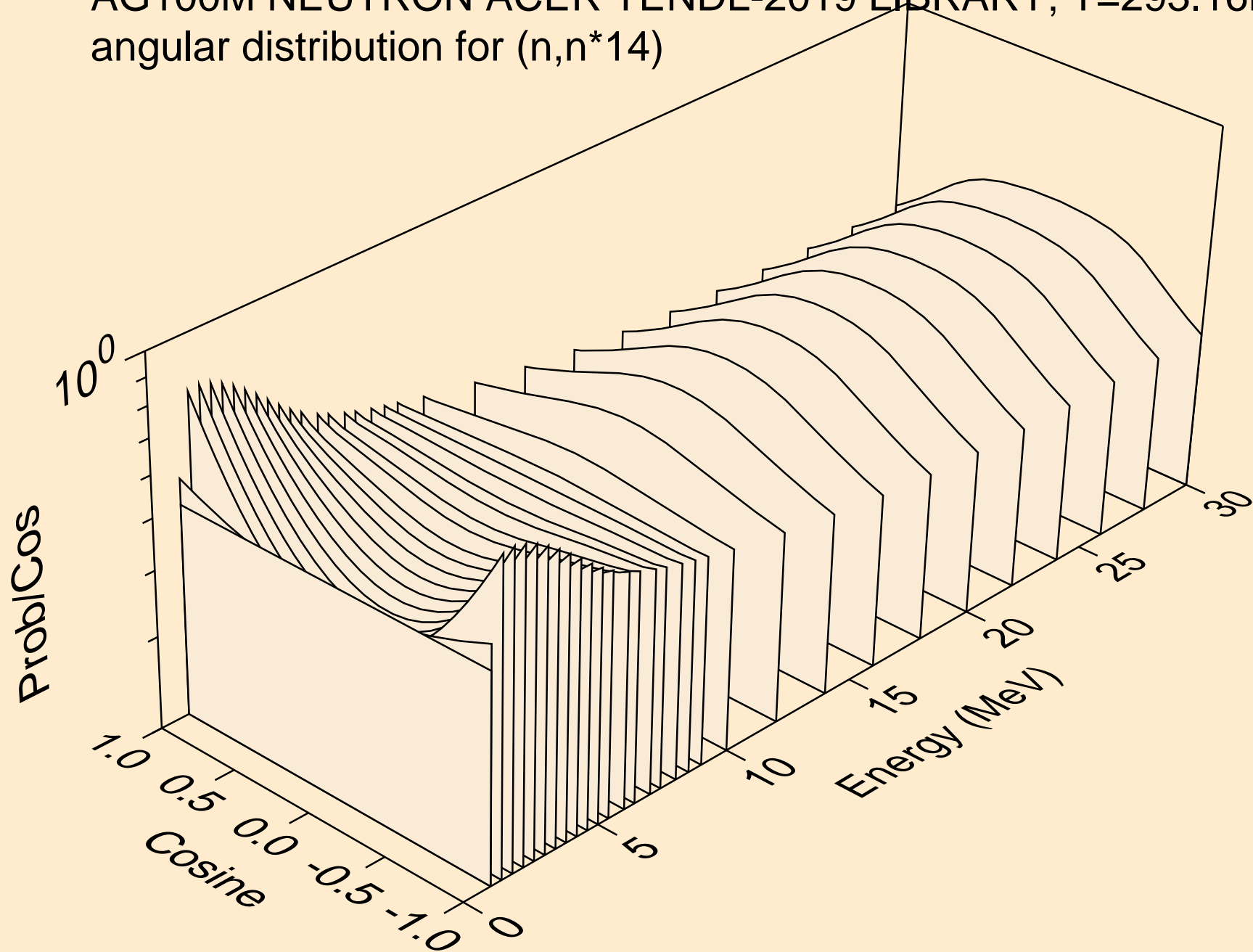

AG100M NEUTRON ACER TENDL-2019 LIBRARY; T=293.16K
angular distribution for (n,n*15)

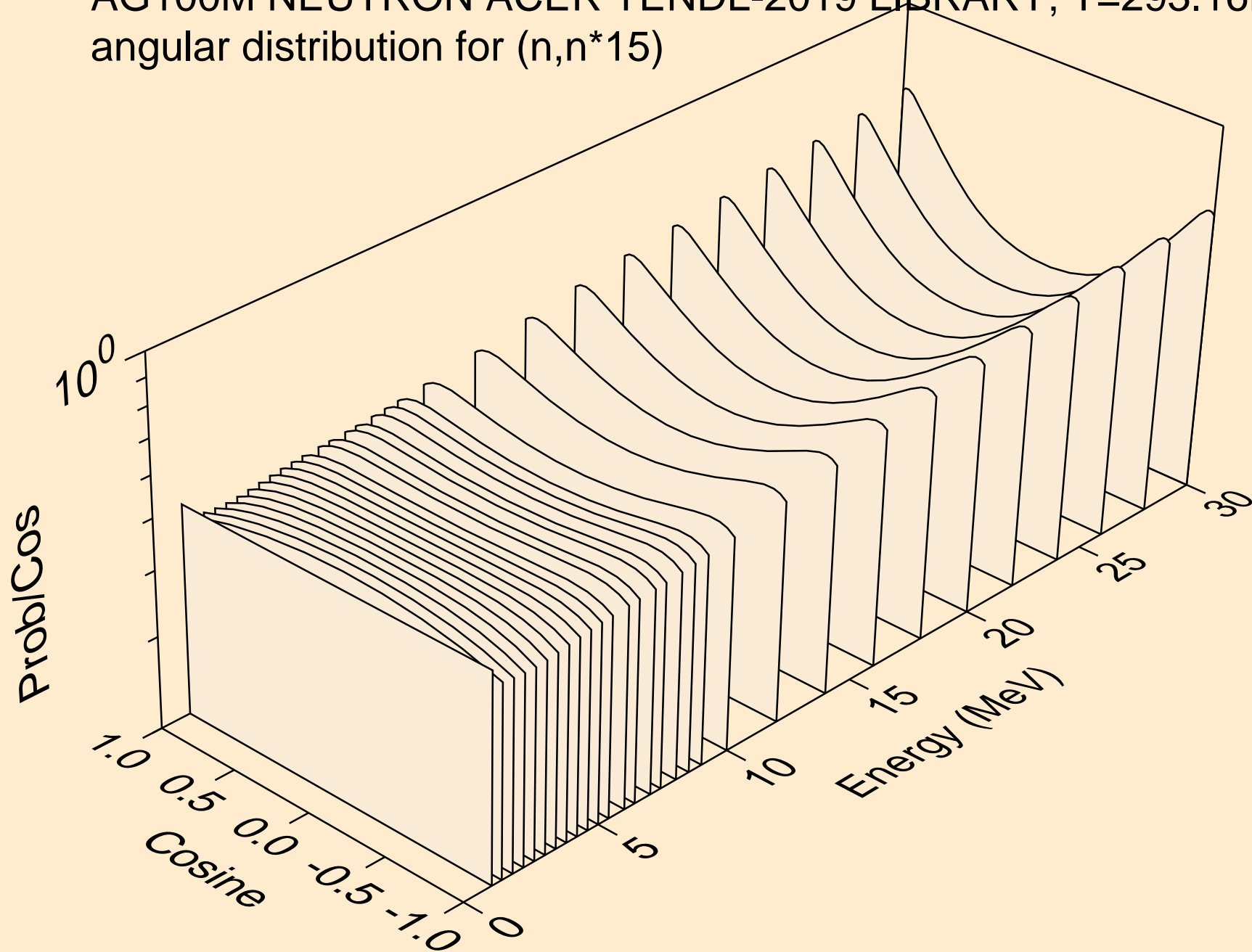

AG100M NEUTRON ACER TENDL-2019 LIBRARY; T=293.16K
angular distribution for (n,n*16)

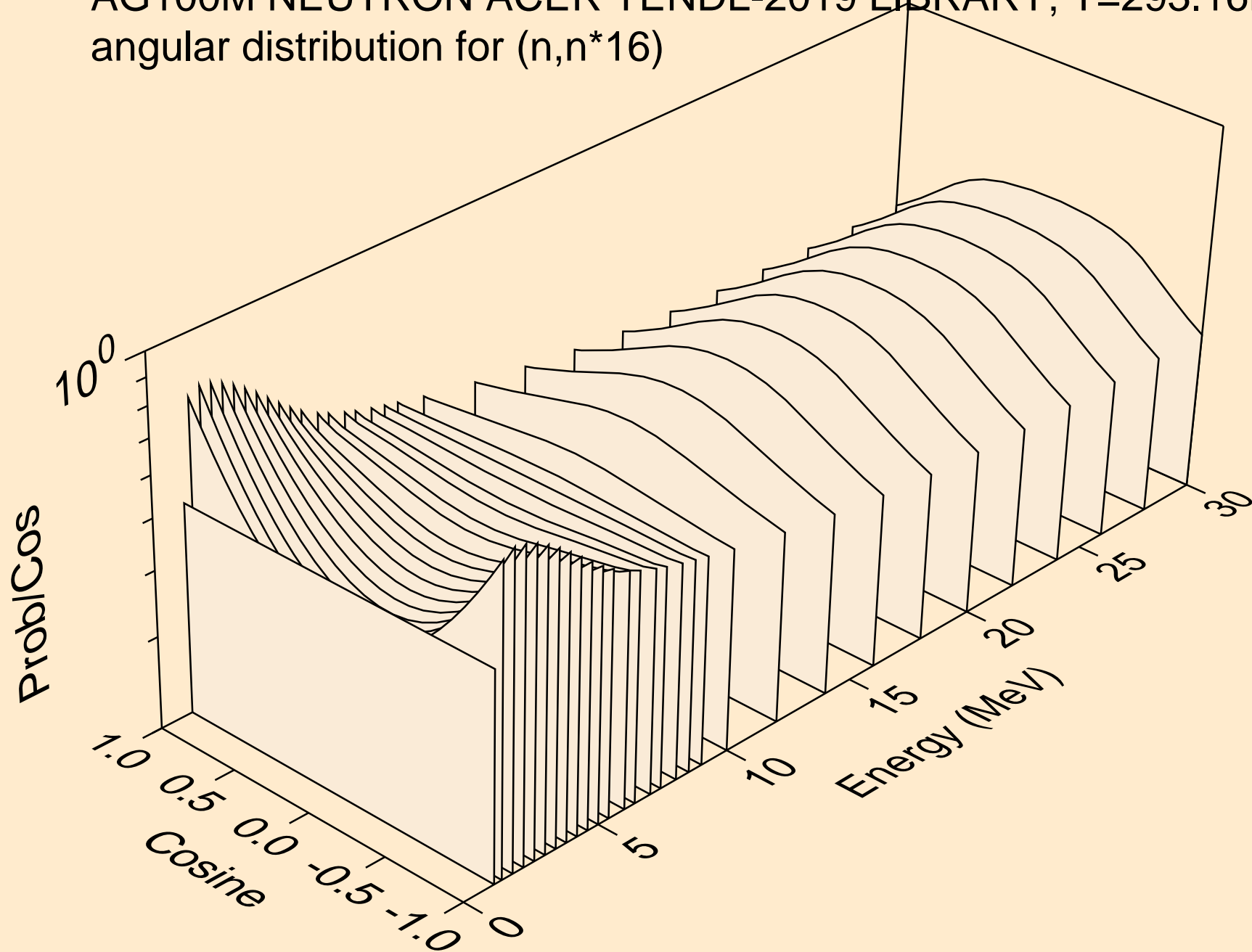

AG100M NEUTRON ACER TENDL-2019 LIBRARY; T=293.16K
angular distribution for (n,n*17)

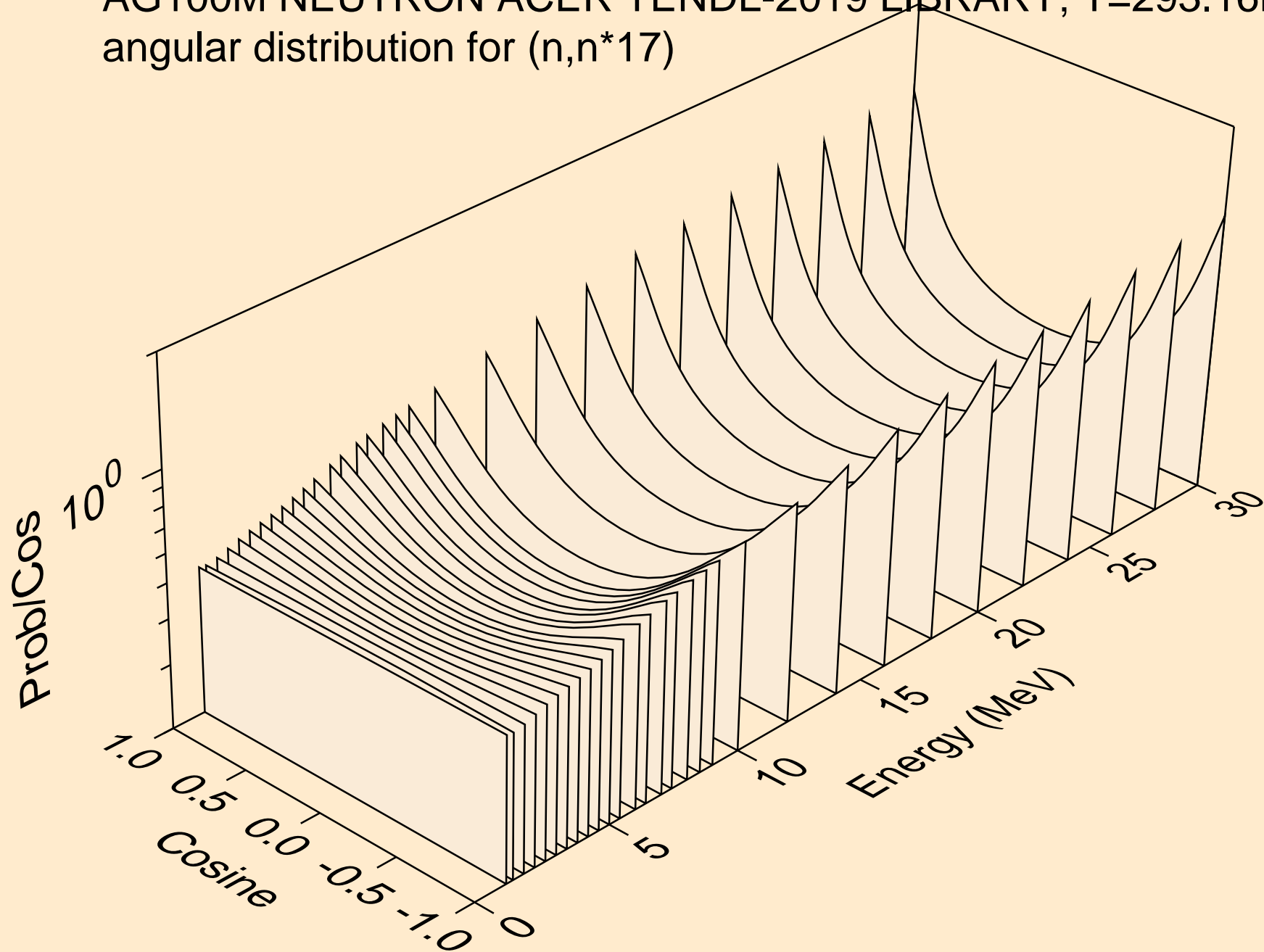

AG100M NEUTRON ACER TENDL-2019 LIBRARY; T=293.16K
angular distribution for (n,n*18)

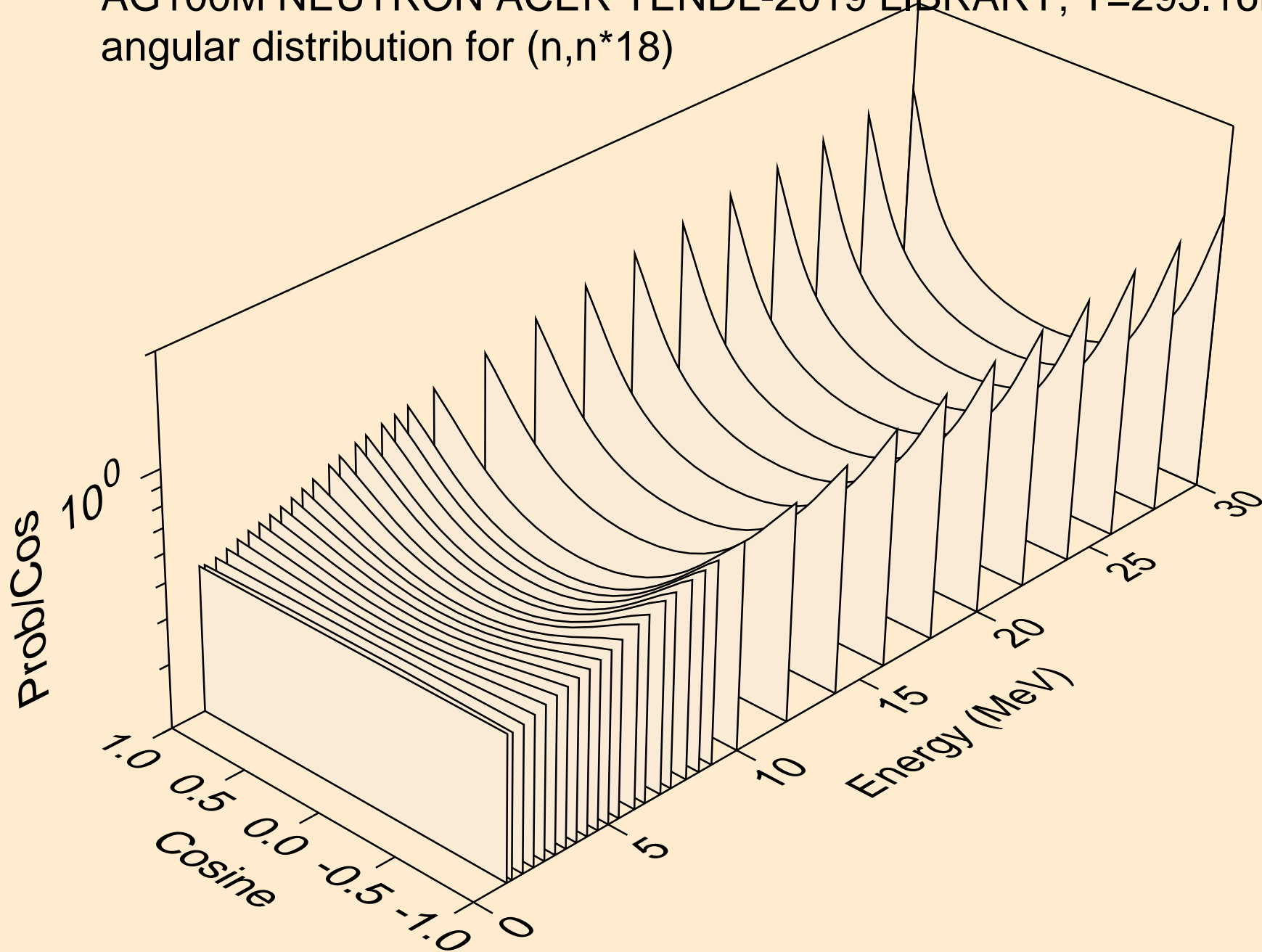

AG100M NEUTRON ACER TENDL-2019 LIBRARY; T=293.16K
angular distribution for (n,n*19)

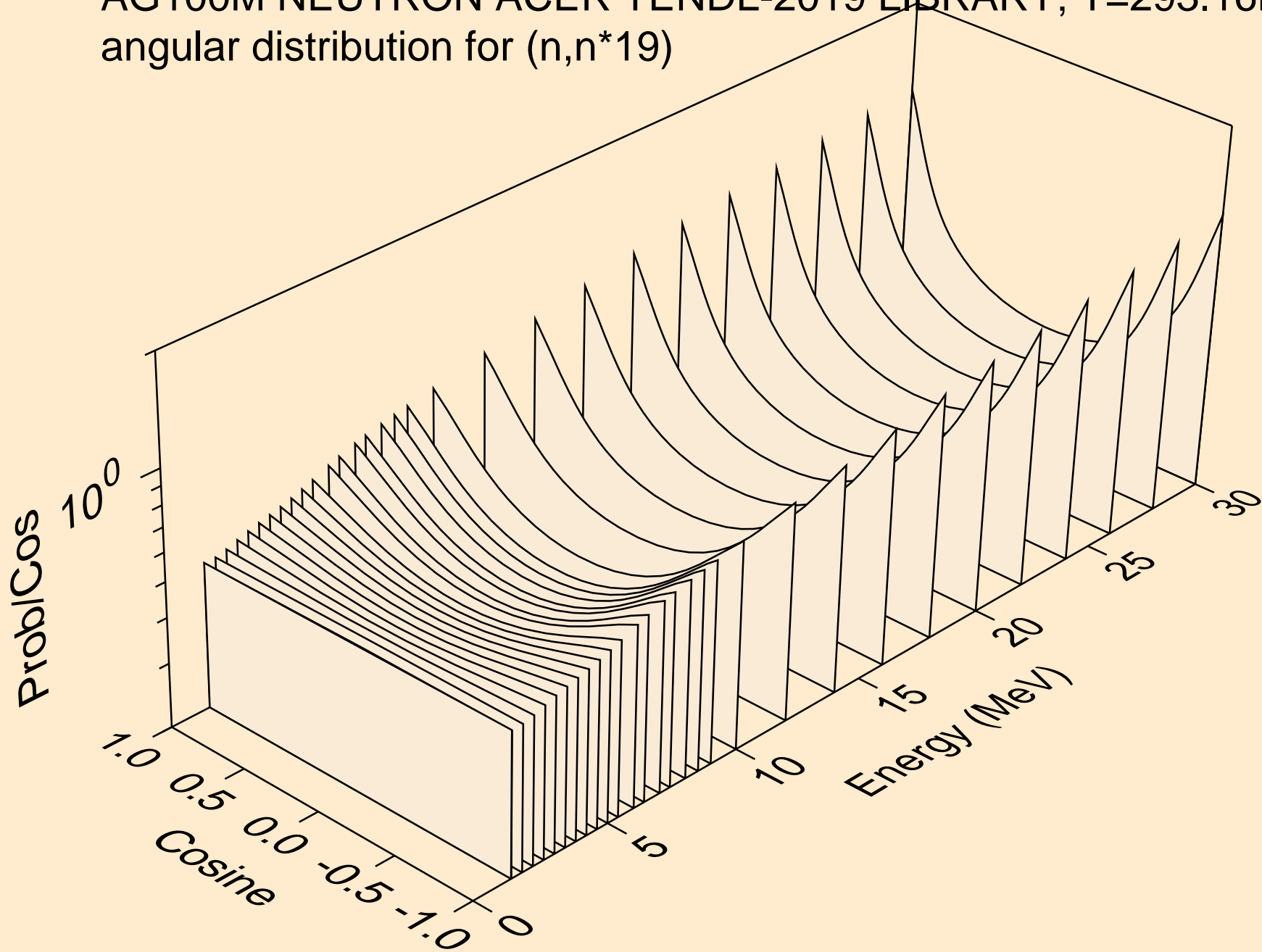

AG100M NEUTRON ACER TENDL-2019 LIBRARY; T=293.16K
angular distribution for (n,n*20)

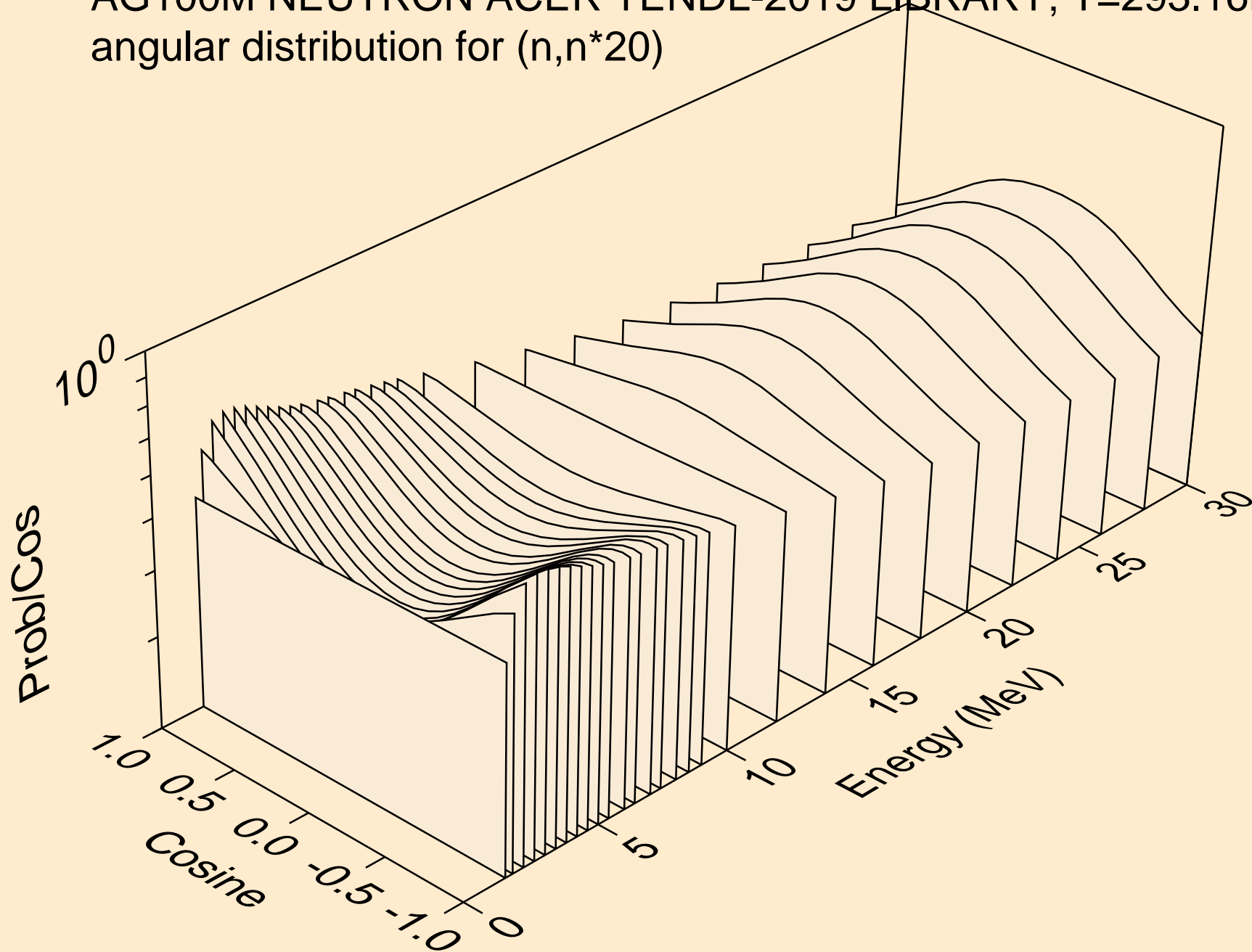

AG100M NEUTRON ACER TENDL-2019 LIBRARY; T=293.16K
angular distribution for (n,n*21)

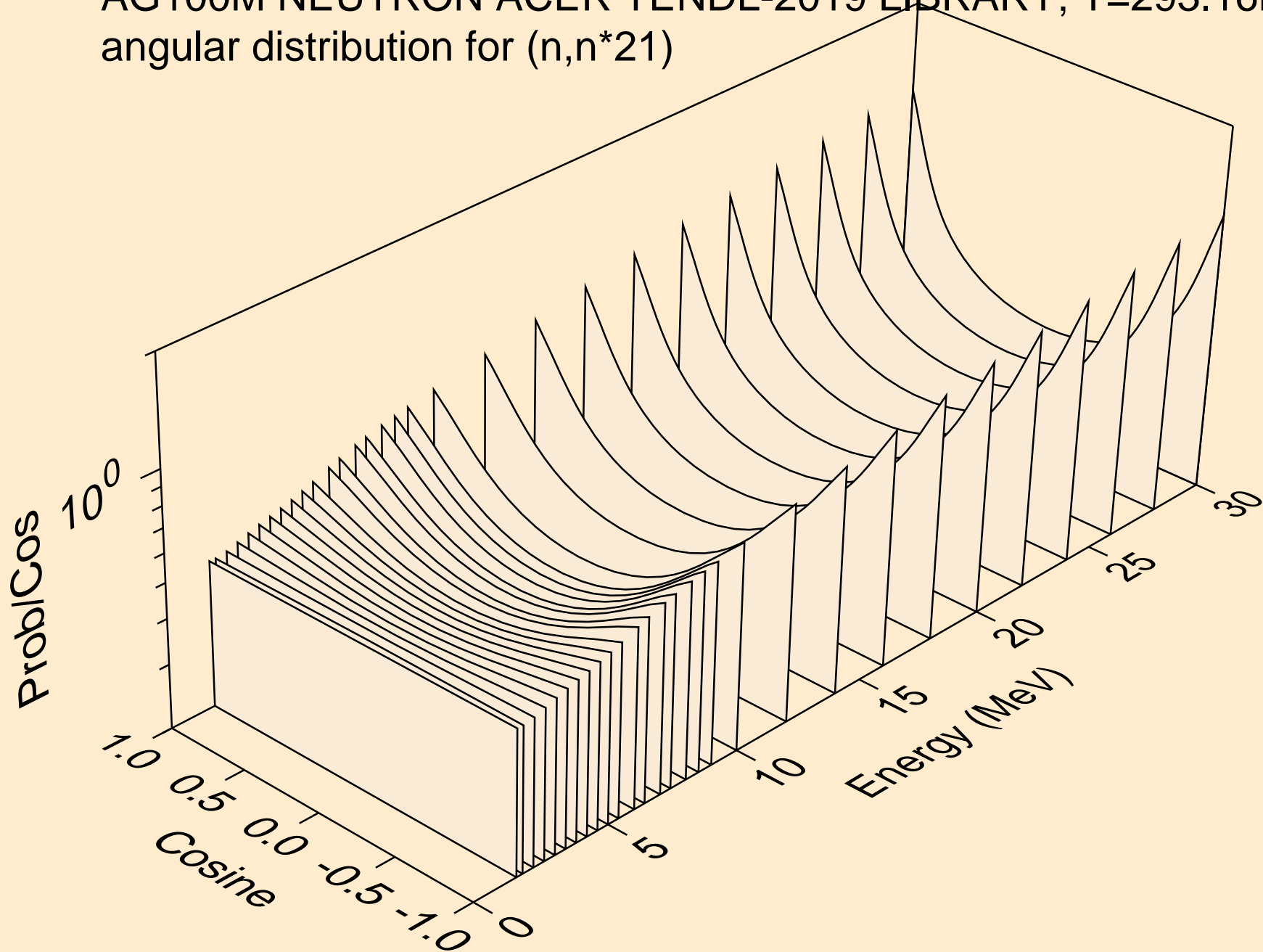

AG100M NEUTRON ACER TENDL-2019 LIBRARY; T=293.16K
angular distribution for (n,n*22)

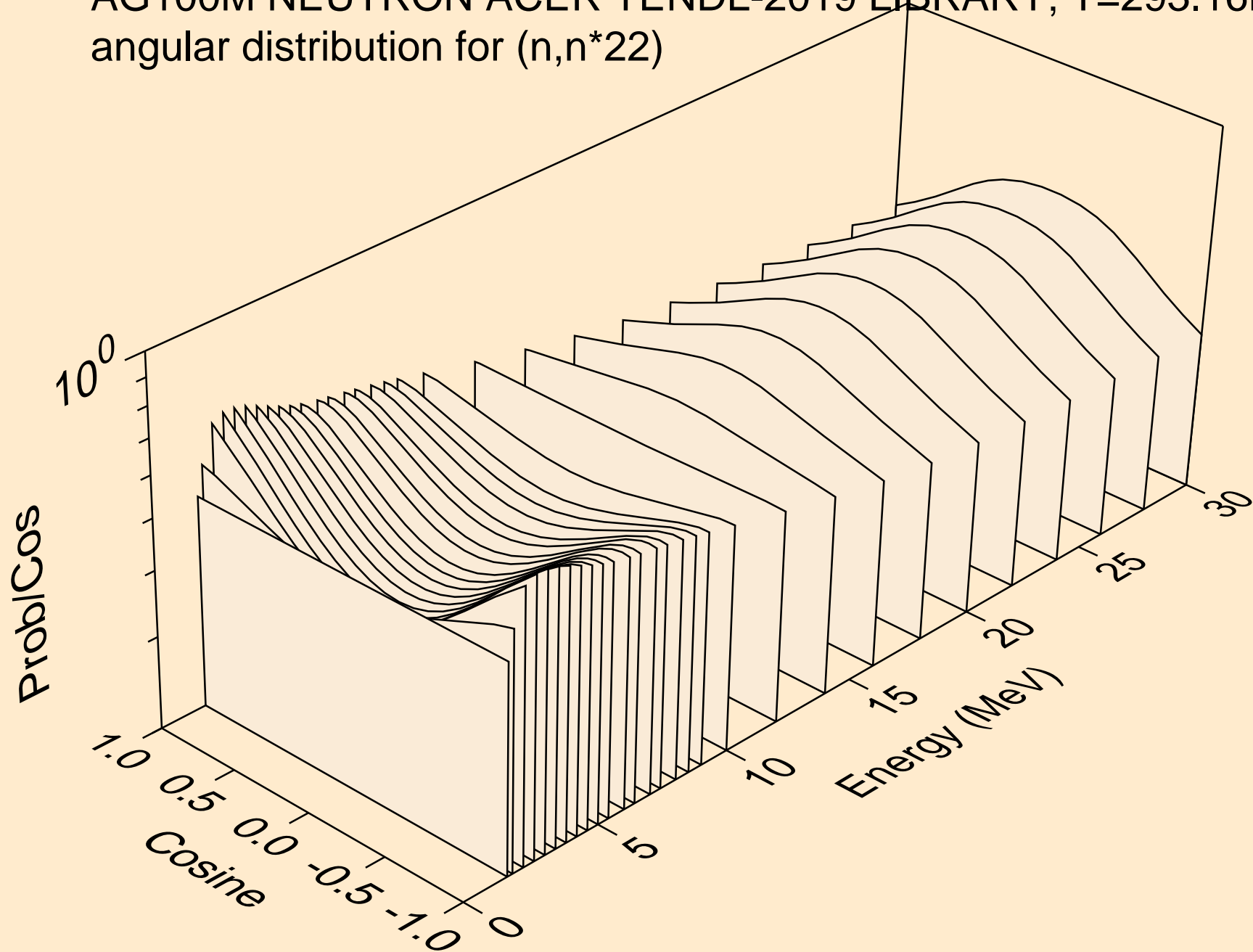

AG100M NEUTRON ACER TENDL-2019 LIBRARY; T=293.16K
angular distribution for (n,n*23)

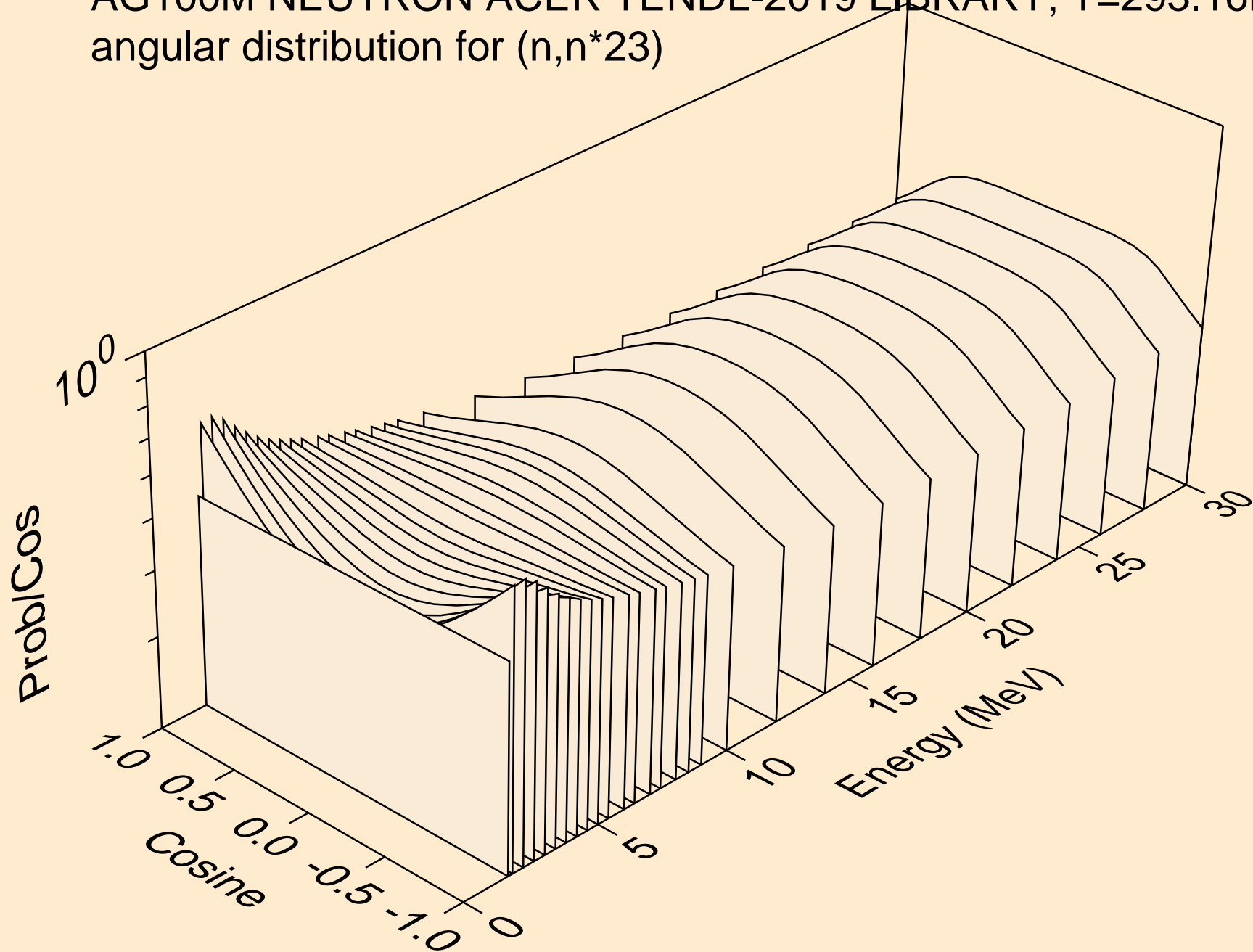

AG100M NEUTRON ACER TENDL-2019 LIBRARY; T=293.16K
angular distribution for (n,n*24)

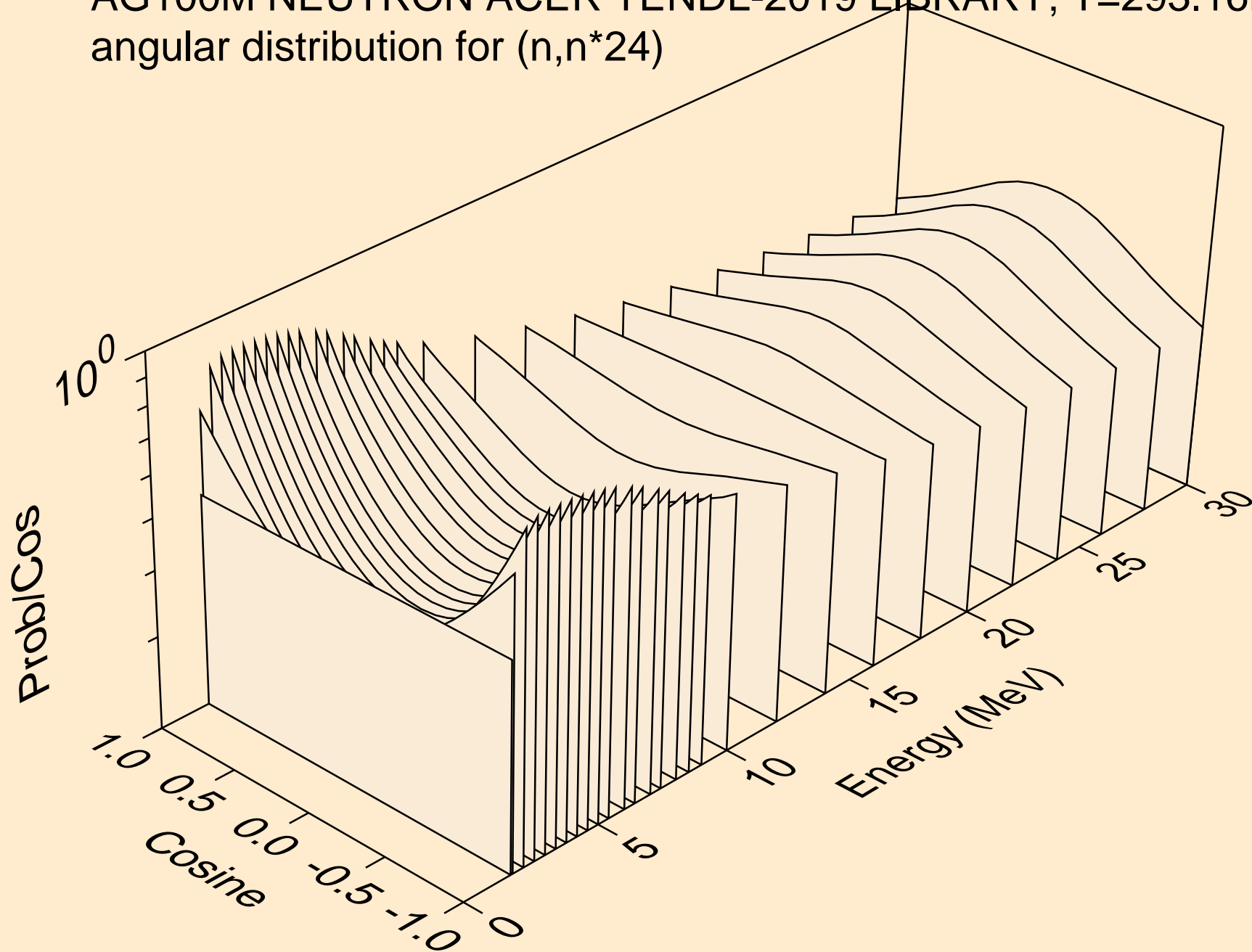

AG100M NEUTRON ACER TENDL-2019 LIBRARY; T=293.16K
angular distribution for (n,n*25)

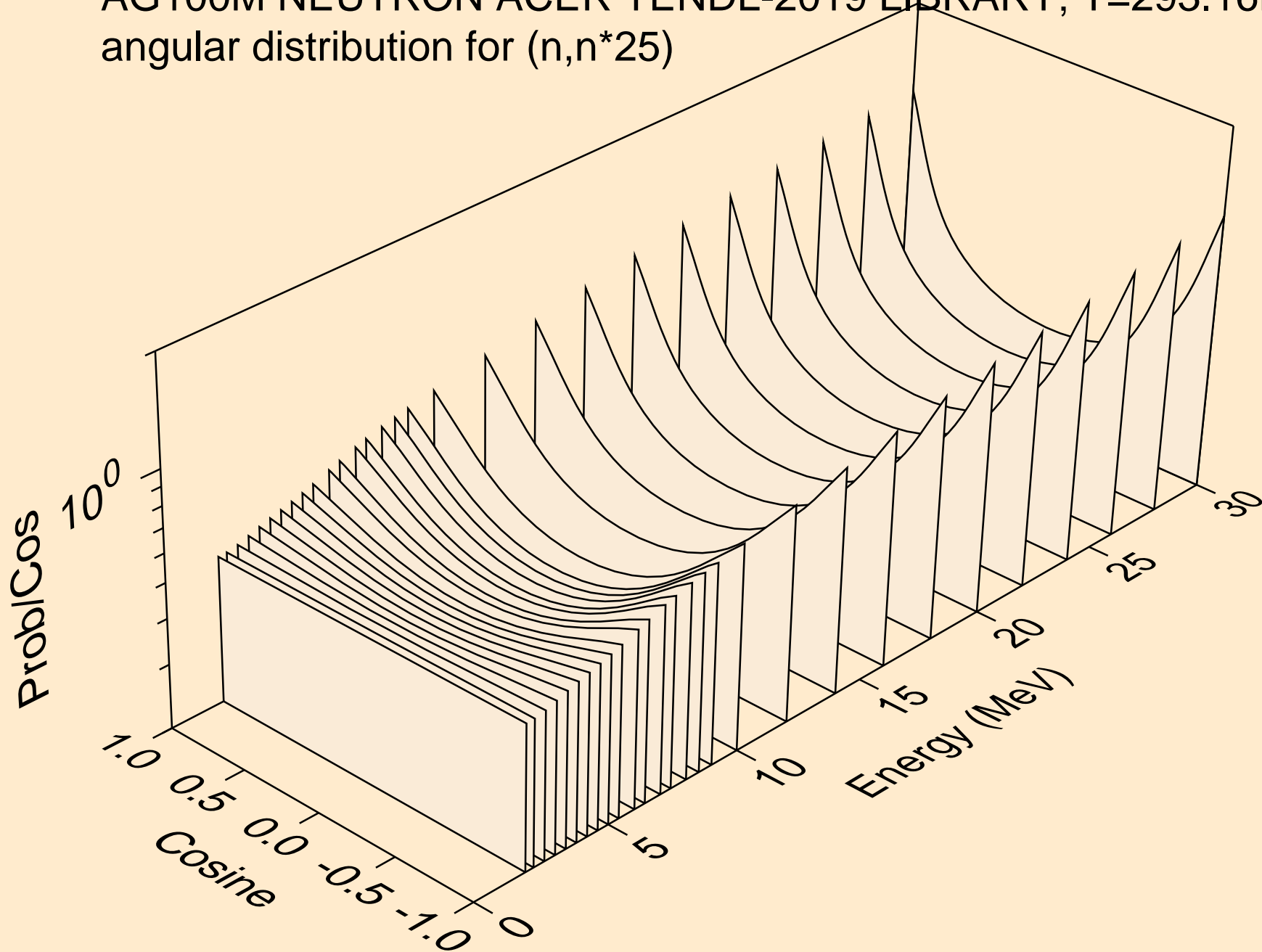

AG100M NEUTRON ACER TENDL-2019 LIBRARY; T=293.16K
angular distribution for (n,n*26)

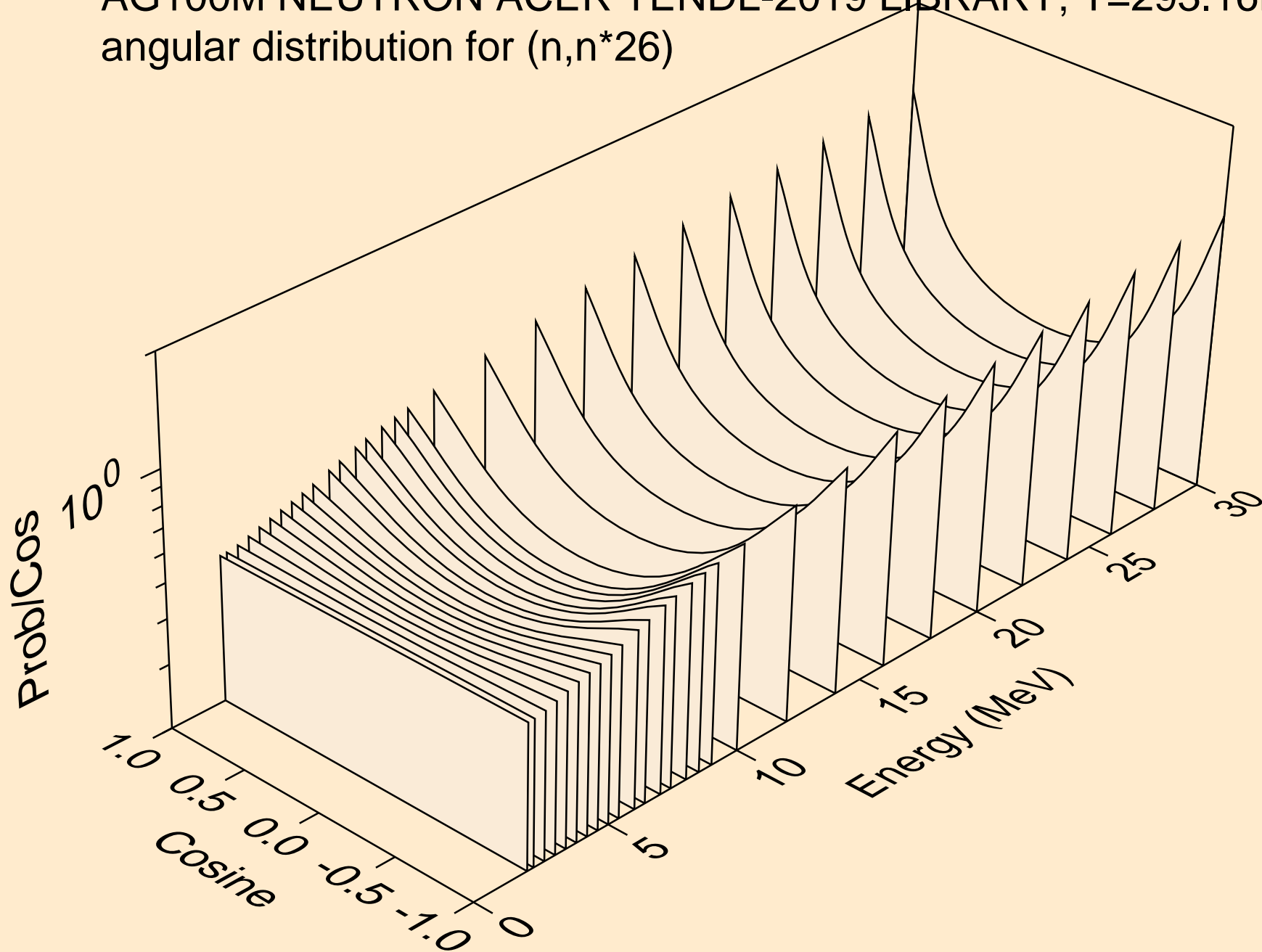

AG100M NEUTRON ACER TENDL-2019 LIBRARY; T=293.16K
angular distribution for (n,n*27)

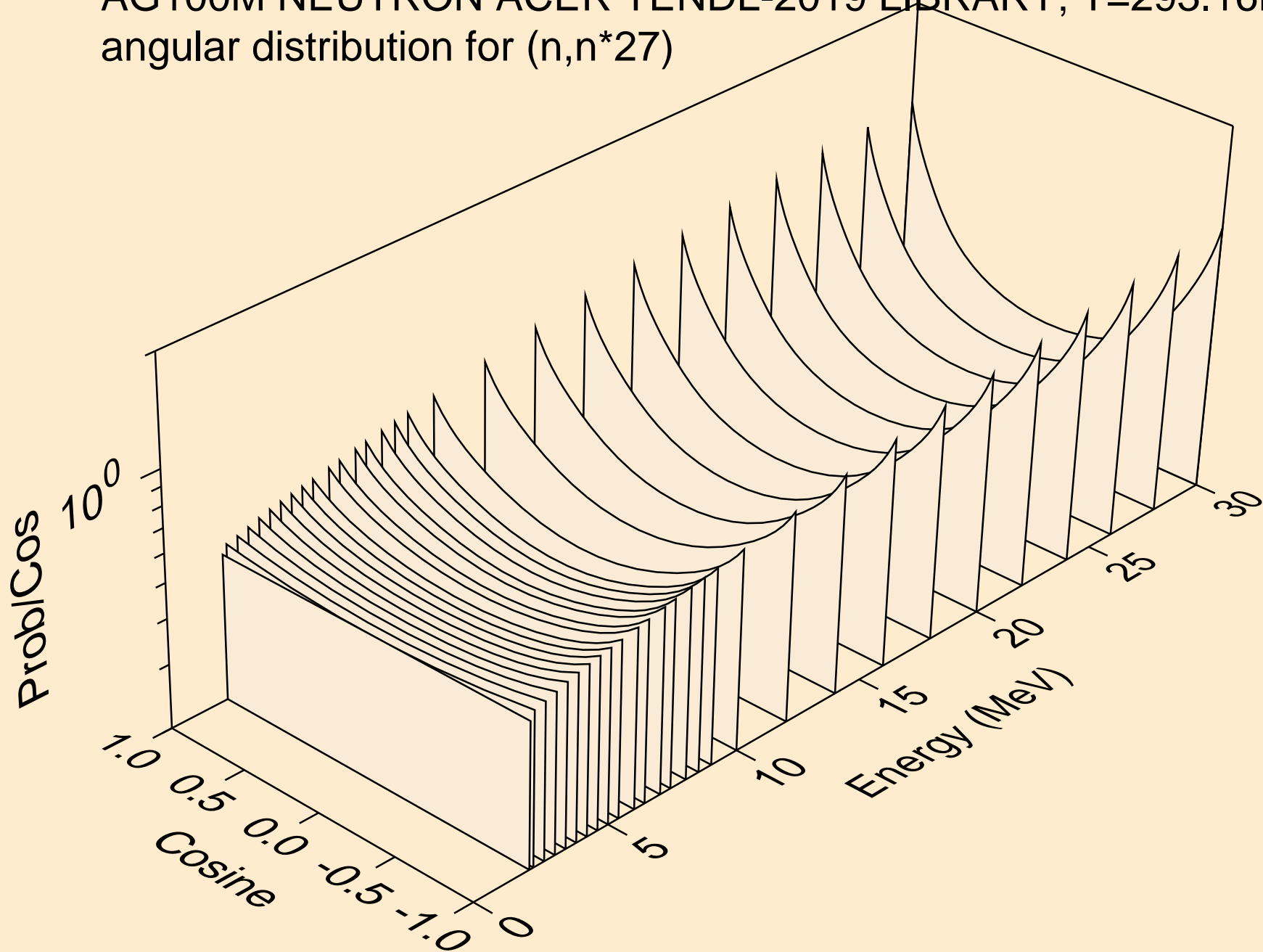

AG100M NEUTRON ACER TENDL-2019 LIBRARY; T=293.16K
Neutron emission for (n,x)

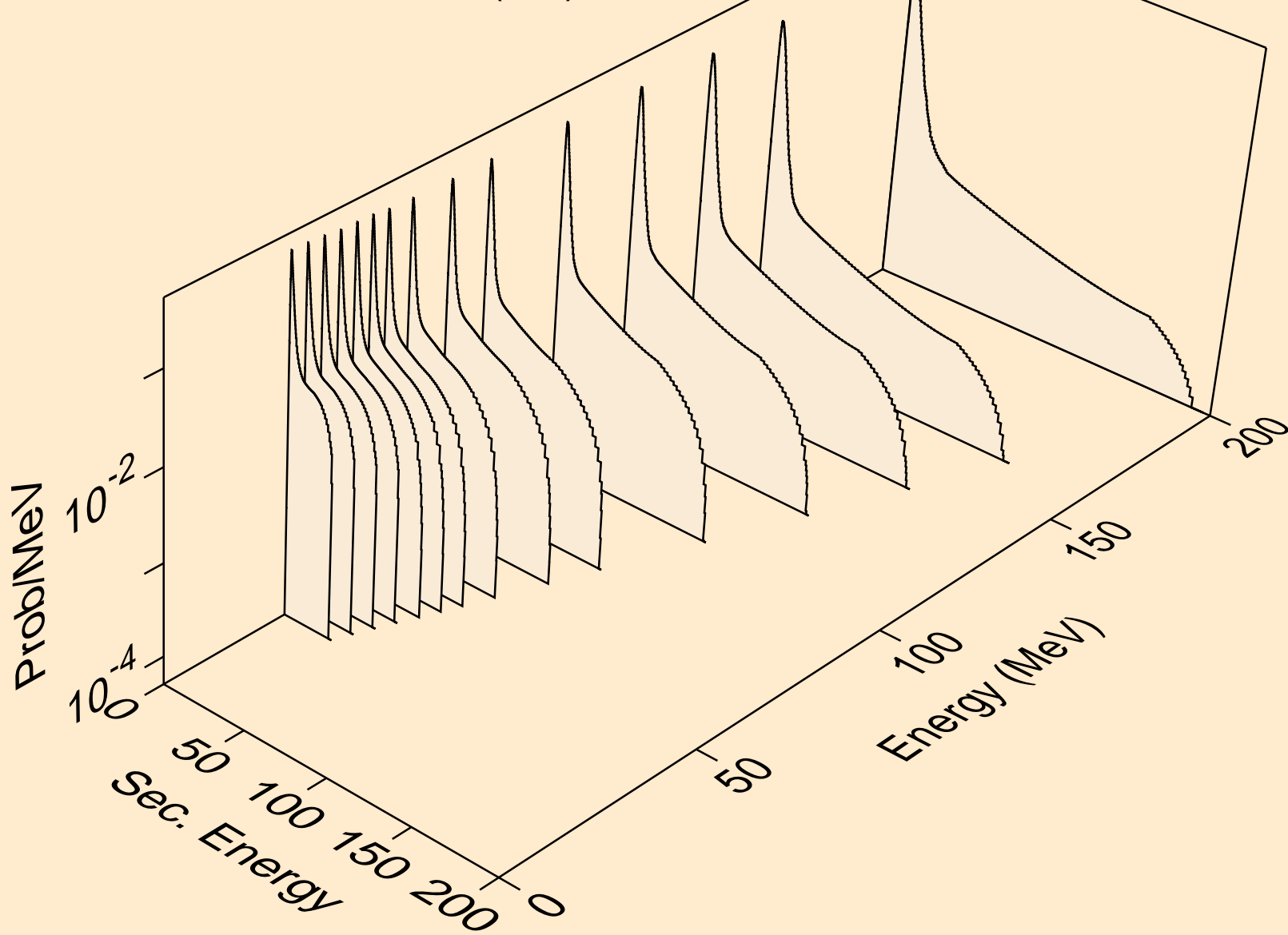

AG100M NEUTRON ACER TENDL-2019 LIBRARY; T=293.16K
Neutron emission for (n,2nd)

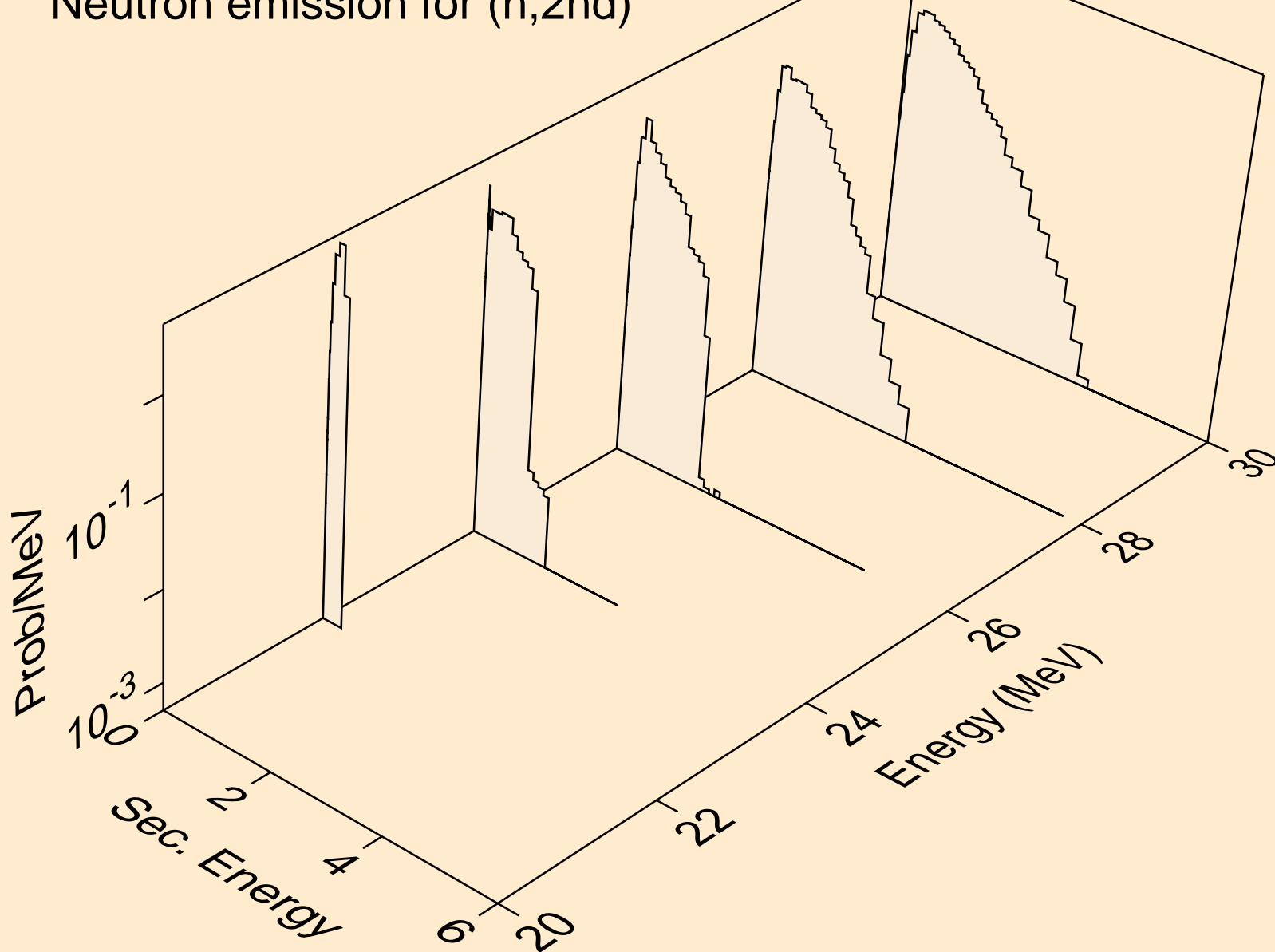

AG100M NEUTRON ACER TENDL-2019 LIBRARY; T=293.16K
Neutron emission for (n,2n)

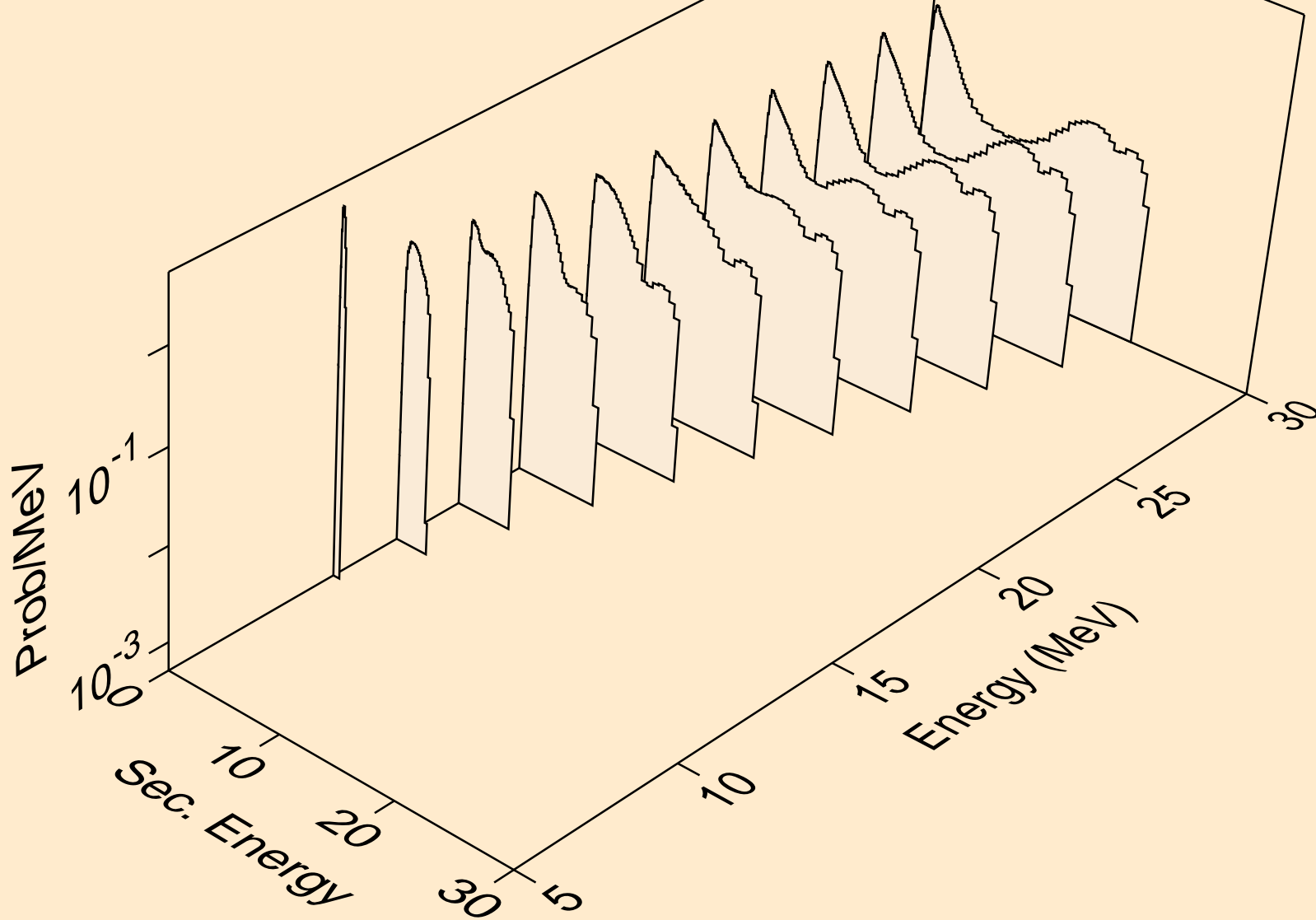

AG100M NEUTRON ACER TENDL-2019 LIBRARY; T=293.16K
Neutron emission for (n,3n)

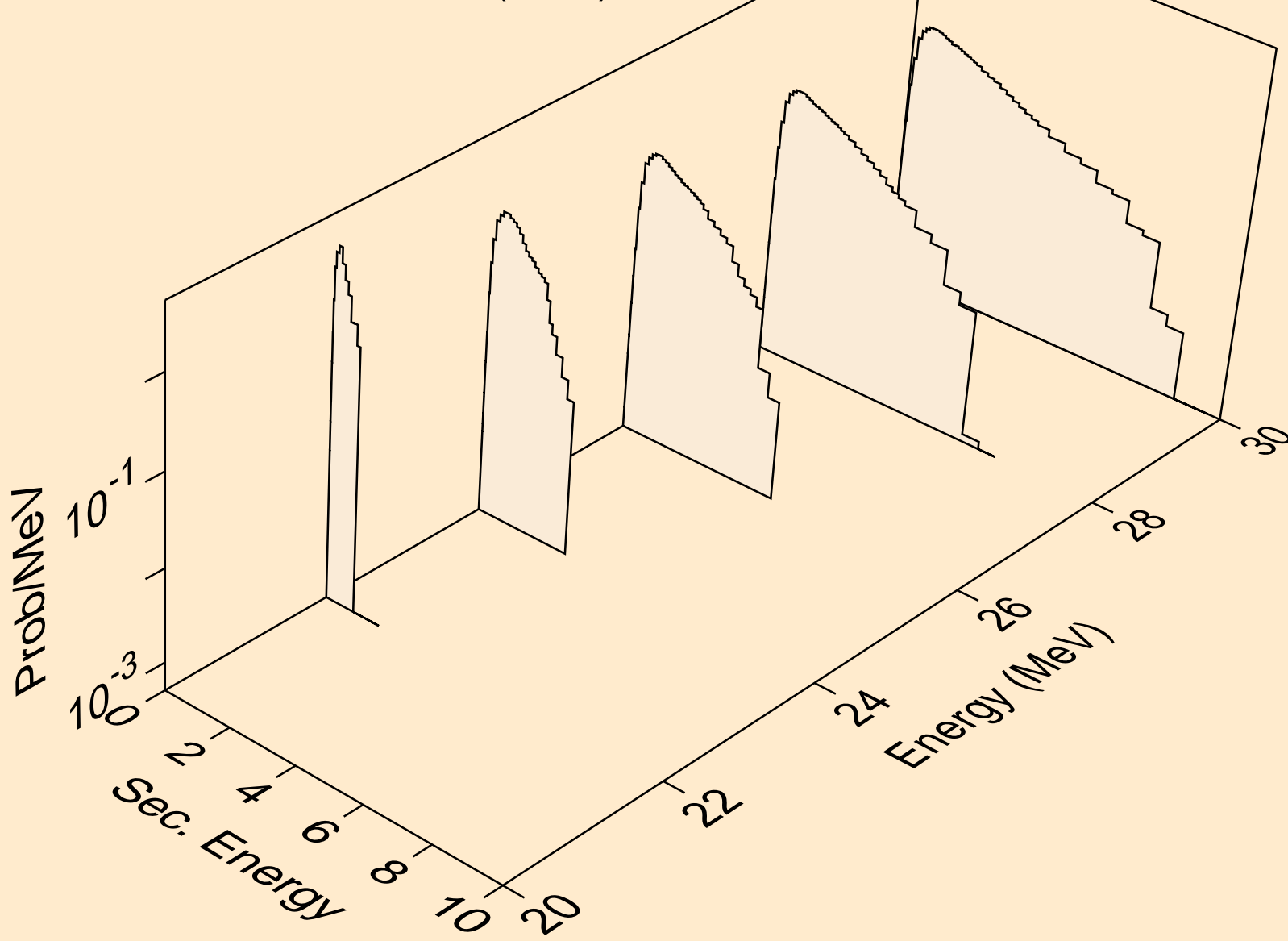

AG100M NEUTRON ACER TENDL-2019 LIBRARY; T=293.16K
Neutron emission for (n,n*)a

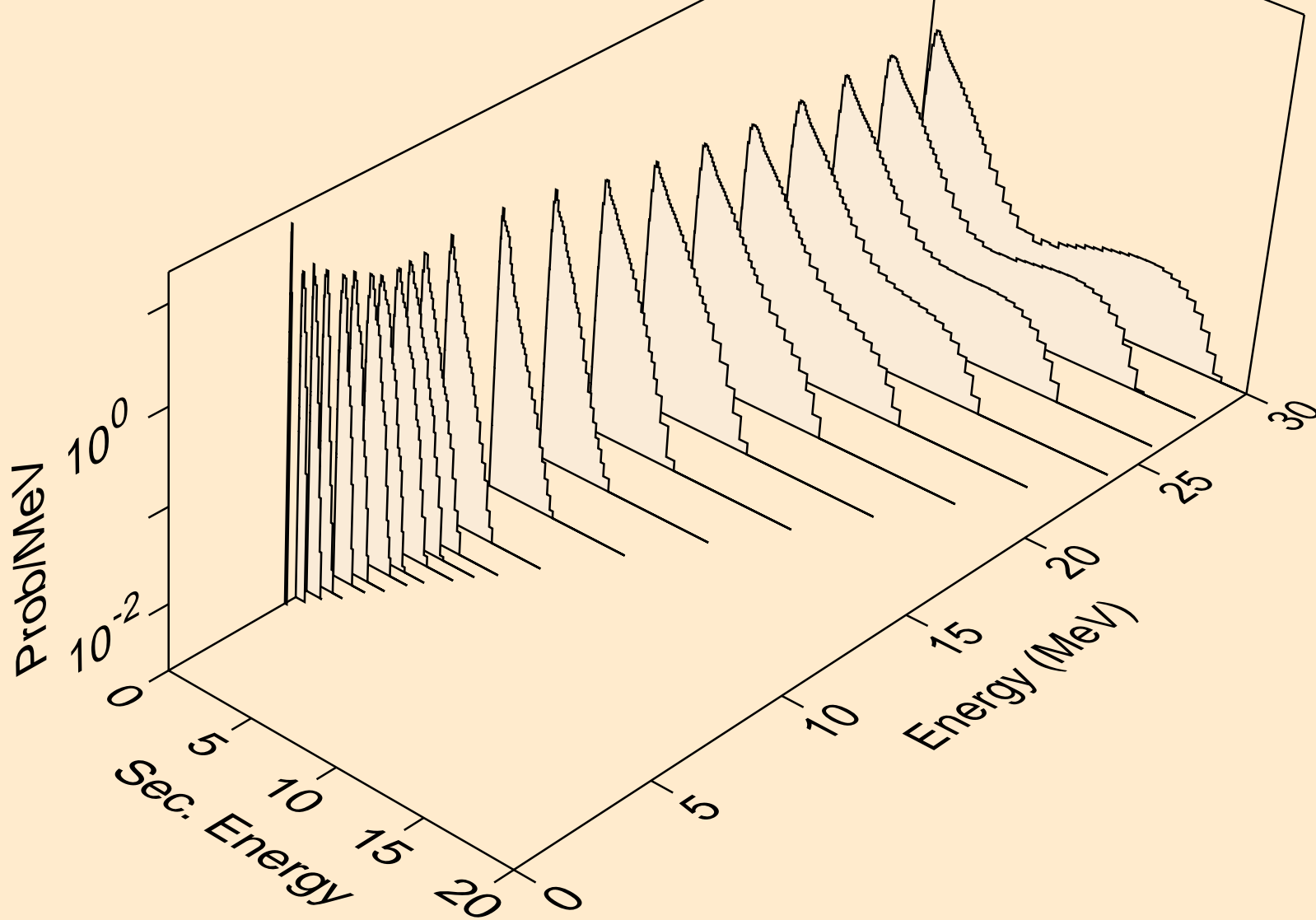

AG100M NEUTRON ACER TENDL-2019 LIBRARY; T=293.16K
Neutron emission for (n,2n)a

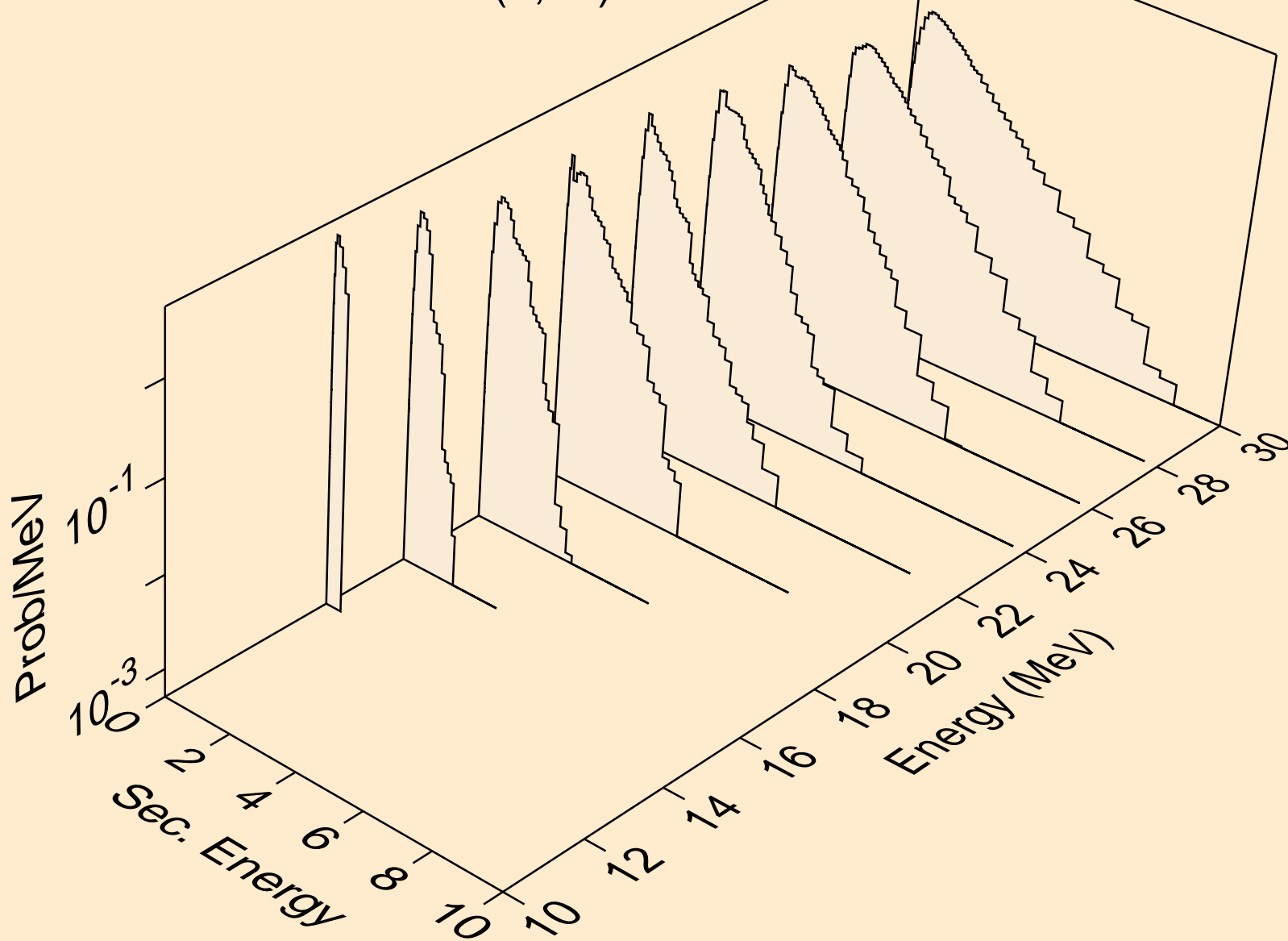

AG100M NEUTRON ACER TENDL-2019 LIBRARY; T=293.16K
Neutron emission for (n,n*)p

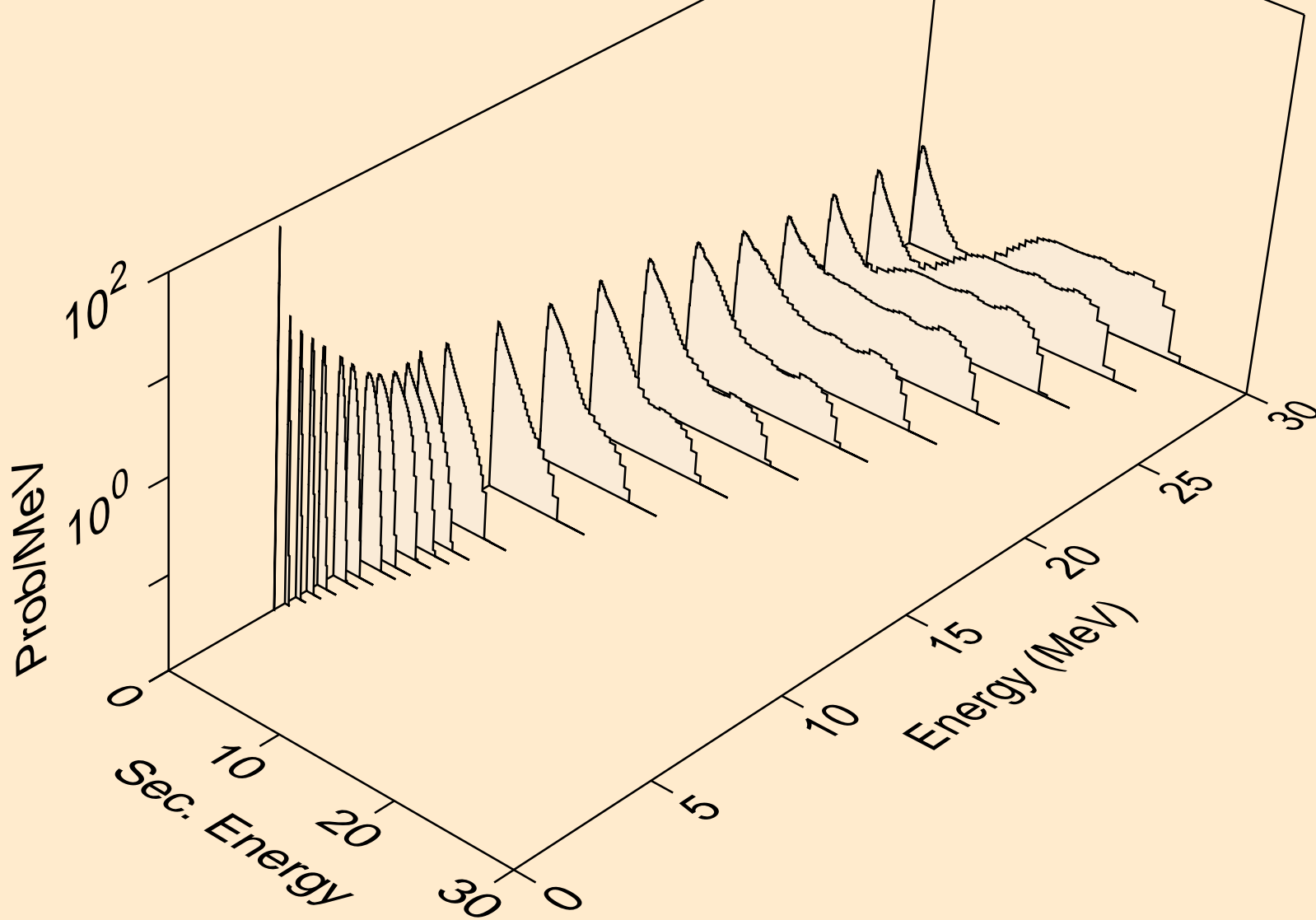

AG100M NEUTRON ACER TENDL-2019 LIBRARY; T=293.16K
Neutron emission for (n,n*)2a

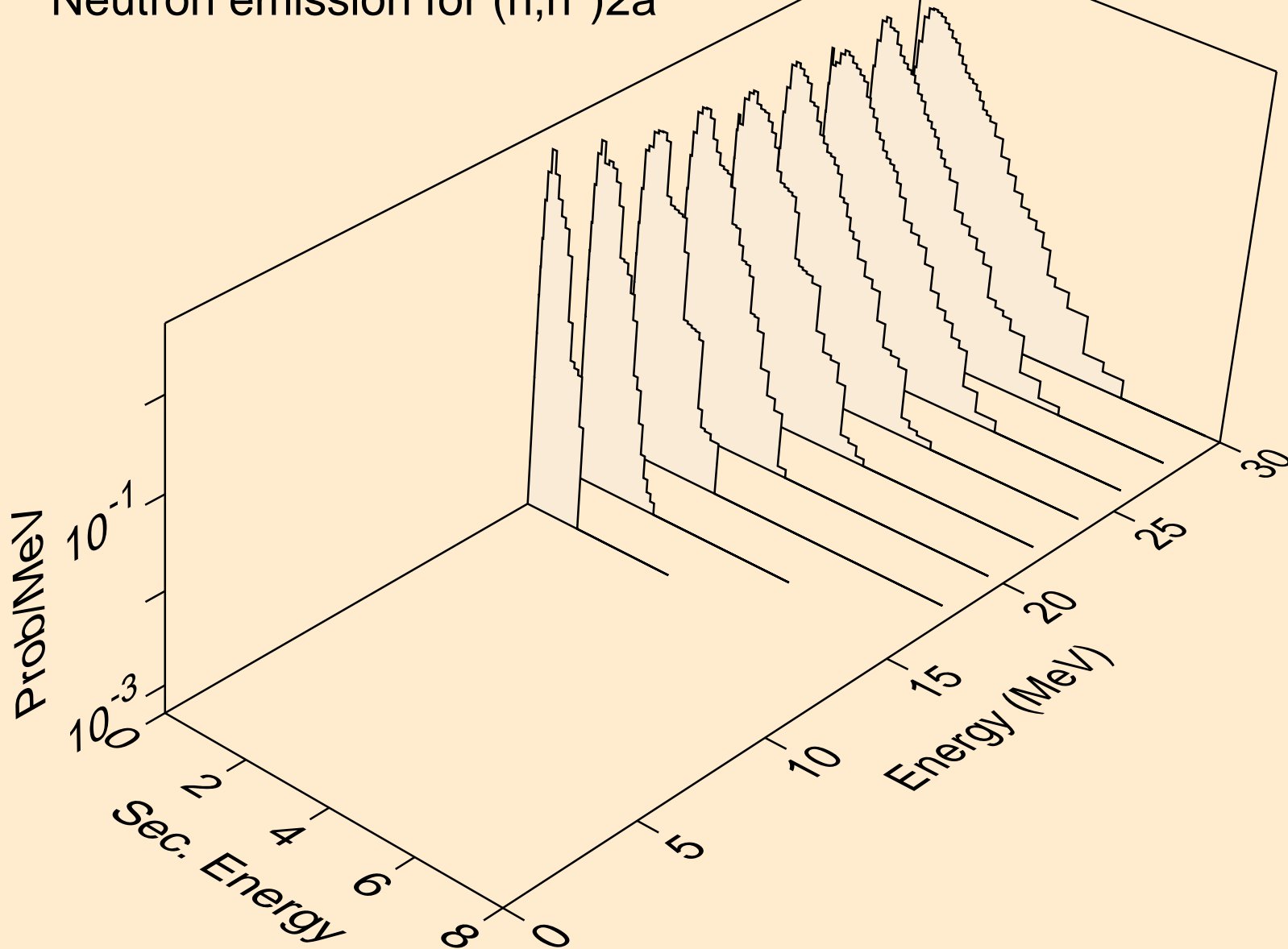

AG100M NEUTRON ACER TENDL-2019 LIBRARY; T=293.16K
Neutron emission for (n,n*)d

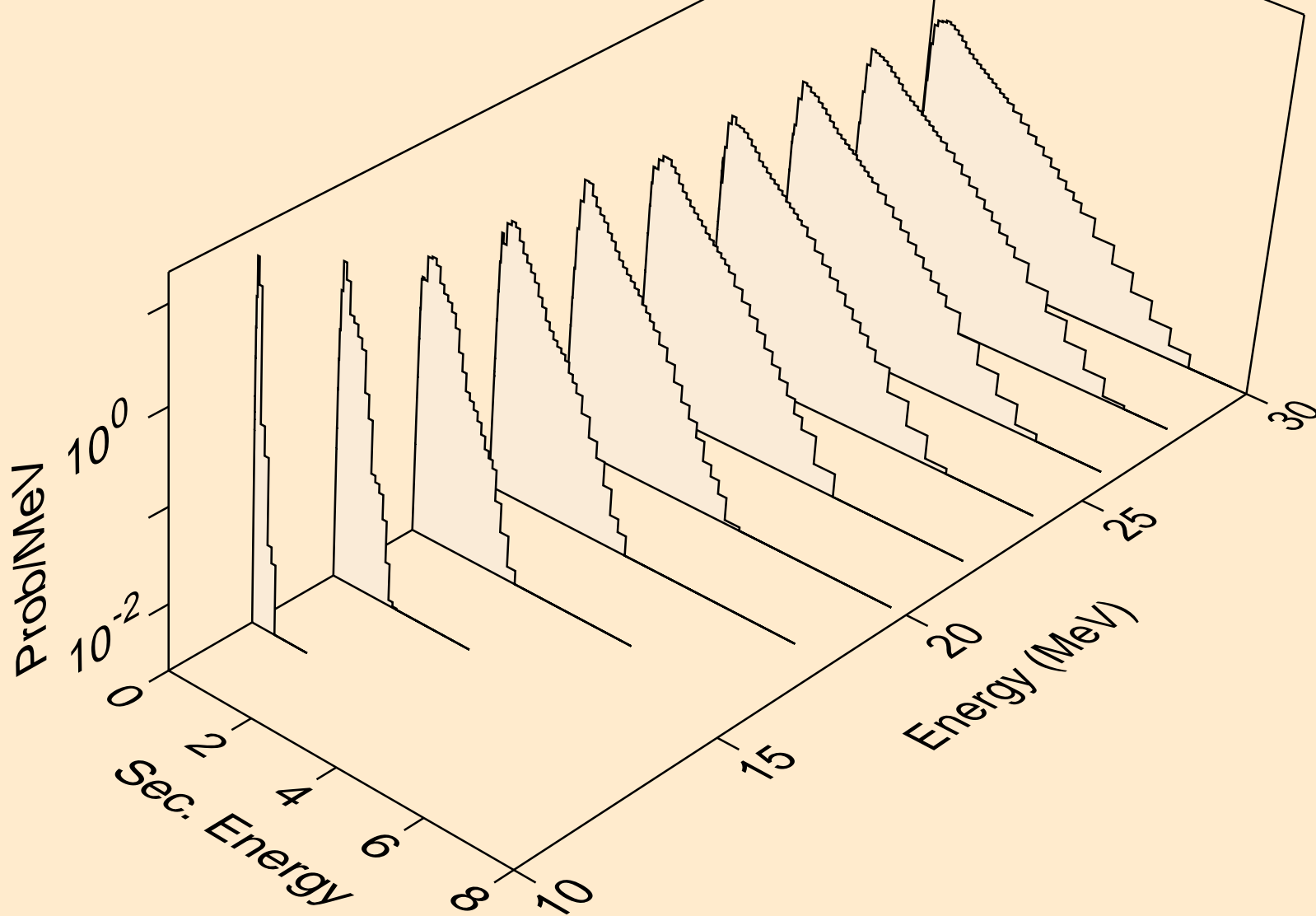

AG100M NEUTRON ACER TENDL-2019 LIBRARY; T=293.16K
Neutron emission for (n,n*)t

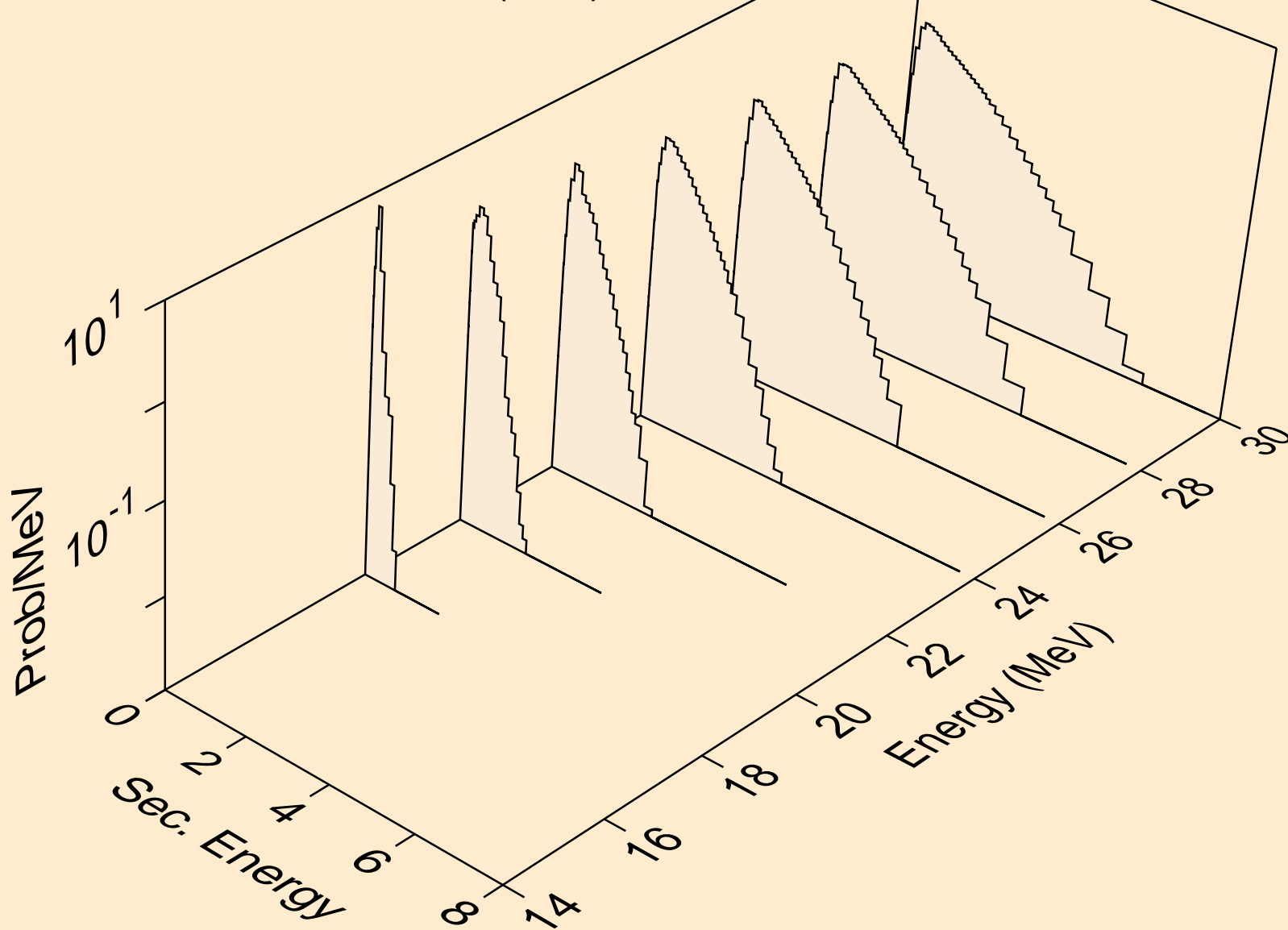

AG100M NEUTRON ACER TENDL-2019 LIBRARY; T=293.16K
Neutron emission for (n,n*)he3

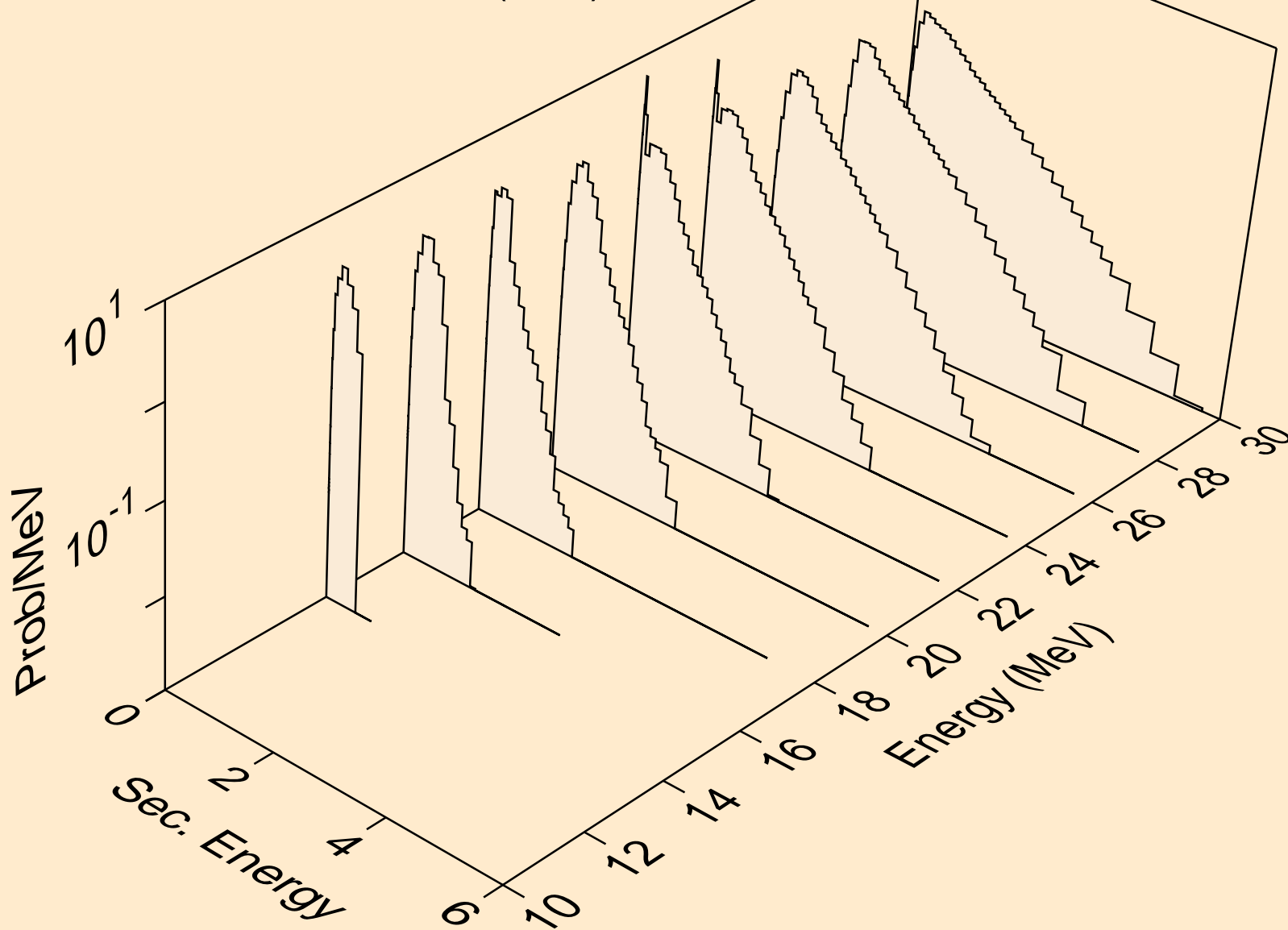

AG100M NEUTRON ACER TENDL-2019 LIBRARY; T=293.16K
Neutron emission for (n,2np)

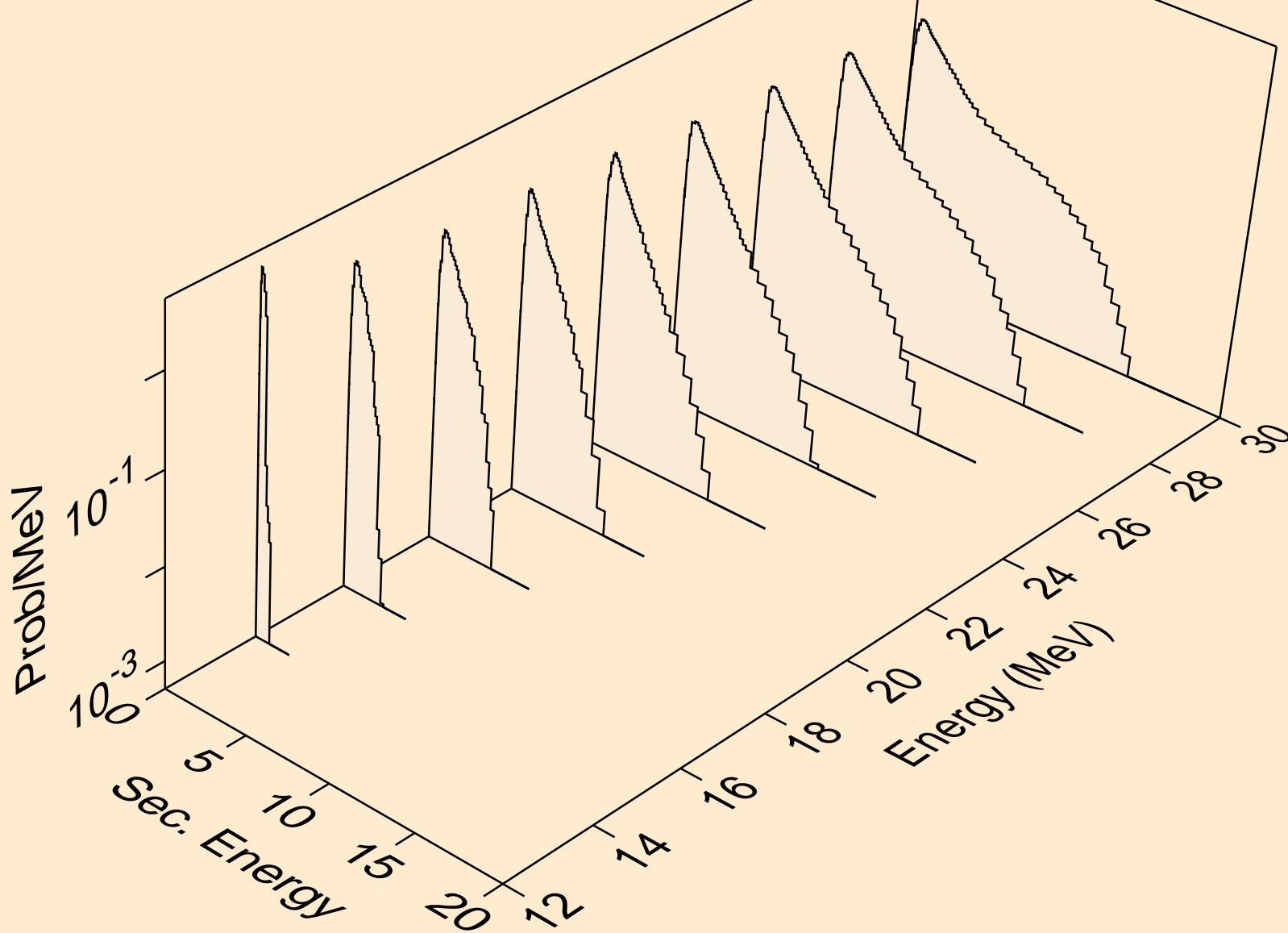

AG100M NEUTRON ACER TENDL-2019 LIBRARY; T=293.16K
Neutron emission for (n,3np)

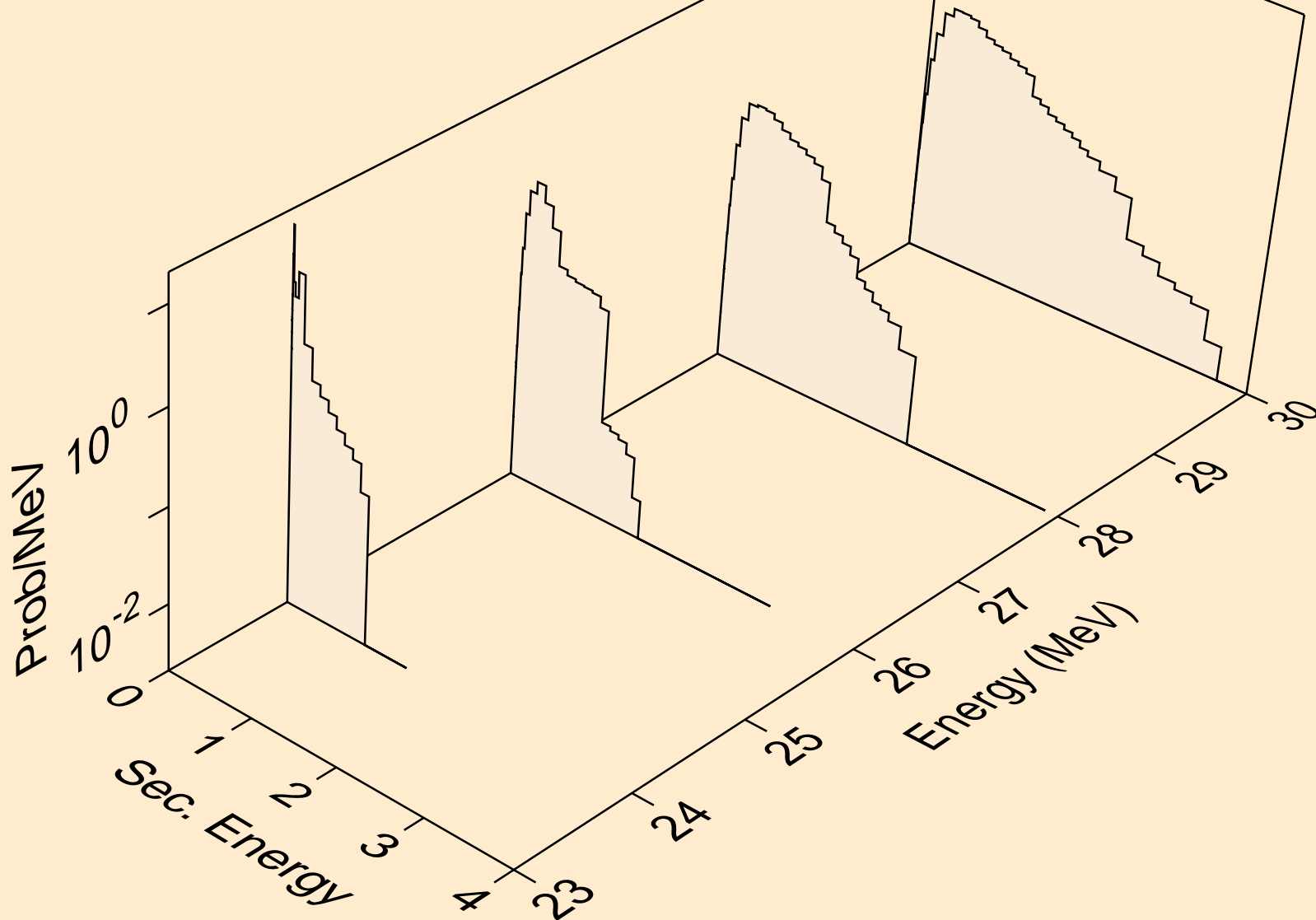

AG100M NEUTRON ACER TENDL-2019 LIBRARY; T=293.16K
Neutron emission for (n,2np)

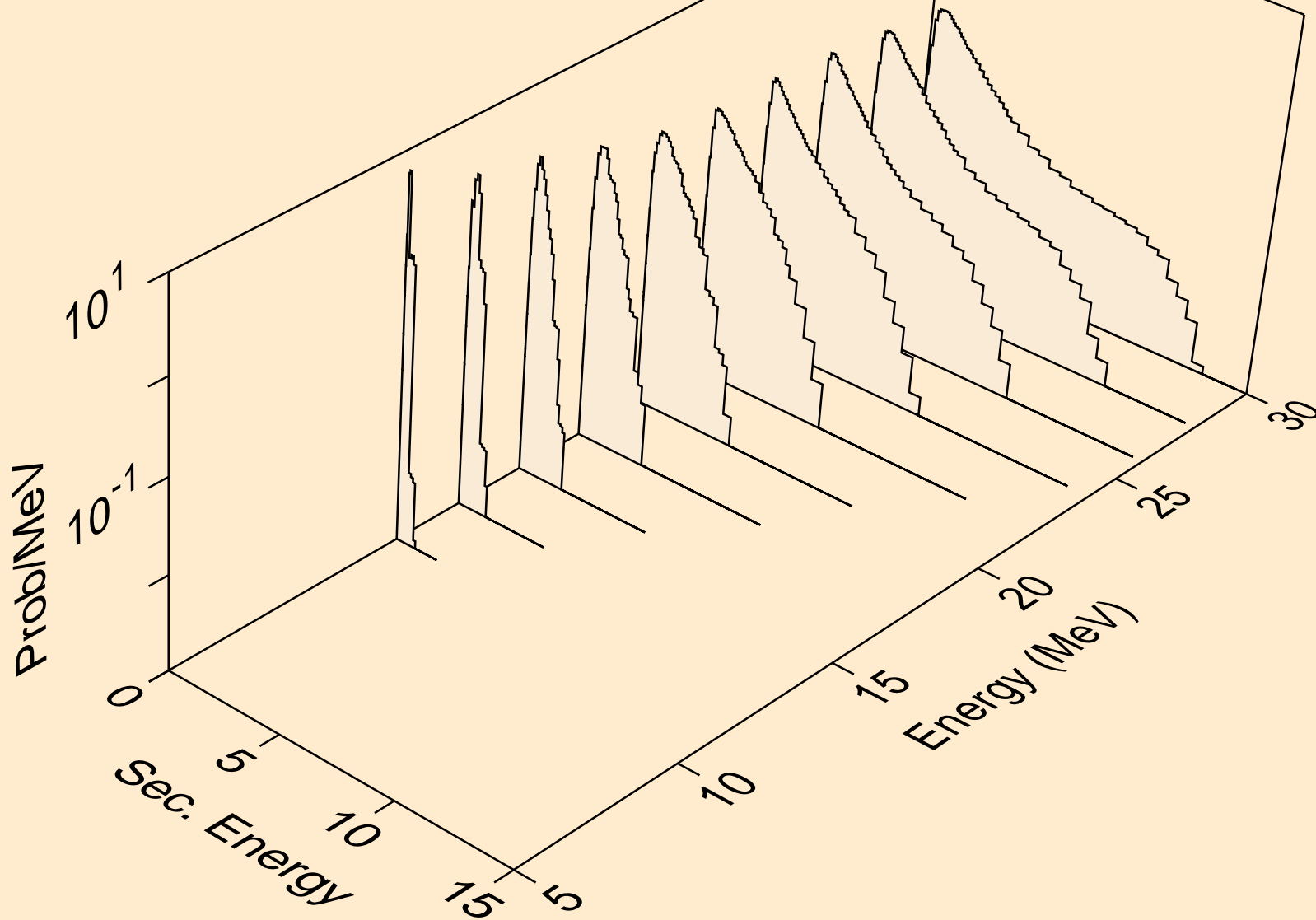

AG100M NEUTRON ACER TENDL-2019 LIBRARY; T=293.16K
Neutron emission for (n,npa)

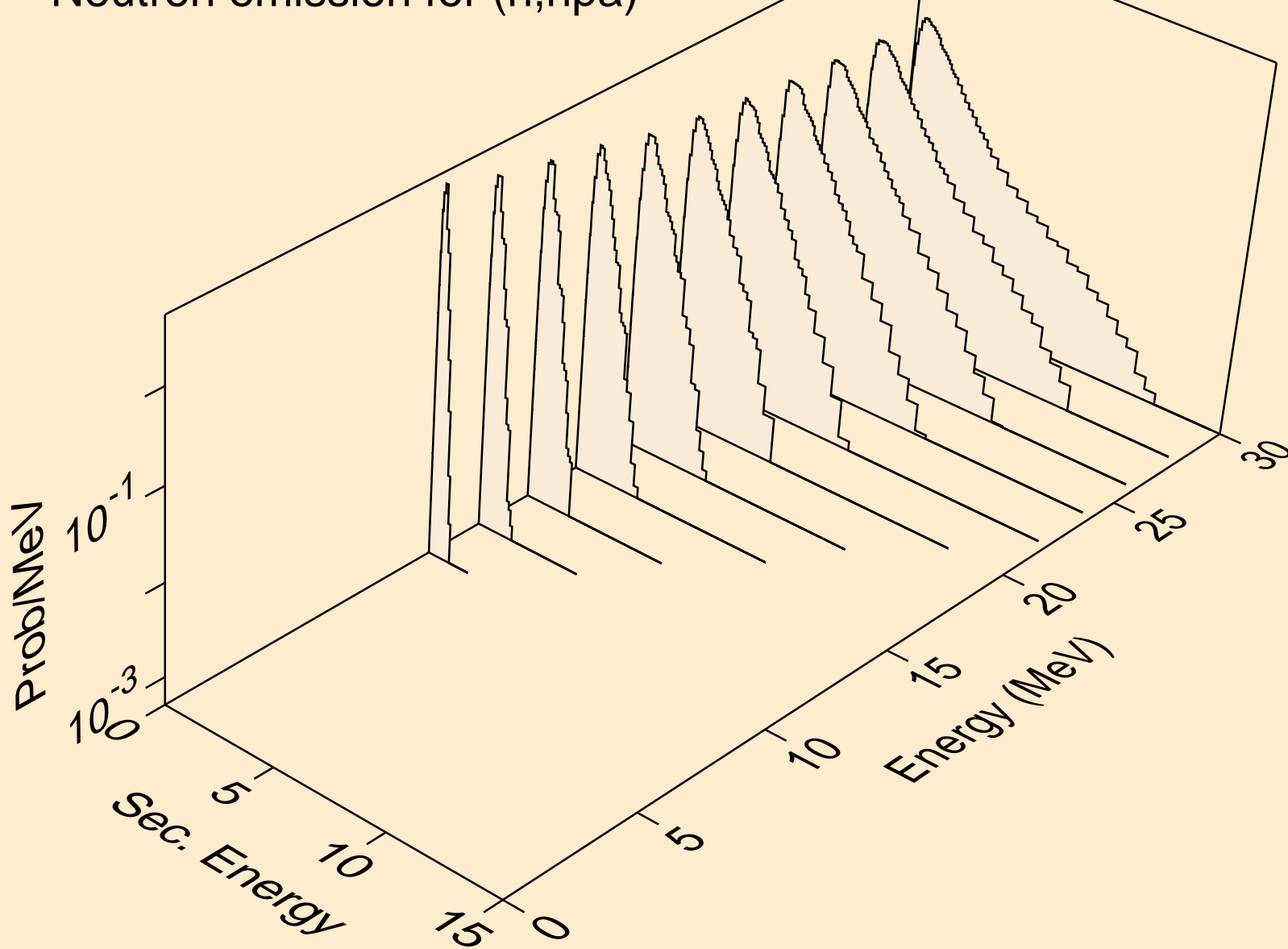

AG100M NEUTRON ACER TENDL-2019 LIBRARY; T=293.16K
Neutron emission for (n,n*c)

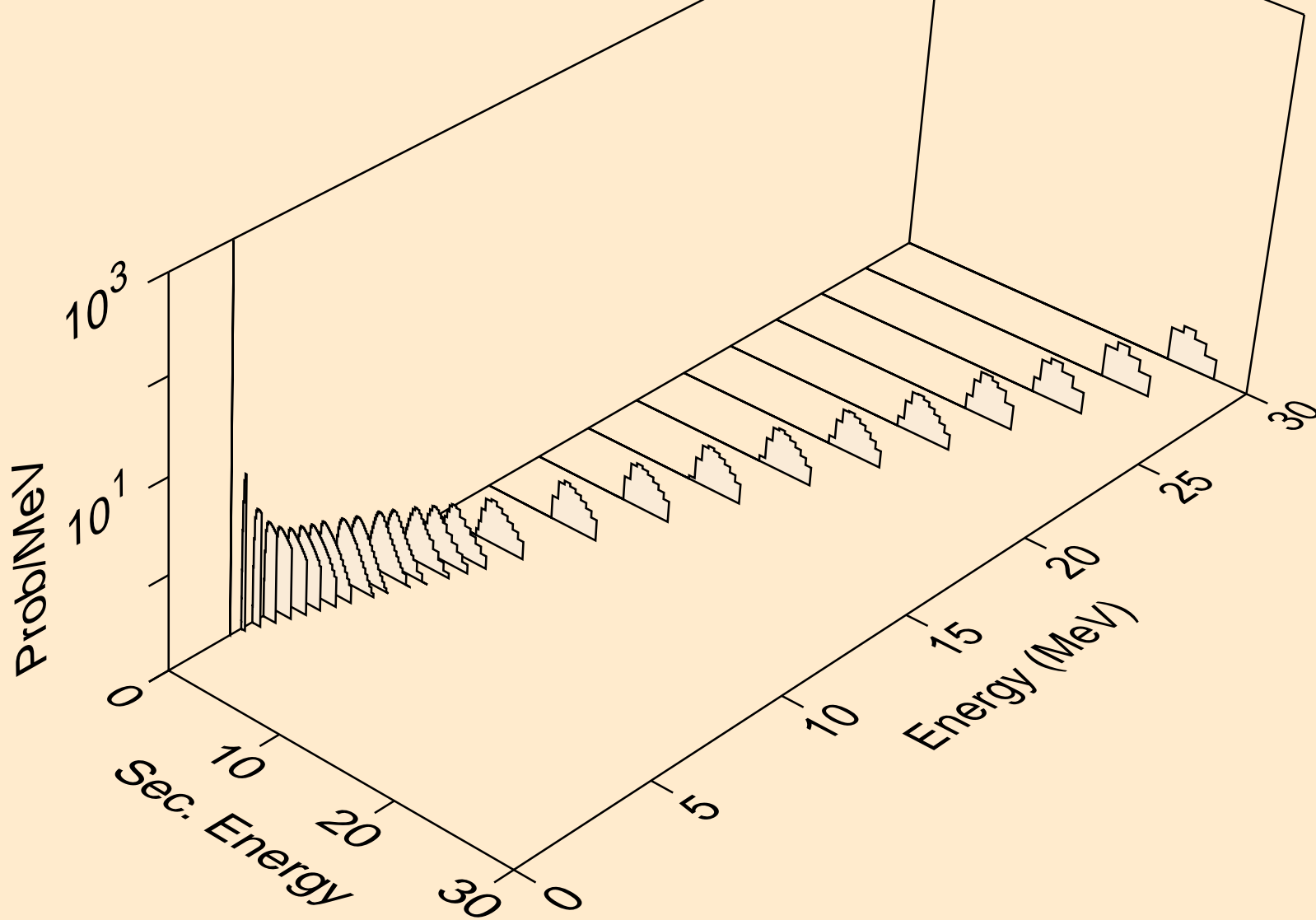

AG100M NEUTRON ACER TENDL-2019 LIBRARY; T=293.16K
Photon emission for (n,x)

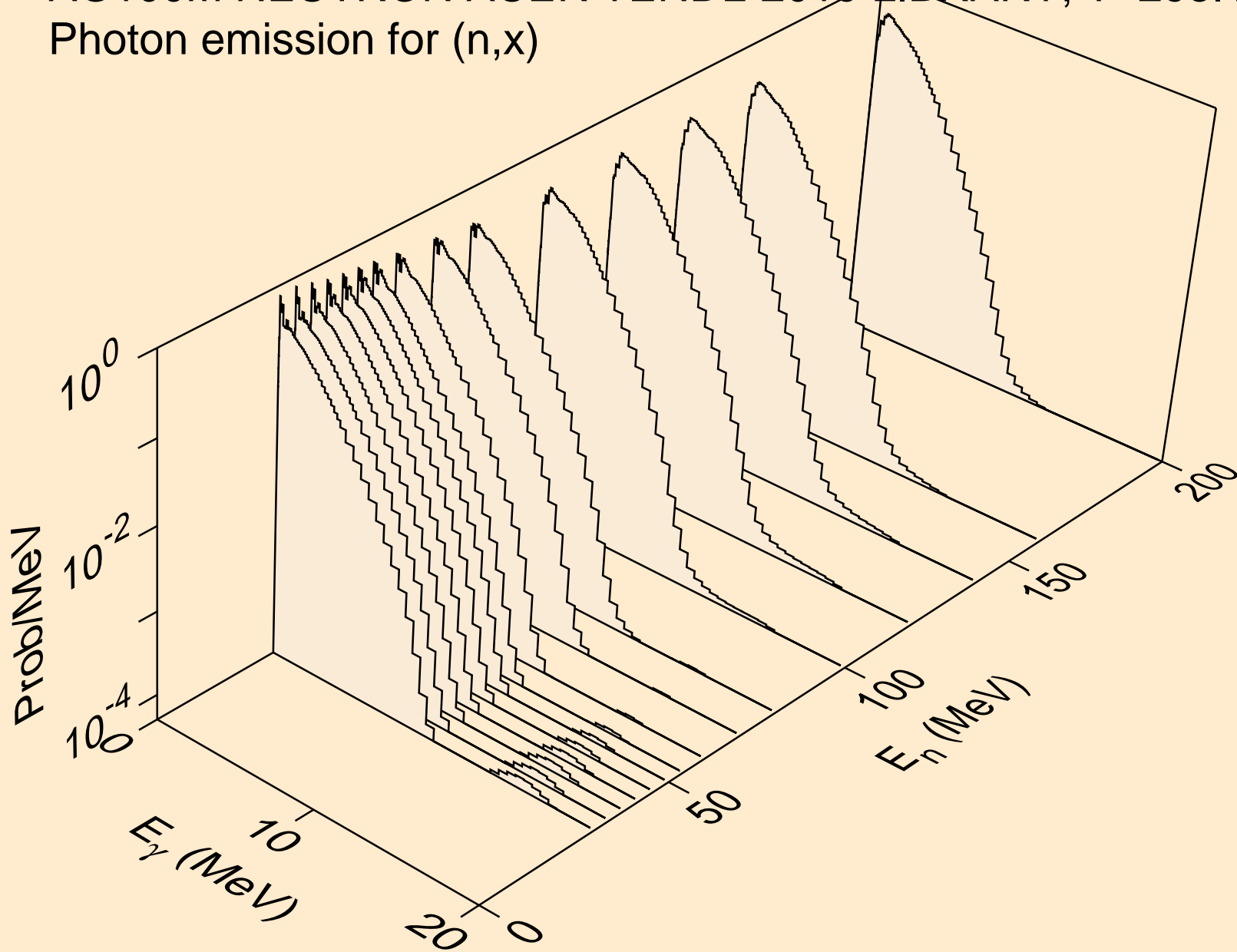

AG100M NEUTRON ACER TENDL-2019 LIBRARY; T=293.16K
Photon emission for (n,2nd)

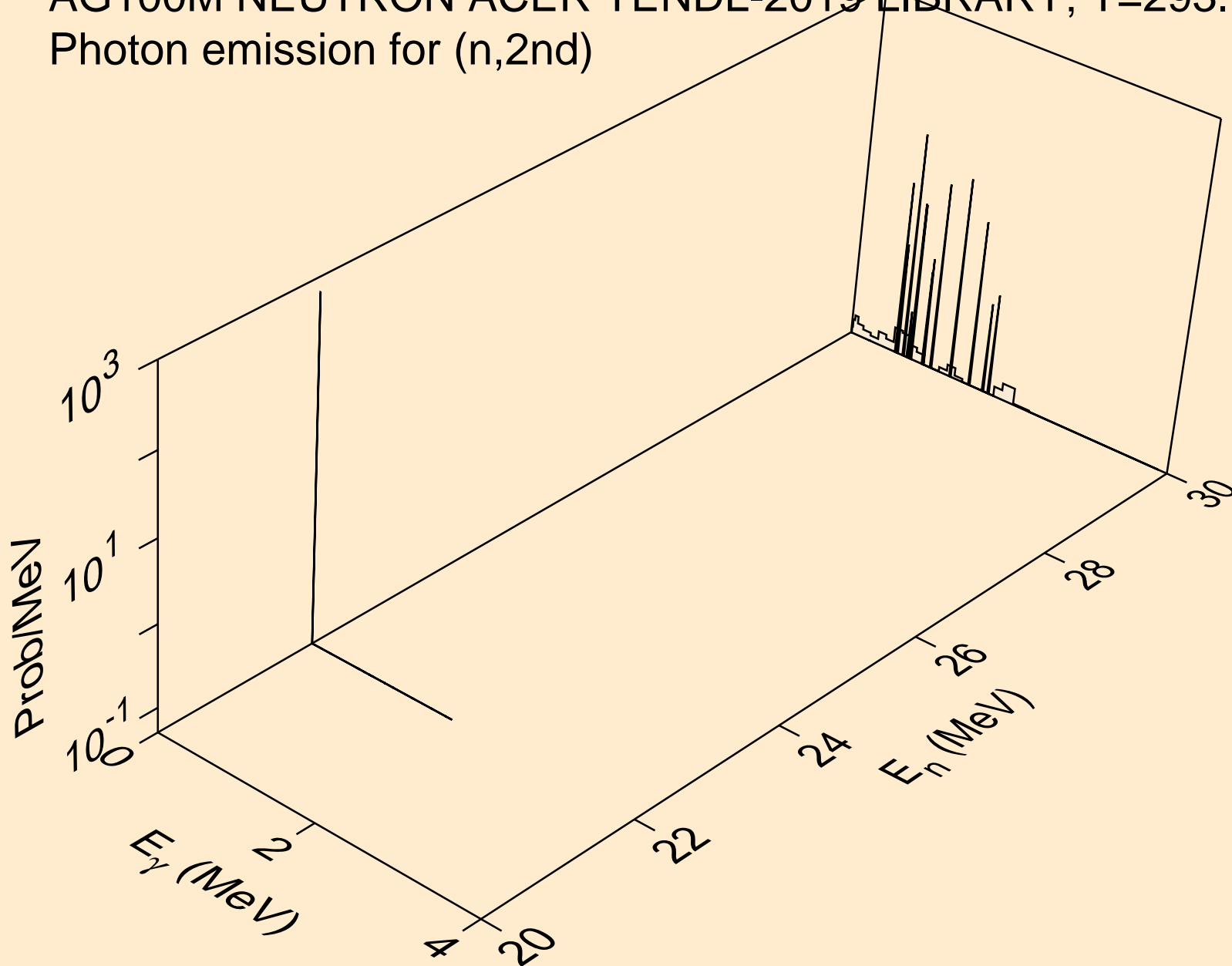

AG100M NEUTRON ACER TENDL-2019 LIBRARY; T=293.16K
Photon emission for (n,2n)

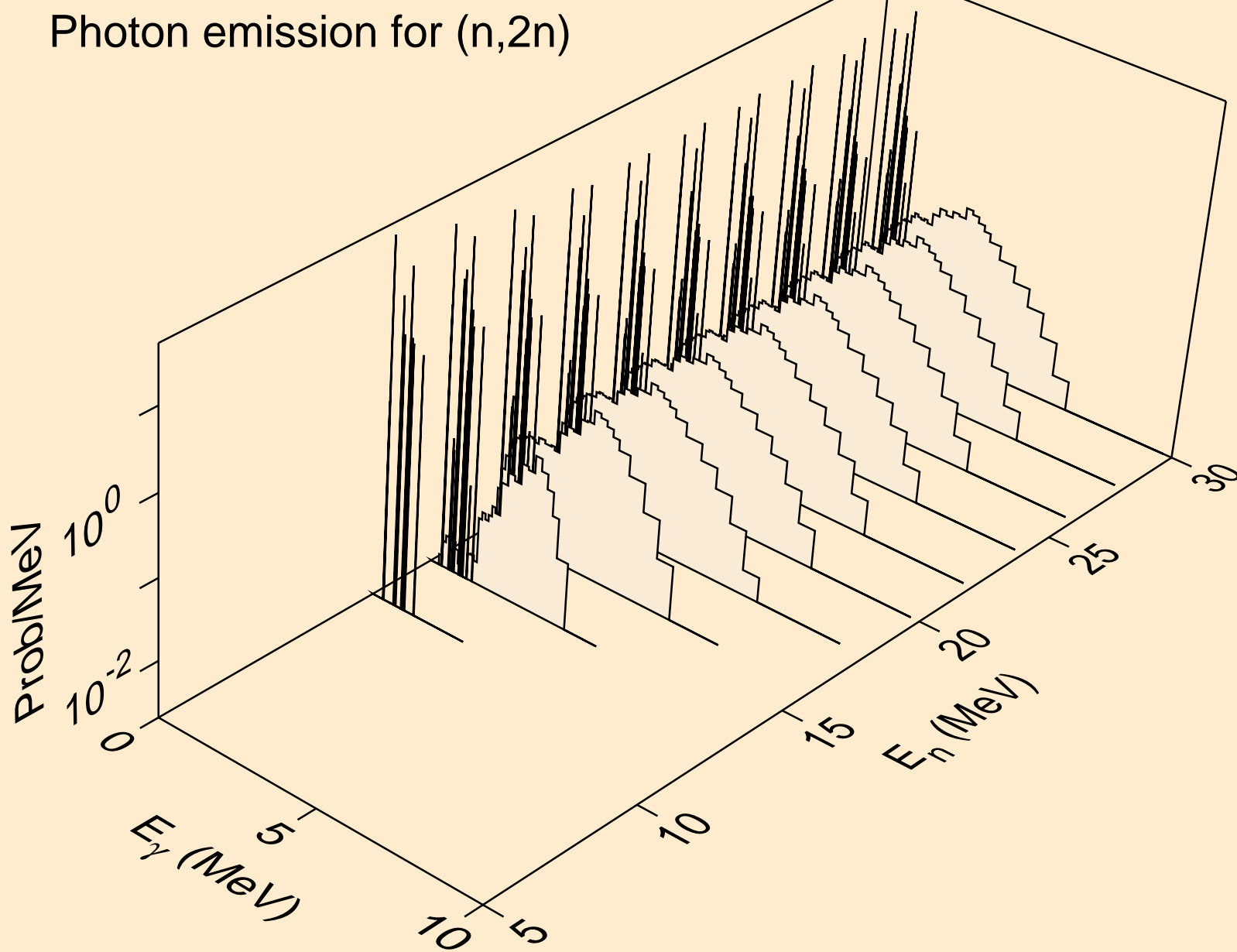

AG100M NEUTRON ACER TENDL-2019 LIBRARY; T=293.16K
Photon emission for (n,3n)

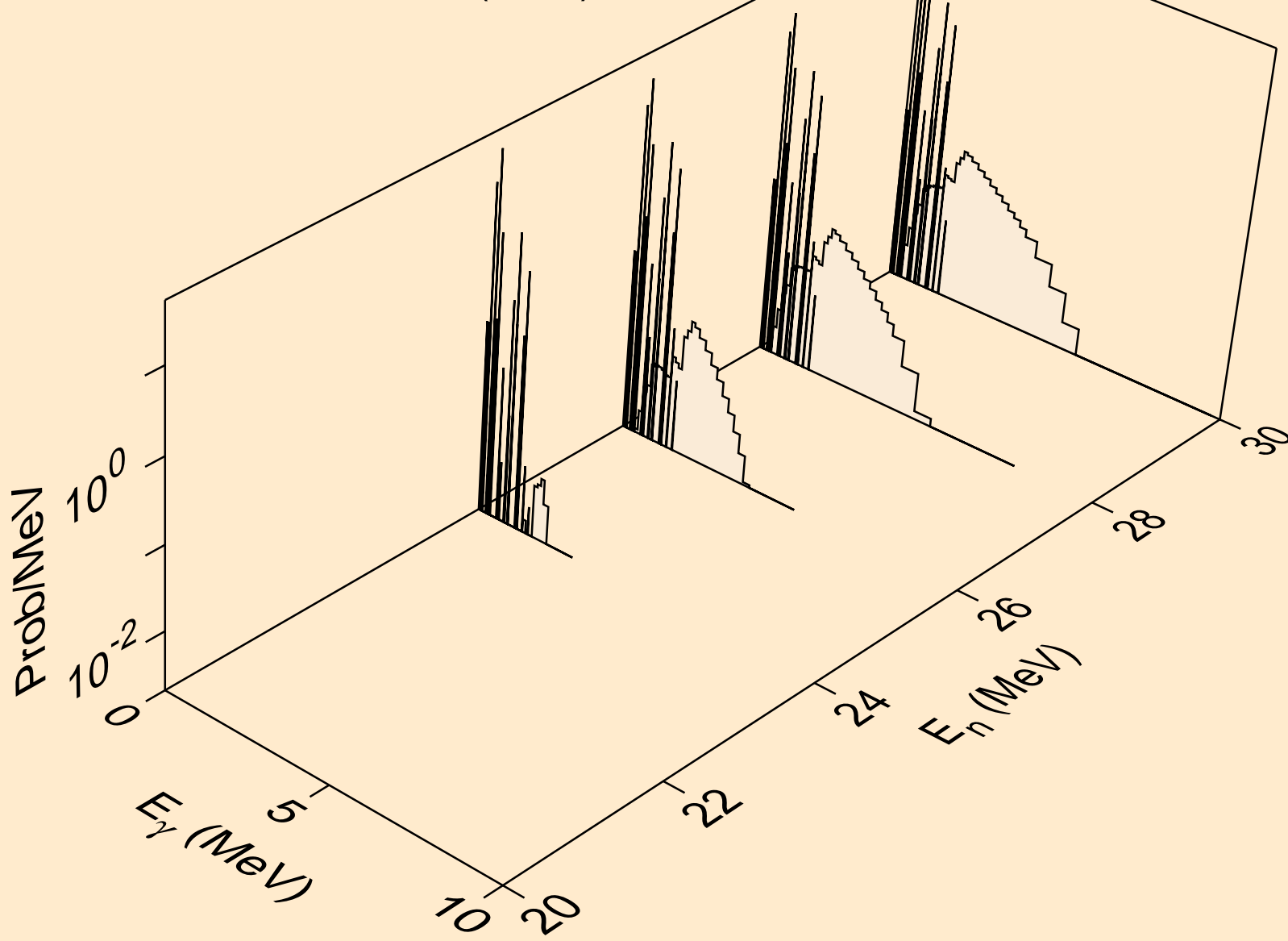

AG100M NEUTRON ACER TENDL-2019 LIBRARY; T=293.16K
Photon emission for (n,n*)a

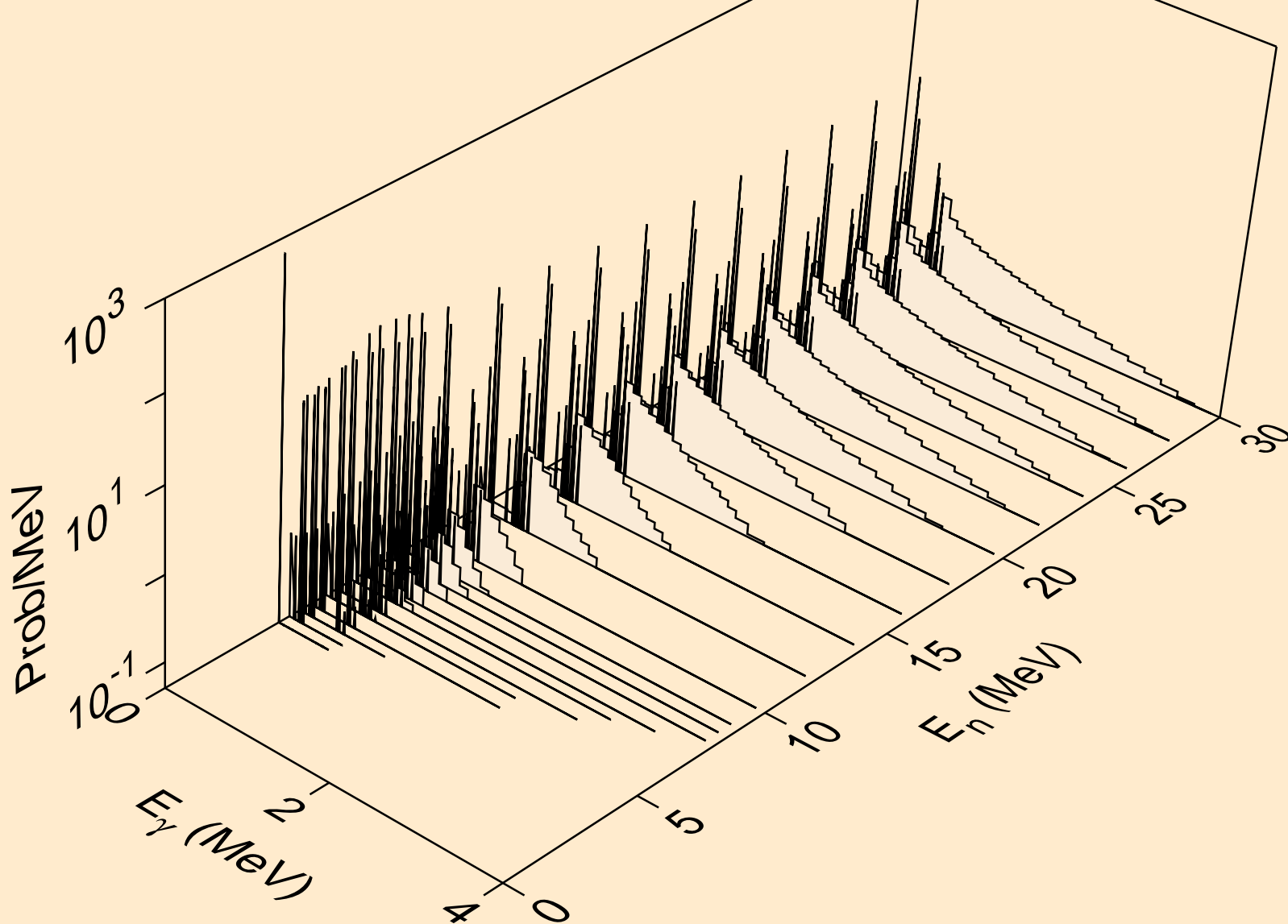

AG100M NEUTRON ACER TENDL-2019 LIBRARY; T=293.16K
Photon emission for (n,2n)a

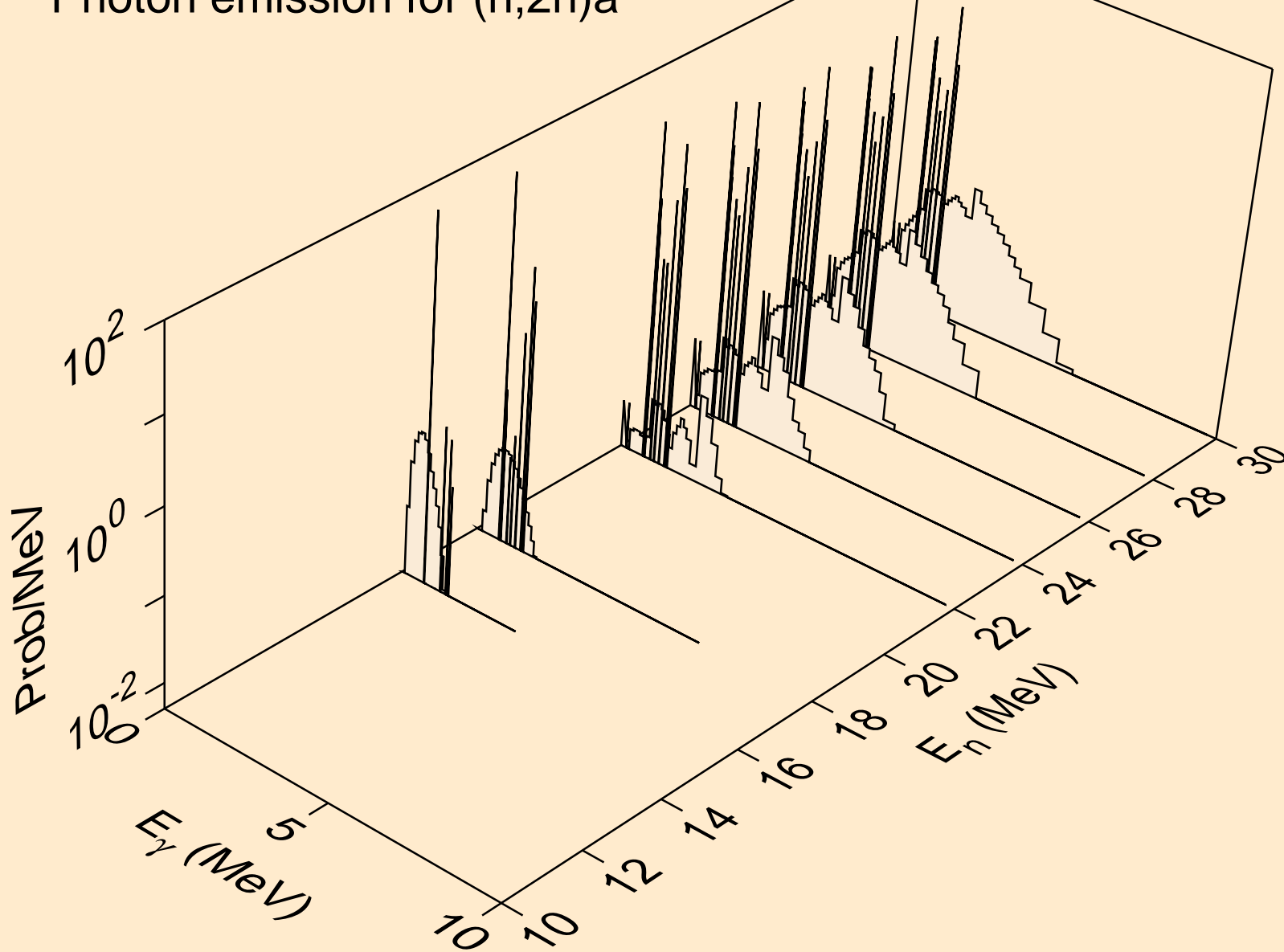

AG100M NEUTRON ACER TENDL-2019 LIBRARY; T=293.16K
Photon emission for (n,n*)p

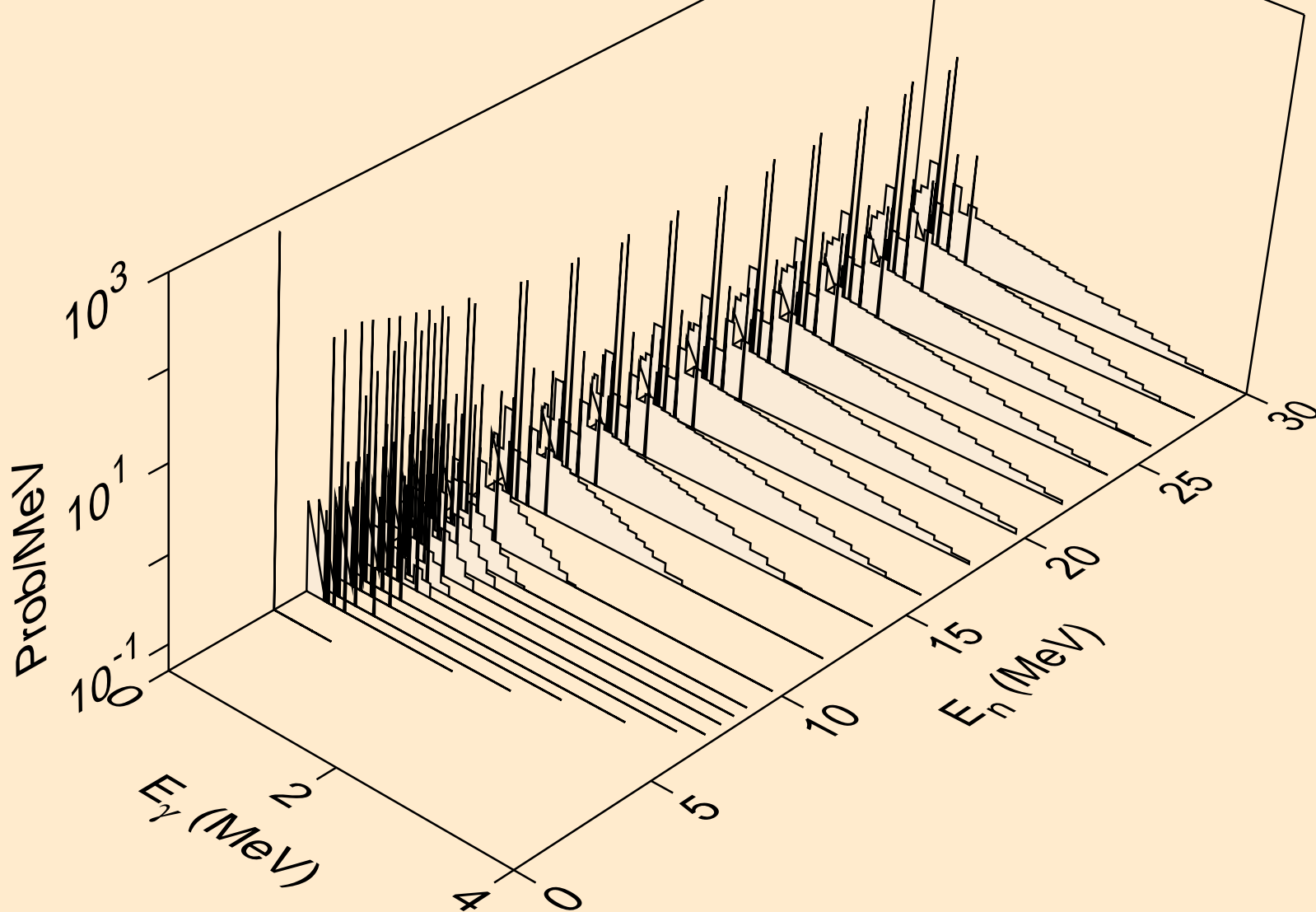

AG100M NEUTRON ACER TENDL-2019 LIBRARY; T=293.16K
Photon emission for (n,n*)2a

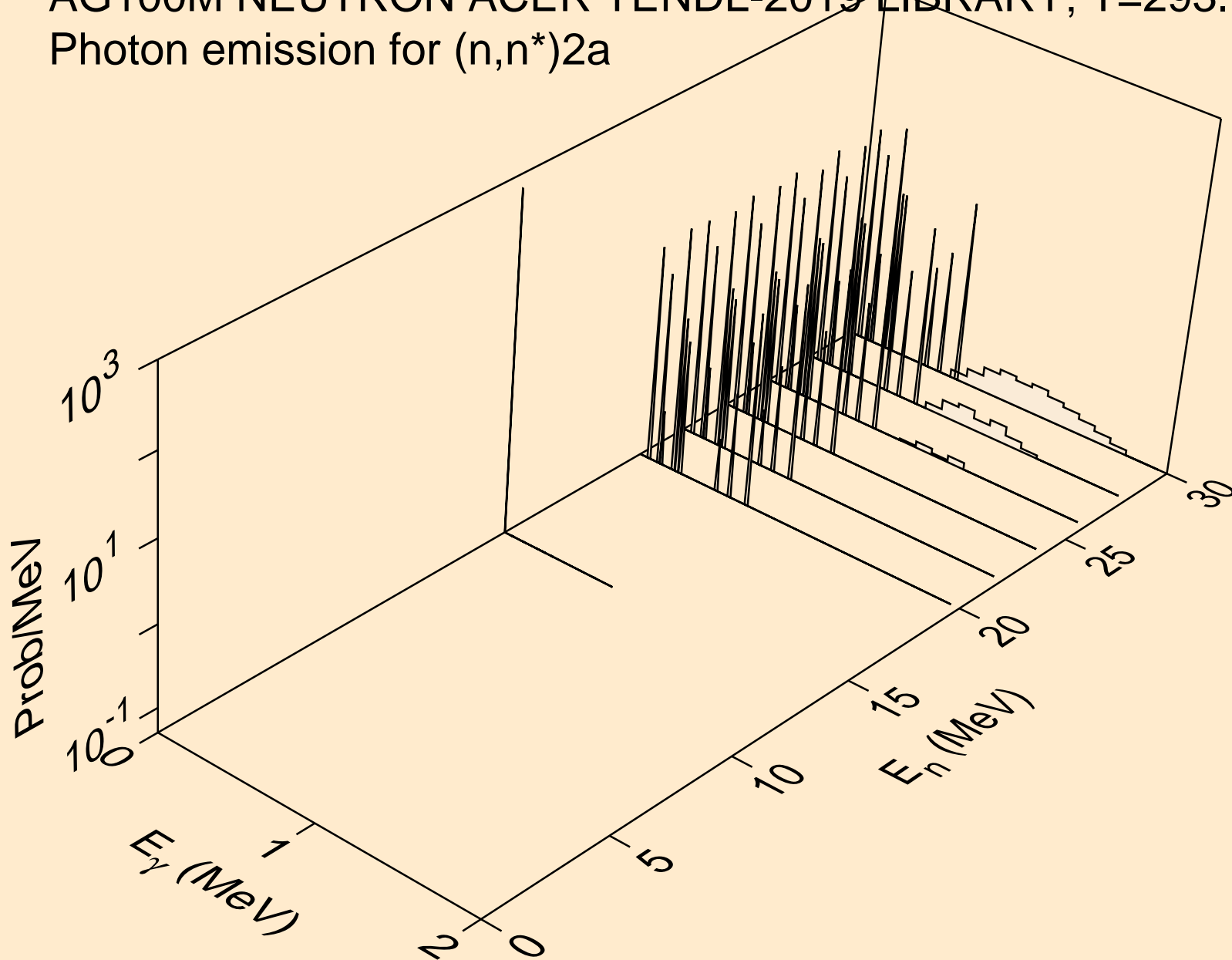

AG100M NEUTRON ACER TENDL-2019 LIBRARY; T=293.16K
Photon emission for (n,n*)d

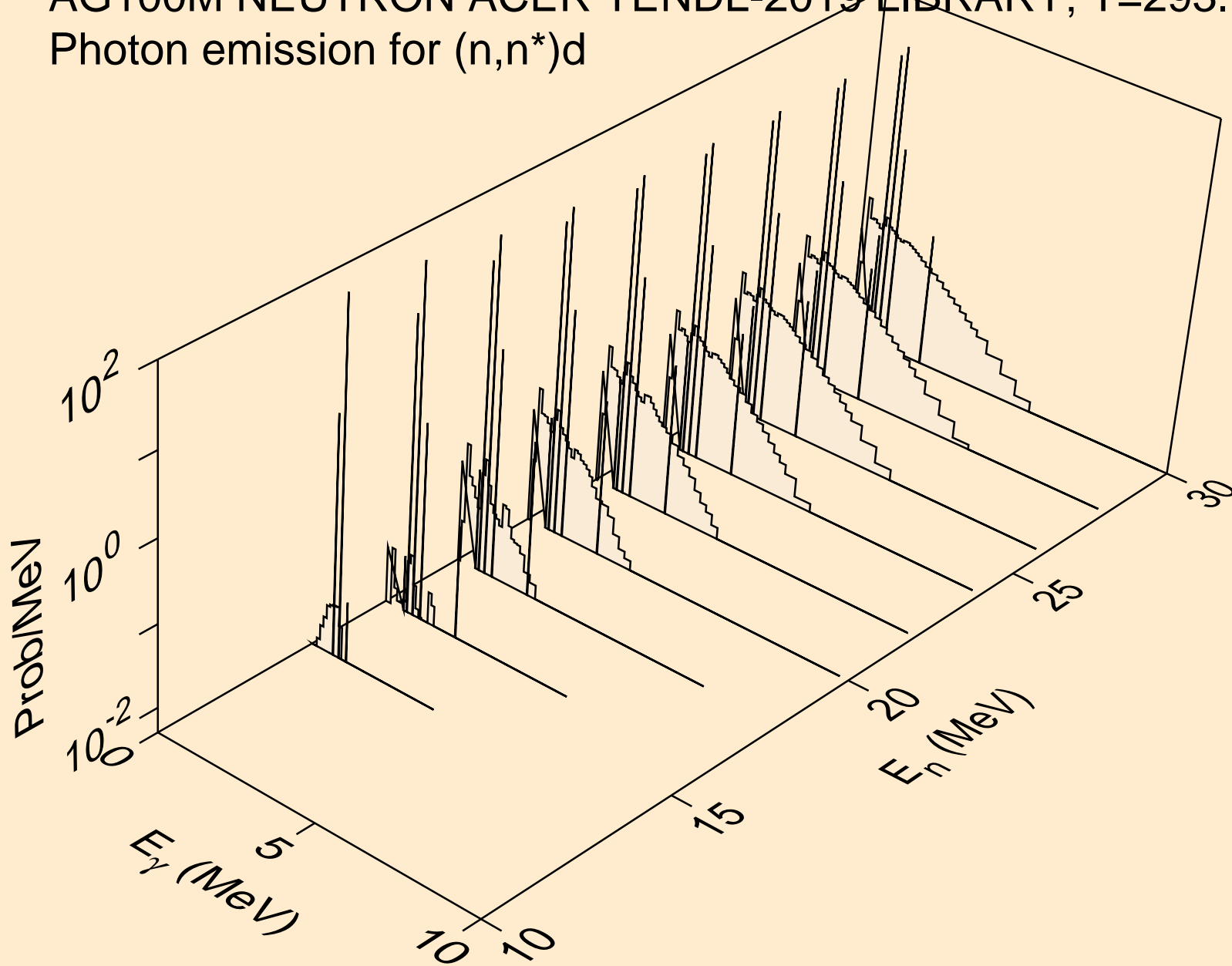

AG100M NEUTRON ACER TENDL-2019 LIBRARY; T=293.16K
Photon emission for (n,n*)t

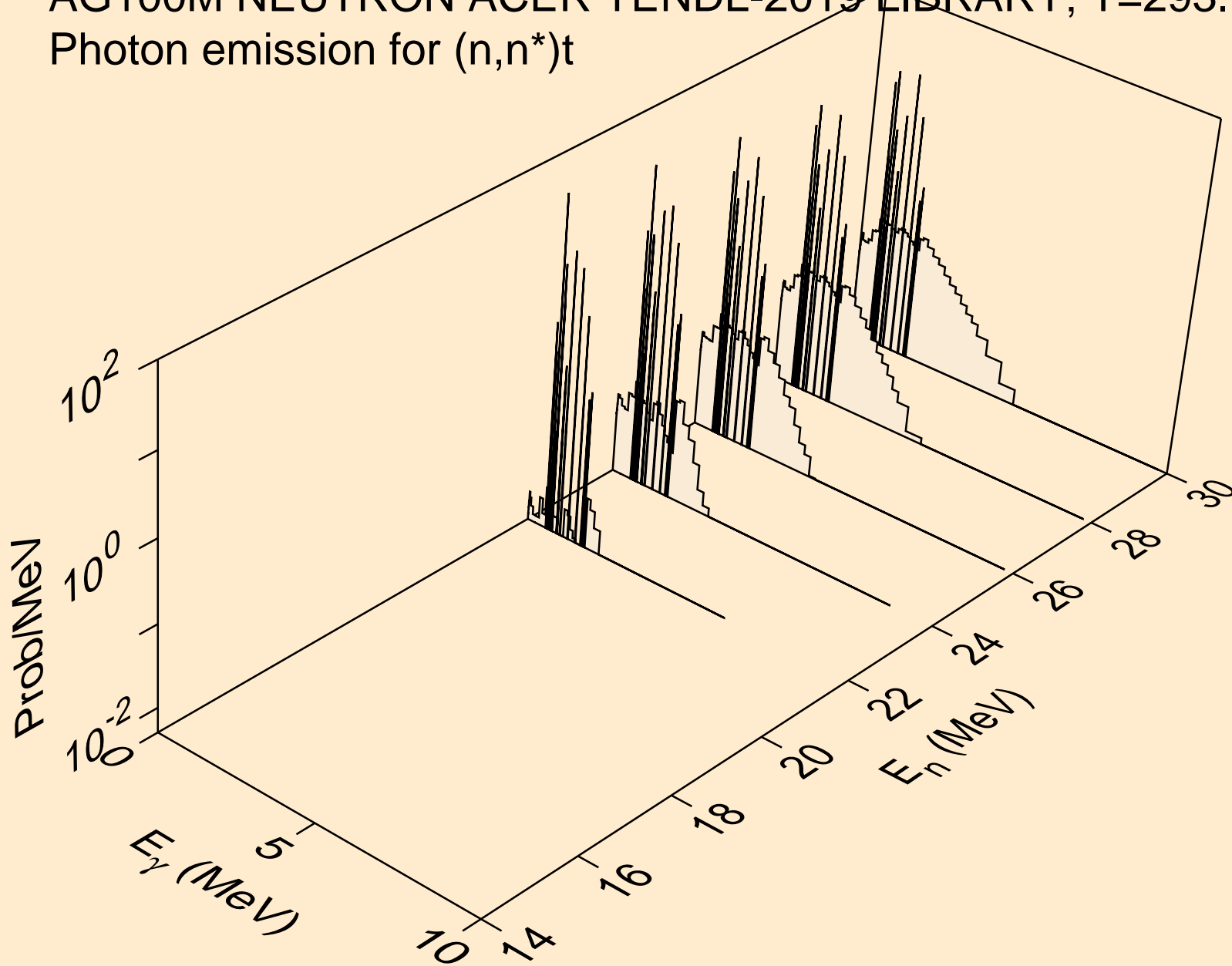

AG100M NEUTRON ACER TENDL-2019 LIBRARY; T=293.16K
Photon emission for (n,n*)he3

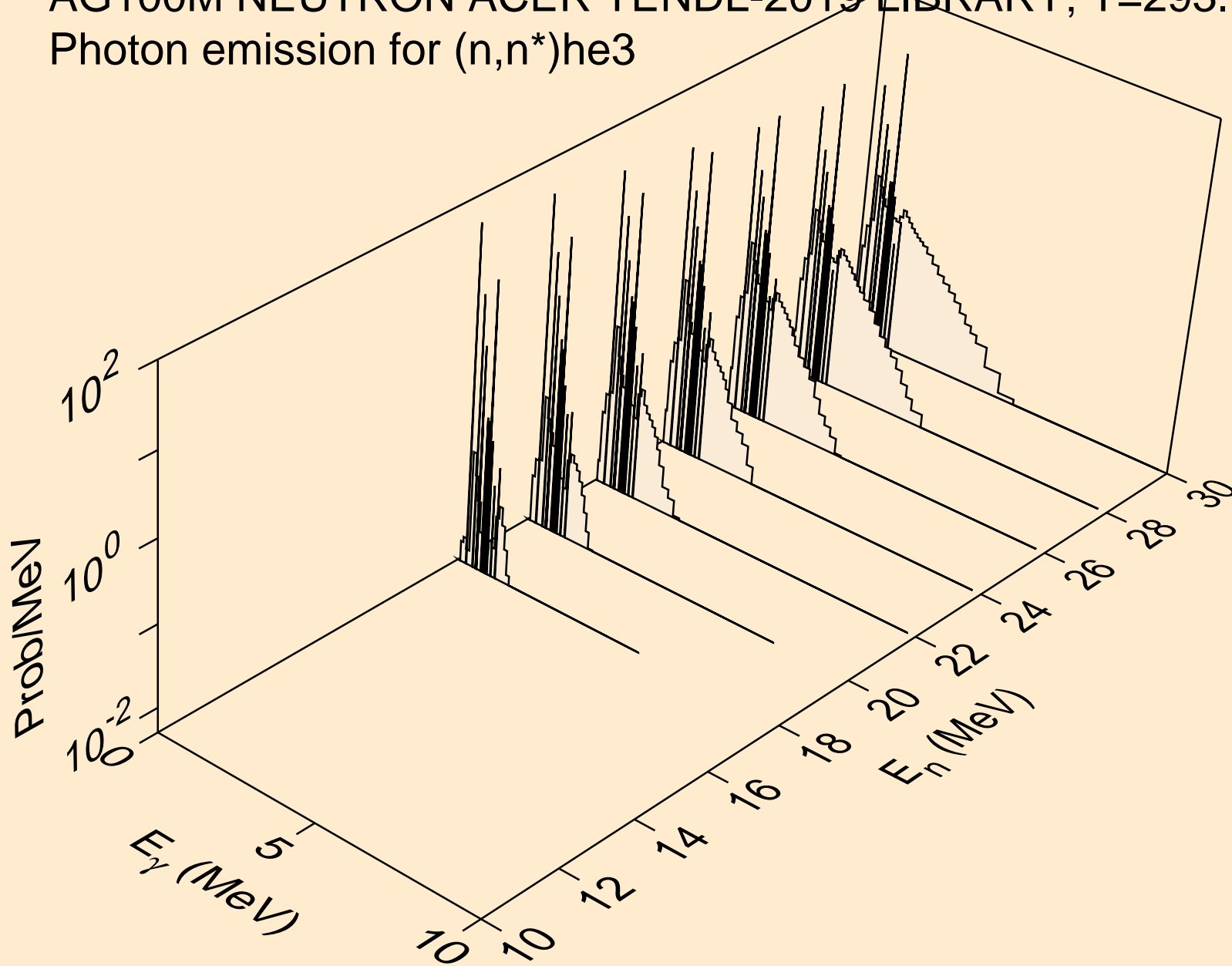

AG100M NEUTRON ACER TENDL-2019 LIBRARY; T=293.16K
Photon emission for (n,2np)

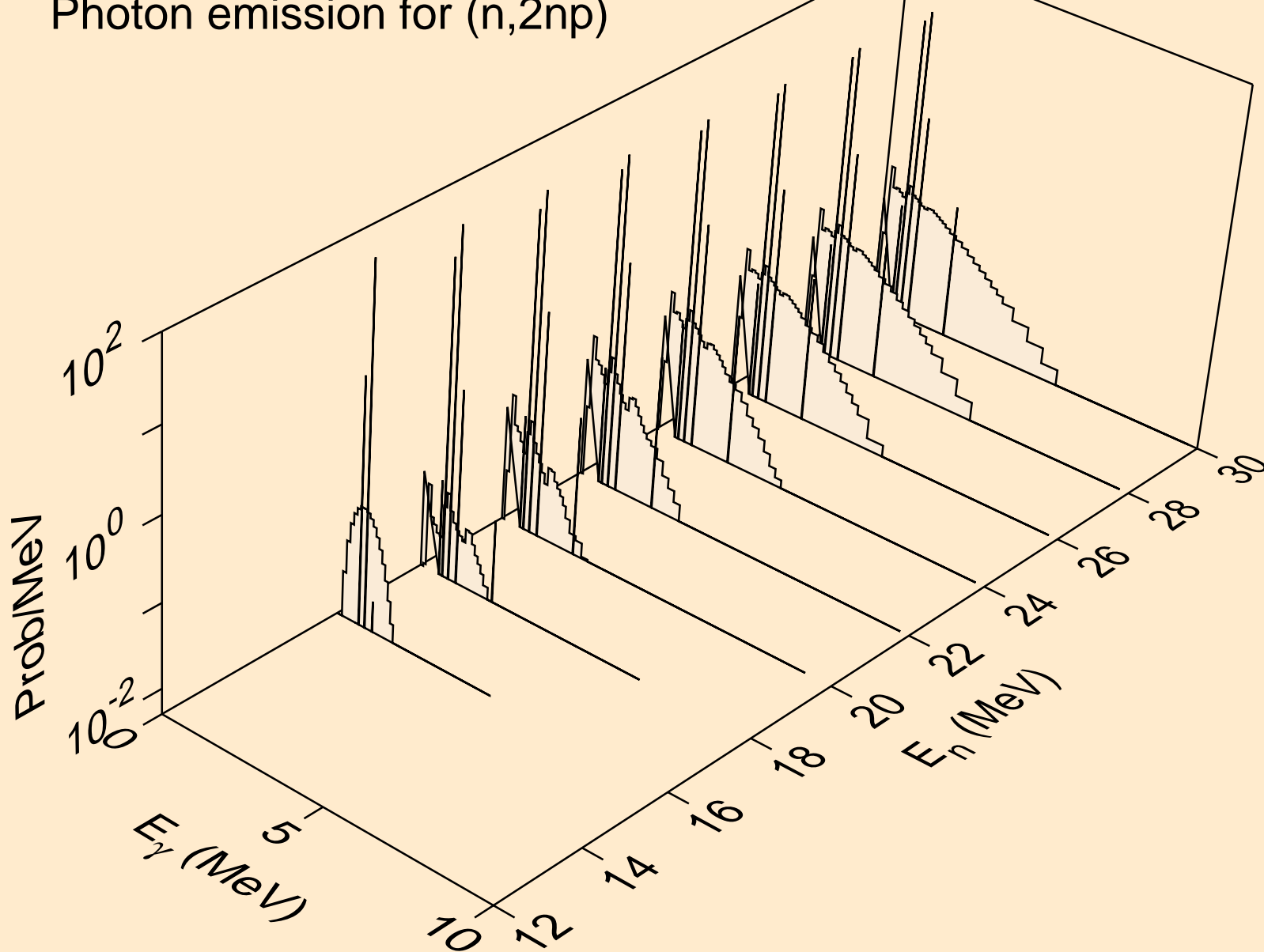

AG100M NEUTRON ACER TENDL-2019 LIBRARY; T=293.16K
Photon emission for (n,3np)

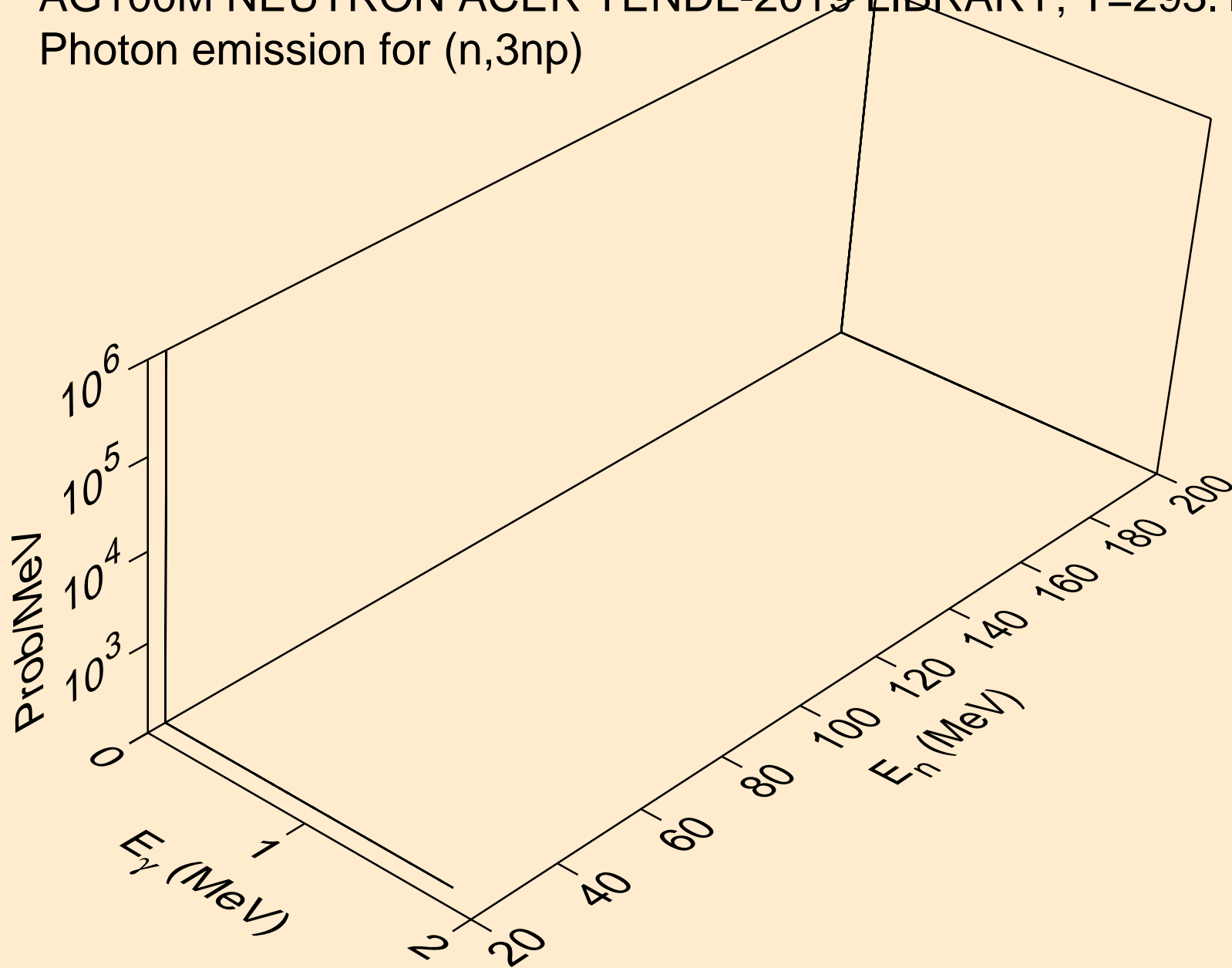

AG100M NEUTRON ACER TENDL-2019 LIBRARY; T=293.16K
Photon emission for (n,2np)

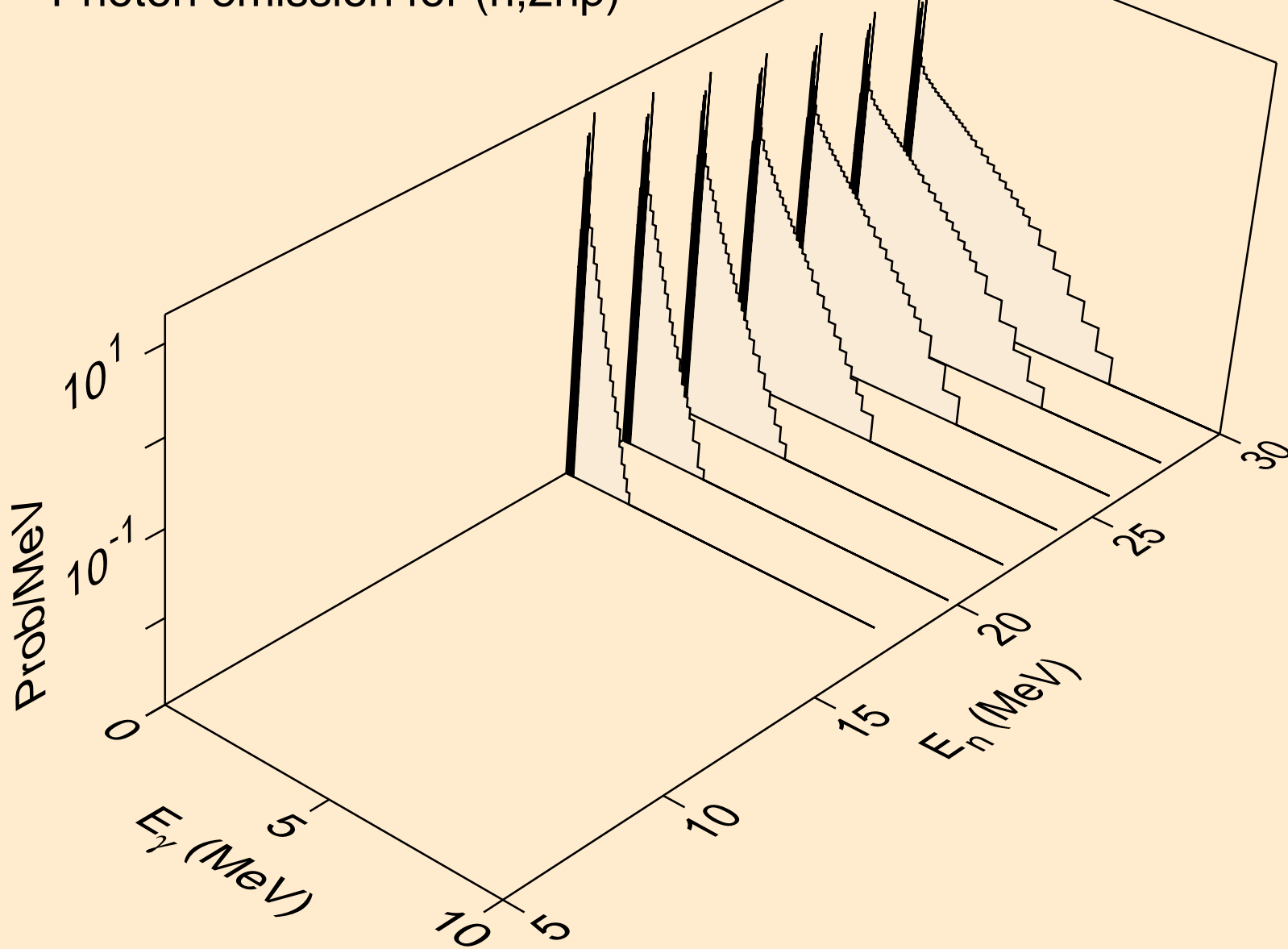

AG100M NEUTRON ACER TENDL-2019 LIBRARY; T=293.16K
Photon emission for (n,npa)

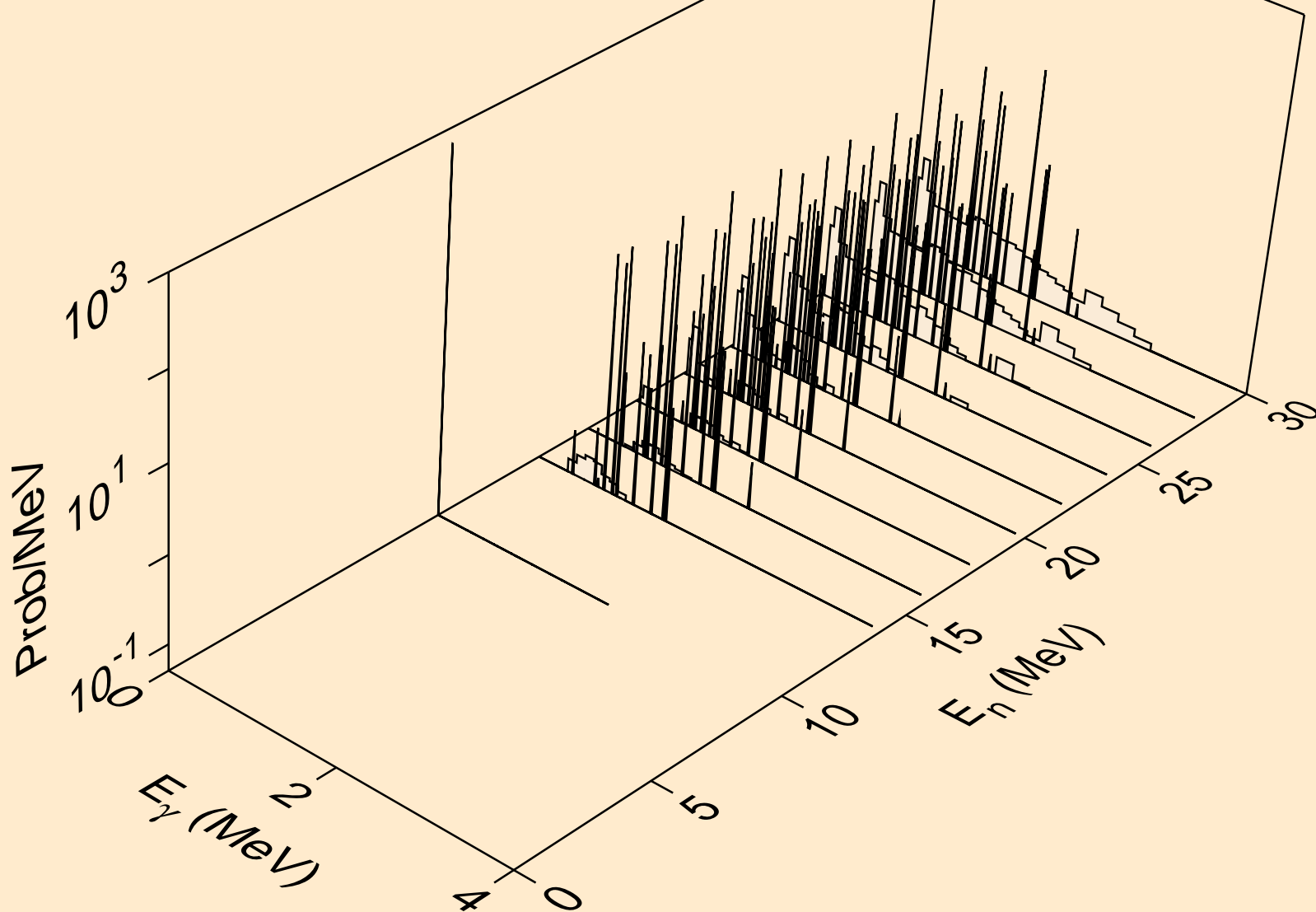

AG100M NEUTRON ACER TENDL-2019 LIBRARY; T=293.16K
Photon emission for (n,n*2)

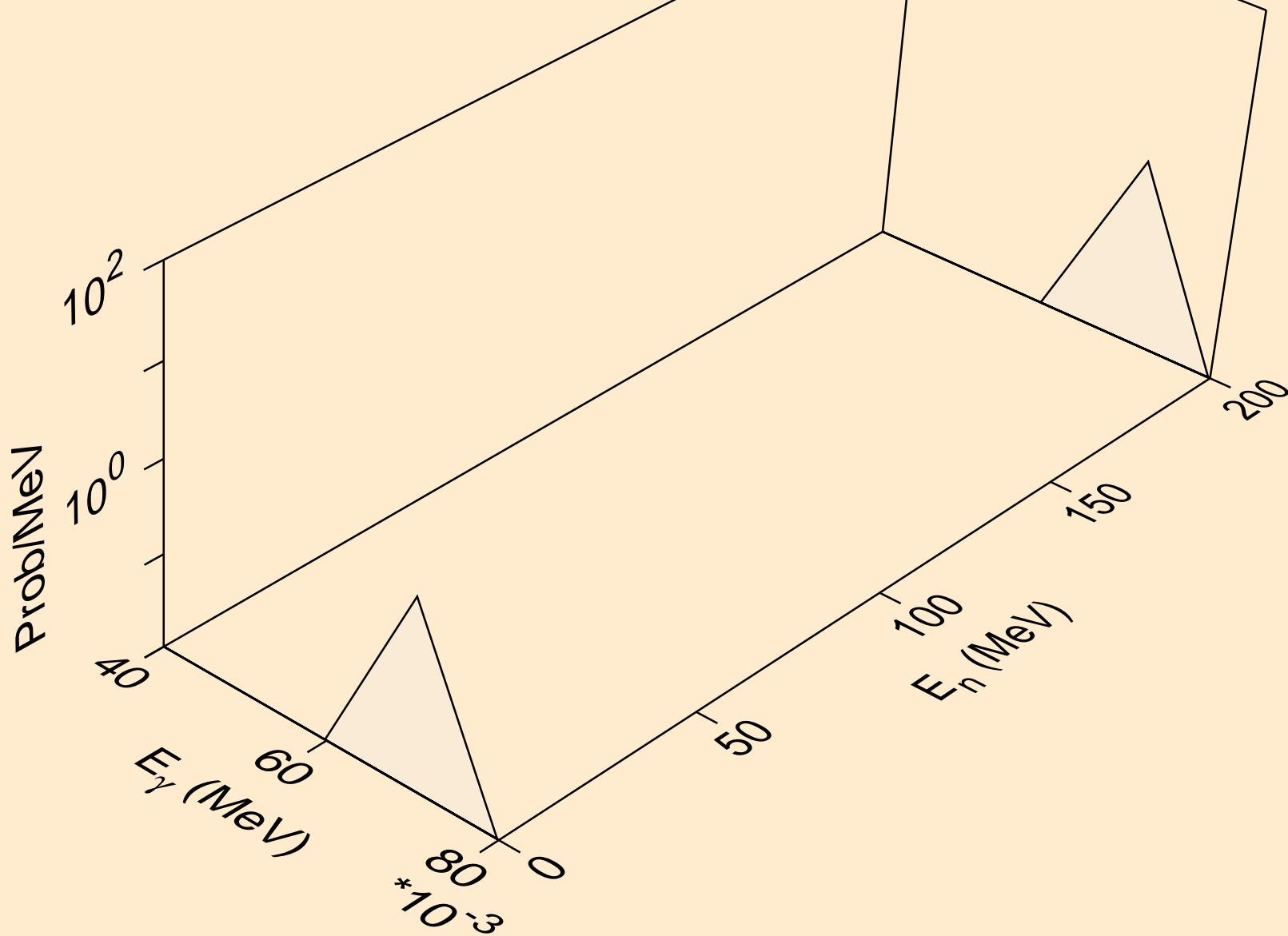

AG100M NEUTRON ACER TENDL-2019 LIBRARY; T=293.16K
Photon emission for (n,n*3)

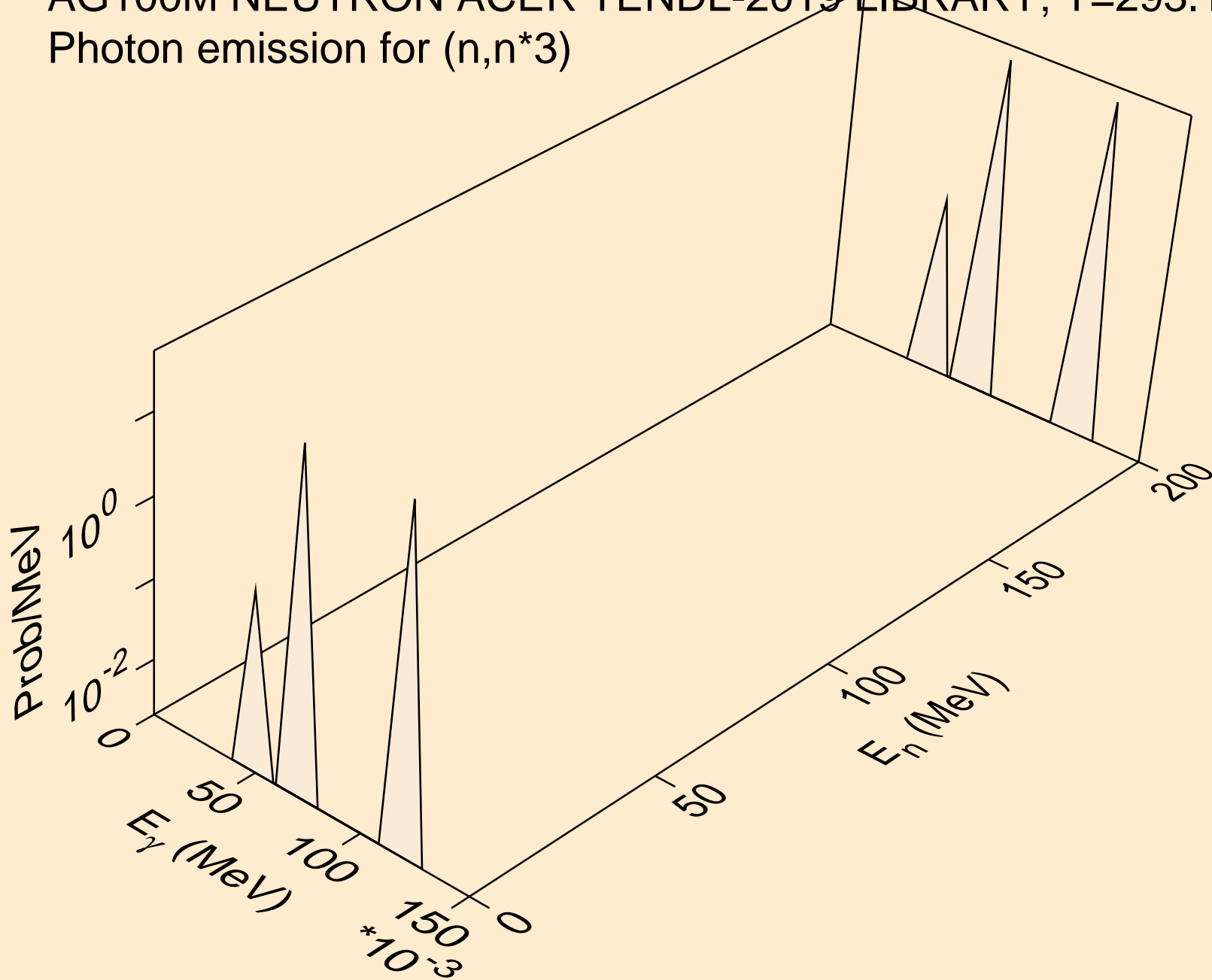

AG100M NEUTRON ACER TENDL-2019 LIBRARY; T=293.16K
Photon emission for (n,n*4)

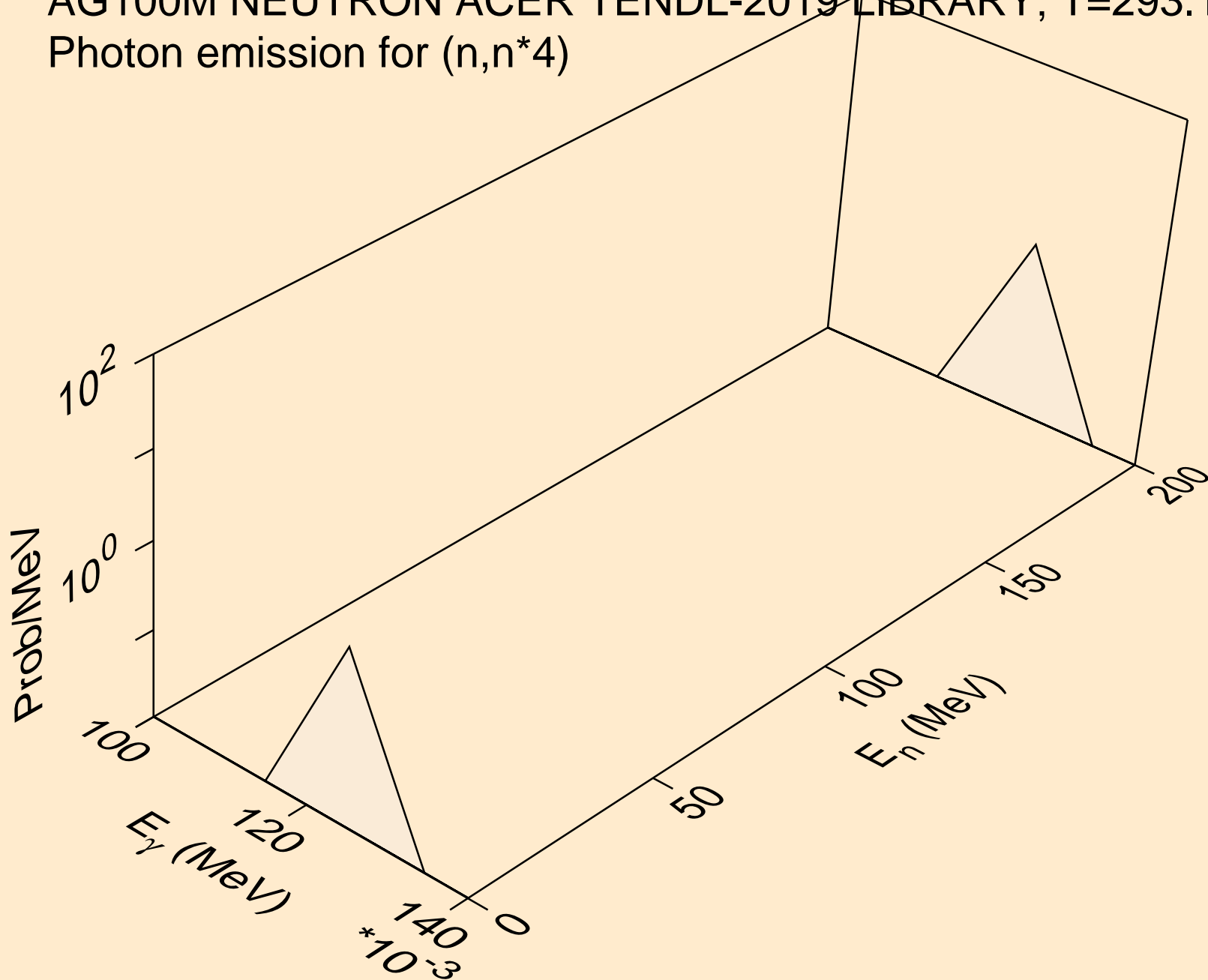

AG100M NEUTRON ACER TENDL-2019 LIBRARY; T=293.16K
Photon emission for (n,n*5)

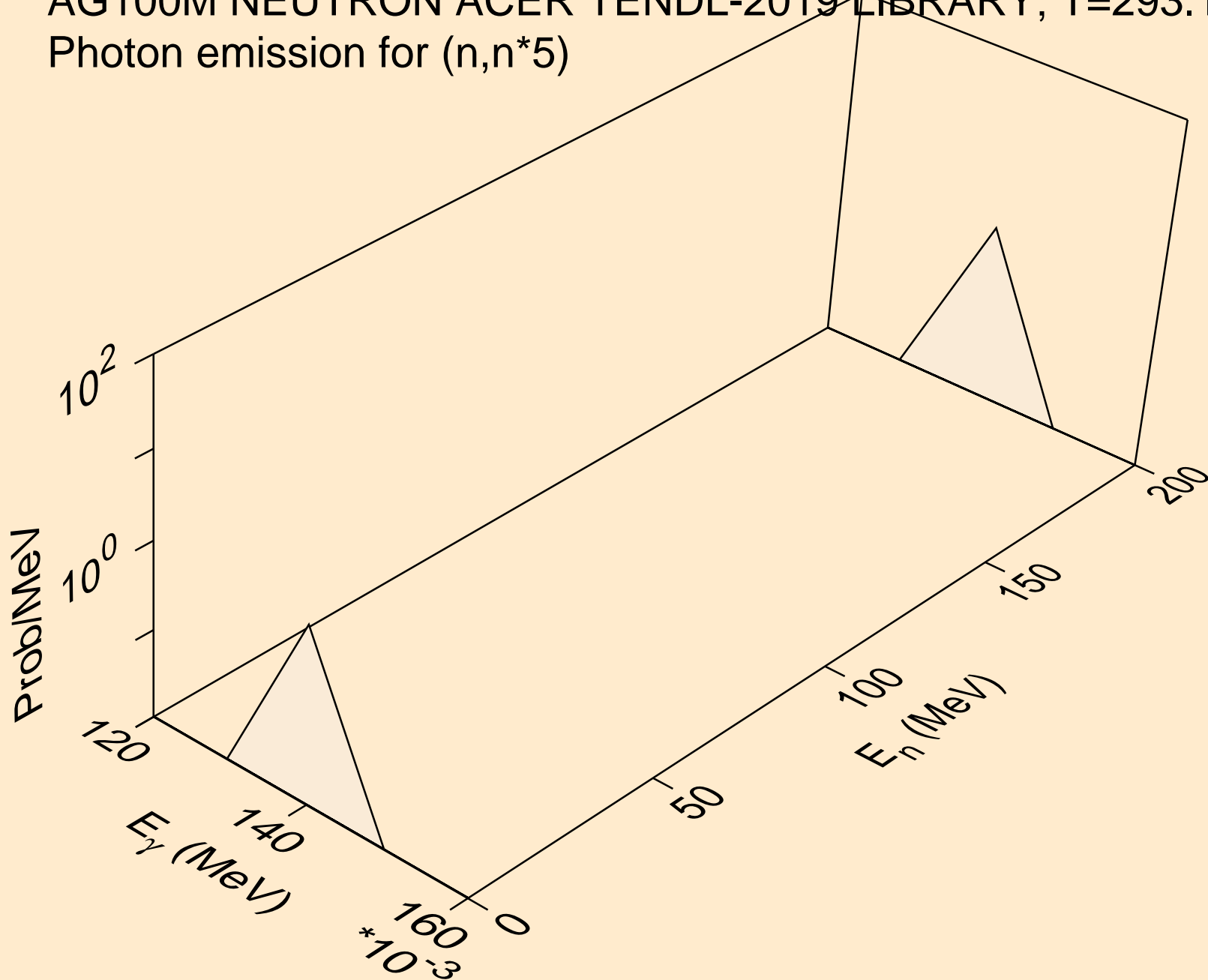

AG100M NEUTRON ACER TENDL-2019 LIBRARY; T=293.16K
Photon emission for (n,n*6)

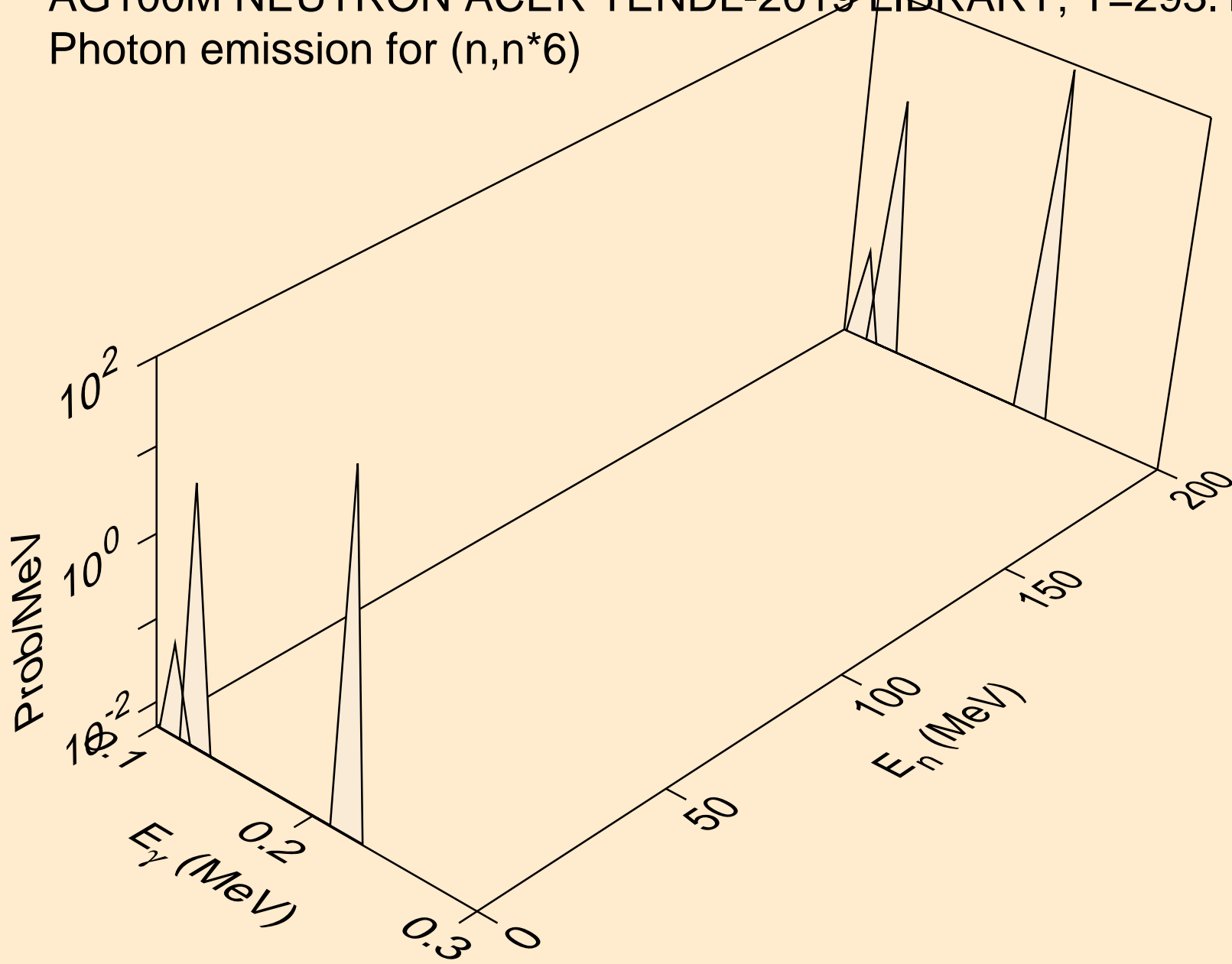

AG100M NEUTRON ACER TENDL-2019 LIBRARY; T=293.16K
Photon emission for (n,n*7)

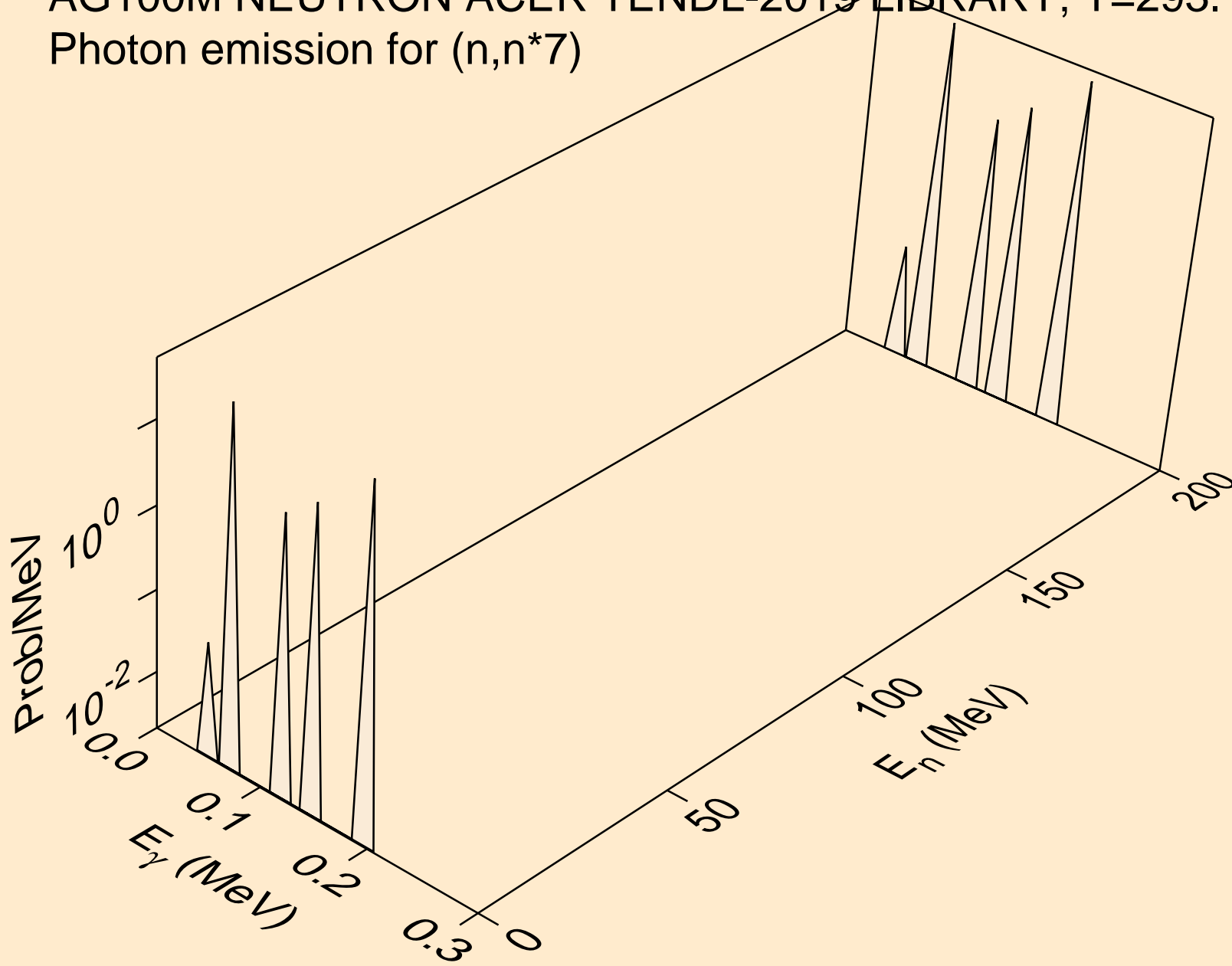

AG100M NEUTRON ACER TENDL-2019 LIBRARY; T=293.16K
Photon emission for (n,n*8)

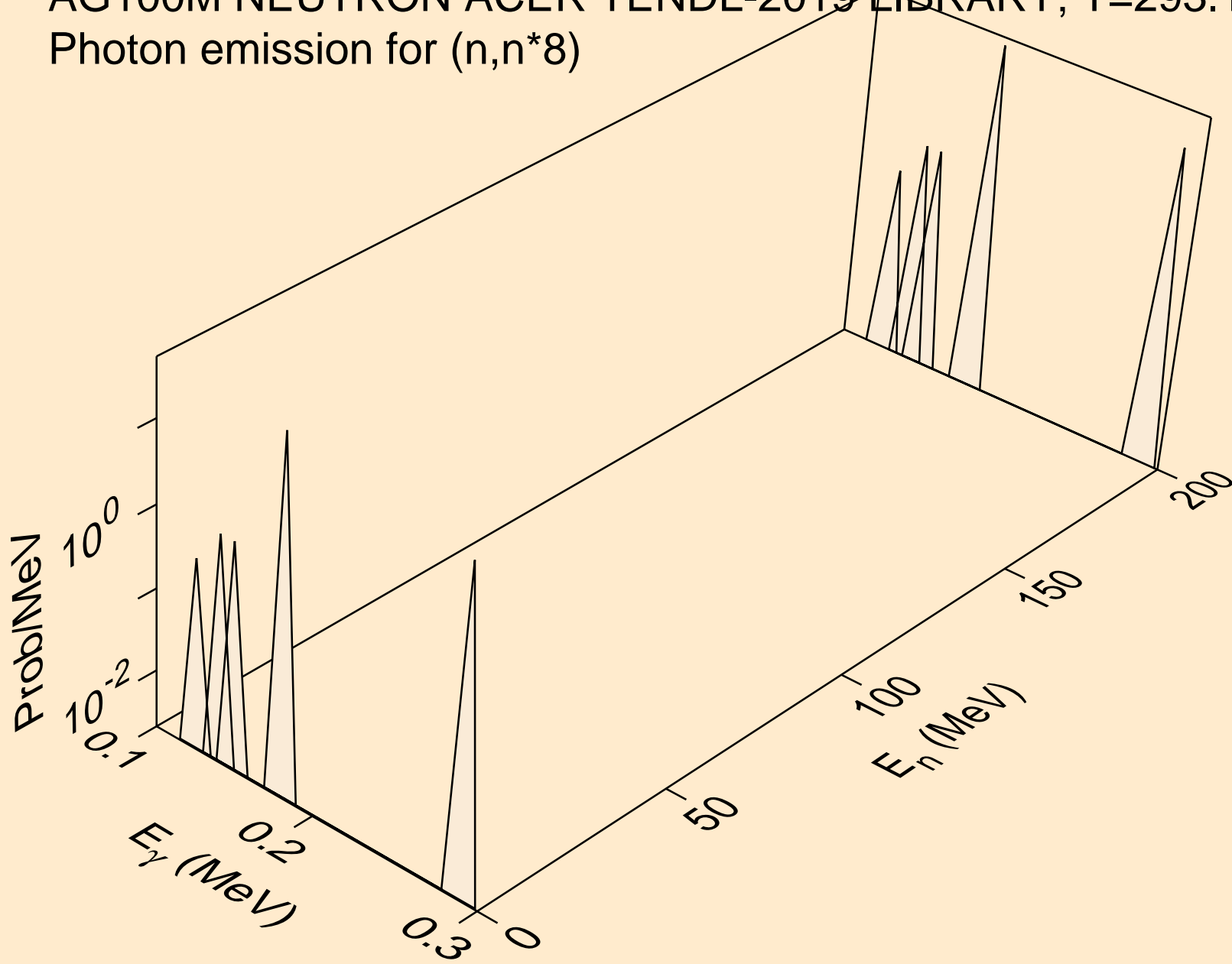

AG100M NEUTRON ACER TENDL-2019 LIBRARY; T=293.16K
Photon emission for (n,n*9)

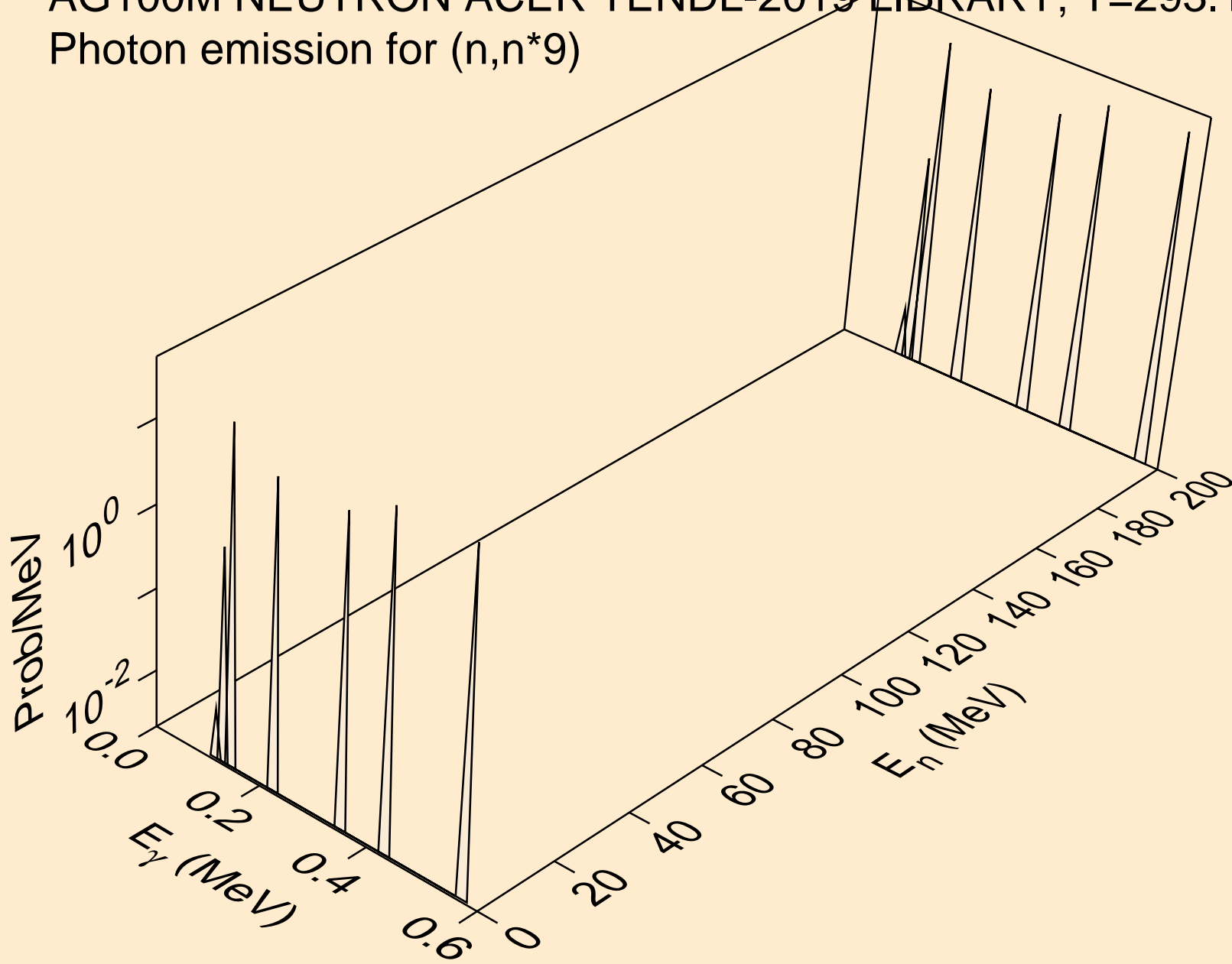

AG100M NEUTRON ACER TENDL-2019 LIBRARY; T=293.16K
Photon emission for (n,n*10)

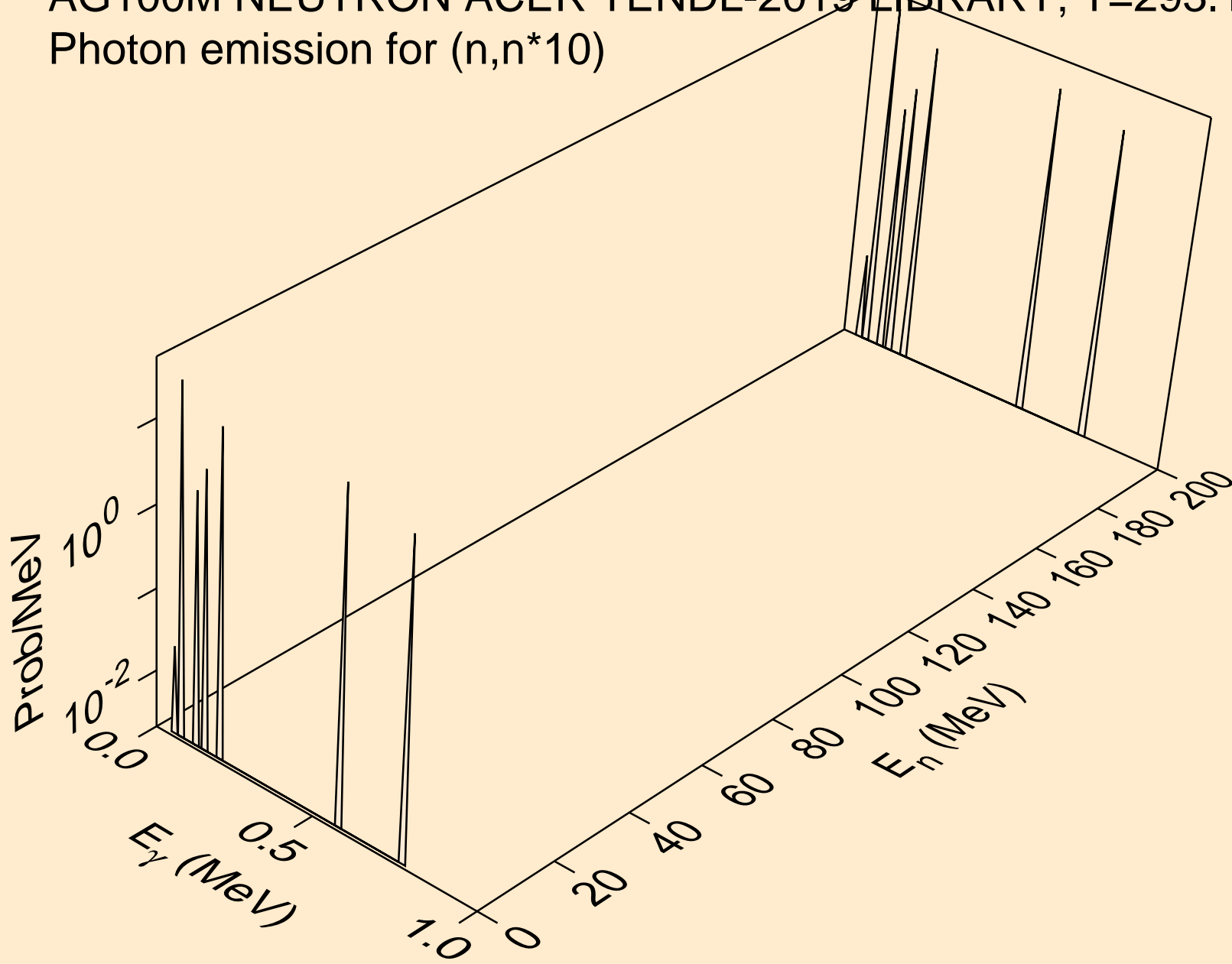

AG100M NEUTRON ACER TENDL-2019 LIBRARY; T=293.16K
Photon emission for (n,n*11)

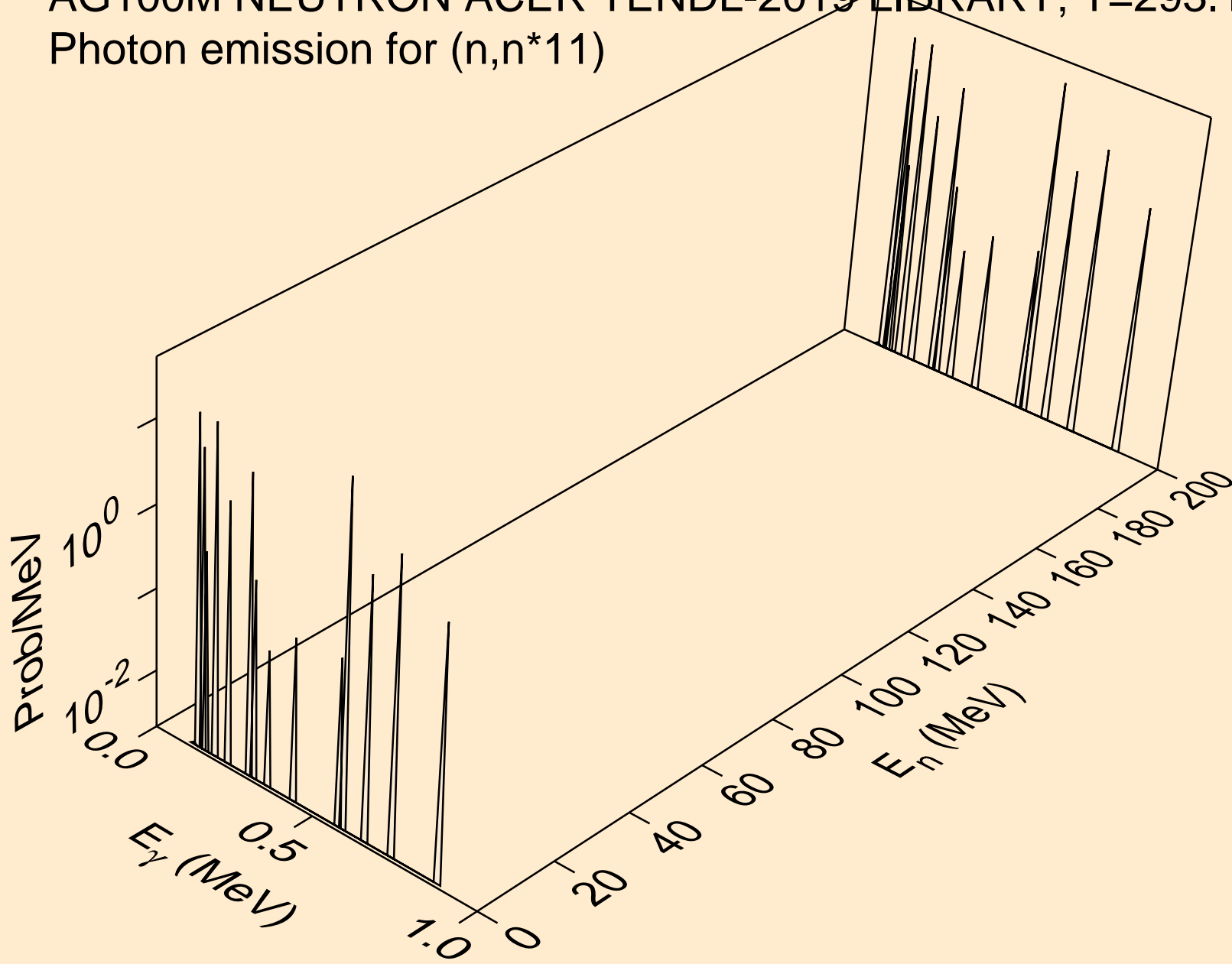

AG100M NEUTRON ACER TENDL-2019 LIBRARY; T=293.16K
Photon emission for (n,n*12)

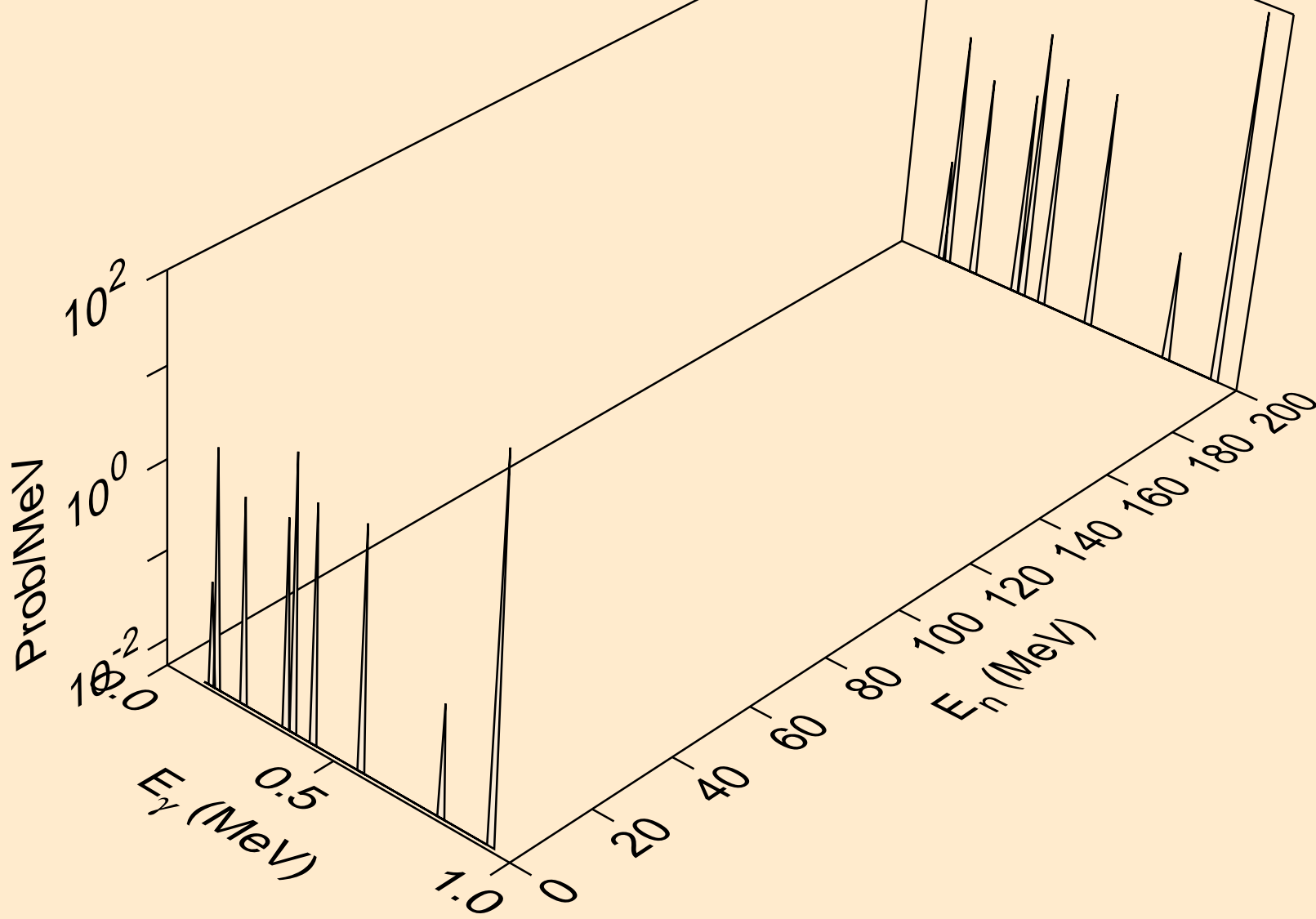

AG100M NEUTRON ACER TENDL-2019 LIBRARY; T=293.16K
Photon emission for (n,n*13)

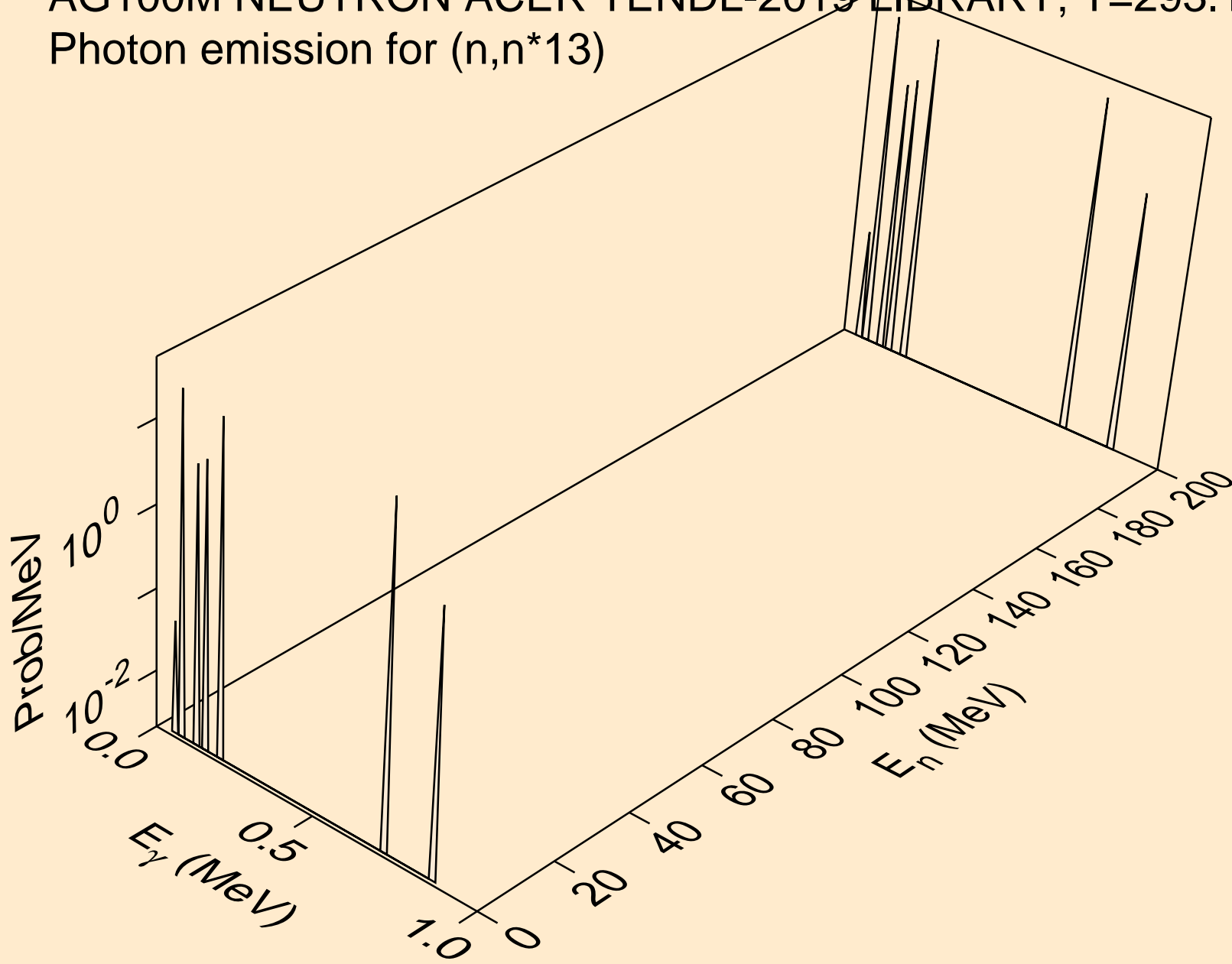

AG100M NEUTRON ACER TENDL-2019 LIBRARY; T=293.16K
Photon emission for (n,n*14)

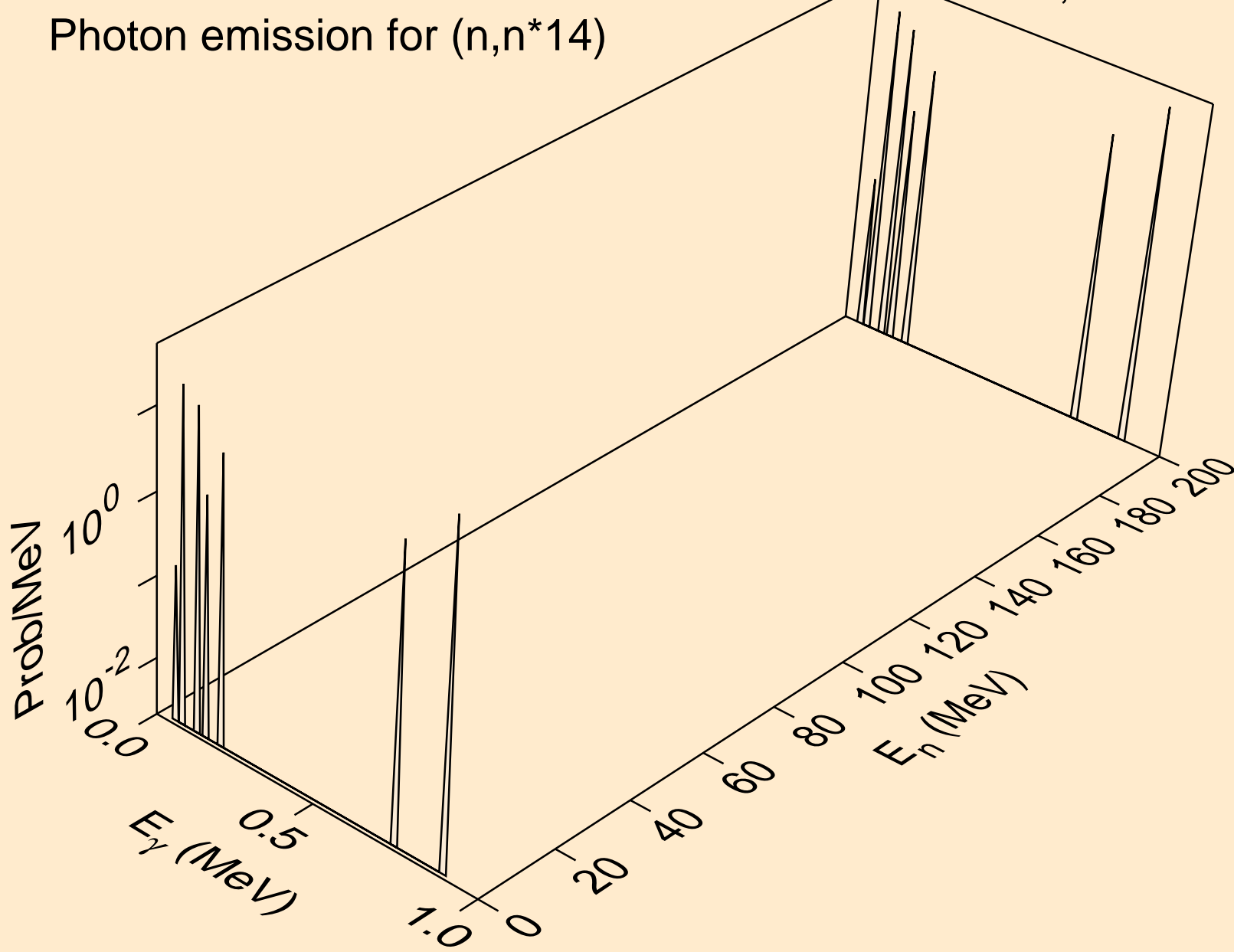

AG100M NEUTRON ACER TENDL-2019 LIBRARY; T=293.16K
Photon emission for (n,n*15)

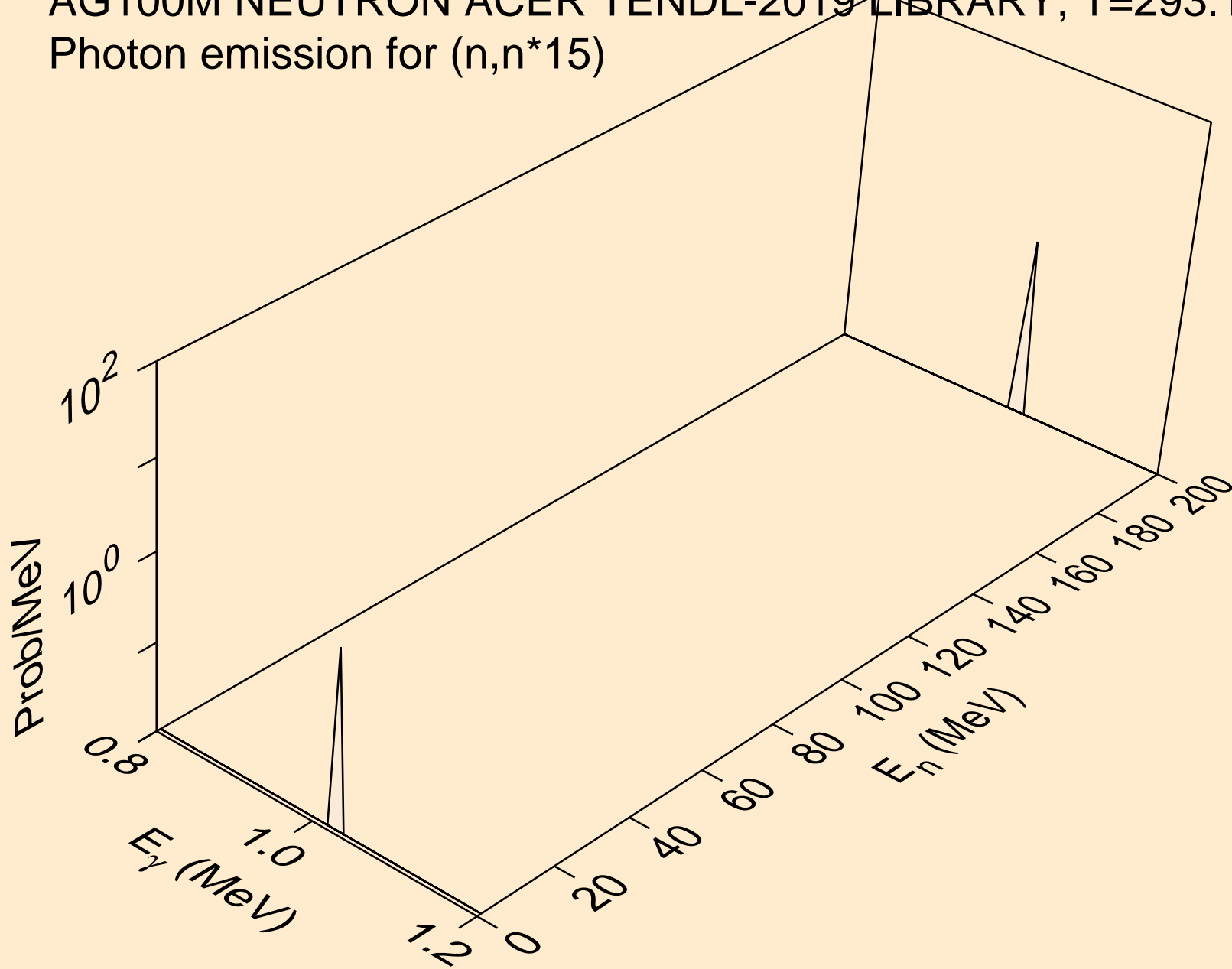

AG100M NEUTRON ACER TENDL-2019 LIBRARY; T=293.16K
Photon emission for (n,n*16)

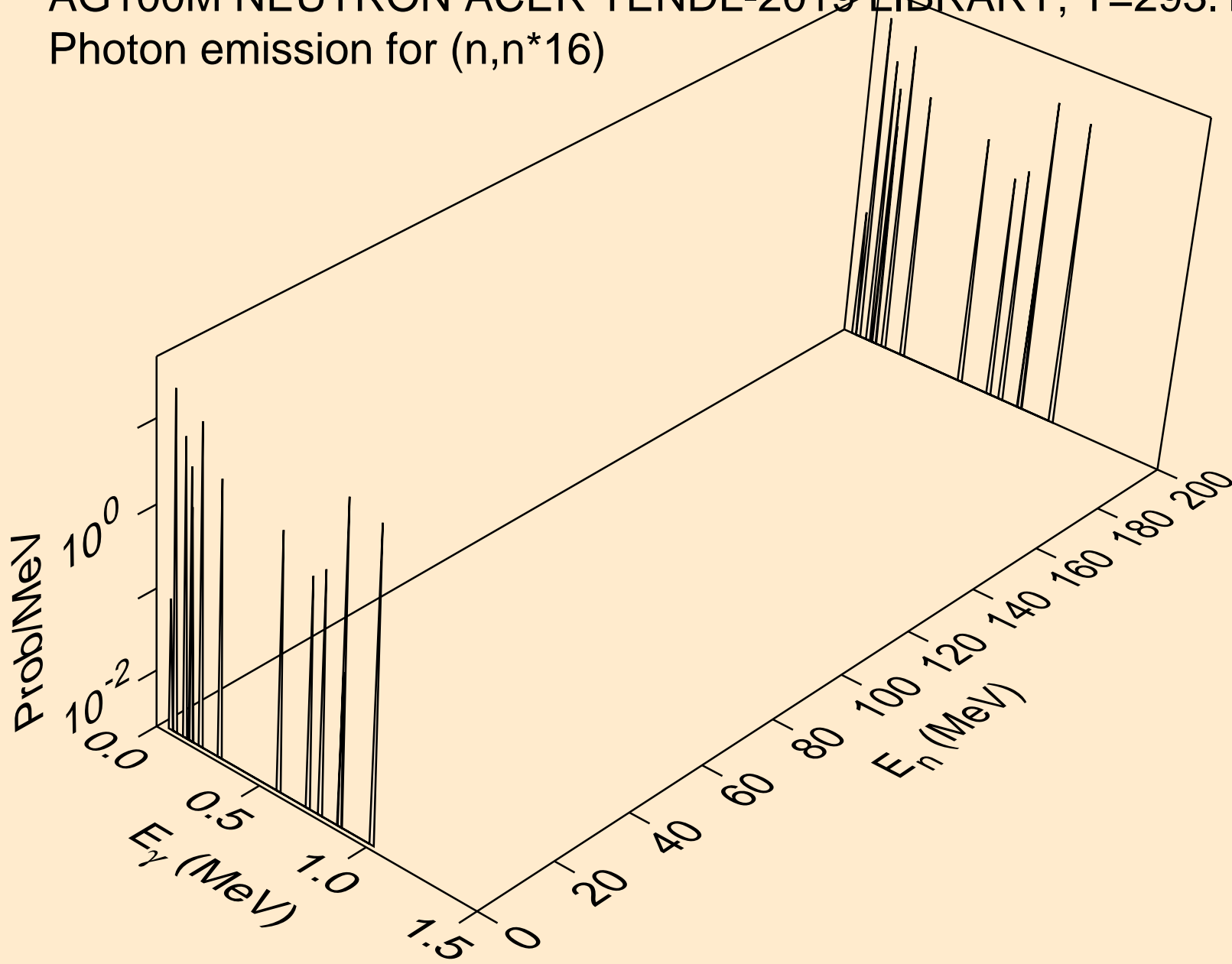

AG100M NEUTRON ACER TENDL-2019 LIBRARY; T=293.16K
Photon emission for (n,n*17)

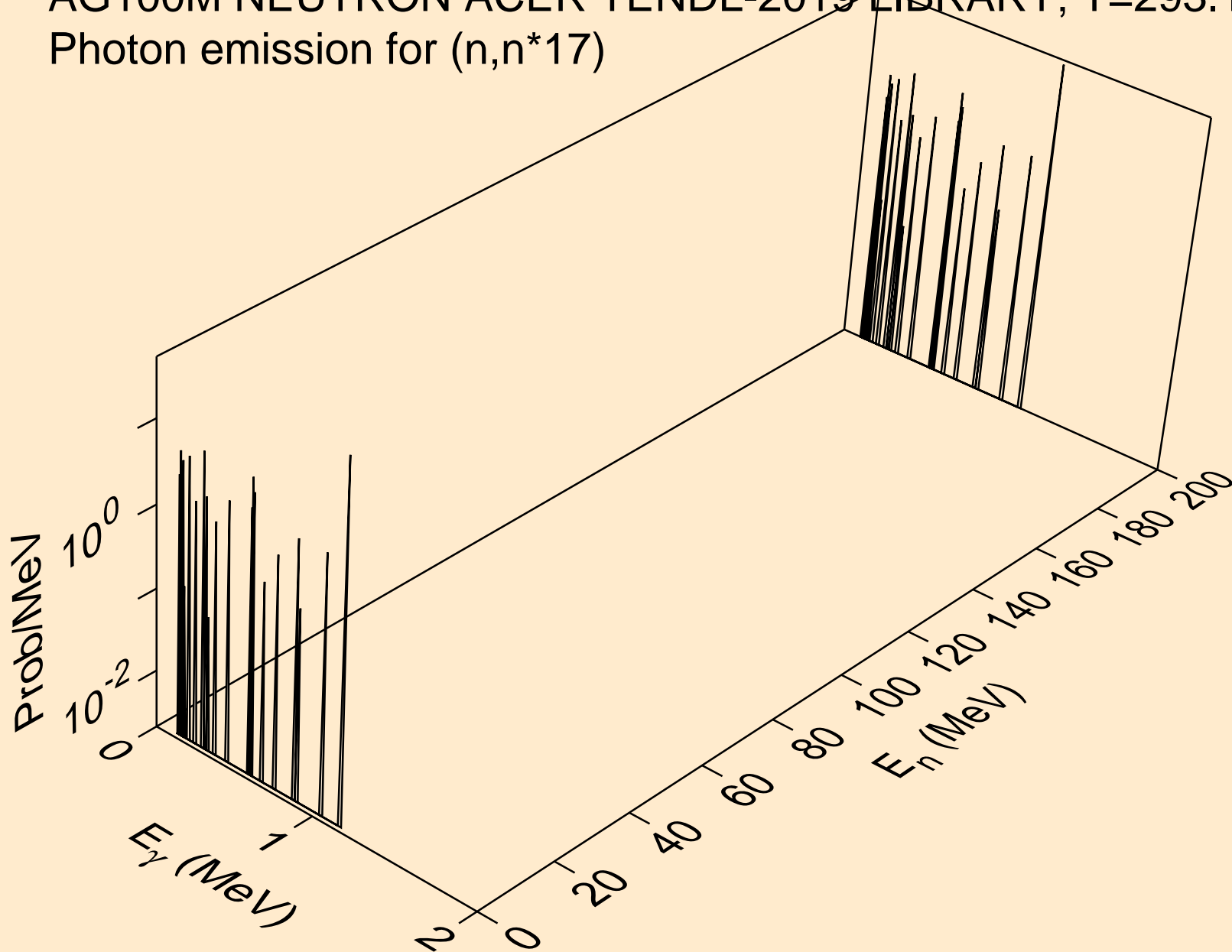

AG100M NEUTRON ACER TENDL-2019 LIBRARY; T=293.16K
Photon emission for (n,n*18)

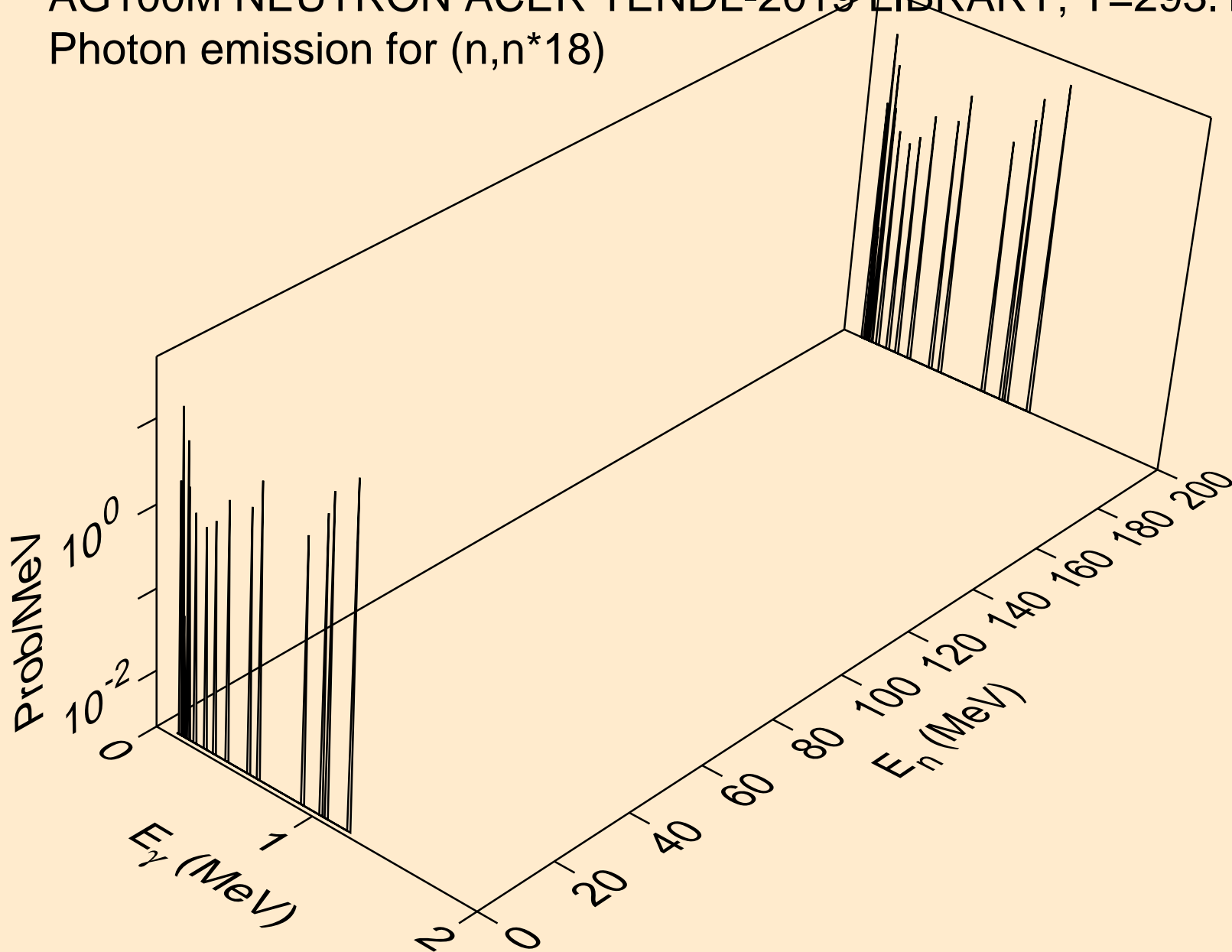

AG100M NEUTRON ACER TENDL-2019 LIBRARY; T=293.16K
Photon emission for (n,n*19)

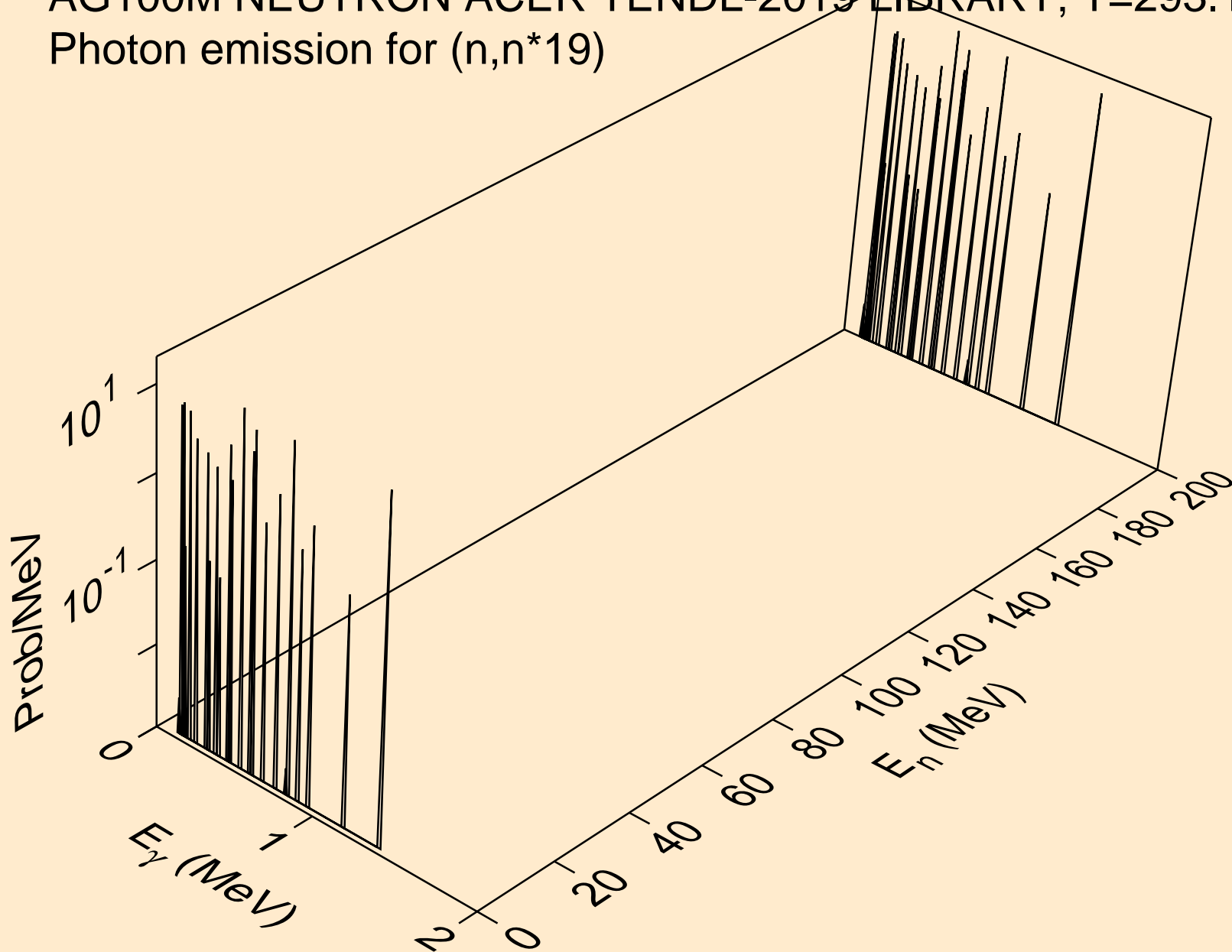

AG100M NEUTRON ACER TENDL-2019 LIBRARY; T=293.16K
Photon emission for (n,n*20)

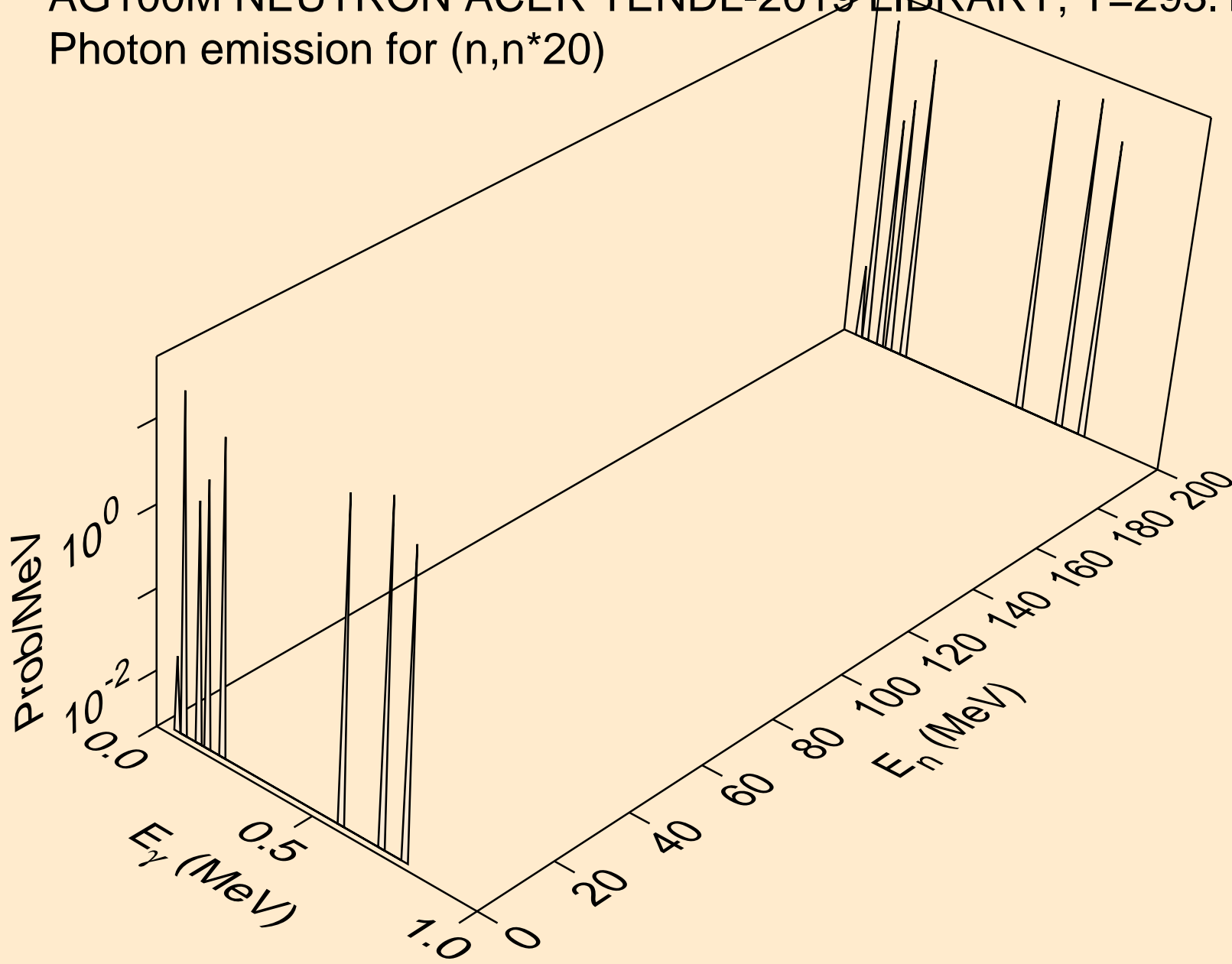

AG100M NEUTRON ACER TENDL-2019 LIBRARY; T=293.16K
Photon emission for (n,n*21)

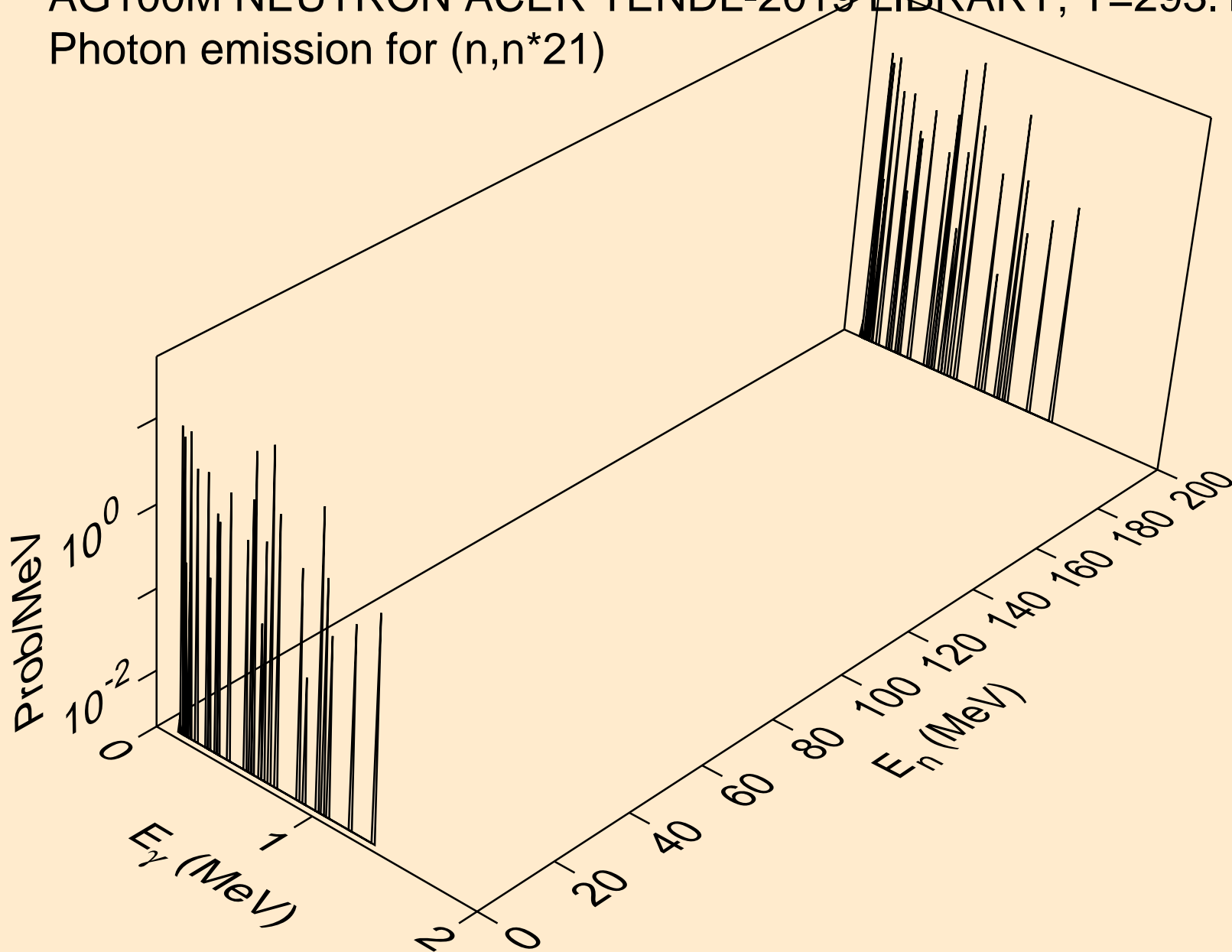

AG100M NEUTRON ACER TENDL-2019 LIBRARY; T=293.16K
Photon emission for (n,n*22)

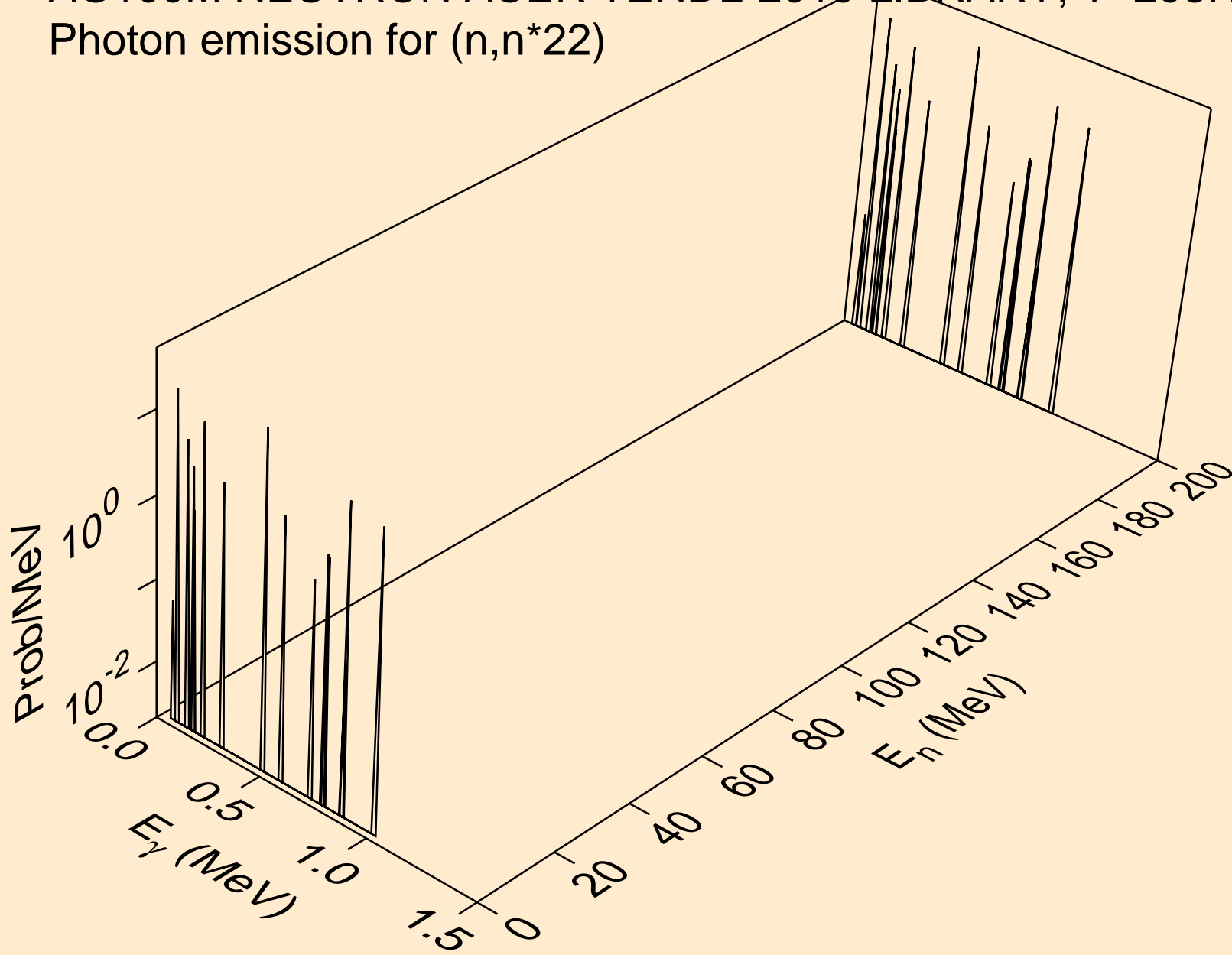

AG100M NEUTRON ACER TENDL-2019 LIBRARY; T=293.16K
Photon emission for (n,n*23)

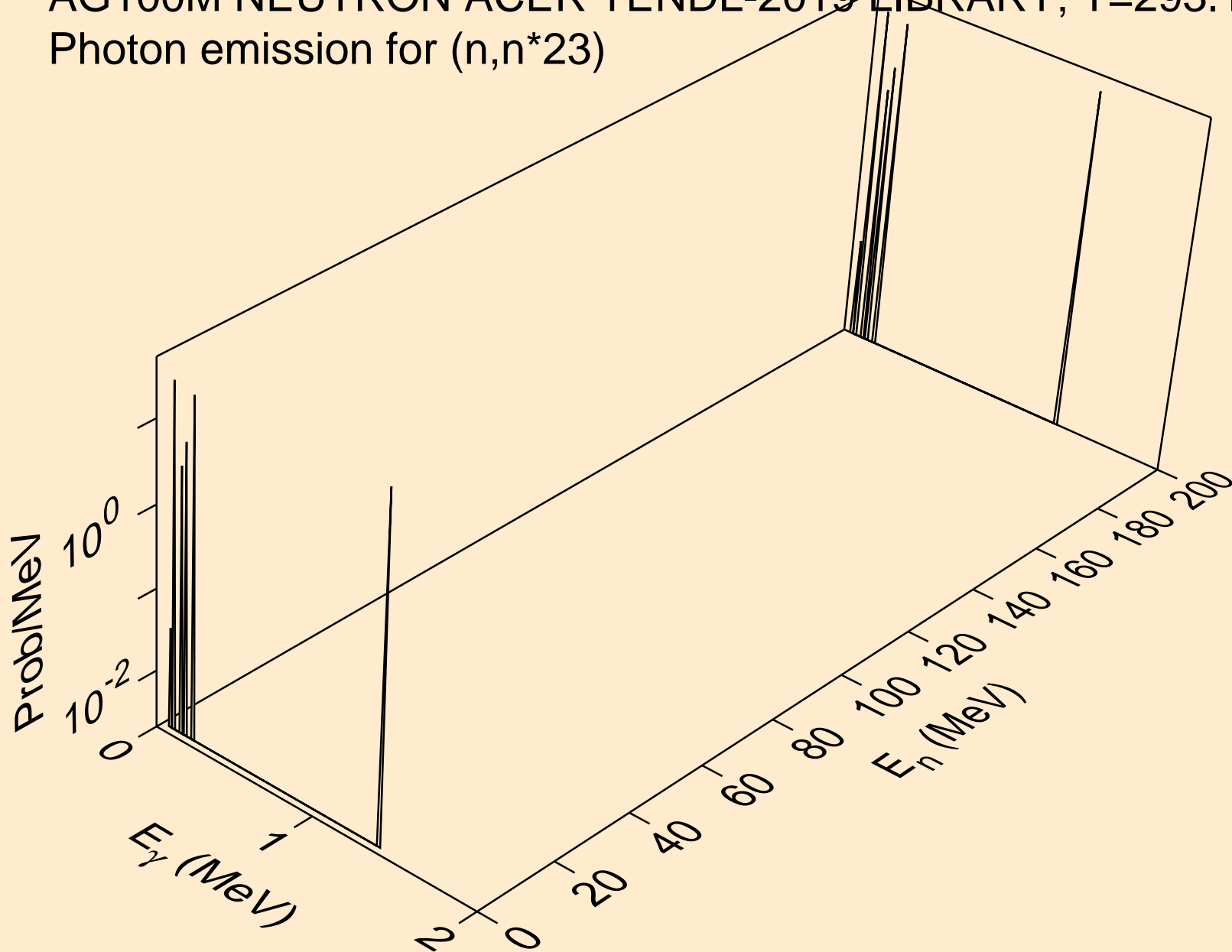

AG100M NEUTRON ACER TENDL-2019 LIBRARY; T=293.16K
Photon emission for (n,n*24)

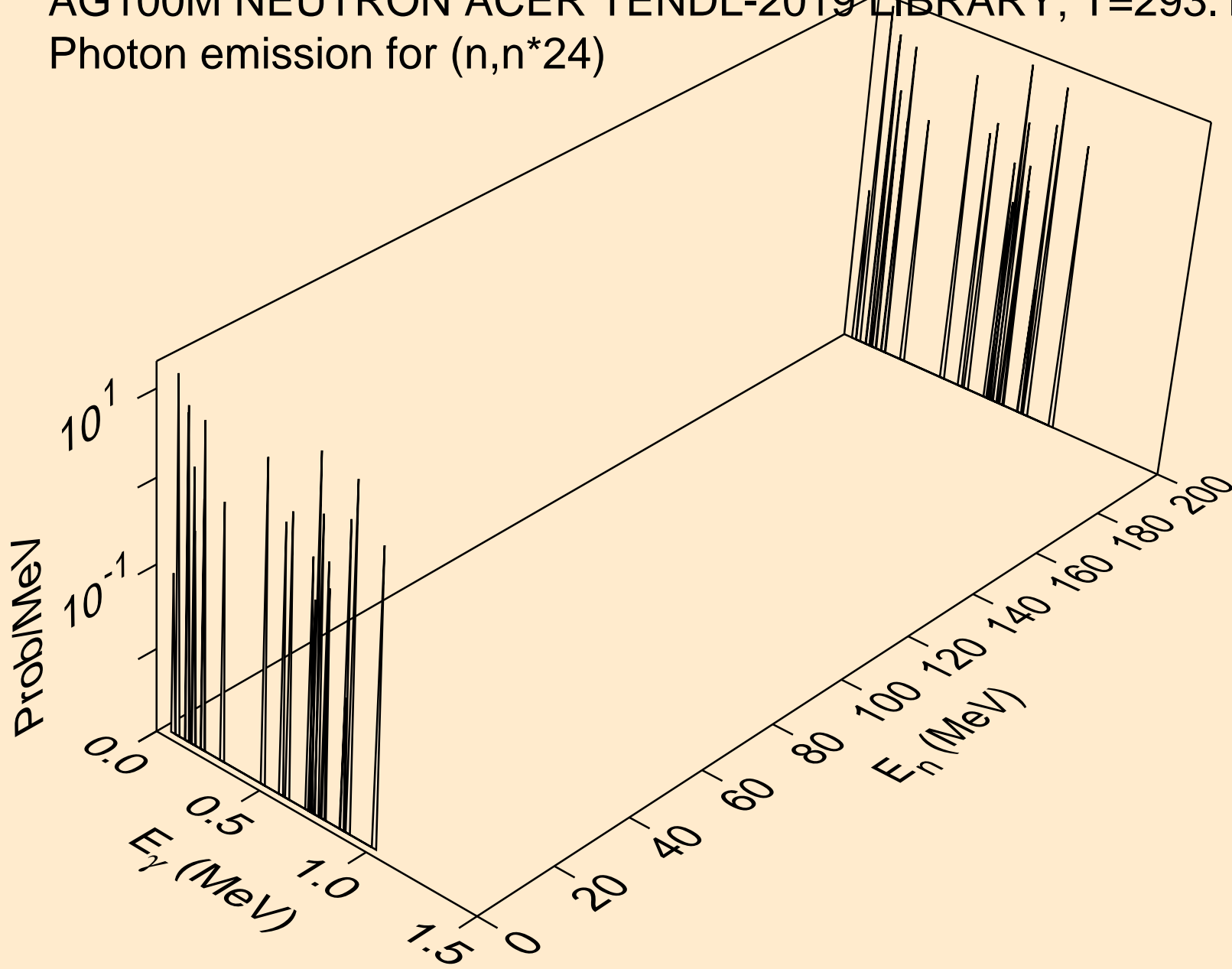

AG100M NEUTRON ACER TENDL-2019 LIBRARY; T=293.16K
Photon emission for (n,n*25)

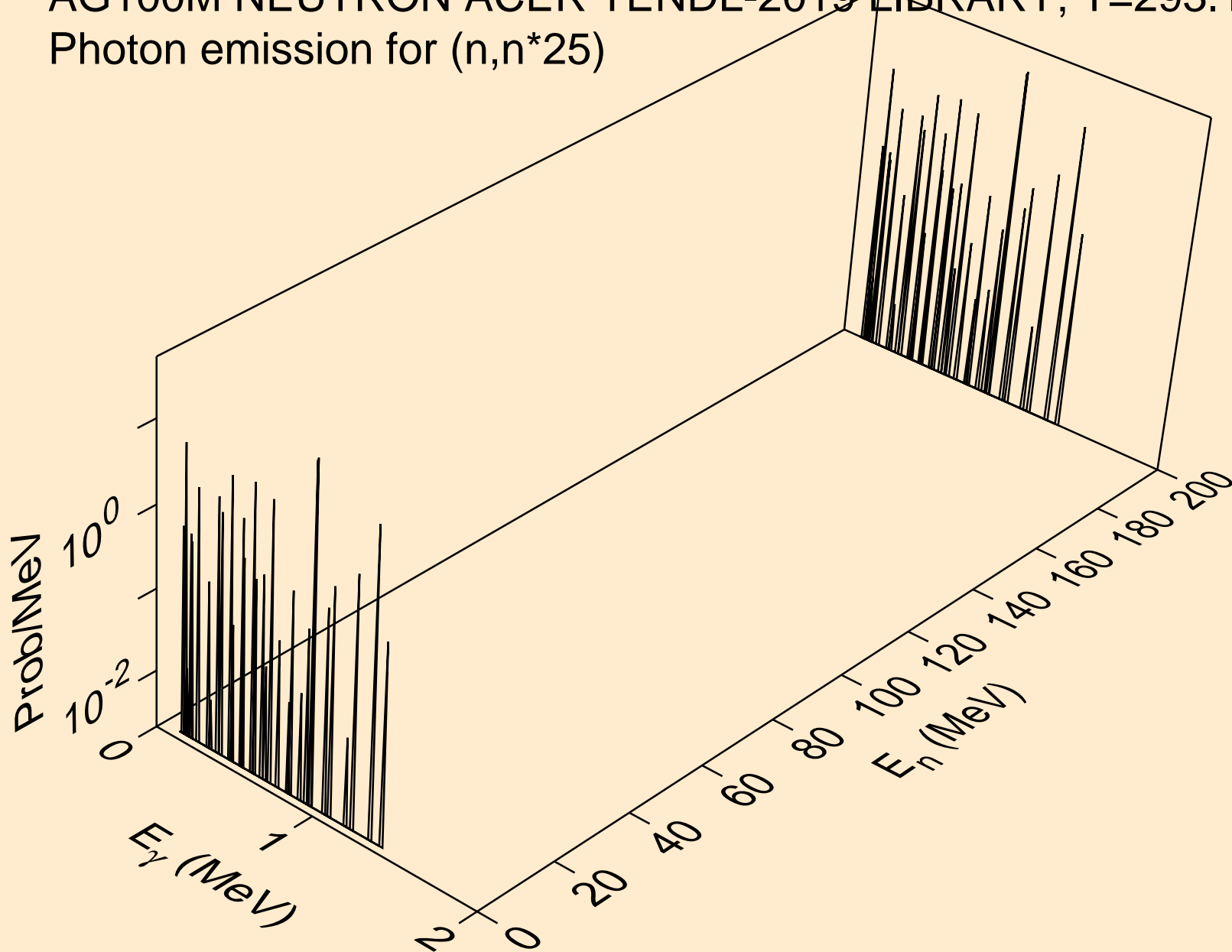

AG100M NEUTRON ACER TENDL-2019 LIBRARY; T=293.16K
Photon emission for (n,n*26)

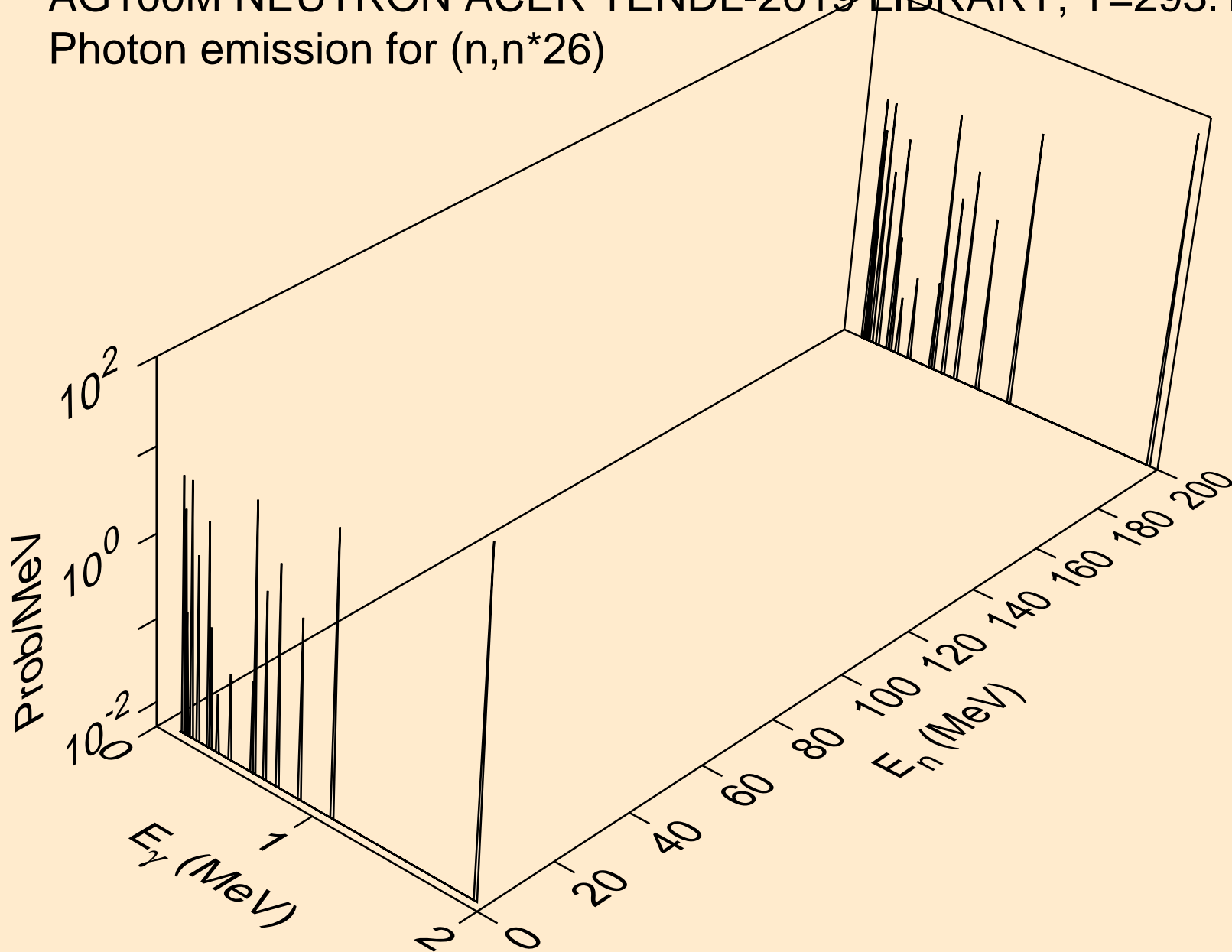

AG100M NEUTRON ACER TENDL-2019 LIBRARY; T=293.16K
Photon emission for (n,n*27)

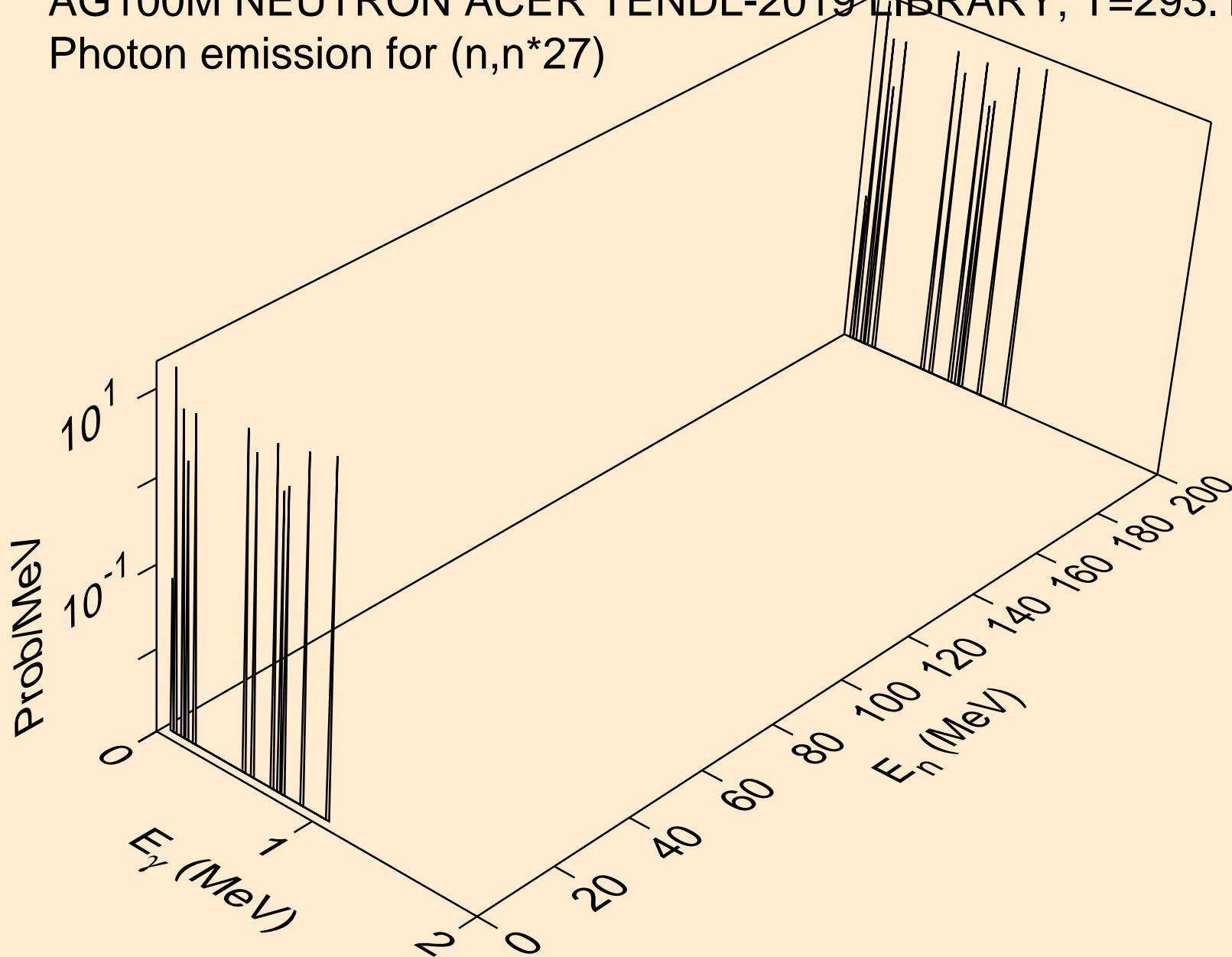

AG100M NEUTRON ACER TENDL-2019 LIBRARY; T=293.16K
Photon emission for (n,n*c)

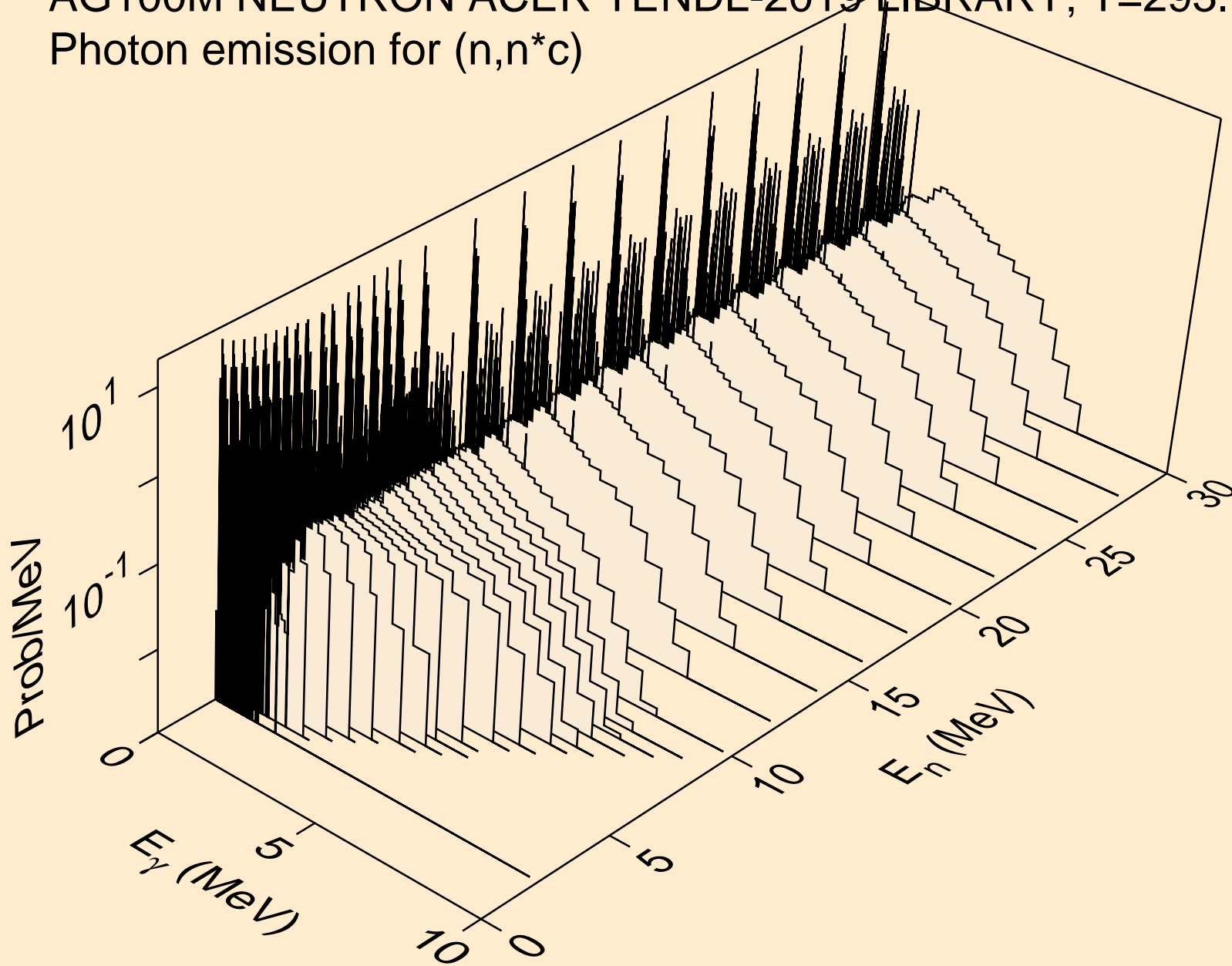

AG100M NEUTRON ACER TENDL-2019 LIBRARY; T=293.16K
Photon emission for (n,gma)

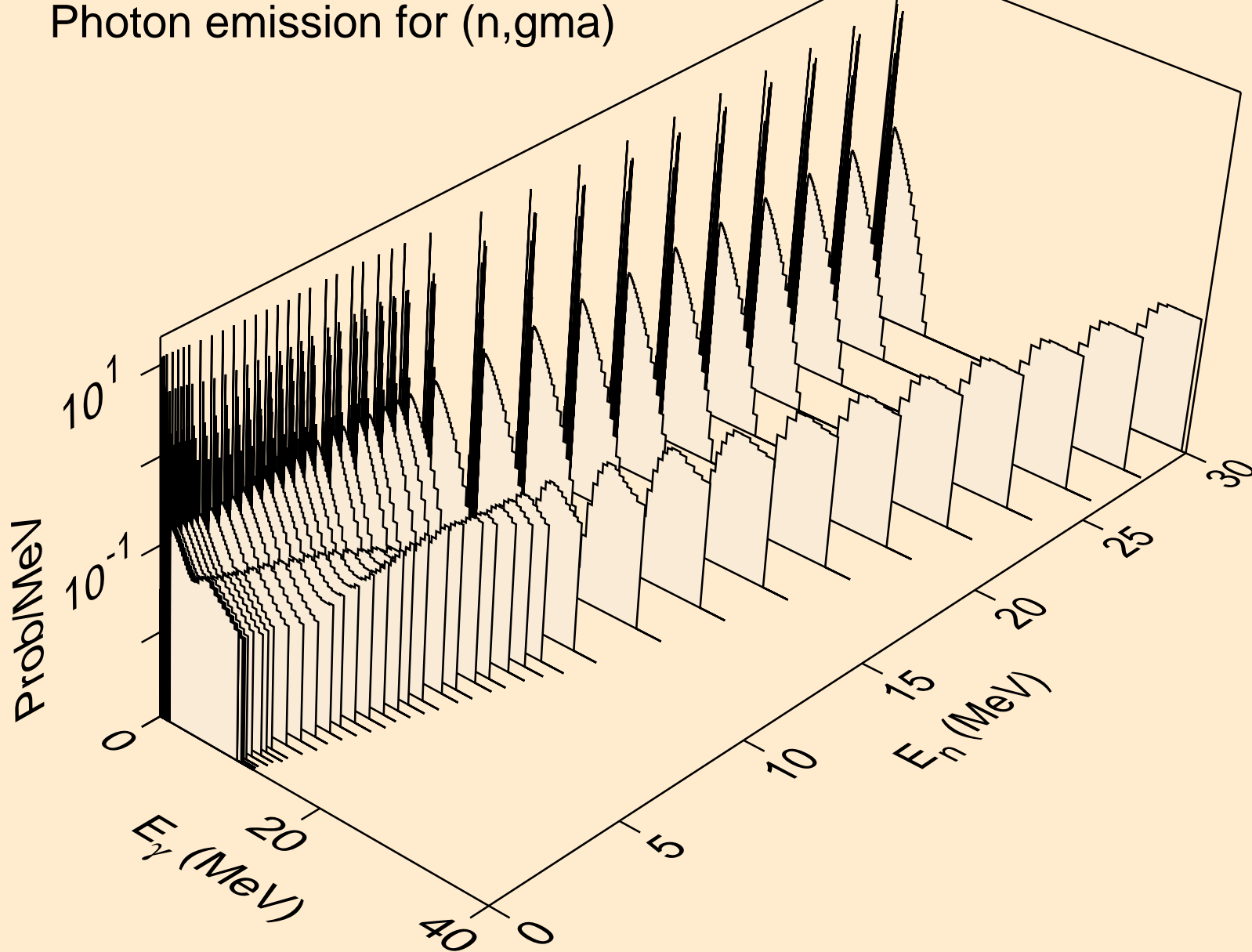

AG100M NEUTRON ACER TENDL-2019 LIBRARY; T=293.16K
Photon emission for (n,p)

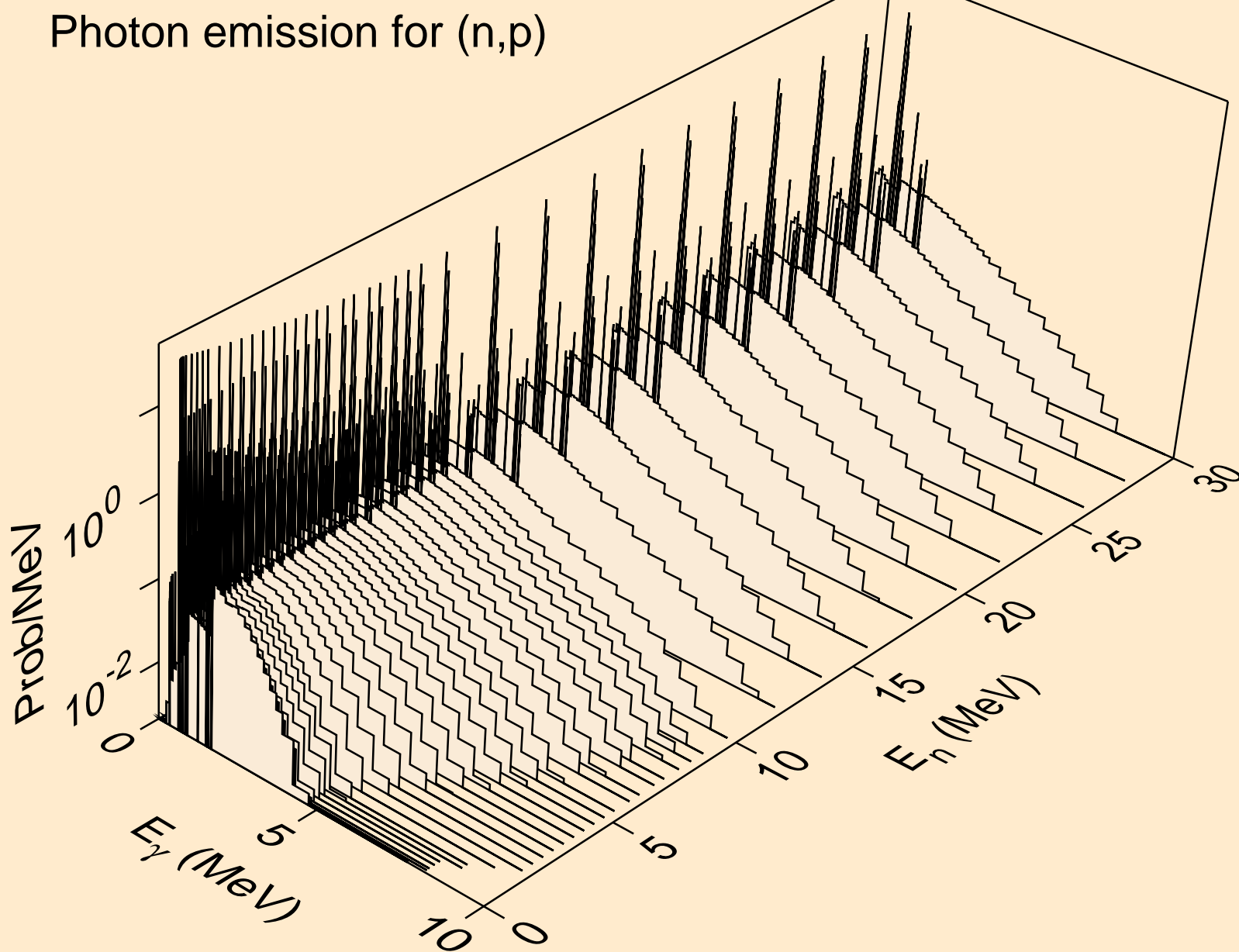

AG100M NEUTRON ACER TENDL-2019 LIBRARY; T=293.16K
Photon emission for (n,d)

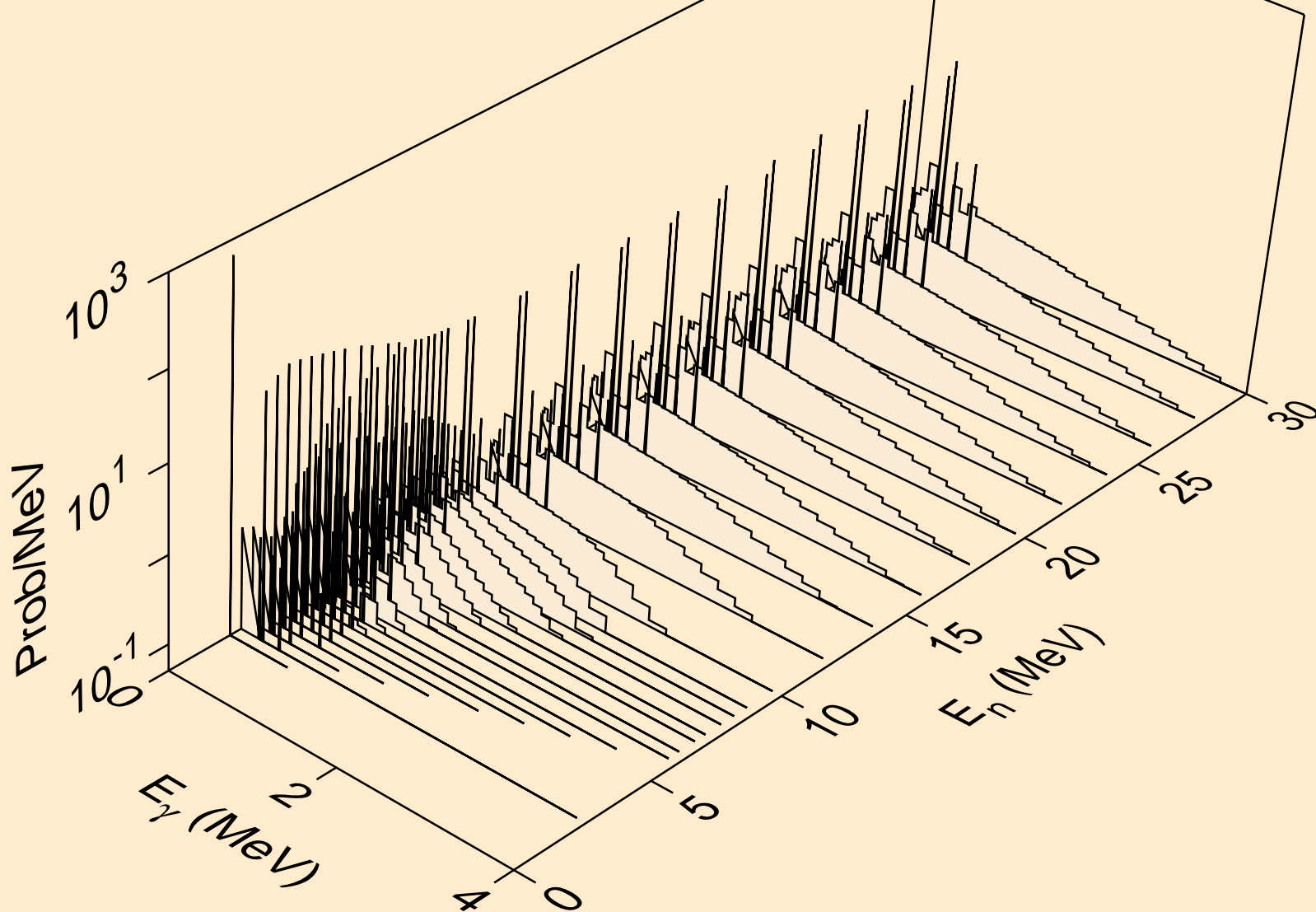

AG100M NEUTRON ACER TENDL-2019 LIBRARY; T=293.16K
Photon emission for (n,t)

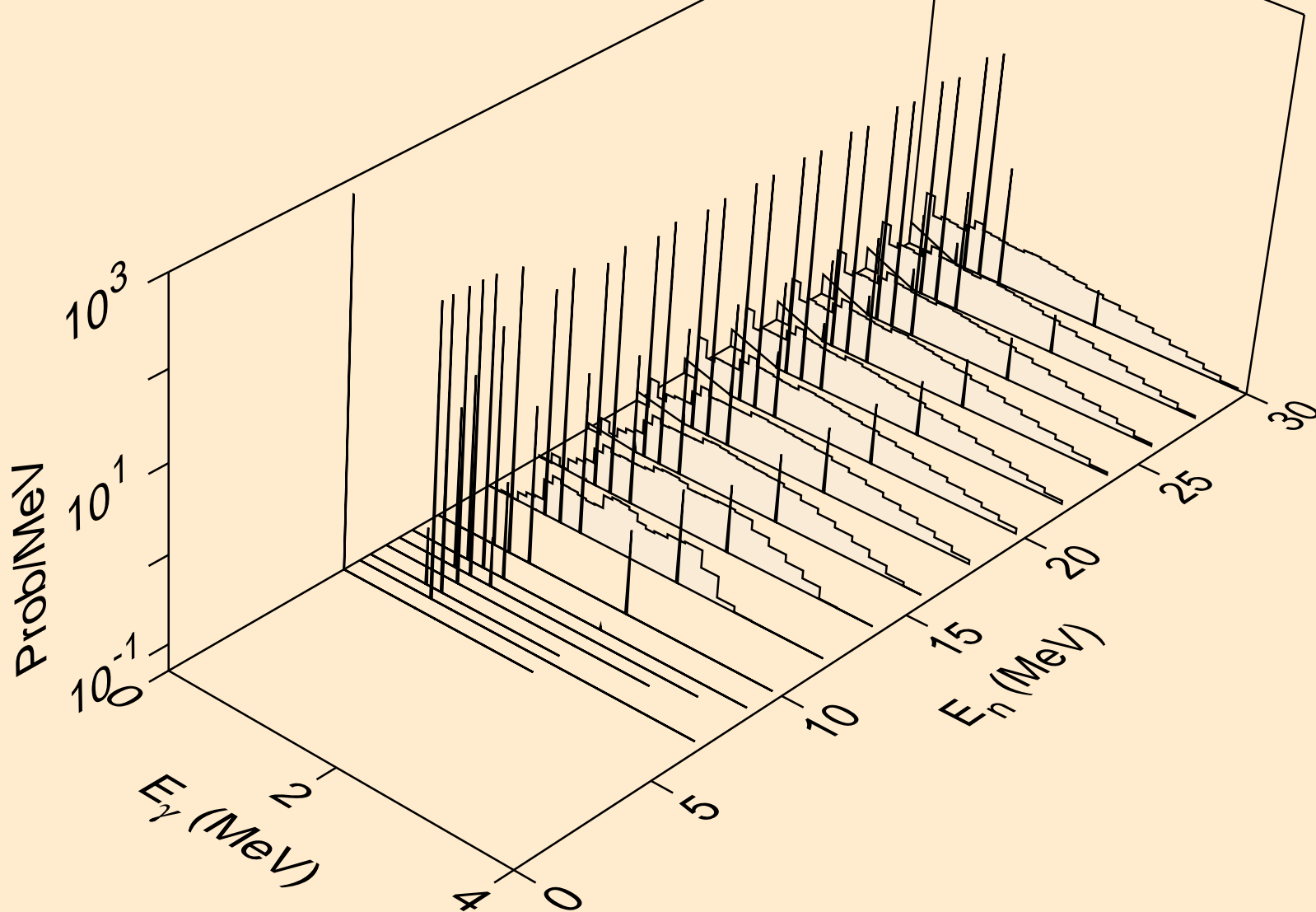

AG100M NEUTRON ACER TENDL-2019 LIBRARY; T=293.16K
Photon emission for (n,he3)

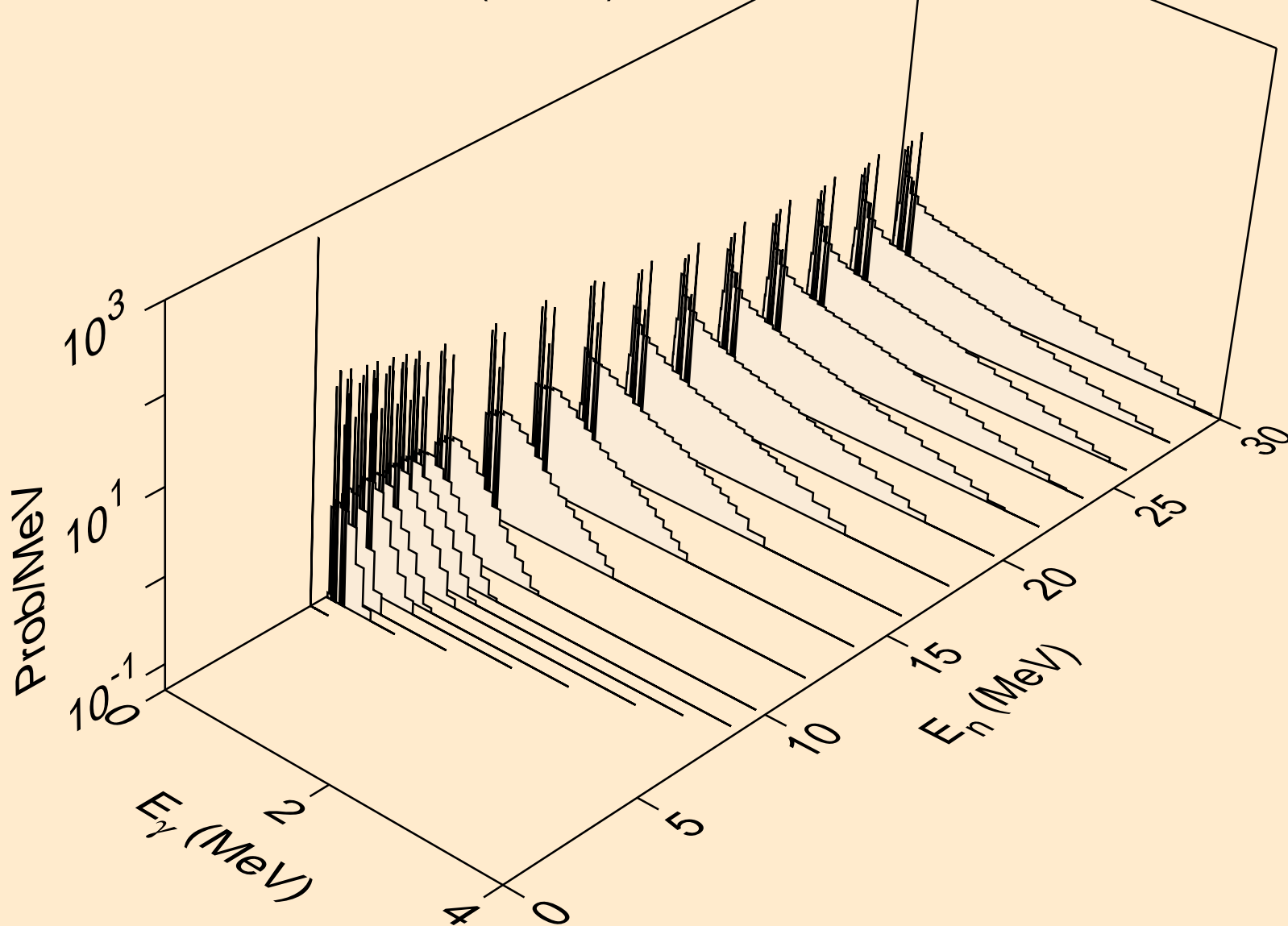

AG100M NEUTRON ACER TENDL-2019 LIBRARY; T=293.16K
Photon emission for (n,a)

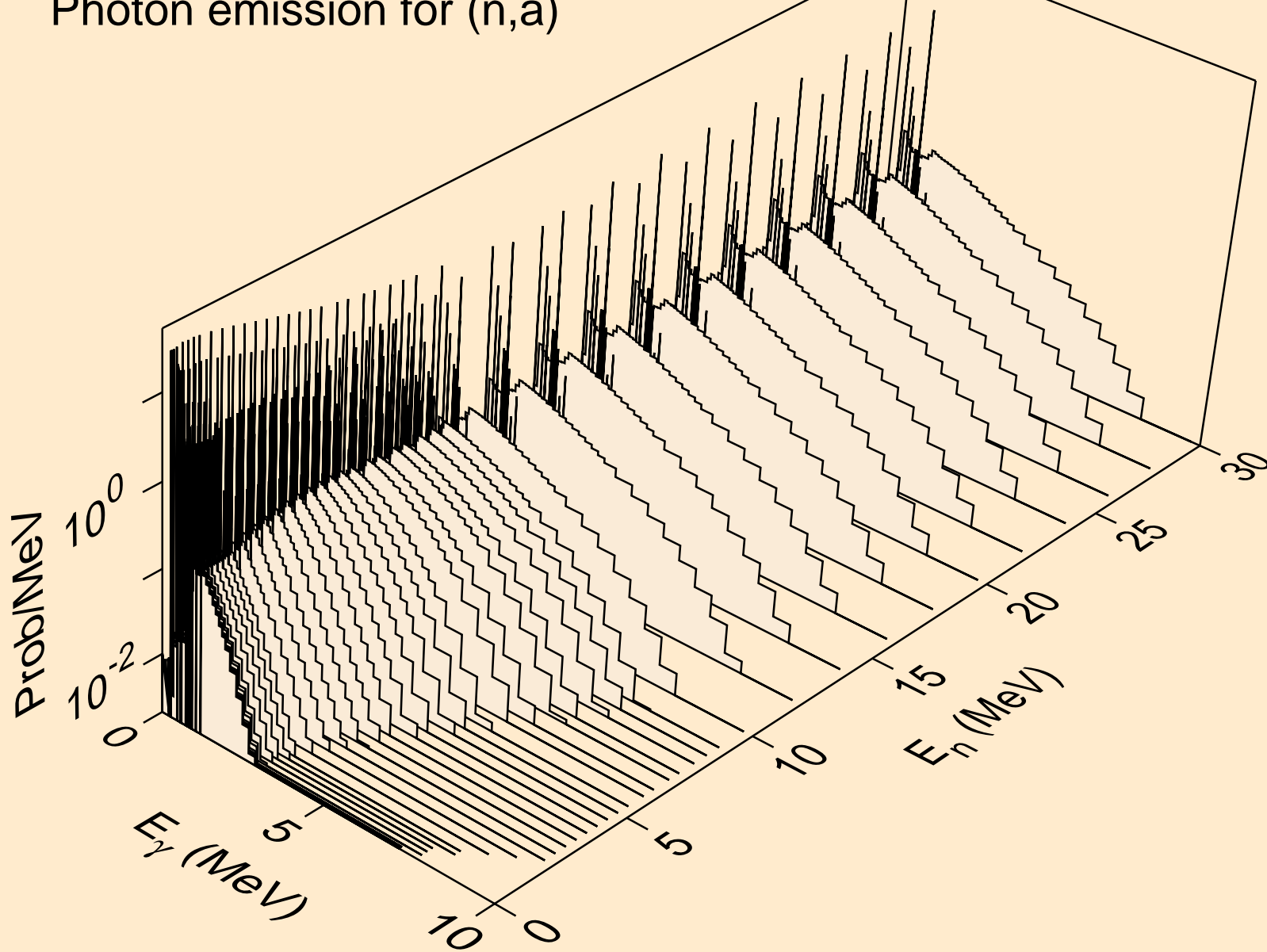

AG100M NEUTRON ACER TENDL-2019 LIBRARY; T=293.16K
Photon emission for (n,2a)

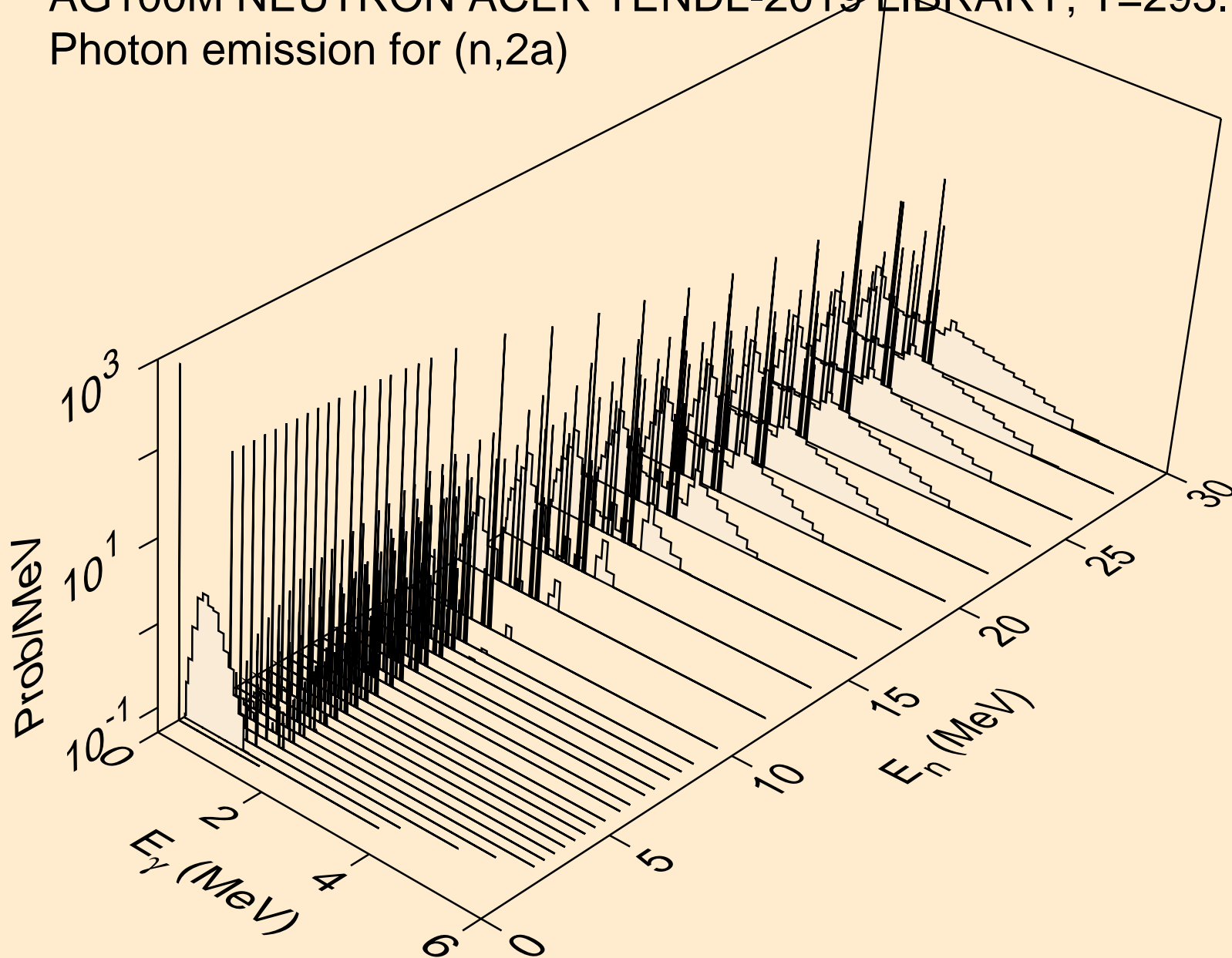

AG100M NEUTRON ACER TENDL-2019 LIBRARY; T=293.16K
Photon emission for (n,3a)

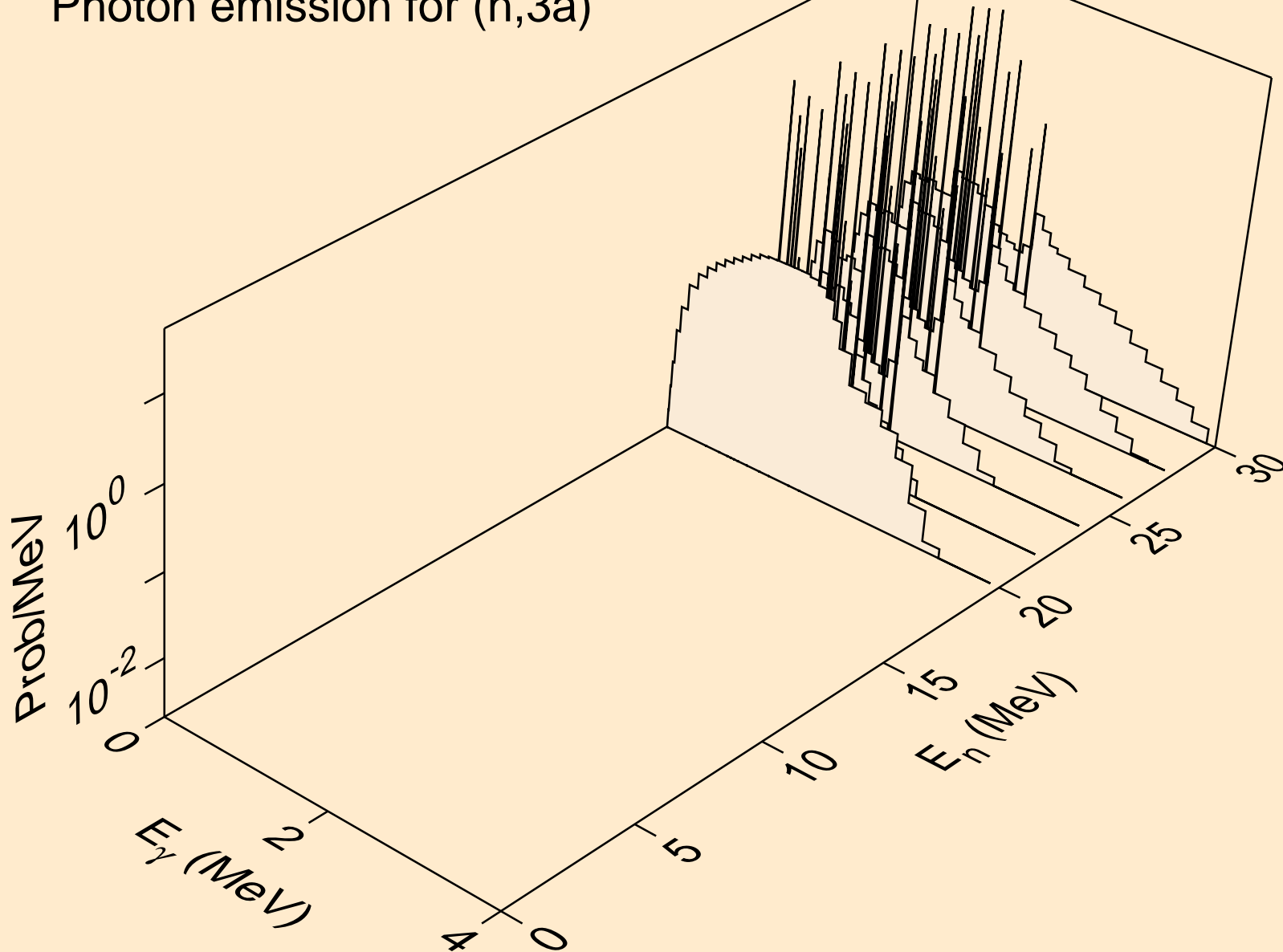

AG100M NEUTRON ACER TENDL-2019 LIBRARY; T=293.16K
Photon emission for (n,2p)

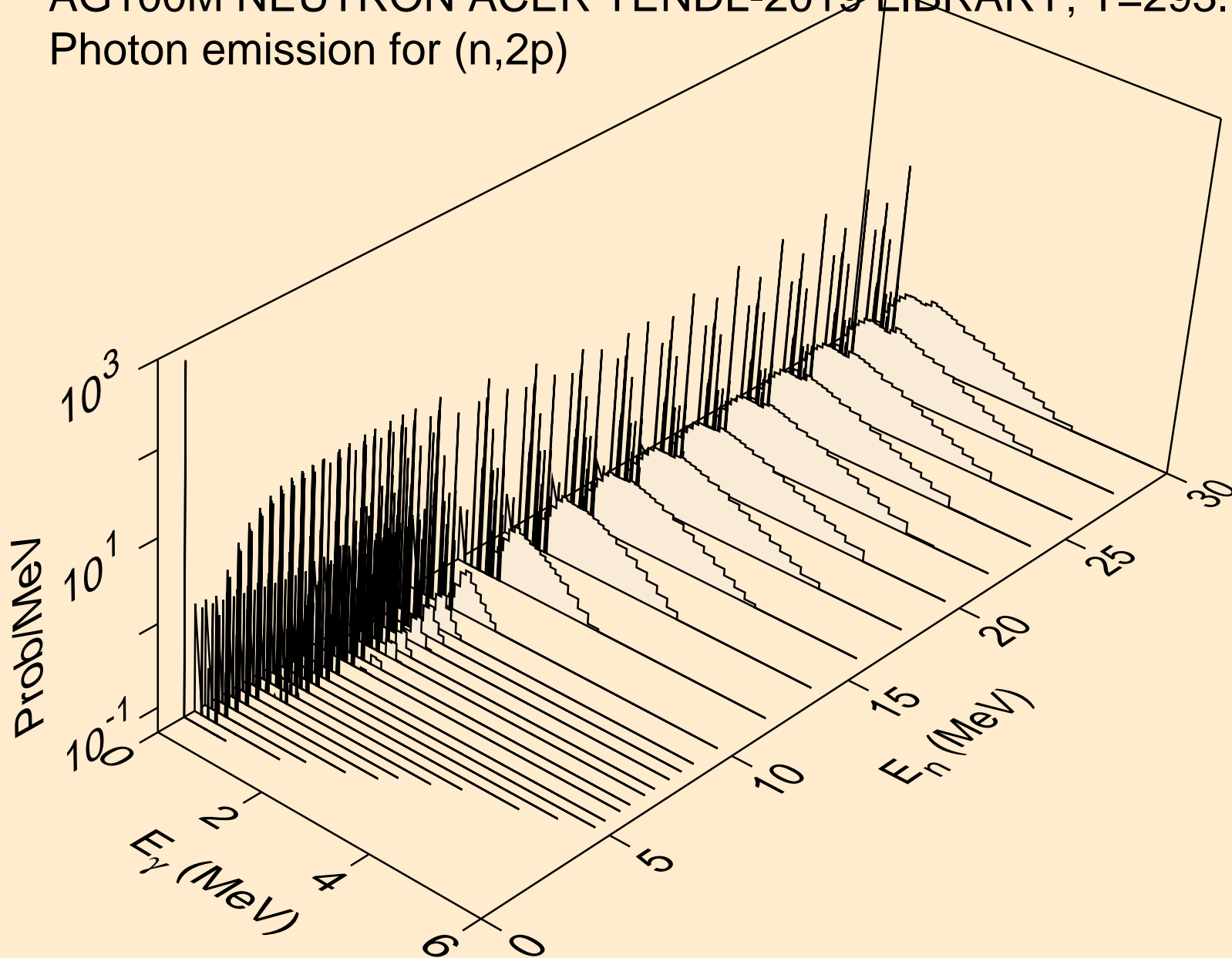

AG100M NEUTRON ACER TENDL-2019 LIBRARY; T=293.16K
Photon emission for (n,p α)

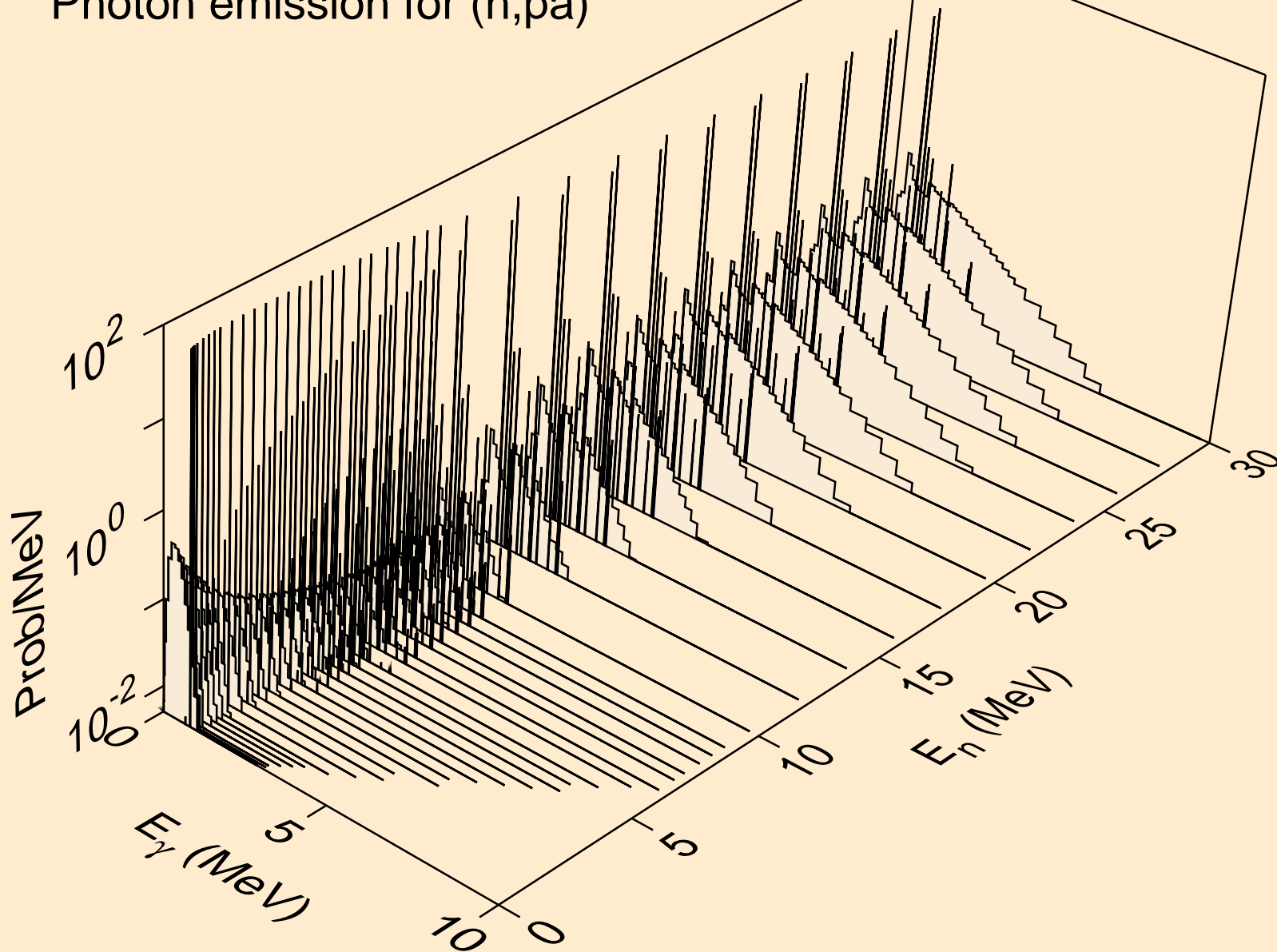

AG100M NEUTRON ACER TENDL-2019 LIBRARY; T=293.16K
Photon emission for (n,pd)

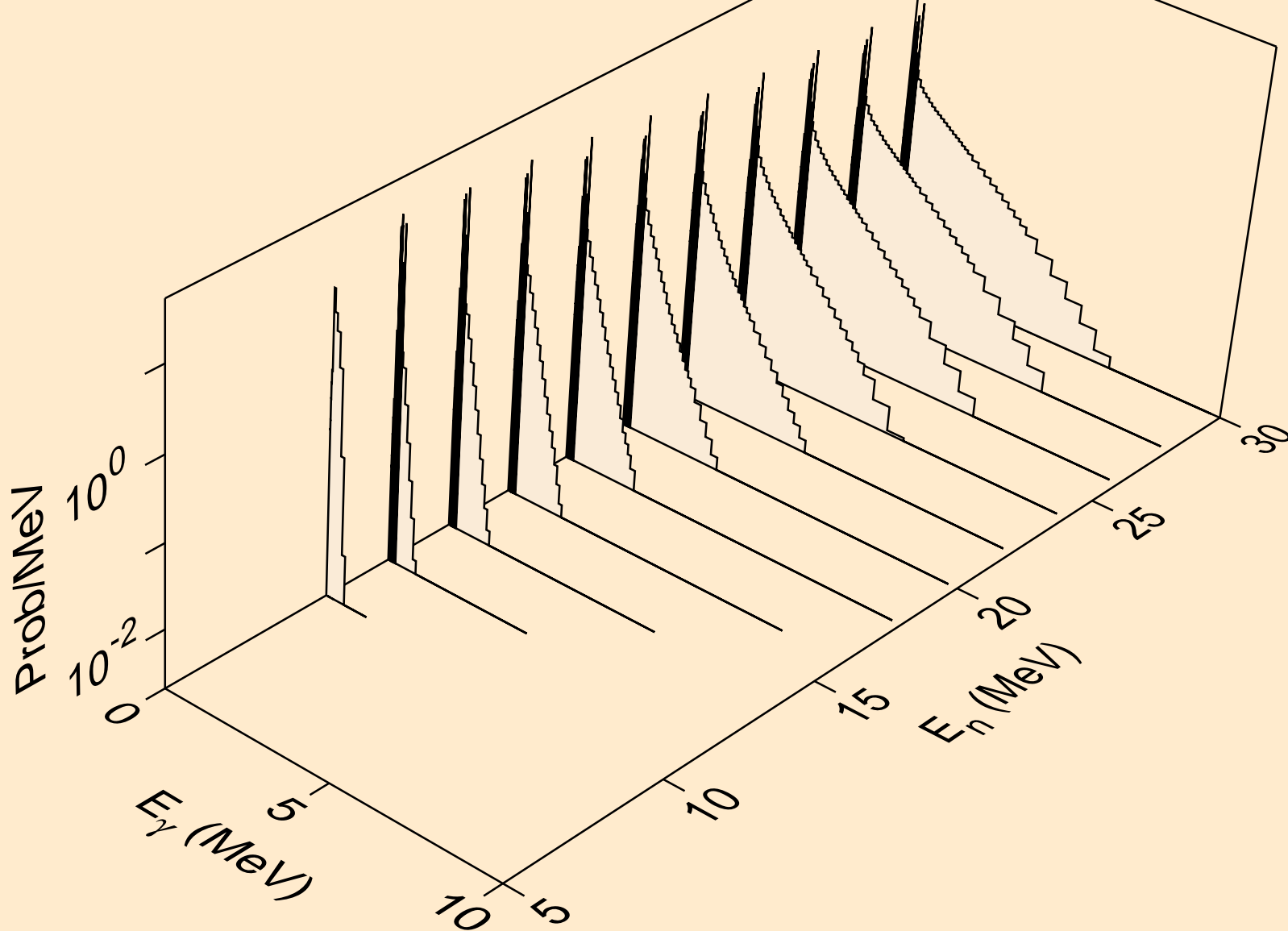

AG100M NEUTRON ACER TENDL-2019 LIBRARY; T=293.16K
Photon emission for (n,pt)

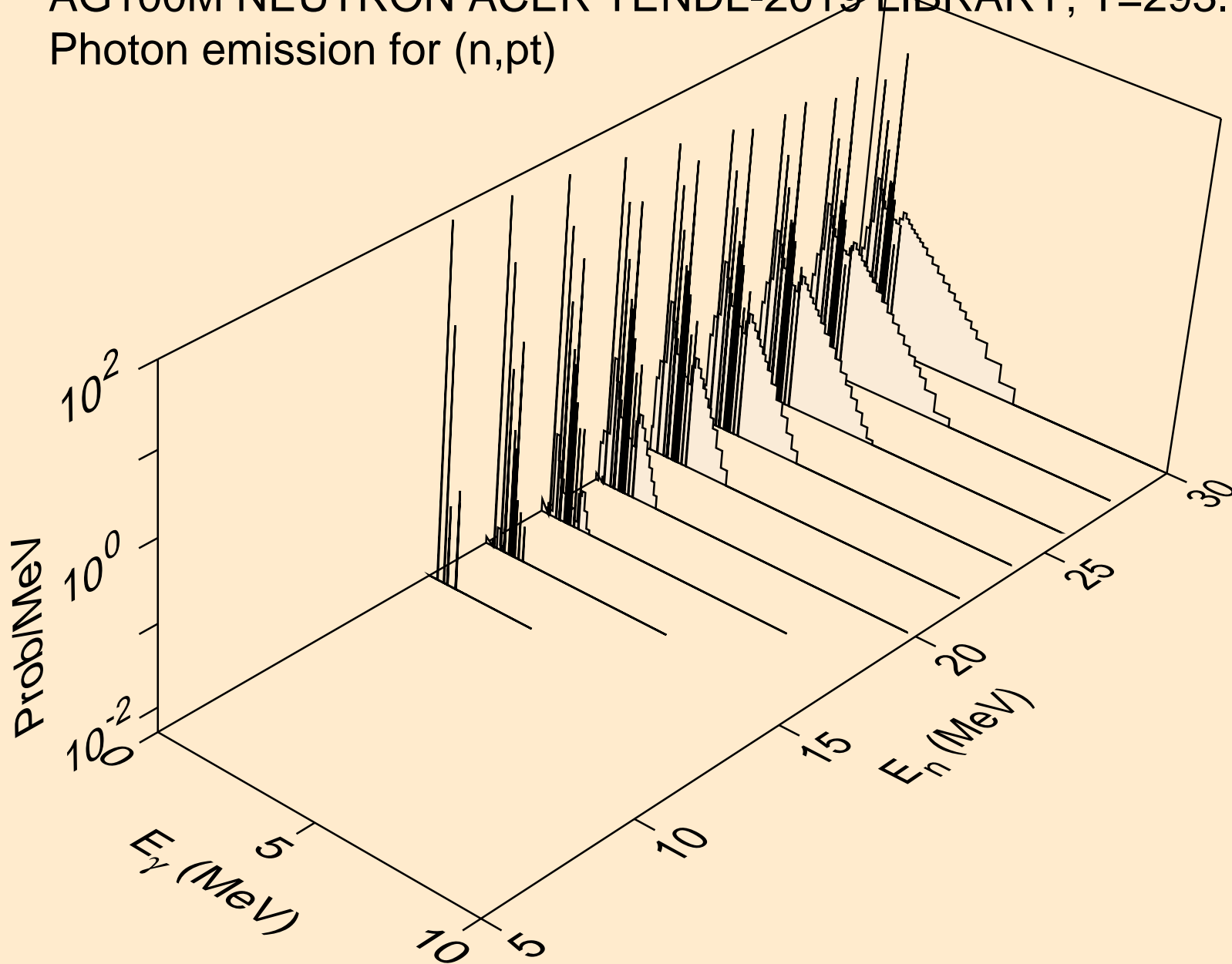

AG100M NEUTRON ACER TENDL-2019 LIBRARY; T=293.16K
Photon emission for (n,da)

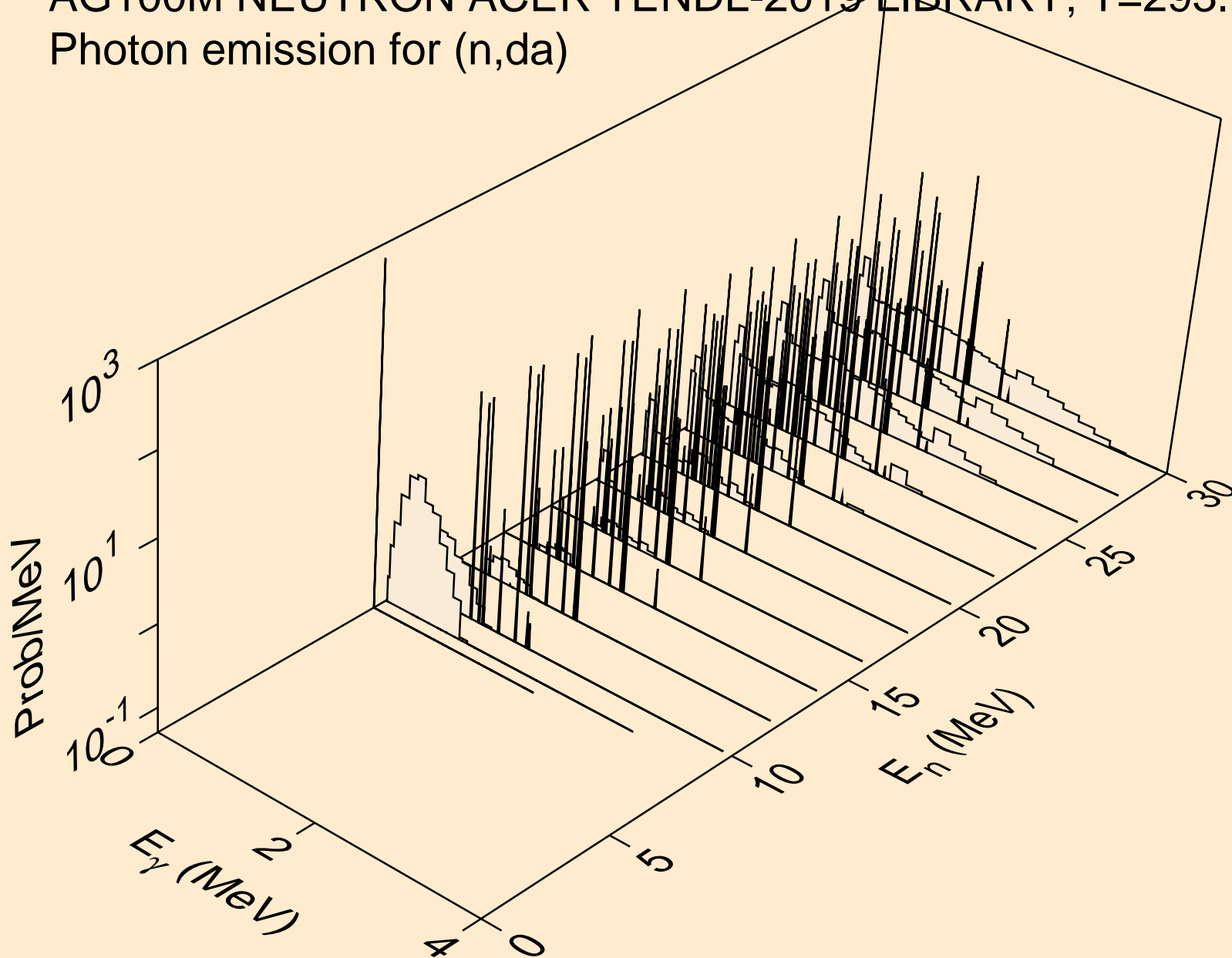

AG100M NEUTRON ACER TENDL-2019 LIBRARY; T=293.16K
thermal capture photon spectrum

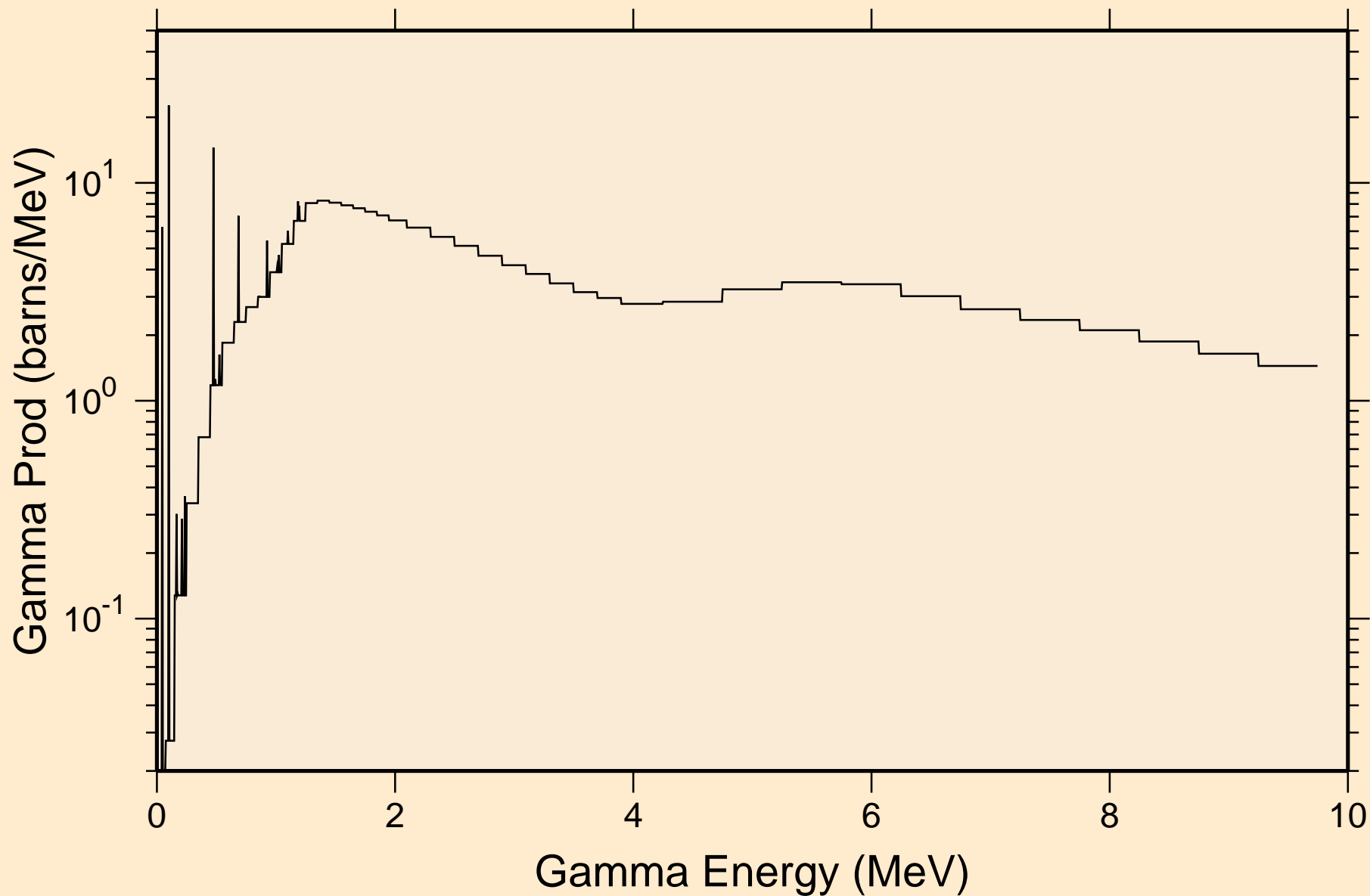

AG100M NEUTRON ACER TENDL-2019 LIBRARY; T=293.16K
14 MeV photon spectrum

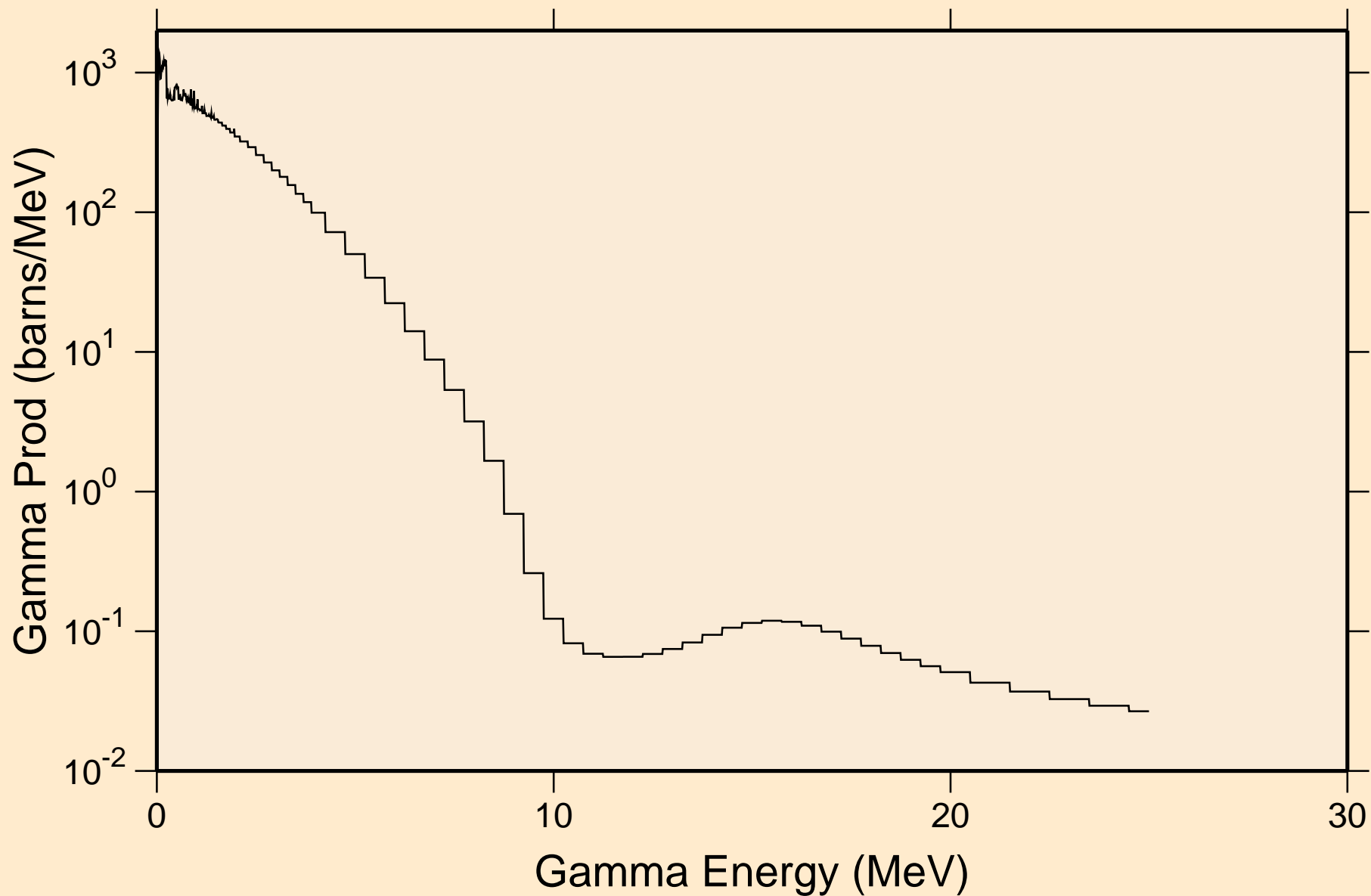

AG100M NEUTRON ACER TENDL-2019 LIBRARY; T=293.16K

Particle heating contributions

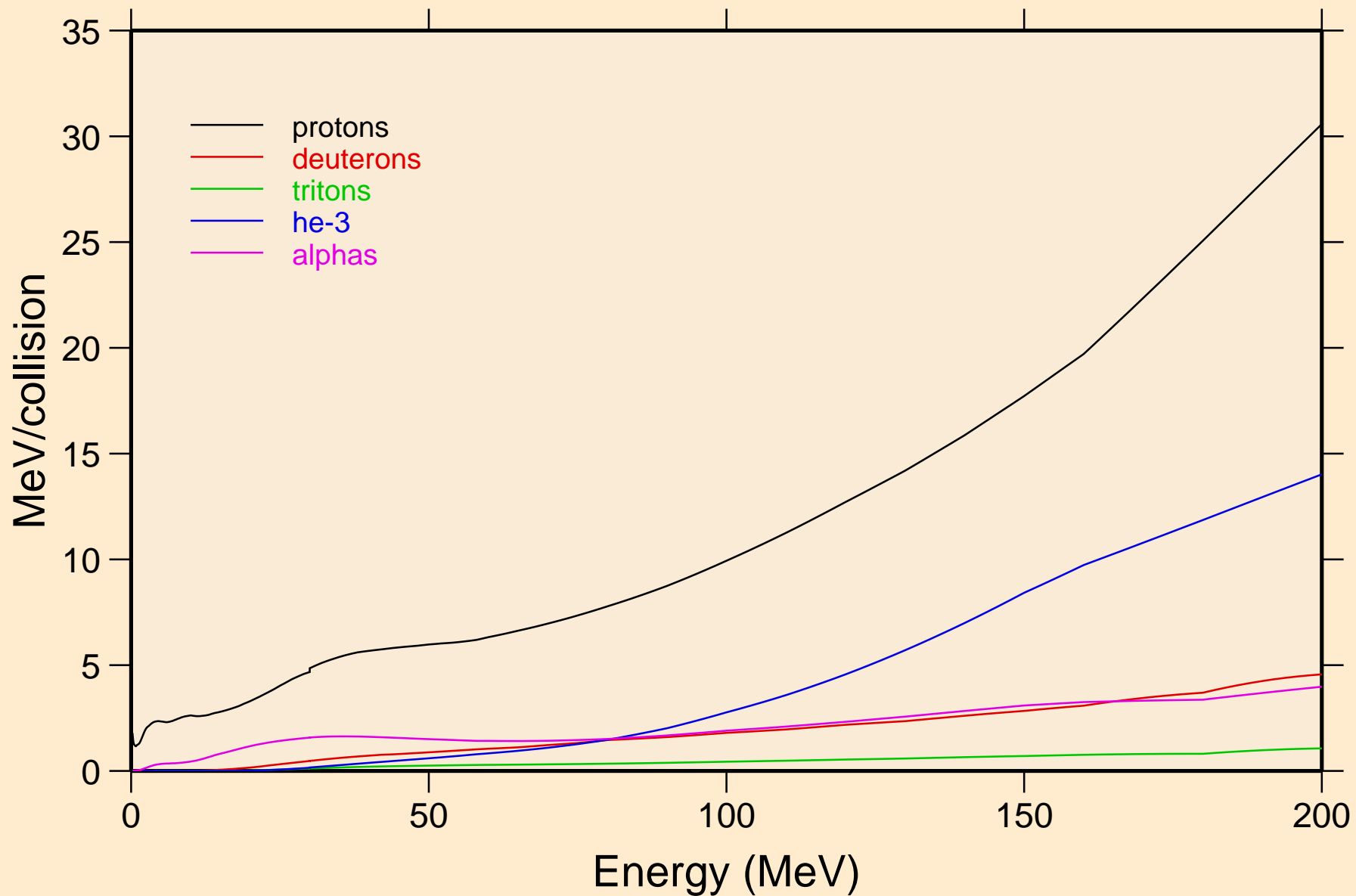

AG100M NEUTRON ACER TENDL-2019 LIBRARY; T=293.16K
Recoil Heating

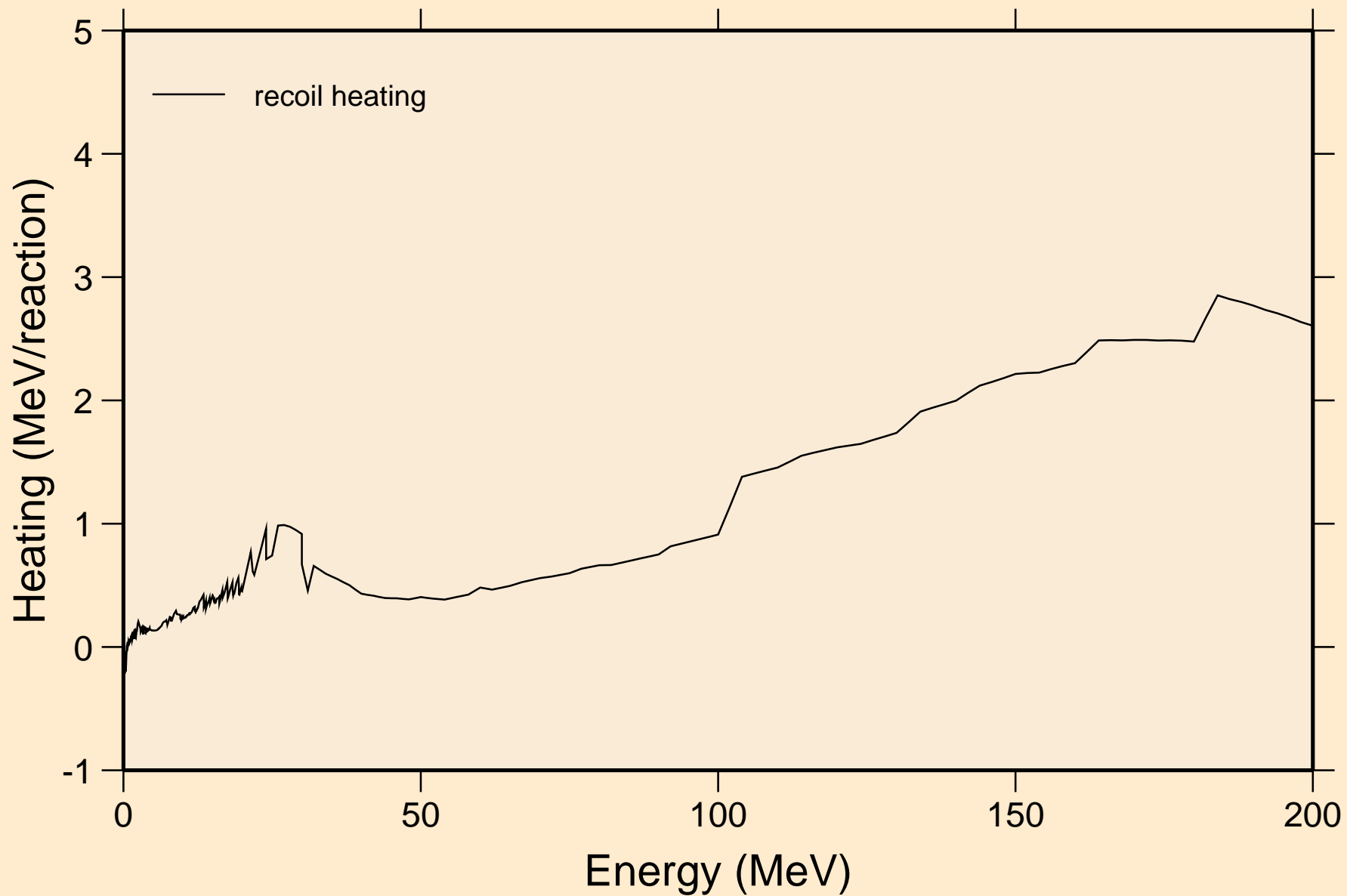

AG100M NEUTRON ACER TENDL-2019 LIBRARY; T=293.16K
Particle production cross sections

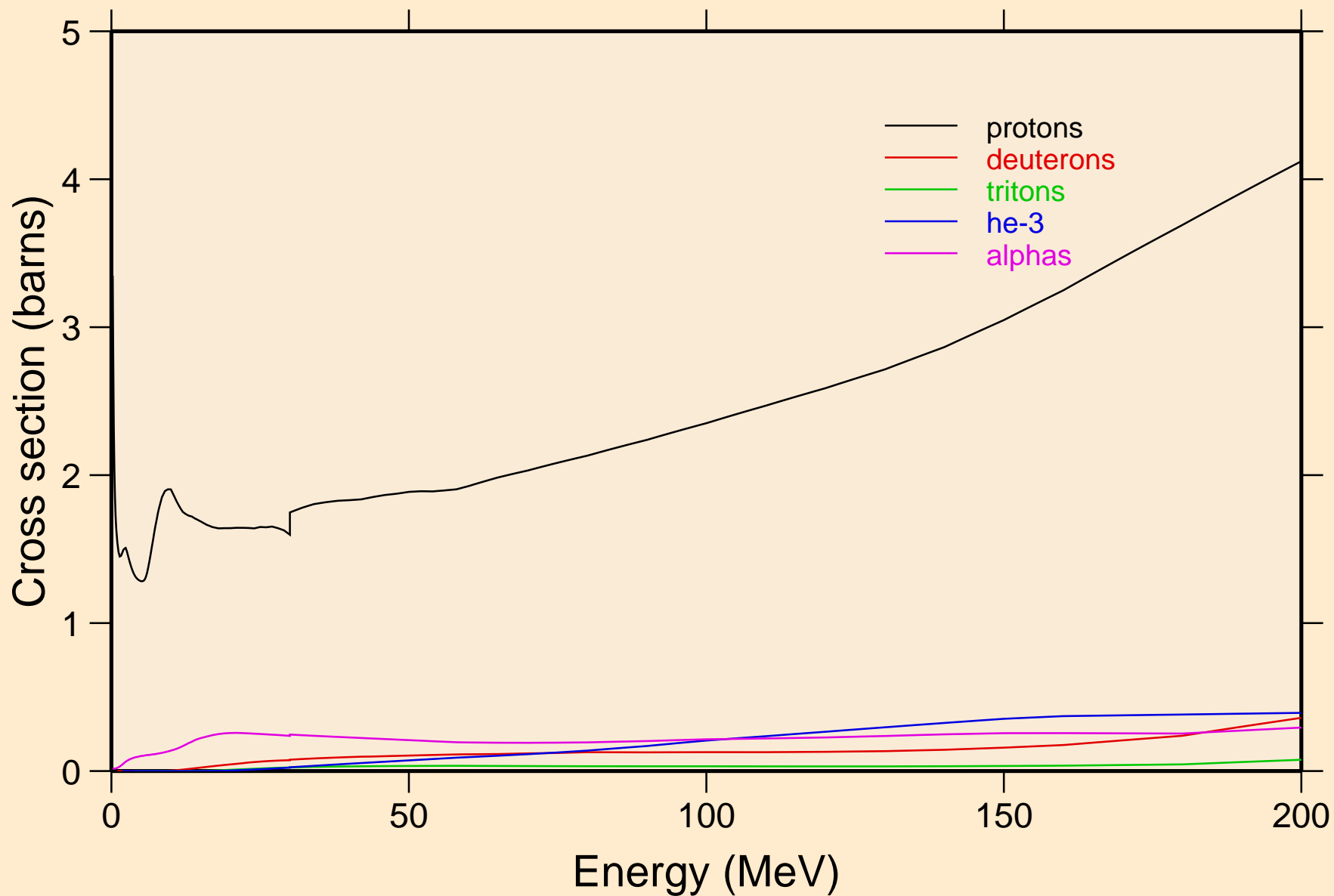

AG100M NEUTRON ACER TENDL-2019 LIBRARY; T=293.16K
protons from (n,x)

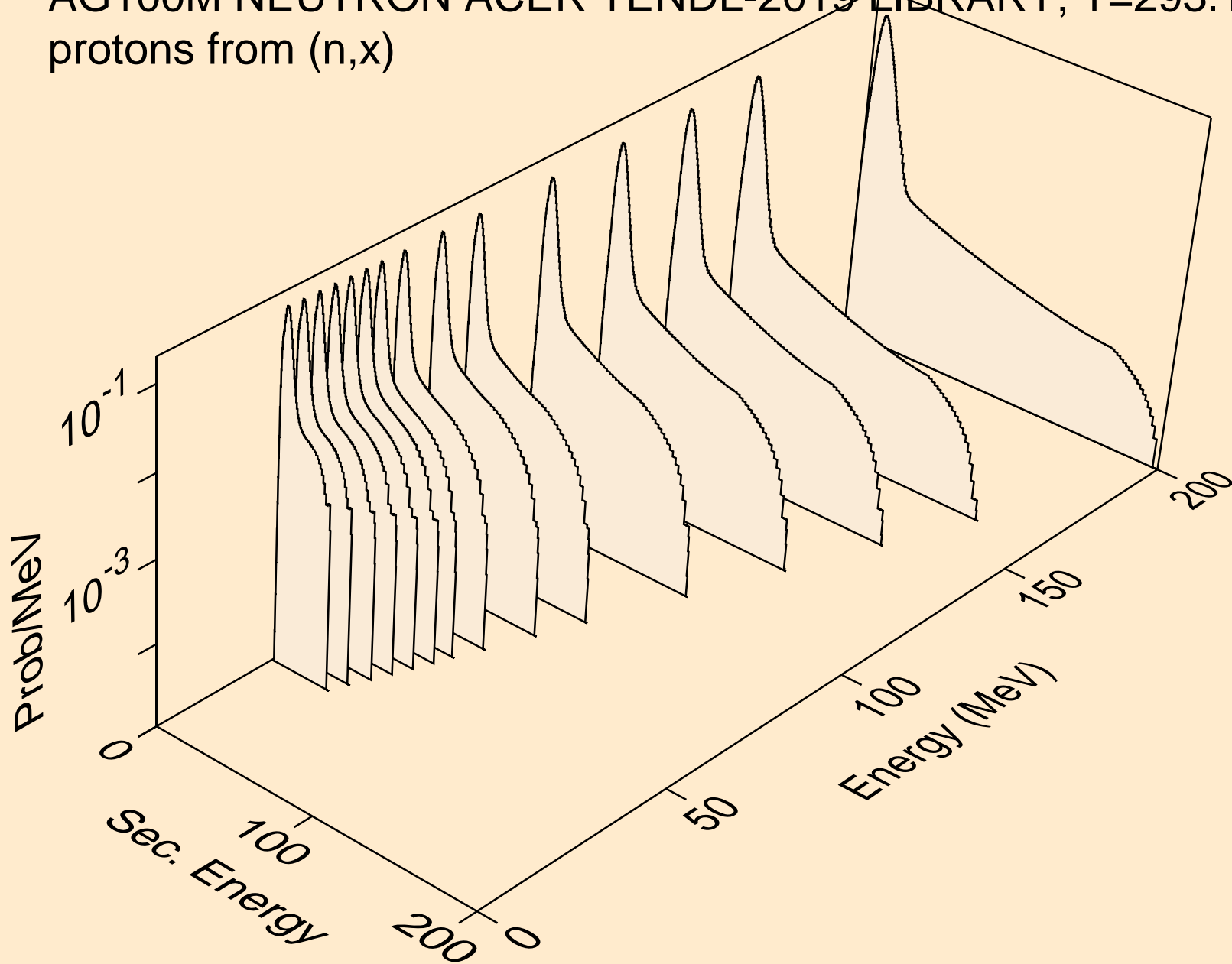

AG100M NEUTRON ACER TENDL-2019 LIBRARY; T=293.16K
protons from (n,n*)p

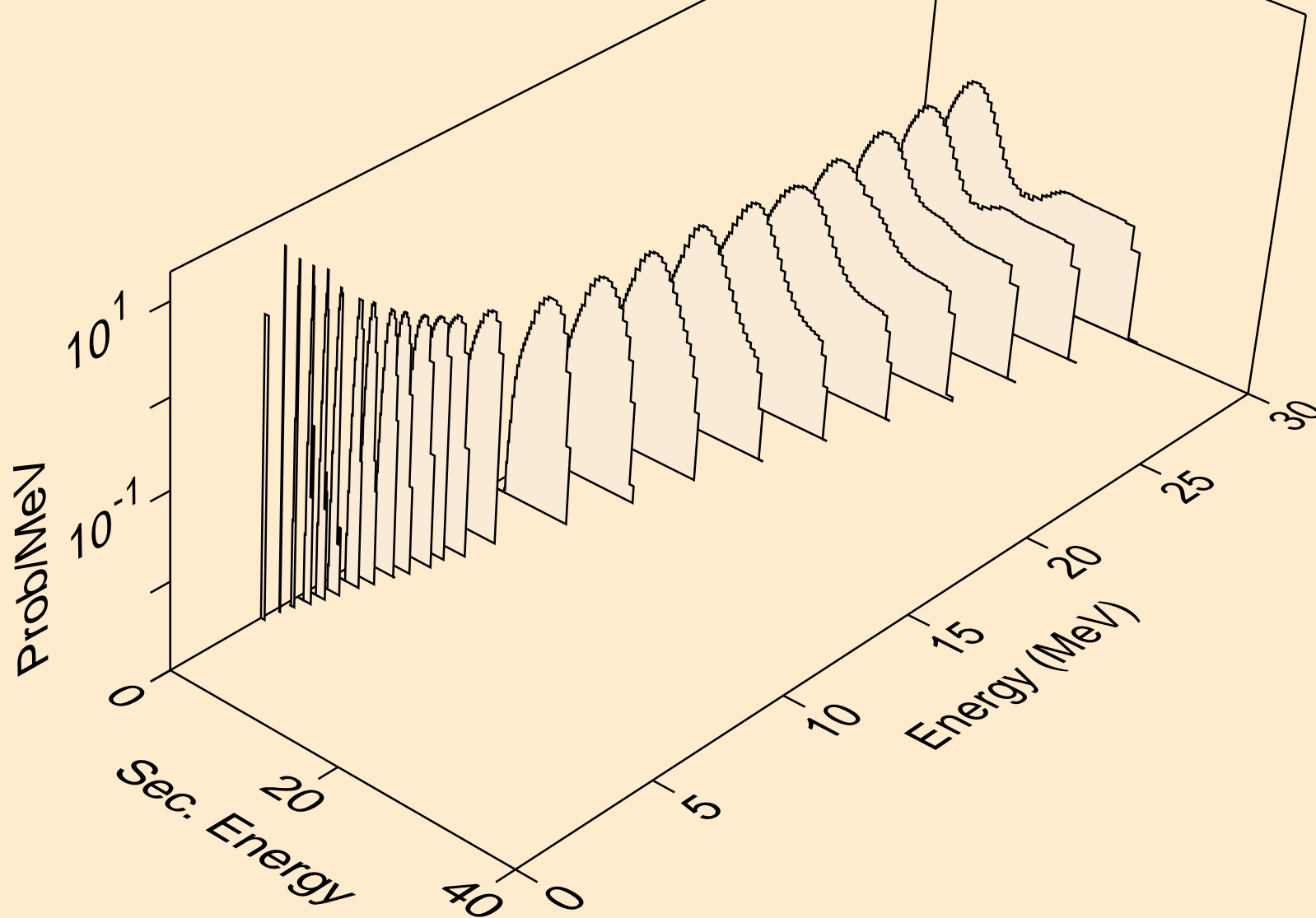

AG100M NEUTRON ACER TENDL-2019 LIBRARY; T=293.16K
protons from (n,2np)

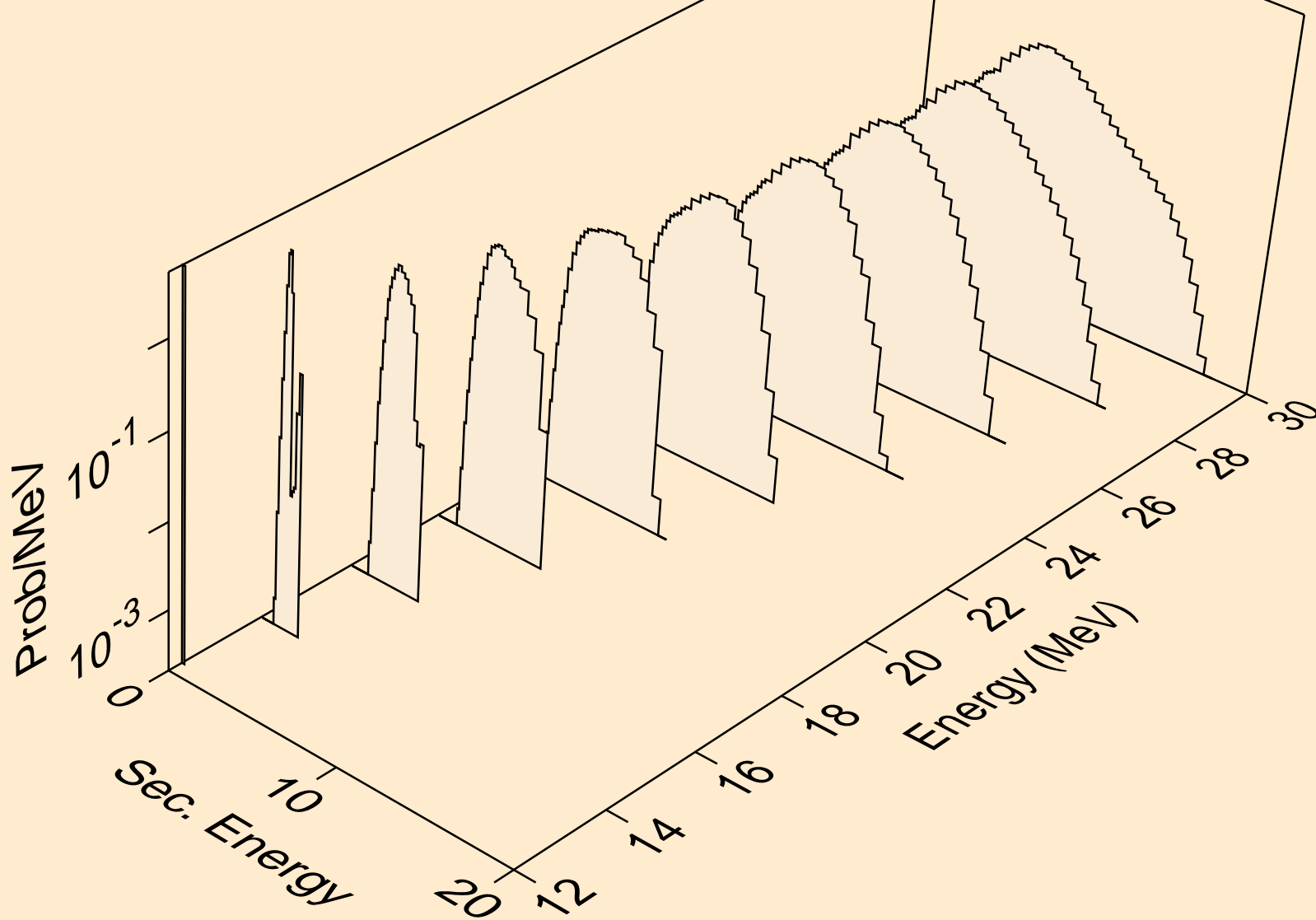

AG100M NEUTRON ACER TENDL-2019 LIBRARY; T=293.16K
protons from (n,3np)

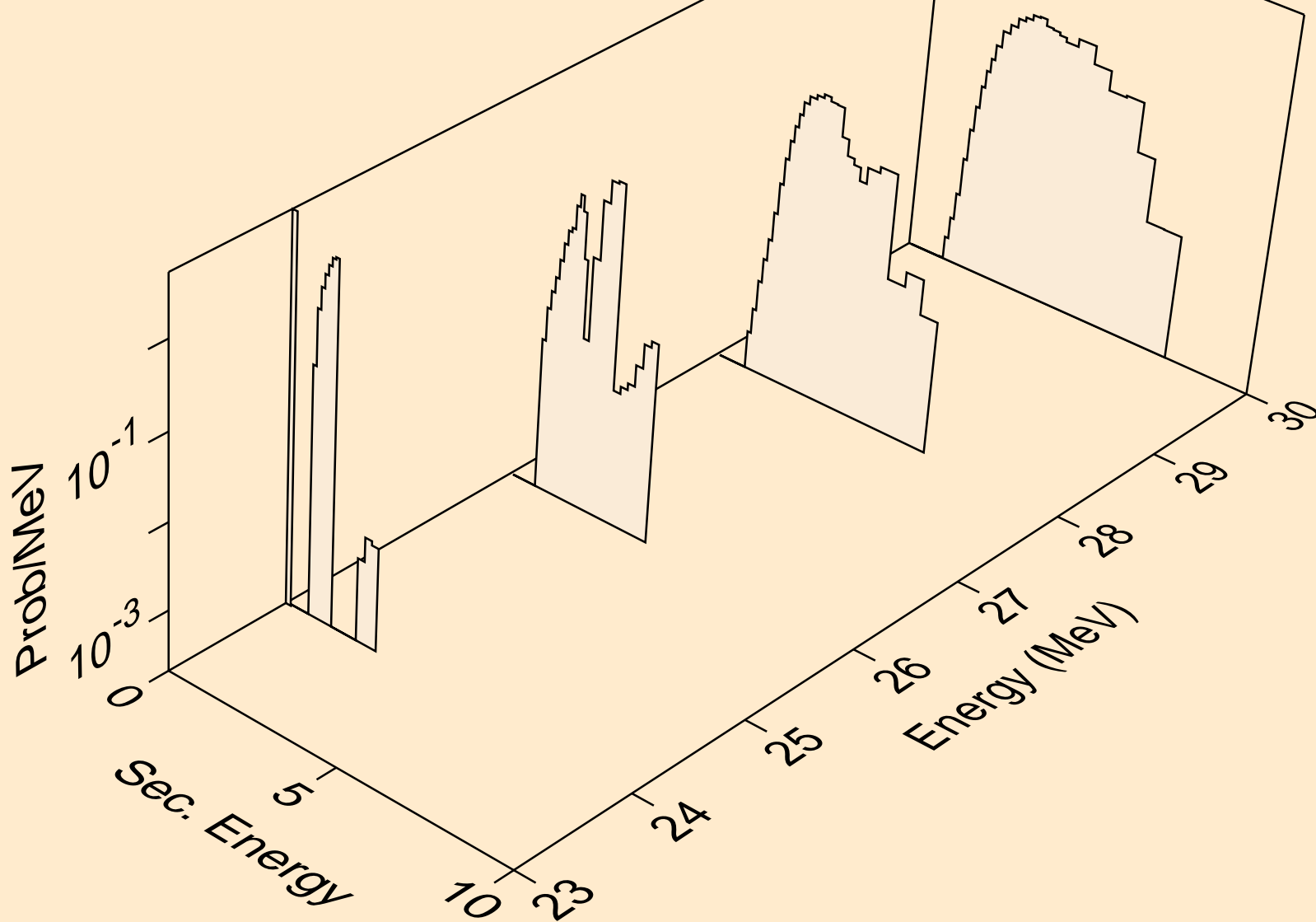

AG100M NEUTRON ACER TENDL-2019 LIBRARY; T=293.16K
protons from (n,2np)

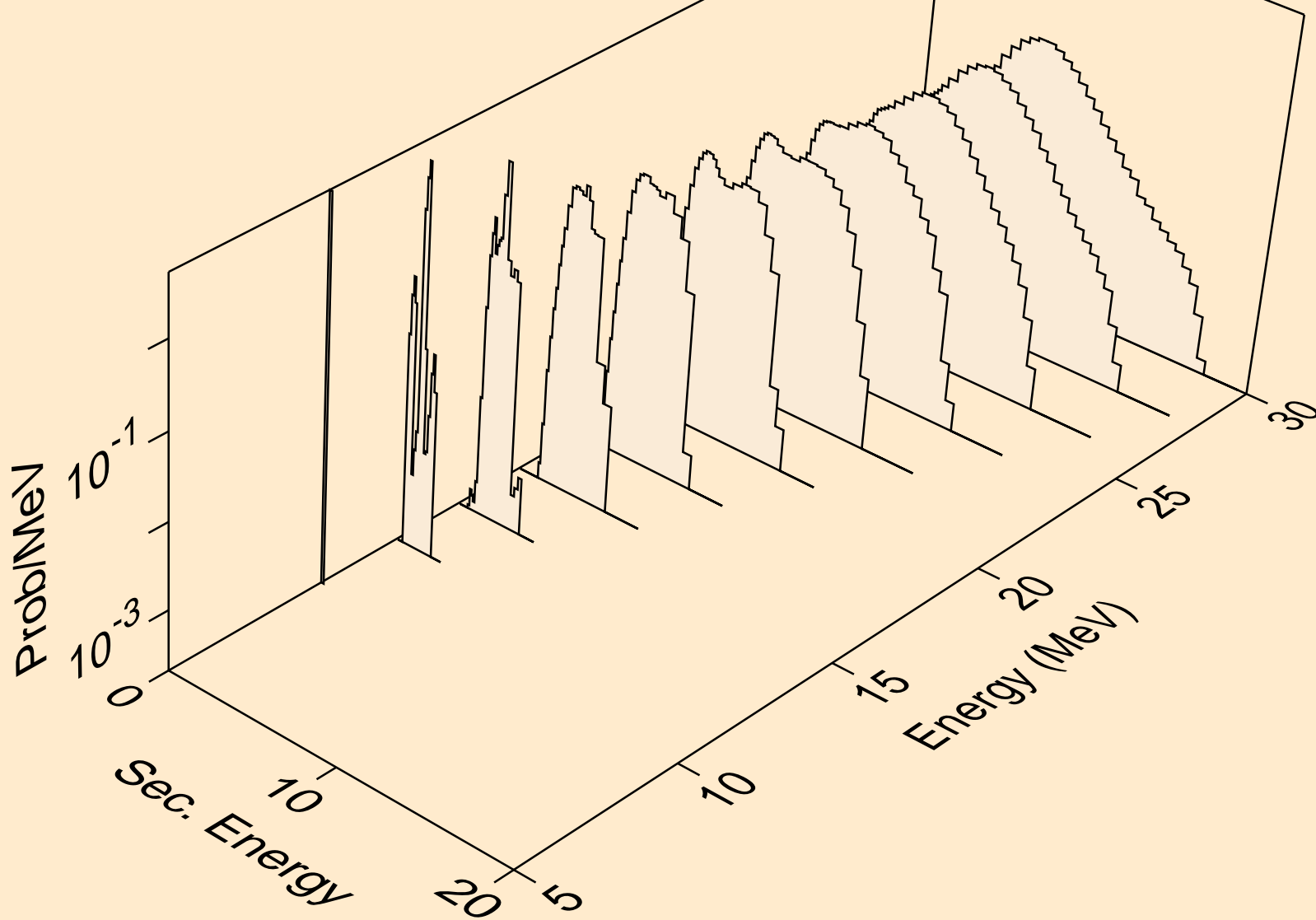

AG100M NEUTRON ACER TENDL-2019 LIBRARY; T=293.16K
protons from (n,npa)

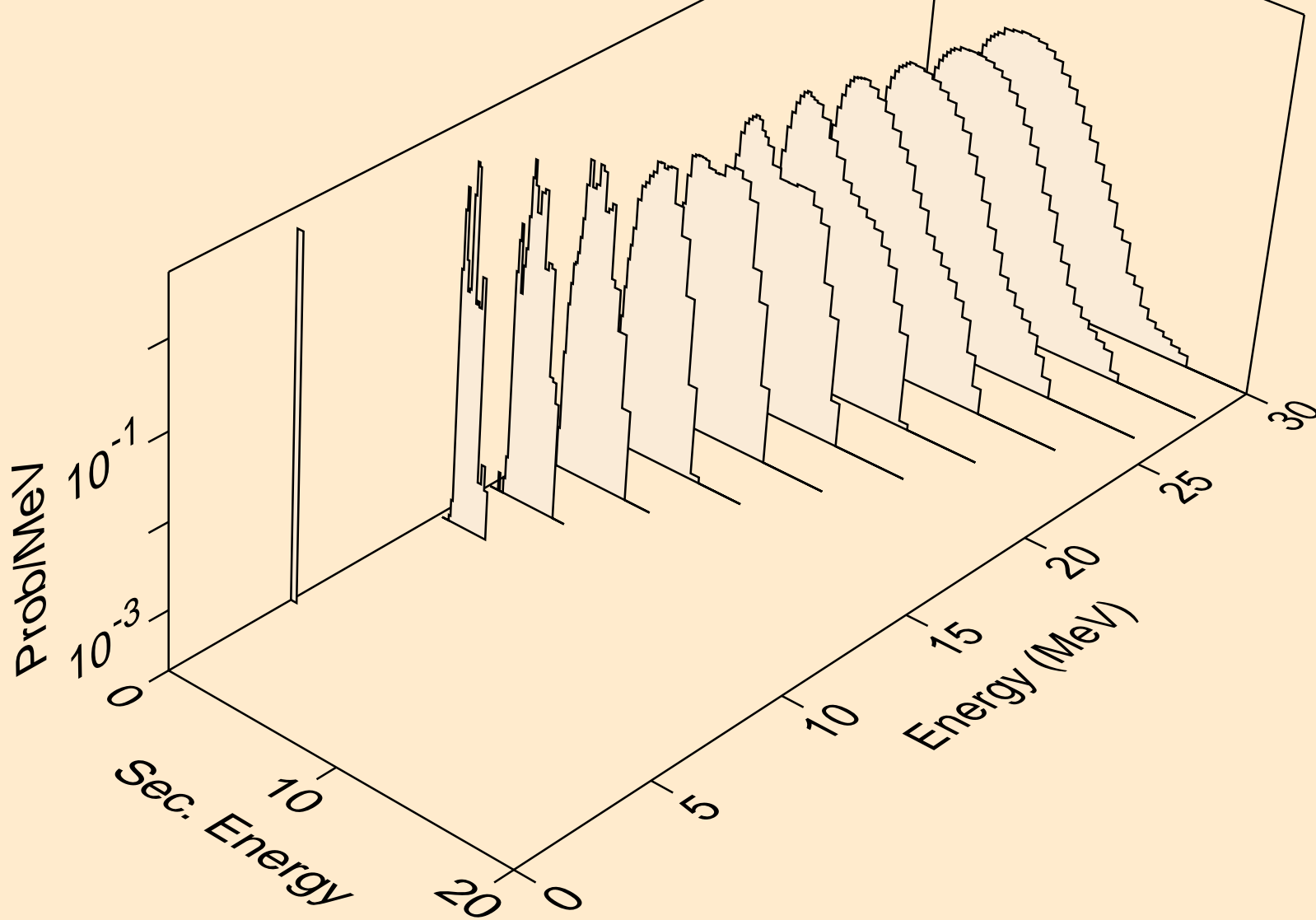

AG100M NEUTRON ACER TENDL-2019 LIBRARY; T=293.16K
protons from (n,p)

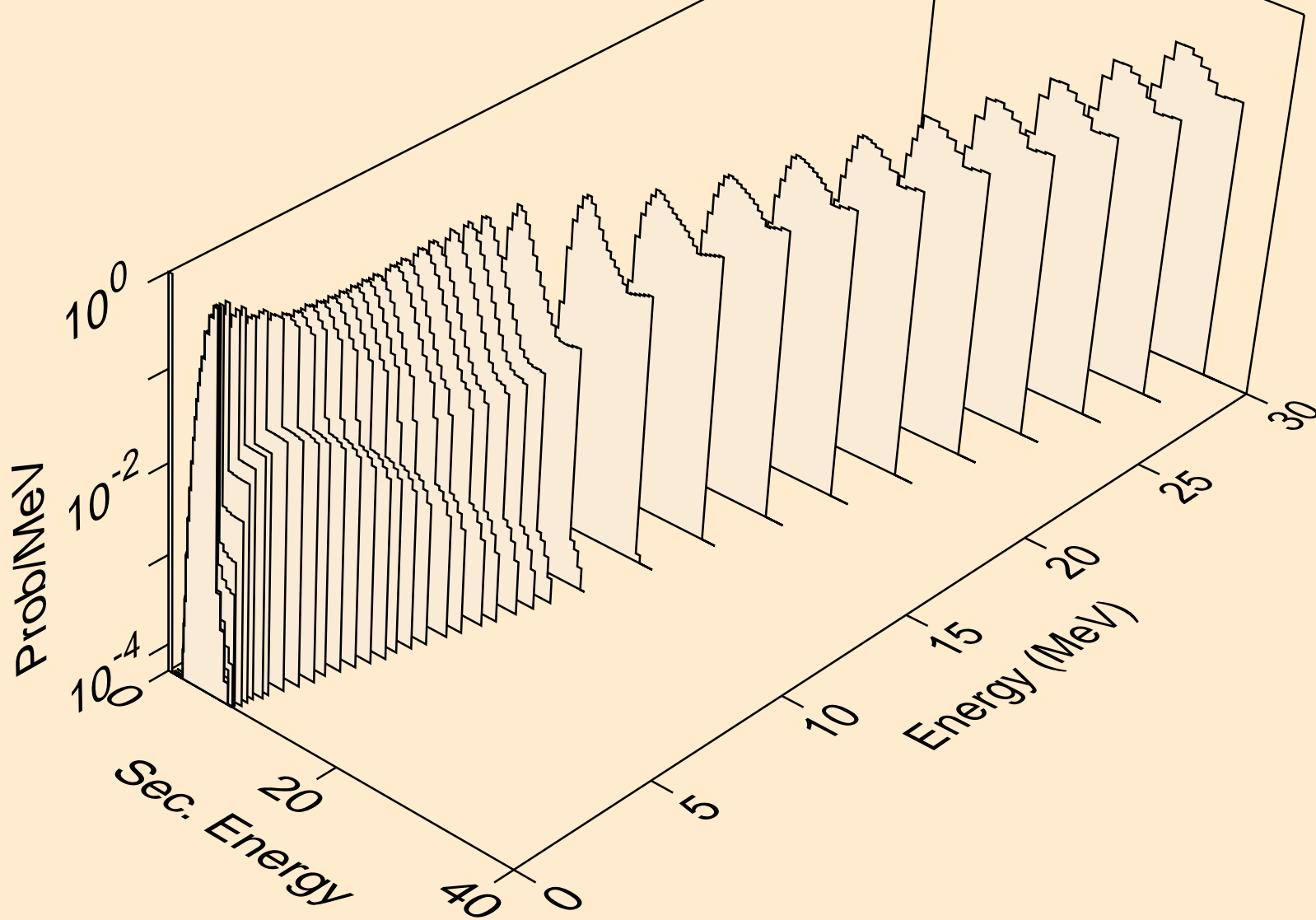

AG100M NEUTRON ACER TENDL-2019 LIBRARY; T=293.16K
protons from (n,2p)

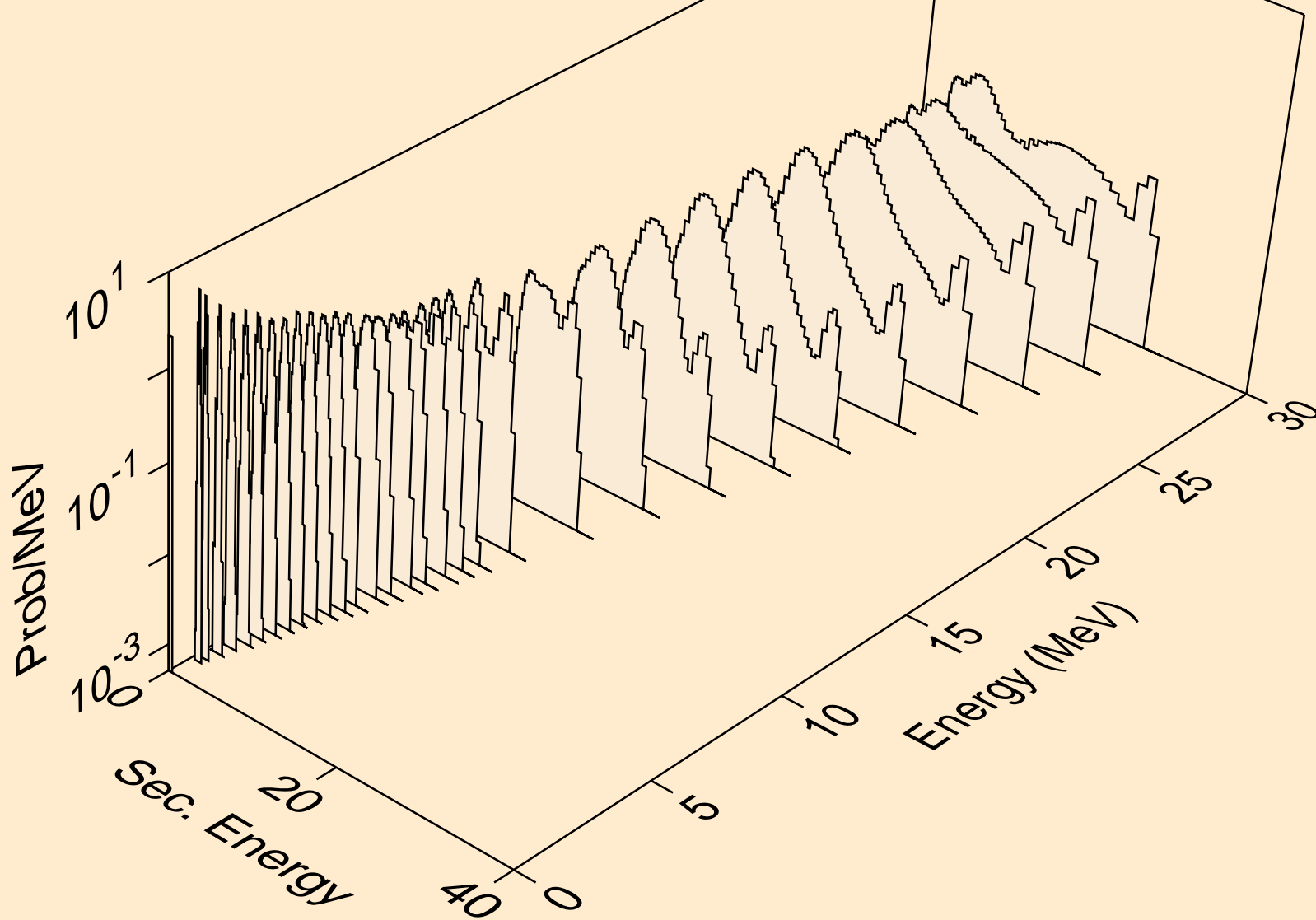

AG100M NEUTRON ACER TENDL-2019 LIBRARY; T=293.16K
protons from (n,p)

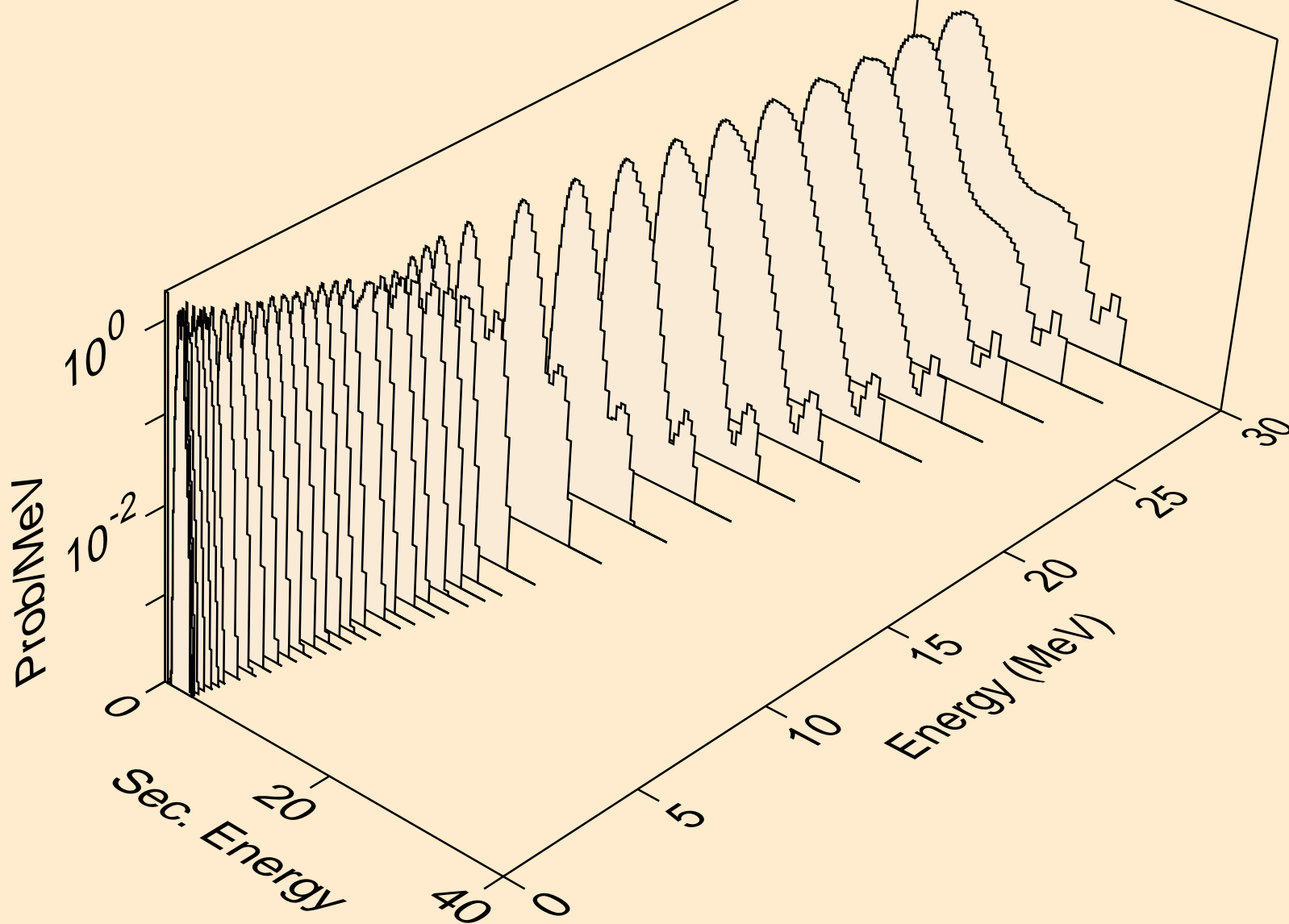

AG100M NEUTRON ACER TENDL-2019 LIBRARY; T=293.16K
protons from (n,pd)

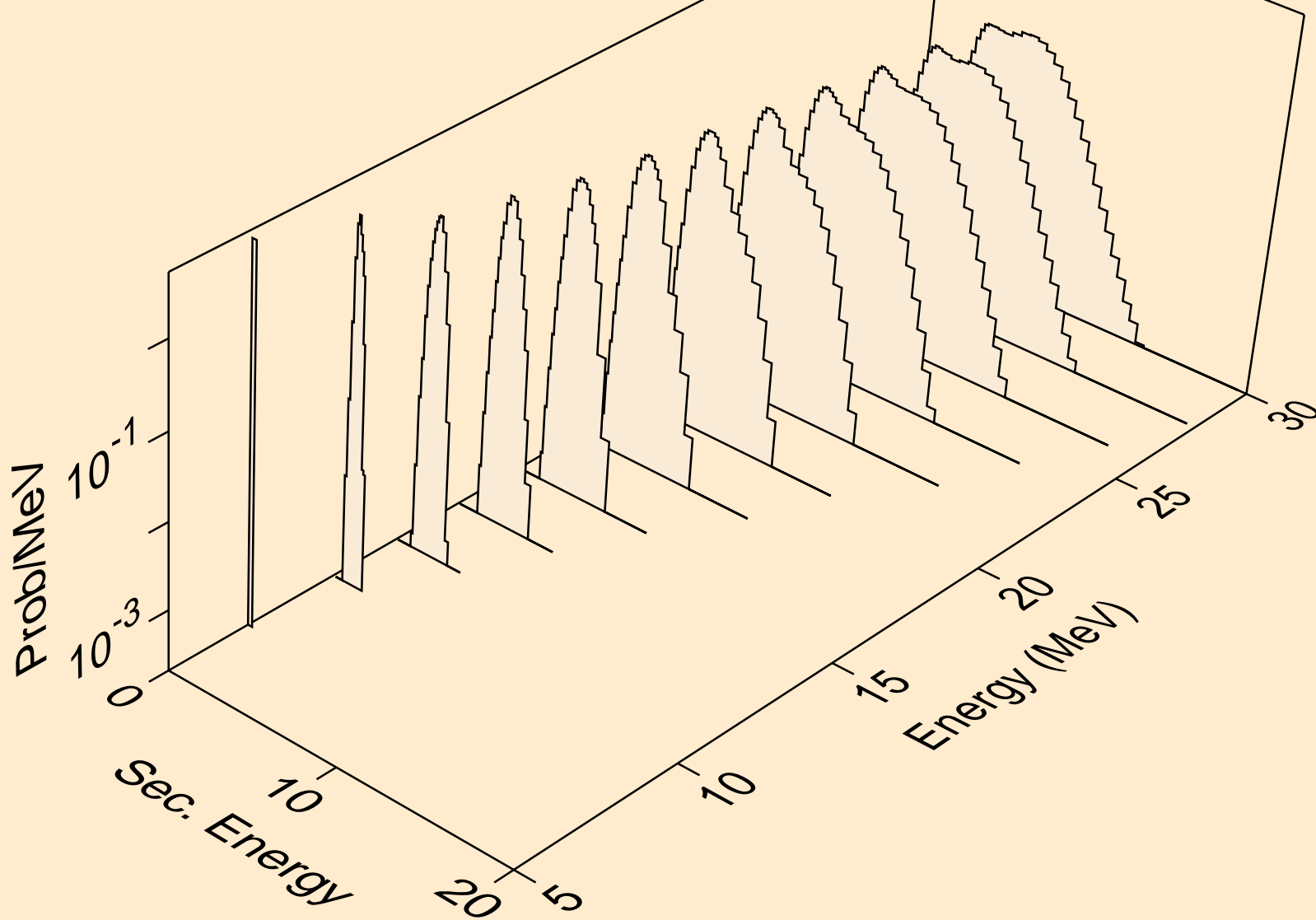

AG100M NEUTRON ACER TENDL-2019 LIBRARY; T=293.16K
protons from (n,pt)

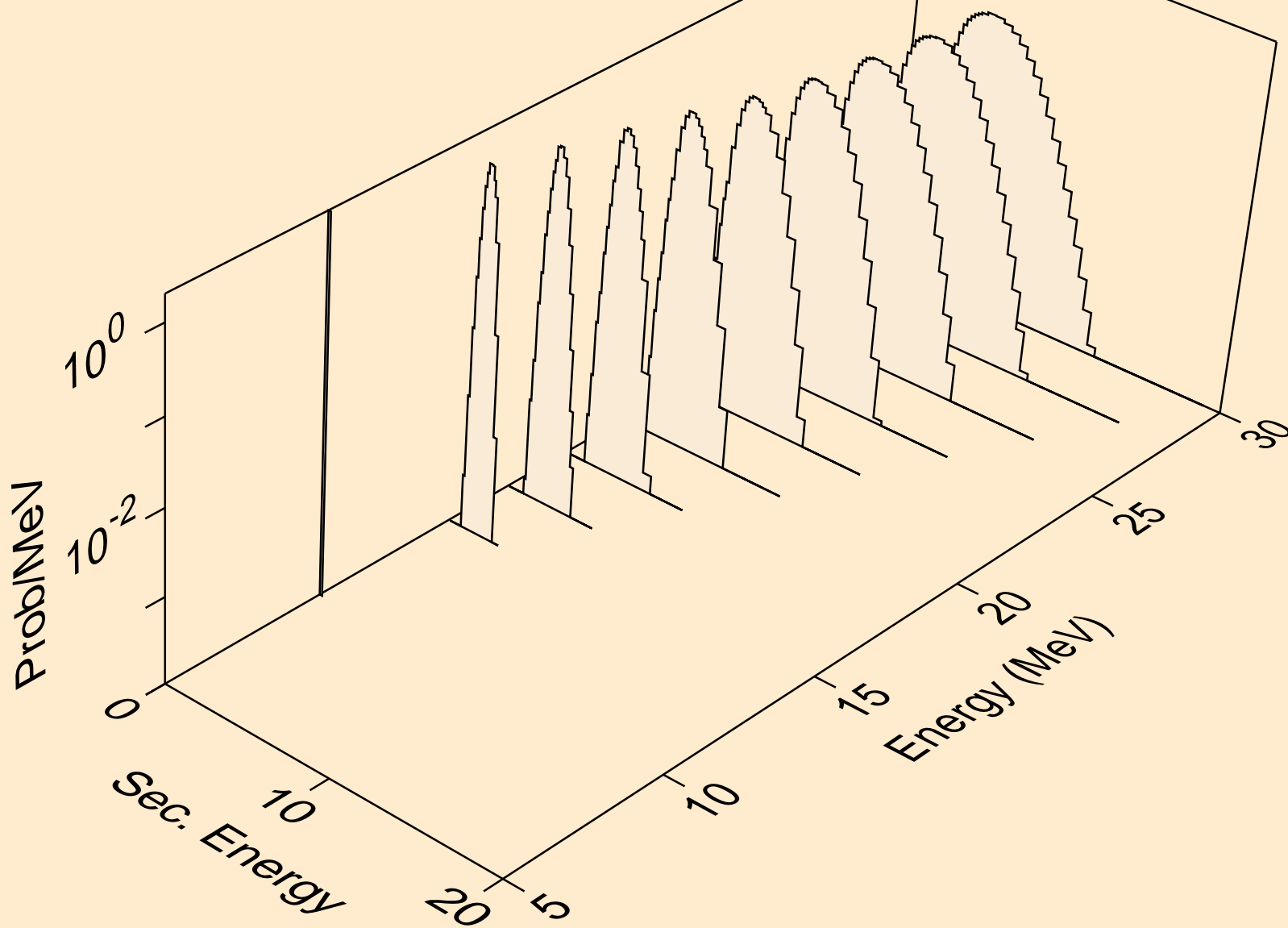

AG100M NEUTRON ACER TENDL-2019 LIBRARY; T=293.16K
deuterons from (n,x)

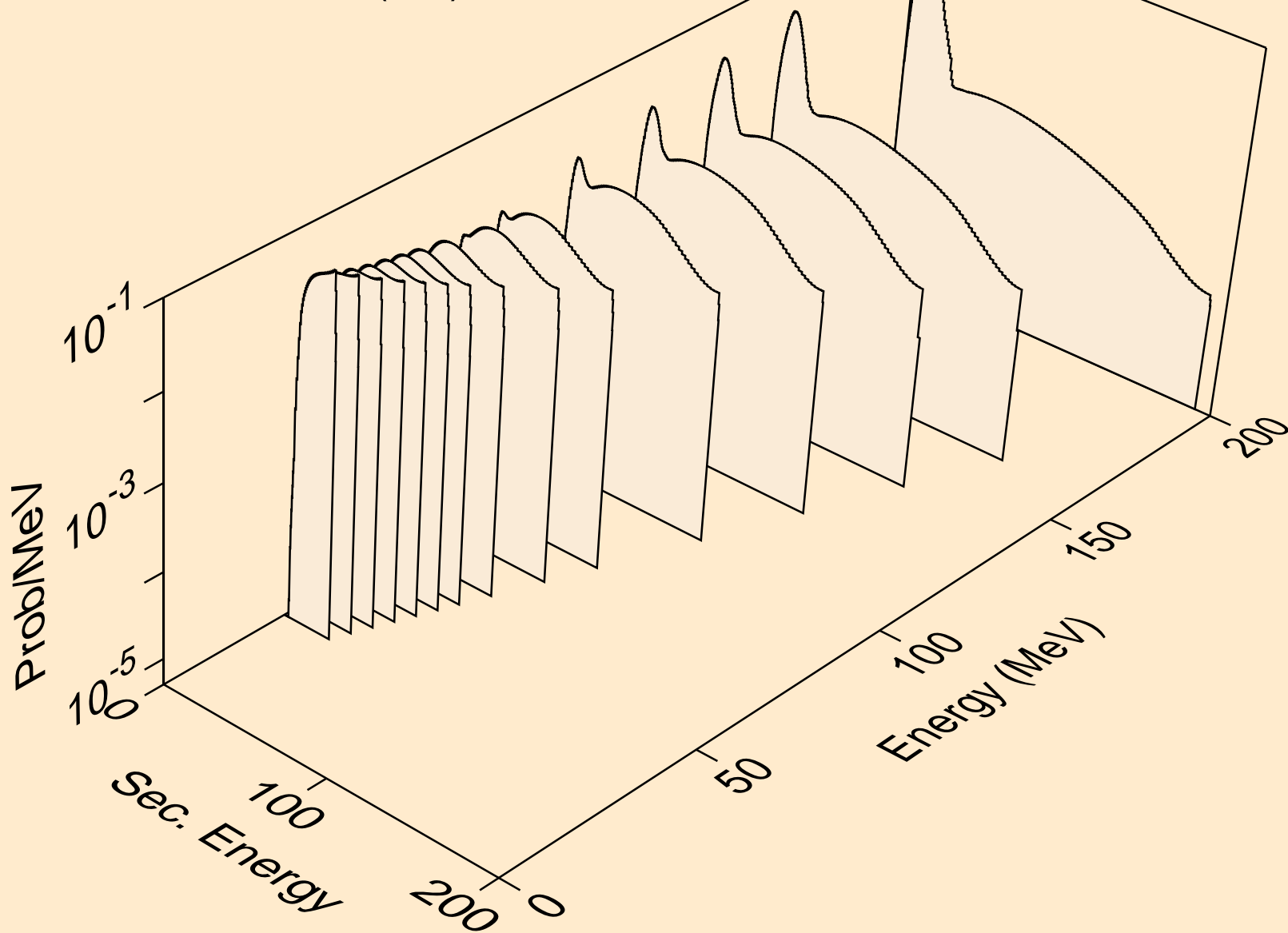

AG100M NEUTRON ACER TENDL-2019 LIBRARY; T=293.16K
deuterons from (n,2nd)

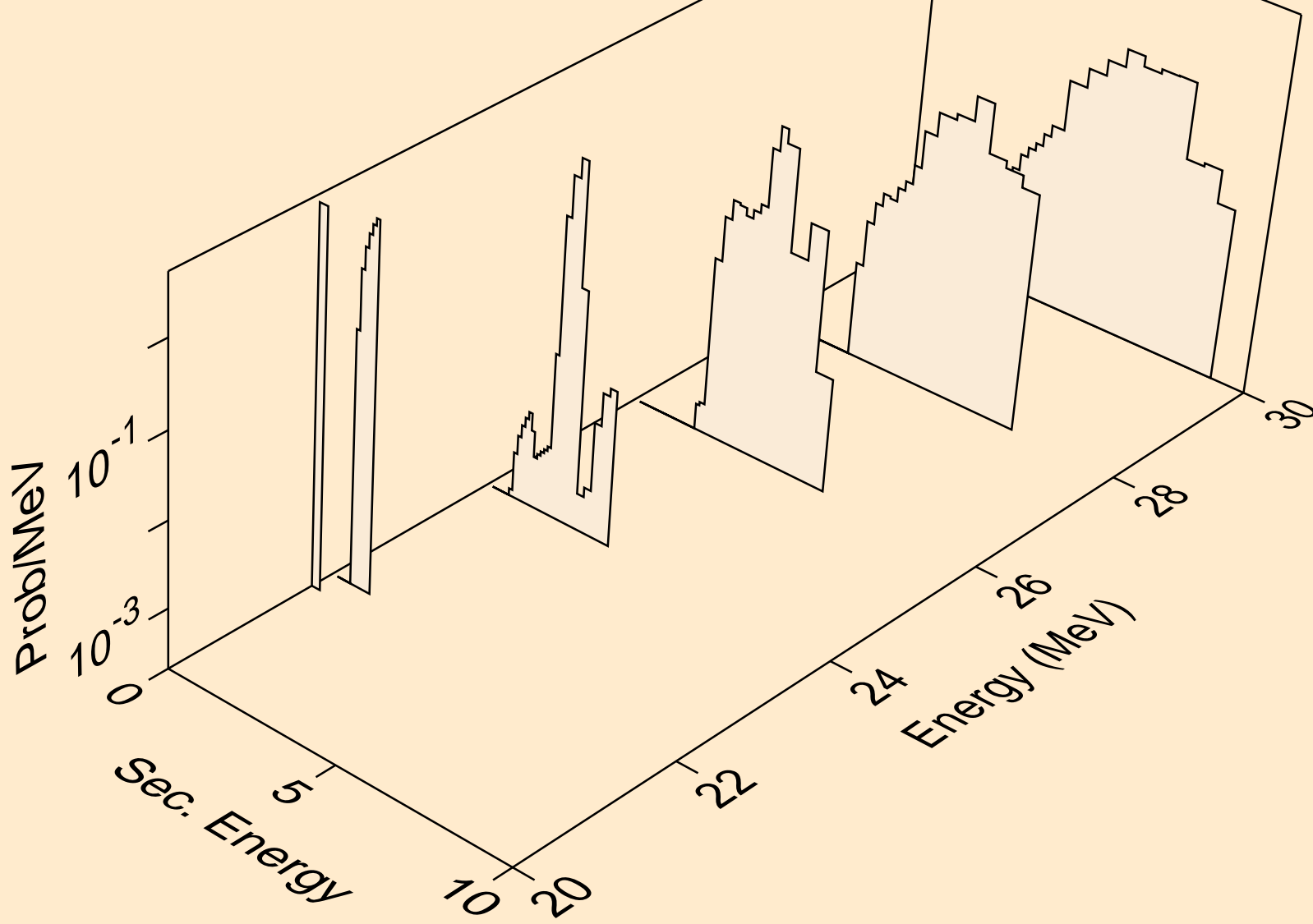

AG100M NEUTRON ACER TENDL-2019 LIBRARY; T=293.16K
deuterons from (n,n*)d

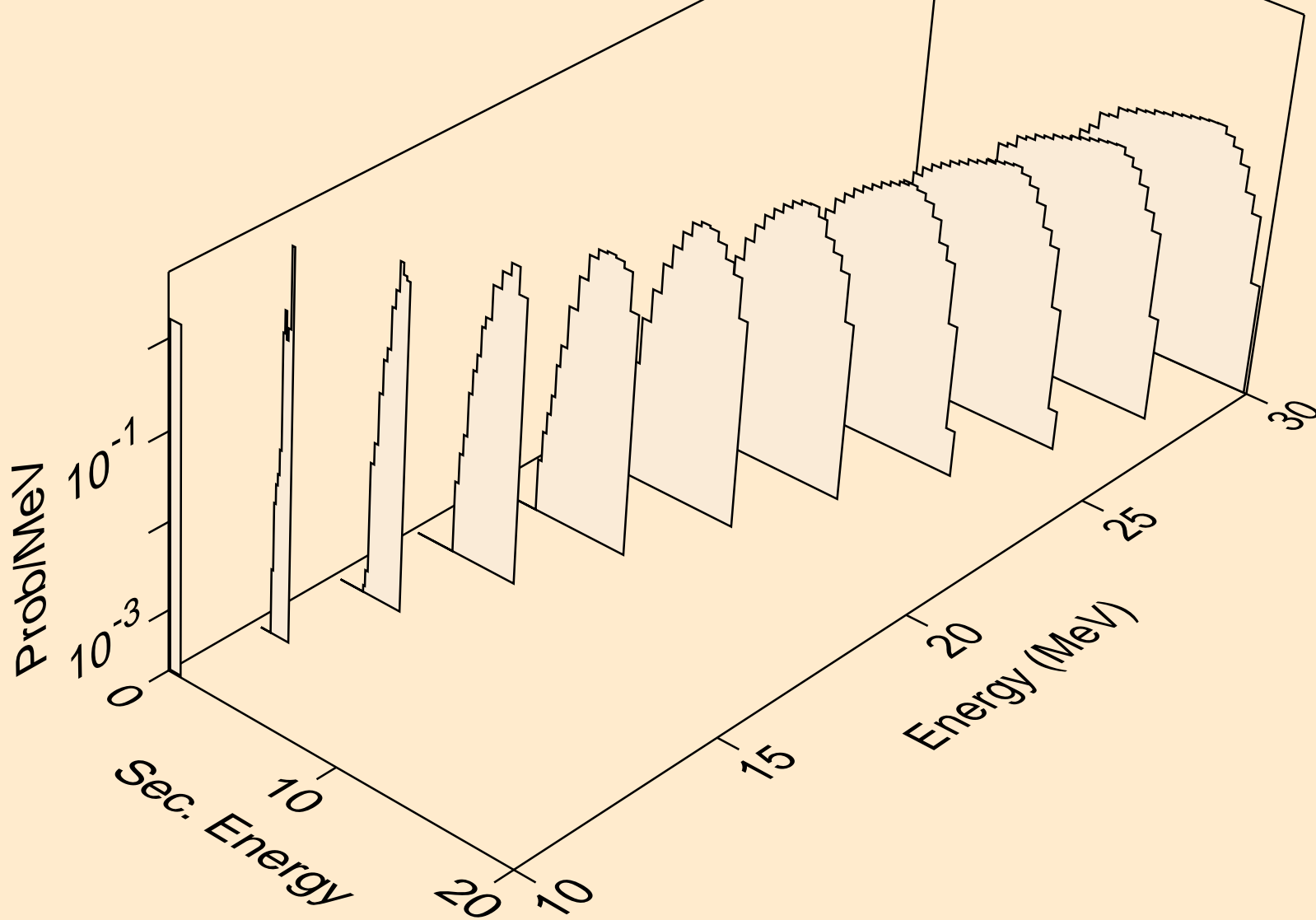

AG100M NEUTRON ACER TENDL-2019 LIBRARY; T=293.16K
deuterons from (n,d)

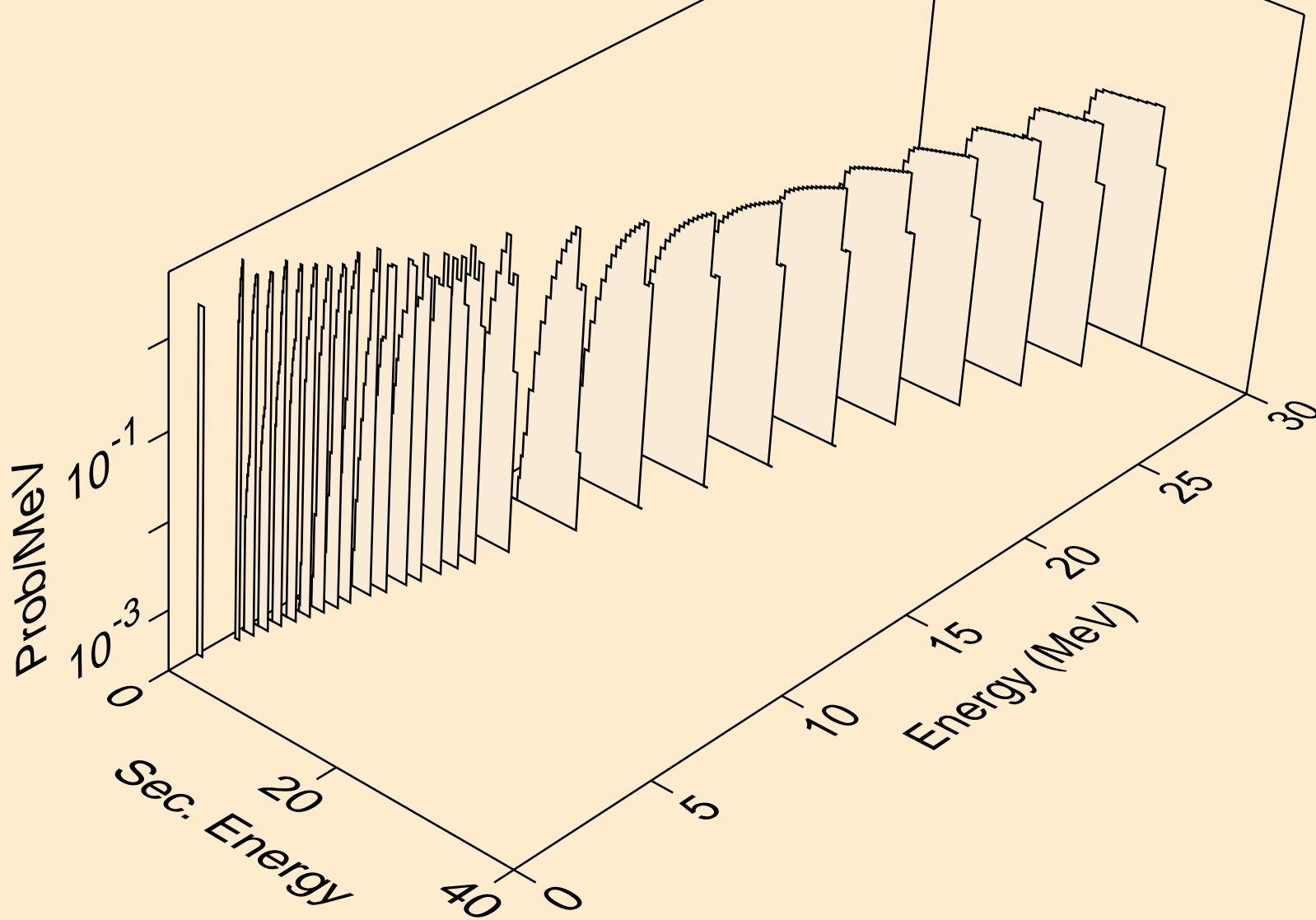

AG100M NEUTRON ACER TENDL-2019 LIBRARY; T=293.16K
deuterons from (n,pd)

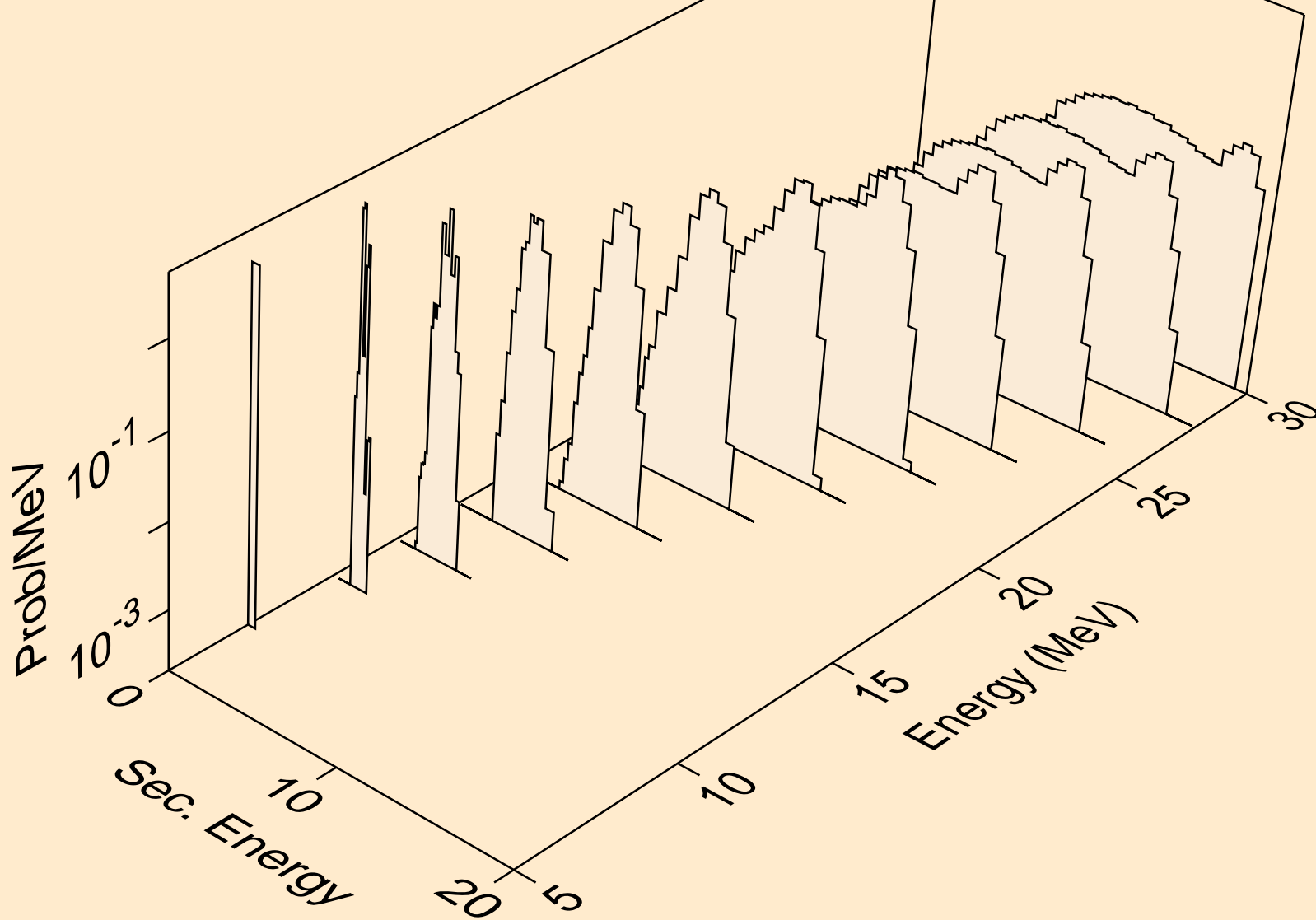

AG100M NEUTRON ACER TENDL-2019 LIBRARY; T=293.16K
deuterons from (n,da)

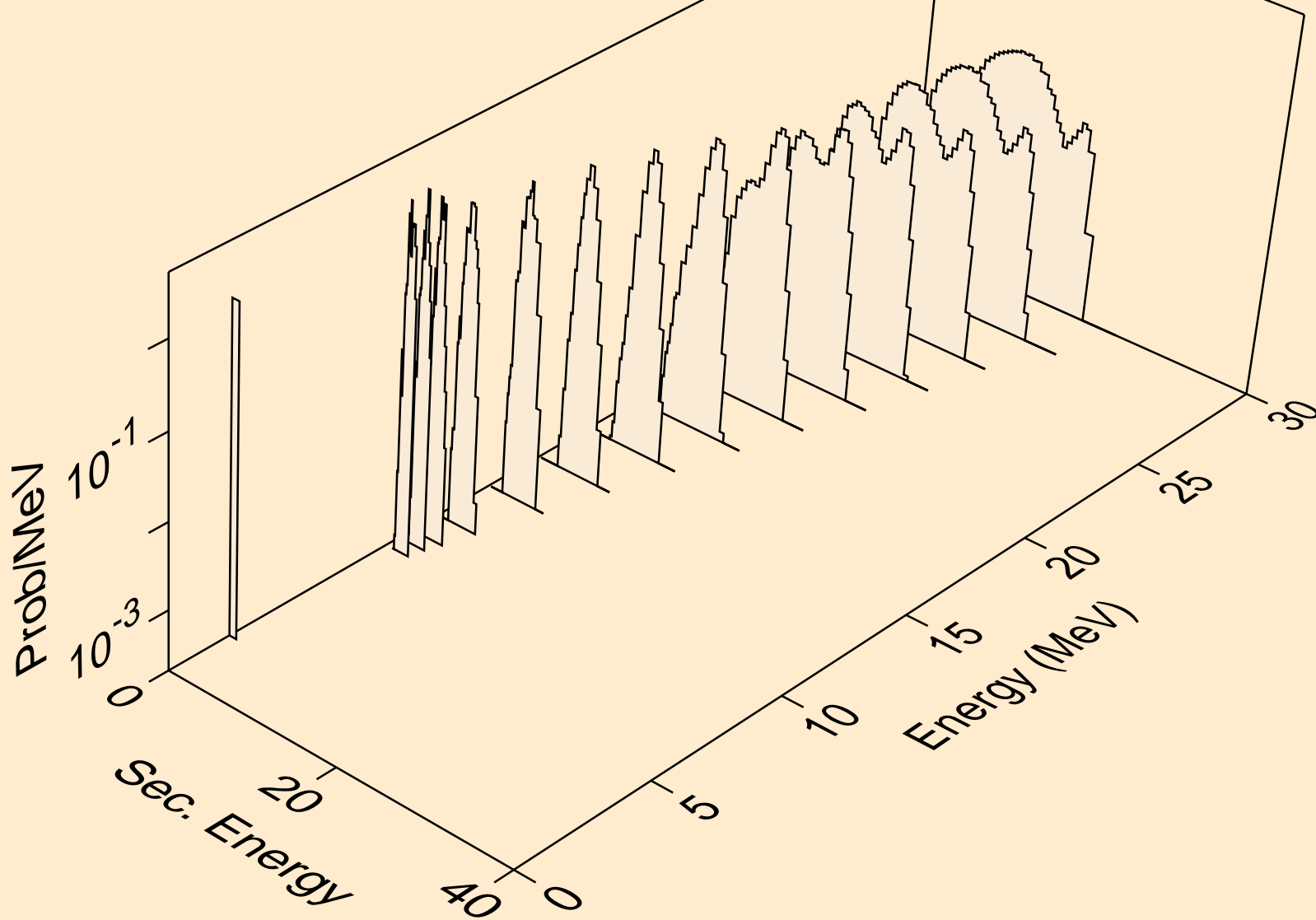

AG100M NEUTRON ACER TENDL-2019 LIBRARY; T=293.16K
tritons from (n,x)

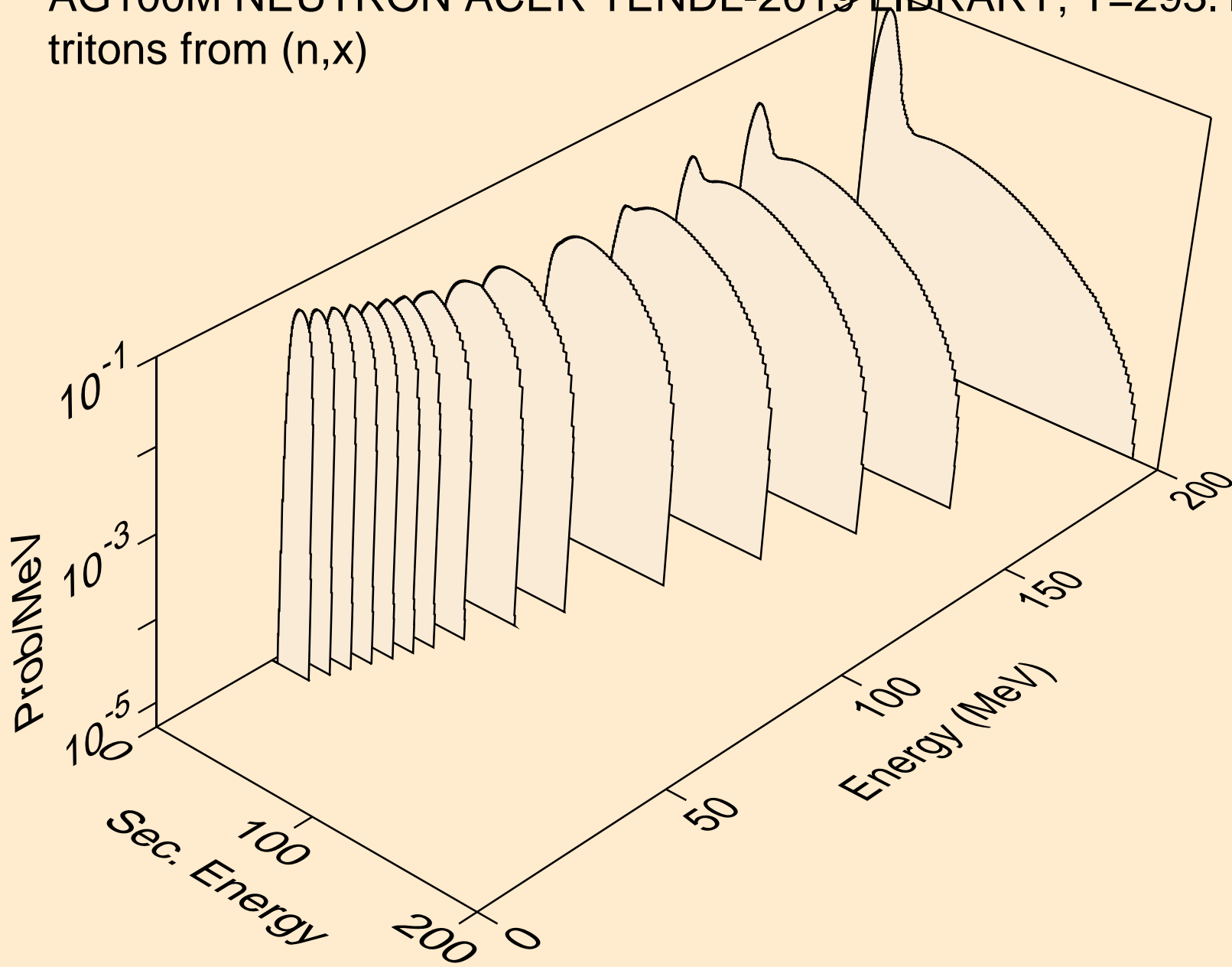

AG100M NEUTRON ACER TENDL-2019 LIBRARY; T=293.16K
tritons from (n,n*)t

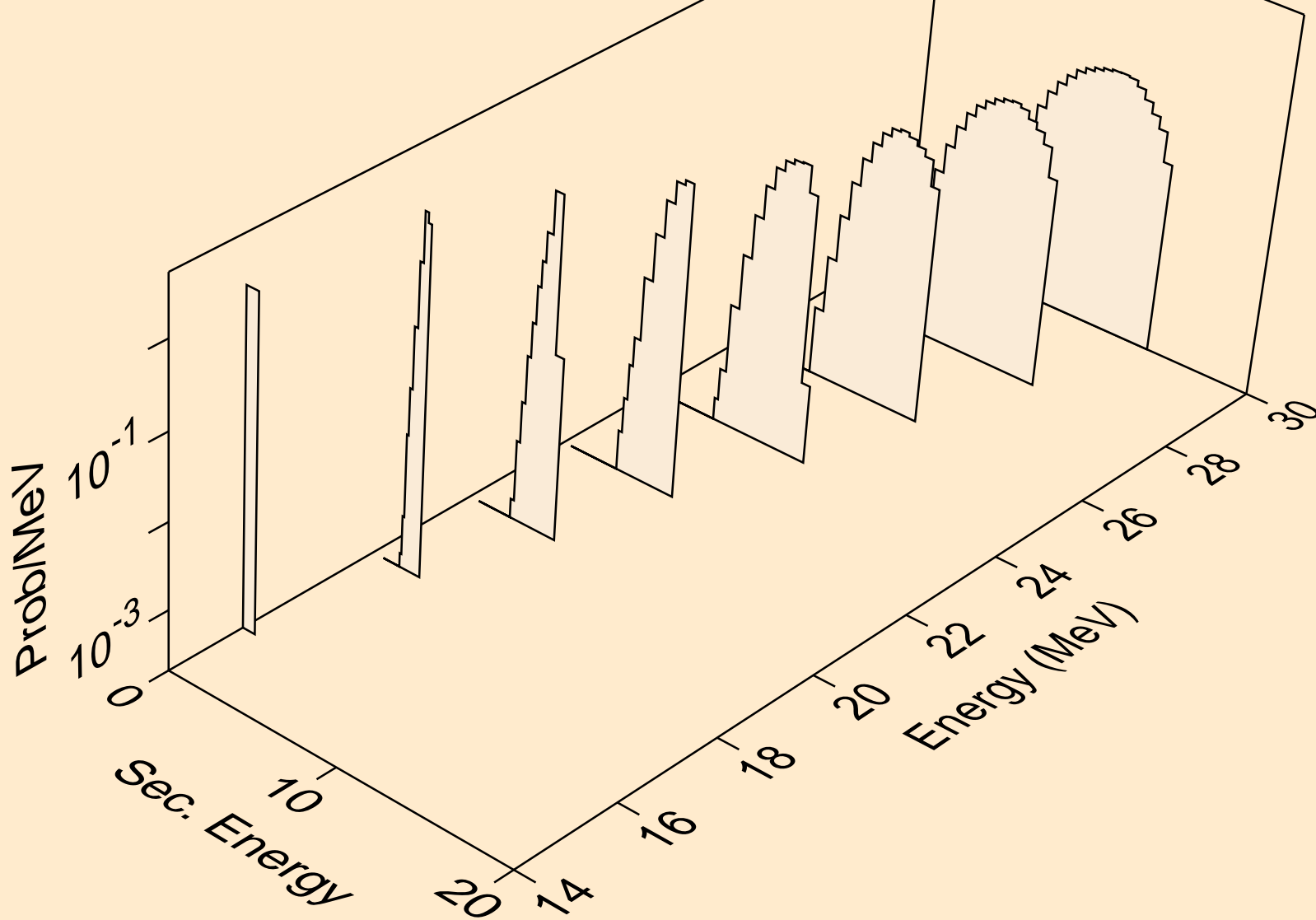

AG100M NEUTRON ACER TENDL-2019 LIBRARY; T=293.16K
tritons from (n,t)

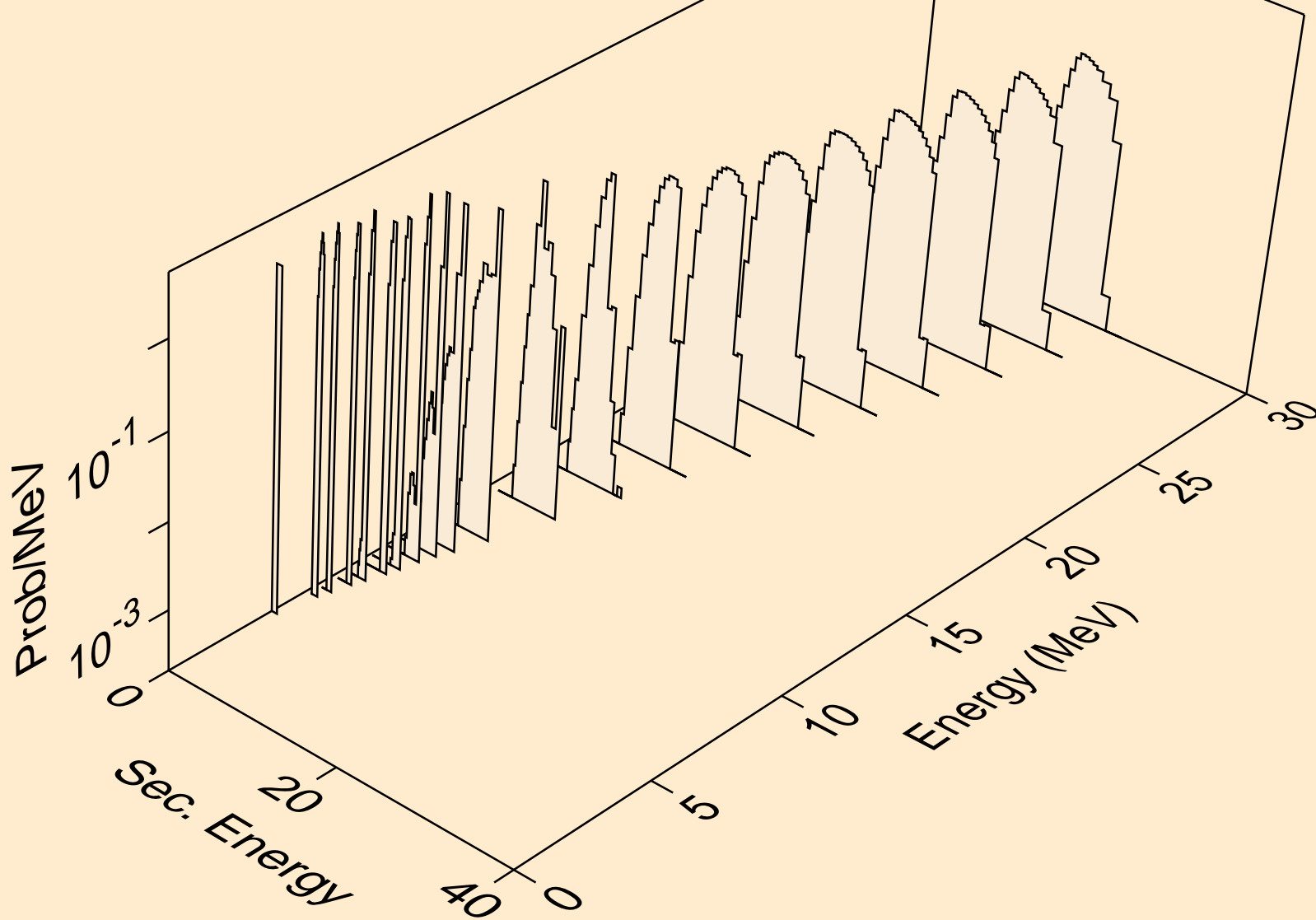

AG100M NEUTRON ACER TENDL-2019 LIBRARY; T=293.16K
tritons from (n,pt)

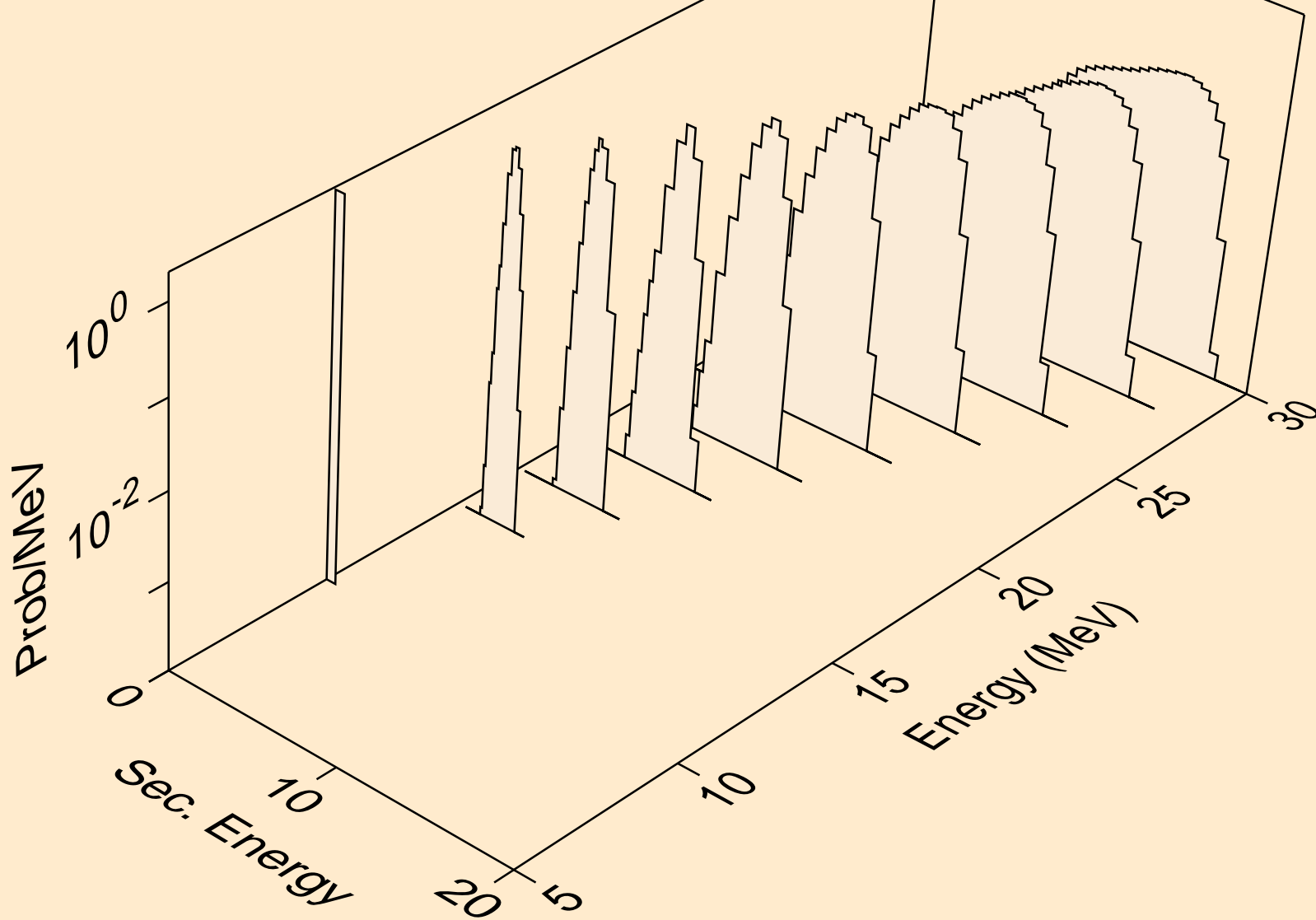

AG100M NEUTRON ACER TENDL-2019 LIBRARY; T=293.16K
he3s from (n,x)

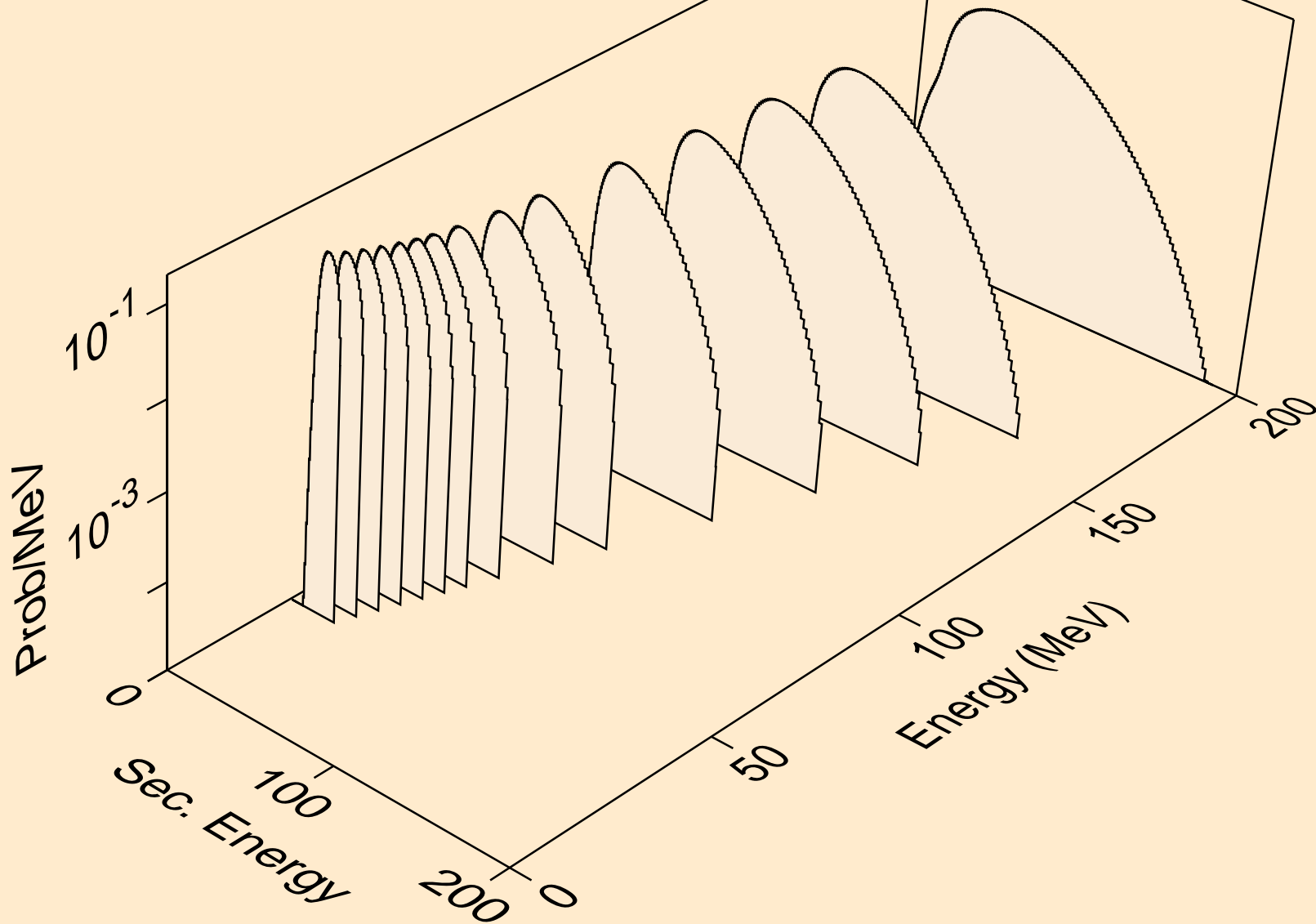

AG100M NEUTRON ACER TENDL-2019 LIBRARY; T=293.16K
he3s from (n,n*)he3

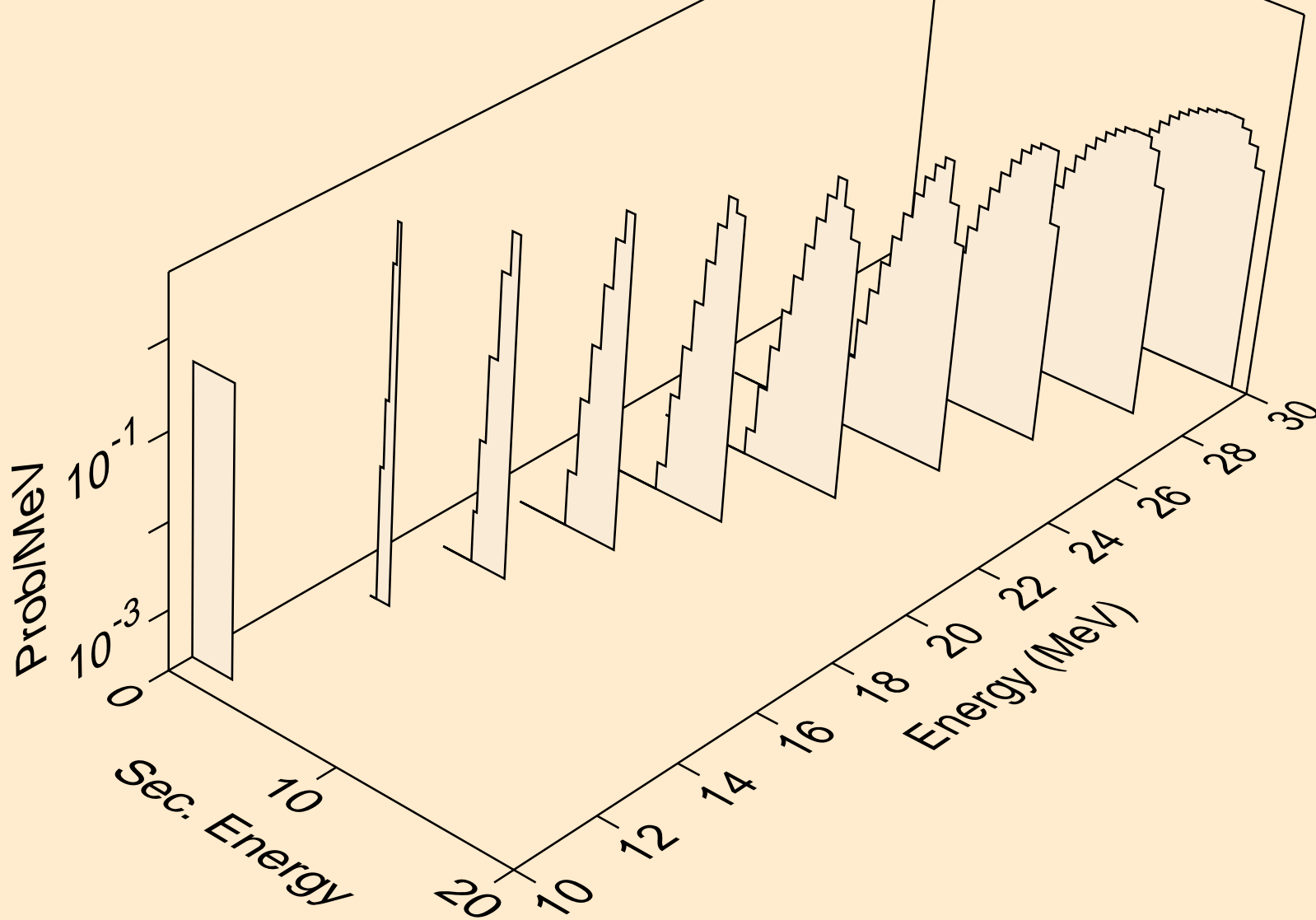

AG100M NEUTRON ACER TENDL-2019 LIBRARY; T=293.16K
he3s from (n,he3)

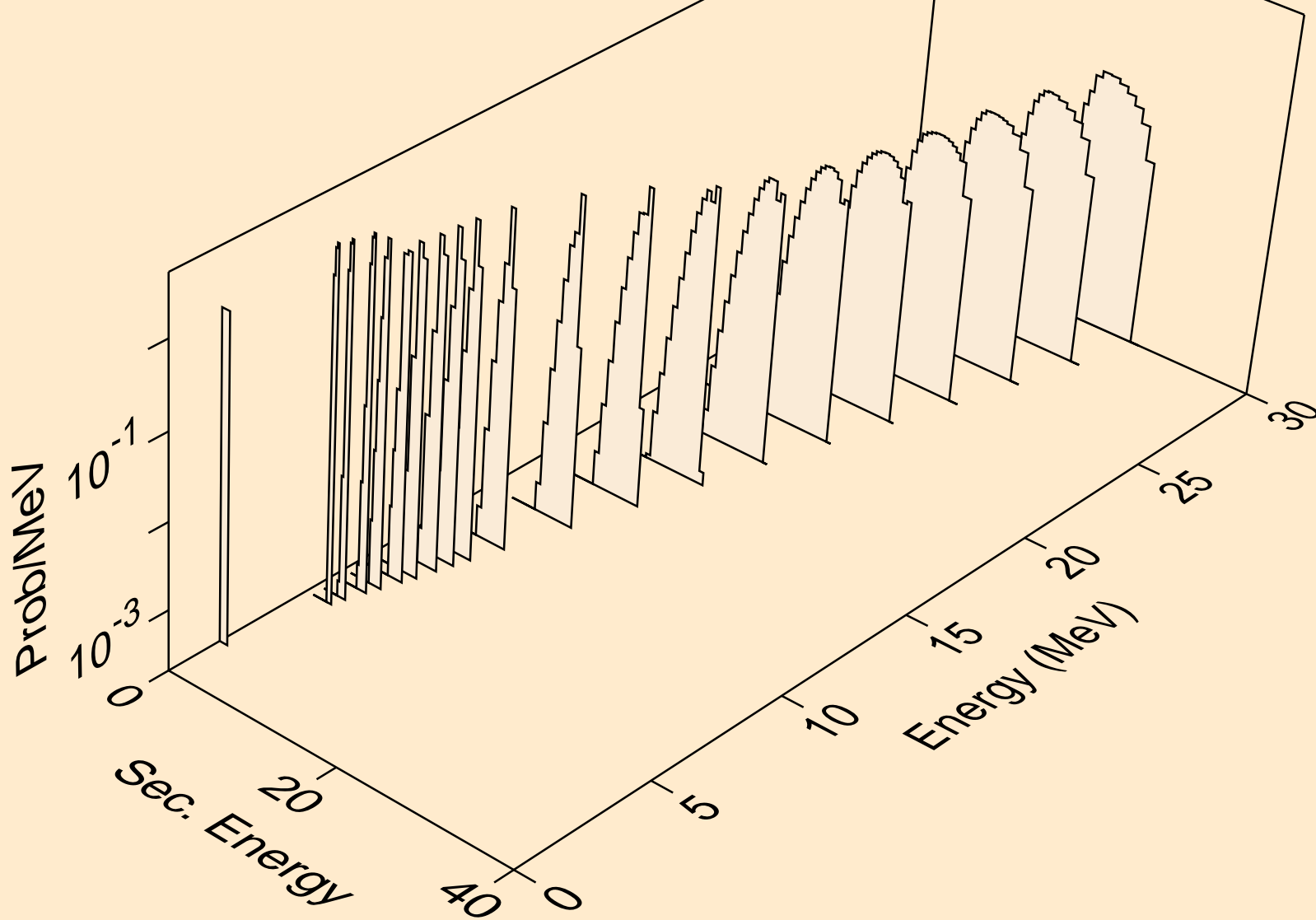

AG100M NEUTRON ACER TENDL-2019 LIBRARY; T=293.16K
alphas from (n,x)

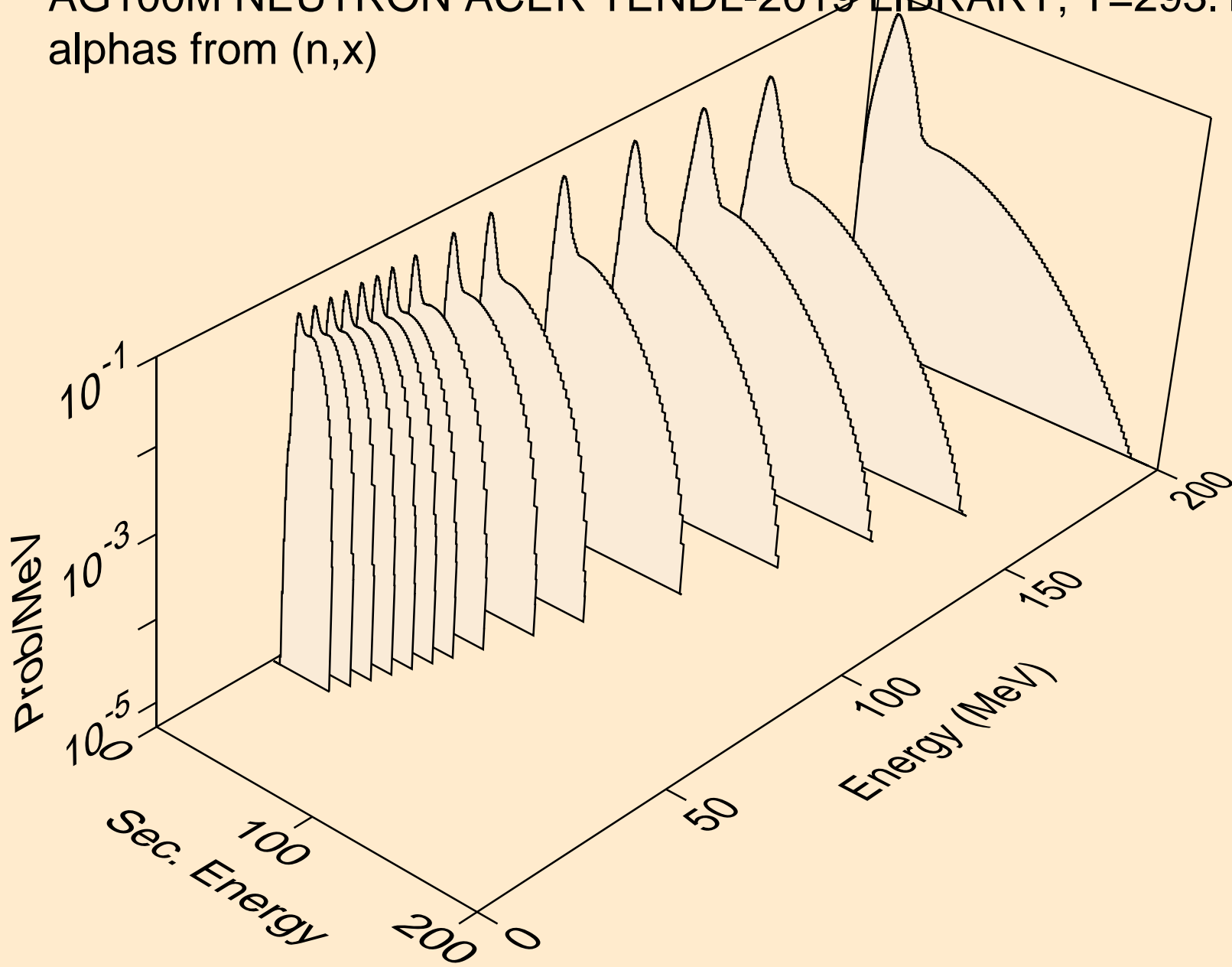

AG100M NEUTRON ACER TENDL-2019 LIBRARY; T=293.16K
alphas from (n,n*)a

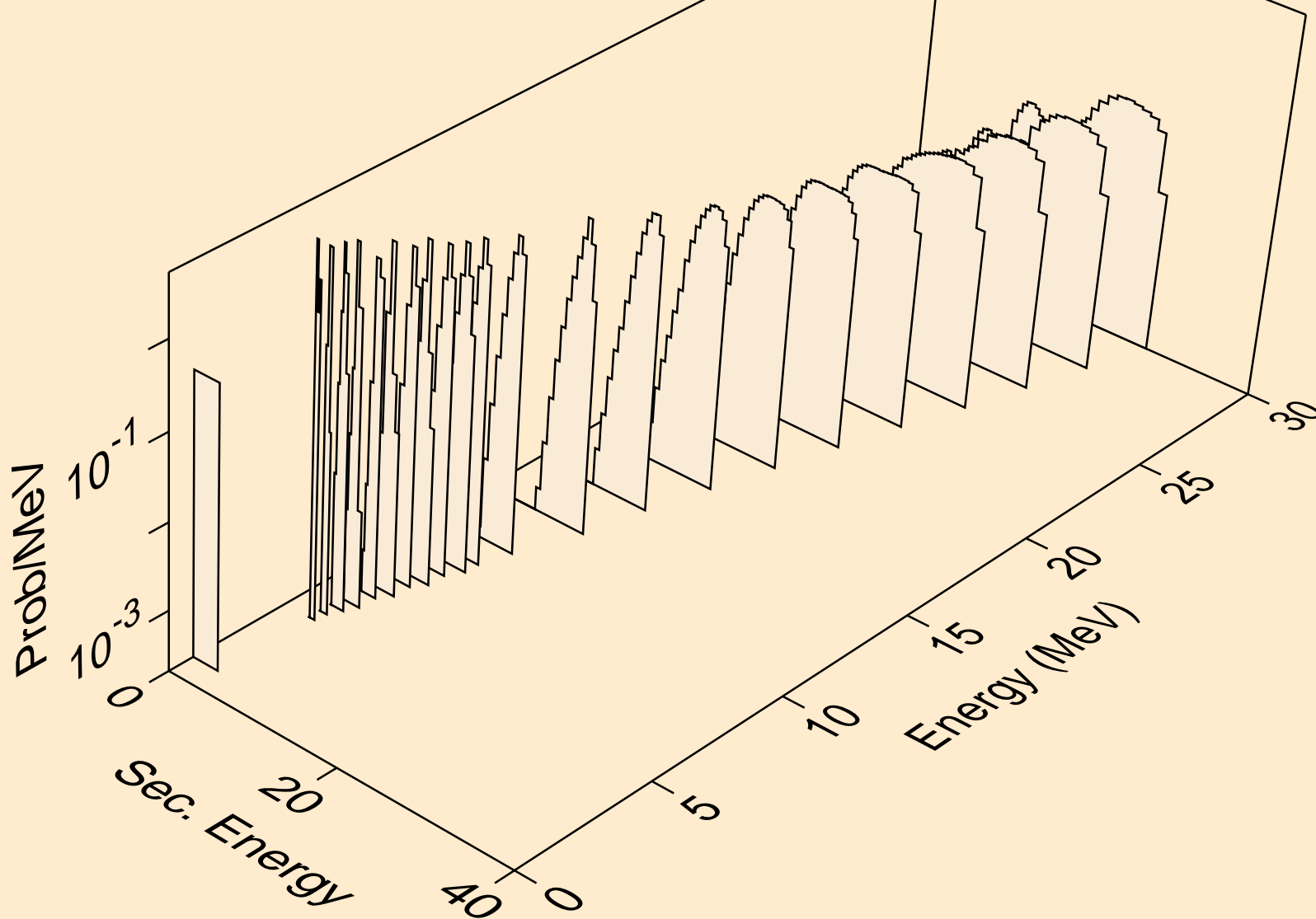

AG100M NEUTRON ACER TENDL-2019 LIBRARY; T=293.16K
alphas from (n,2n)a

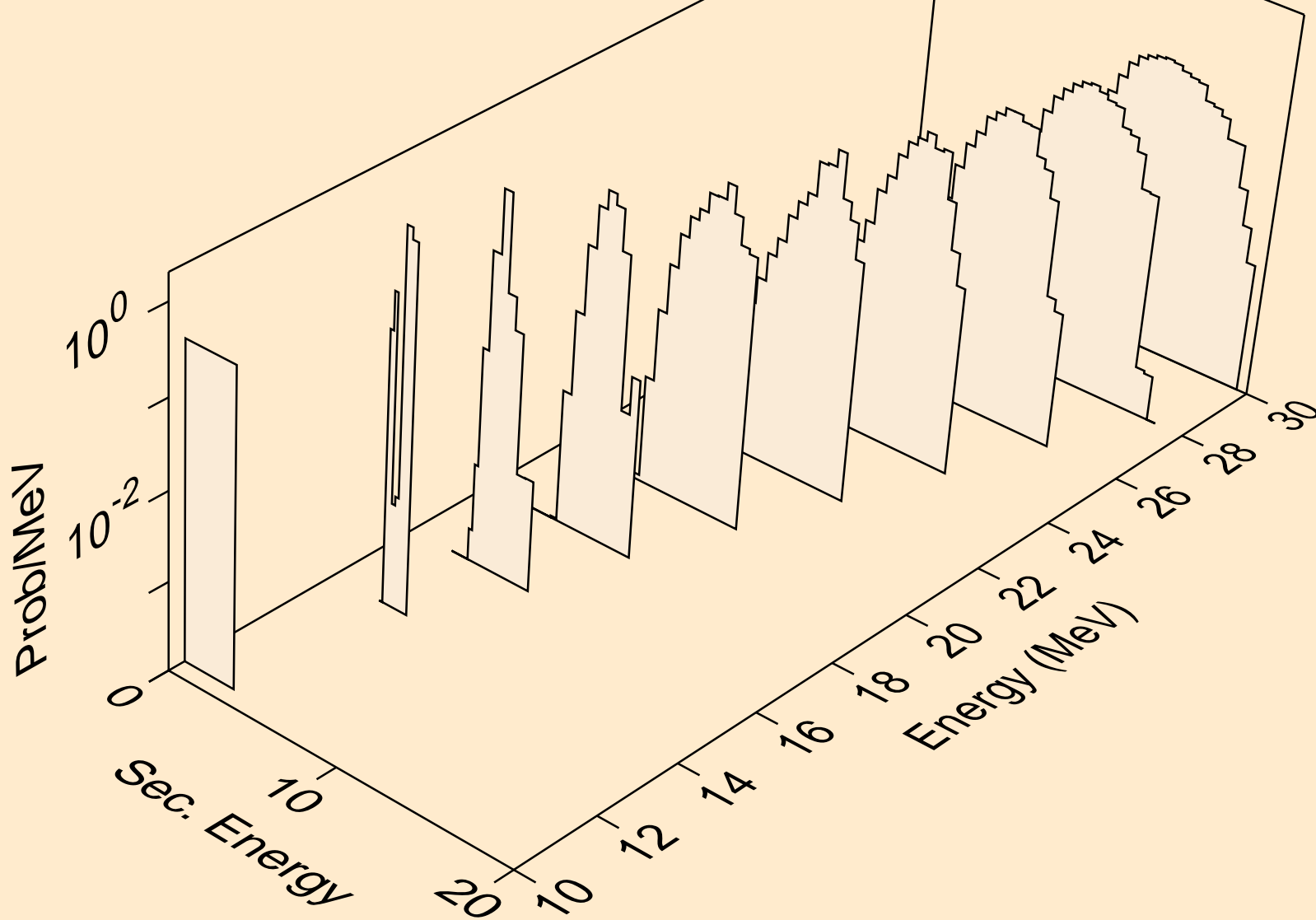

AG100M NEUTRON ACER TENDL-2019 LIBRARY; T=293.16K
alphas from (n,n*)2a

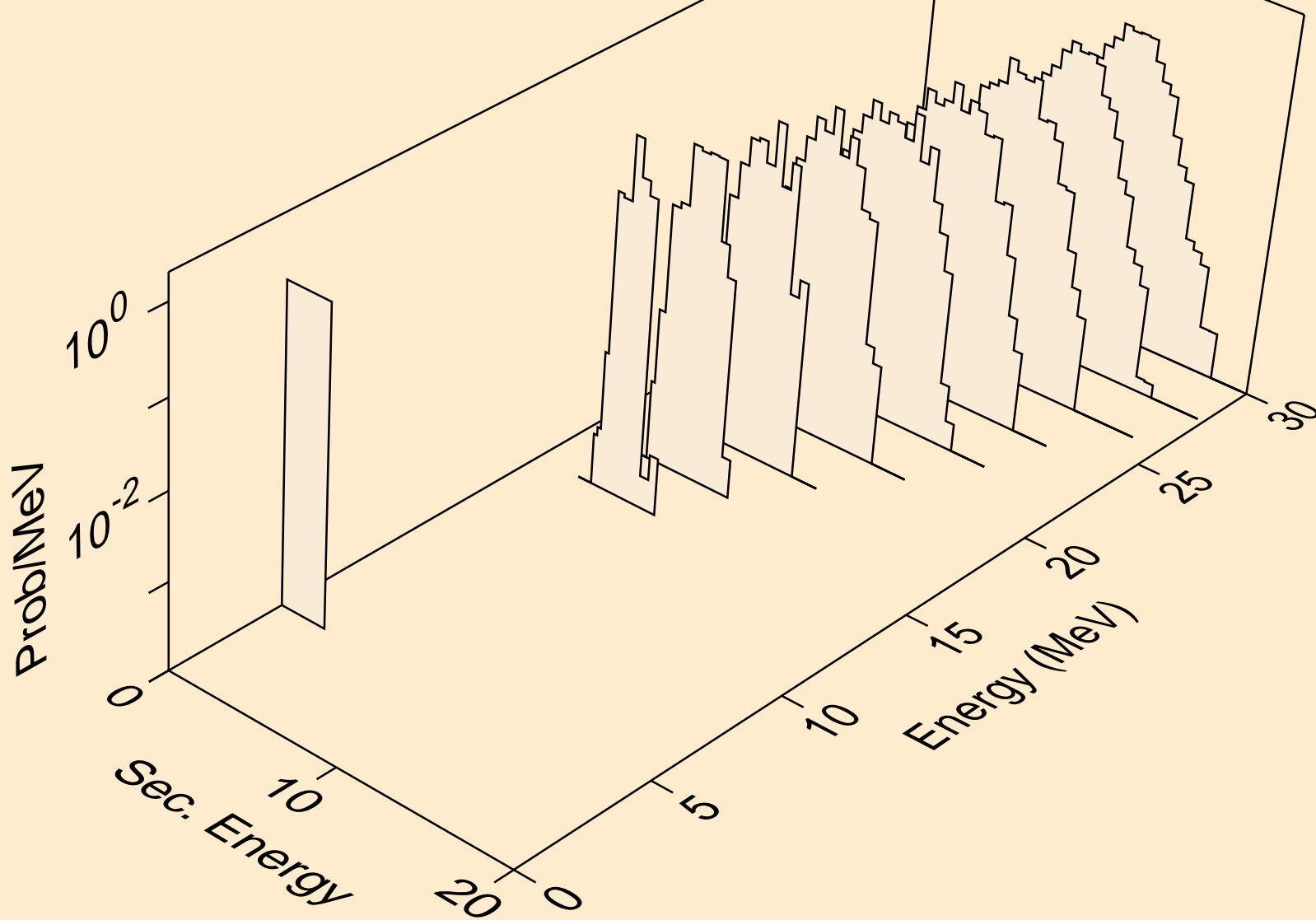

AG100M NEUTRON ACER TENDL-2019 LIBRARY; T=293.16K
alphas from (n,npa)

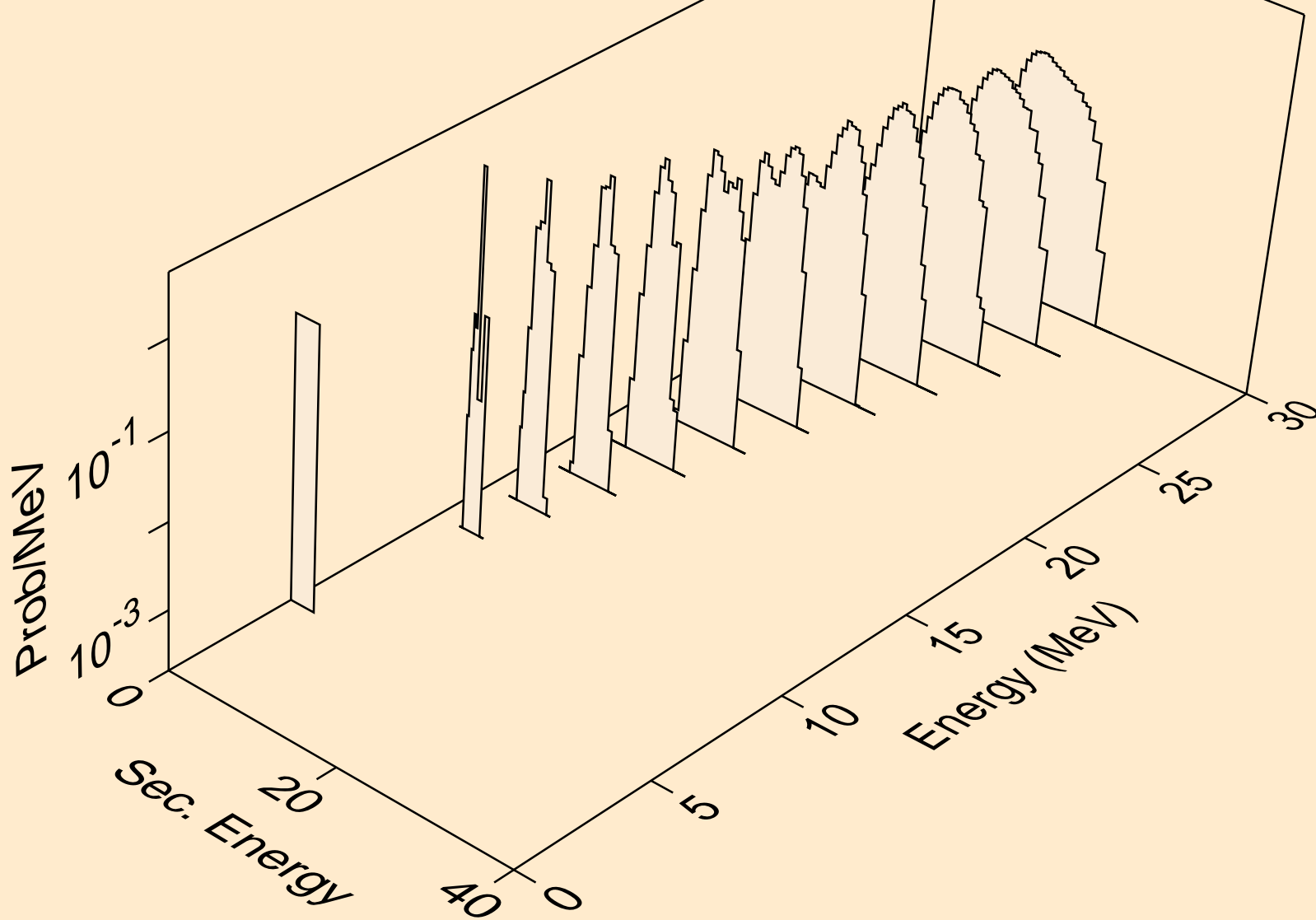

AG100M NEUTRON ACER TENDL-2019 LIBRARY; T=293.16K
alphas from (n,a)

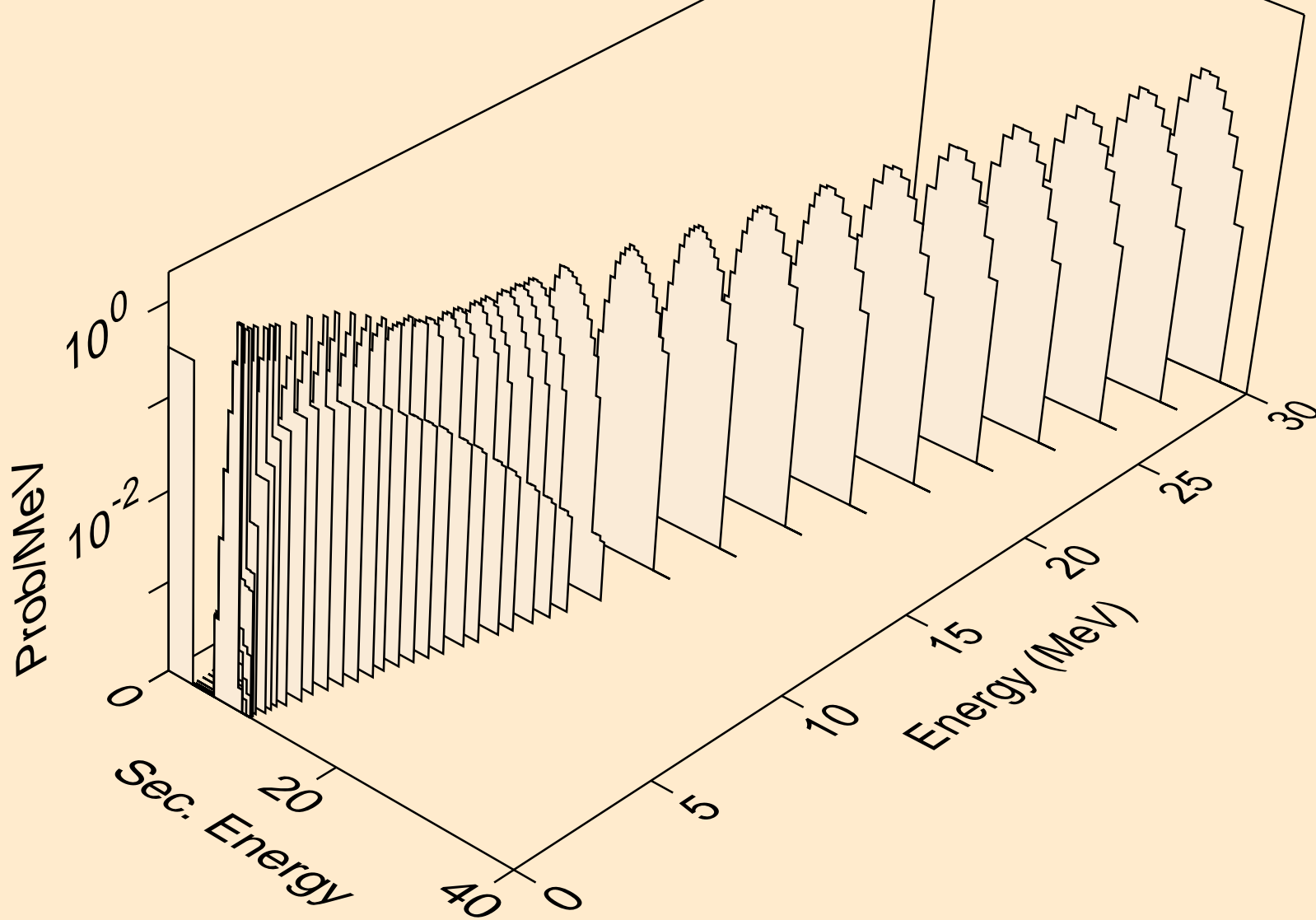

AG100M NEUTRON ACER TENDL-2019 LIBRARY; T=293.16K
alphas from (n,2a)

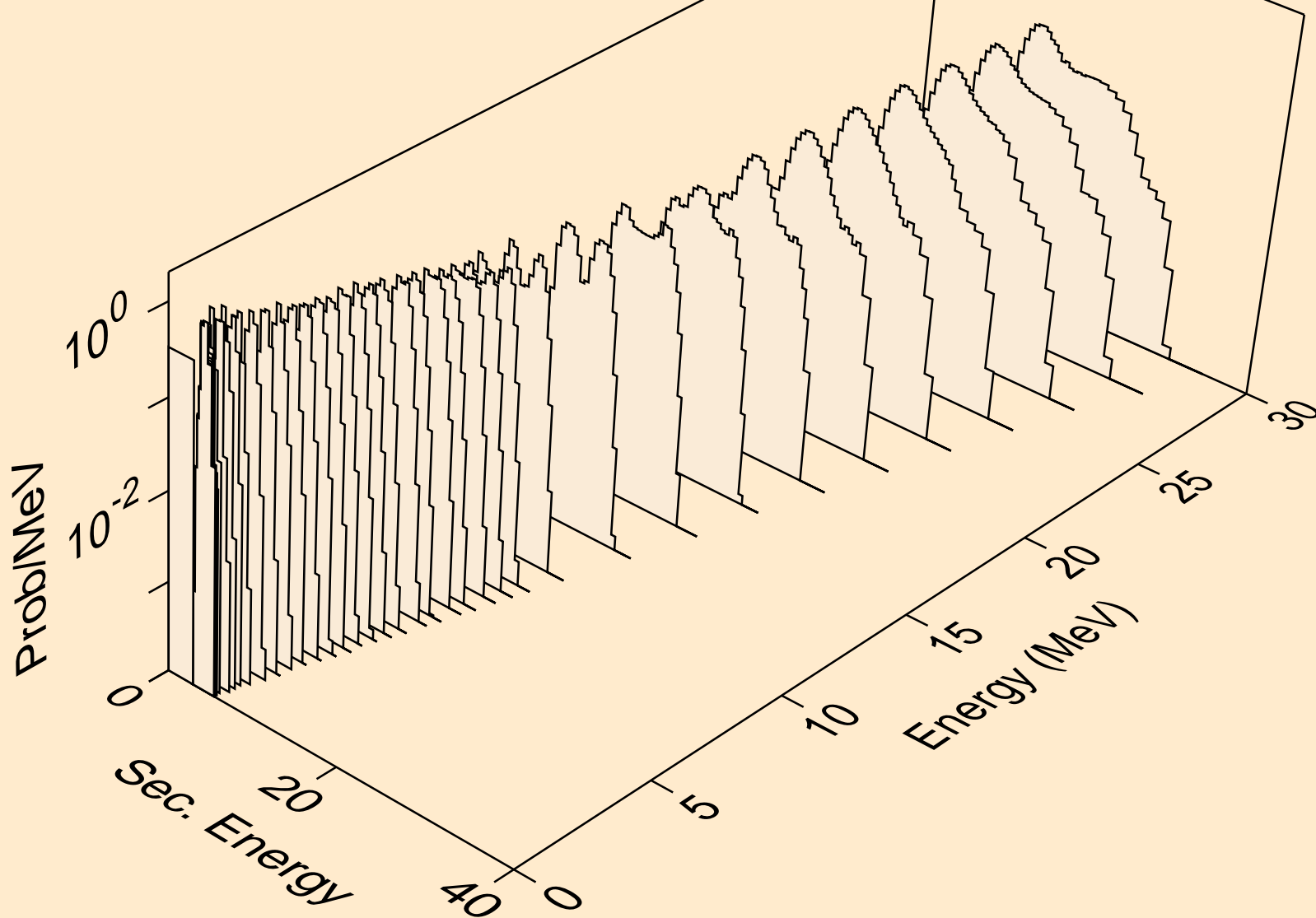

AG100M NEUTRON ACER TENDL-2019 LIBRARY; T=293.16K
alphas from (n,3a)

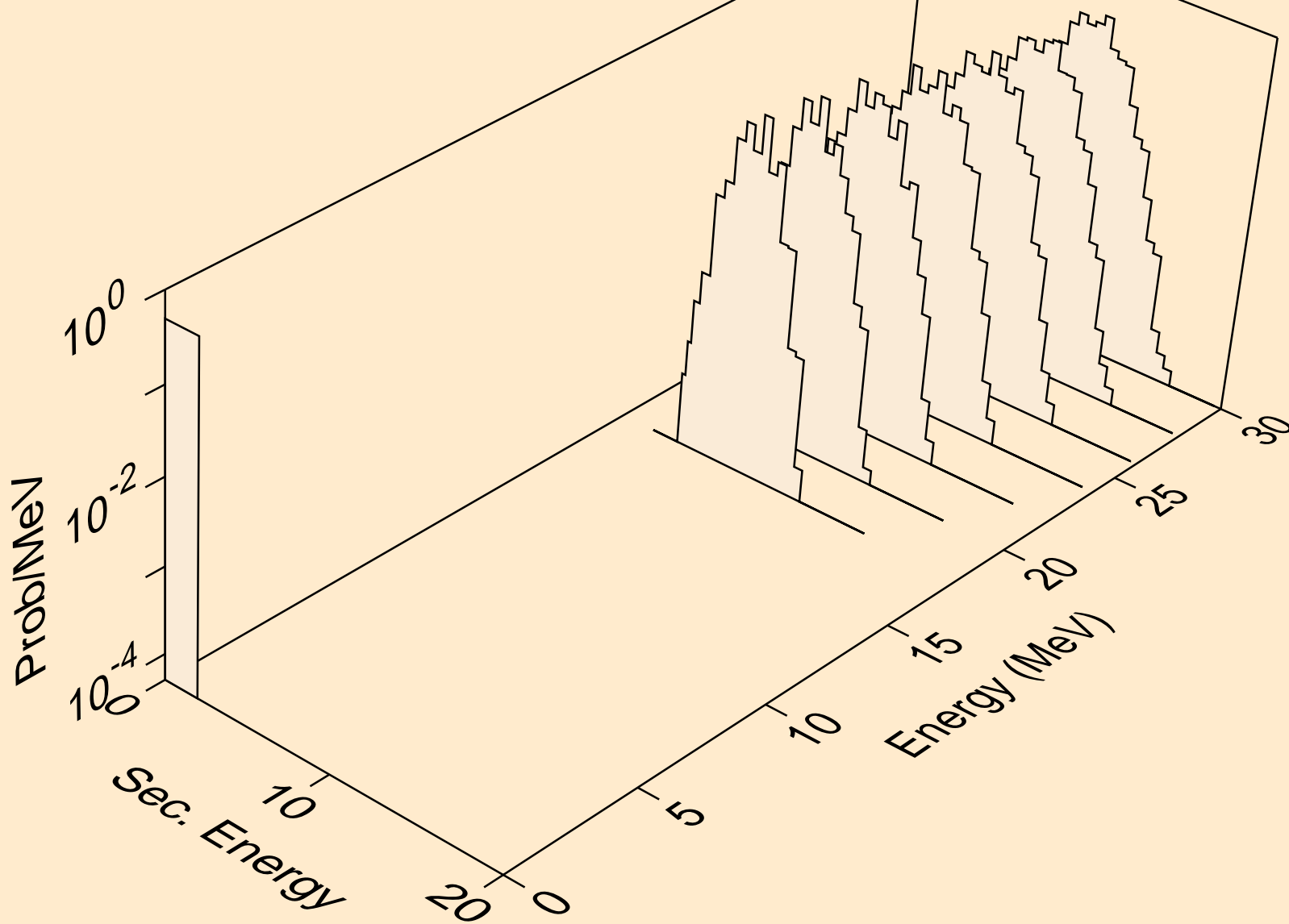

AG100M NEUTRON ACER TENDL-2019 LIBRARY; T=293.16K
alphas from (n,pa)

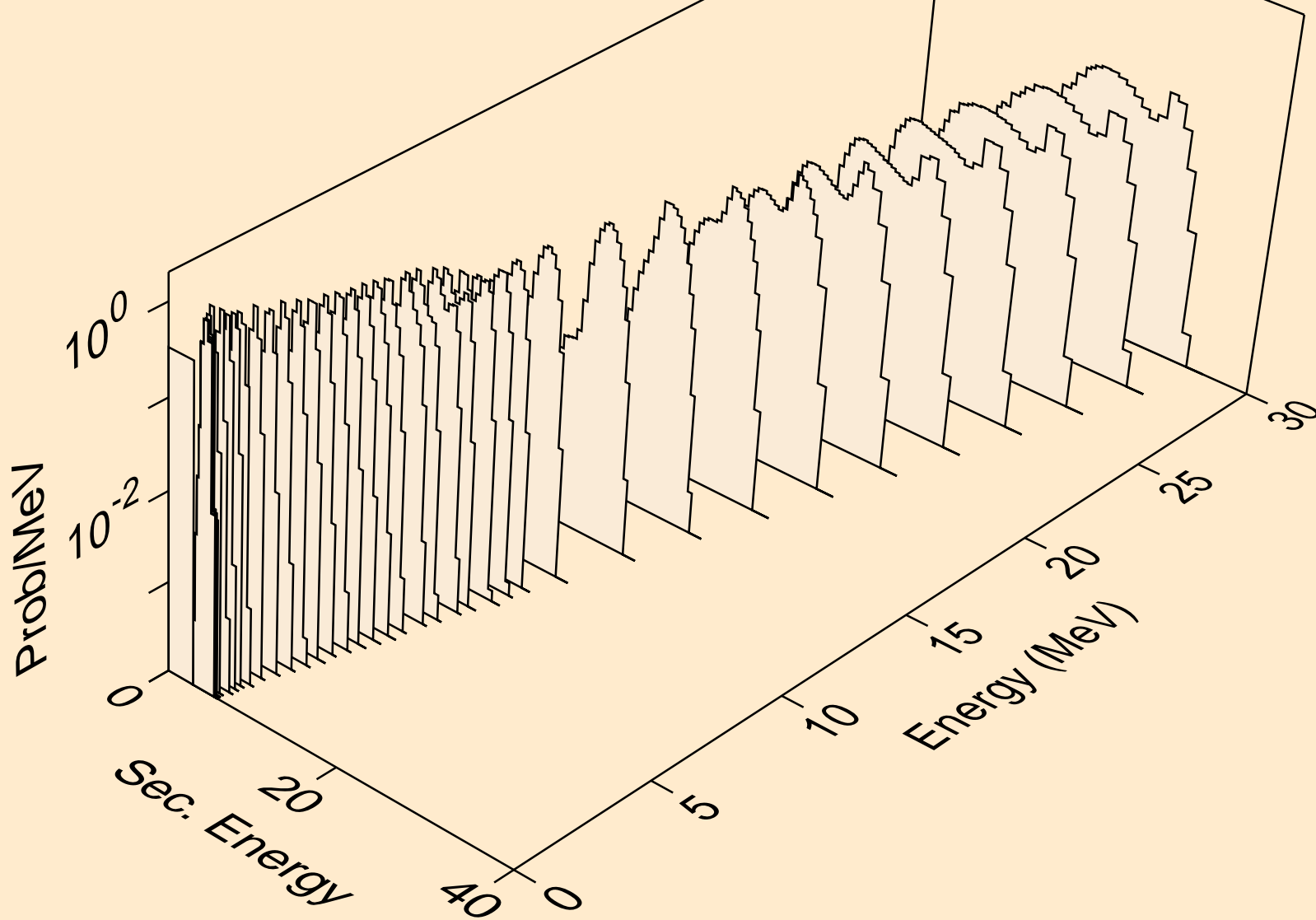

AG100M NEUTRON ACER TENDL-2019 LIBRARY; T=293.16K
alphas from (n,da)

