

AG106 NEUTRON ACER TENDL-2019 LIBRARY; T=293.16K  
Principal cross sections

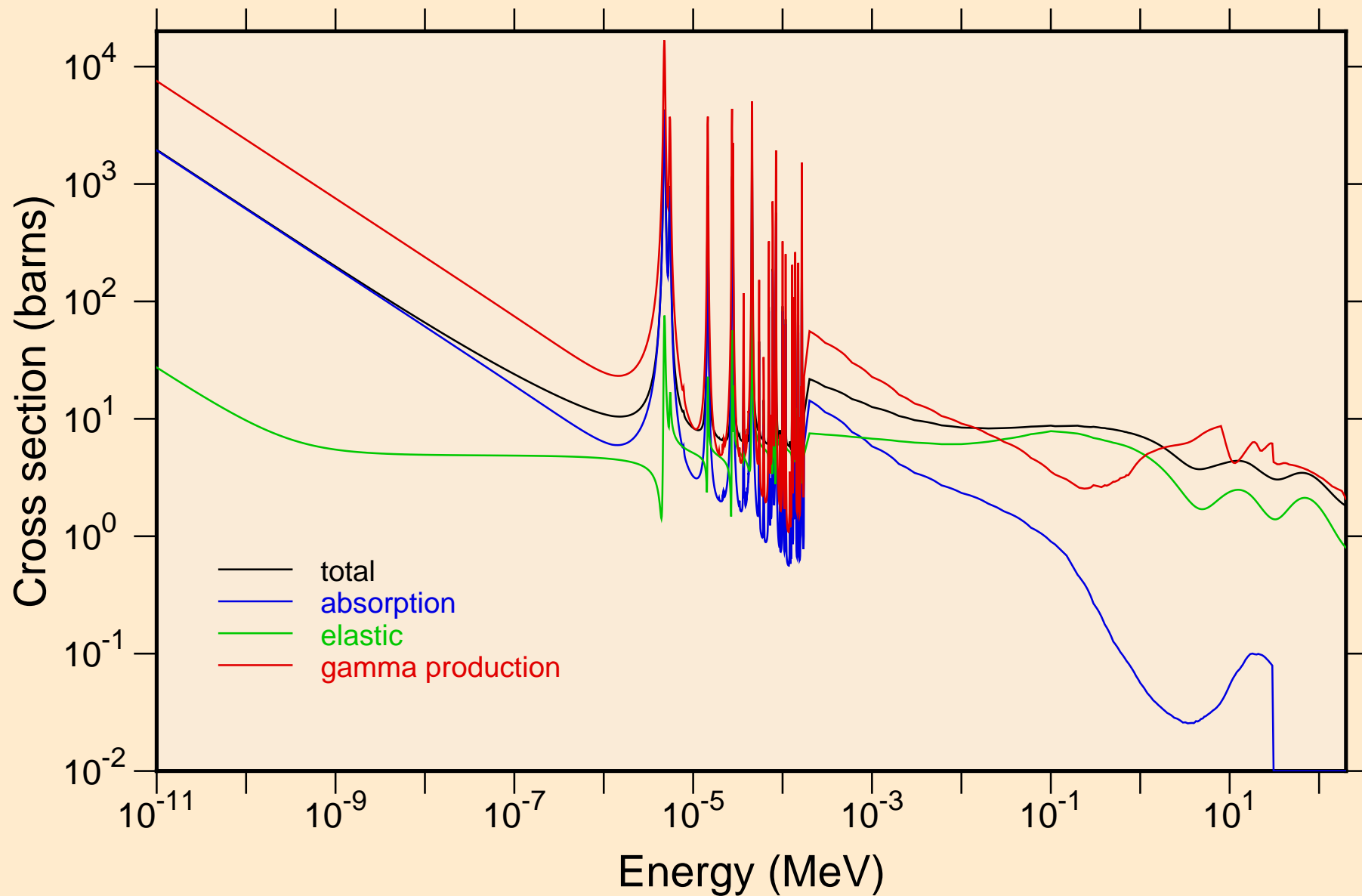

AG106 NEUTRON ACER TENDL-2019 LIBRARY; T=293.16K  
resonance total cross section

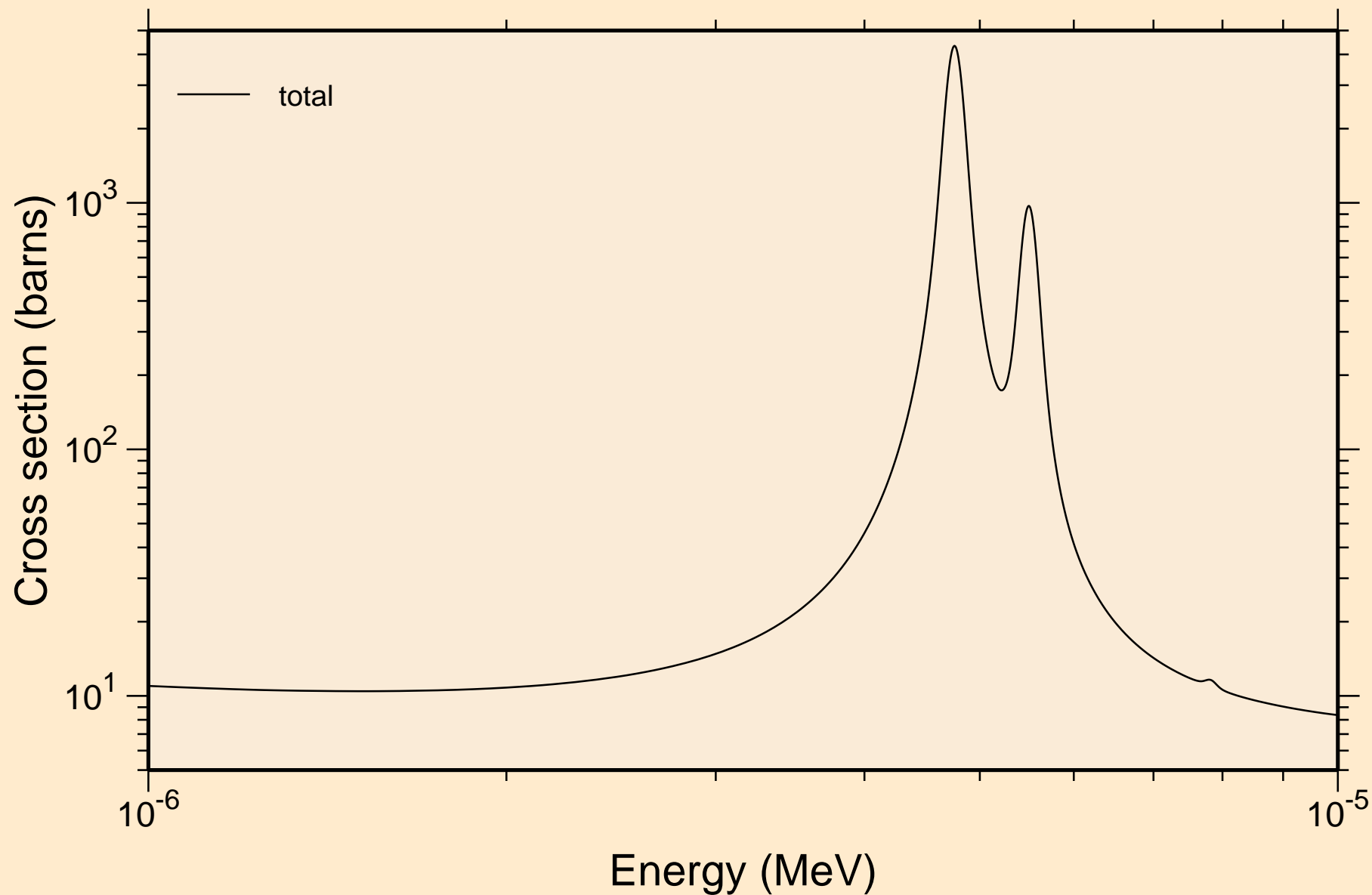

AG106 NEUTRON ACER TENDL-2019 LIBRARY; T=293.16K  
resonance total cross section

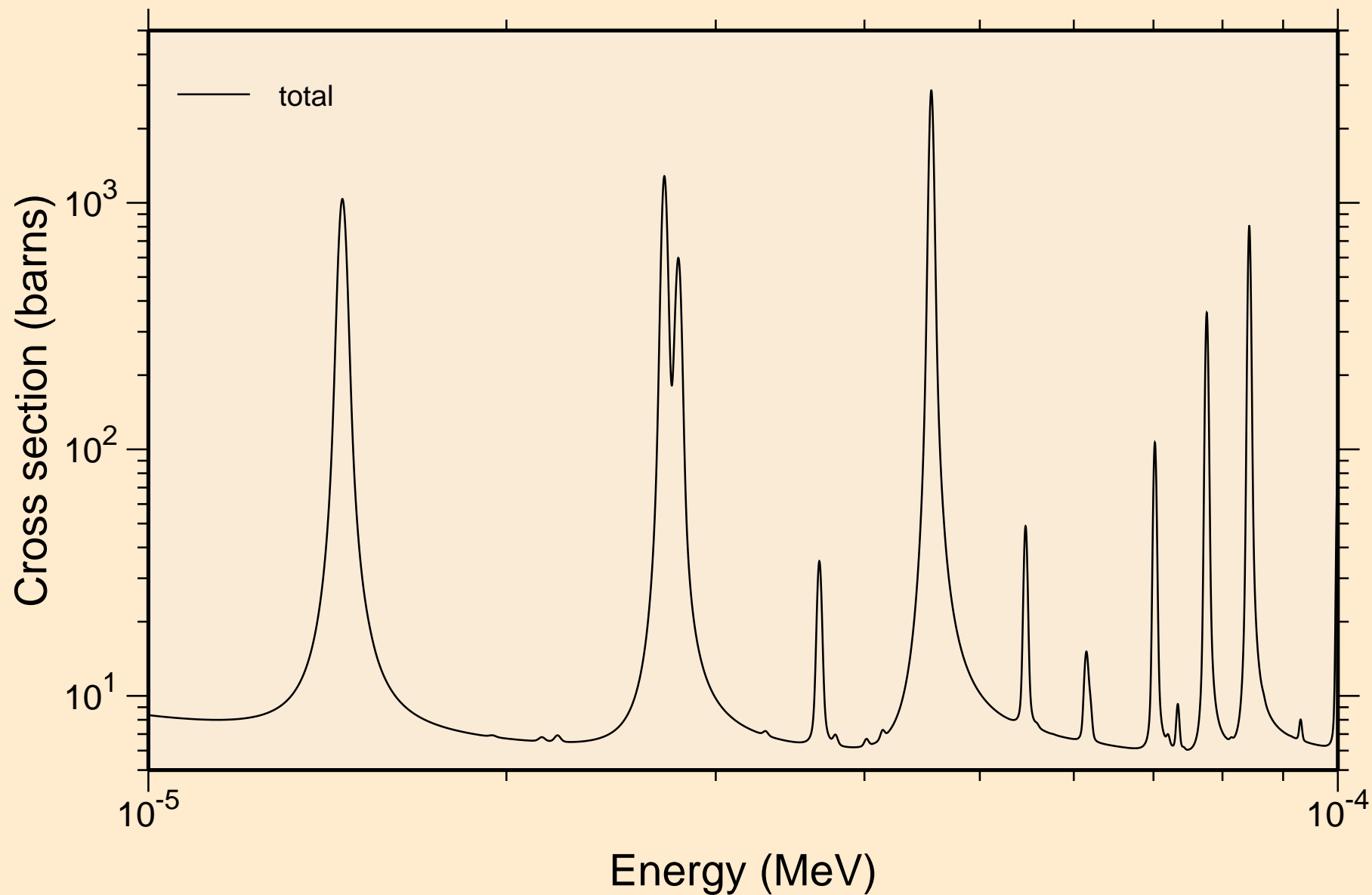

AG106 NEUTRON ACER TENDL-2019 LIBRARY; T=293.16K  
resonance total cross section

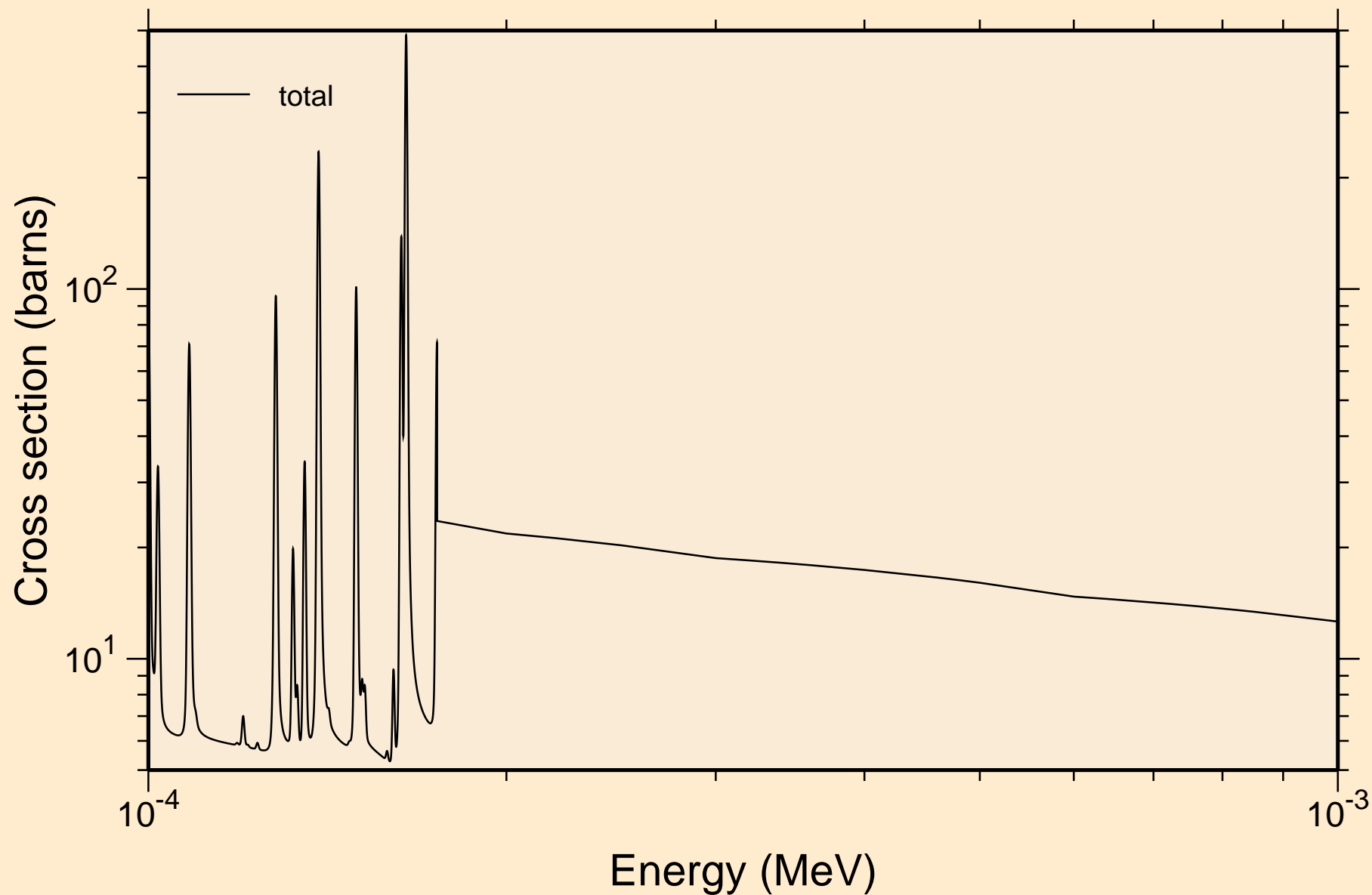

AG106 NEUTRON ACER TENDL-2019 LIBRARY; T=293.16K  
resonance total cross section

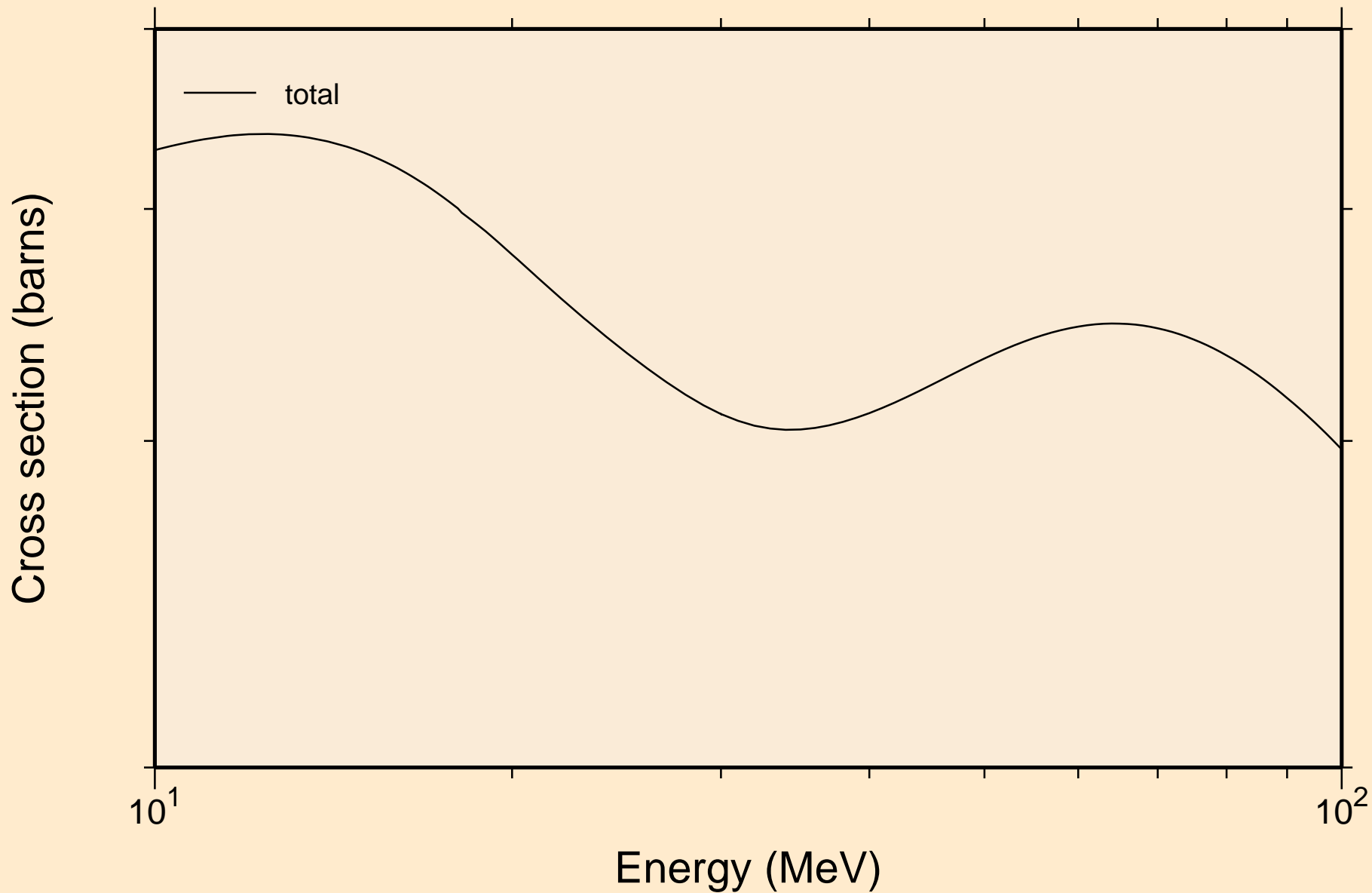

AG106 NEUTRON ACER TENDL-2019 LIBRARY; T=293.16K  
resonance absorption cross sections

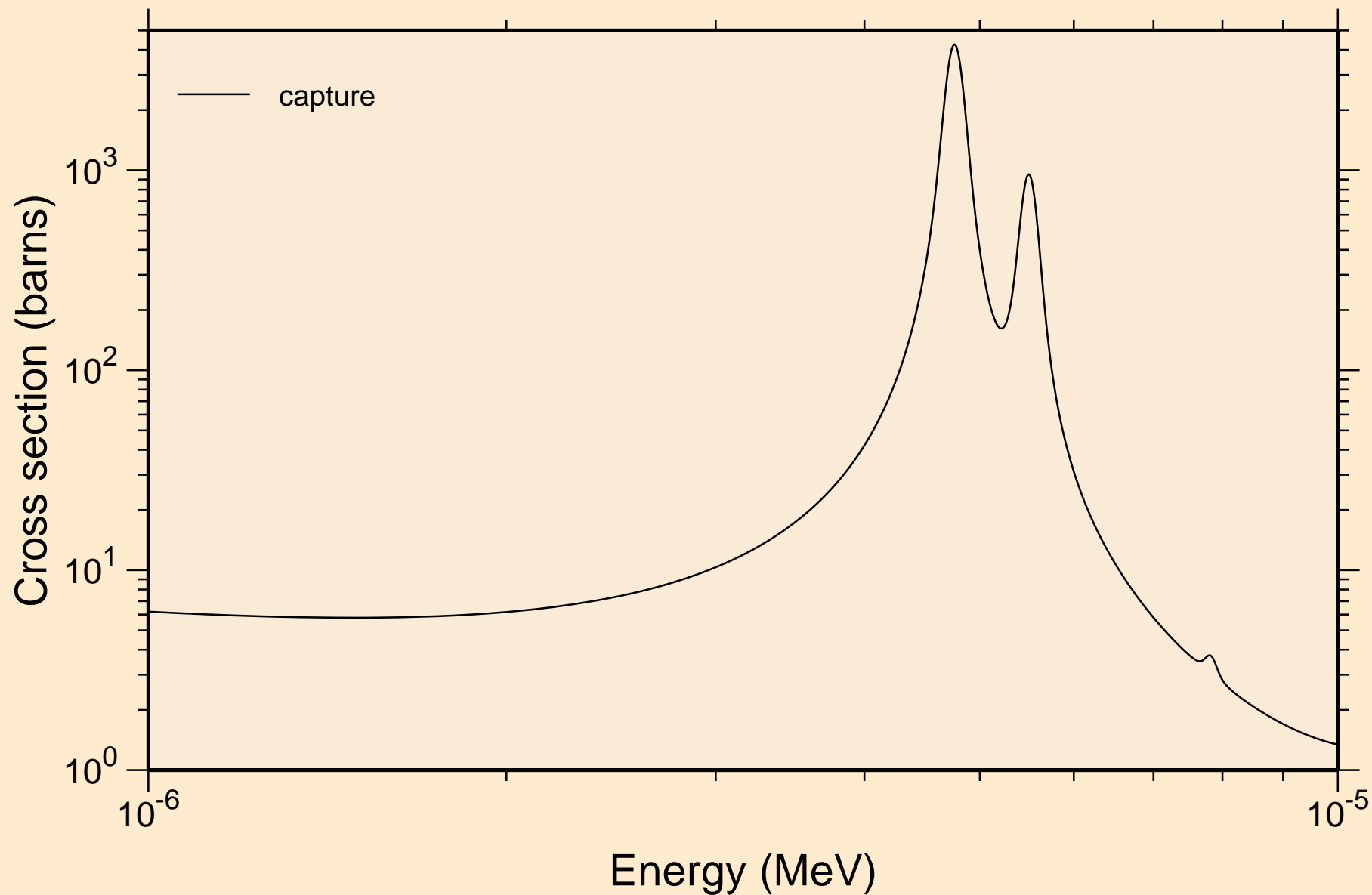

AG106 NEUTRON ACER TENDL-2019 LIBRARY; T=293.16K  
resonance absorption cross sections

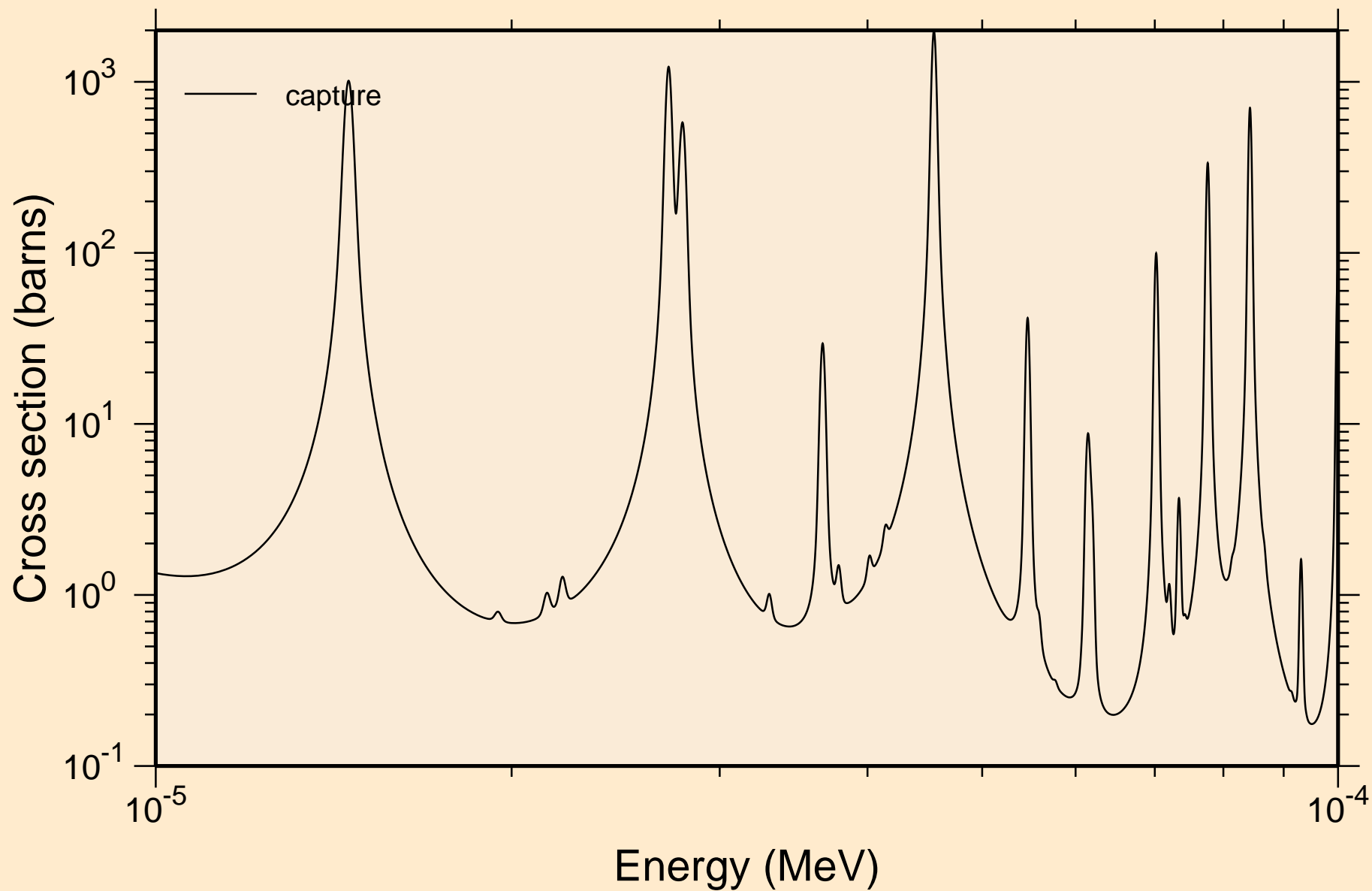

AG106 NEUTRON ACER TENDL-2019 LIBRARY; T=293.16K  
resonance absorption cross sections

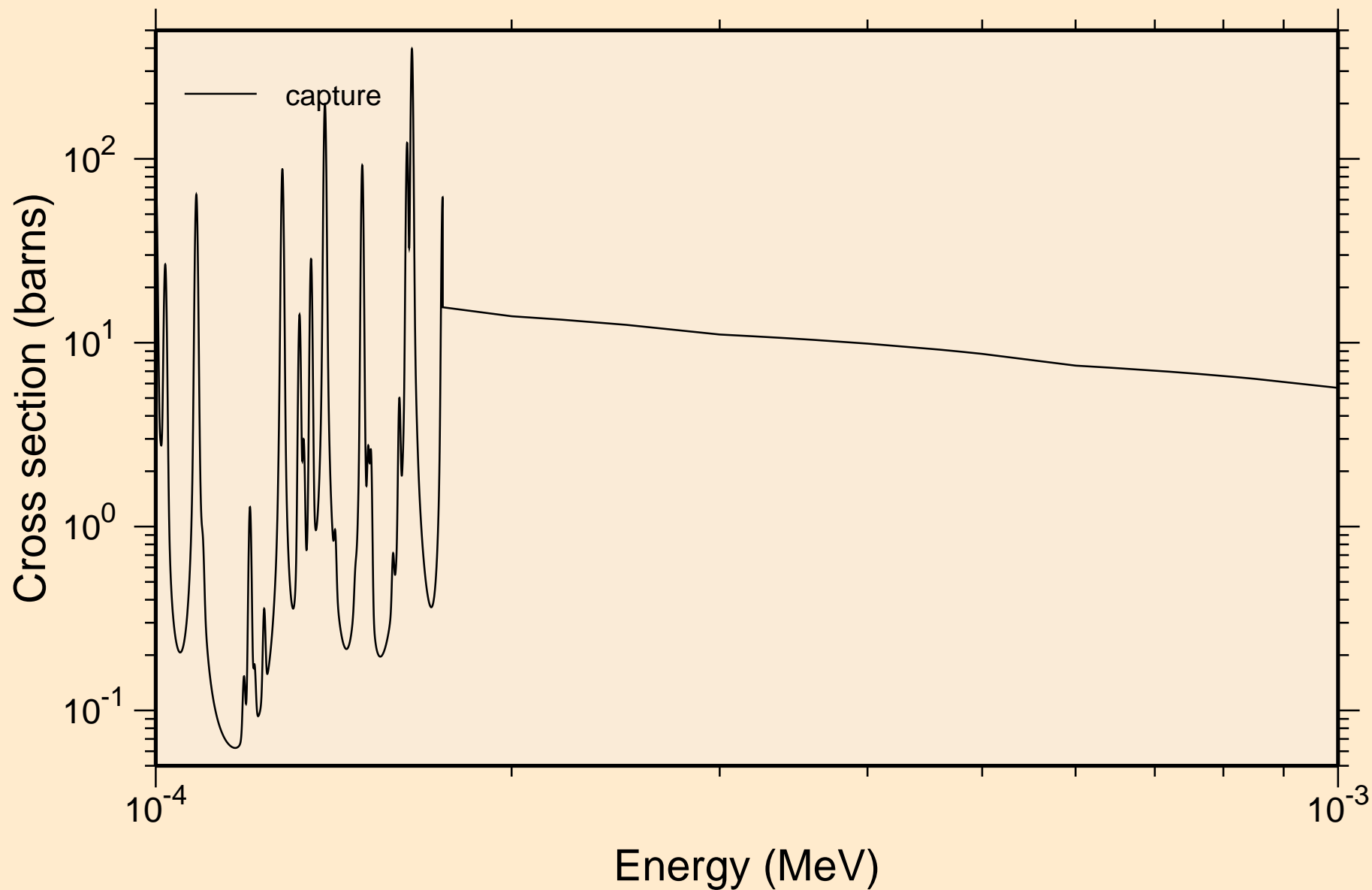



AG106 NEUTRON ACER TENDL-2019 LIBRARY; T=293.16K  
resonance absorption cross sections

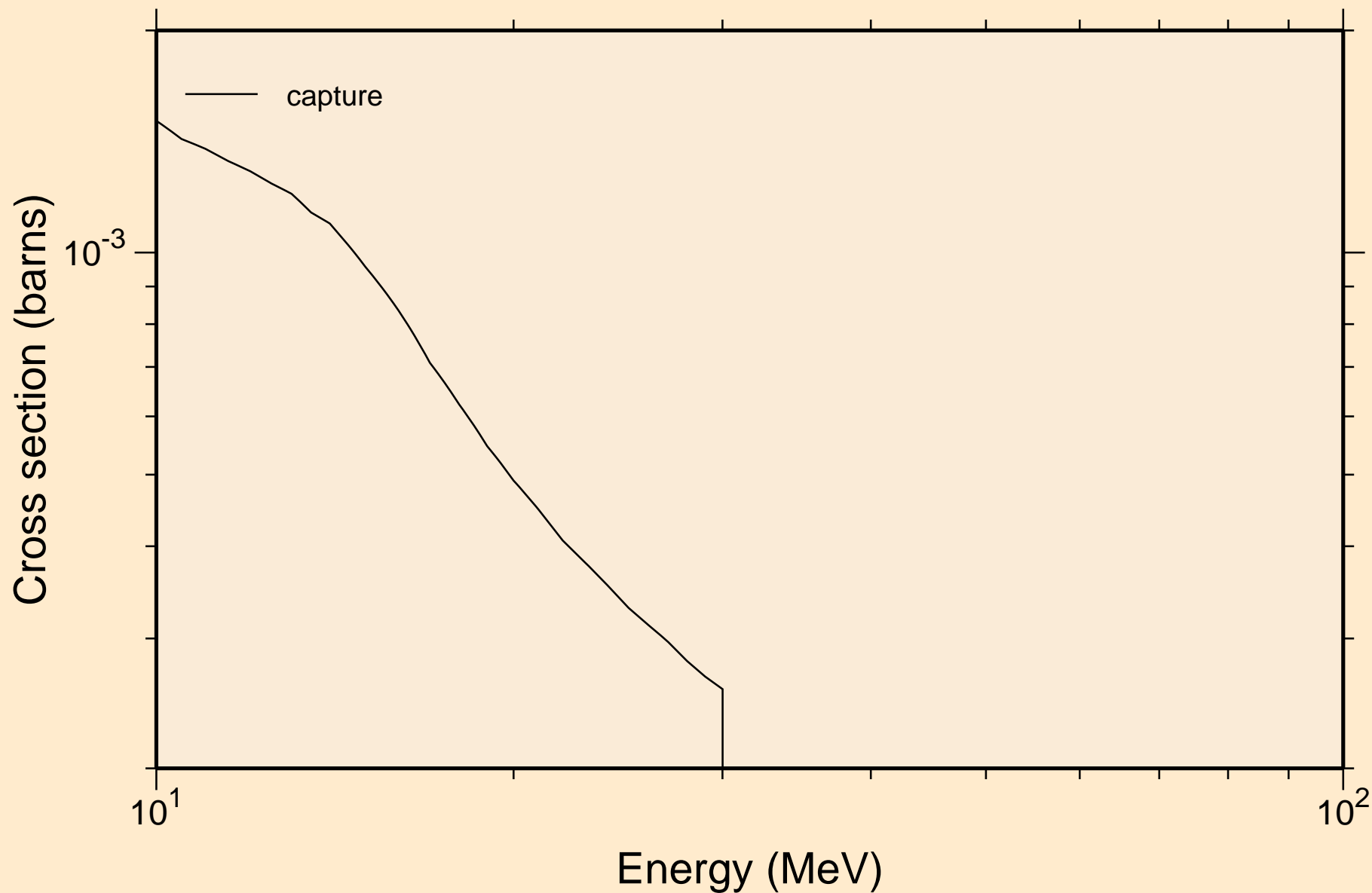

AG106 NEUTRON ACER TENDL-2019 LIBRARY; T=293.16K  
Heating

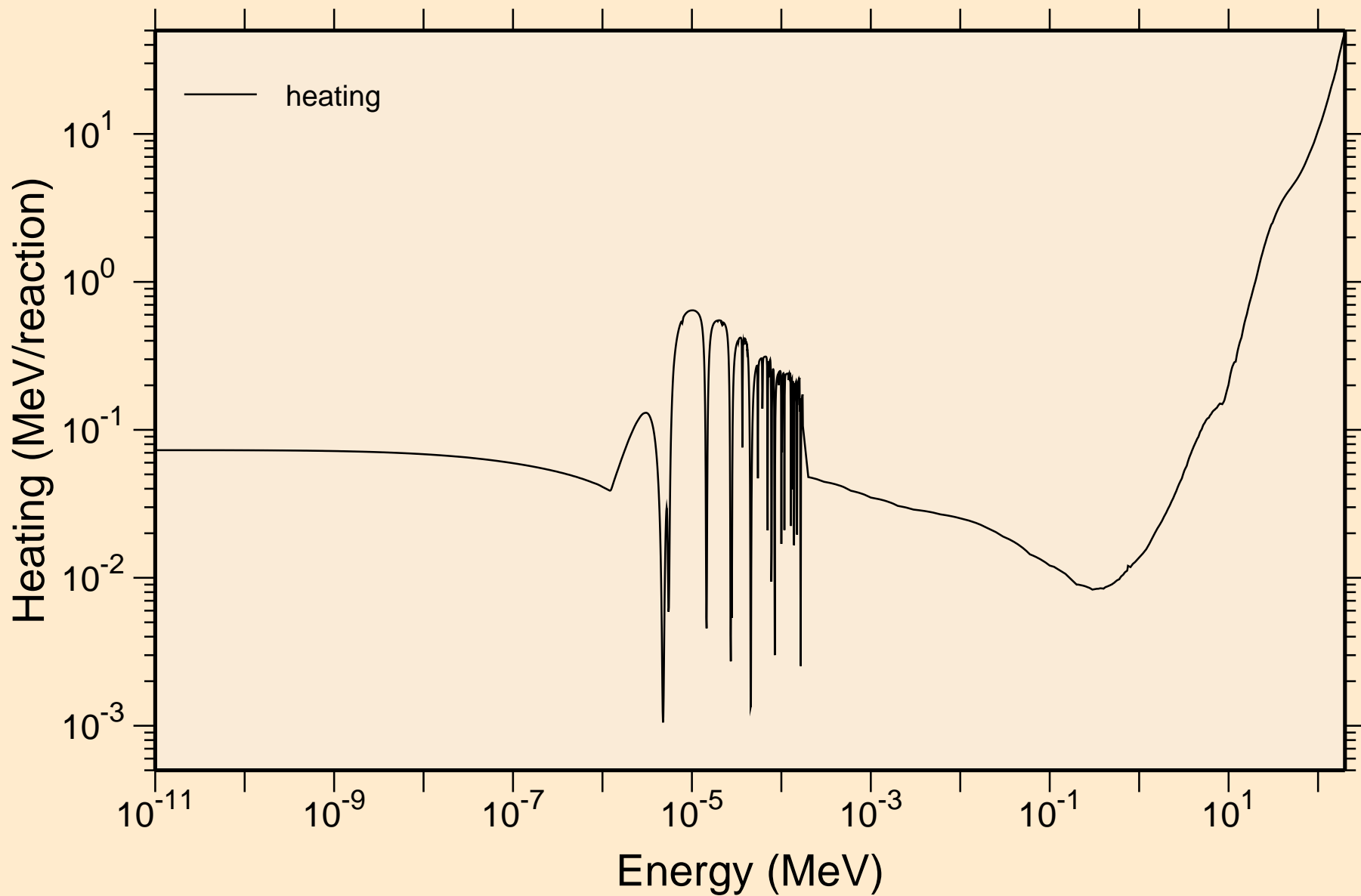

AG106 NEUTRON ACER TENDL-2019 LIBRARY; T=293.16K  
Damage

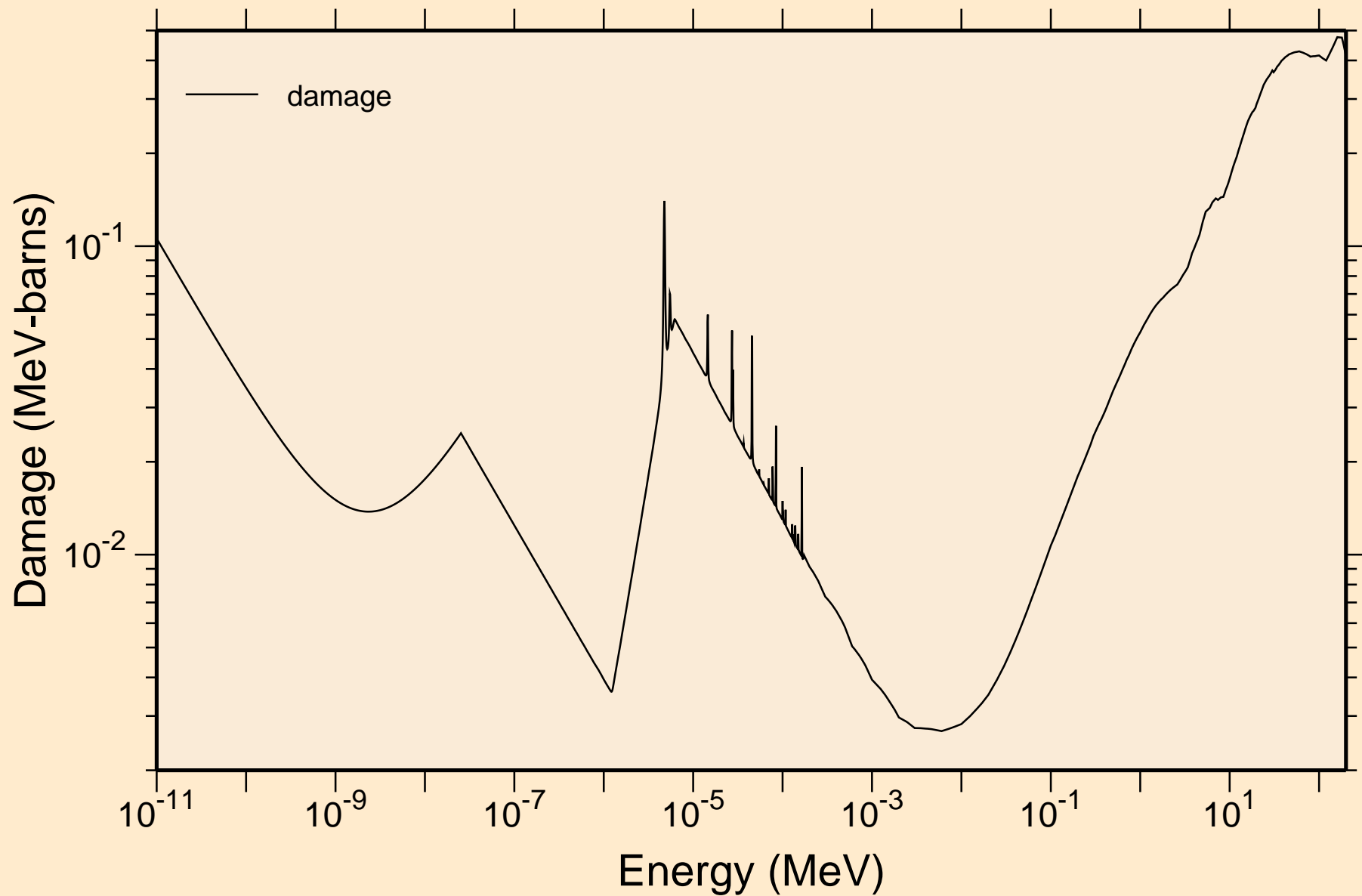

AG106 NEUTRON ACER TENDL-2019 LIBRARY; T=293.16K  
Non-threshold reactions

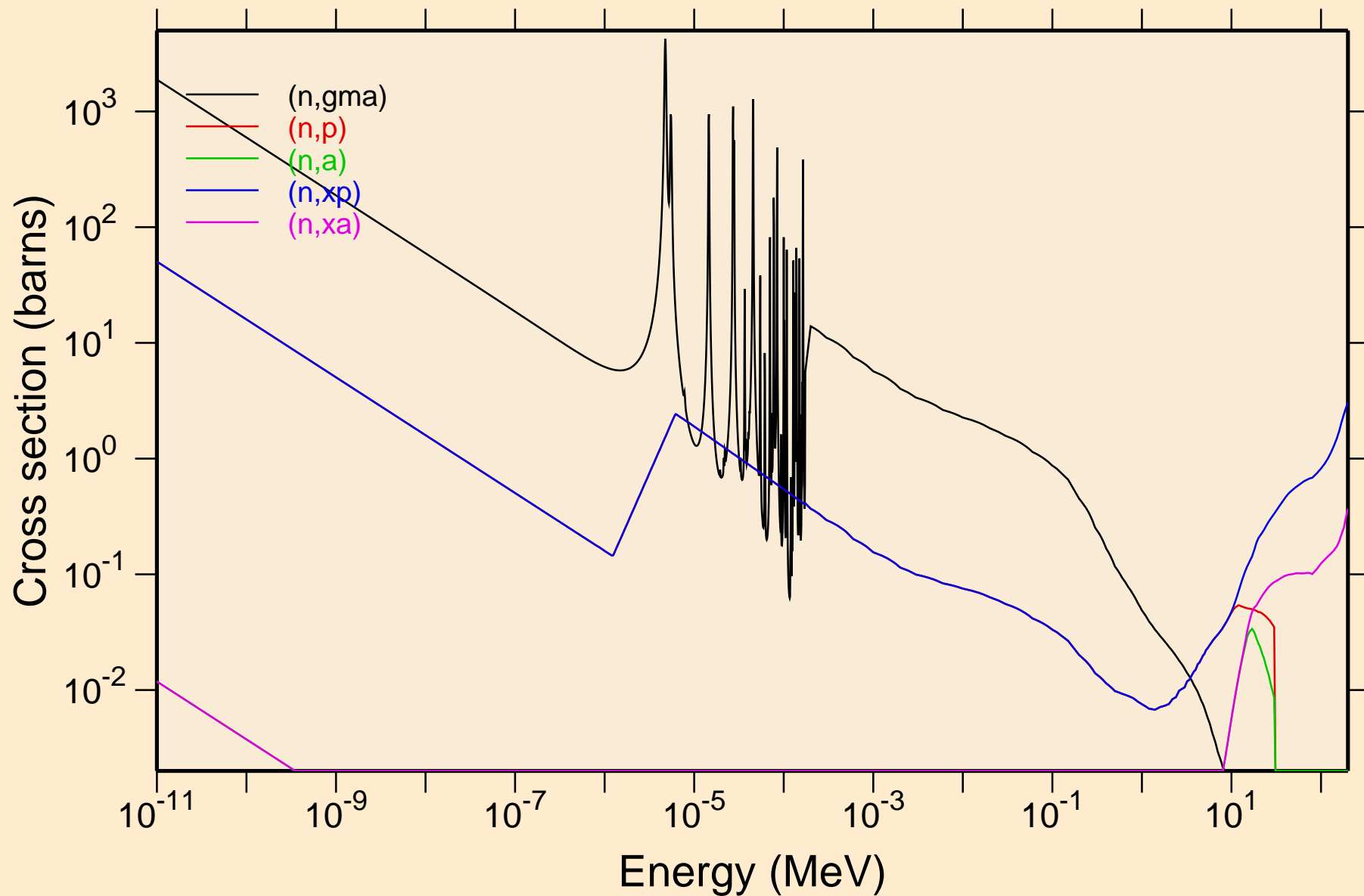

AG106 NEUTRON ACER TENDL-2019 LIBRARY; T=293.16K  
Principal cross sections

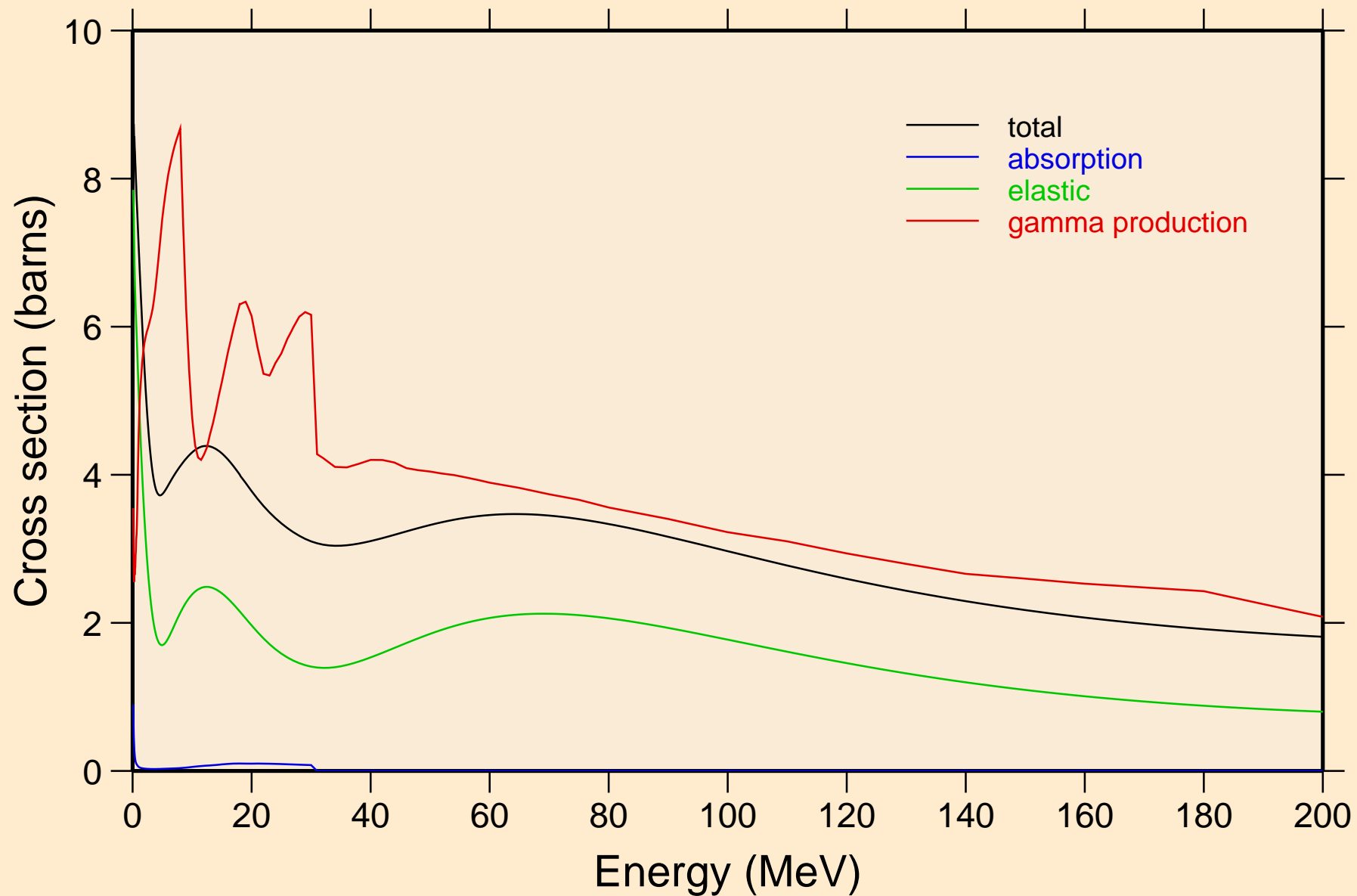

AG106 NEUTRON ACER TENDL-2019 LIBRARY; T=293.16K  
Heating

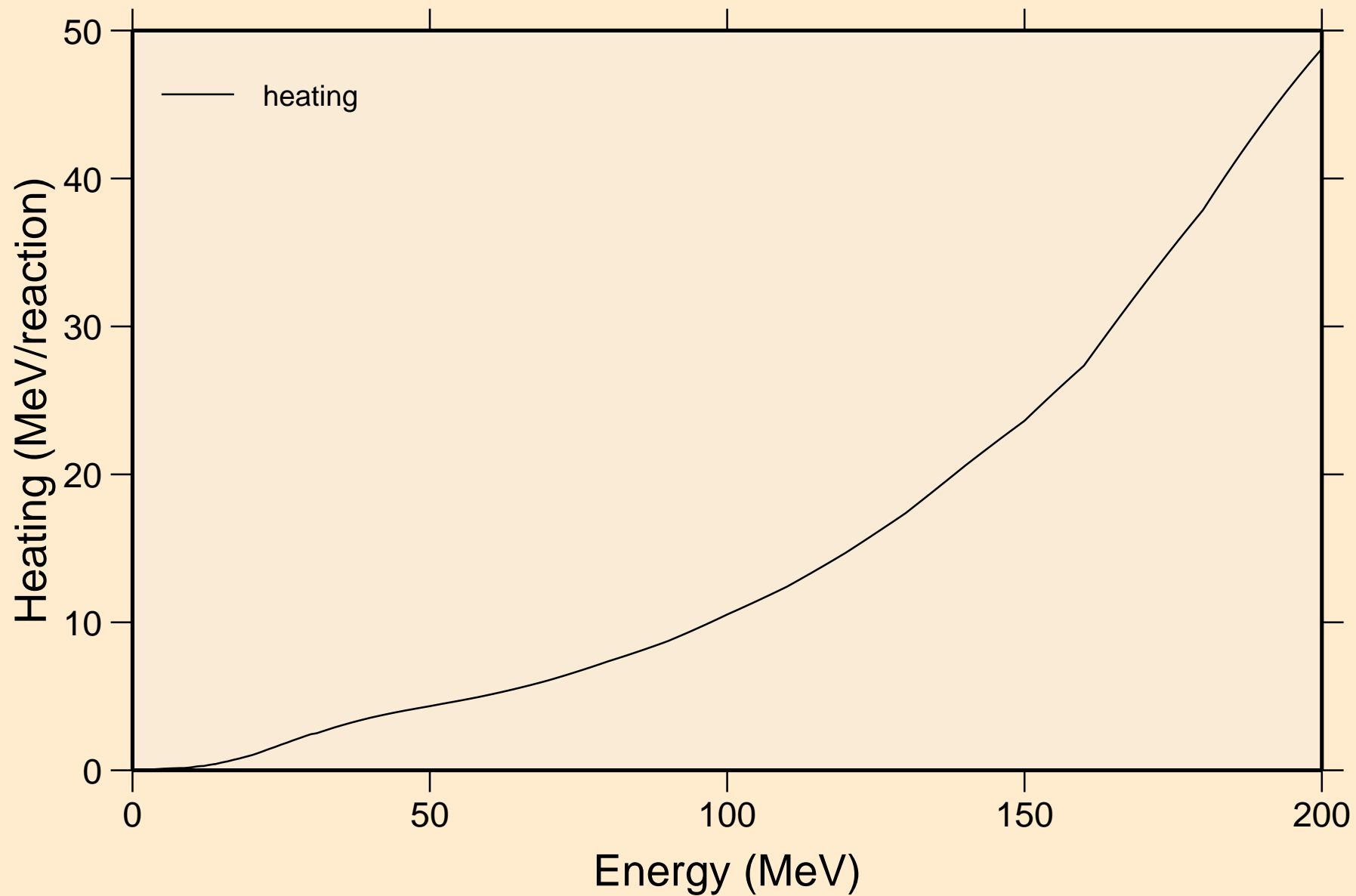

AG106 NEUTRON ACER TENDL-2019 LIBRARY; T=293.16K  
Damage

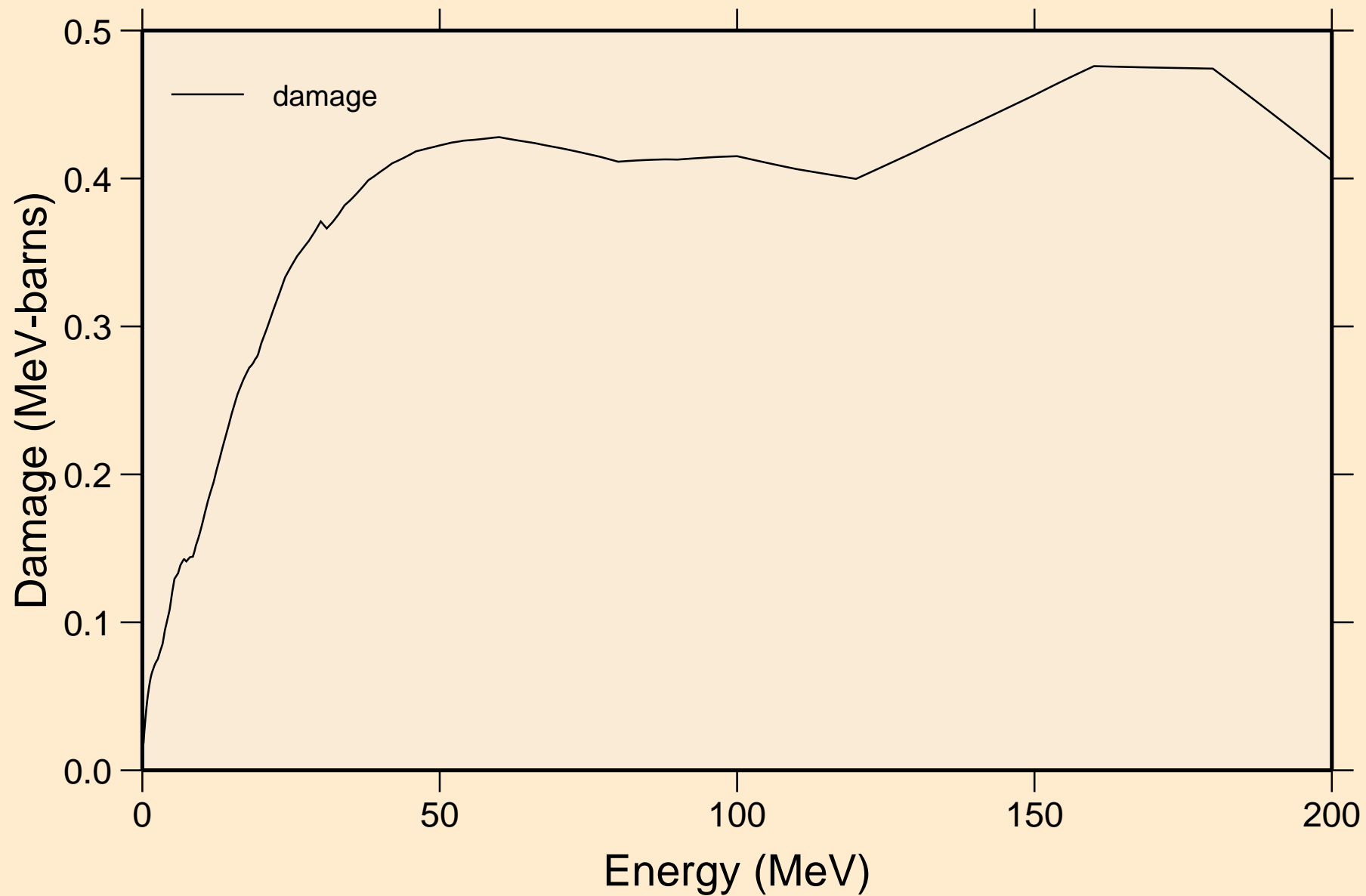

AG106 NEUTRON ACER TENDL-2019 LIBRARY; T=293.16K  
Non-threshold reactions

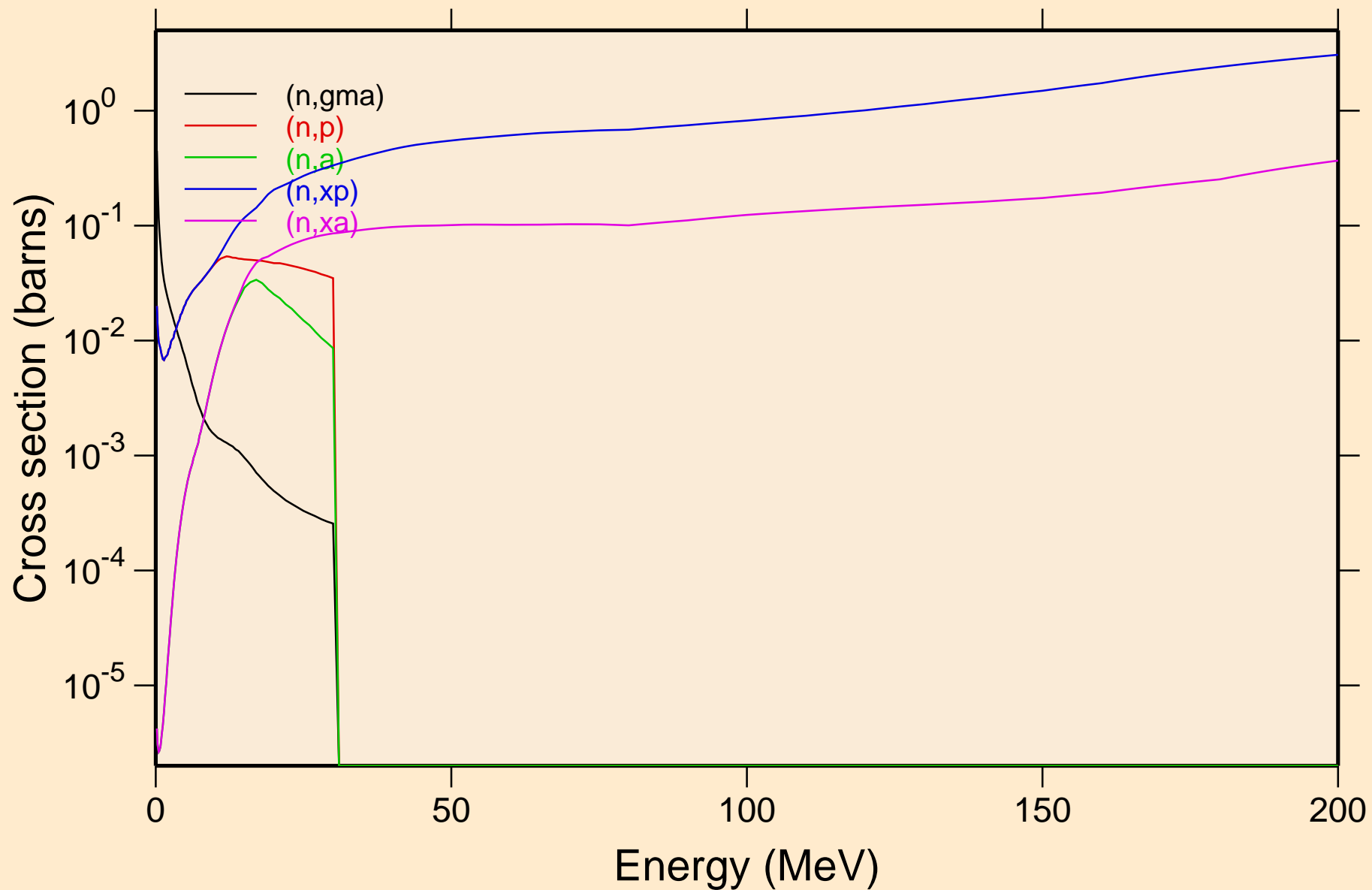



AG106 NEUTRON ACER TENDL-2019 LIBRARY; T=293.16K  
Inelastic levels

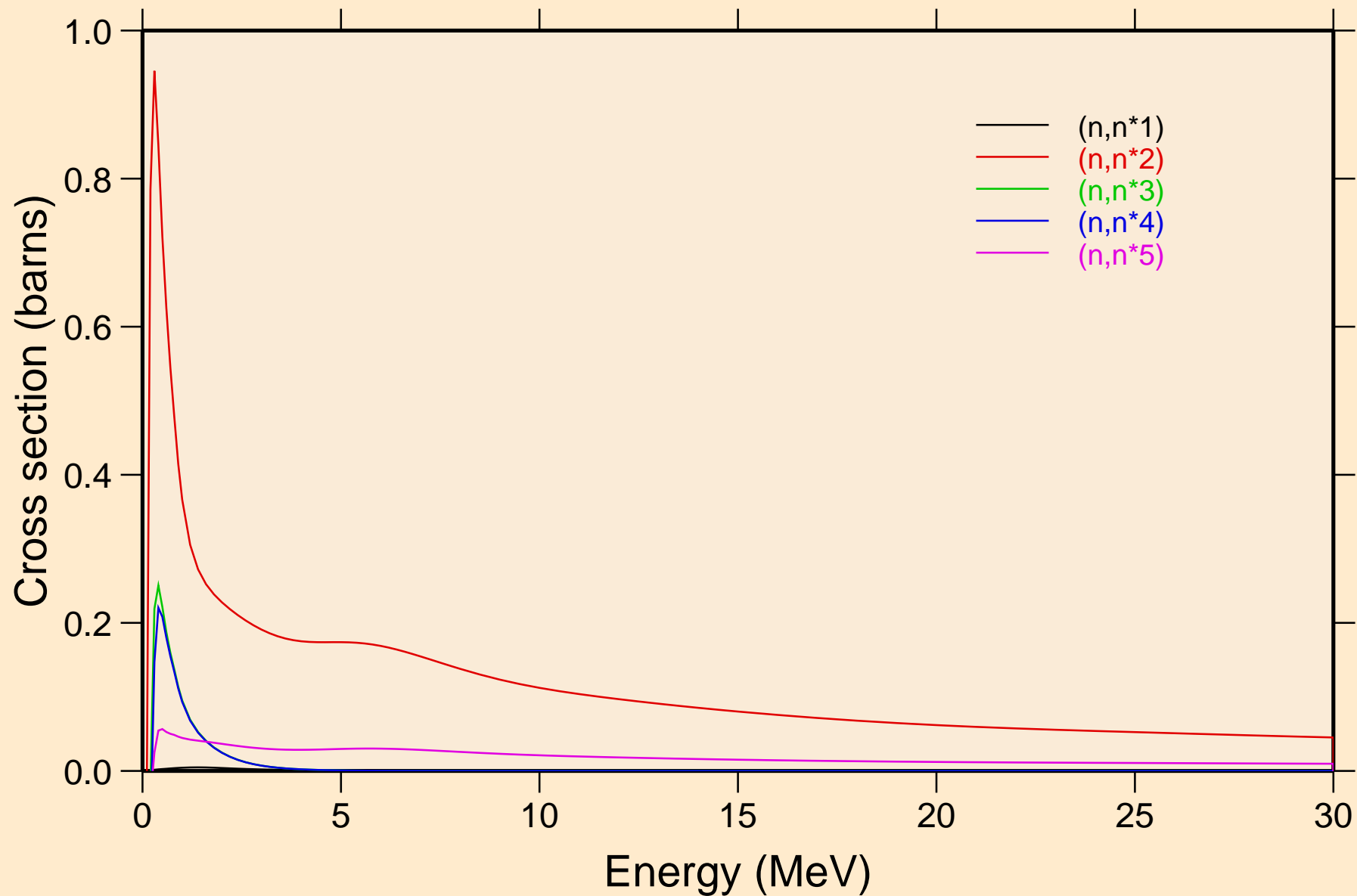

AG106 NEUTRON ACER TENDL-2019 LIBRARY; T=293.16K  
Inelastic levels

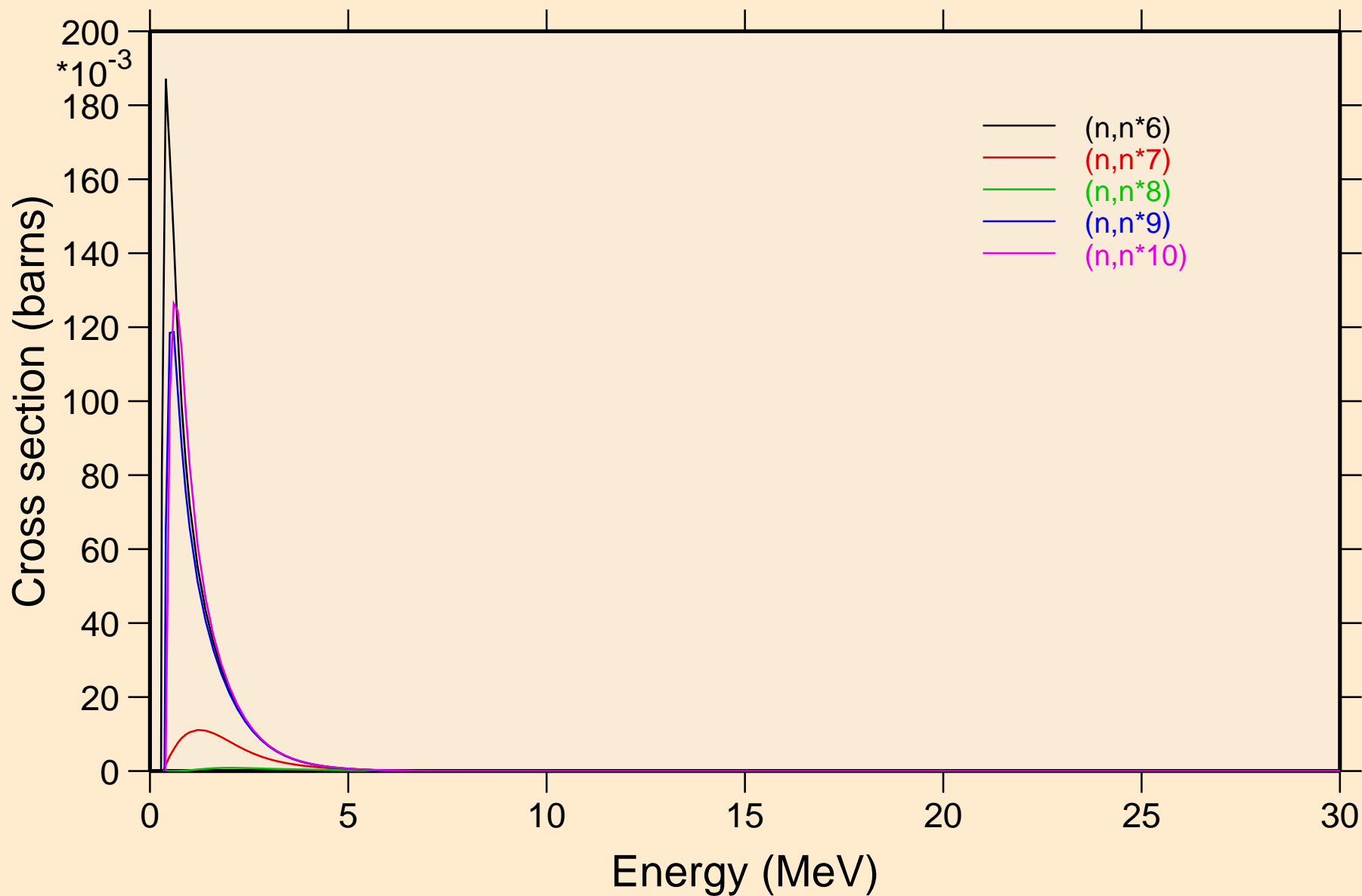

AG106 NEUTRON ACER TENDL-2019 LIBRARY; T=293.16K  
Inelastic levels

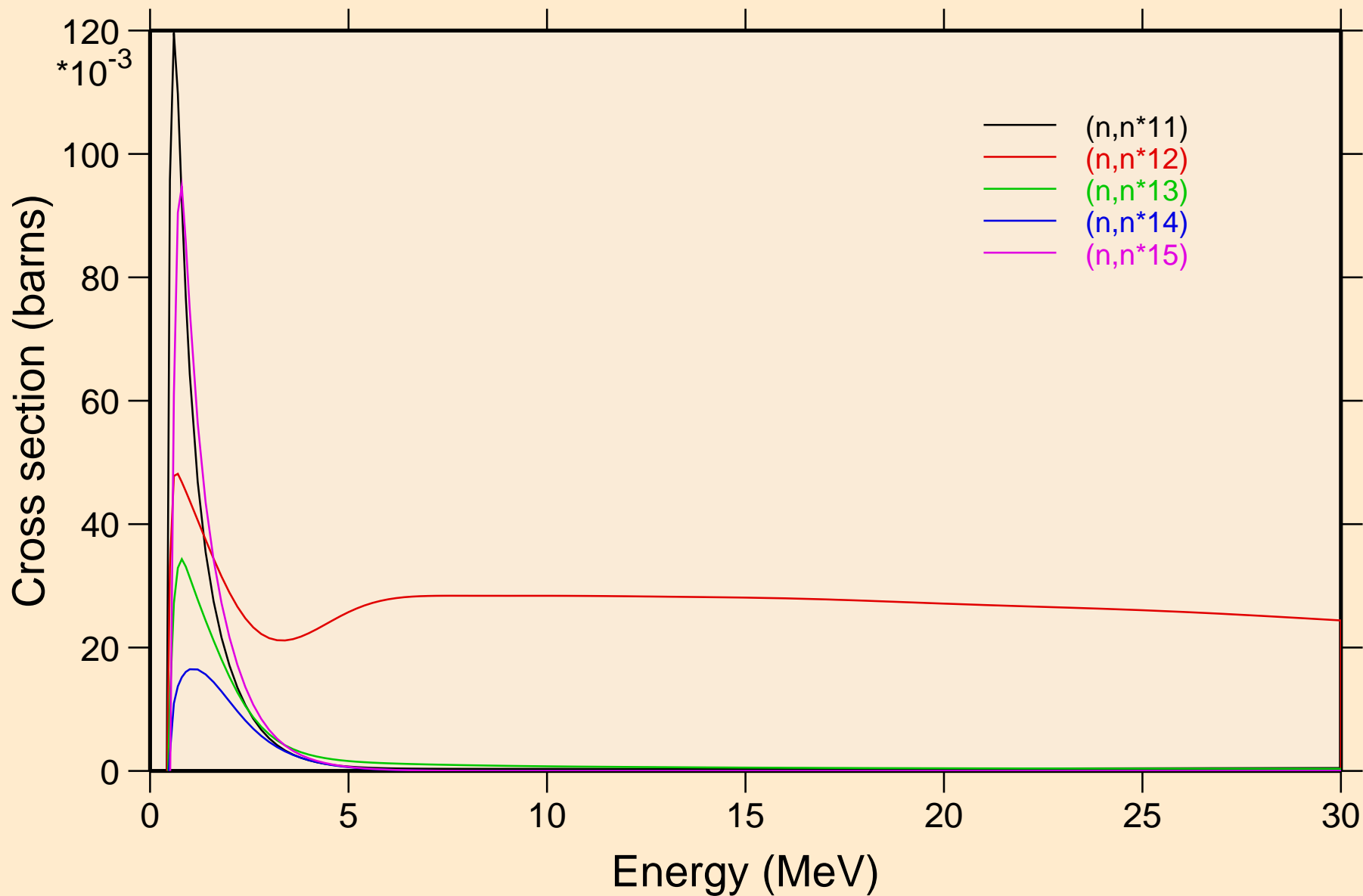

AG106 NEUTRON ACER TENDL-2019 LIBRARY; T=293.16K  
Inelastic levels

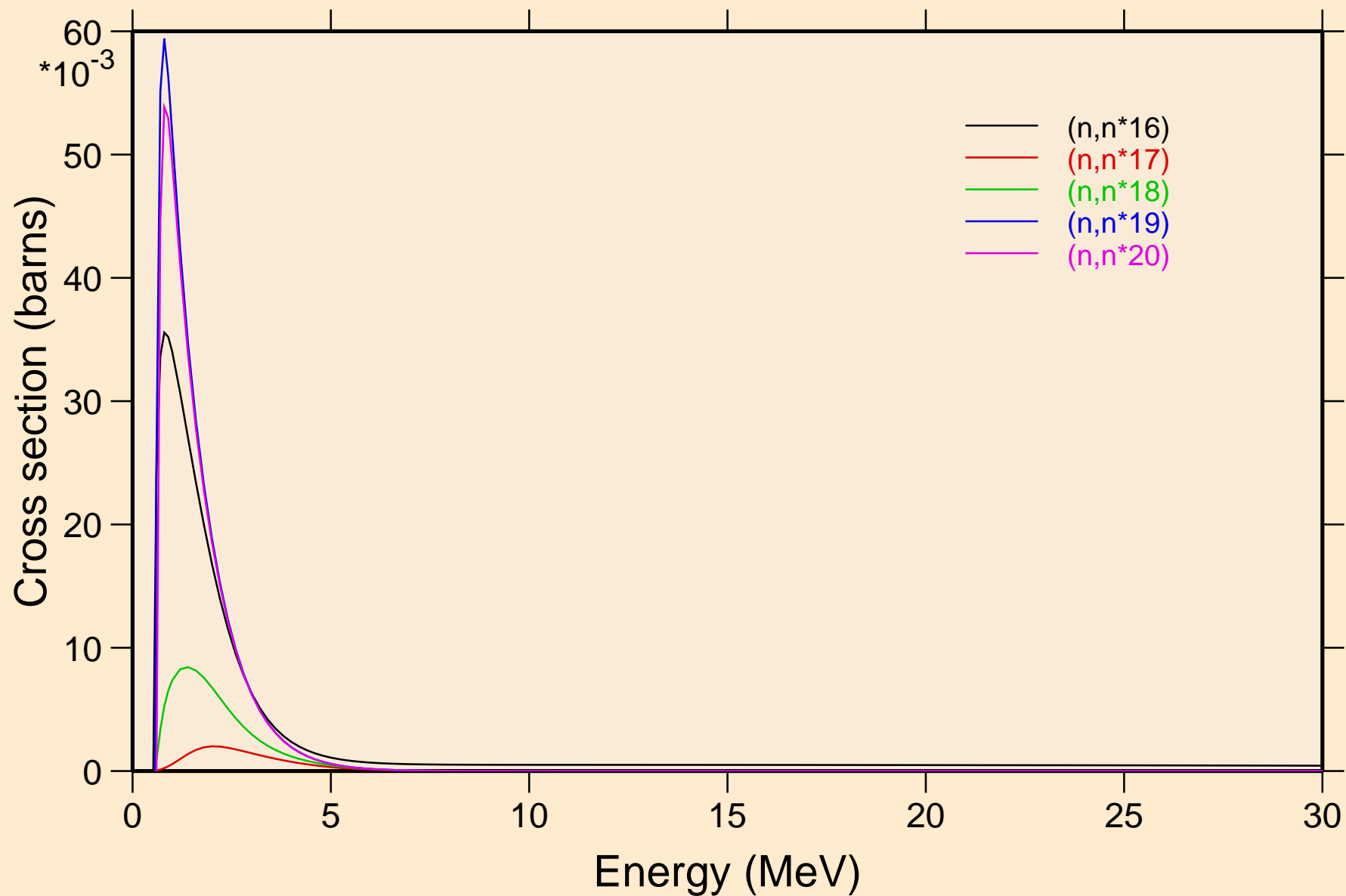

AG106 NEUTRON ACER TENDL-2019 LIBRARY; T=293.16K  
Inelastic levels

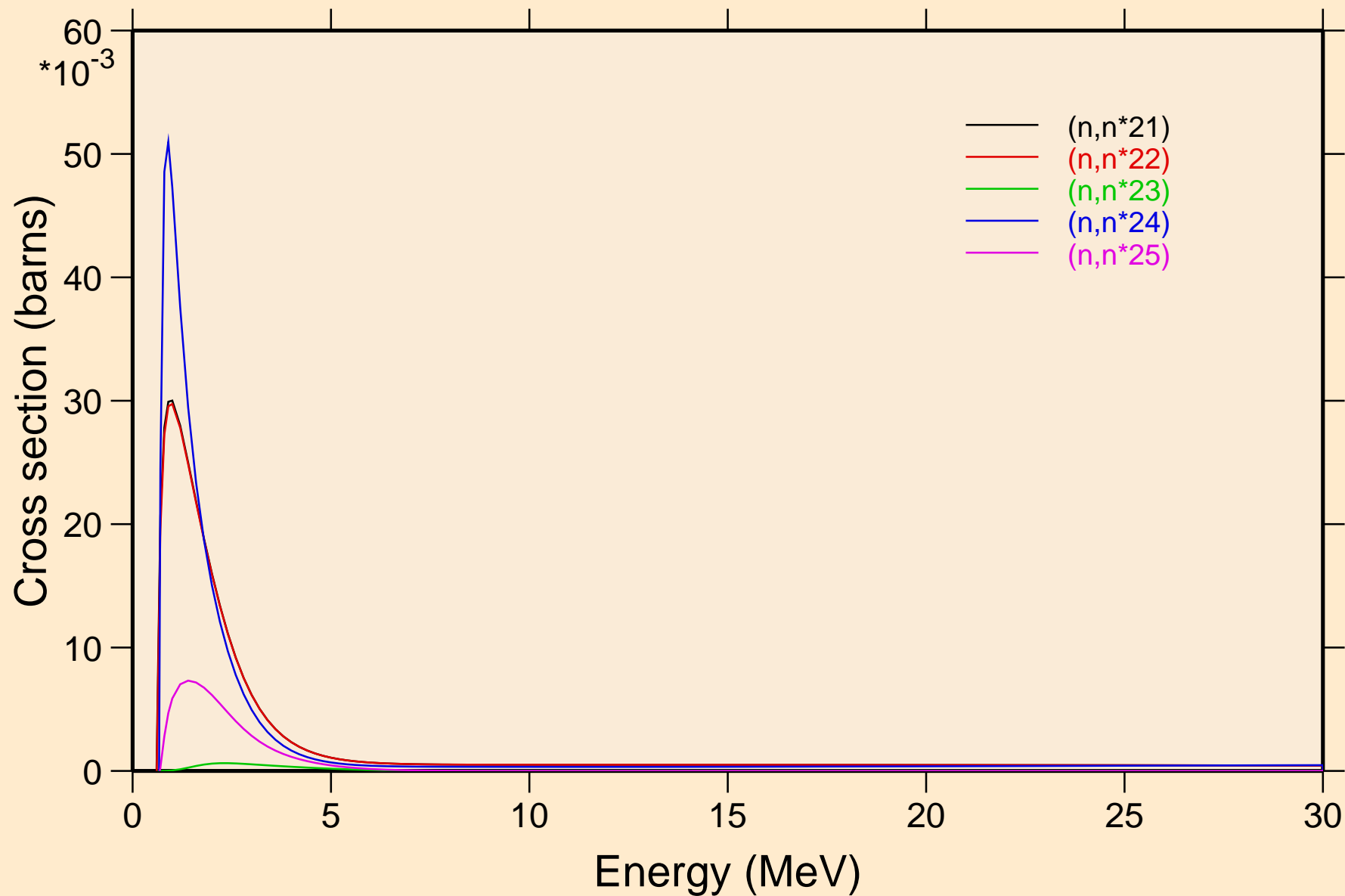

AG106 NEUTRON ACER TENDL-2019 LIBRARY; T=293.16K  
Inelastic levels

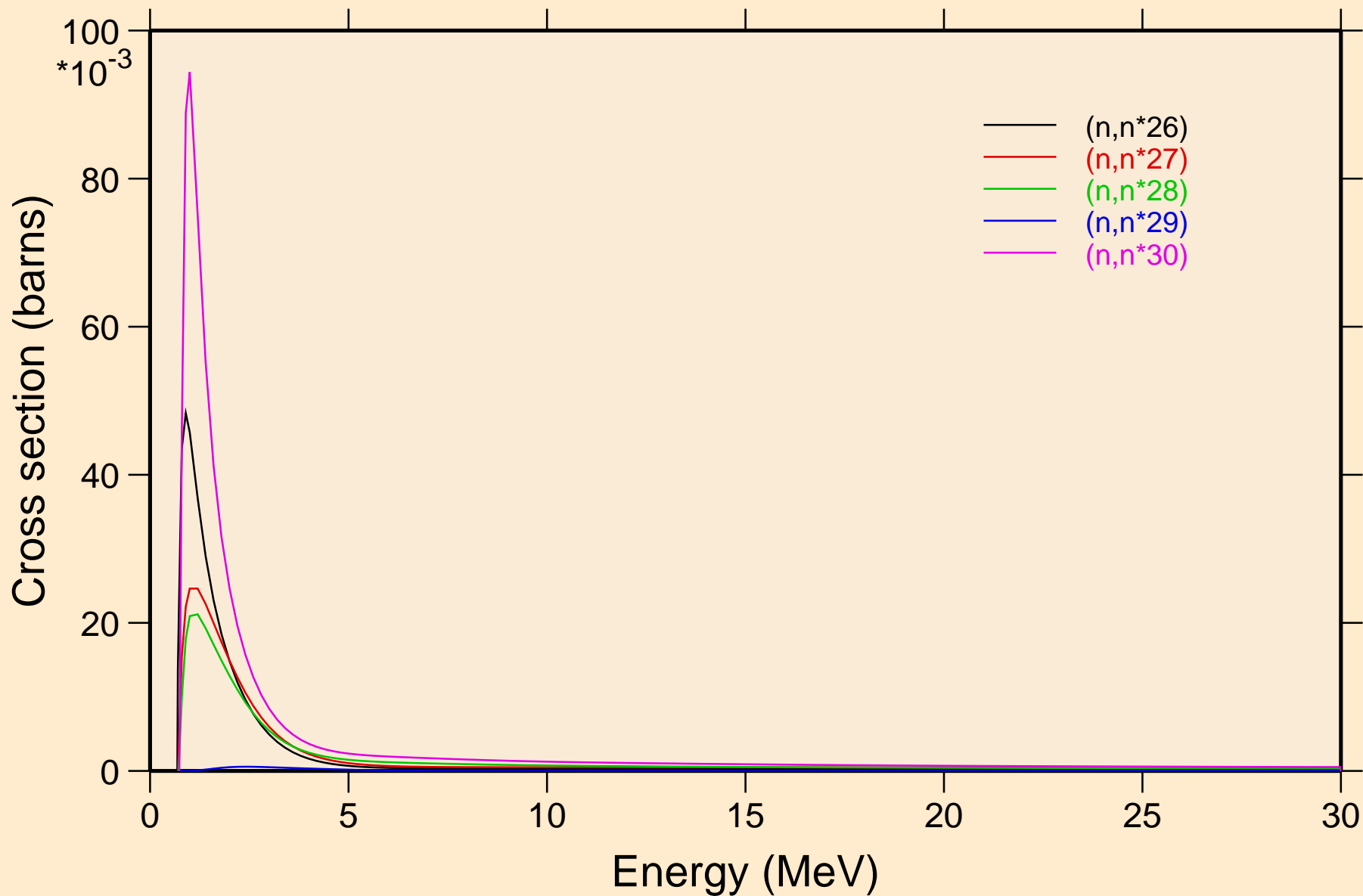

AG106 NEUTRON ACER TENDL-2019 LIBRARY; T=293.16K  
Threshold reactions

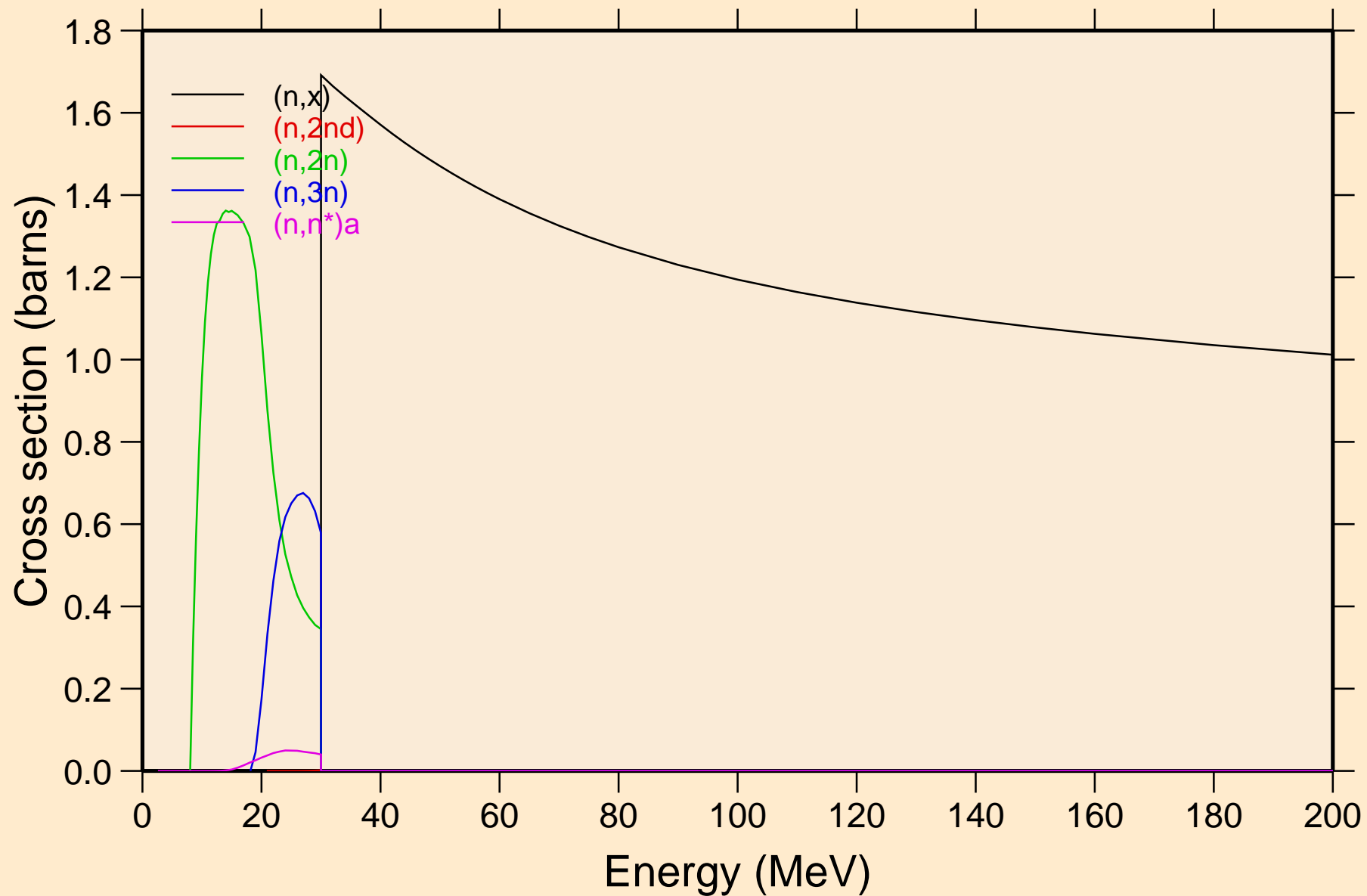

AG106 NEUTRON ACER TENDL-2019 LIBRARY; T=293.16K  
Threshold reactions

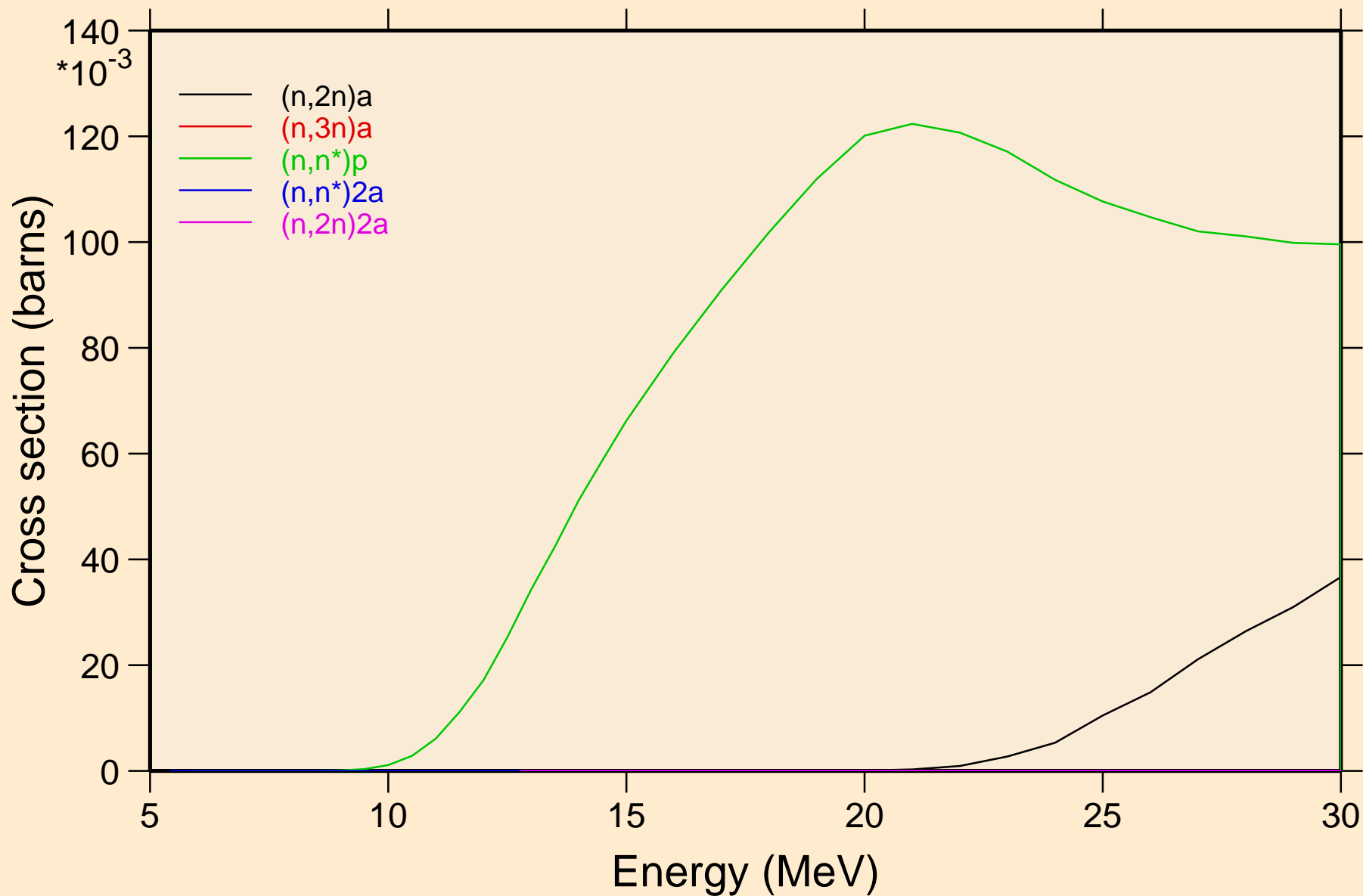



AG106 NEUTRON ACER TENDL-2019 LIBRARY; T=293.16K  
Threshold reactions

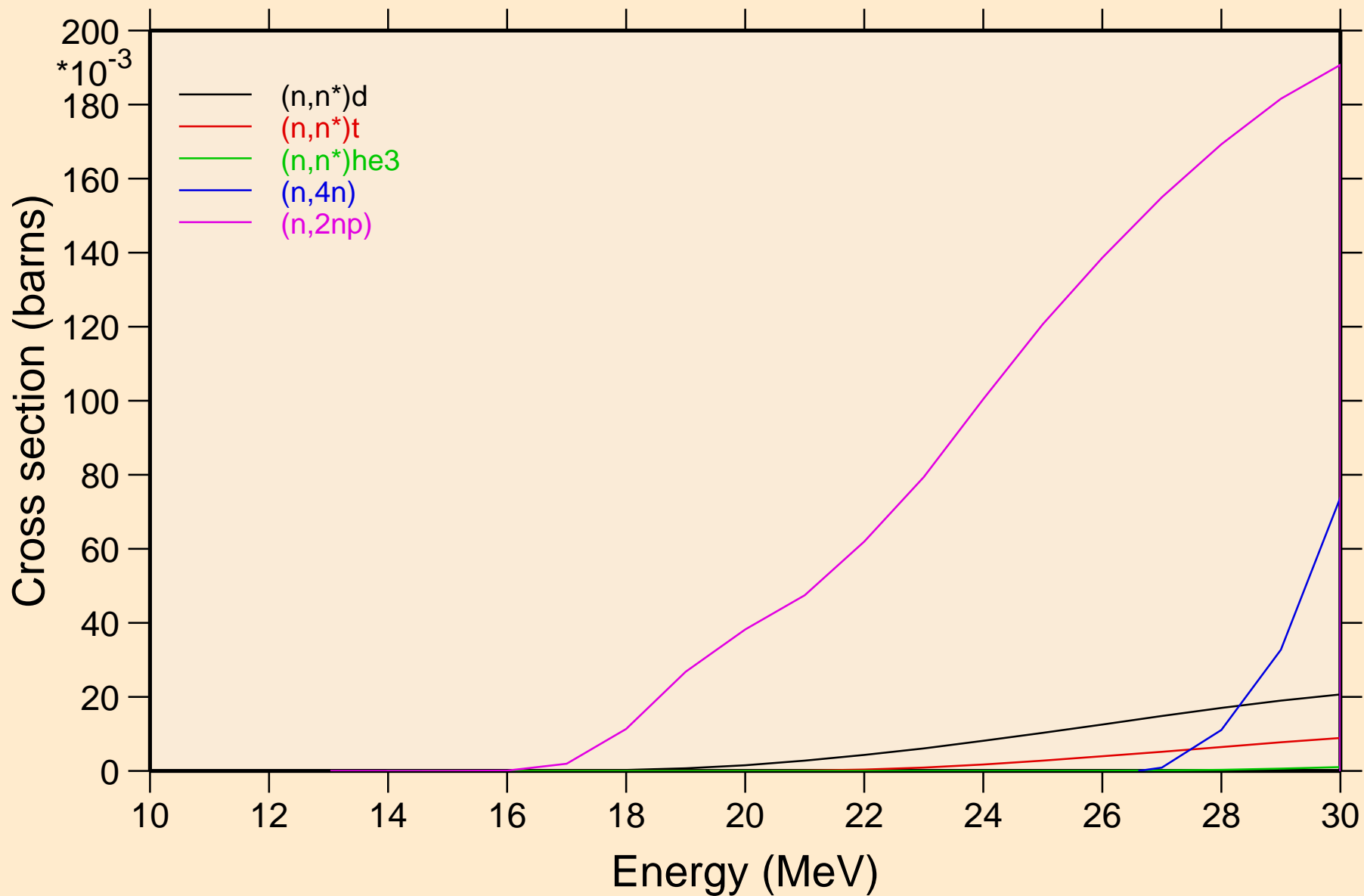

AG106 NEUTRON ACER TENDL-2019 LIBRARY; T=293.16K  
Threshold reactions

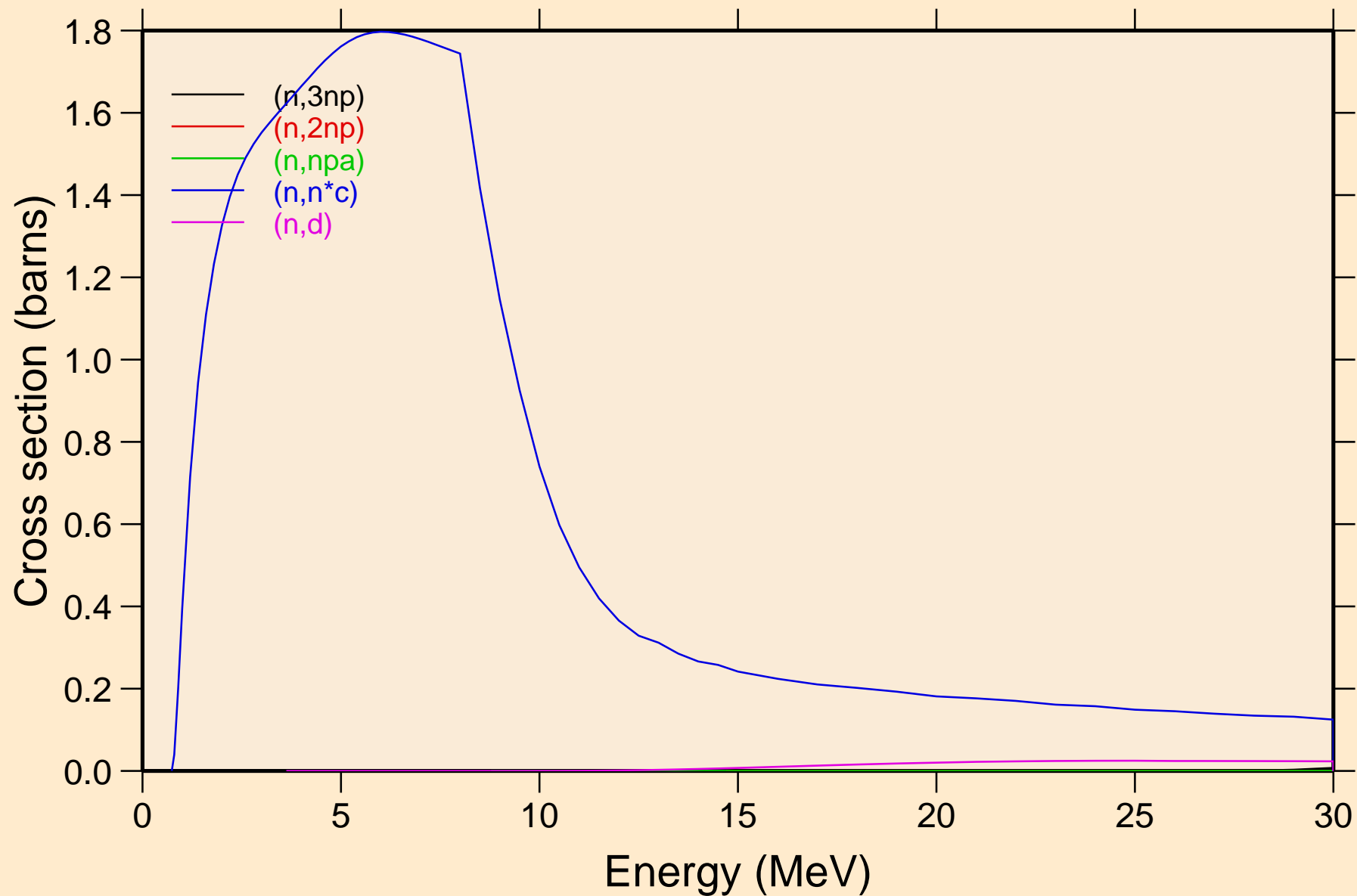

AG106 NEUTRON ACER TENDL-2019 LIBRARY; T=293.16K  
Threshold reactions

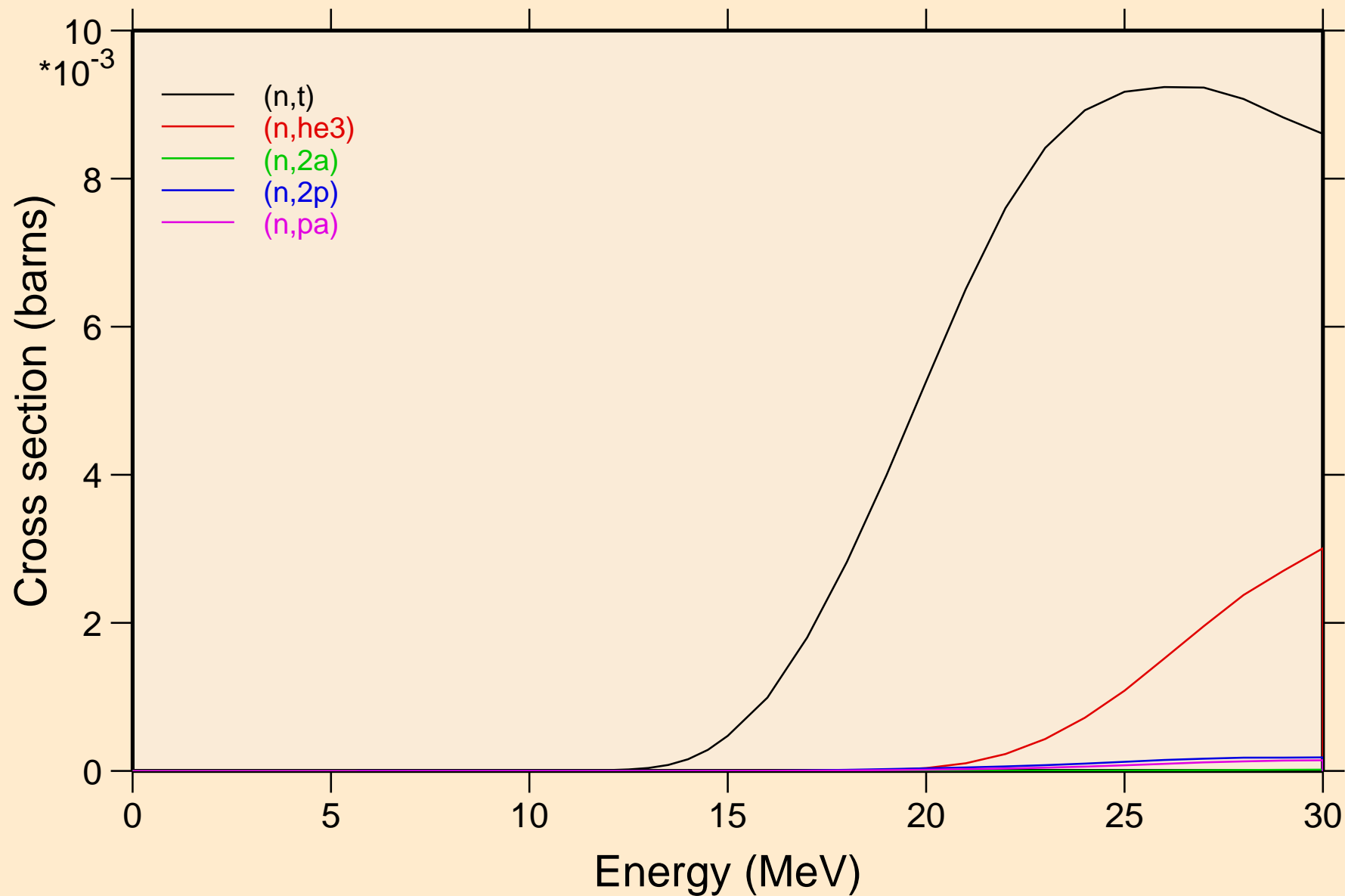

AG106 NEUTRON ACER TENDL-2019 LIBRARY; T=293.16K  
Threshold reactions

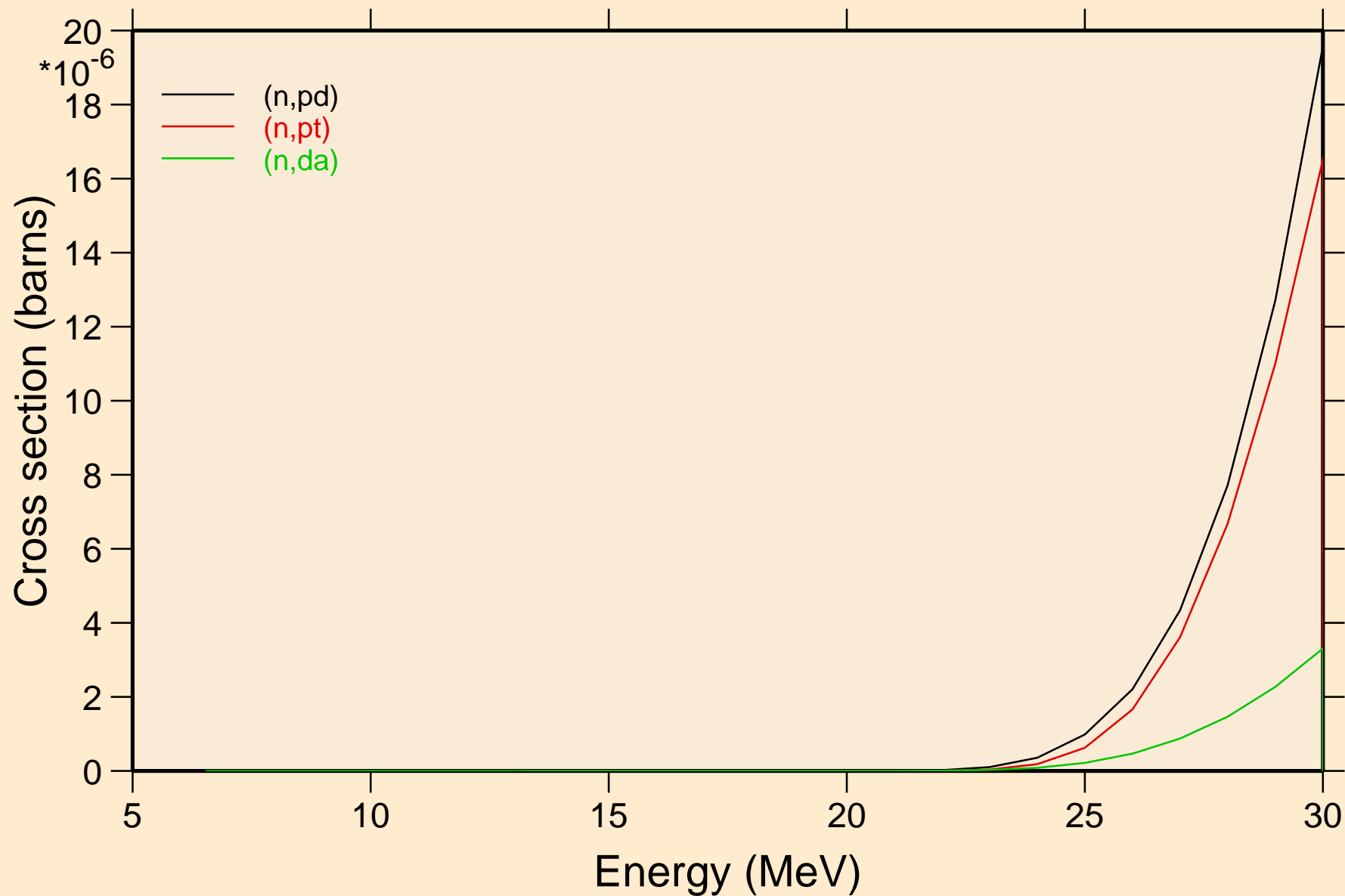

AG106 NEUTRON ACER TENDL-2019 LIBRARY; T=293.16K  
Threshold reactions

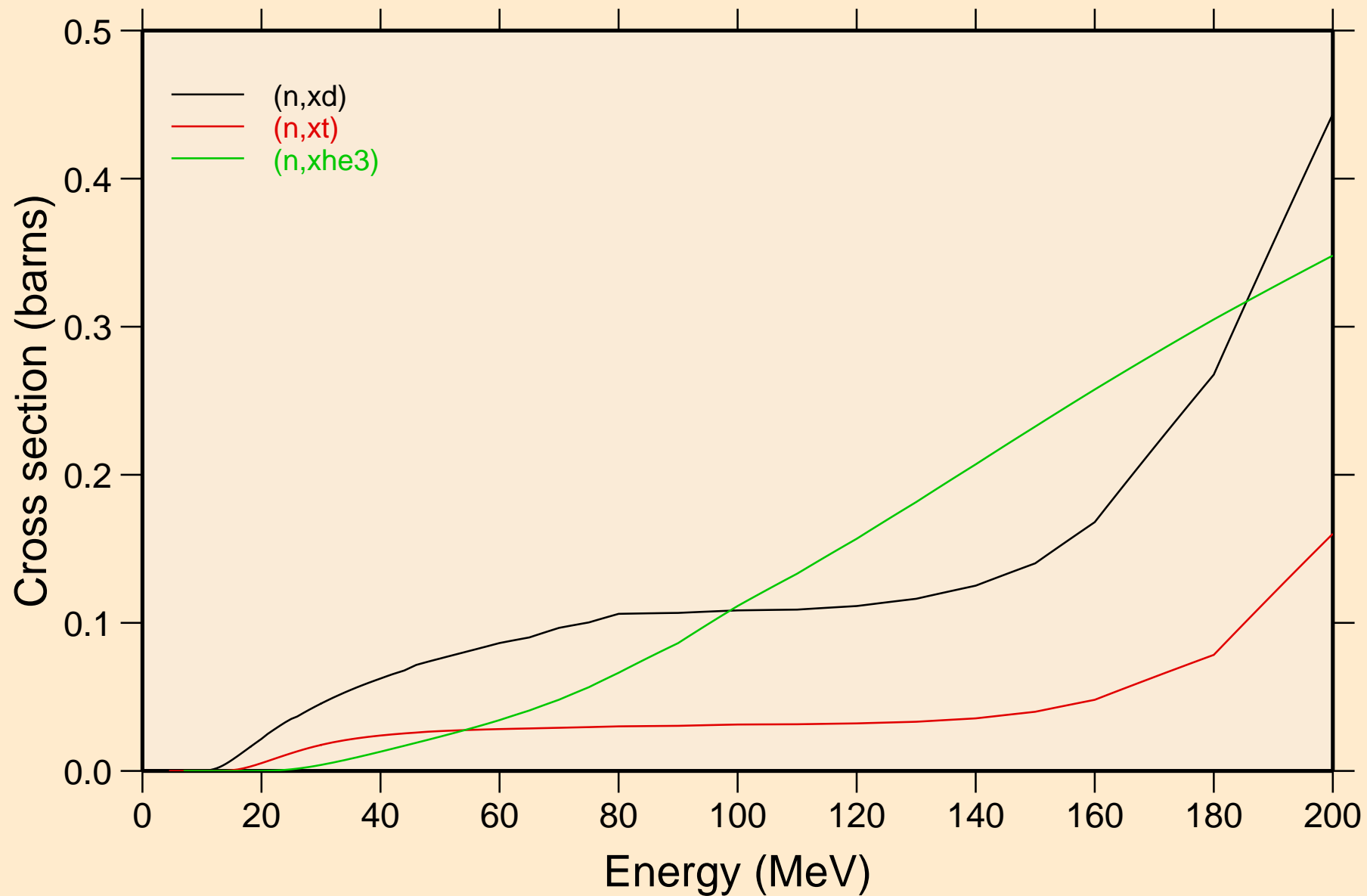

AG106 NEUTRON ACER TENDL-2019 LIBRARY; T=293.16K  
angular distribution for elastic

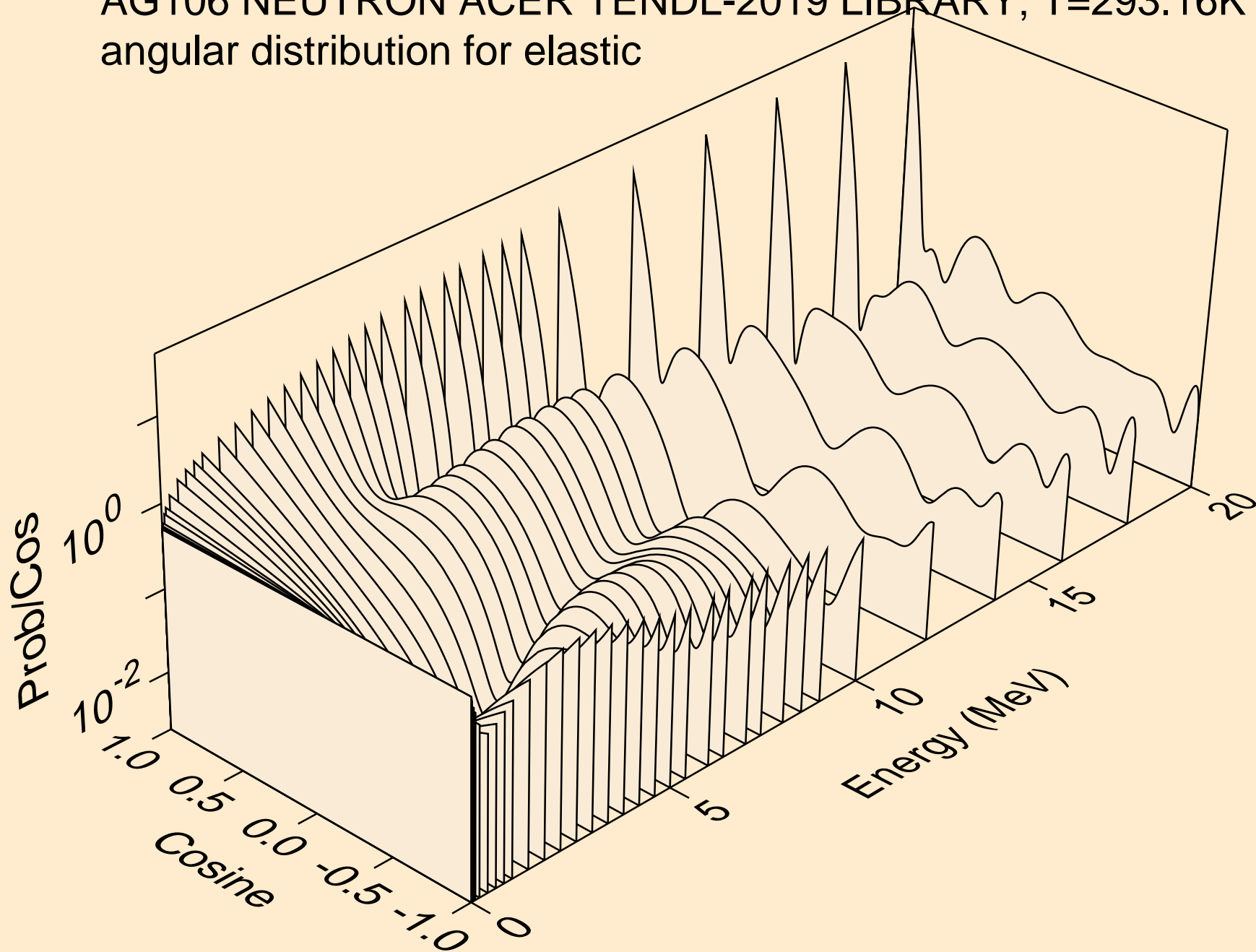

AG106 NEUTRON ACER TENDL-2019 LIBRARY; T=293.16K  
angular distribution for elastic

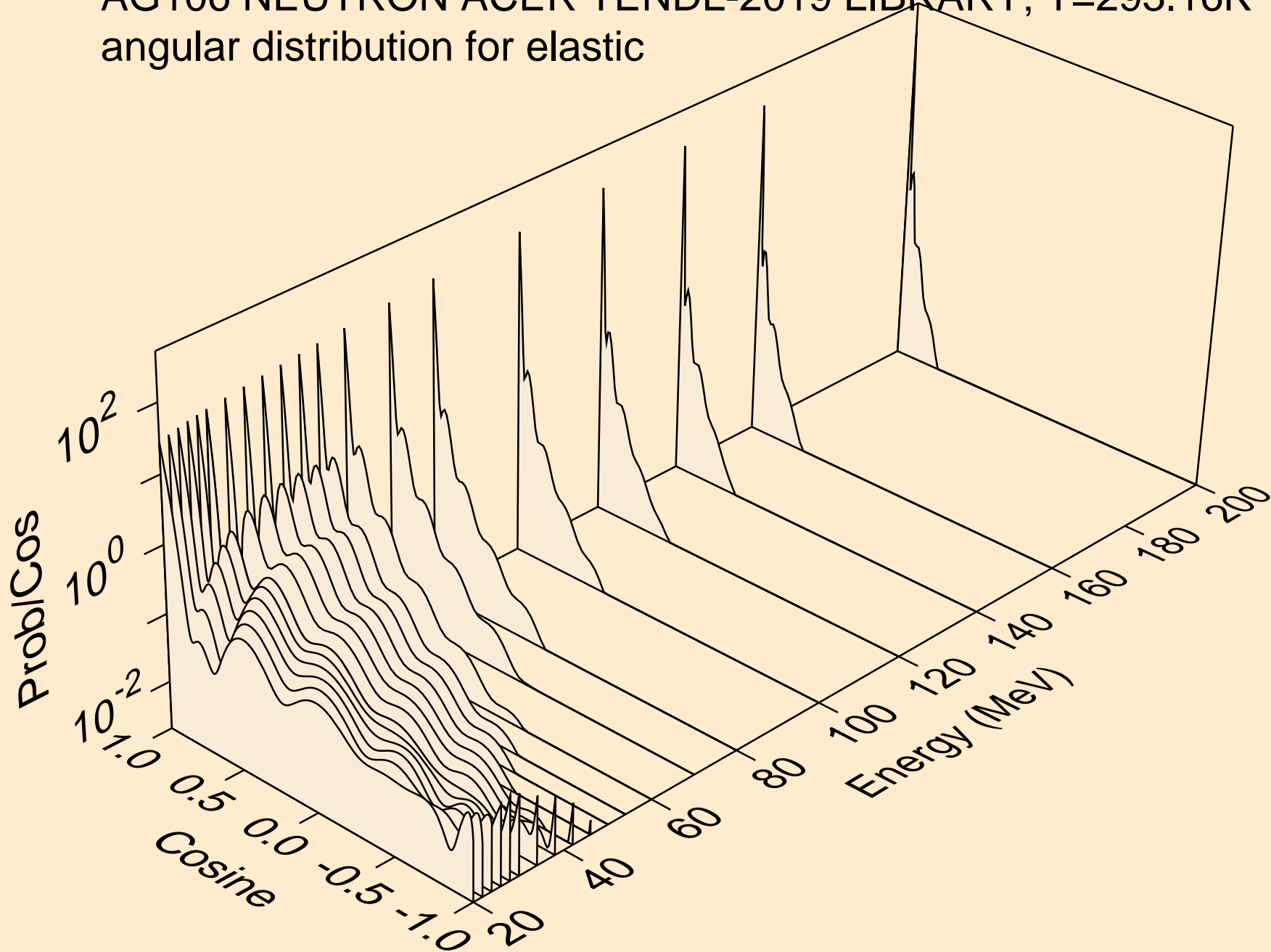

AG106 NEUTRON ACER TENDL-2019 LIBRARY; T=293.16K  
angular distribution for (n,n\*1)

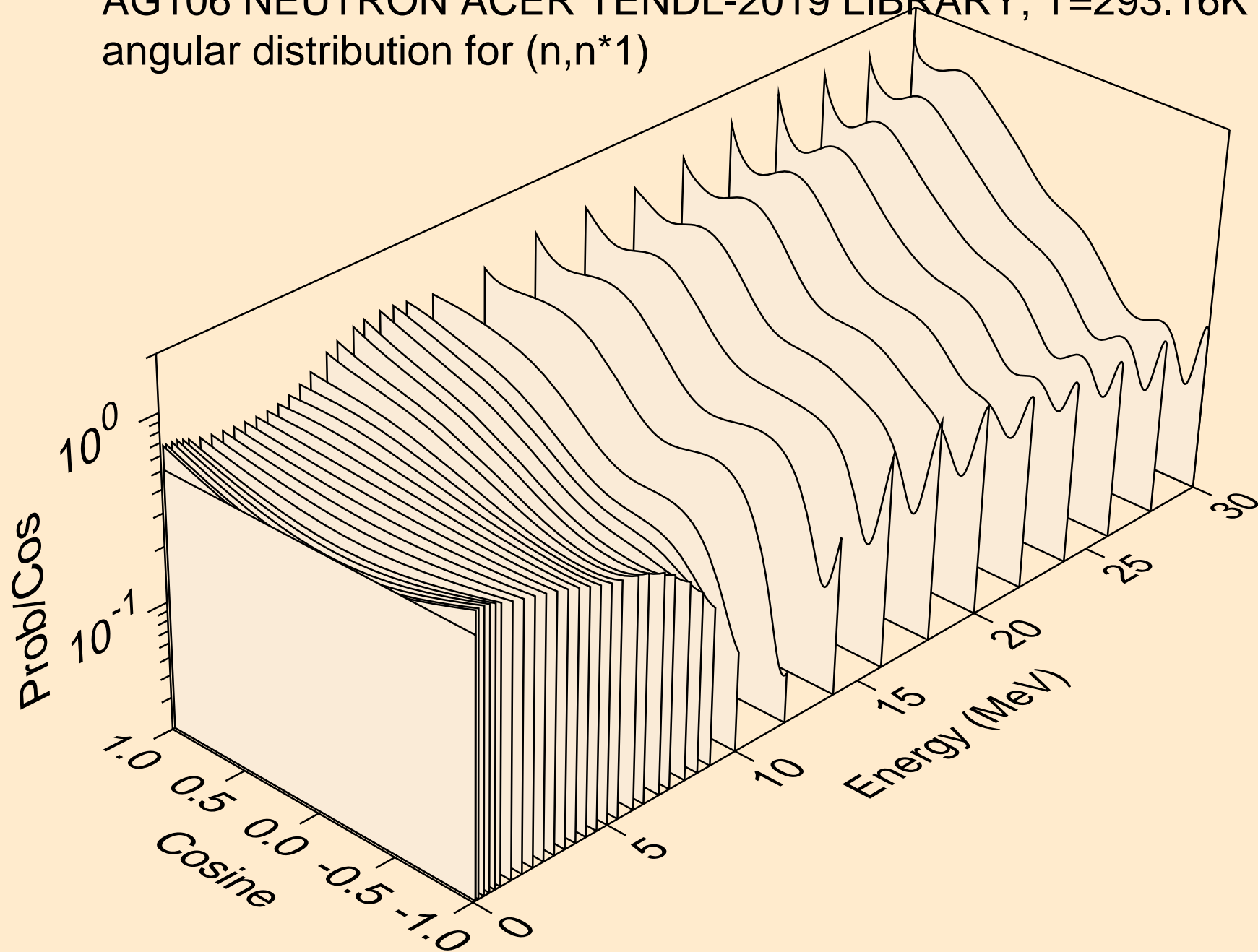



AG106 NEUTRON ACER TENDL-2019 LIBRARY; T=293.16K  
angular distribution for (n,n\*2)

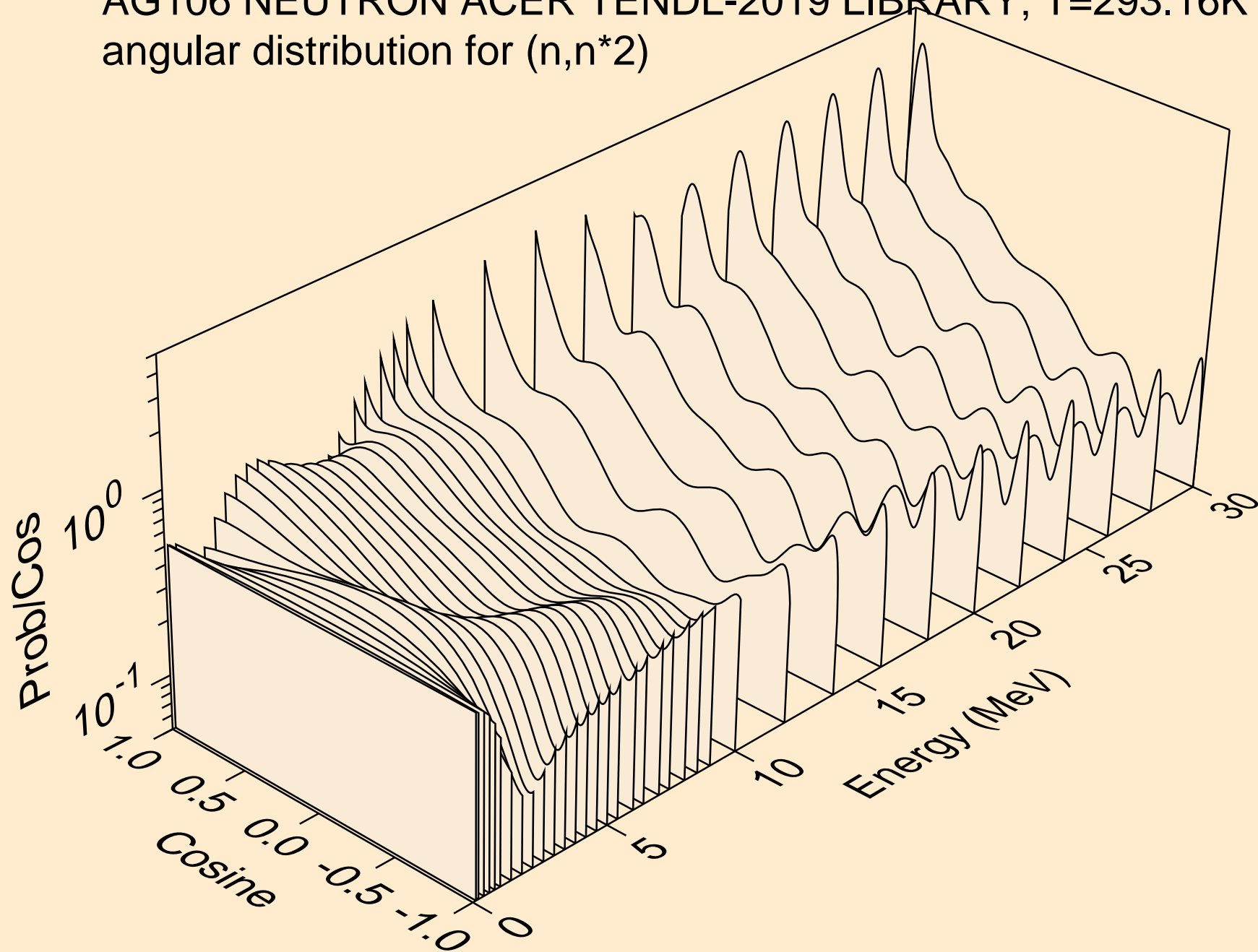

AG106 NEUTRON ACER TENDL-2019 LIBRARY; T=293.16K  
angular distribution for (n,n\*3)

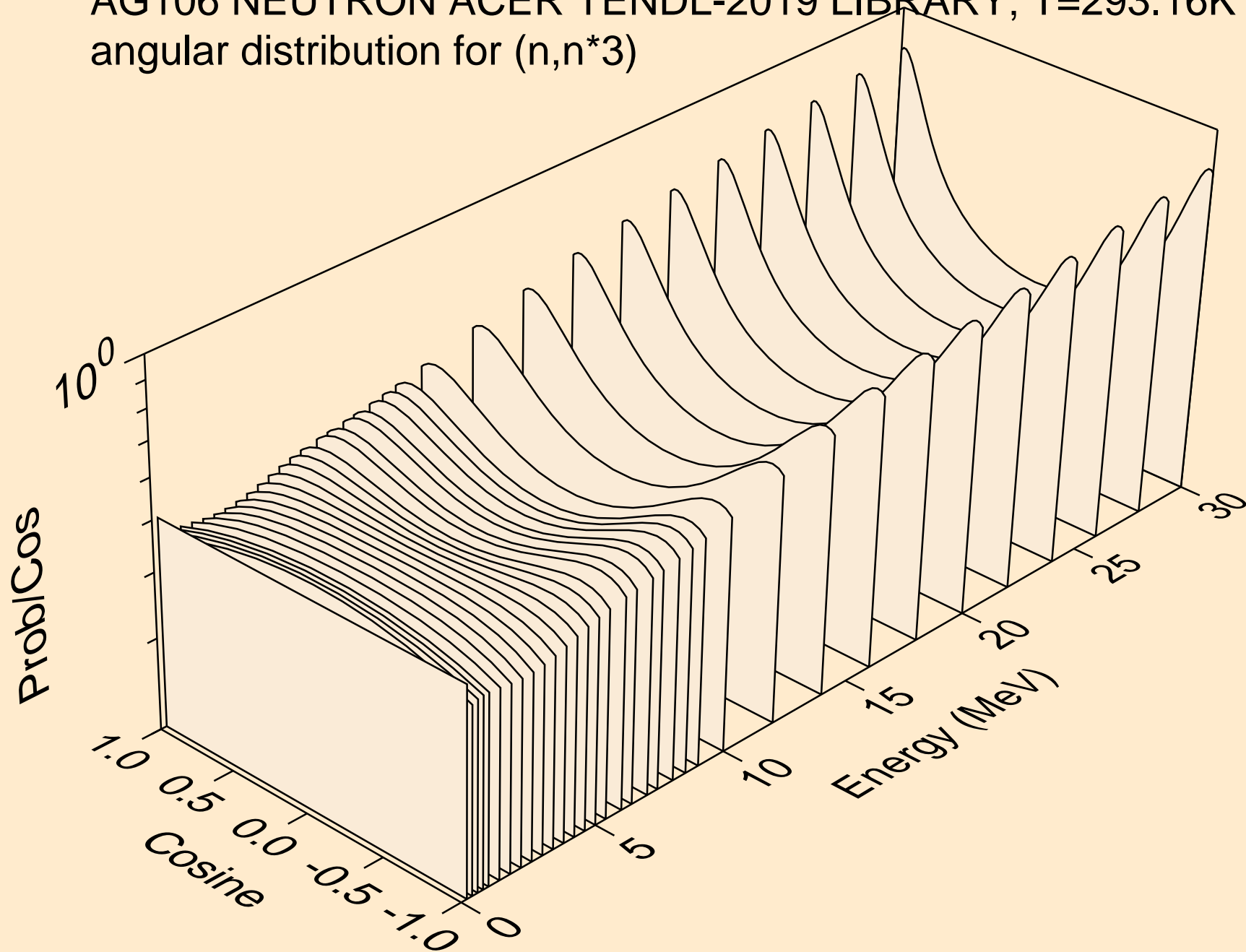

AG106 NEUTRON ACER TENDL-2019 LIBRARY; T=293.16K  
angular distribution for (n,n\*4)

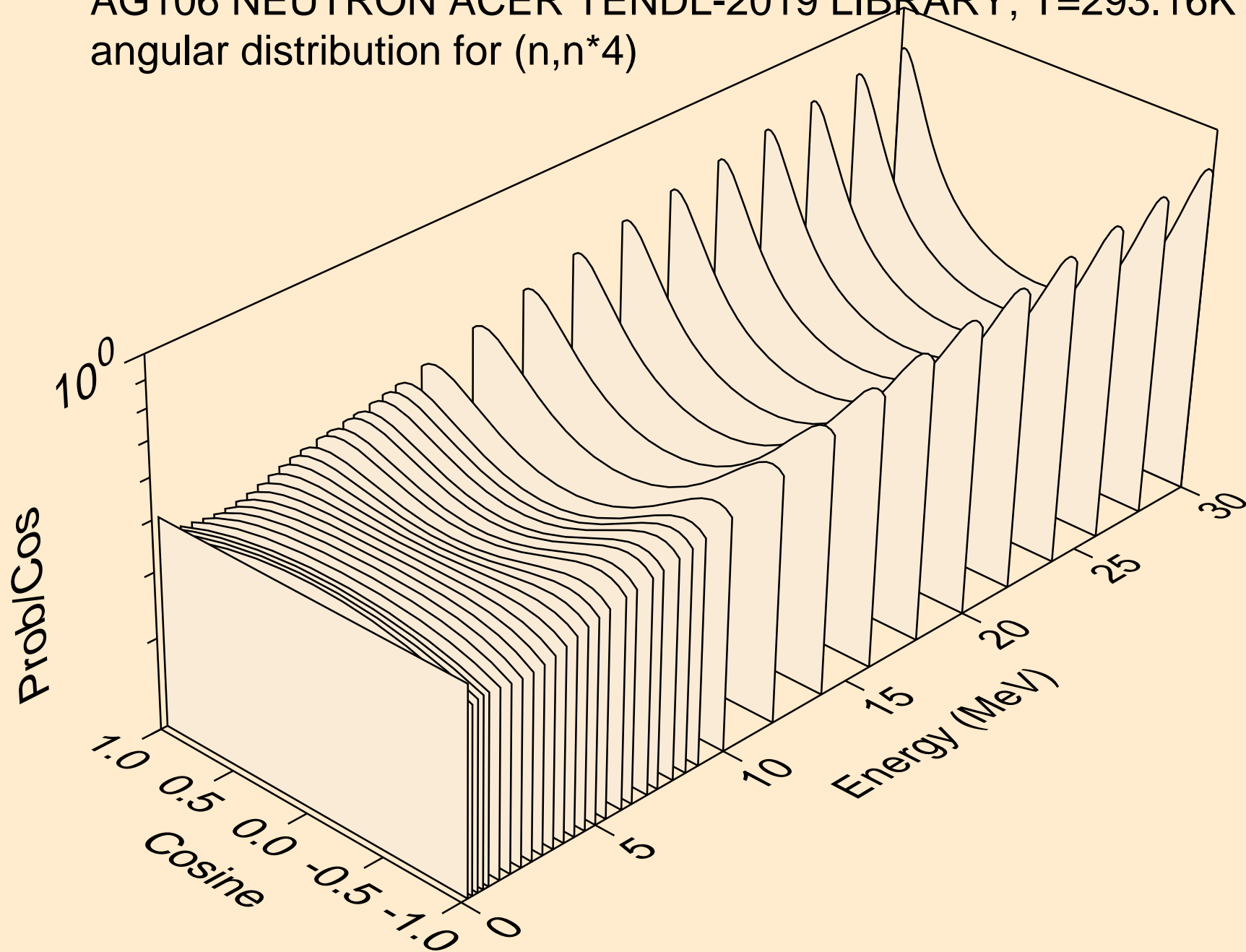

AG106 NEUTRON ACER TENDL-2019 LIBRARY; T=293.16K  
angular distribution for (n,n\*5)

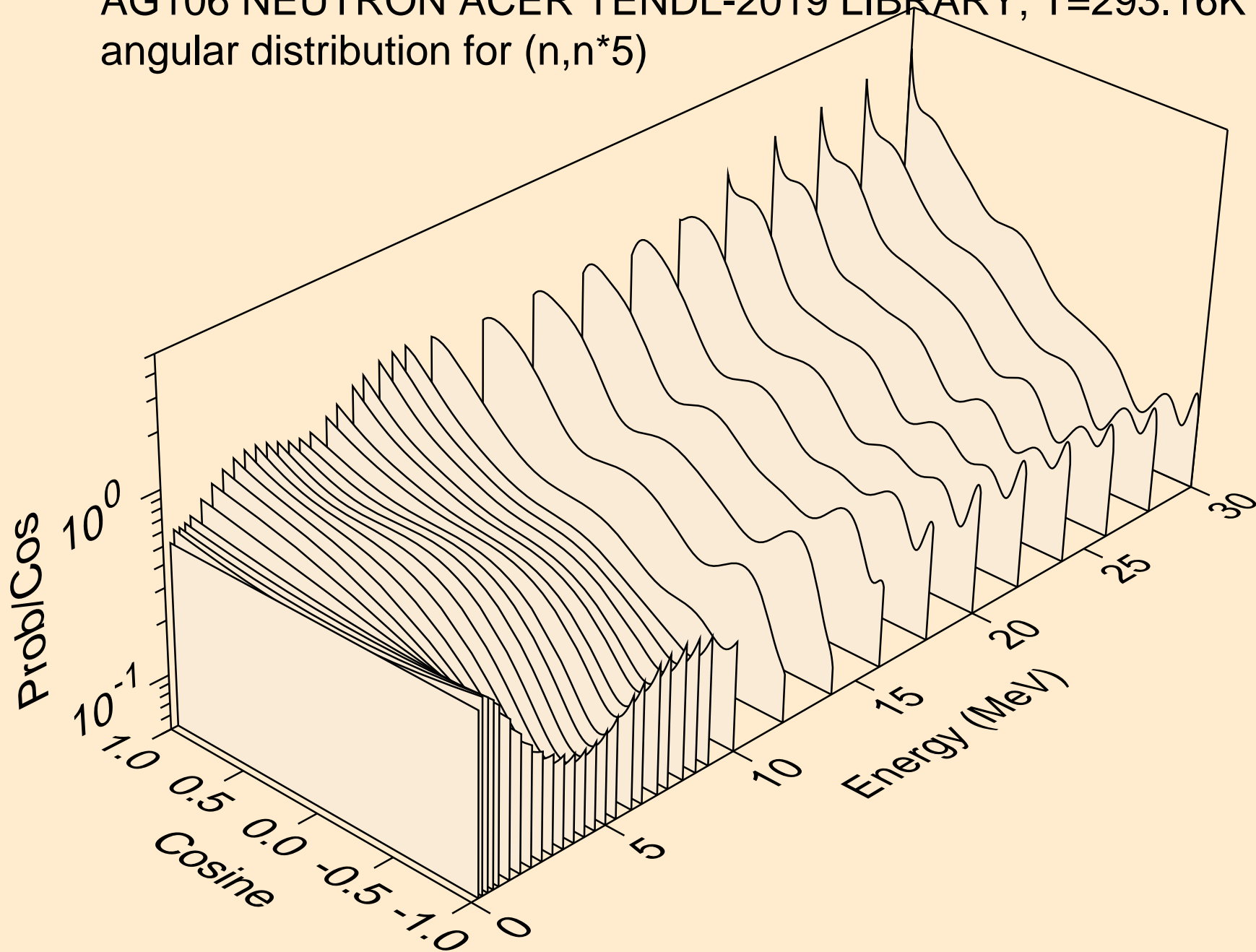

AG106 NEUTRON ACER TENDL-2019 LIBRARY; T=293.16K  
angular distribution for (n,n\*6)

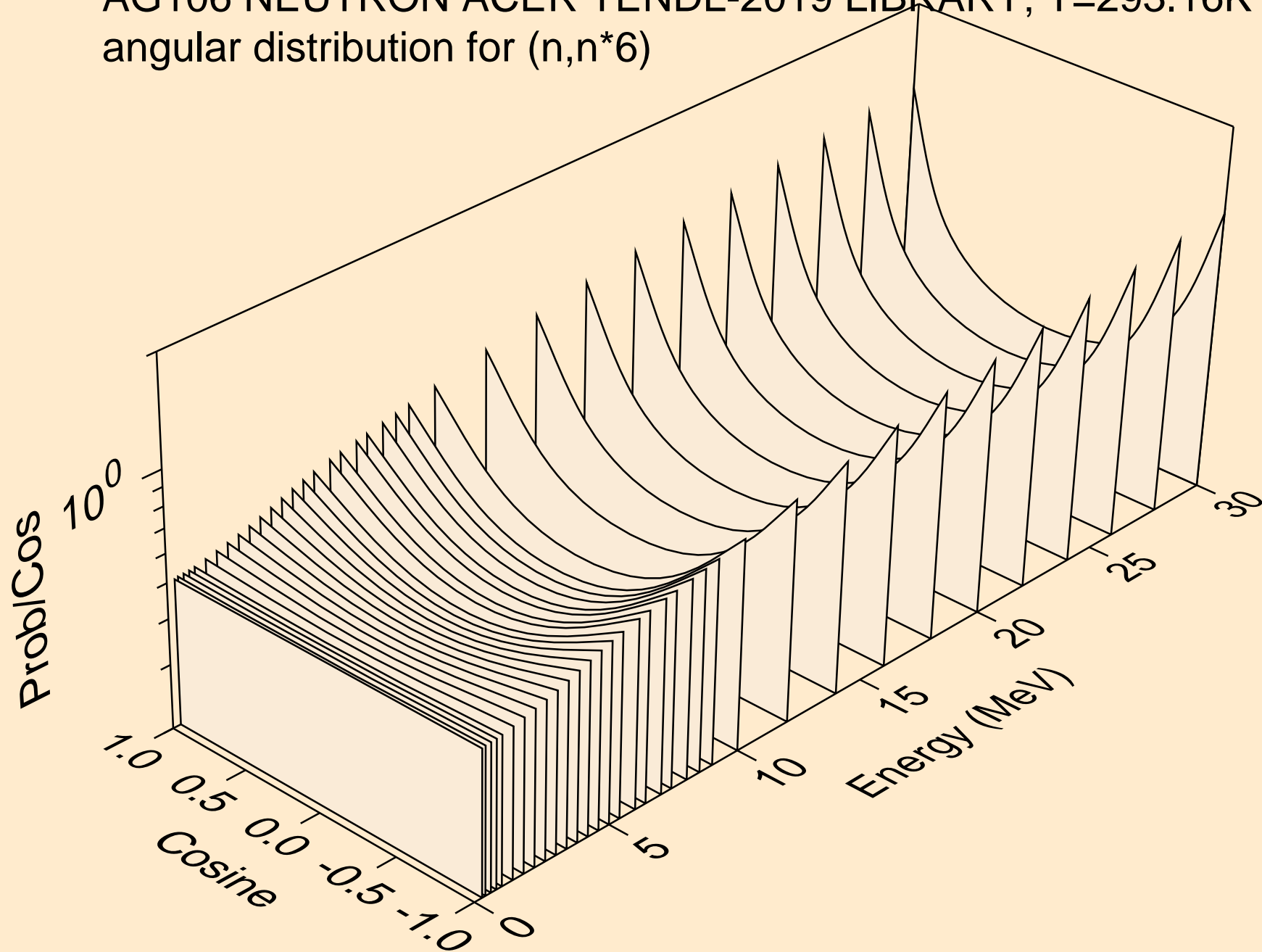

AG106 NEUTRON ACER TENDL-2019 LIBRARY; T=293.16K  
angular distribution for (n,n\*7)

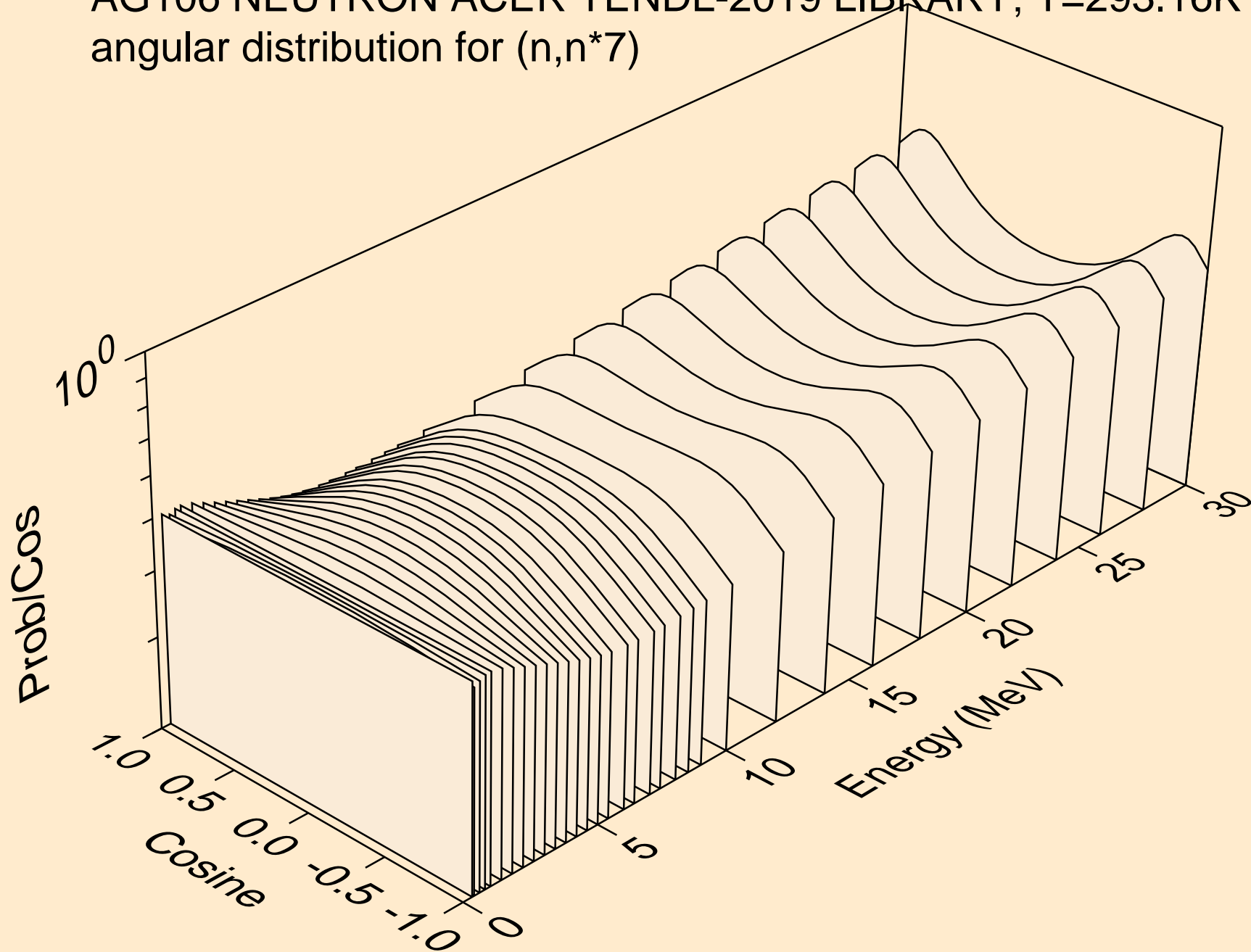

AG106 NEUTRON ACER TENDL-2019 LIBRARY; T=293.16K  
angular distribution for (n,n\*8)

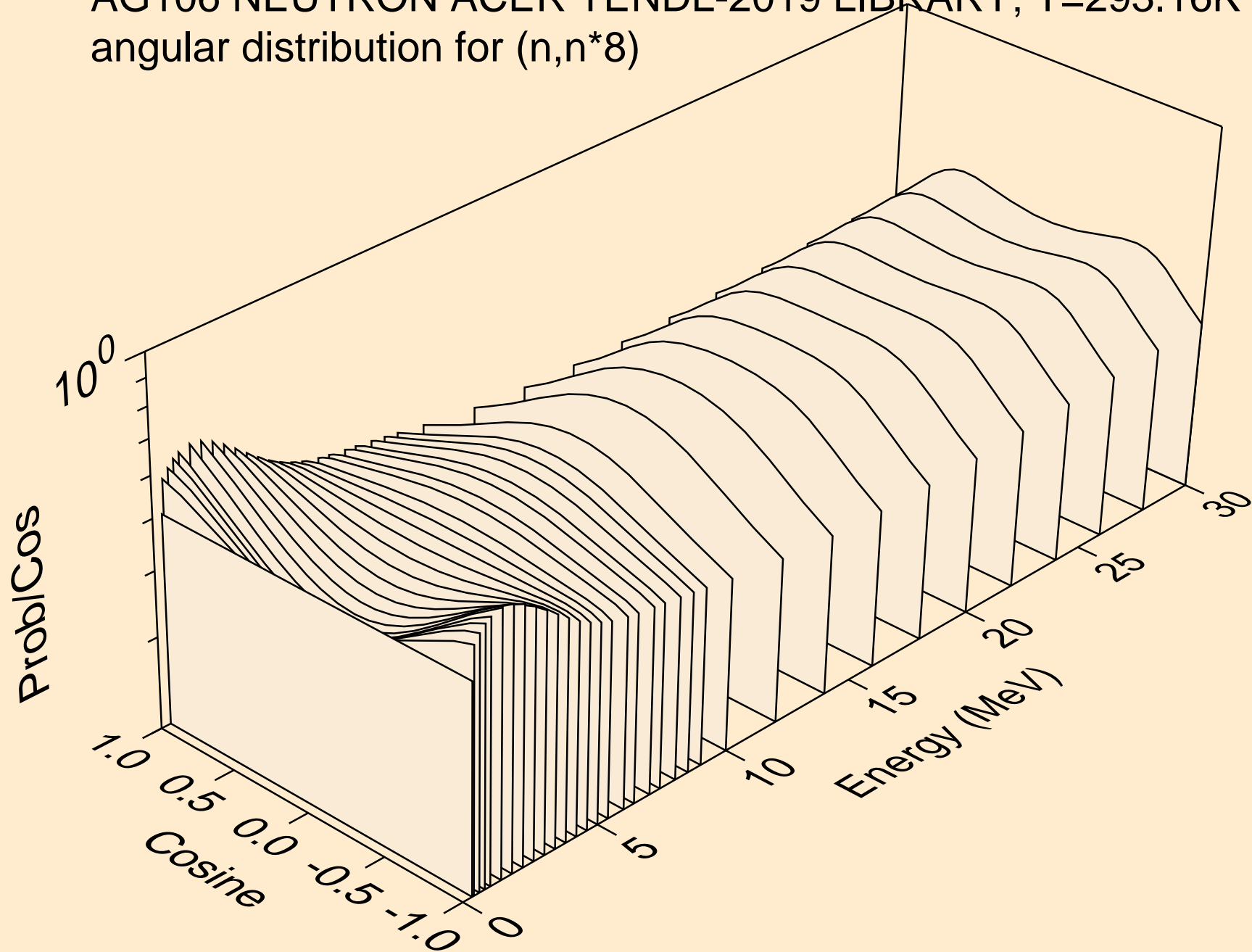

AG106 NEUTRON ACER TENDL-2019 LIBRARY; T=293.16K  
angular distribution for (n,n\*9)

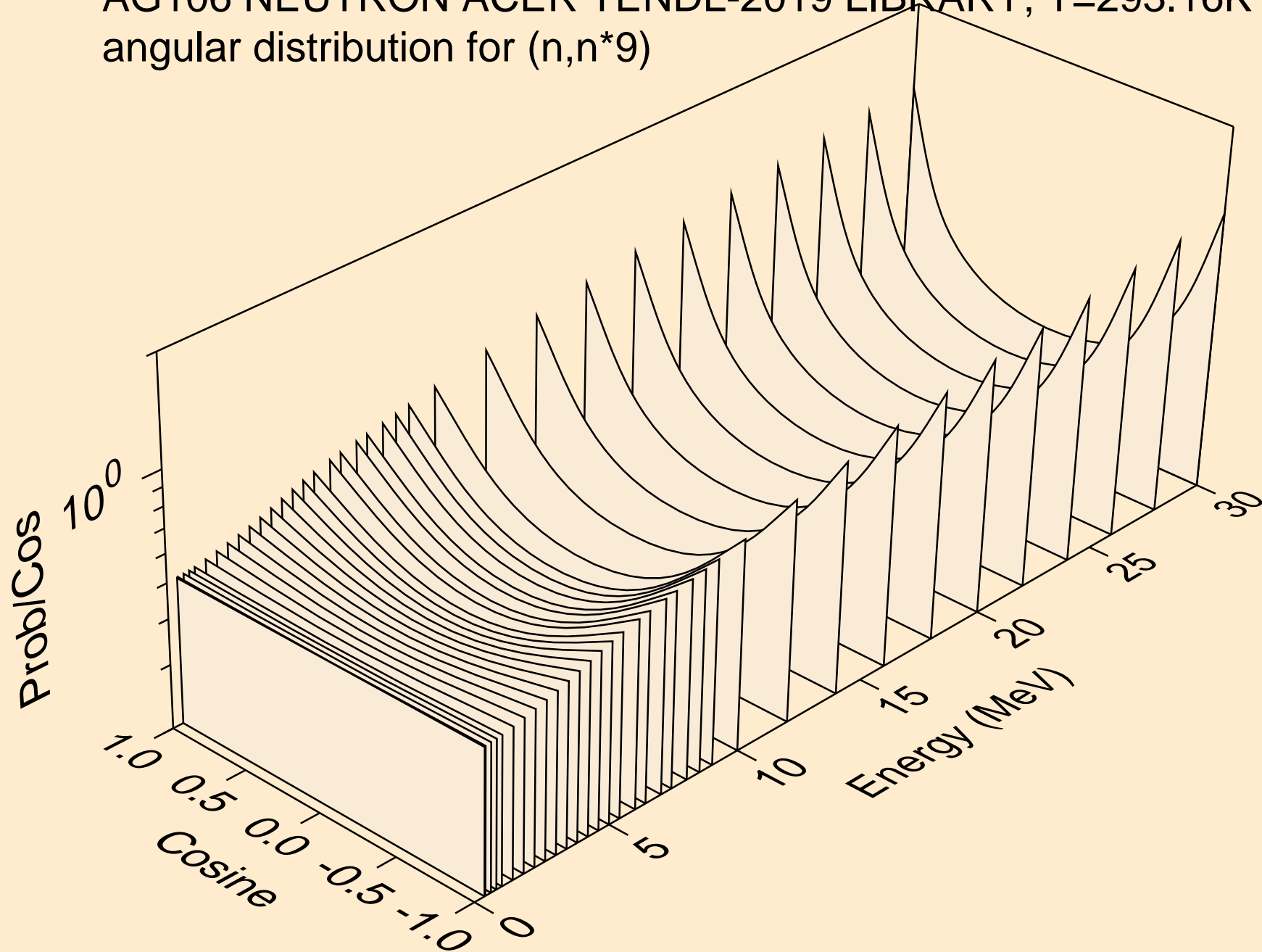



AG106 NEUTRON ACER TENDL-2019 LIBRARY; T=293.16K  
angular distribution for (n,n\*10)

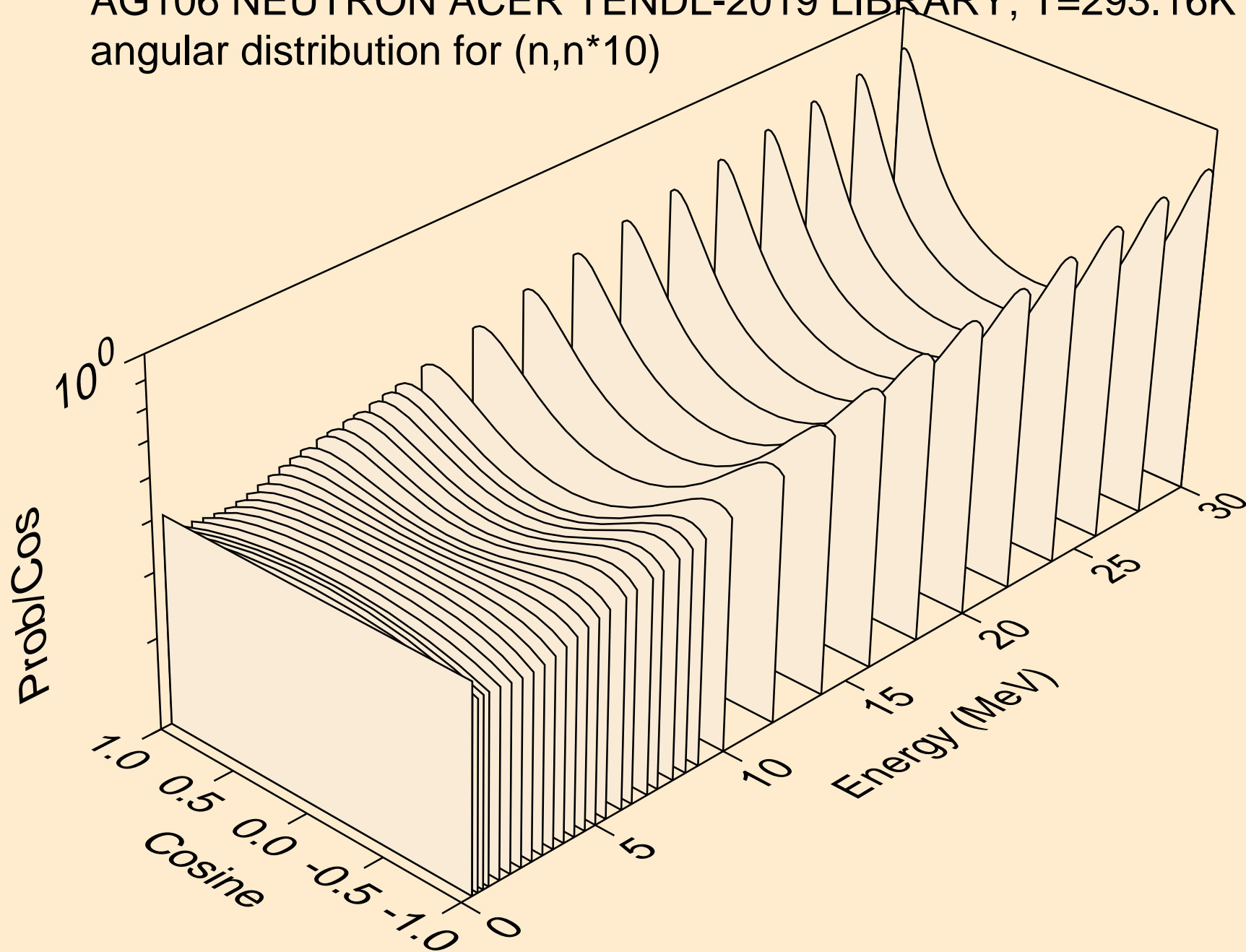

AG106 NEUTRON ACER TENDL-2019 LIBRARY; T=293.16K  
angular distribution for (n,n\*11)

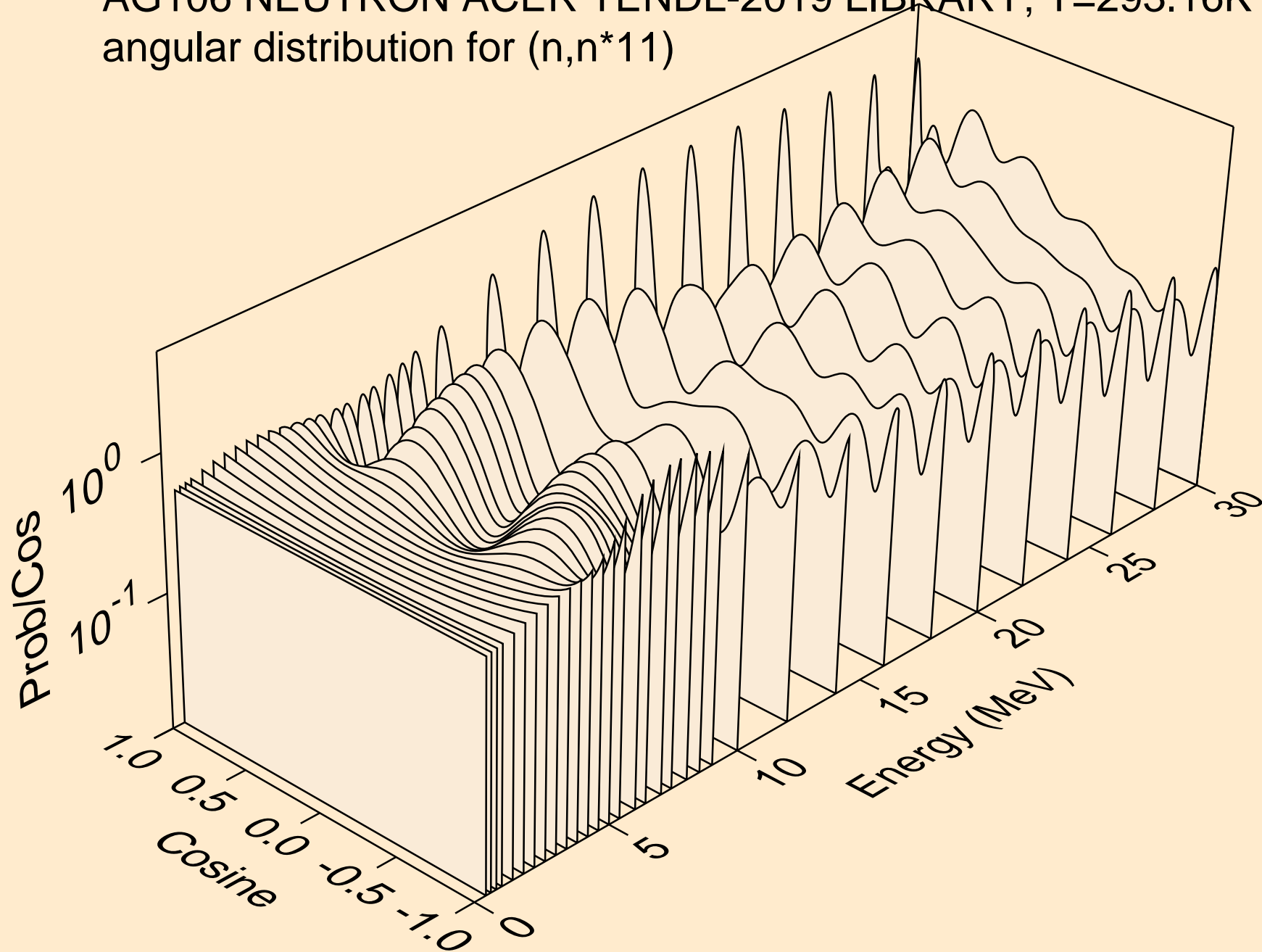

AG106 NEUTRON ACER TENDL-2019 LIBRARY; T=293.16K  
angular distribution for (n,n\*12)

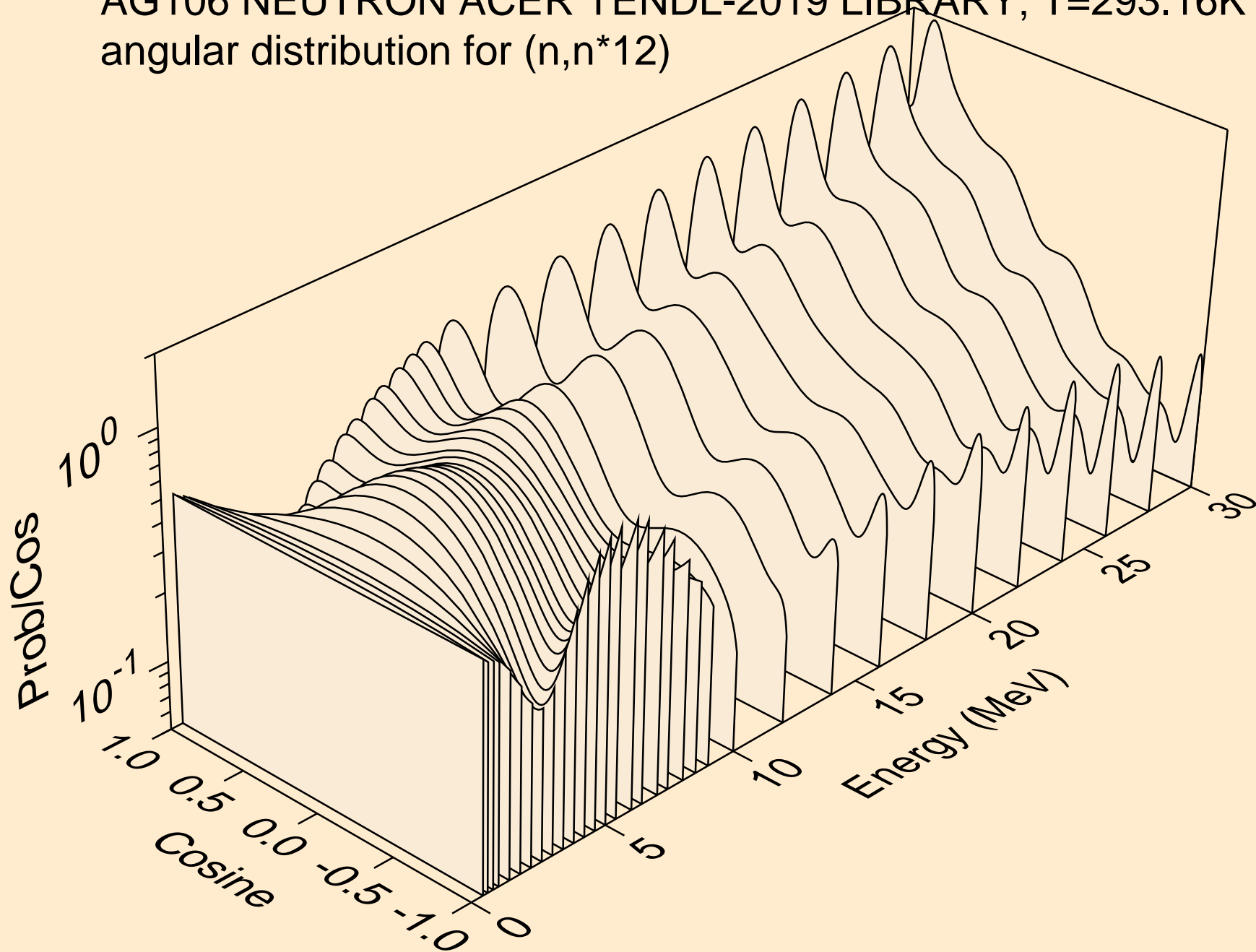

AG106 NEUTRON ACER TENDL-2019 LIBRARY; T=293.16K  
angular distribution for (n,n\*13)

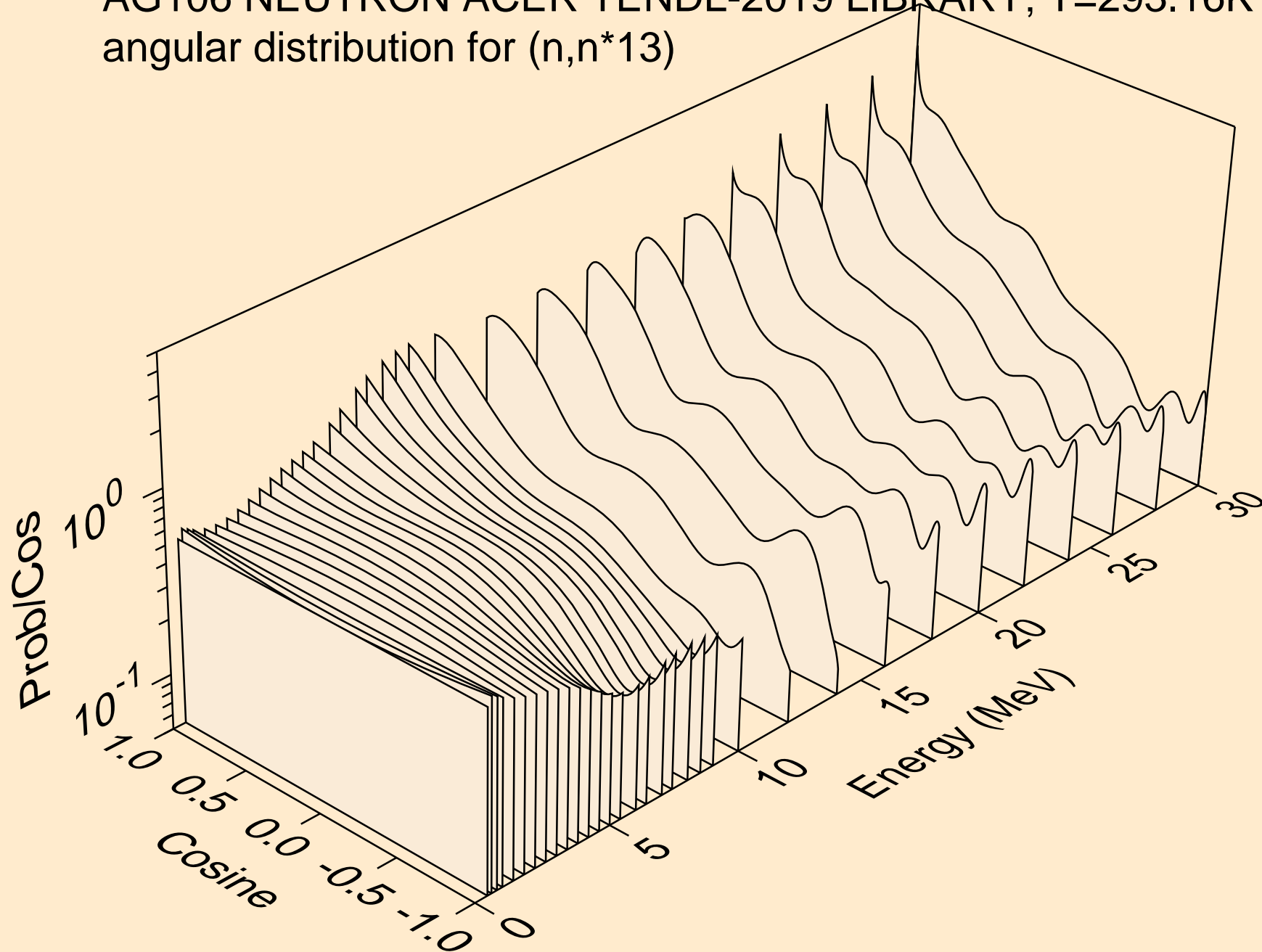

AG106 NEUTRON ACER TENDL-2019 LIBRARY; T=293.16K  
angular distribution for (n,n\*14)

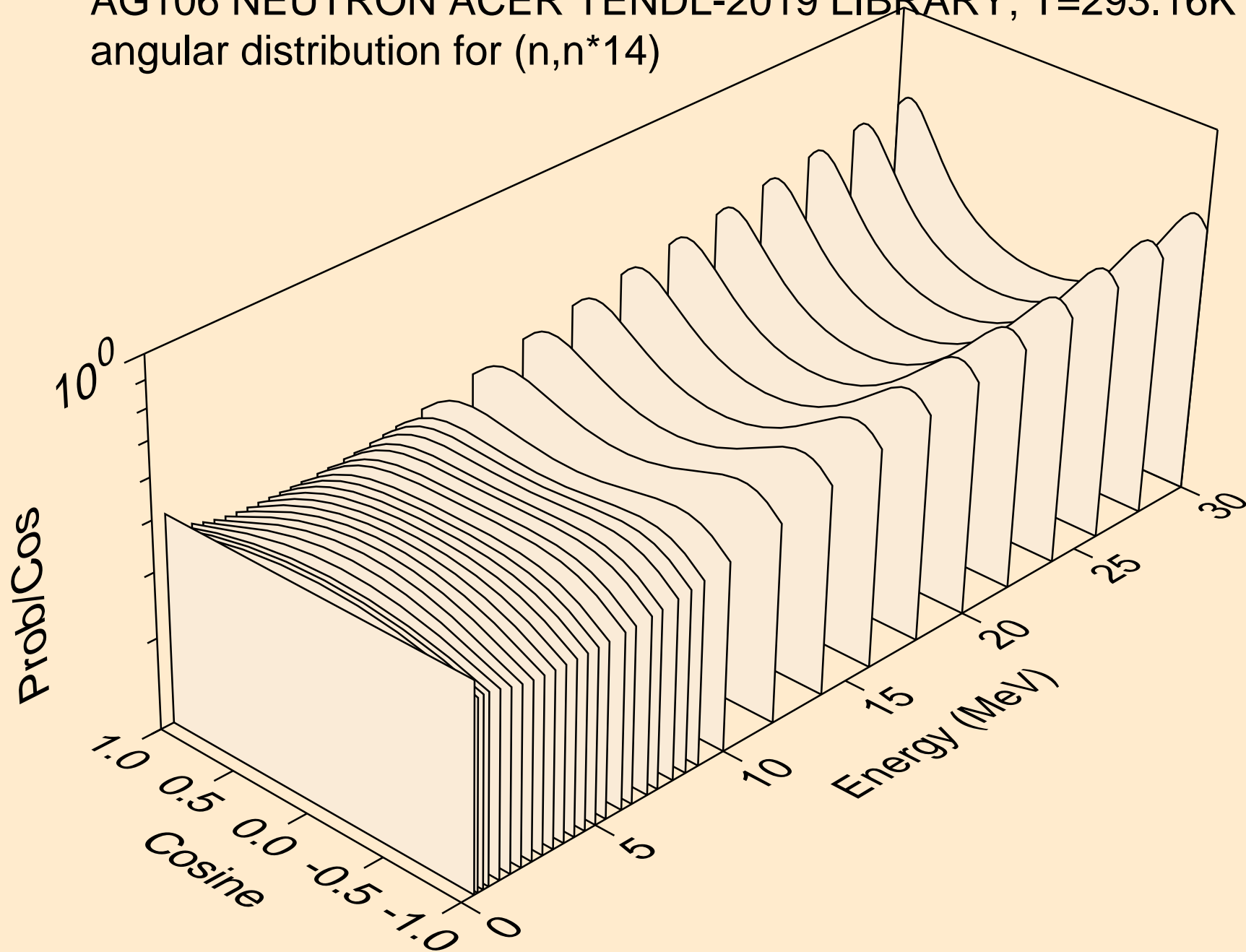

AG106 NEUTRON ACER TENDL-2019 LIBRARY; T=293.16K  
angular distribution for (n,n\*15)

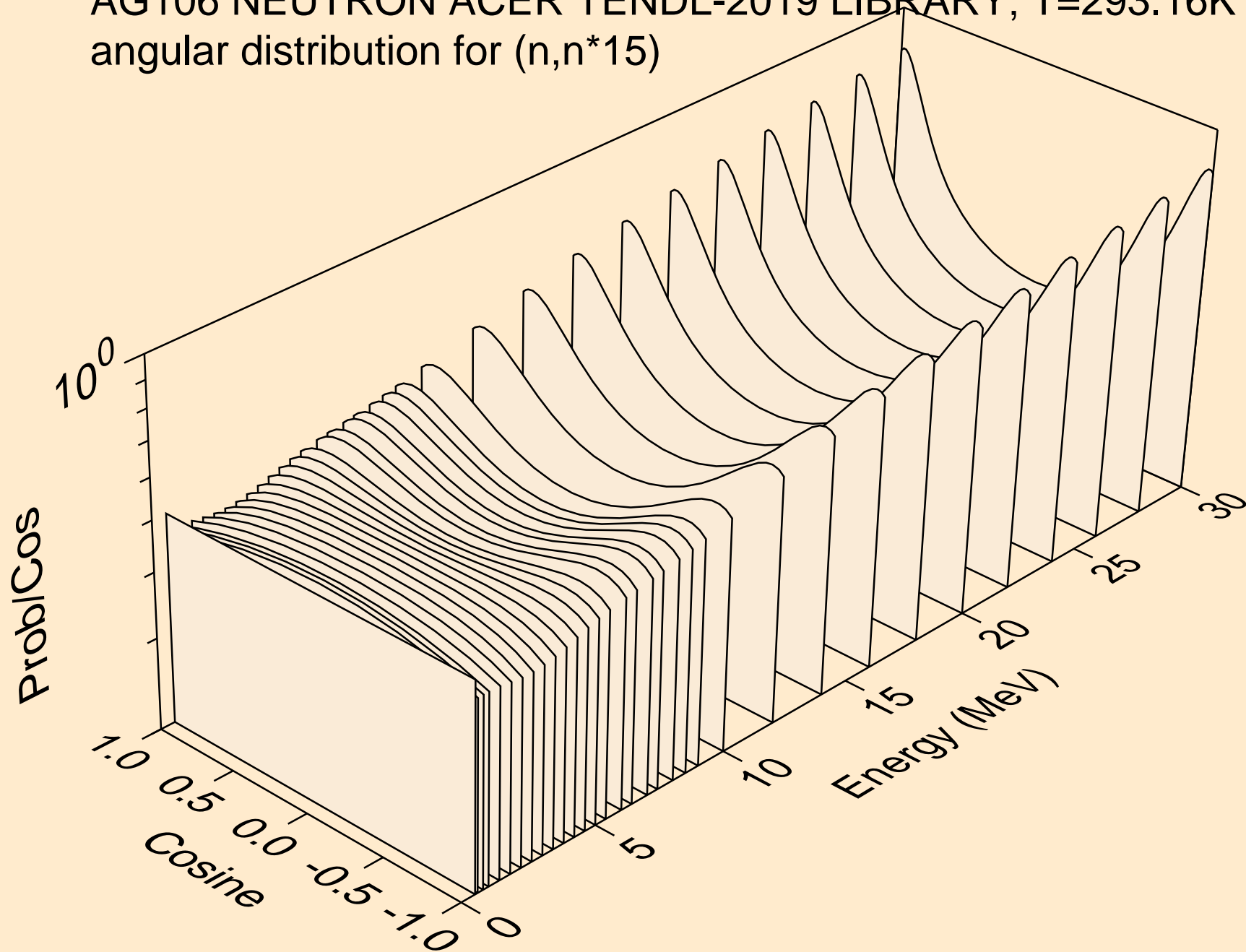

AG106 NEUTRON ACER TENDL-2019 LIBRARY; T=293.16K  
angular distribution for (n,n\*16)

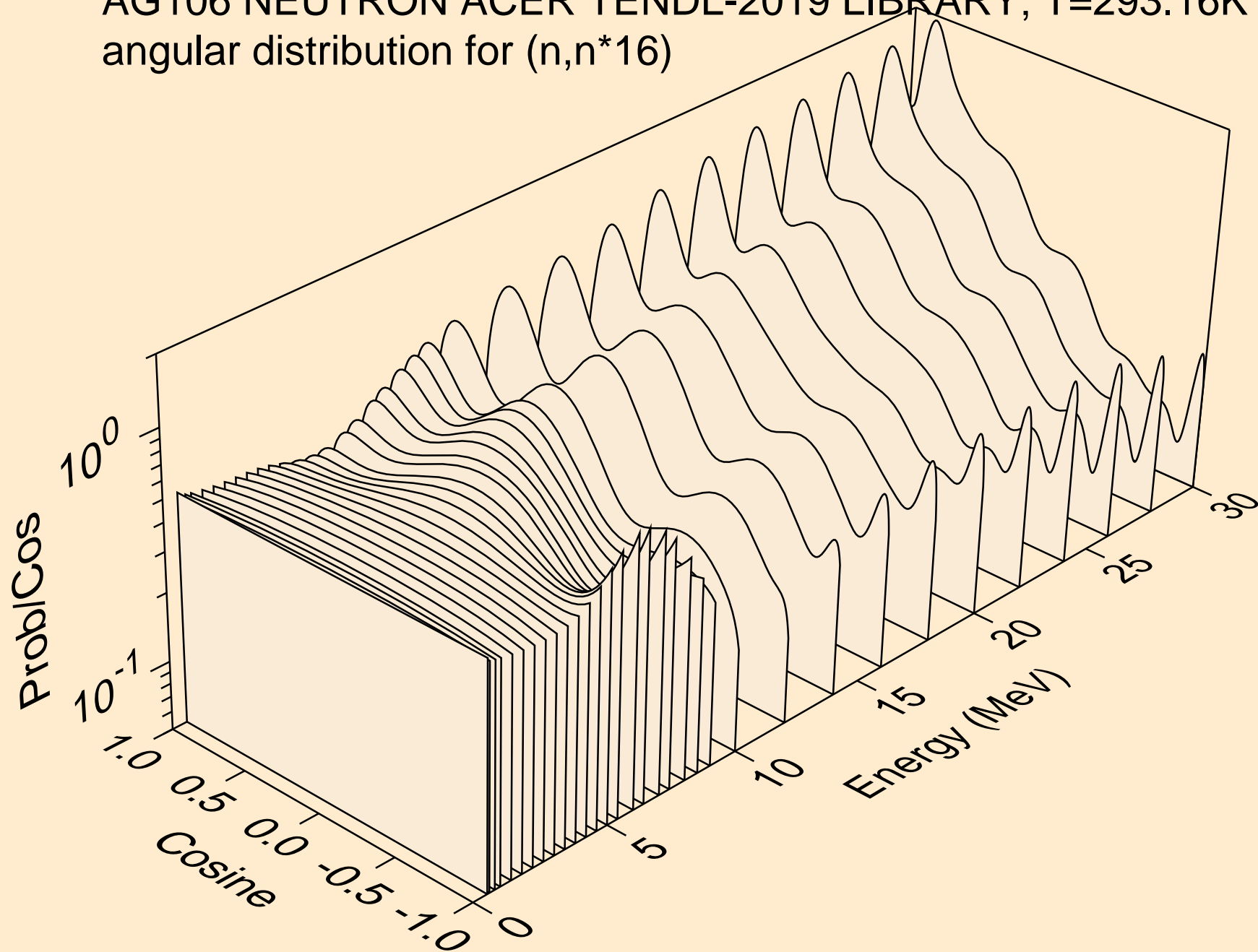

AG106 NEUTRON ACER TENDL-2019 LIBRARY; T=293.16K  
angular distribution for (n,n\*17)

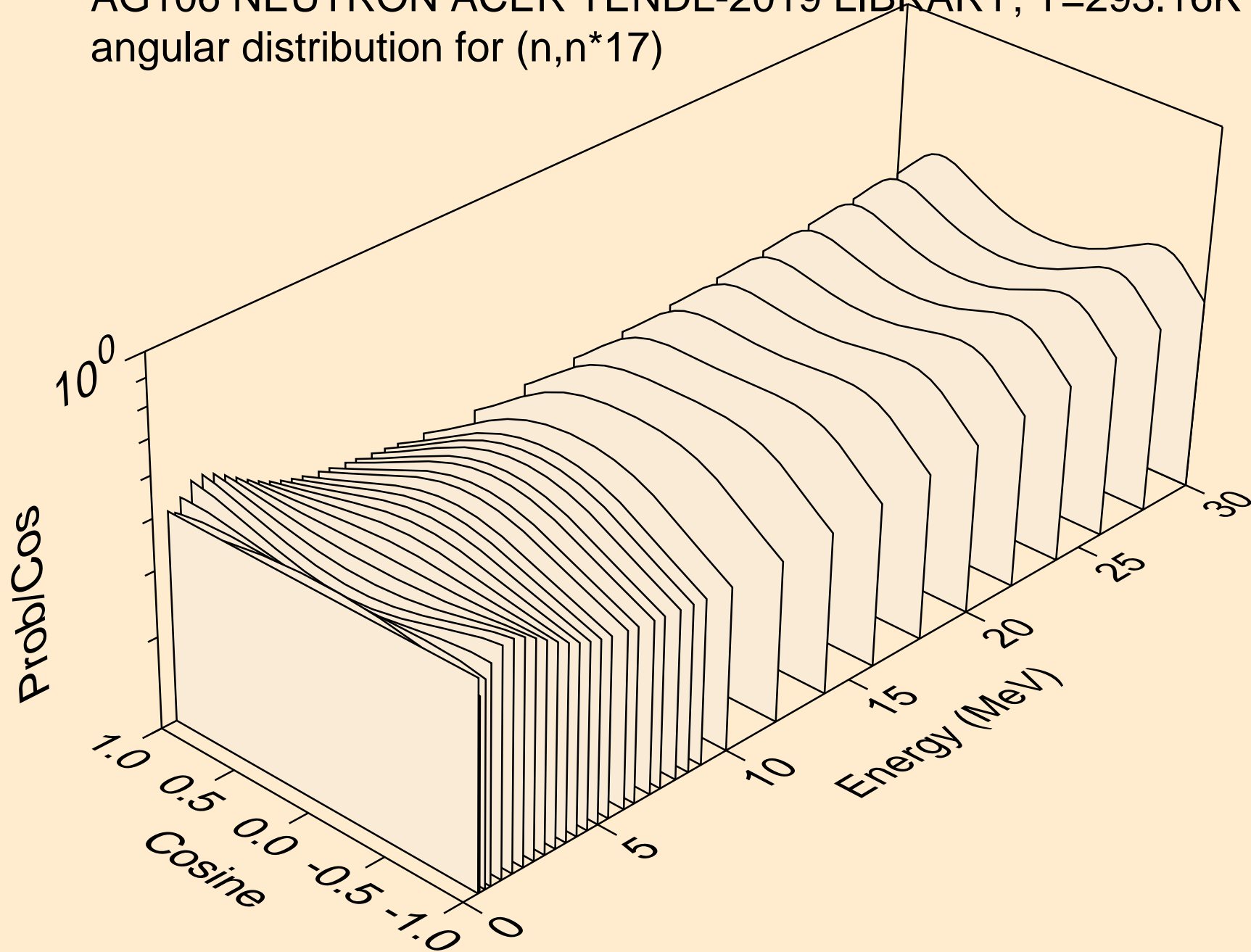



AG106 NEUTRON ACER TENDL-2019 LIBRARY; T=293.16K  
angular distribution for (n,n\*18)

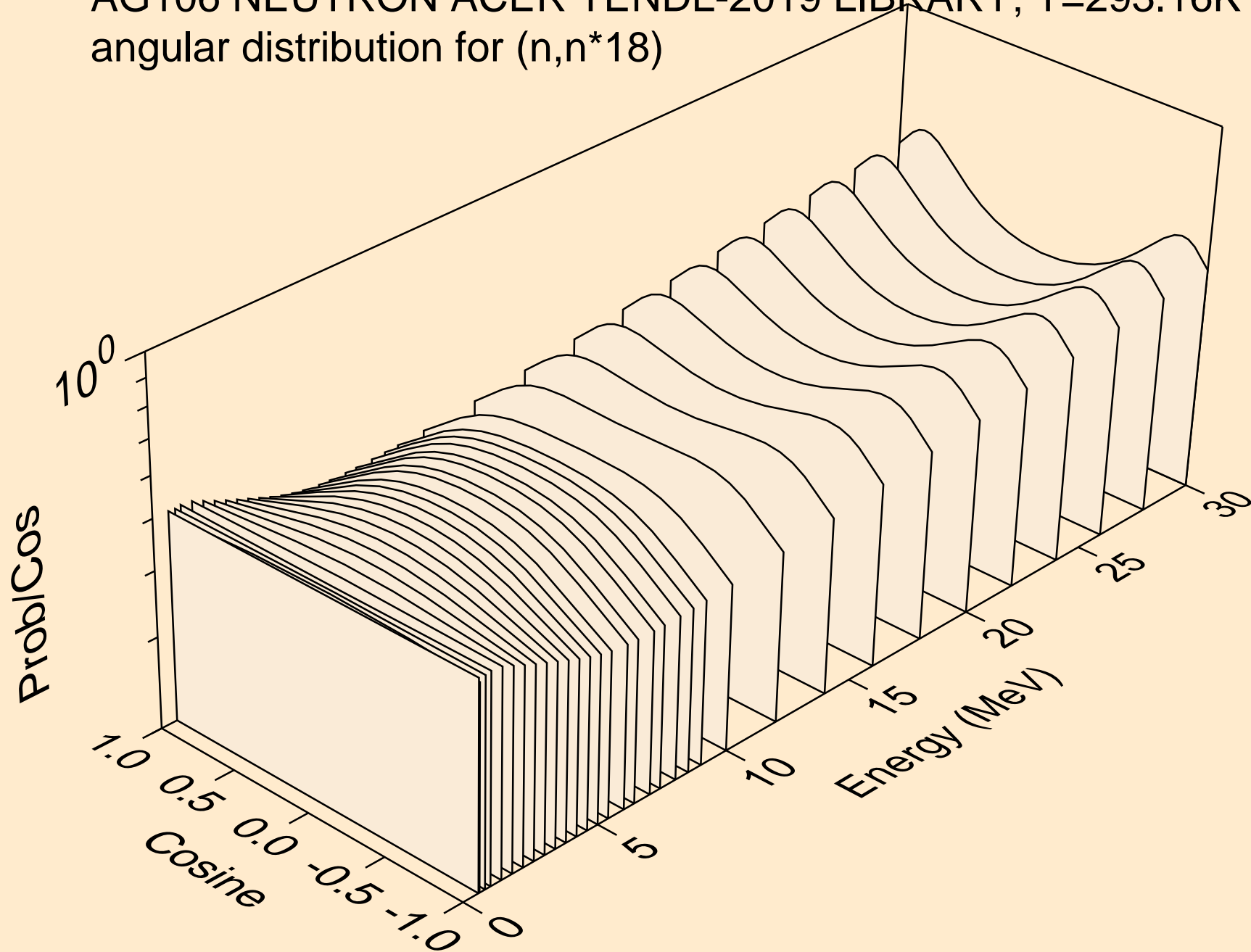

AG106 NEUTRON ACER TENDL-2019 LIBRARY; T=293.16K  
angular distribution for (n,n\*19)

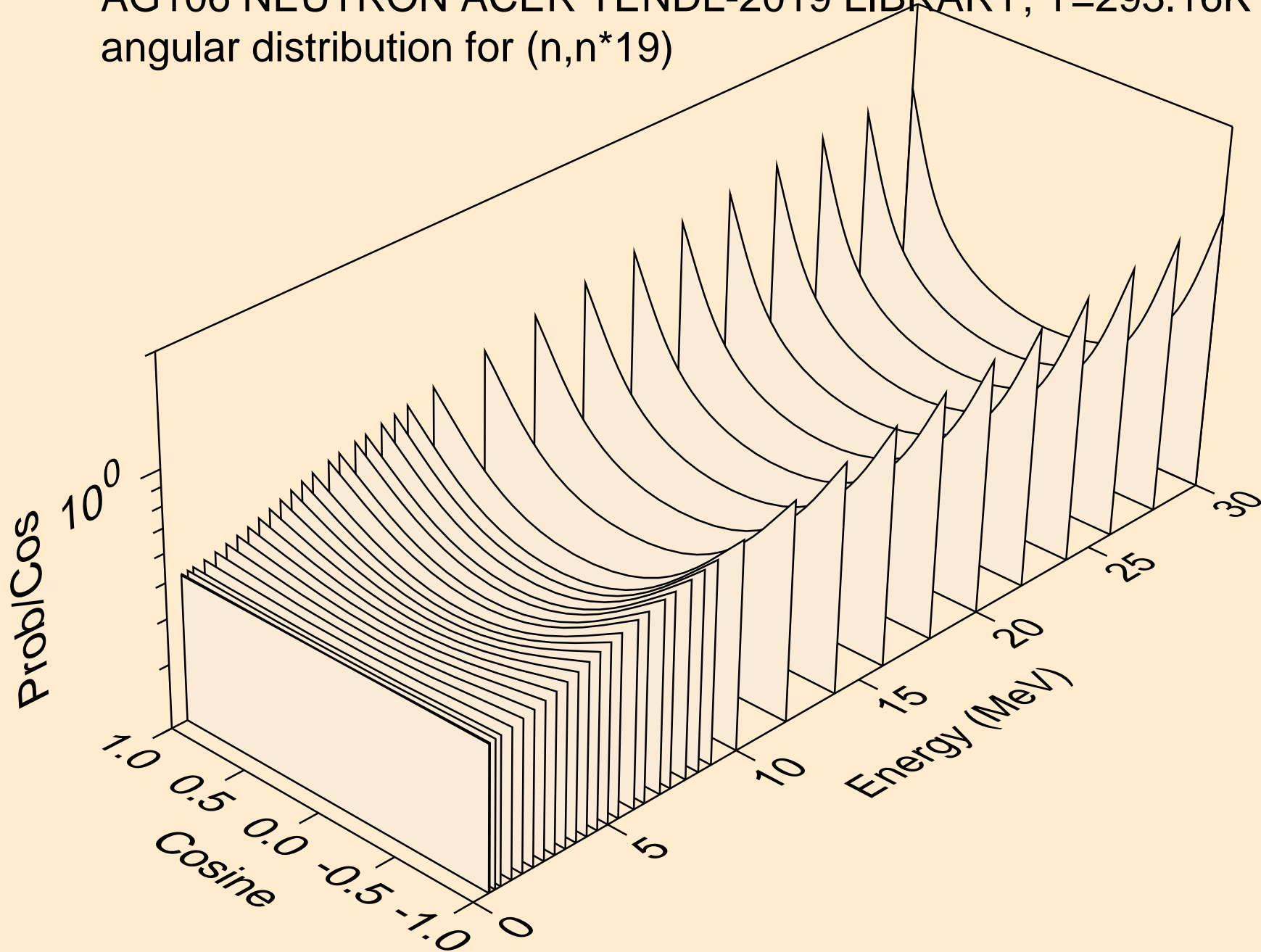

AG106 NEUTRON ACER TENDL-2019 LIBRARY; T=293.16K  
angular distribution for (n,n\*20)

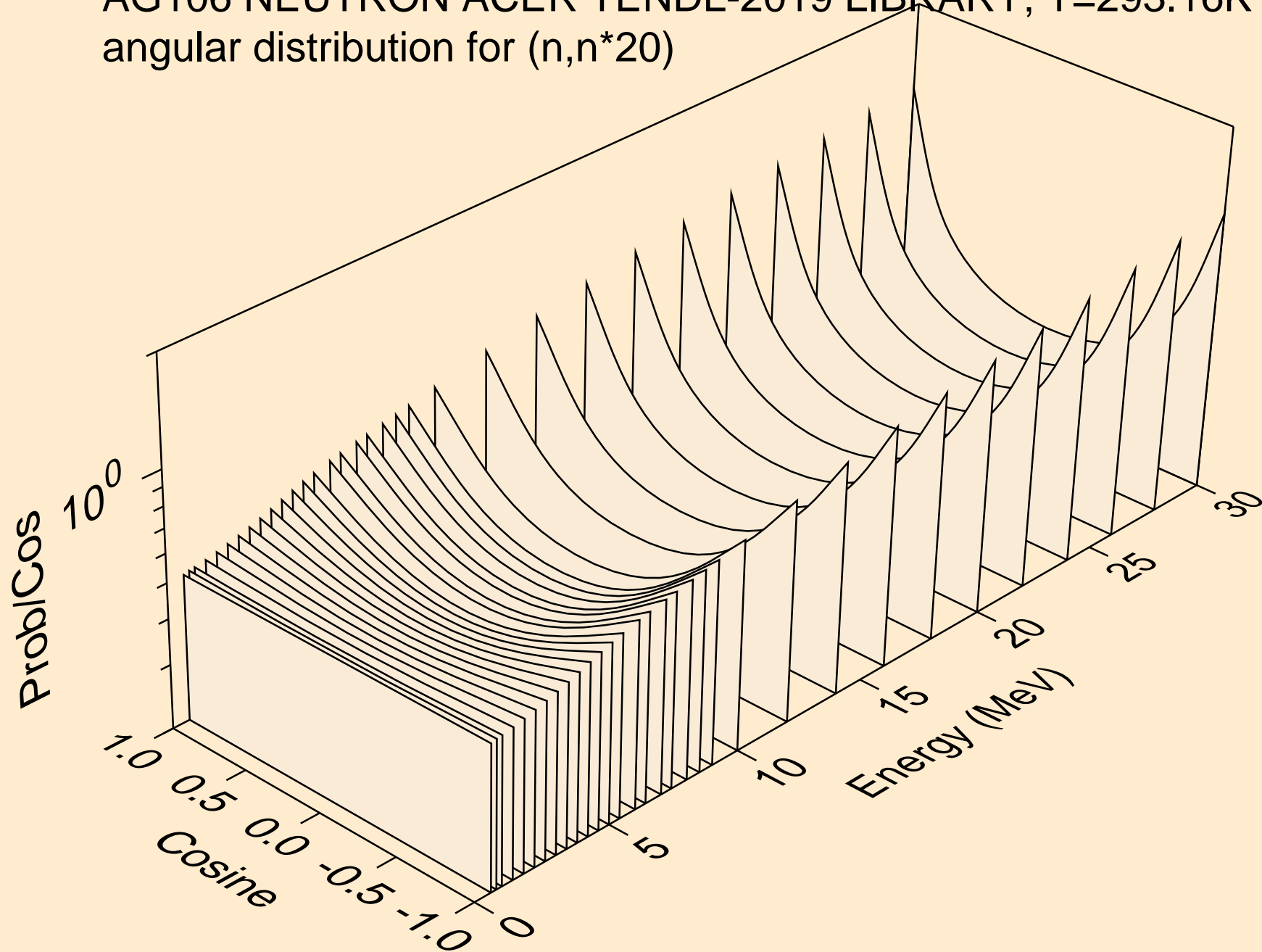

AG106 NEUTRON ACER TENDL-2019 LIBRARY; T=293.16K  
angular distribution for (n,n\*21)

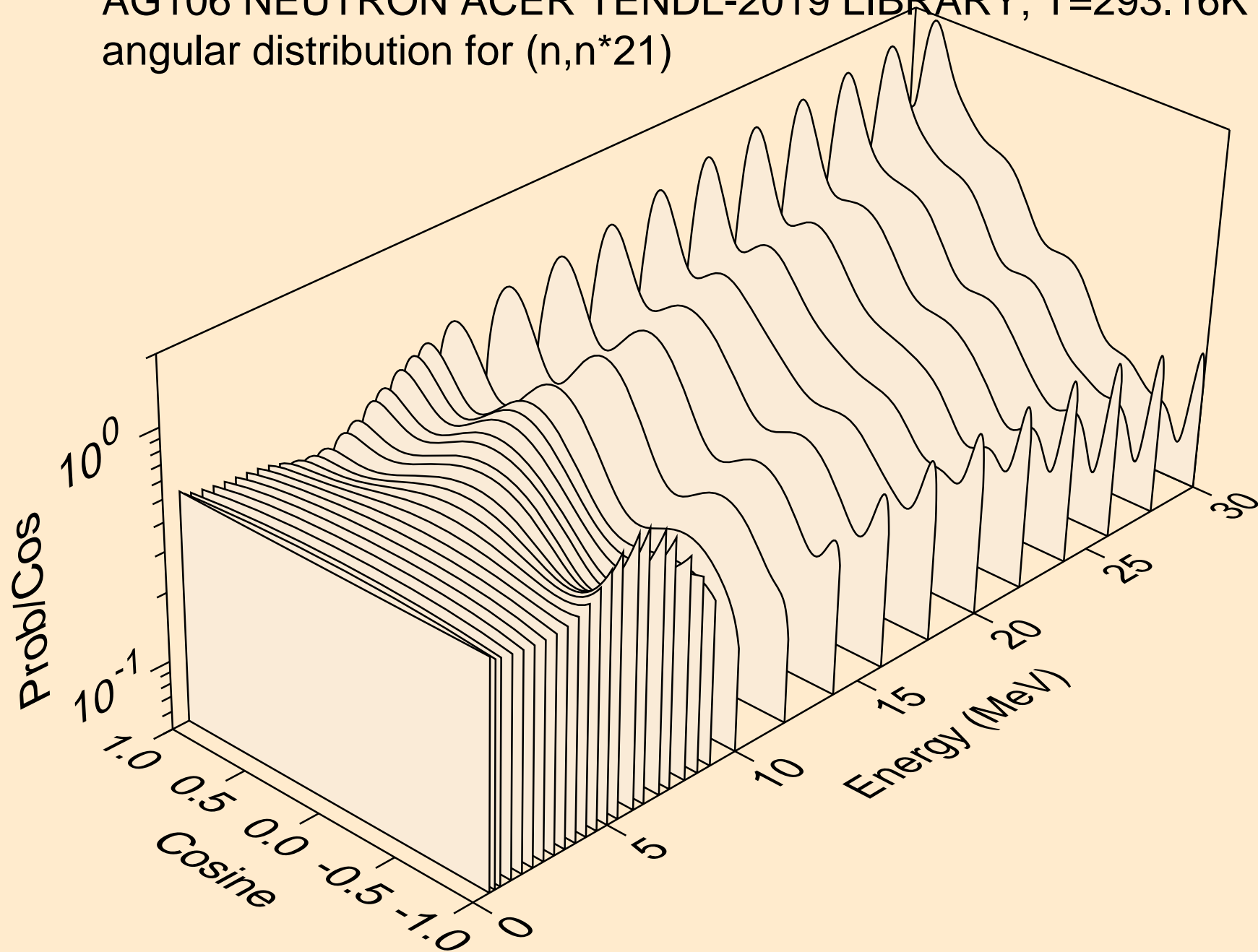

AG106 NEUTRON ACER TENDL-2019 LIBRARY; T=293.16K  
angular distribution for (n,n\*22)

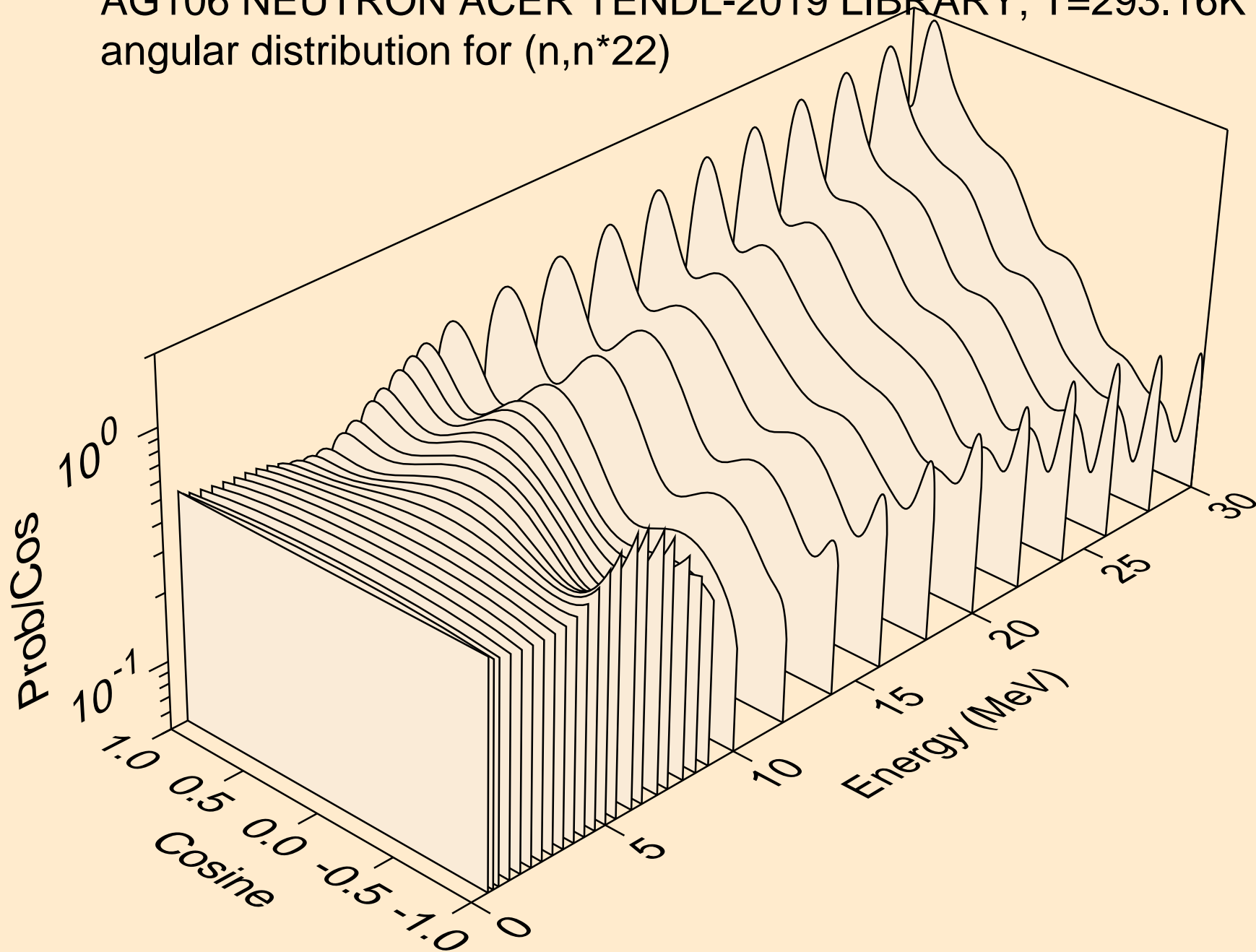

AG106 NEUTRON ACER TENDL-2019 LIBRARY; T=293.16K  
angular distribution for (n,n\*23)

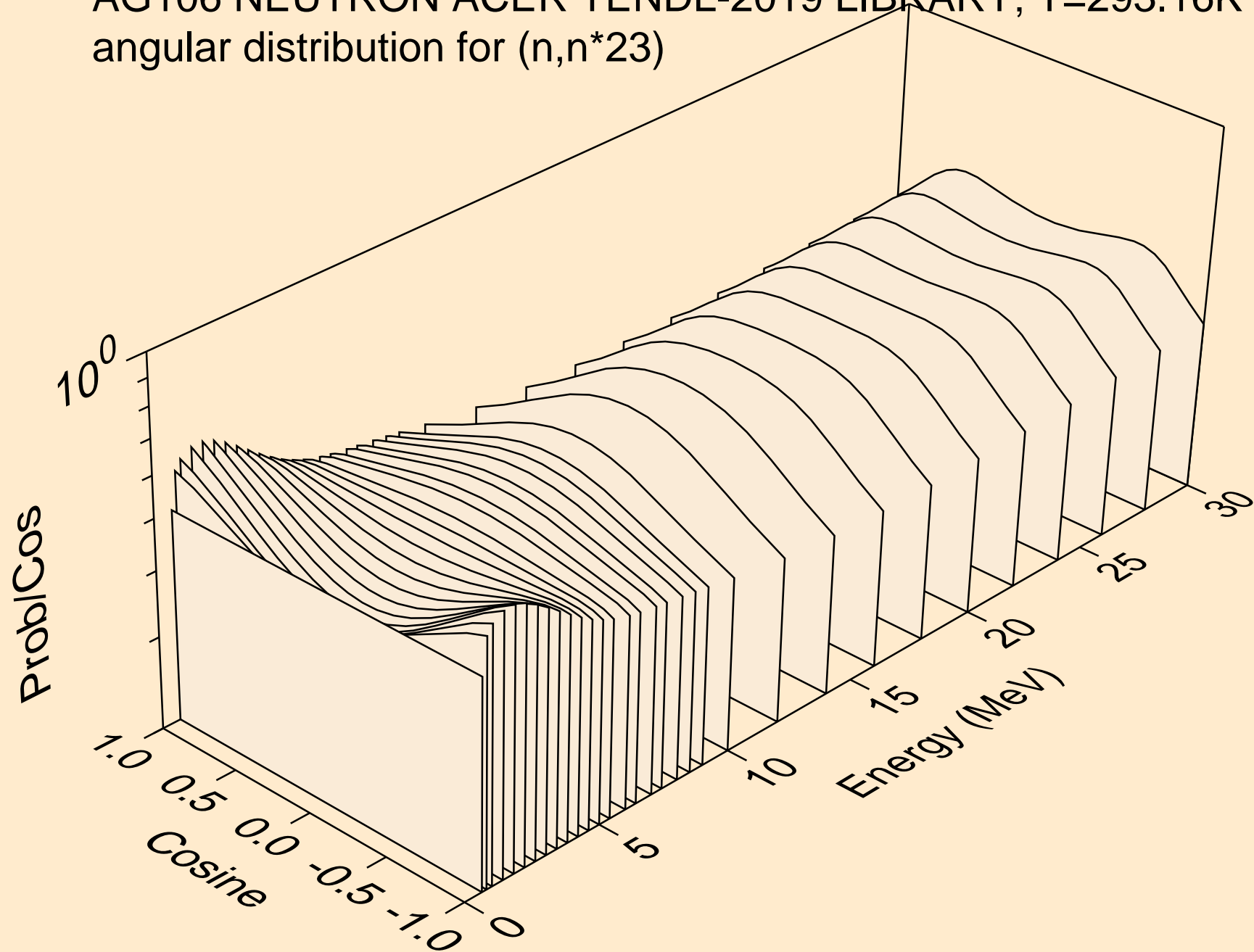

AG106 NEUTRON ACER TENDL-2019 LIBRARY; T=293.16K  
angular distribution for (n,n\*24)

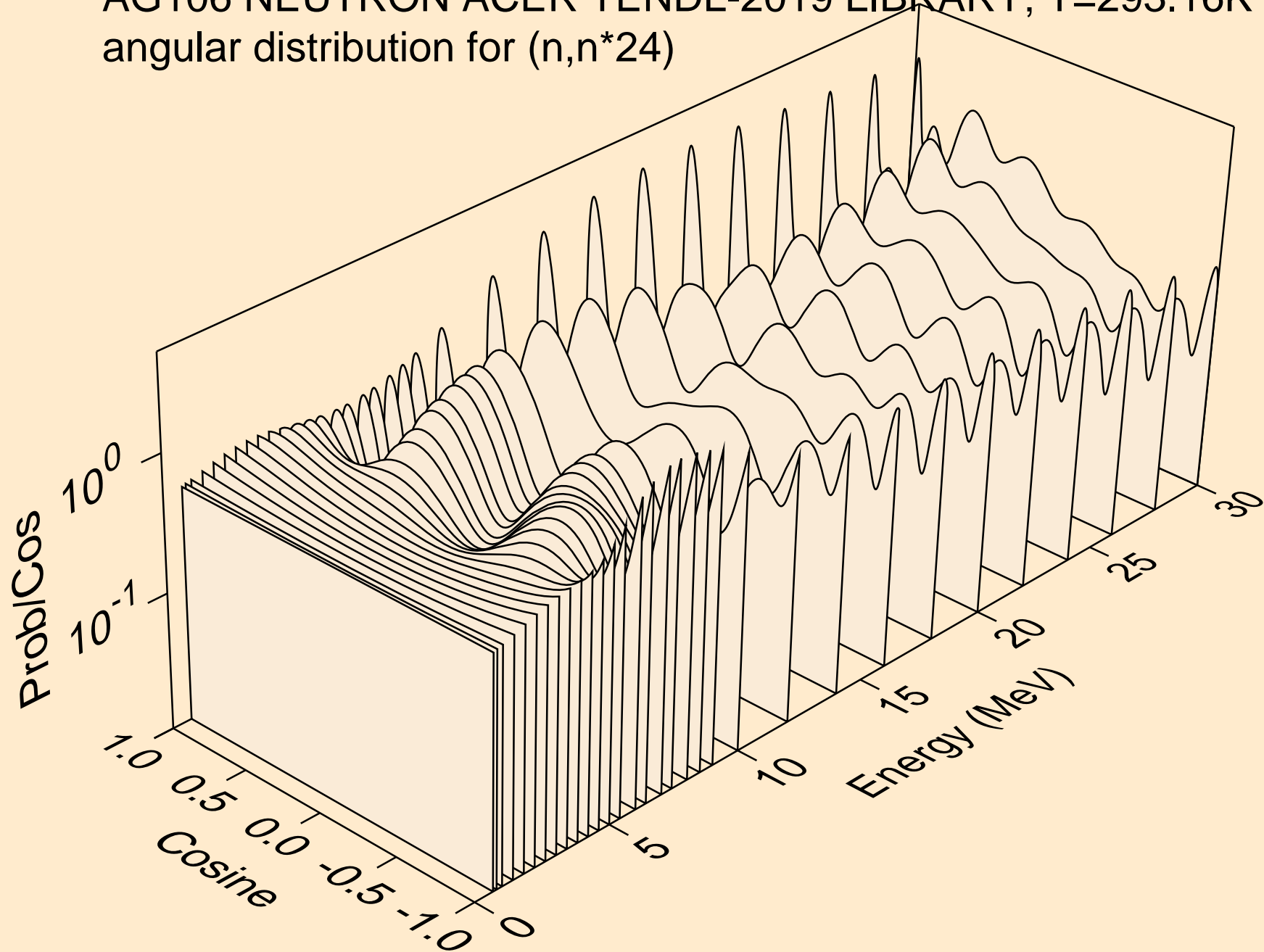

AG106 NEUTRON ACER TENDL-2019 LIBRARY; T=293.16K  
angular distribution for (n,n\*25)

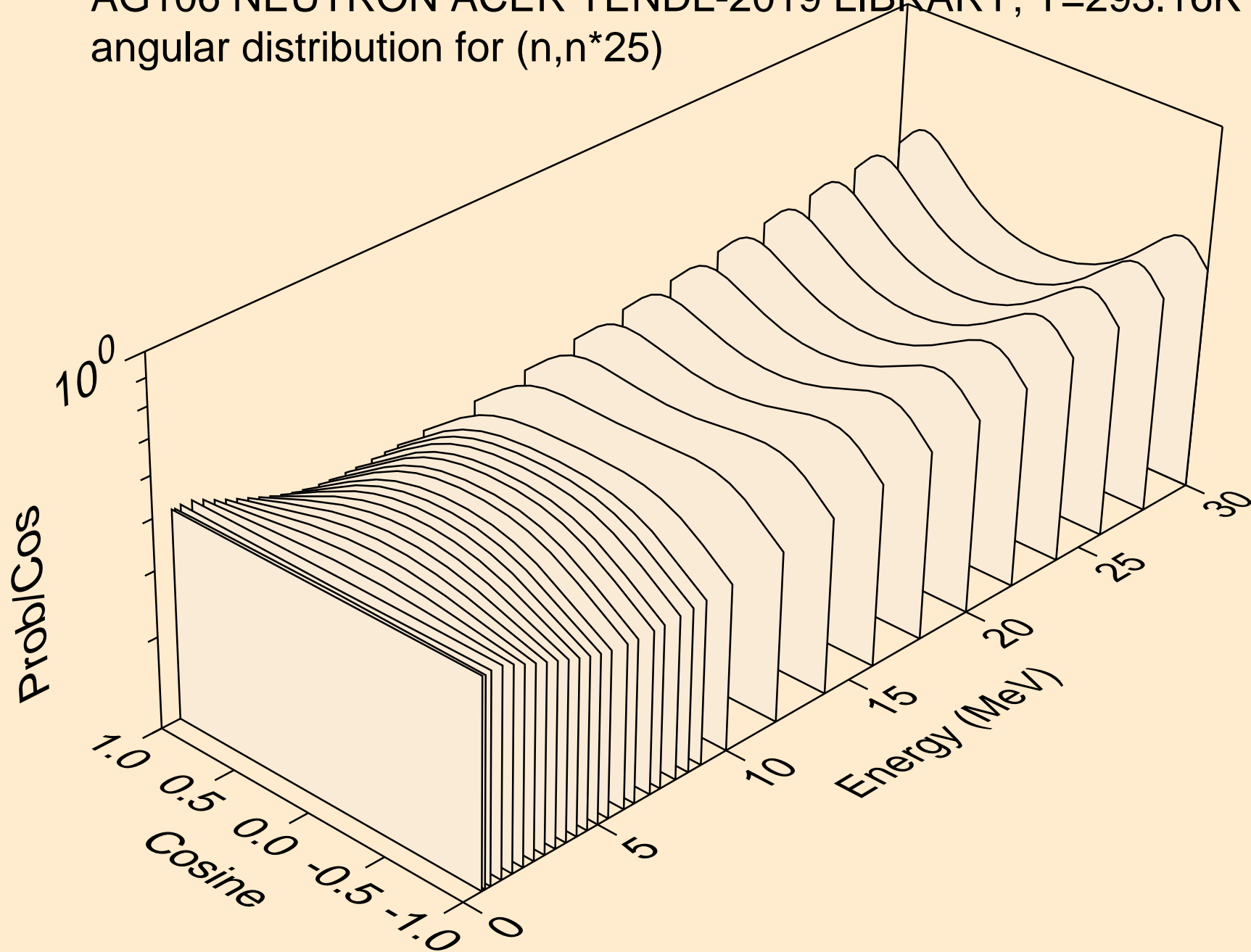



AG106 NEUTRON ACER TENDL-2019 LIBRARY; T=293.16K  
angular distribution for (n,n\*26)

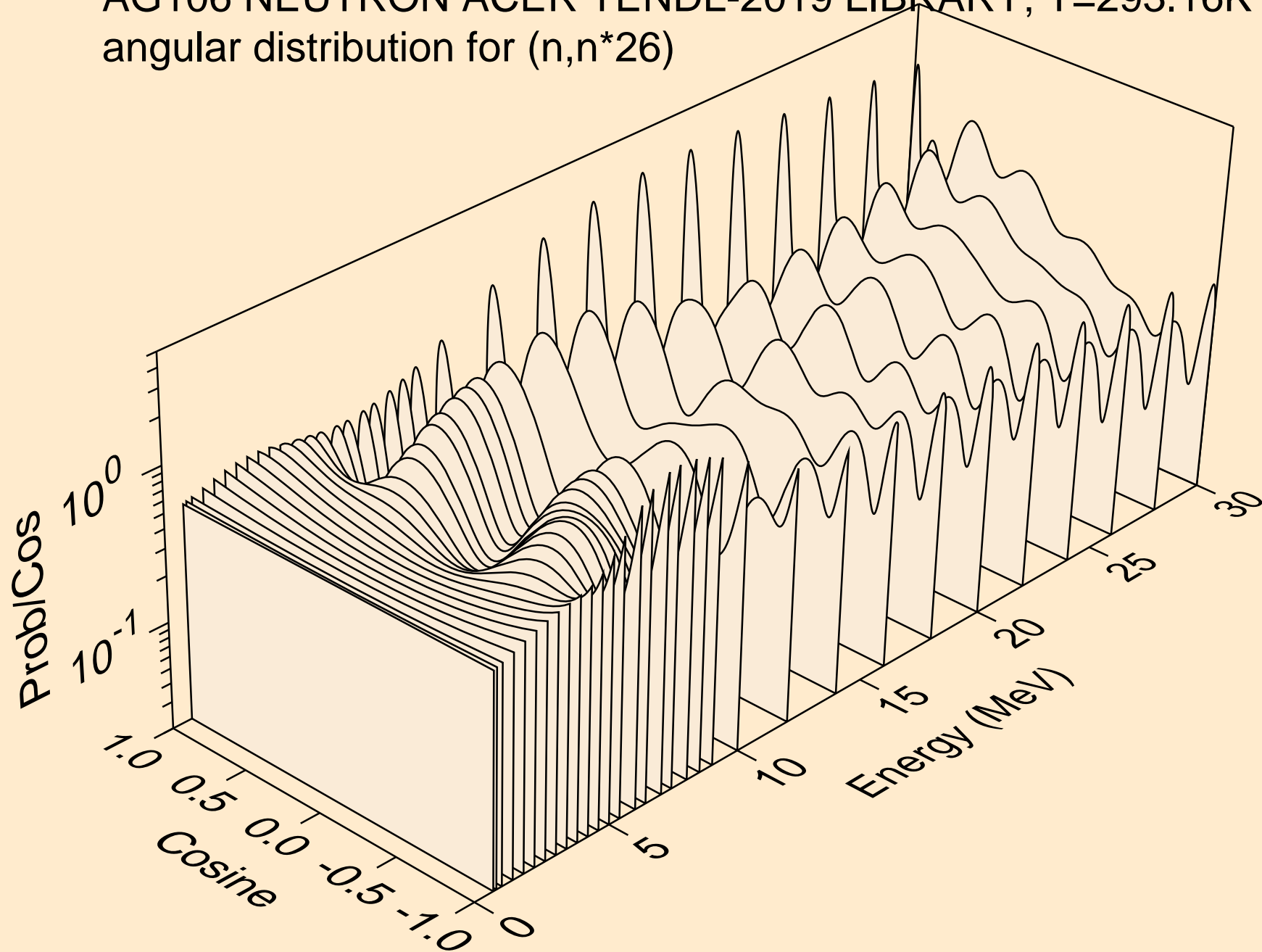

AG106 NEUTRON ACER TENDL-2019 LIBRARY; T=293.16K  
angular distribution for (n,n\*27)

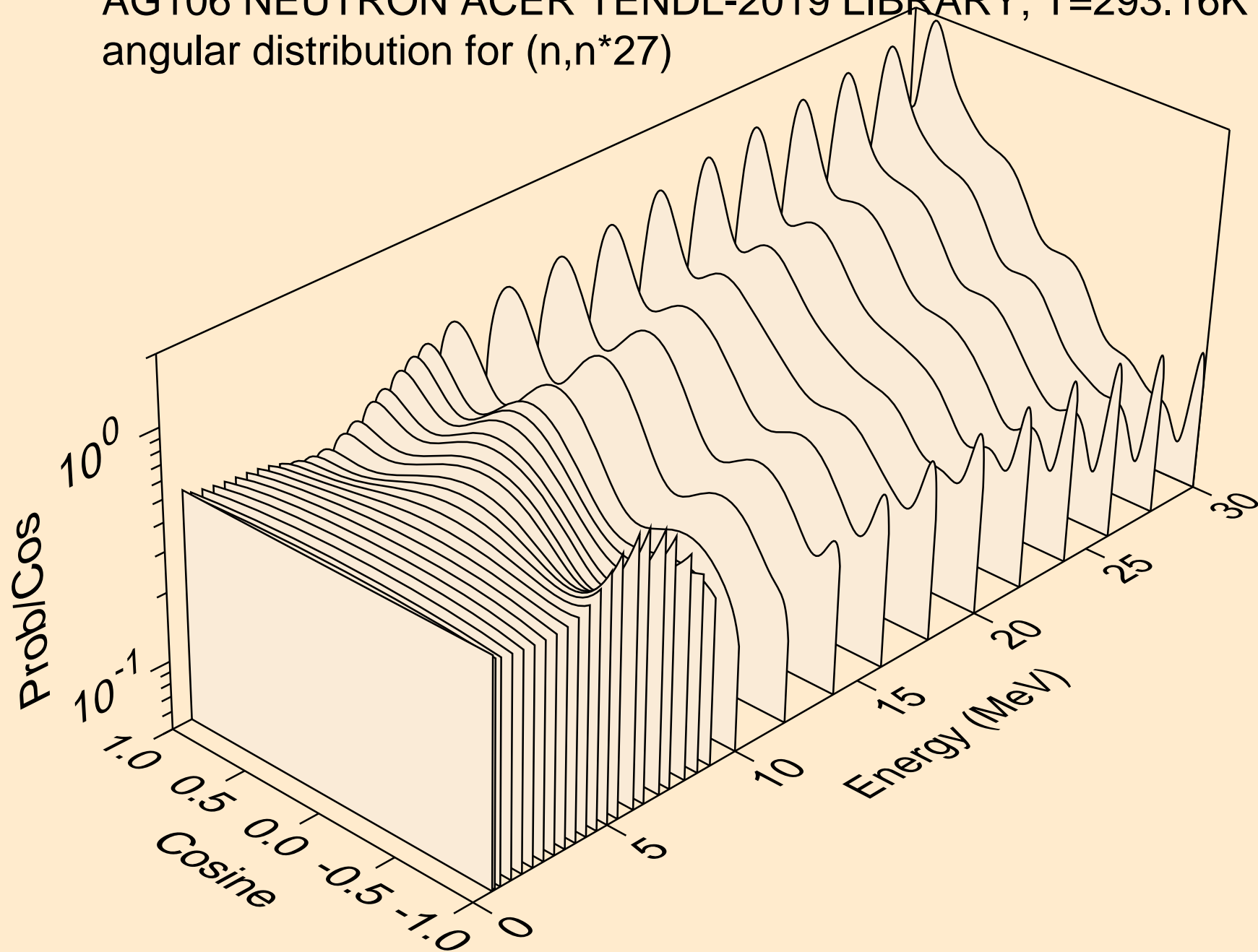

AG106 NEUTRON ACER TENDL-2019 LIBRARY; T=293.16K  
angular distribution for (n,n\*28)

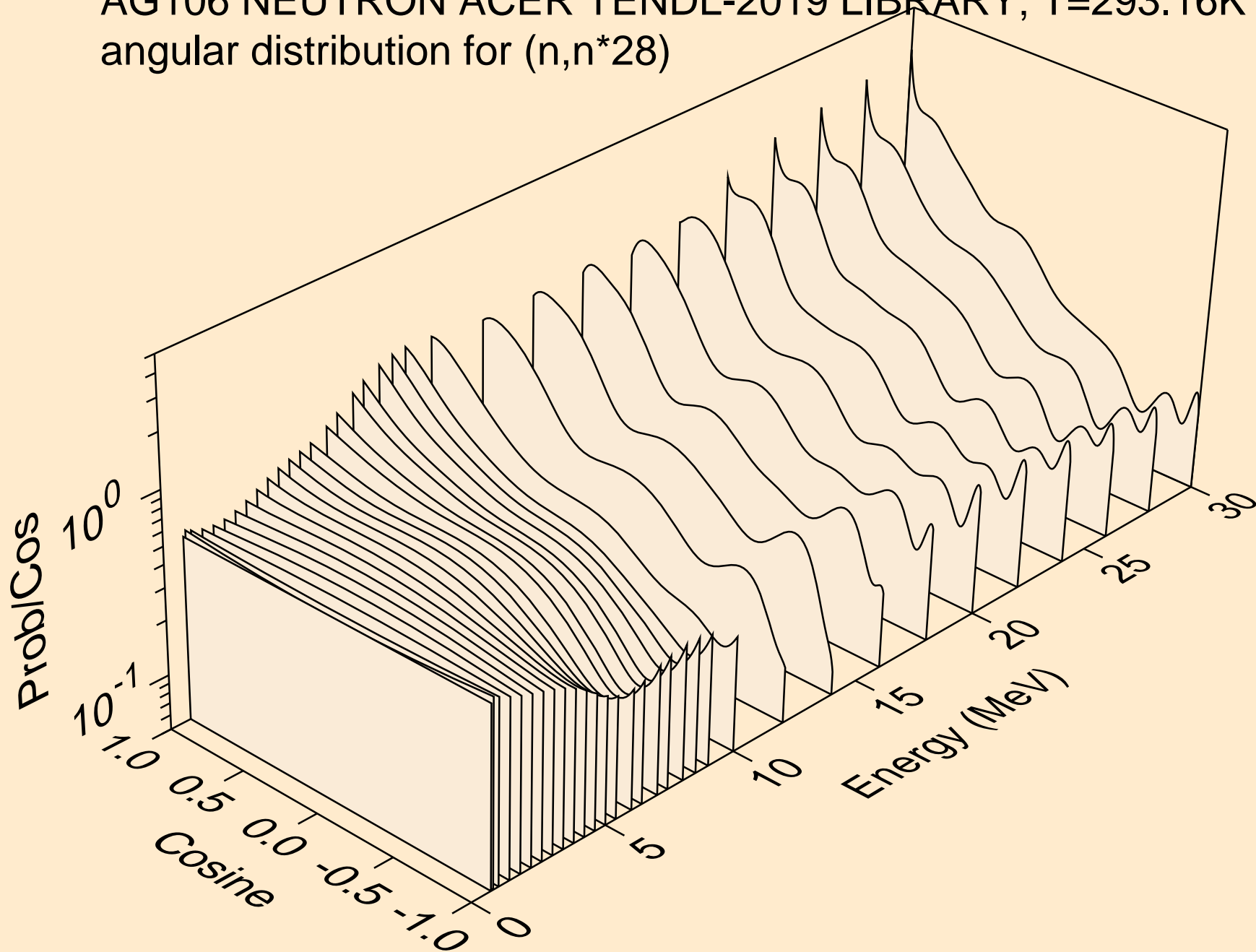

AG106 NEUTRON ACER TENDL-2019 LIBRARY; T=293.16K  
angular distribution for (n,n\*29)

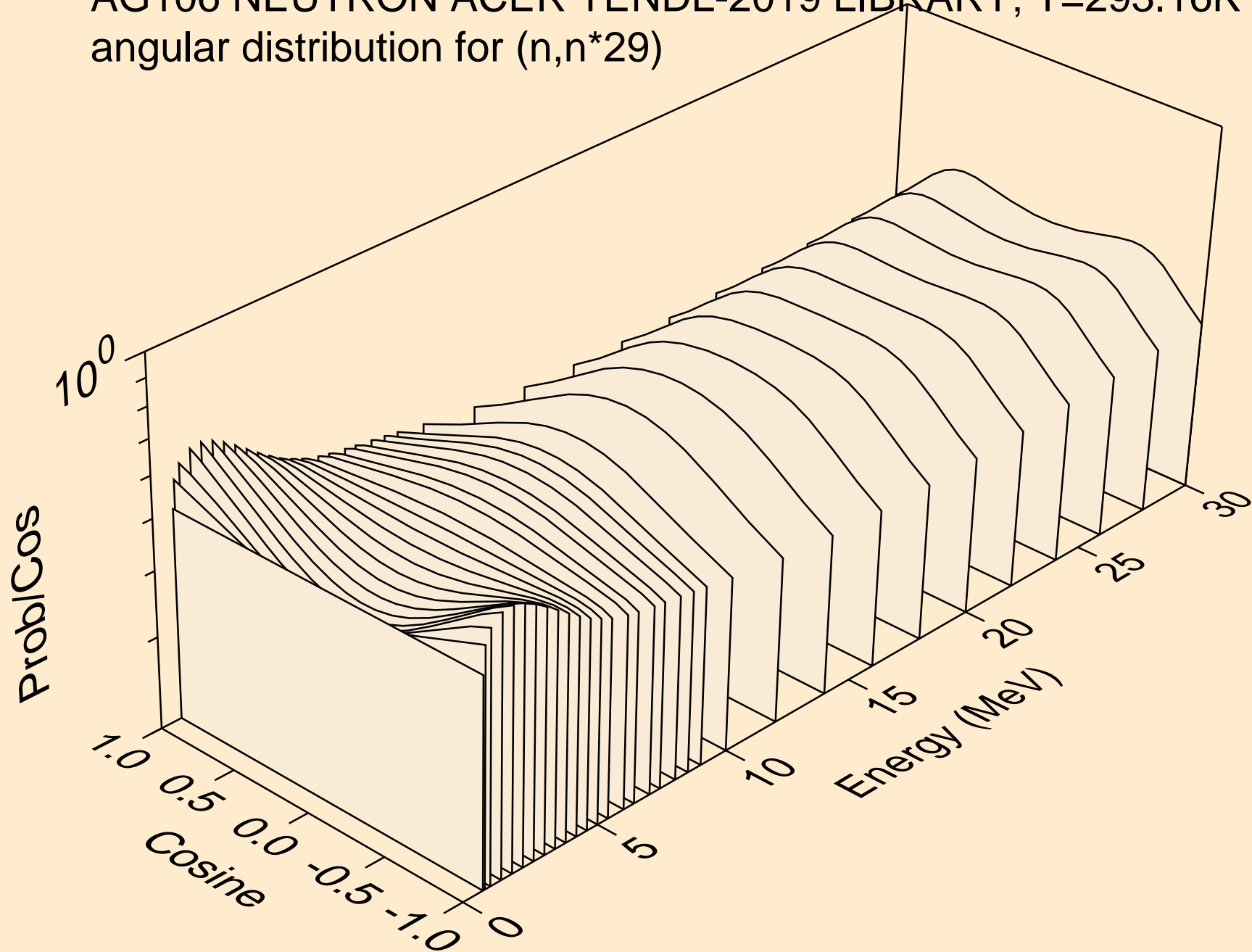

AG106 NEUTRON ACER TENDL-2019 LIBRARY; T=293.16K  
angular distribution for (n,n\*30)

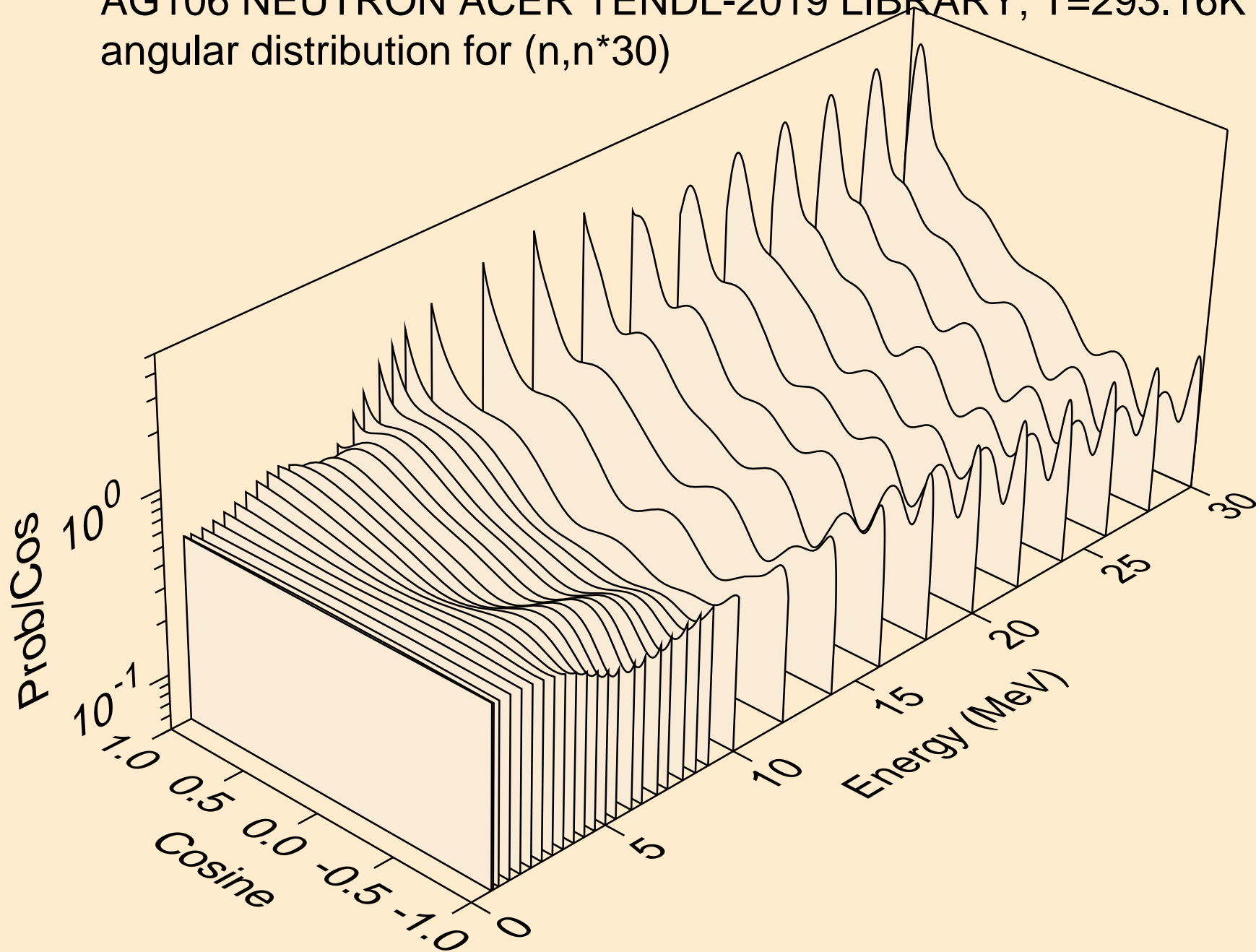

AG106 NEUTRON ACER TENDL-2019 LIBRARY; T=293.16K  
Neutron emission for (n,x)

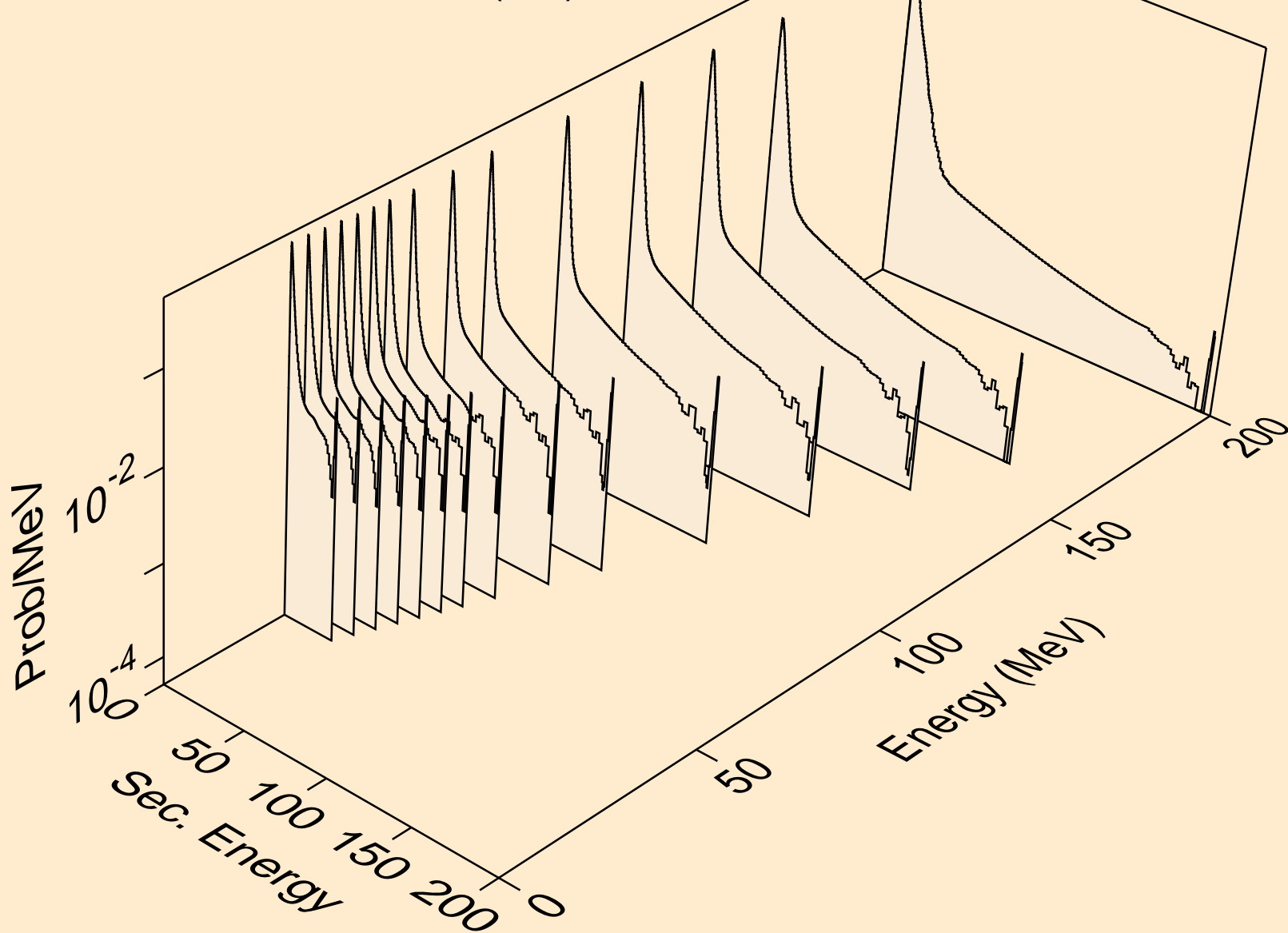

AG106 NEUTRON ACER TENDL-2019 LIBRARY; T=293.16K  
Neutron emission for (n,2nd)

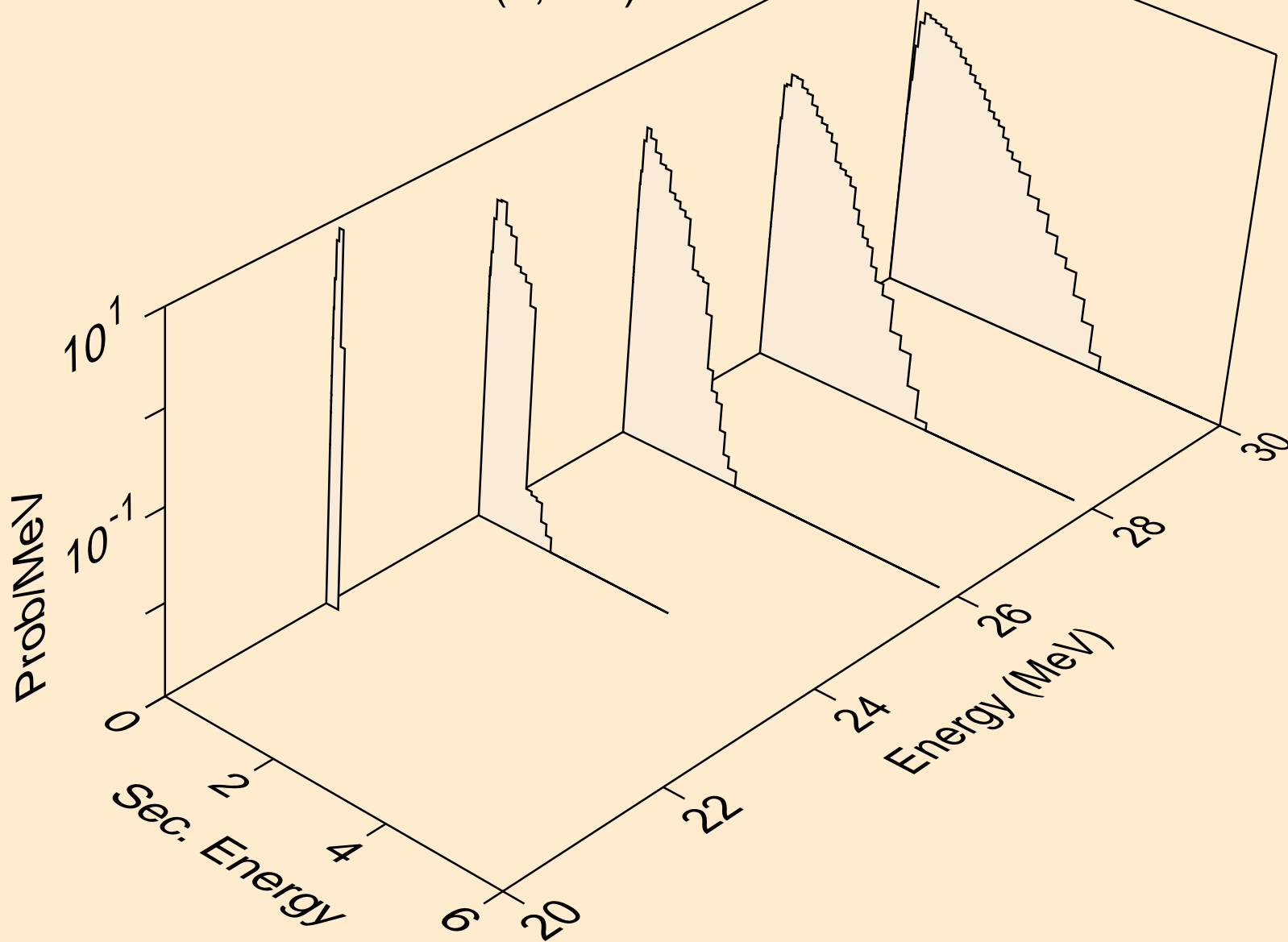

AG106 NEUTRON ACER TENDL-2019 LIBRARY; T=293.16K  
Neutron emission for (n,2n)

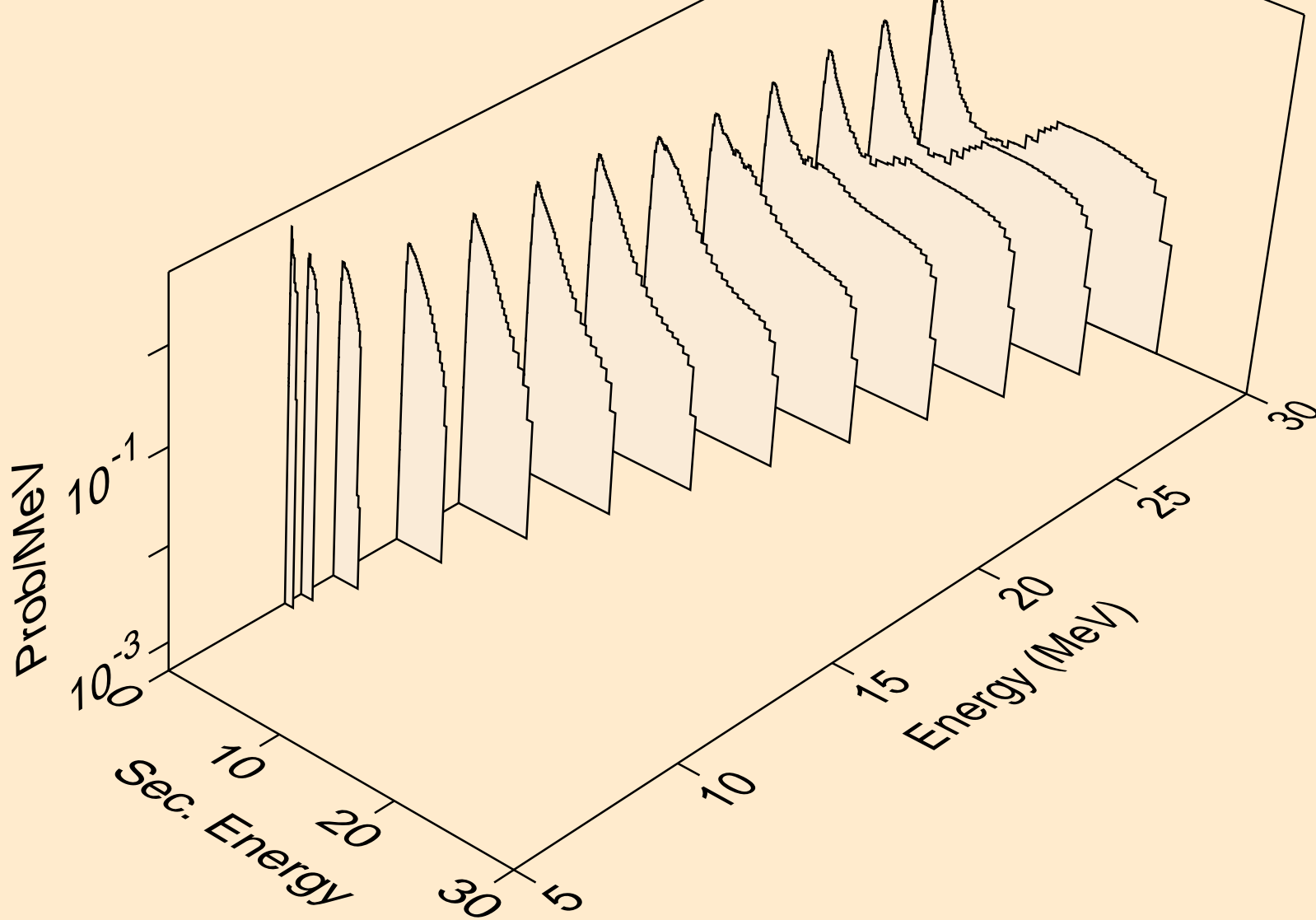



AG106 NEUTRON ACER TENDL-2019 LIBRARY; T=293.16K  
Neutron emission for (n,3n)

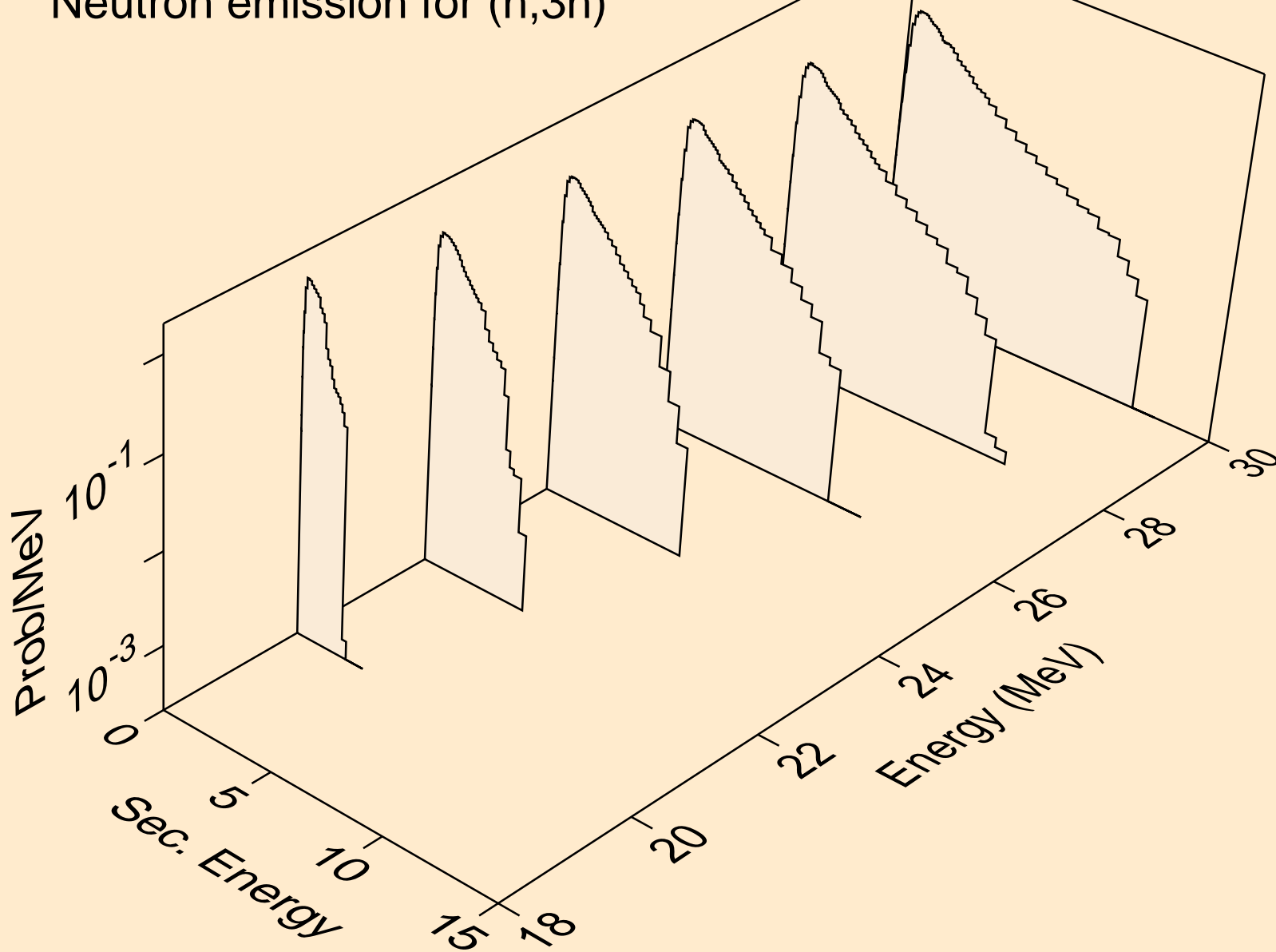

AG106 NEUTRON ACER TENDL-2019 LIBRARY; T=293.16K  
Neutron emission for (n,n\*)a

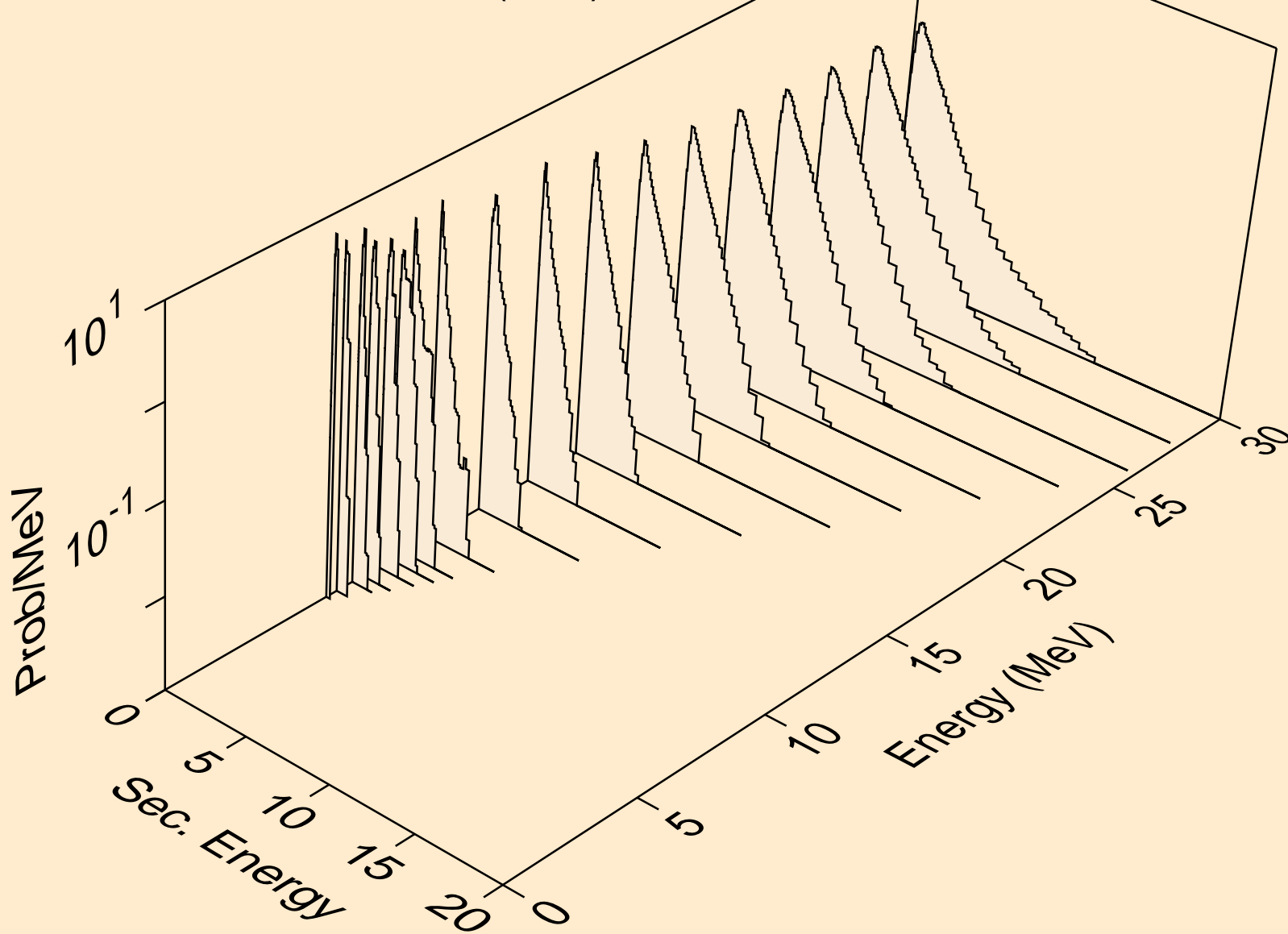

AG106 NEUTRON ACER TENDL-2019 LIBRARY; T=293.16K  
Neutron emission for (n,2n)a

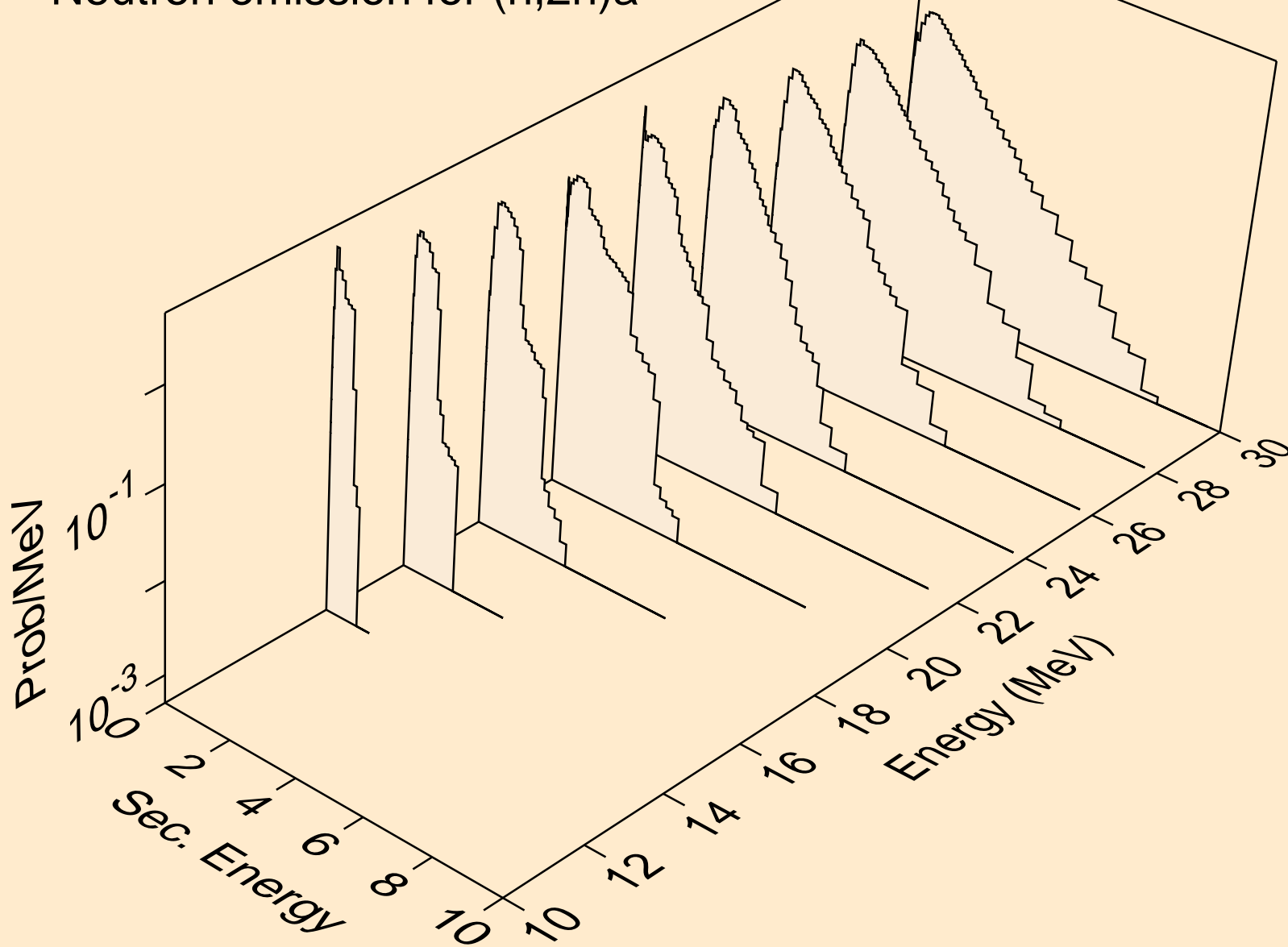

AG106 NEUTRON ACER TENDL-2019 LIBRARY; T=293.16K  
Neutron emission for (n,3n)a

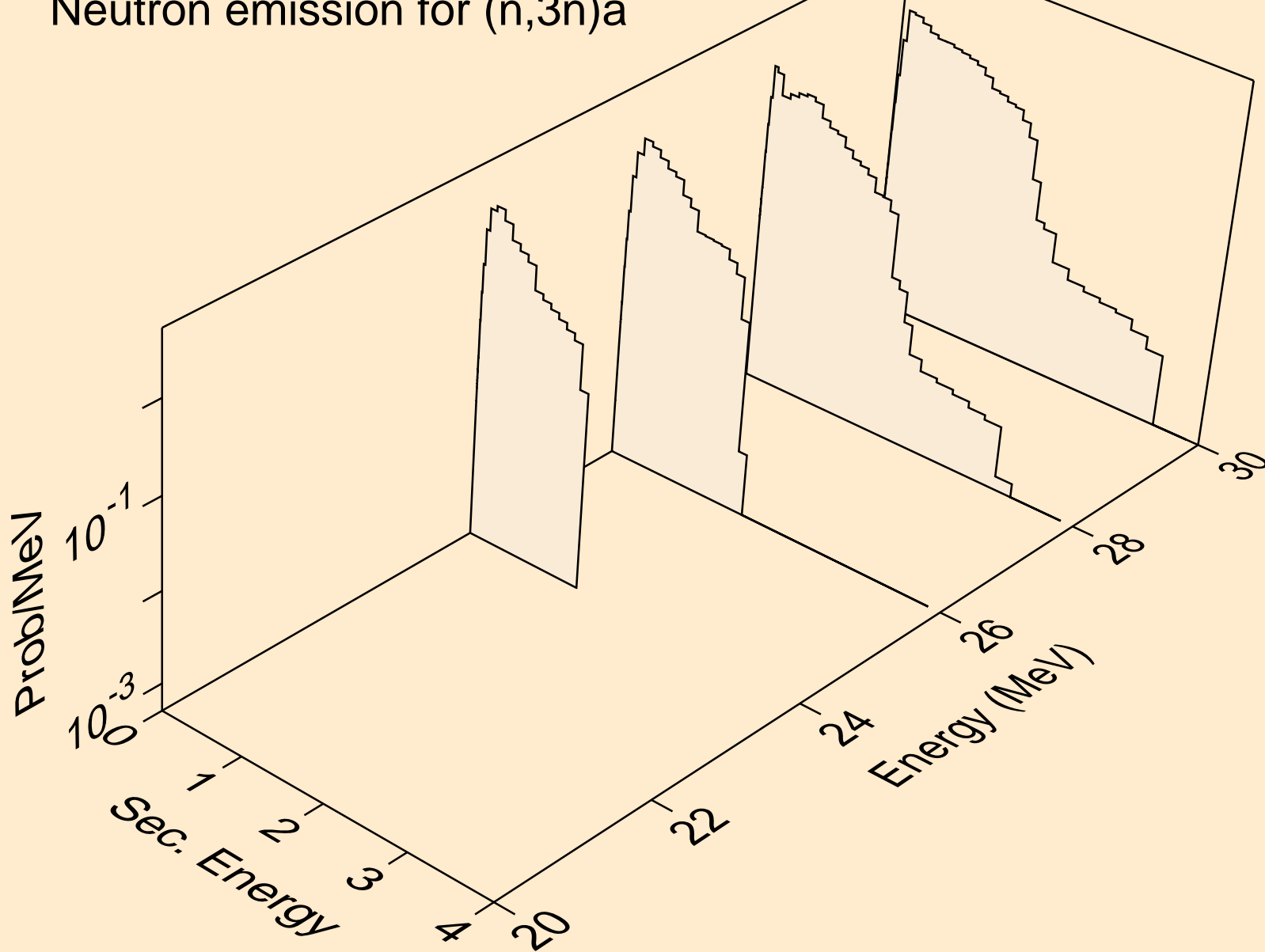

AG106 NEUTRON ACER TENDL-2019 LIBRARY; T=293.16K  
Neutron emission for (n,n\*)p

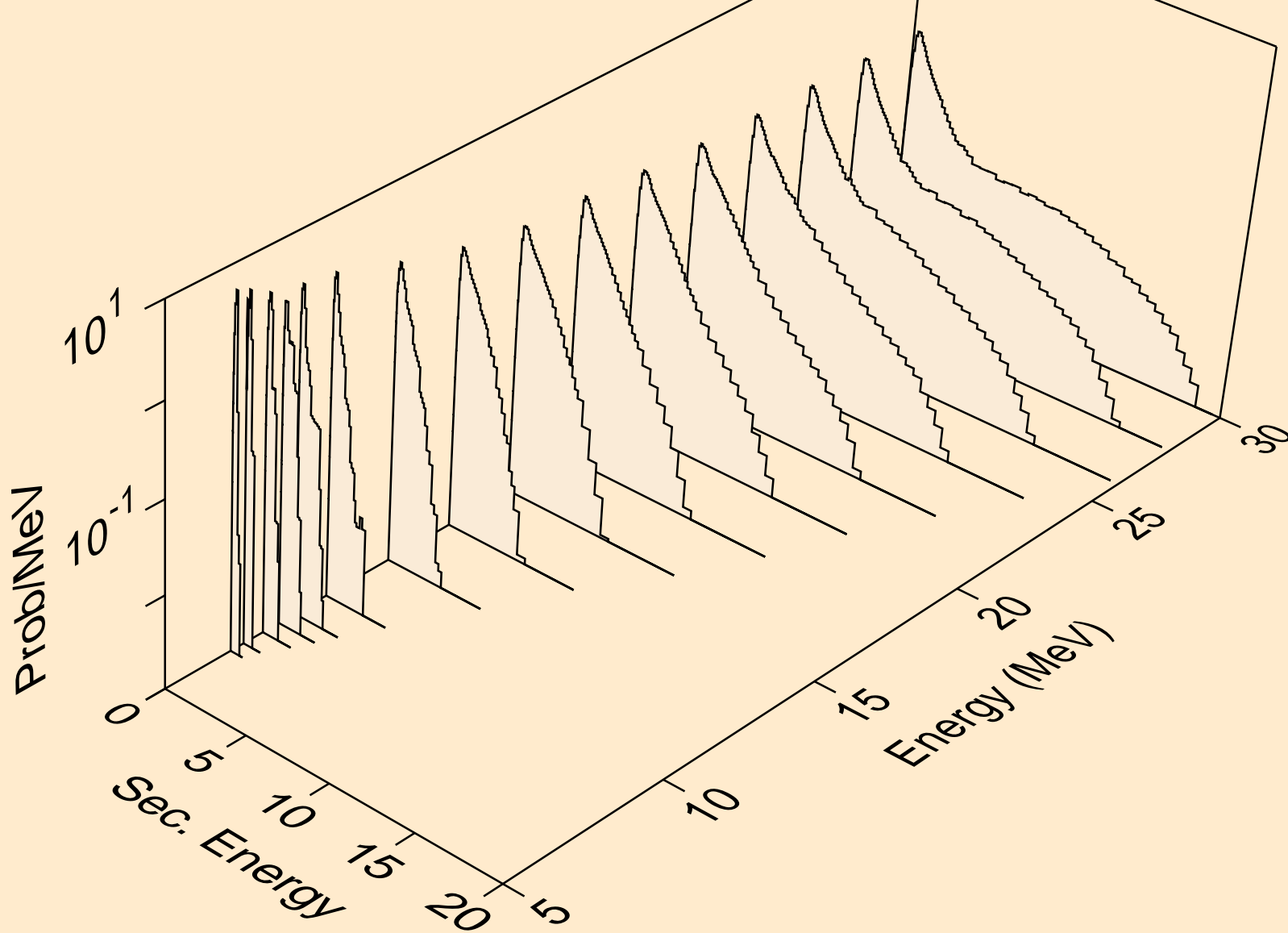

AG106 NEUTRON ACER TENDL-2019 LIBRARY; T=293.16K  
Neutron emission for (n,n\*)2a

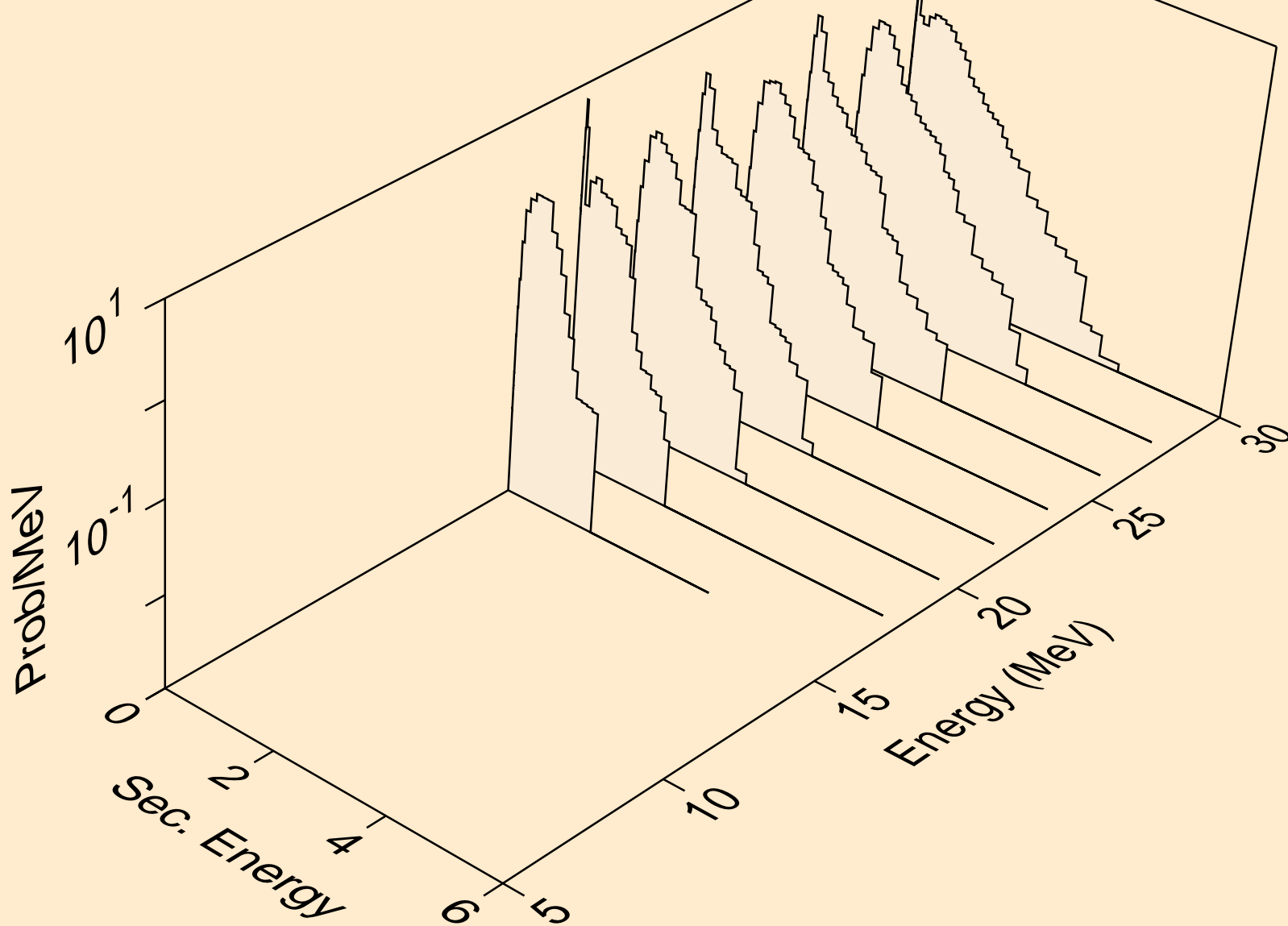

AG106 NEUTRON ACER TENDL-2019 LIBRARY; T=293.16K  
Neutron emission for (n,2n)2a

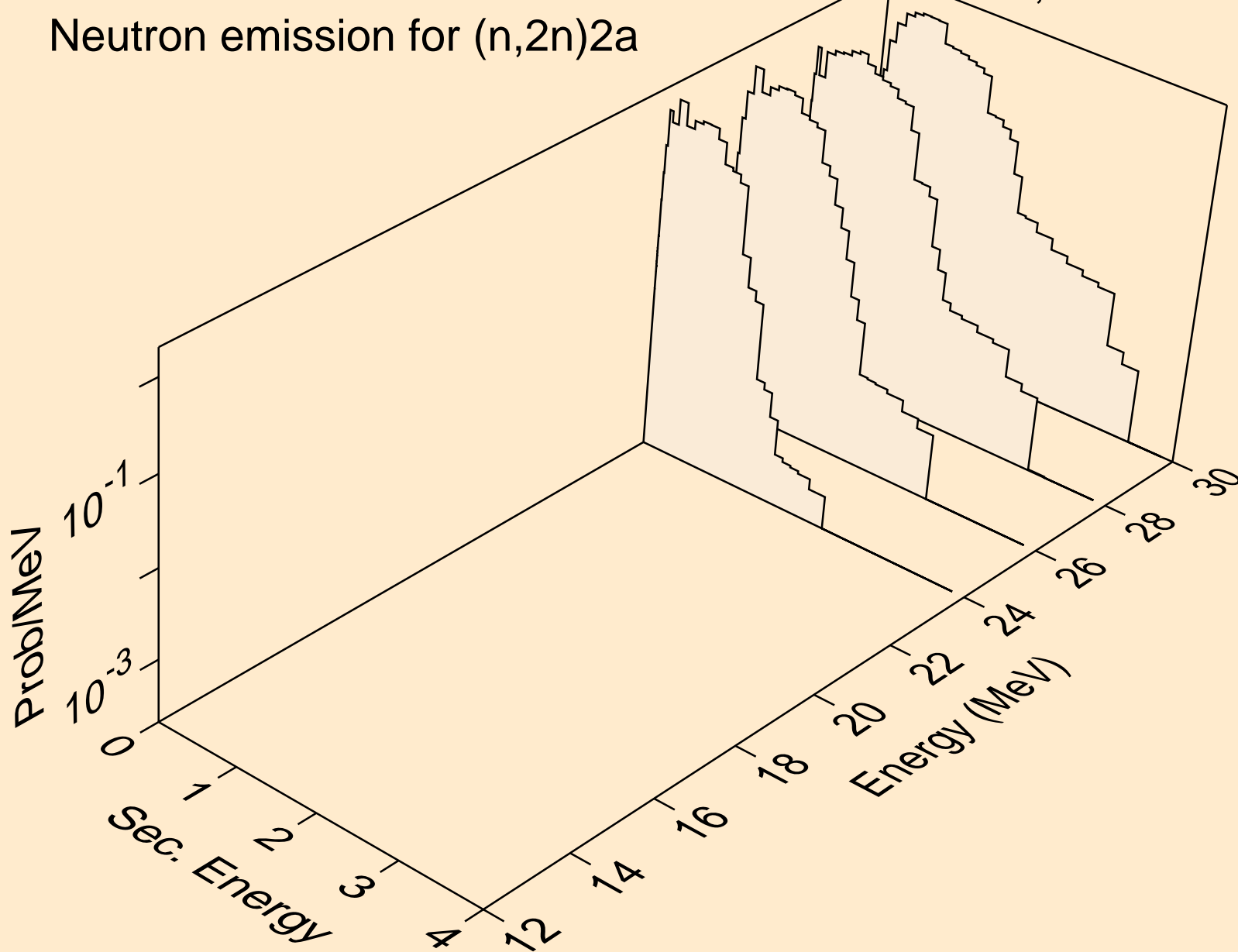

AG106 NEUTRON ACER TENDL-2019 LIBRARY; T=293.16K  
Neutron emission for (n,n\*)d

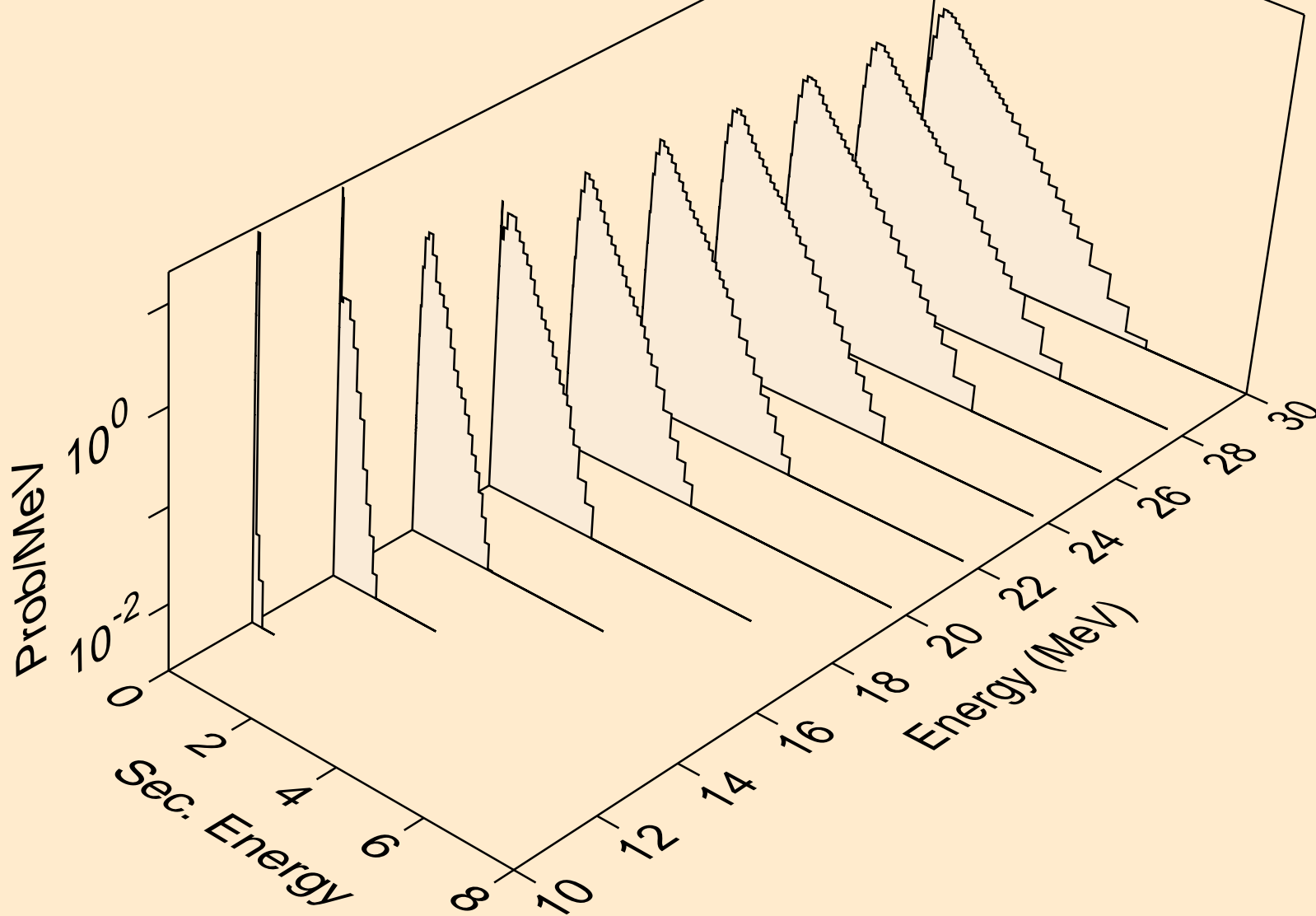



AG106 NEUTRON ACER TENDL-2019 LIBRARY; T=293.16K  
Neutron emission for (n,n\*)t

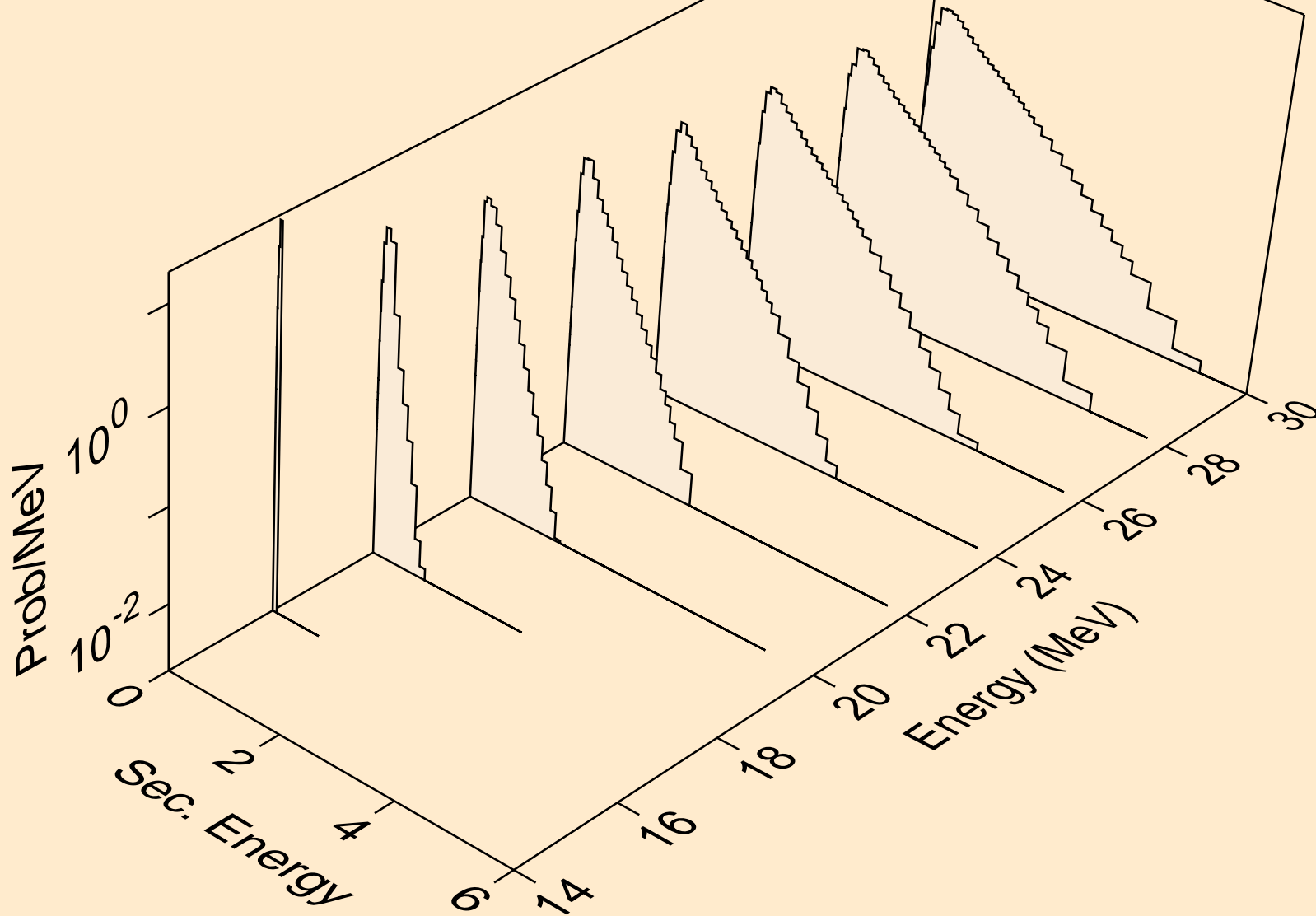

AG106 NEUTRON ACER TENDL-2019 LIBRARY; T=293.16K  
Neutron emission for (n,n\*)he3

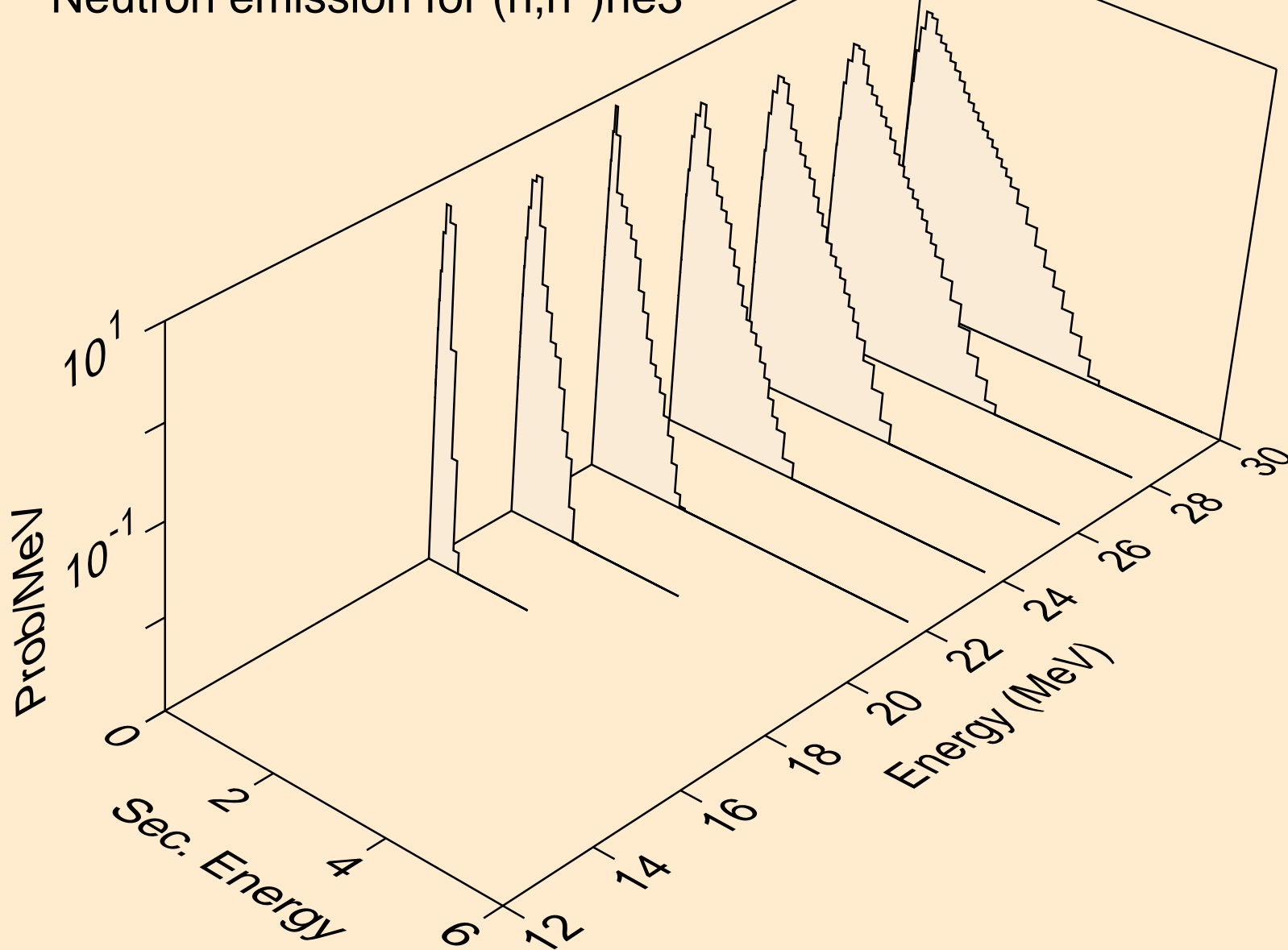

AG106 NEUTRON ACER TENDL-2019 LIBRARY; T=293.16K  
Neutron emission for (n,4n)

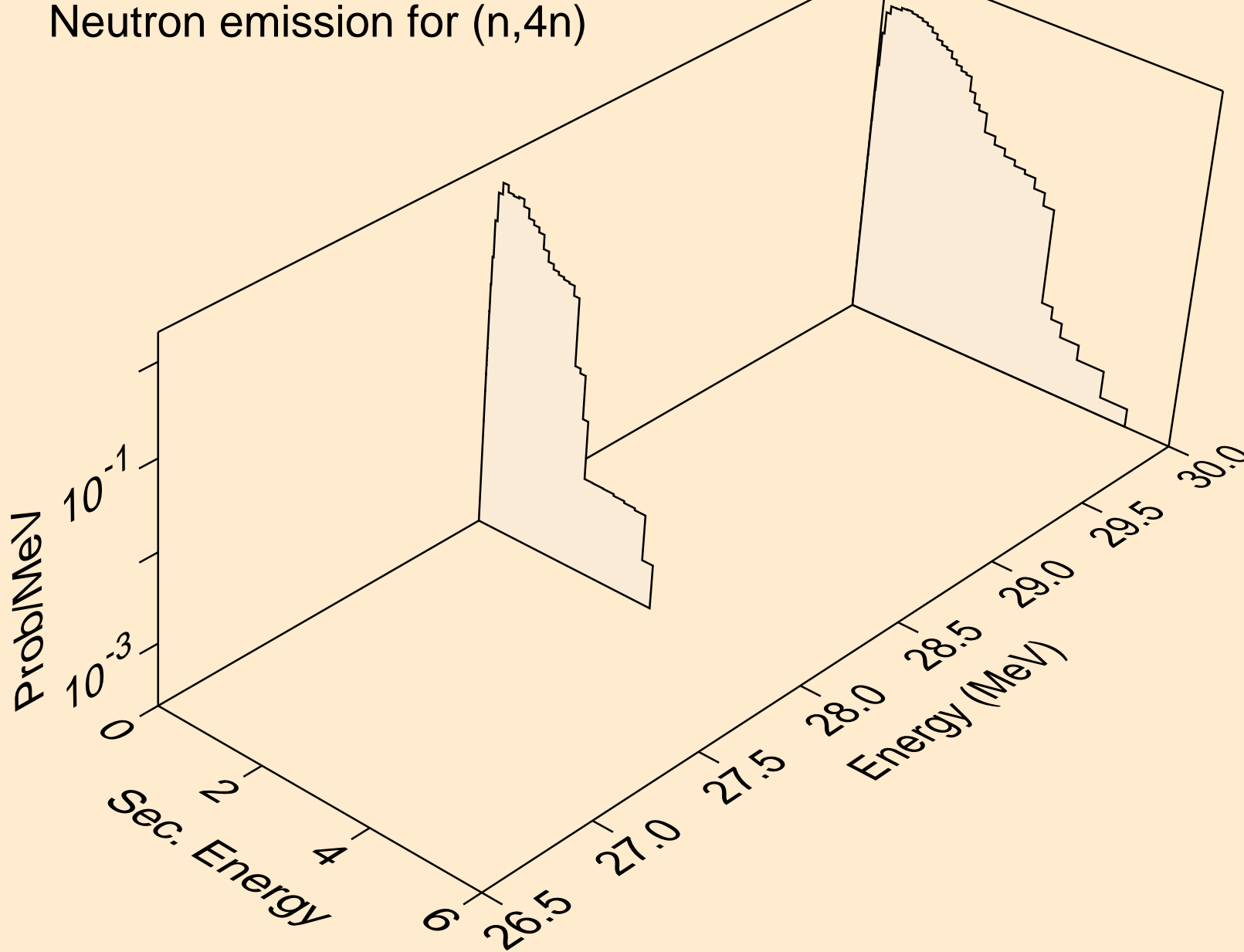

AG106 NEUTRON ACER TENDL-2019 LIBRARY; T=293.16K  
Neutron emission for (n,2np)

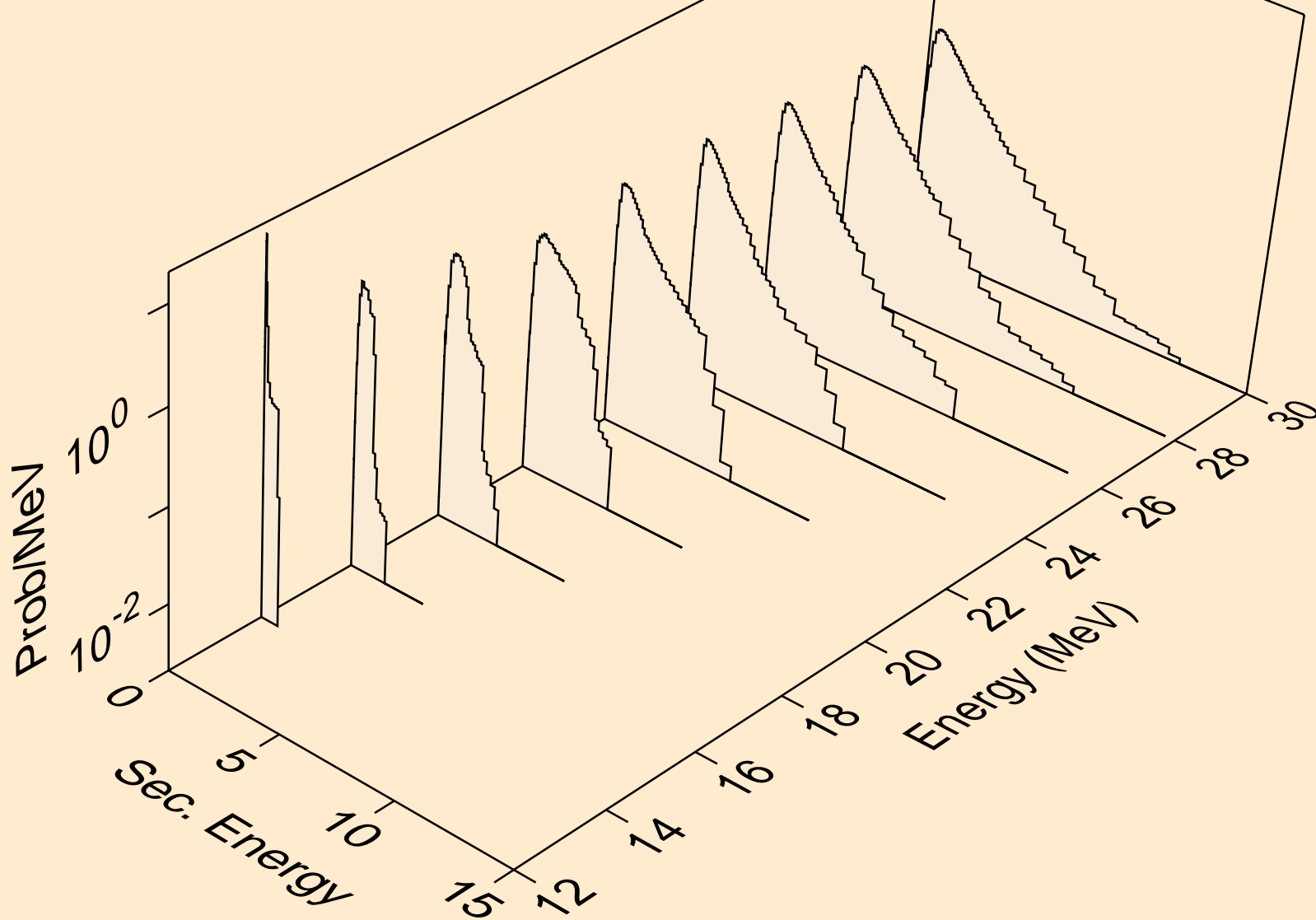

AG106 NEUTRON ACER TENDL-2019 LIBRARY; T=293.16K  
Neutron emission for (n,3np)

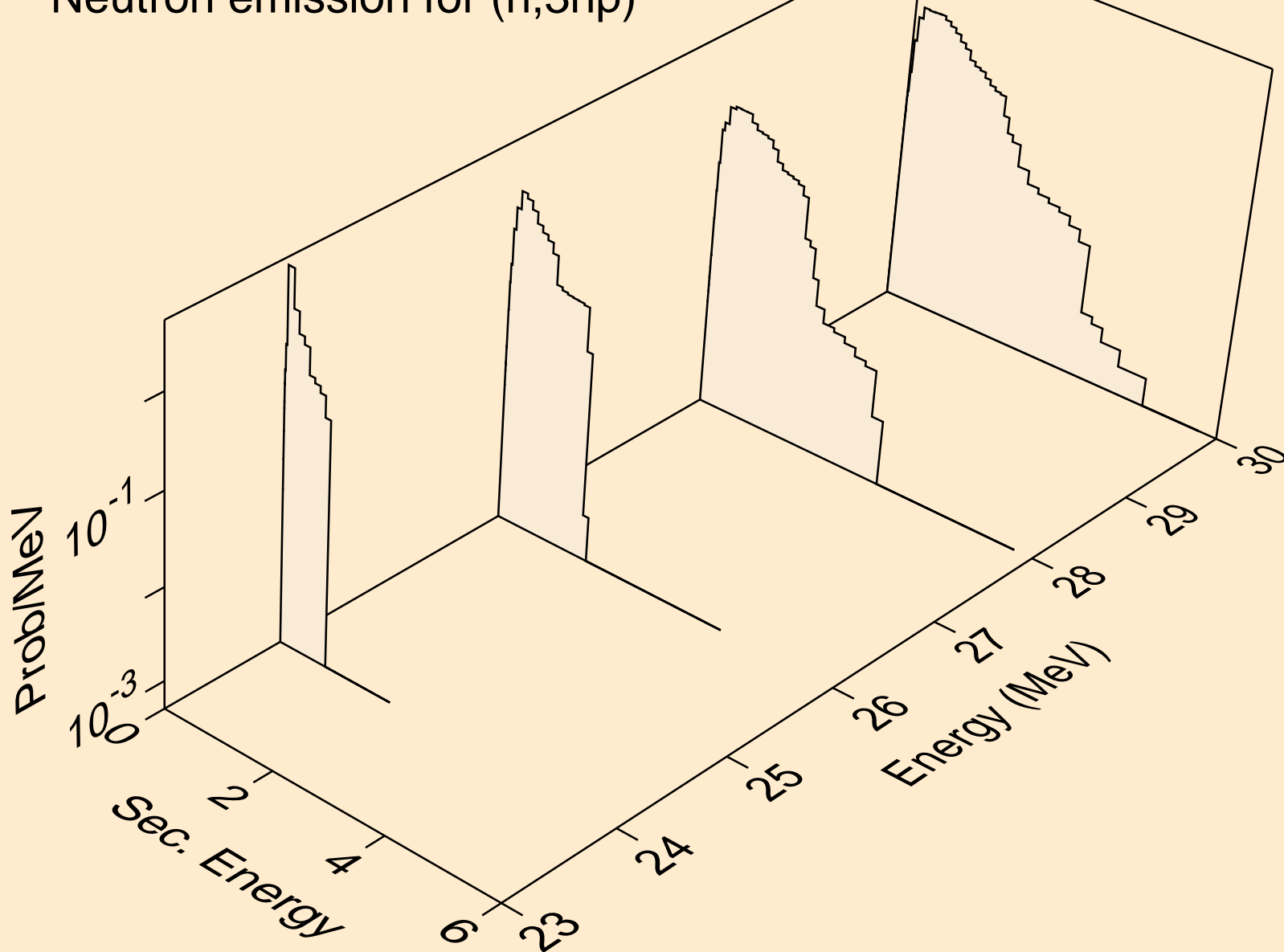

AG106 NEUTRON ACER TENDL-2019 LIBRARY; T=293.16K  
Neutron emission for (n,2np)

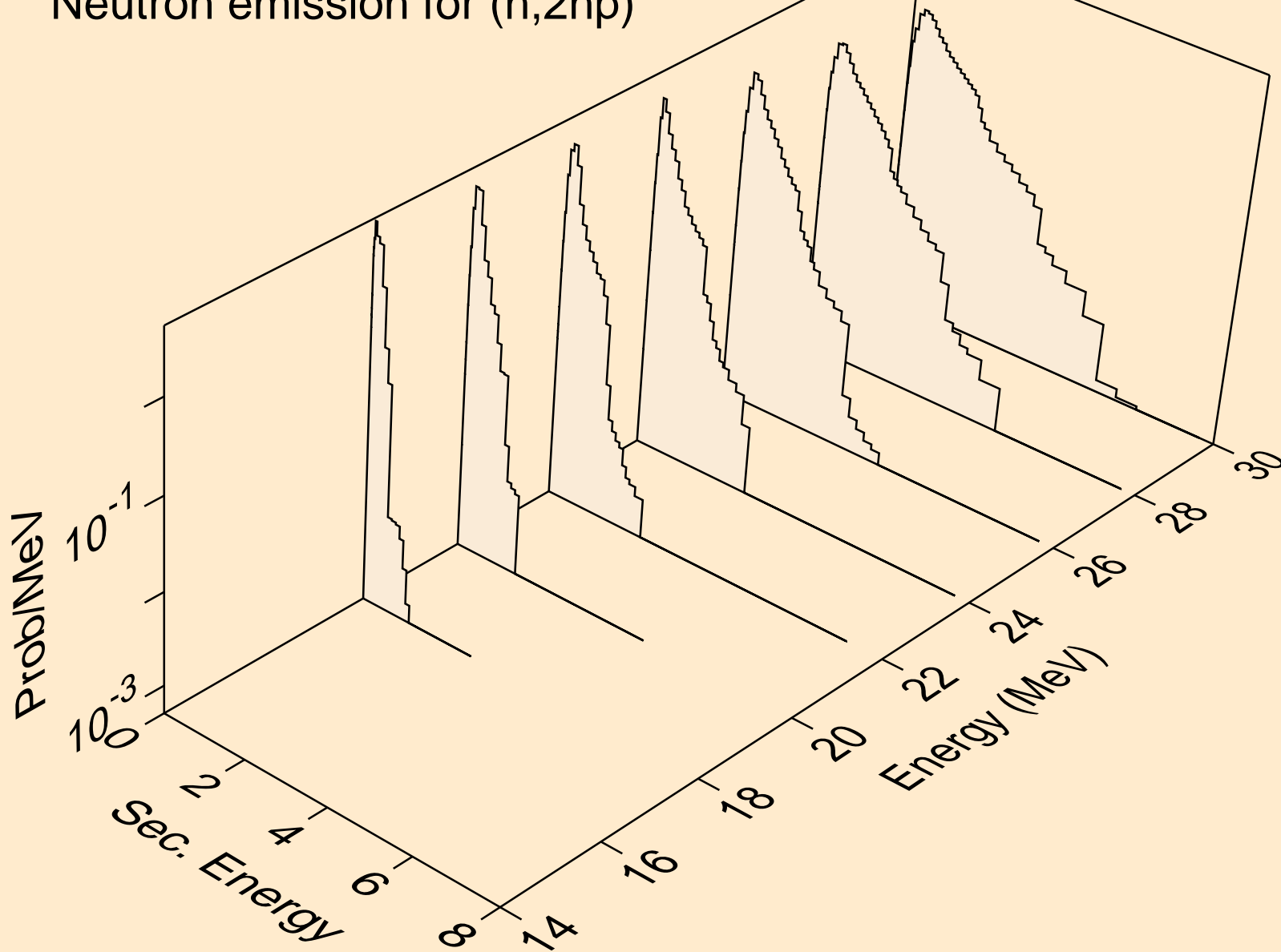

AG106 NEUTRON ACER TENDL-2019 LIBRARY; T=293.16K  
Neutron emission for (n,npa)

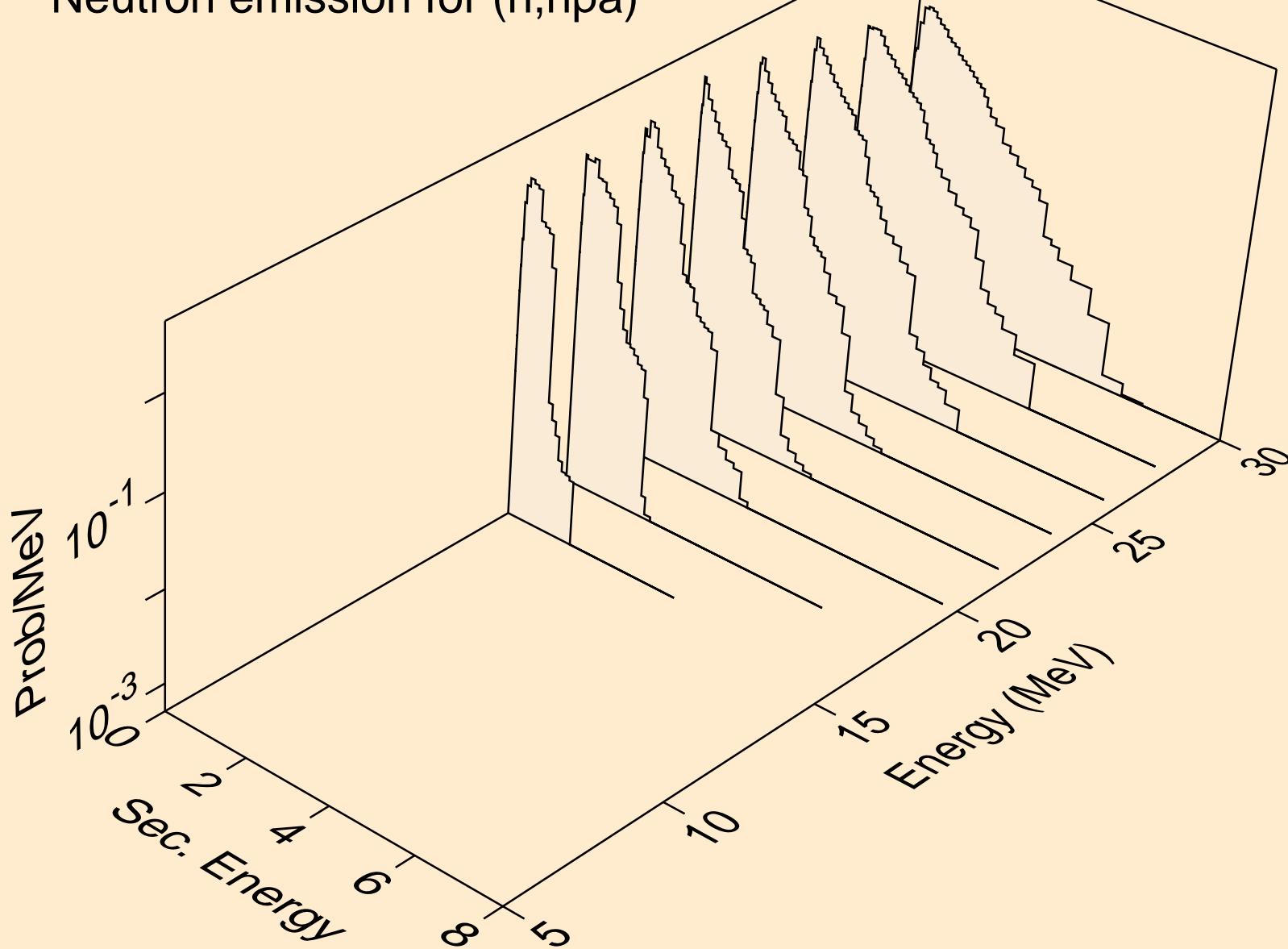

AG106 NEUTRON ACER TENDL-2019 LIBRARY; T=293.16K  
Neutron emission for (n,n\*c)

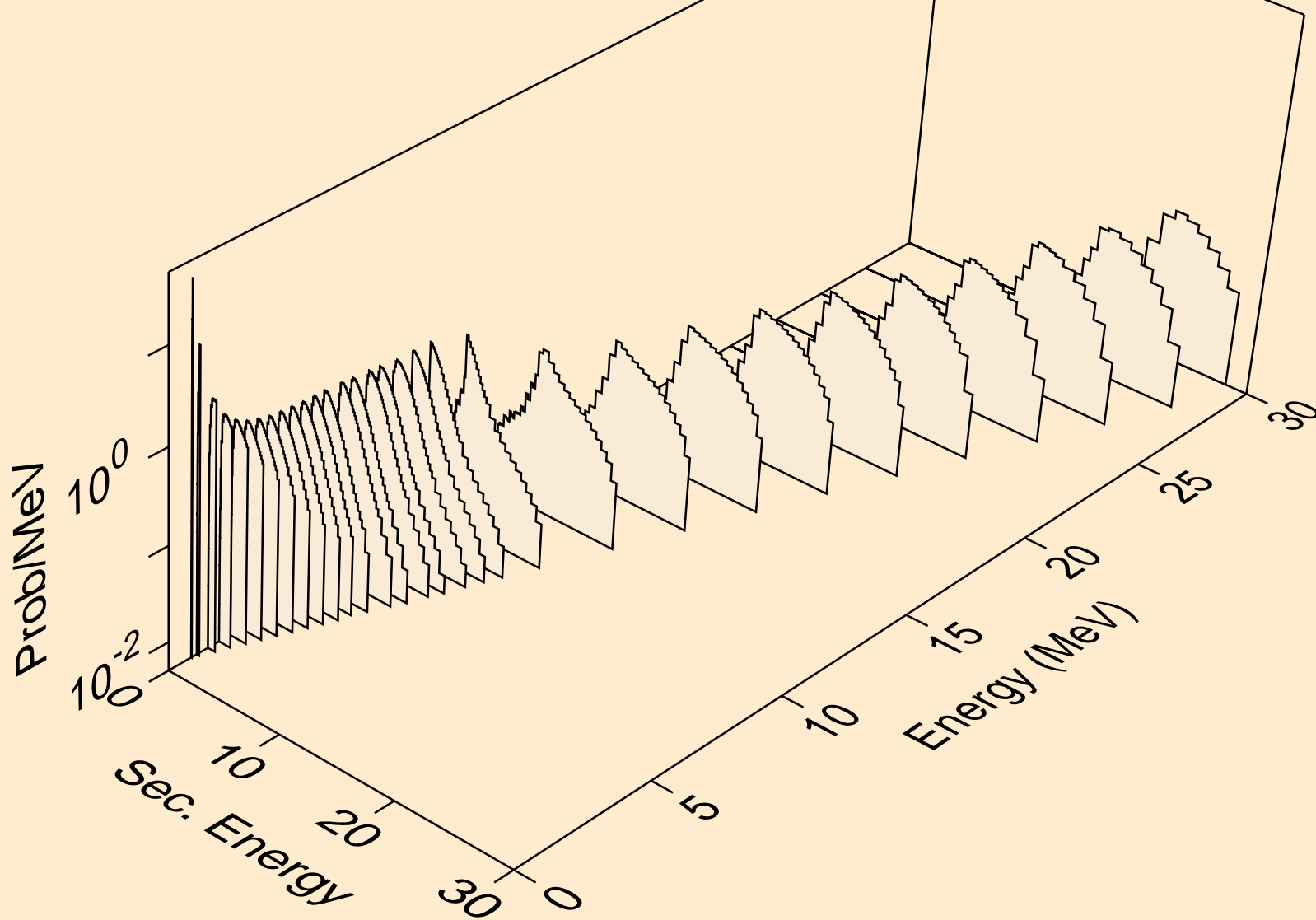



AG106 NEUTRON ACER TENDL-2019 LIBRARY; T=293.16K  
Photon emission for (n,x)

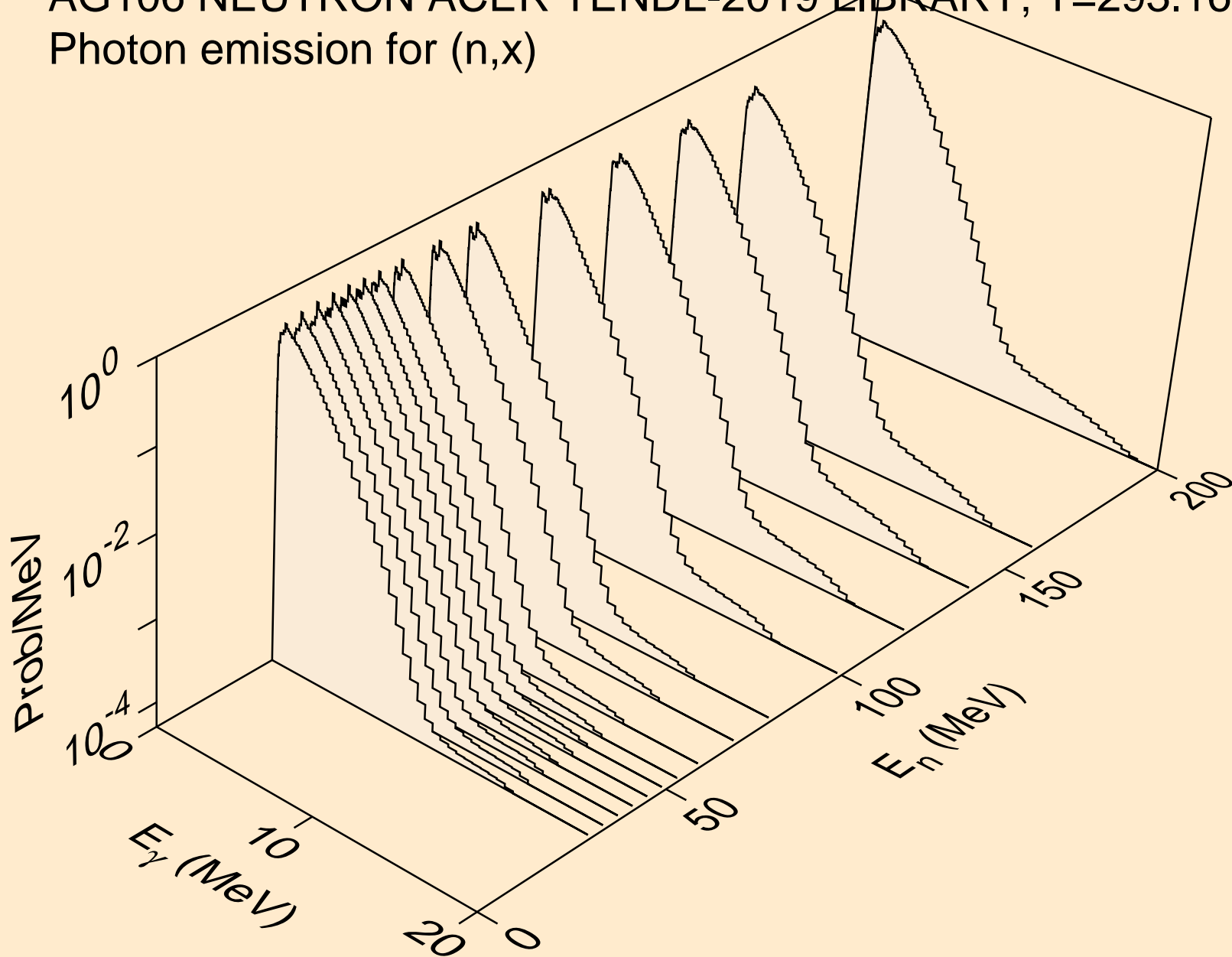

AG106 NEUTRON ACER TENDL-2019 LIBRARY; T=293.16K  
Photon emission for (n,2nd)

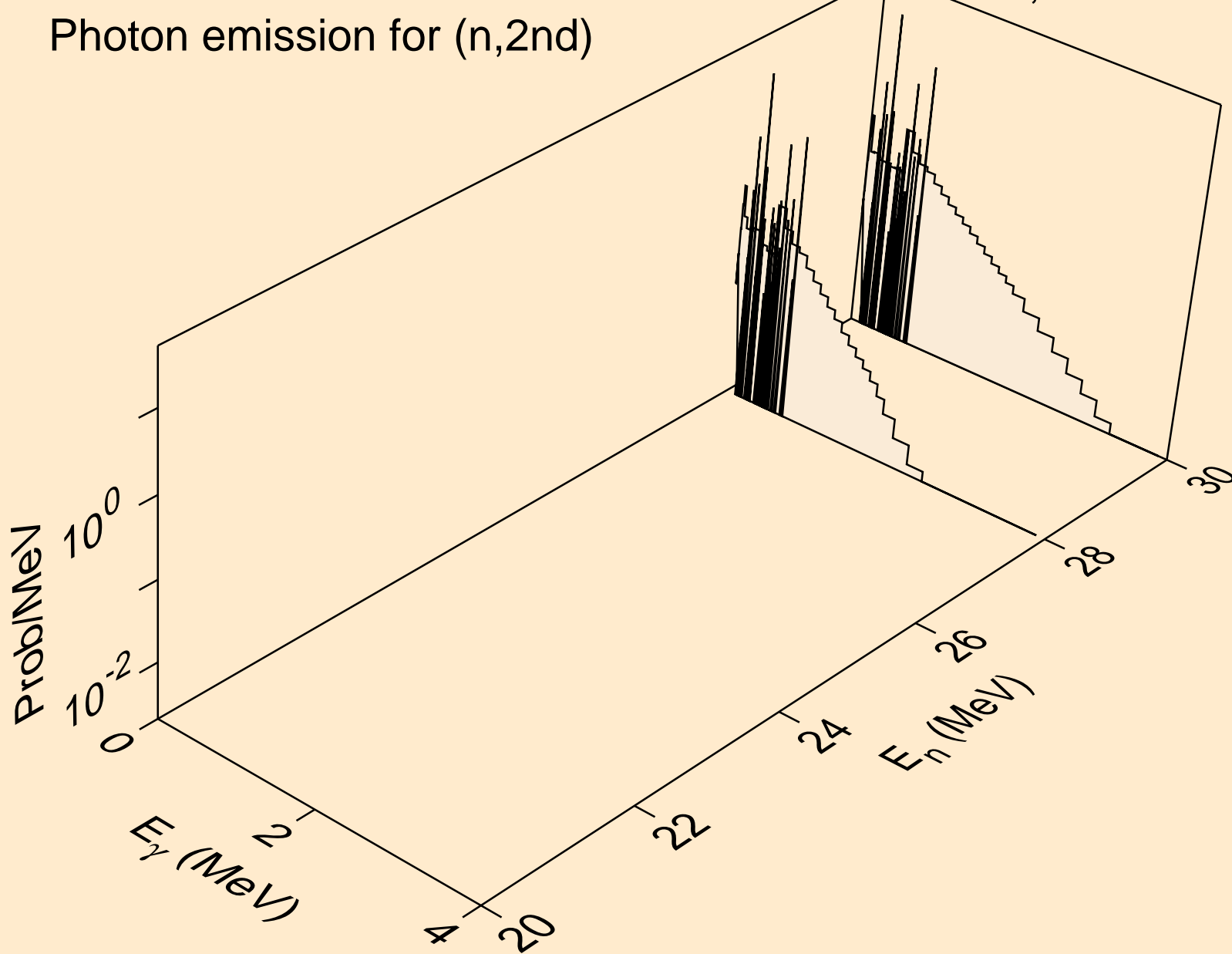

AG106 NEUTRON ACER TENDL-2019 LIBRARY; T=293.16K  
Photon emission for (n,2n)

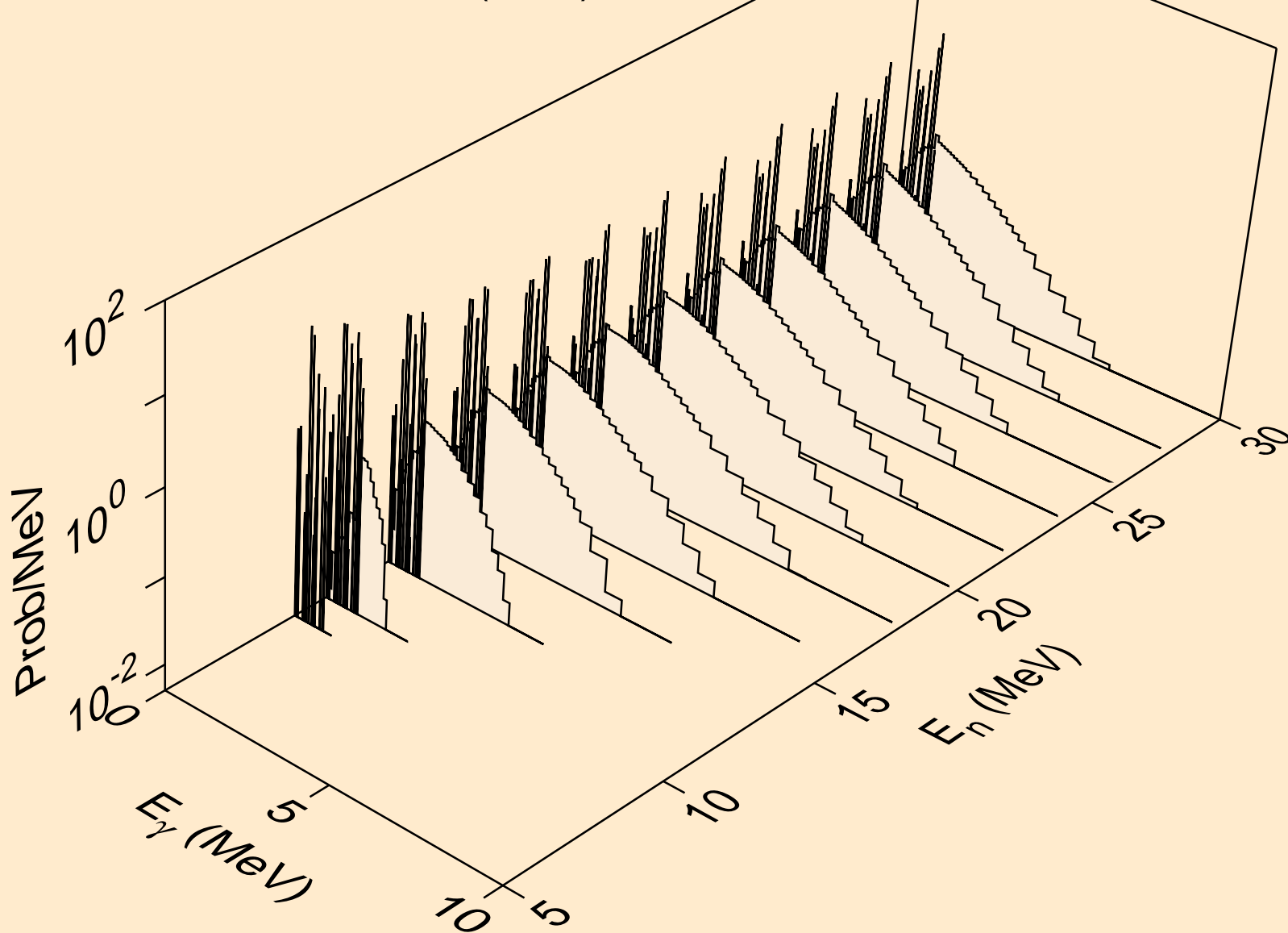

AG106 NEUTRON ACER TENDL-2019 LIBRARY; T=293.16K  
Photon emission for (n,3n)

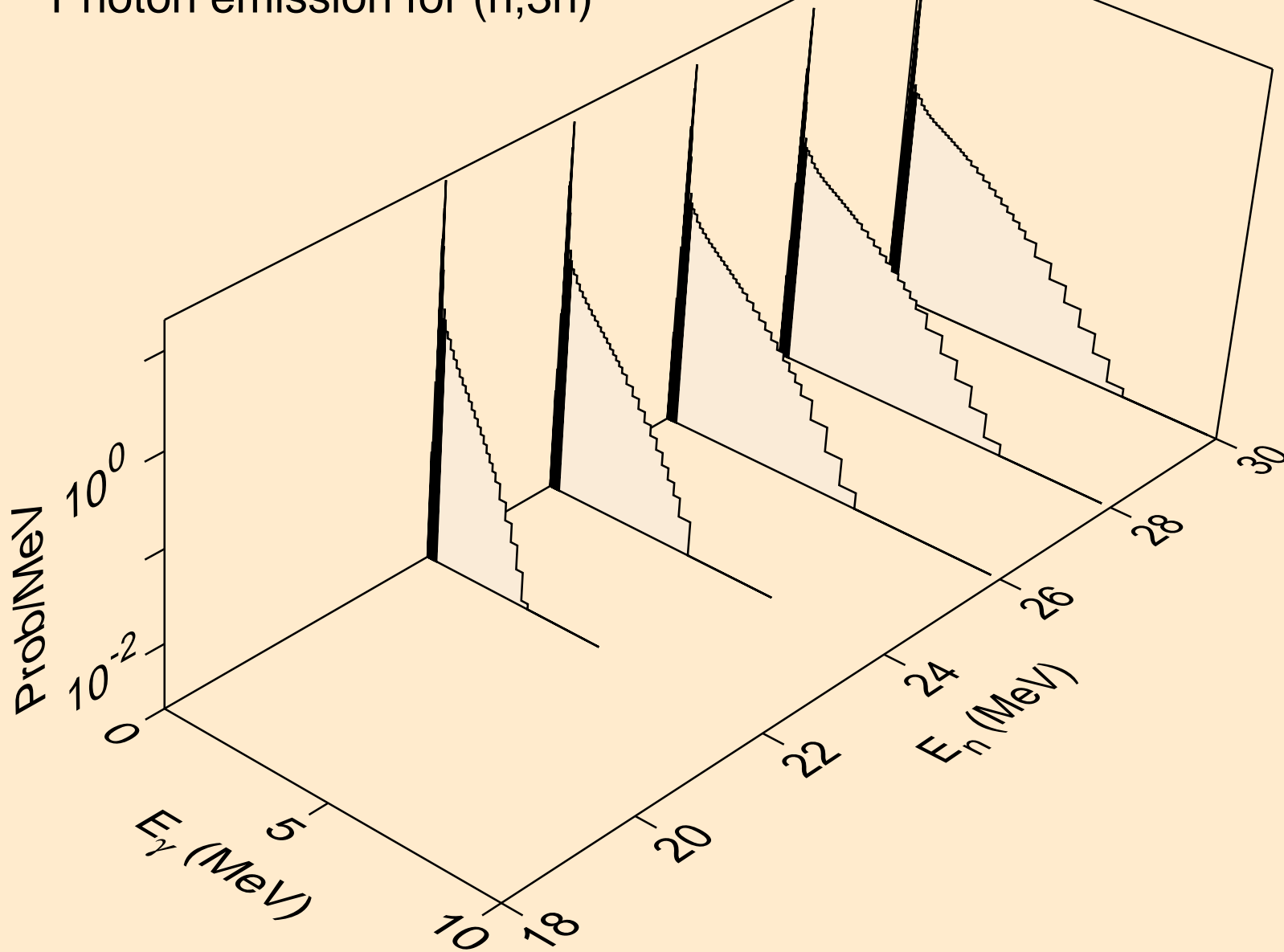

AG106 NEUTRON ACER TENDL-2019 LIBRARY; T=293.16K  
Photon emission for (n,n\*)a

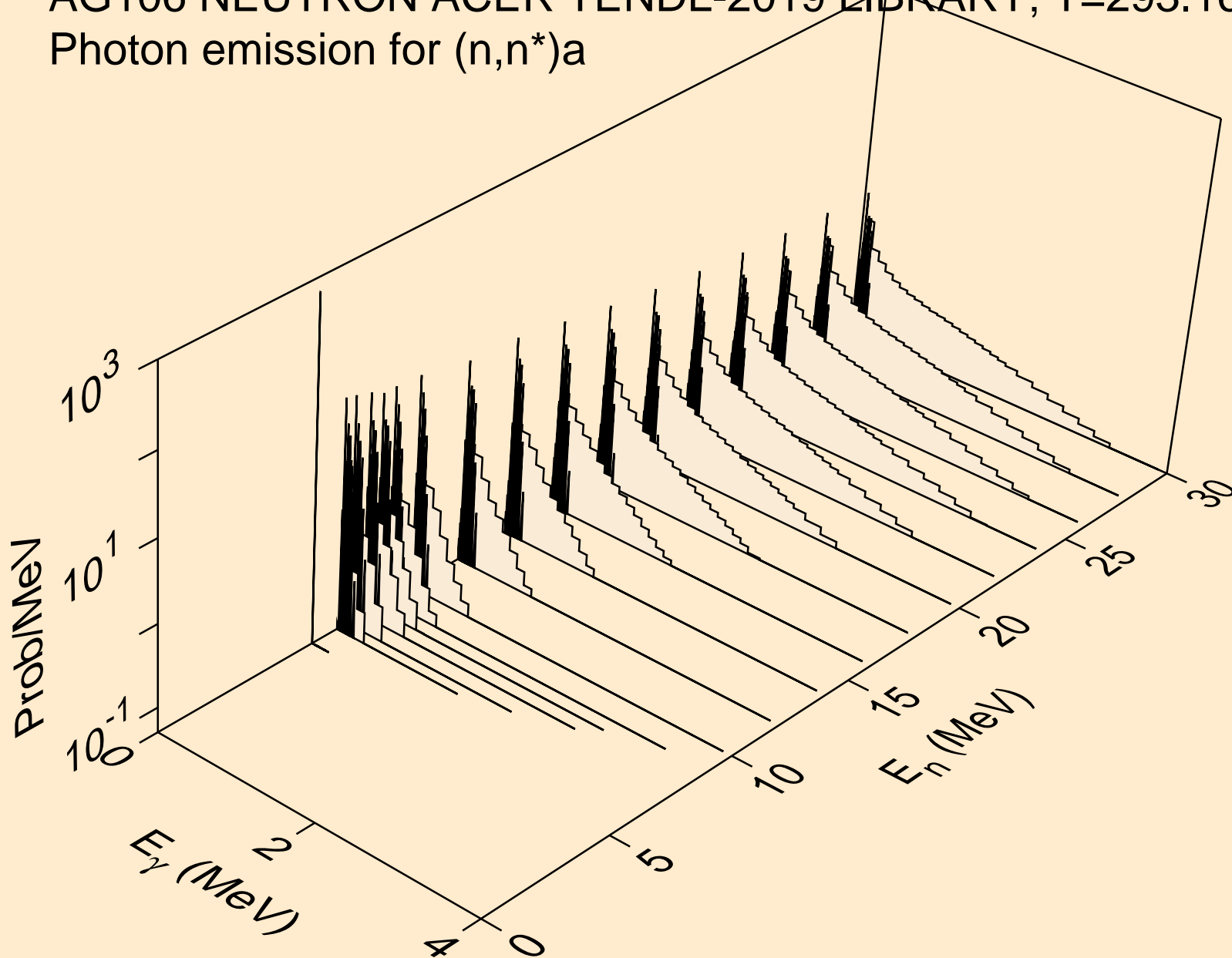

AG106 NEUTRON ACER TENDL-2019 LIBRARY; T=293.16K  
Photon emission for (n,2n)a

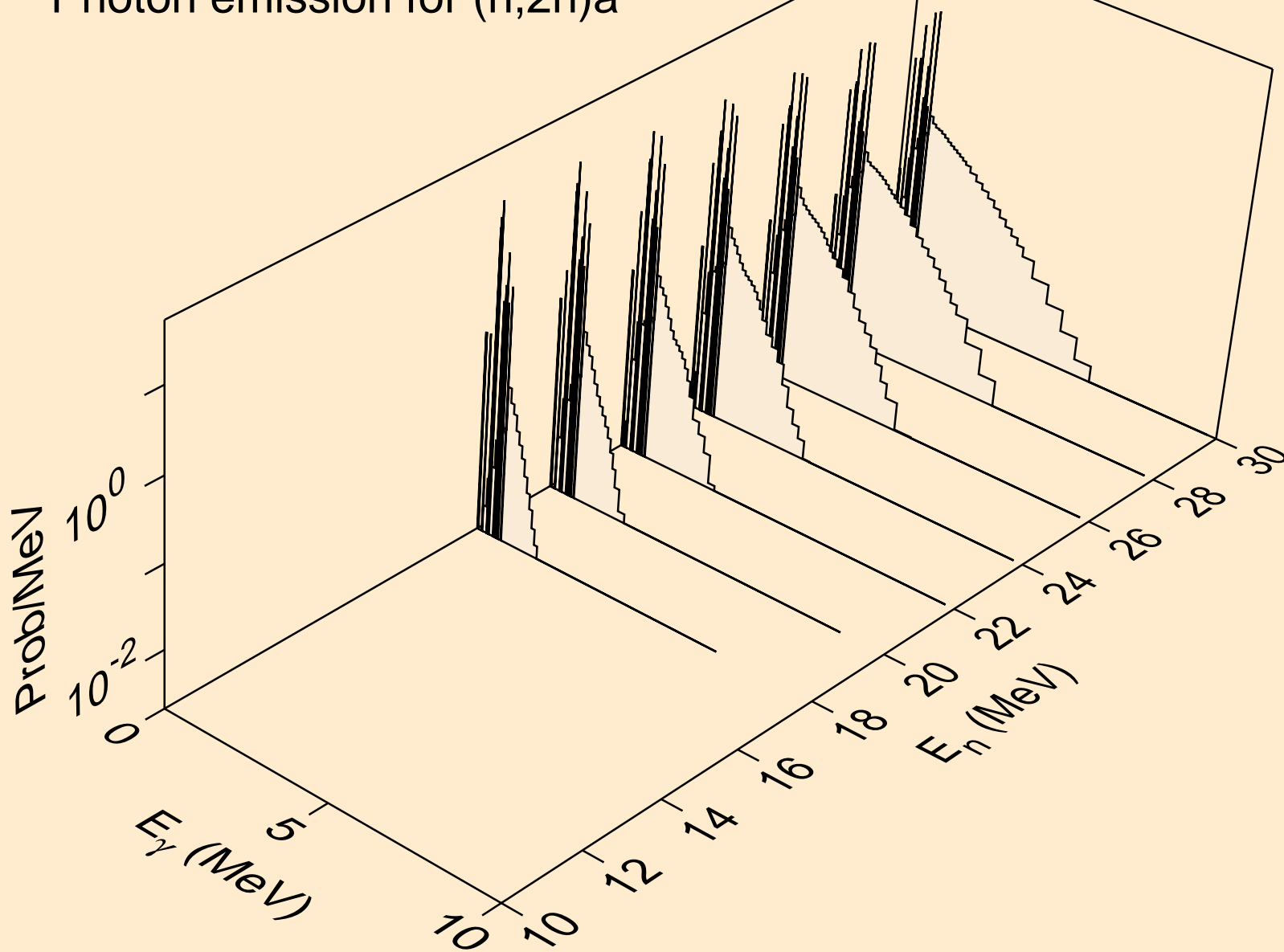

AG106 NEUTRON ACER TENDL-2019 LIBRARY; T=293.16K  
Photon emission for (n,3n)a

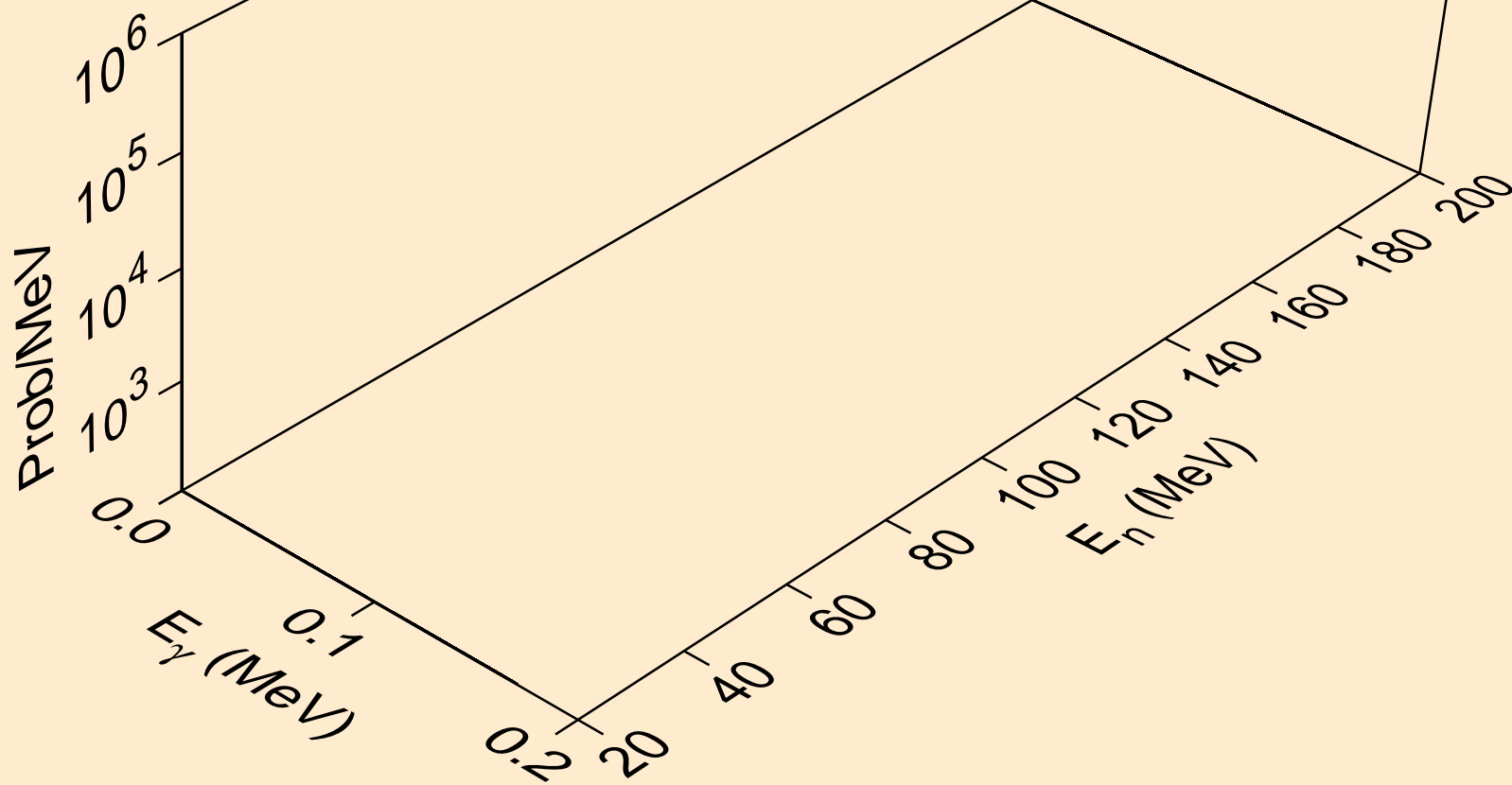

AG106 NEUTRON ACER TENDL-2019 LIBRARY; T=293.16K  
Photon emission for (n,n\*)p

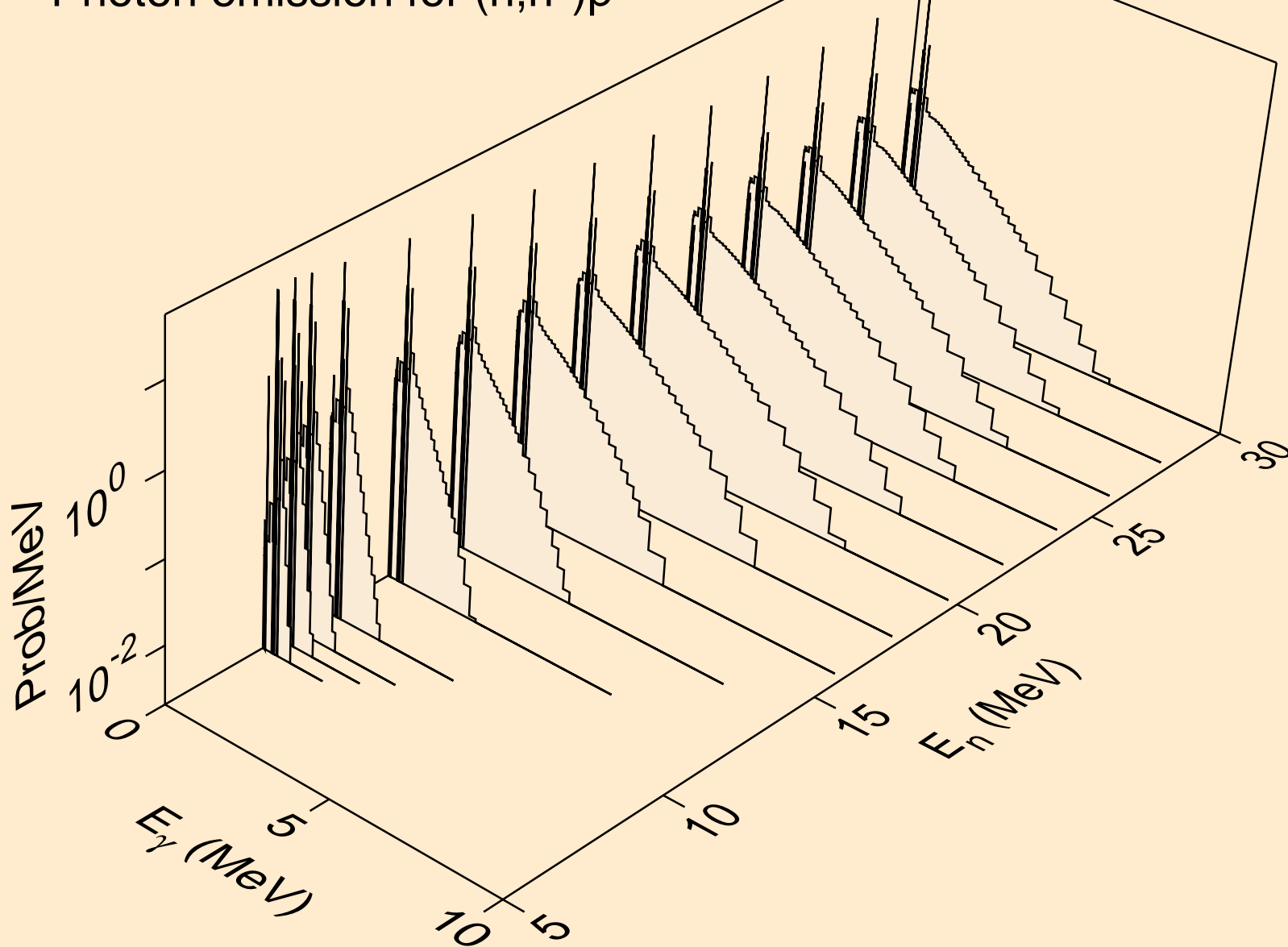



AG106 NEUTRON ACER TENDL-2019 LIBRARY; T=293.16K  
Photon emission for (n,n\*)2a

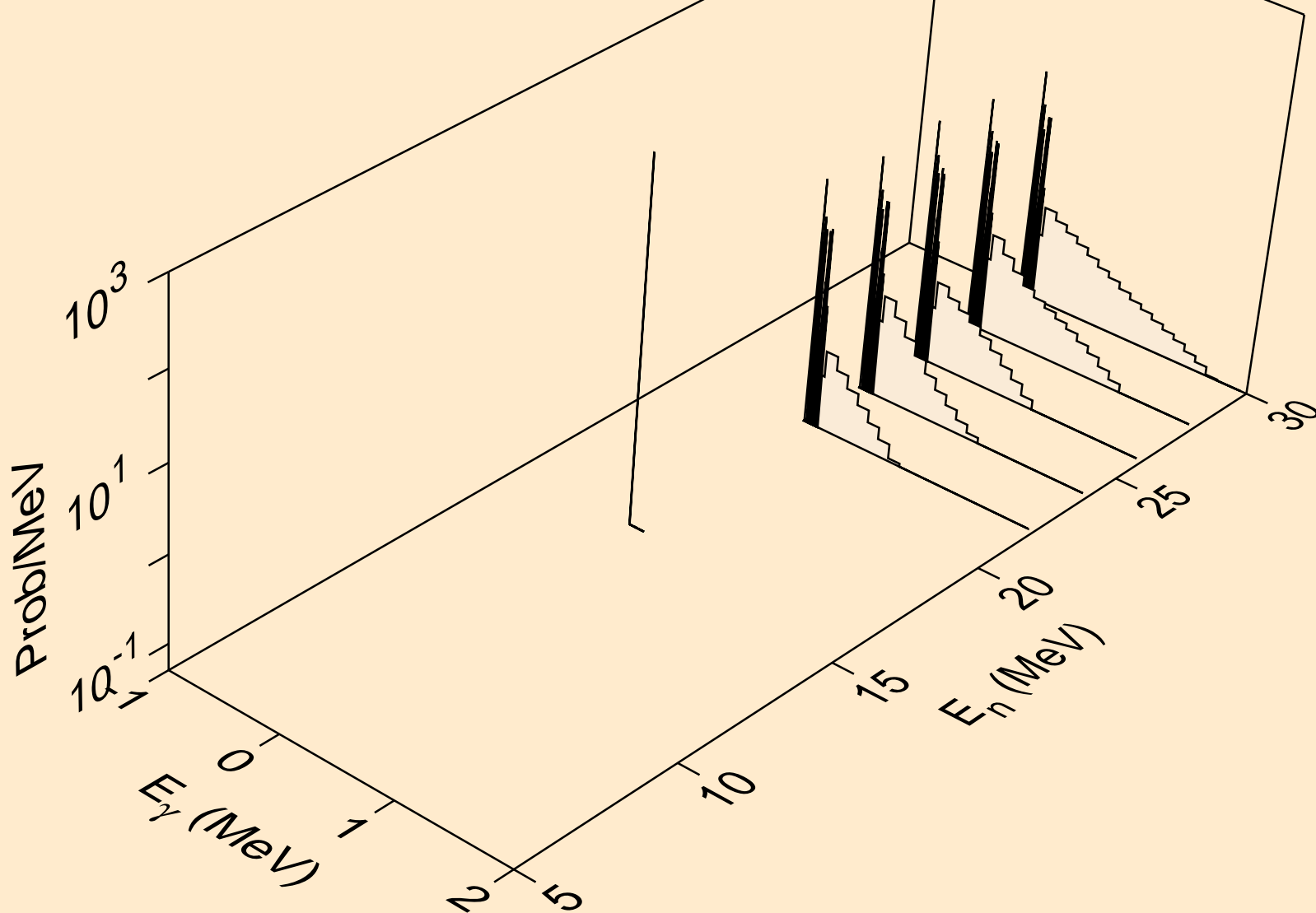

AG106 NEUTRON ACER TENDL-2019 LIBRARY; T=293.16K  
Photon emission for (n,2n)2a

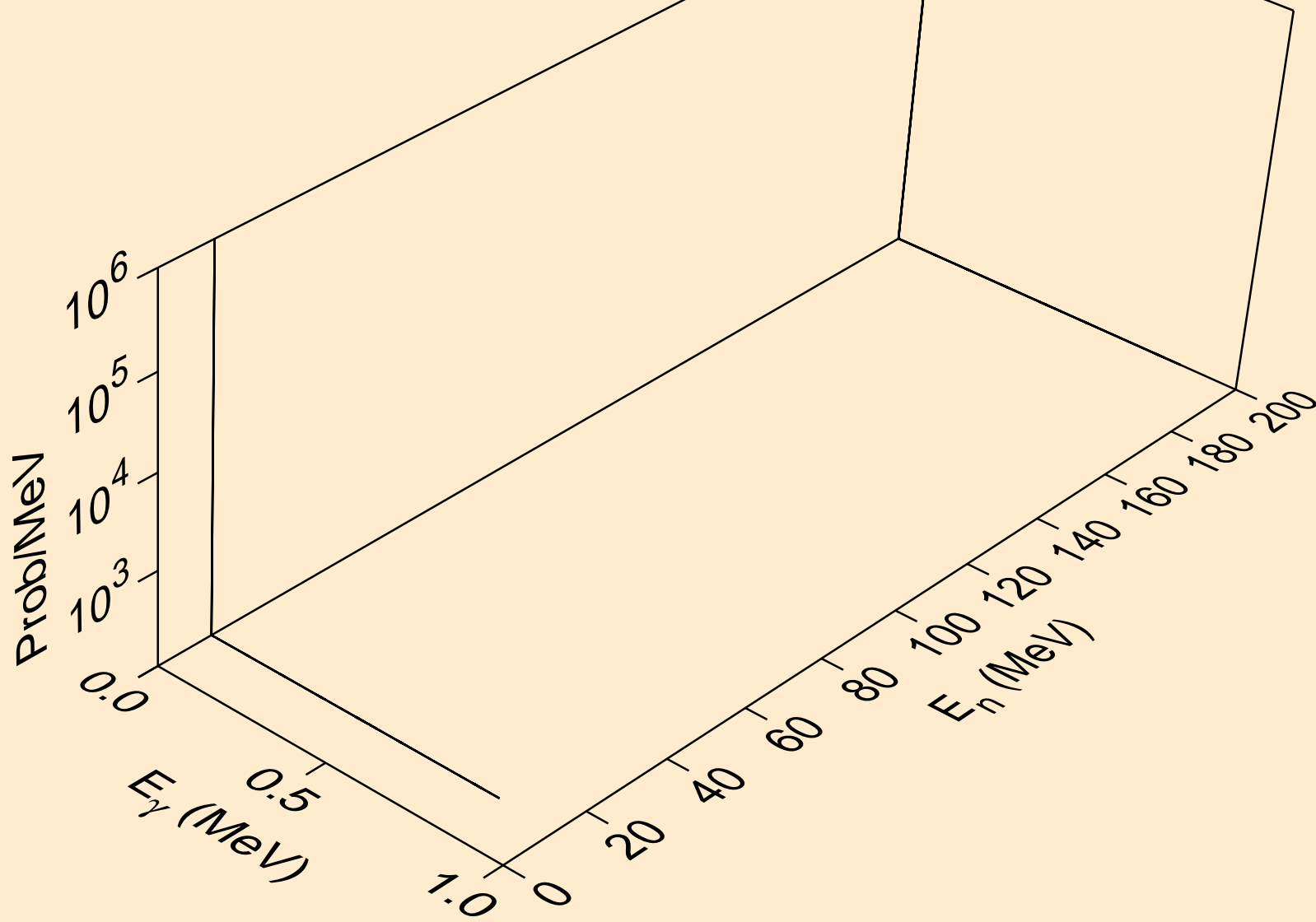

AG106 NEUTRON ACER TENDL-2019 LIBRARY; T=293.16K  
Photon emission for (n,n\*)d

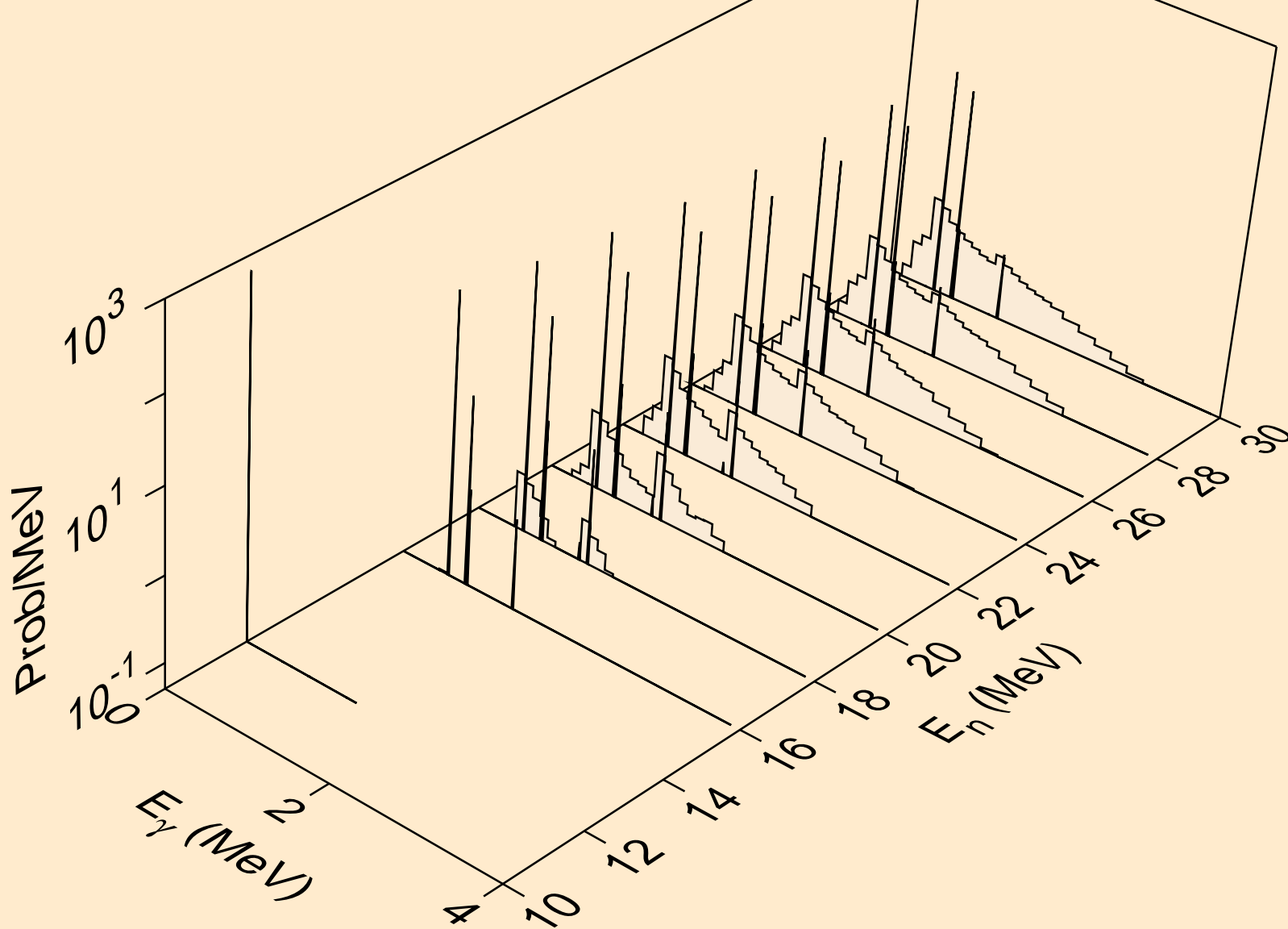

AG106 NEUTRON ACER TENDL-2019 LIBRARY; T=293.16K  
Photon emission for (n,n\*)t

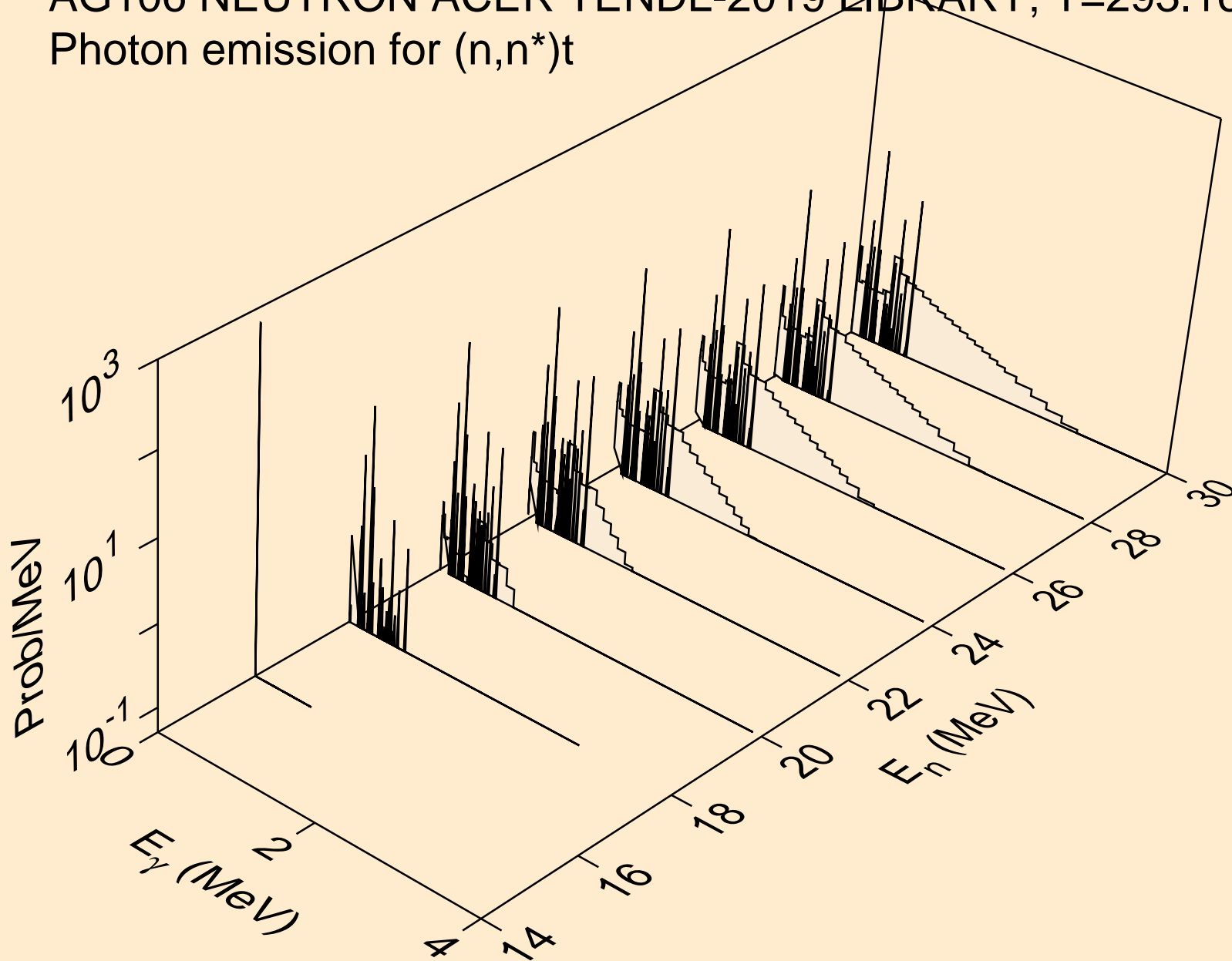

AG106 NEUTRON ACER TENDL-2019 LIBRARY; T=293.16K  
Photon emission for (n,n\*)he3

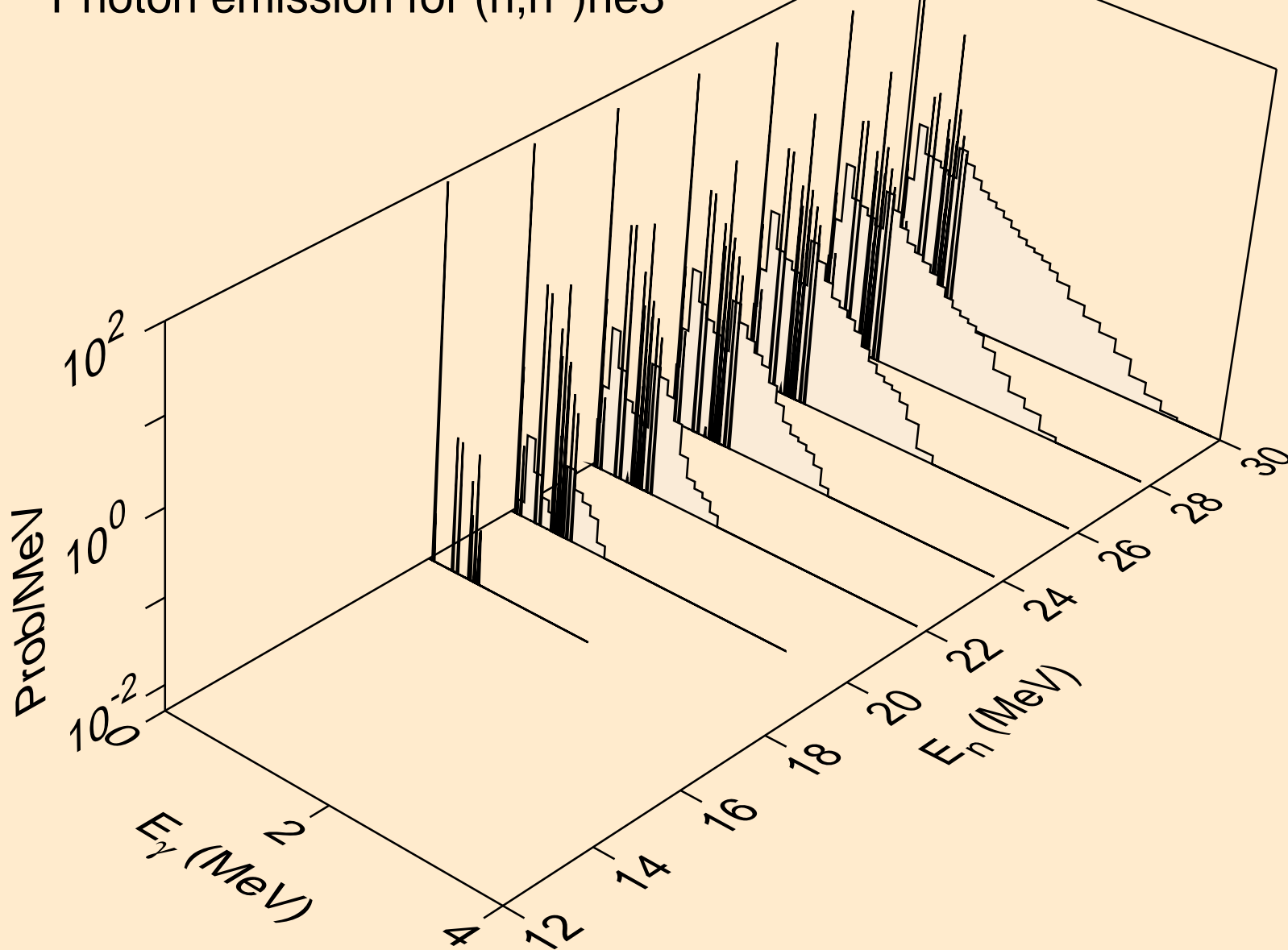

AG106 NEUTRON ACER TENDL-2019 LIBRARY; T=293.16K  
Photon emission for (n,4n)

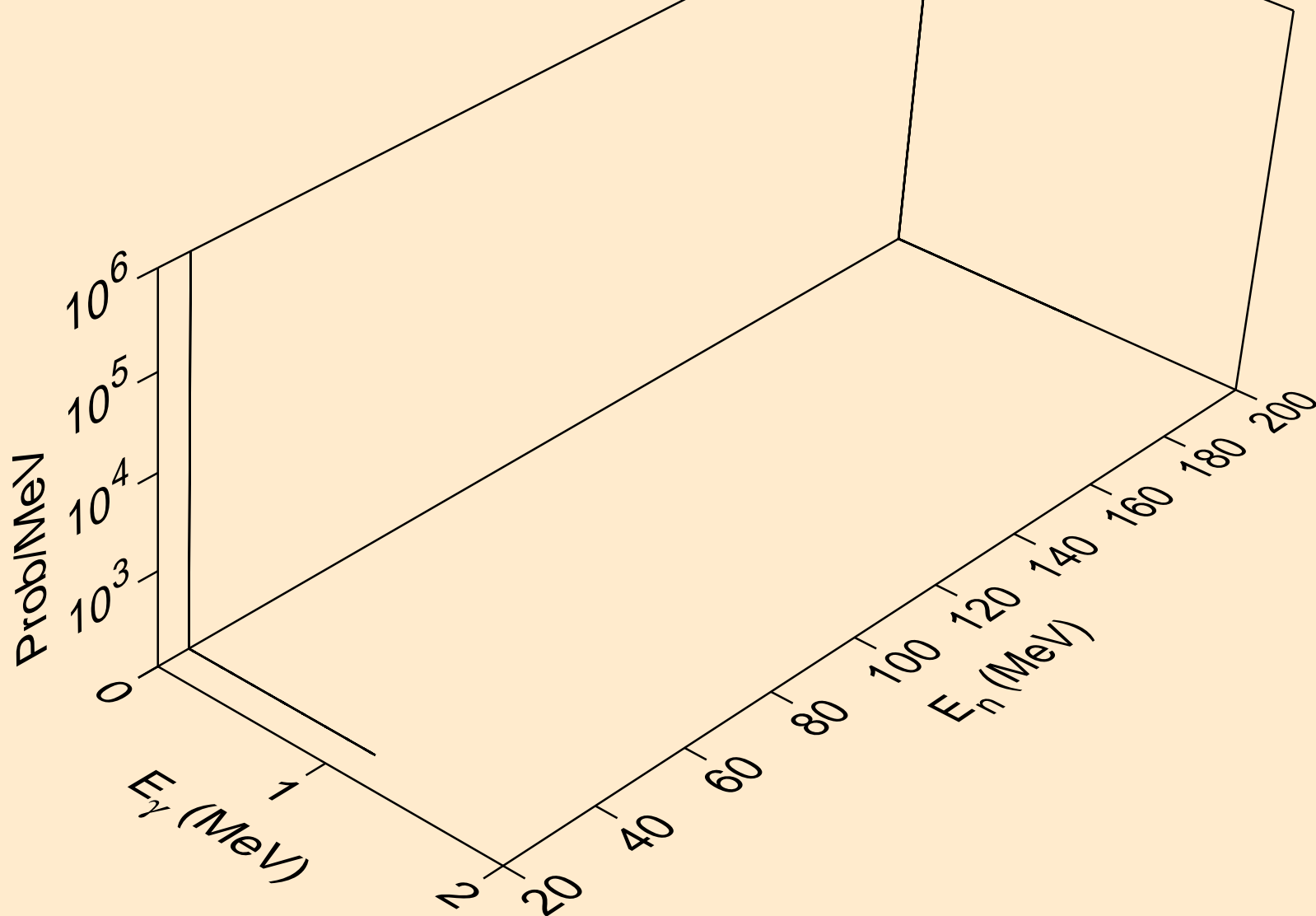

AG106 NEUTRON ACER TENDL-2019 LIBRARY; T=293.16K  
Photon emission for (n,2np)

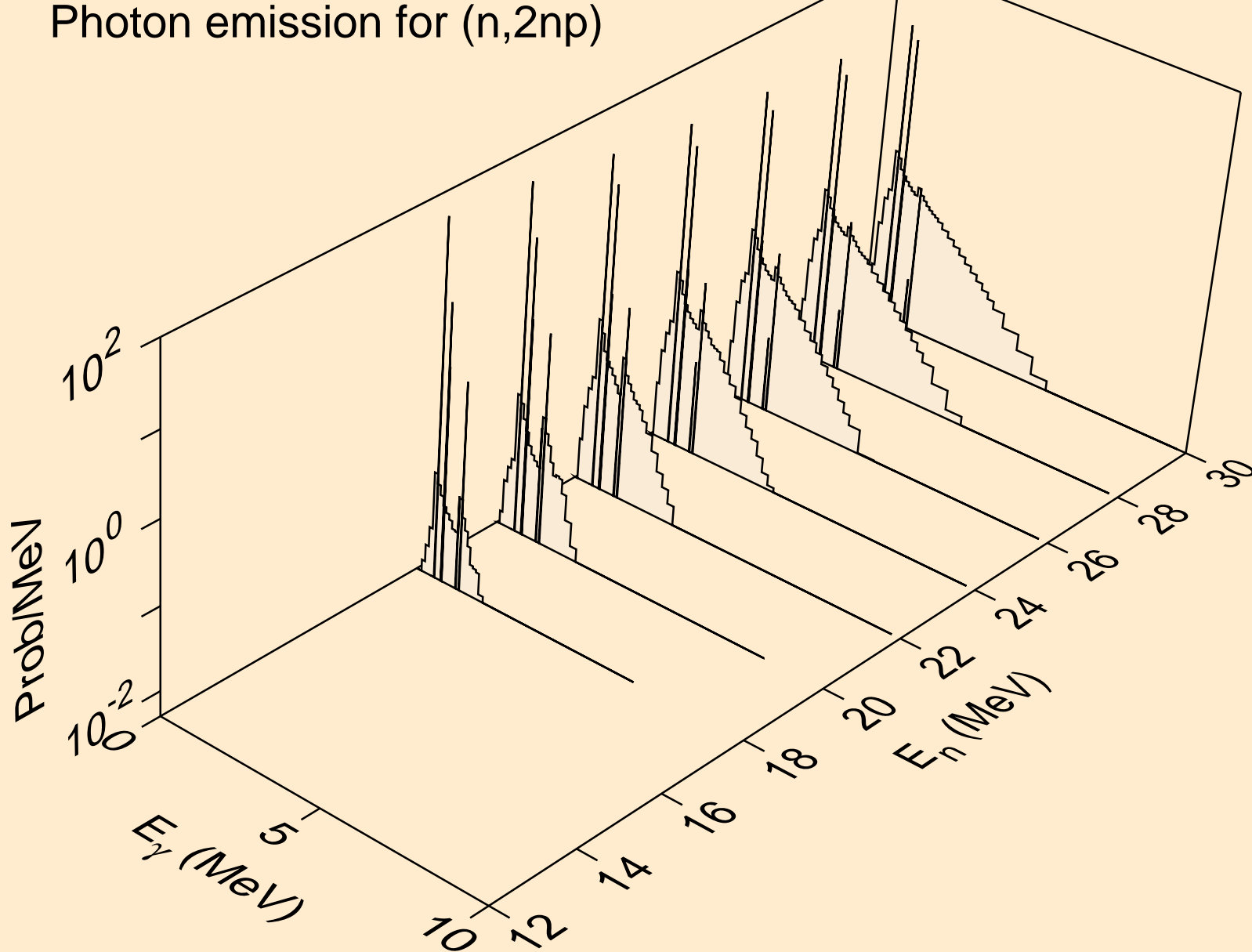

AG106 NEUTRON ACER TENDL-2019 LIBRARY; T=293.16K  
Photon emission for (n,3np)

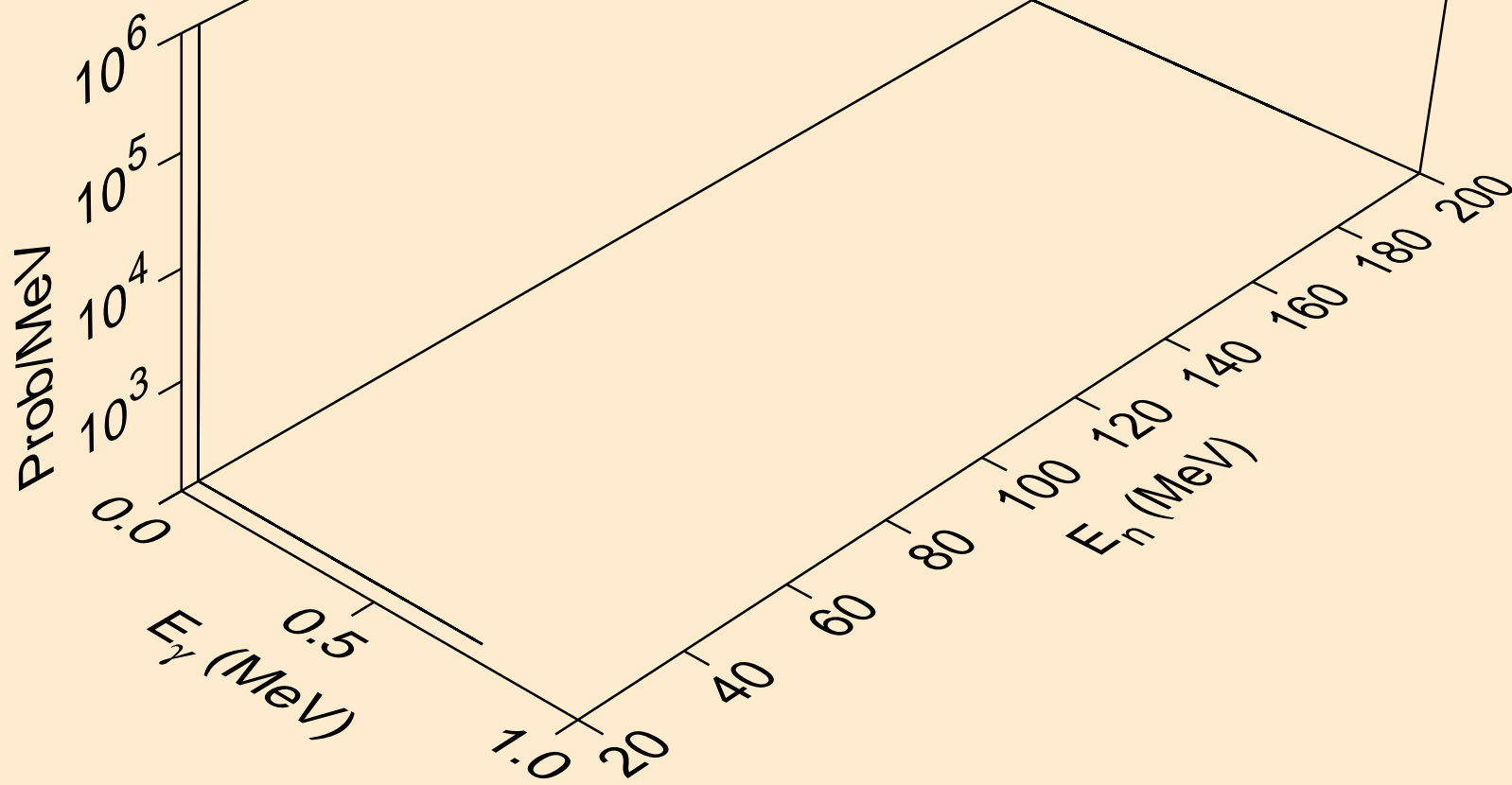



AG106 NEUTRON ACER TENDL-2019 LIBRARY; T=293.16K  
Photon emission for (n,2np)

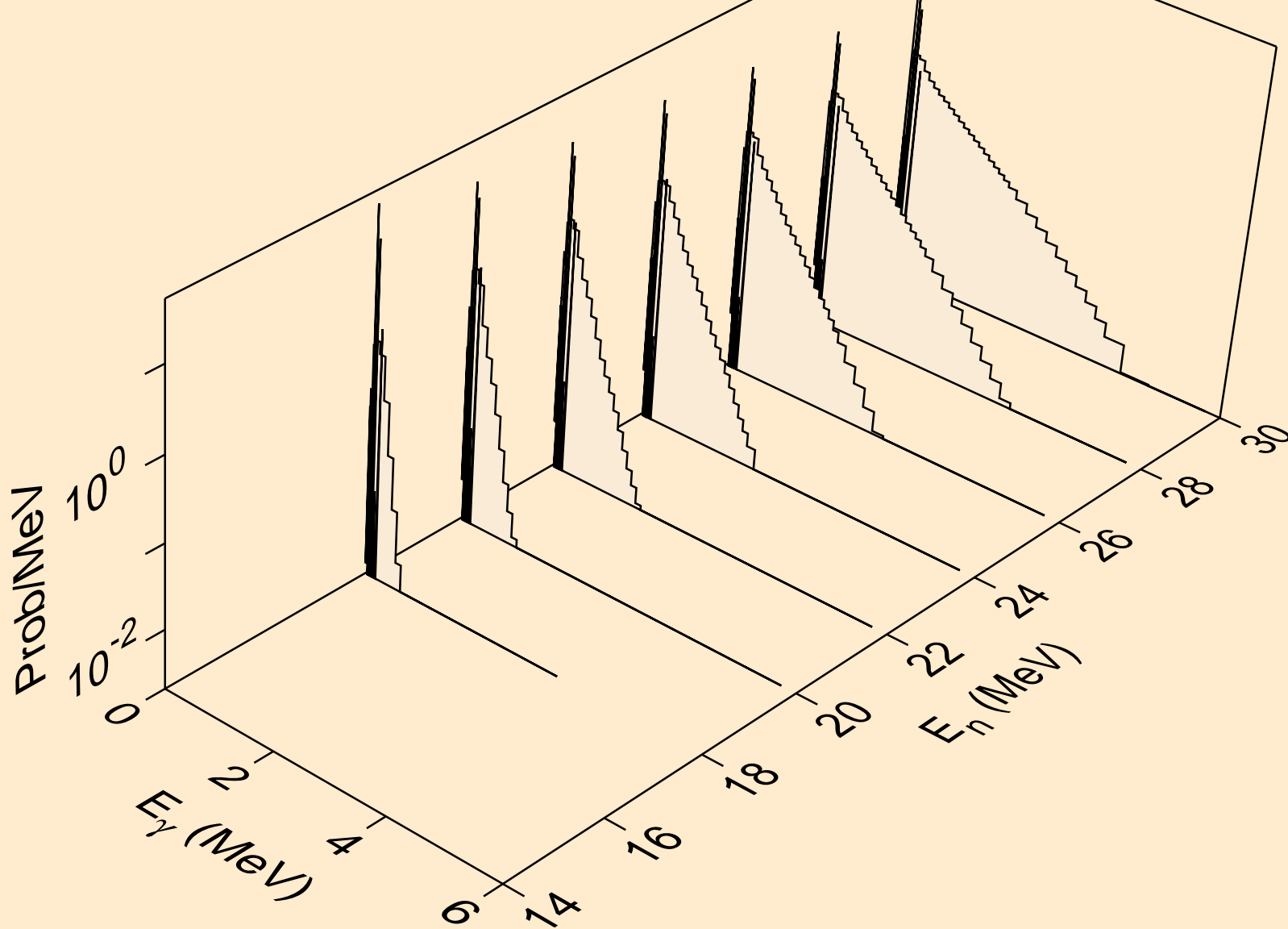

AG106 NEUTRON ACER TENDL-2019 LIBRARY; T=293.16K  
Photon emission for (n,npa)

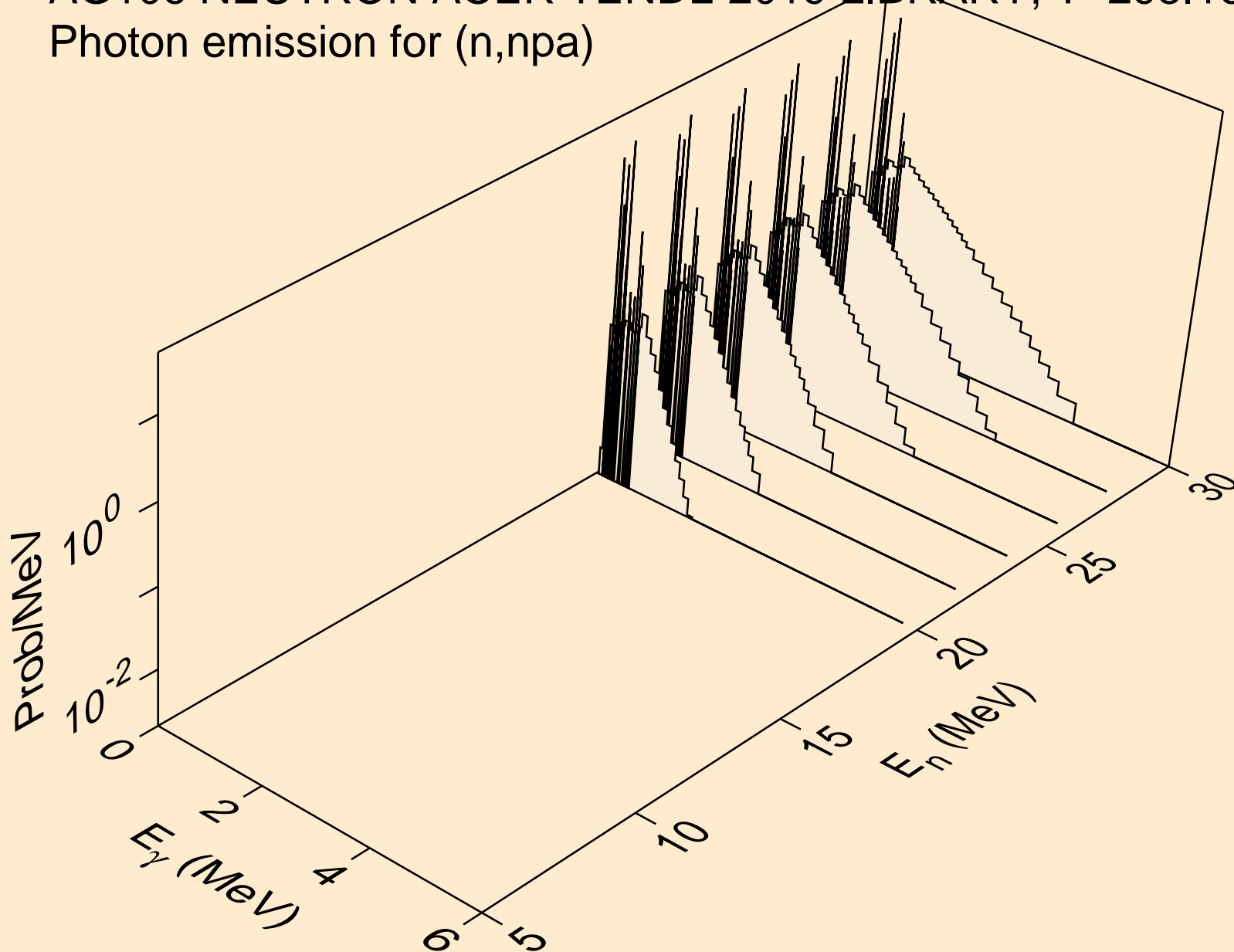

AG106 NEUTRON ACER TENDL-2019 LIBRARY; T=293.16K  
Photon emission for (n,n\*c)

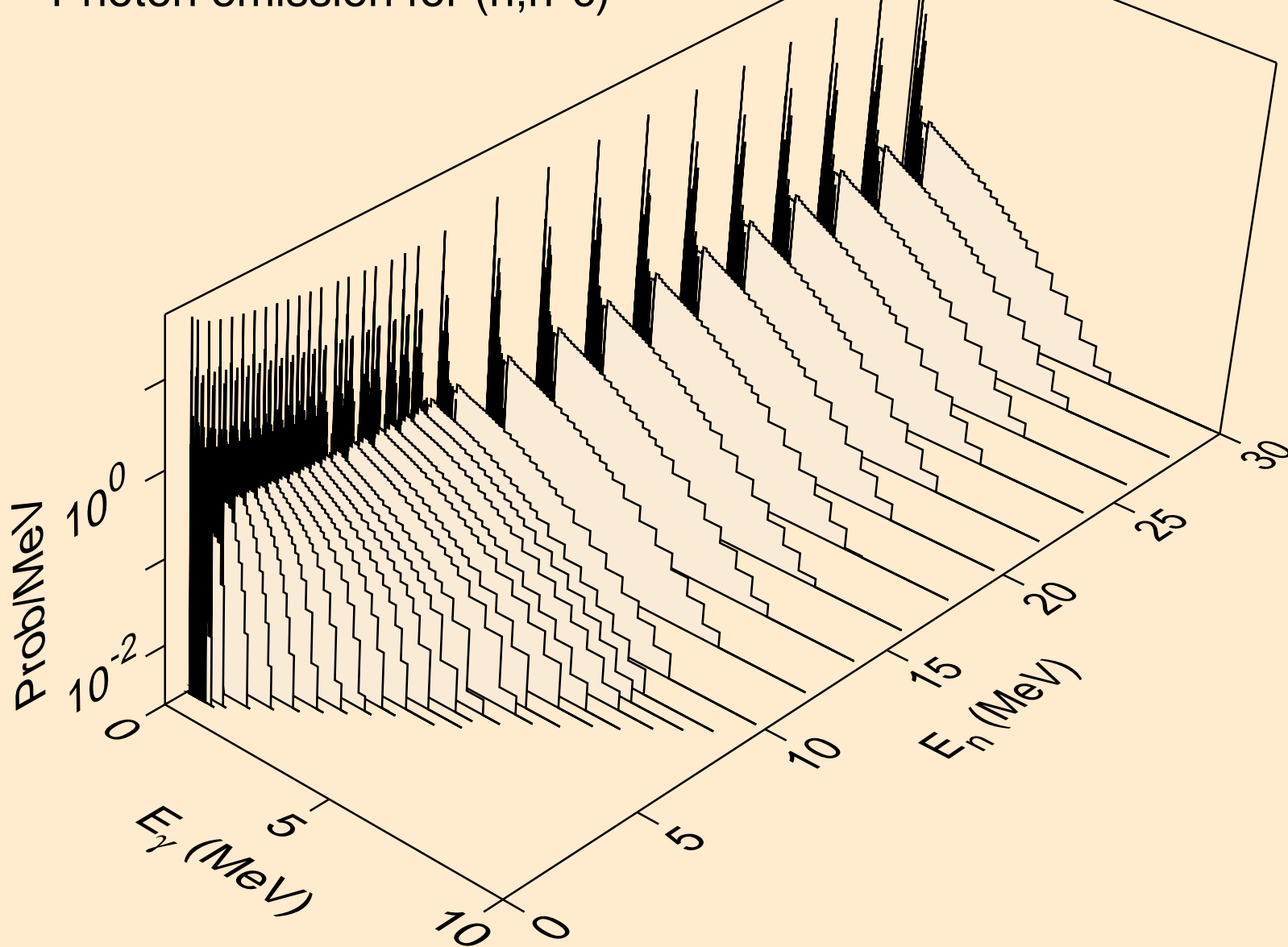

AG106 NEUTRON ACER TENDL-2019 LIBRARY; T=293.16K  
Photon emission for (n,gma)

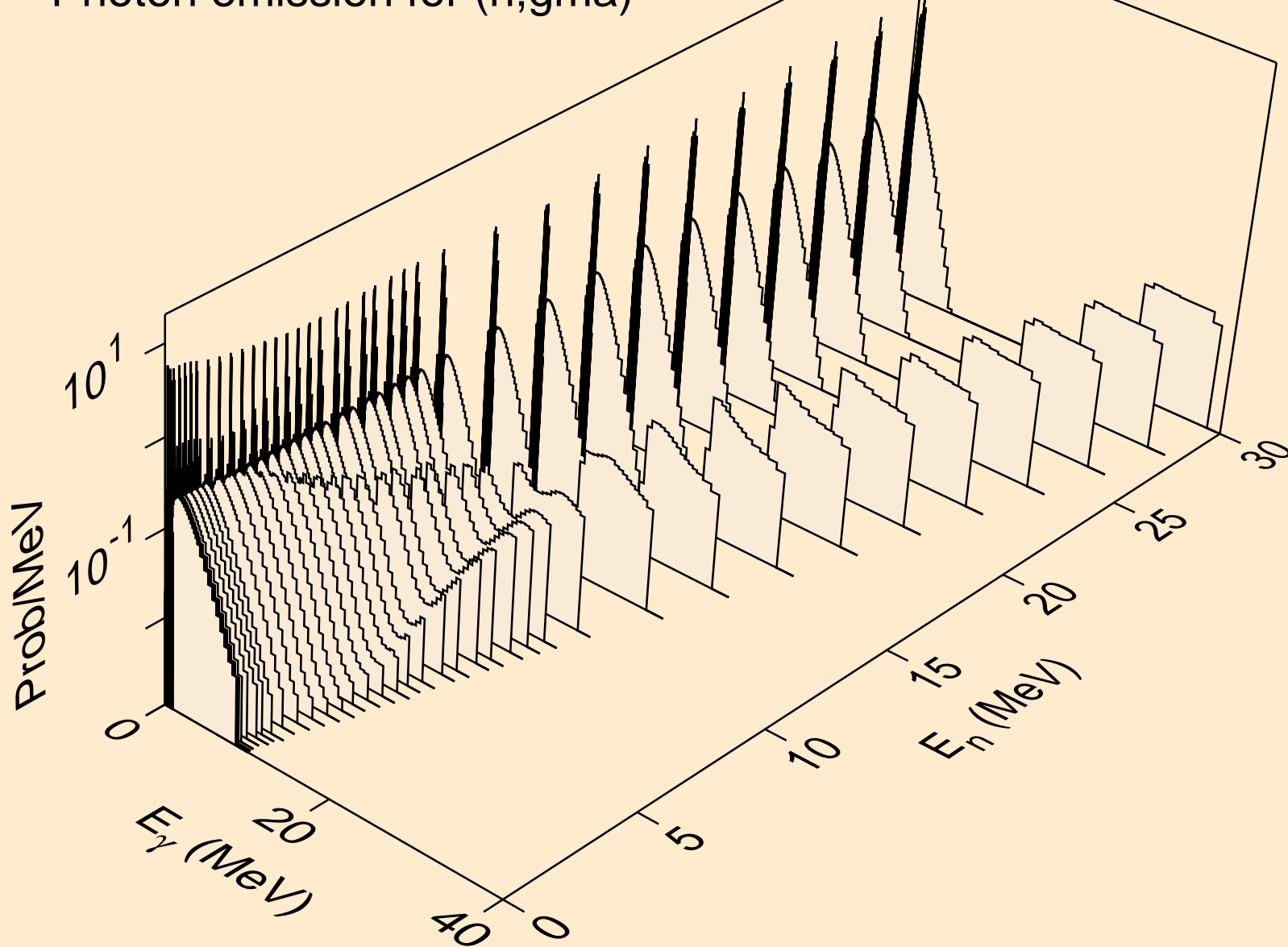

AG106 NEUTRON ACER TENDL-2019 LIBRARY; T=293.16K  
Photon emission for (n,p)

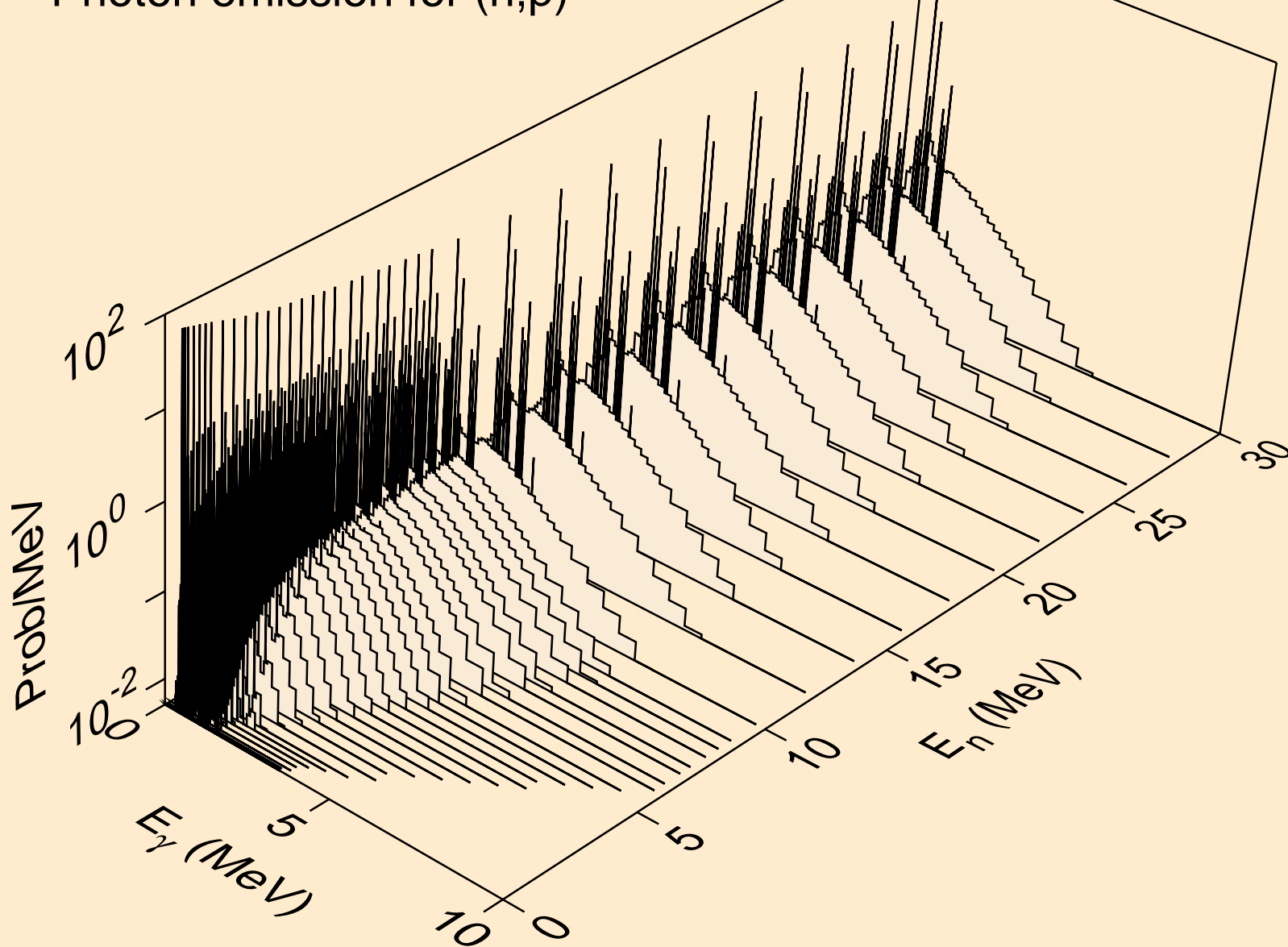

AG106 NEUTRON ACER TENDL-2019 LIBRARY; T=293.16K  
Photon emission for (n,d)

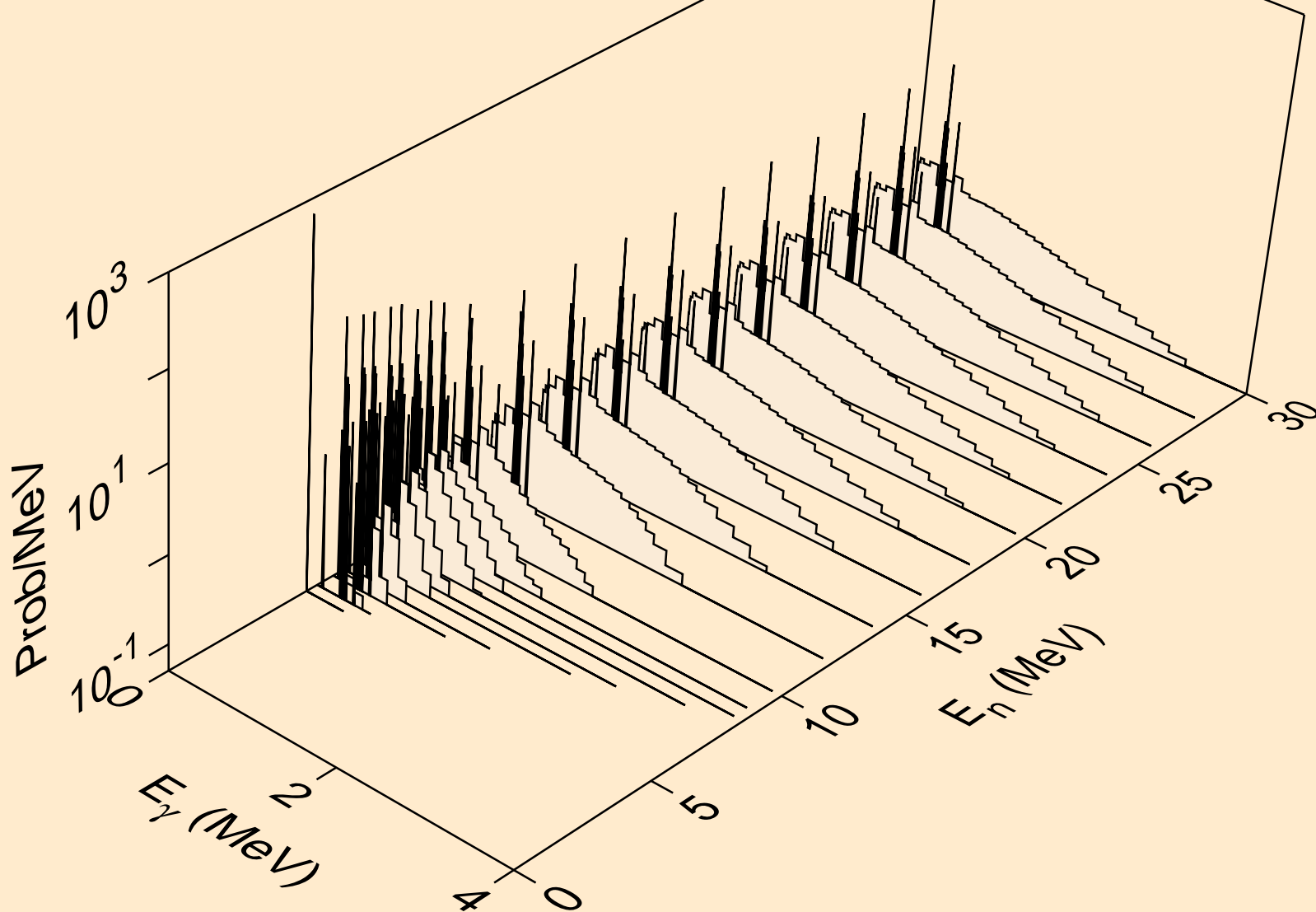

AG106 NEUTRON ACER TENDL-2019 LIBRARY; T=293.16K  
Photon emission for (n,t)

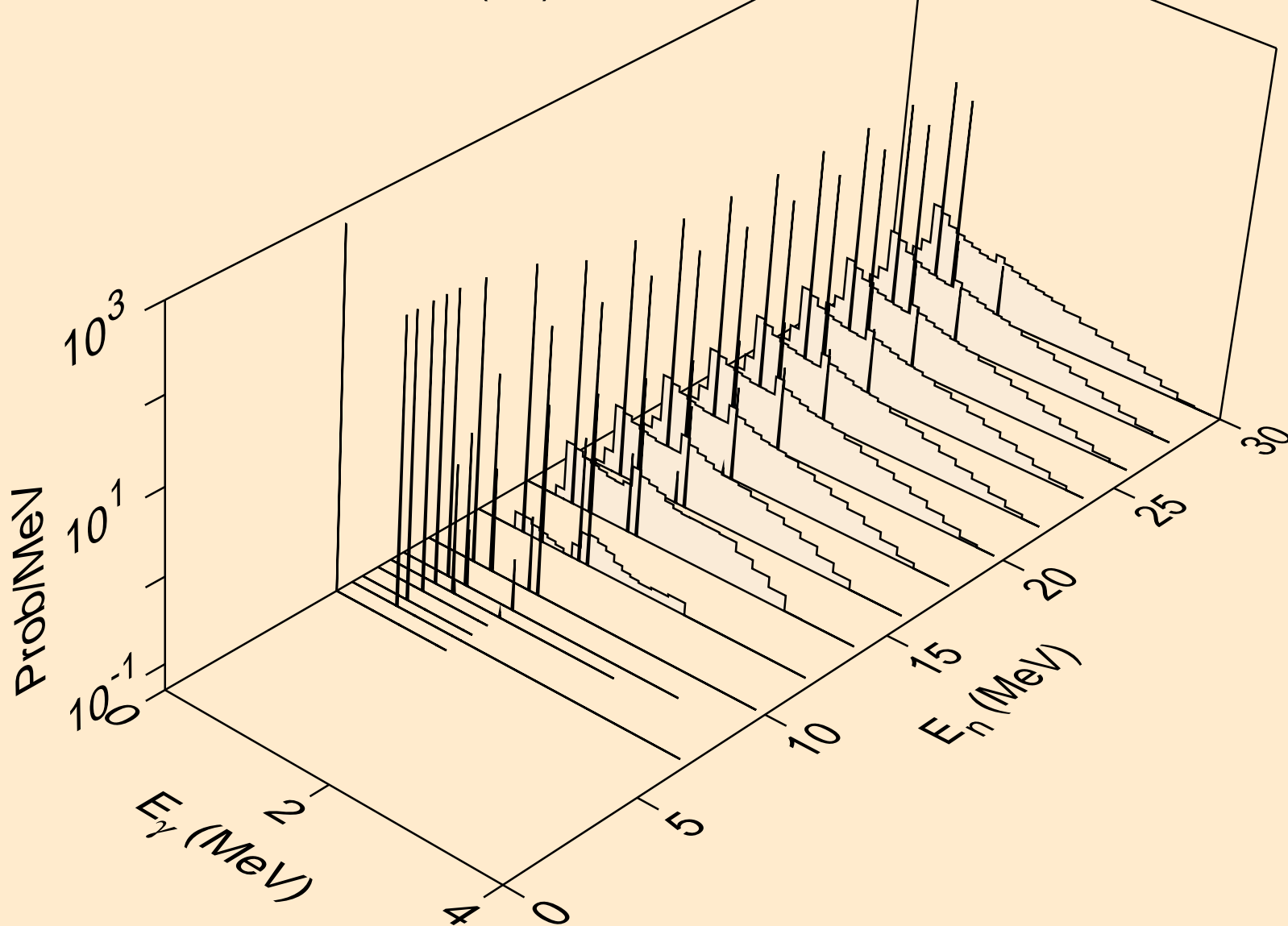

AG106 NEUTRON ACER TENDL-2019 LIBRARY; T=293.16K  
Photon emission for (n,he3)

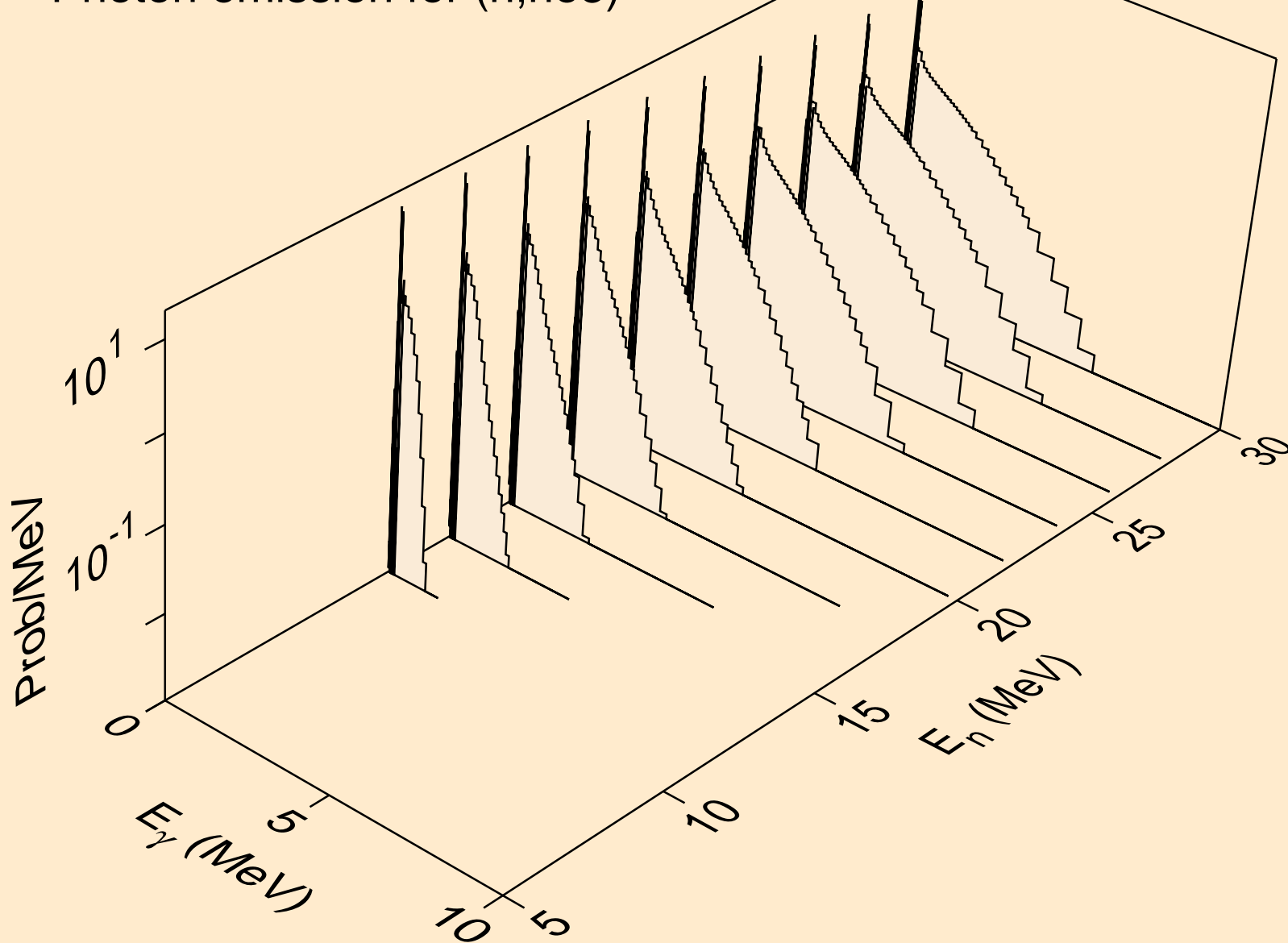



AG106 NEUTRON ACER TENDL-2019 LIBRARY; T=293.16K  
Photon emission for (n,a)

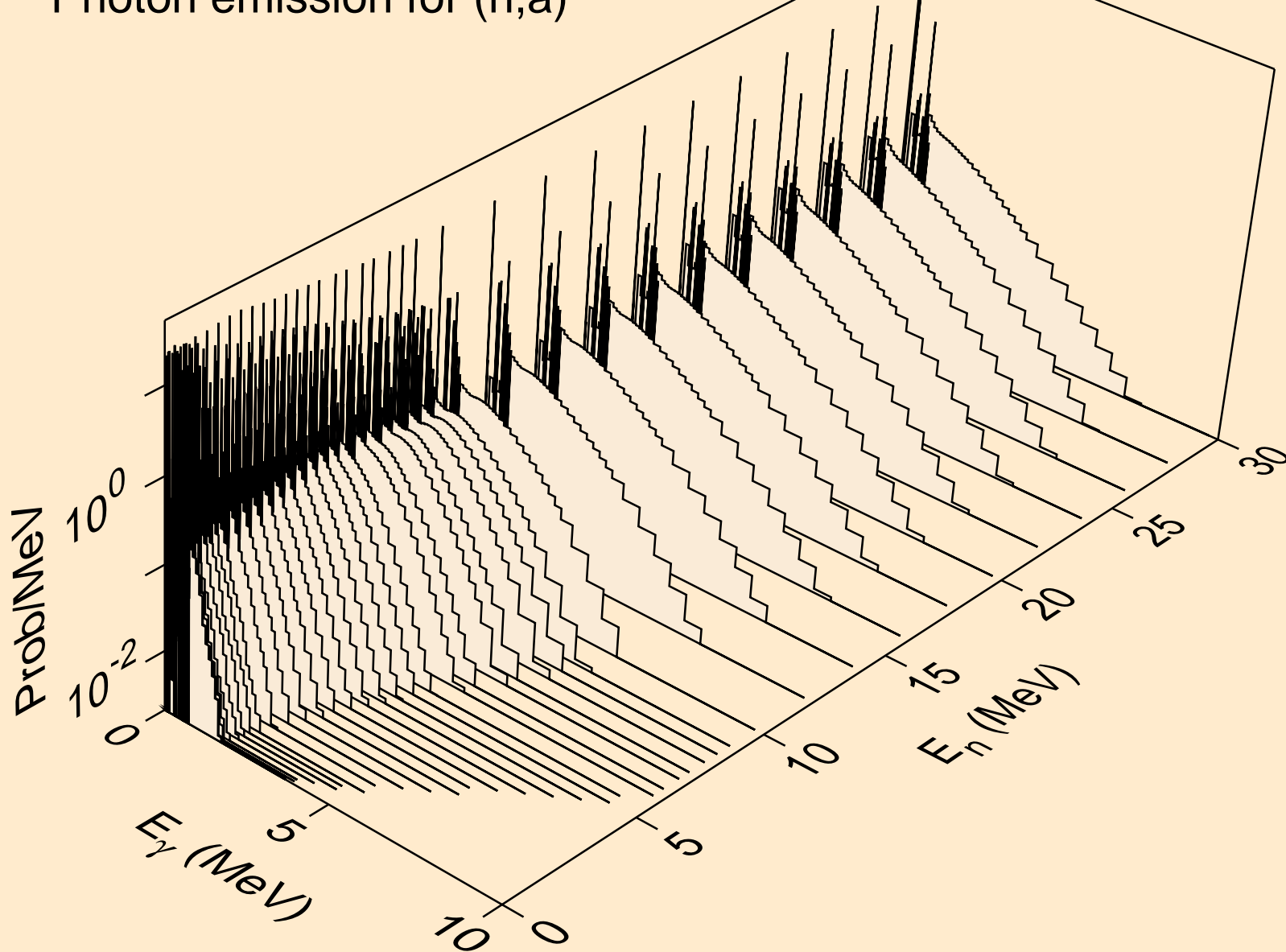

AG106 NEUTRON ACER TENDL-2019 LIBRARY; T=293.16K  
Photon emission for (n,2a)

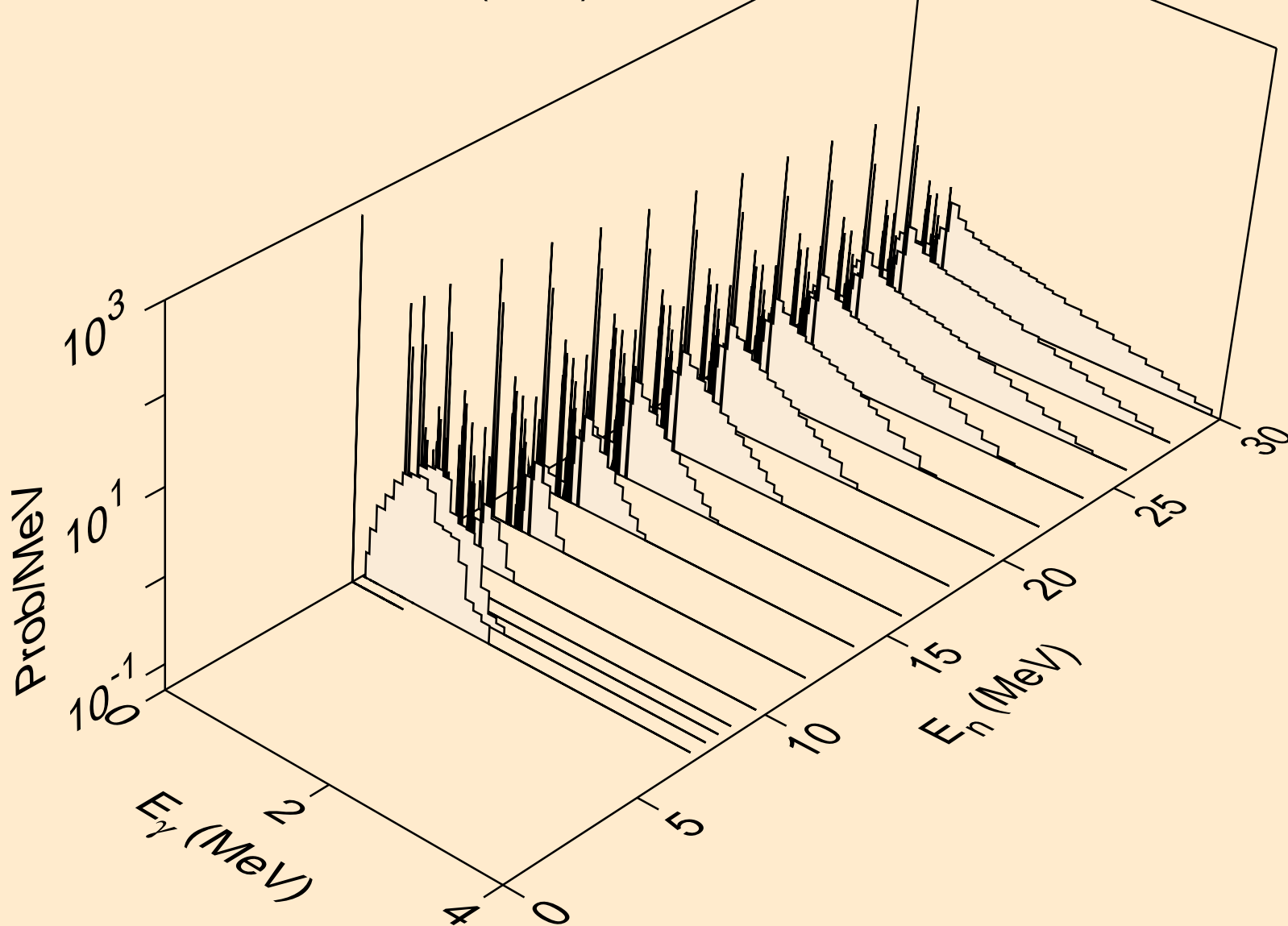

AG106 NEUTRON ACER TENDL-2019 LIBRARY; T=293.16K  
Photon emission for (n,2p)

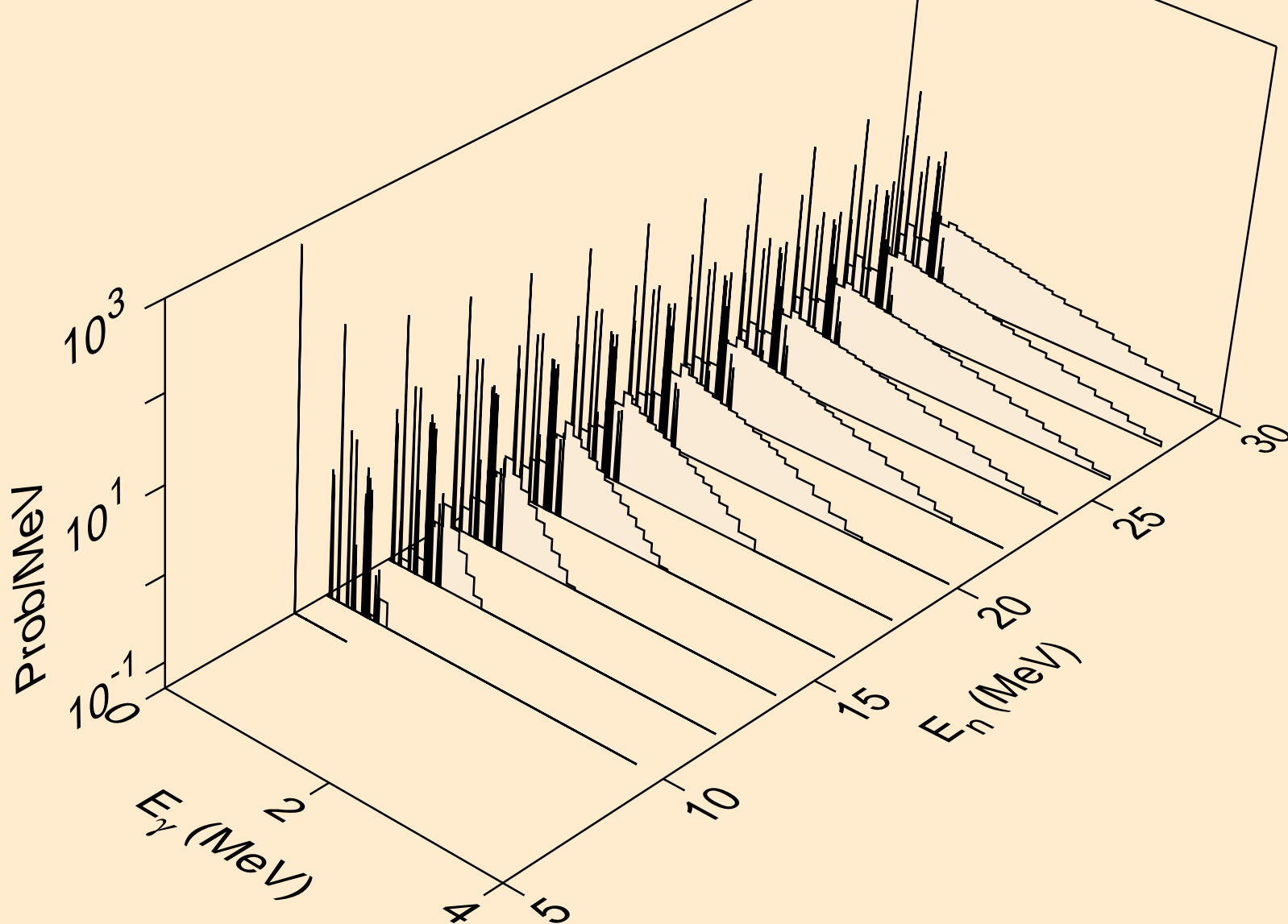

AG106 NEUTRON ACER TENDL-2019 LIBRARY; T=293.16K  
Photon emission for (n,p $\alpha$ )

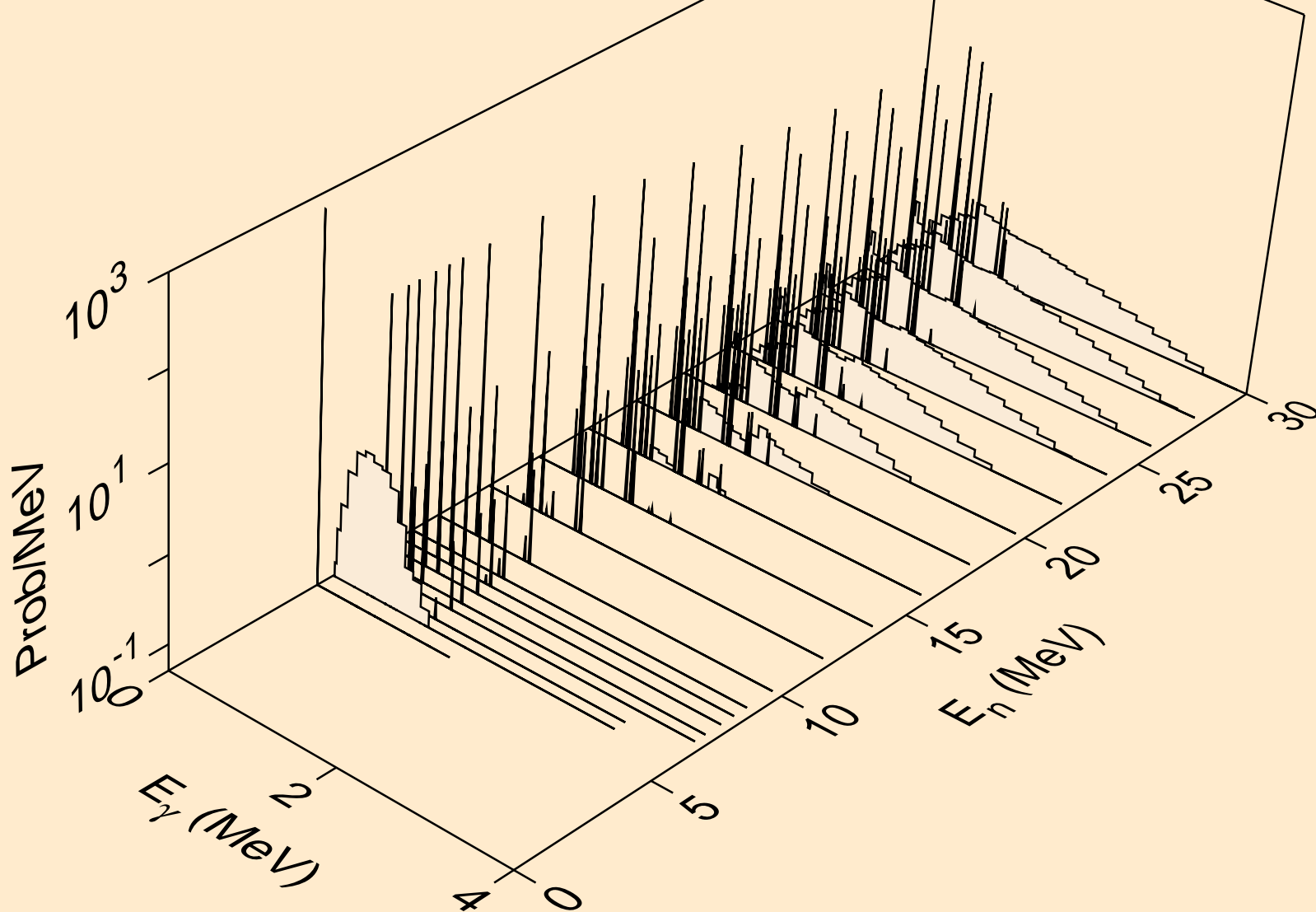

AG106 NEUTRON ACER TENDL-2019 LIBRARY; T=293.16K  
Photon emission for (n,pd)

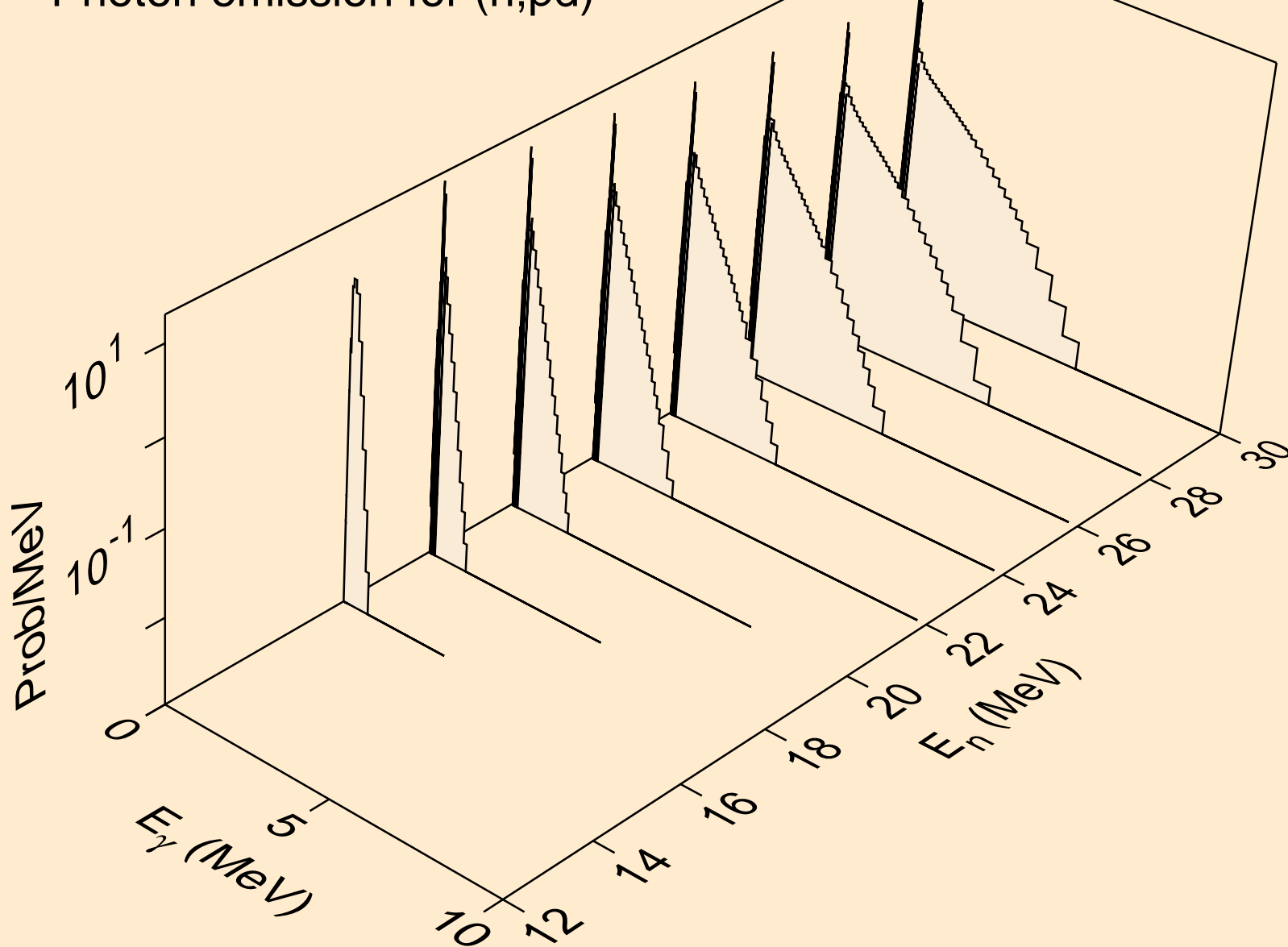

AG106 NEUTRON ACER TENDL-2019 LIBRARY; T=293.16K  
Photon emission for (n,pt)

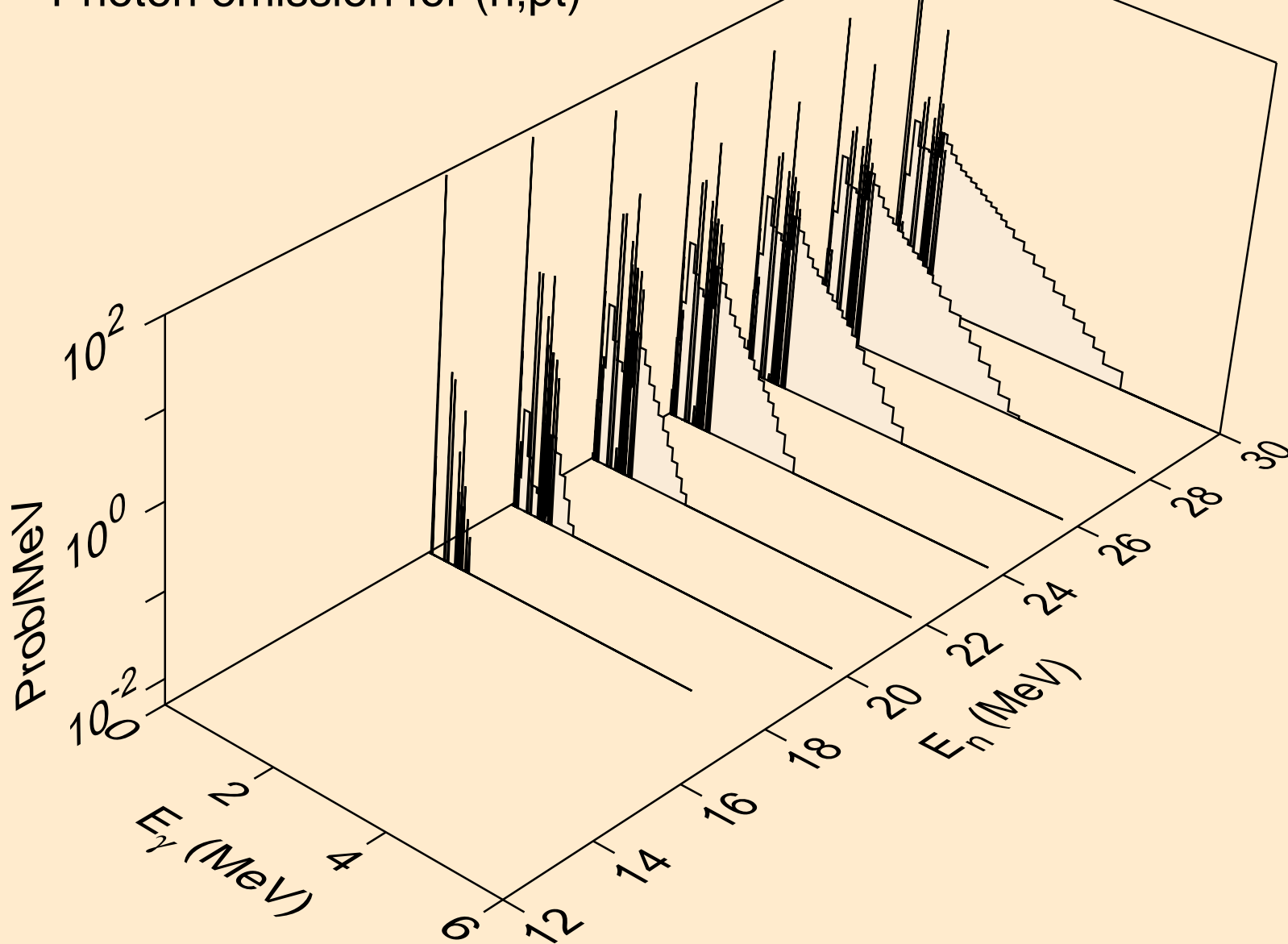

AG106 NEUTRON ACER TENDL-2019 LIBRARY; T=293.16K  
Photon emission for (n,da)

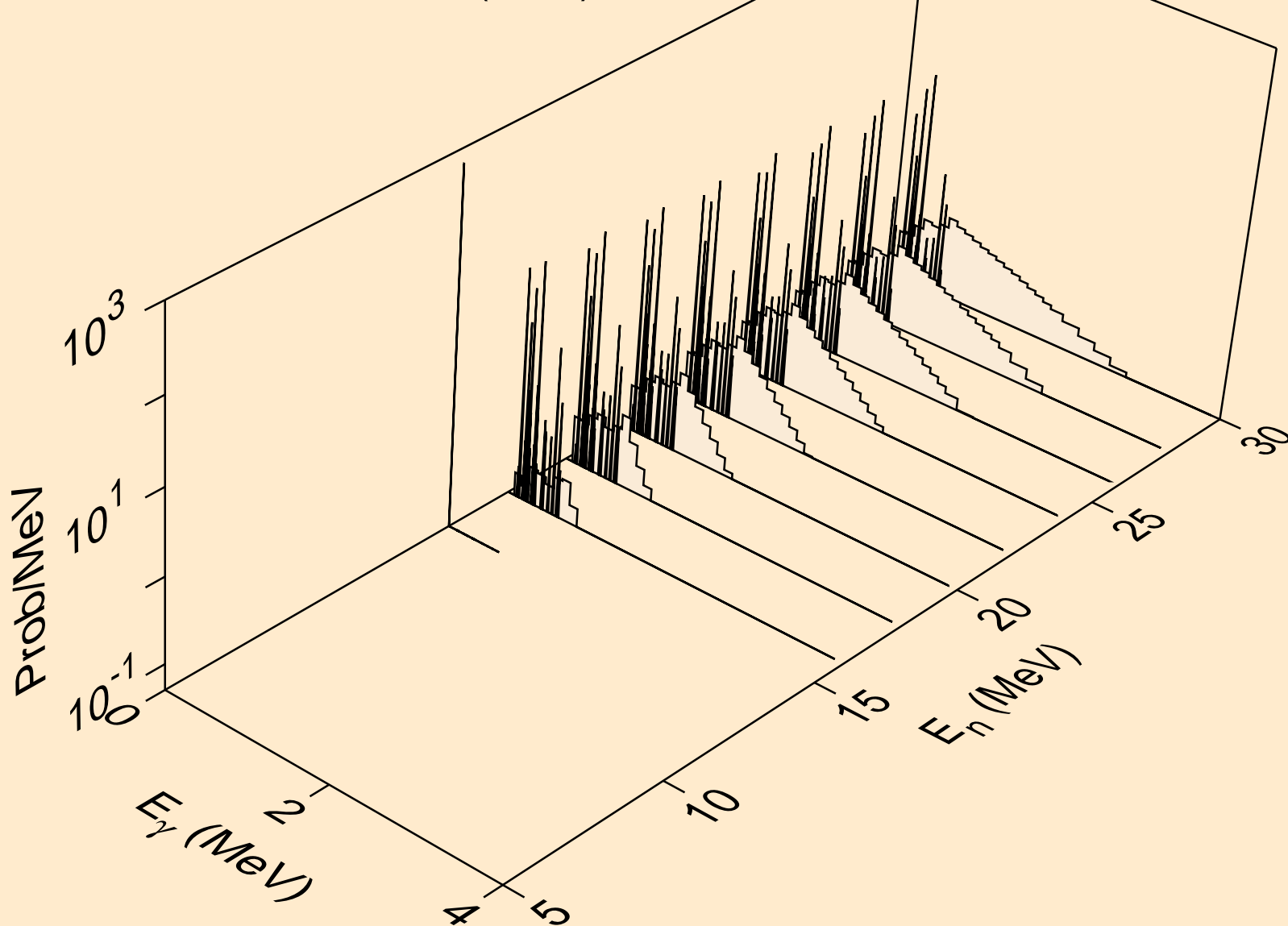

AG106 NEUTRON ACER TENDL-2019 LIBRARY; T=293.16K  
thermal capture photon spectrum

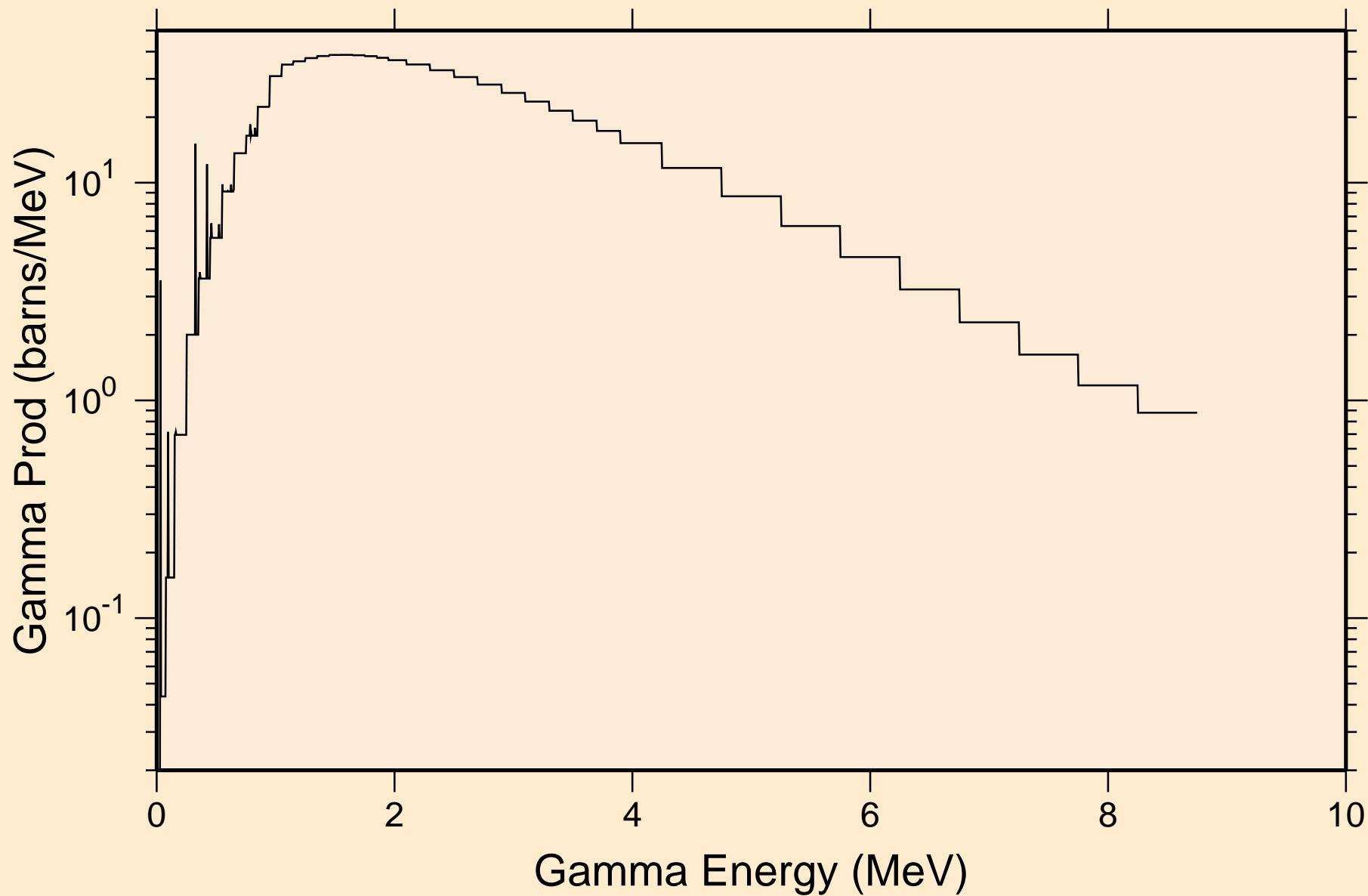



AG106 NEUTRON ACER TENDL-2019 LIBRARY; T=293.16K  
14 MeV photon spectrum

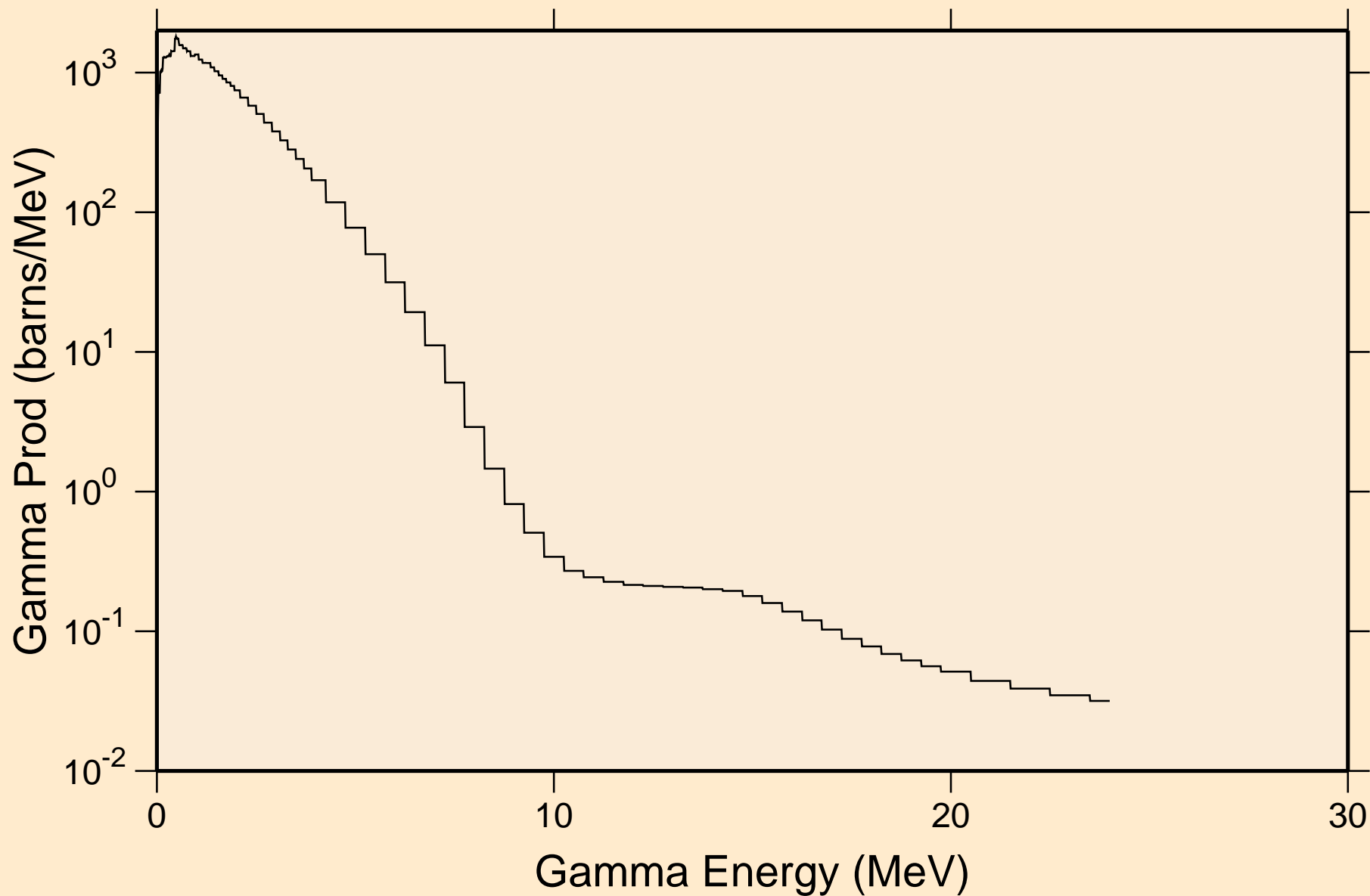

AG106 NEUTRON ACER TENDL-2019 LIBRARY; T=293.16K  
Particle heating contributions

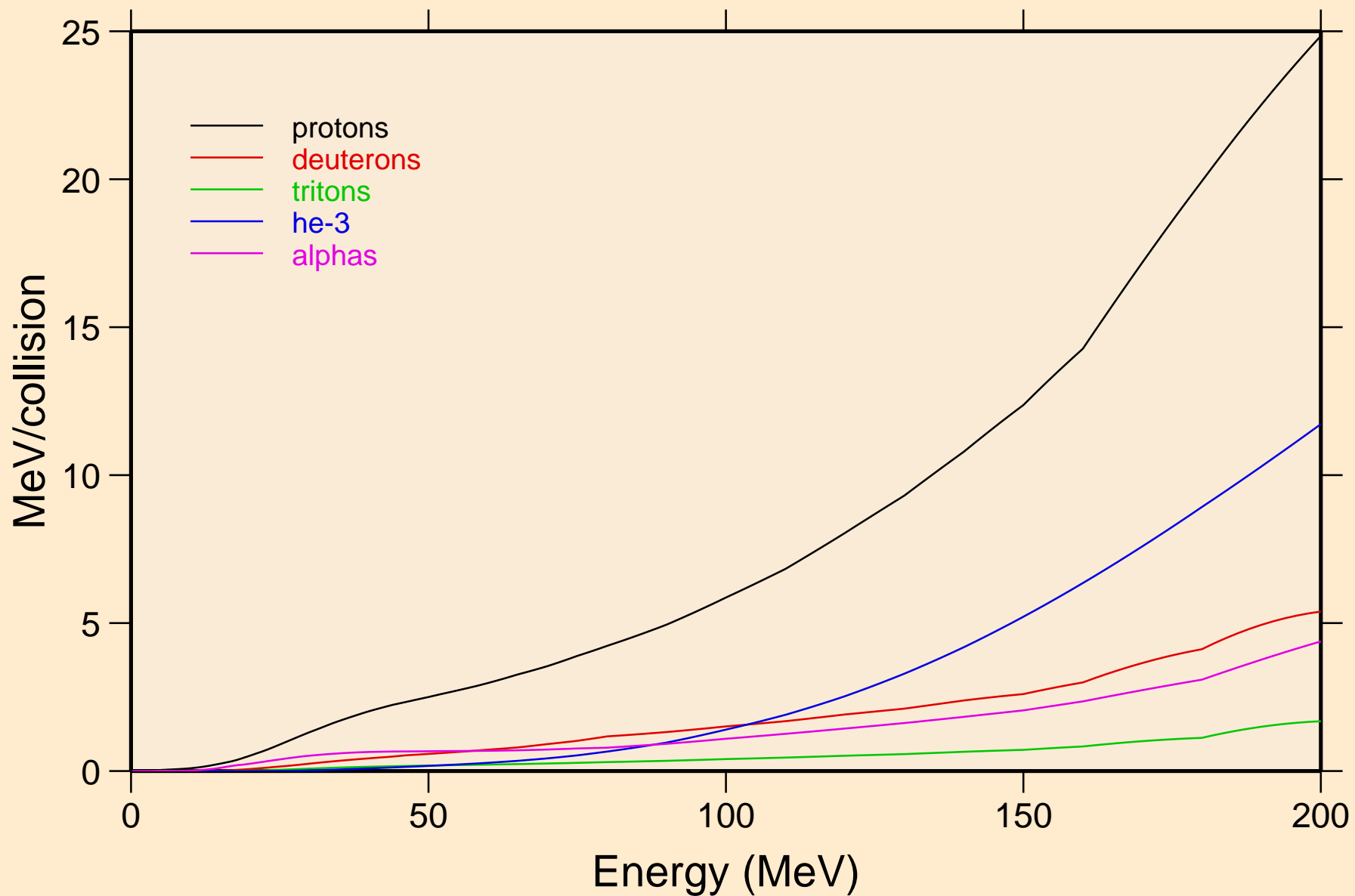

AG106 NEUTRON ACER TENDL-2019 LIBRARY; T=293.16K  
Recoil Heating

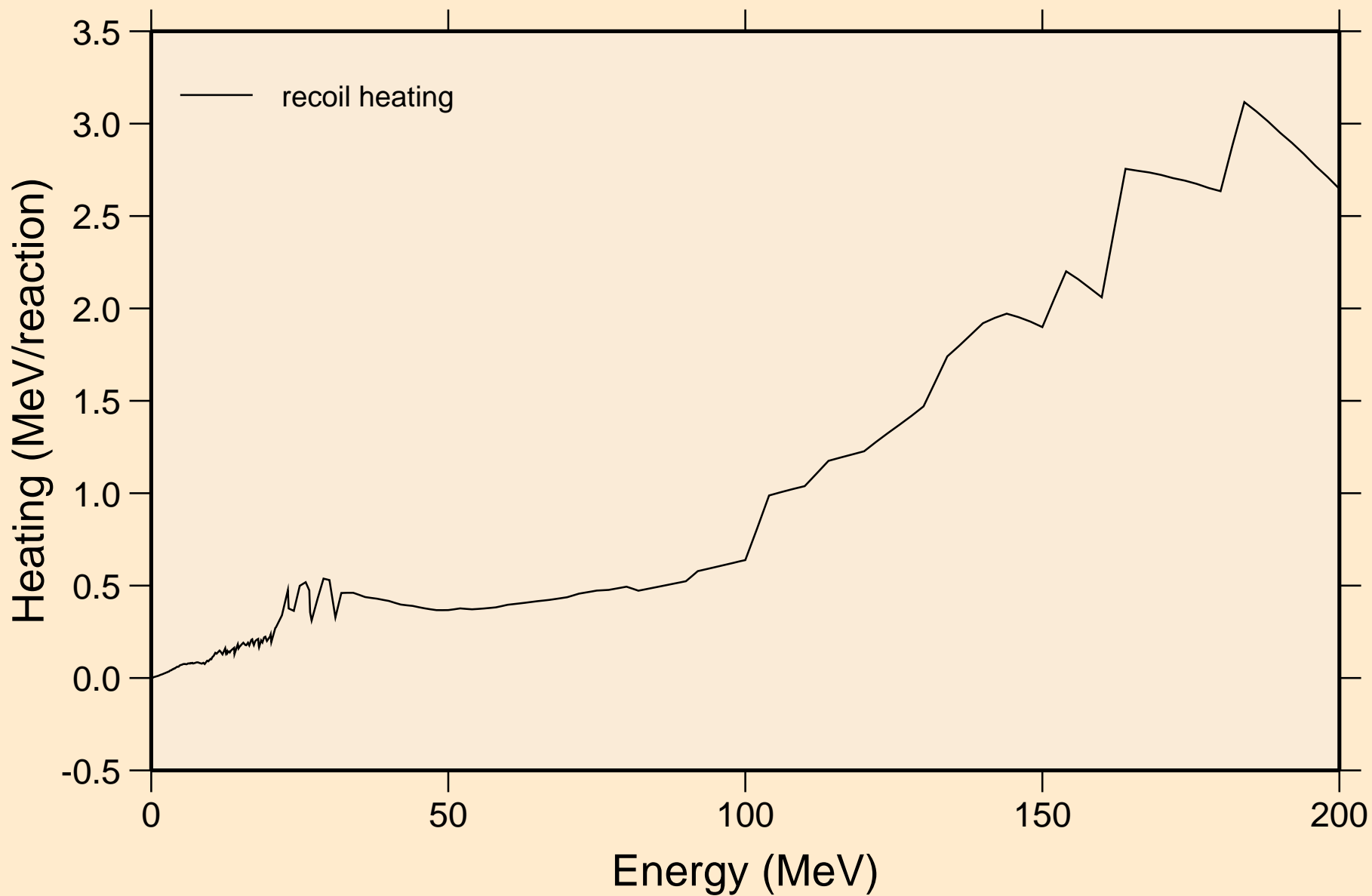

AG106 NEUTRON ACER TENDL-2019 LIBRARY; T=293.16K  
Particle production cross sections

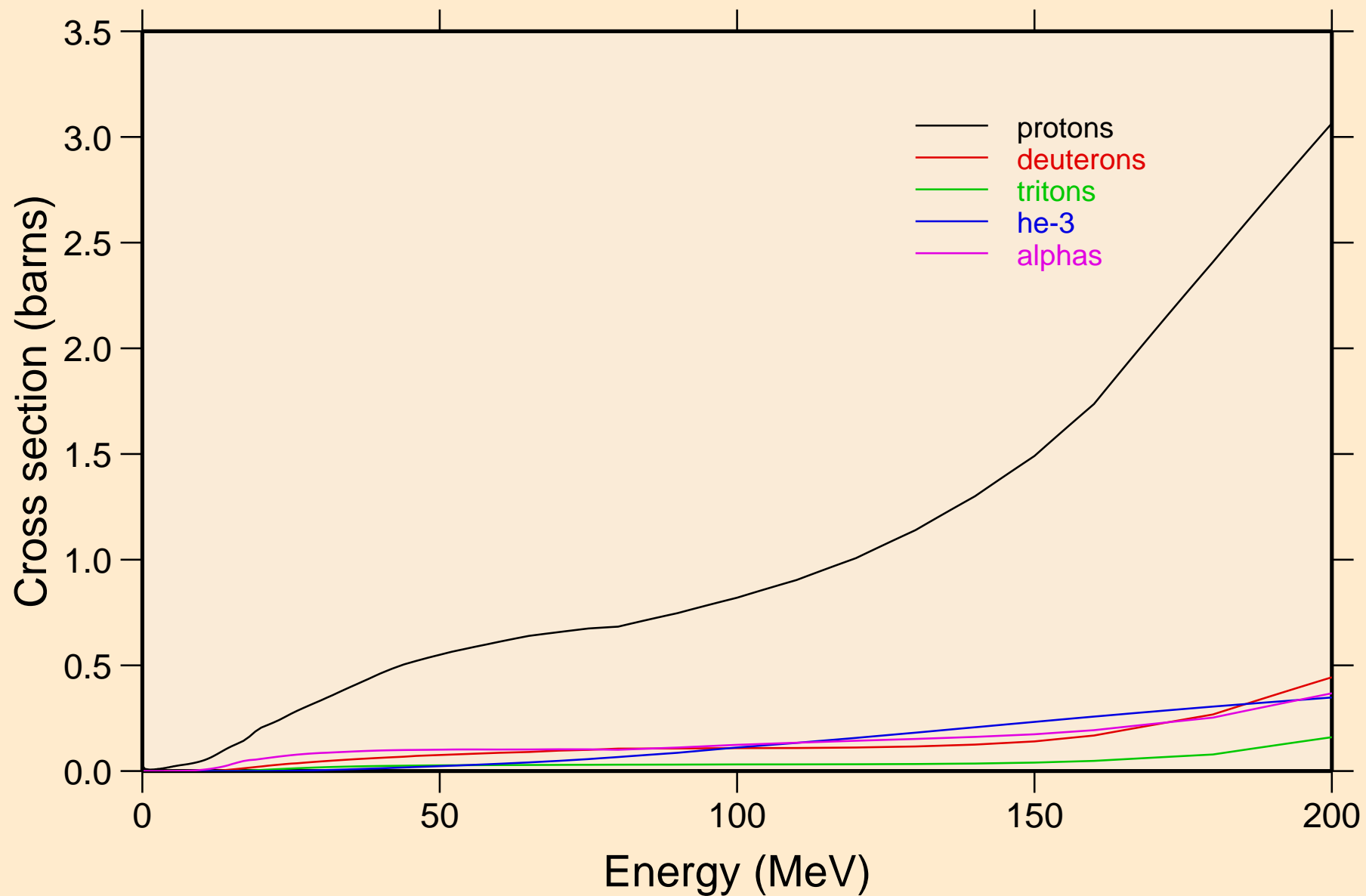

AG106 NEUTRON ACER TENDL-2019 LIBRARY; T=293.16K  
protons from (n,x)

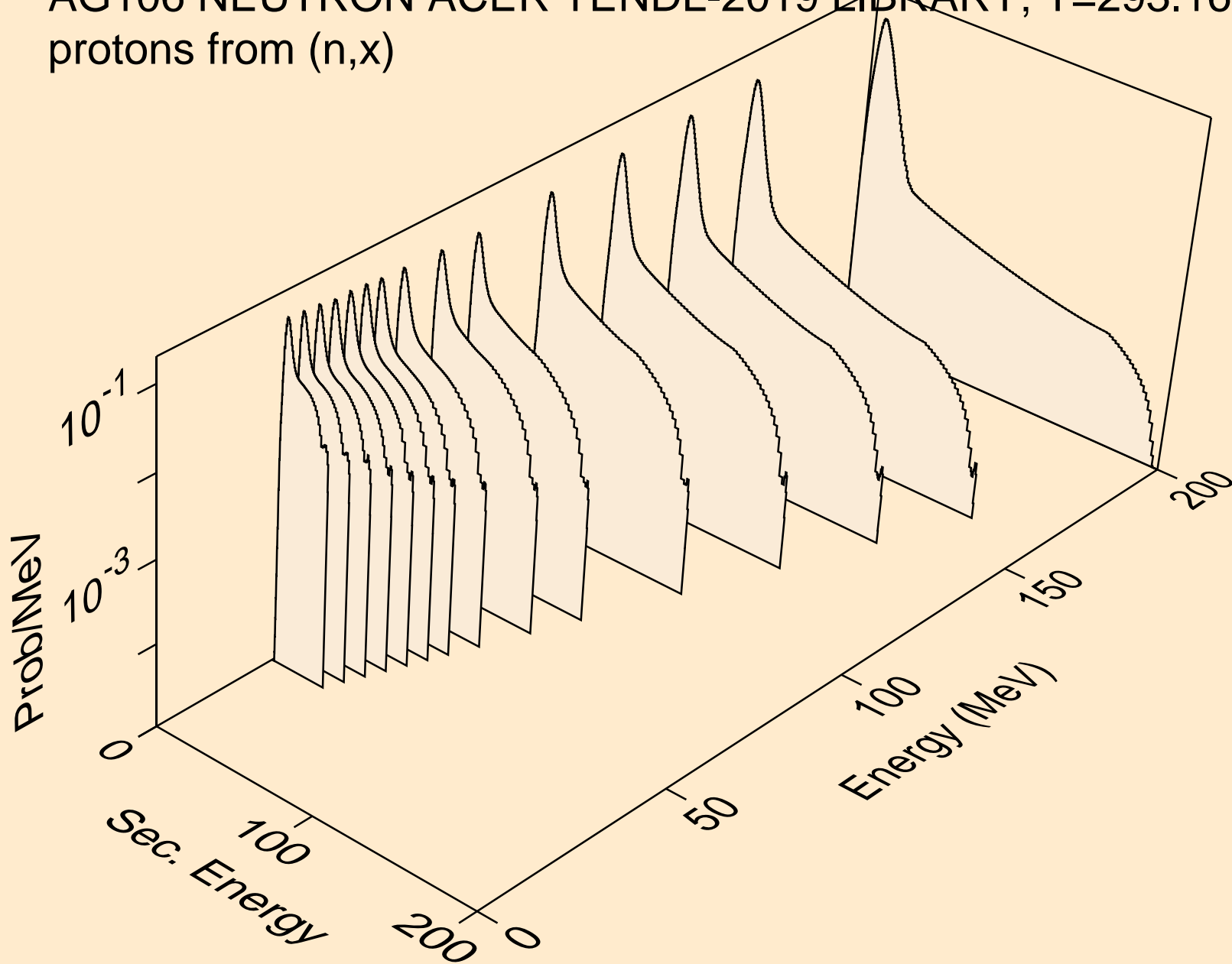

AG106 NEUTRON ACER TENDL-2019 LIBRARY; T=293.16K  
protons from (n,n\*)p

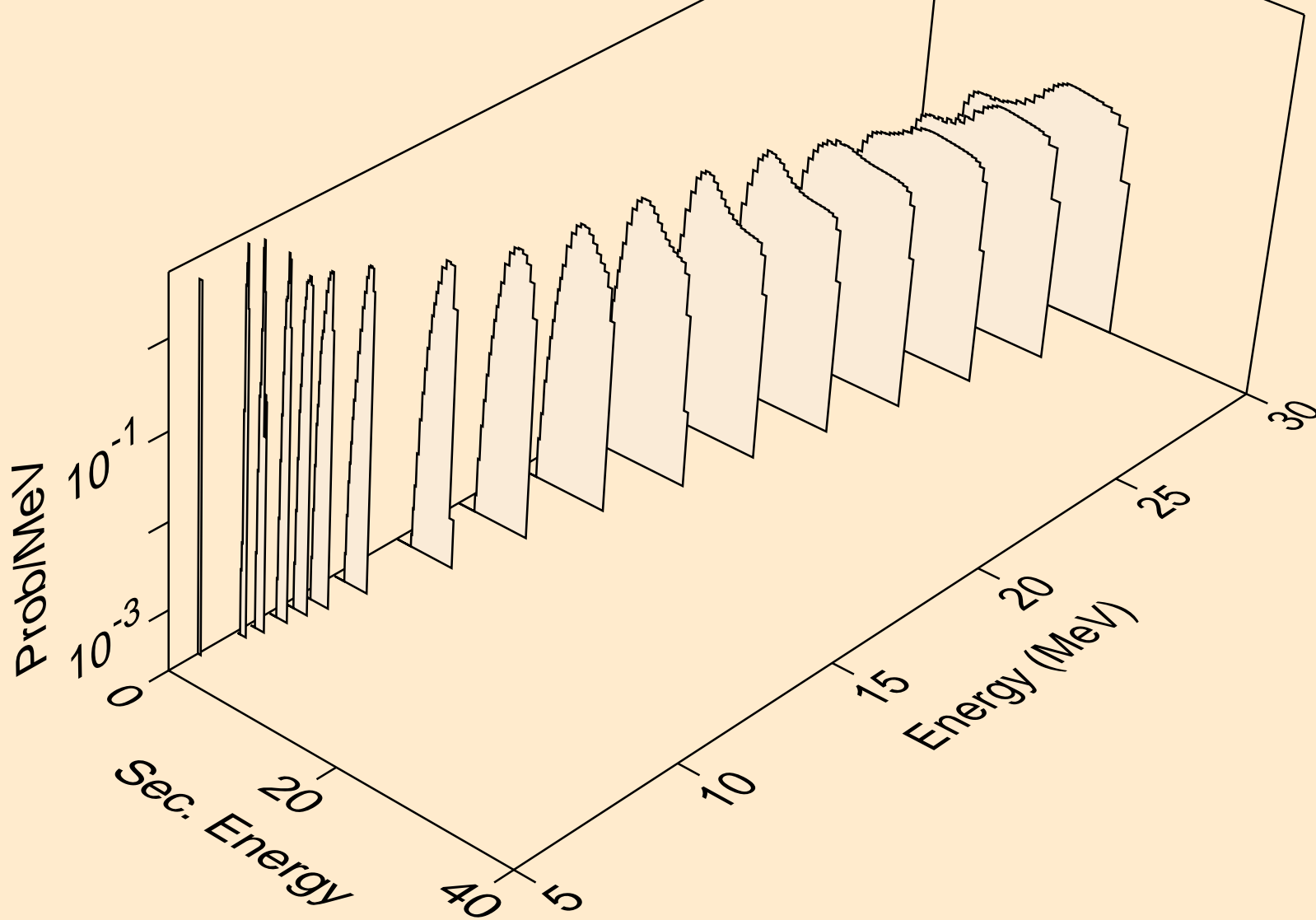

AG106 NEUTRON ACER TENDL-2019 LIBRARY; T=293.16K  
protons from (n,2np)

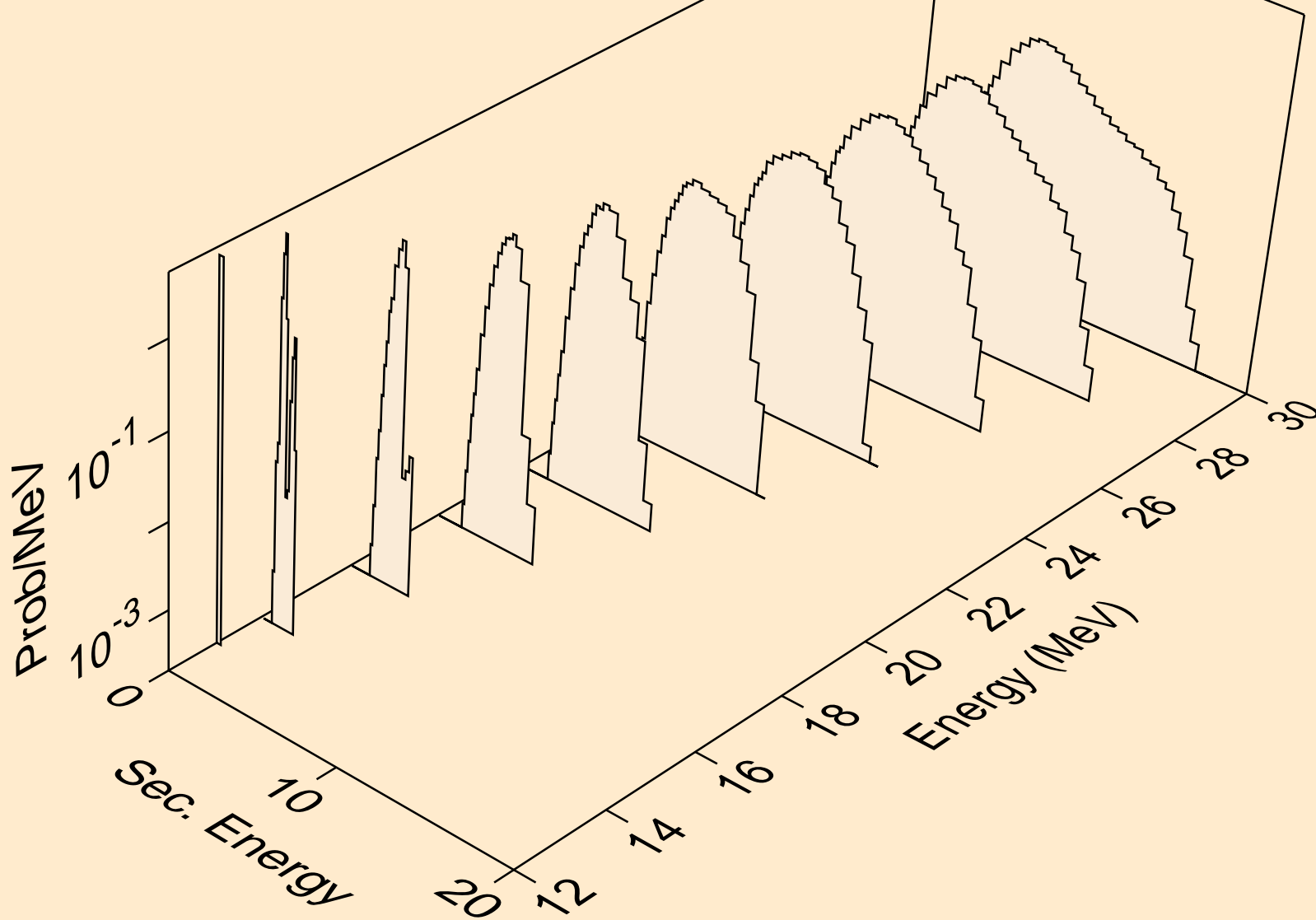

AG106 NEUTRON ACER TENDL-2019 LIBRARY; T=293.16K  
protons from (n,3np)

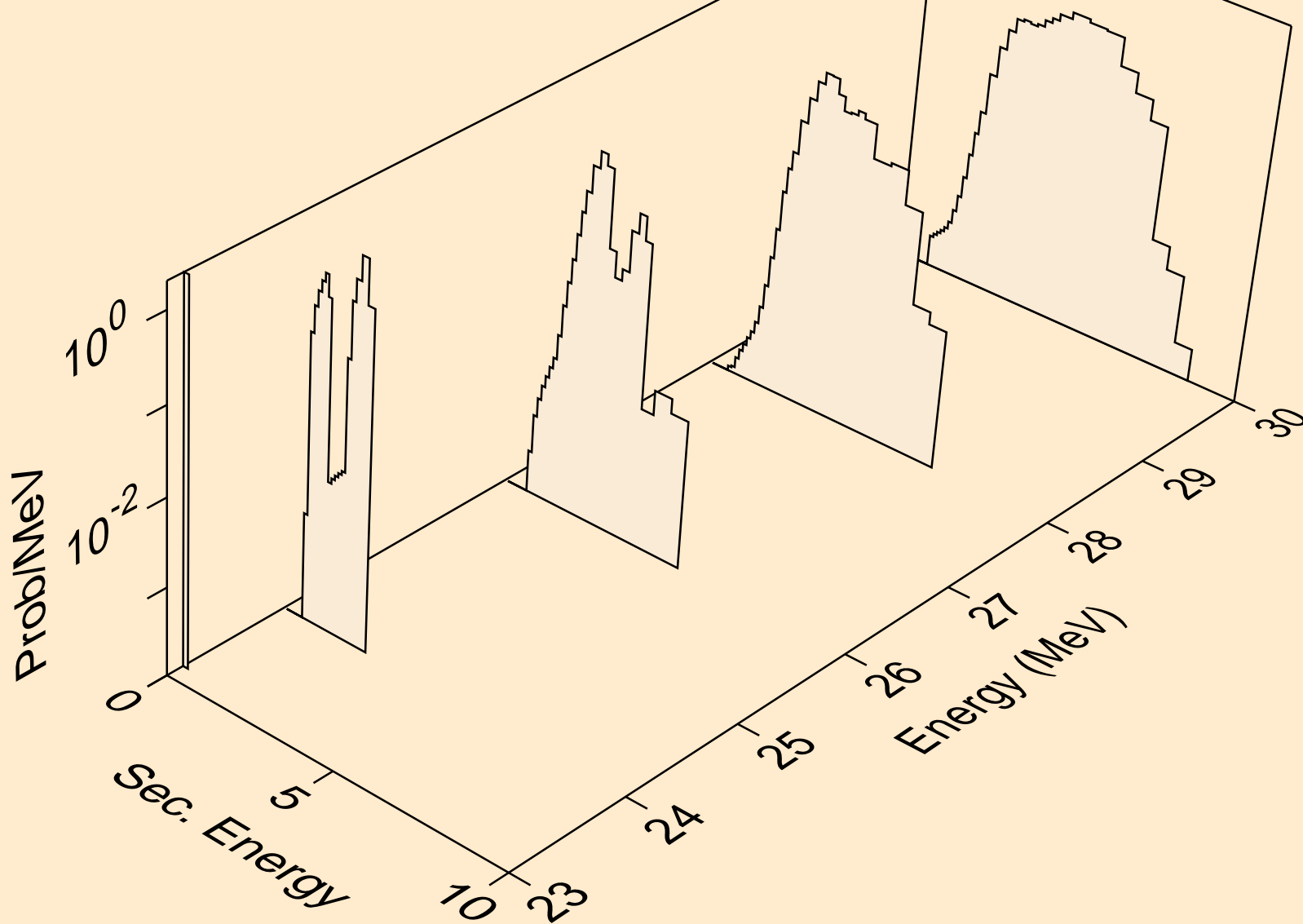



AG106 NEUTRON ACER TENDL-2019 LIBRARY; T=293.16K  
protons from (n,2np)

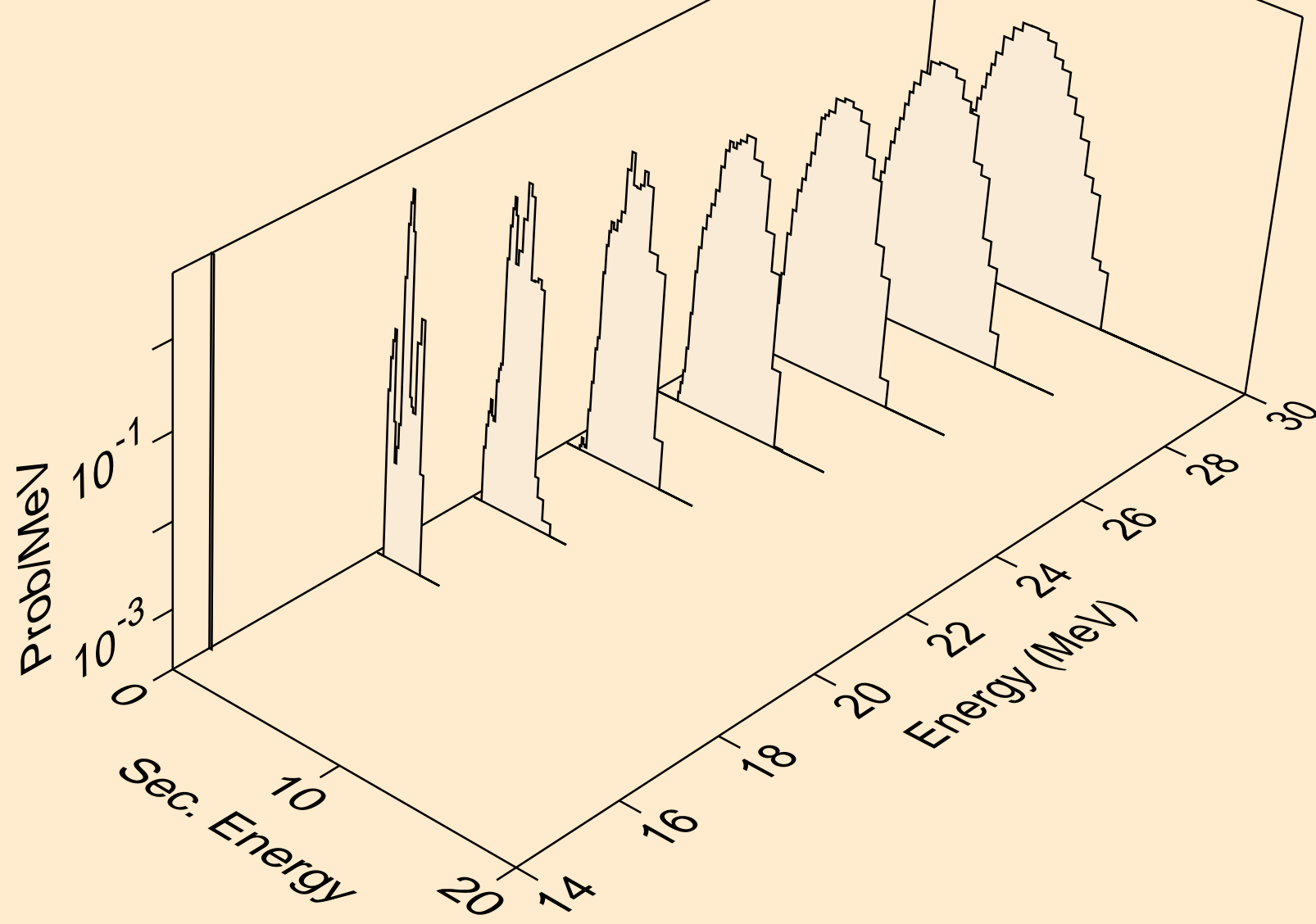

AG106 NEUTRON ACER TENDL-2019 LIBRARY; T=293.16K  
protons from (n,npa)

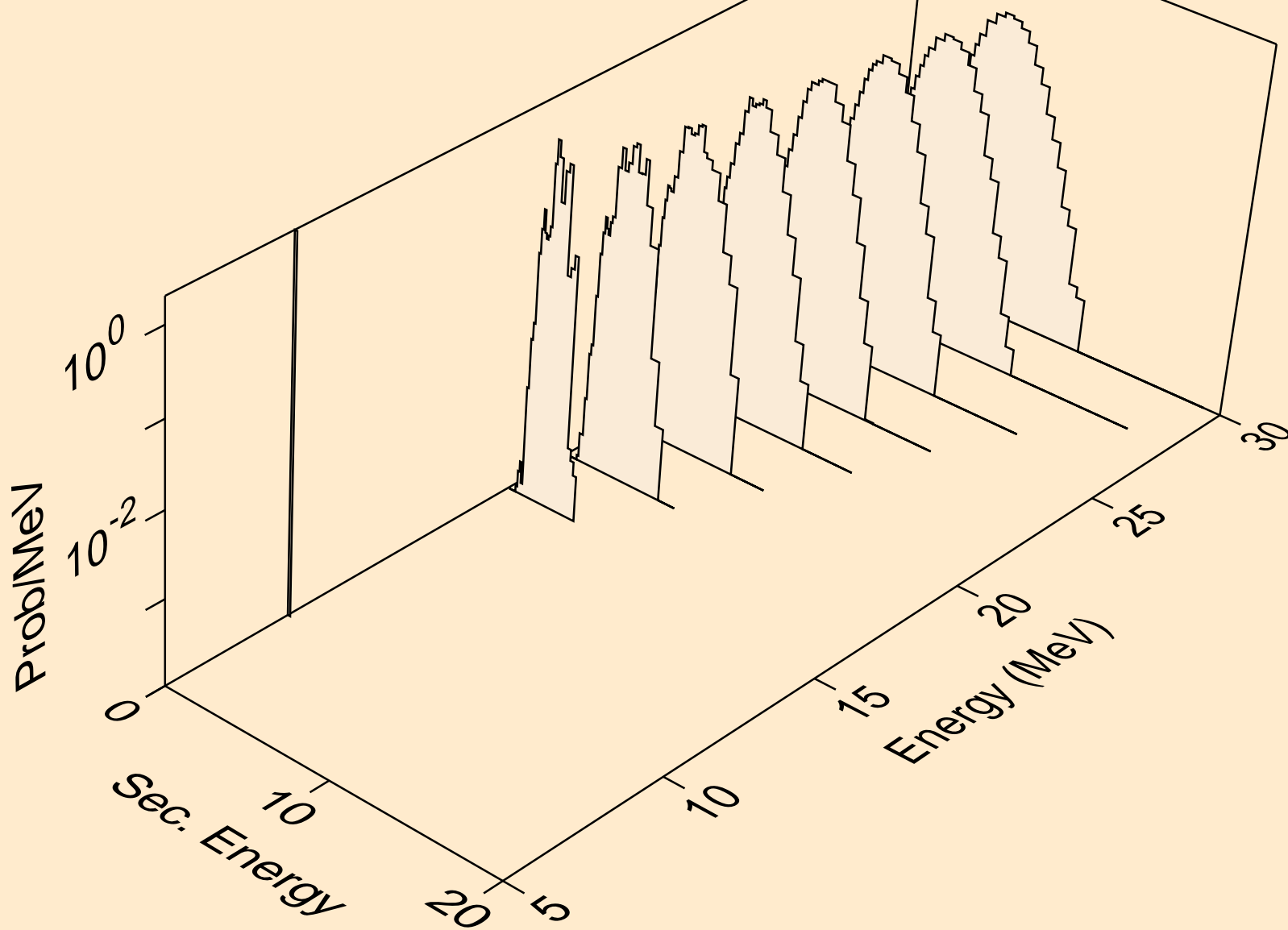

AG106 NEUTRON ACER TENDL-2019 LIBRARY; T=293.16K  
protons from (n,p)

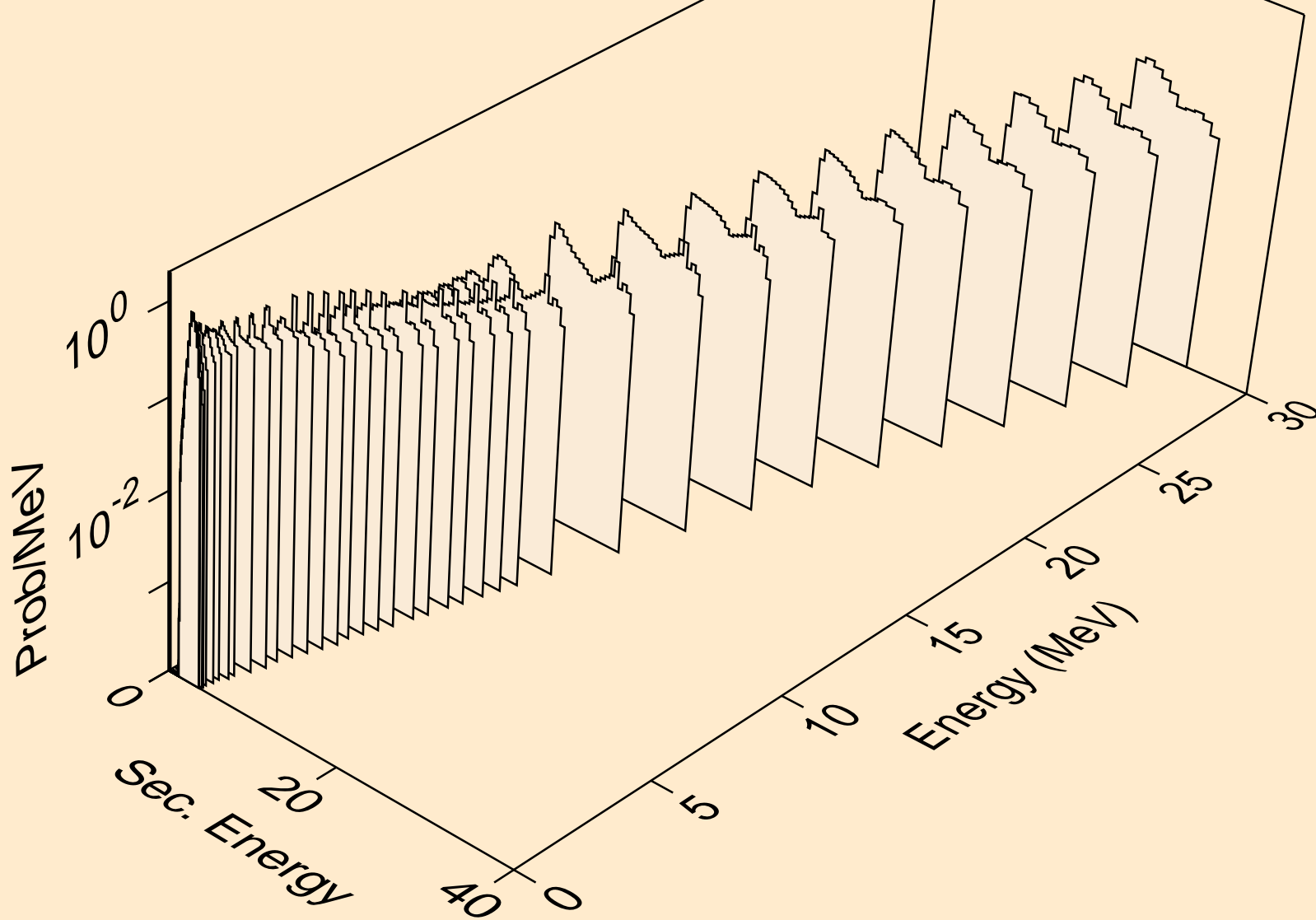

AG106 NEUTRON ACER TENDL-2019 LIBRARY; T=293.16K  
protons from (n,2p)

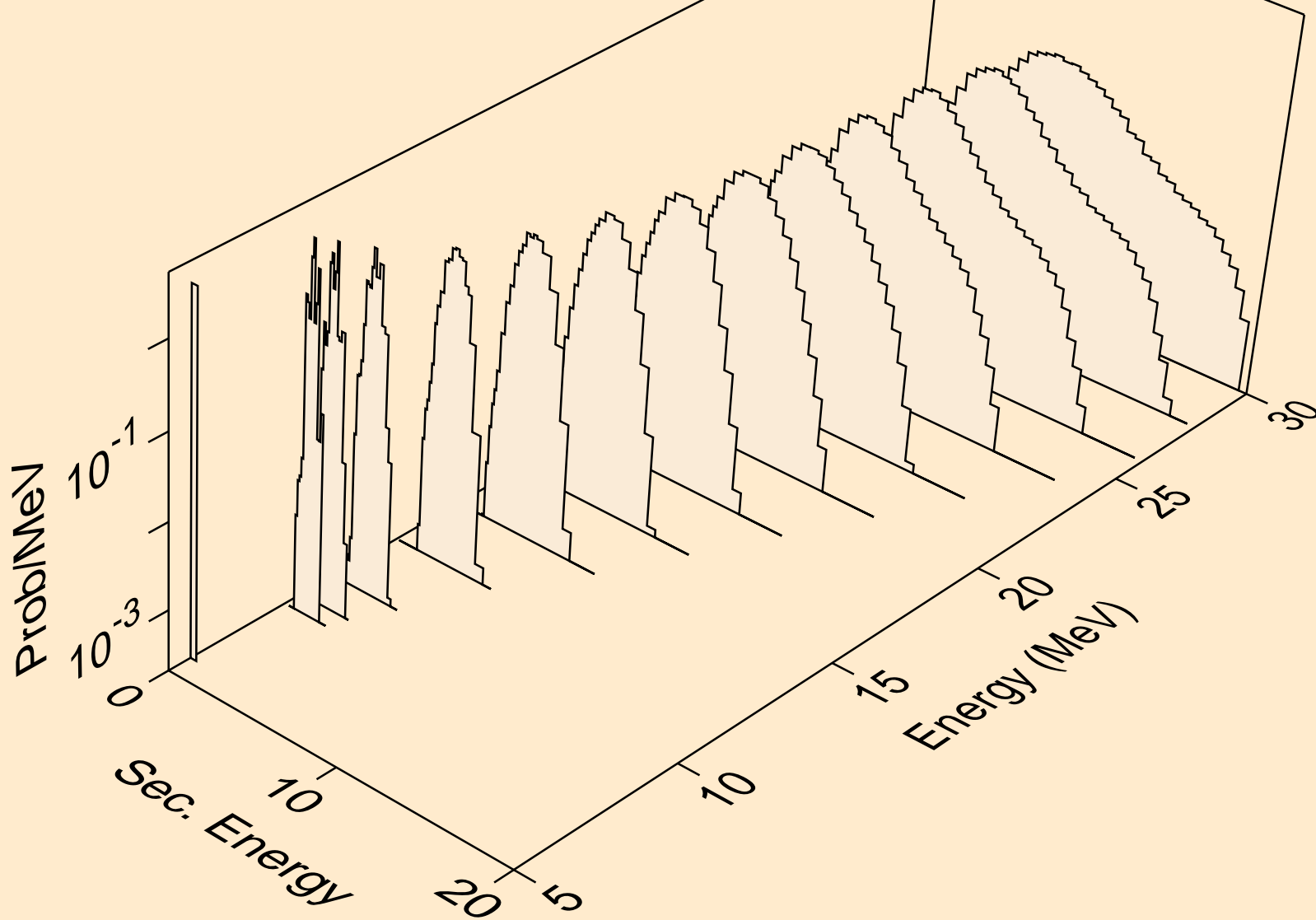

AG106 NEUTRON ACER TENDL-2019 LIBRARY; T=293.16K  
protons from (n,p)

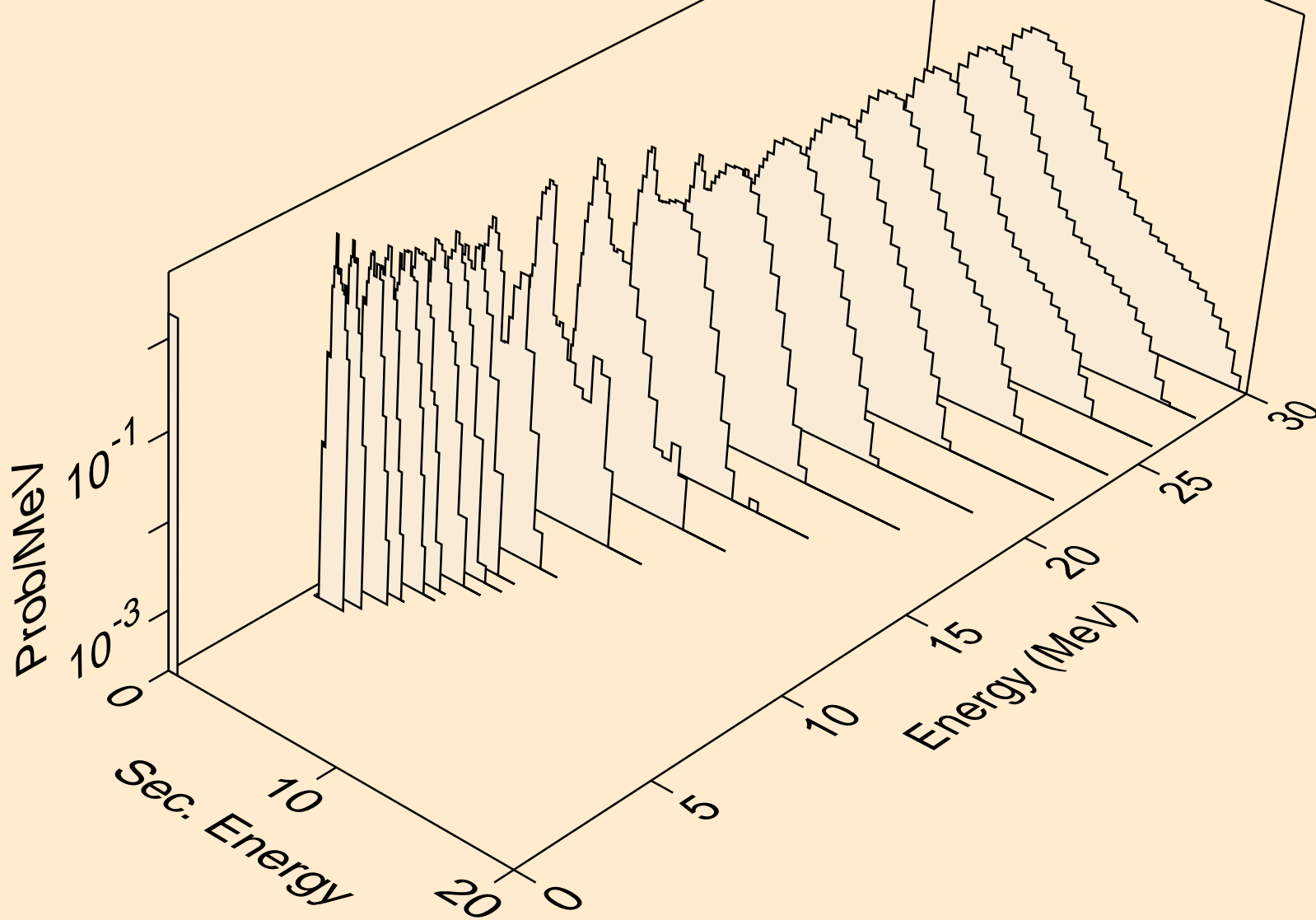

AG106 NEUTRON ACER TENDL-2019 LIBRARY; T=293.16K  
protons from (n,pd)

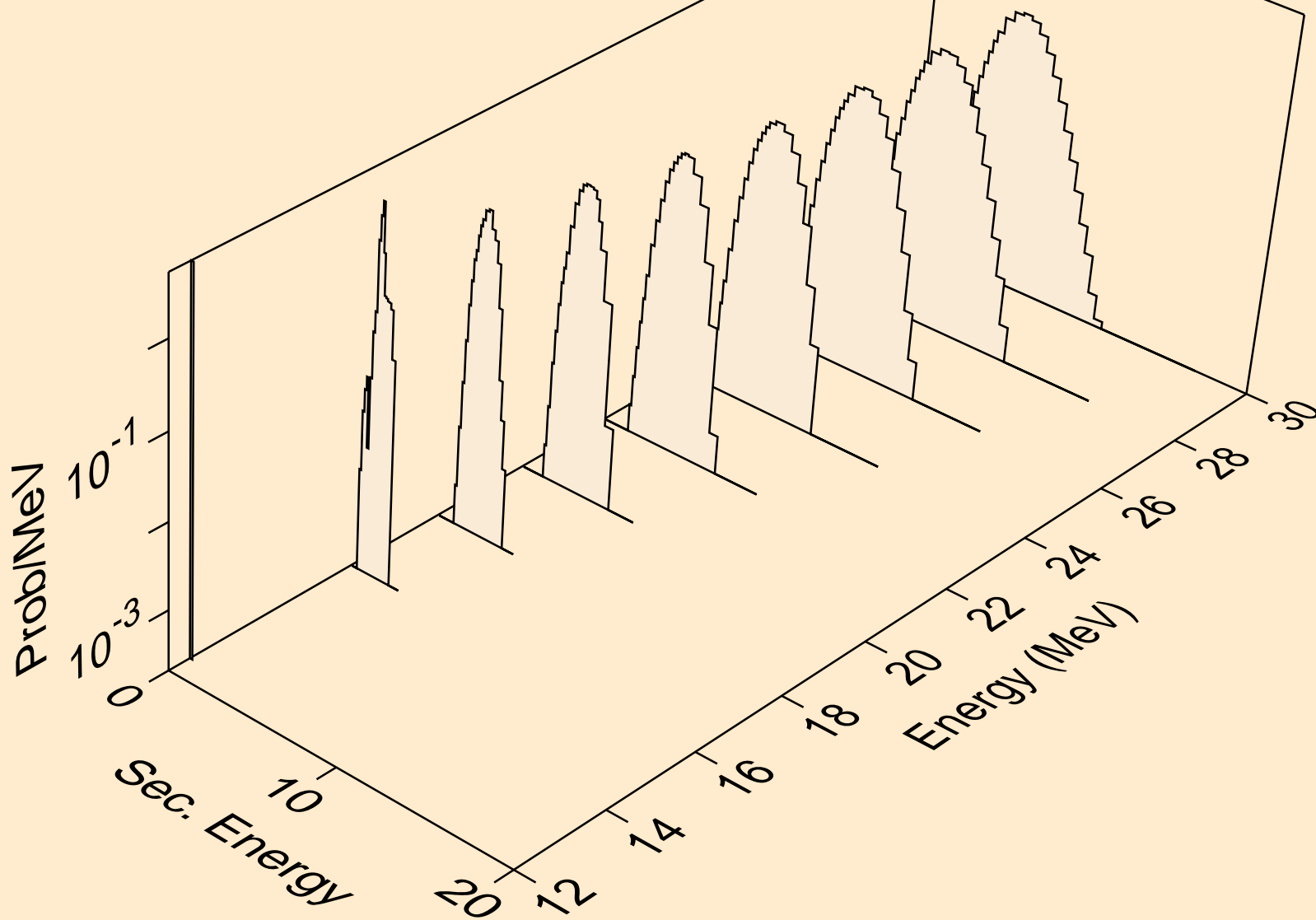

AG106 NEUTRON ACER TENDL-2019 LIBRARY; T=293.16K  
protons from (n,pt)

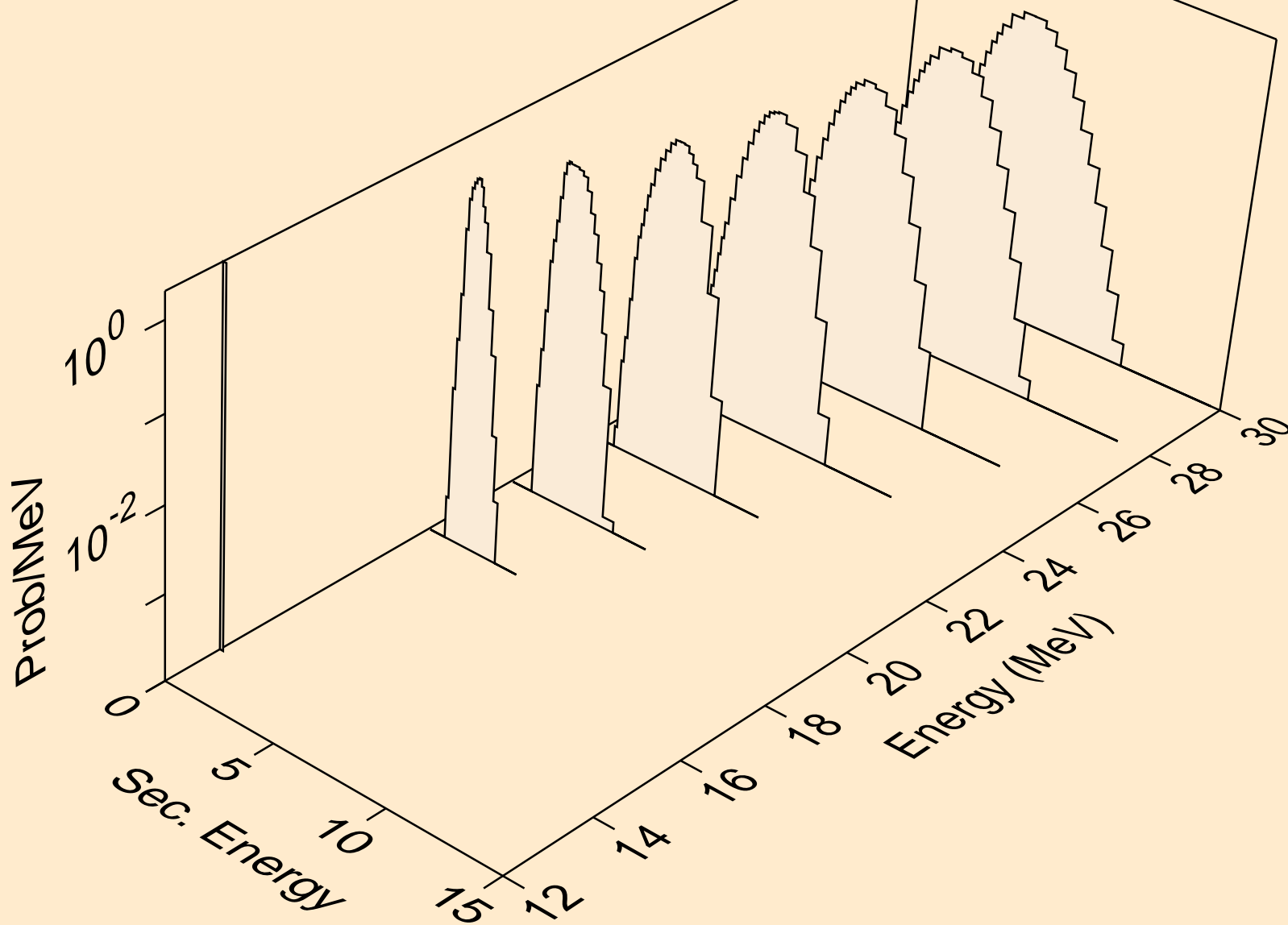

AG106 NEUTRON ACER TENDL-2019 LIBRARY; T=293.16K  
deuterons from (n,x)

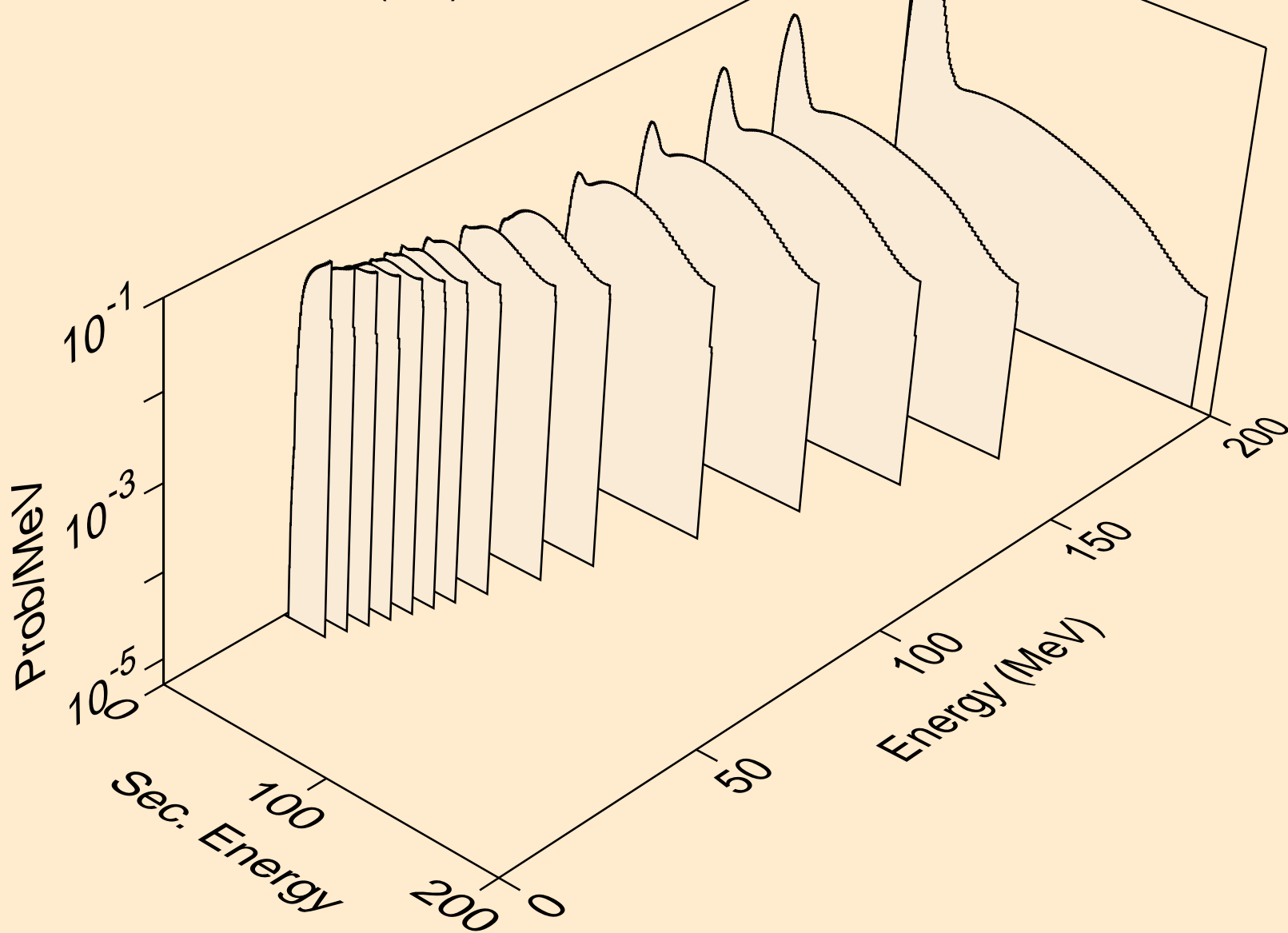



AG106 NEUTRON ACER TENDL-2019 LIBRARY; T=293.16K  
deuterons from (n,2nd)

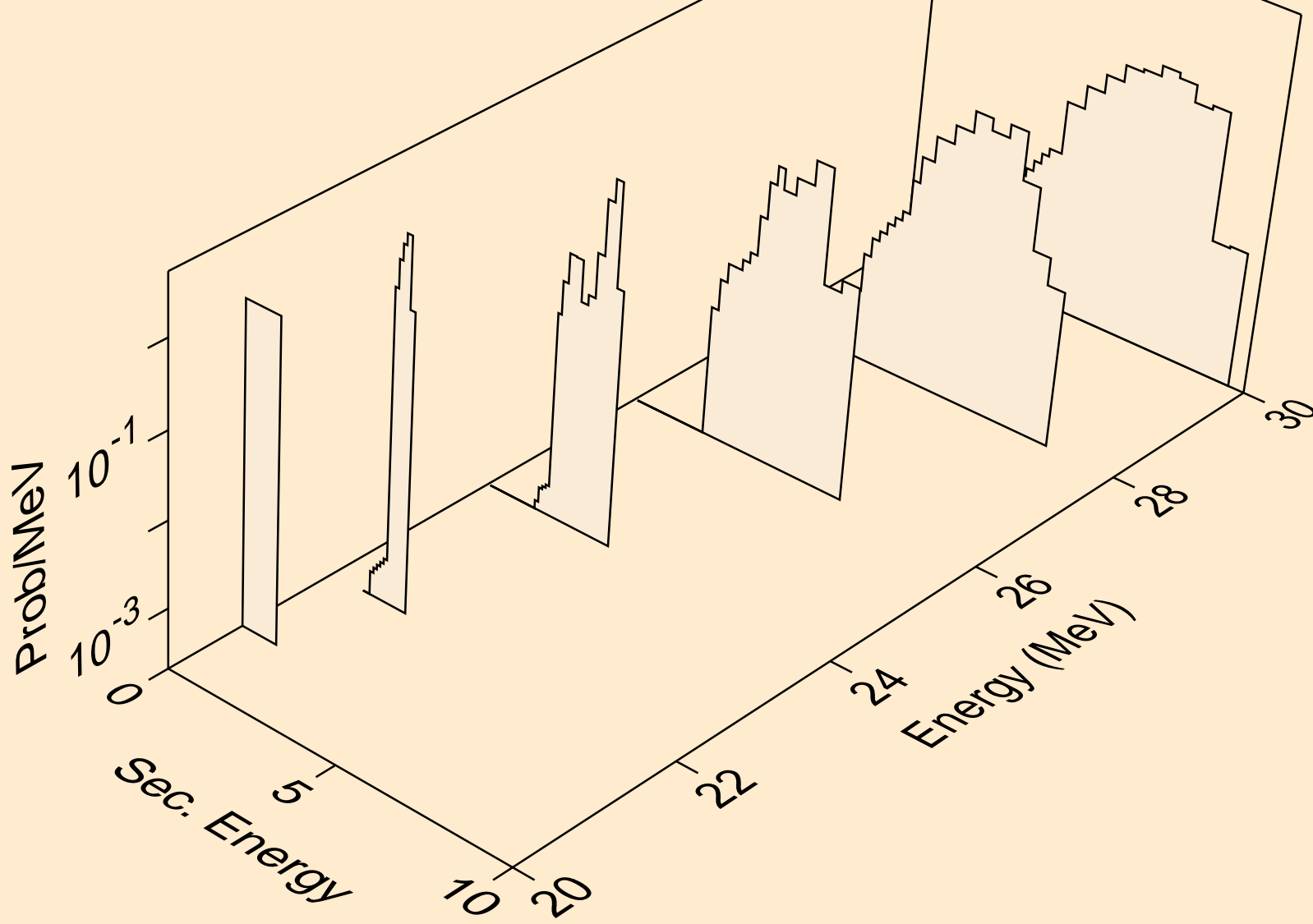

AG106 NEUTRON ACER TENDL-2019 LIBRARY; T=293.16K  
deuterons from (n,n\*)d

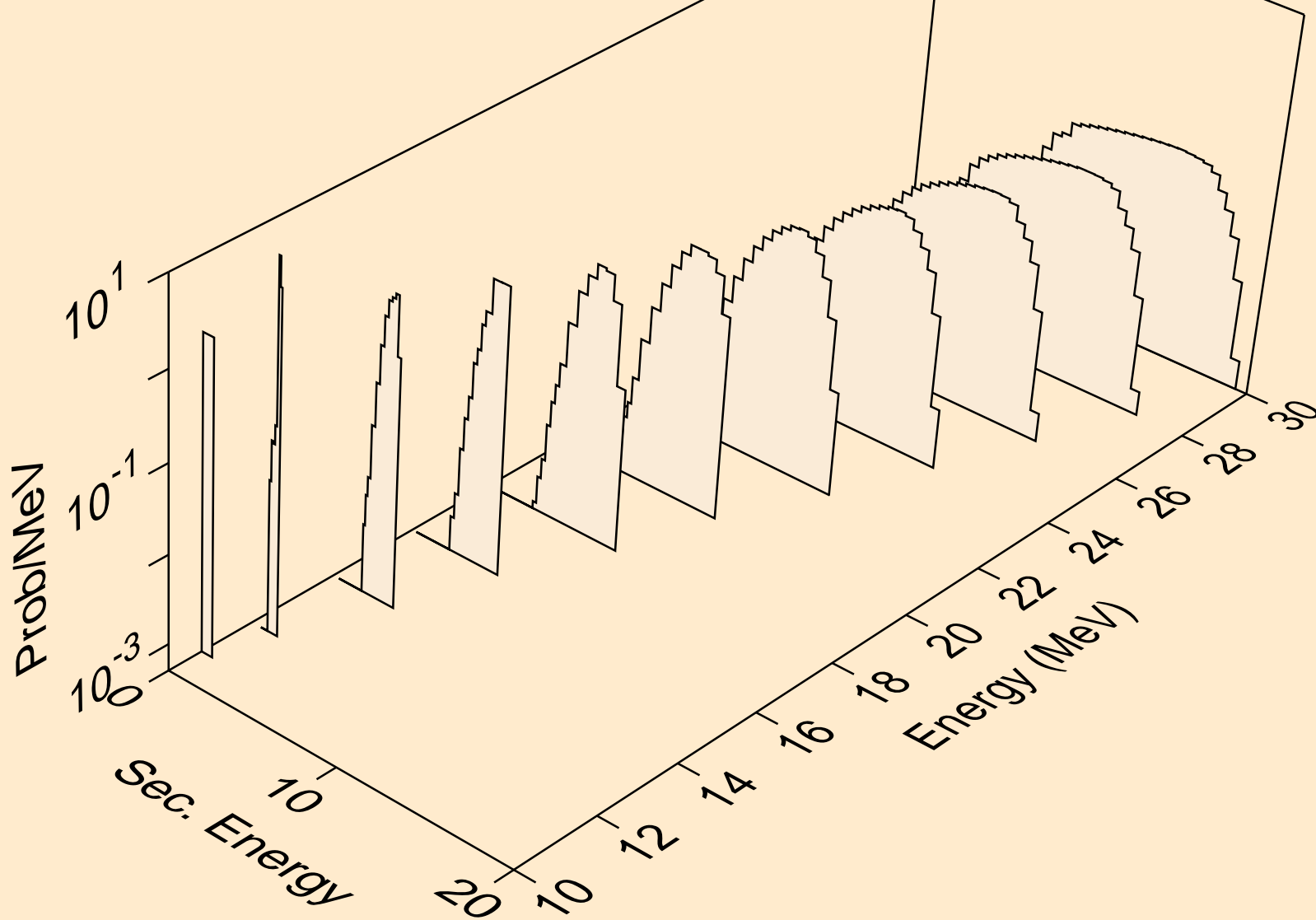

AG106 NEUTRON ACER TENDL-2019 LIBRARY; T=293.16K  
deuterons from (n,d)

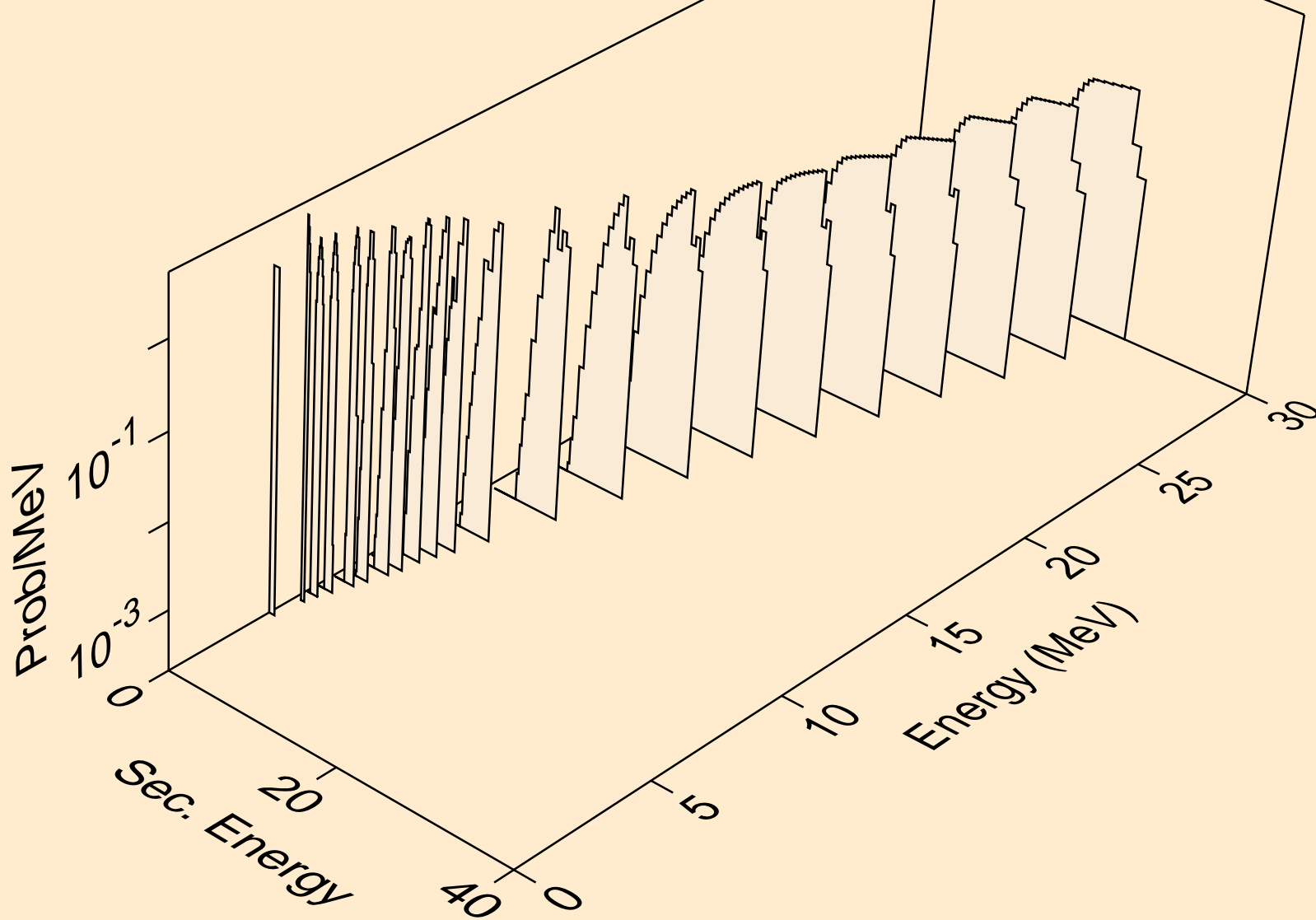

AG106 NEUTRON ACER TENDL-2019 LIBRARY; T=293.16K  
deuterons from (n,pd)

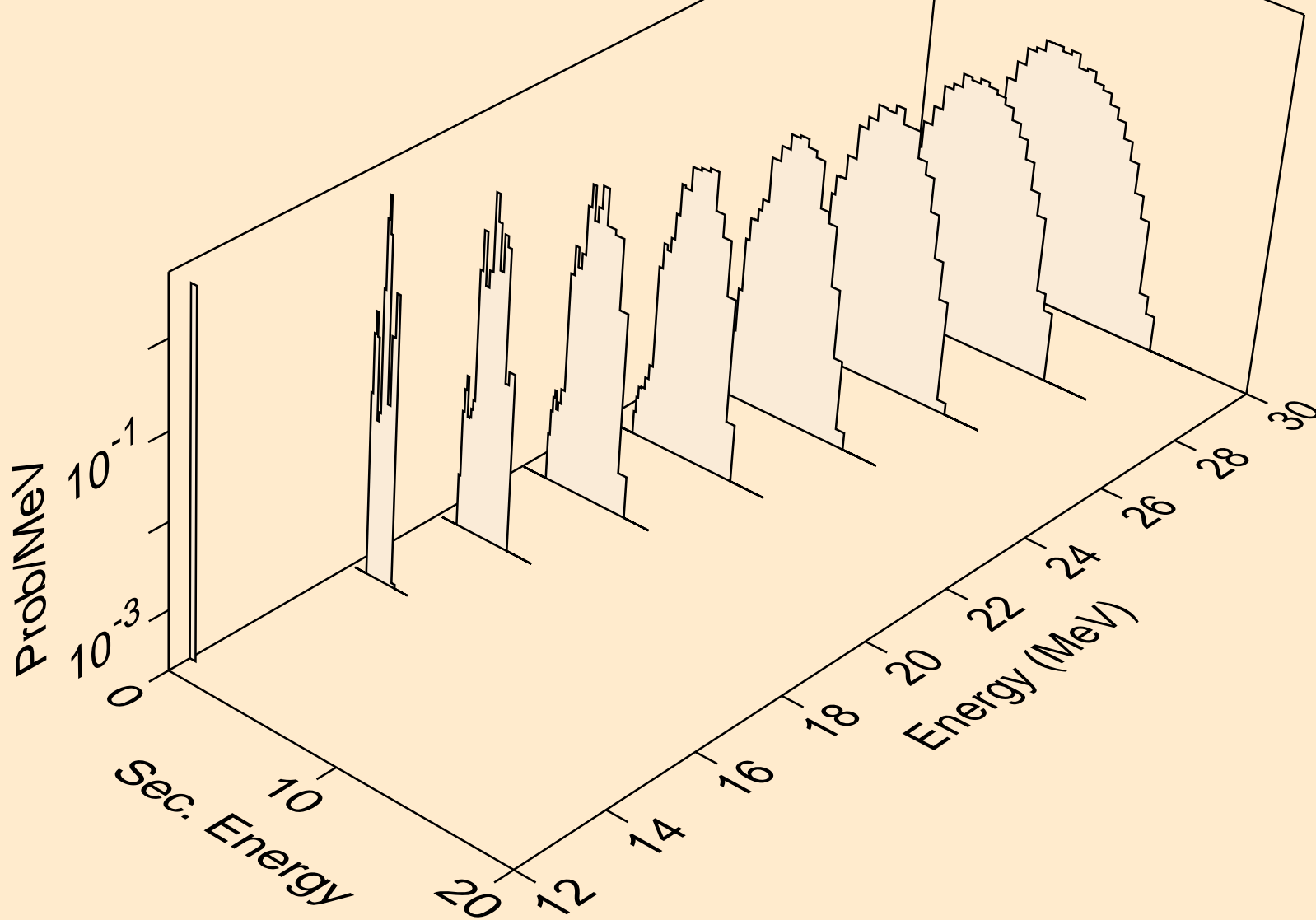

AG106 NEUTRON ACER TENDL-2019 LIBRARY; T=293.16K  
deuterons from (n,da)

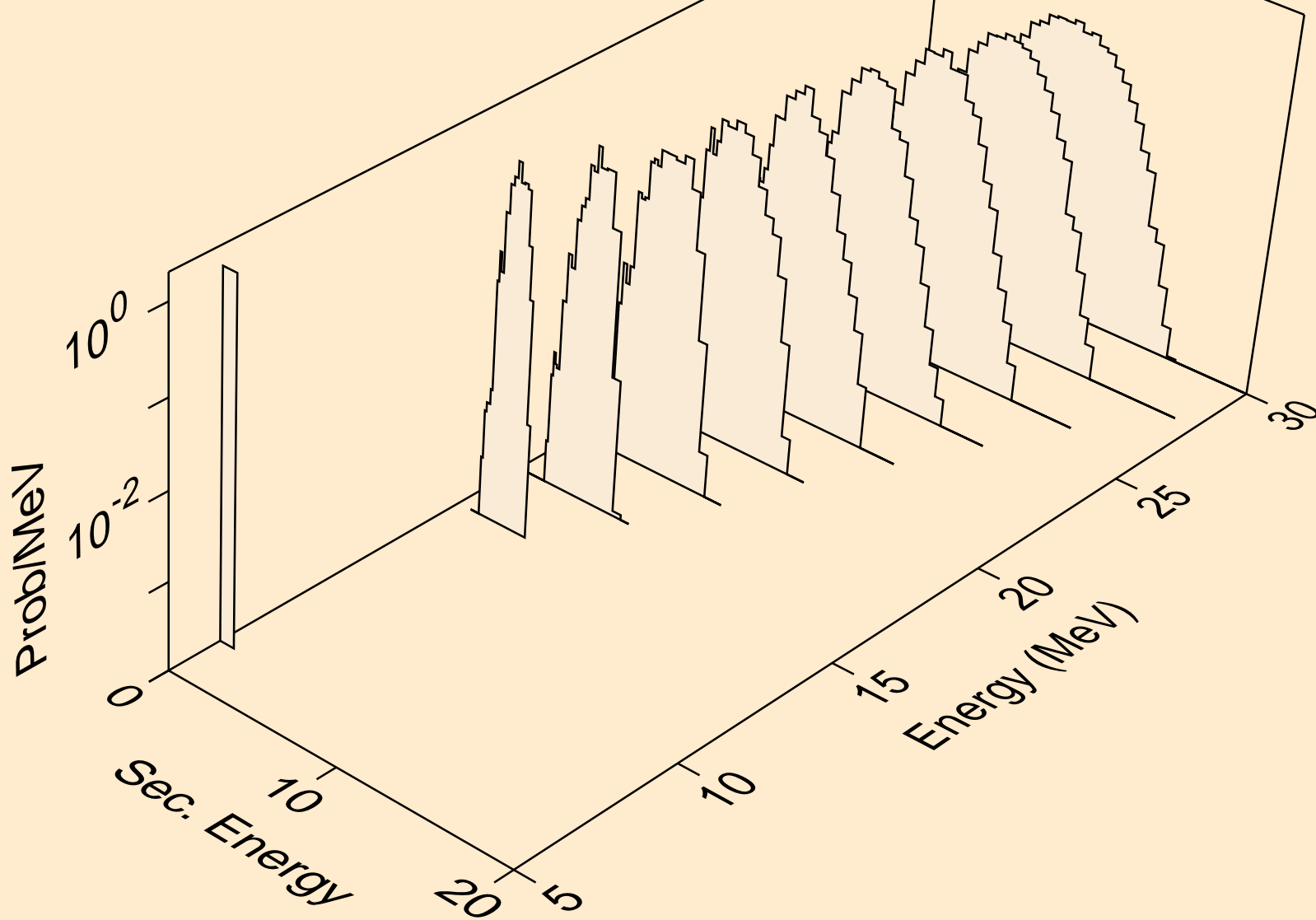

AG106 NEUTRON ACER TENDL-2019 LIBRARY; T=293.16K  
tritons from (n,x)

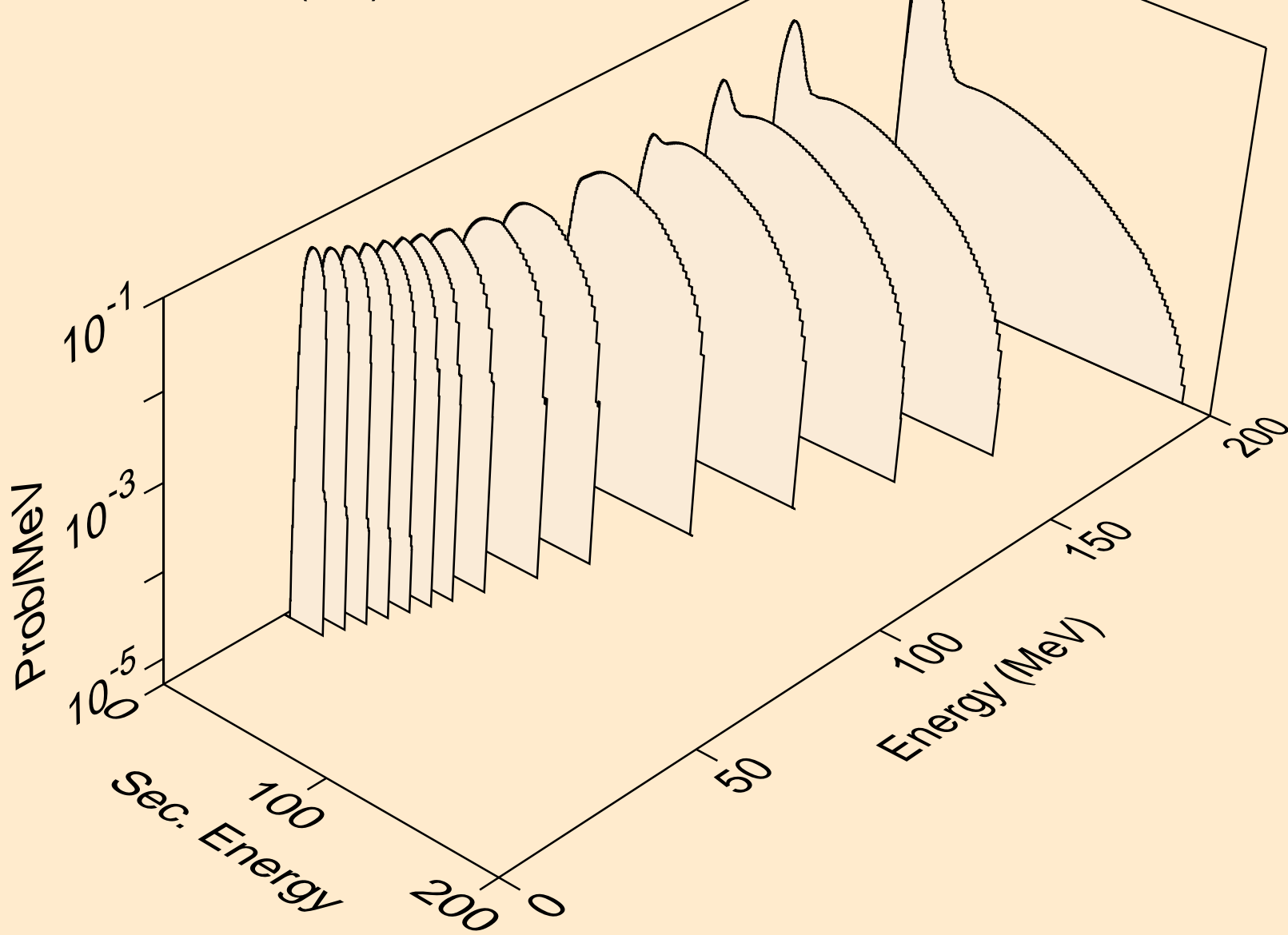

AG106 NEUTRON ACER TENDL-2019 LIBRARY; T=293.16K  
tritons from (n,n\*)t

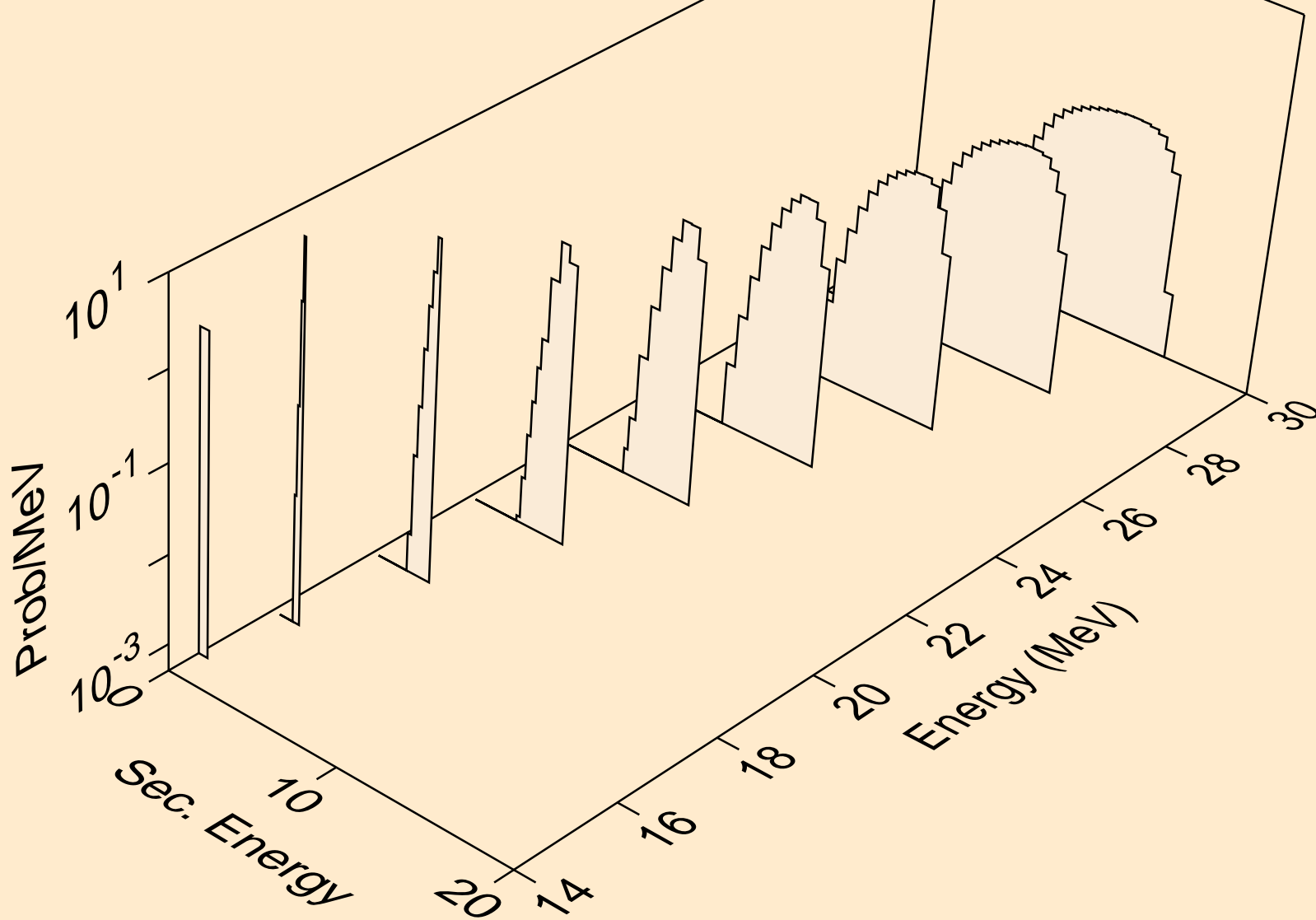

AG106 NEUTRON ACER TENDL-2019 LIBRARY; T=293.16K  
tritons from (n,t)

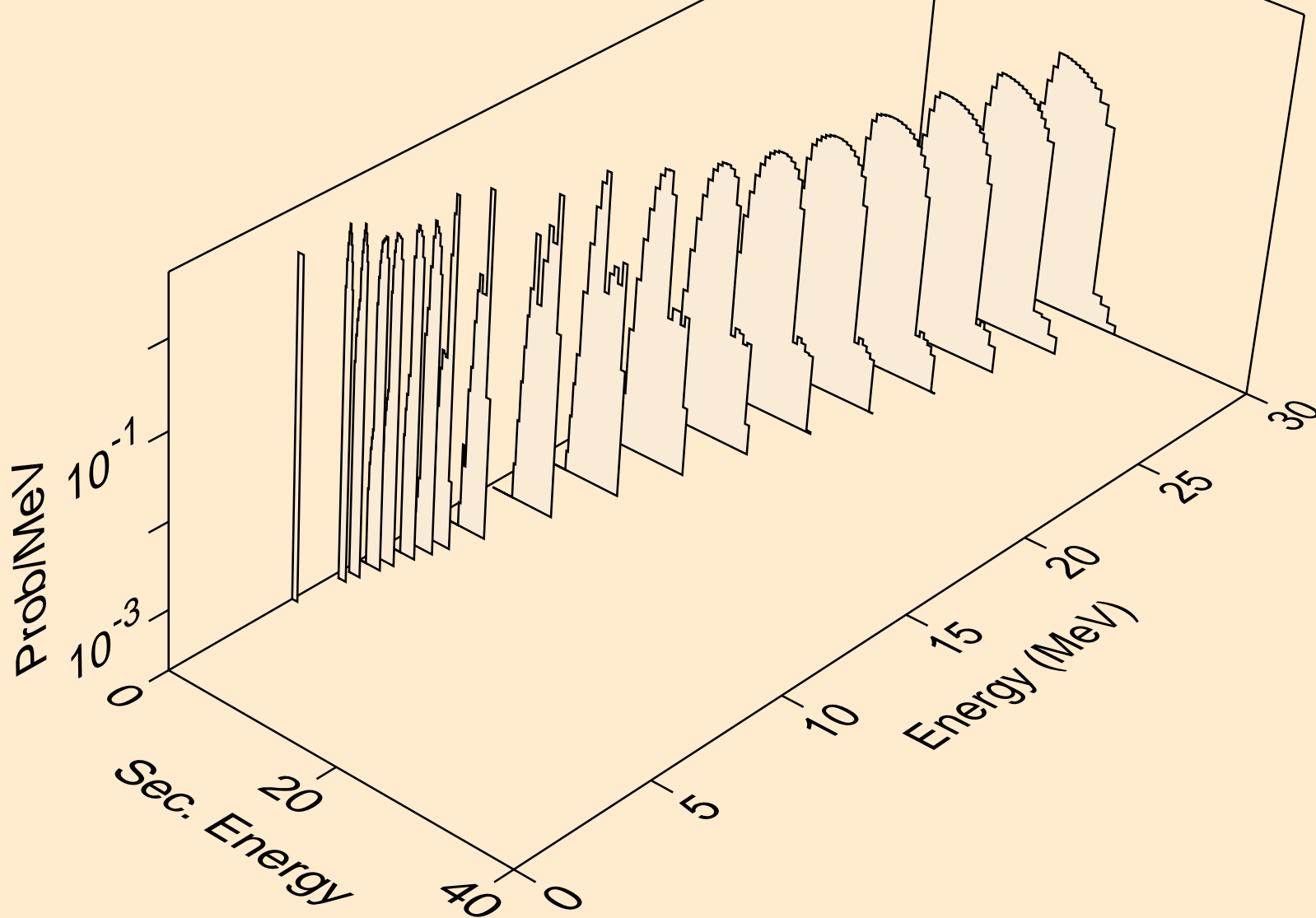



AG106 NEUTRON ACER TENDL-2019 LIBRARY; T=293.16K  
tritons from (n,pt)

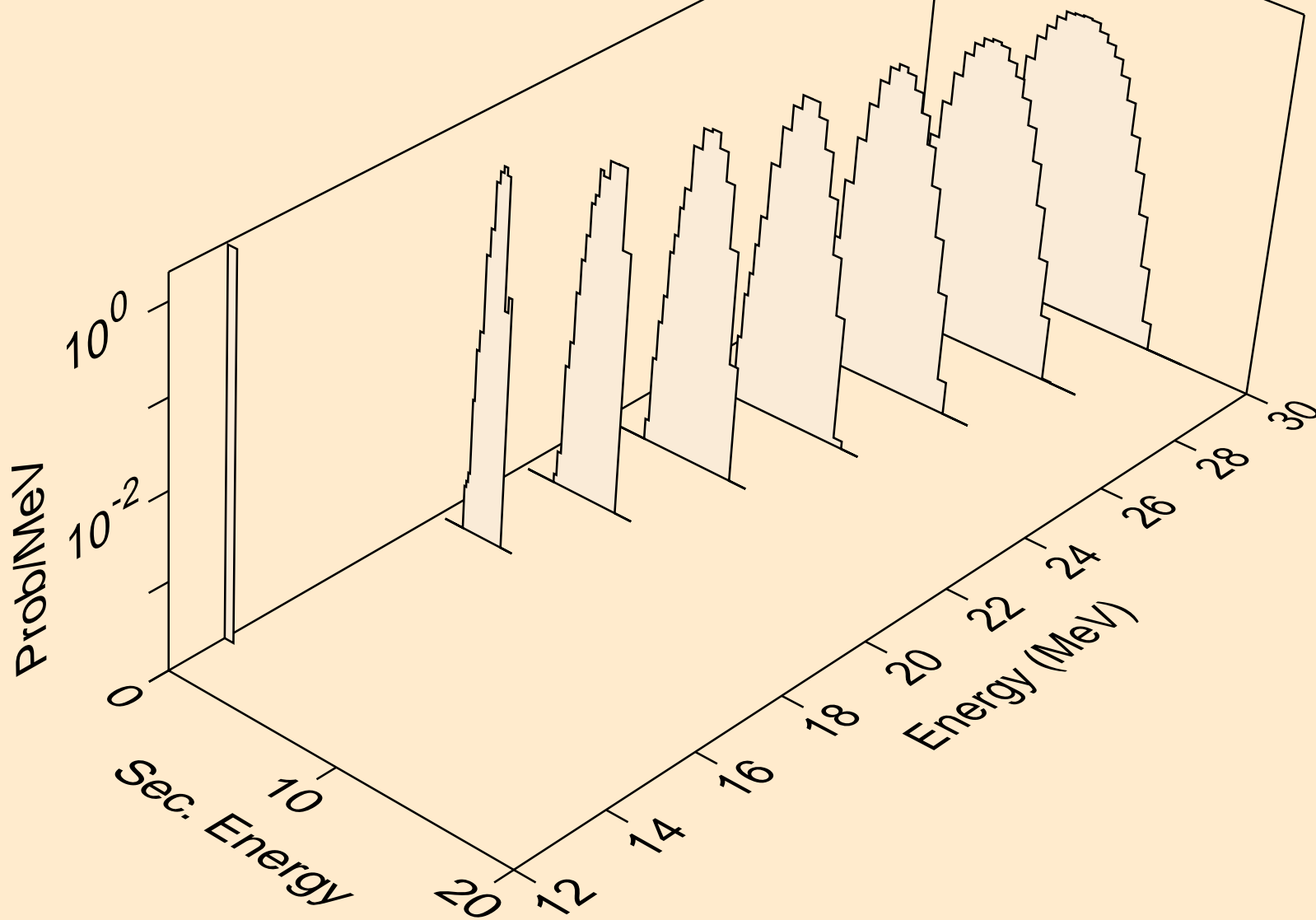

AG106 NEUTRON ACER TENDL-2019 LIBRARY; T=293.16K  
he3s from (n,x)

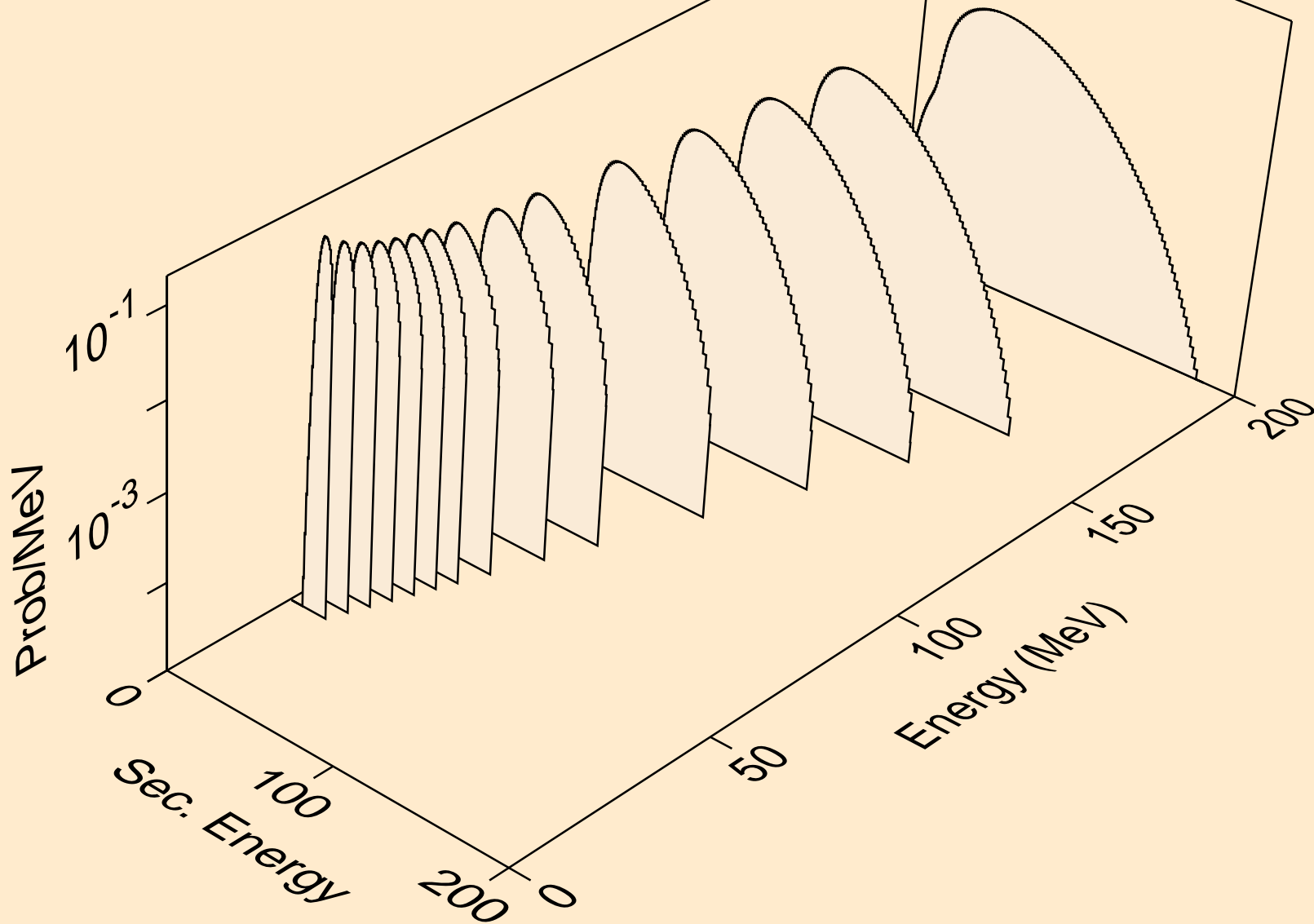

AG106 NEUTRON ACER TENDL-2019 LIBRARY; T=293.16K  
he3s from (n,n\*)he3

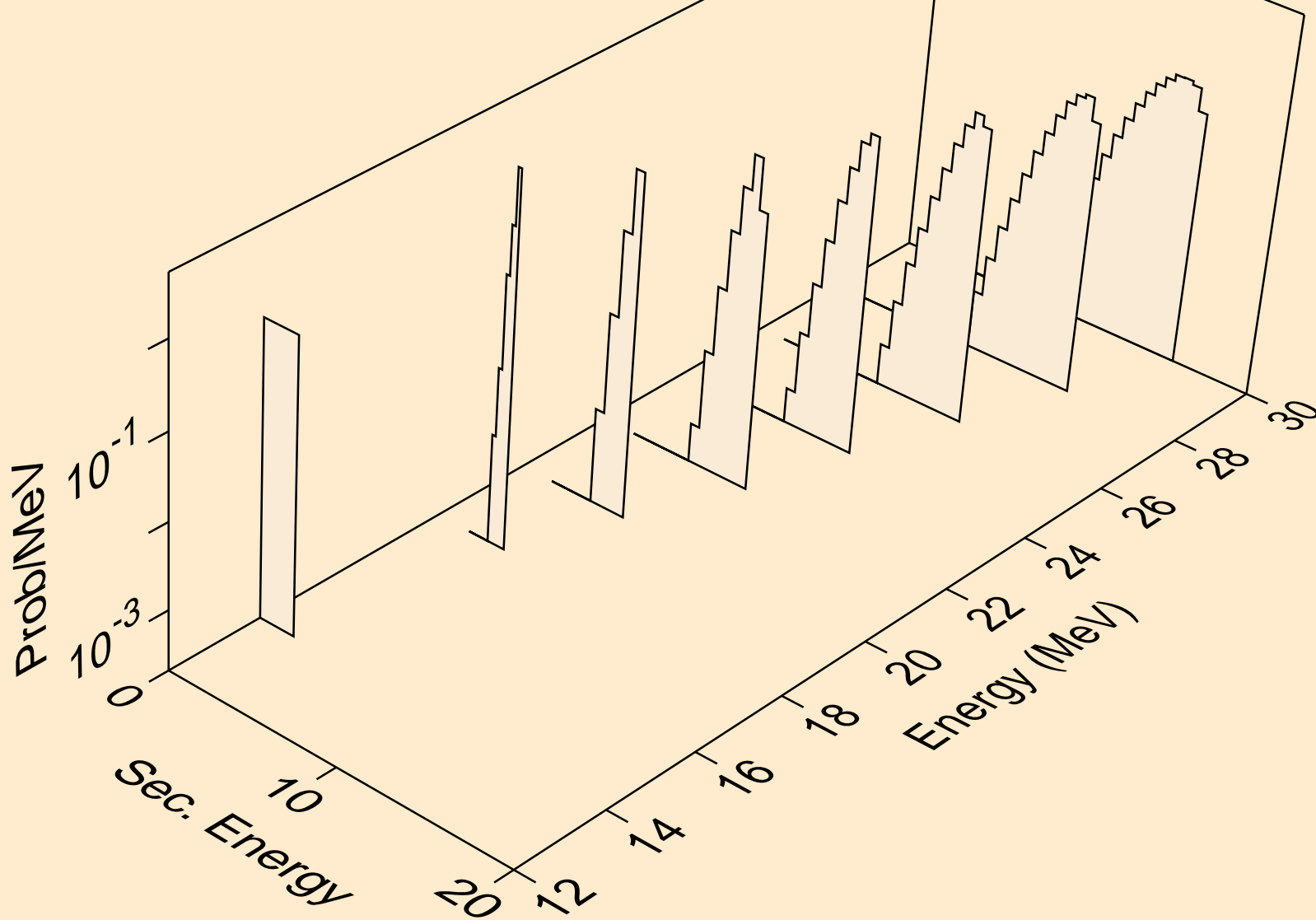

AG106 NEUTRON ACER TENDL-2019 LIBRARY; T=293.16K  
he3s from (n,he3)

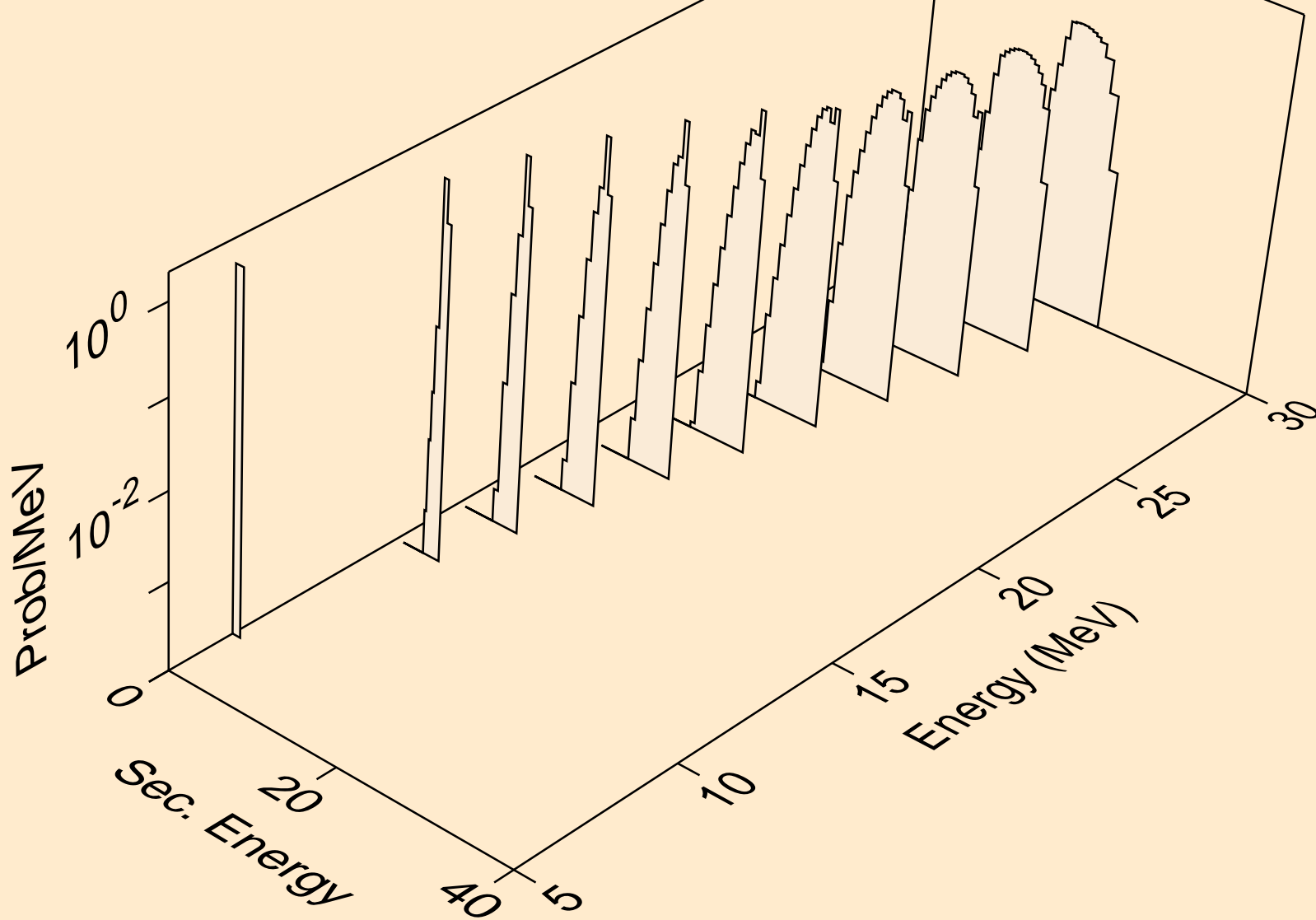

AG106 NEUTRON ACER TENDL-2019 LIBRARY; T=293.16K  
alphas from (n,x)

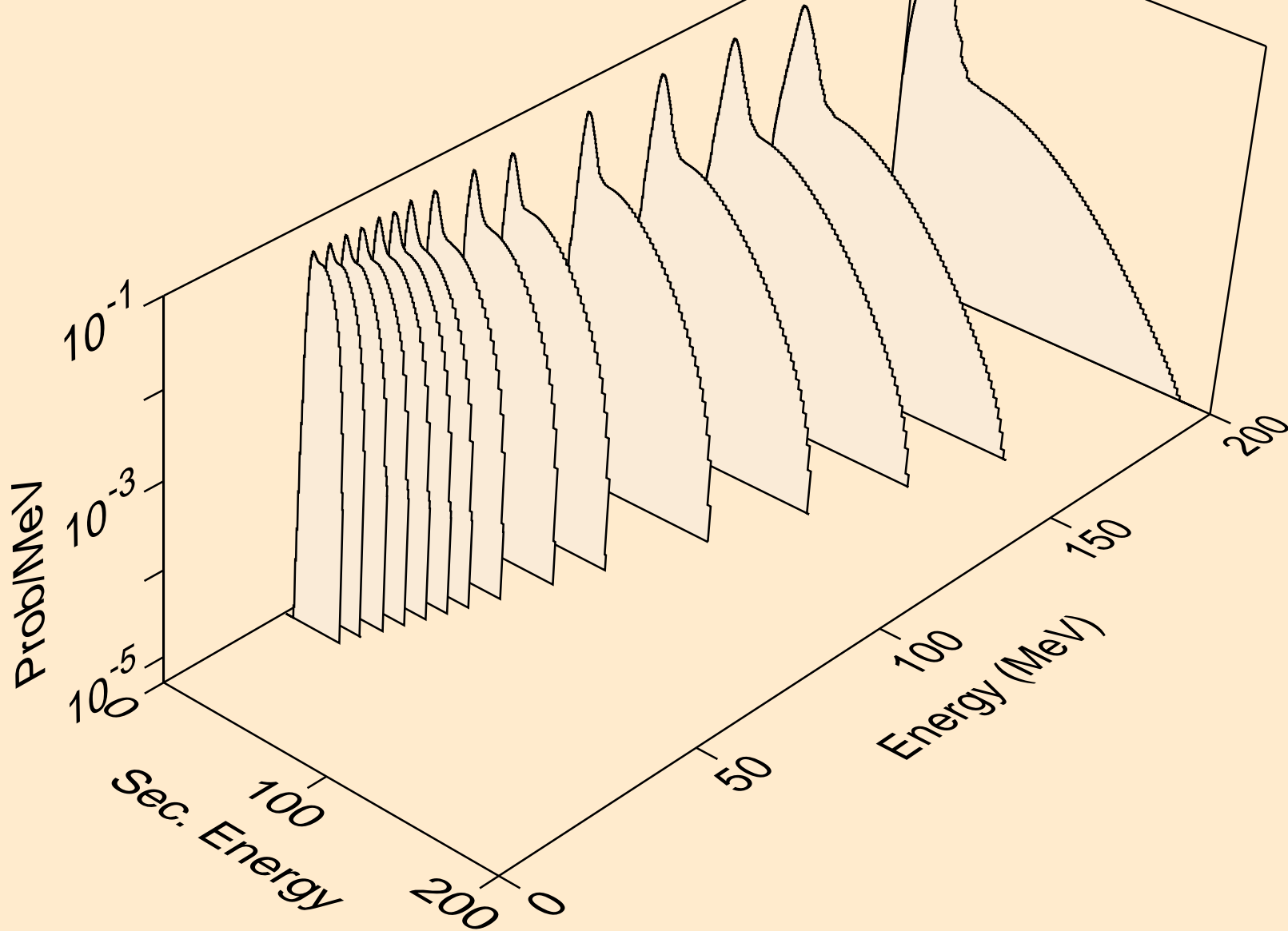

AG106 NEUTRON ACER TENDL-2019 LIBRARY; T=293.16K  
alphas from (n,n\*)a

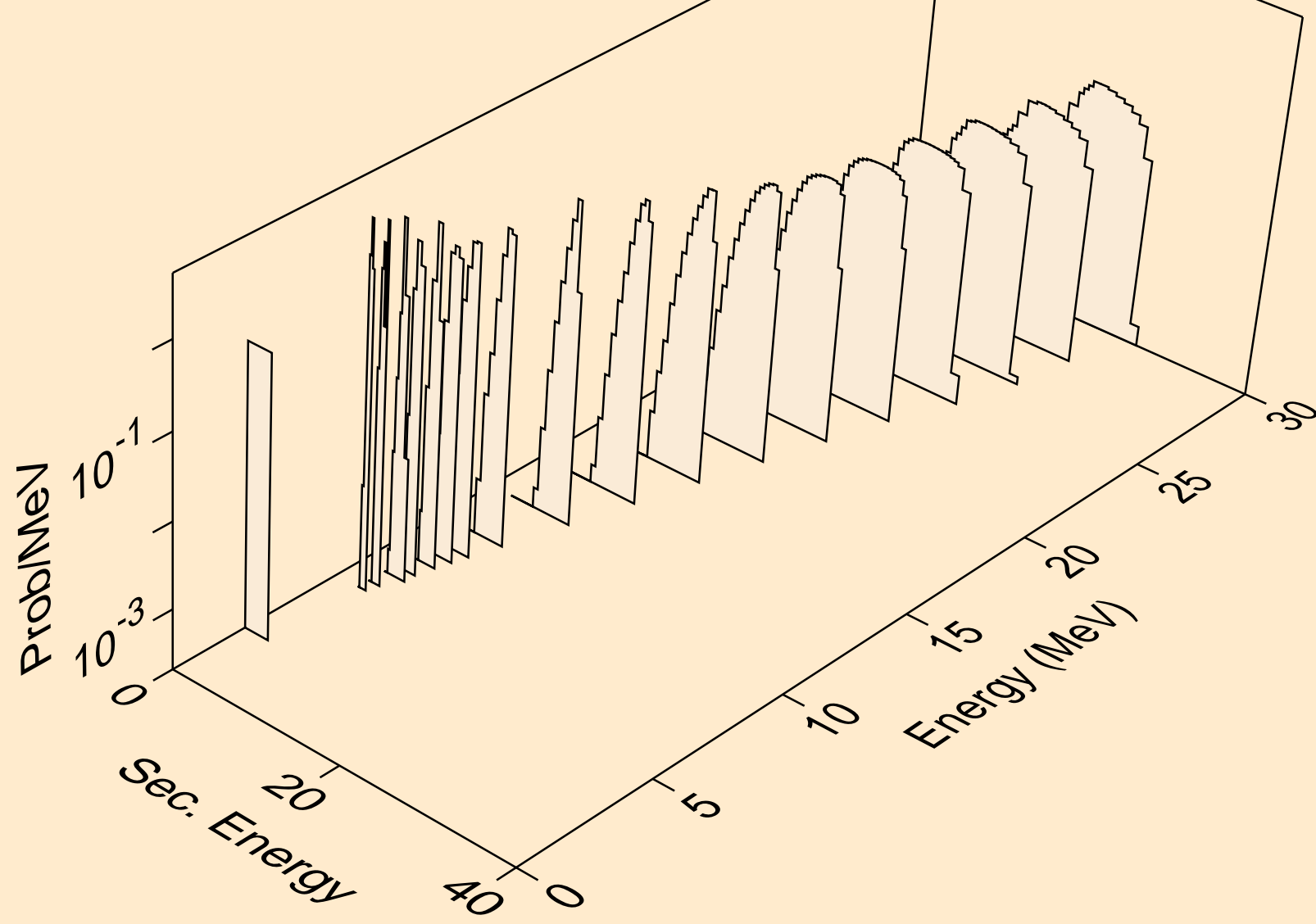

AG106 NEUTRON ACER TENDL-2019 LIBRARY; T=293.16K  
alphas from (n,2n)a

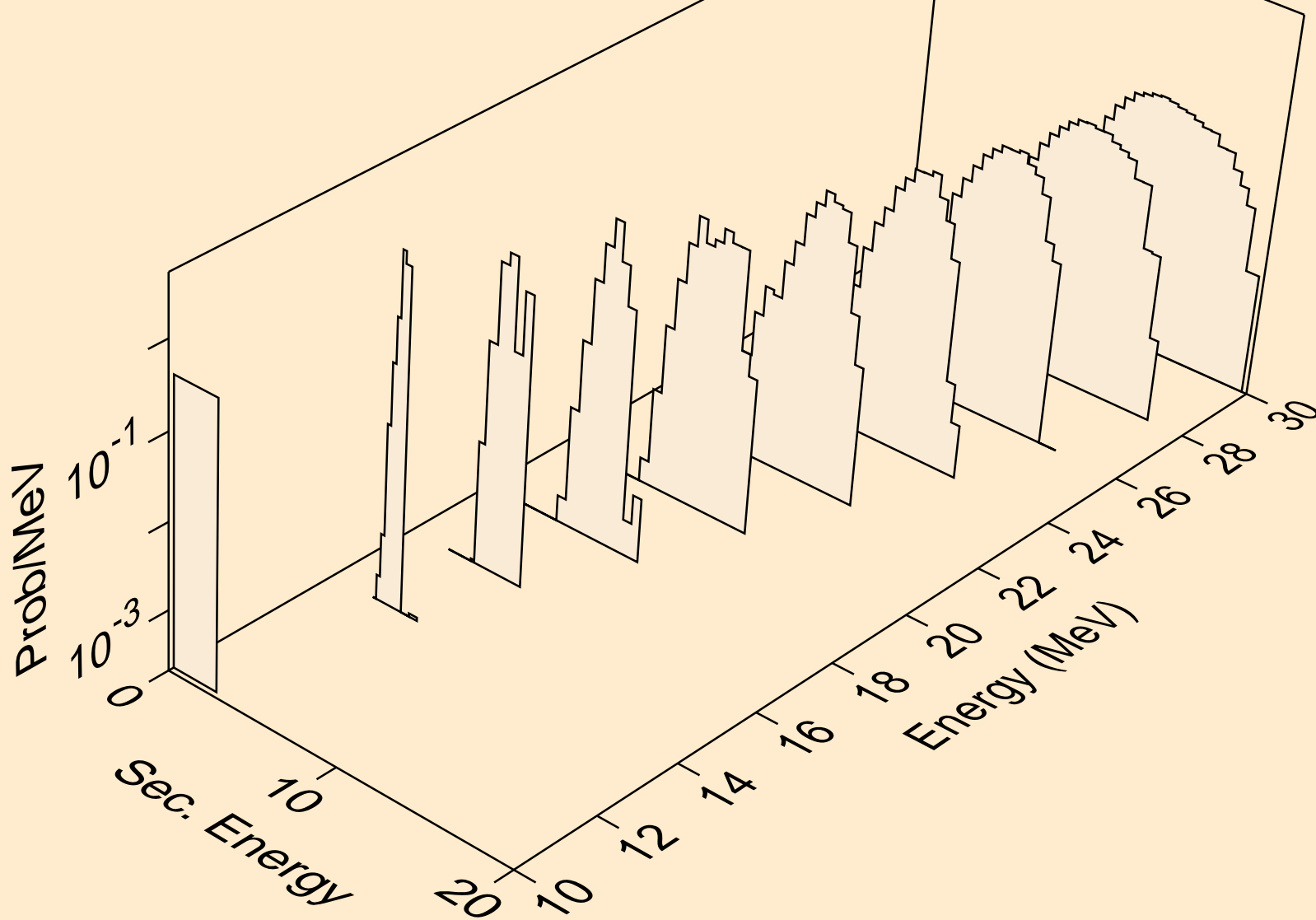

AG106 NEUTRON ACER TENDL-2019 LIBRARY; T=293.16K  
alphas from (n,3n)a

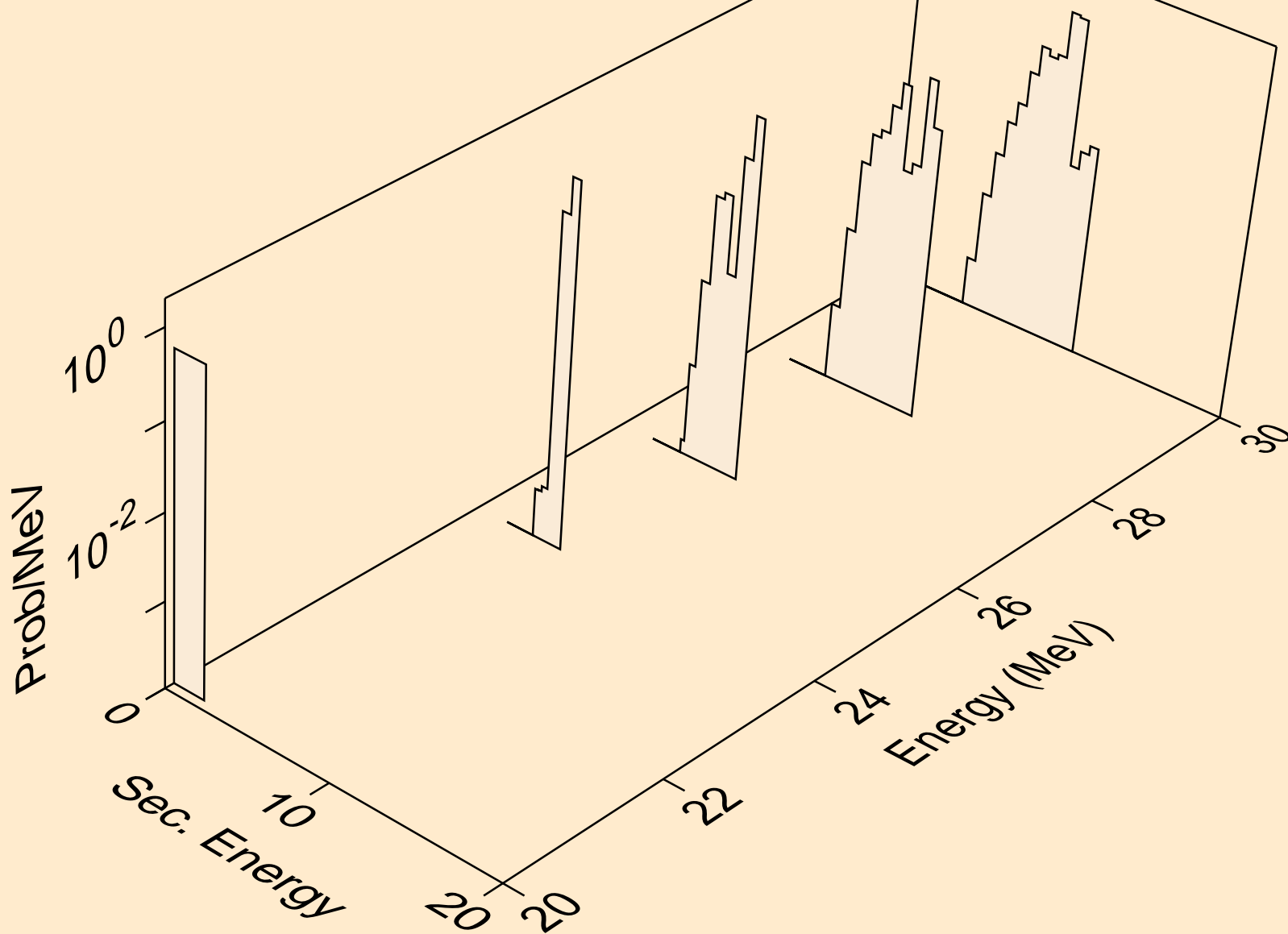



AG106 NEUTRON ACER TENDL-2019 LIBRARY; T=293.16K  
alphas from (n,n\*)2a

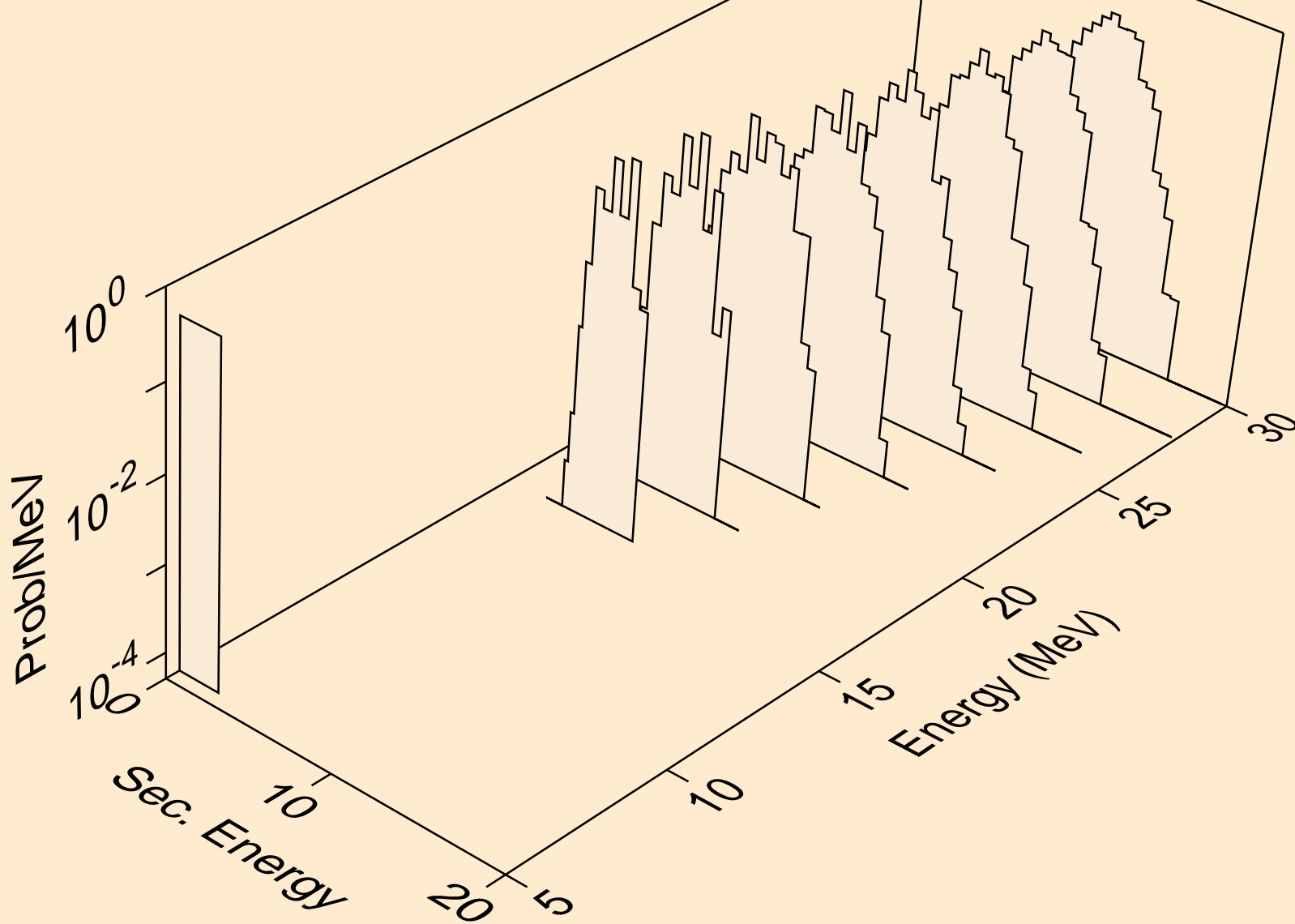

AG106 NEUTRON ACER TENDL-2019 LIBRARY; T=293.16K  
alphas from (n,2n)2a

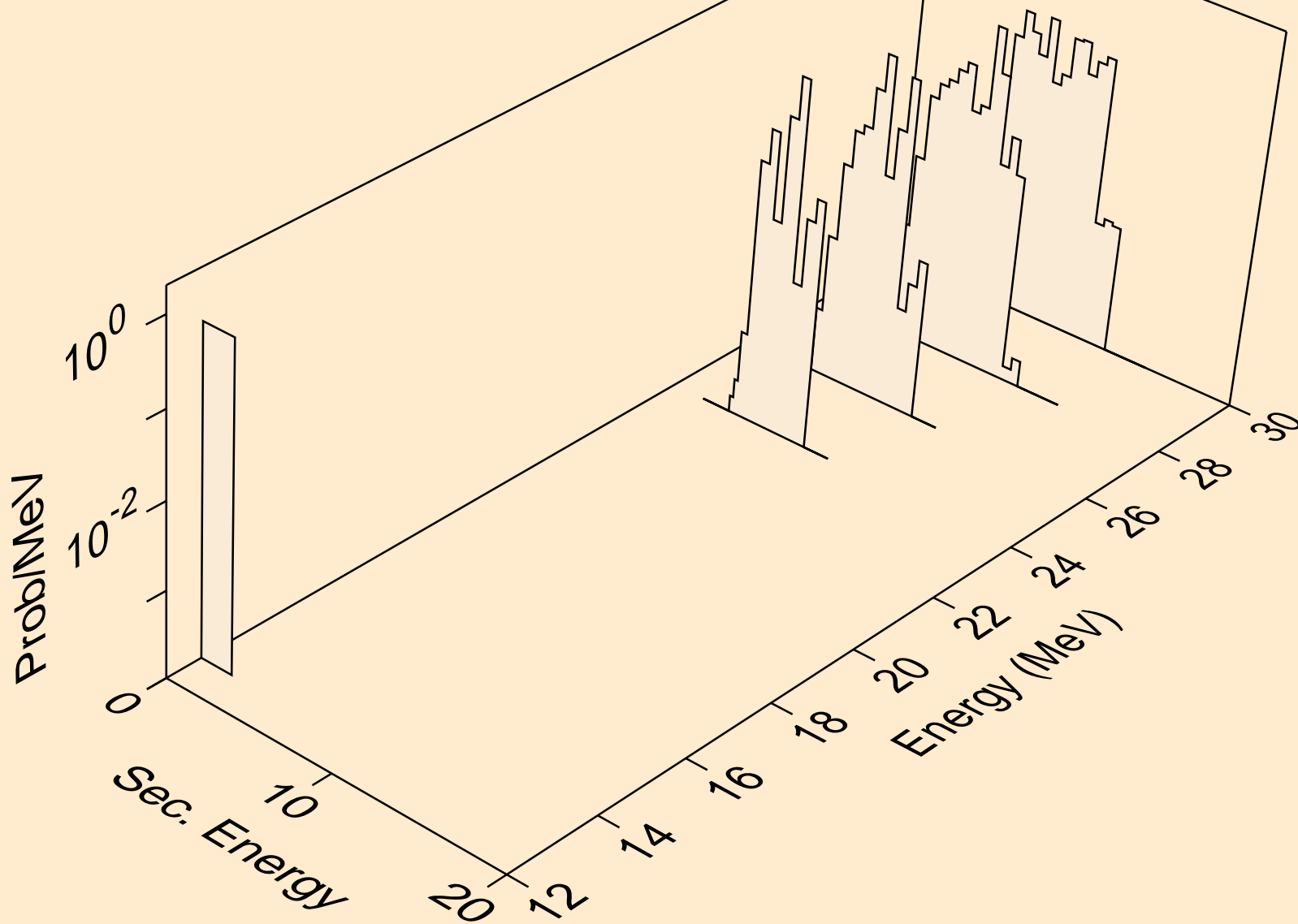

AG106 NEUTRON ACER TENDL-2019 LIBRARY; T=293.16K  
alphas from (n,npa)

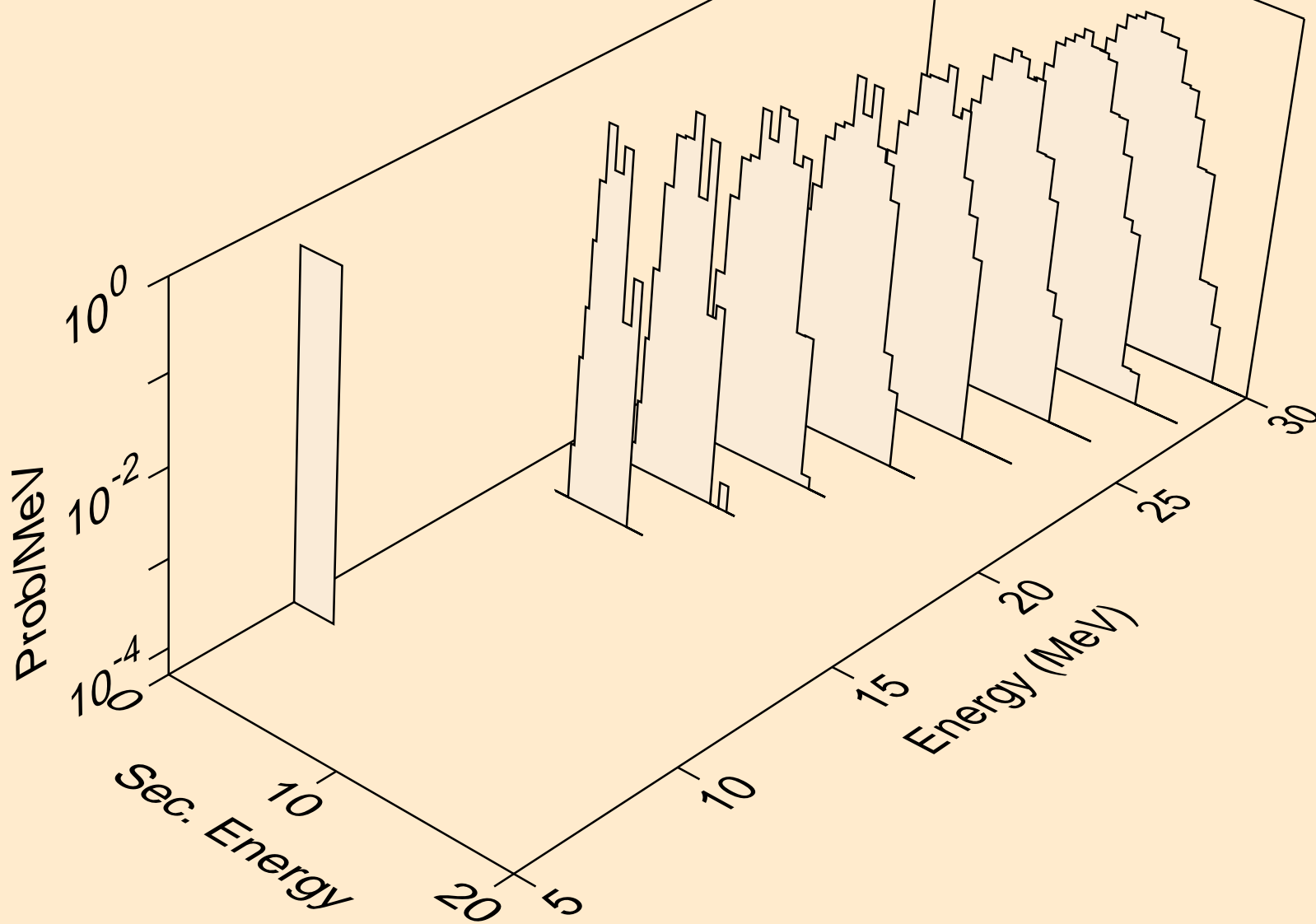

AG106 NEUTRON ACER TENDL-2019 LIBRARY; T=293.16K  
alphas from (n,a)

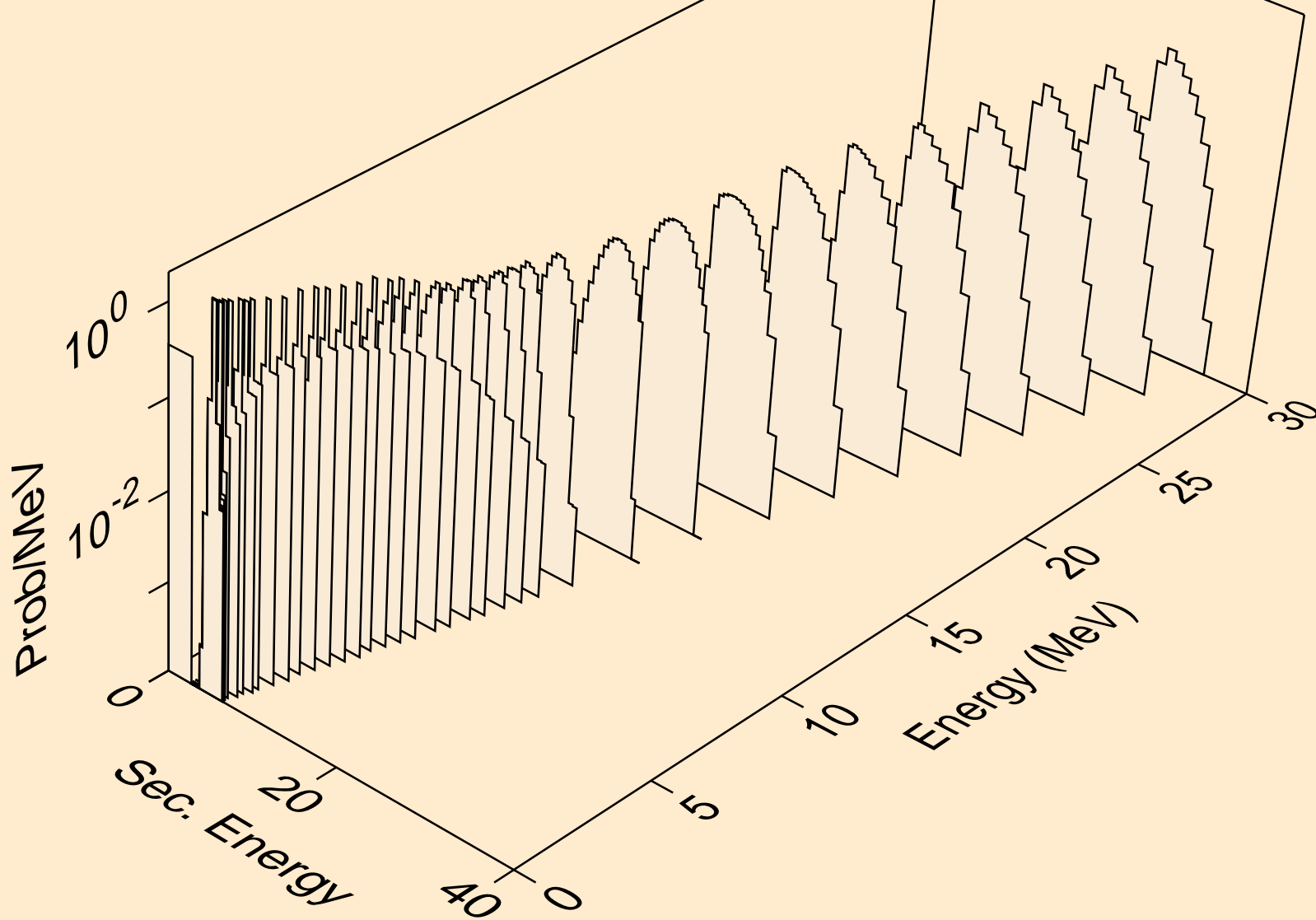

AG106 NEUTRON ACER TENDL-2019 LIBRARY; T=293.16K  
alphas from (n,2a)

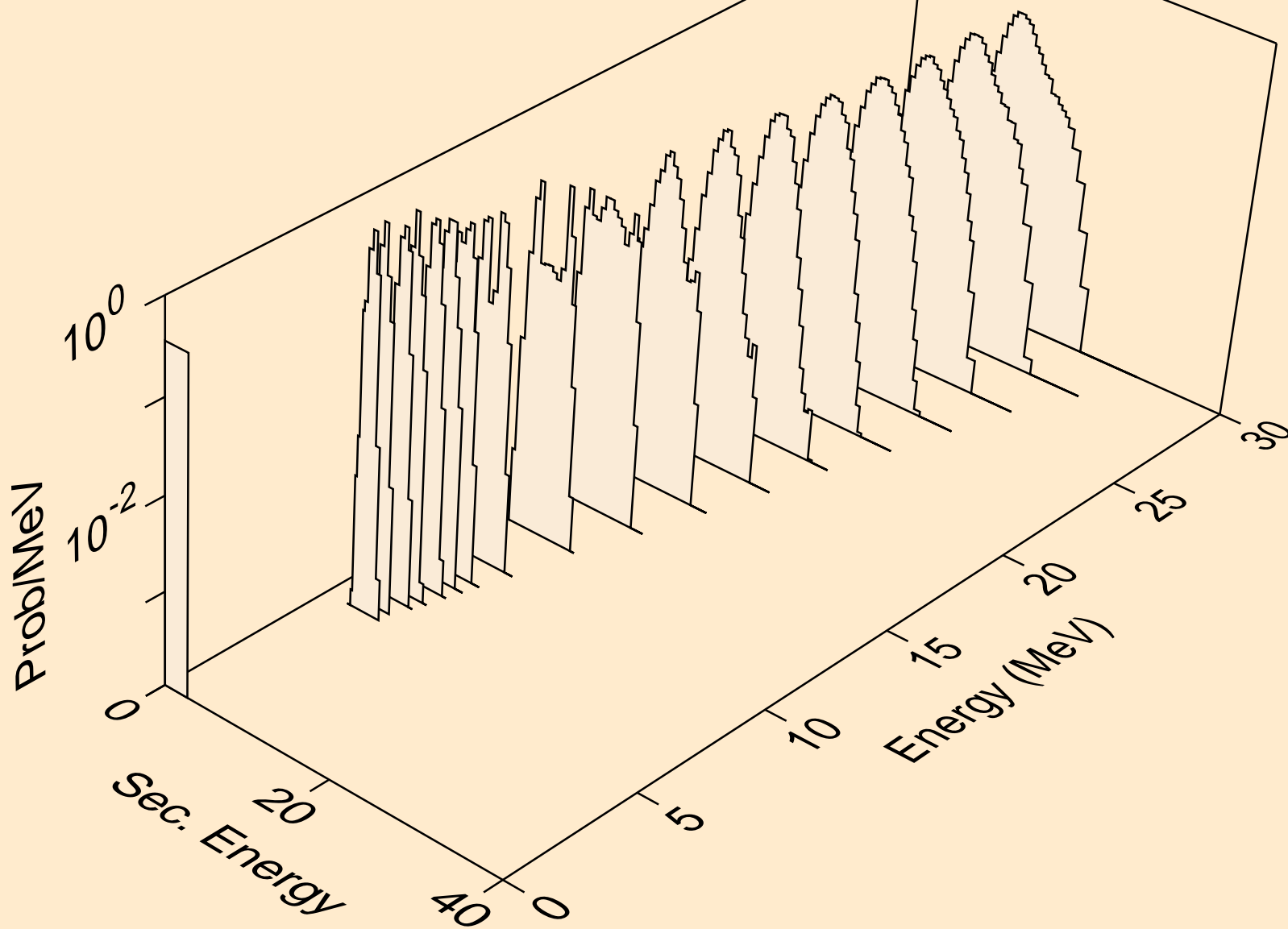

AG106 NEUTRON ACER TENDL-2019 LIBRARY; T=293.16K  
alphas from (n,pa)

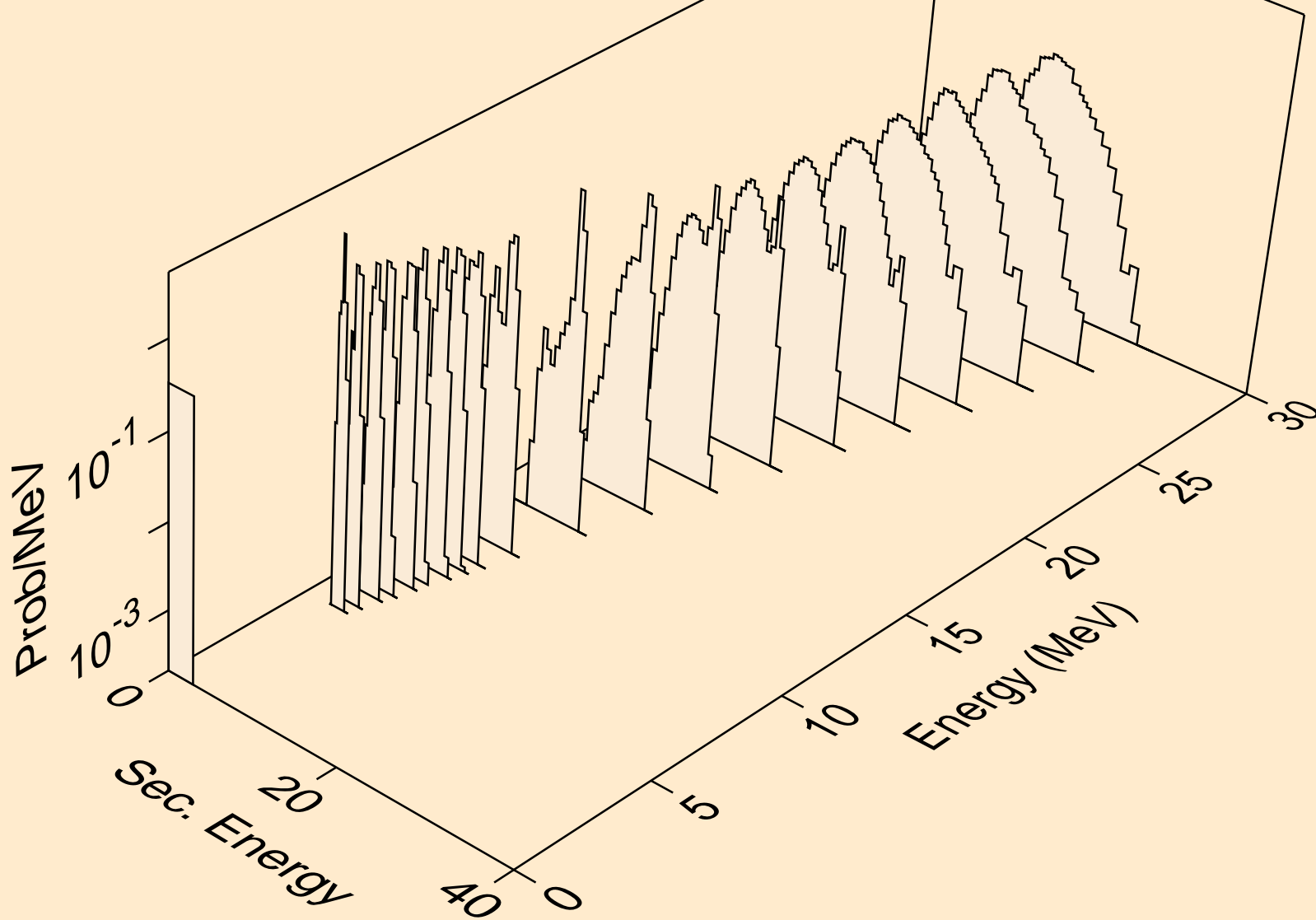

AG106 NEUTRON ACER TENDL-2019 LIBRARY; T=293.16K  
alphas from (n,da)

