

AG120 NEUTRON ACER TENDL-2019 LIBRARY; T=293.16K
Principal cross sections

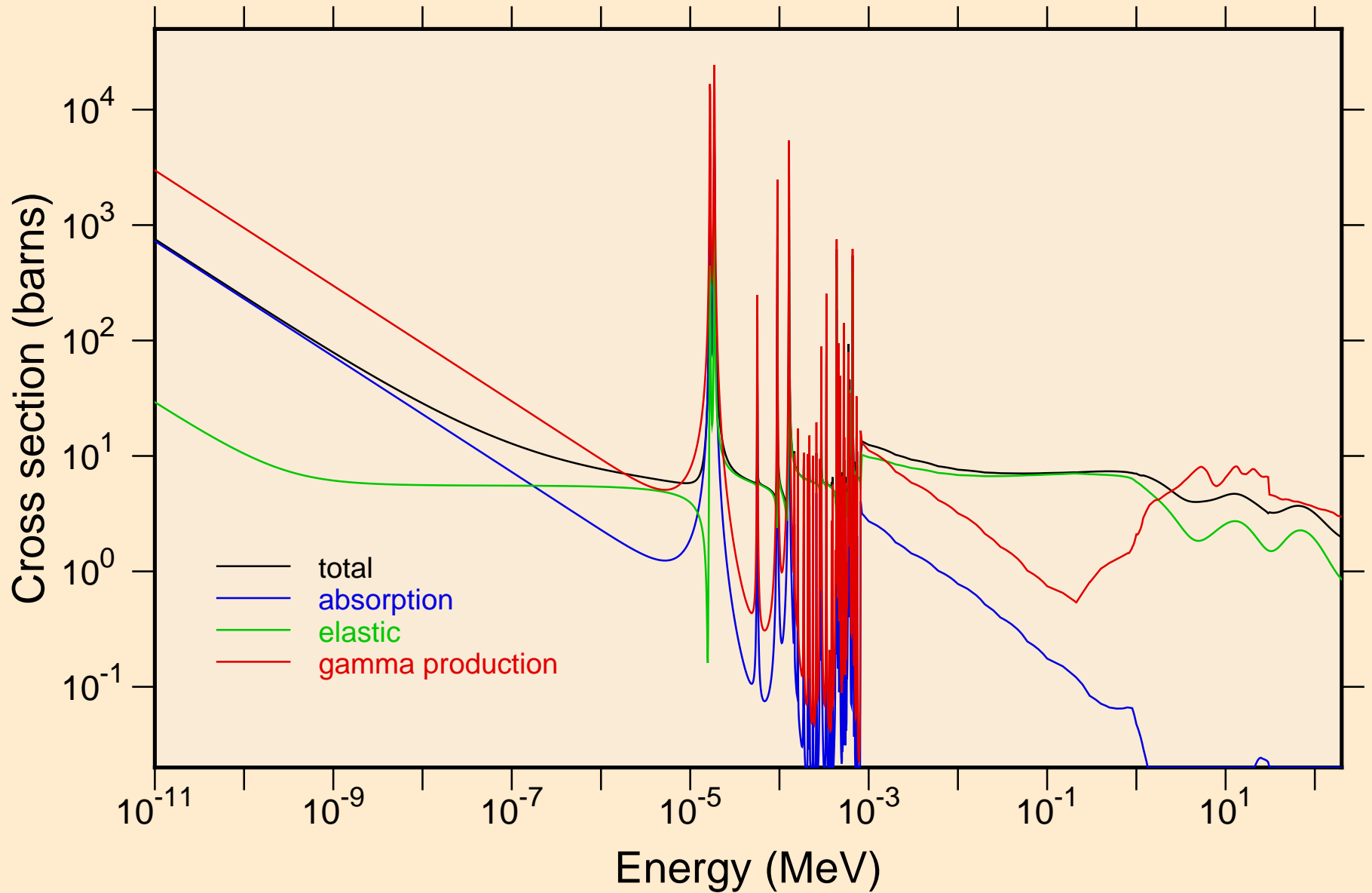

AG120 NEUTRON ACER TENDL-2019 LIBRARY; T=293.16K
resonance total cross section

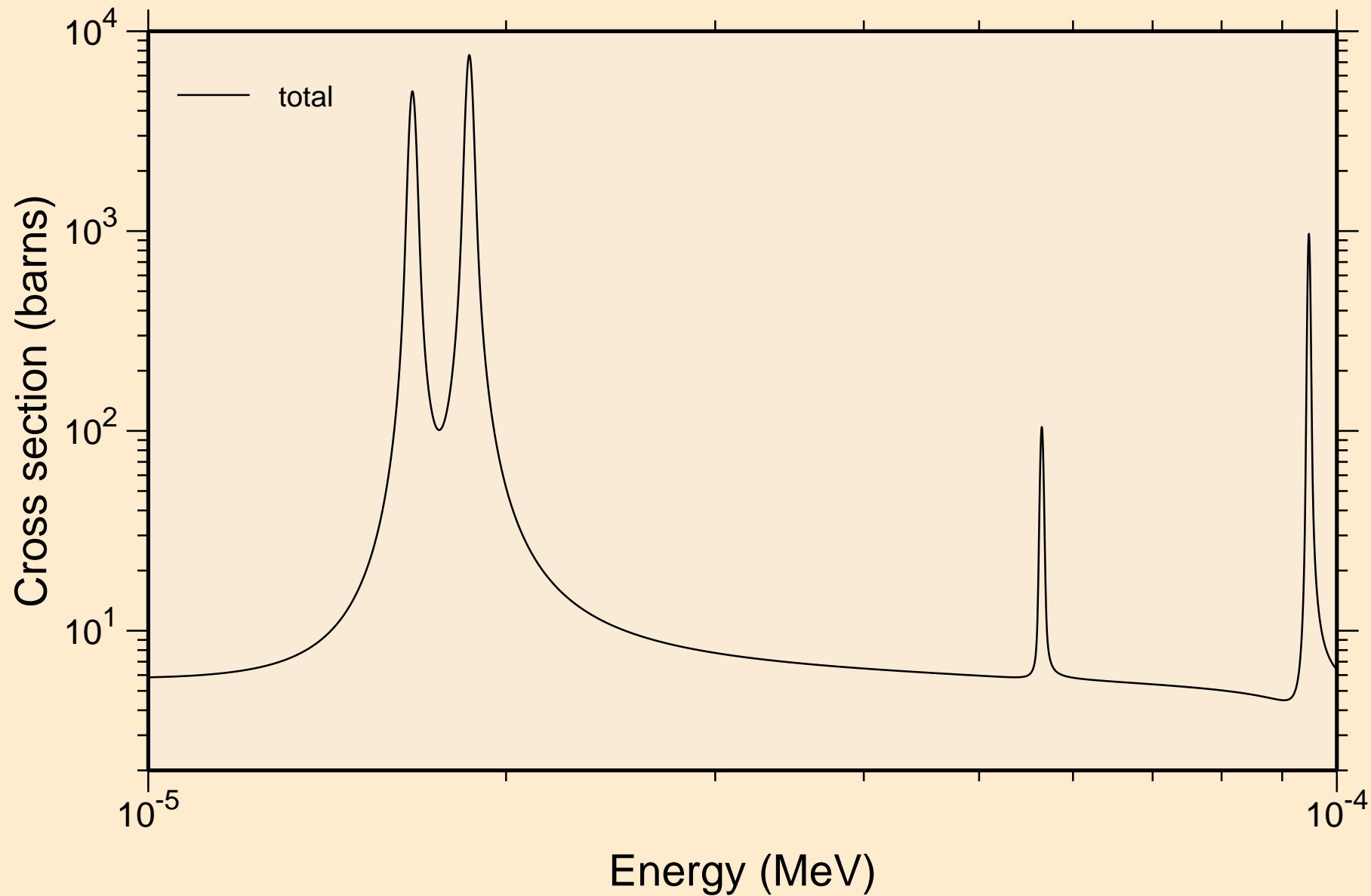

AG120 NEUTRON ACER TENDL-2019 LIBRARY; T=293.16K
resonance total cross section

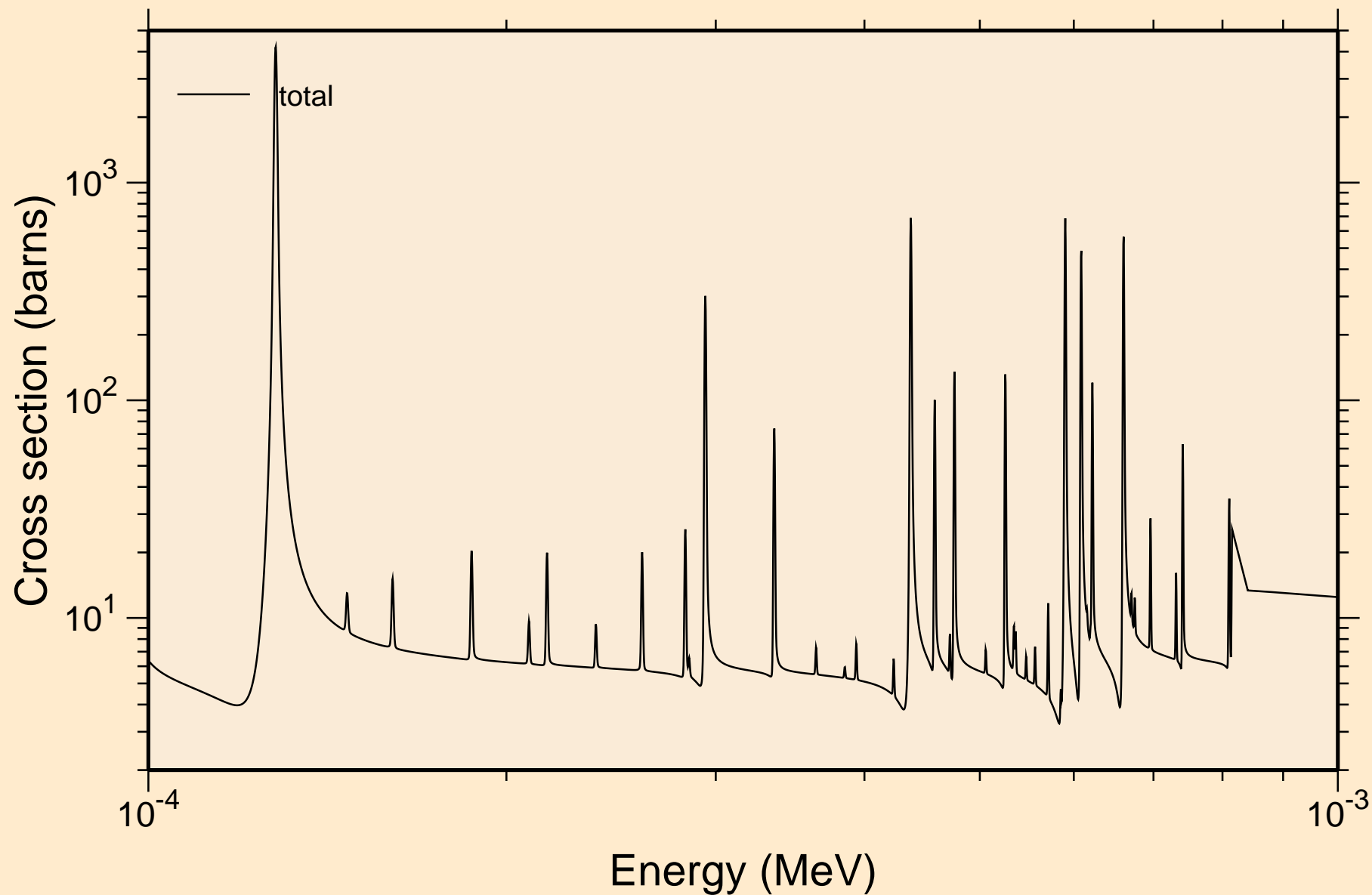

AG120 NEUTRON ACER TENDL-2019 LIBRARY; T=293.16K
resonance total cross section

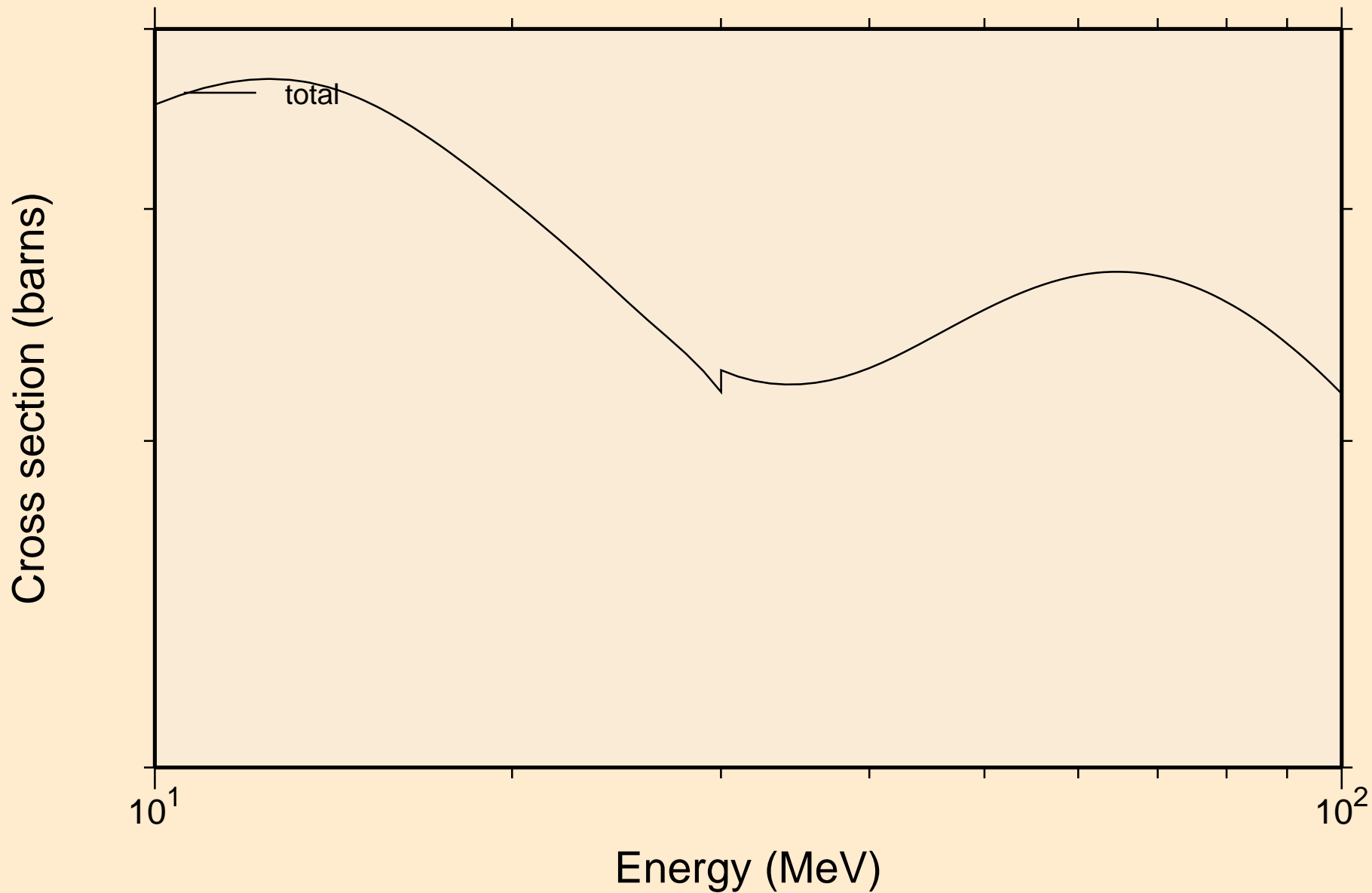

AG120 NEUTRON ACER TENDL-2019 LIBRARY; T=293.16K
resonance absorption cross sections

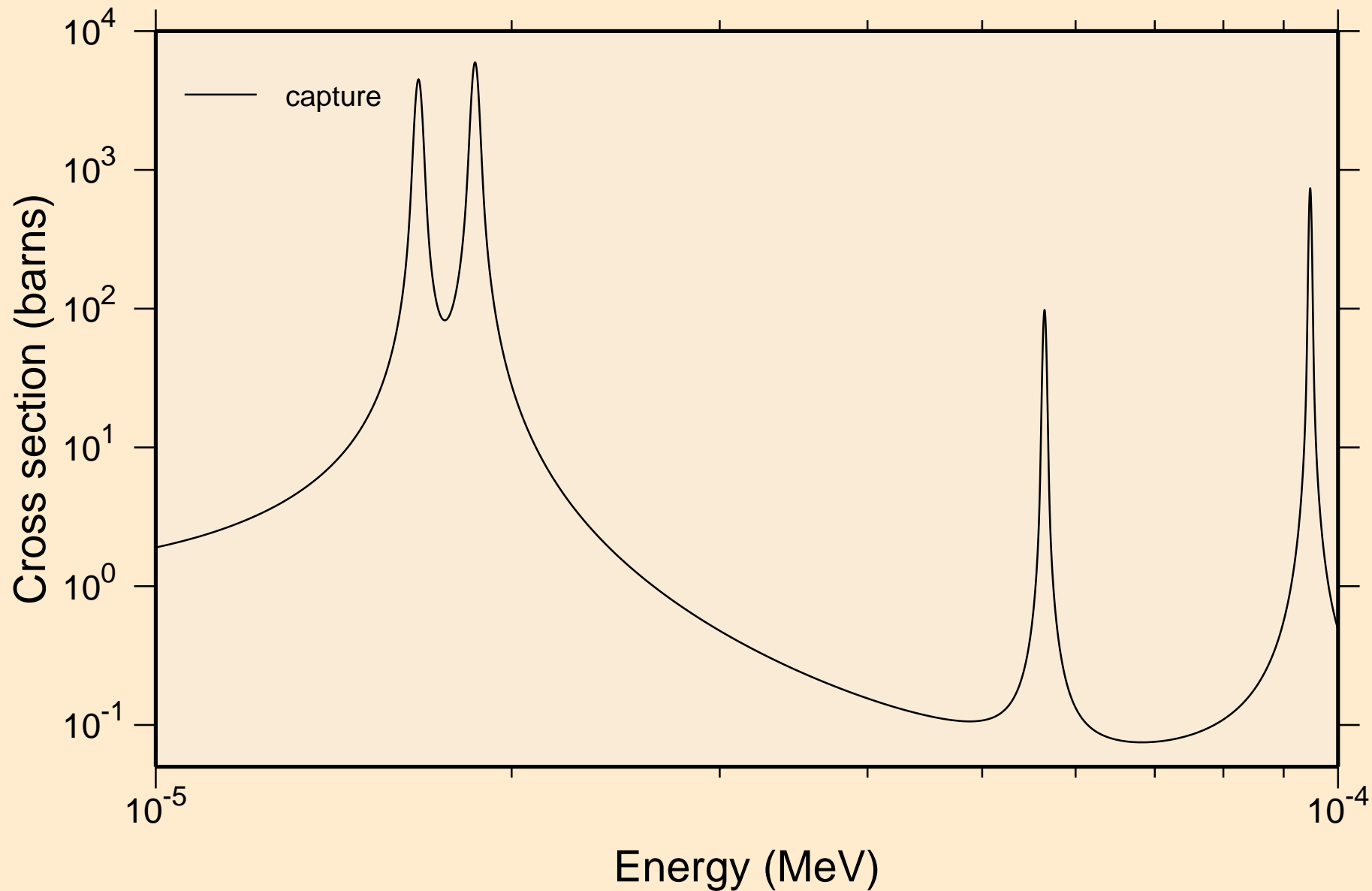

AG120 NEUTRON ACER TENDL-2019 LIBRARY; T=293.16K
resonance absorption cross sections

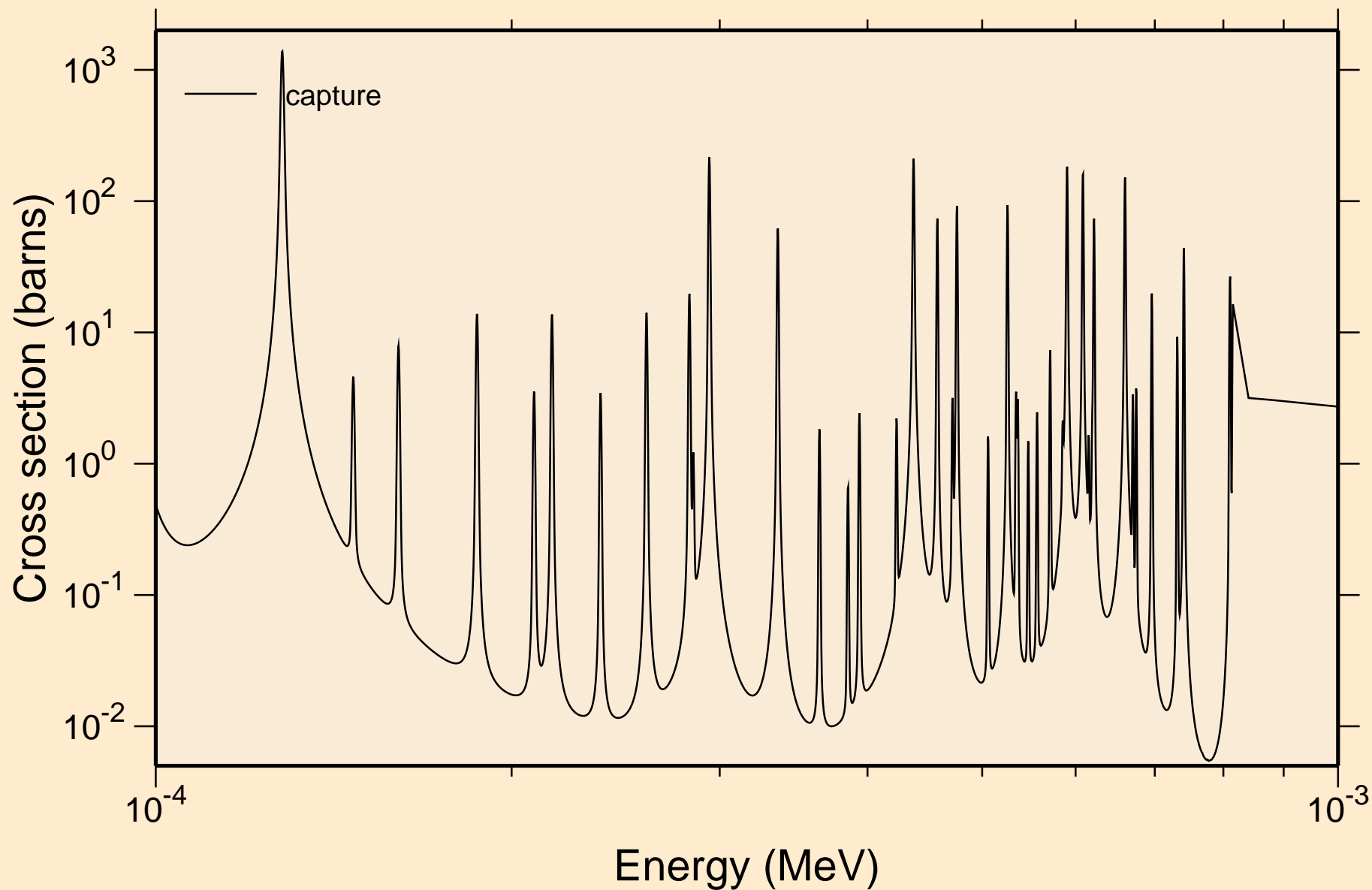

AG120 NEUTRON ACER TENDL-2019 LIBRARY; T=293.16K
resonance absorption cross sections

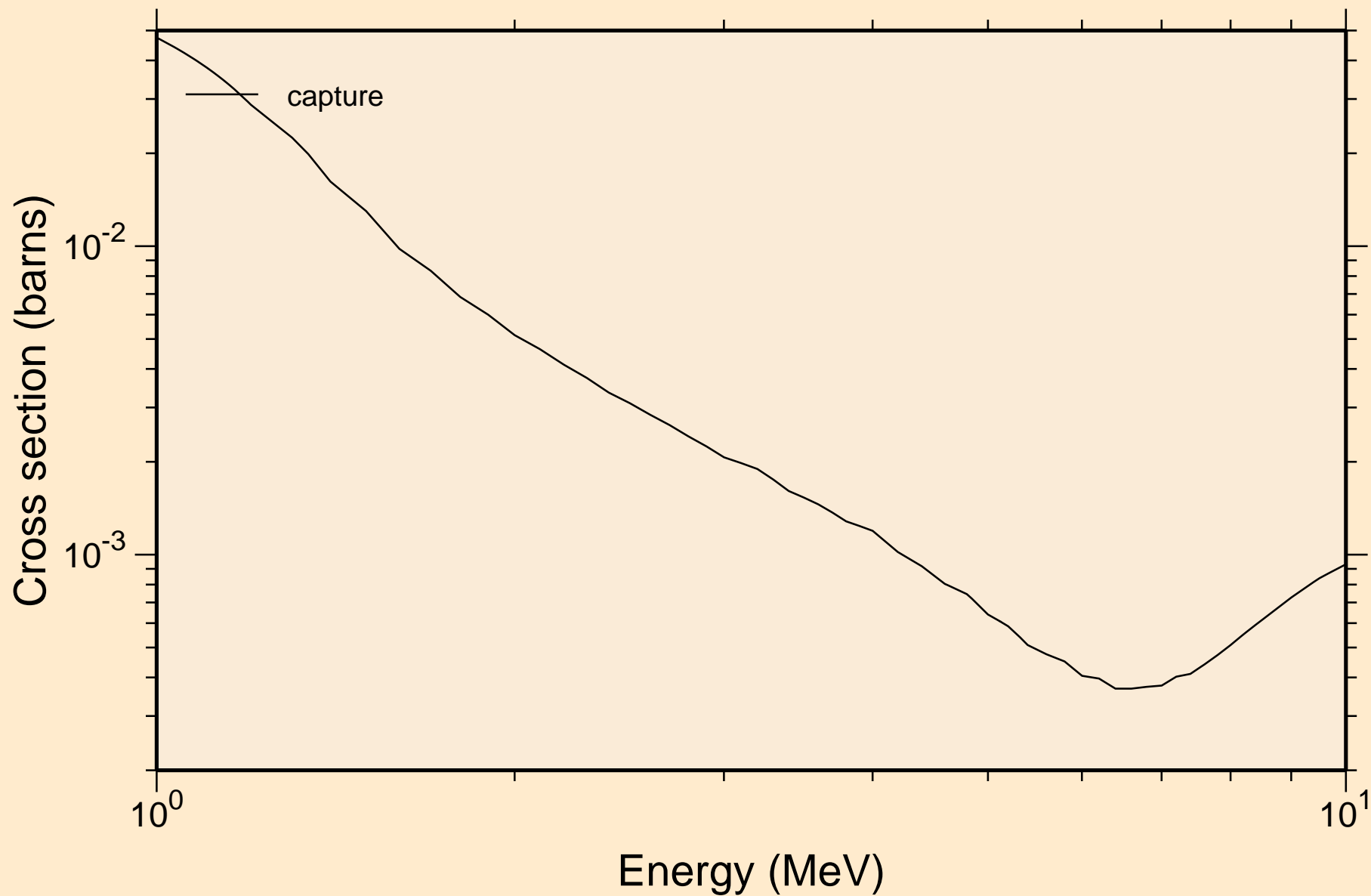

AG120 NEUTRON ACER TENDL-2019 LIBRARY; T=293.16K
Heating

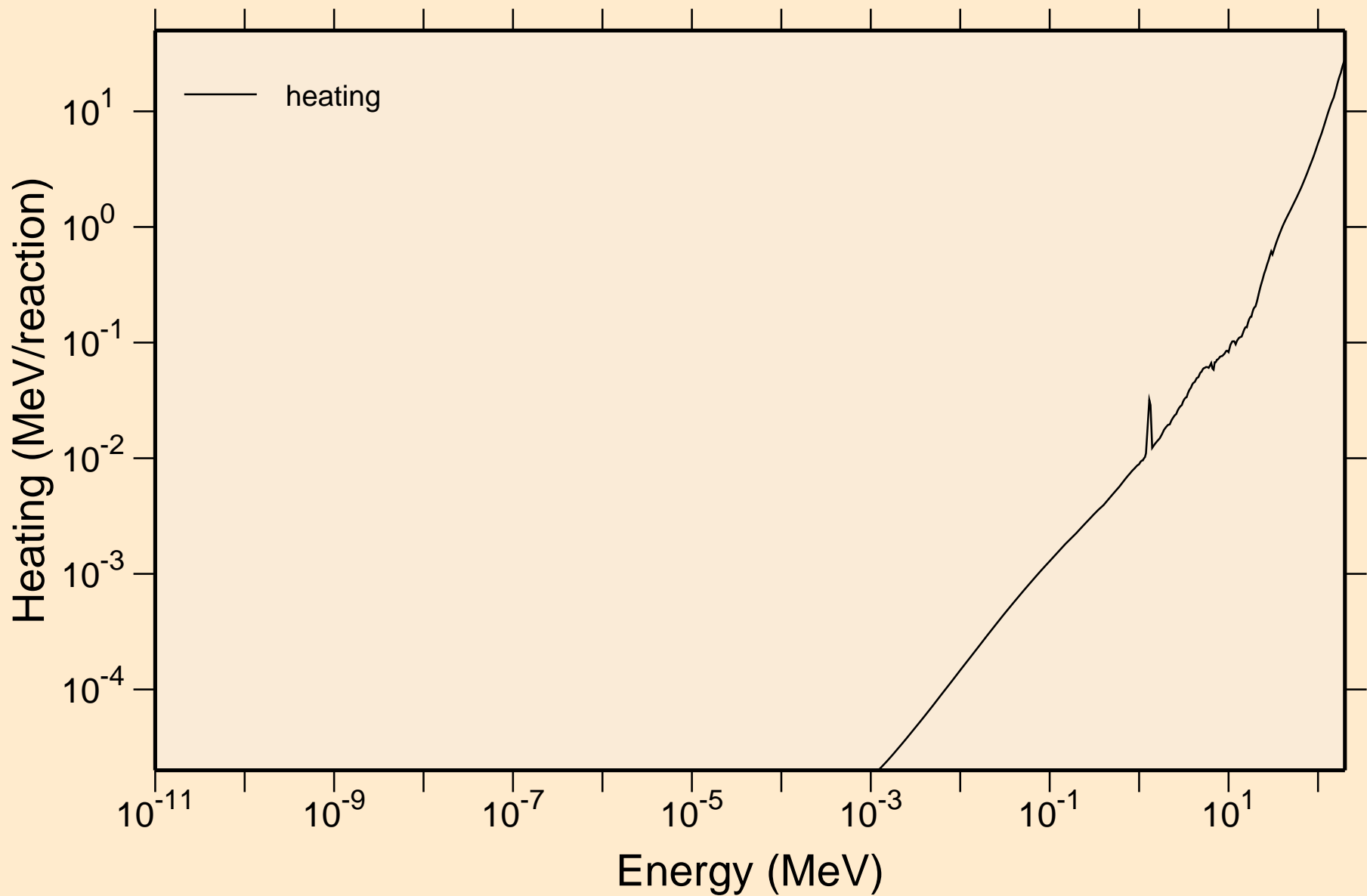

AG120 NEUTRON ACER TENDL-2019 LIBRARY; T=293.16K
Damage

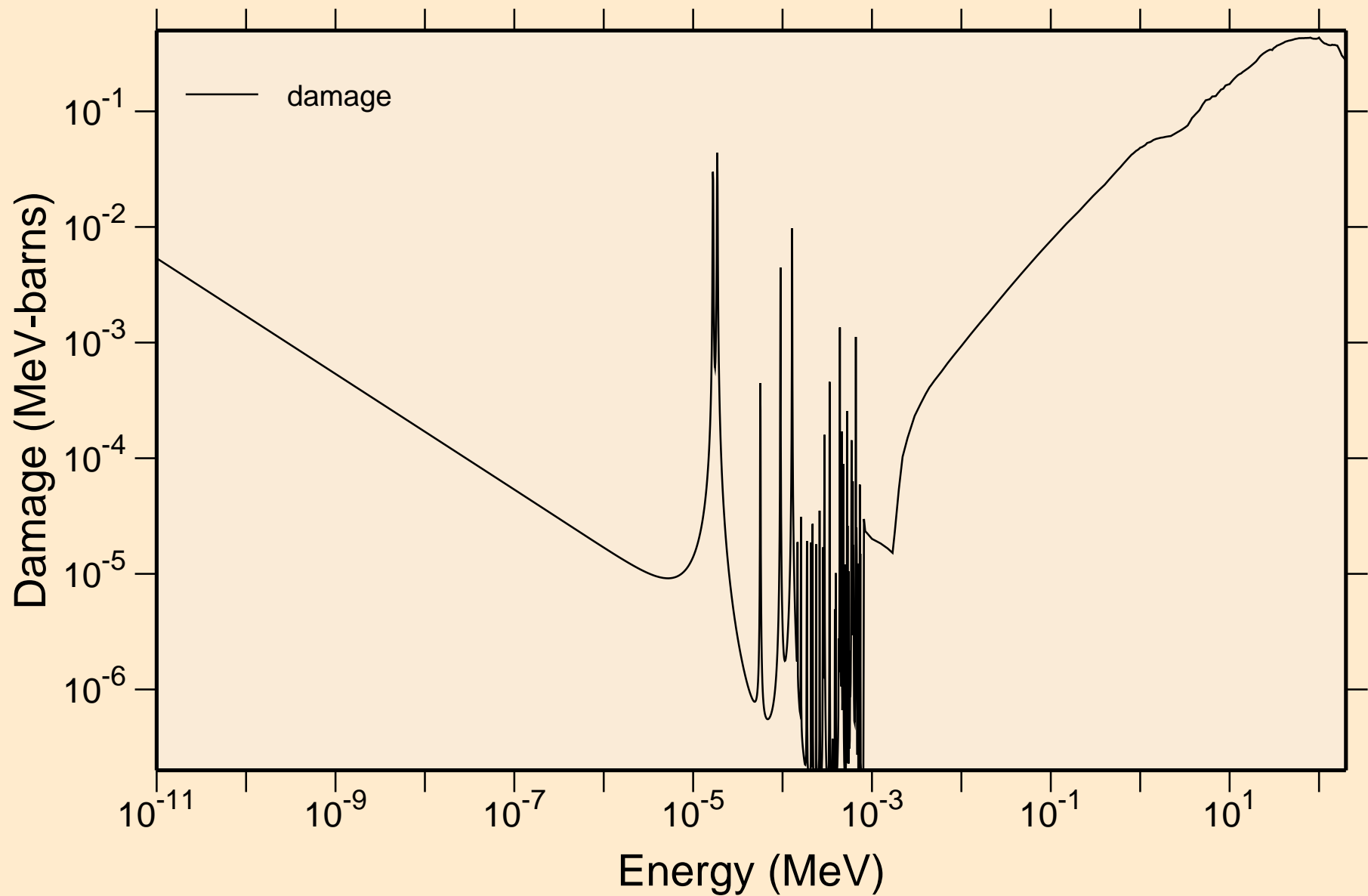

AG120 NEUTRON ACER TENDL-2019 LIBRARY; T=293.16K
Non-threshold reactions

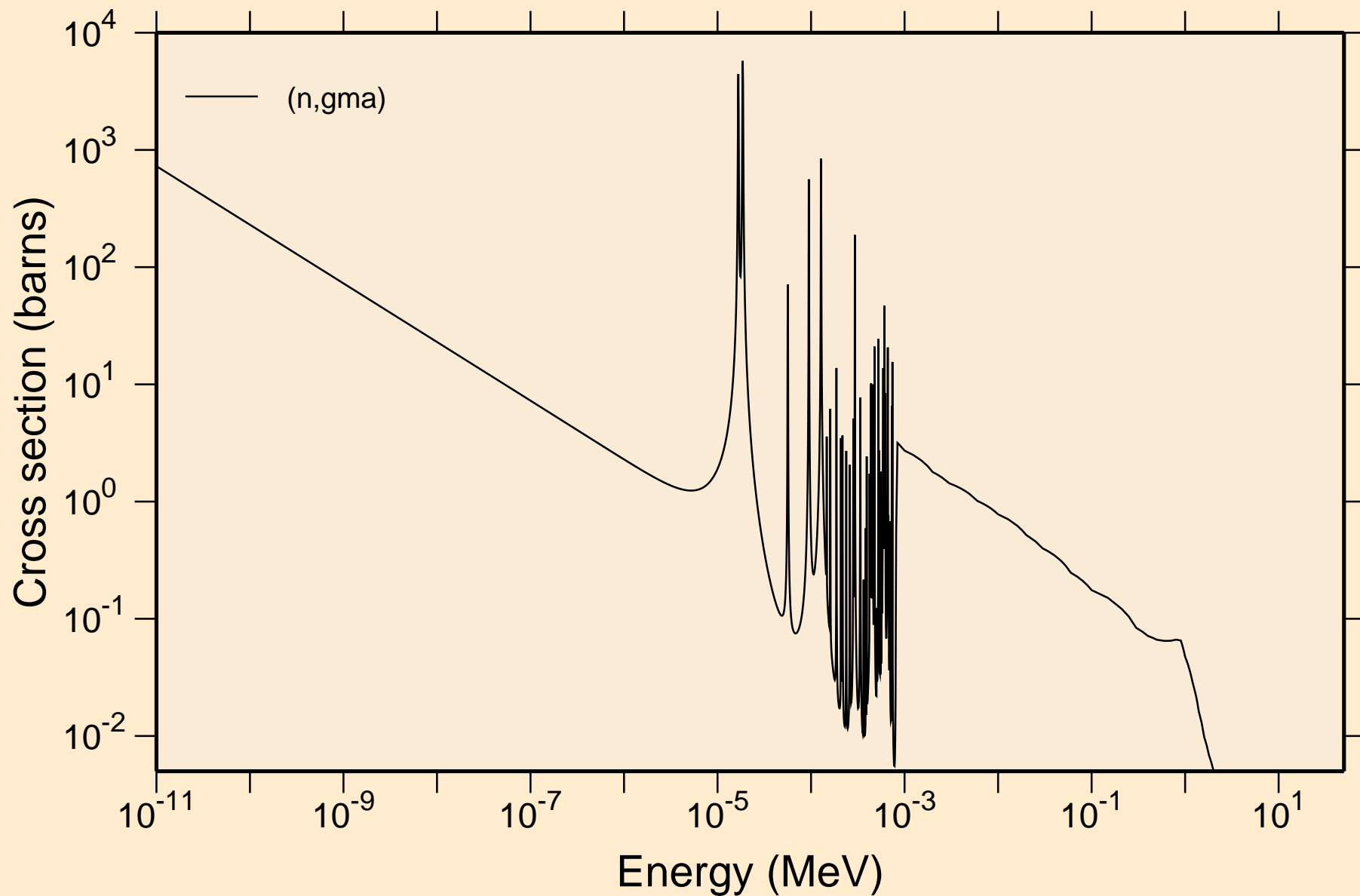

AG120 NEUTRON ACER TENDL-2019 LIBRARY; T=293.16K
Principal cross sections

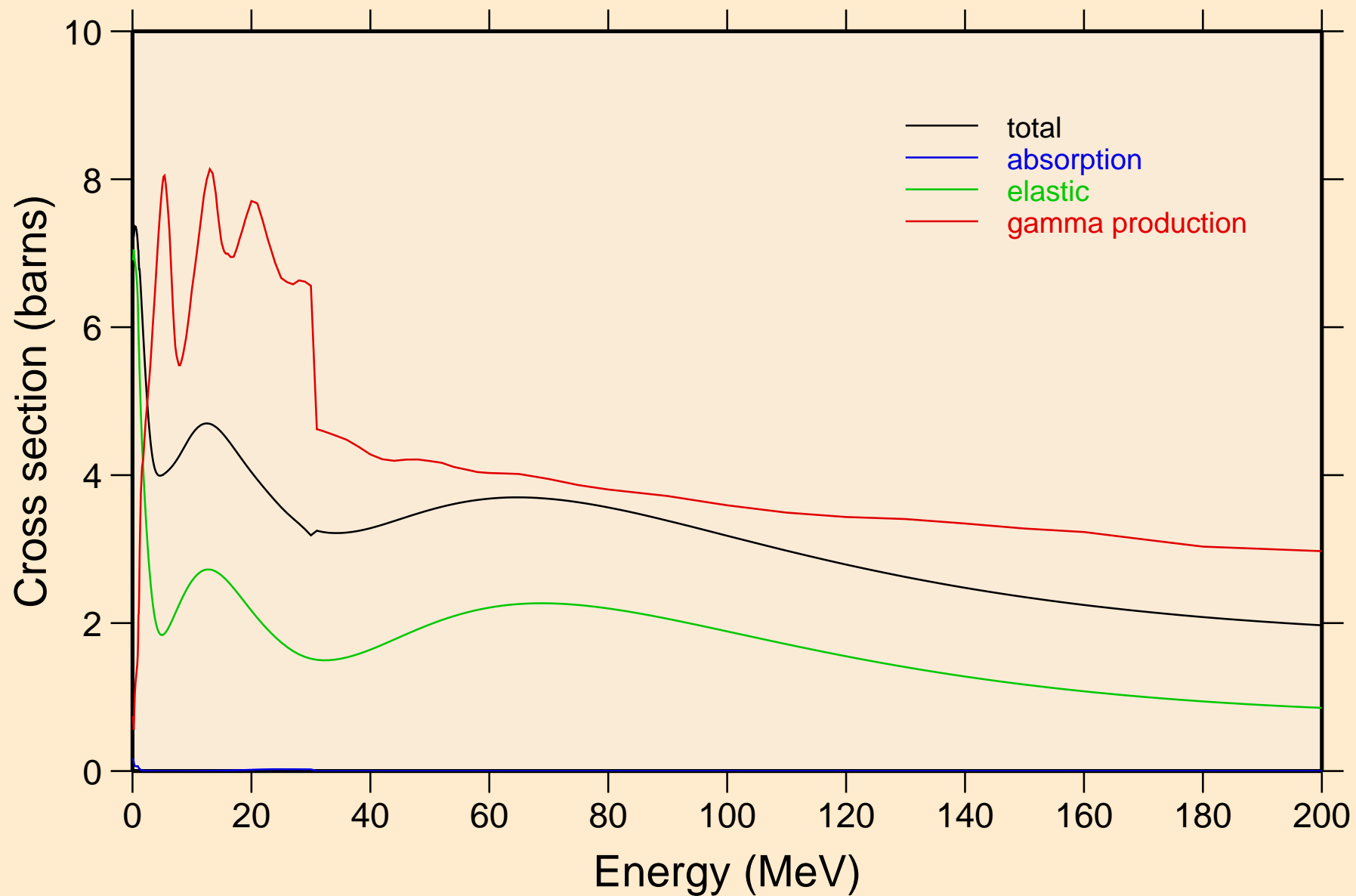

AG120 NEUTRON ACER TENDL-2019 LIBRARY; T=293.16K
Heating

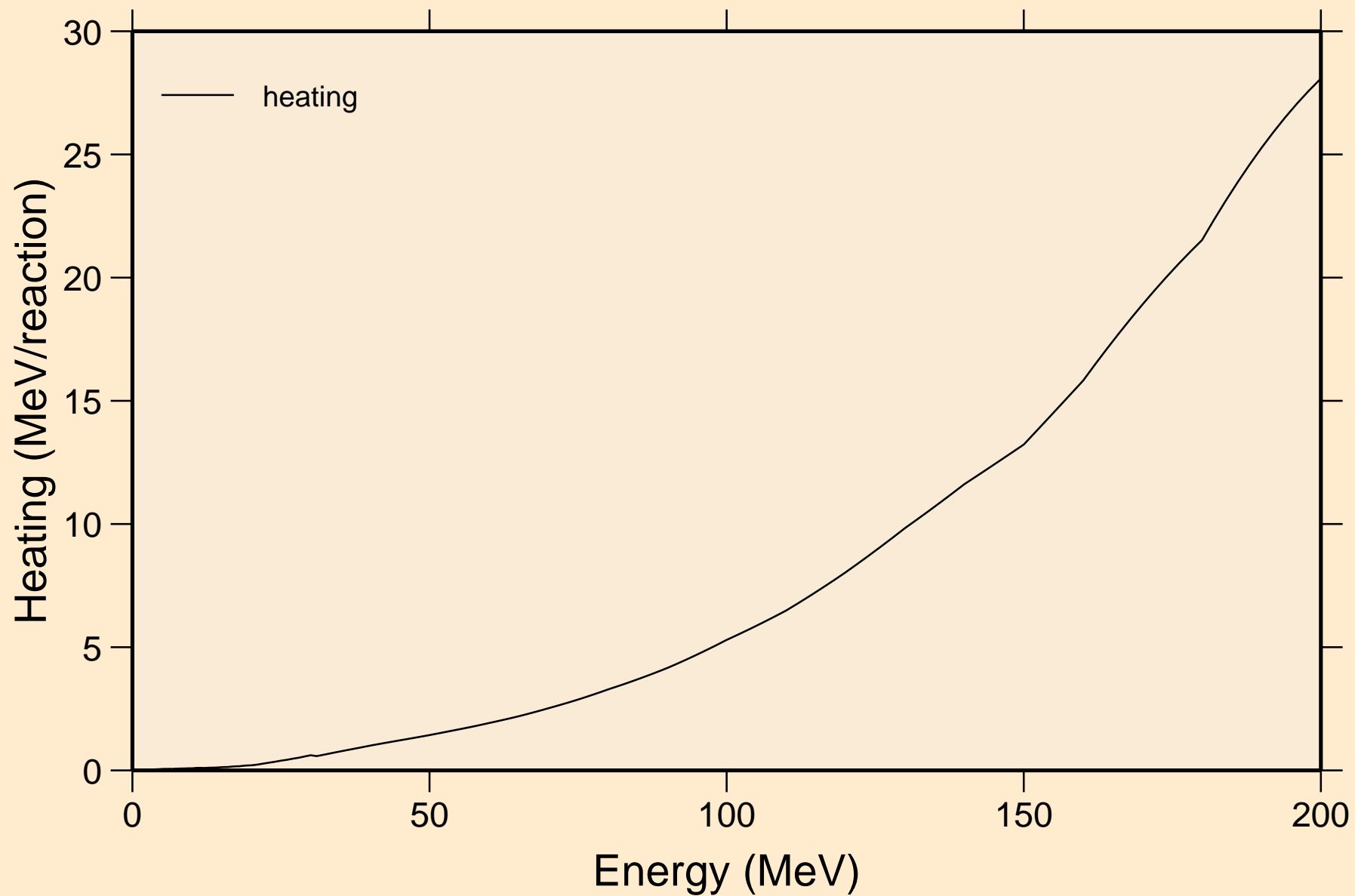

AG120 NEUTRON ACER TENDL-2019 LIBRARY; T=293.16K
Damage

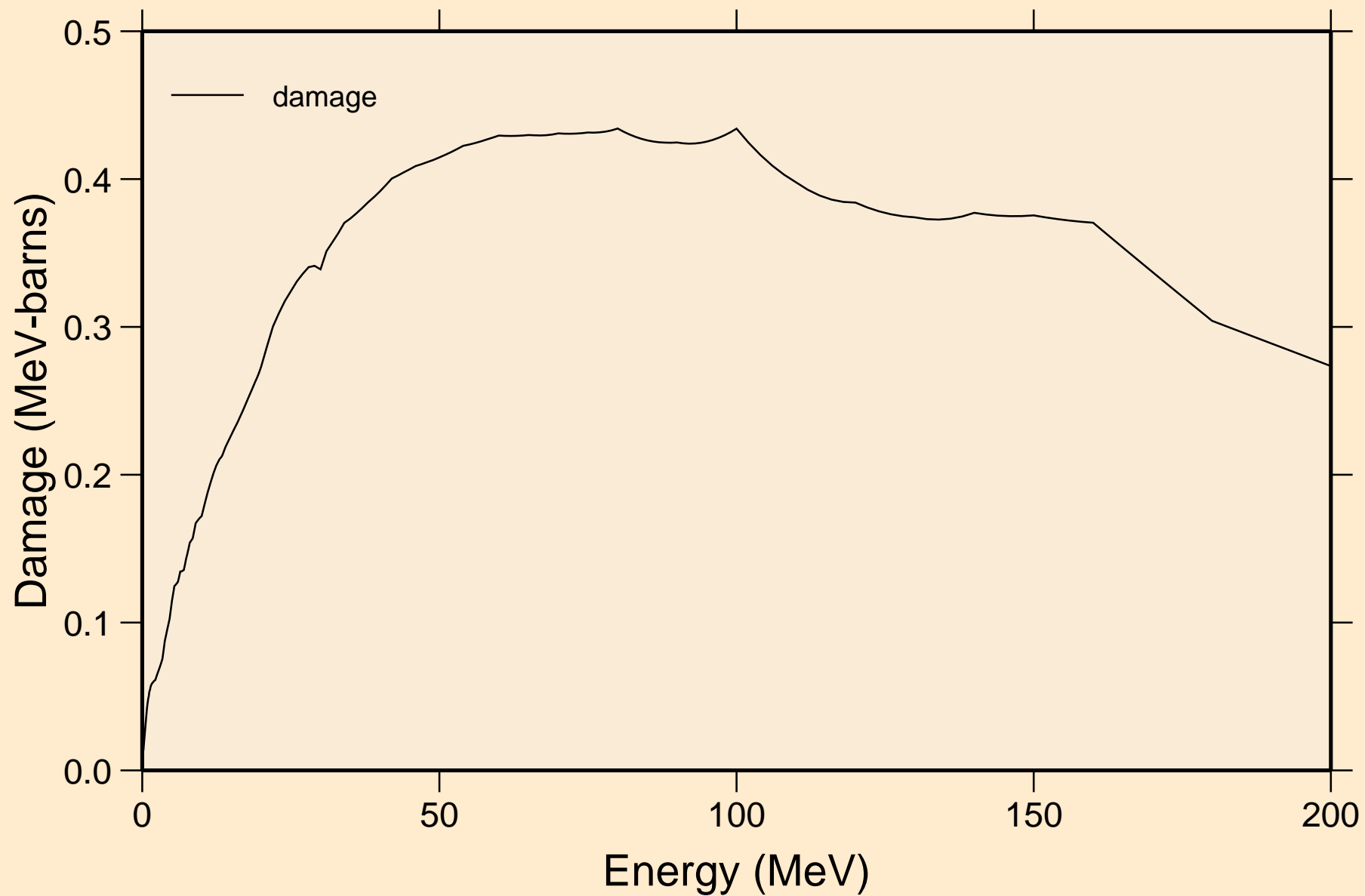

AG120 NEUTRON ACER TENDL-2019 LIBRARY; T=293.16K
Non-threshold reactions

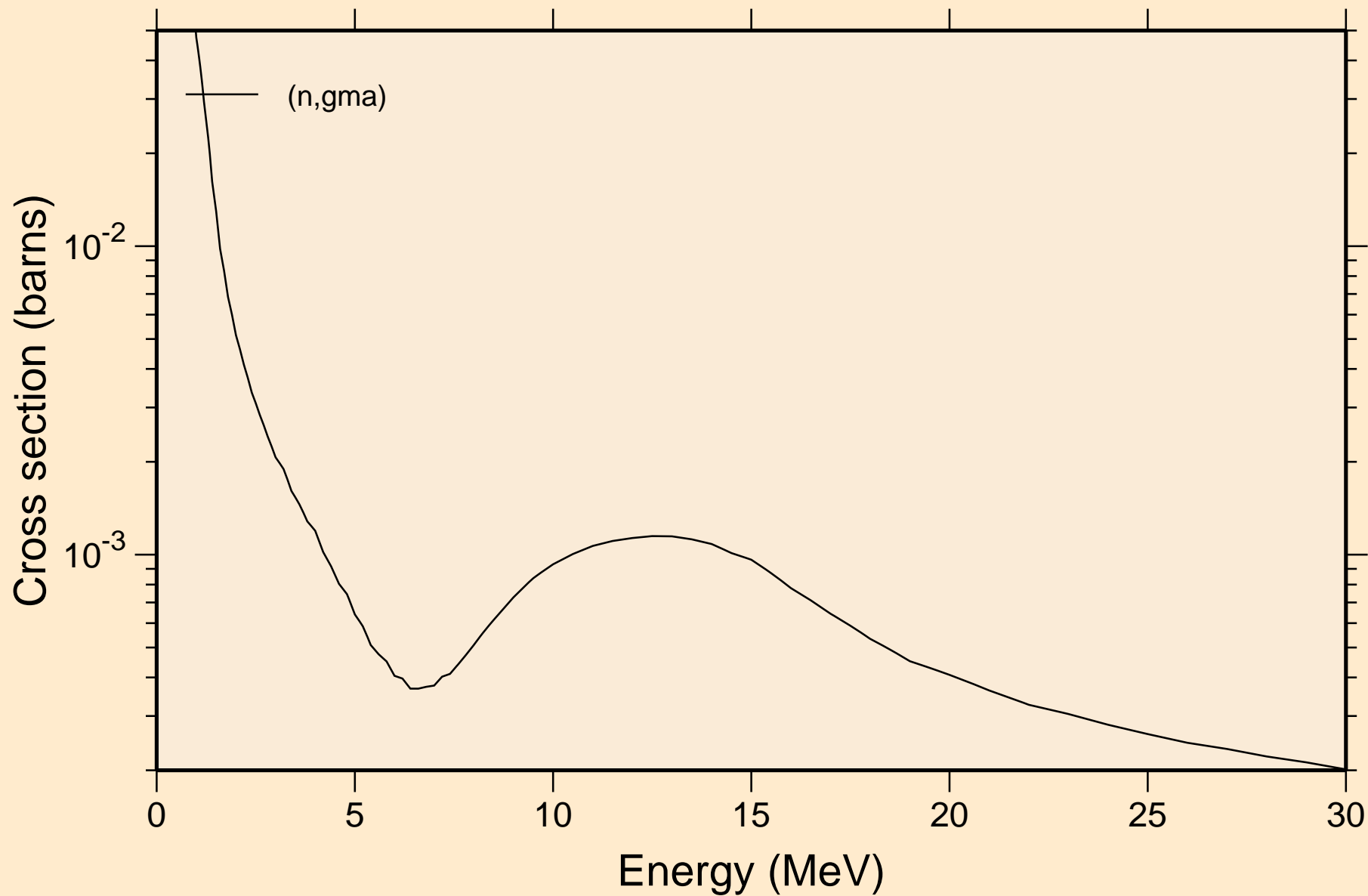

AG120 NEUTRON ACER TENDL-2019 LIBRARY; T=293.16K
Inelastic levels

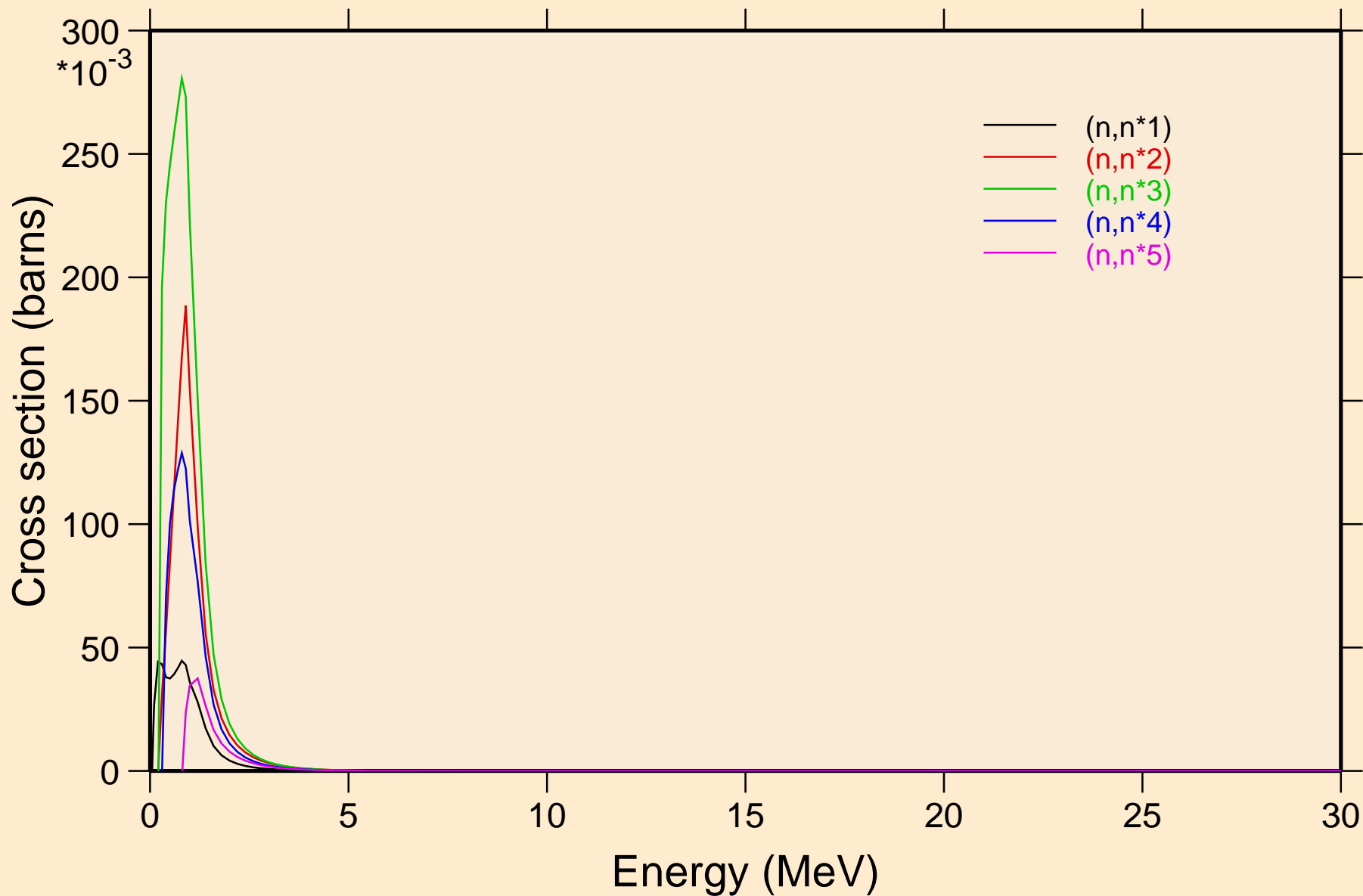

AG120 NEUTRON ACER TENDL-2019 LIBRARY; T=293.16K
Inelastic levels

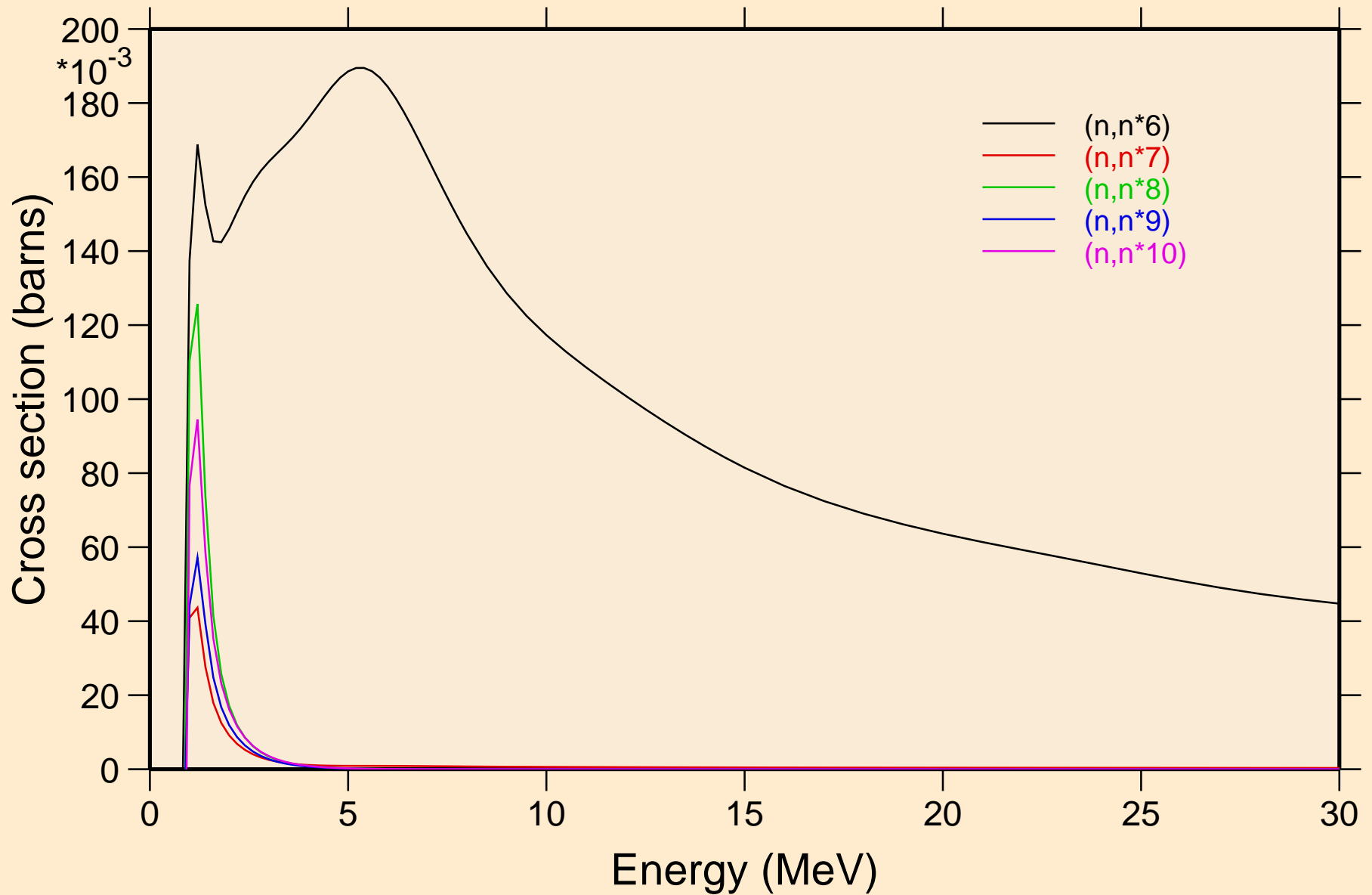

AG120 NEUTRON ACER TENDL-2019 LIBRARY; T=293.16K
Inelastic levels

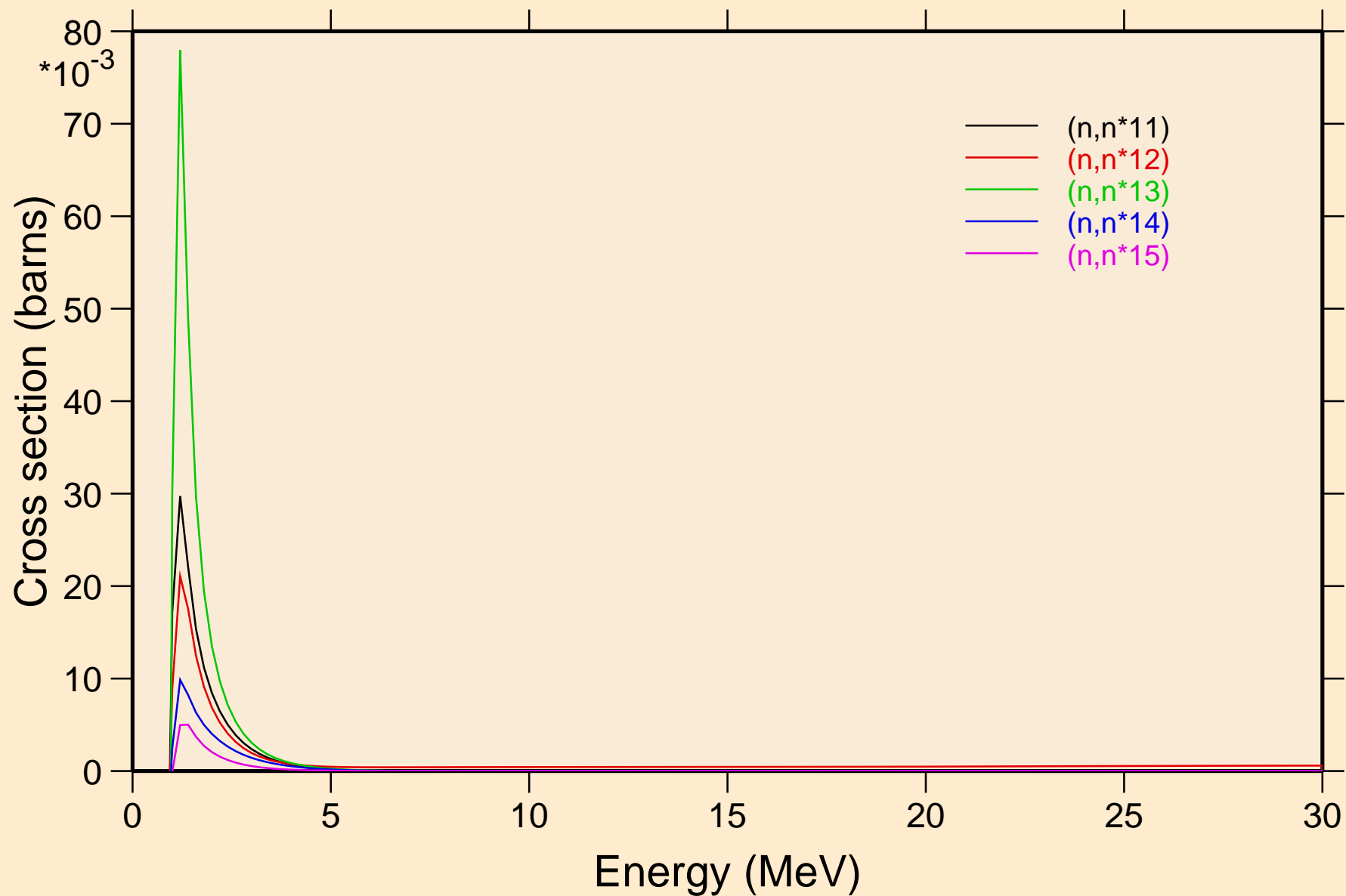

AG120 NEUTRON ACER TENDL-2019 LIBRARY; T=293.16K
Inelastic levels

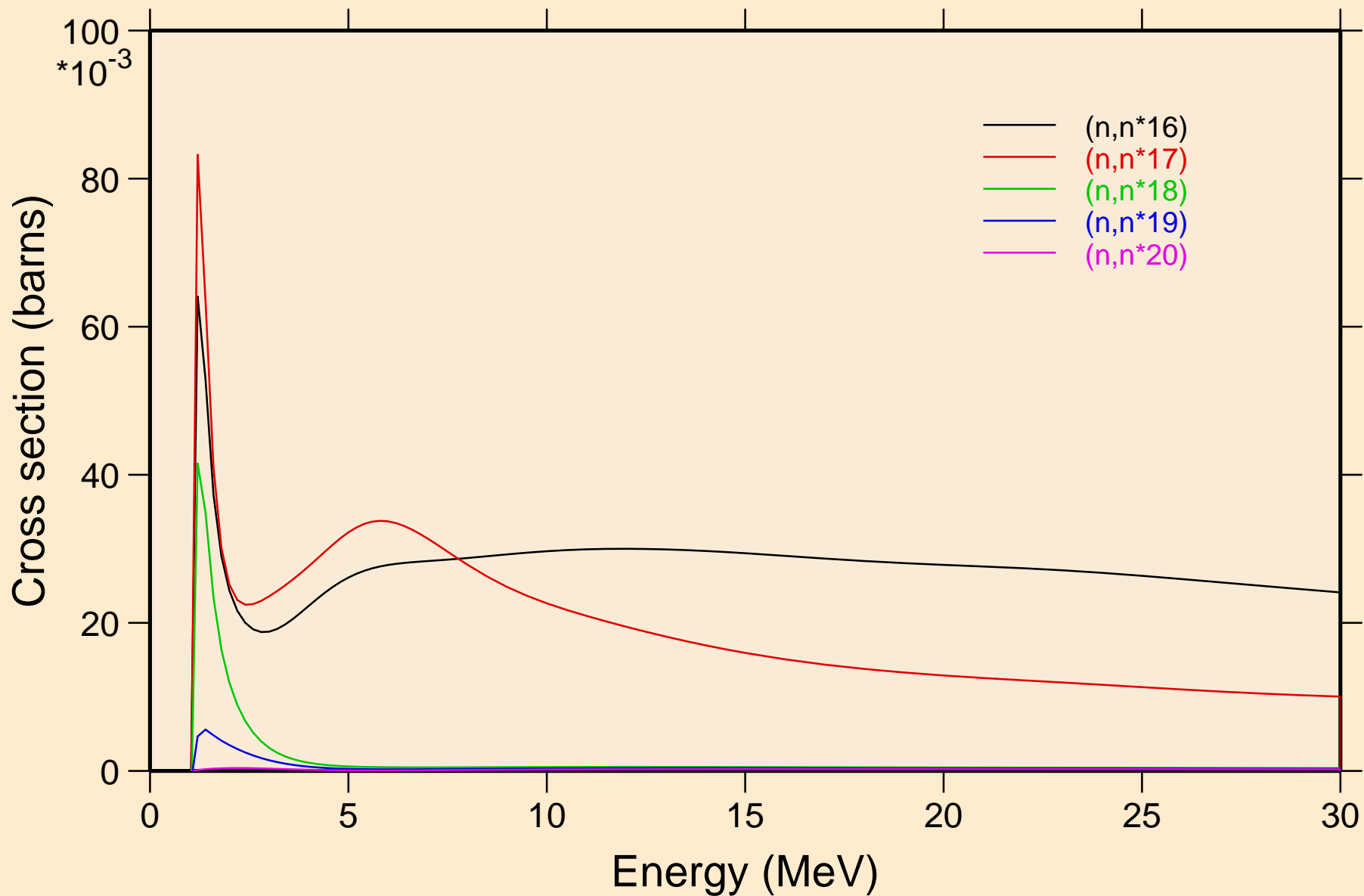

AG120 NEUTRON ACER TENDL-2019 LIBRARY; T=293.16K
Inelastic levels

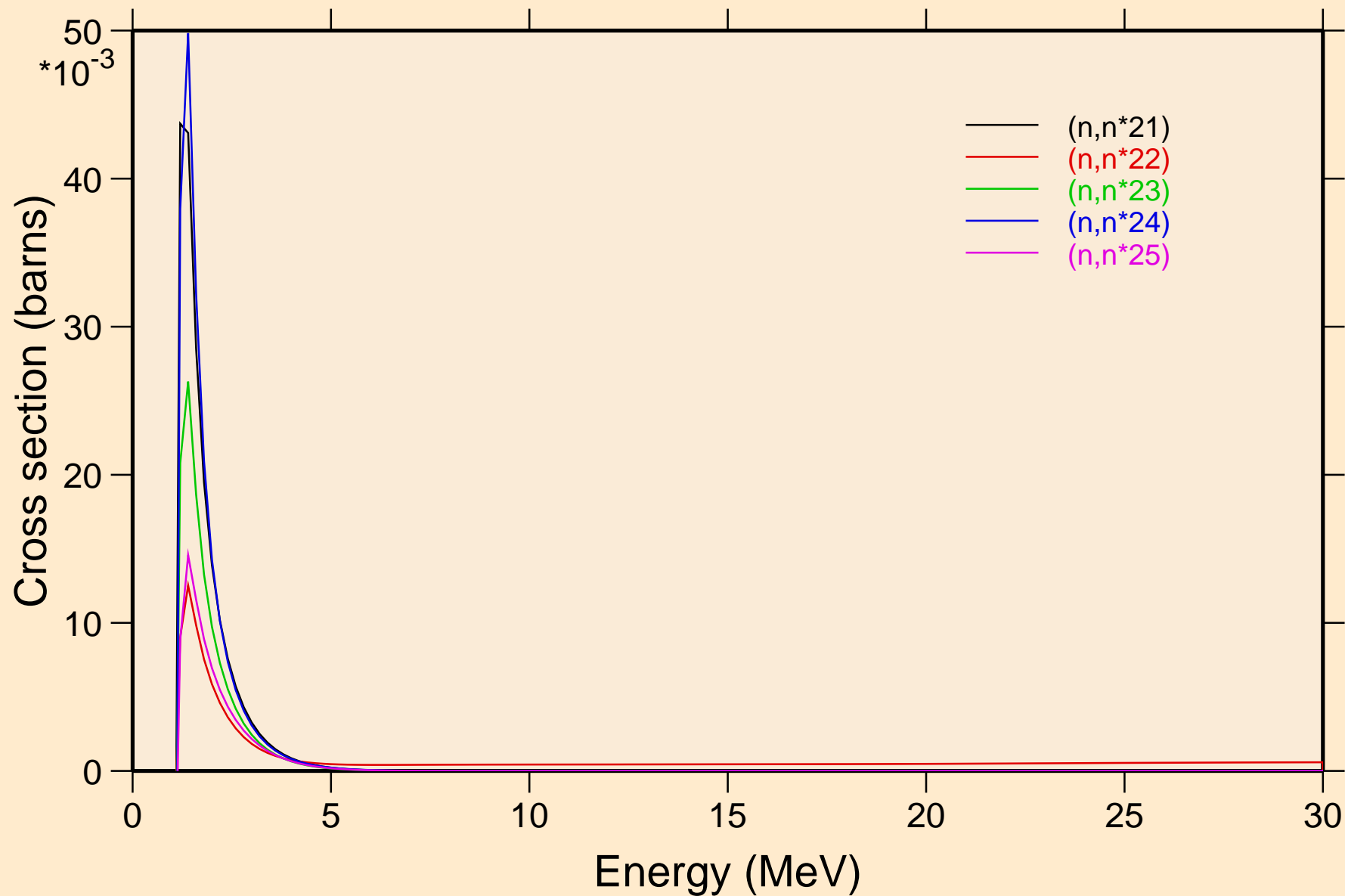

AG120 NEUTRON ACER TENDL-2019 LIBRARY; T=293.16K
Inelastic levels

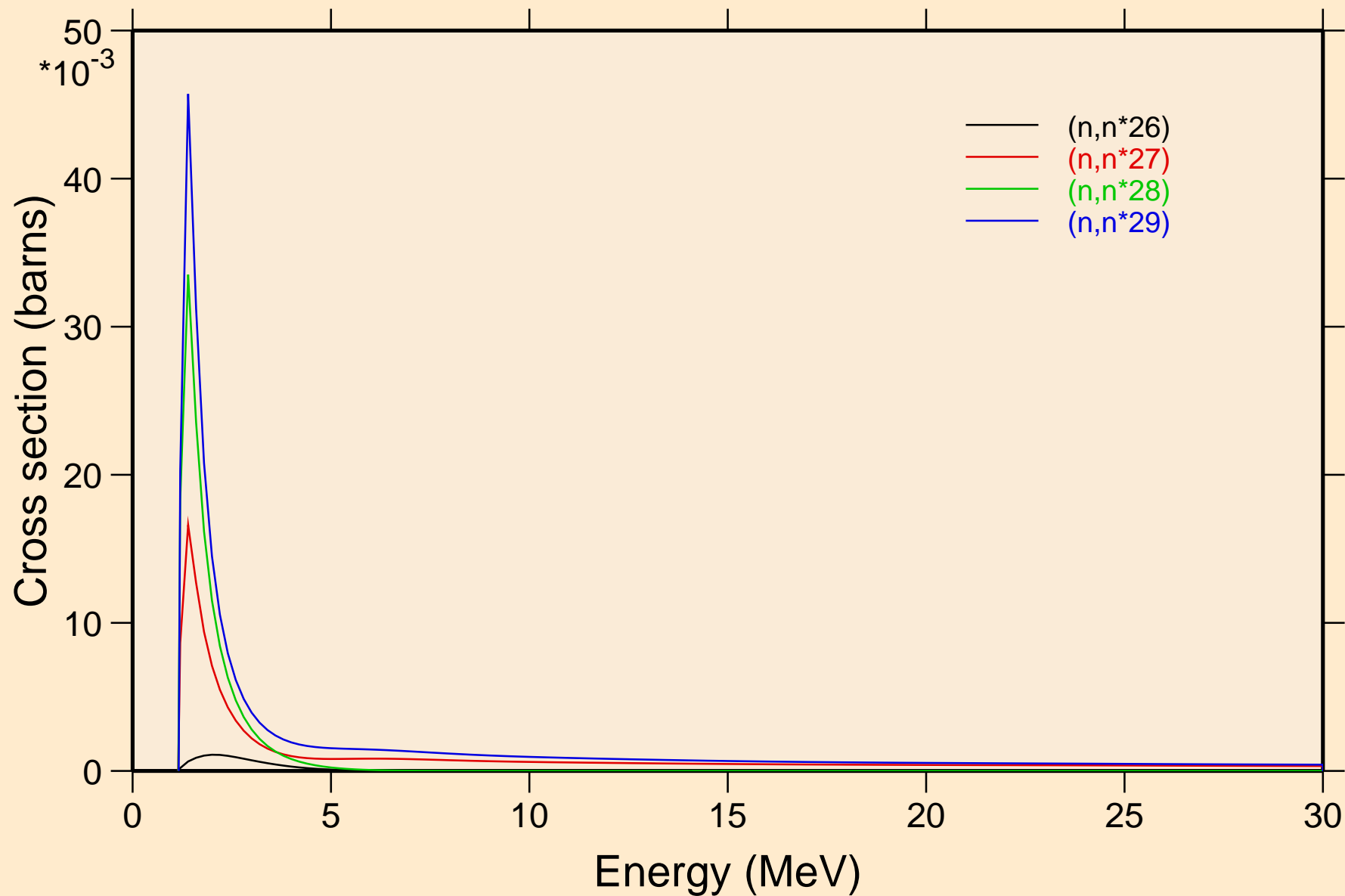

AG120 NEUTRON ACER TENDL-2019 LIBRARY; T=293.16K
Threshold reactions

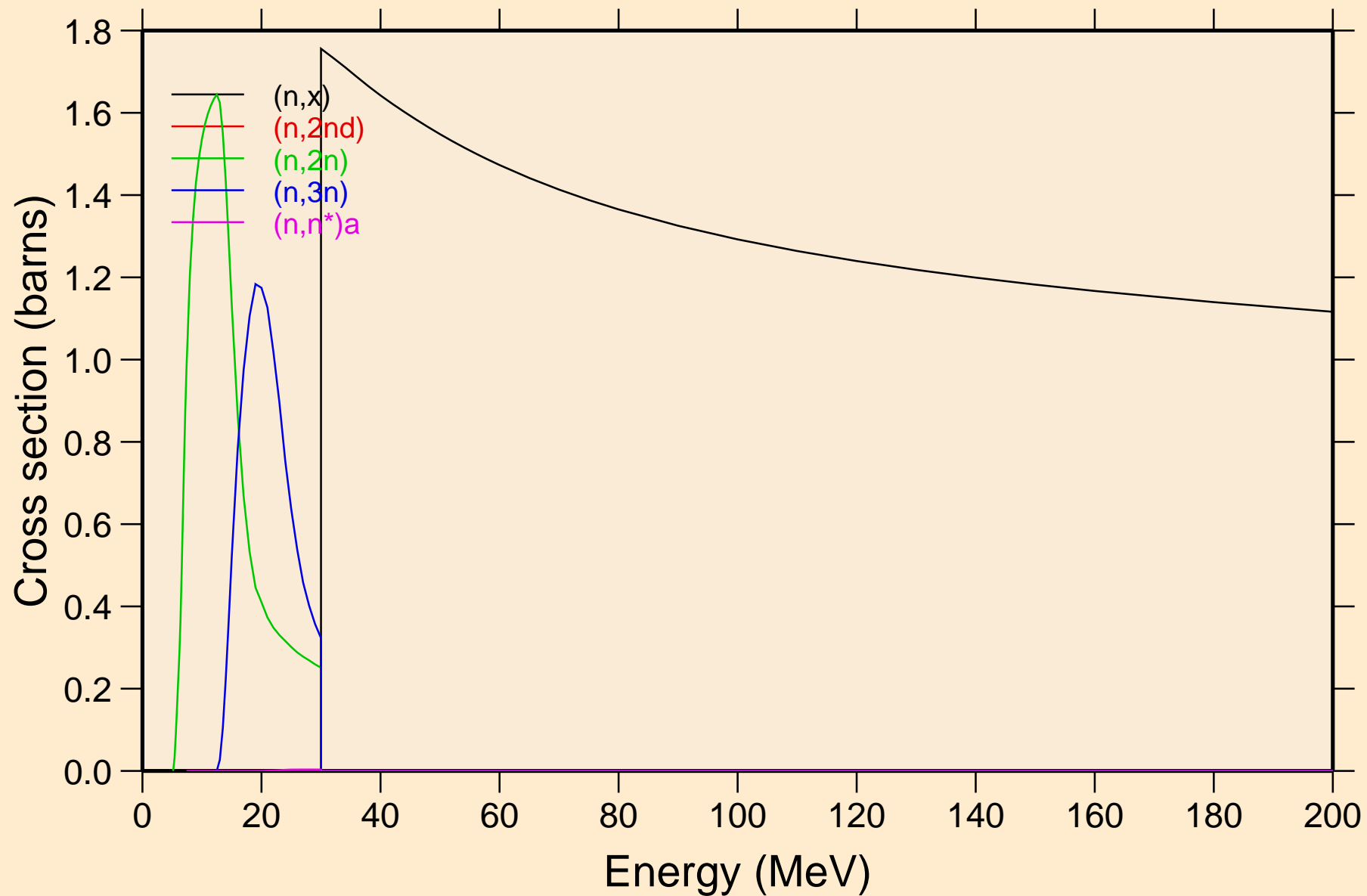

AG120 NEUTRON ACER TENDL-2019 LIBRARY; T=293.16K
Threshold reactions

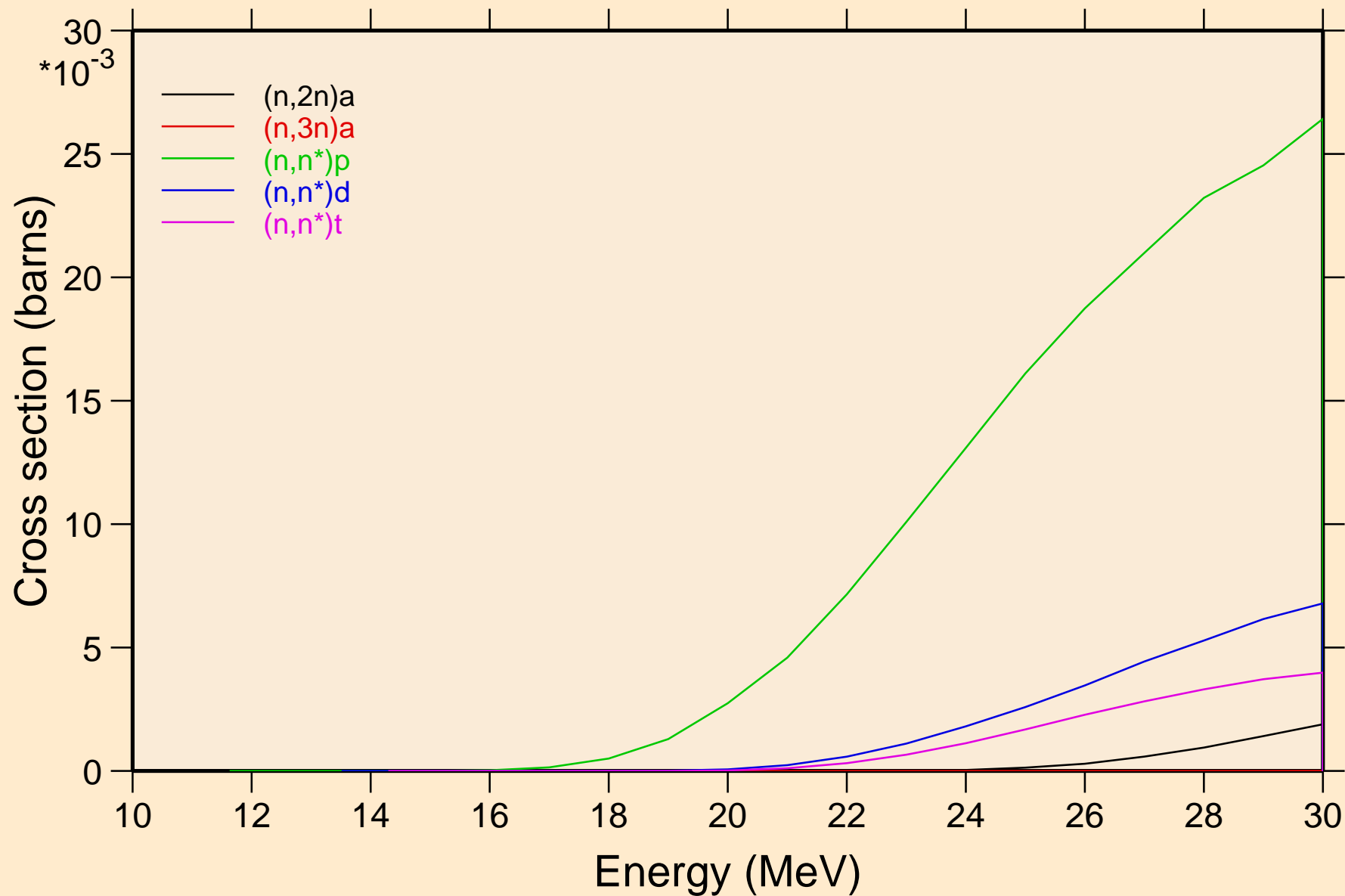

AG120 NEUTRON ACER TENDL-2019 LIBRARY; T=293.16K
Threshold reactions

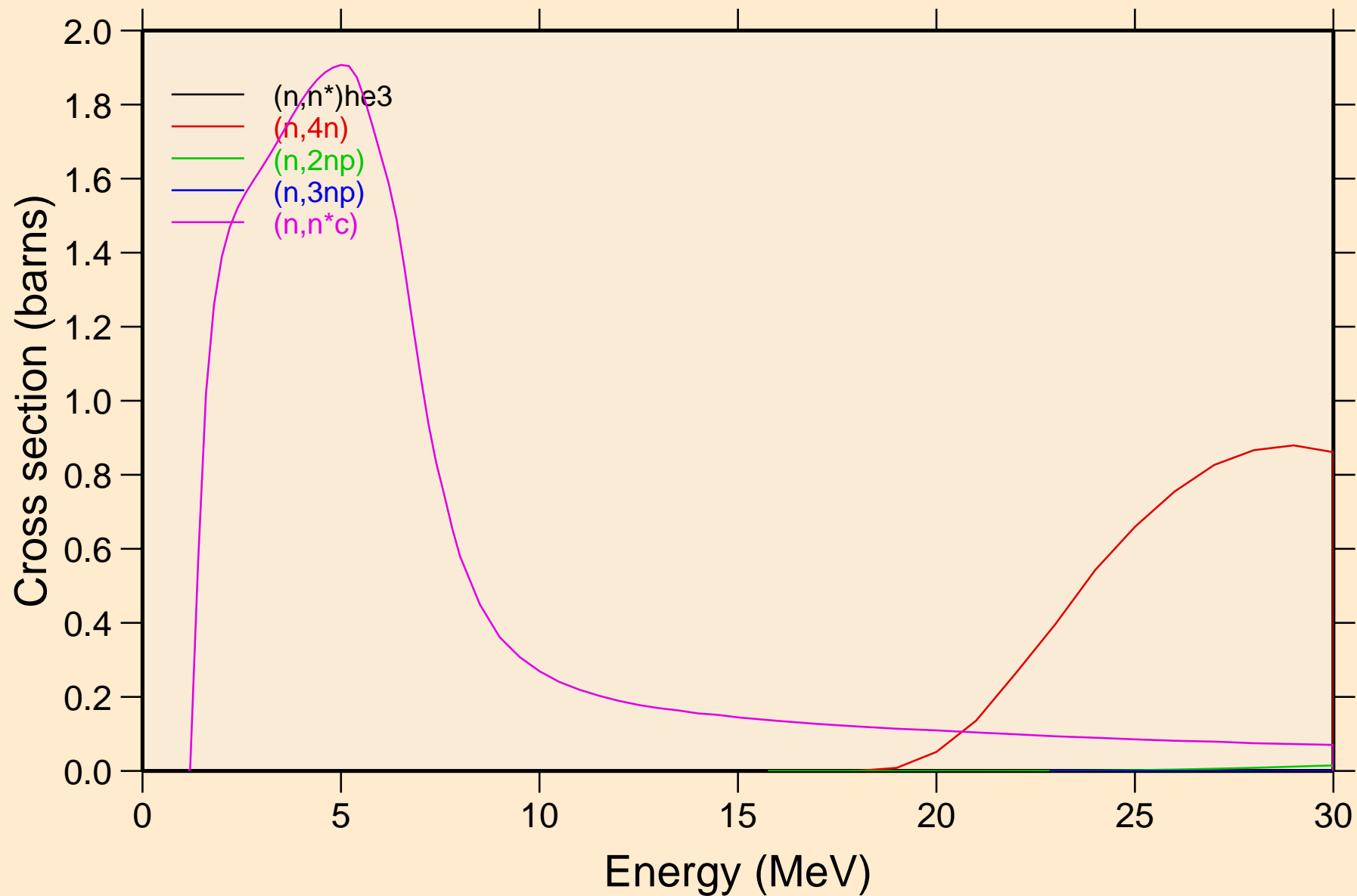

AG120 NEUTRON ACER TENDL-2019 LIBRARY; T=293.16K
Threshold reactions

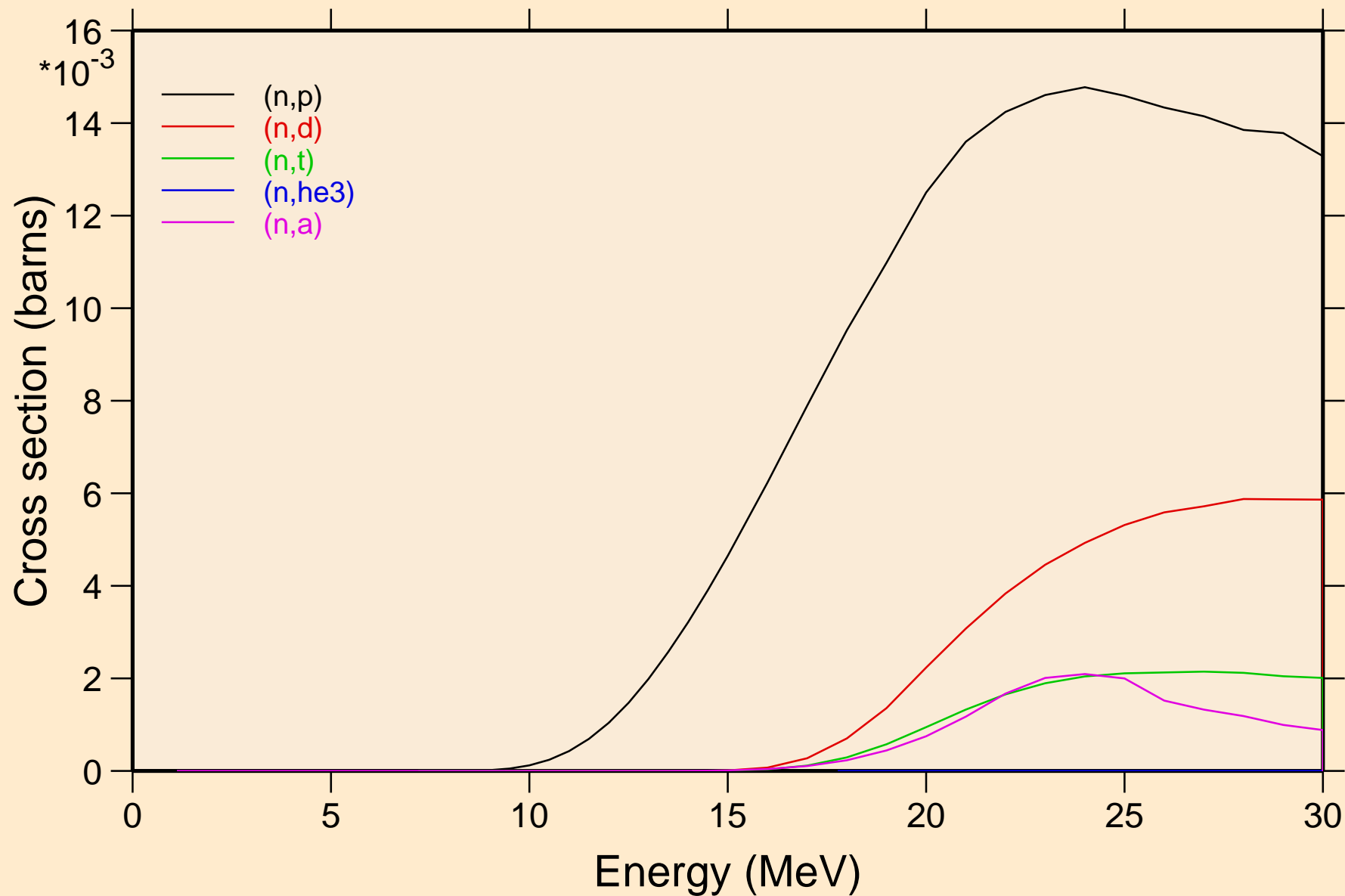

AG120 NEUTRON ACER TENDL-2019 LIBRARY; T=293.16K
Threshold reactions

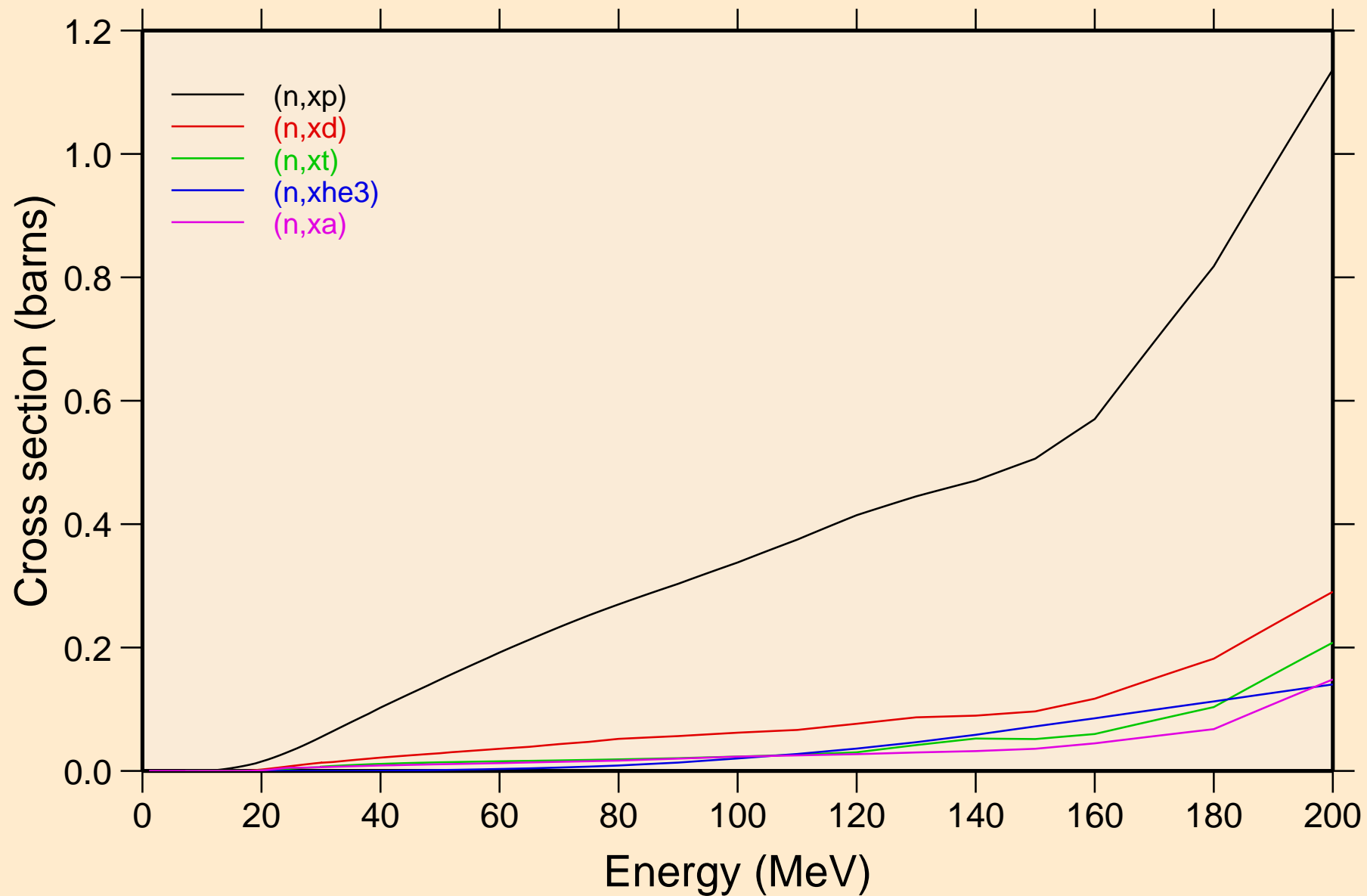

AG120 NEUTRON ACER TENDL-2019 LIBRARY; T=293.16K
angular distribution for elastic

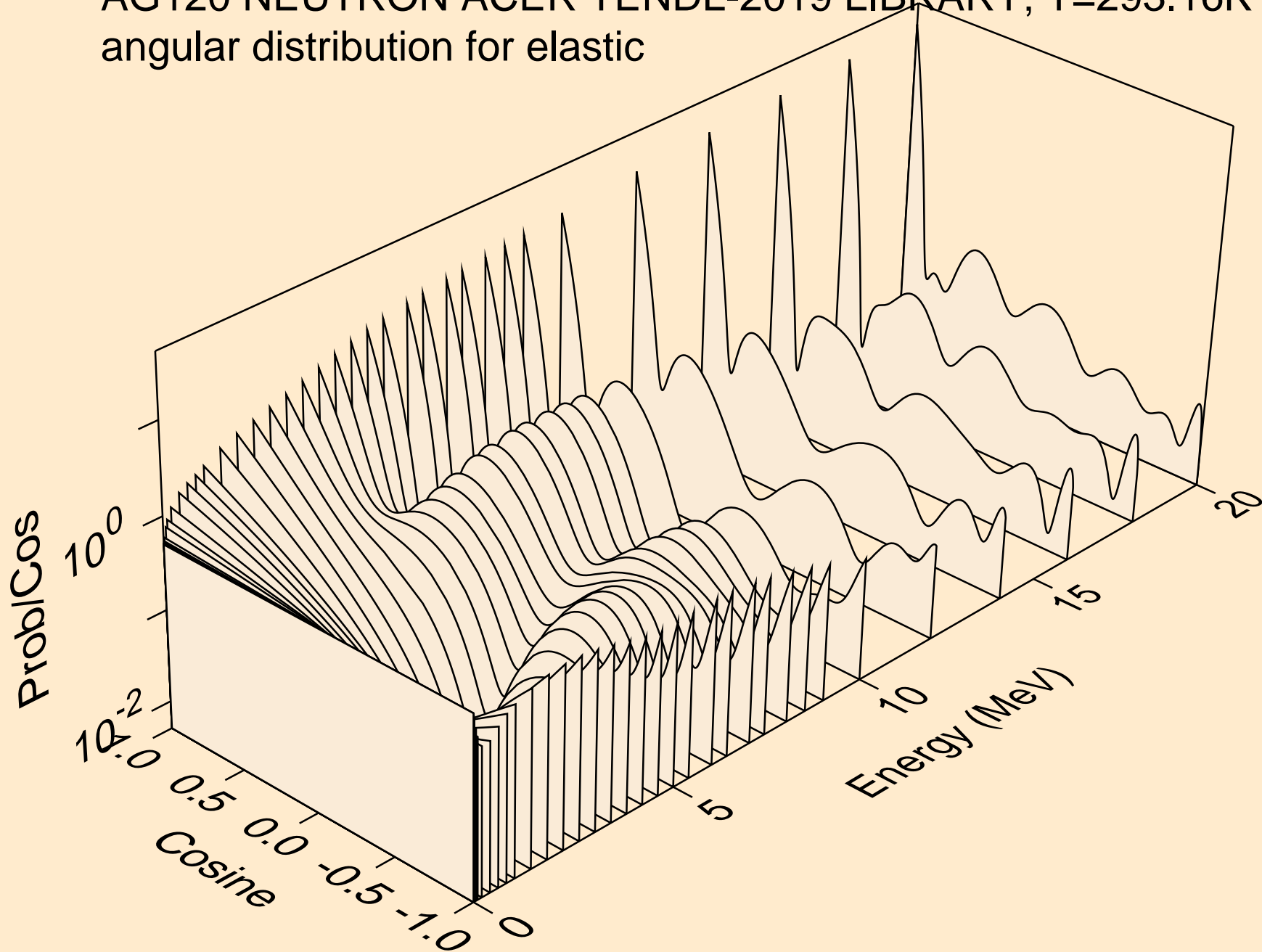

AG120 NEUTRON ACER TENDL-2019 LIBRARY; T=293.16K
angular distribution for elastic

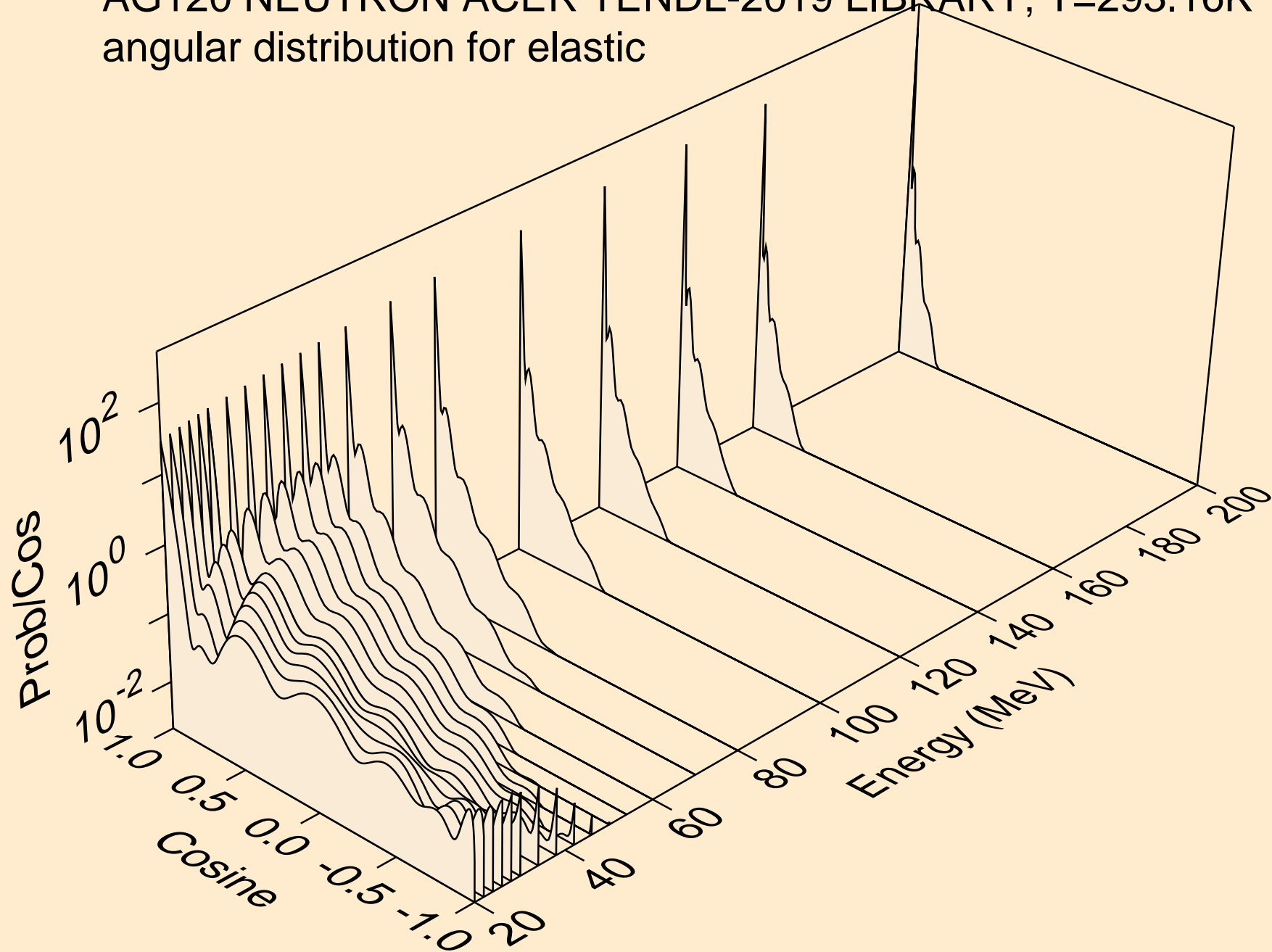

AG120 NEUTRON ACER TENDL-2019 LIBRARY; T=293.16K
angular distribution for (n,n*1)

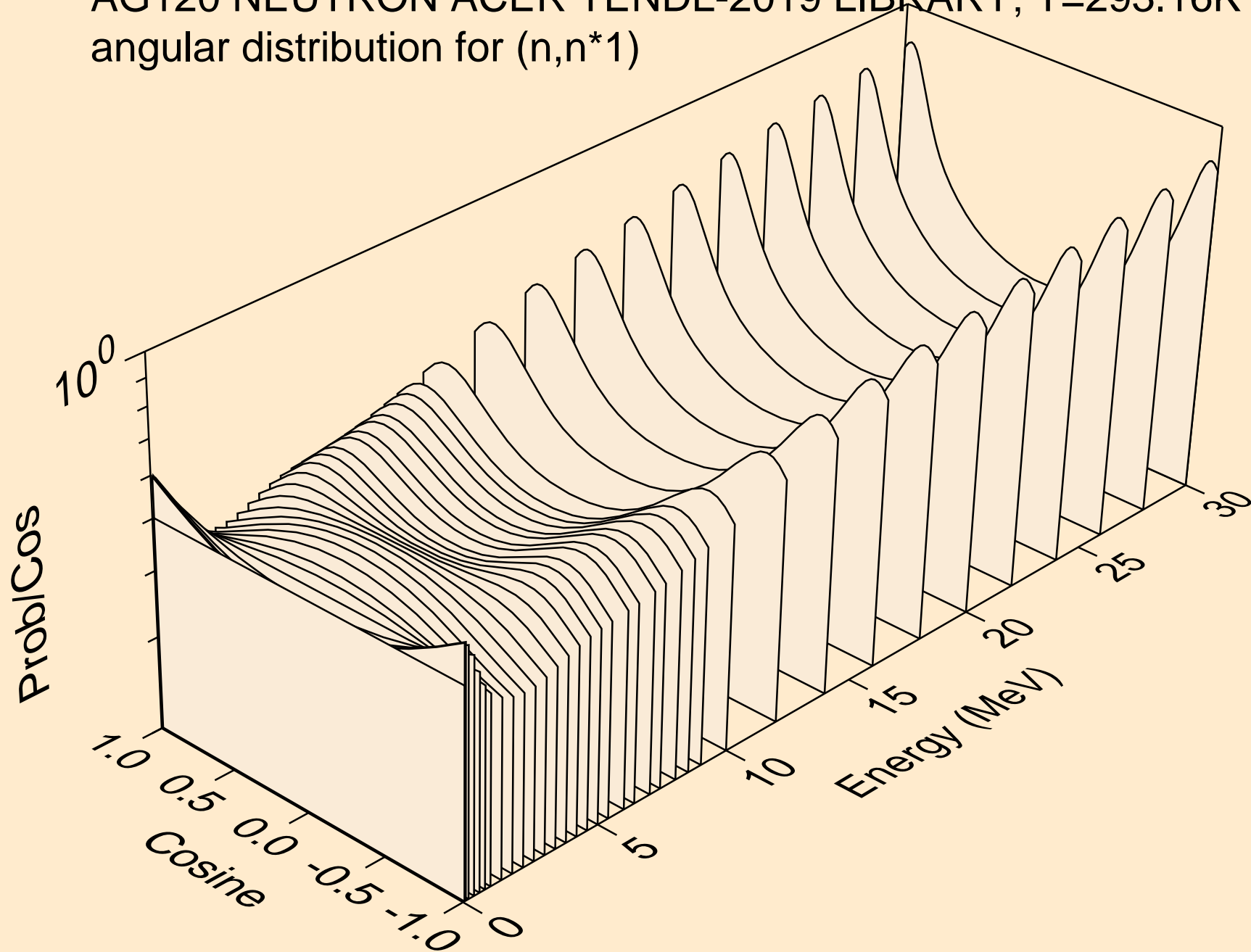

AG120 NEUTRON ACER TENDL-2019 LIBRARY; T=293.16K
angular distribution for (n,n*2)

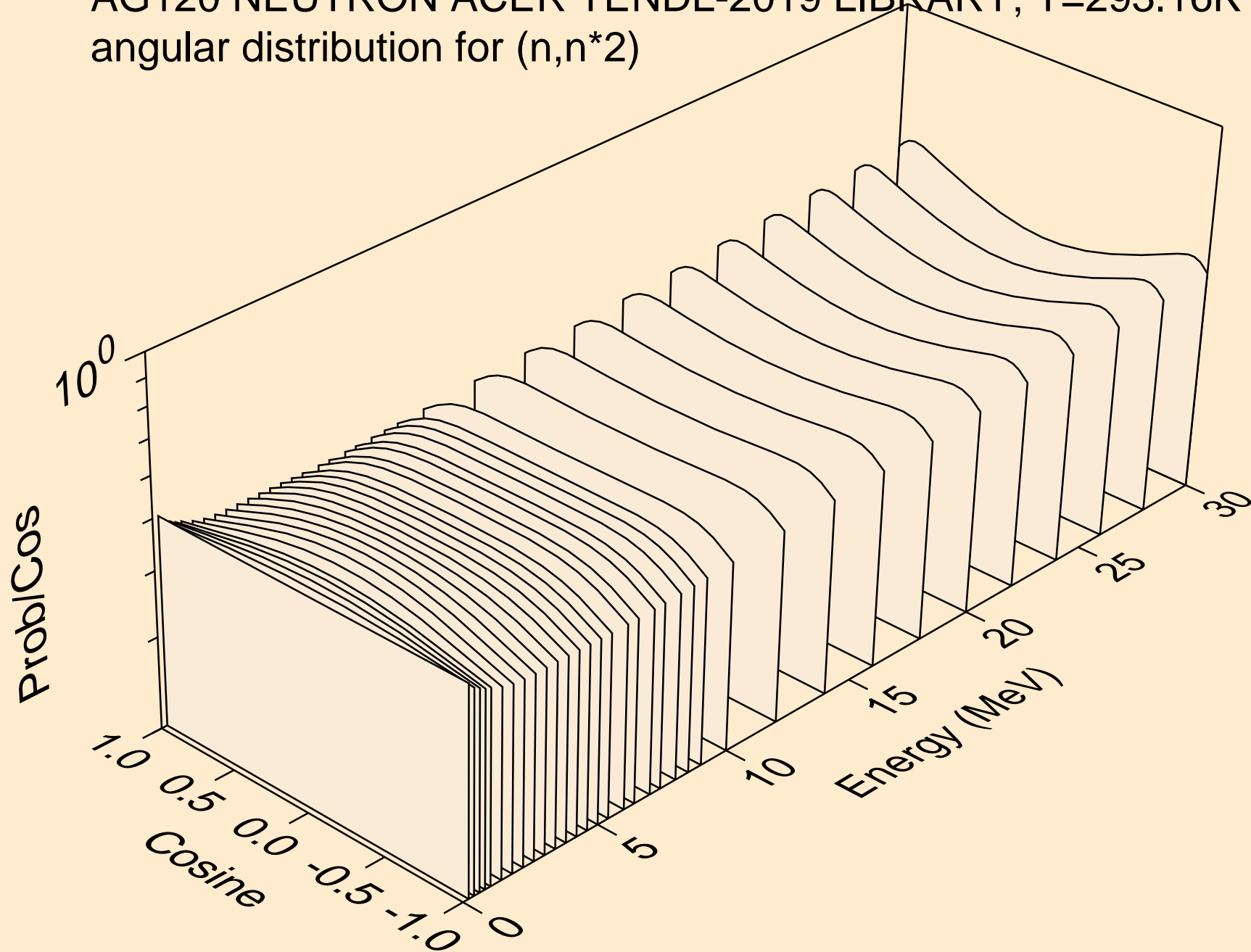

AG120 NEUTRON ACER TENDL-2019 LIBRARY; T=293.16K
angular distribution for (n,n*3)

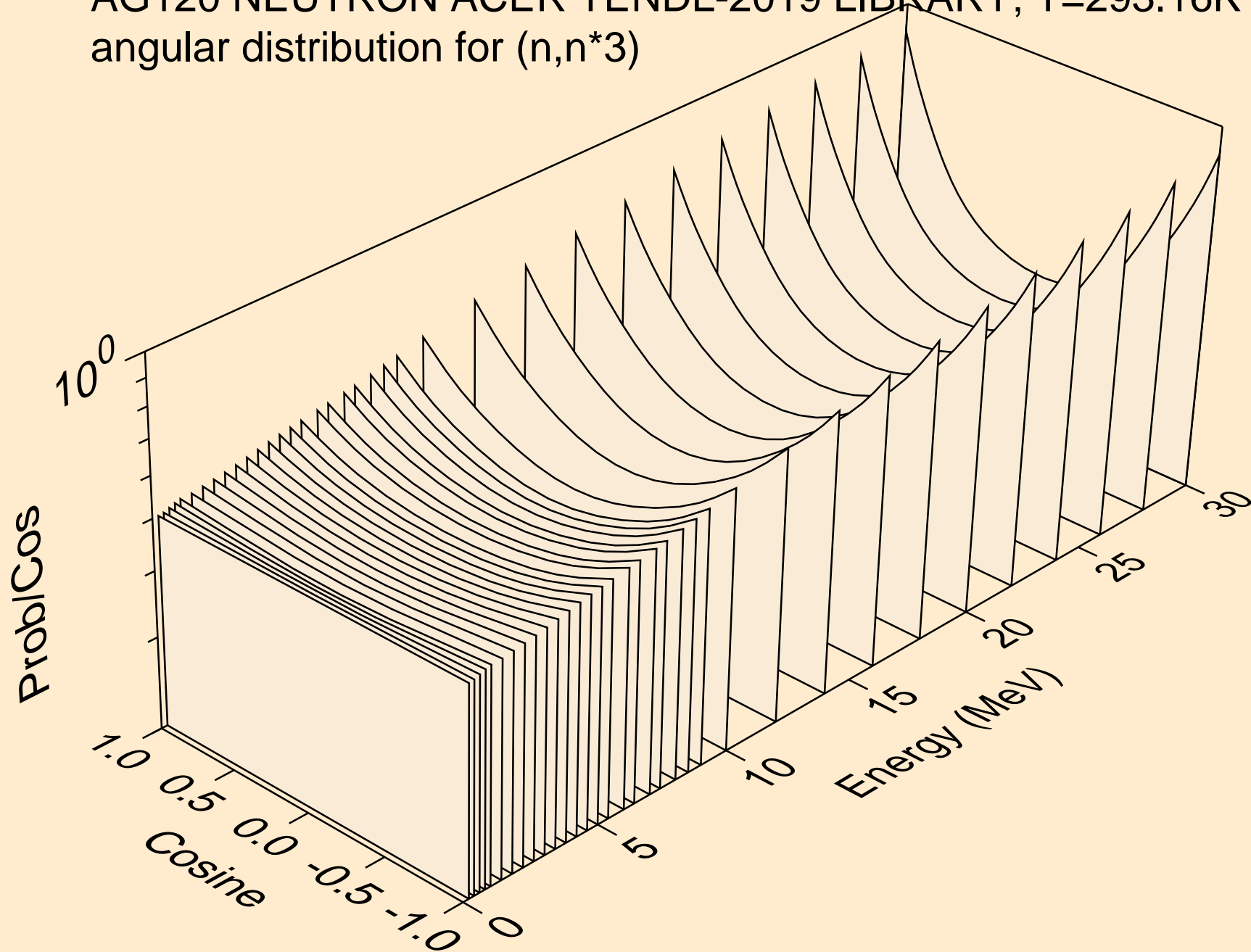

AG120 NEUTRON ACER TENDL-2019 LIBRARY; T=293.16K
angular distribution for (n,n*4)

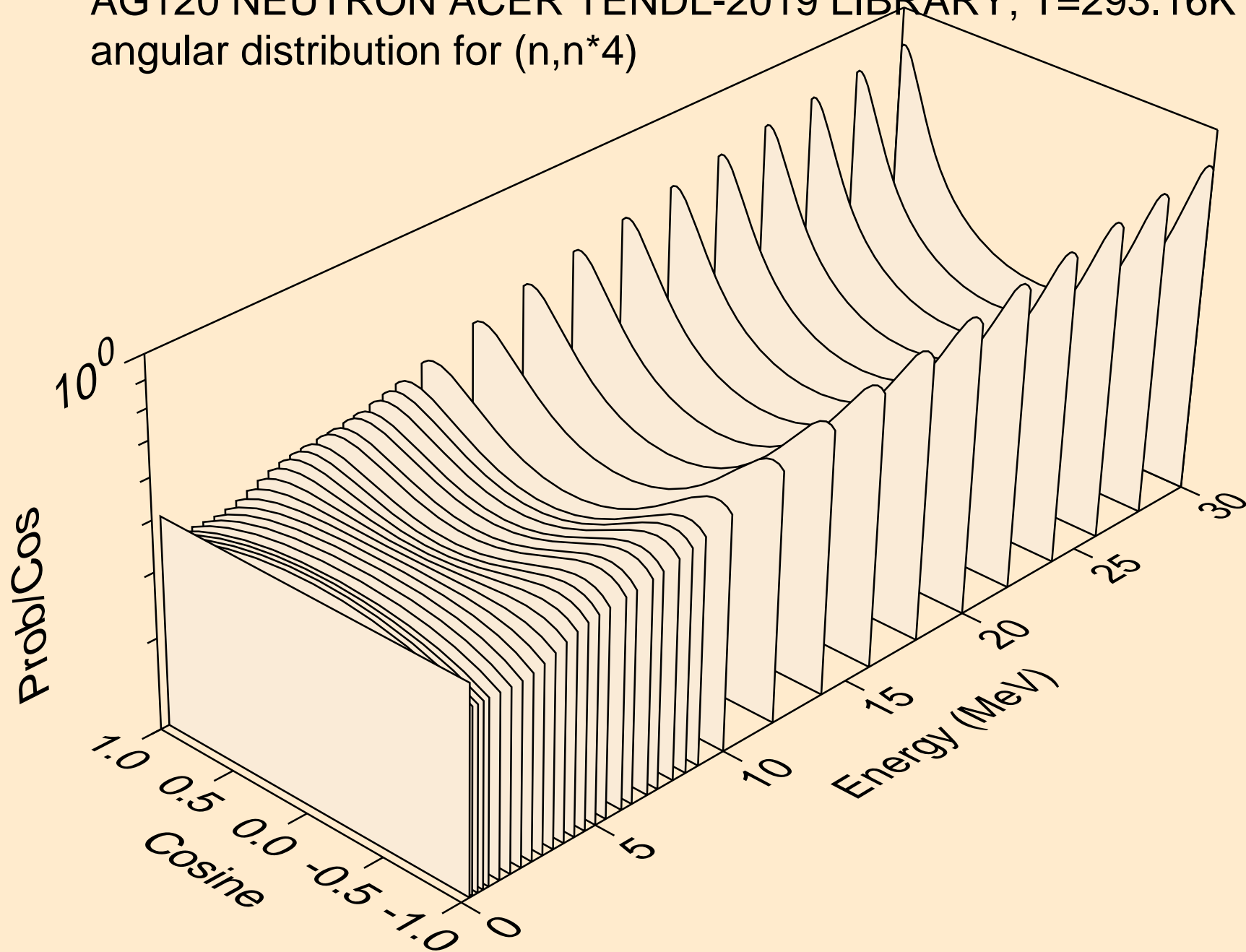

AG120 NEUTRON ACER TENDL-2019 LIBRARY; T=293.16K
angular distribution for (n,n*5)

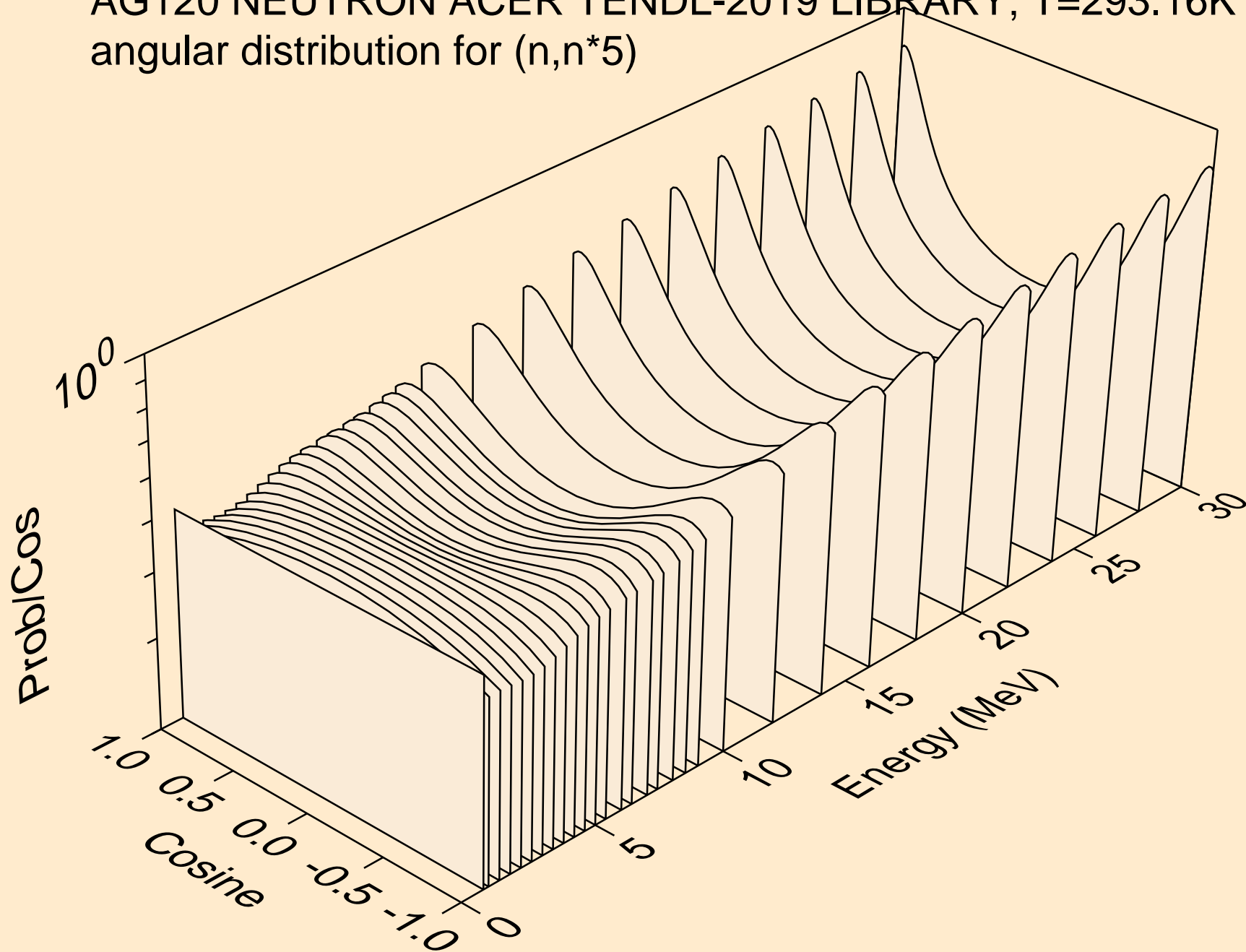

AG120 NEUTRON ACER TENDL-2019 LIBRARY; T=293.16K
angular distribution for (n,n*6)

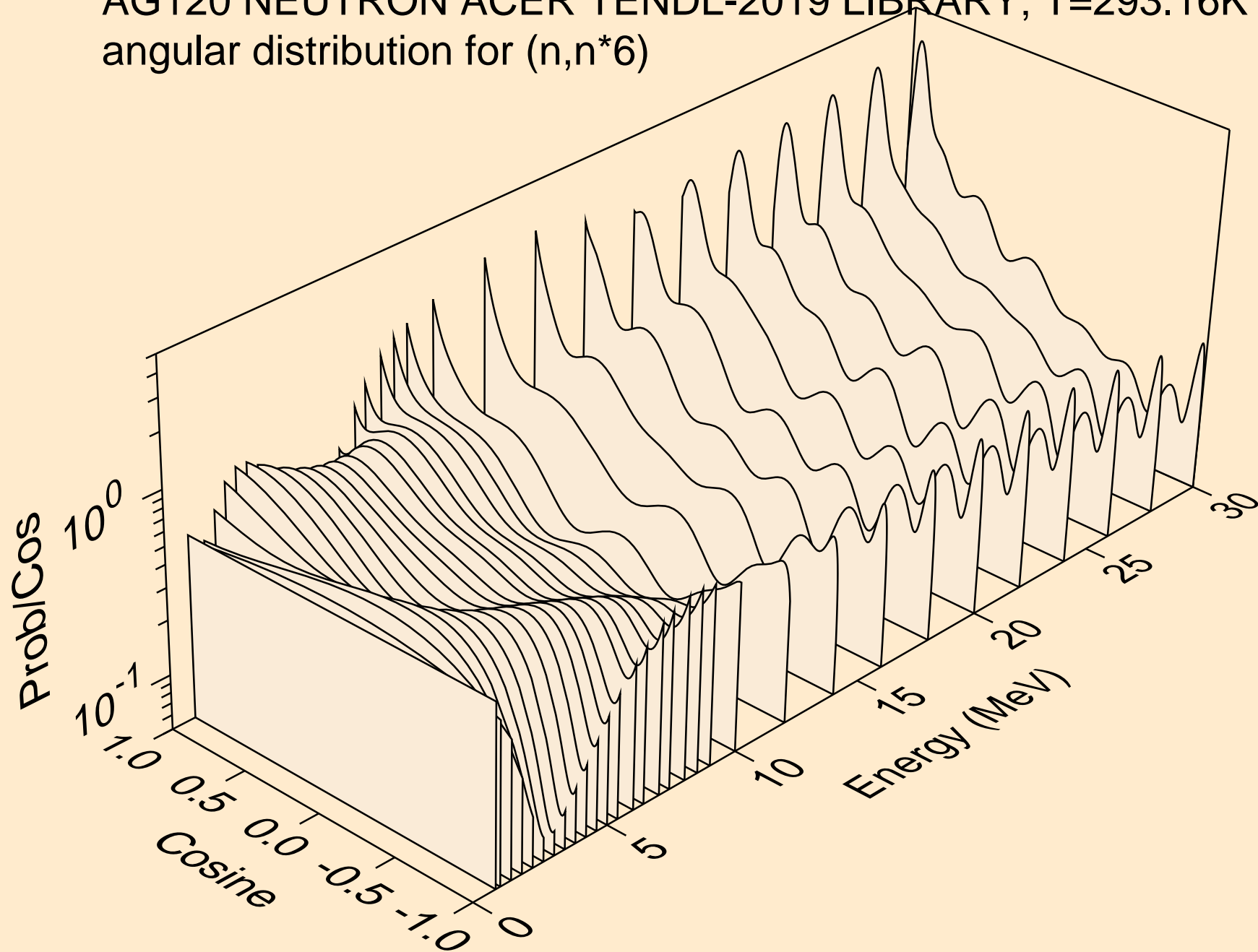

AG120 NEUTRON ACER TENDL-2019 LIBRARY; T=293.16K
angular distribution for (n,n*7)

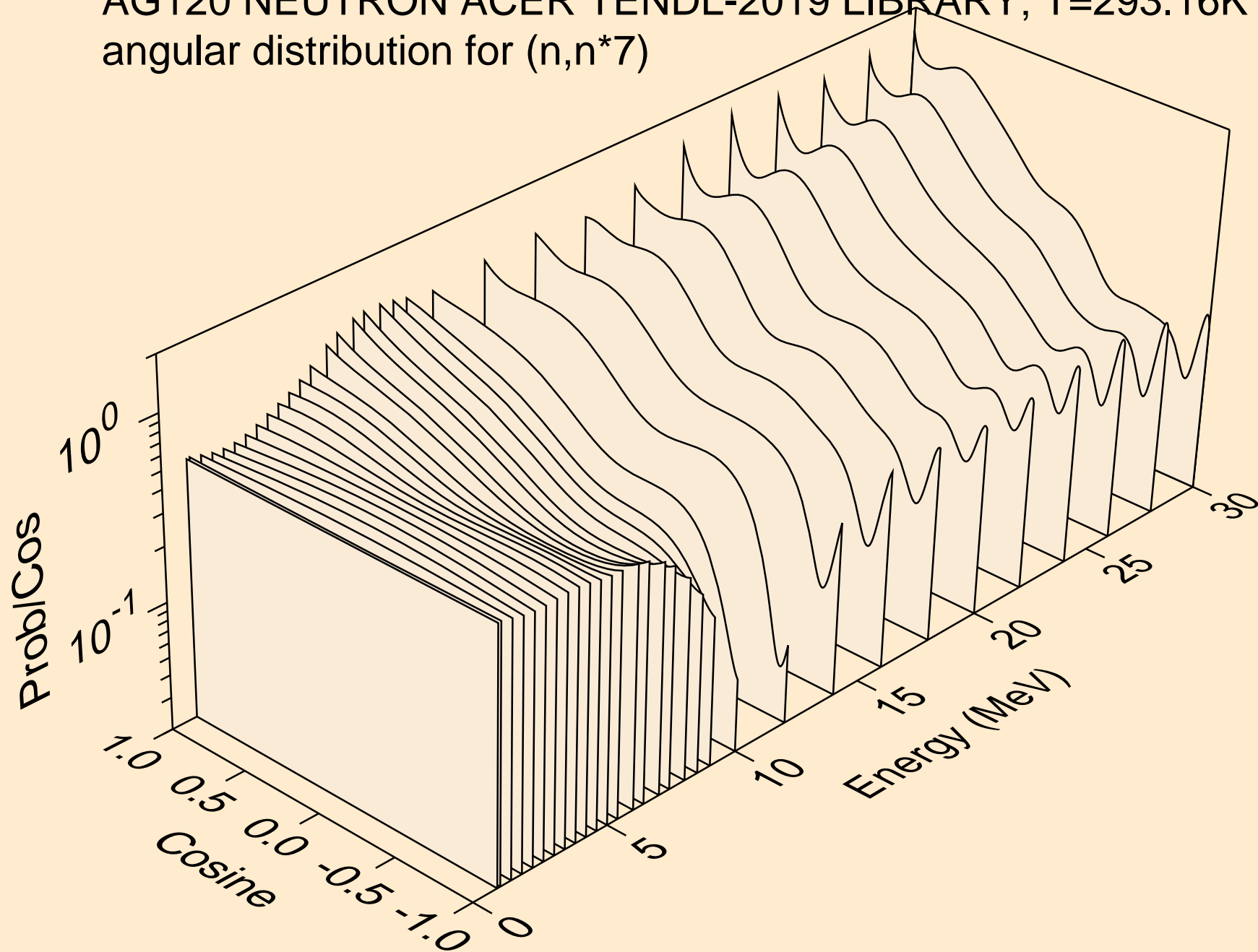

AG120 NEUTRON ACER TENDL-2019 LIBRARY; T=293.16K
angular distribution for (n,n*8)

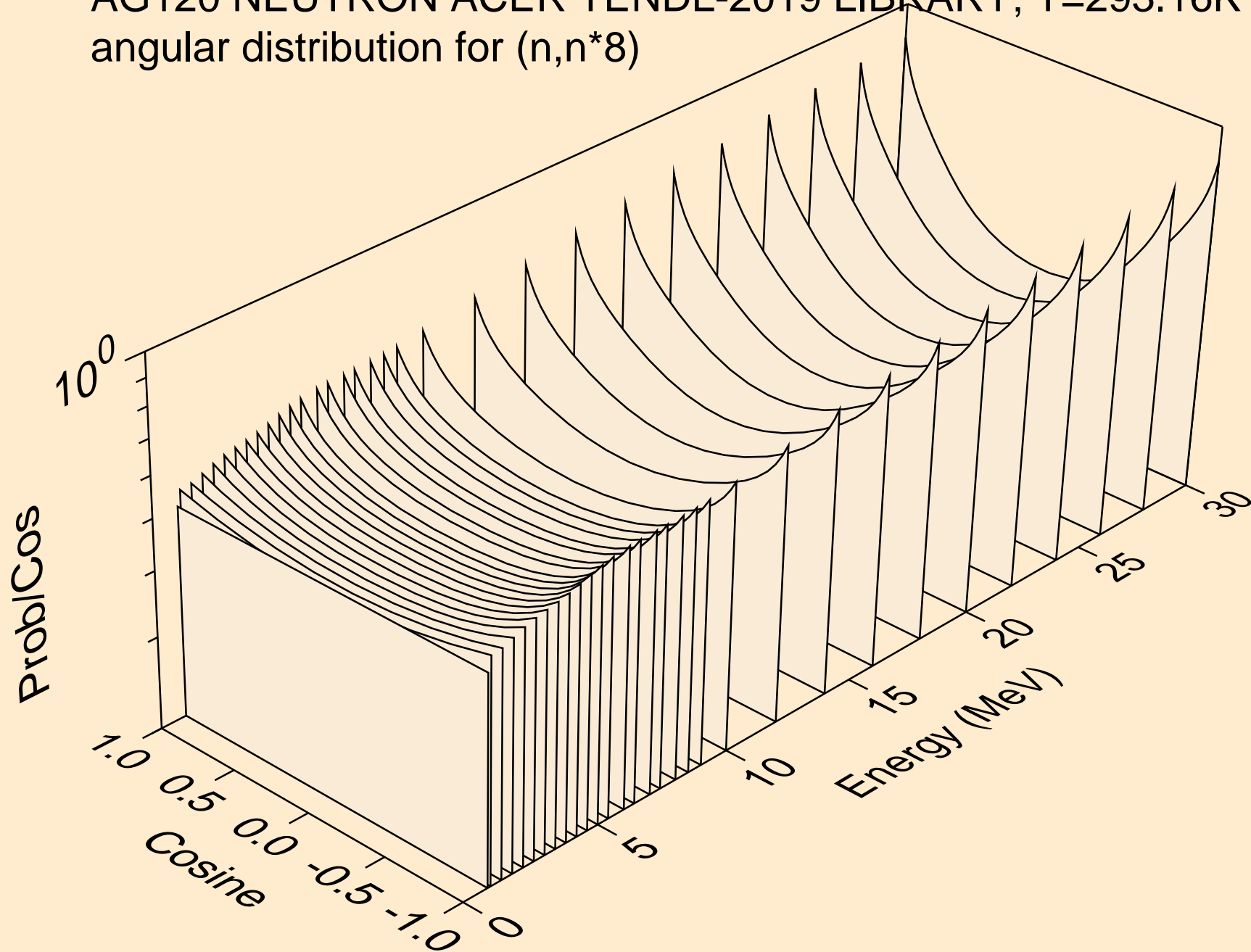

AG120 NEUTRON ACER TENDL-2019 LIBRARY; T=293.16K
angular distribution for (n,n*9)

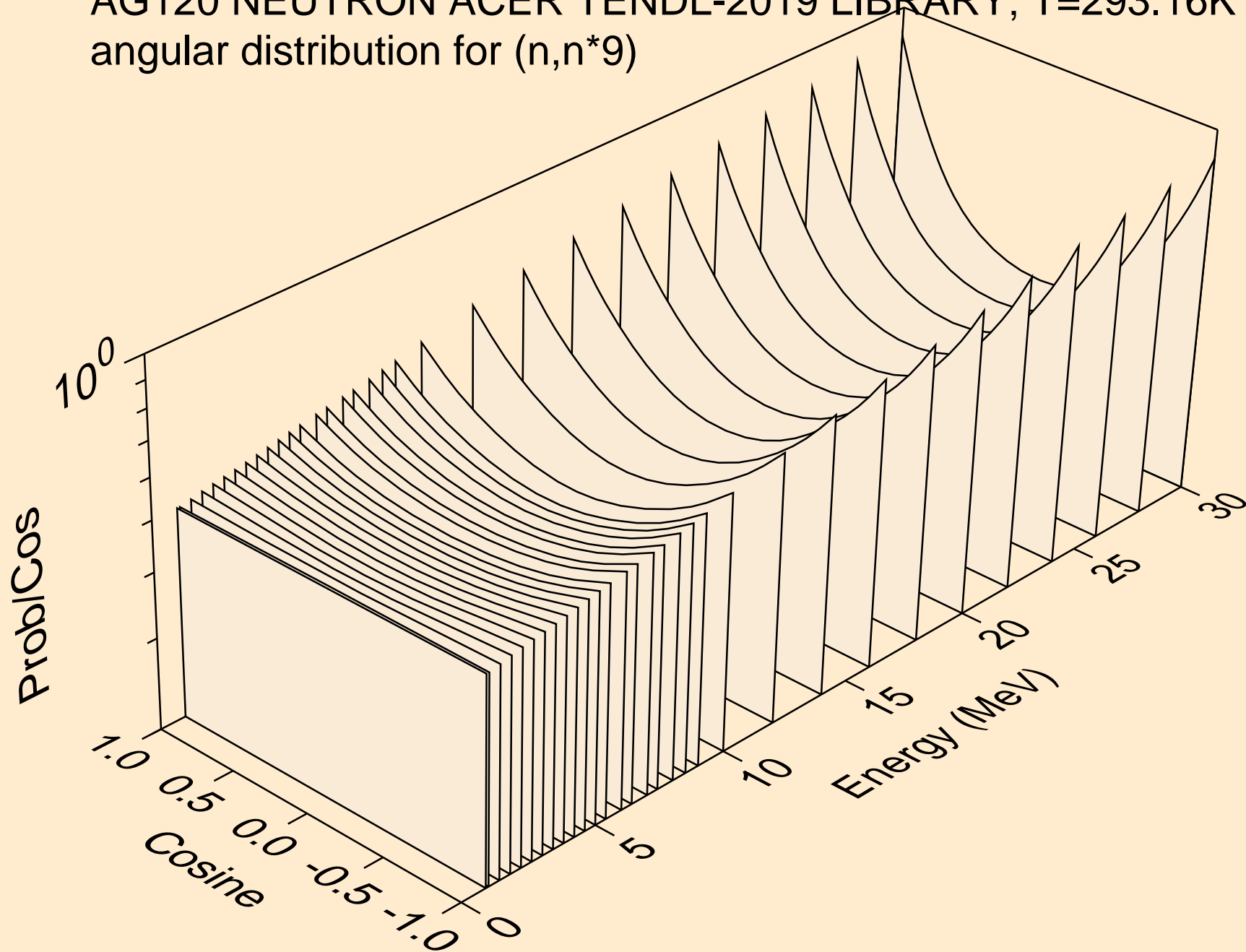

AG120 NEUTRON ACER TENDL-2019 LIBRARY; T=293.16K
angular distribution for (n,n*10)

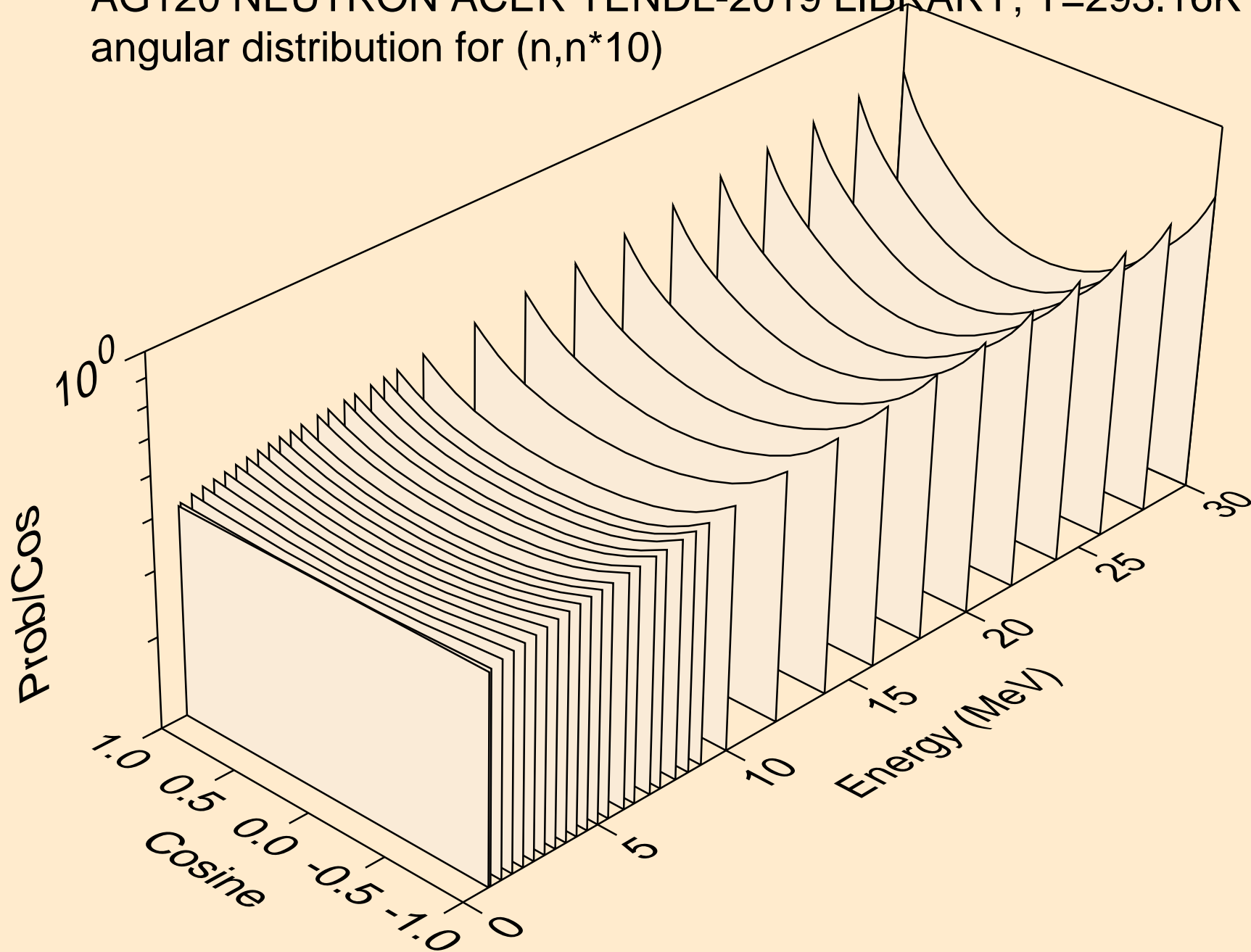

AG120 NEUTRON ACER TENDL-2019 LIBRARY; T=293.16K
angular distribution for (n,n*11)

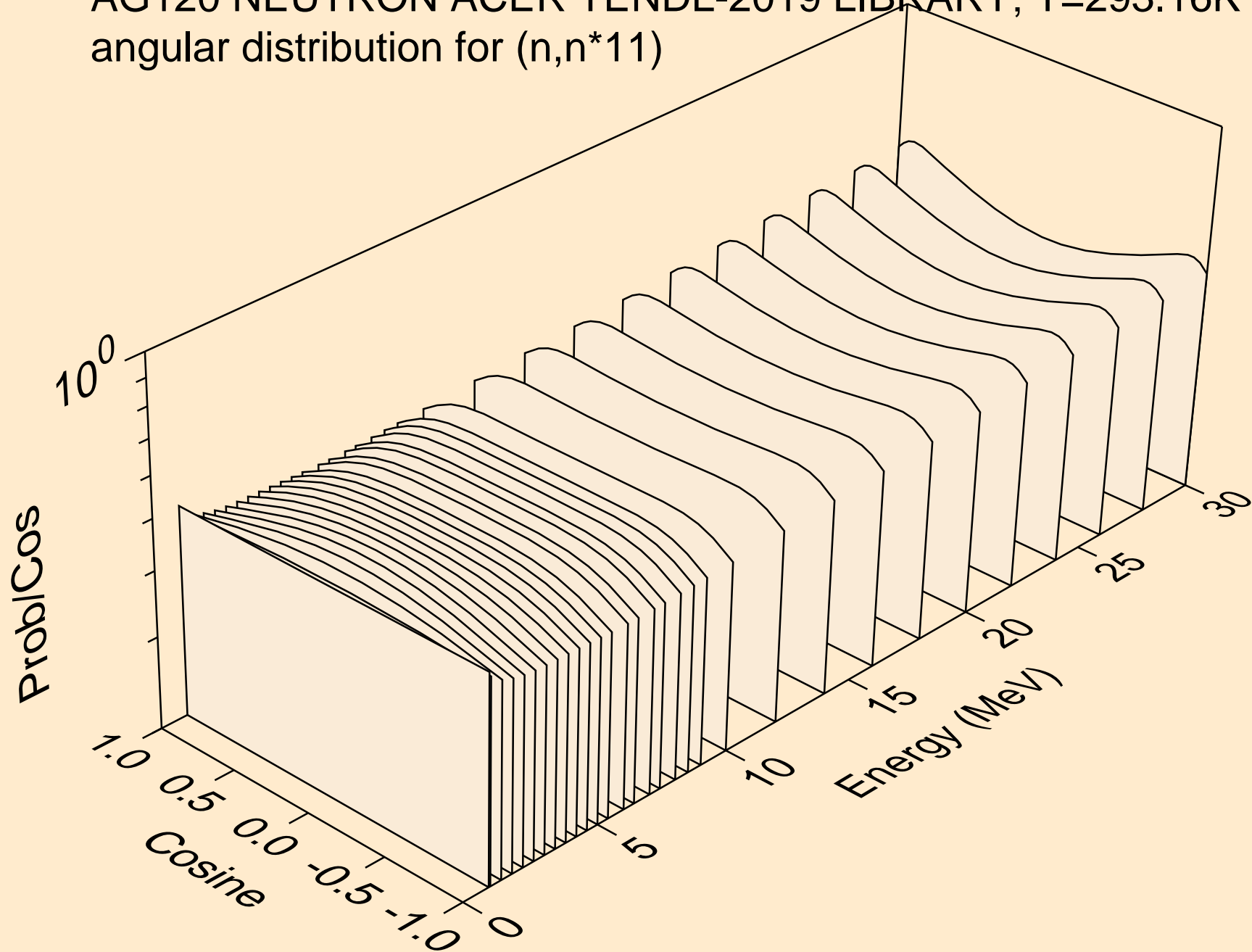

AG120 NEUTRON ACER TENDL-2019 LIBRARY; T=293.16K
angular distribution for (n,n*12)

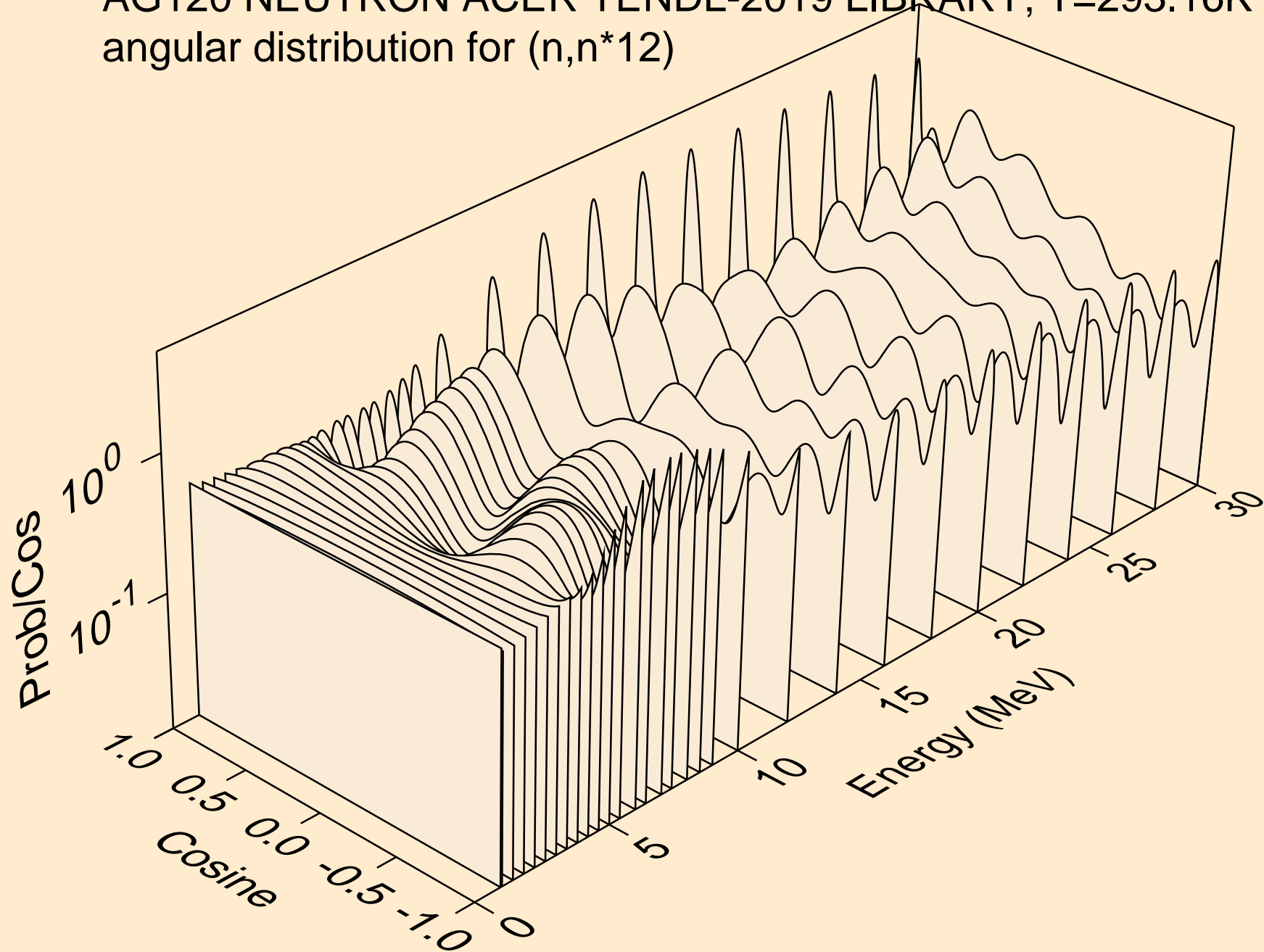

AG120 NEUTRON ACER TENDL-2019 LIBRARY; T=293.16K
angular distribution for (n,n*13)

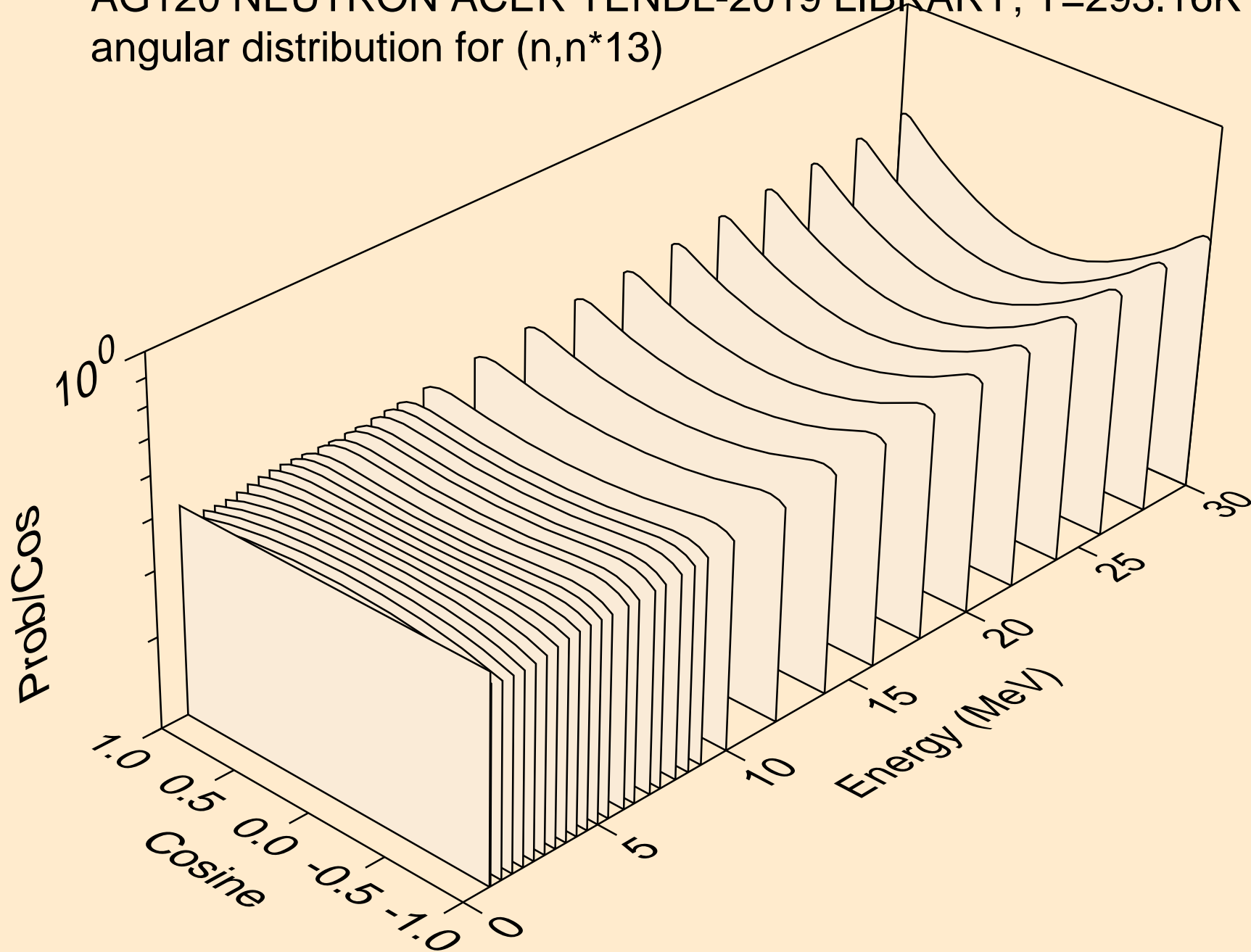

AG120 NEUTRON ACER TENDL-2019 LIBRARY; T=293.16K
angular distribution for (n,n*14)

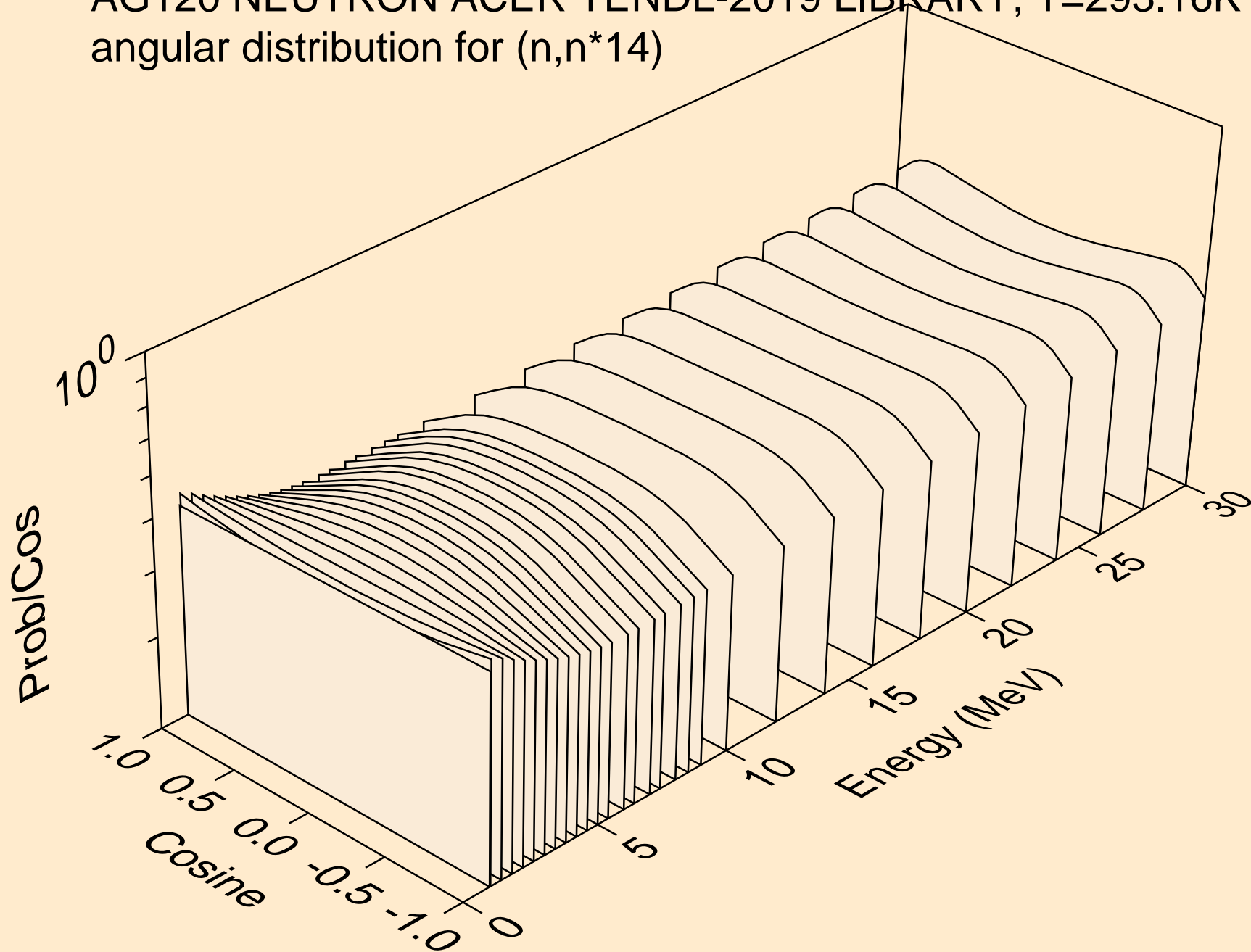

AG120 NEUTRON ACER TENDL-2019 LIBRARY; T=293.16K
angular distribution for (n,n*15)

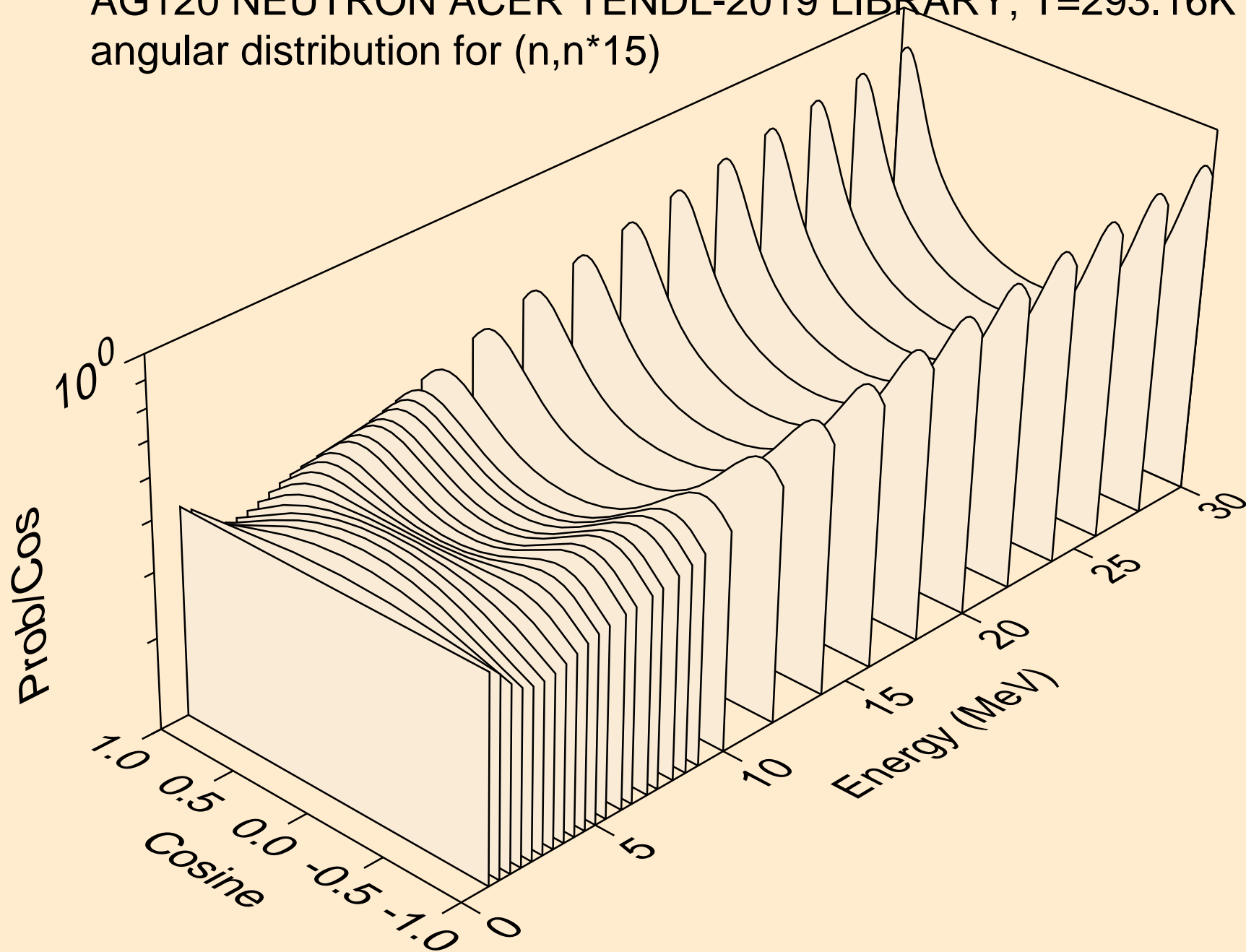

AG120 NEUTRON ACER TENDL-2019 LIBRARY; T=293.16K
angular distribution for (n,n*16)

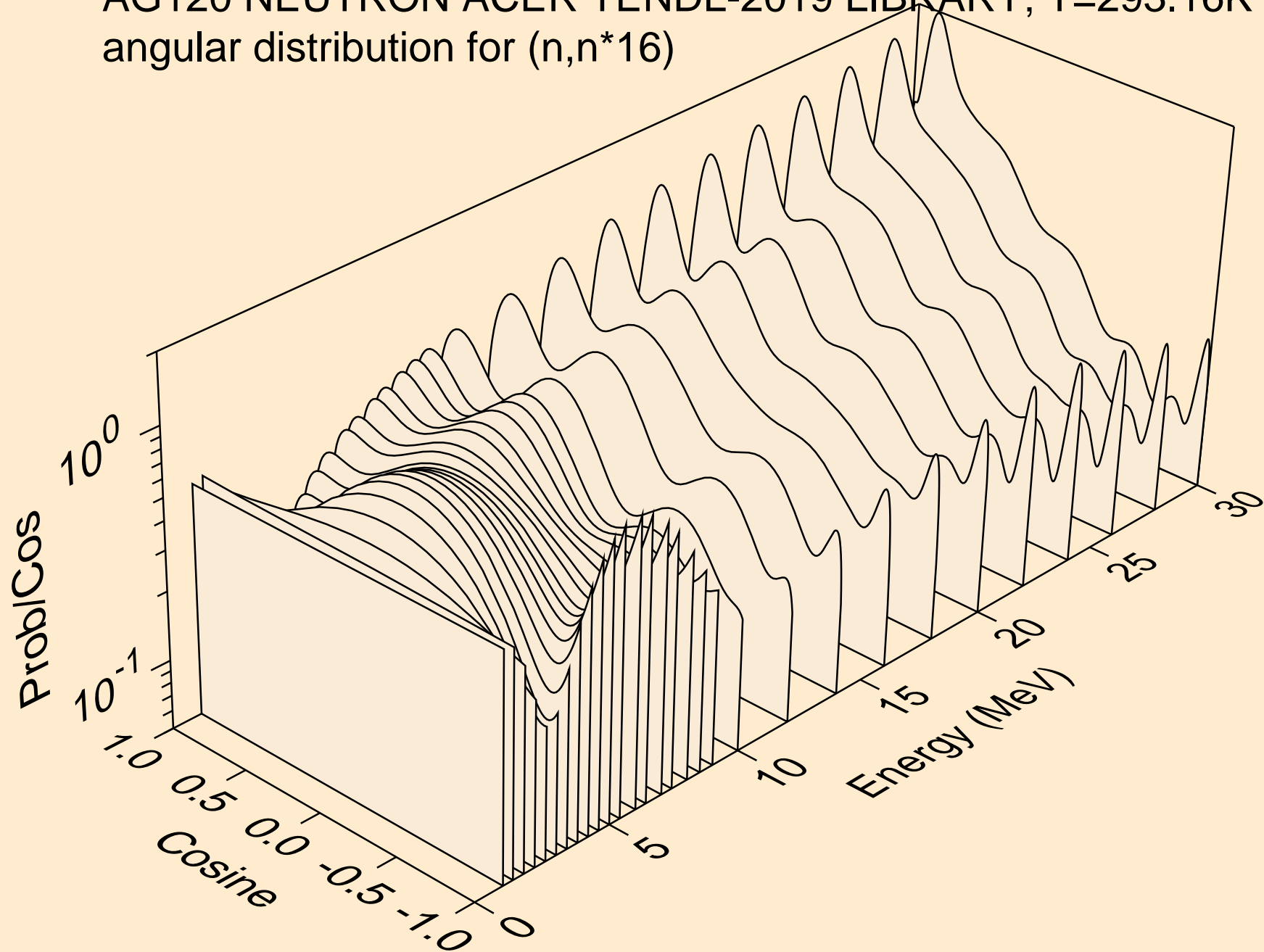

AG120 NEUTRON ACER TENDL-2019 LIBRARY; T=293.16K
angular distribution for (n,n*17)

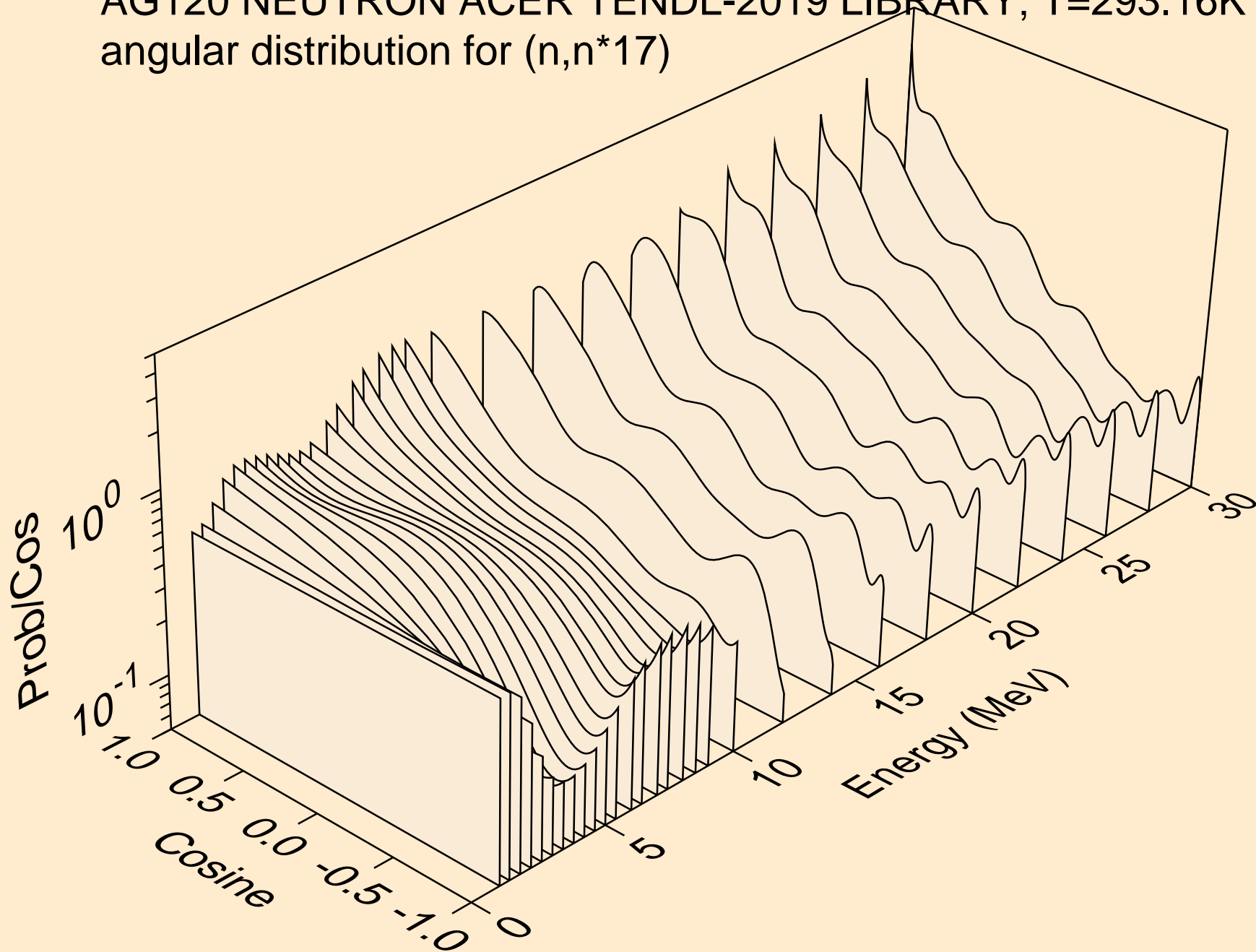

AG120 NEUTRON ACER TENDL-2019 LIBRARY; T=293.16K
angular distribution for (n,n*18)

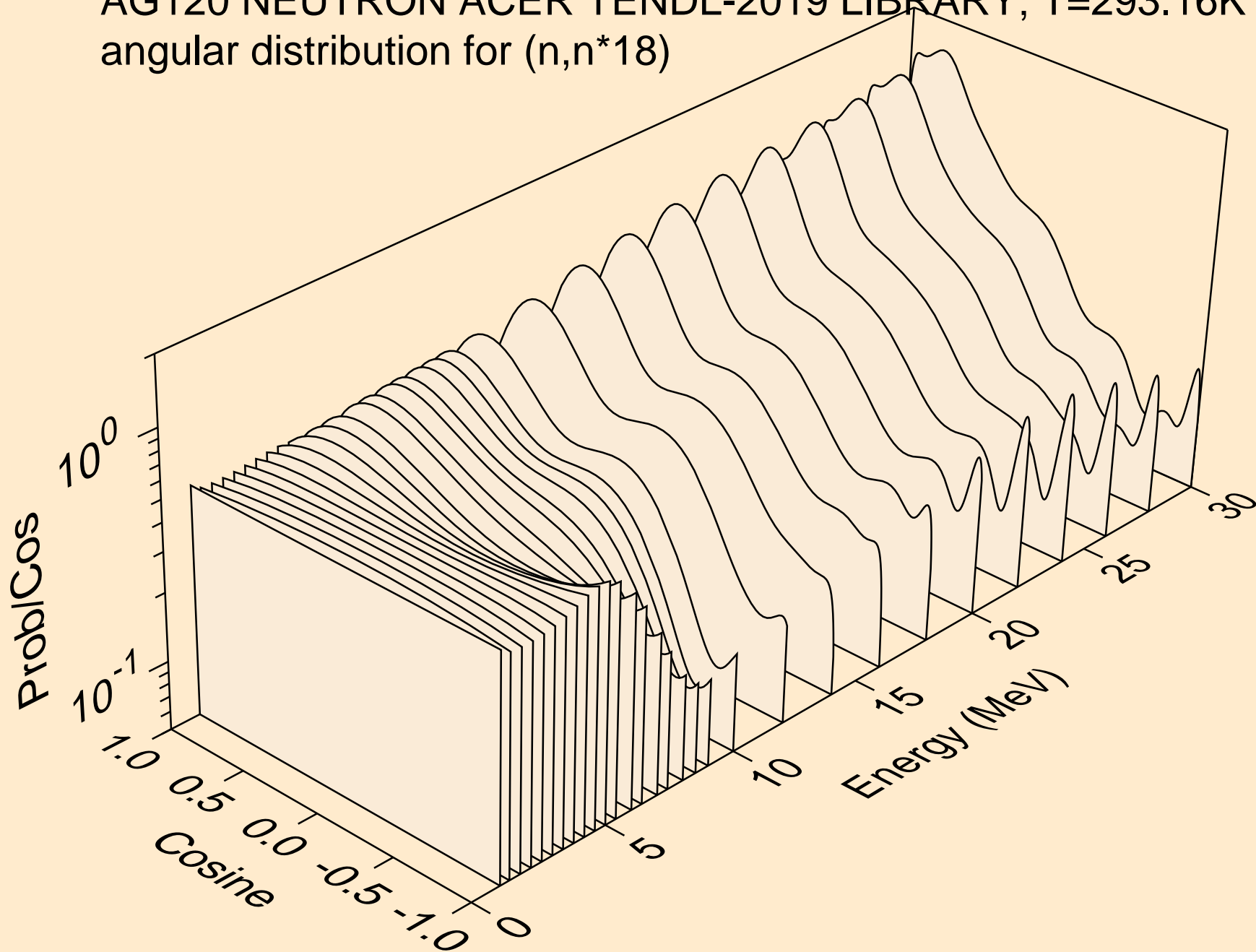

AG120 NEUTRON ACER TENDL-2019 LIBRARY; T=293.16K
angular distribution for (n,n*19)

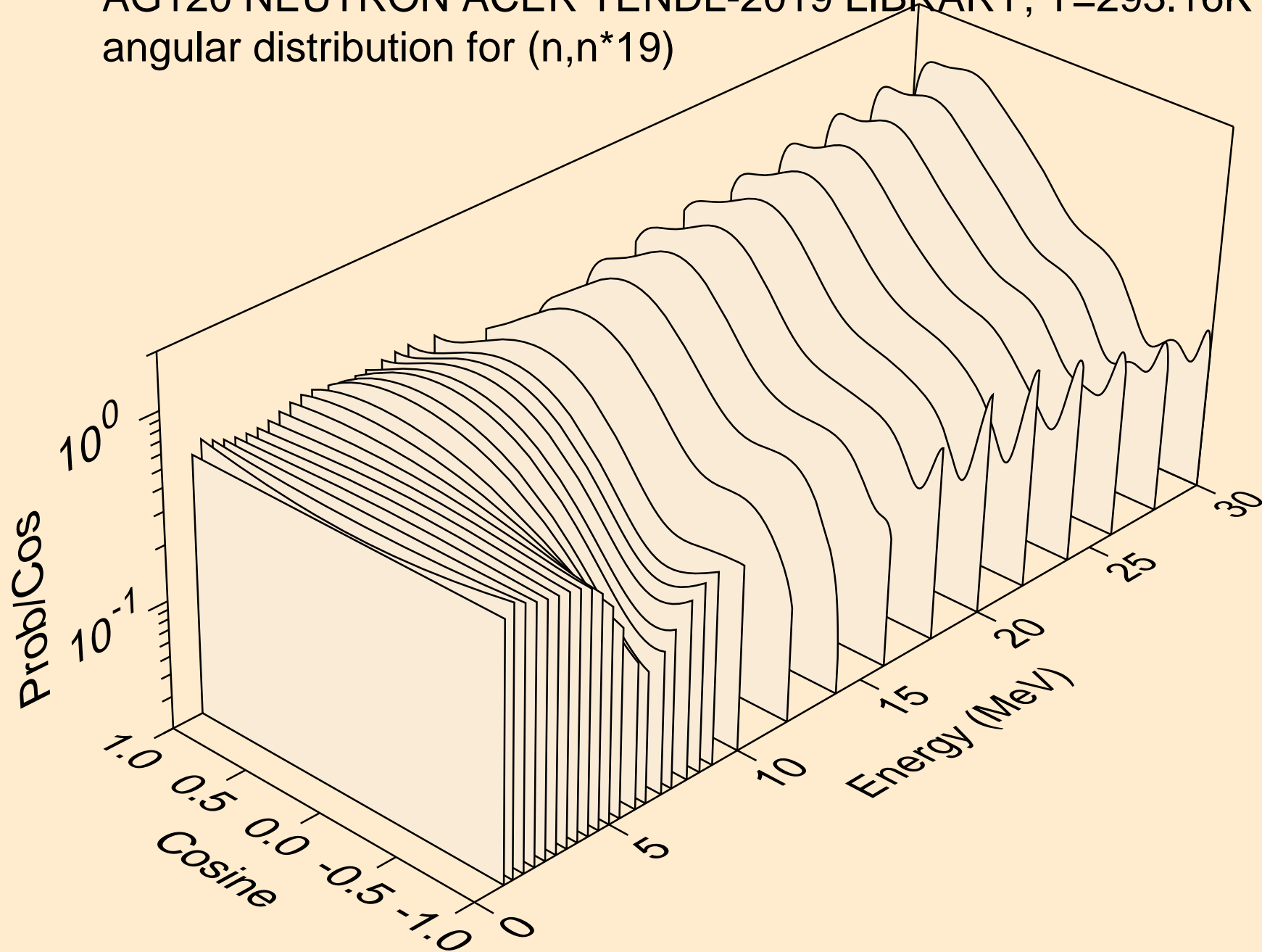

AG120 NEUTRON ACER TENDL-2019 LIBRARY; T=293.16K
angular distribution for (n,n*20)

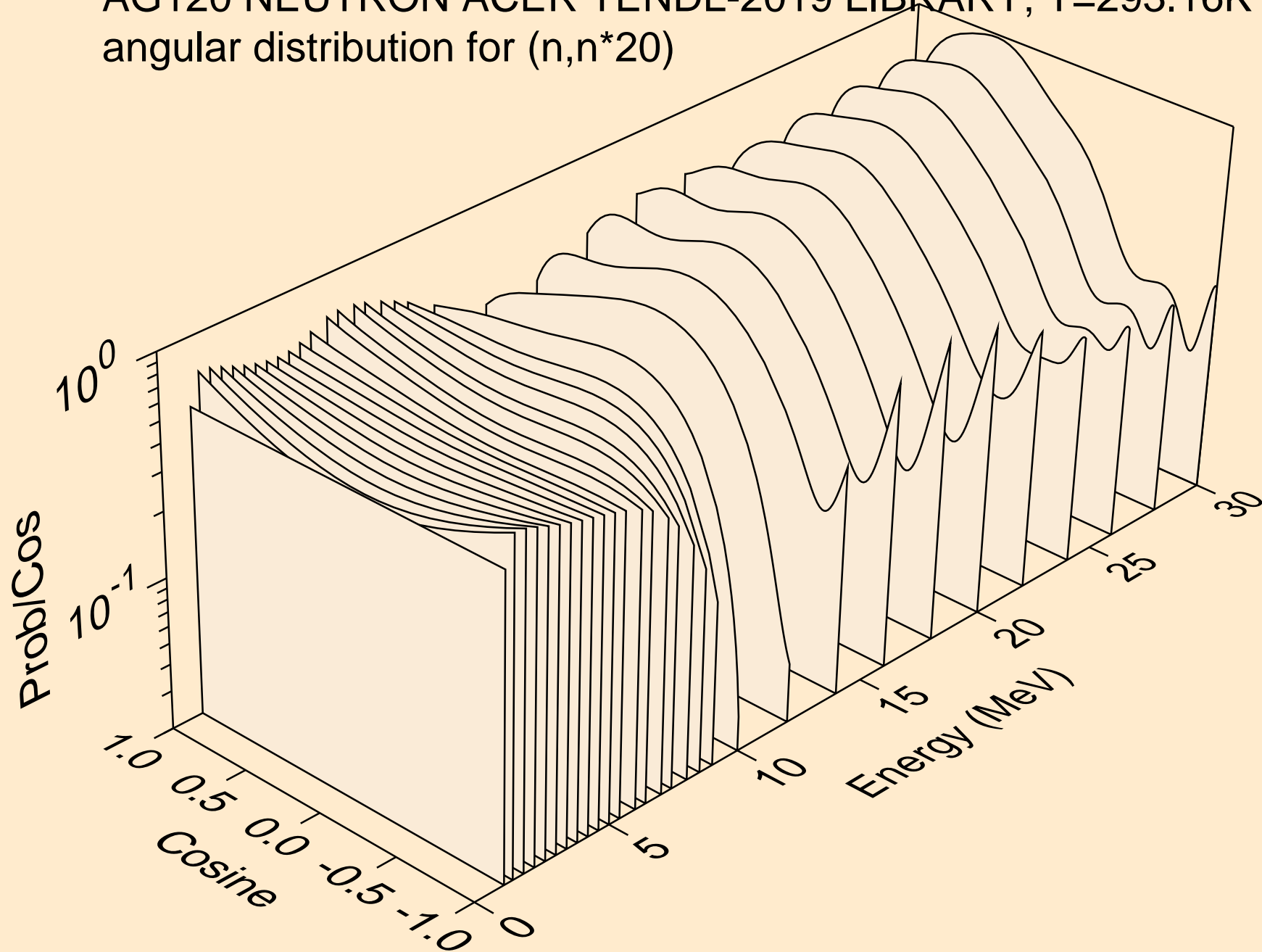

AG120 NEUTRON ACER TENDL-2019 LIBRARY; T=293.16K
angular distribution for (n,n*21)

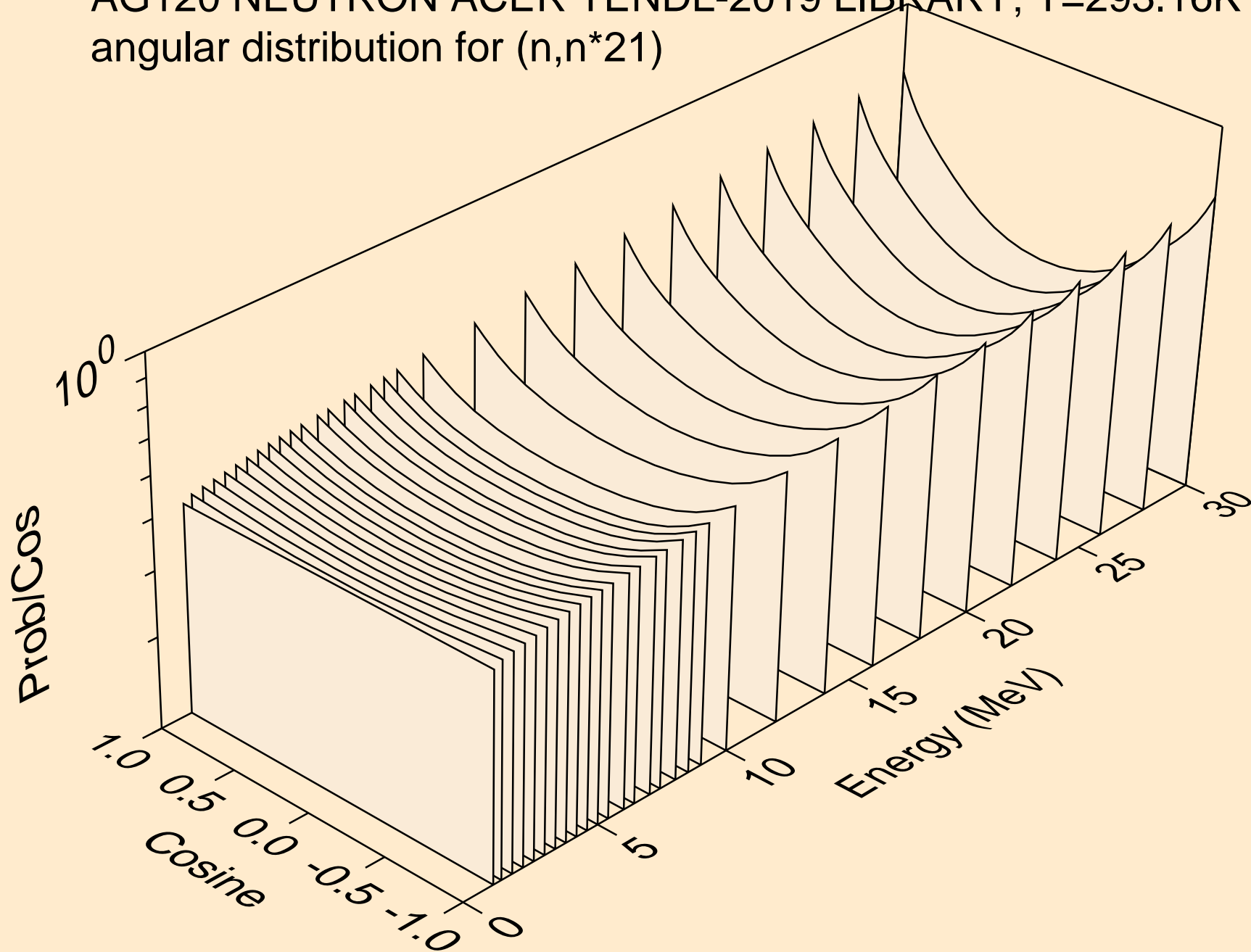

AG120 NEUTRON ACER TENDL-2019 LIBRARY; T=293.16K
angular distribution for (n,n*22)

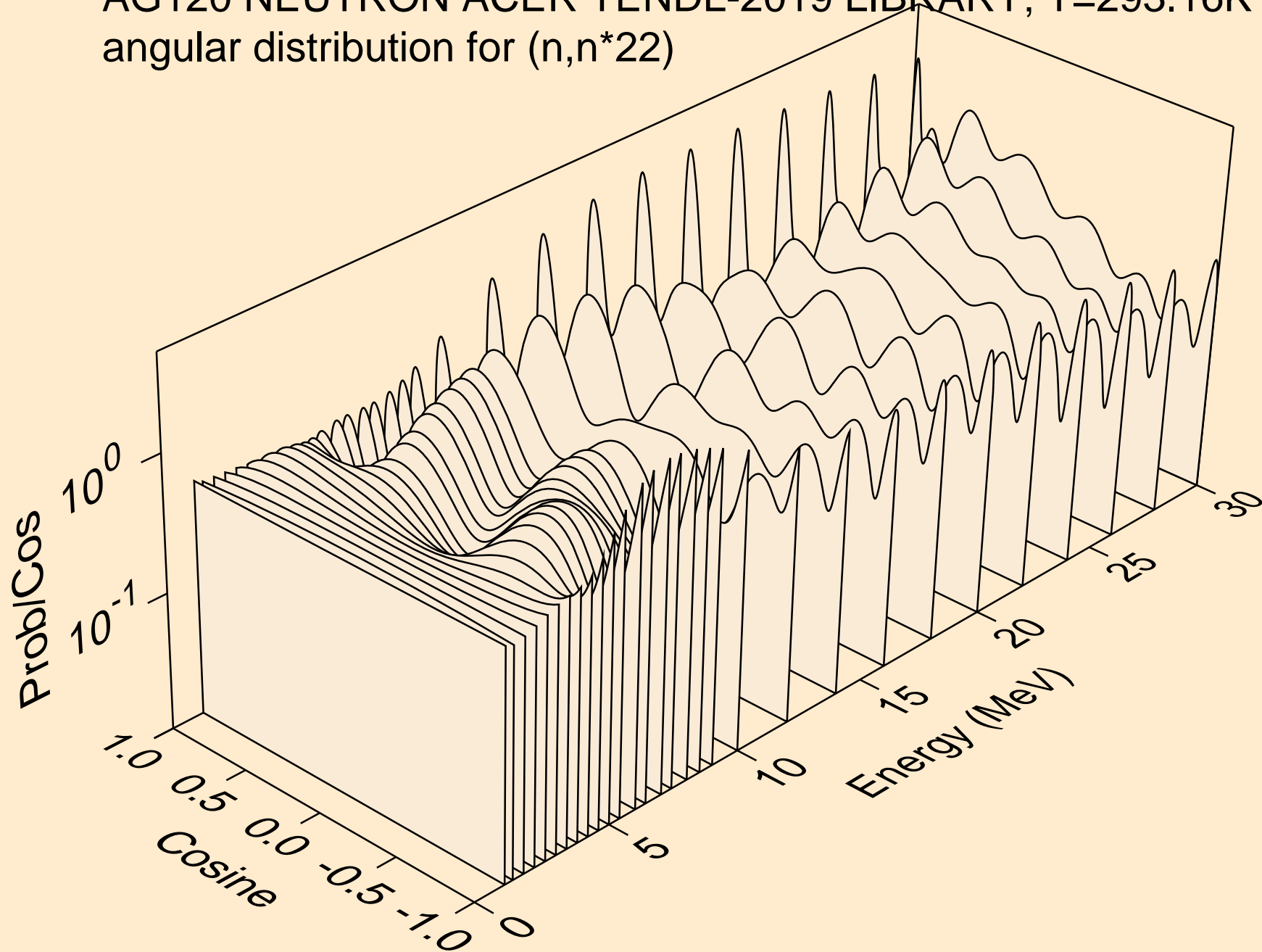

AG120 NEUTRON ACER TENDL-2019 LIBRARY; T=293.16K
angular distribution for (n,n*23)

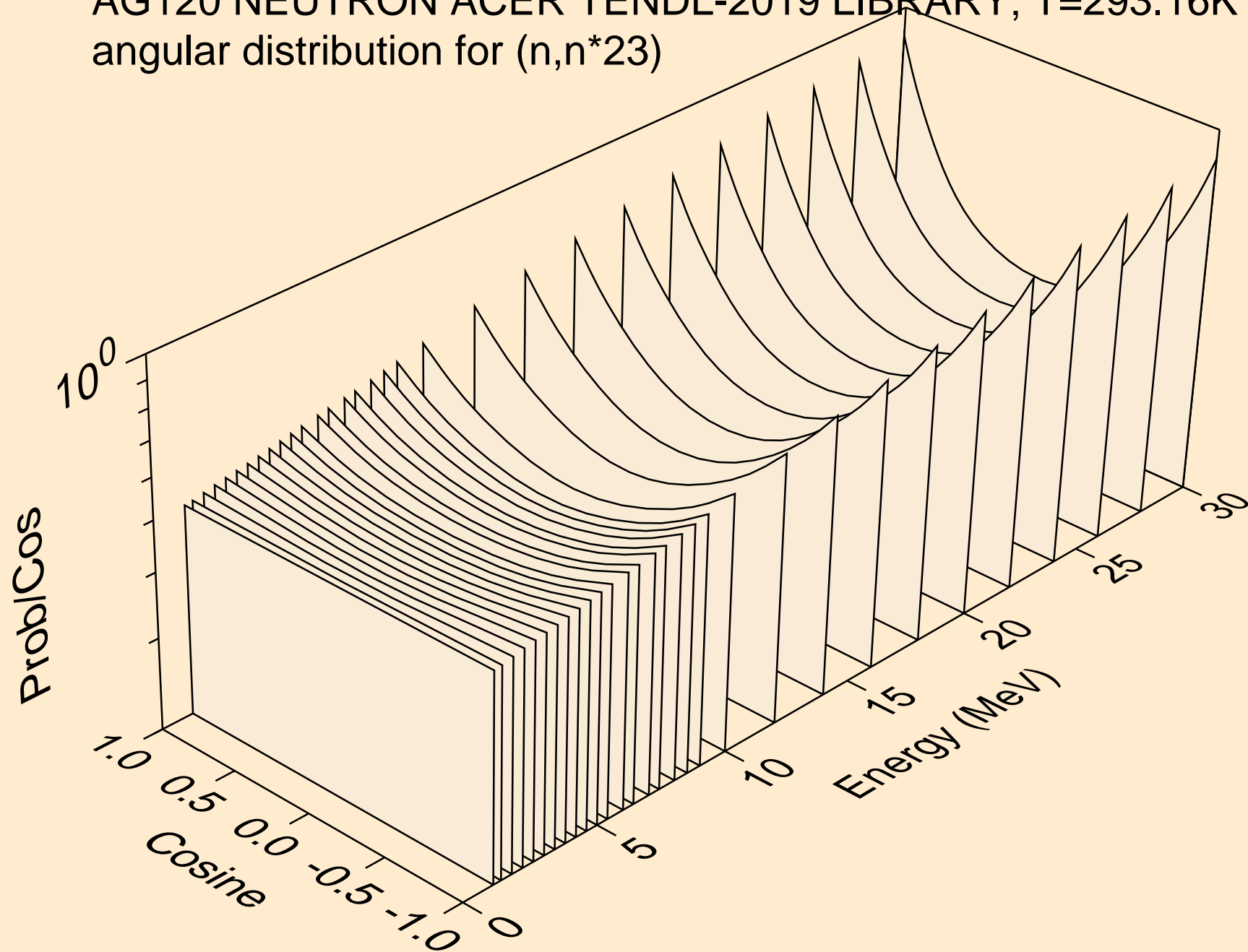

AG120 NEUTRON ACER TENDL-2019 LIBRARY; T=293.16K
angular distribution for (n,n*24)

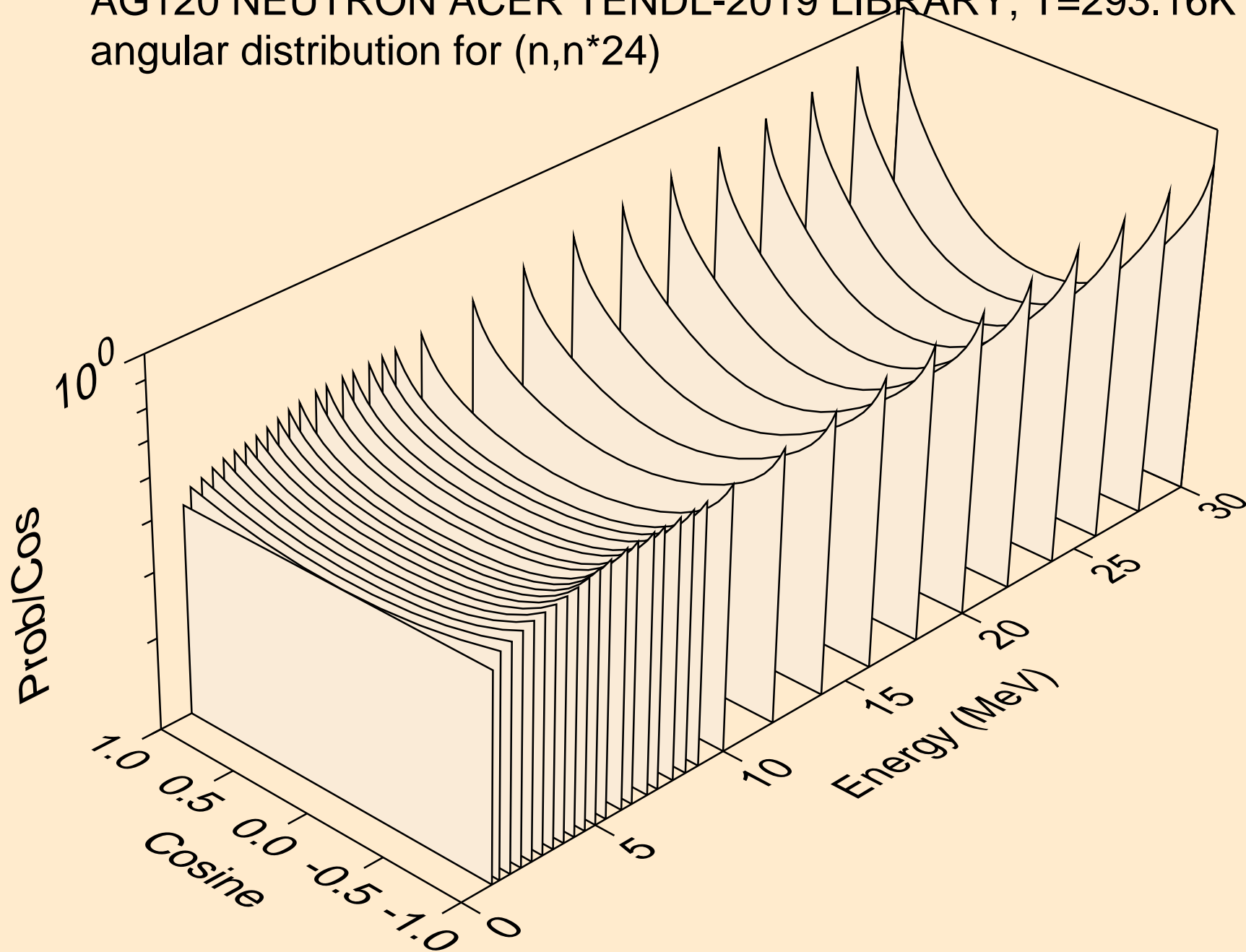

AG120 NEUTRON ACER TENDL-2019 LIBRARY; T=293.16K
angular distribution for (n,n*25)

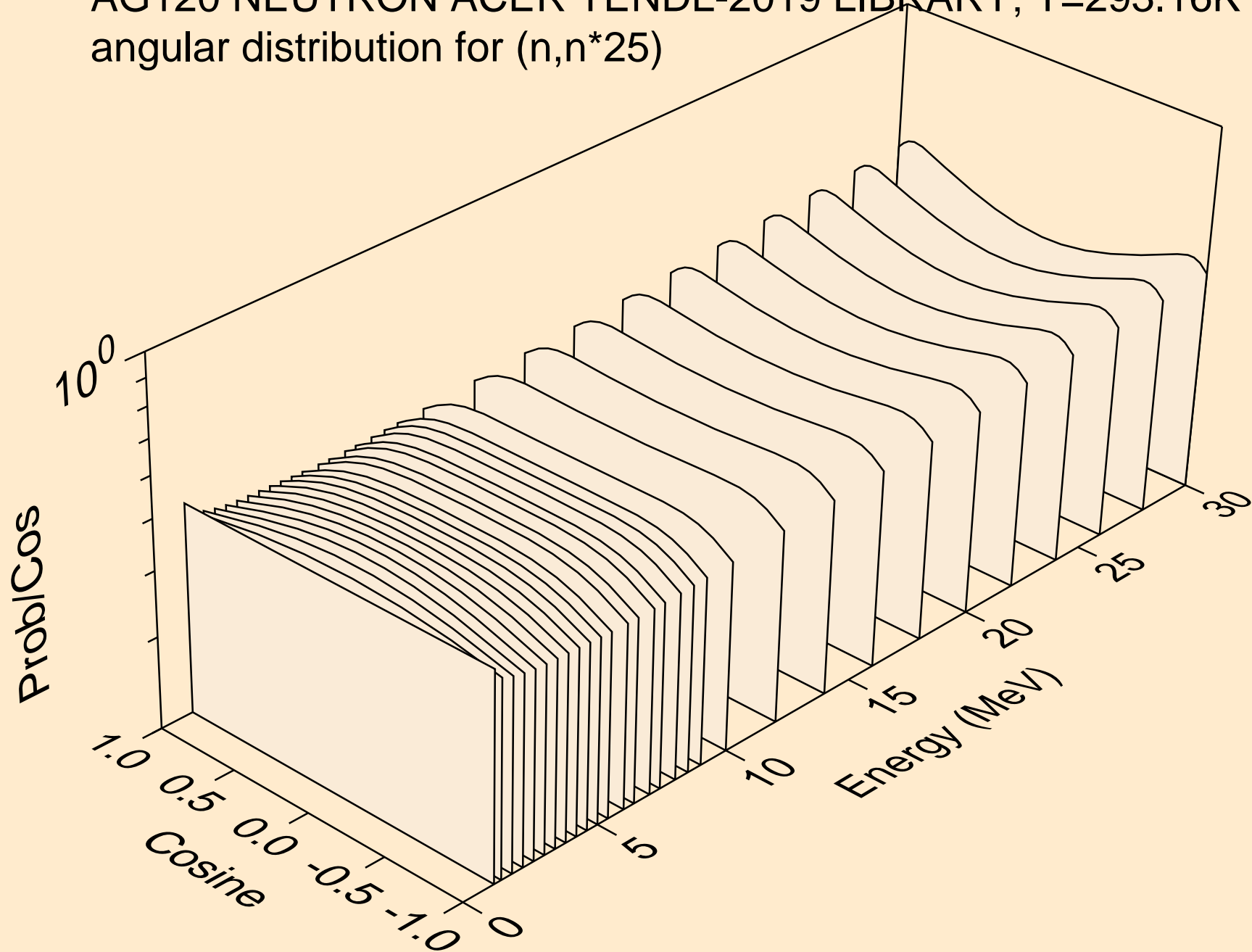

AG120 NEUTRON ACER TENDL-2019 LIBRARY; T=293.16K
angular distribution for (n,n*26)

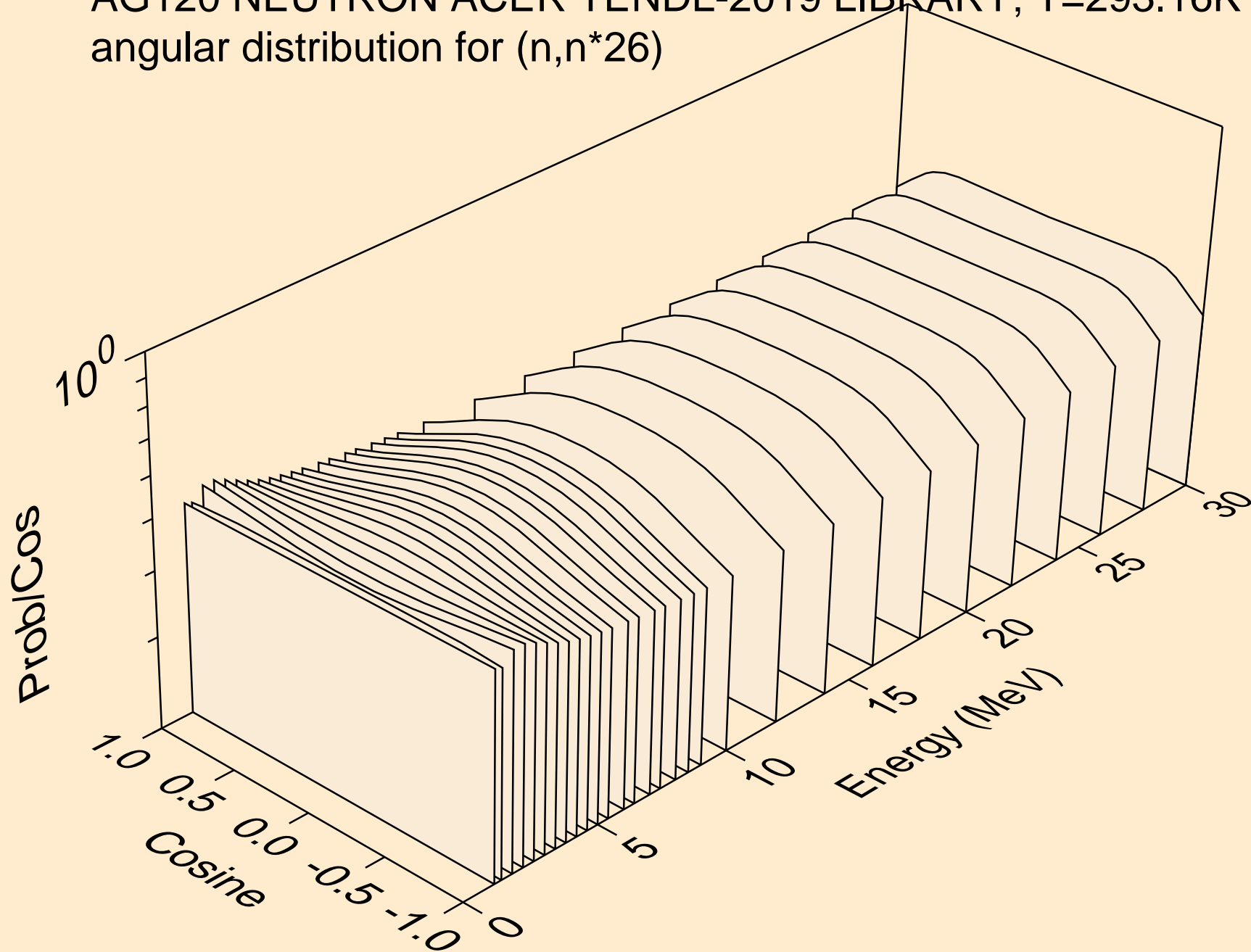

AG120 NEUTRON ACER TENDL-2019 LIBRARY; T=293.16K
angular distribution for (n,n*27)

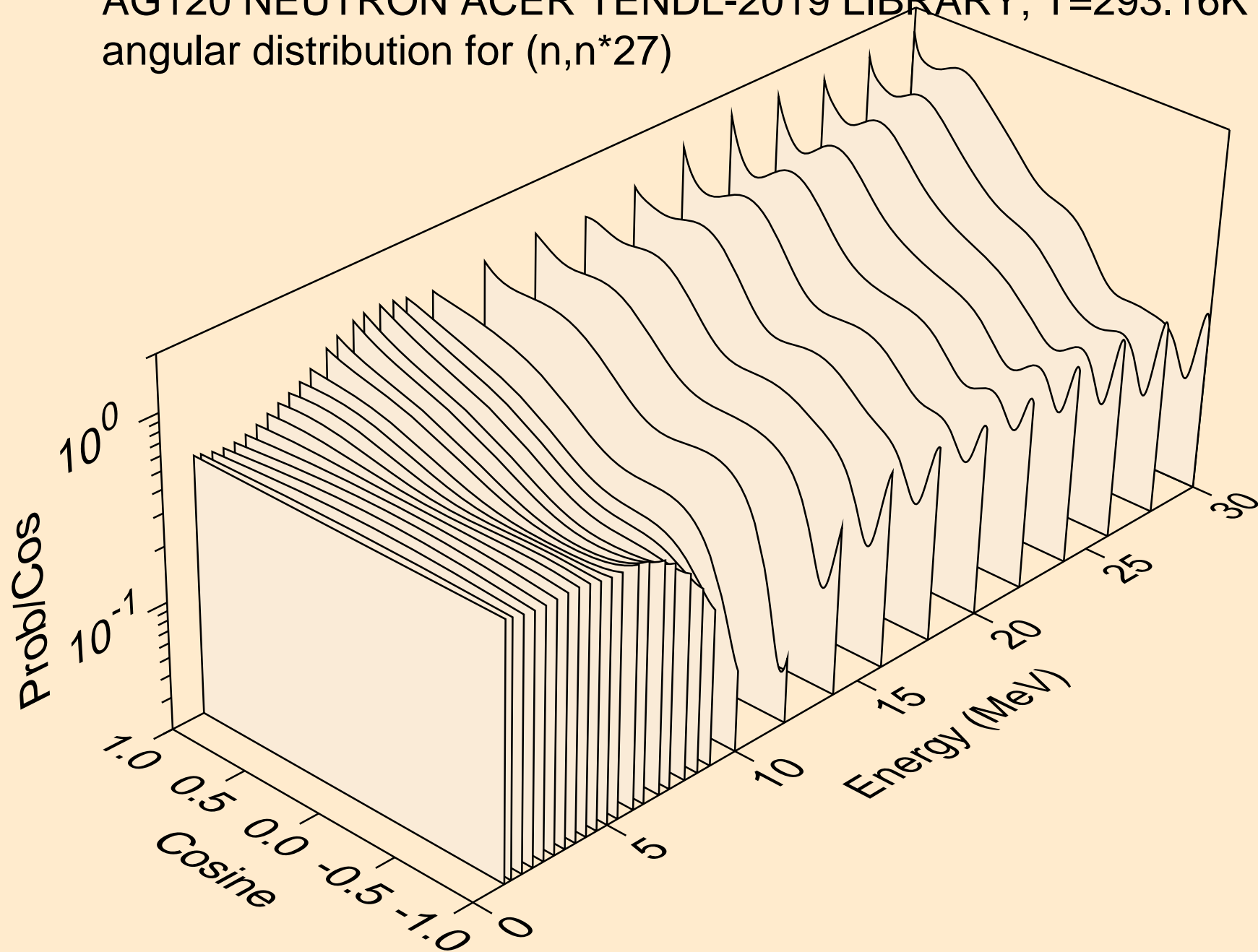

AG120 NEUTRON ACER TENDL-2019 LIBRARY; T=293.16K
angular distribution for (n,n*28)

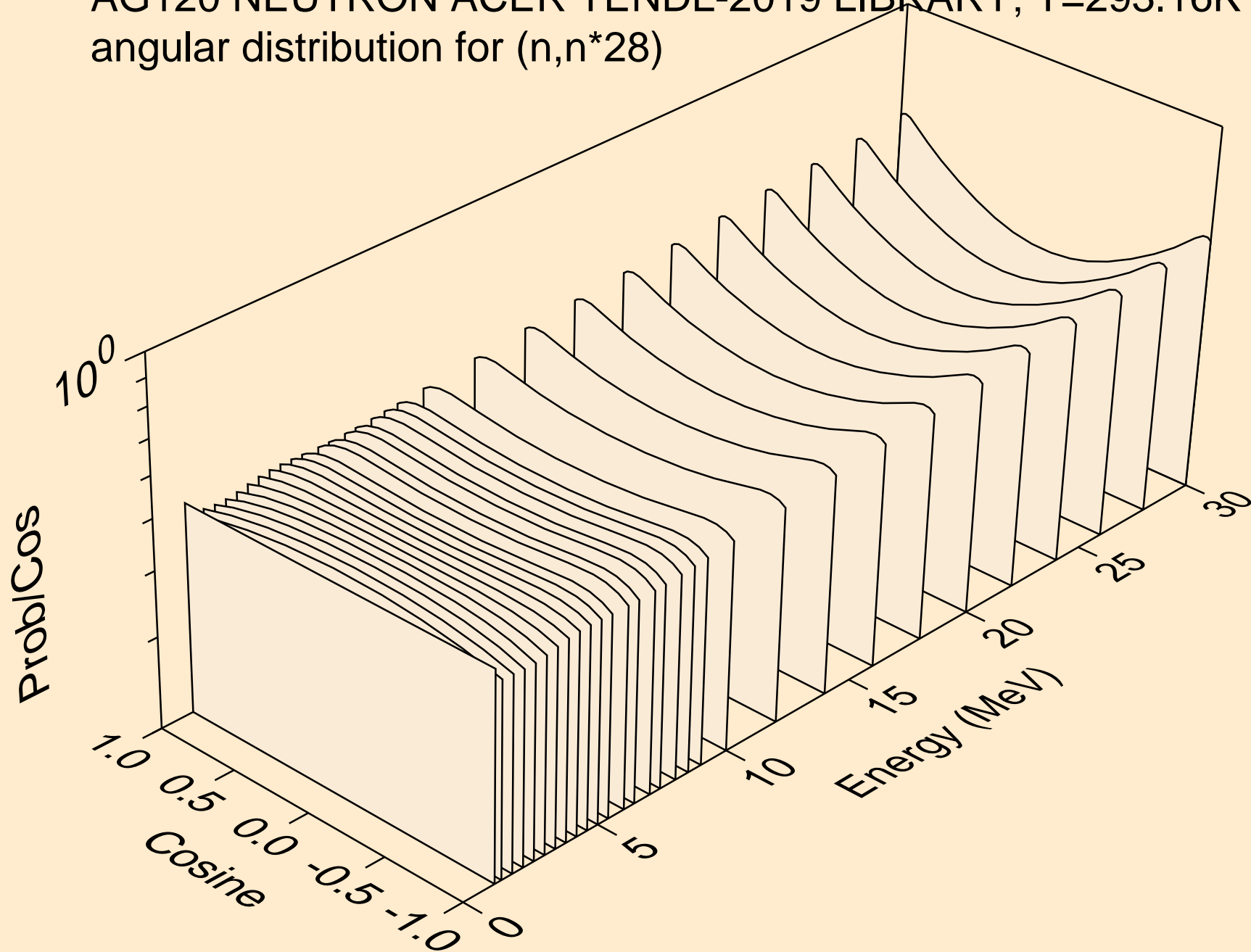

AG120 NEUTRON ACER TENDL-2019 LIBRARY; T=293.16K
angular distribution for (n,n*29)

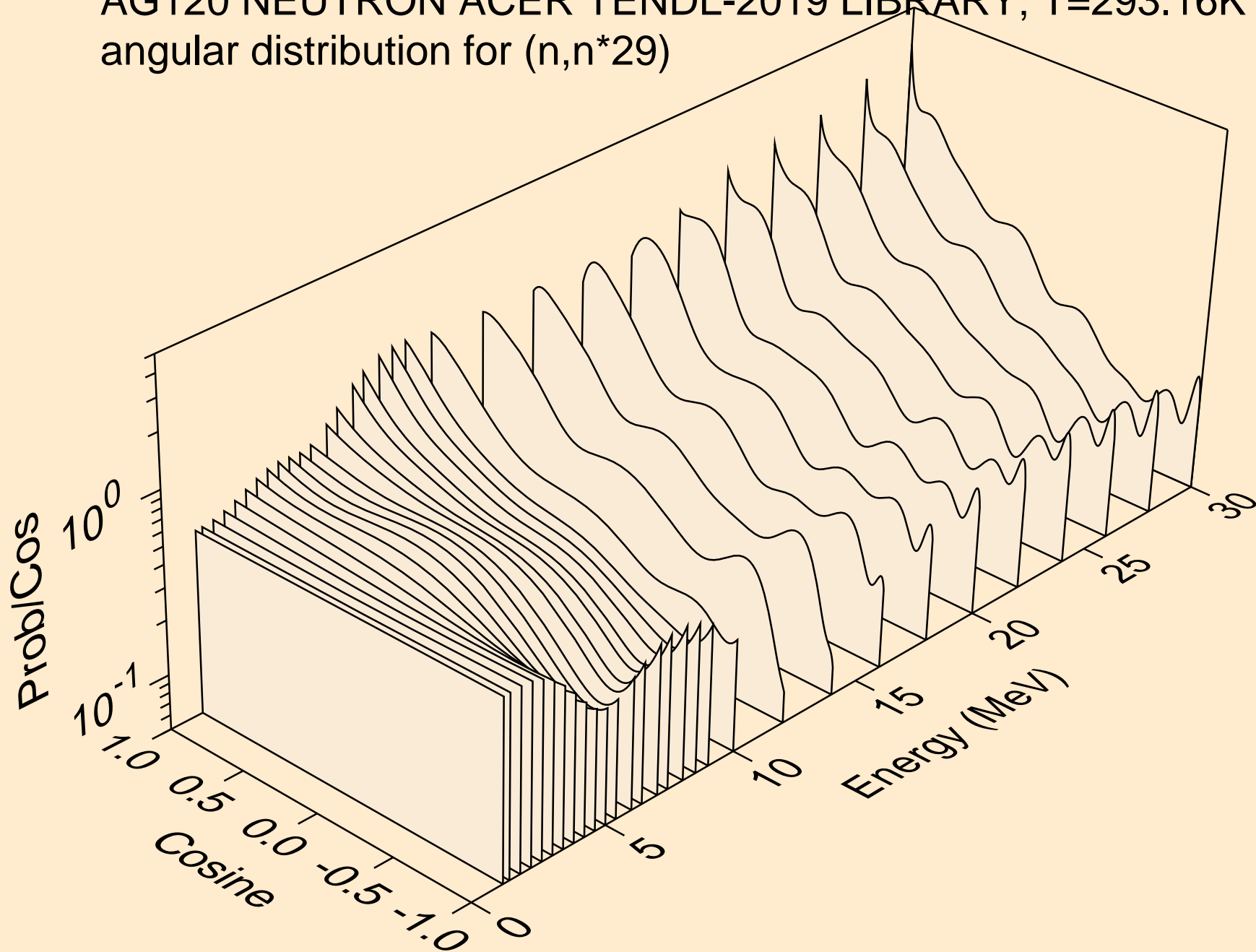

AG120 NEUTRON ACER TENDL-2019 LIBRARY; T=293.16K
Neutron emission for (n,x)

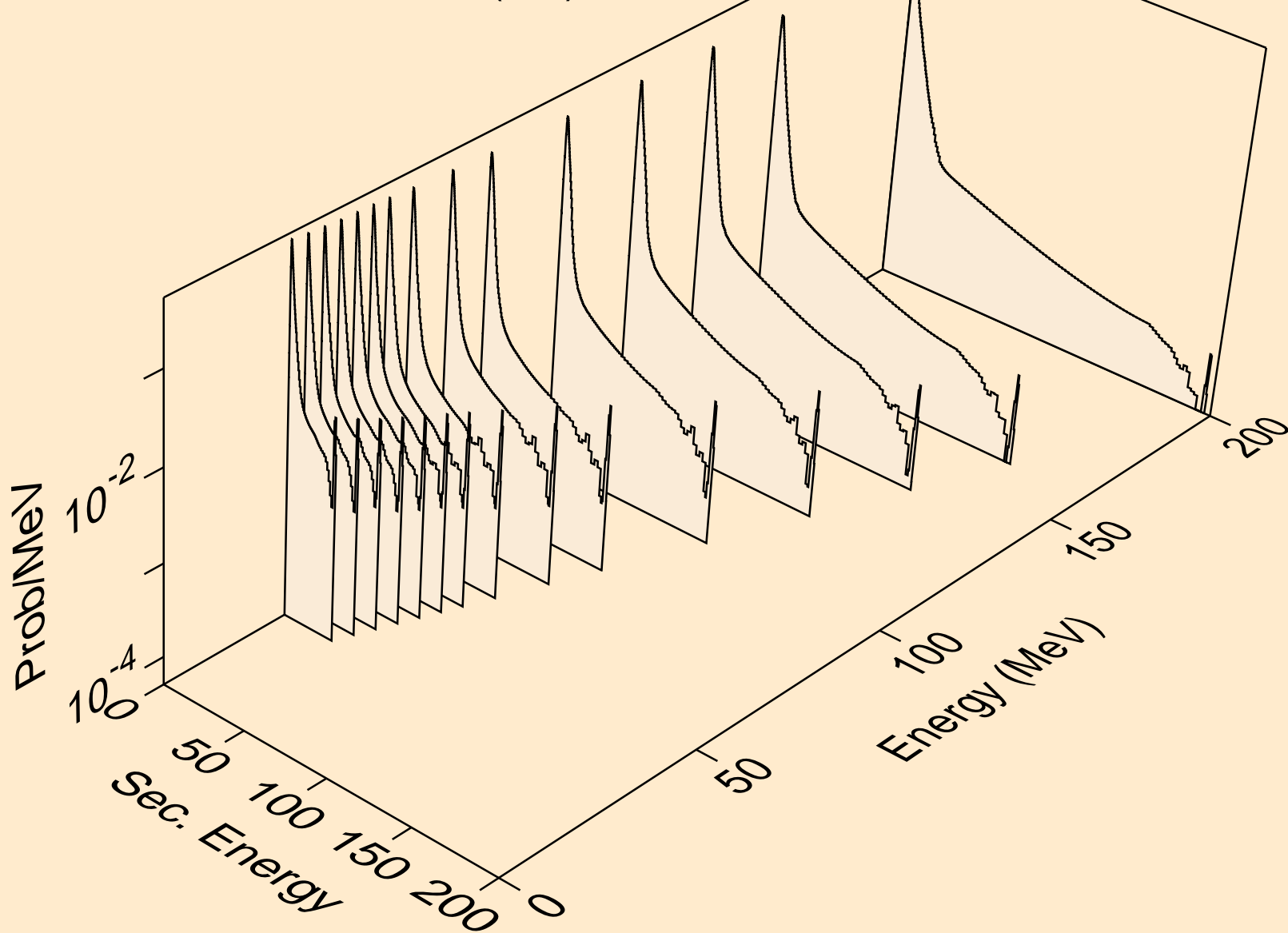

AG120 NEUTRON ACER TENDL-2019 LIBRARY; T=293.16K
Neutron emission for (n,2nd)

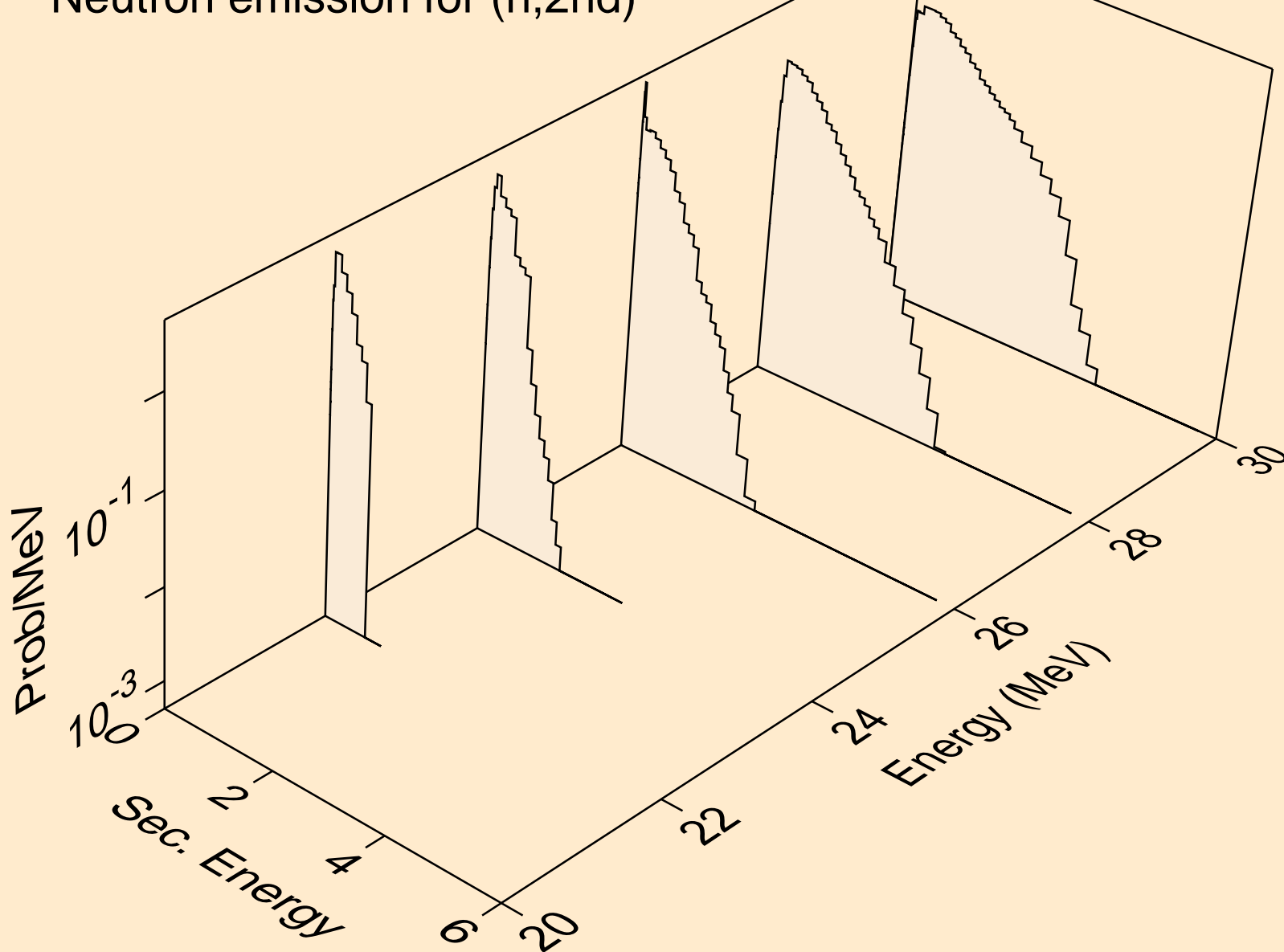

AG120 NEUTRON ACER TENDL-2019 LIBRARY; T=293.16K
Neutron emission for (n,2n)

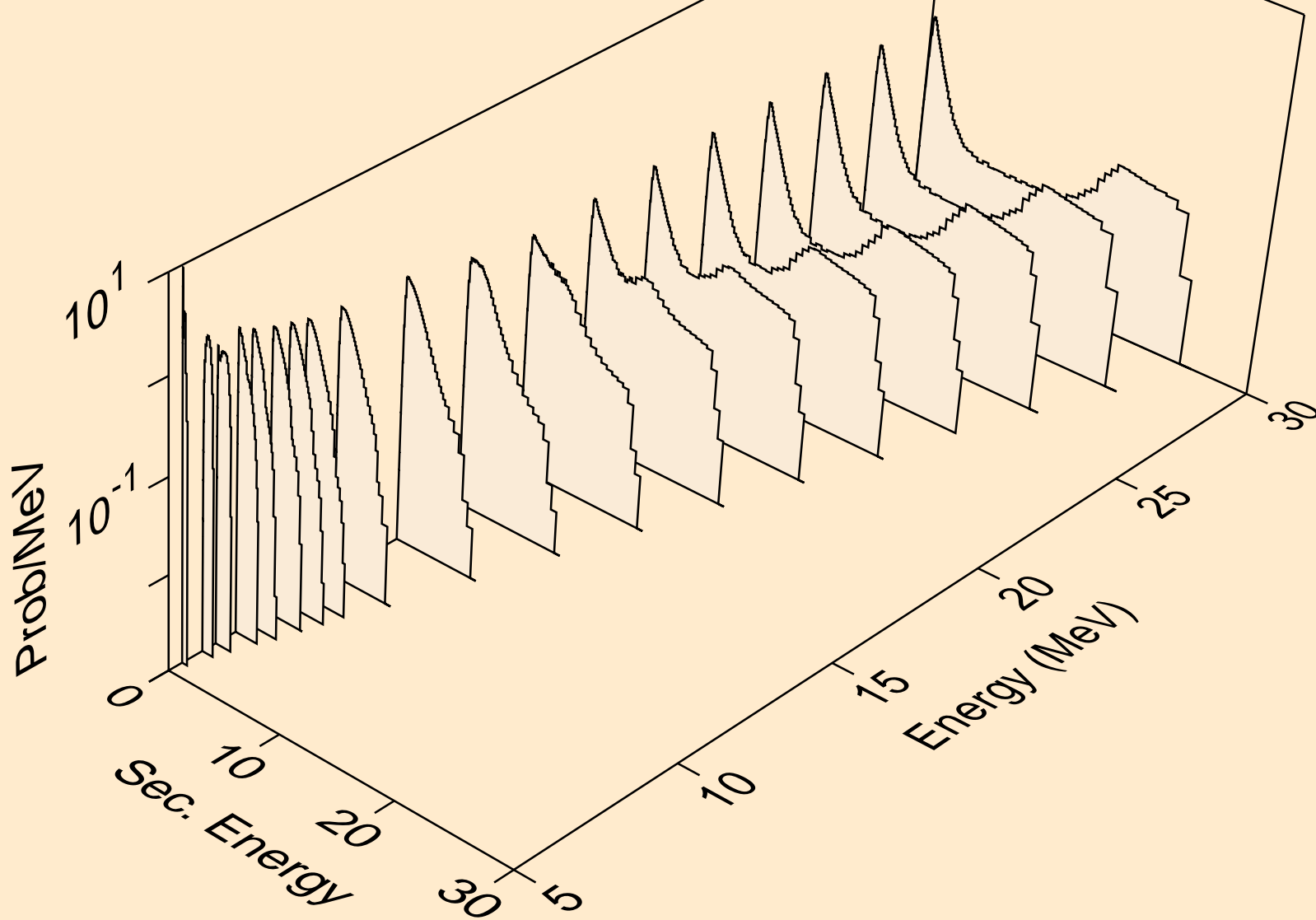

AG120 NEUTRON ACER TENDL-2019 LIBRARY; T=293.16K
Neutron emission for (n,3n)

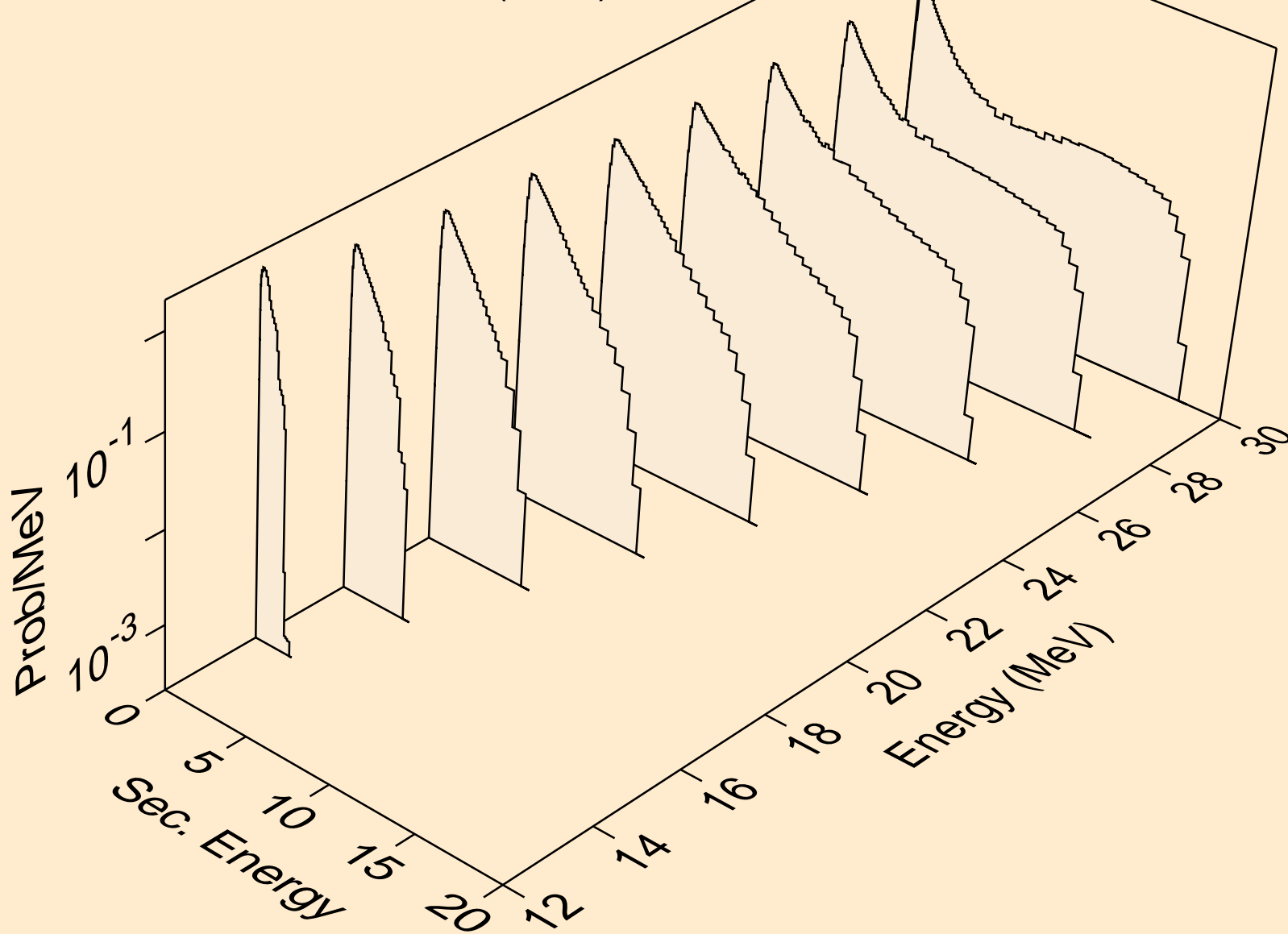

AG120 NEUTRON ACER TENDL-2019 LIBRARY; T=293.16K
Neutron emission for (n,n*)a

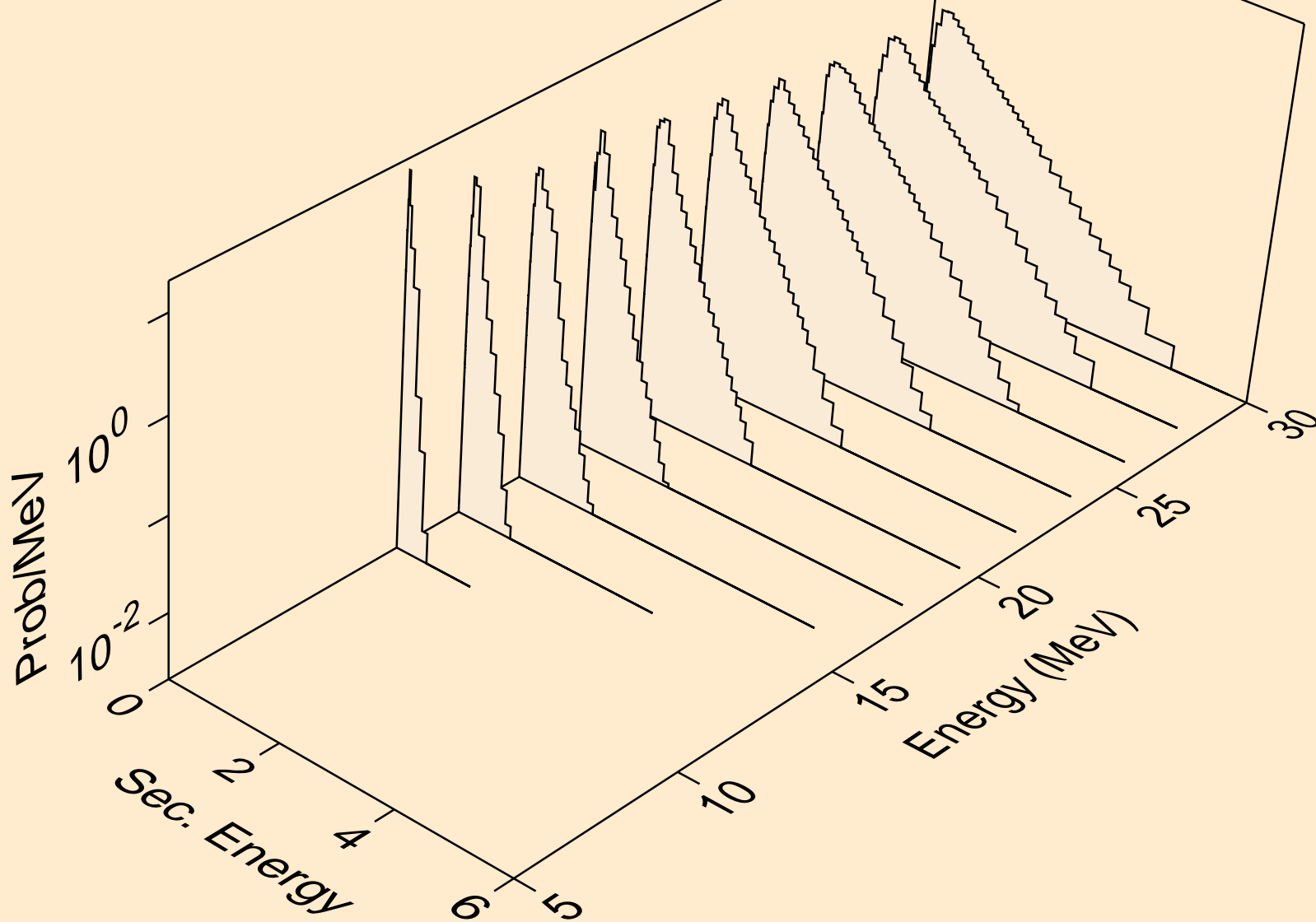

AG120 NEUTRON ACER TENDL-2019 LIBRARY; T=293.16K
Neutron emission for (n,2n)a

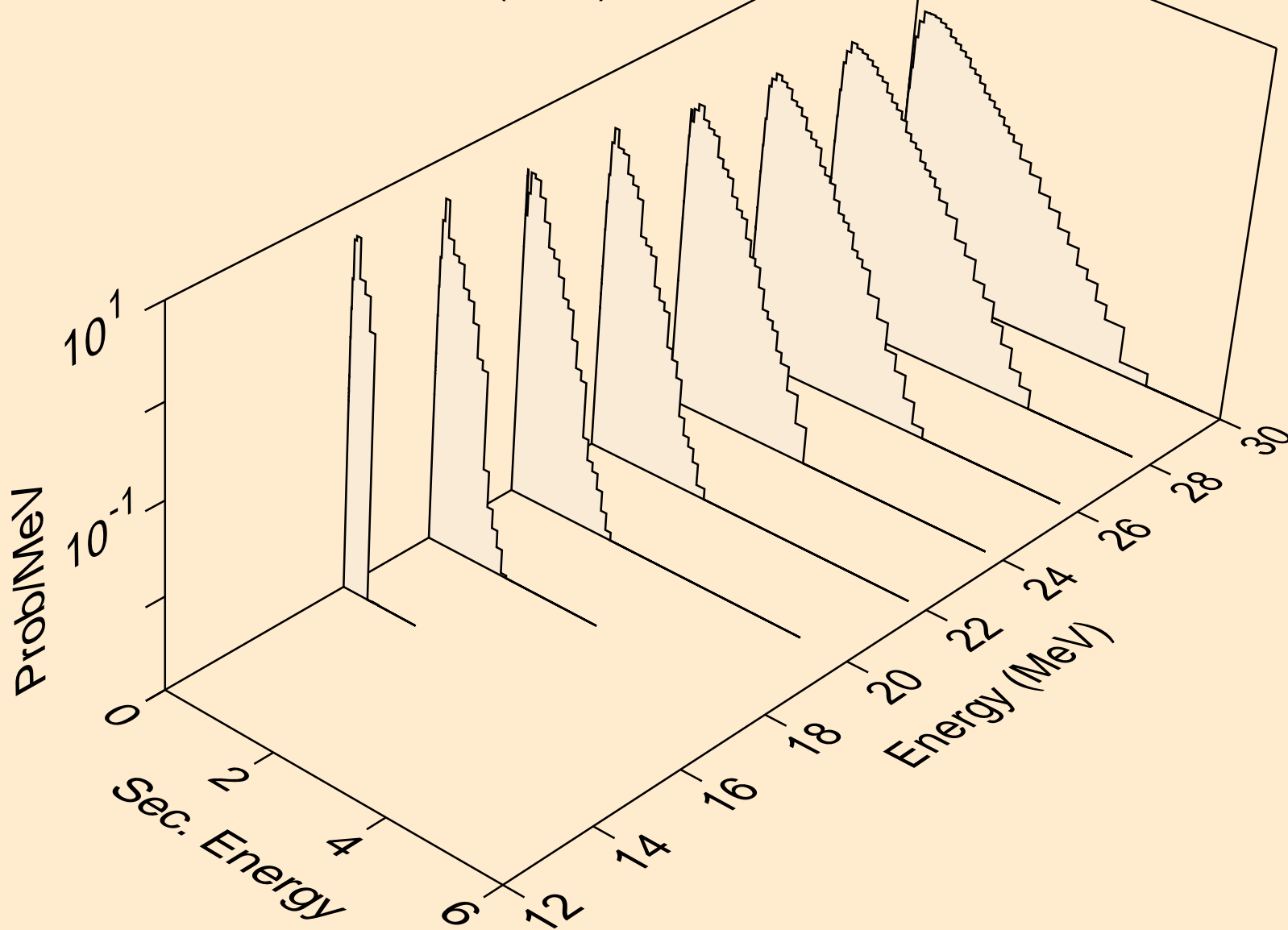

AG120 NEUTRON ACER TENDL-2019 LIBRARY; T=293.16K
Neutron emission for (n,3n)a

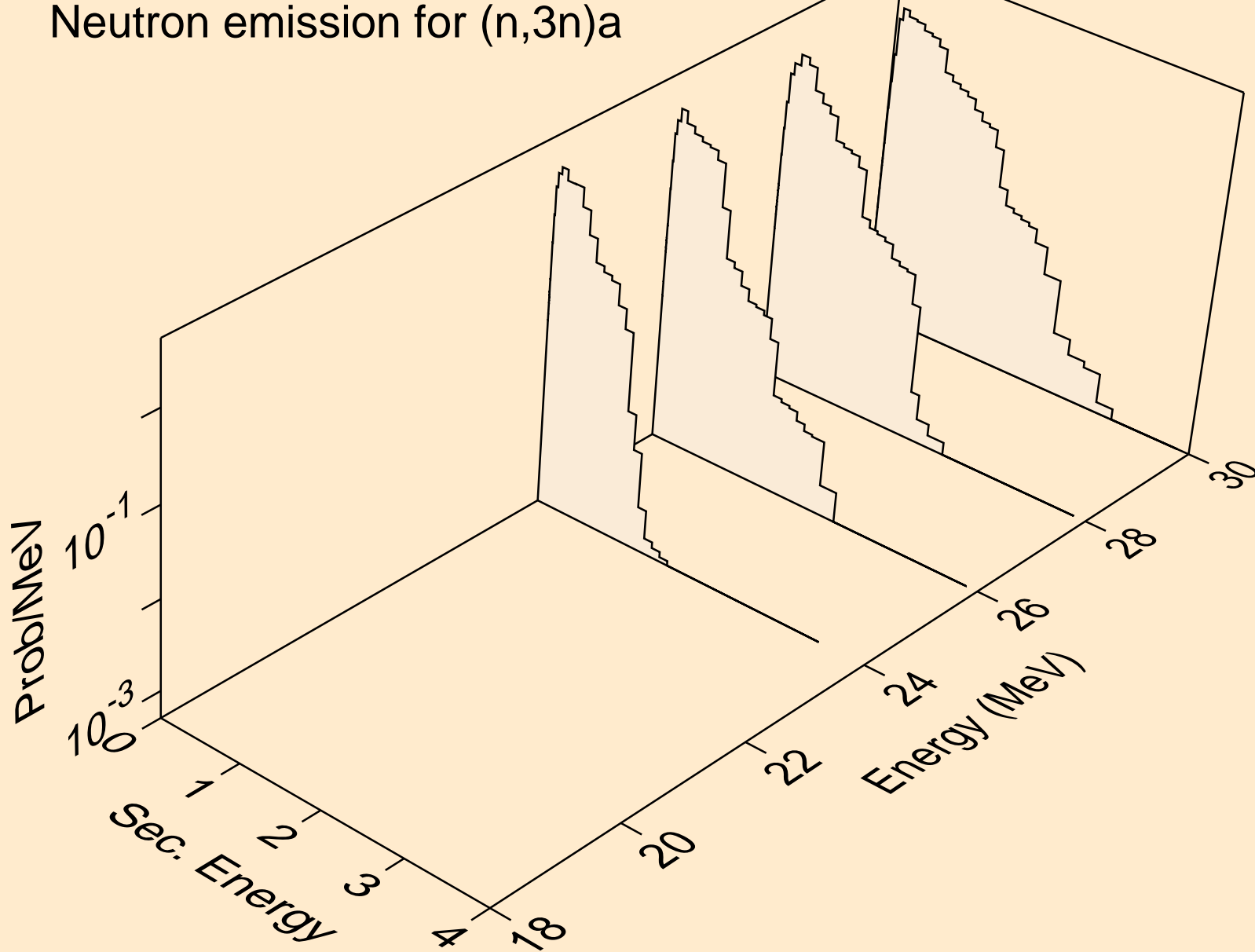

AG120 NEUTRON ACER TENDL-2019 LIBRARY; T=293.16K
Neutron emission for (n,n*)p

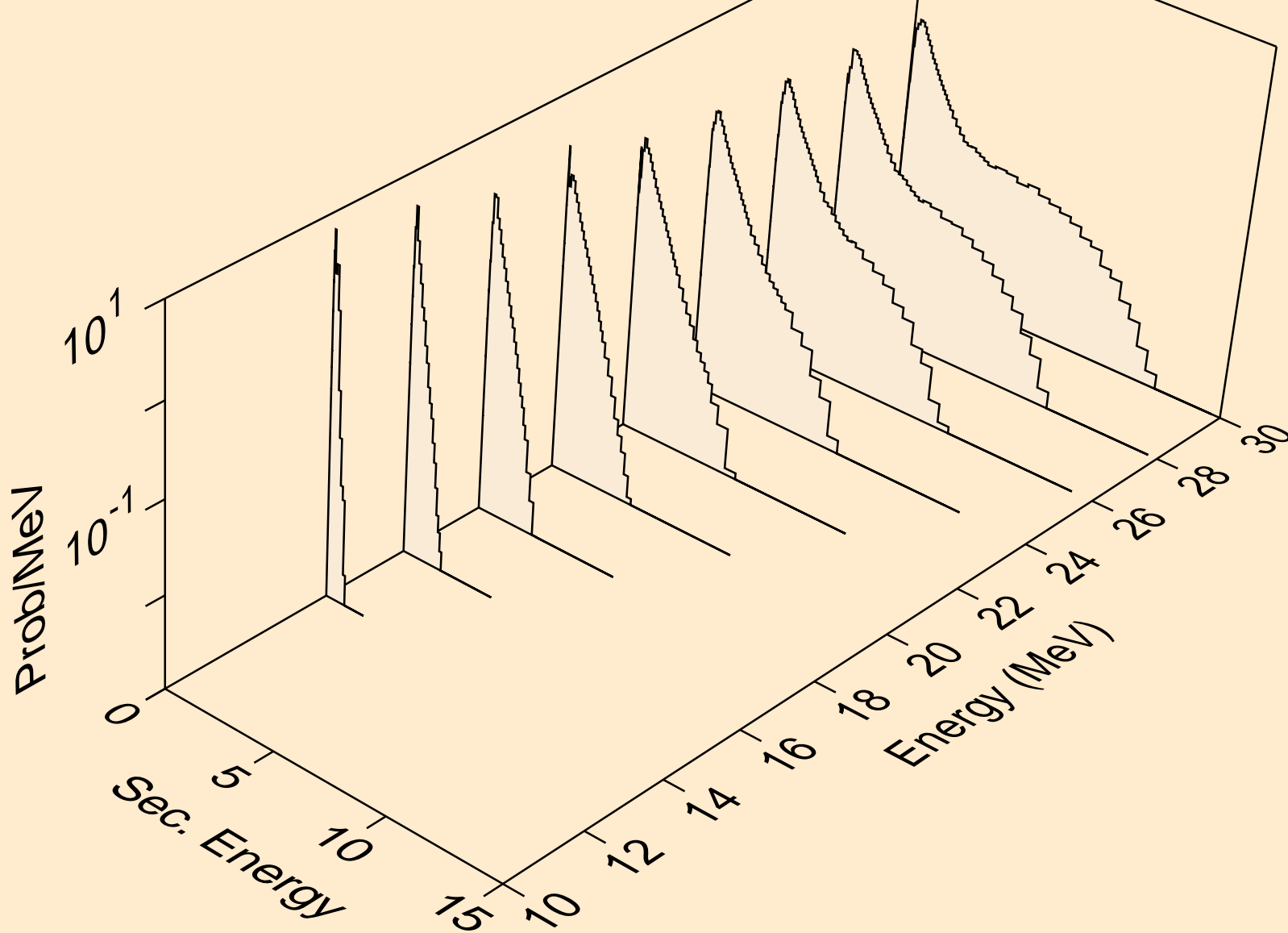

AG120 NEUTRON ACER TENDL-2019 LIBRARY; T=293.16K
Neutron emission for (n,n*)d

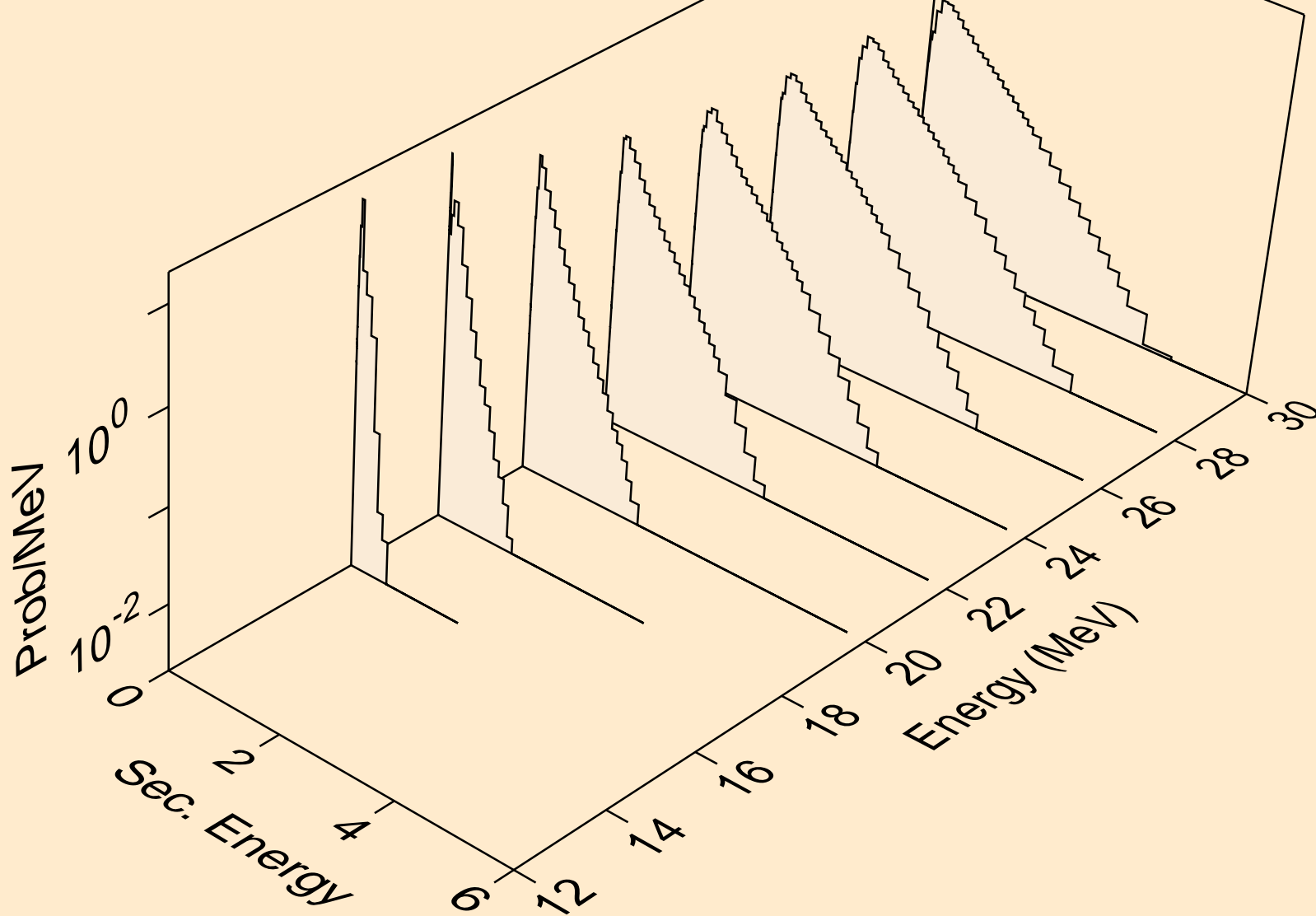

AG120 NEUTRON ACER TENDL-2019 LIBRARY; T=293.16K
Neutron emission for (n,n*)t

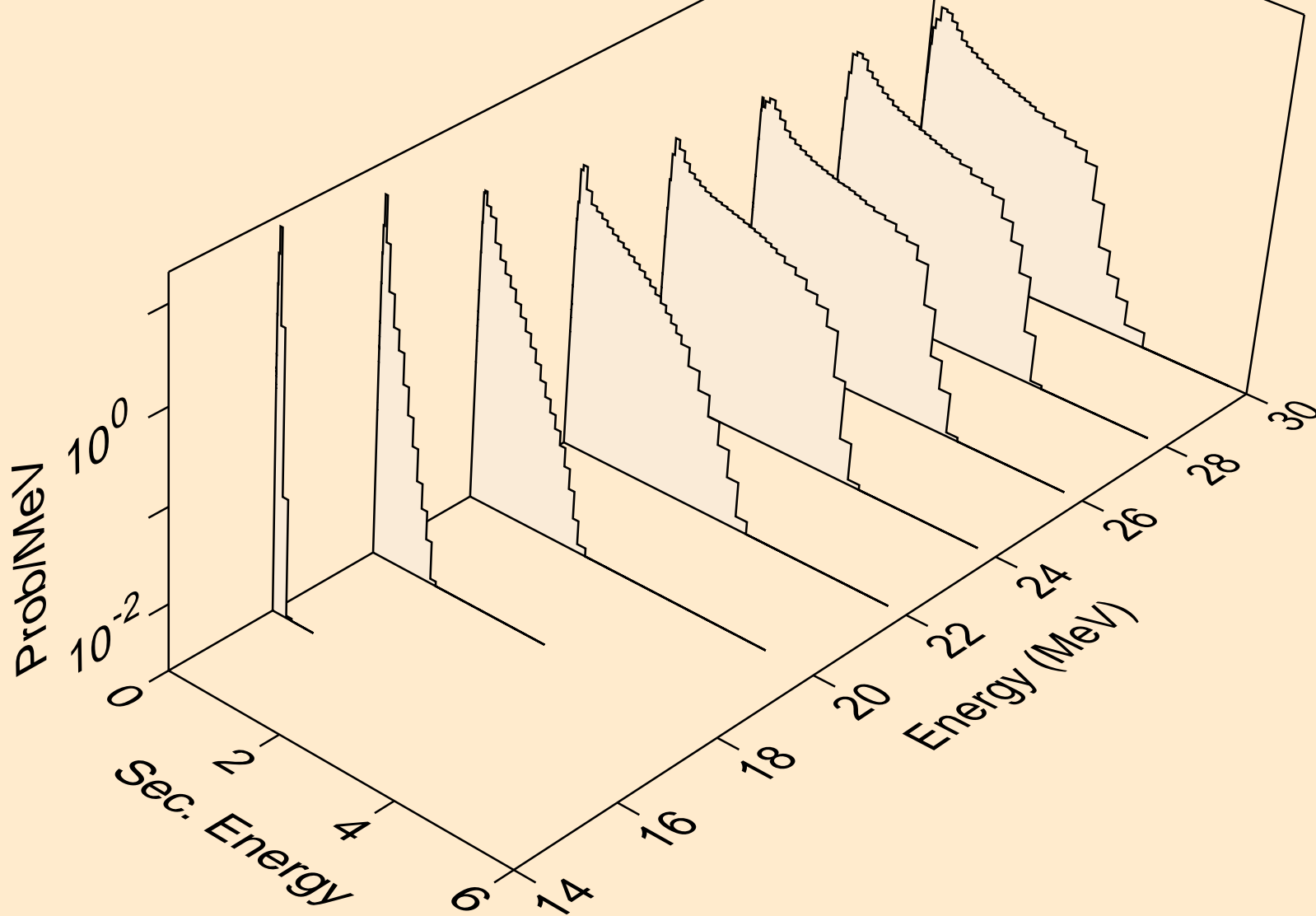

AG120 NEUTRON ACER TENDL-2019 LIBRARY; T=293.16K
Neutron emission for (n,n*)he3

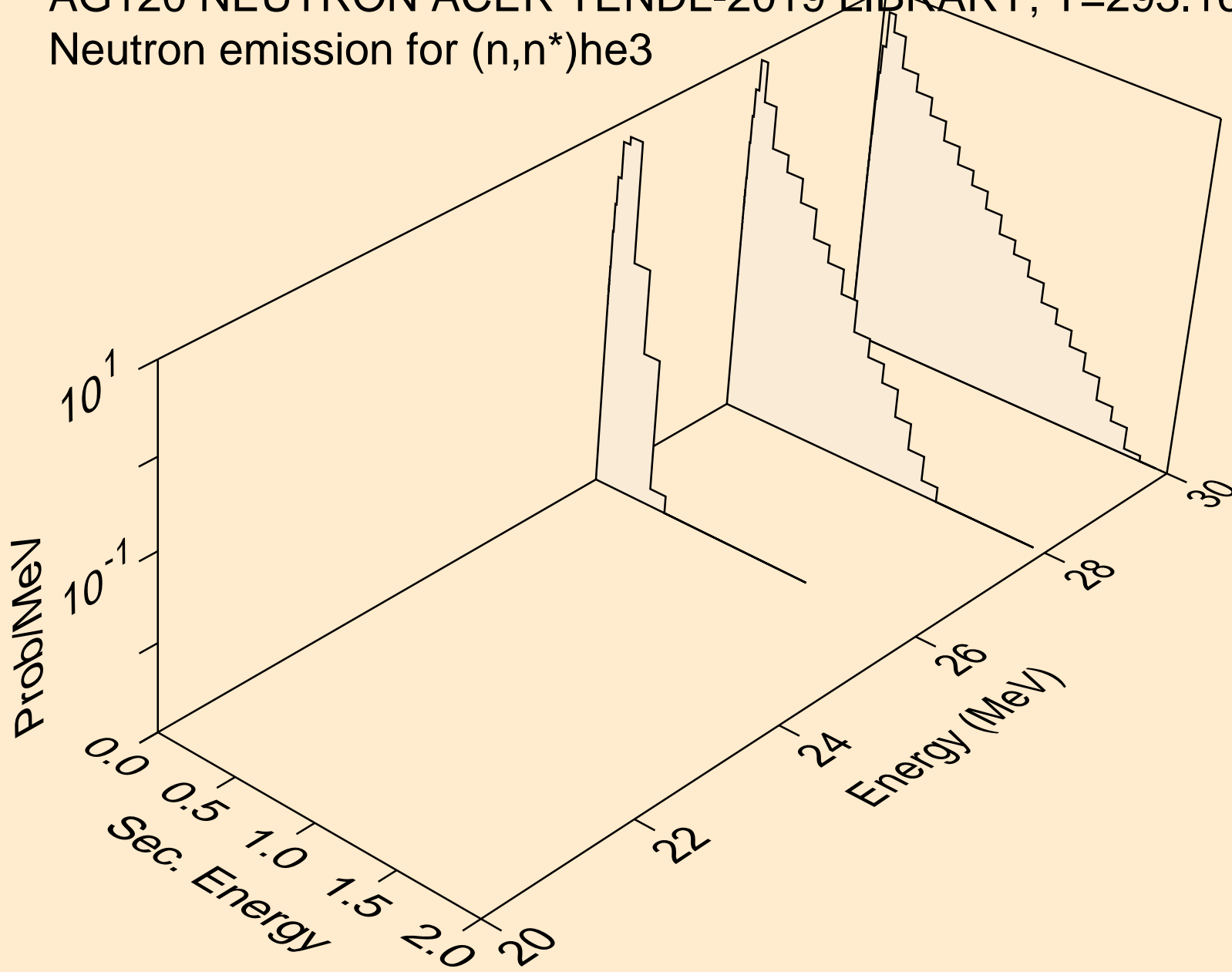

AG120 NEUTRON ACER TENDL-2019 LIBRARY; T=293.16K
Neutron emission for (n,4n)

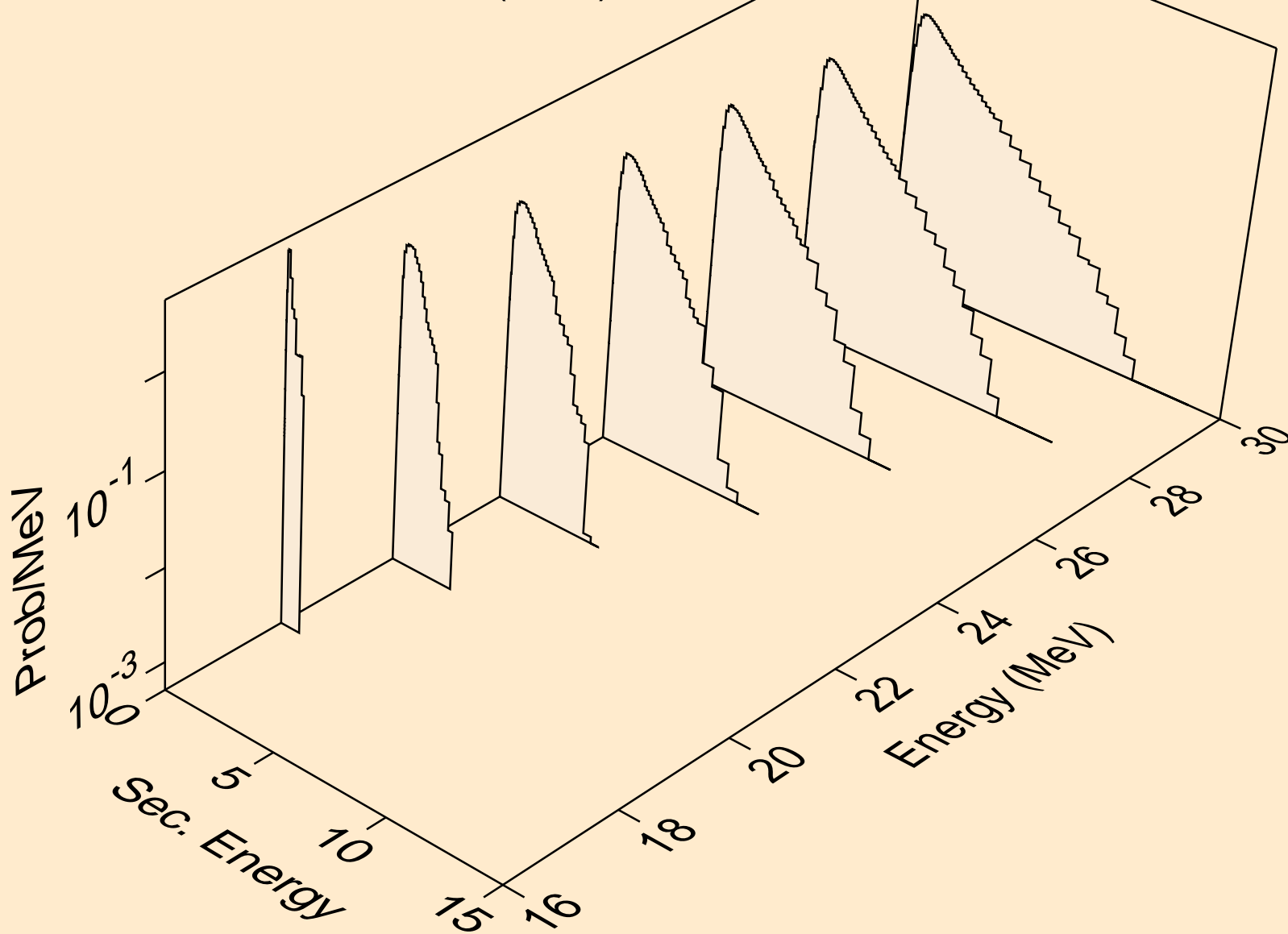

AG120 NEUTRON ACER TENDL-2019 LIBRARY; T=293.16K
Neutron emission for (n,2np)

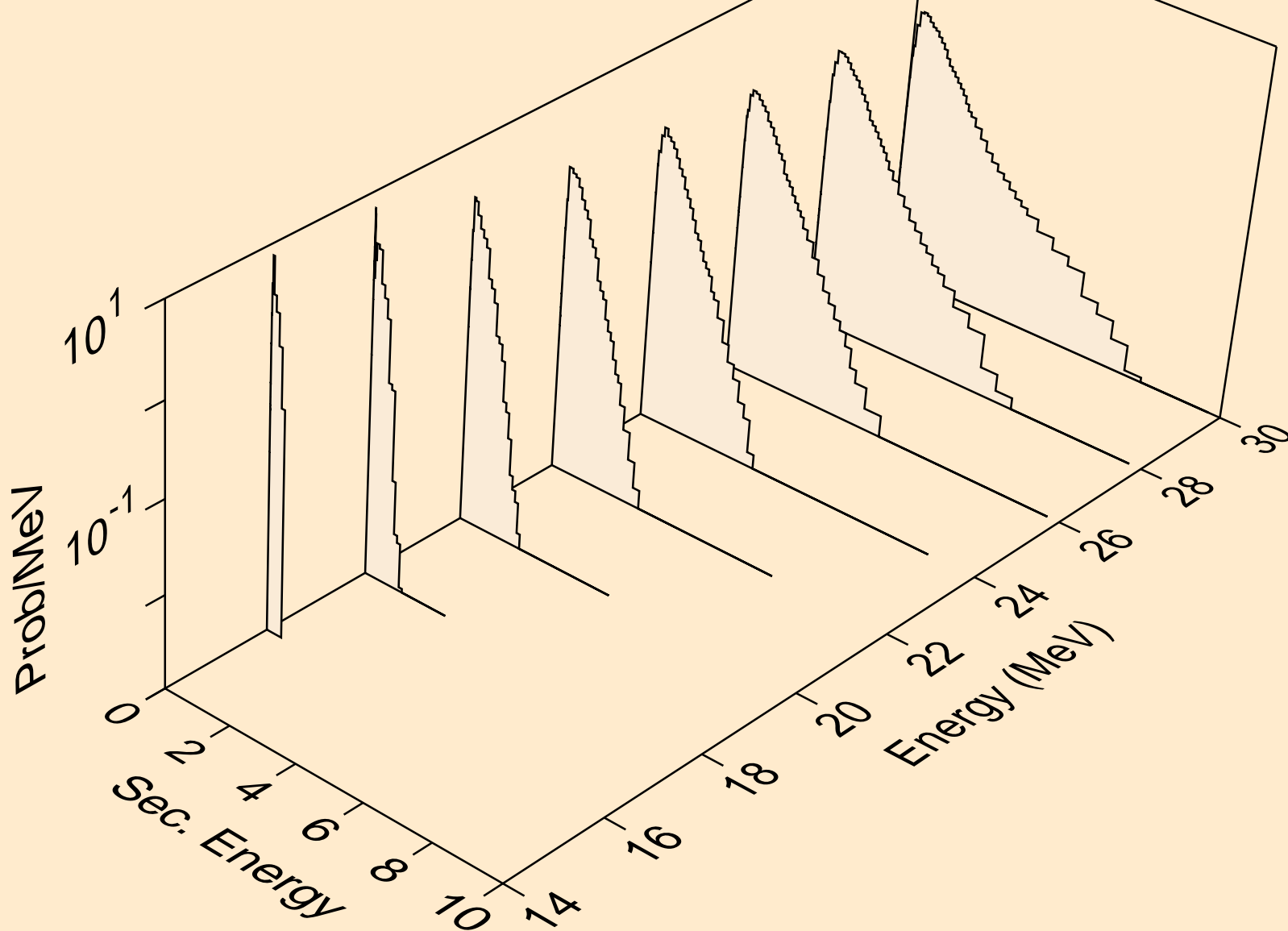

AG120 NEUTRON ACER TENDL-2019 LIBRARY; T=293.16K
Neutron emission for (n,3np)

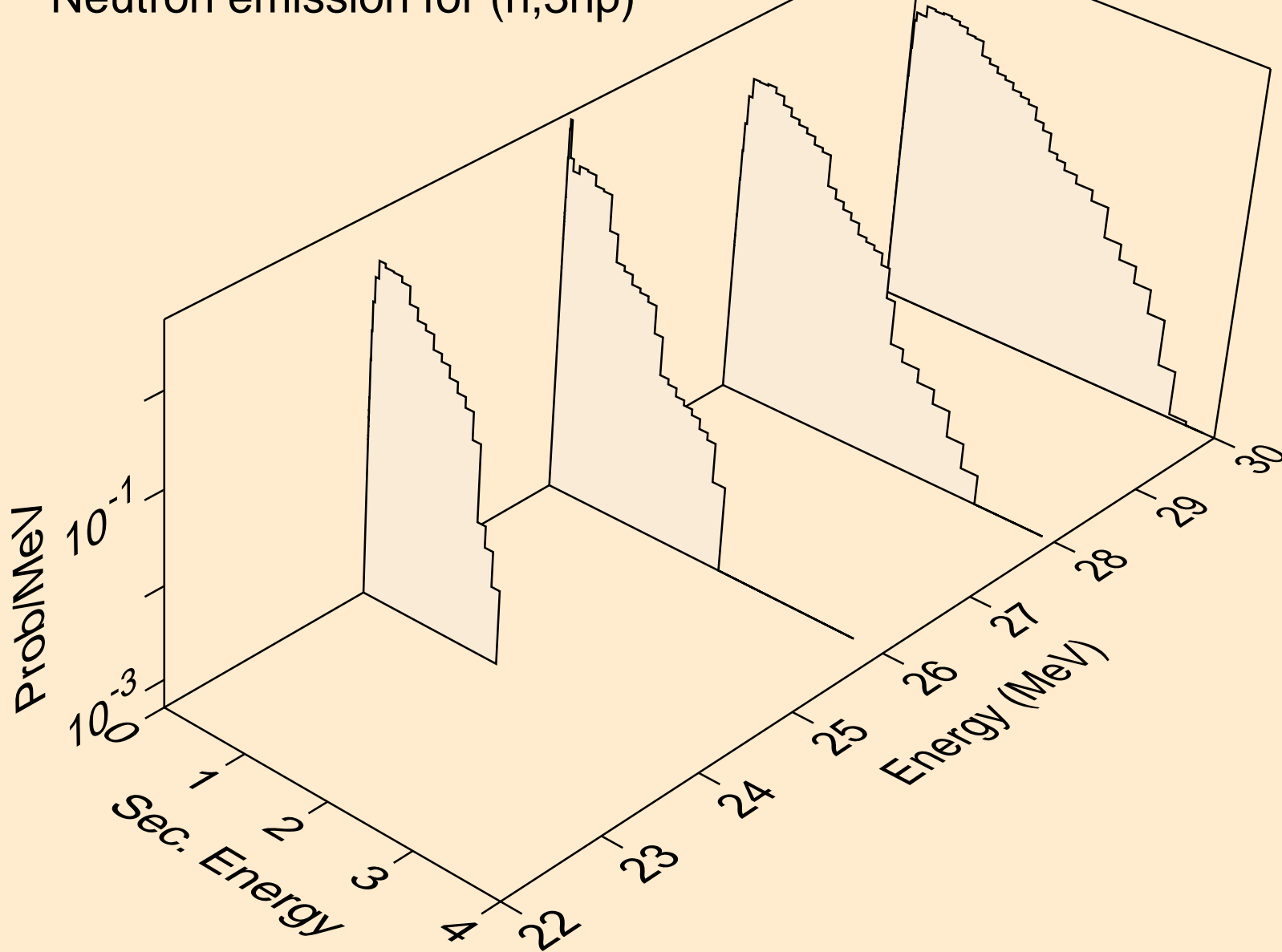

AG120 NEUTRON ACER TENDL-2019 LIBRARY; T=293.16K
Neutron emission for (n,n*c)

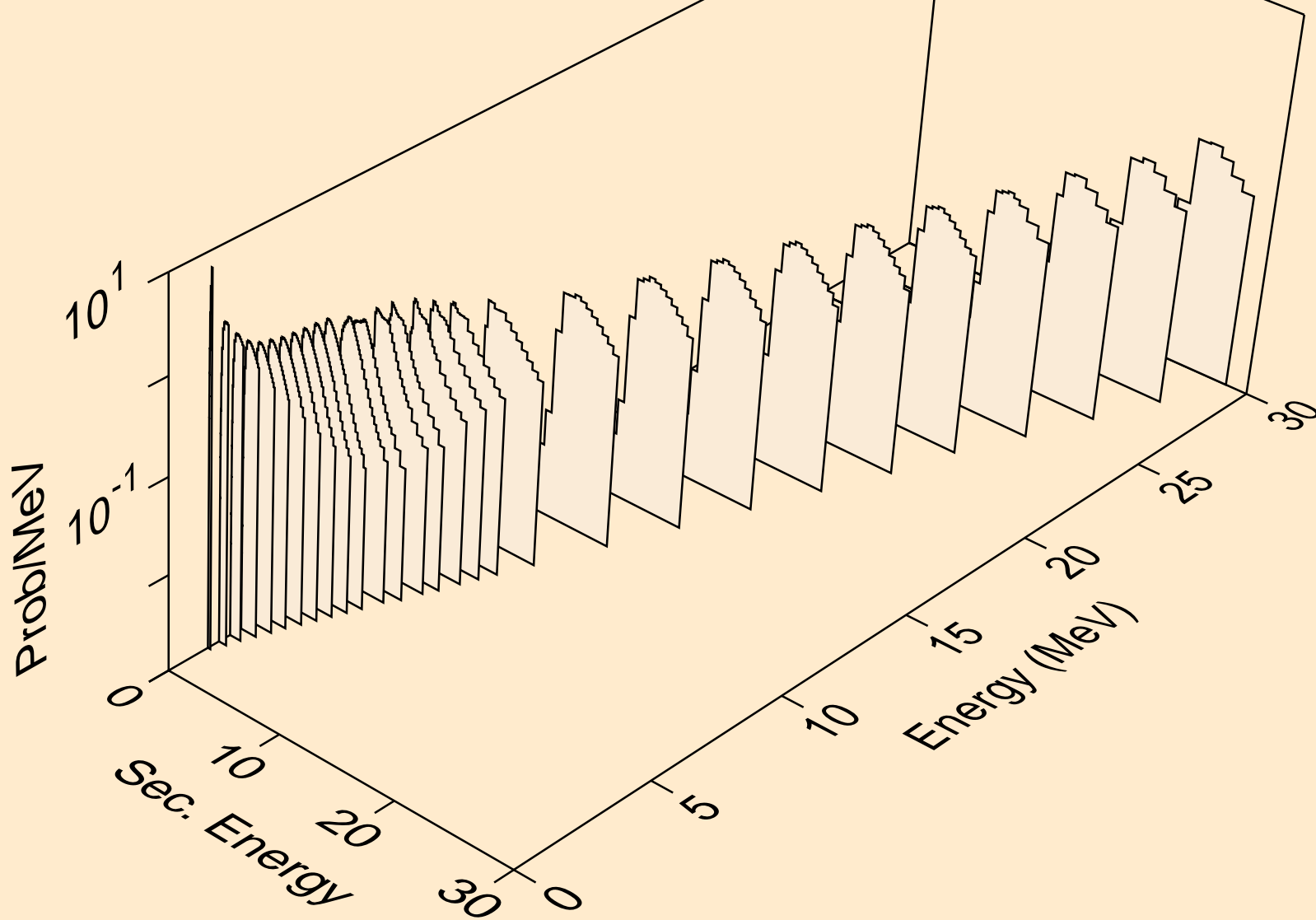

AG120 NEUTRON ACER TENDL-2019 LIBRARY; T=293.16K
Photon emission for (n,x)

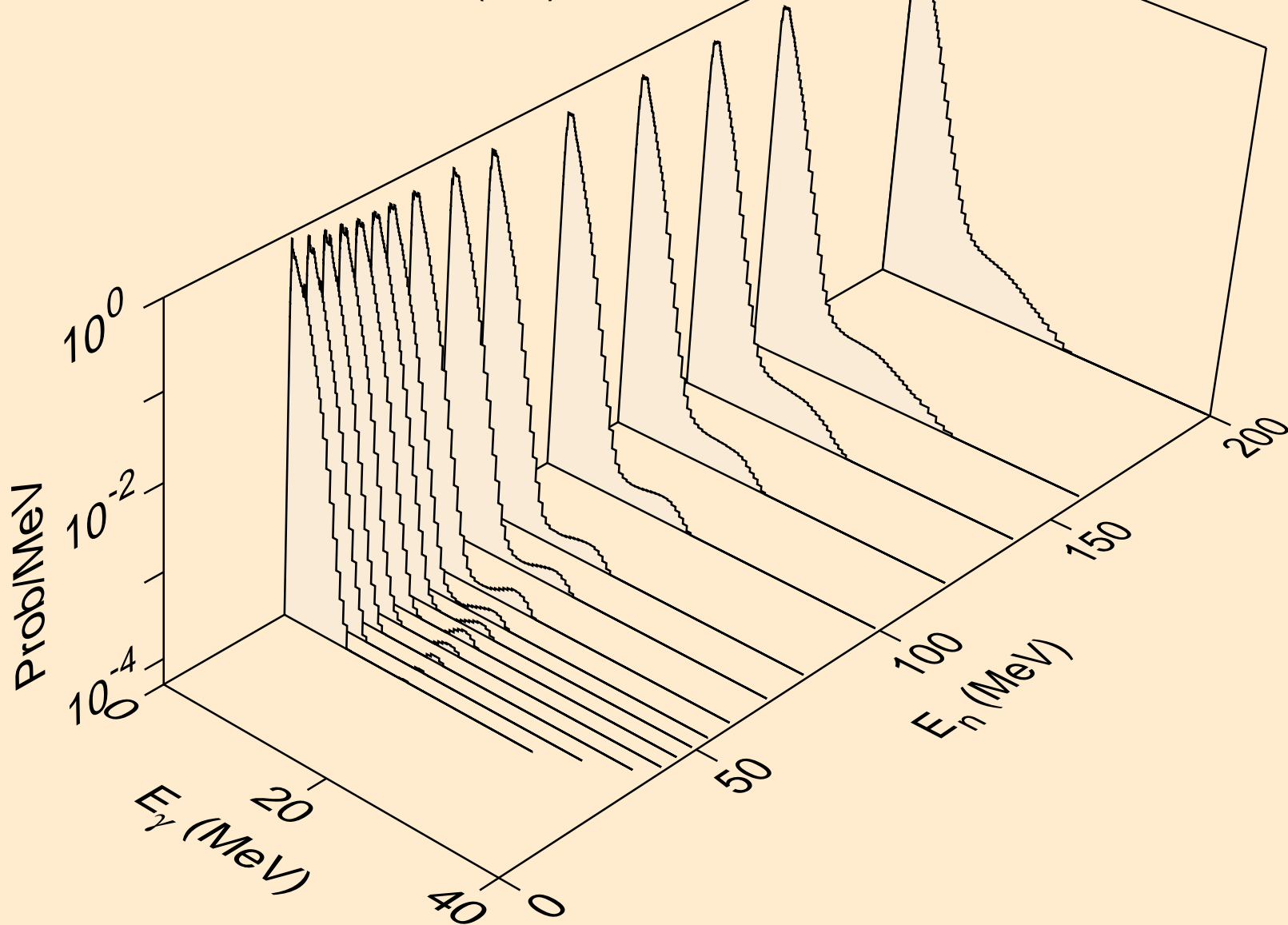

AG120 NEUTRON ACER TENDL-2019 LIBRARY; T=293.16K
Photon emission for (n,2nd)

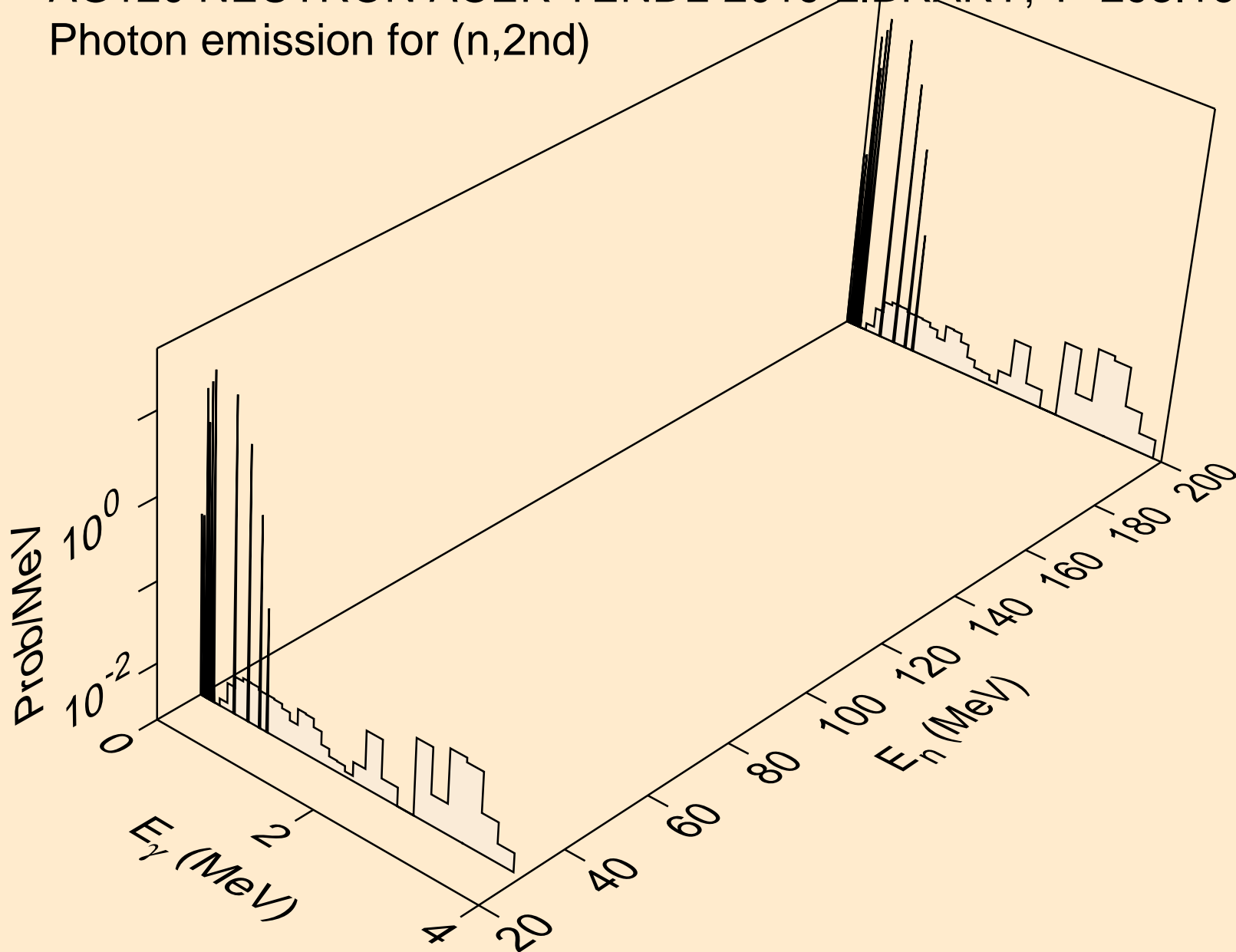

AG120 NEUTRON ACER TENDL-2019 LIBRARY; T=293.16K
Photon emission for (n,2n)

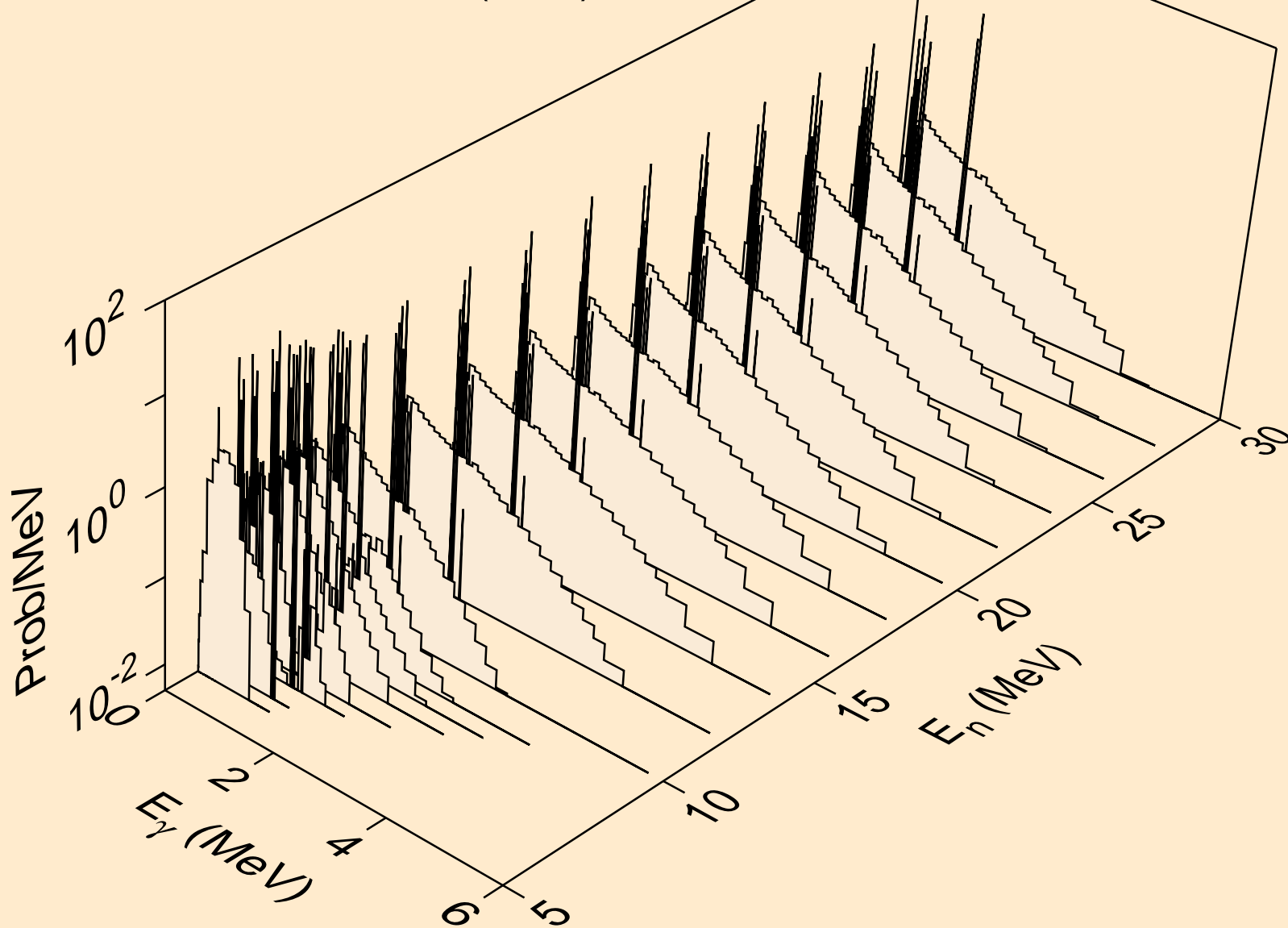

AG120 NEUTRON ACER TENDL-2019 LIBRARY; T=293.16K
Photon emission for (n,3n)

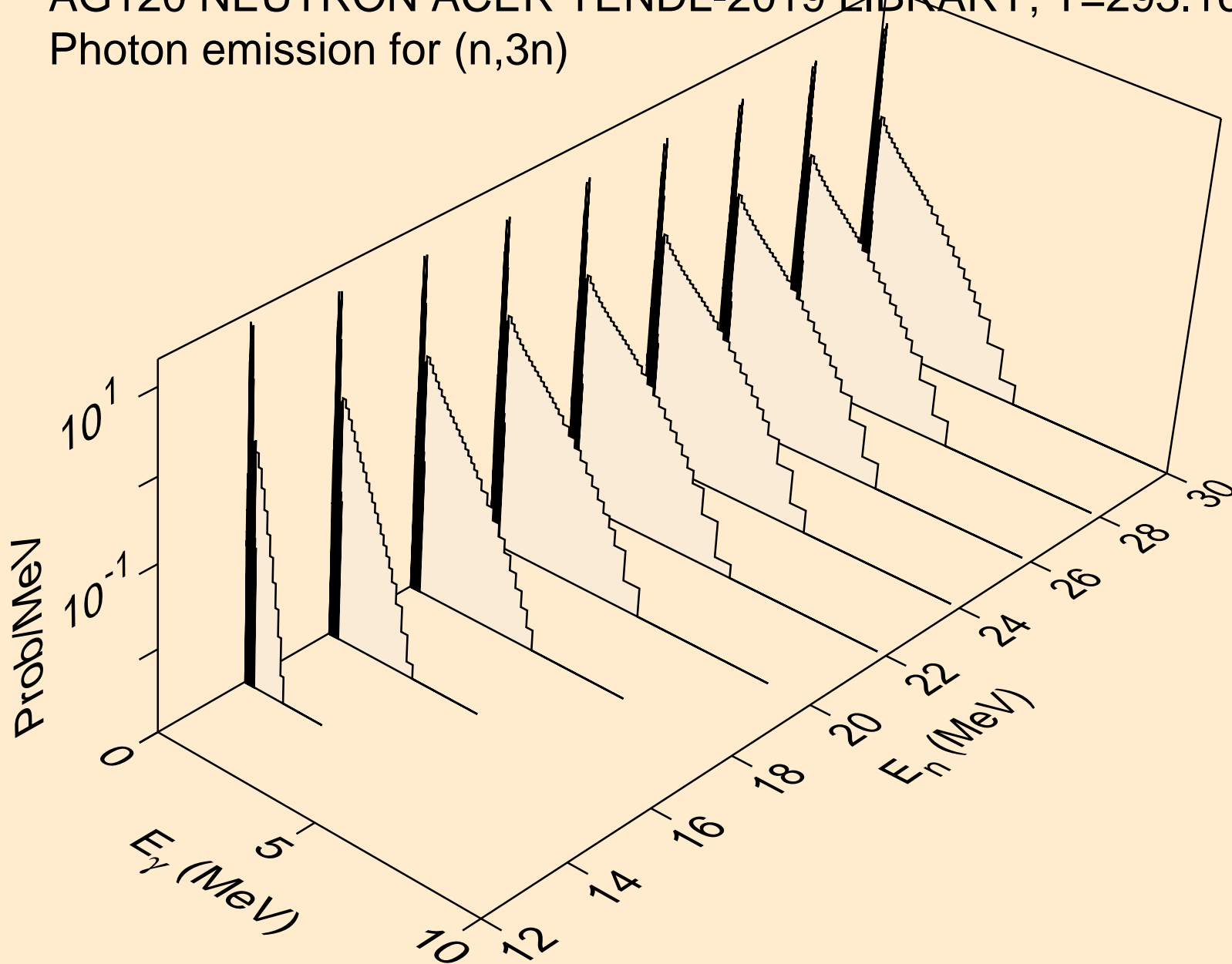

AG120 NEUTRON ACER TENDL-2019 LIBRARY; T=293.16K
Photon emission for (n,n*)a

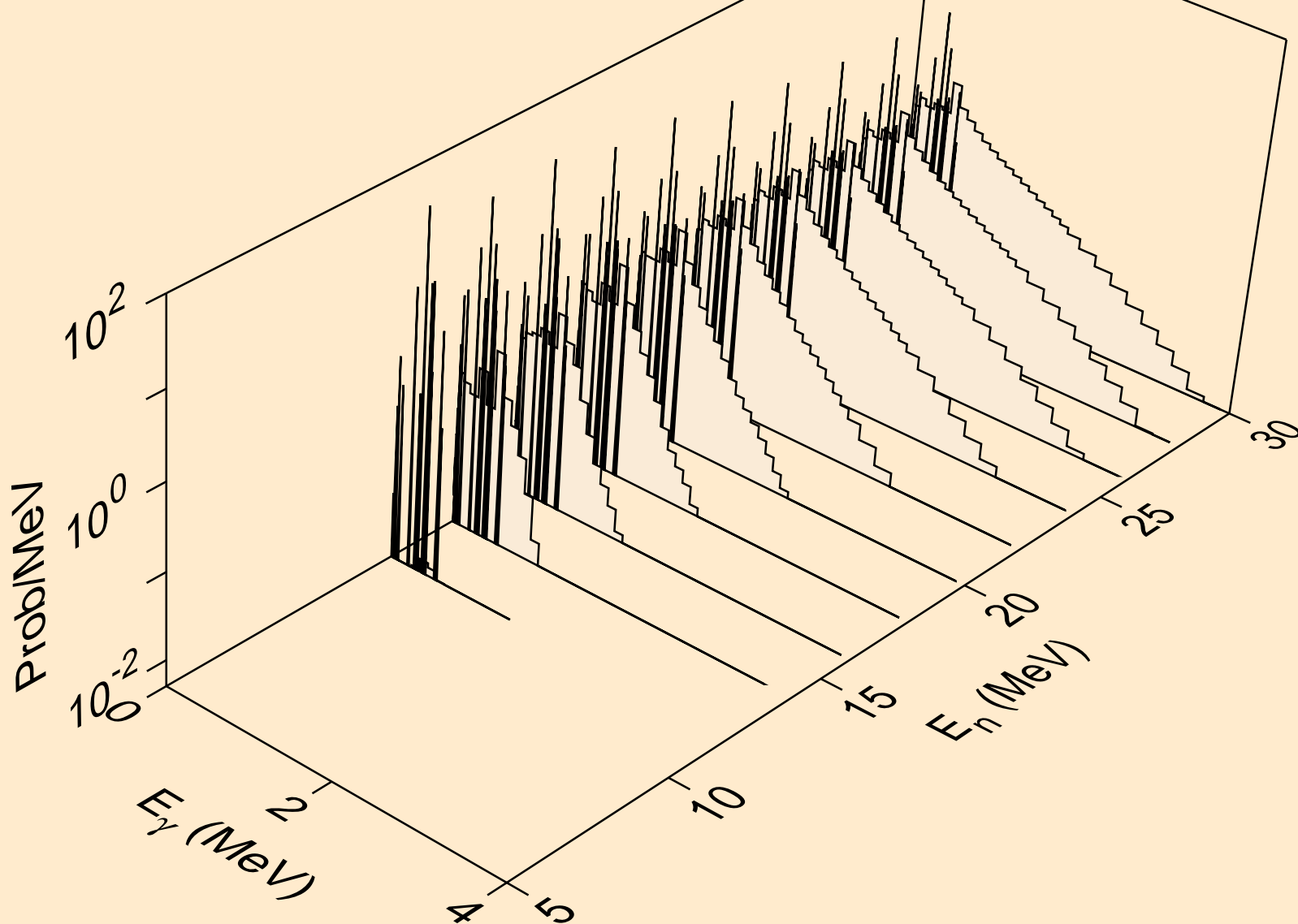

AG120 NEUTRON ACER TENDL-2019 LIBRARY; T=293.16K
Photon emission for (n,2n)a

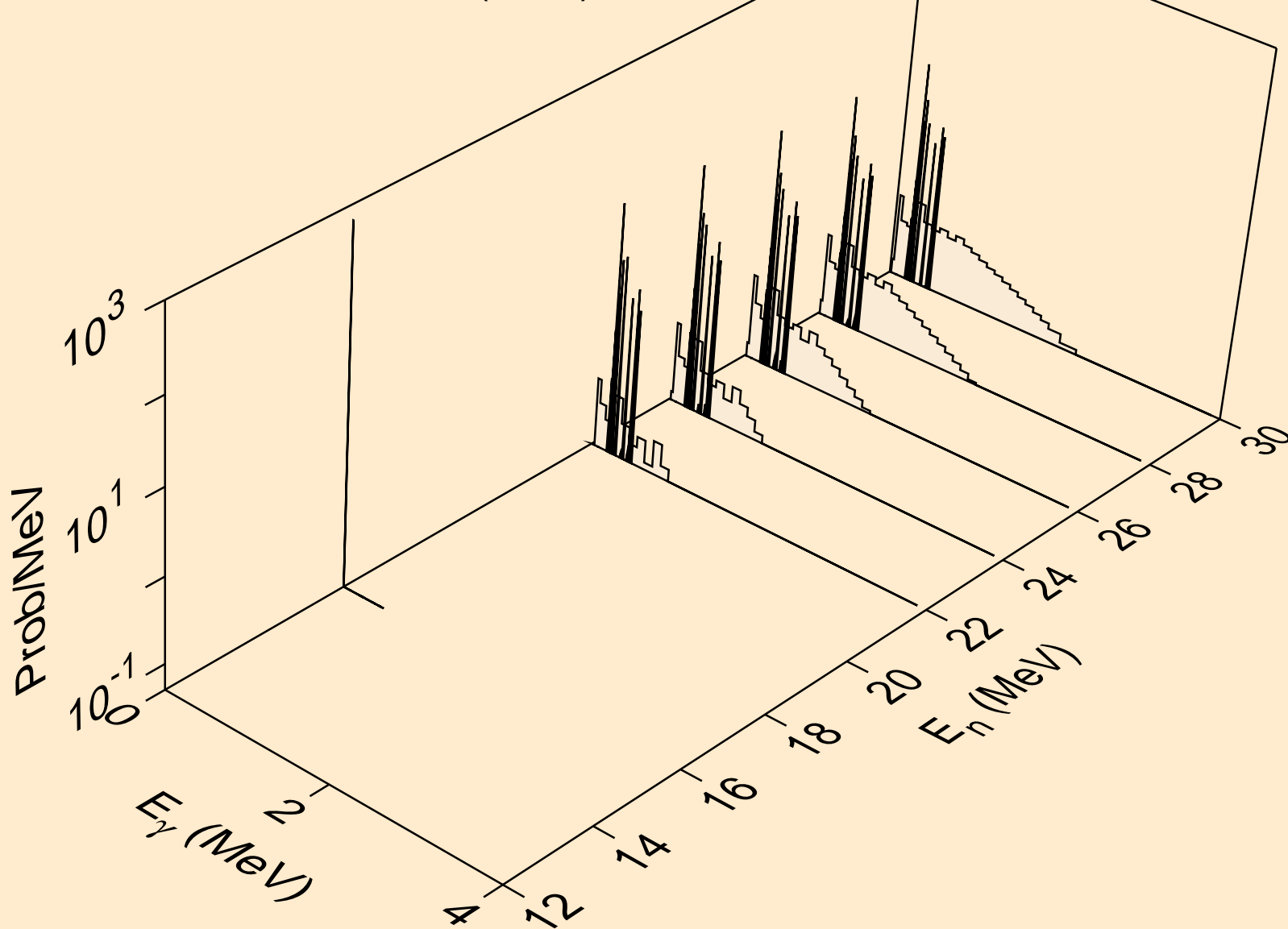

AG120 NEUTRON ACER TENDL-2019 LIBRARY; T=293.16K
Photon emission for (n,3n)a

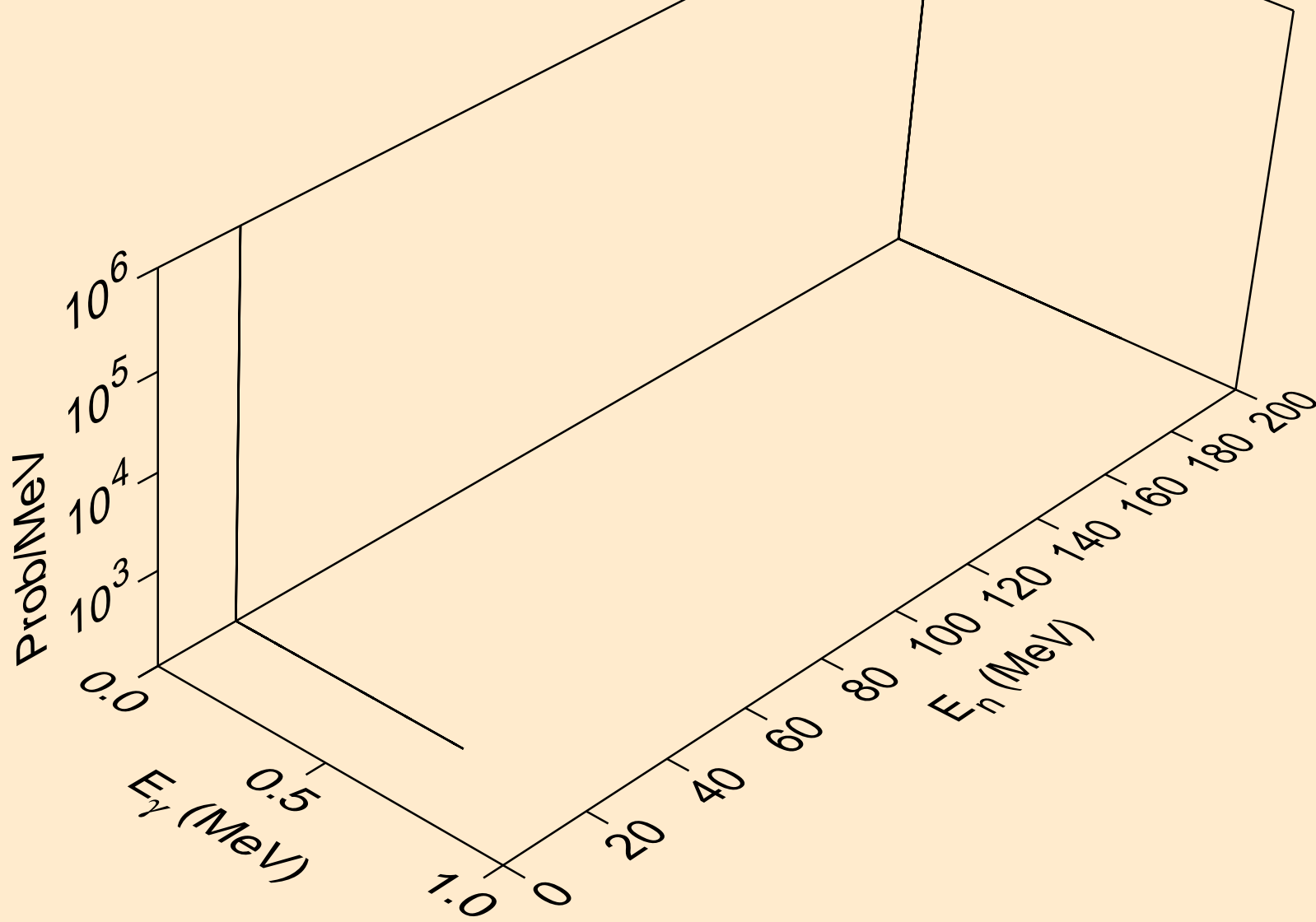

AG120 NEUTRON ACER TENDL-2019 LIBRARY; T=293.16K
Photon emission for (n,n*)p

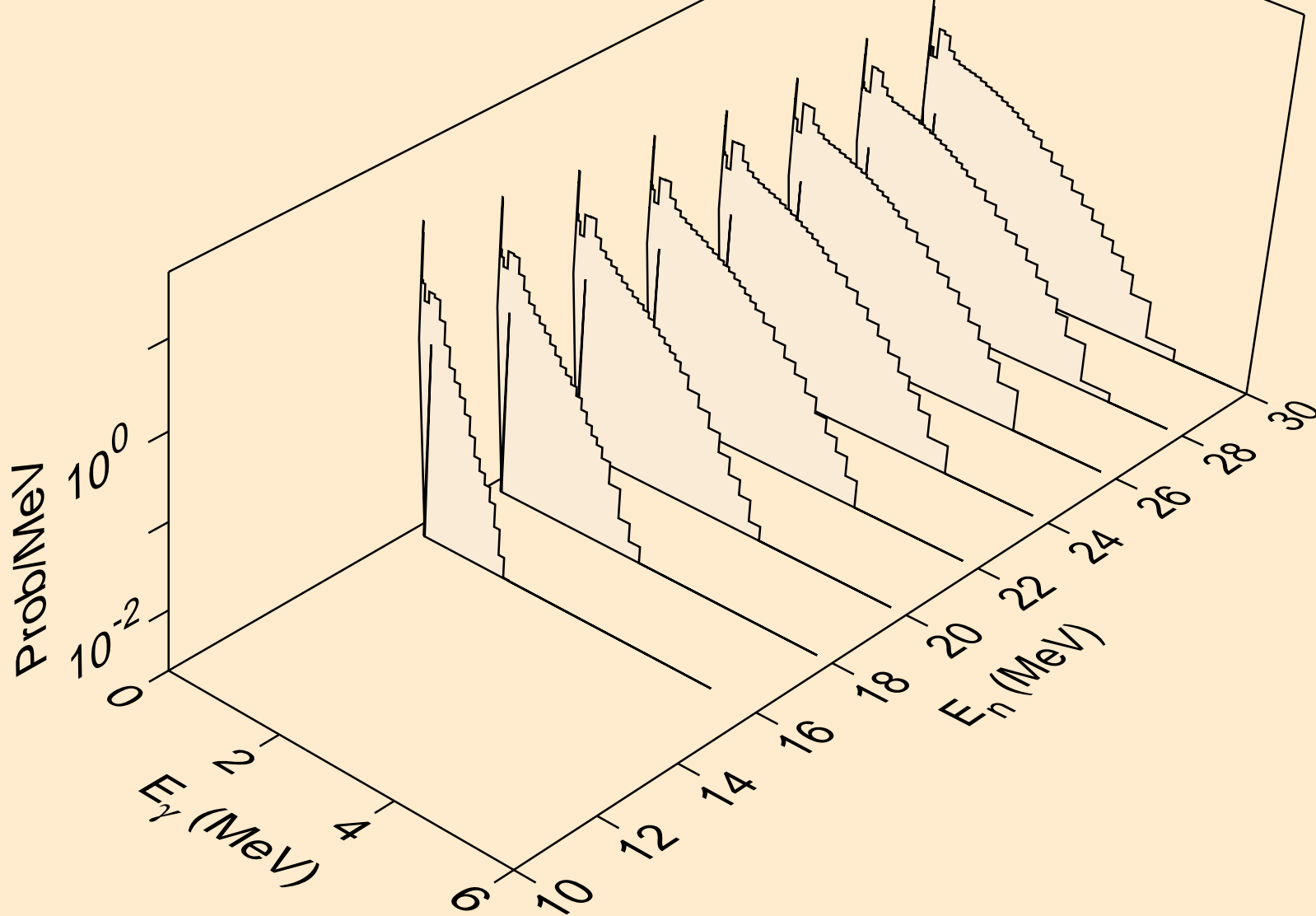

AG120 NEUTRON ACER TENDL-2019 LIBRARY; T=293.16K
Photon emission for (n,n*)d

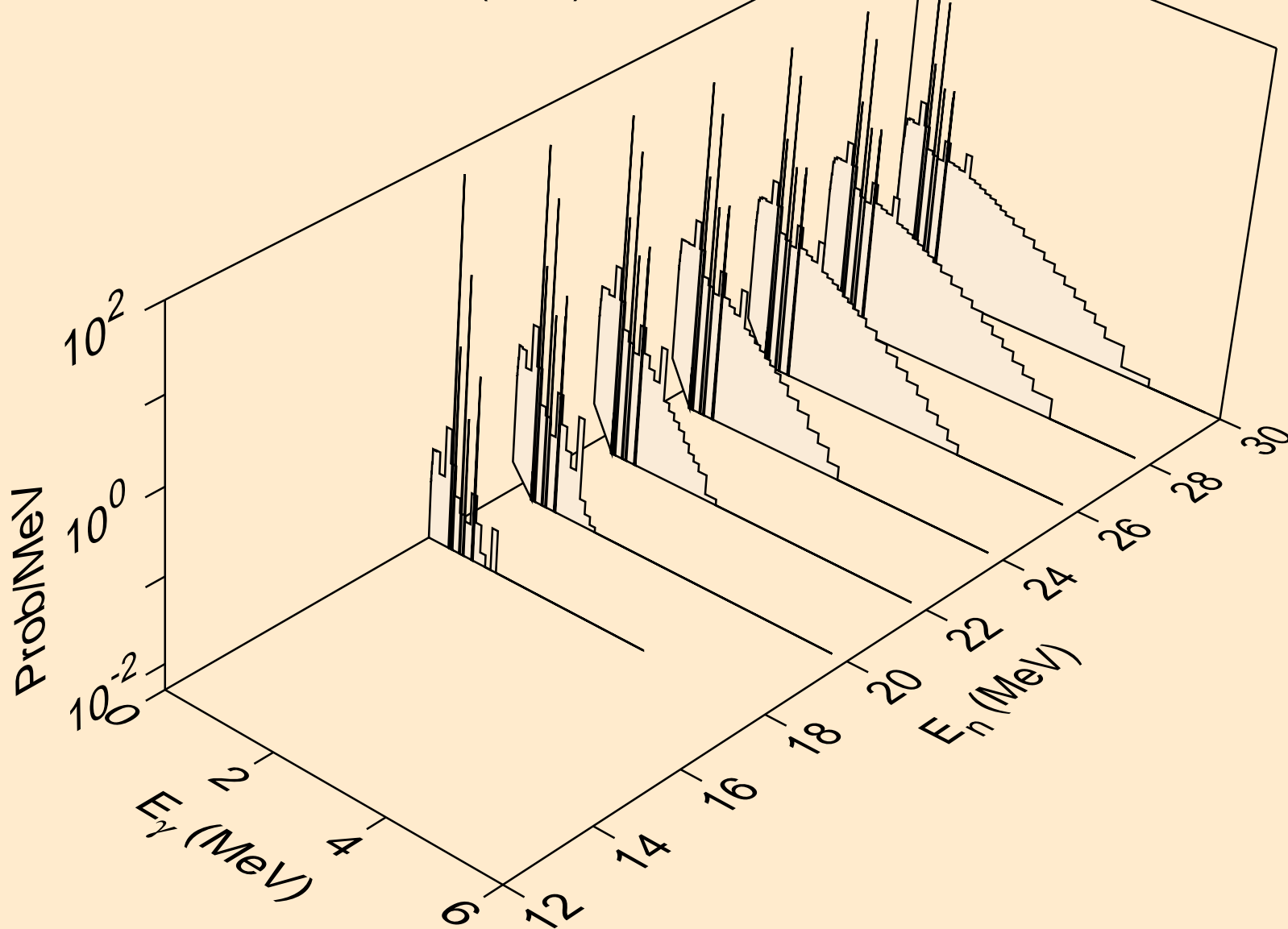

AG120 NEUTRON ACER TENDL-2019 LIBRARY; T=293.16K
Photon emission for (n,n*)t

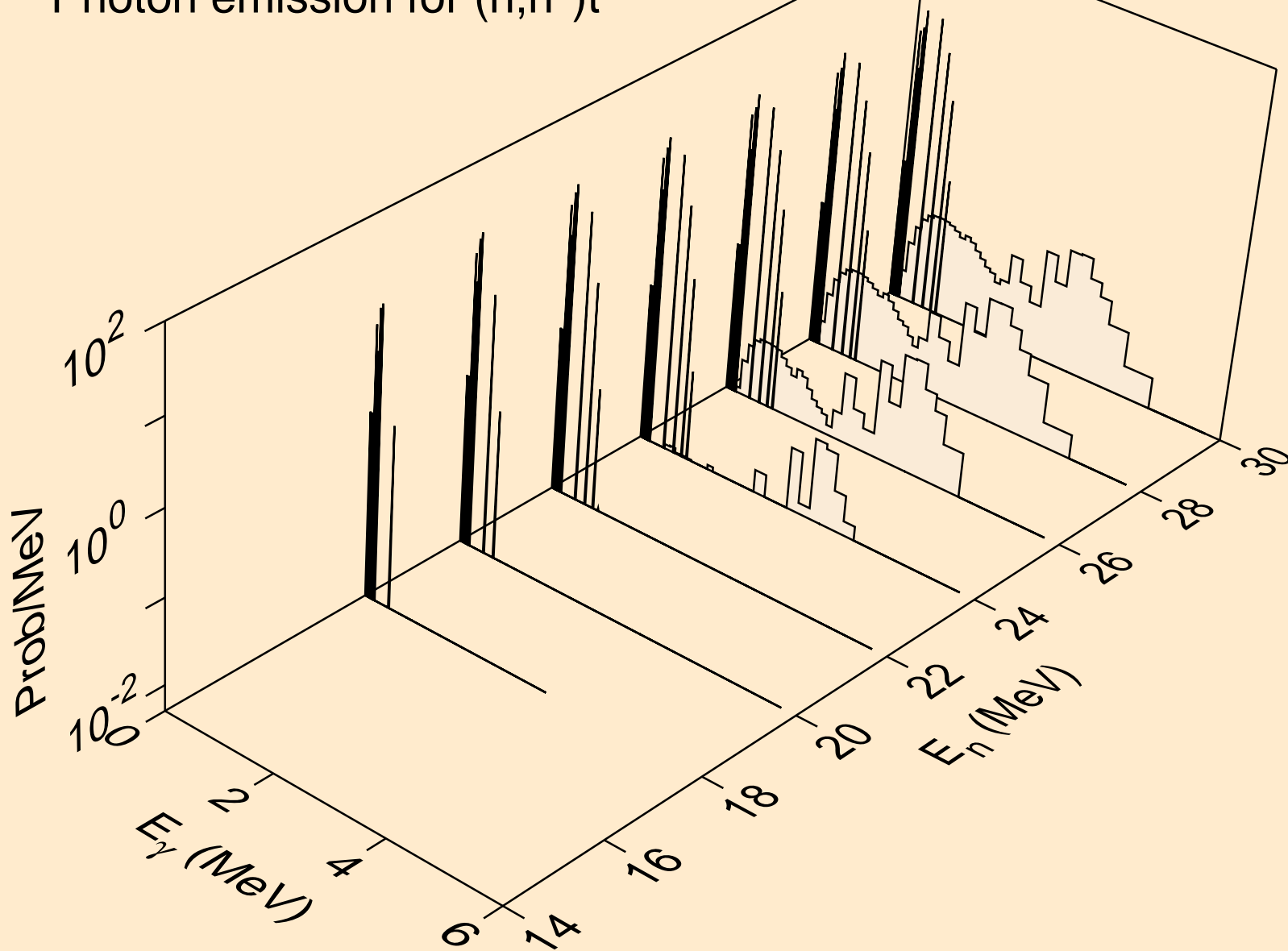

AG120 NEUTRON ACER TENDL-2019 LIBRARY; T=293.16K
Photon emission for (n,n*)he3

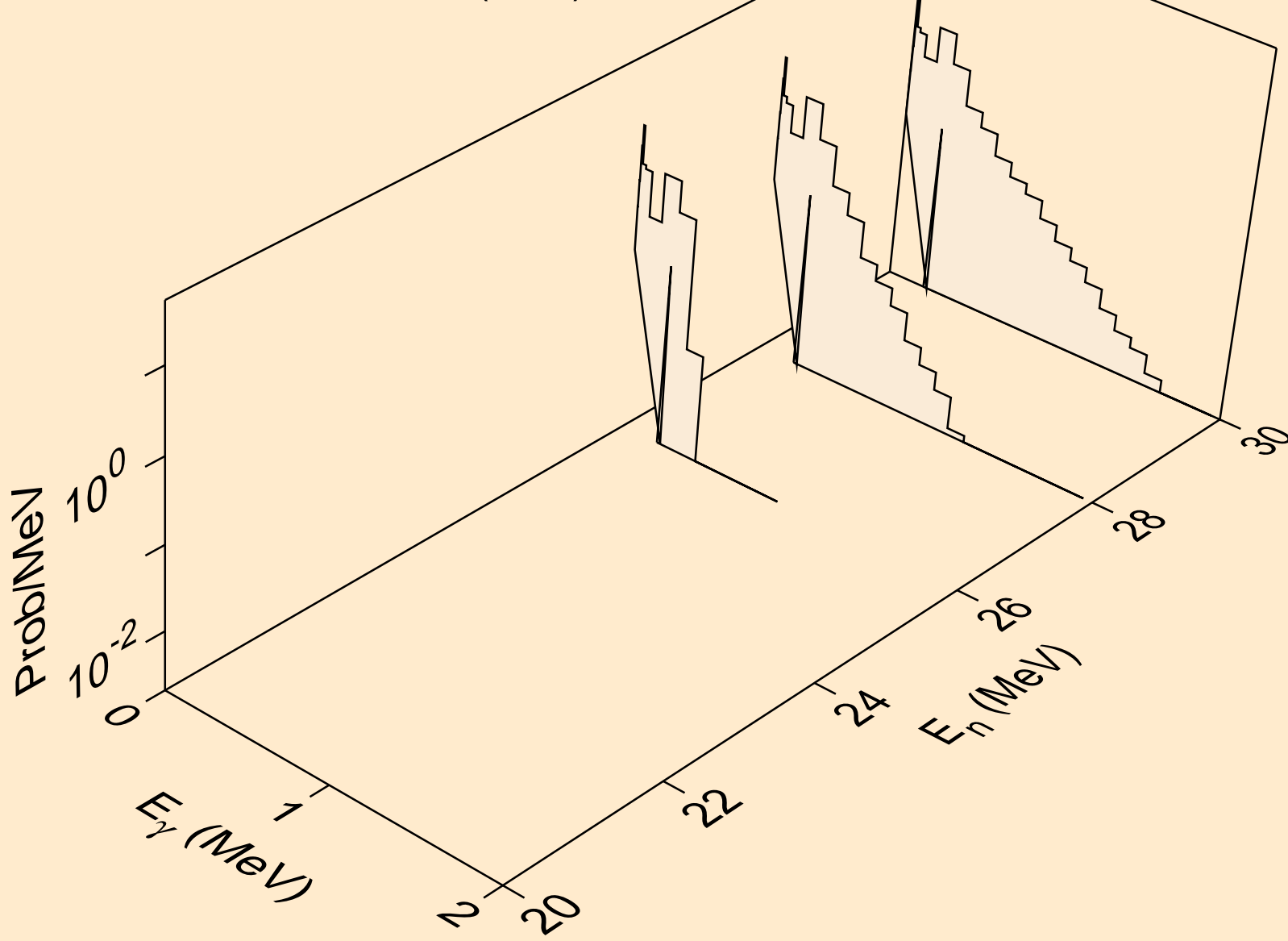

AG120 NEUTRON ACER TENDL-2019 LIBRARY; T=293.16K
Photon emission for (n,4n)

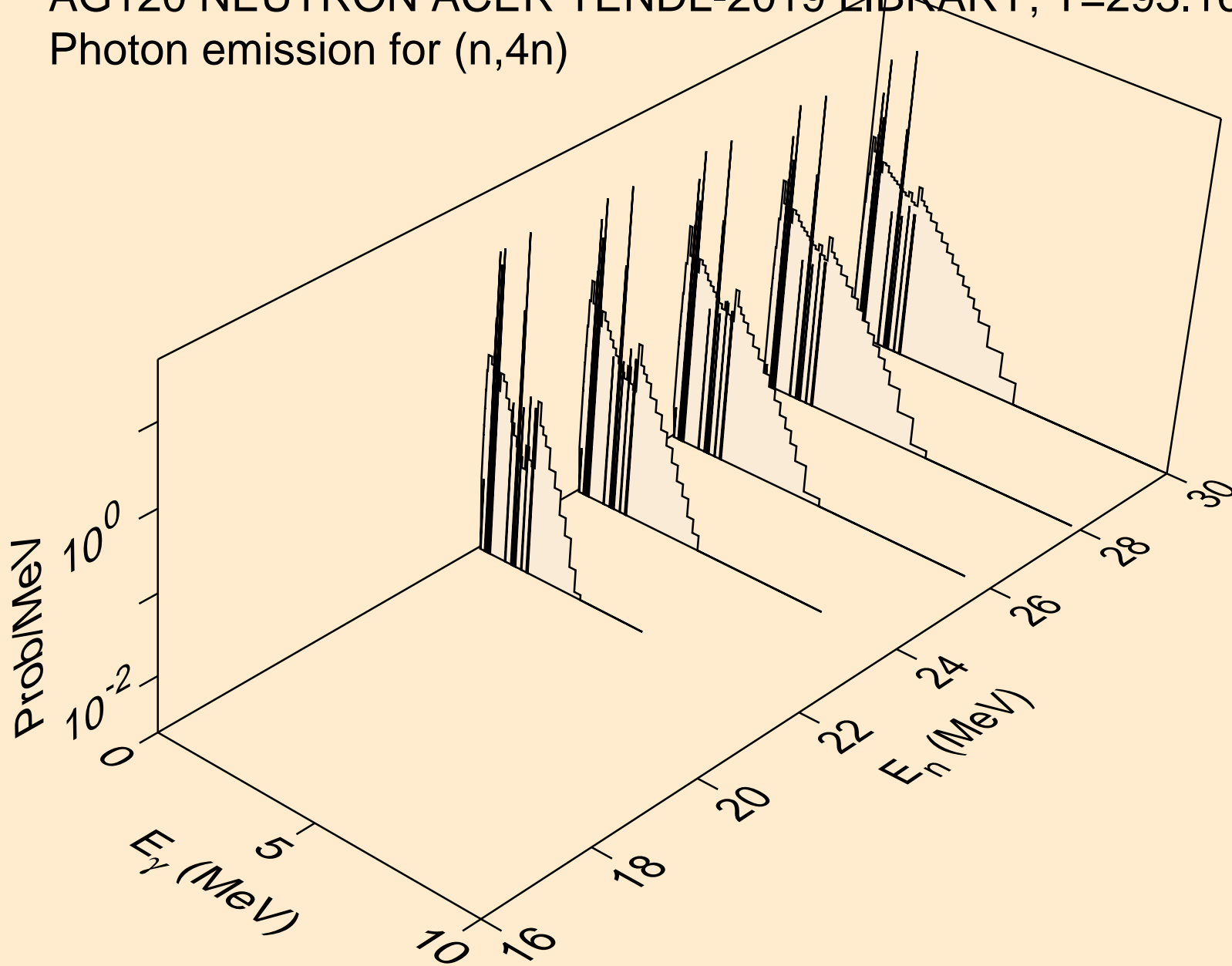

AG120 NEUTRON ACER TENDL-2019 LIBRARY; T=293.16K
Photon emission for (n,2np)

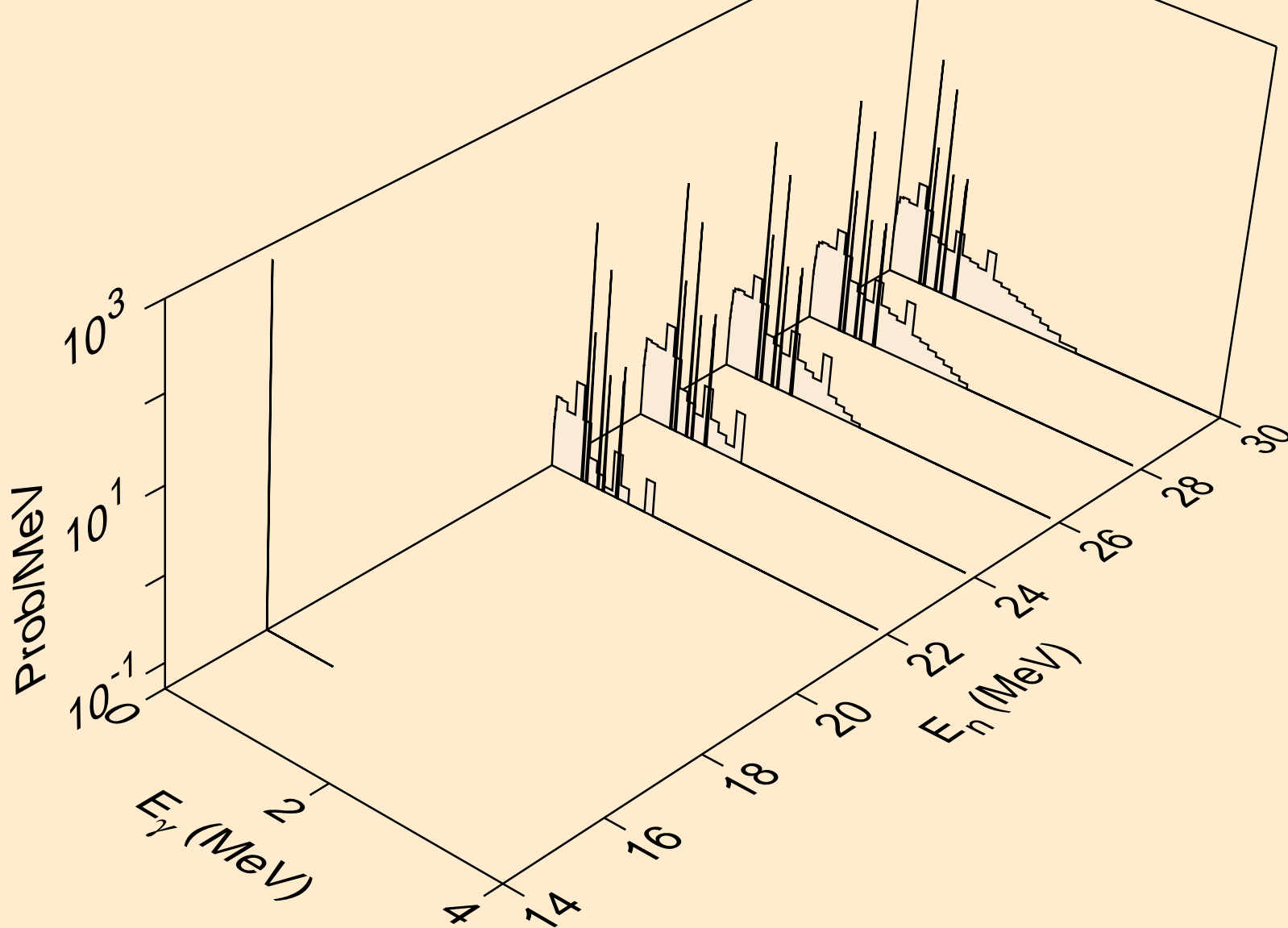

AG120 NEUTRON ACER TENDL-2019 LIBRARY; T=293.16K
Photon emission for (n,3np)

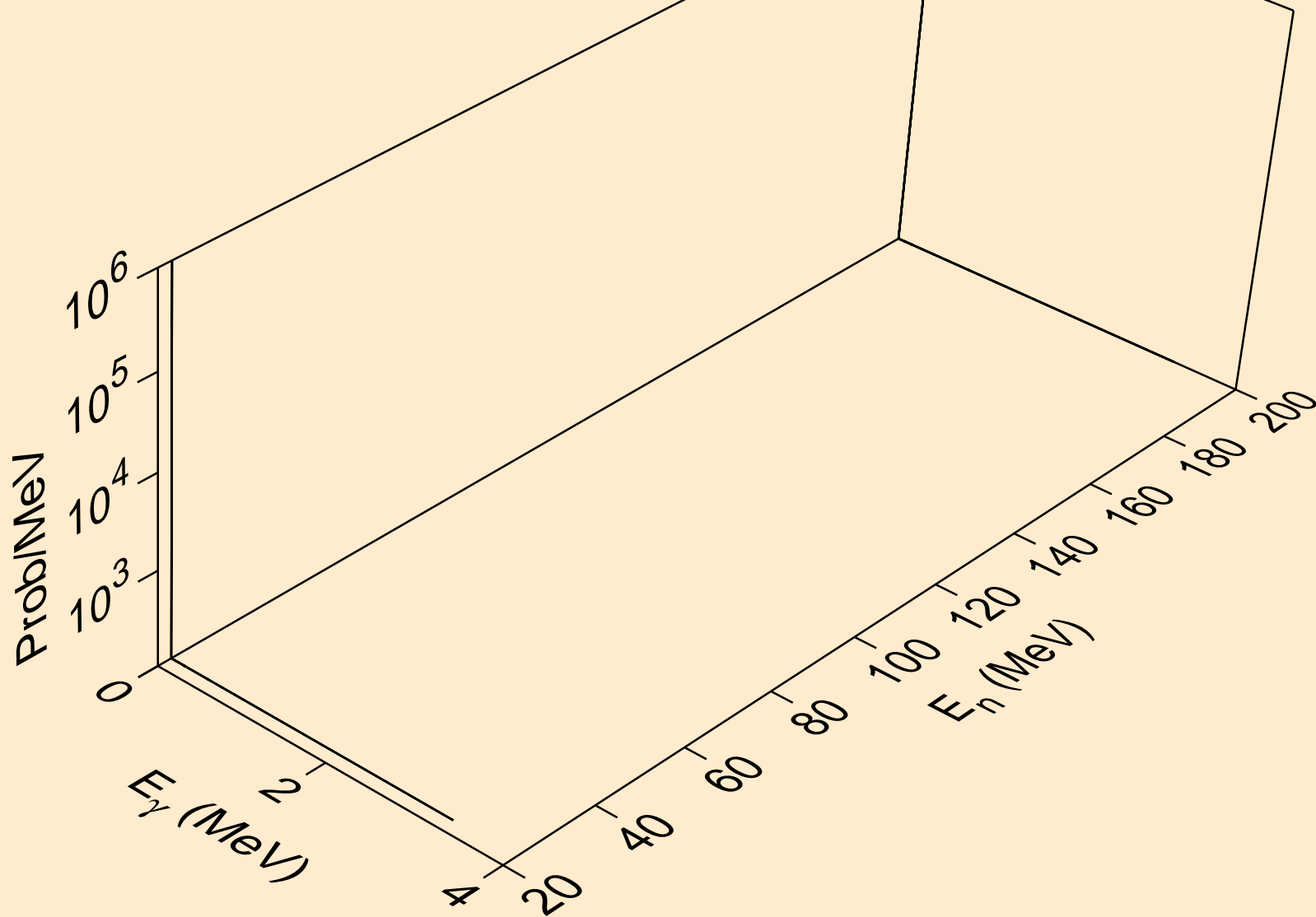

AG120 NEUTRON ACER TENDL-2019 LIBRARY; T=293.16K
Photon emission for (n,n*c)

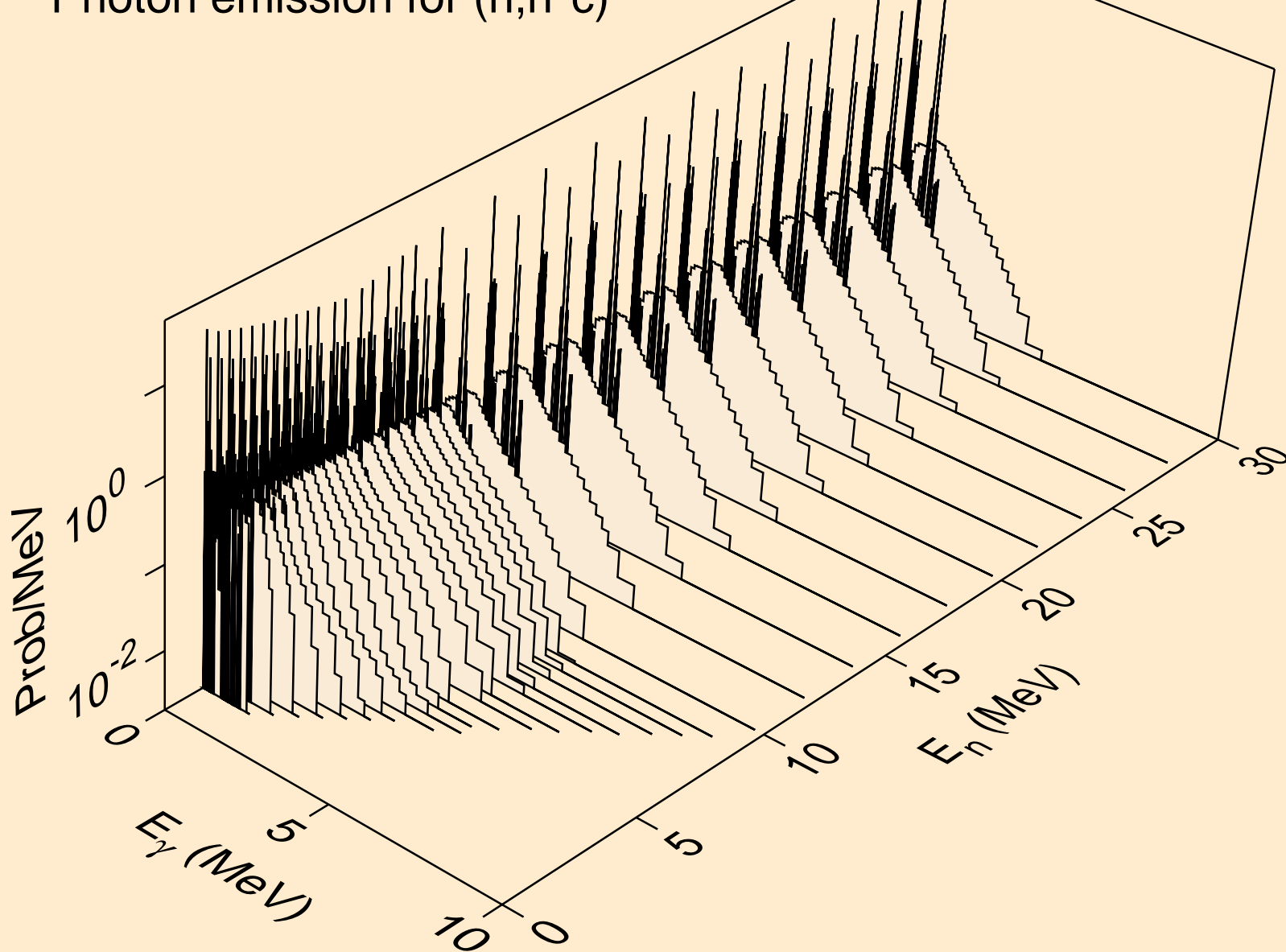

AG120 NEUTRON ACER TENDL-2019 LIBRARY; T=293.16K
Photon emission for (n,gma)

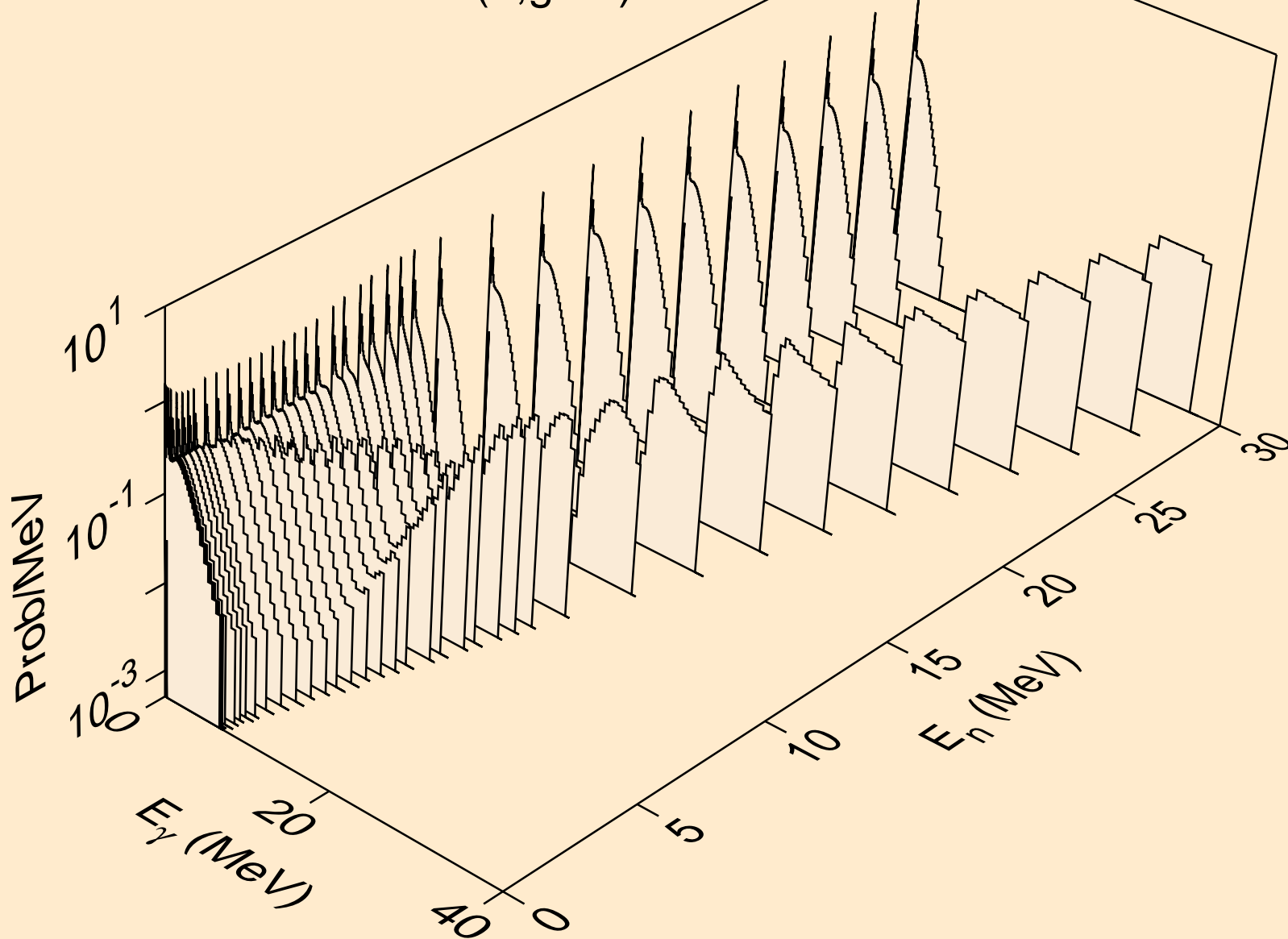

AG120 NEUTRON ACER TENDL-2019 LIBRARY; T=293.16K
Photon emission for (n,p)

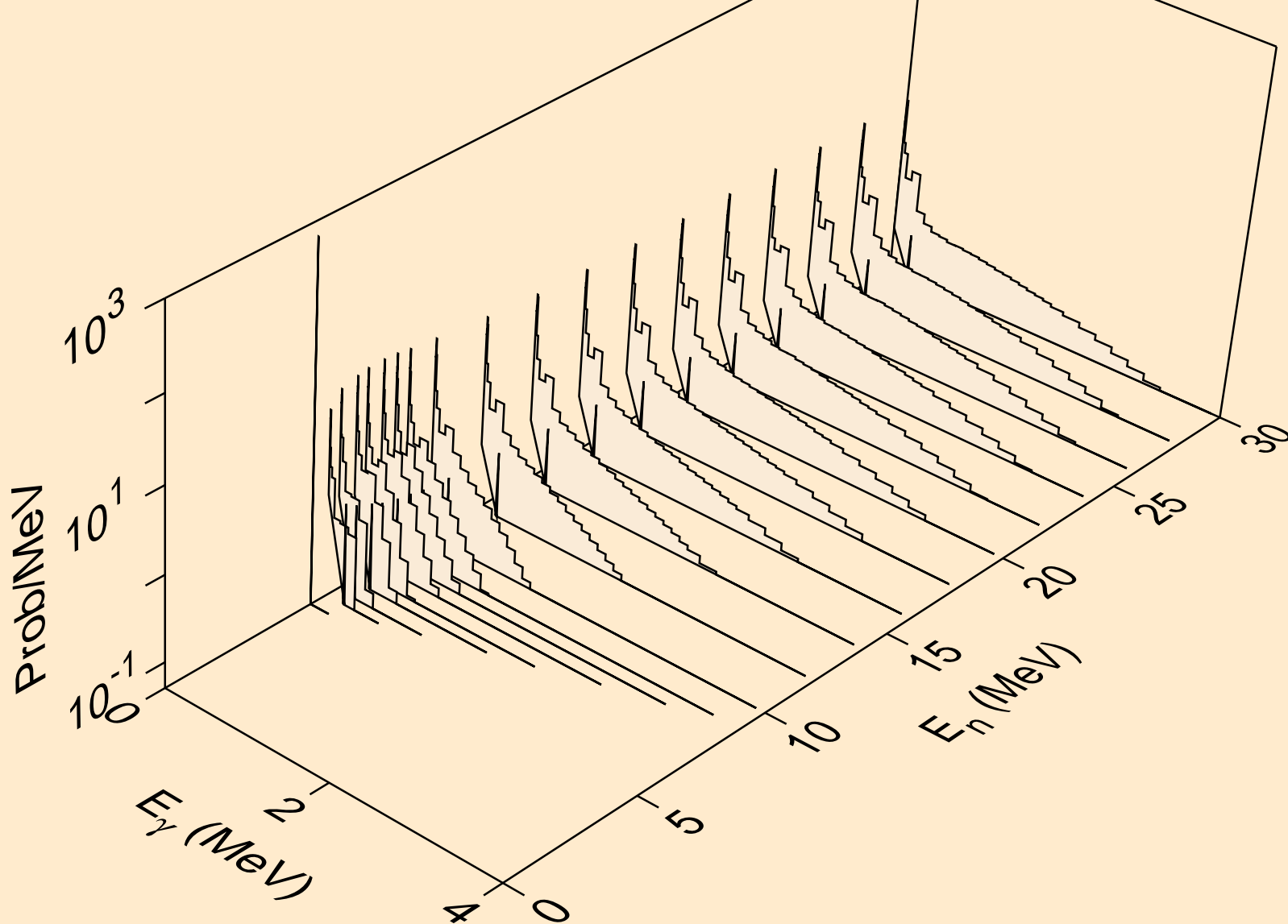

AG120 NEUTRON ACER TENDL-2019 LIBRARY; T=293.16K
Photon emission for (n,d)

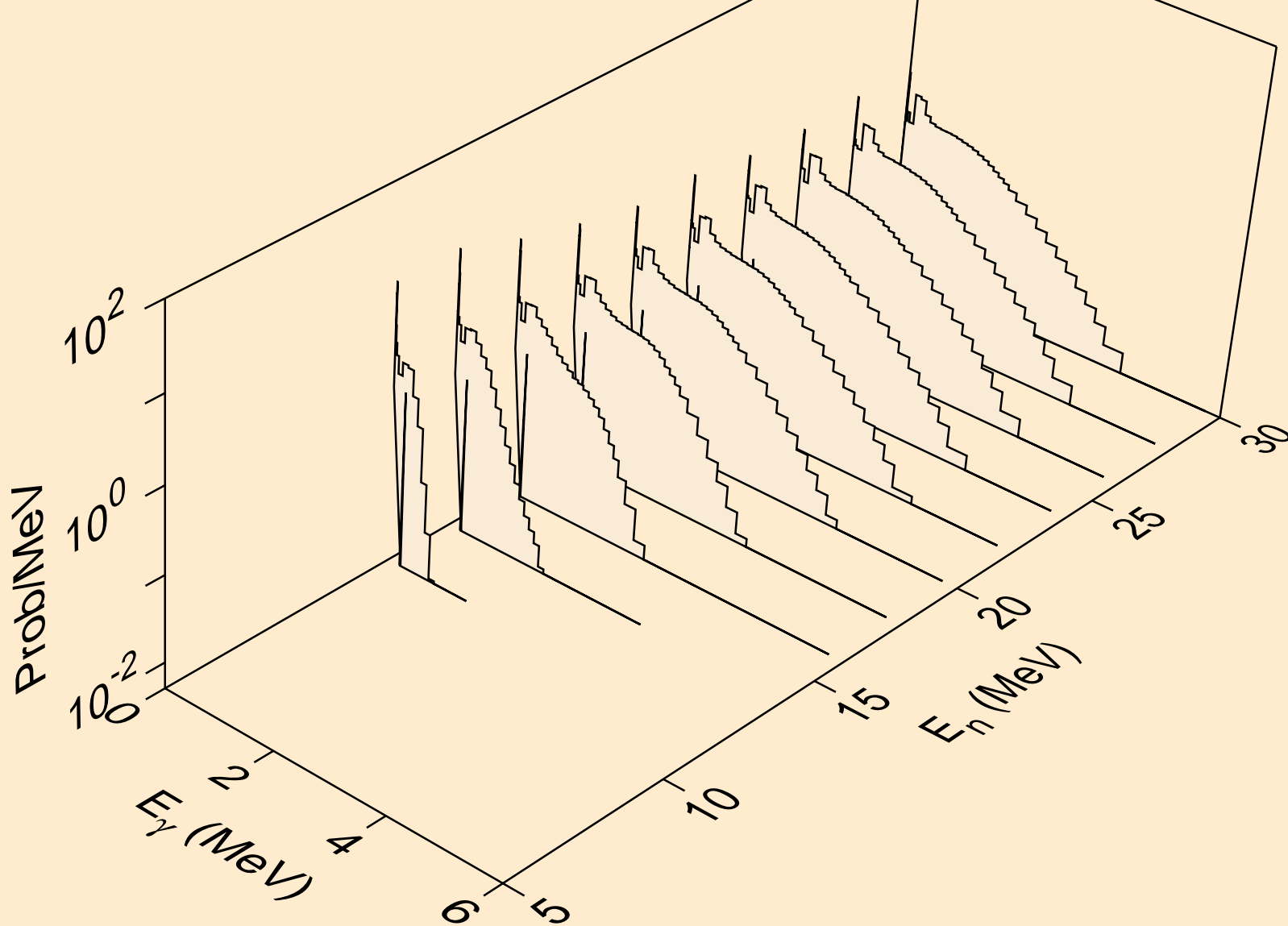

AG120 NEUTRON ACER TENDL-2019 LIBRARY; T=293.16K
Photon emission for (n,t)

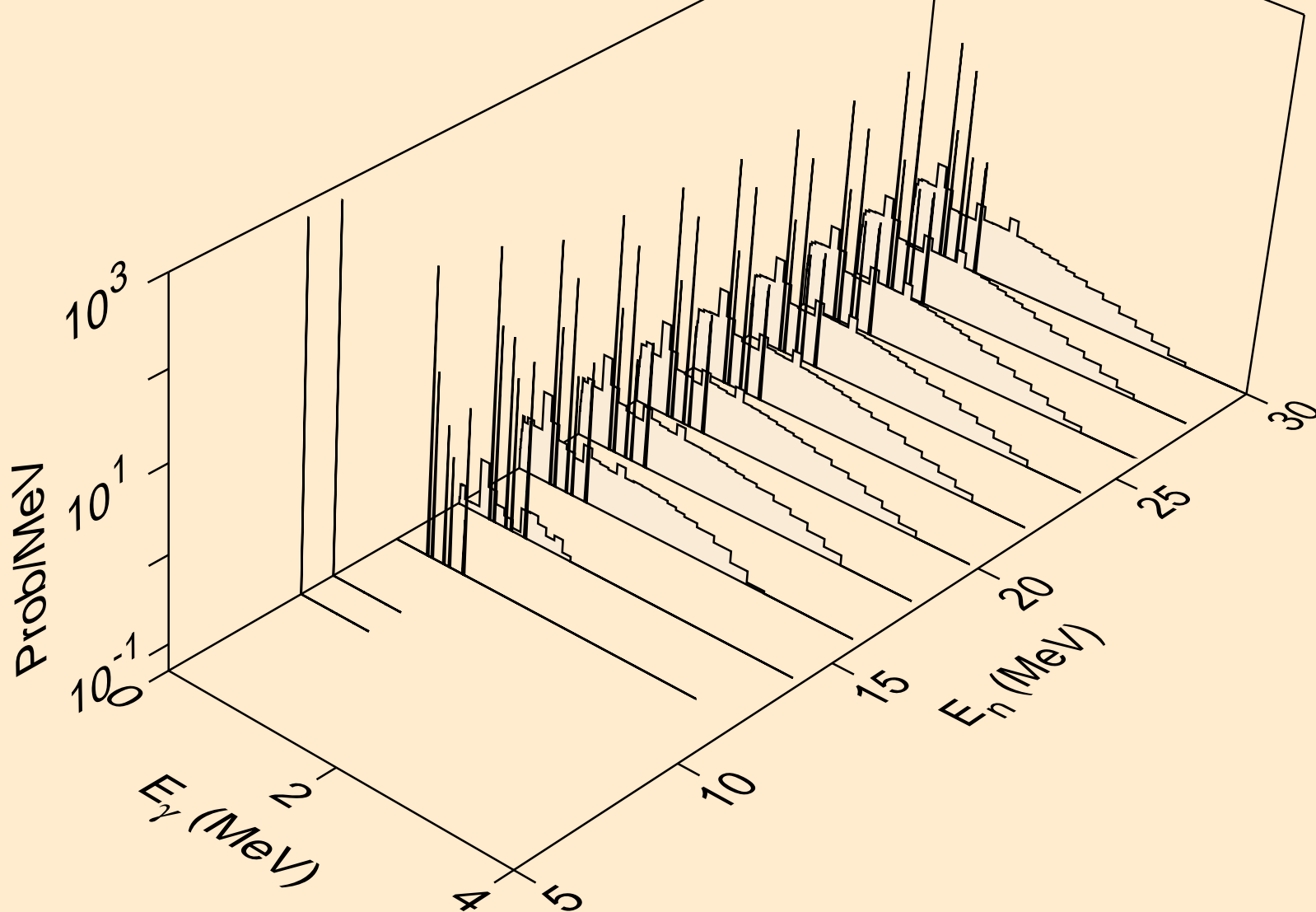

AG120 NEUTRON ACER TENDL-2019 LIBRARY; T=293.16K
Photon emission for (n,he3)

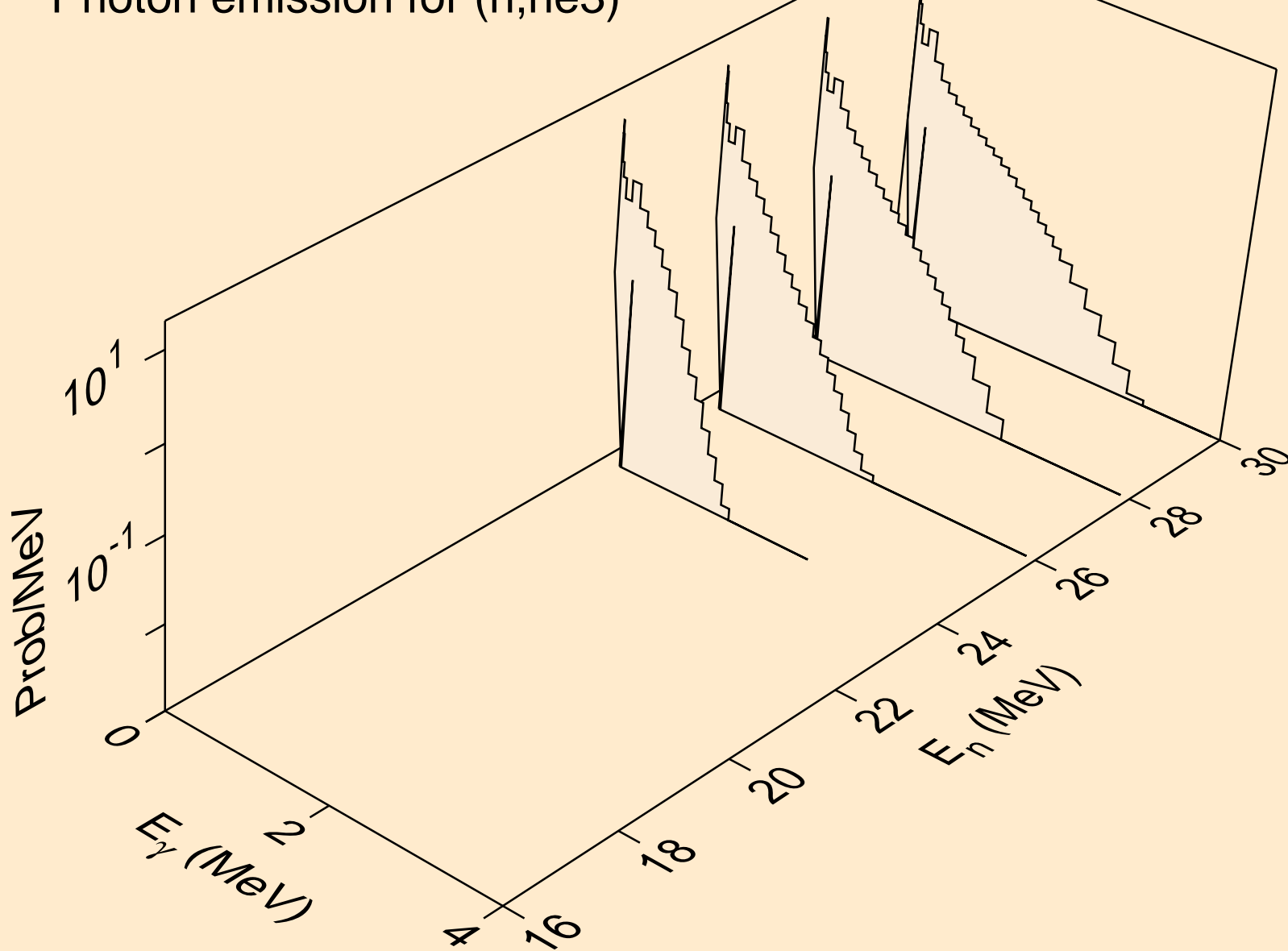

AG120 NEUTRON ACER TENDL-2019 LIBRARY; T=293.16K
Photon emission for (n,a)

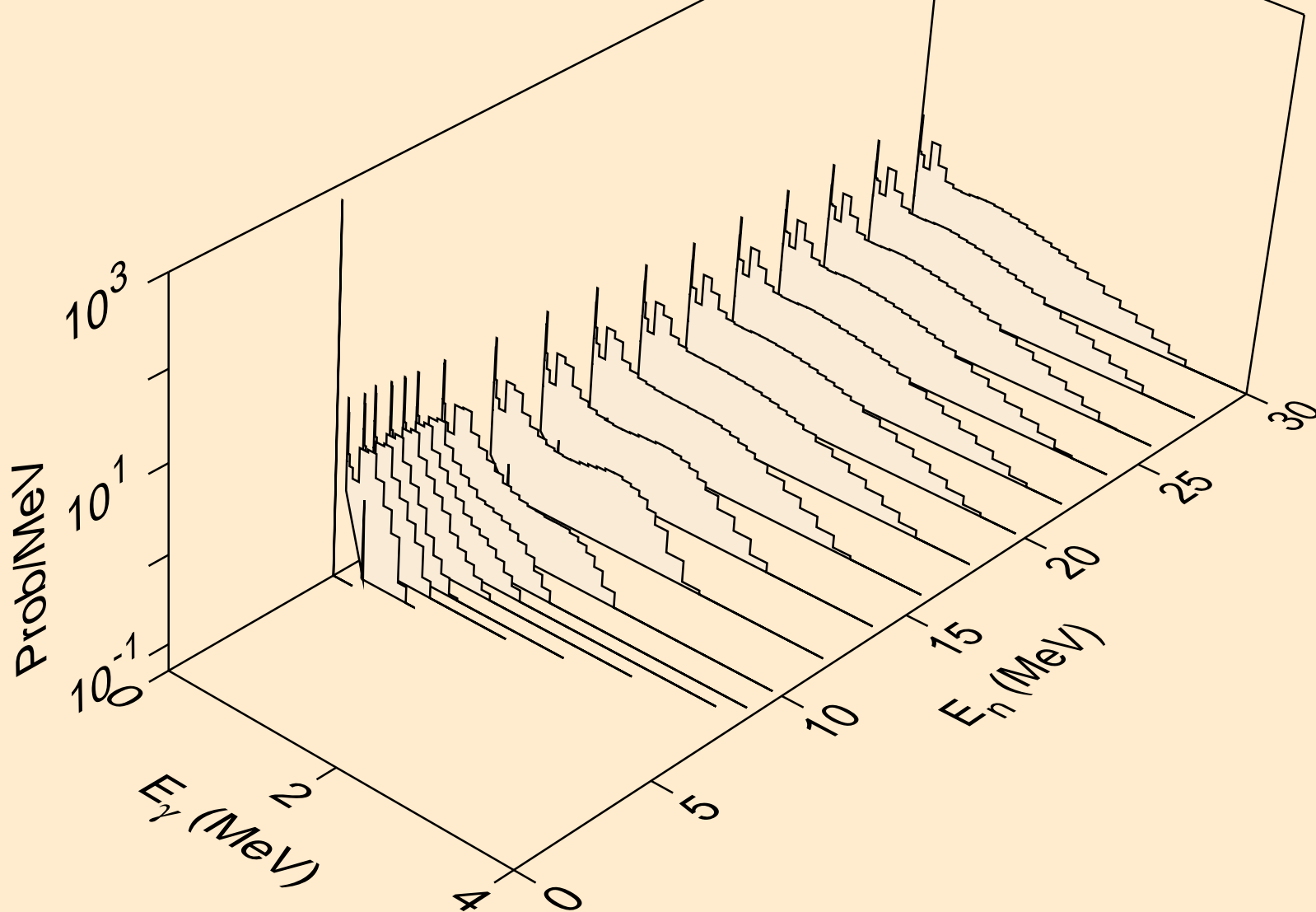

AG120 NEUTRON ACER TENDL-2019 LIBRARY; T=293.16K
thermal capture photon spectrum

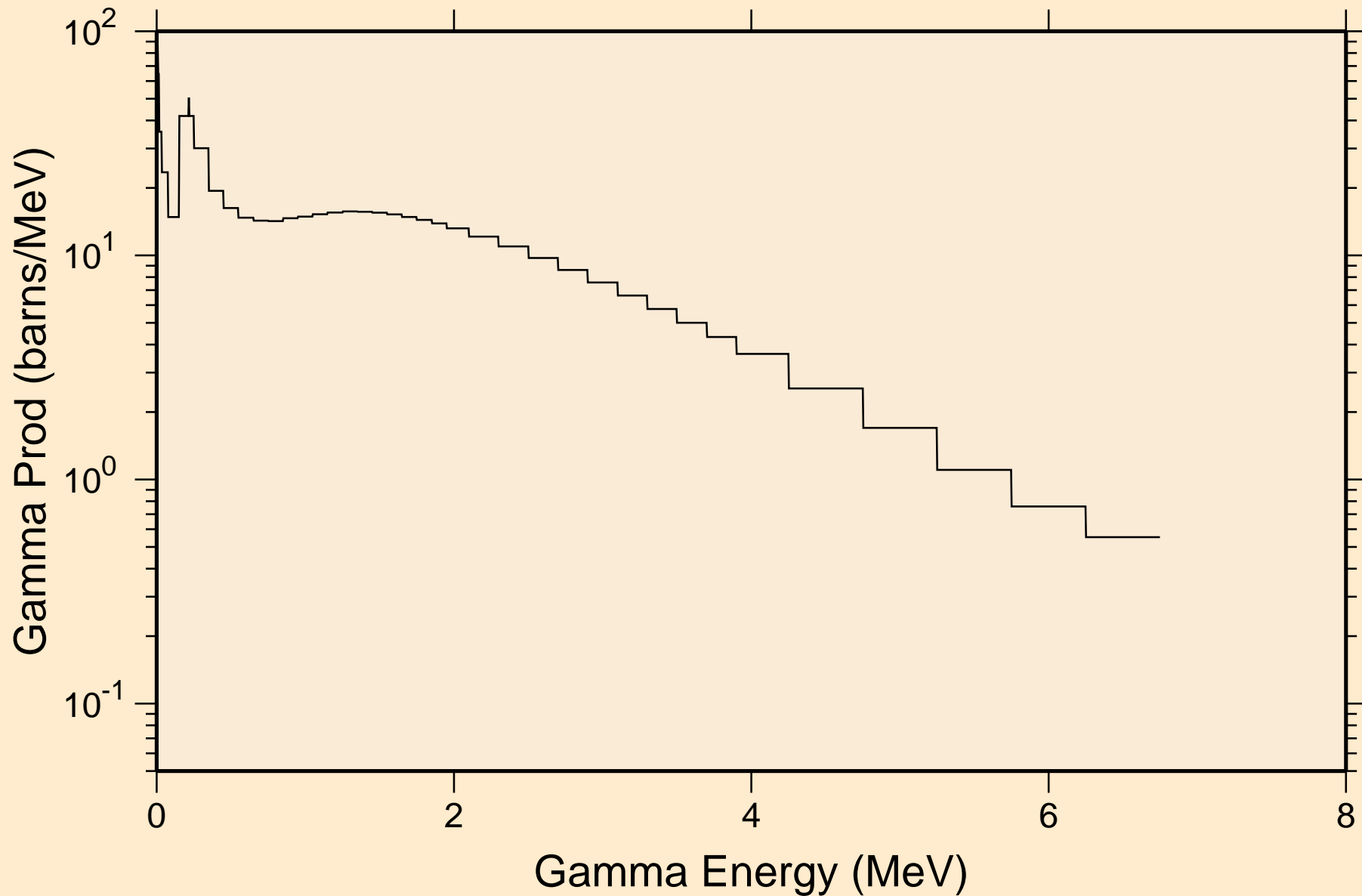

AG120 NEUTRON ACER TENDL-2019 LIBRARY; T=293.16K
14 MeV photon spectrum

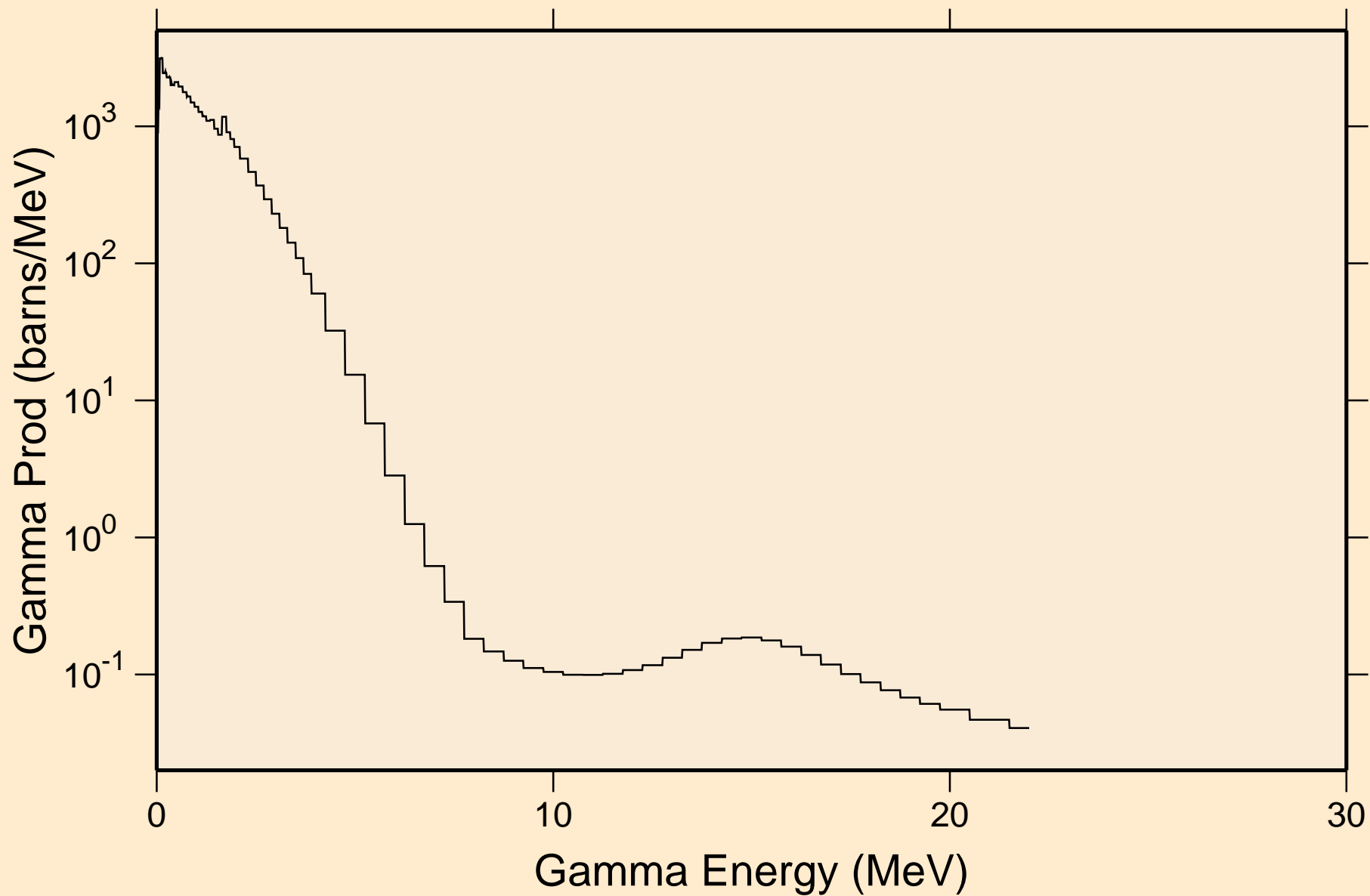

AG120 NEUTRON ACER TENDL-2019 LIBRARY; T=293.16K

Particle heating contributions

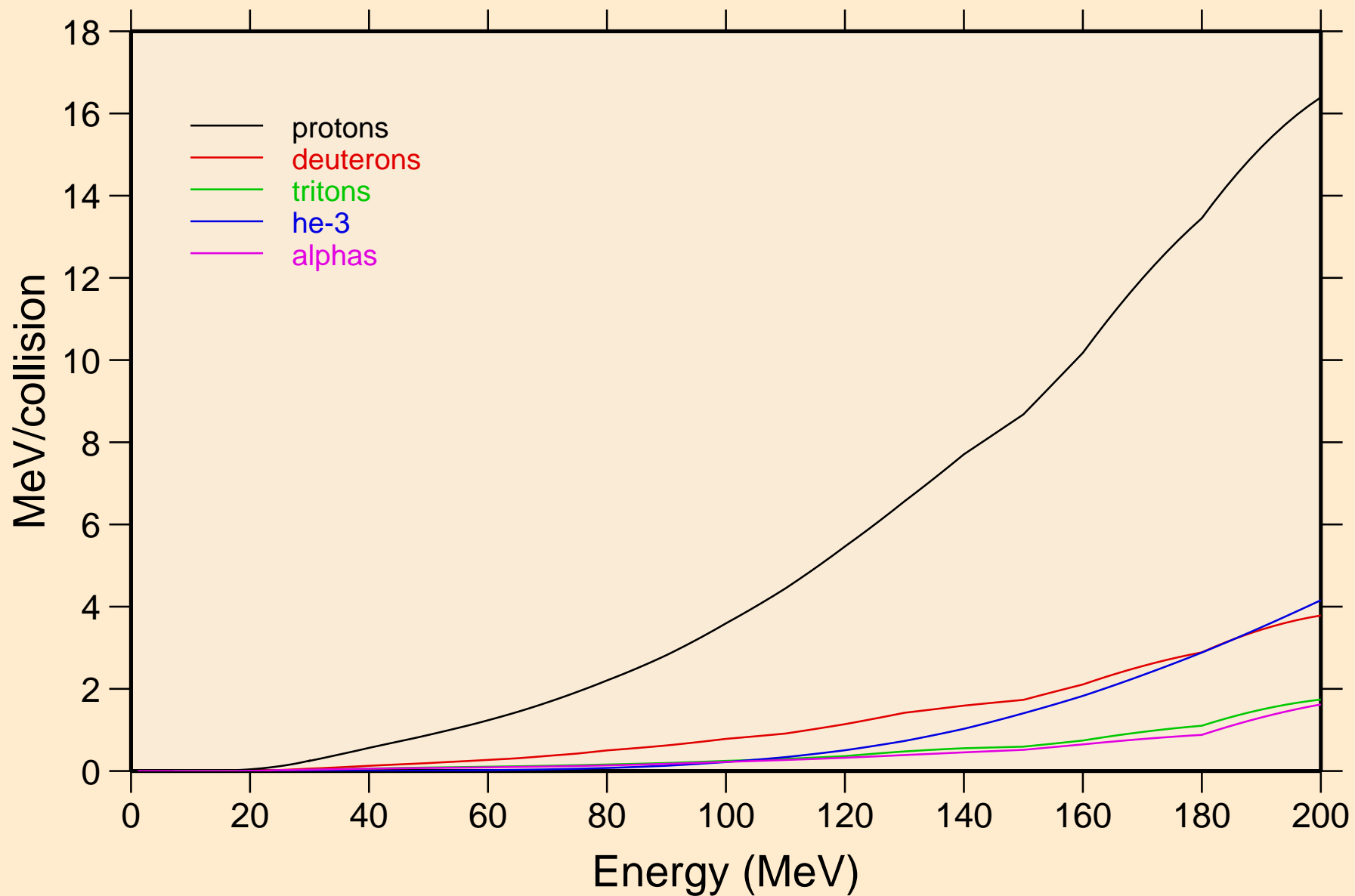

AG120 NEUTRON ACER TENDL-2019 LIBRARY; T=293.16K
Recoil Heating

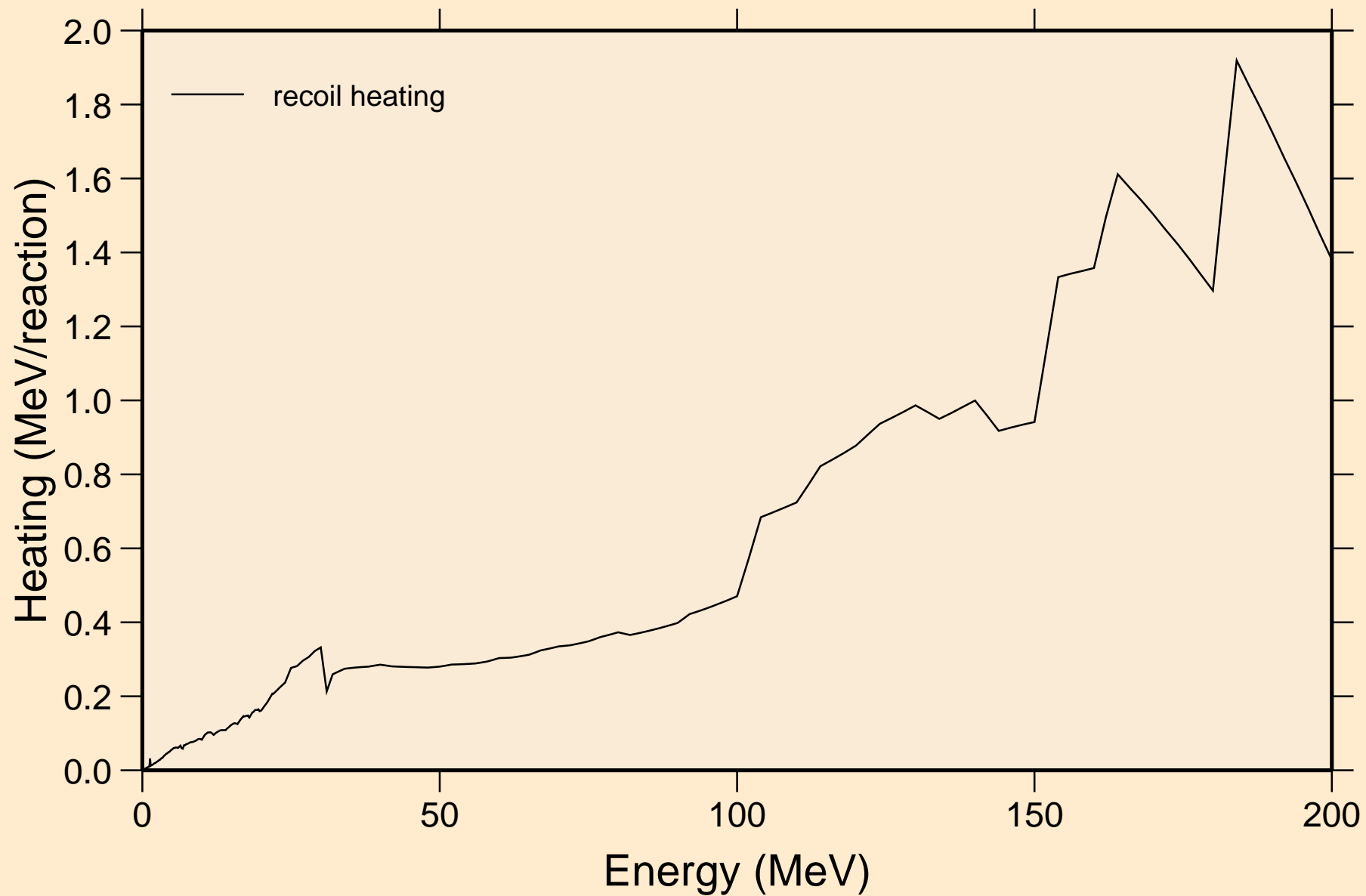

AG120 NEUTRON ACER TENDL-2019 LIBRARY; T=293.16K
Particle production cross sections

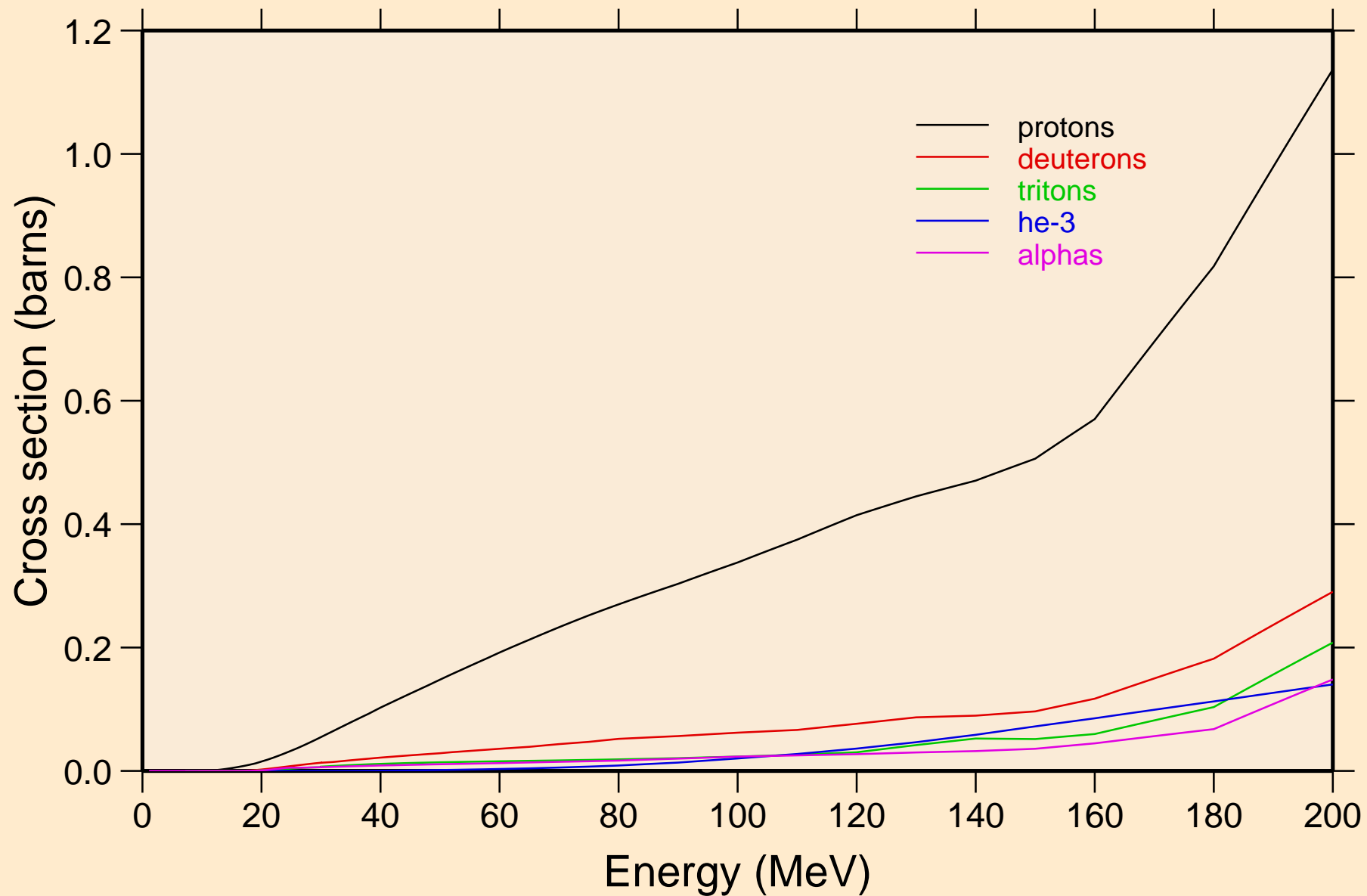

AG120 NEUTRON ACER TENDL-2019 LIBRARY; T=293.16K
protons from (n,x)

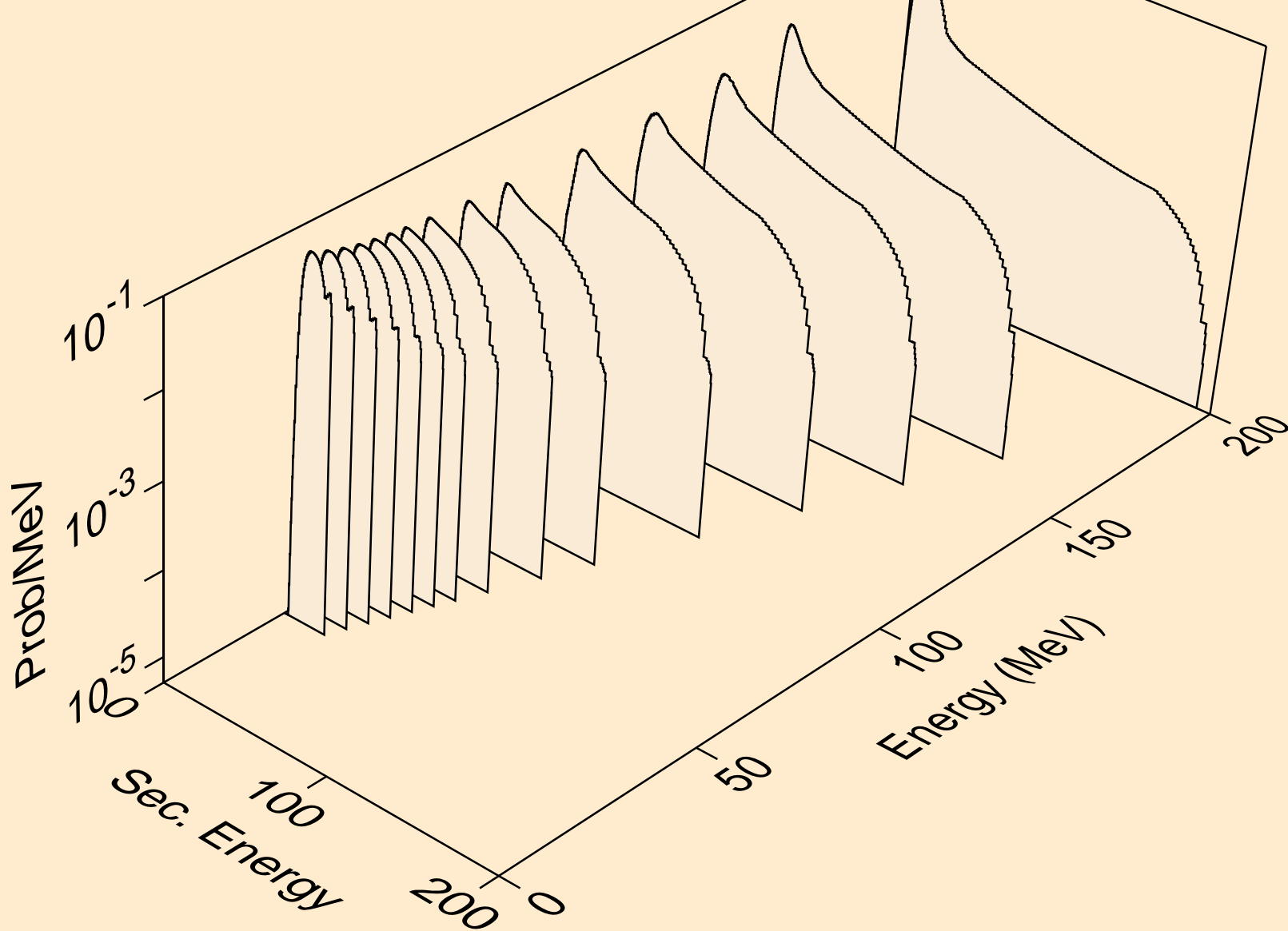

AG120 NEUTRON ACER TENDL-2019 LIBRARY; T=293.16K
protons from (n,n*)p

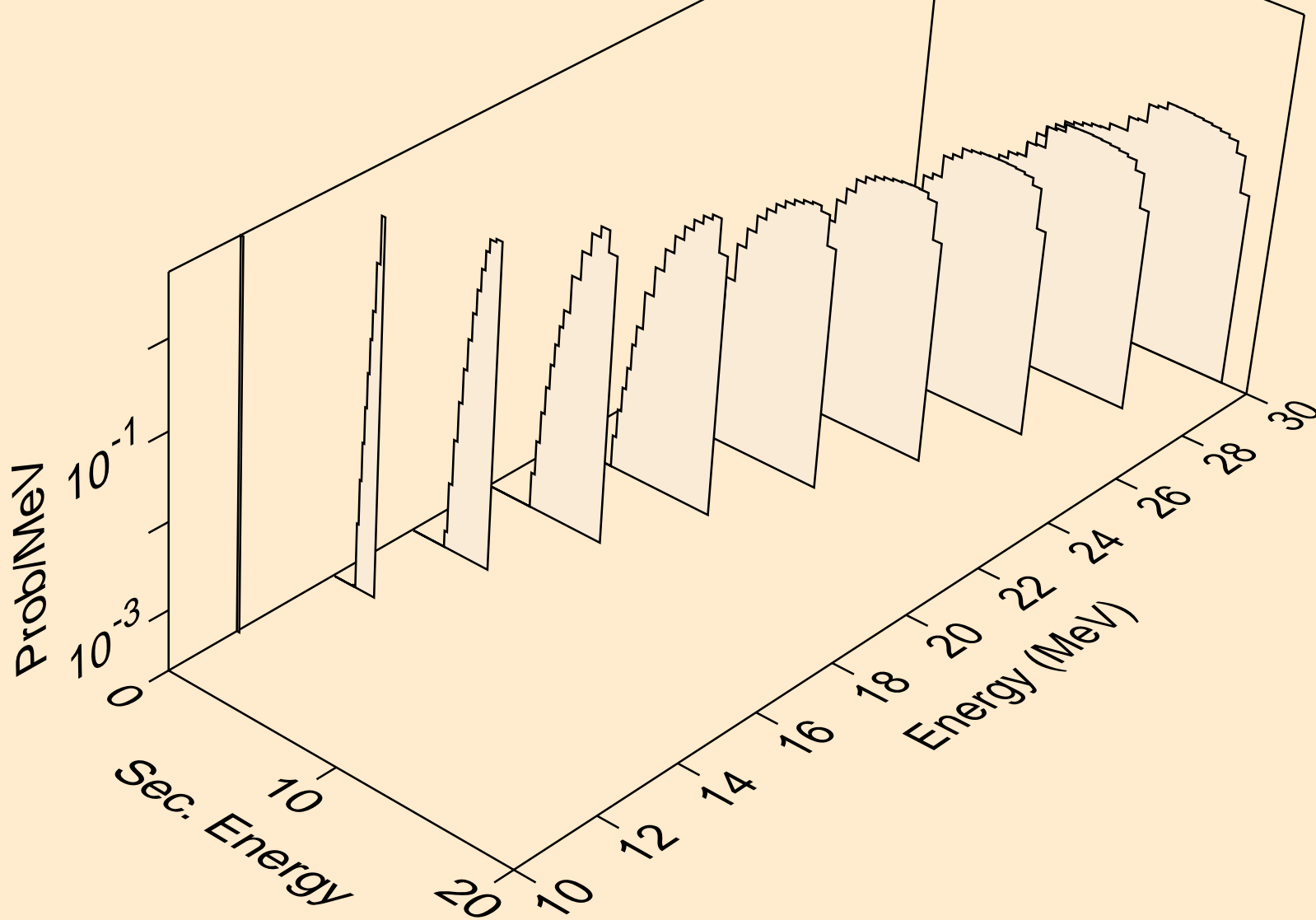

AG120 NEUTRON ACER TENDL-2019 LIBRARY; T=293.16K
protons from (n,2np)

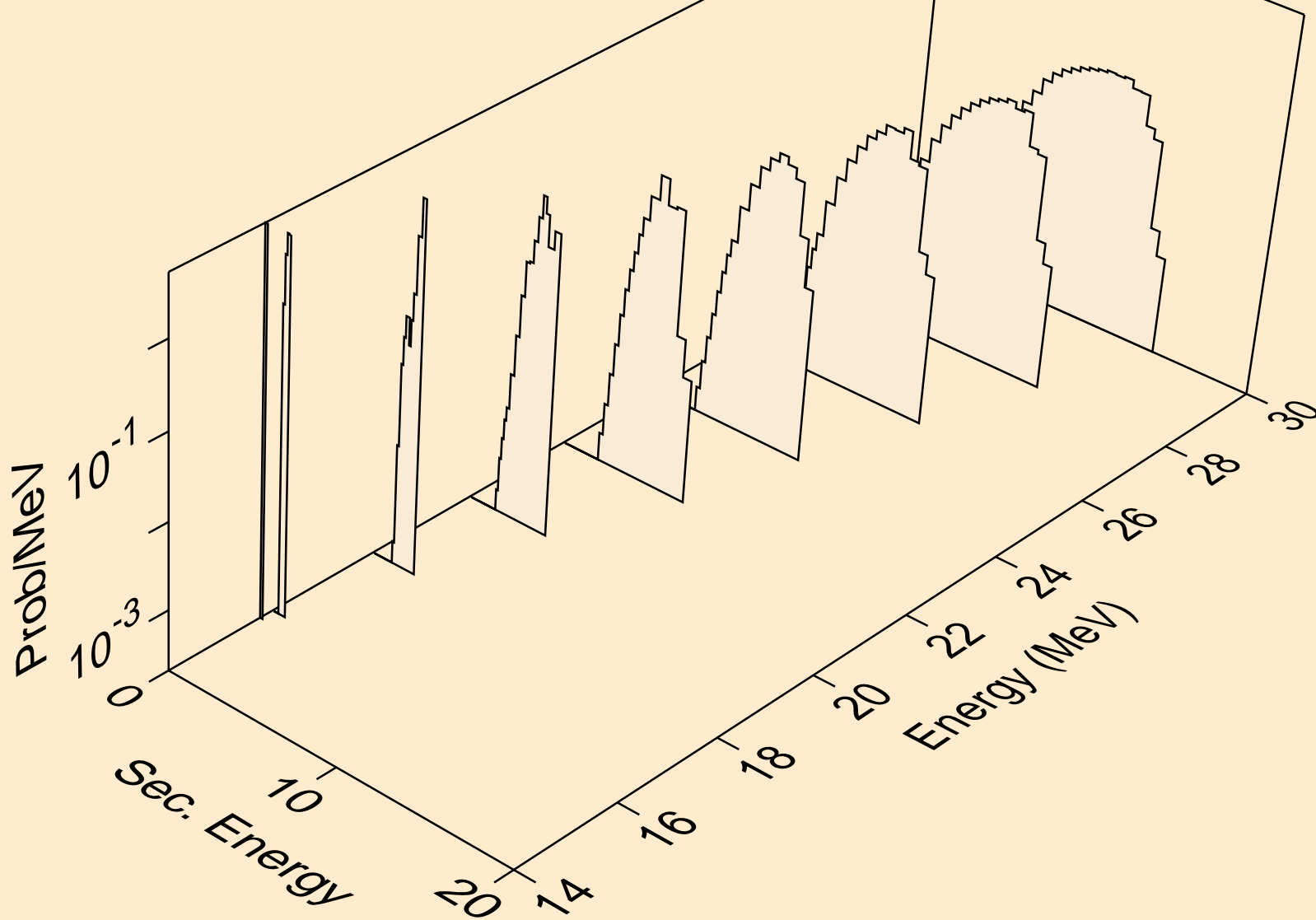

AG120 NEUTRON ACER TENDL-2019 LIBRARY; T=293.16K
protons from (n,3np)

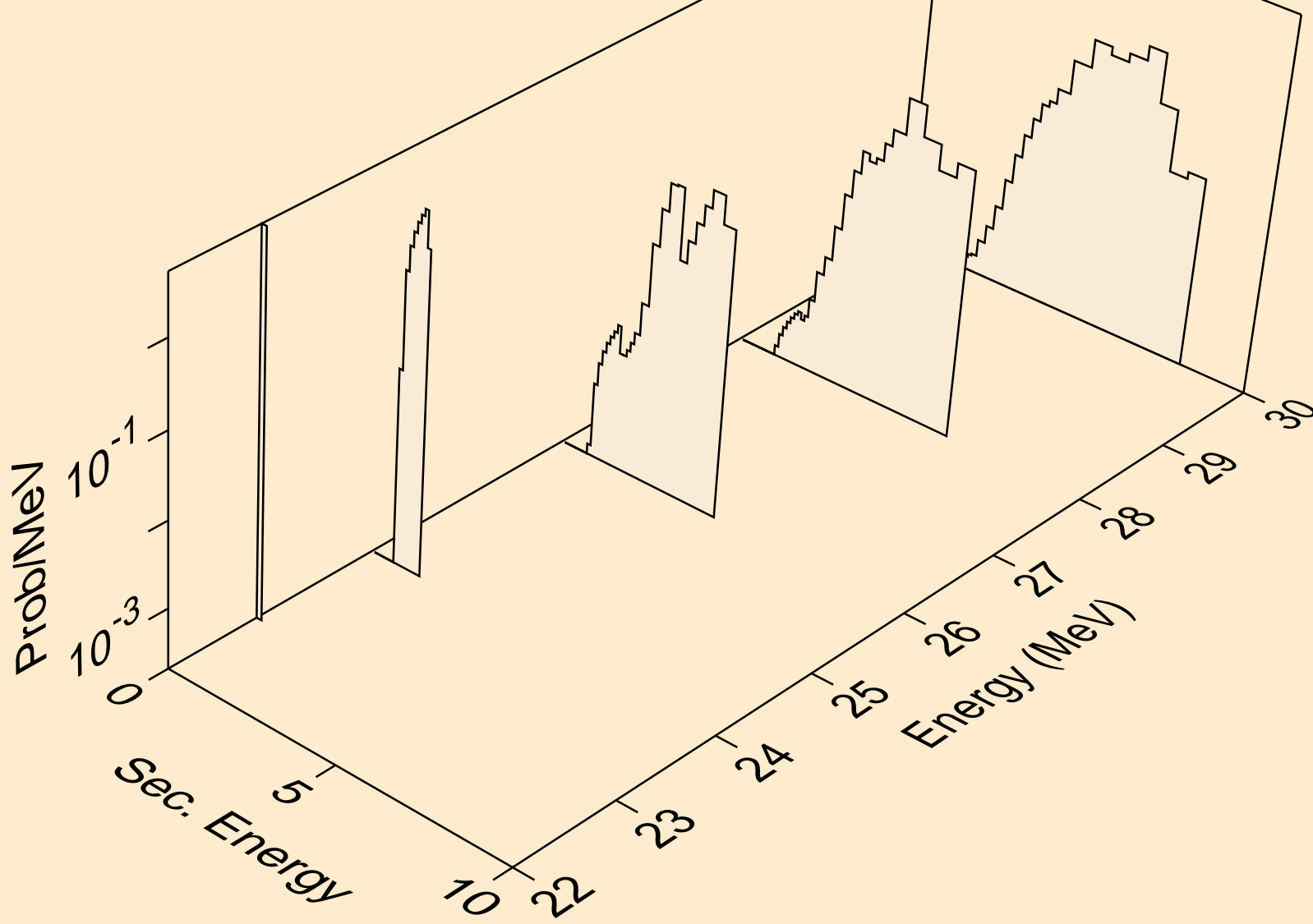

AG120 NEUTRON ACER TENDL-2019 LIBRARY; T=293.16K
protons from (n,p)

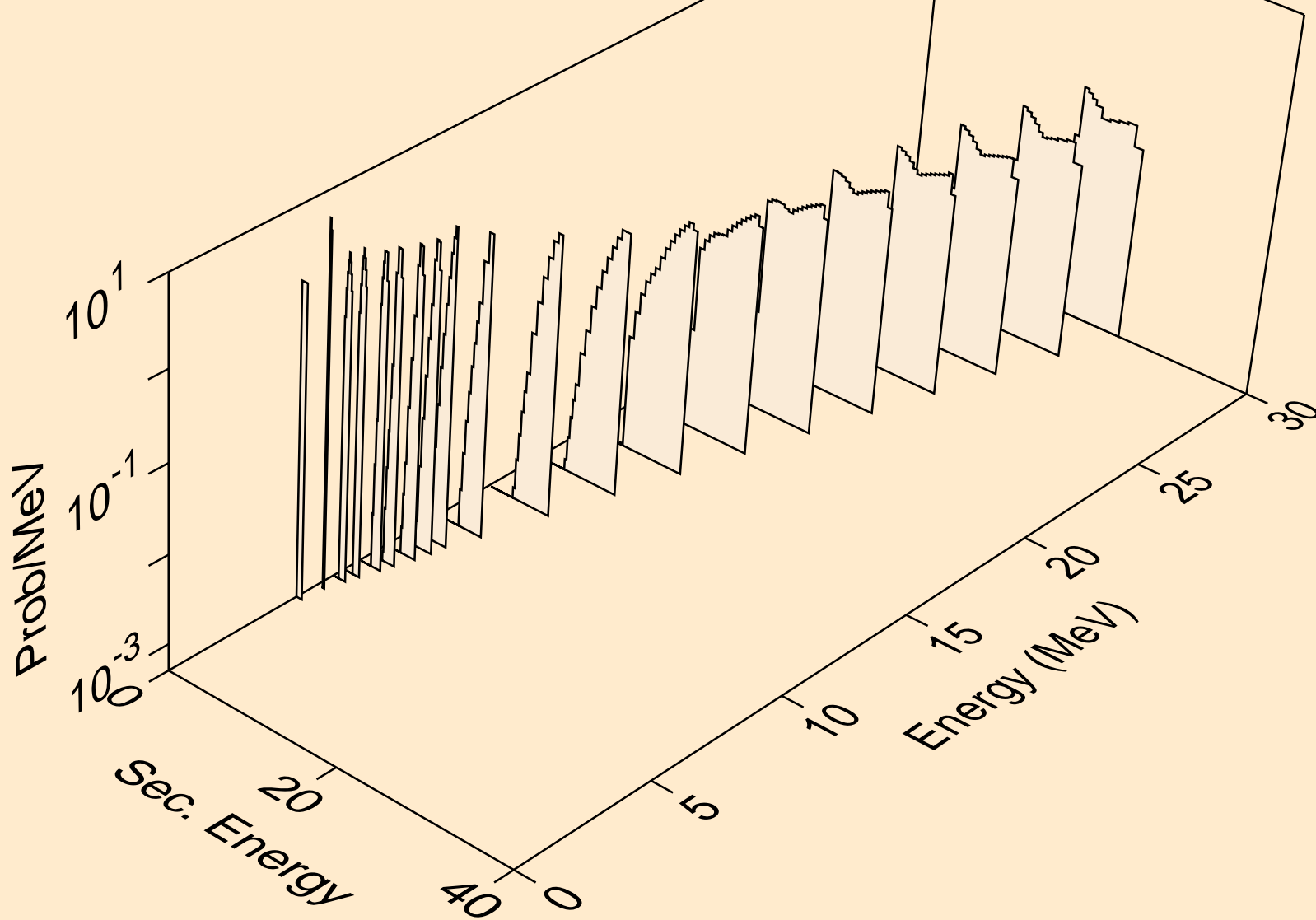

AG120 NEUTRON ACER TENDL-2019 LIBRARY; T=293.16K
deuterons from (n,x)

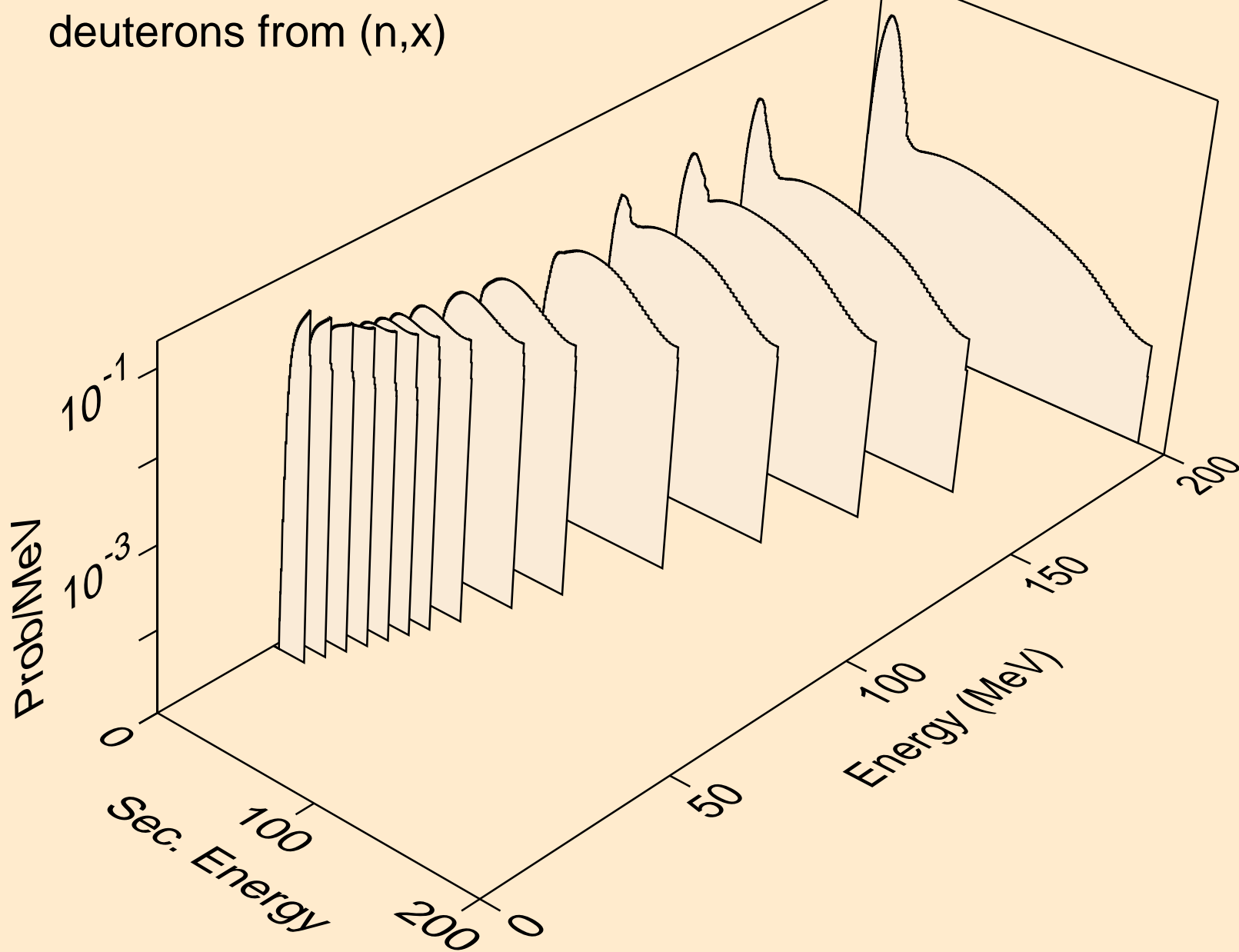

AG120 NEUTRON ACER TENDL-2019 LIBRARY; T=293.16K
deuterons from (n,2nd)

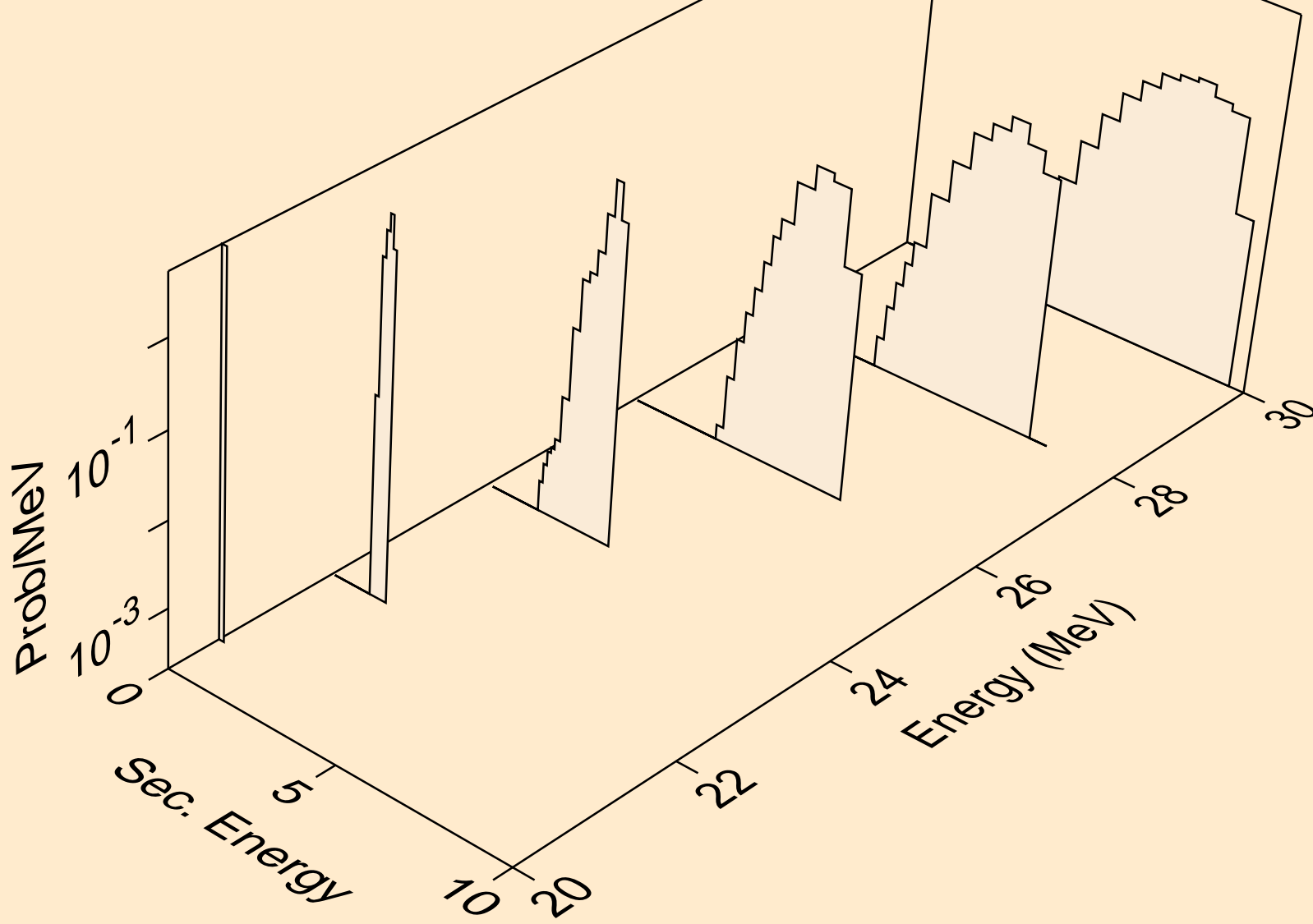

AG120 NEUTRON ACER TENDL-2019 LIBRARY; T=293.16K
deuterons from (n,n*)d

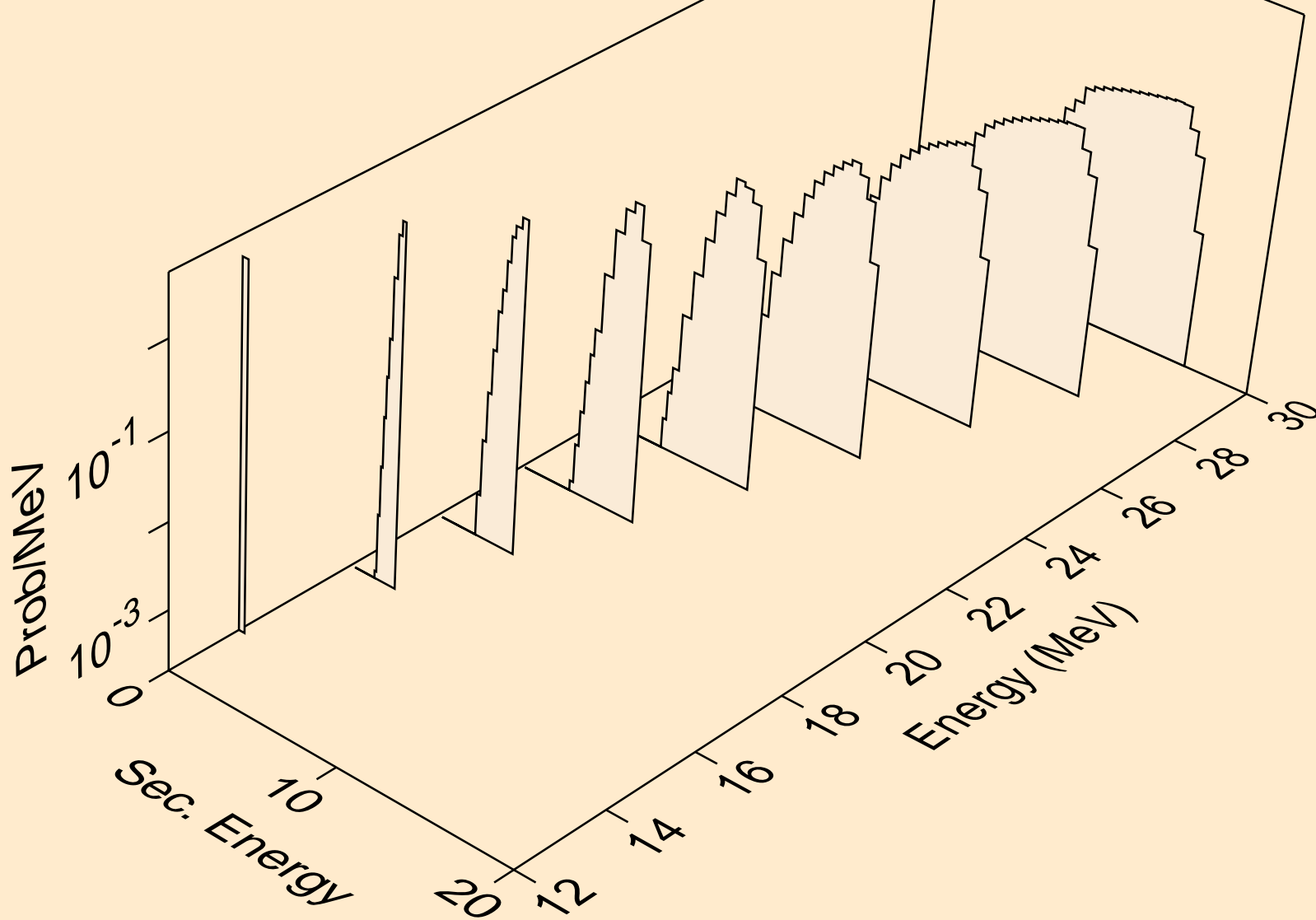

AG120 NEUTRON ACER TENDL-2019 LIBRARY; T=293.16K
deuterons from (n,d)

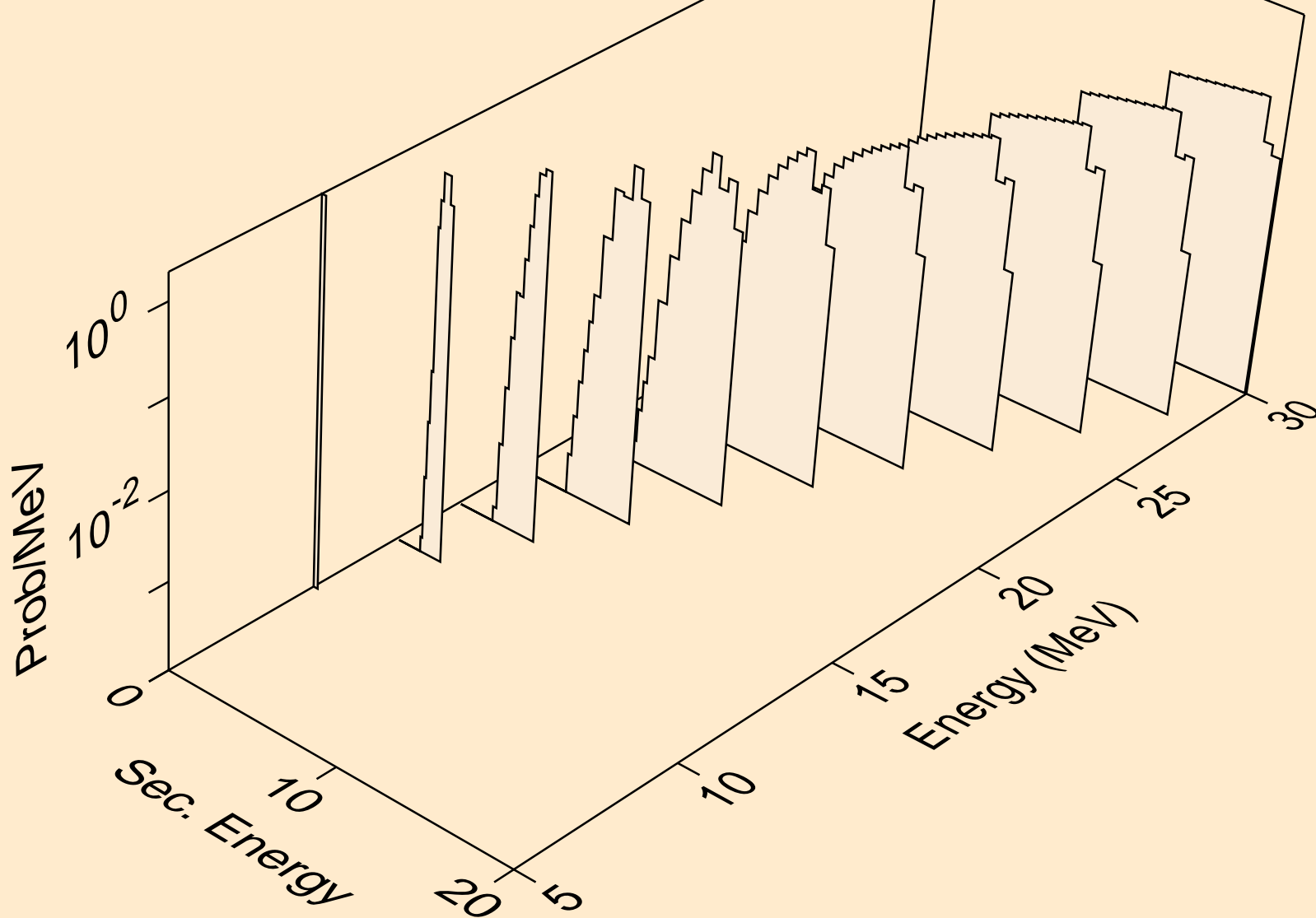

AG120 NEUTRON ACER TENDL-2019 LIBRARY; T=293.16K
tritons from (n,x)

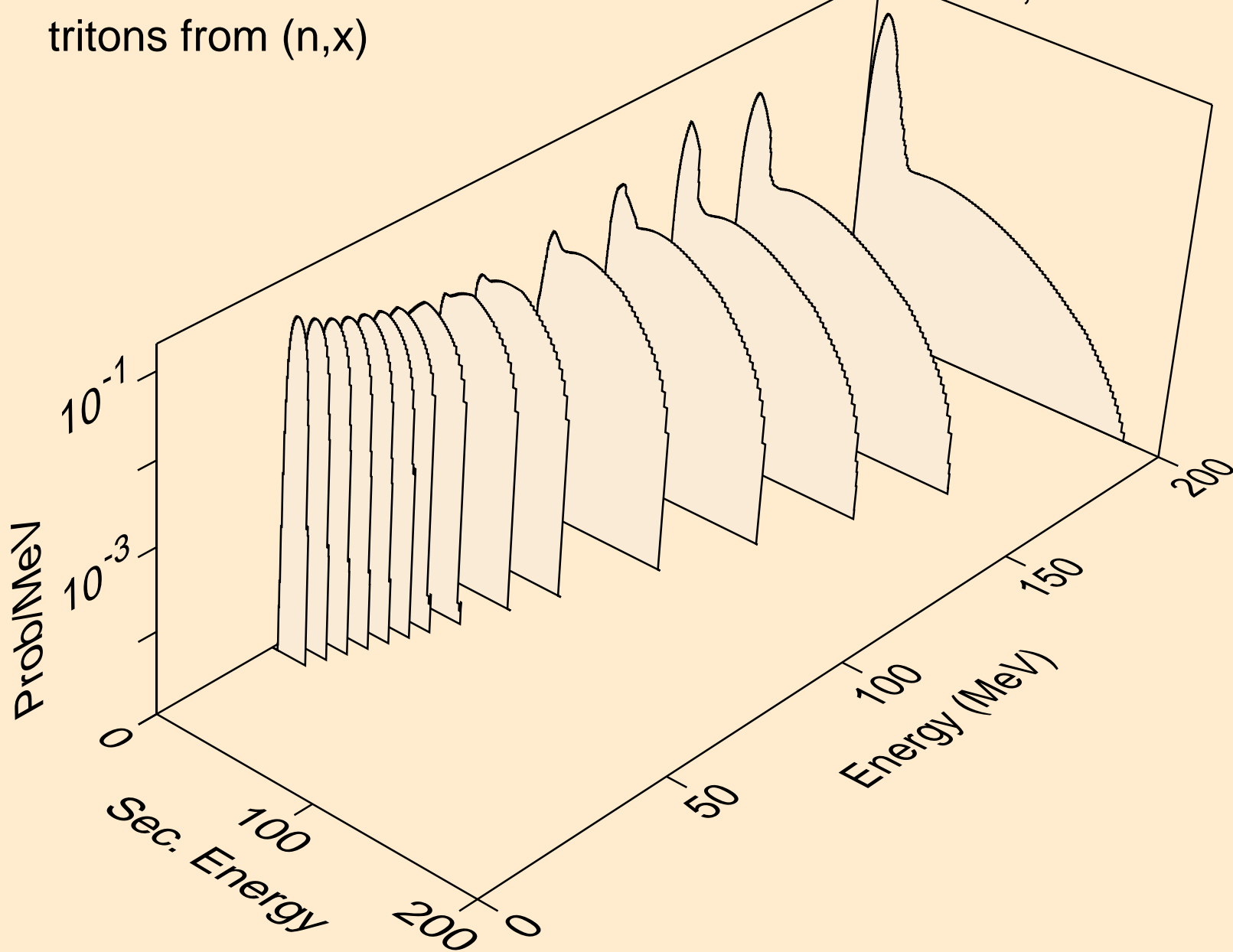

AG120 NEUTRON ACER TENDL-2019 LIBRARY; T=293.16K
tritons from (n,n*)t

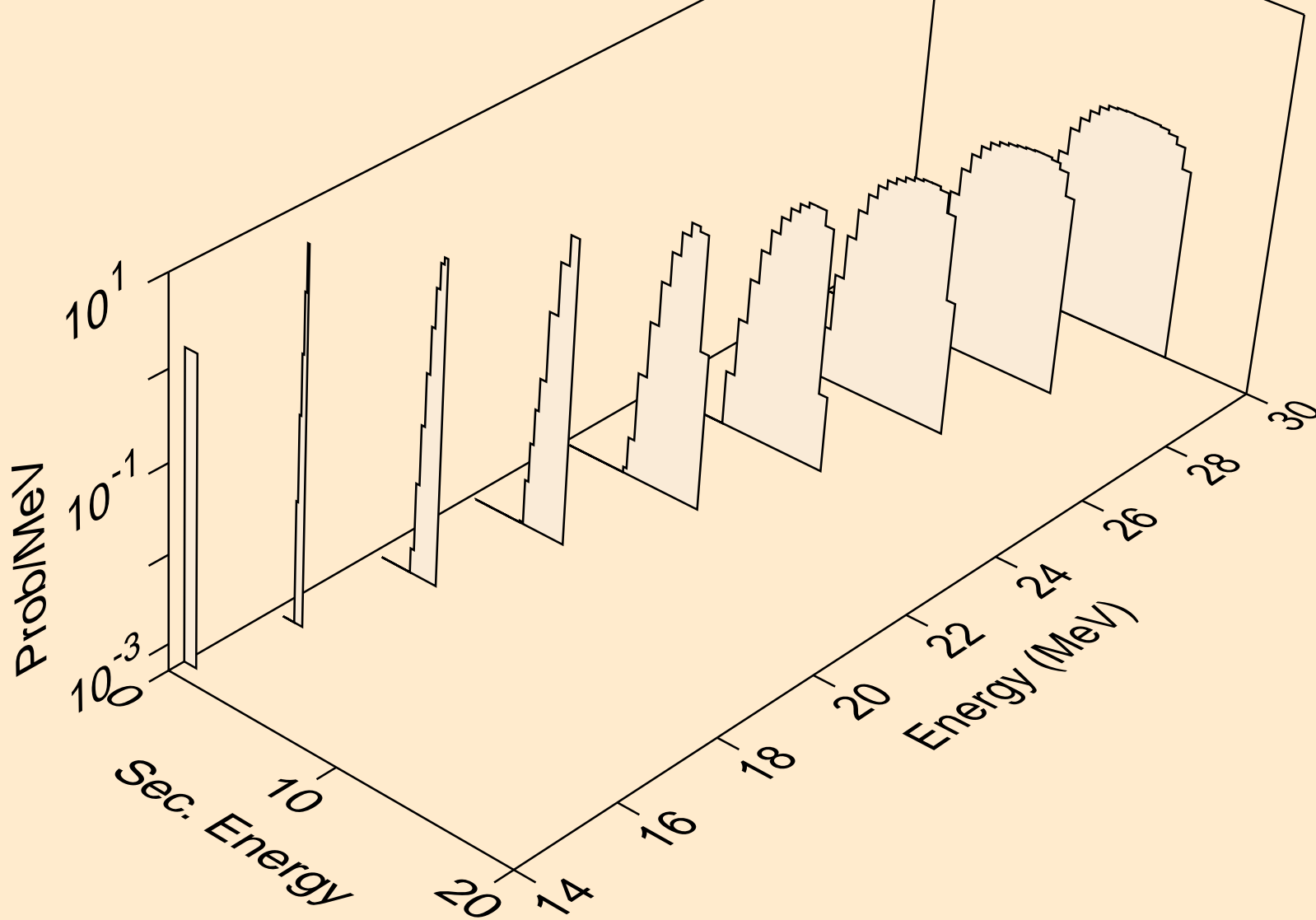

AG120 NEUTRON ACER TENDL-2019 LIBRARY; T=293.16K
tritons from (n,t)

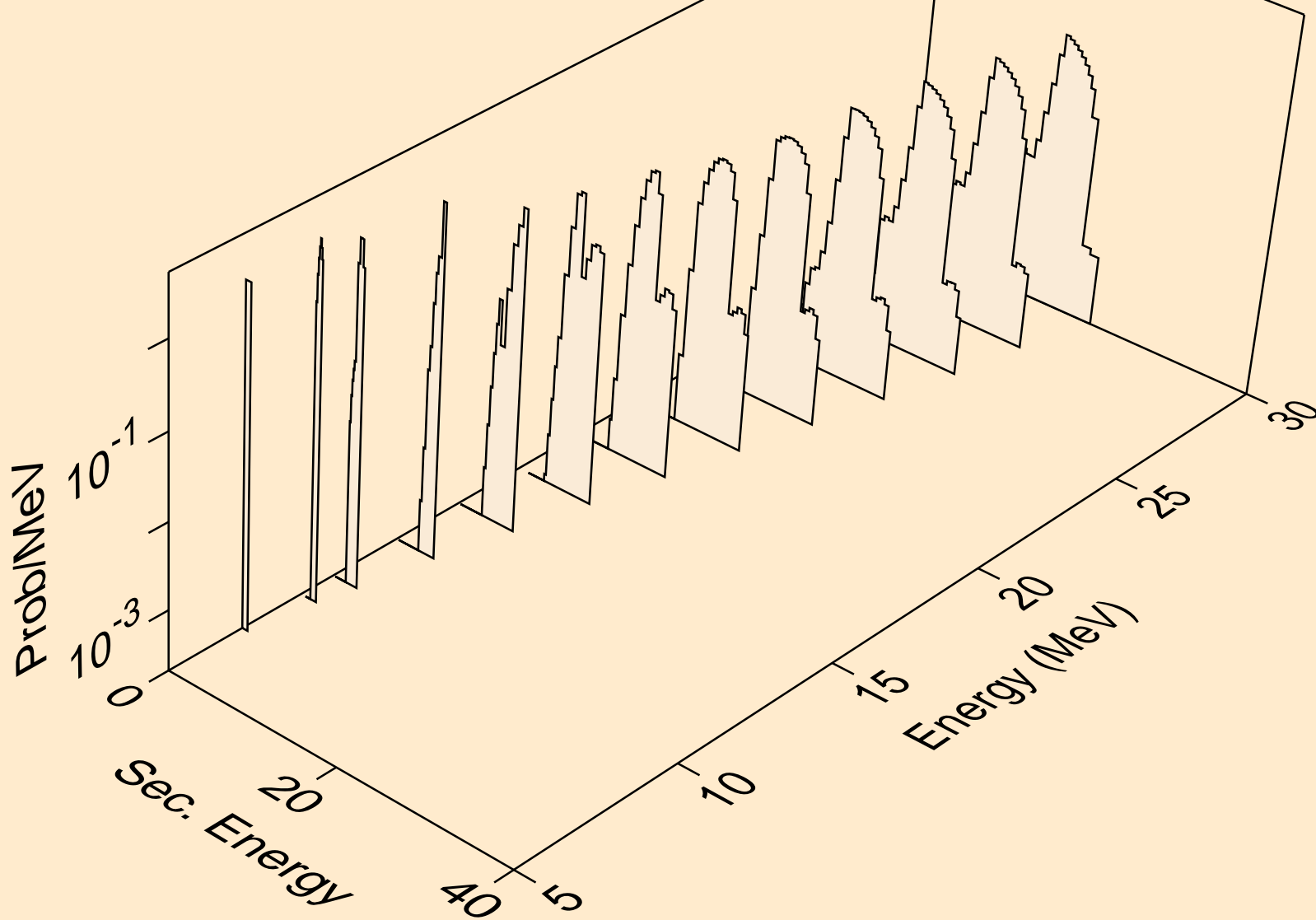

AG120 NEUTRON ACER TENDL-2019 LIBRARY; T=293.16K
he3s from (n,x)

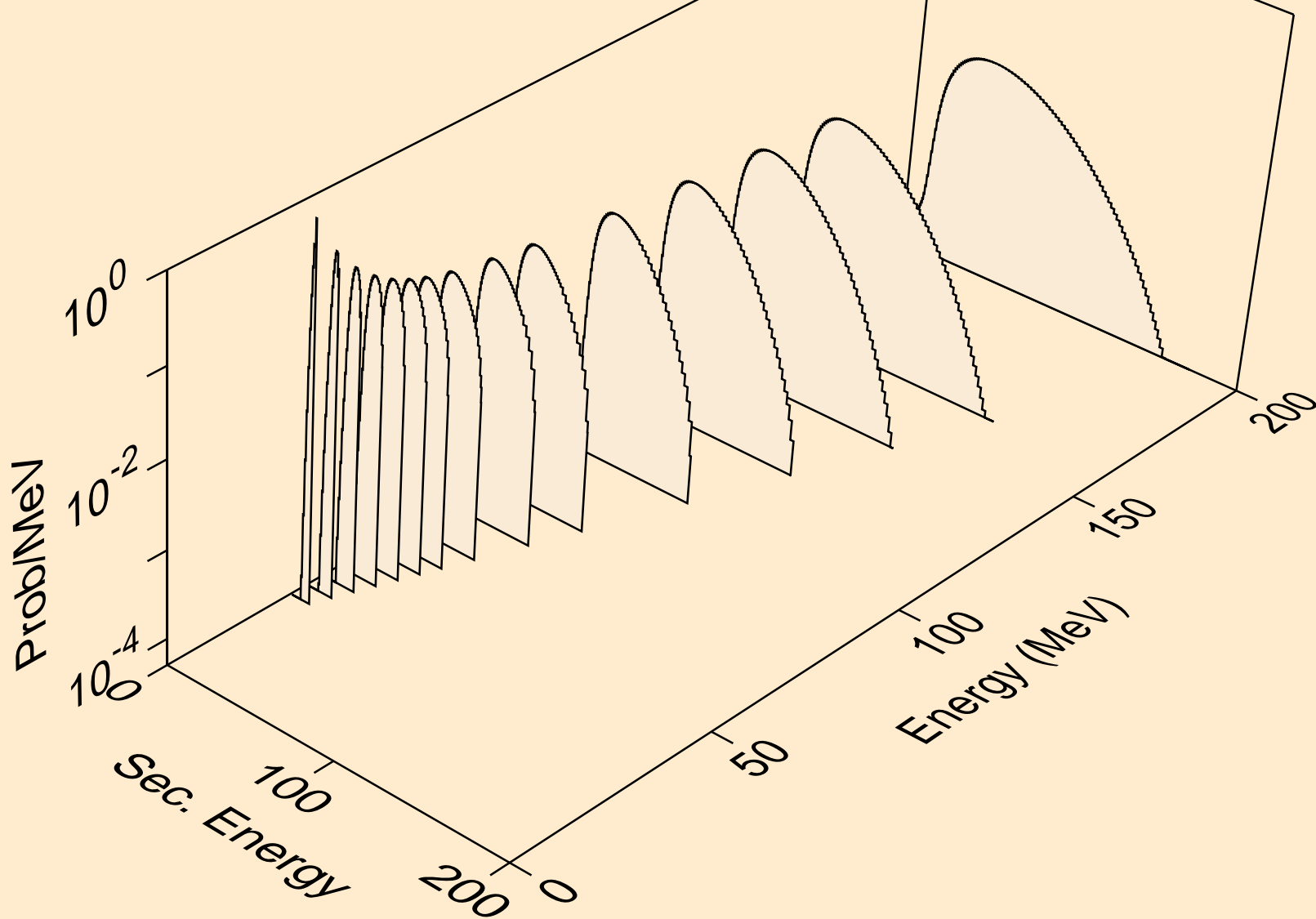

AG120 NEUTRON ACER TENDL-2019 LIBRARY; T=293.16K
he3s from (n,n*)he3

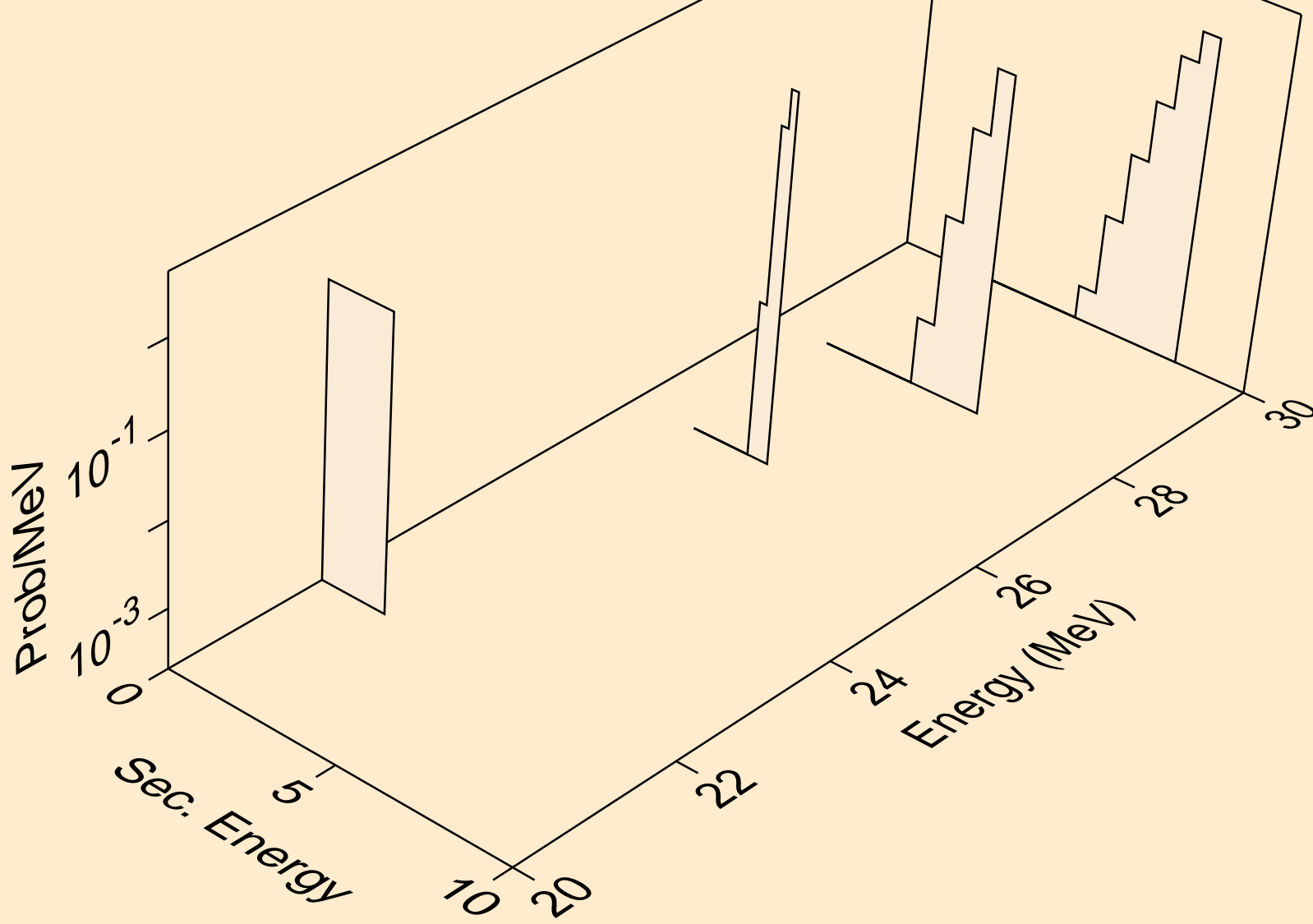

AG120 NEUTRON ACER TENDL-2019 LIBRARY; T=293.16K
he3s from (n,he3)

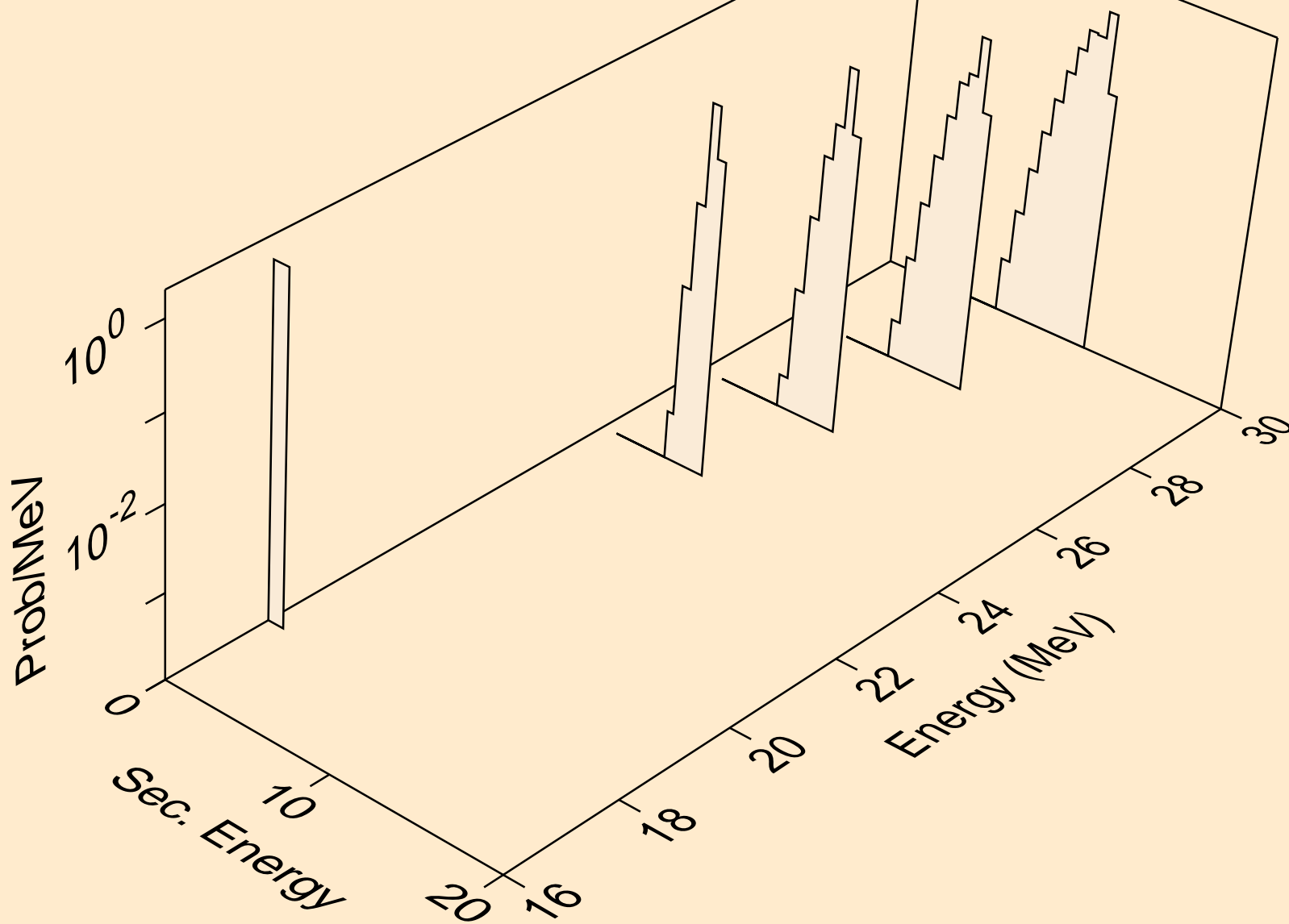

AG120 NEUTRON ACER TENDL-2019 LIBRARY; T=293.16K
alphas from (n,x)

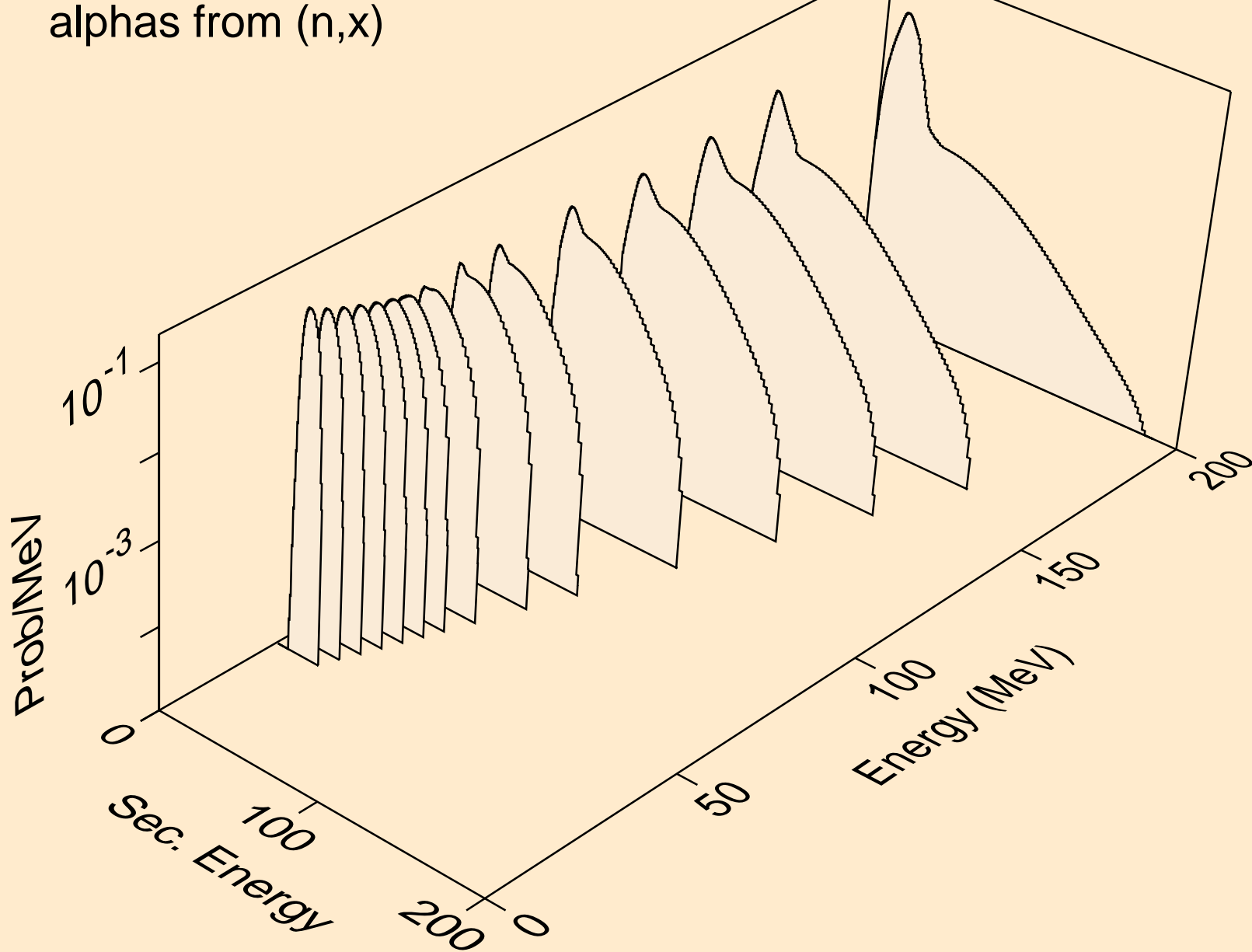

AG120 NEUTRON ACER TENDL-2019 LIBRARY; T=293.16K
alphas from (n,n*)a

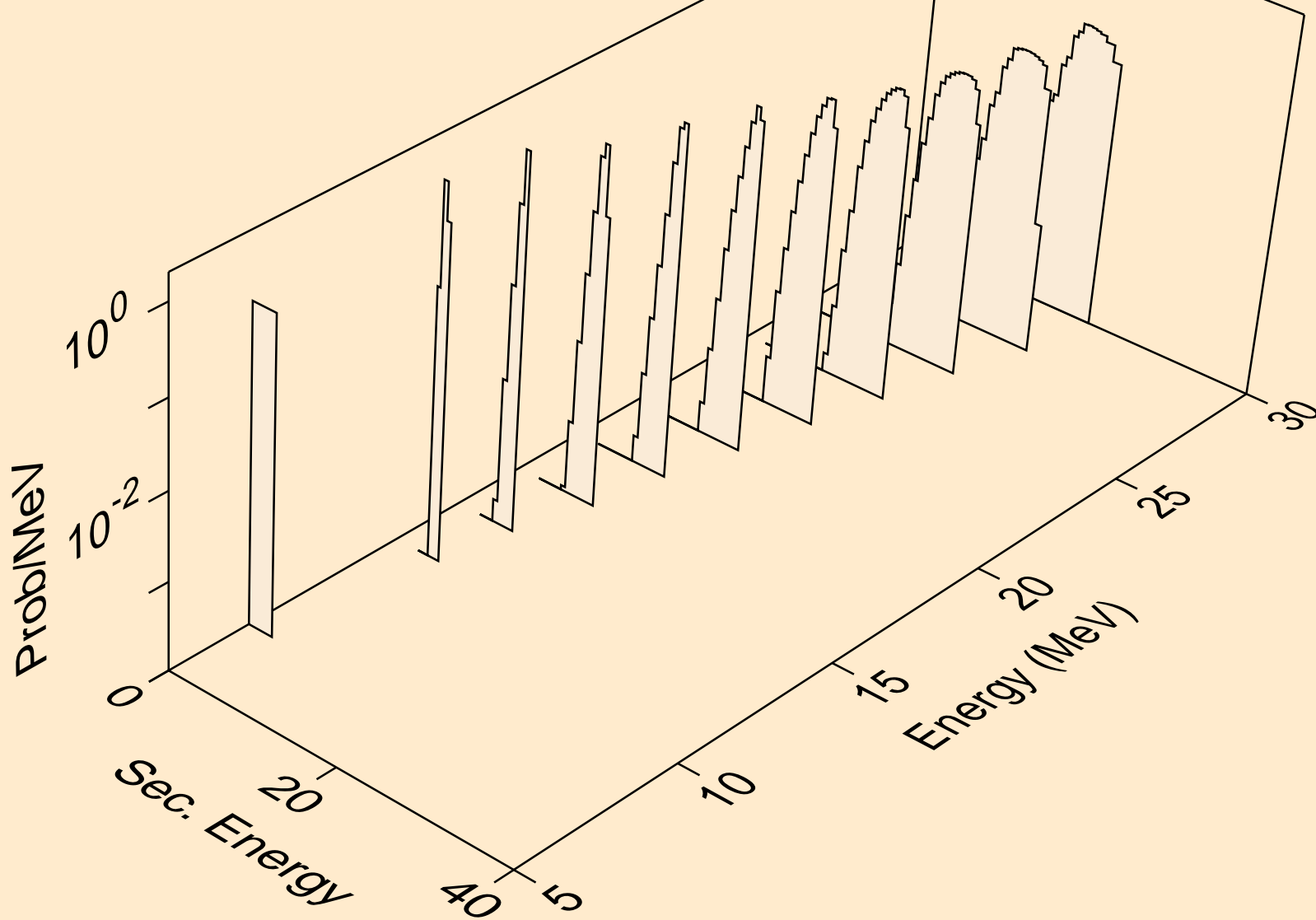

AG120 NEUTRON ACER TENDL-2019 LIBRARY; T=293.16K
alphas from (n,2n)a

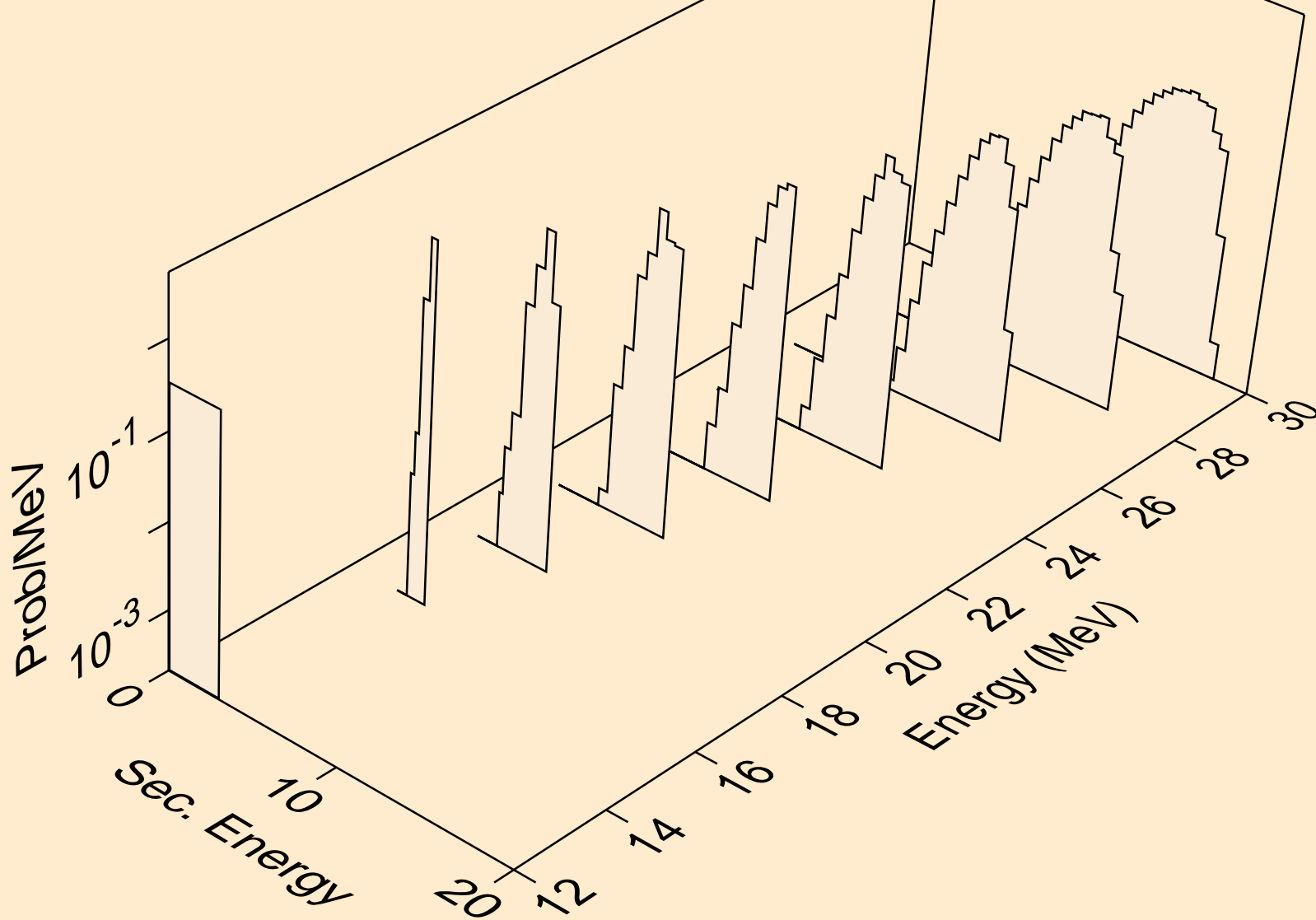

AG120 NEUTRON ACER TENDL-2019 LIBRARY; T=293.16K
alphas from (n,3n)a

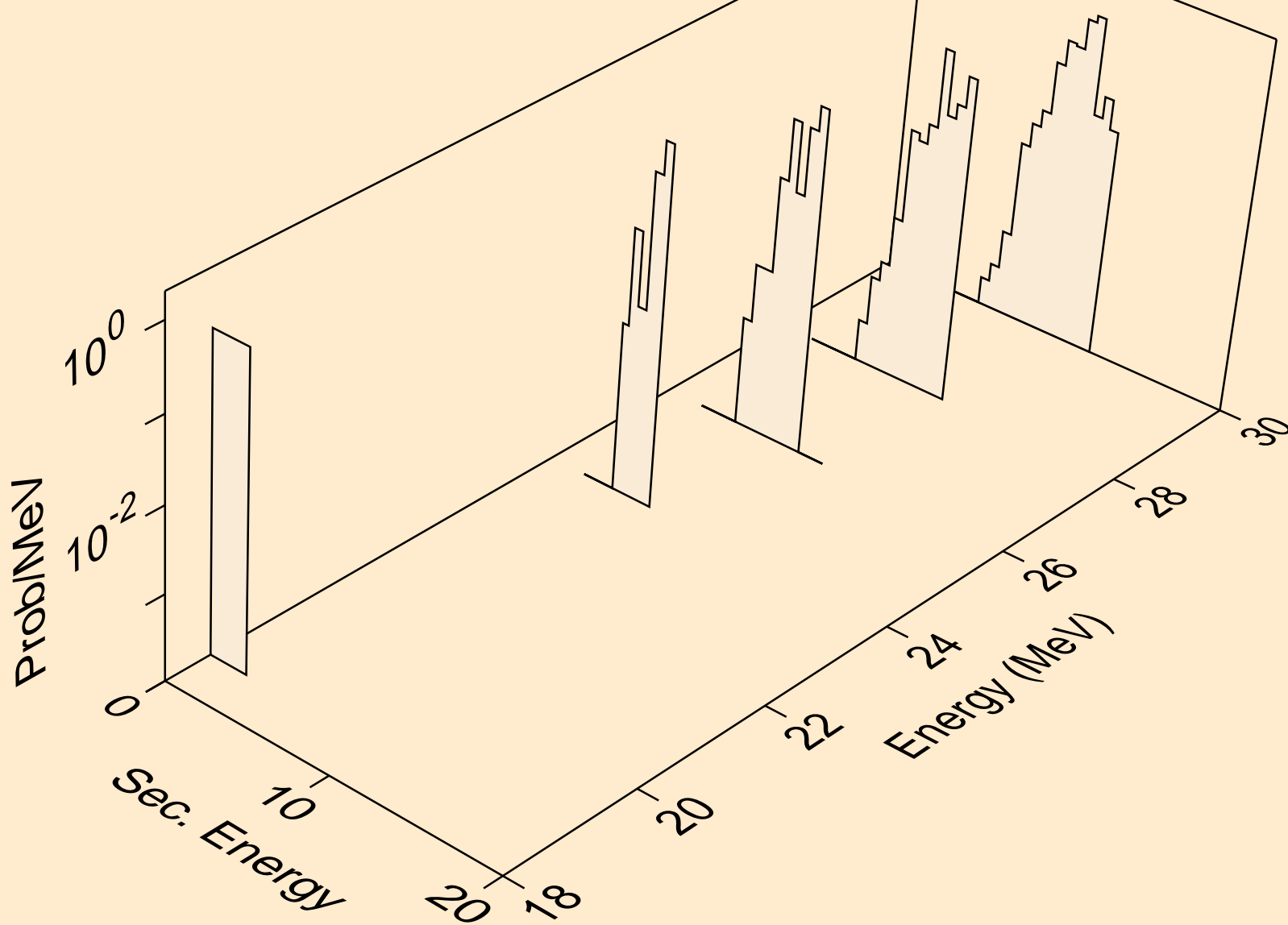

AG120 NEUTRON ACER TENDL-2019 LIBRARY; T=293.16K
alphas from (n,a)

