

AR042 NEUTRON ACER TENDL-2019 LIBRARY; T=293.16K  
Principal cross sections

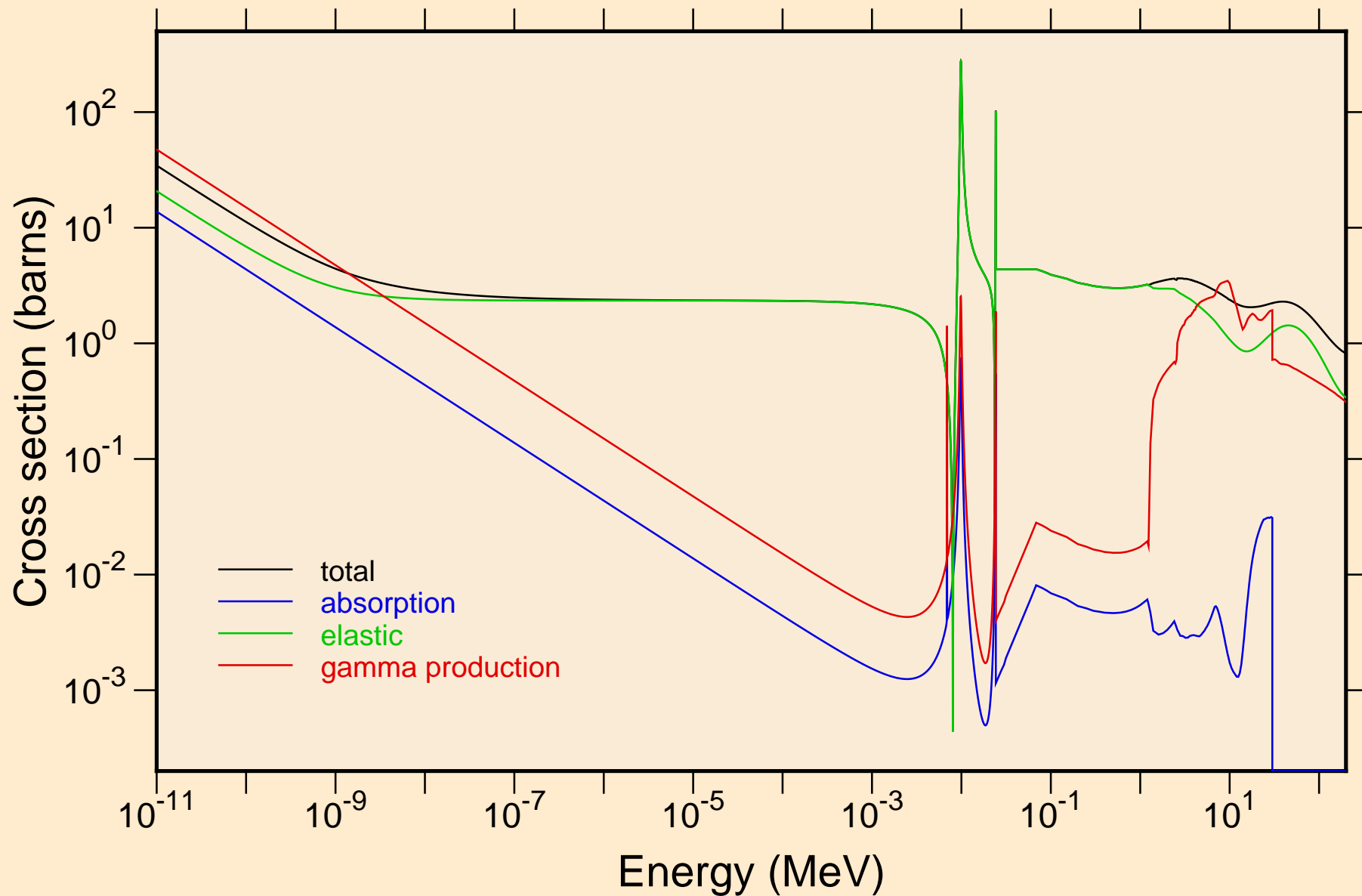

AR042 NEUTRON ACER TENDL-2019 LIBRARY; T=293.16K  
Heating

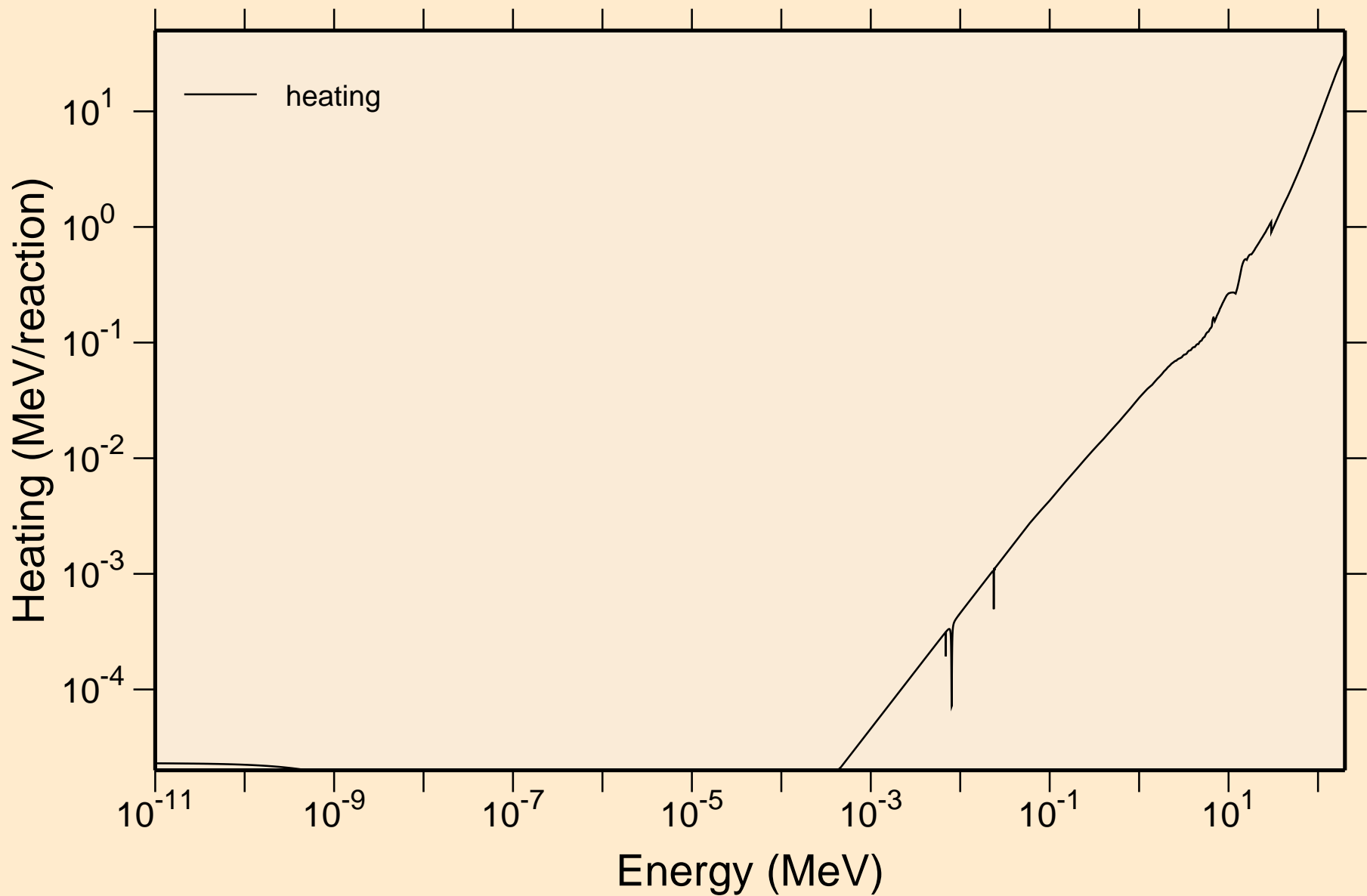

AR042 NEUTRON ACER TENDL-2019 LIBRARY; T=293.16K  
Damage

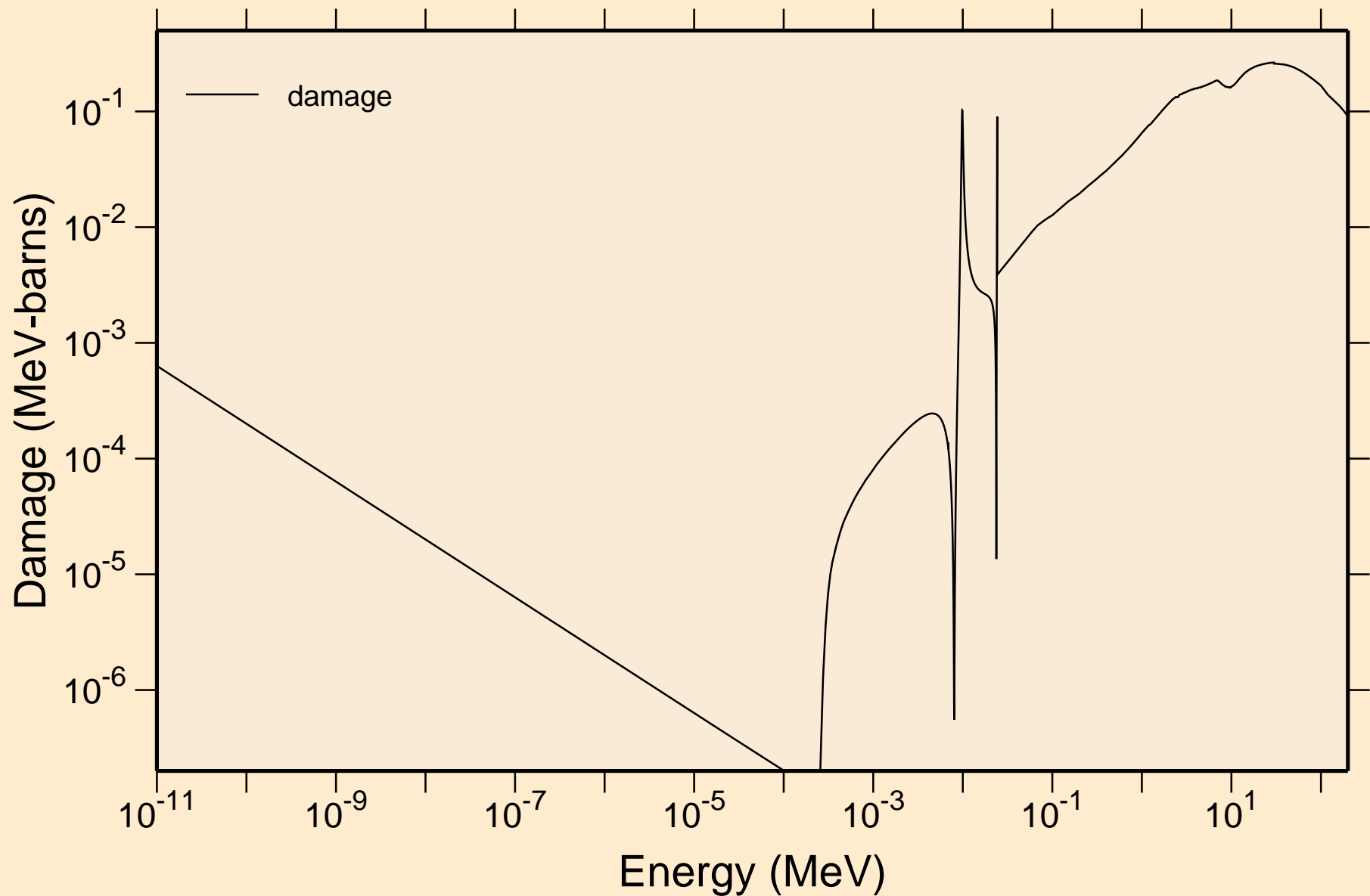

AR042 NEUTRON ACER TENDL-2019 LIBRARY; T=293.16K  
Non-threshold reactions

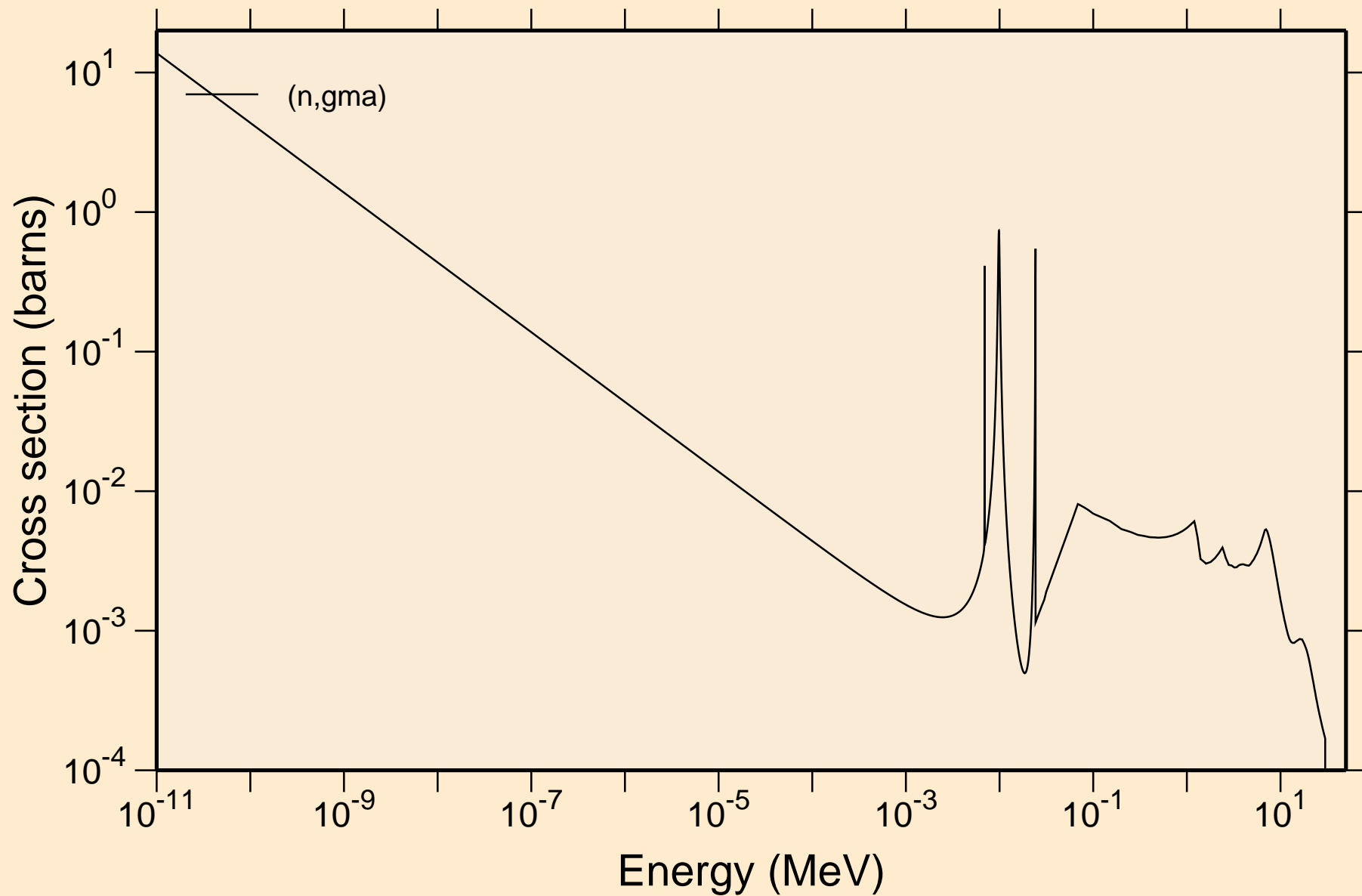

# AR042 NEUTRON ACER TENDL-2019 LIBRARY; T=293.16K

## Principal cross sections

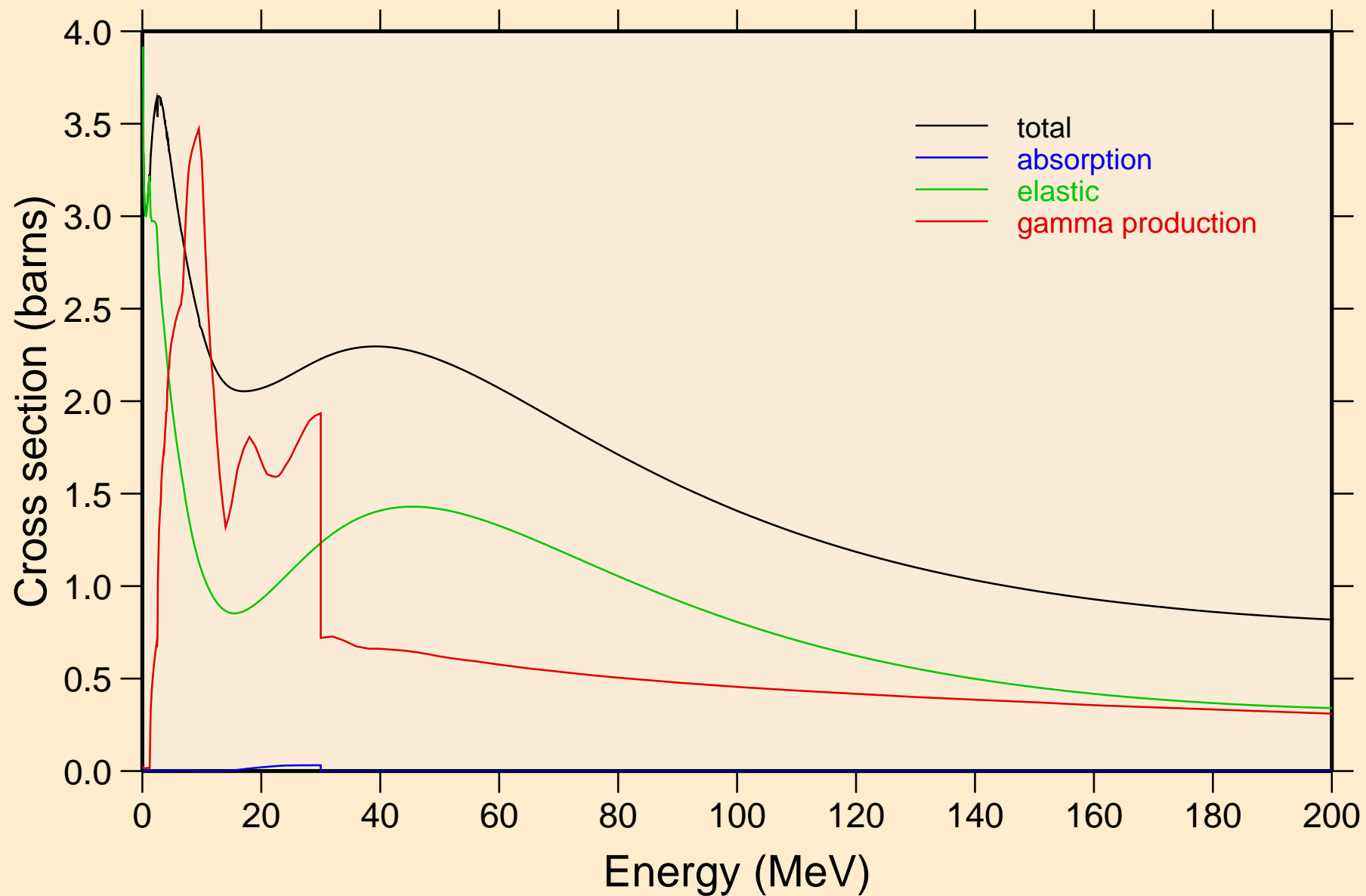

AR042 NEUTRON ACER TENDL-2019 LIBRARY; T=293.16K  
Heating

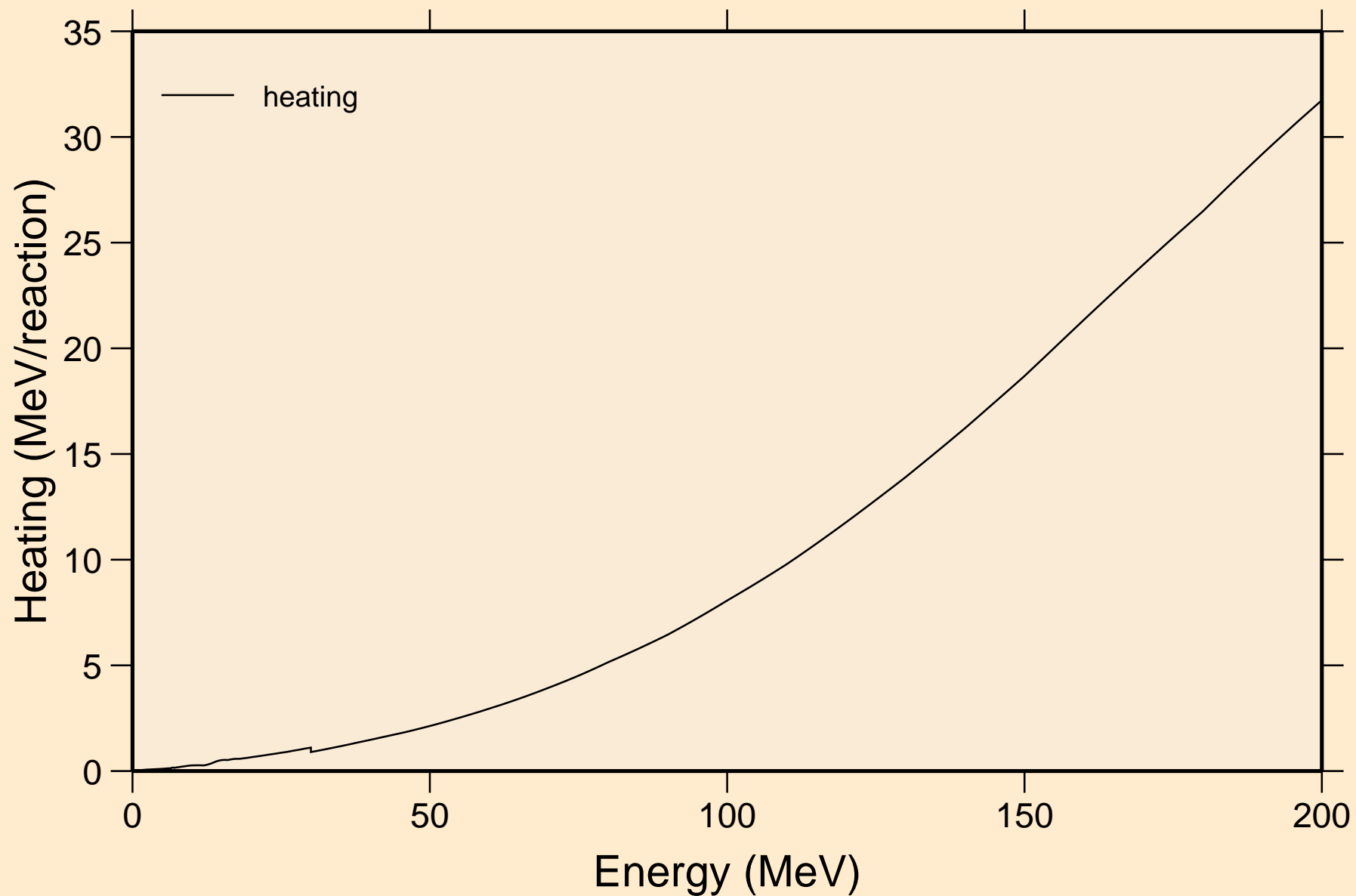

AR042 NEUTRON ACER TENDL-2019 LIBRARY; T=293.16K  
Damage

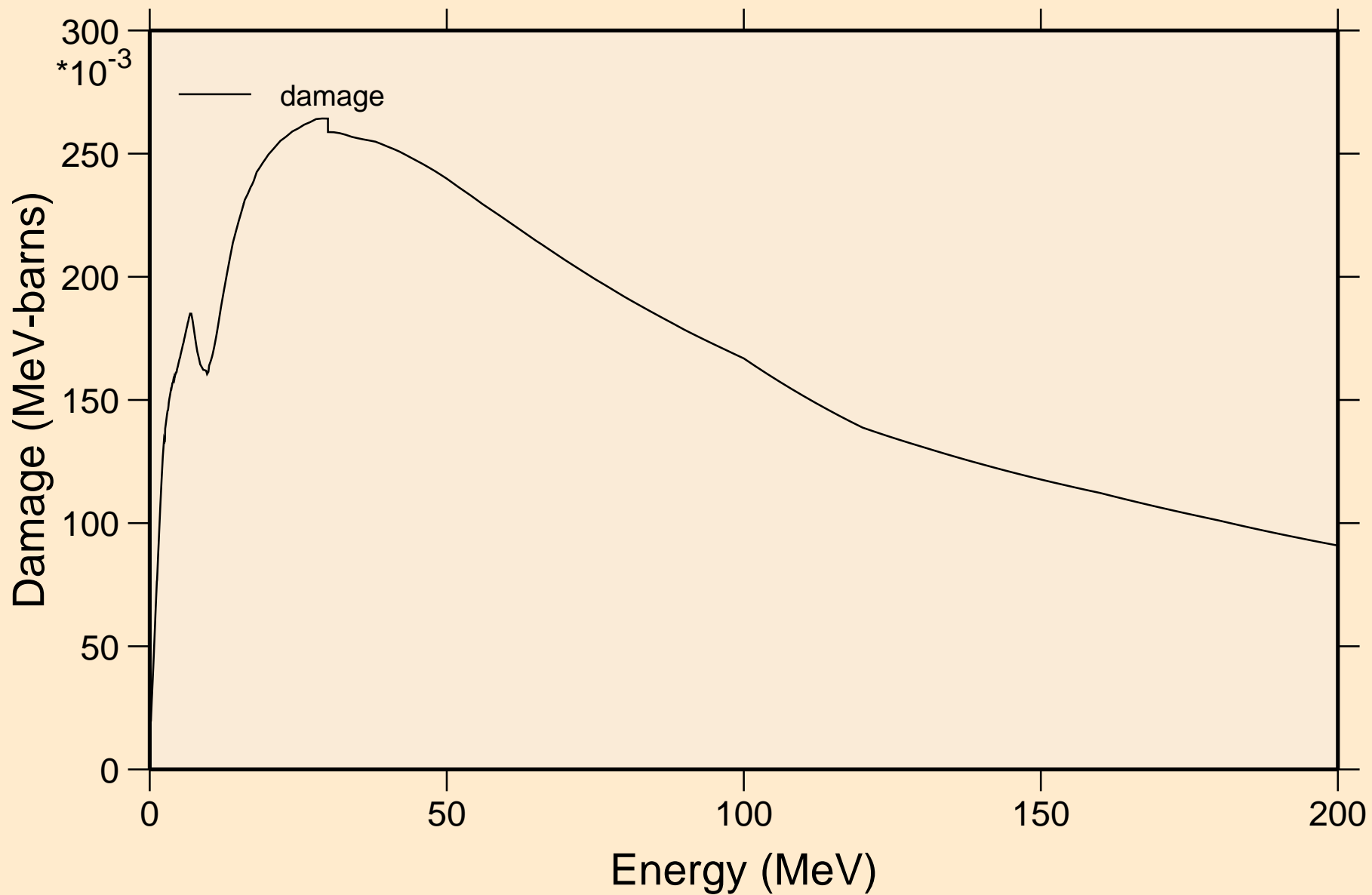

AR042 NEUTRON ACER TENDL-2019 LIBRARY; T=293.16K  
Non-threshold reactions

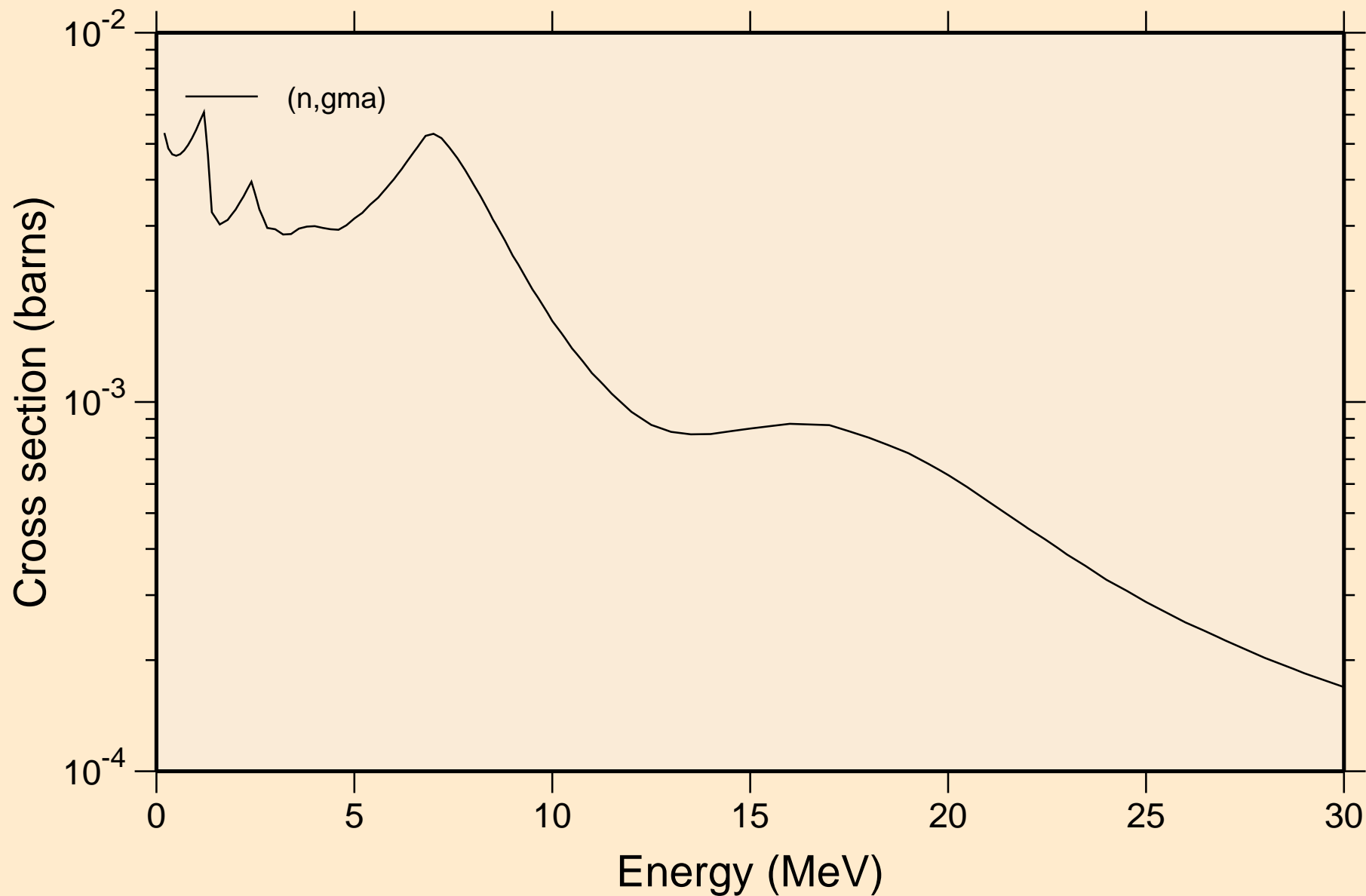



AR042 NEUTRON ACER TENDL-2019 LIBRARY; T=293.16K  
Inelastic levels

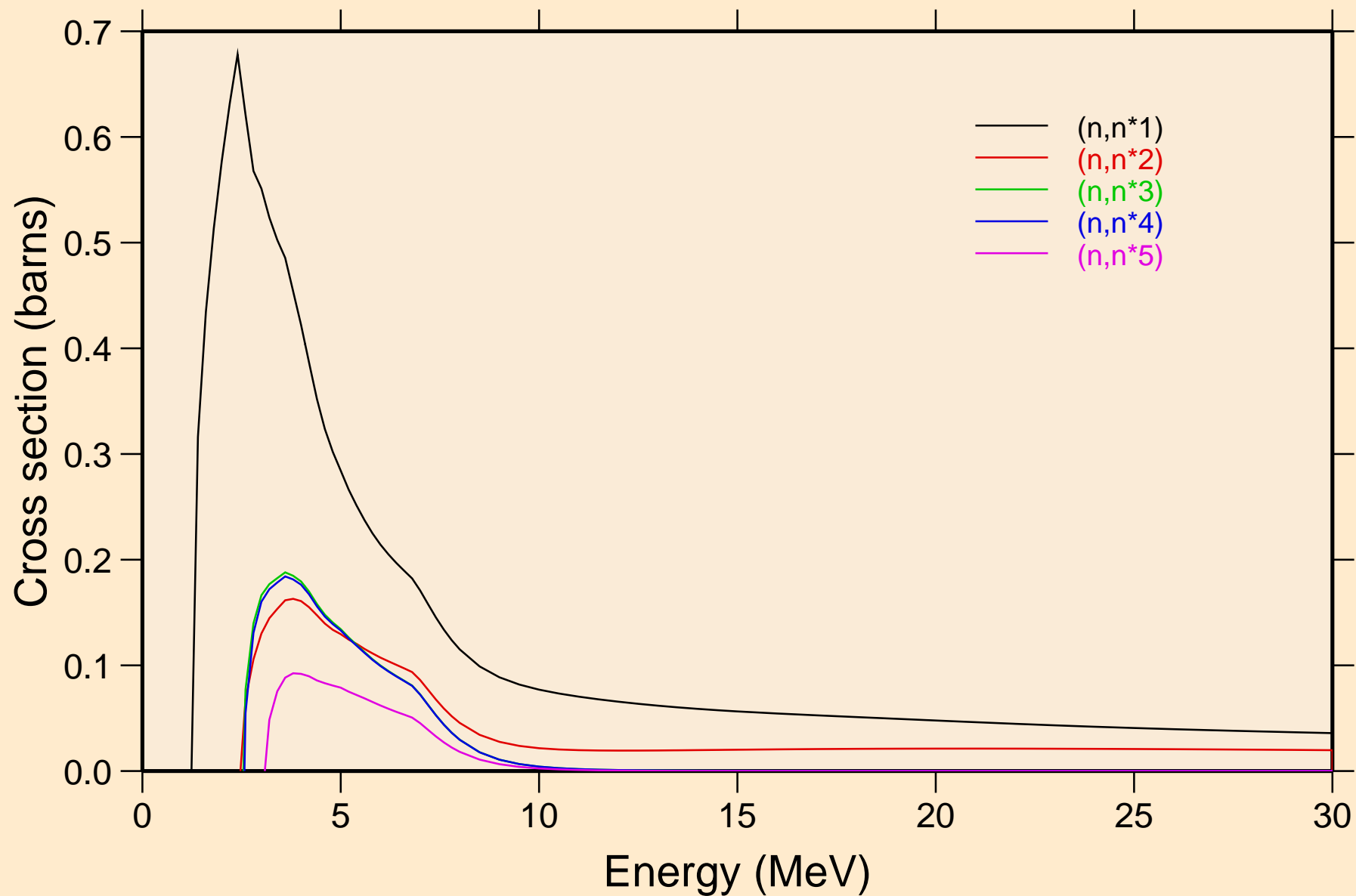

AR042 NEUTRON ACER TENDL-2019 LIBRARY; T=293.16K  
Inelastic levels

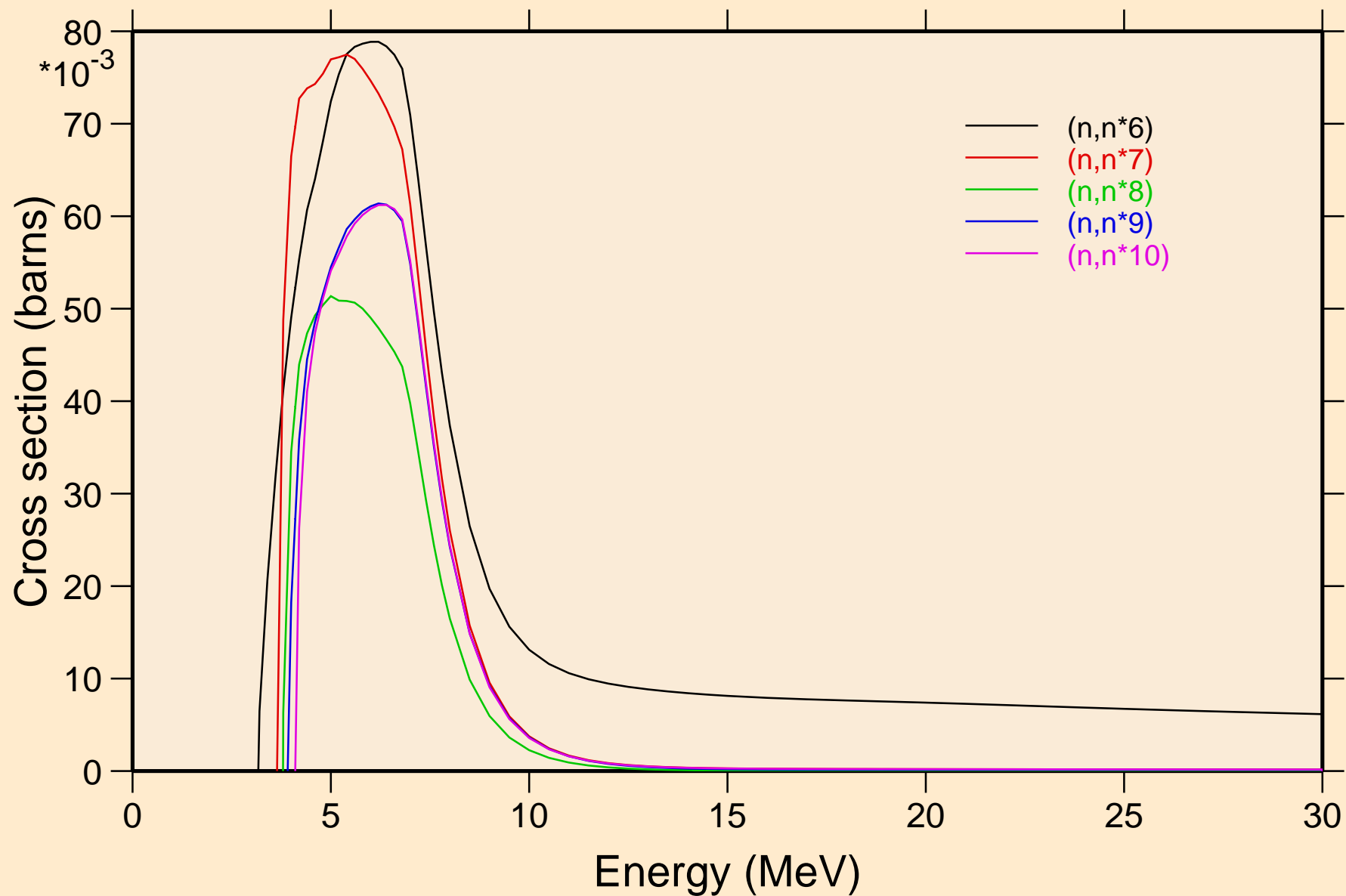

AR042 NEUTRON ACER TENDL-2019 LIBRARY; T=293.16K  
Inelastic levels

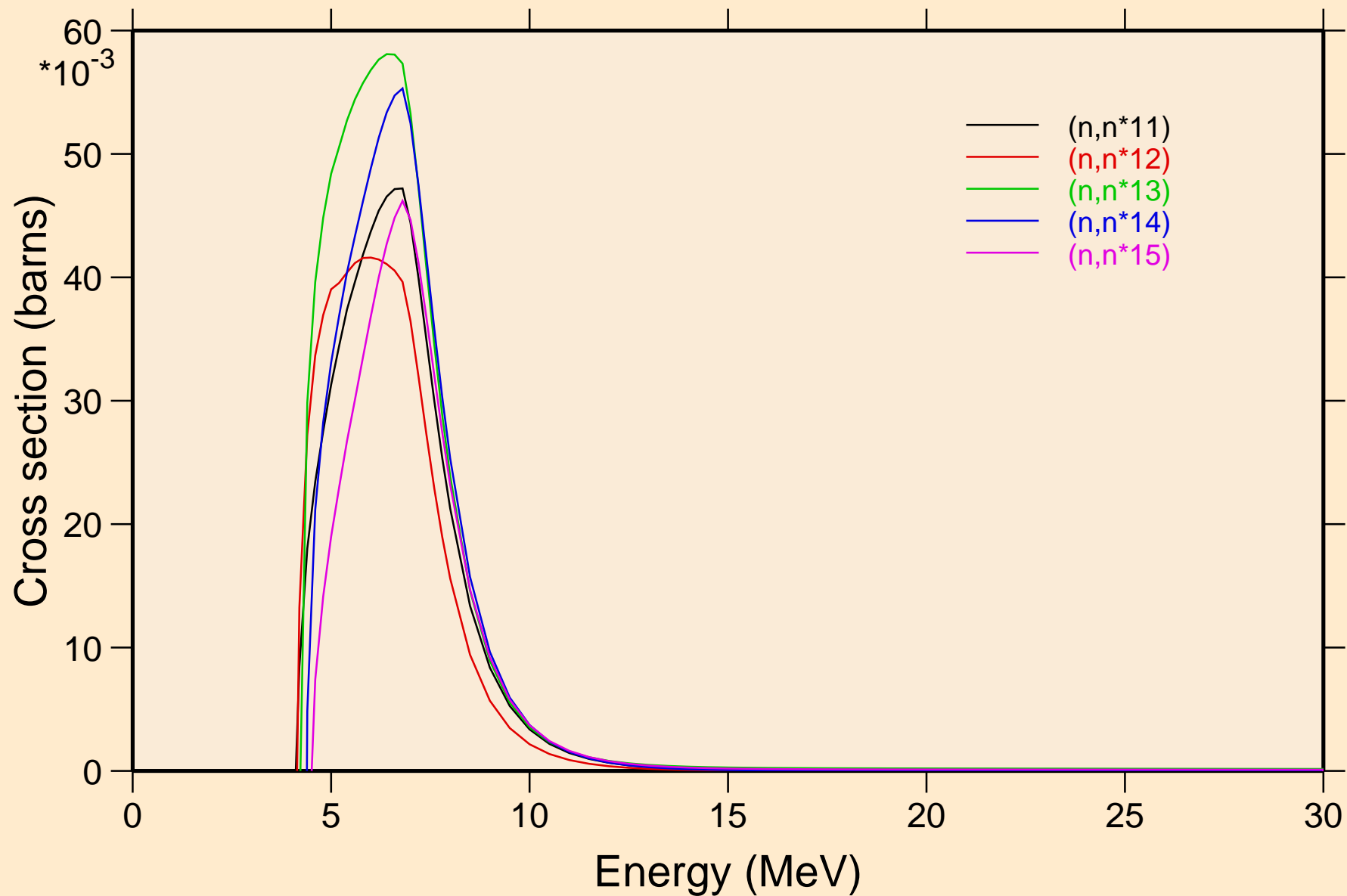

AR042 NEUTRON ACER TENDL-2019 LIBRARY; T=293.16K  
Inelastic levels

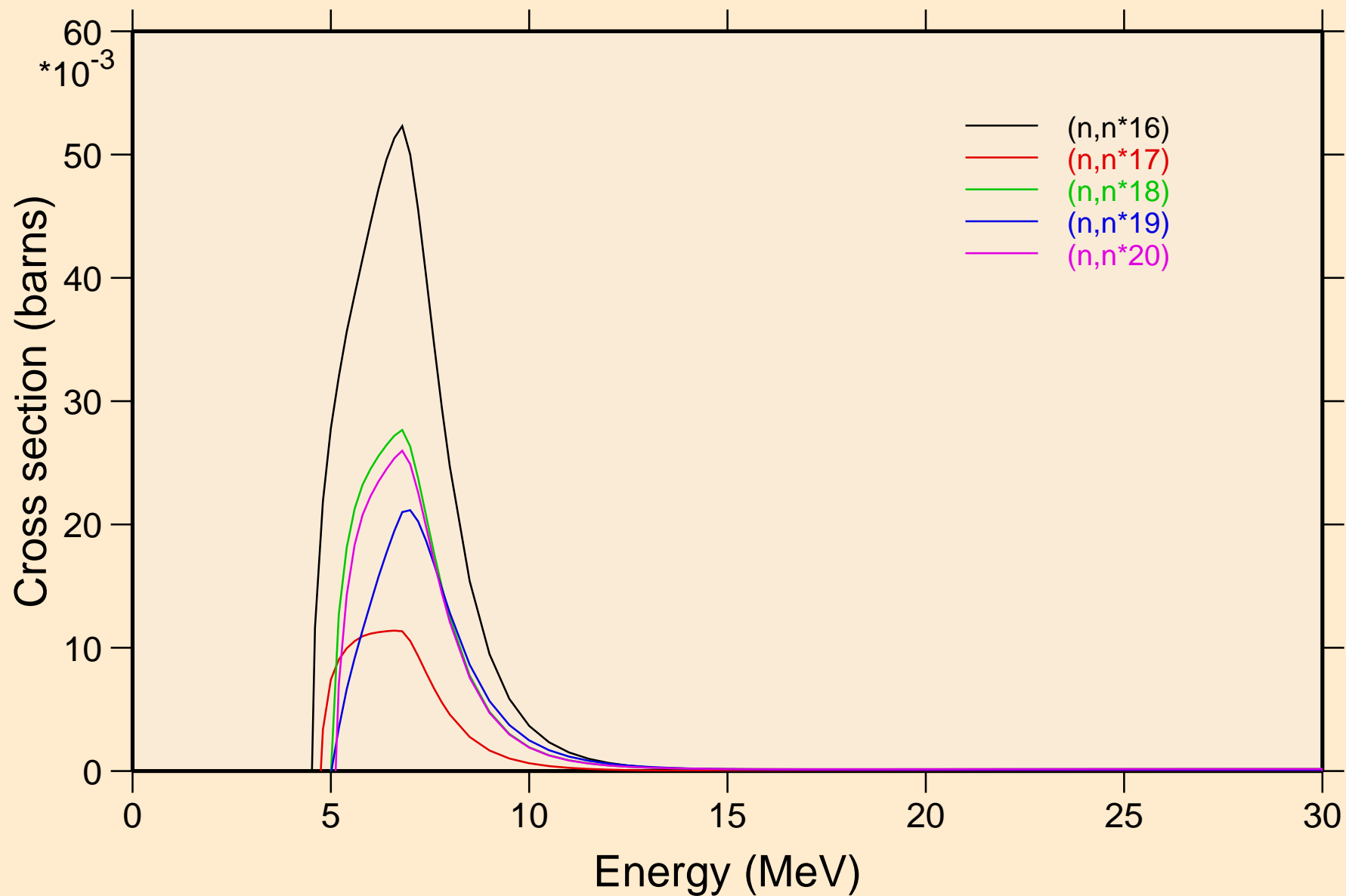

AR042 NEUTRON ACER TENDL-2019 LIBRARY; T=293.16K  
Inelastic levels

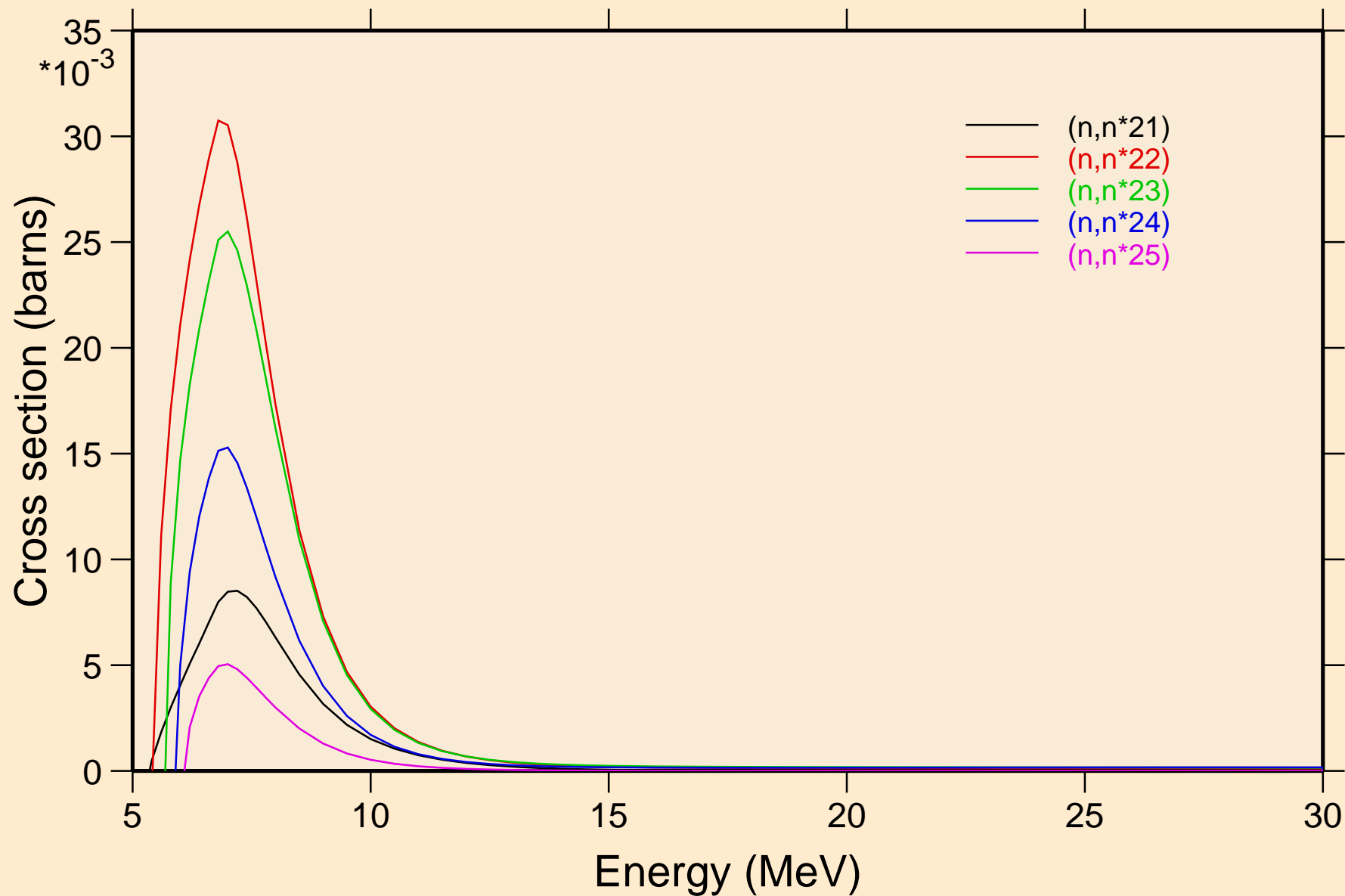

AR042 NEUTRON ACER TENDL-2019 LIBRARY; T=293.16K  
Inelastic levels

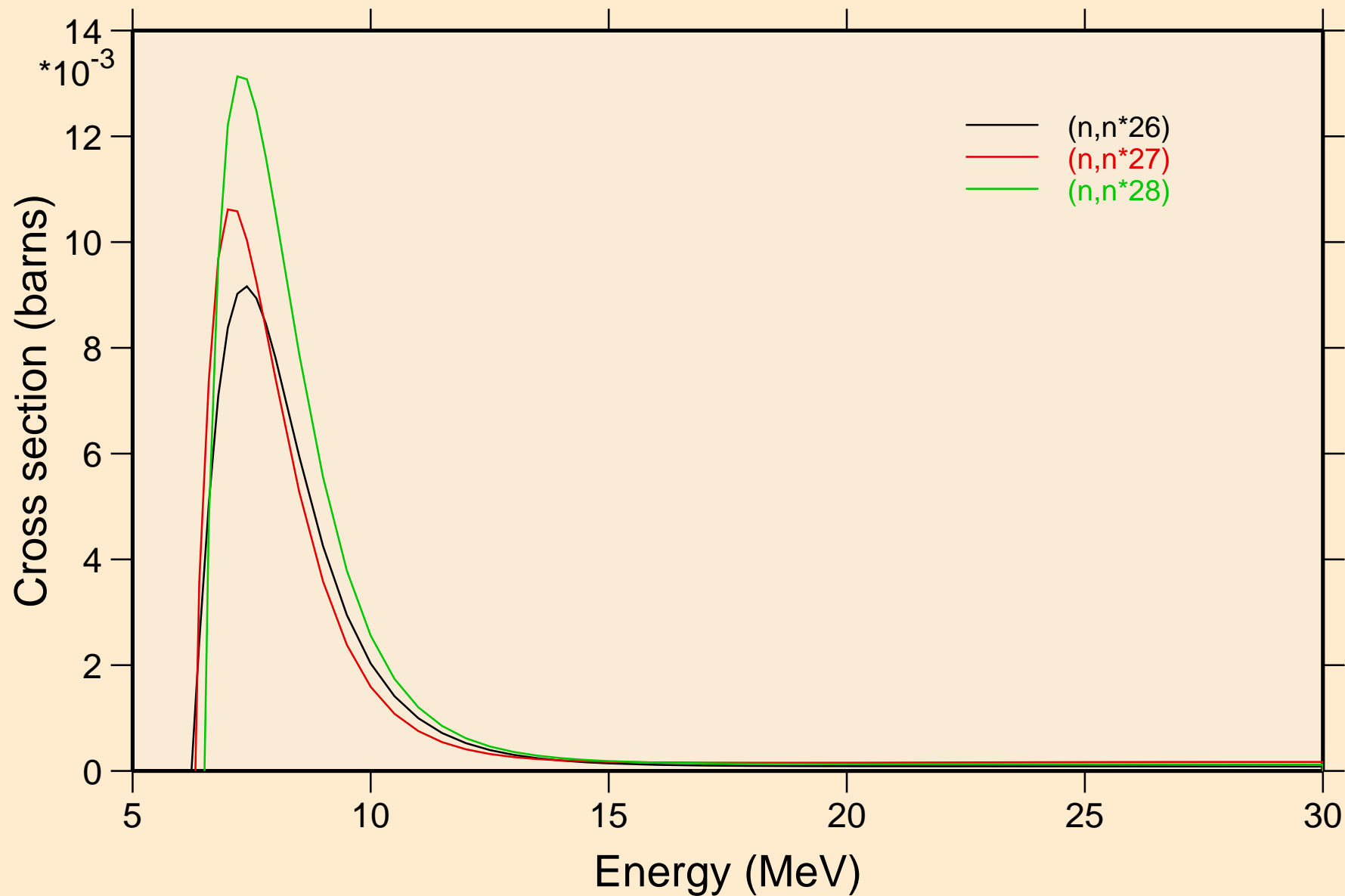

AR042 NEUTRON ACER TENDL-2019 LIBRARY; T=293.16K  
Threshold reactions

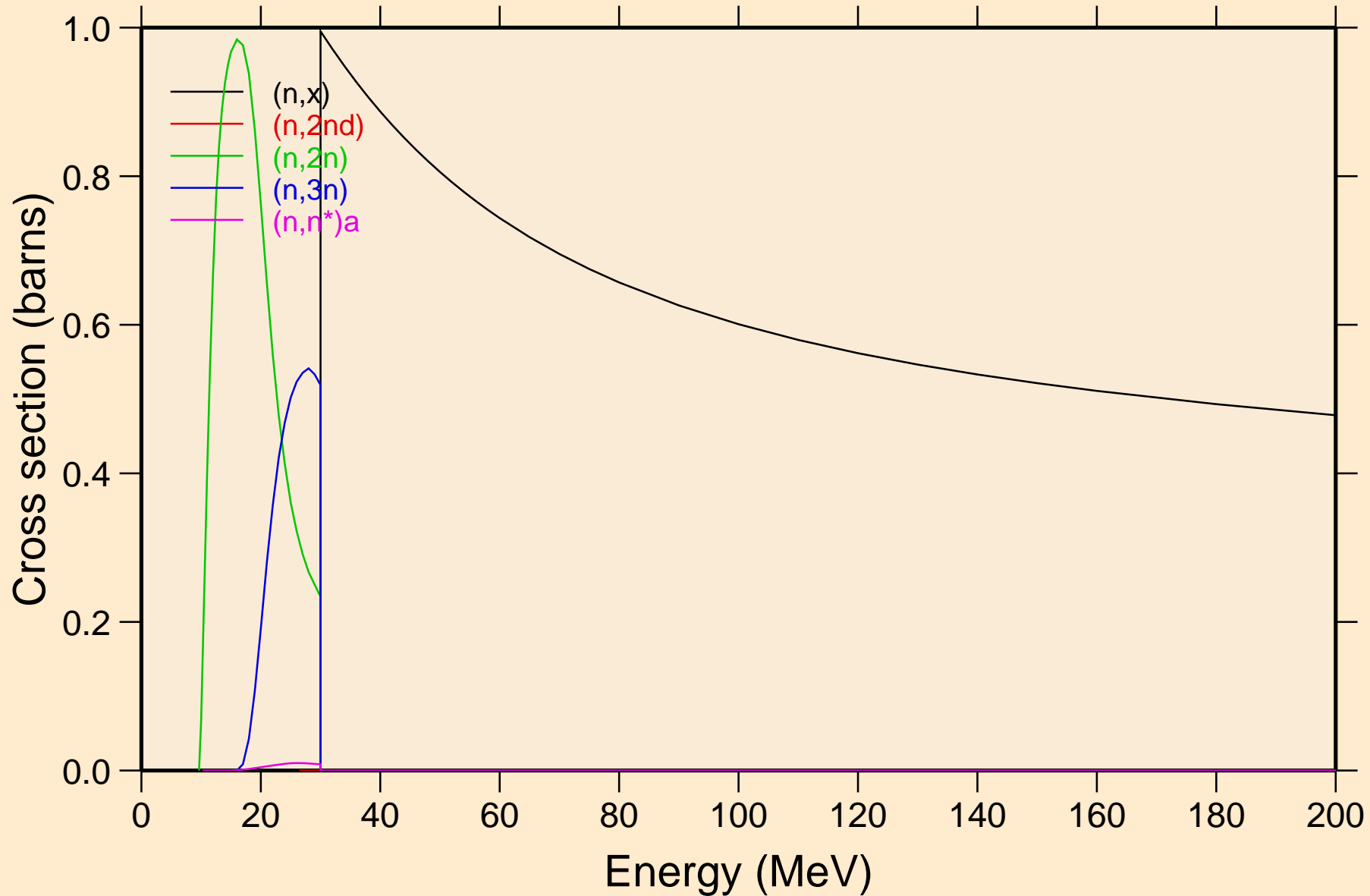

AR042 NEUTRON ACER TENDL-2019 LIBRARY; T=293.16K  
Threshold reactions

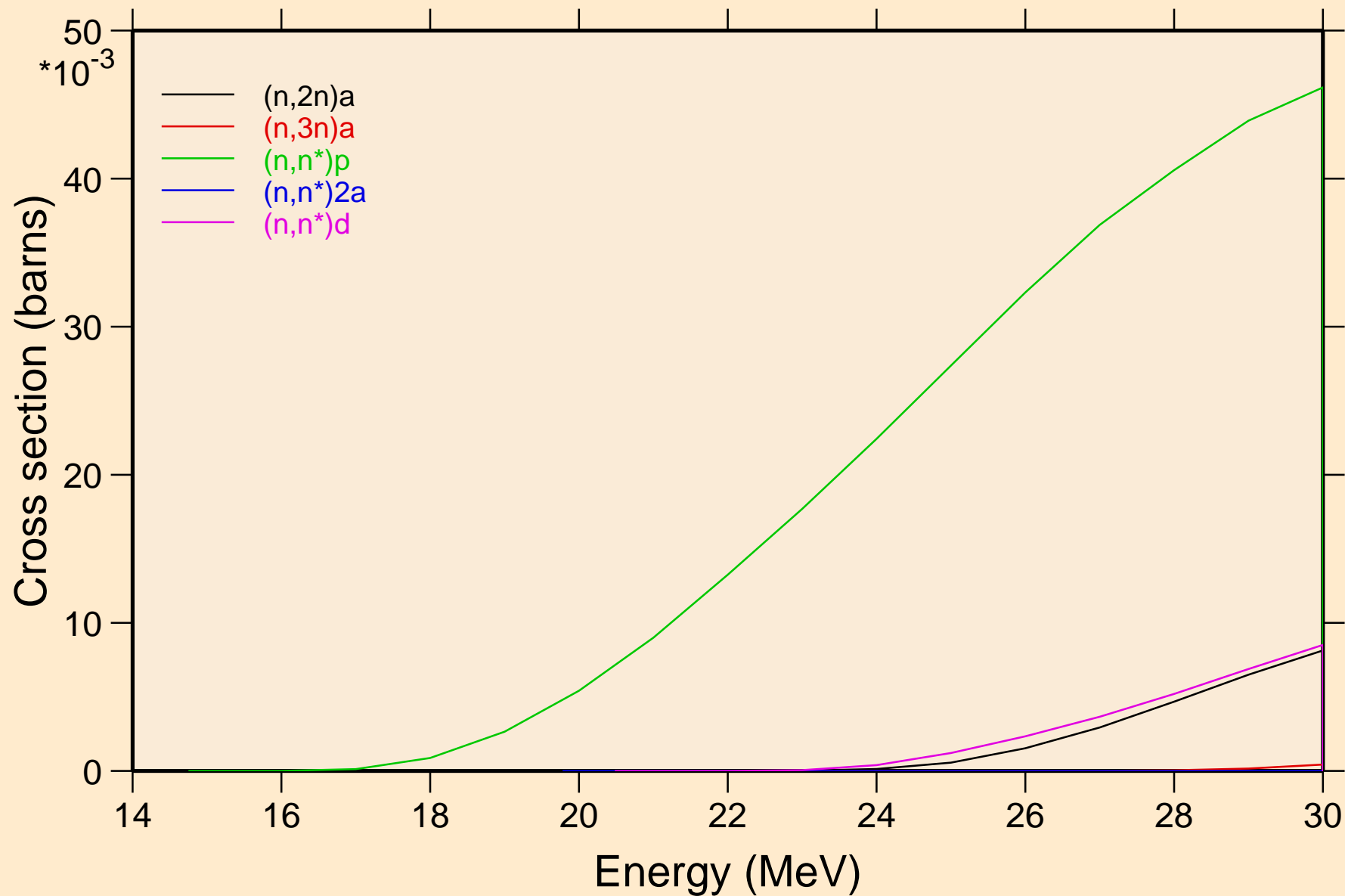



AR042 NEUTRON ACER TENDL-2019 LIBRARY; T=293.16K  
Threshold reactions

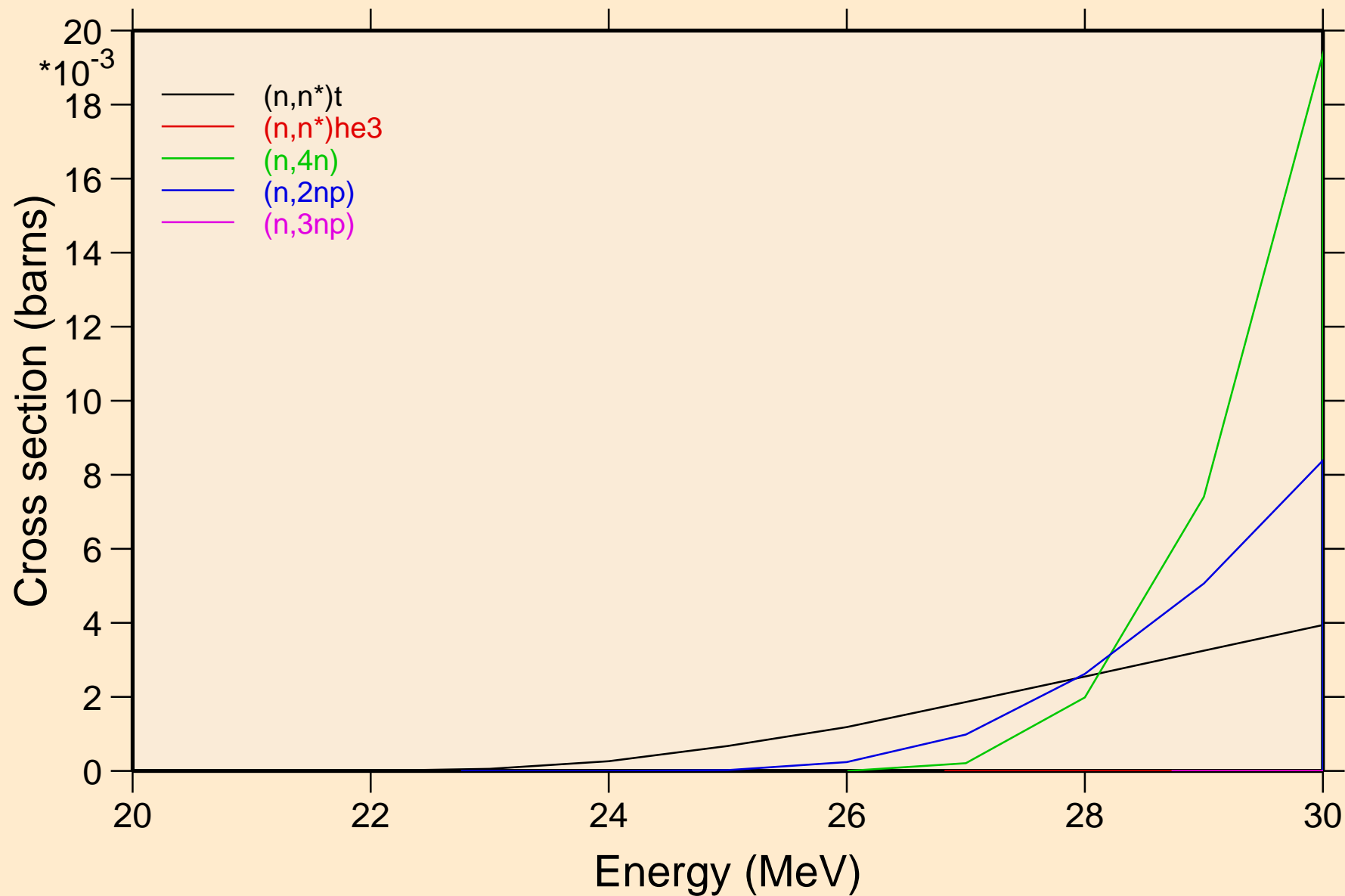

AR042 NEUTRON ACER TENDL-2019 LIBRARY; T=293.16K  
Threshold reactions

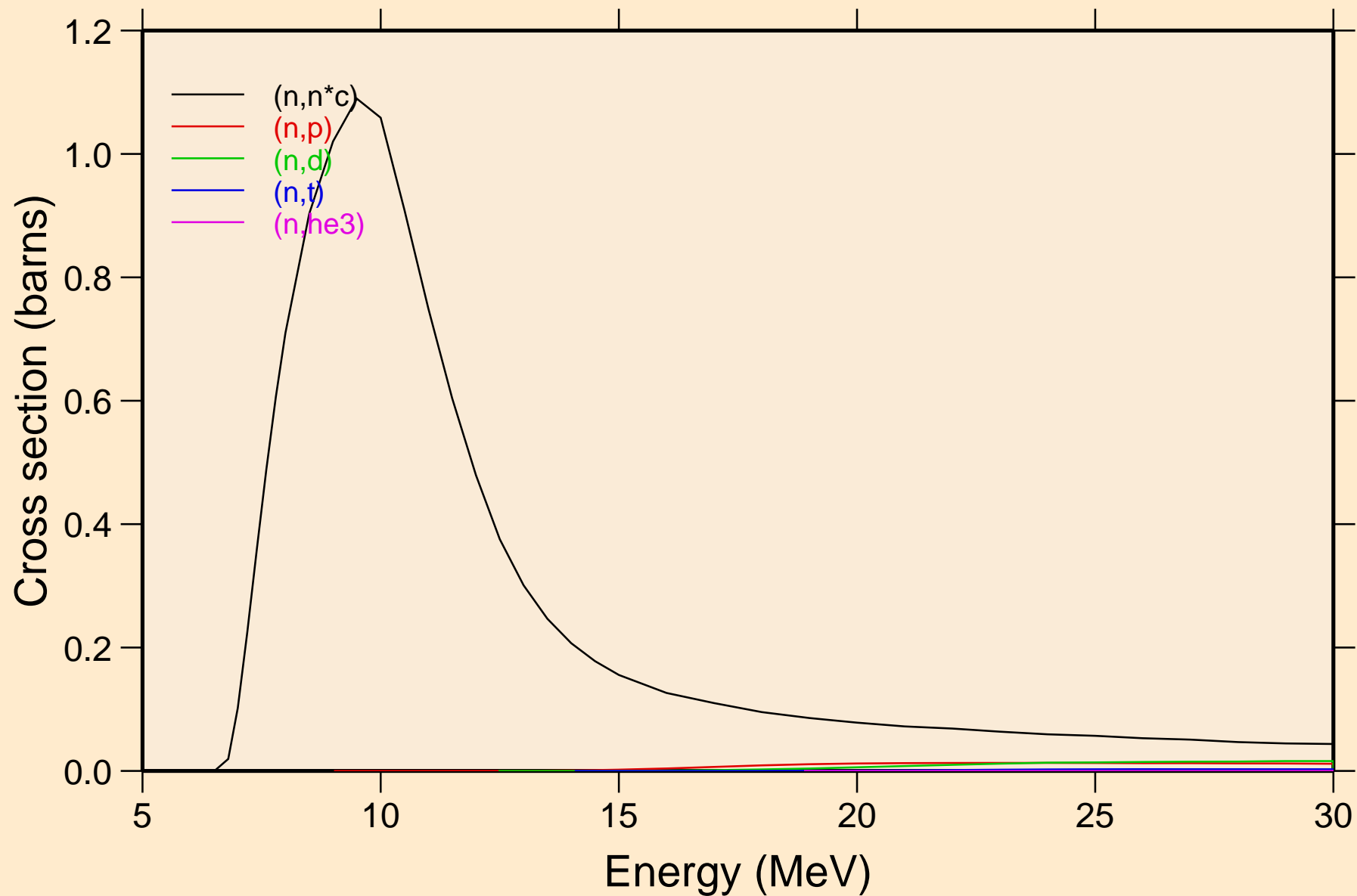

AR042 NEUTRON ACER TENDL-2019 LIBRARY; T=293.16K  
Threshold reactions

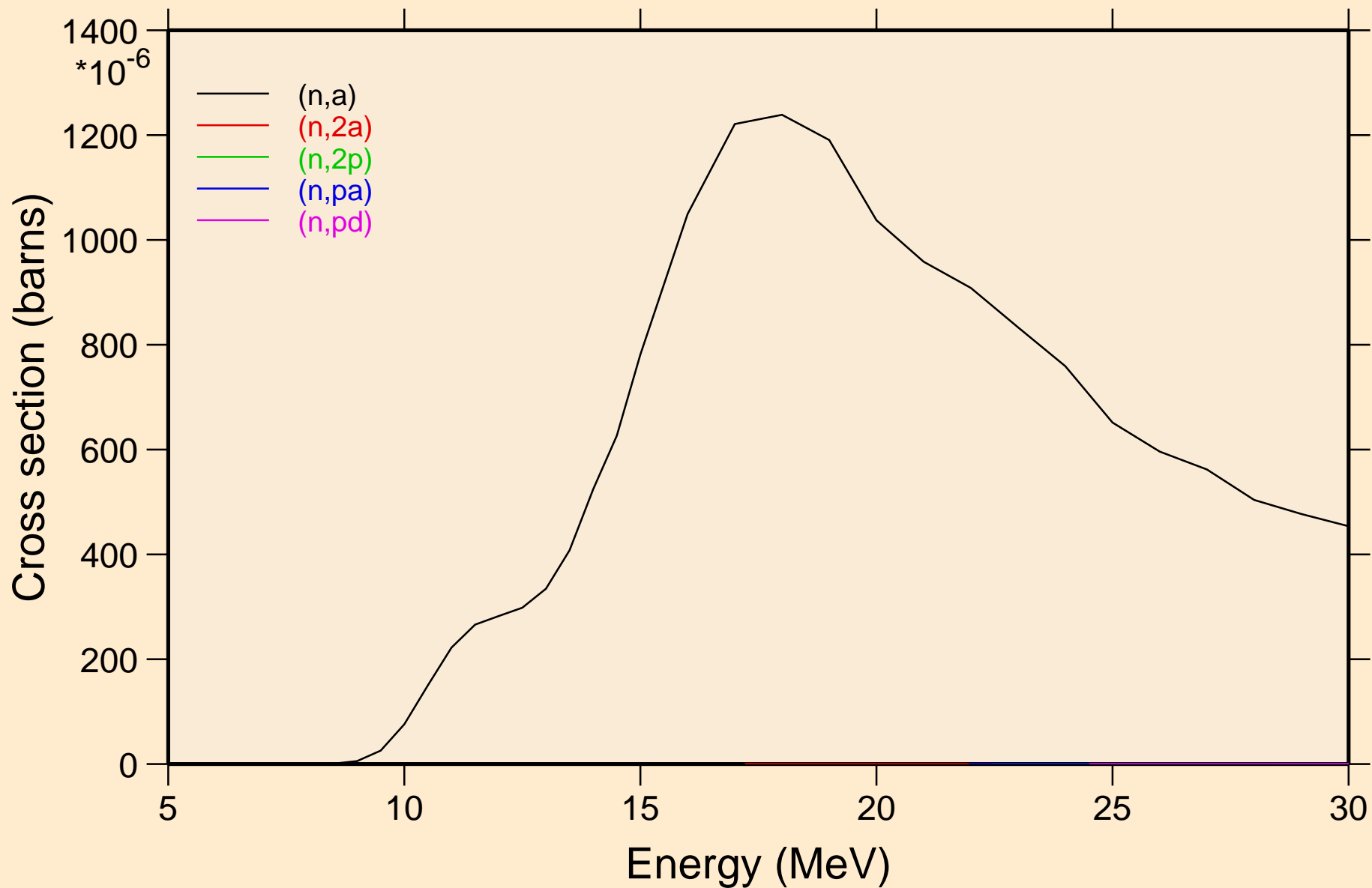

AR042 NEUTRON ACER TENDL-2019 LIBRARY; T=293.16K  
Threshold reactions

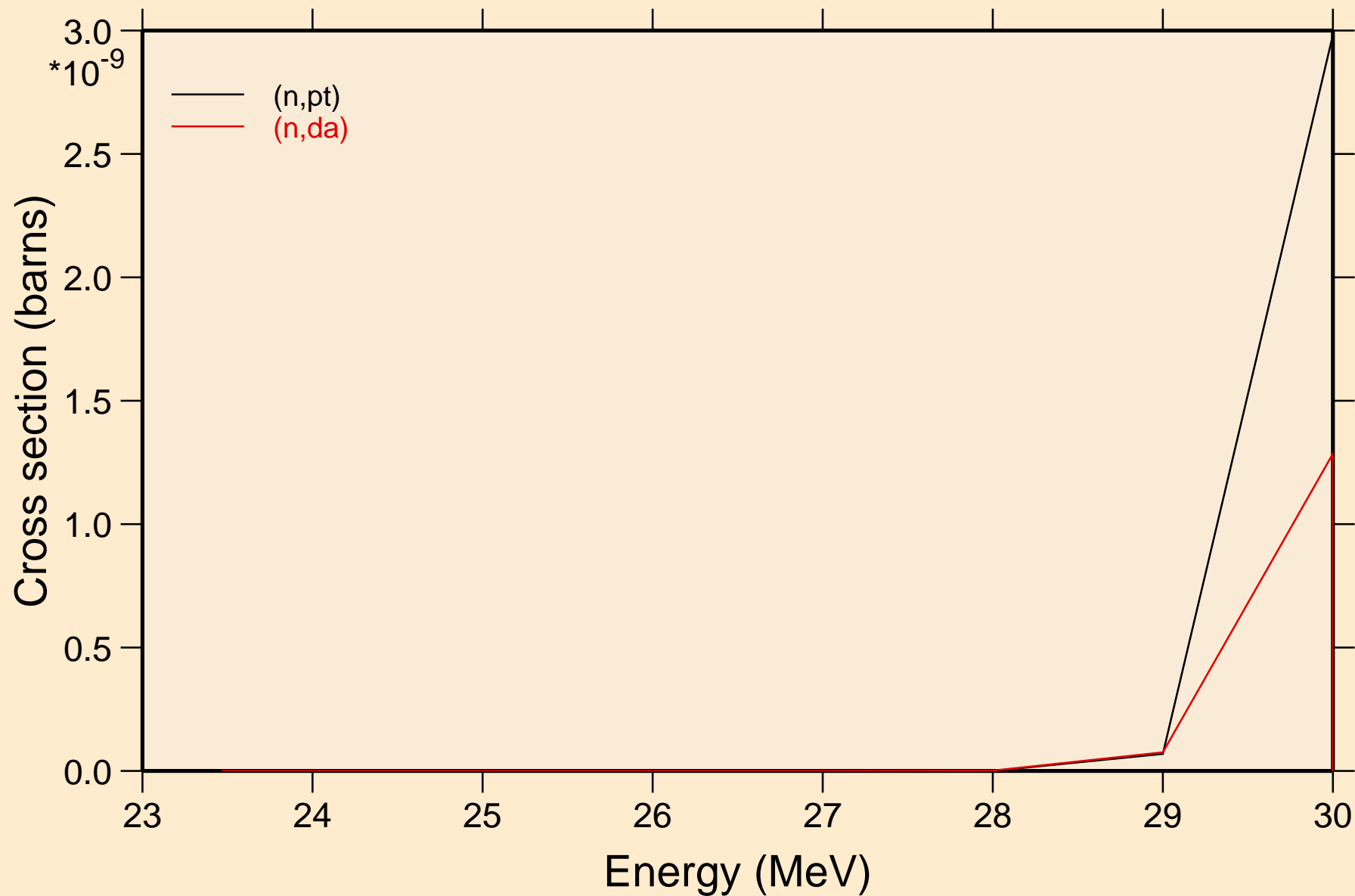

AR042 NEUTRON ACER TENDL-2019 LIBRARY; T=293.16K  
Threshold reactions

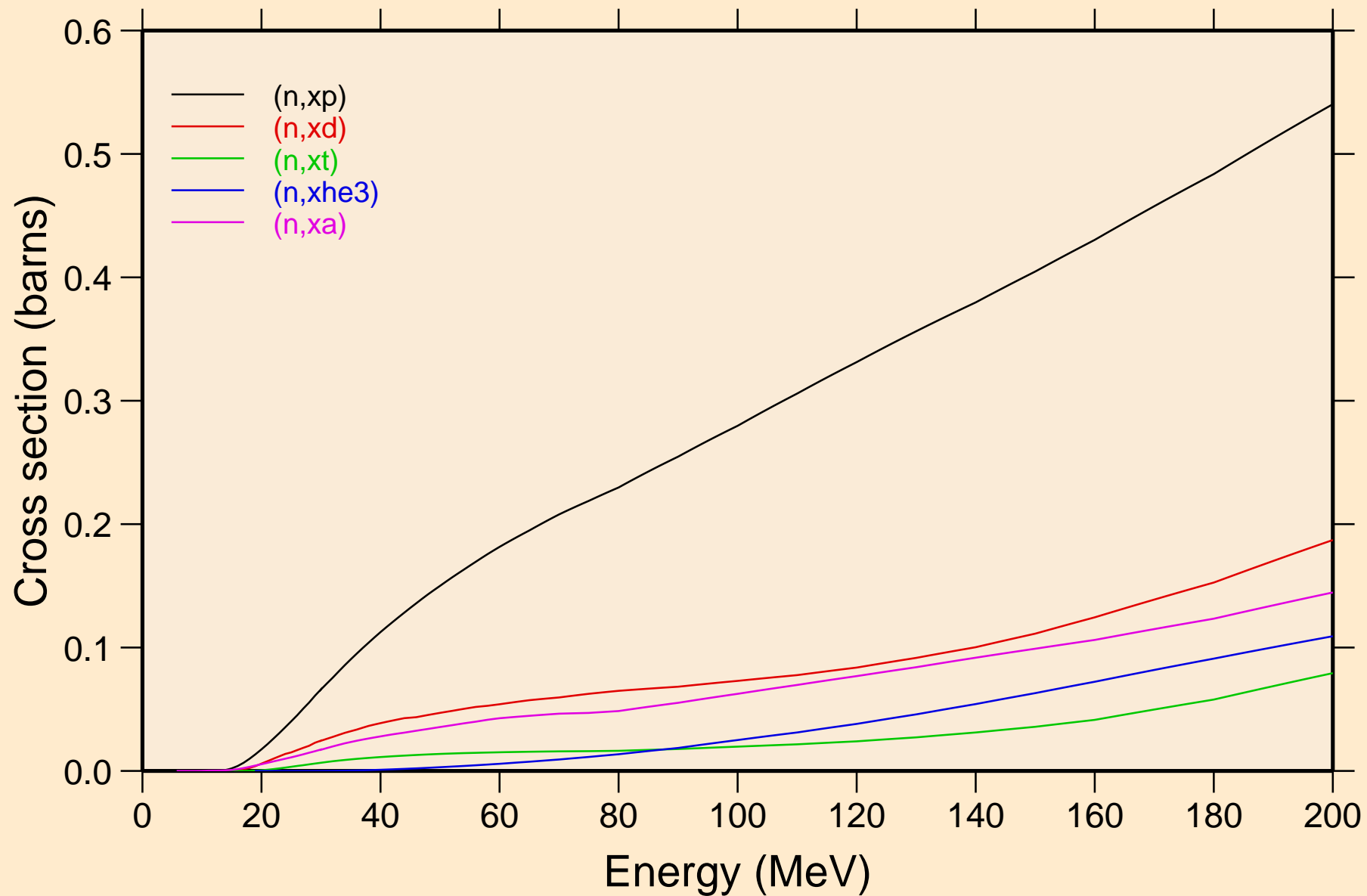

AR042 NEUTRON ACER TENDL-2019 LIBRARY; T=293.16K  
angular distribution for elastic

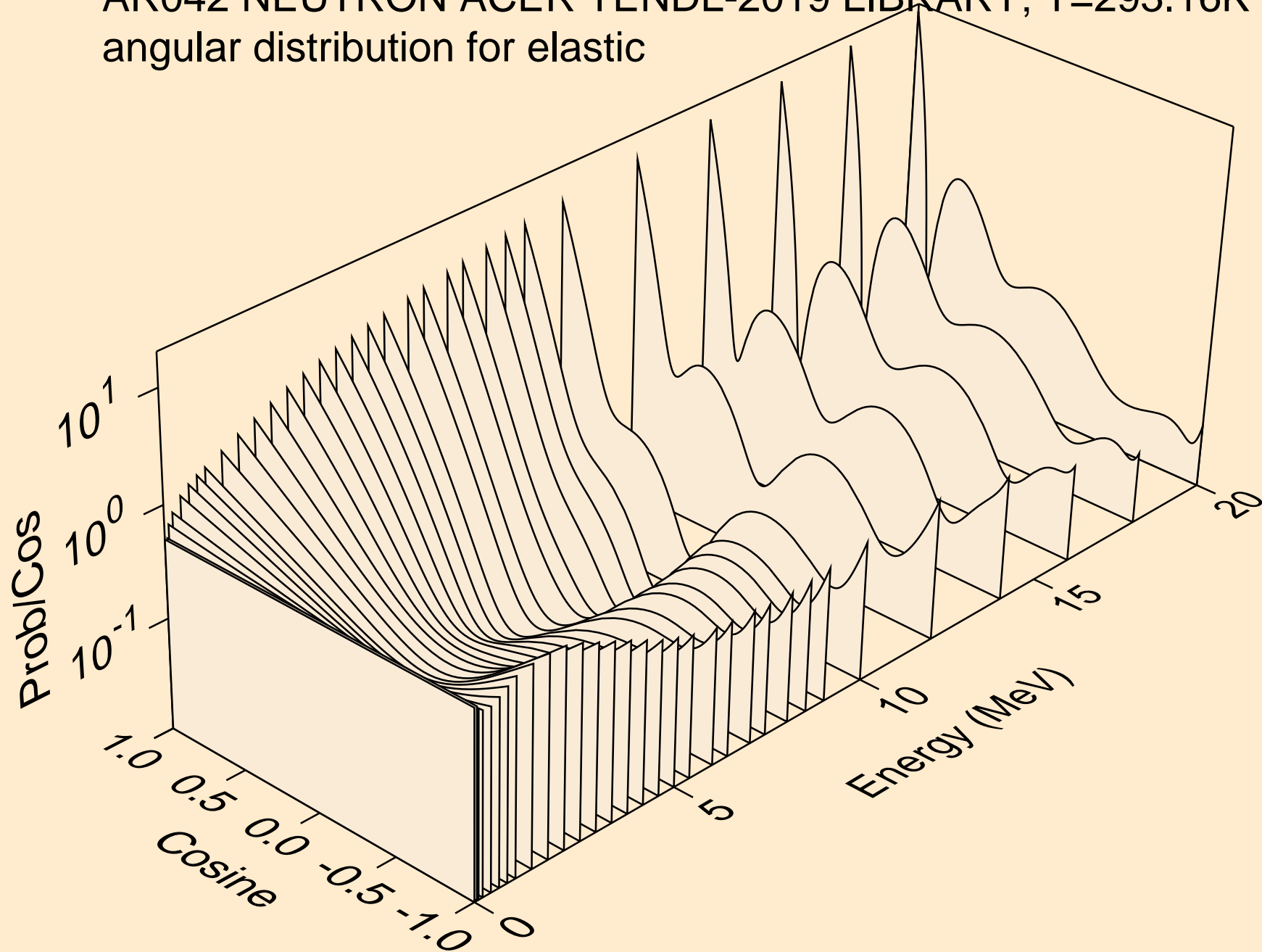

AR042 NEUTRON ACER TENDL-2019 LIBRARY; T=293.16K  
angular distribution for elastic

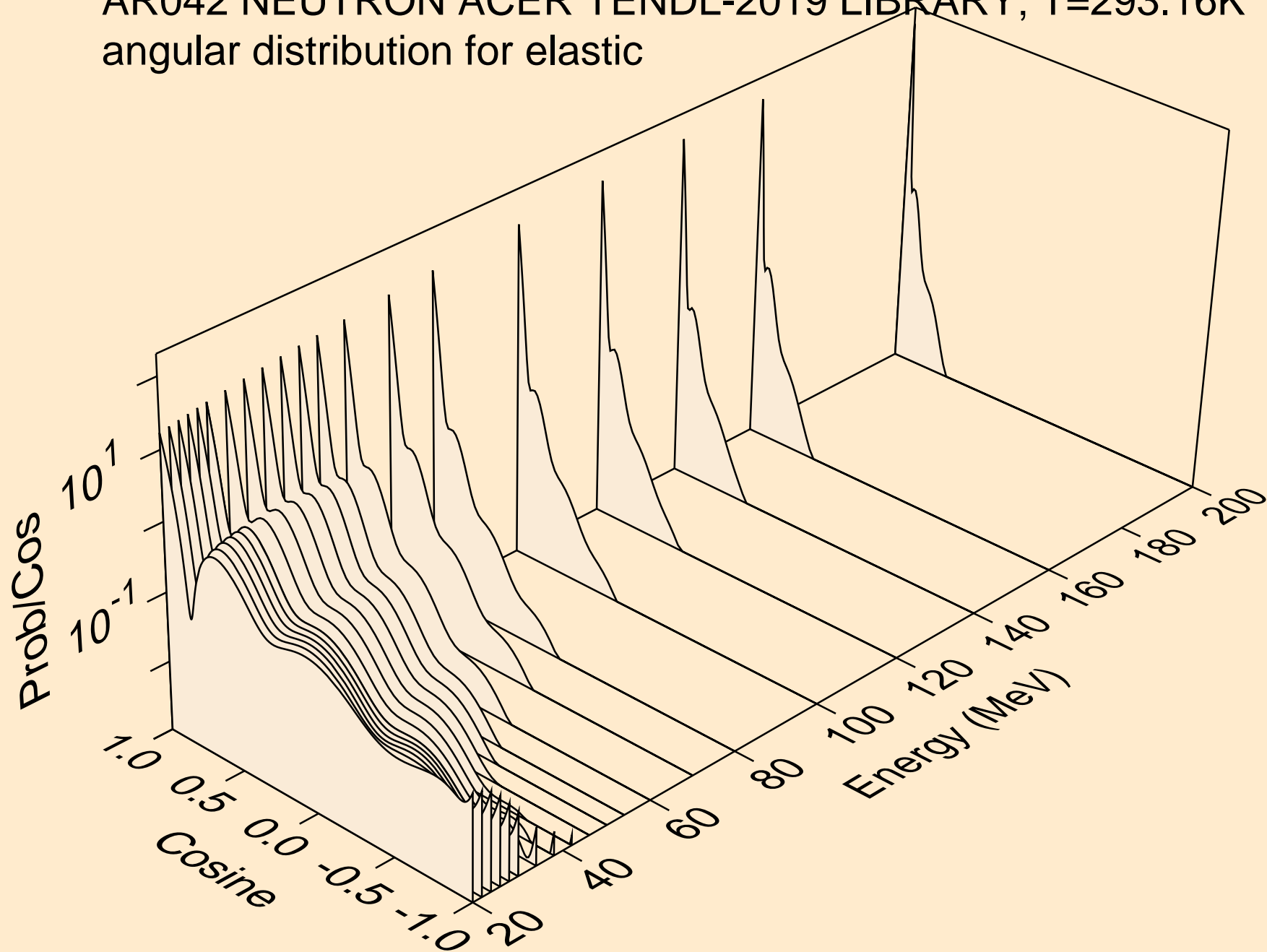

AR042 NEUTRON ACER TENDL-2019 LIBRARY; T=293.16K  
angular distribution for (n,n\*1)

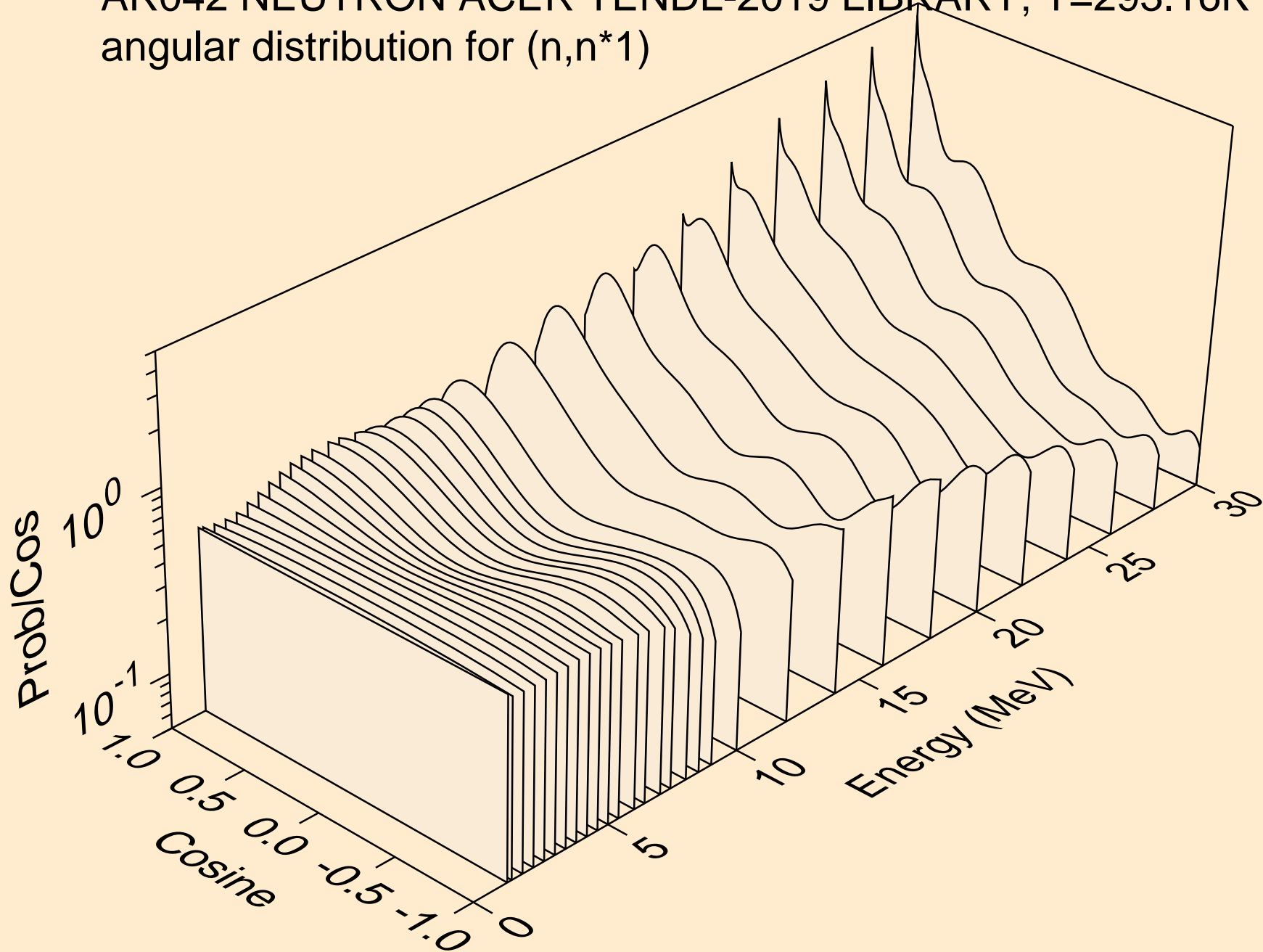



AR042 NEUTRON ACER TENDL-2019 LIBRARY; T=293.16K  
angular distribution for (n,n\*2)

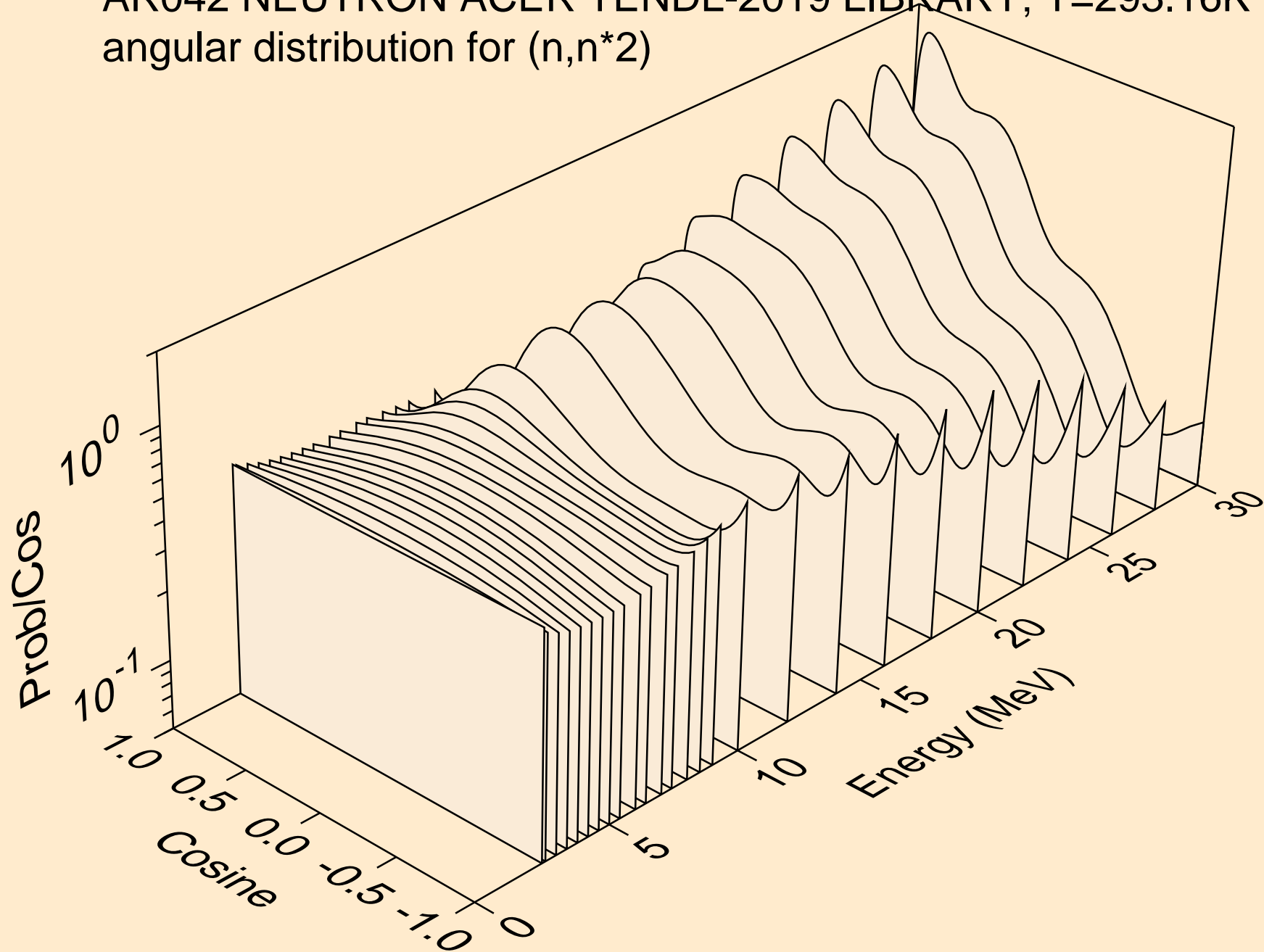

AR042 NEUTRON ACER TENDL-2019 LIBRARY; T=293.16K  
angular distribution for (n,n\*3)

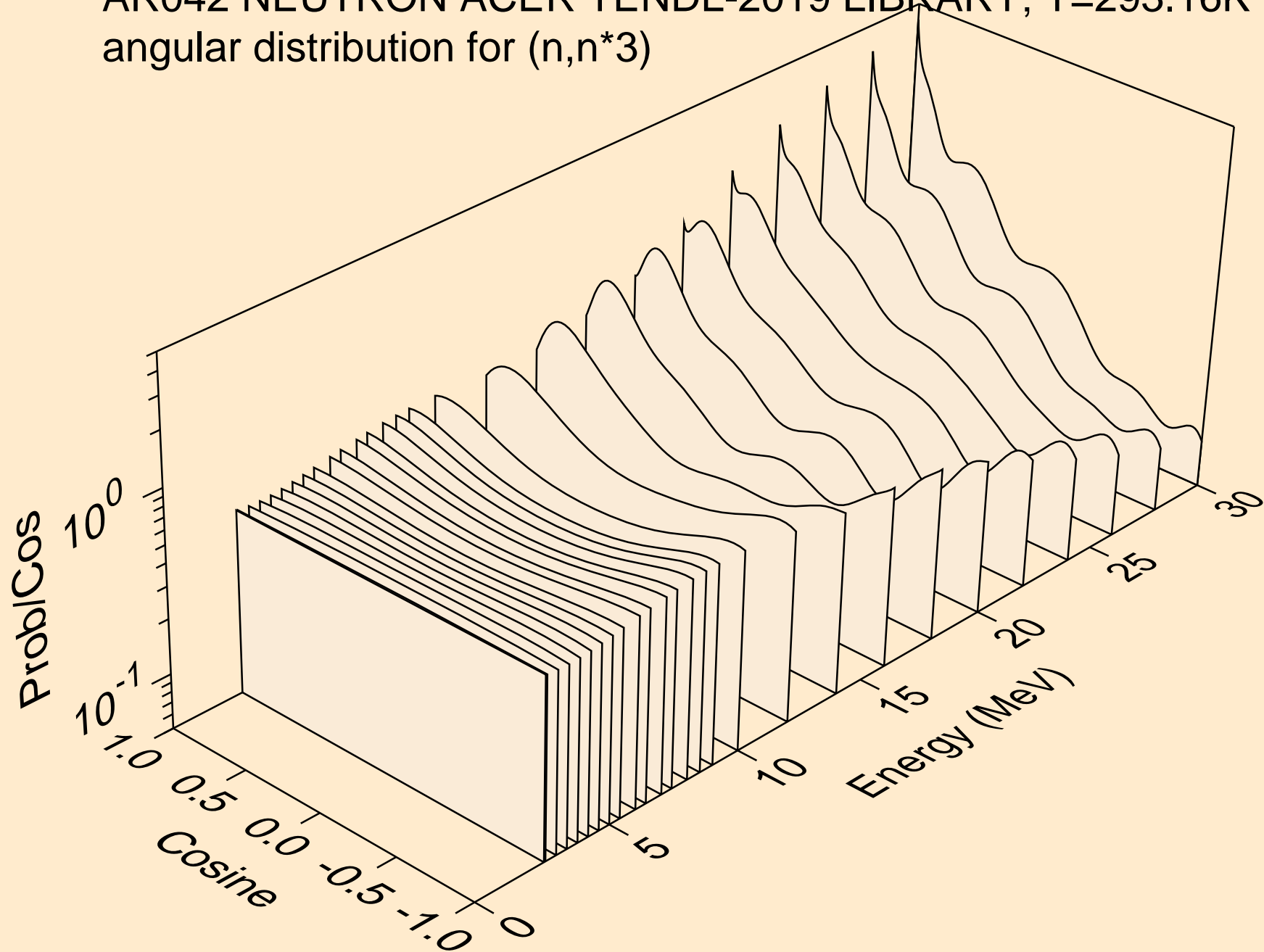

AR042 NEUTRON ACER TENDL-2019 LIBRARY; T=293.16K  
angular distribution for (n,n\*4)

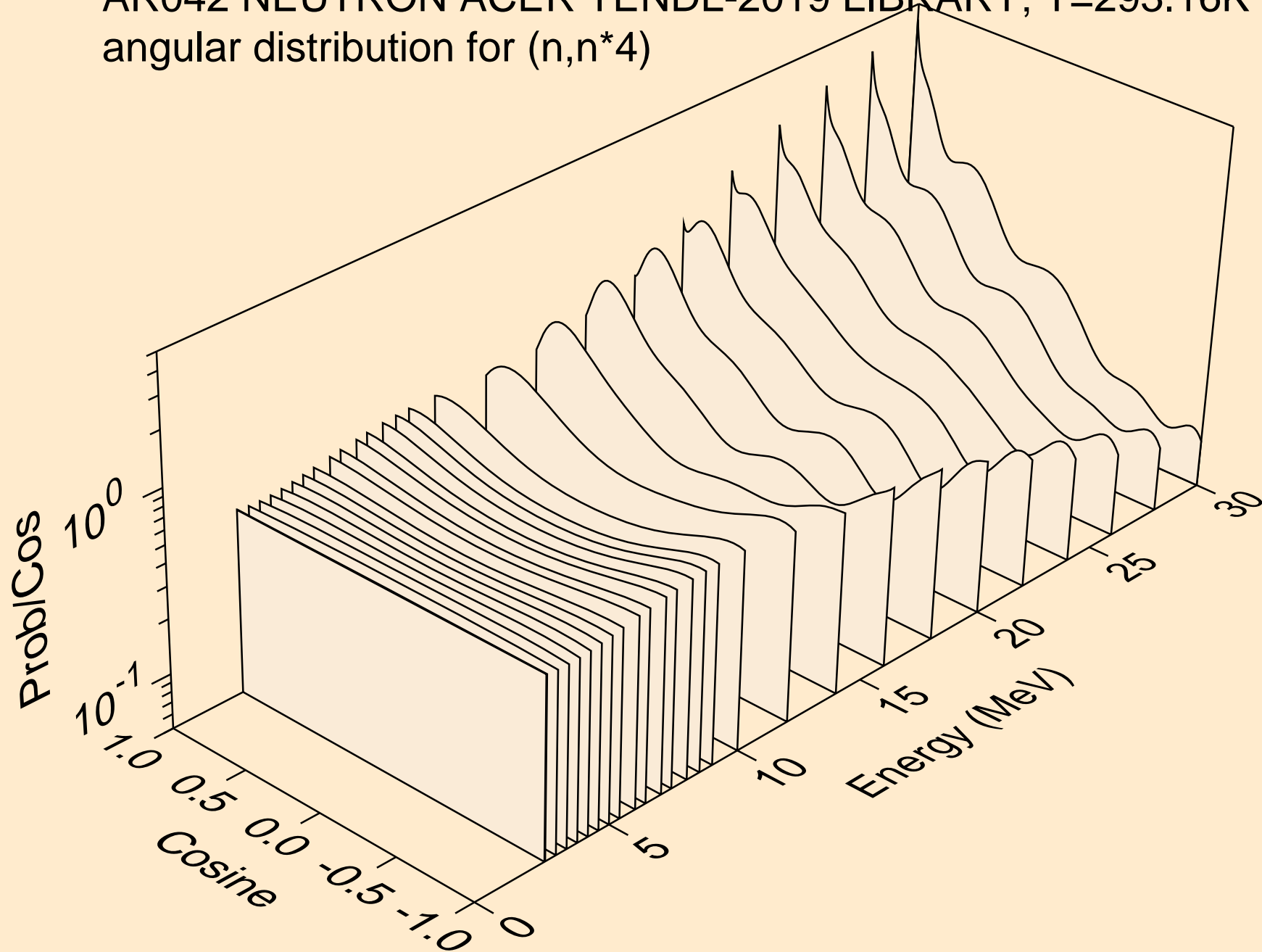

AR042 NEUTRON ACER TENDL-2019 LIBRARY; T=293.16K  
angular distribution for (n,n\*5)

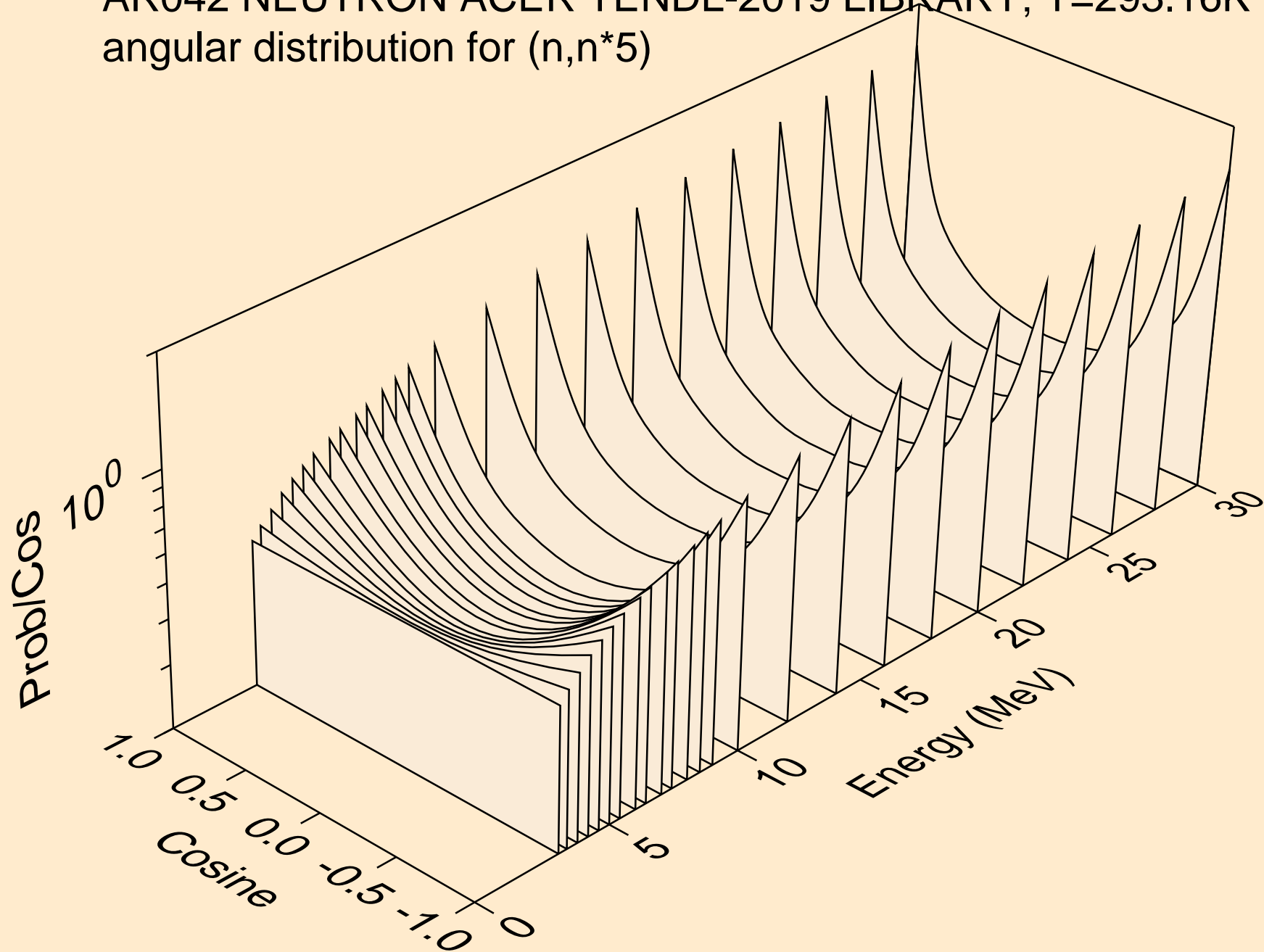

AR042 NEUTRON ACER TENDL-2019 LIBRARY; T=293.16K  
angular distribution for (n,n\*6)

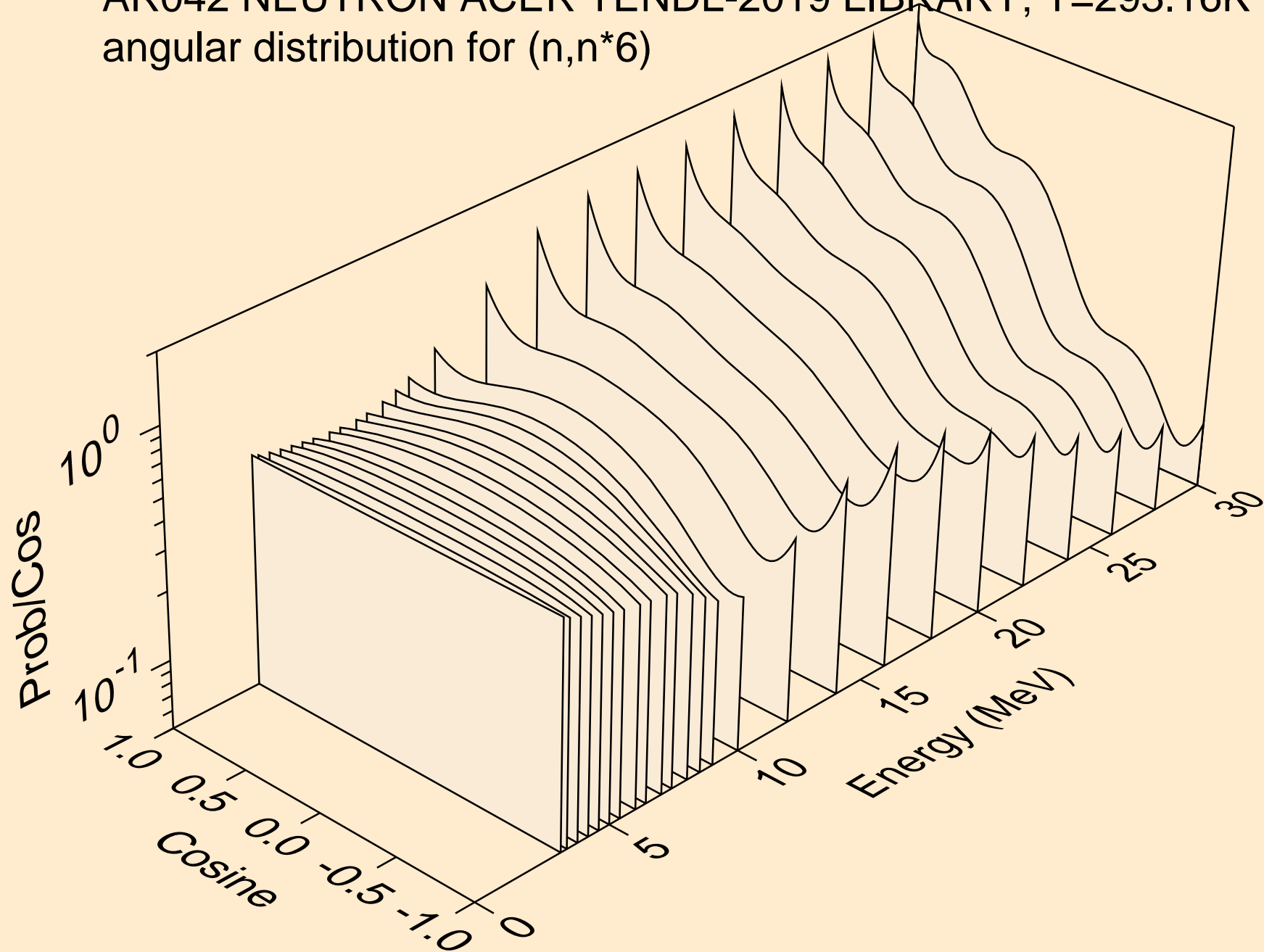

AR042 NEUTRON ACER TENDL-2019 LIBRARY; T=293.16K  
angular distribution for (n,n\*7)

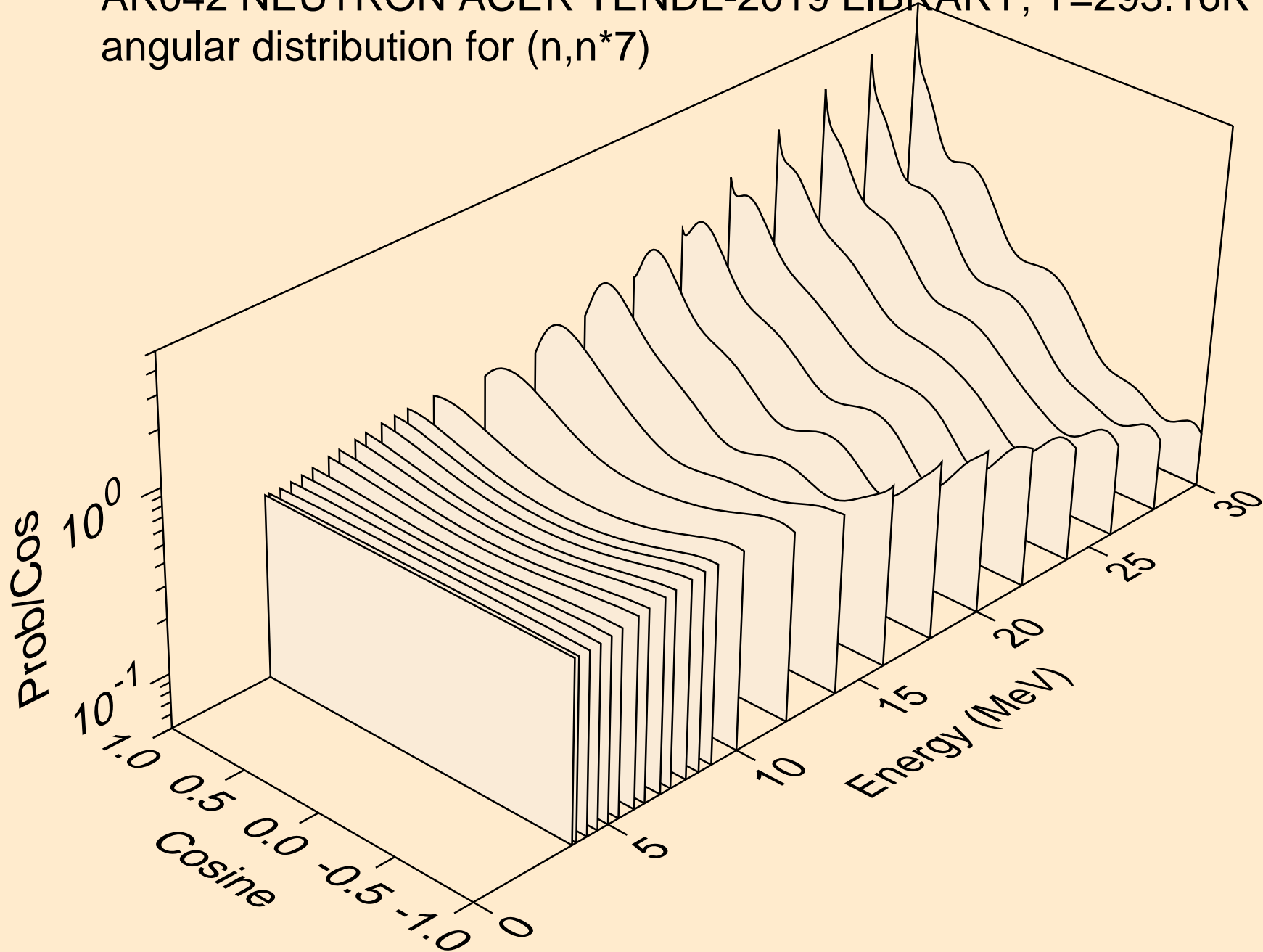

AR042 NEUTRON ACER TENDL-2019 LIBRARY; T=293.16K  
angular distribution for (n,n\*8)

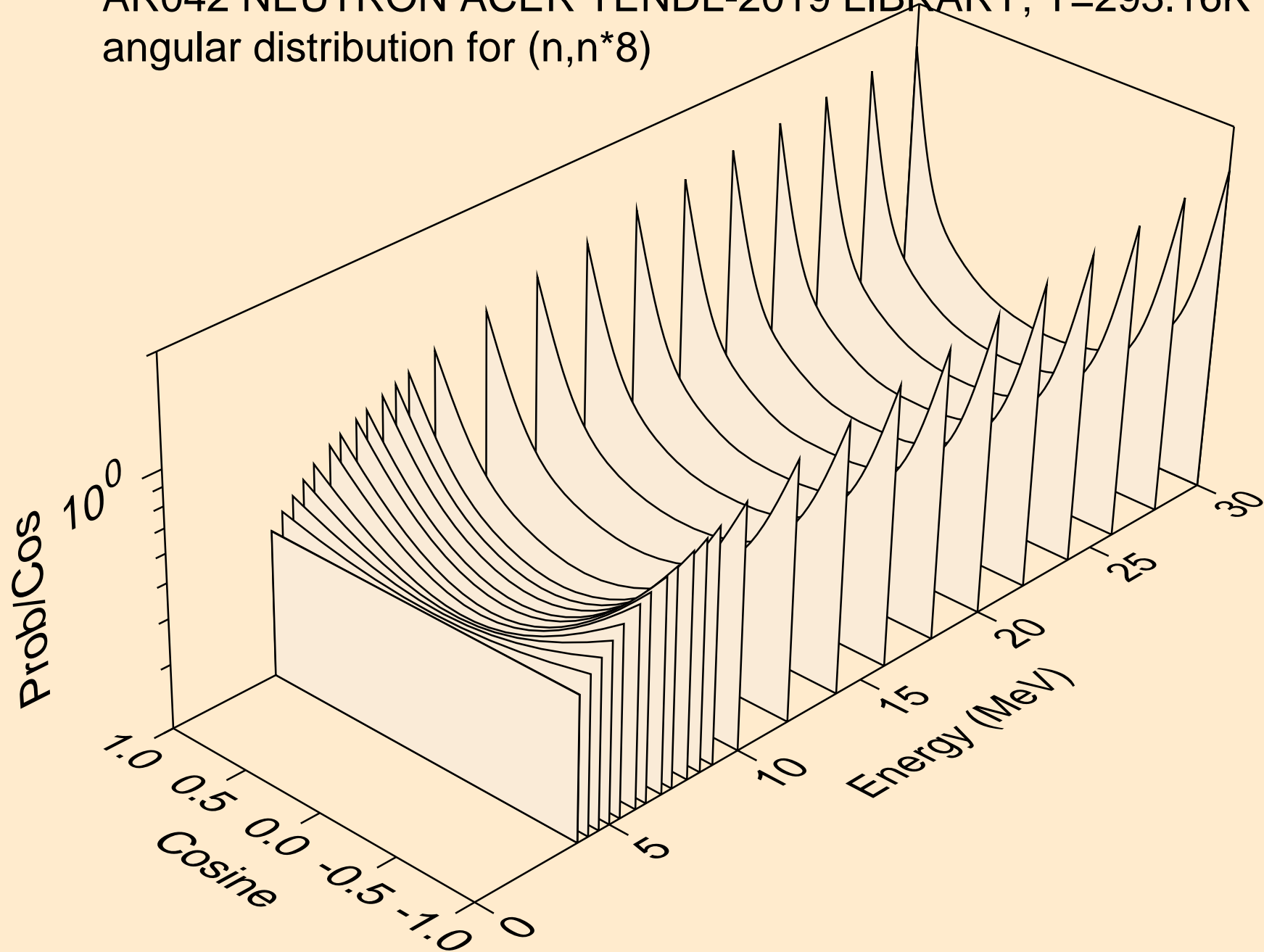

AR042 NEUTRON ACER TENDL-2019 LIBRARY; T=293.16K  
angular distribution for (n,n\*9)

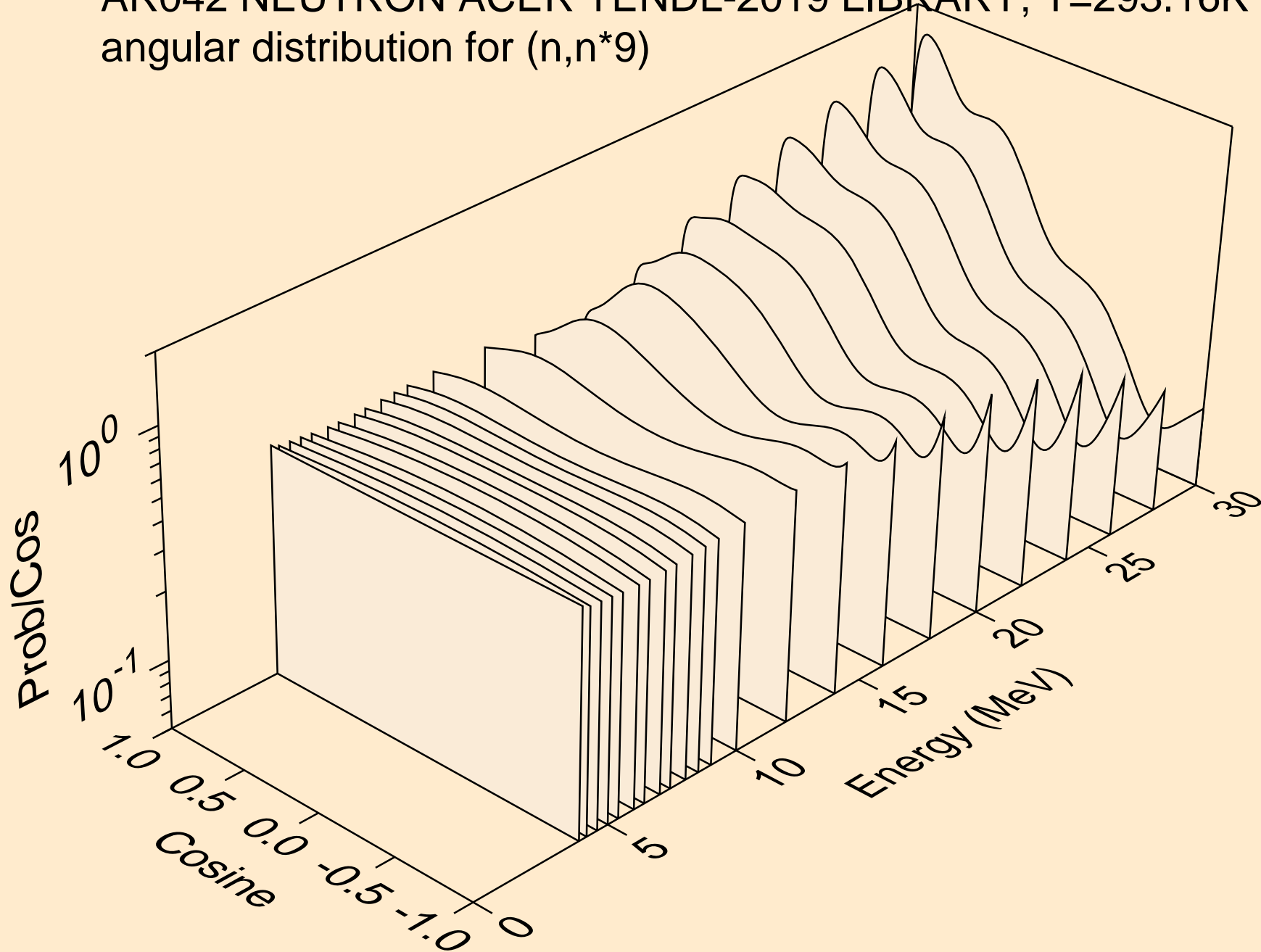



AR042 NEUTRON ACER TENDL-2019 LIBRARY; T=293.16K  
angular distribution for (n,n\*10)

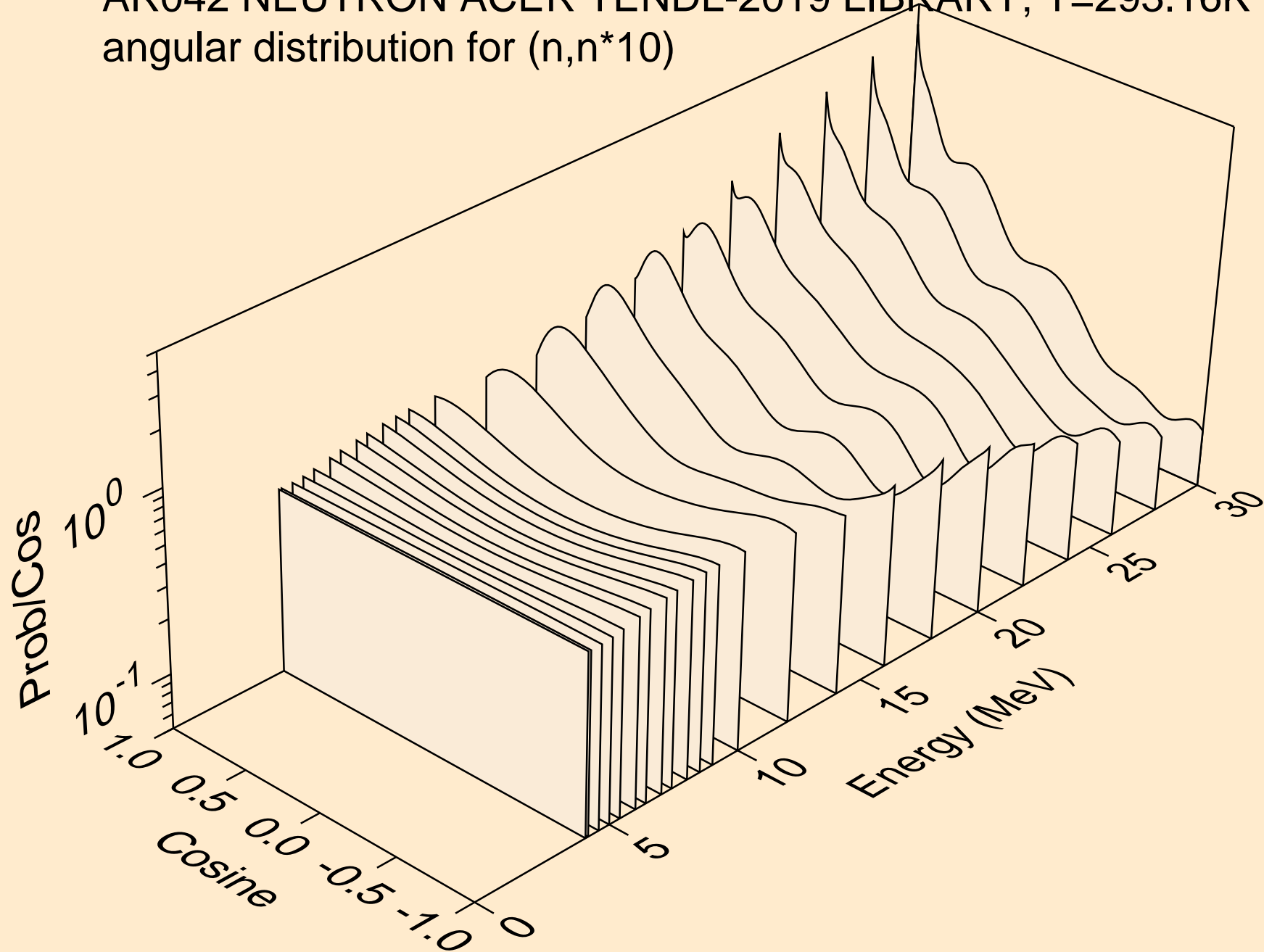

AR042 NEUTRON ACER TENDL-2019 LIBRARY; T=293.16K  
angular distribution for (n,n\*11)

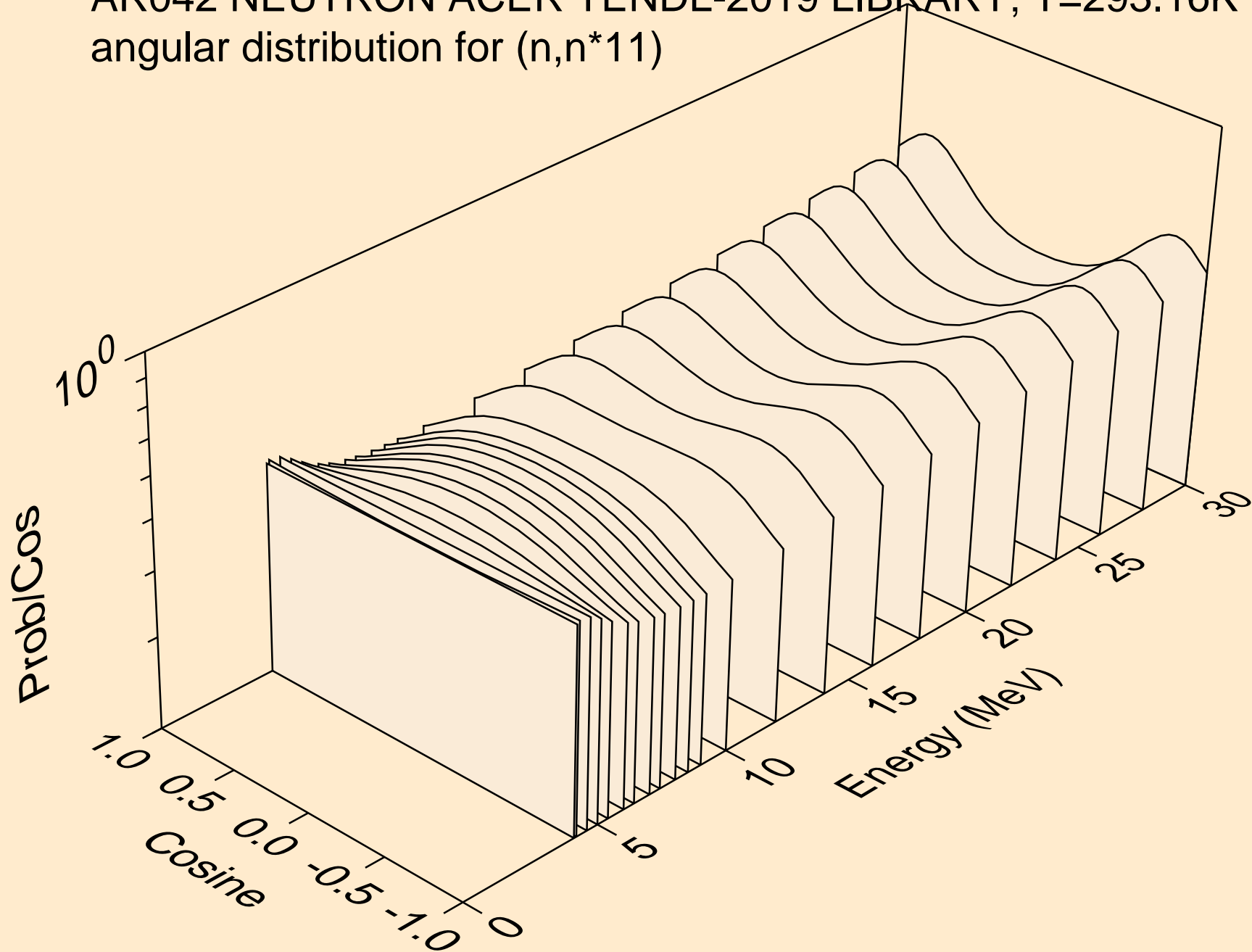

AR042 NEUTRON ACER TENDL-2019 LIBRARY; T=293.16K  
angular distribution for (n,n\*12)

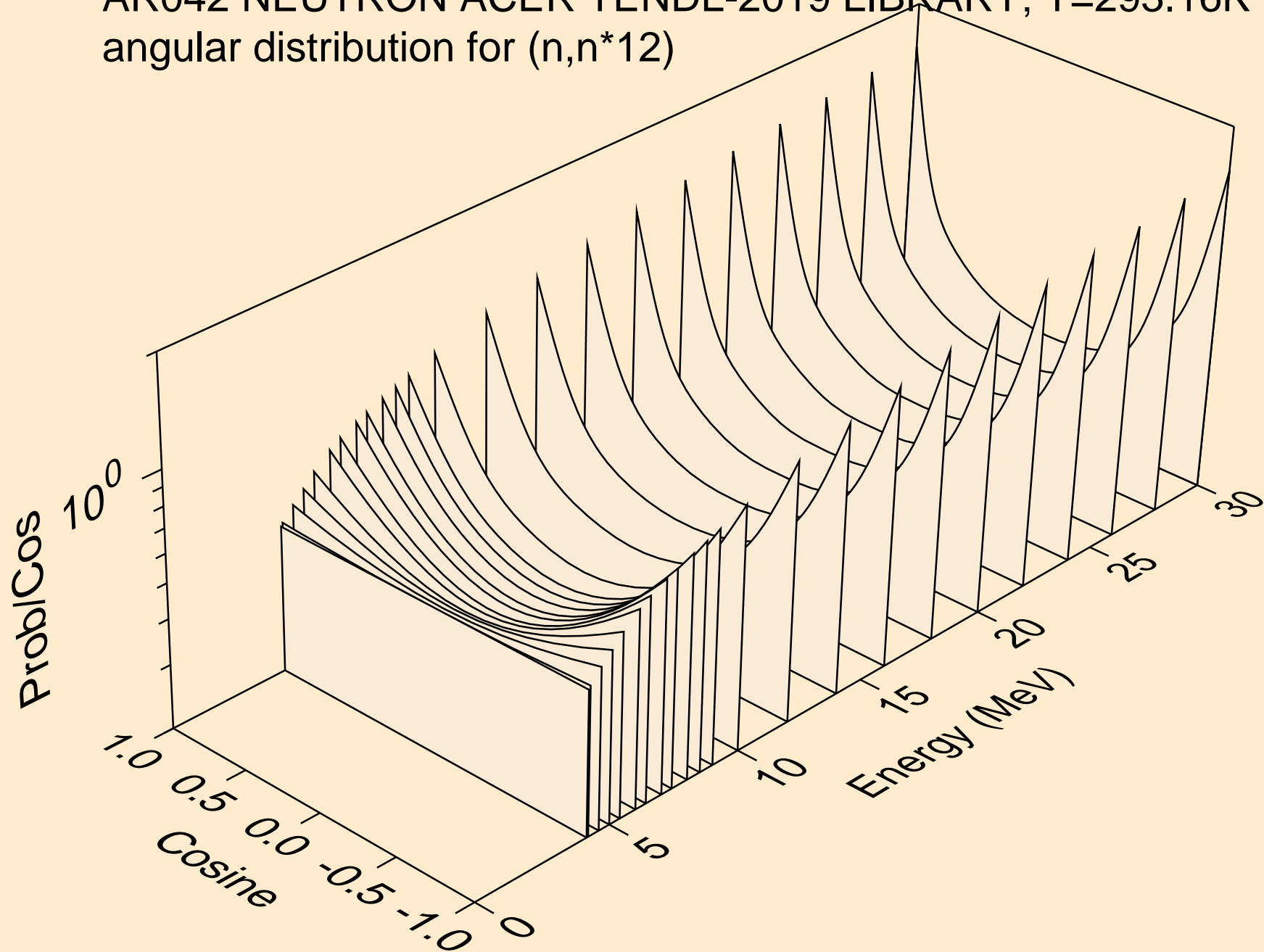

AR042 NEUTRON ACER TENDL-2019 LIBRARY; T=293.16K  
angular distribution for (n,n\*13)

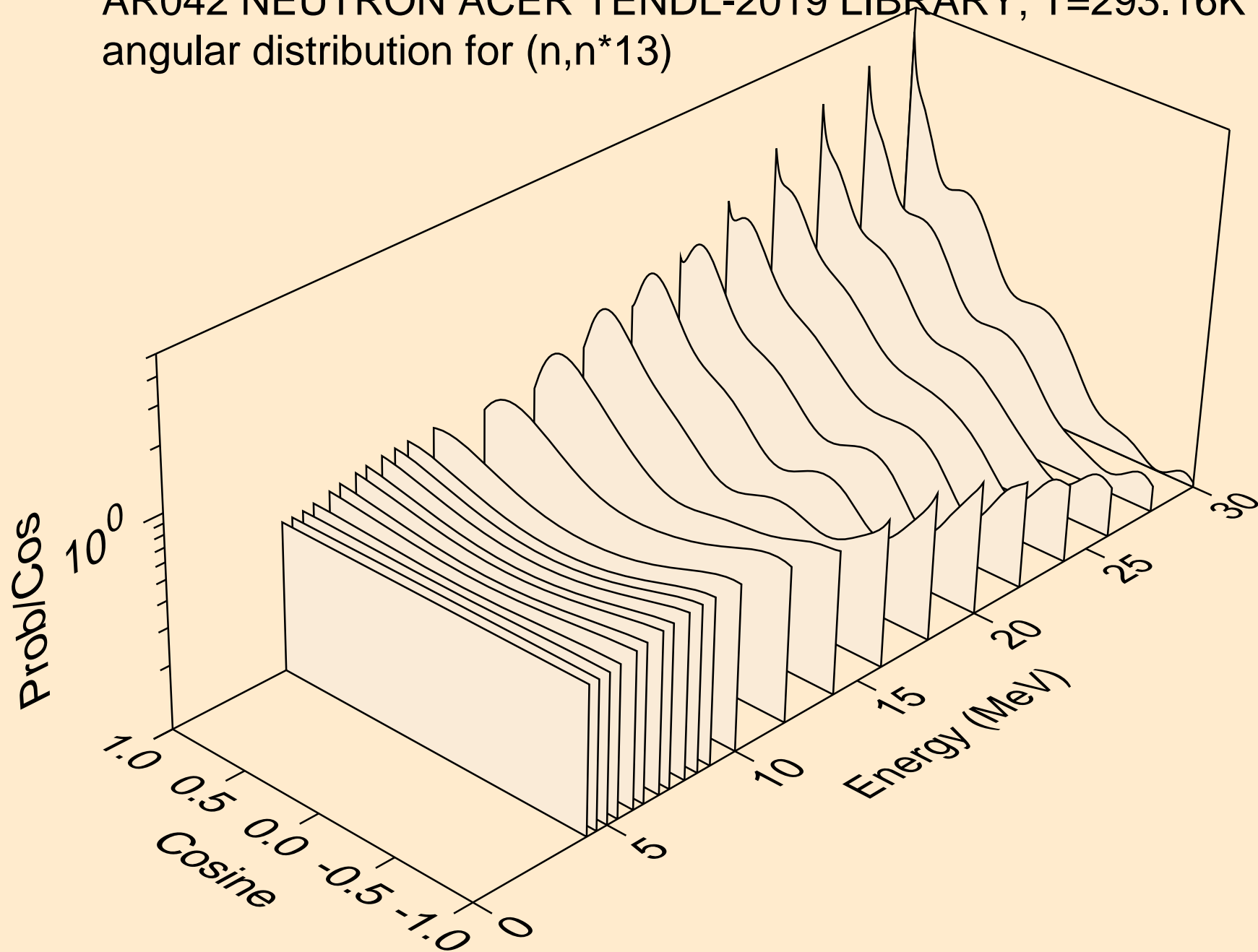

AR042 NEUTRON ACER TENDL-2019 LIBRARY; T=293.16K  
angular distribution for (n,n\*14)

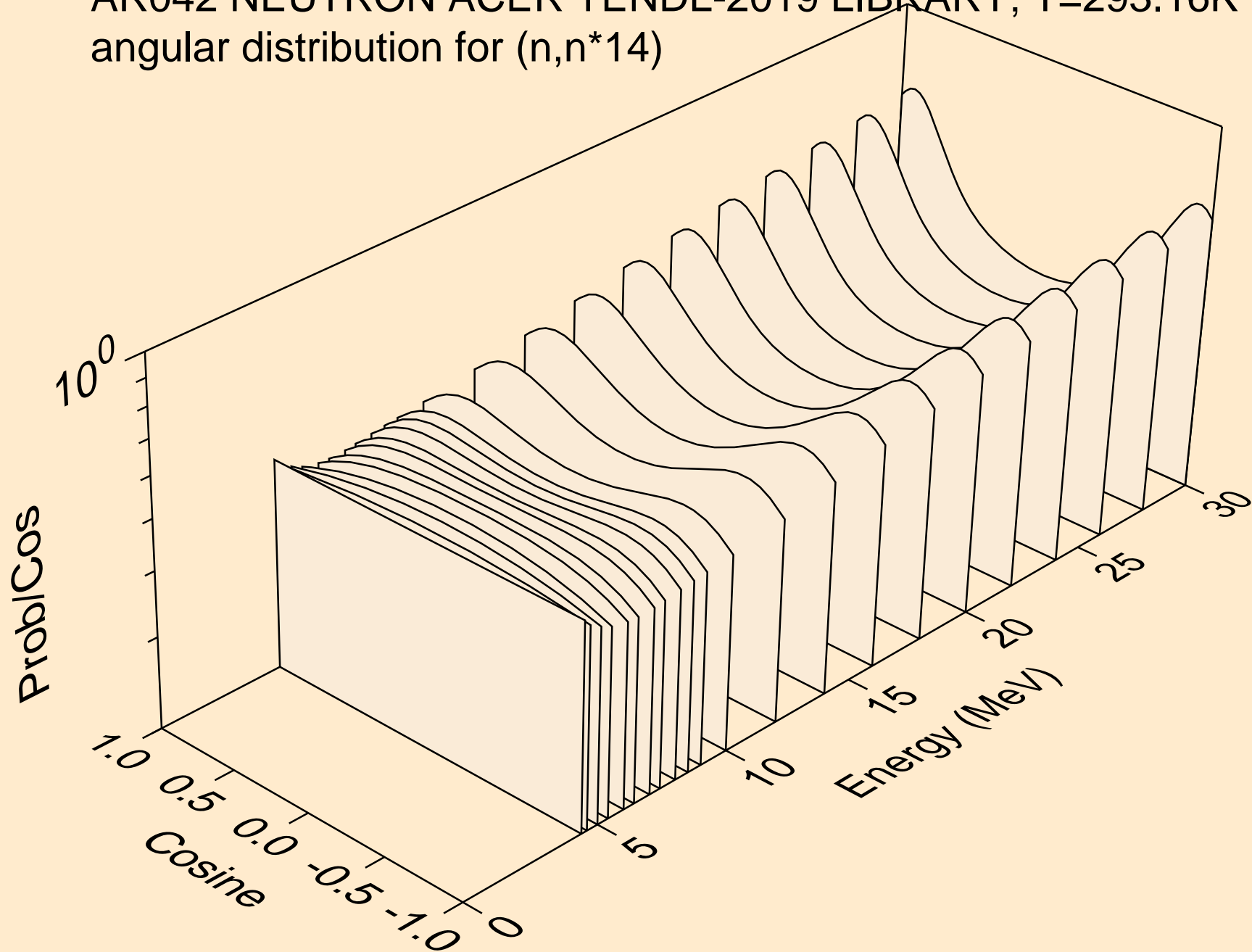

AR042 NEUTRON ACER TENDL-2019 LIBRARY; T=293.16K  
angular distribution for (n,n\*15)

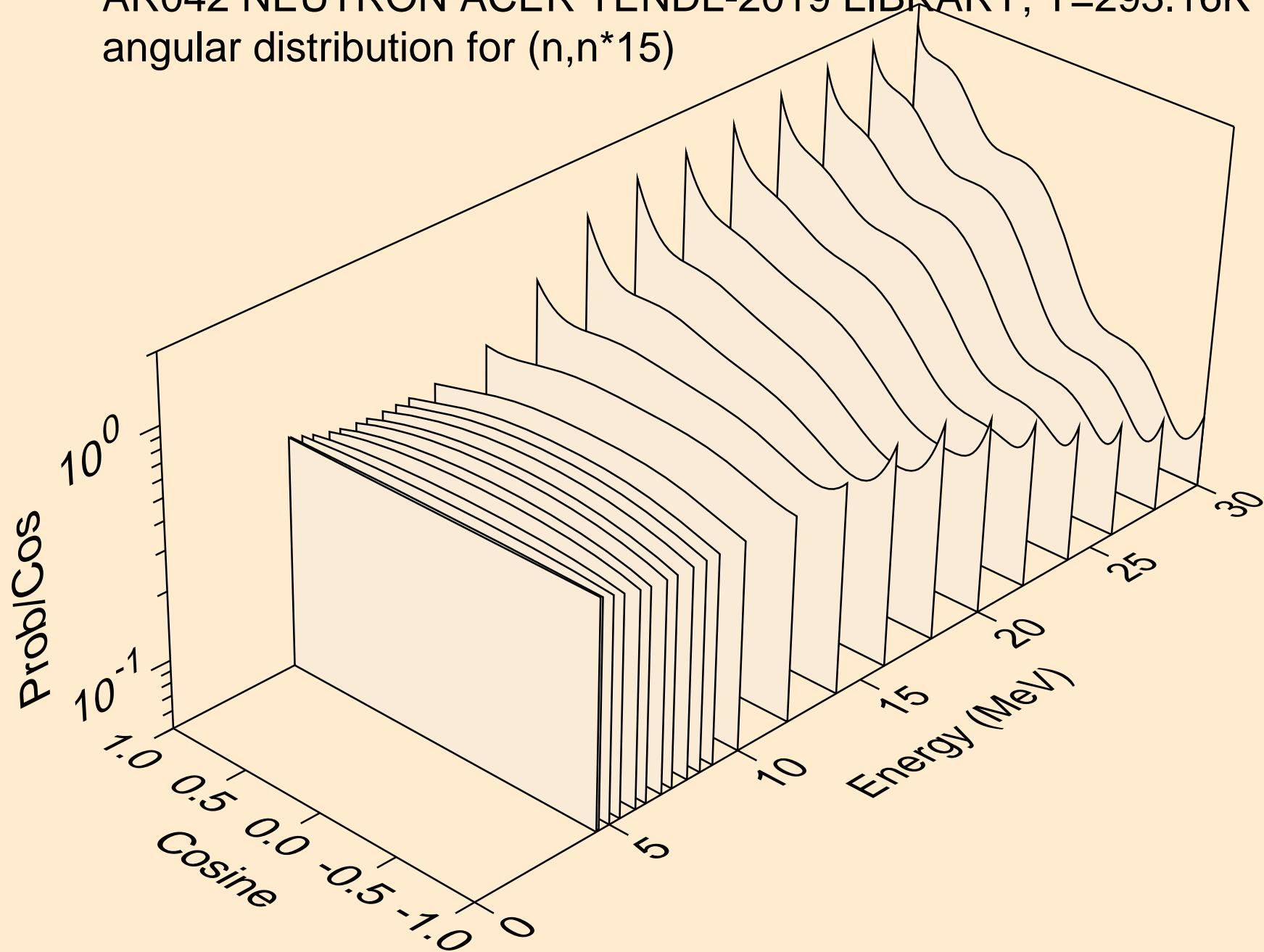

AR042 NEUTRON ACER TENDL-2019 LIBRARY; T=293.16K  
angular distribution for (n,n\*16)

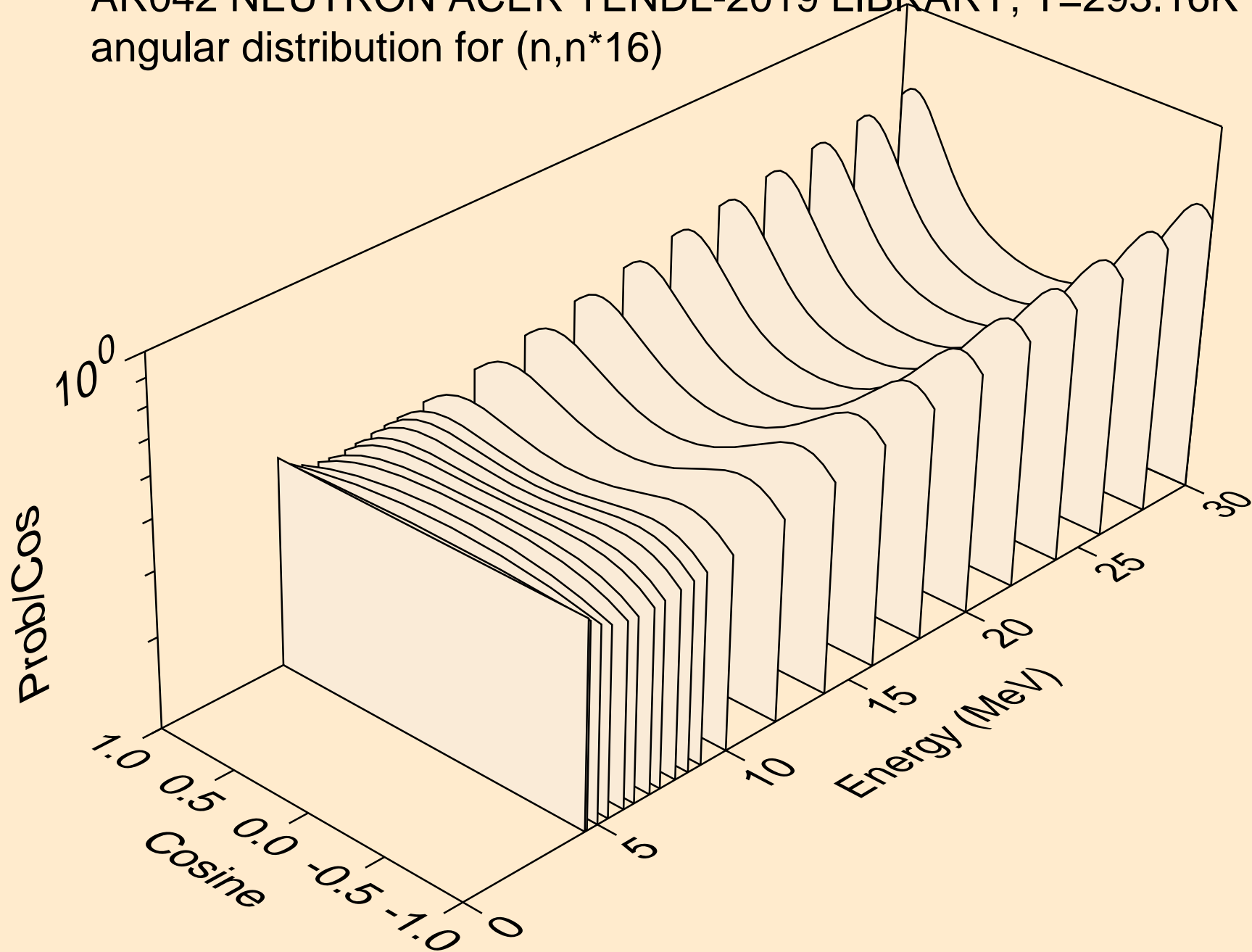

AR042 NEUTRON ACER TENDL-2019 LIBRARY; T=293.16K  
angular distribution for (n,n\*17)

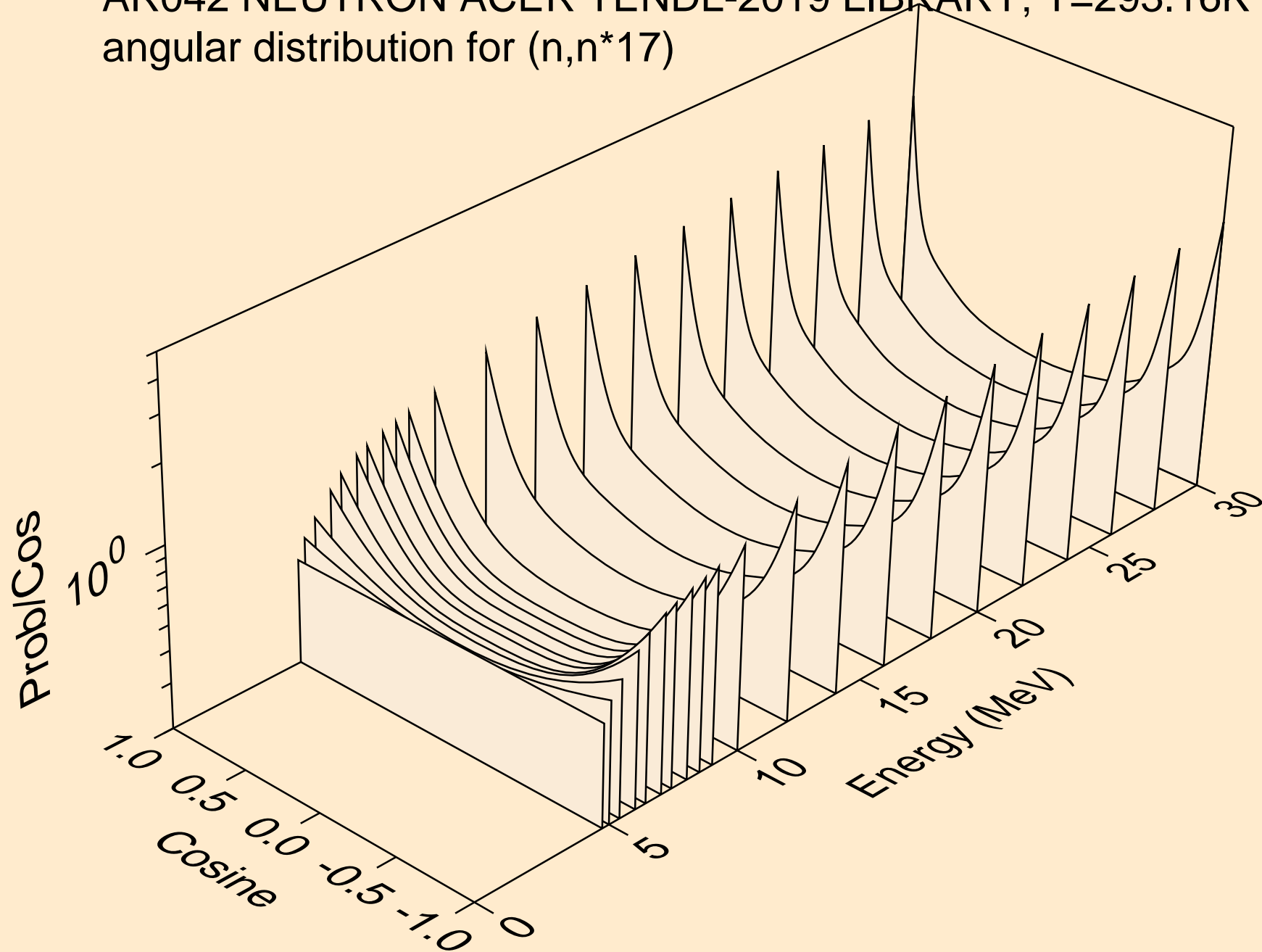



AR042 NEUTRON ACER TENDL-2019 LIBRARY; T=293.16K  
angular distribution for (n,n\*18)

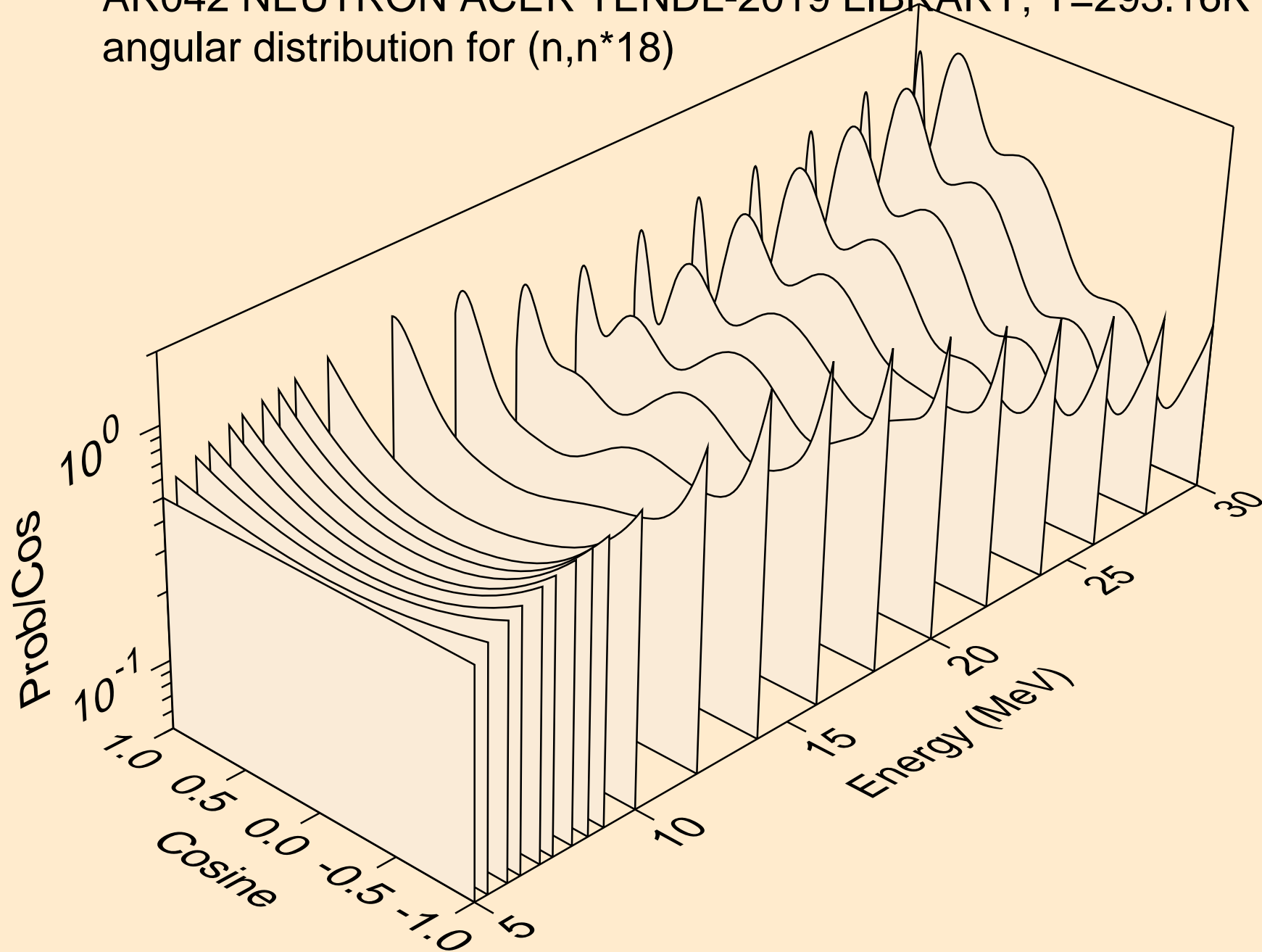

AR042 NEUTRON ACER TENDL-2019 LIBRARY; T=293.16K  
angular distribution for (n,n\*19)

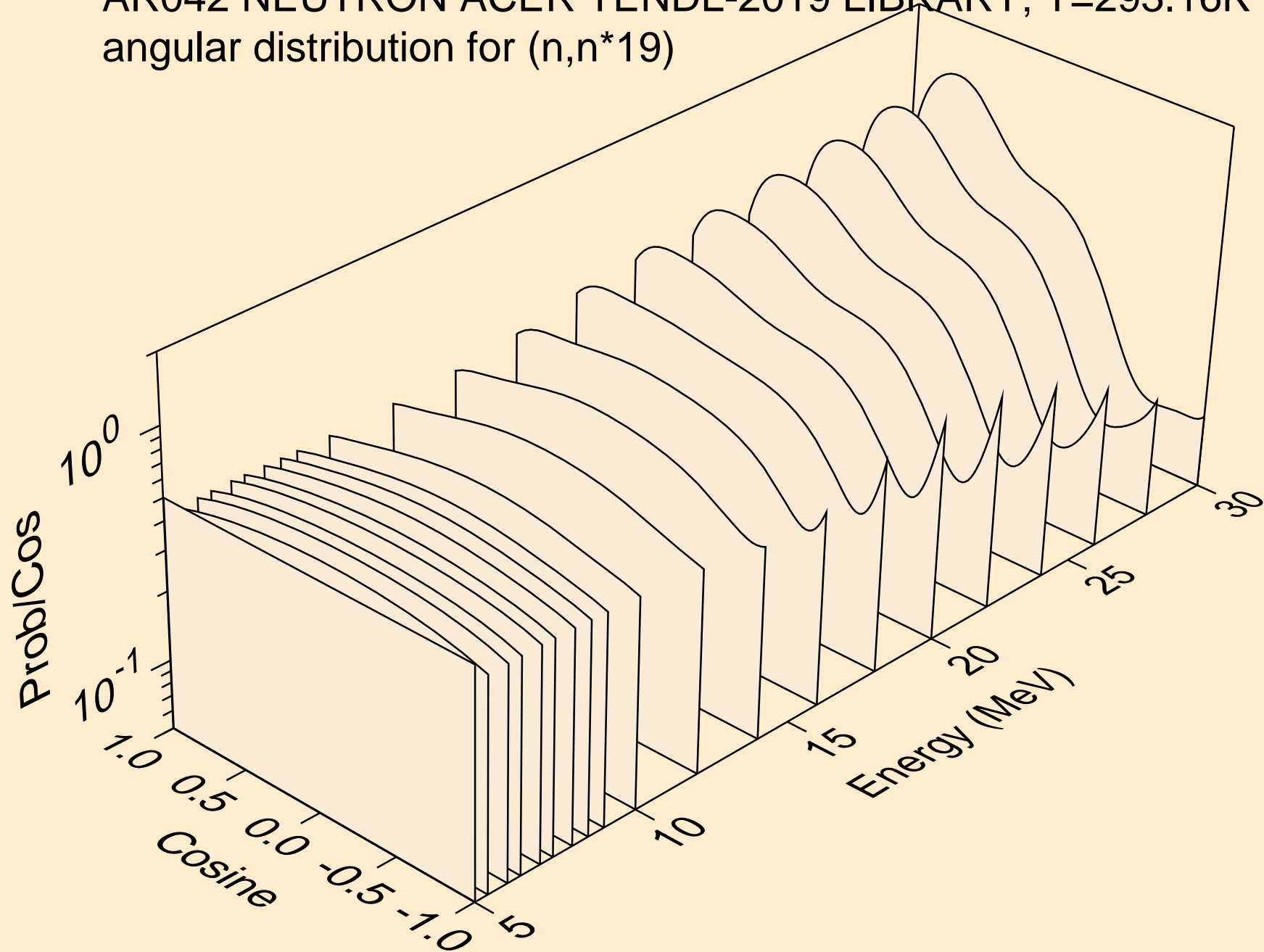

AR042 NEUTRON ACER TENDL-2019 LIBRARY; T=293.16K  
angular distribution for (n,n\*20)

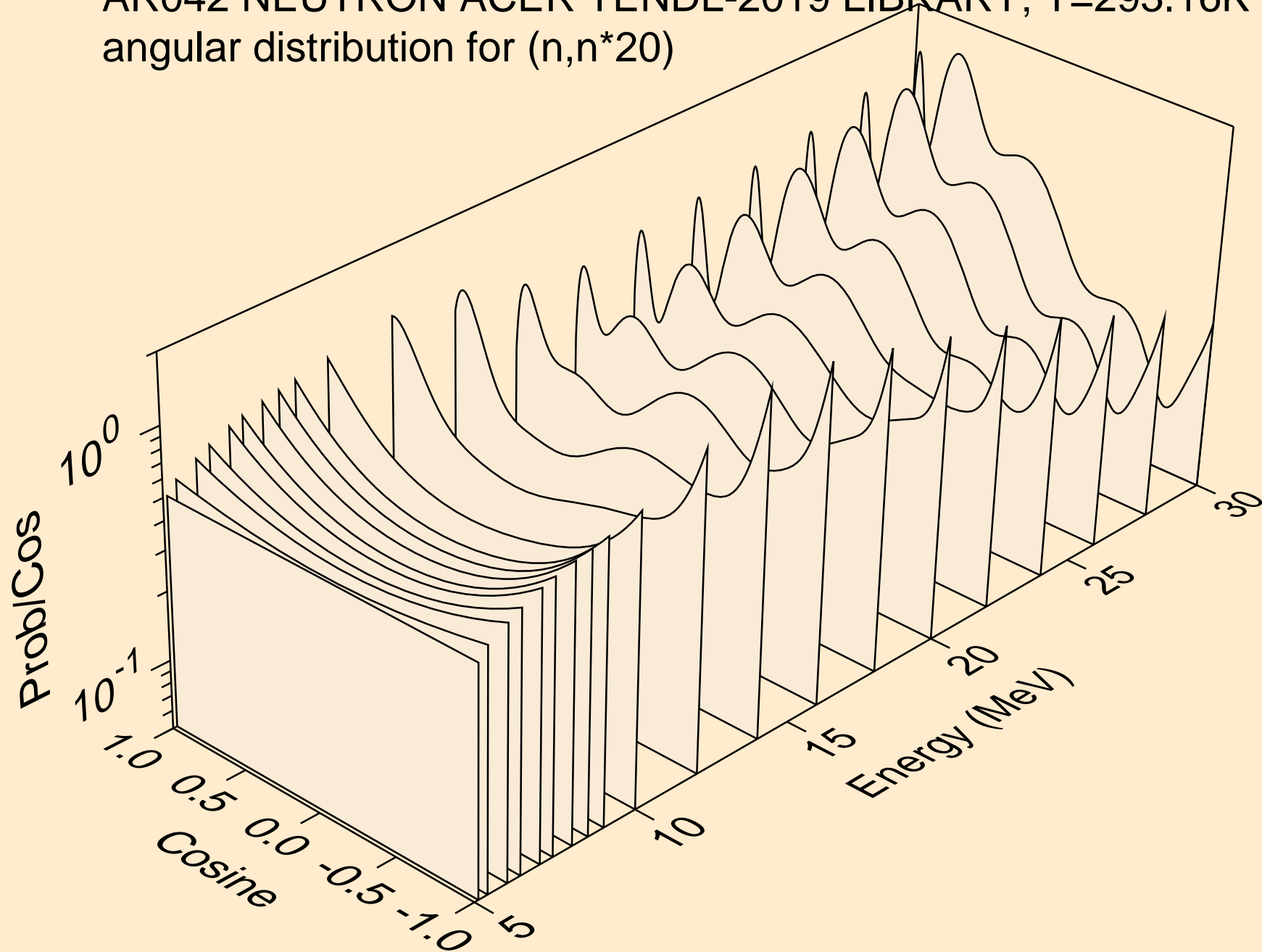

AR042 NEUTRON ACER TENDL-2019 LIBRARY; T=293.16K  
angular distribution for (n,n\*21)

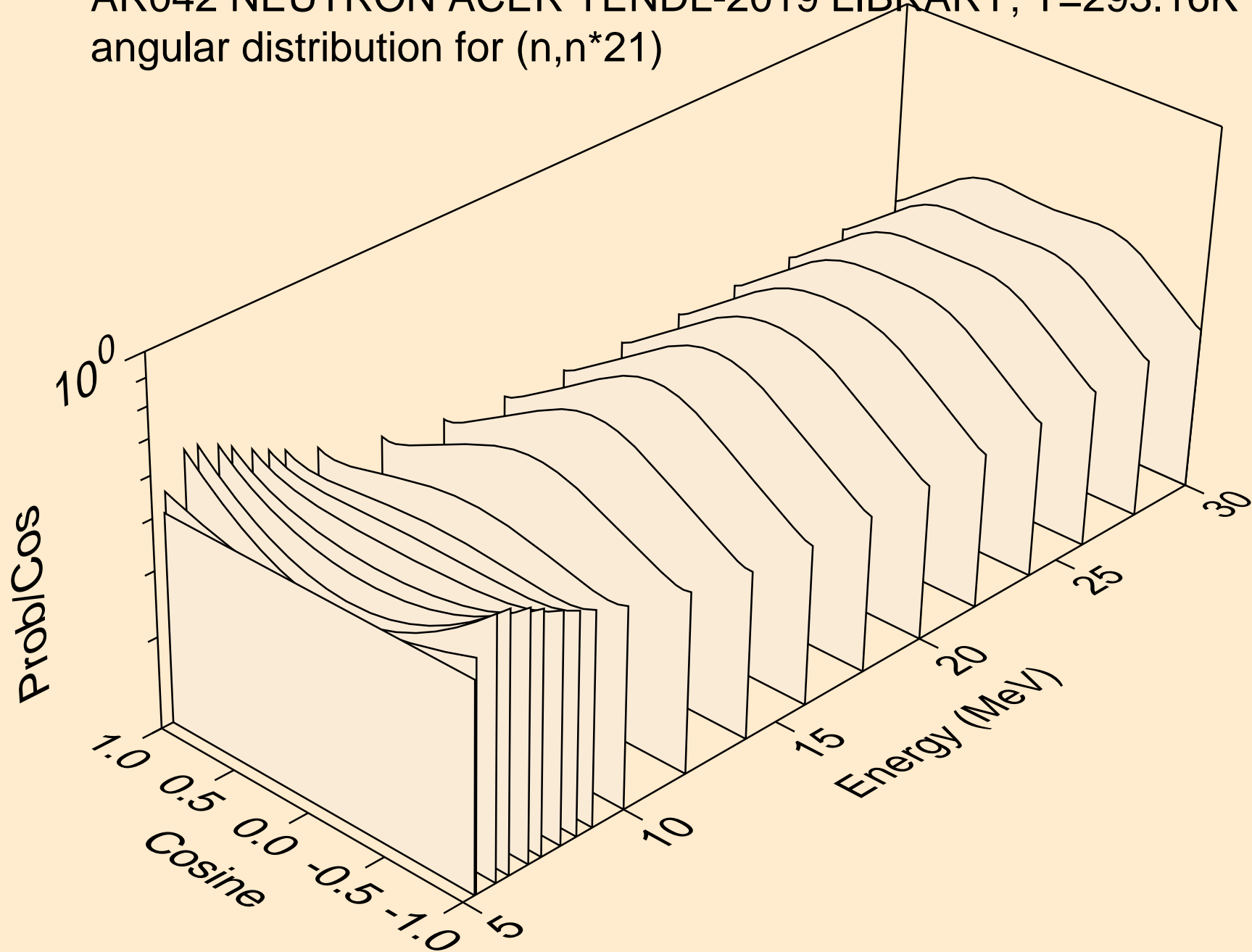

AR042 NEUTRON ACER TENDL-2019 LIBRARY; T=293.16K  
angular distribution for (n,n\*22)

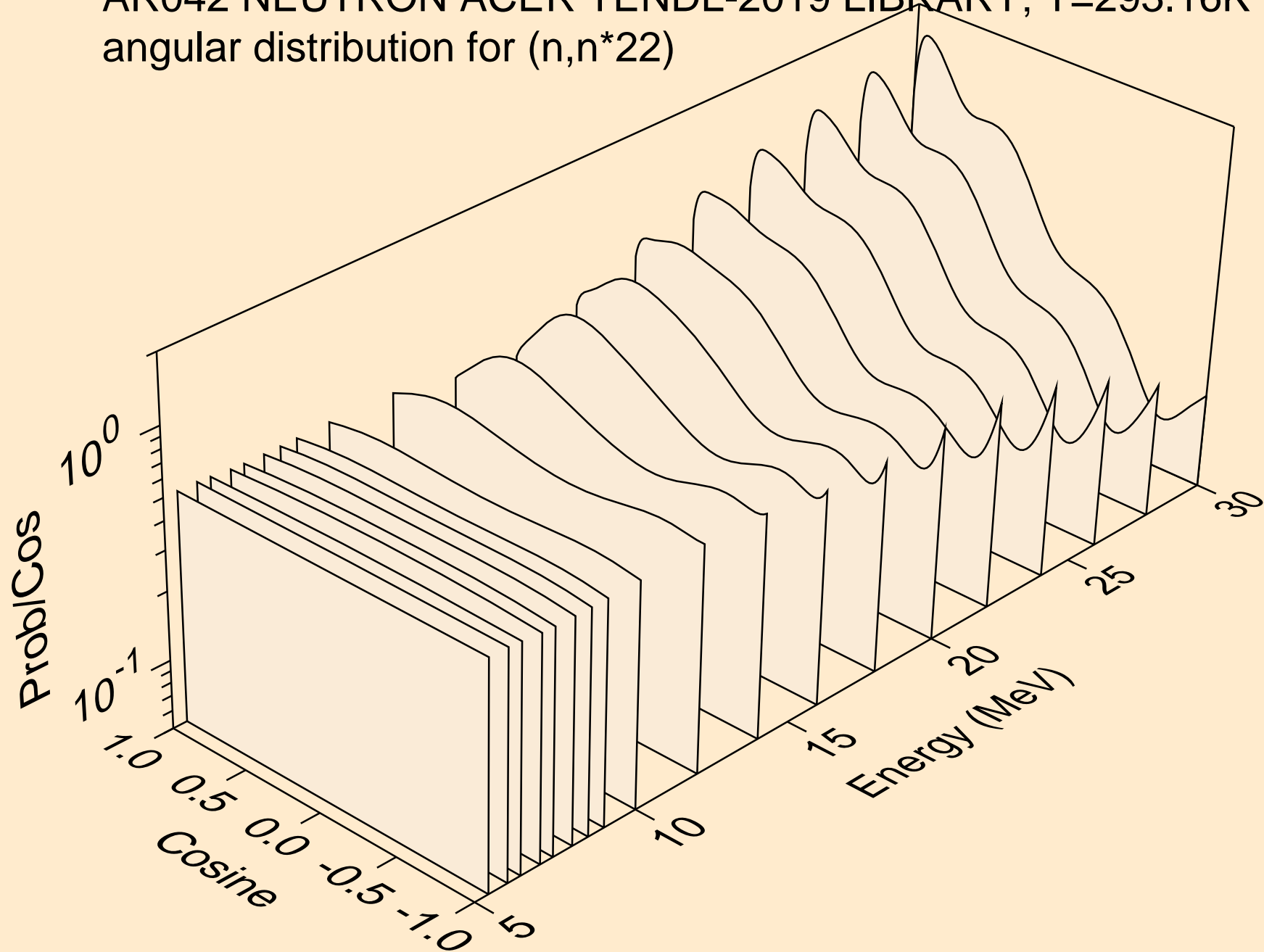

AR042 NEUTRON ACER TENDL-2019 LIBRARY; T=293.16K  
angular distribution for (n,n\*23)

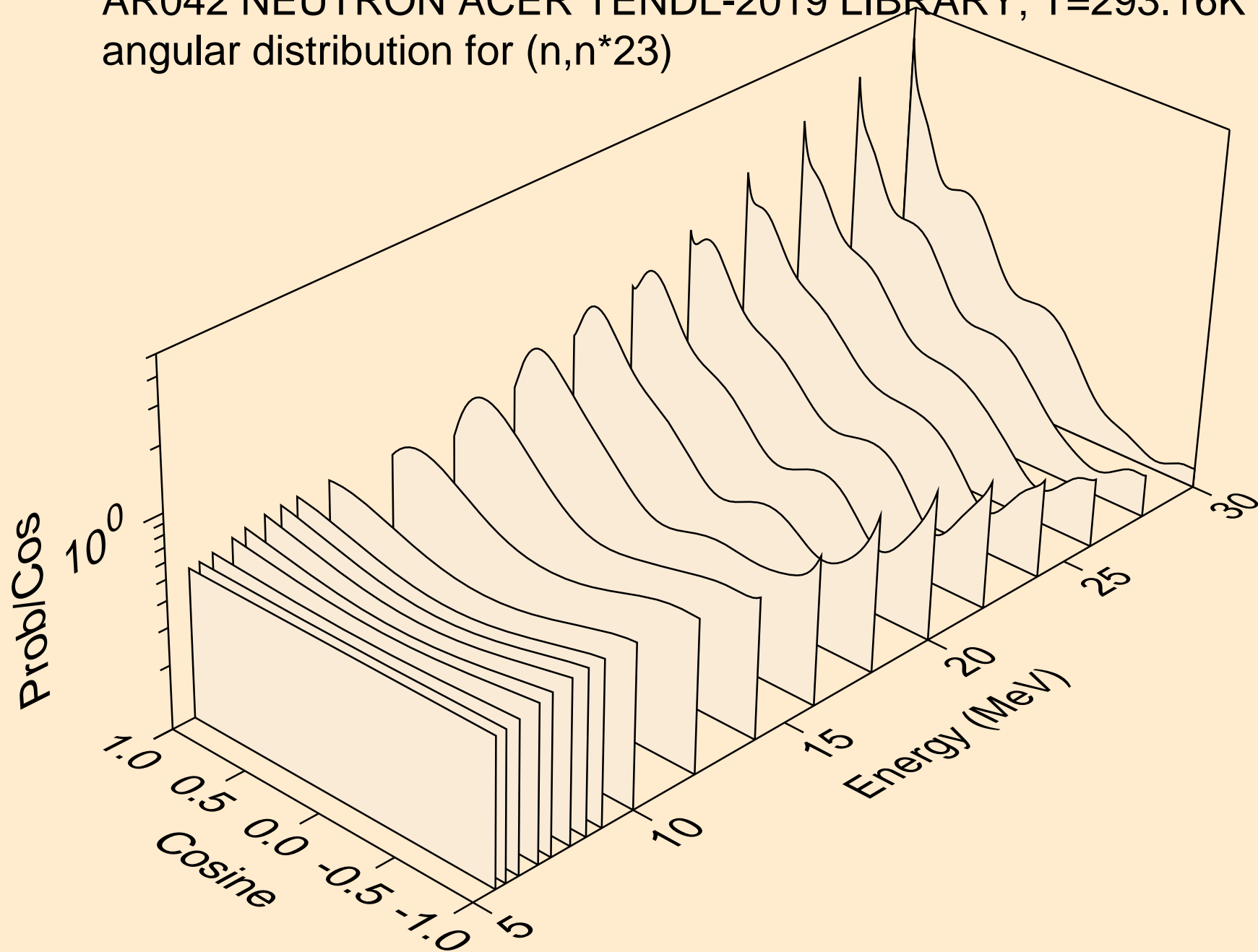

AR042 NEUTRON ACER TENDL-2019 LIBRARY; T=293.16K  
angular distribution for (n,n\*24)

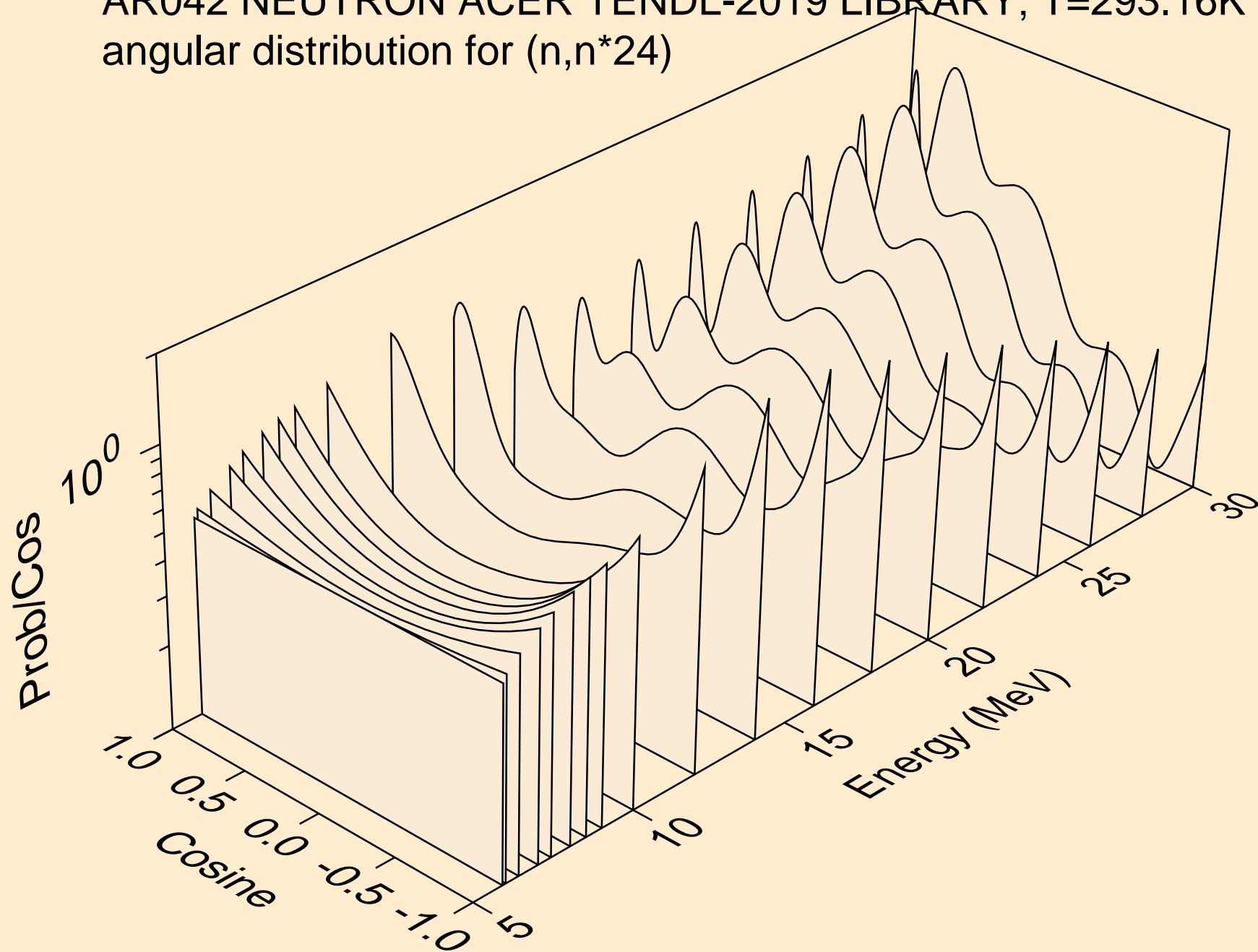

AR042 NEUTRON ACER TENDL-2019 LIBRARY; T=293.16K  
angular distribution for (n,n\*25)

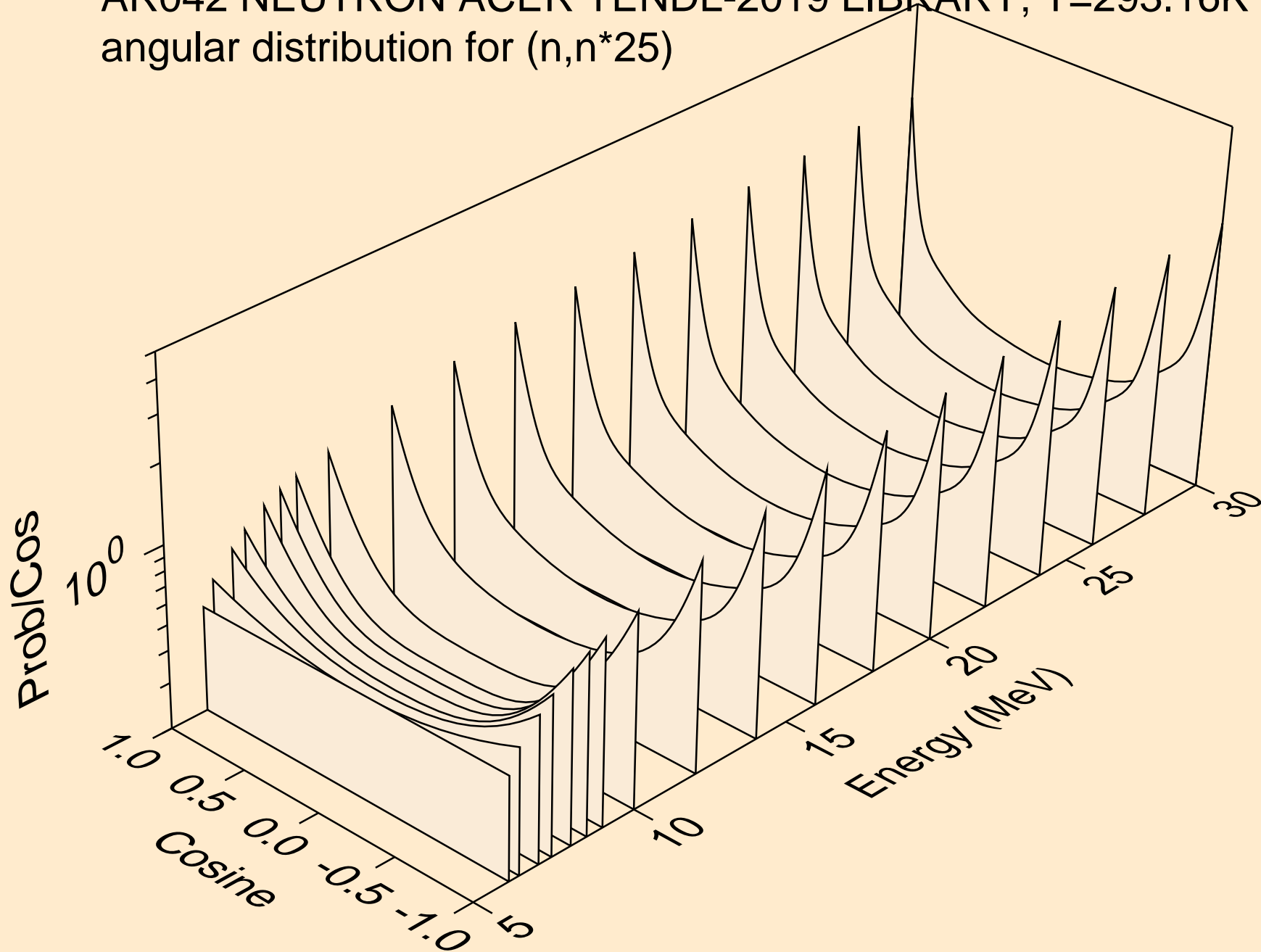



AR042 NEUTRON ACER TENDL-2019 LIBRARY; T=293.16K  
angular distribution for (n,n\*26)

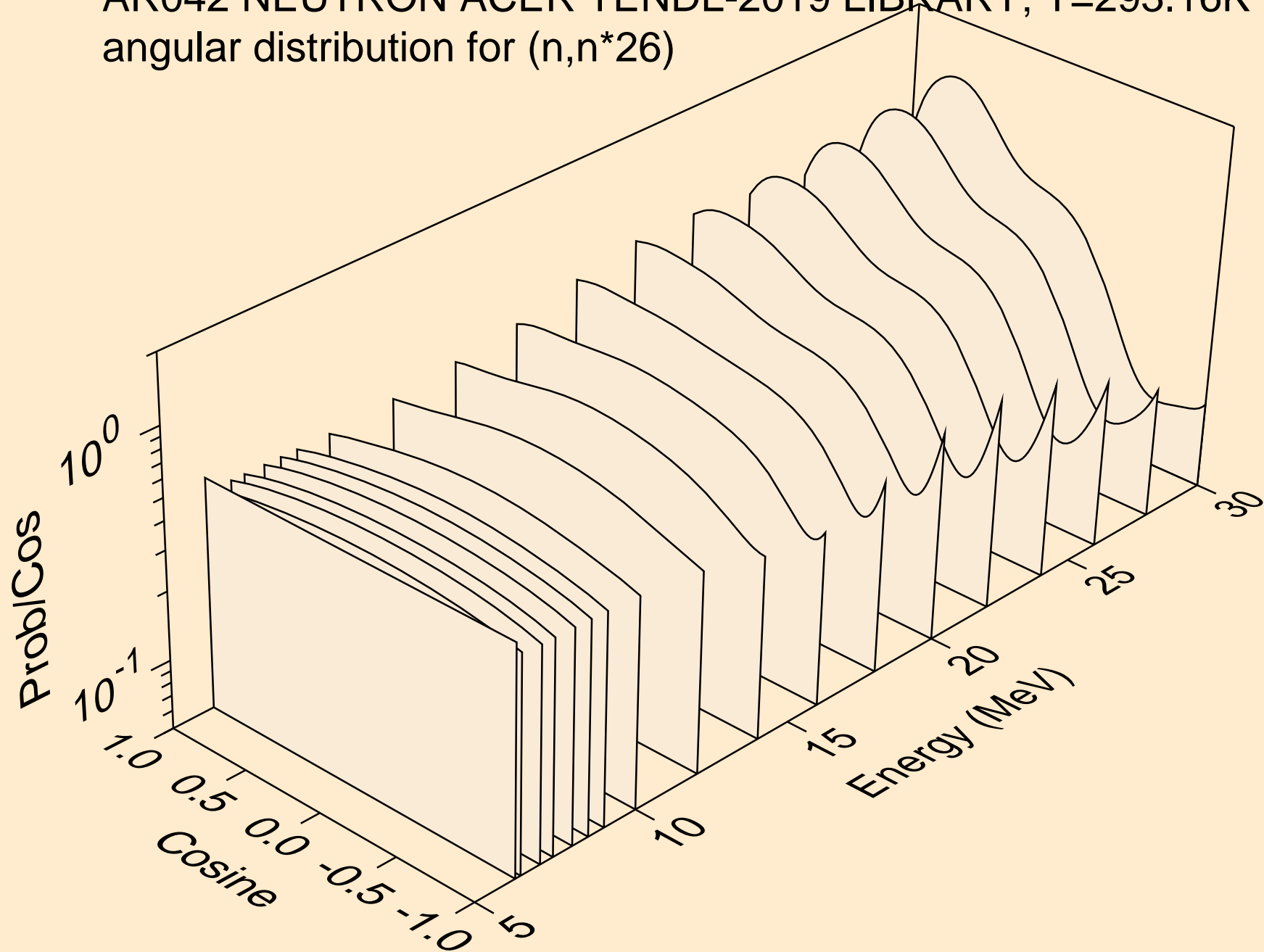

AR042 NEUTRON ACER TENDL-2019 LIBRARY; T=293.16K  
angular distribution for (n,n\*27)

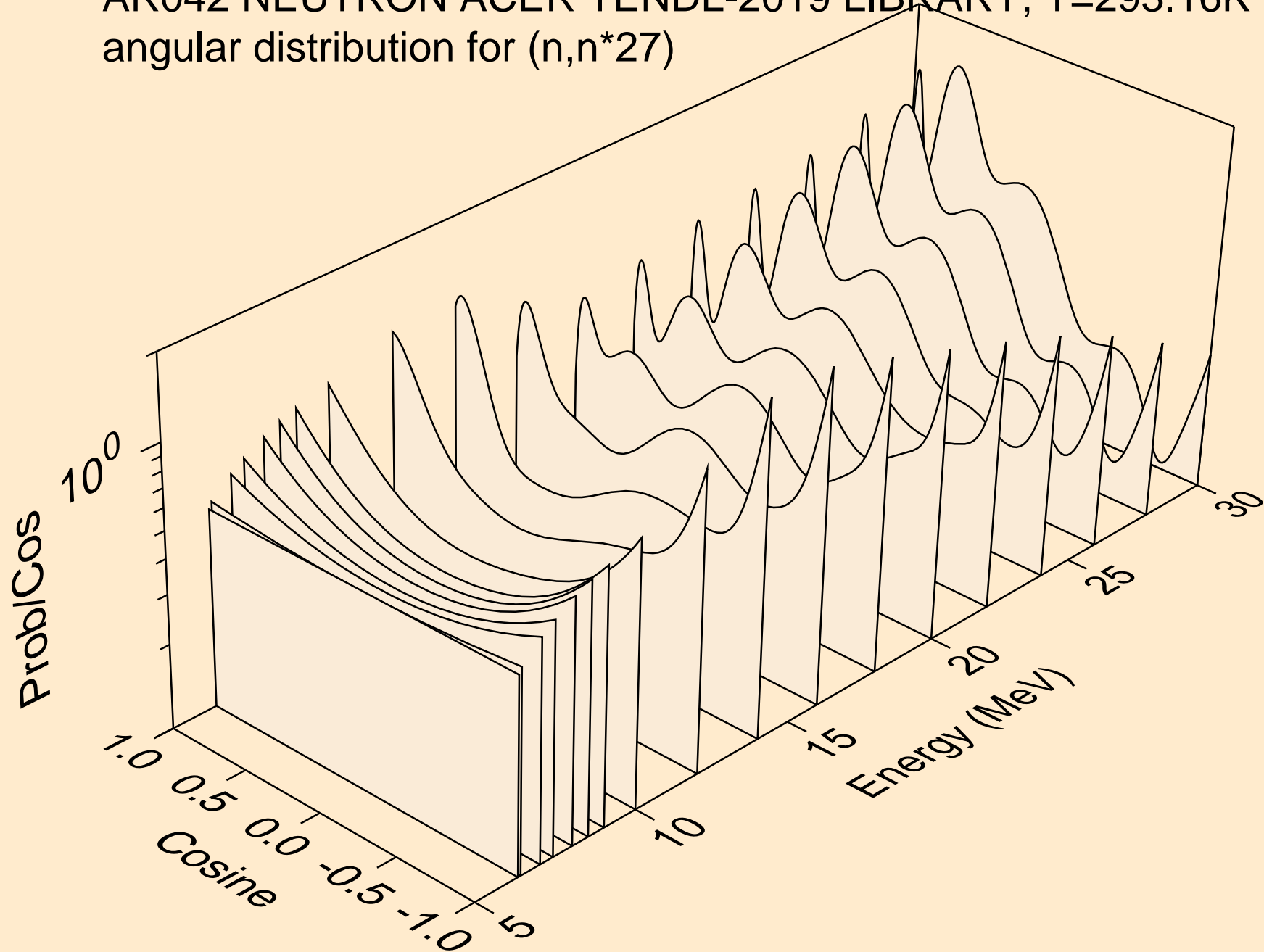

AR042 NEUTRON ACER TENDL-2019 LIBRARY; T=293.16K  
angular distribution for (n,n\*28)

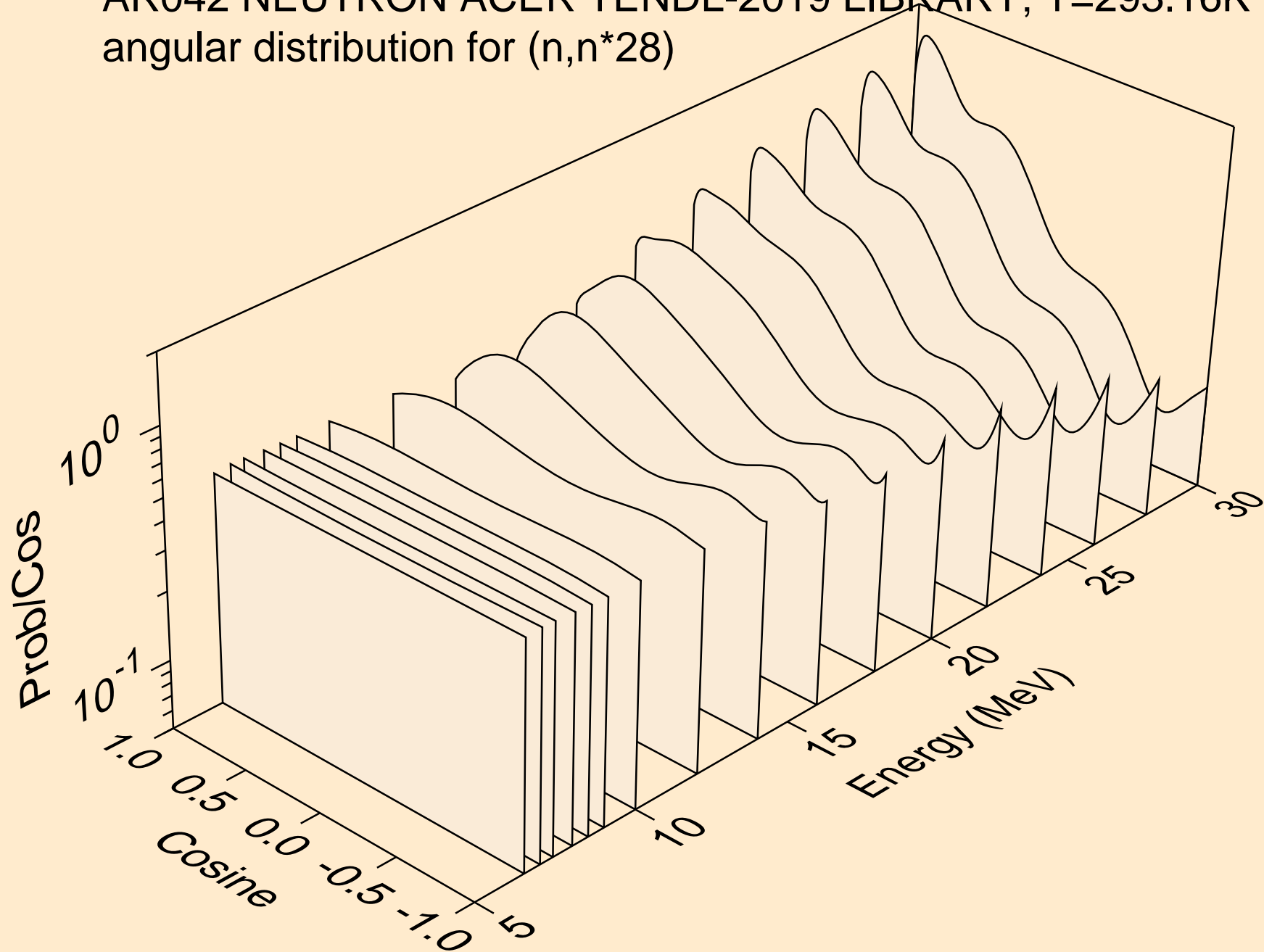

AR042 NEUTRON ACER TENDL-2019 LIBRARY; T=293.16K  
Neutron emission for (n,x)

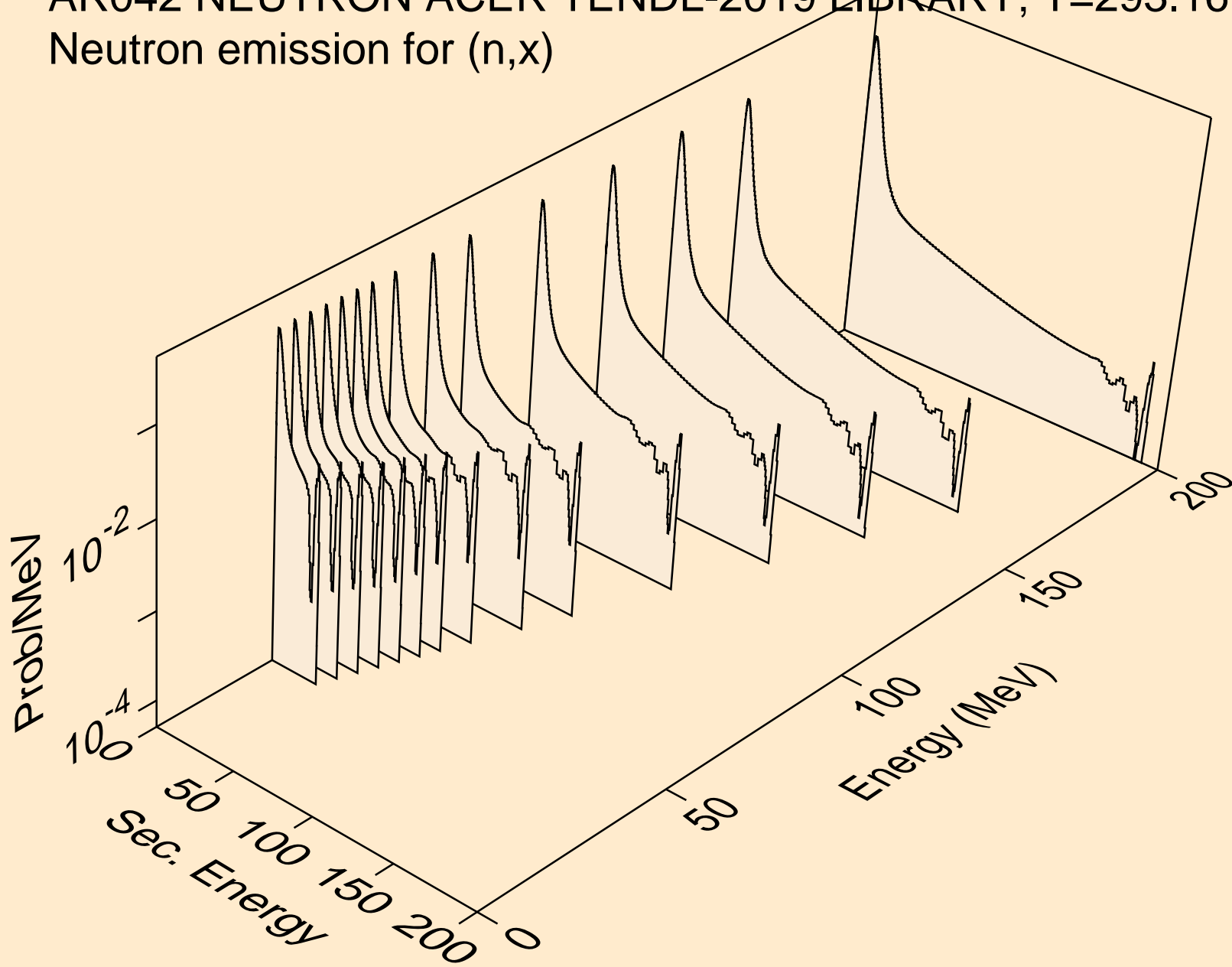

AR042 NEUTRON ACER TENDL-2019 LIBRARY; T=293.16K  
Neutron emission for (n,2nd)

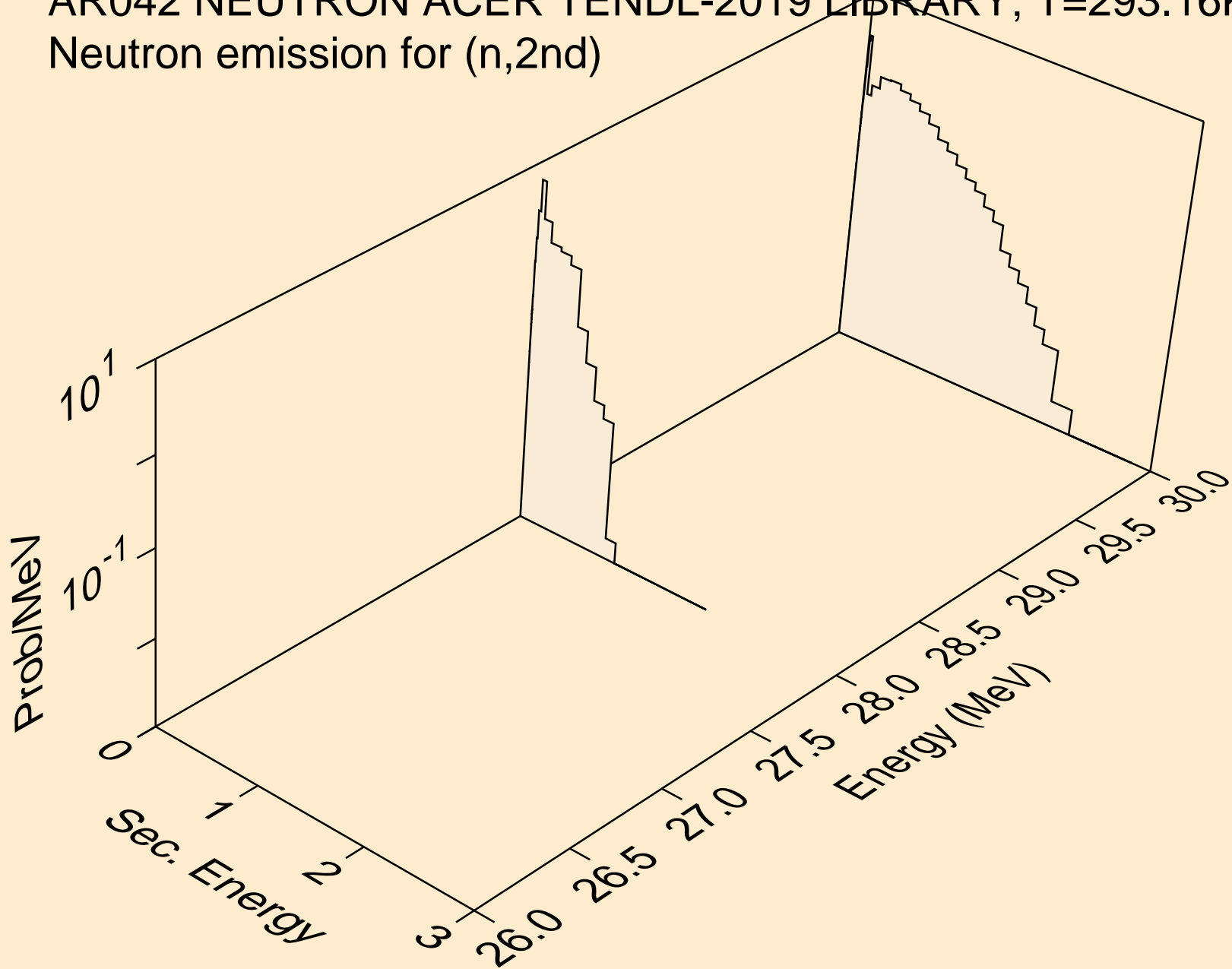

AR042 NEUTRON ACER TENDL-2019 LIBRARY; T=293.16K  
Neutron emission for (n,2n)

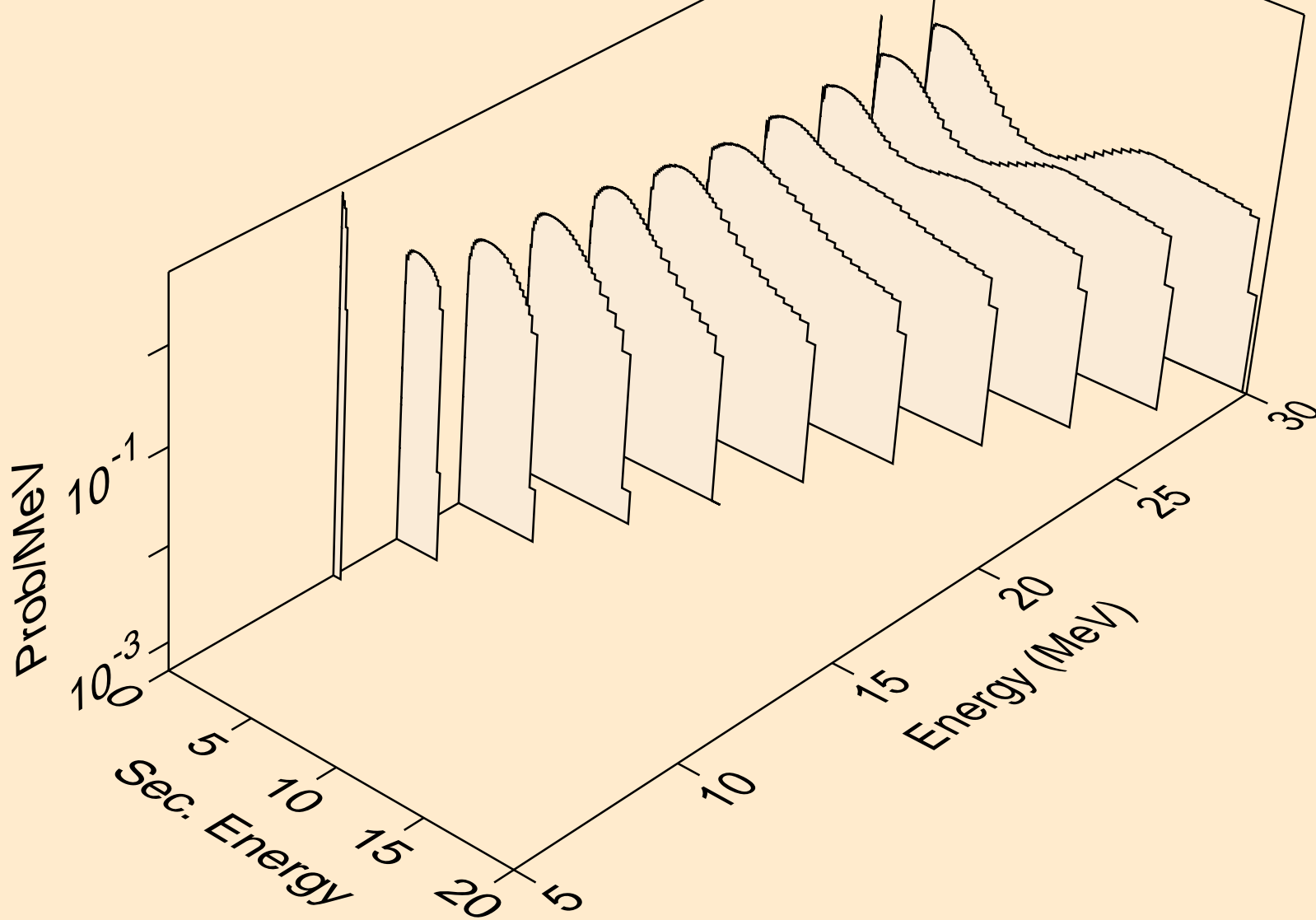

AR042 NEUTRON ACER TENDL-2019 LIBRARY; T=293.16K  
Neutron emission for (n,3n)

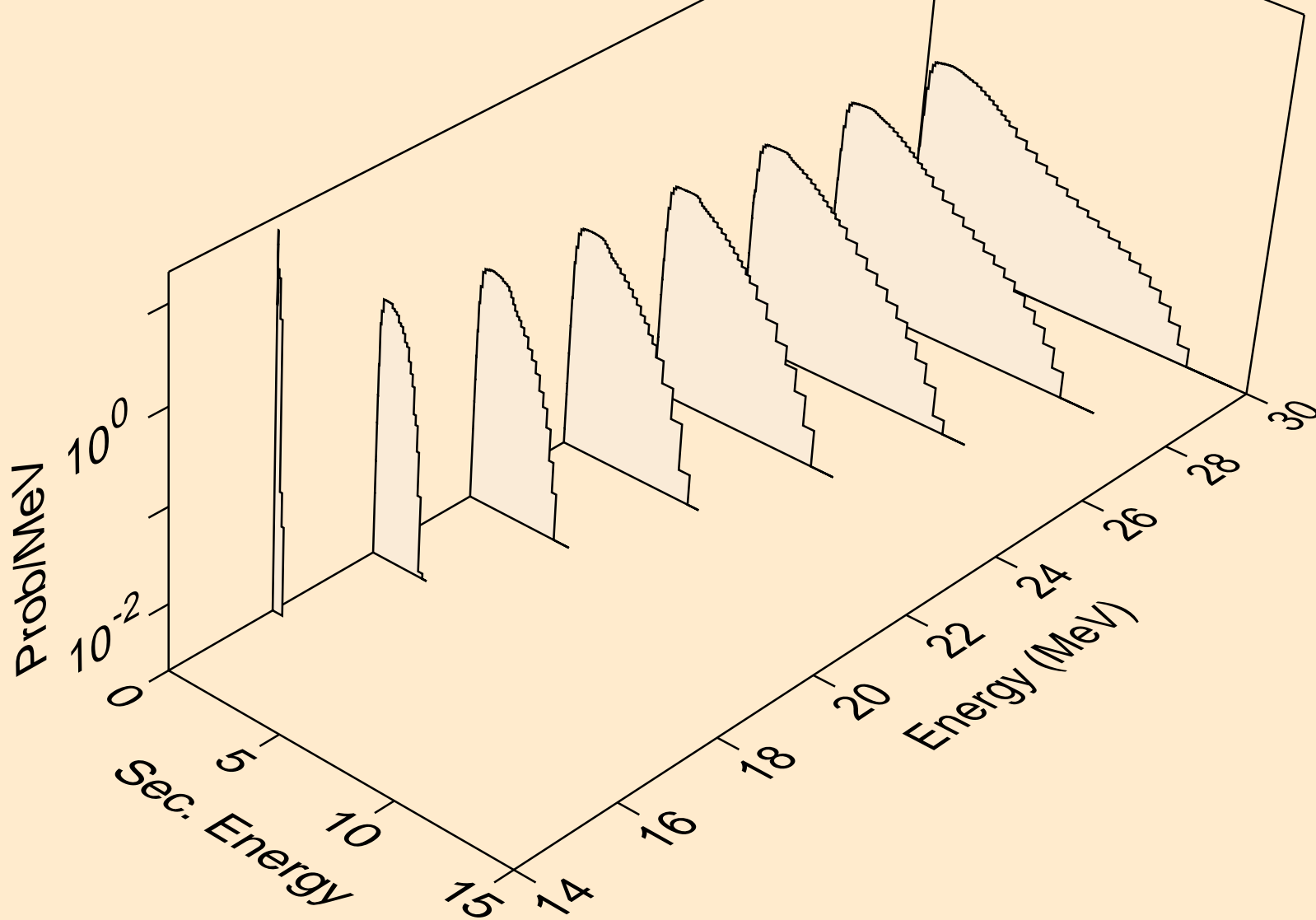

AR042 NEUTRON ACER TENDL-2019 LIBRARY; T=293.16K  
Neutron emission for (n,n\*)a

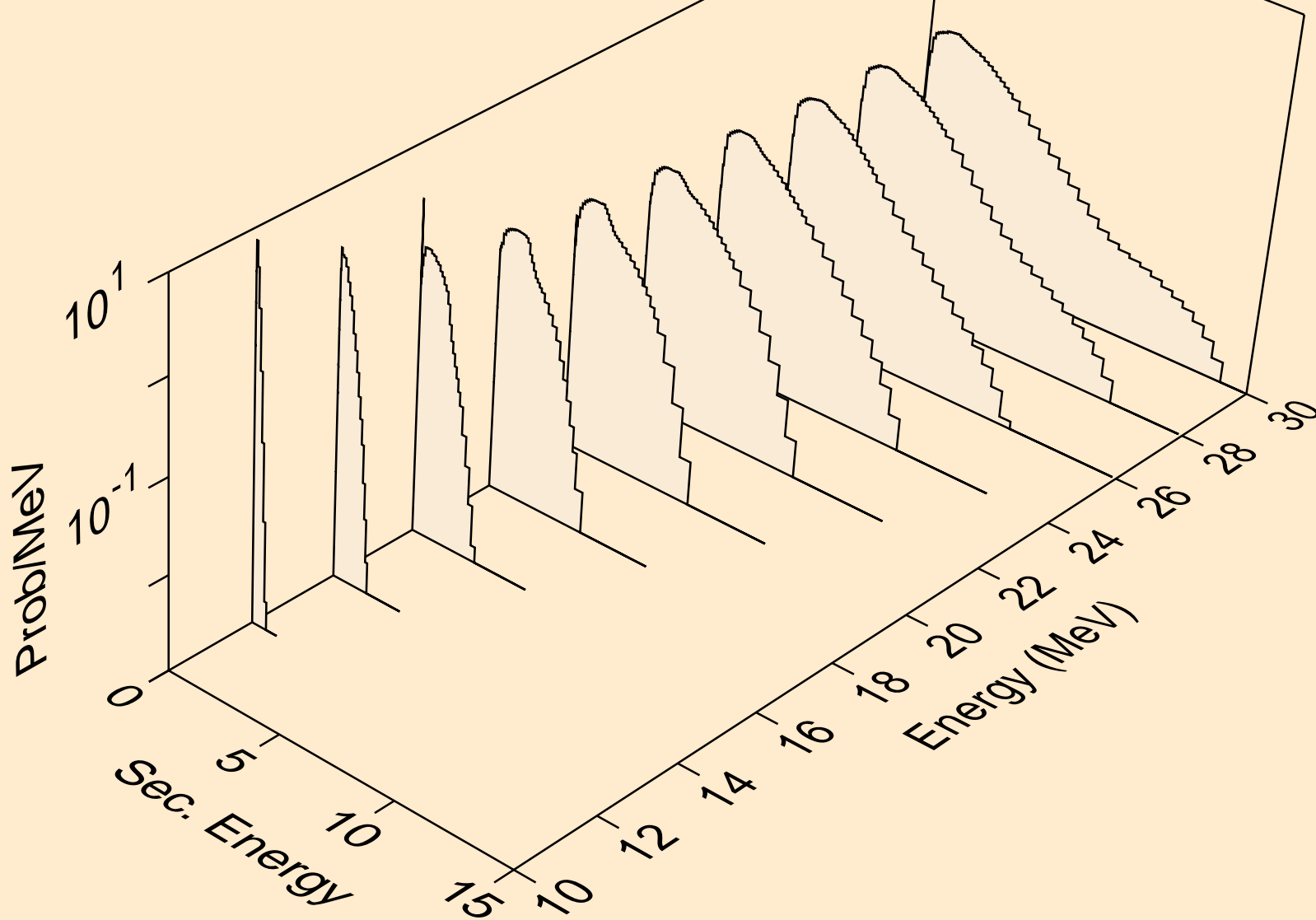



AR042 NEUTRON ACER TENDL-2019 LIBRARY; T=293.16K  
Neutron emission for (n,2n)a

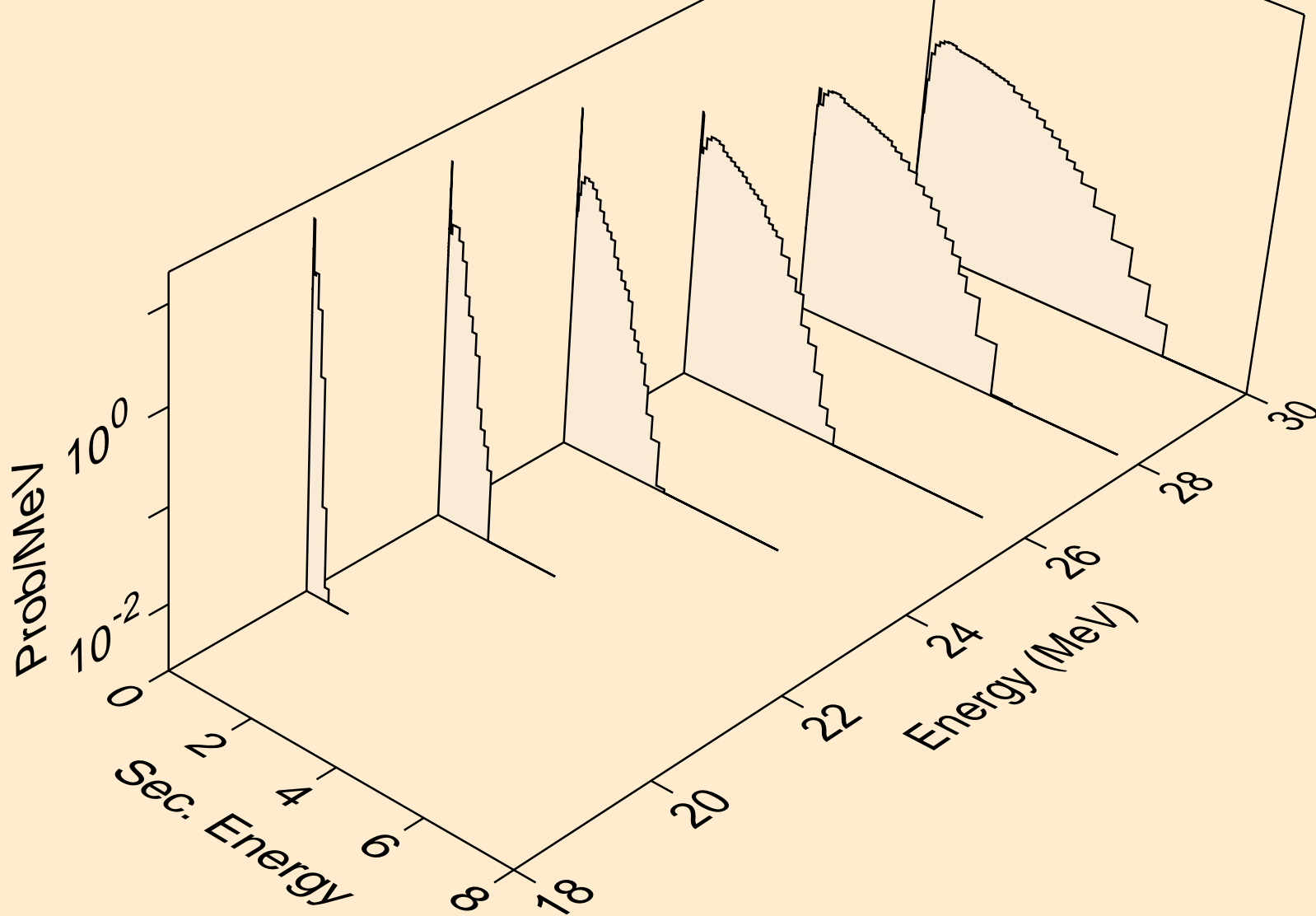

AR042 NEUTRON ACER TENDL-2019 LIBRARY; T=293.16K  
Neutron emission for (n,3n)a

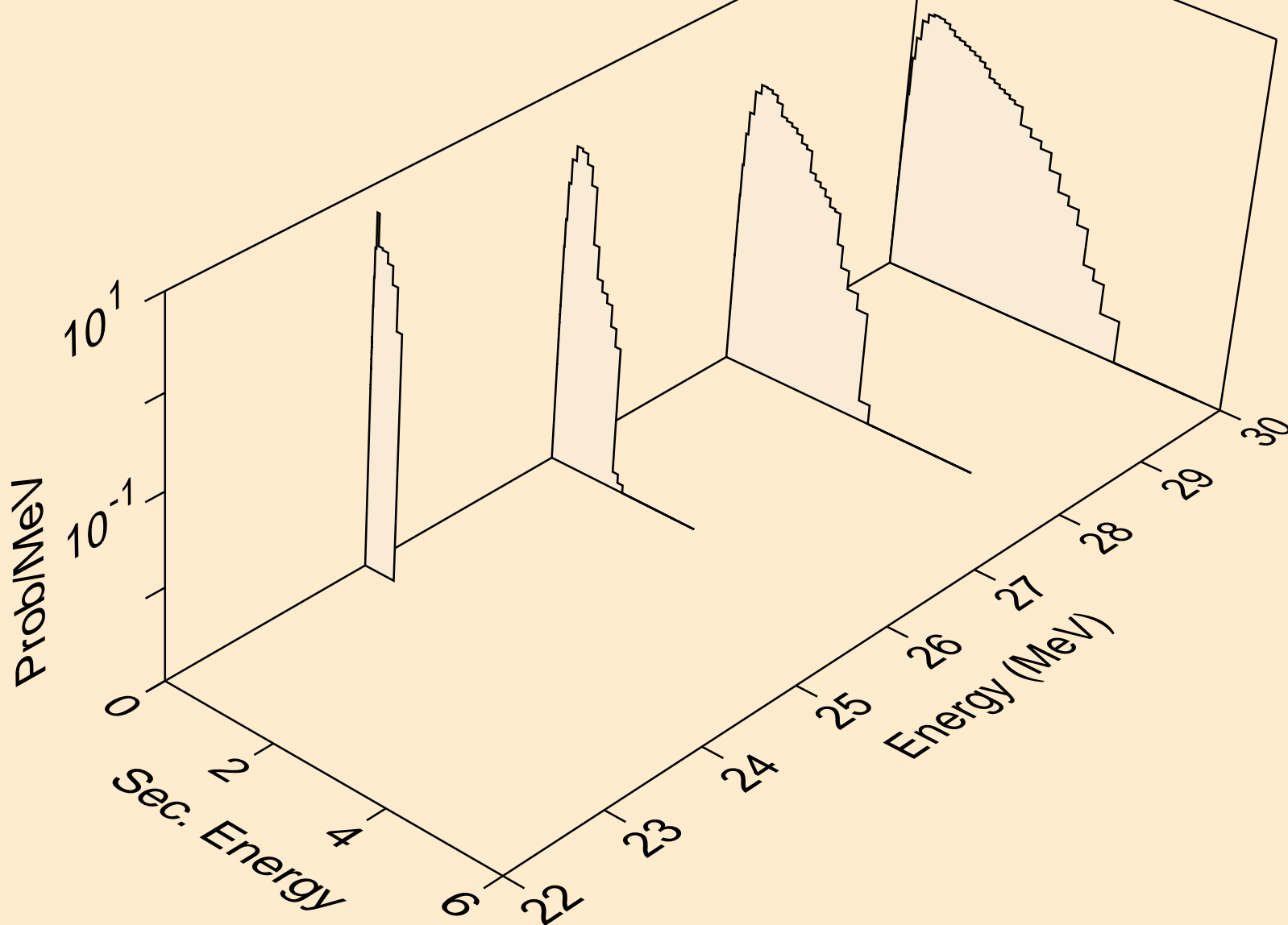

AR042 NEUTRON ACER TENDL-2019 LIBRARY; T=293.16K  
Neutron emission for (n,n\*)p

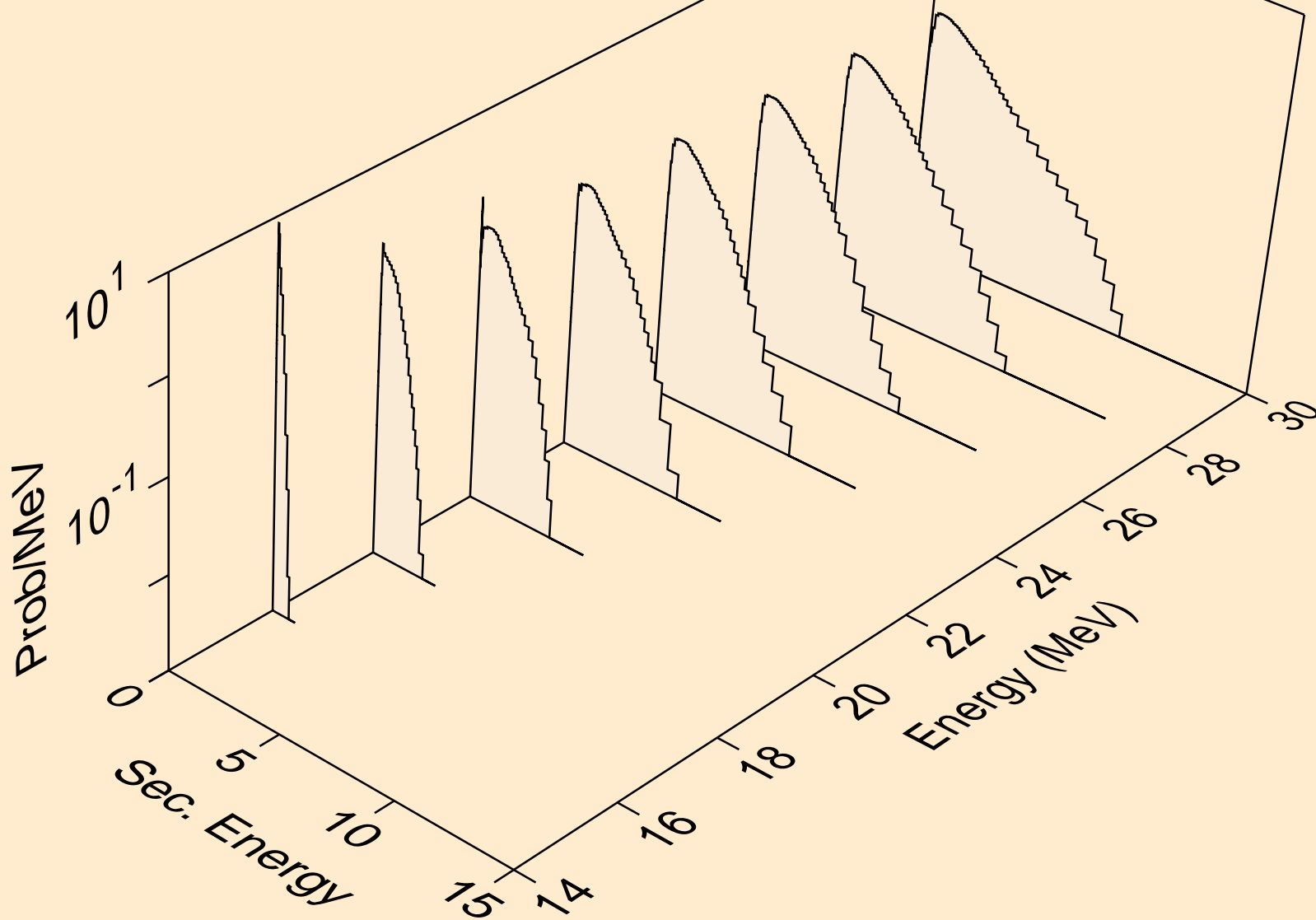

AR042 NEUTRON ACER TENDL-2019 LIBRARY; T=293.16K  
Neutron emission for (n,n\*)2a

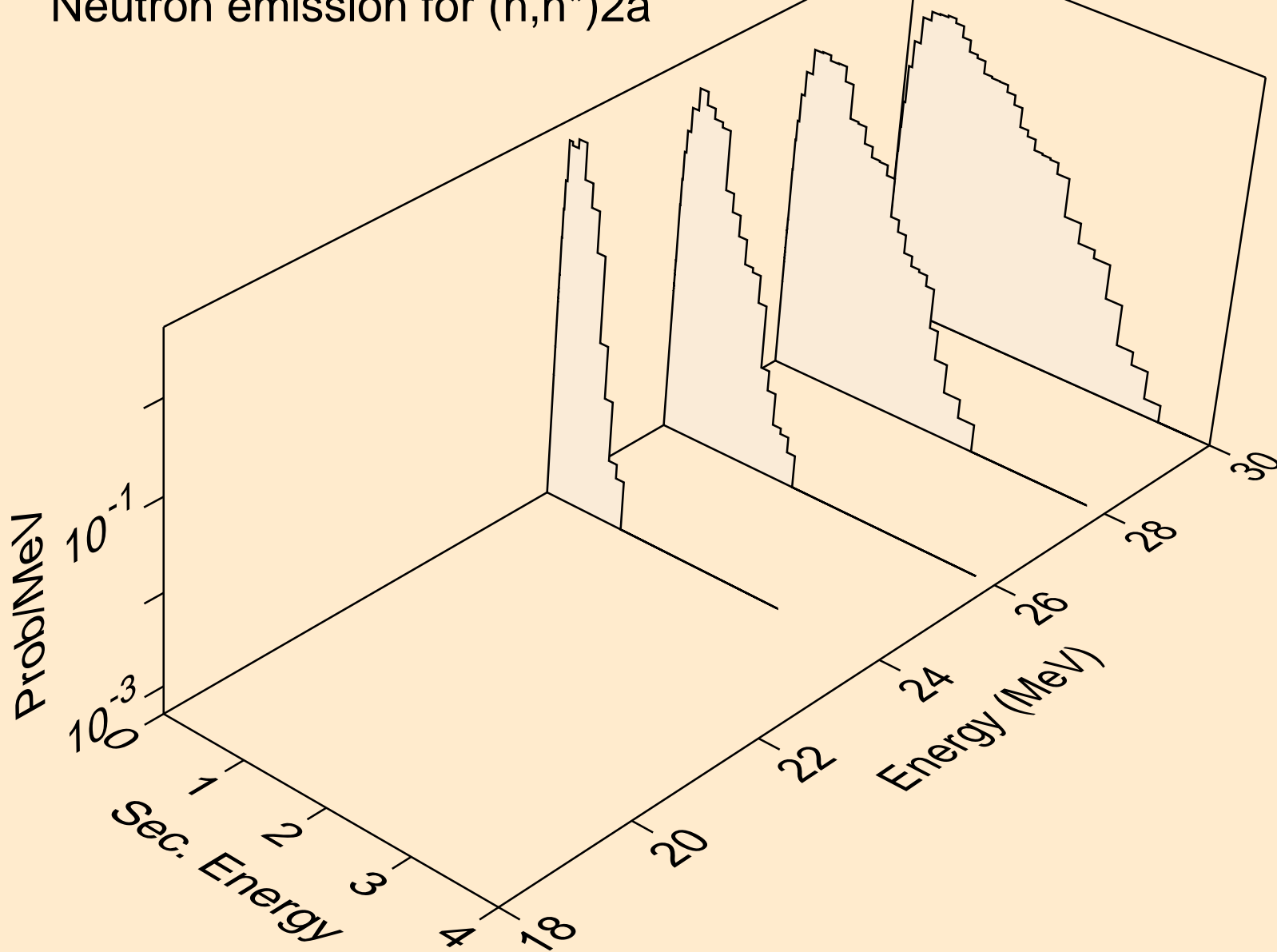

AR042 NEUTRON ACER TENDL-2019 LIBRARY; T=293.16K  
Neutron emission for (n,n\*)d

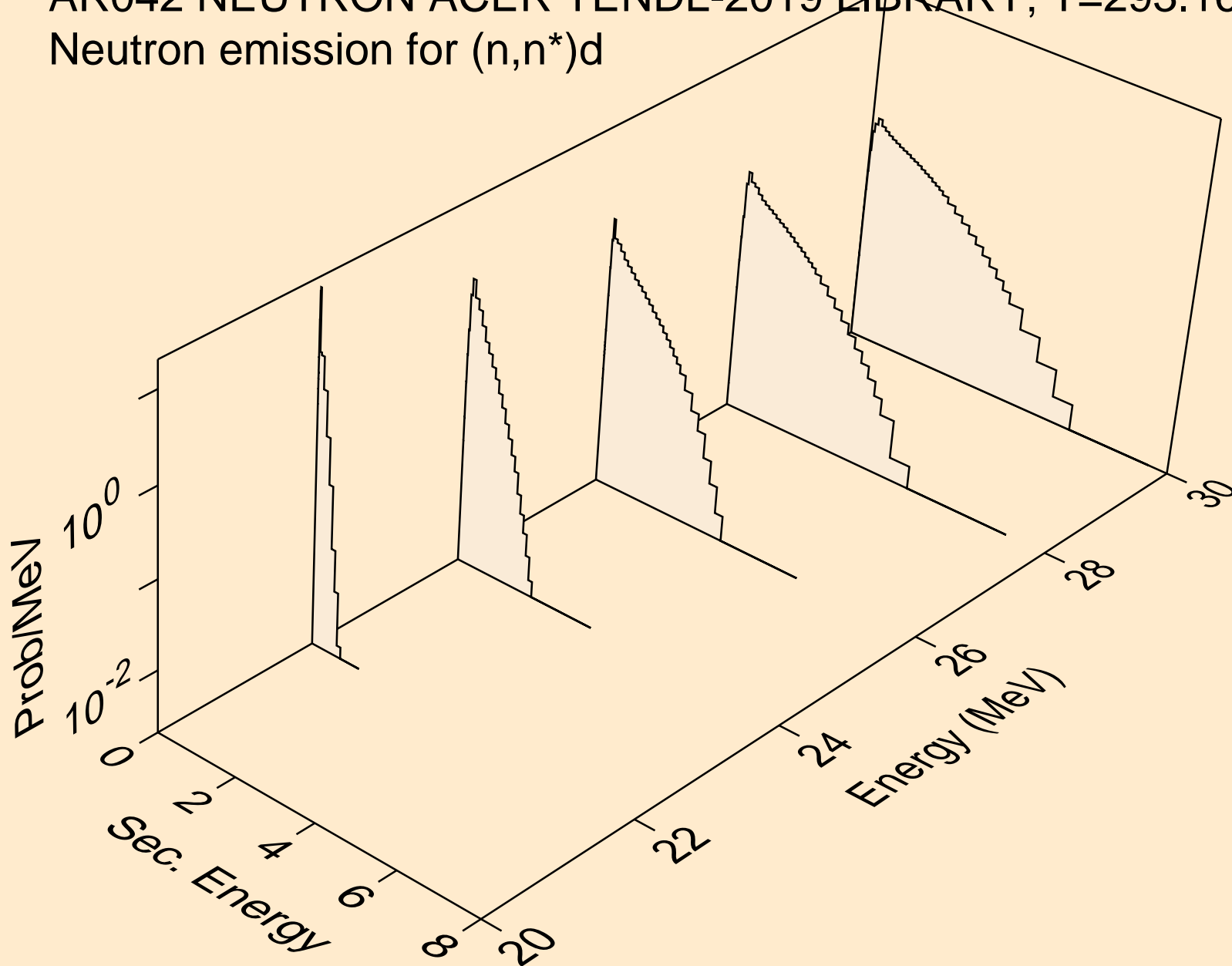

AR042 NEUTRON ACER TENDL-2019 LIBRARY; T=293.16K  
Neutron emission for (n,n\*)t

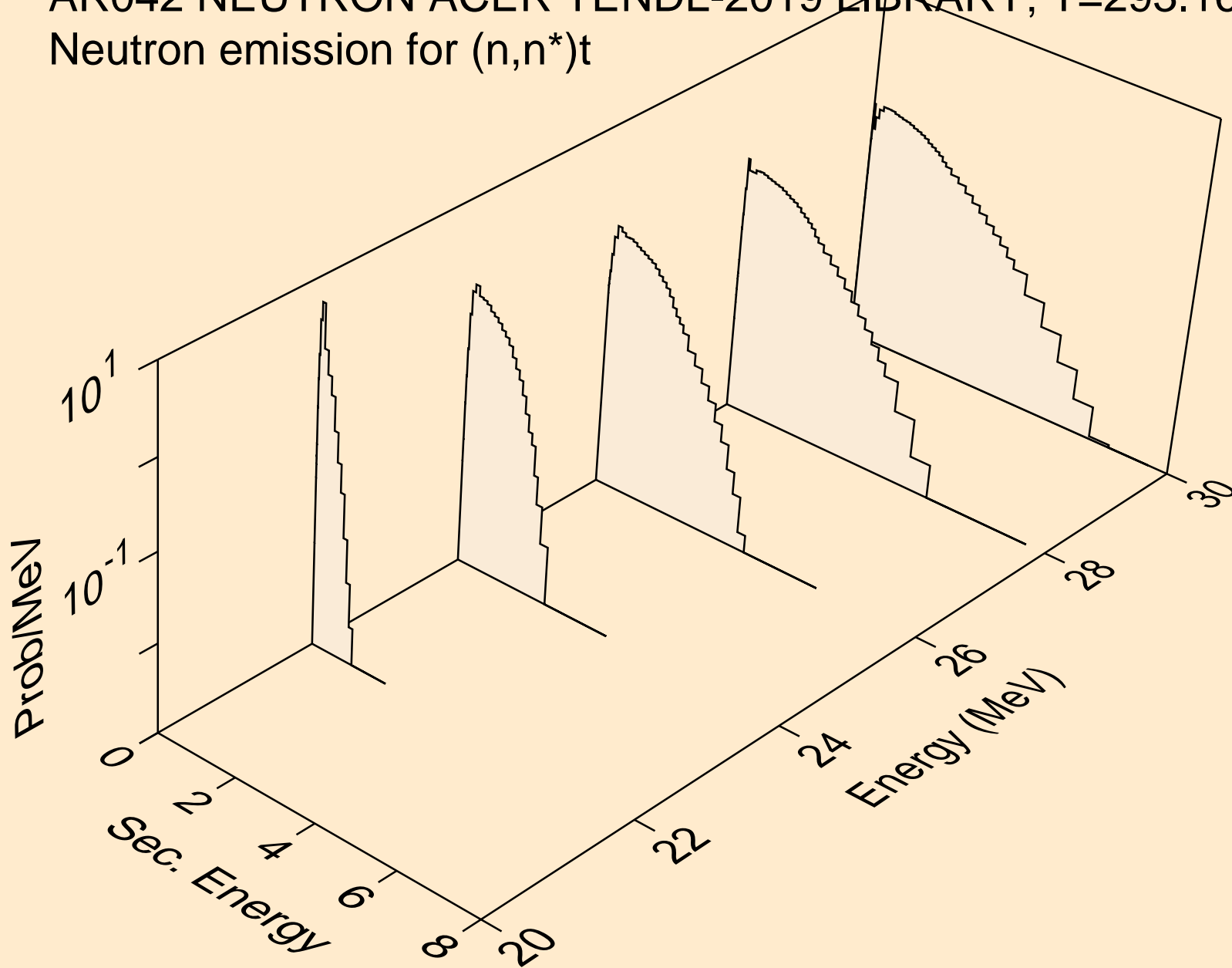

AR042 NEUTRON ACER TENDL-2019 LIBRARY; T=293.16K  
Neutron emission for (n,n\*)he3

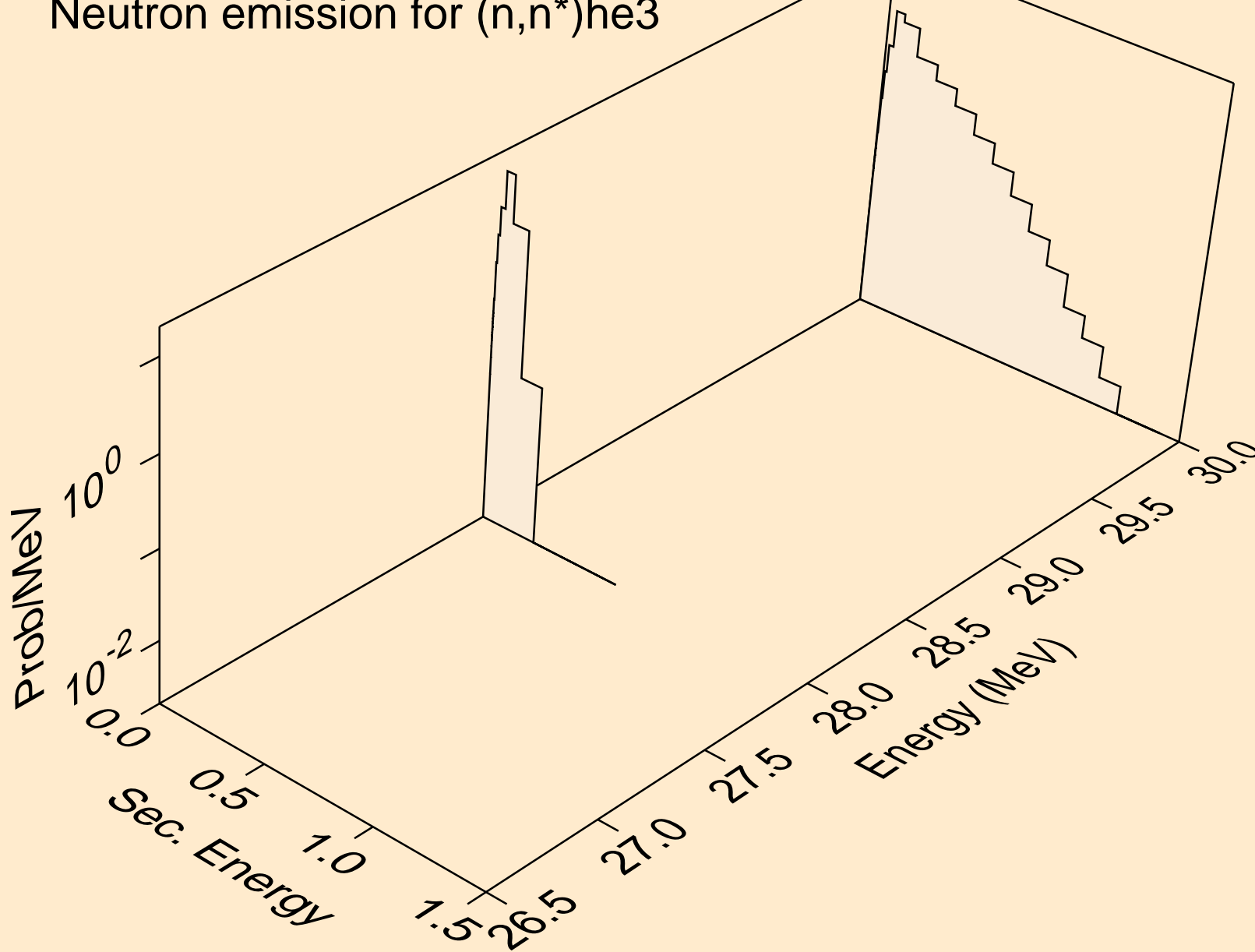

AR042 NEUTRON ACER TENDL-2019 LIBRARY; T=293.16K  
Neutron emission for (n,4n)

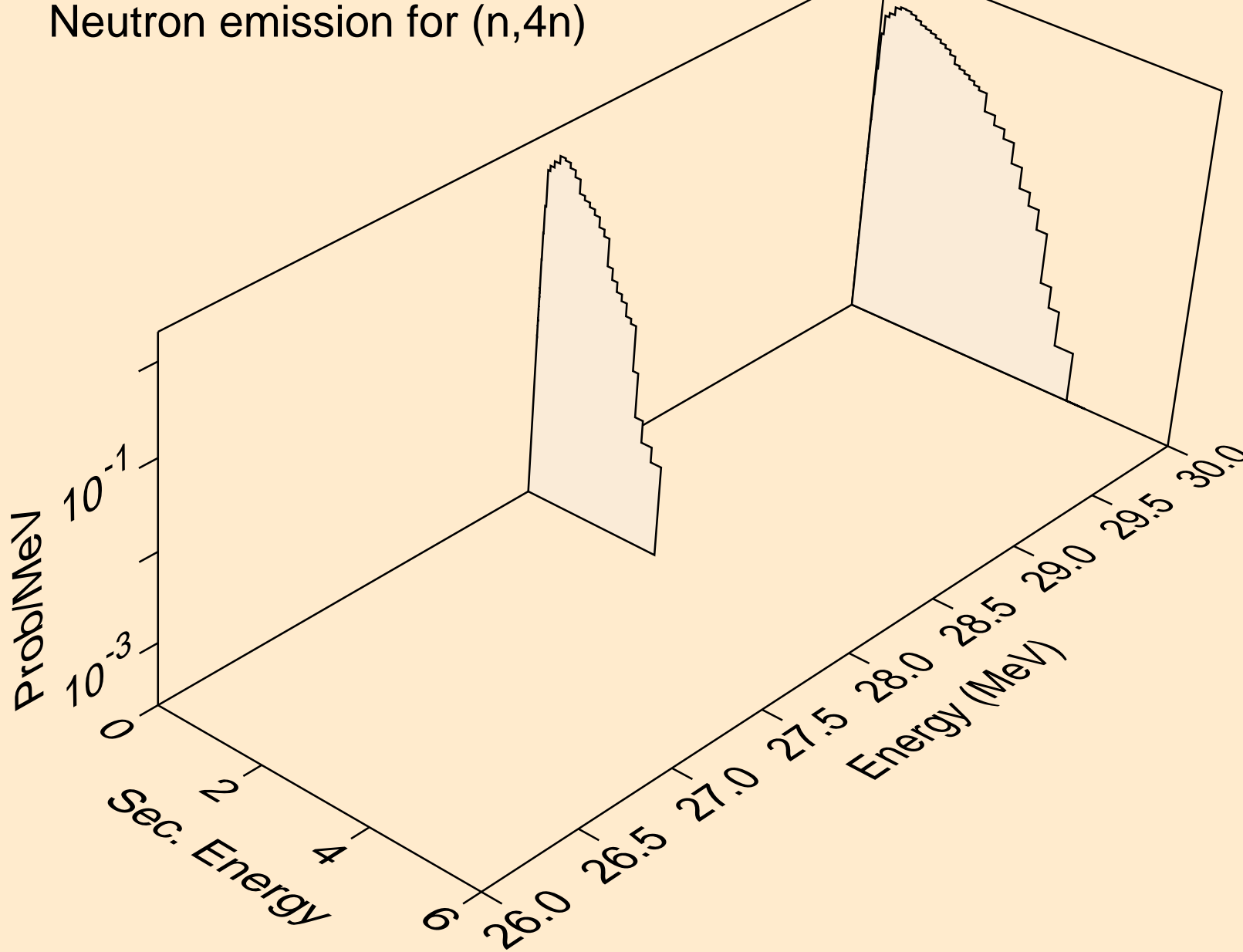



AR042 NEUTRON ACER TENDL-2019 LIBRARY; T=293.16K  
Neutron emission for (n,2np)

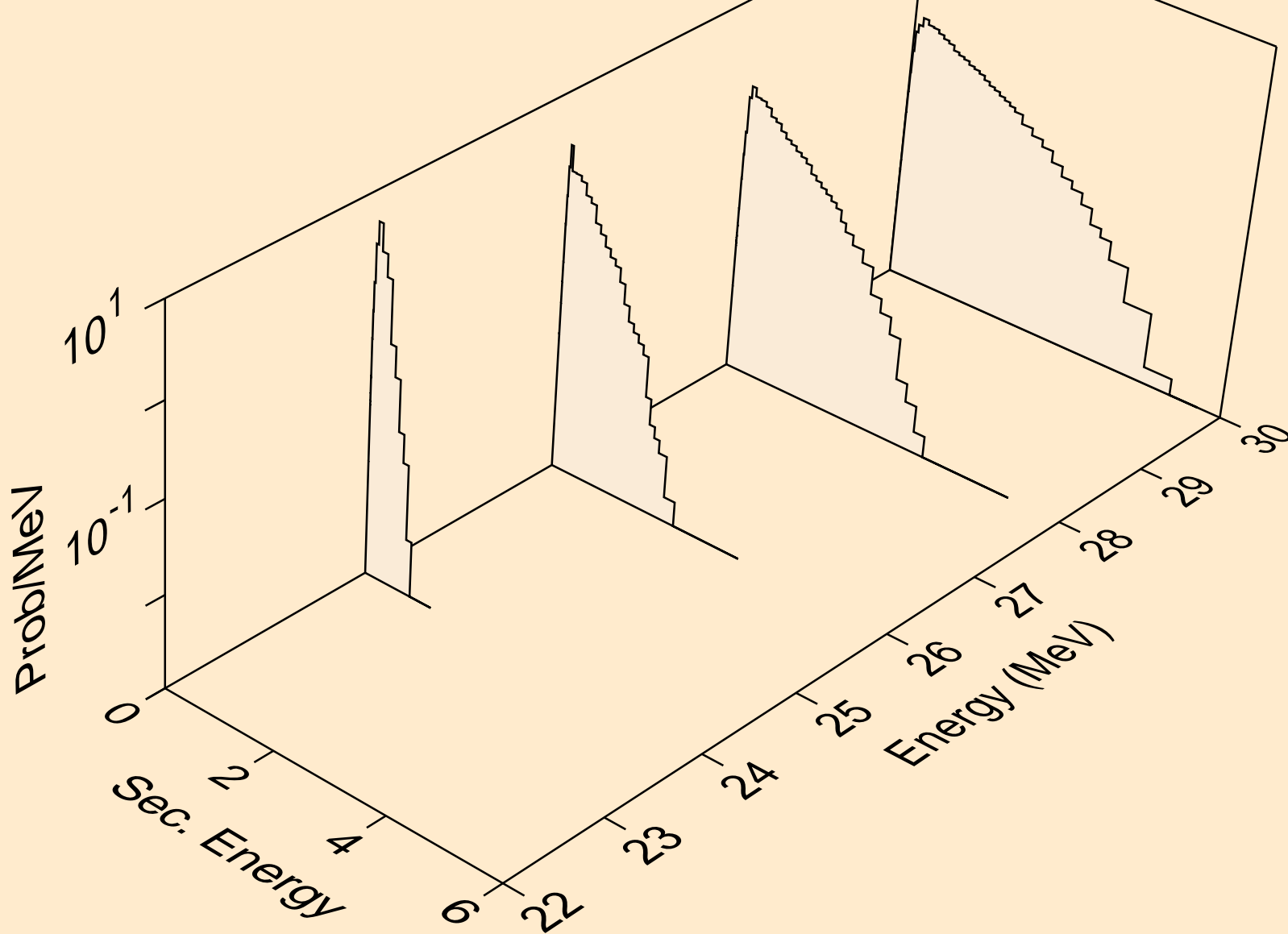

AR042 NEUTRON ACER TENDL-2019 LIBRARY; T=293.16K  
Neutron emission for (n,3np)

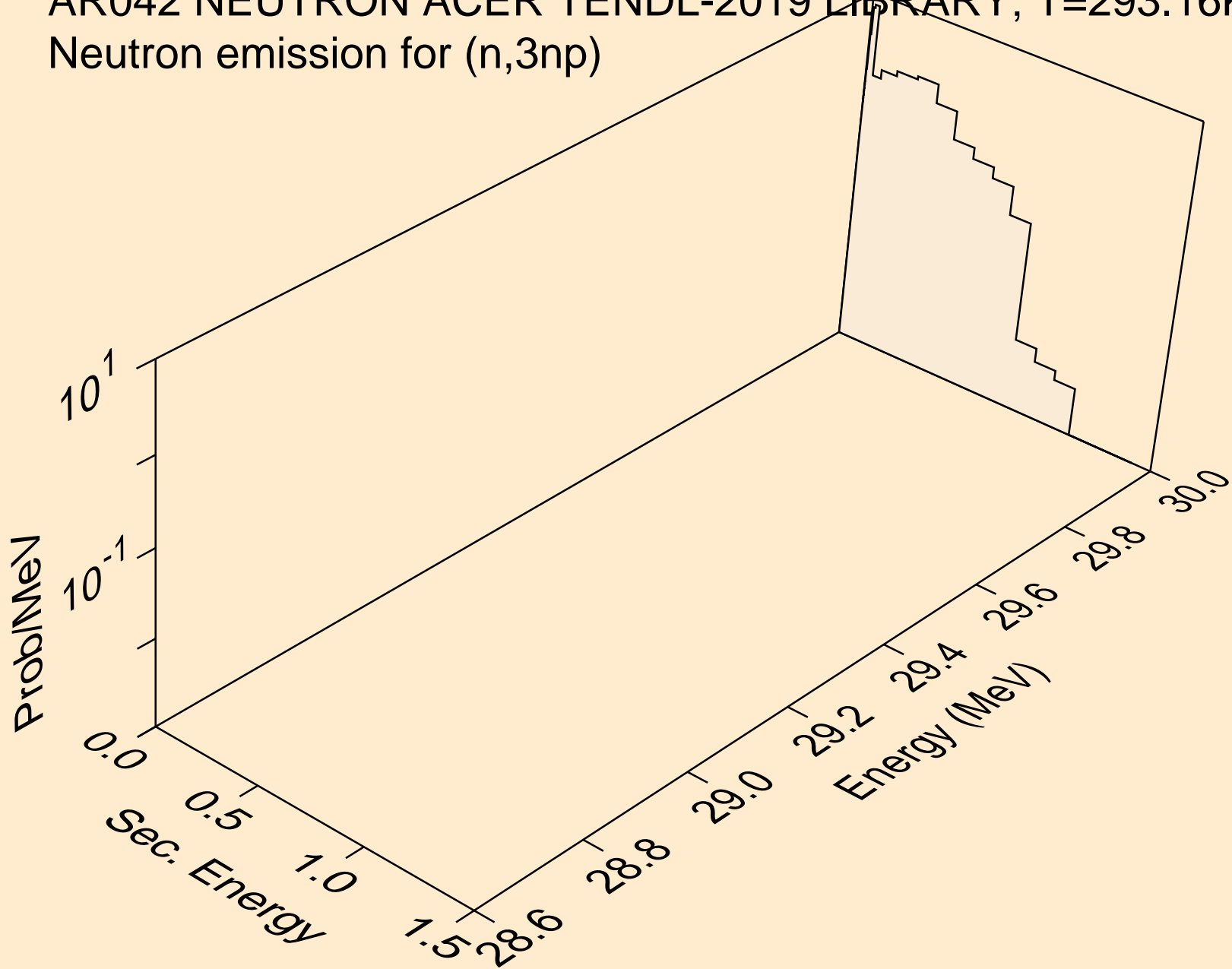

AR042 NEUTRON ACER TENDL-2019 LIBRARY; T=293.16K  
Neutron emission for (n,n\*c)

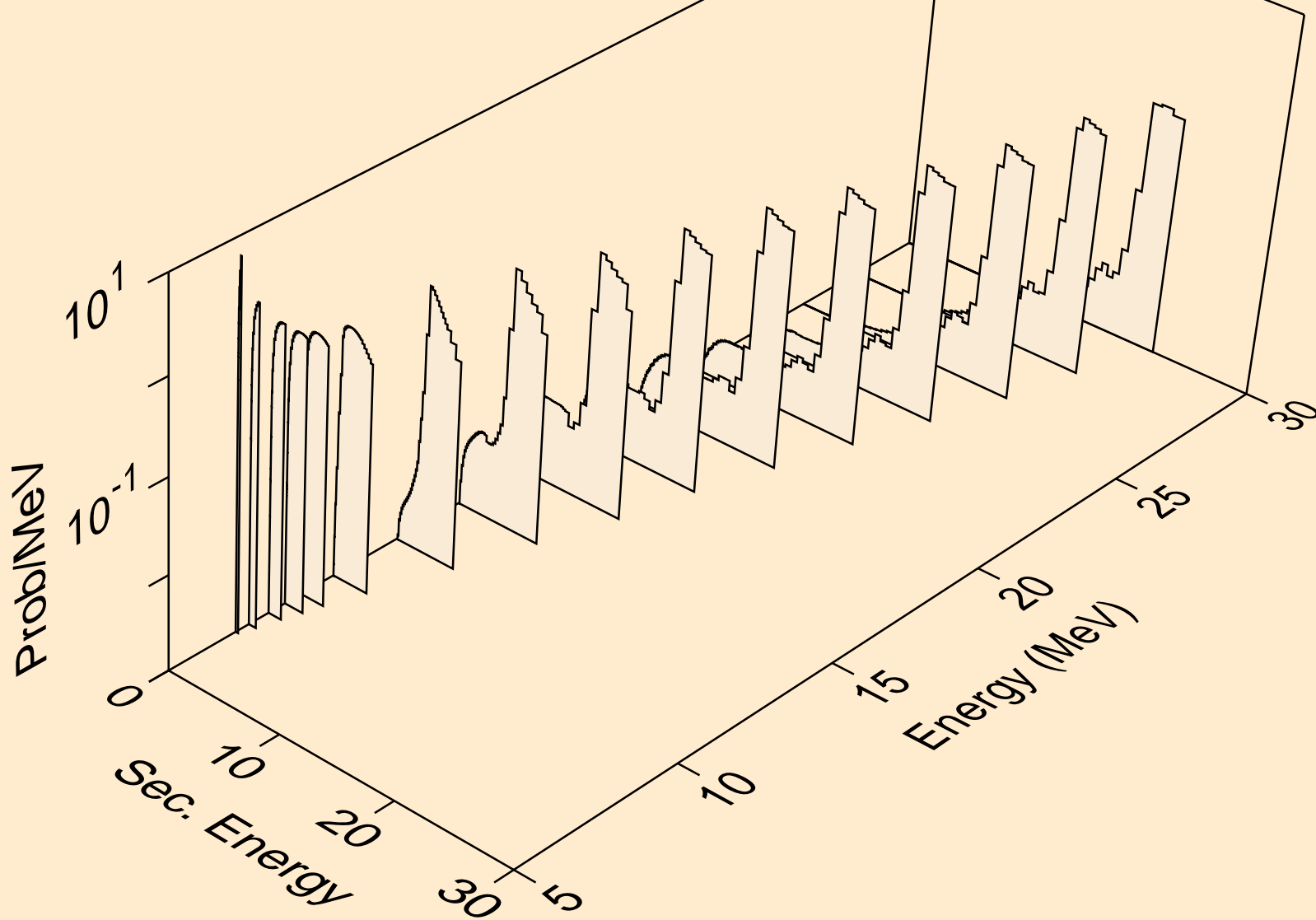

AR042 NEUTRON ACER TENDL-2019 LIBRARY; T=293.16K  
Photon emission for (n,x)

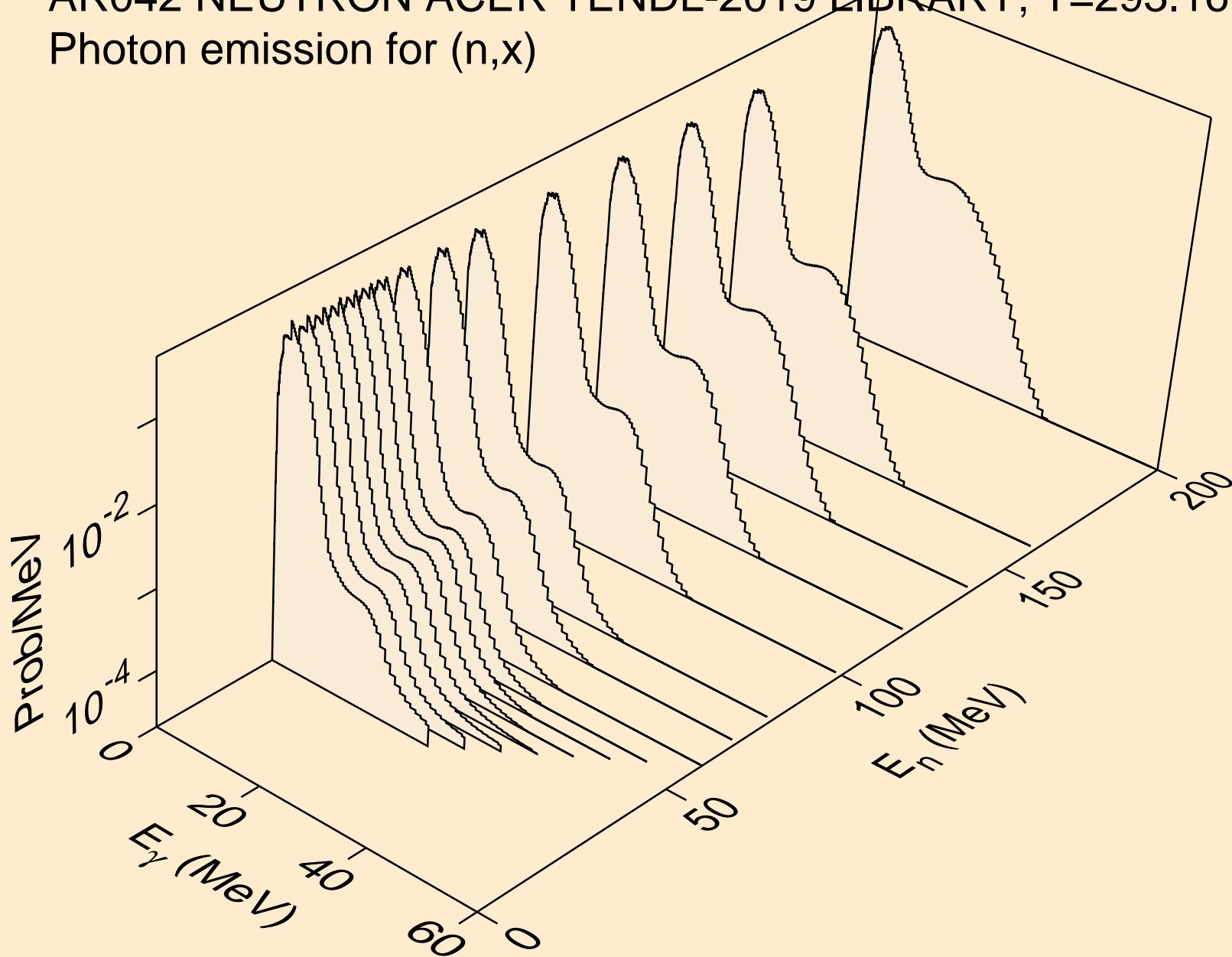

AR042 NEUTRON ACER TENDL-2019 LIBRARY; T=293.16K  
Photon emission for (n,2nd)

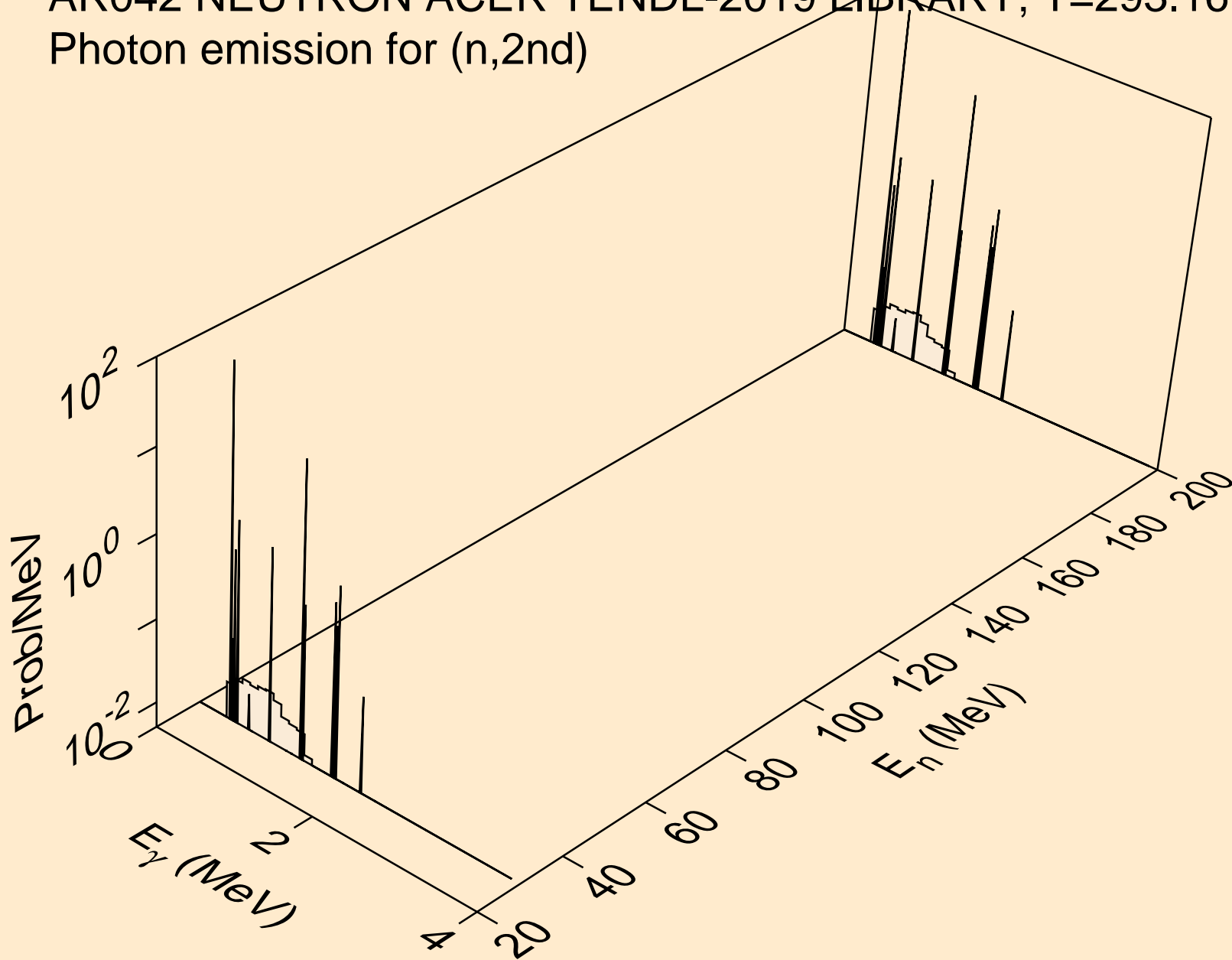

AR042 NEUTRON ACER TENDL-2019 LIBRARY; T=293.16K  
Photon emission for (n,2n)

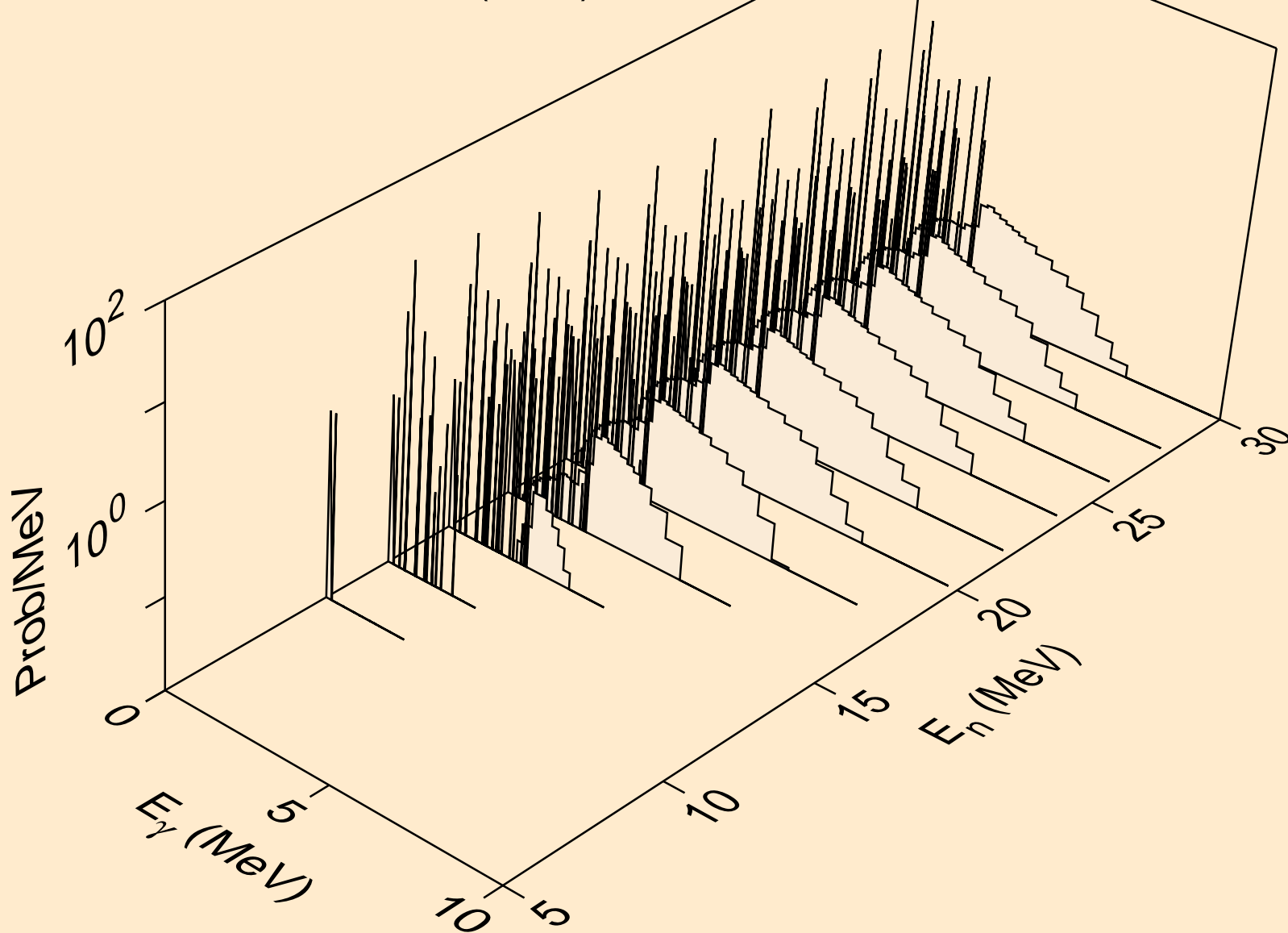

AR042 NEUTRON ACER TENDL-2019 LIBRARY; T=293.16K  
Photon emission for (n,3n)

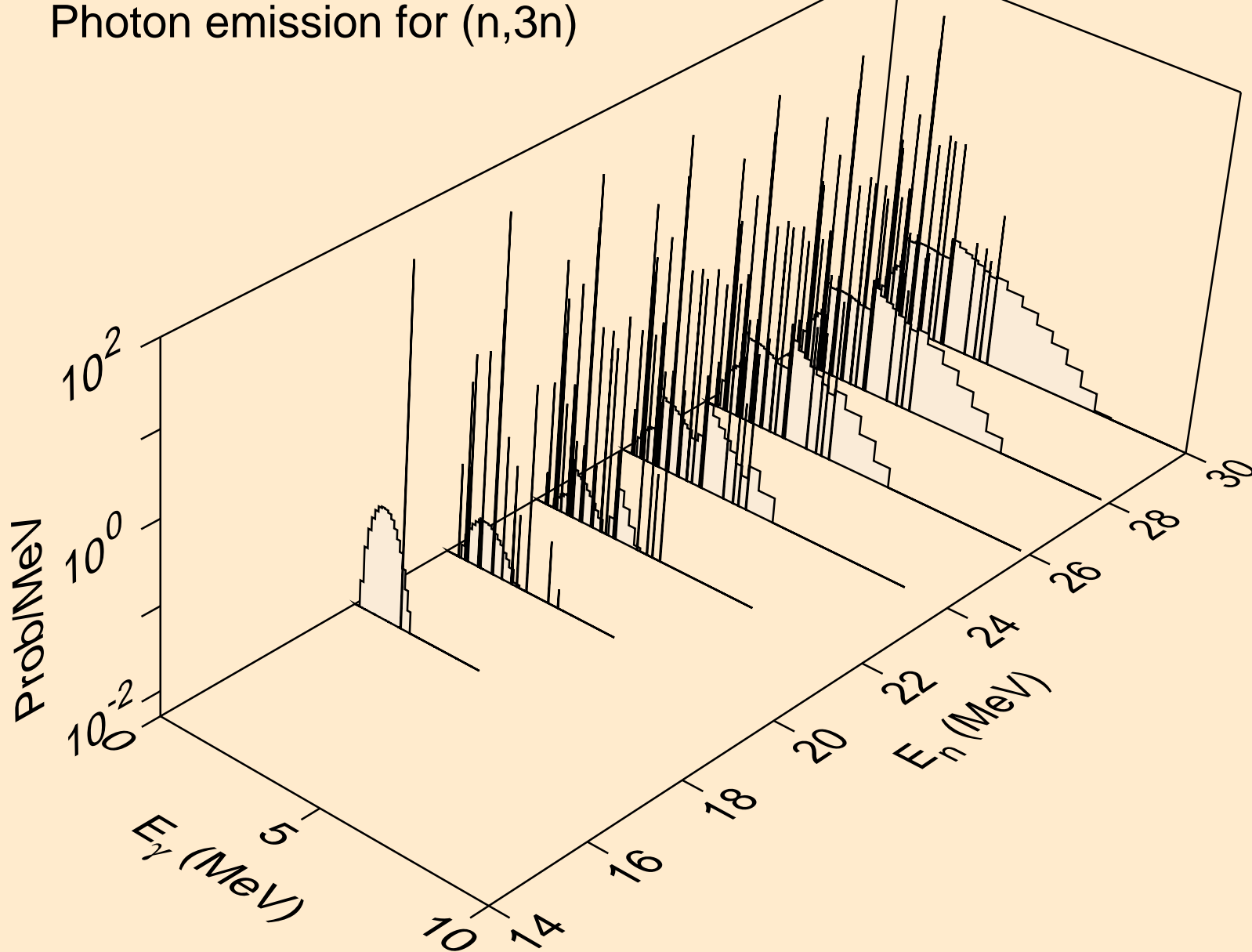

AR042 NEUTRON ACER TENDL-2019 LIBRARY; T=293.16K  
Photon emission for (n,n\*)a

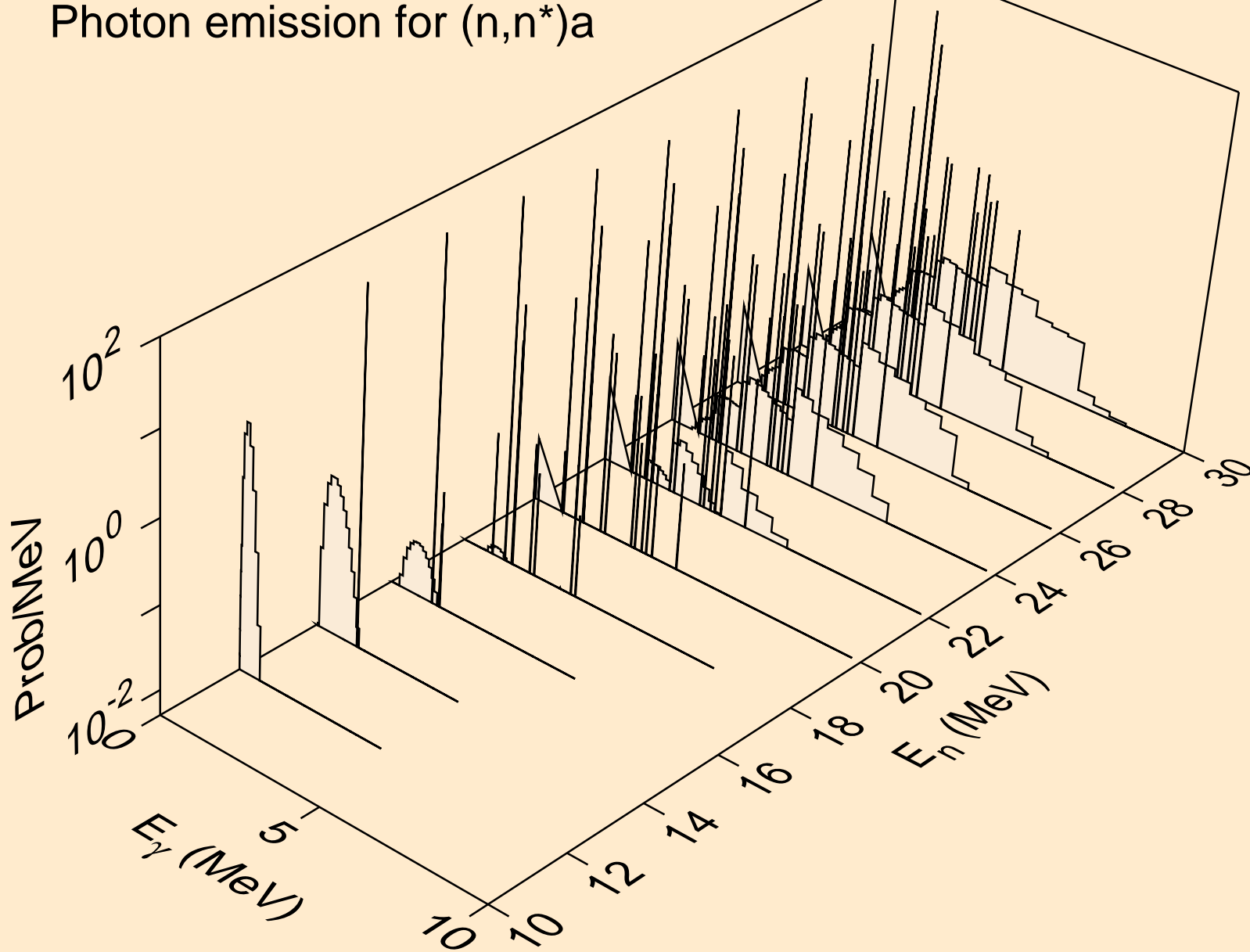



AR042 NEUTRON ACER TENDL-2019 LIBRARY; T=293.16K  
Photon emission for (n,2n)a

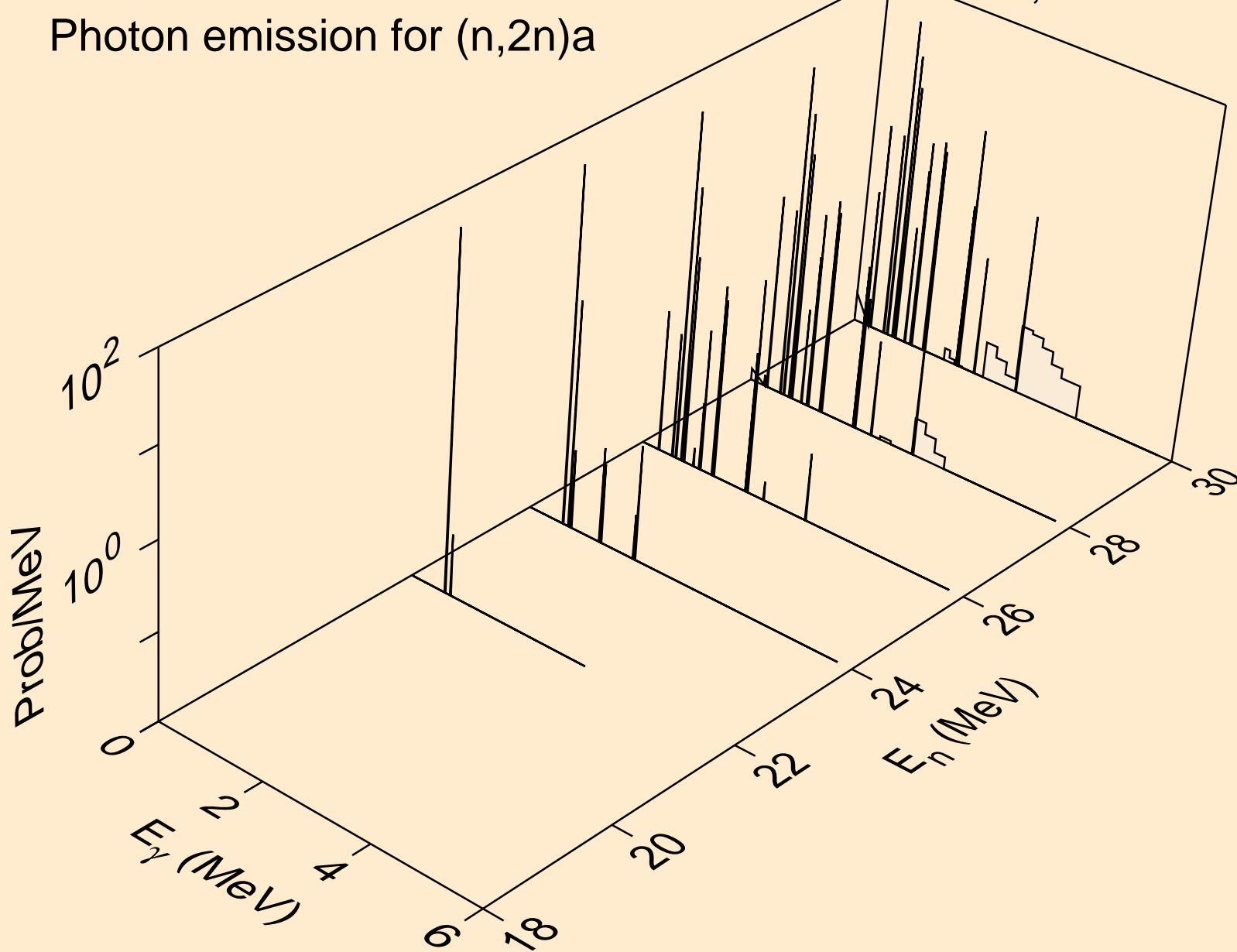

AR042 NEUTRON ACER TENDL-2019 LIBRARY; T=293.16K  
Photon emission for (n,3n)a

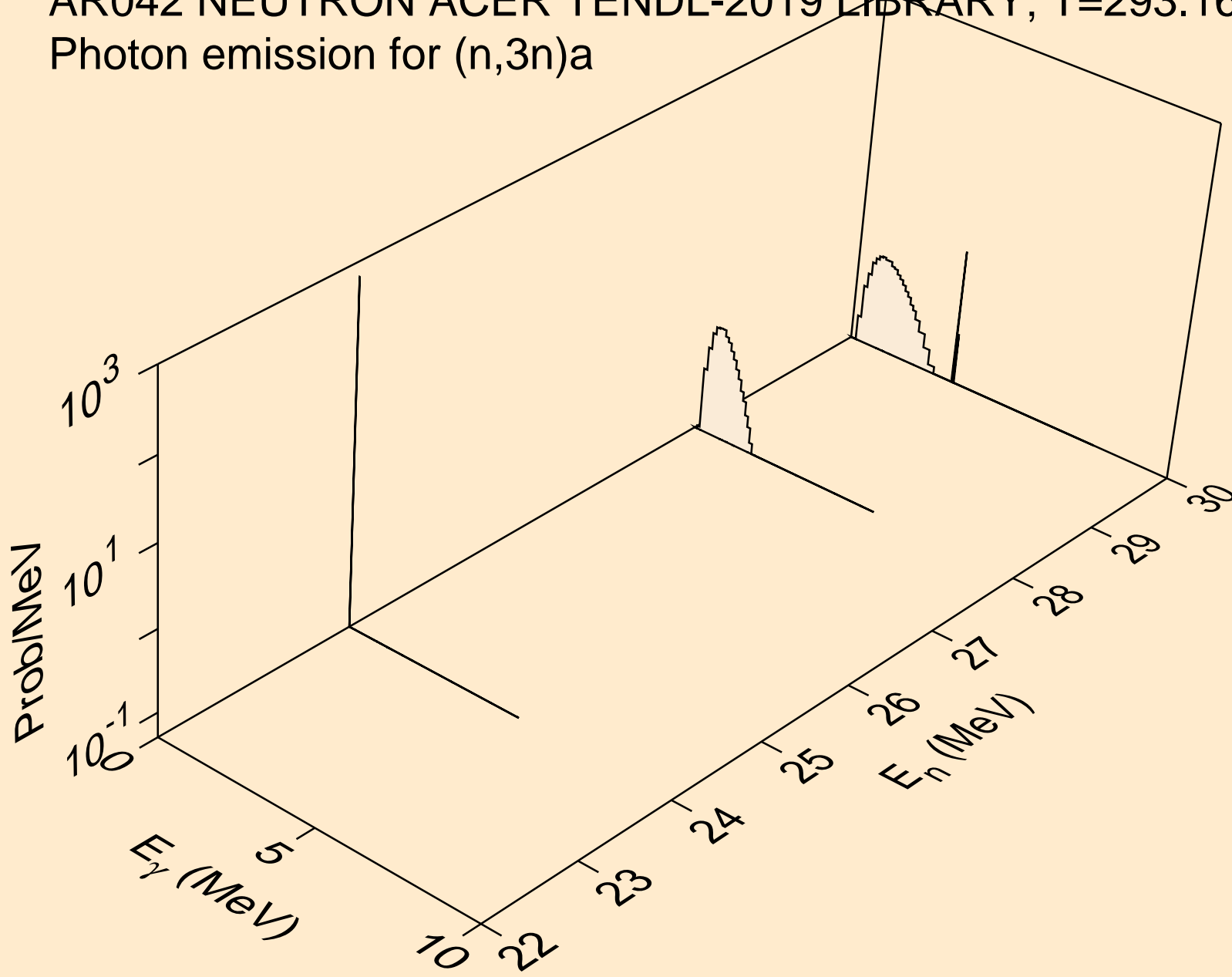

AR042 NEUTRON ACER TENDL-2019 LIBRARY; T=293.16K  
Photon emission for (n,n\*)p

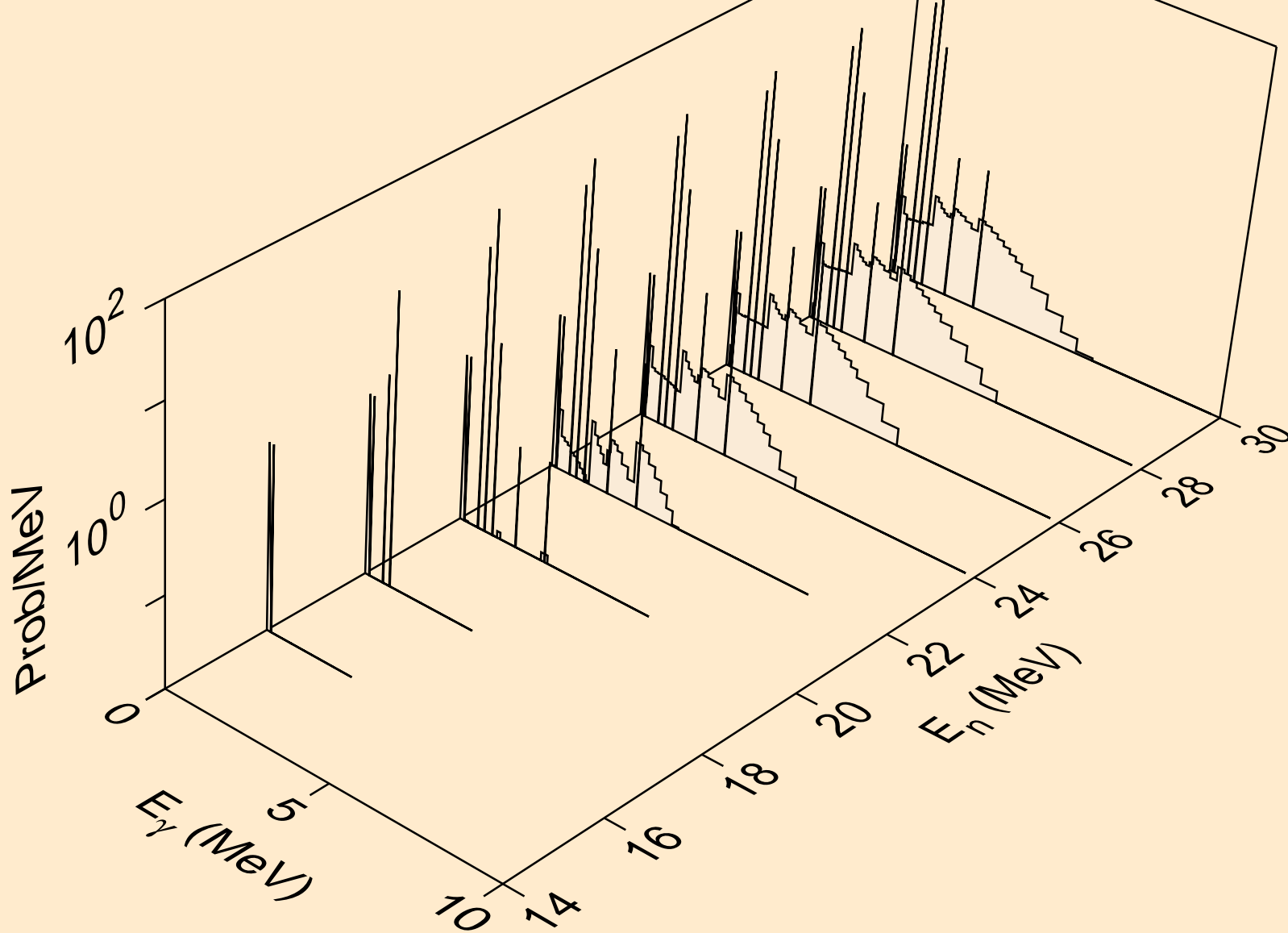

AR042 NEUTRON ACER TENDL-2019 LIBRARY; T=293.16K  
Photon emission for (n,n\*)2a

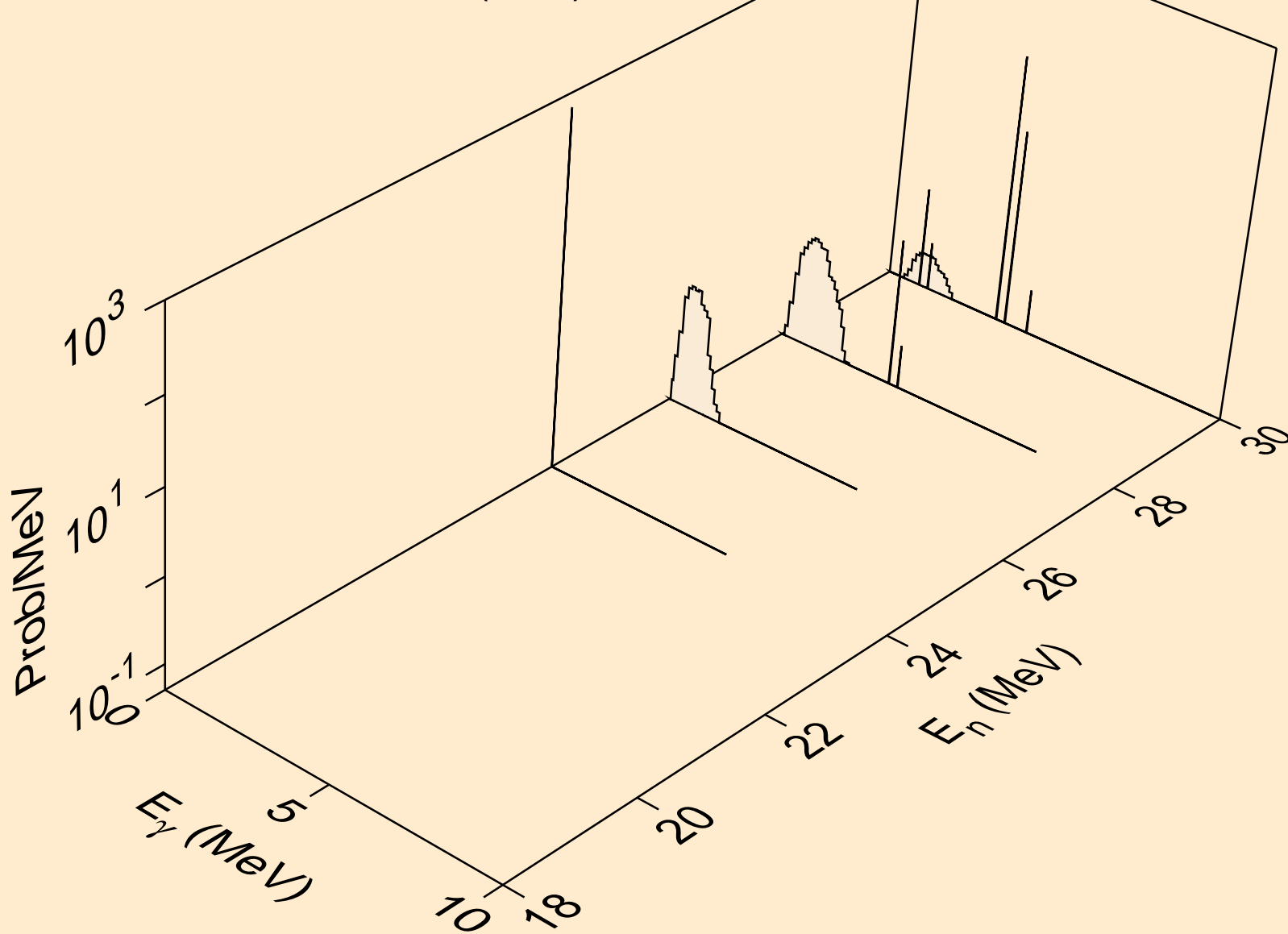

AR042 NEUTRON ACER TENDL-2019 LIBRARY; T=293.16K  
Photon emission for (n,n\*)d

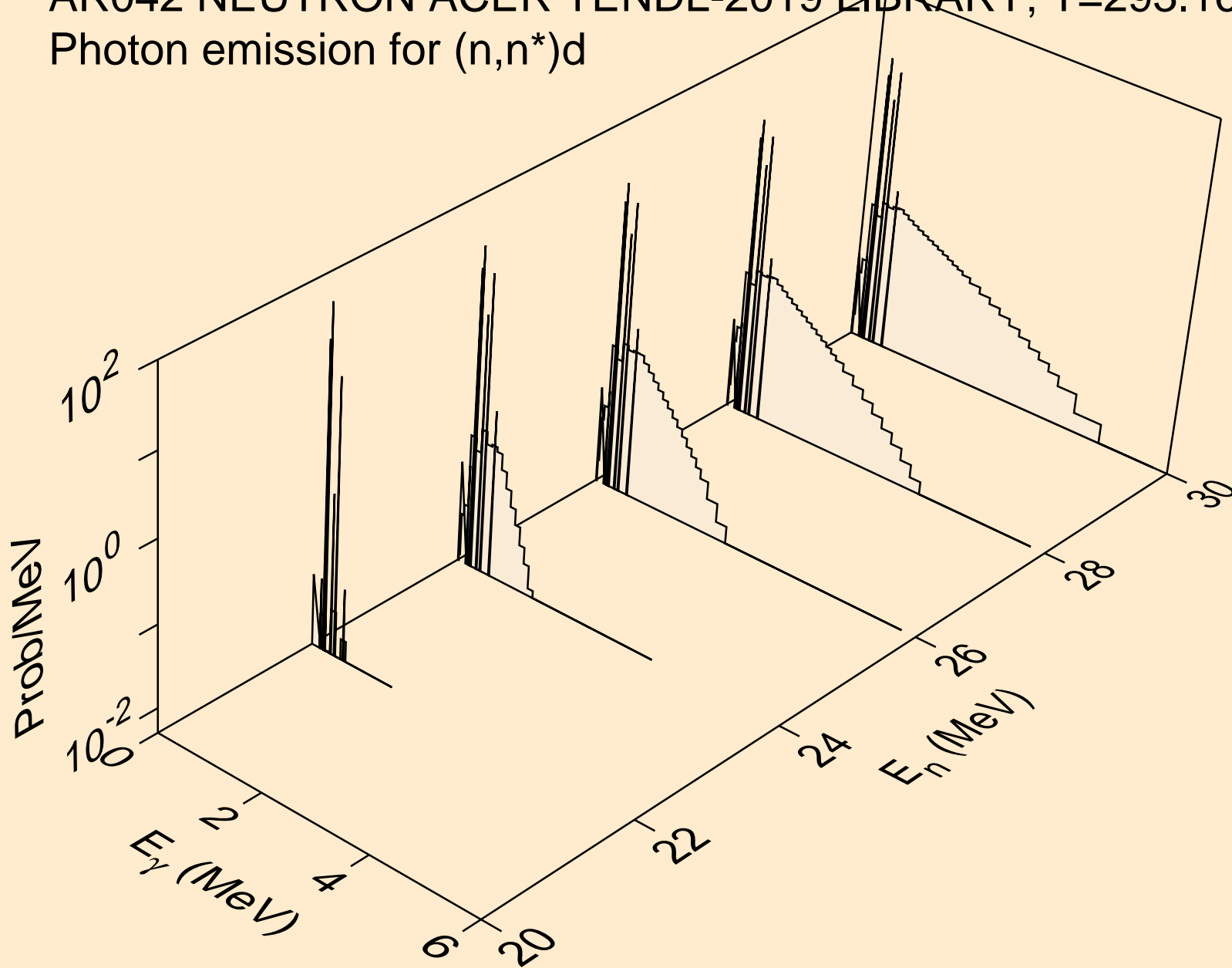

AR042 NEUTRON ACER TENDL-2019 LIBRARY; T=293.16K  
Photon emission for (n,n\*)t

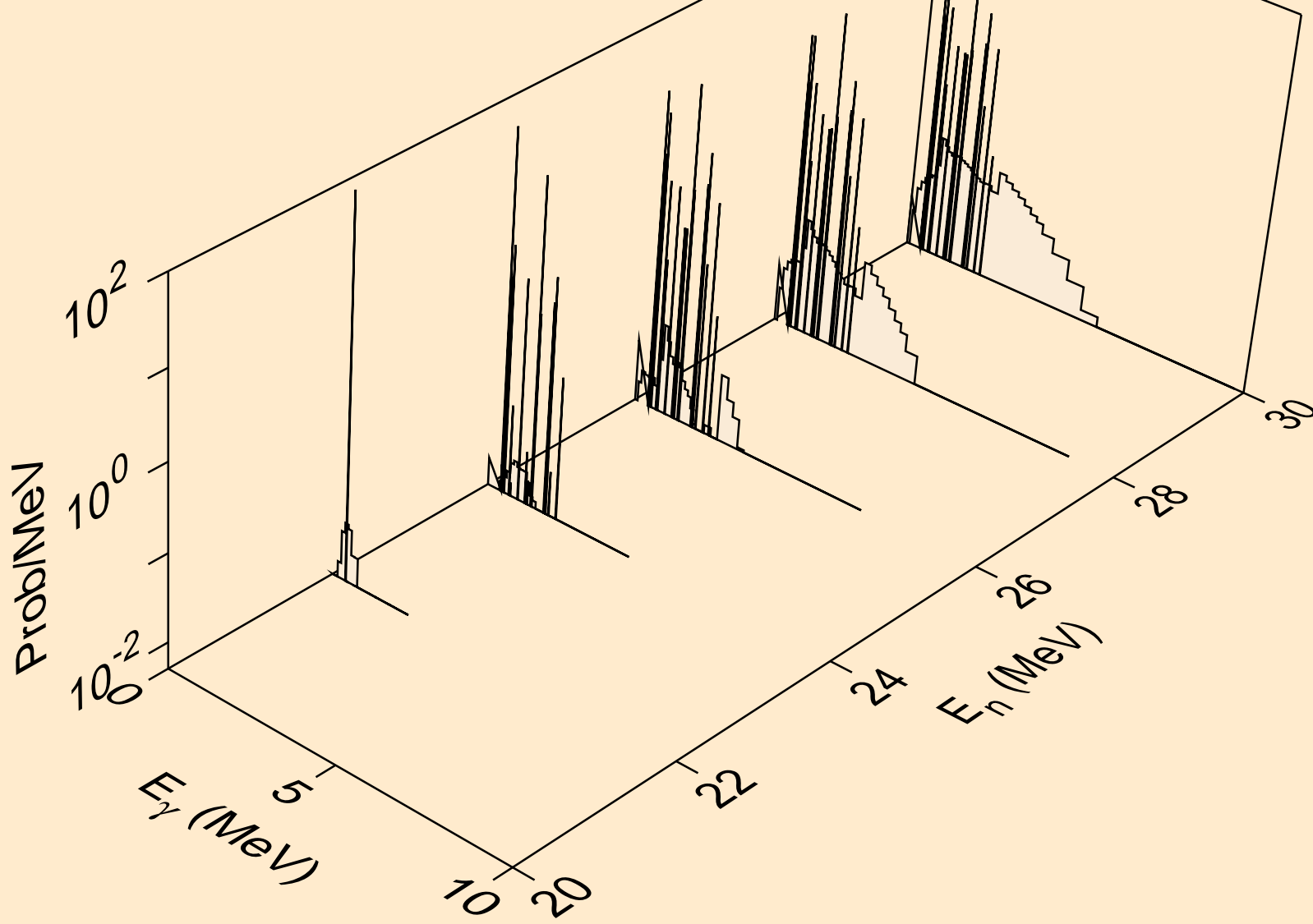

AR042 NEUTRON ACER TENDL-2019 LIBRARY; T=293.16K  
Photon emission for (n,n\*)he3

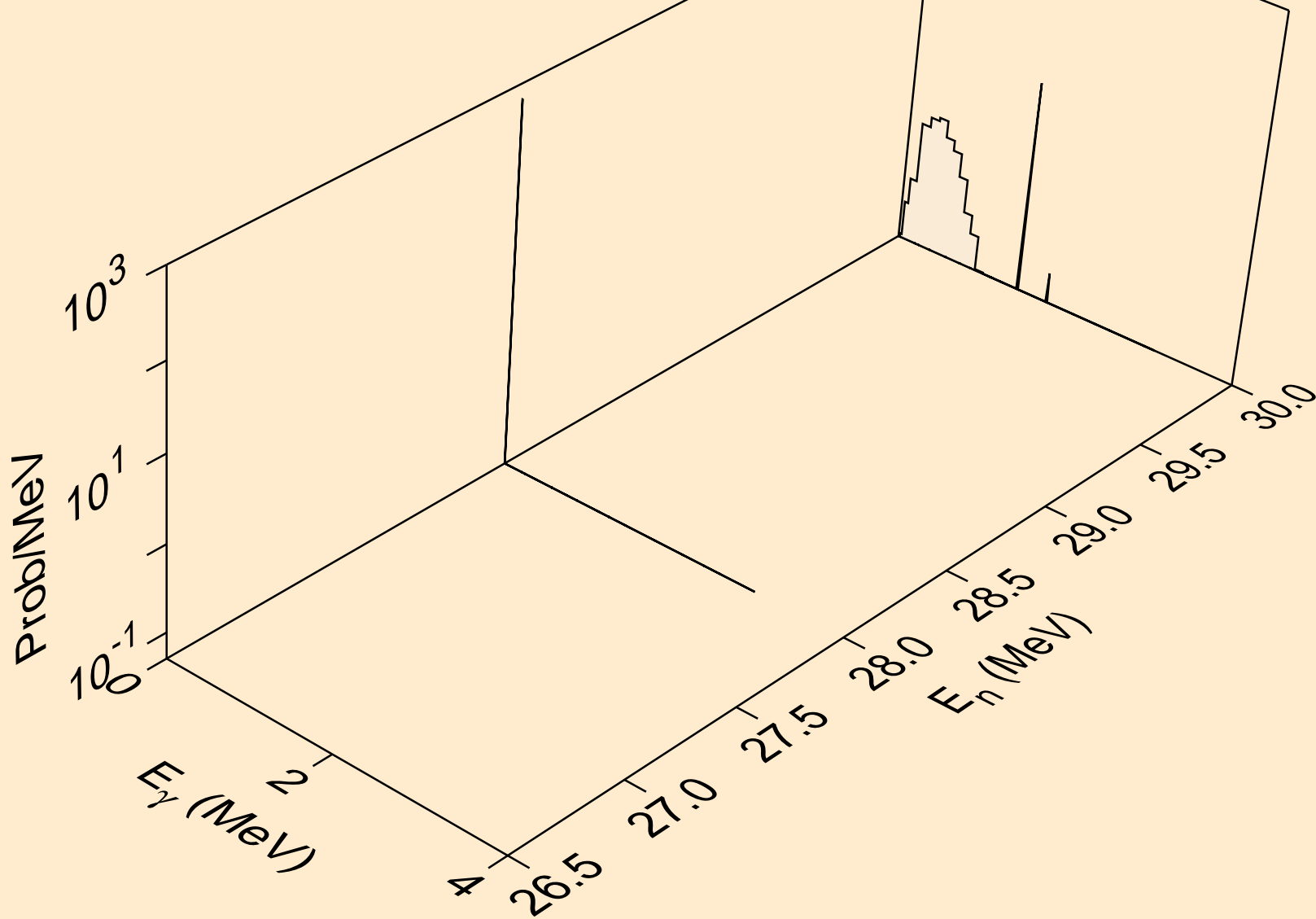

AR042 NEUTRON ACER TENDL-2019 LIBRARY; T=293.16K  
Photon emission for (n,4n)

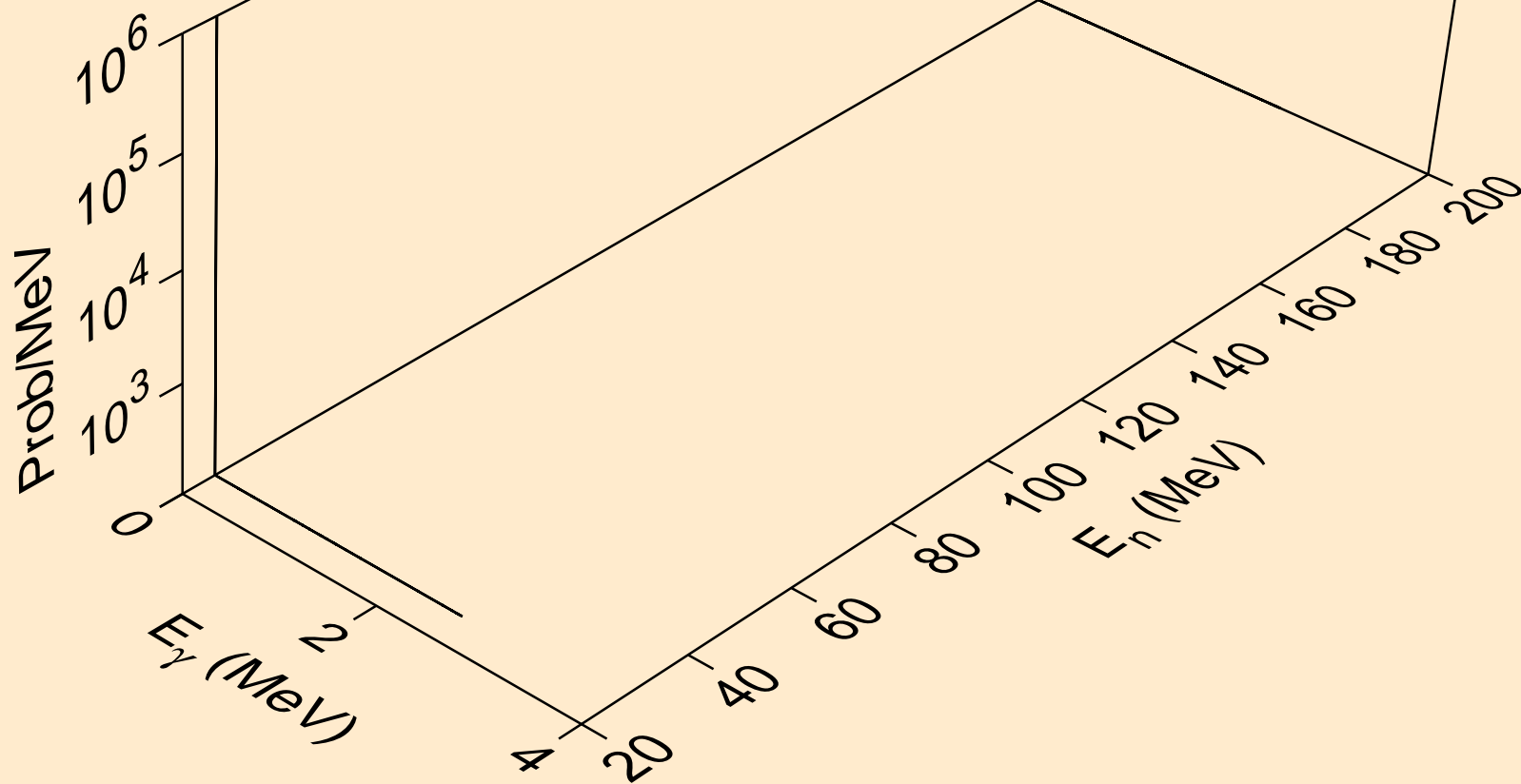



AR042 NEUTRON ACER TENDL-2019 LIBRARY; T=293.16K  
Photon emission for (n,2np)

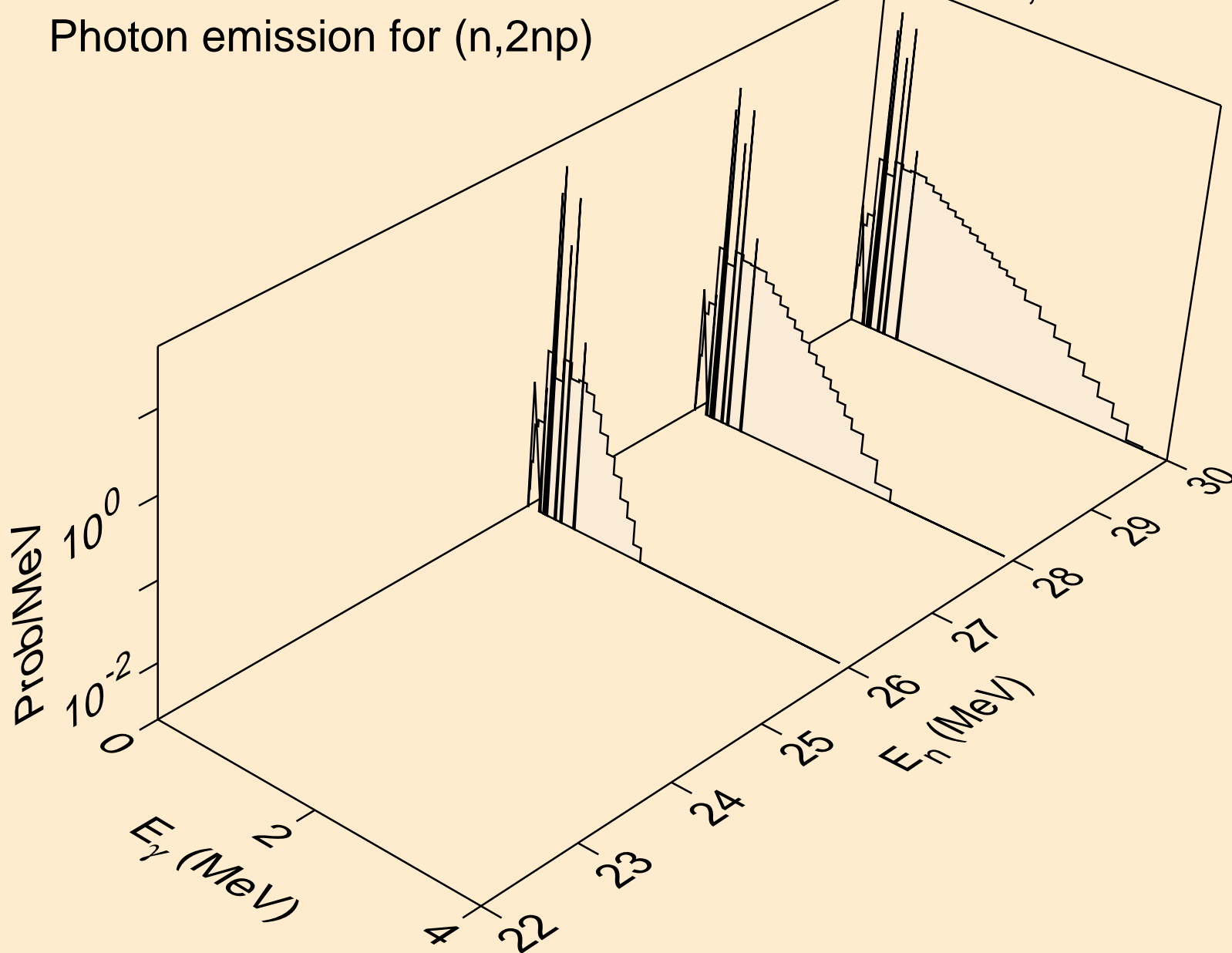

AR042 NEUTRON ACER TENDL-2019 LIBRARY; T=293.16K  
Photon emission for (n,3np)

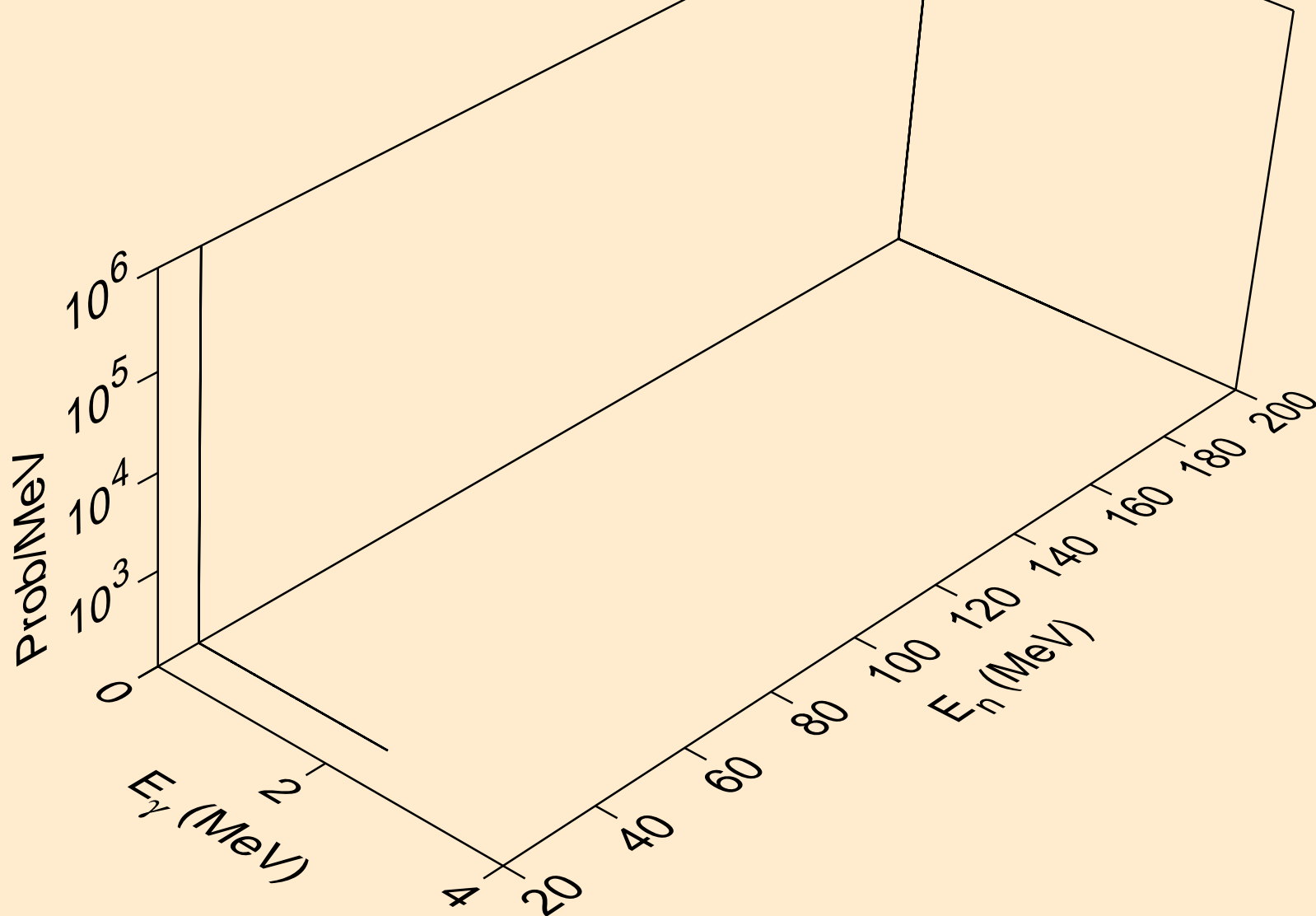

AR042 NEUTRON ACER TENDL-2019 LIBRARY; T=293.16K  
Photon emission for (n,n\*c)

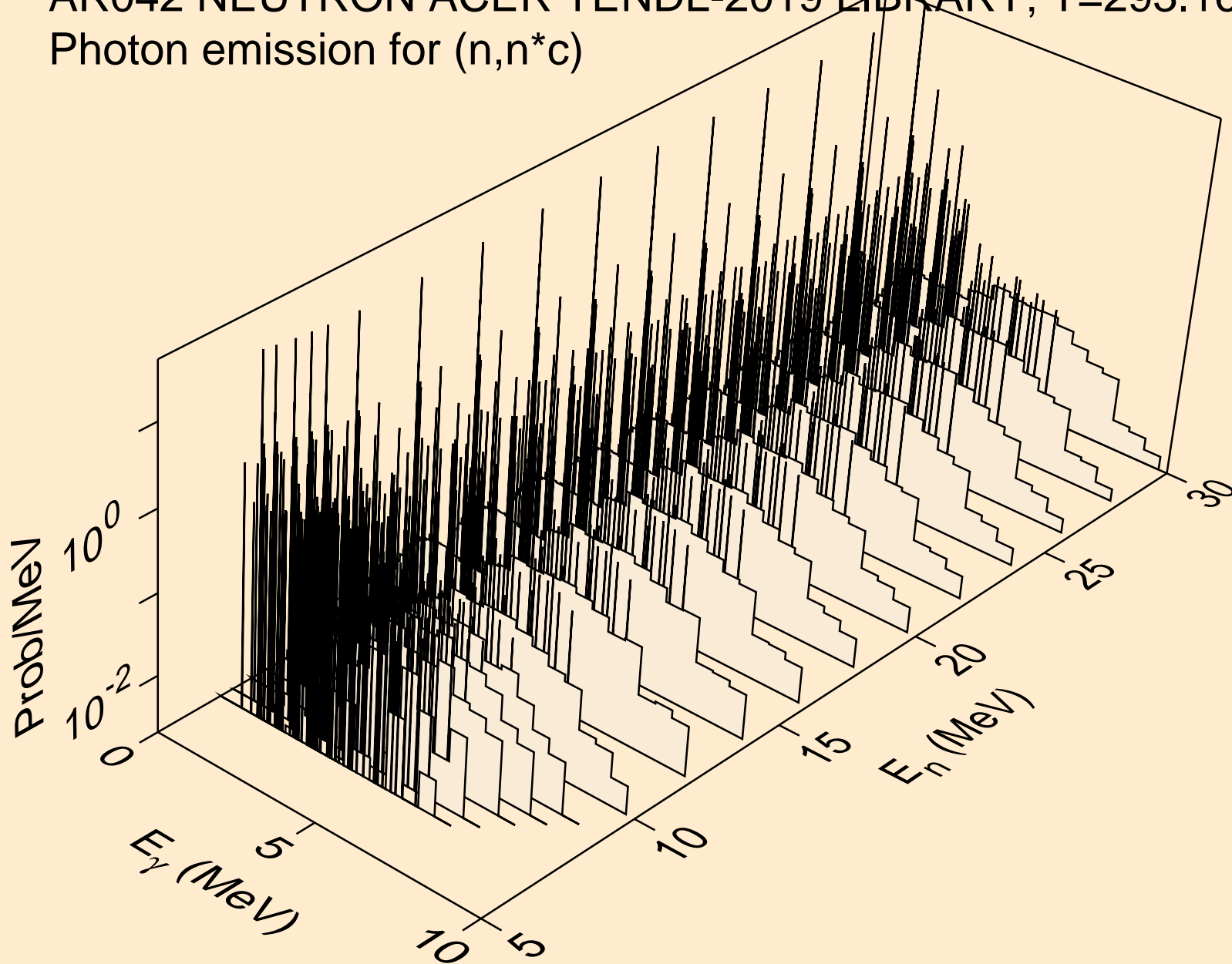

AR042 NEUTRON ACER TENDL-2019 LIBRARY; T=293.16K  
Photon emission for (n,gma)

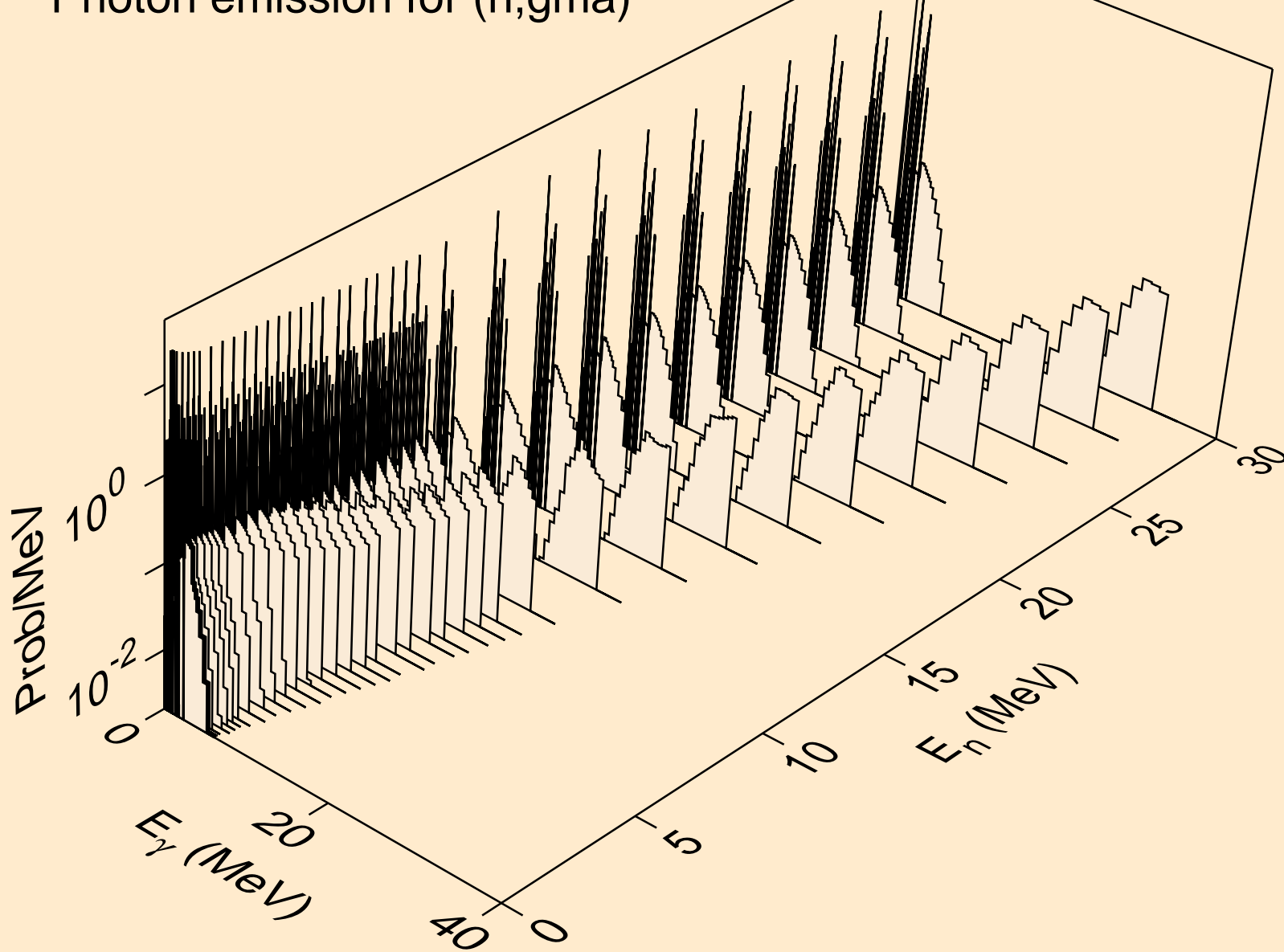

AR042 NEUTRON ACER TENDL-2019 LIBRARY; T=293.16K  
Photon emission for (n,p)

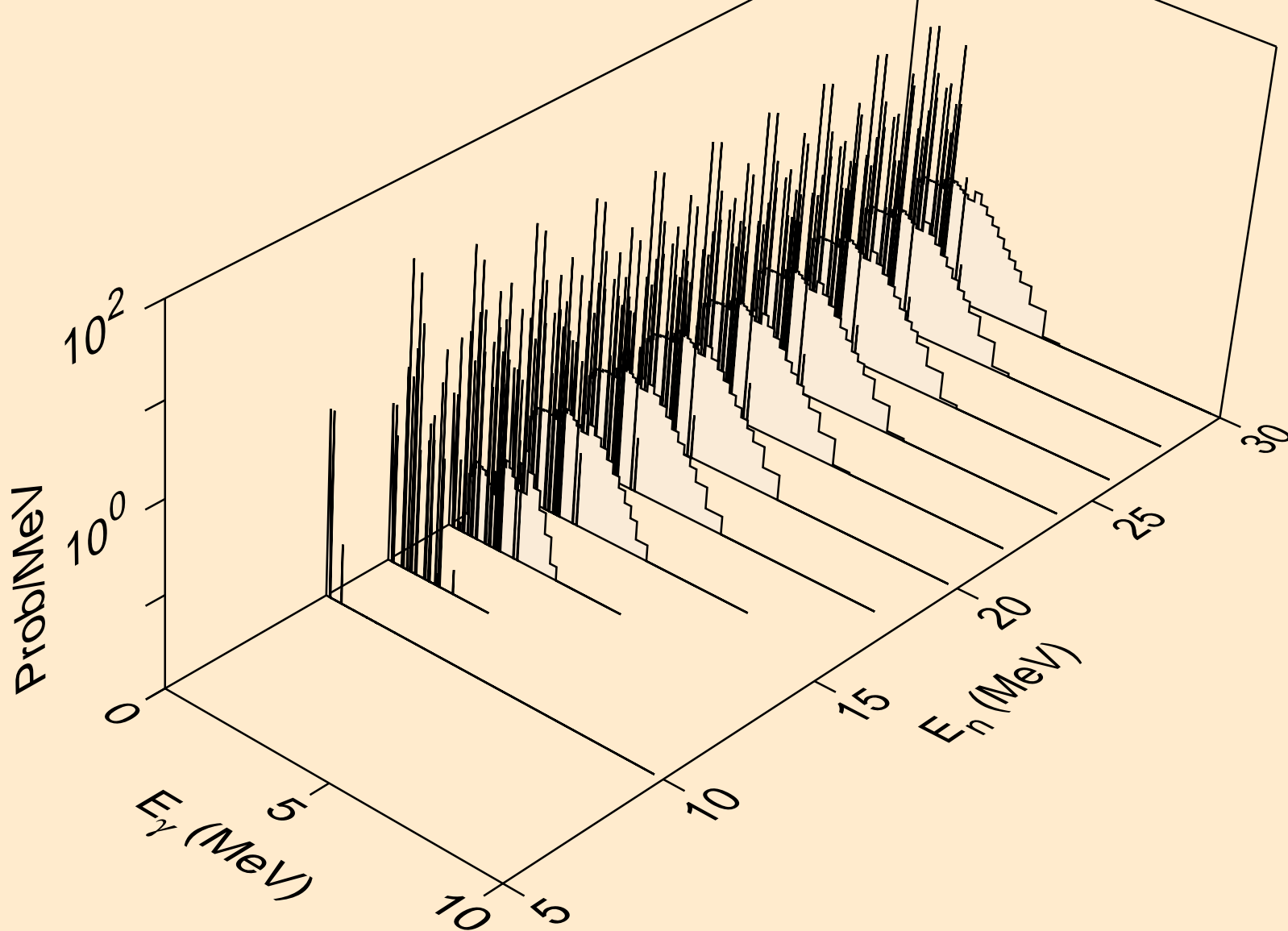

AR042 NEUTRON ACER TENDL-2019 LIBRARY; T=293.16K  
Photon emission for (n,d)

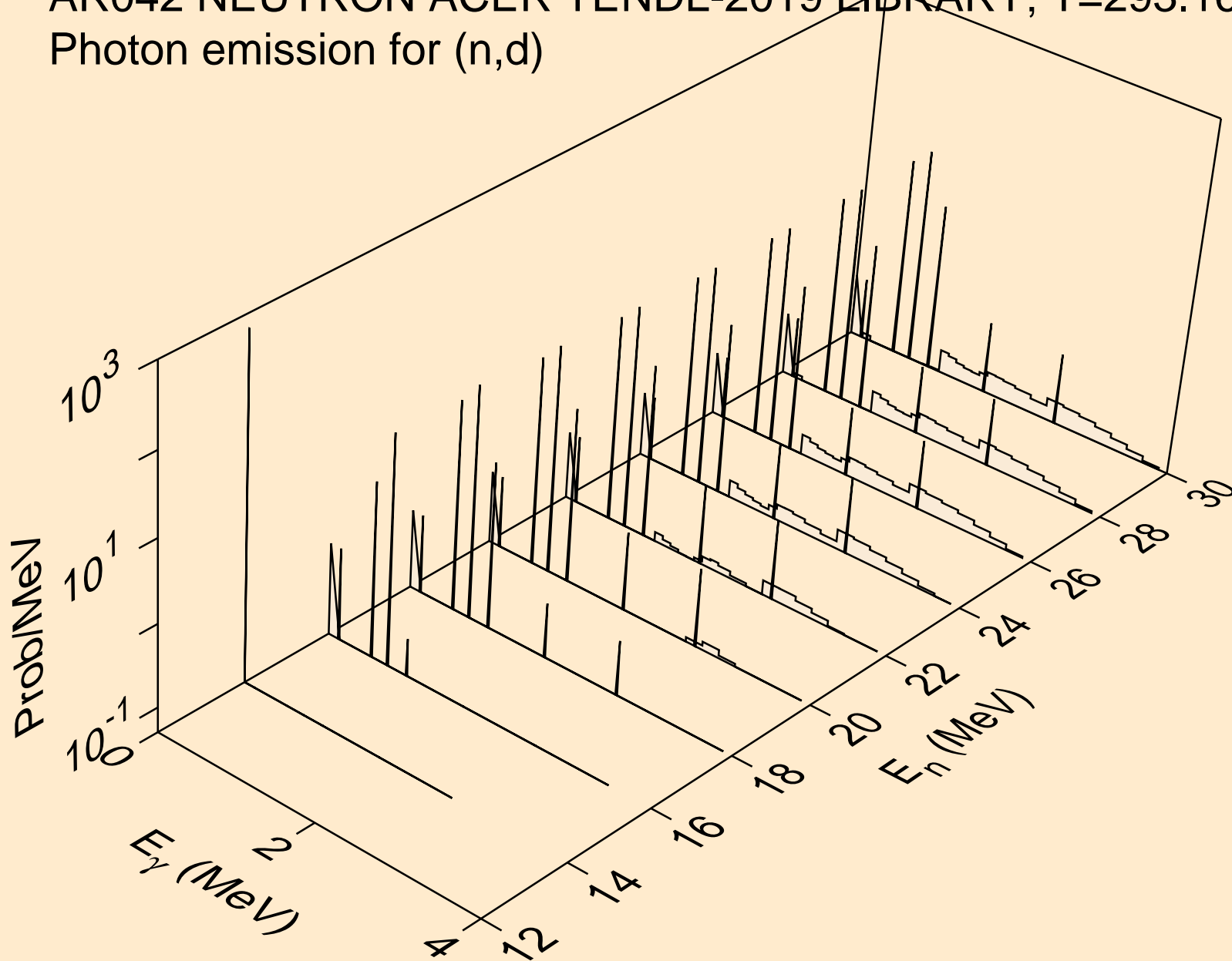

AR042 NEUTRON ACER TENDL-2019 LIBRARY; T=293.16K  
Photon emission for (n,t)

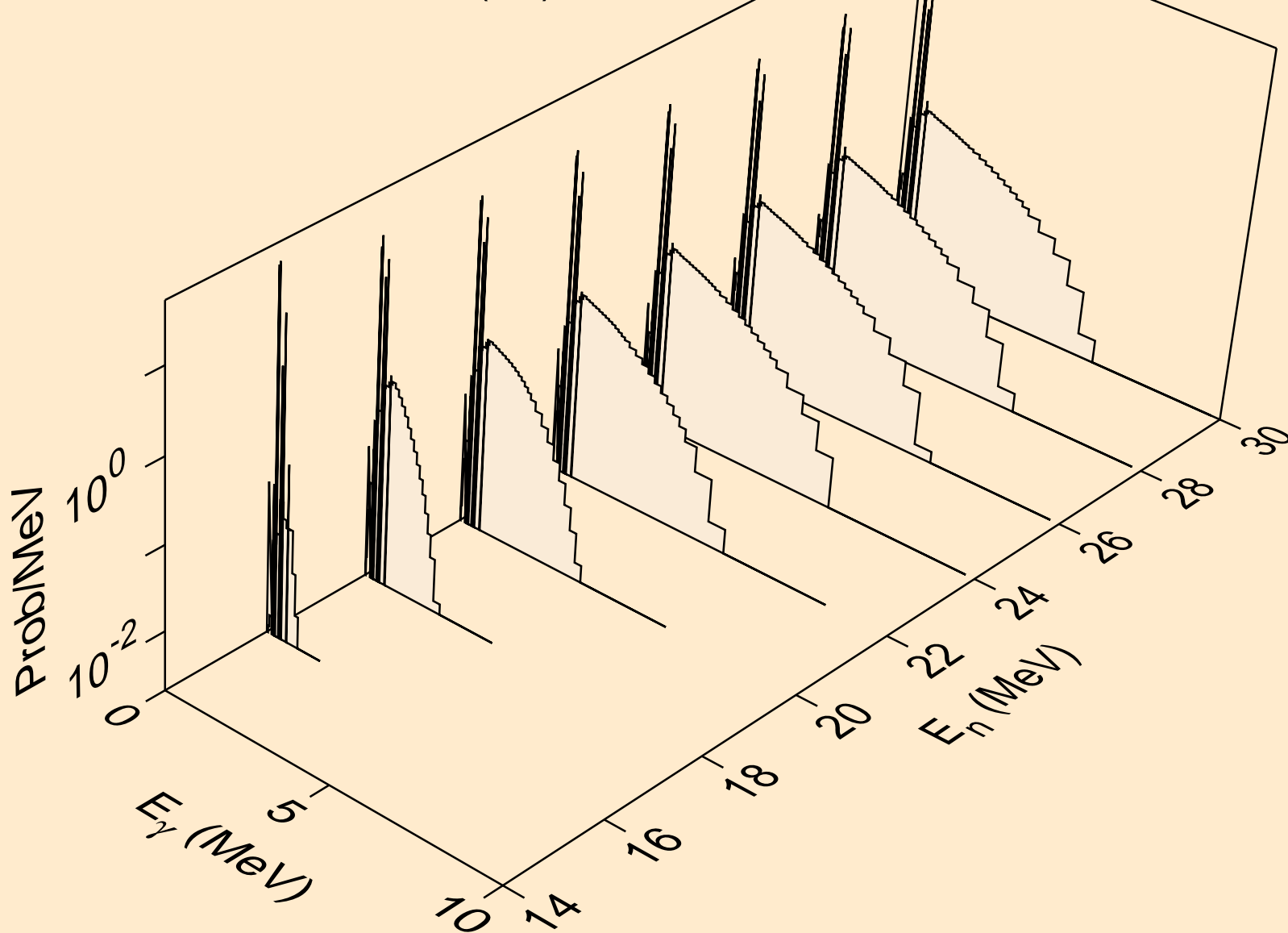

AR042 NEUTRON ACER TENDL-2019 LIBRARY; T=293.16K  
Photon emission for (n,he3)

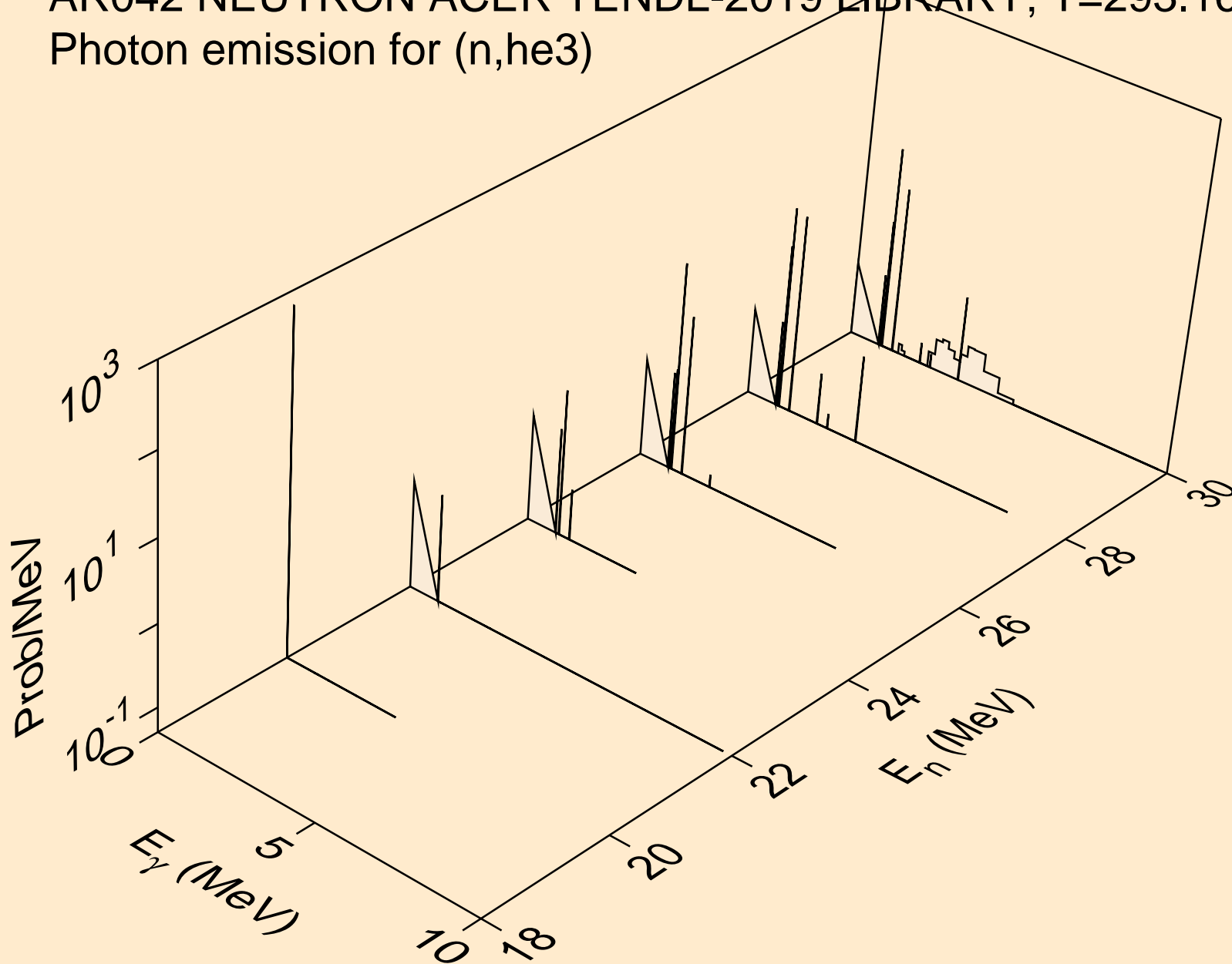



AR042 NEUTRON ACER TENDL-2019 LIBRARY; T=293.16K  
Photon emission for (n,a)

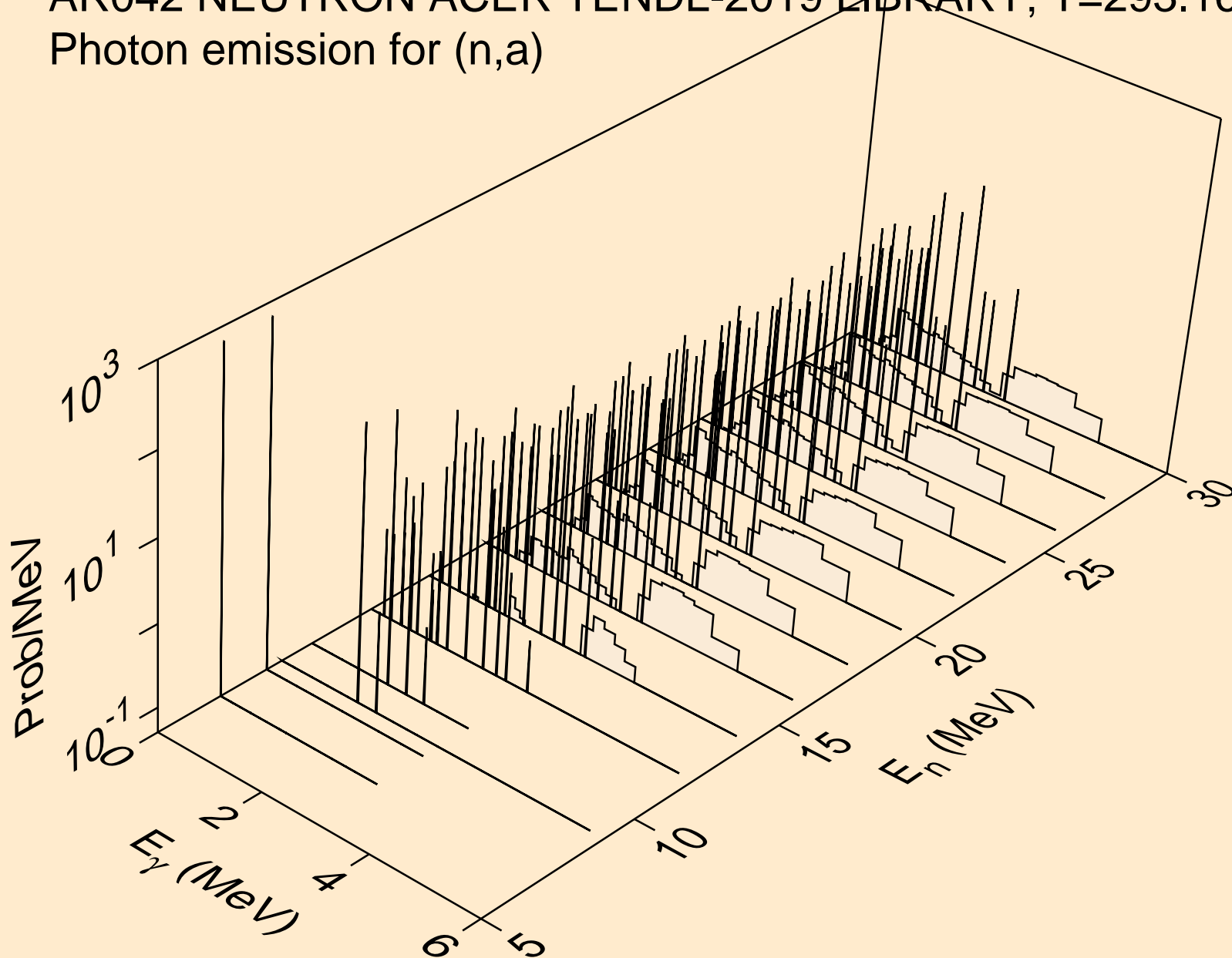

AR042 NEUTRON ACER TENDL-2019 LIBRARY; T=293.16K  
Photon emission for (n,2a)

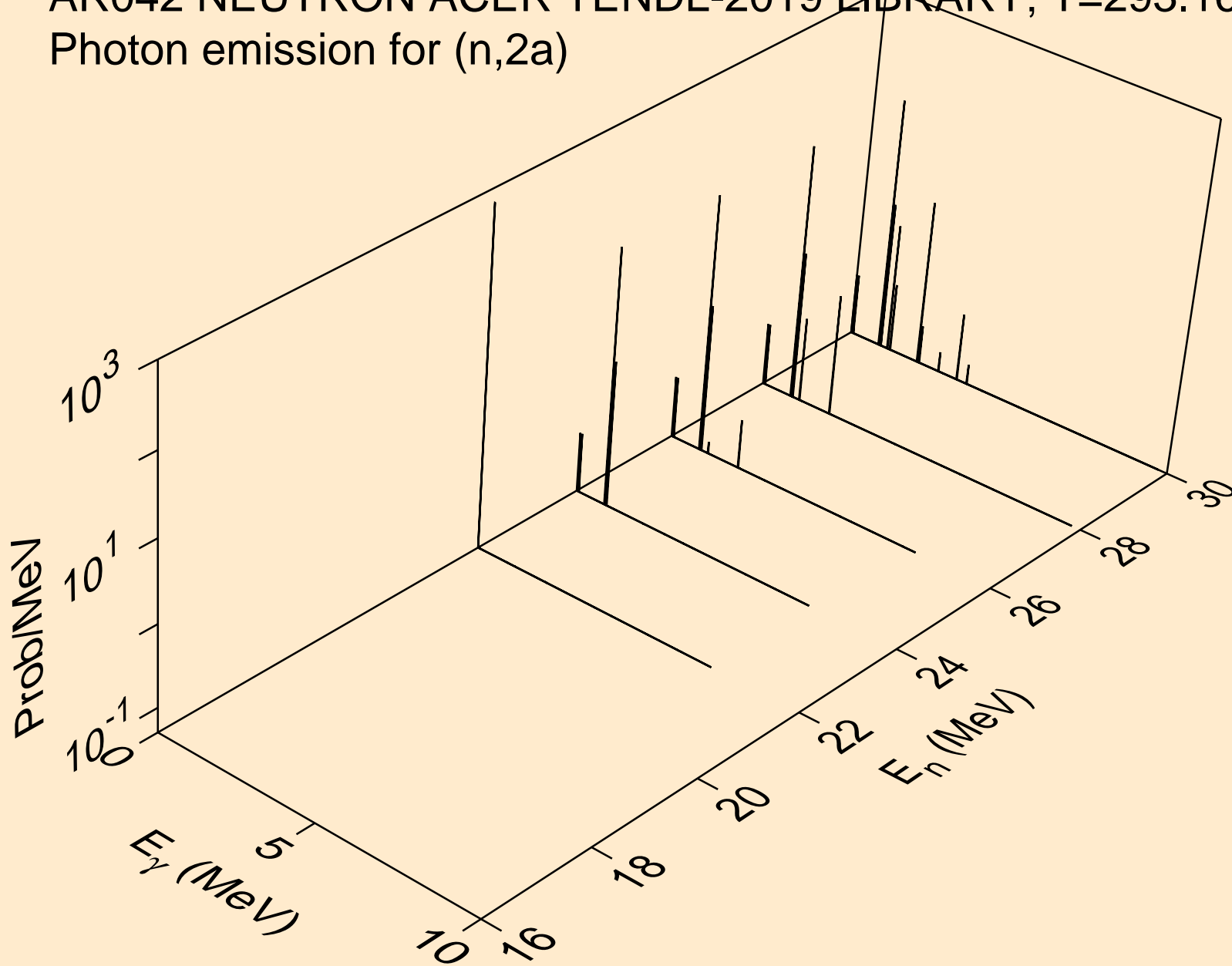

AR042 NEUTRON ACER TENDL-2019 LIBRARY; T=293.16K  
Photon emission for (n,2p)

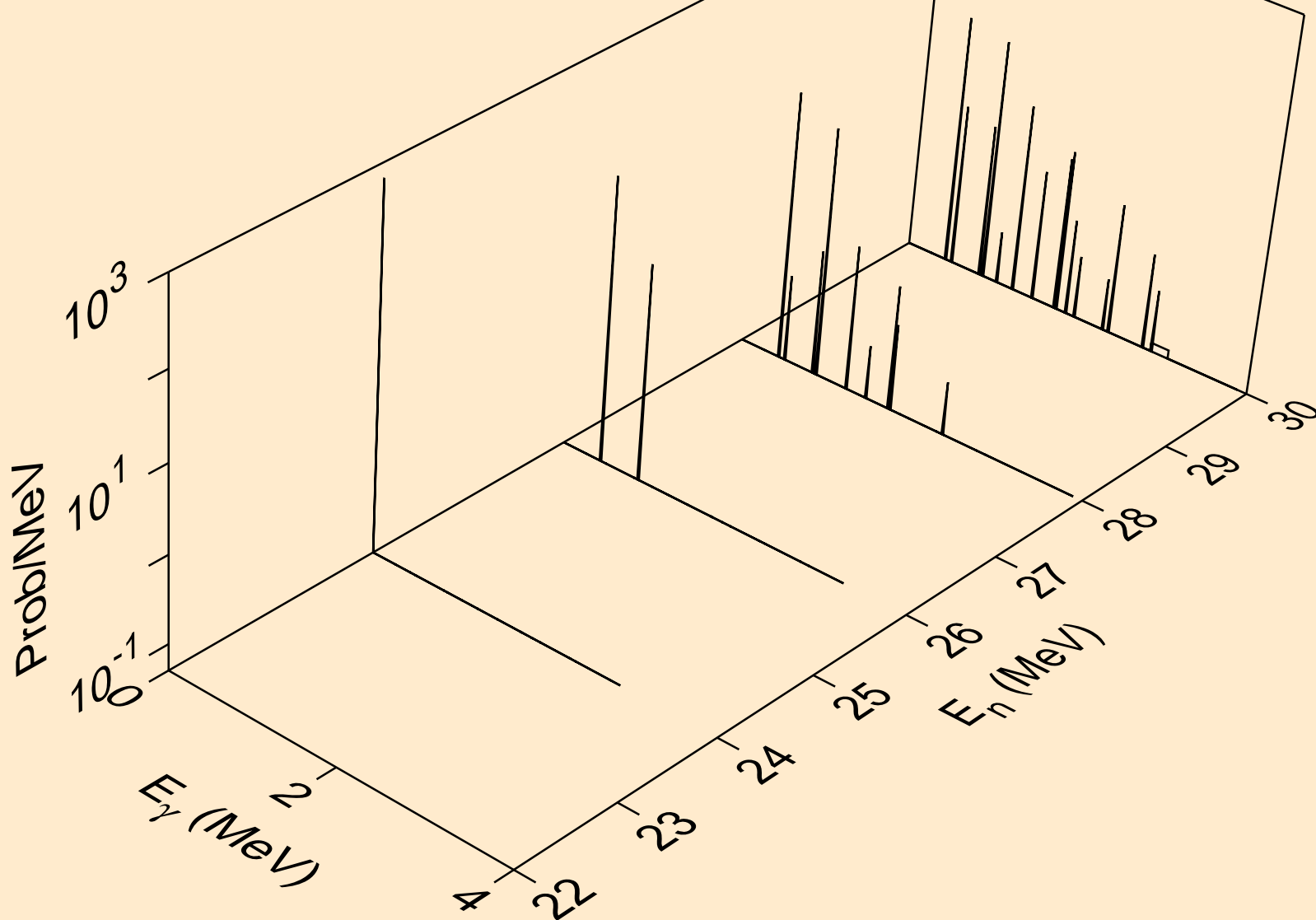

AR042 NEUTRON ACER TENDL-2019 LIBRARY; T=293.16K  
Photon emission for (n,p)

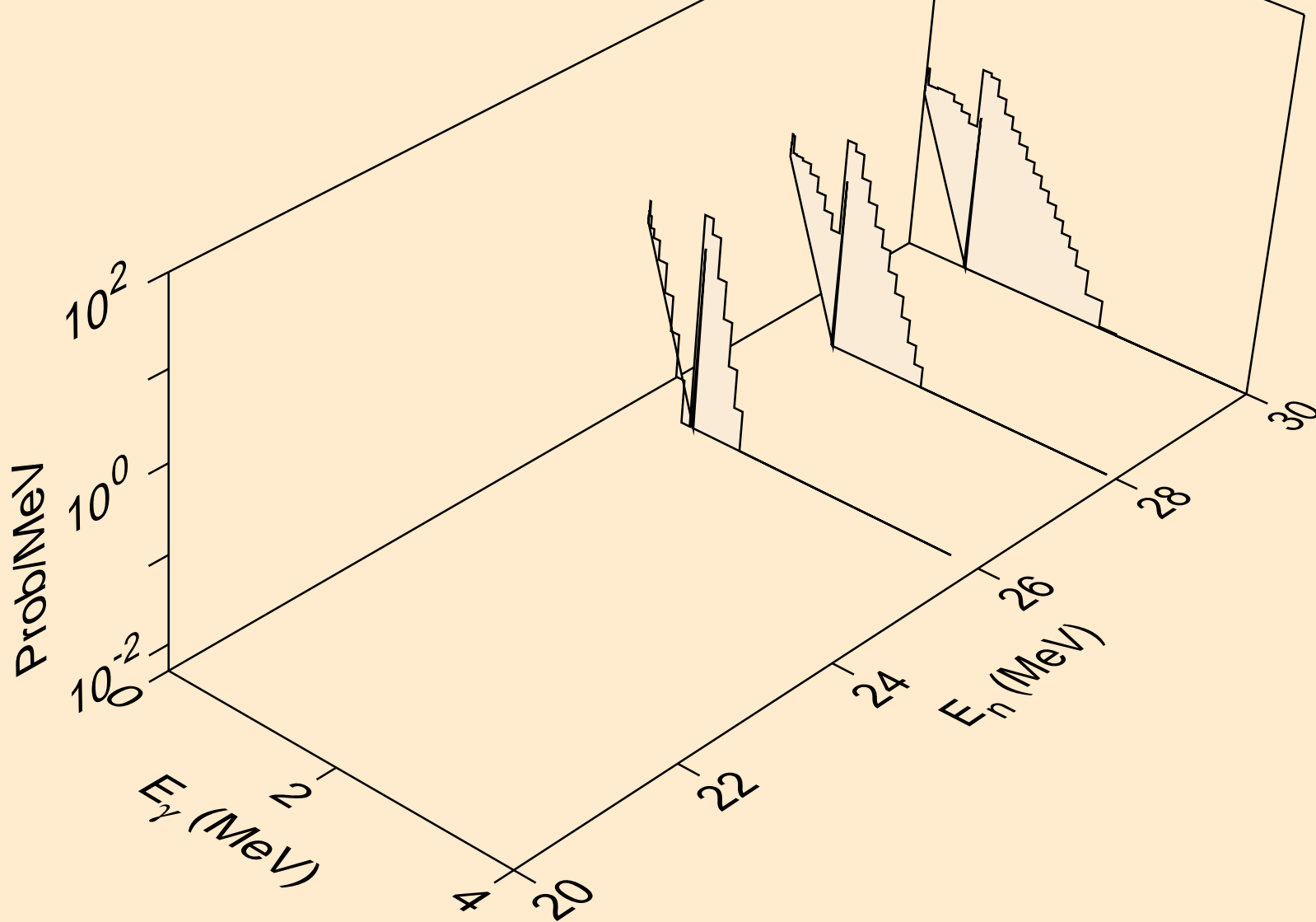

AR042 NEUTRON ACER TENDL-2019 LIBRARY; T=293.16K  
Photon emission for (n,pd)

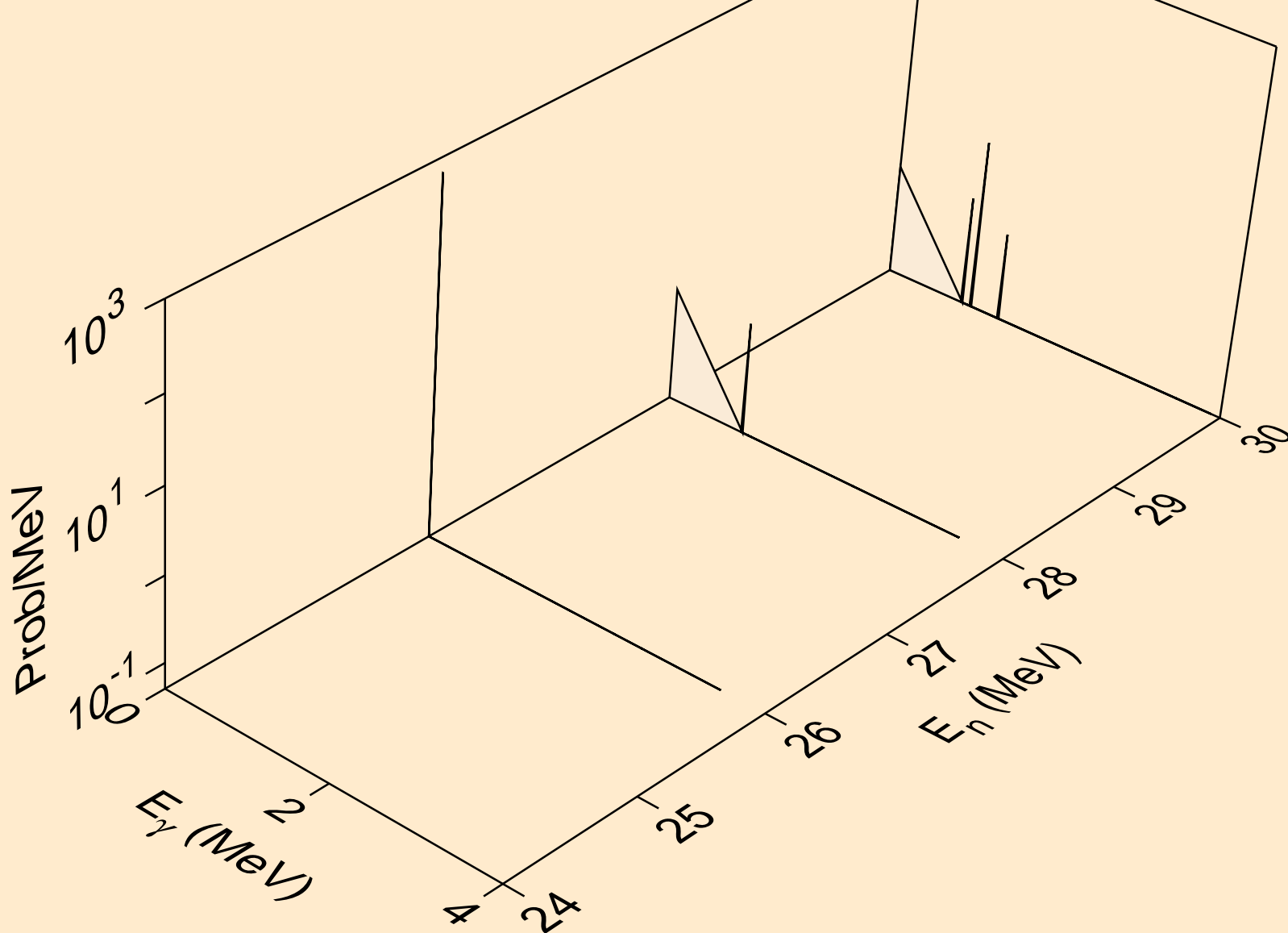

AR042 NEUTRON ACER TENDL-2019 LIBRARY; T=293.16K  
Photon emission for (n,pt)

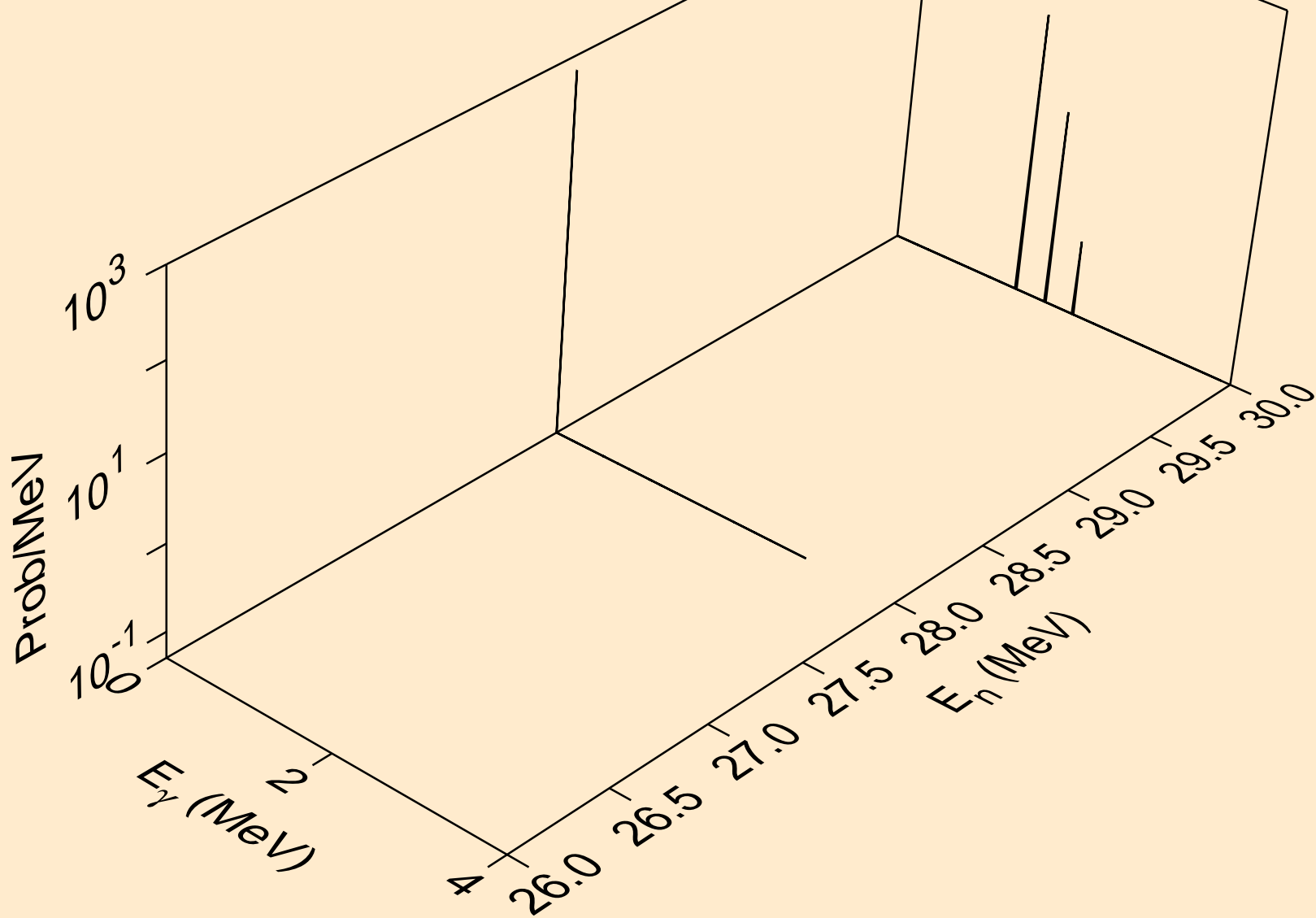

AR042 NEUTRON ACER TENDL-2019 LIBRARY; T=293.16K  
Photon emission for (n,da)

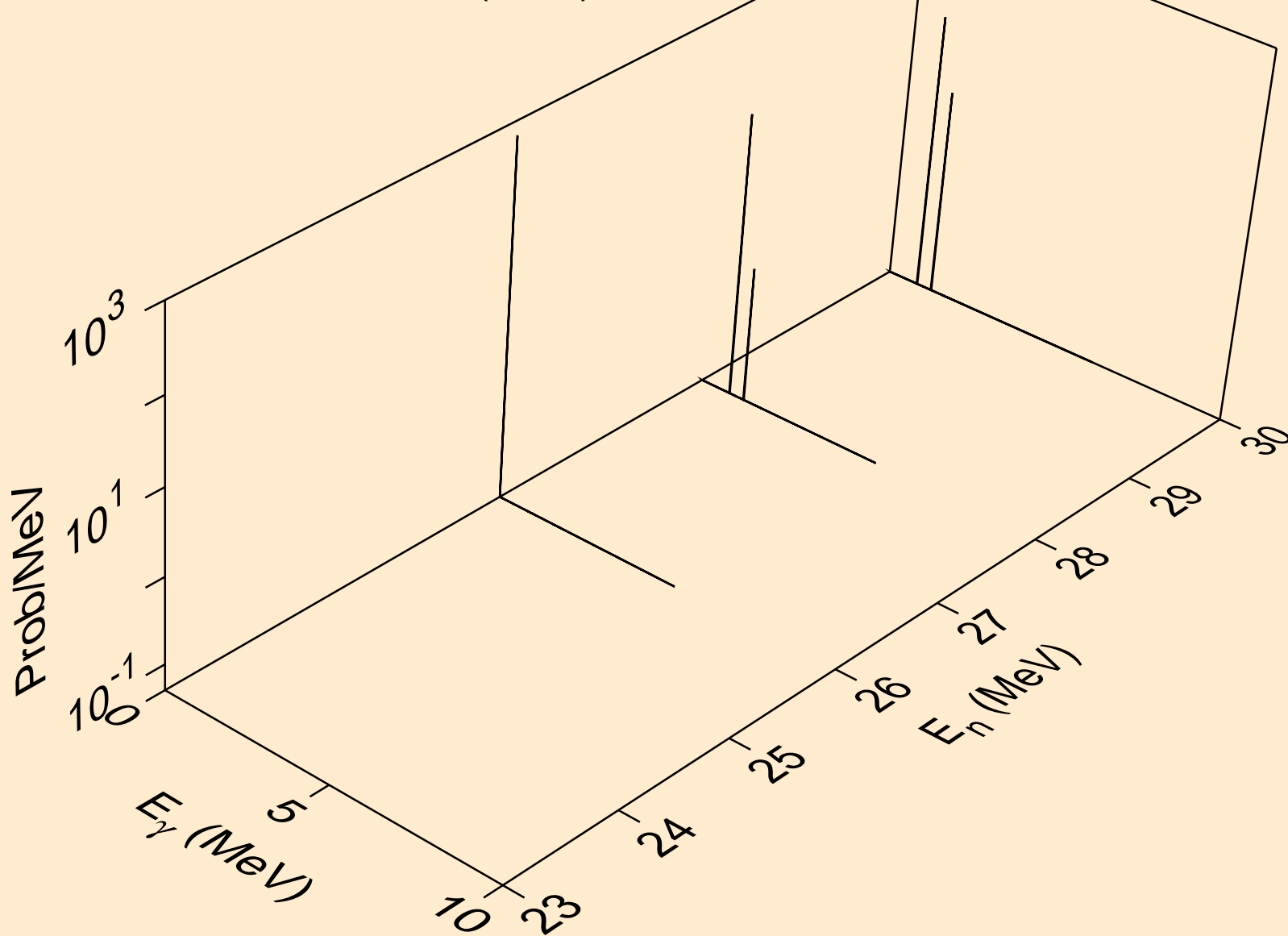

AR042 NEUTRON ACER TENDL-2019 LIBRARY; T=293.16K  
thermal capture photon spectrum

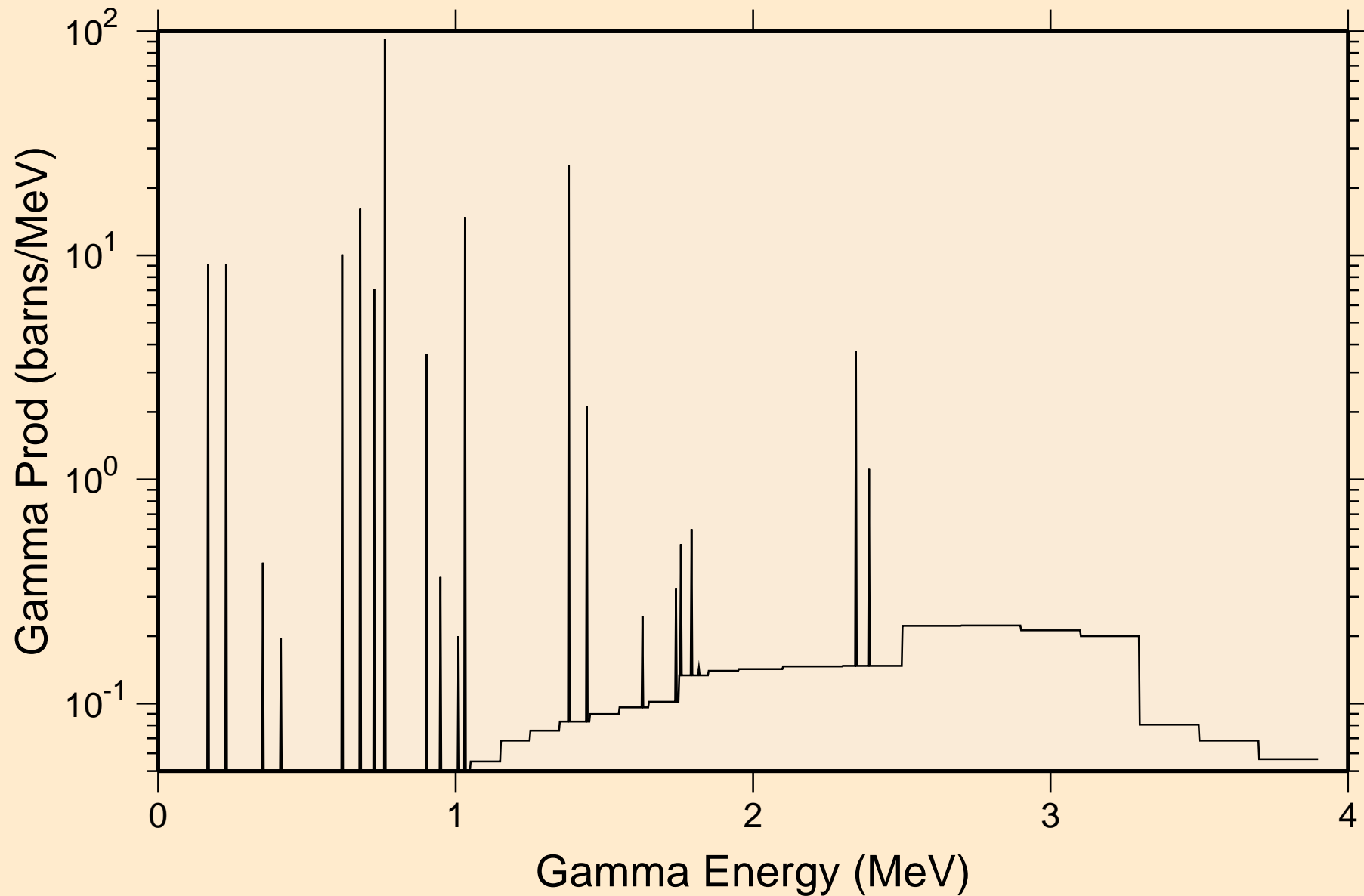



AR042 NEUTRON ACER TENDL-2019 LIBRARY; T=293.16K  
14 MeV photon spectrum

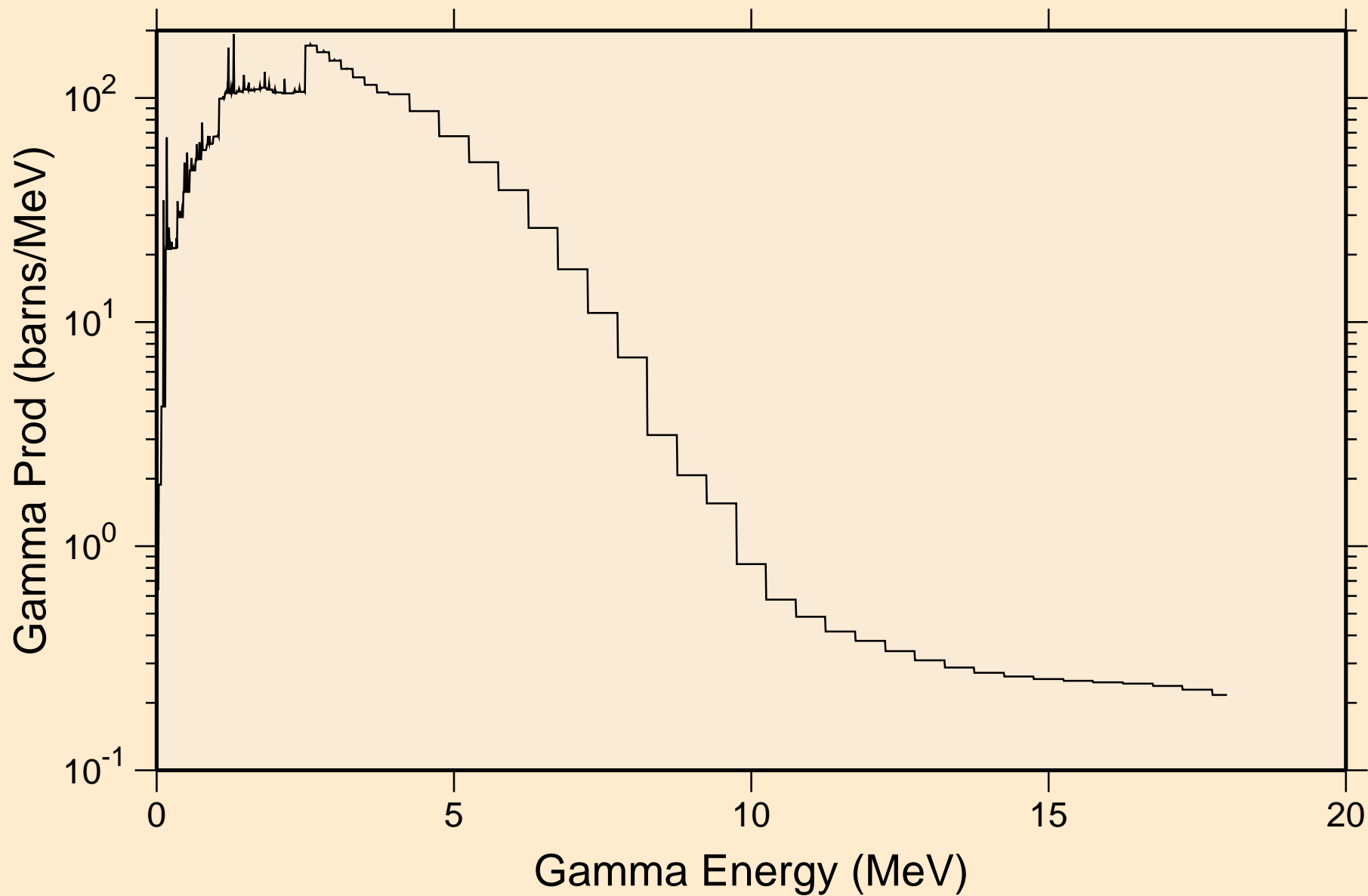

AR042 NEUTRON ACER TENDL-2019 LIBRARY; T=293.16K  
Particle heating contributions

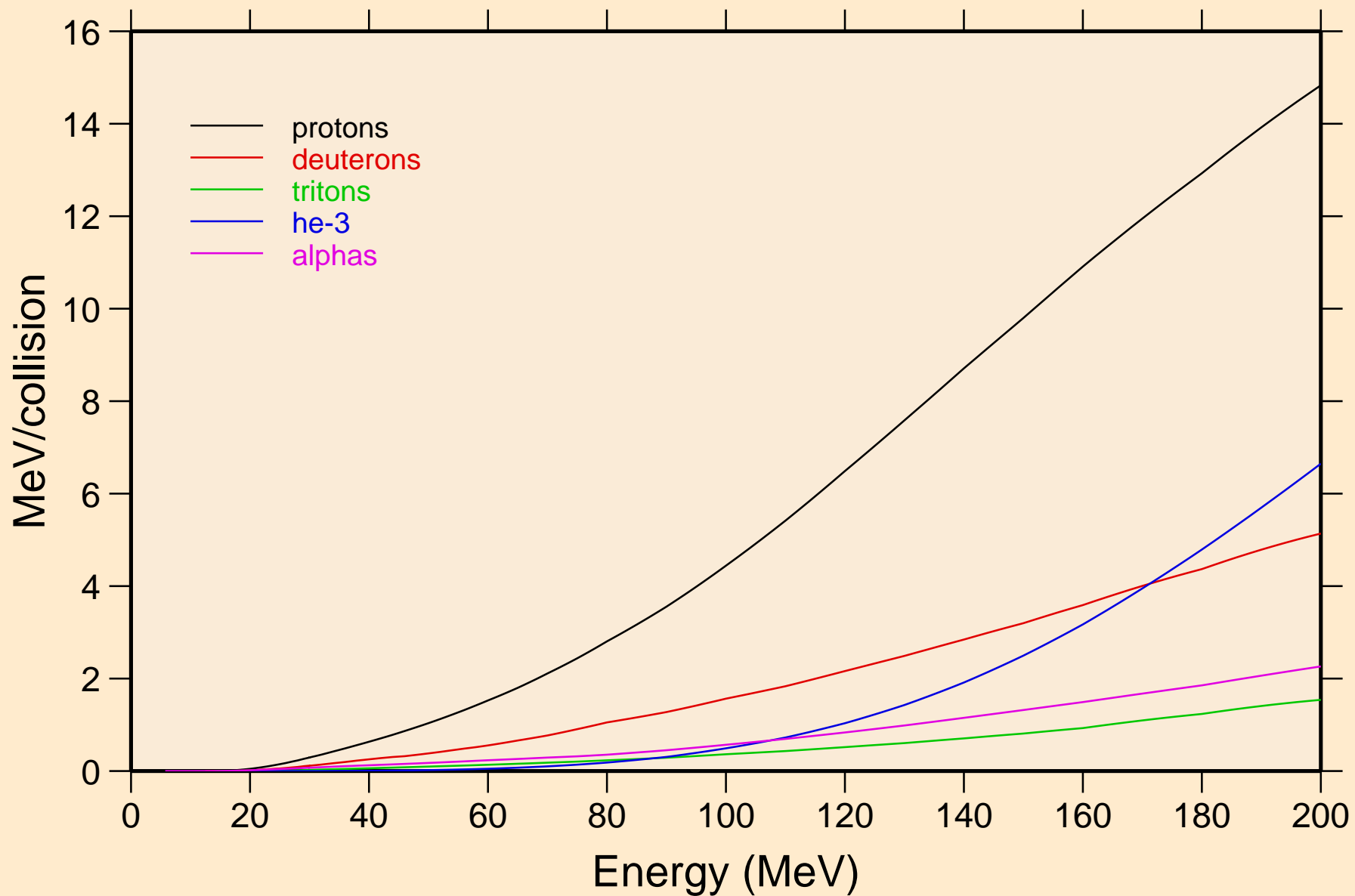

AR042 NEUTRON ACER TENDL-2019 LIBRARY; T=293.16K  
Recoil Heating

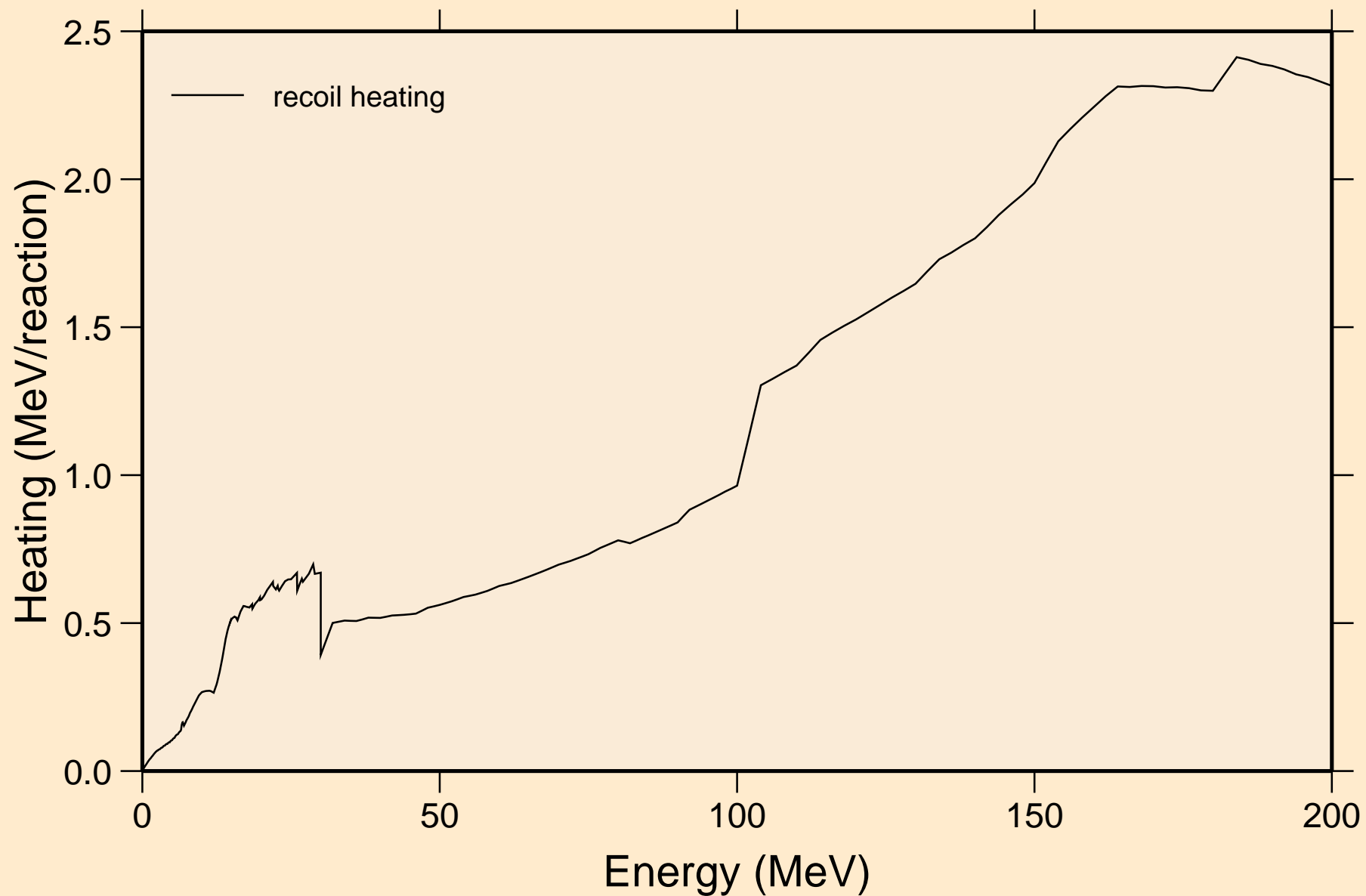

AR042 NEUTRON ACER TENDL-2019 LIBRARY; T=293.16K  
Particle production cross sections

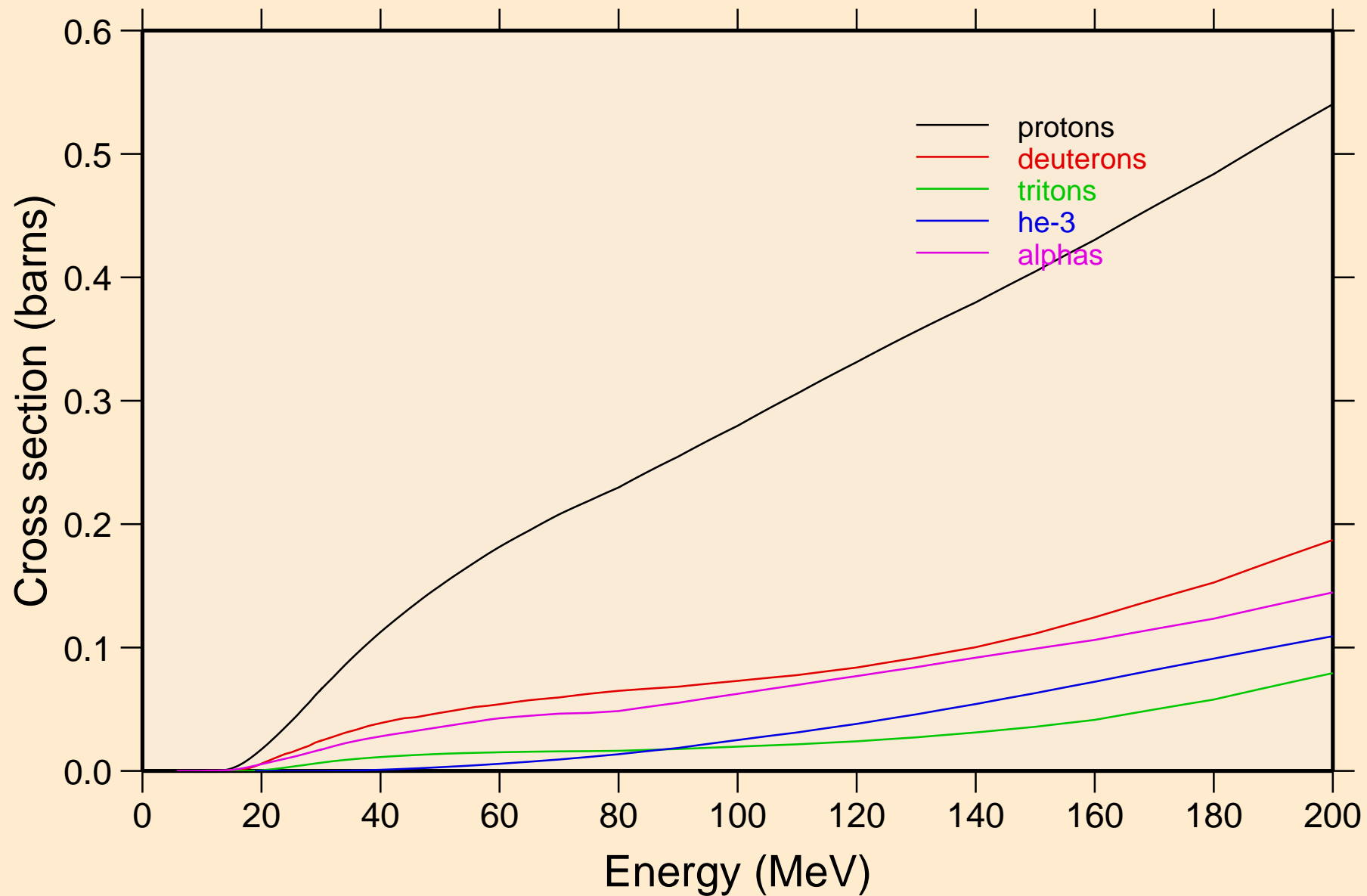

AR042 NEUTRON ACER TENDL-2019 LIBRARY; T=293.16K  
protons from (n,x)

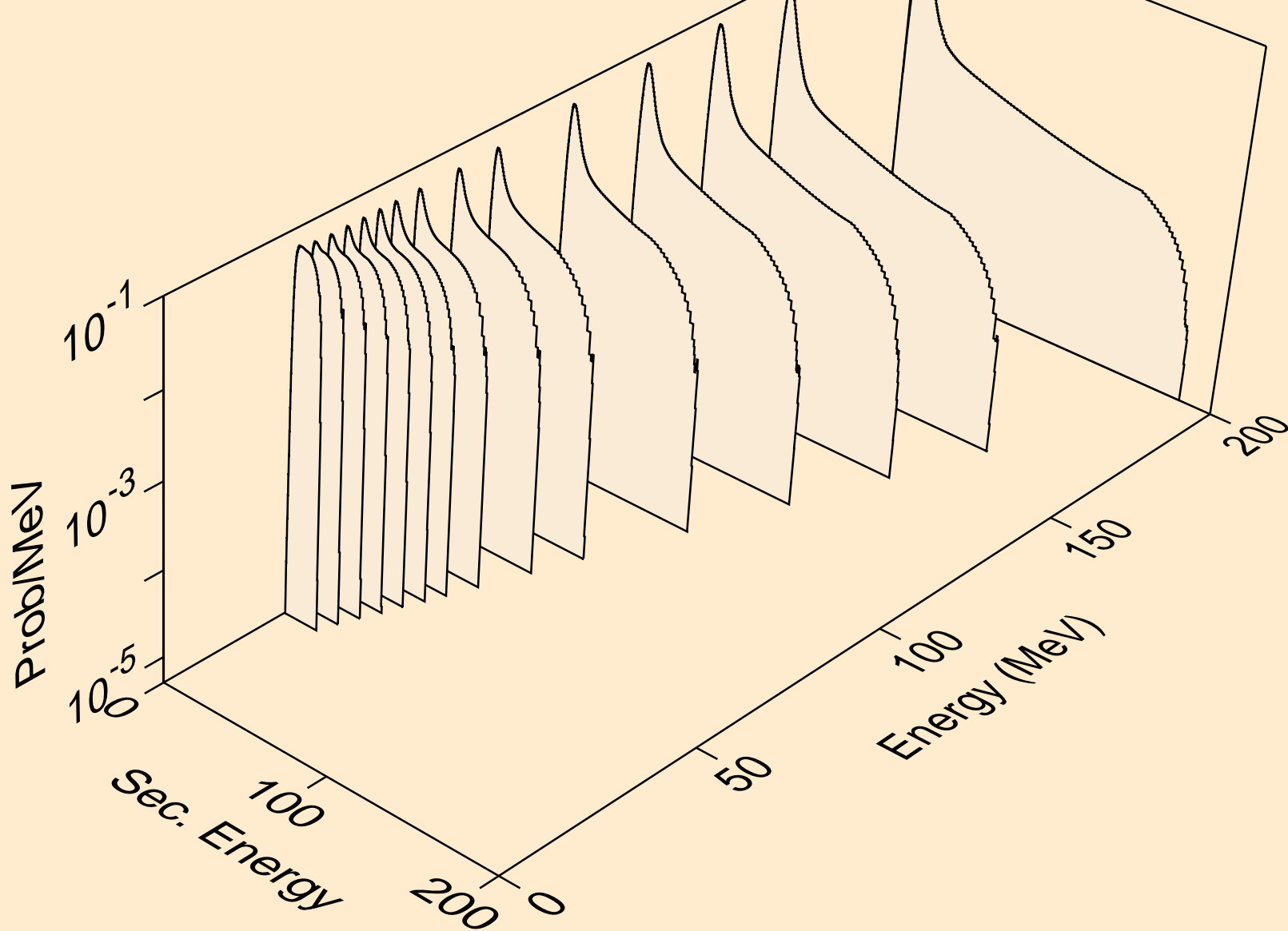

AR042 NEUTRON ACER TENDL-2019 LIBRARY; T=293.16K  
protons from (n,n\*)p

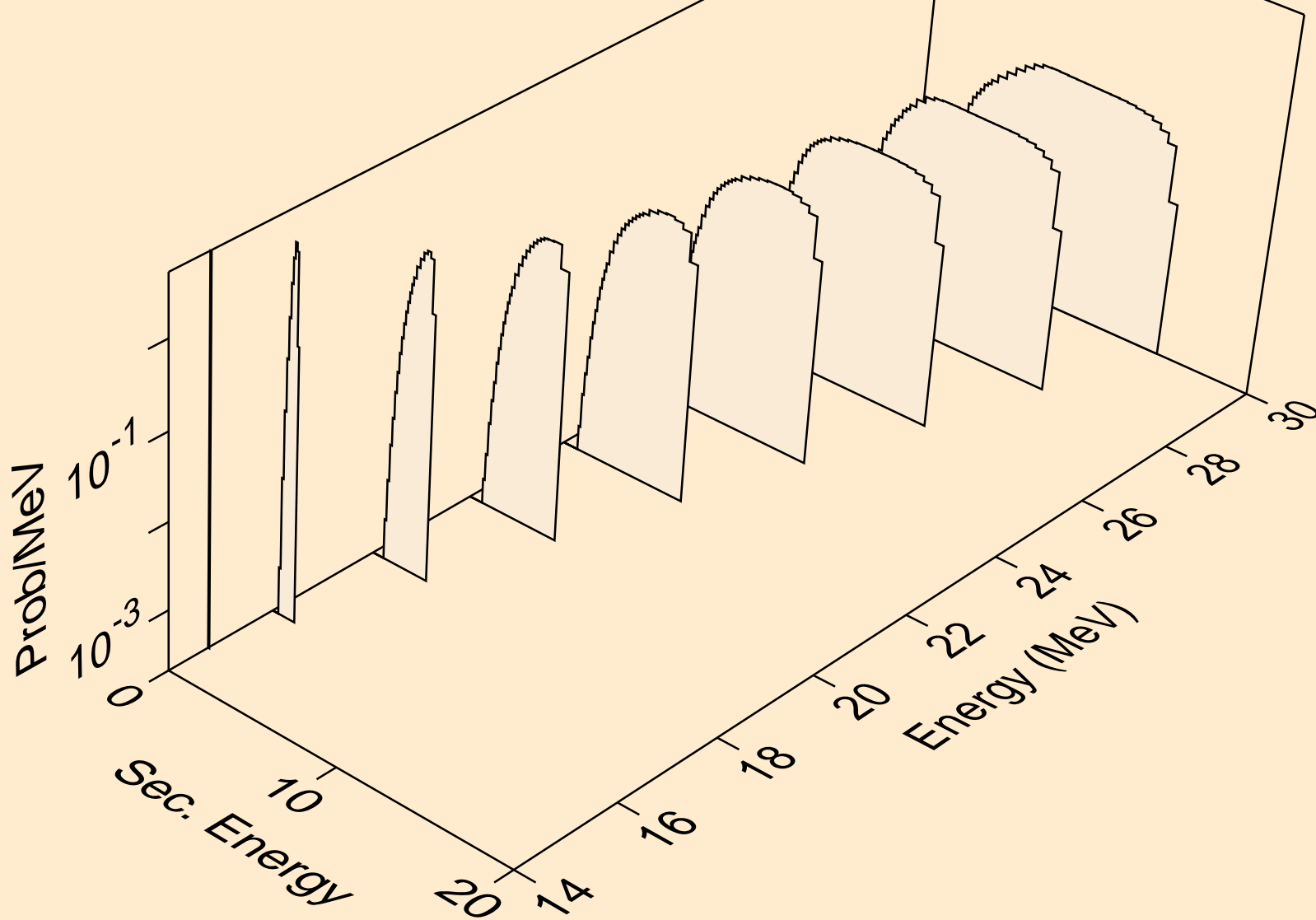

AR042 NEUTRON ACER TENDL-2019 LIBRARY; T=293.16K  
protons from (n,2np)

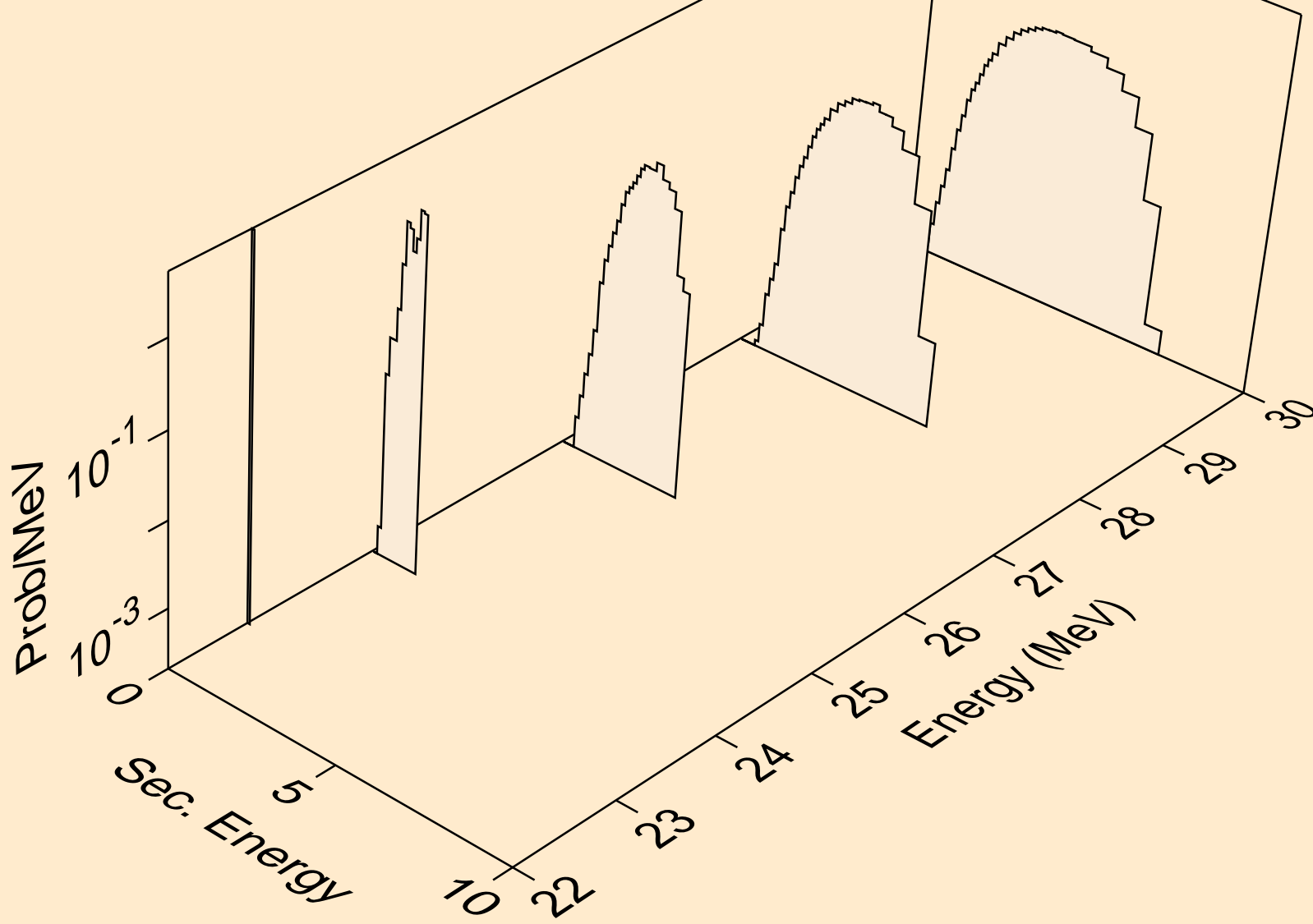

AR042 NEUTRON ACER TENDL-2019 LIBRARY; T=293.16K  
protons from (n,3np)

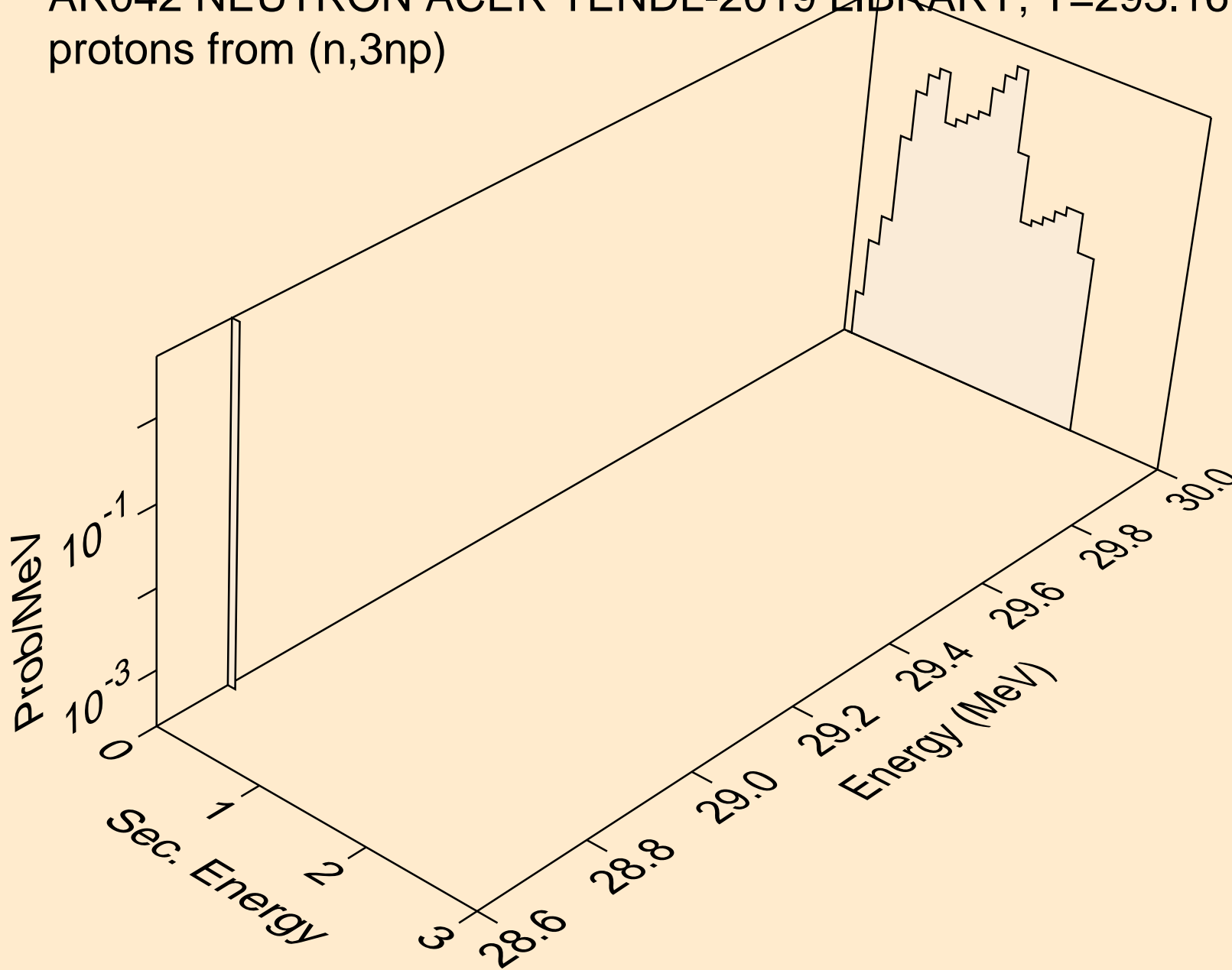



AR042 NEUTRON ACER TENDL-2019 LIBRARY; T=293.16K  
protons from (n,p)

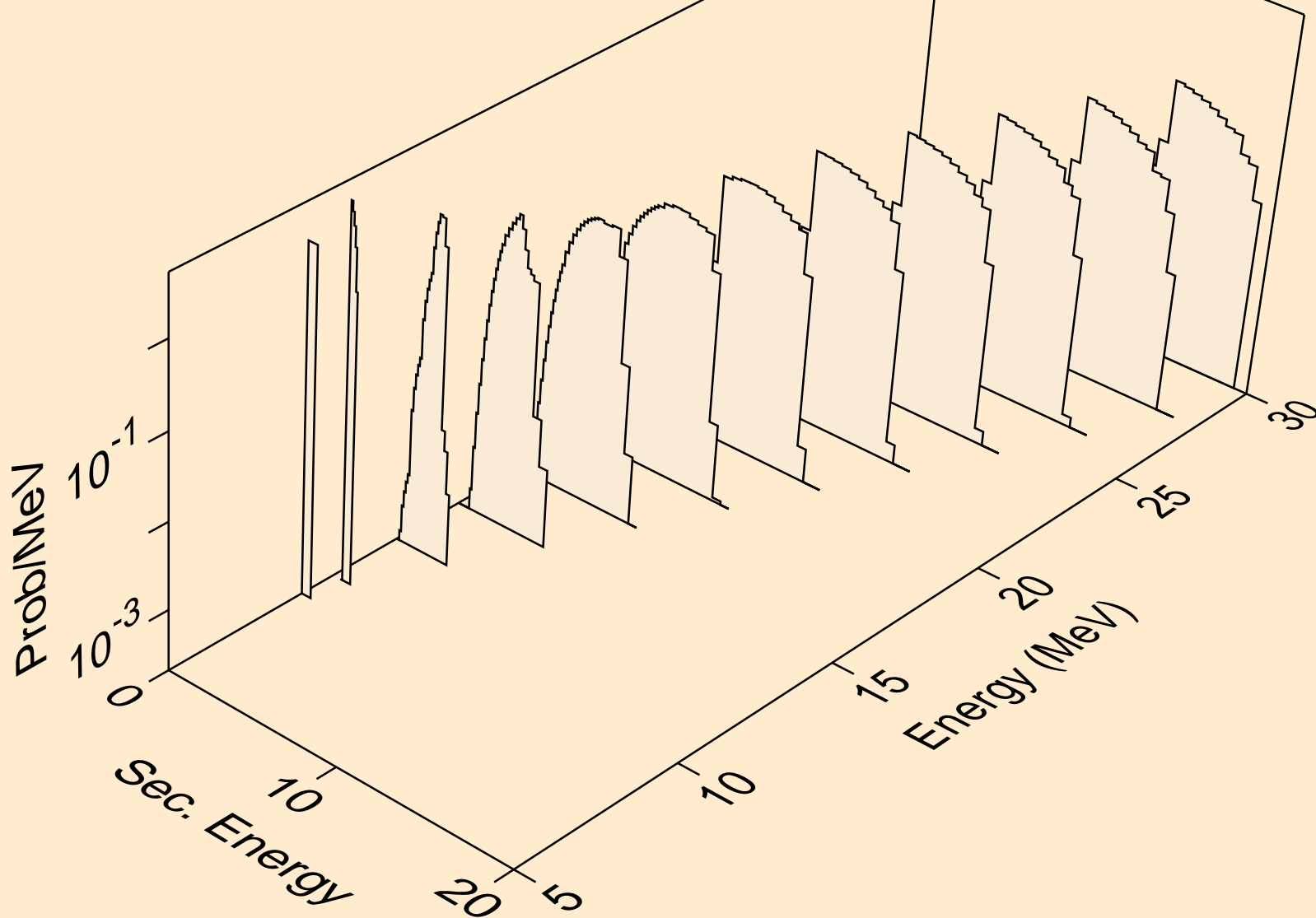

AR042 NEUTRON ACER TENDL-2019 LIBRARY; T=293.16K  
protons from (n,2p)

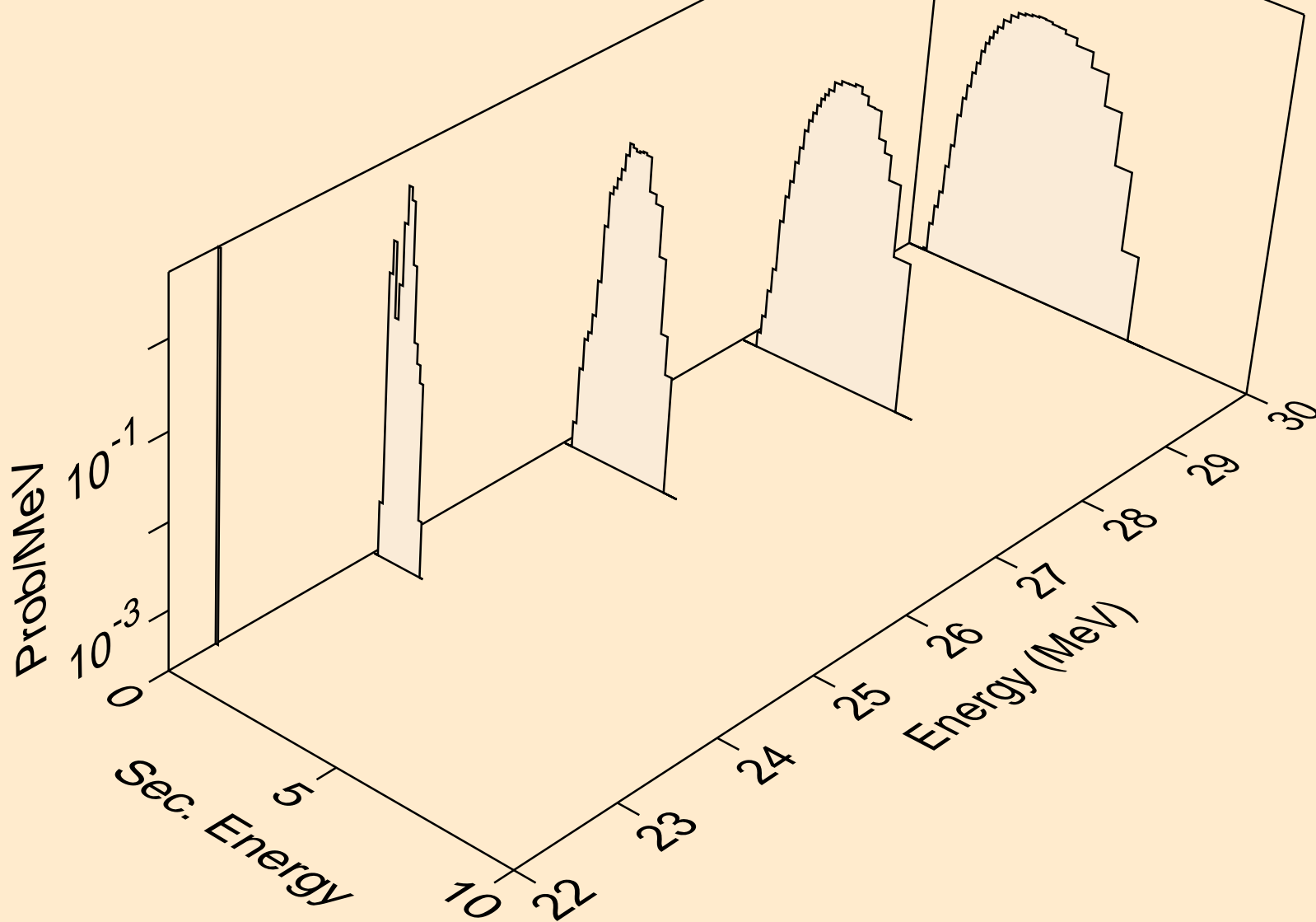

AR042 NEUTRON ACER TENDL-2019 LIBRARY; T=293.16K  
protons from (n,p)

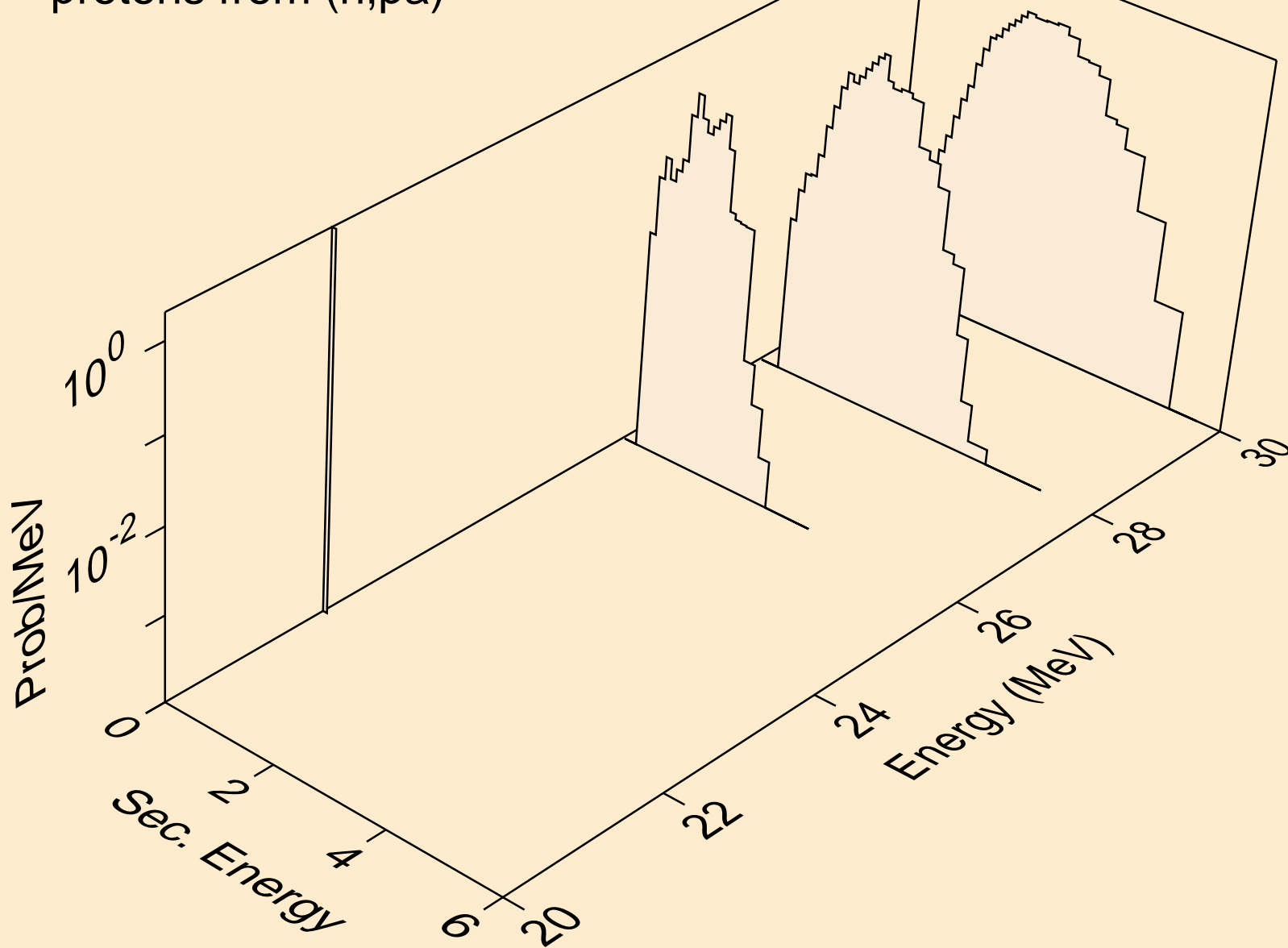

AR042 NEUTRON ACER TENDL-2019 LIBRARY; T=293.16K  
protons from (n,pd)

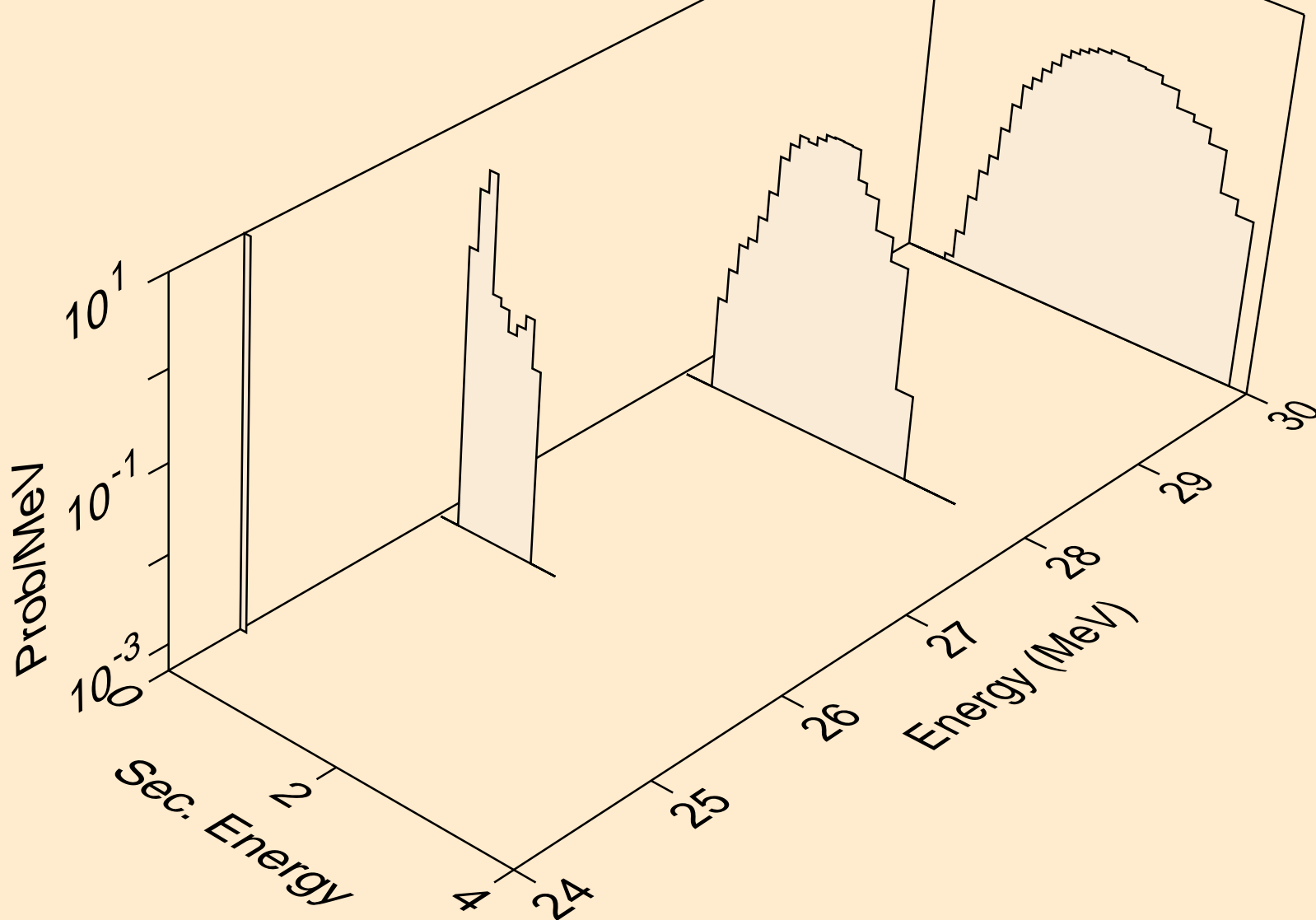

AR042 NEUTRON ACER TENDL-2019 LIBRARY; T=293.16K  
protons from (n,pt)

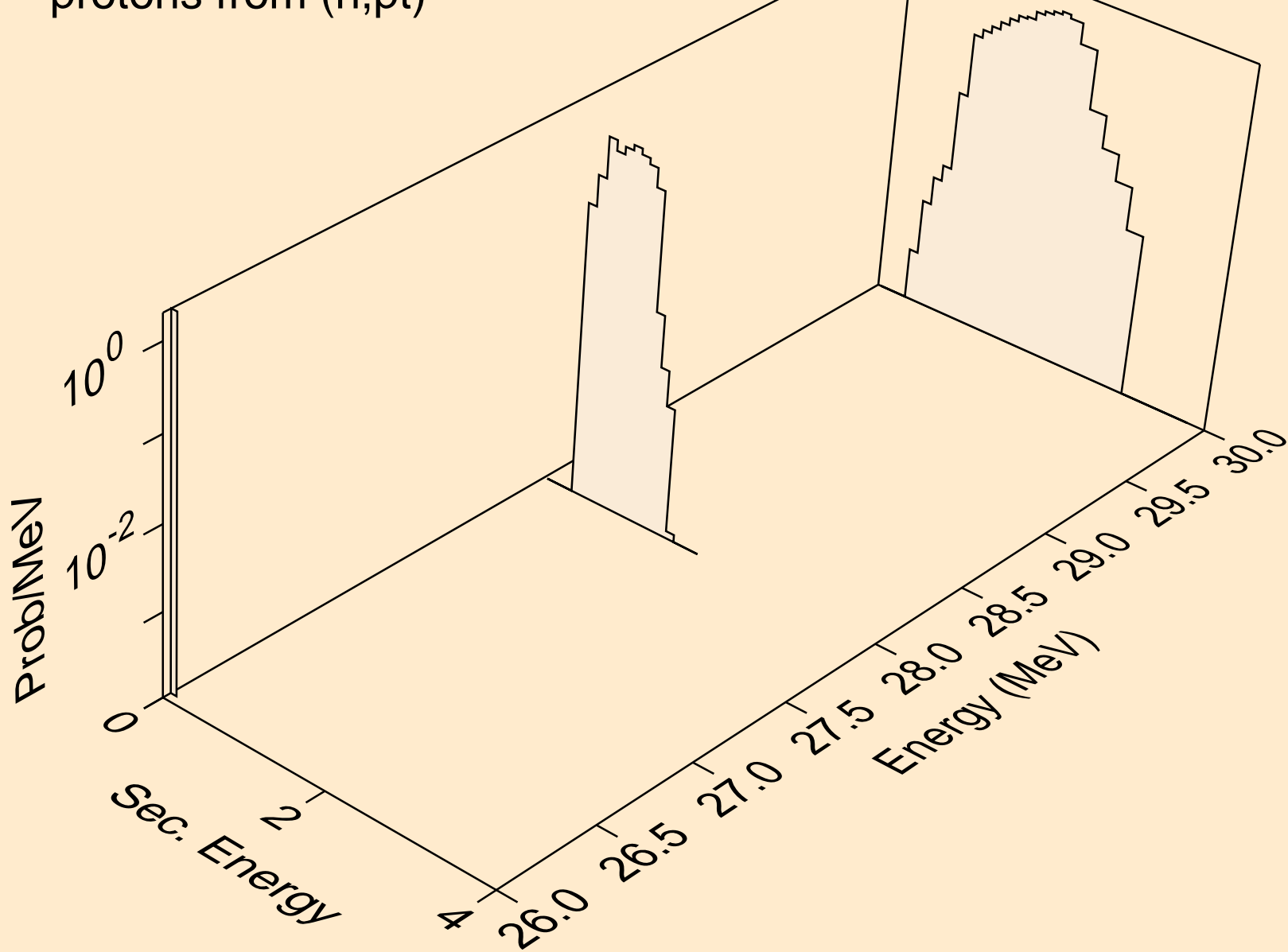

AR042 NEUTRON ACER TENDL-2019 LIBRARY; T=293.16K  
deuterons from (n,x)

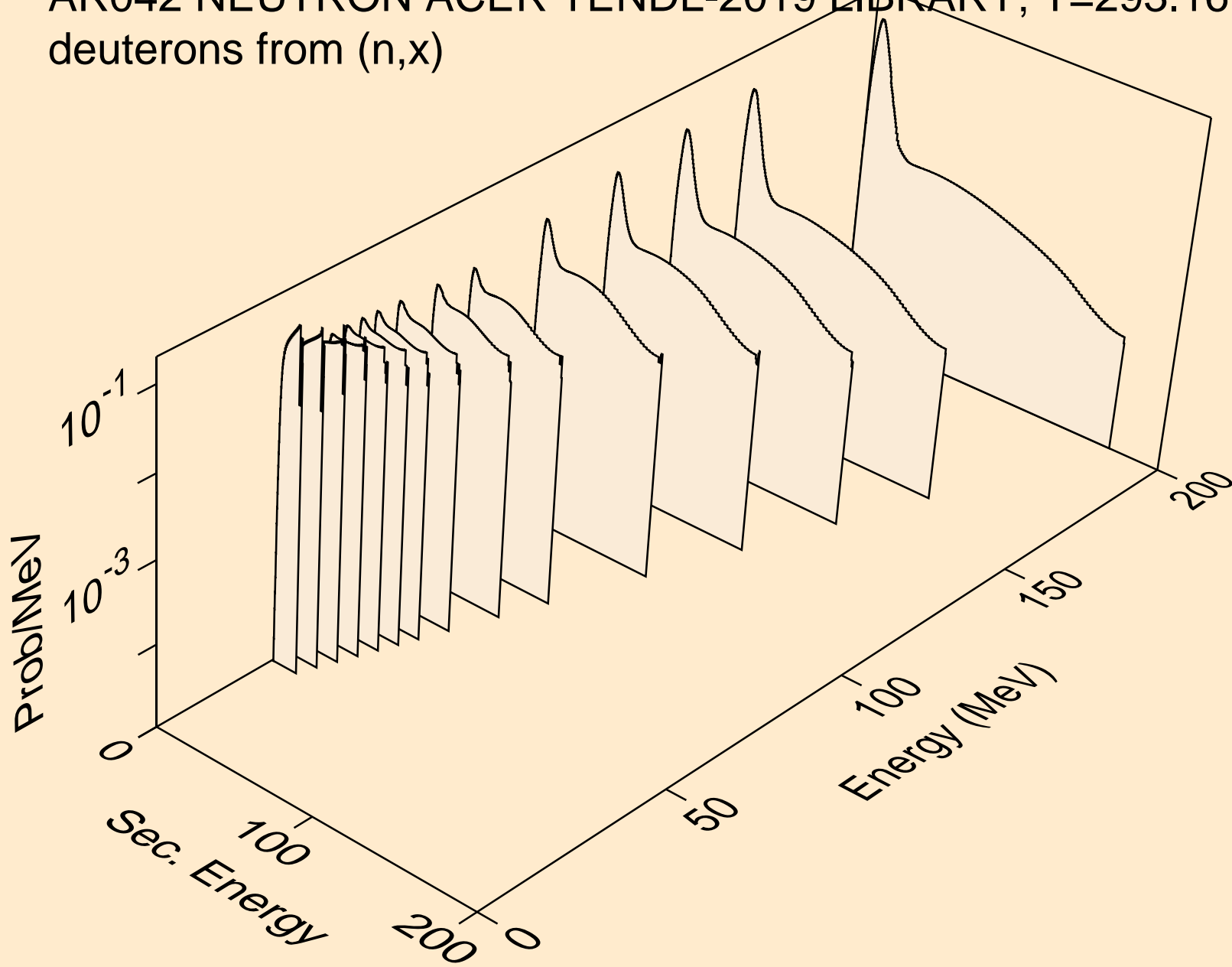

AR042 NEUTRON ACER TENDL-2019 LIBRARY; T=293.16K  
deuterons from (n,2nd)

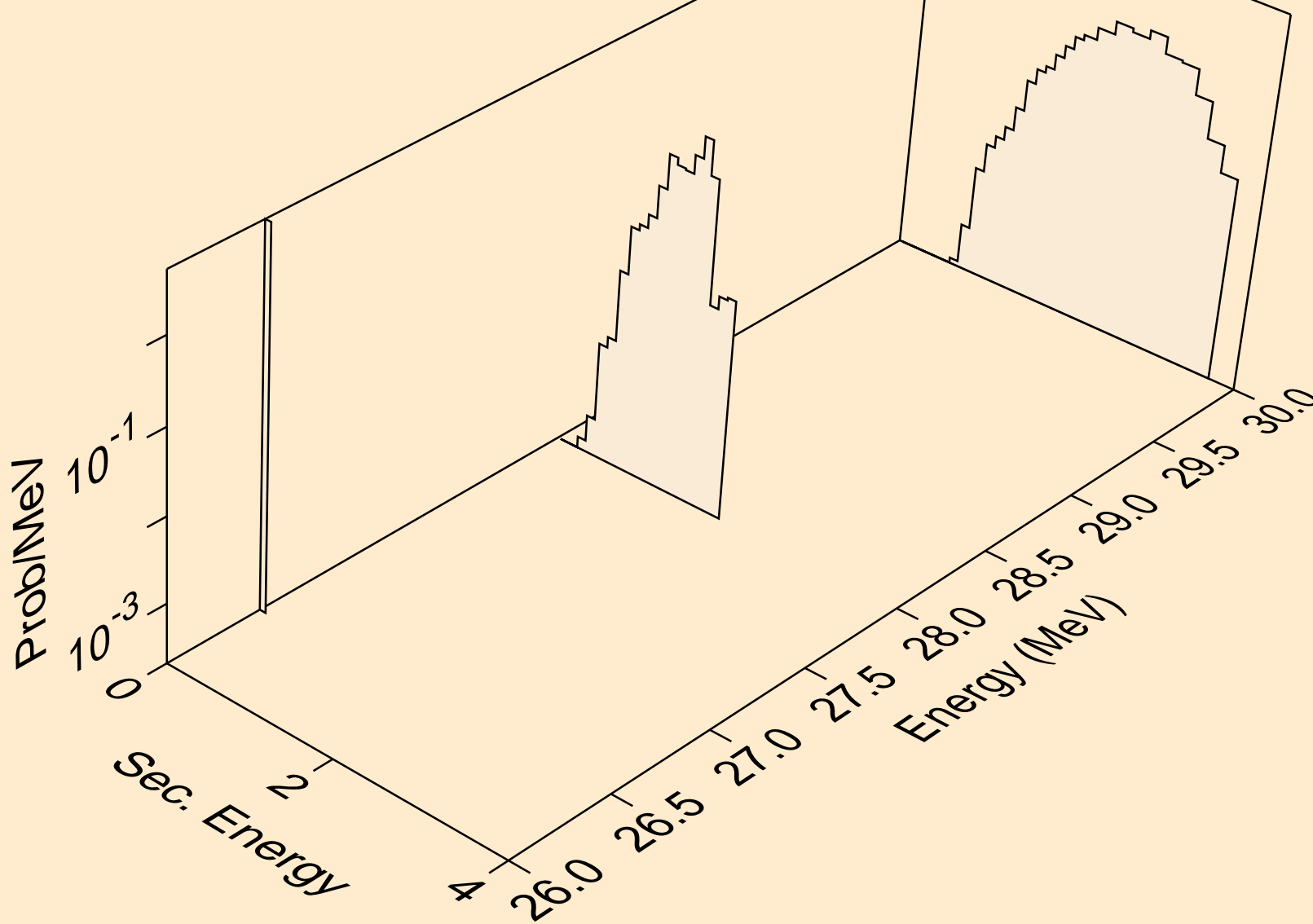

AR042 NEUTRON ACER TENDL-2019 LIBRARY; T=293.16K  
deuterons from (n,n\*)d

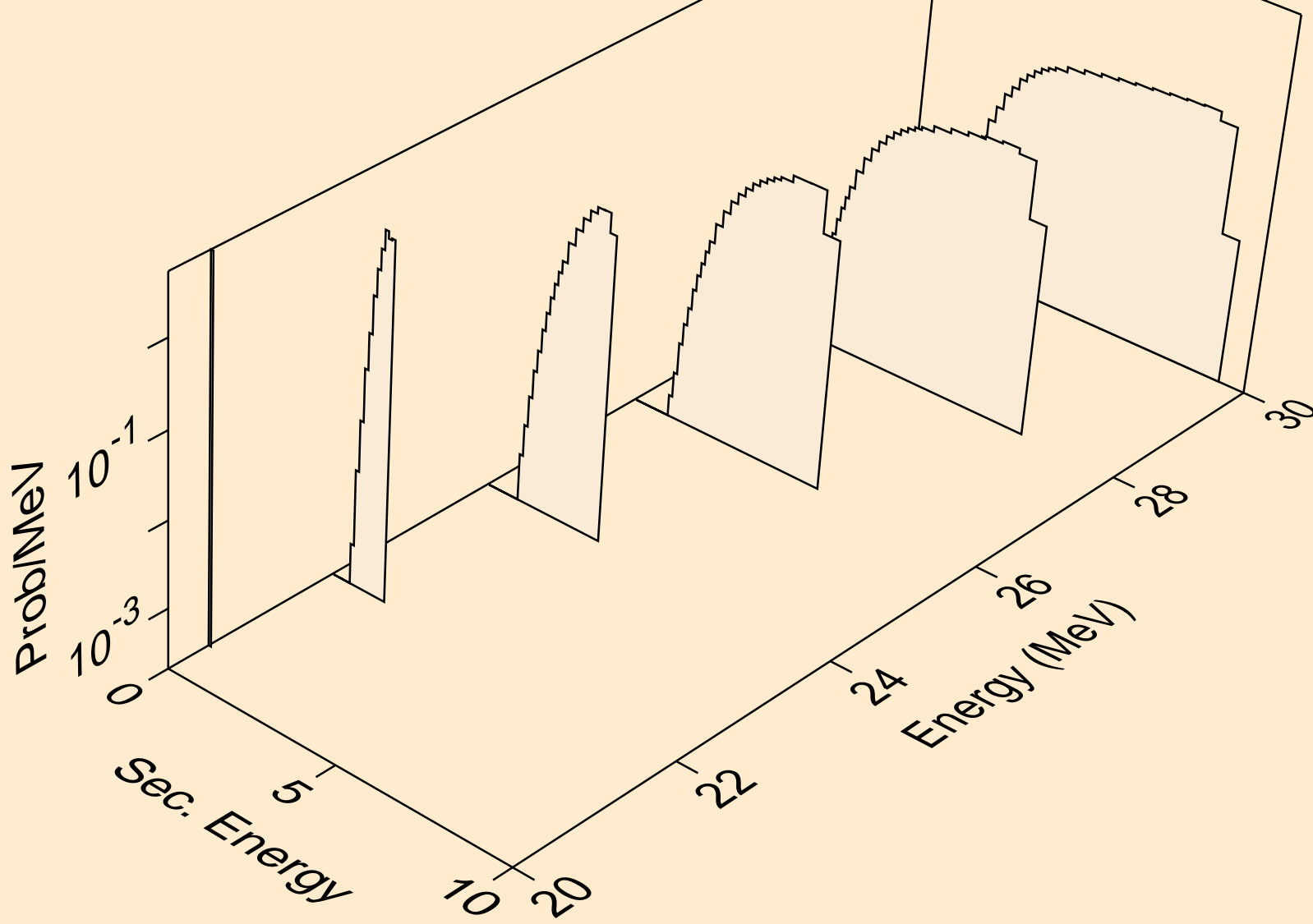



AR042 NEUTRON ACER TENDL-2019 LIBRARY; T=293.16K  
deuterons from (n,d)

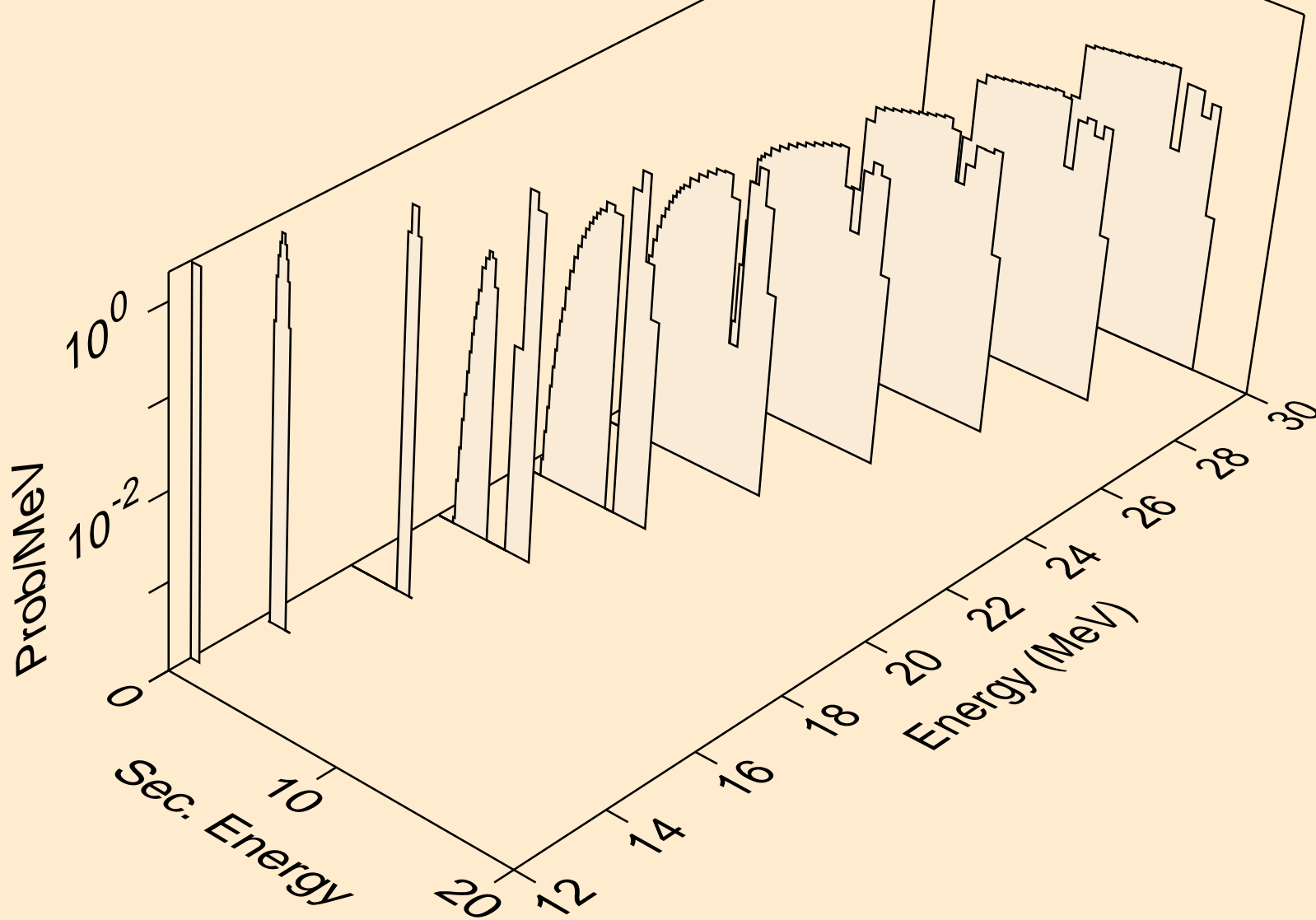

AR042 NEUTRON ACER TENDL-2019 LIBRARY; T=293.16K  
deuterons from (n,pd)

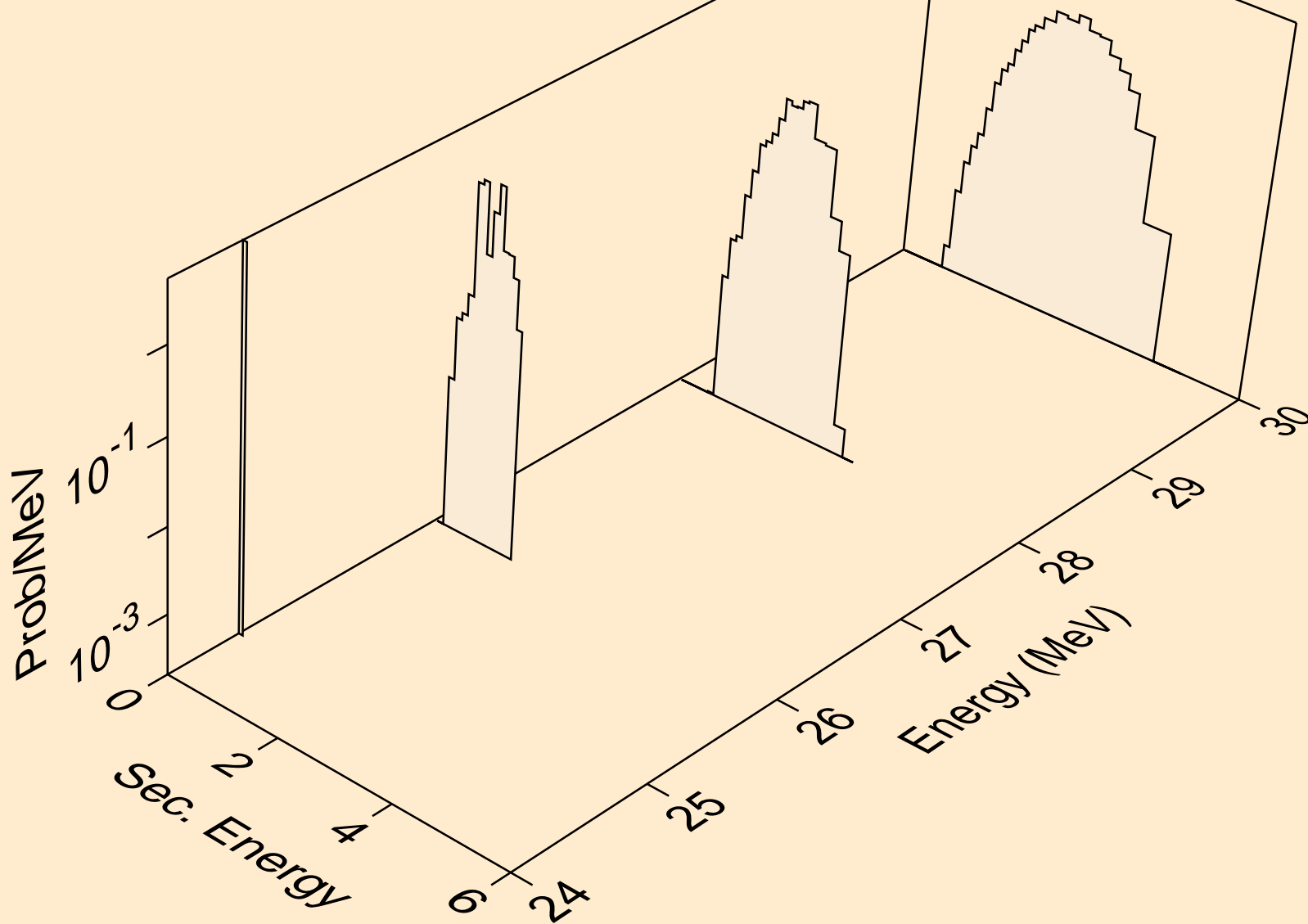

AR042 NEUTRON ACER TENDL-2019 LIBRARY; T=293.16K  
deuterons from (n,da)

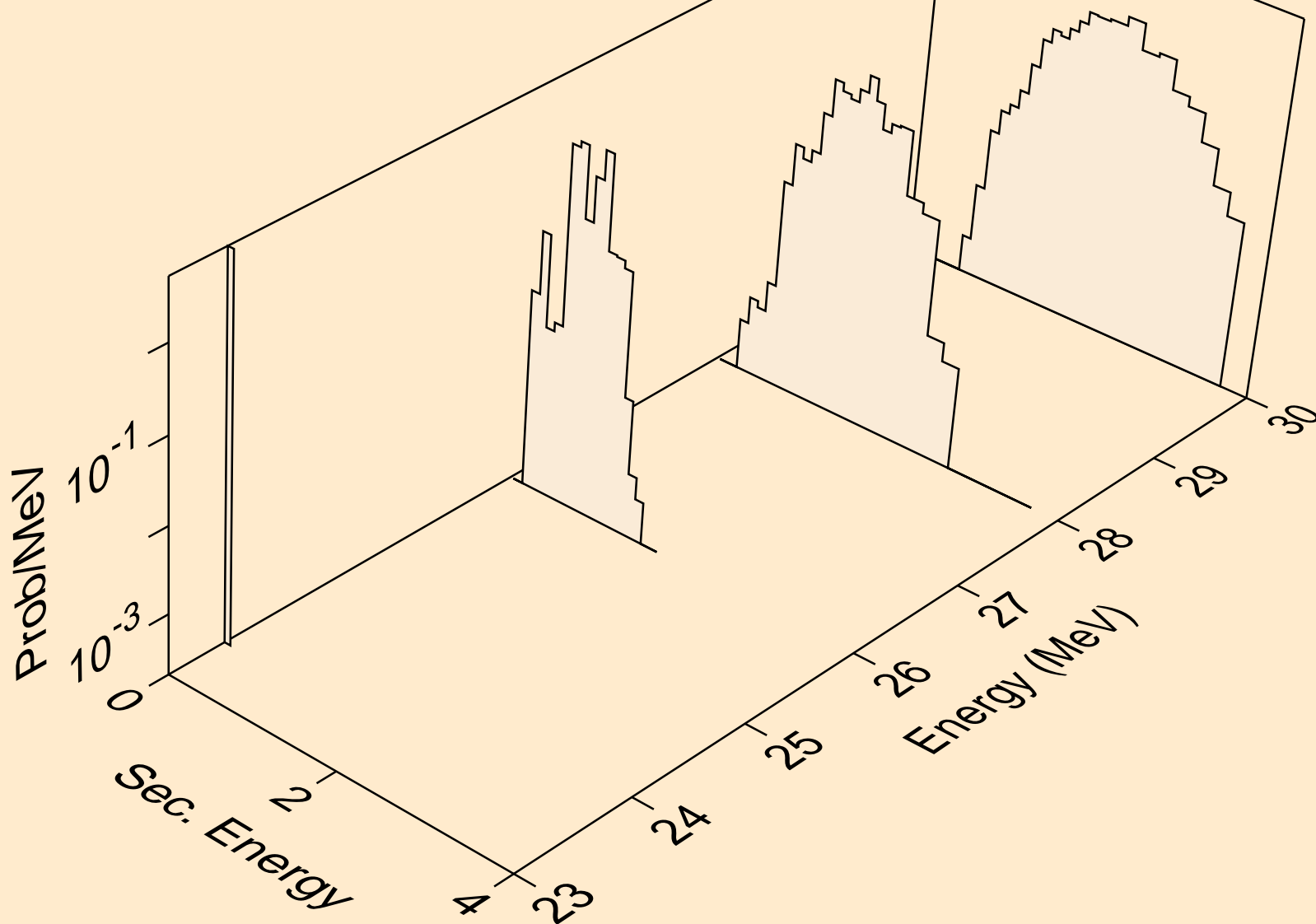

AR042 NEUTRON ACER TENDL-2019 LIBRARY; T=293.16K  
tritons from (n,x)

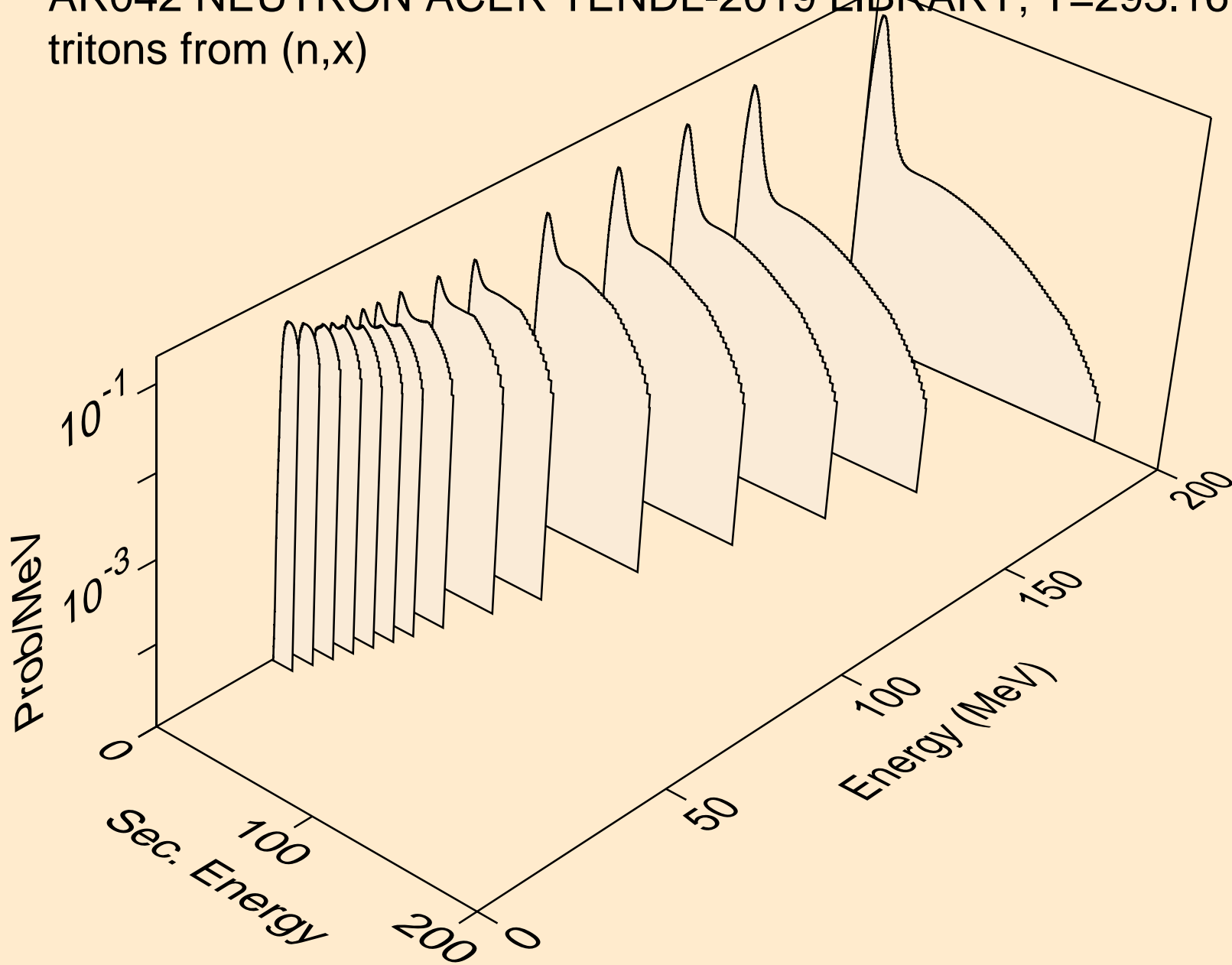

AR042 NEUTRON ACER TENDL-2019 LIBRARY; T=293.16K  
tritons from (n,n\*)t

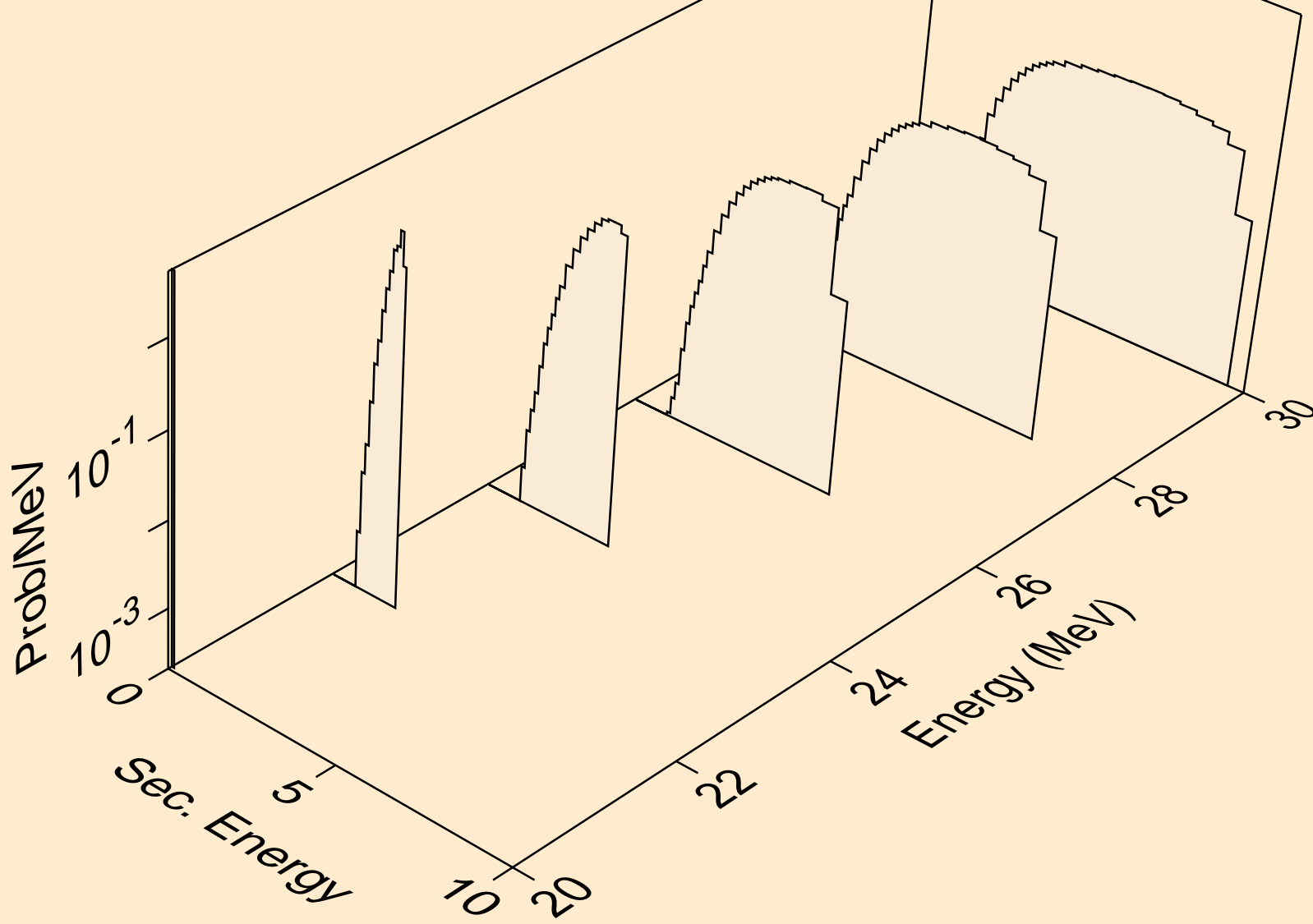

AR042 NEUTRON ACER TENDL-2019 LIBRARY; T=293.16K  
tritons from (n,t)

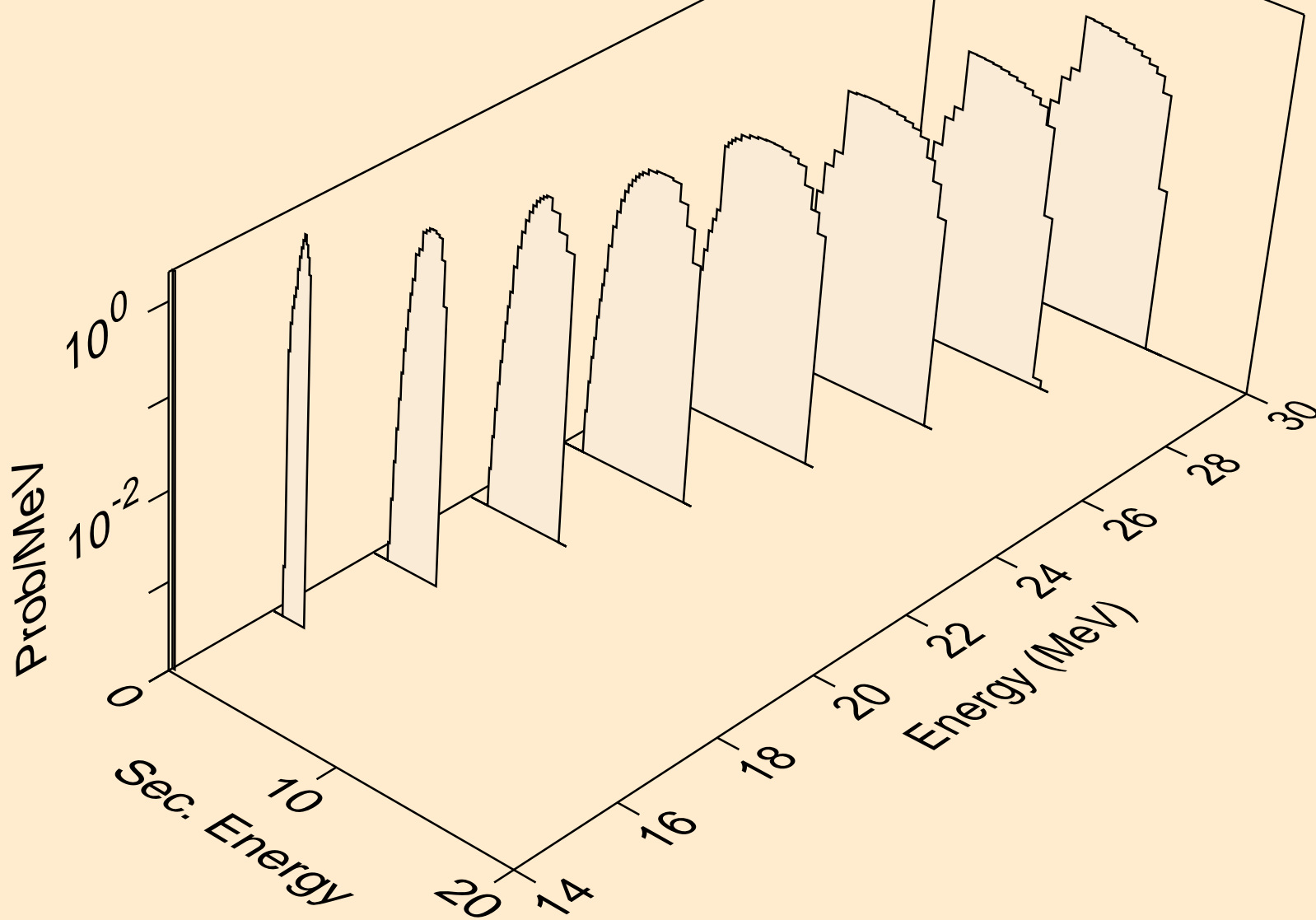

AR042 NEUTRON ACER TENDL-2019 LIBRARY; T=293.16K  
tritons from (n,pt)

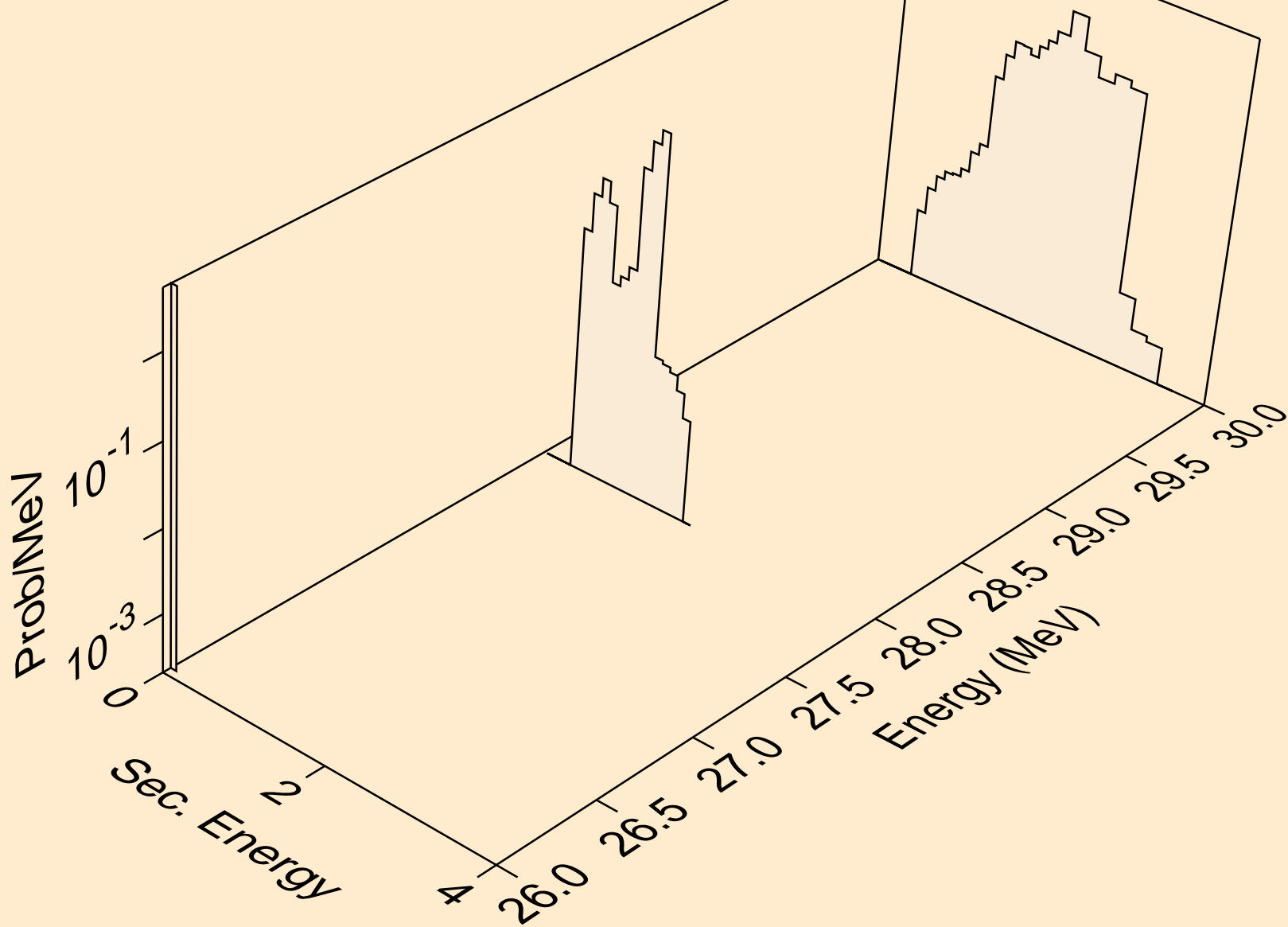

AR042 NEUTRON ACER TENDL-2019 LIBRARY; T=293.16K  
he3s from (n,x)

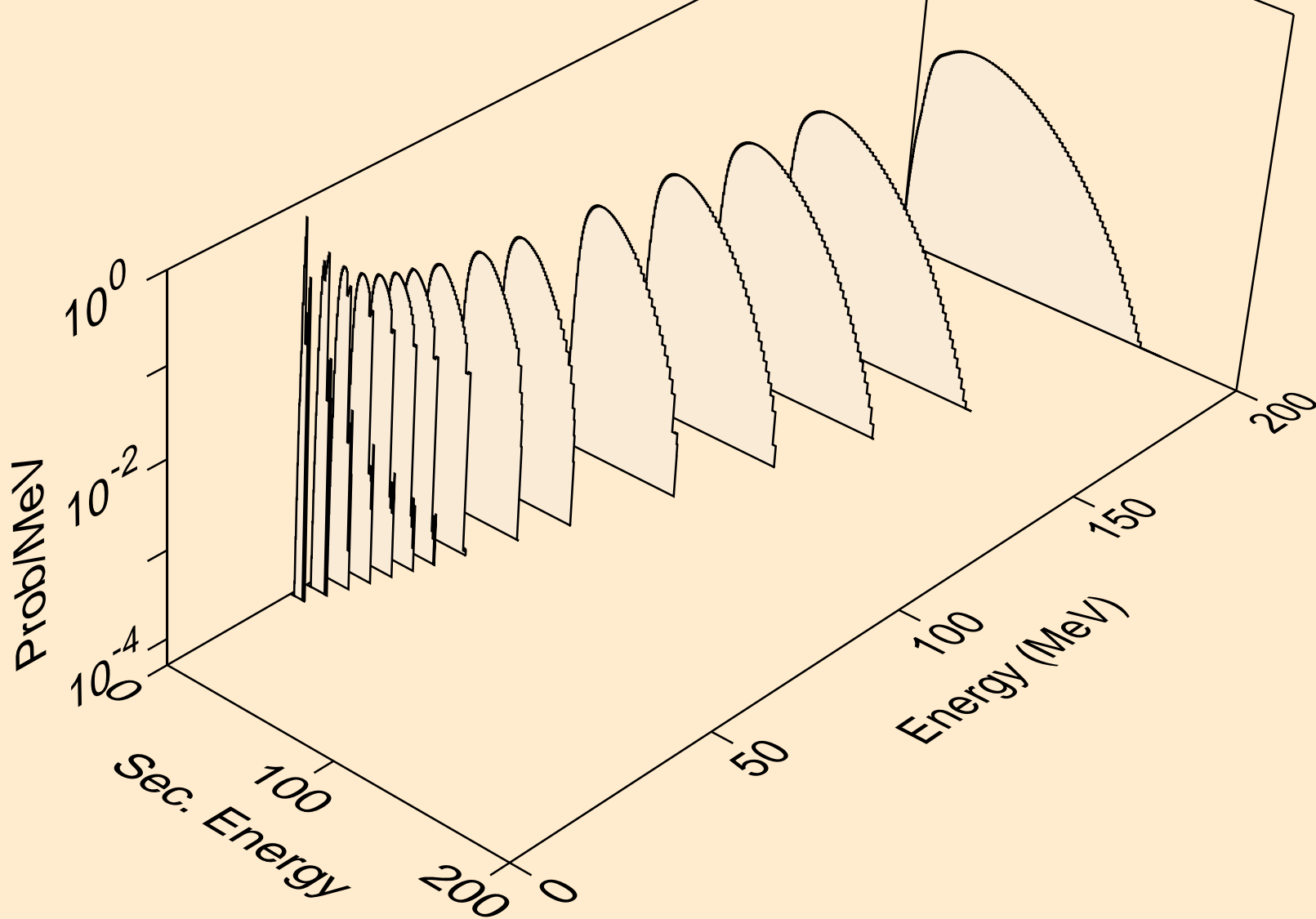



AR042 NEUTRON ACER TENDL-2019 LIBRARY; T=293.16K  
he3s from (n,n\*)he3

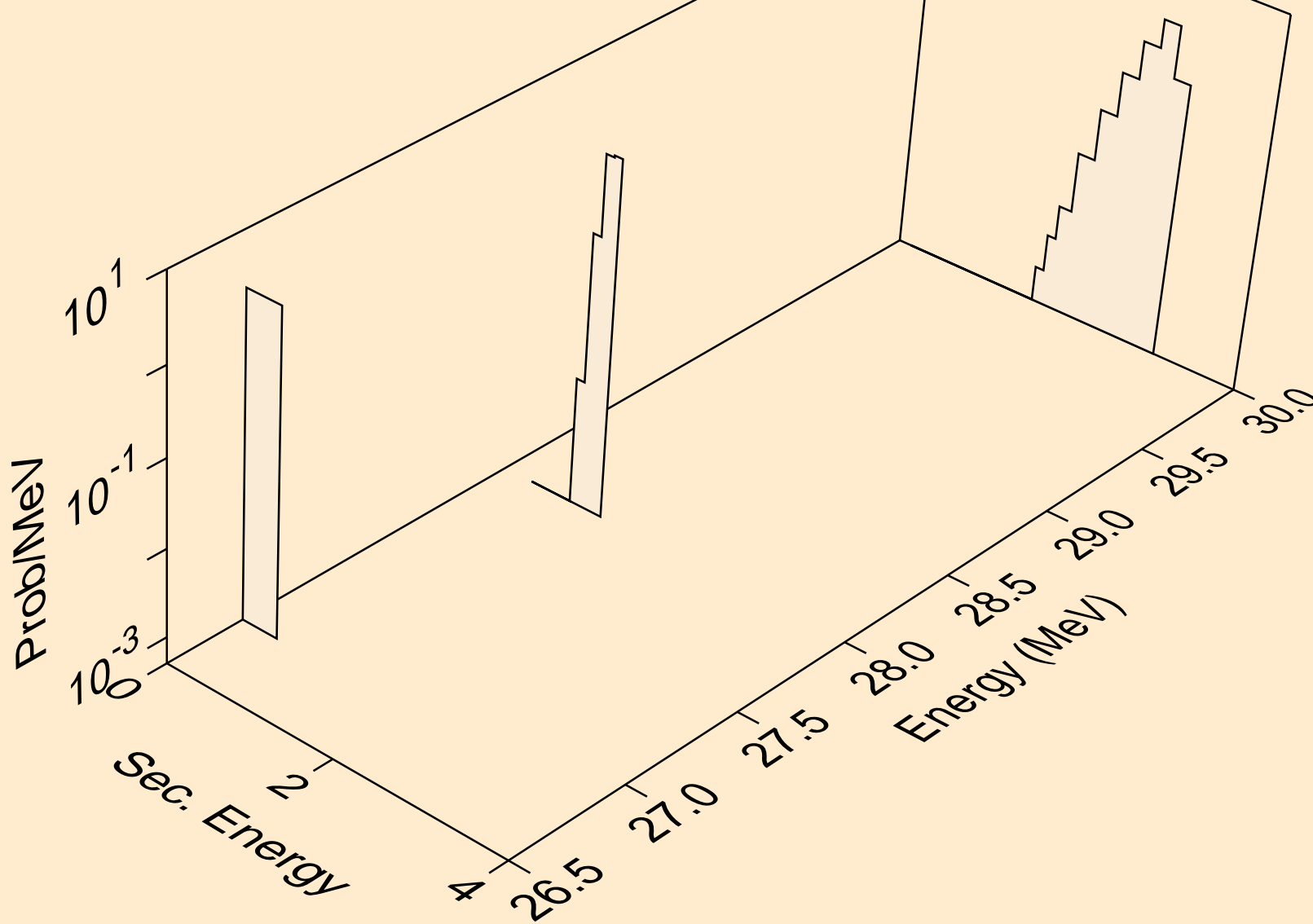

AR042 NEUTRON ACER TENDL-2019 LIBRARY; T=293.16K  
he3s from (n,he3)

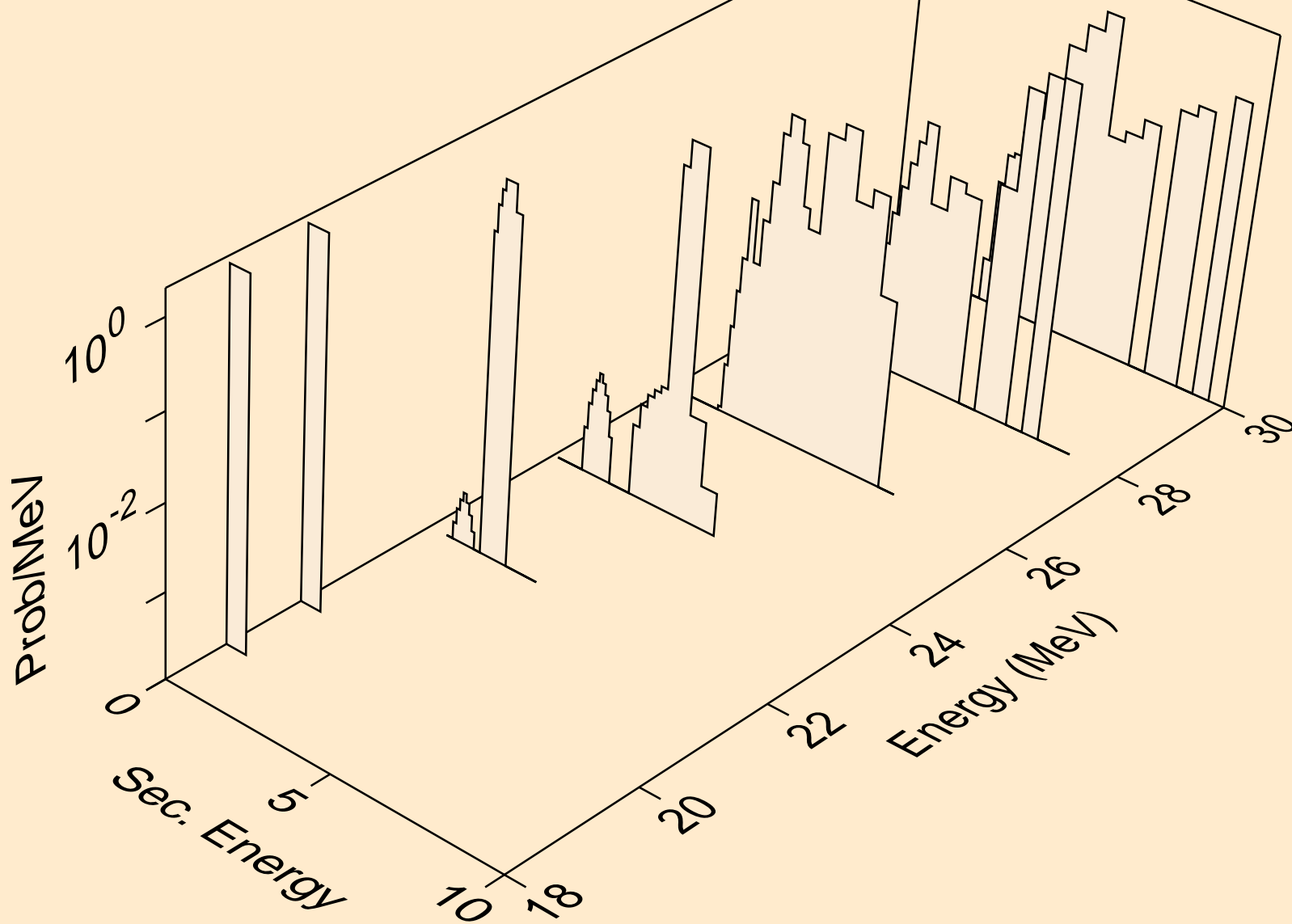

AR042 NEUTRON ACER TENDL-2019 LIBRARY; T=293.16K  
alphas from (n,x)

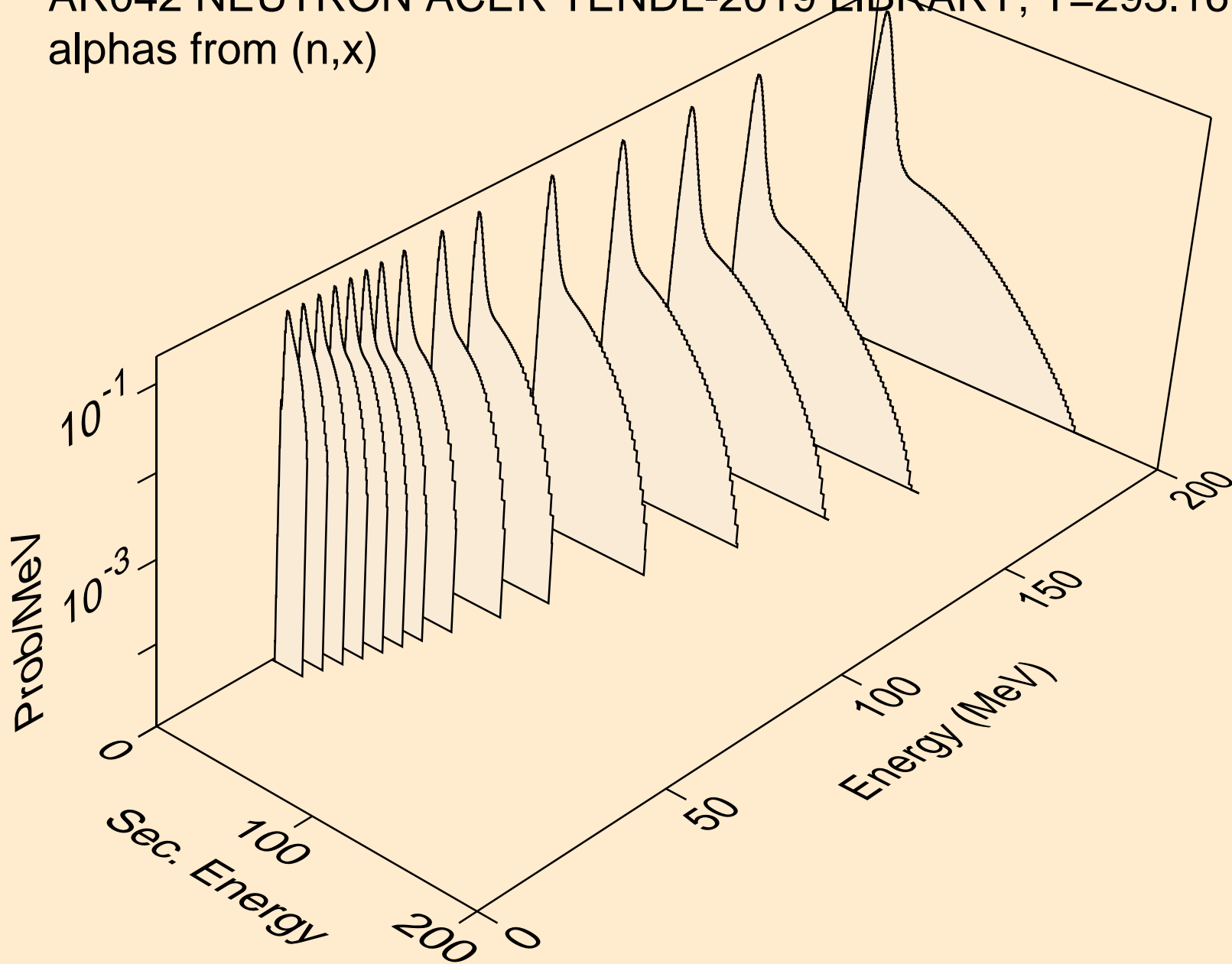

AR042 NEUTRON ACER TENDL-2019 LIBRARY; T=293.16K  
alphas from (n,n\*)a

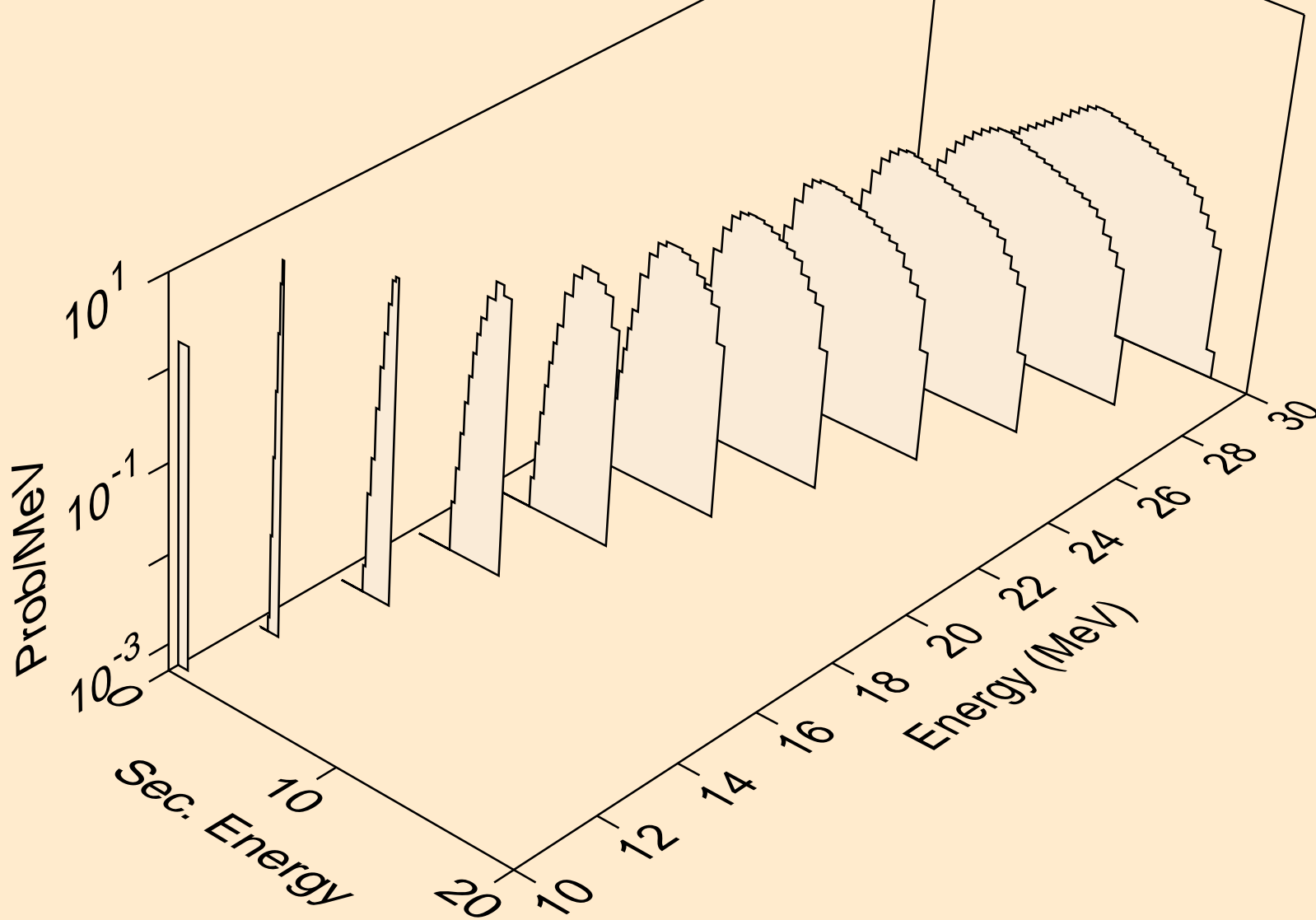

AR042 NEUTRON ACER TENDL-2019 LIBRARY; T=293.16K  
alphas from (n,2n)a

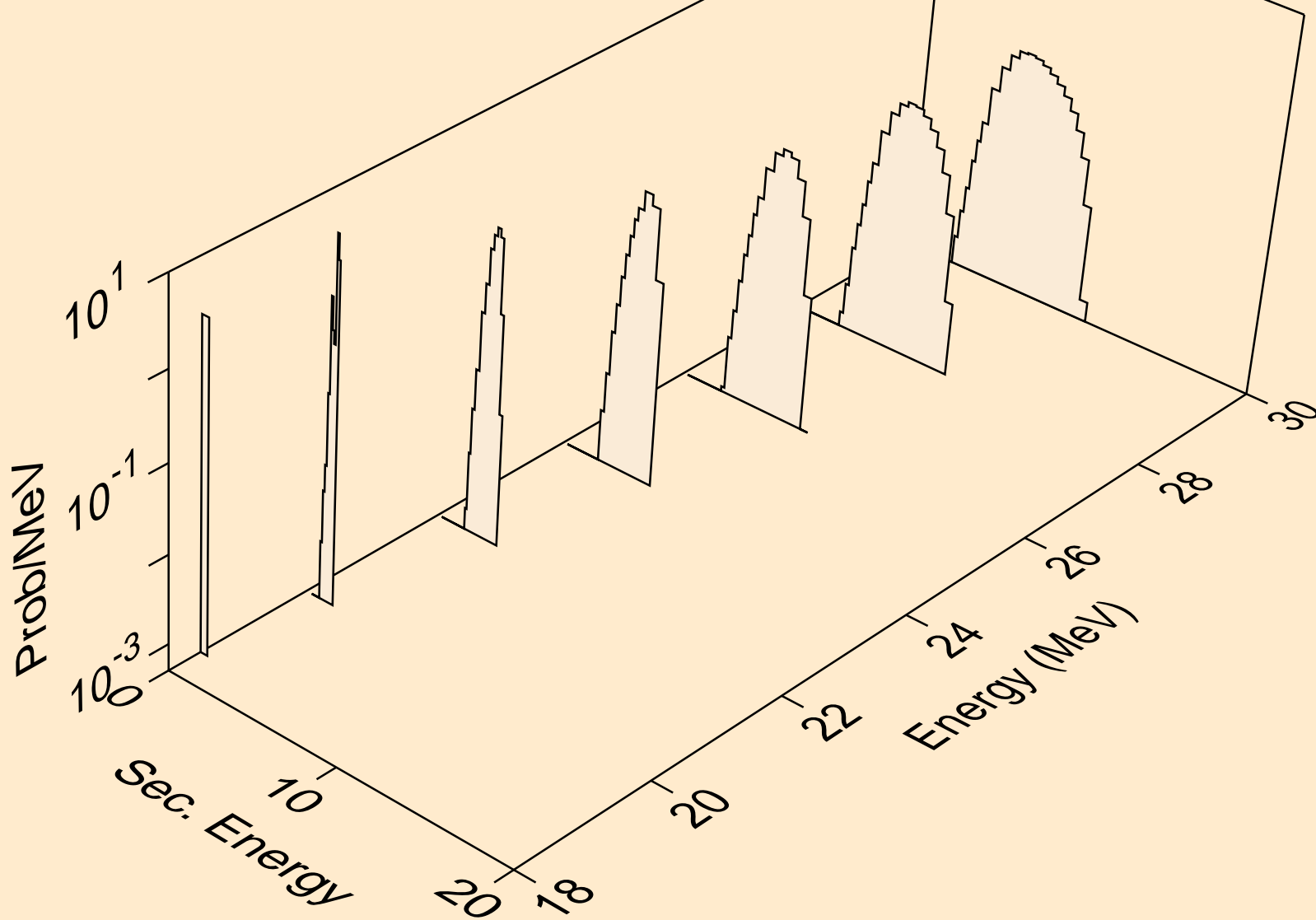

AR042 NEUTRON ACER TENDL-2019 LIBRARY; T=293.16K  
alphas from (n,3n)a

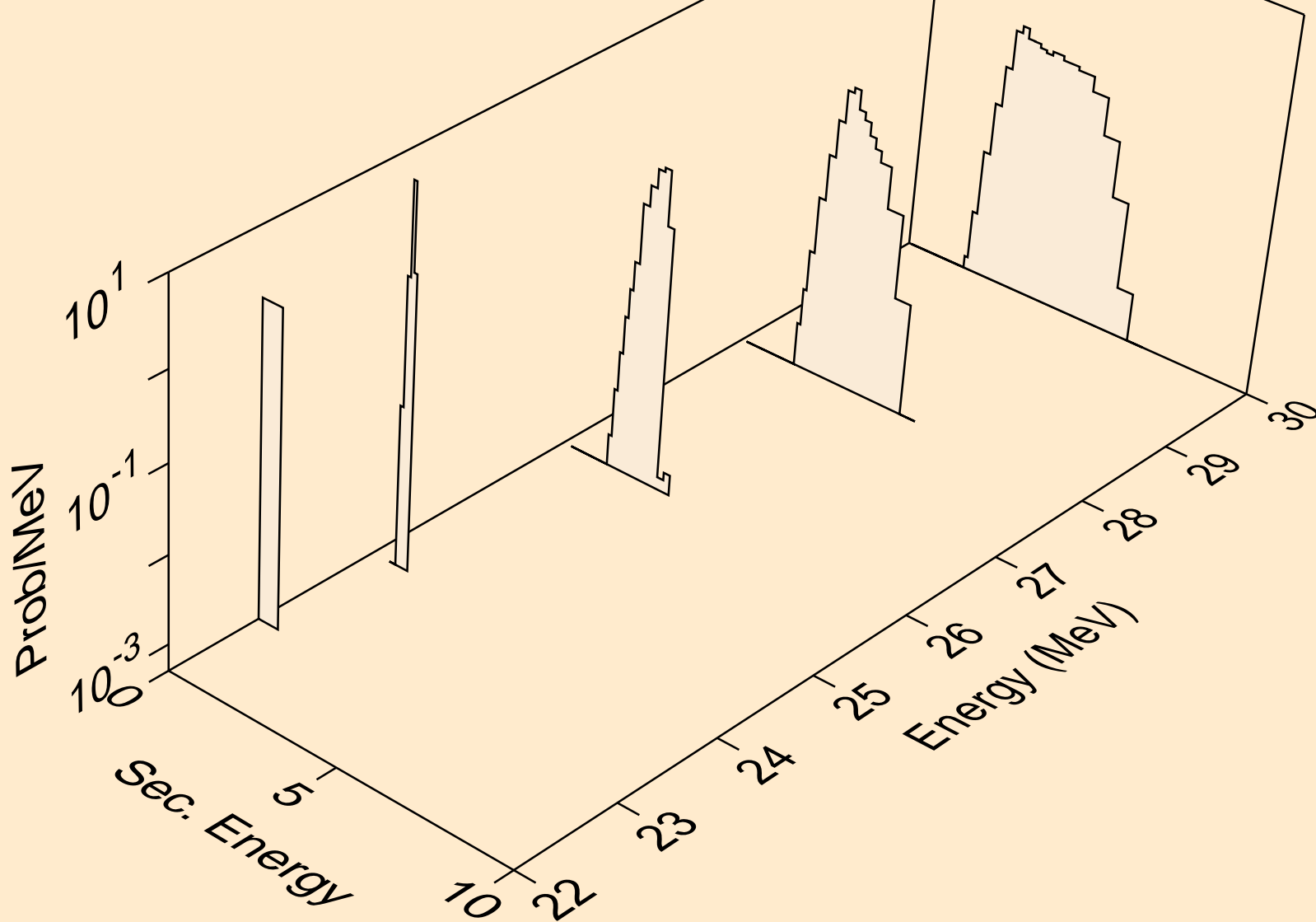

AR042 NEUTRON ACER TENDL-2019 LIBRARY; T=293.16K  
alphas from (n,n\*)2a

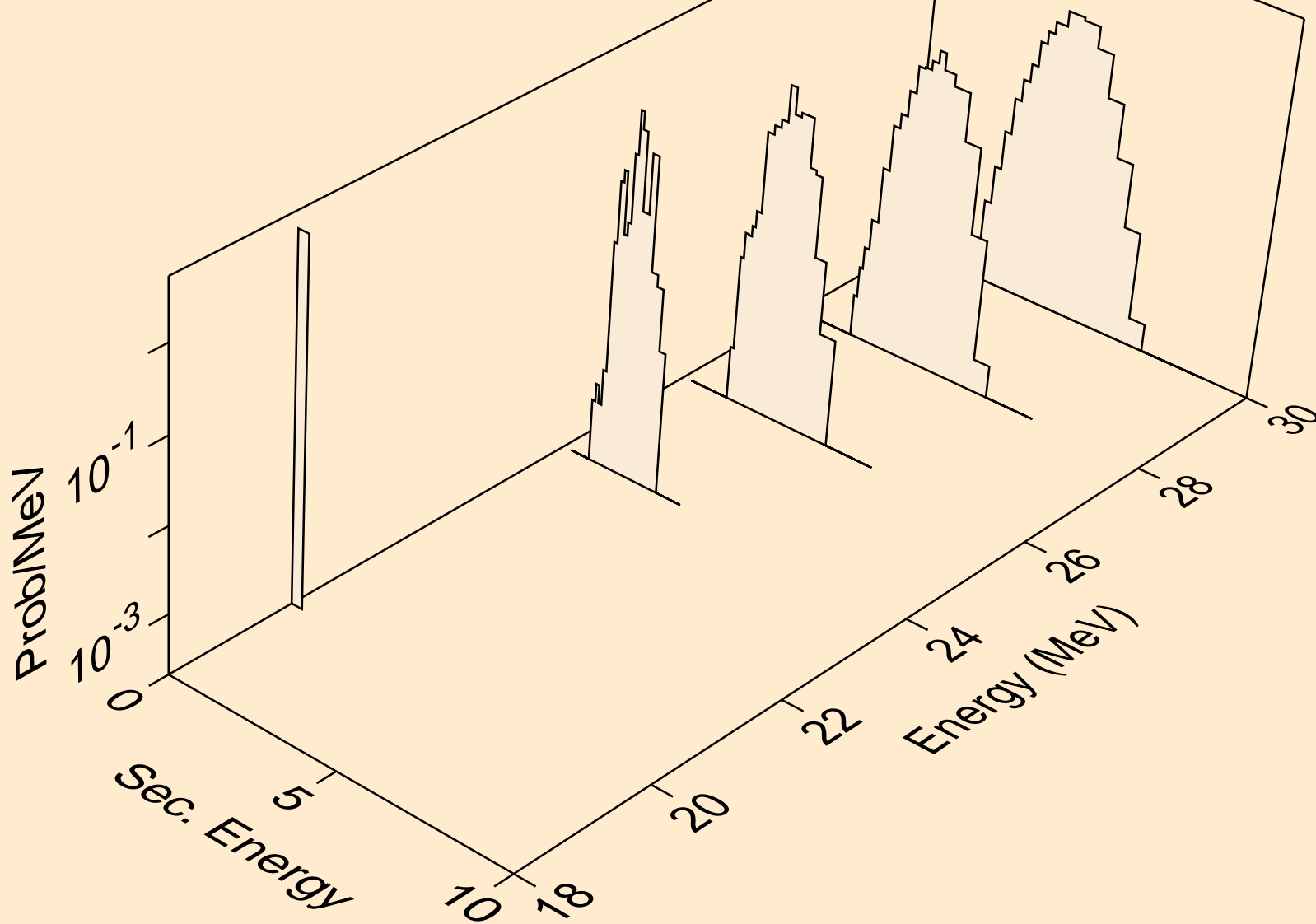

AR042 NEUTRON ACER TENDL-2019 LIBRARY; T=293.16K  
alphas from (n,a)

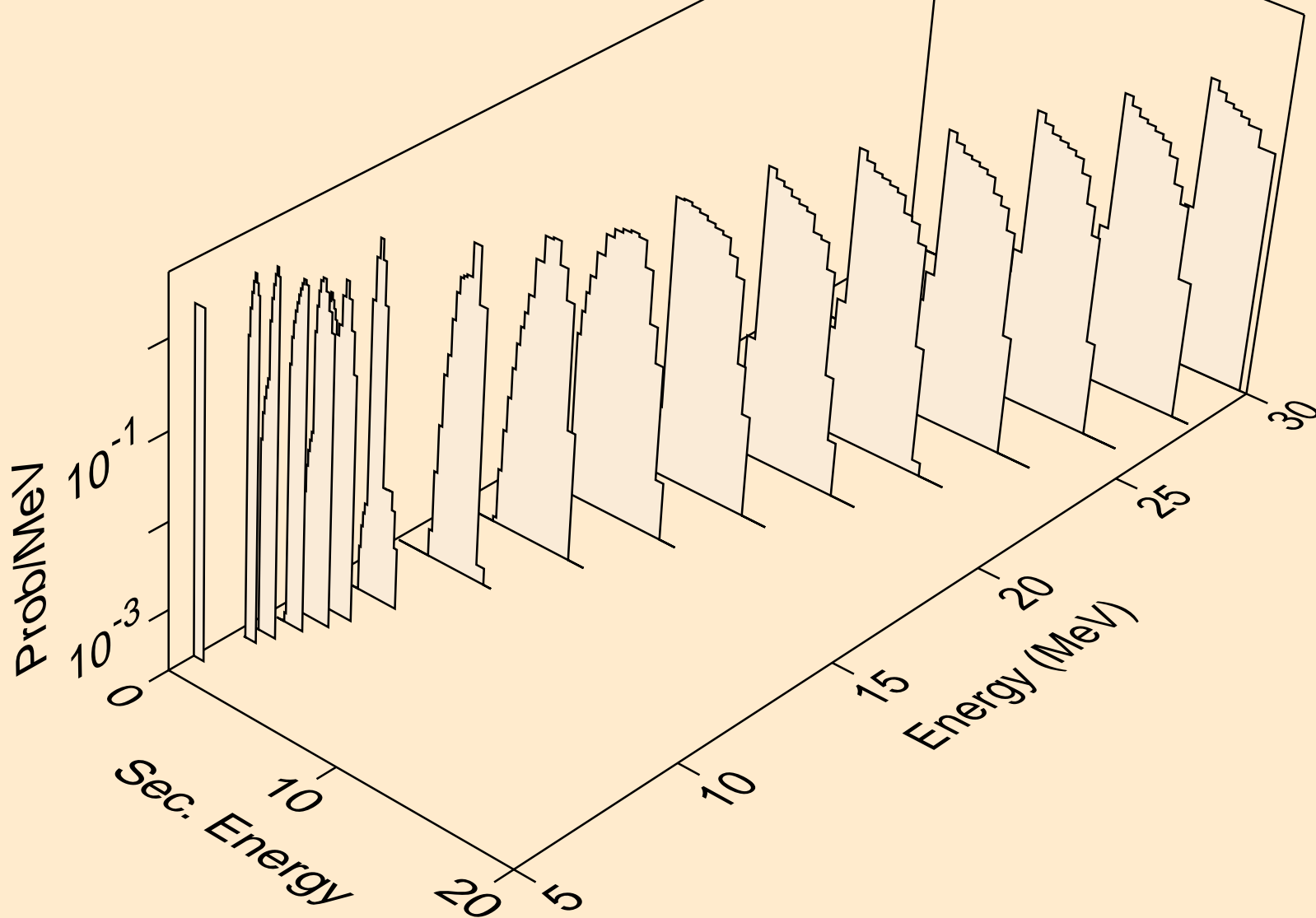



AR042 NEUTRON ACER TENDL-2019 LIBRARY; T=293.16K  
alphas from (n,2a)

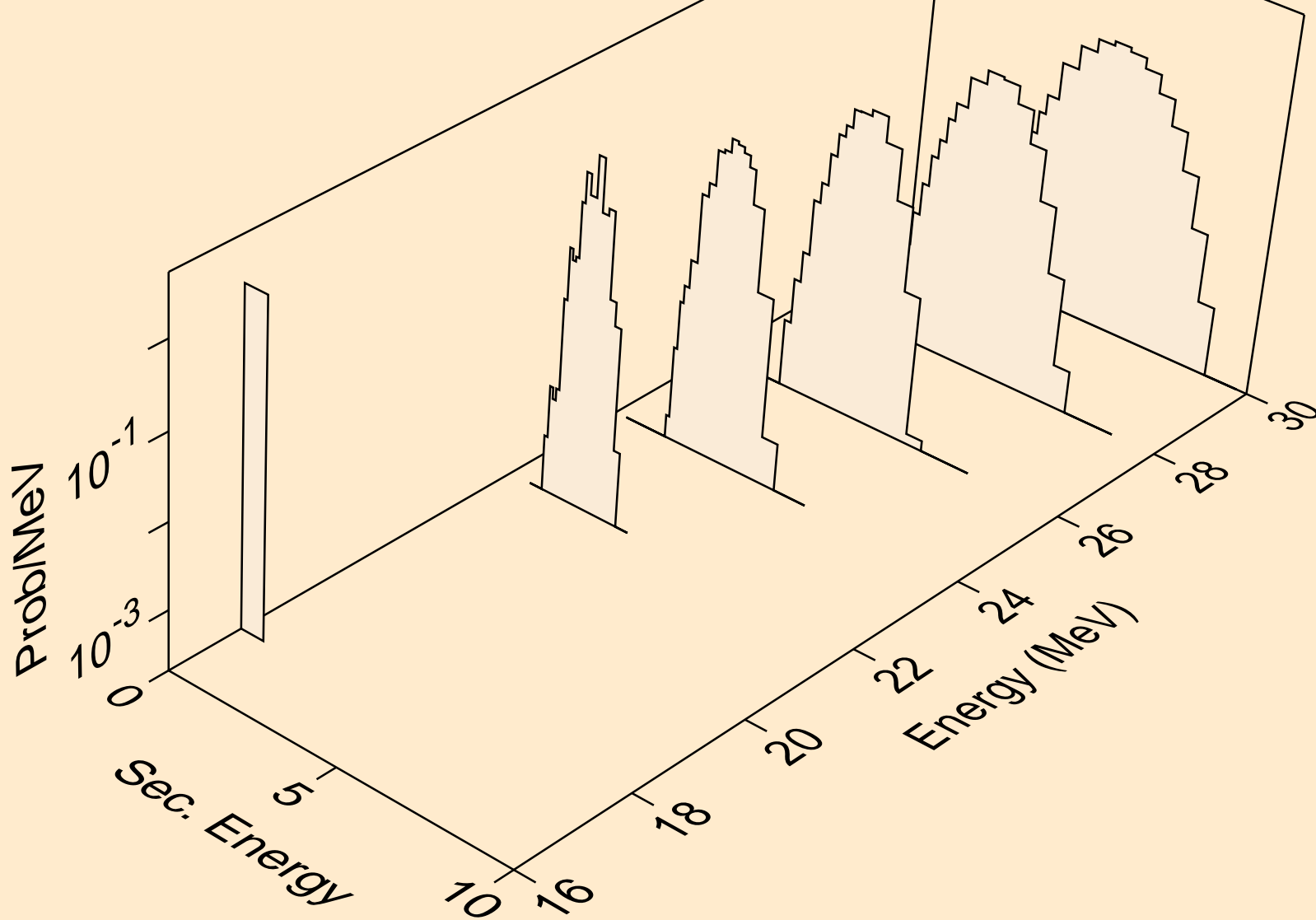

AR042 NEUTRON ACER TENDL-2019 LIBRARY; T=293.16K  
alphas from (n,pa)

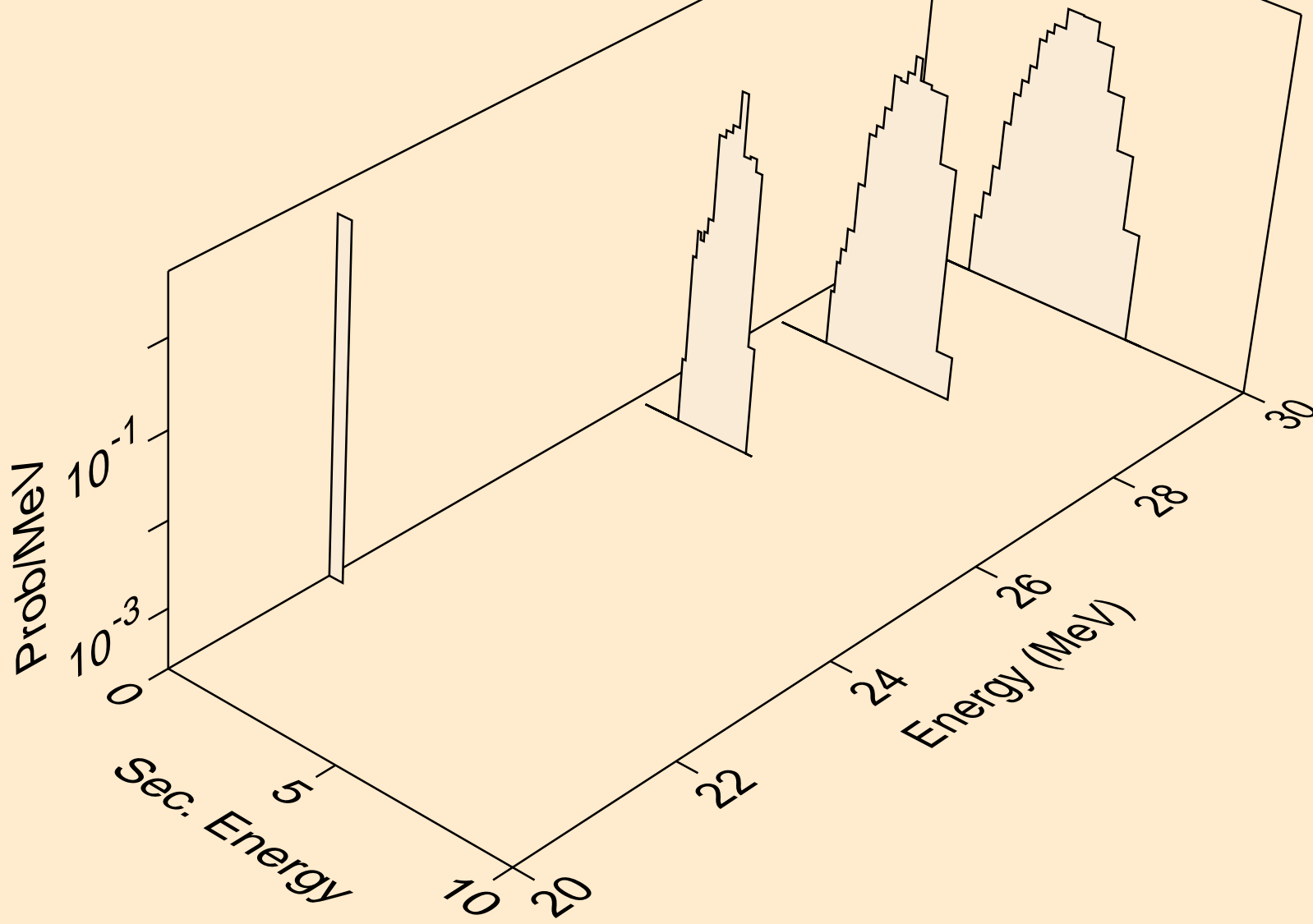

AR042 NEUTRON ACER TENDL-2019 LIBRARY; T=293.16K  
alphas from (n,da)

