

AS081 NEUTRON ACER TENDL-2019 LIBRARY; T=293.16K  
Principal cross sections

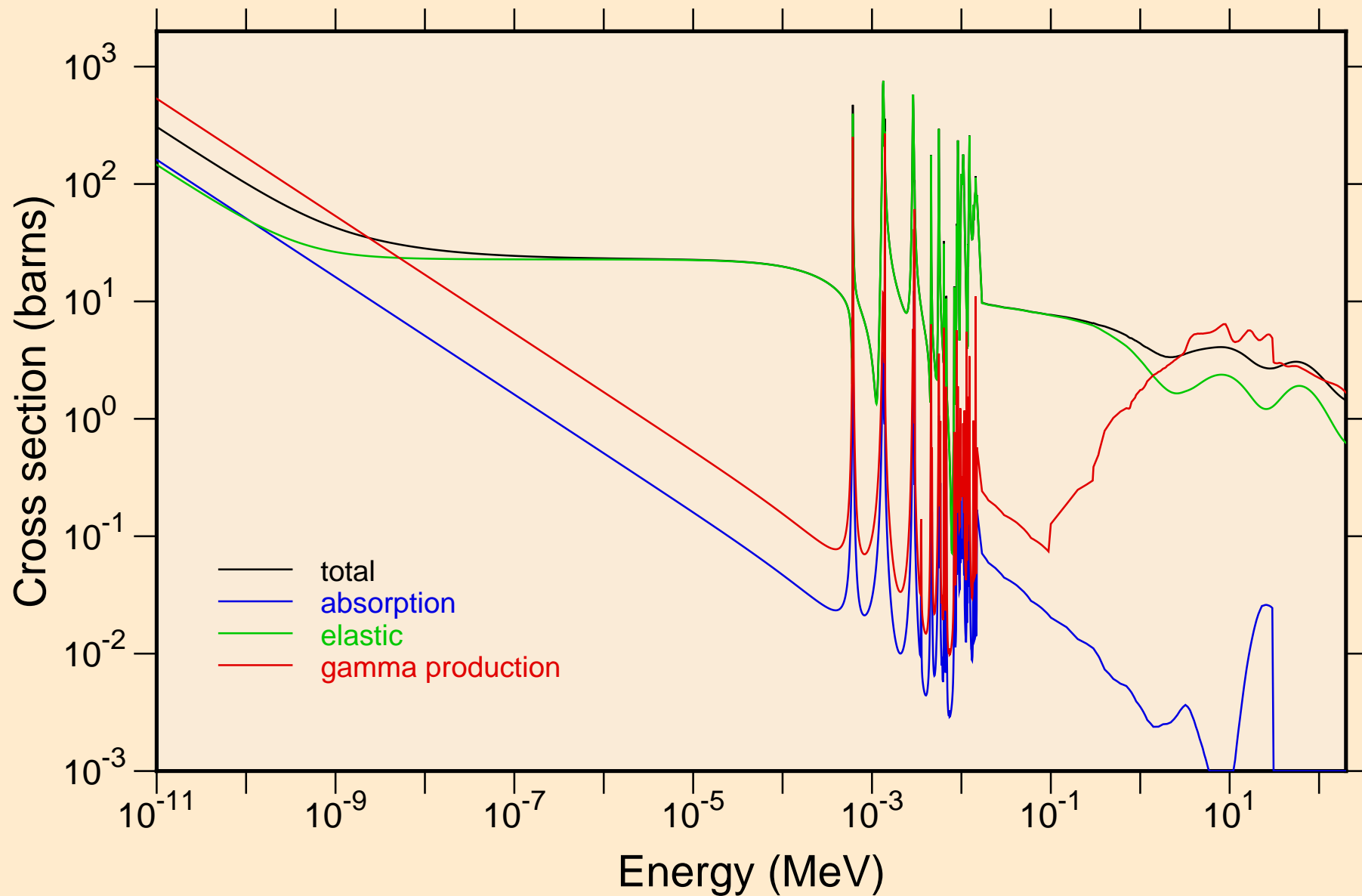

AS081 NEUTRON ACER TENDL-2019 LIBRARY; T=293.16K  
resonance total cross section

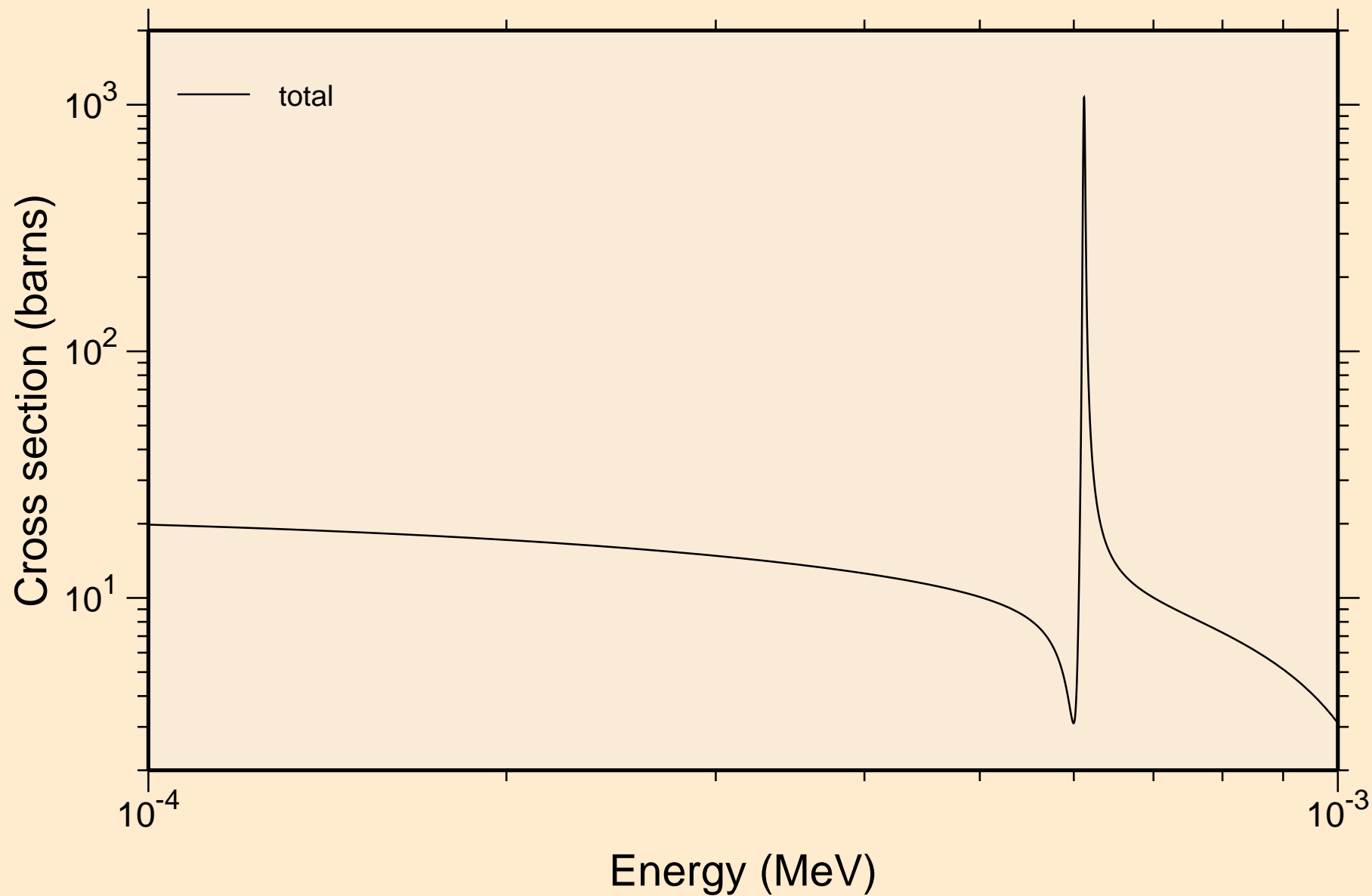

AS081 NEUTRON ACER TENDL-2019 LIBRARY; T=293.16K  
resonance total cross section

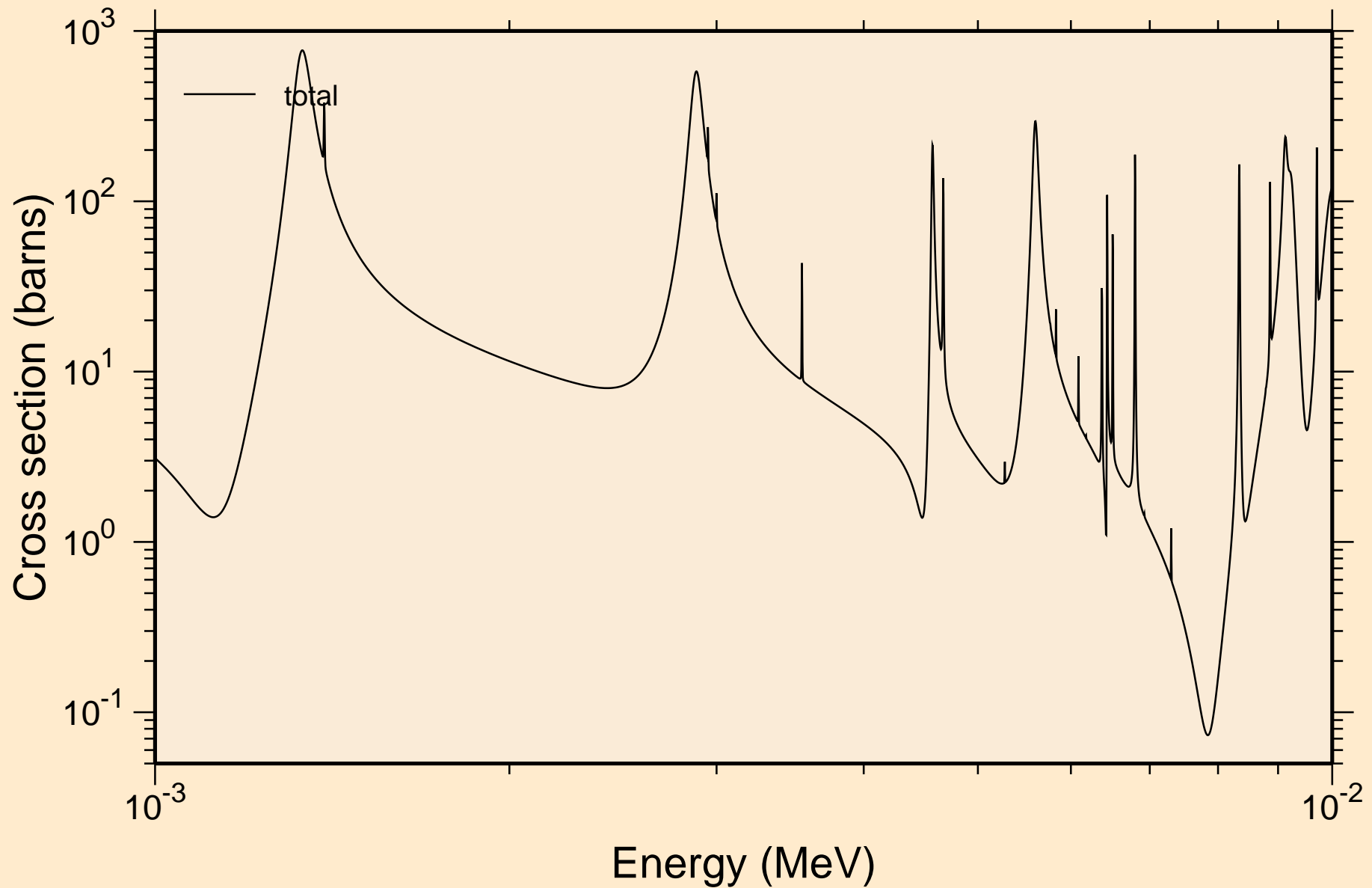

AS081 NEUTRON ACER TENDL-2019 LIBRARY; T=293.16K  
resonance total cross section

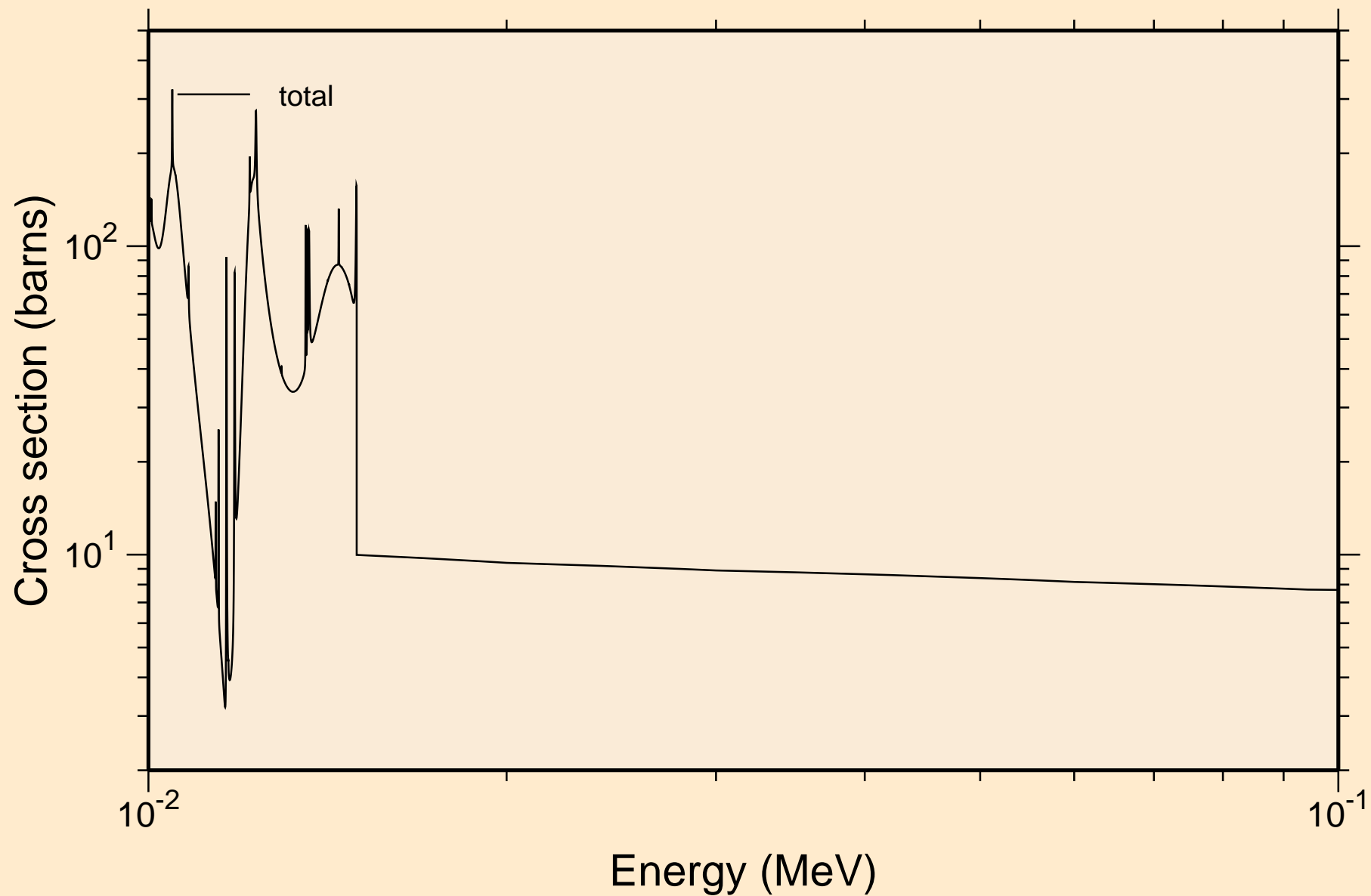

Ā081 NEUTRON ACER TENDL-2019 LIBRARY; T=293.16K  
resonance total cross section

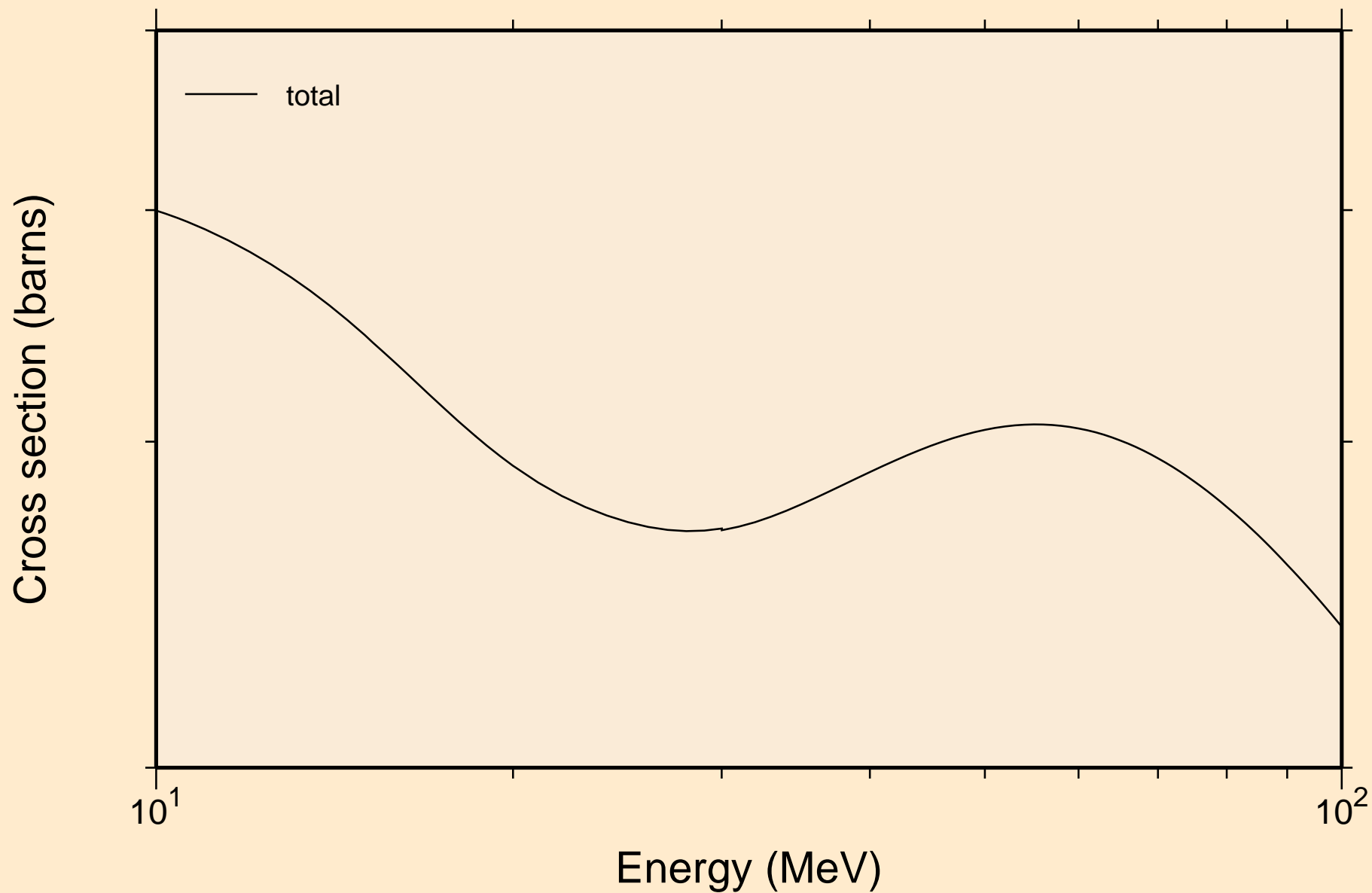

AS081 NEUTRON ACER TENDL-2019 LIBRARY; T=293.16K  
resonance absorption cross sections

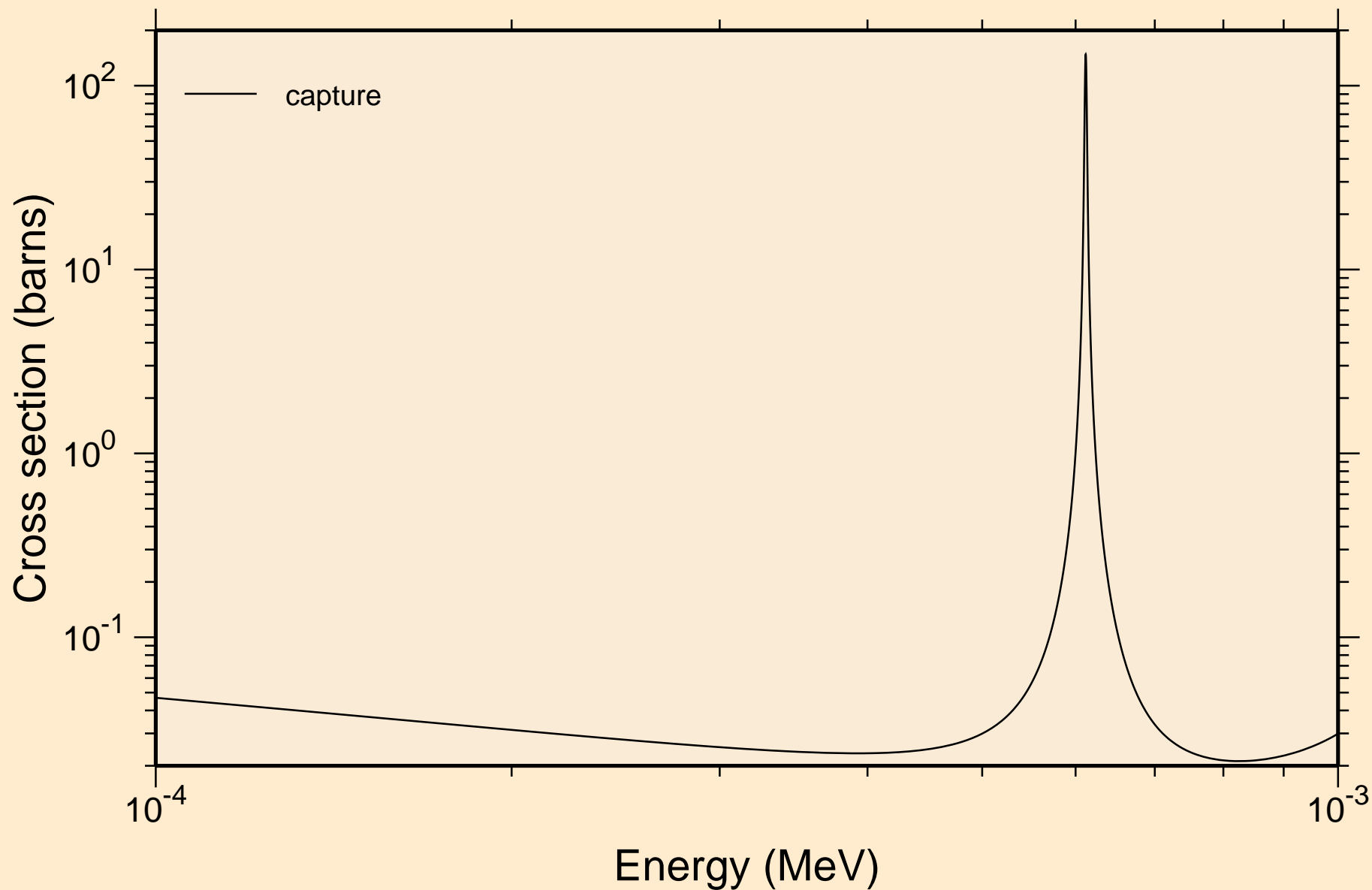

AS081 NEUTRON ACER TENDL-2019 LIBRARY; T=293.16K  
resonance absorption cross sections

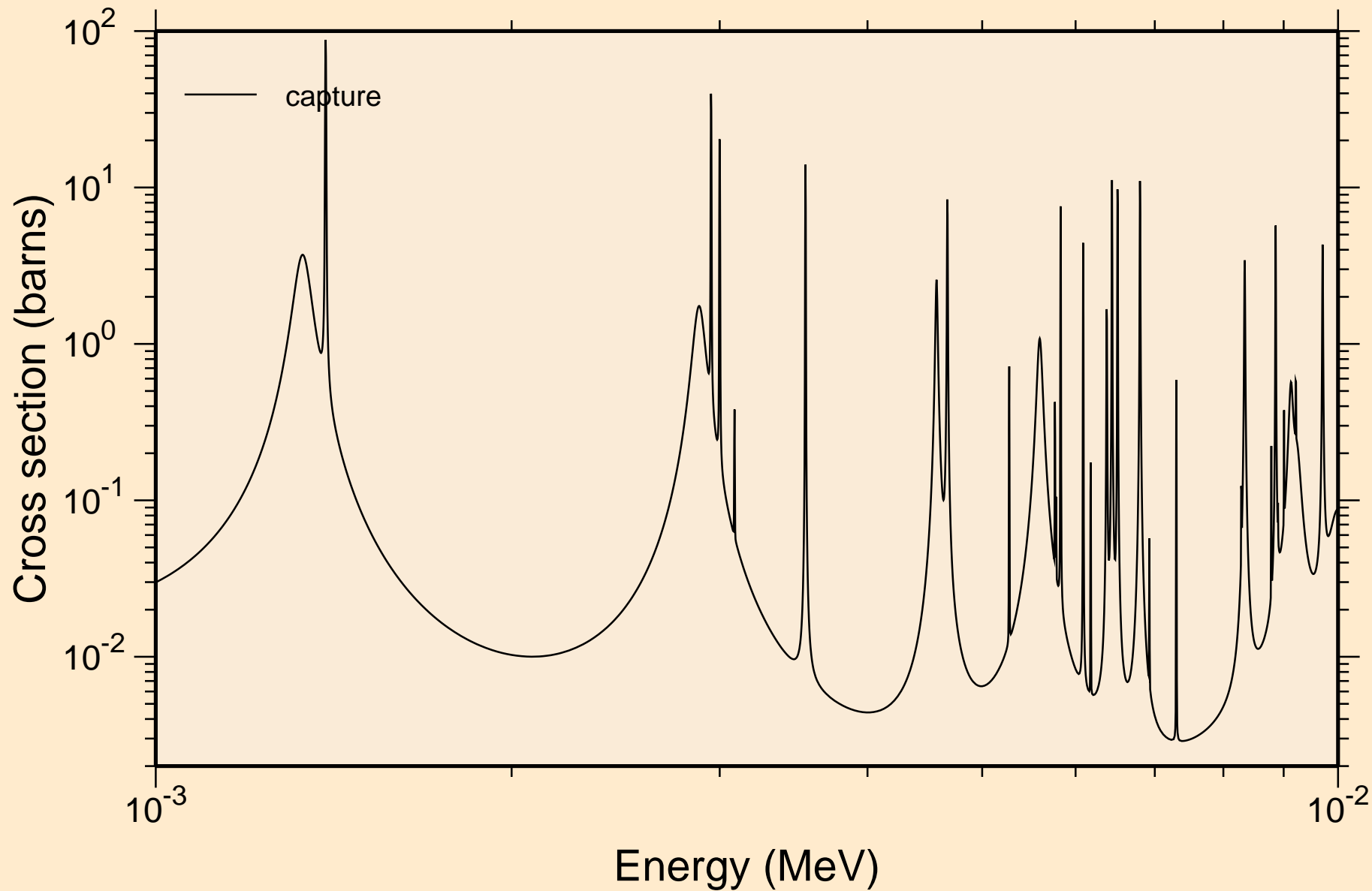

AS081 NEUTRON ACER TENDL-2019 LIBRARY; T=293.16K  
resonance absorption cross sections

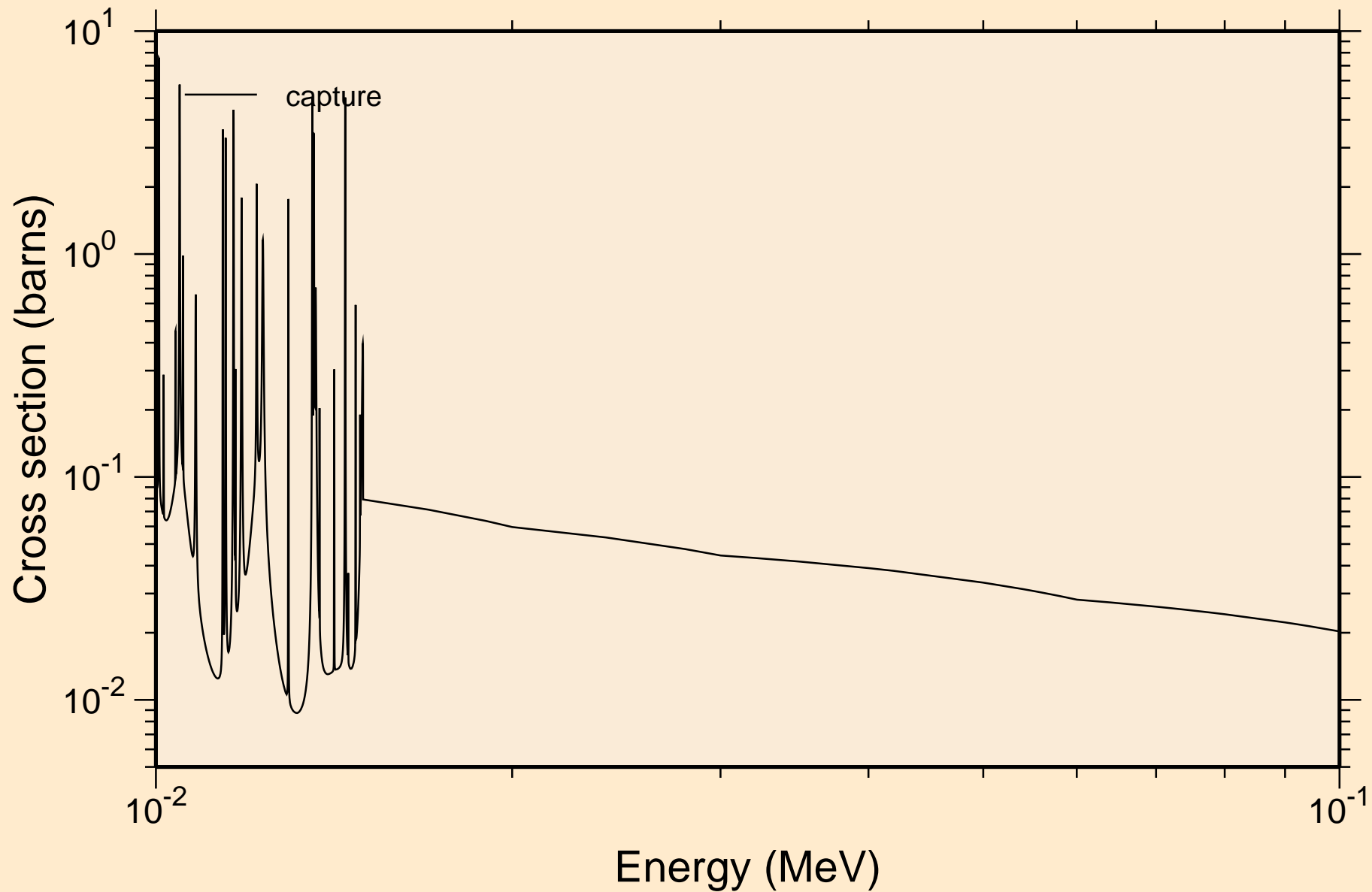



AS081 NEUTRON ACER TENDL-2019 LIBRARY; T=293.16K  
resonance absorption cross sections

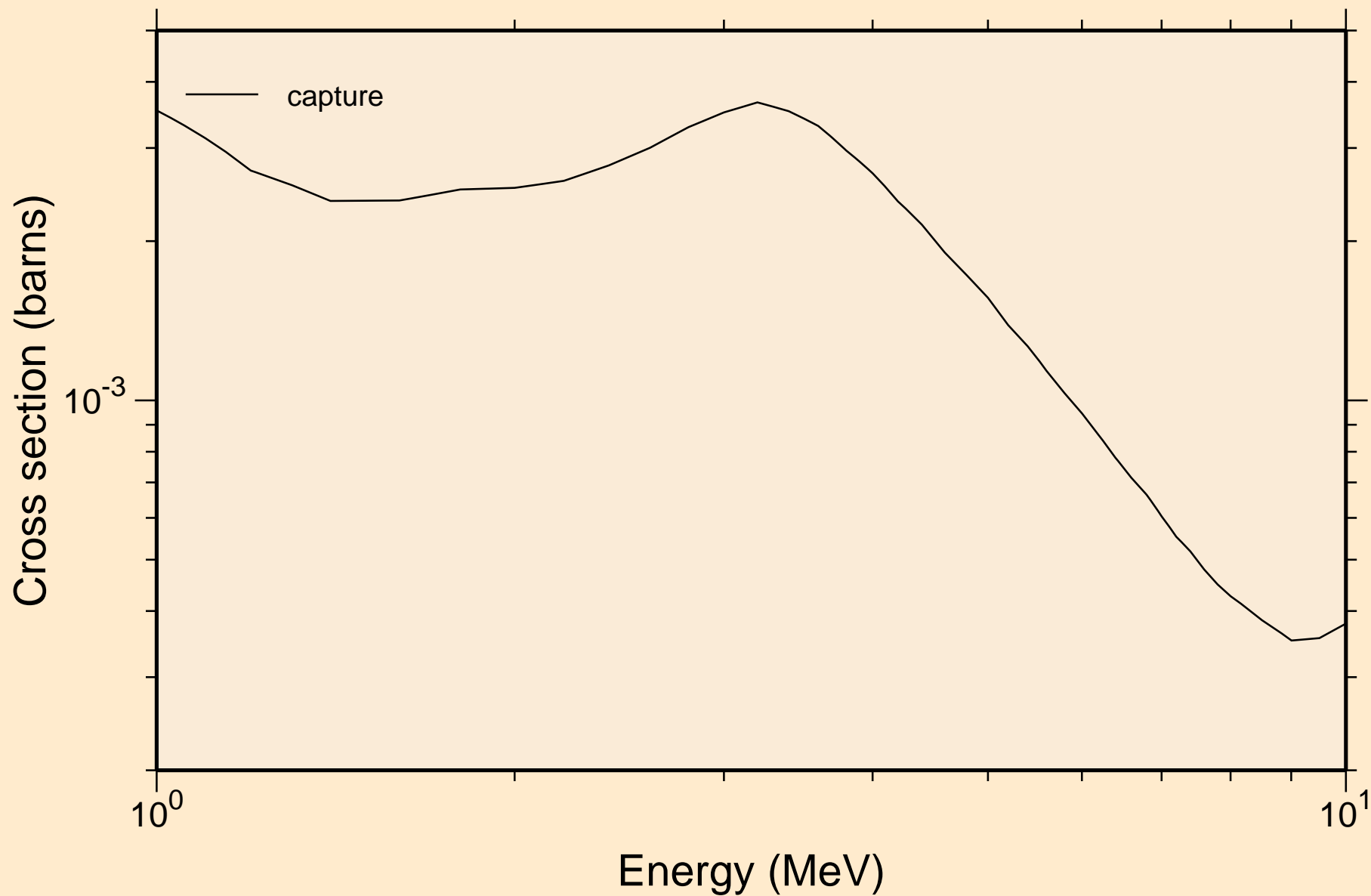

AS081 NEUTRON ACER TENDL-2019 LIBRARY; T=293.16K  
Heating

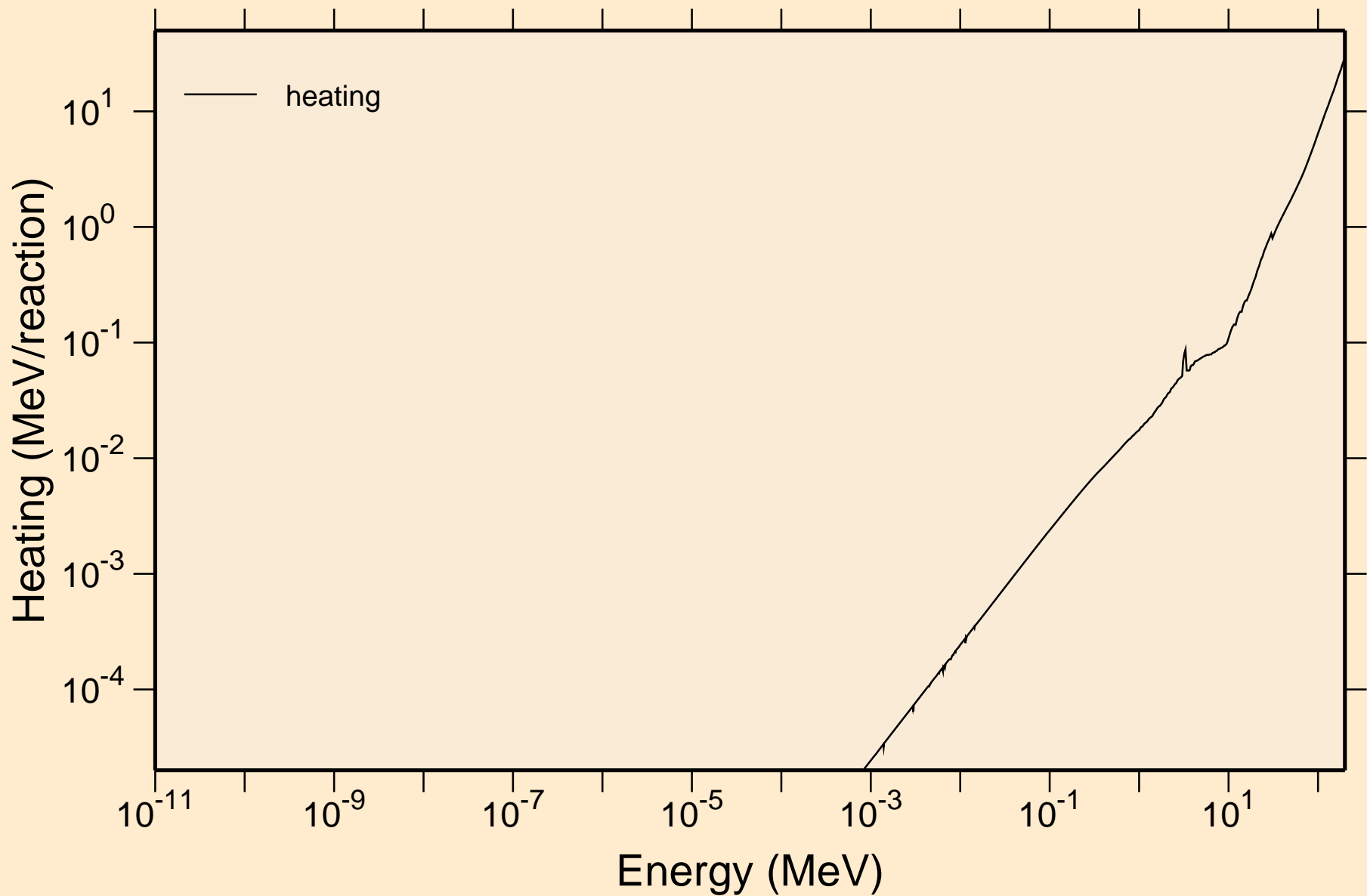

AS081 NEUTRON ACER TENDL-2019 LIBRARY; T=293.16K  
Damage

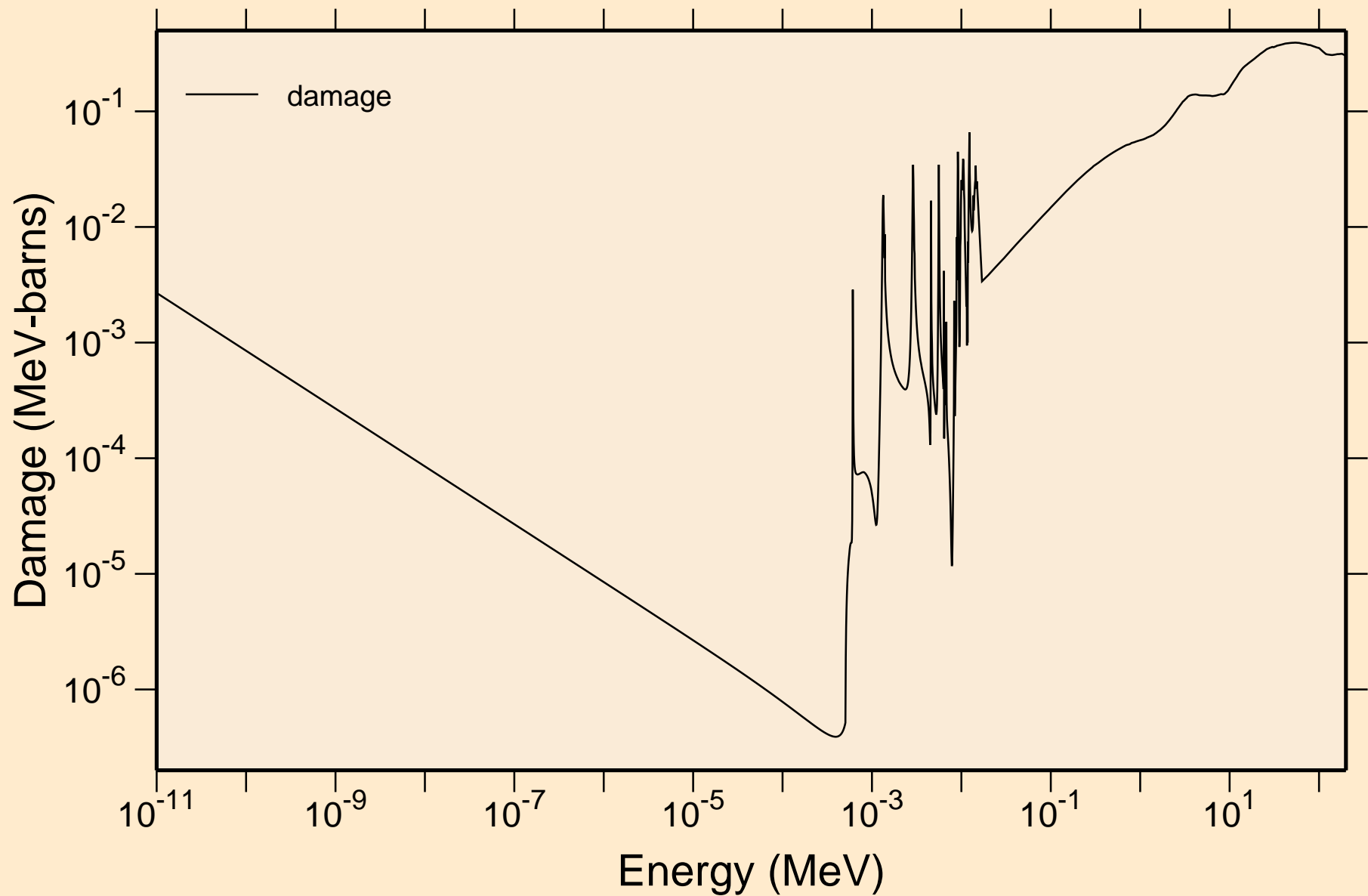

AS081 NEUTRON ACER TENDL-2019 LIBRARY; T=293.16K  
Non-threshold reactions

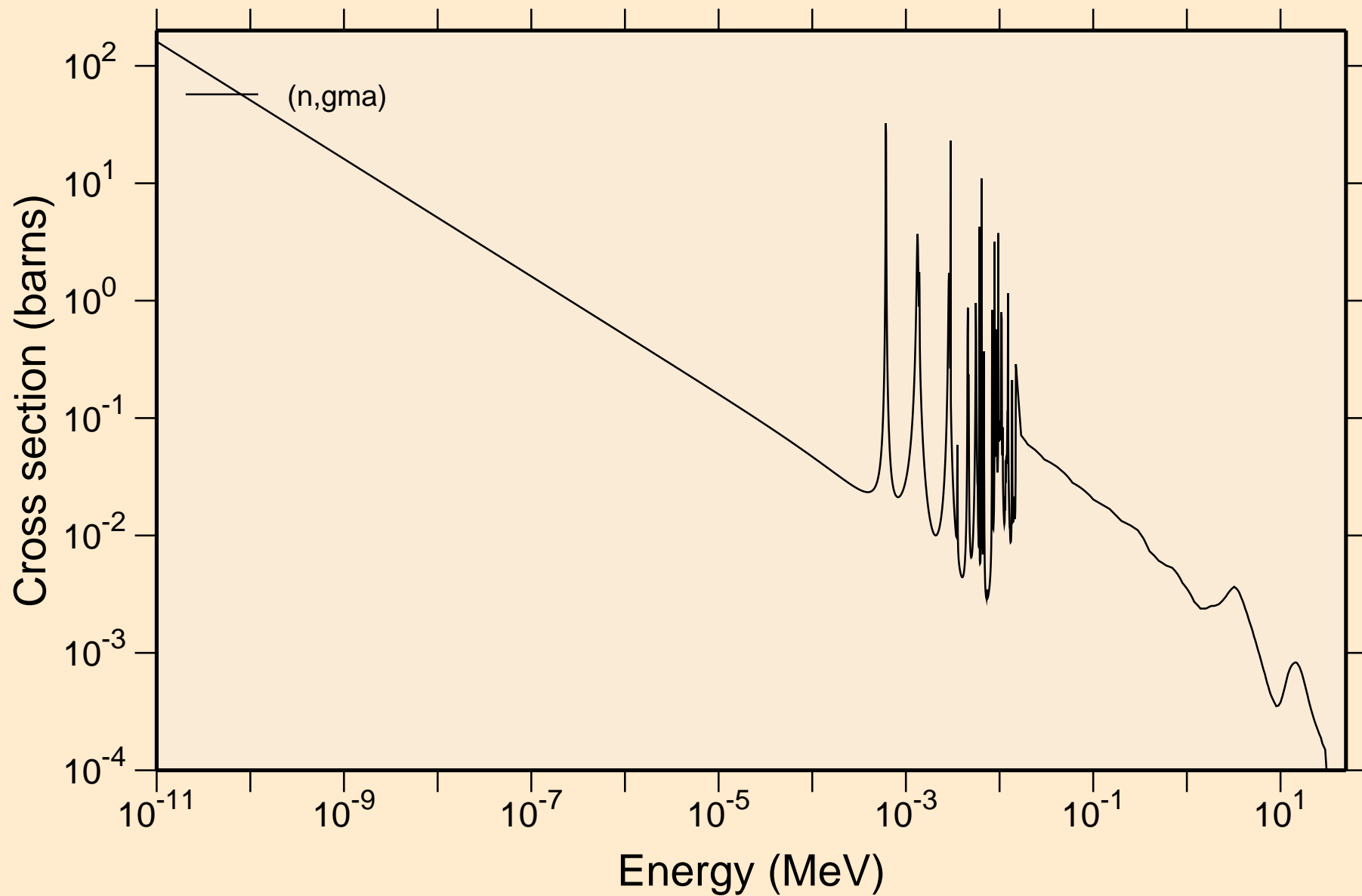

AS081 NEUTRON ACER TENDL-2019 LIBRARY; T=293.16K  
Principal cross sections

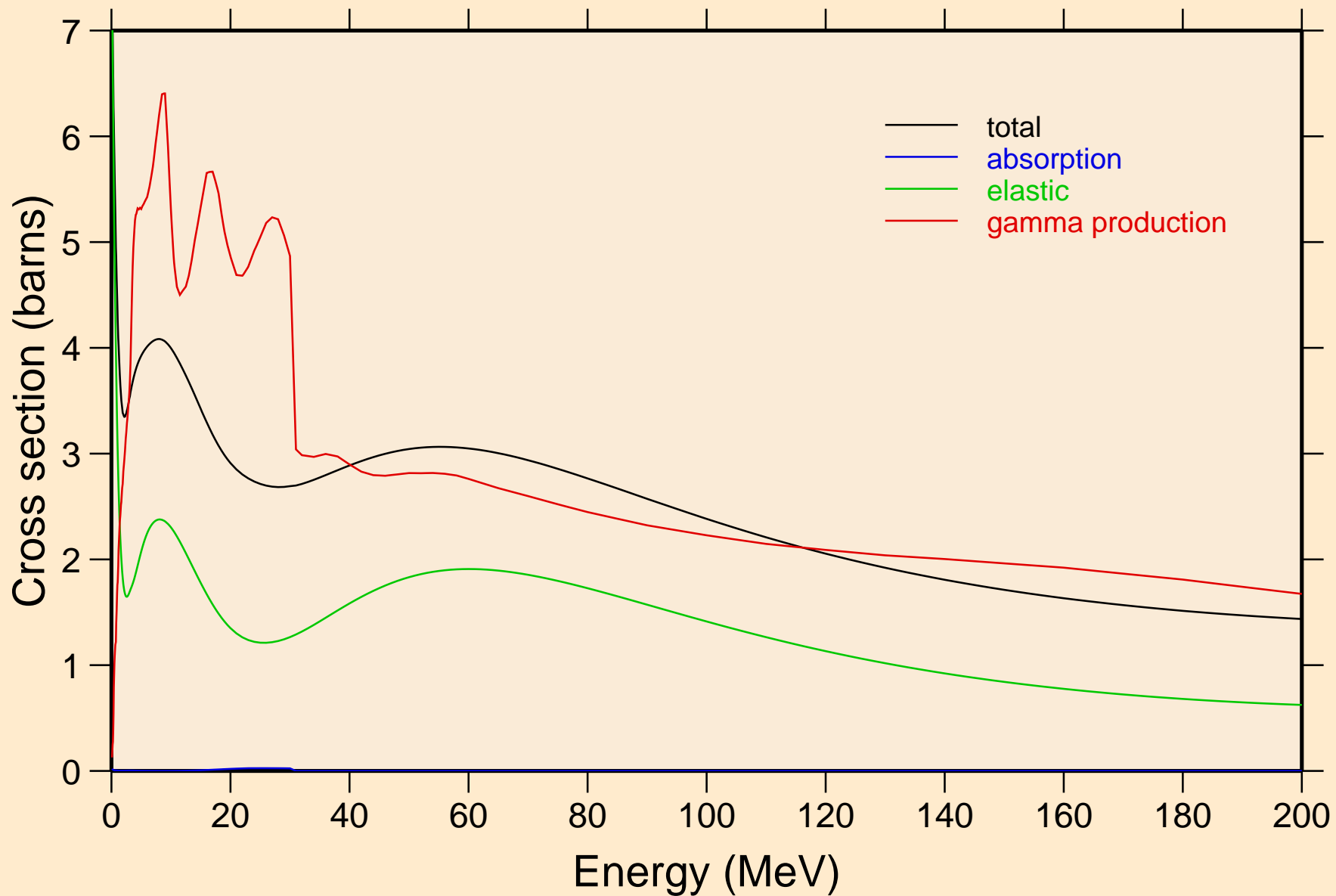

AS081 NEUTRON ACER TENDL-2019 LIBRARY; T=293.16K  
Heating

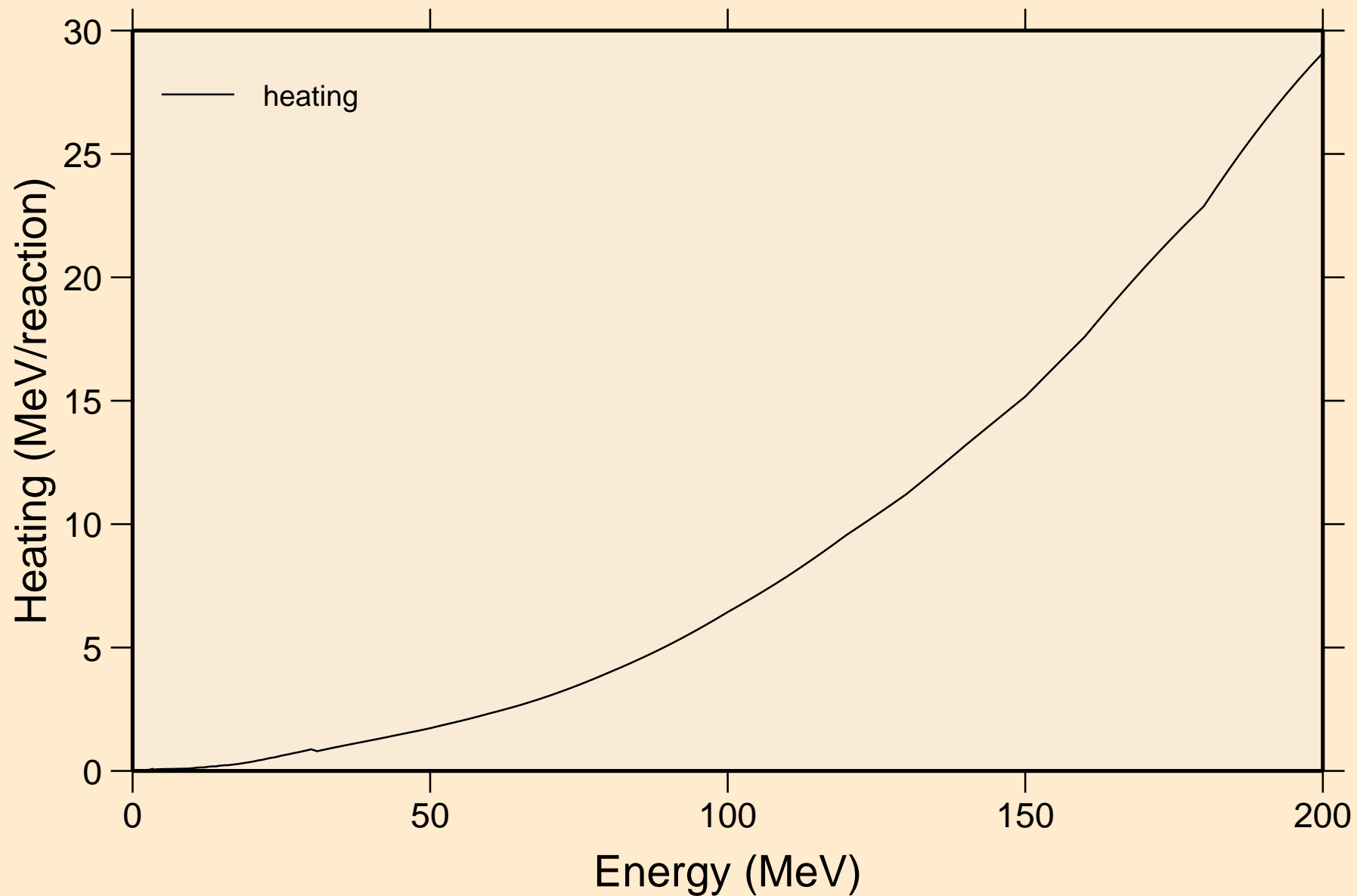

AS081 NEUTRON ACER TENDL-2019 LIBRARY; T=293.16K  
Damage

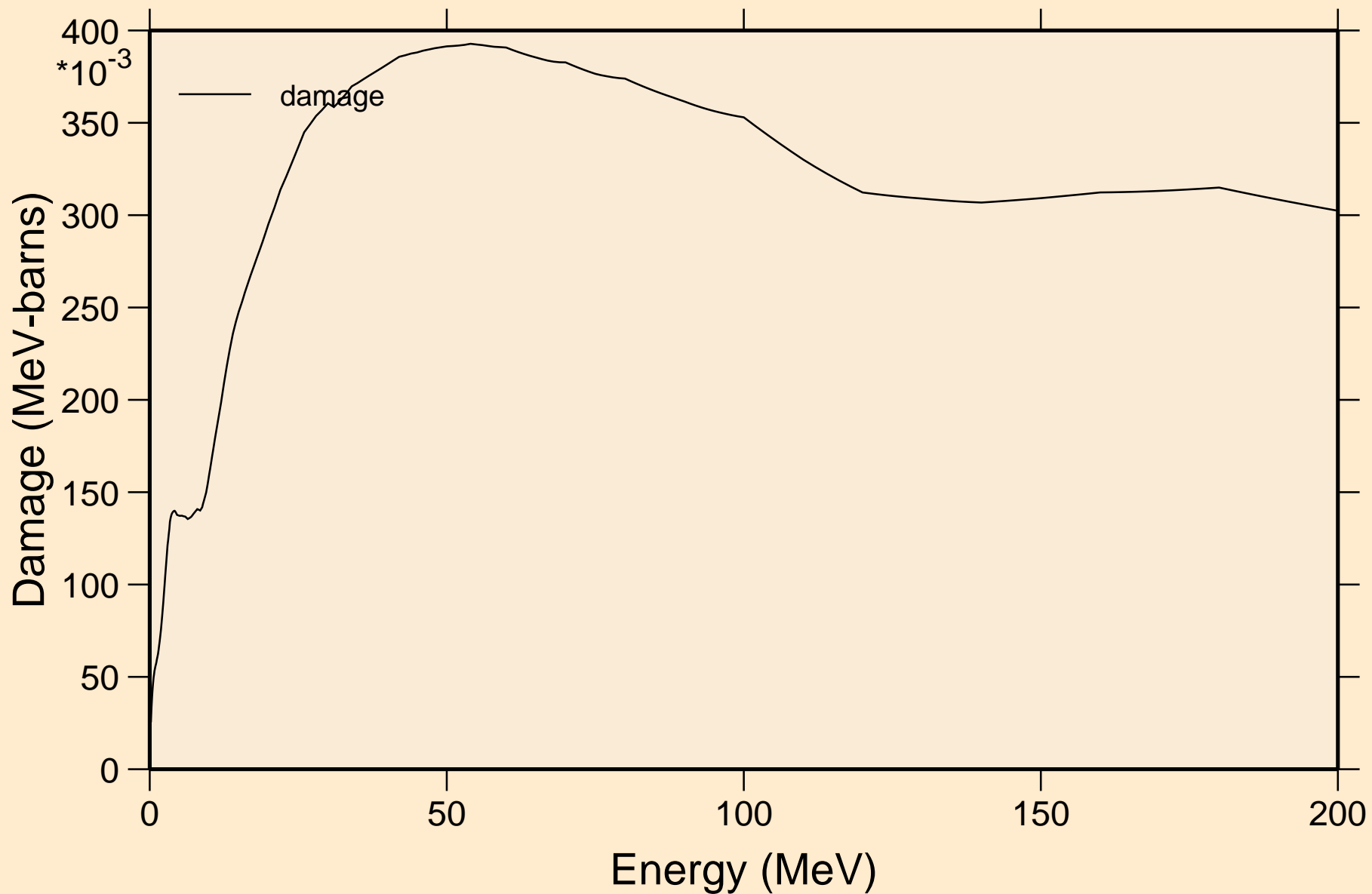

AS081 NEUTRON ACER TENDL-2019 LIBRARY; T=293.16K  
Non-threshold reactions

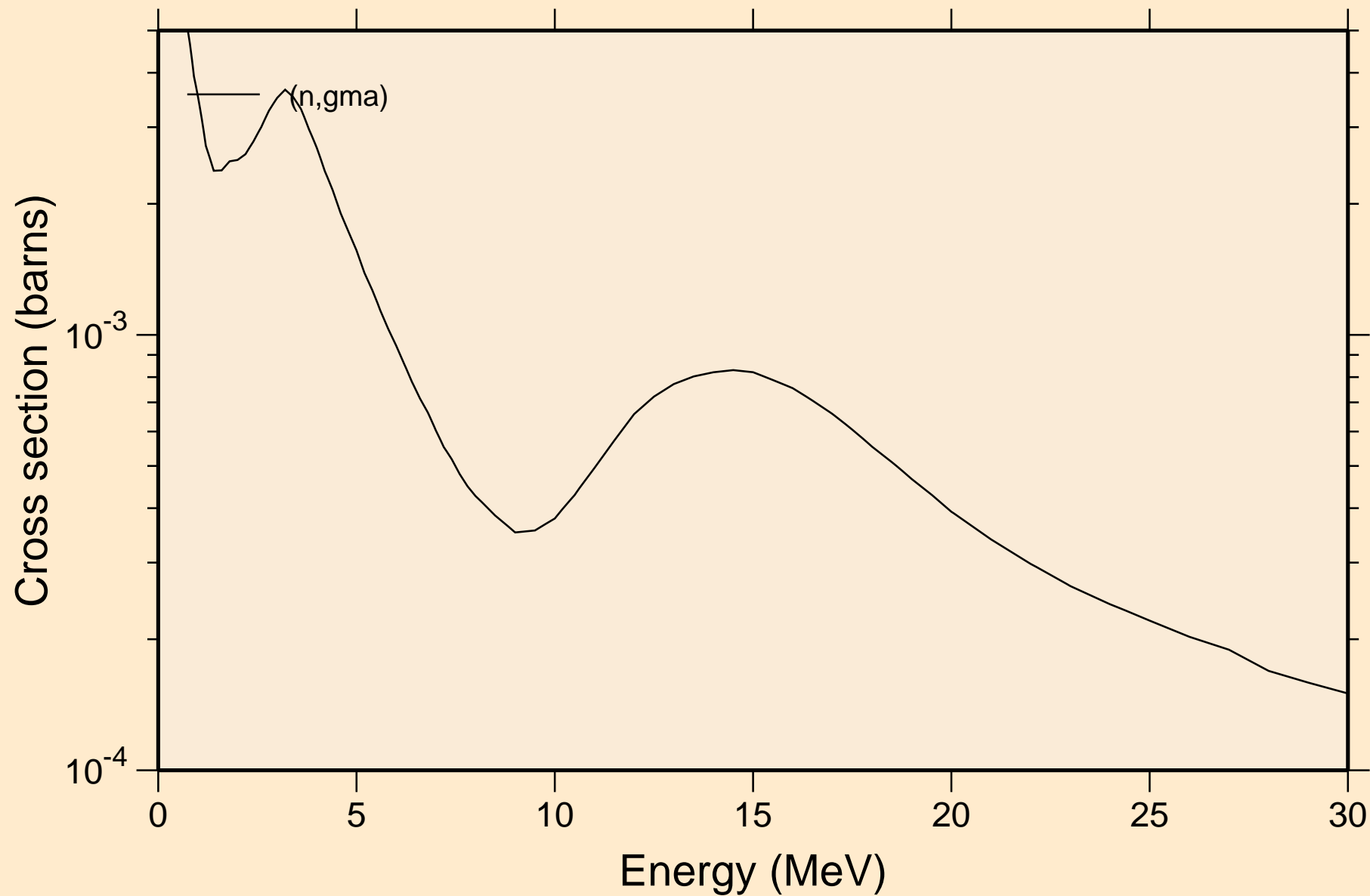



AS081 NEUTRON ACER TENDL-2019 LIBRARY; T=293.16K  
Inelastic levels

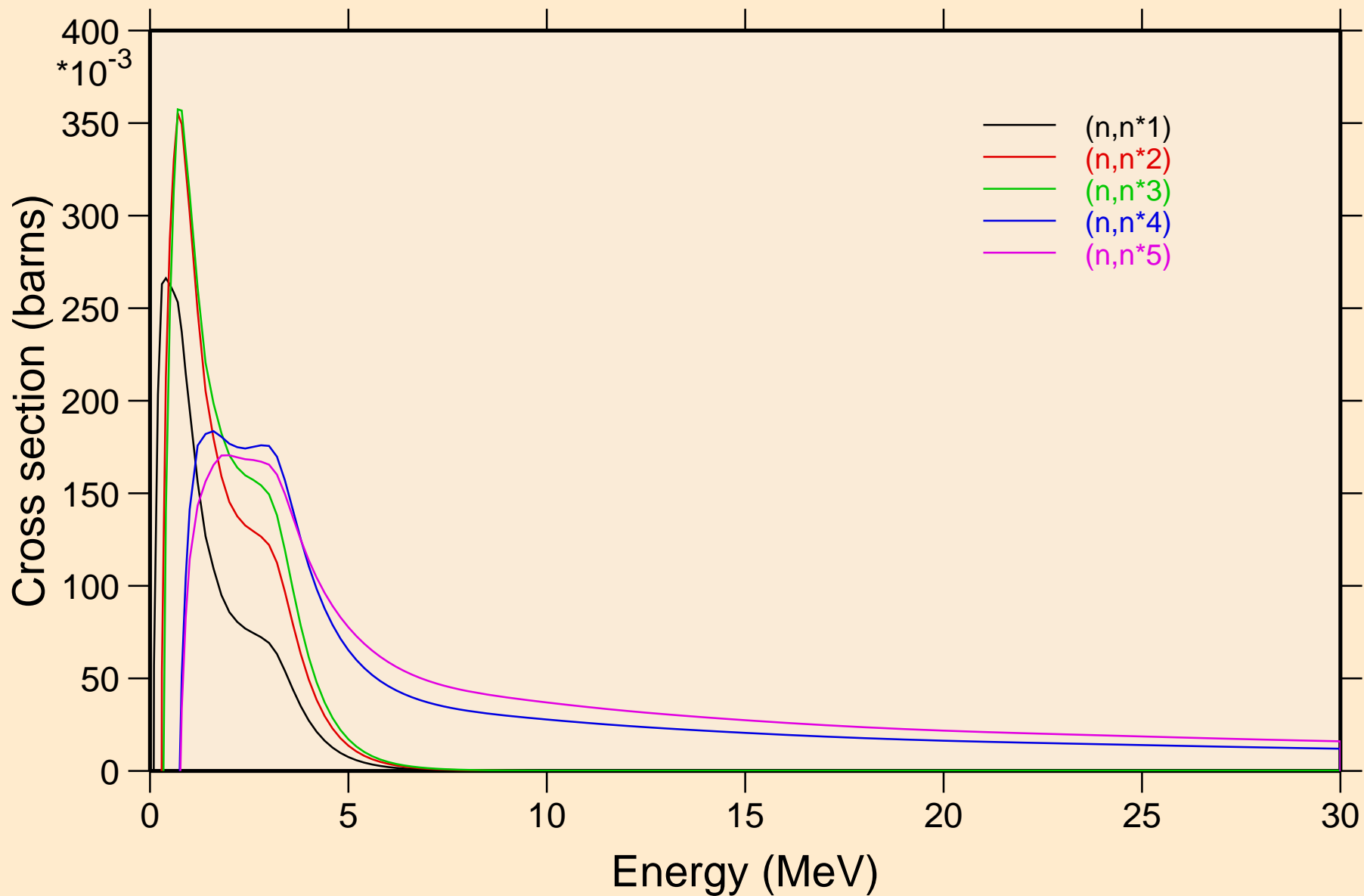

AS081 NEUTRON ACER TENDL-2019 LIBRARY; T=293.16K  
Inelastic levels

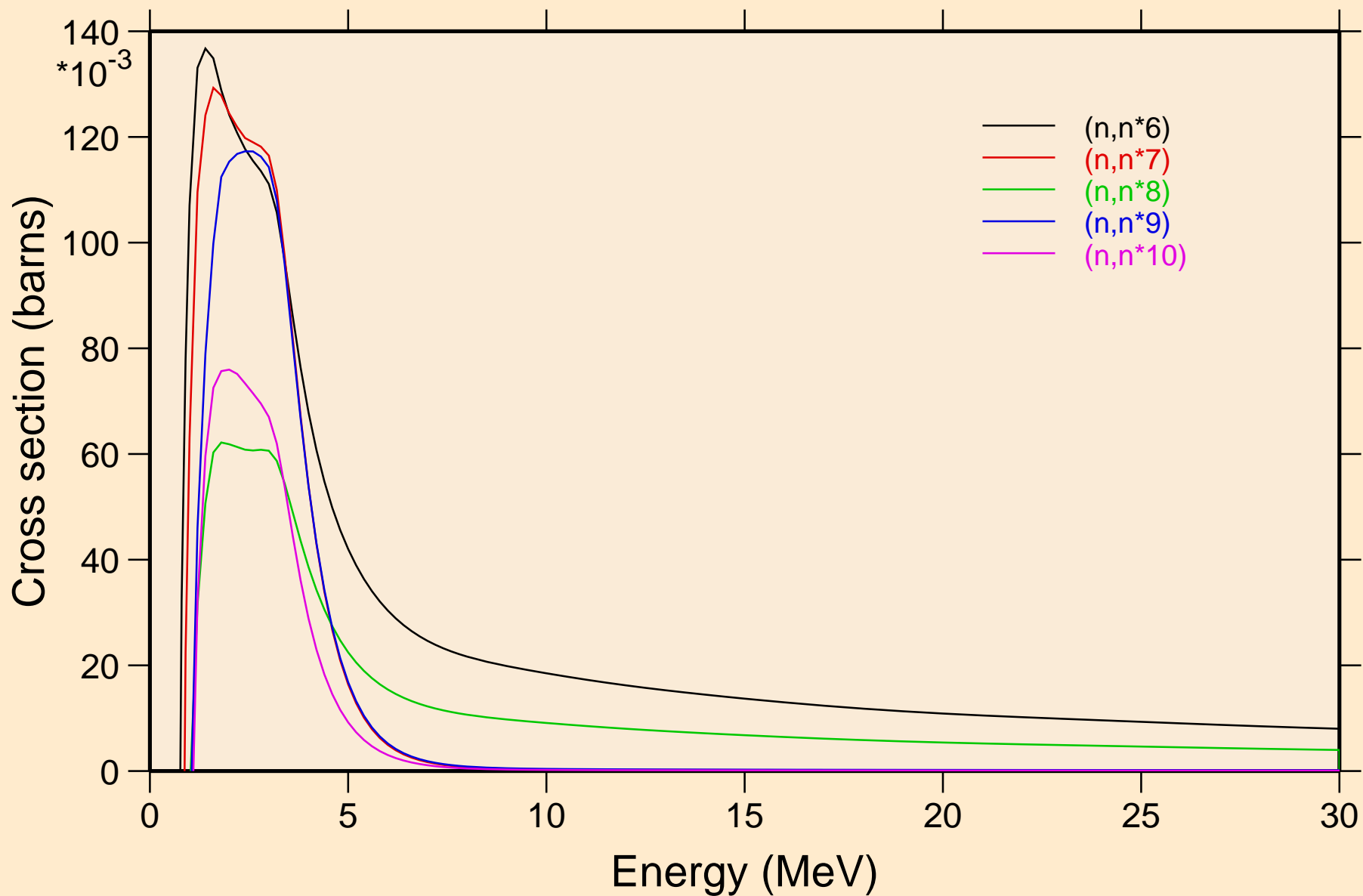

AS081 NEUTRON ACER TENDL-2019 LIBRARY; T=293.16K  
Inelastic levels

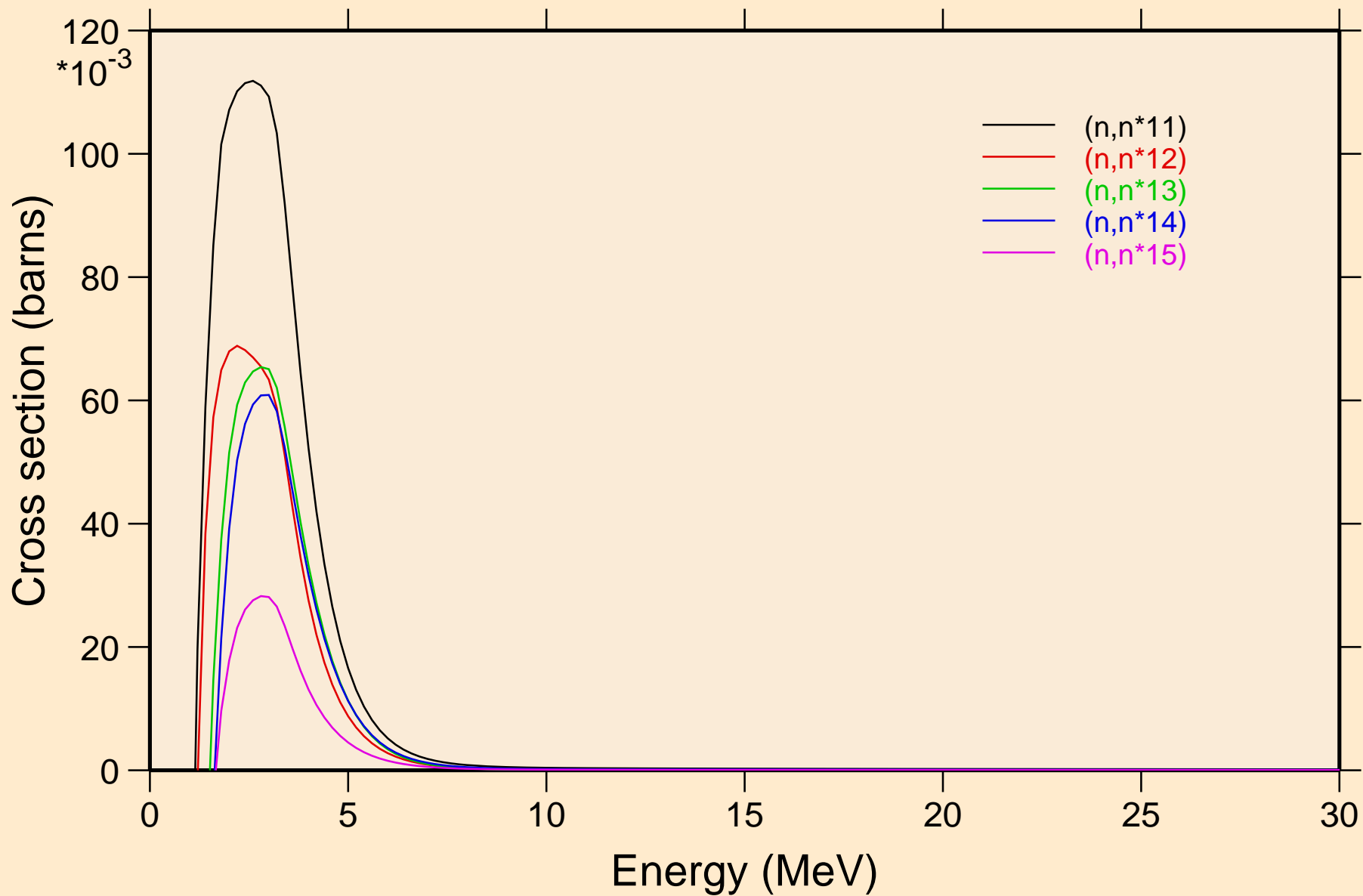

AS081 NEUTRON ACER TENDL-2019 LIBRARY; T=293.16K  
Inelastic levels

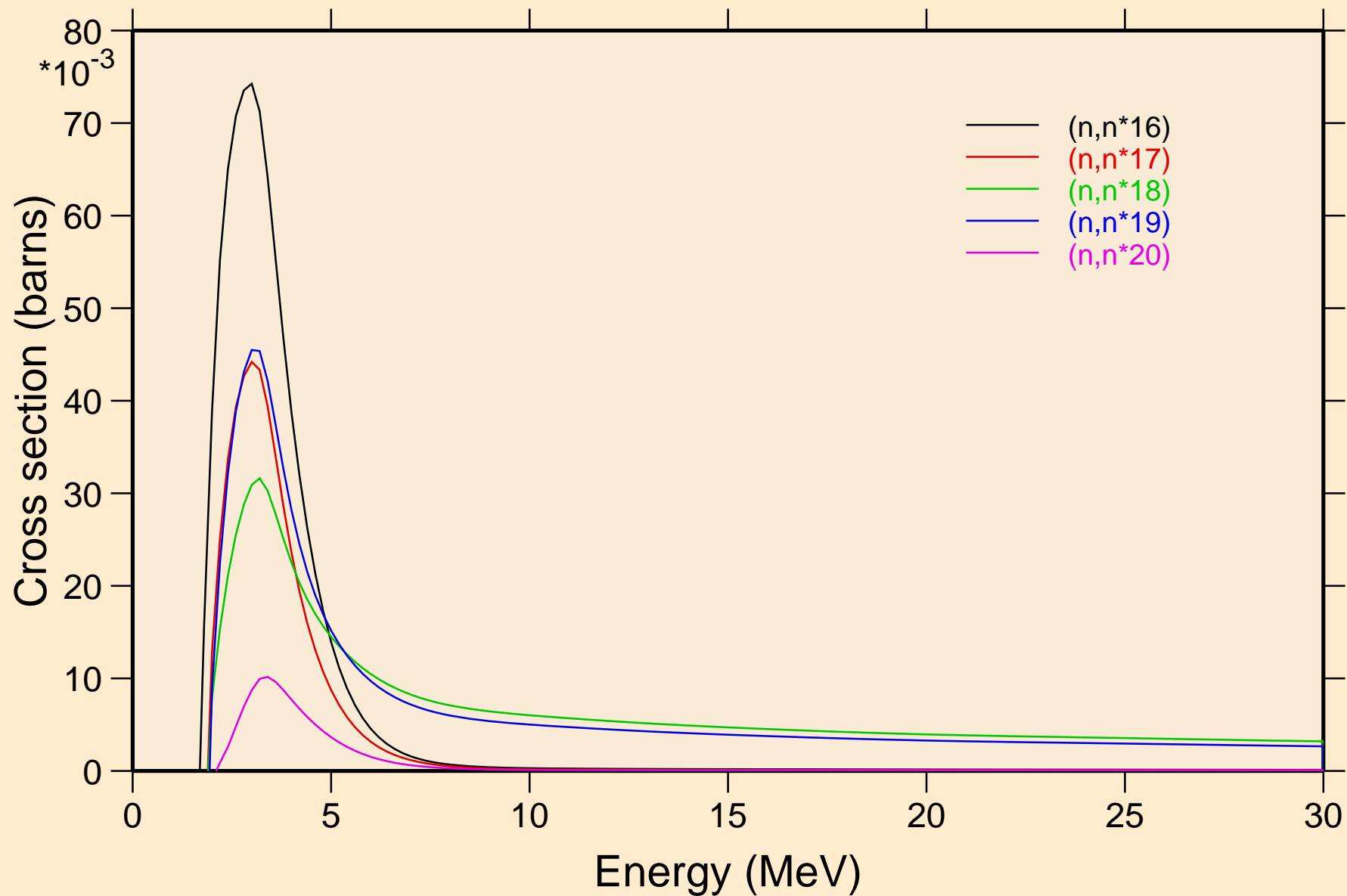

AS081 NEUTRON ACER TENDL-2019 LIBRARY; T=293.16K  
Inelastic levels

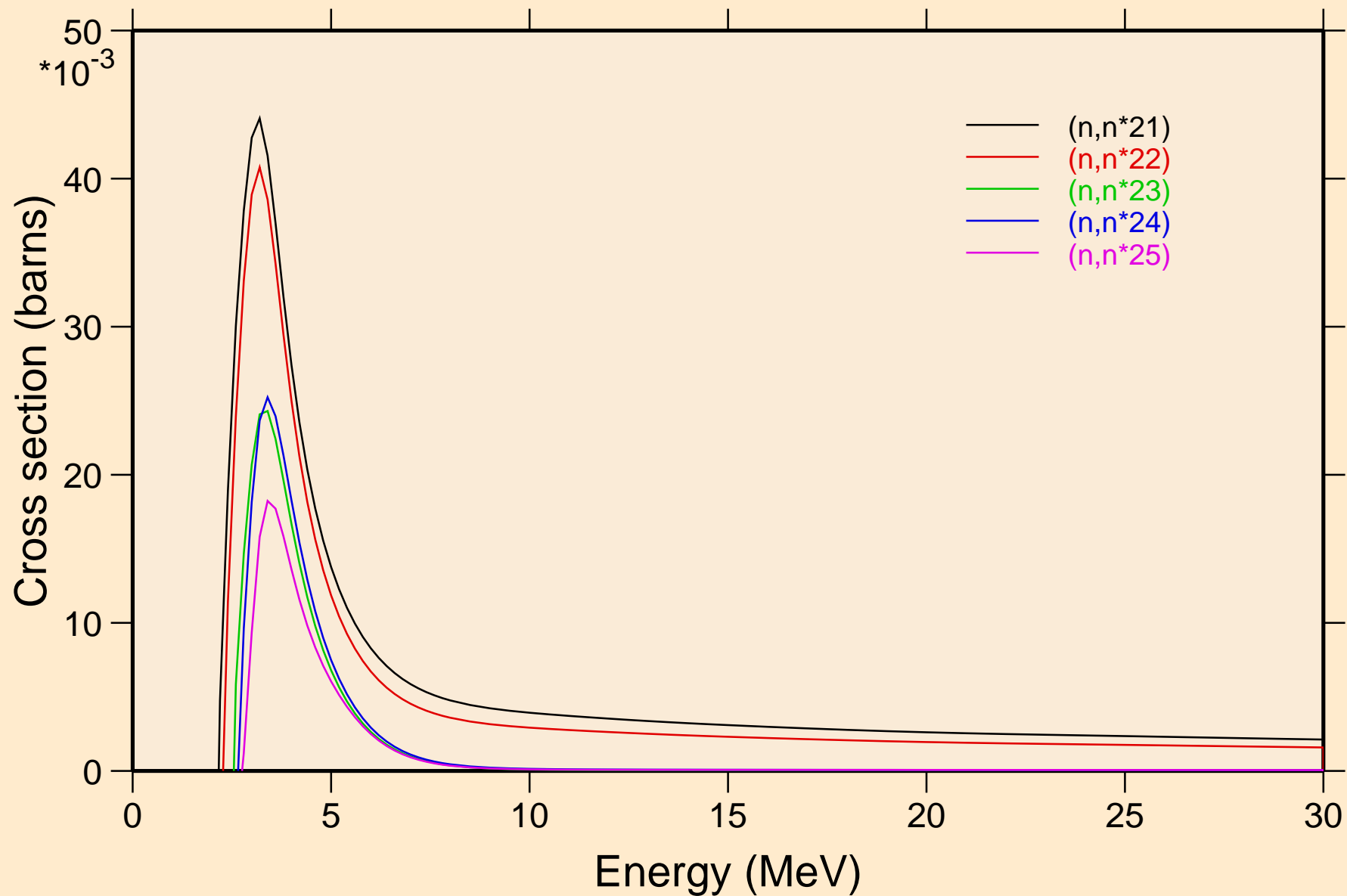

AS081 NEUTRON ACER TENDL-2019 LIBRARY; T=293.16K  
Inelastic levels

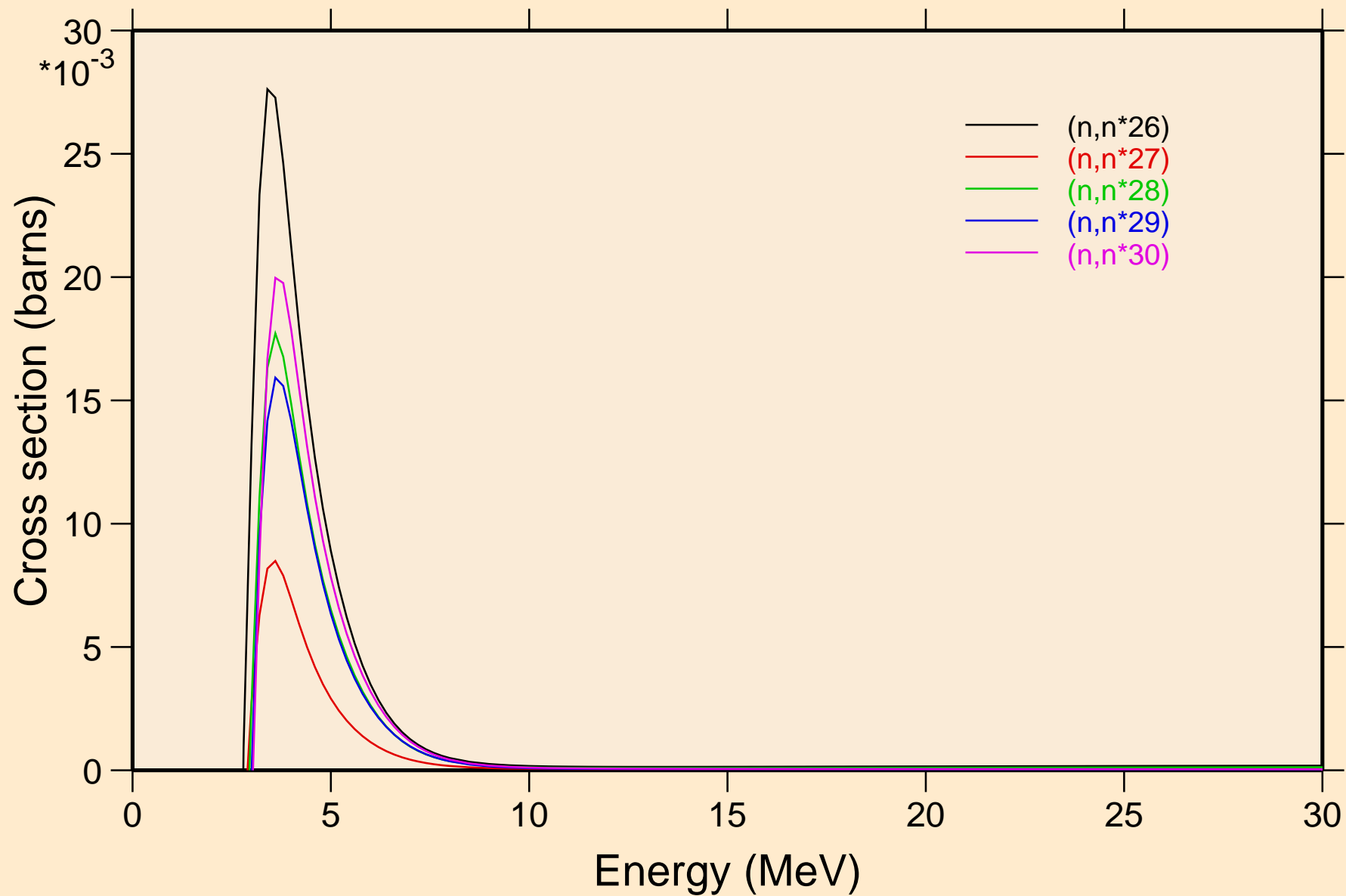

AS081 NEUTRON ACER TENDL-2019 LIBRARY; T=293.16K  
Threshold reactions

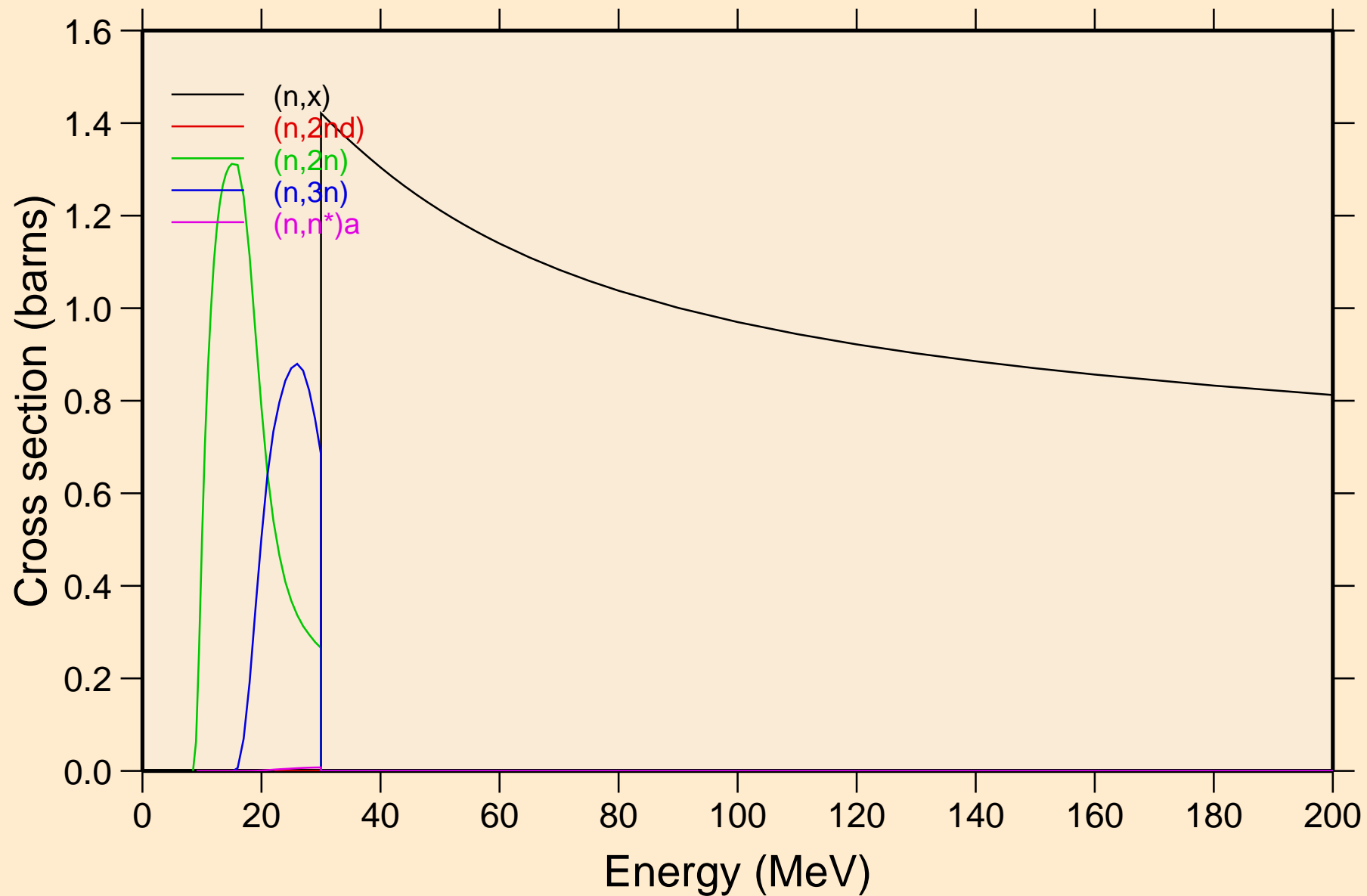

AS081 NEUTRON ACER TENDL-2019 LIBRARY; T=293.16K  
Threshold reactions

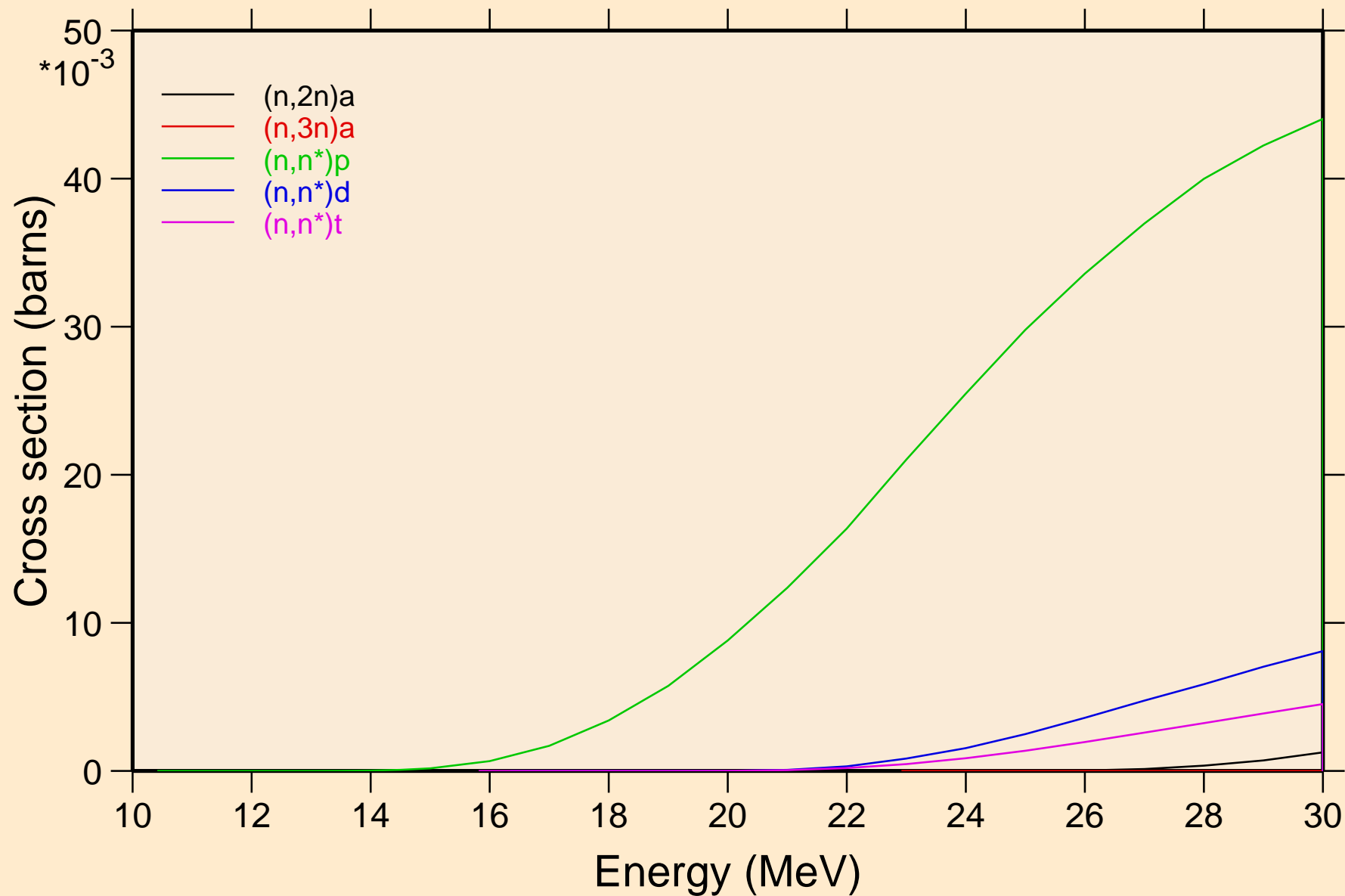



AS081 NEUTRON ACER TENDL-2019 LIBRARY; T=293.16K  
Threshold reactions

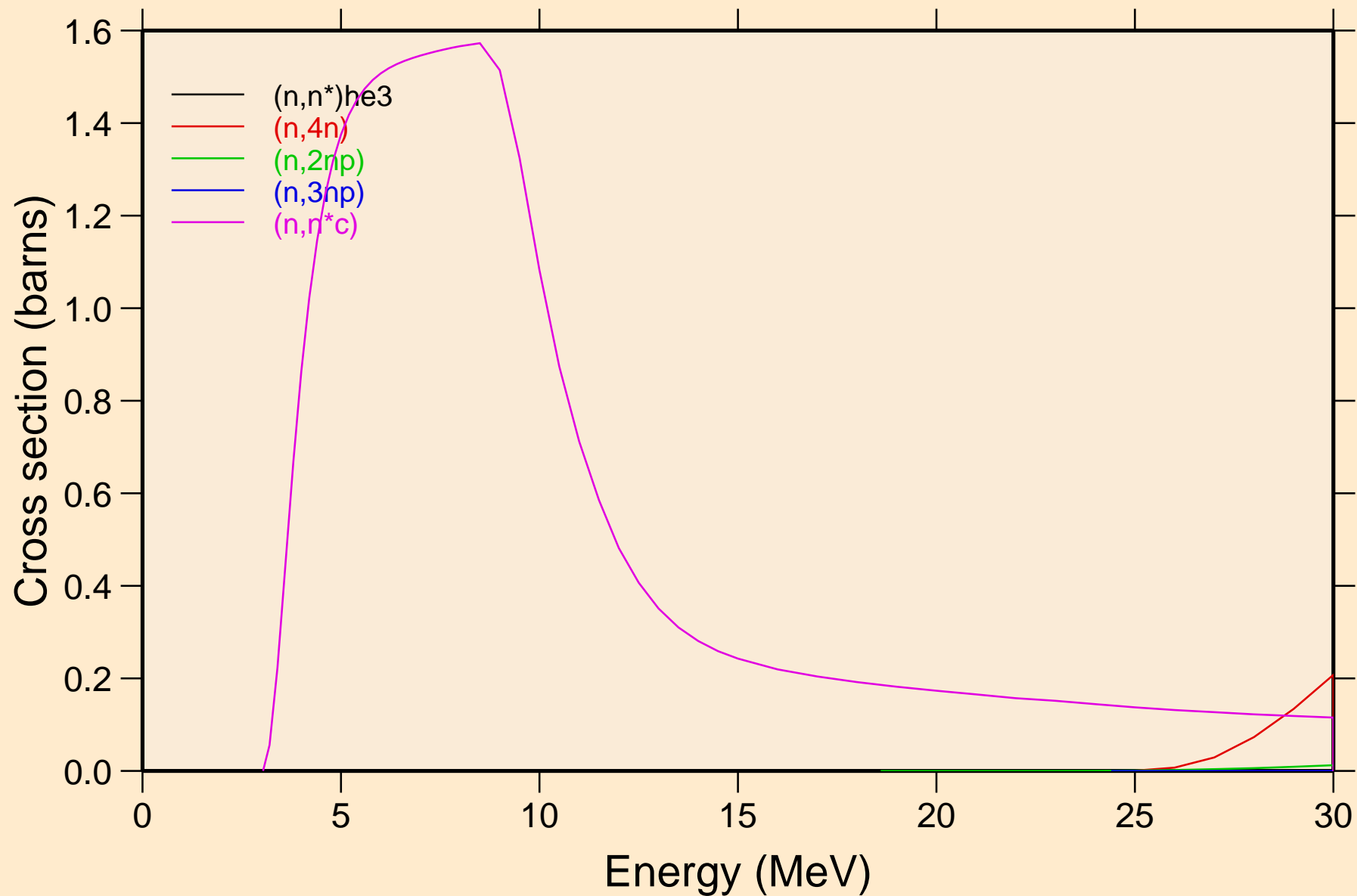

AS081 NEUTRON ACER TENDL-2019 LIBRARY; T=293.16K  
Threshold reactions

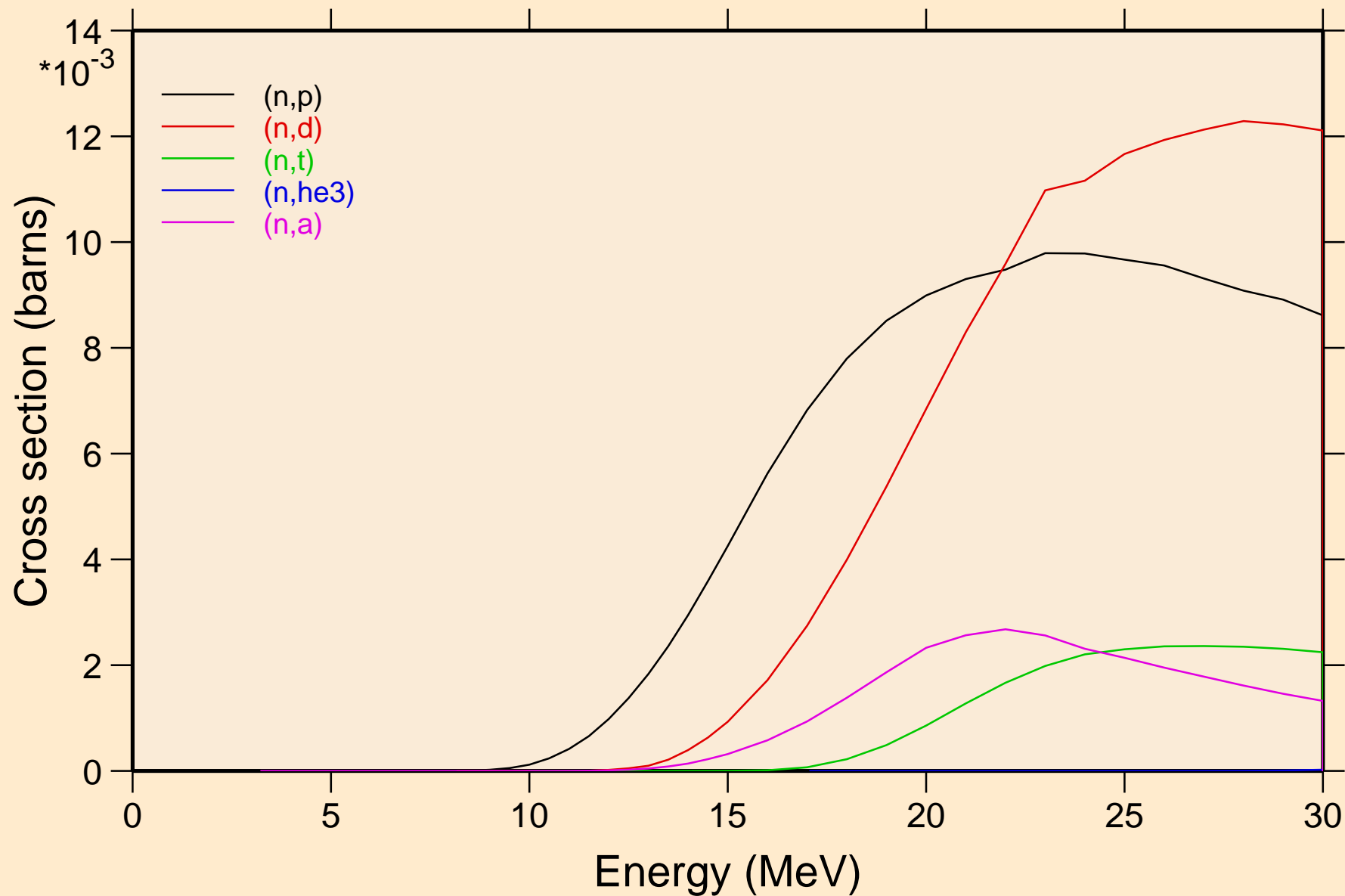

AS081 NEUTRON ACER TENDL-2019 LIBRARY; T=293.16K  
Threshold reactions

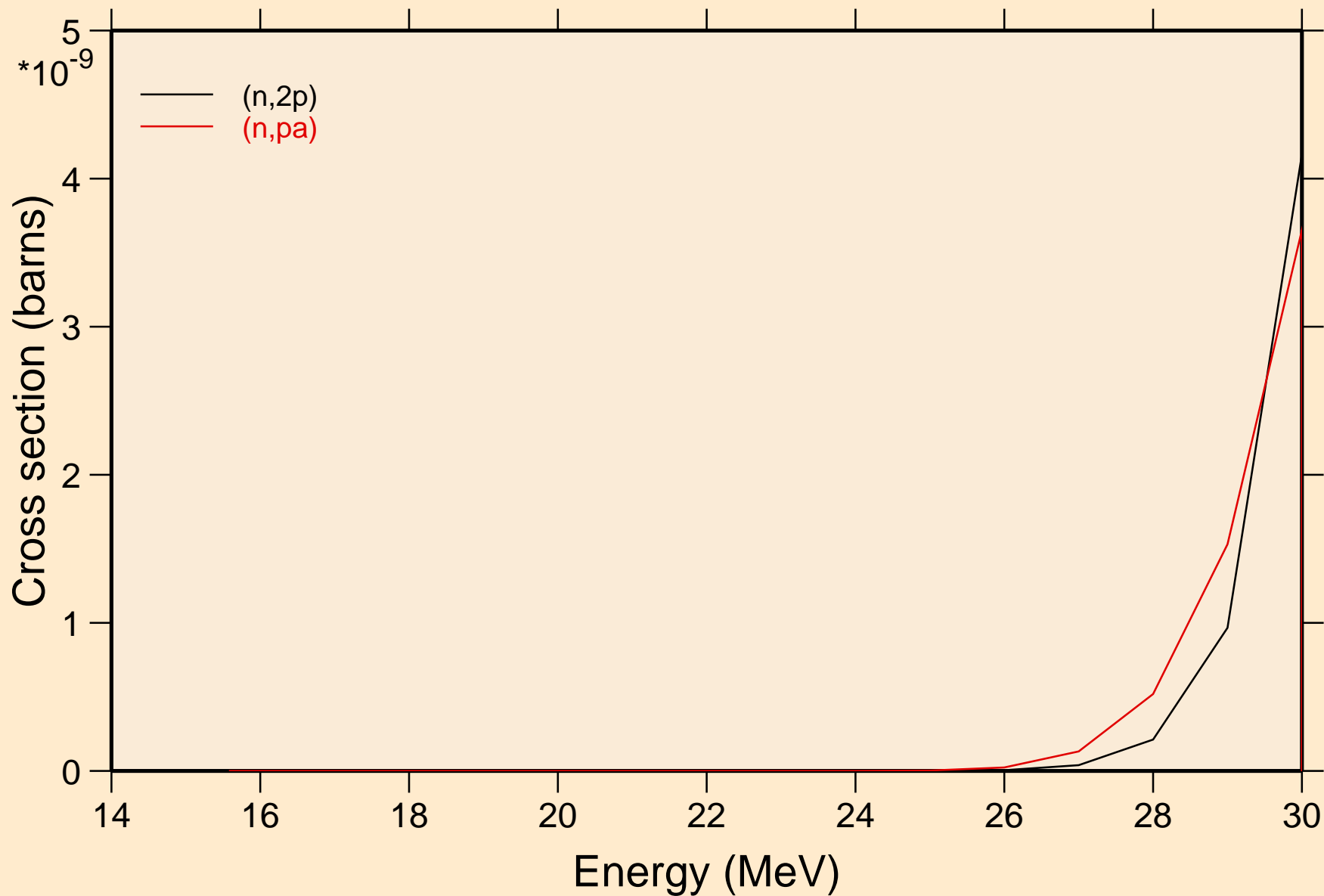

AS081 NEUTRON ACER TENDL-2019 LIBRARY; T=293.16K  
Threshold reactions

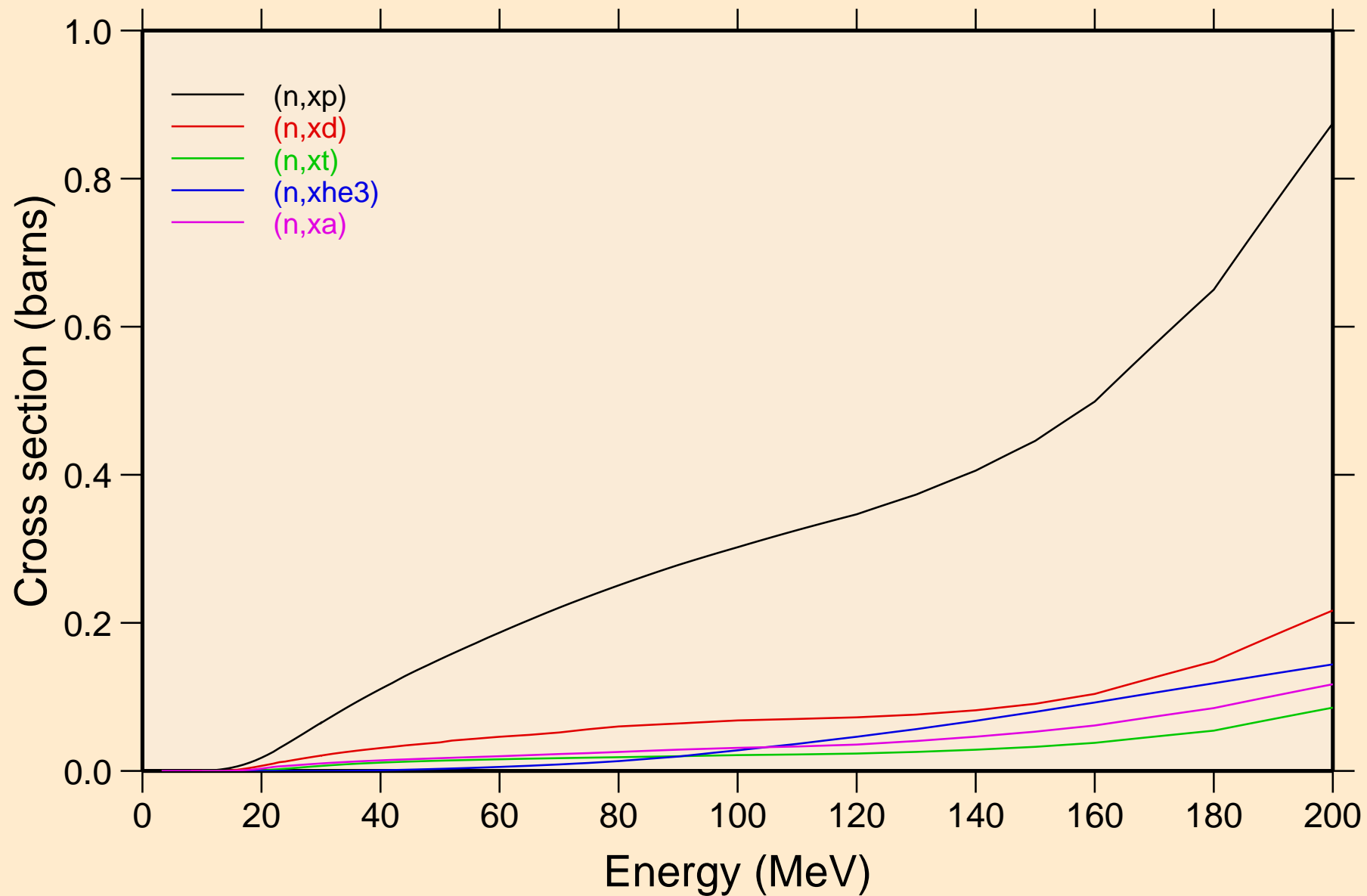

AS081 NEUTRON ACER TENDL-2019 LIBRARY; T=293.16K  
angular distribution for elastic

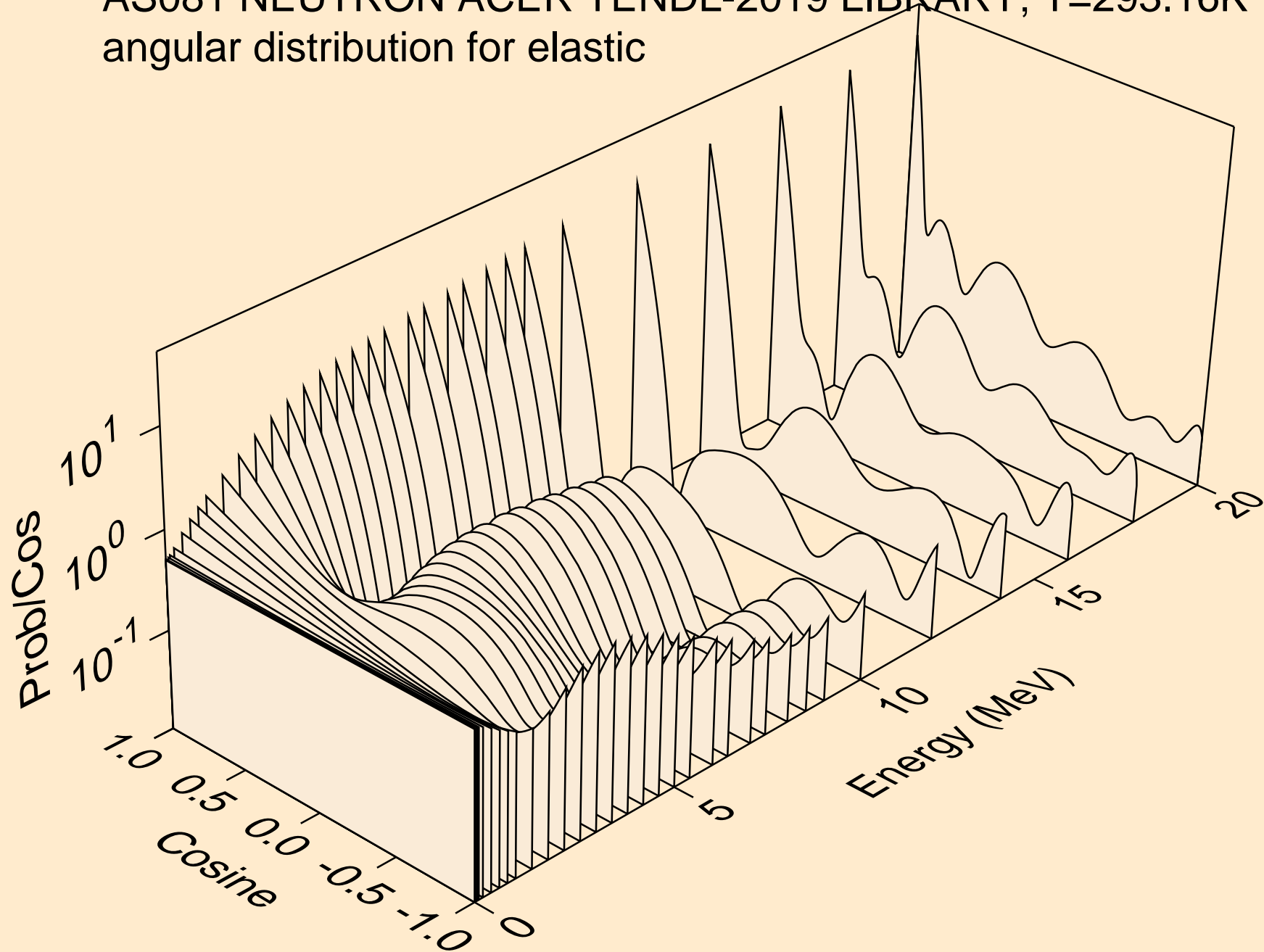

AS081 NEUTRON ACER TENDL-2019 LIBRARY; T=293.16K  
angular distribution for elastic

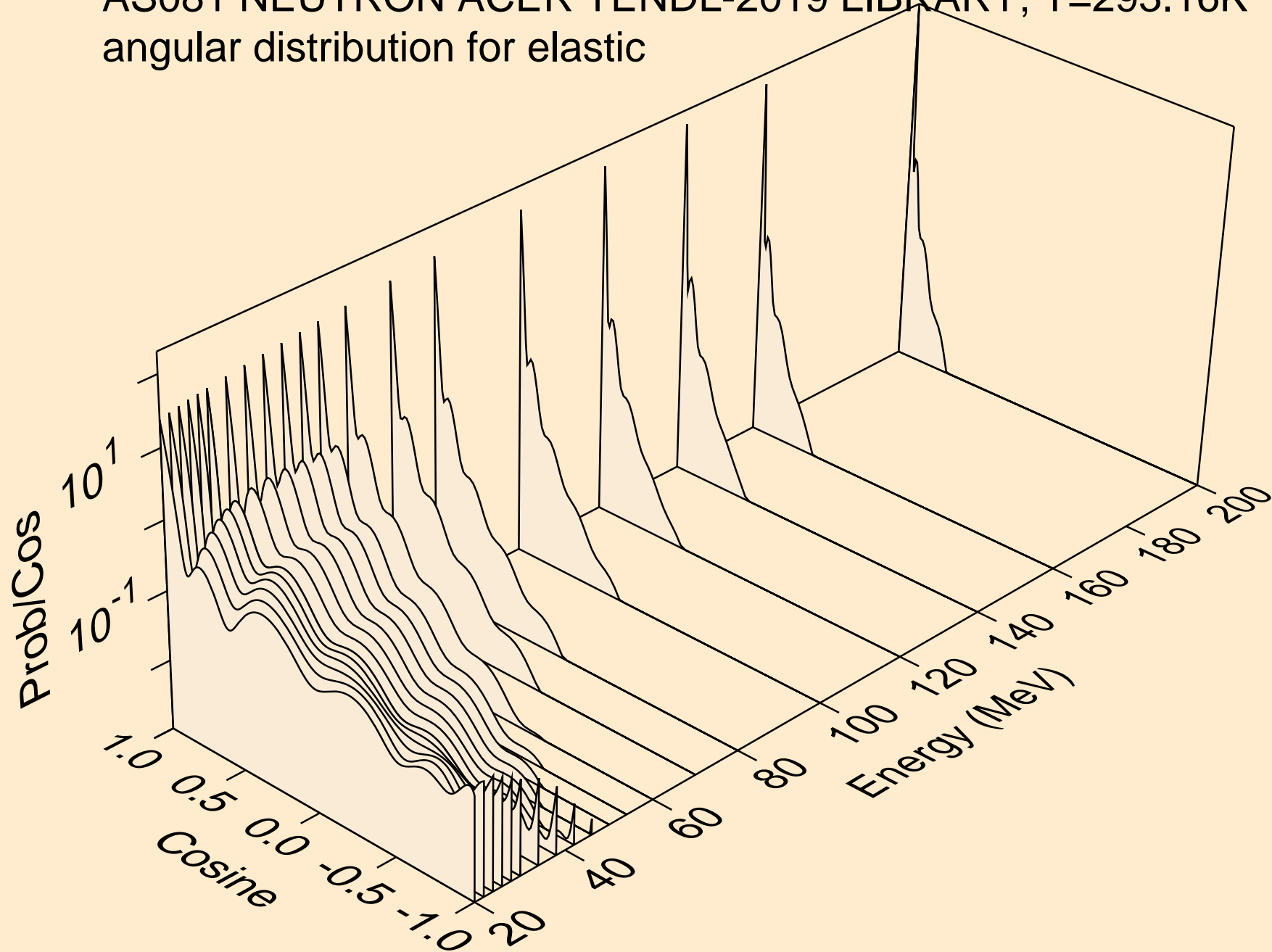

AS081 NEUTRON ACER TENDL-2019 LIBRARY; T=293.16K  
angular distribution for (n,n\*1)

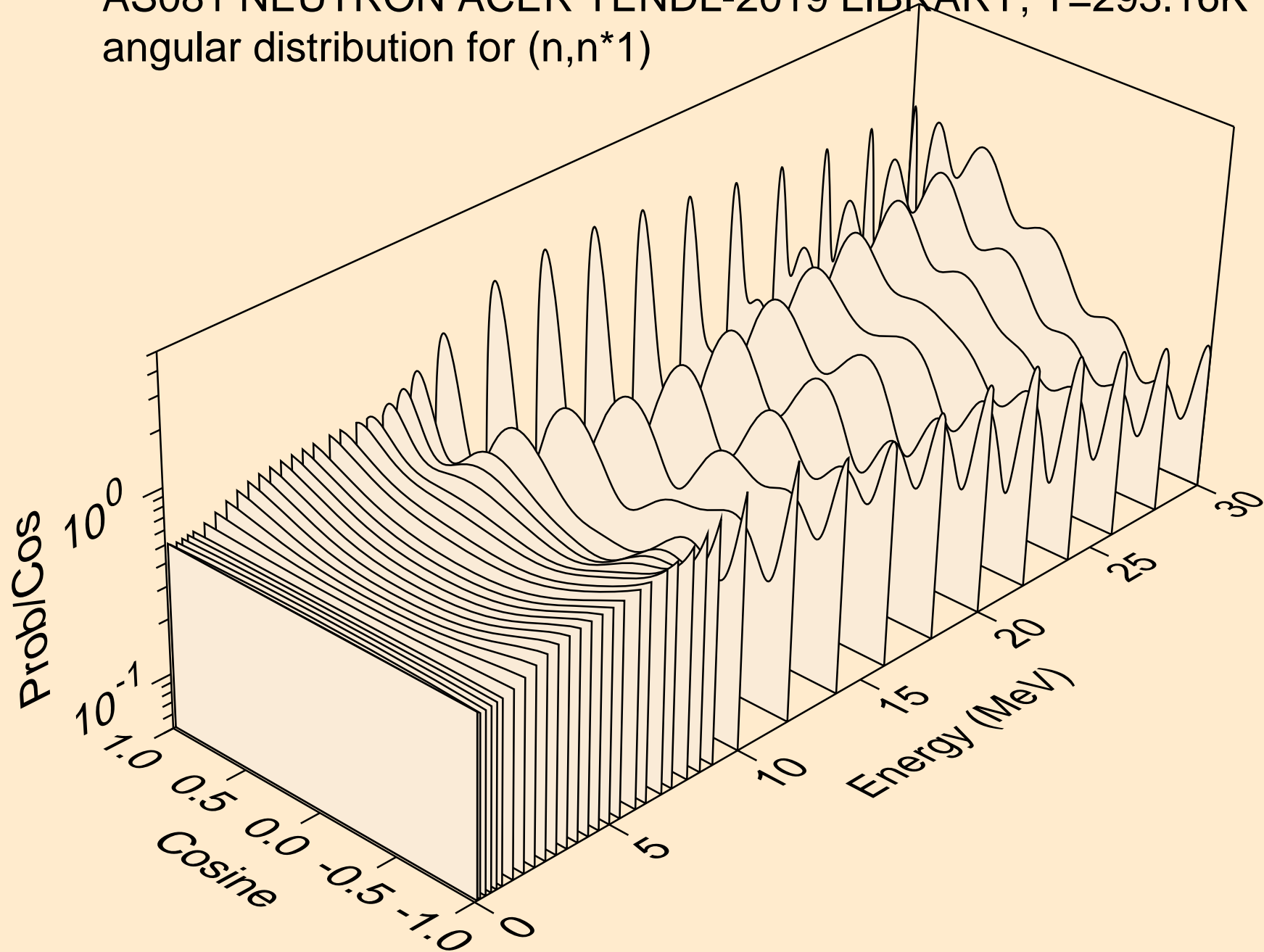

AS081 NEUTRON ACER TENDL-2019 LIBRARY; T=293.16K  
angular distribution for (n,n\*2)

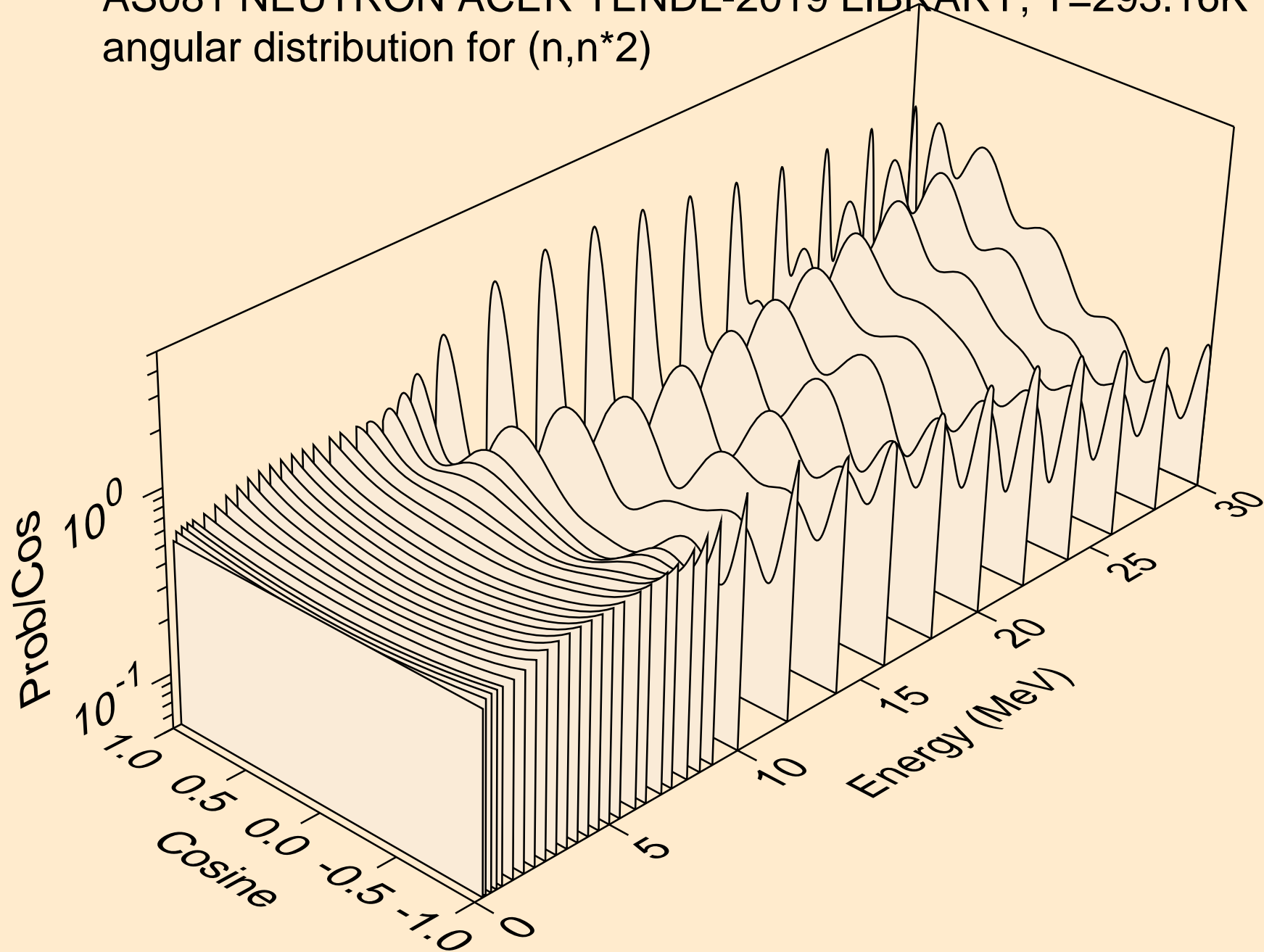



AS081 NEUTRON ACER TENDL-2019 LIBRARY; T=293.16K  
angular distribution for (n,n\*3)

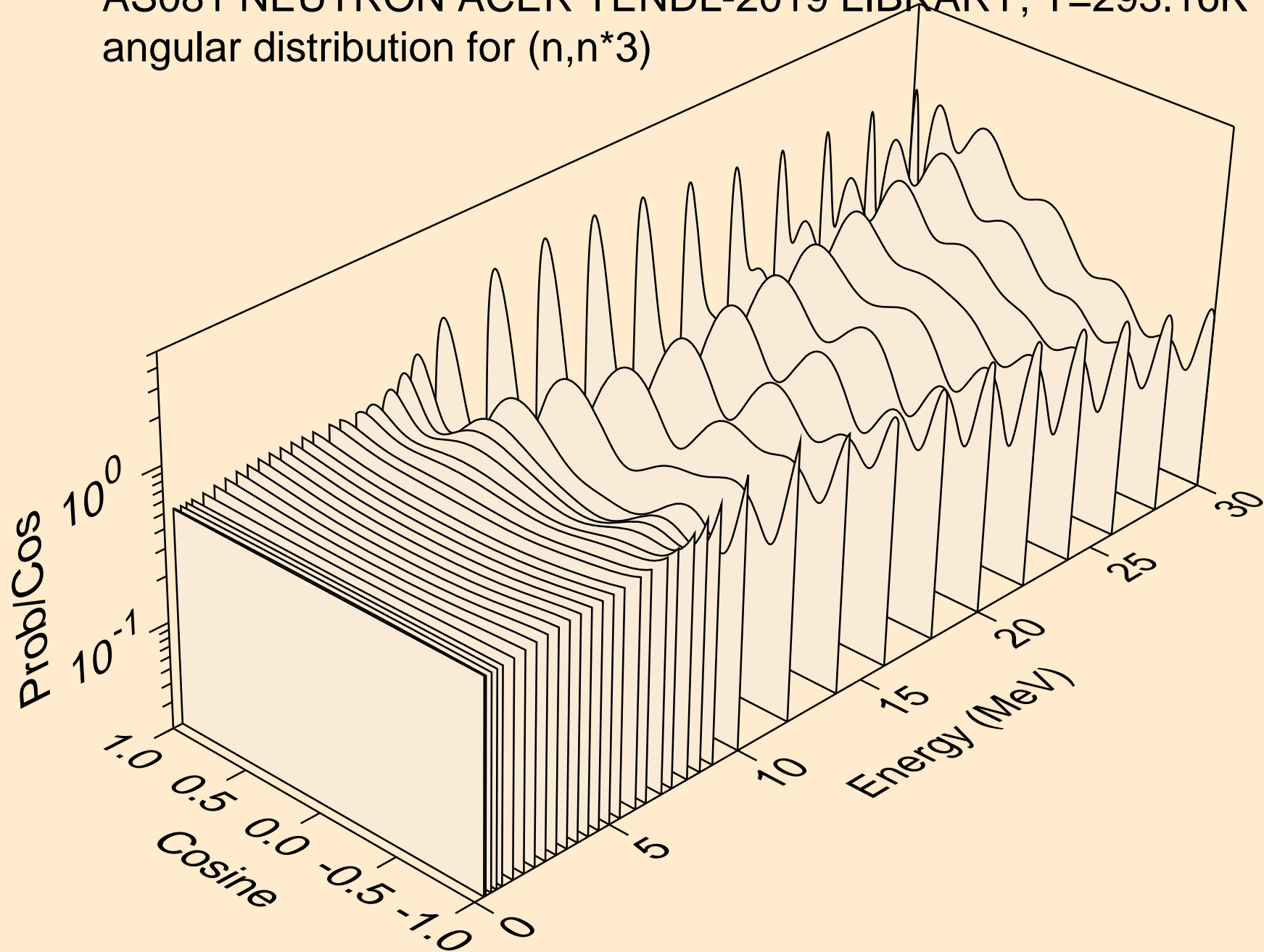

AS081 NEUTRON ACER TENDL-2019 LIBRARY; T=293.16K  
angular distribution for (n,n\*4)

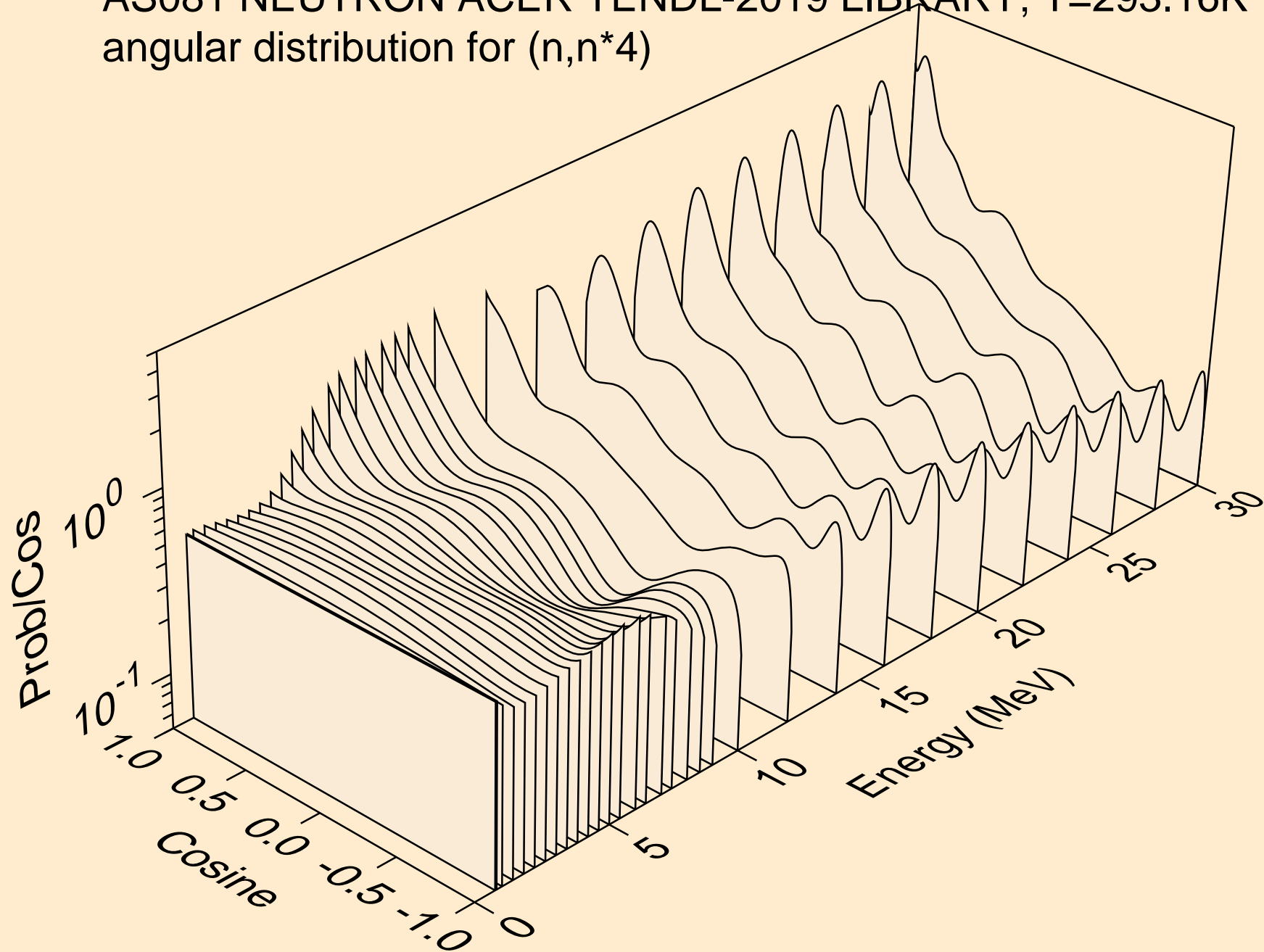

AS081 NEUTRON ACER TENDL-2019 LIBRARY; T=293.16K  
angular distribution for (n,n\*5)

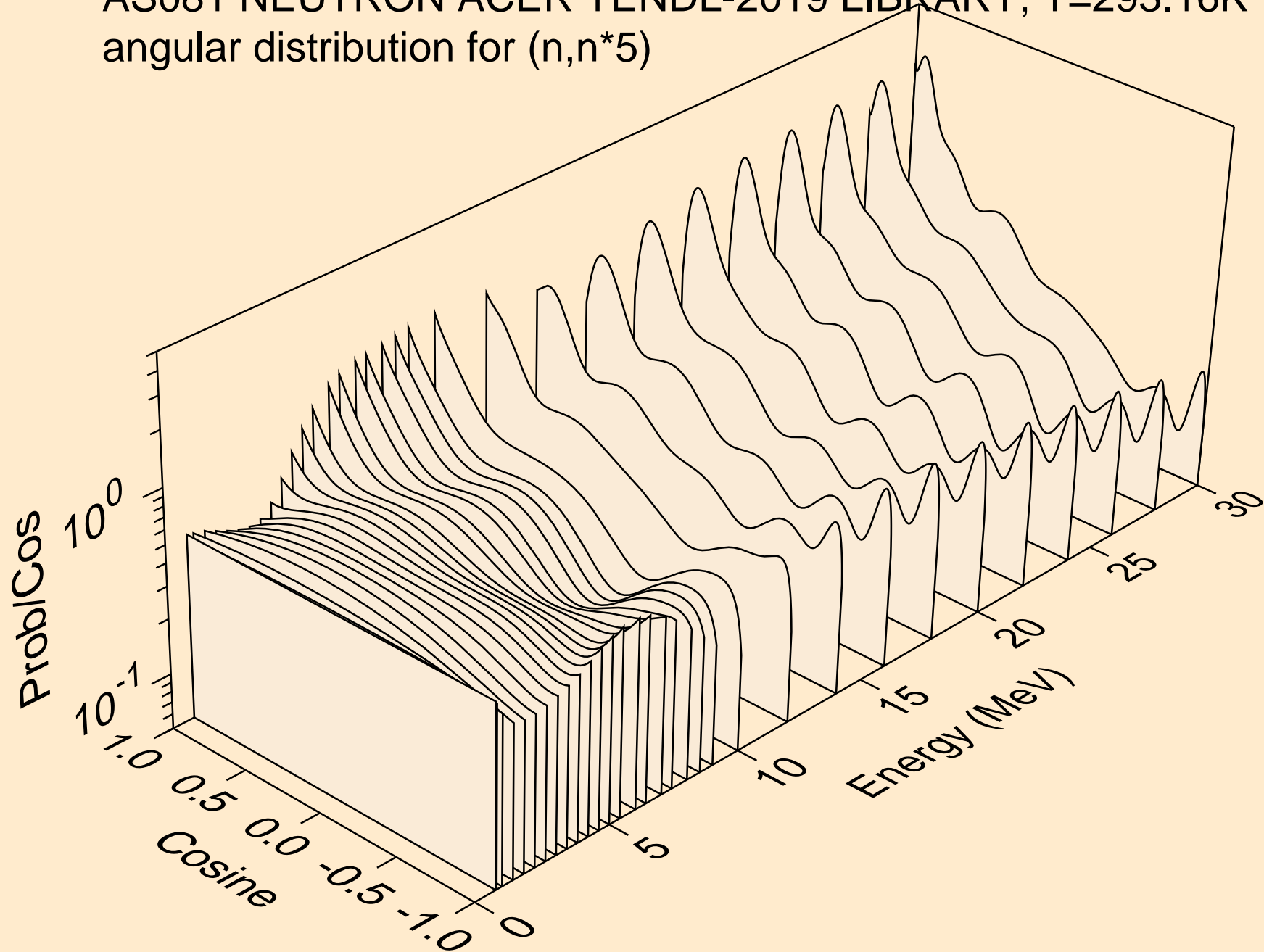

AS081 NEUTRON ACER TENDL-2019 LIBRARY; T=293.16K  
angular distribution for (n,n\*6)

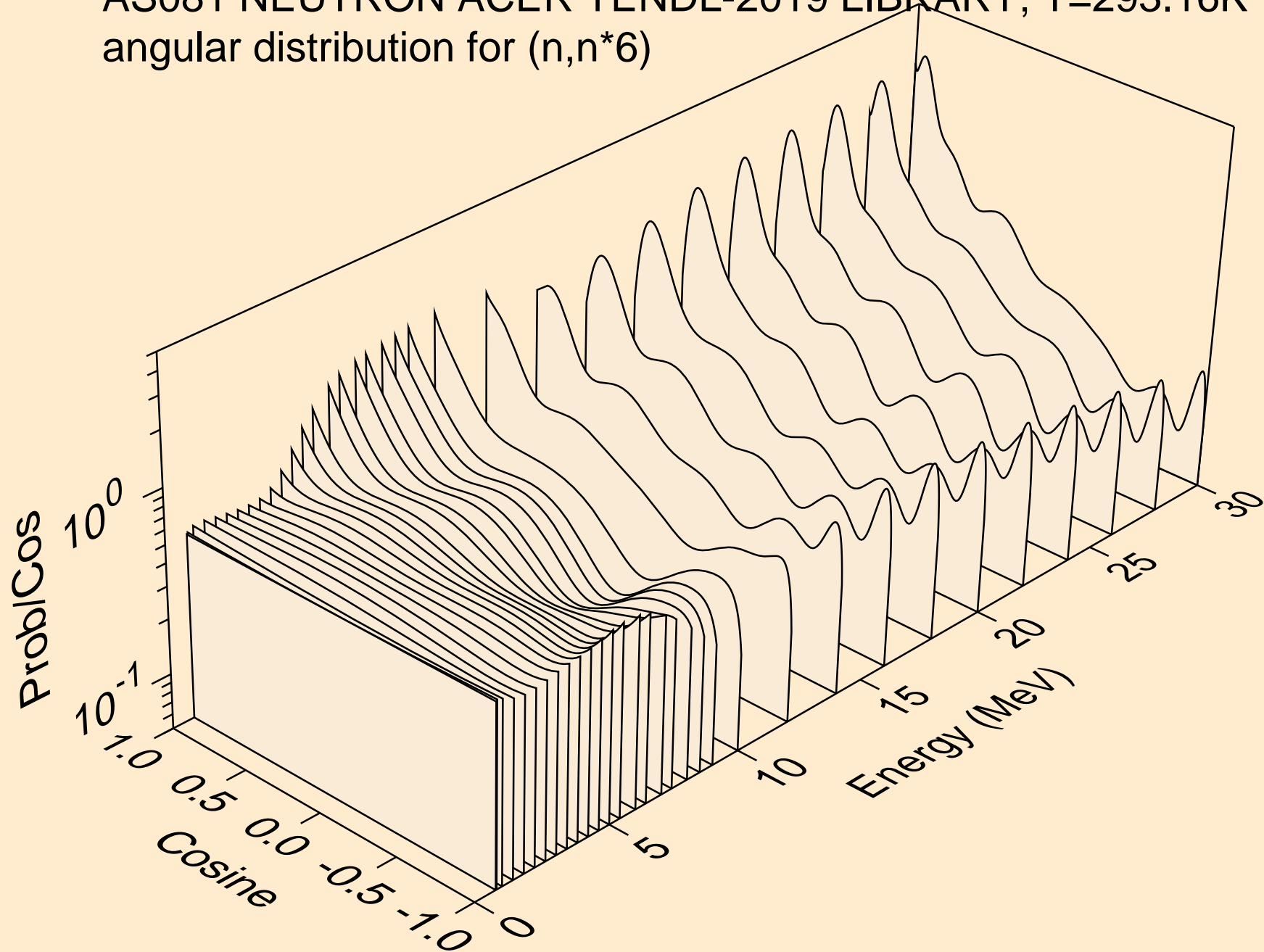

AS081 NEUTRON ACER TENDL-2019 LIBRARY; T=293.16K  
angular distribution for (n,n\*7)

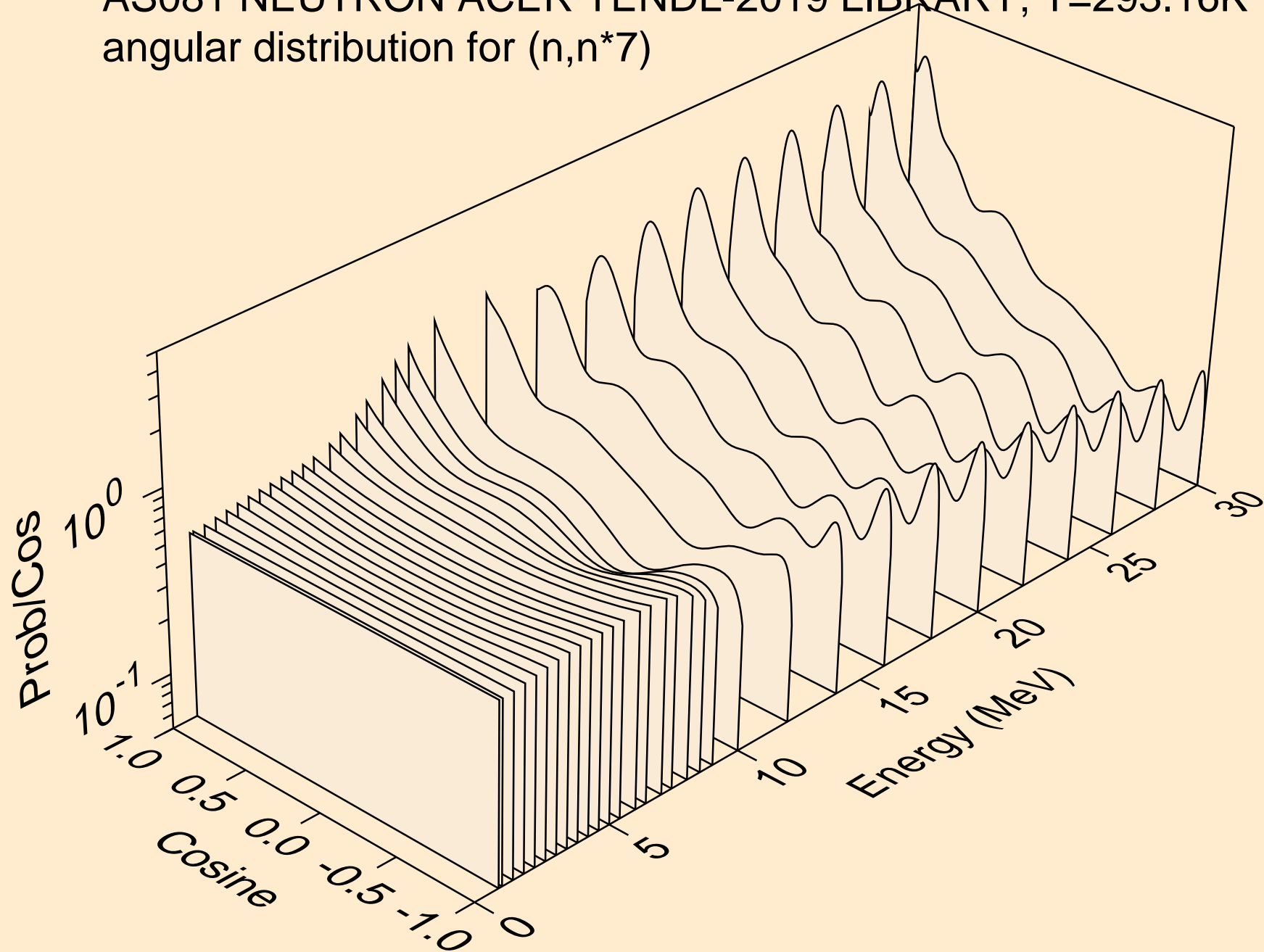

AS081 NEUTRON ACER TENDL-2019 LIBRARY; T=293.16K  
angular distribution for (n,n\*8)

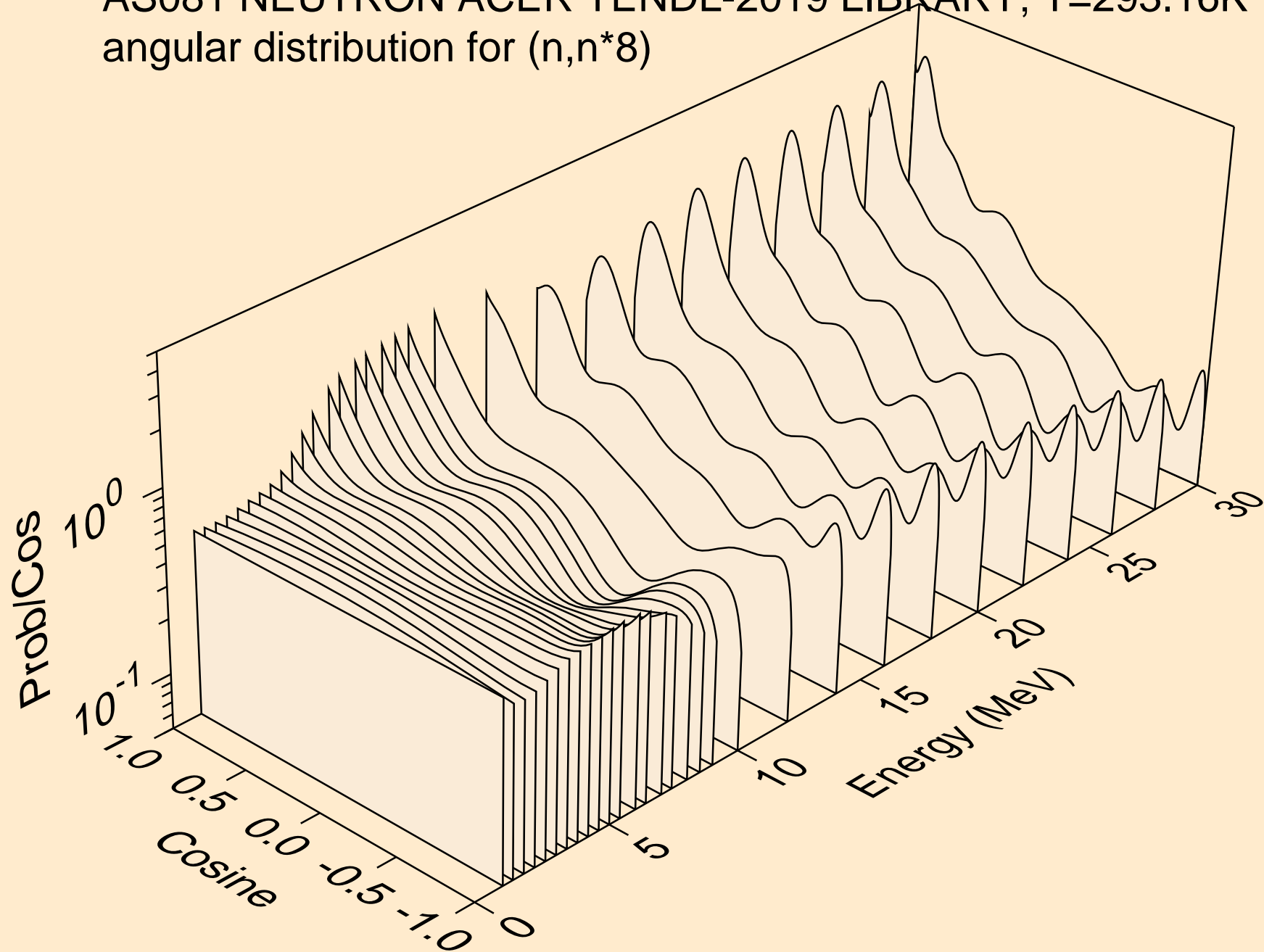

AS081 NEUTRON ACER TENDL-2019 LIBRARY; T=293.16K  
angular distribution for (n,n\*9)

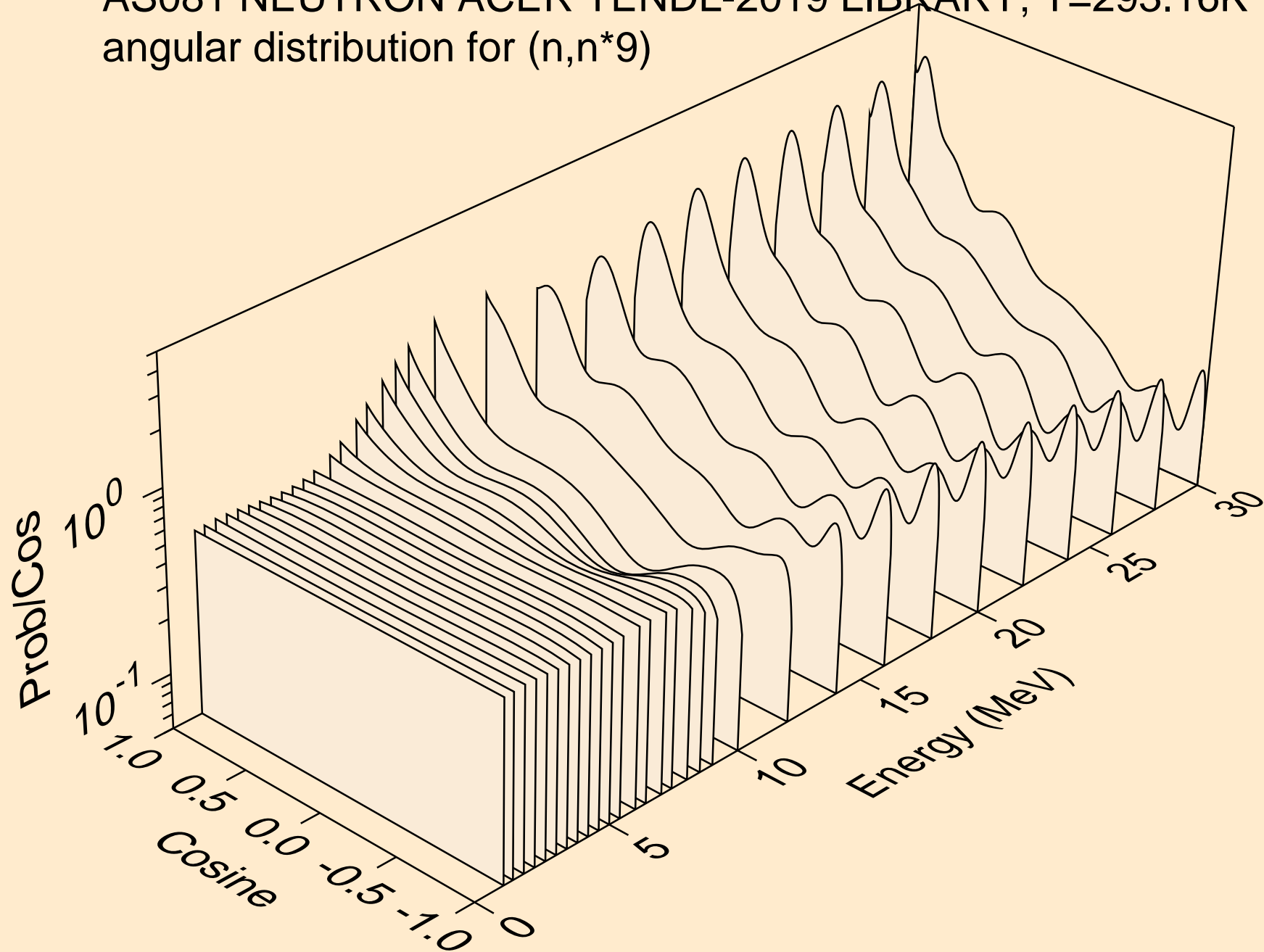

AS081 NEUTRON ACER TENDL-2019 LIBRARY; T=293.16K  
angular distribution for (n,n\*10)

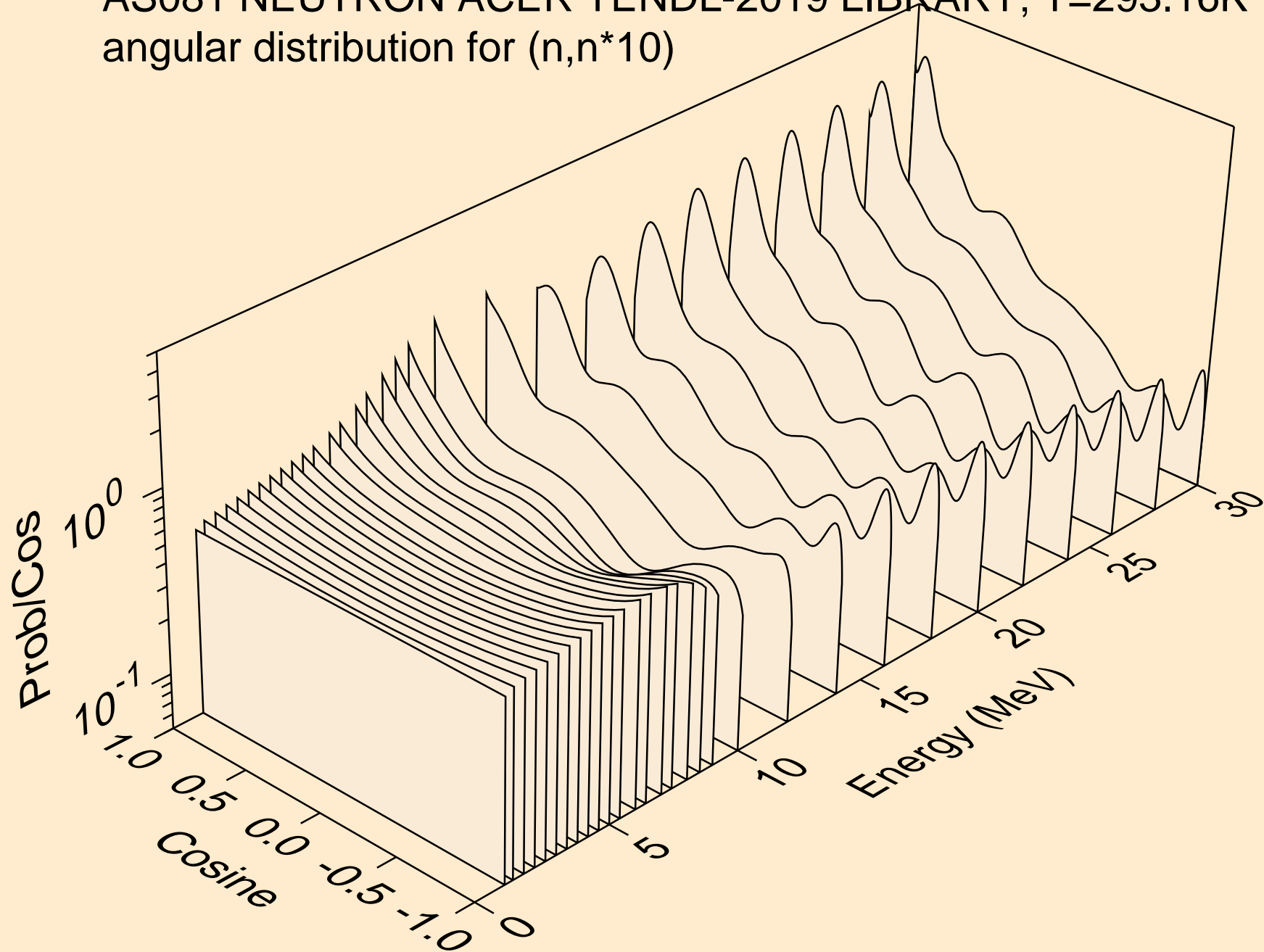



AS081 NEUTRON ACER TENDL-2019 LIBRARY; T=293.16K  
angular distribution for (n,n\*11)

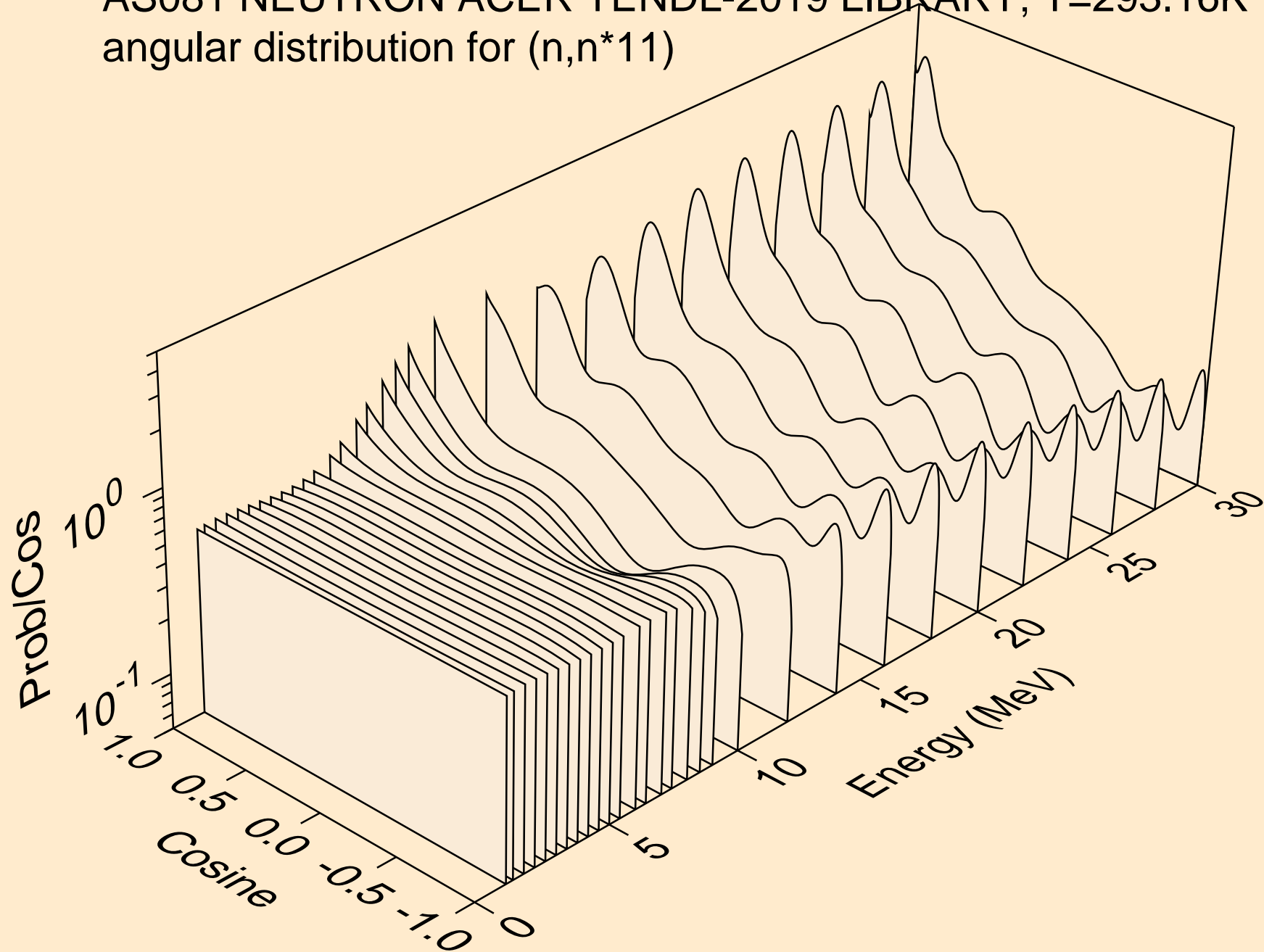

AS081 NEUTRON ACER TENDL-2019 LIBRARY; T=293.16K  
angular distribution for (n,n\*12)

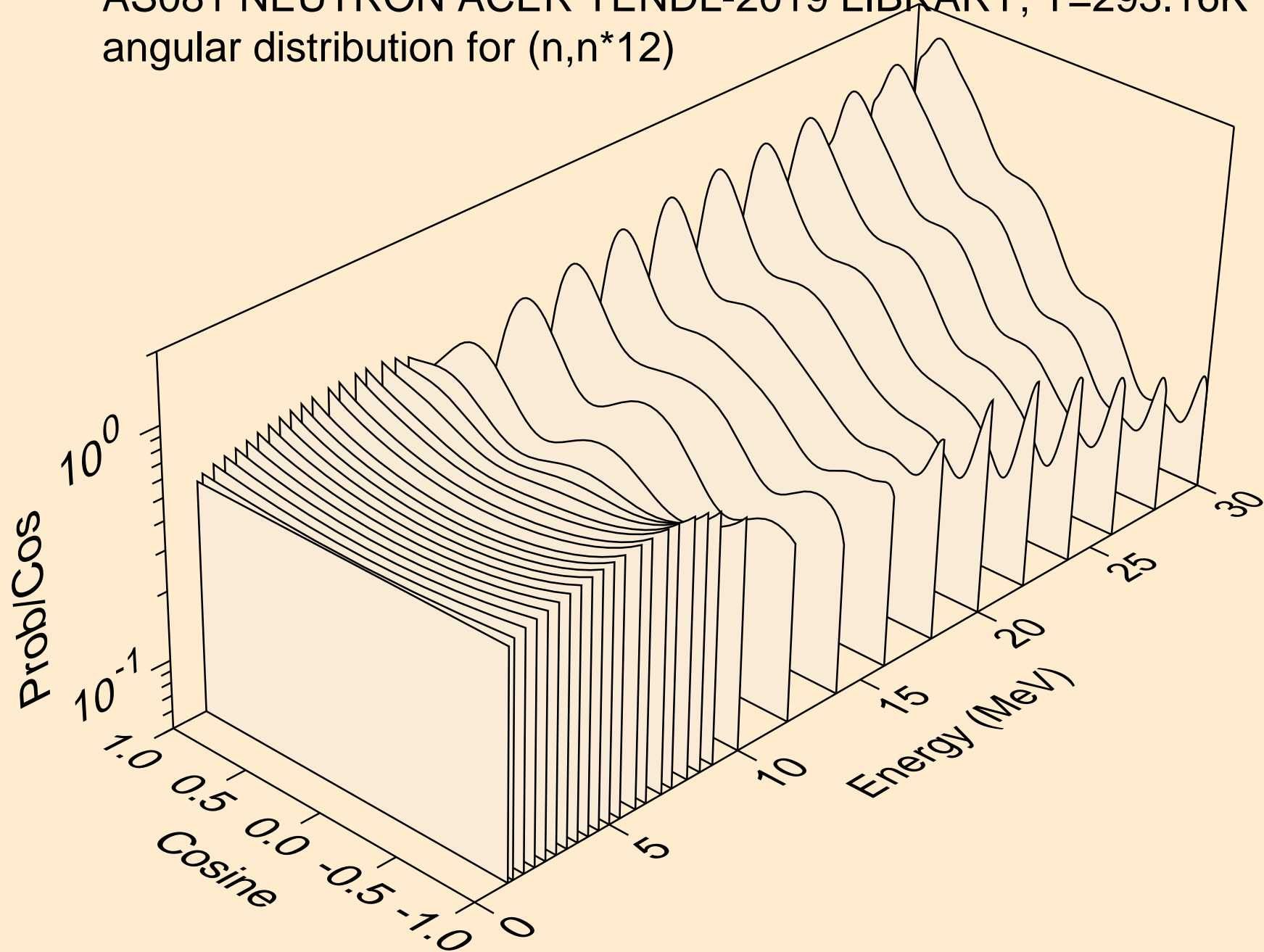

AS081 NEUTRON ACER TENDL-2019 LIBRARY; T=293.16K  
angular distribution for (n,n\*13)

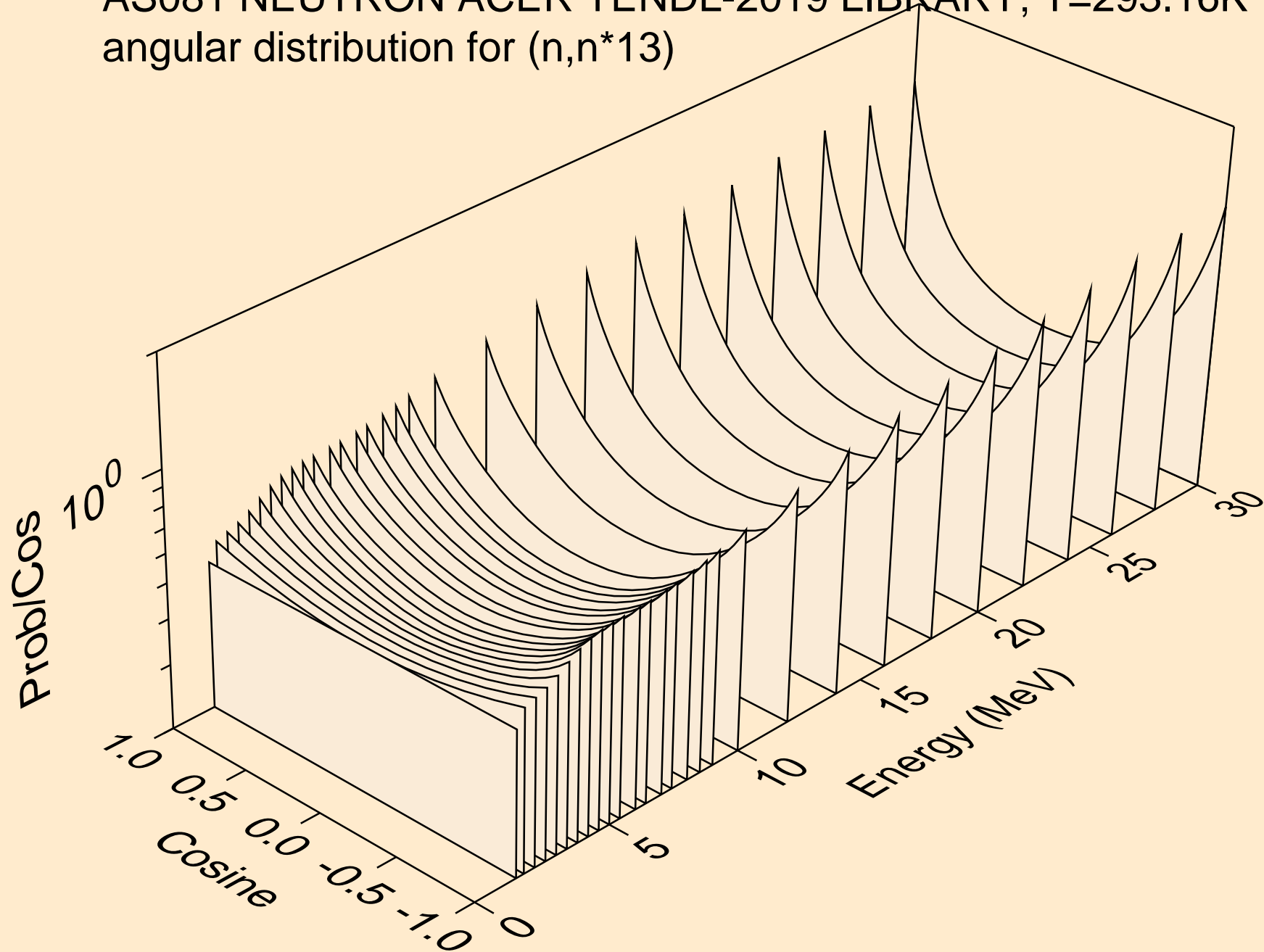

AS081 NEUTRON ACER TENDL-2019 LIBRARY; T=293.16K  
angular distribution for (n,n\*14)

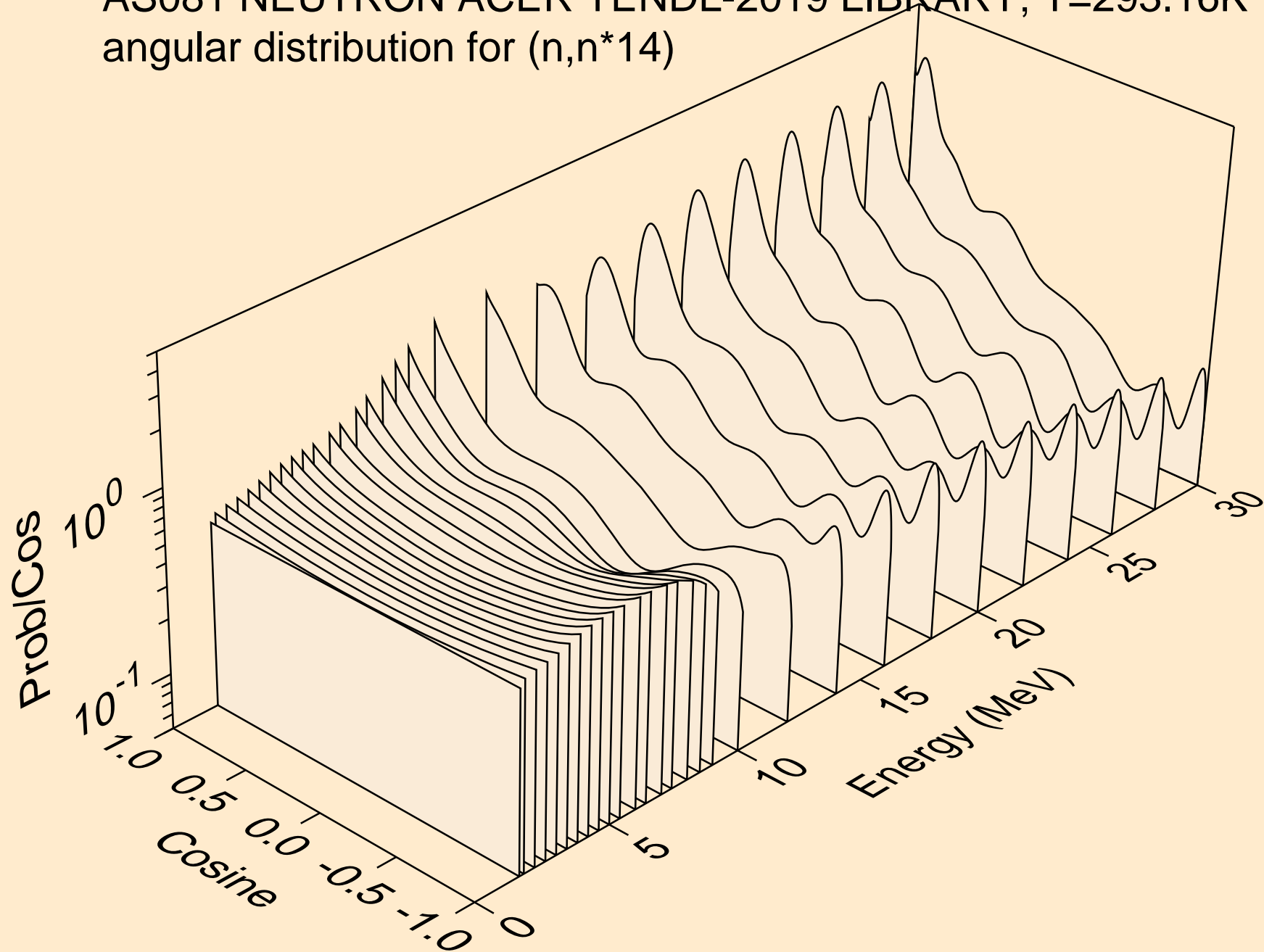

AS081 NEUTRON ACER TENDL-2019 LIBRARY; T=293.16K  
angular distribution for (n,n\*15)

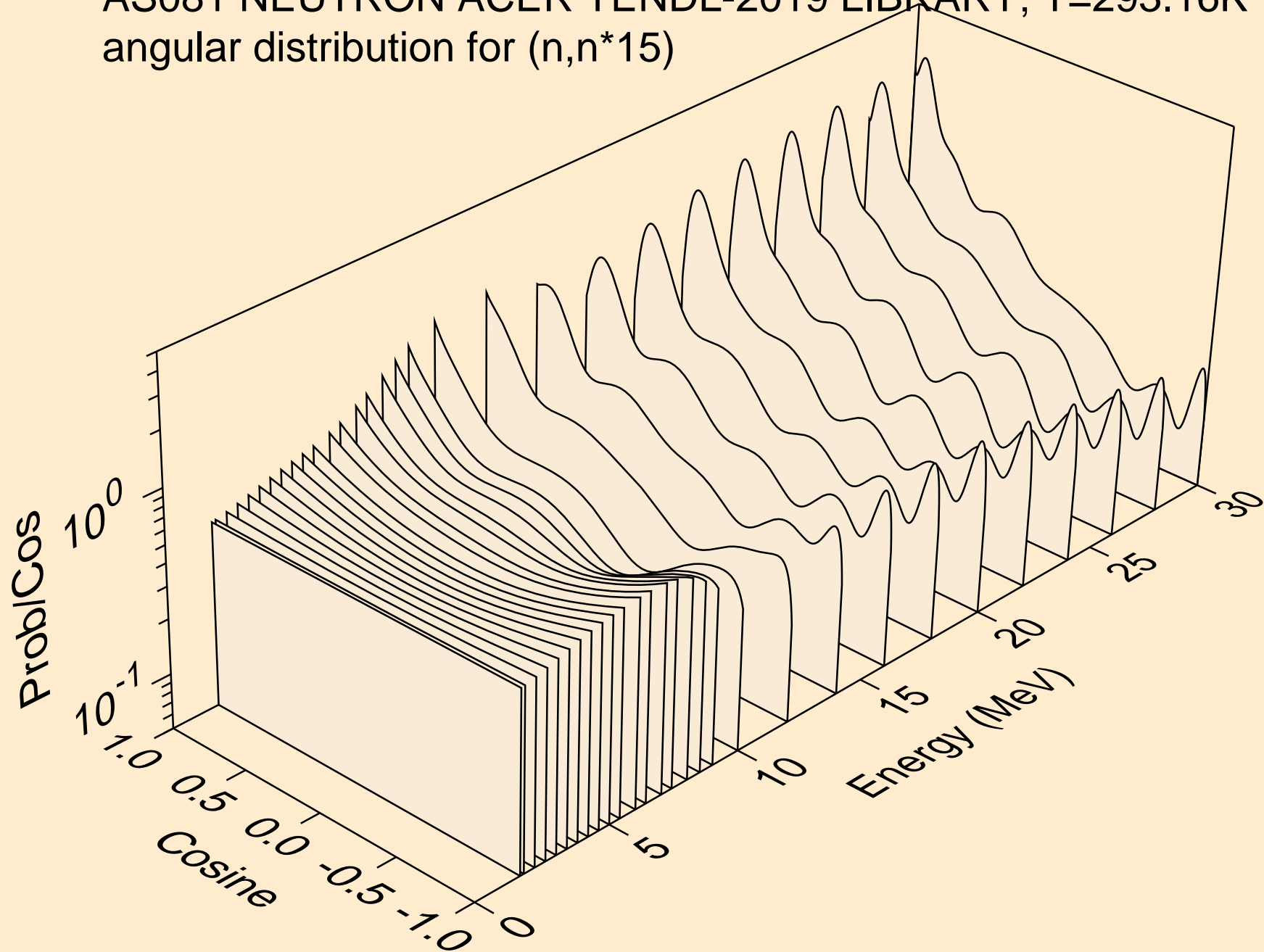

AS081 NEUTRON ACER TENDL-2019 LIBRARY; T=293.16K  
angular distribution for (n,n\*16)

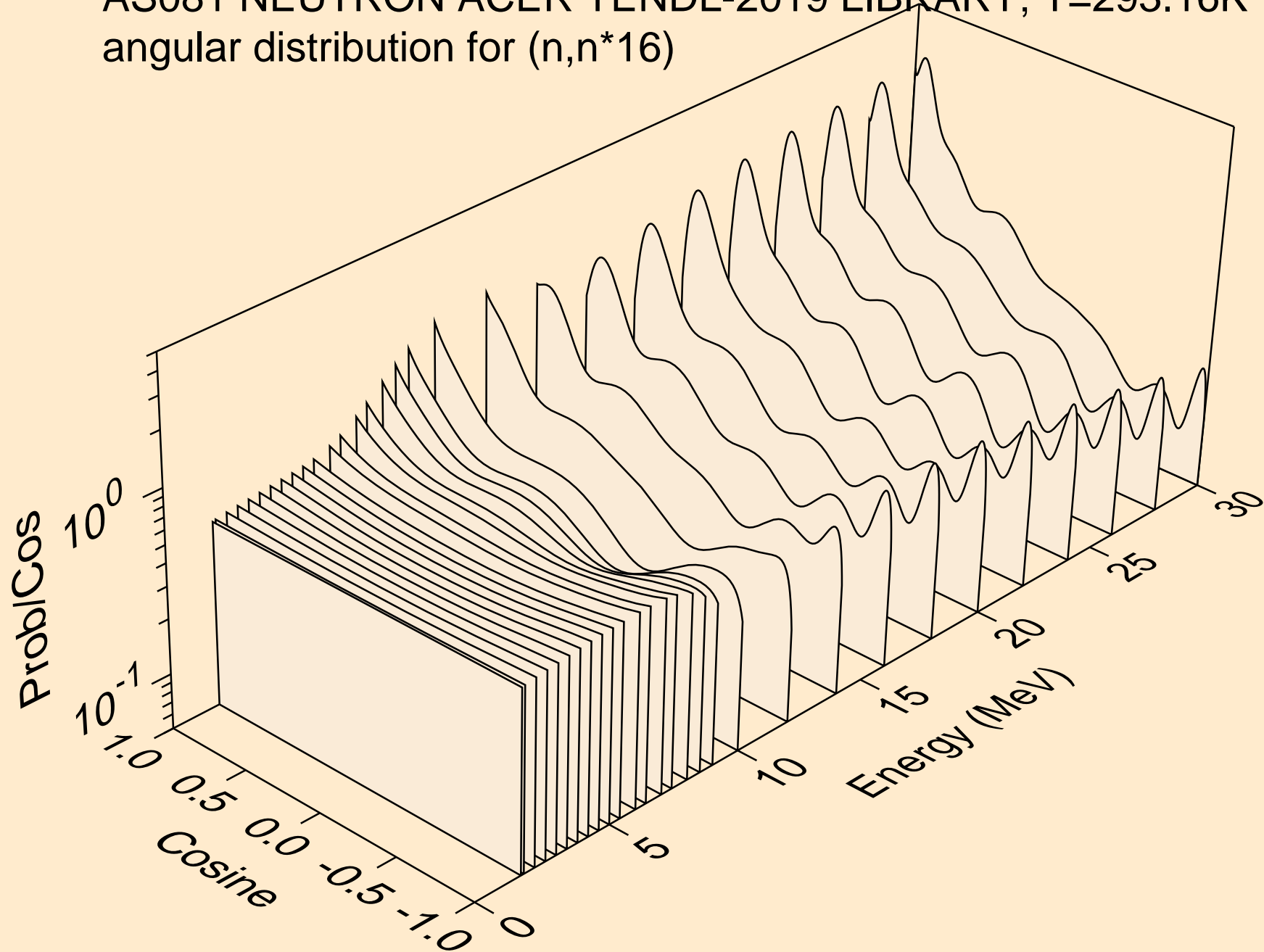

AS081 NEUTRON ACER TENDL-2019 LIBRARY; T=293.16K  
angular distribution for (n,n\*17)

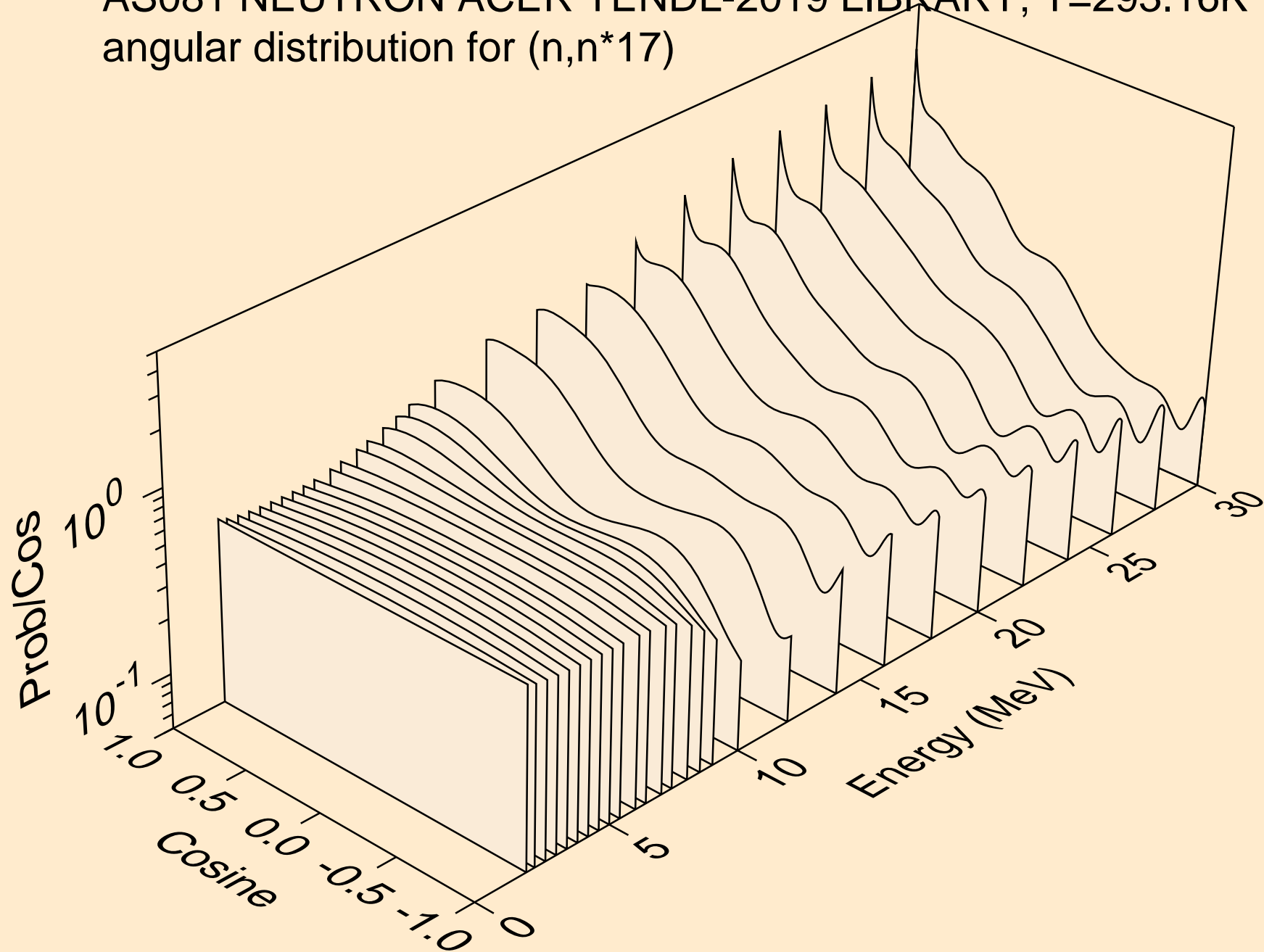

AS081 NEUTRON ACER TENDL-2019 LIBRARY; T=293.16K  
angular distribution for (n,n\*18)

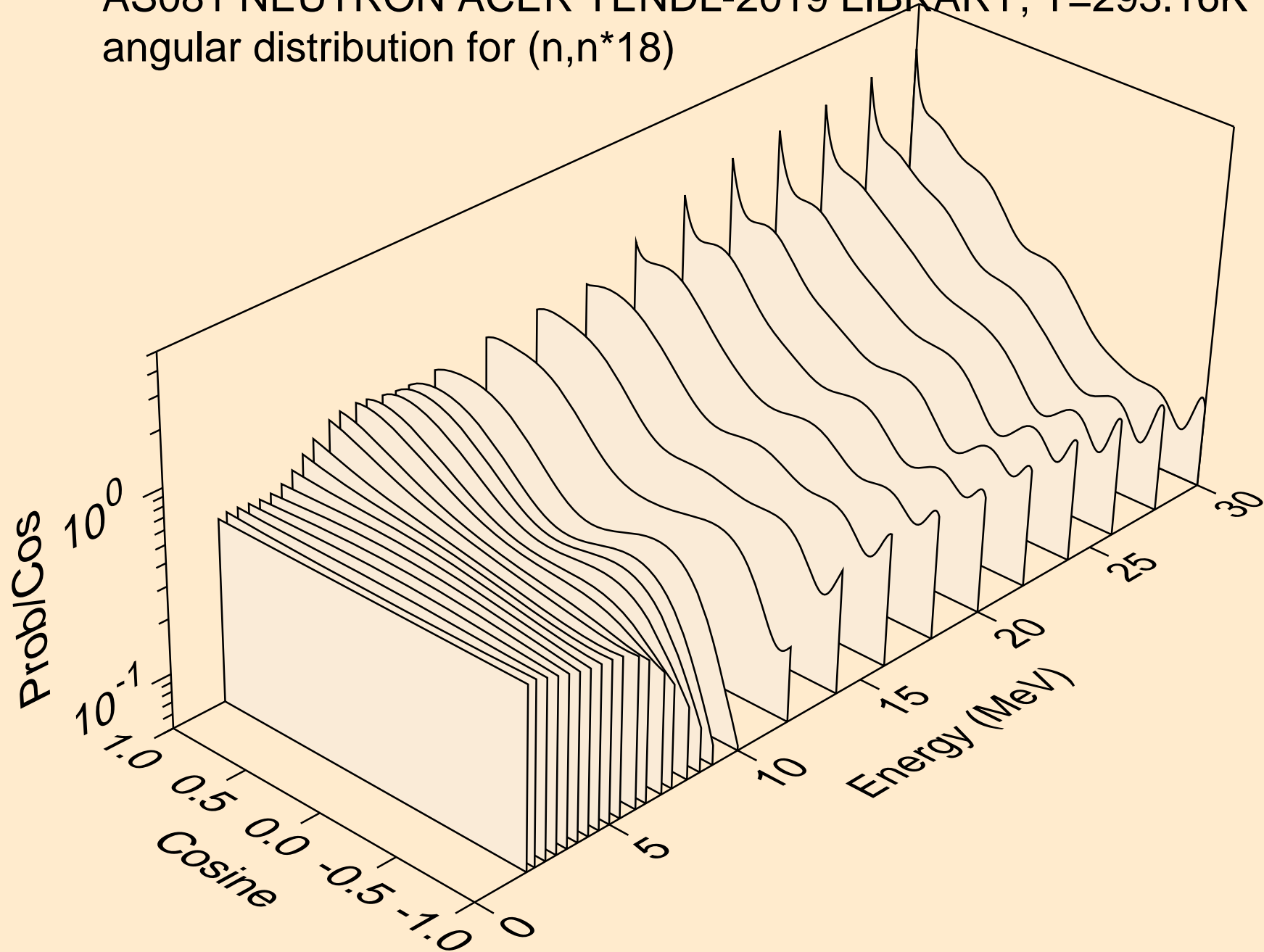



AS081 NEUTRON ACER TENDL-2019 LIBRARY; T=293.16K  
angular distribution for (n,n\*19)

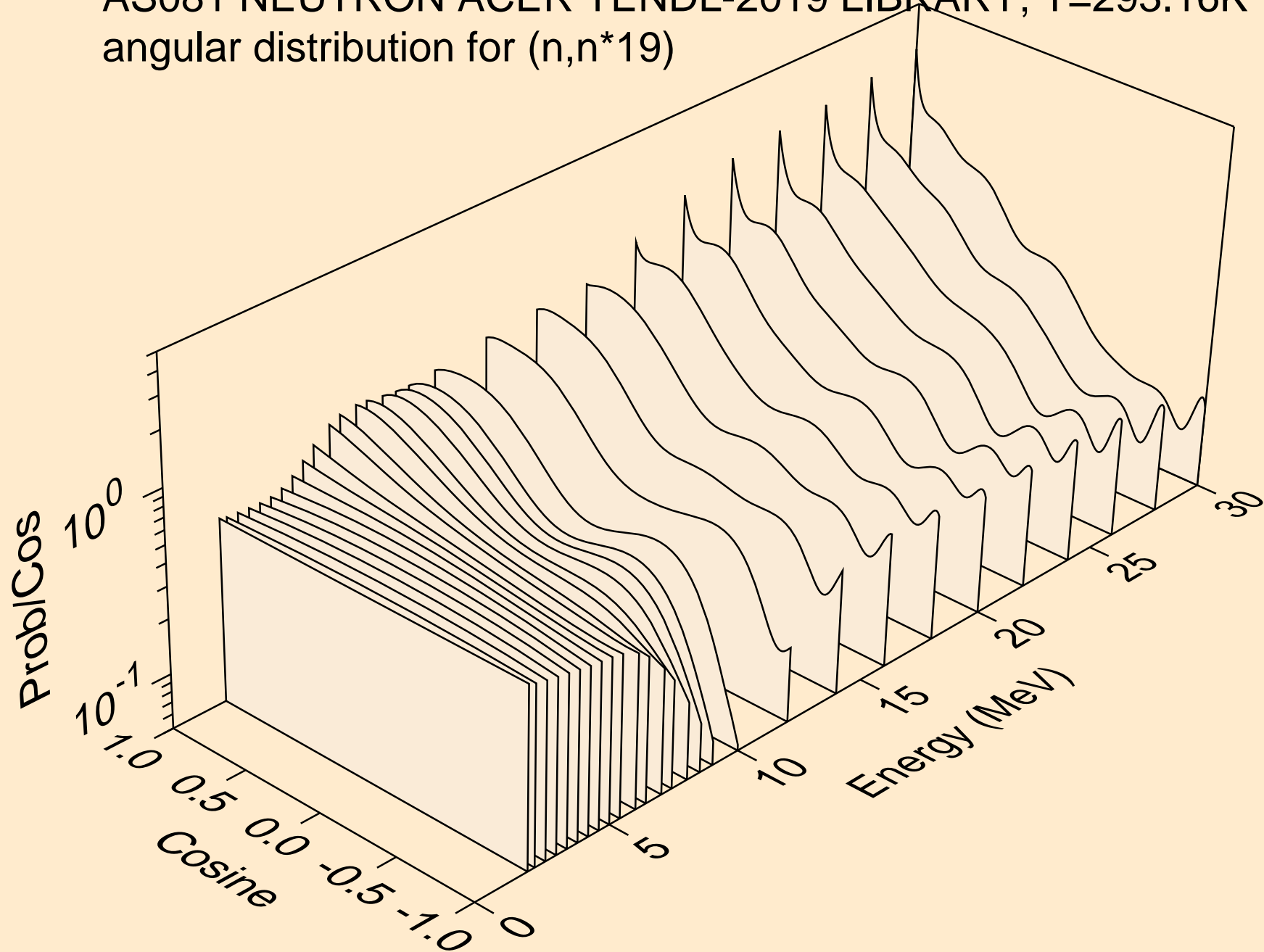

AS081 NEUTRON ACER TENDL-2019 LIBRARY; T=293.16K  
angular distribution for (n,n\*20)

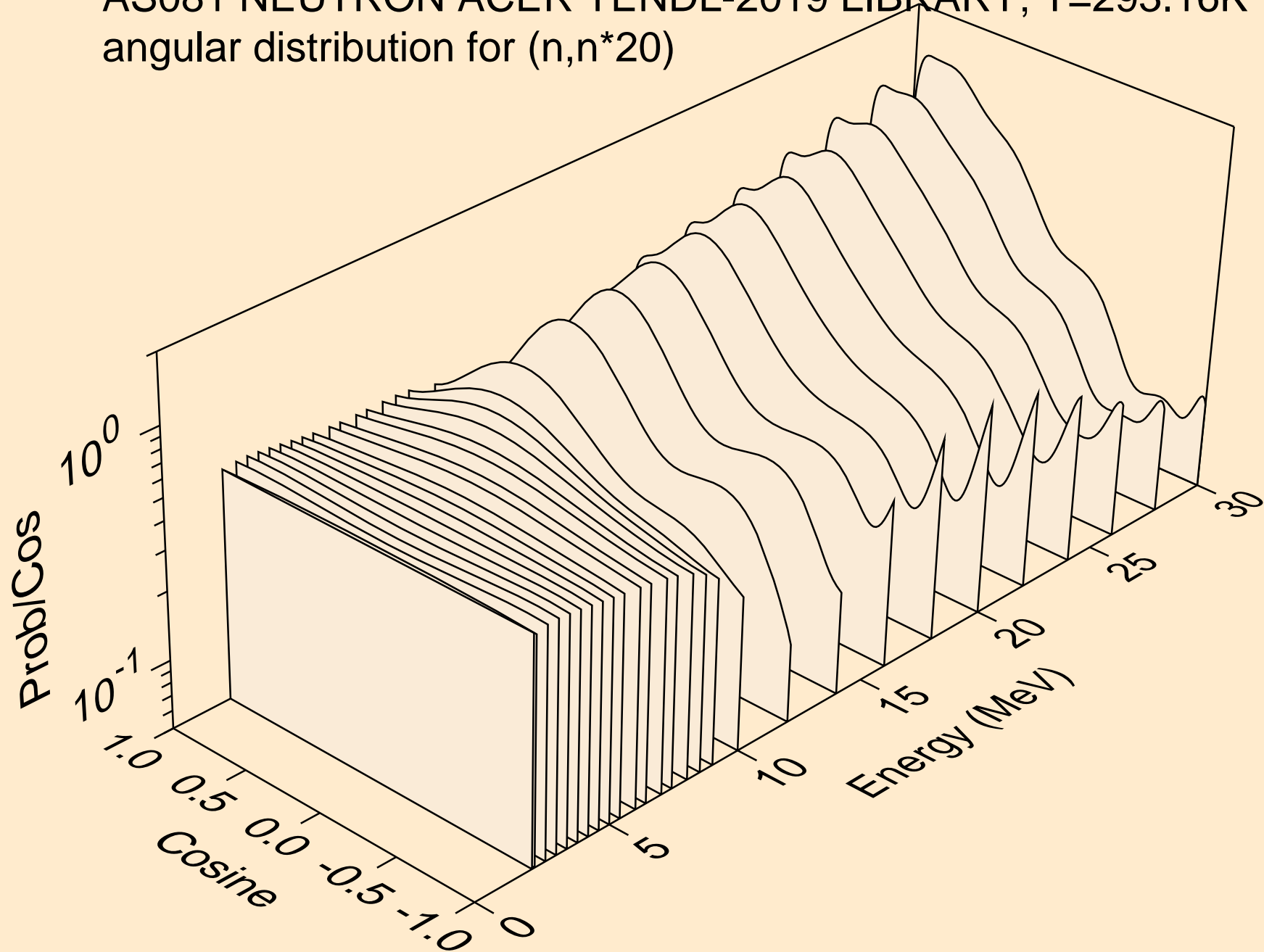

AS081 NEUTRON ACER TENDL-2019 LIBRARY; T=293.16K  
angular distribution for (n,n\*21)

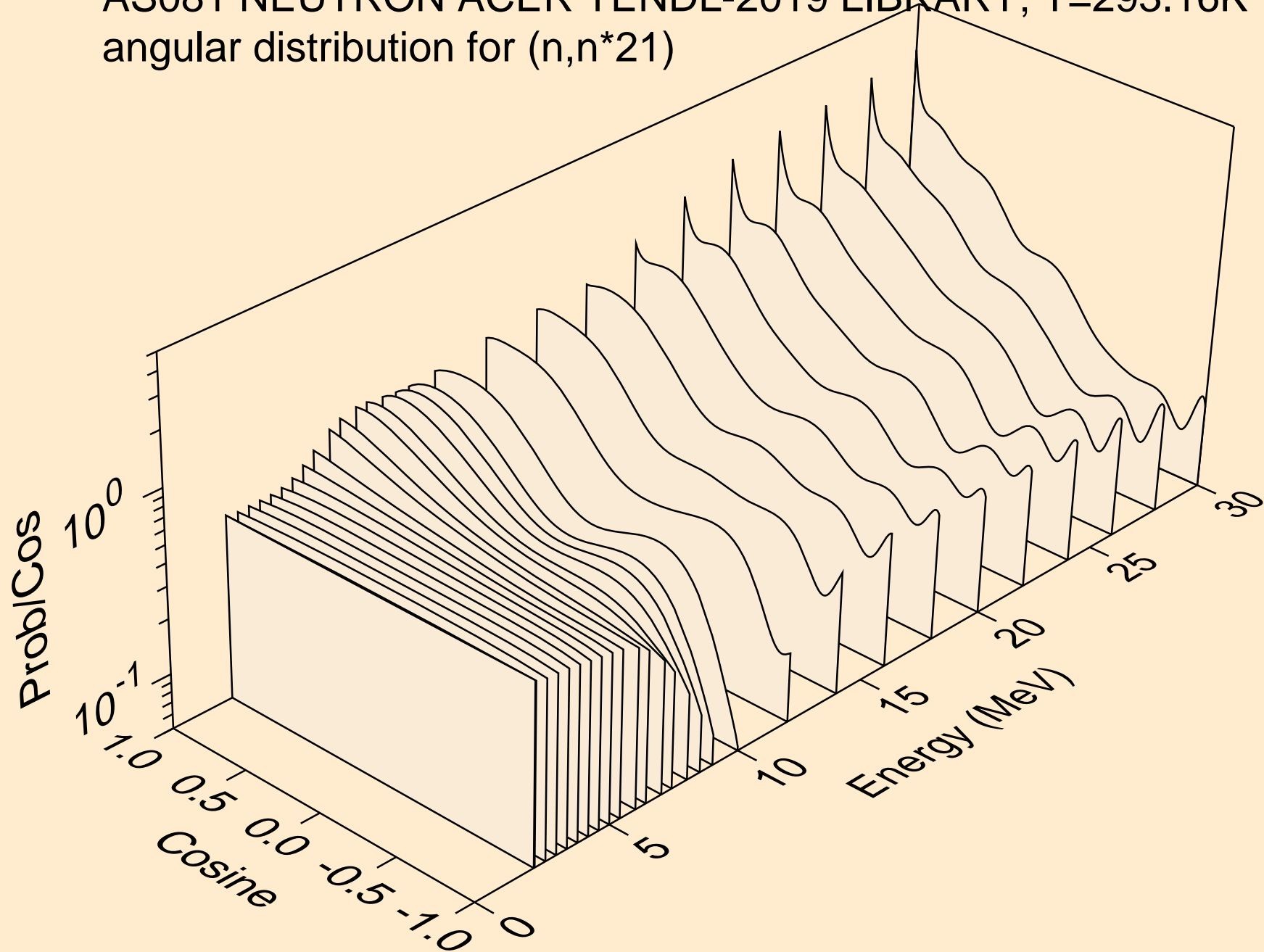

AS081 NEUTRON ACER TENDL-2019 LIBRARY; T=293.16K  
angular distribution for (n,n\*22)

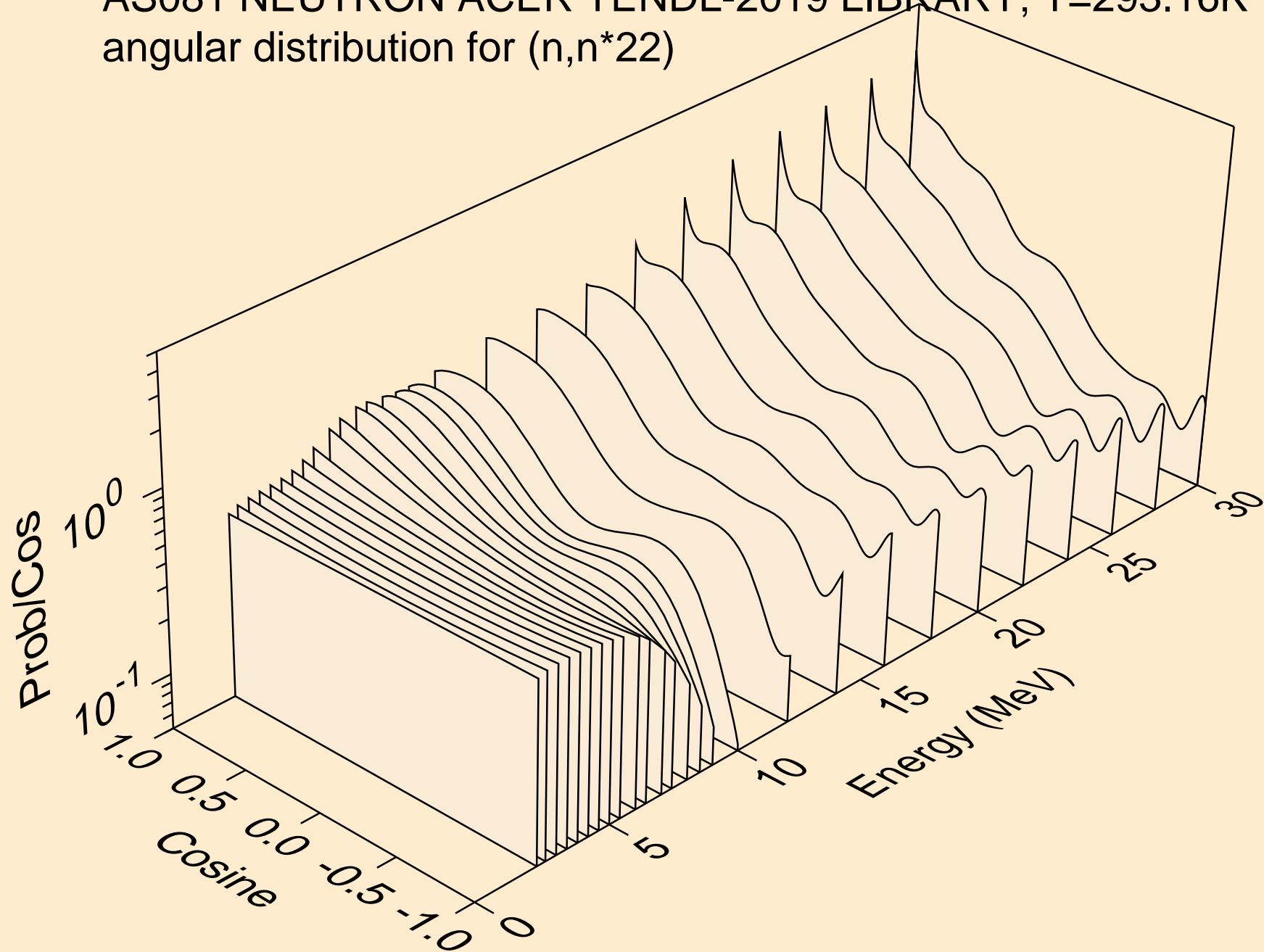

AS081 NEUTRON ACER TENDL-2019 LIBRARY; T=293.16K  
angular distribution for (n,n\*23)

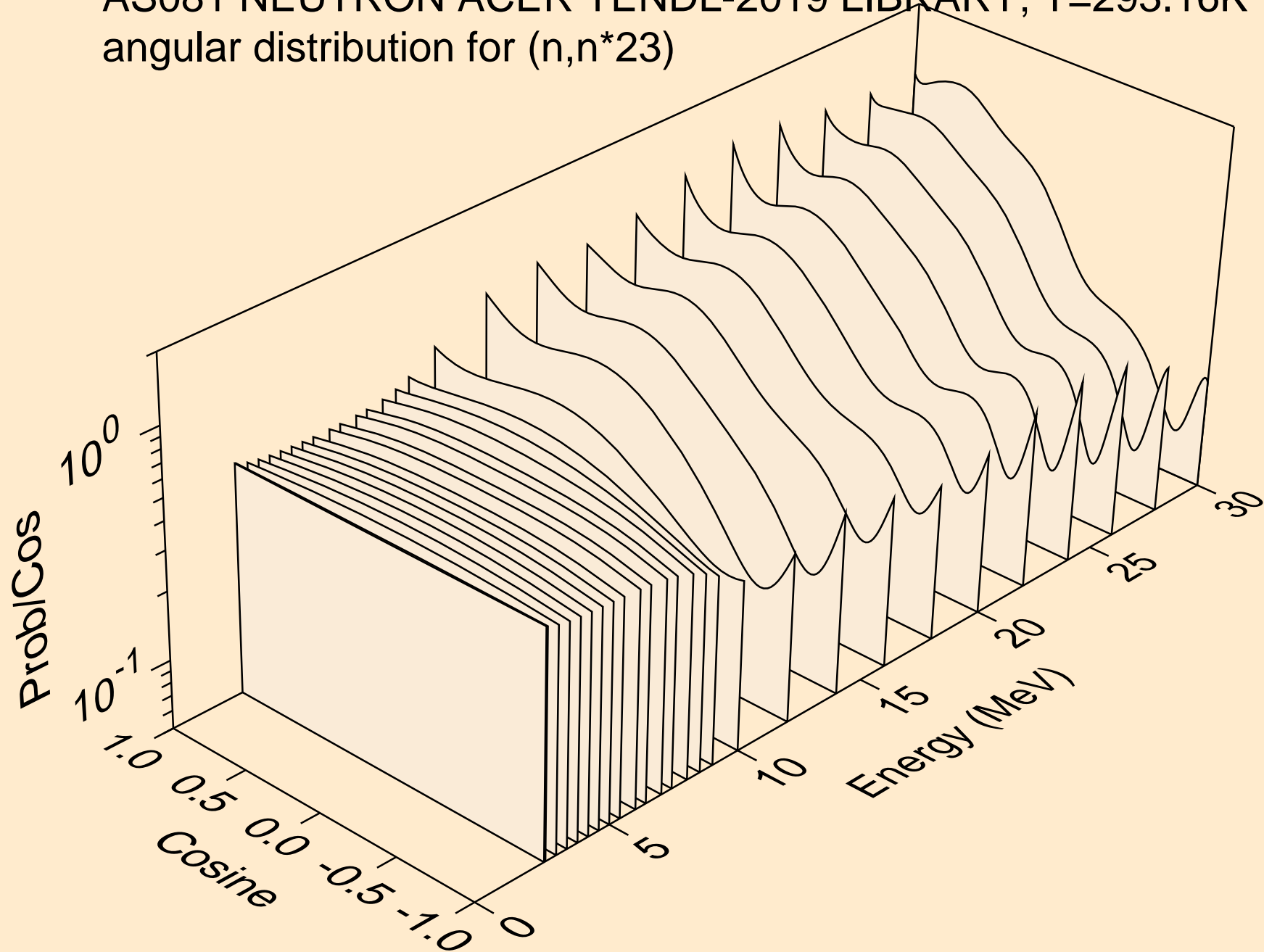

AS081 NEUTRON ACER TENDL-2019 LIBRARY; T=293.16K  
angular distribution for (n,n\*24)

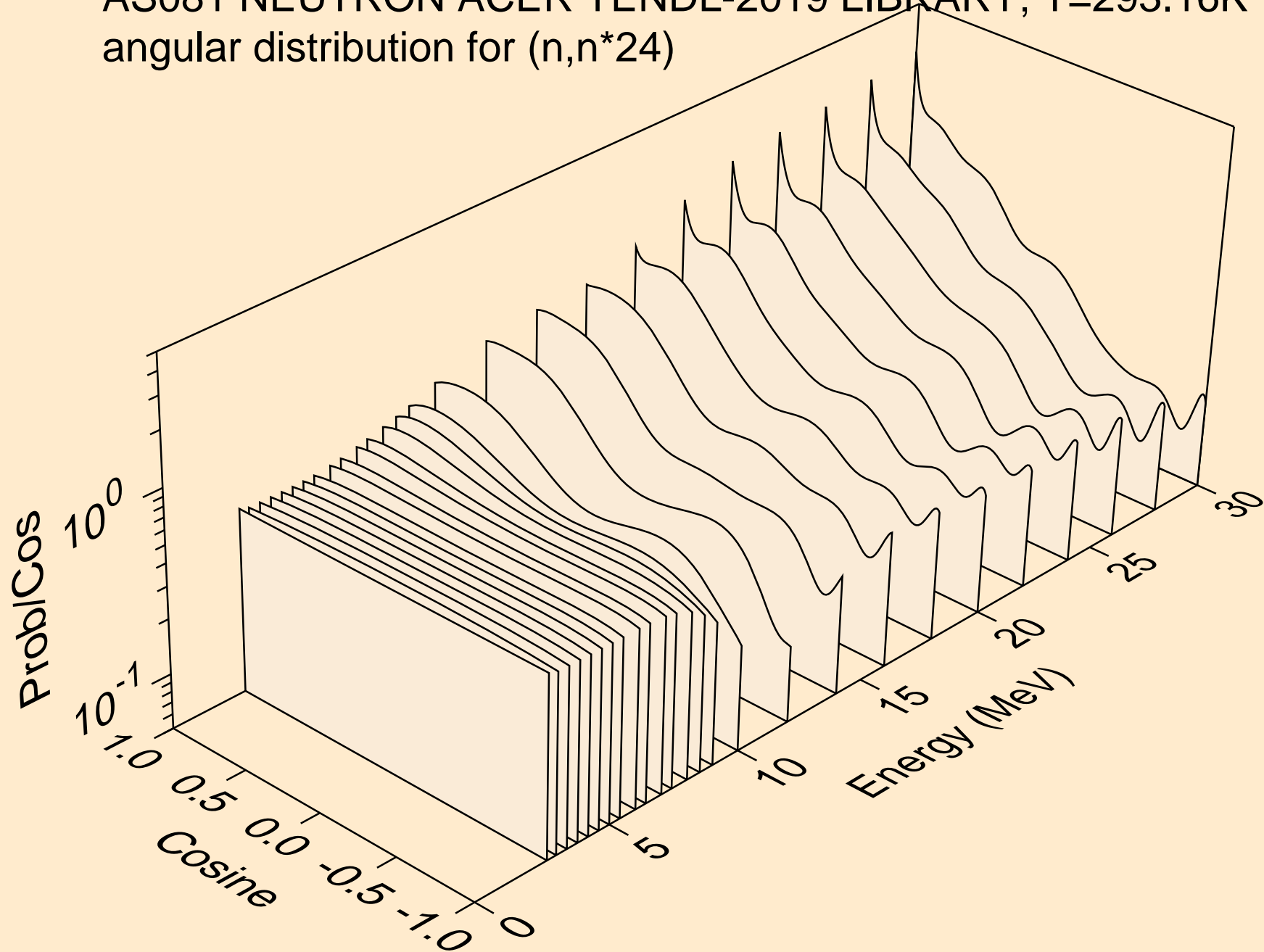

AS081 NEUTRON ACER TENDL-2019 LIBRARY; T=293.16K  
angular distribution for (n,n\*25)

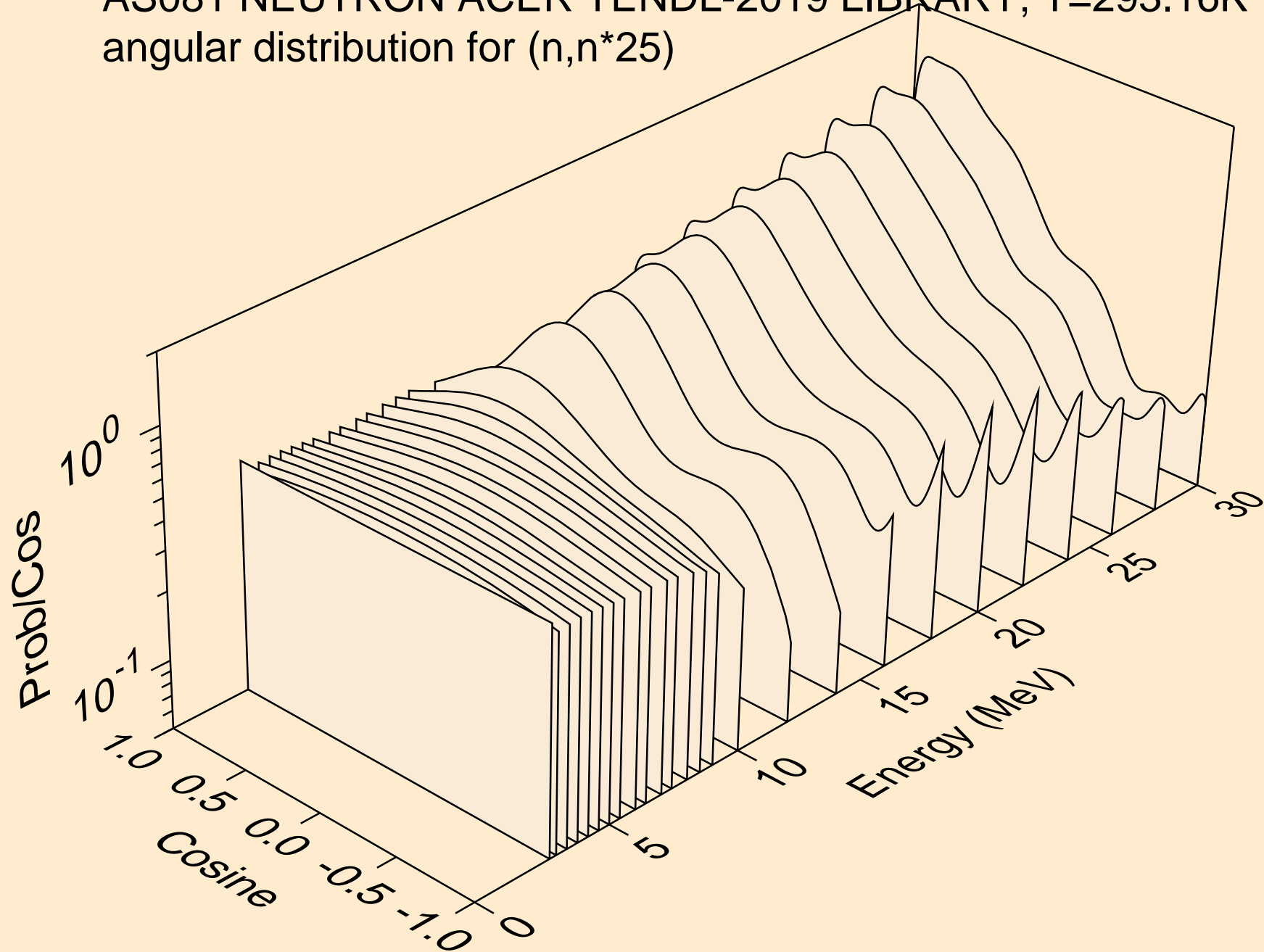

AS081 NEUTRON ACER TENDL-2019 LIBRARY; T=293.16K  
angular distribution for (n,n\*26)

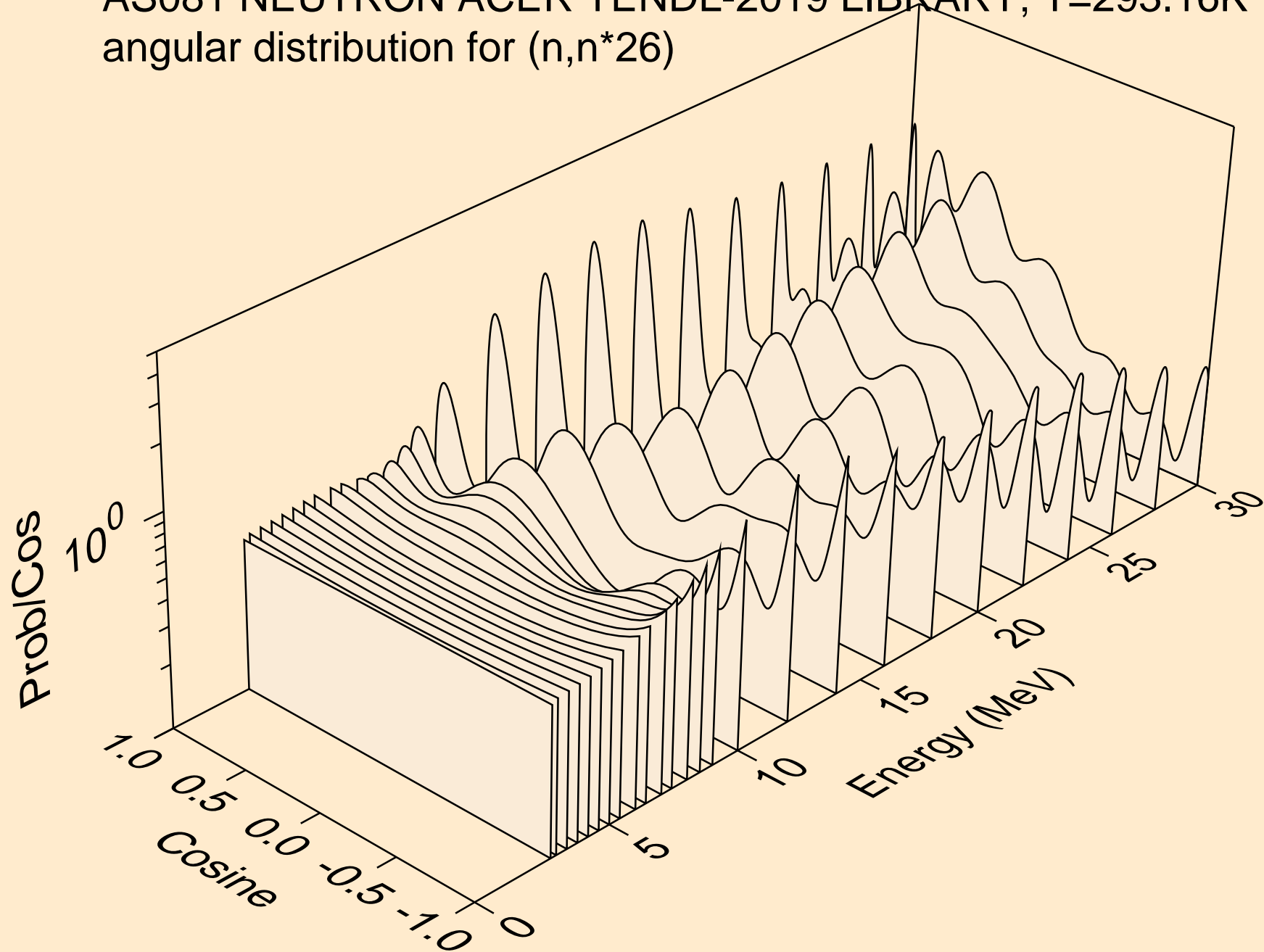



AS081 NEUTRON ACER TENDL-2019 LIBRARY; T=293.16K  
angular distribution for (n,n\*27)

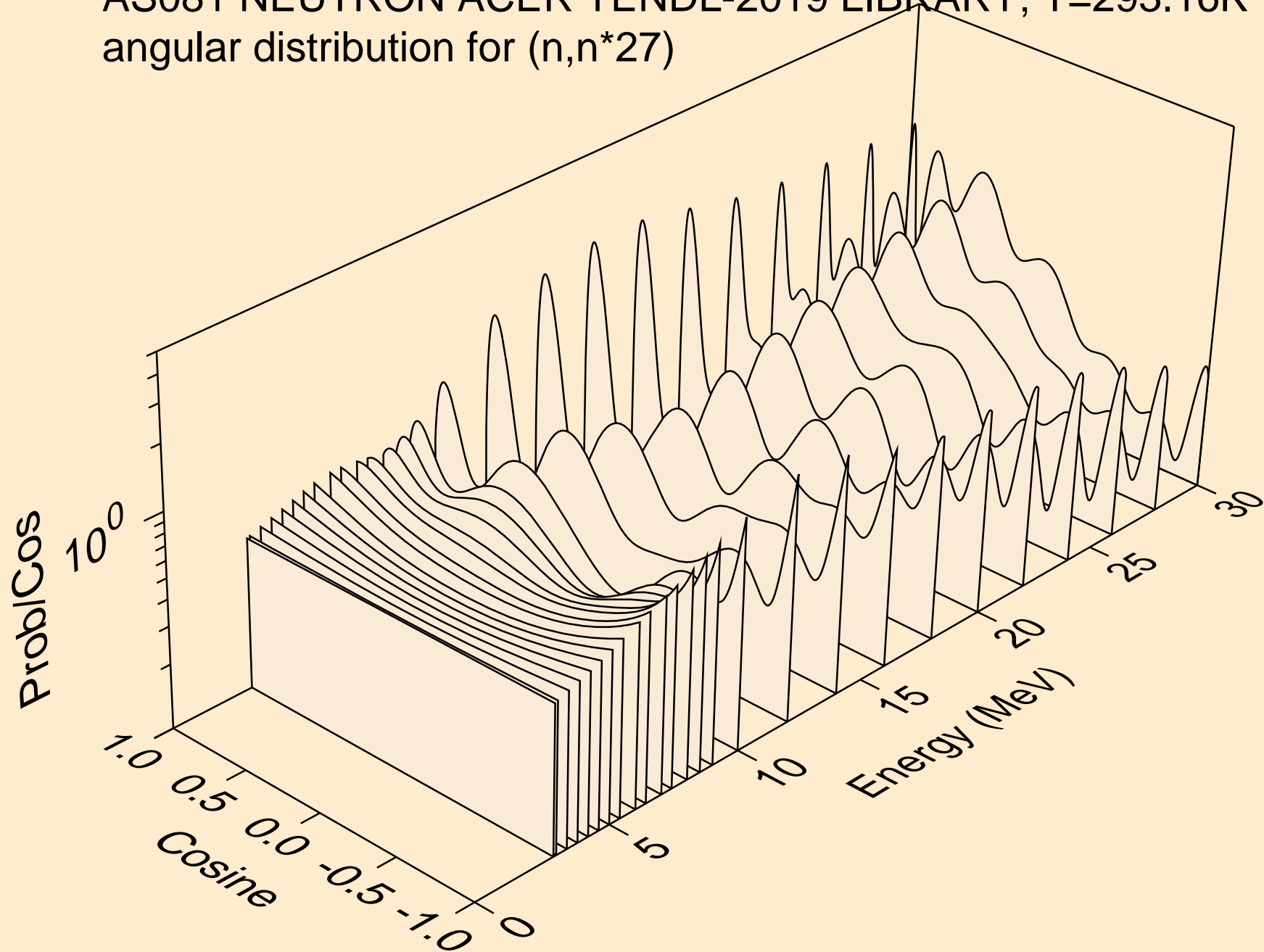

AS081 NEUTRON ACER TENDL-2019 LIBRARY; T=293.16K  
angular distribution for (n,n\*28)

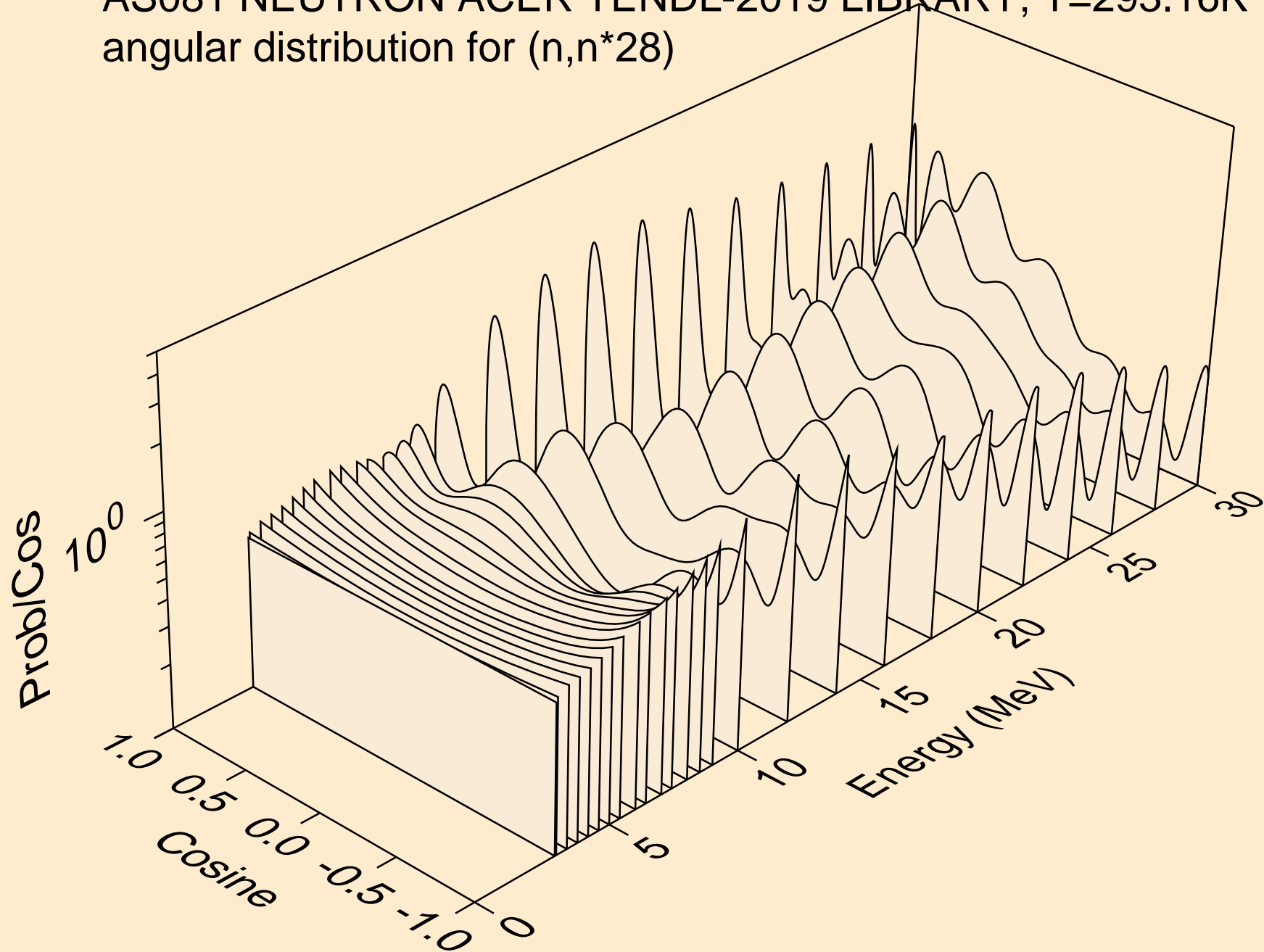

AS081 NEUTRON ACER TENDL-2019 LIBRARY; T=293.16K  
angular distribution for (n,n\*29)

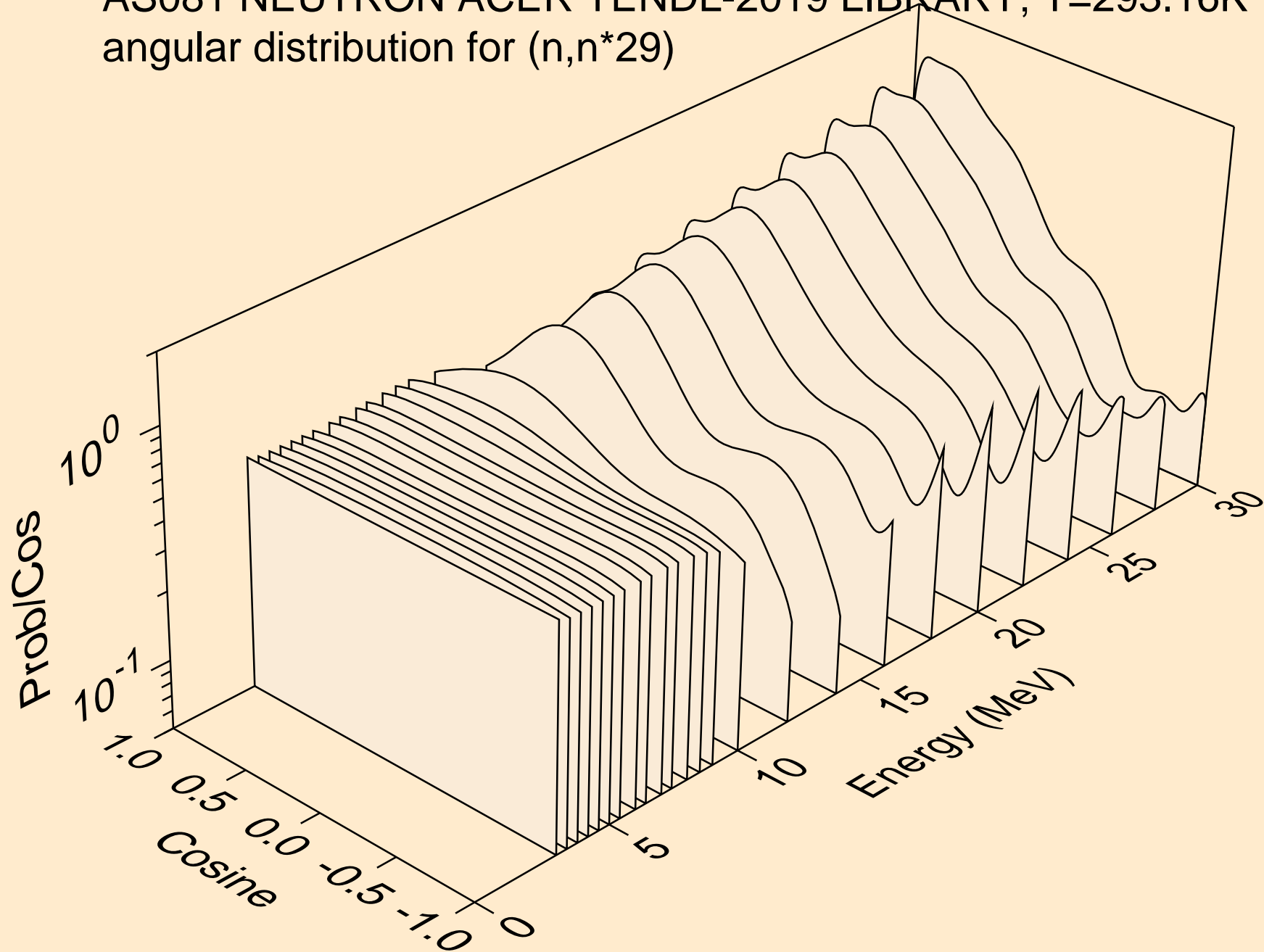

AS081 NEUTRON ACER TENDL-2019 LIBRARY; T=293.16K  
angular distribution for (n,n\*30)

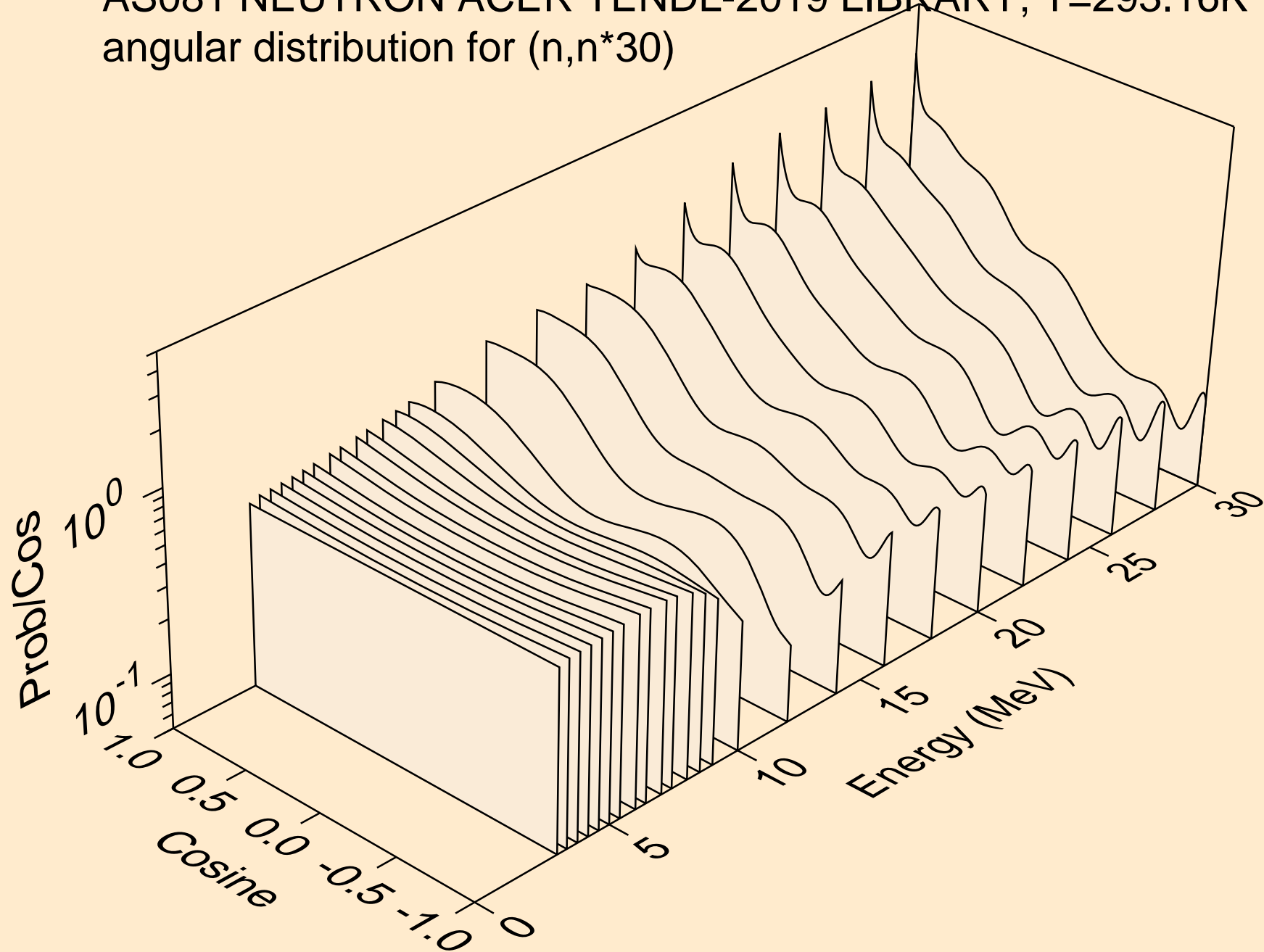

AS081 NEUTRON ACER TENDL-2019 LIBRARY; T=293.16K  
Neutron emission for (n,x)

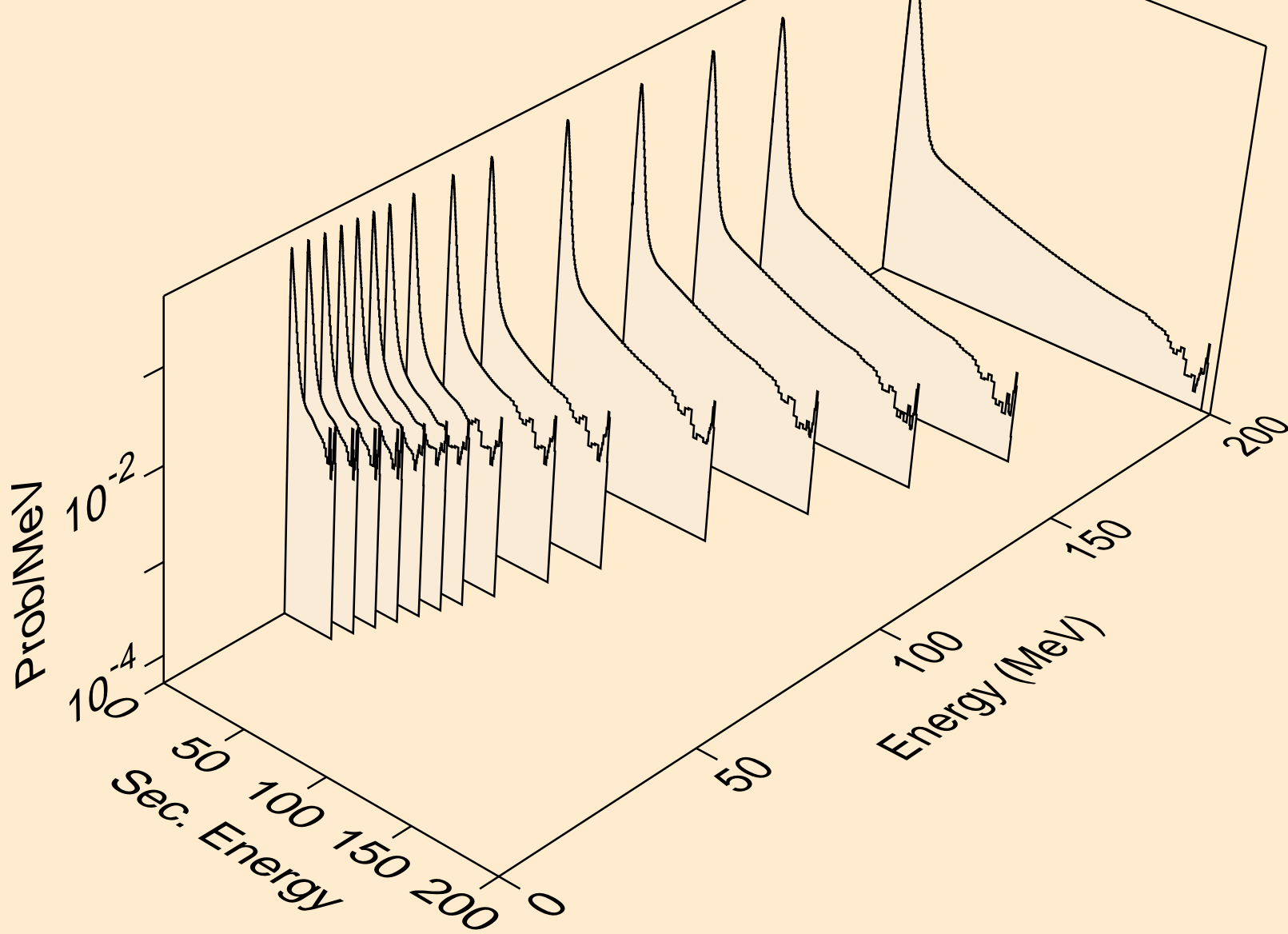

AS081 NEUTRON ACER TENDL-2019 LIBRARY; T=293.16K  
Neutron emission for (n,2nd)

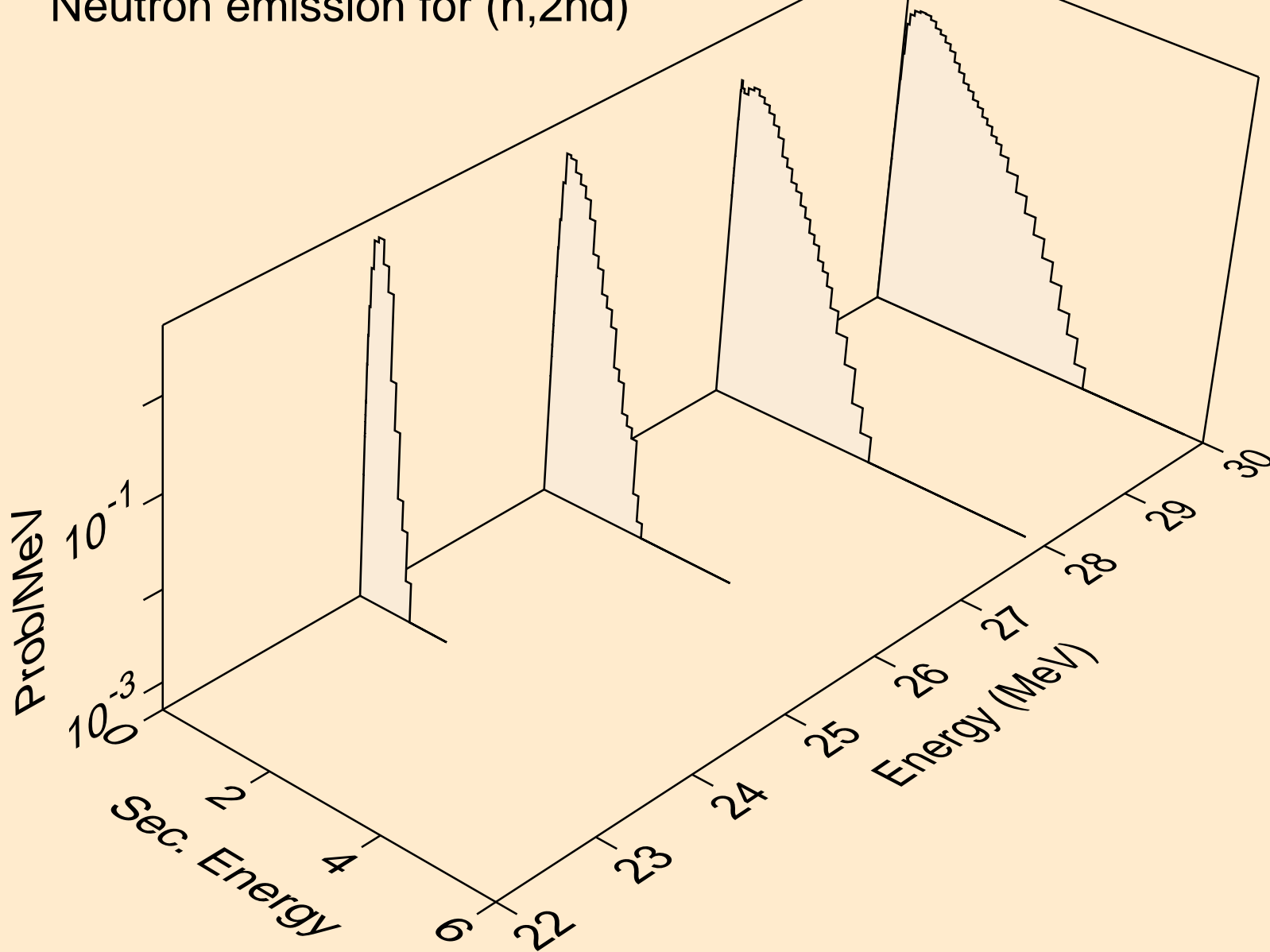

AS081 NEUTRON ACER TENDL-2019 LIBRARY; T=293.16K  
Neutron emission for (n,2n)

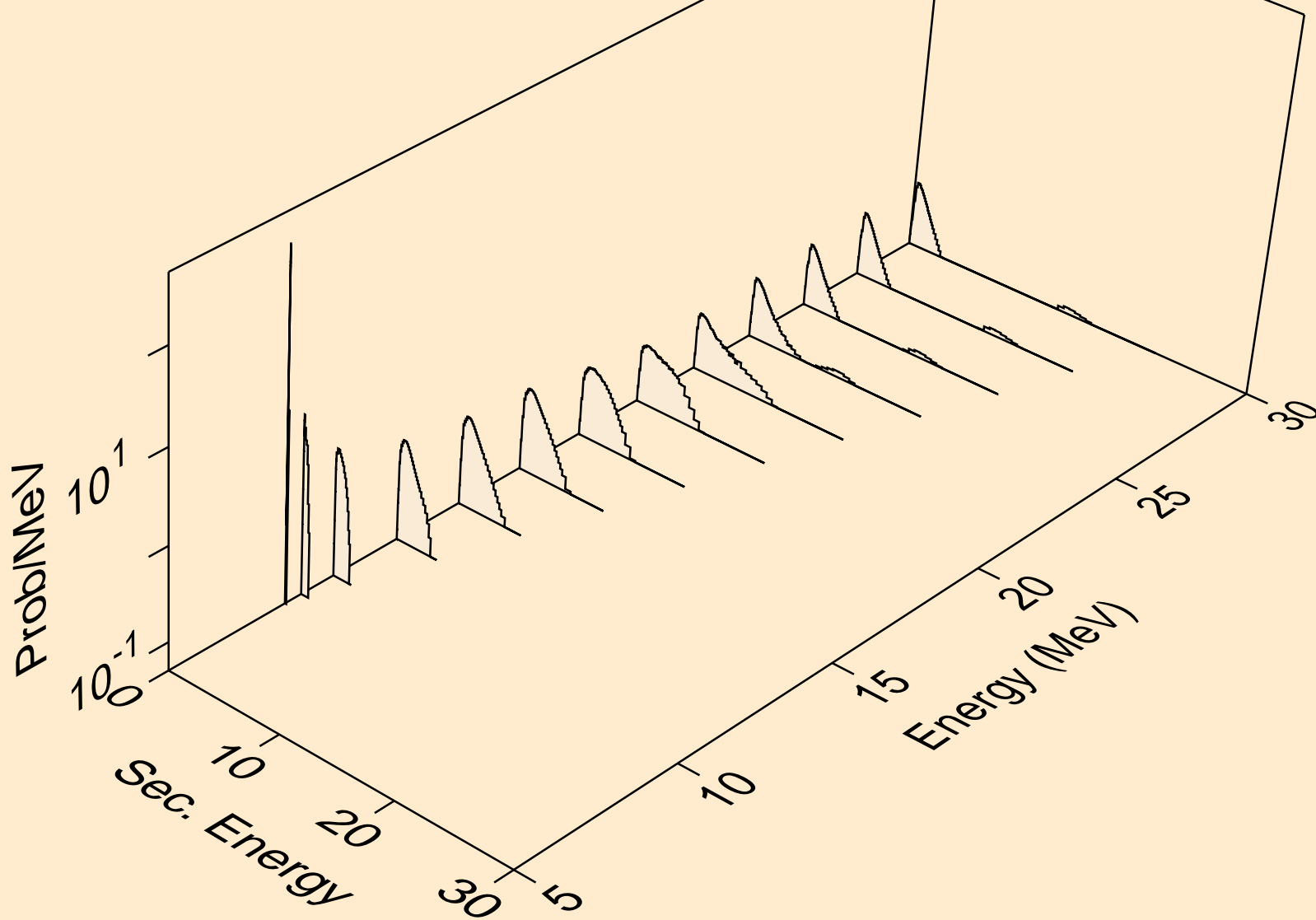

AS081 NEUTRON ACER TENDL-2019 LIBRARY; T=293.16K  
Neutron emission for (n,3n)

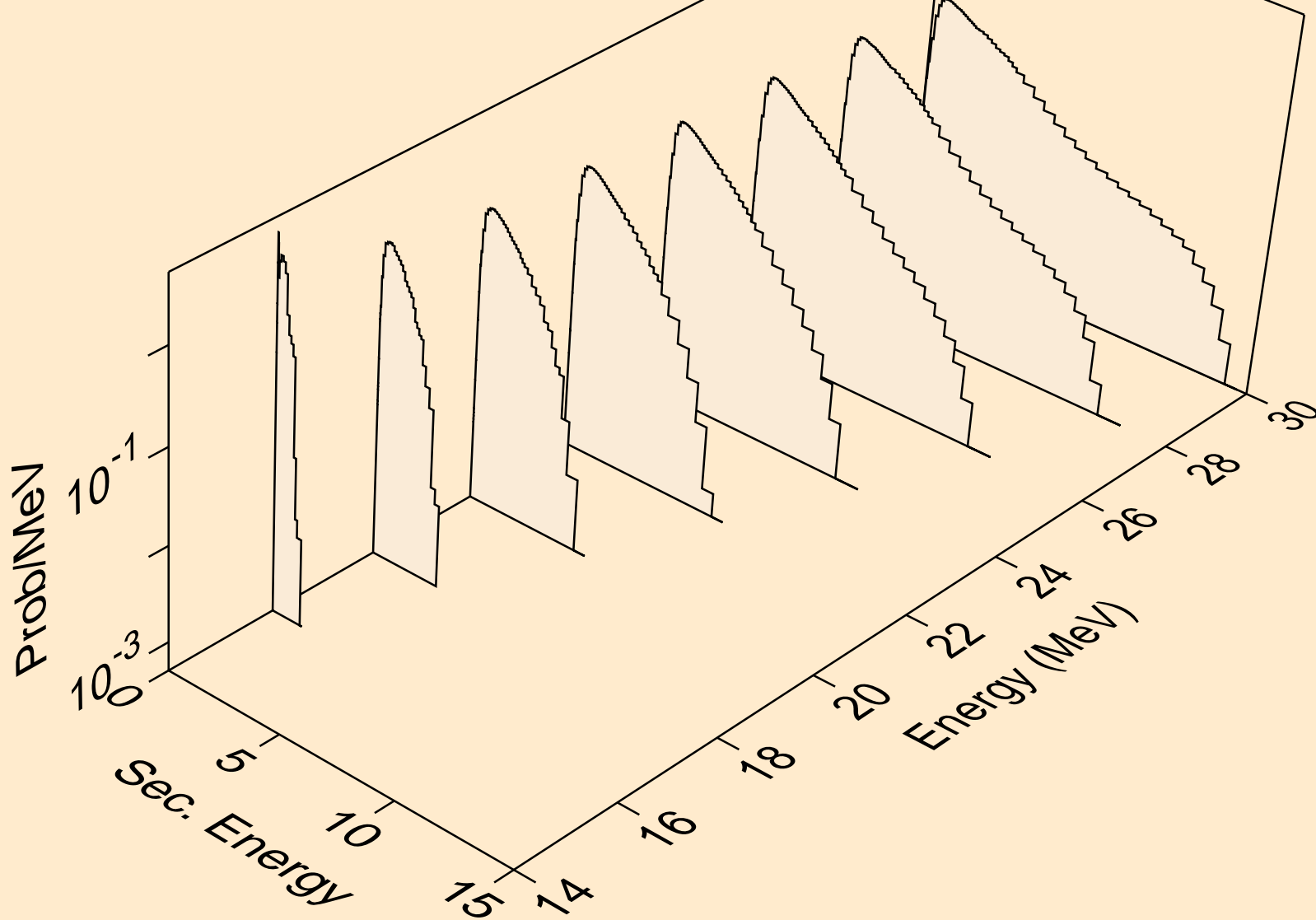



AS081 NEUTRON ACER TENDL-2019 LIBRARY; T=293.16K  
Neutron emission for (n,n\*)a

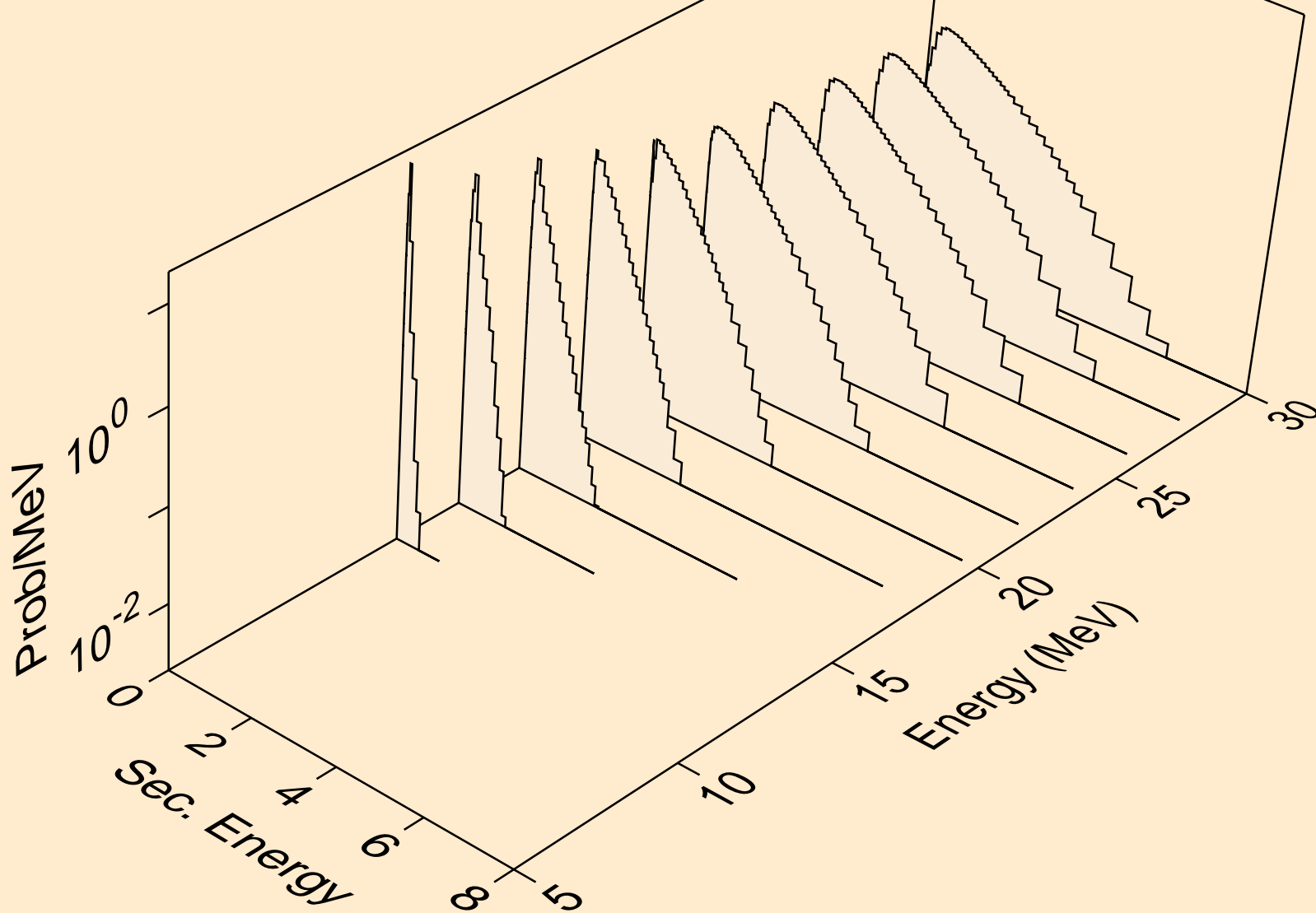

AS081 NEUTRON ACER TENDL-2019 LIBRARY; T=293.16K  
Neutron emission for (n,2n)a

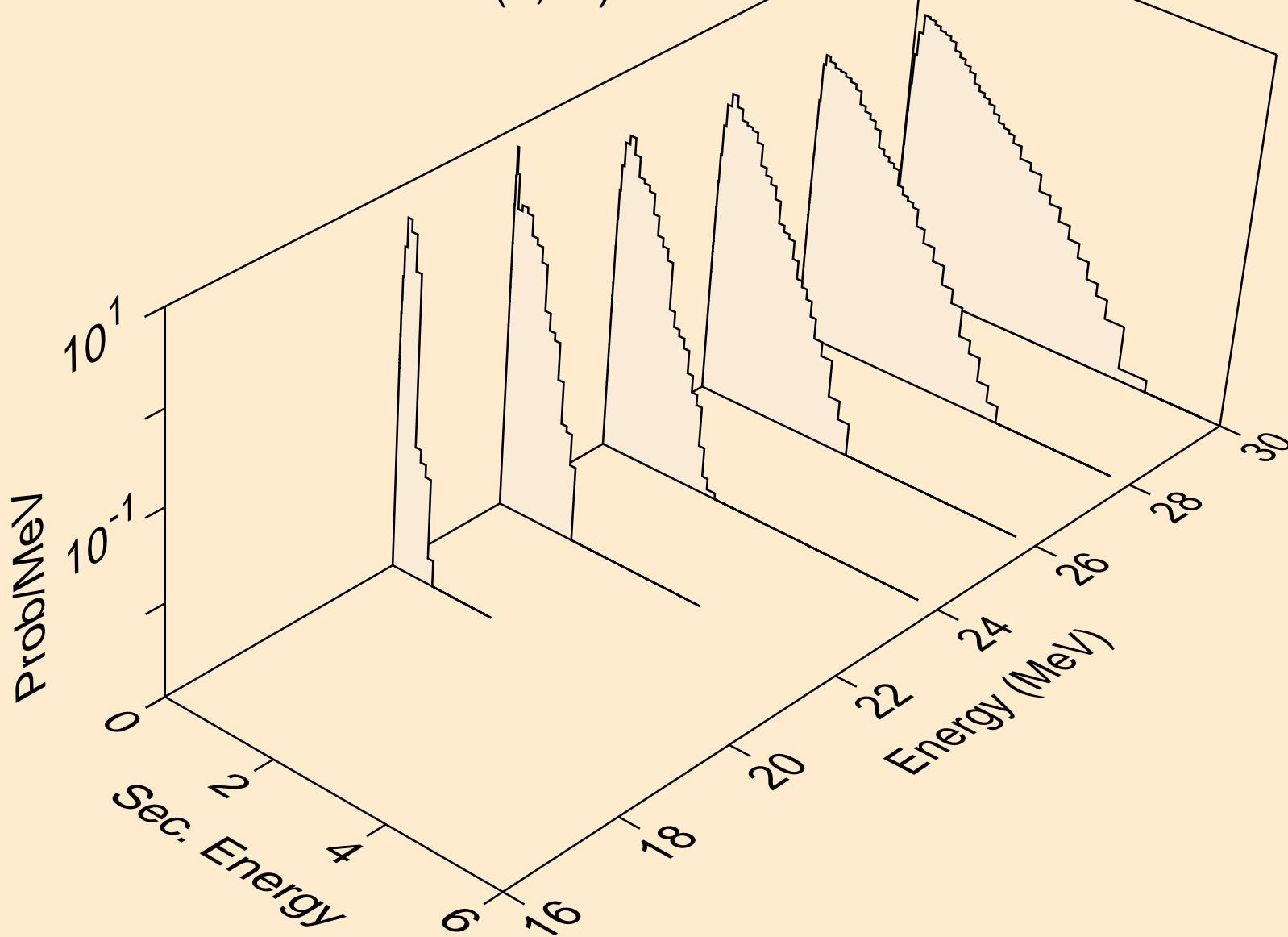

AS081 NEUTRON ACER TENDL-2019 LIBRARY; T=293.16K  
Neutron emission for (n,3n)a

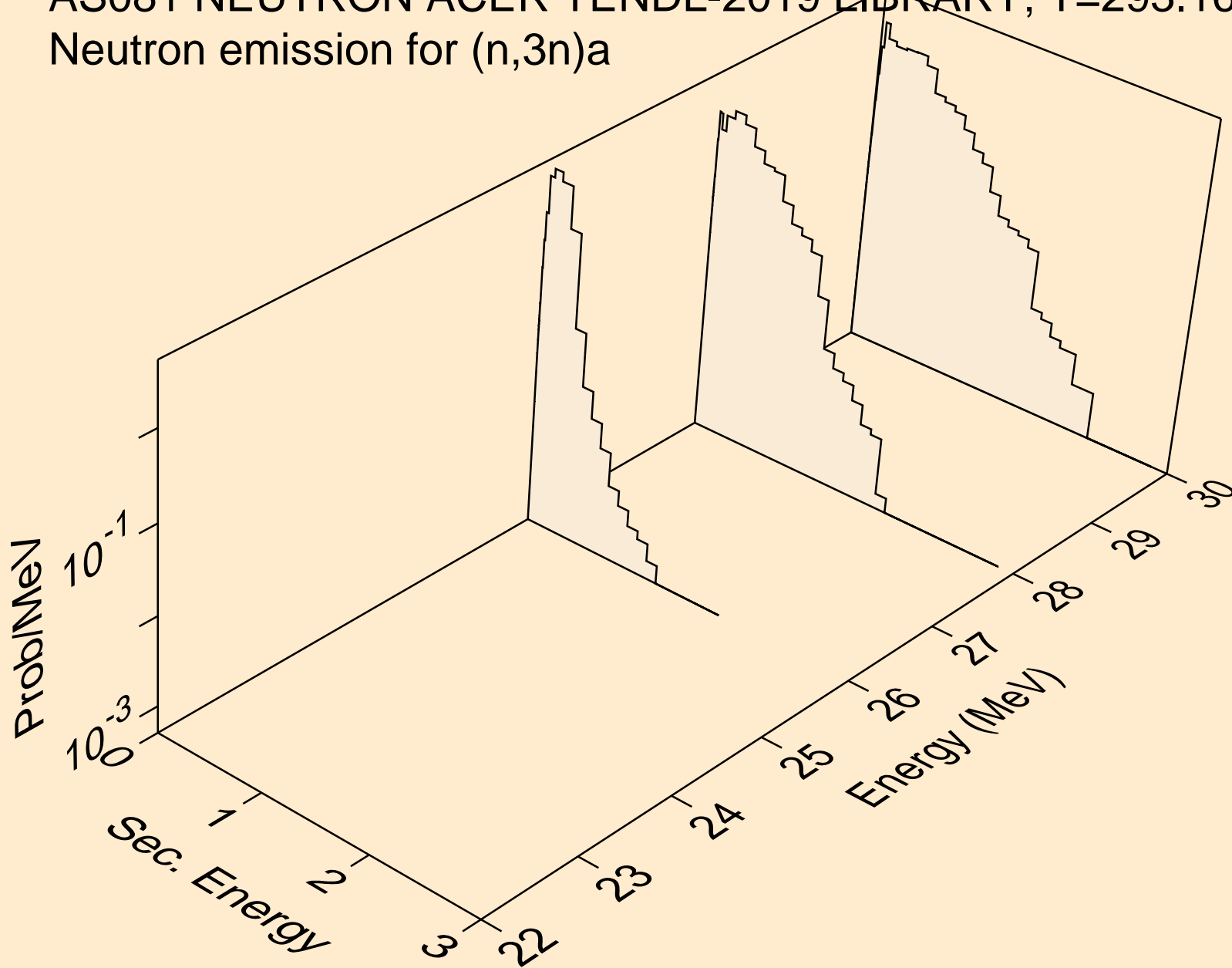

AS081 NEUTRON ACER TENDL-2019 LIBRARY; T=293.16K  
Neutron emission for (n,n\*)p

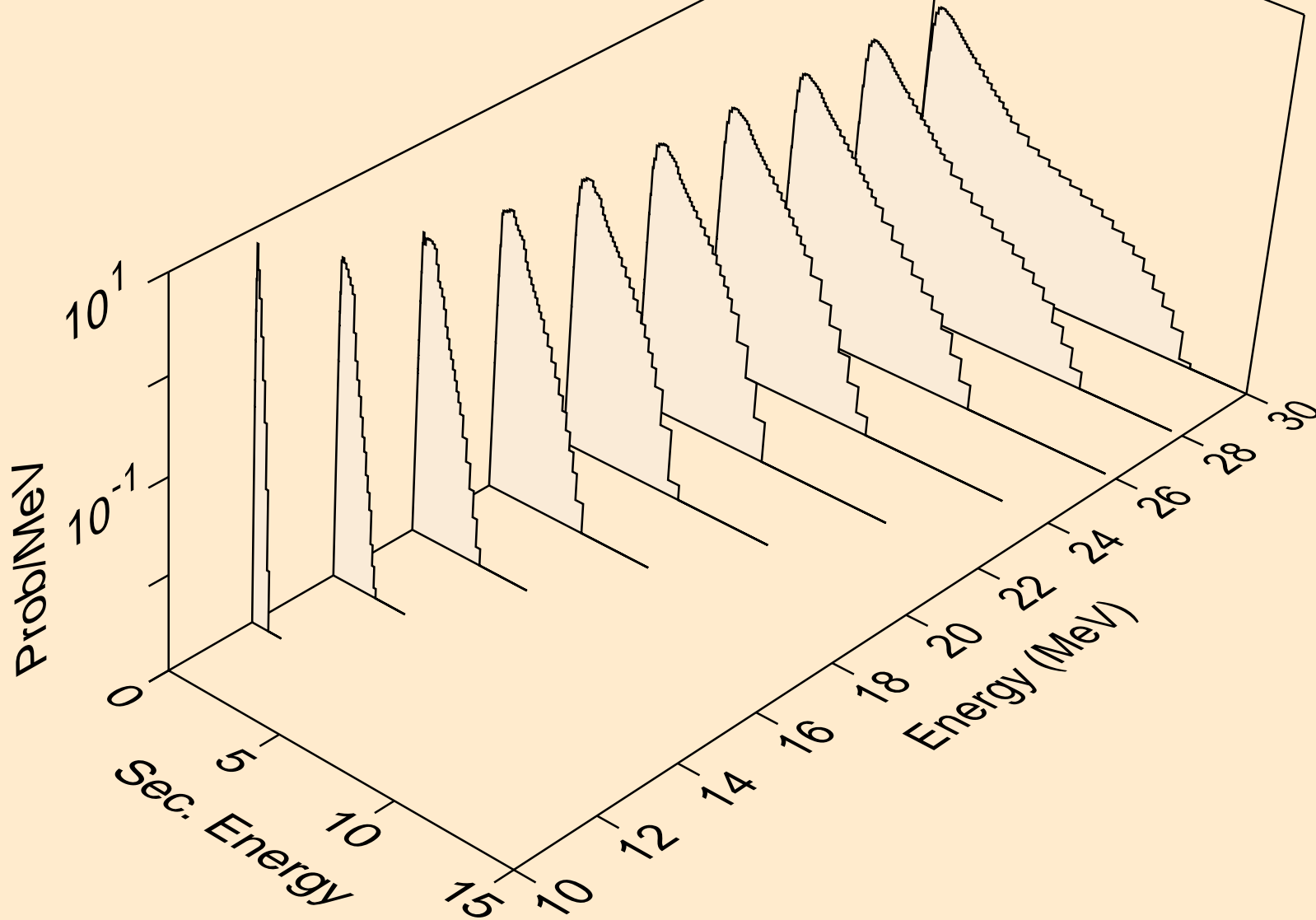

AS081 NEUTRON ACER TENDL-2019 LIBRARY; T=293.16K  
Neutron emission for (n,n\*)d

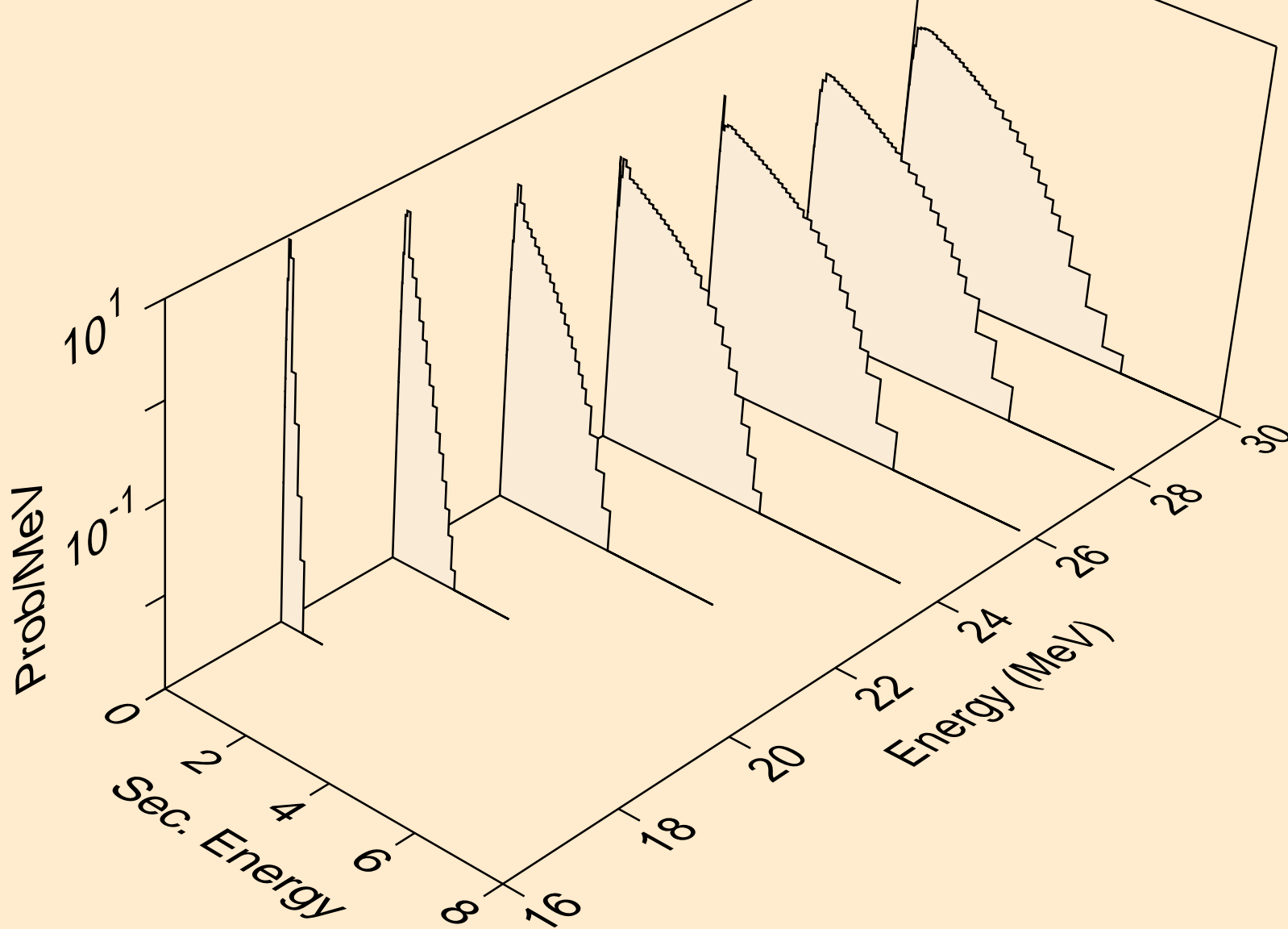

AS081 NEUTRON ACER TENDL-2019 LIBRARY; T=293.16K  
Neutron emission for (n,n\*)t

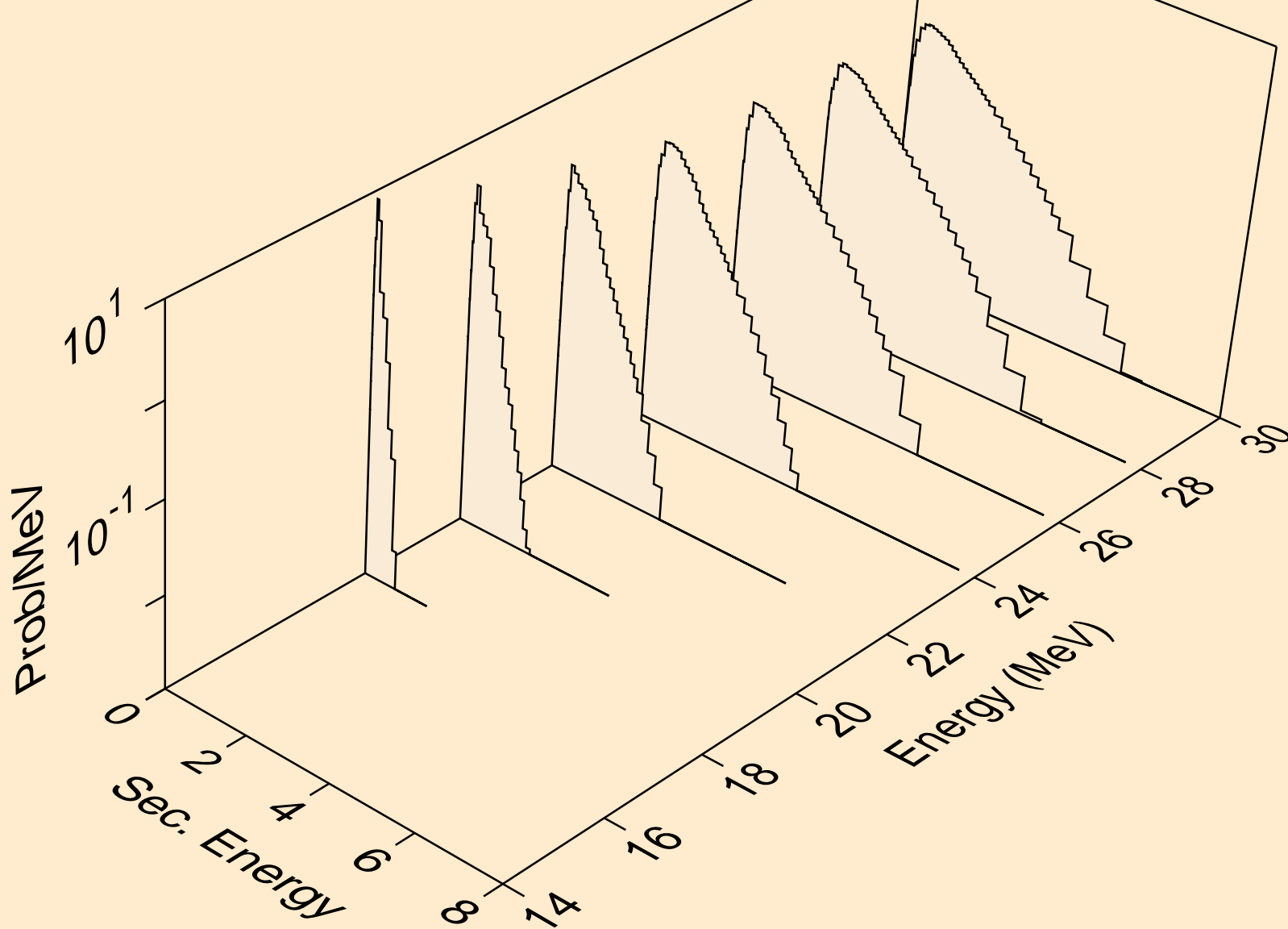

AS081 NEUTRON ACER TENDL-2019 LIBRARY; T=293.16K  
Neutron emission for (n,n\*)he3

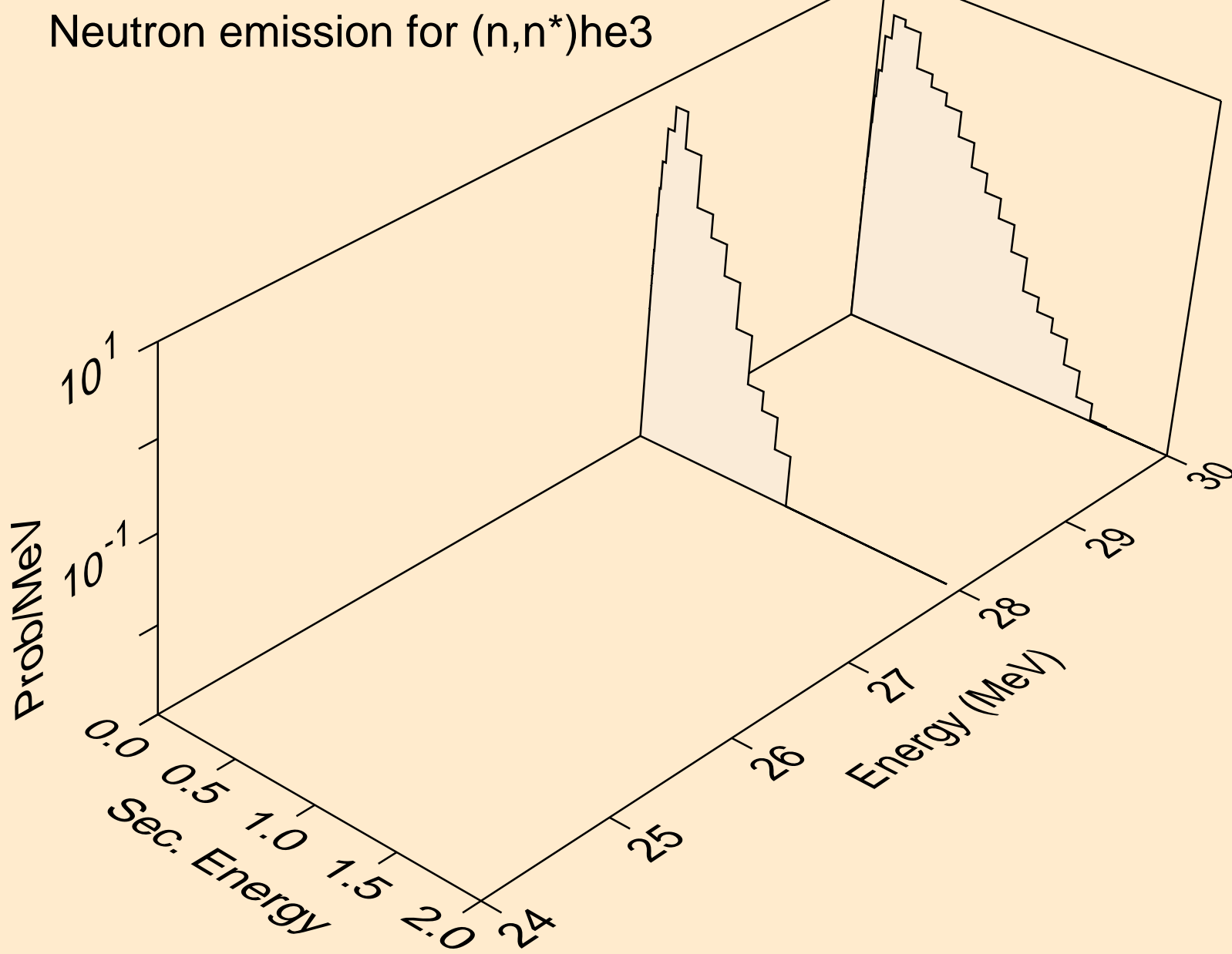

AS081 NEUTRON ACER TENDL-2019 LIBRARY; T=293.16K  
Neutron emission for (n,4n)

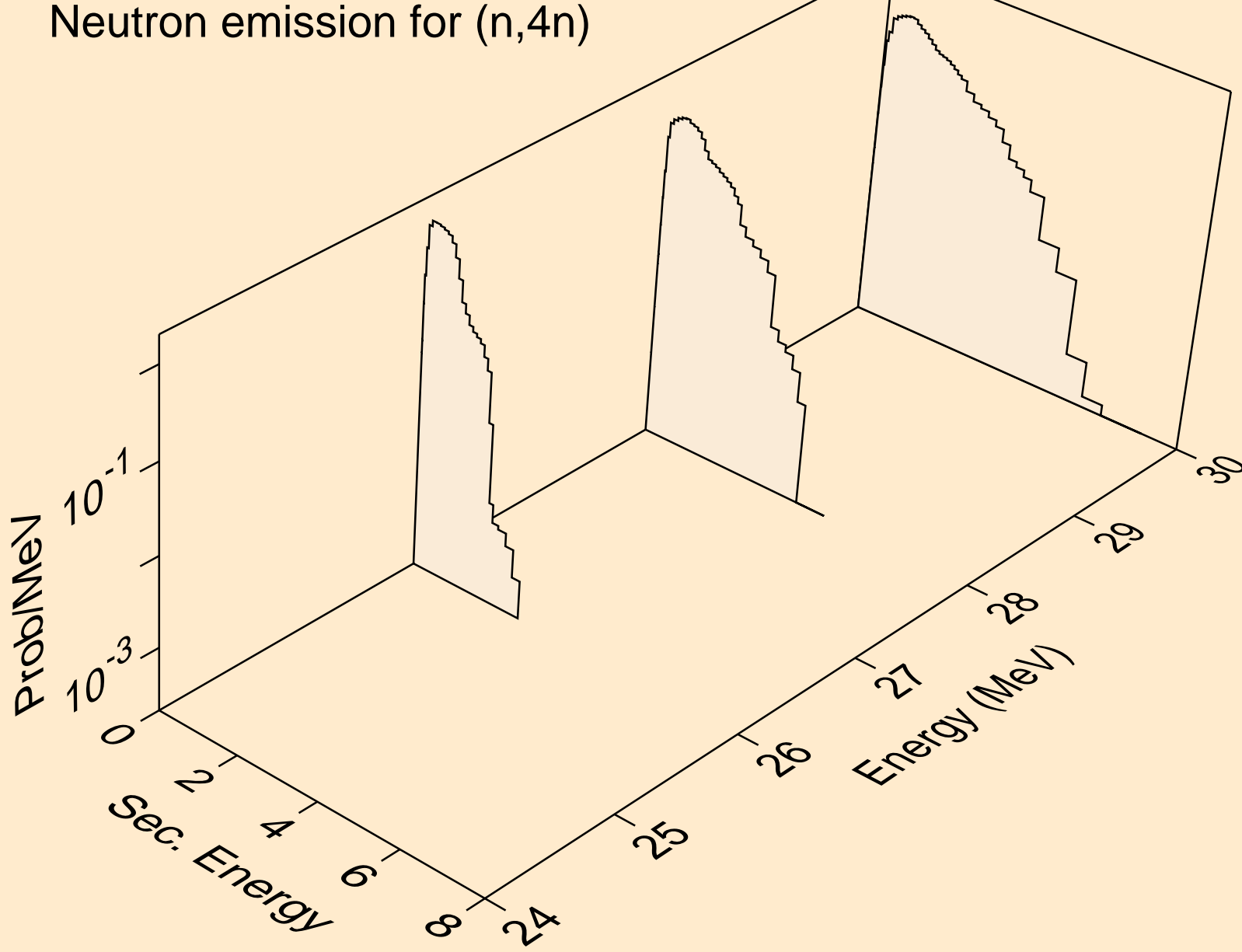



AS081 NEUTRON ACER TENDL-2019 LIBRARY; T=293.16K  
Neutron emission for (n,2np)

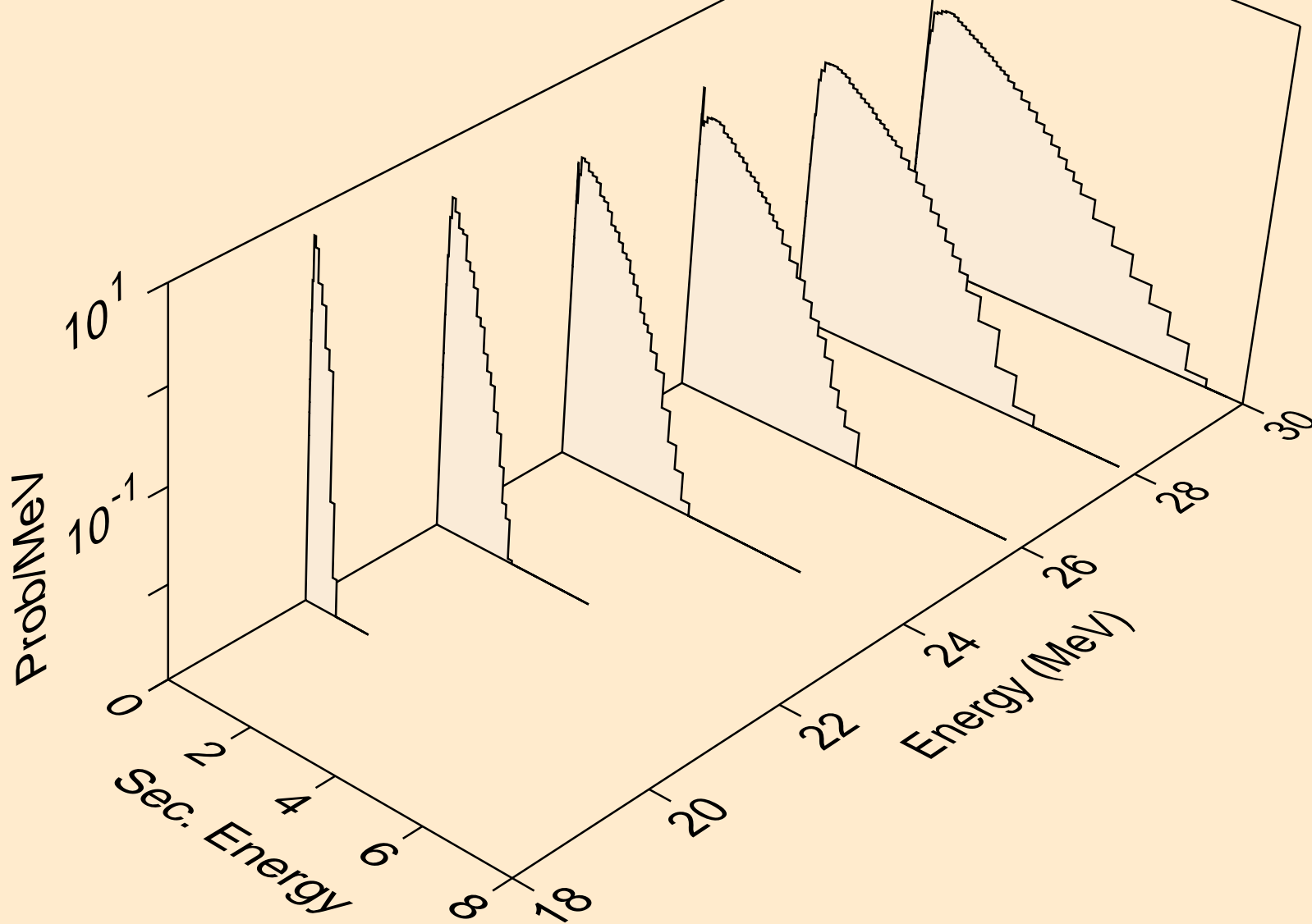

AS081 NEUTRON ACER TENDL-2019 LIBRARY; T=293.16K  
Neutron emission for (n,3np)

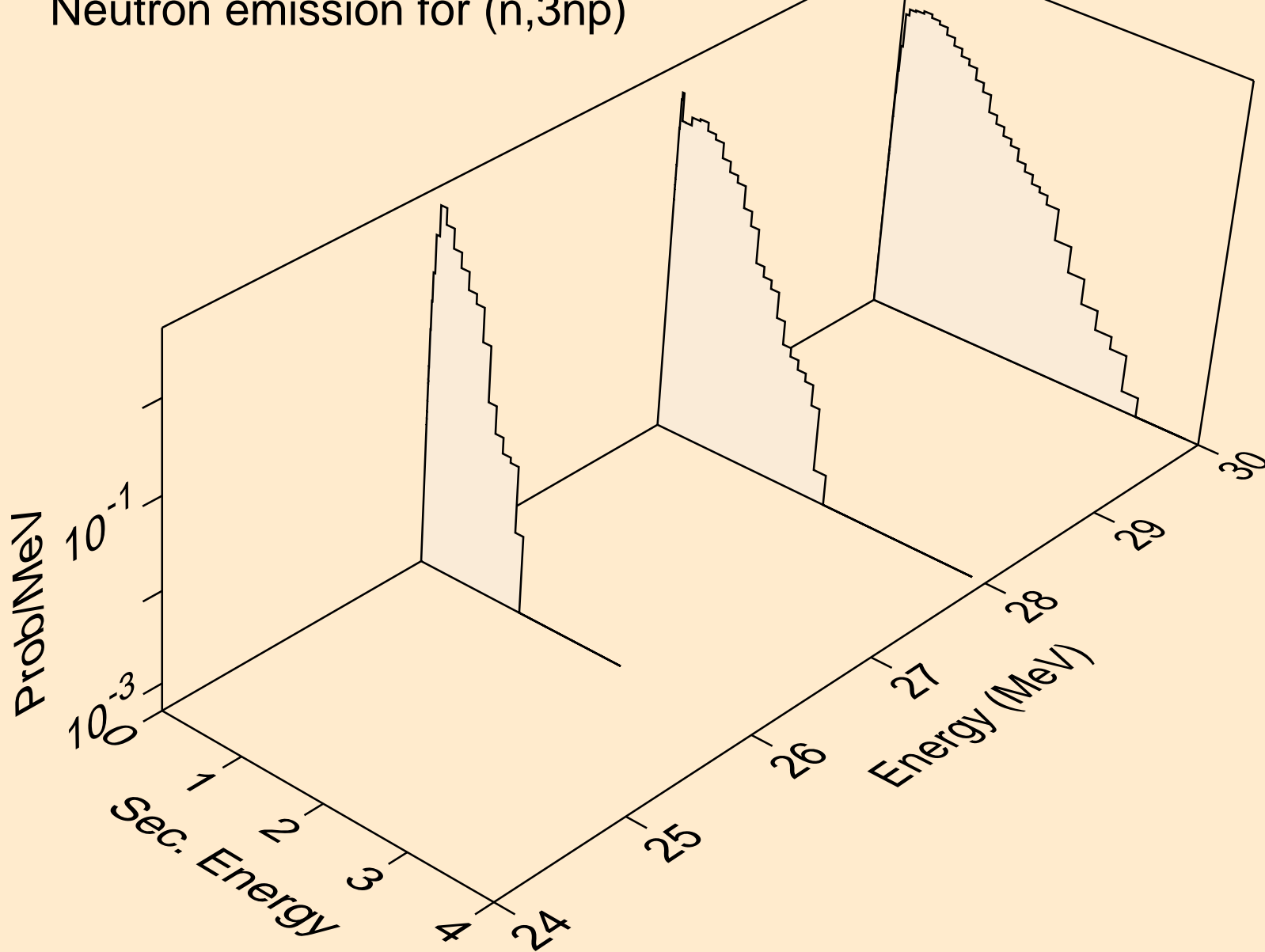

AS081 NEUTRON ACER TENDL-2019 LIBRARY; T=293.16K  
Neutron emission for (n,n\*c)

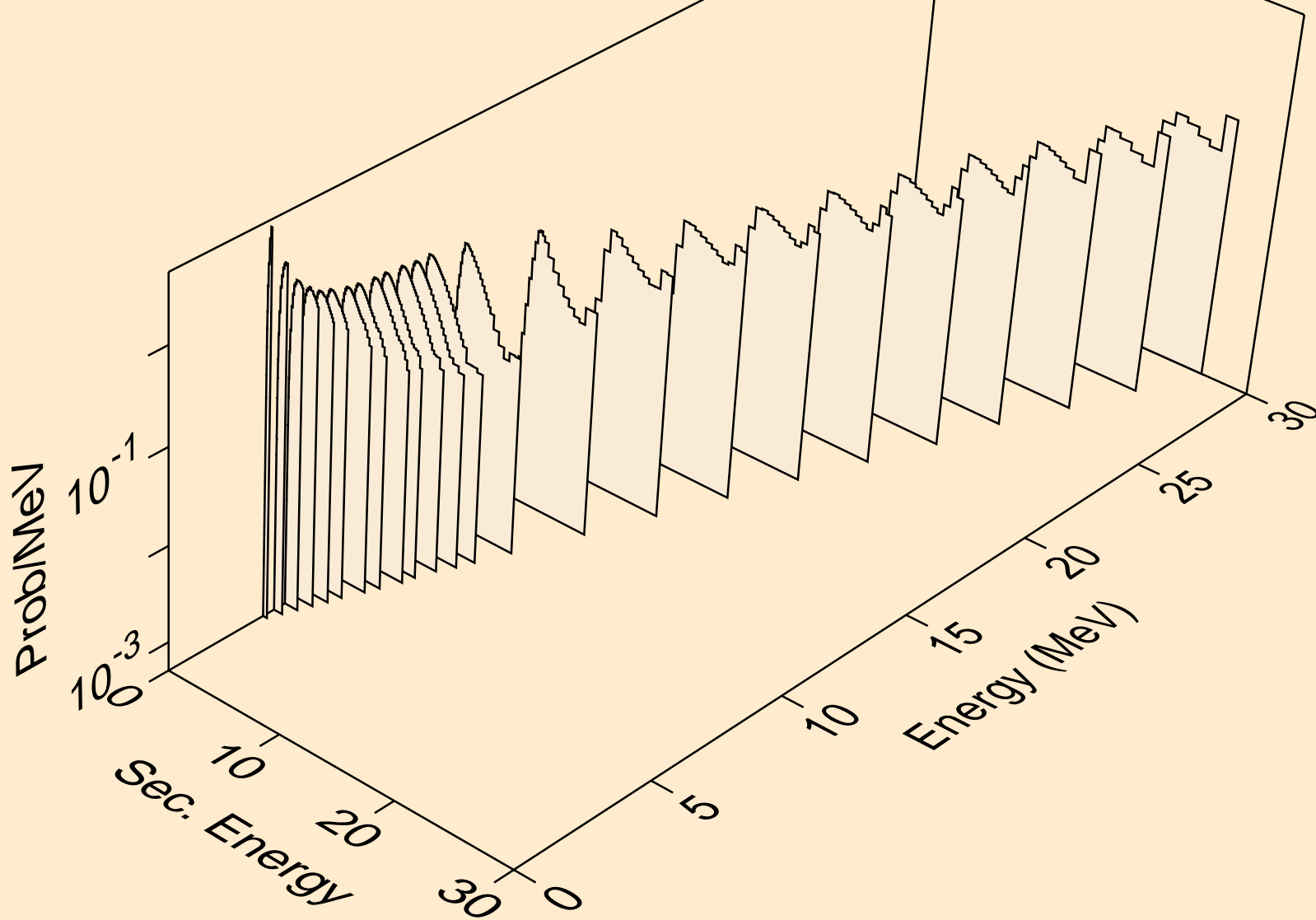

AS081 NEUTRON ACER TENDL-2019 LIBRARY; T=293.16K  
Photon emission for (n,x)

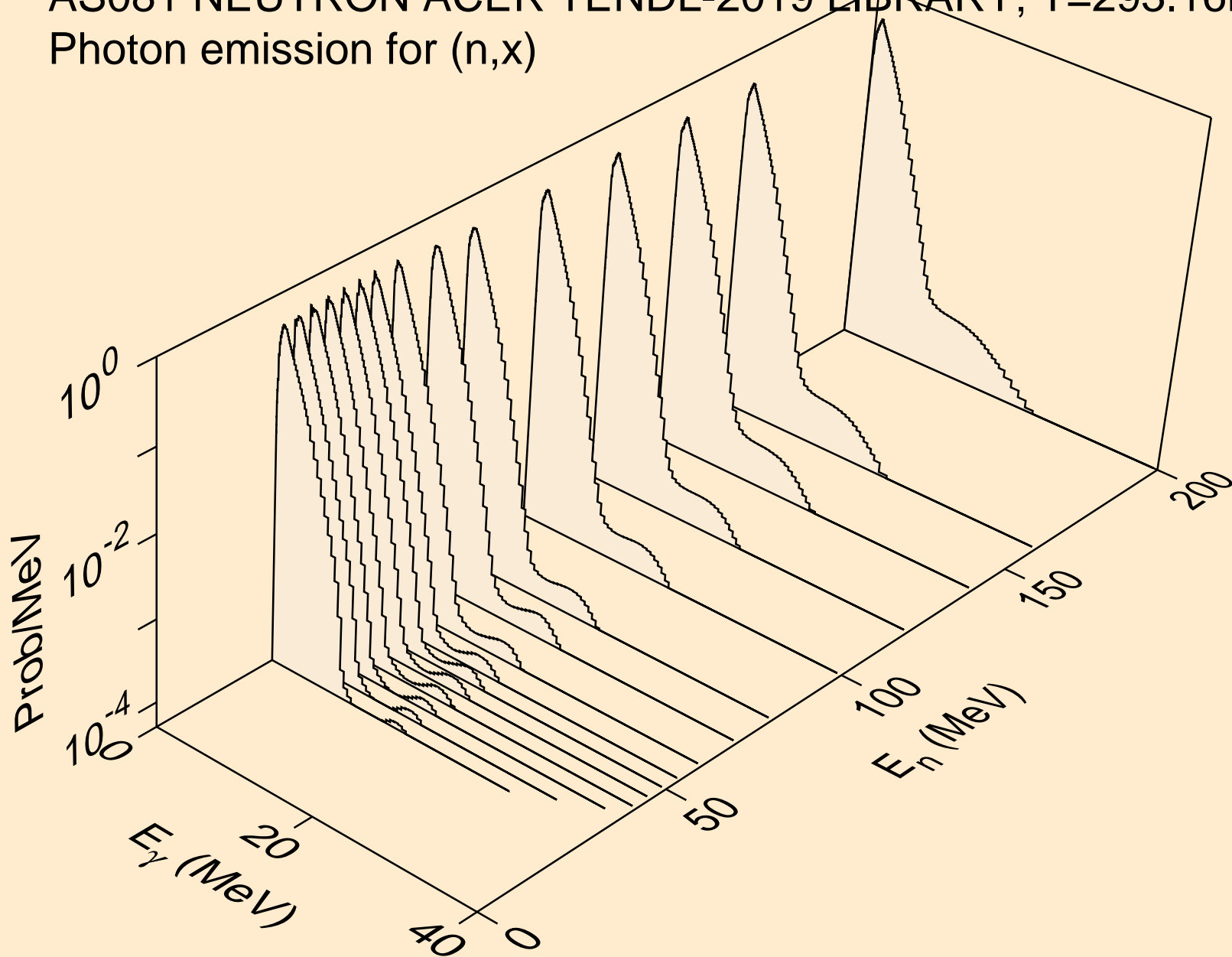

AS081 NEUTRON ACER TENDL-2019 LIBRARY; T=293.16K  
Photon emission for (n,2nd)

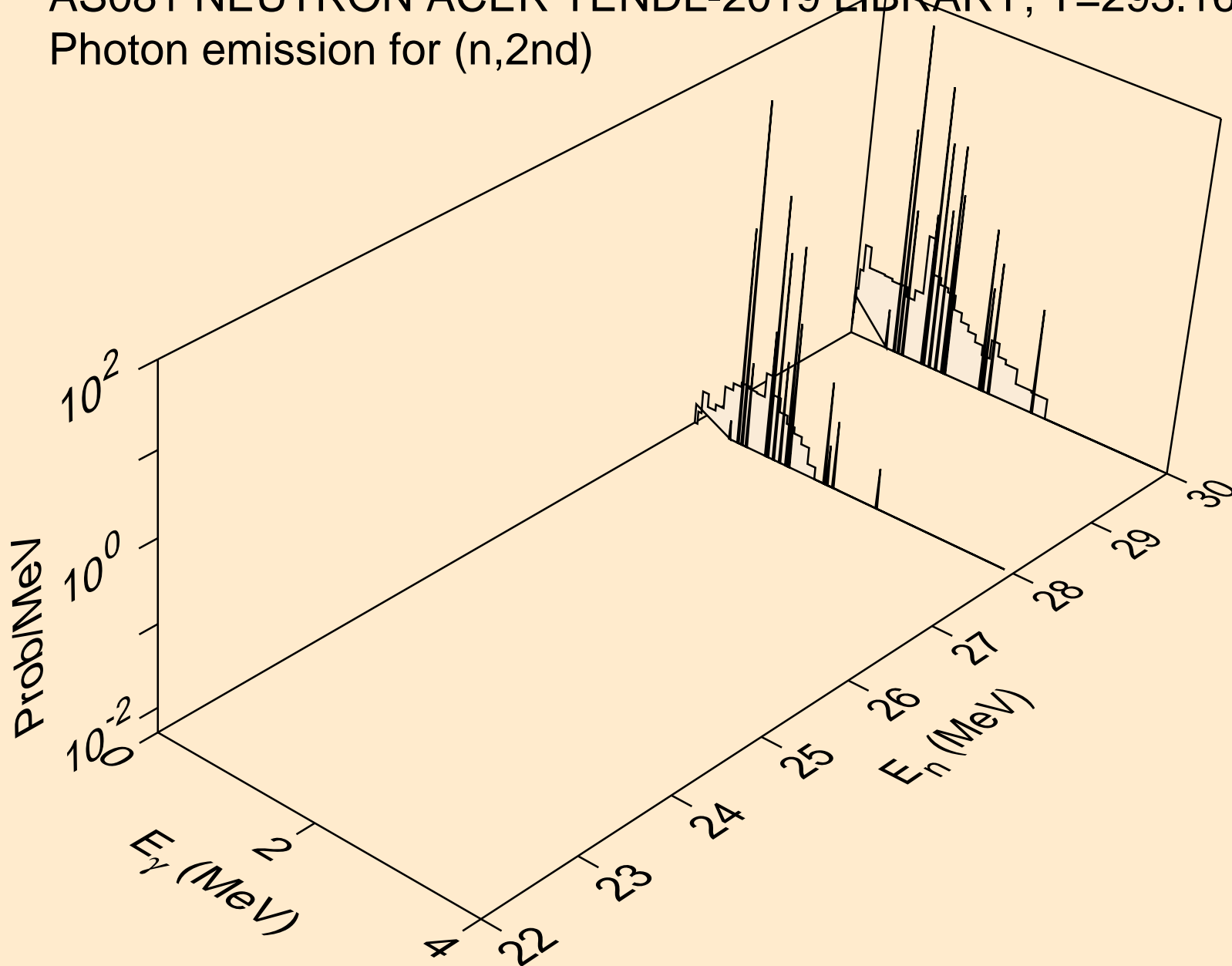

AS081 NEUTRON ACER TENDL-2019 LIBRARY; T=293.16K  
Photon emission for (n,2n)

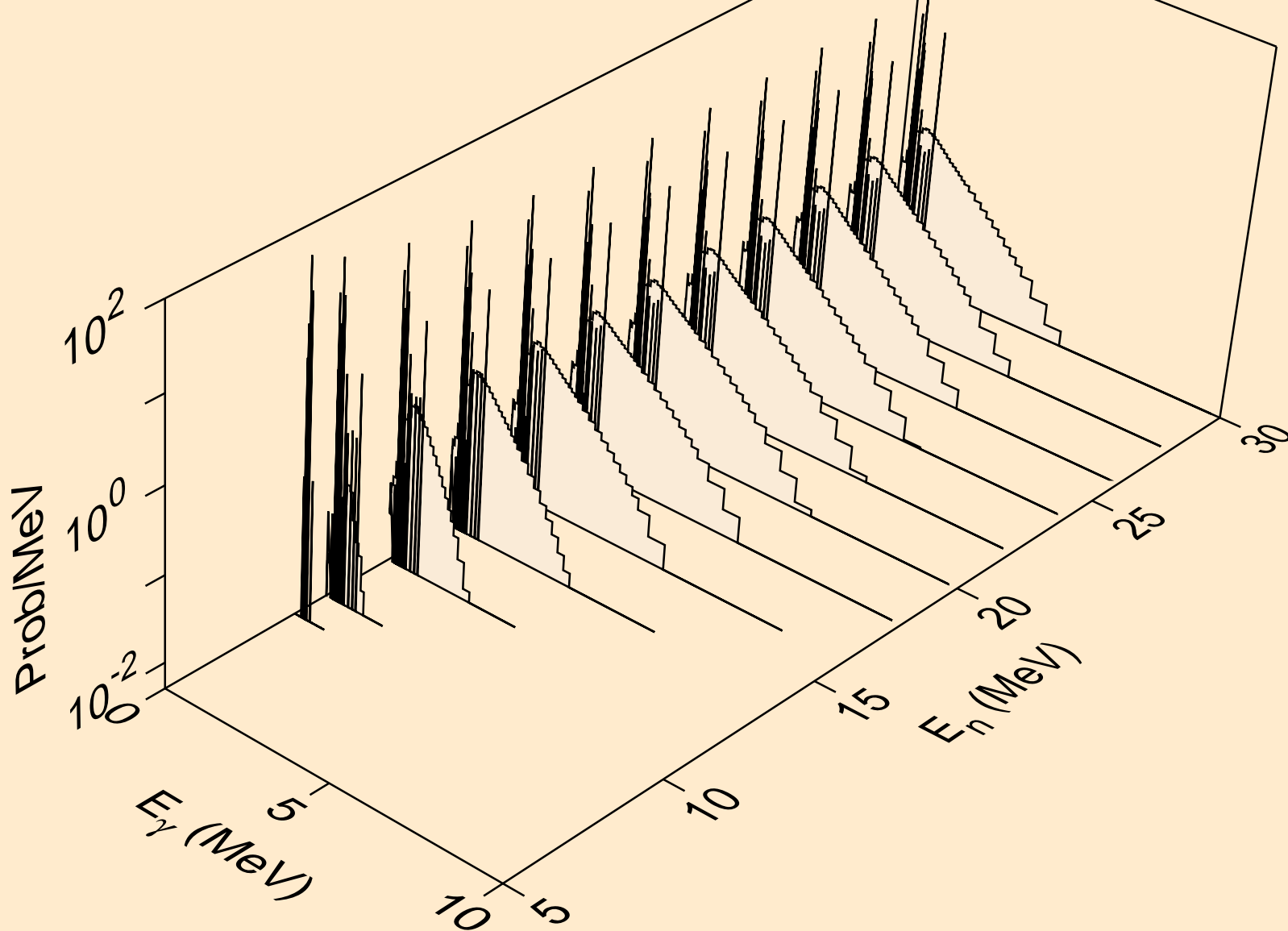

AS081 NEUTRON ACER TENDL-2019 LIBRARY; T=293.16K  
Photon emission for (n,3n)

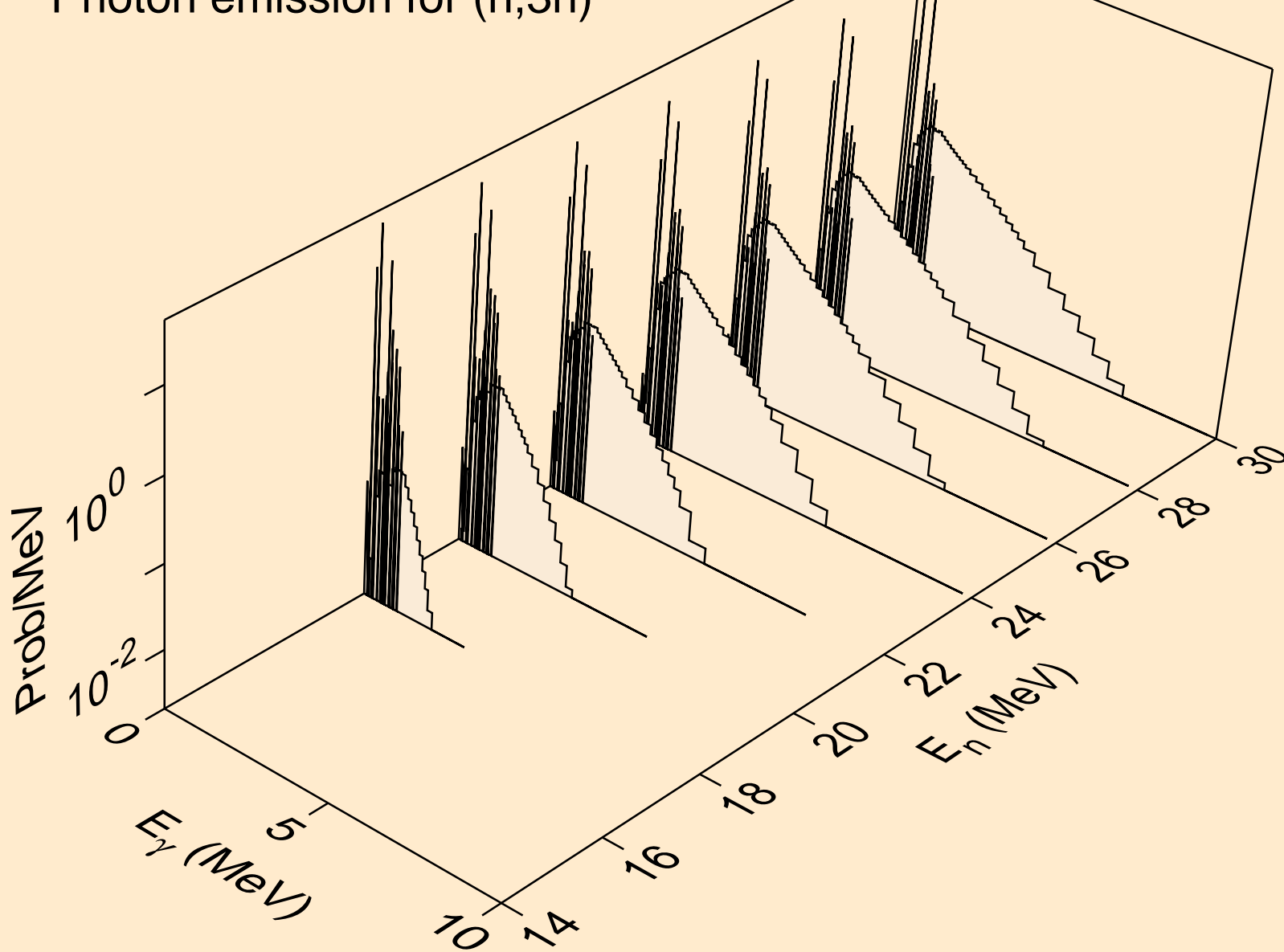

AS081 NEUTRON ACER TENDL-2019 LIBRARY; T=293.16K  
Photon emission for (n,n\*)a

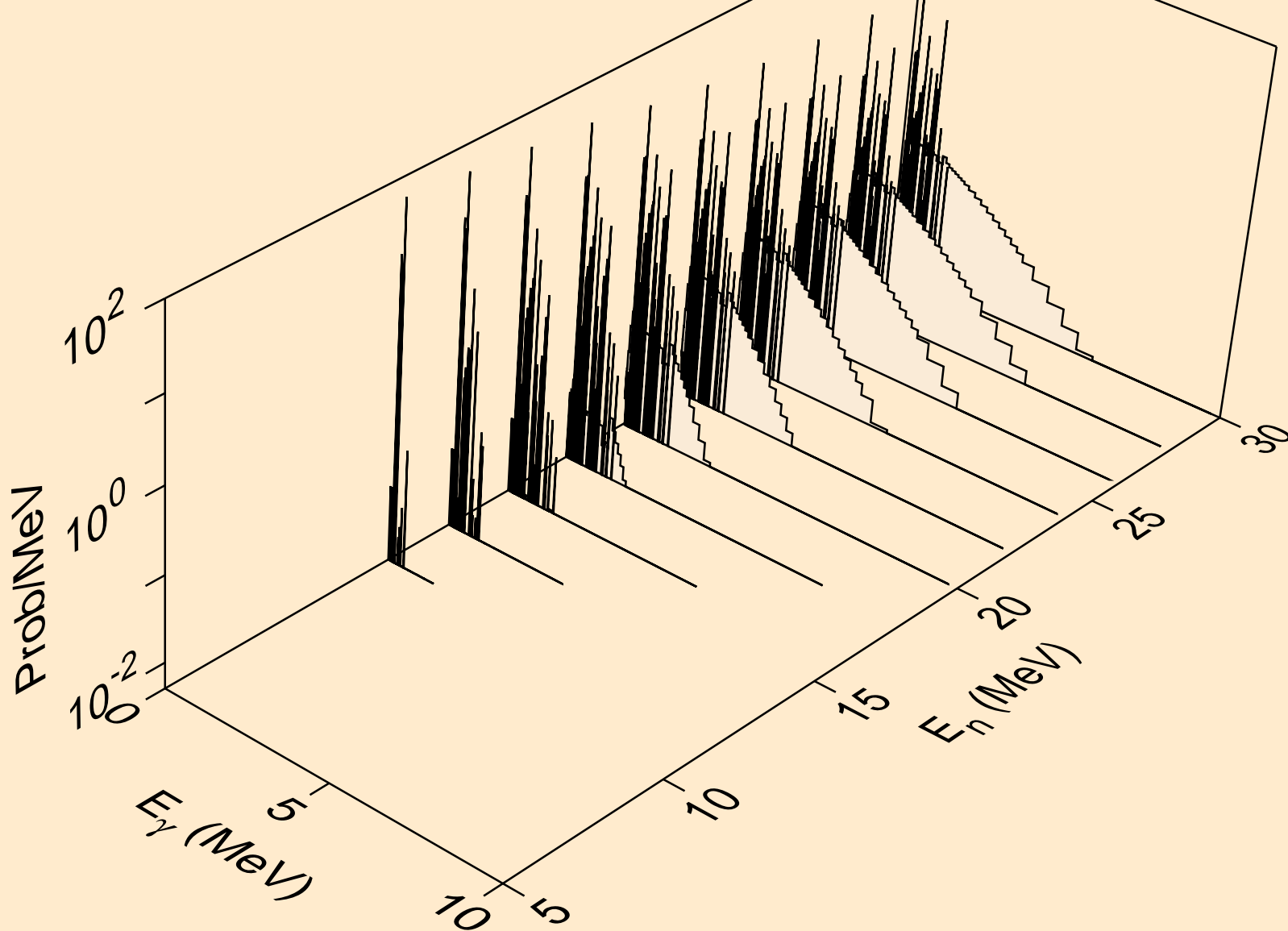



AS081 NEUTRON ACER TENDL-2019 LIBRARY; T=293.16K  
Photon emission for (n,2n)a

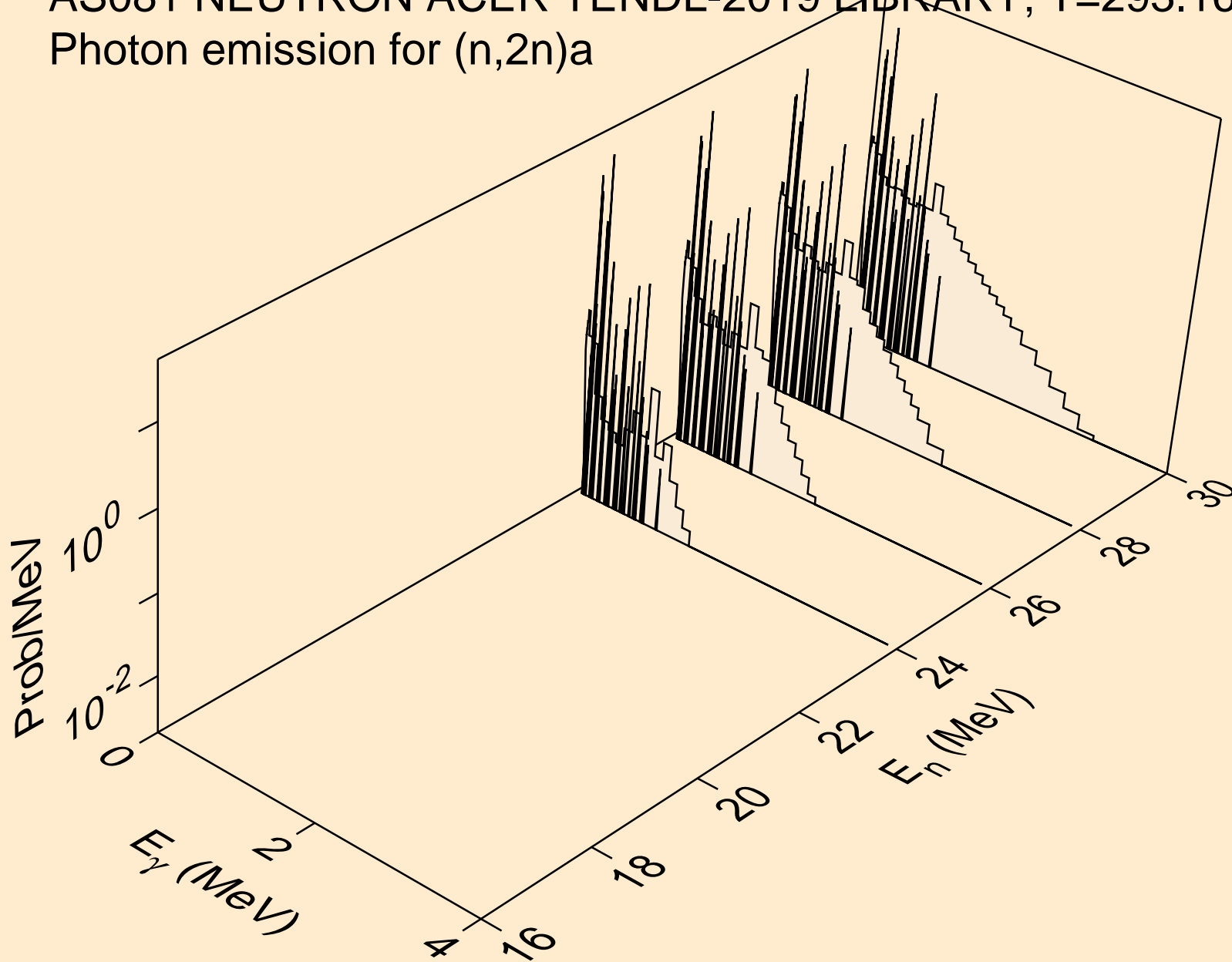

AS081 NEUTRON ACER TENDL-2019 LIBRARY; T=293.16K  
Photon emission for (n,3n)a

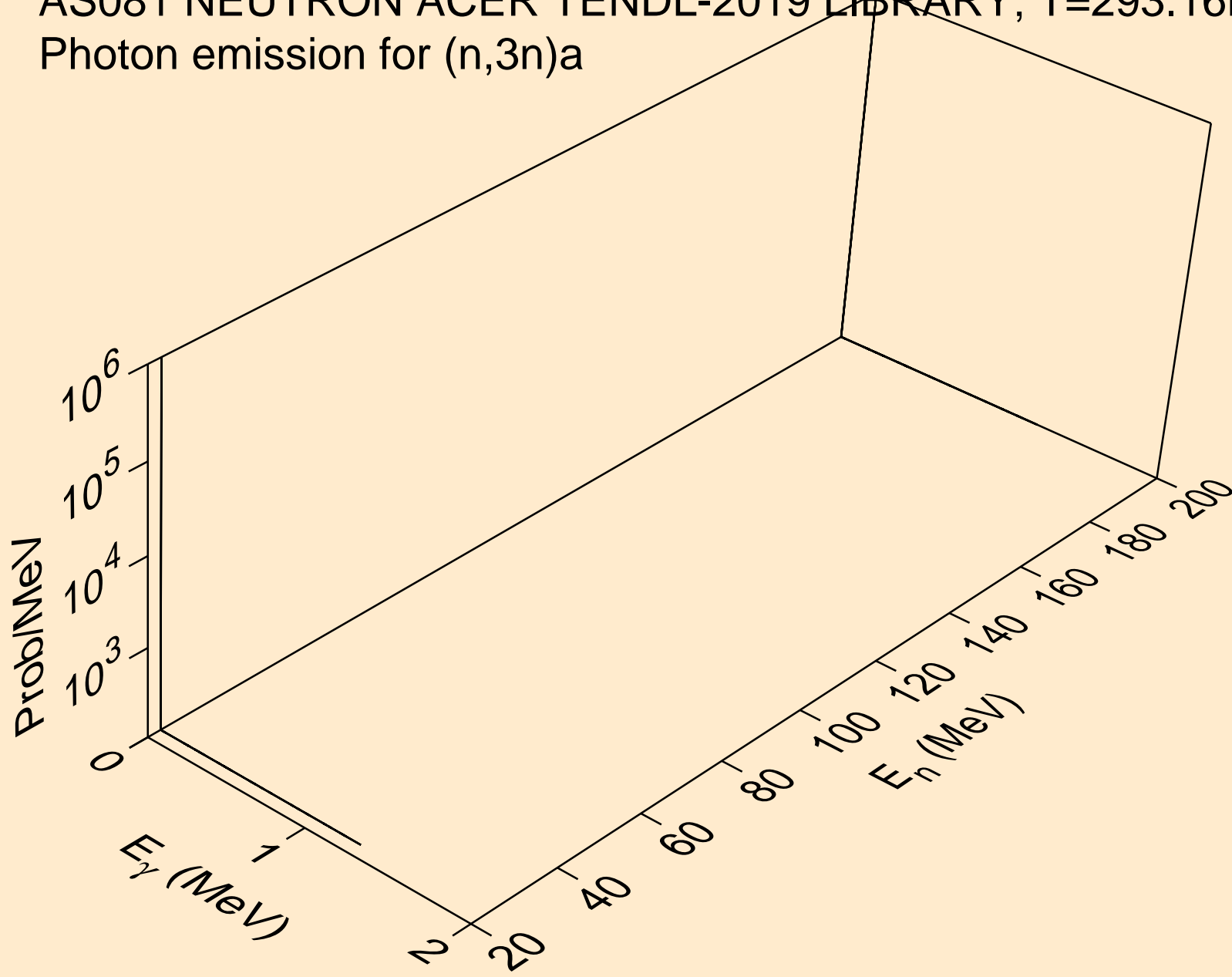

AS081 NEUTRON ACER TENDL-2019 LIBRARY; T=293.16K  
Photon emission for (n,n\*)p

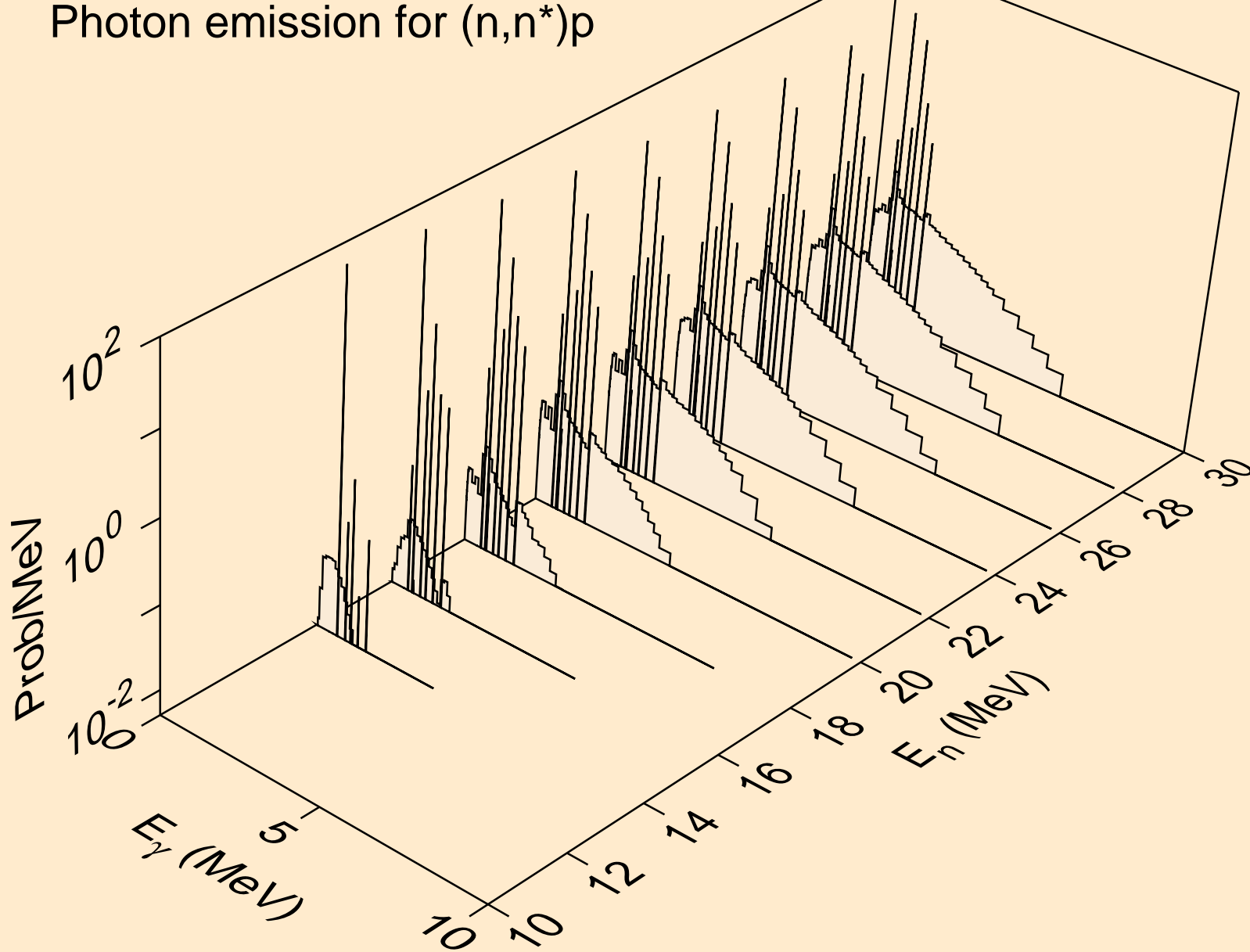

AS081 NEUTRON ACER TENDL-2019 LIBRARY; T=293.16K  
Photon emission for (n,n\*)d

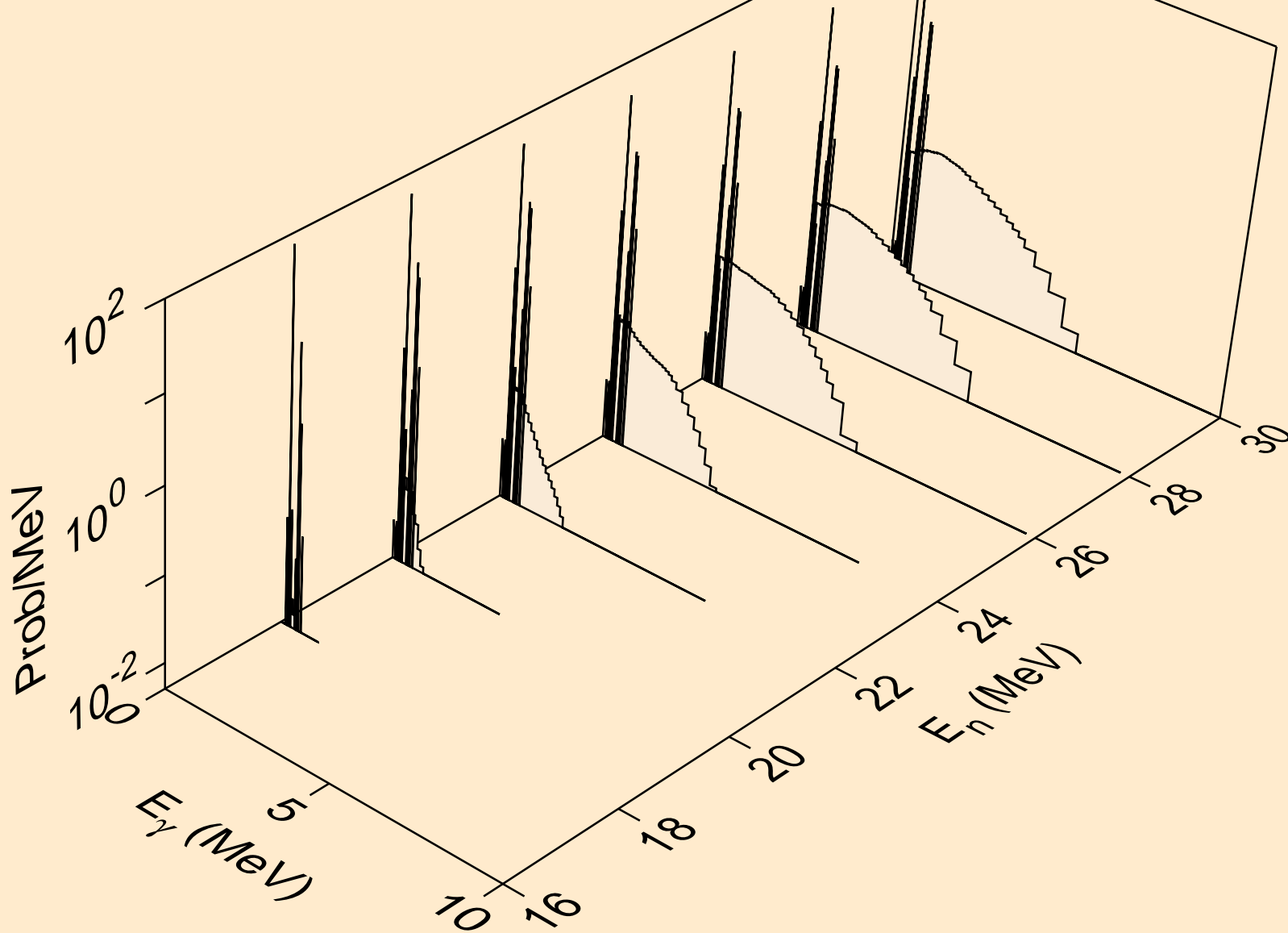

AS081 NEUTRON ACER TENDL-2019 LIBRARY; T=293.16K  
Photon emission for (n,n\*)t

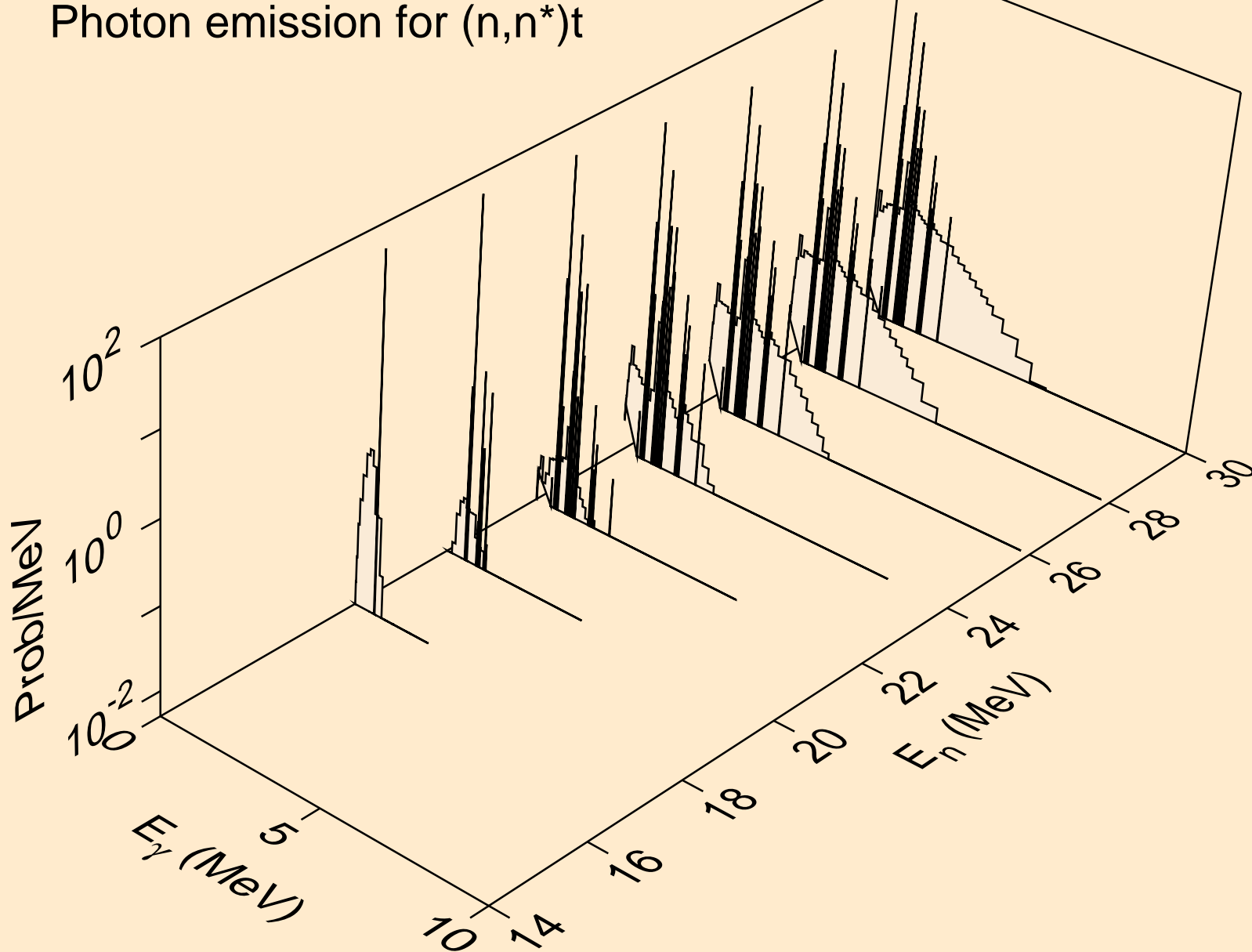

AS081 NEUTRON ACER TENDL-2019 LIBRARY; T=293.16K  
Photon emission for (n,n\*)he3

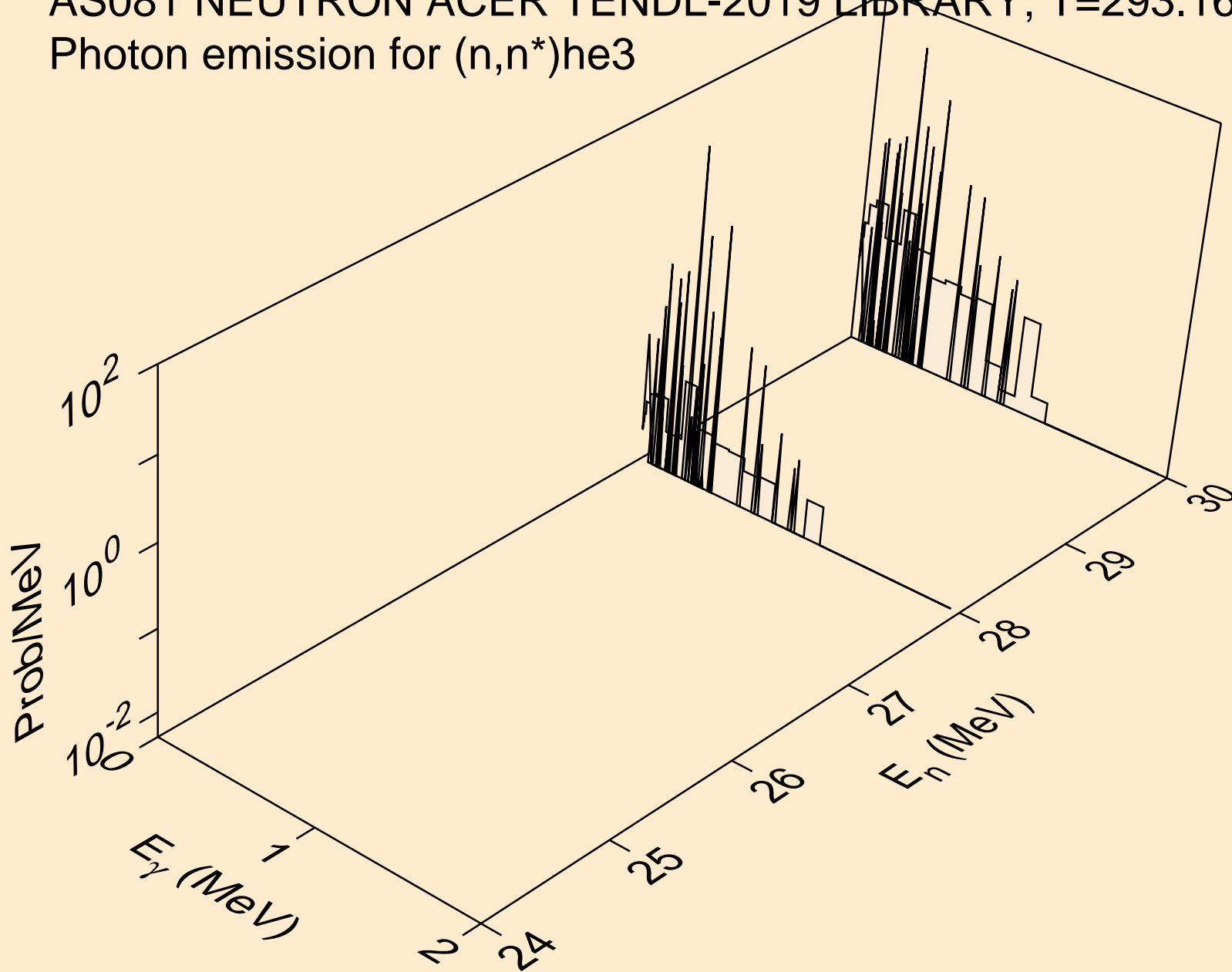

AS081 NEUTRON ACER TENDL-2019 LIBRARY; T=293.16K  
Photon emission for (n,4n)

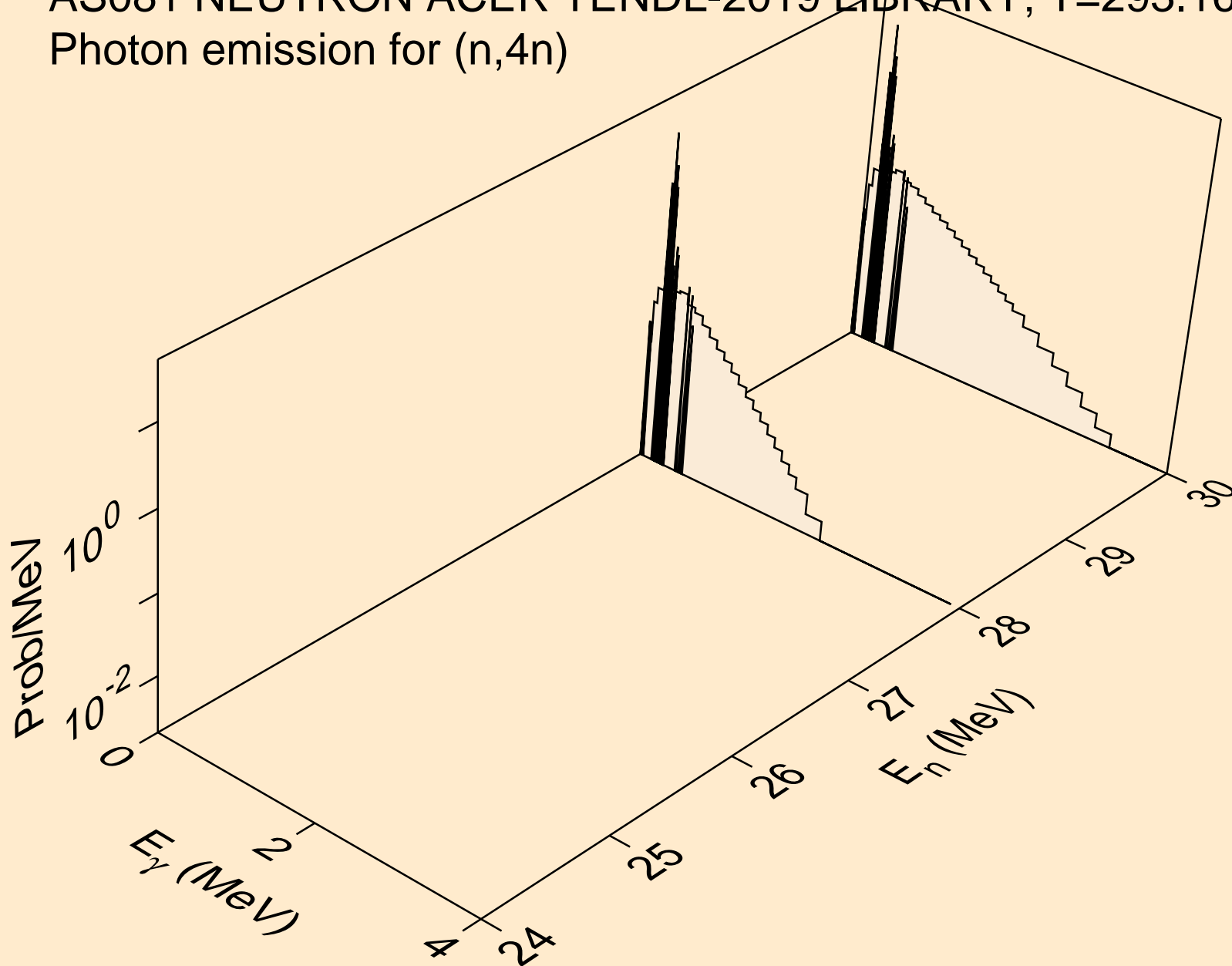

AS081 NEUTRON ACER TENDL-2019 LIBRARY; T=293.16K  
Photon emission for (n,2np)

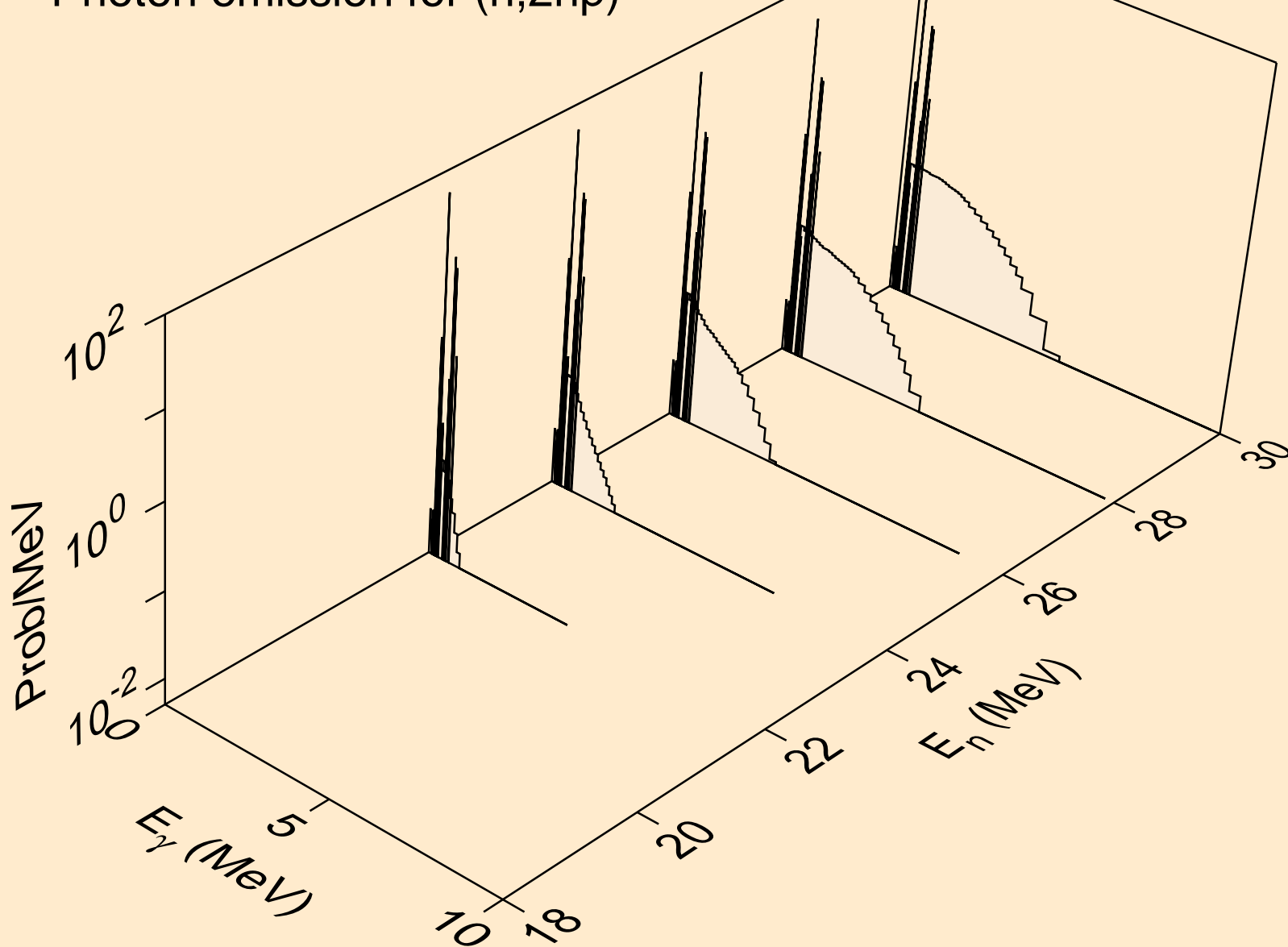



AS081 NEUTRON ACER TENDL-2019 LIBRARY; T=293.16K  
Photon emission for (n,3np)

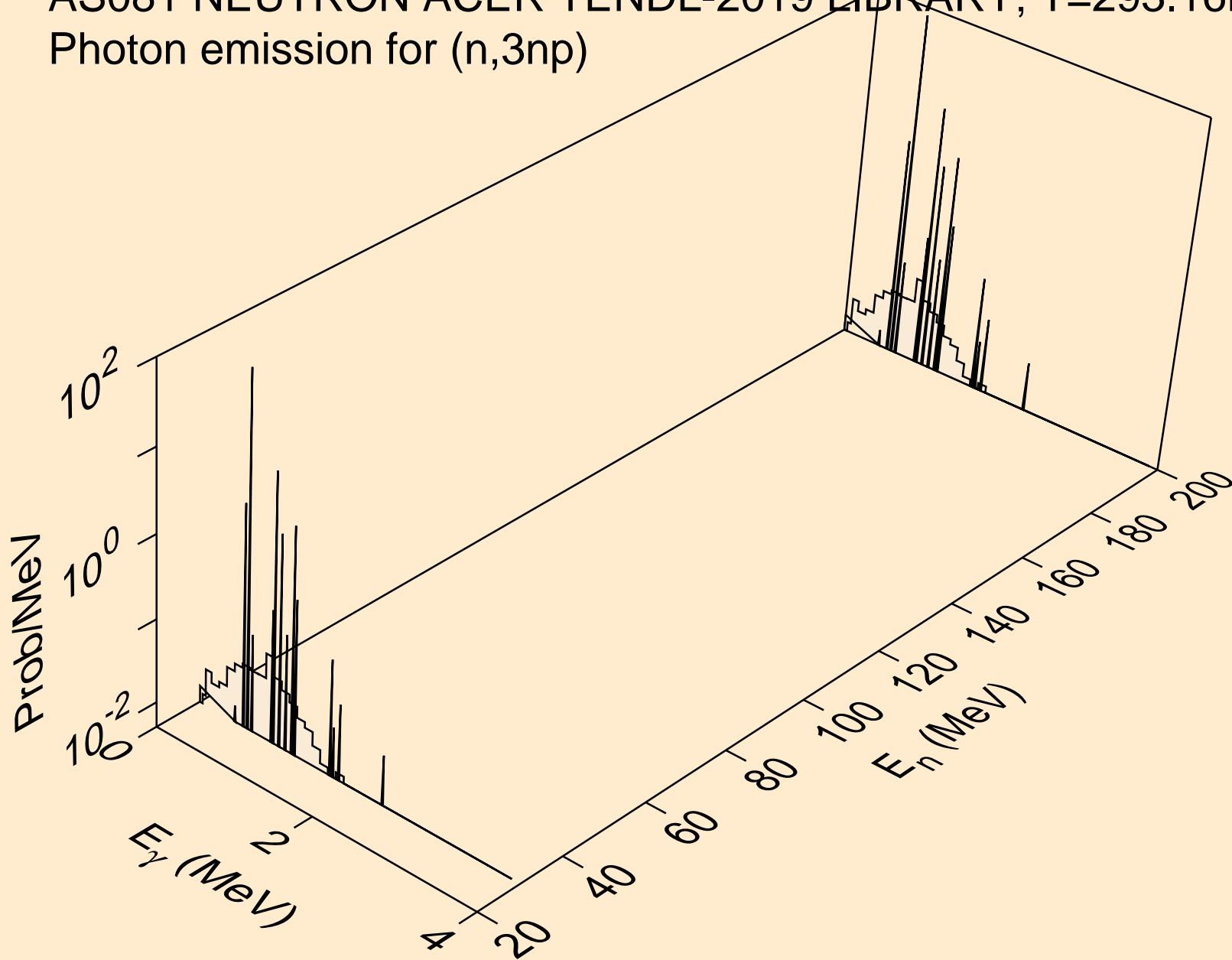

AS081 NEUTRON ACER TENDL-2019 LIBRARY; T=293.16K  
Photon emission for (n,n\*c)

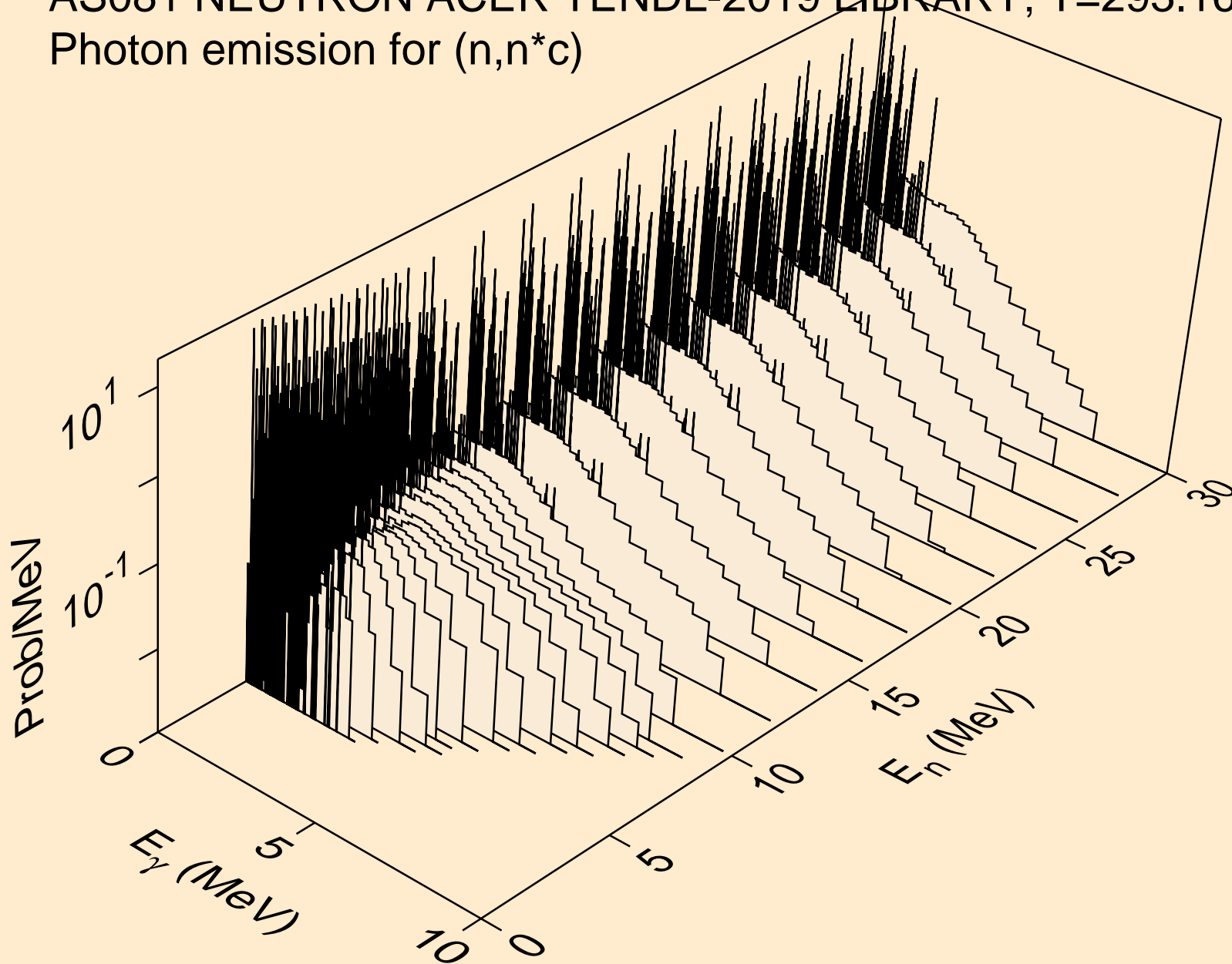

AS081 NEUTRON ACER TENDL-2019 LIBRARY; T=293.16K  
Photon emission for (n,gma)

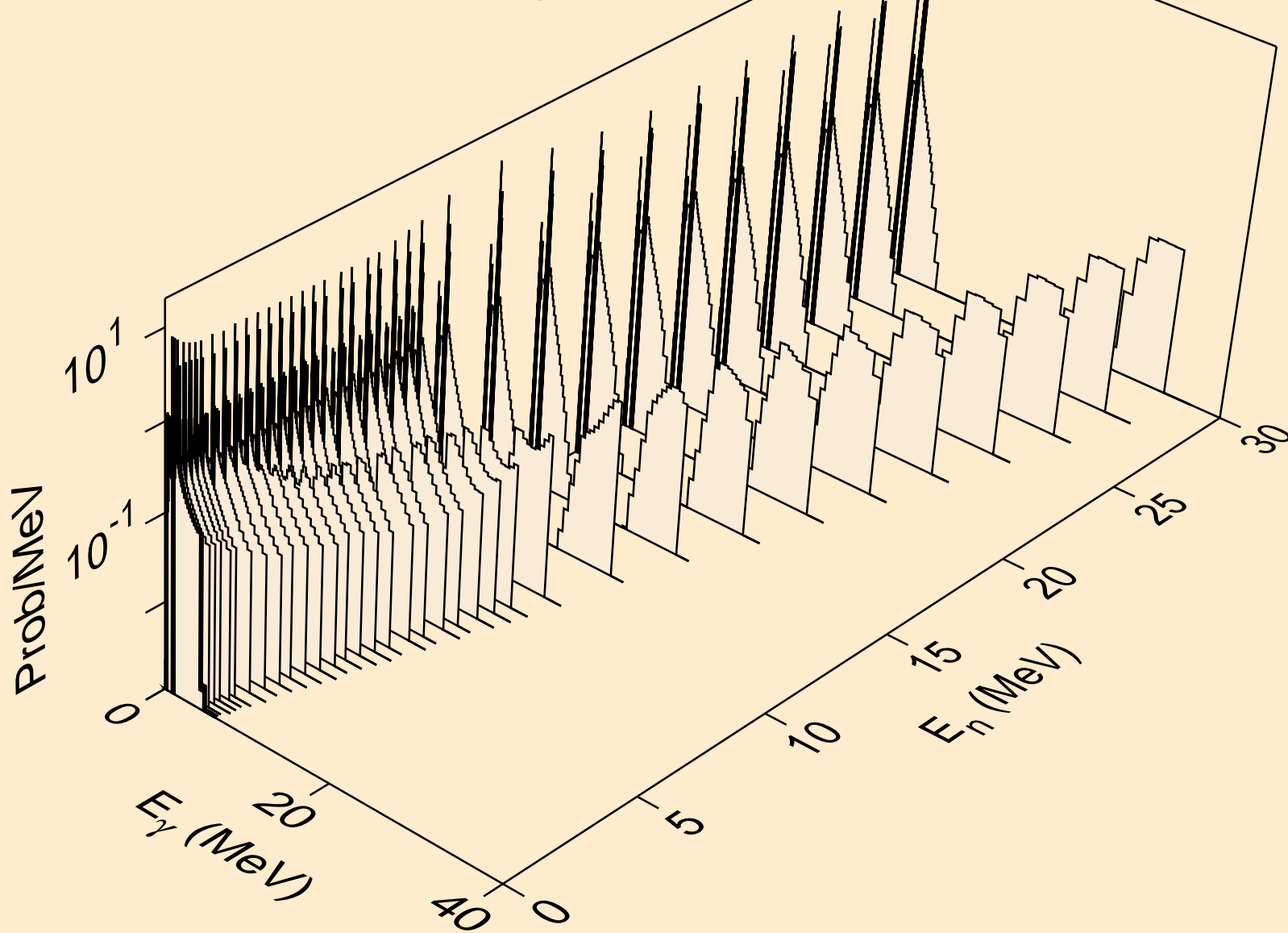

AS081 NEUTRON ACER TENDL-2019 LIBRARY; T=293.16K  
Photon emission for (n,p)

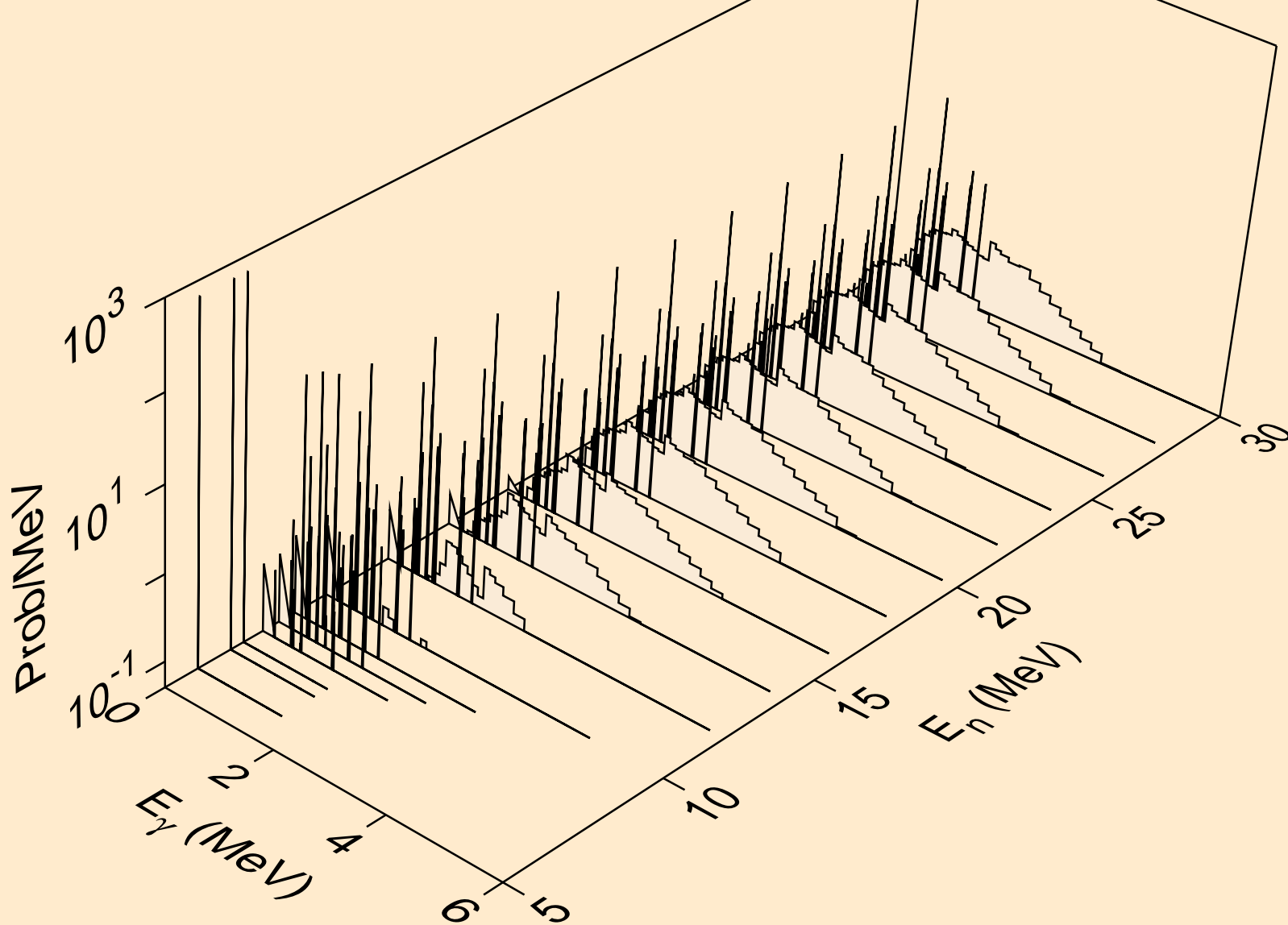

AS081 NEUTRON ACER TENDL-2019 LIBRARY; T=293.16K  
Photon emission for (n,d)

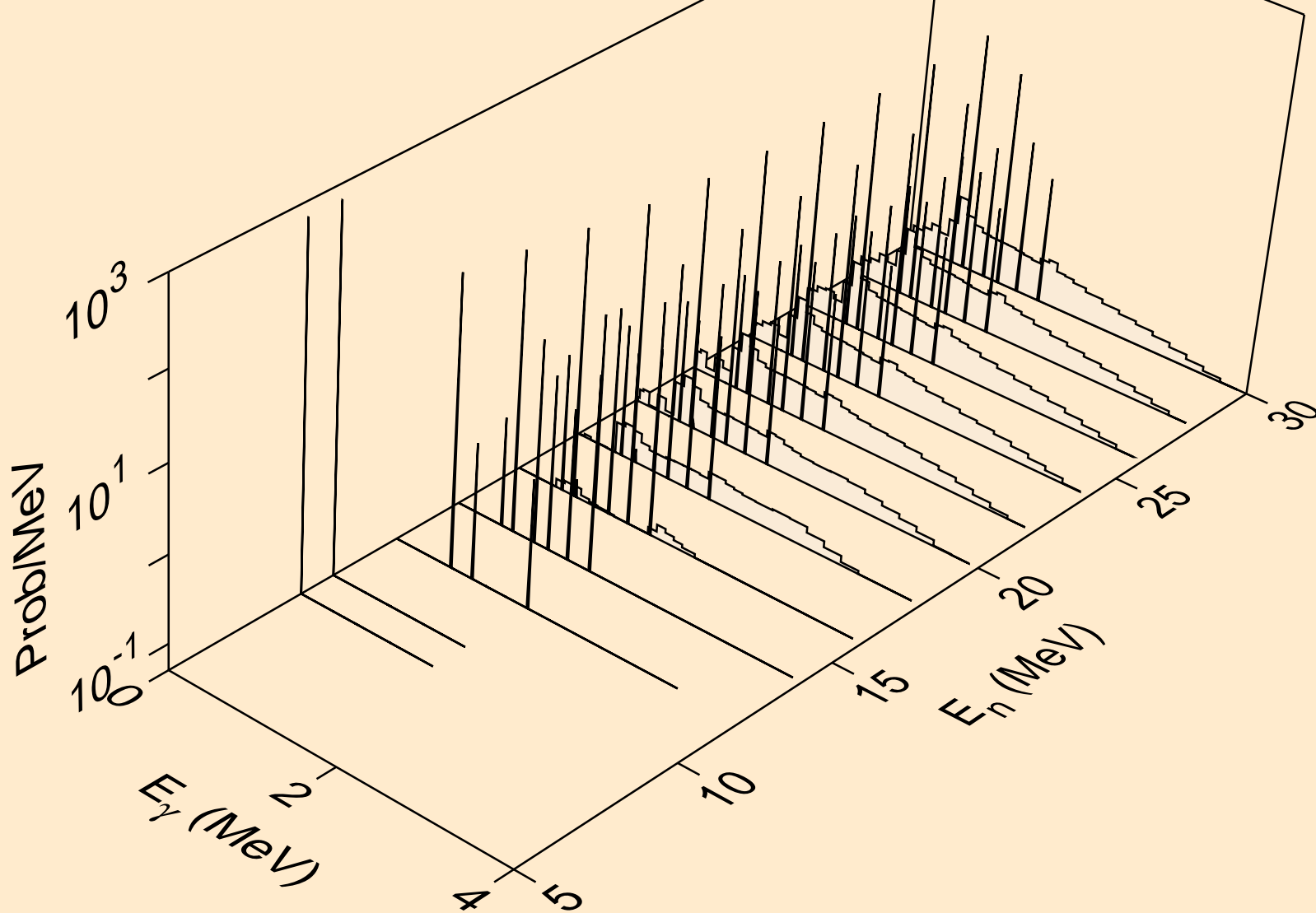

AS081 NEUTRON ACER TENDL-2019 LIBRARY; T=293.16K  
Photon emission for (n,t)

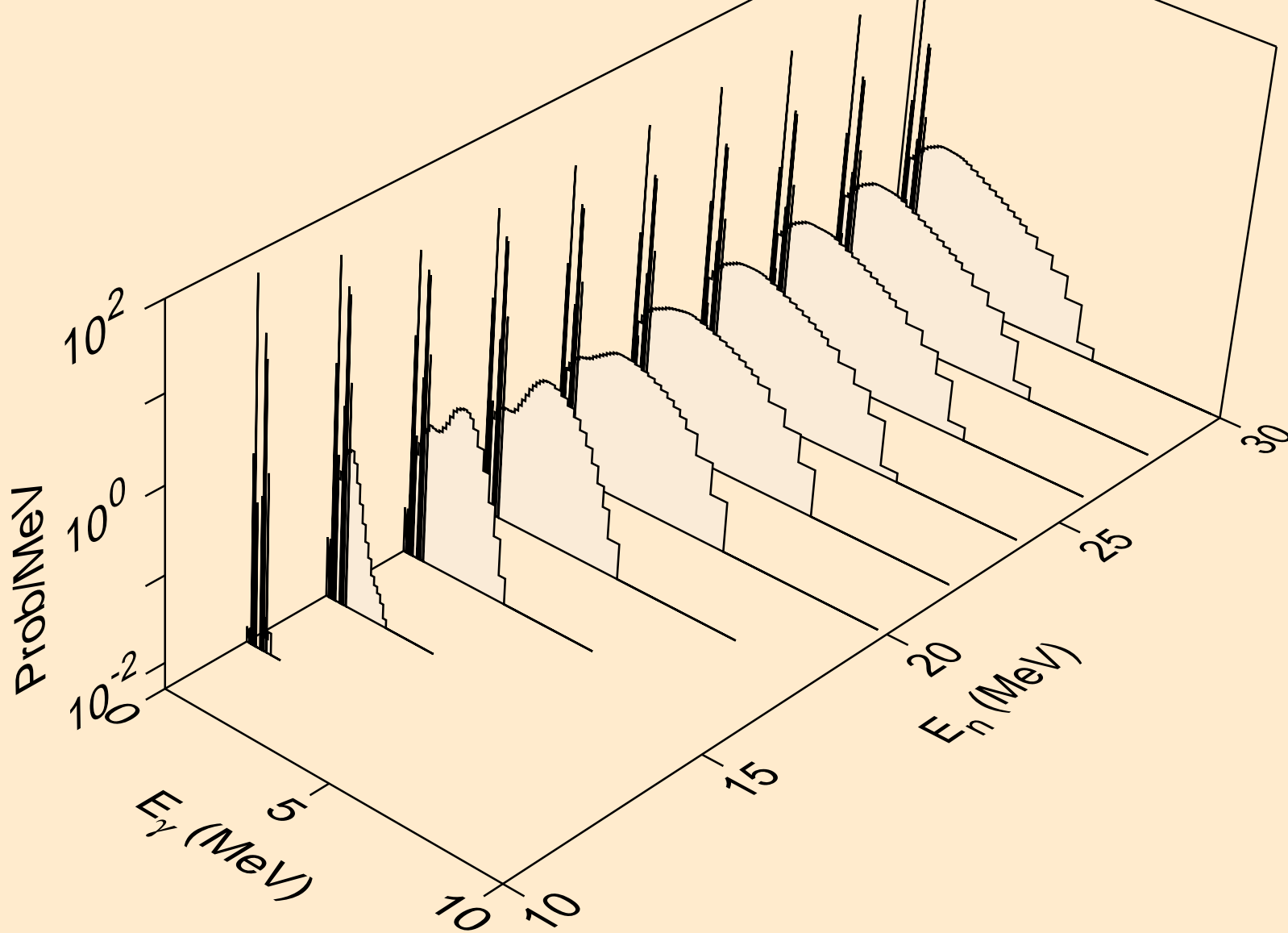

AS081 NEUTRON ACER TENDL-2019 LIBRARY; T=293.16K  
Photon emission for (n,he3)

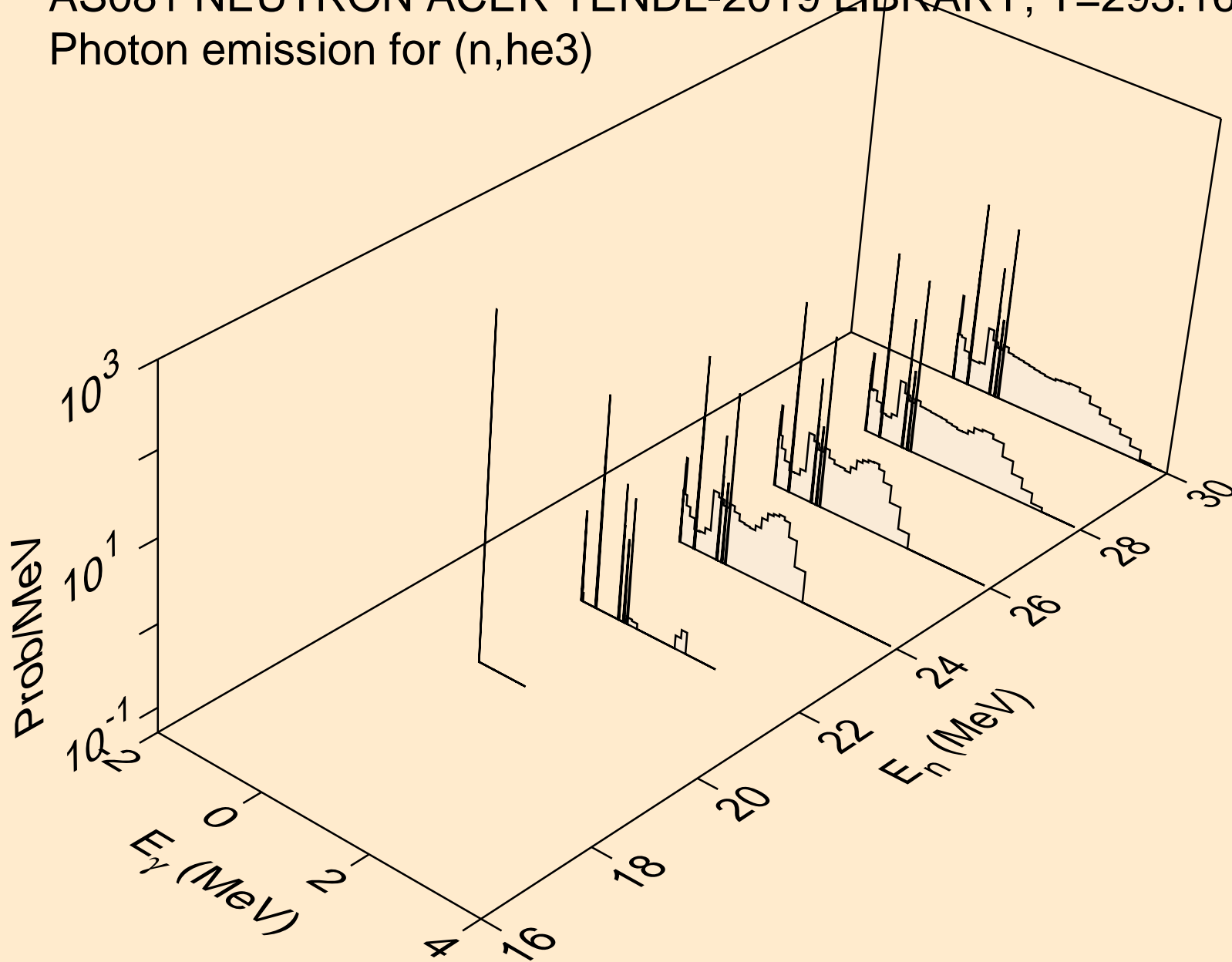

AS081 NEUTRON ACER TENDL-2019 LIBRARY; T=293.16K  
Photon emission for (n,a)

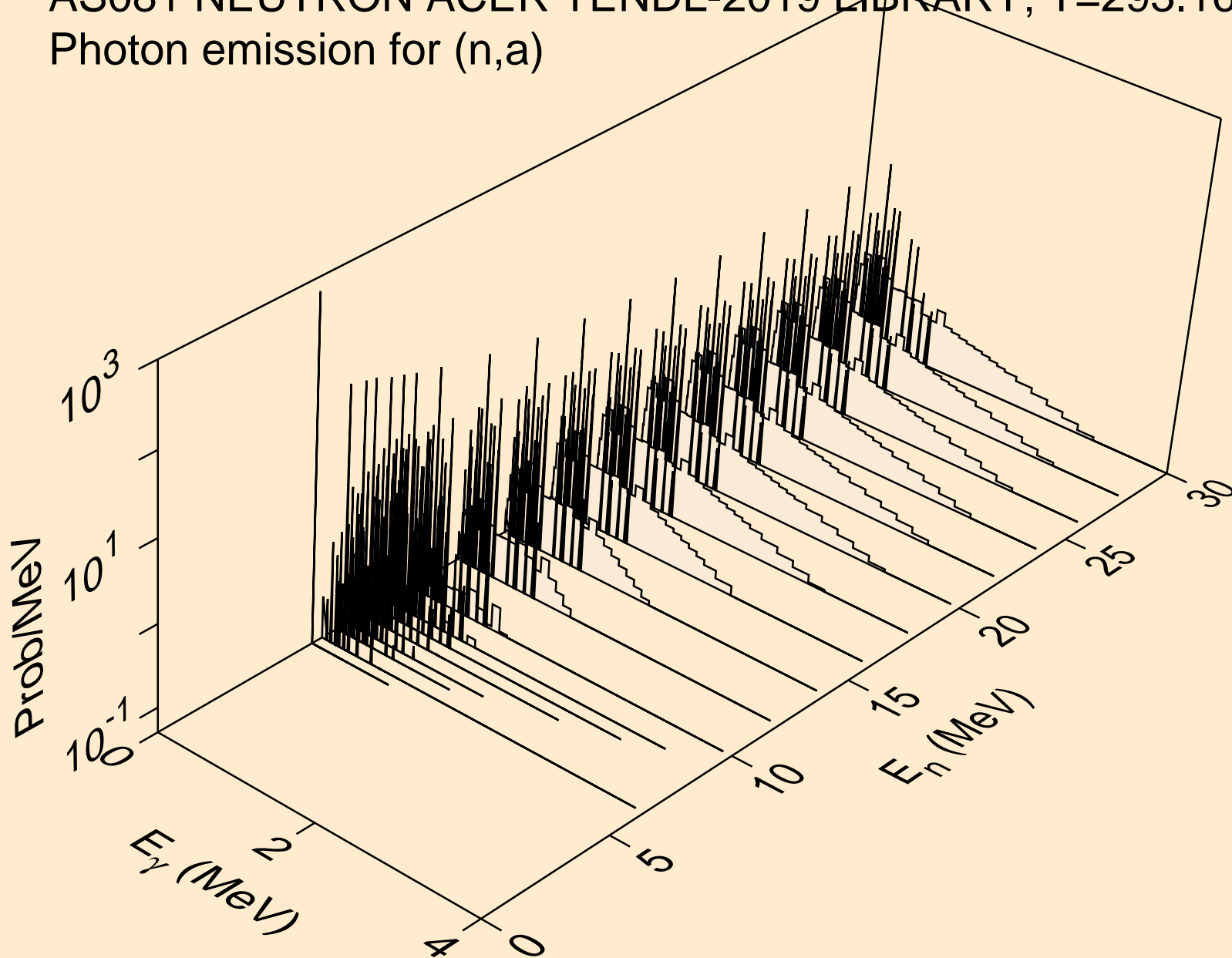



AS081 NEUTRON ACER TENDL-2019 LIBRARY; T=293.16K  
Photon emission for (n,2p)

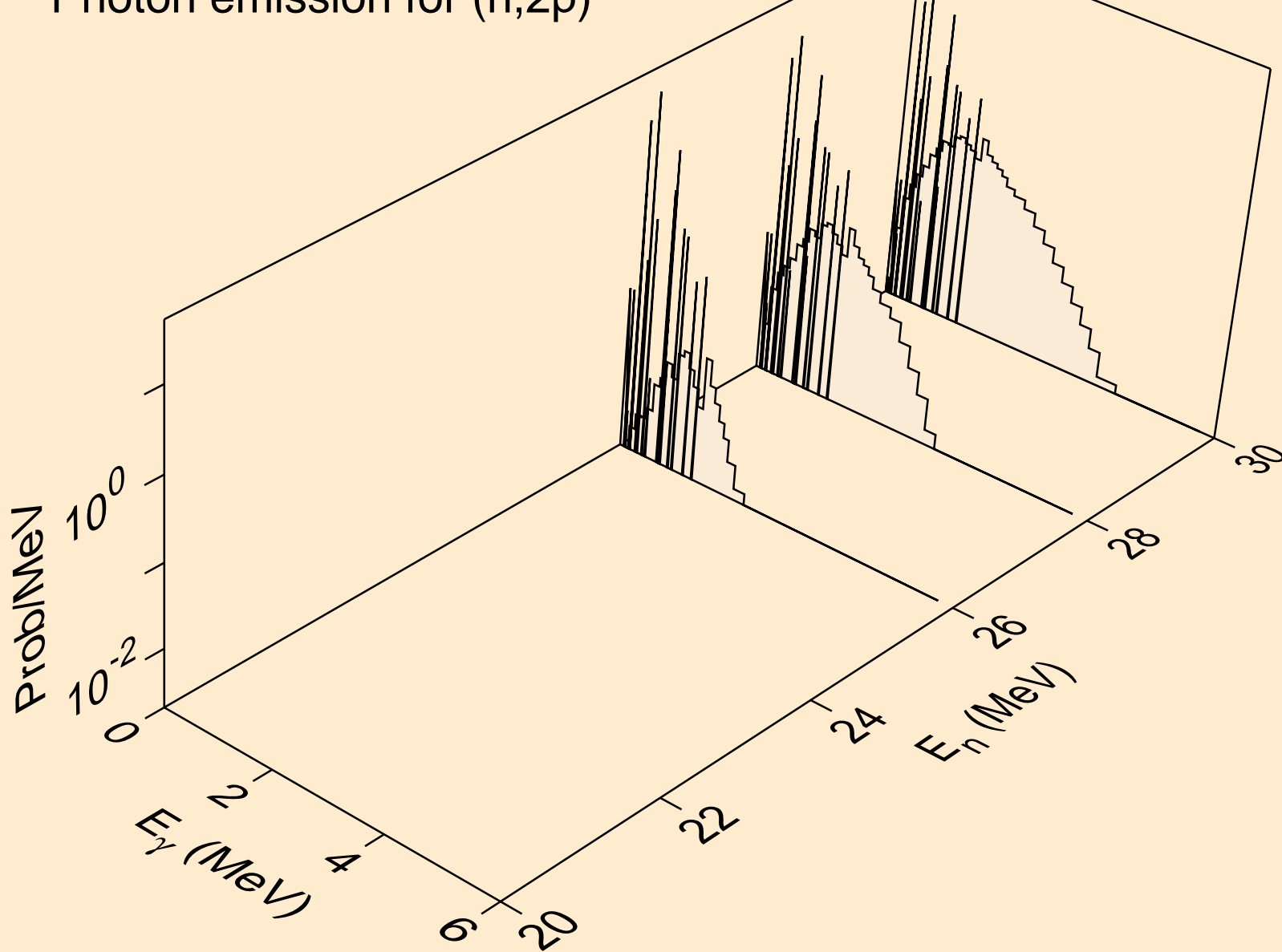

AS081 NEUTRON ACER TENDL-2019 LIBRARY; T=293.16K  
Photon emission for (n,p $\alpha$ )

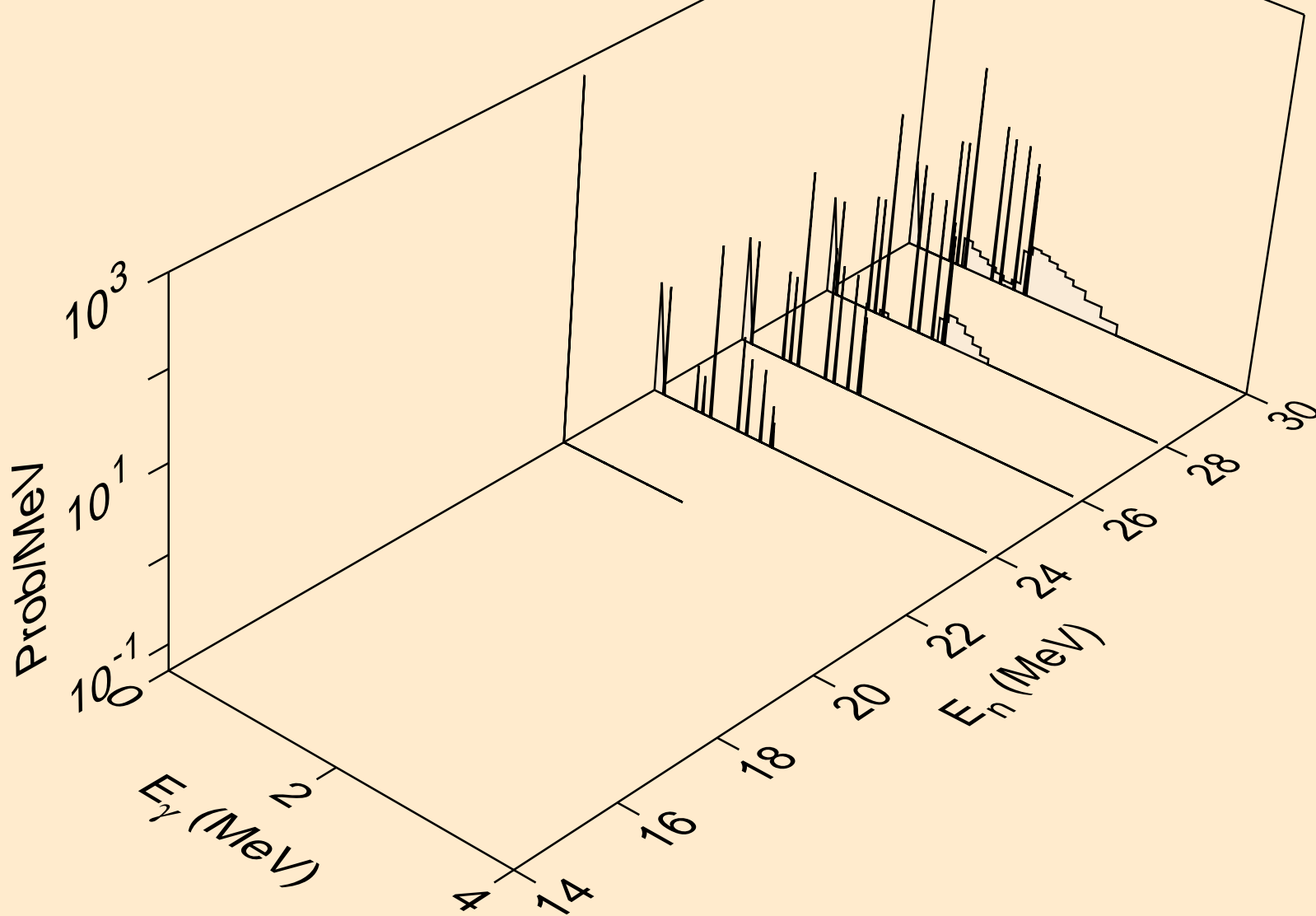

AS081 NEUTRON ACER TENDL-2019 LIBRARY; T=293.16K  
thermal capture photon spectrum

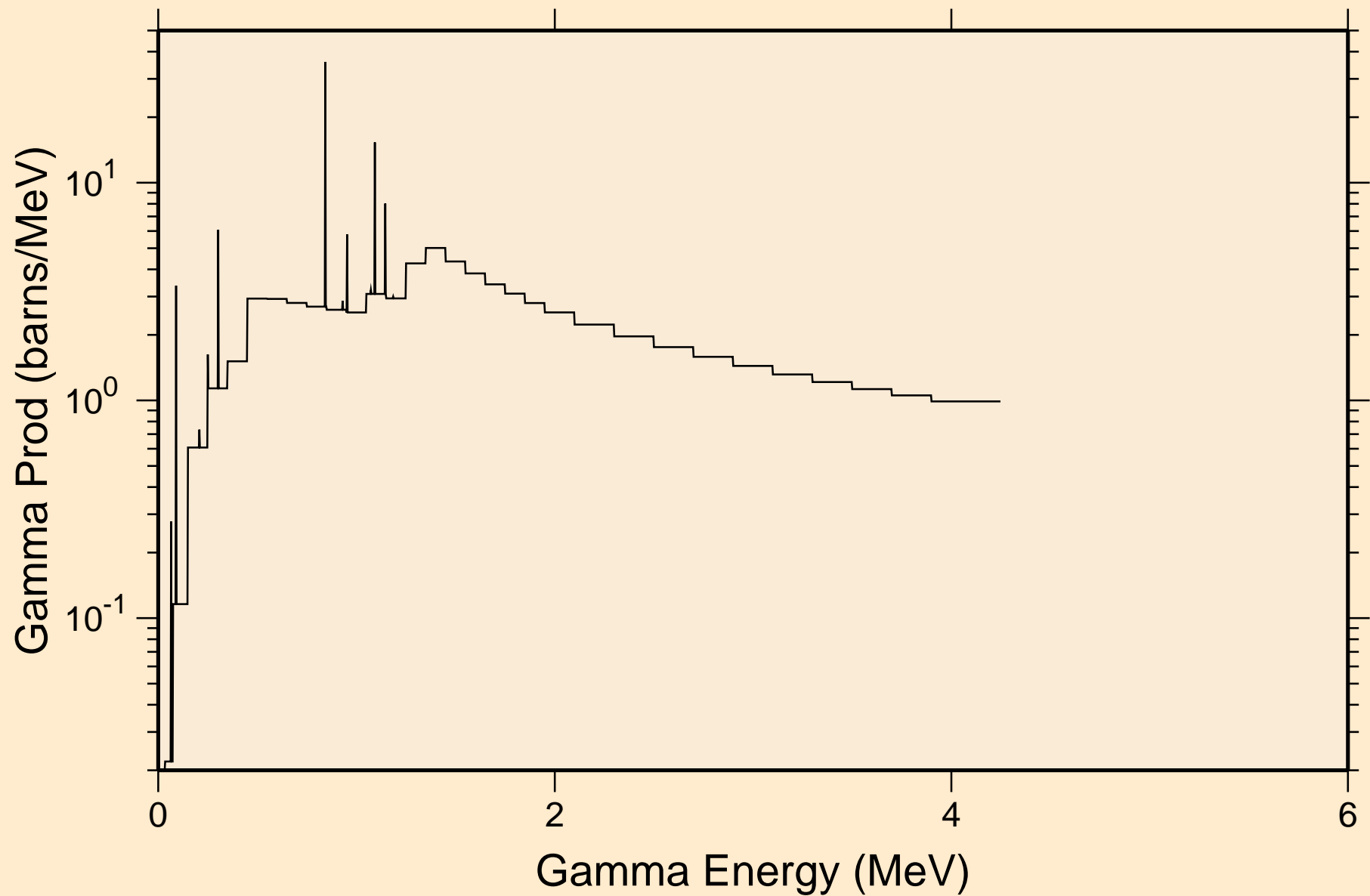

AS081 NEUTRON ACER TENDL-2019 LIBRARY; T=293.16K  
14 MeV photon spectrum

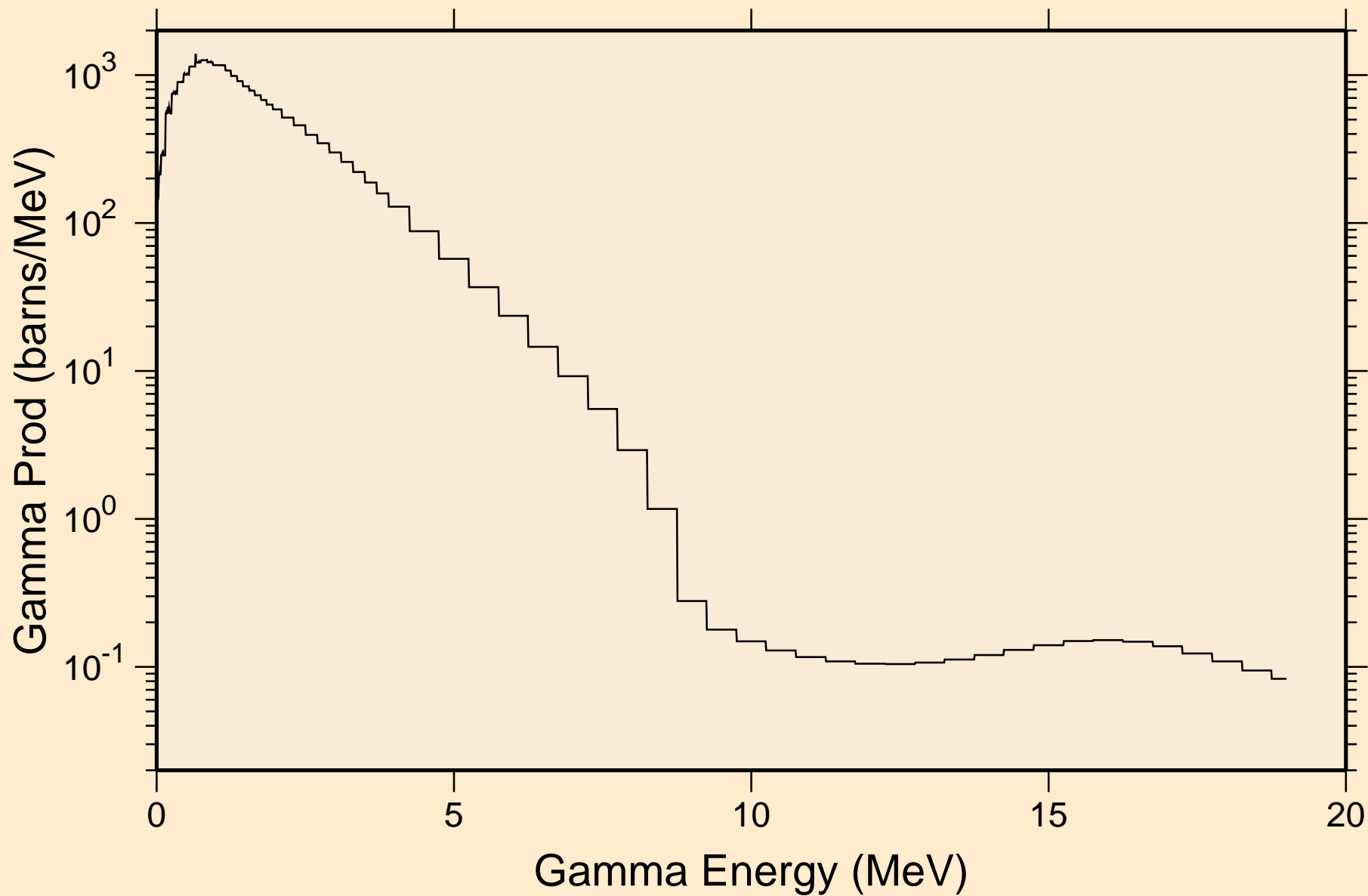

AS081 NEUTRON ACER TENDL-2019 LIBRARY; T=293.16K  
Particle heating contributions

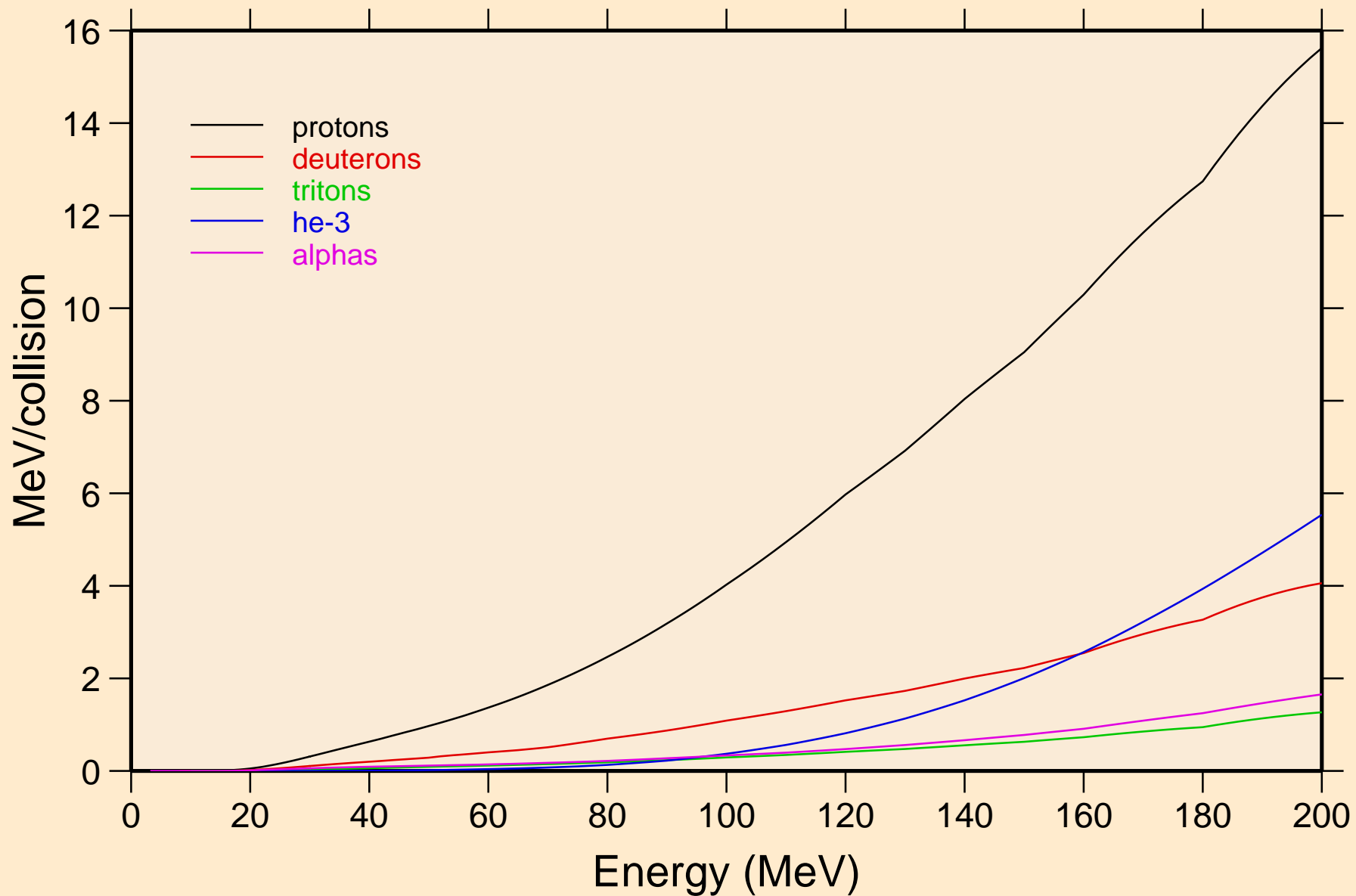

AS081 NEUTRON ACER TENDL-2019 LIBRARY; T=293.16K  
Recoil Heating

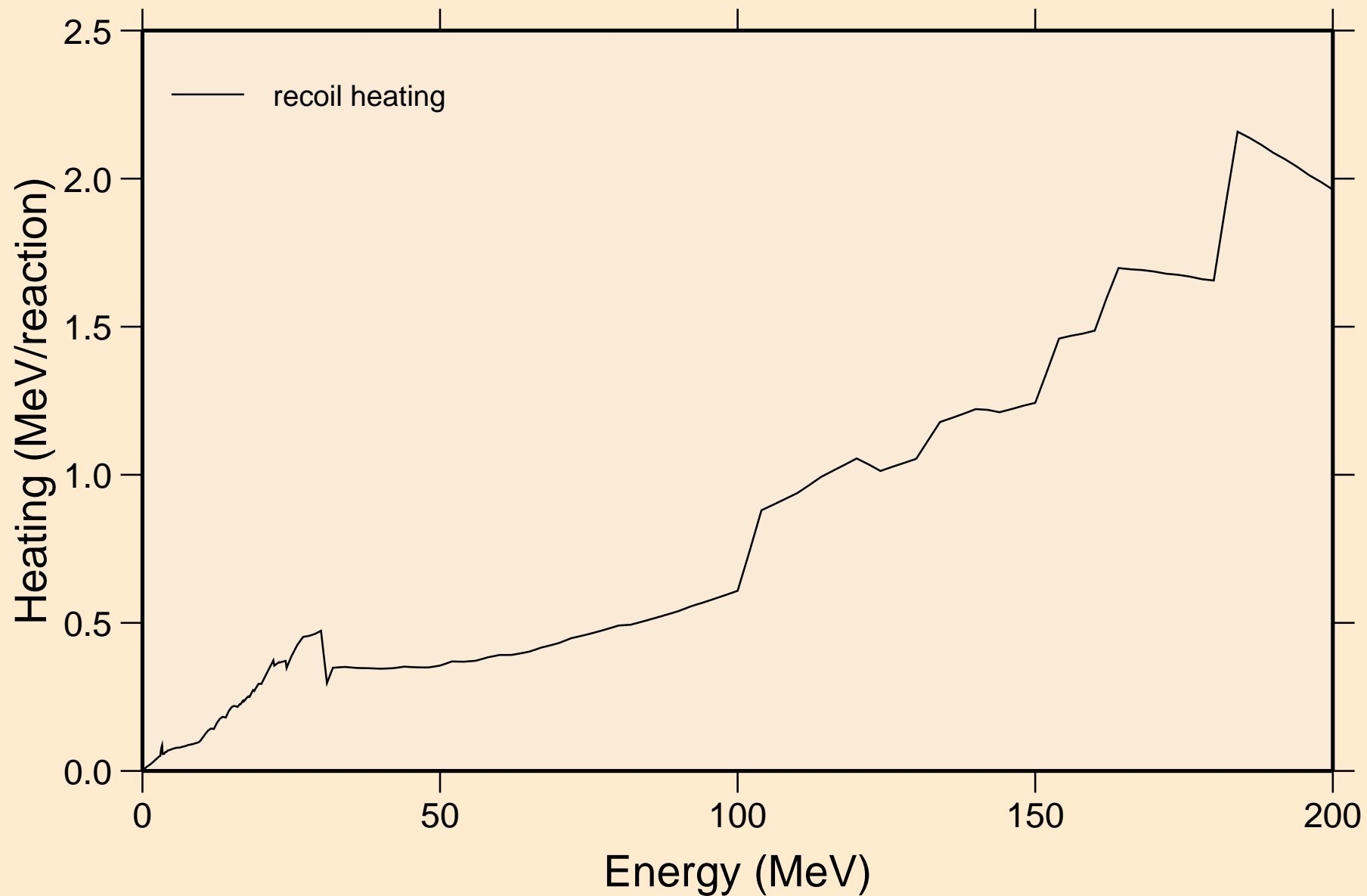

AS081 NEUTRON ACER TENDL-2019 LIBRARY; T=293.16K  
Particle production cross sections

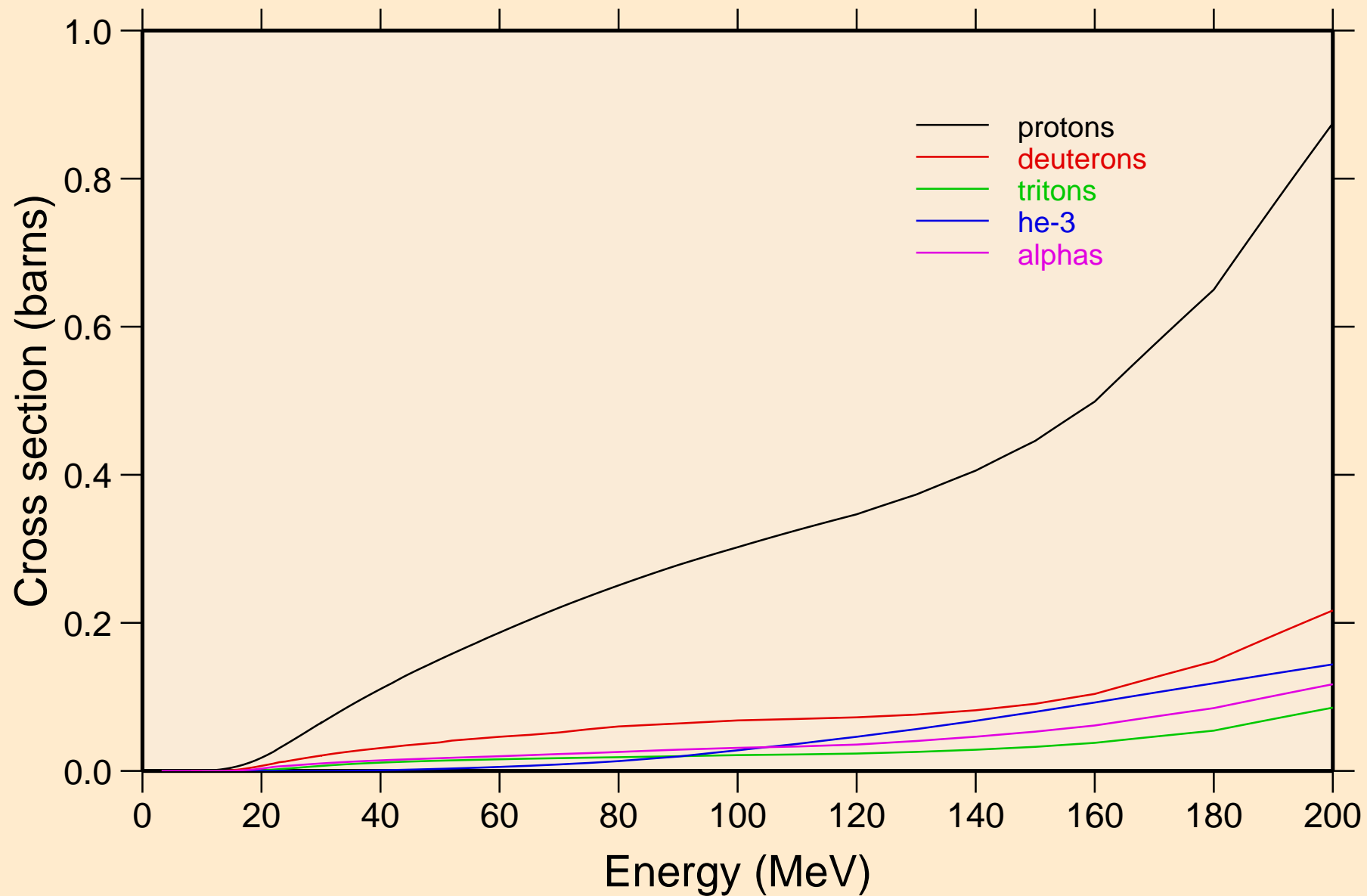

AS081 NEUTRON ACER TENDL-2019 LIBRARY; T=293.16K  
protons from (n,x)

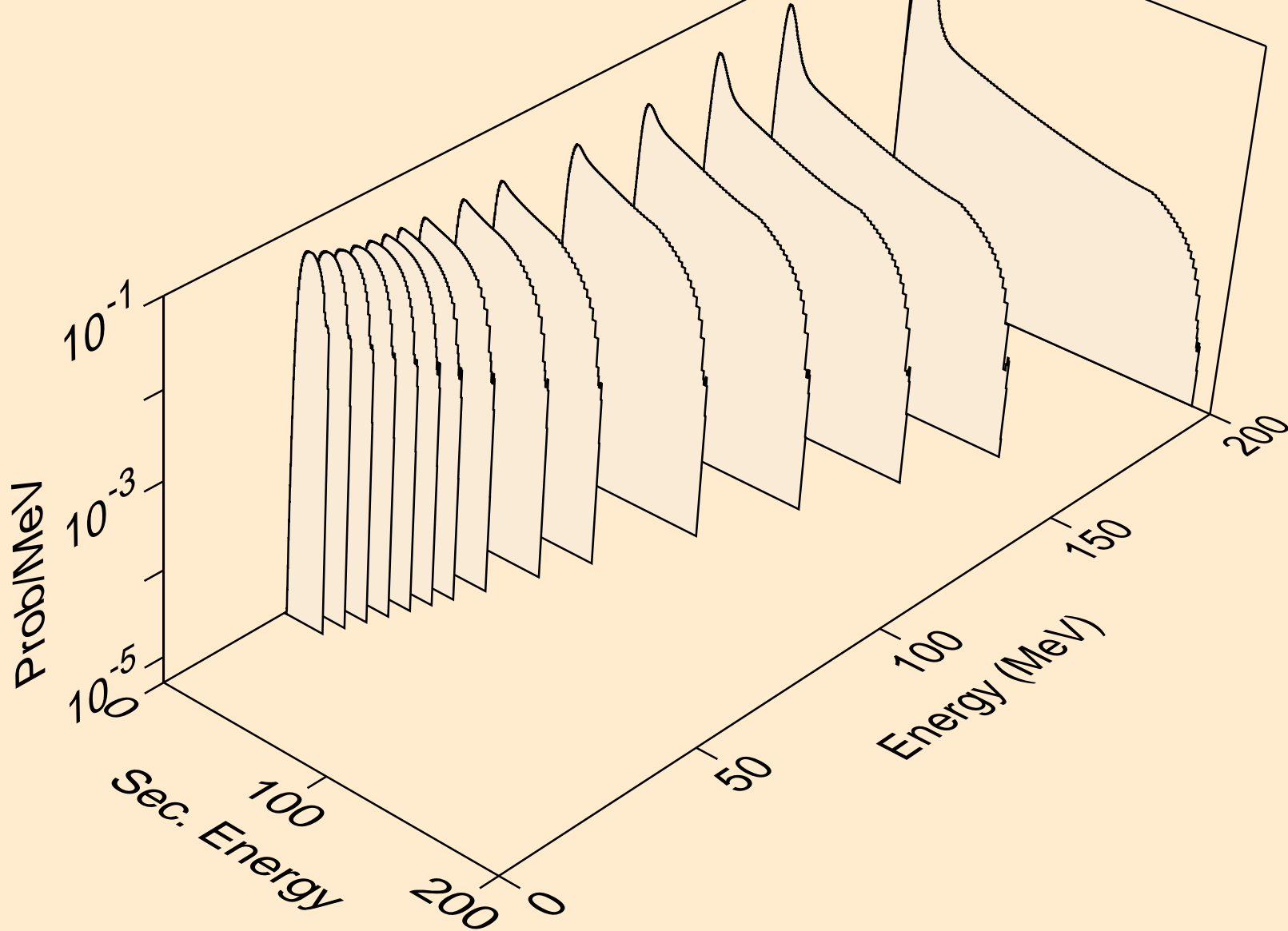



AS081 NEUTRON ACER TENDL-2019 LIBRARY; T=293.16K  
protons from (n,n\*)p

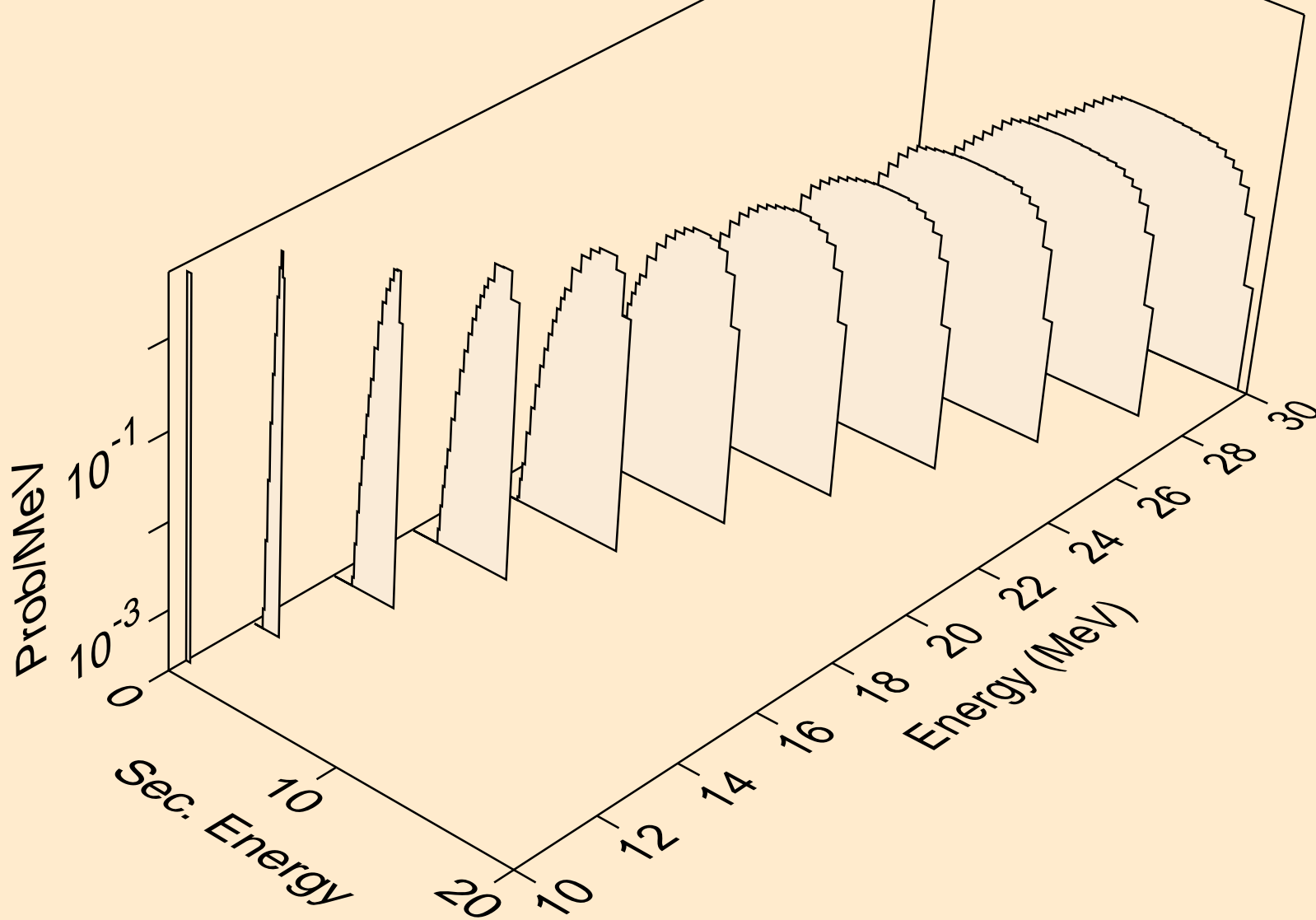

AS081 NEUTRON ACER TENDL-2019 LIBRARY; T=293.16K  
protons from (n,2np)

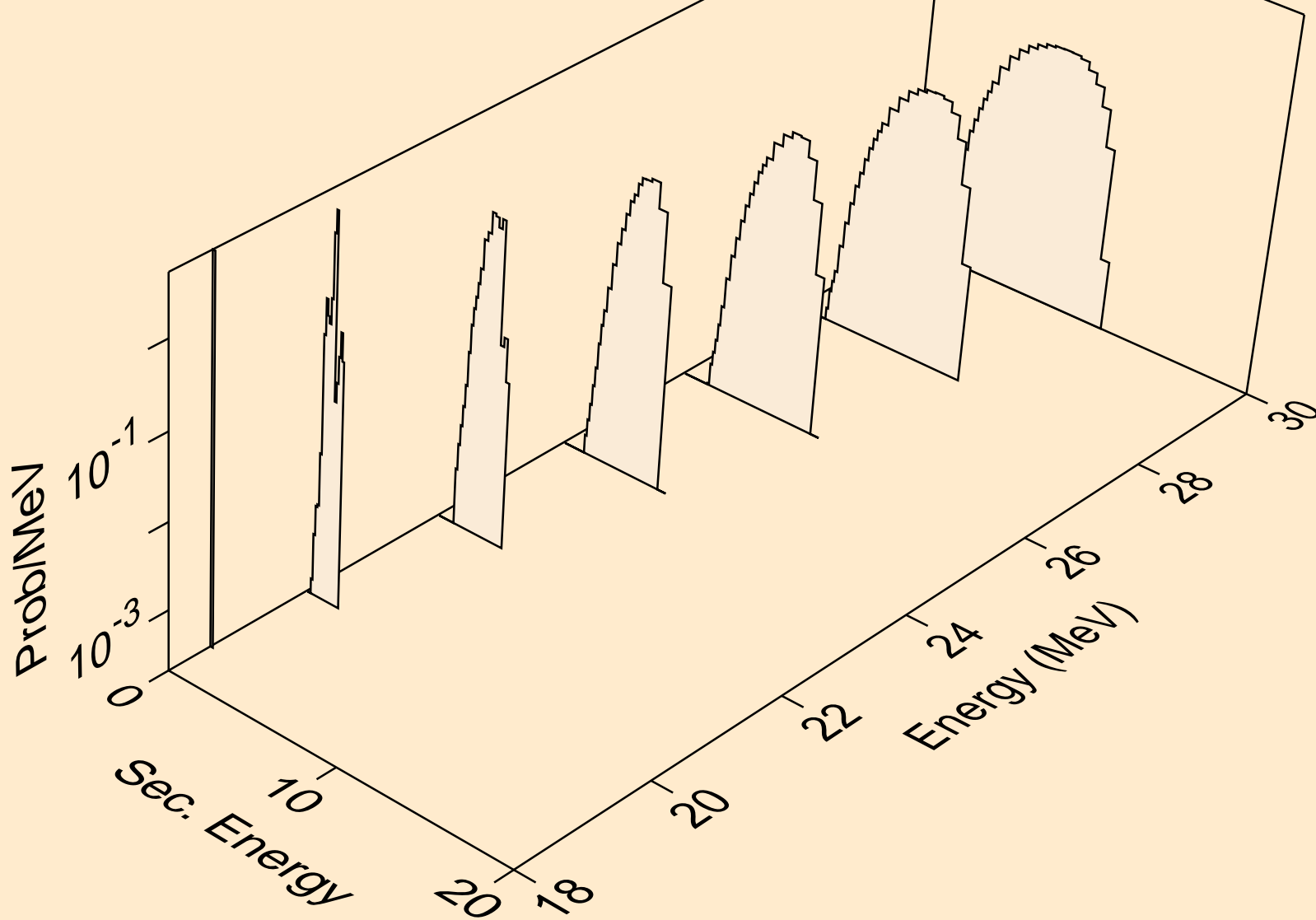

AS081 NEUTRON ACER TENDL-2019 LIBRARY; T=293.16K  
protons from (n,3np)

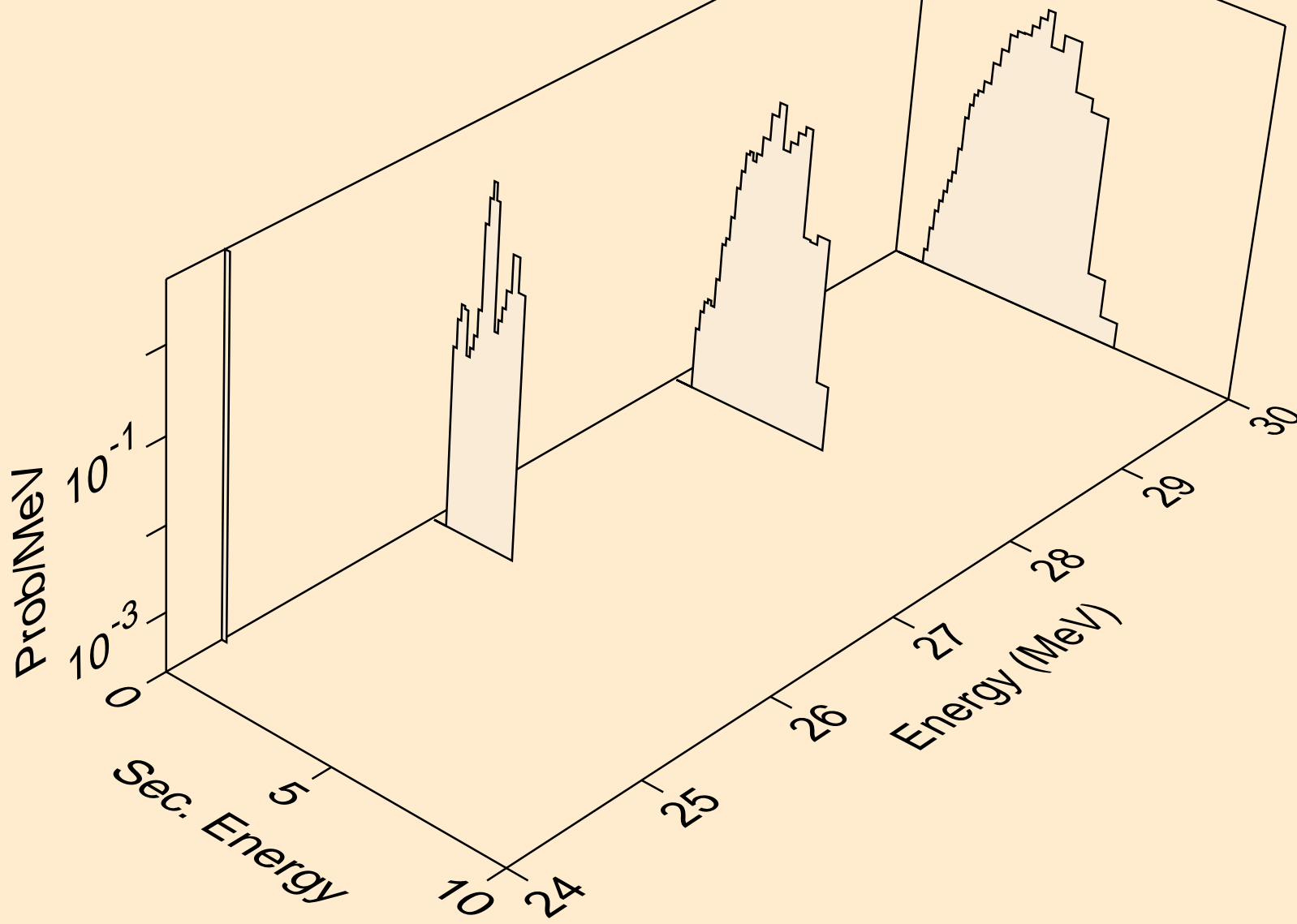

AS081 NEUTRON ACER TENDL-2019 LIBRARY; T=293.16K  
protons from (n,p)

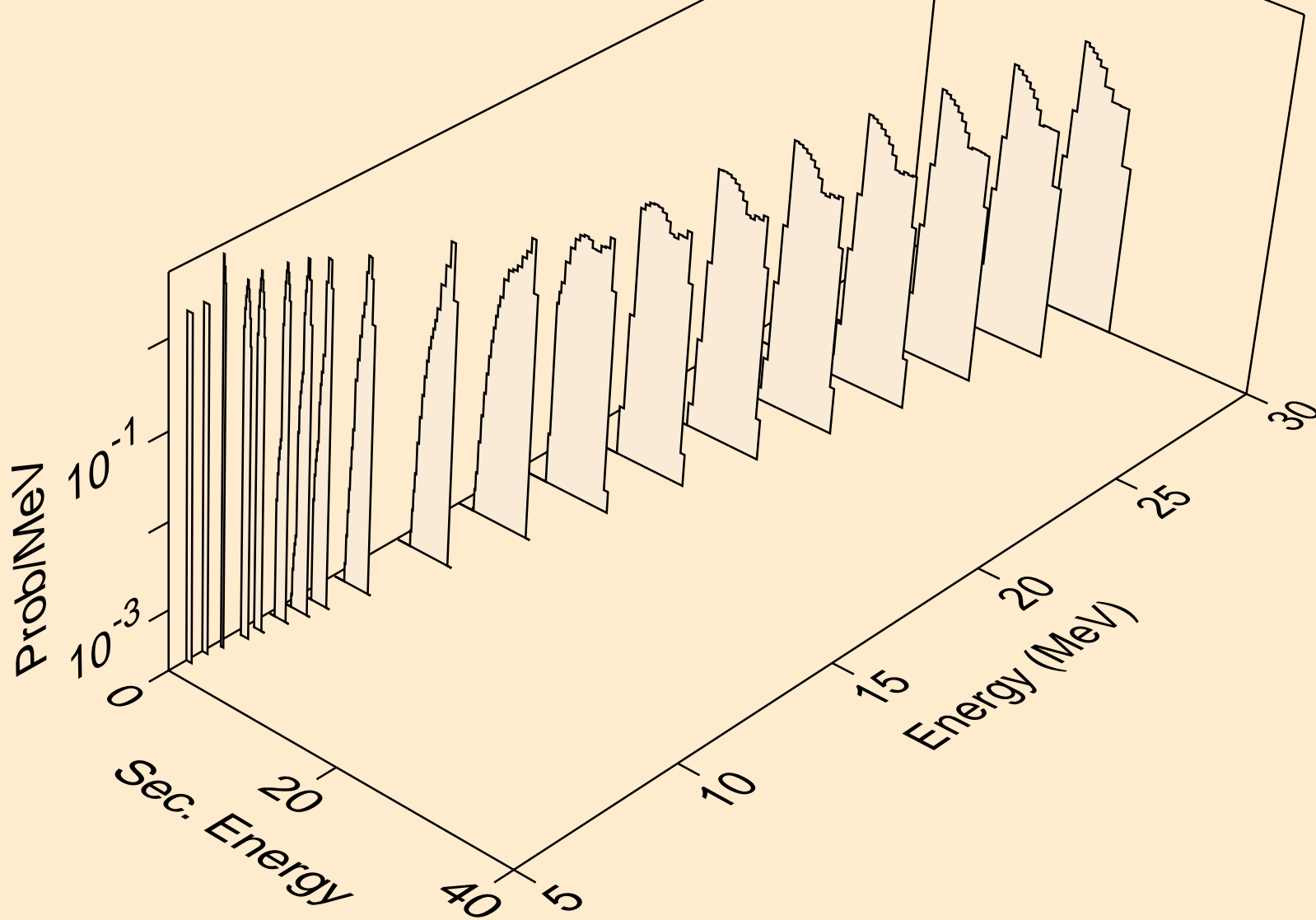

AS081 NEUTRON ACER TENDL-2019 LIBRARY; T=293.16K  
protons from (n,2p)

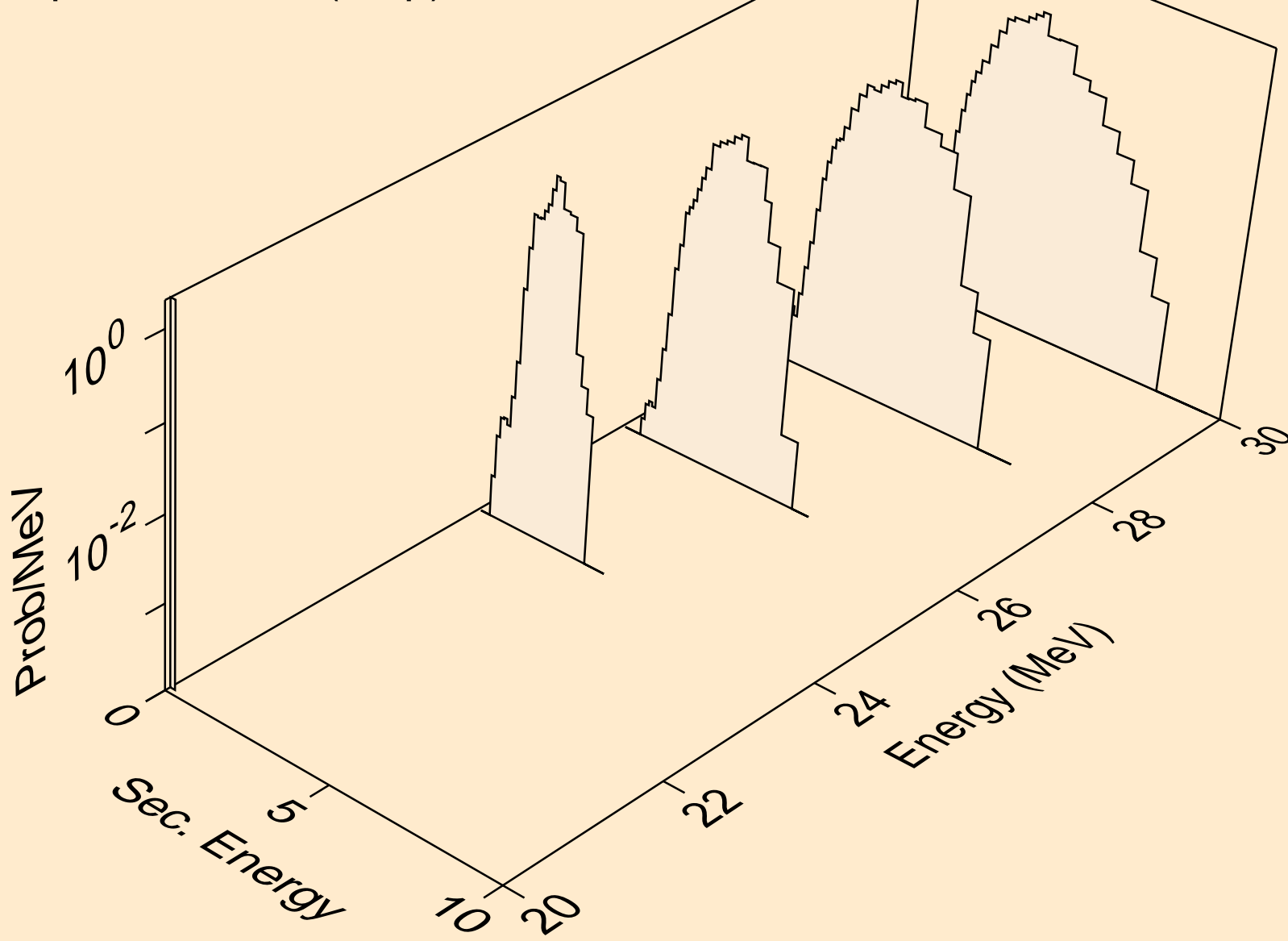

AS081 NEUTRON ACER TENDL-2019 LIBRARY; T=293.16K  
protons from (n,p)

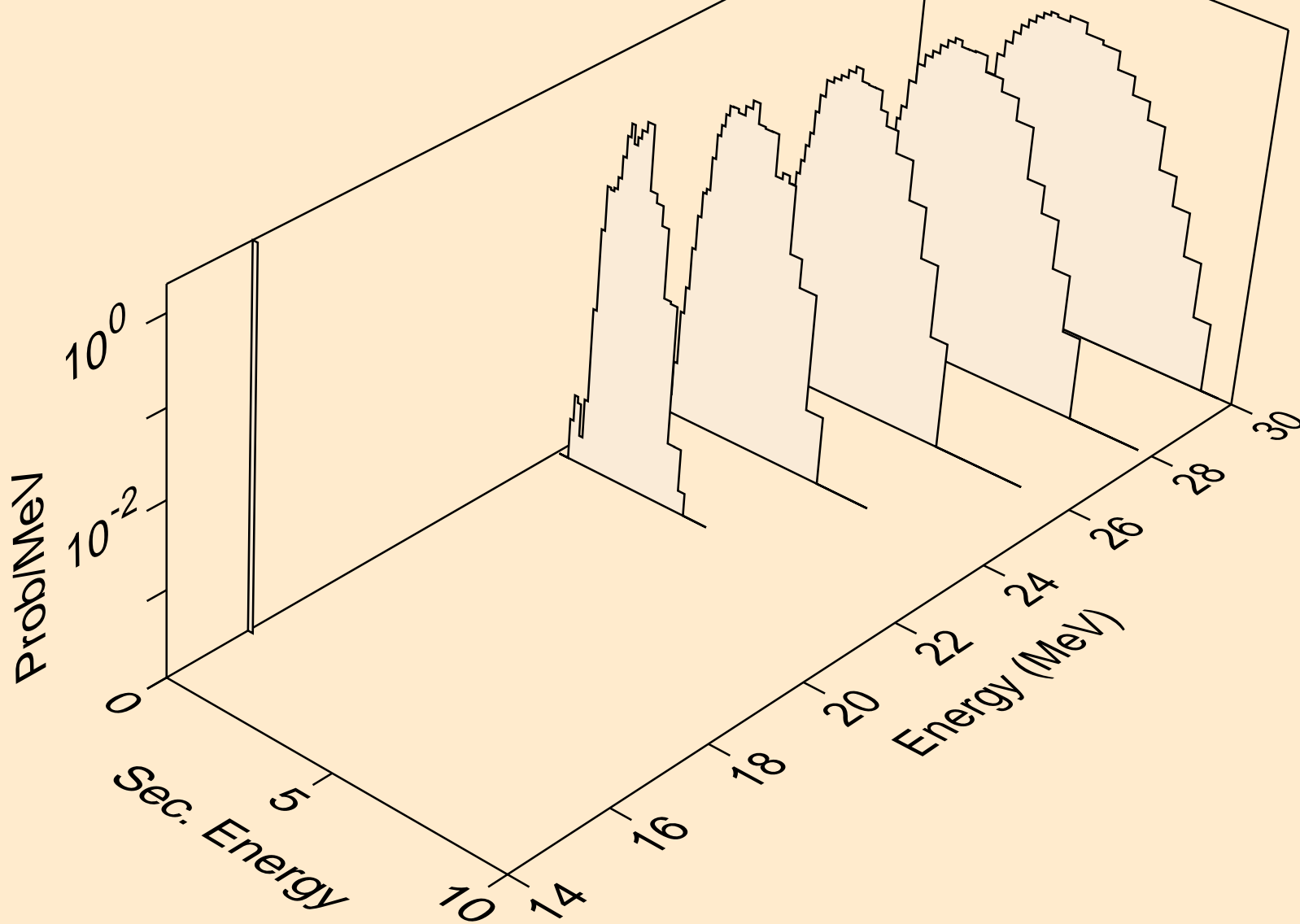

AS081 NEUTRON ACER TENDL-2019 LIBRARY; T=293.16K  
deuterons from (n,x)

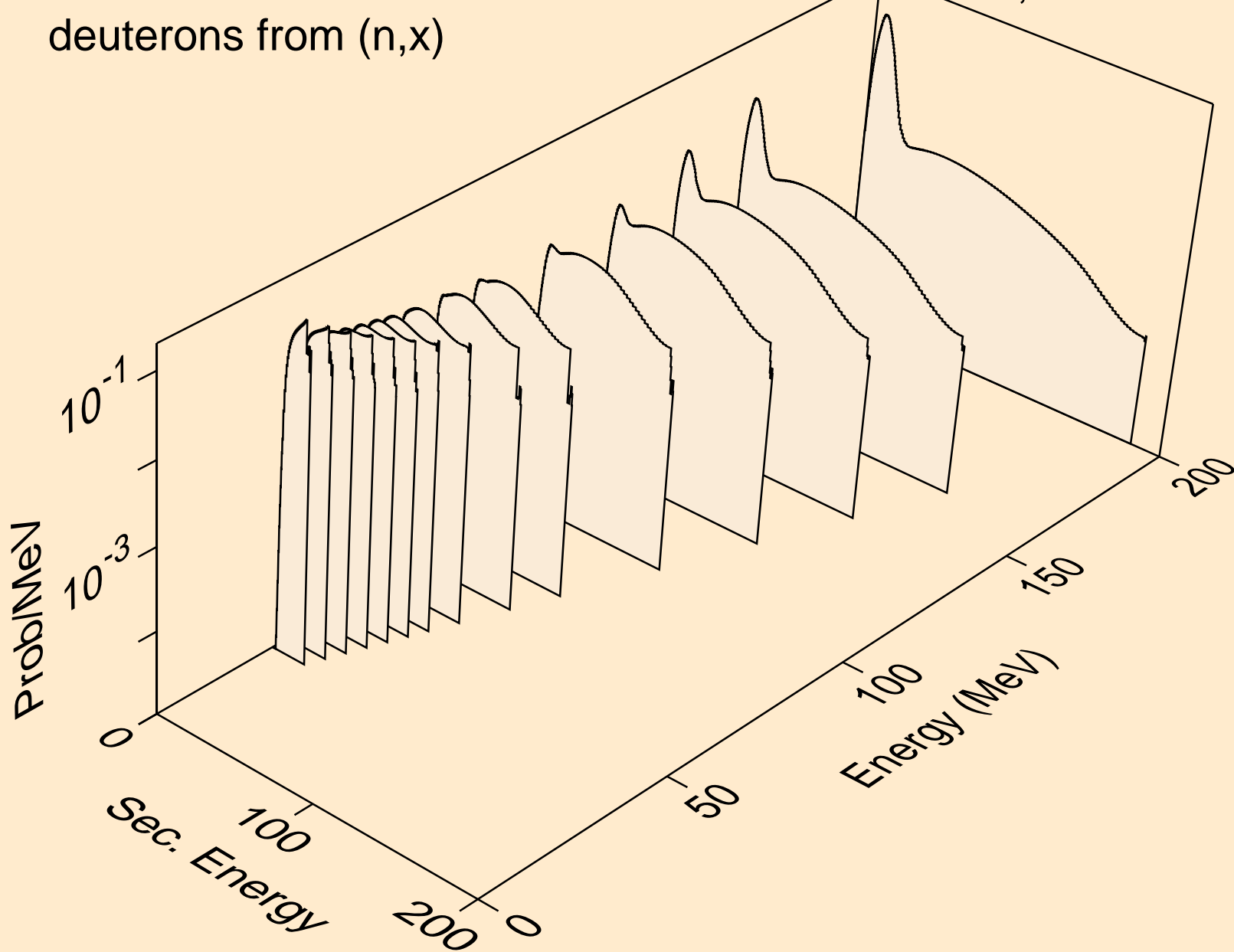

AS081 NEUTRON ACER TENDL-2019 LIBRARY; T=293.16K  
deuterons from (n,2nd)

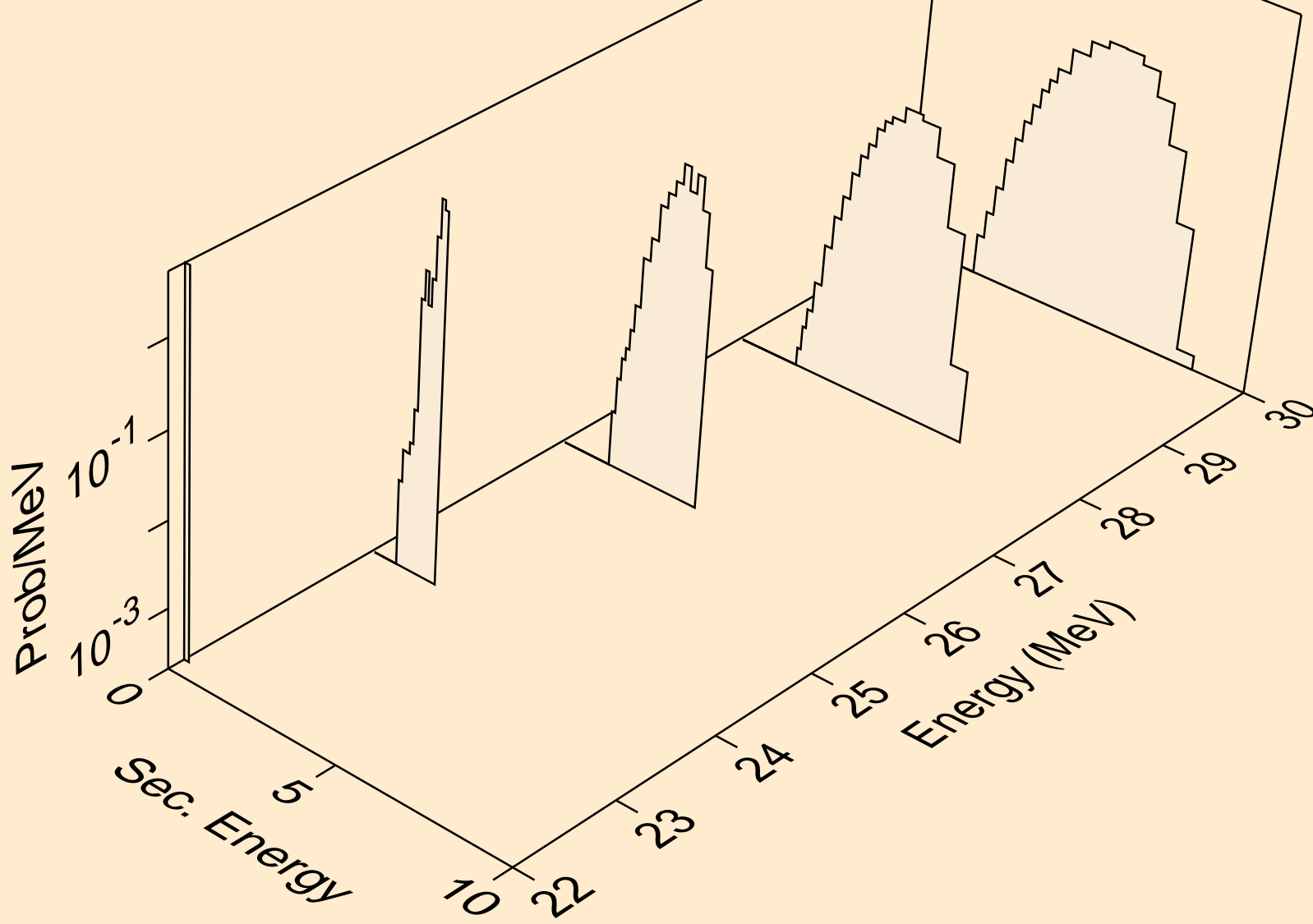



AS081 NEUTRON ACER TENDL-2019 LIBRARY; T=293.16K  
deuterons from (n,n\*)d

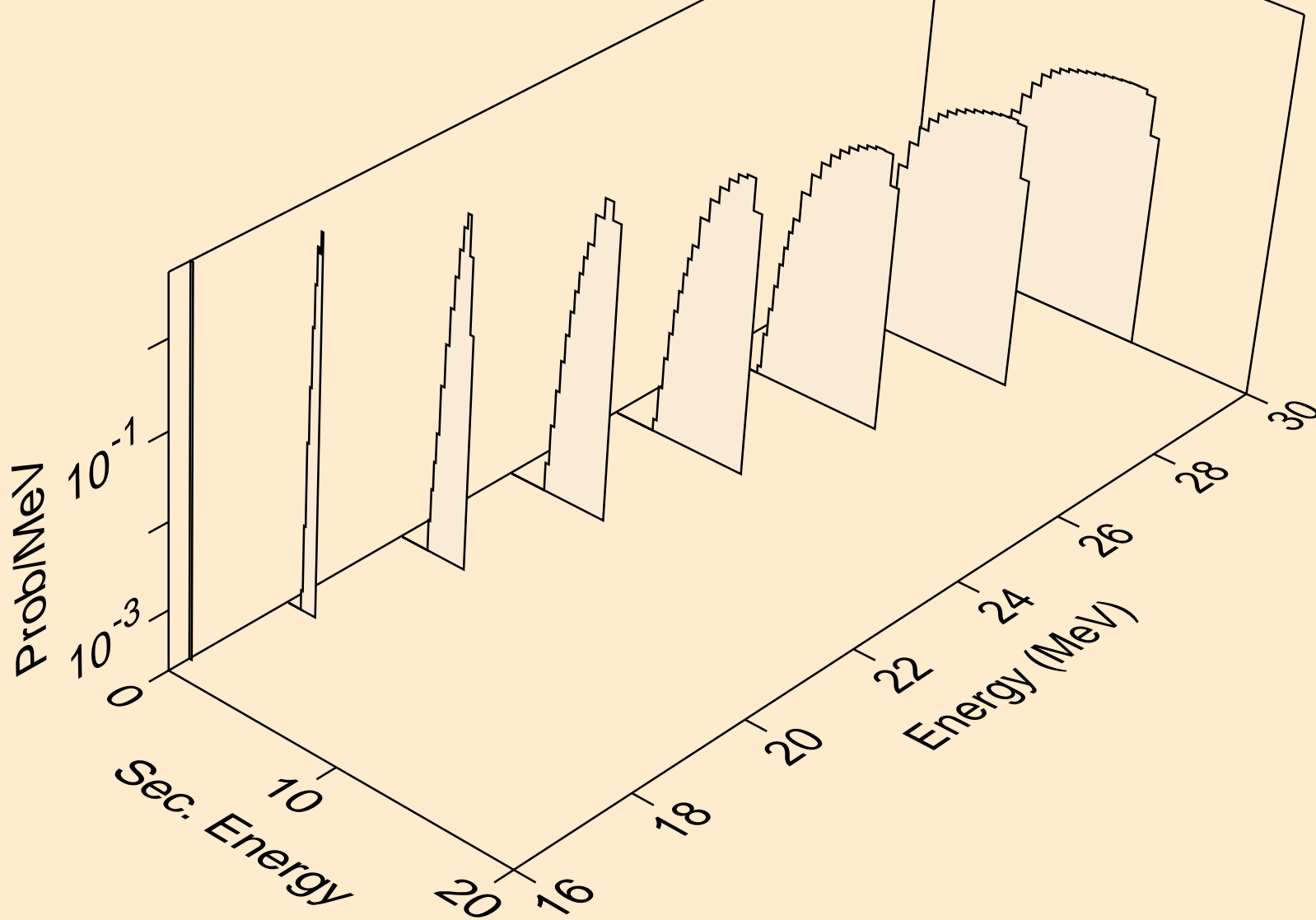

AS081 NEUTRON ACER TENDL-2019 LIBRARY; T=293.16K  
deuterons from (n,d)

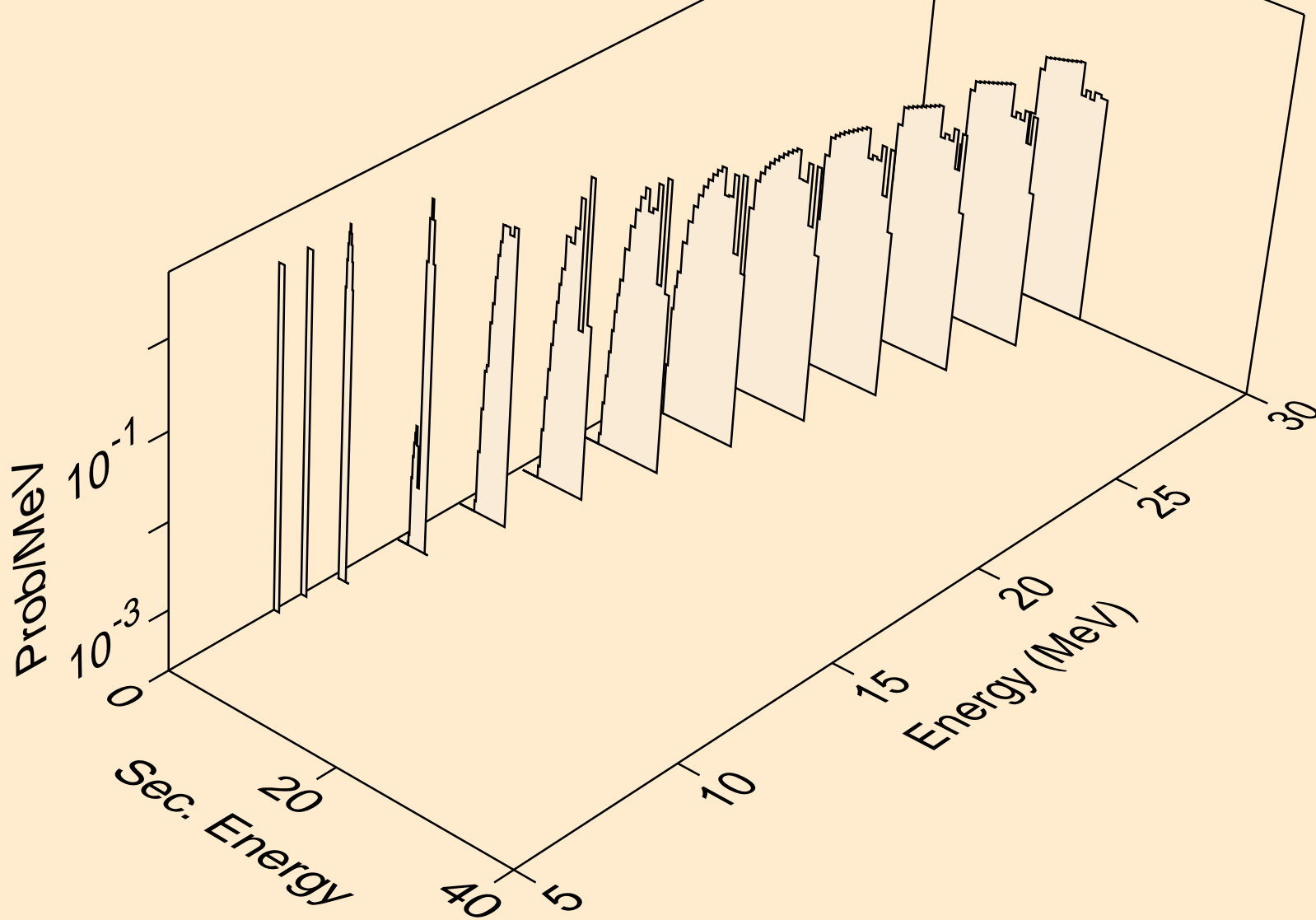

AS081 NEUTRON ACER TENDL-2019 LIBRARY; T=293.16K  
tritons from (n,x)

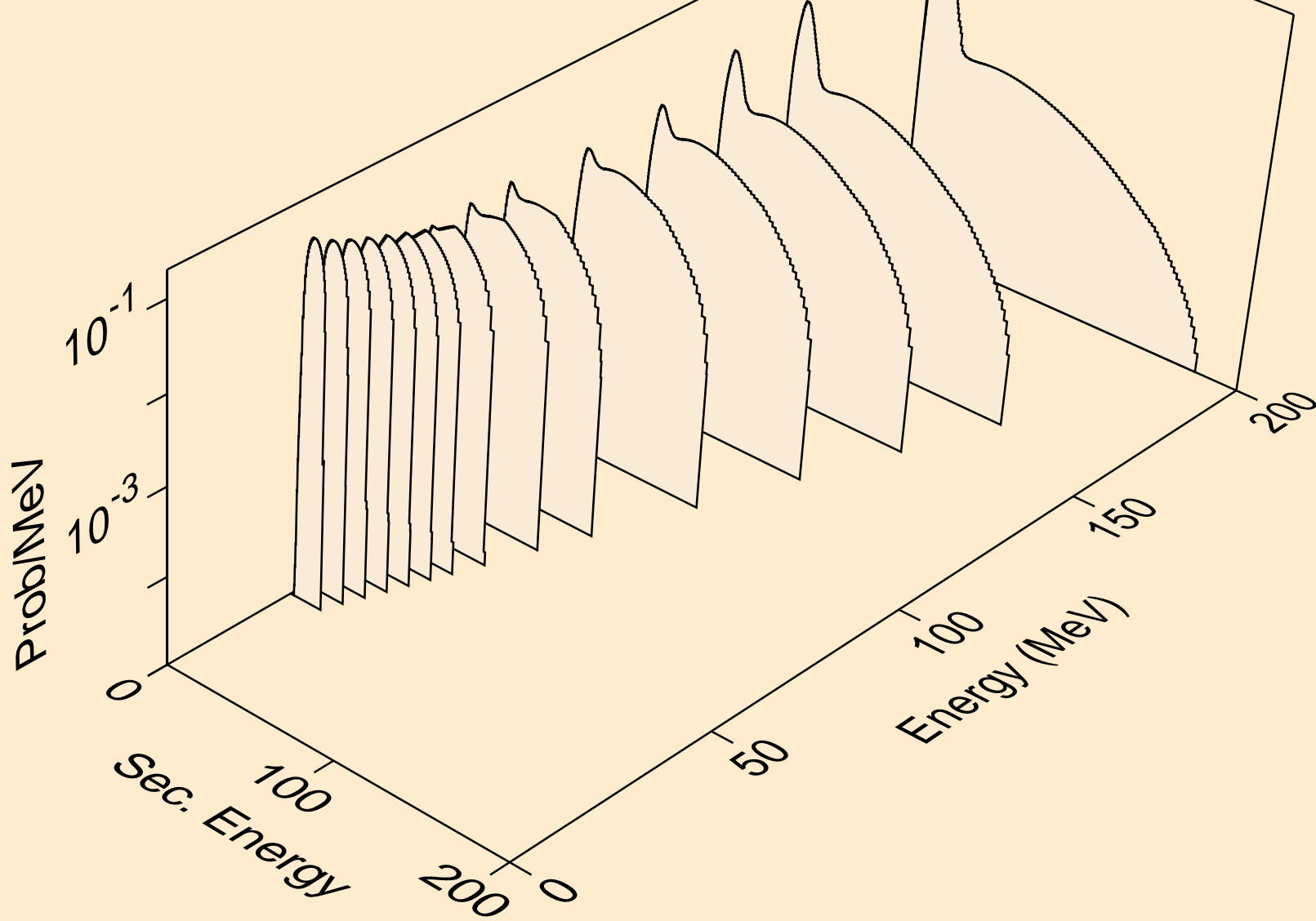

AS081 NEUTRON ACER TENDL-2019 LIBRARY; T=293.16K  
tritons from (n,n\*)t

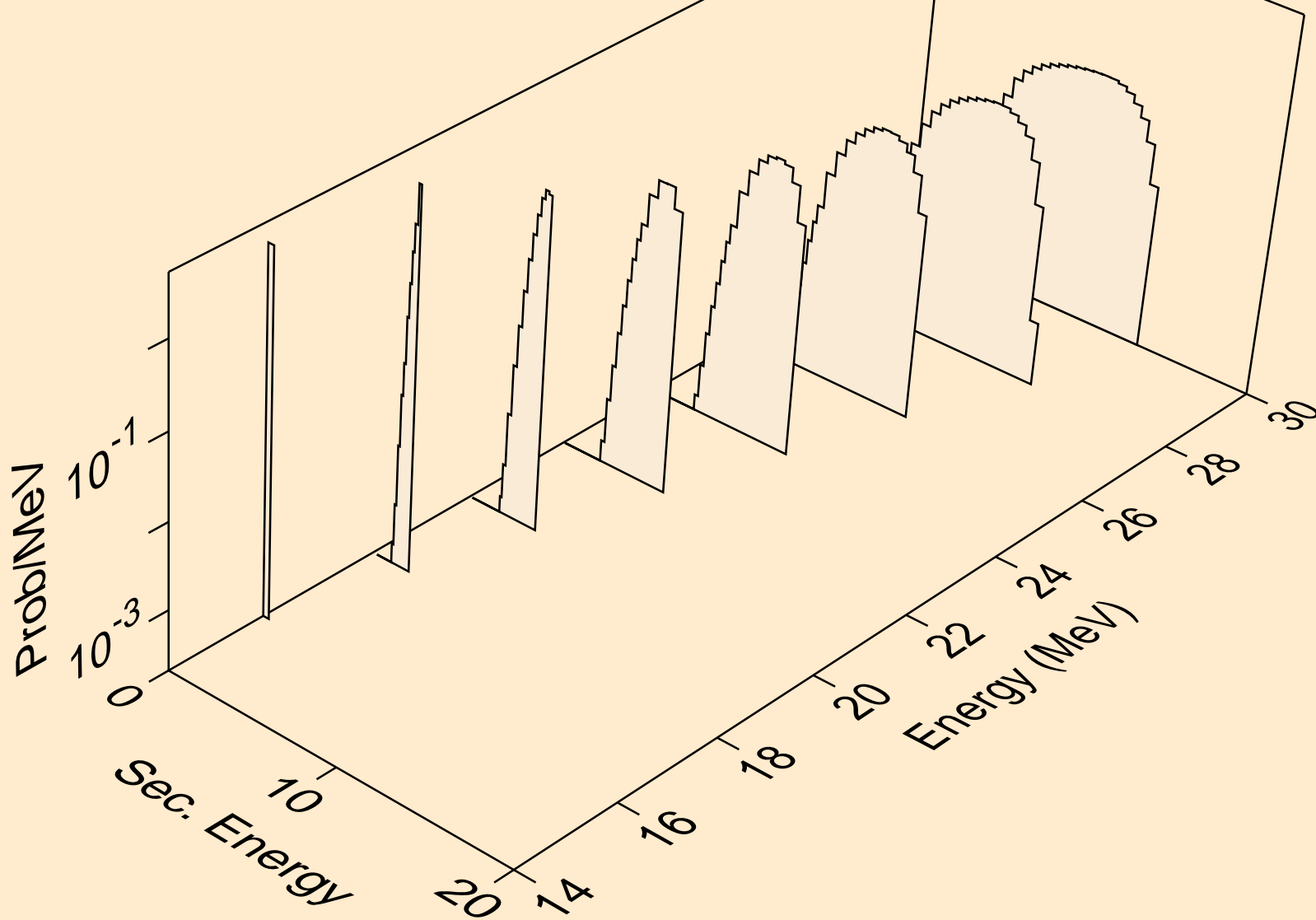

AS081 NEUTRON ACER TENDL-2019 LIBRARY; T=293.16K  
tritons from (n,t)

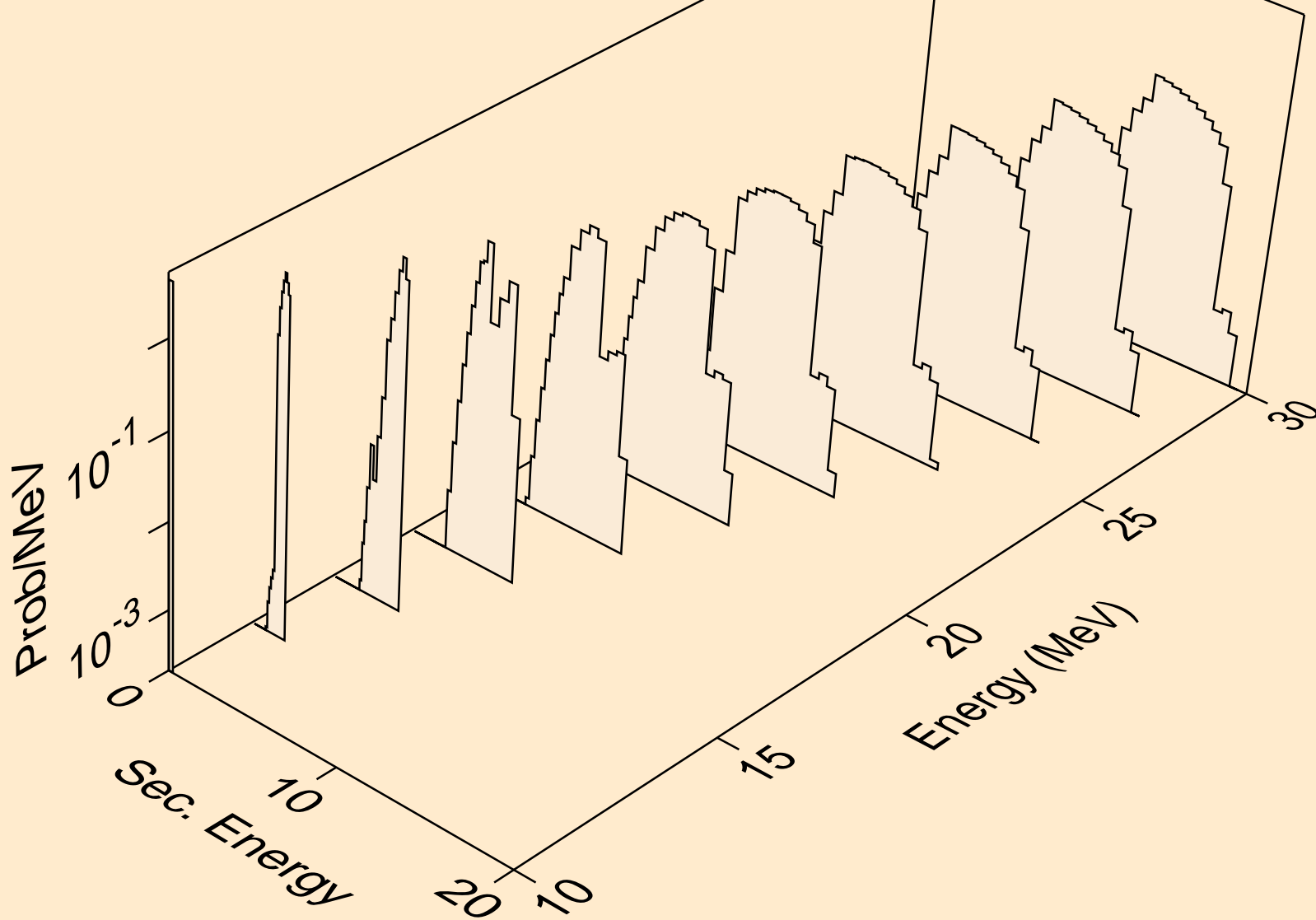

AS081 NEUTRON ACER TENDL-2019 LIBRARY; T=293.16K  
he3s from (n,x)

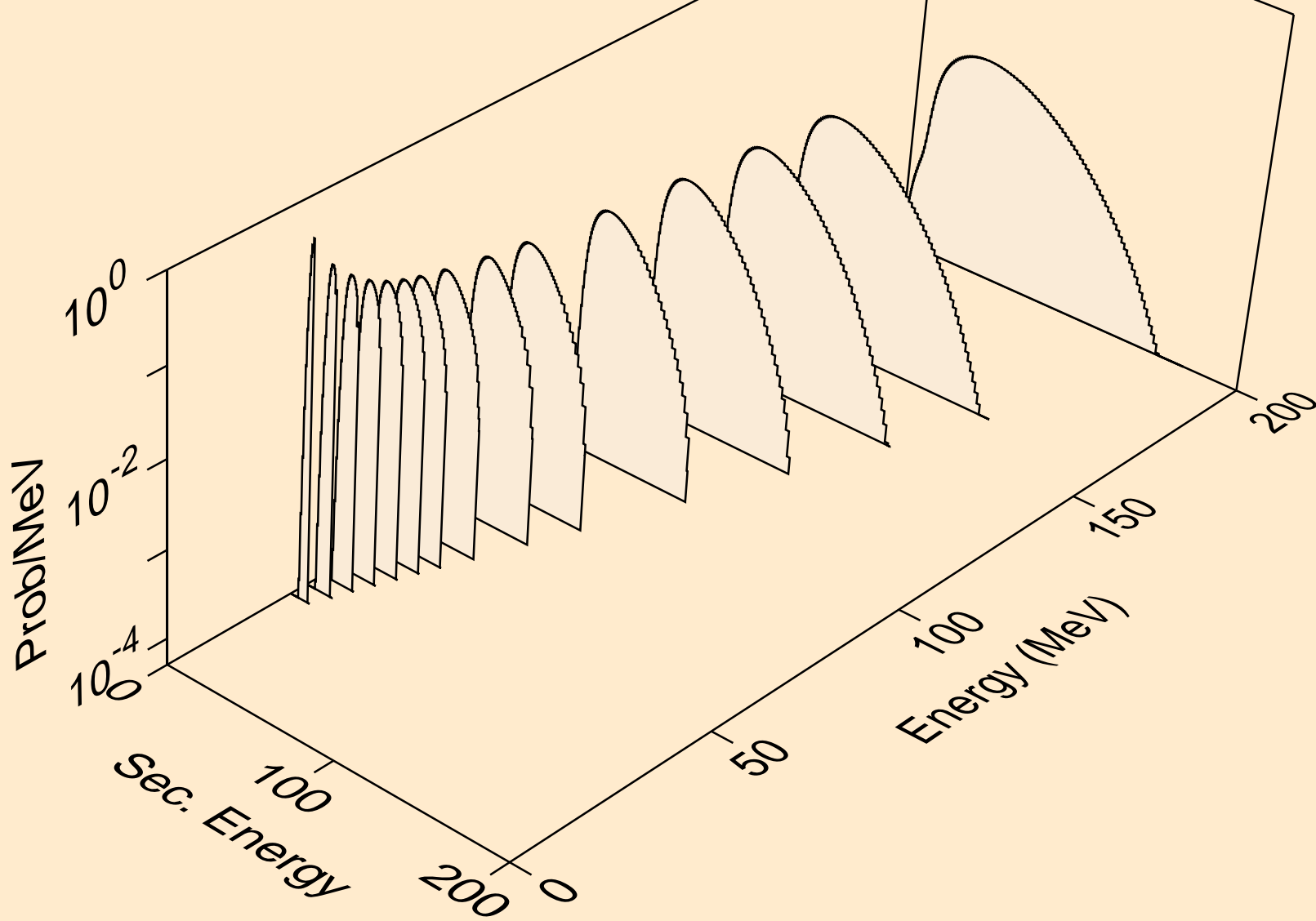

AS081 NEUTRON ACER TENDL-2019 LIBRARY; T=293.16K  
he3s from (n,n\*)he3

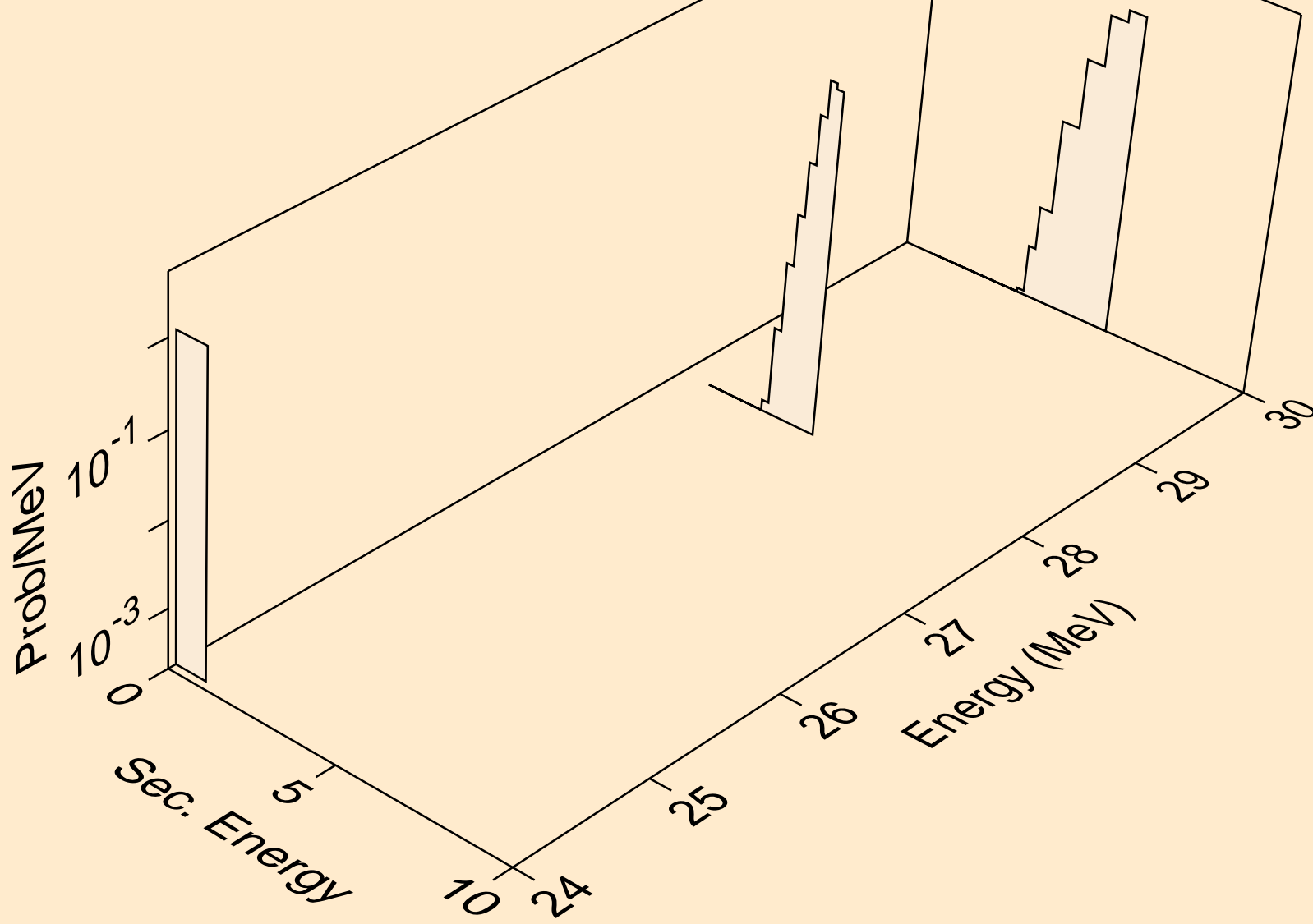

AS081 NEUTRON ACER TENDL-2019 LIBRARY; T=293.16K  
he3s from (n,he3)

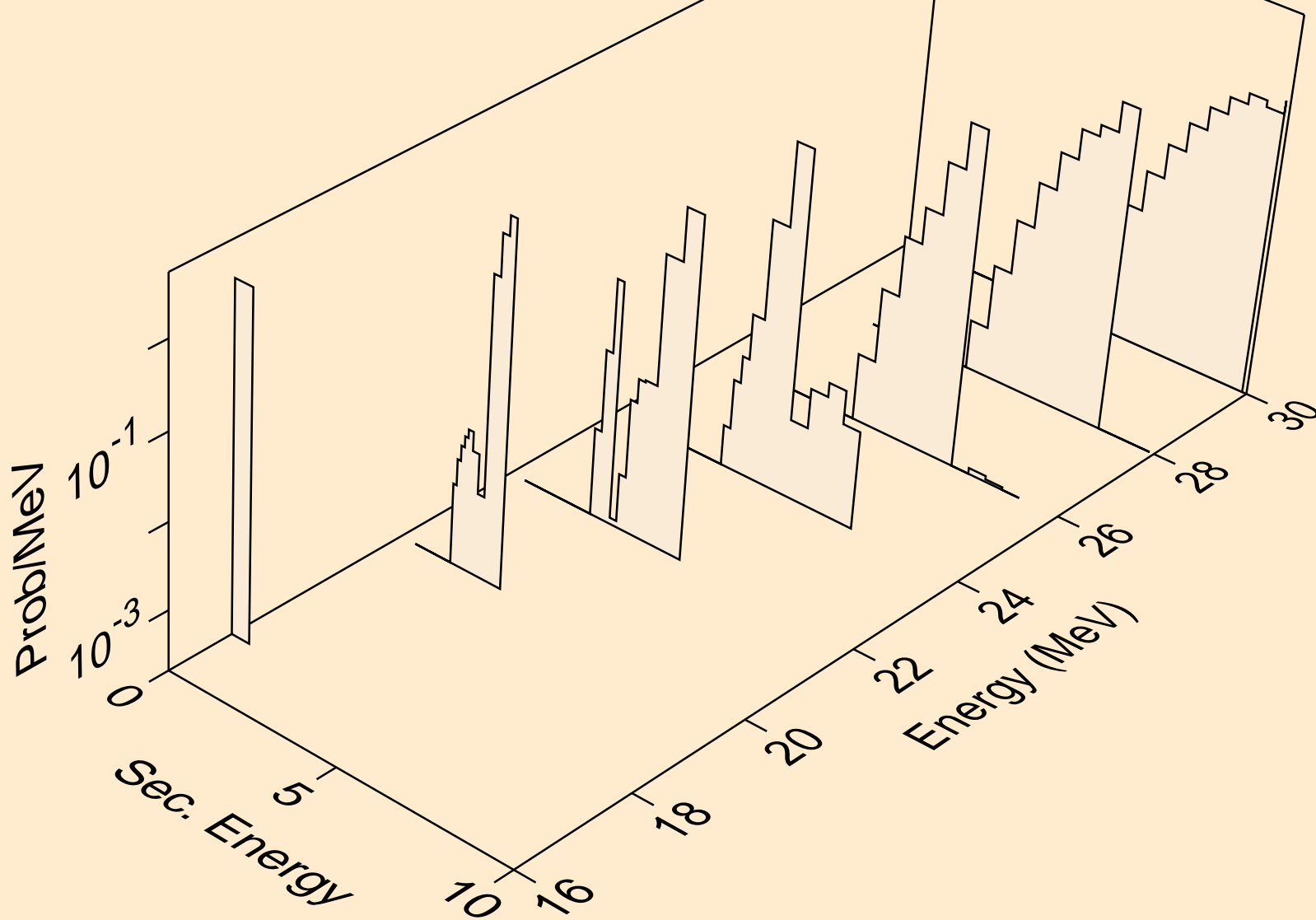



AS081 NEUTRON ACER TENDL-2019 LIBRARY; T=293.16K  
alphas from (n,x)

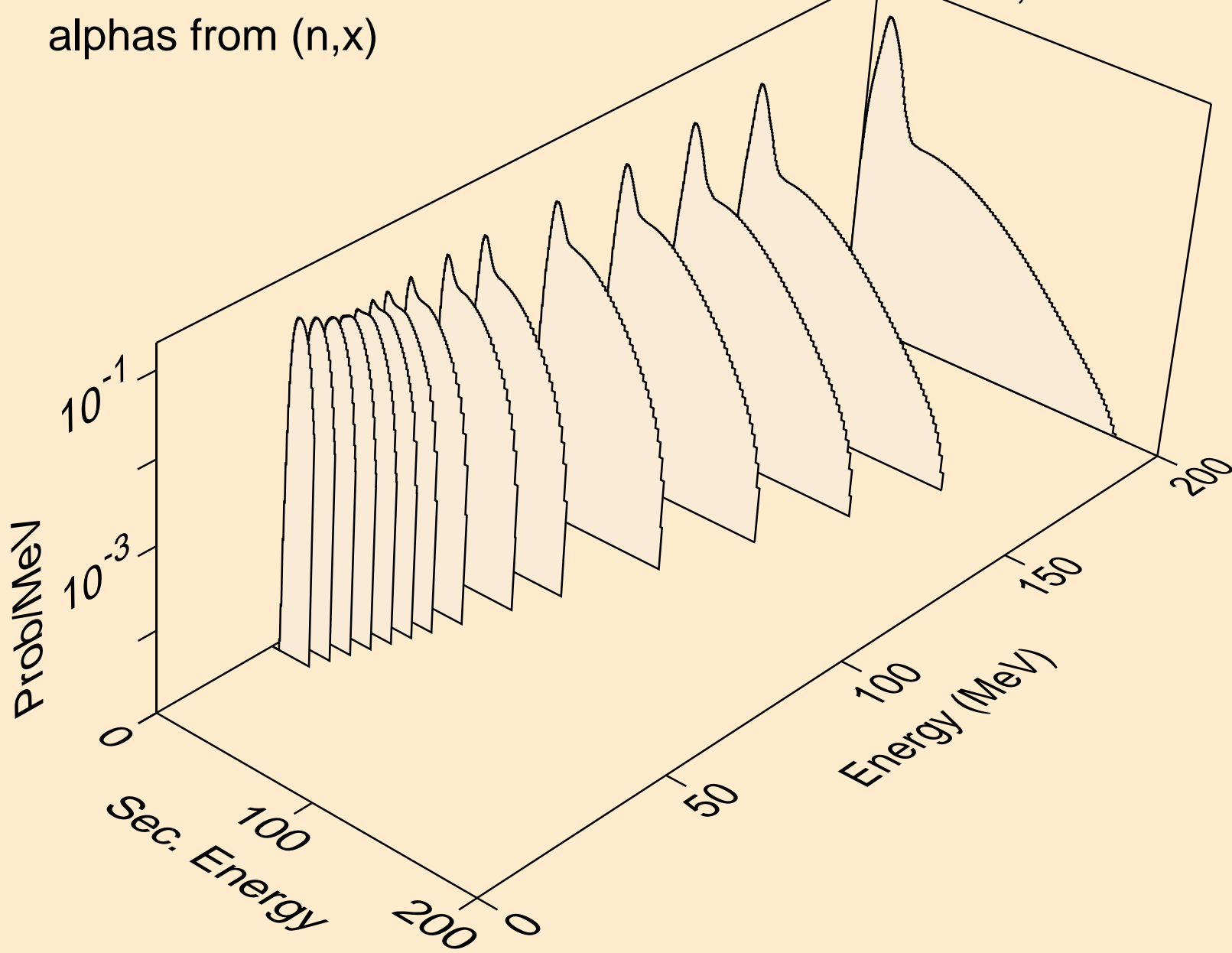

AS081 NEUTRON ACER TENDL-2019 LIBRARY; T=293.16K  
alphas from (n,n\*)a

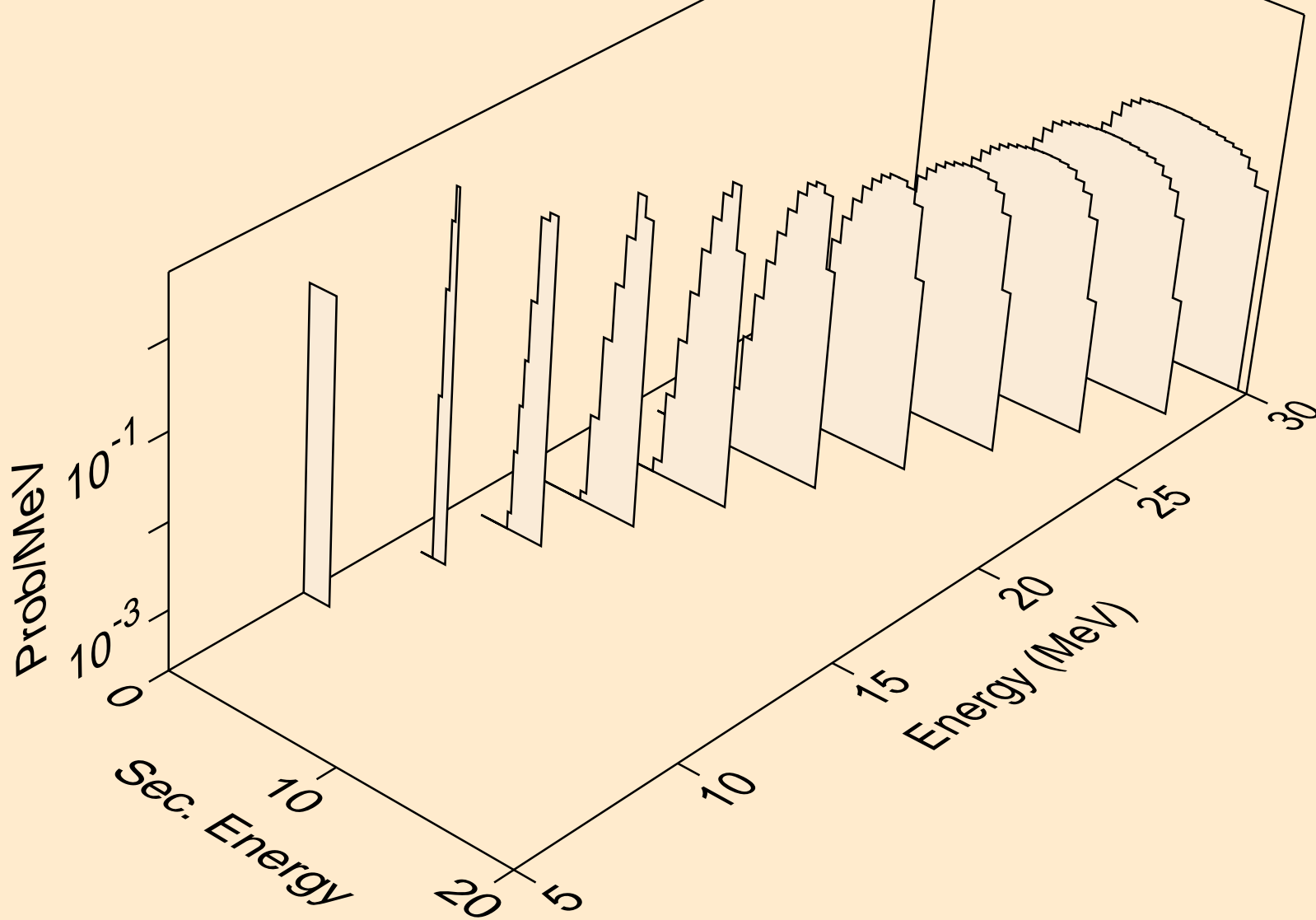

AS081 NEUTRON ACER TENDL-2019 LIBRARY; T=293.16K  
alphas from (n,2n)a

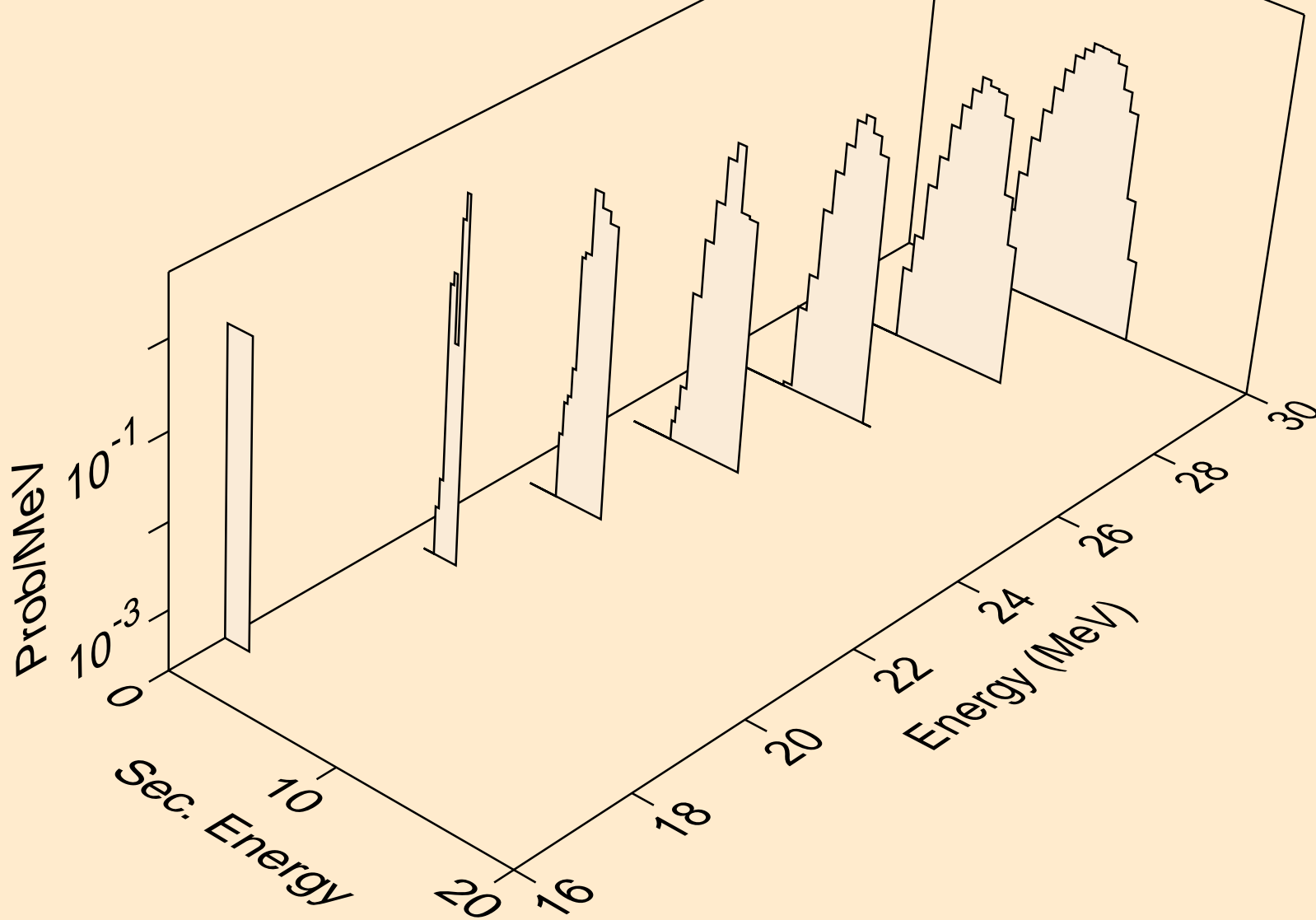

AS081 NEUTRON ACER TENDL-2019 LIBRARY; T=293.16K  
alphas from (n,3n)a

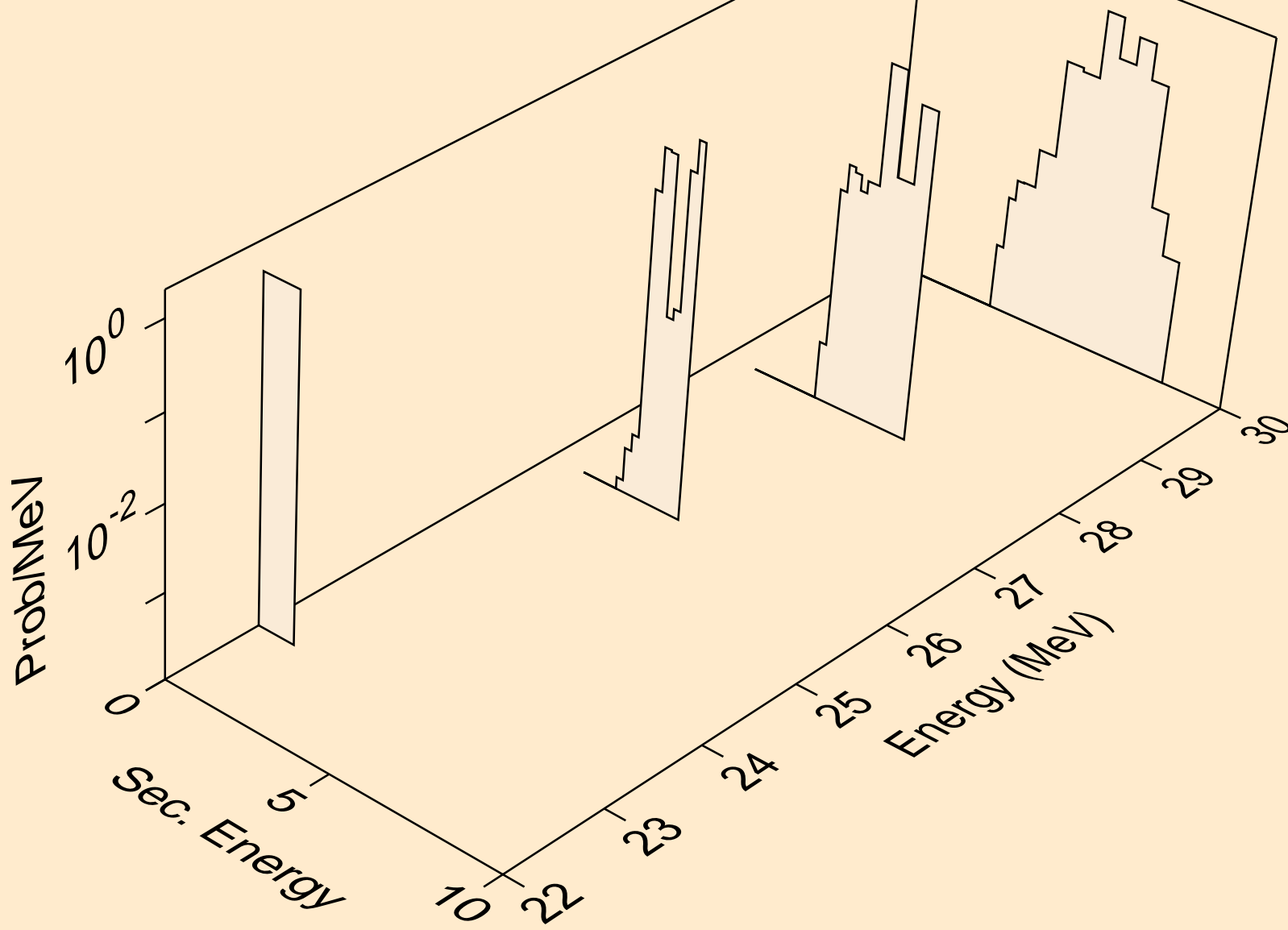

AS081 NEUTRON ACER TENDL-2019 LIBRARY; T=293.16K  
alphas from (n,a)

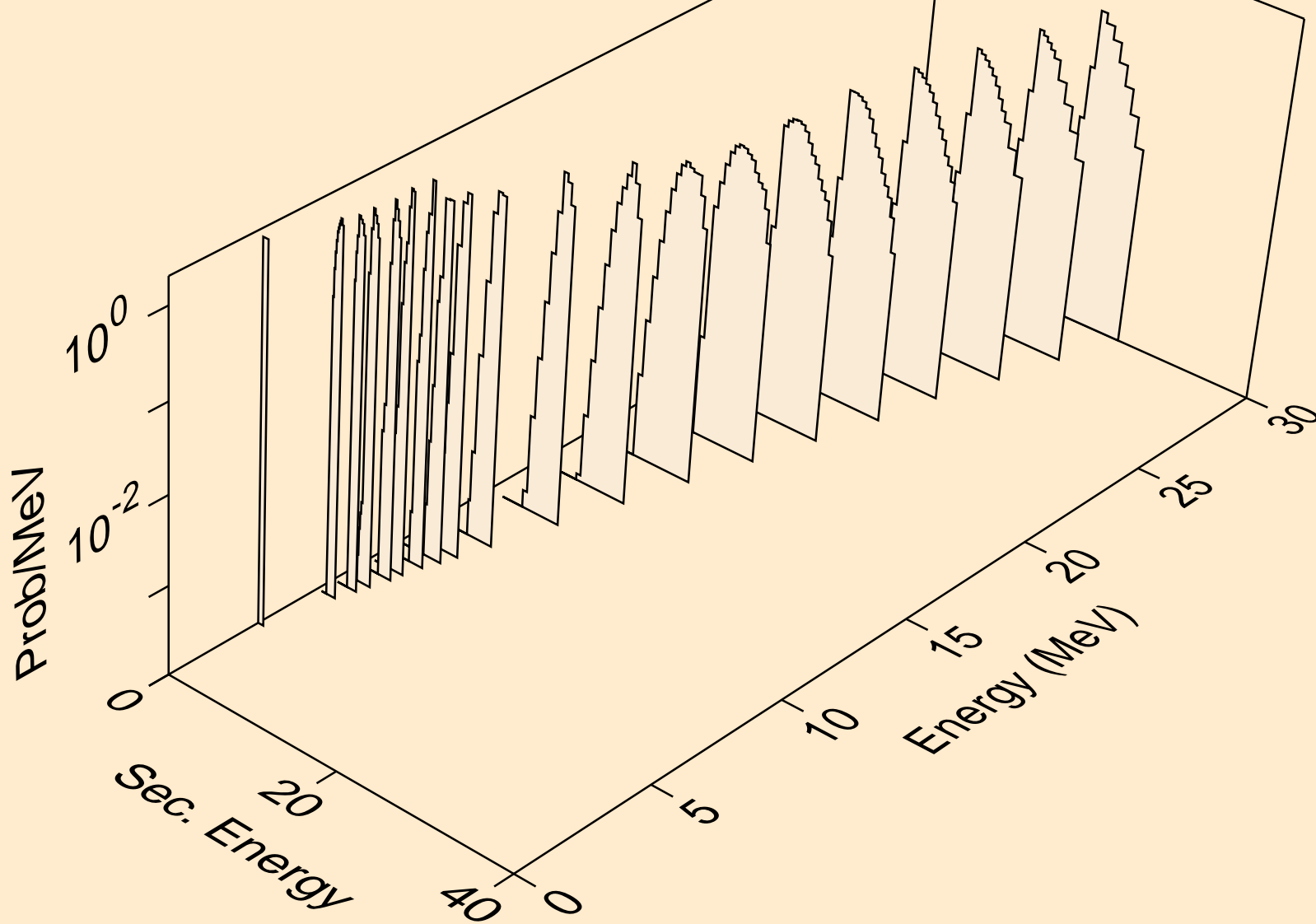

AS081 NEUTRON ACER TENDL-2019 LIBRARY; T=293.16K  
alphas from (n,pa)

