

AT200N NEUTRON ACER TENDL-2019 LIBRARY; T=293.16K
Principal cross sections

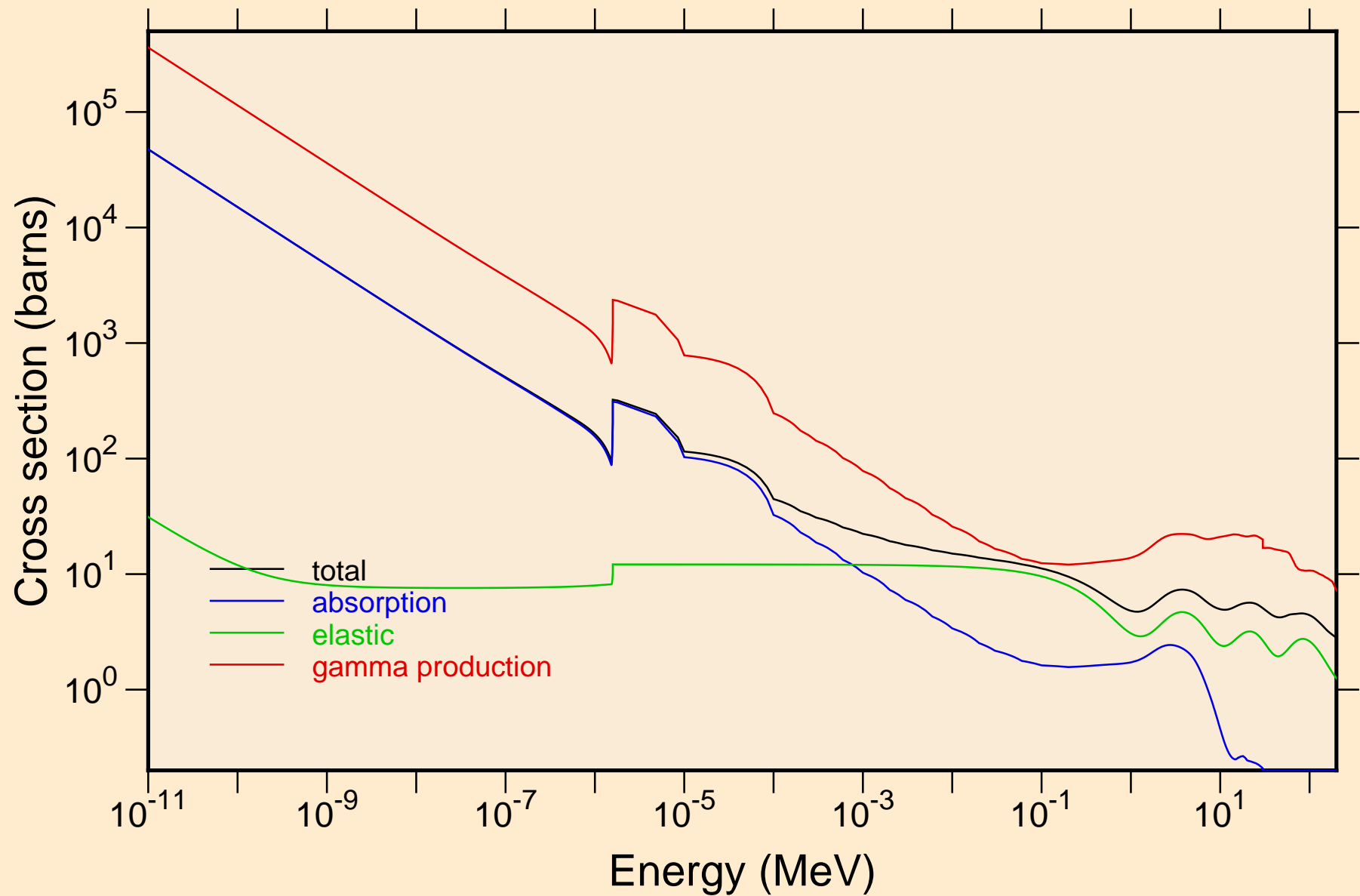

AT200N NEUTRON ACER TENDL-2019 LIBRARY; T=293.16K
Heating

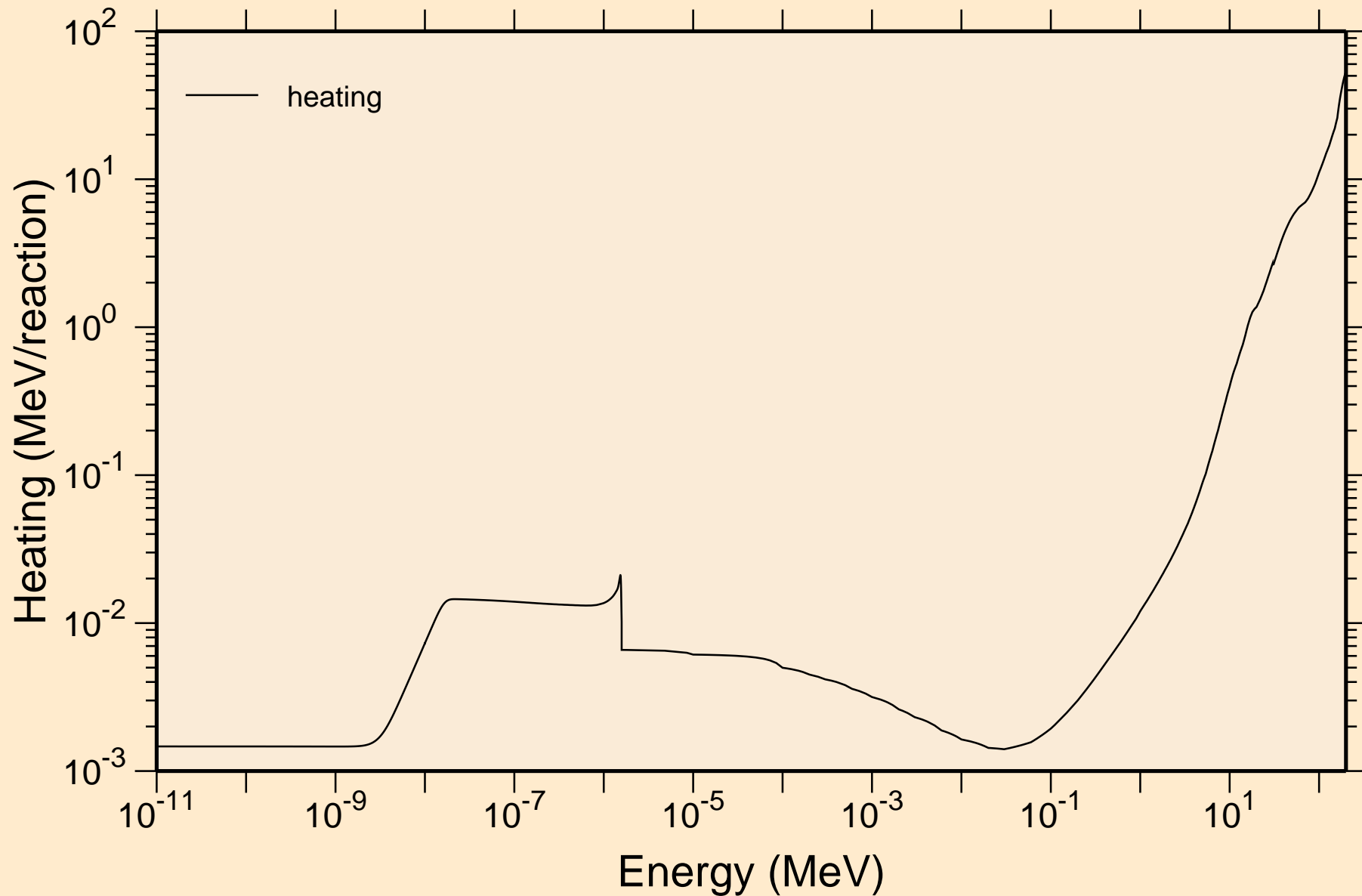

AT200N NEUTRON ACER TENDL-2019 LIBRARY; T=293.16K
Damage

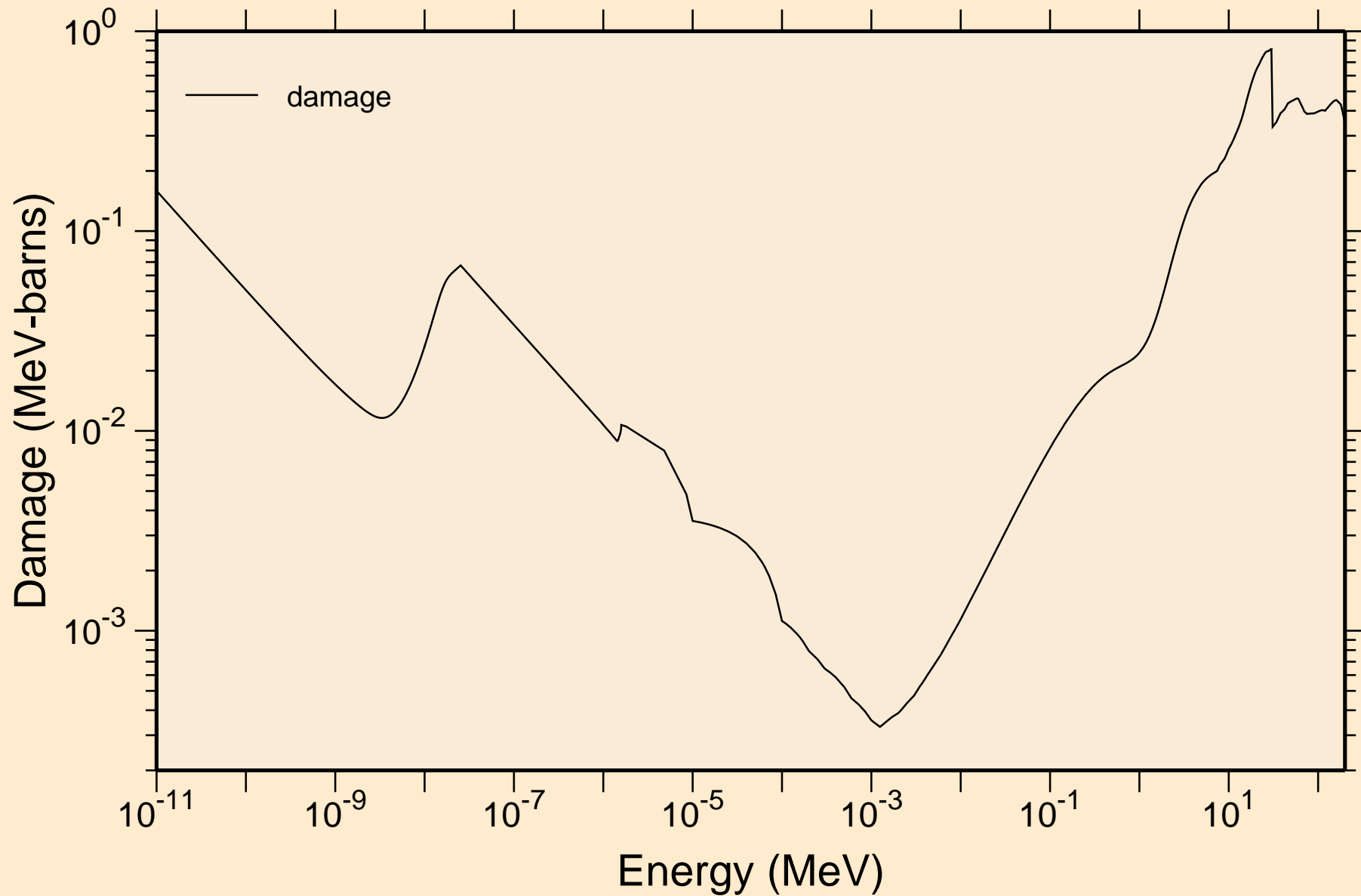

AT200N NEUTRON ACER TENDL-2019 LIBRARY; T=293.16K
Non-threshold reactions

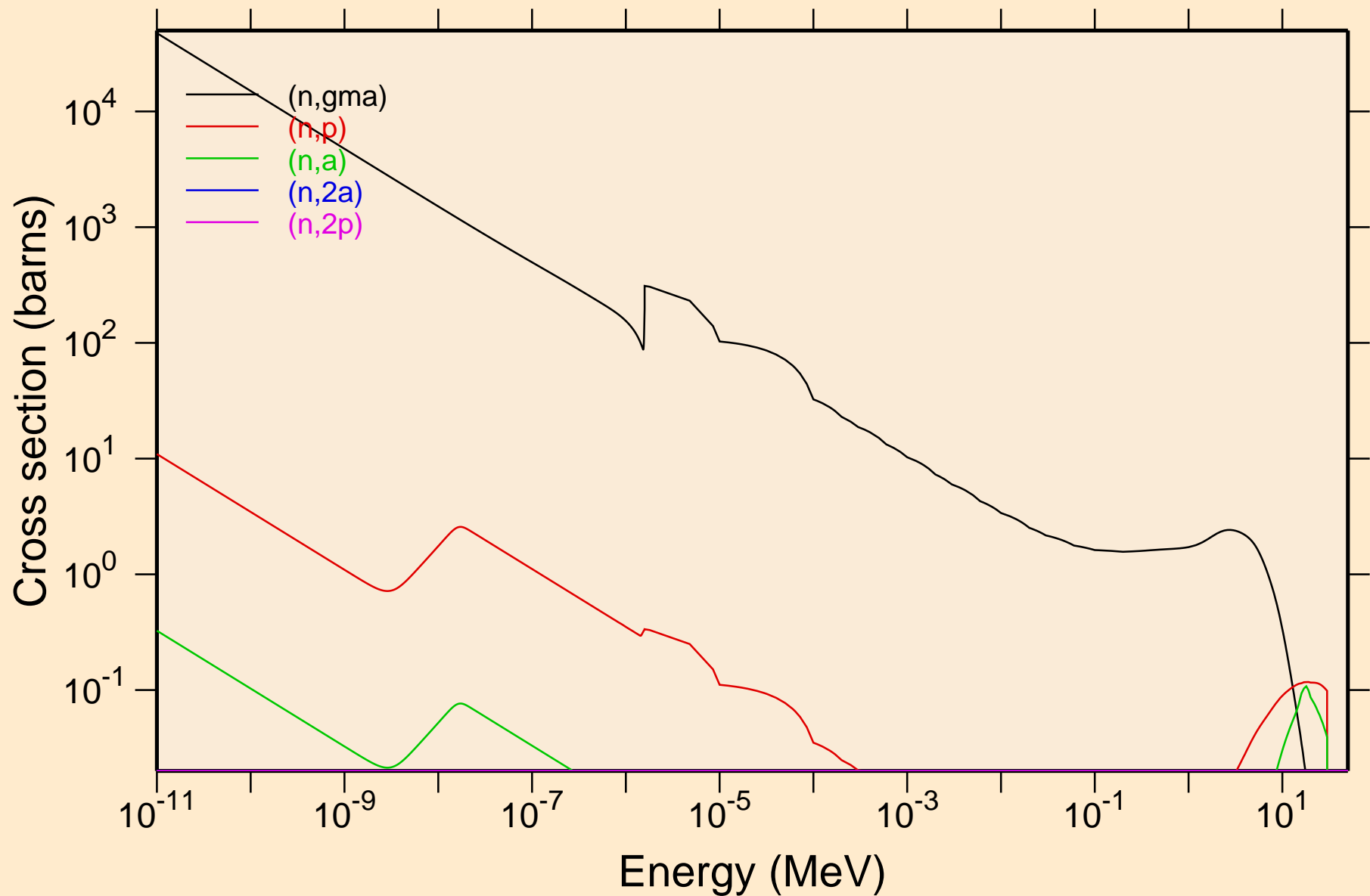

AT200N NEUTRON ACER TENDL-2019 LIBRARY; T=293.16K
Non-threshold reactions

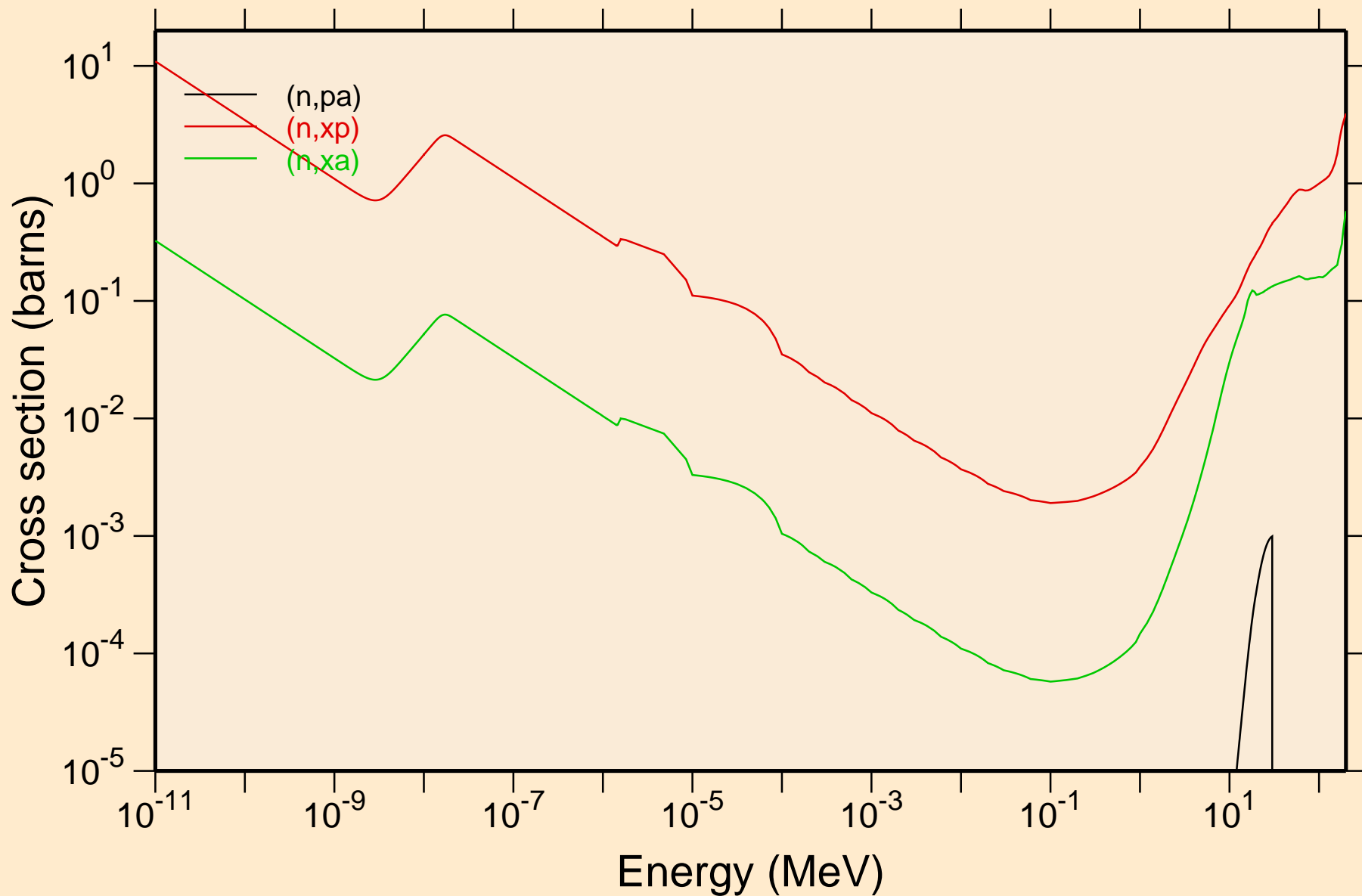

AT200N NEUTRON ACER TENDL-2019 LIBRARY; T=293.16K
Principal cross sections

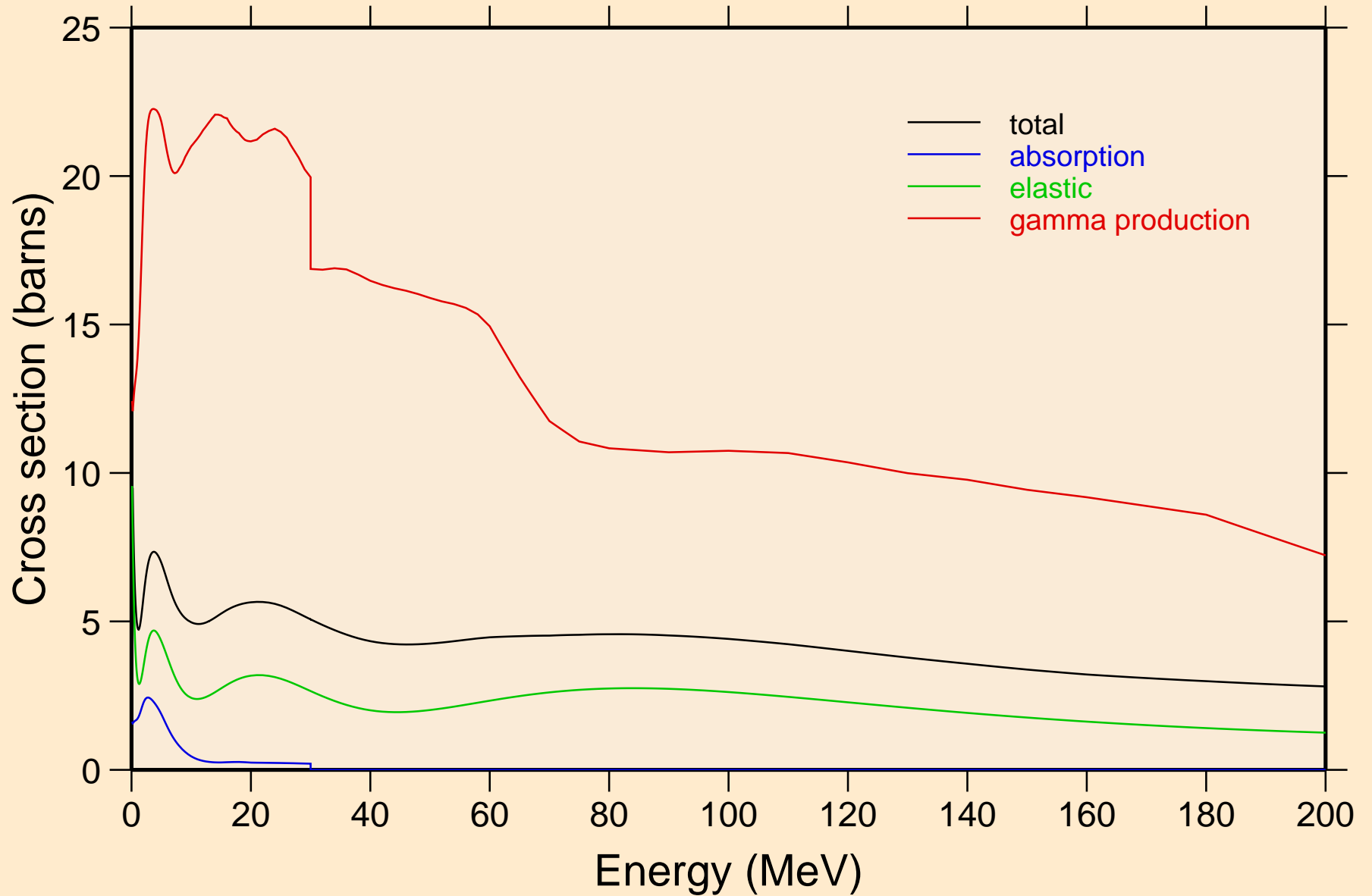

AT200N NEUTRON ACER TENDL-2019 LIBRARY; T=293.16K
Heating

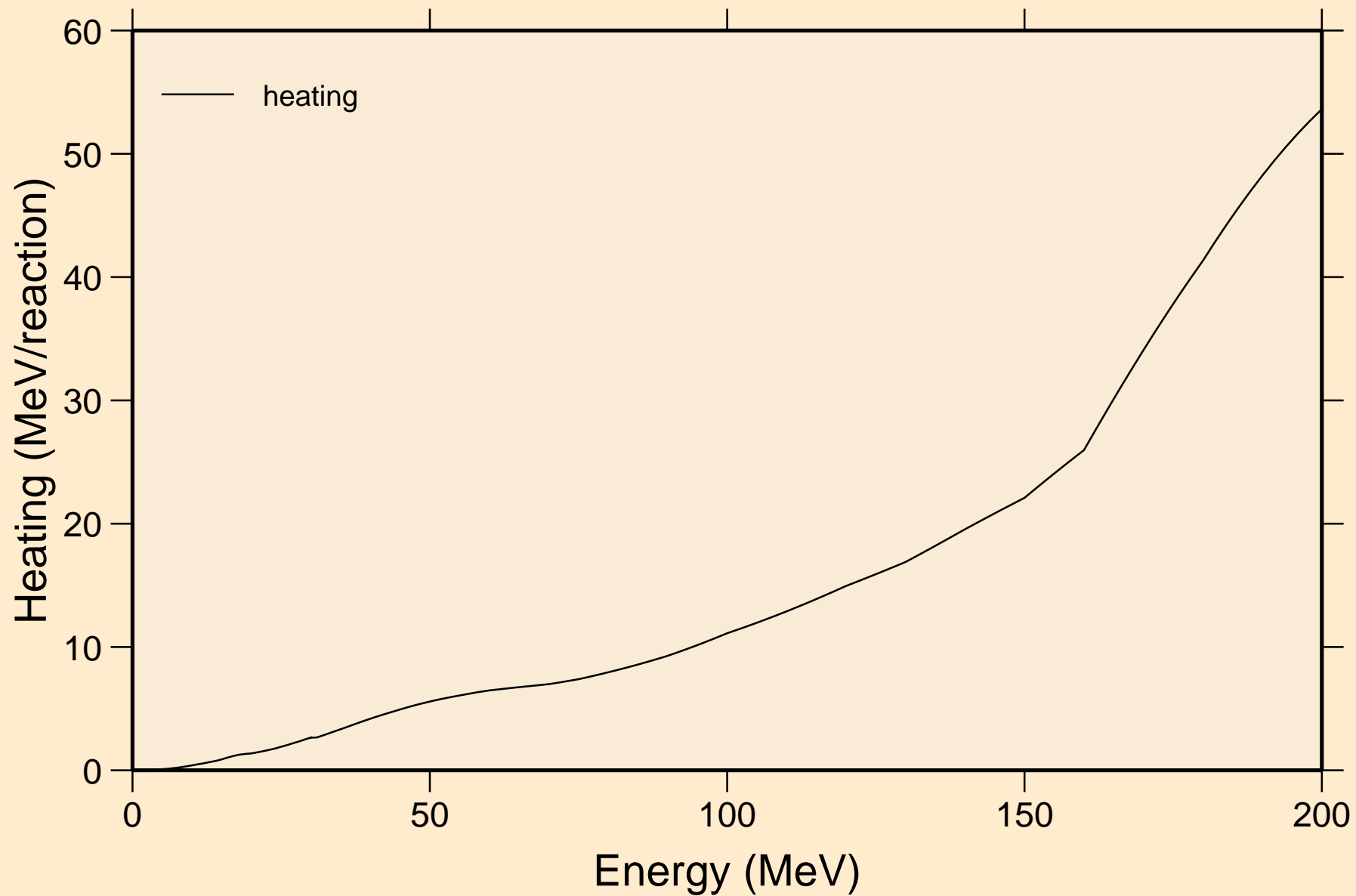

AT200N NEUTRON ACER TENDL-2019 LIBRARY; T=293.16K
Damage

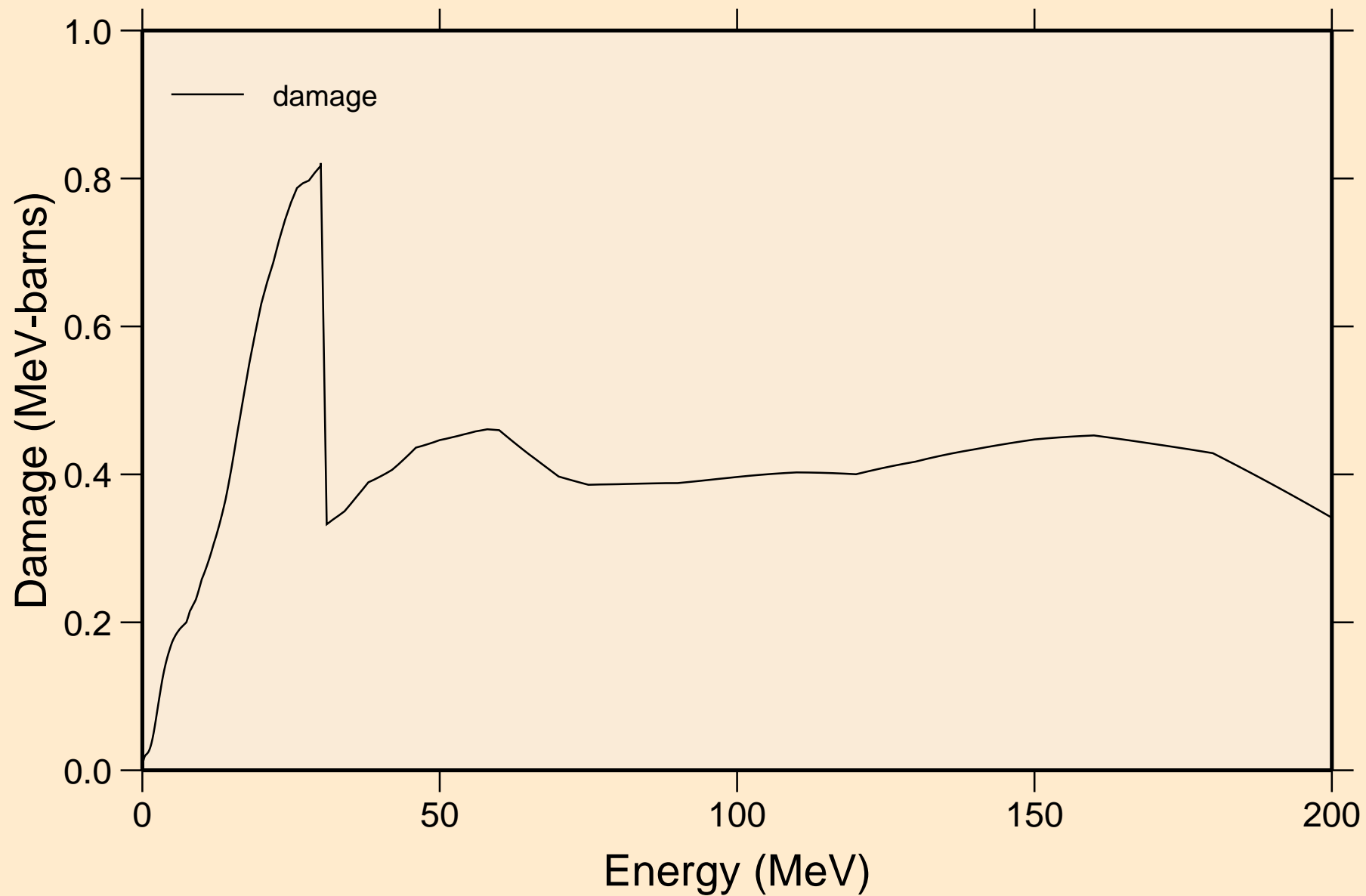

AT200N NEUTRON ACER TENDL-2019 LIBRARY; T=293.16K
Non-threshold reactions

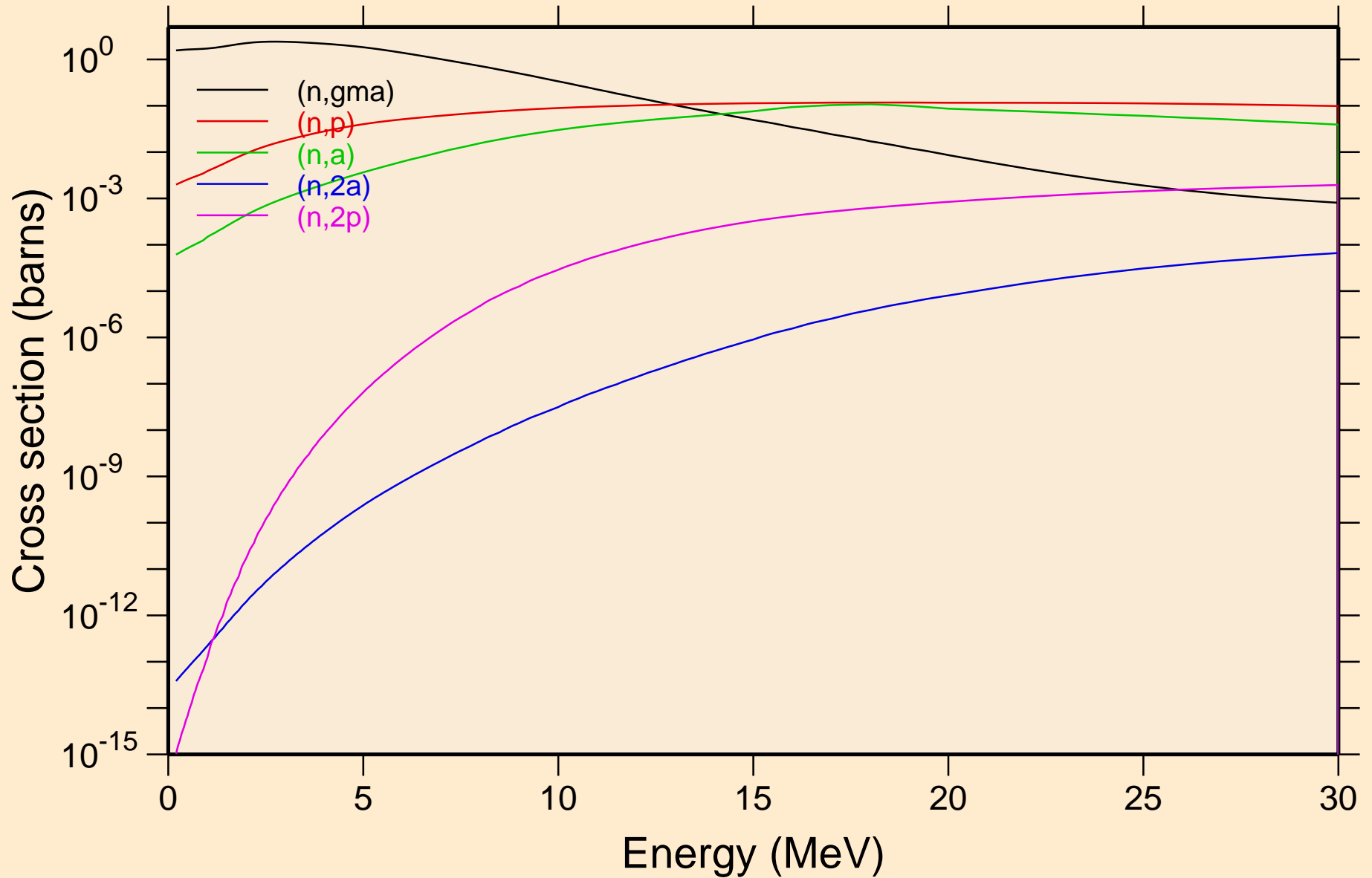

AT200N NEUTRON ACER TENDL-2019 LIBRARY; T=293.16K
Non-threshold reactions

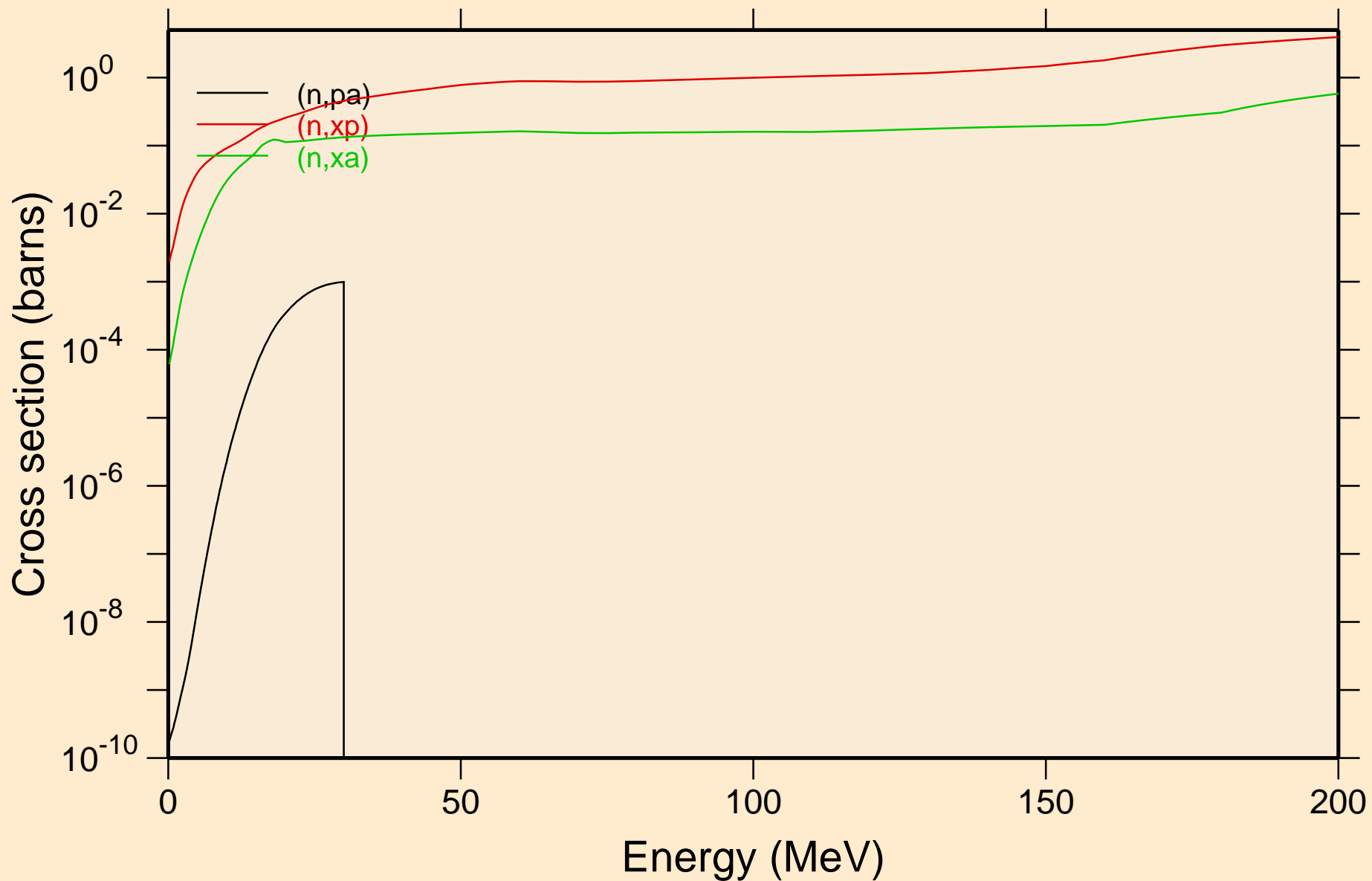

AT200N NEUTRON ACER TENDL-2019 LIBRARY; T=293.16K
Inelastic levels

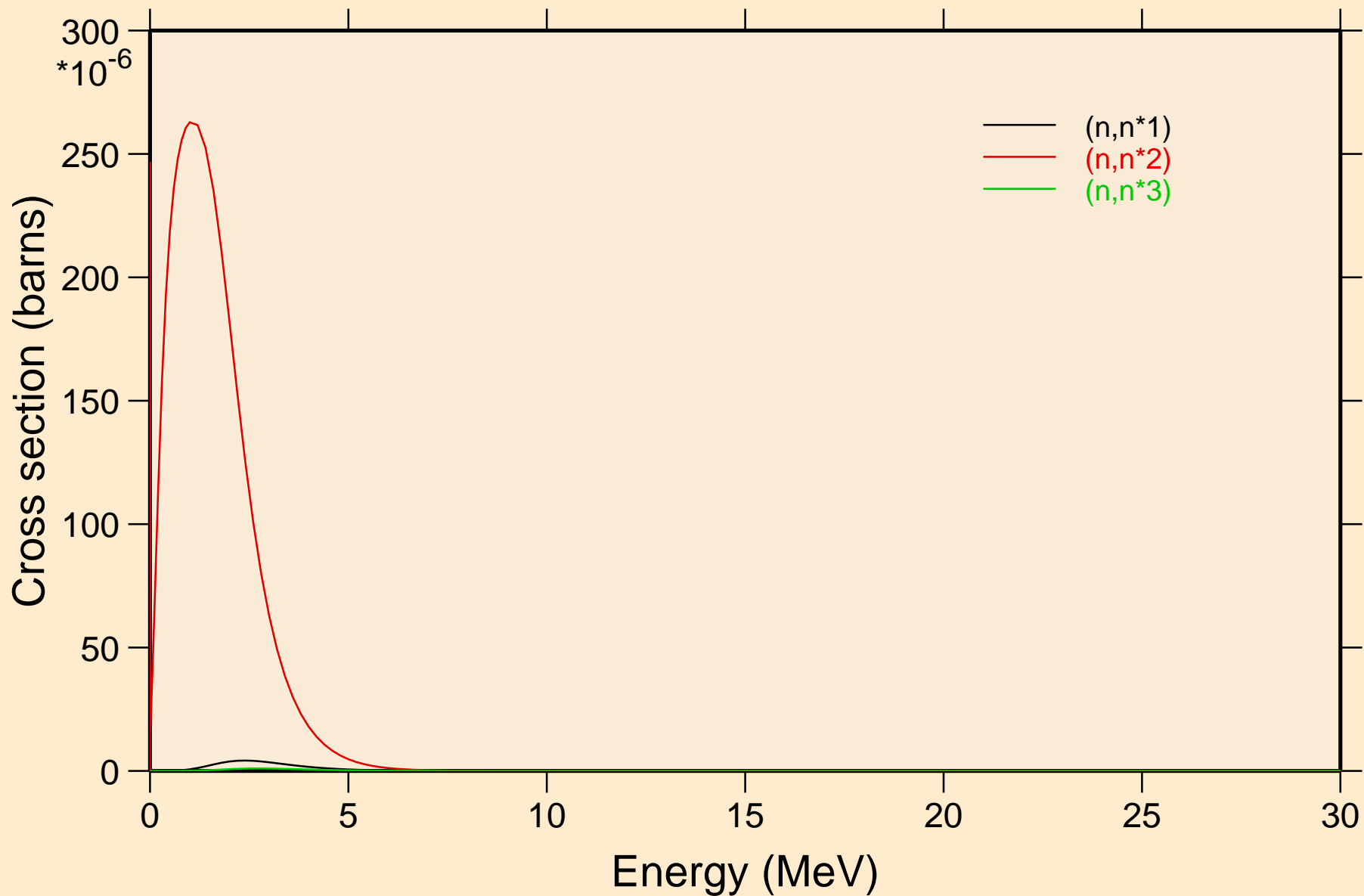

AT200N NEUTRON ACER TENDL-2019 LIBRARY; T=293.16K
Threshold reactions

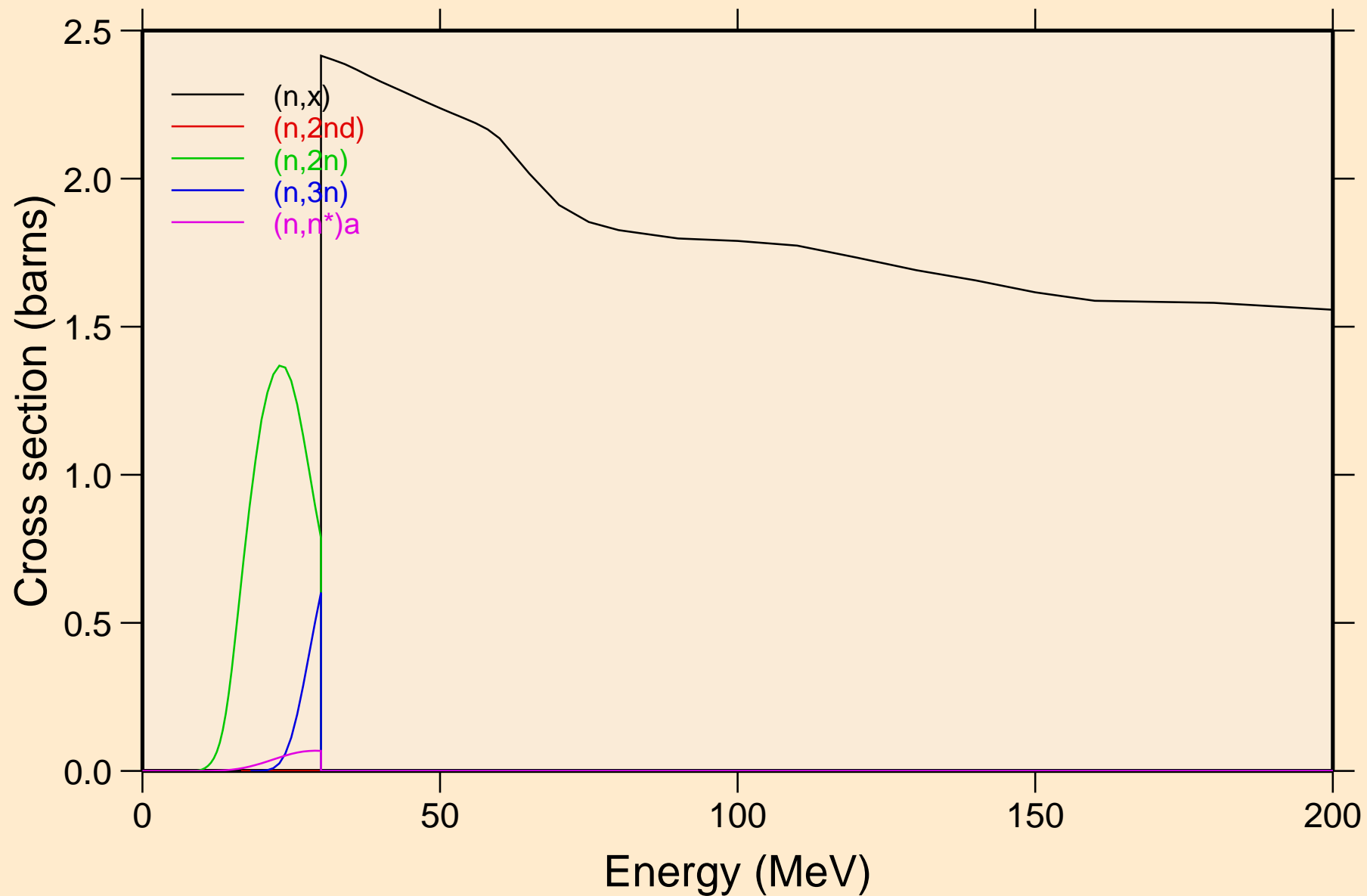

AT200N NEUTRON ACER TENDL-2019 LIBRARY; T=293.16K
Threshold reactions

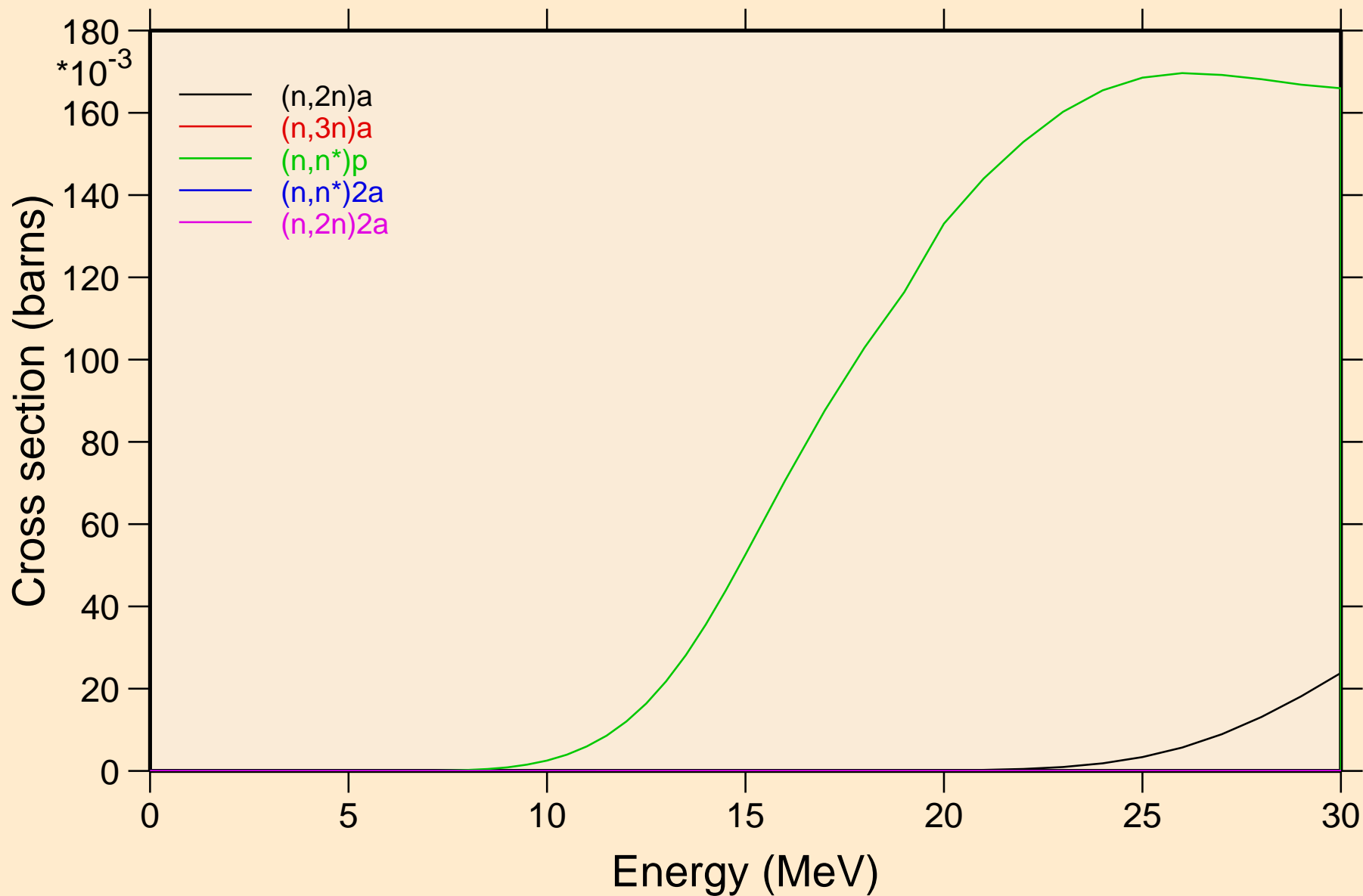

AT200N NEUTRON ACER TENDL-2019 LIBRARY; T=293.16K
Threshold reactions

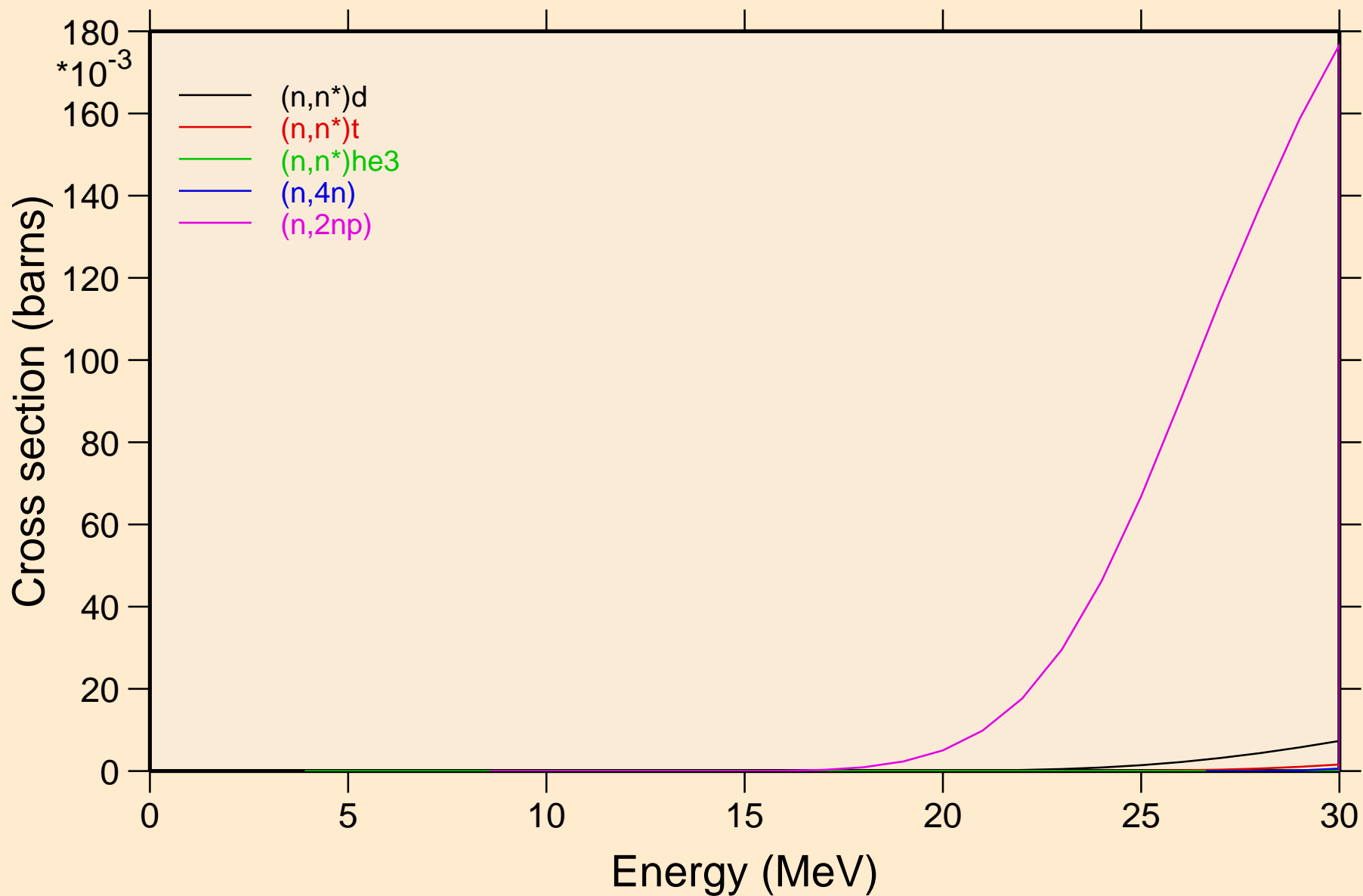

AT200N NEUTRON ACER TENDL-2019 LIBRARY; T=293.16K
Threshold reactions

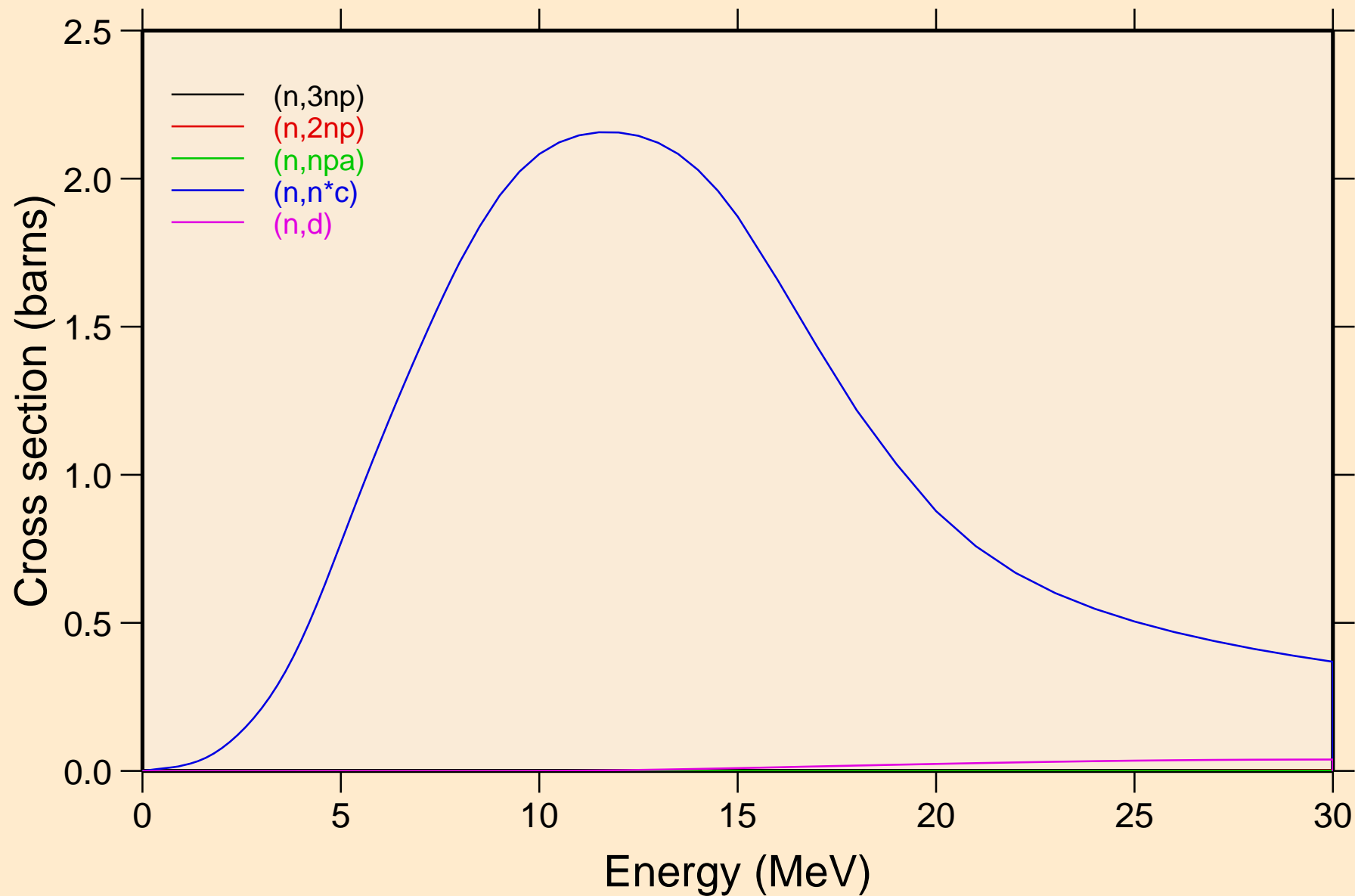

AT200N NEUTRON ACER TENDL-2019 LIBRARY; T=293.16K
Threshold reactions

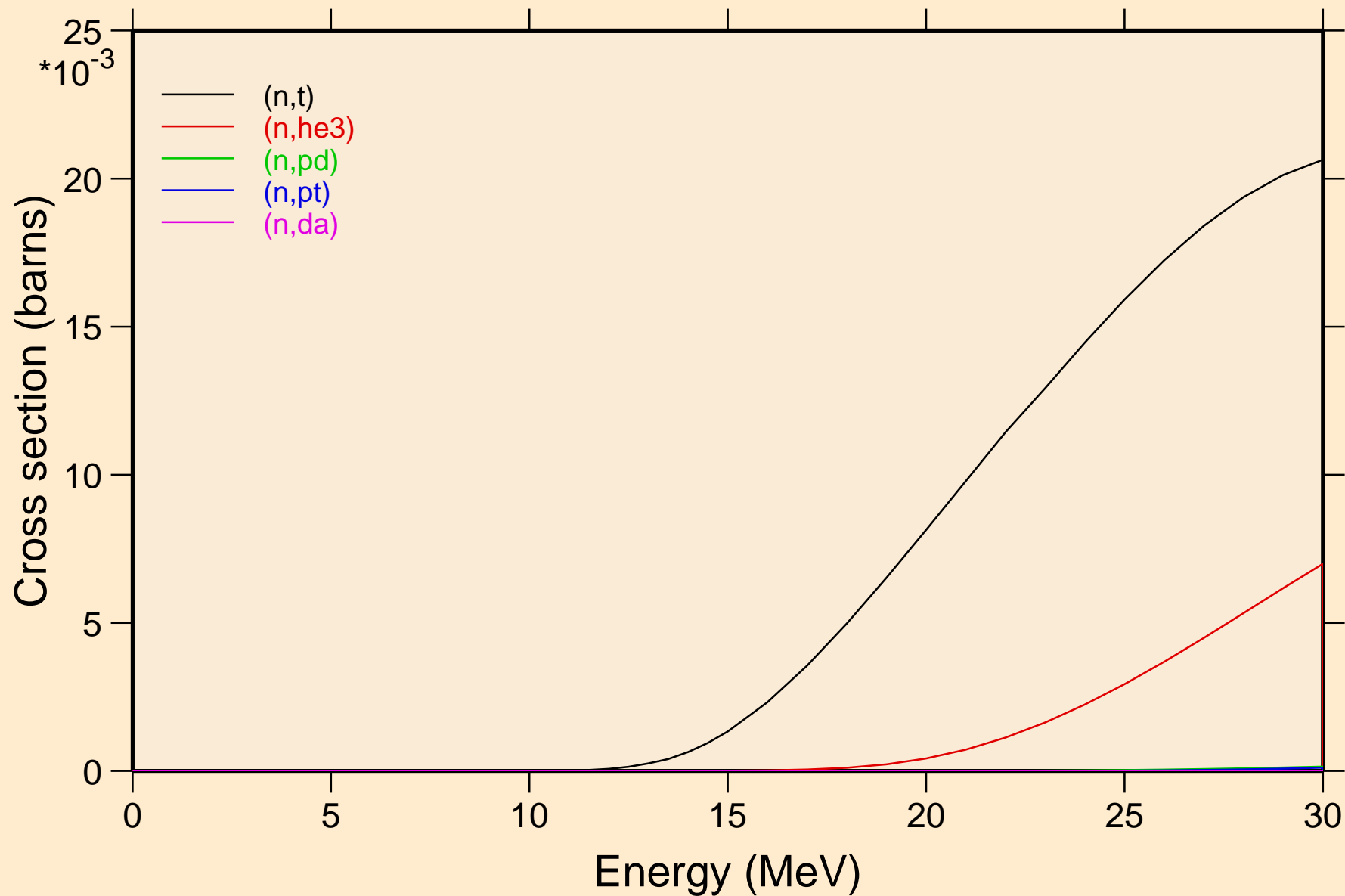

AT200N NEUTRON ACER TENDL-2019 LIBRARY; T=293.16K
Threshold reactions

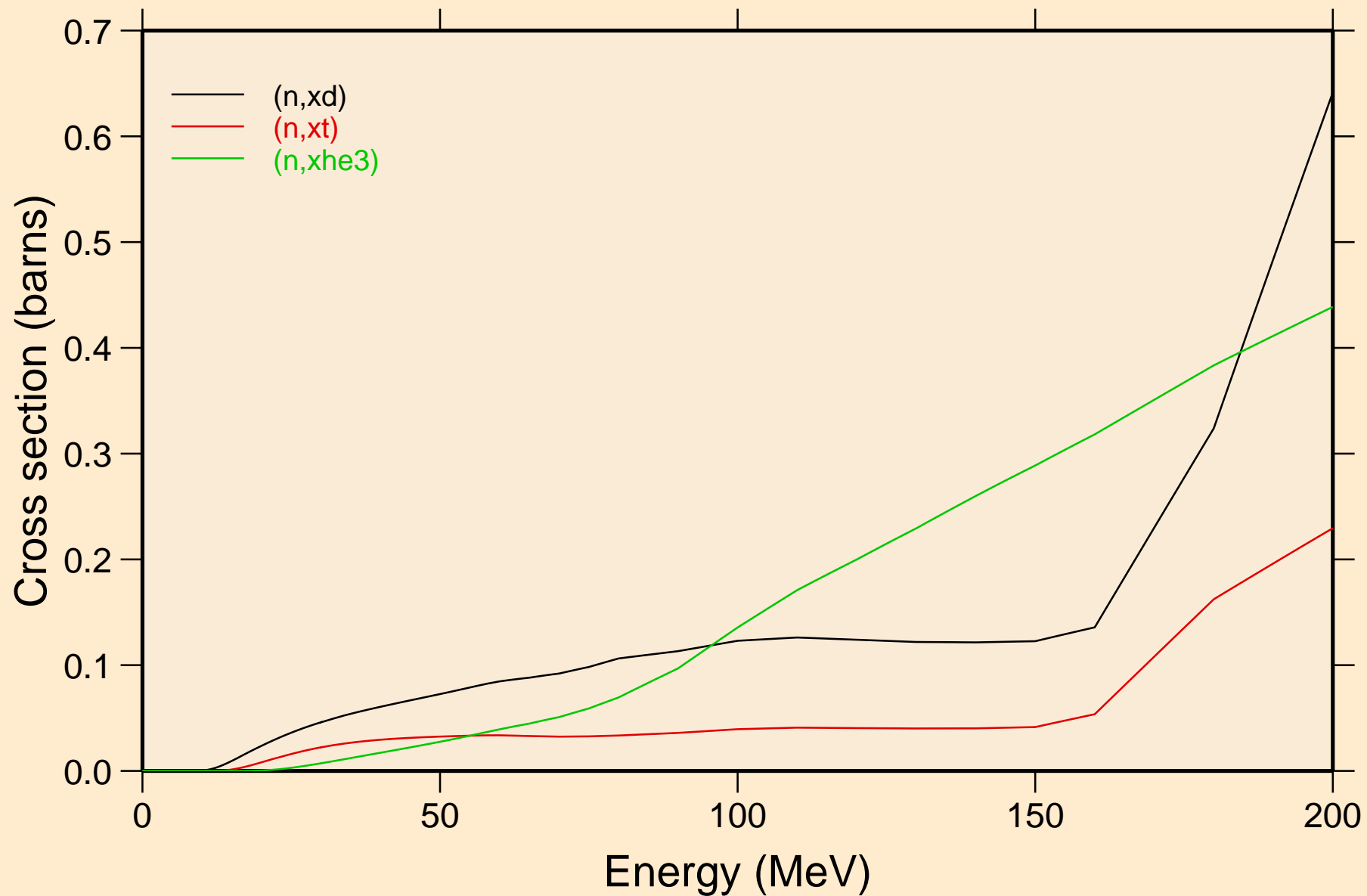

AT200N NEUTRON ACER TENDL-2019 LIBRARY; T=293.16K
angular distribution for elastic

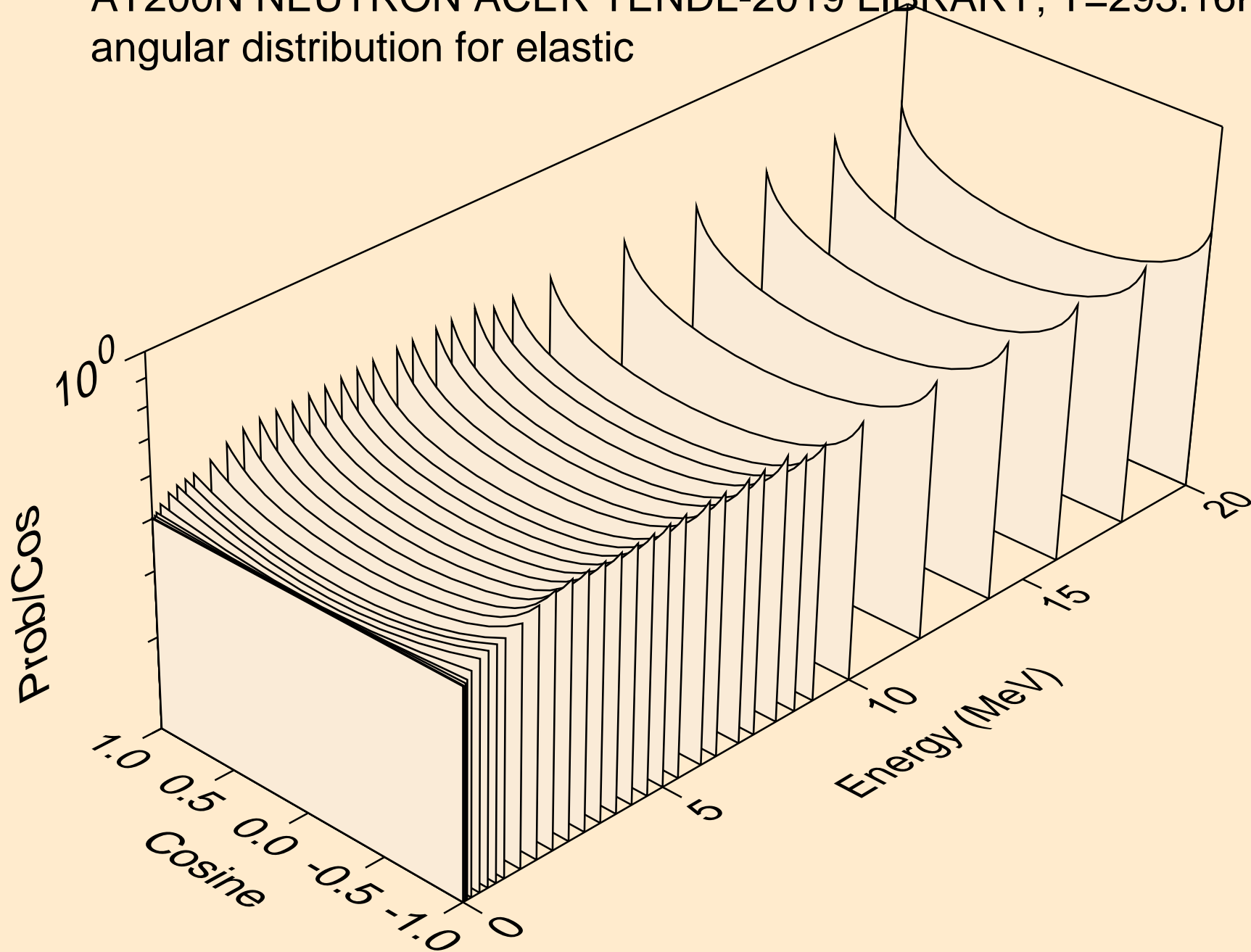

AT200N NEUTRON ACER TENDL-2019 LIBRARY; T=293.16K
angular distribution for elastic

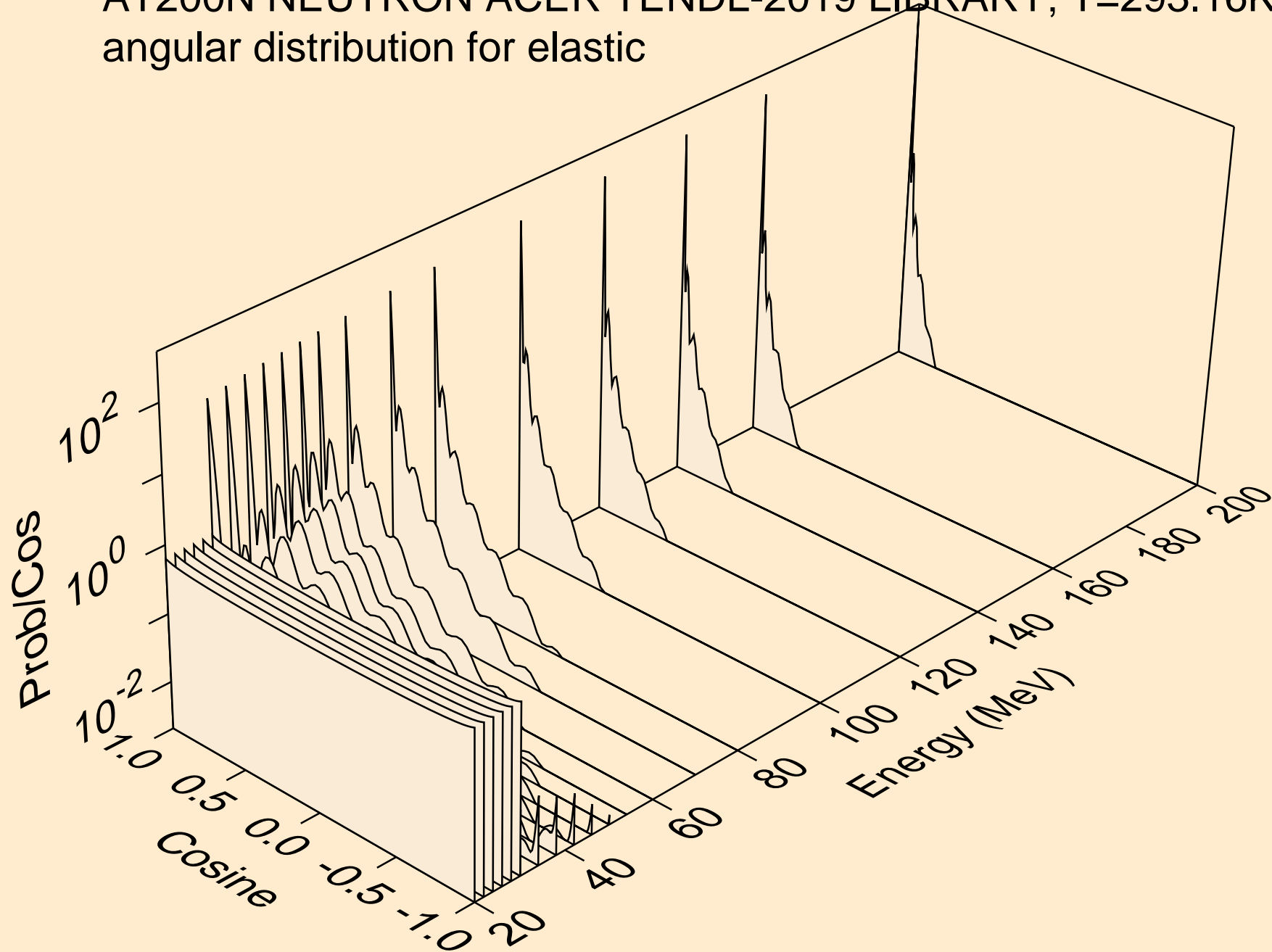

AT200N NEUTRON ACER TENDL-2019 LIBRARY; T=293.16K
angular distribution for (n,n*1)

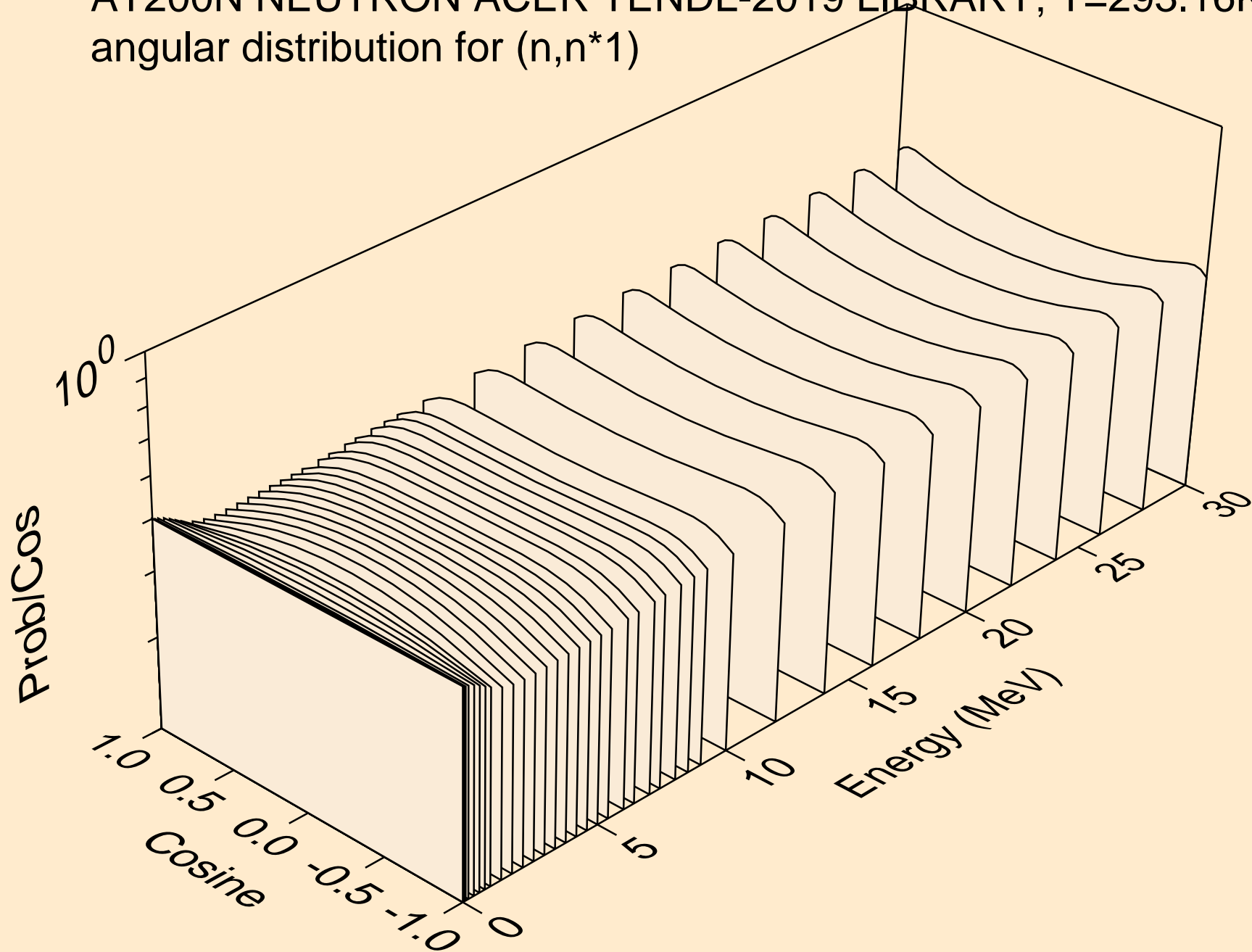

AT200N NEUTRON ACER TENDL-2019 LIBRARY; T=293.16K
angular distribution for (n,n*2)

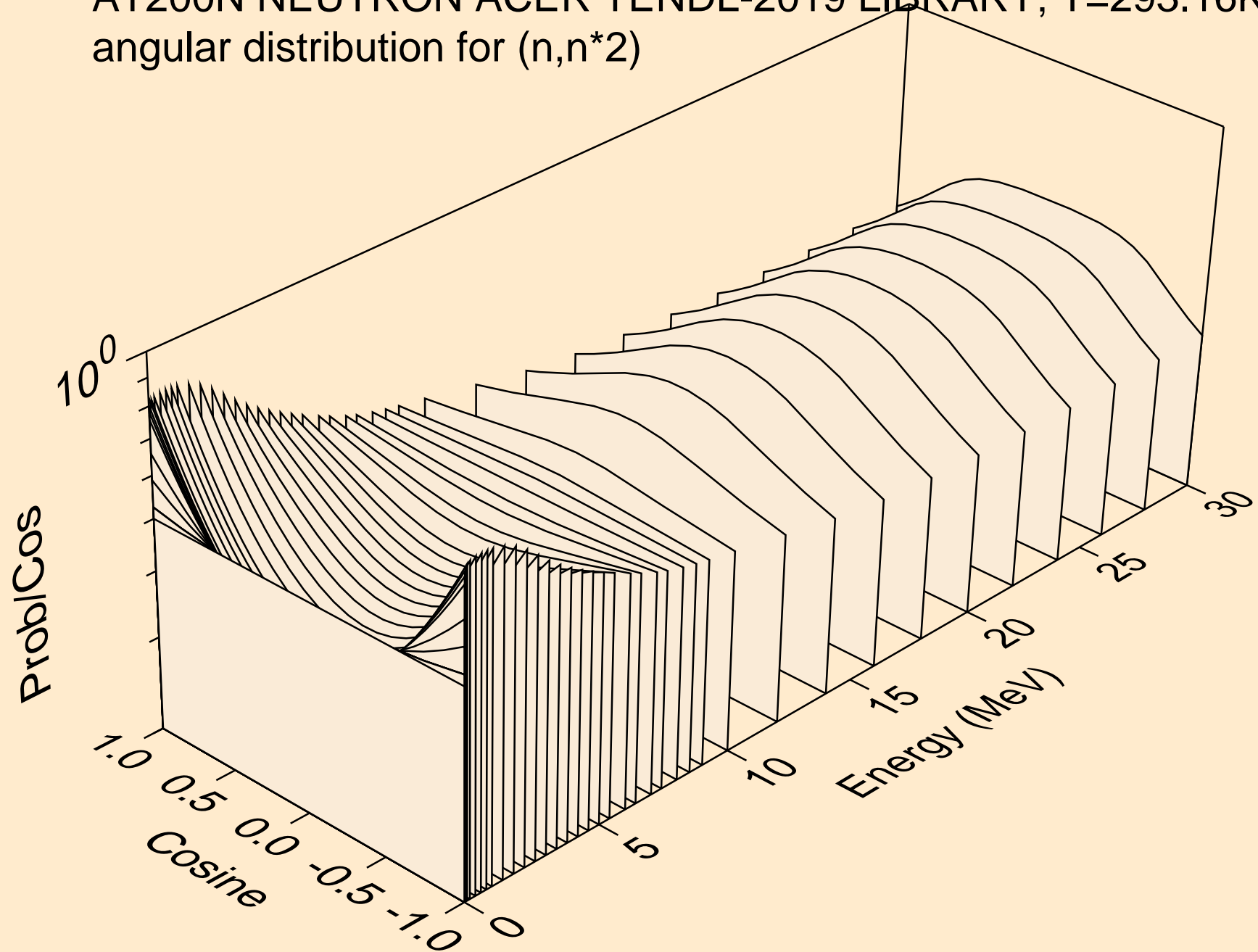

AT200N NEUTRON ACER TENDL-2019 LIBRARY; T=293.16K
angular distribution for (n,n*3)

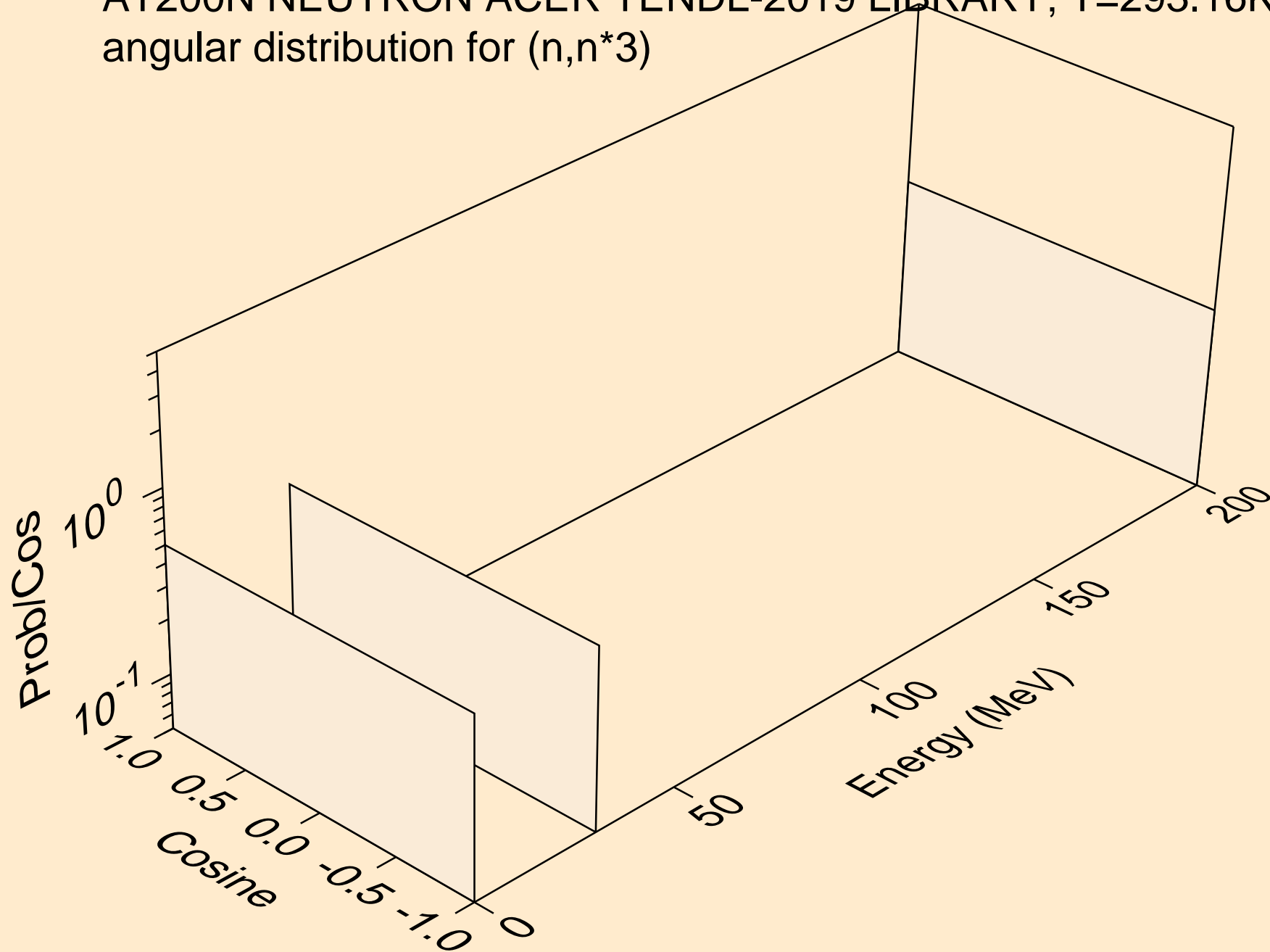

AT200N NEUTRON ACER TENDL-2019 LIBRARY; T=293.16K
Neutron emission for (n,x)

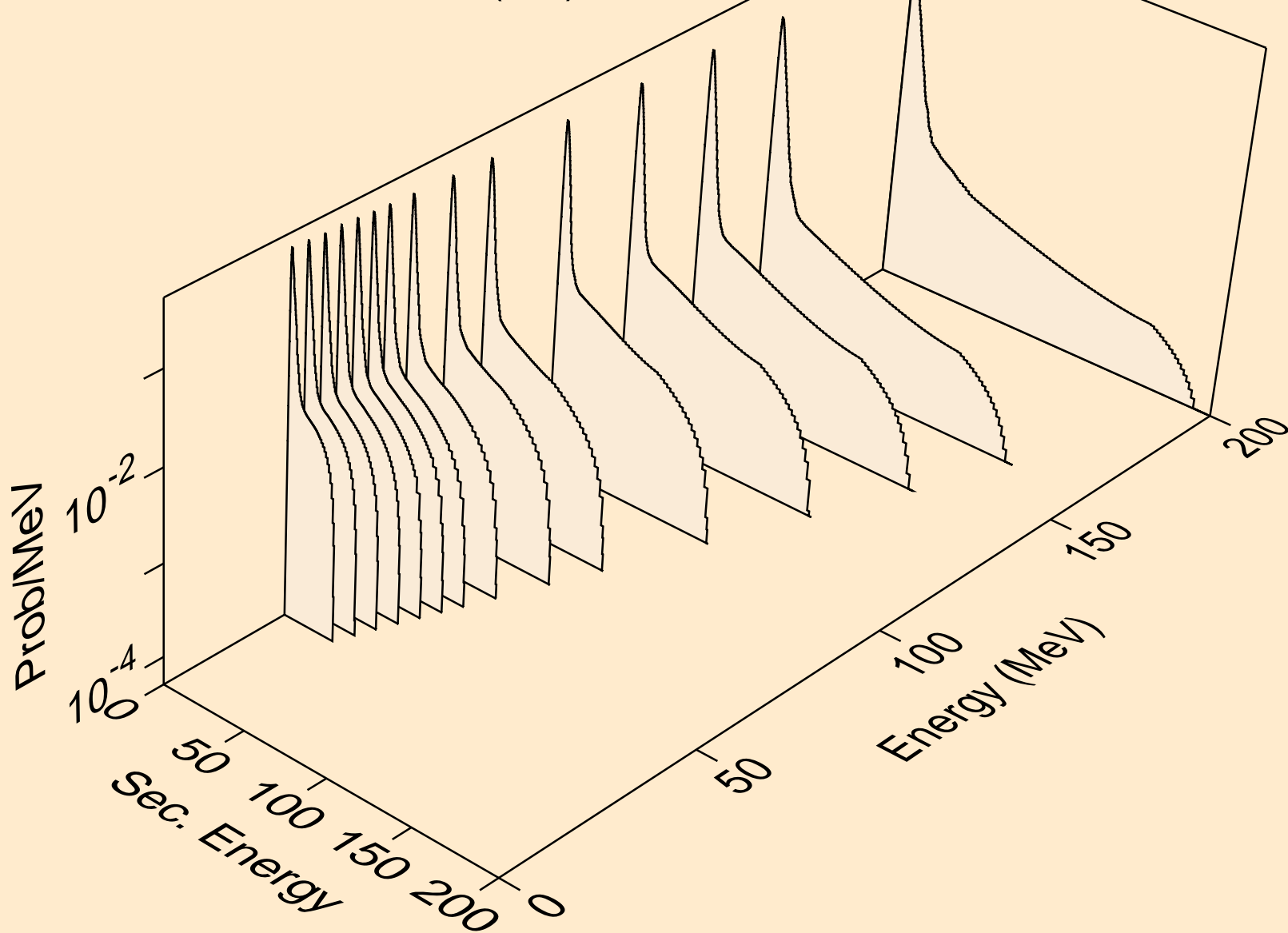

AT200N NEUTRON ACER TENDL-2019 LIBRARY; T=293.16K
Neutron emission for (n,2nd)

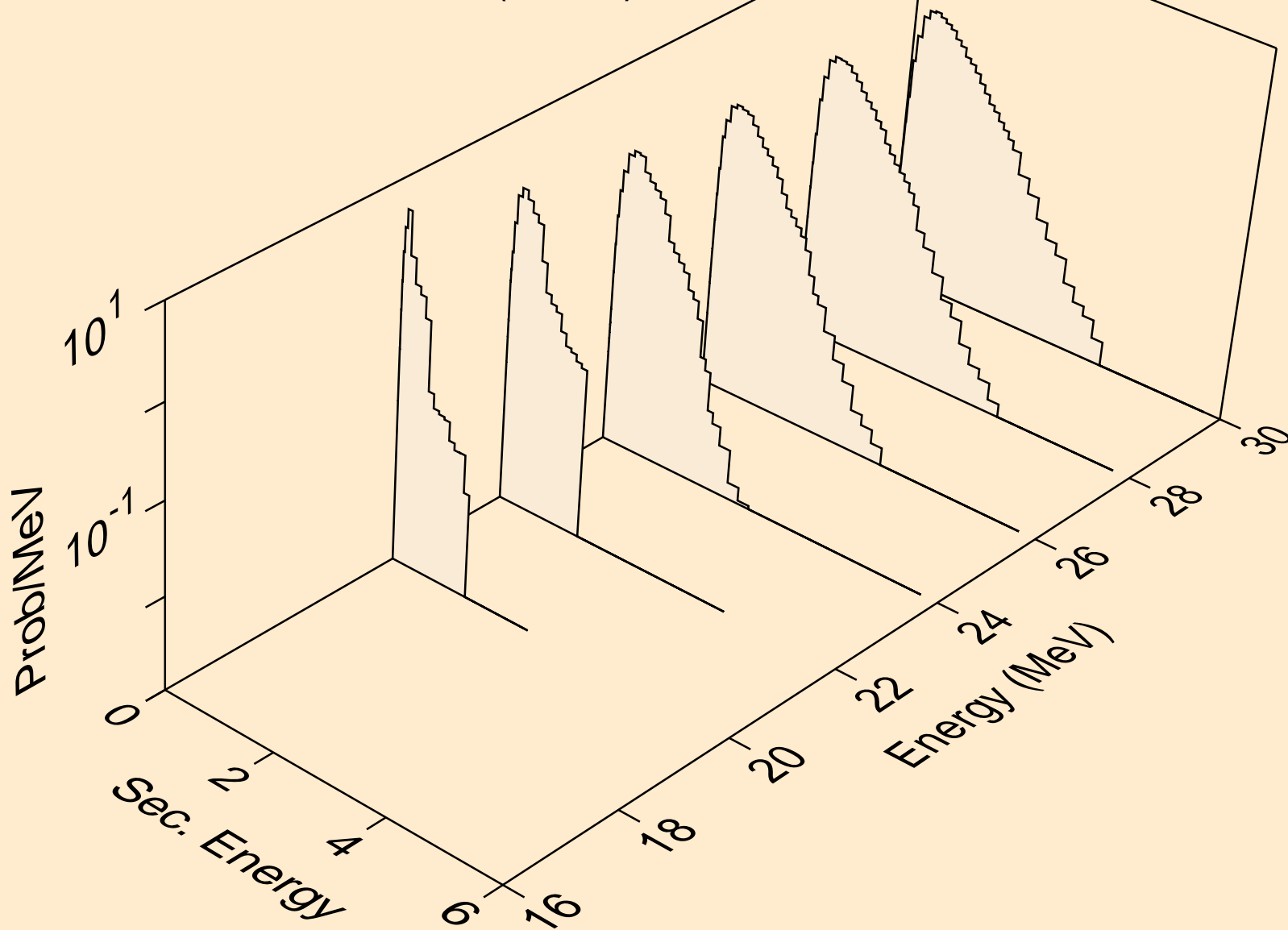

AT200N NEUTRON ACER TENDL-2019 LIBRARY; T=293.16K
Neutron emission for (n,2n)

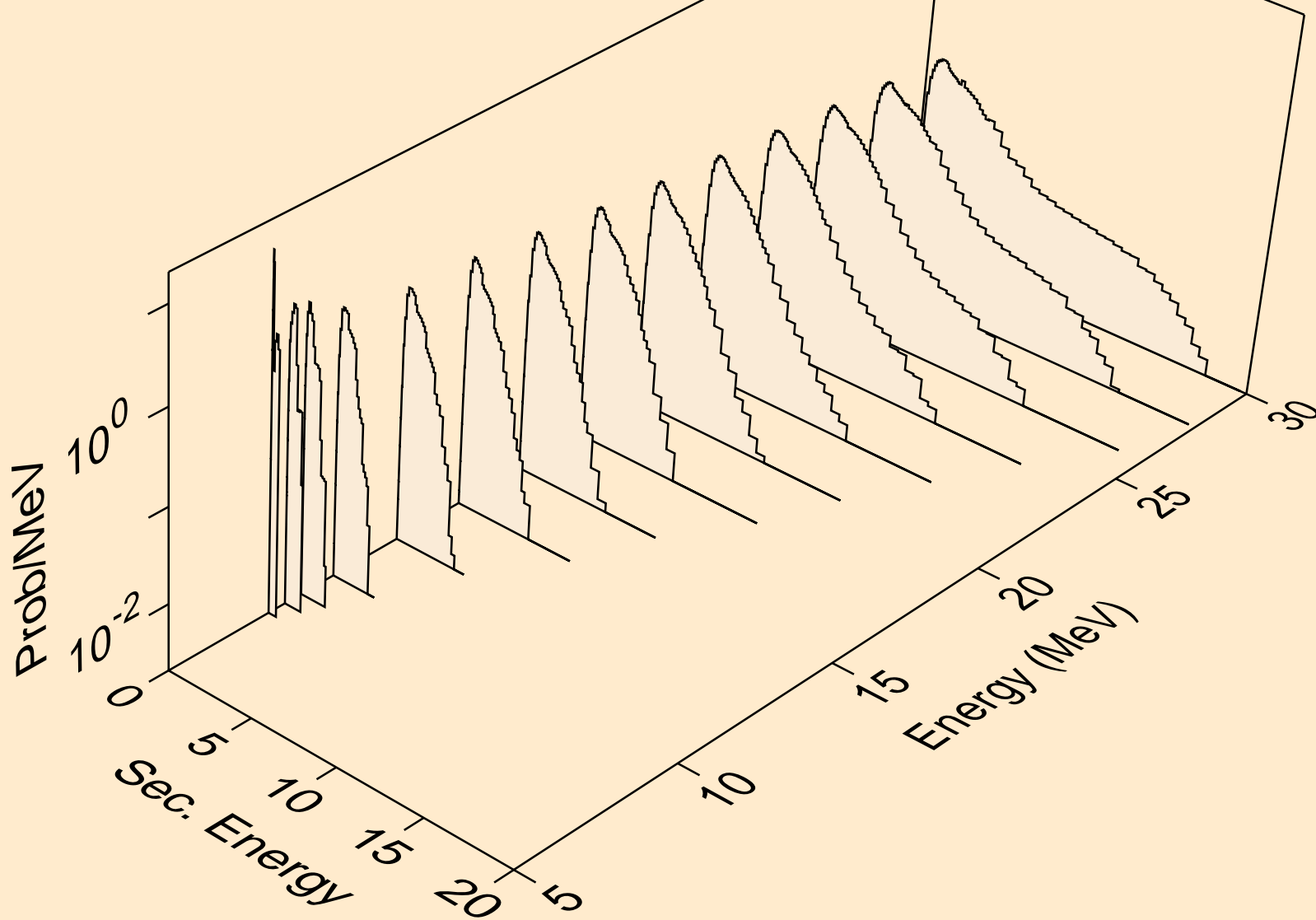

AT200N NEUTRON ACER TENDL-2019 LIBRARY; T=293.16K
Neutron emission for (n,3n)

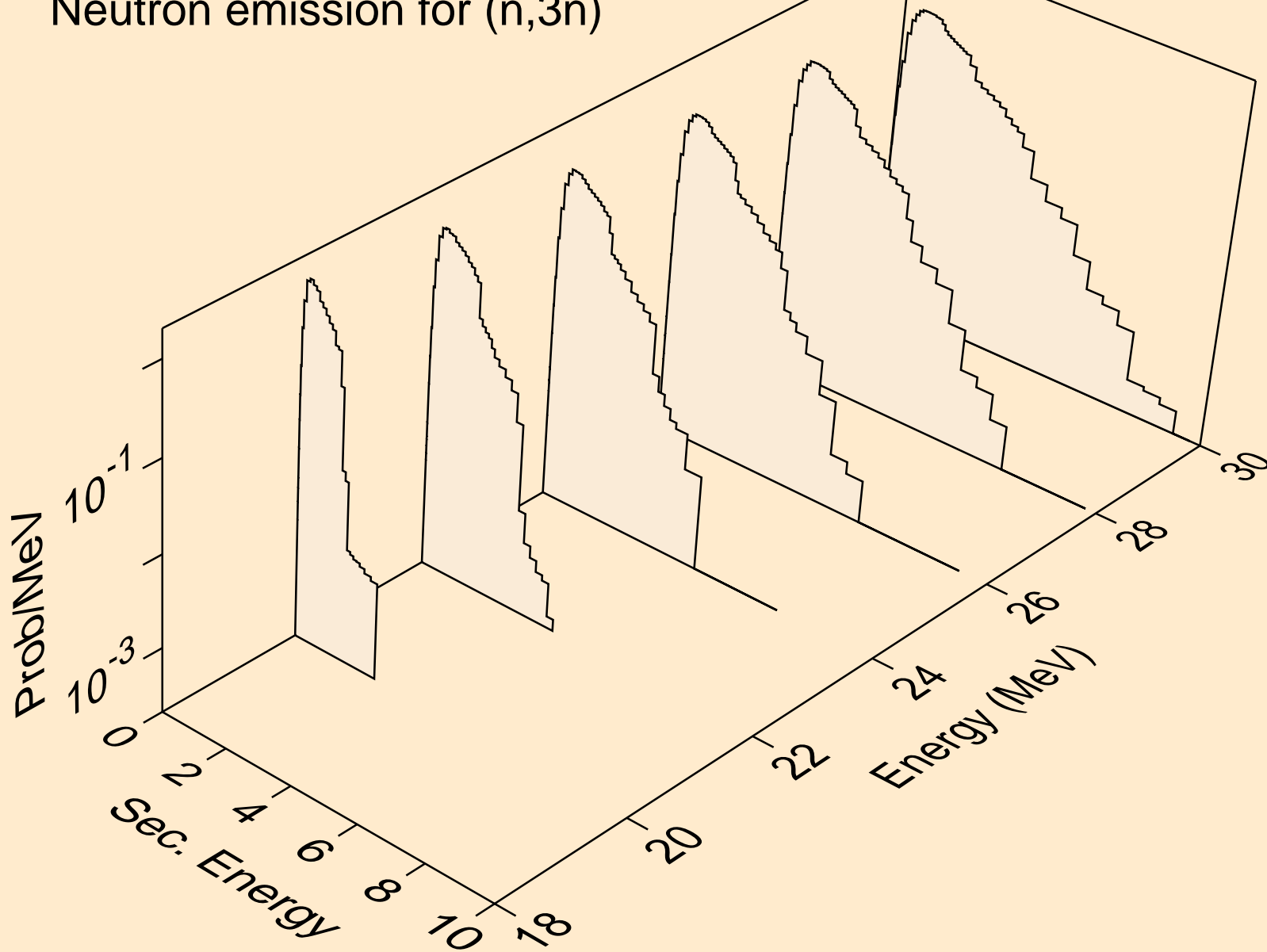

AT200N NEUTRON ACER TENDL-2019 LIBRARY; T=293.16K
Neutron emission for (n,n*)a

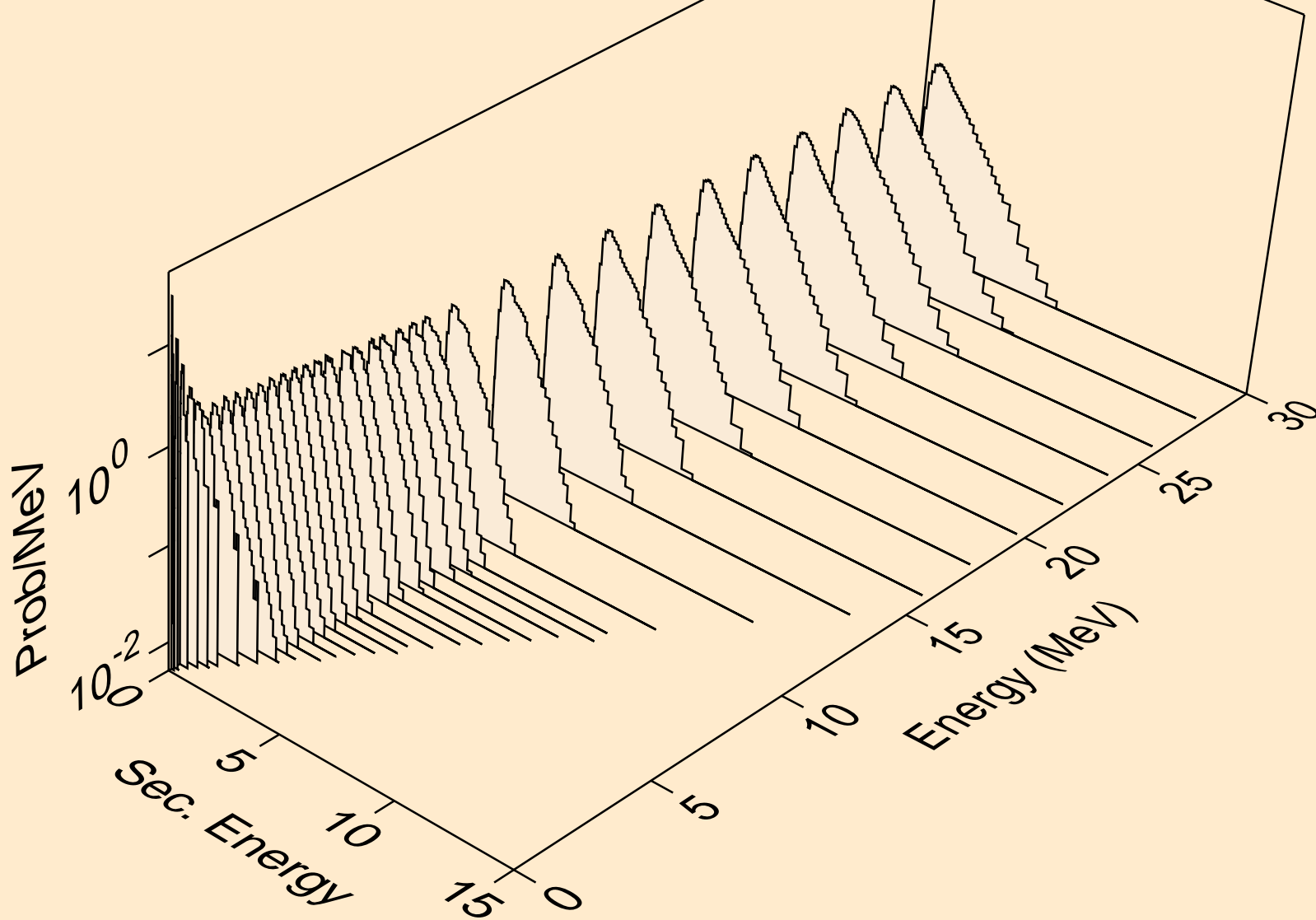

AT200N NEUTRON ACER TENDL-2019 LIBRARY; T=293.16K
Neutron emission for (n,2n)a

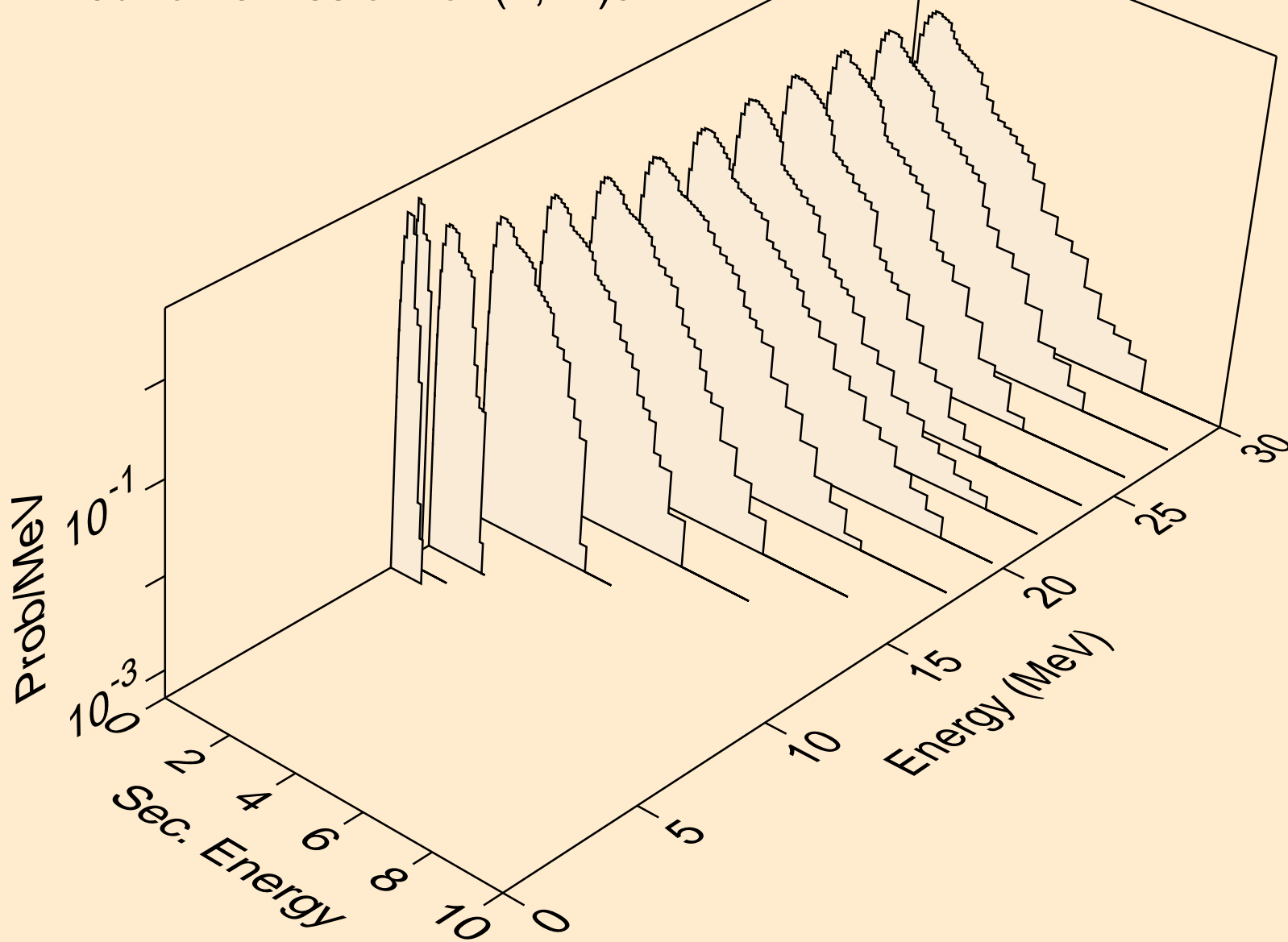

AT200N NEUTRON ACER TENDL-2019 LIBRARY; T=293.16K
Neutron emission for (n,3n)a

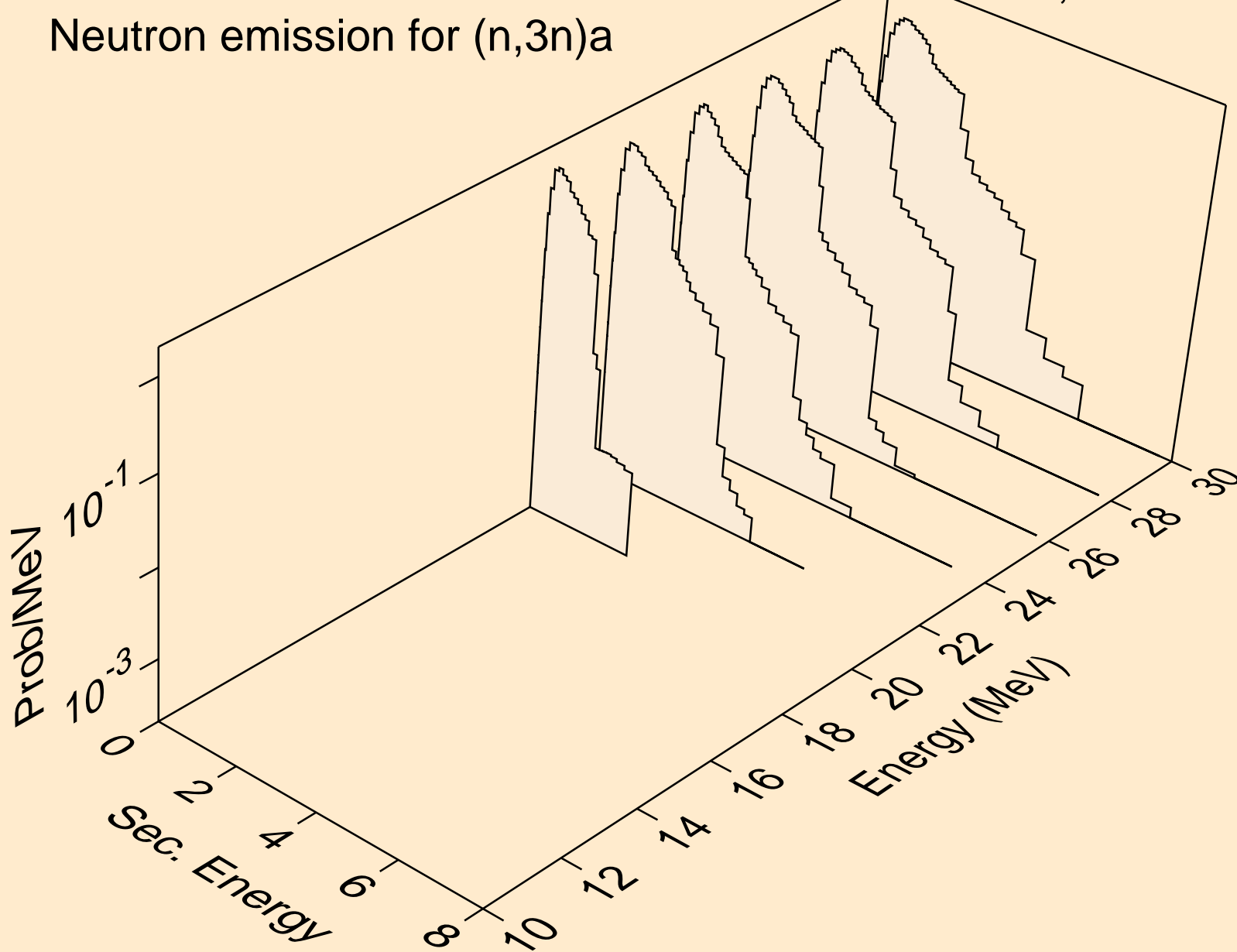

AT200N NEUTRON ACER TENDL-2019 LIBRARY; T=293.16K
Neutron emission for (n,n*)p

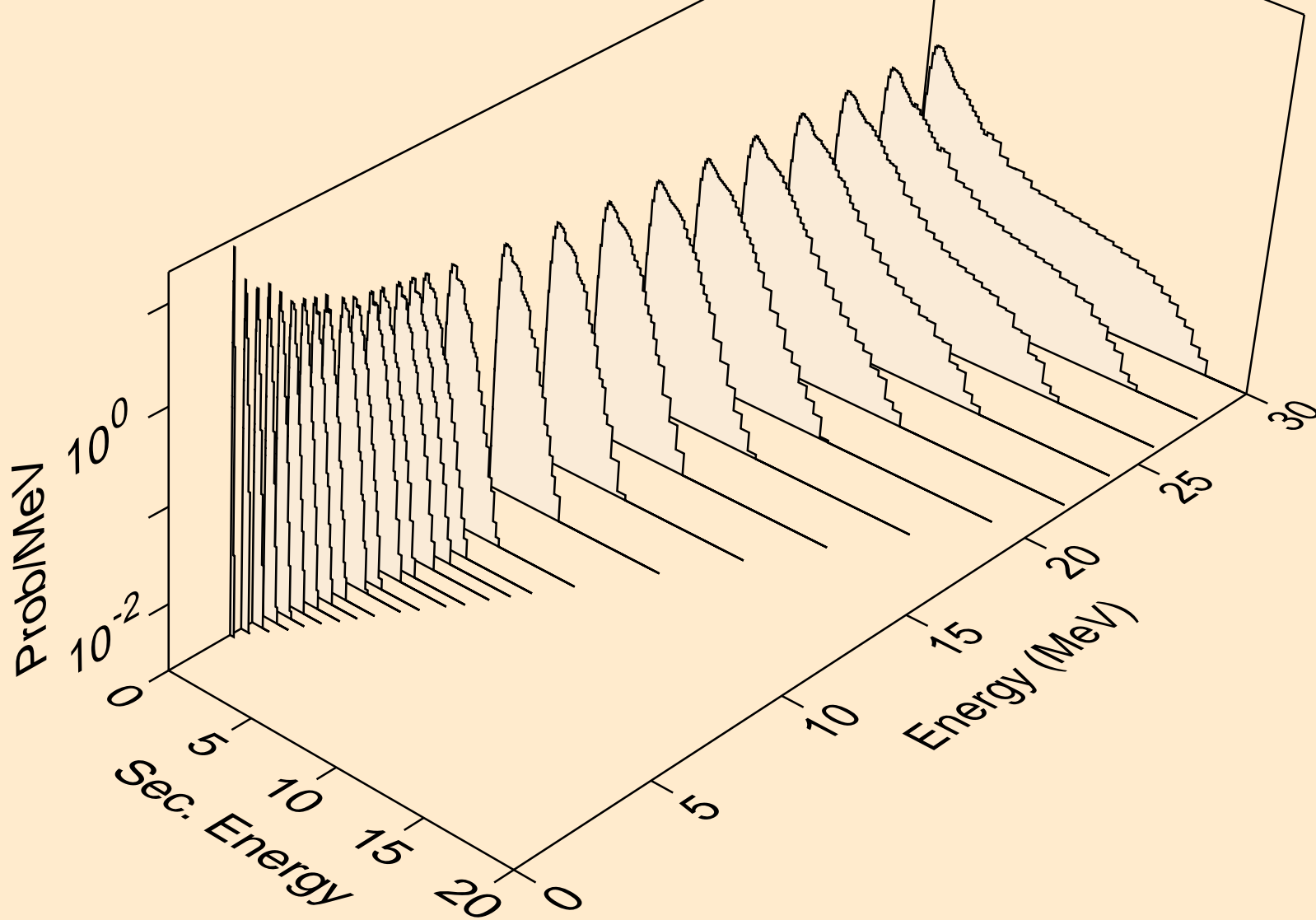

AT200N NEUTRON ACER TENDL-2019 LIBRARY; T=293.16K
Neutron emission for (n,n*)2a

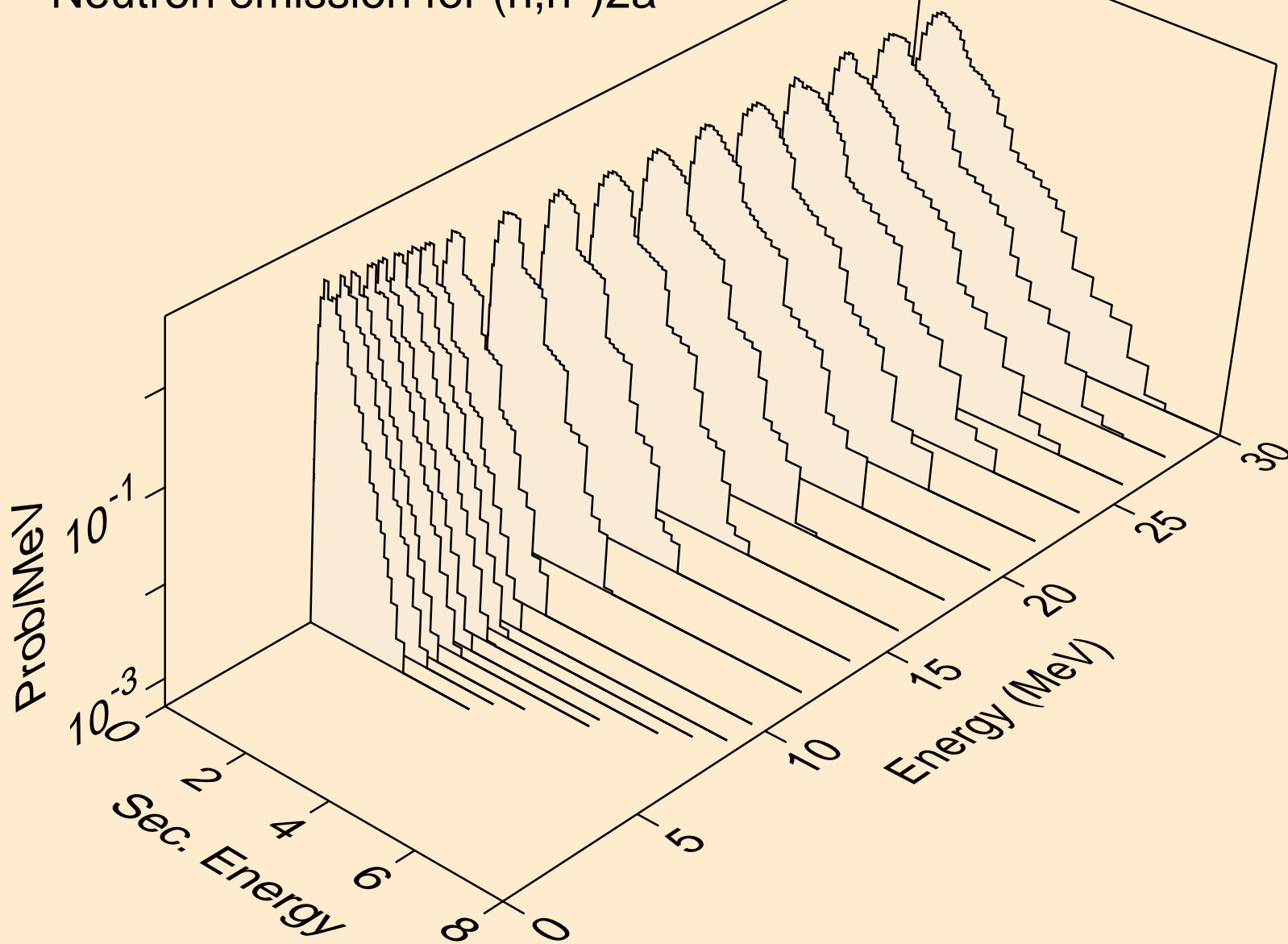

AT200N NEUTRON ACER TENDL-2019 LIBRARY; T=293.16K
Neutron emission for (n,2n)2a

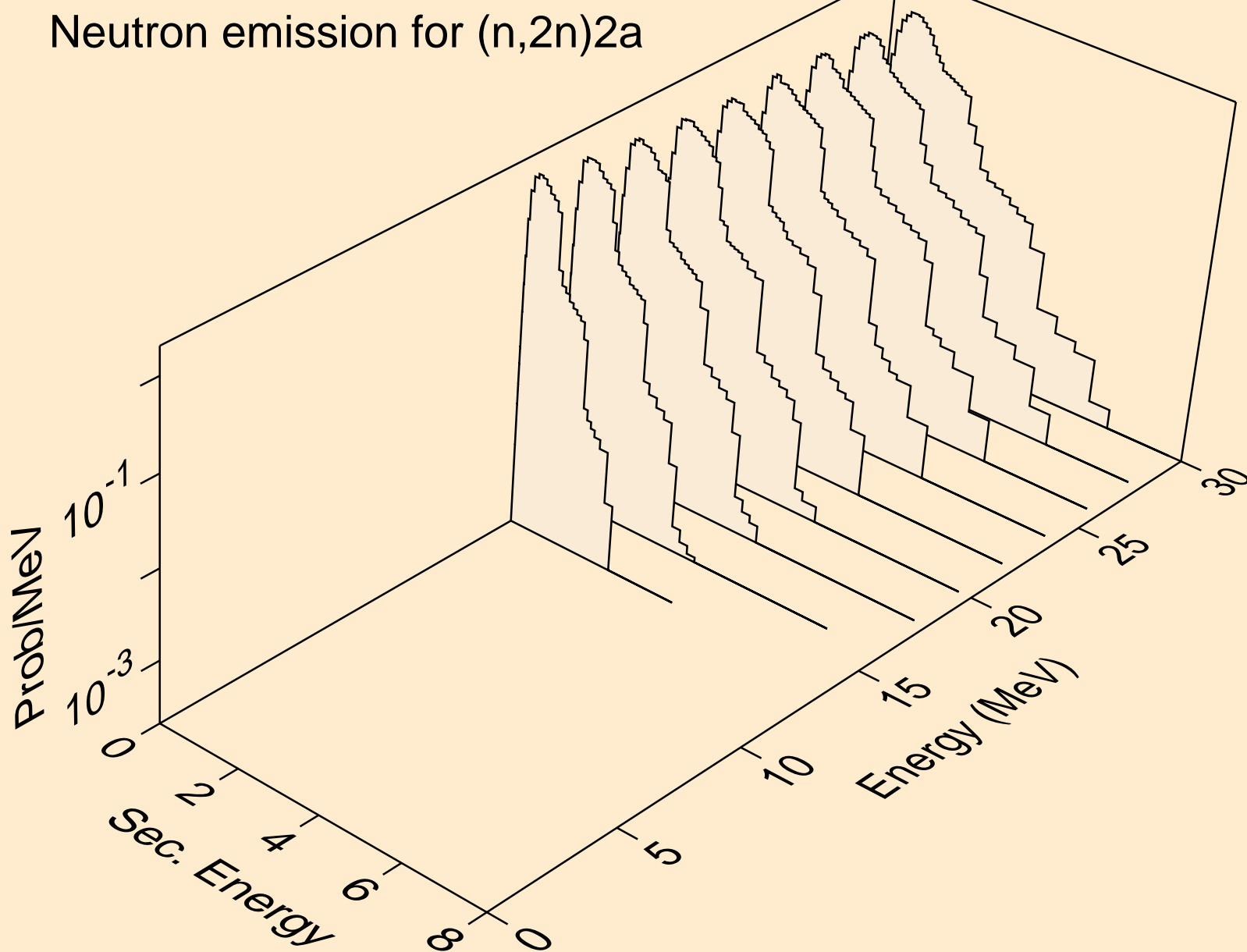

AT200N NEUTRON ACER TENDL-2019 LIBRARY; T=293.16K
Neutron emission for (n,n*)d

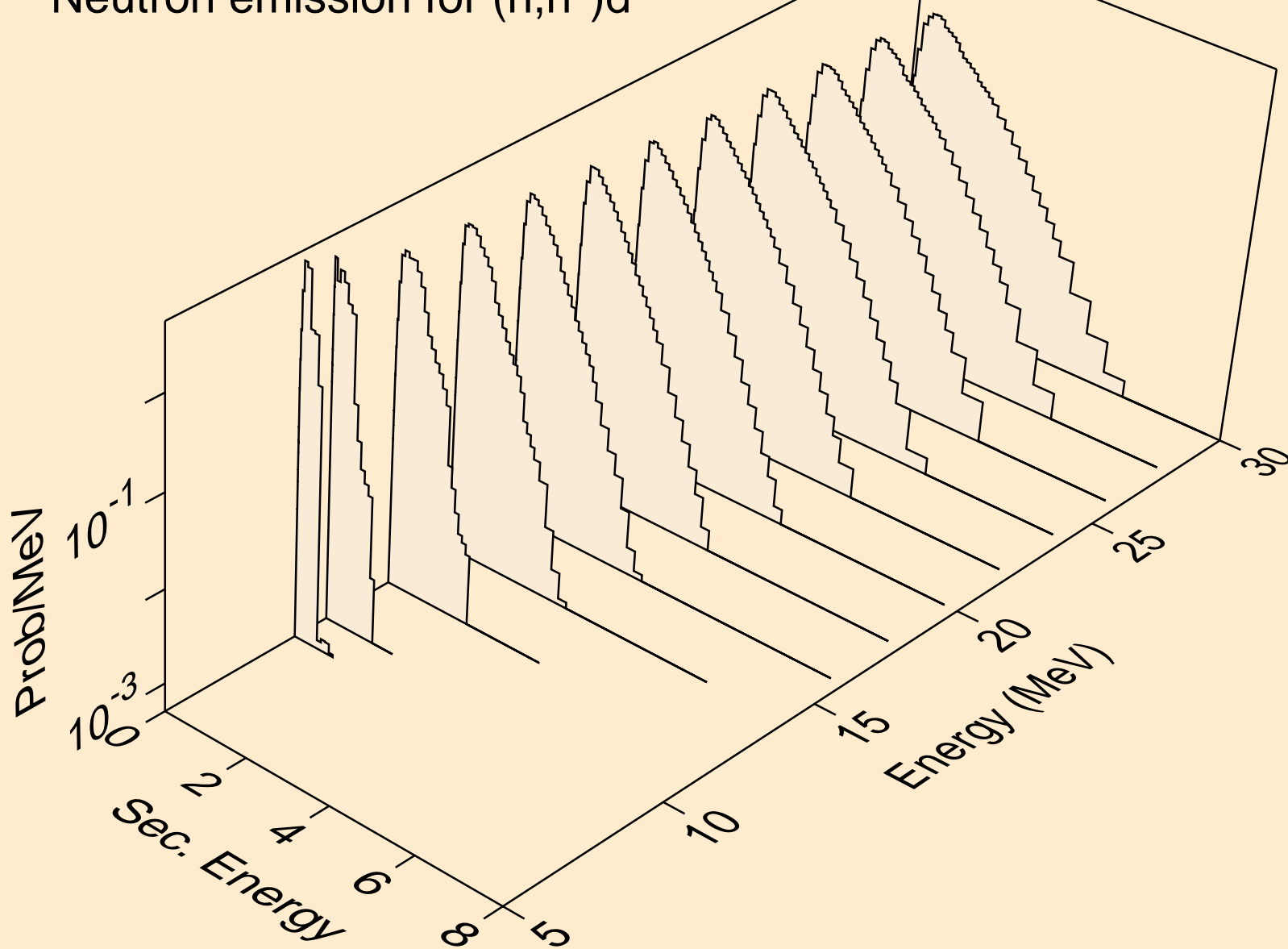

AT200N NEUTRON ACER TENDL-2019 LIBRARY; T=293.16K
Neutron emission for (n,n*)t

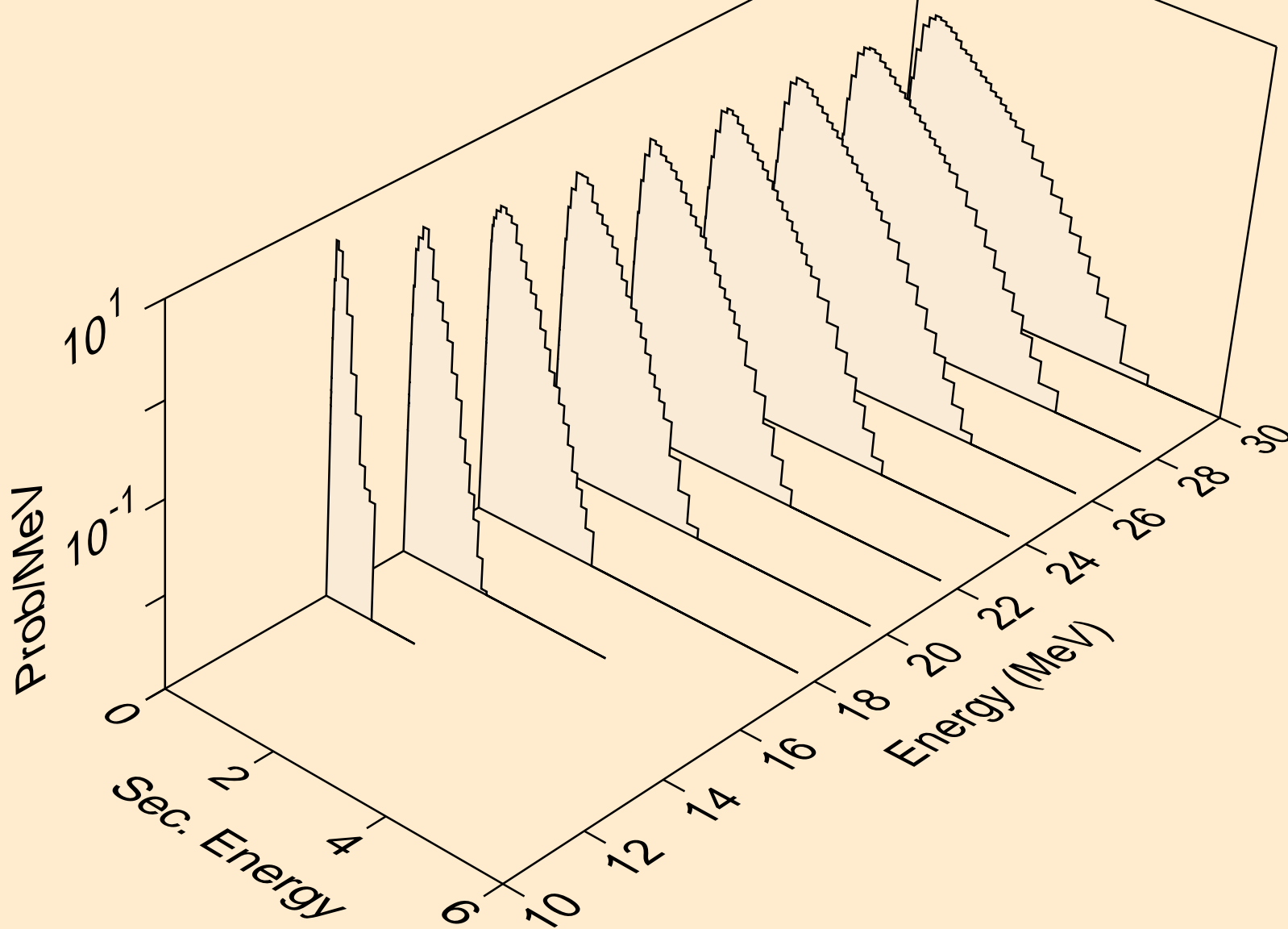

AT200N NEUTRON ACER TENDL-2019 LIBRARY; T=293.16K
Neutron emission for (n,n*)he3

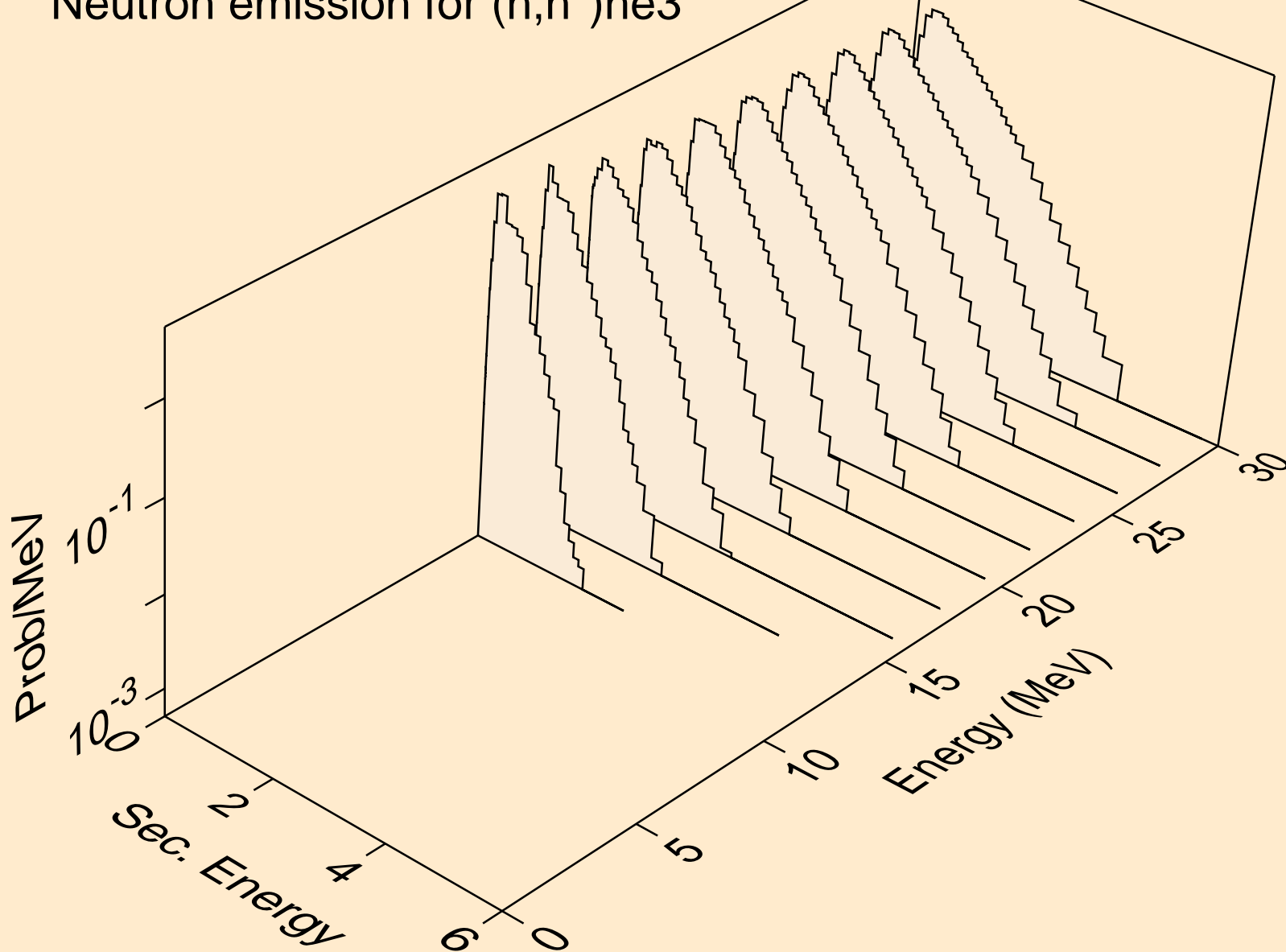

AT200N NEUTRON ACER TENDL-2019 LIBRARY; T=293.16K
Neutron emission for (n,4n)

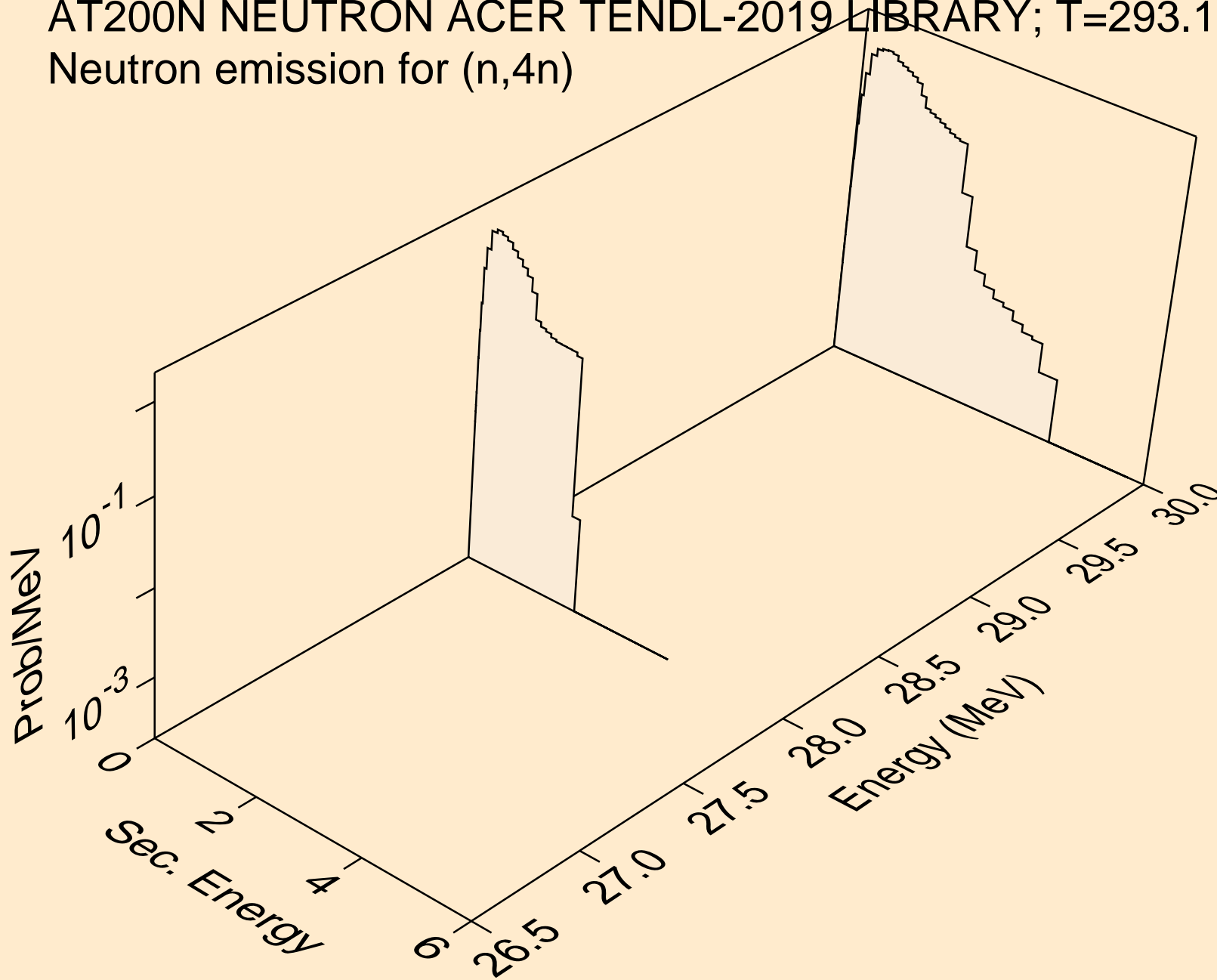

AT200N NEUTRON ACER TENDL-2019 LIBRARY; T=293.16K
Neutron emission for (n,2np)

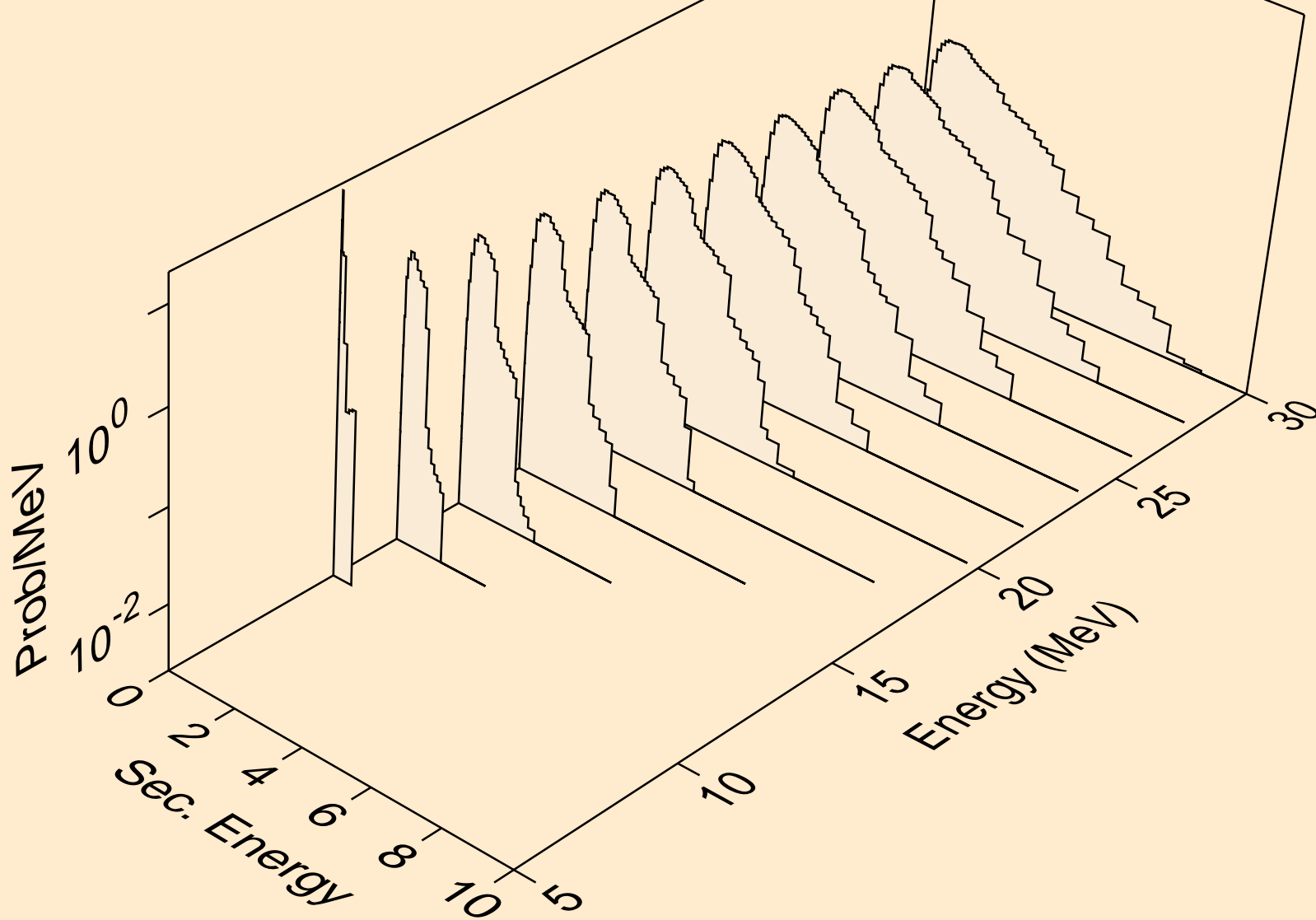

AT200N NEUTRON ACER TENDL-2019 LIBRARY; T=293.16K
Neutron emission for (n,3np)

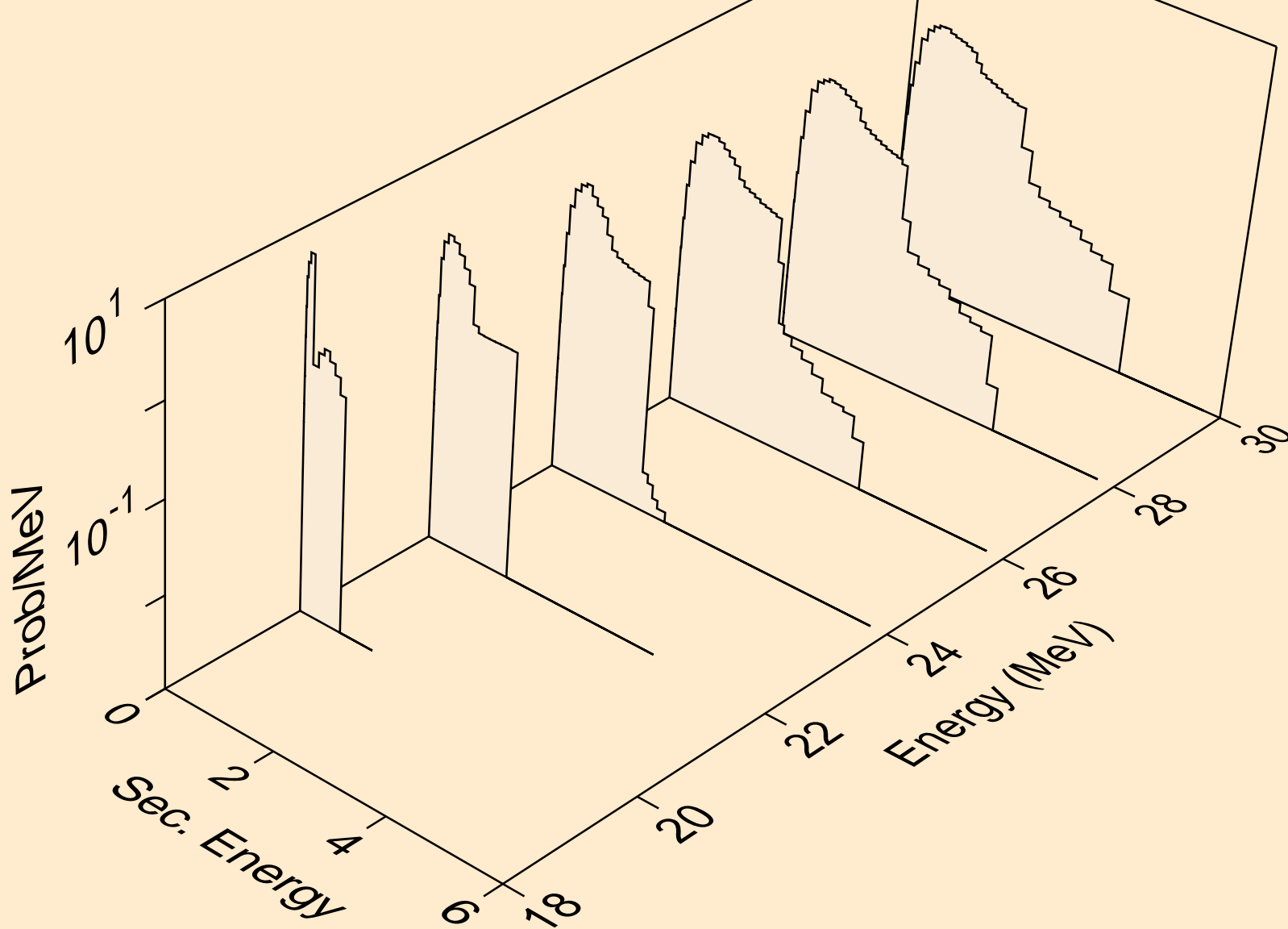

AT200N NEUTRON ACER TENDL-2019 LIBRARY; T=293.16K
Neutron emission for (n,2np)

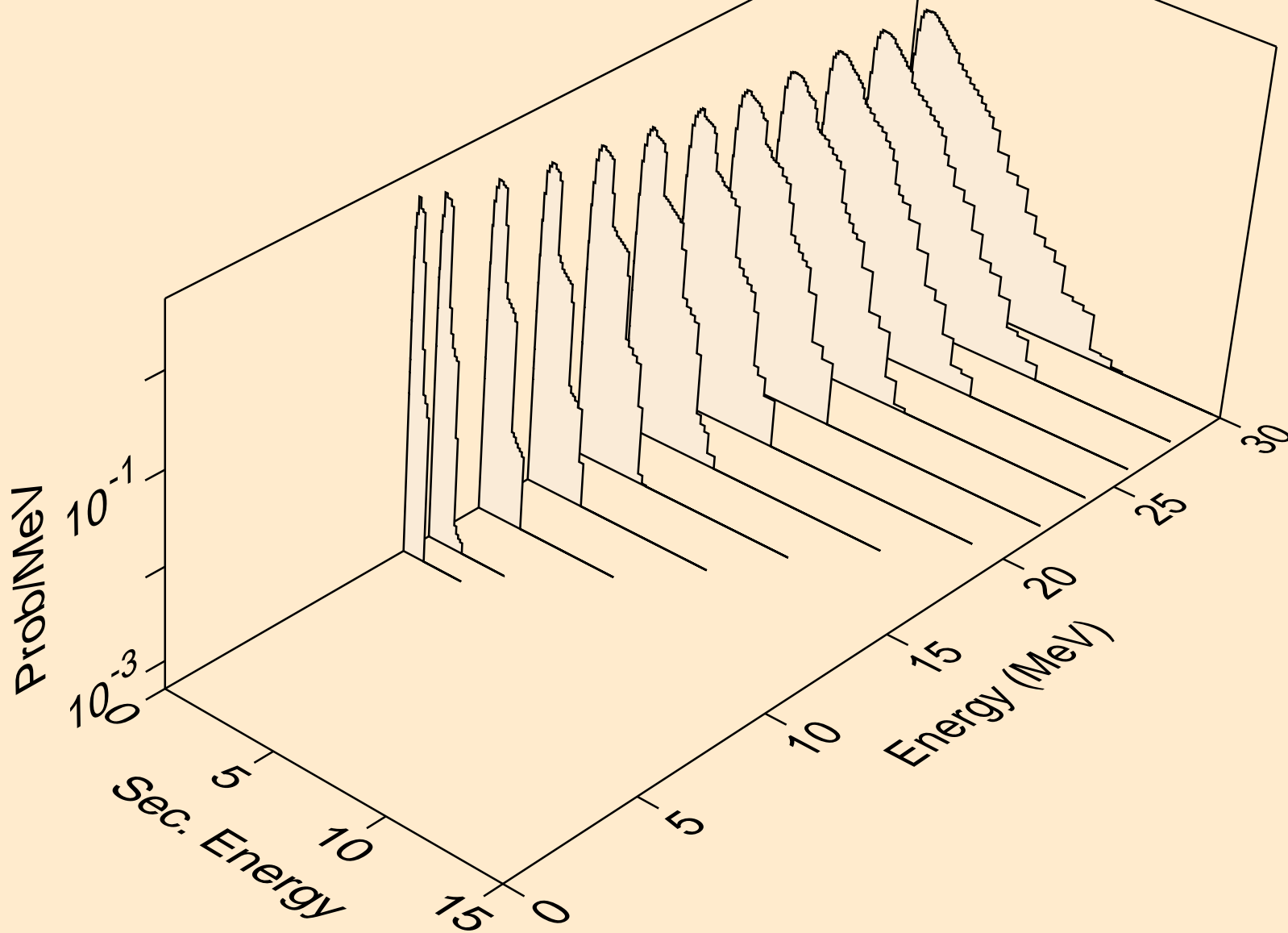

AT200N NEUTRON ACER TENDL-2019 LIBRARY; T=293.16K
Neutron emission for (n,npa)

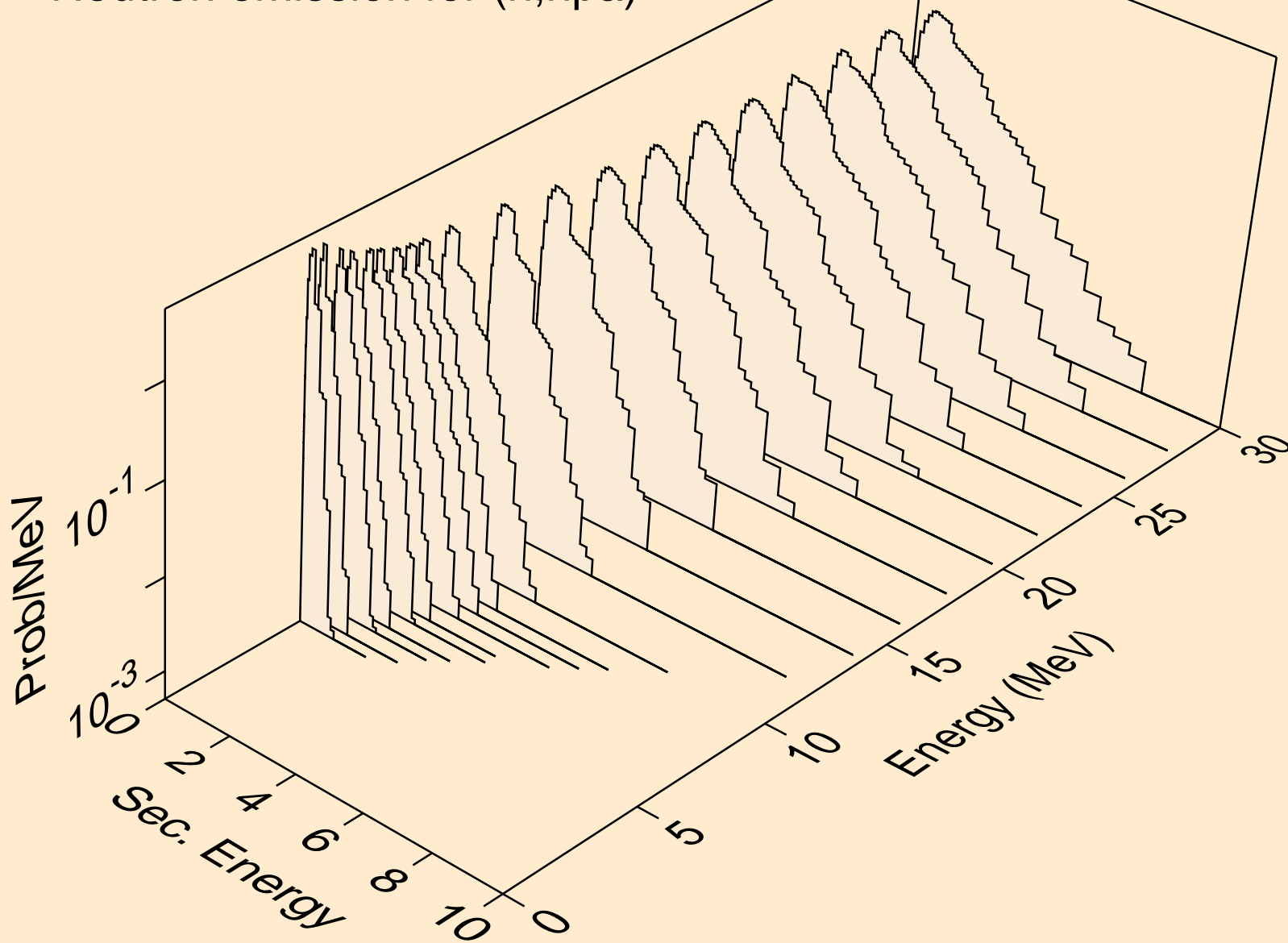

AT200N NEUTRON ACER TENDL-2019 LIBRARY; T=293.16K
Neutron emission for (n,n*c)

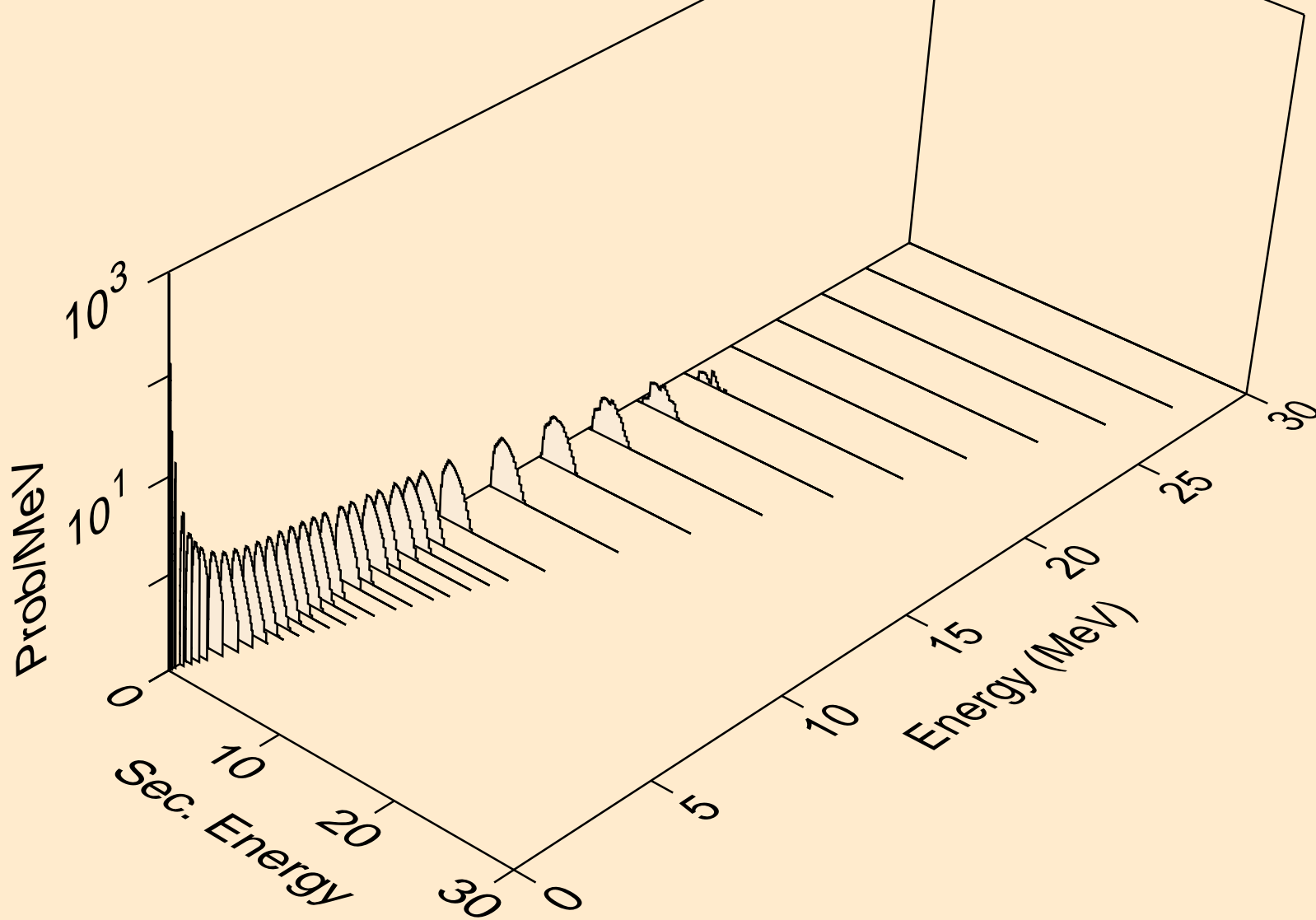

AT200N NEUTRON ACER TENDL-2019 LIBRARY; T=293.16K
Photon emission for (n,x)

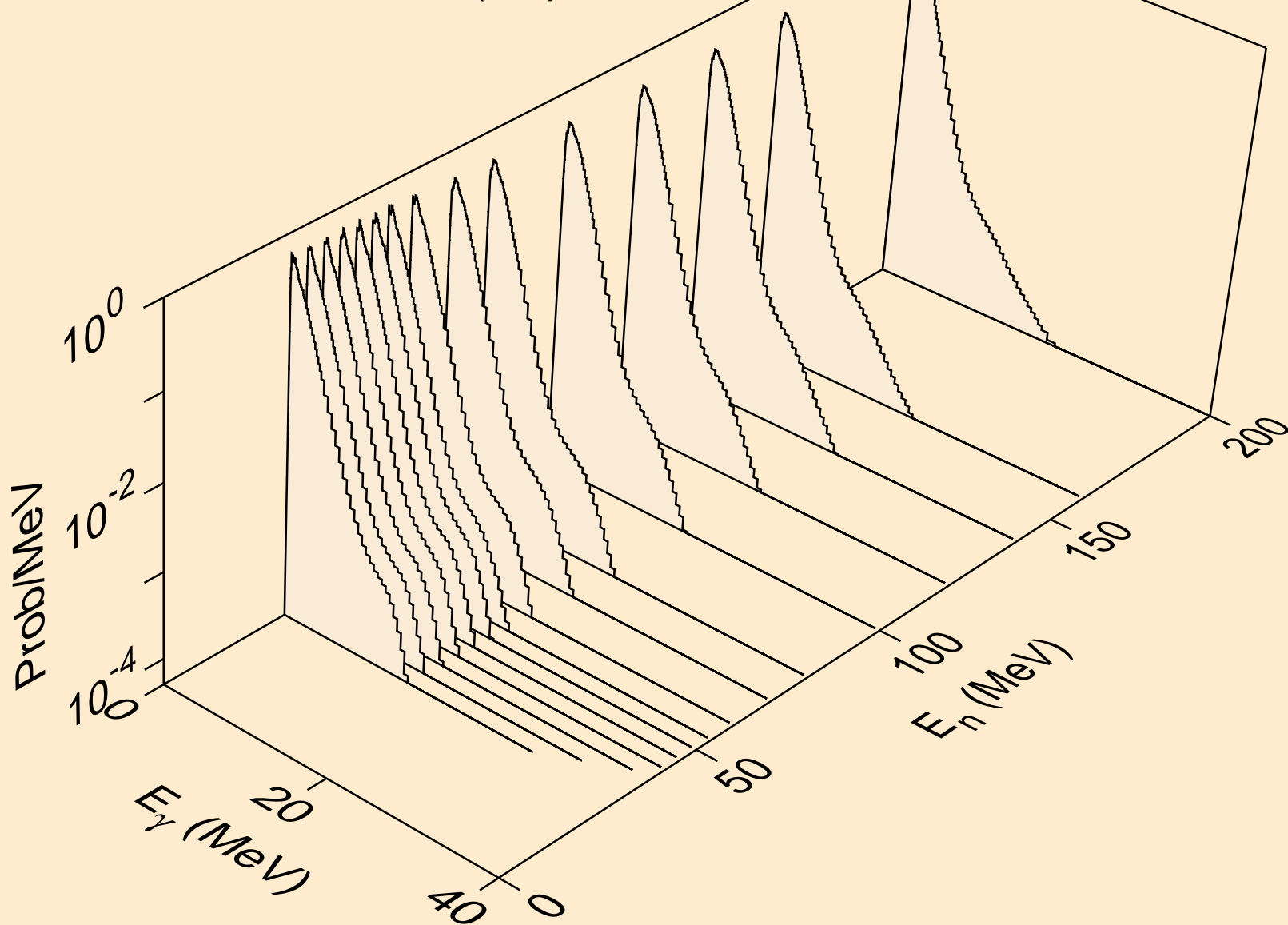

AT200N NEUTRON ACER TENDL-2019 LIBRARY; T=293.16K
Photon emission for (n,2nd)

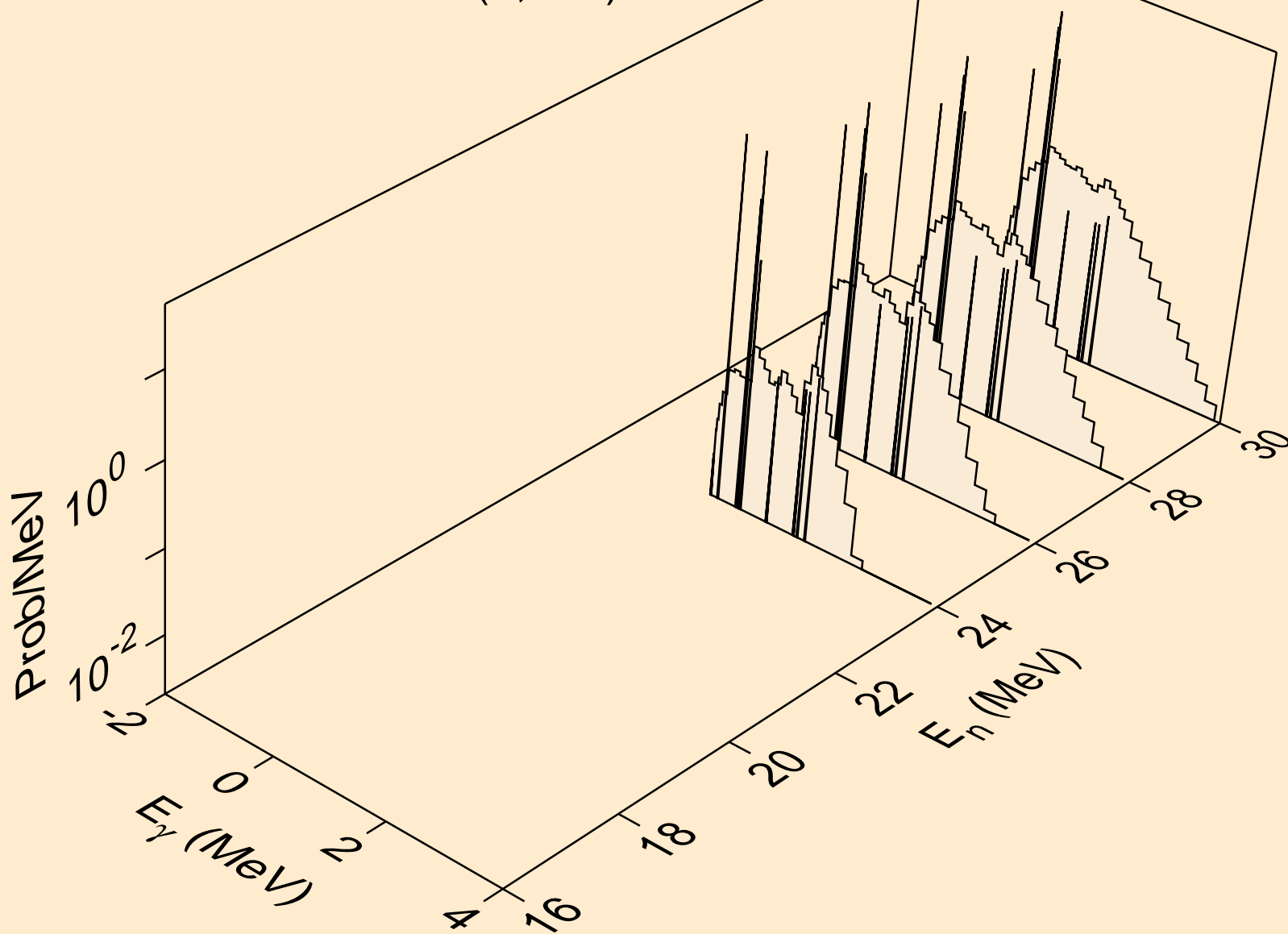

AT200N NEUTRON ACER TENDL-2019 LIBRARY; T=293.16K
Photon emission for (n,2n)

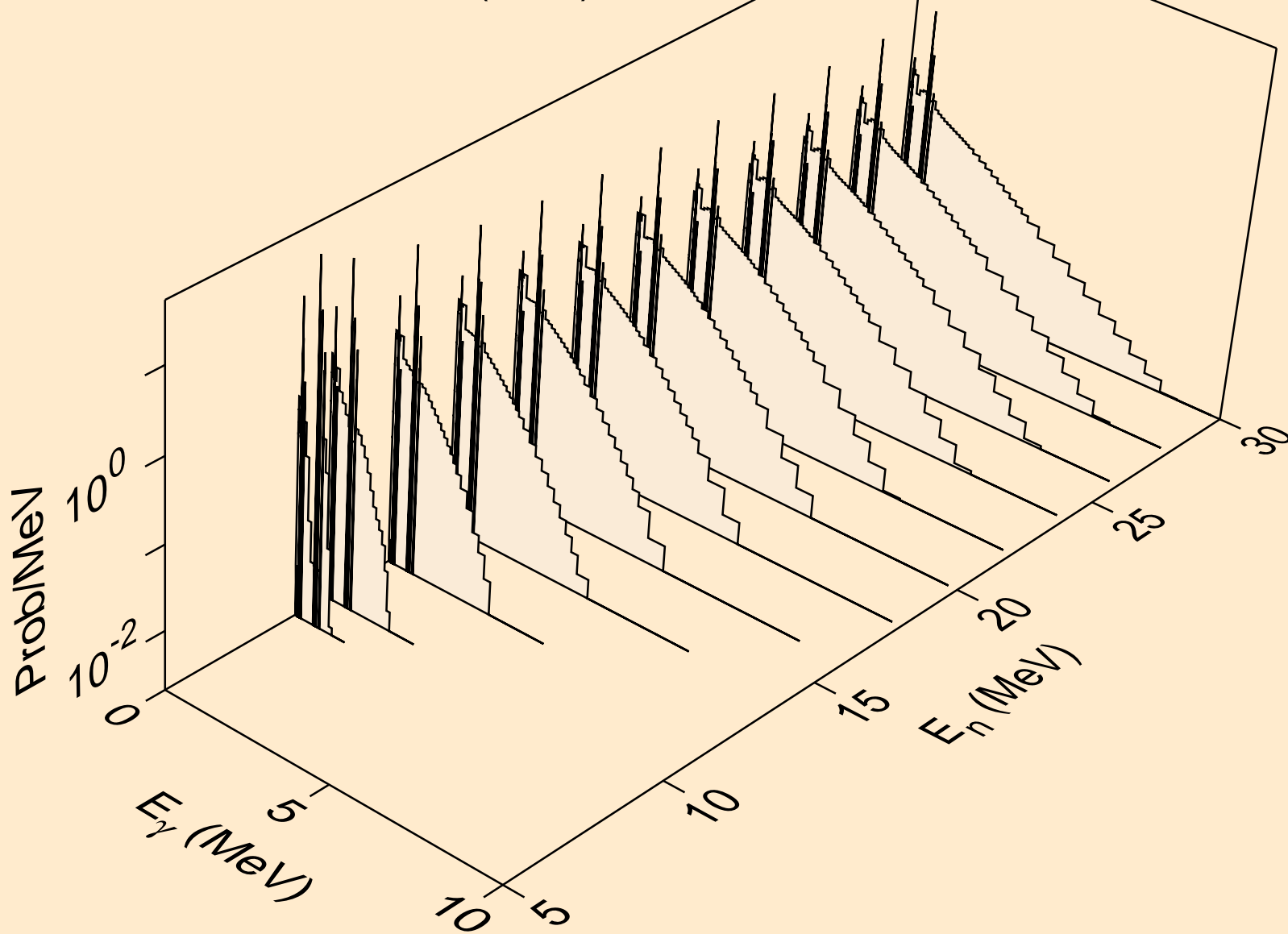

AT200N NEUTRON ACER TENDL-2019 LIBRARY; T=293.16K
Photon emission for (n,3n)

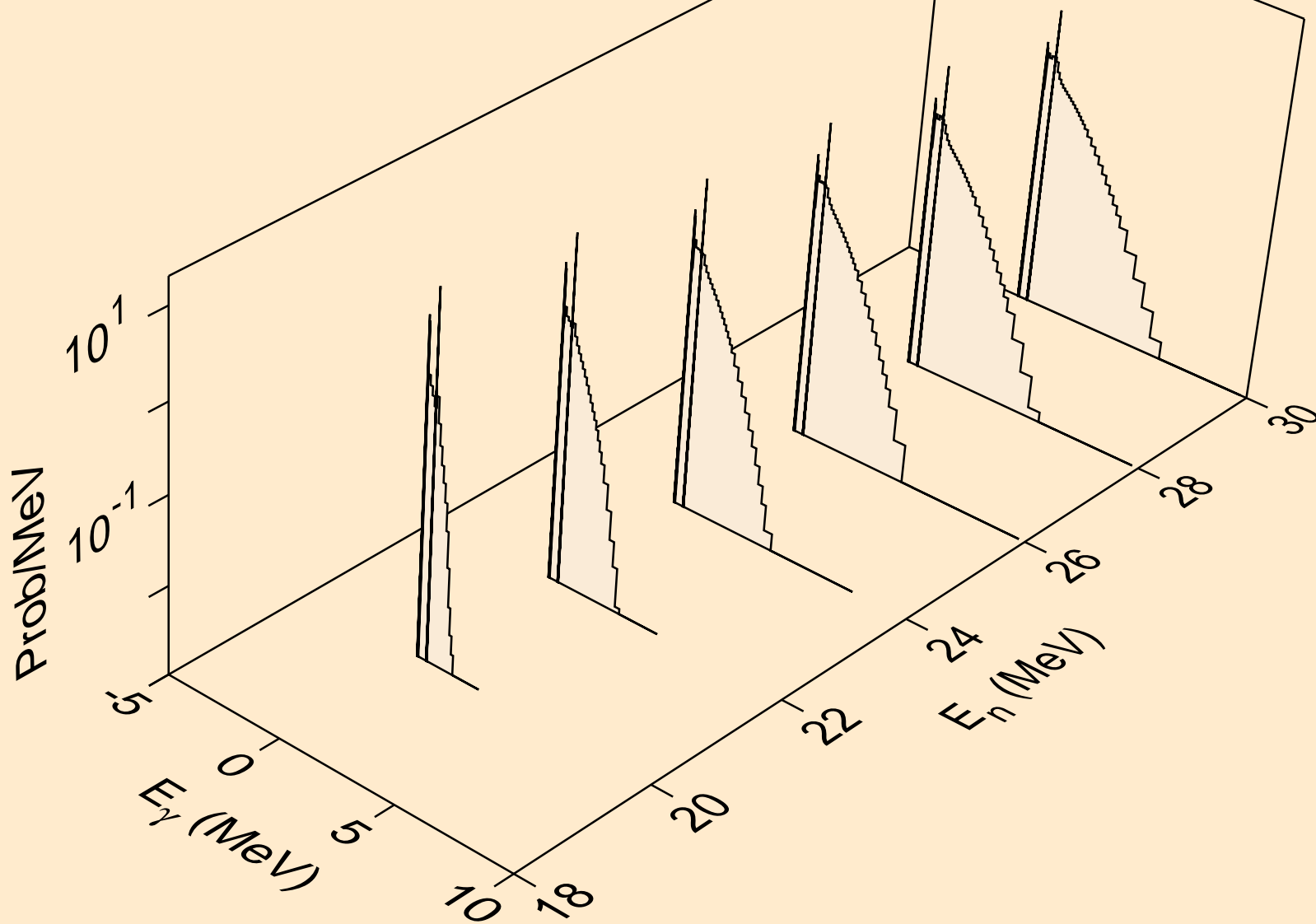

AT200N NEUTRON ACER TENDL-2019 LIBRARY; T=293.16K
Photon emission for (n,n*)a

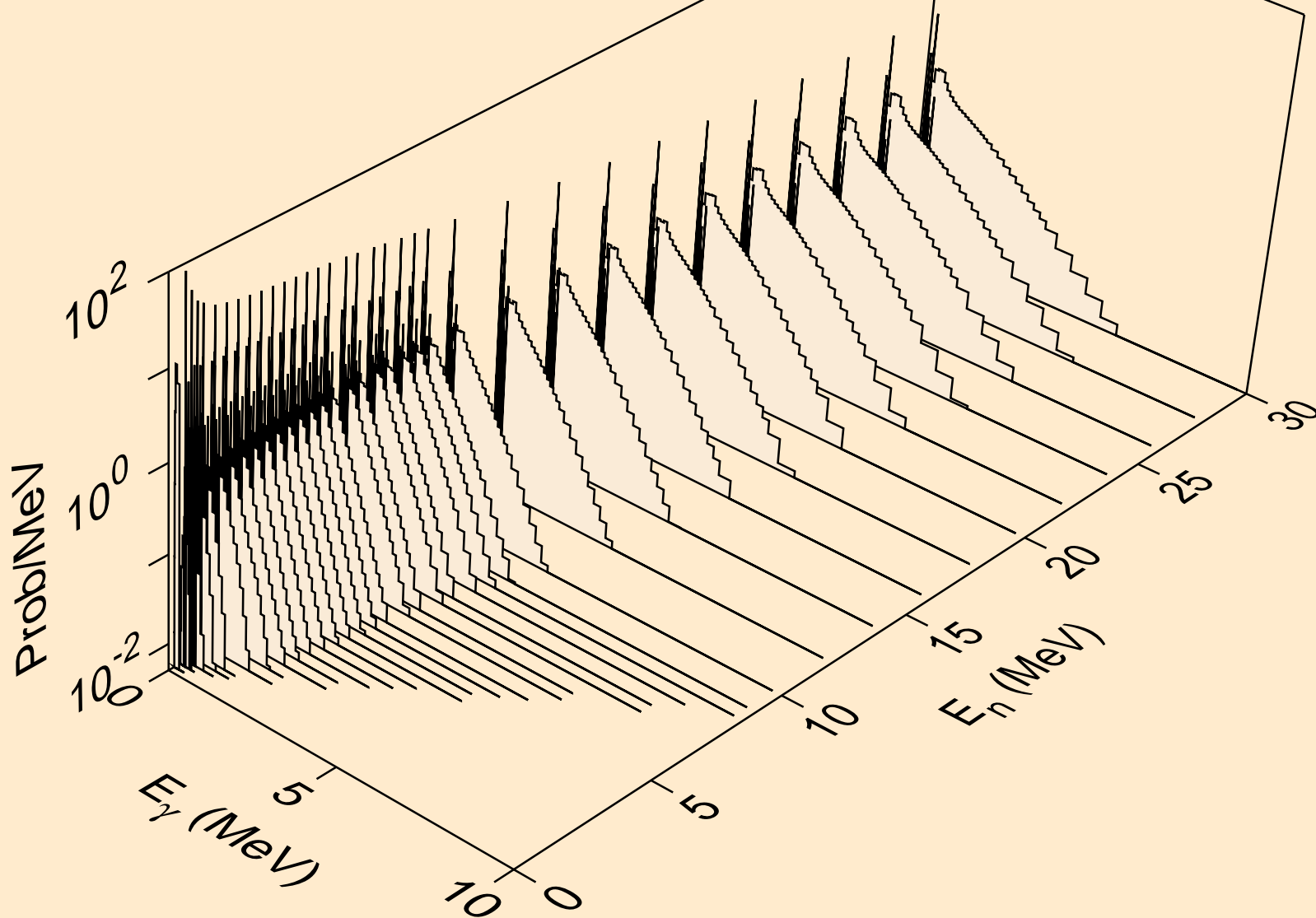

AT200N NEUTRON ACER TENDL-2019 LIBRARY; T=293.16K
Photon emission for (n,2n)a

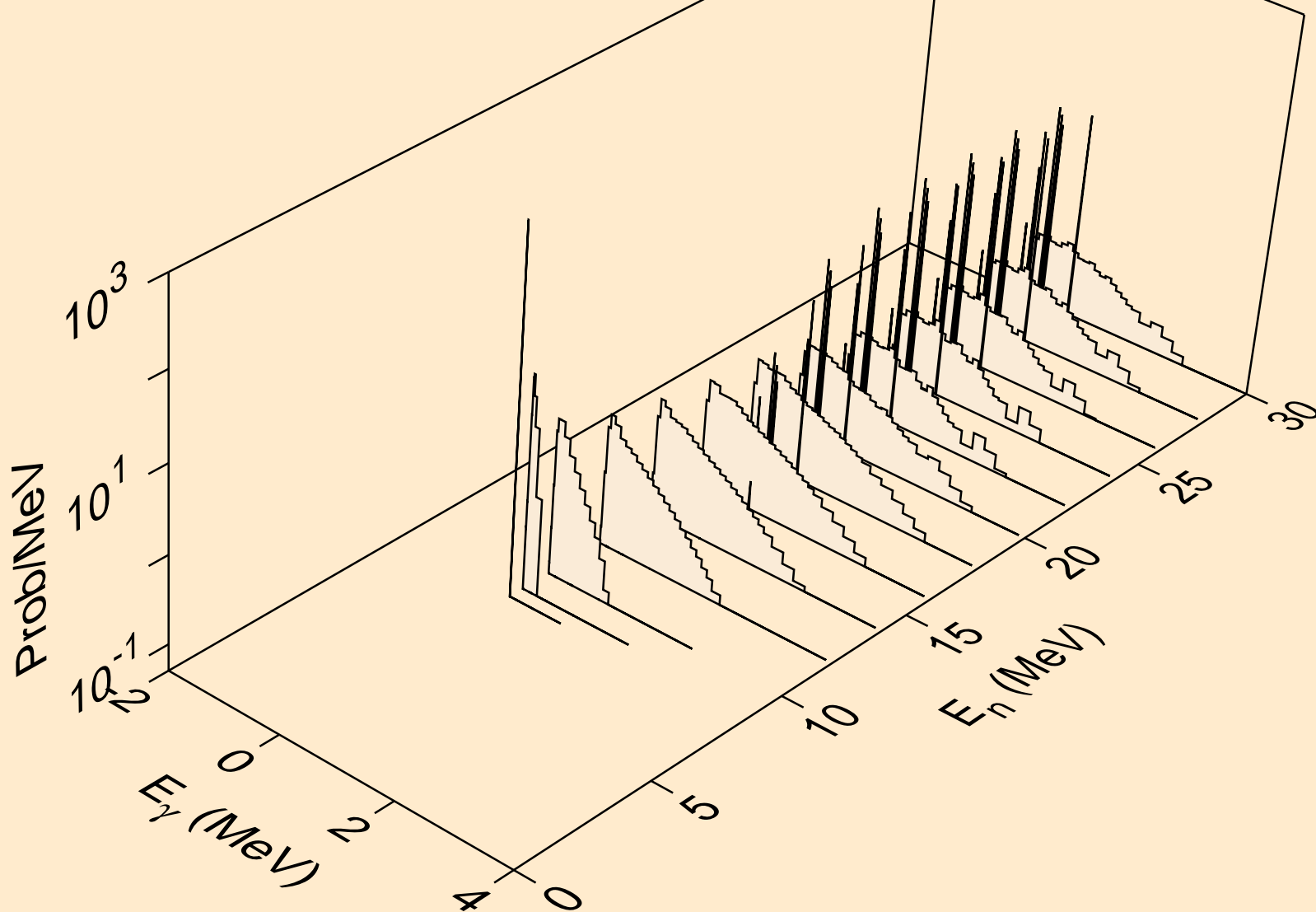

AT200N NEUTRON ACER TENDL-2019 LIBRARY; T=293.16K
Photon emission for (n,3n)a

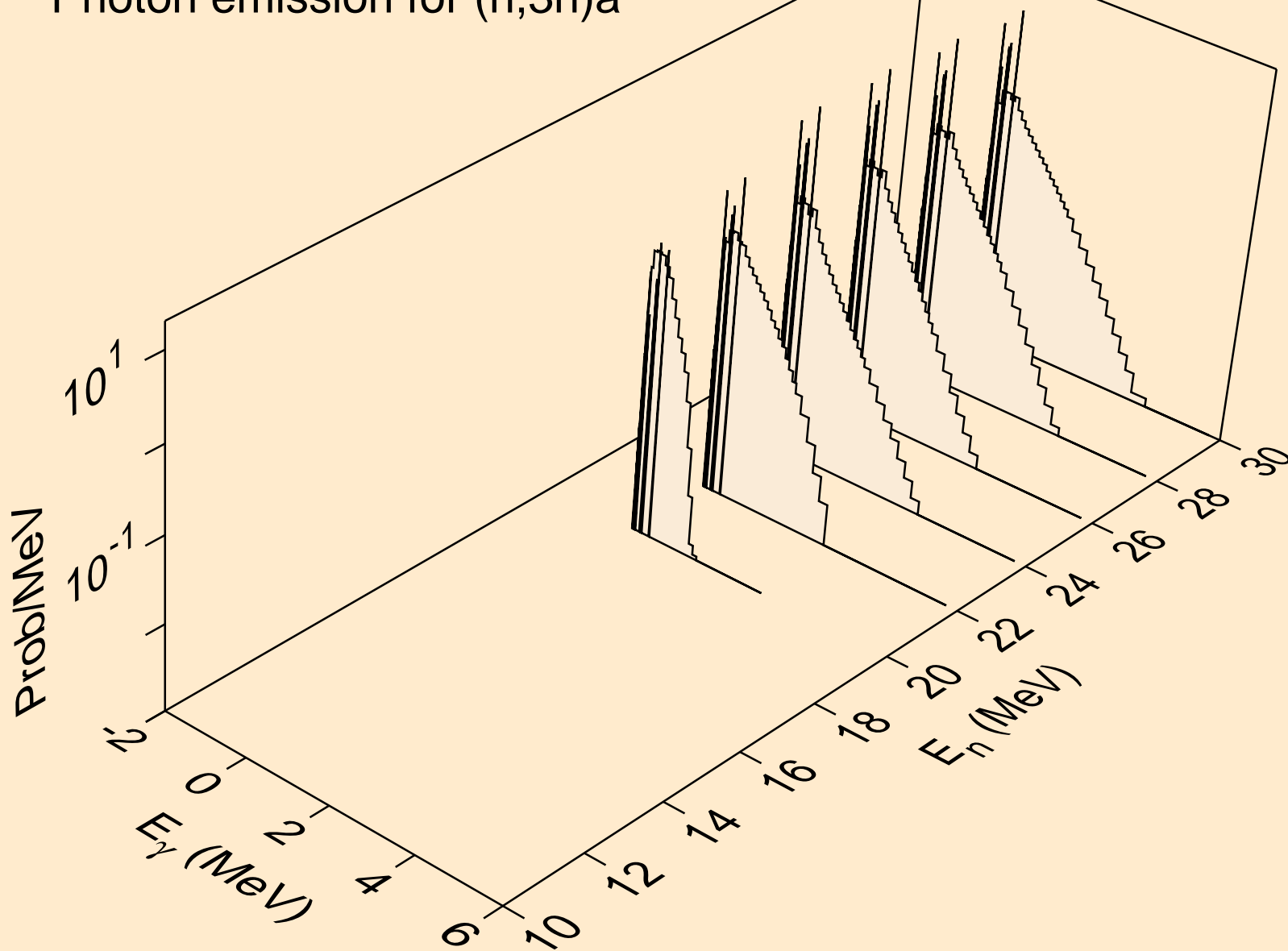

AT200N NEUTRON ACER TENDL-2019 LIBRARY; T=293.16K
Photon emission for (n,n*)p

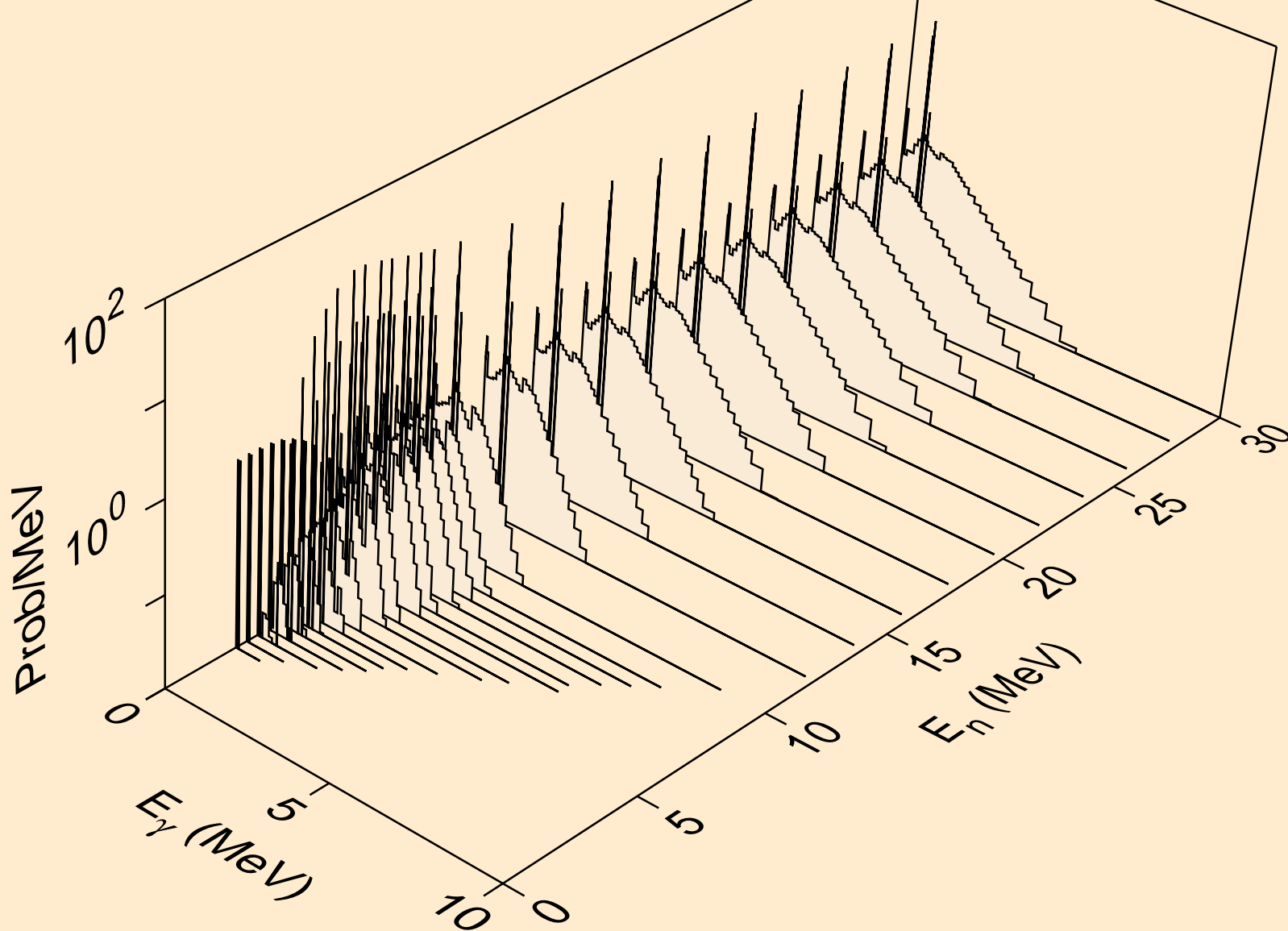

AT200N NEUTRON ACER TENDL-2019 LIBRARY; T=293.16K
Photon emission for (n,n*)2a

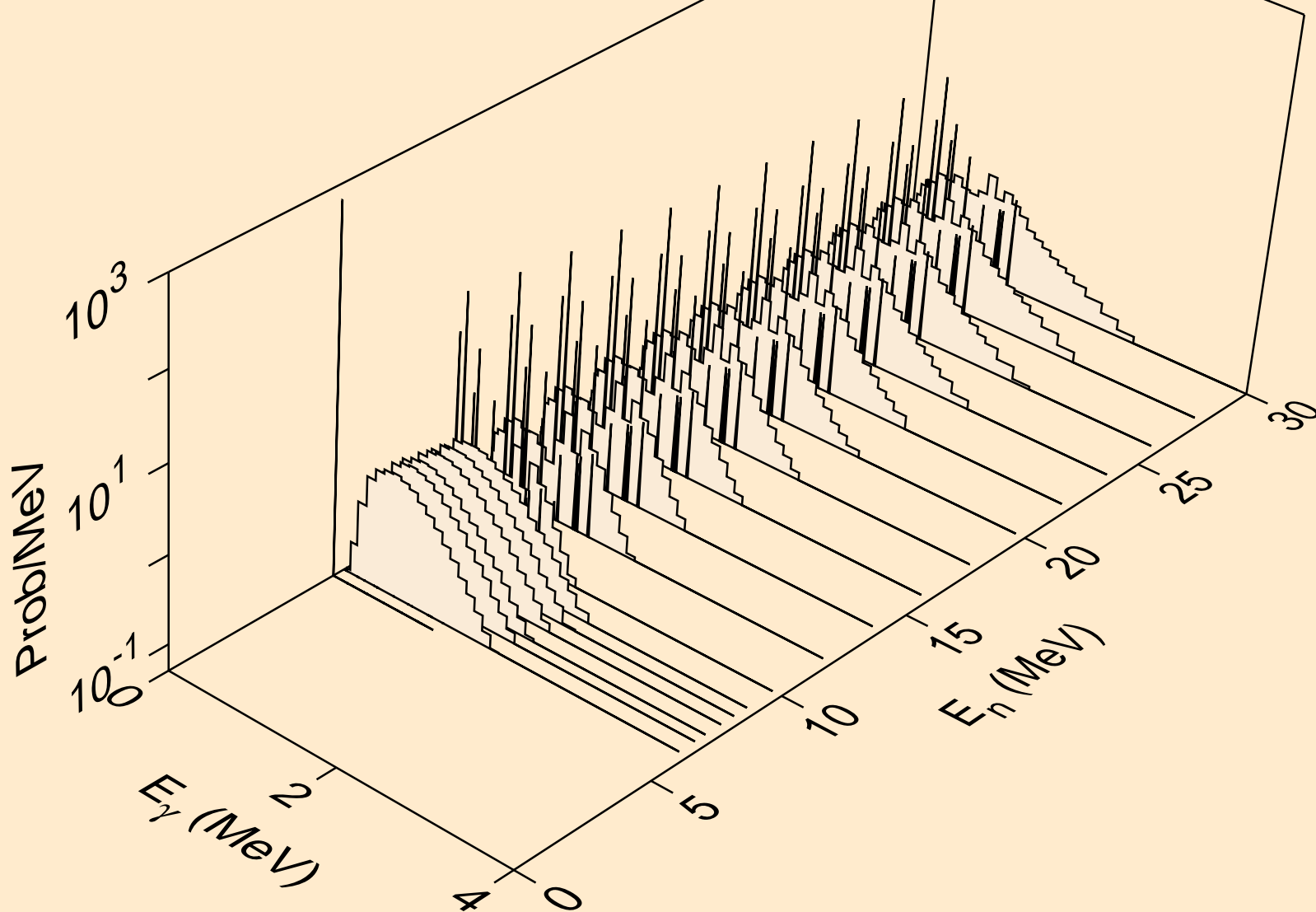

AT200N NEUTRON ACER TENDL-2019 LIBRARY; T=293.16K
Photon emission for (n,2n)2a

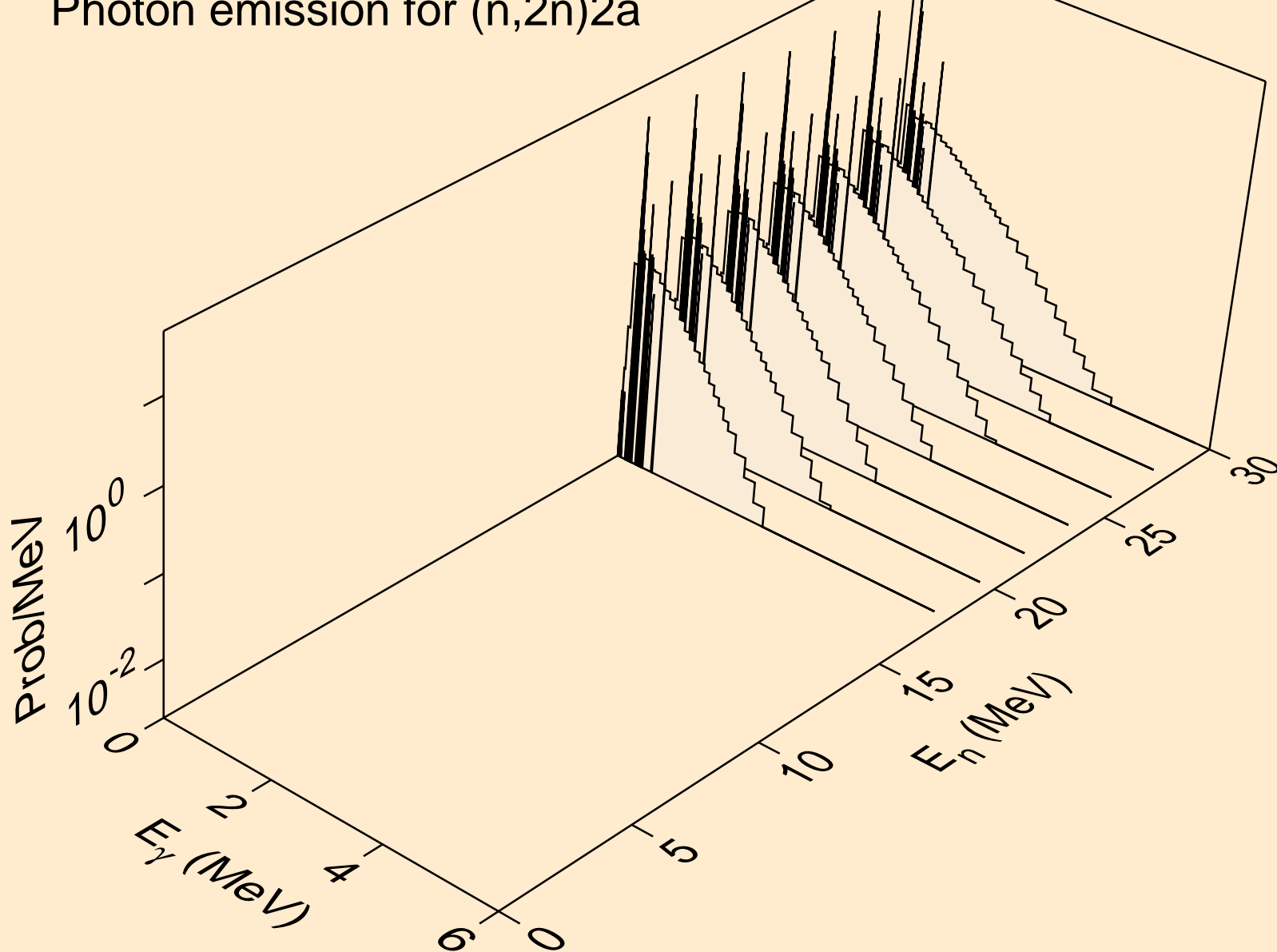

AT200N NEUTRON ACER TENDL-2019 LIBRARY; T=293.16K
Photon emission for (n,n*)d

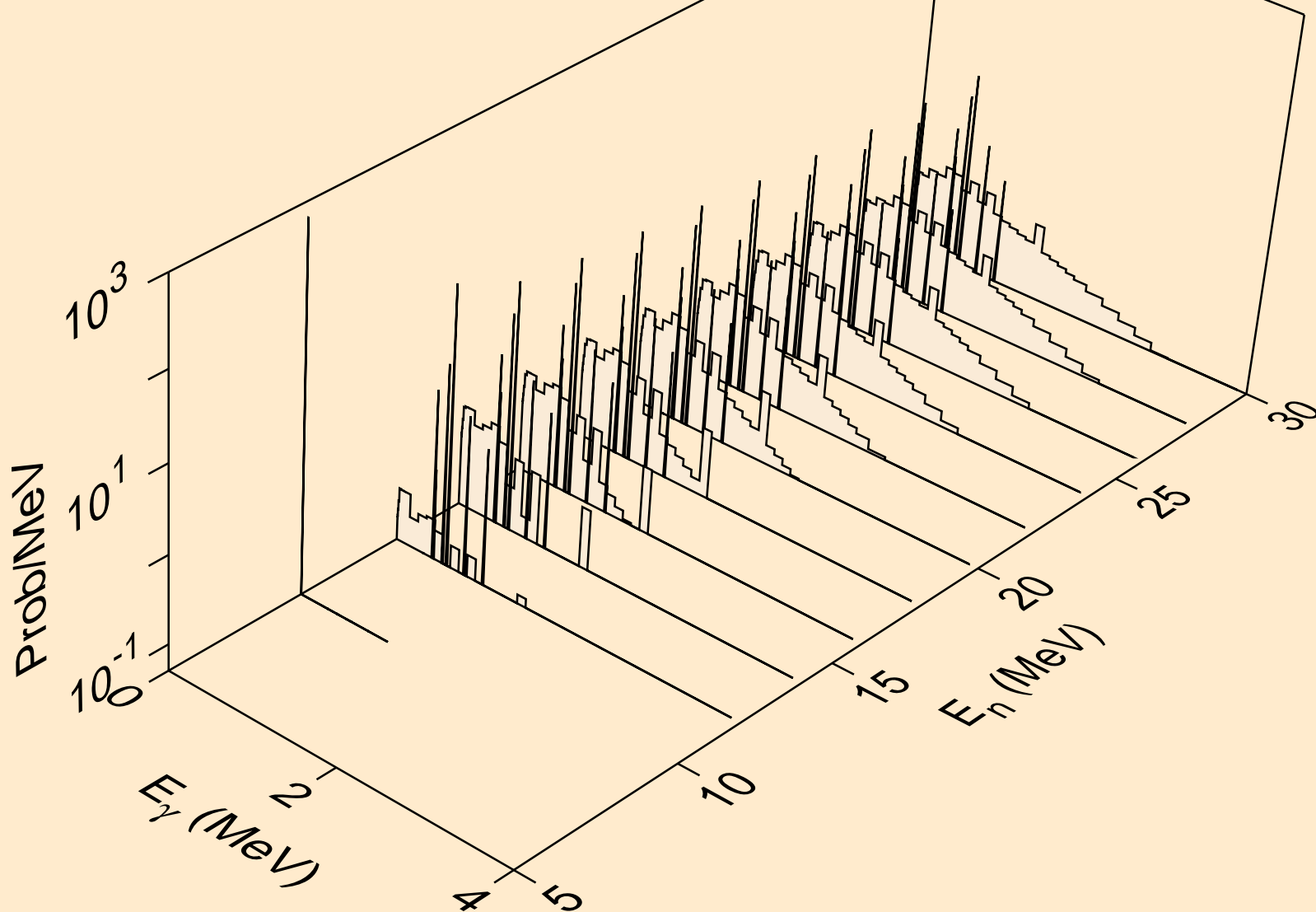

AT200N NEUTRON ACER TENDL-2019 LIBRARY; T=293.16K
Photon emission for (n,n*)t

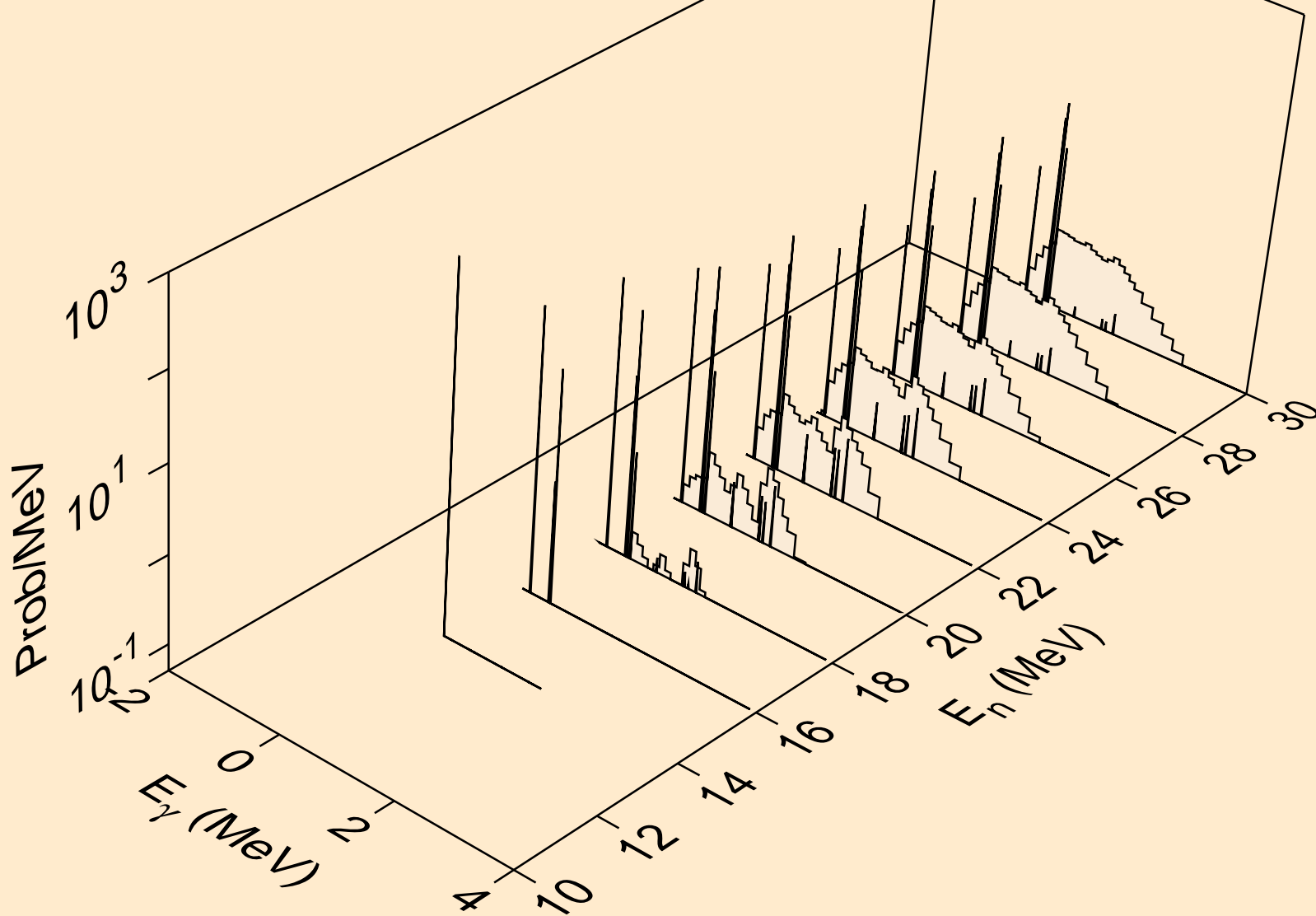

AT200N NEUTRON ACER TENDL-2019 LIBRARY; T=293.16K
Photon emission for (n,n*)he3

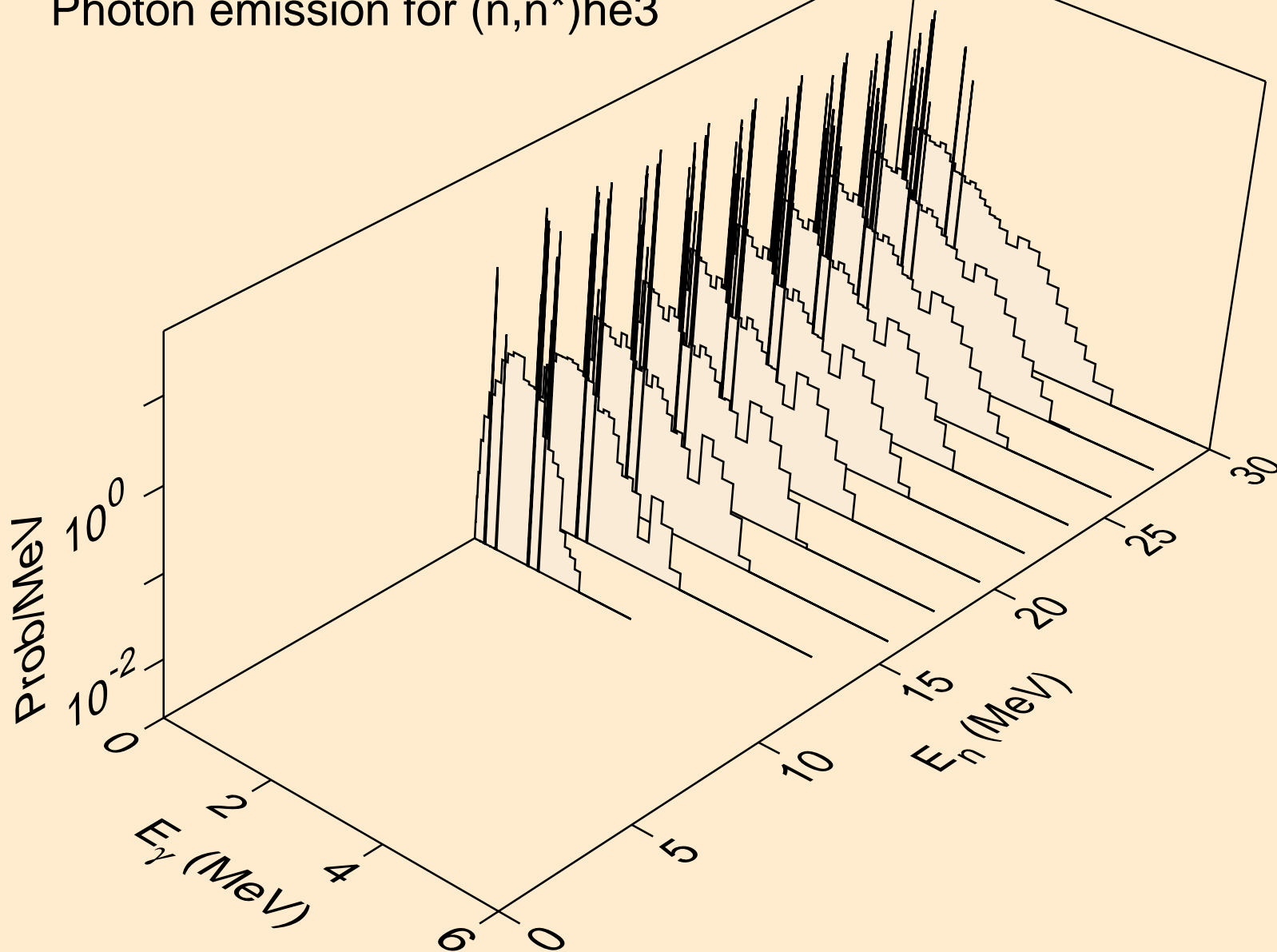

AT200N NEUTRON ACER TENDL-2019 LIBRARY; T=293.16K
Photon emission for (n,4n)

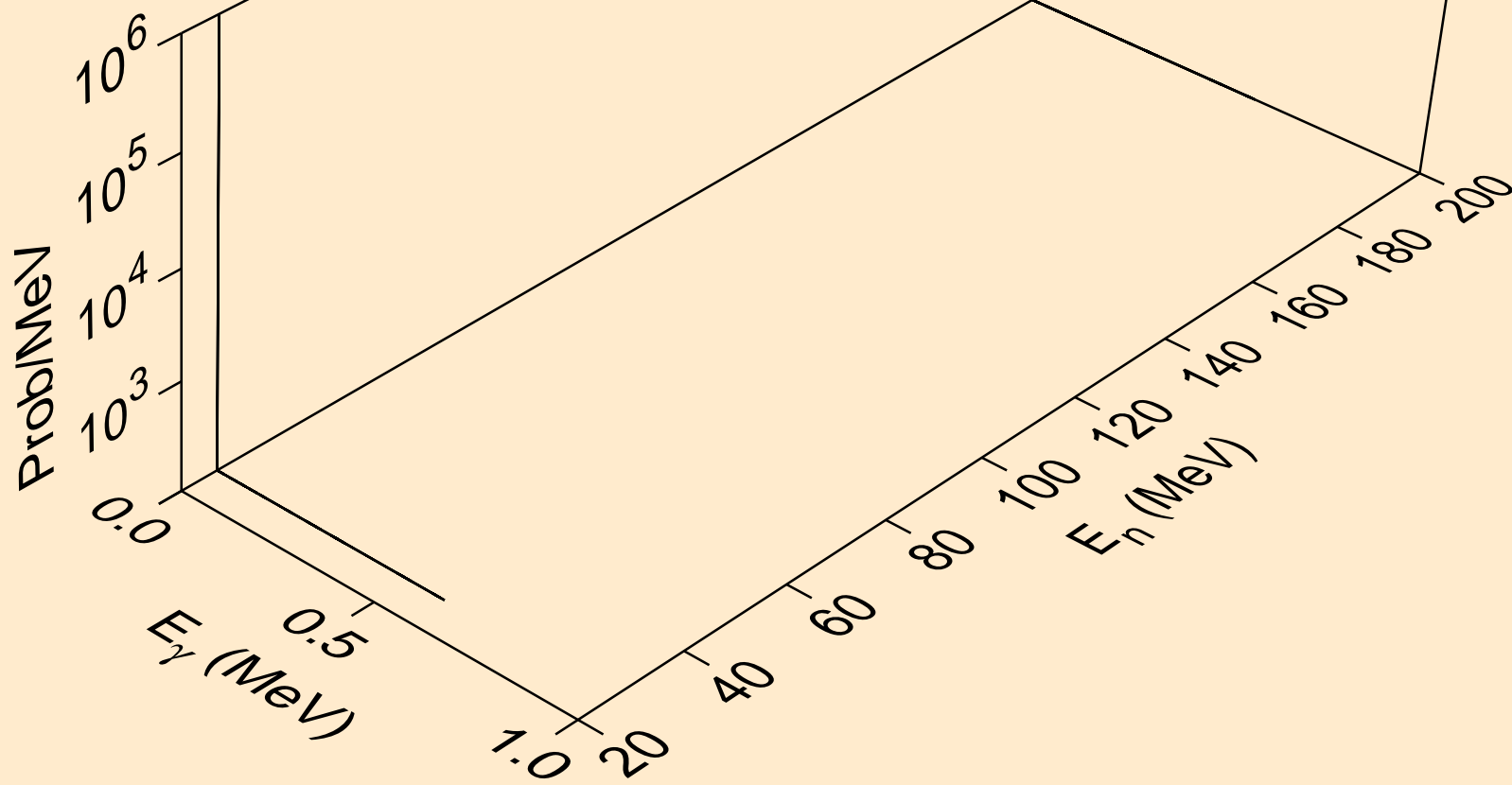

AT200N NEUTRON ACER TENDL-2019 LIBRARY; T=293.16K
Photon emission for (n,2np)

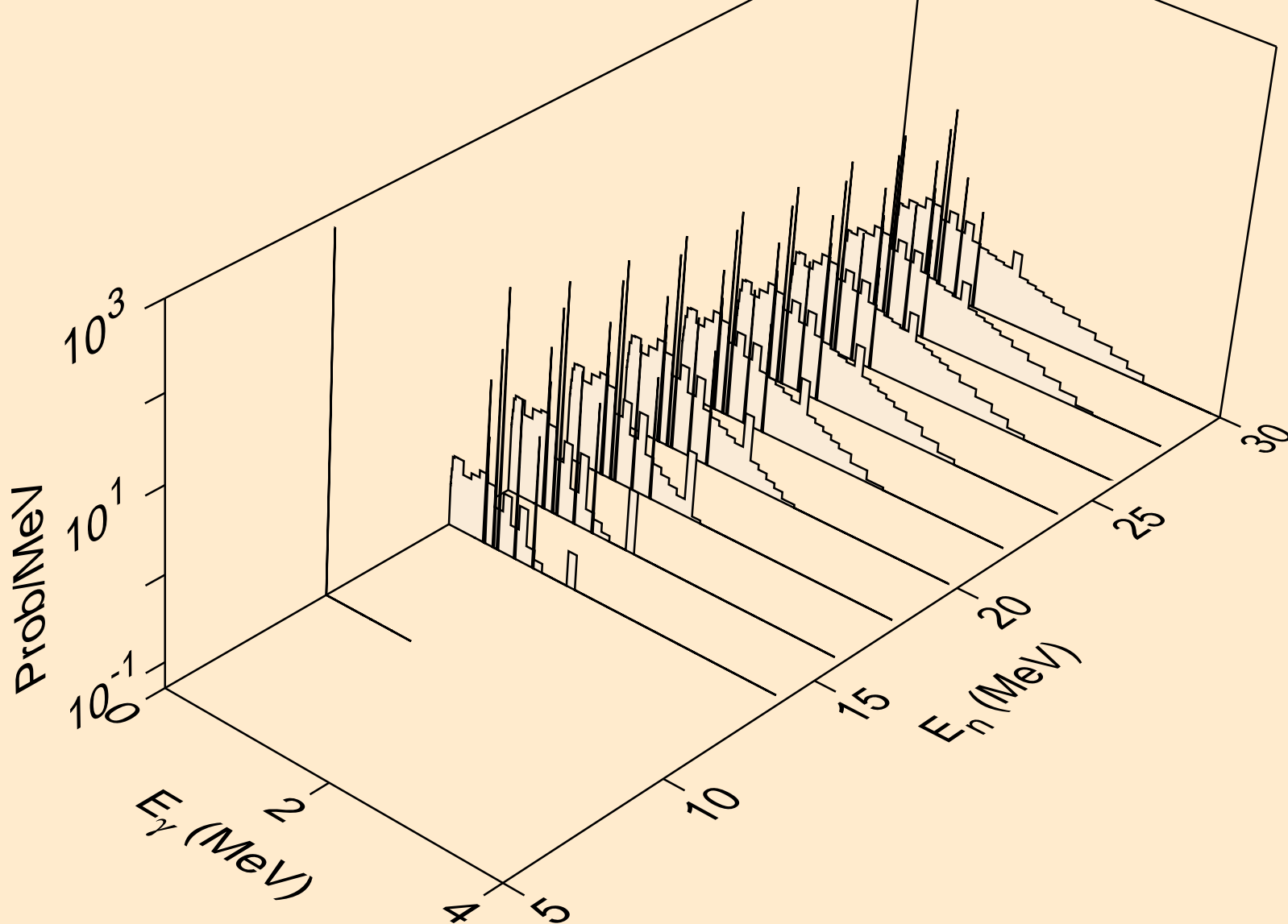

AT200N NEUTRON ACER TENDL-2019 LIBRARY; T=293.16K
Photon emission for (n,3np)

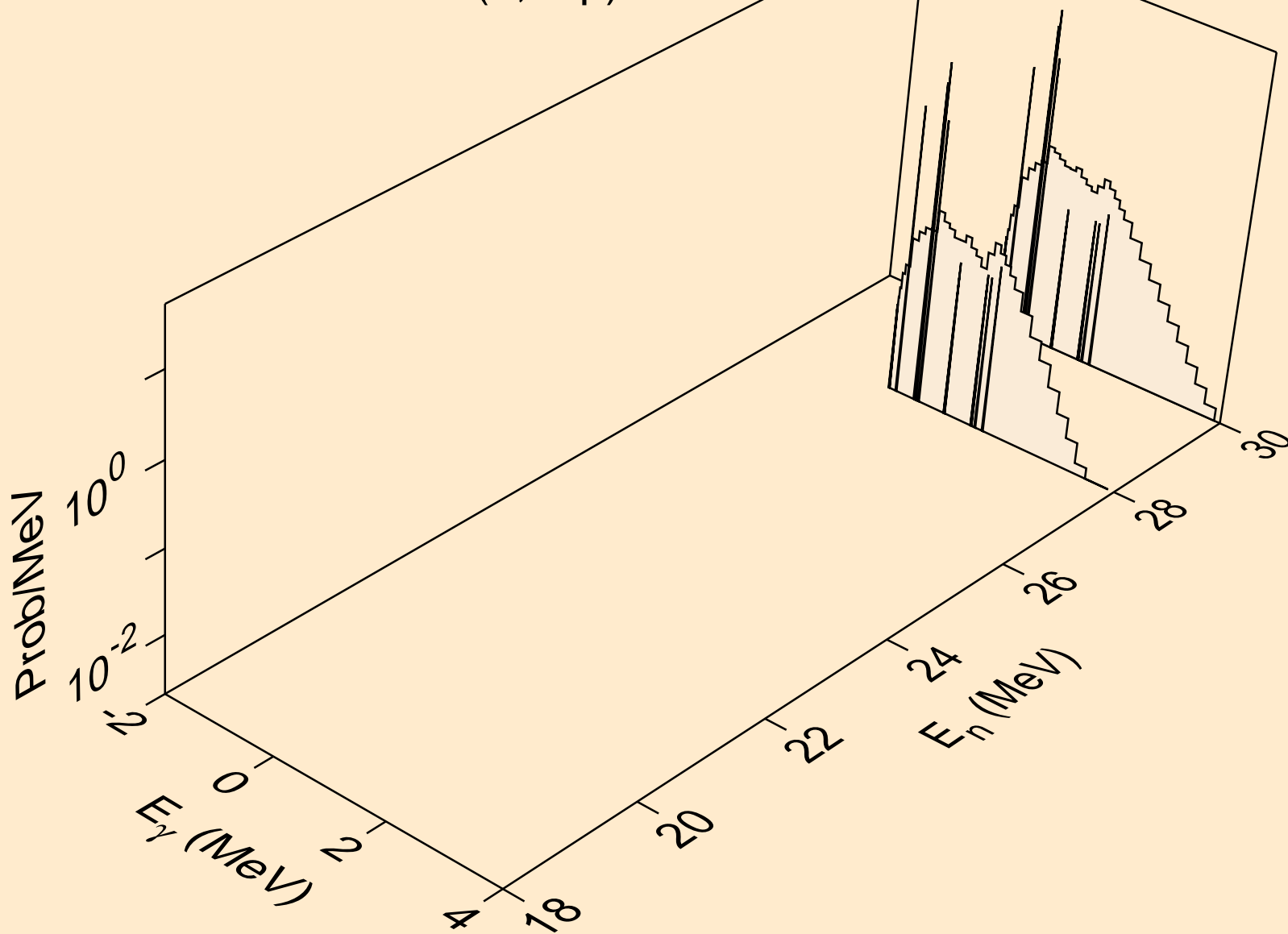

AT200N NEUTRON ACER TENDL-2019 LIBRARY; T=293.16K
Photon emission for (n,2np)

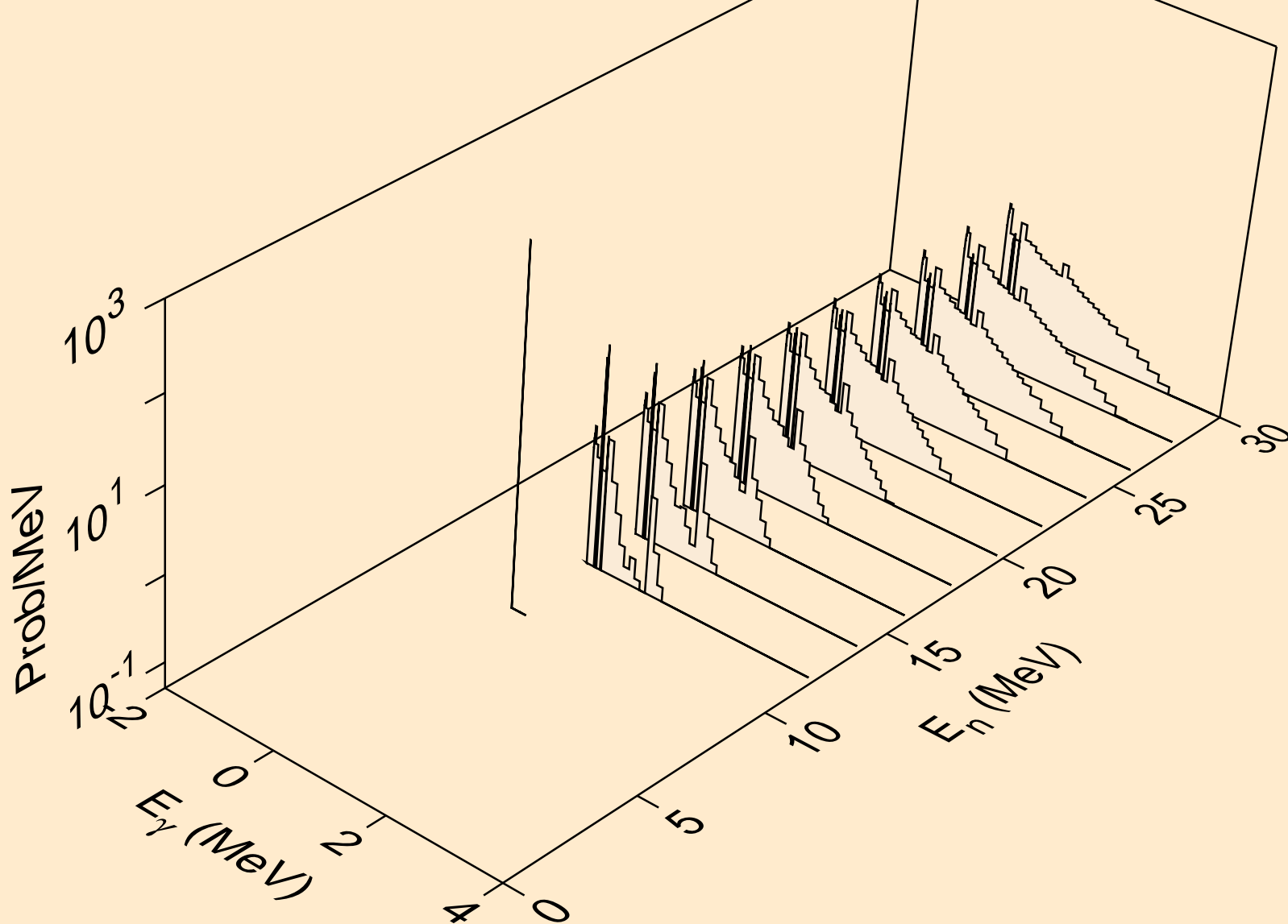

AT200N NEUTRON ACER TENDL-2019 LIBRARY; T=293.16K
Photon emission for (n,npa)

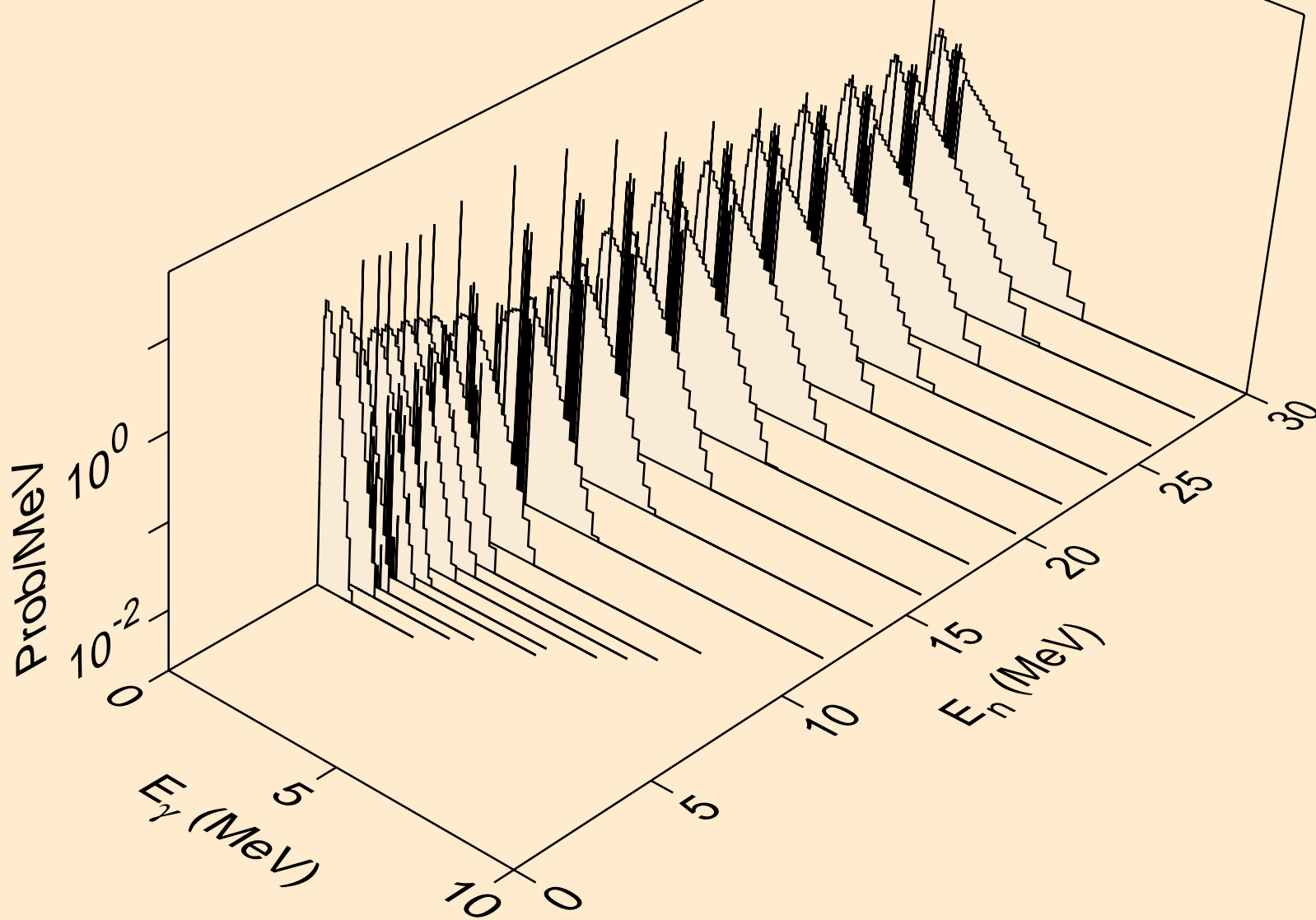

AT200N NEUTRON ACER TENDL-2019 LIBRARY; T=293.16K
Photon emission for (n,n*2)

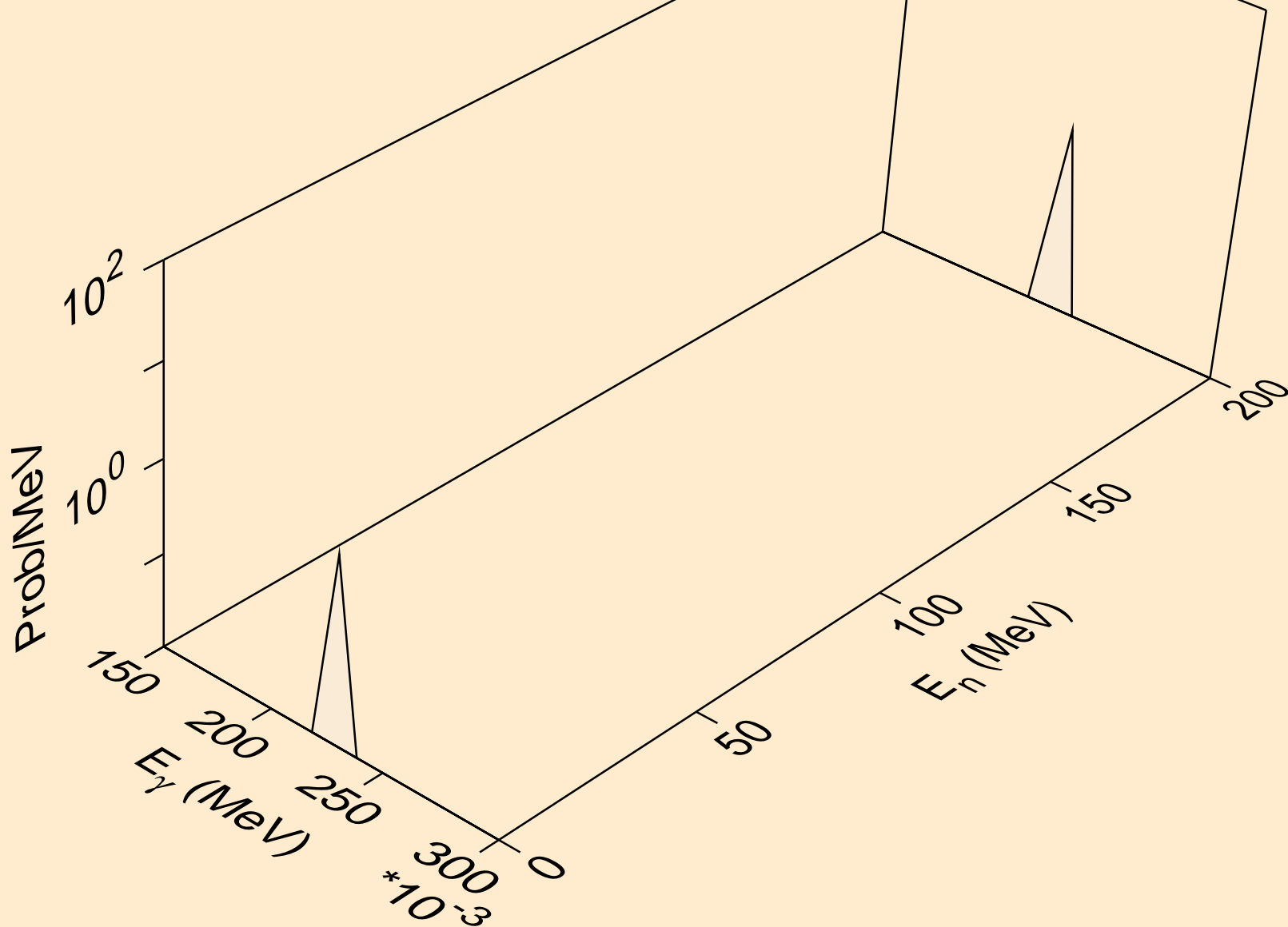

AT200N NEUTRON ACER TENDL-2019 LIBRARY; T=293.16K
Photon emission for (n,n*c)

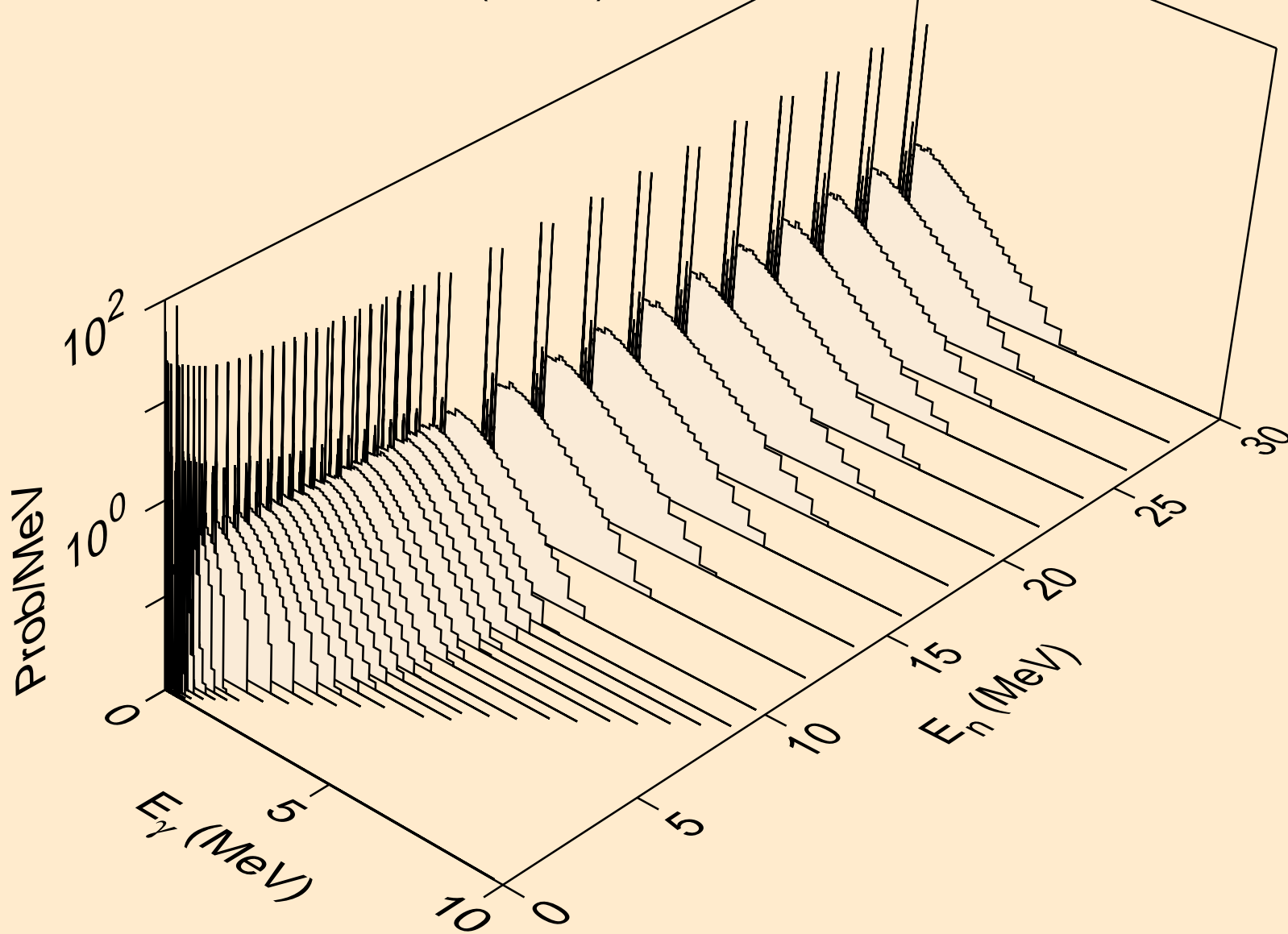

AT200N NEUTRON ACER TENDL-2019 LIBRARY; T=293.16K
Photon emission for (n,gma)

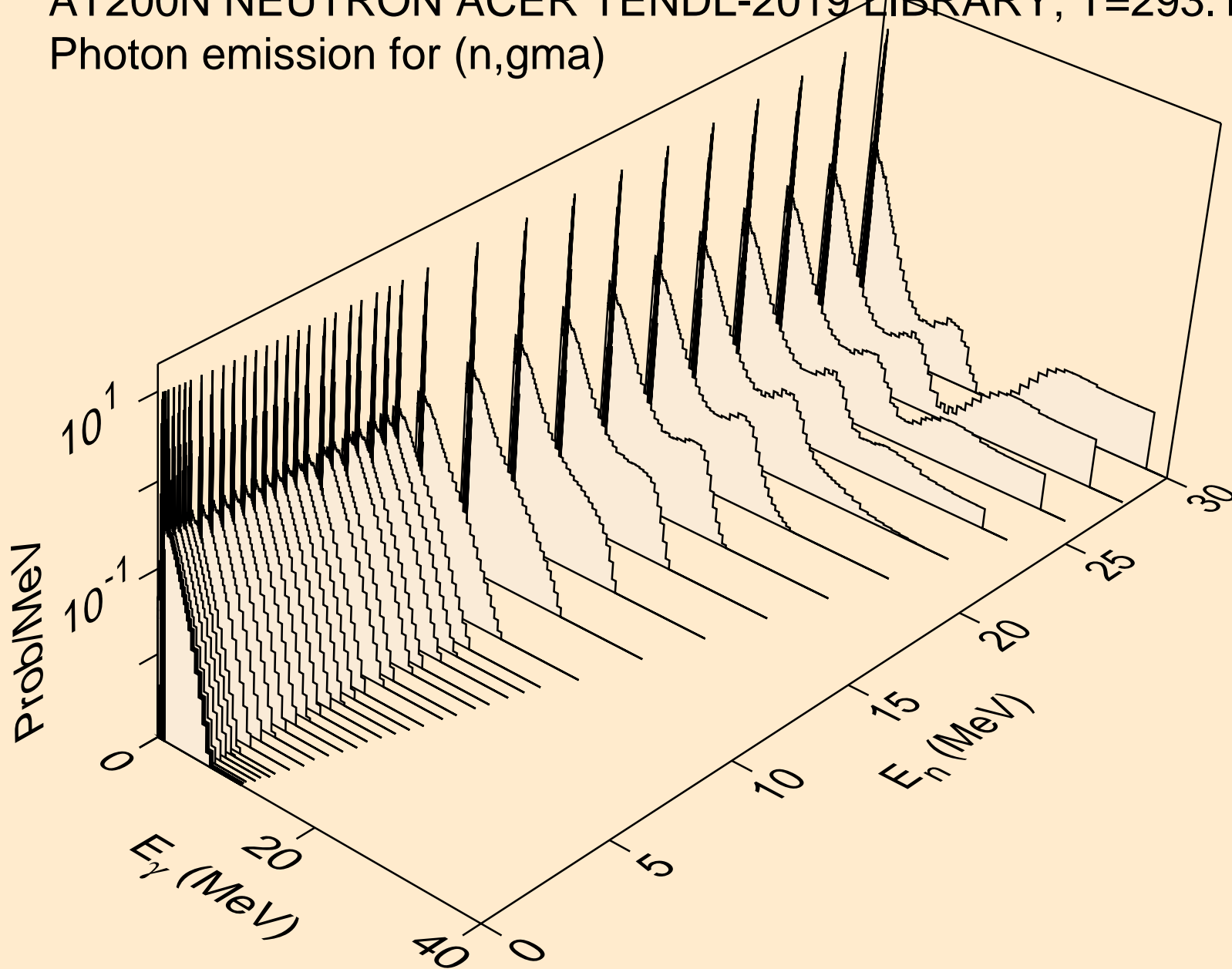

AT200N NEUTRON ACER TENDL-2019 LIBRARY; T=293.16K
Photon emission for (n,p)

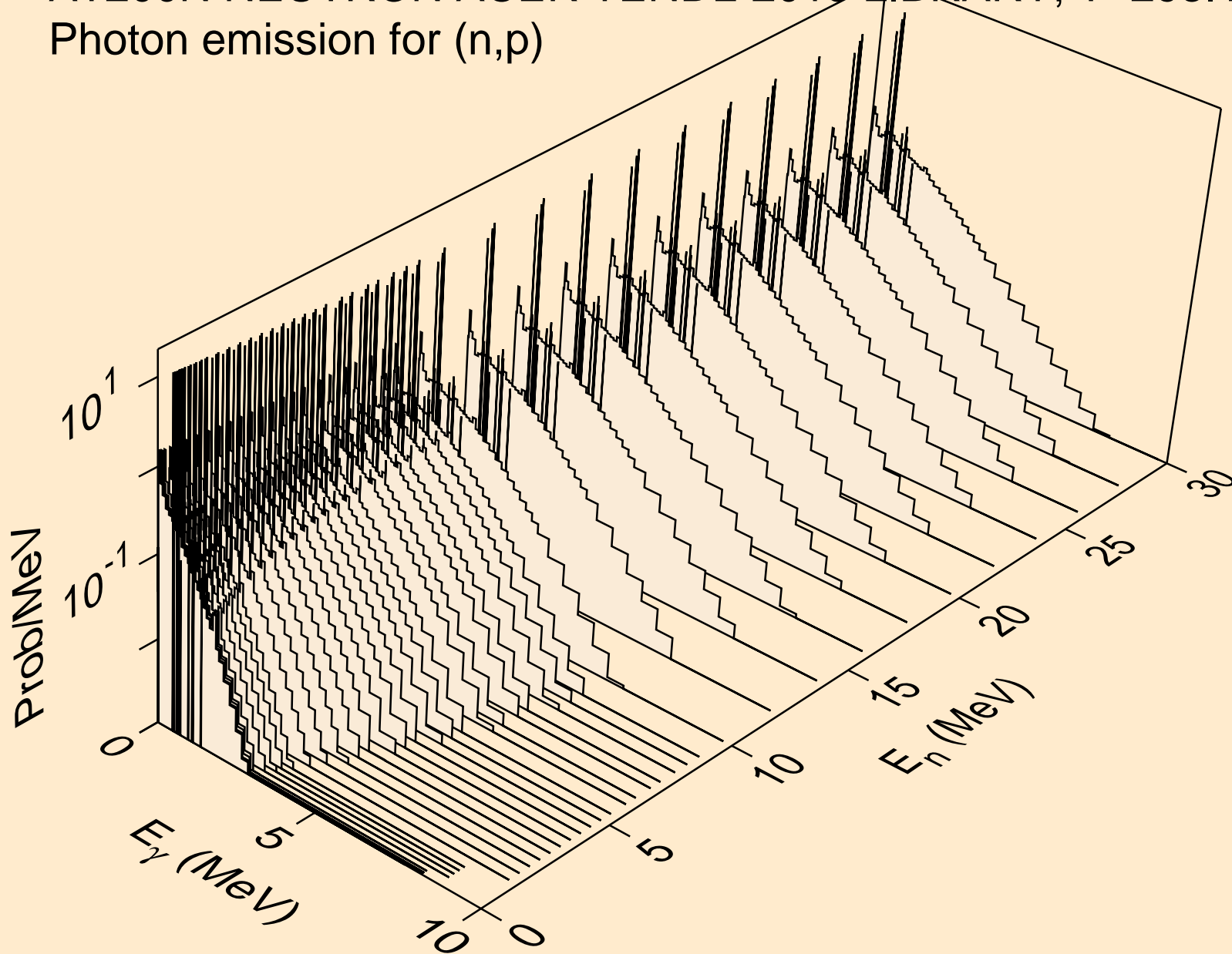

AT200N NEUTRON ACER TENDL-2019 LIBRARY; T=293.16K
Photon emission for (n,d)

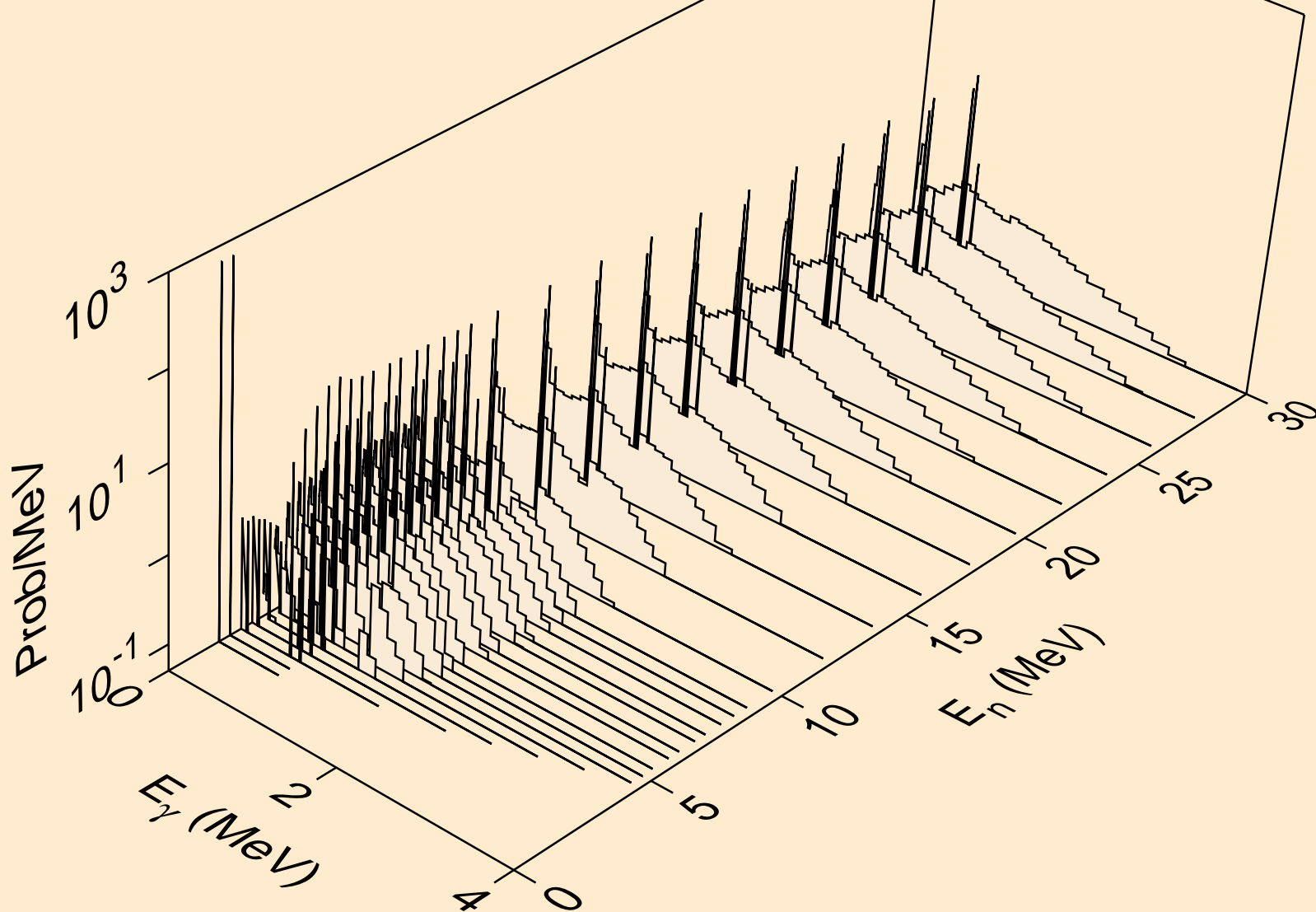

AT200N NEUTRON ACER TENDL-2019 LIBRARY; T=293.16K
Photon emission for (n,t)

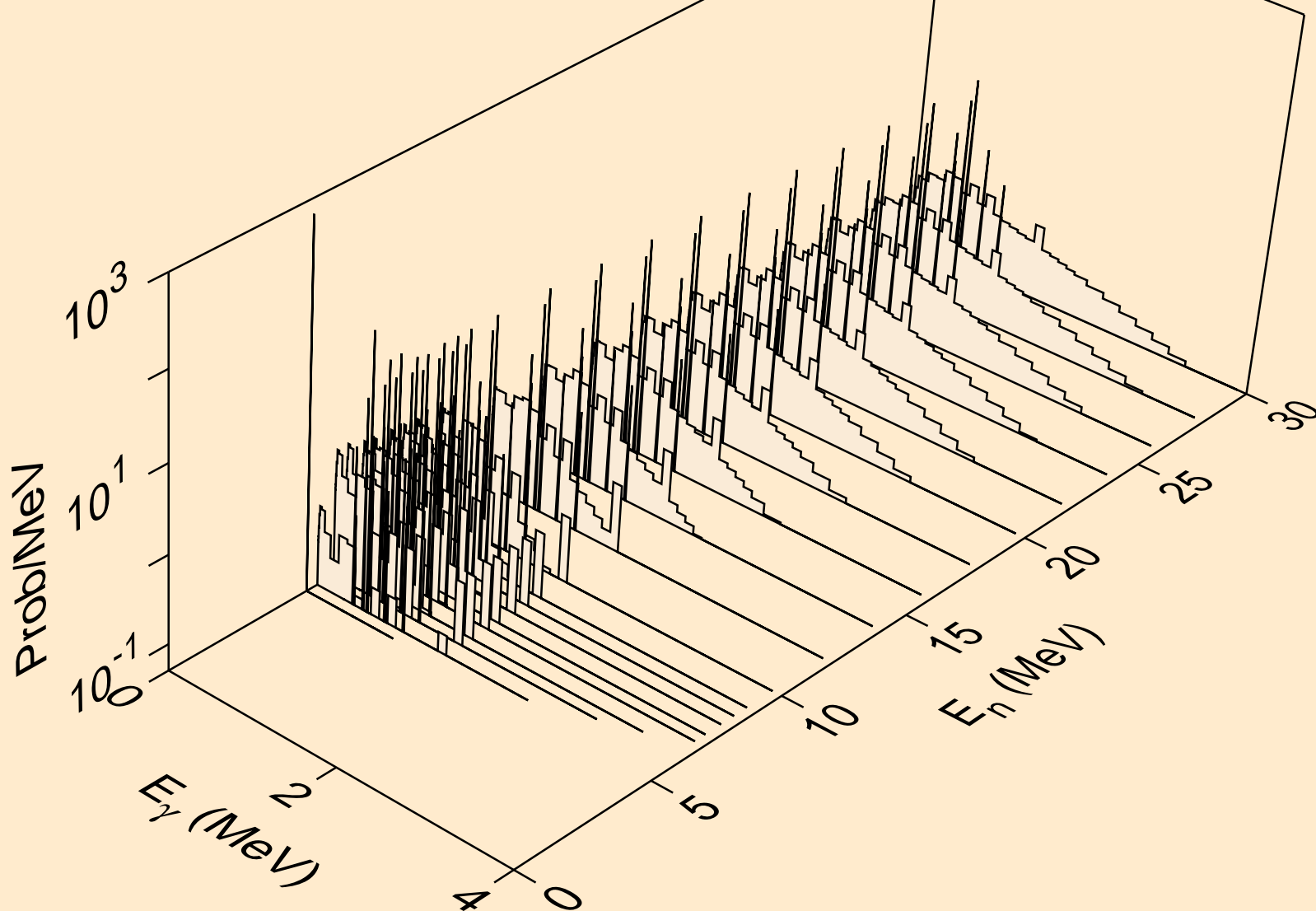

AT200N NEUTRON ACER TENDL-2019 LIBRARY; T=293.16K
Photon emission for (n,he3)

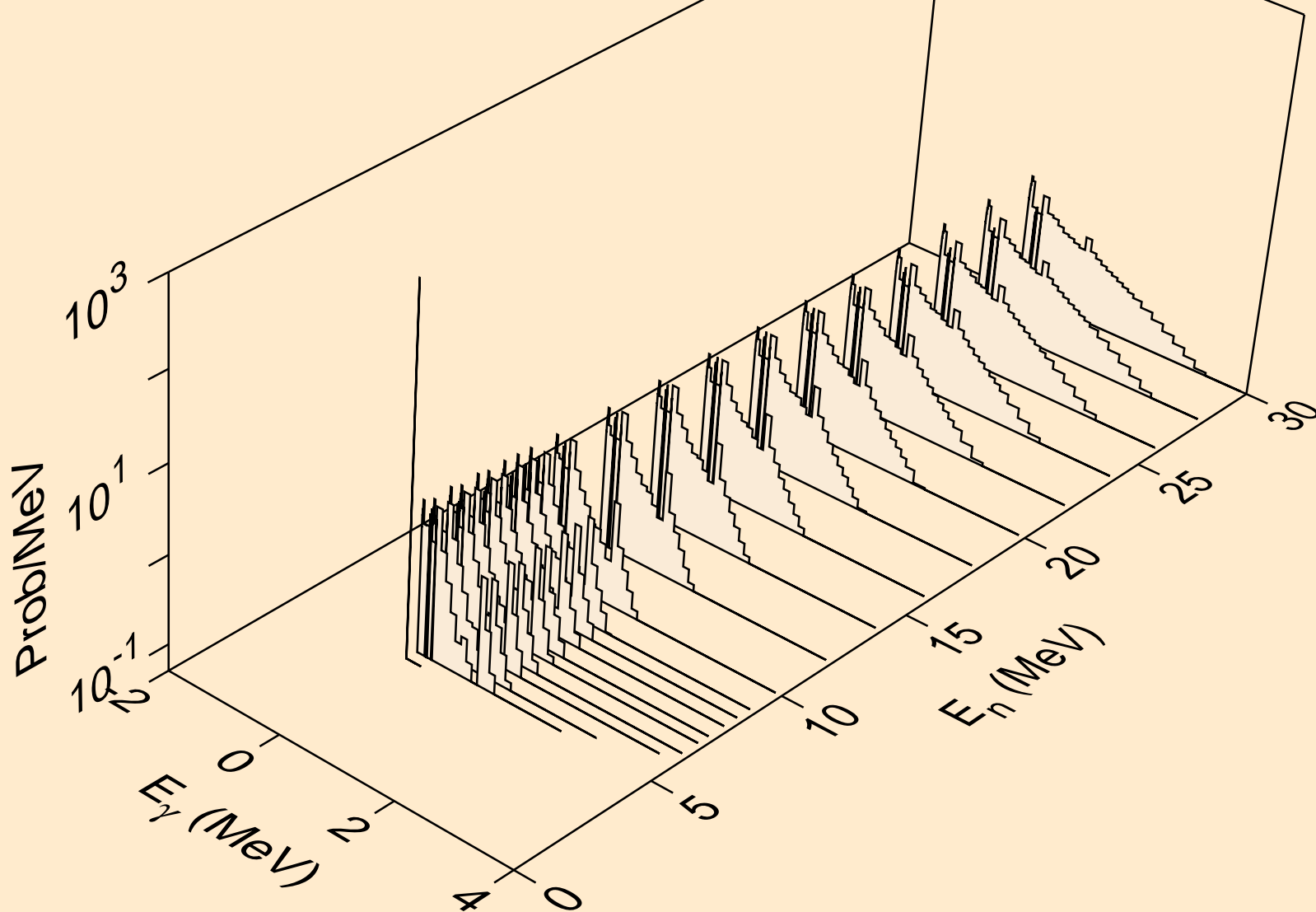

AT200N NEUTRON ACER TENDL-2019 LIBRARY; T=293.16K
Photon emission for (n,a)

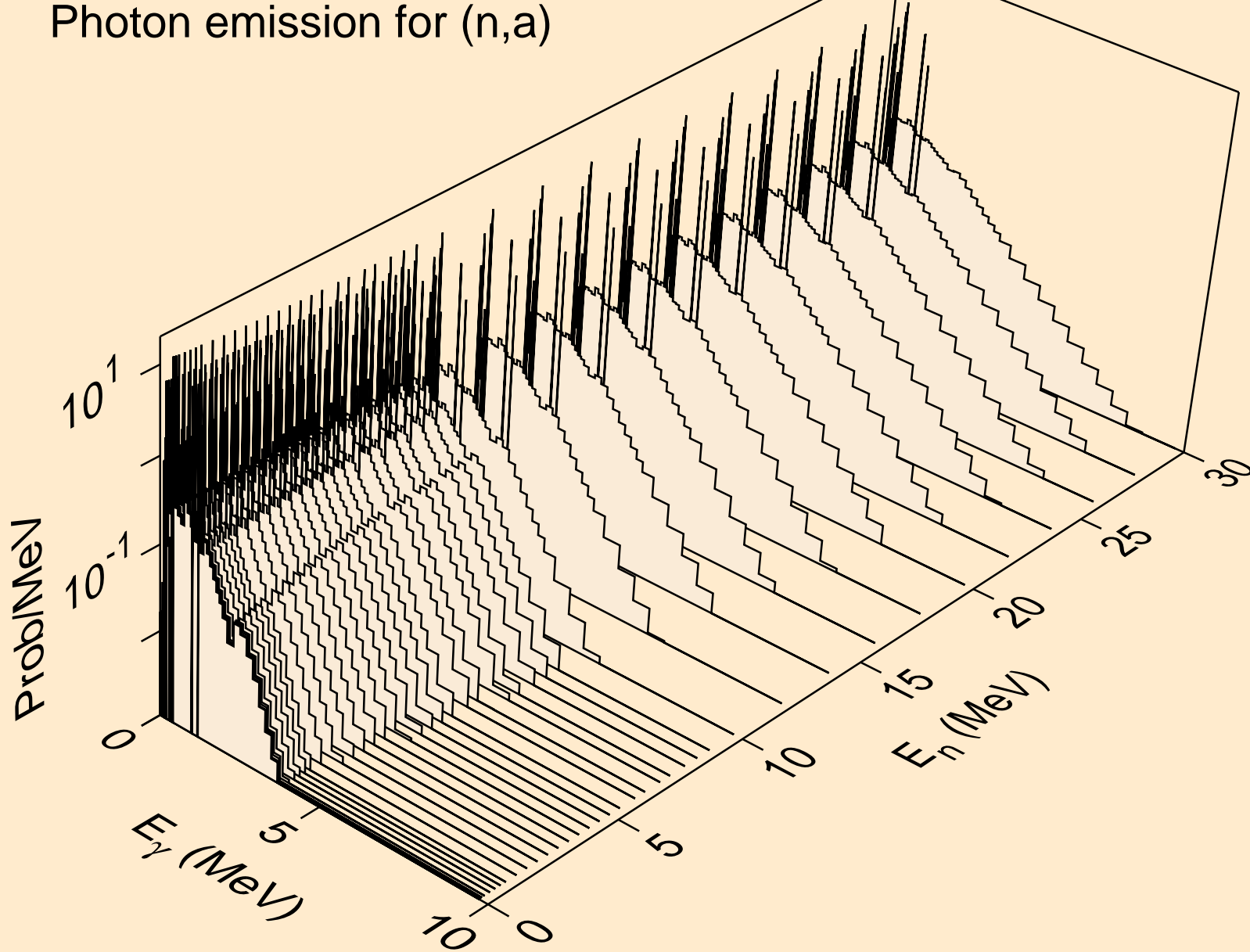

AT200N NEUTRON ACER TENDL-2019 LIBRARY; T=293.16K
Photon emission for (n,2a)

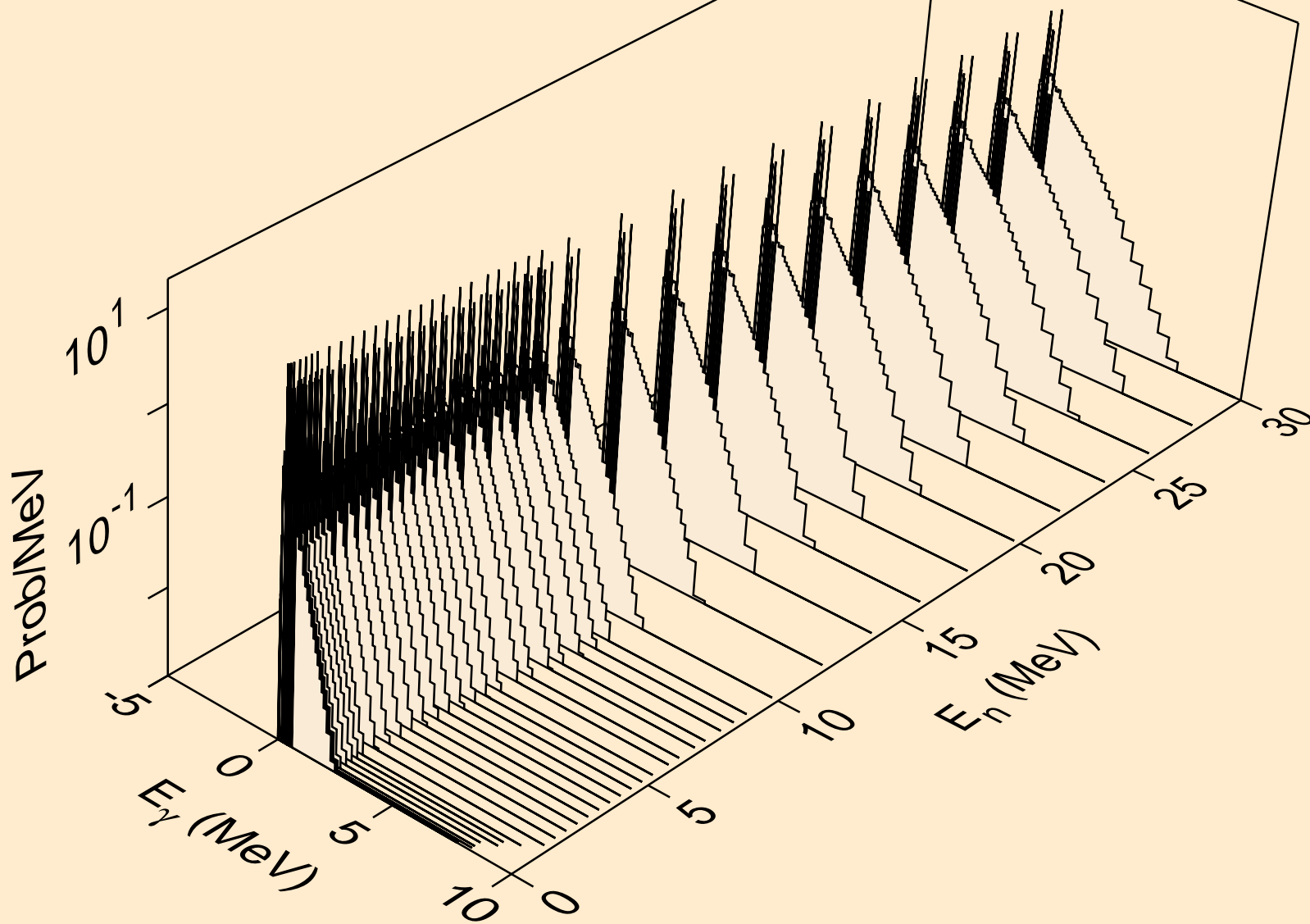

AT200N NEUTRON ACER TENDL-2019 LIBRARY; T=293.16K
Photon emission for (n,2p)

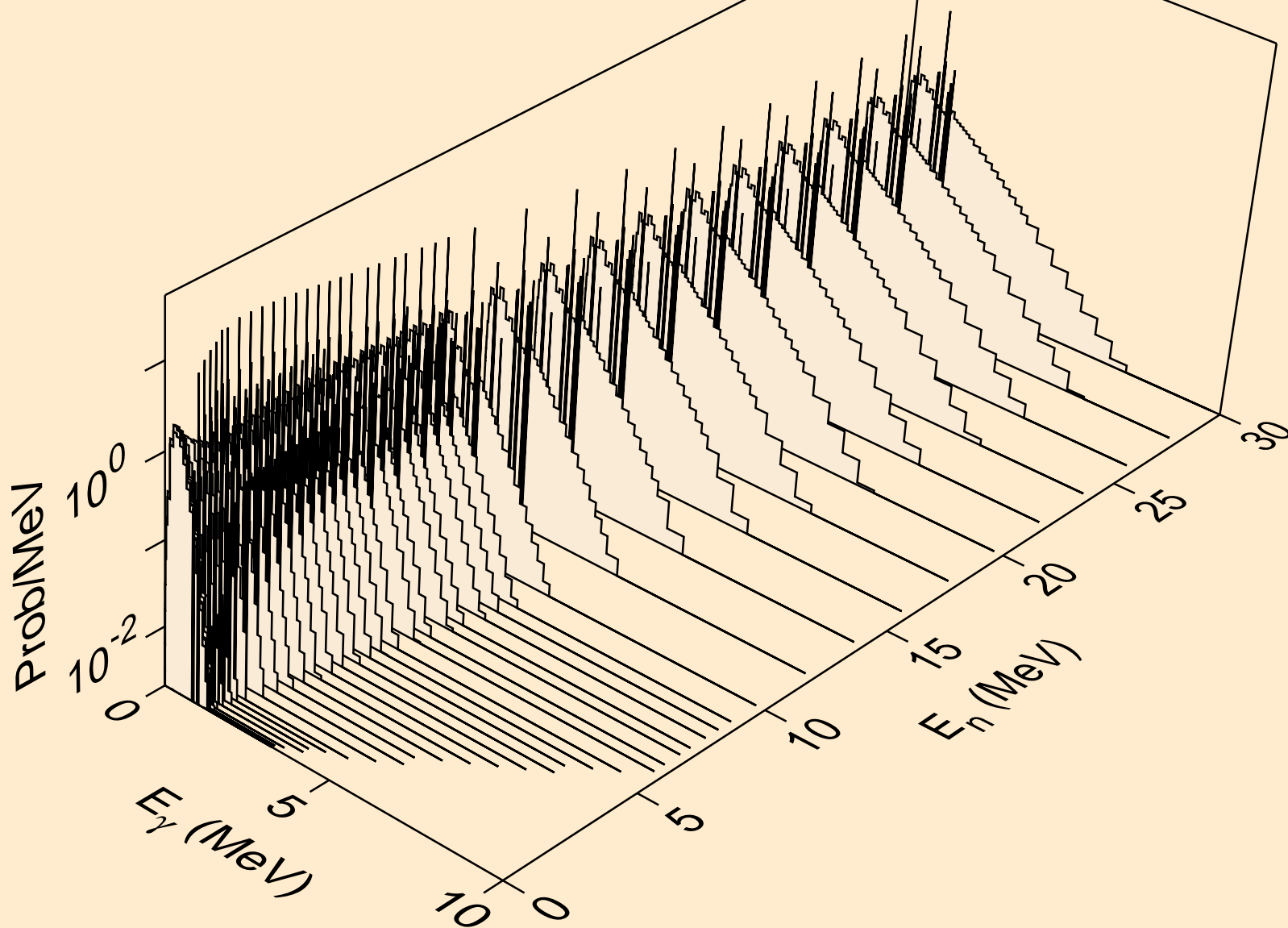

AT200N NEUTRON ACER TENDL-2019 LIBRARY; T=293.16K
Photon emission for (n,p)

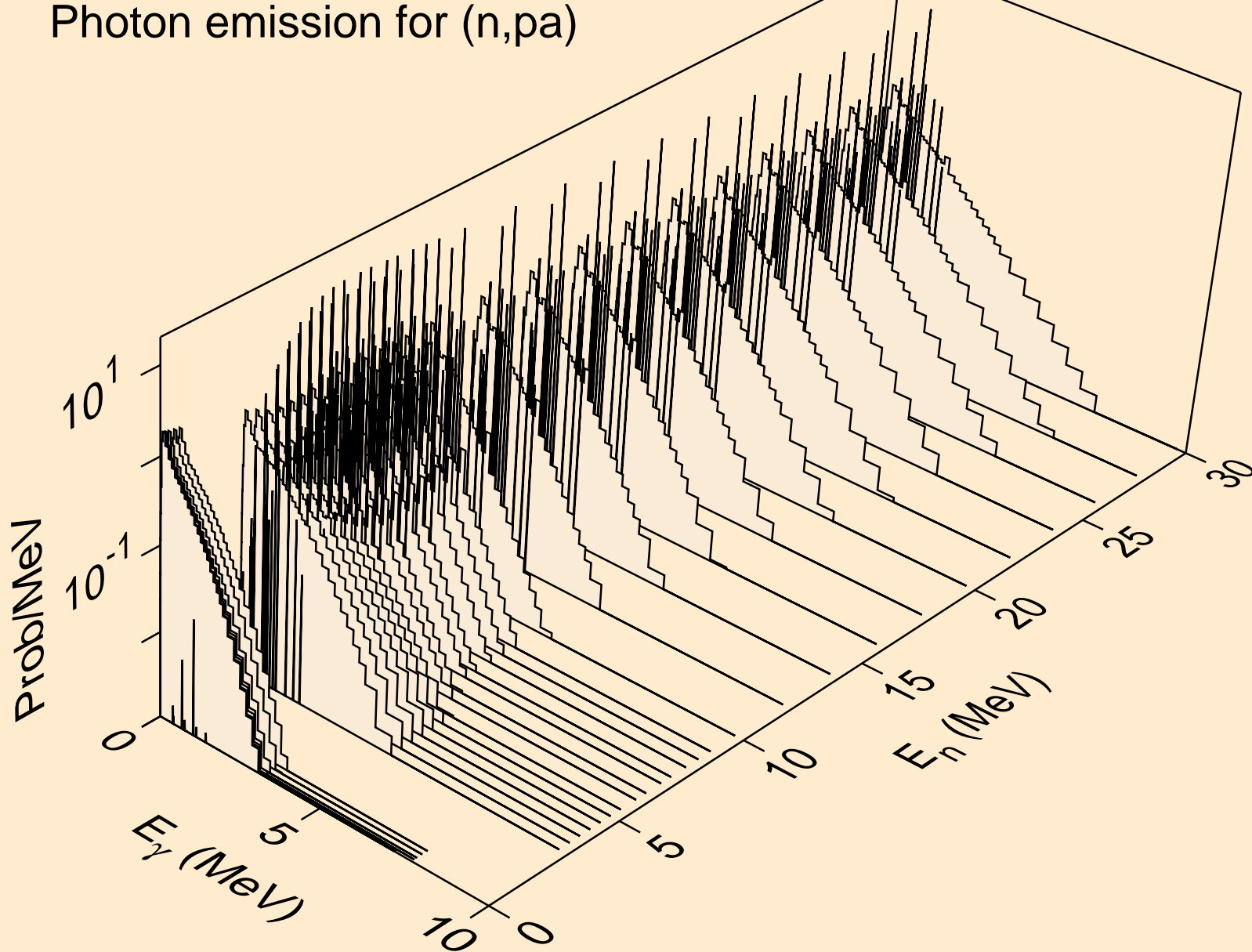

AT200N NEUTRON ACER TENDL-2019 LIBRARY; T=293.16K
Photon emission for (n,pd)

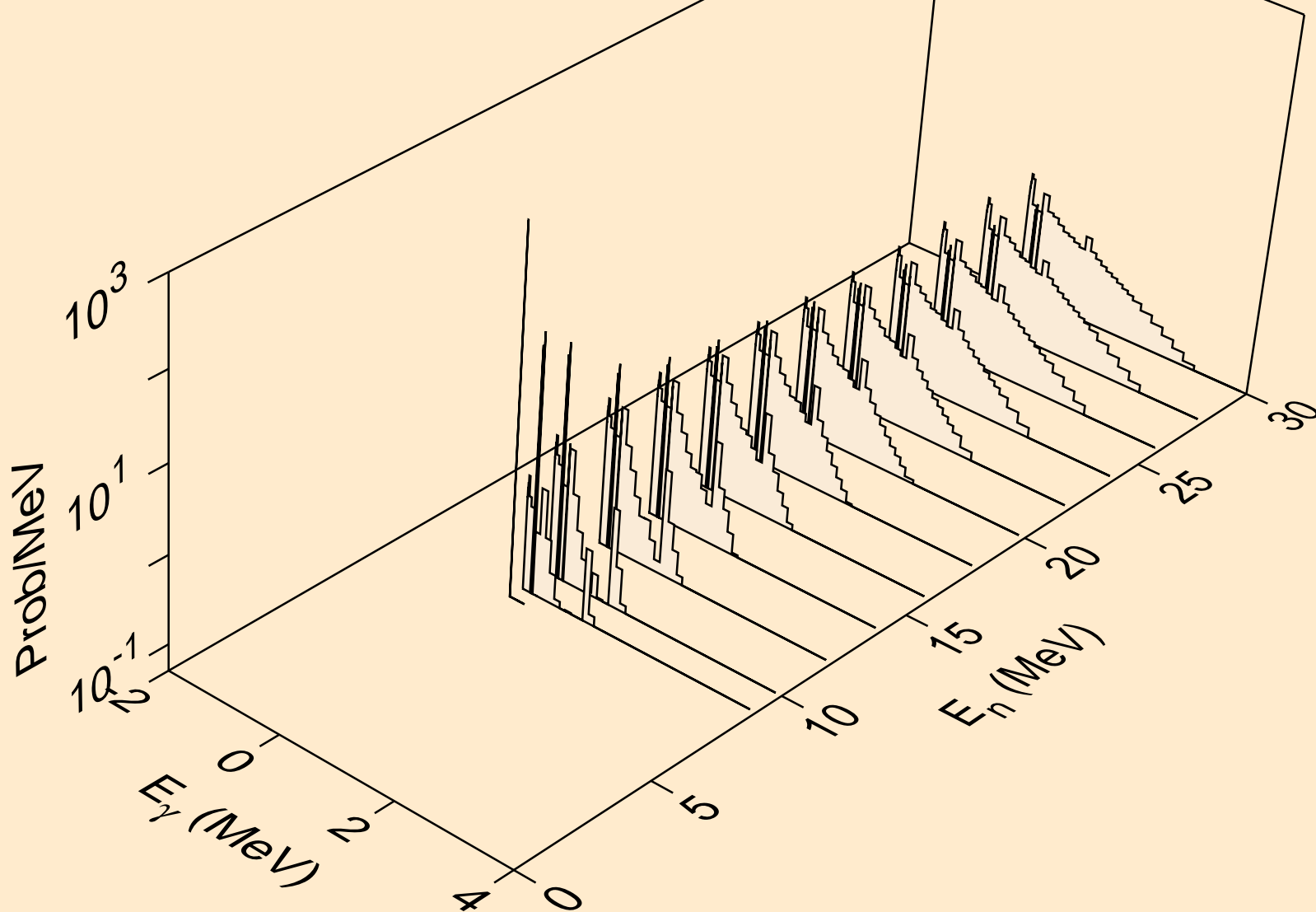

AT200N NEUTRON ACER TENDL-2019 LIBRARY; T=293.16K
Photon emission for (n,pt)

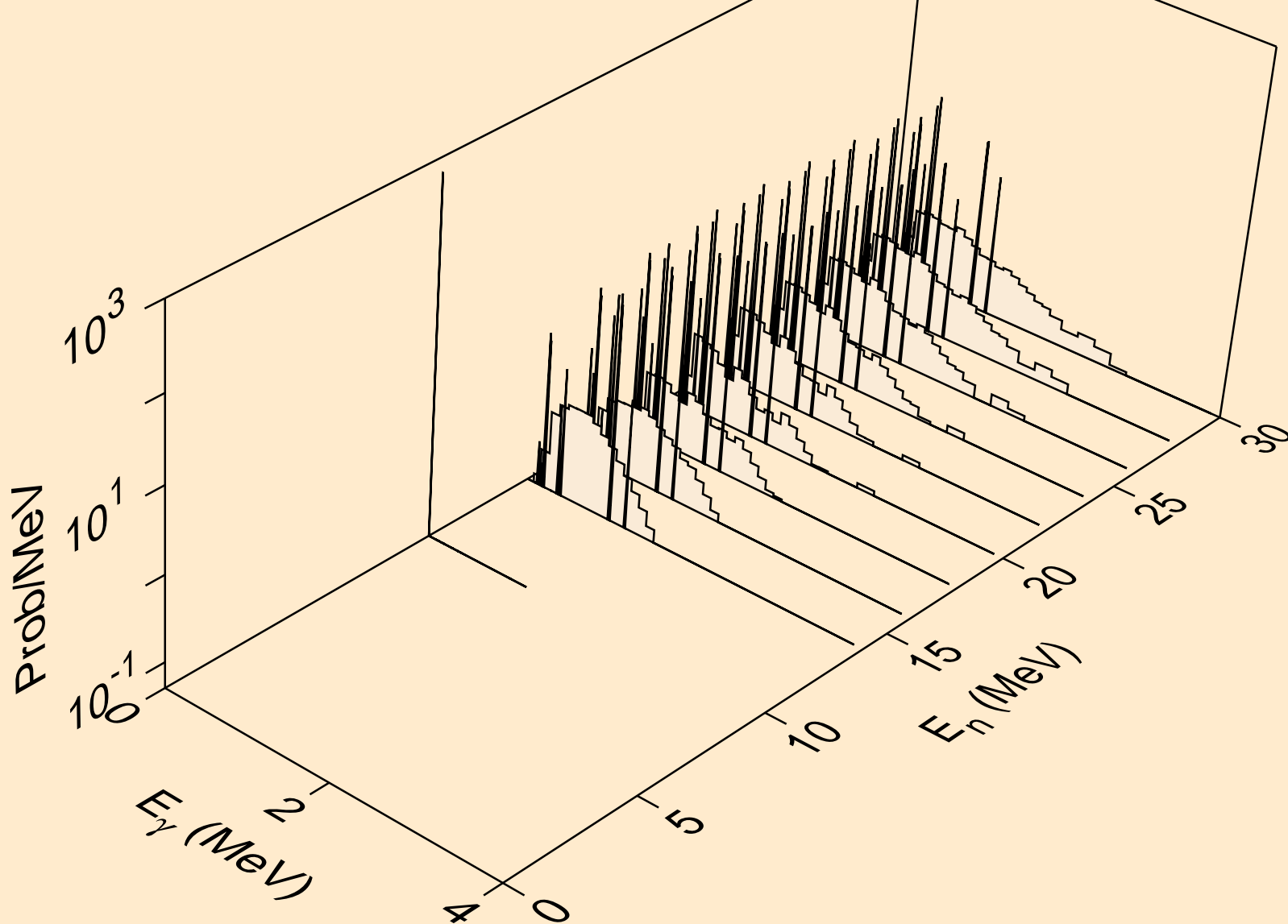

AT200N NEUTRON ACER TENDL-2019 LIBRARY; T=293.16K
Photon emission for (n,da)

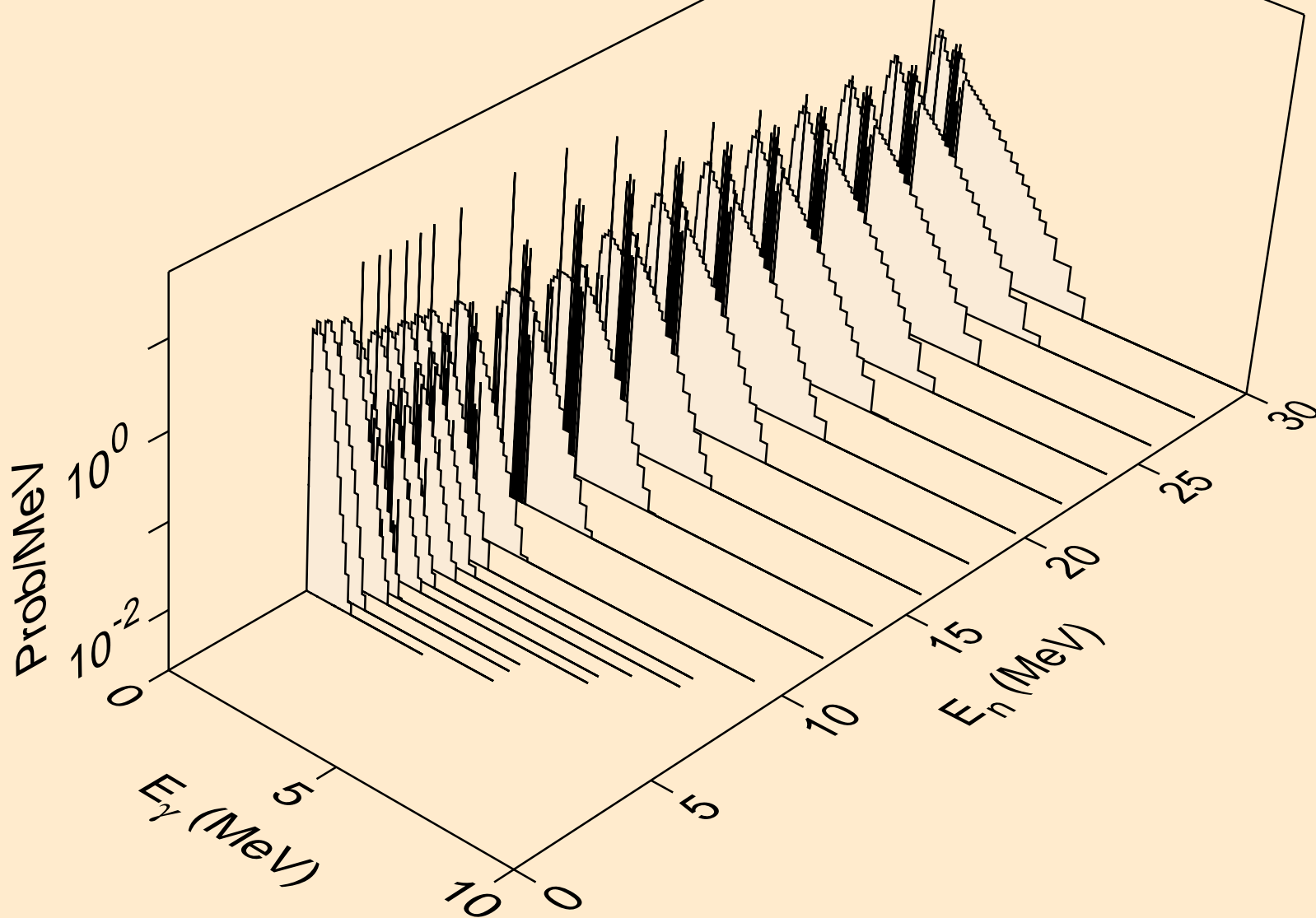

AT200N NEUTRON ACER TENDL-2019 LIBRARY; T=293.16K
thermal capture photon spectrum

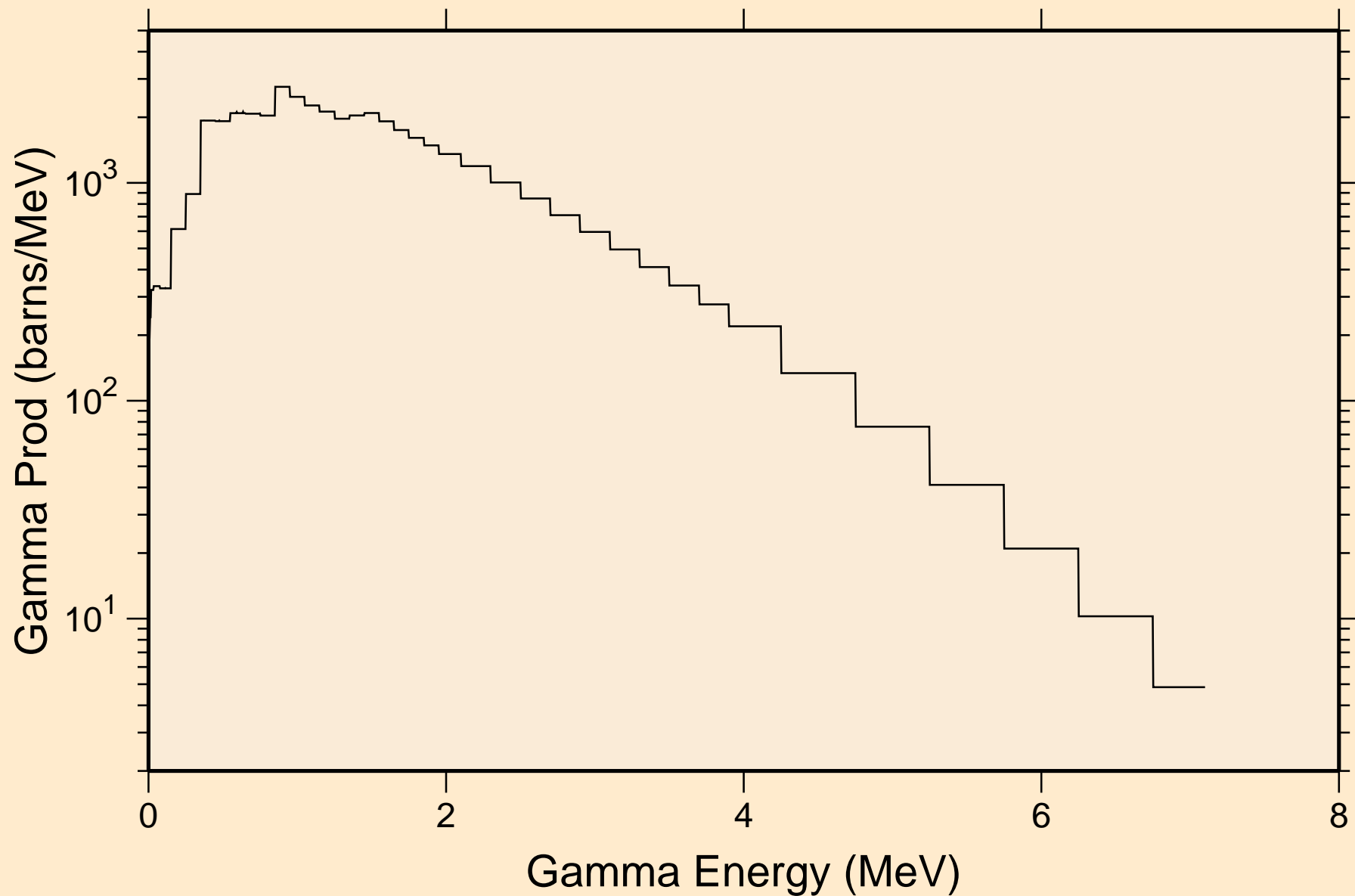

AT200N NEUTRON ACER TENDL-2019 LIBRARY; T=293.16K
14 MeV photon spectrum

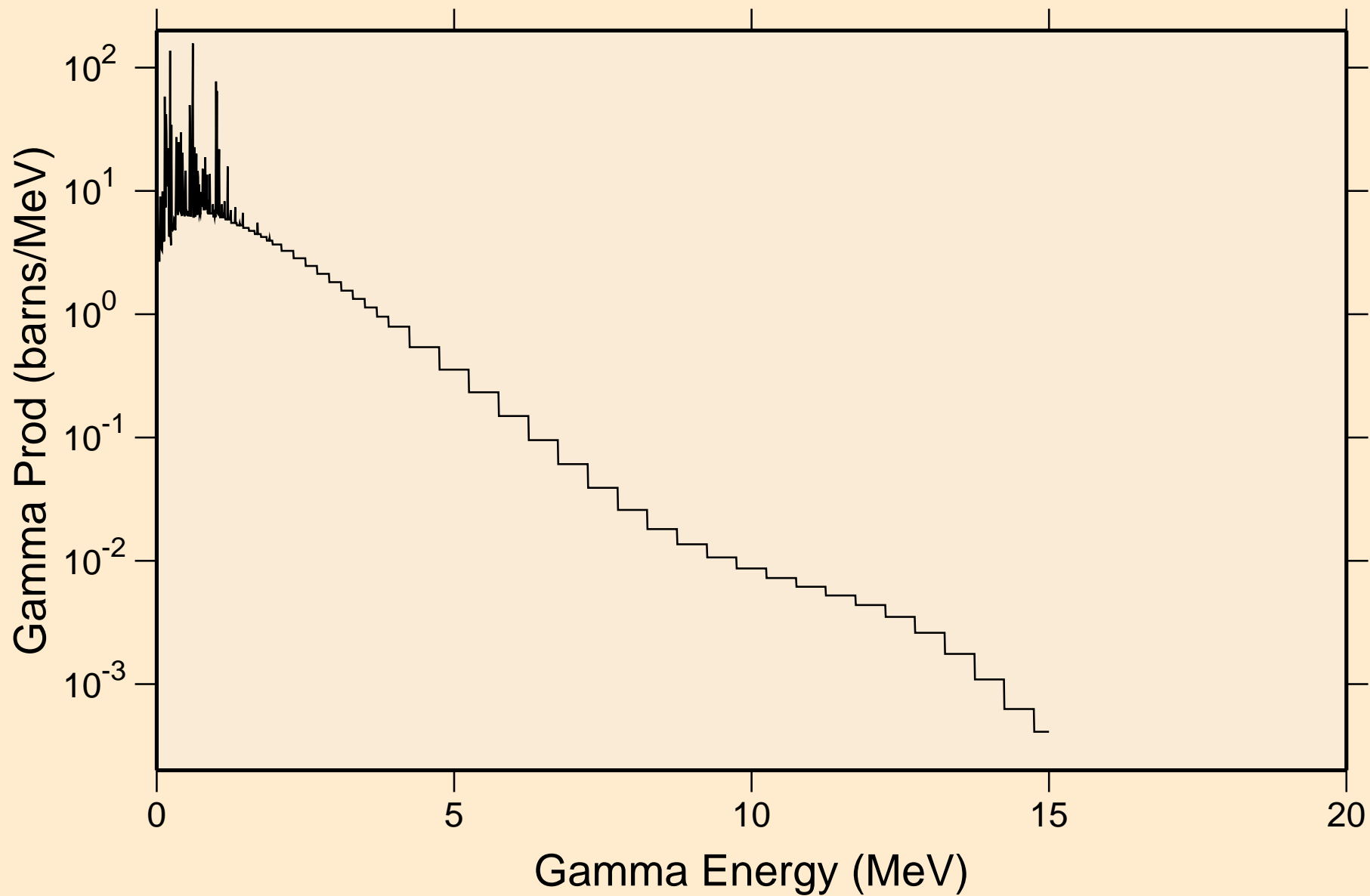

AT200N NEUTRON ACER TENDL-2019 LIBRARY; T=293.16K
Particle heating contributions

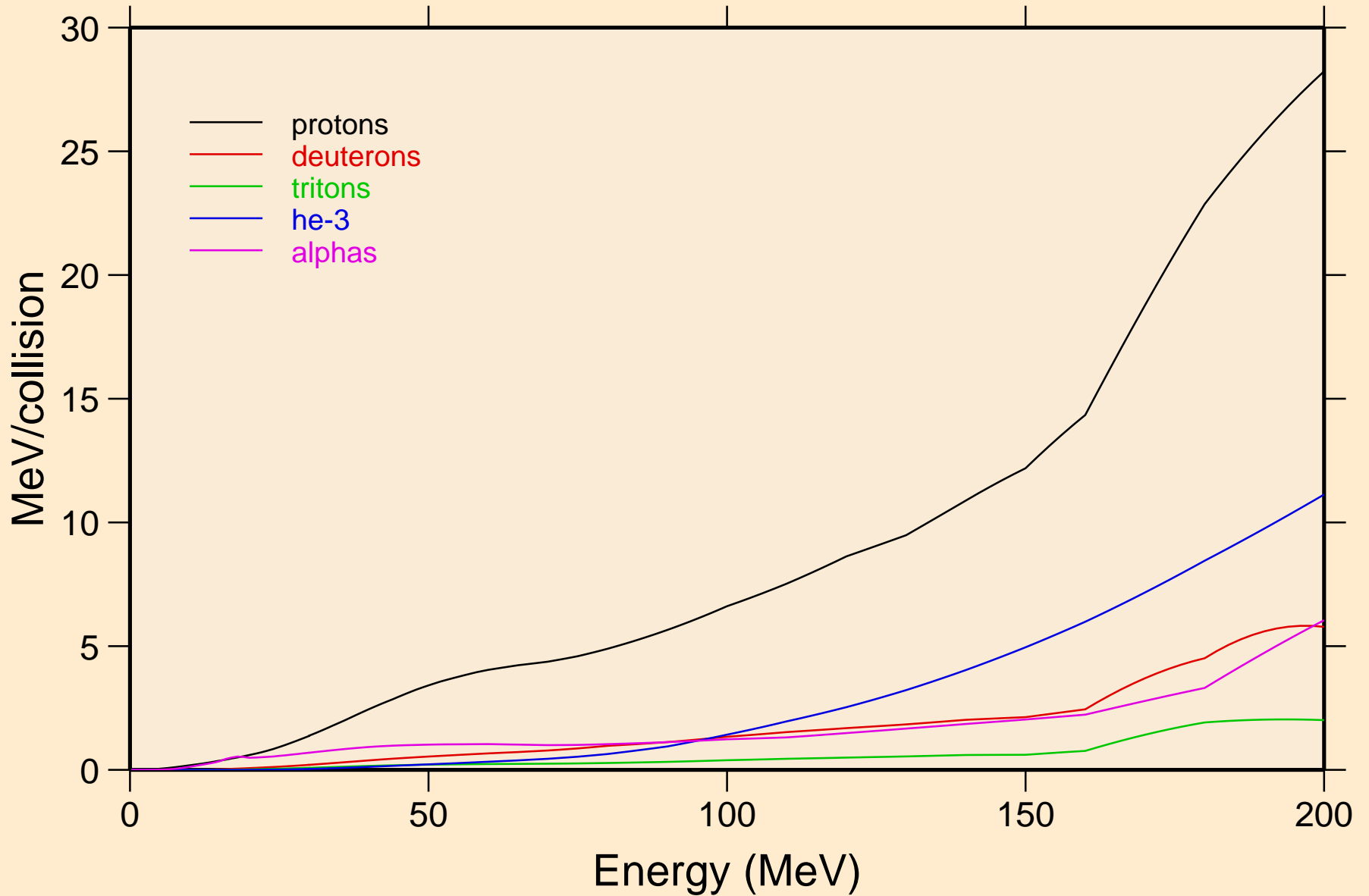

AT200N NEUTRON ACER TENDL-2019 LIBRARY; T=293.16K
Recoil Heating

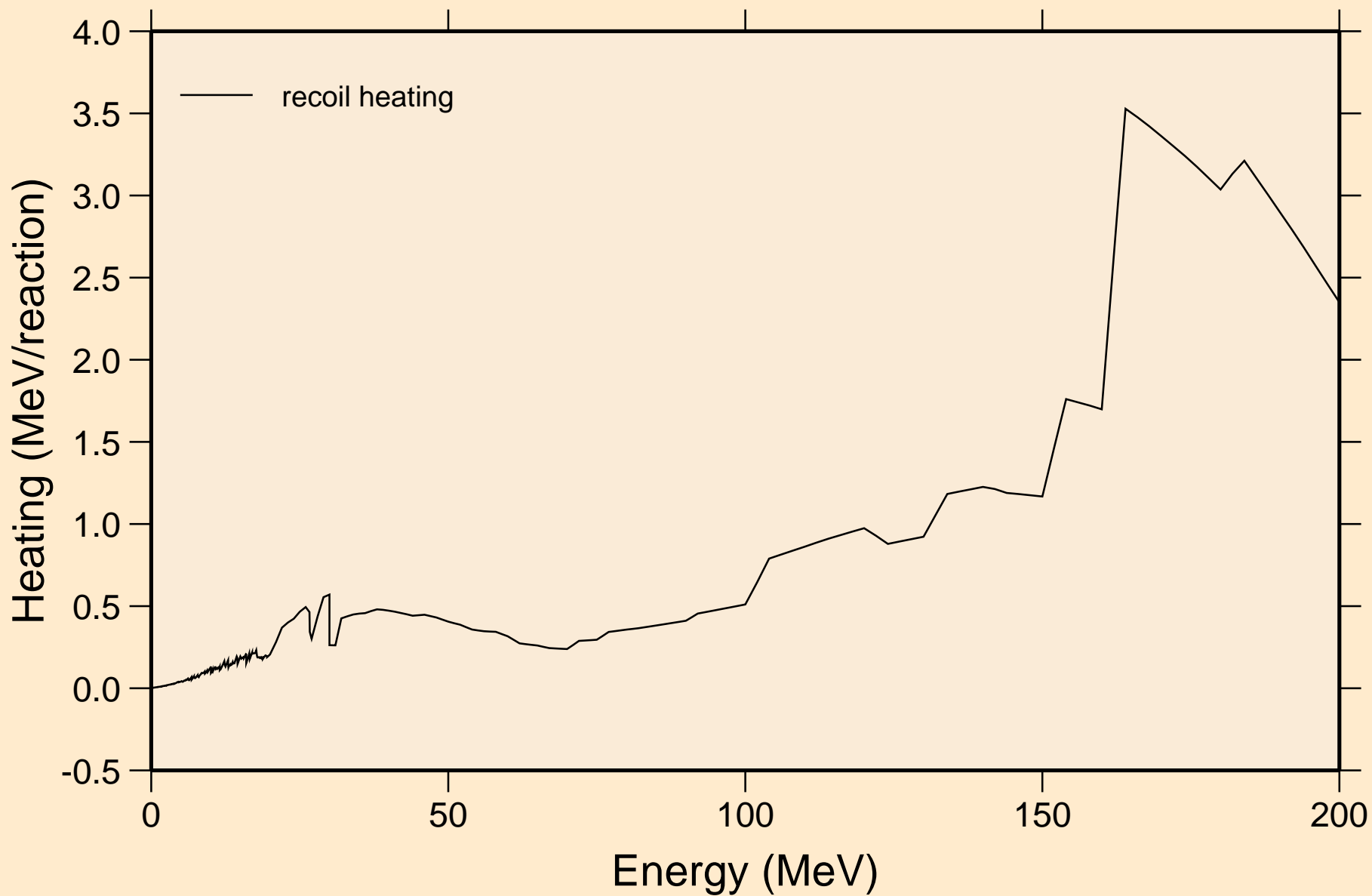

AT200N NEUTRON ACER TENDL-2019 LIBRARY; T=293.16K
Particle production cross sections

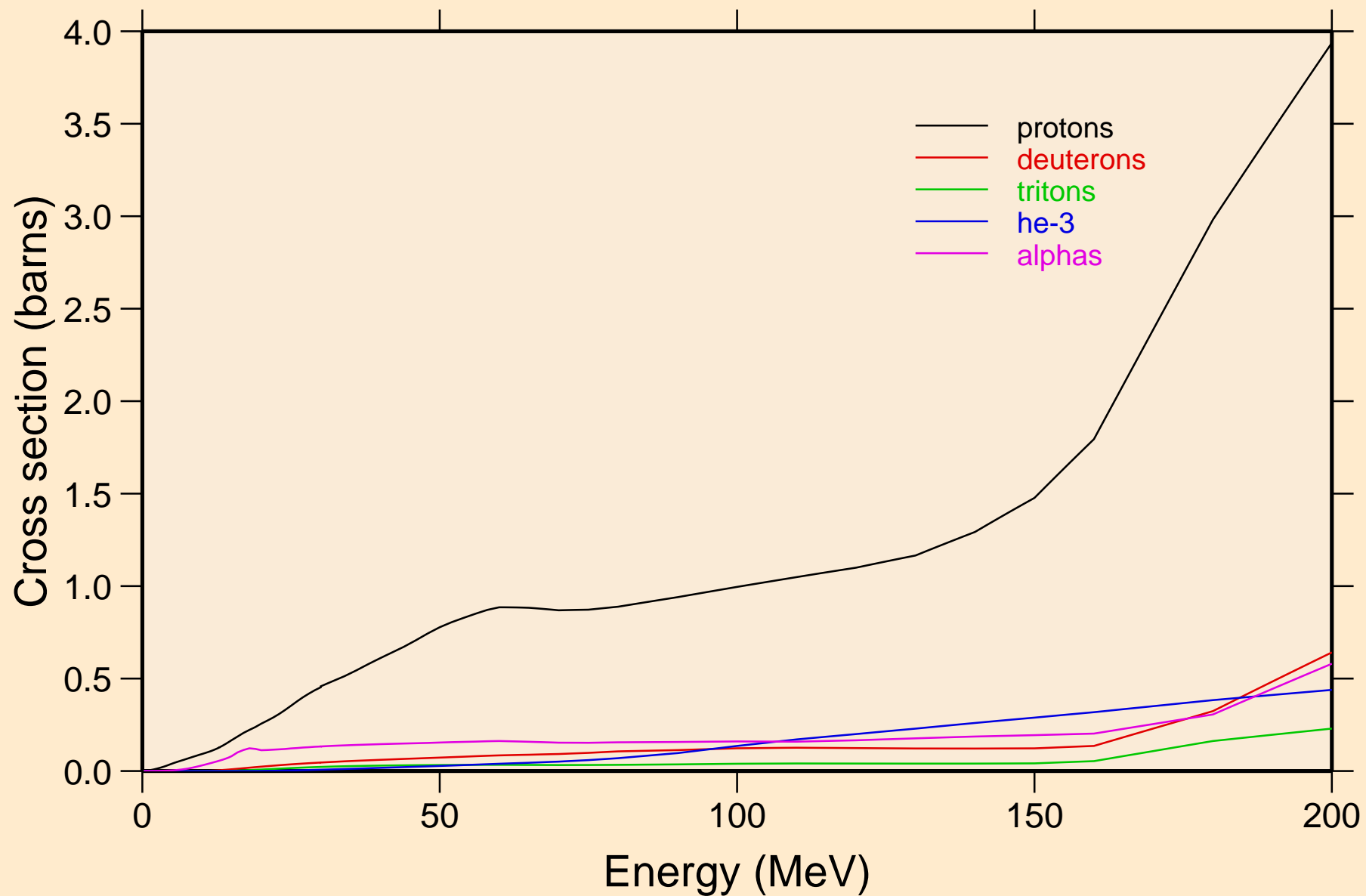

AT200N NEUTRON ACER TENDL-2019 LIBRARY; T=293.16K
protons from (n,x)

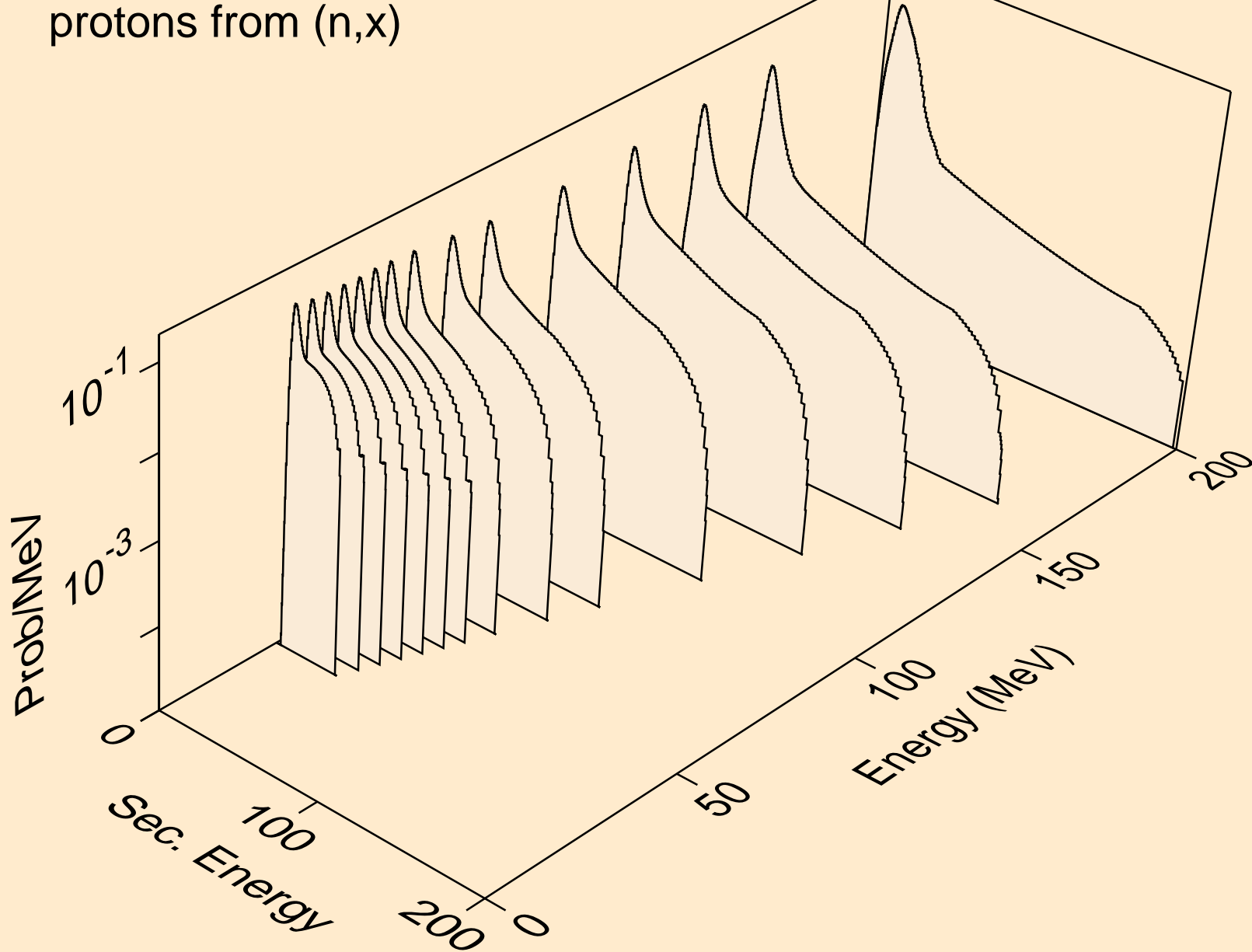

AT200N NEUTRON ACER TENDL-2019 LIBRARY; T=293.16K
protons from (n,n*)p

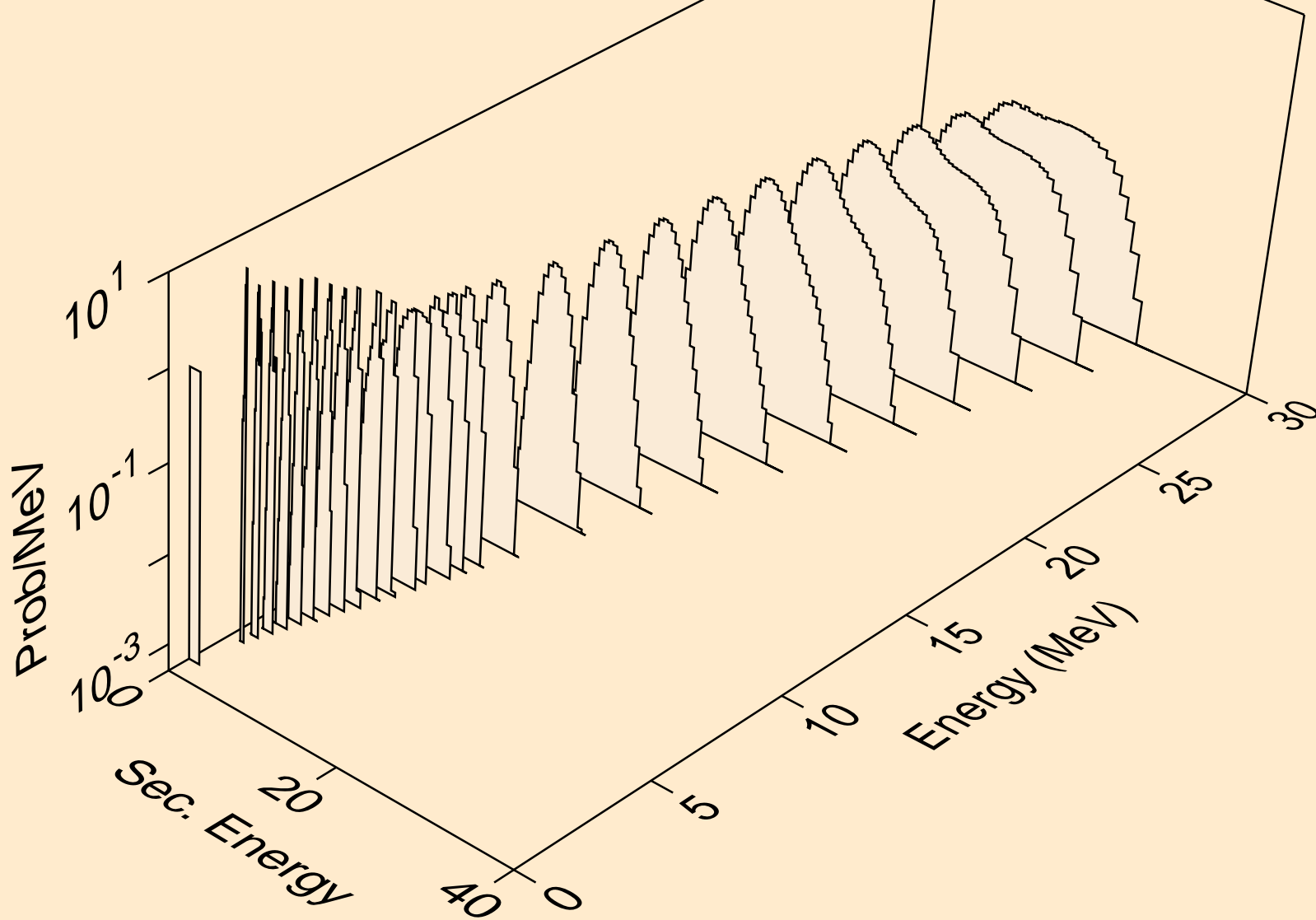

AT200N NEUTRON ACER TENDL-2019 LIBRARY; T=293.16K
protons from (n,2np)

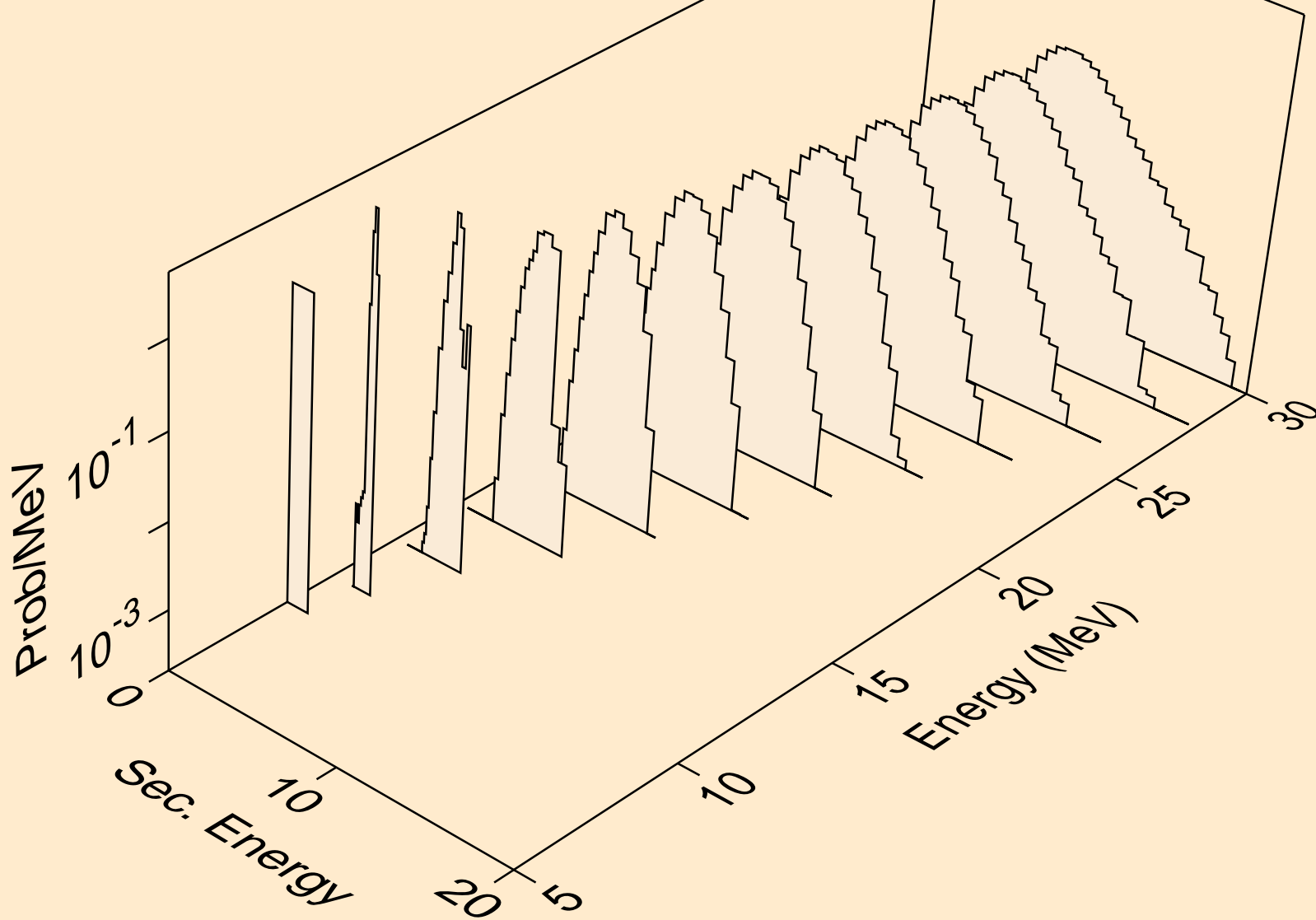

AT200N NEUTRON ACER TENDL-2019 LIBRARY; T=293.16K
protons from (n,3np)

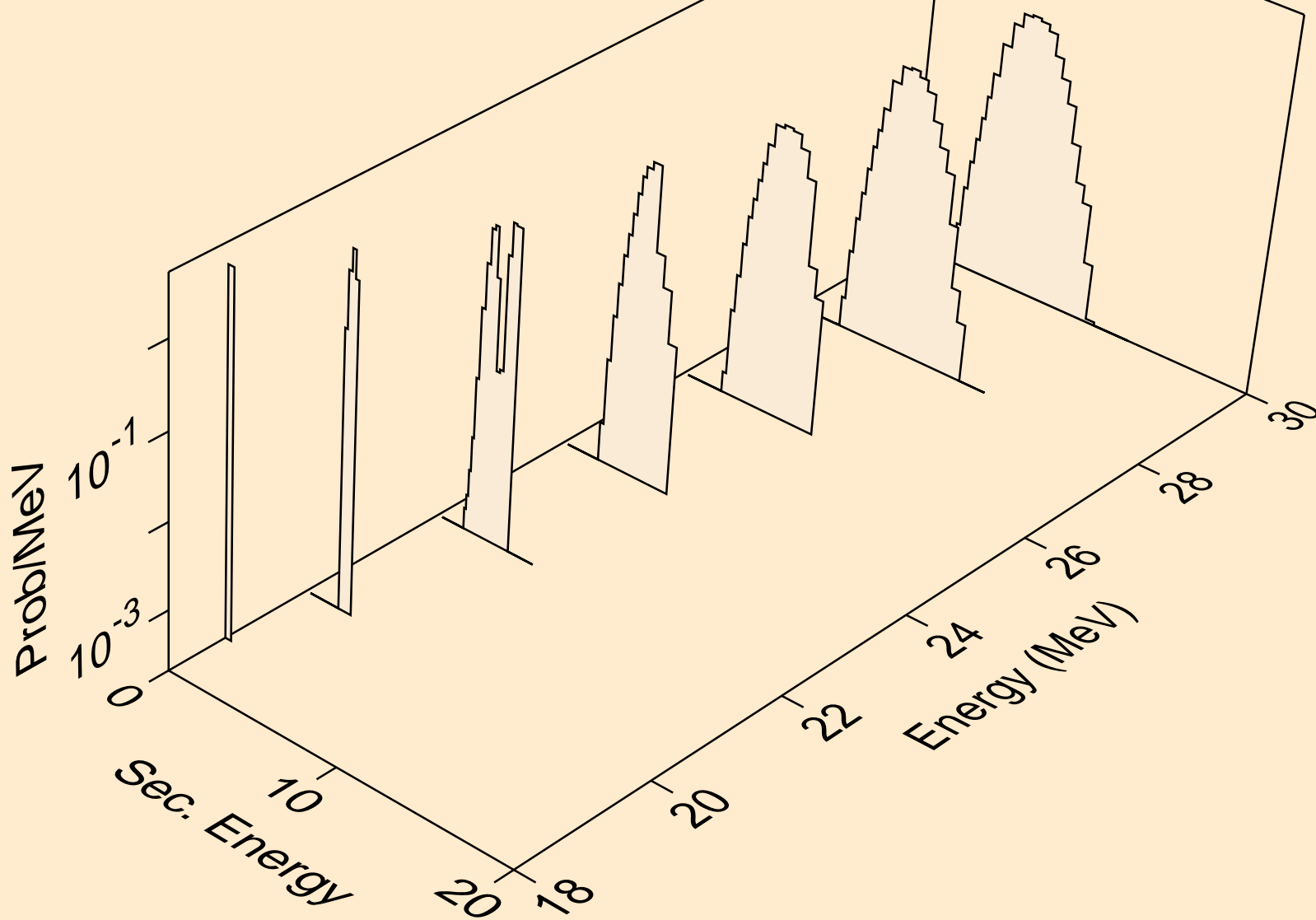

AT200N NEUTRON ACER TENDL-2019 LIBRARY; T=293.16K
protons from (n,2np)

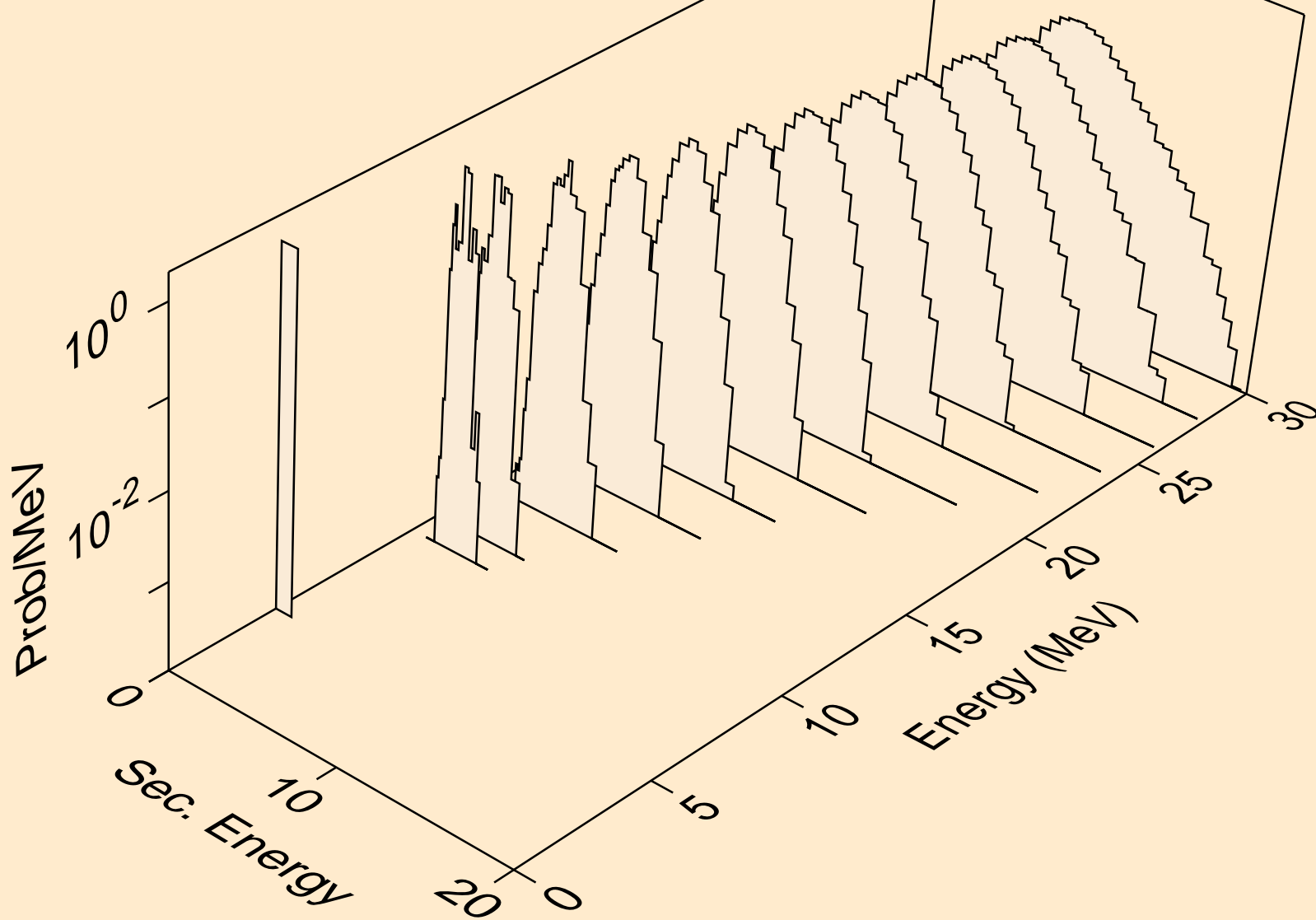

AT200N NEUTRON ACER TENDL-2019 LIBRARY; T=293.16K
protons from (n,npa)

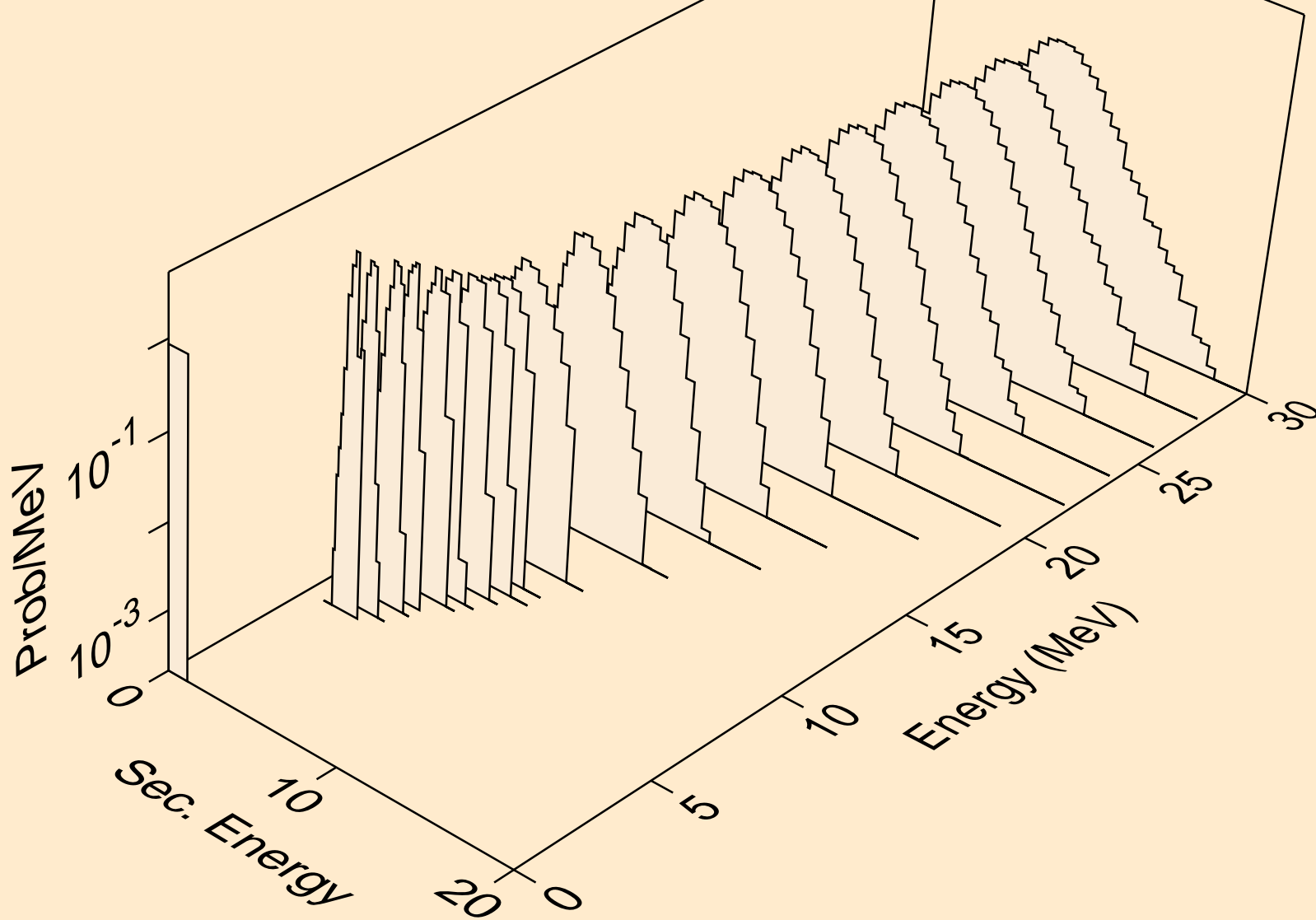

AT200N NEUTRON ACER TENDL-2019 LIBRARY; T=293.16K
protons from (n,p)

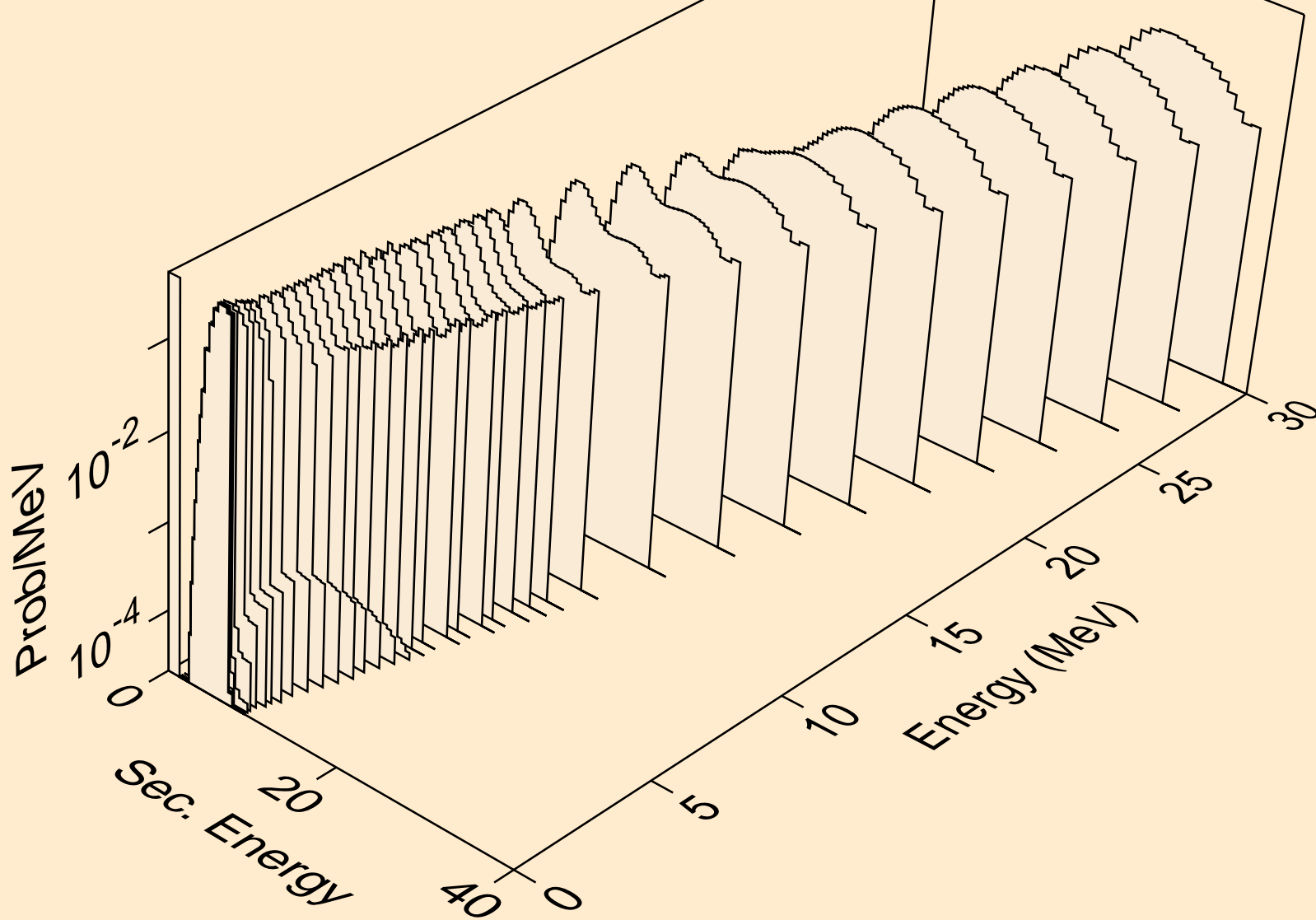

AT200N NEUTRON ACER TENDL-2019 LIBRARY; T=293.16K
protons from (n,2p)

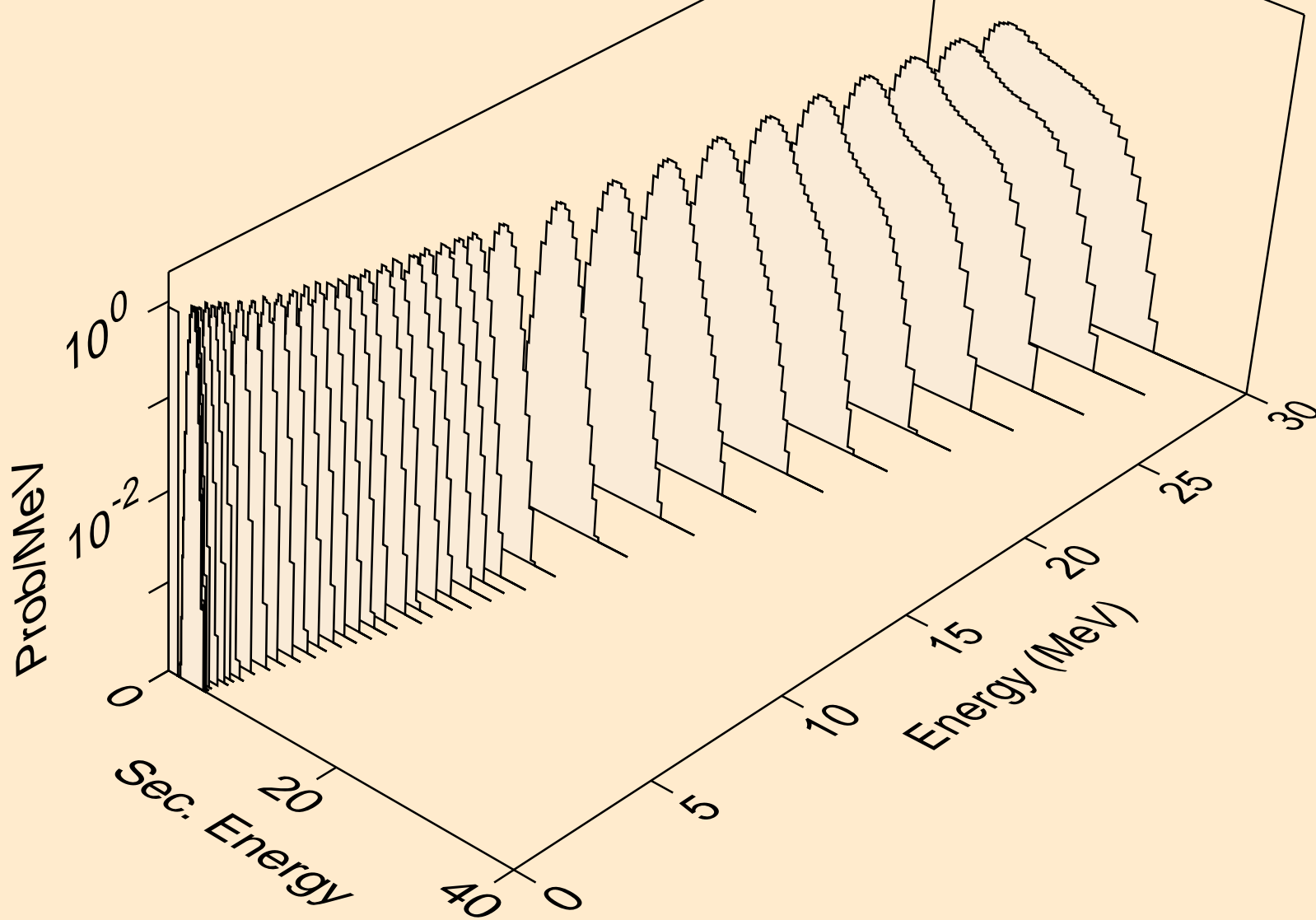

AT200N NEUTRON ACER TENDL-2019 LIBRARY; T=293.16K
protons from (n,p)

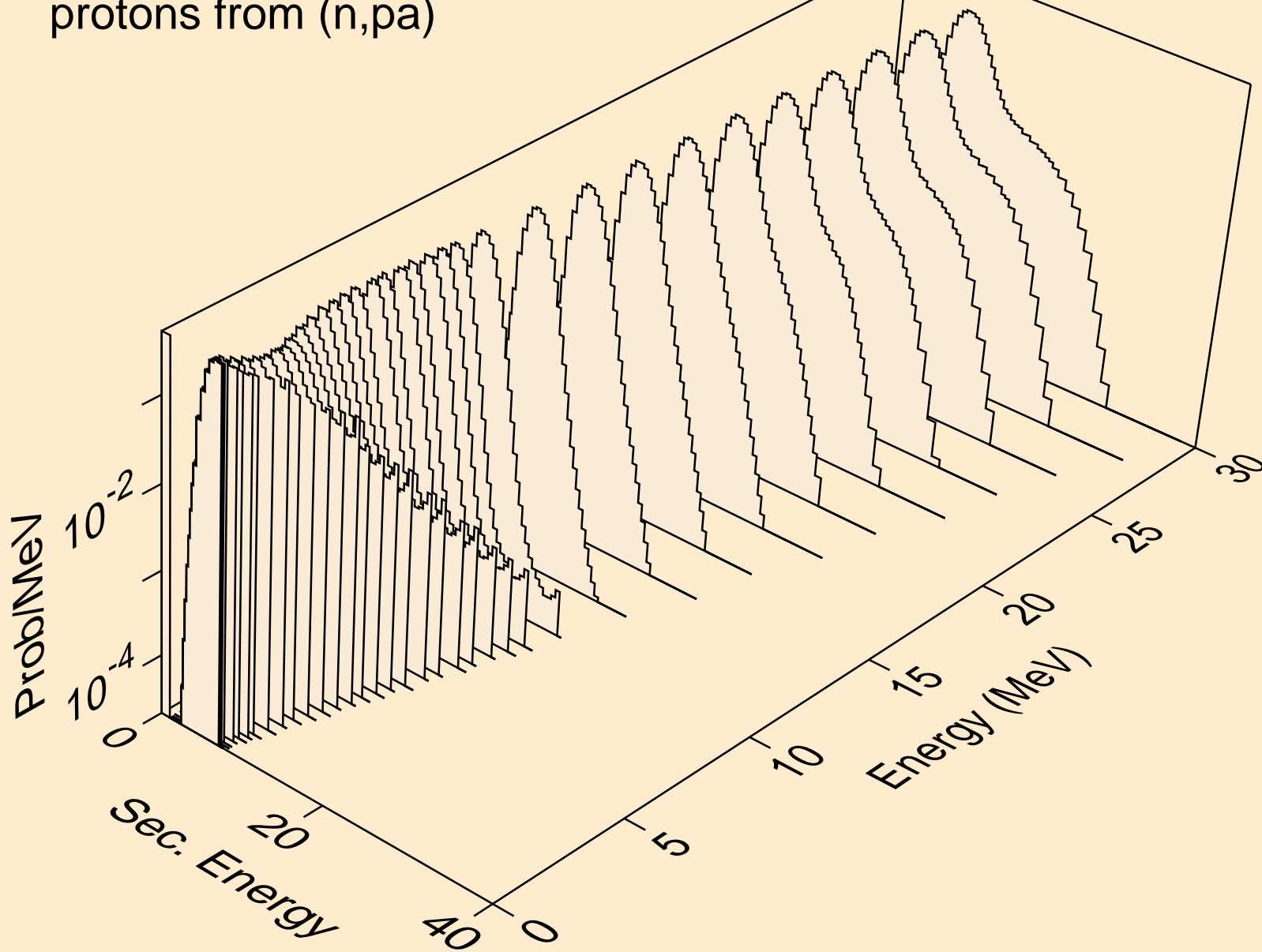

AT200N NEUTRON ACER TENDL-2019 LIBRARY; T=293.16K
protons from (n,pd)

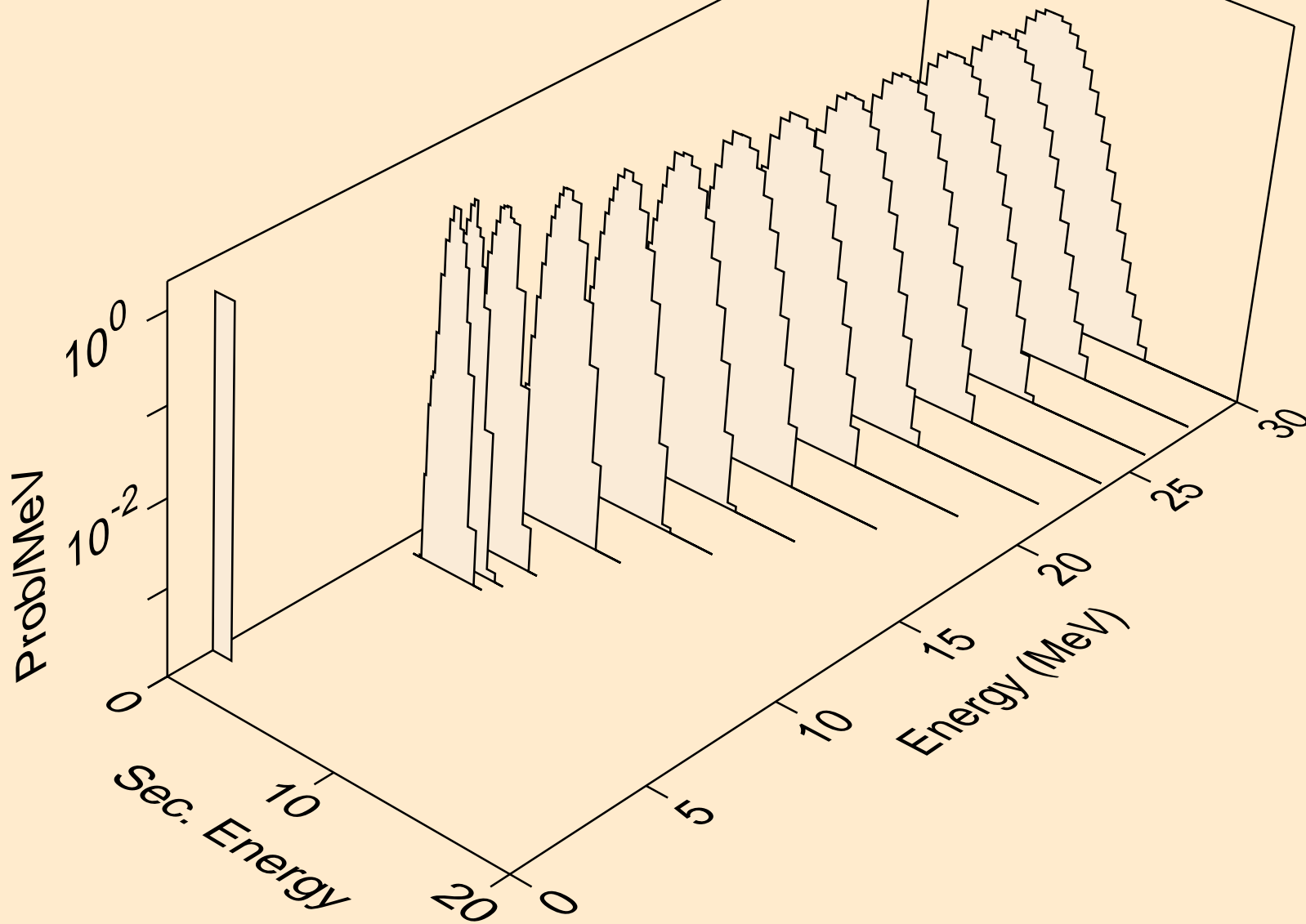

AT200N NEUTRON ACER TENDL-2019 LIBRARY; T=293.16K
protons from (n,pt)

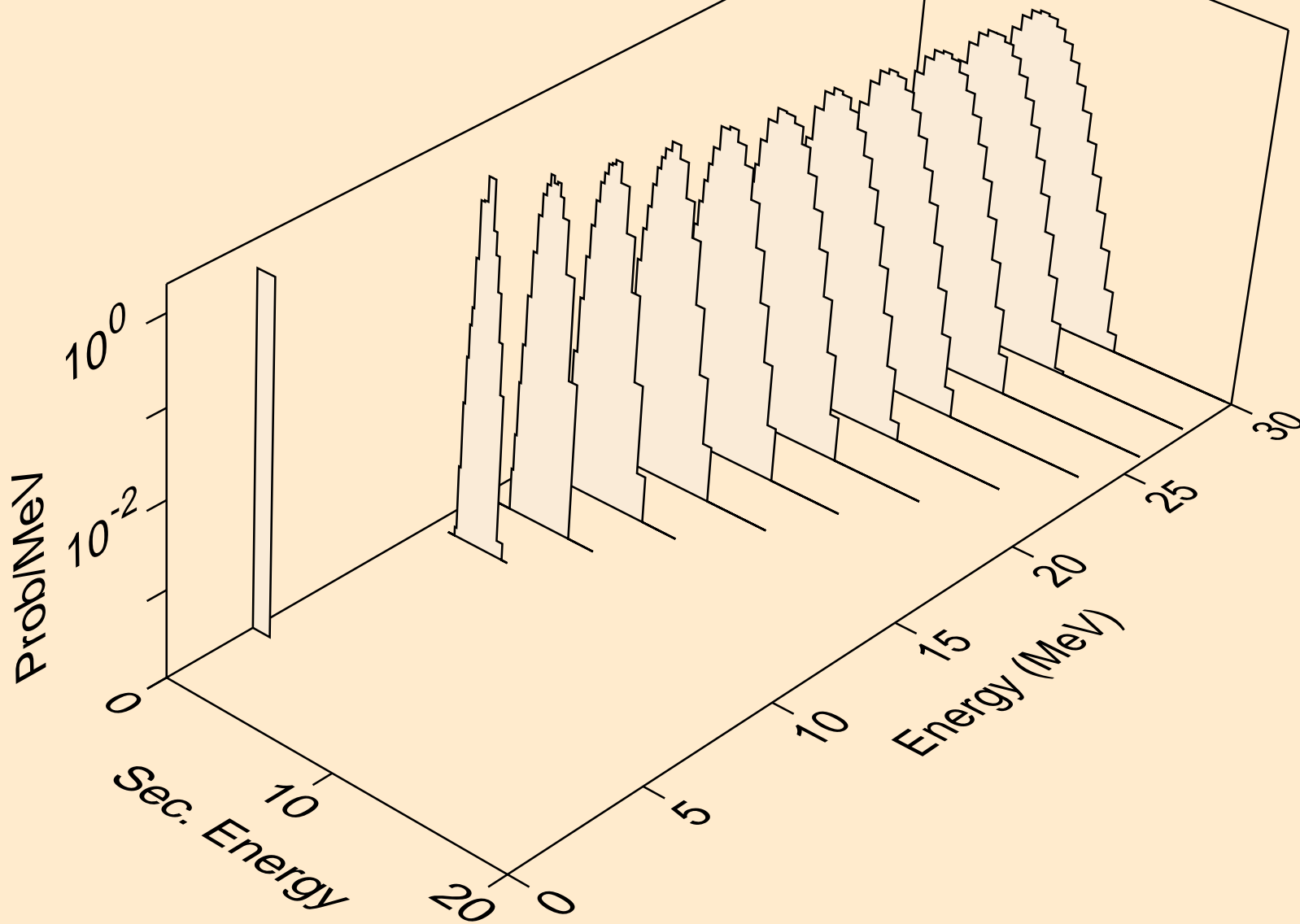

AT200N NEUTRON ACER TENDL-2019 LIBRARY; T=293.16K
deuterons from (n,x)

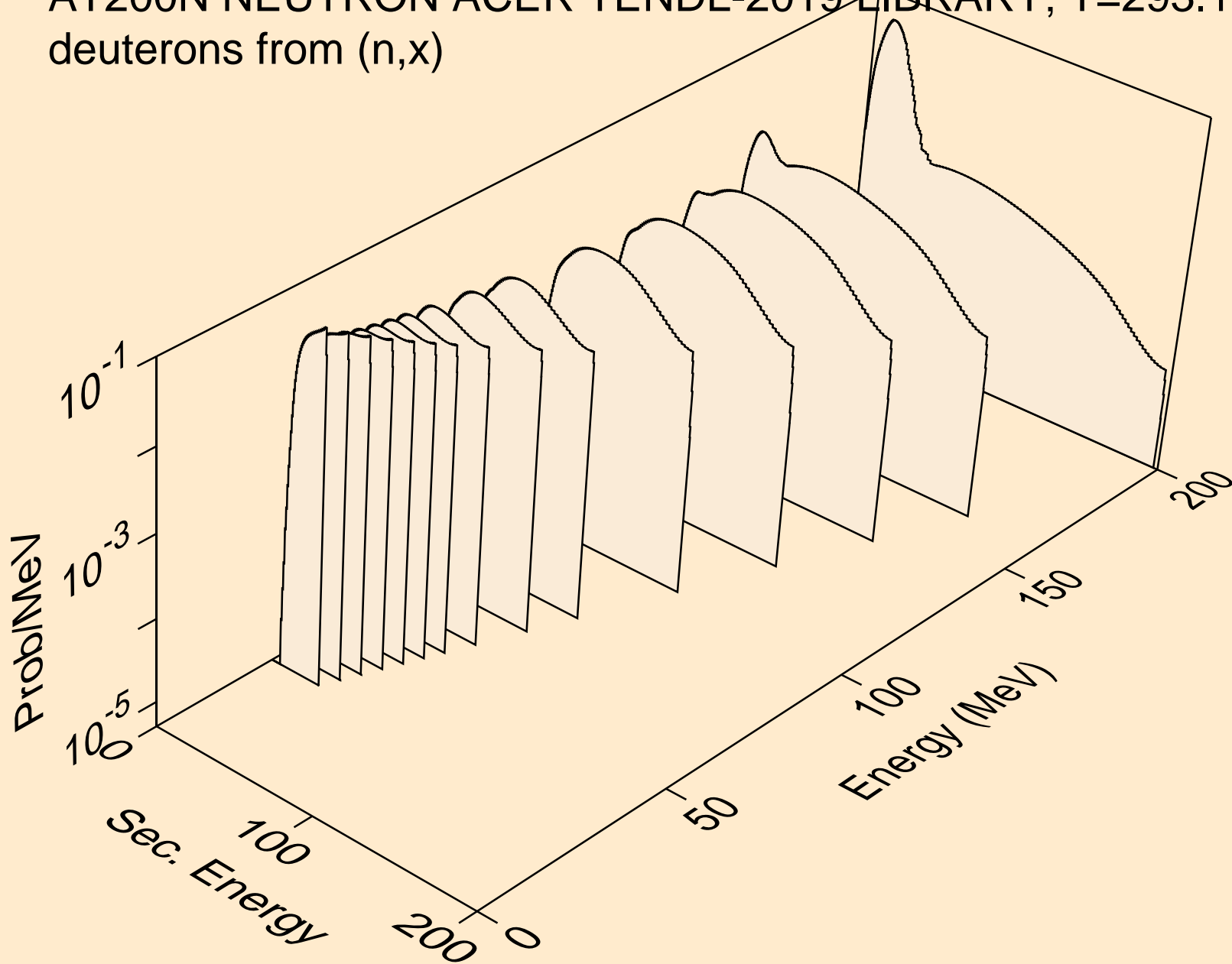

AT200N NEUTRON ACER TENDL-2019 LIBRARY; T=293.16K
deuterons from (n,2nd)

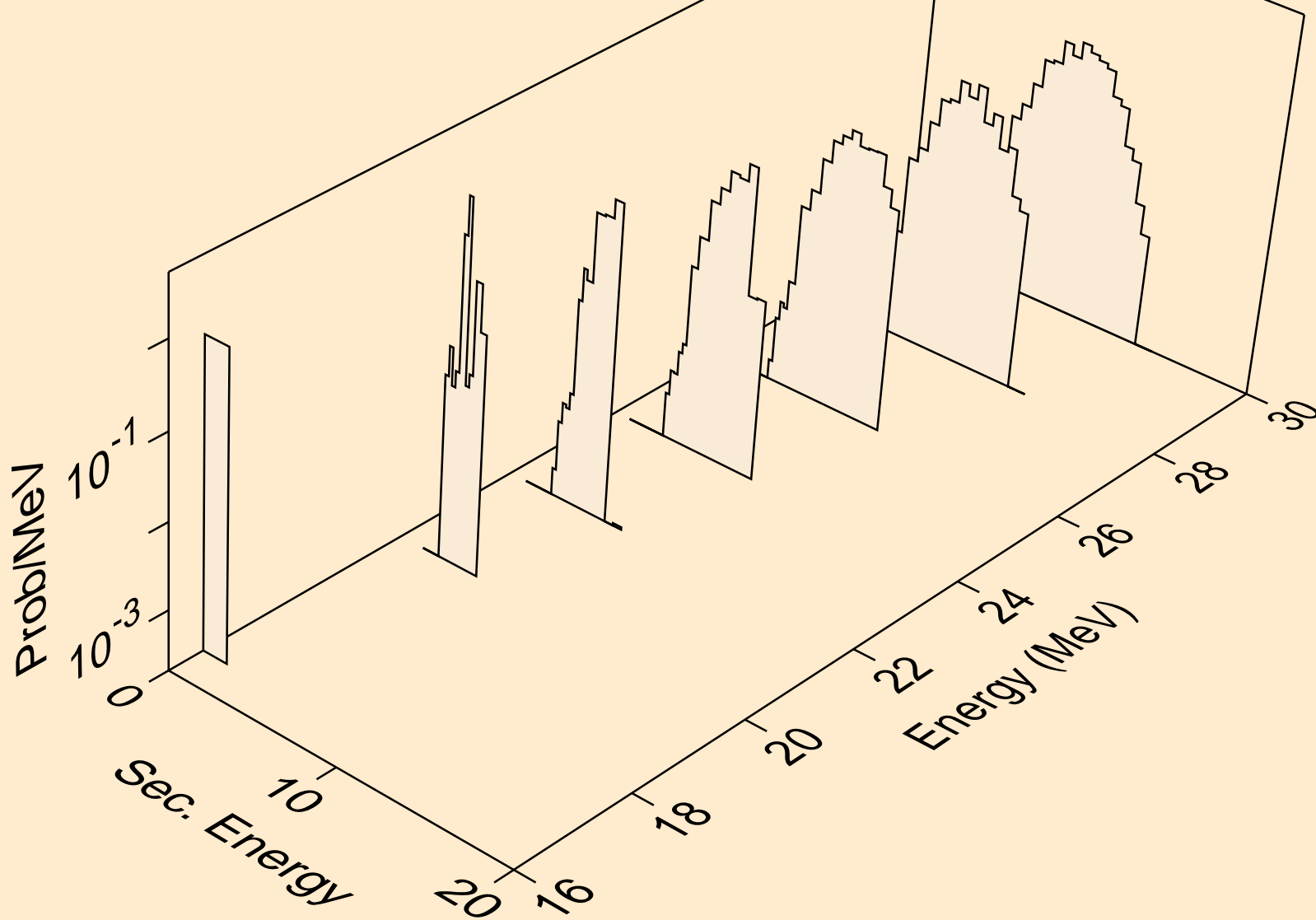

AT200N NEUTRON ACER TENDL-2019 LIBRARY; T=293.16K
deuterons from (n,n*)d

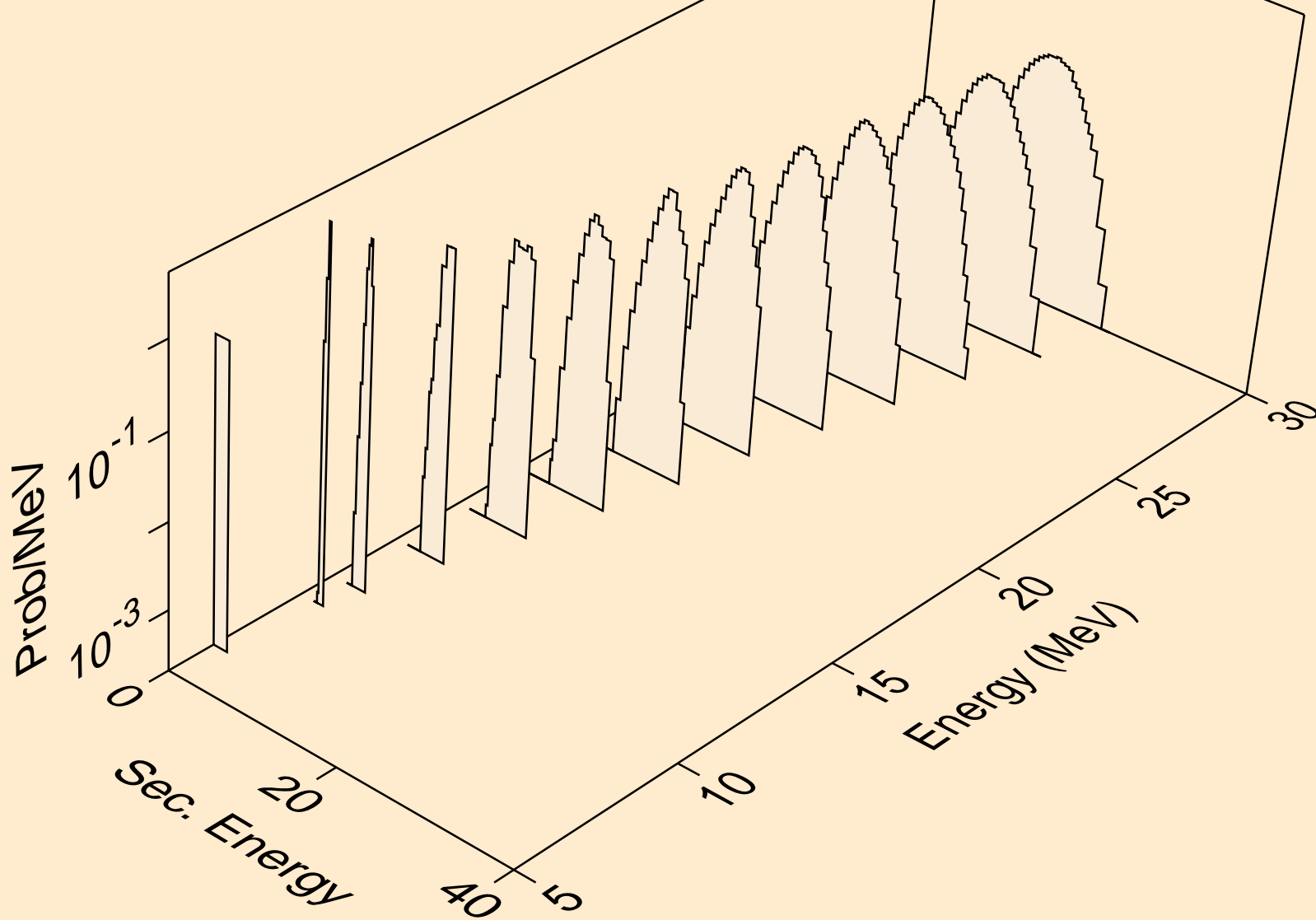

AT200N NEUTRON ACER TENDL-2019 LIBRARY; T=293.16K
deuterons from (n,d)

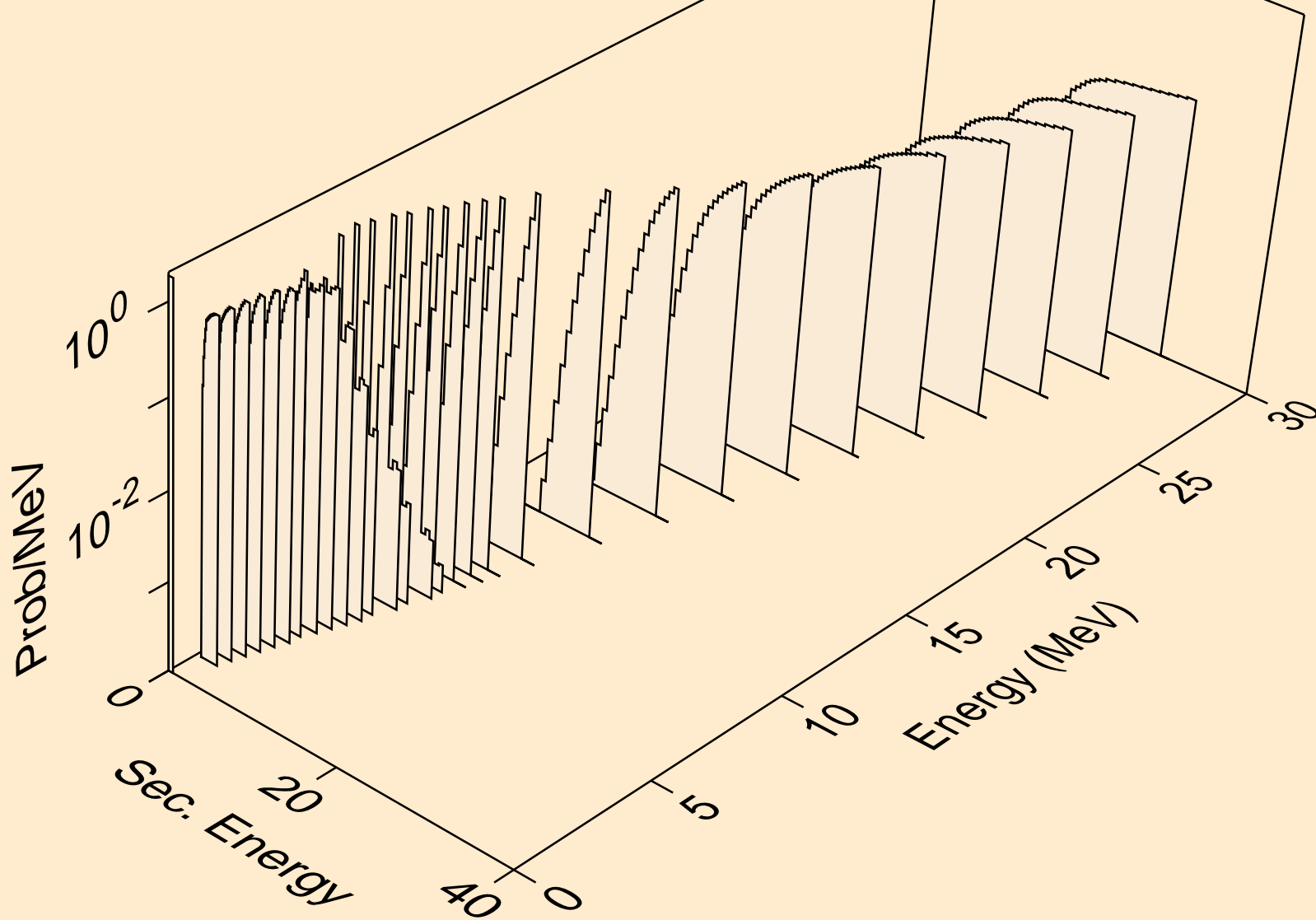

AT200N NEUTRON ACER TENDL-2019 LIBRARY; T=293.16K
deuterons from (n,pd)

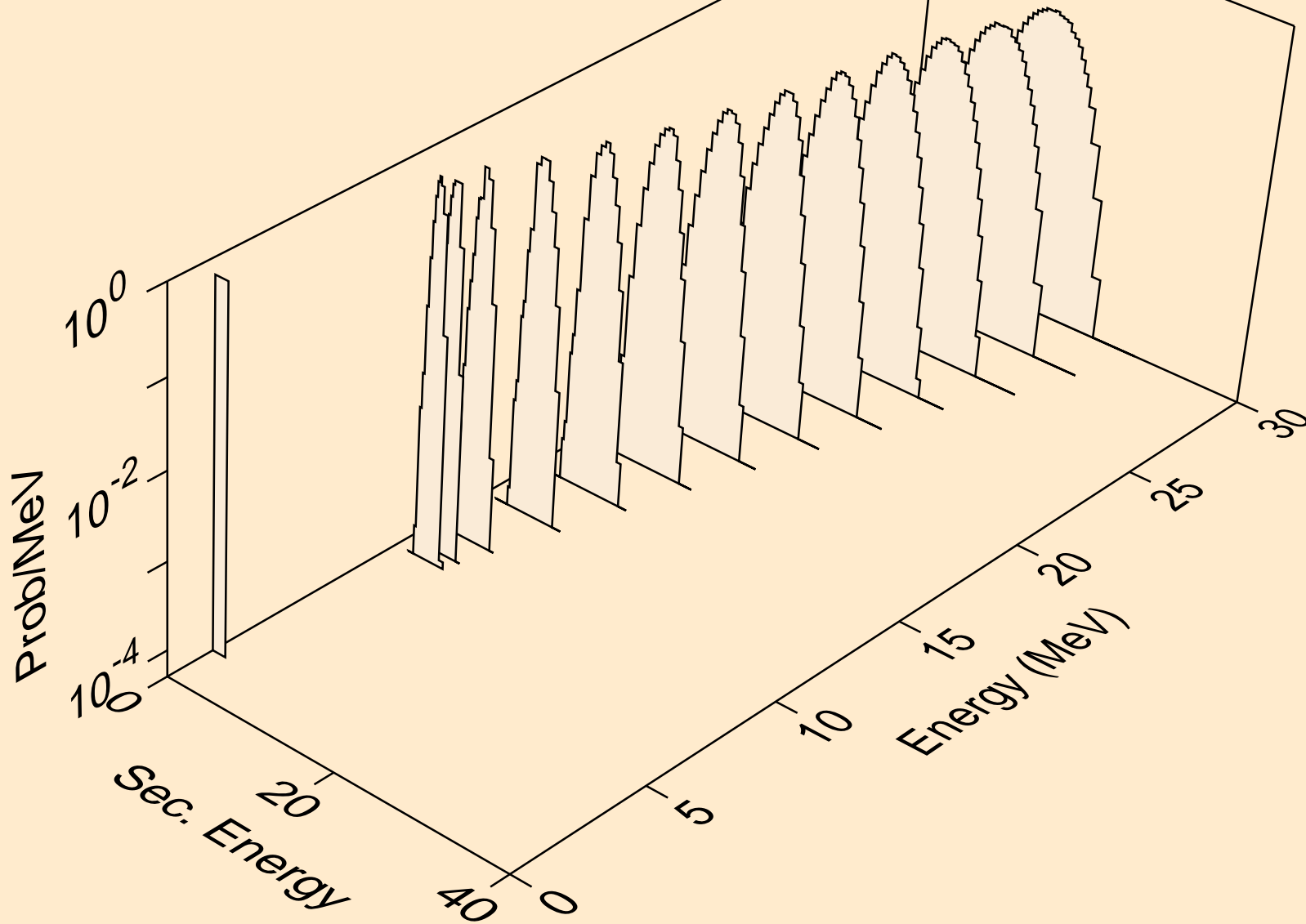

AT200N NEUTRON ACER TENDL-2019 LIBRARY; T=293.16K
deuterons from (n,da)

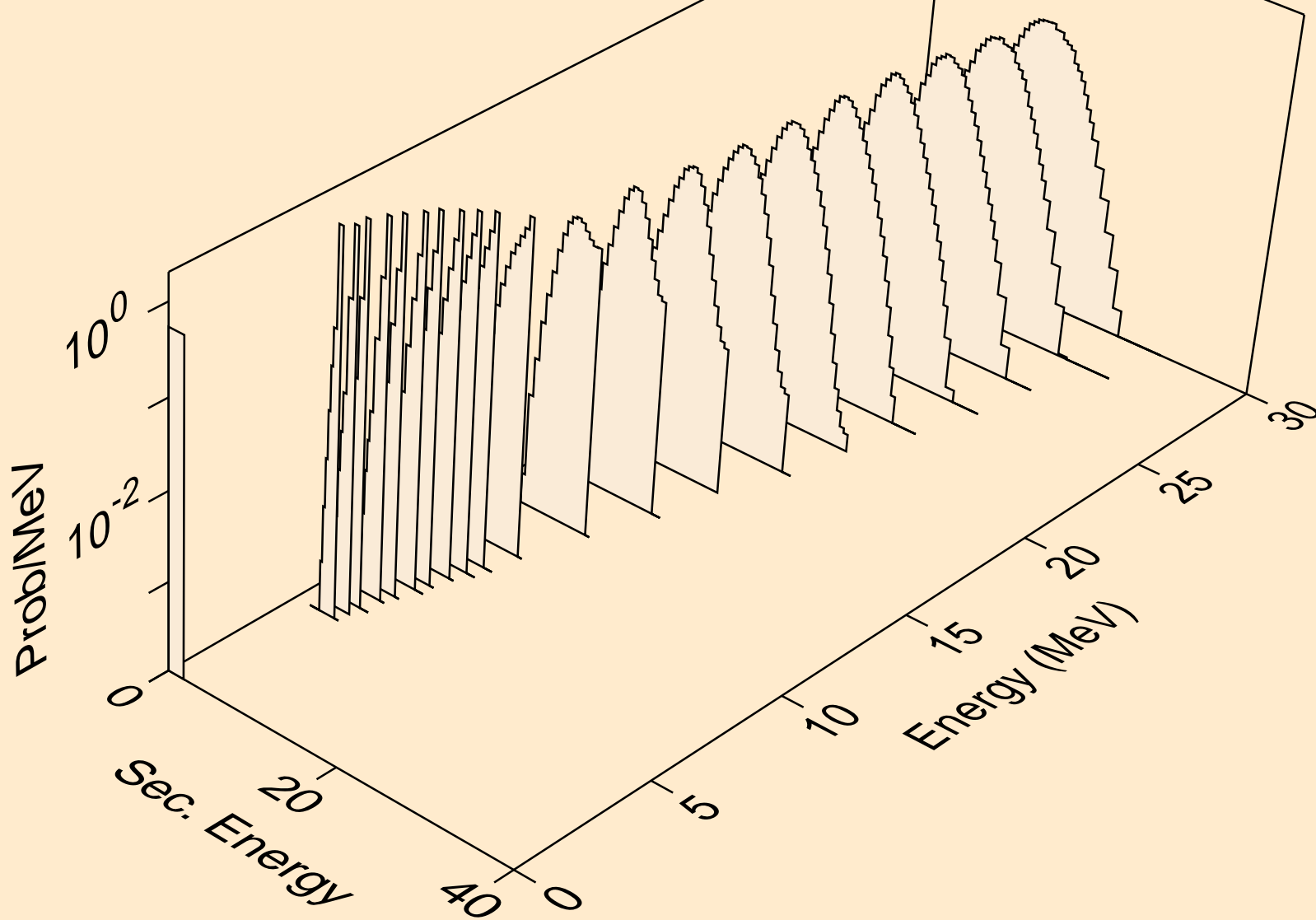

AT200N NEUTRON ACER TENDL-2019 LIBRARY; T=293.16K
tritons from (n,x)

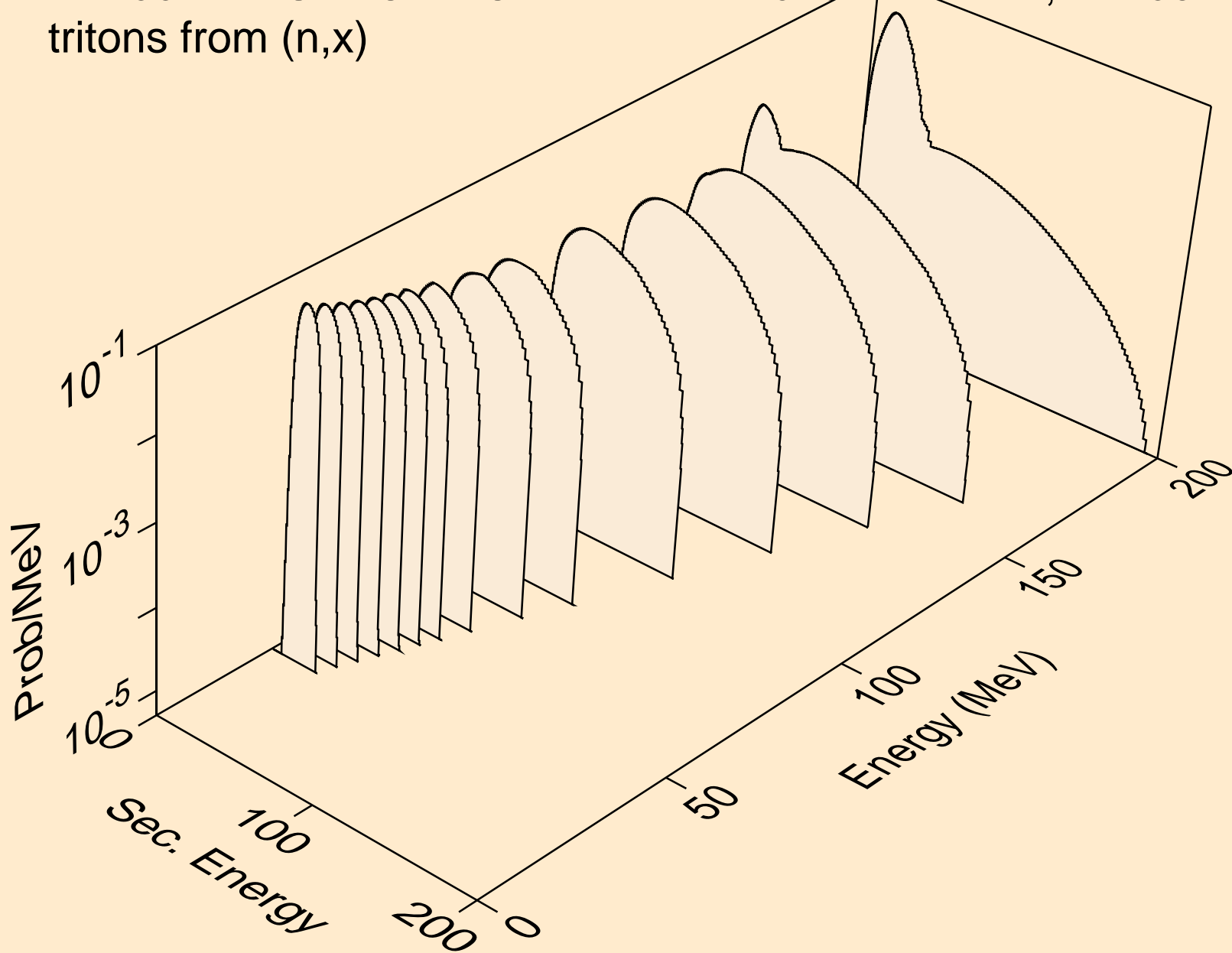

AT200N NEUTRON ACER TENDL-2019 LIBRARY; T=293.16K
tritons from (n,n*)t

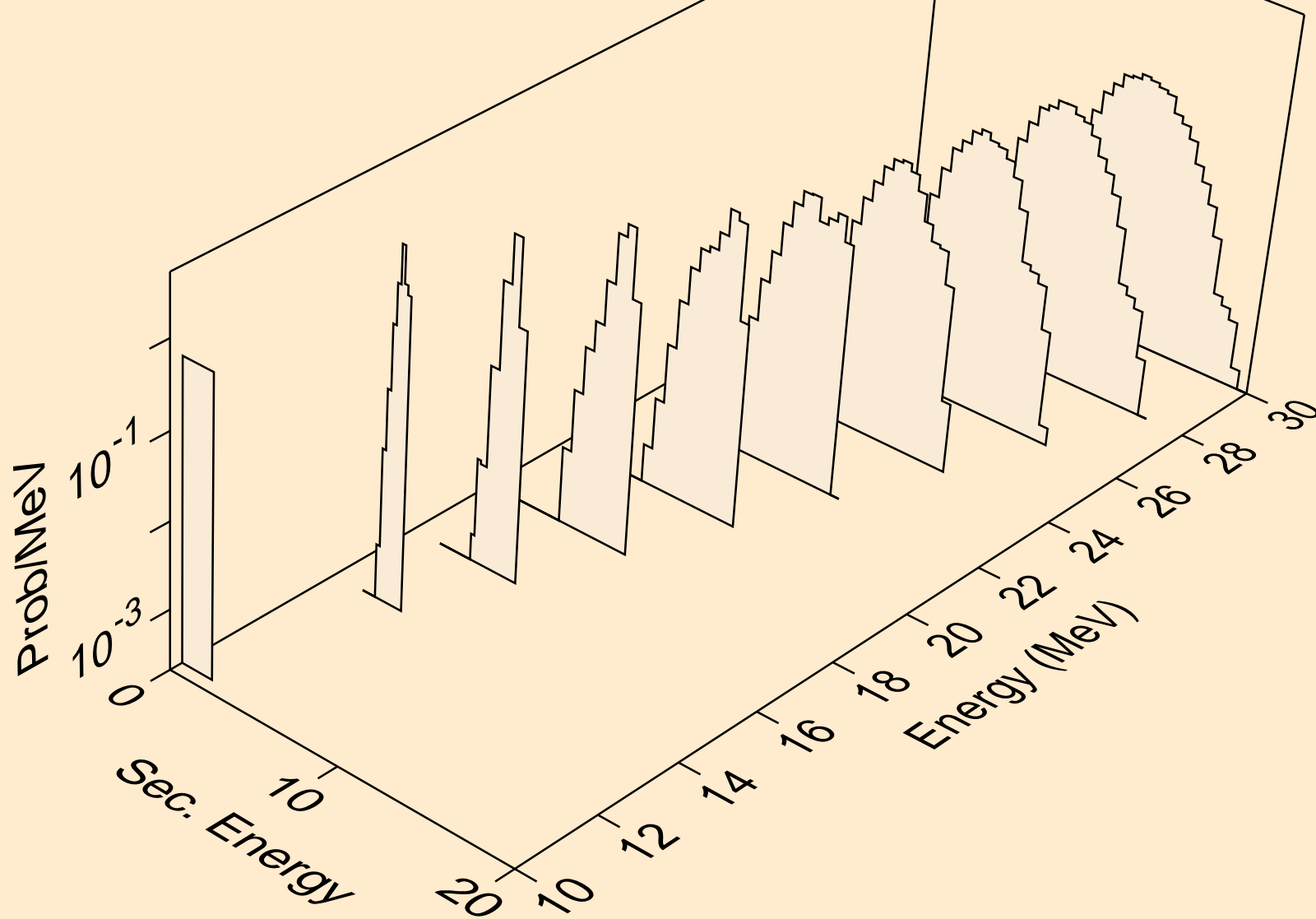

AT200N NEUTRON ACER TENDL-2019 LIBRARY; T=293.16K
tritons from (n,t)

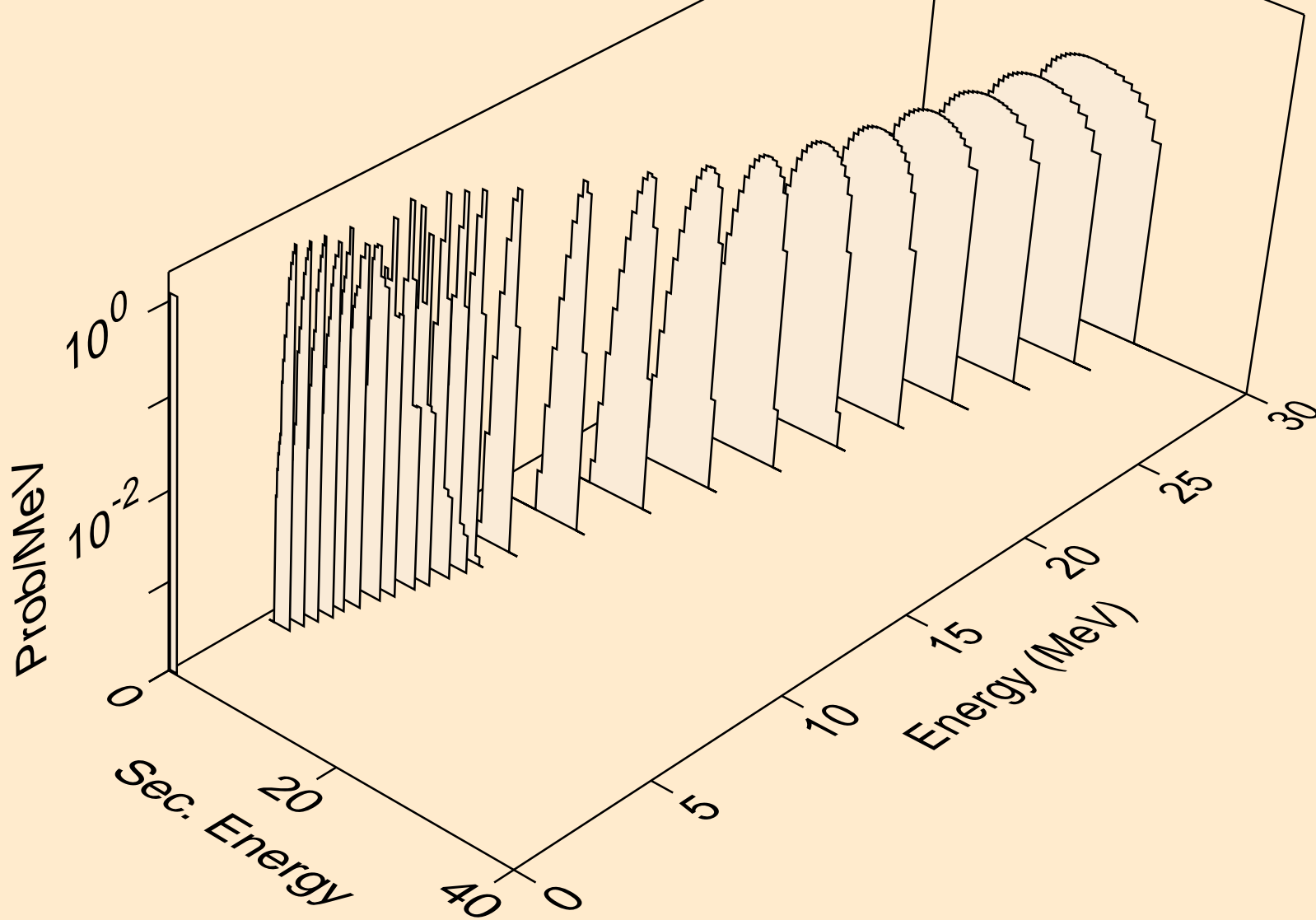

AT200N NEUTRON ACER TENDL-2019 LIBRARY; T=293.16K
tritons from (n,pt)

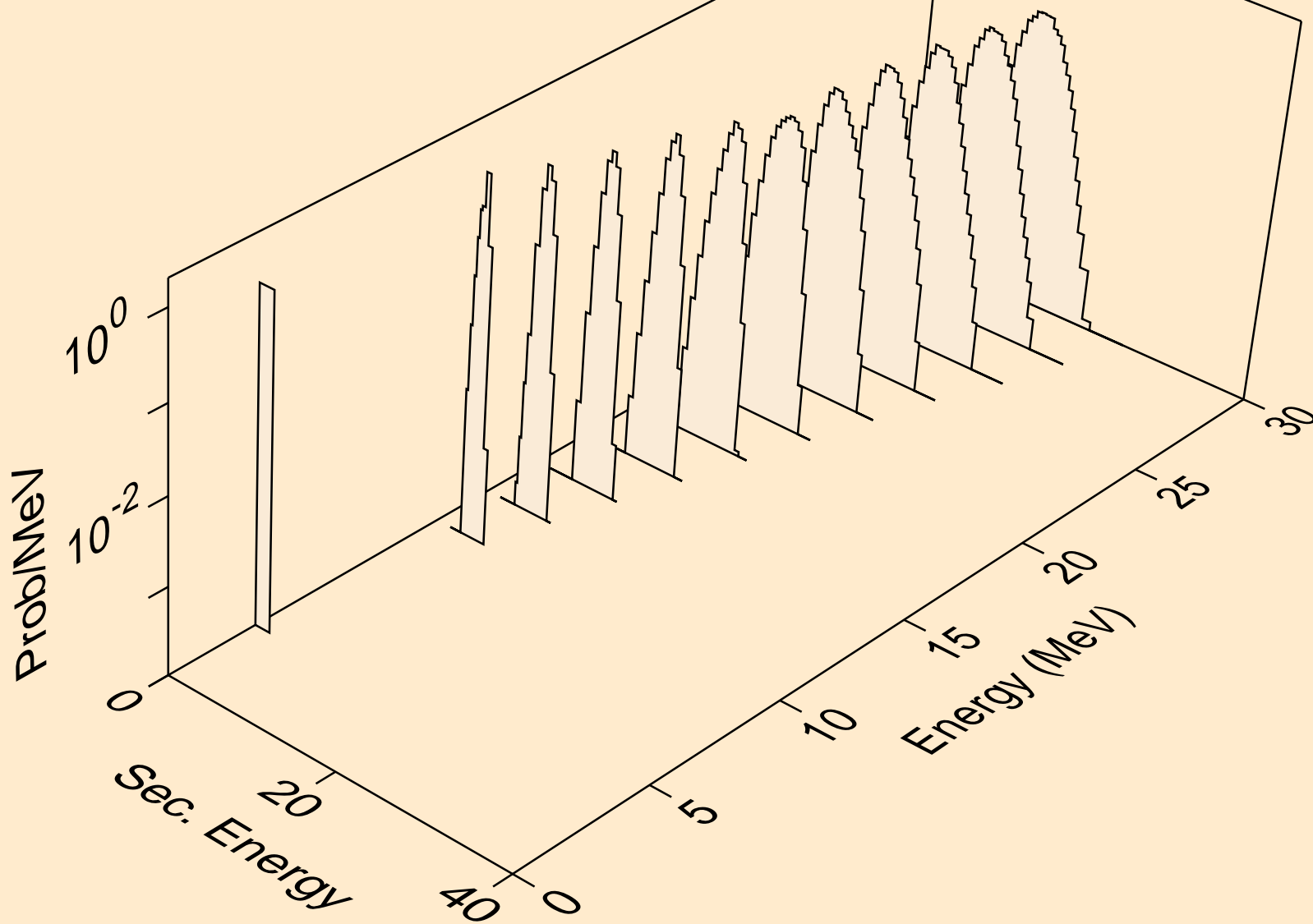

AT200N NEUTRON ACER TENDL-2019 LIBRARY; T=293.16K
he3s from (n,x)

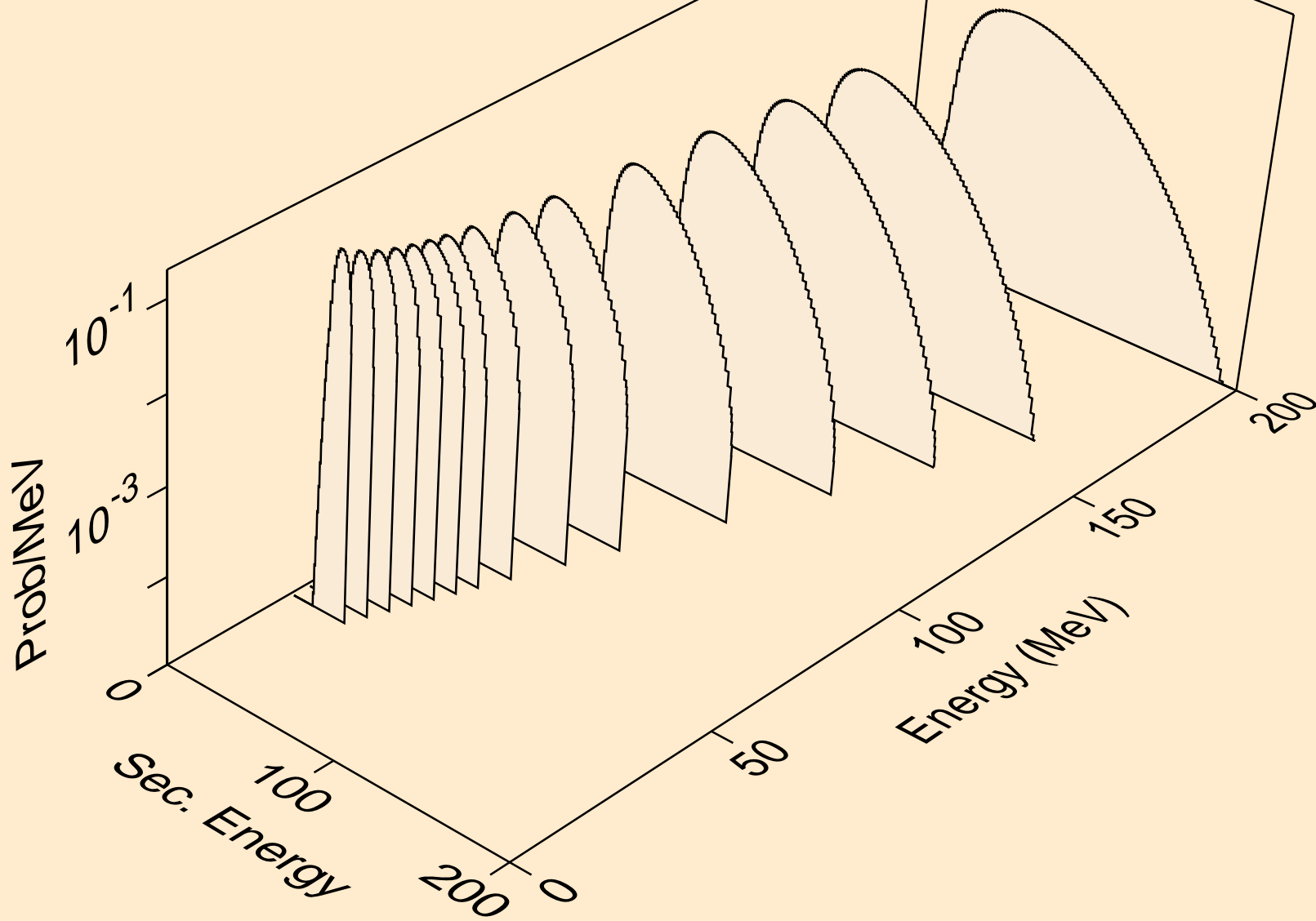

AT200N NEUTRON ACER TENDL-2019 LIBRARY; T=293.16K
he3s from (n,n*)he3

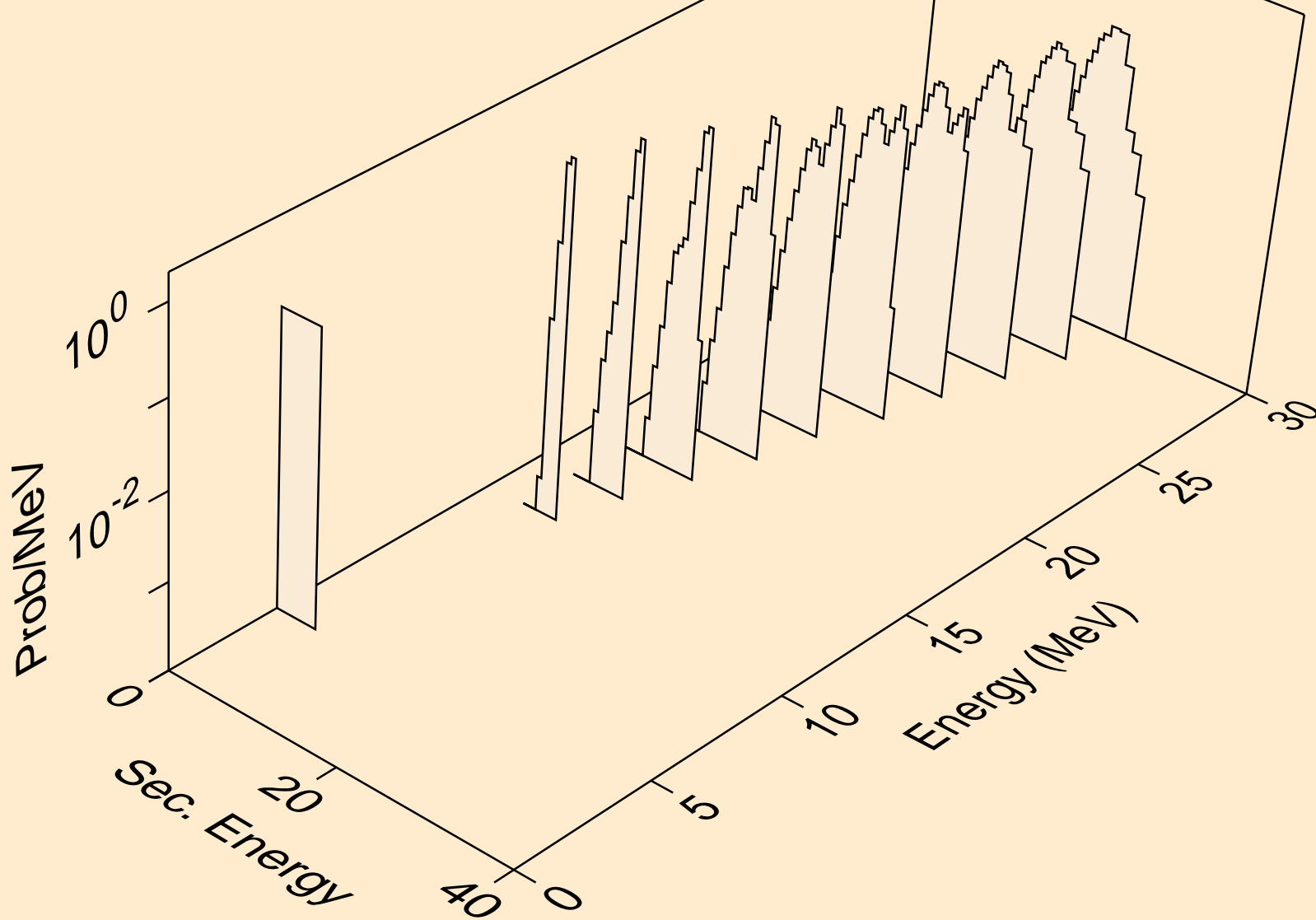

AT200N NEUTRON ACER TENDL-2019 LIBRARY; T=293.16K
he3s from (n,he3)

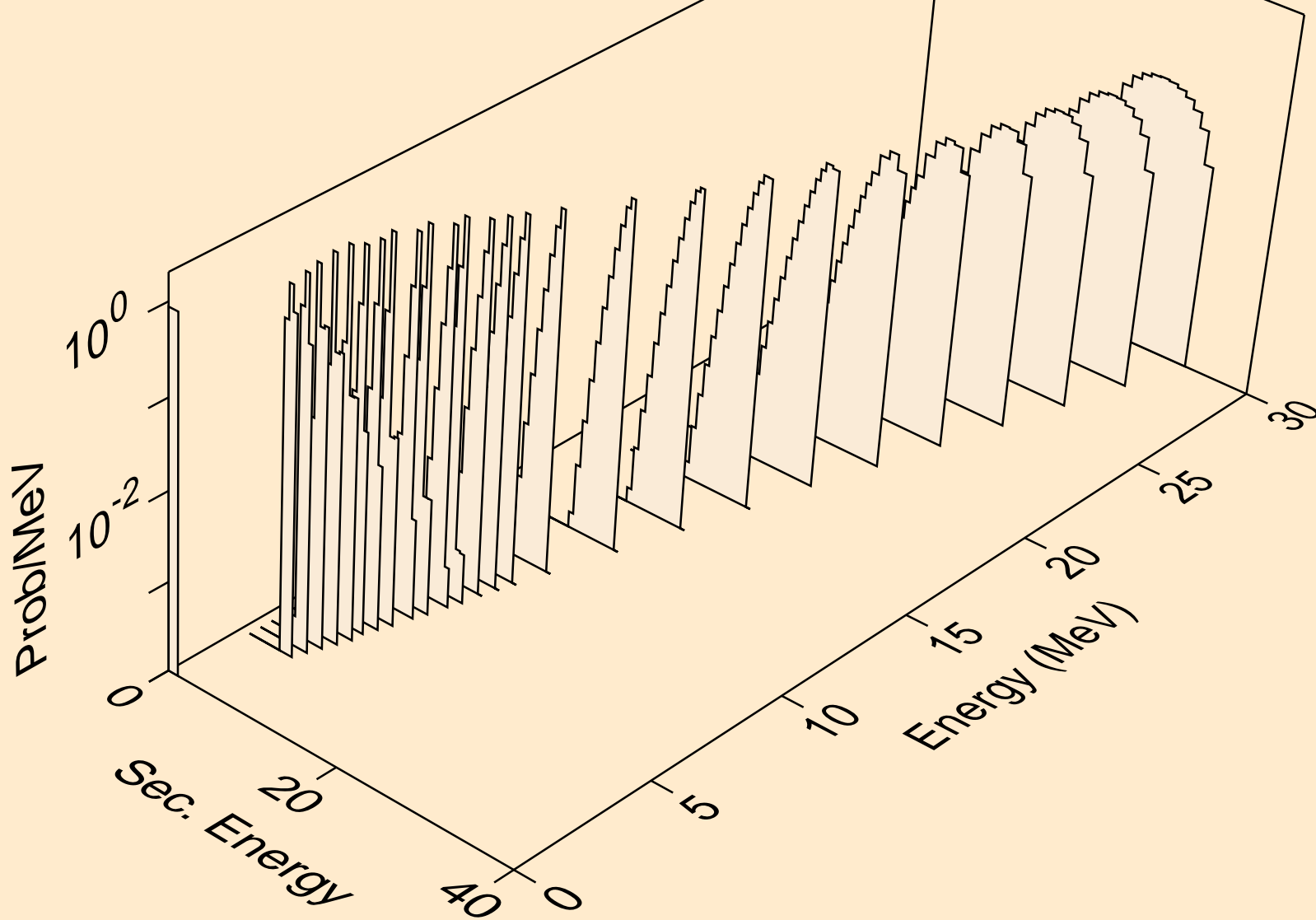

AT200N NEUTRON ACER TENDL-2019 LIBRARY; T=293.16K
alphas from (n,x)

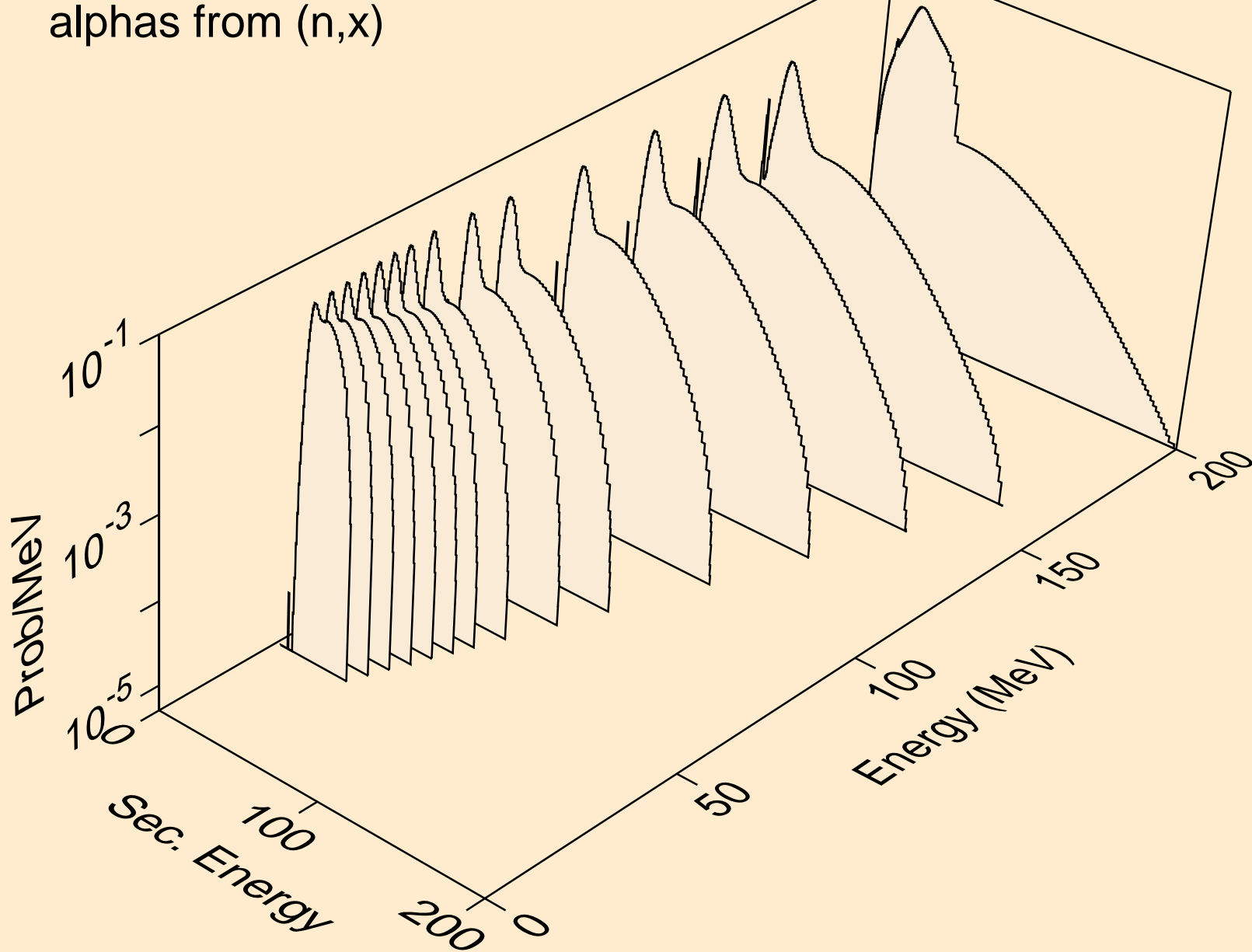

AT200N NEUTRON ACER TENDL-2019 LIBRARY; T=293.16K
alphas from (n,n*)a

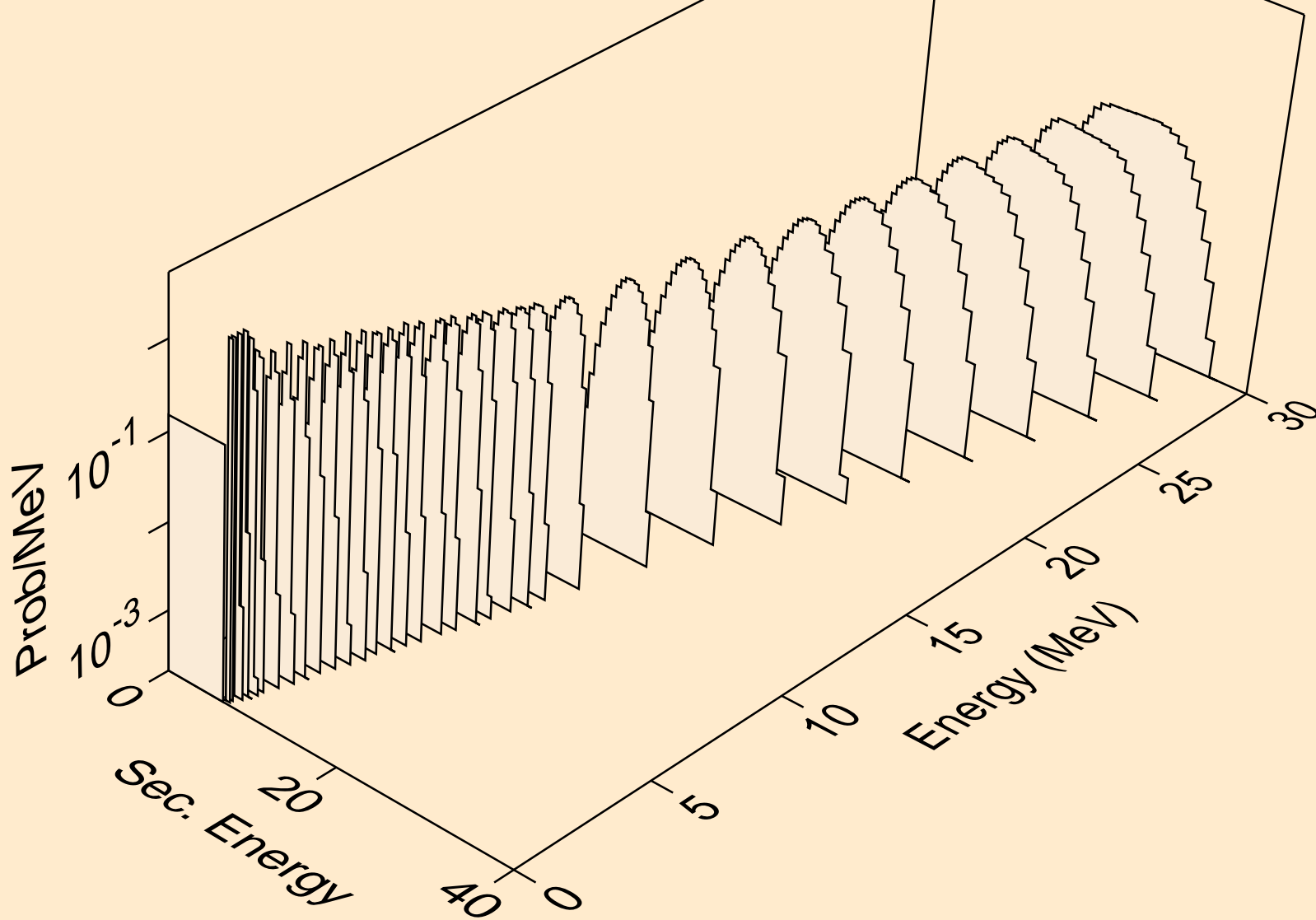

AT200N NEUTRON ACER TENDL-2019 LIBRARY; T=293.16K
alphas from (n,2n)a

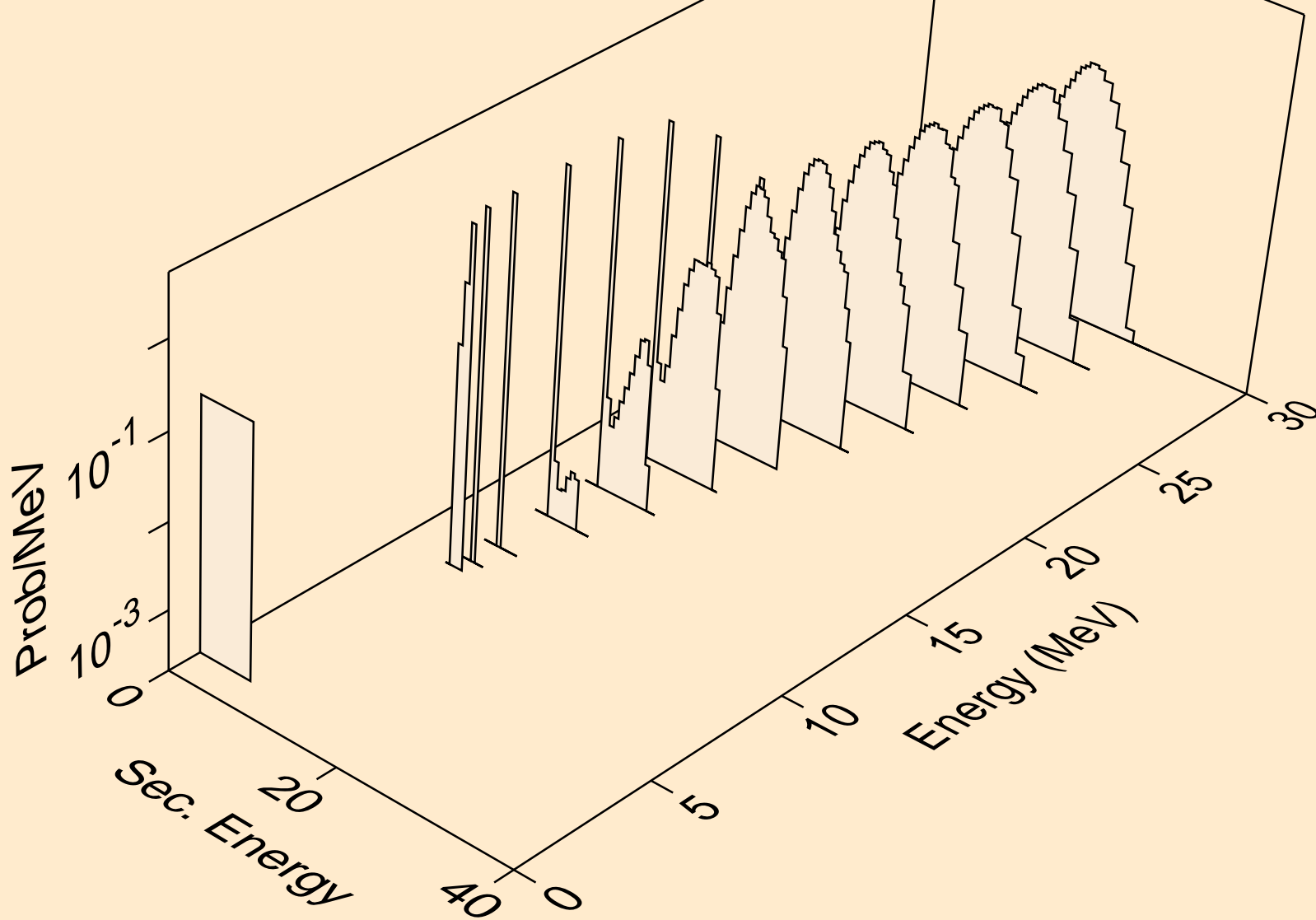

AT200N NEUTRON ACER TENDL-2019 LIBRARY; T=293.16K
alphas from (n,3n)a

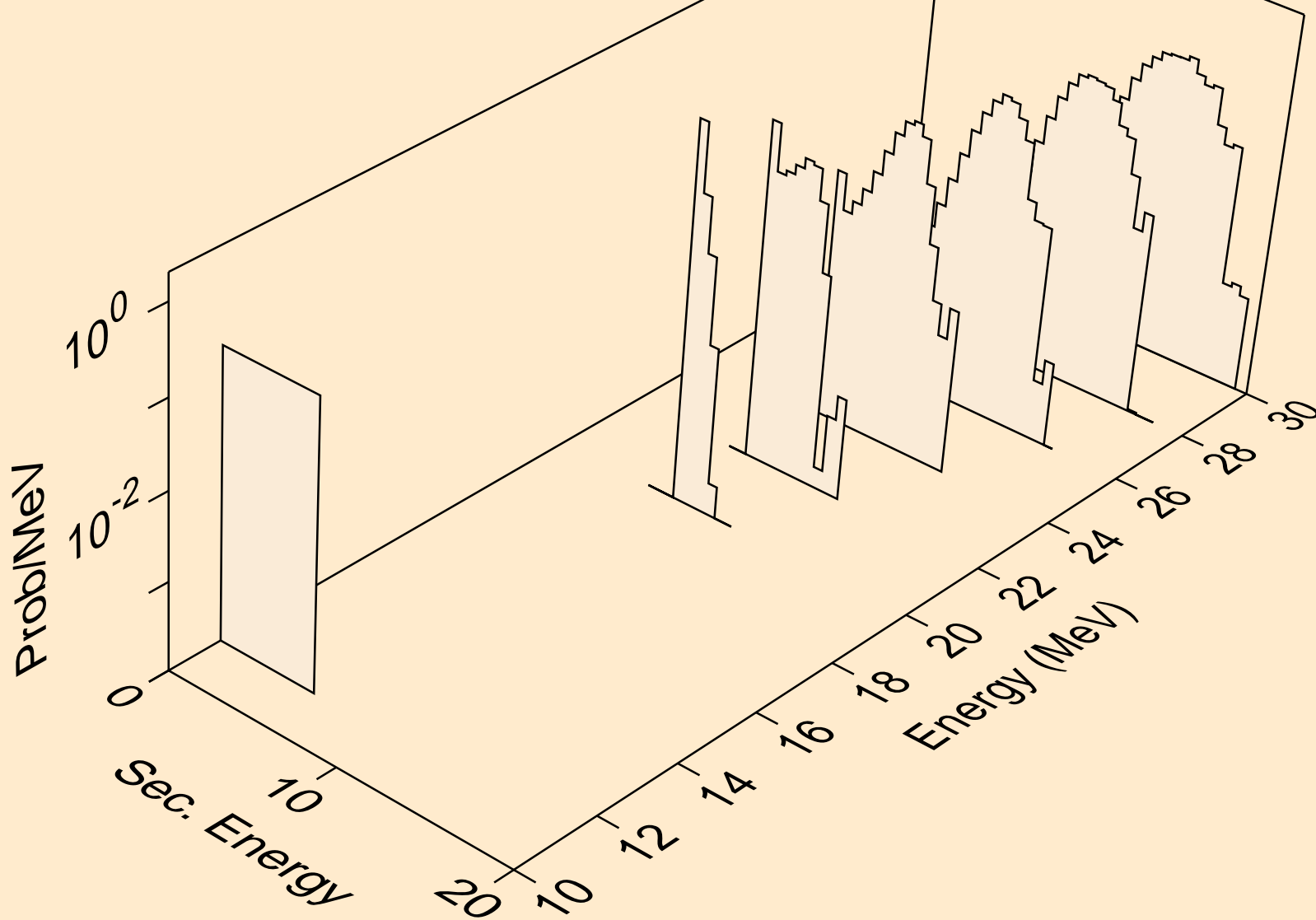

AT200N NEUTRON ACER TENDL-2019 LIBRARY; T=293.16K
alphas from (n,n*)2a

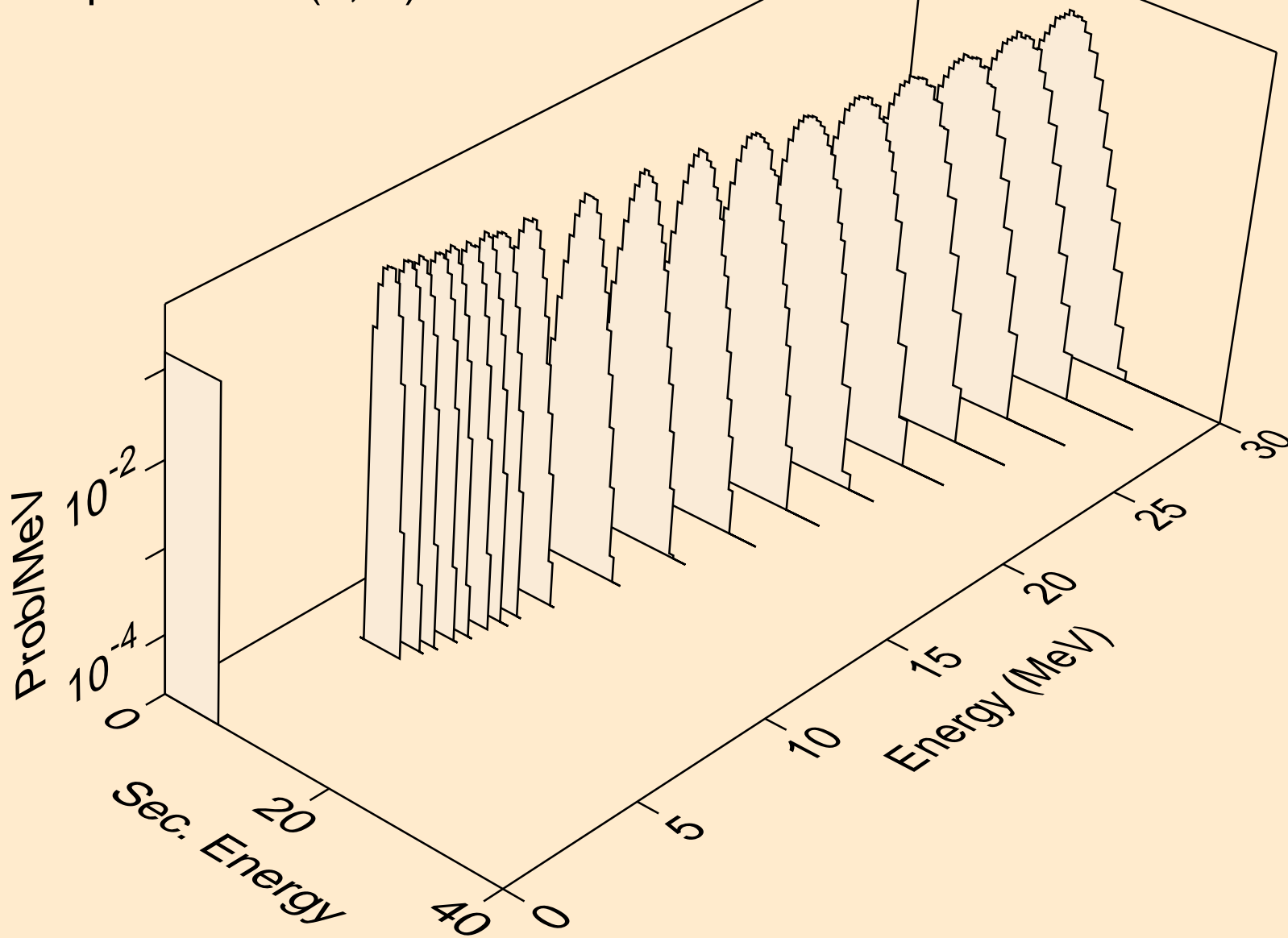

AT200N NEUTRON ACER TENDL-2019 LIBRARY; T=293.16K
alphas from (n,2n)2a

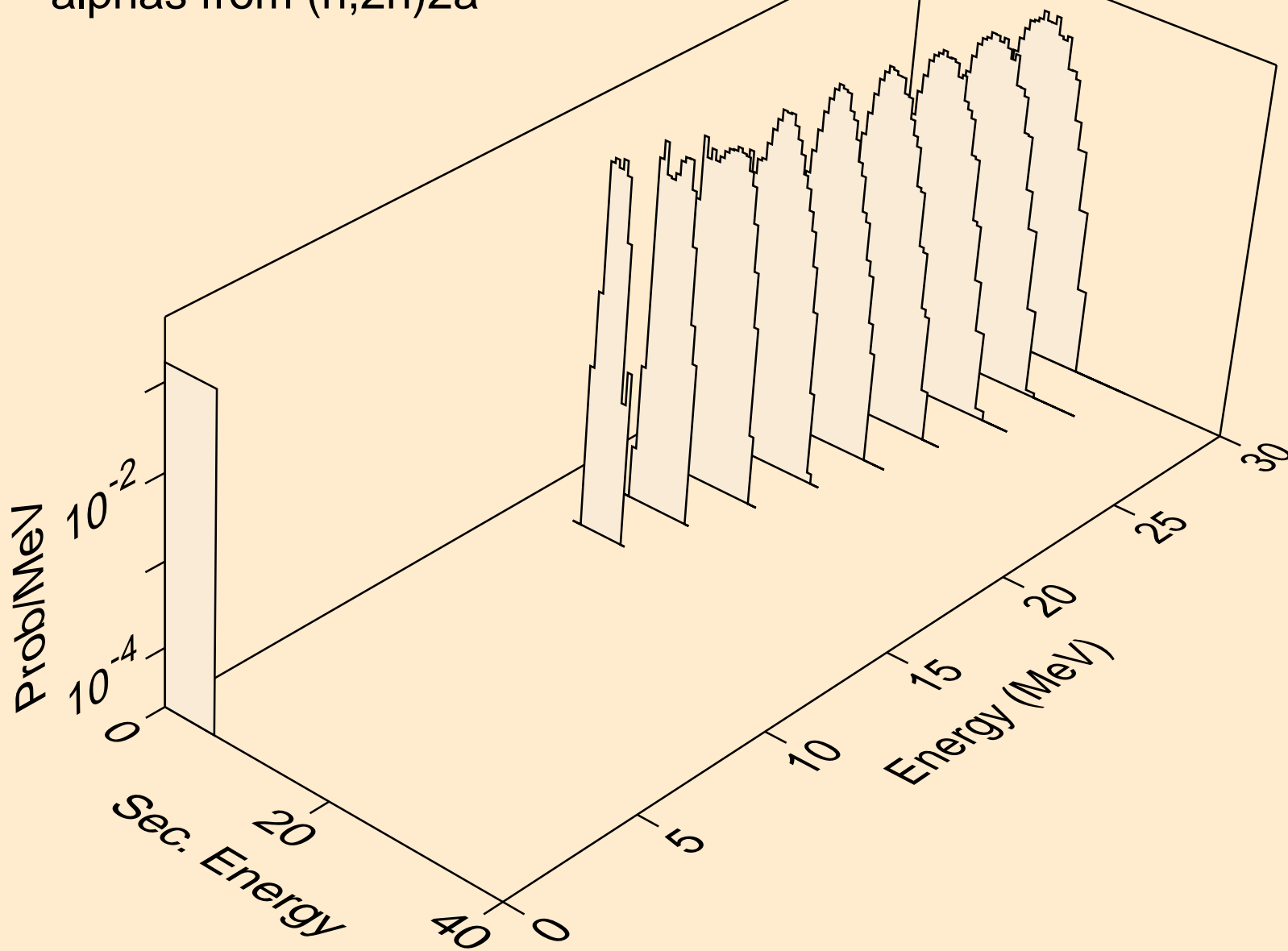

AT200N NEUTRON ACER TENDL-2019 LIBRARY; T=293.16K
alphas from (n,npa)

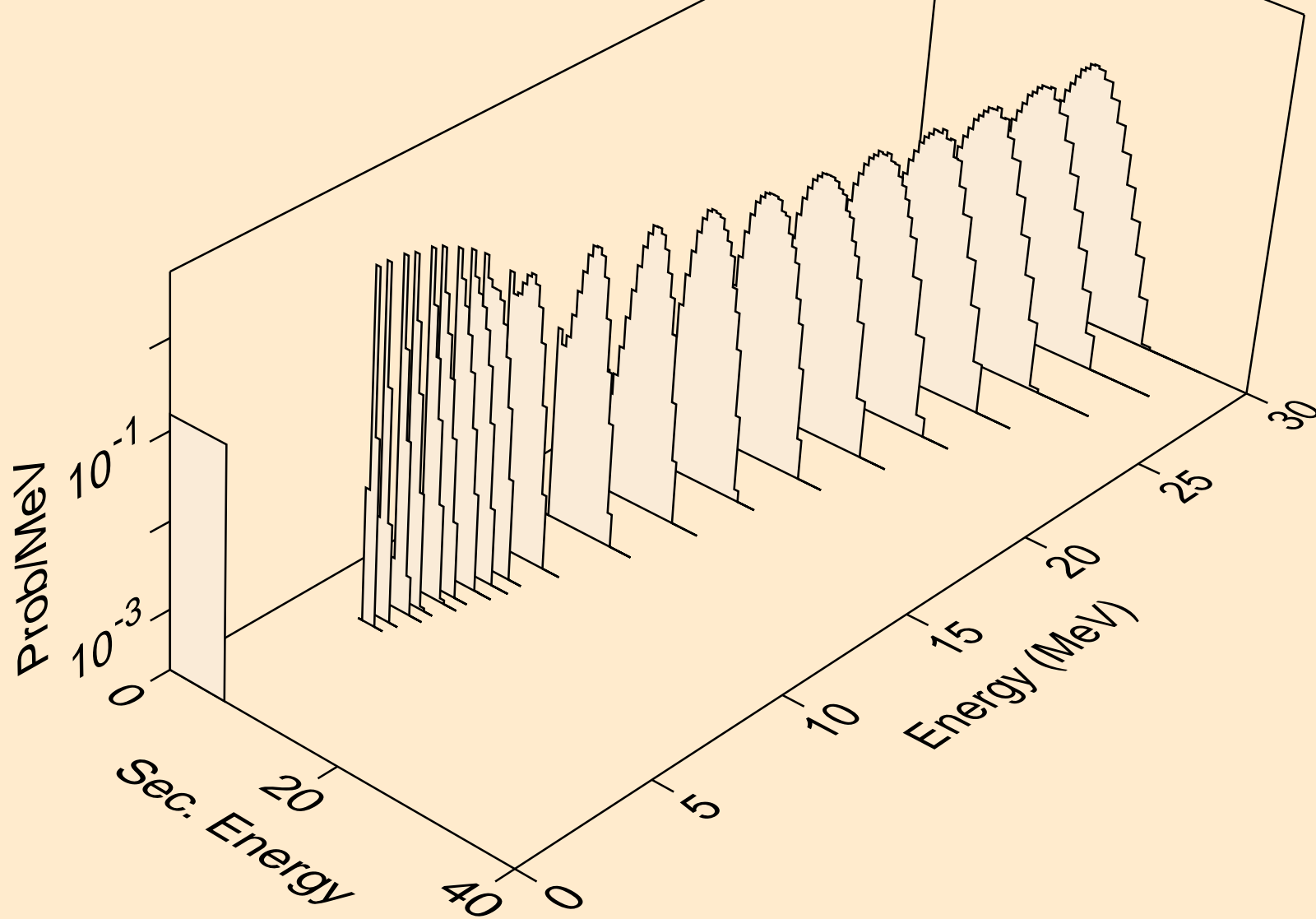

AT200N NEUTRON ACER TENDL-2019 LIBRARY; T=293.16K
alphas from (n,a)

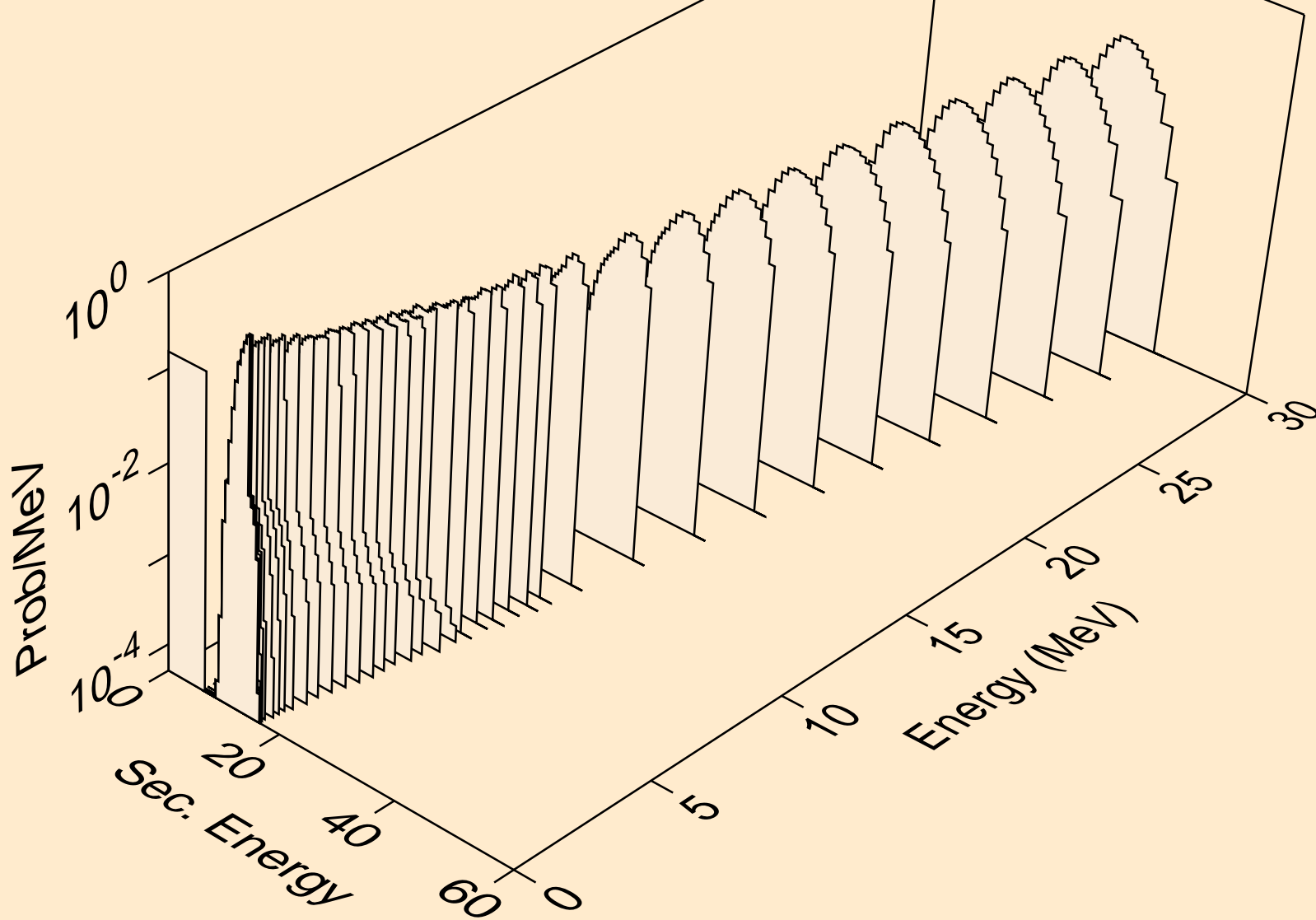

AT200N NEUTRON ACER TENDL-2019 LIBRARY; T=293.16K
alphas from (n,2a)

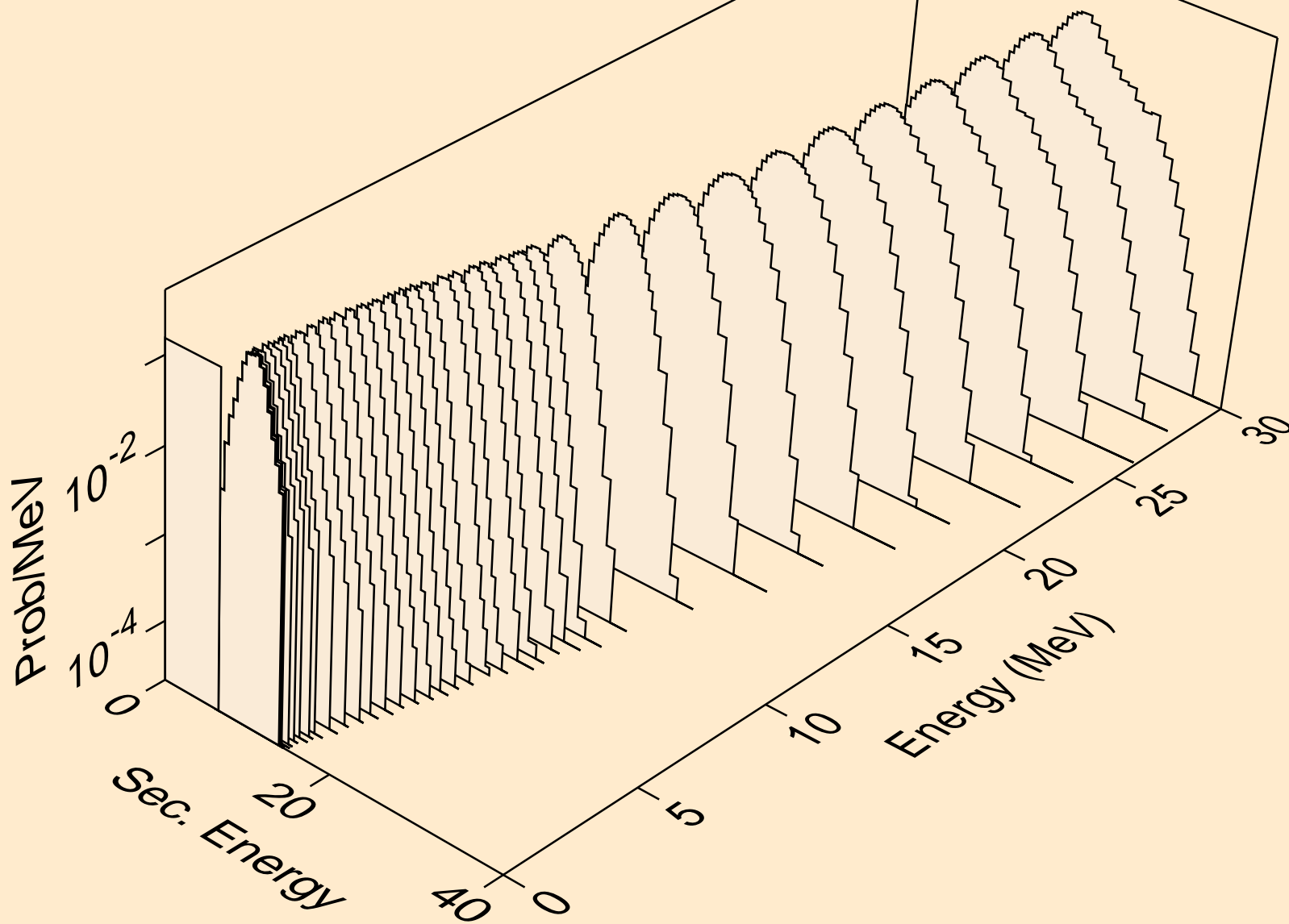

AT200N NEUTRON ACER TENDL-2019 LIBRARY; T=293.16K
alphas from (n,pa)

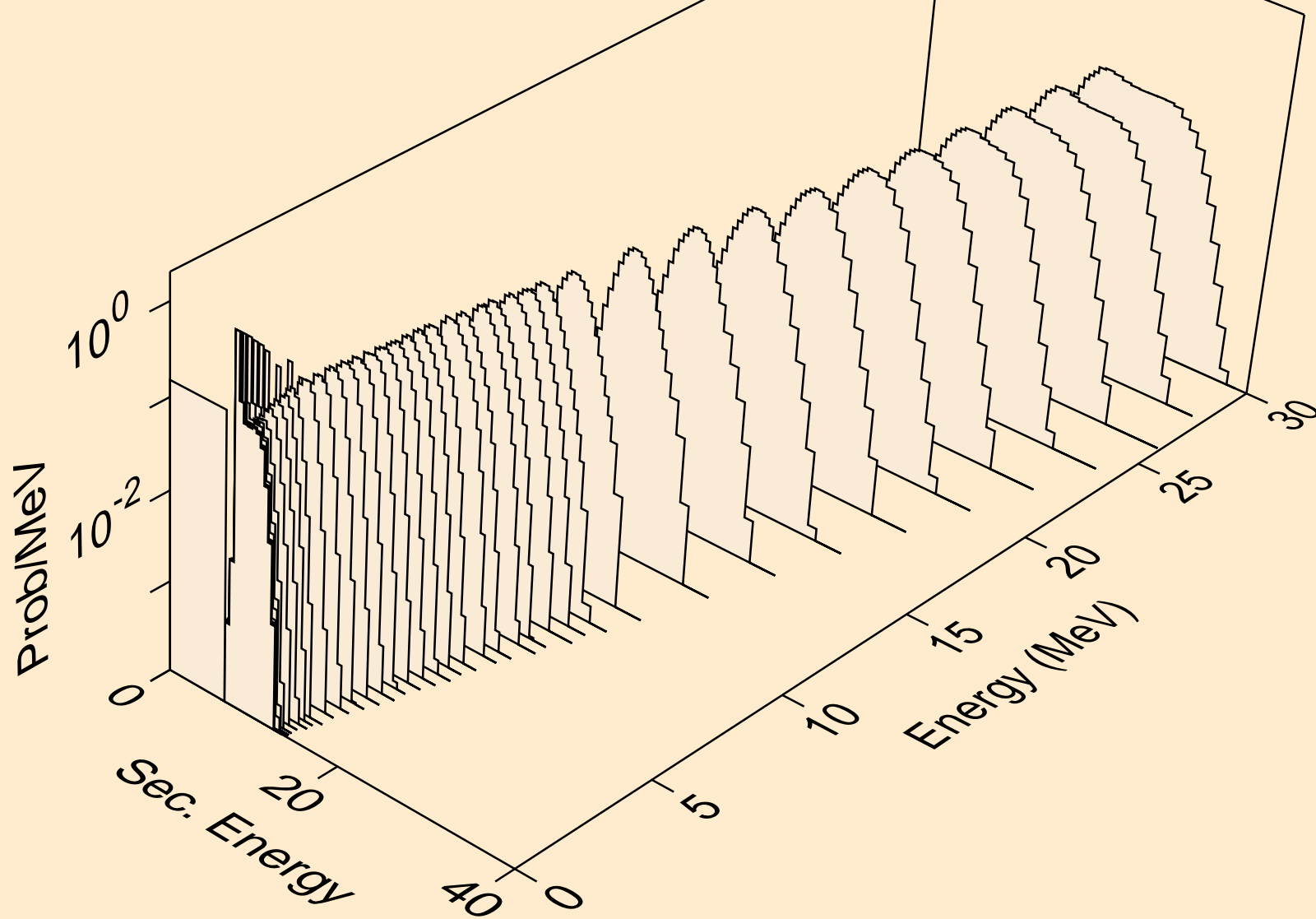

AT200N NEUTRON ACER TENDL-2019 LIBRARY; T=293.16K
alphas from (n,da)

