

AT211 NEUTRON ACER TENDL-2019 LIBRARY; T=293.16K
Principal cross sections

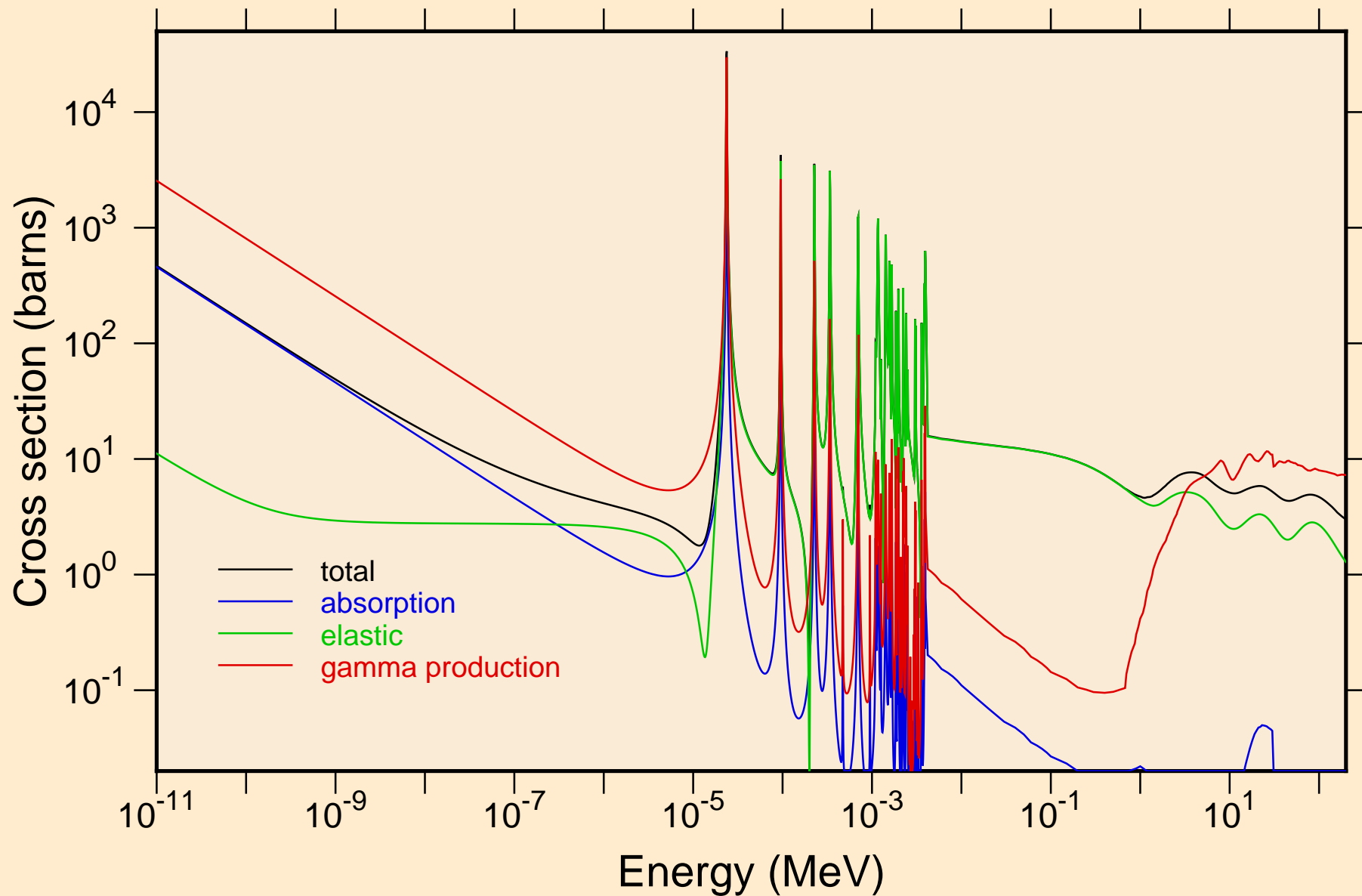

AT211 NEUTRON ACER TENDL-2019 LIBRARY; T=293.16K
resonance total cross section

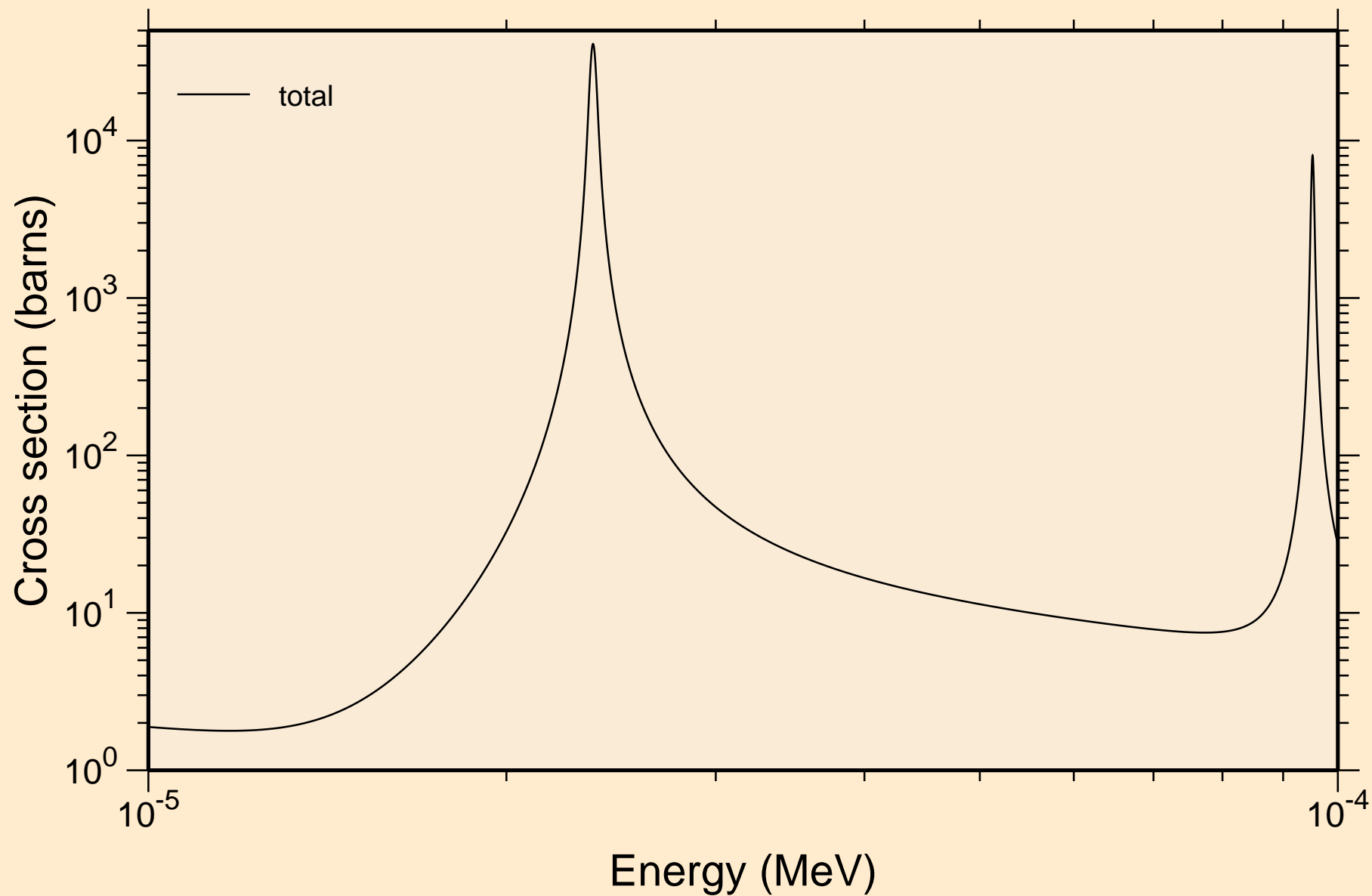

AT211 NEUTRON ACER TENDL-2019 LIBRARY; T=293.16K
resonance total cross section

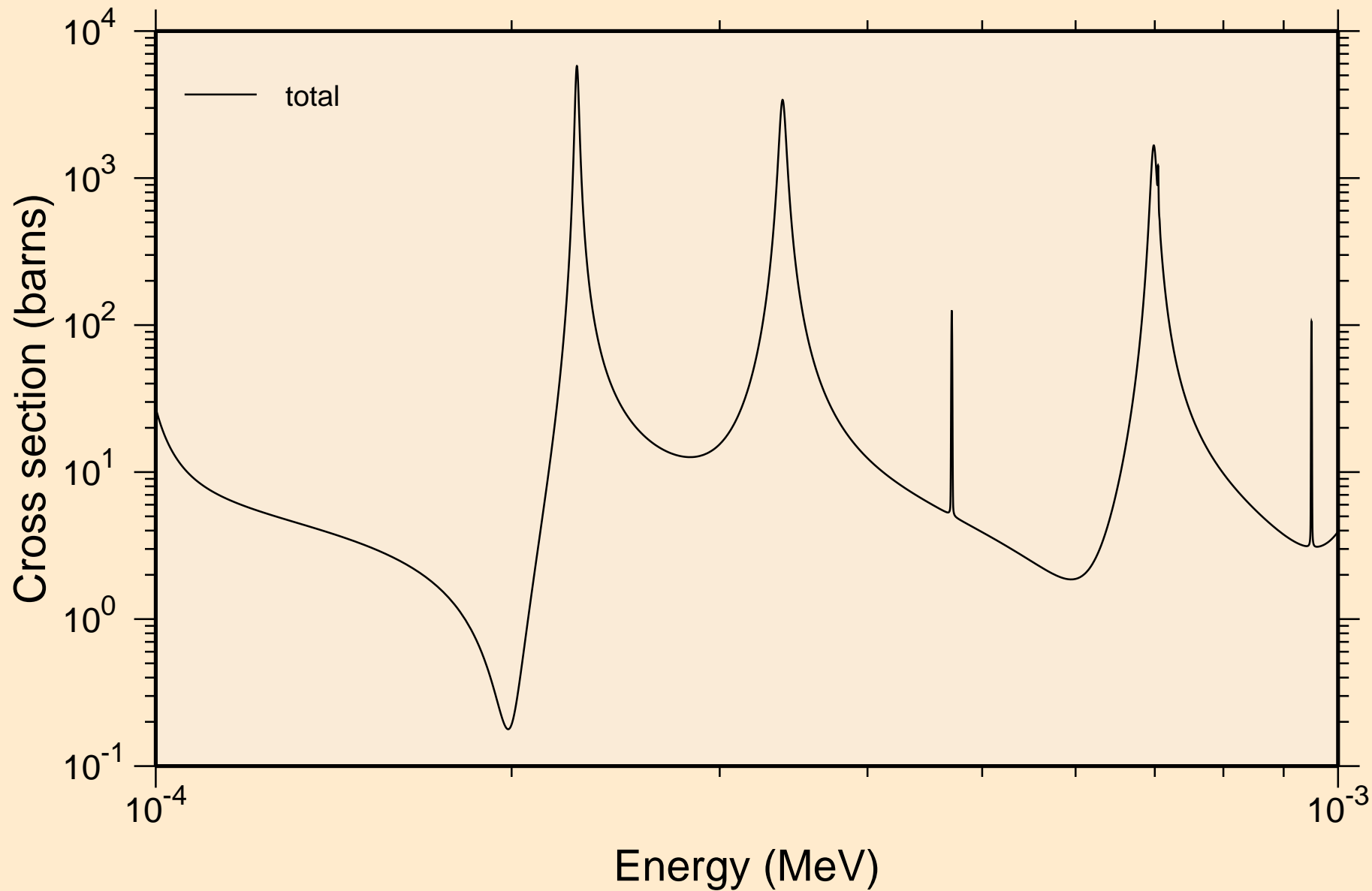

AT211 NEUTRON ACER TENDL-2019 LIBRARY; T=293.16K
resonance total cross section

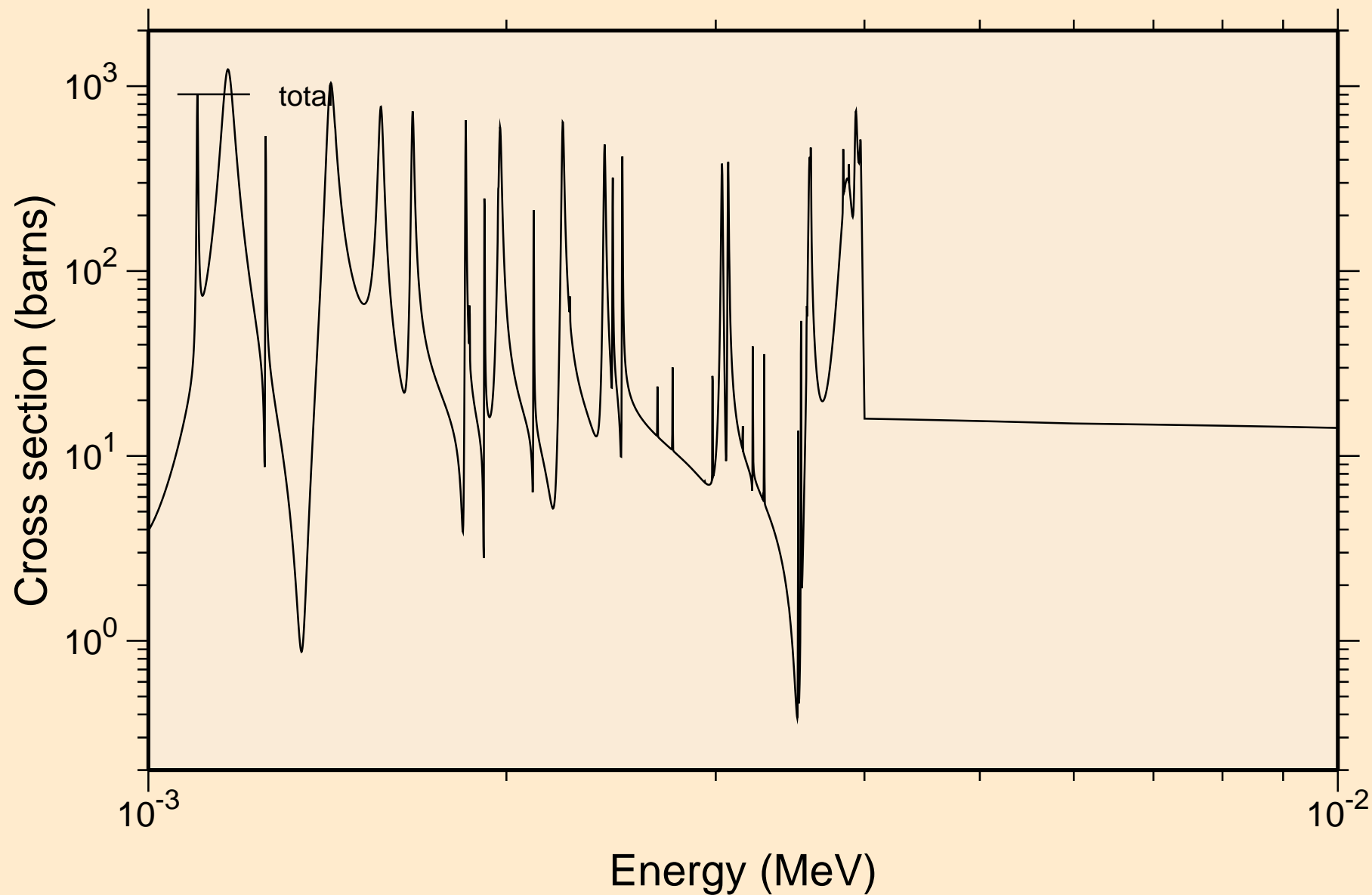

AT211 NEUTRON ACER TENDL-2019 LIBRARY; T=293.16K
resonance total cross section

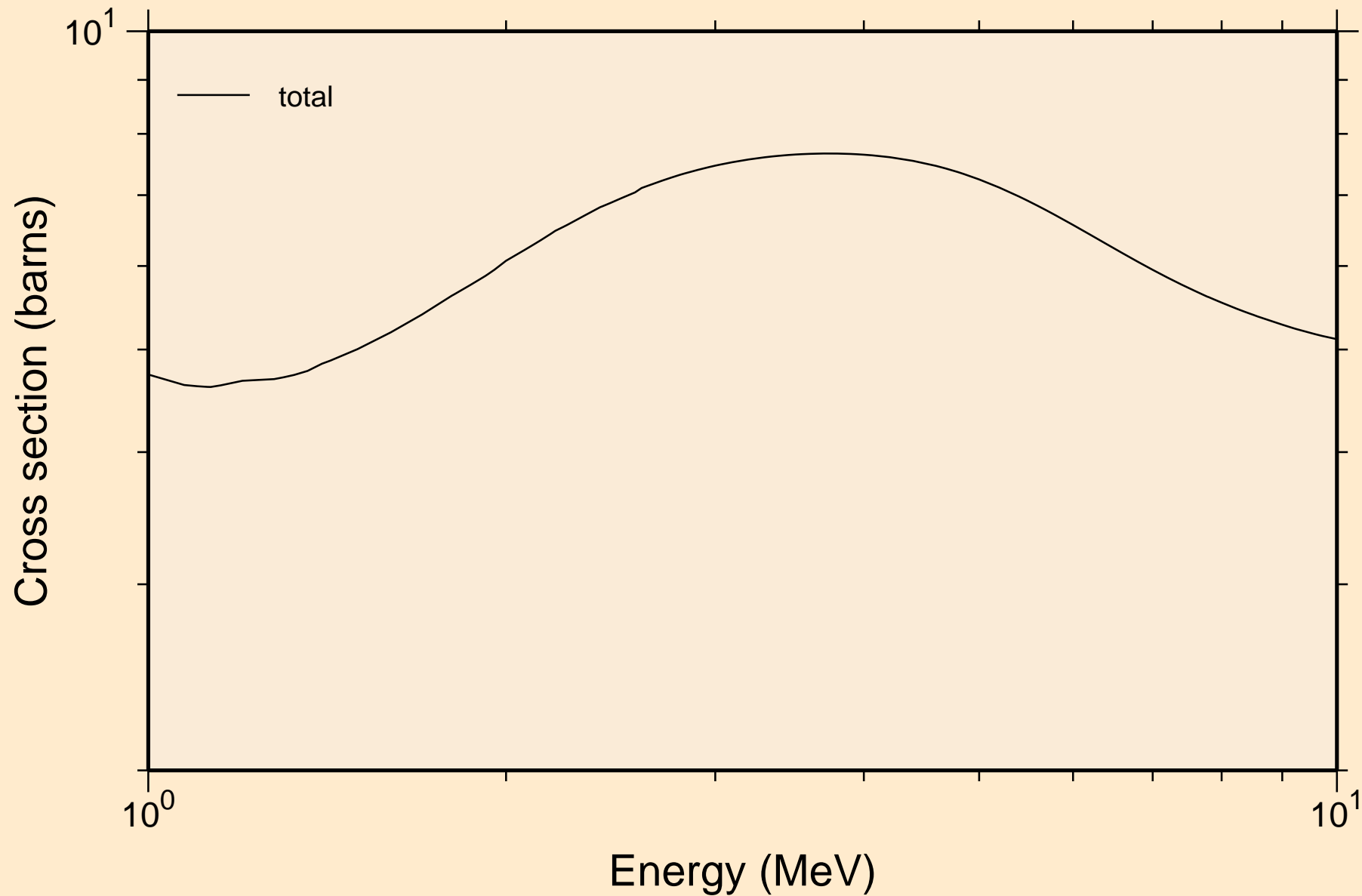

AT211 NEUTRON ACER TENDL-2019 LIBRARY; T=293.16K
resonance absorption cross sections

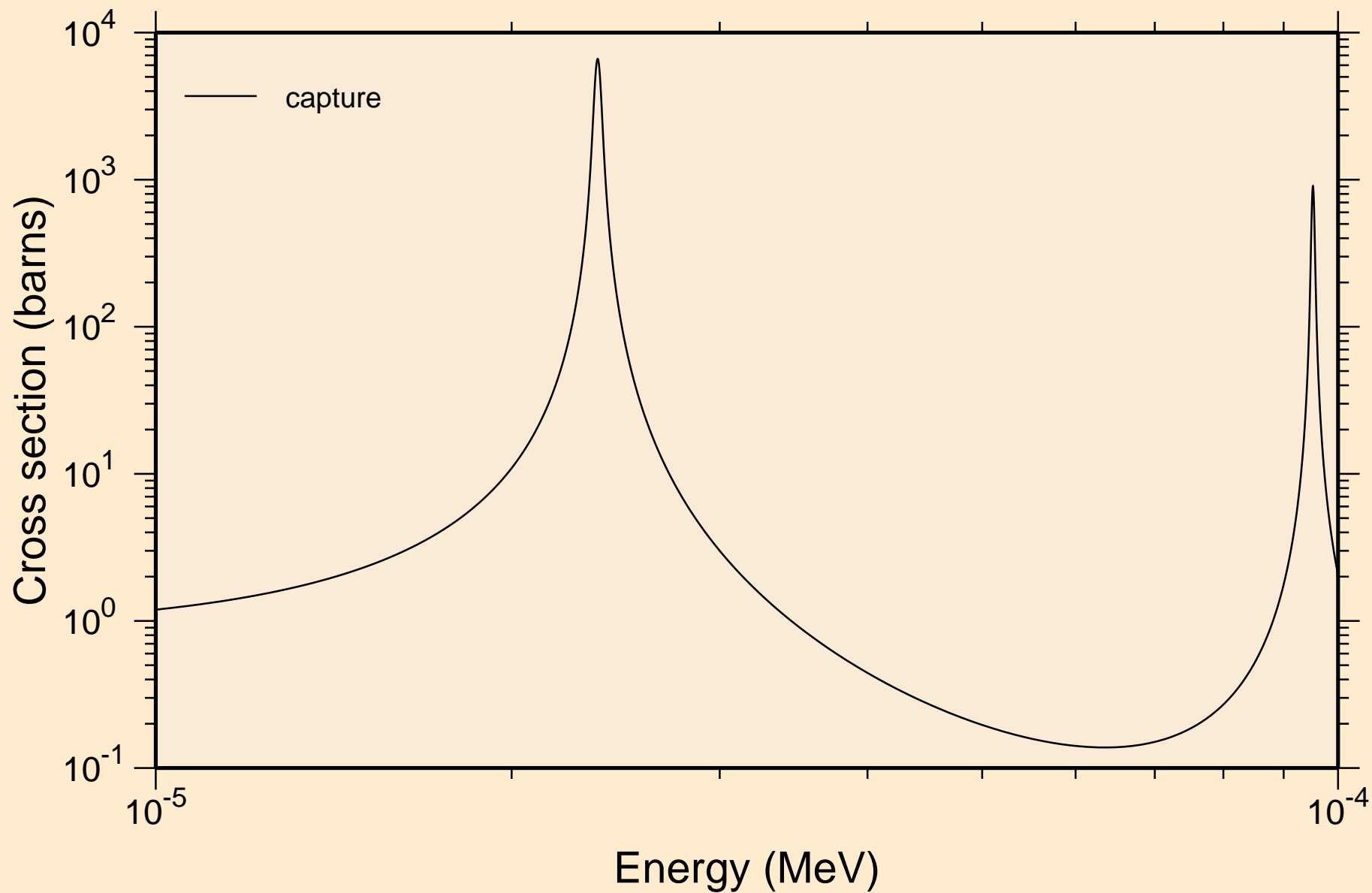

AT211 NEUTRON ACER TENDL-2019 LIBRARY; T=293.16K
resonance absorption cross sections

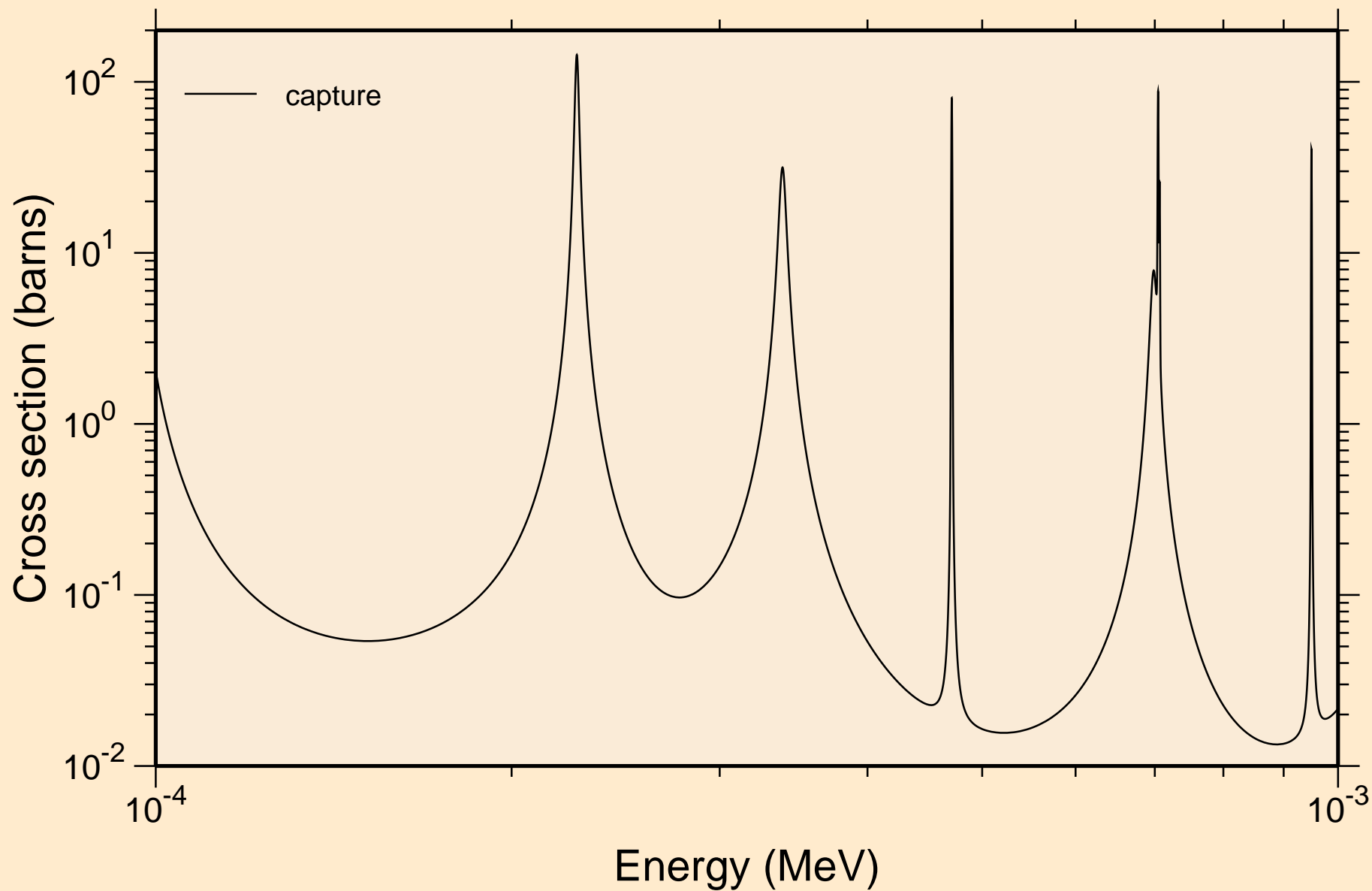

AT211 NEUTRON ACER TENDL-2019 LIBRARY; T=293.16K
resonance absorption cross sections

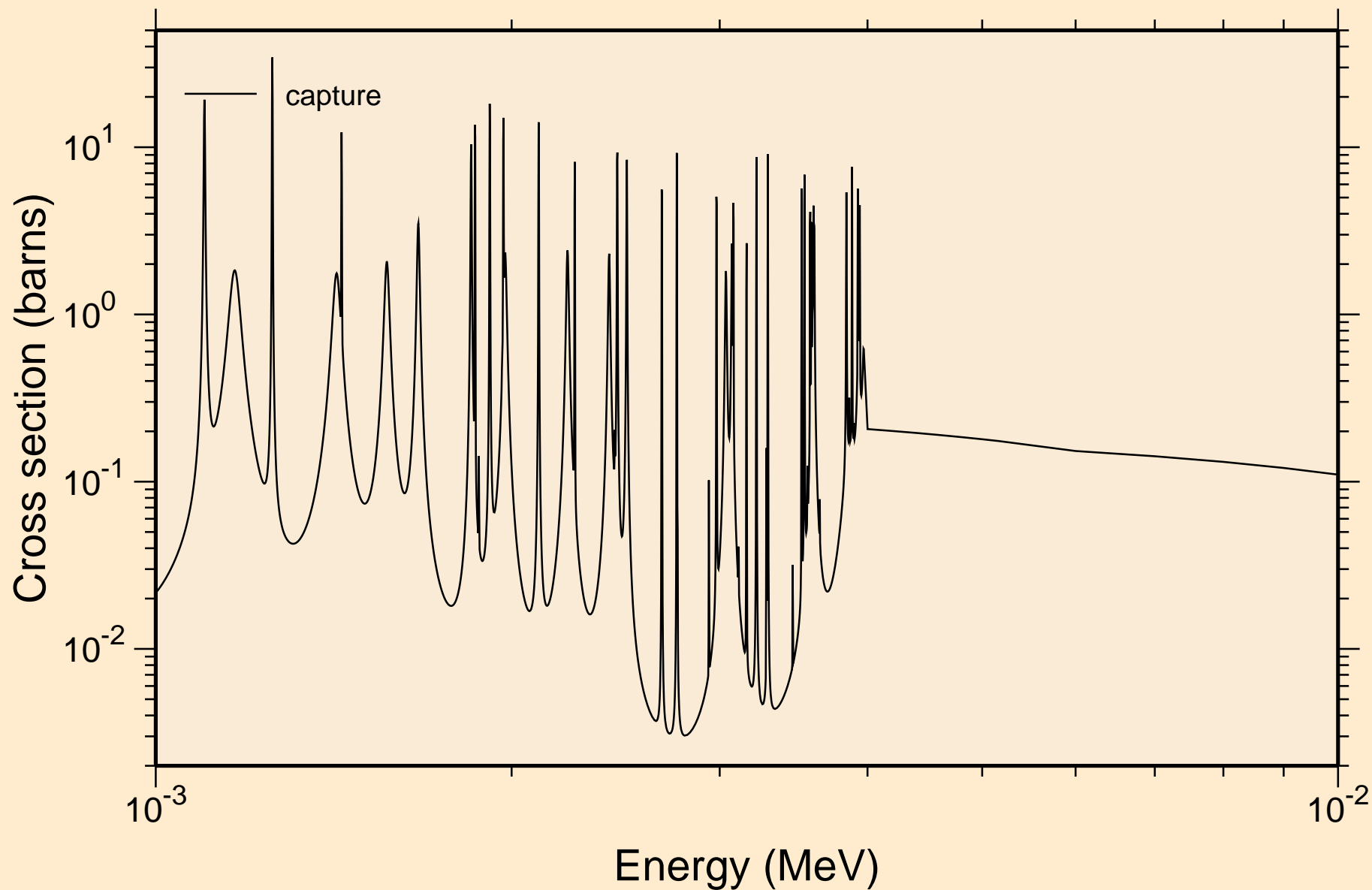

AT211 NEUTRON ACER TENDL-2019 LIBRARY; T=293.16K
resonance absorption cross sections

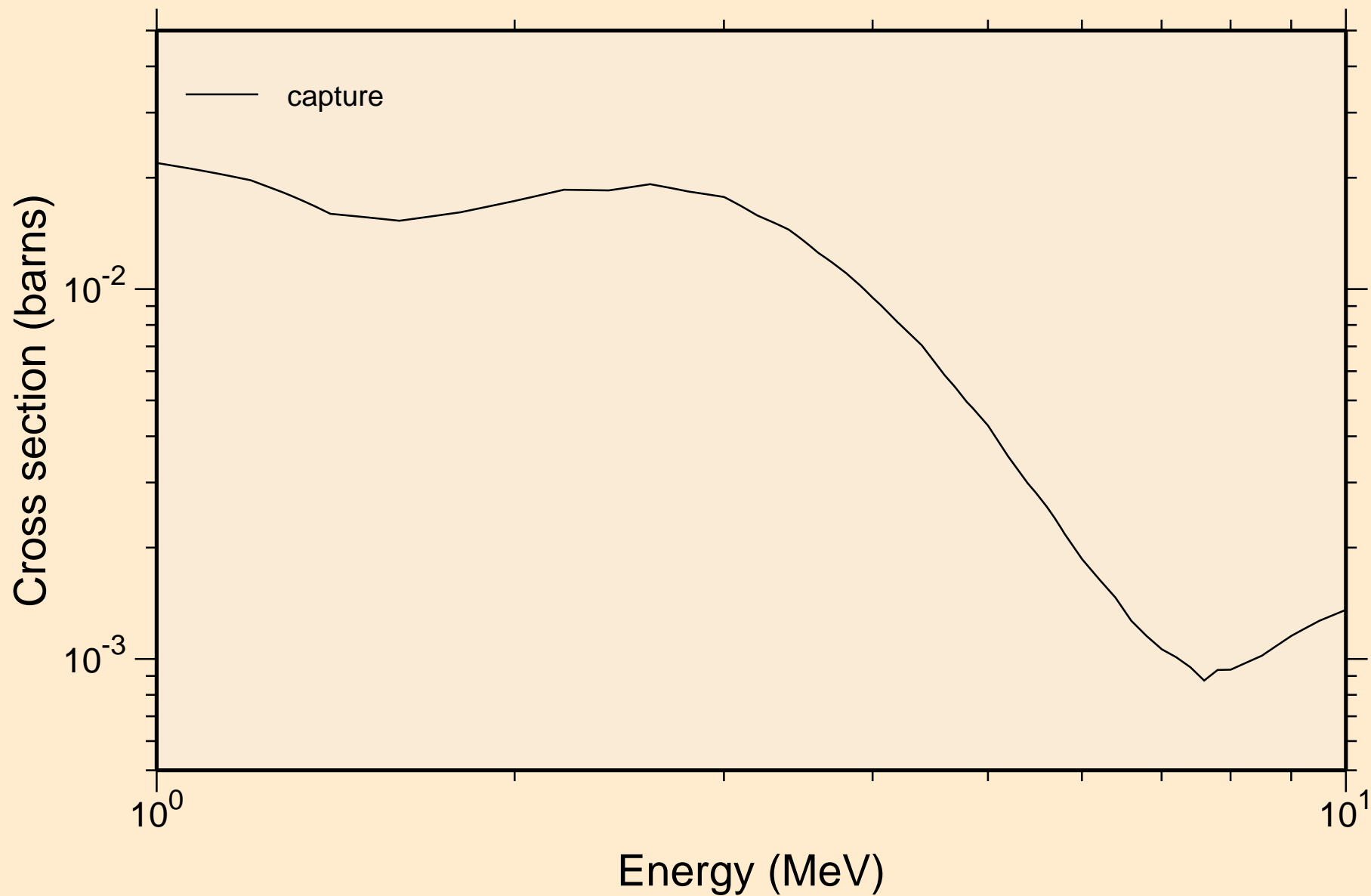

AT211 NEUTRON ACER TENDL-2019 LIBRARY; T=293.16K
Heating

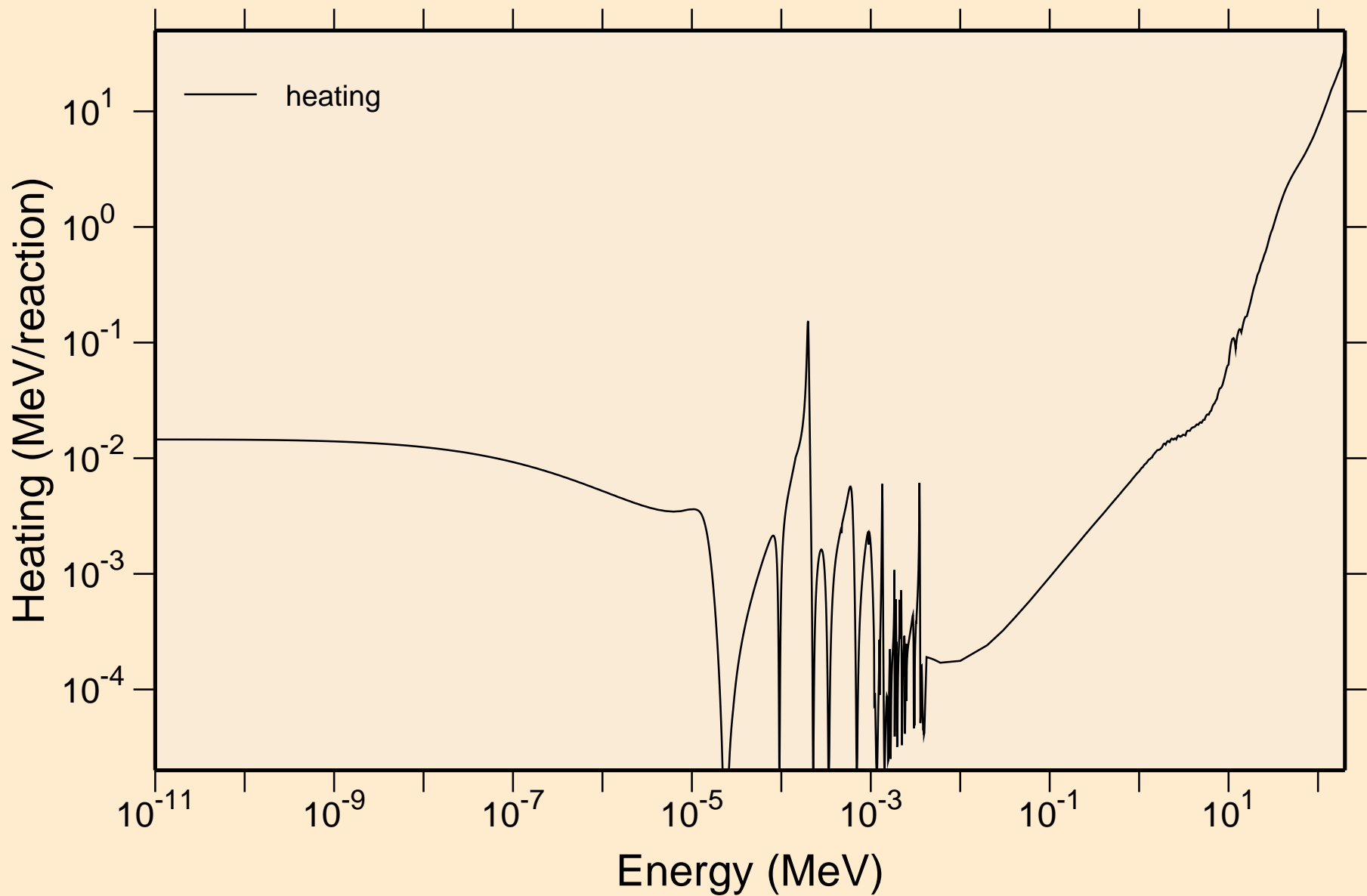

AT211 NEUTRON ACER TENDL-2019 LIBRARY; T=293.16K

Damage

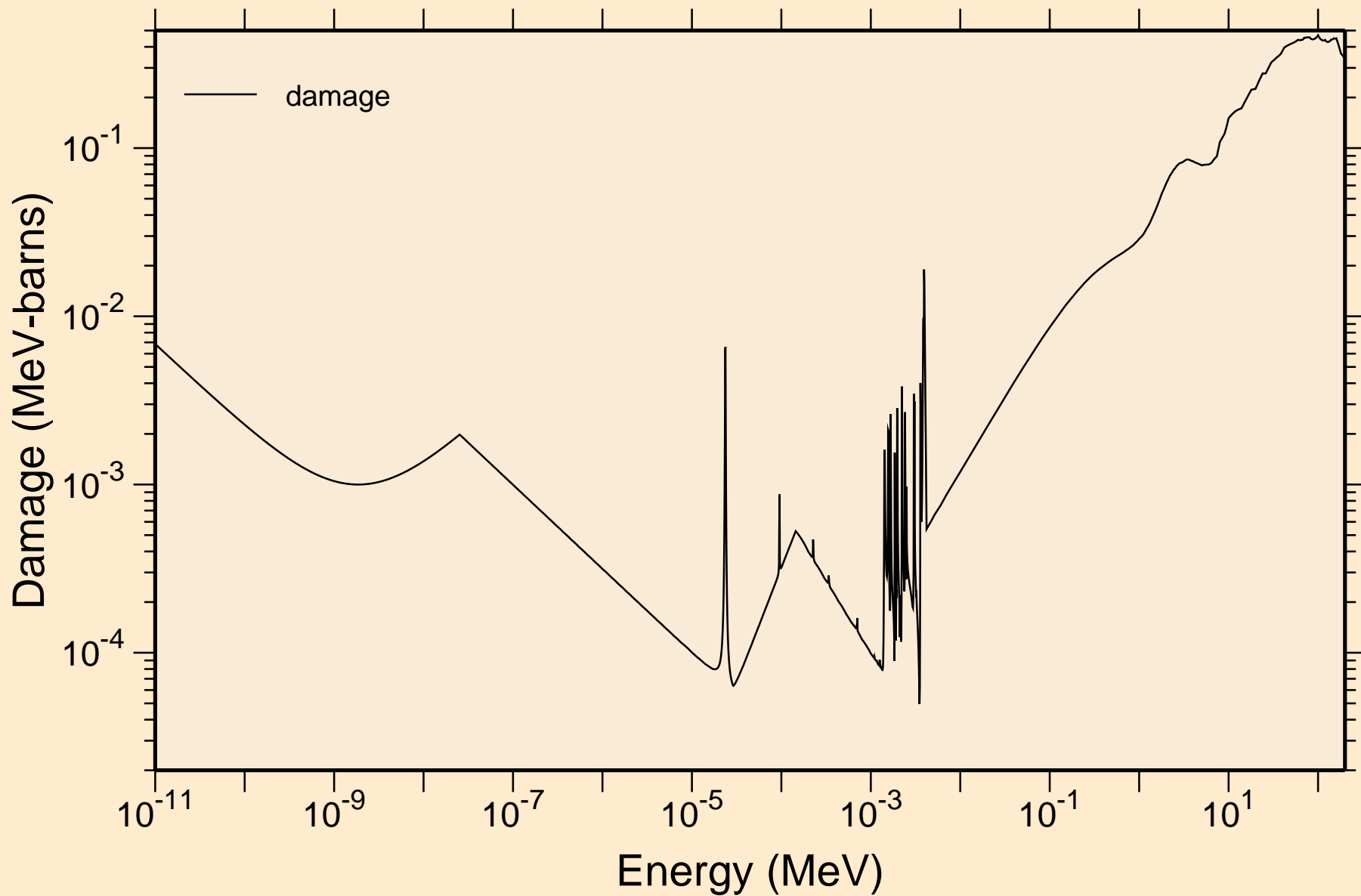

AT211 NEUTRON ACER TENDL-2019 LIBRARY; T=293.16K

Non-threshold reactions

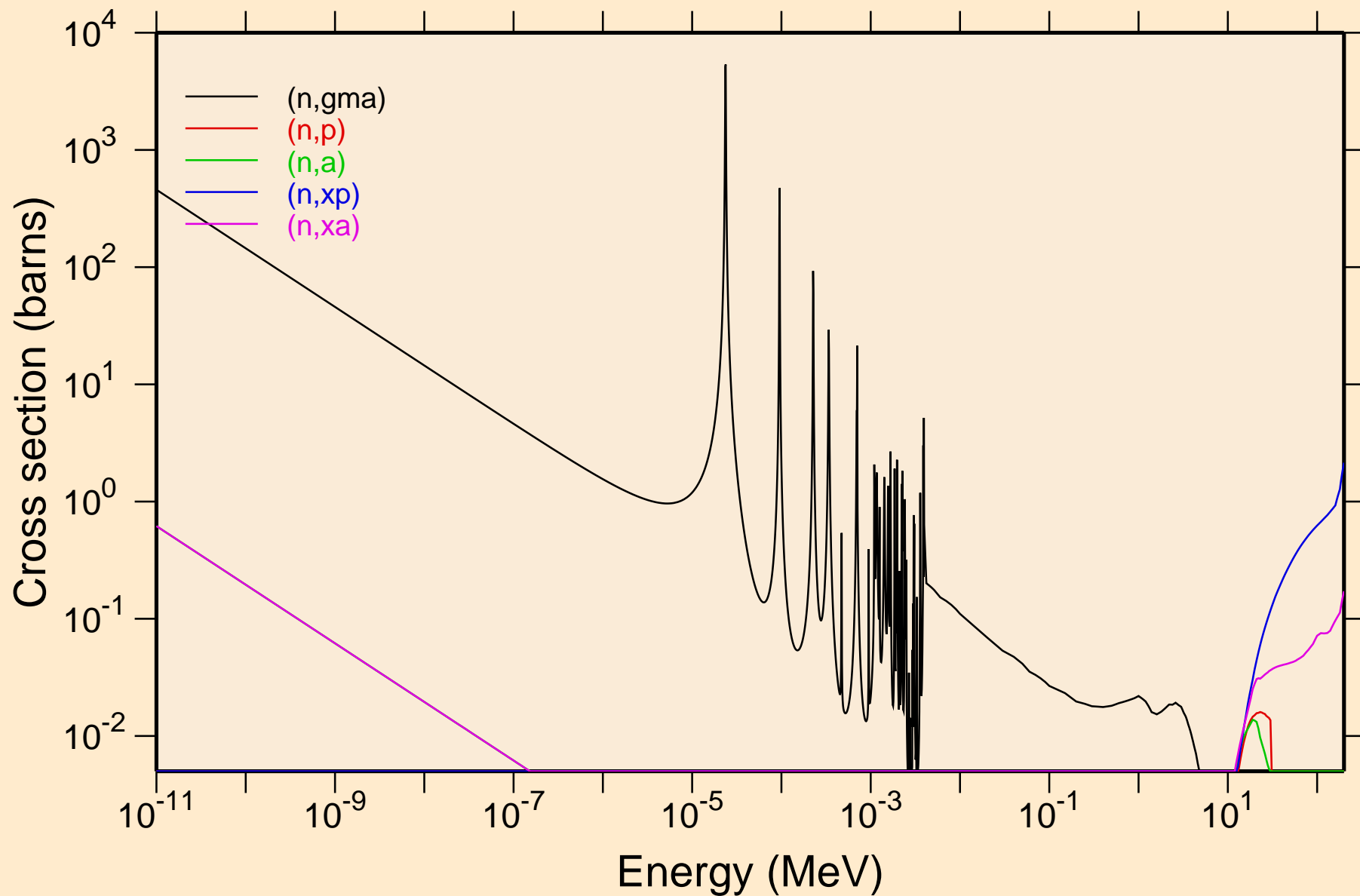

AT211 NEUTRON ACER TENDL-2019 LIBRARY; T=293.16K
Principal cross sections

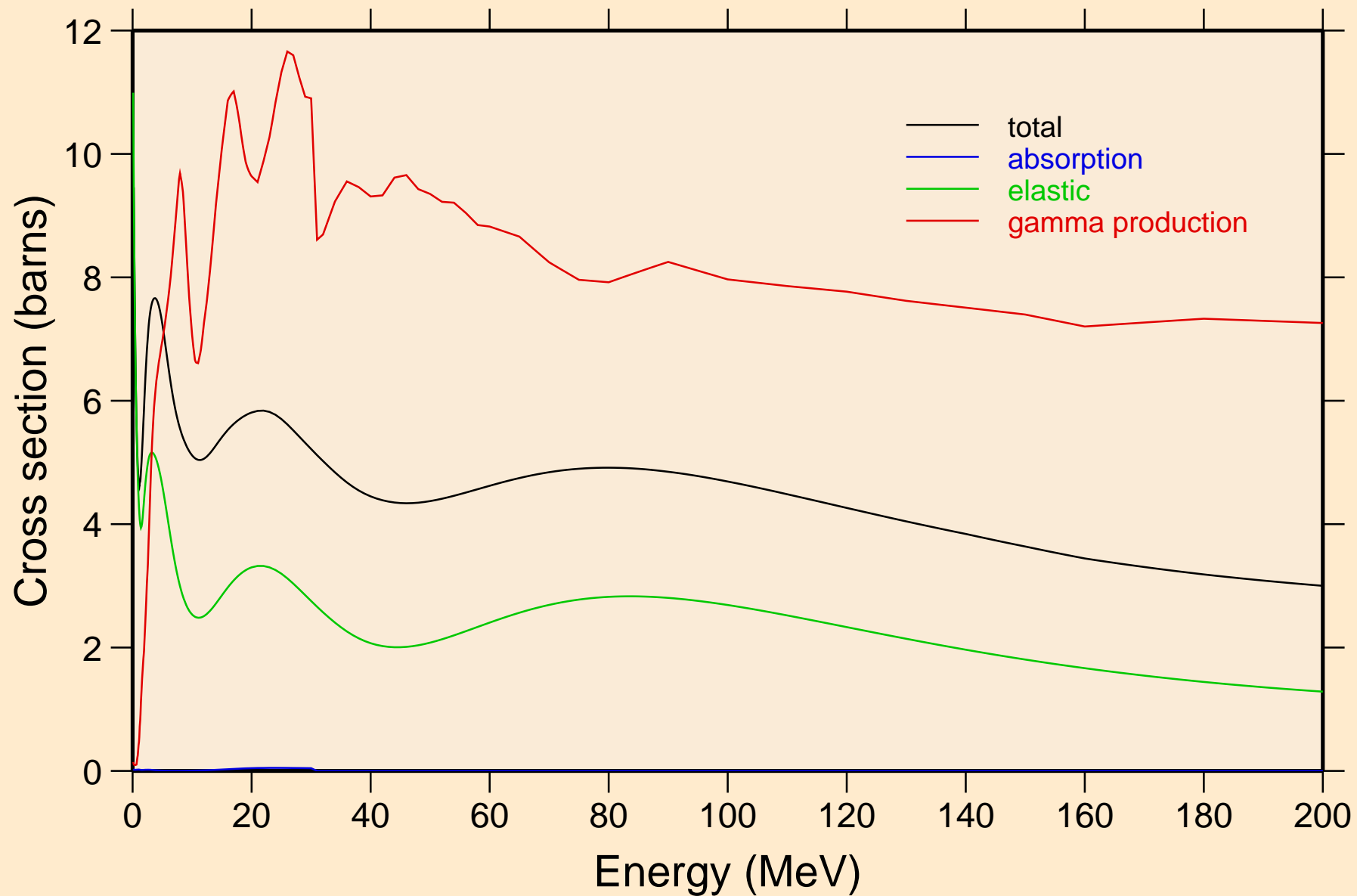

AT211 NEUTRON ACER TENDL-2019 LIBRARY; T=293.16K
Heating

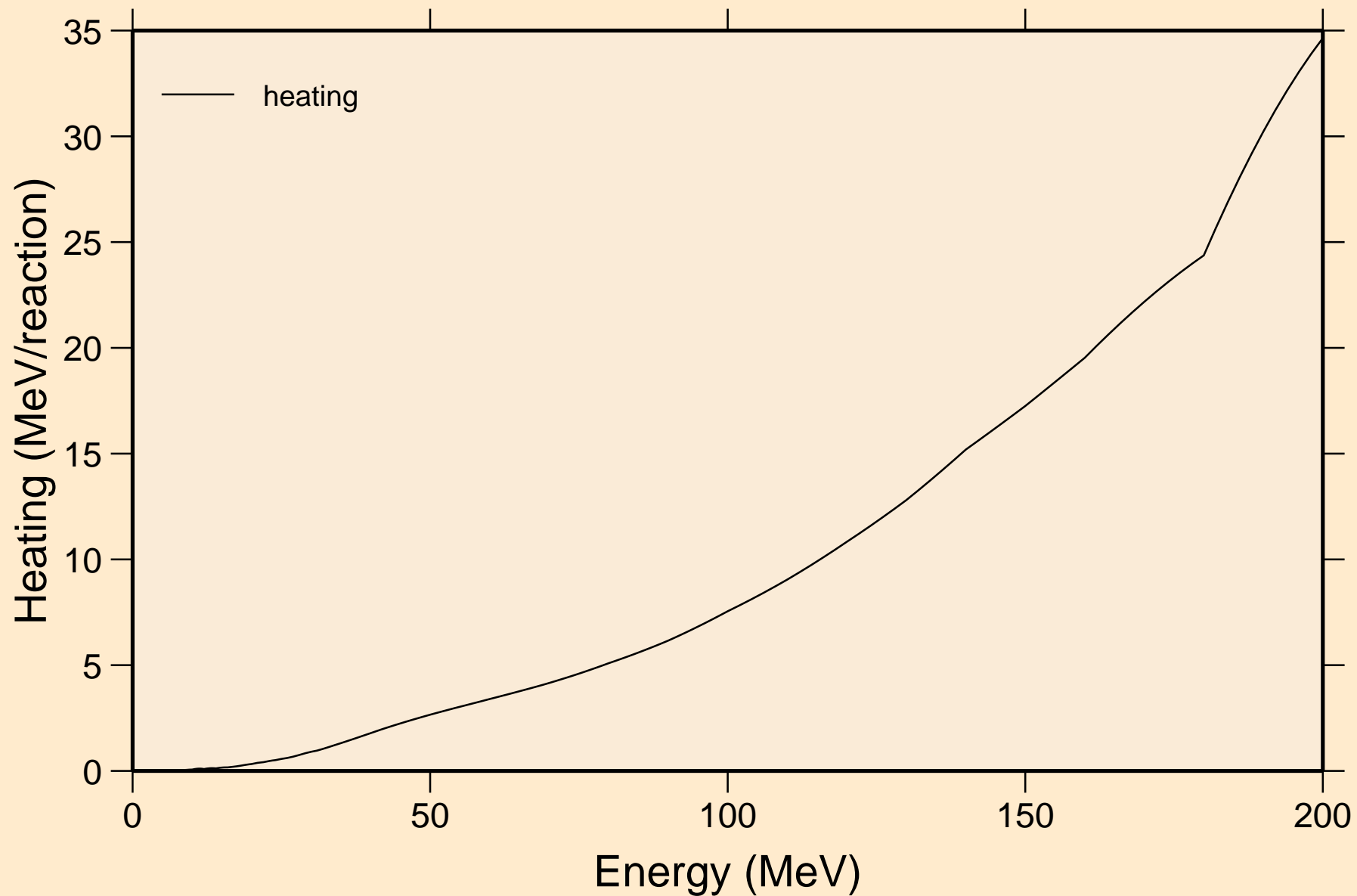

AT211 NEUTRON ACER TENDL-2019 LIBRARY; T=293.16K
Damage

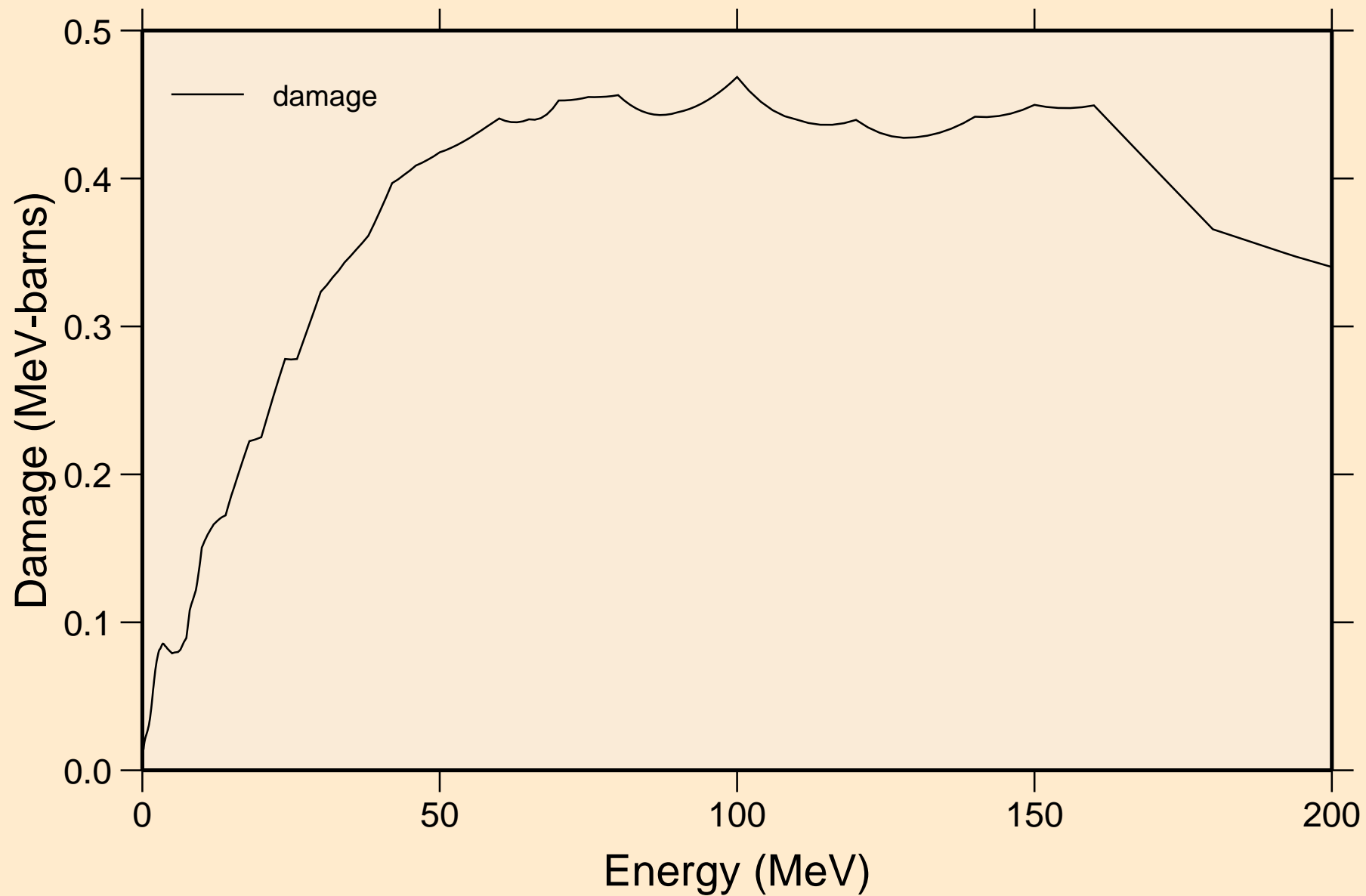

AT211 NEUTRON ACER TENDL-2019 LIBRARY; T=293.16K
Non-threshold reactions

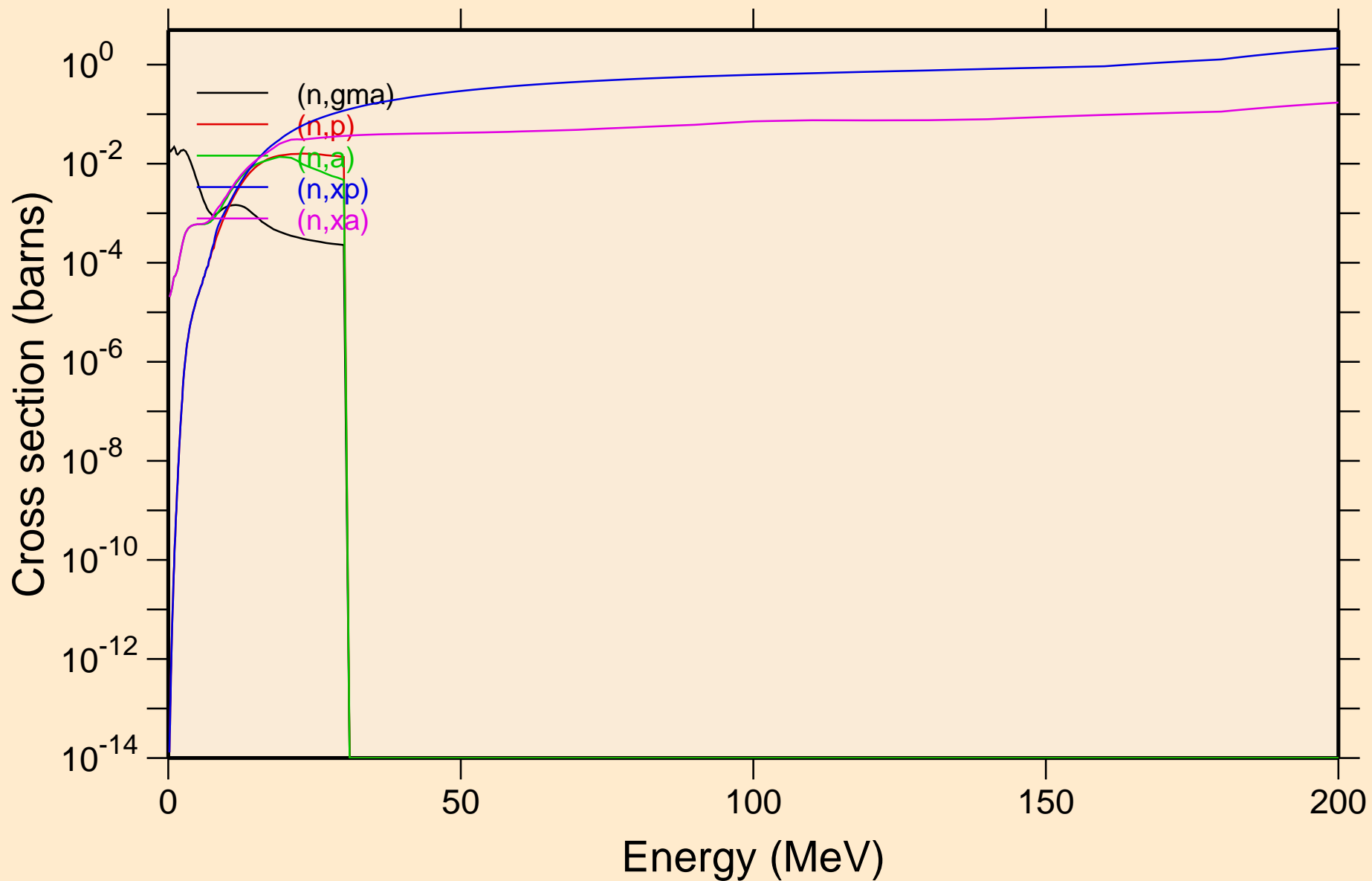

AT211 NEUTRON ACER TENDL-2019 LIBRARY; T=293.16K
Inelastic levels

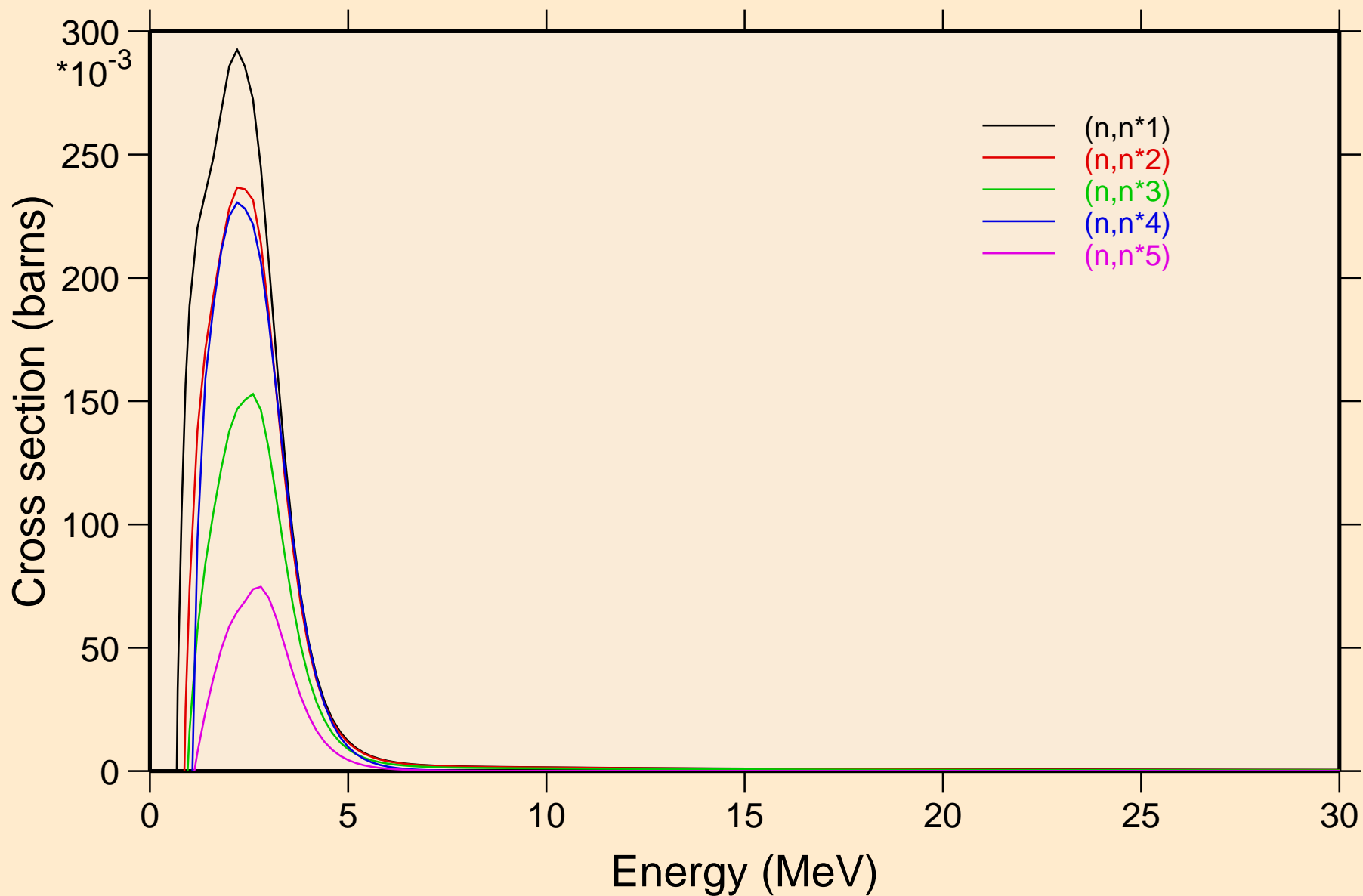

AT211 NEUTRON ACER TENDL-2019 LIBRARY; T=293.16K
Inelastic levels

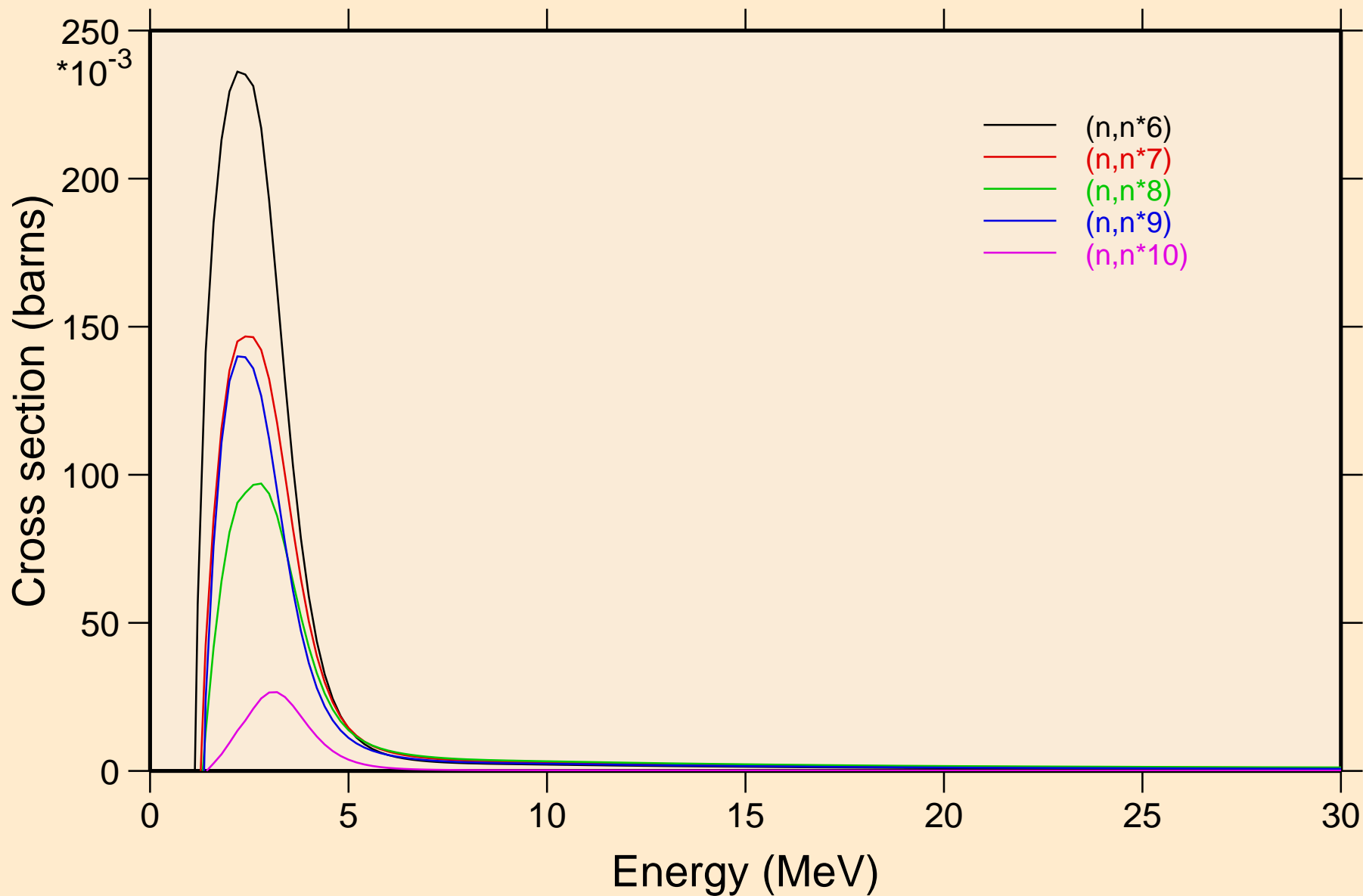

AT211 NEUTRON ACER TENDL-2019 LIBRARY; T=293.16K
Inelastic levels

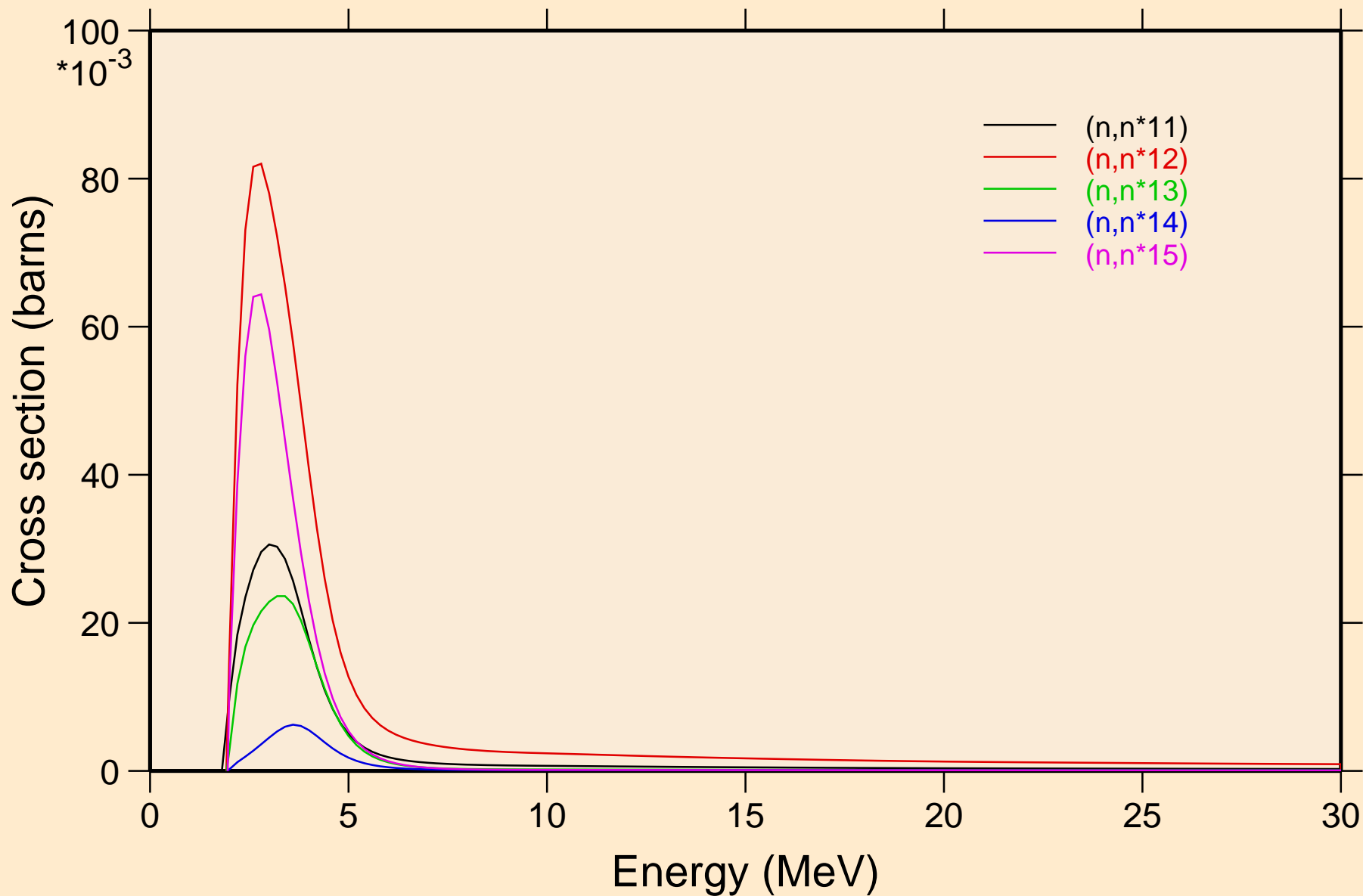

AT211 NEUTRON ACER TENDL-2019 LIBRARY; T=293.16K
Inelastic levels

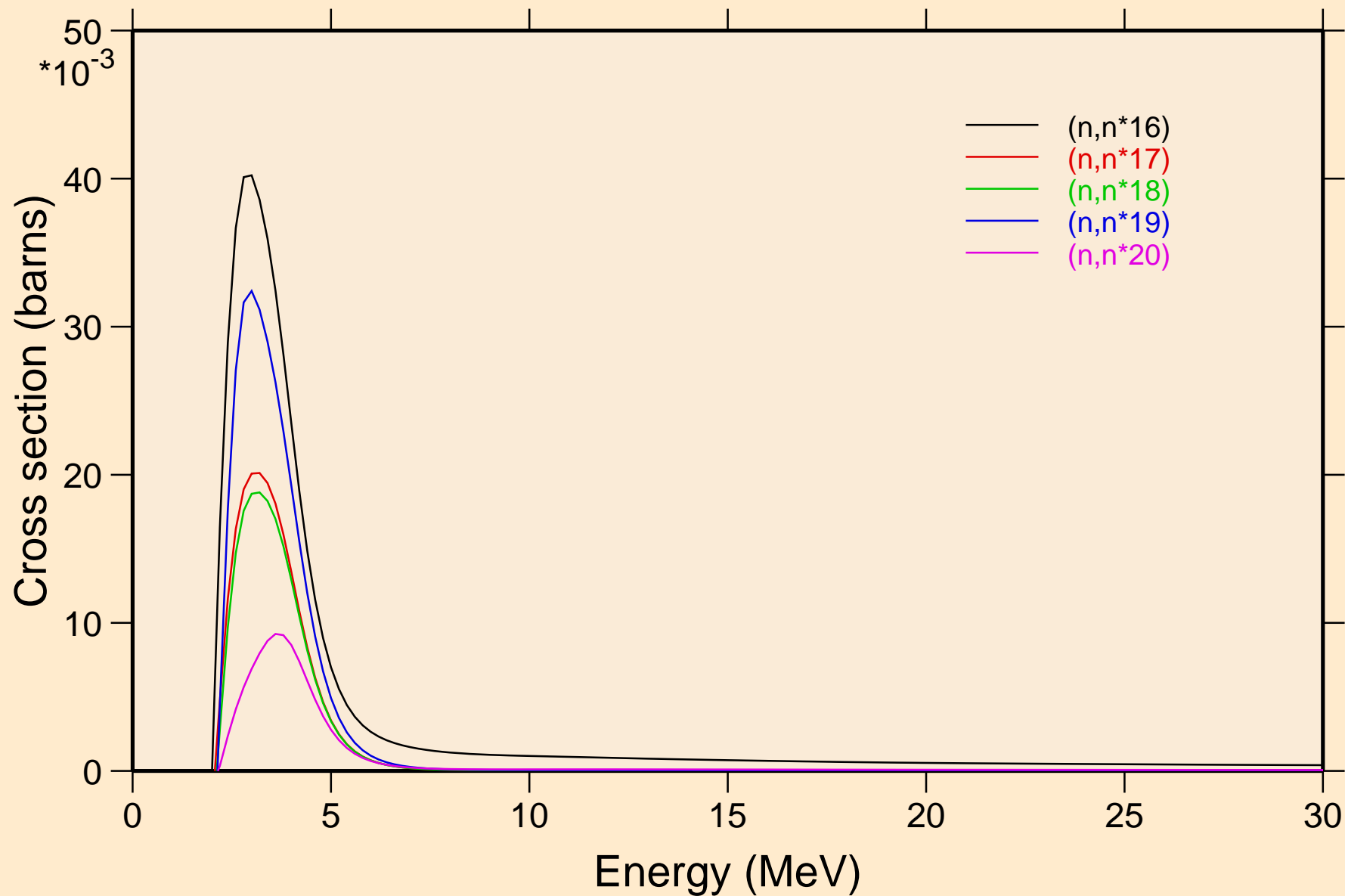

AT211 NEUTRON ACER TENDL-2019 LIBRARY; T=293.16K
Inelastic levels

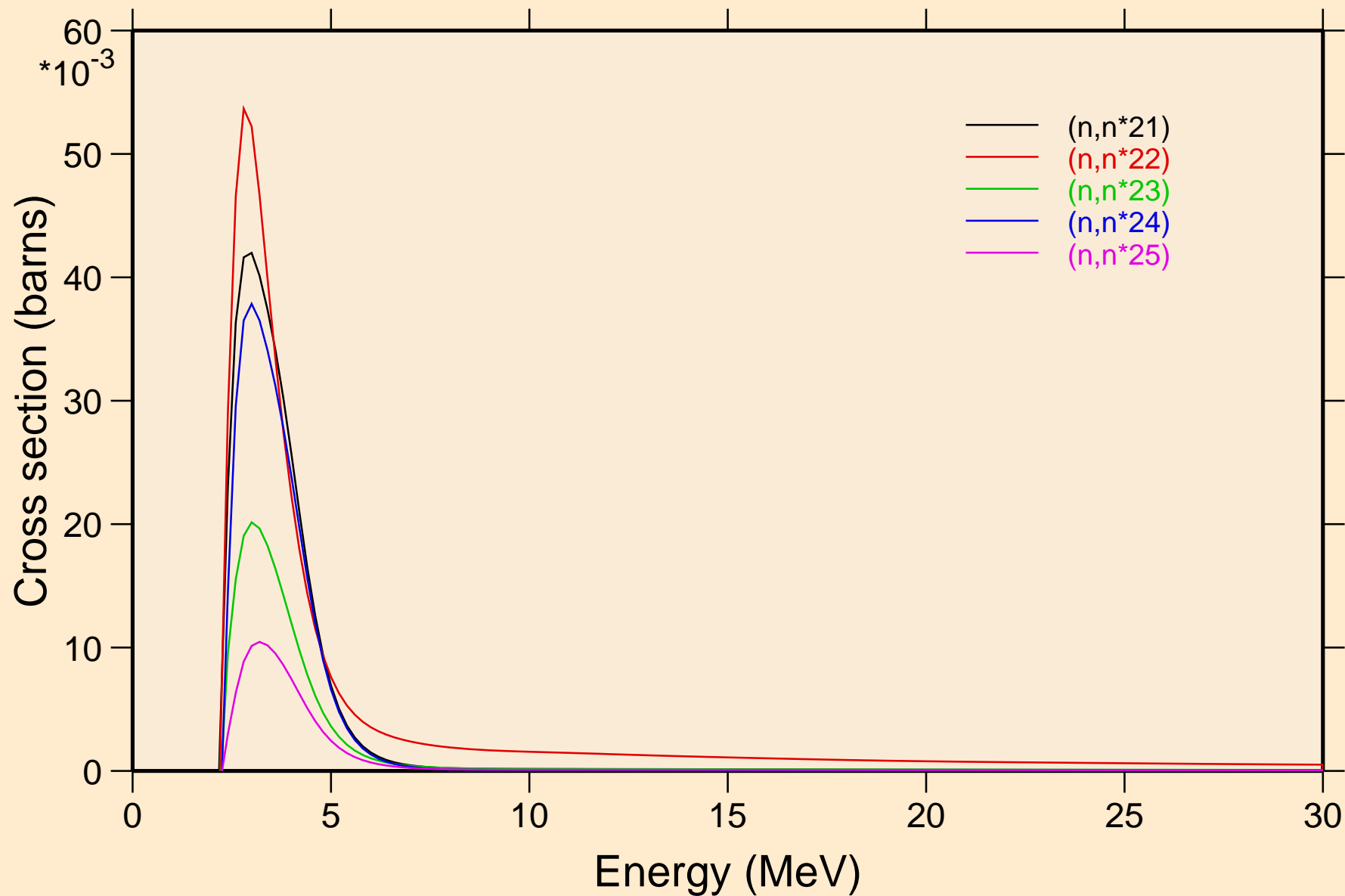

AT211 NEUTRON ACER TENDL-2019 LIBRARY; T=293.16K
Inelastic levels

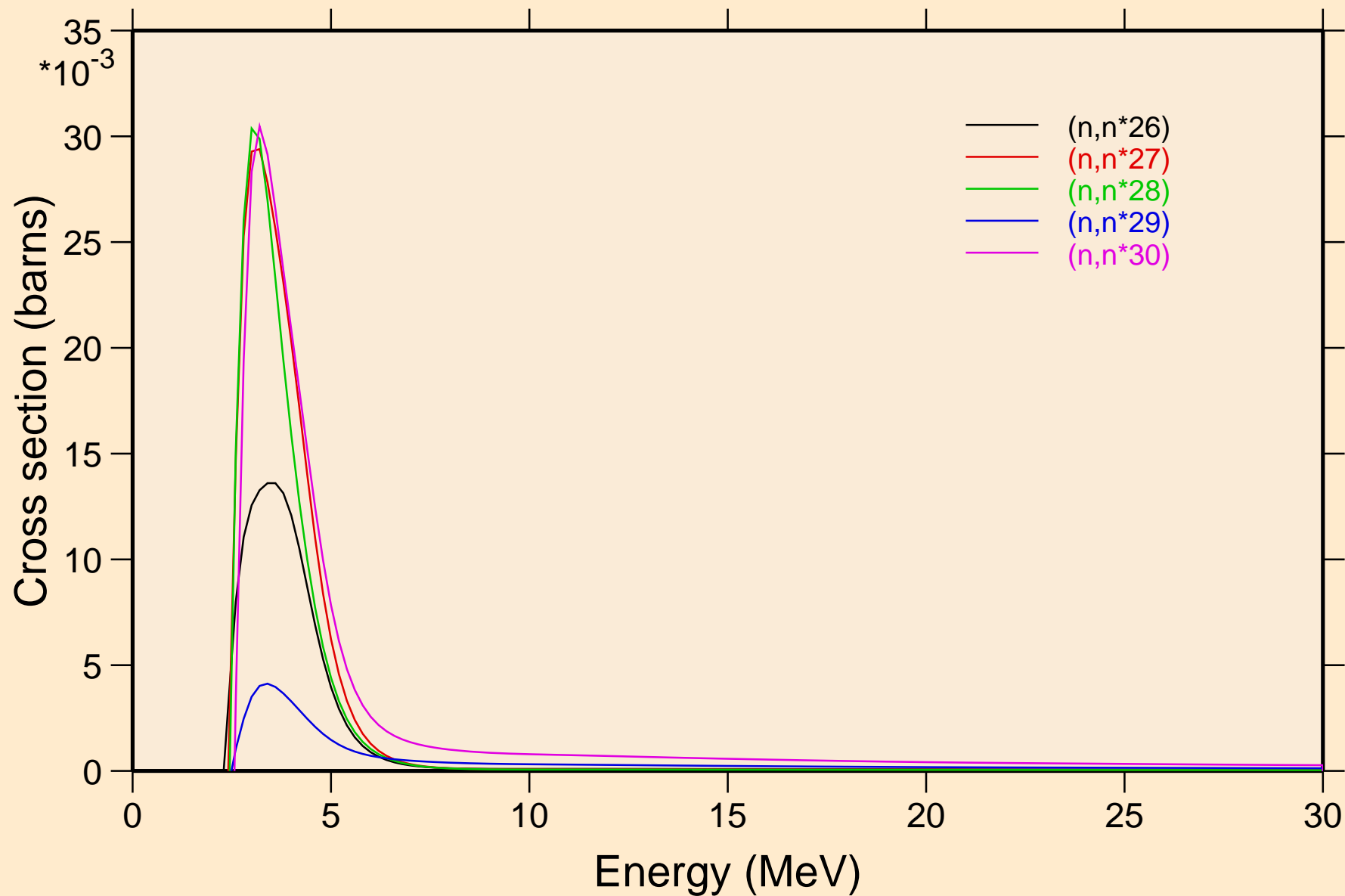

AT211 NEUTRON ACER TENDL-2019 LIBRARY; T=293.16K
Threshold reactions

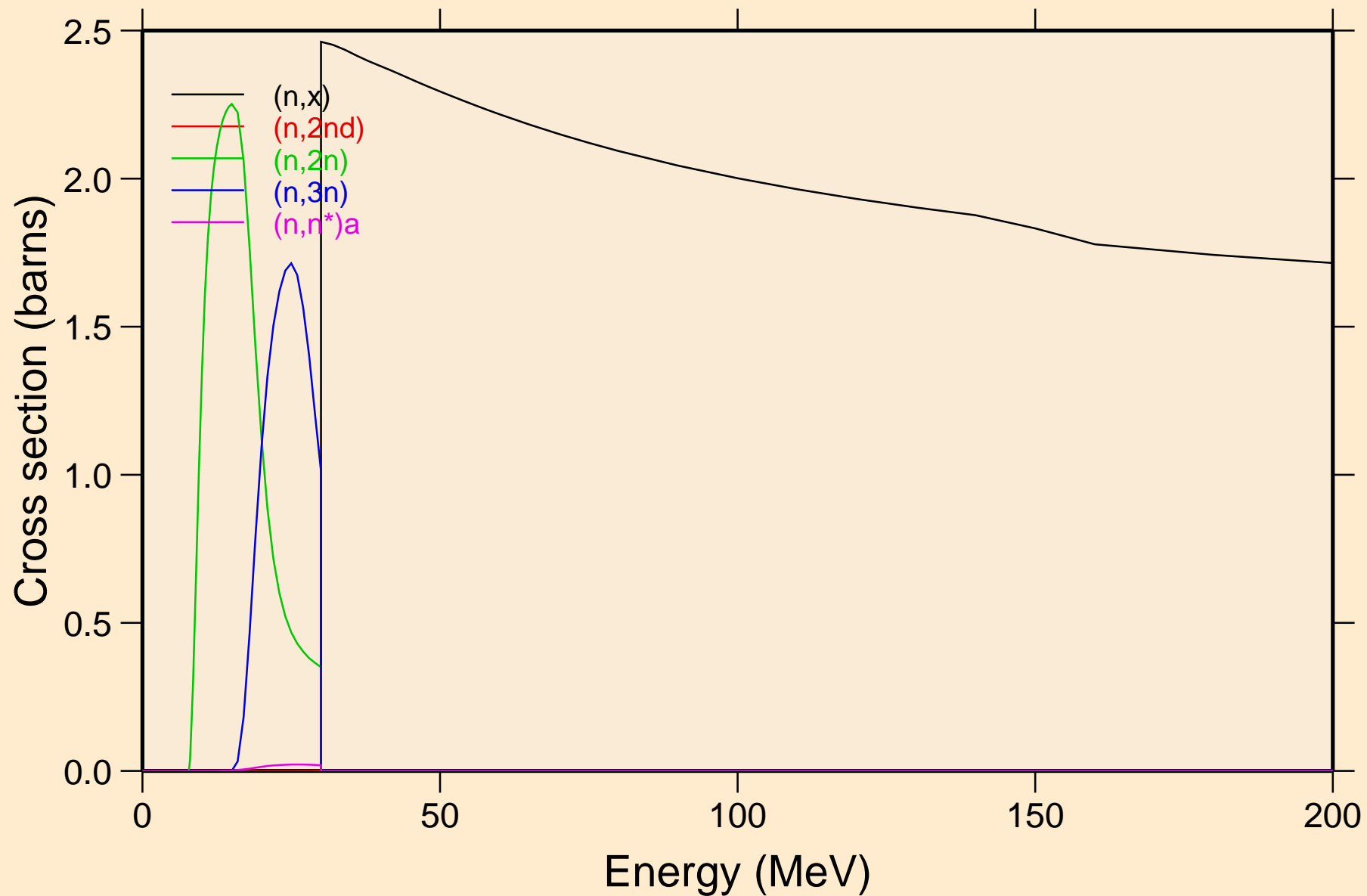

AT211 NEUTRON ACER TENDL-2019 LIBRARY; T=293.16K
Threshold reactions

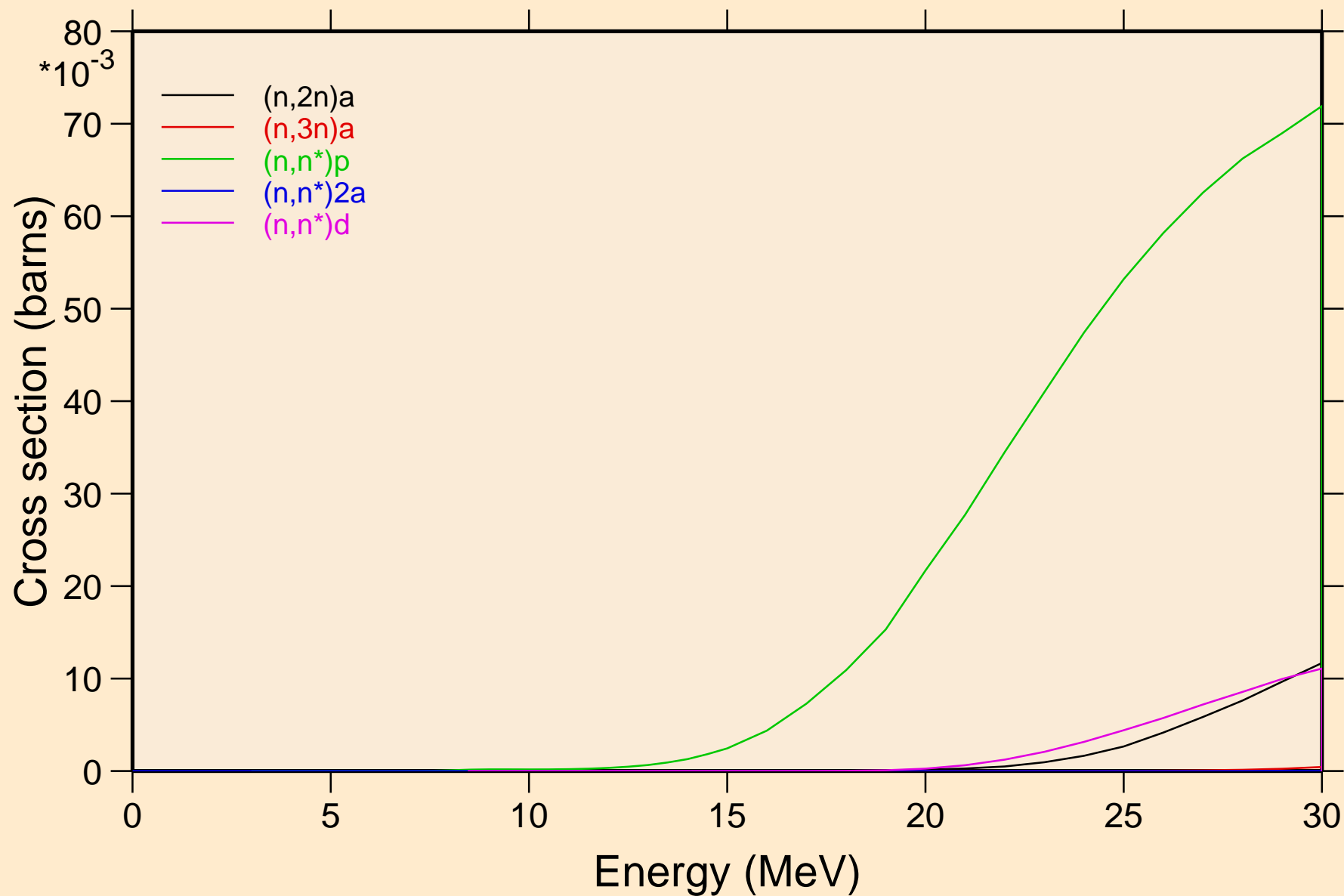

AT211 NEUTRON ACER TENDL-2019 LIBRARY; T=293.16K
Threshold reactions

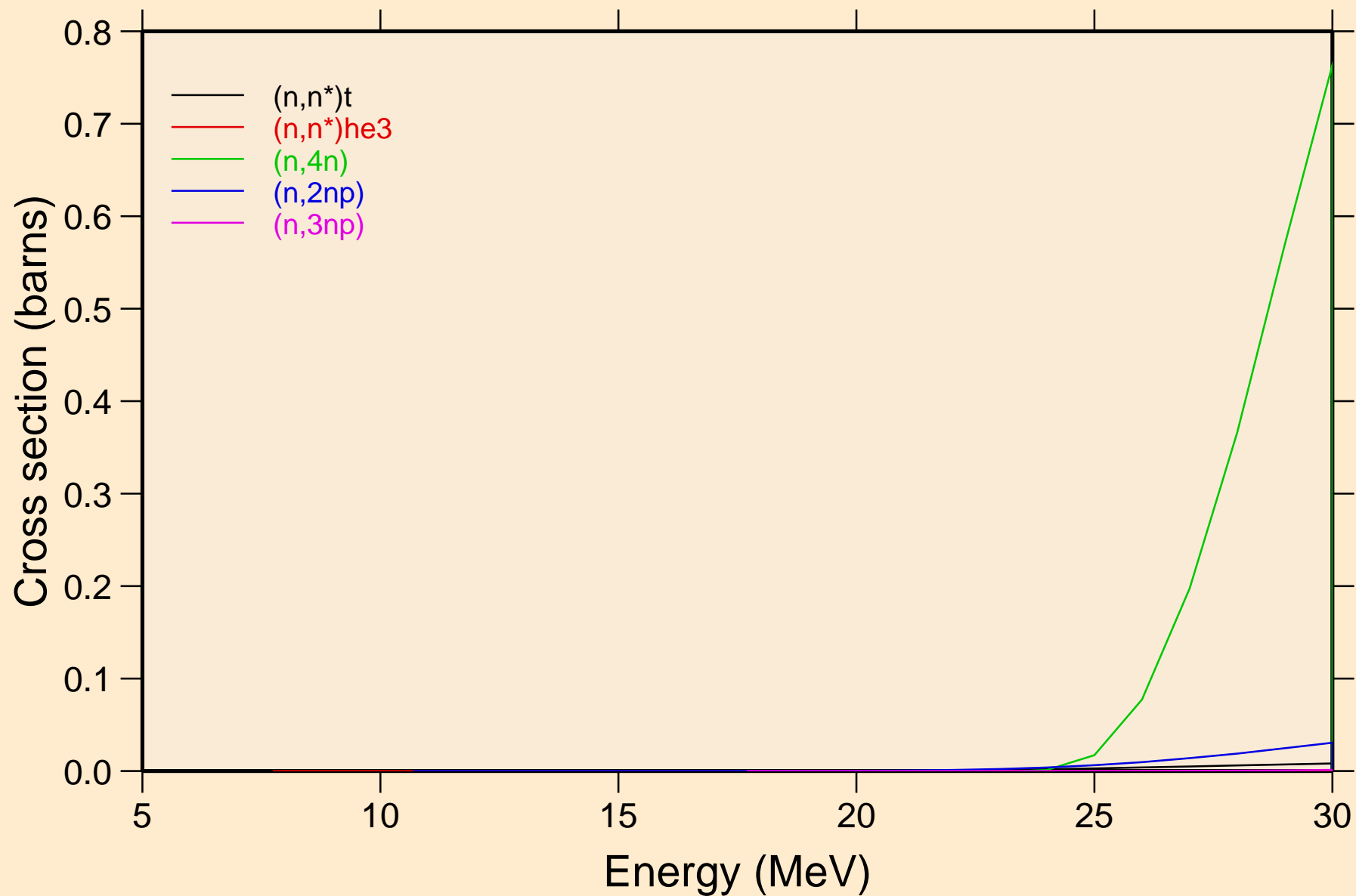

AT211 NEUTRON ACER TENDL-2019 LIBRARY; T=293.16K
Threshold reactions

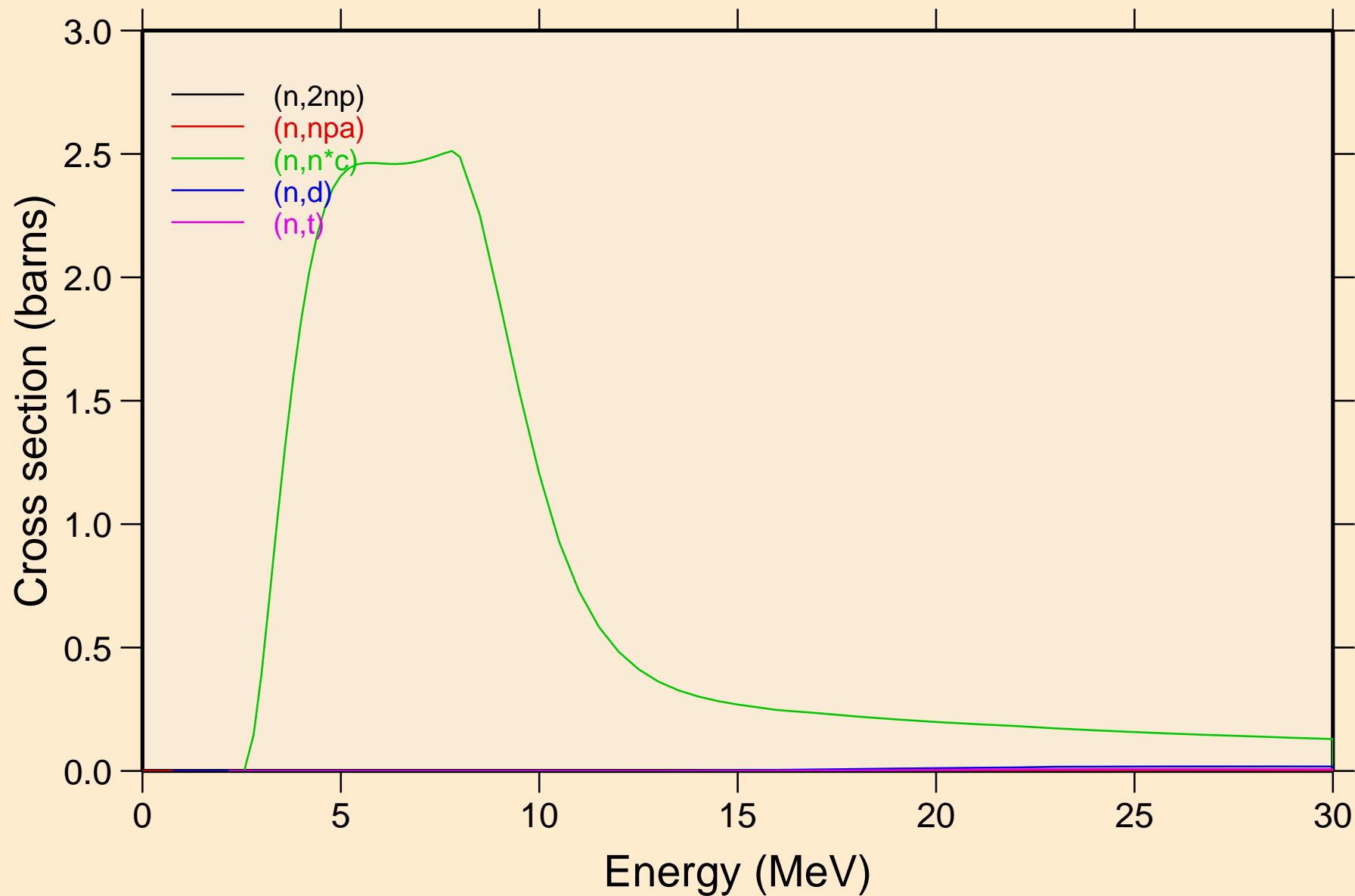

AT211 NEUTRON ACER TENDL-2019 LIBRARY; T=293.16K
Threshold reactions

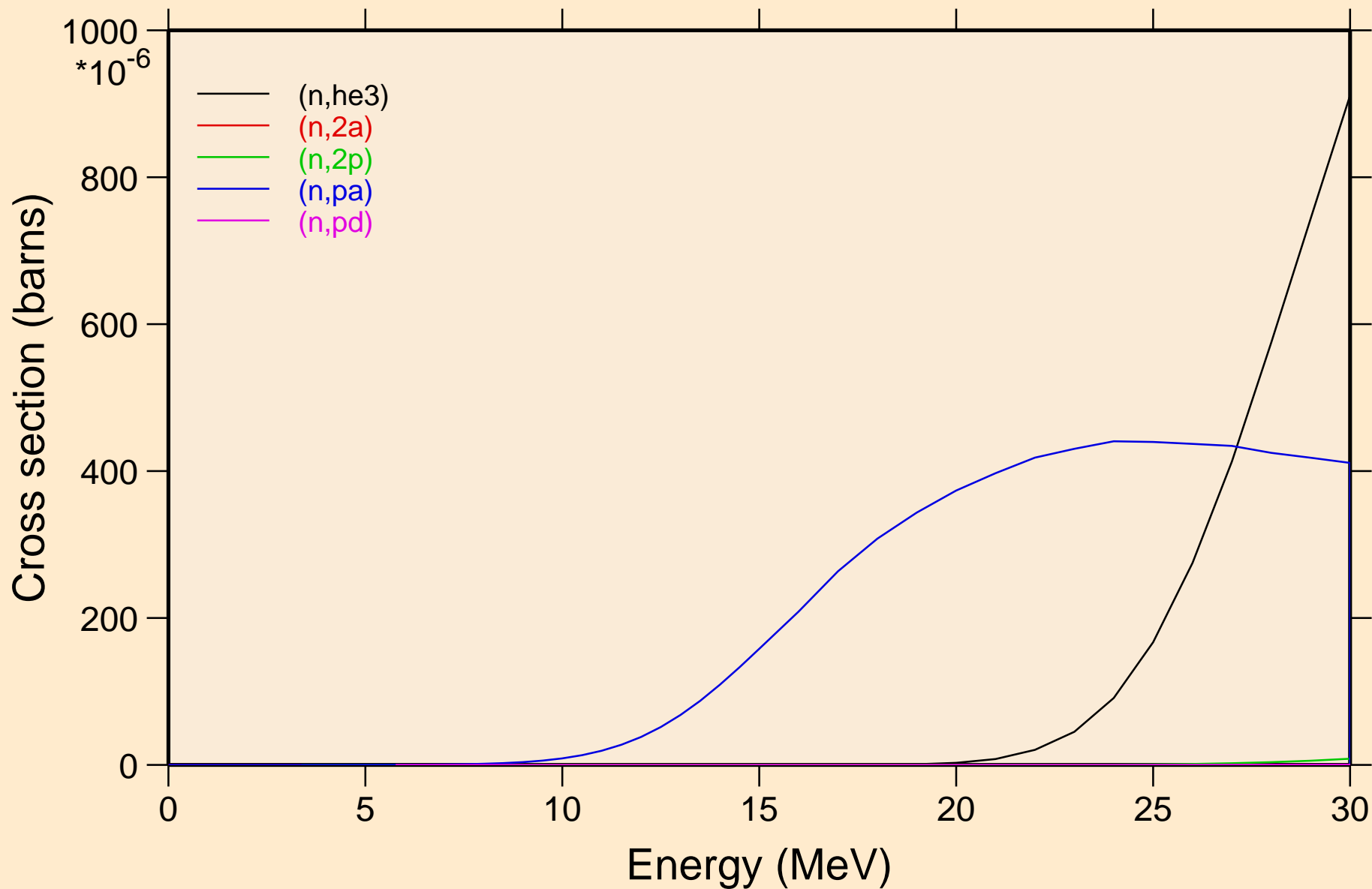

AT211 NEUTRON ACER TENDL-2019 LIBRARY; T=293.16K
Threshold reactions

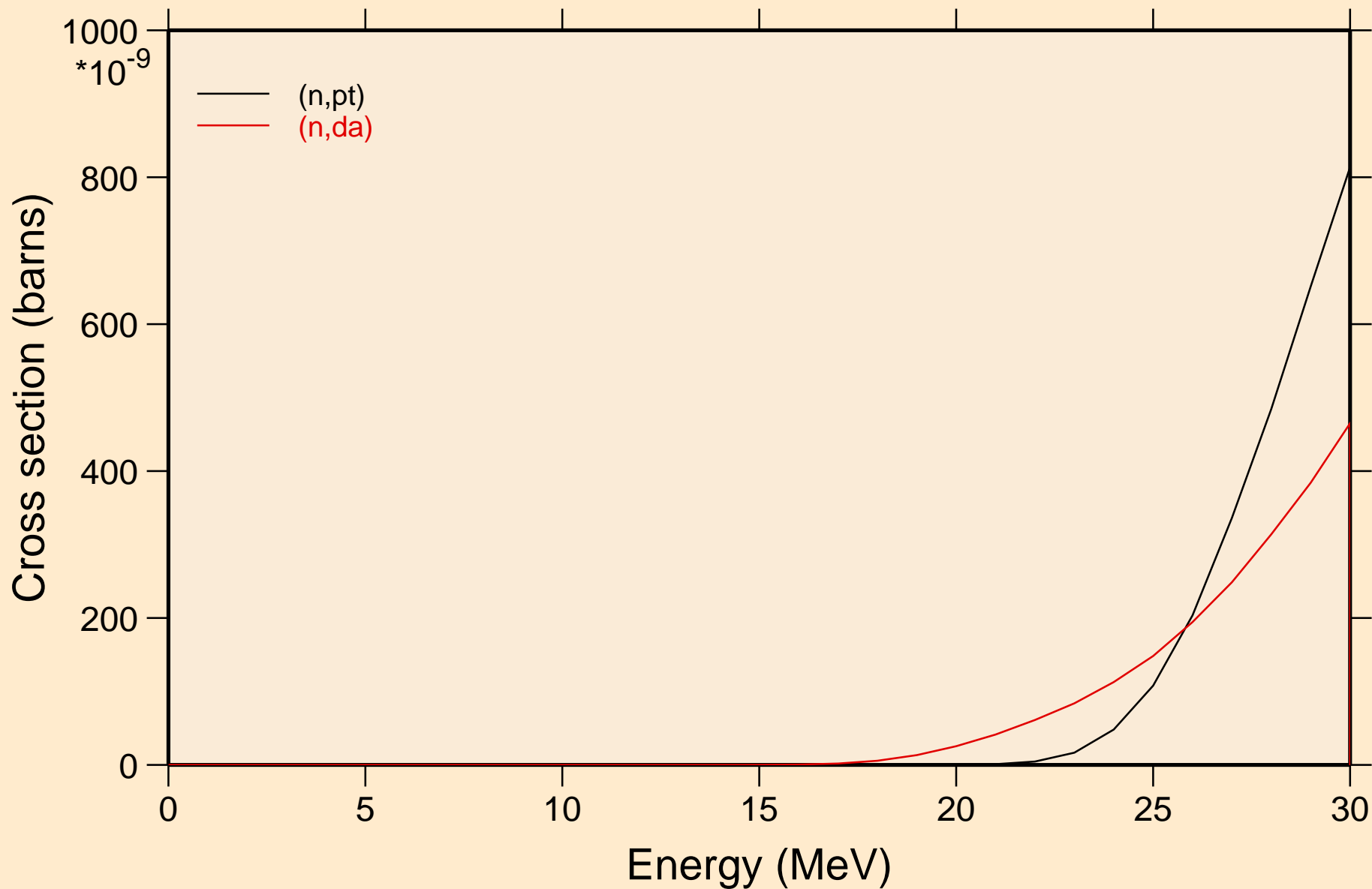

AT211 NEUTRON ACER TENDL-2019 LIBRARY; T=293.16K
Threshold reactions

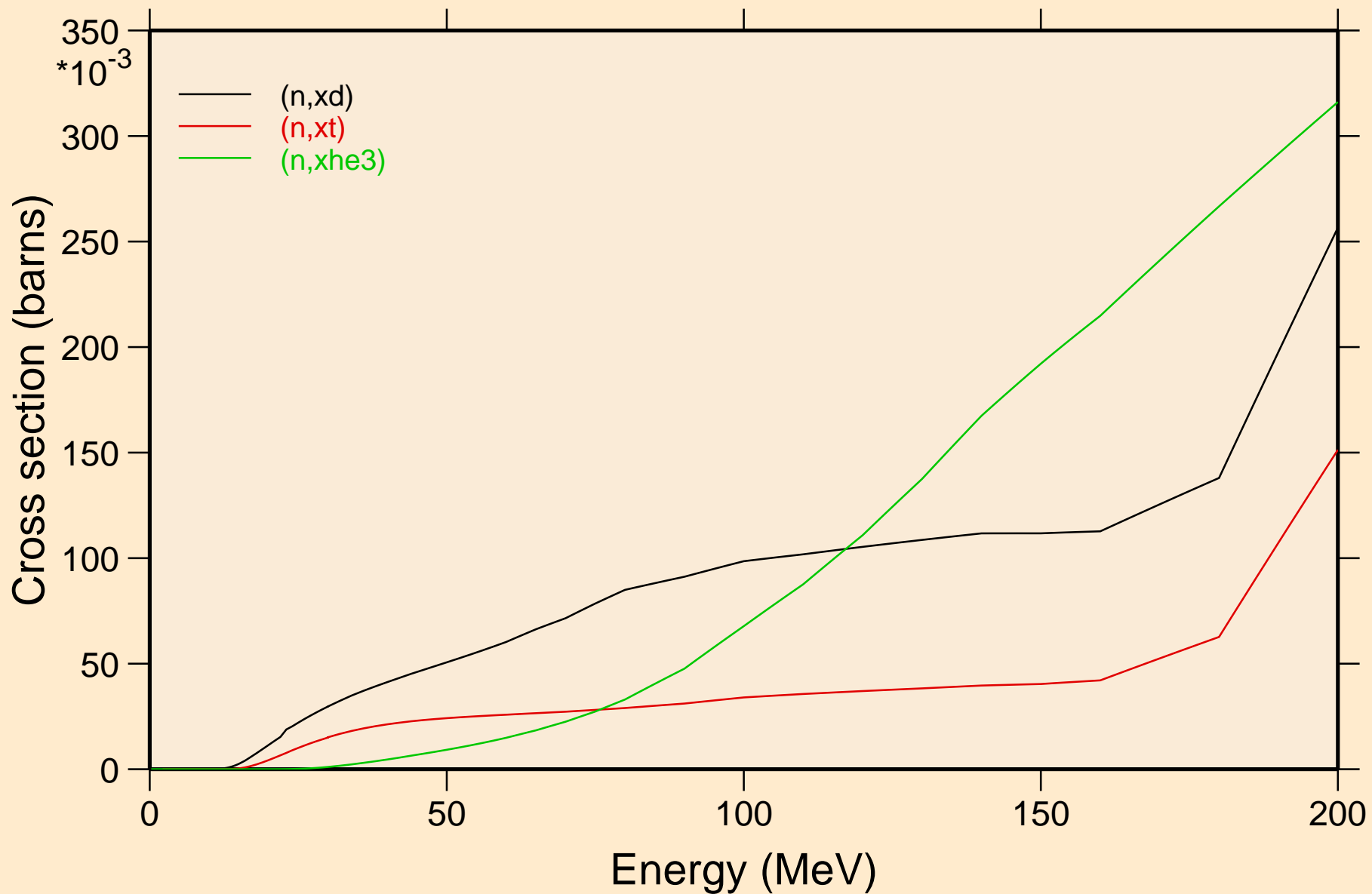

AT211 NEUTRON ACER TENDL-2019 LIBRARY; T=293.16K
angular distribution for elastic

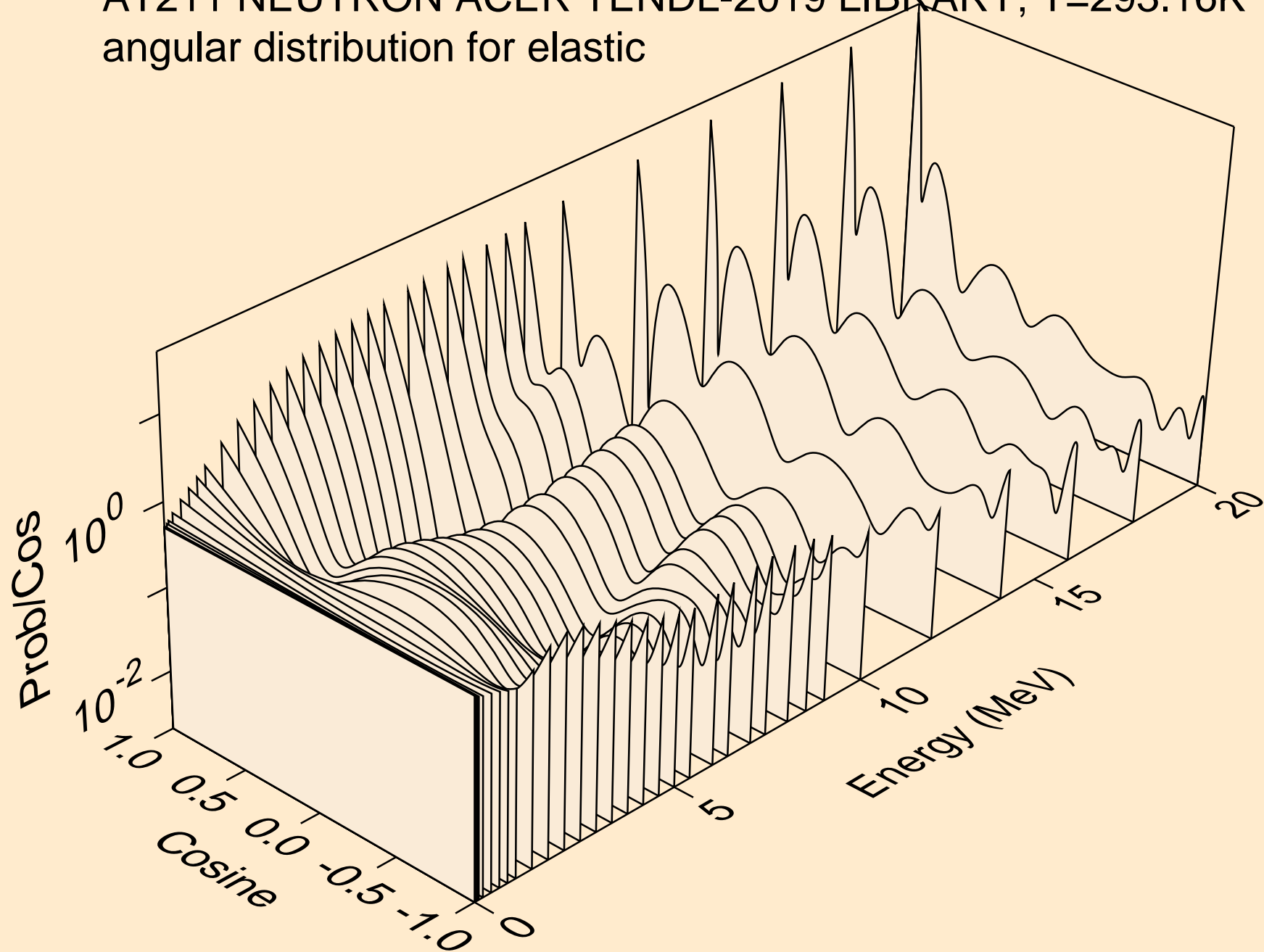

AT211 NEUTRON ACER TENDL-2019 LIBRARY; T=293.16K
angular distribution for elastic

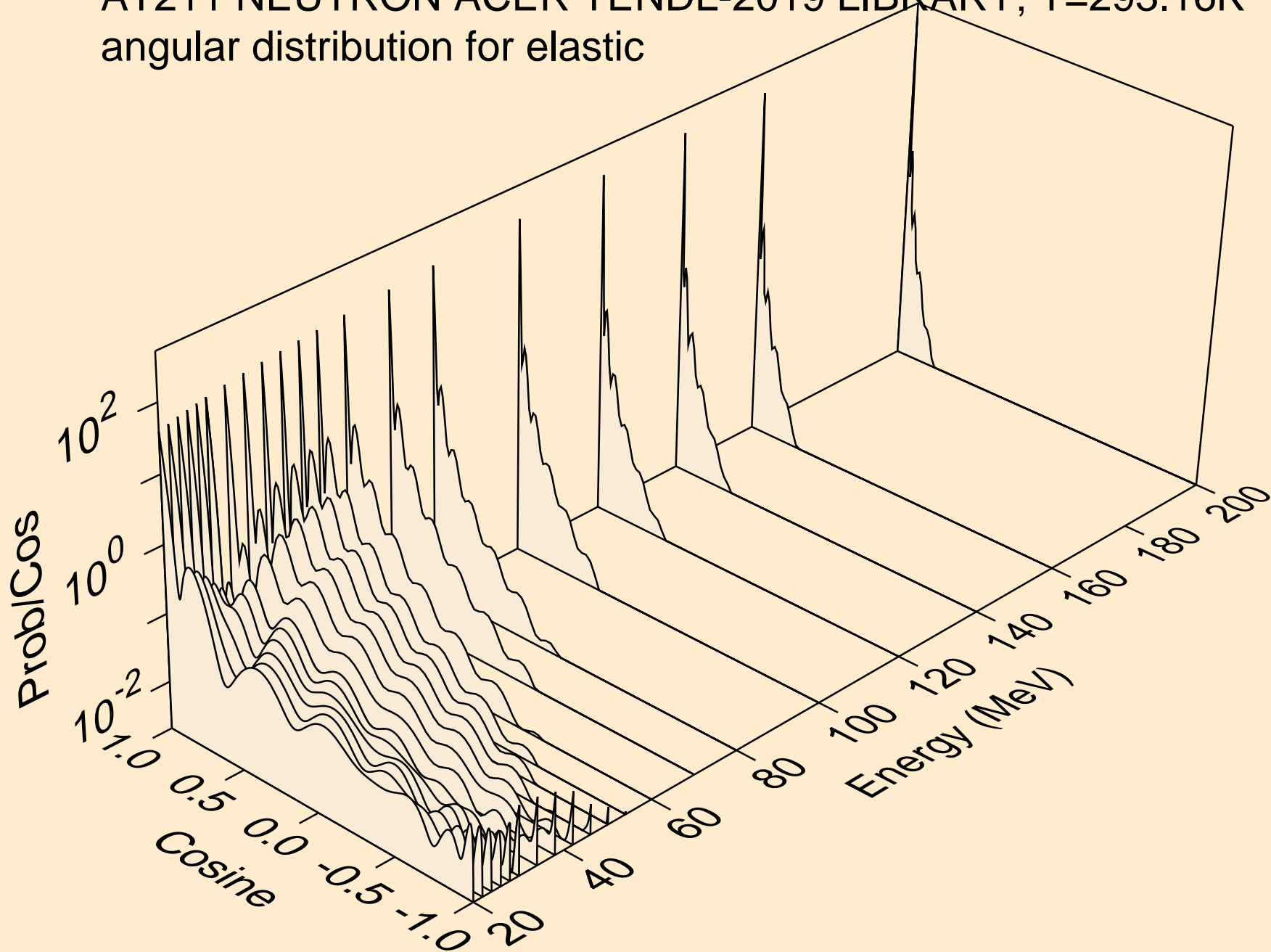

AT211 NEUTRON ACER TENDL-2019 LIBRARY; T=293.16K
angular distribution for (n,n*1)

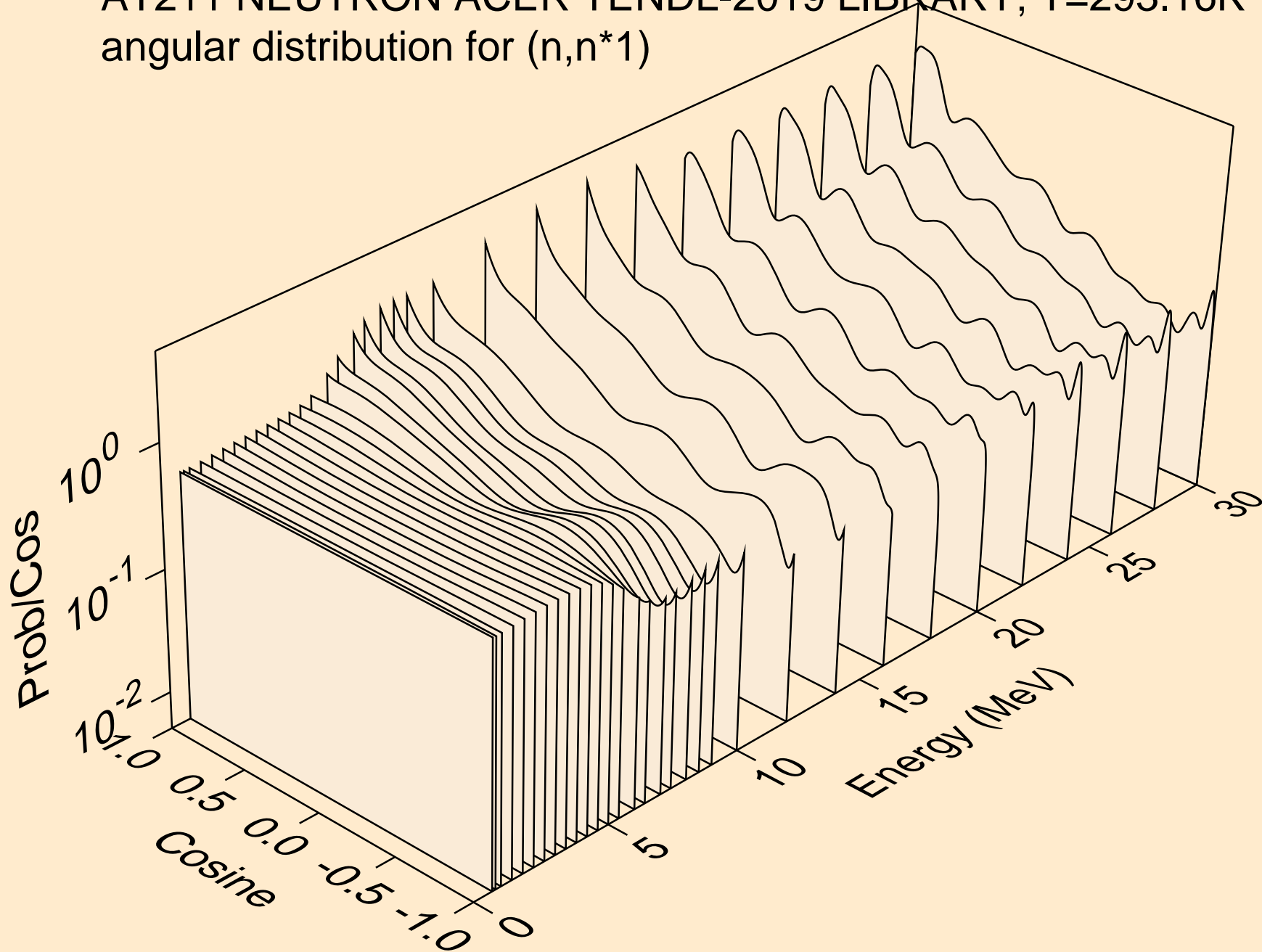

AT211 NEUTRON ACER TENDL-2019 LIBRARY; T=293.16K
angular distribution for (n,n*2)

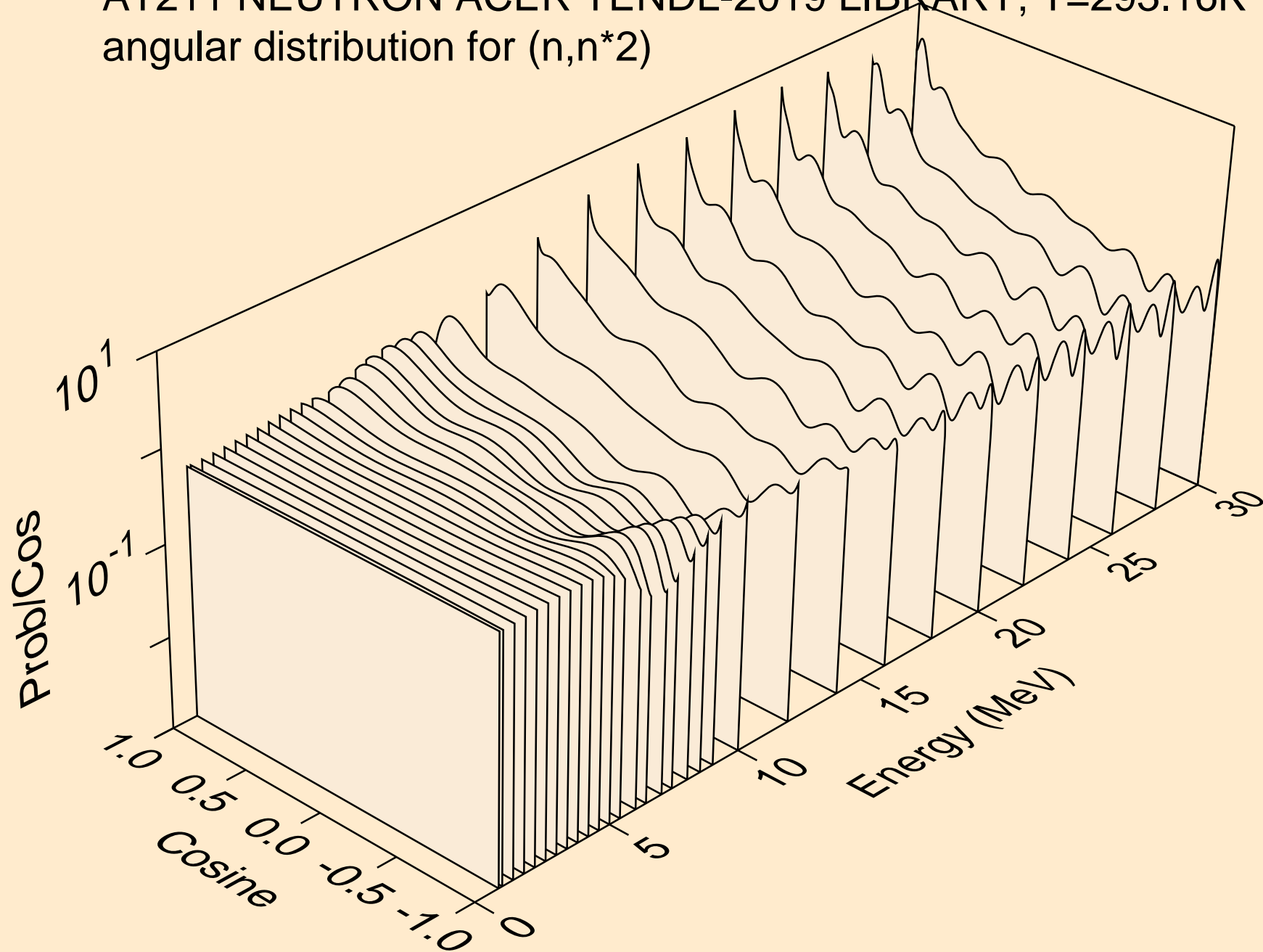

AT211 NEUTRON ACER TENDL-2019 LIBRARY; T=293.16K
angular distribution for (n,n*3)

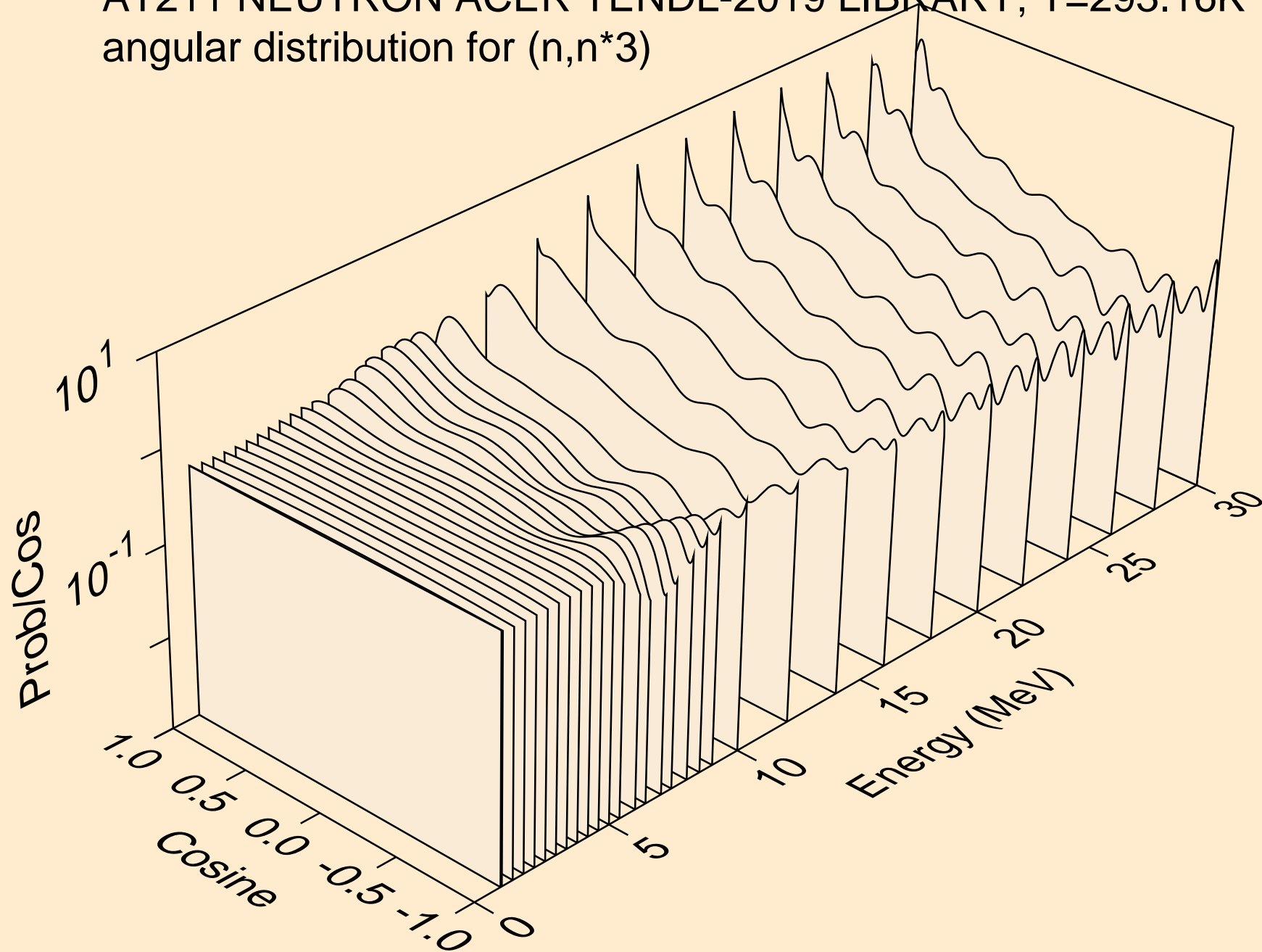

AT211 NEUTRON ACER TENDL-2019 LIBRARY; T=293.16K
angular distribution for (n,n*4)

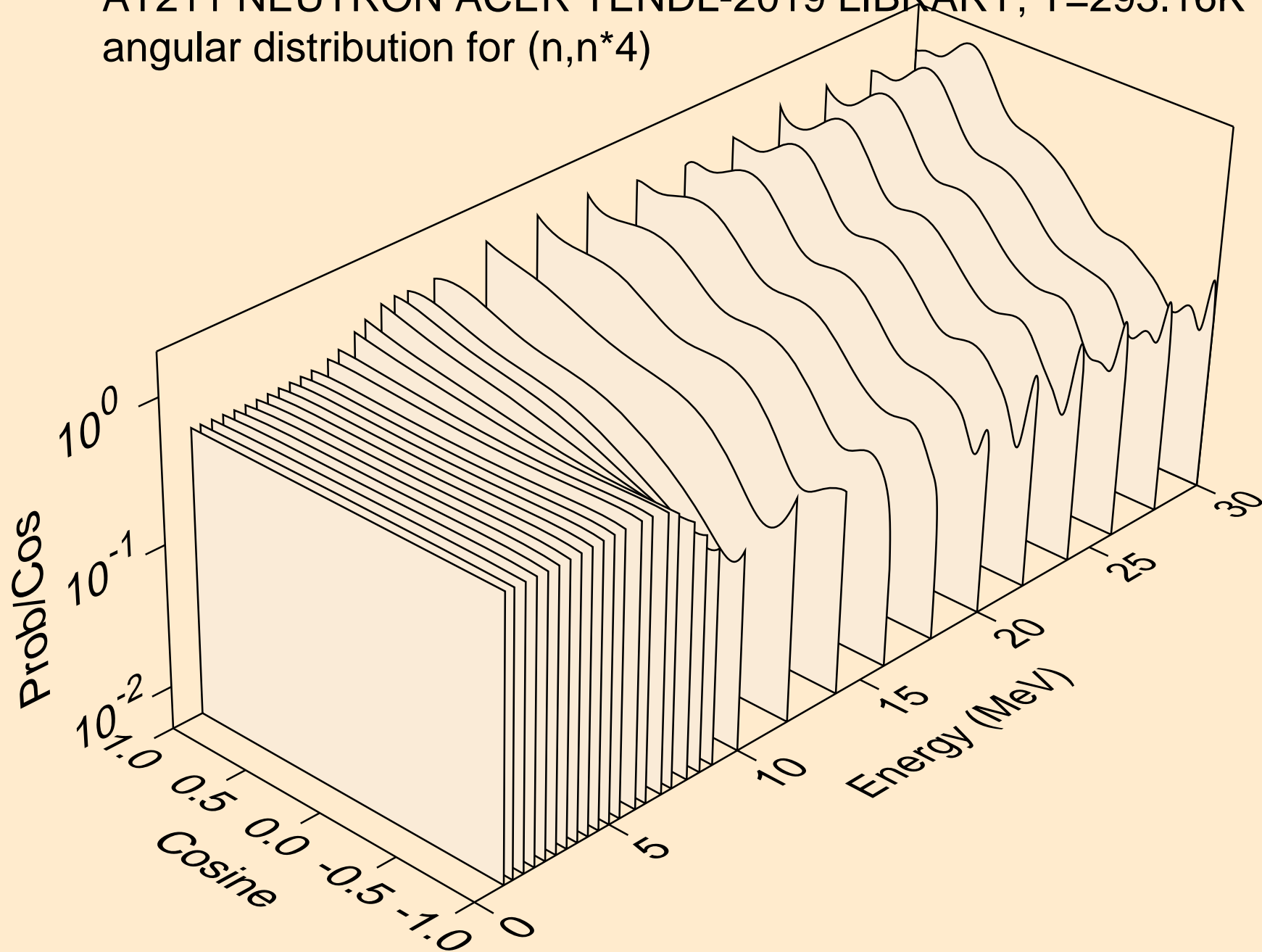

AT211 NEUTRON ACER TENDL-2019 LIBRARY; T=293.16K
angular distribution for (n,n*5)

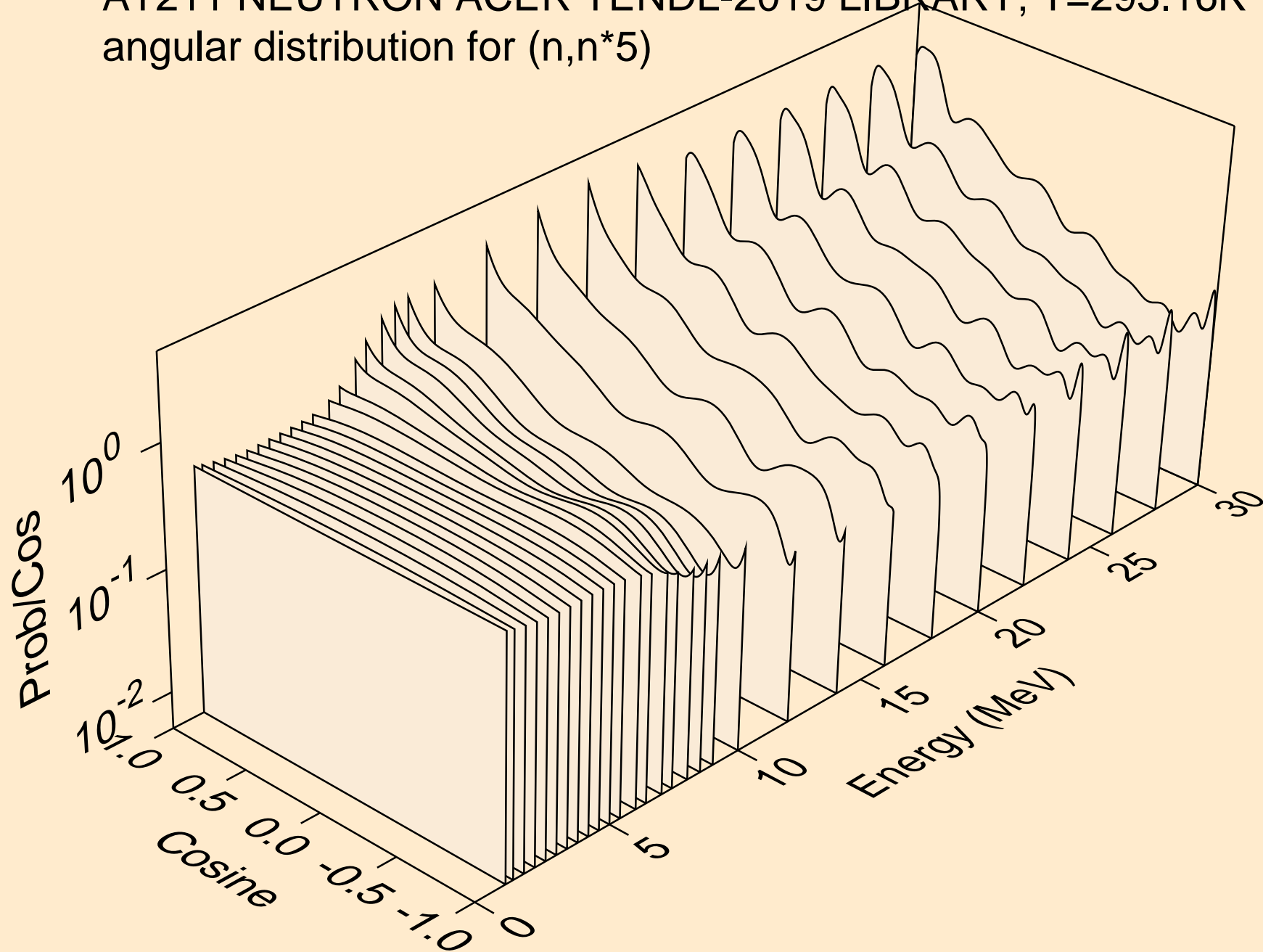

AT211 NEUTRON ACER TENDL-2019 LIBRARY; T=293.16K
angular distribution for (n,n*6)

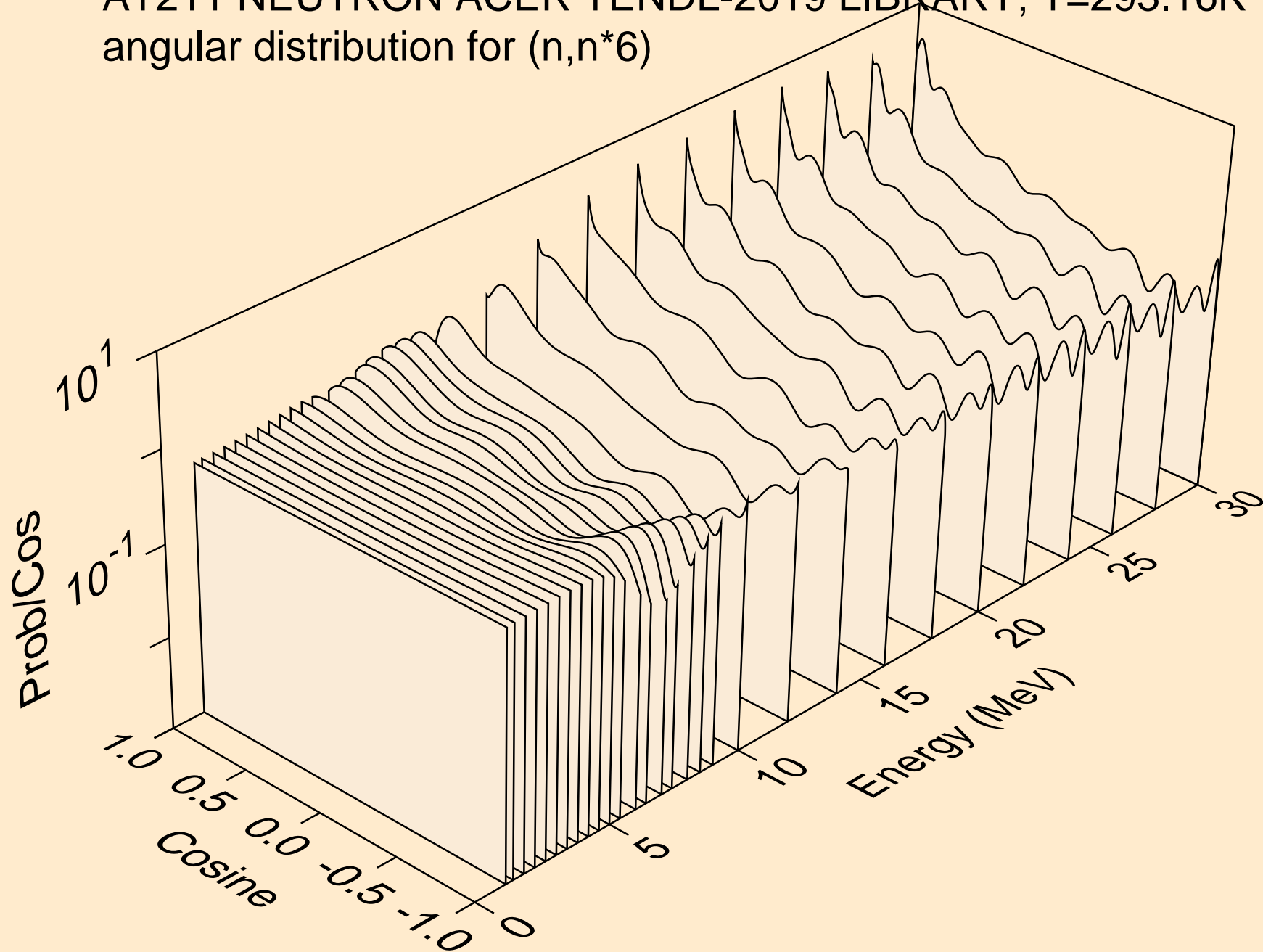

AT211 NEUTRON ACER TENDL-2019 LIBRARY; T=293.16K
angular distribution for (n,n*7)

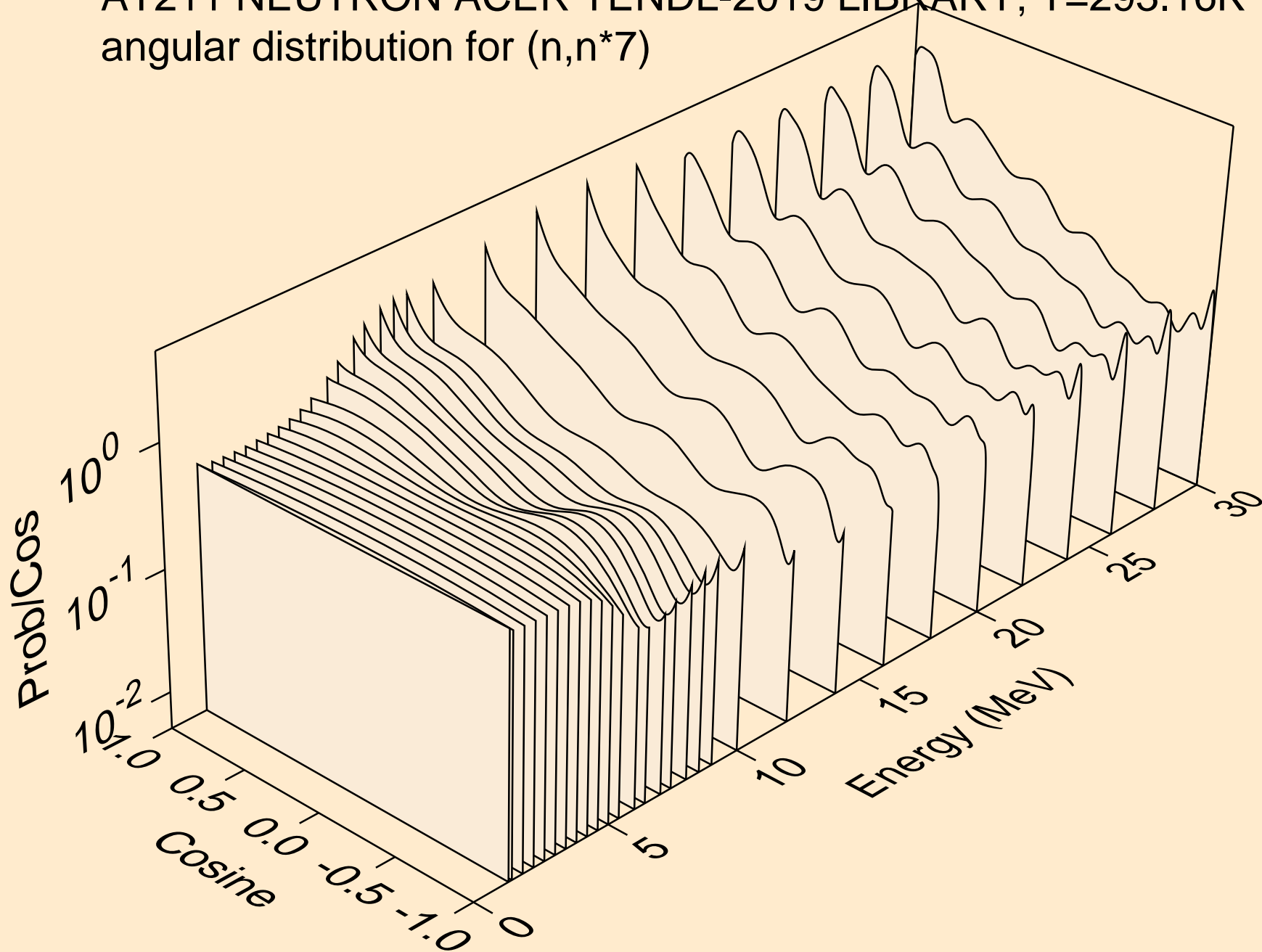

AT211 NEUTRON ACER TENDL-2019 LIBRARY; T=293.16K
angular distribution for (n,n*8)

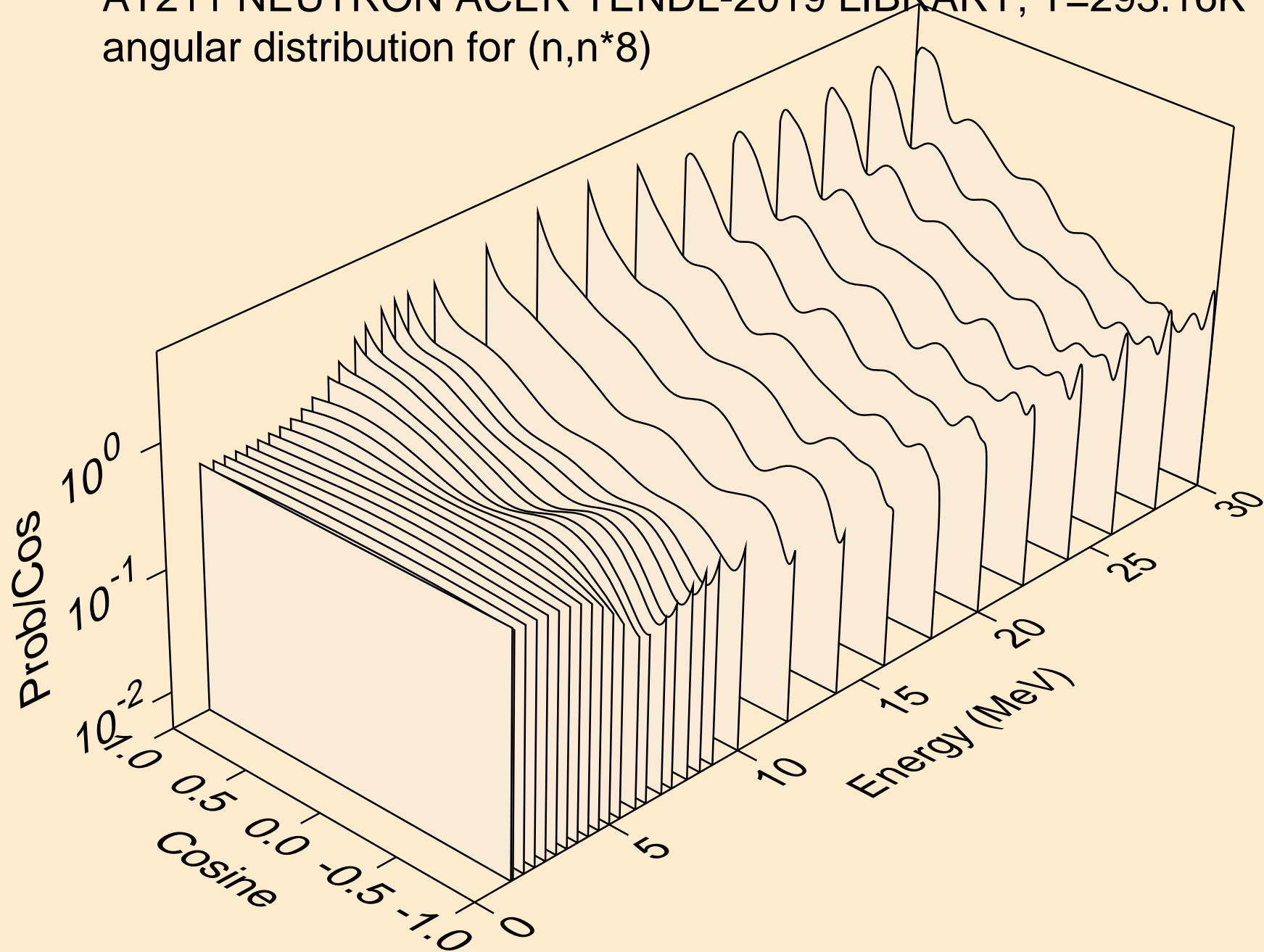

AT211 NEUTRON ACER TENDL-2019 LIBRARY; T=293.16K
angular distribution for (n,n*9)

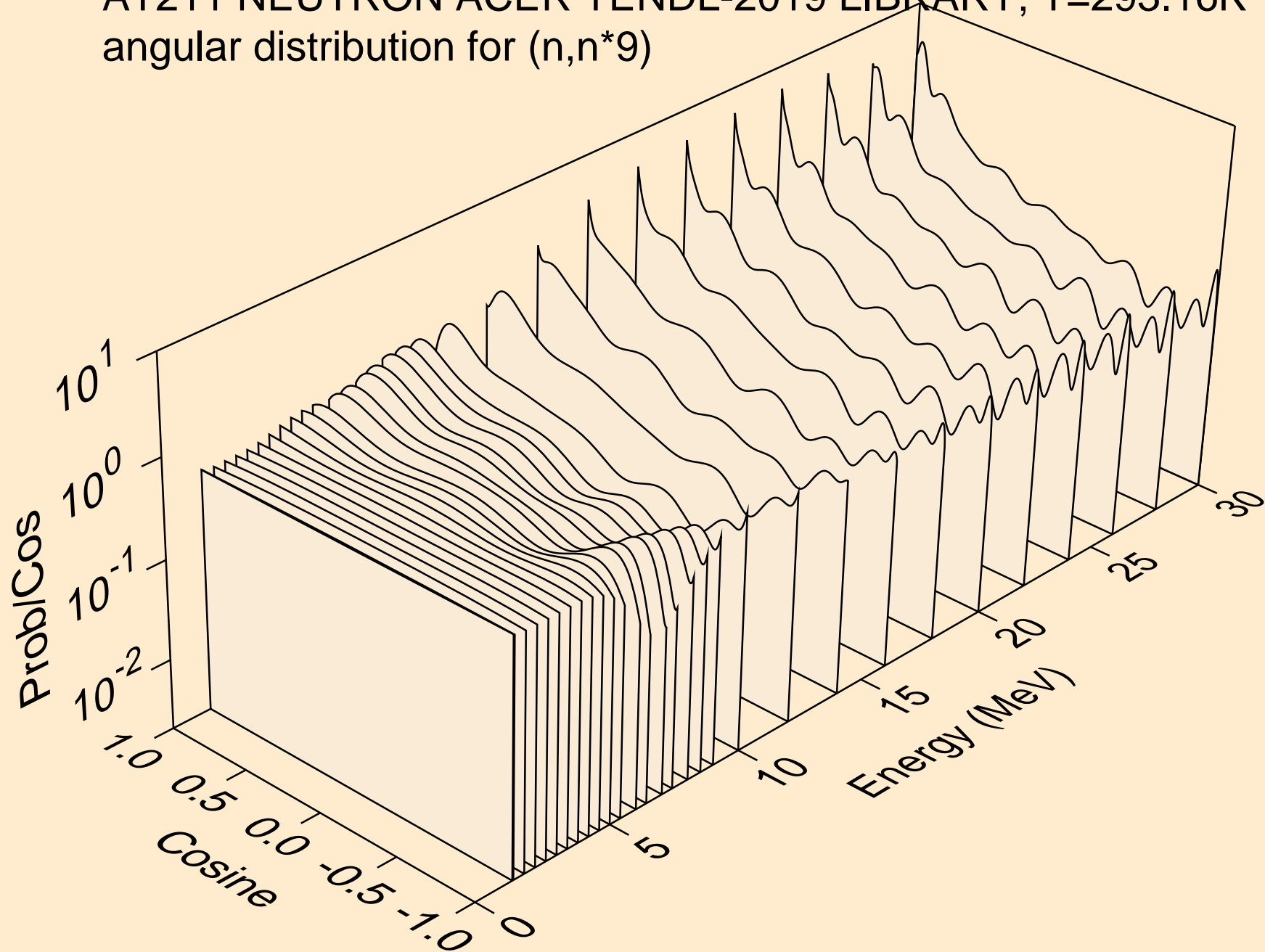

AT211 NEUTRON ACER TENDL-2019 LIBRARY; T=293.16K
angular distribution for (n,n*10)

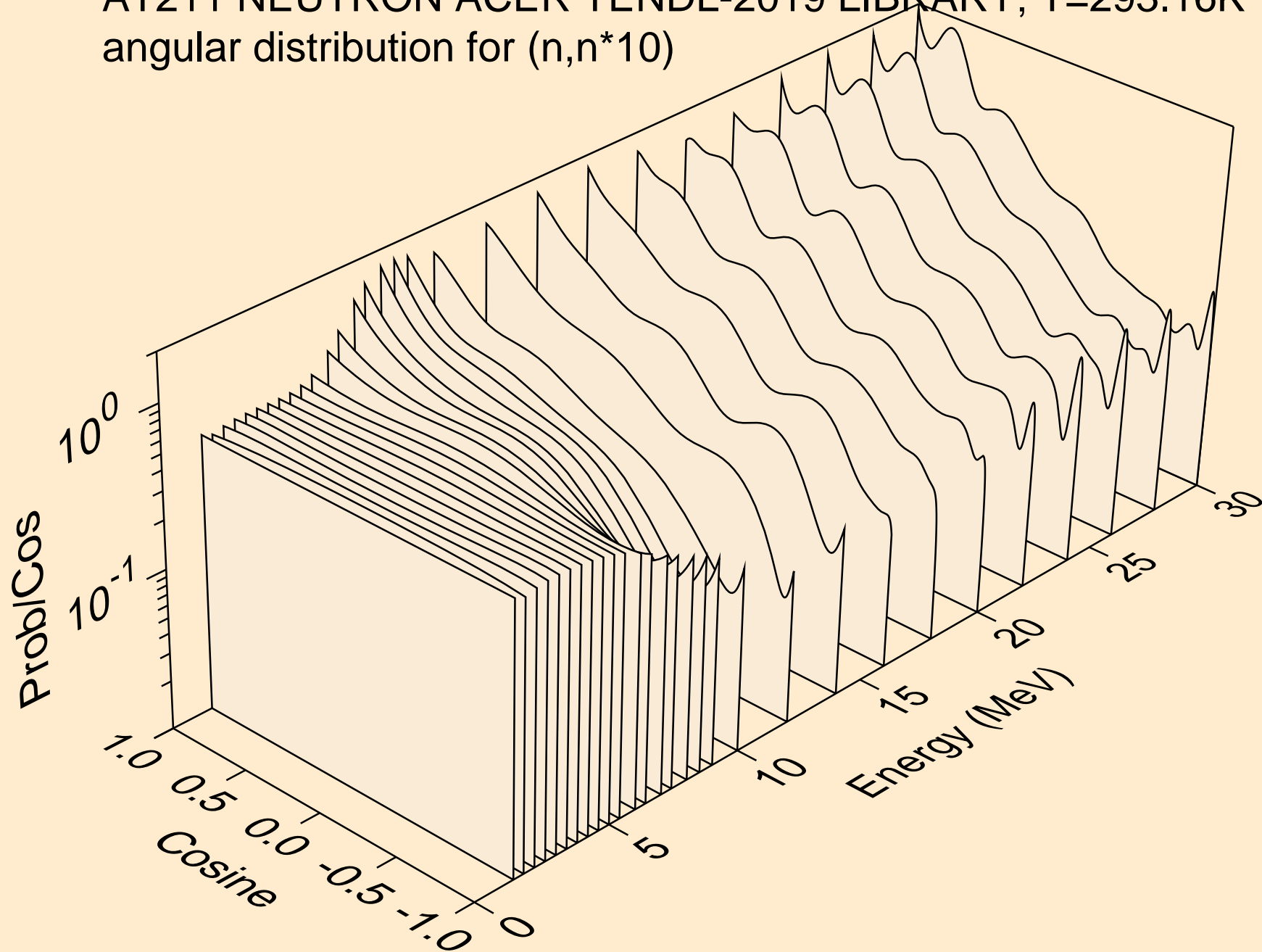

AT211 NEUTRON ACER TENDL-2019 LIBRARY; T=293.16K
angular distribution for (n,n*11)

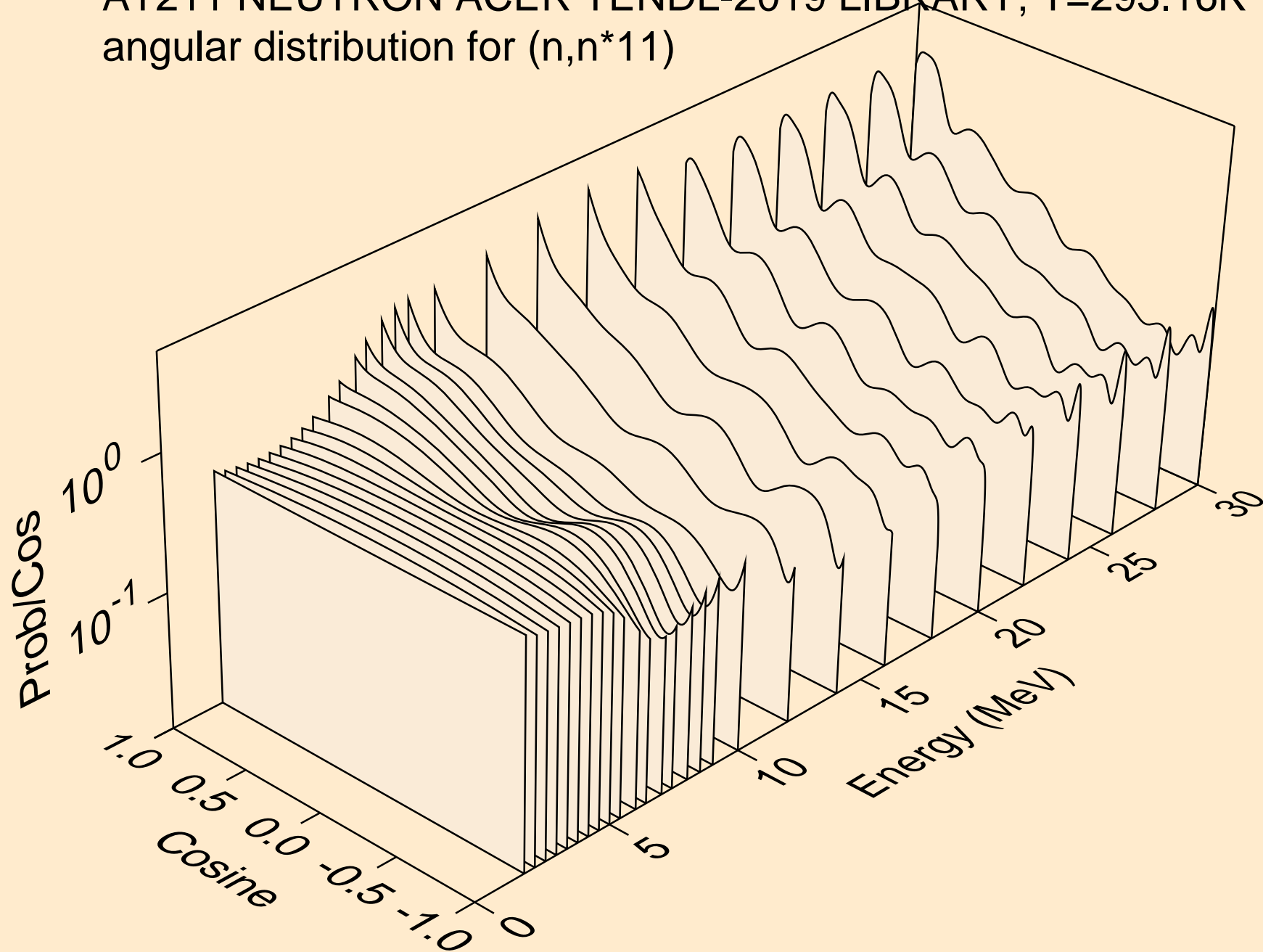

AT211 NEUTRON ACER TENDL-2019 LIBRARY; T=293.16K
angular distribution for (n,n*12)

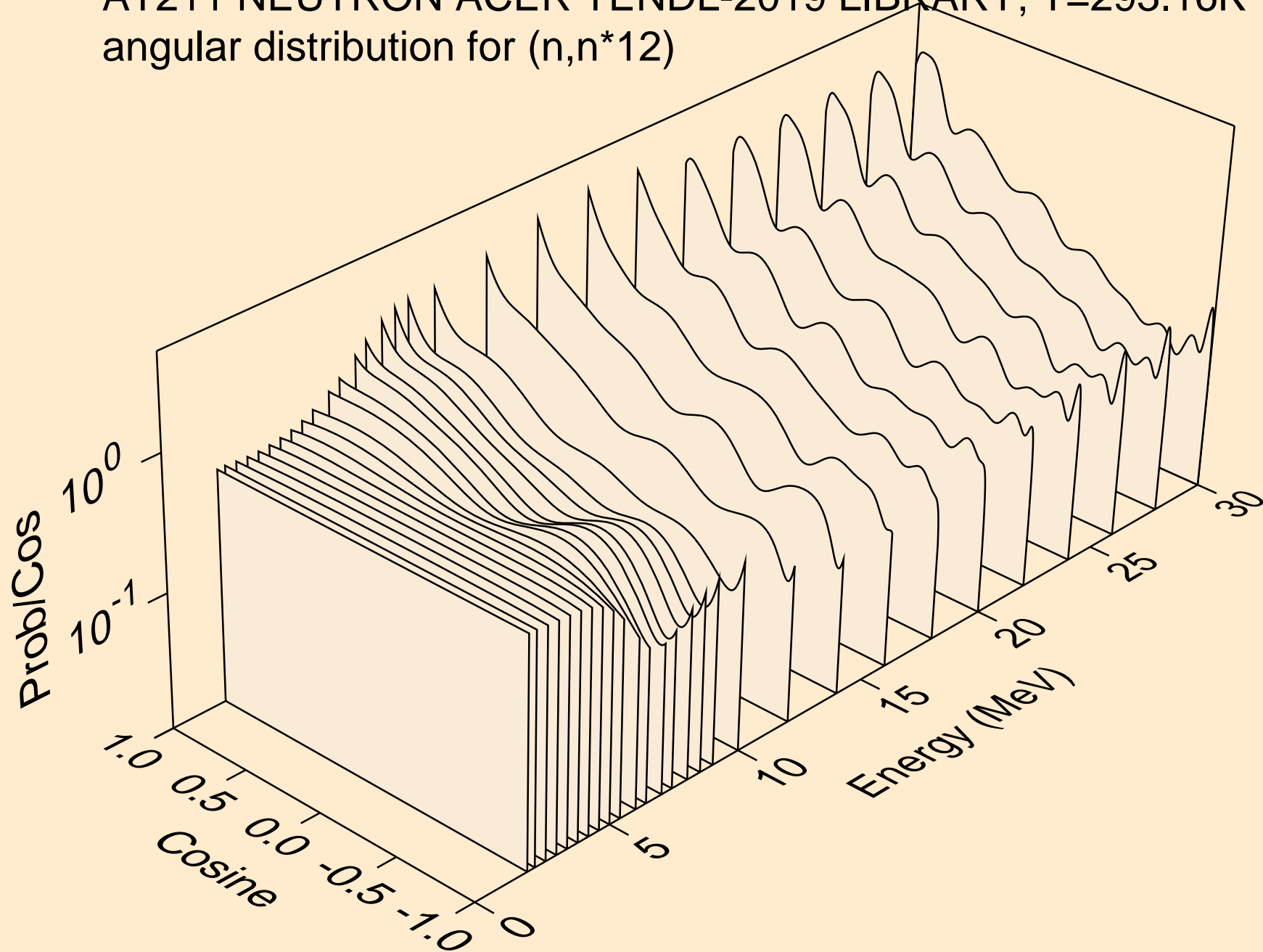

AT211 NEUTRON ACER TENDL-2019 LIBRARY; T=293.16K
angular distribution for (n,n*13)

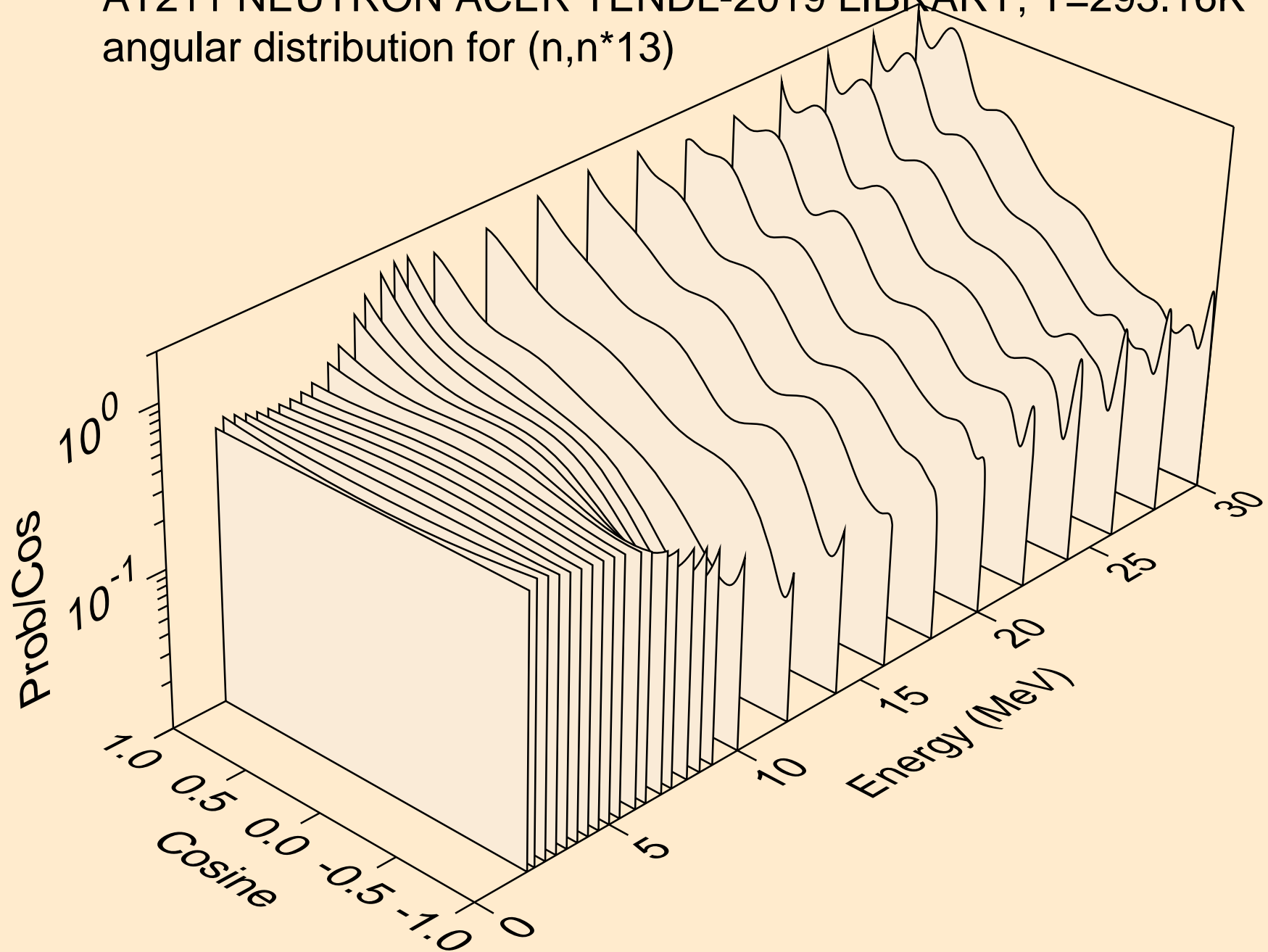

AT211 NEUTRON ACER TENDL-2019 LIBRARY; T=293.16K
angular distribution for (n,n*14)

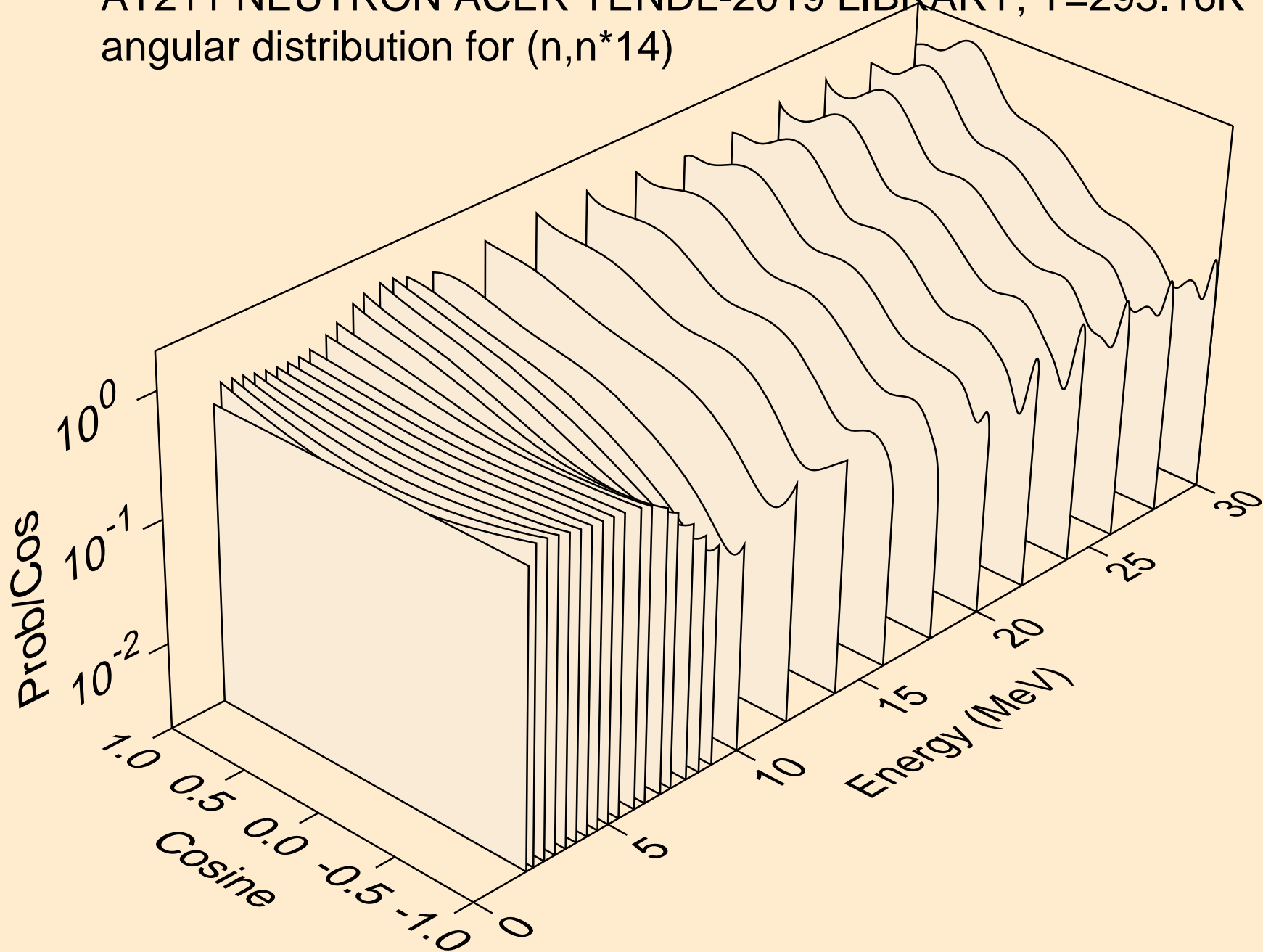

AT211 NEUTRON ACER TENDL-2019 LIBRARY; T=293.16K
angular distribution for (n,n*15)

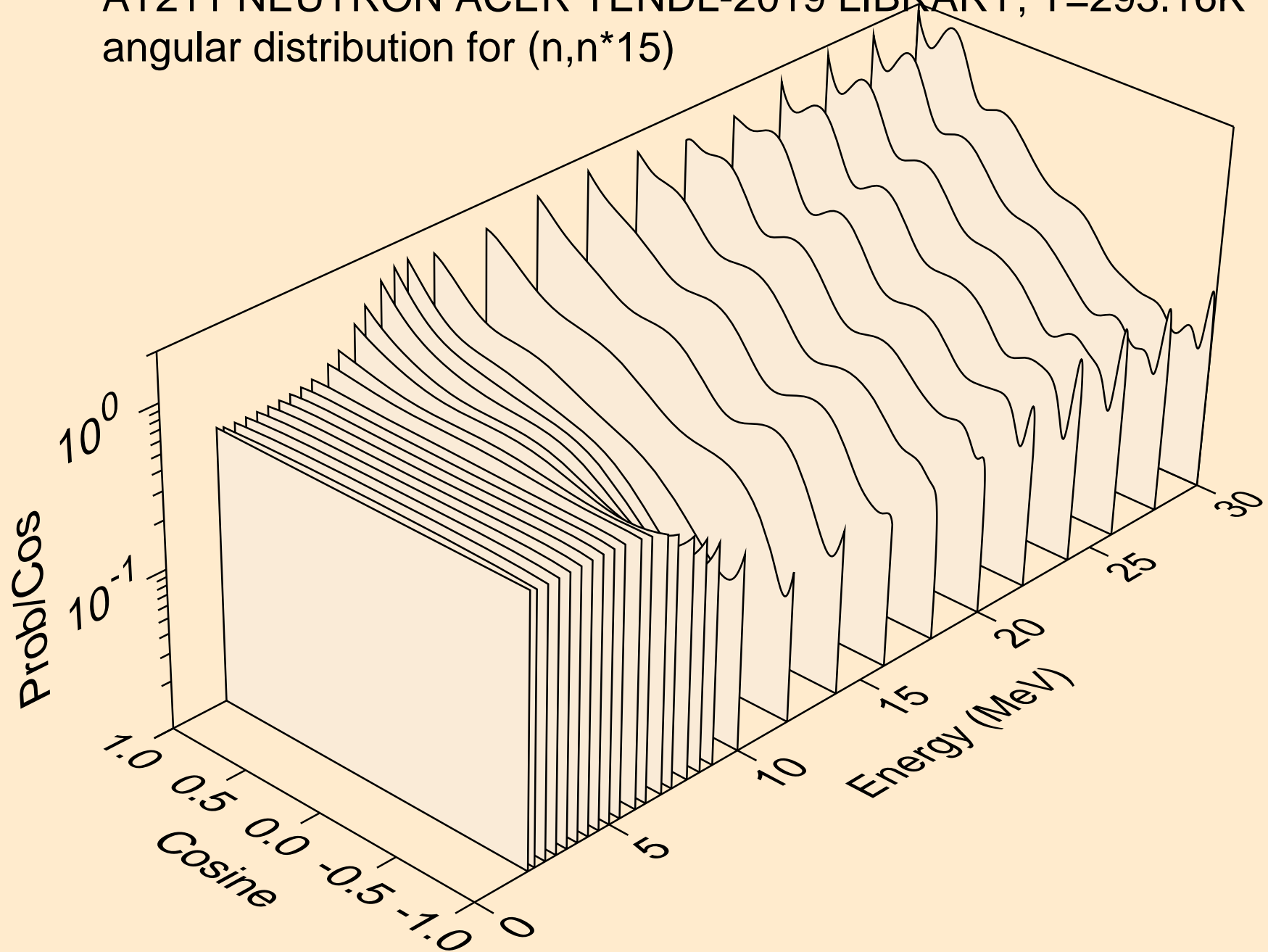

AT211 NEUTRON ACER TENDL-2019 LIBRARY; T=293.16K
angular distribution for (n,n*16)

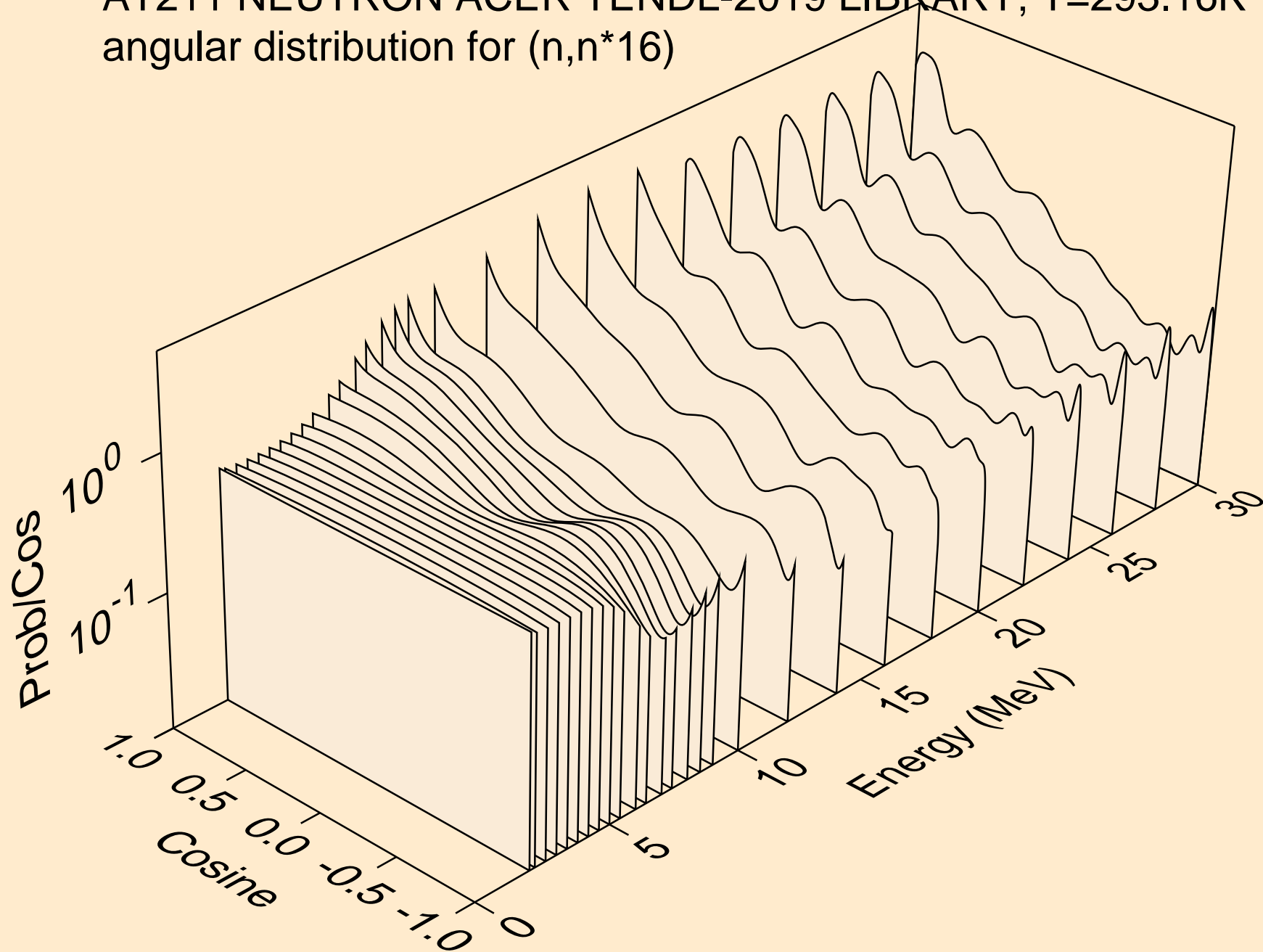

AT211 NEUTRON ACER TENDL-2019 LIBRARY; T=293.16K
angular distribution for (n,n*17)

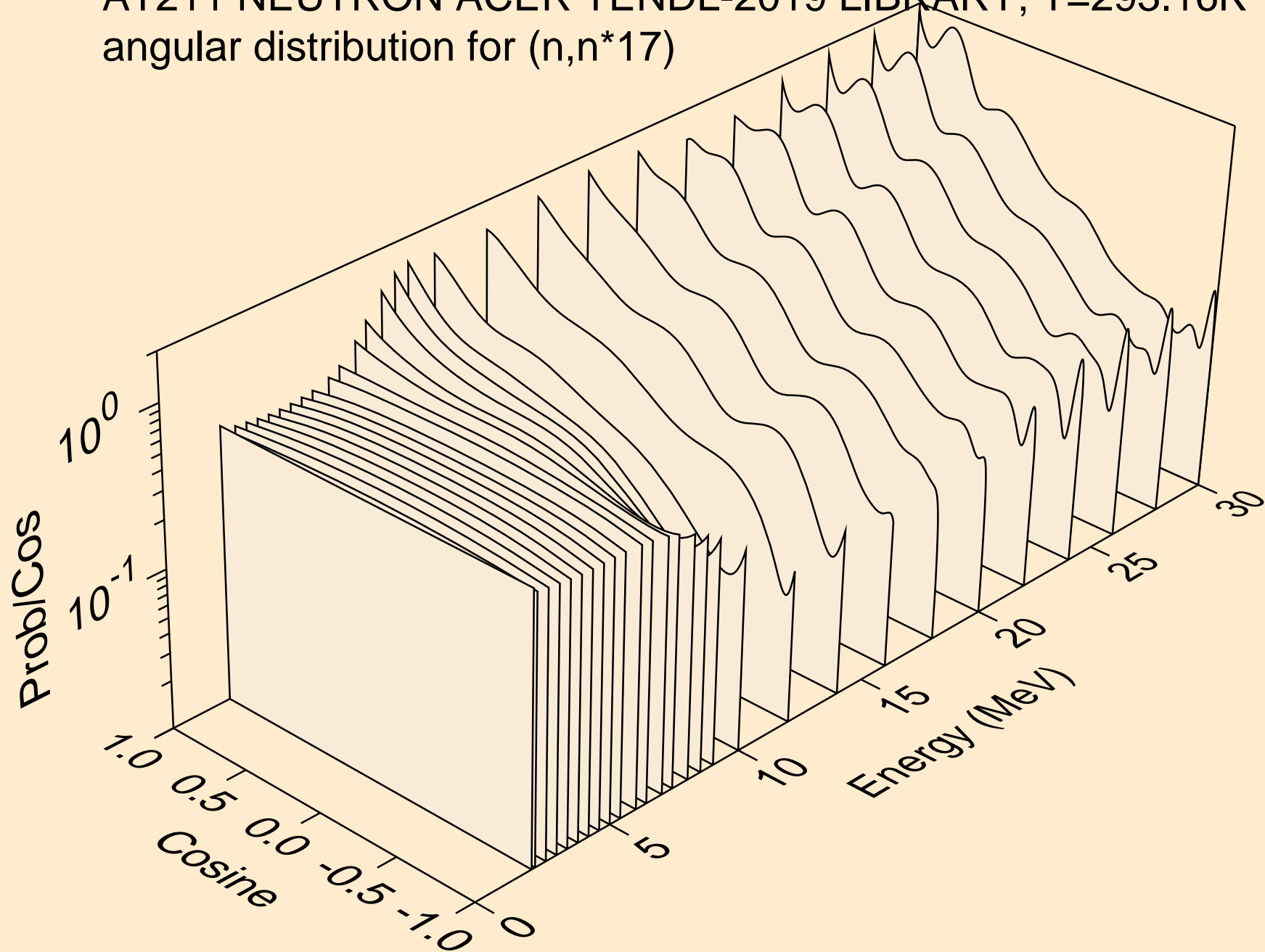

AT211 NEUTRON ACER TENDL-2019 LIBRARY; T=293.16K
angular distribution for (n,n*18)

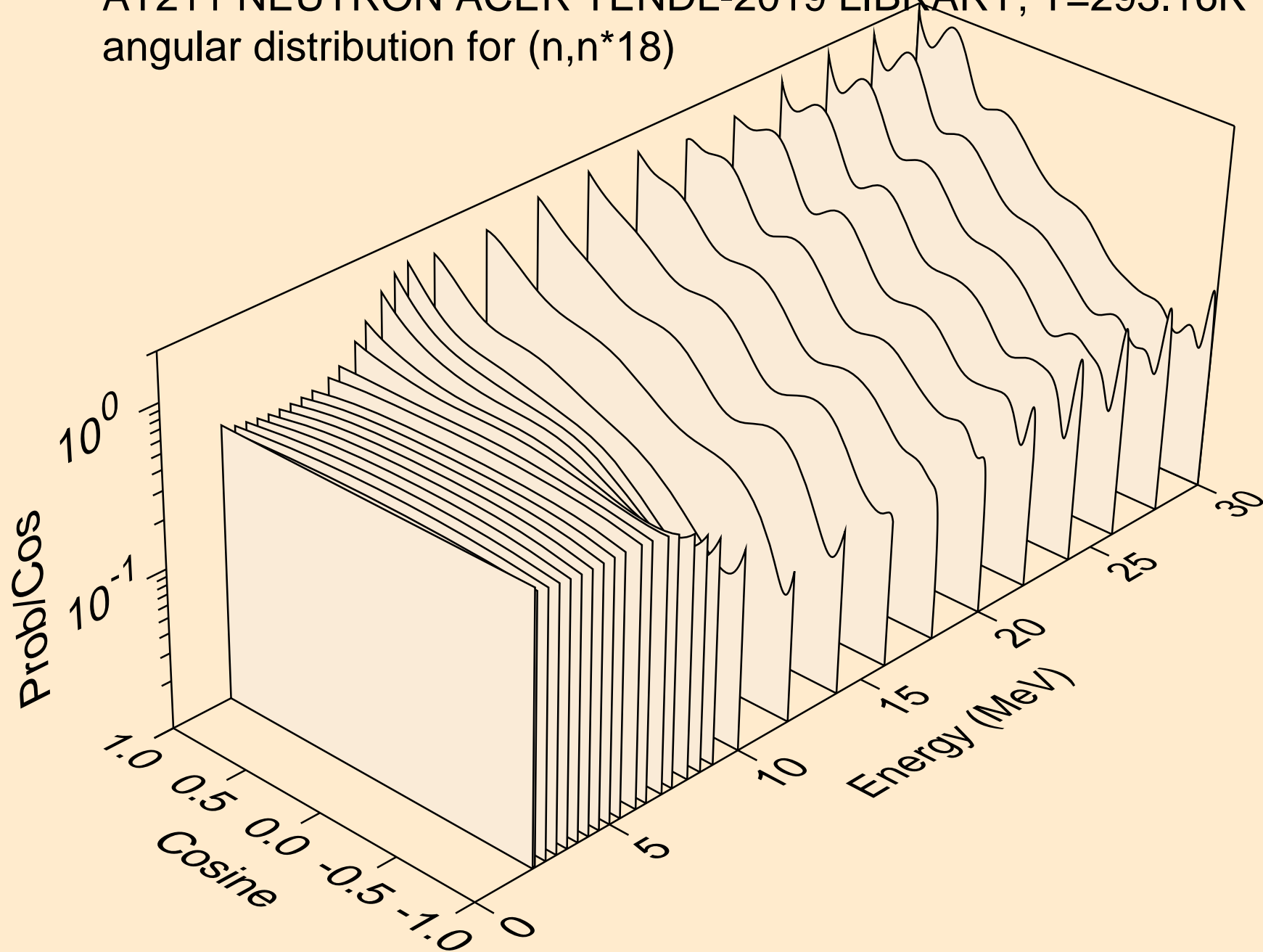

AT211 NEUTRON ACER TENDL-2019 LIBRARY; T=293.16K
angular distribution for (n,n*19)

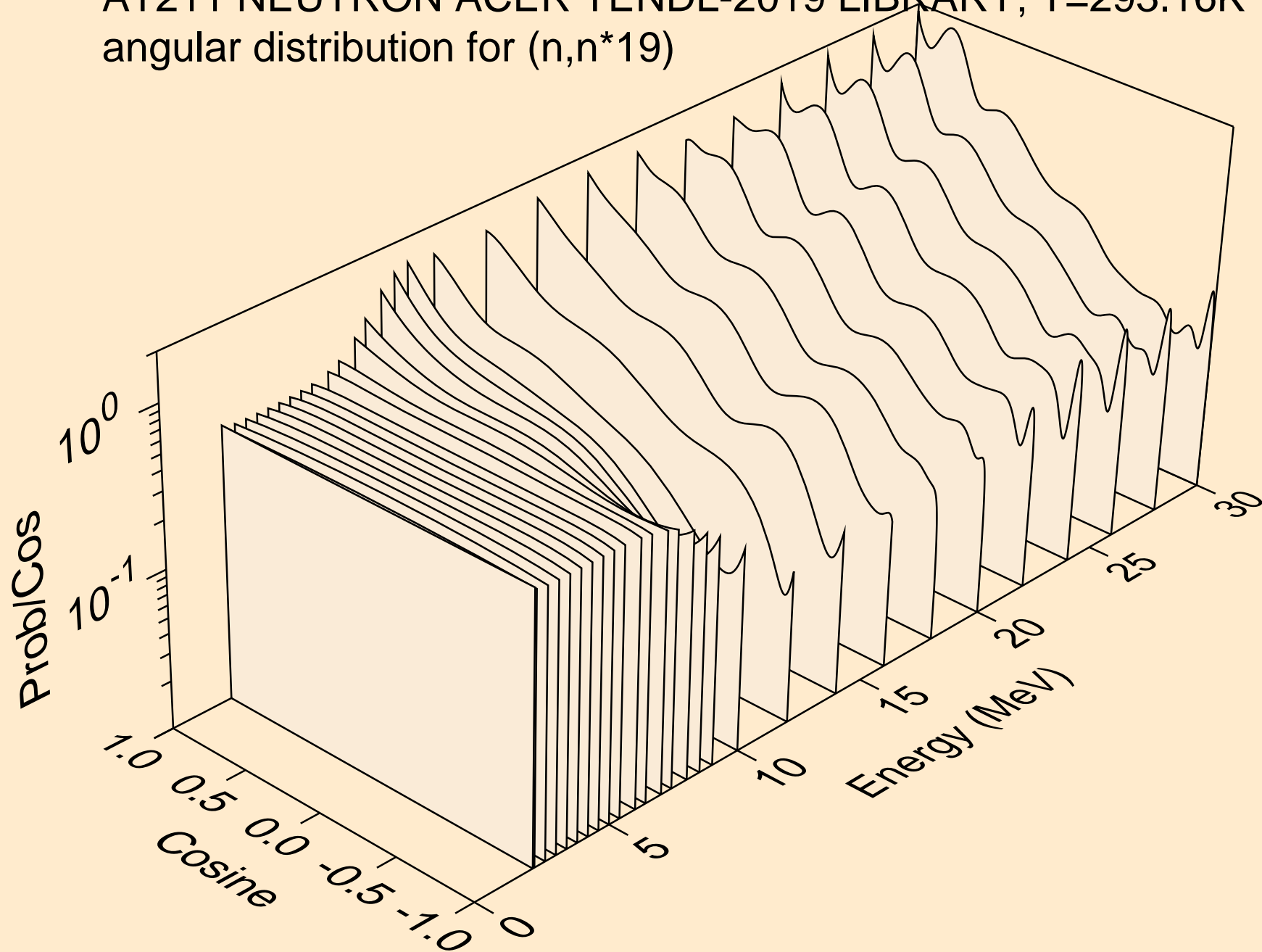

AT211 NEUTRON ACER TENDL-2019 LIBRARY; T=293.16K
angular distribution for (n,n*20)

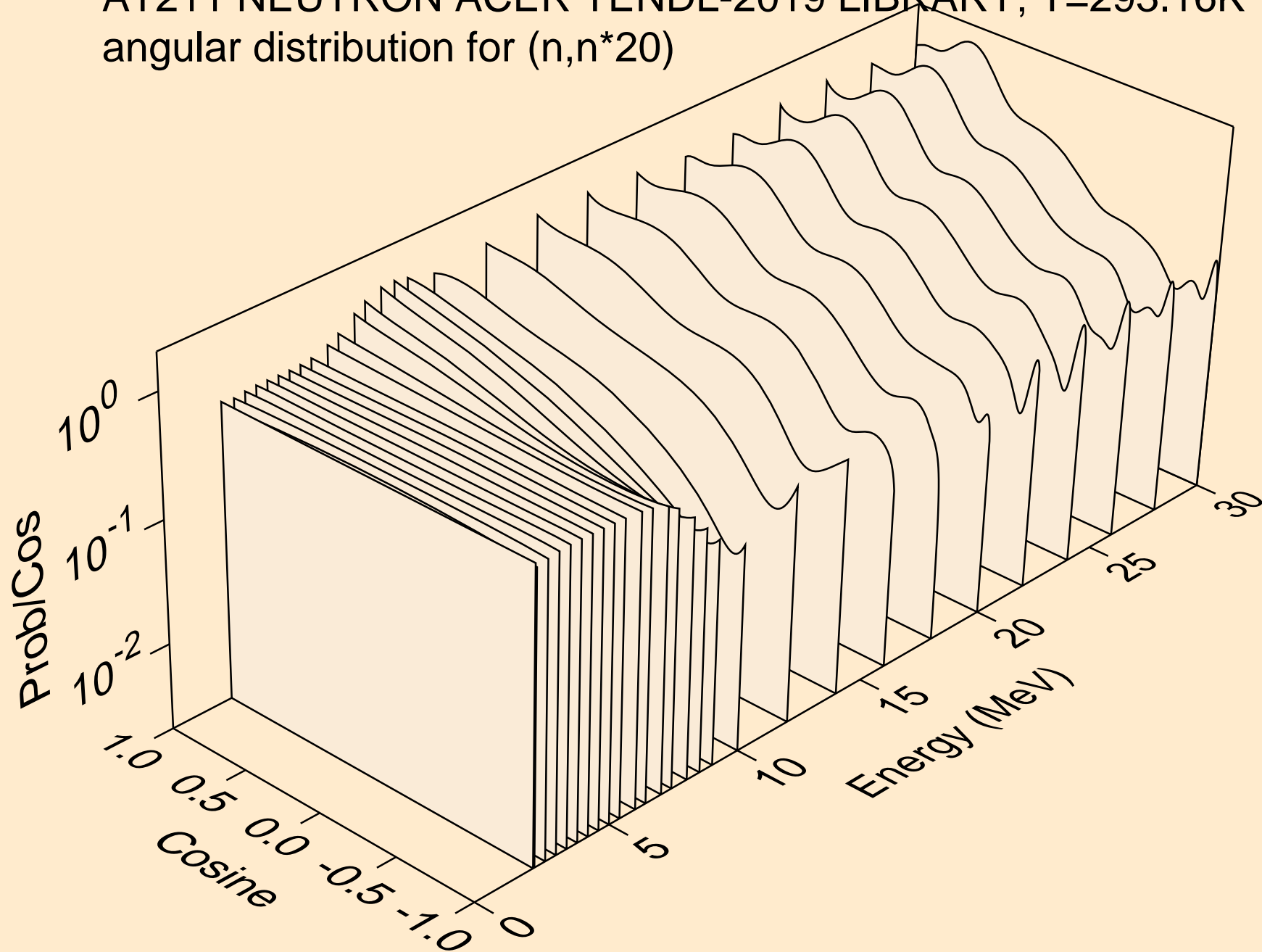

AT211 NEUTRON ACER TENDL-2019 LIBRARY; T=293.16K
angular distribution for (n,n*21)

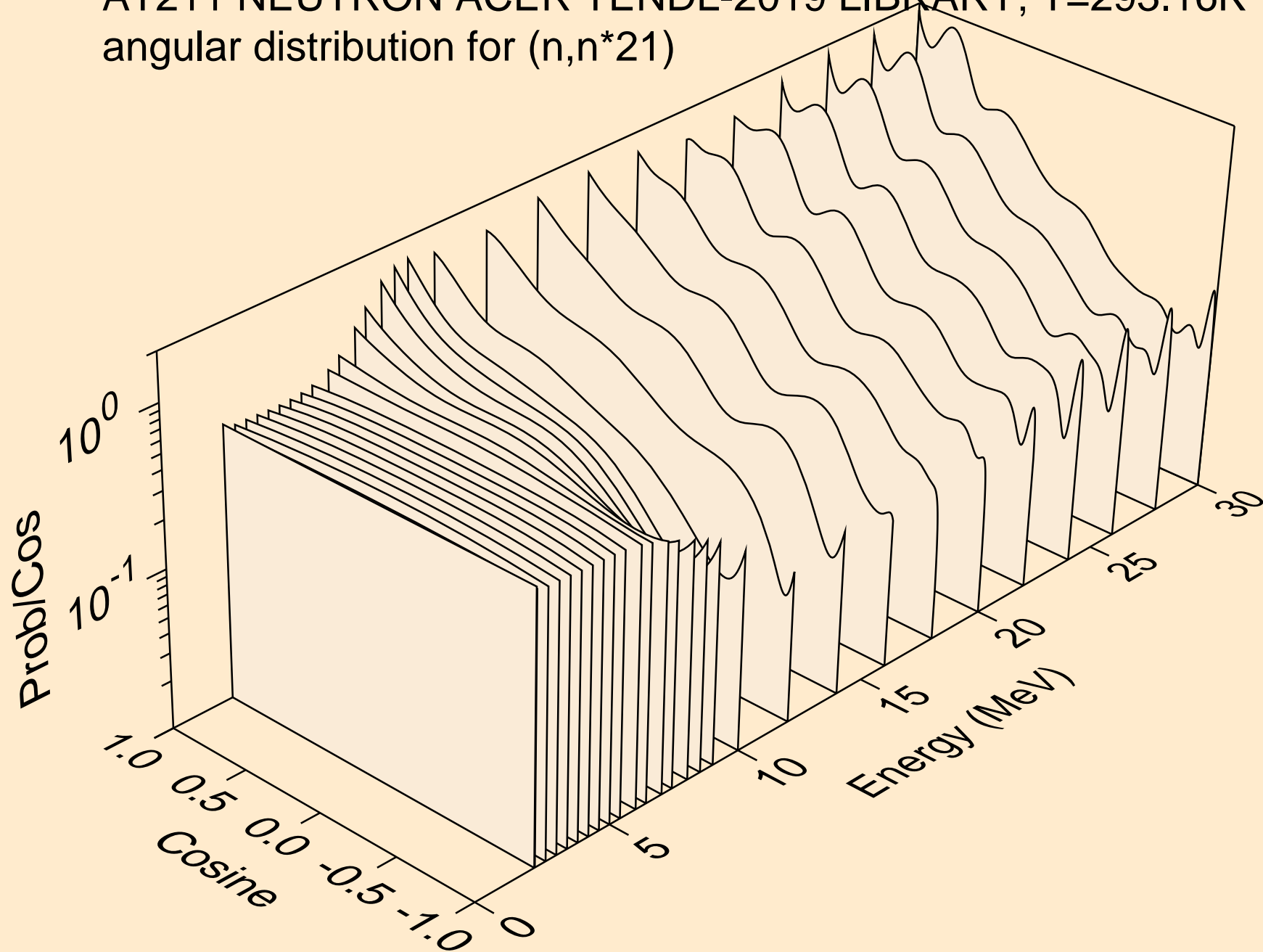

AT211 NEUTRON ACER TENDL-2019 LIBRARY; T=293.16K
angular distribution for (n,n*22)

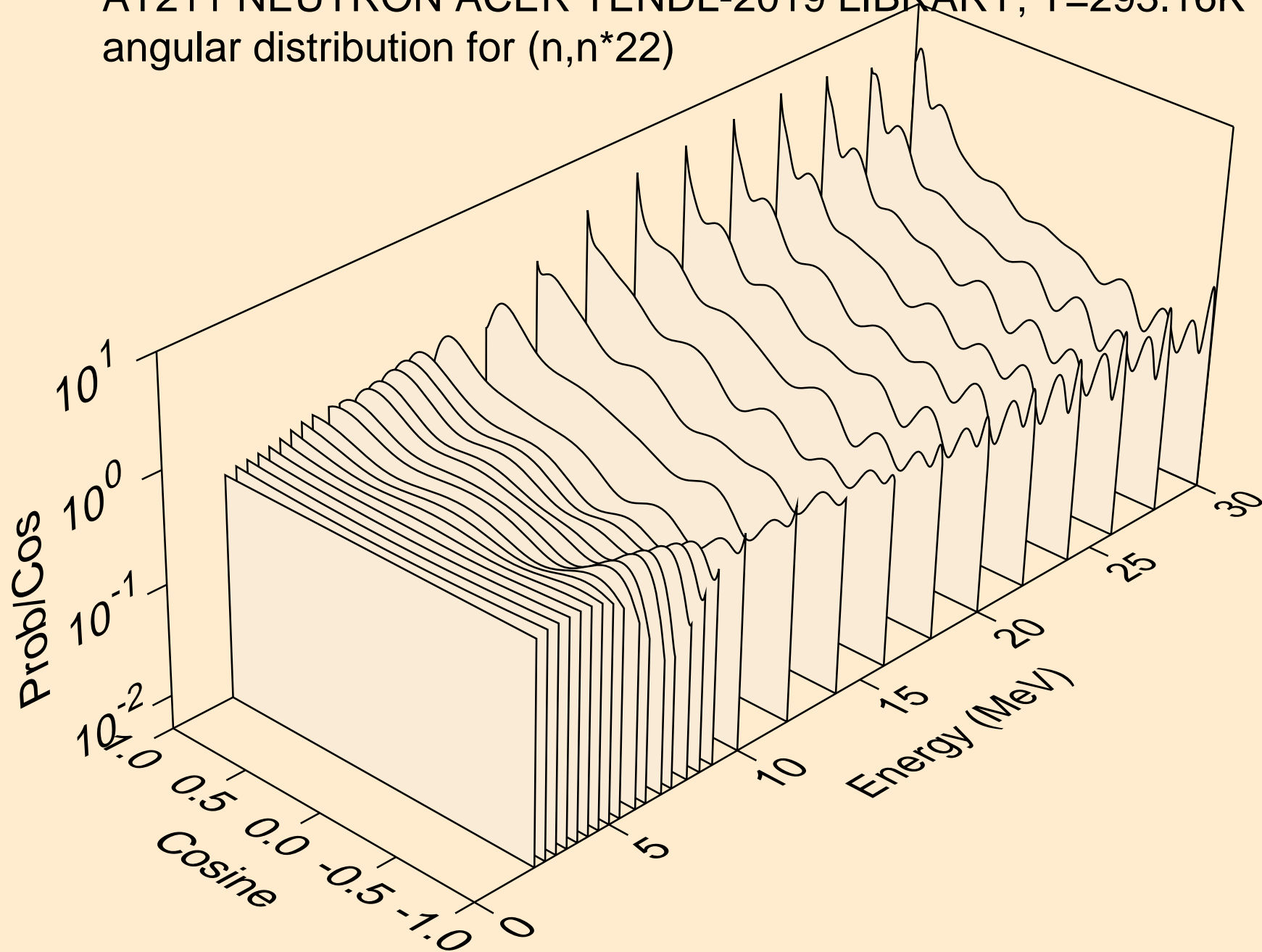

AT211 NEUTRON ACER TENDL-2019 LIBRARY; T=293.16K
angular distribution for (n,n*23)

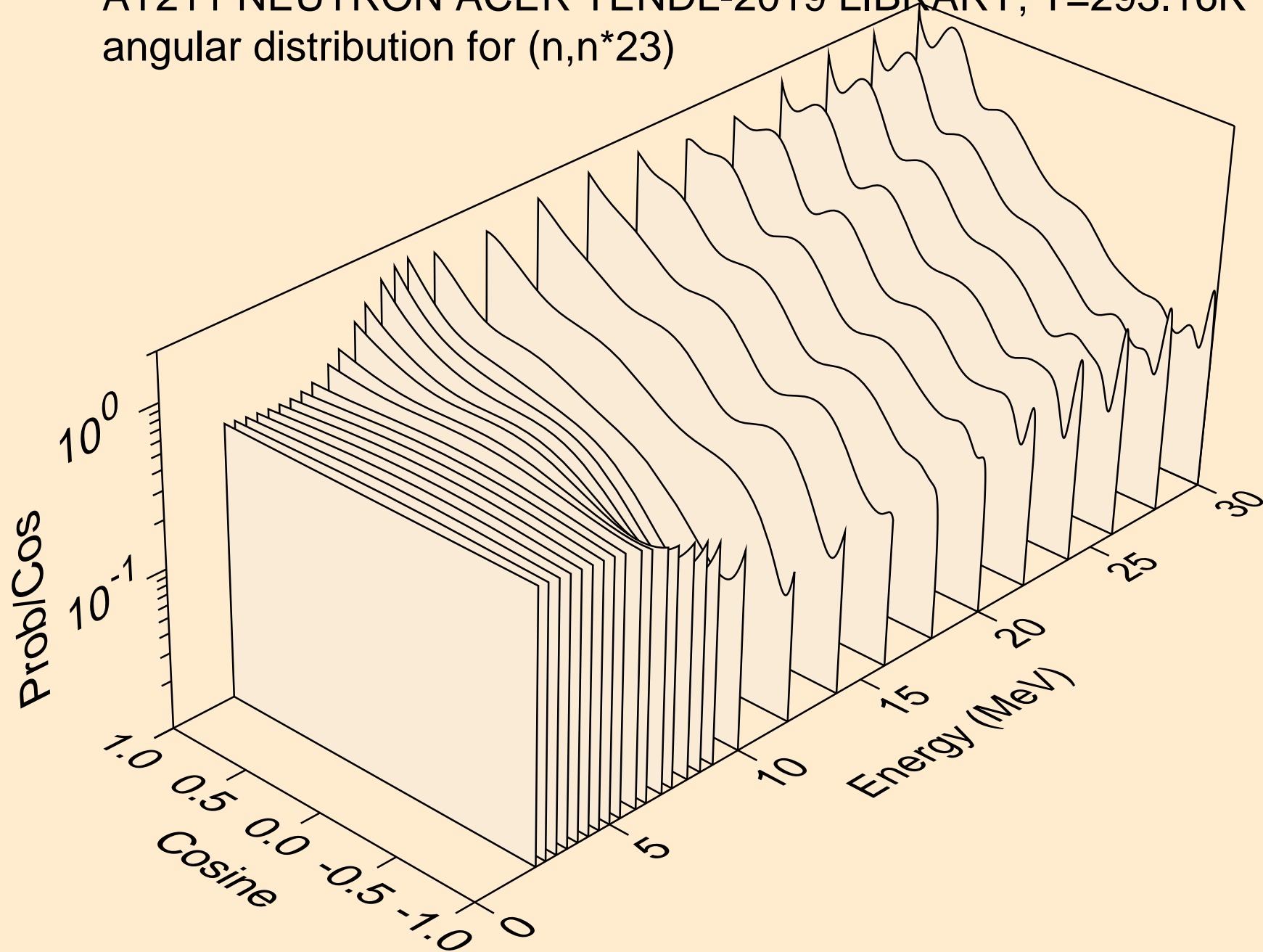

AT211 NEUTRON ACER TENDL-2019 LIBRARY; T=293.16K
angular distribution for (n,n*24)

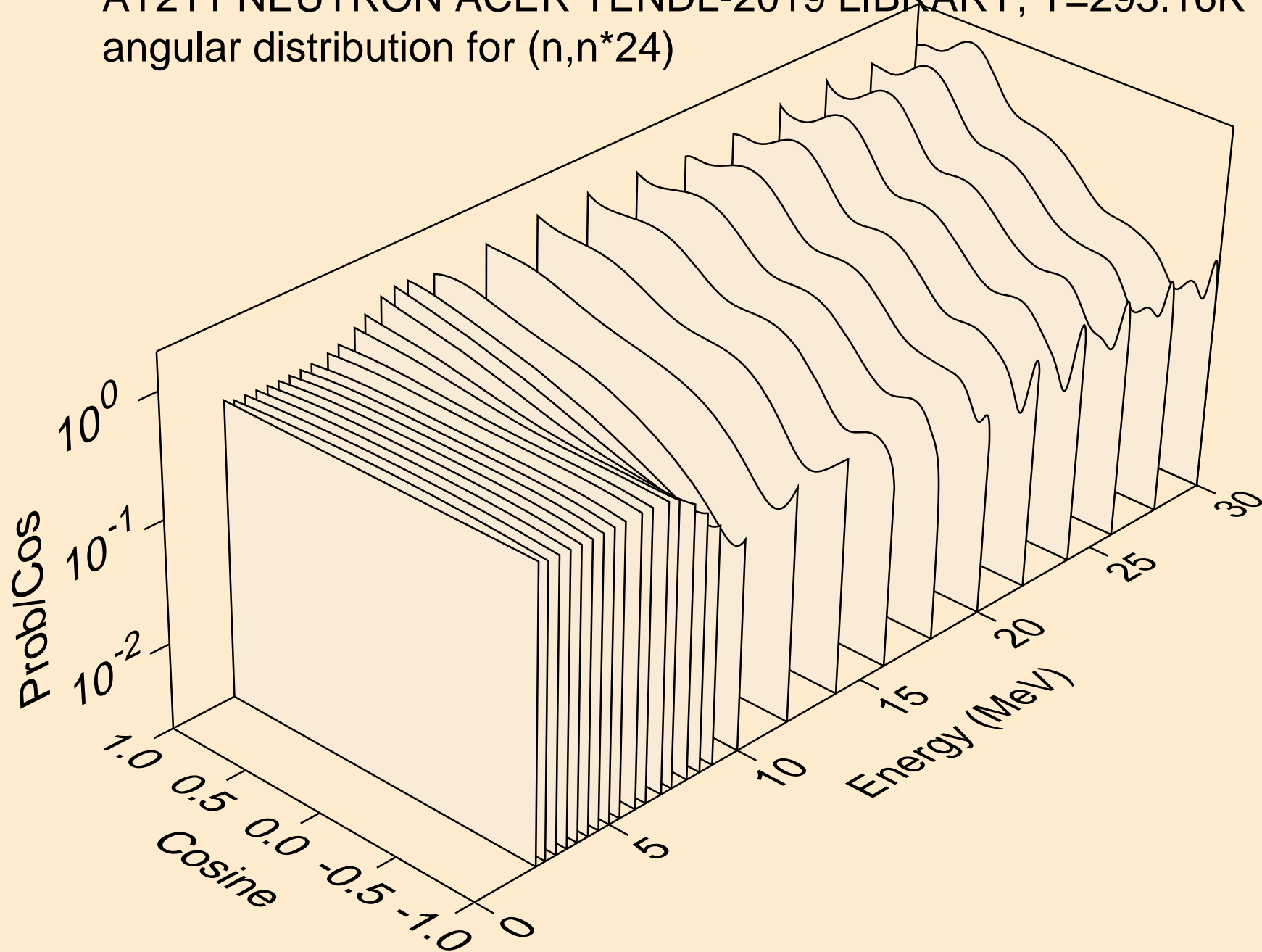

AT211 NEUTRON ACER TENDL-2019 LIBRARY; T=293.16K
angular distribution for (n,n*25)

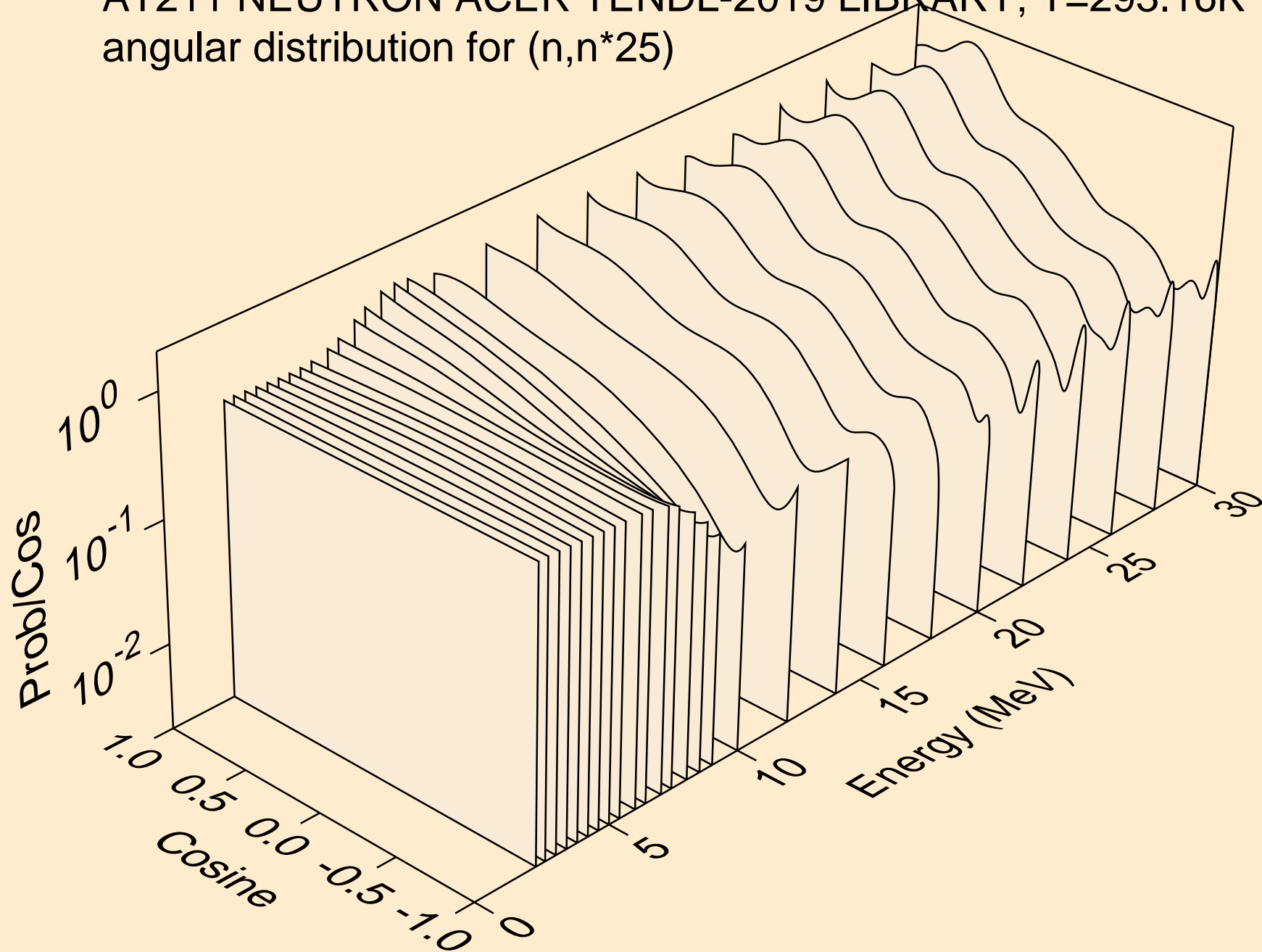

AT211 NEUTRON ACER TENDL-2019 LIBRARY; T=293.16K
angular distribution for (n,n*26)

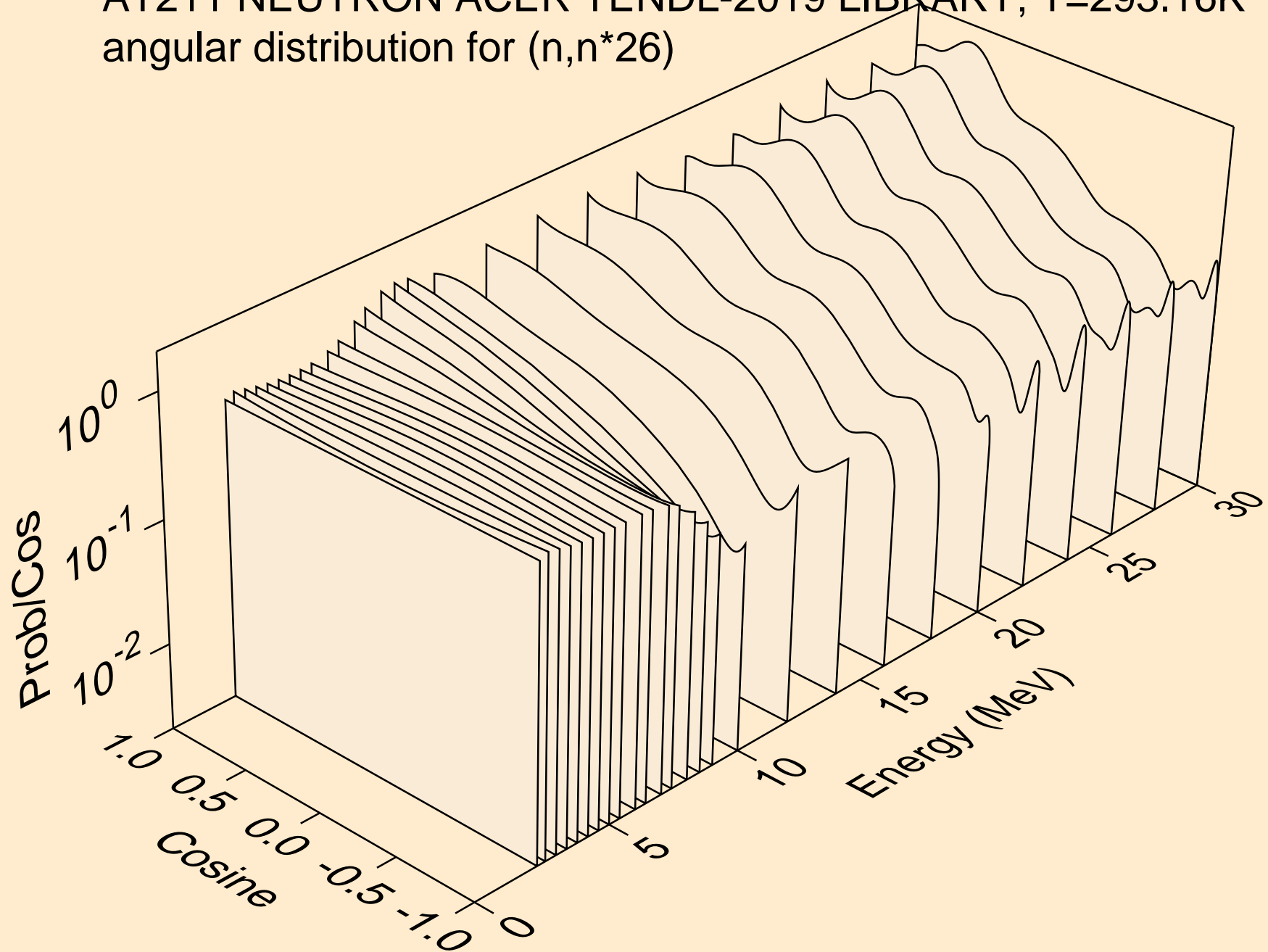

AT211 NEUTRON ACER TENDL-2019 LIBRARY; T=293.16K
angular distribution for (n,n*27)

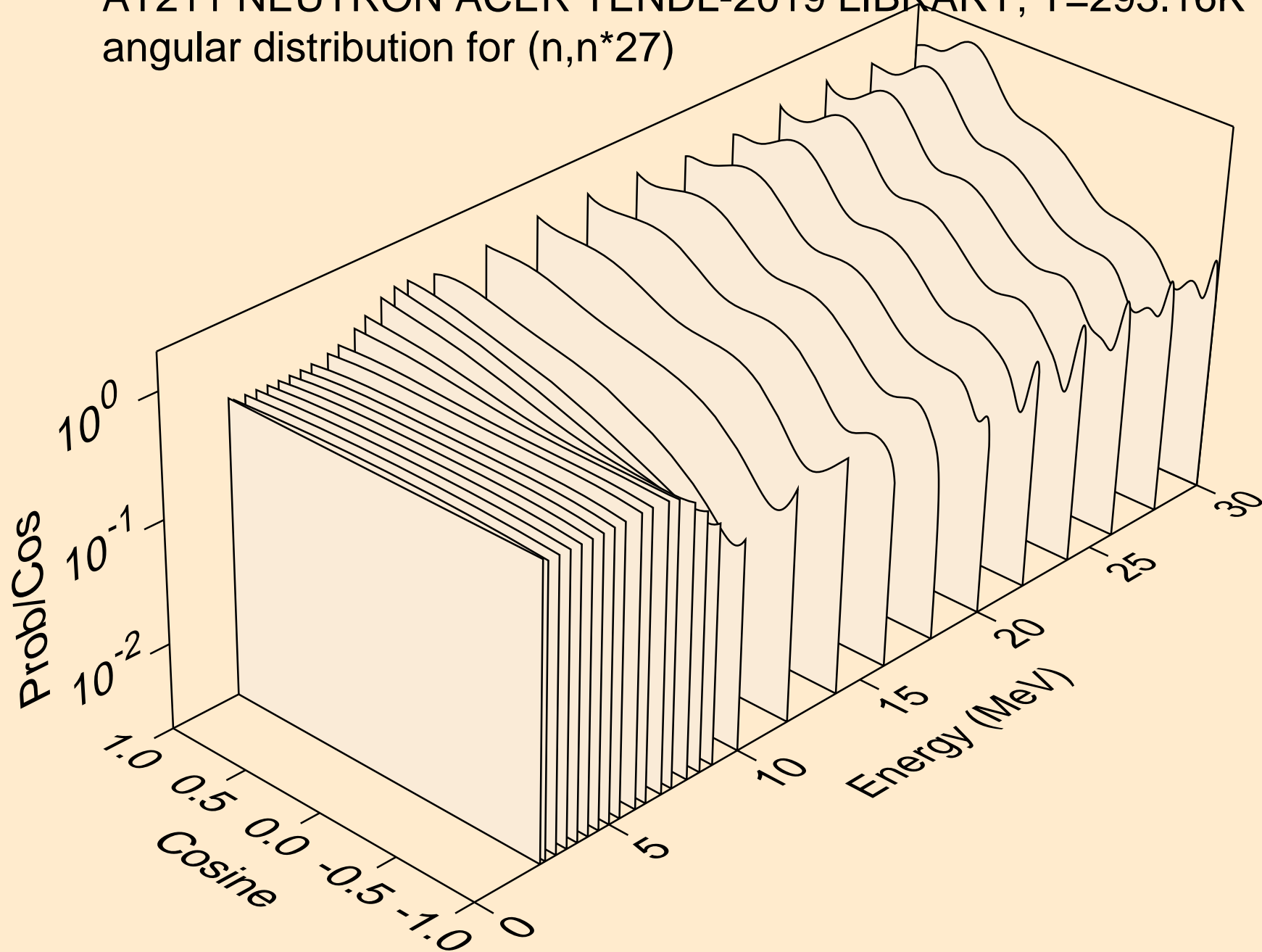

AT211 NEUTRON ACER TENDL-2019 LIBRARY; T=293.16K
angular distribution for (n,n*28)

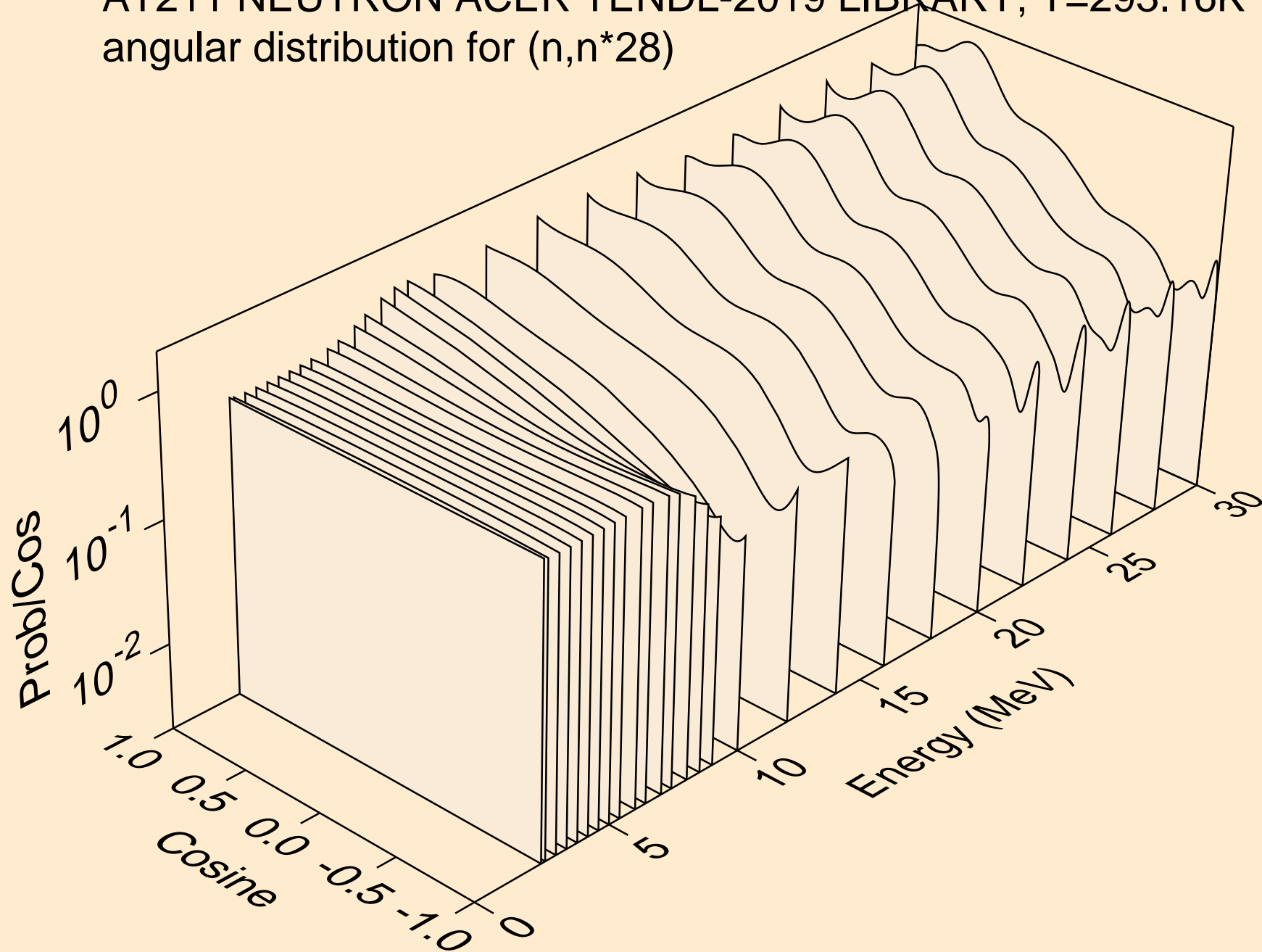

AT211 NEUTRON ACER TENDL-2019 LIBRARY; T=293.16K
angular distribution for (n,n*29)

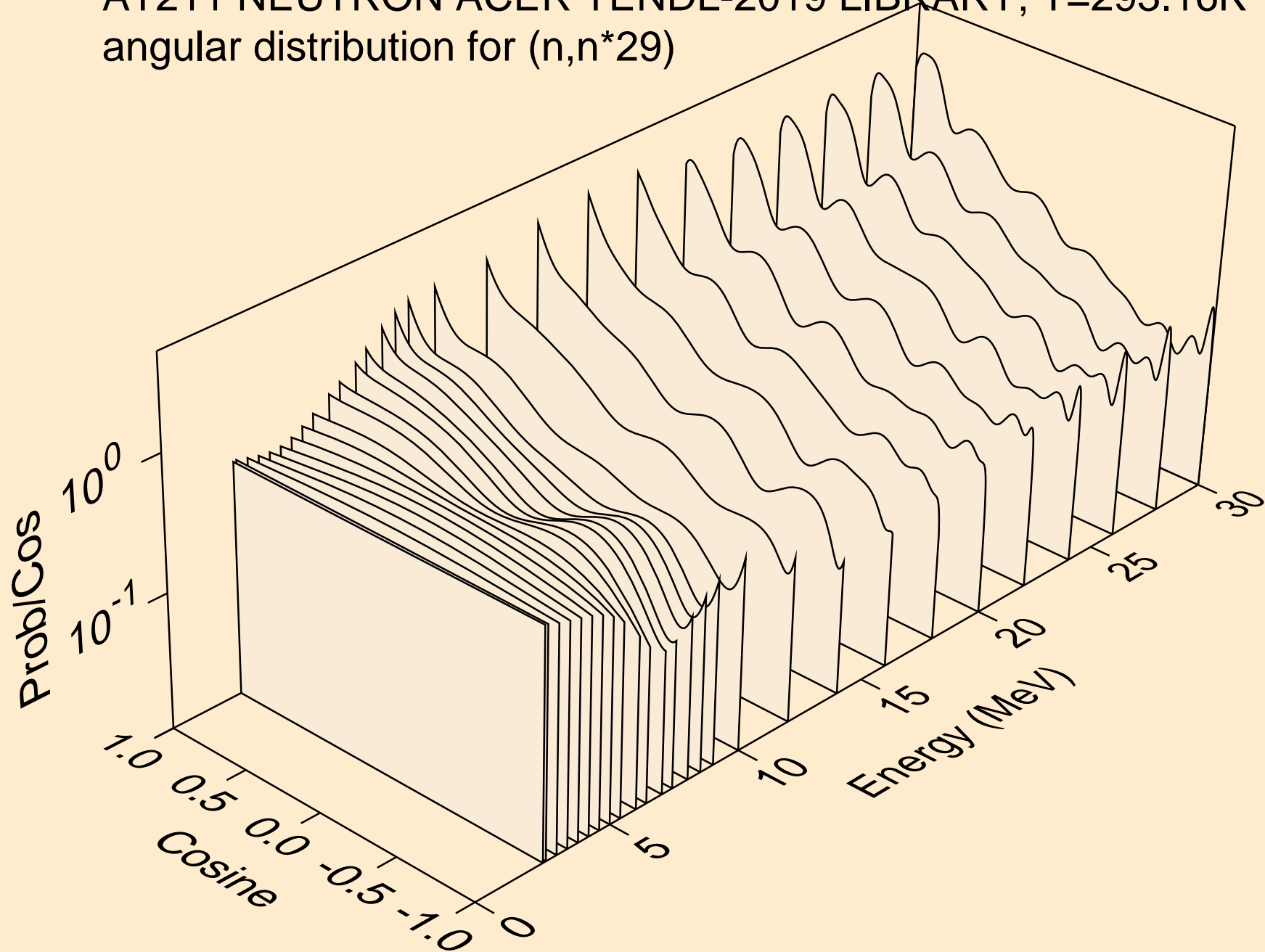

AT211 NEUTRON ACER TENDL-2019 LIBRARY; T=293.16K
angular distribution for (n,n*30)

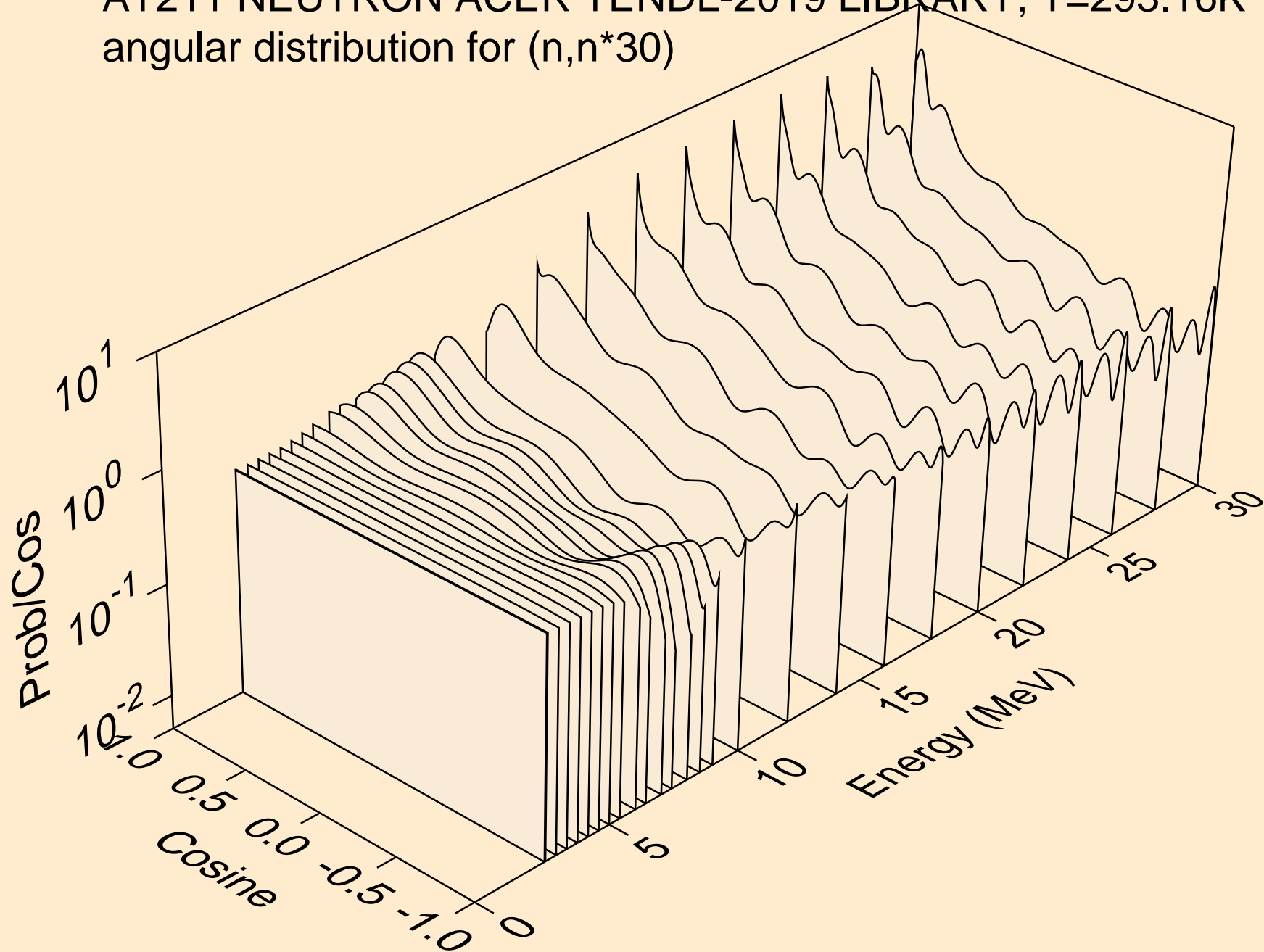

AT211 NEUTRON ACER TENDL-2019 LIBRARY; T=293.16K
Neutron emission for (n,x)

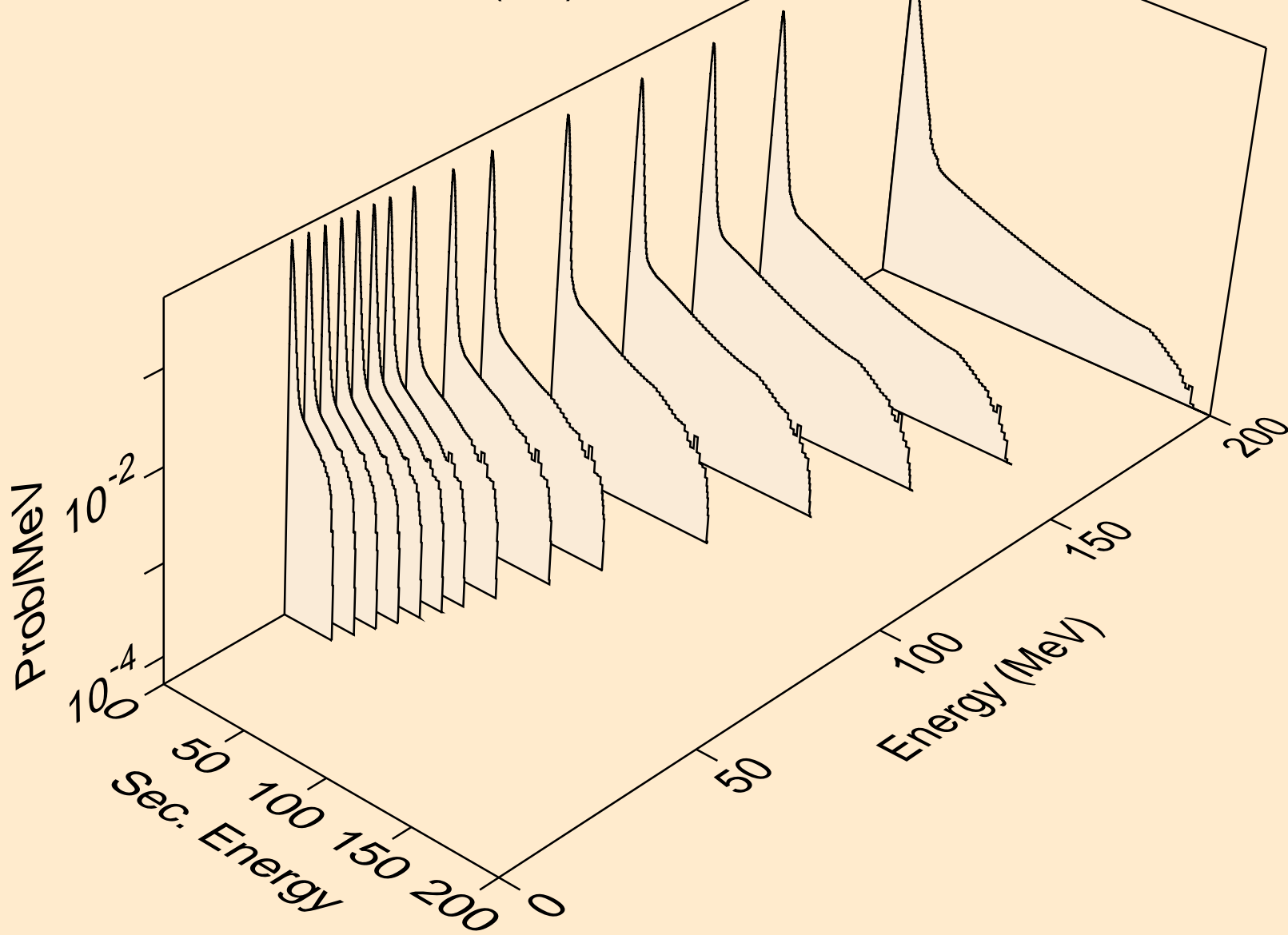

AT211 NEUTRON ACER TENDL-2019 LIBRARY; T=293.16K
Neutron emission for (n,2nd)

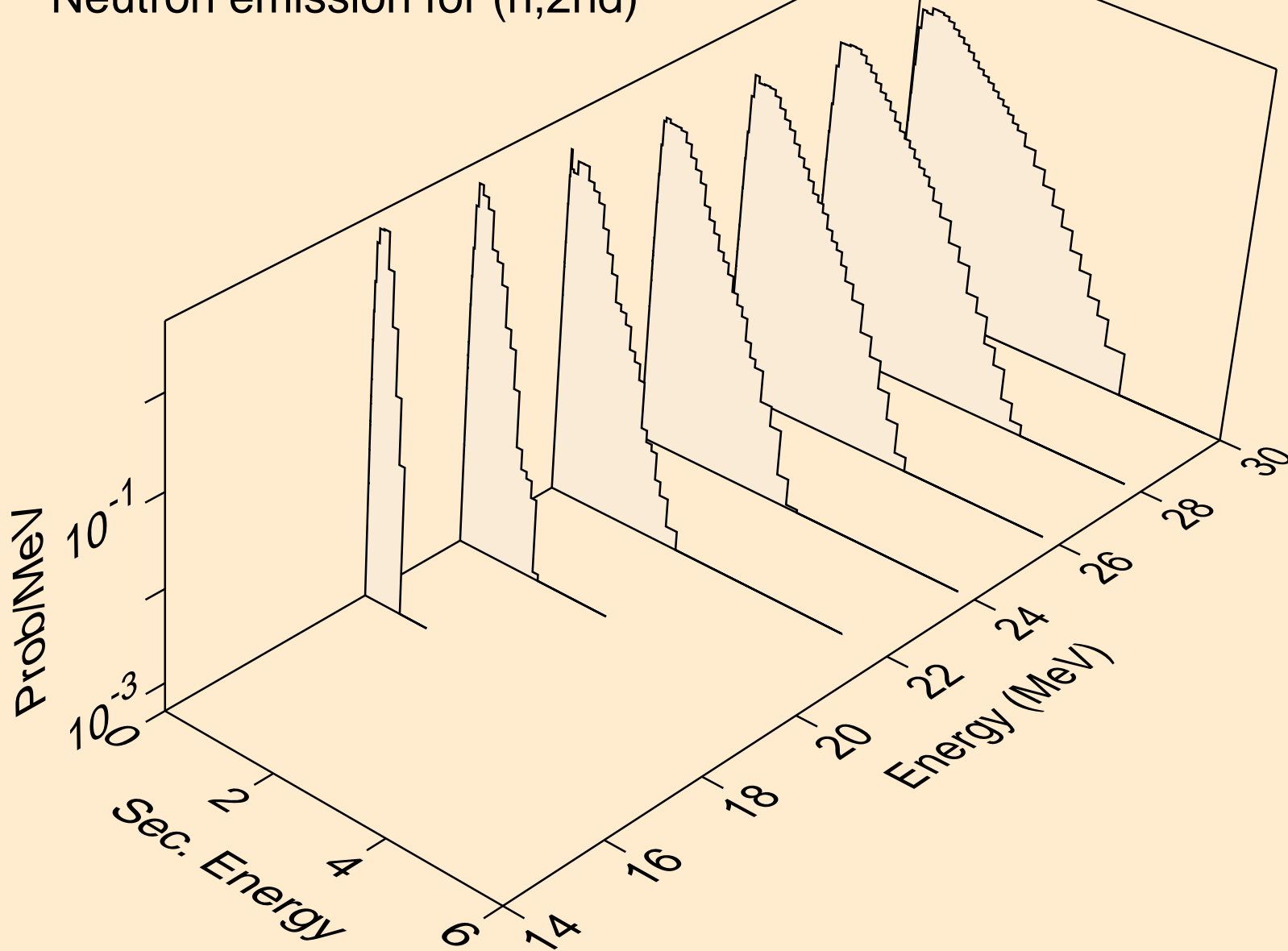

AT211 NEUTRON ACER TENDL-2019 LIBRARY; T=293.16K
Neutron emission for (n,2n)

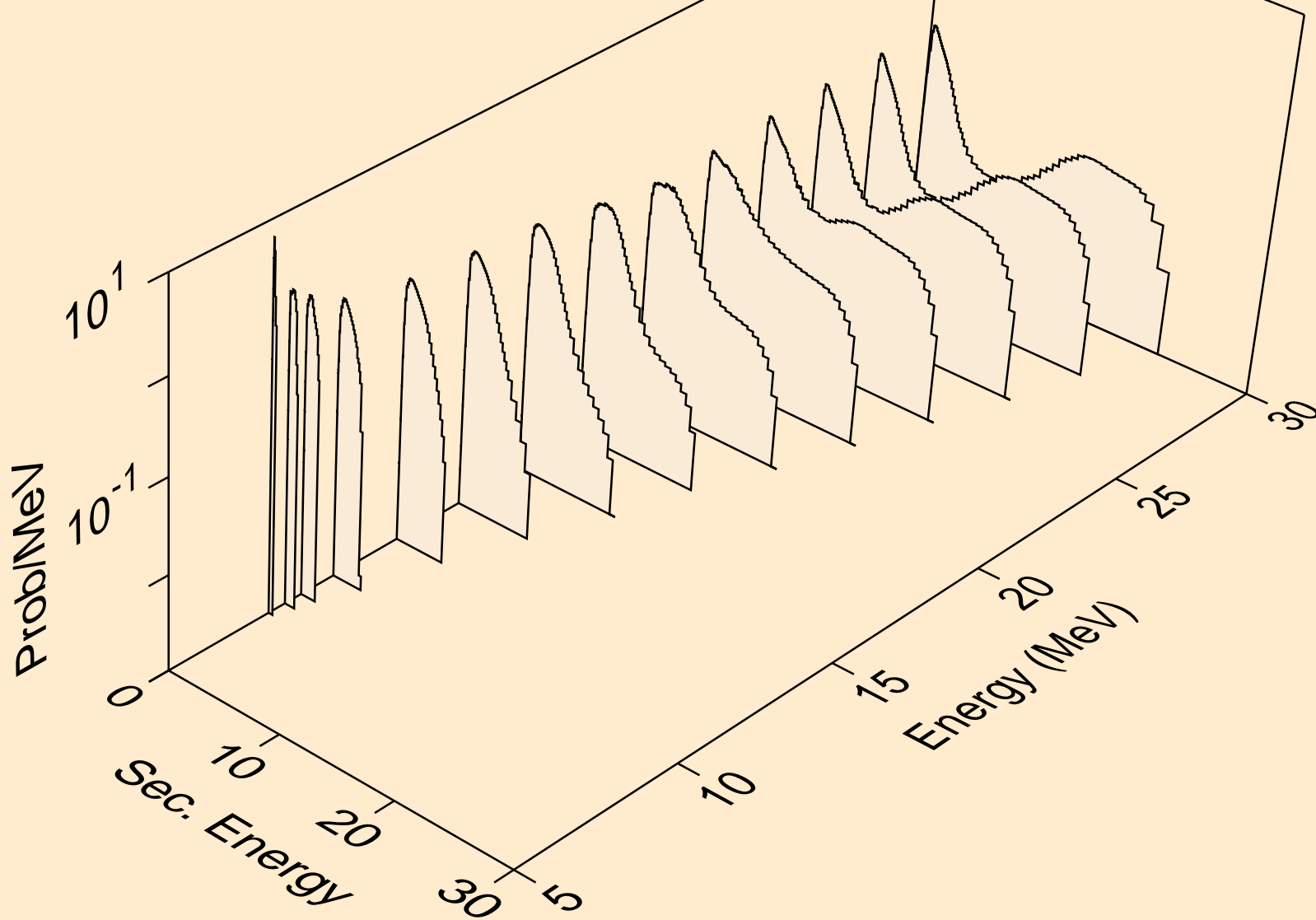

AT211 NEUTRON ACER TENDL-2019 LIBRARY; T=293.16K
Neutron emission for (n,3n)

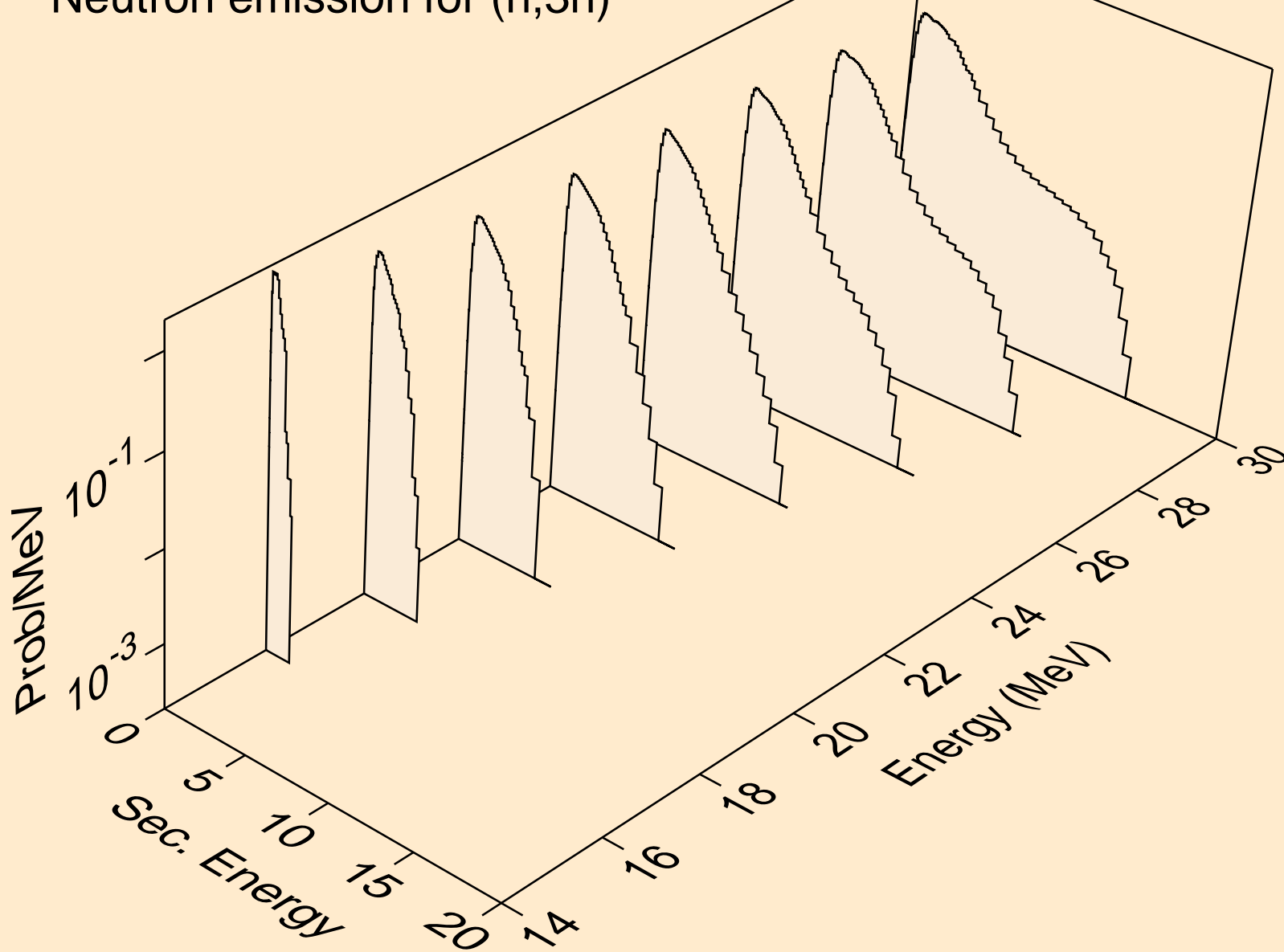

AT211 NEUTRON ACER TENDL-2019 LIBRARY; T=293.16K
Neutron emission for (n,n*)a

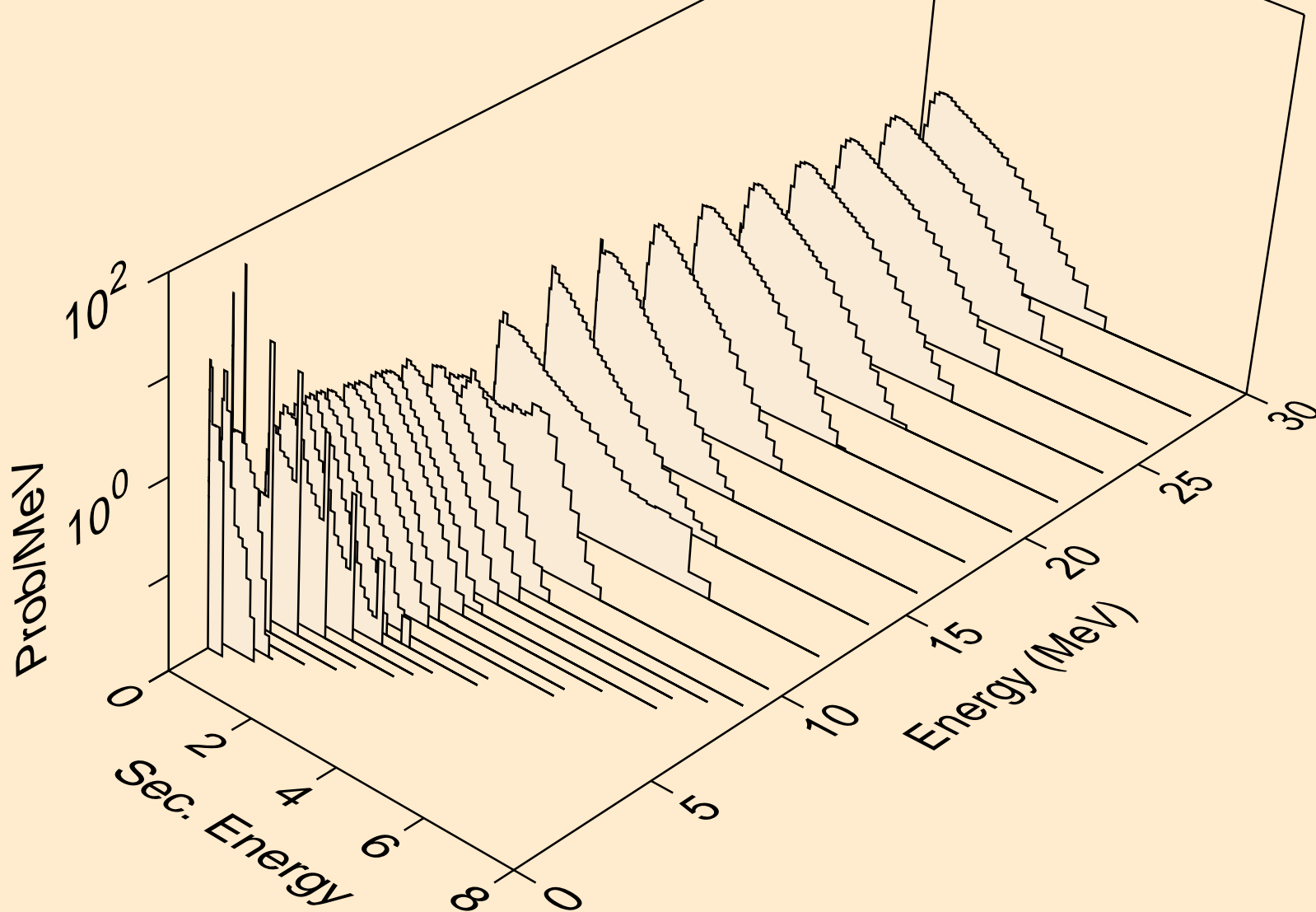

AT211 NEUTRON ACER TENDL-2019 LIBRARY; T=293.16K
Neutron emission for (n,2n)_a

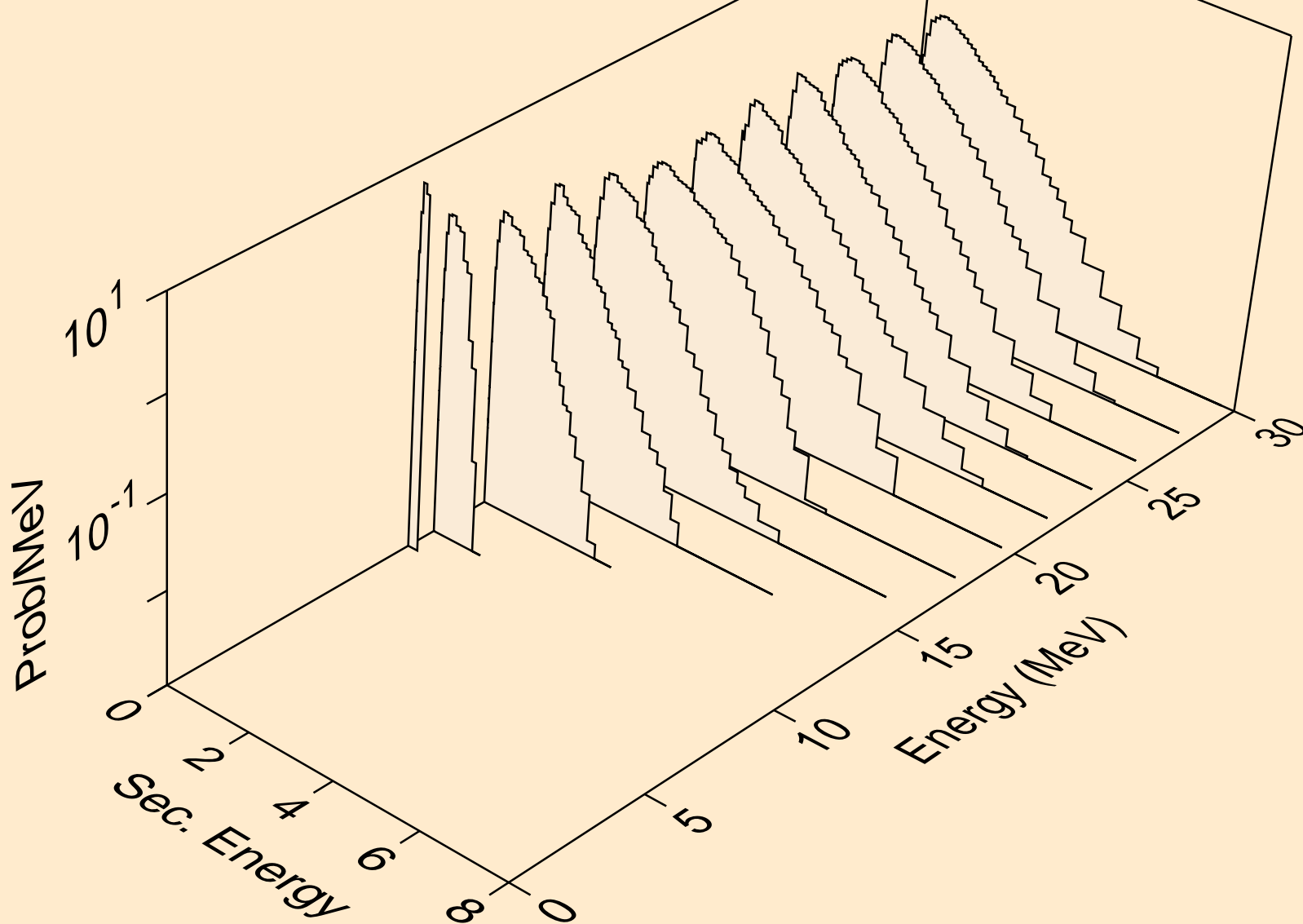

AT211 NEUTRON ACER TENDL-2019 LIBRARY; T=293.16K
Neutron emission for (n,3n)a

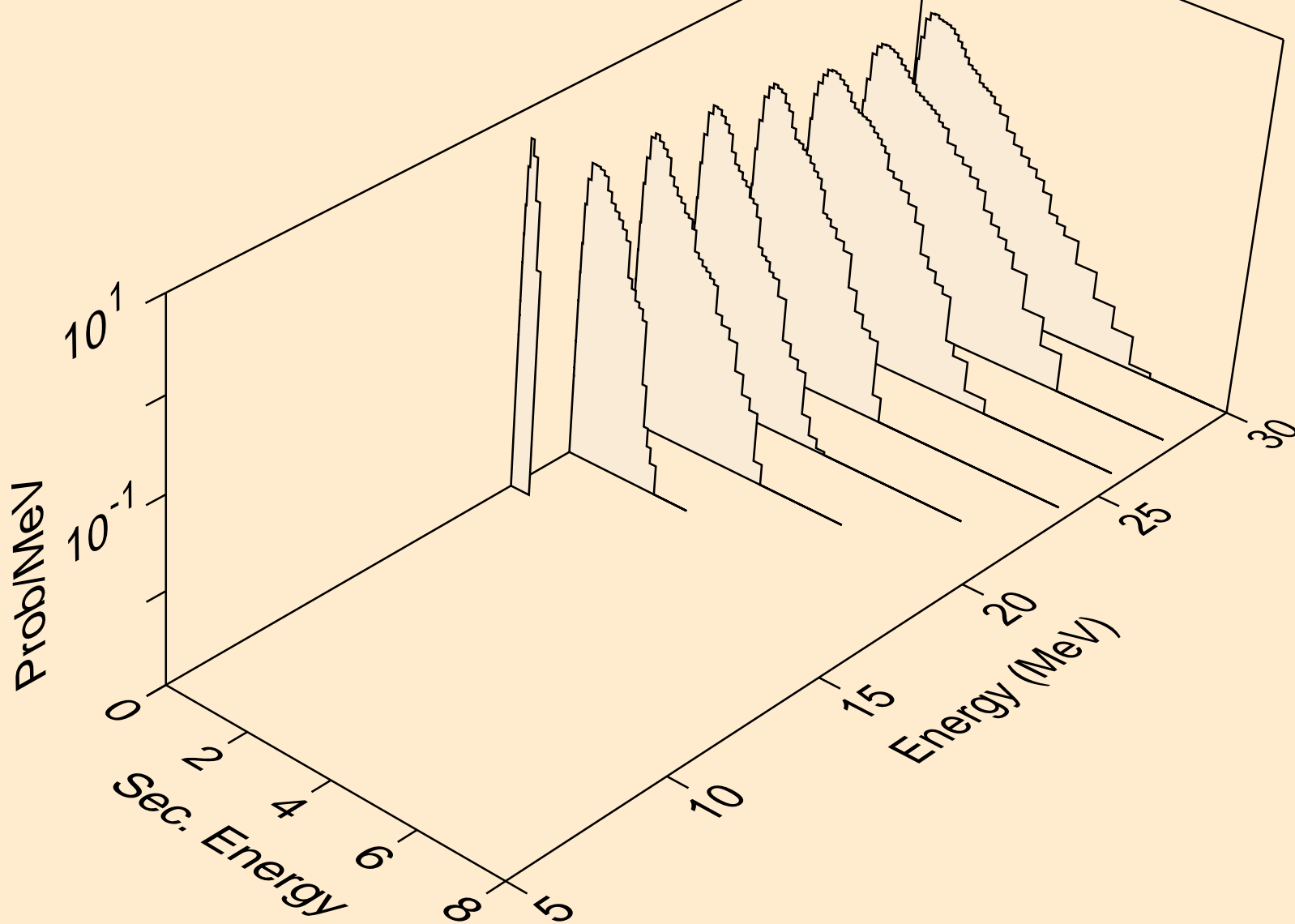

AT211 NEUTRON ACER TENDL-2019 LIBRARY; T=293.16K
Neutron emission for (n,n*)p

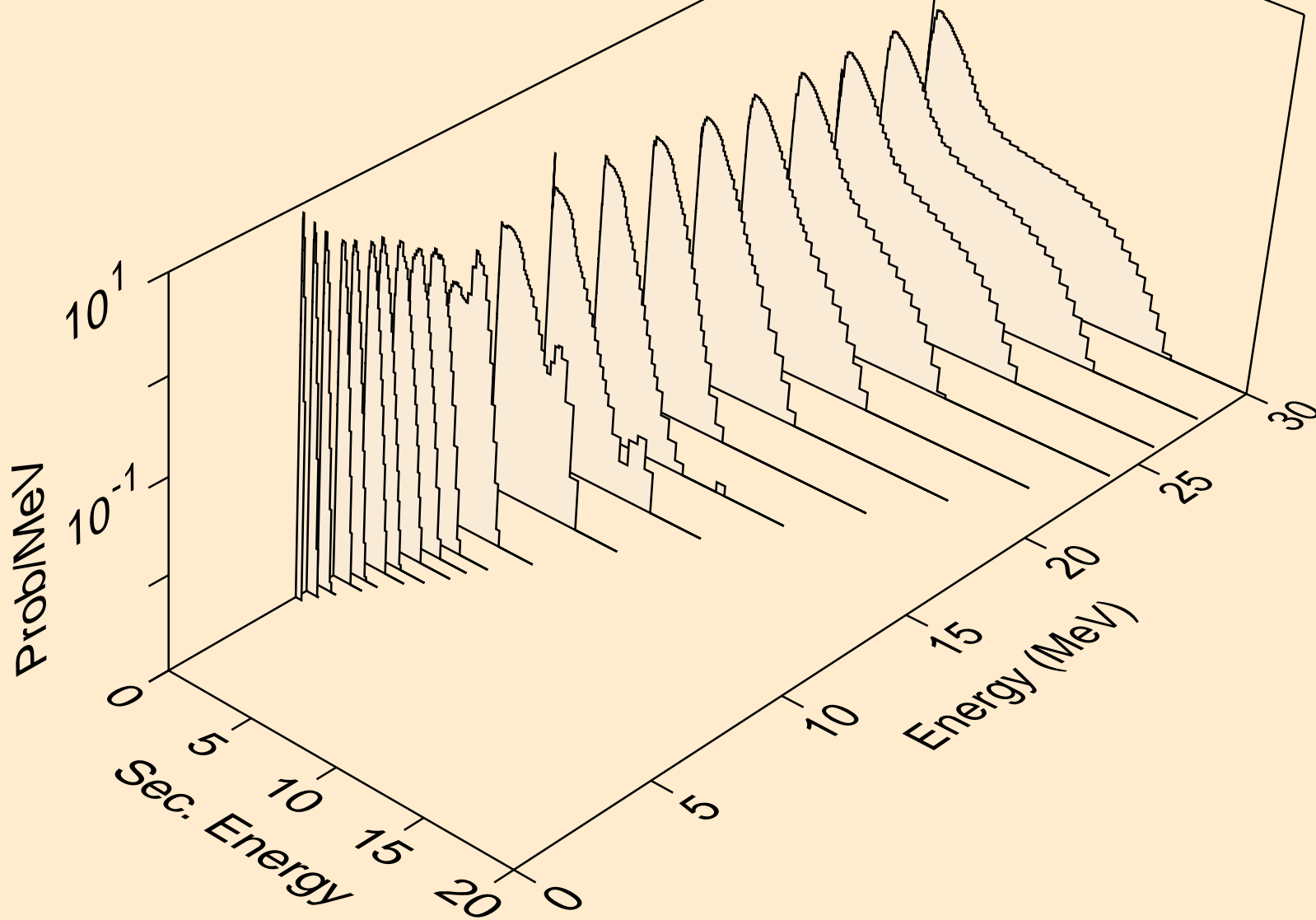

AT211 NEUTRON ACER TENDL-2019 LIBRARY; T=293.16K
Neutron emission for (n,n*)2a

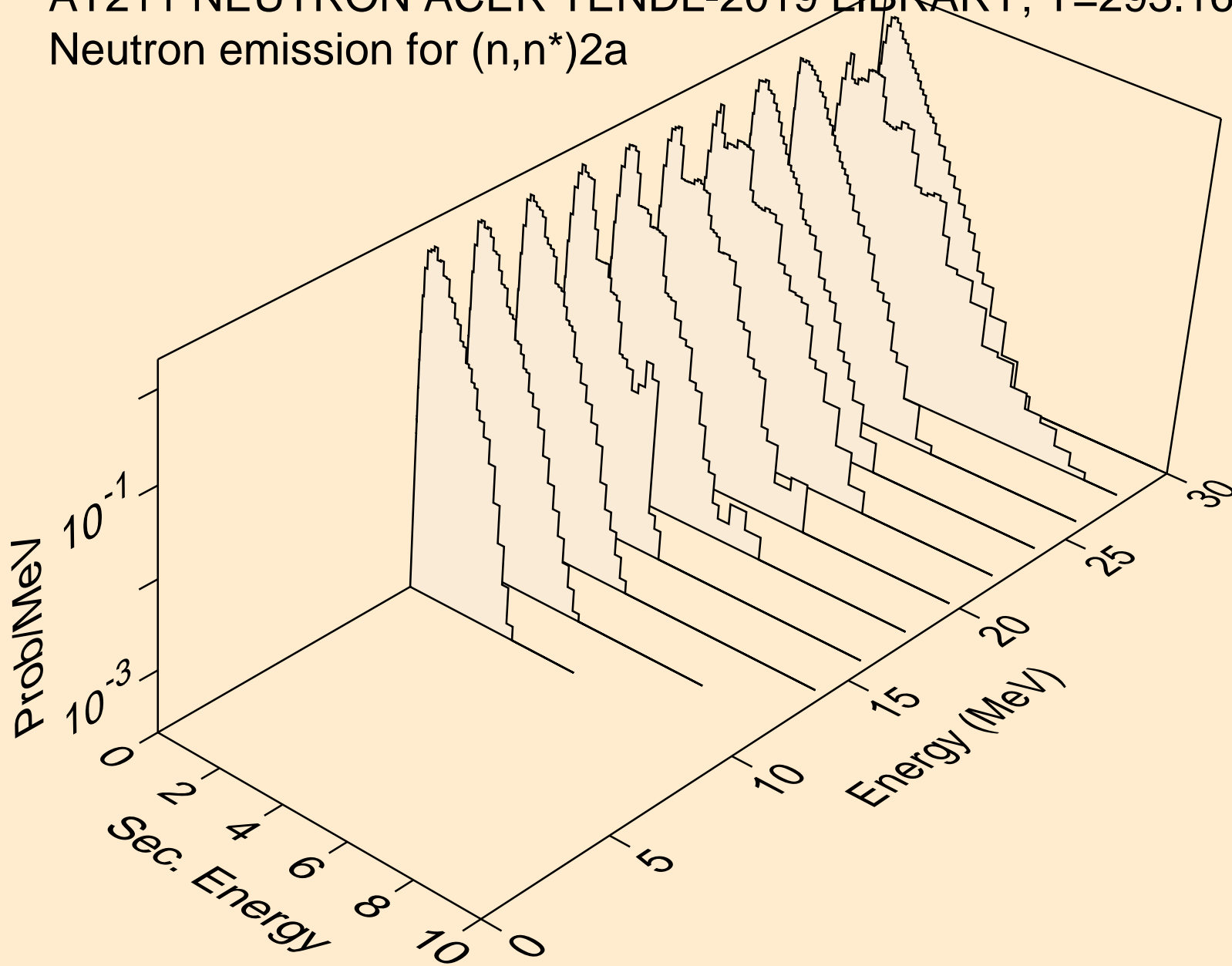

AT211 NEUTRON ACER TENDL-2019 LIBRARY; T=293.16K
Neutron emission for (n,n*)d

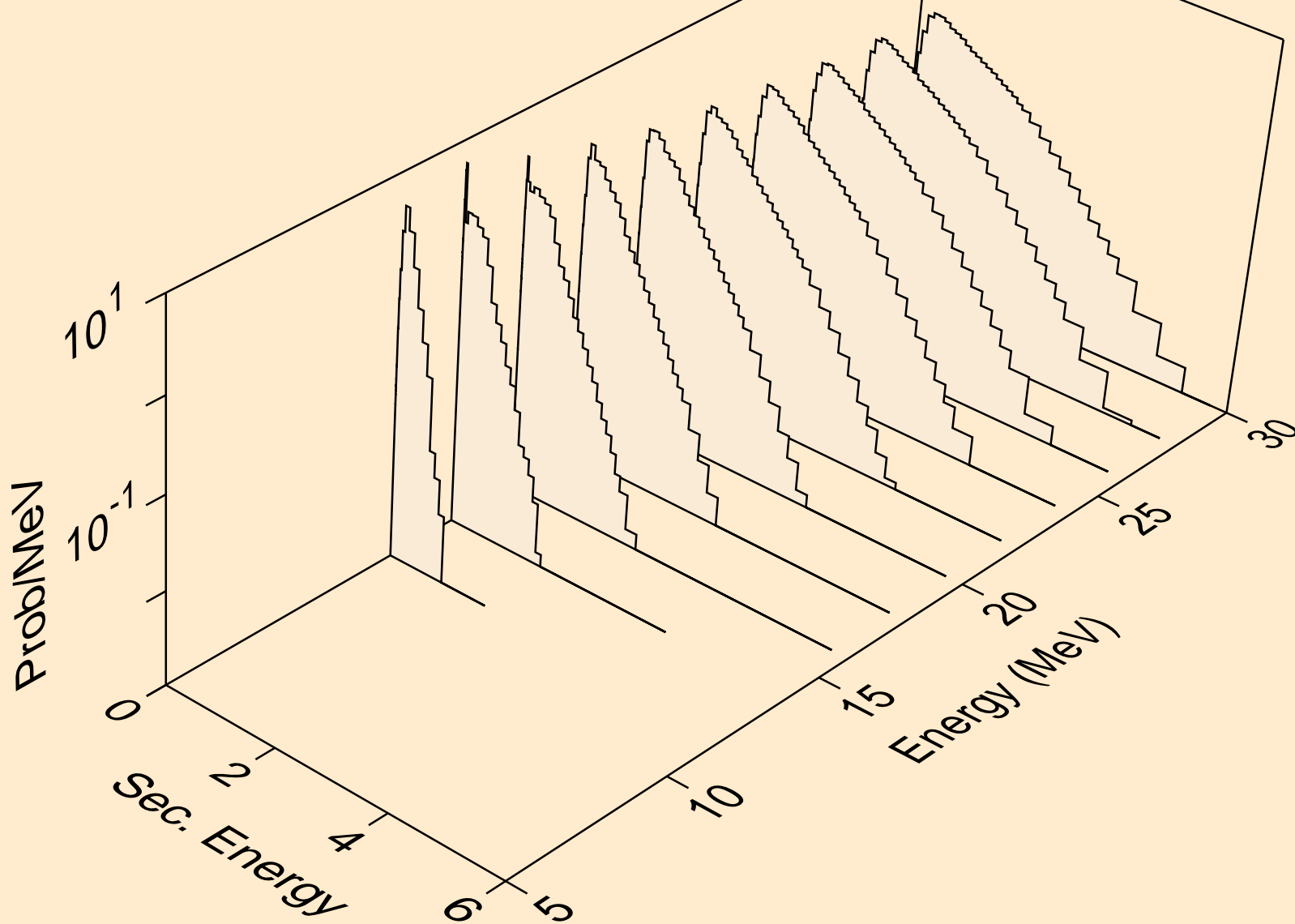

AT211 NEUTRON ACER TENDL-2019 LIBRARY; T=293.16K
Neutron emission for (n,n*)t

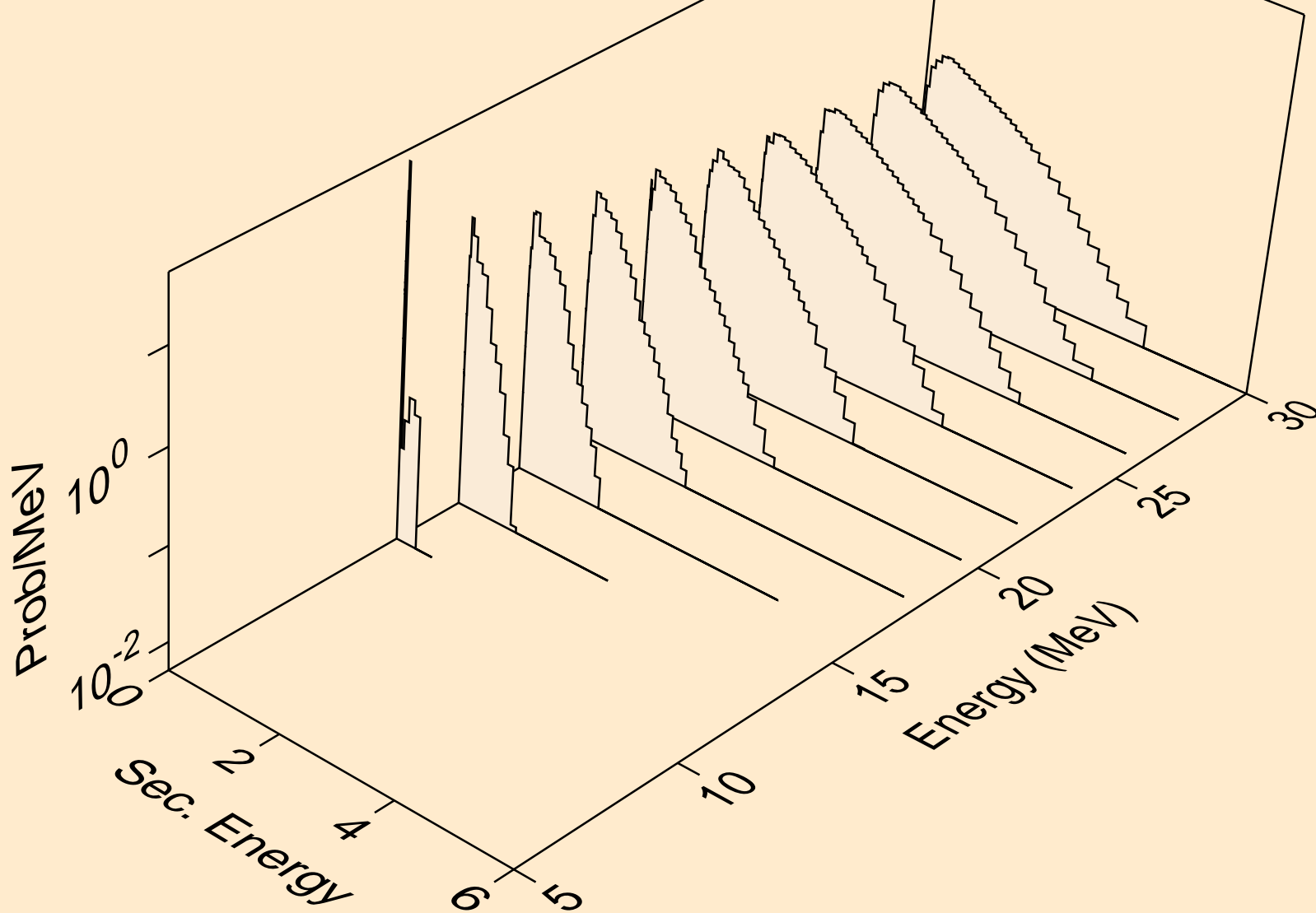

AT211 NEUTRON ACER TENDL-2019 LIBRARY; T=293.16K
Neutron emission for (n,n*)he3

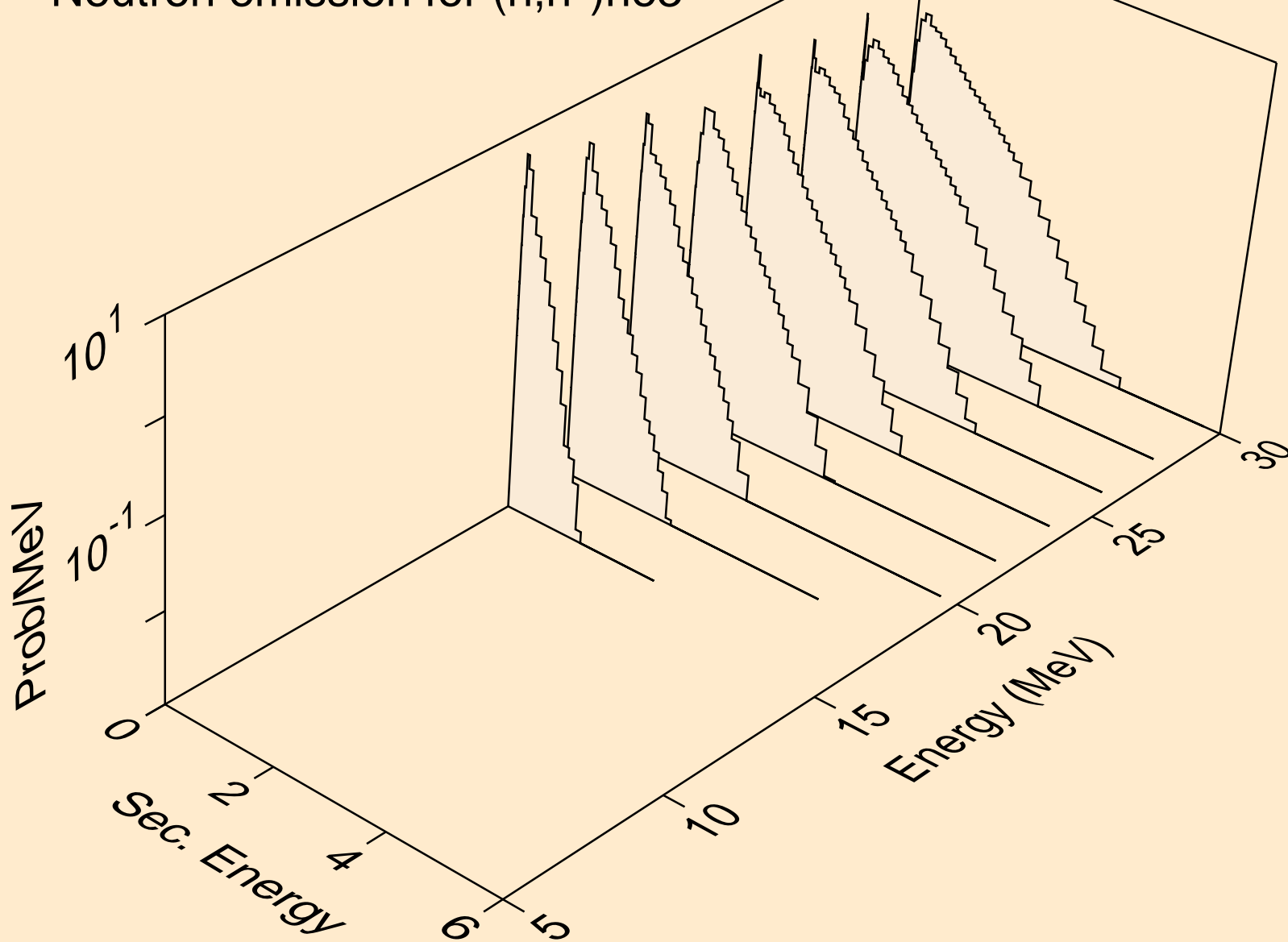

AT211 NEUTRON ACER TENDL-2019 LIBRARY; T=293.16K
Neutron emission for (n,4n)

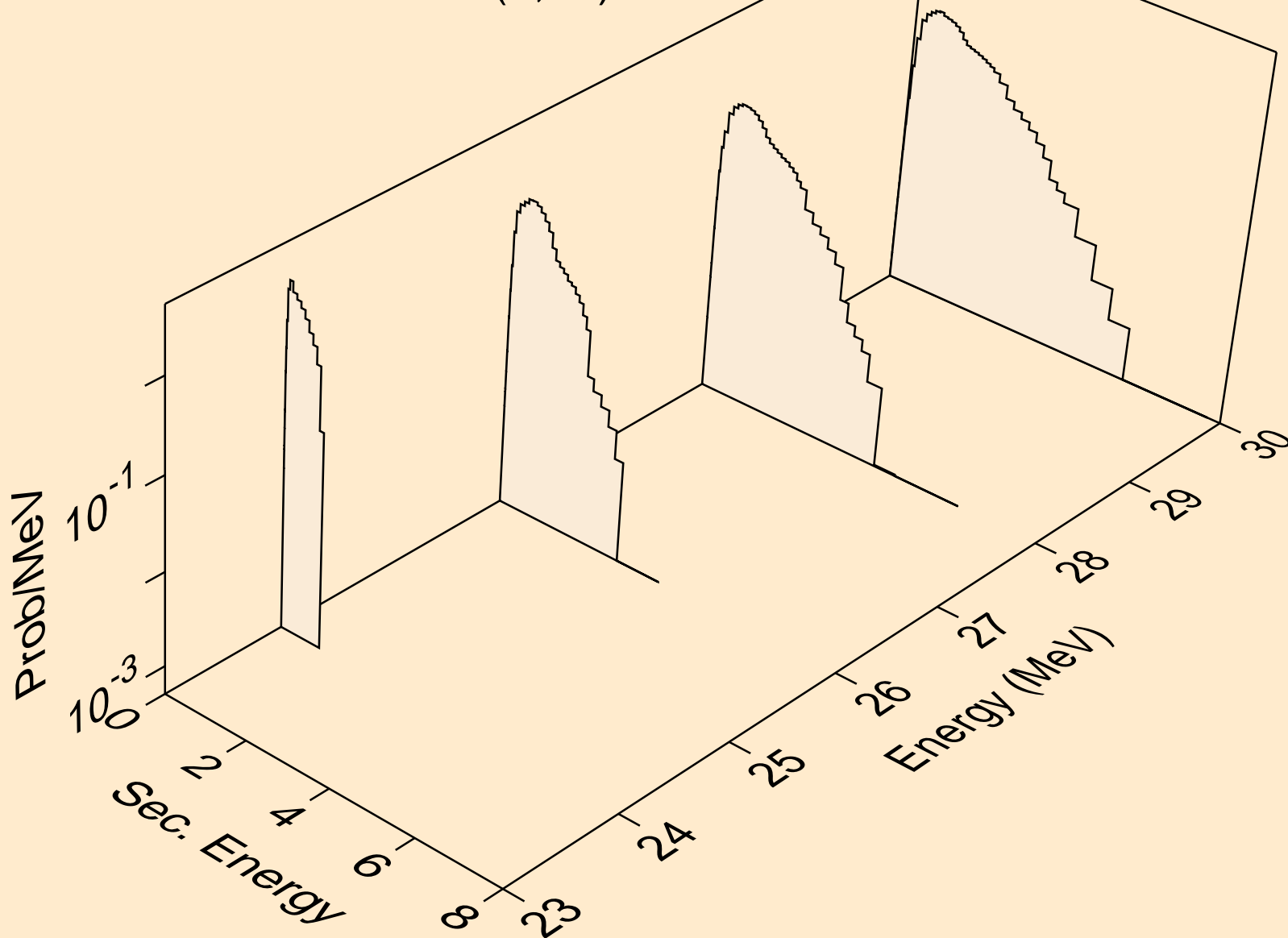

AT211 NEUTRON ACER TENDL-2019 LIBRARY; T=293.16K
Neutron emission for (n,2np)

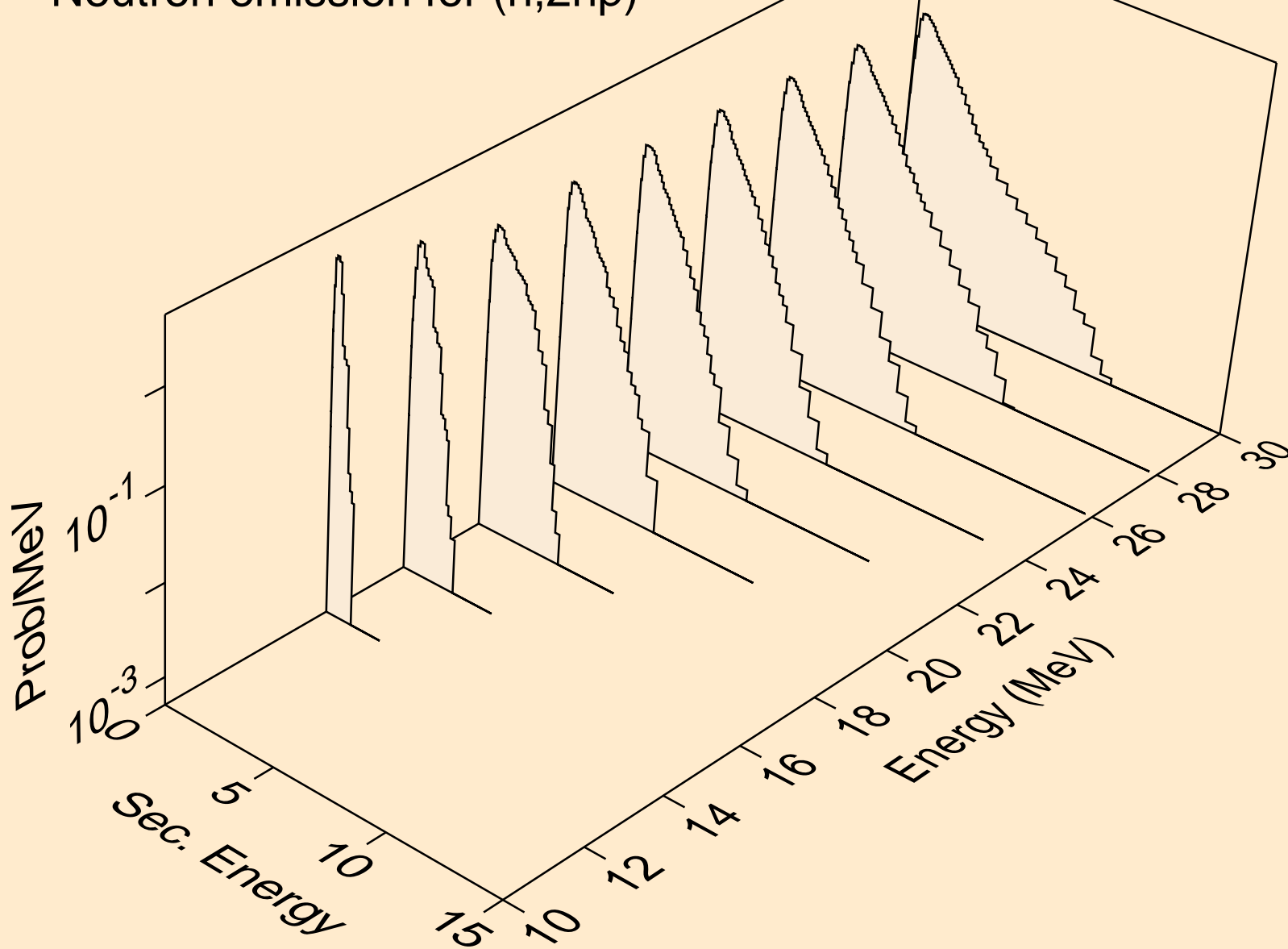

AT211 NEUTRON ACER TENDL-2019 LIBRARY; T=293.16K
Neutron emission for (n,3np)

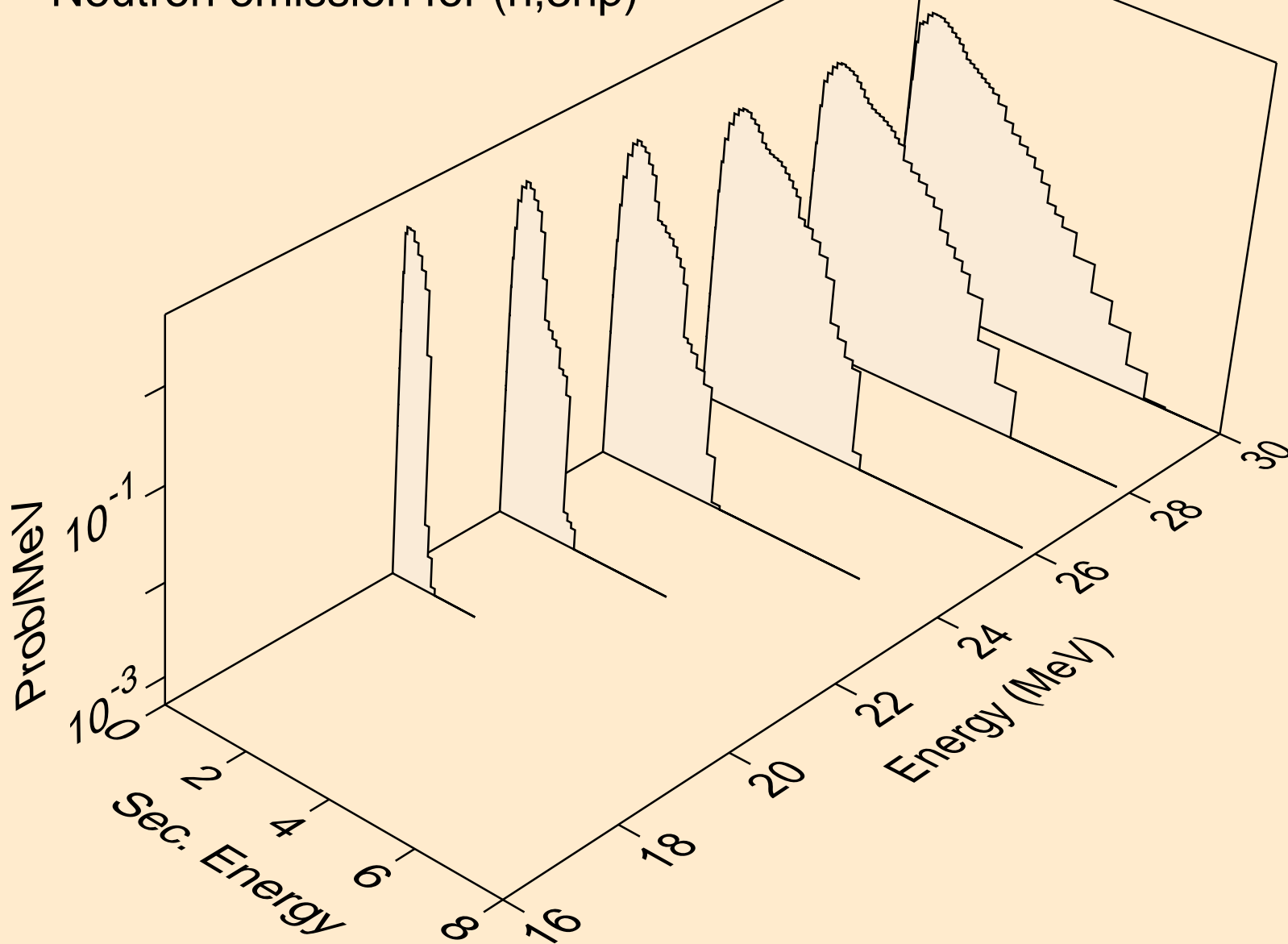

AT211 NEUTRON ACER TENDL-2019 LIBRARY; T=293.16K
Neutron emission for (n,2np)

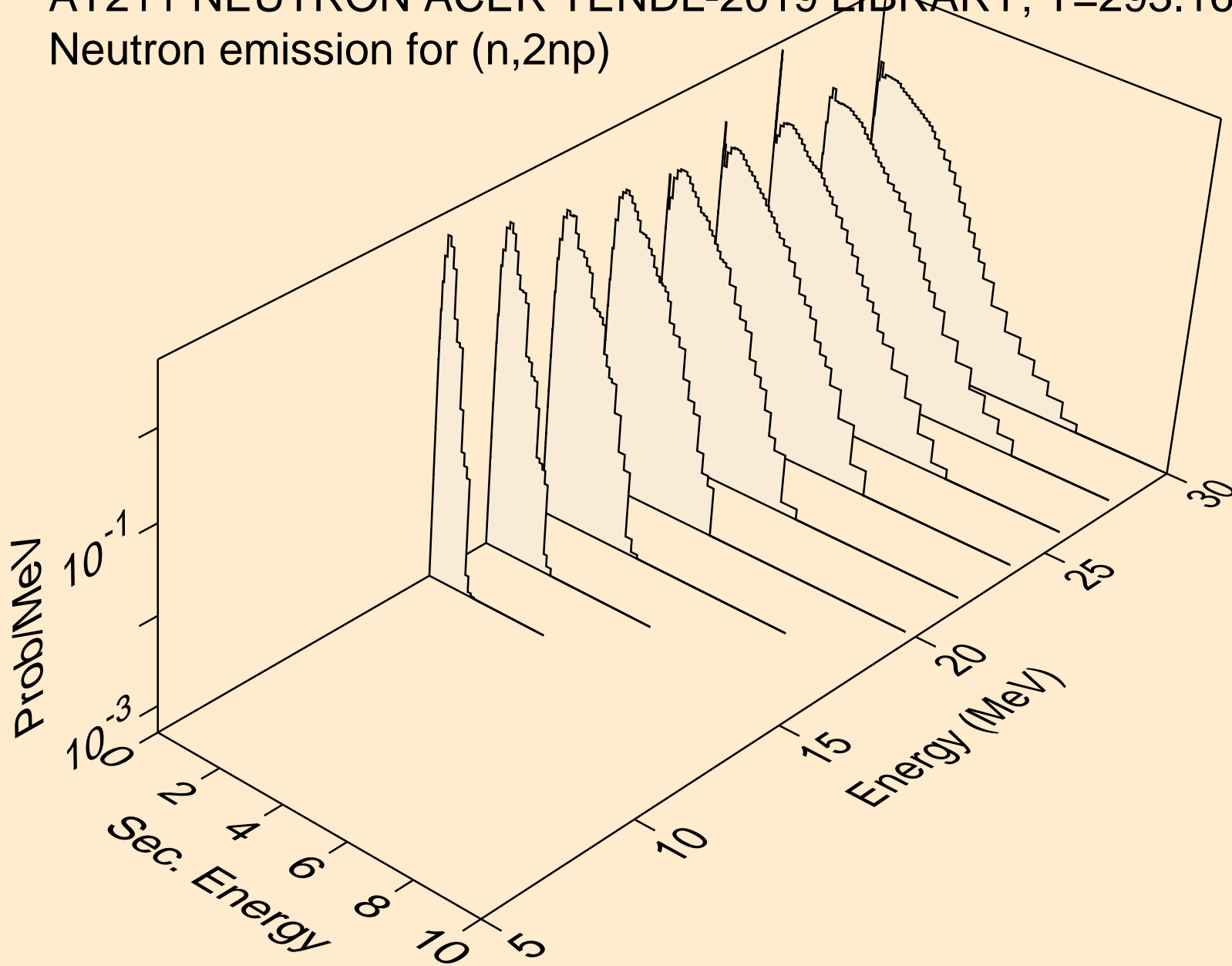

AT211 NEUTRON ACER TENDL-2019 LIBRARY; T=293.16K
Neutron emission for (n,npa)

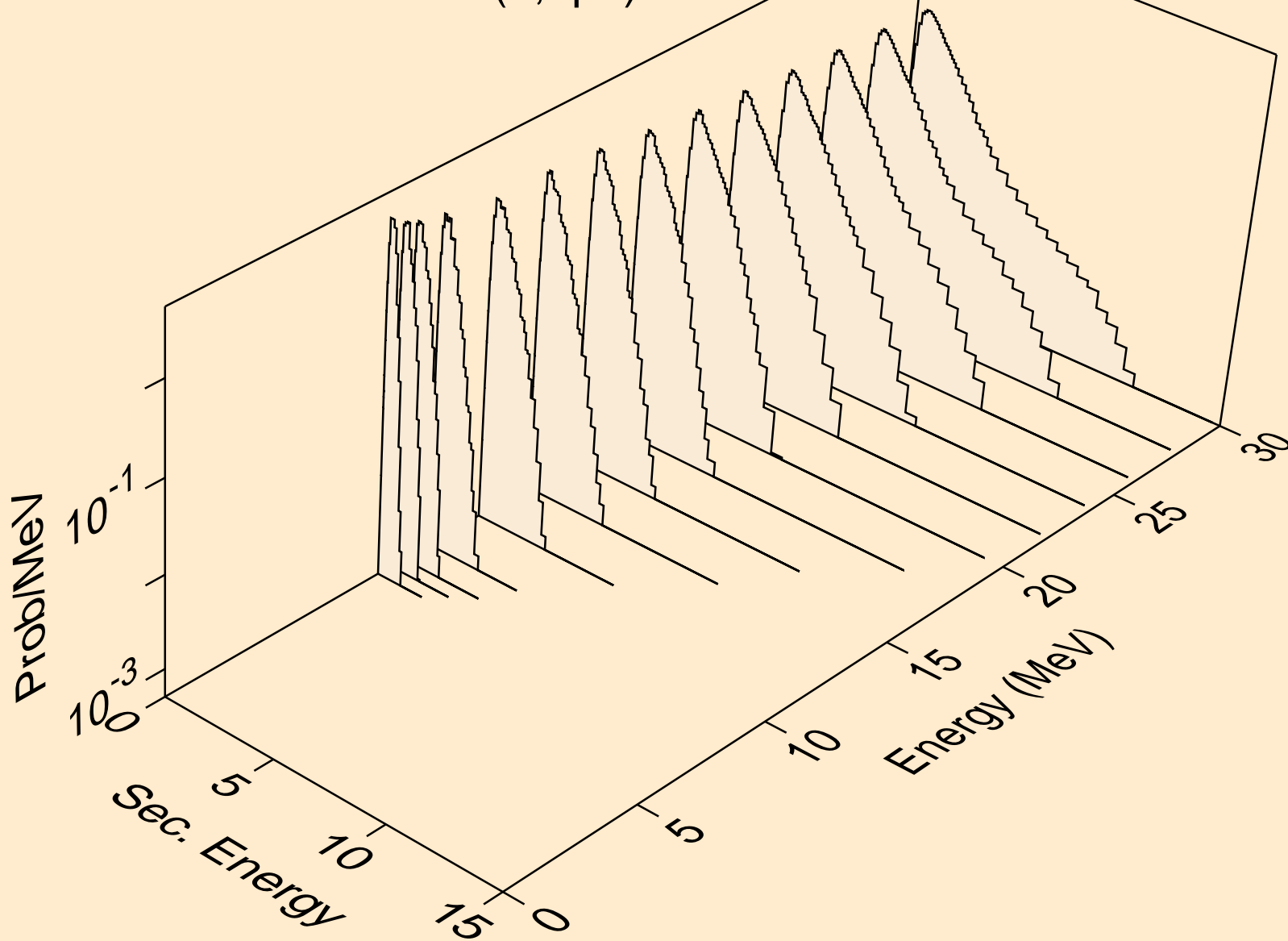

AT211 NEUTRON ACER TENDL-2019 LIBRARY; T=293.16K
Neutron emission for (n,n*c)

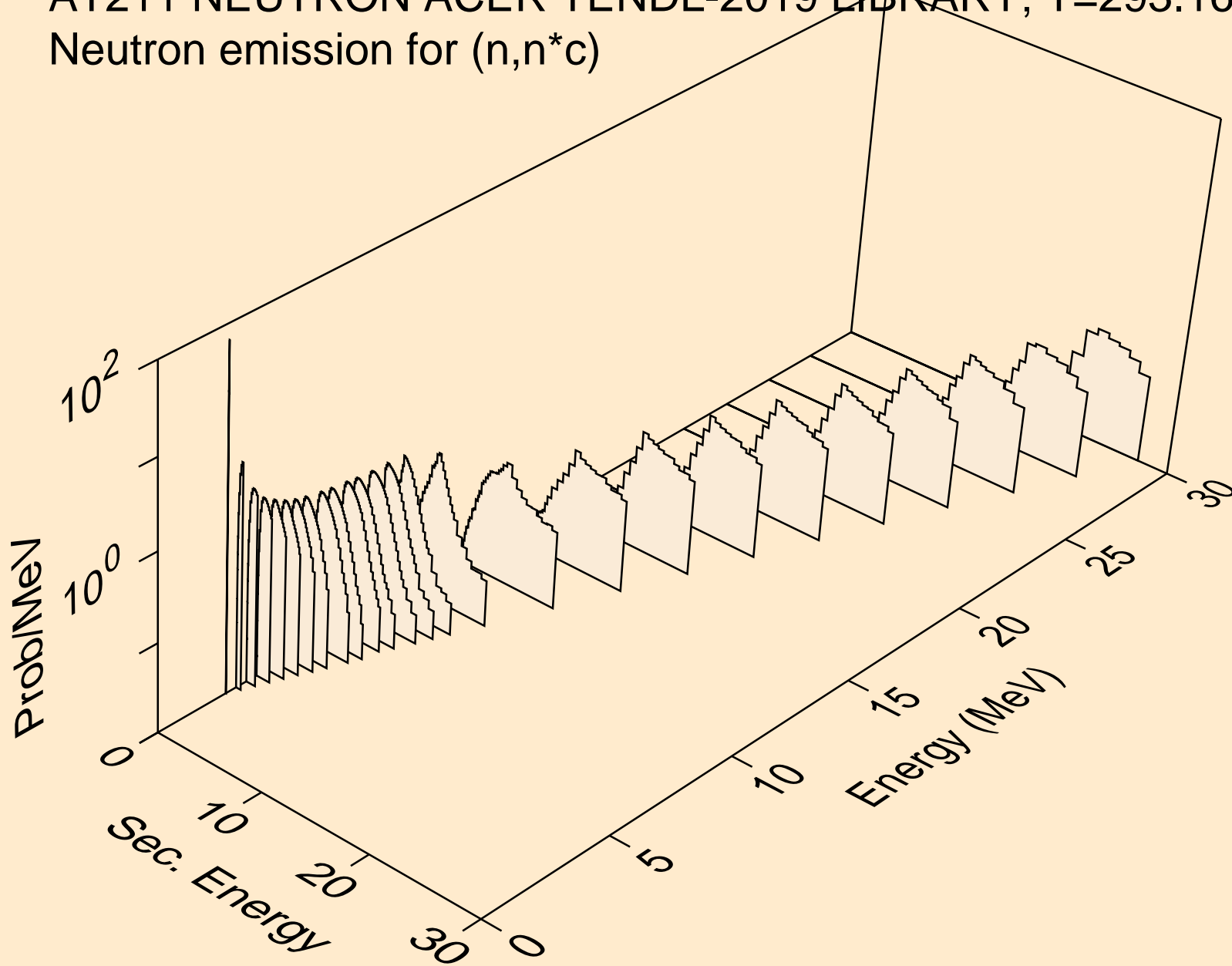

AT211 NEUTRON ACER TENDL-2019 LIBRARY; T=293.16K
Photon emission for (n,x)

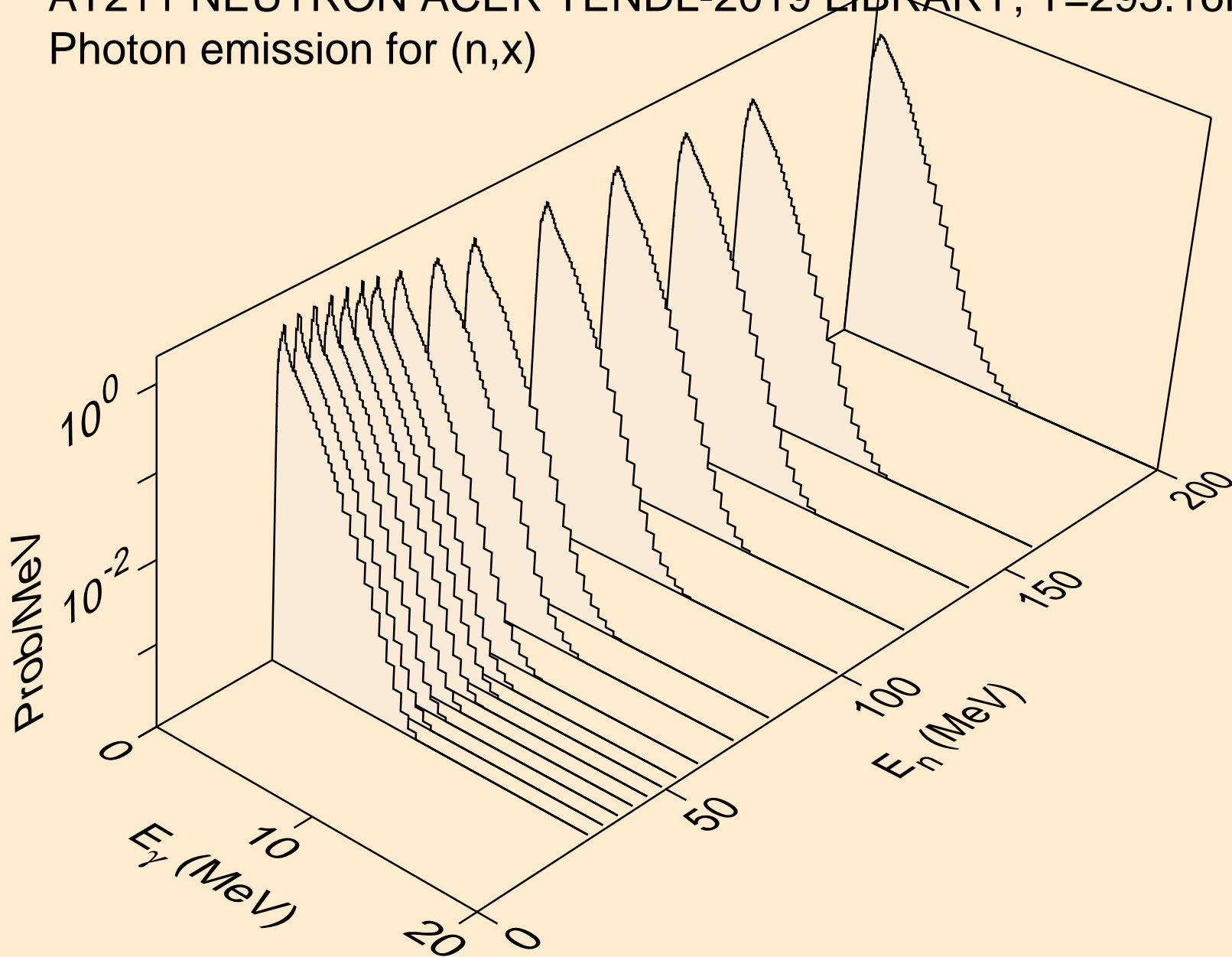

AT211 NEUTRON ACER TENDL-2019 LIBRARY; T=293.16K
Photon emission for (n,2nd)

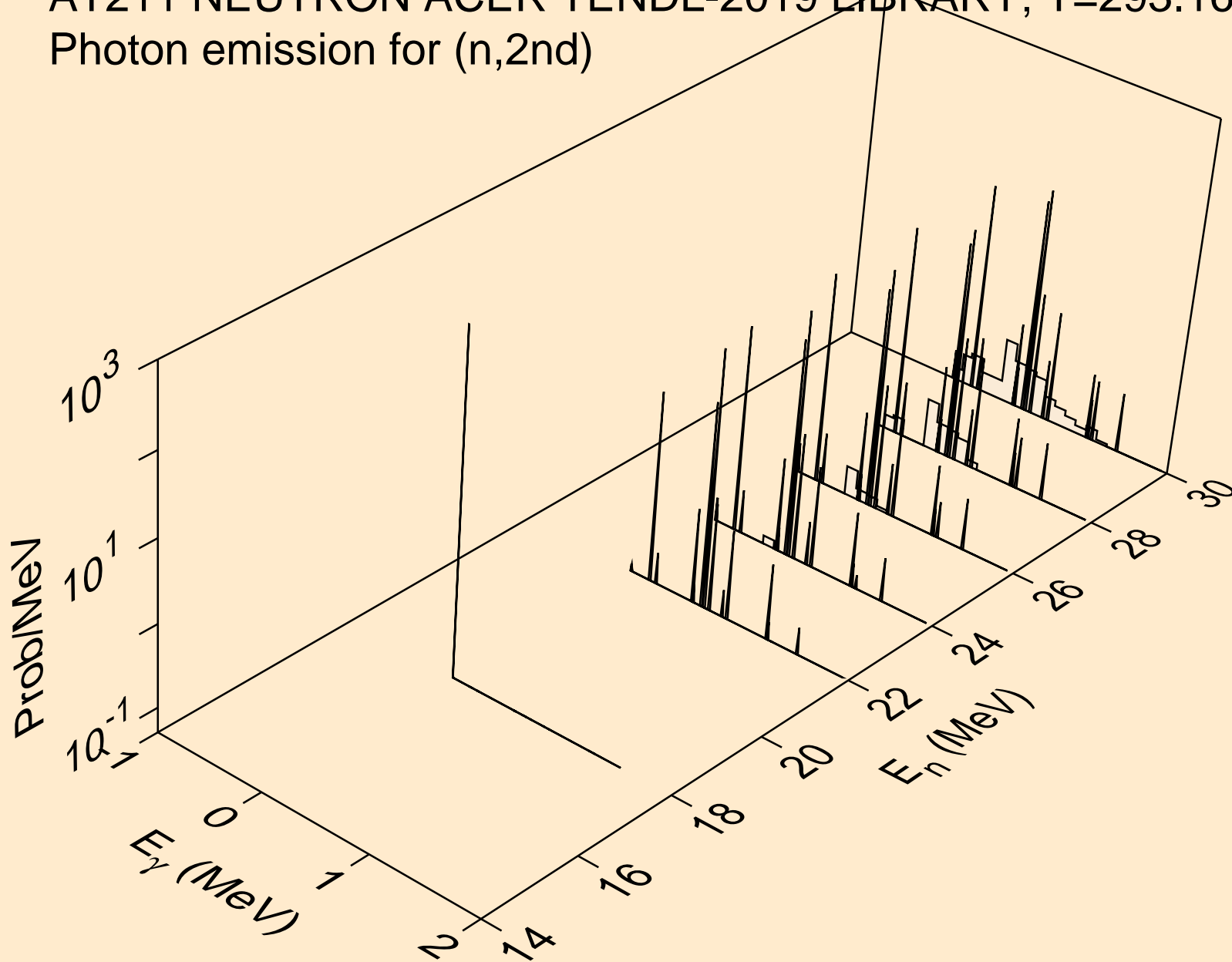

AT211 NEUTRON ACER TENDL-2019 LIBRARY; T=293.16K
Photon emission for (n,2n)

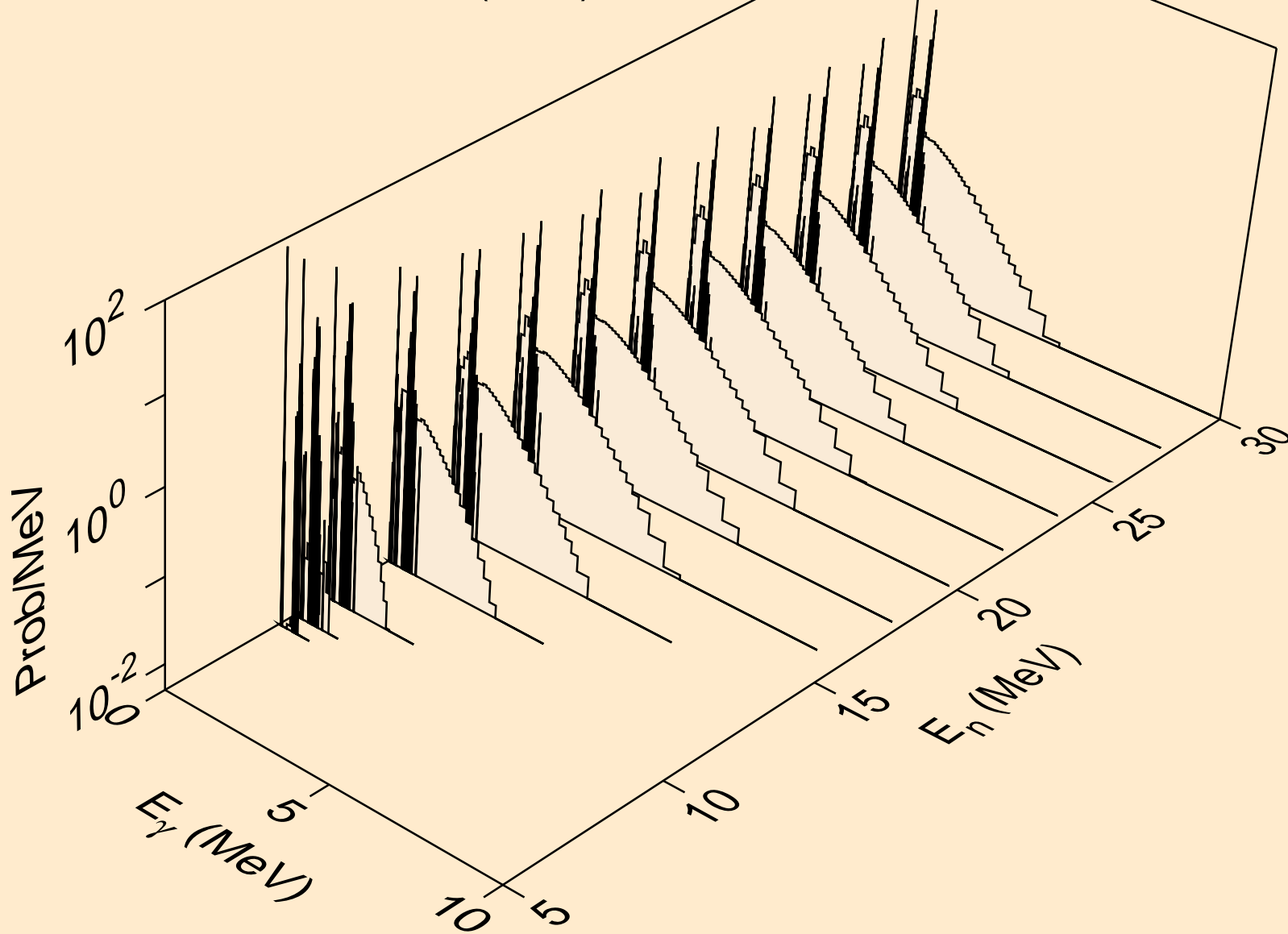

AT211 NEUTRON ACER TENDL-2019 LIBRARY; T=293.16K
Photon emission for (n,3n)

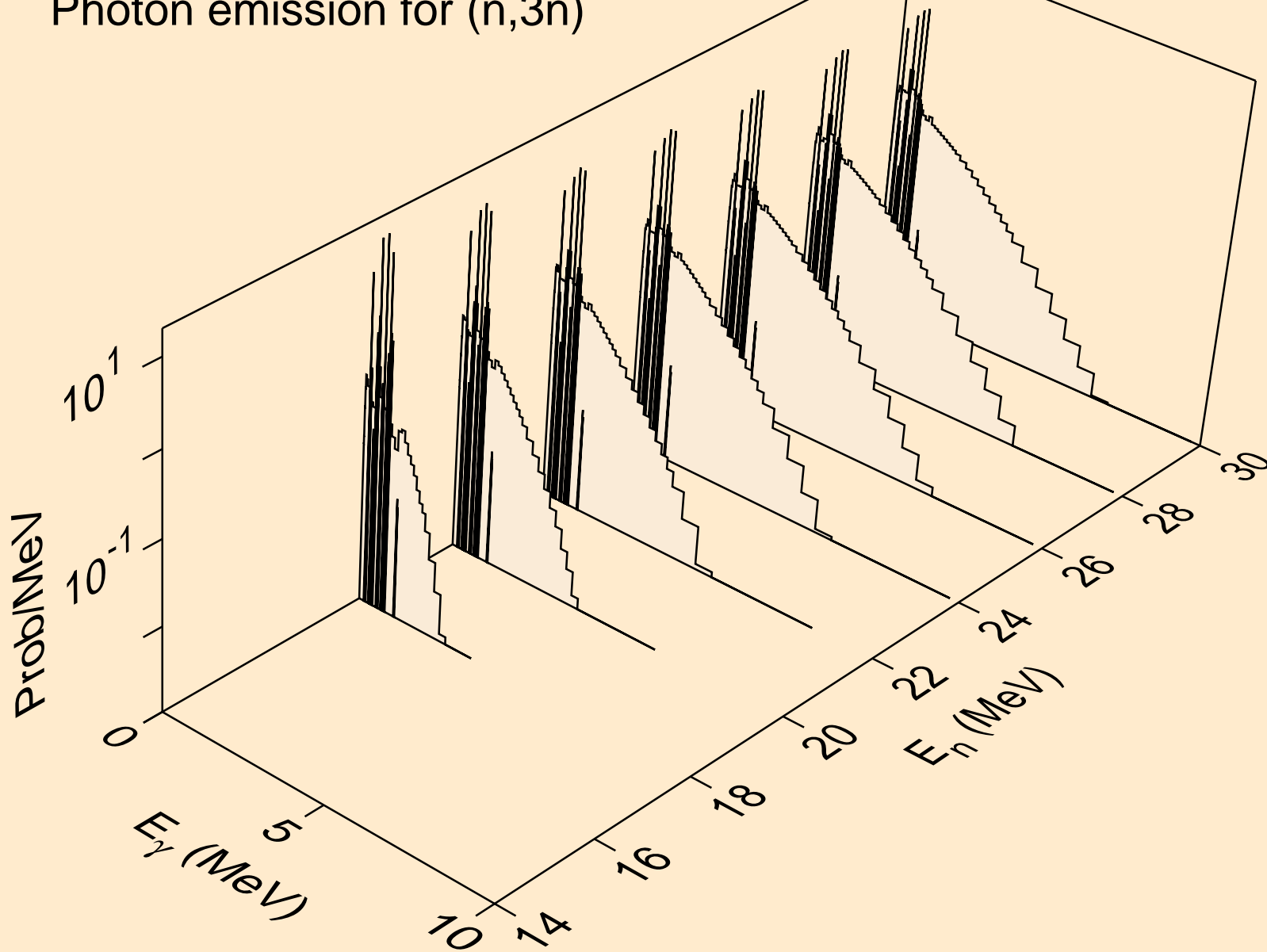

AT211 NEUTRON ACER TENDL-2019 LIBRARY; T=293.16K
Photon emission for (n,n*)a

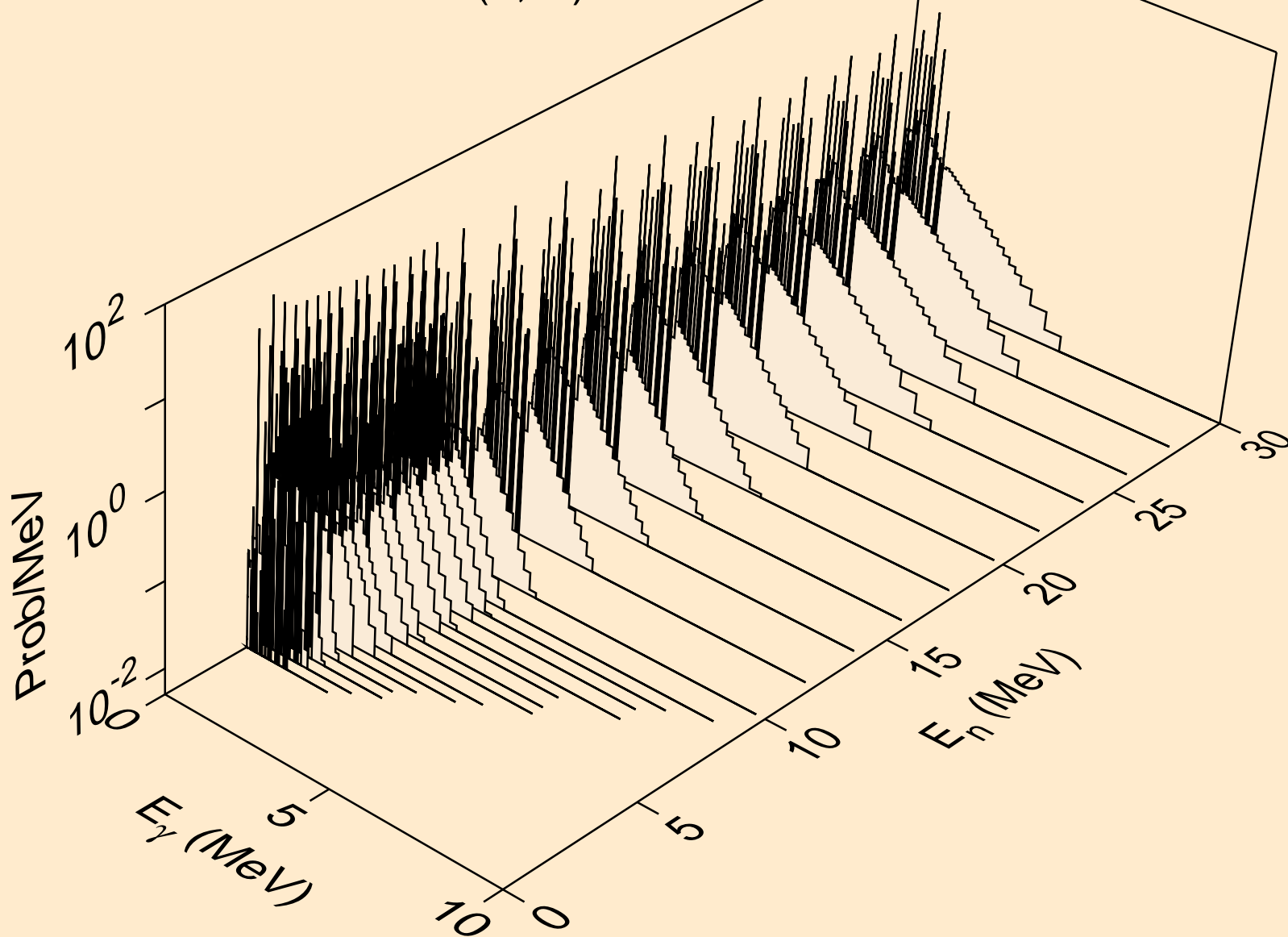

AT211 NEUTRON ACER TENDL-2019 LIBRARY; T=293.16K
Photon emission for (n,2n)a

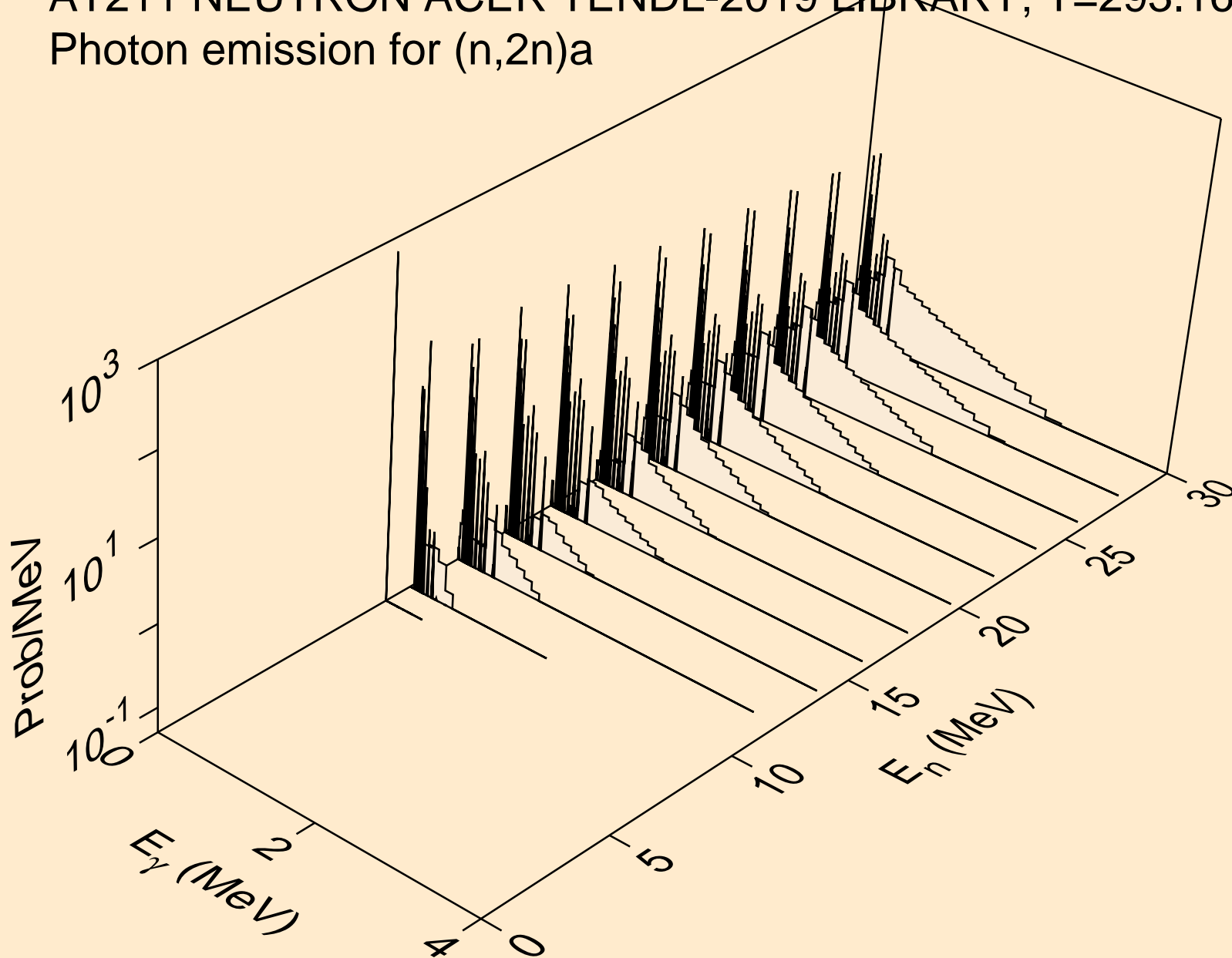

AT211 NEUTRON ACER TENDL-2019 LIBRARY; T=293.16K
Photon emission for (n,3n)a

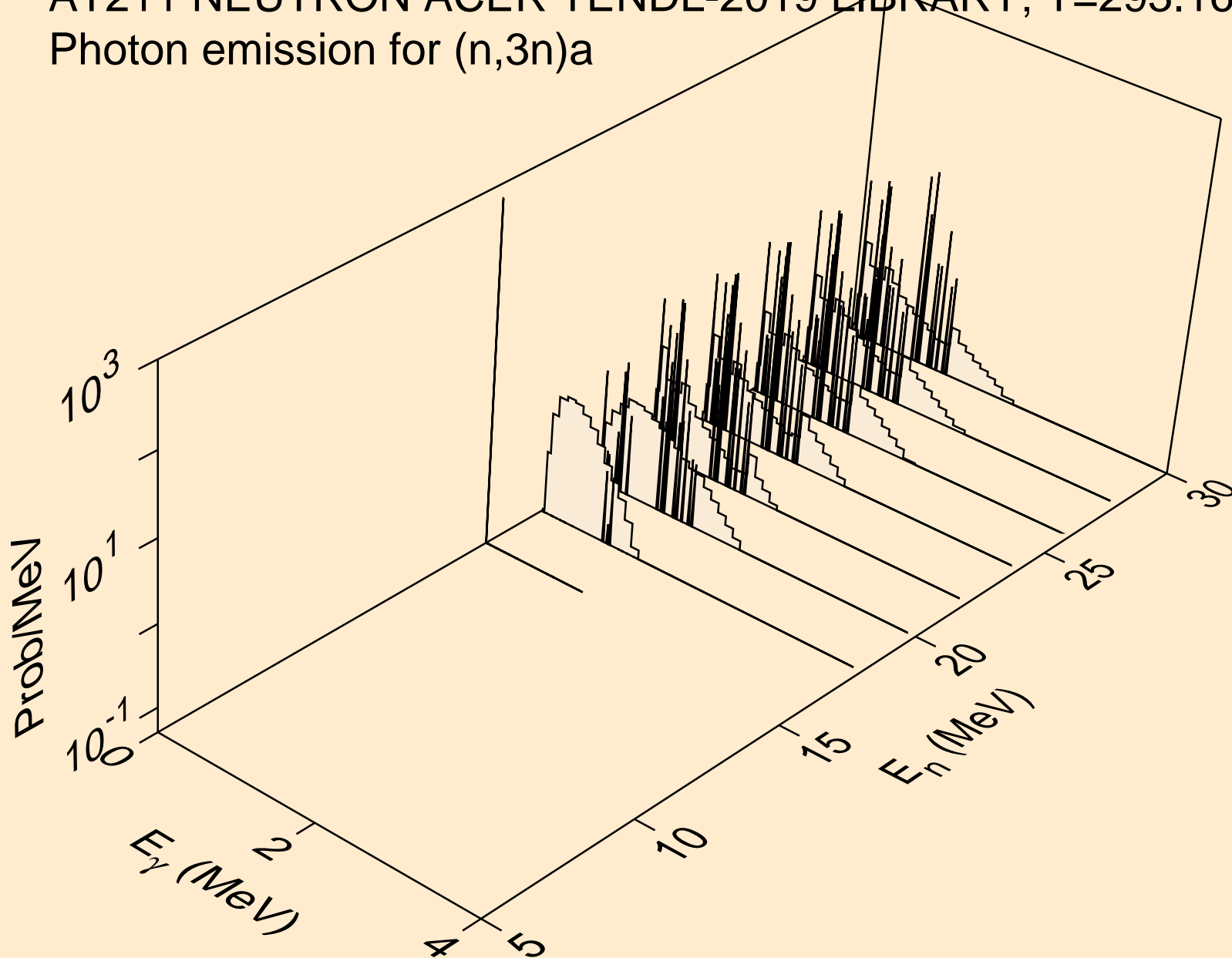

AT211 NEUTRON ACER TENDL-2019 LIBRARY; T=293.16K
Photon emission for (n,n*)p

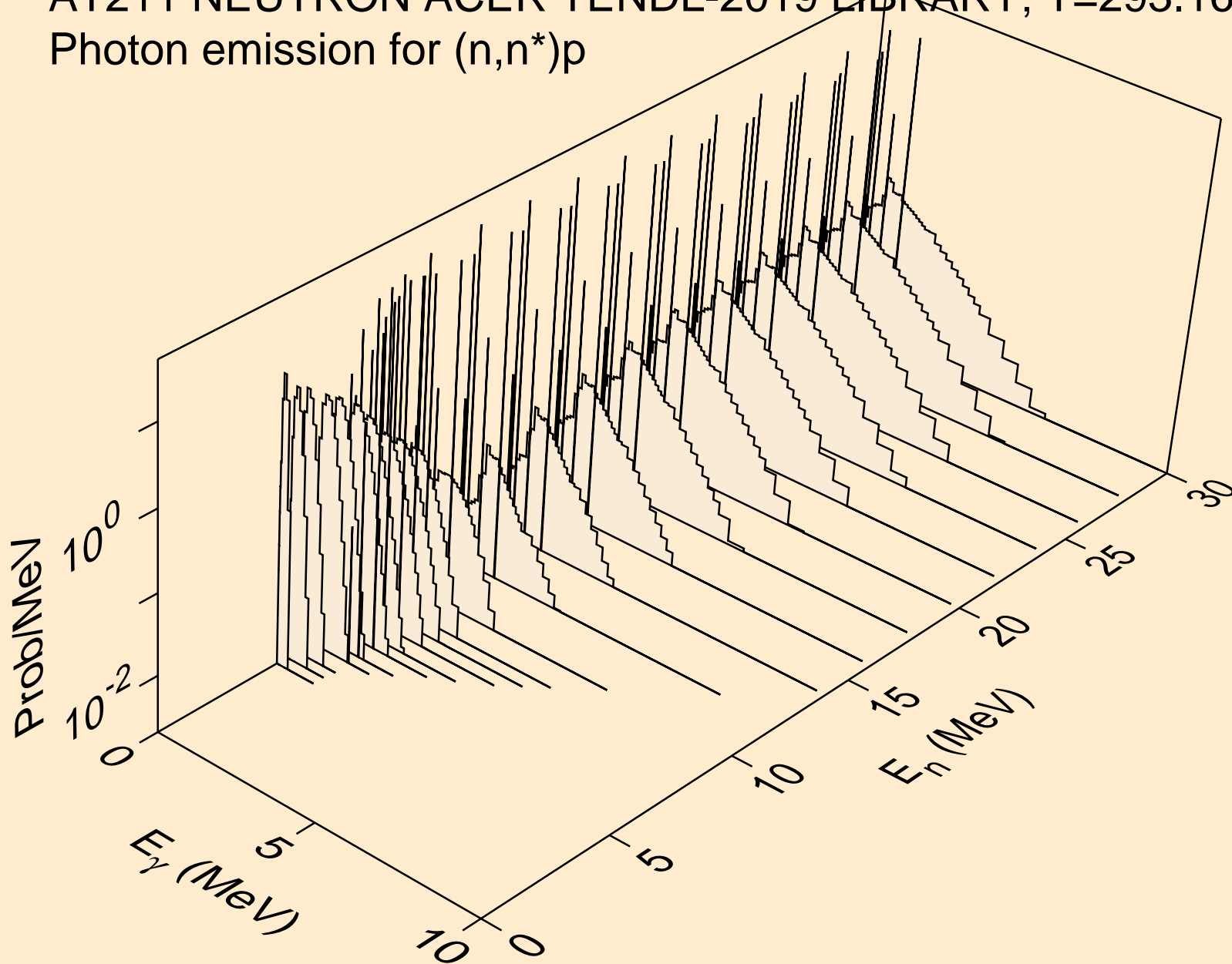

AT211 NEUTRON ACER TENDL-2019 LIBRARY; T=293.16K
Photon emission for (n,n*)2a

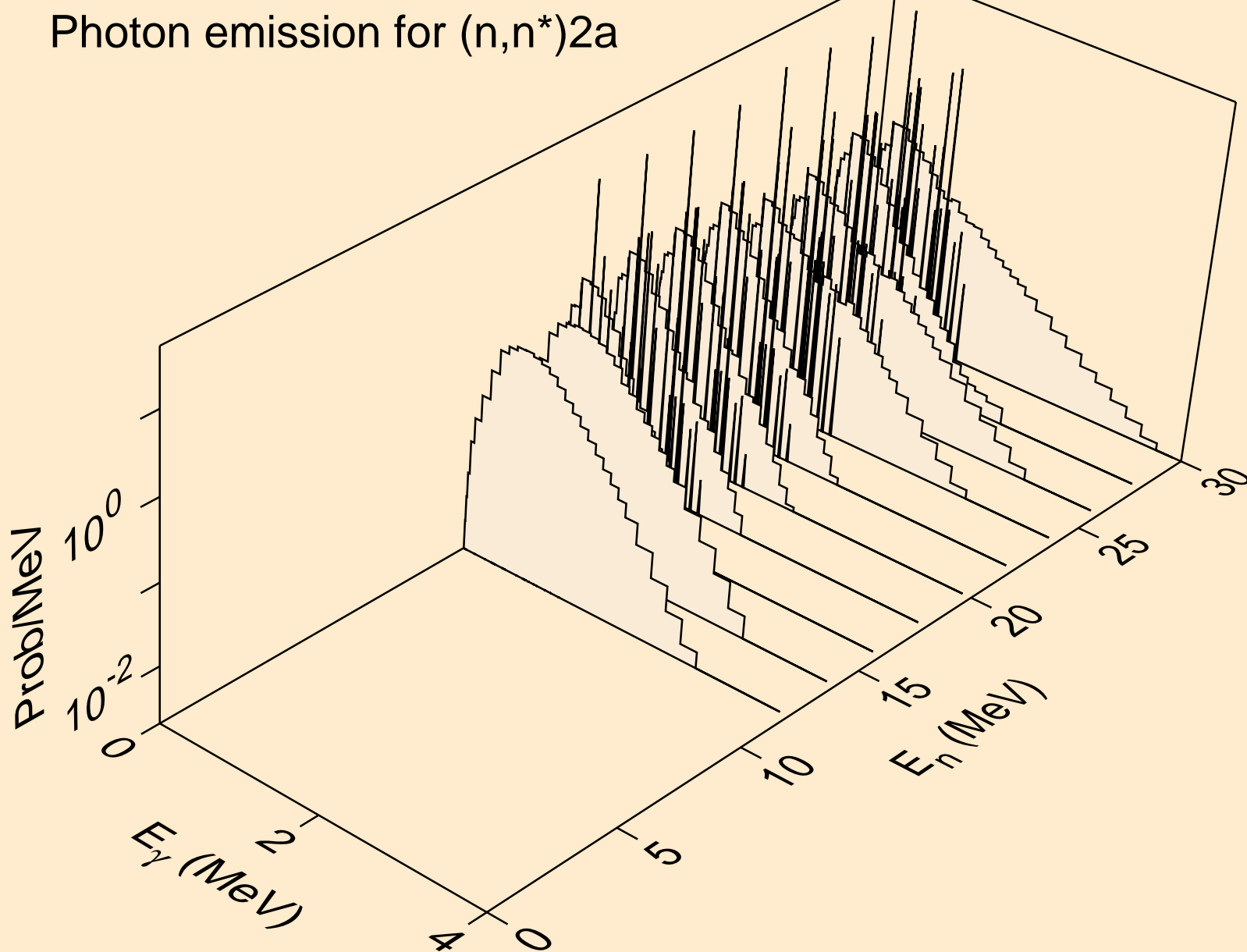

AT211 NEUTRON ACER TENDL-2019 LIBRARY; T=293.16K
Photon emission for (n,n*)d

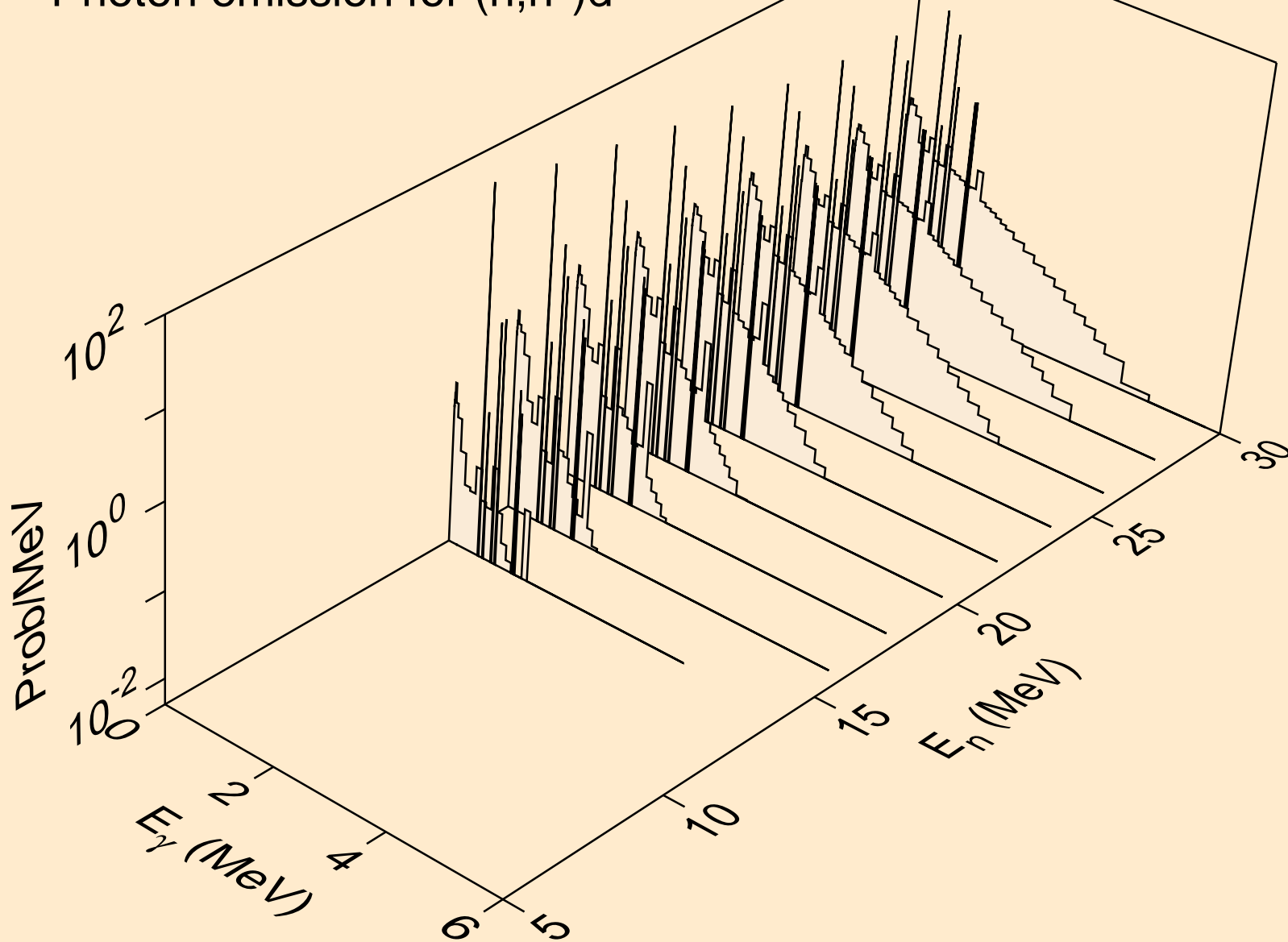

AT211 NEUTRON ACER TENDL-2019 LIBRARY; T=293.16K
Photon emission for (n,n*)t

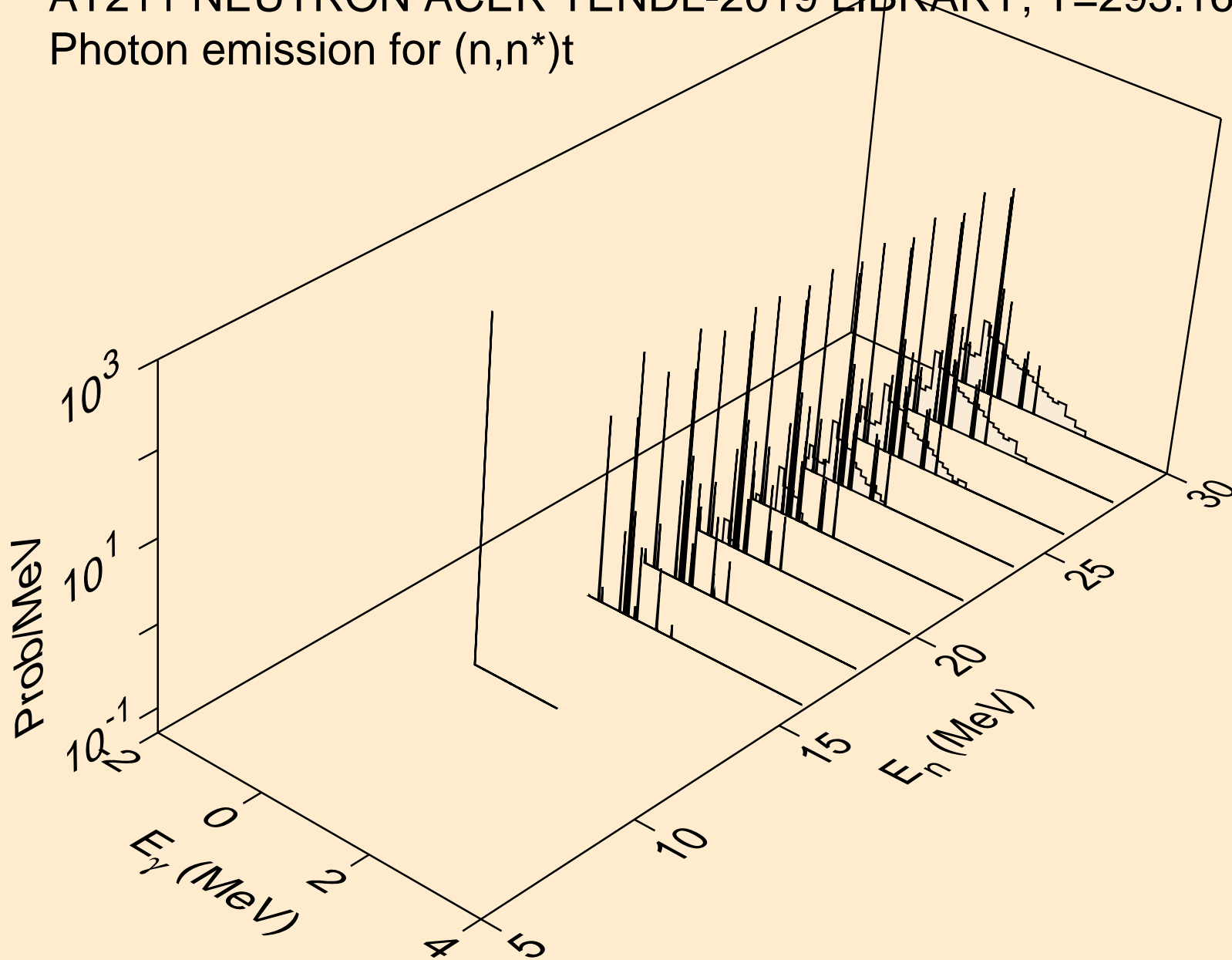

AT211 NEUTRON ACER TENDL-2019 LIBRARY; T=293.16K
Photon emission for (n,n*)he3

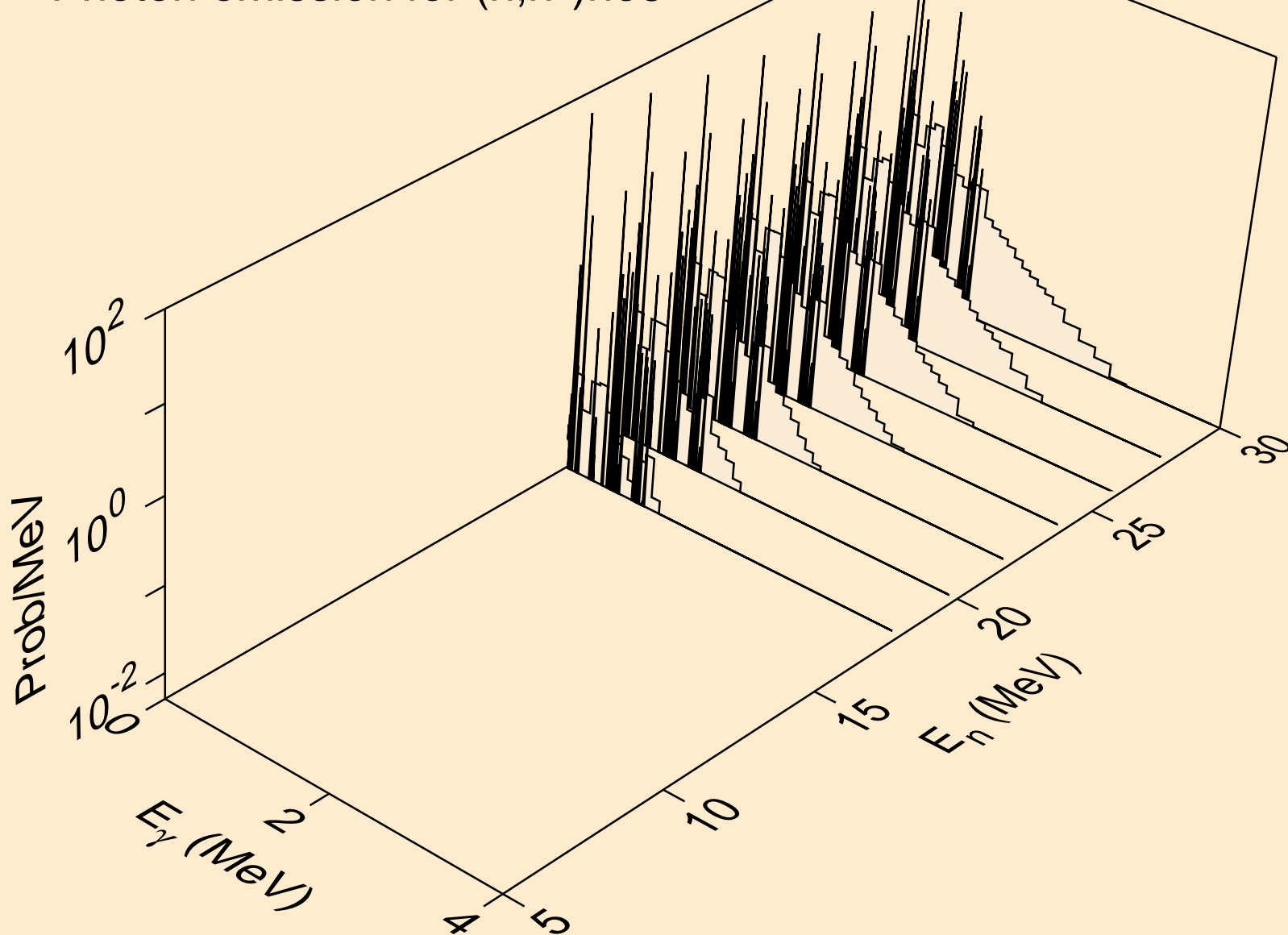

AT211 NEUTRON ACER TENDL-2019 LIBRARY; T=293.16K
Photon emission for (n,4n)

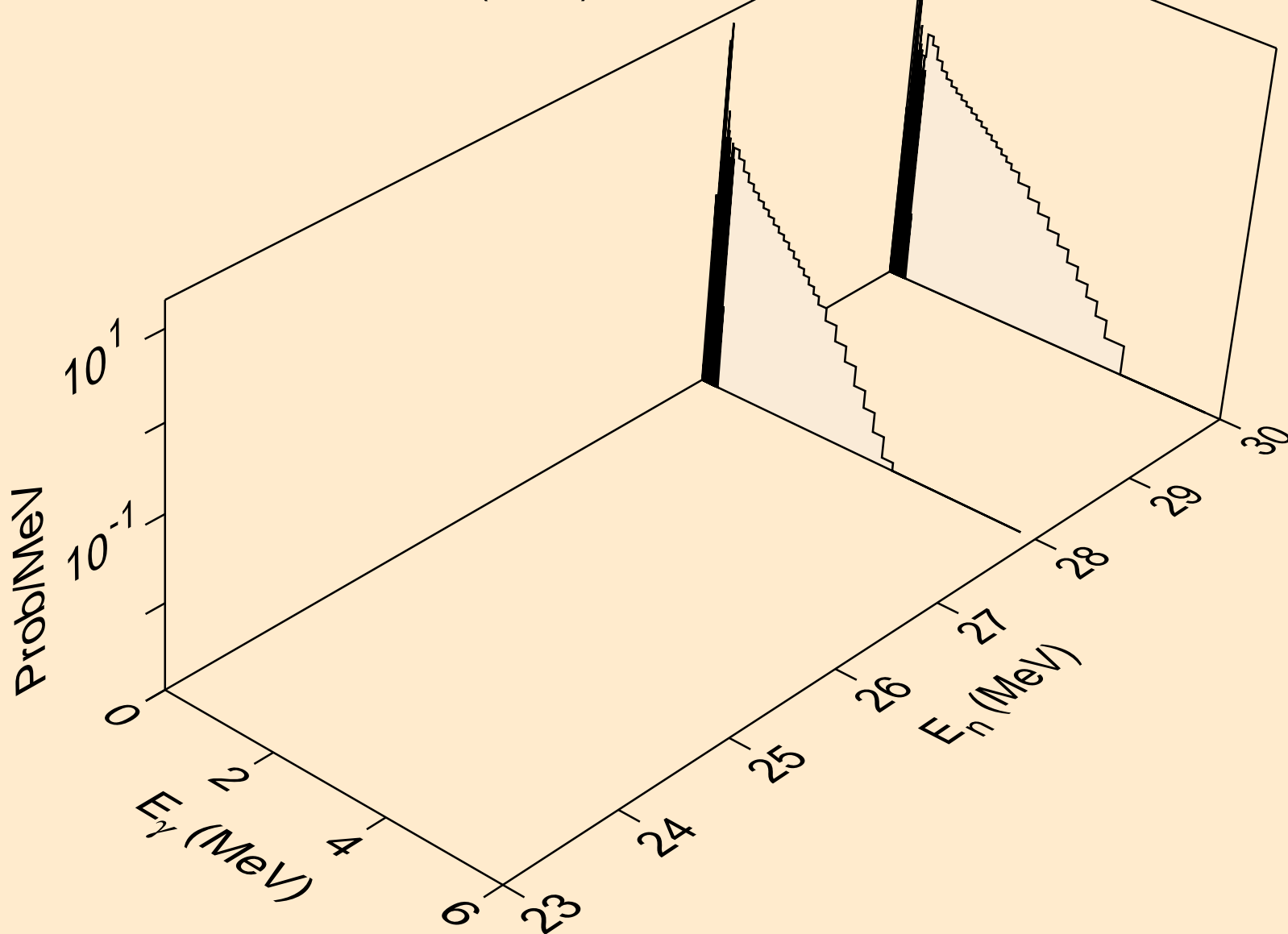

AT211 NEUTRON ACER TENDL-2019 LIBRARY; T=293.16K
Photon emission for (n,2np)

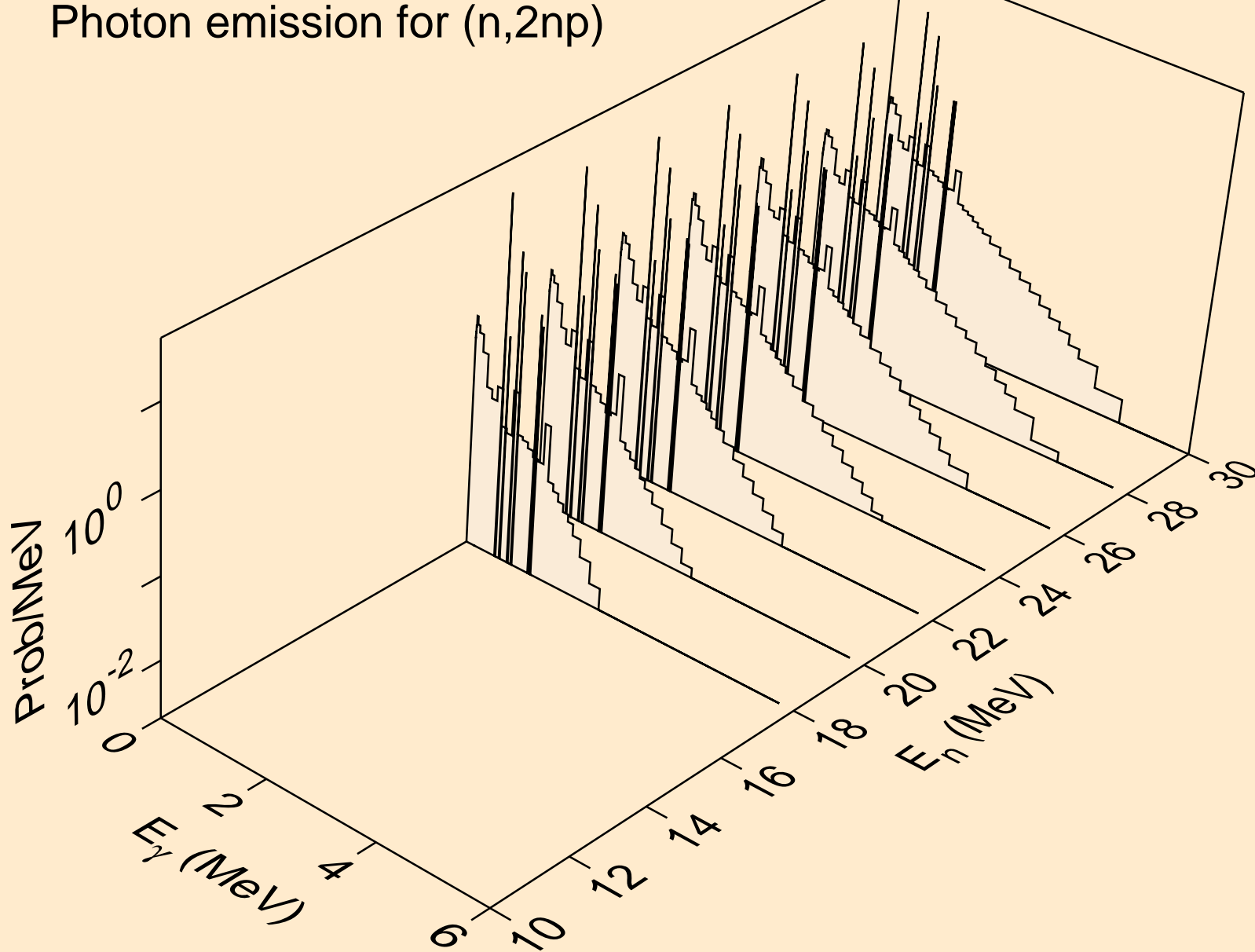

AT211 NEUTRON ACER TENDL-2019 LIBRARY; T=293.16K
Photon emission for (n,3np)

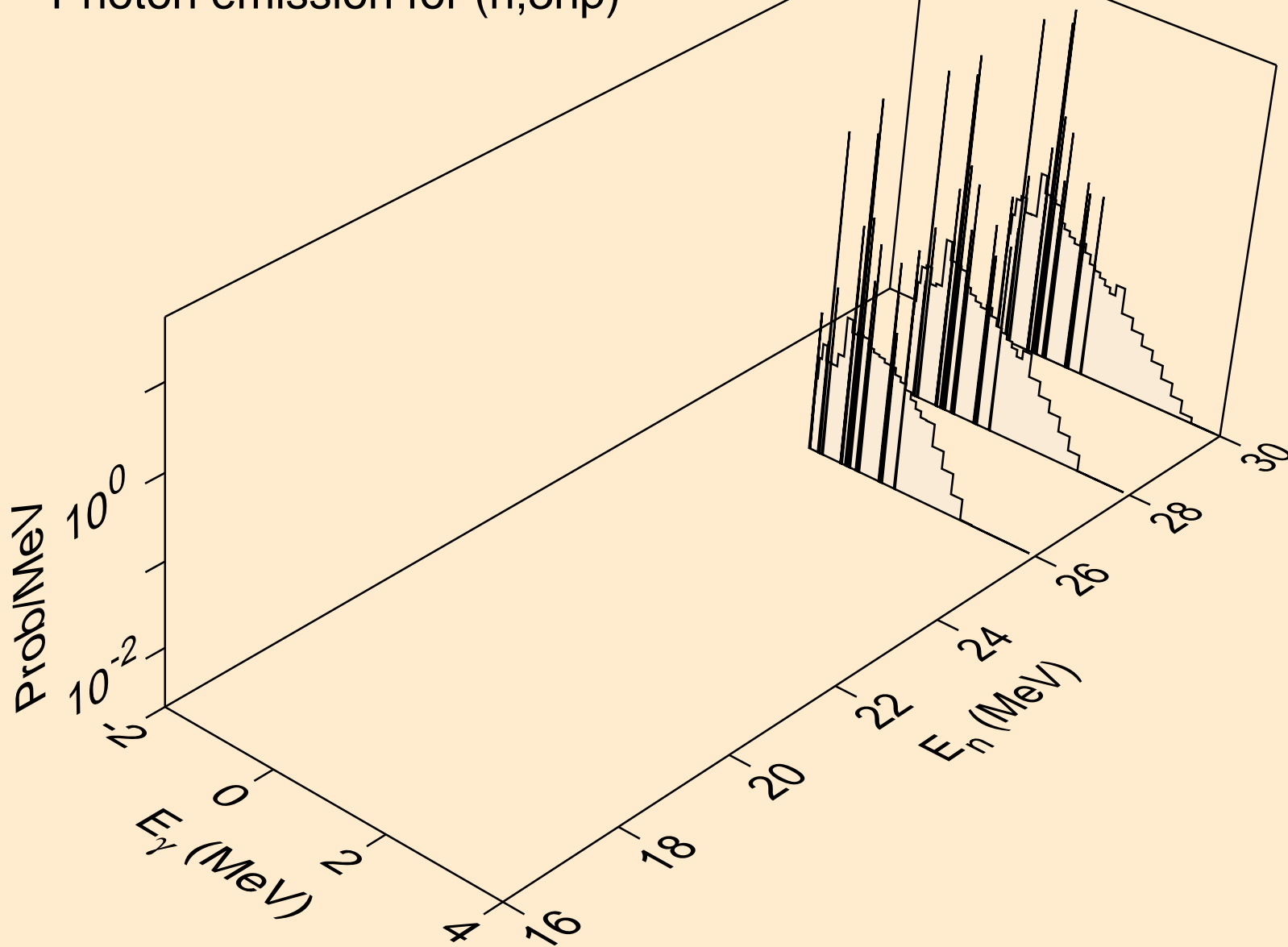

AT211 NEUTRON ACER TENDL-2019 LIBRARY; T=293.16K
Photon emission for (n,2np)

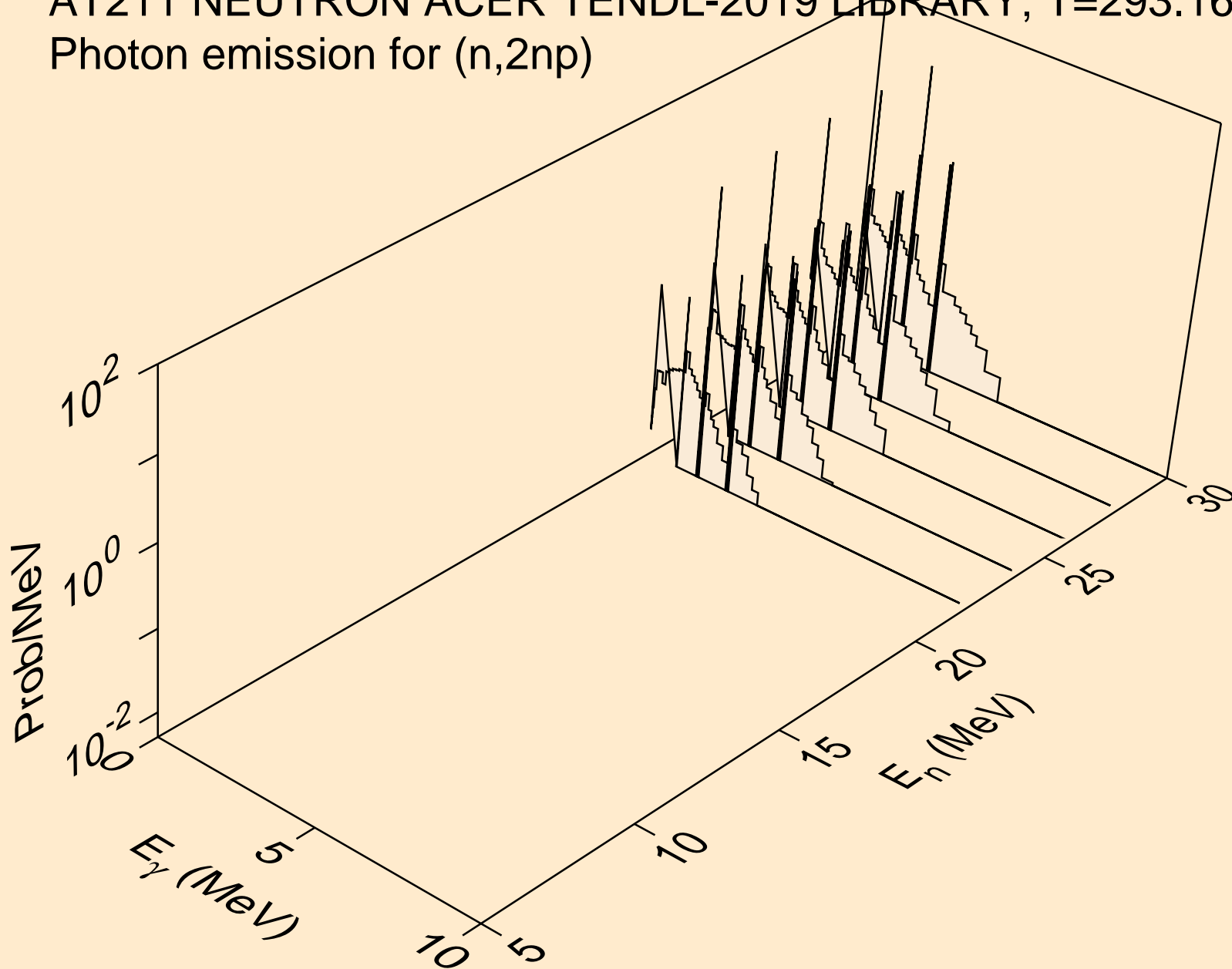

AT211 NEUTRON ACER TENDL-2019 LIBRARY; T=293.16K
Photon emission for (n,npa)

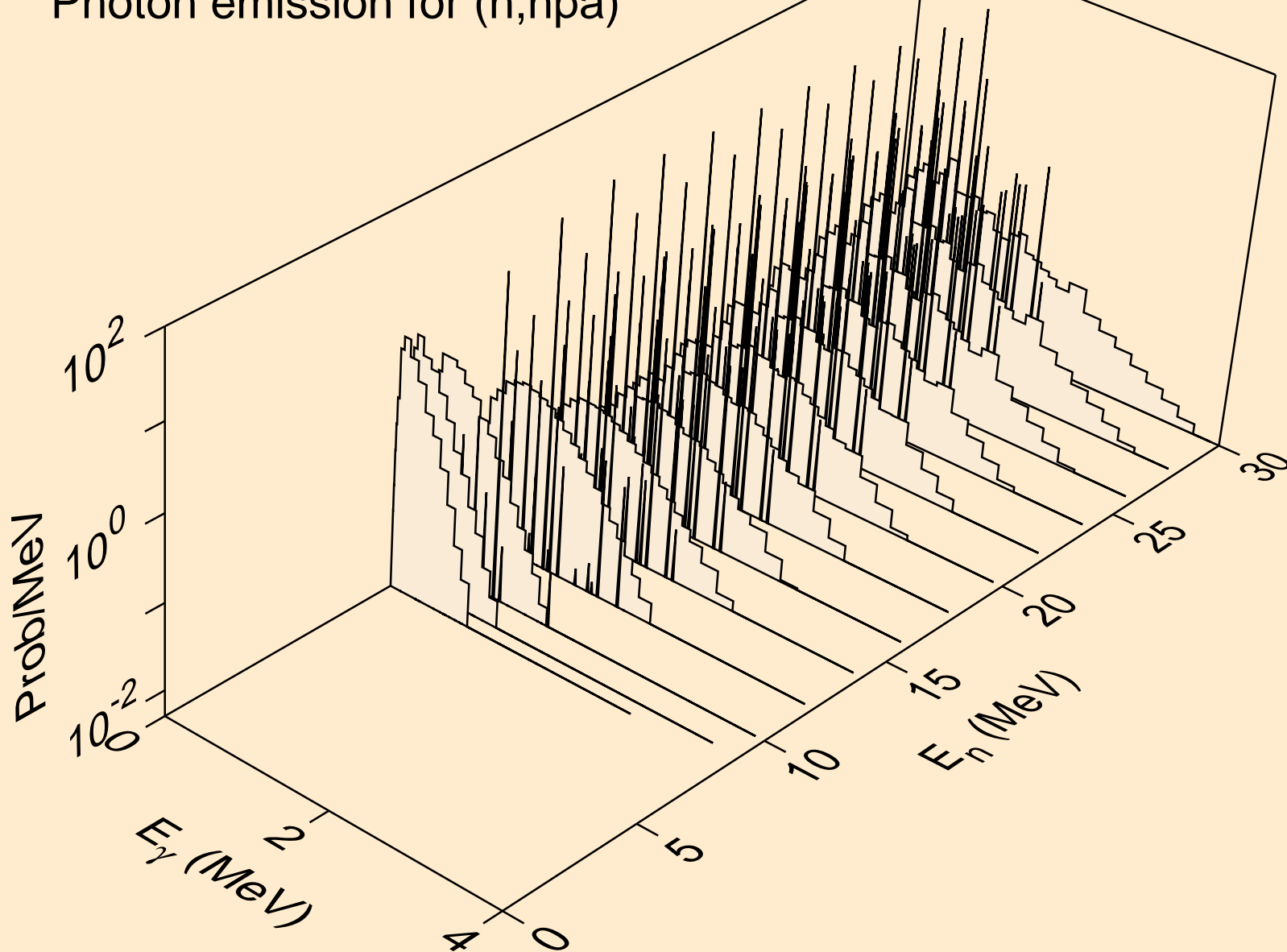

AT211 NEUTRON ACER TENDL-2019 LIBRARY; T=293.16K
Photon emission for (n,n*c)

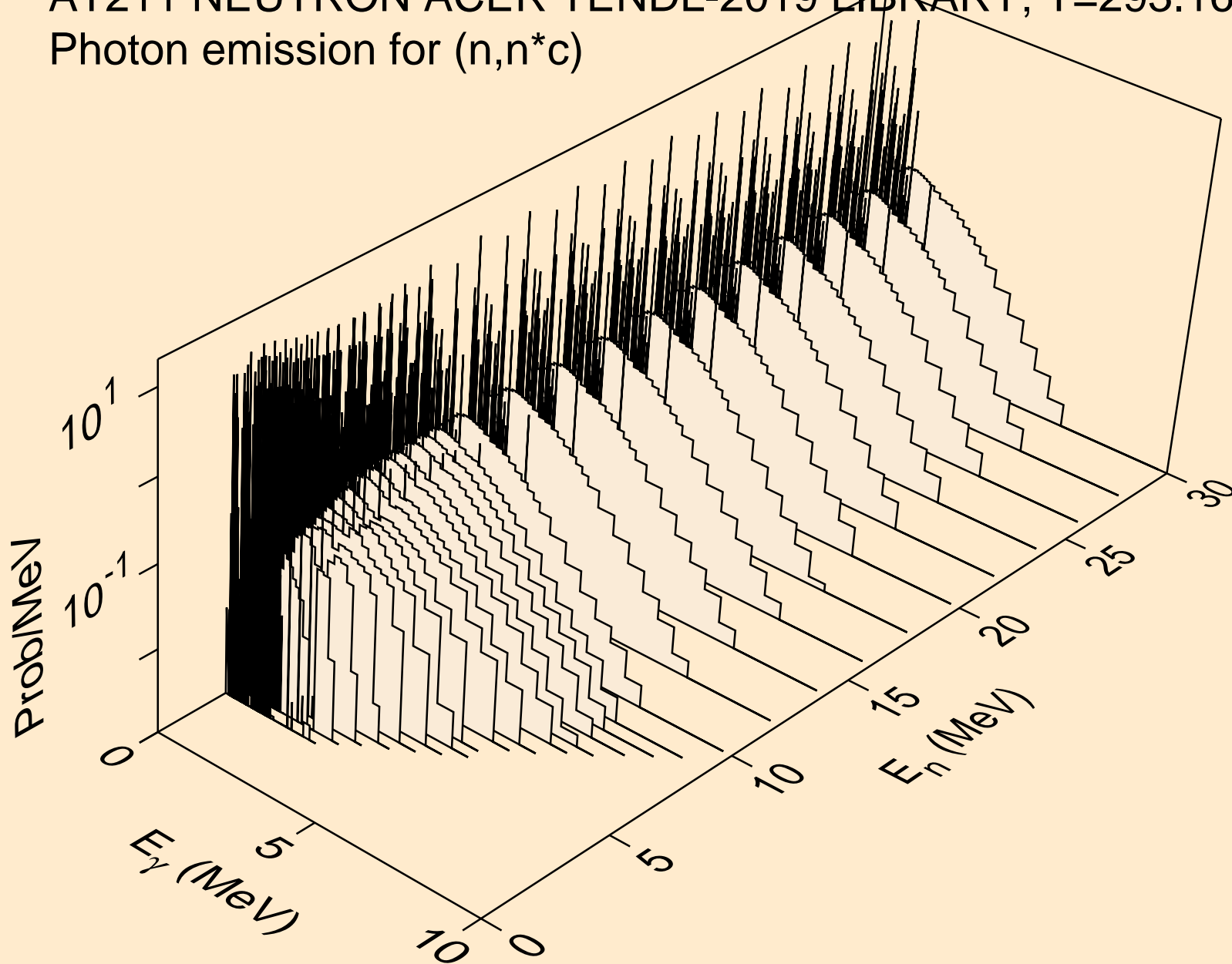

AT211 NEUTRON ACER TENDL-2019 LIBRARY; T=293.16K
Photon emission for (n,gma)

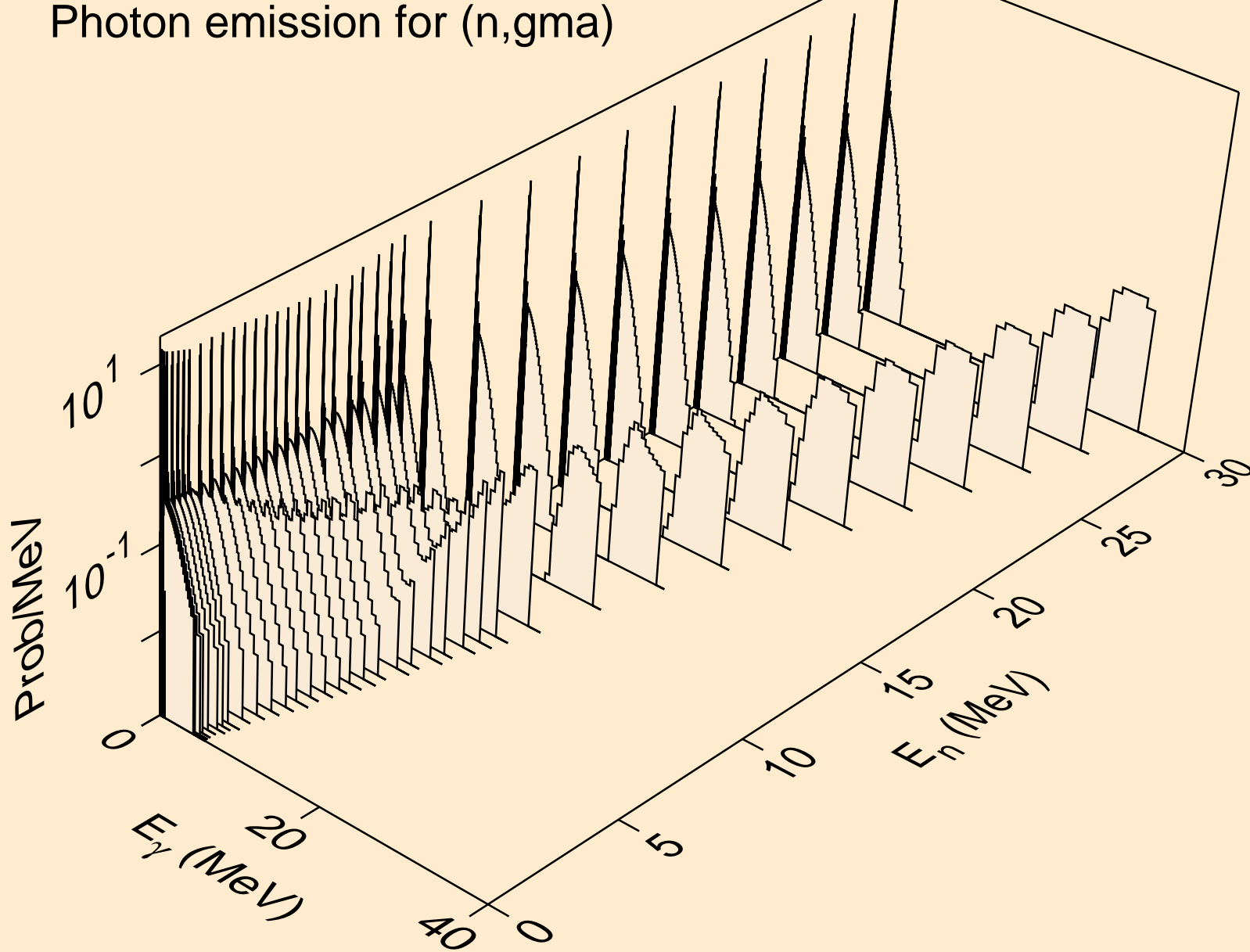

AT211 NEUTRON ACER TENDL-2019 LIBRARY; T=293.16K
Photon emission for (n,p)

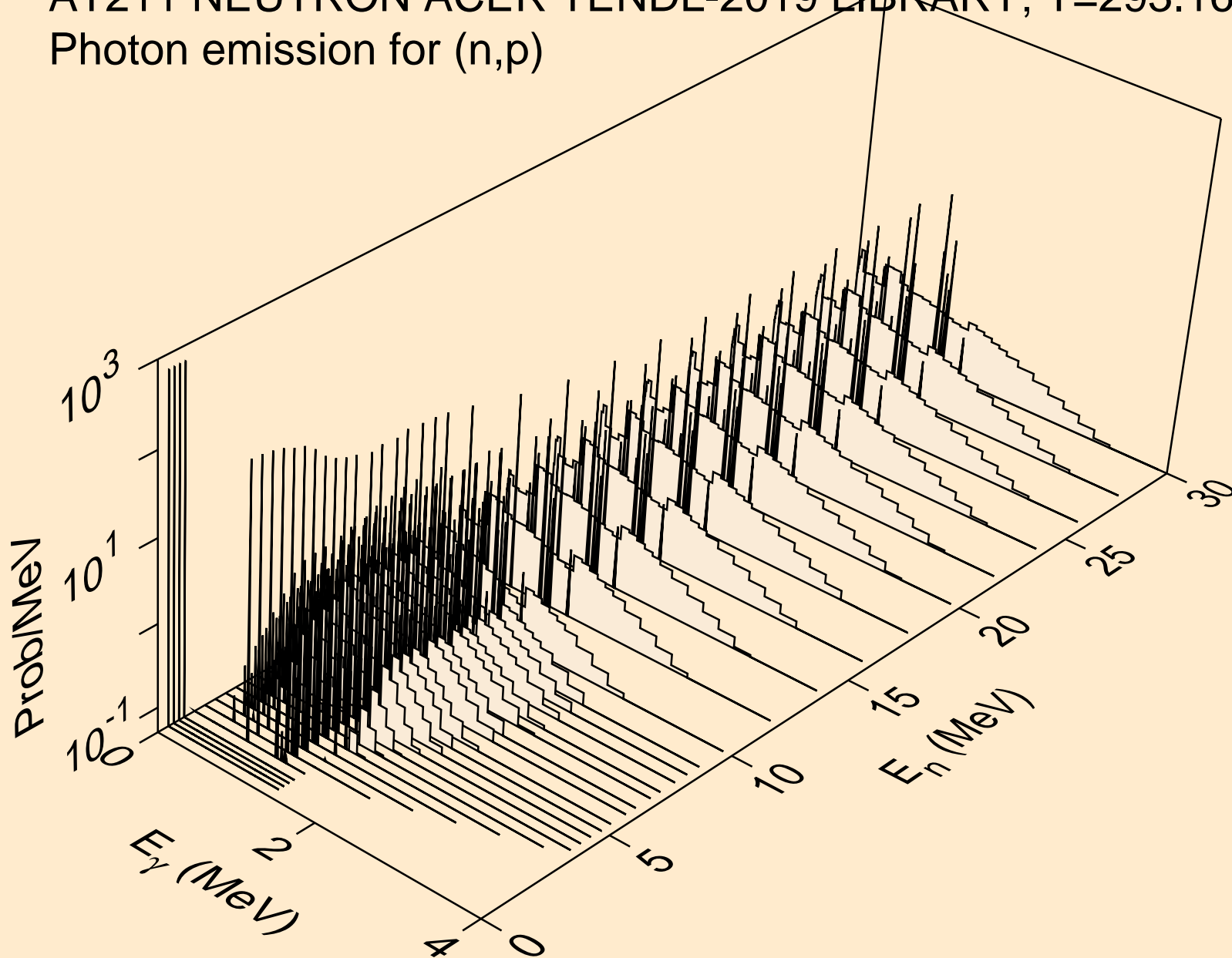

AT211 NEUTRON ACER TENDL-2019 LIBRARY; T=293.16K
Photon emission for (n,d)

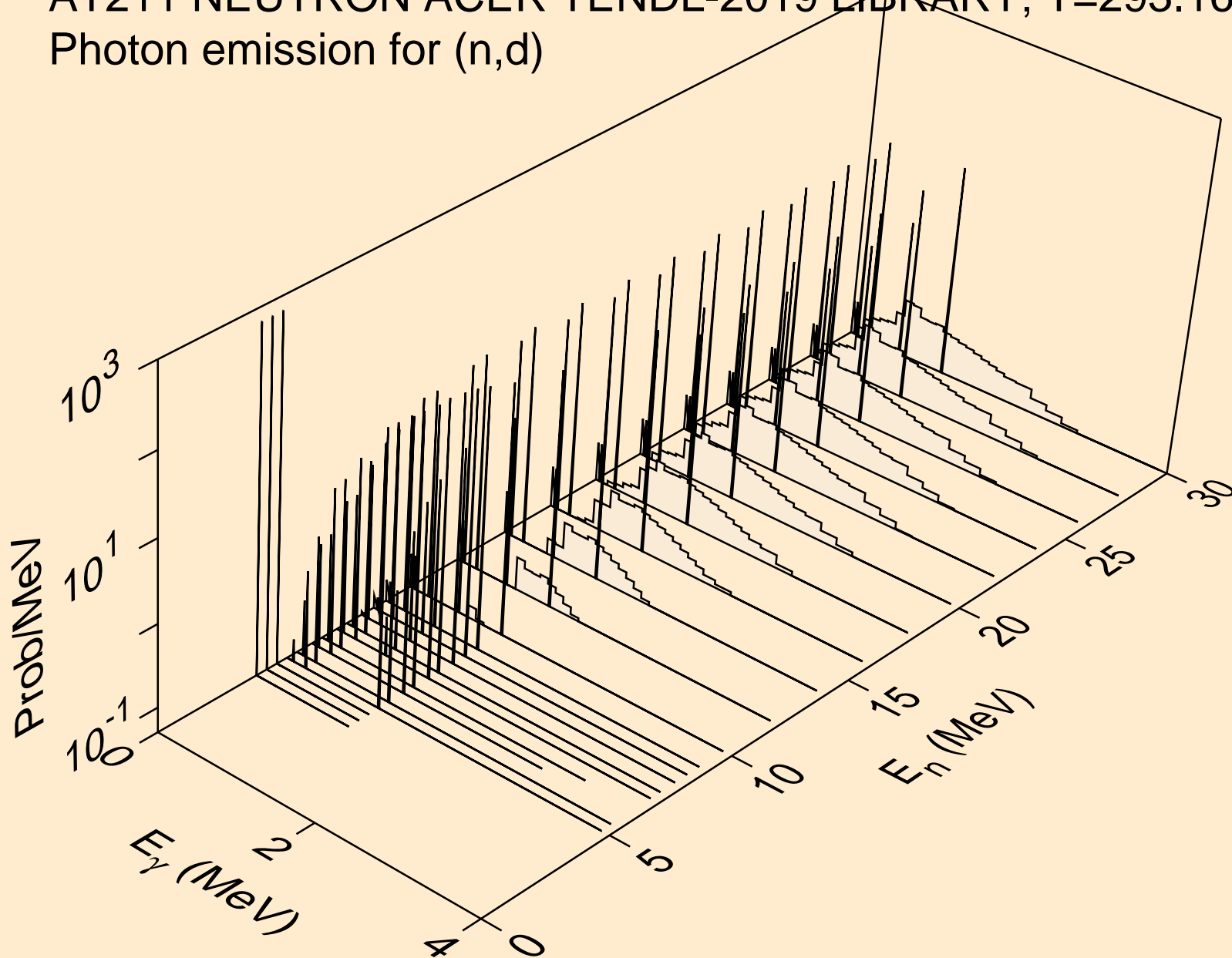

AT211 NEUTRON ACER TENDL-2019 LIBRARY; T=293.16K
Photon emission for (n,t)

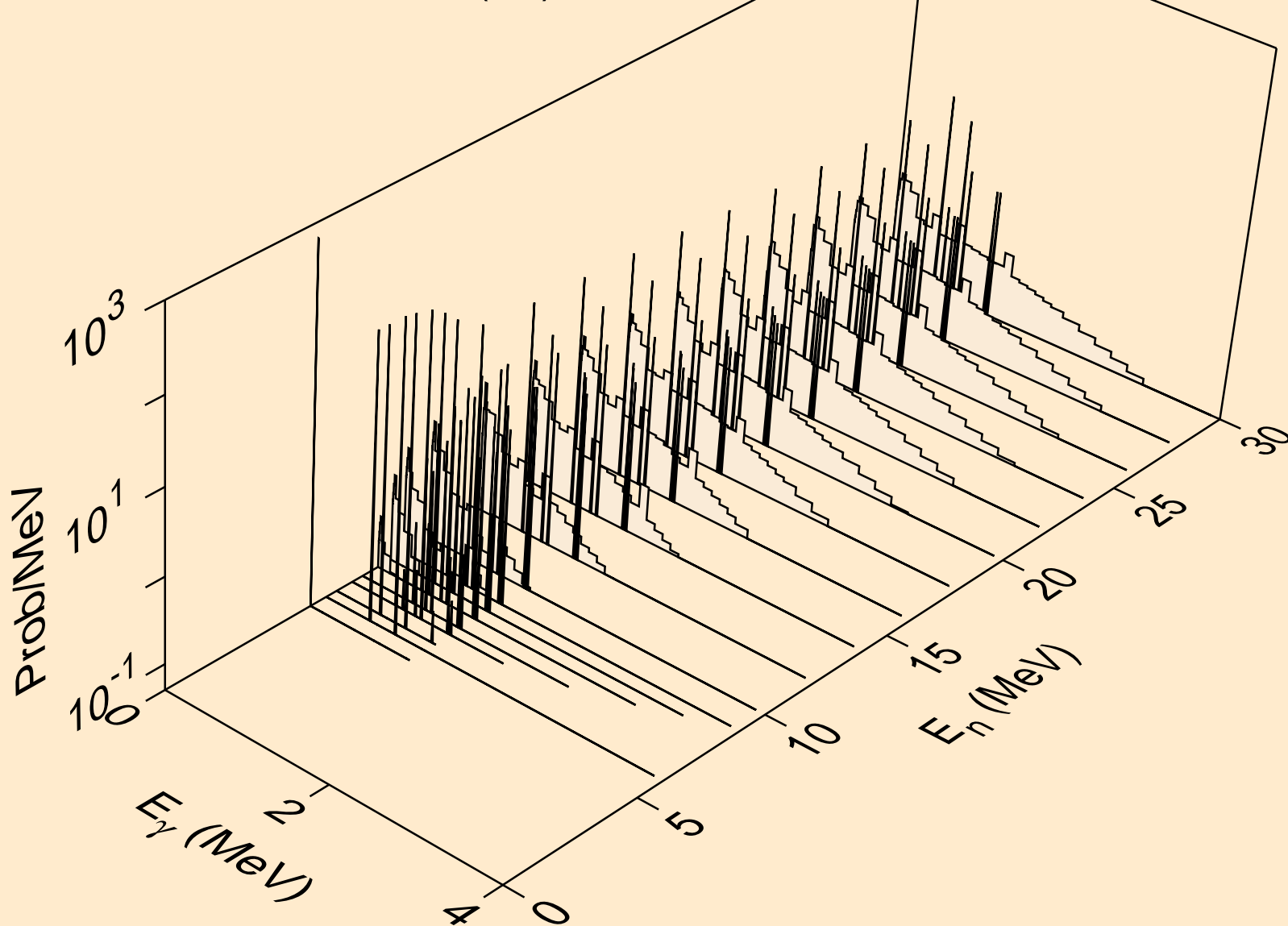

AT211 NEUTRON ACER TENDL-2019 LIBRARY; T=293.16K
Photon emission for (n,he3)

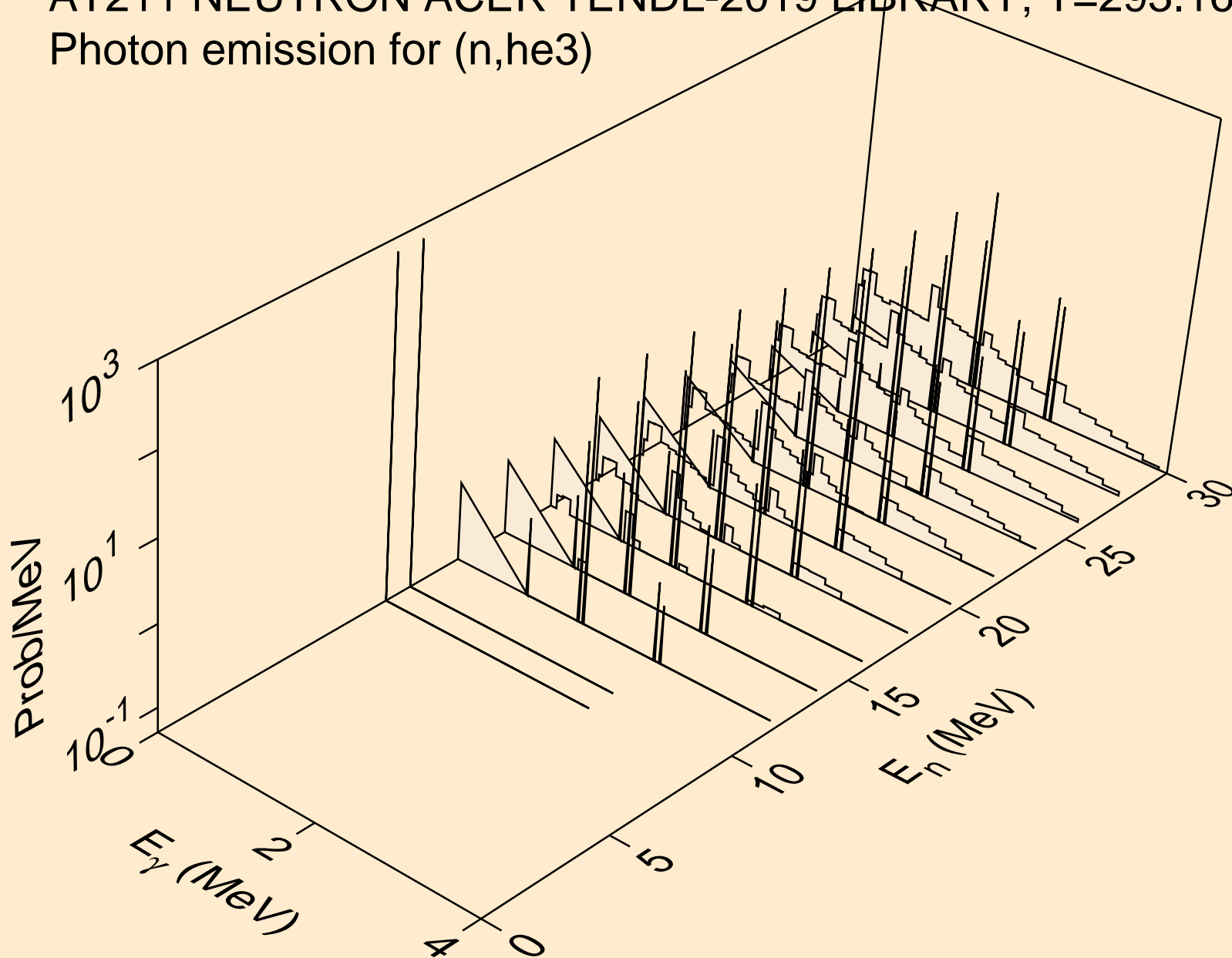

AT211 NEUTRON ACER TENDL-2019 LIBRARY; T=293.16K
Photon emission for (n,a)

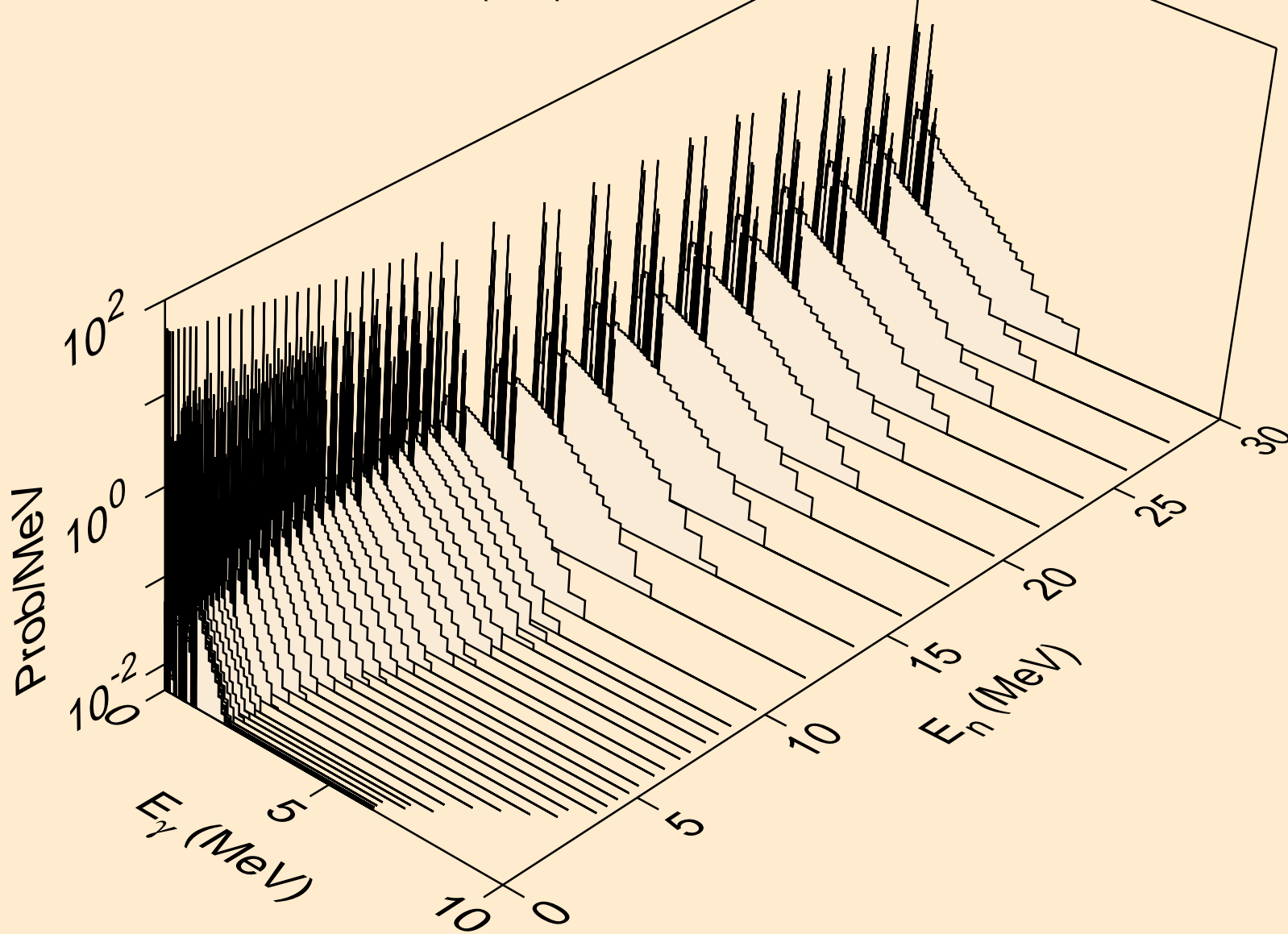

AT211 NEUTRON ACER TENDL-2019 LIBRARY; T=293.16K
Photon emission for (n,2a)

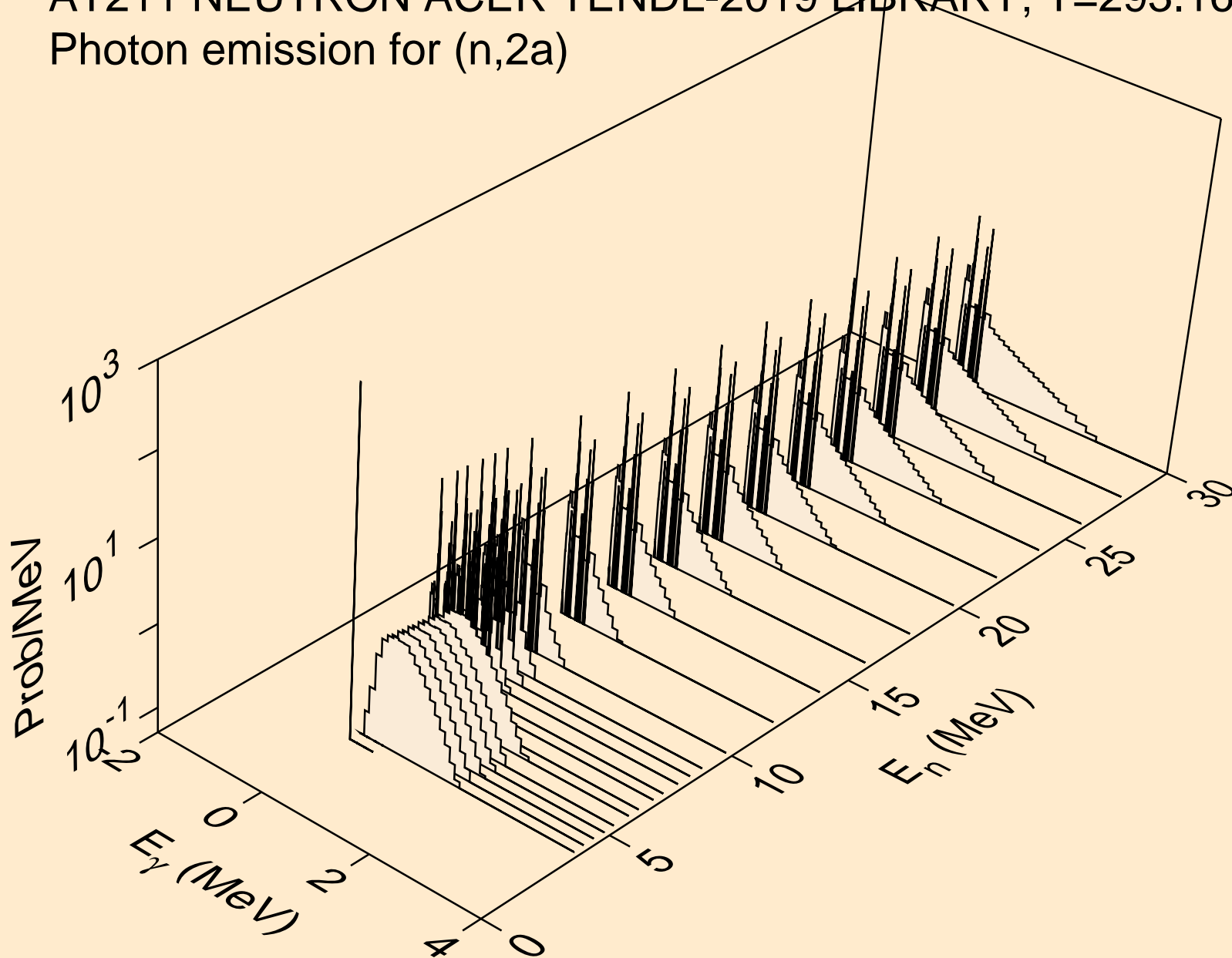

AT211 NEUTRON ACER TENDL-2019 LIBRARY; T=293.16K
Photon emission for (n,2p)

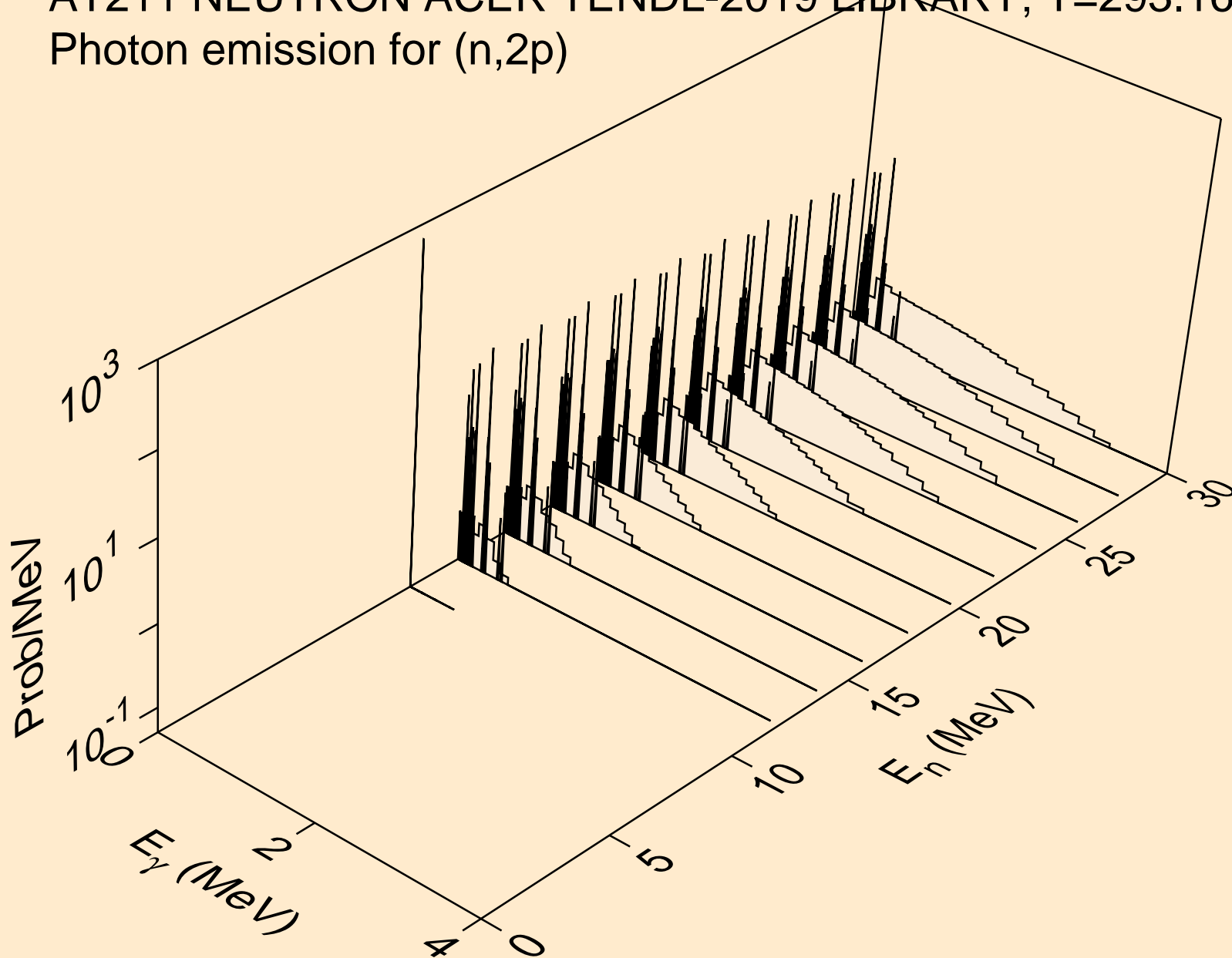

AT211 NEUTRON ACER TENDL-2019 LIBRARY; T=293.16K
Photon emission for (n,p α)

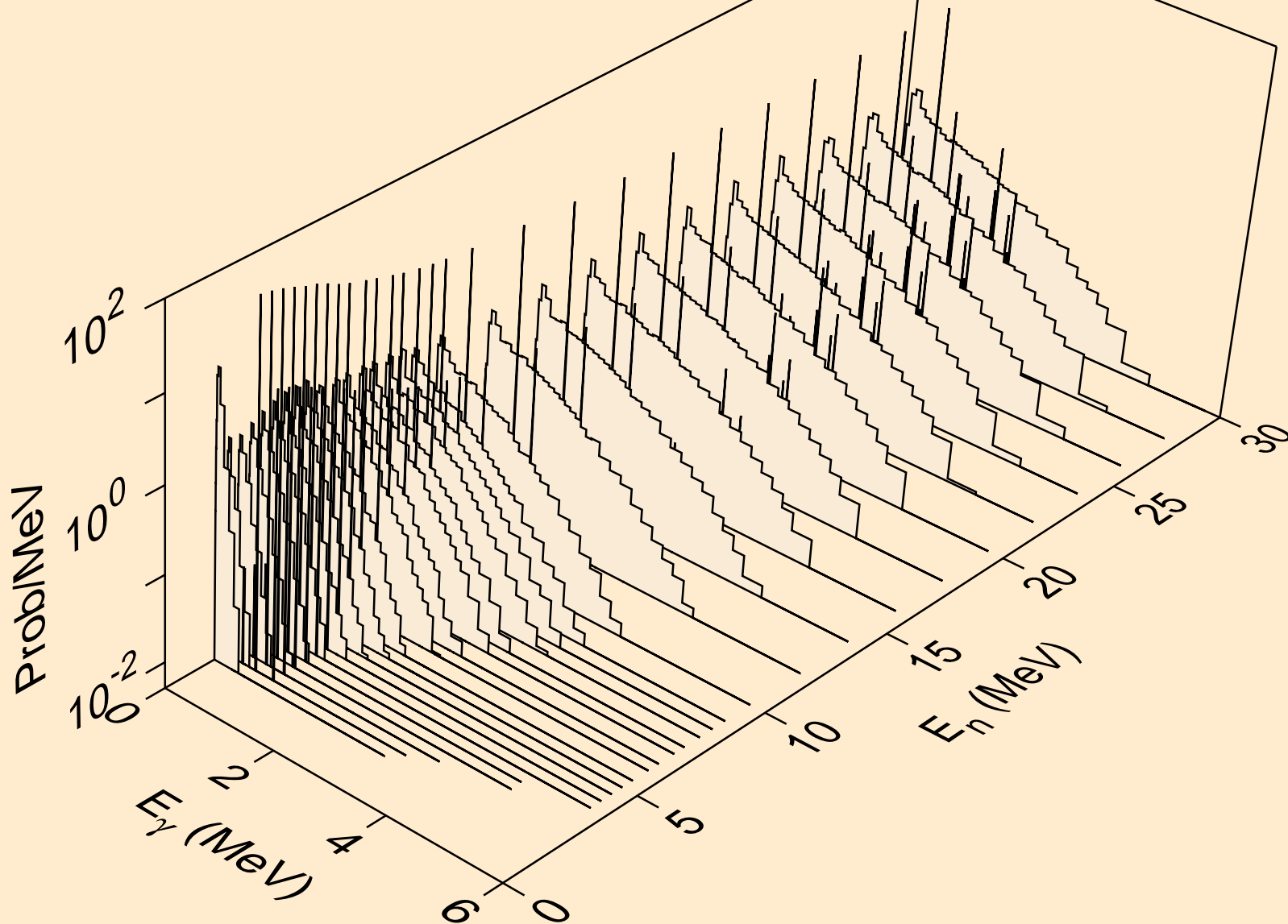

AT211 NEUTRON ACER TENDL-2019 LIBRARY; T=293.16K
Photon emission for (n,pd)

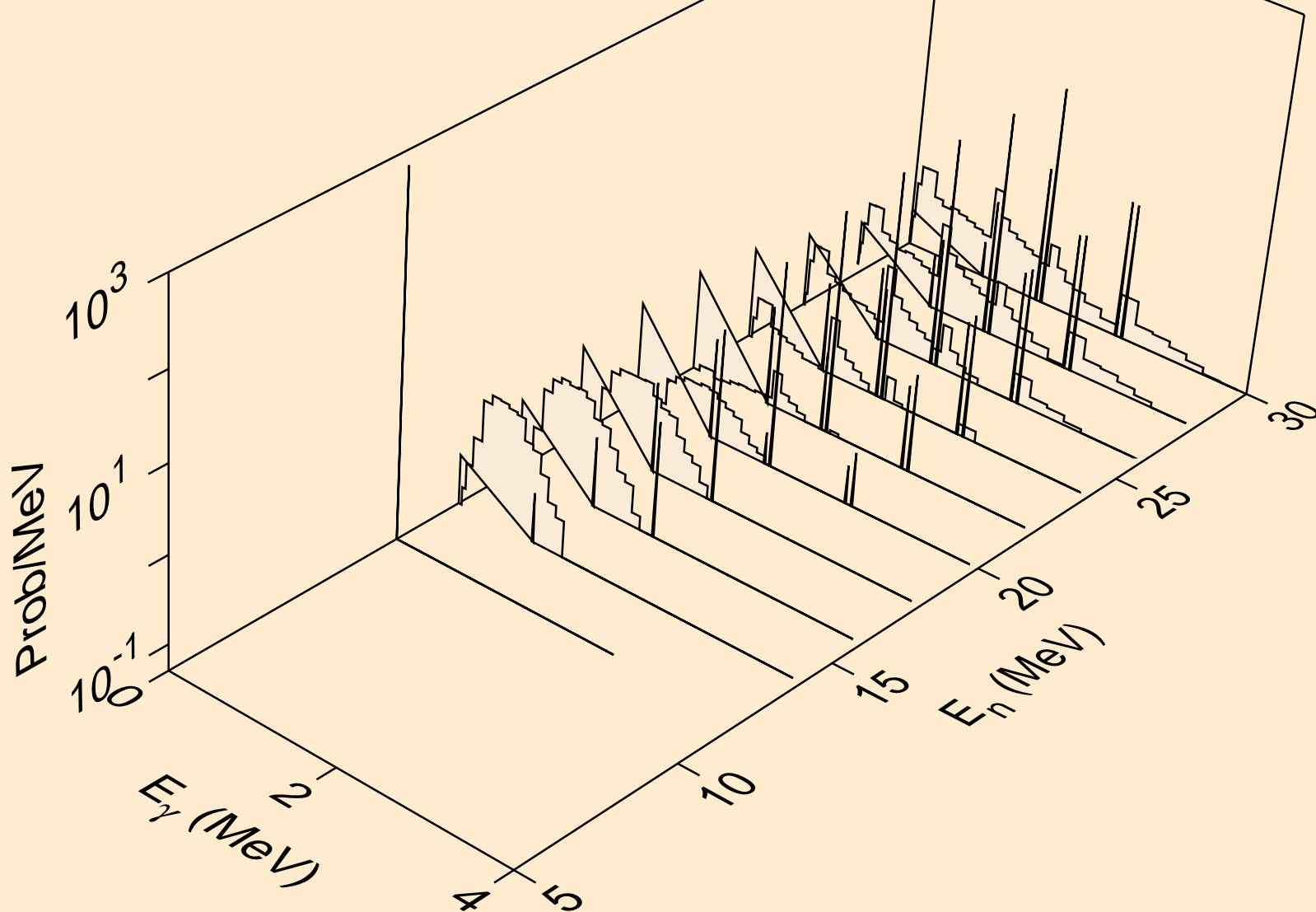

AT211 NEUTRON ACER TENDL-2019 LIBRARY; T=293.16K
Photon emission for (n,pt)

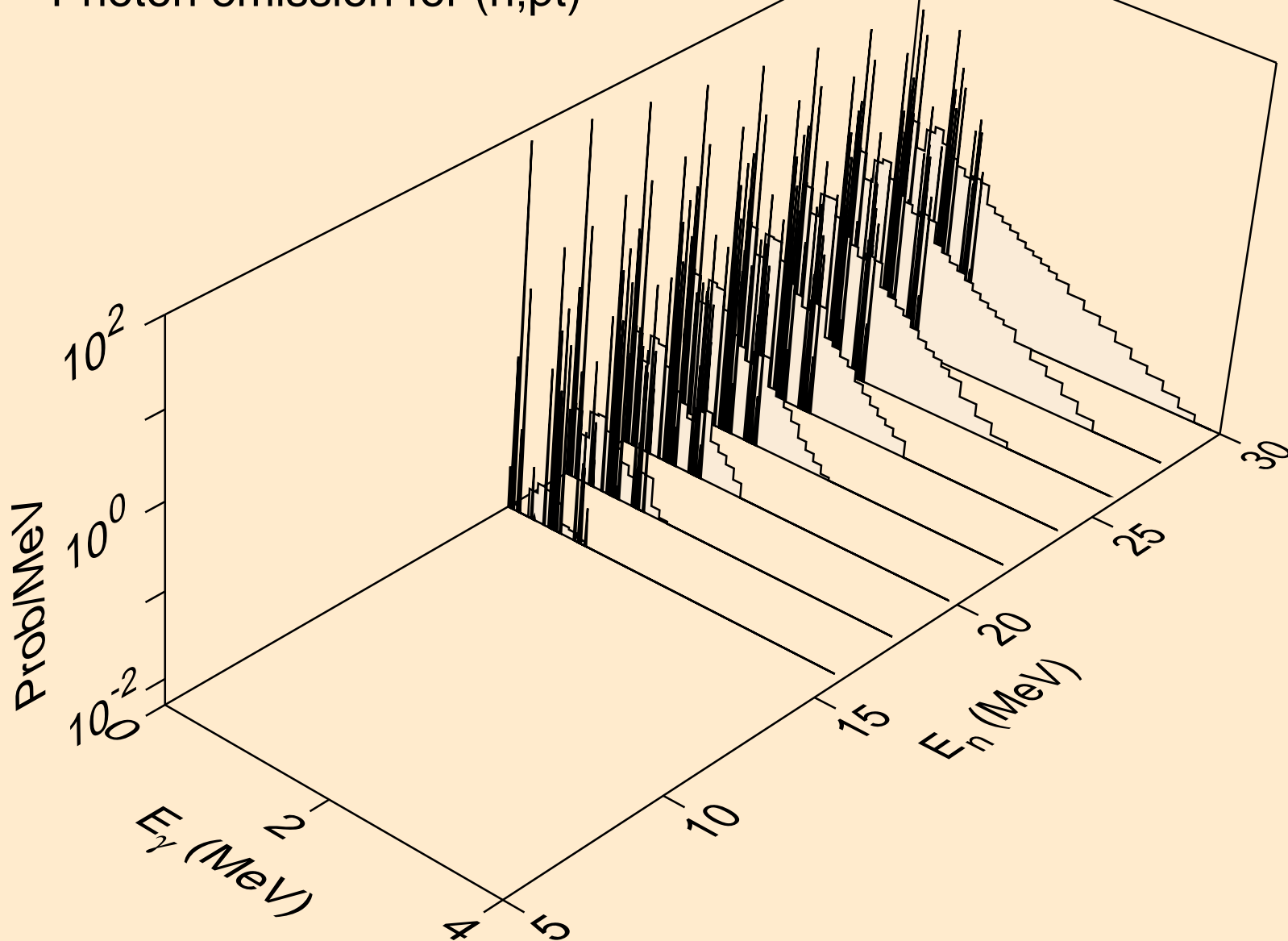

AT211 NEUTRON ACER TENDL-2019 LIBRARY; T=293.16K
Photon emission for (n,da)

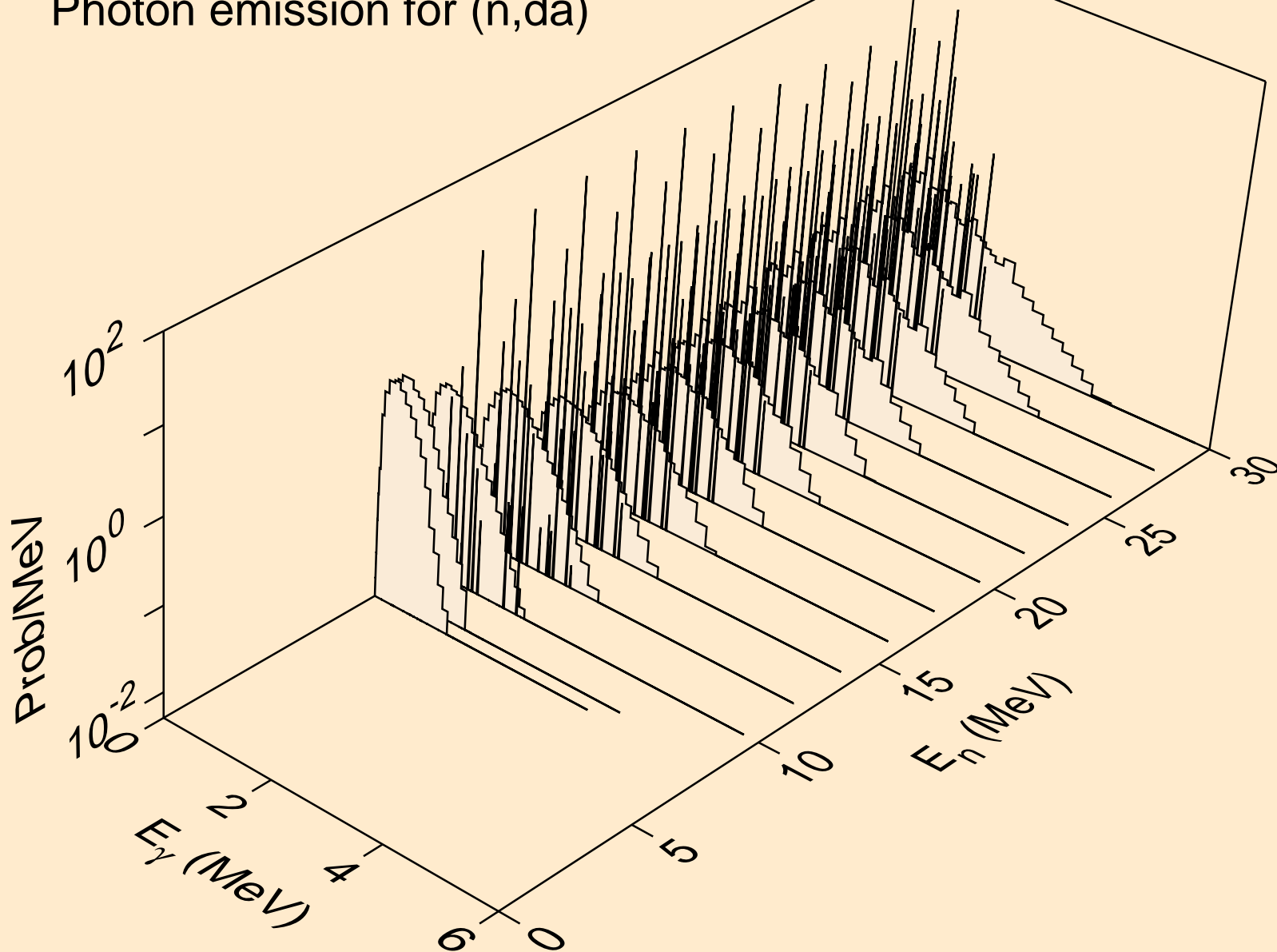

AT211 NEUTRON ACER TENDL-2019 LIBRARY; T=293.16K
thermal capture photon spectrum

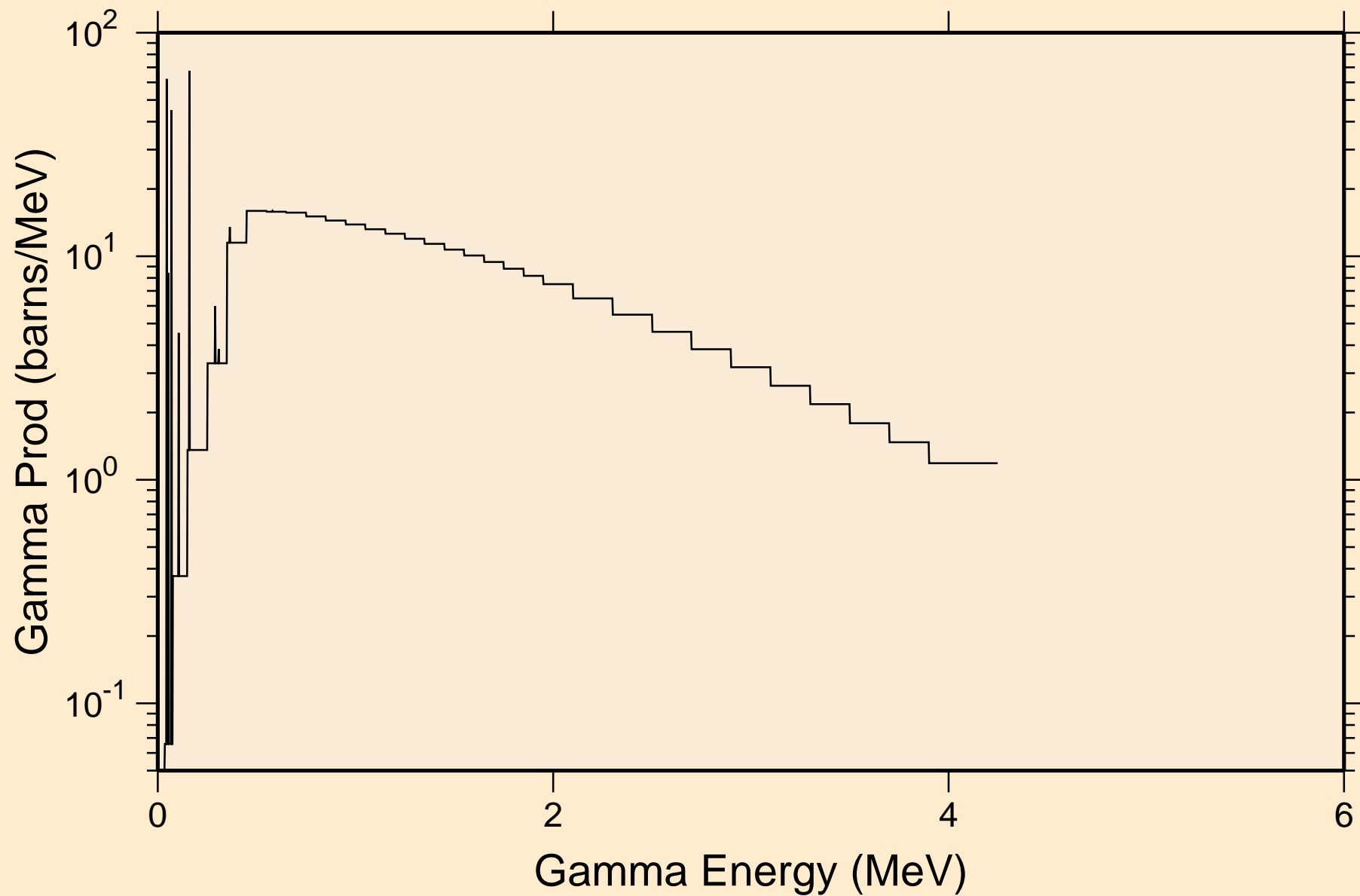

AT211 NEUTRON ACER TENDL-2019 LIBRARY; T=293.16K
14 MeV photon spectrum

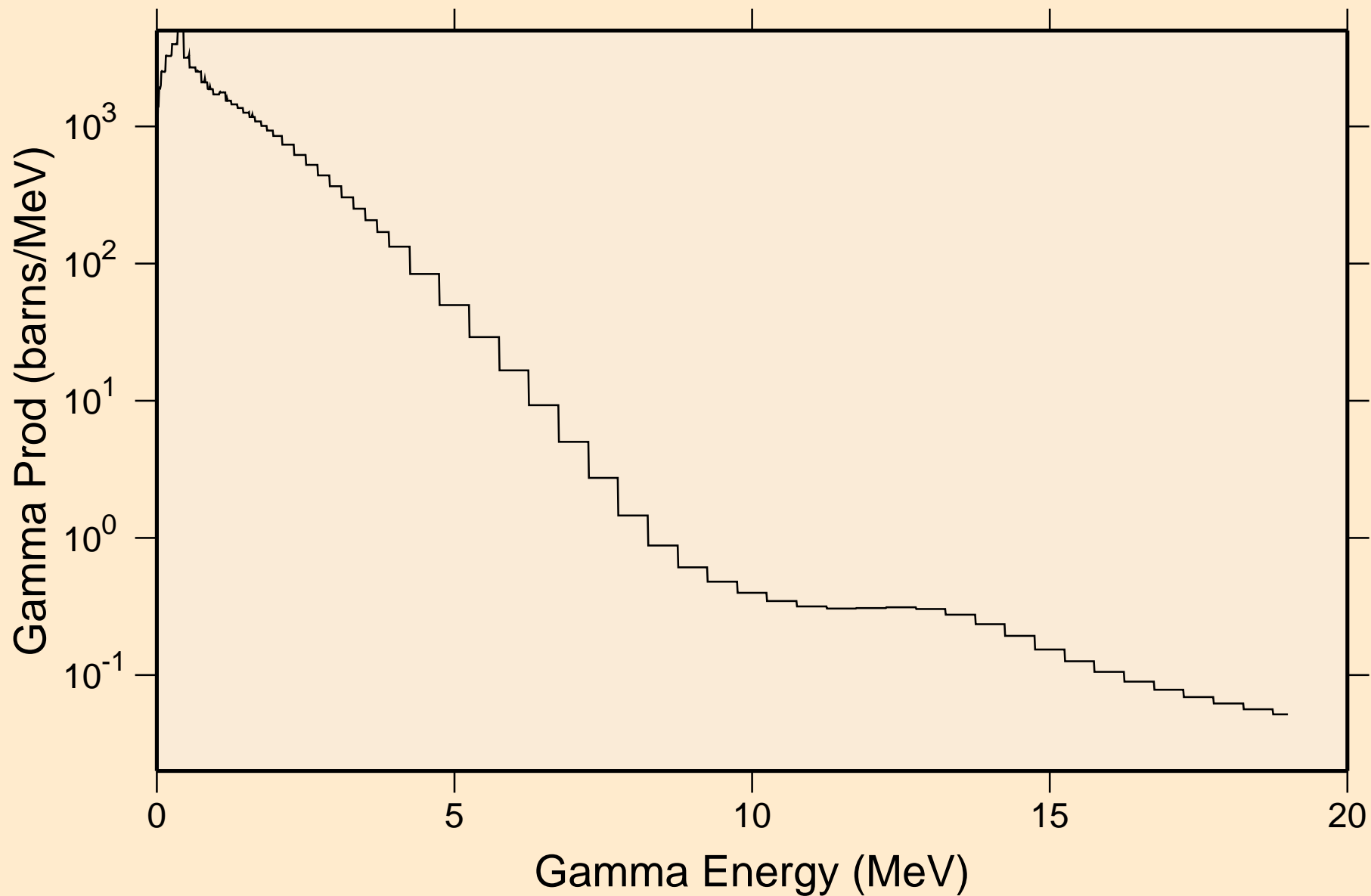

AT211 NEUTRON ACER TENDL-2019 LIBRARY; T=293.16K

Particle heating contributions

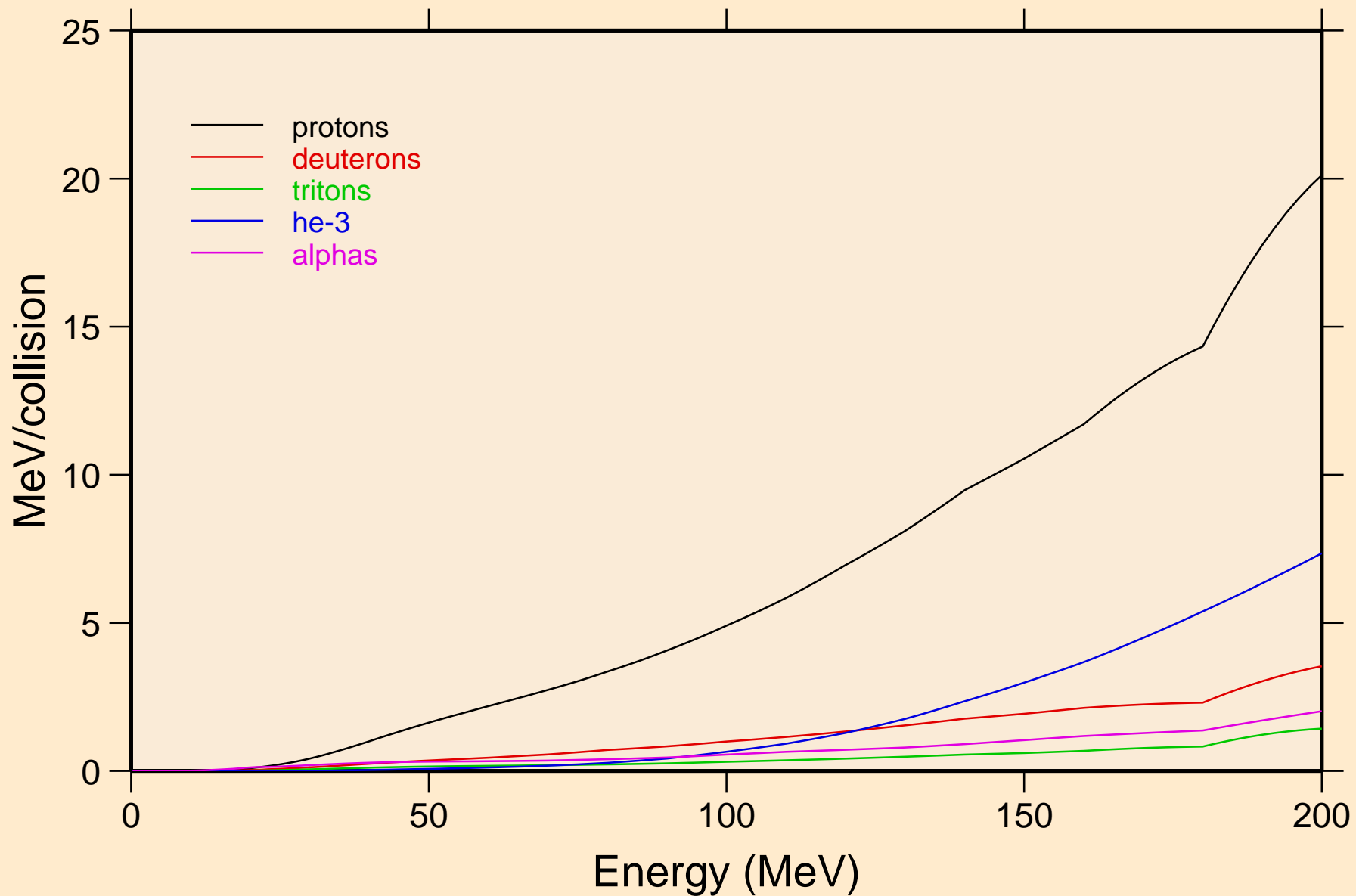

AT211 NEUTRON ACER TENDL-2019 LIBRARY; T=293.16K
Recoil Heating

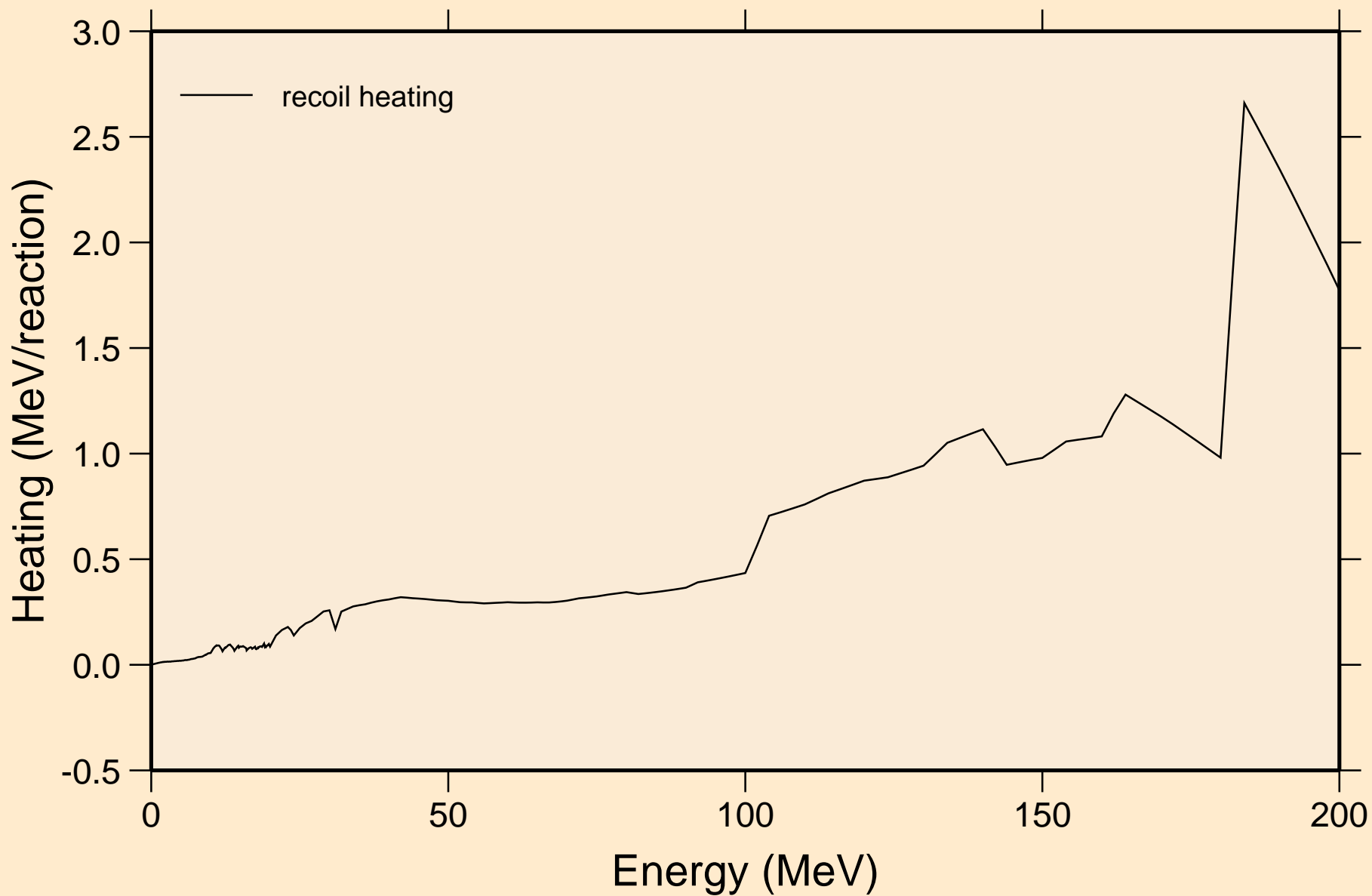

AT211 NEUTRON ACER TENDL-2019 LIBRARY; T=293.16K
Particle production cross sections

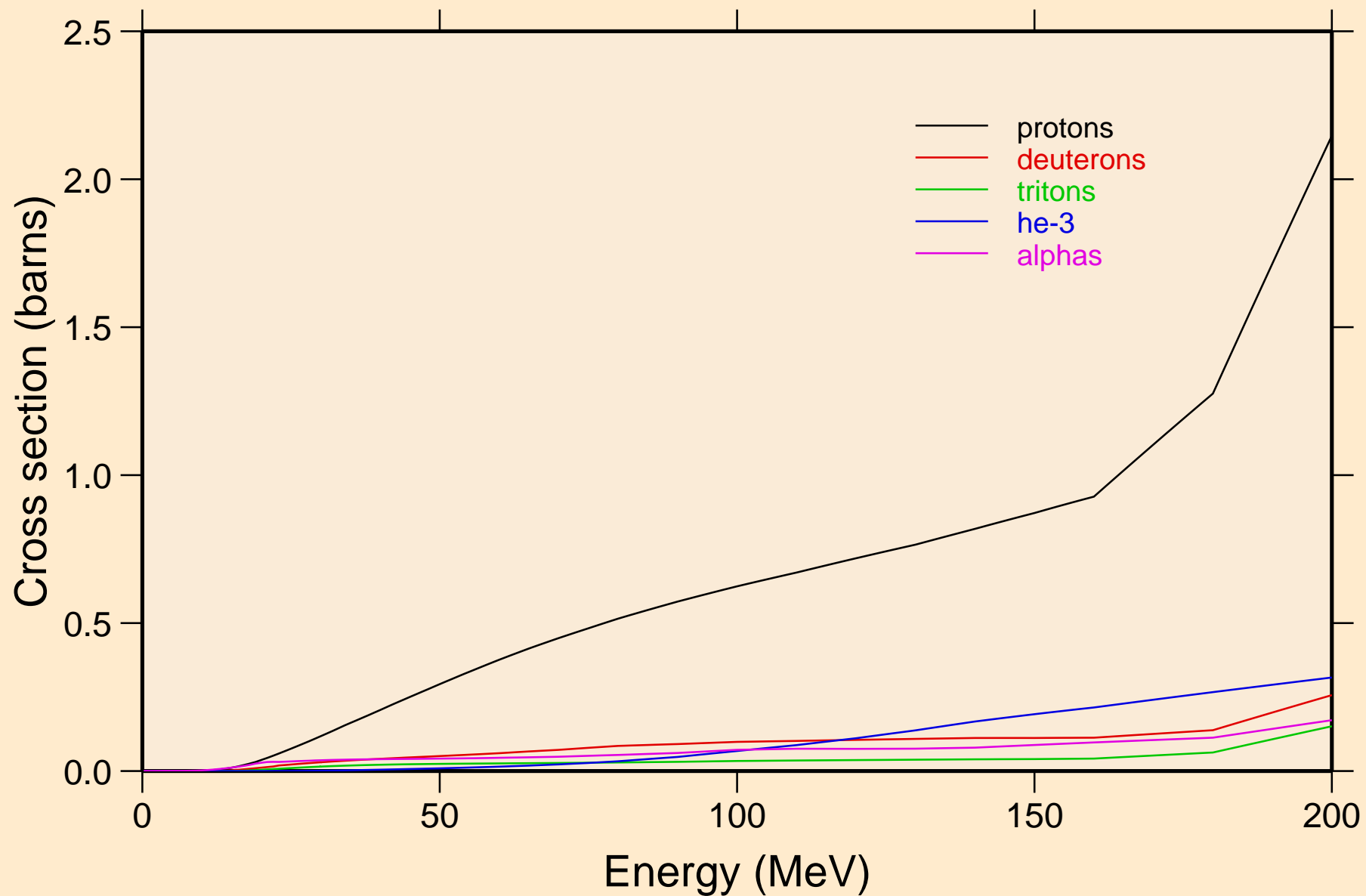

AT211 NEUTRON ACER TENDL-2019 LIBRARY; T=293.16K
protons from (n,x)

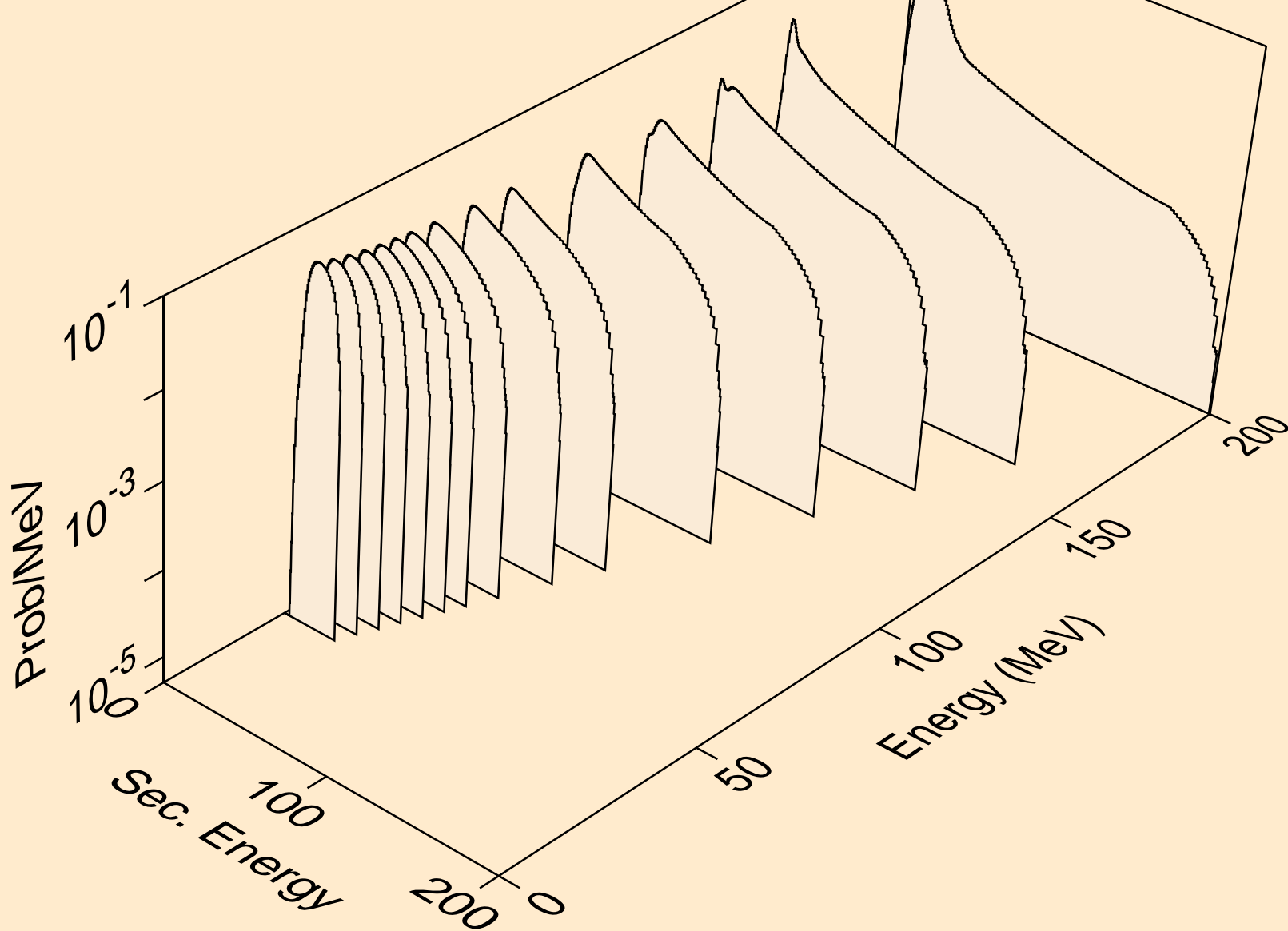

AT211 NEUTRON ACER TENDL-2019 LIBRARY; T=293.16K
protons from (n,n*)p

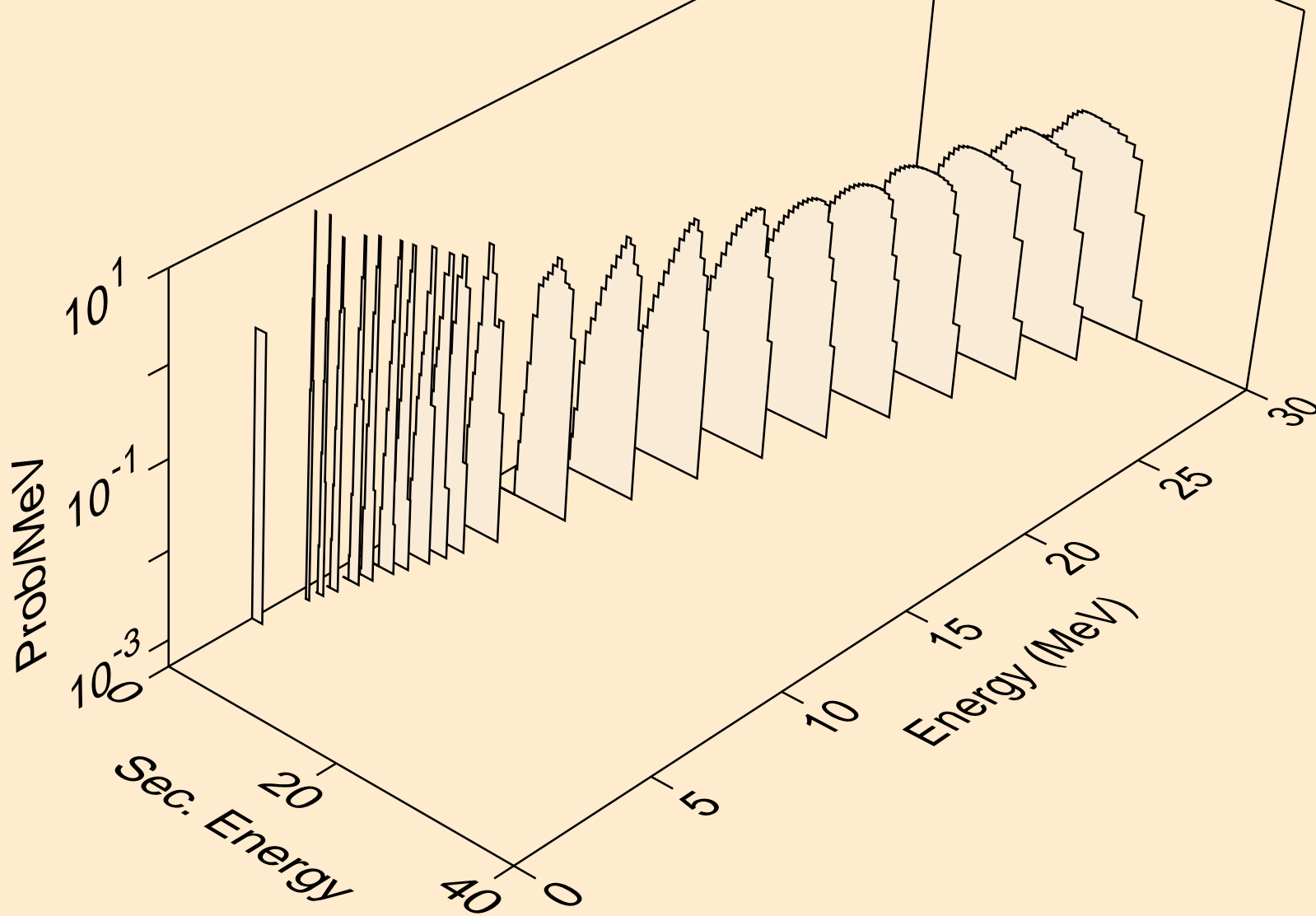

AT211 NEUTRON ACER TENDL-2019 LIBRARY; T=293.16K
protons from (n,2np)

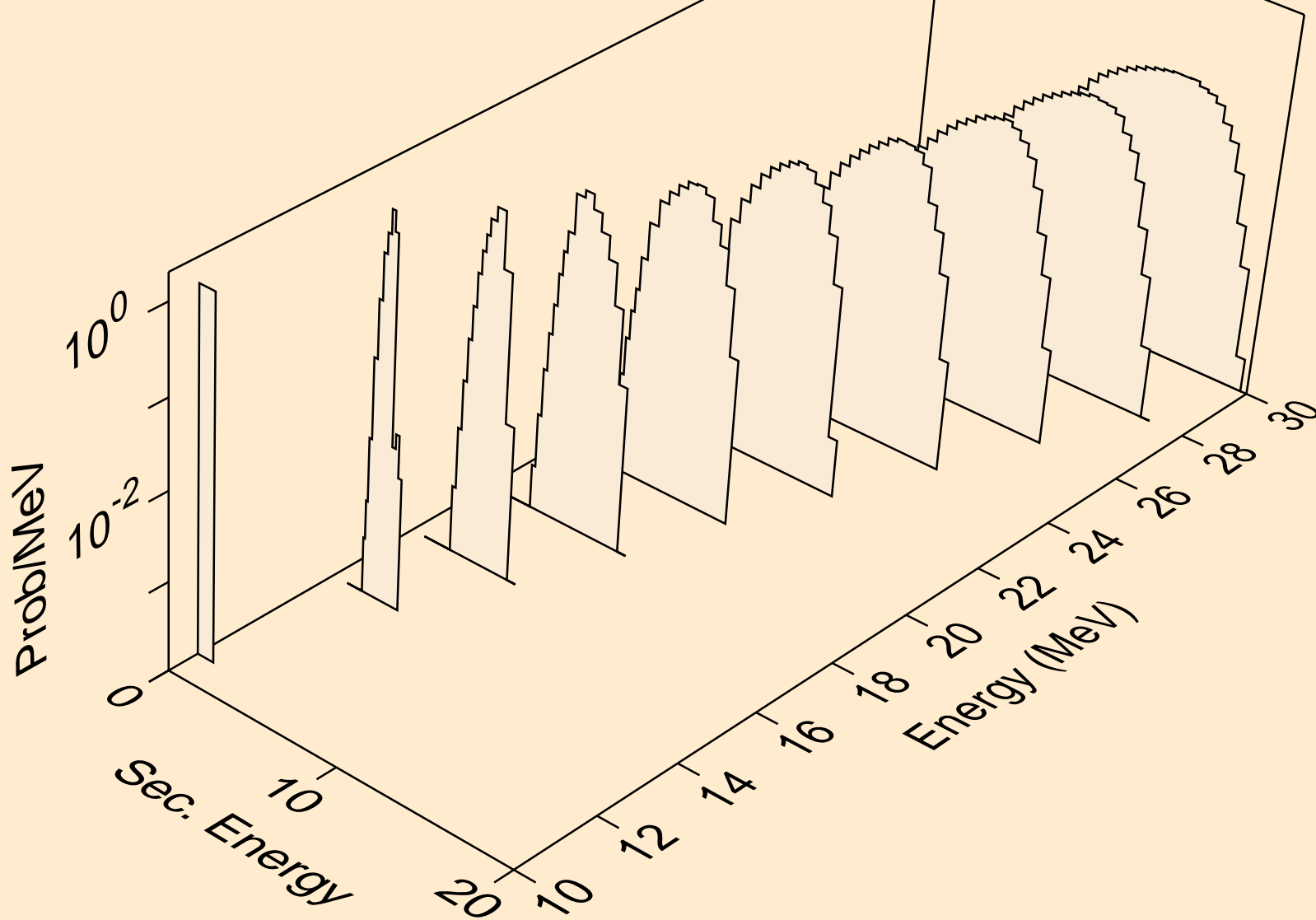

AT211 NEUTRON ACER TENDL-2019 LIBRARY; T=293.16K
protons from (n,3np)

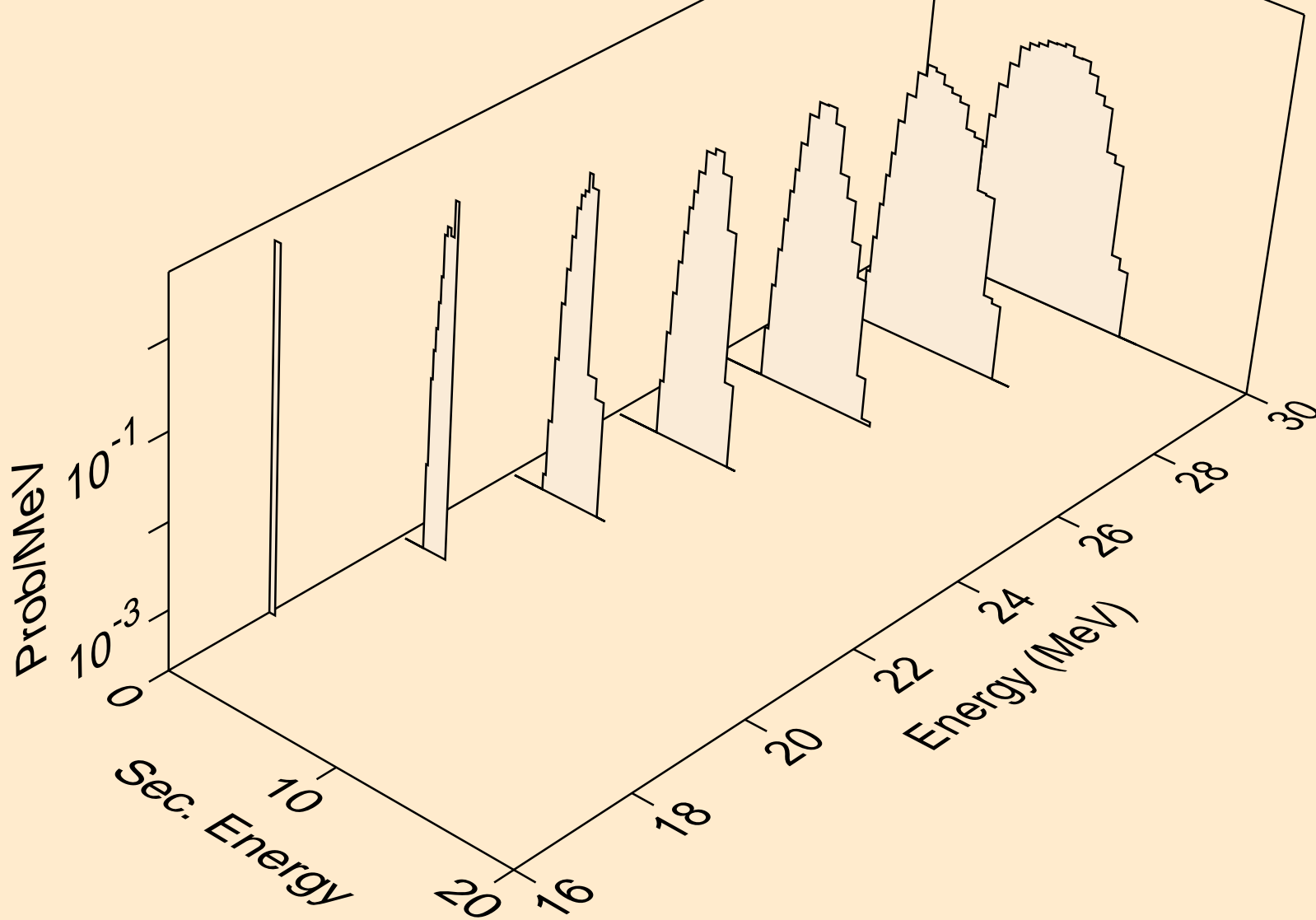

AT211 NEUTRON ACER TENDL-2019 LIBRARY; T=293.16K
protons from (n,2np)

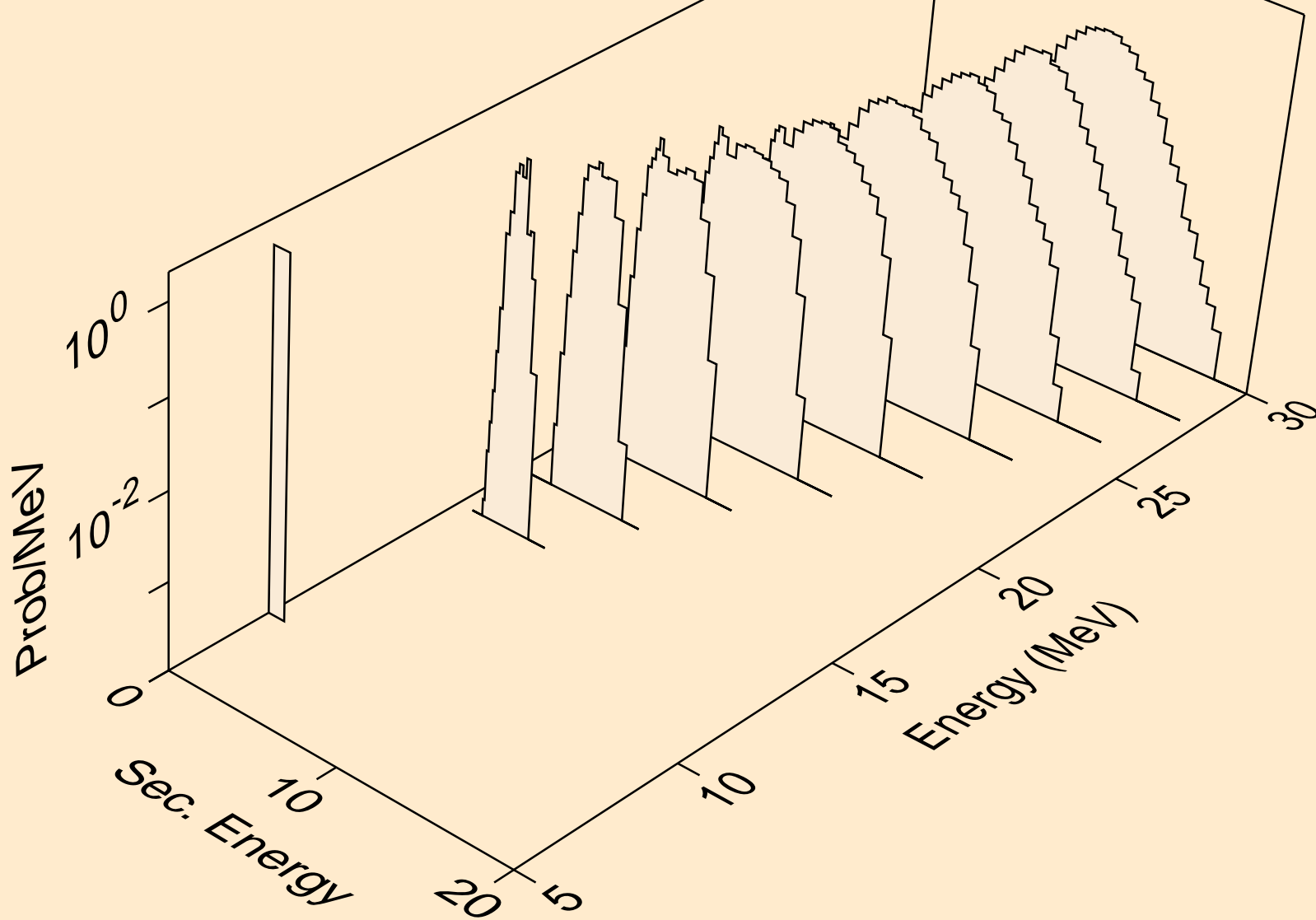

AT211 NEUTRON ACER TENDL-2019 LIBRARY; T=293.16K
protons from (n,npa)

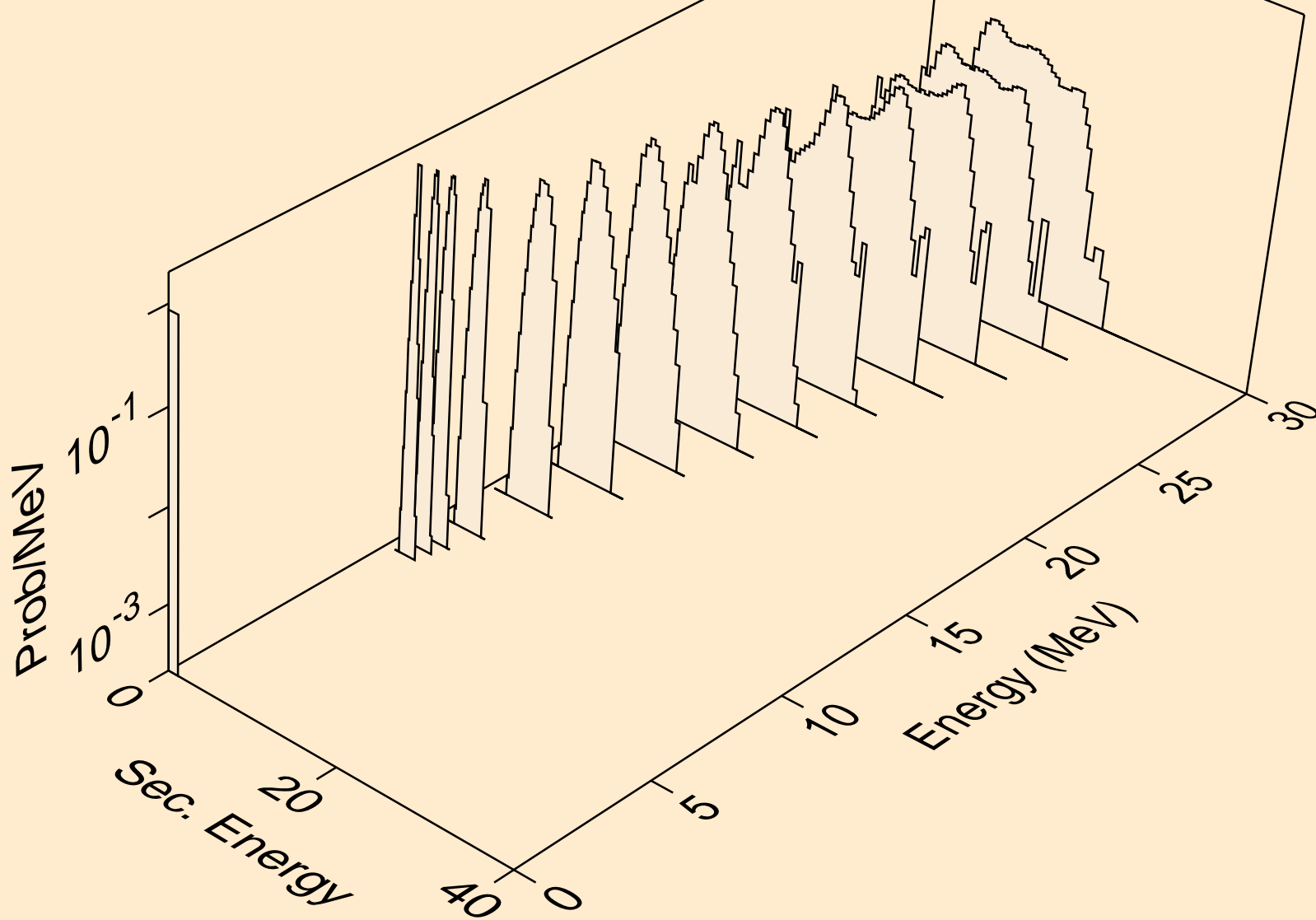

AT211 NEUTRON ACER TENDL-2019 LIBRARY; T=293.16K
protons from (n,p)

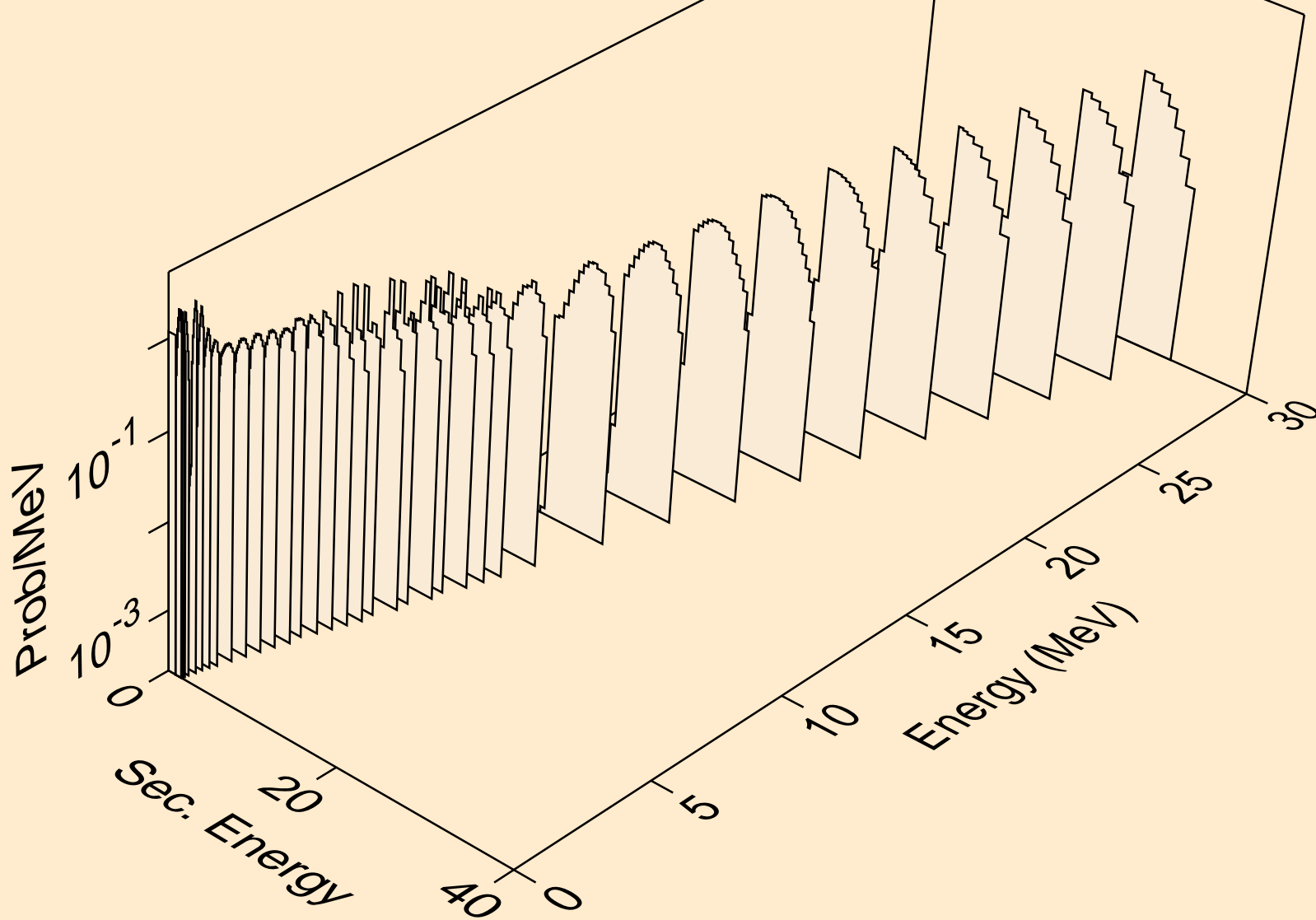

AT211 NEUTRON ACER TENDL-2019 LIBRARY; T=293.16K
protons from (n,2p)

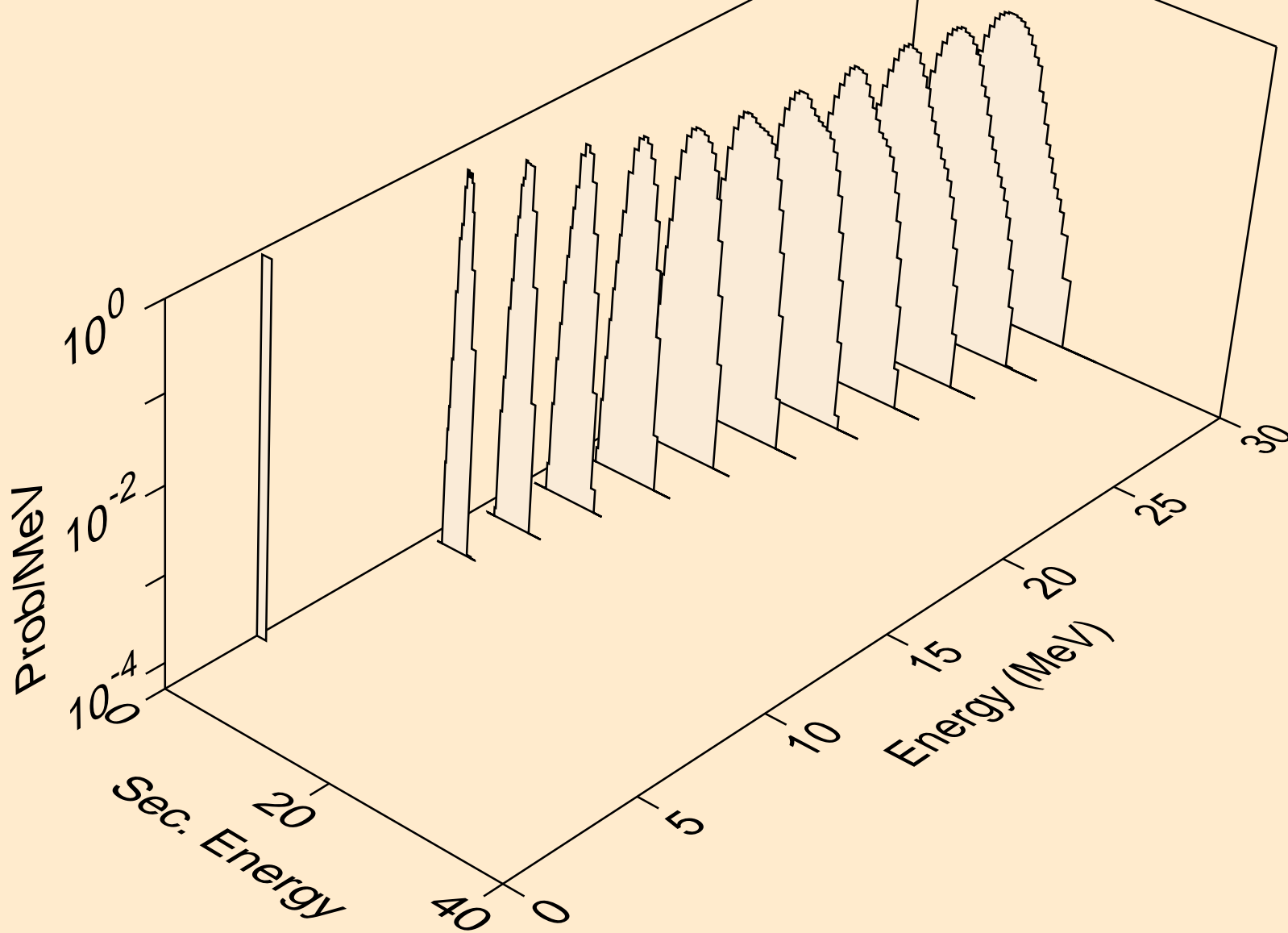

AT211 NEUTRON ACER TENDL-2019 LIBRARY; T=293.16K
protons from (n,p)

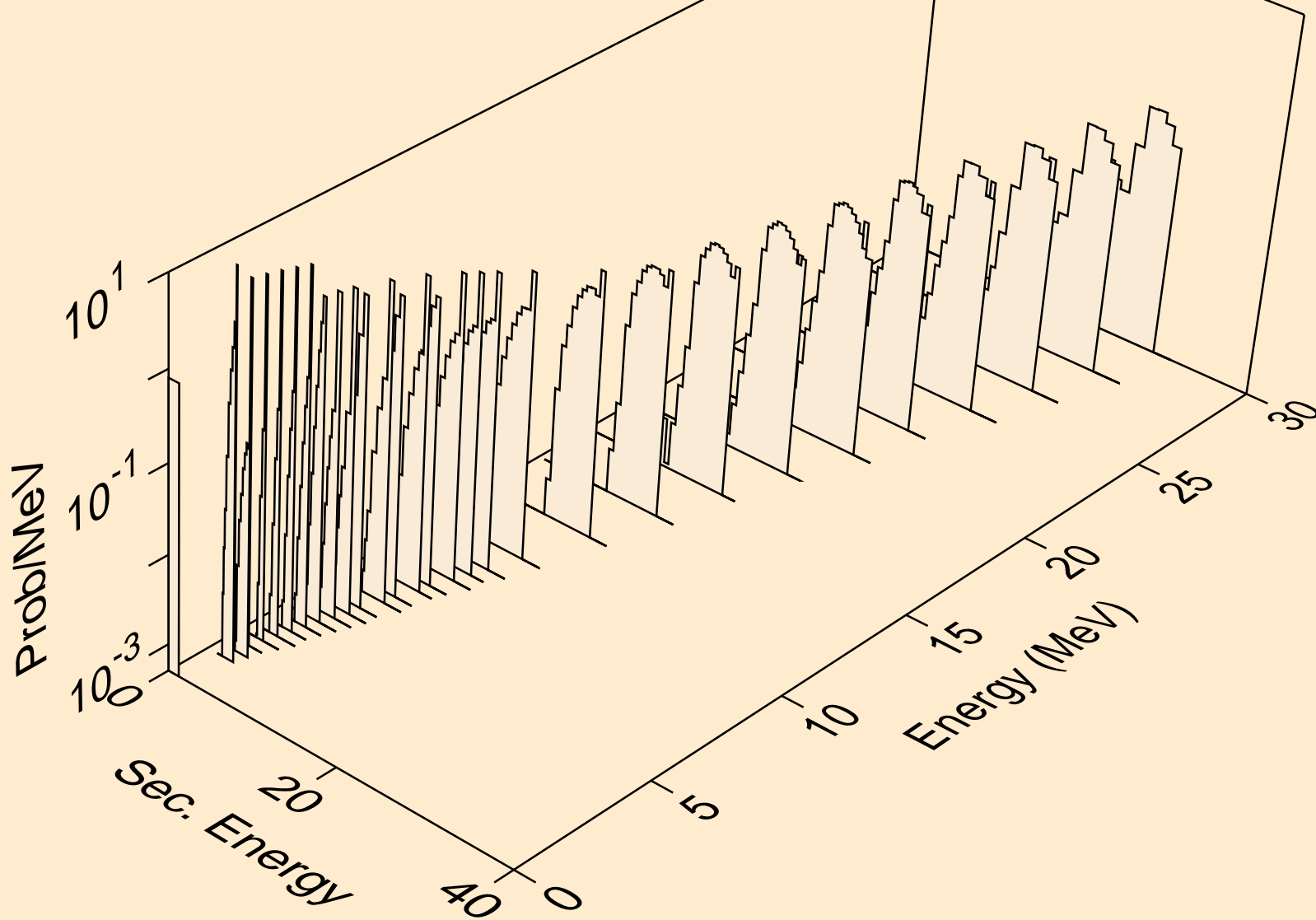

AT211 NEUTRON ACER TENDL-2019 LIBRARY; T=293.16K
protons from (n,pd)

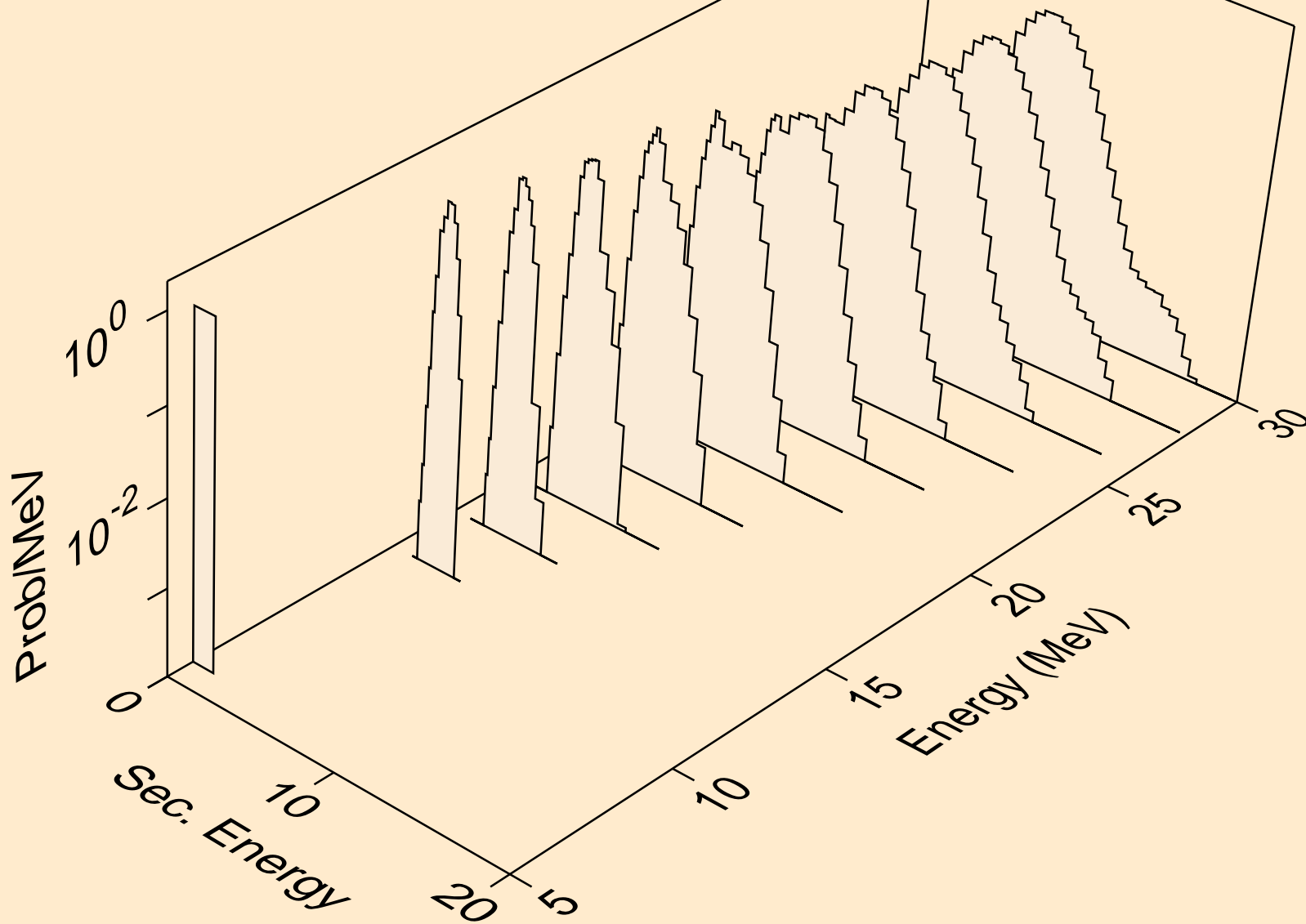

AT211 NEUTRON ACER TENDL-2019 LIBRARY; T=293.16K
protons from (n,pt)

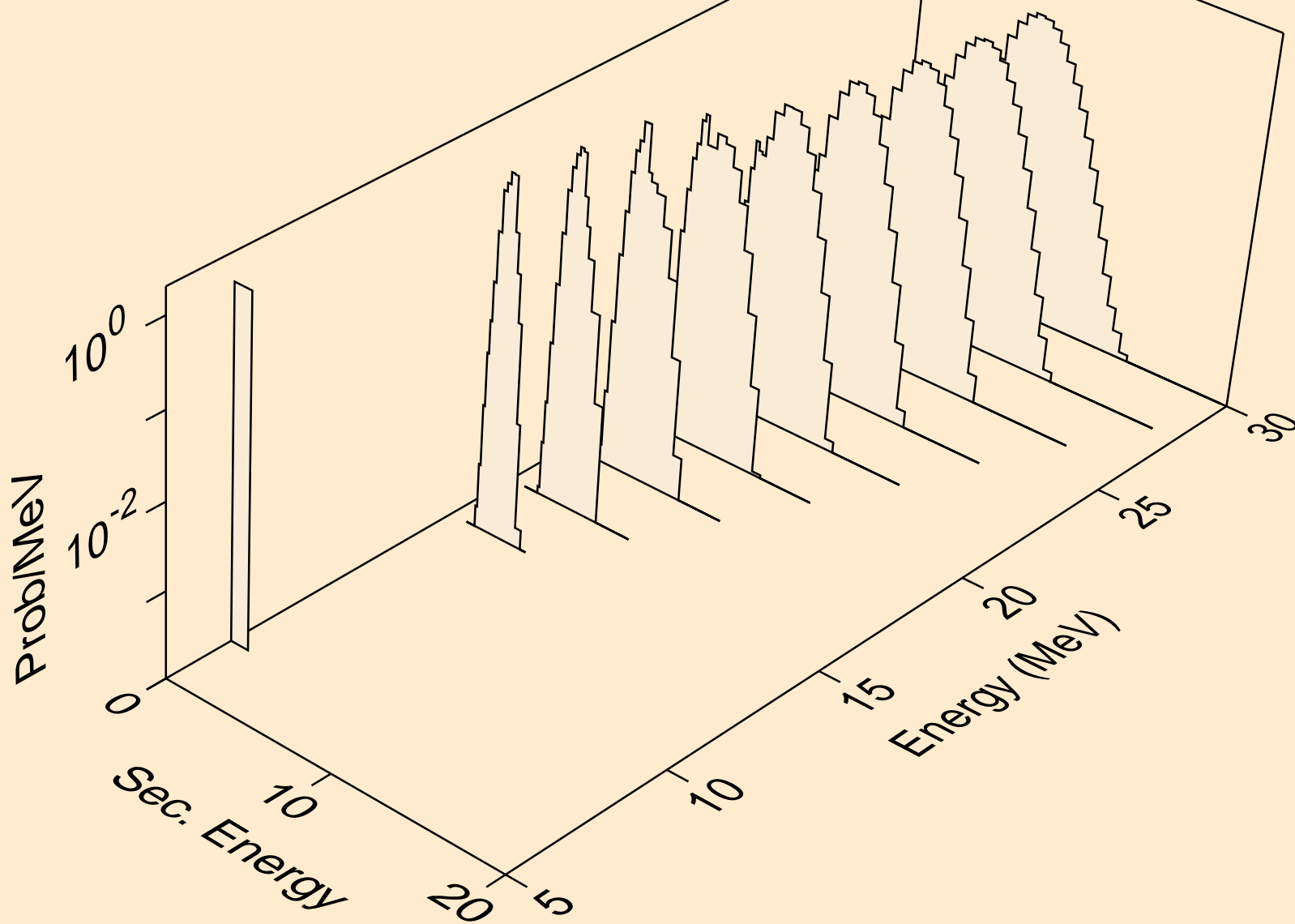

AT211 NEUTRON ACER TENDL-2019 LIBRARY; T=293.16K
deuterons from (n,x)

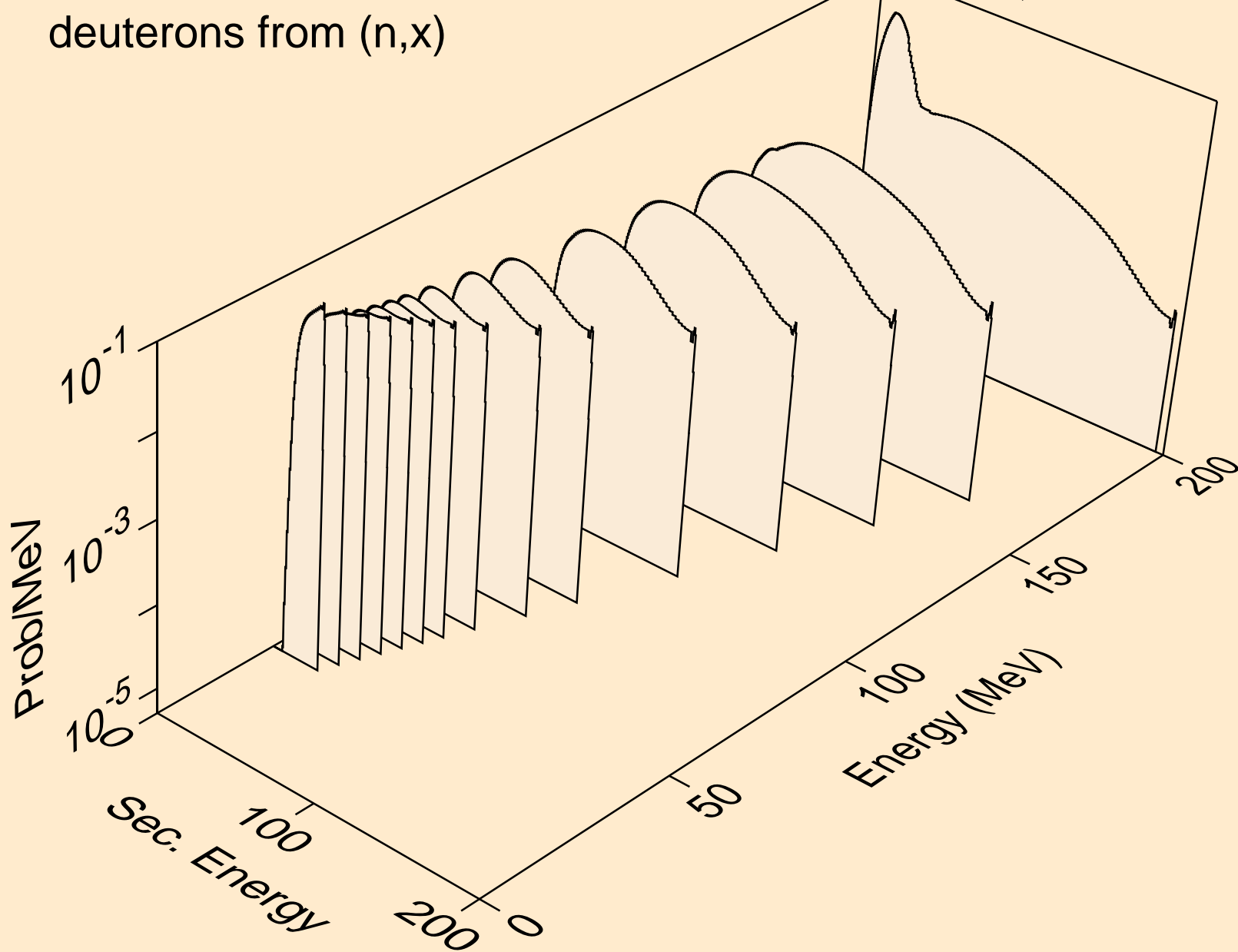

AT211 NEUTRON ACER TENDL-2019 LIBRARY; T=293.16K
deuterons from (n,2nd)

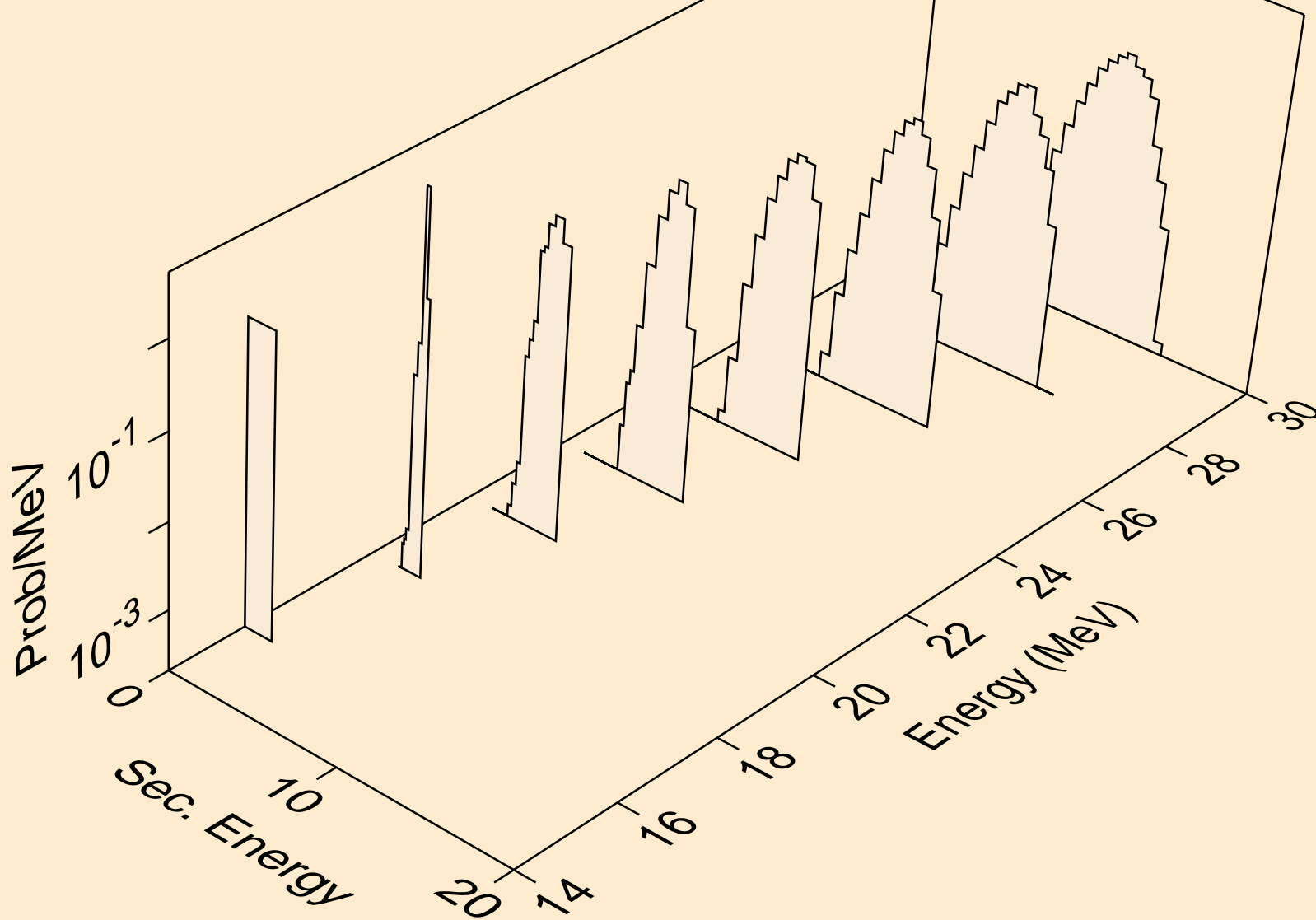

AT211 NEUTRON ACER TENDL-2019 LIBRARY; T=293.16K
deuterons from (n,n*)d

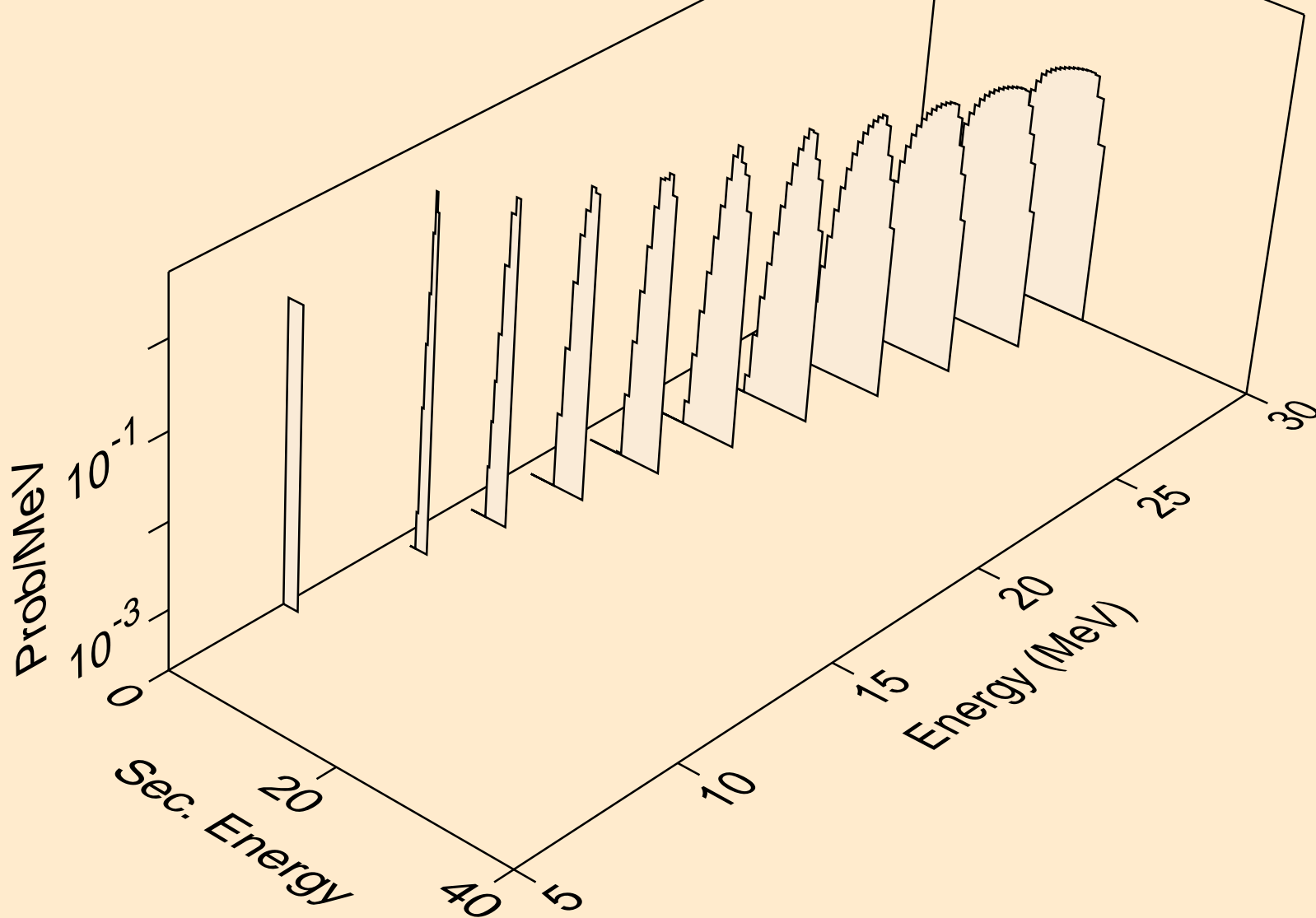

AT211 NEUTRON ACER TENDL-2019 LIBRARY; T=293.16K
deuterons from (n,d)

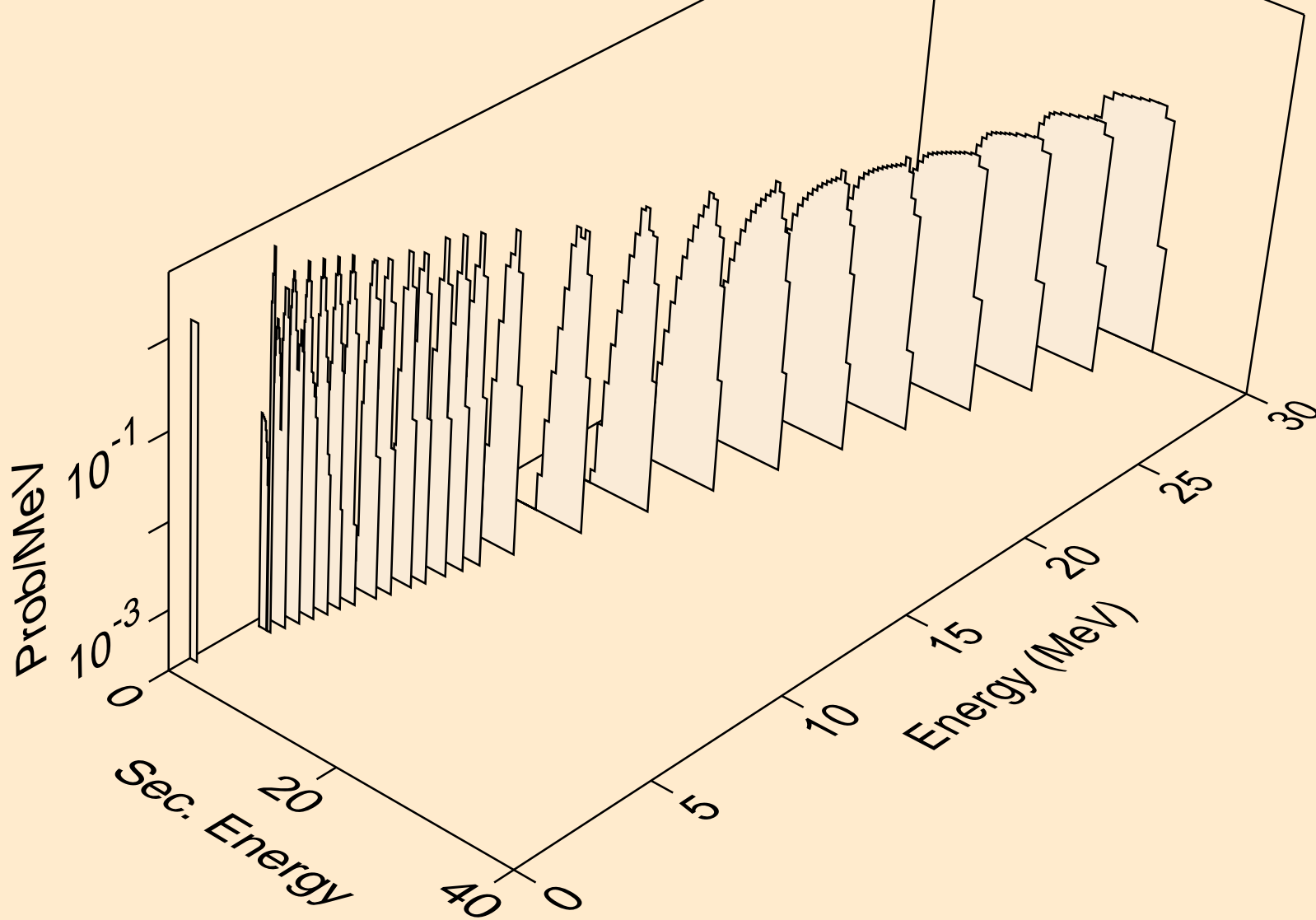

AT211 NEUTRON ACER TENDL-2019 LIBRARY; T=293.16K
deuterons from (n,pd)

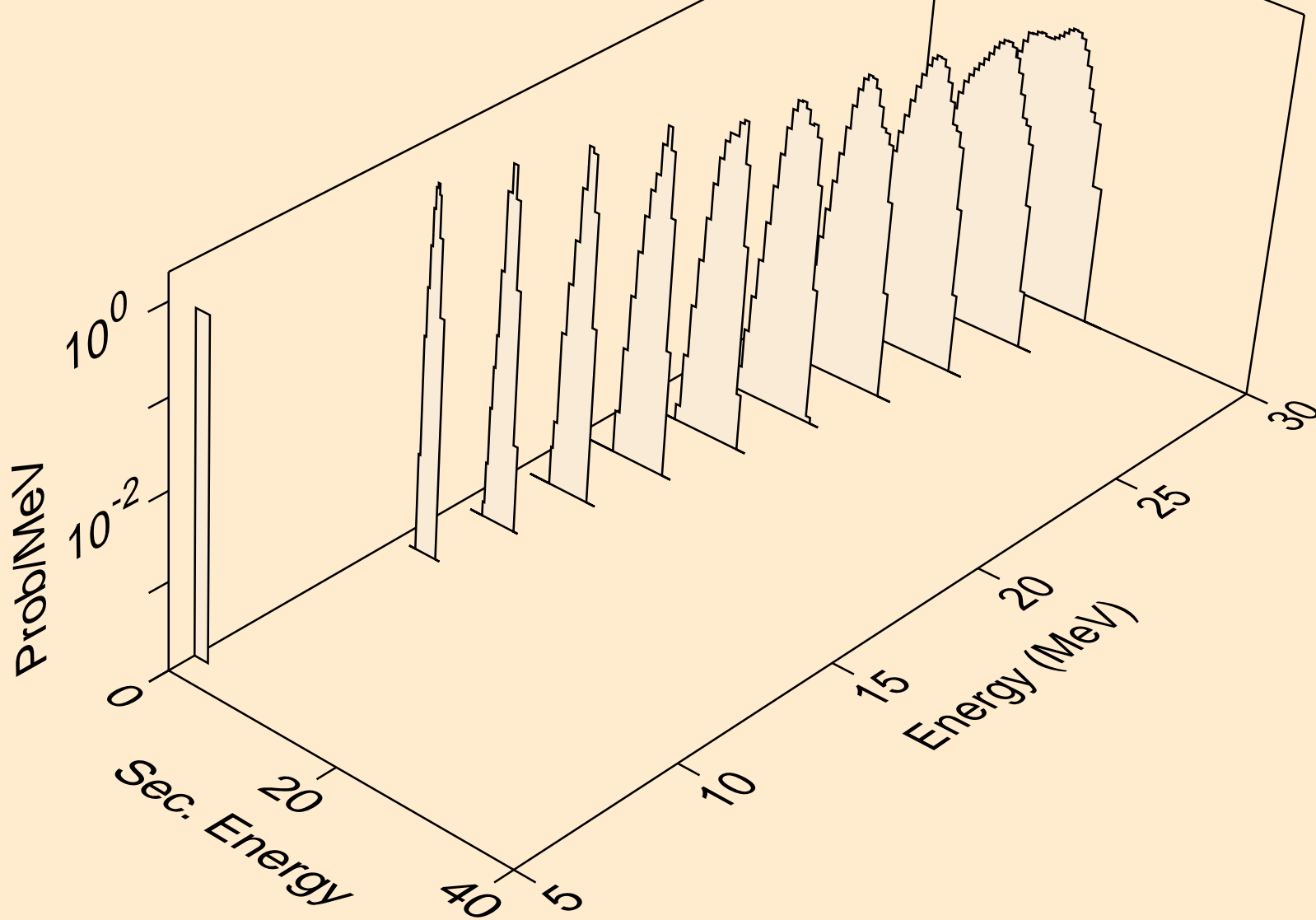

AT211 NEUTRON ACER TENDL-2019 LIBRARY; T=293.16K
deuterons from (n,da)

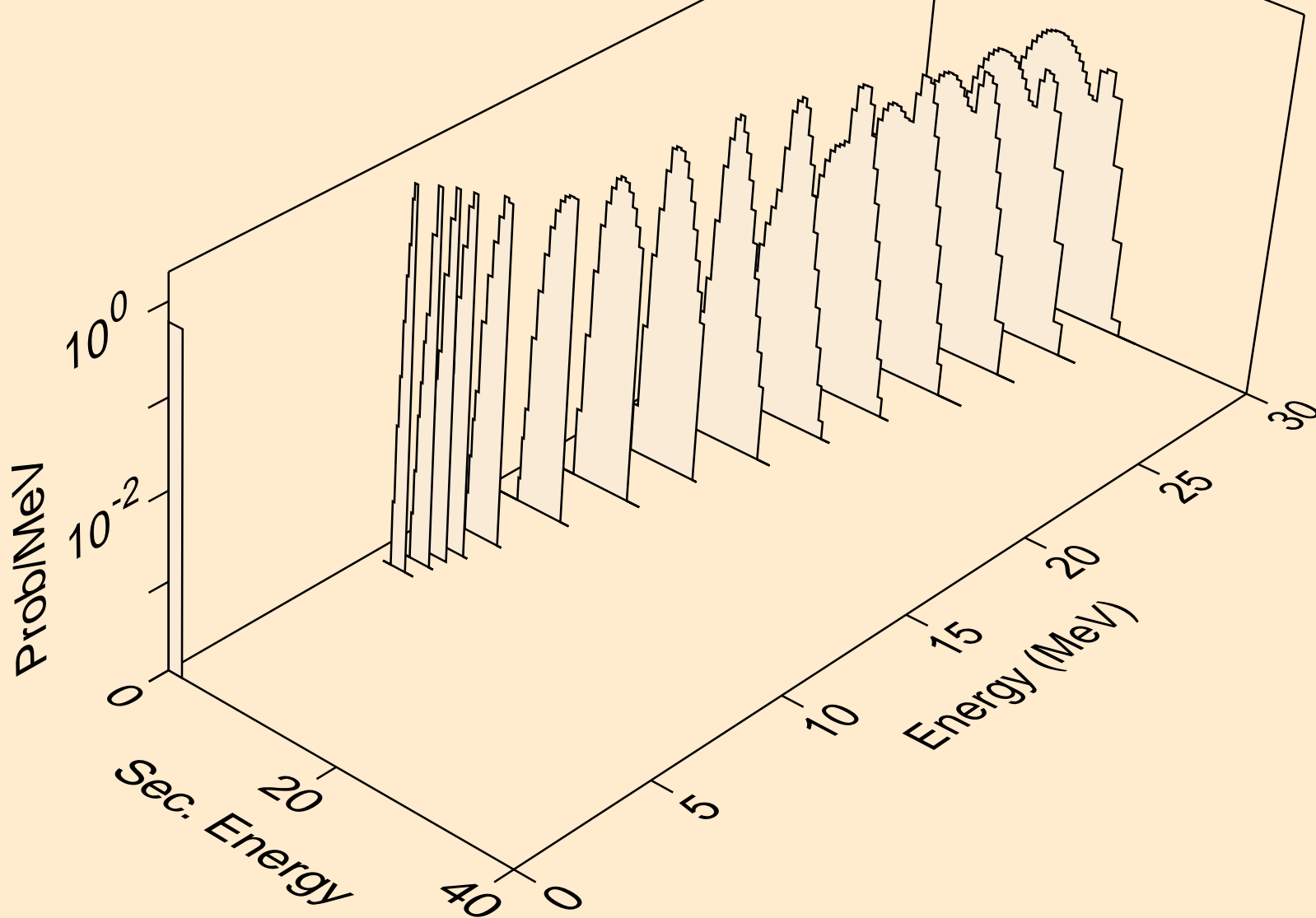

AT211 NEUTRON ACER TENDL-2019 LIBRARY; T=293.16K
tritons from (n,x)

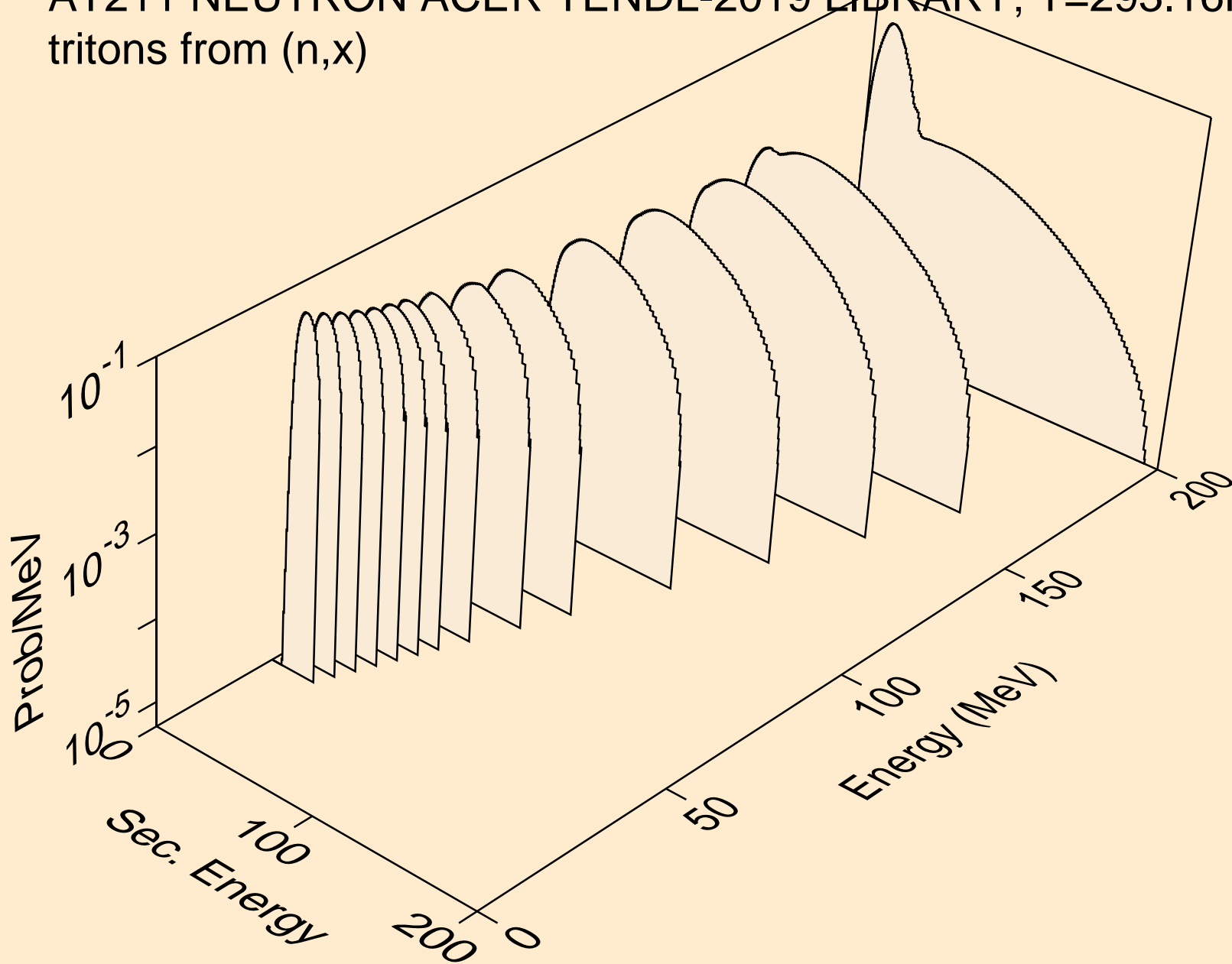

AT211 NEUTRON ACER TENDL-2019 LIBRARY; T=293.16K
tritons from (n,n*)t

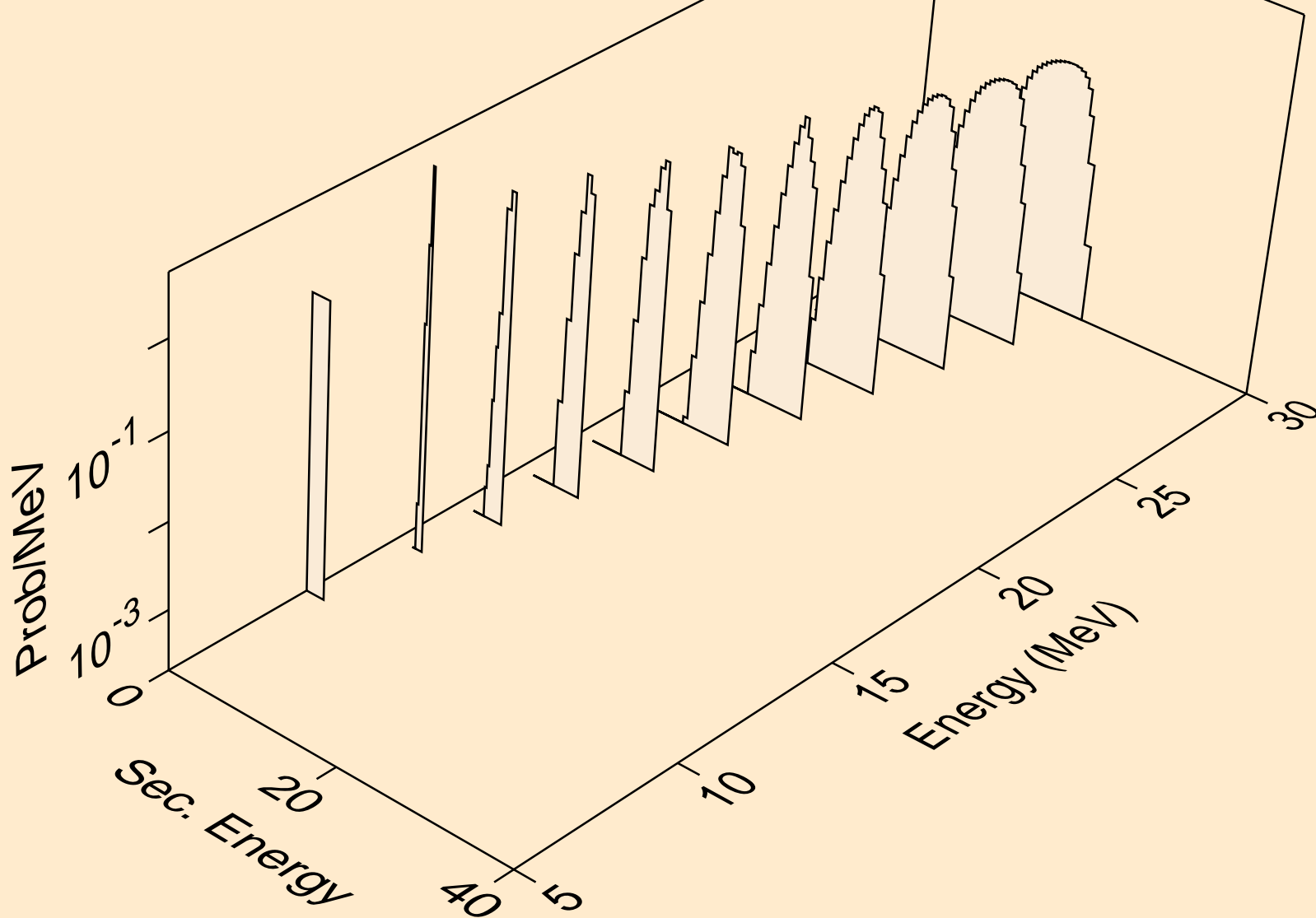

AT211 NEUTRON ACER TENDL-2019 LIBRARY; T=293.16K
tritons from (n,t)

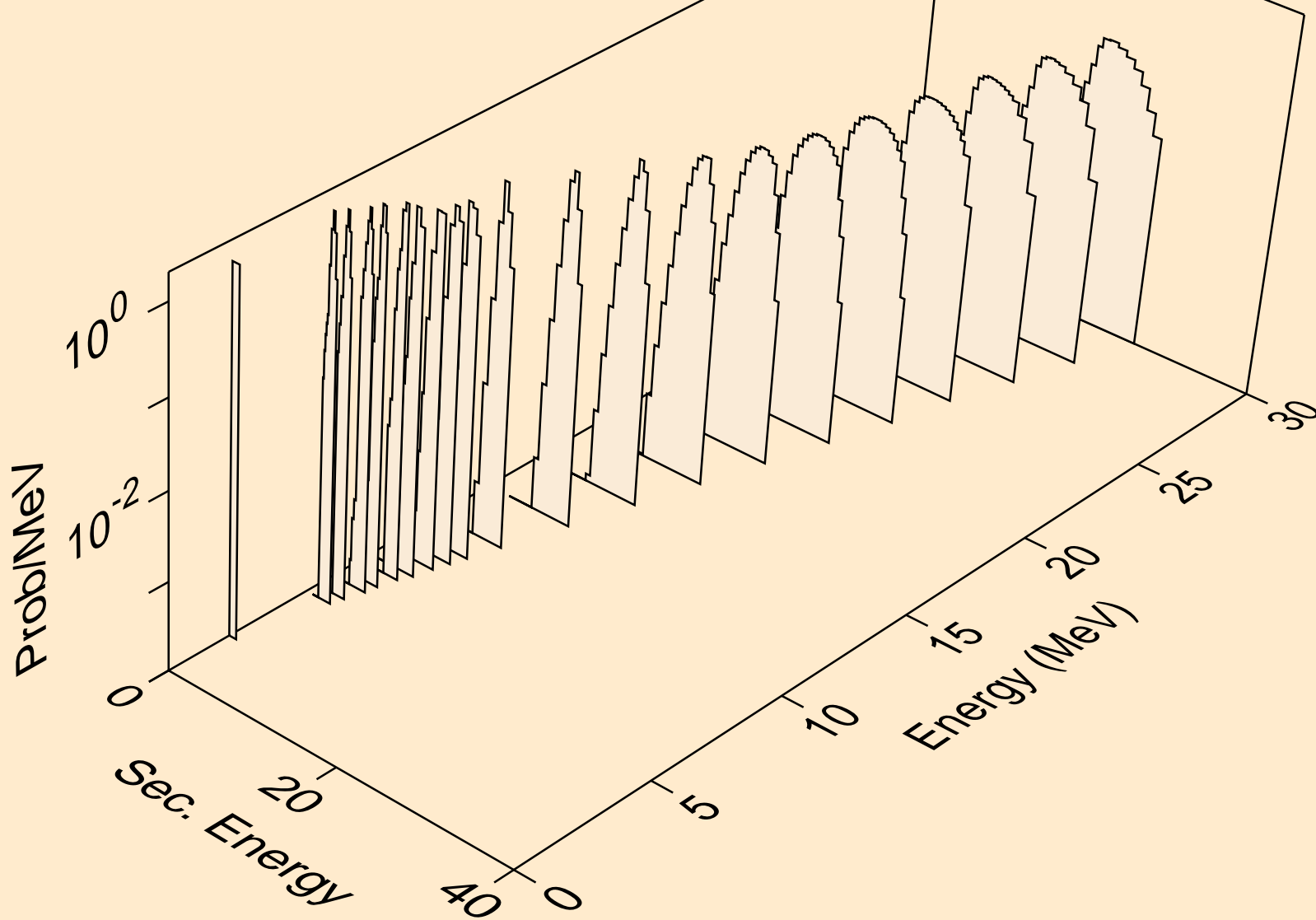

AT211 NEUTRON ACER TENDL-2019 LIBRARY; T=293.16K
tritons from (n,pt)

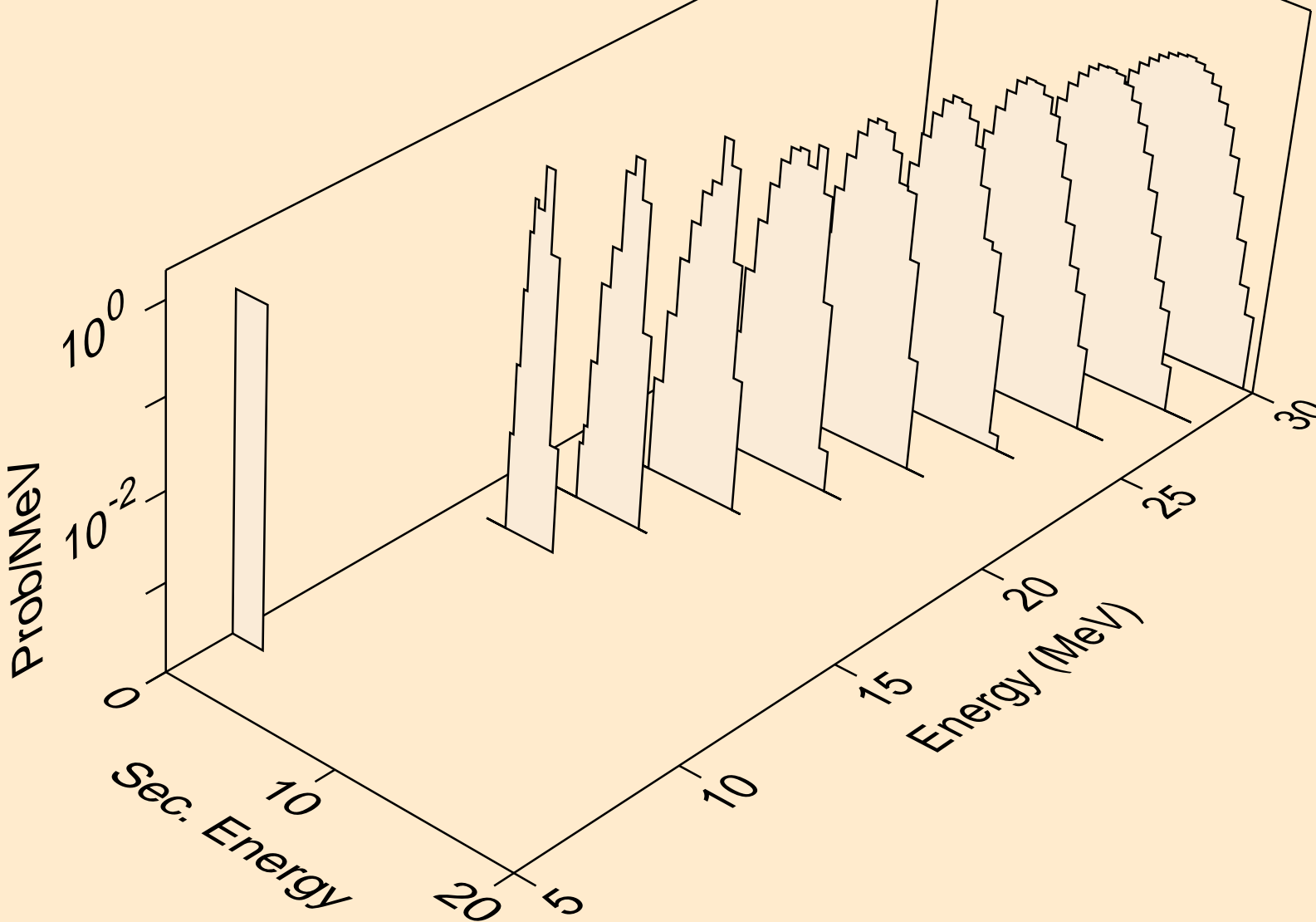

AT211 NEUTRON ACER TENDL-2019 LIBRARY; T=293.16K
he3s from (n,x)

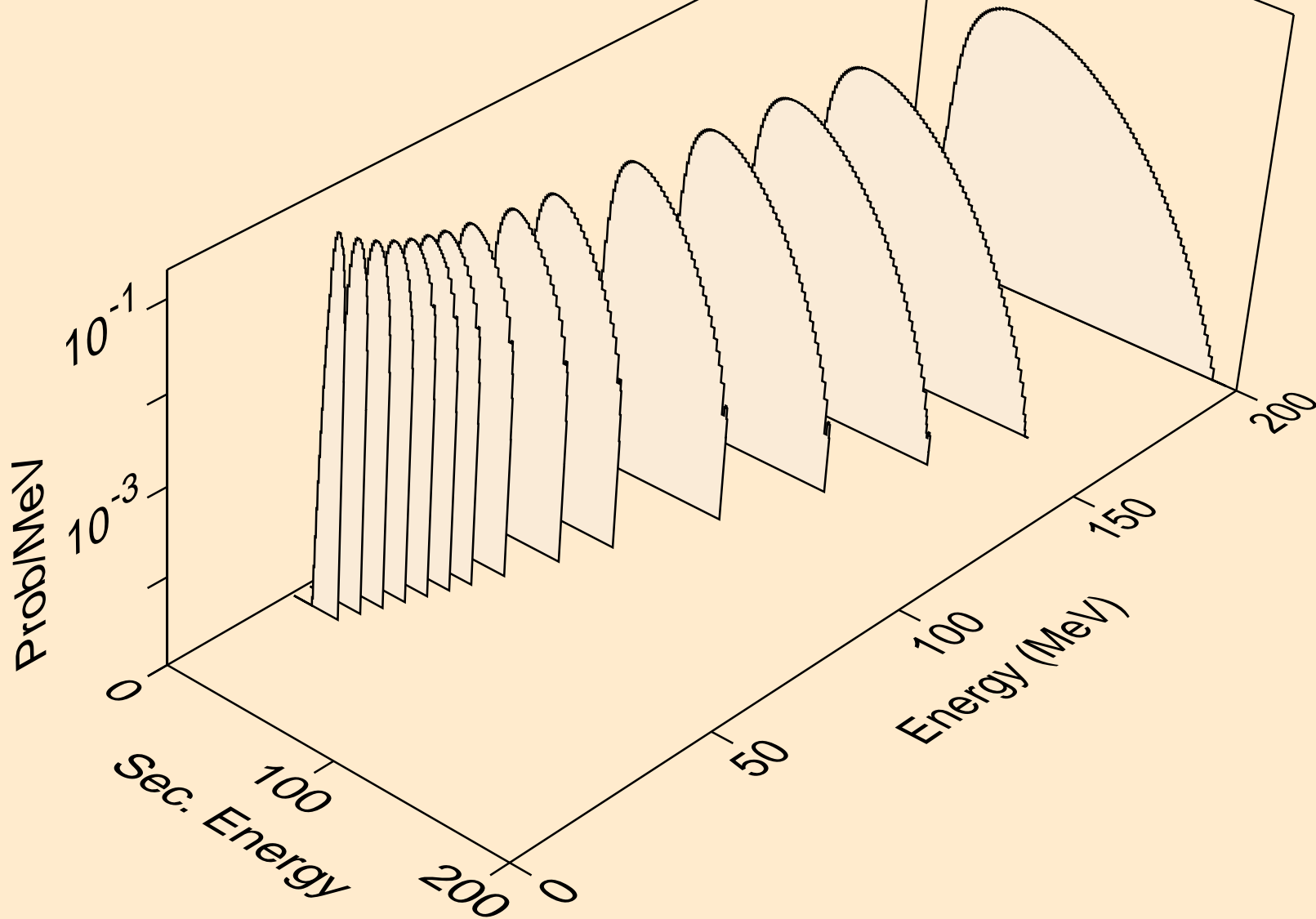

AT211 NEUTRON ACER TENDL-2019 LIBRARY; T=293.16K
he3s from (n,n*)he3

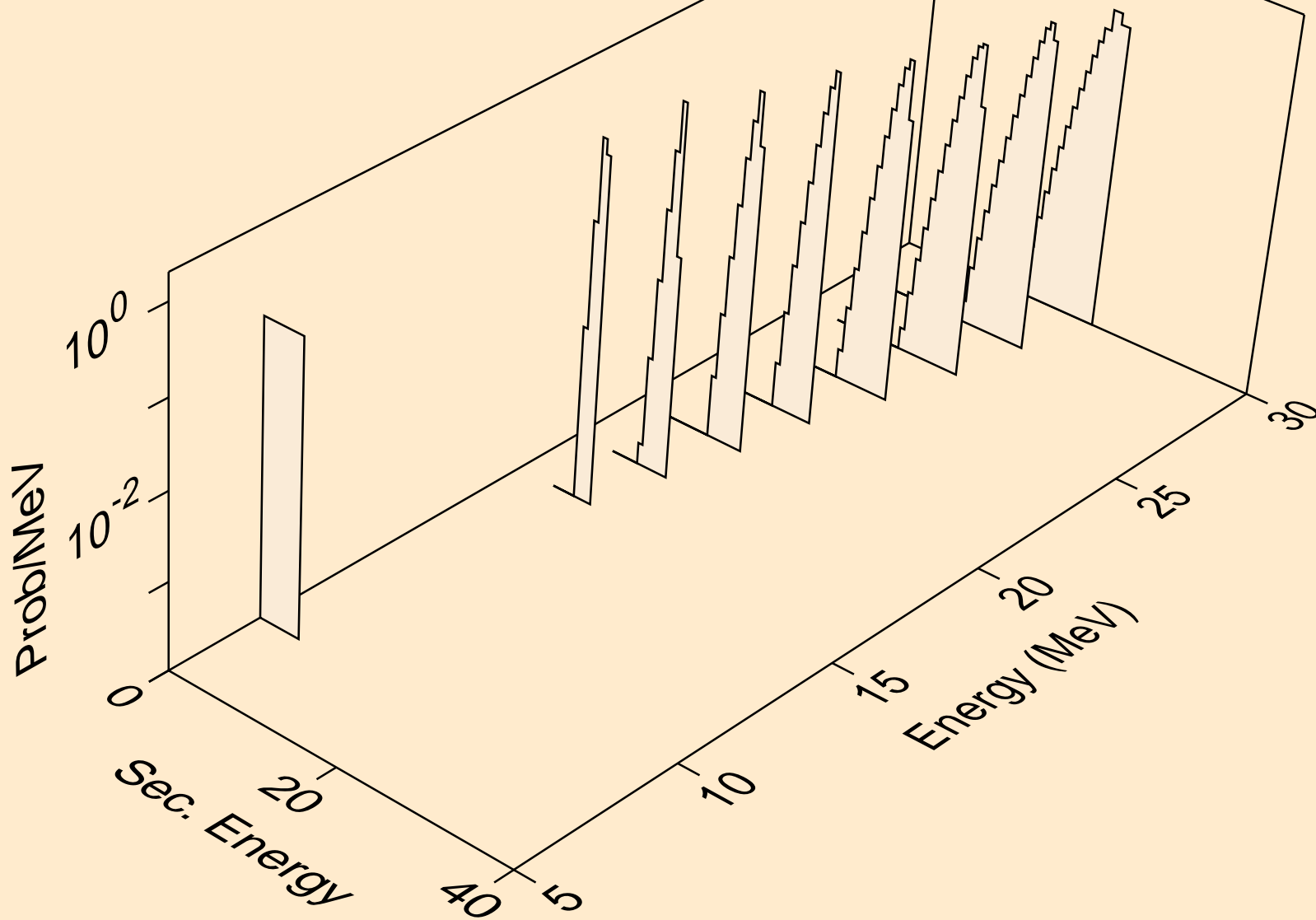

AT211 NEUTRON ACER TENDL-2019 LIBRARY; T=293.16K
he3s from (n,he3)

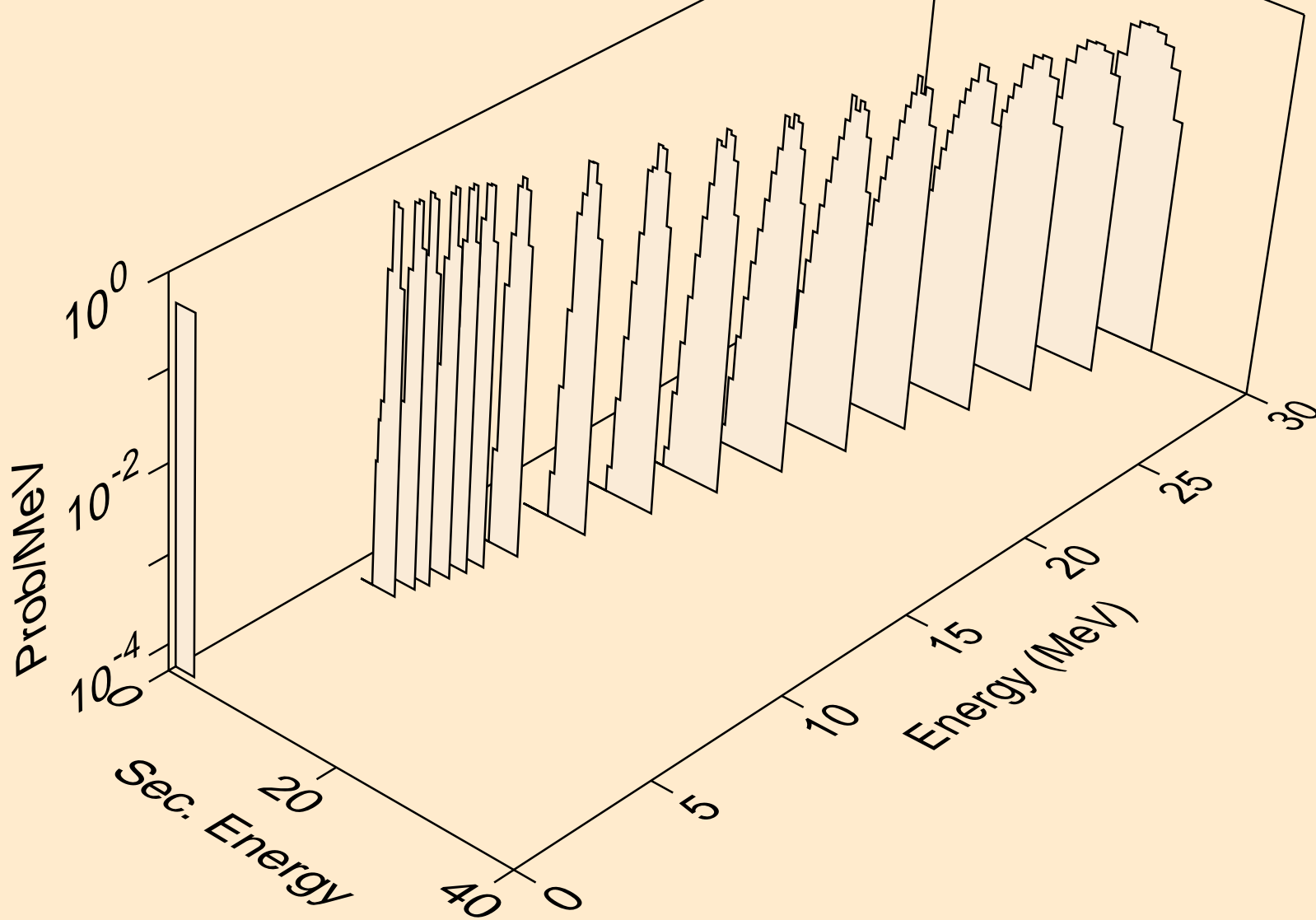

AT211 NEUTRON ACER TENDL-2019 LIBRARY; T=293.16K
alphas from (n,x)

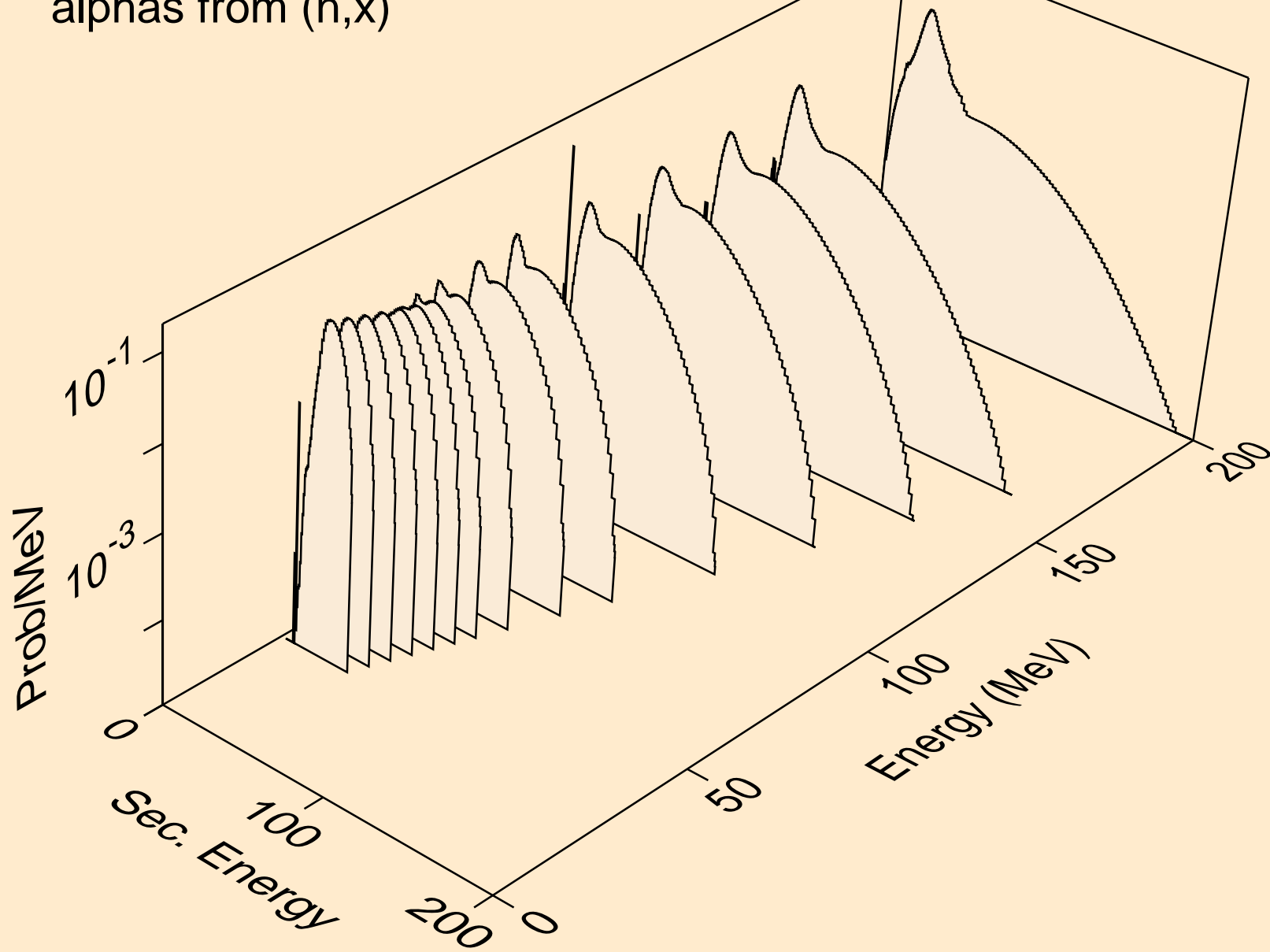

AT211 NEUTRON ACER TENDL-2019 LIBRARY; T=293.16K
alphas from (n,n*)a

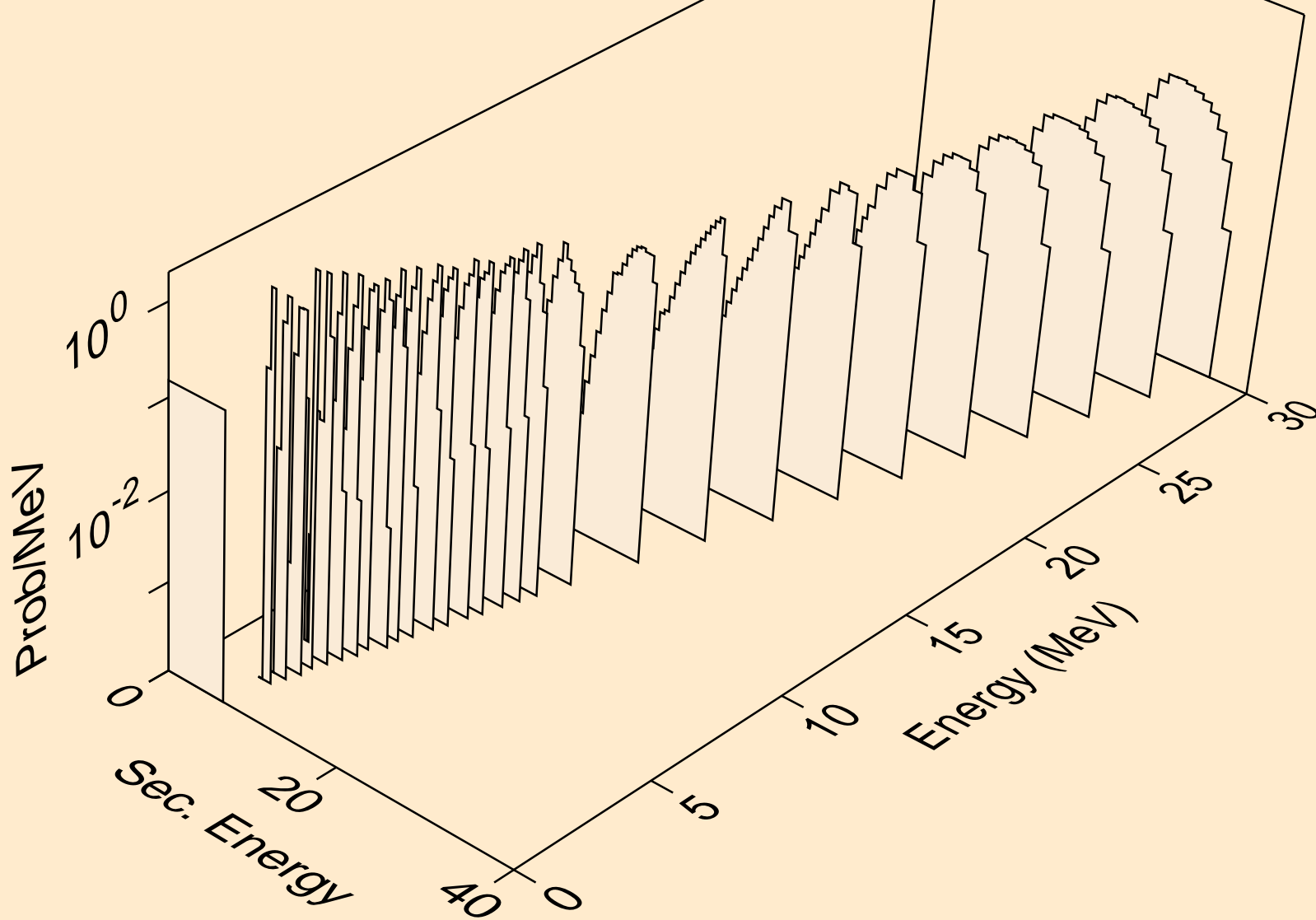

AT211 NEUTRON ACER TENDL-2019 LIBRARY; T=293.16K
alphas from (n,2n)a

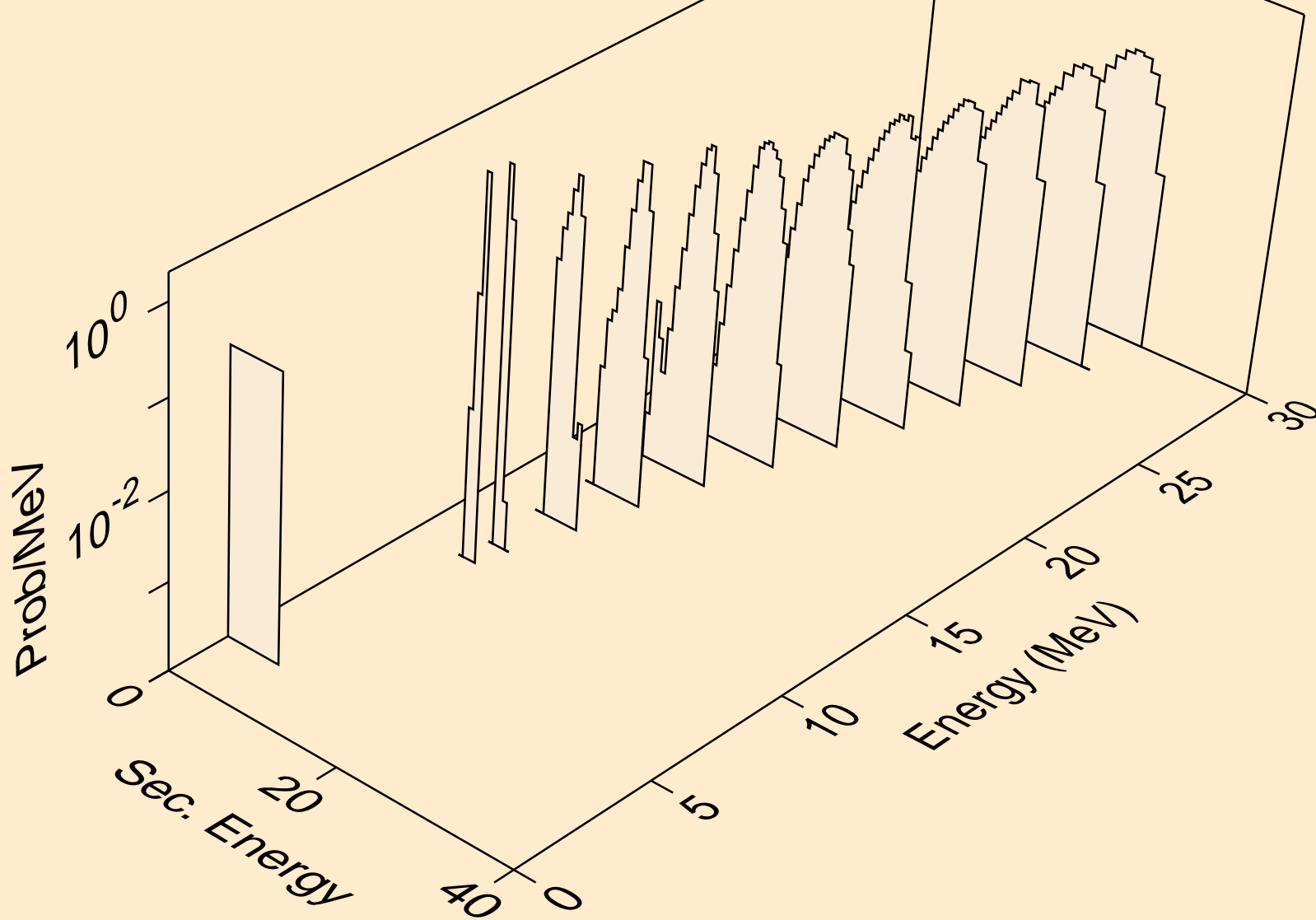

AT211 NEUTRON ACER TENDL-2019 LIBRARY; T=293.16K
alphas from (n,3n)a

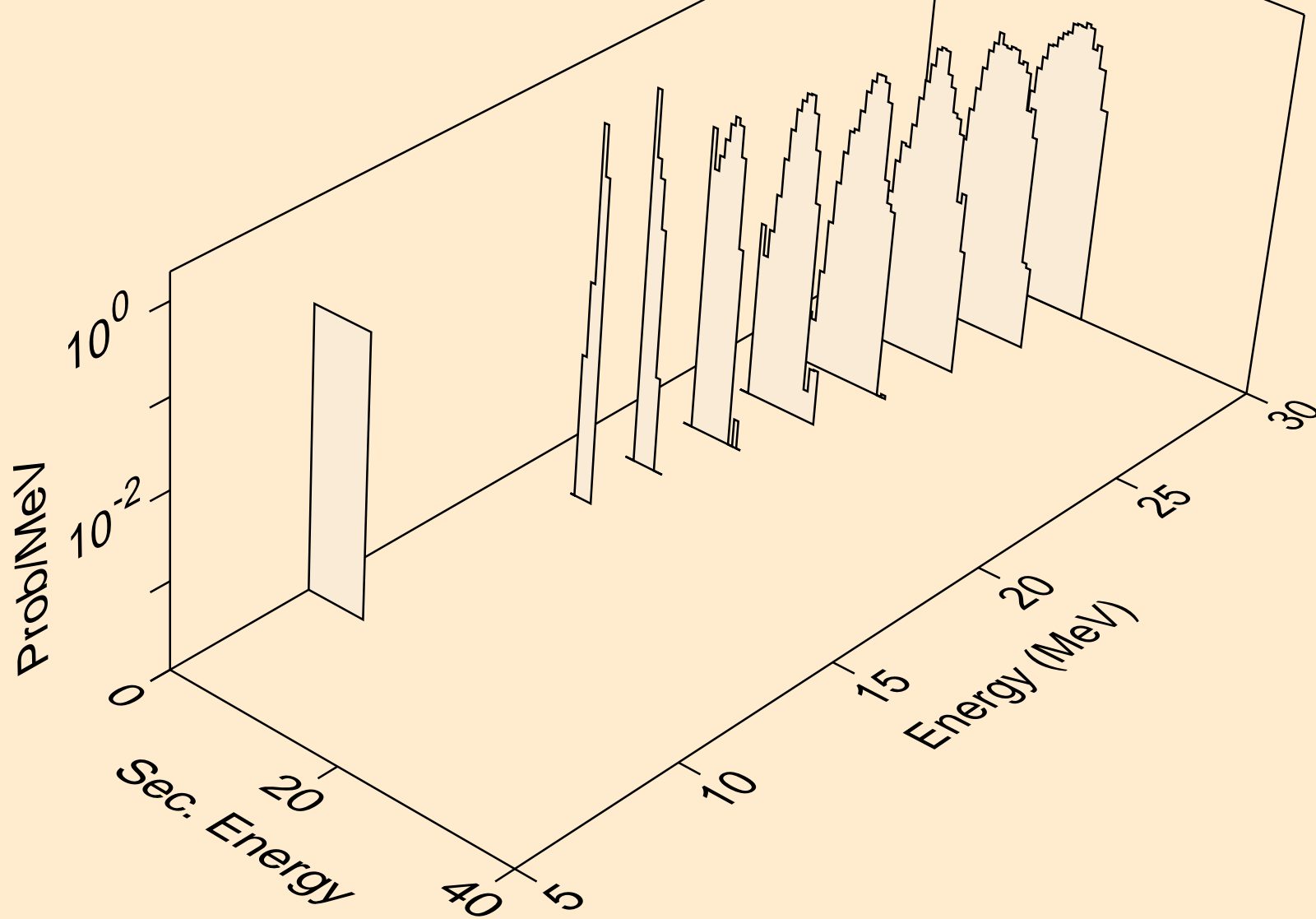

AT211 NEUTRON ACER TENDL-2019 LIBRARY; T=293.16K
alphas from (n,n*)2a

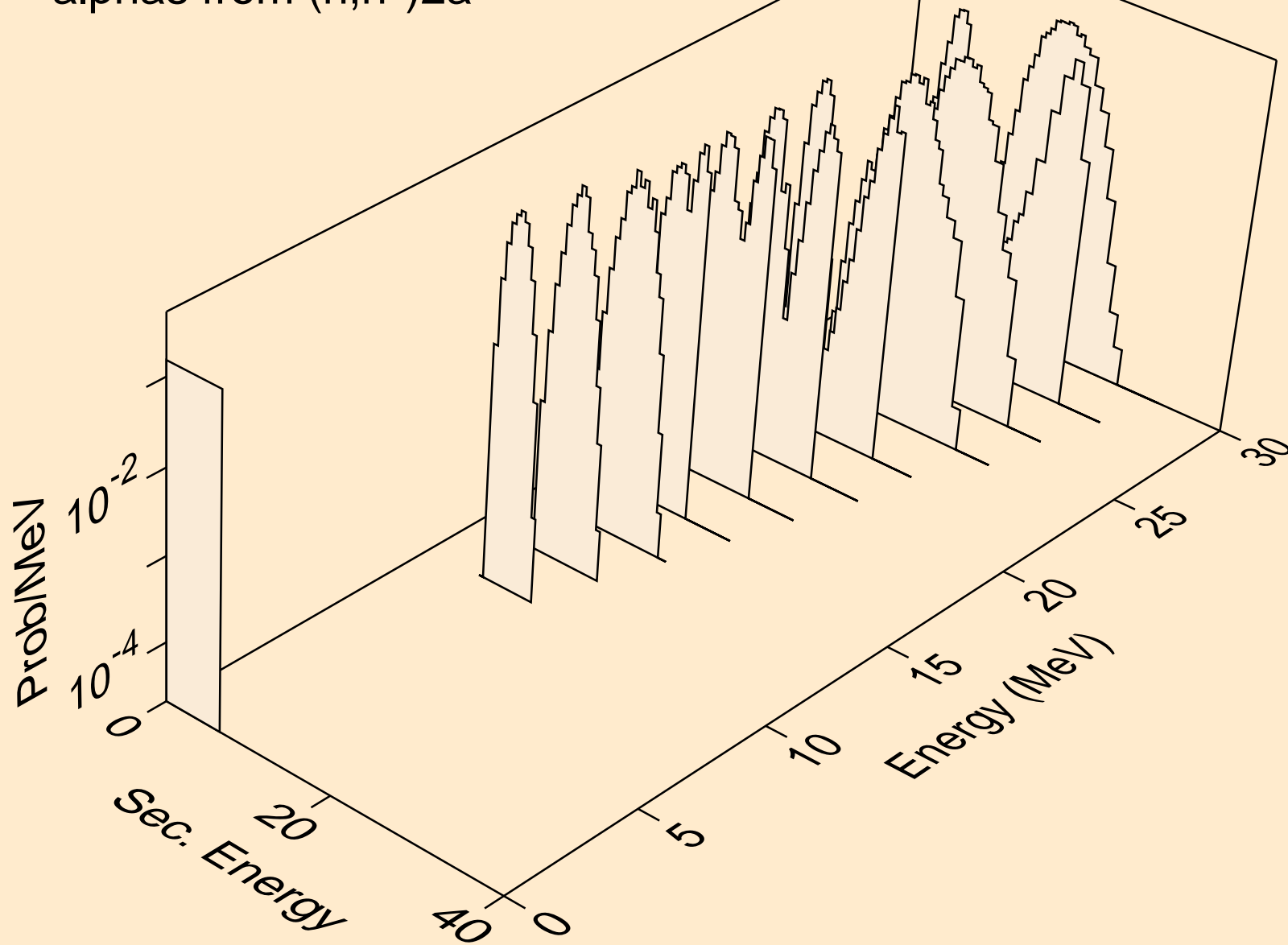

AT211 NEUTRON ACER TENDL-2019 LIBRARY; T=293.16K
alphas from (n,npa)

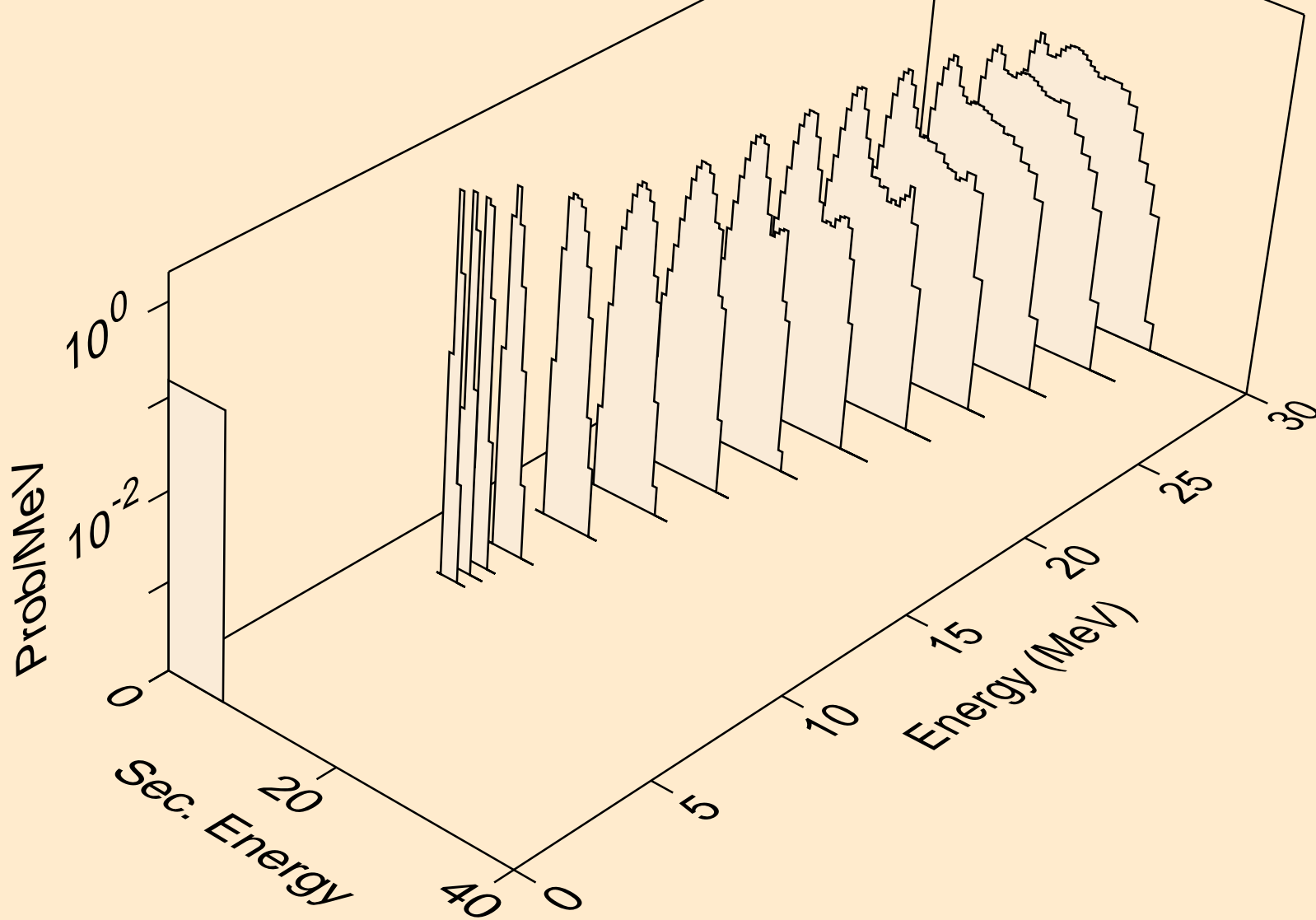

AT211 NEUTRON ACER TENDL-2019 LIBRARY; T=293.16K
alphas from (n,a)

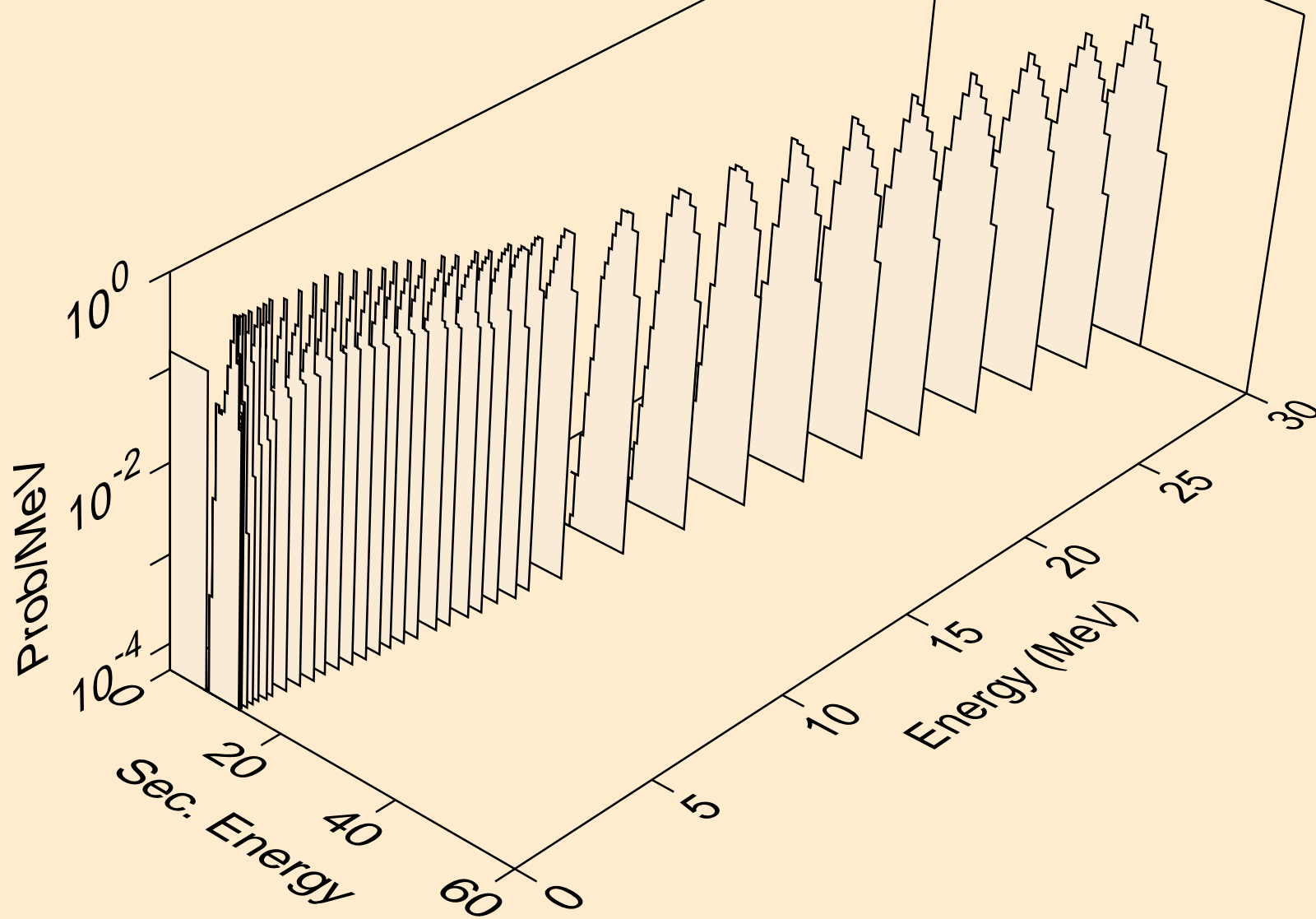

AT211 NEUTRON ACER TENDL-2019 LIBRARY; T=293.16K
alphas from (n,2a)

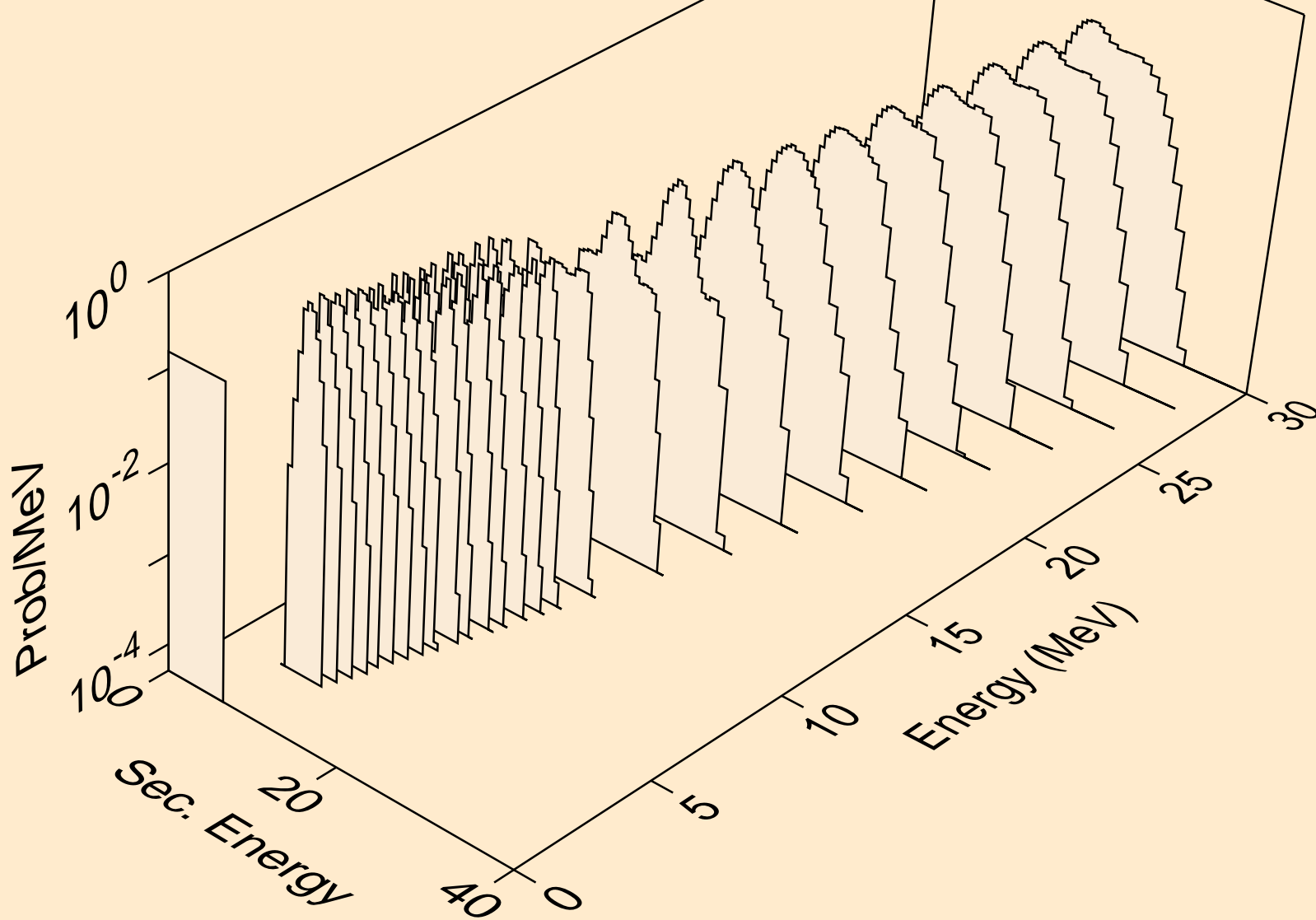

AT211 NEUTRON ACER TENDL-2019 LIBRARY; T=293.16K
alphas from (n,pa)

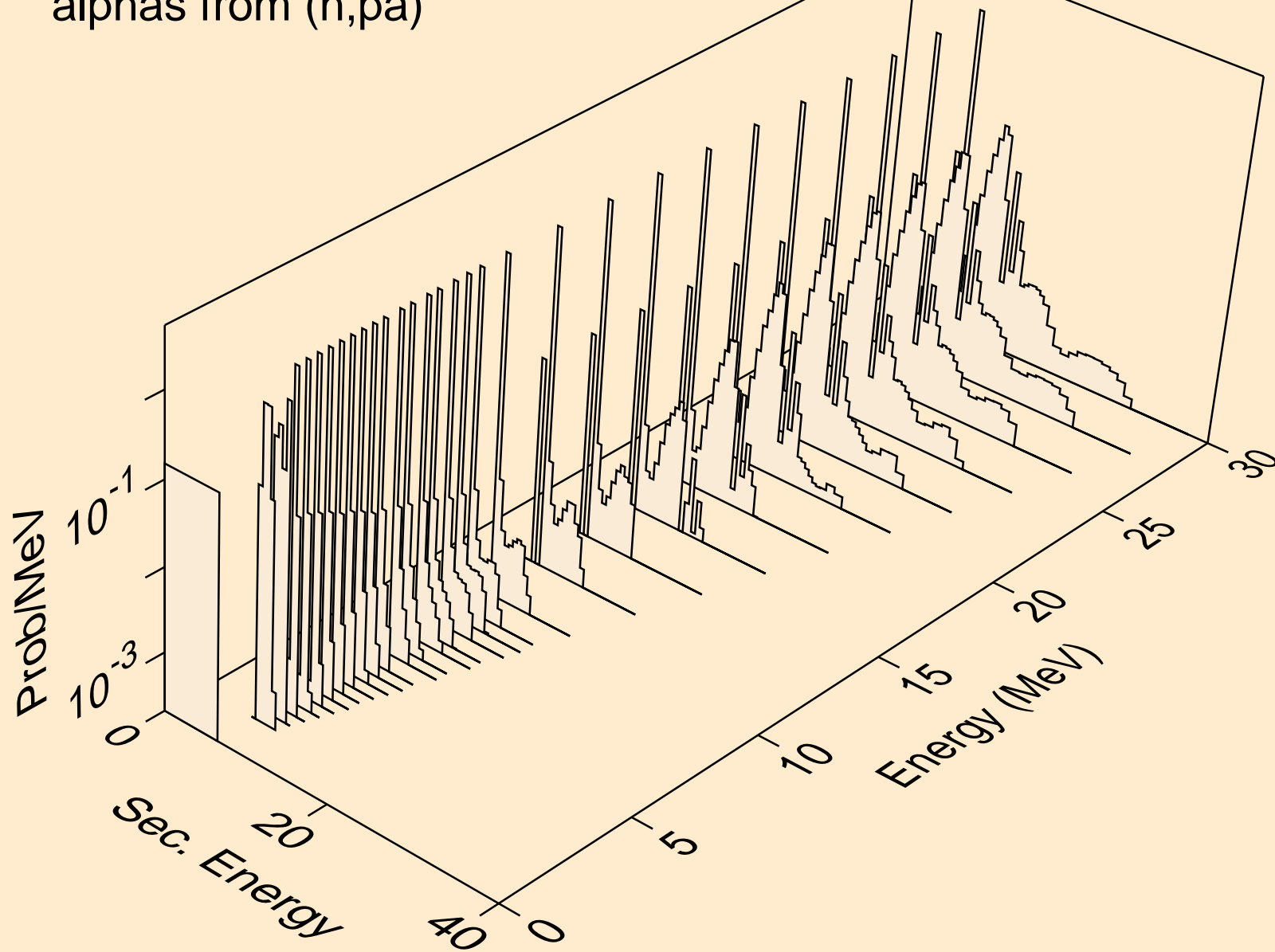

AT211 NEUTRON ACER TENDL-2019 LIBRARY; T=293.16K
alphas from (n,da)

