

AU178 NEUTRON ACER TENDL-2019 LIBRARY; T=293.16K
Principal cross sections

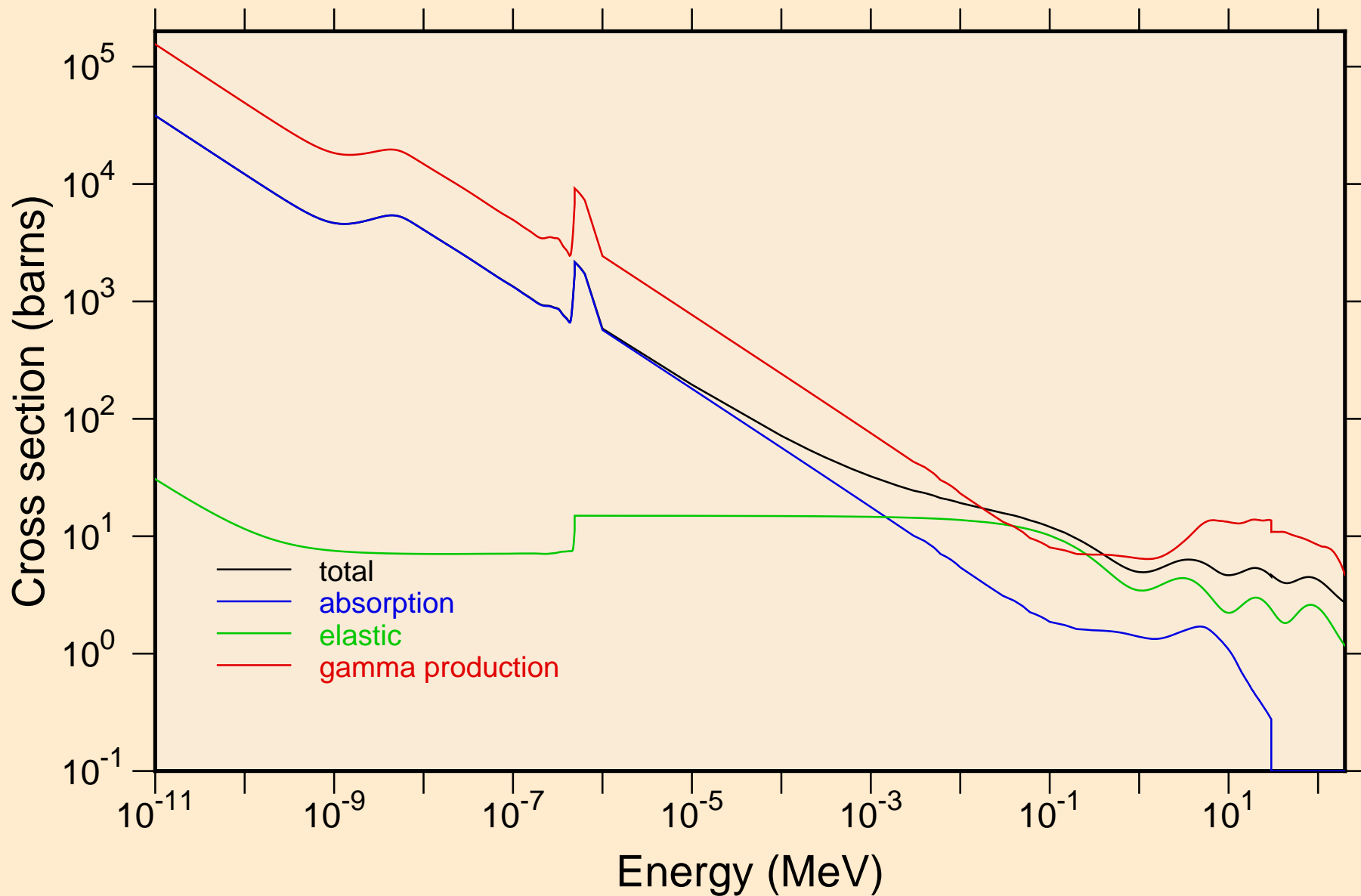

AU178 NEUTRON ACER TENDL-2019 LIBRARY; T=293.16K
Heating

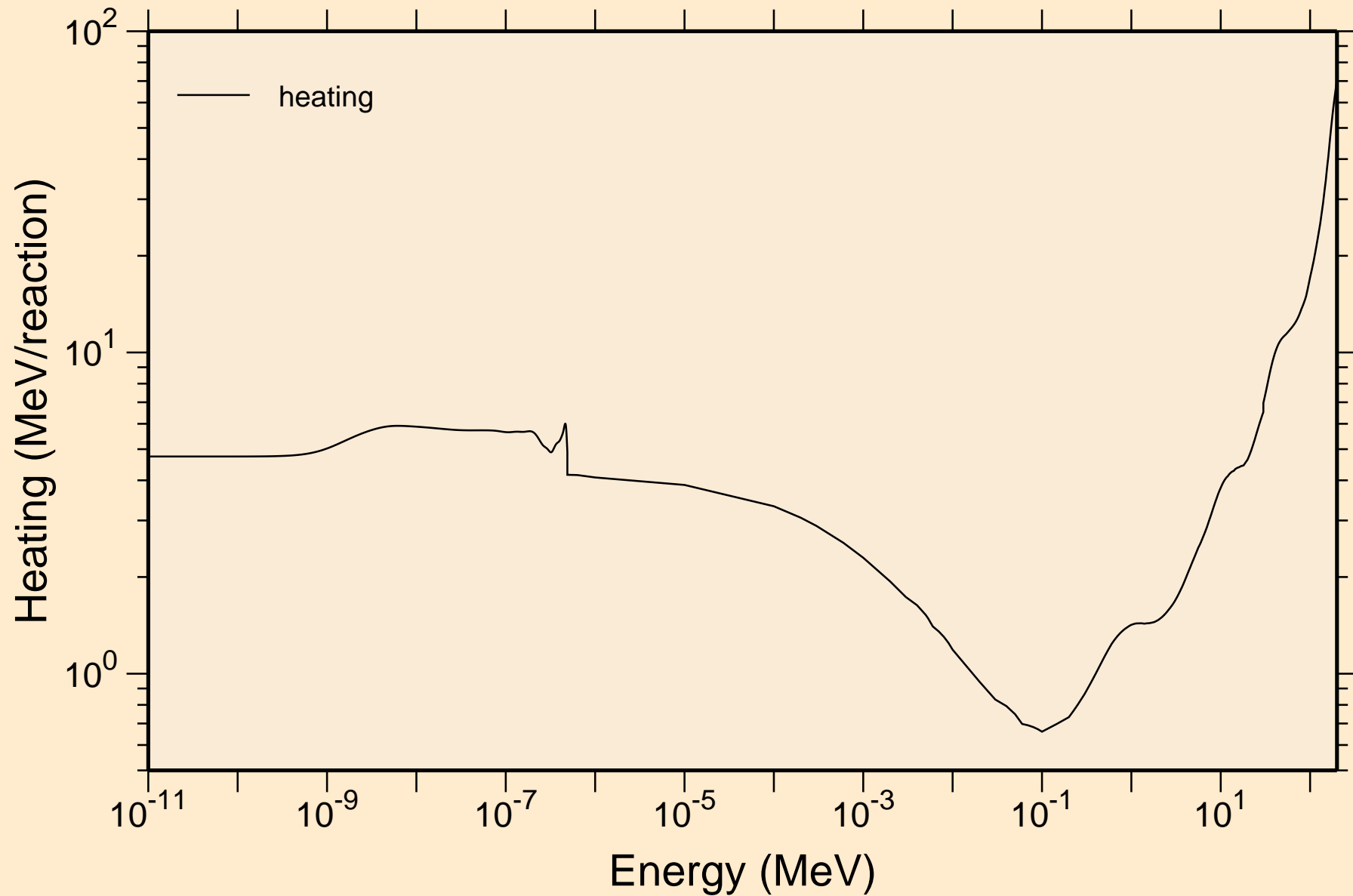

AU178 NEUTRON ACER TENDL-2019 LIBRARY; T=293.16K
Damage

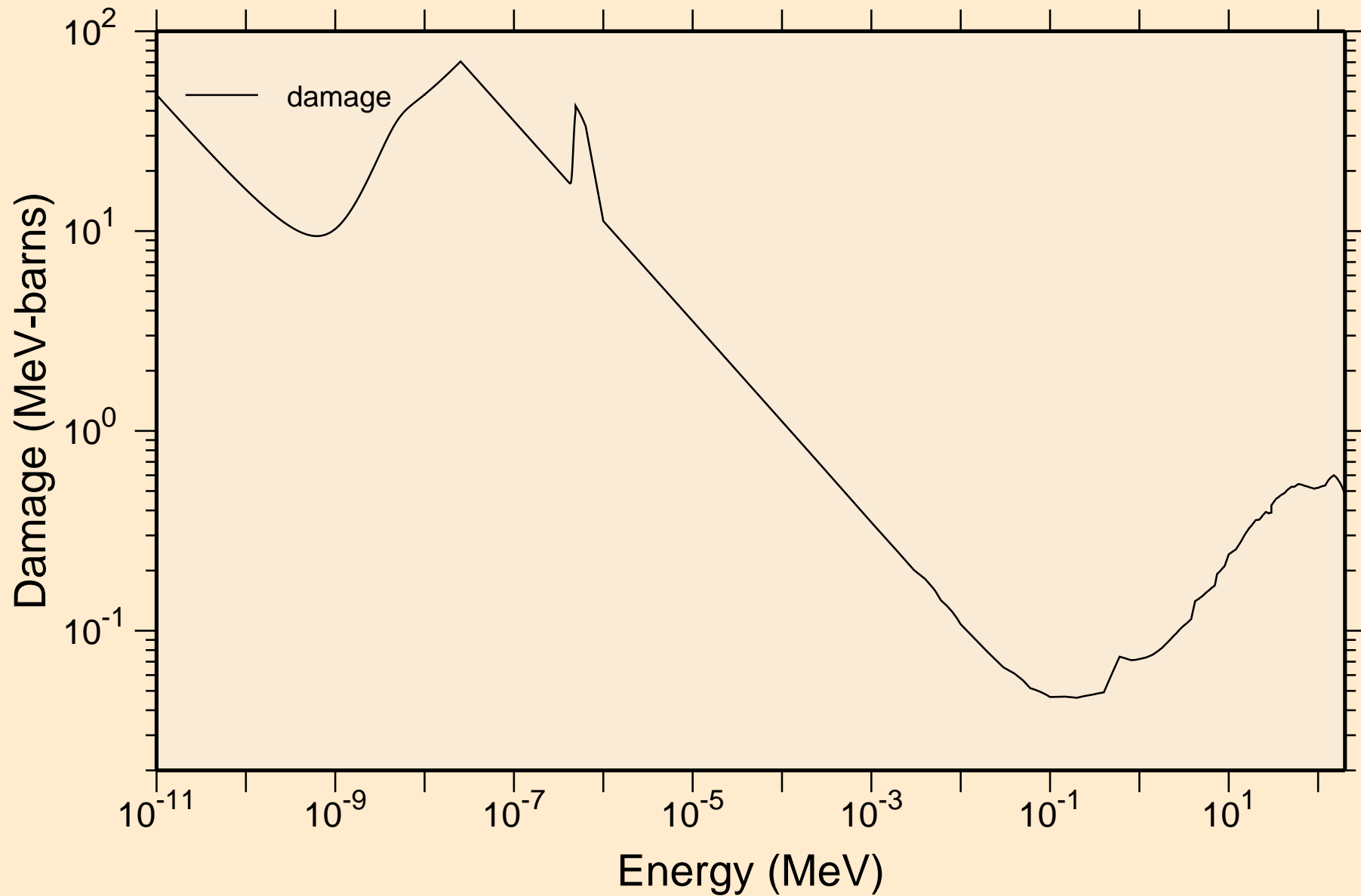

AU178 NEUTRON ACER TENDL-2019 LIBRARY; T=293.16K
Non-threshold reactions

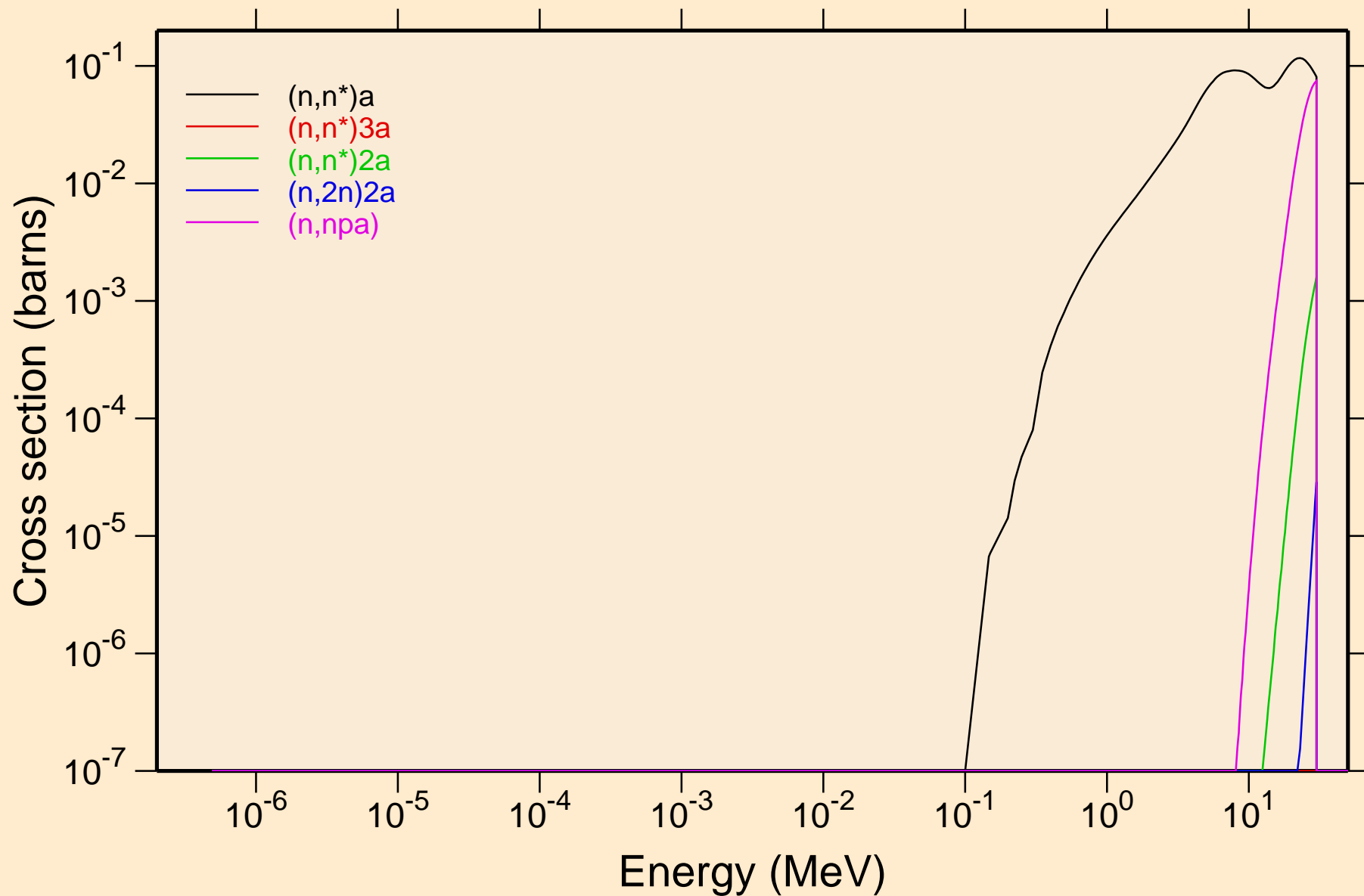

AU178 NEUTRON ACER TENDL-2019 LIBRARY; T=293.16K
Non-threshold reactions

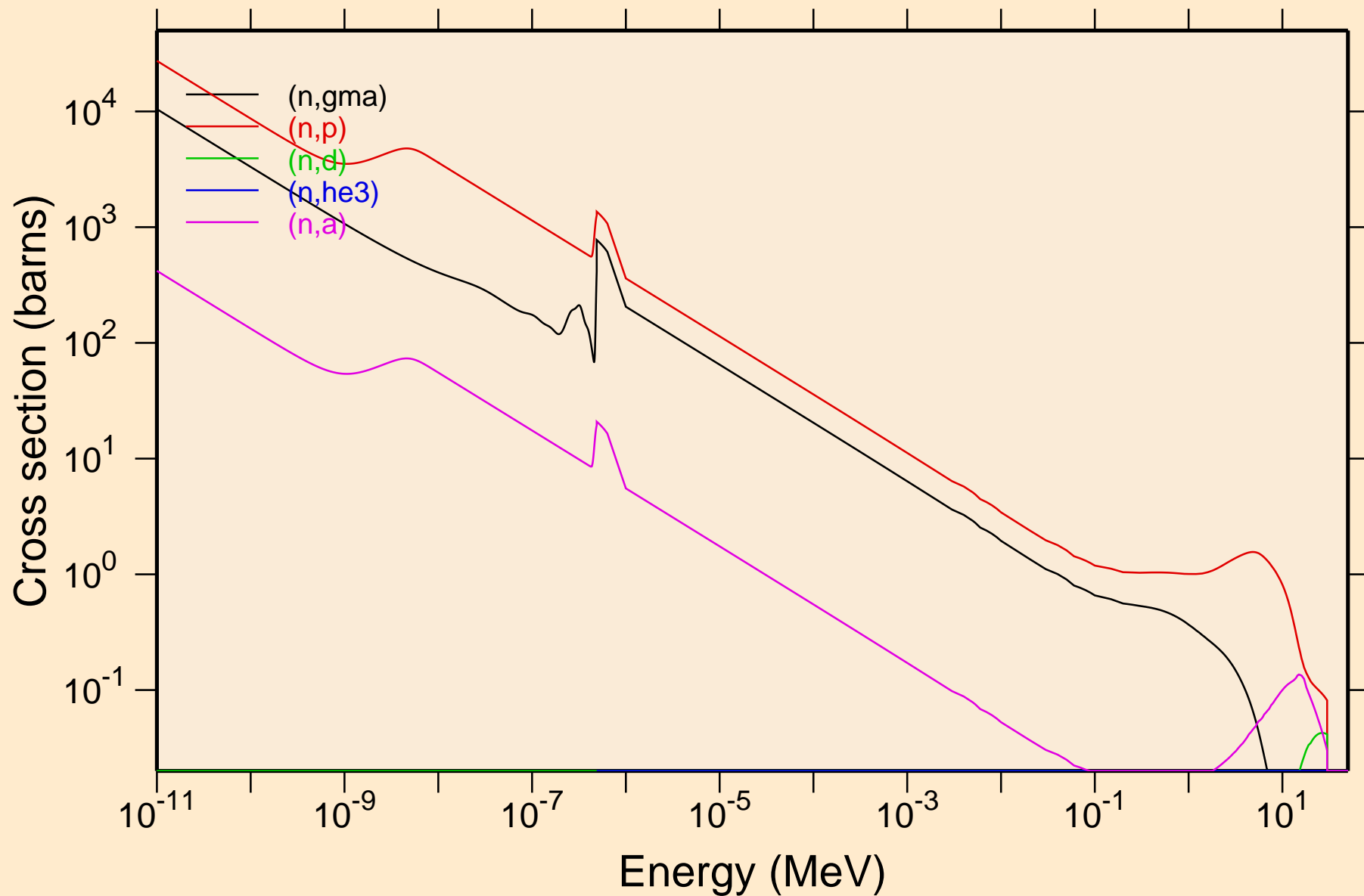

AU178 NEUTRON ACER TENDL-2019 LIBRARY; T=293.16K
Non-threshold reactions

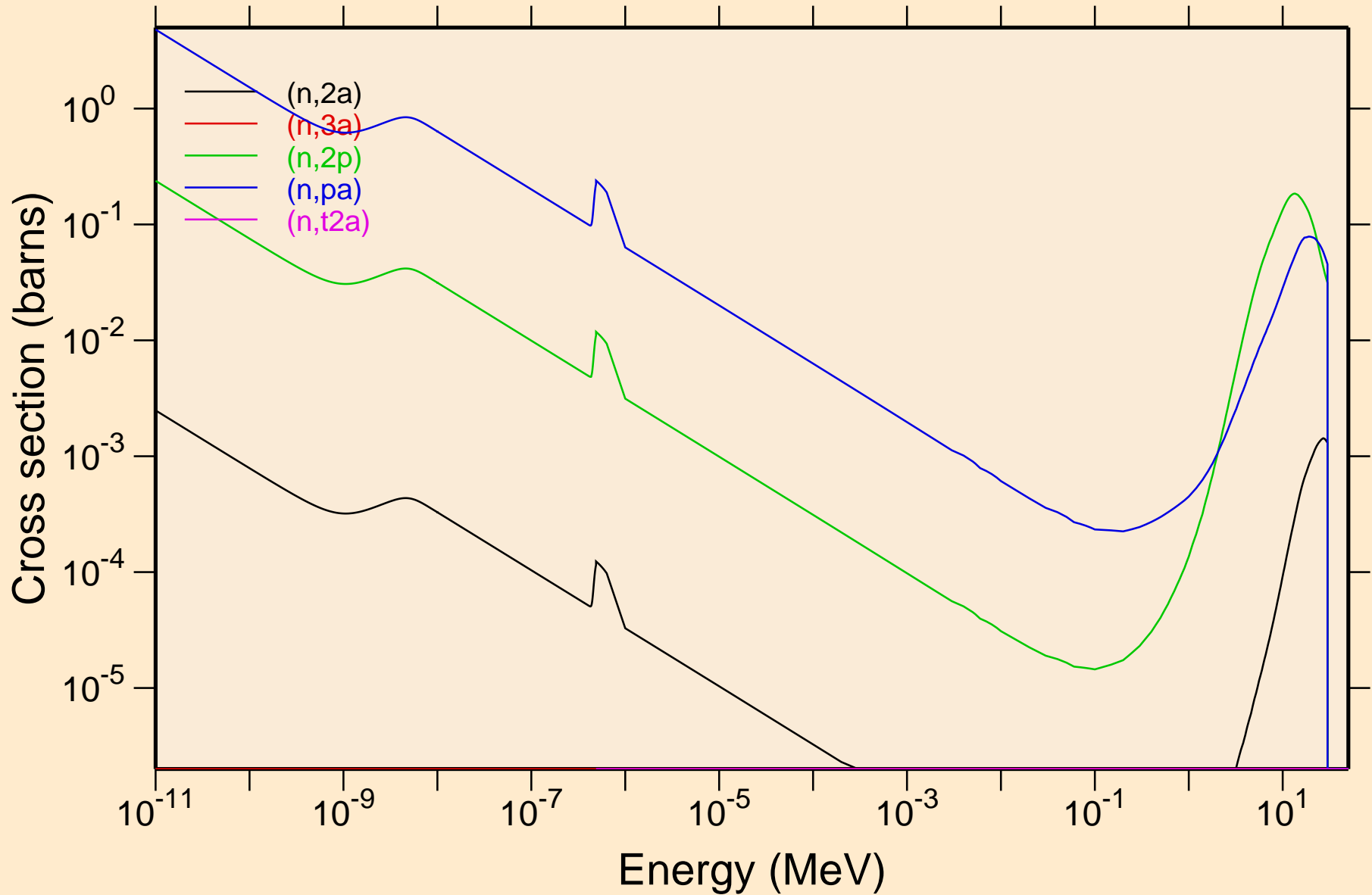

AU178 NEUTRON ACER TENDL-2019 LIBRARY; T=293.16K
Non-threshold reactions

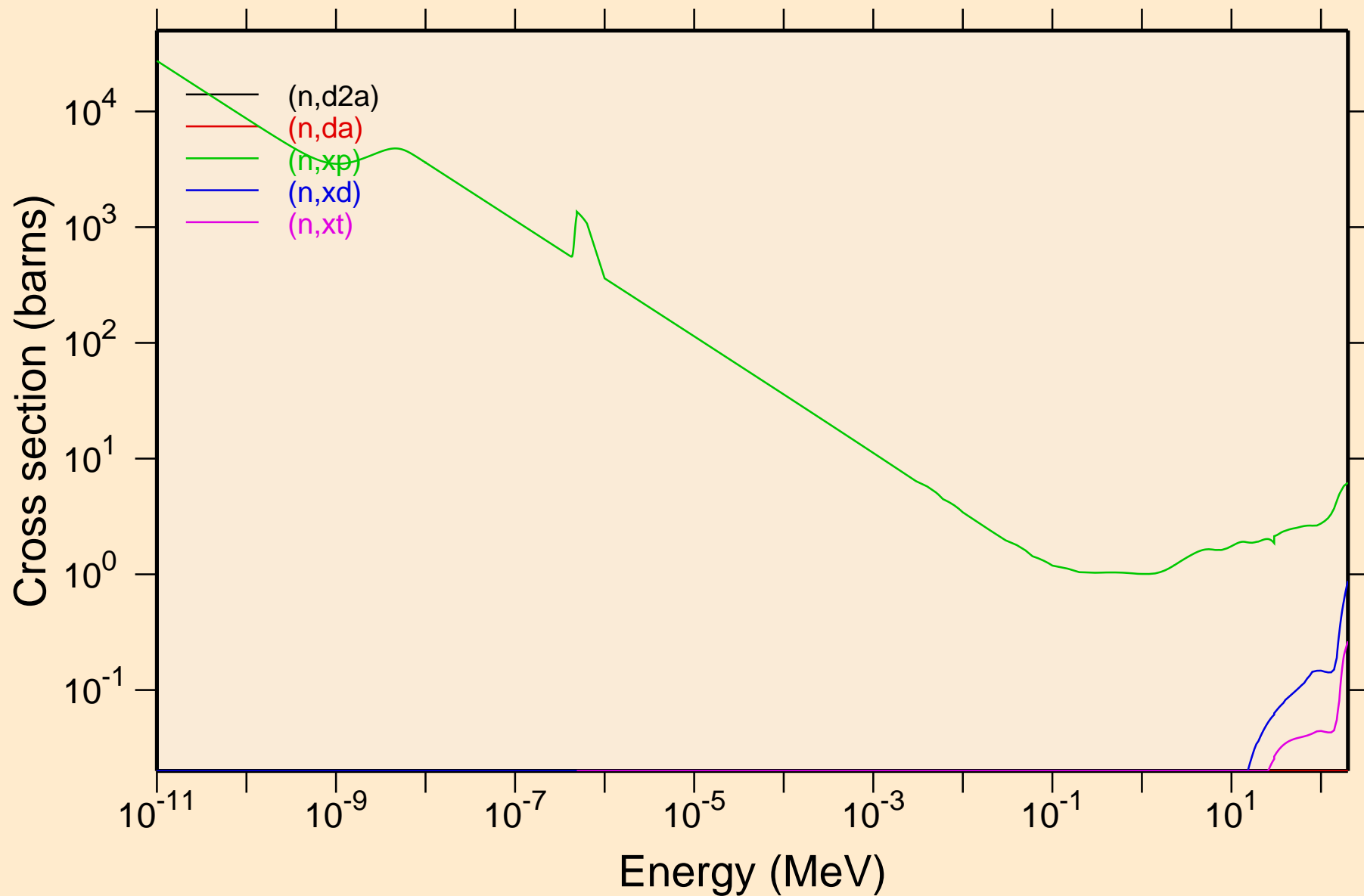

AU178 NEUTRON ACER TENDL-2019 LIBRARY; T=293.16K
Non-threshold reactions

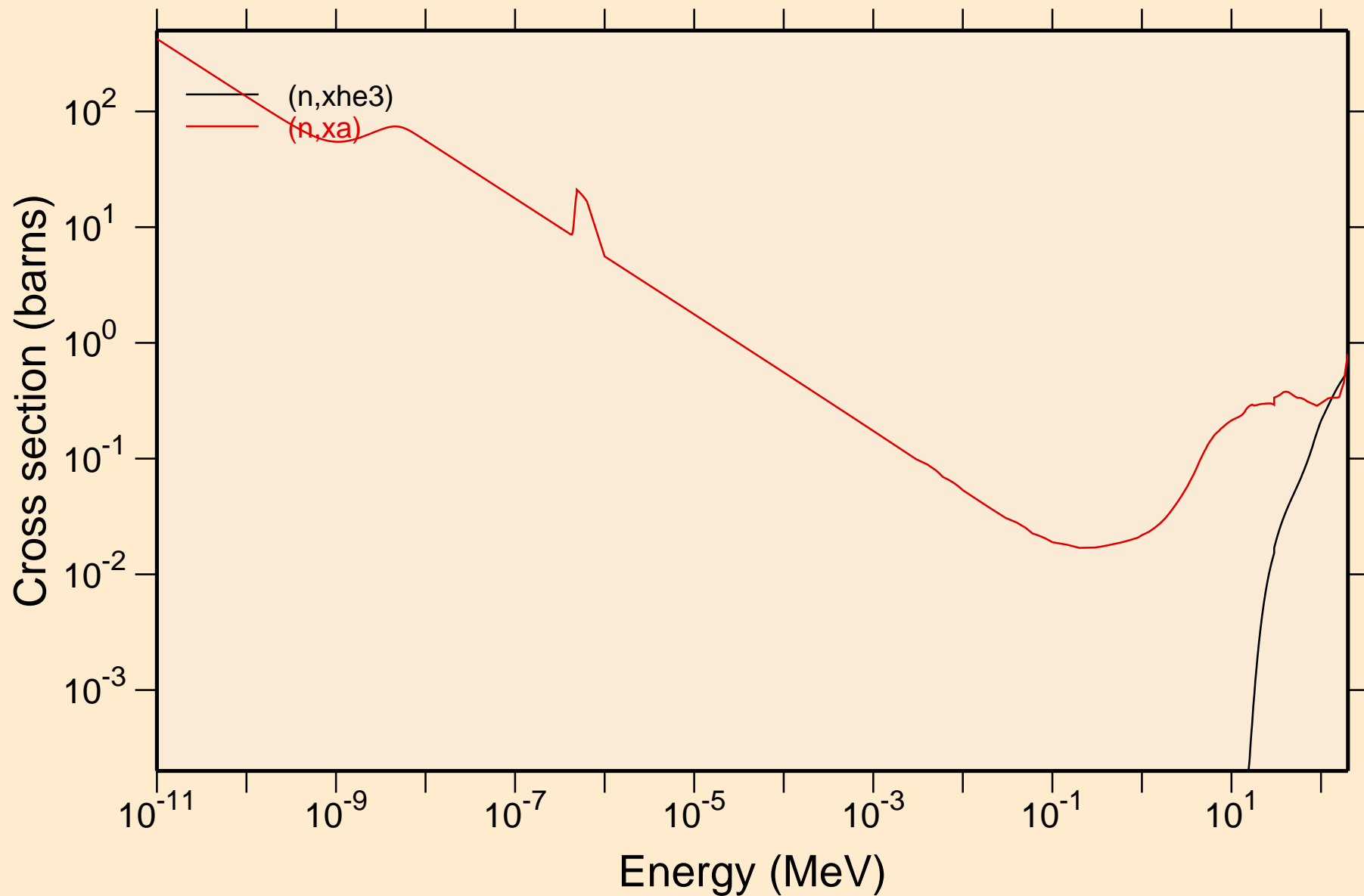

AU178 NEUTRON ACER TENDL-2019 LIBRARY; T=293.16K
Principal cross sections

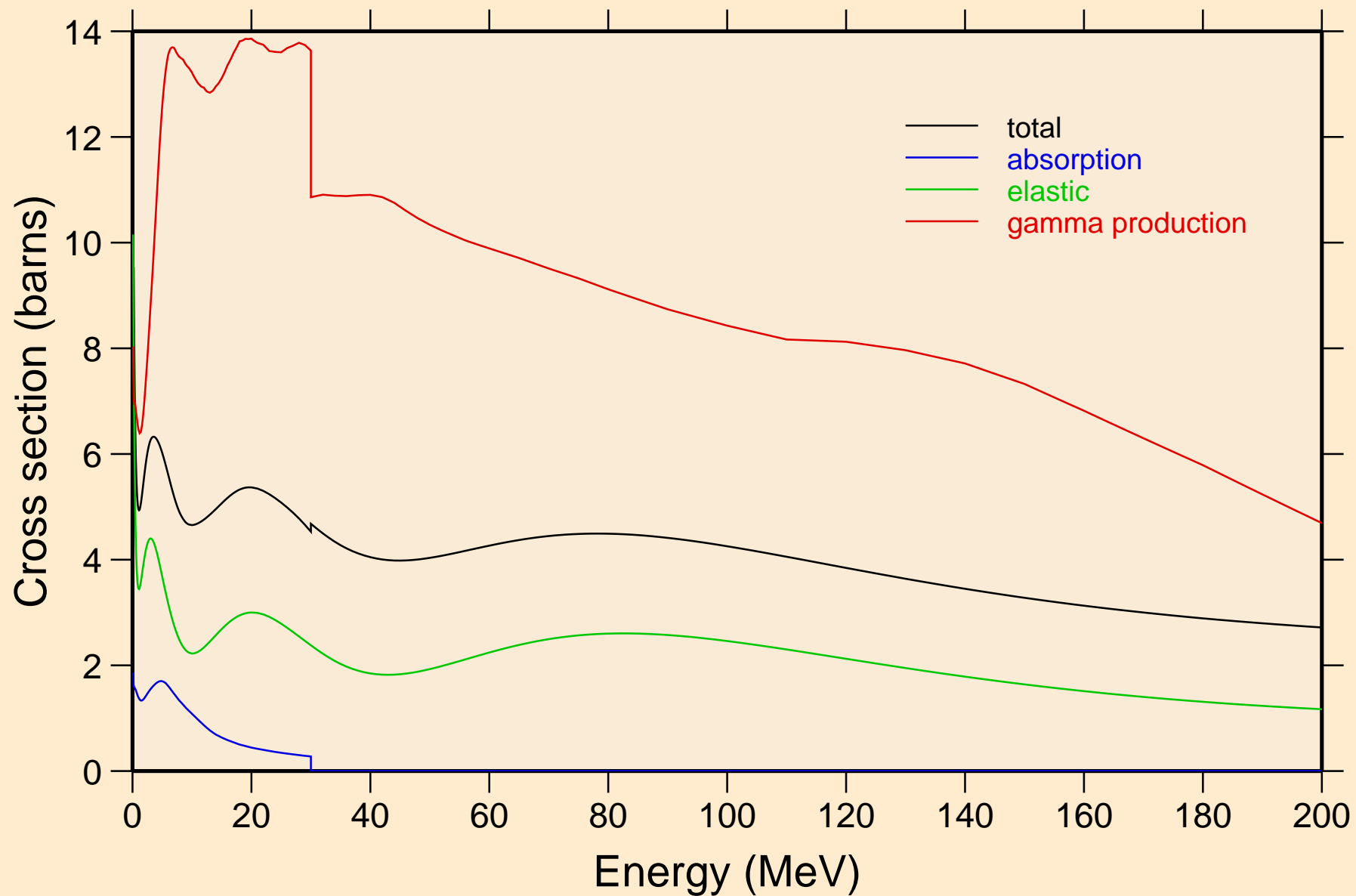

AU178 NEUTRON ACER TENDL-2019 LIBRARY; T=293.16K
Heating

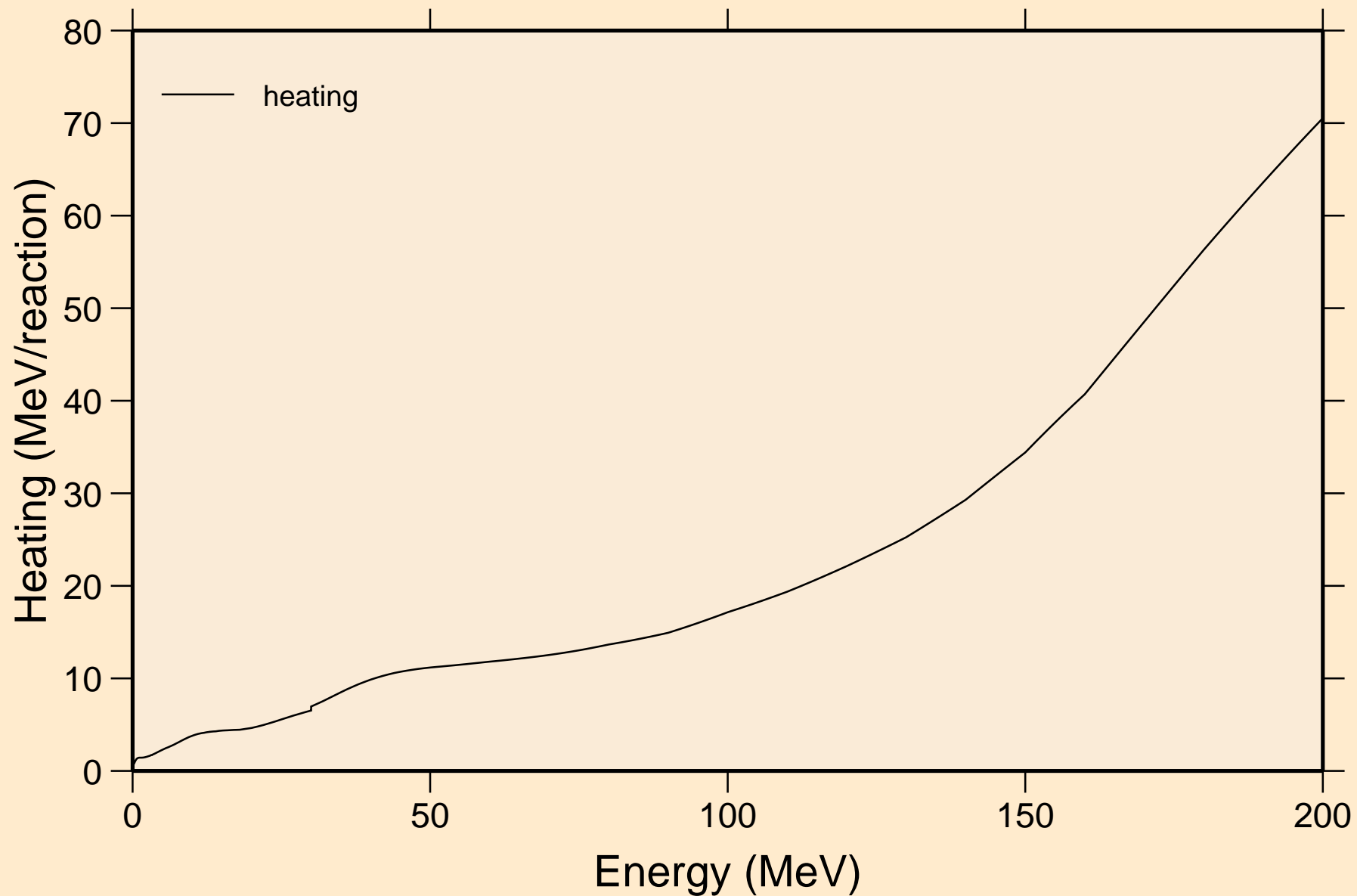

AU178 NEUTRON ACER TENDL-2019 LIBRARY; T=293.16K
Damage

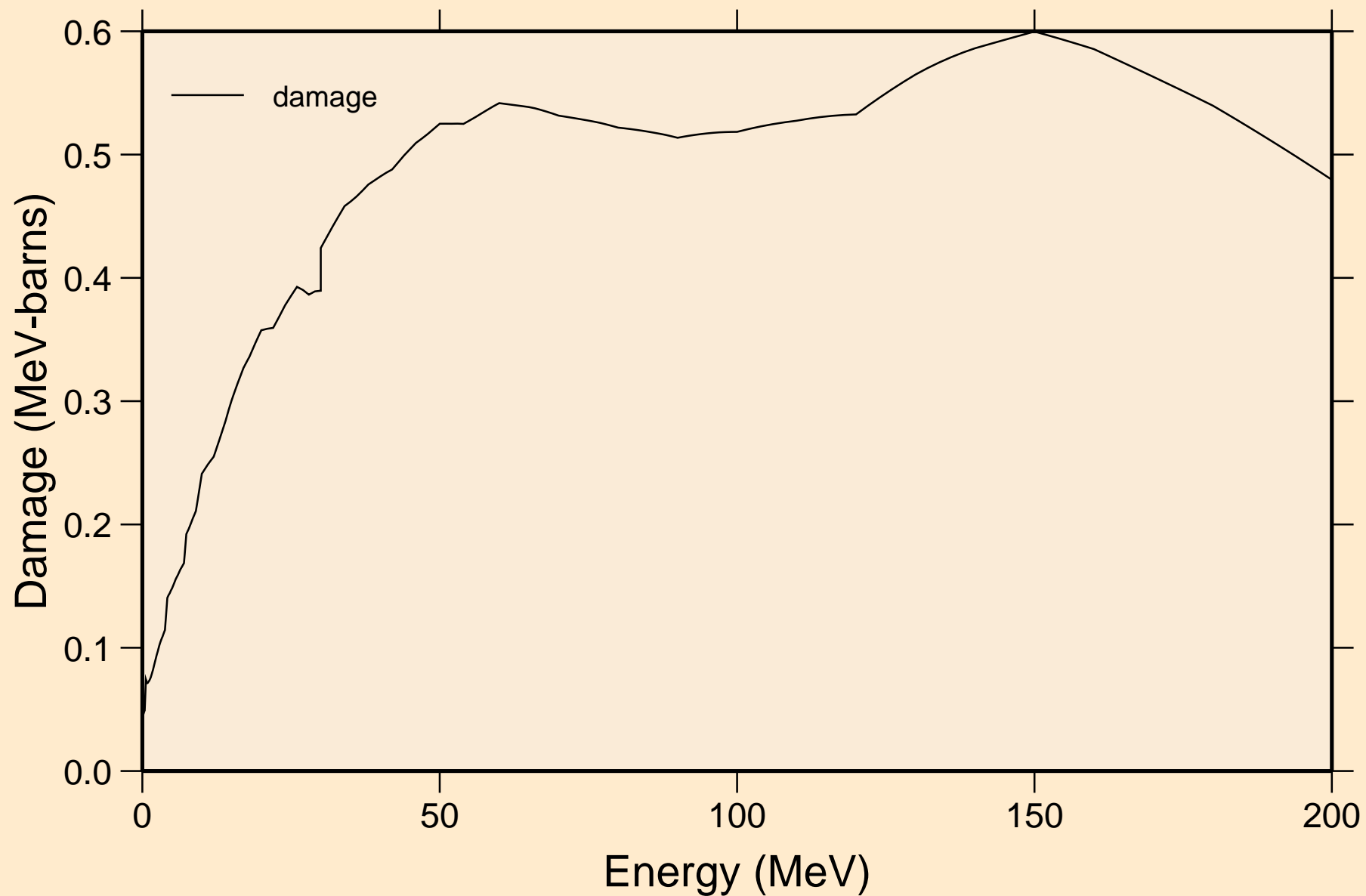

AU178 NEUTRON ACER TENDL-2019 LIBRARY; T=293.16K
Non-threshold reactions

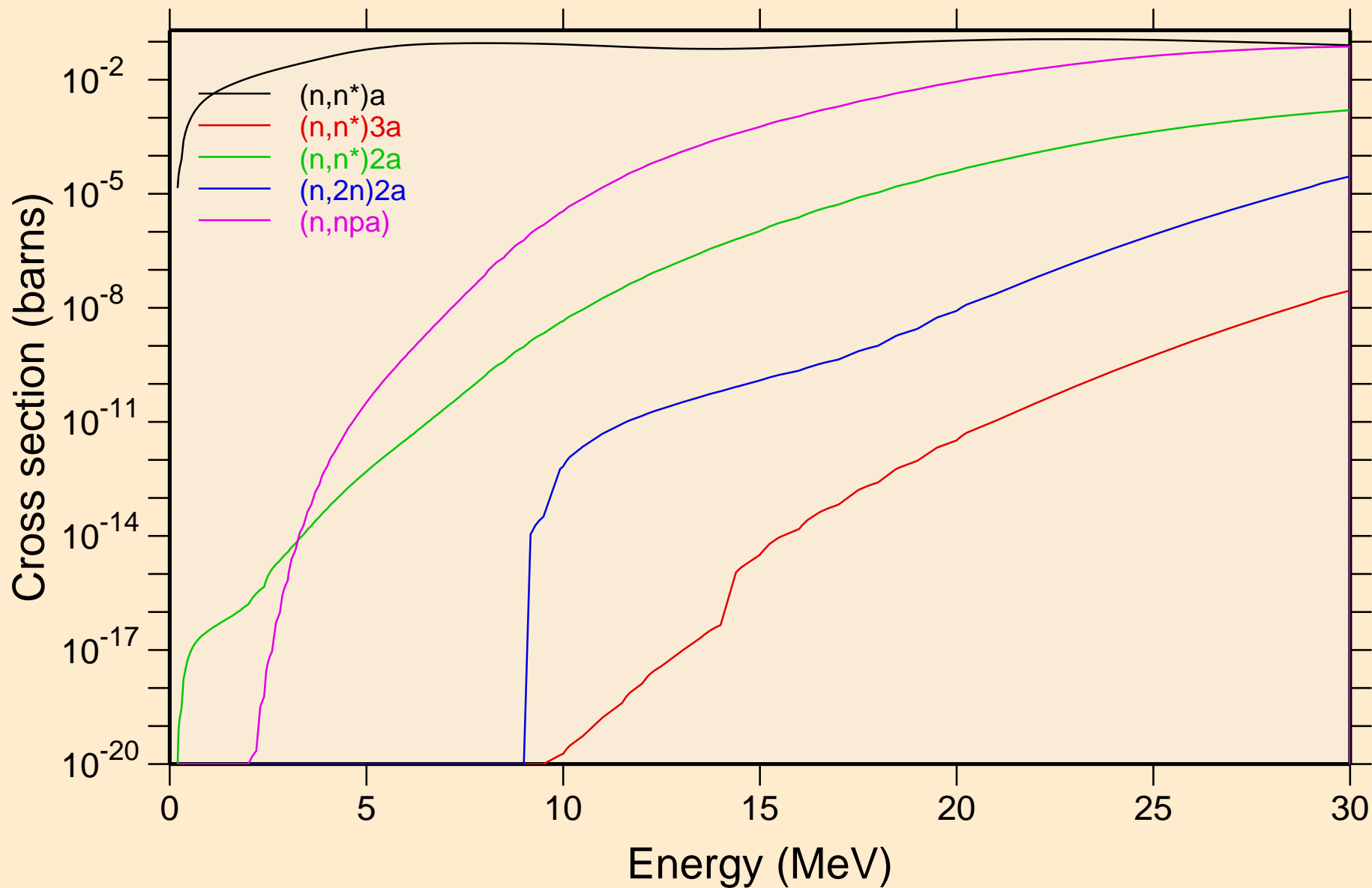

AU178 NEUTRON ACER TENDL-2019 LIBRARY; T=293.16K
Non-threshold reactions

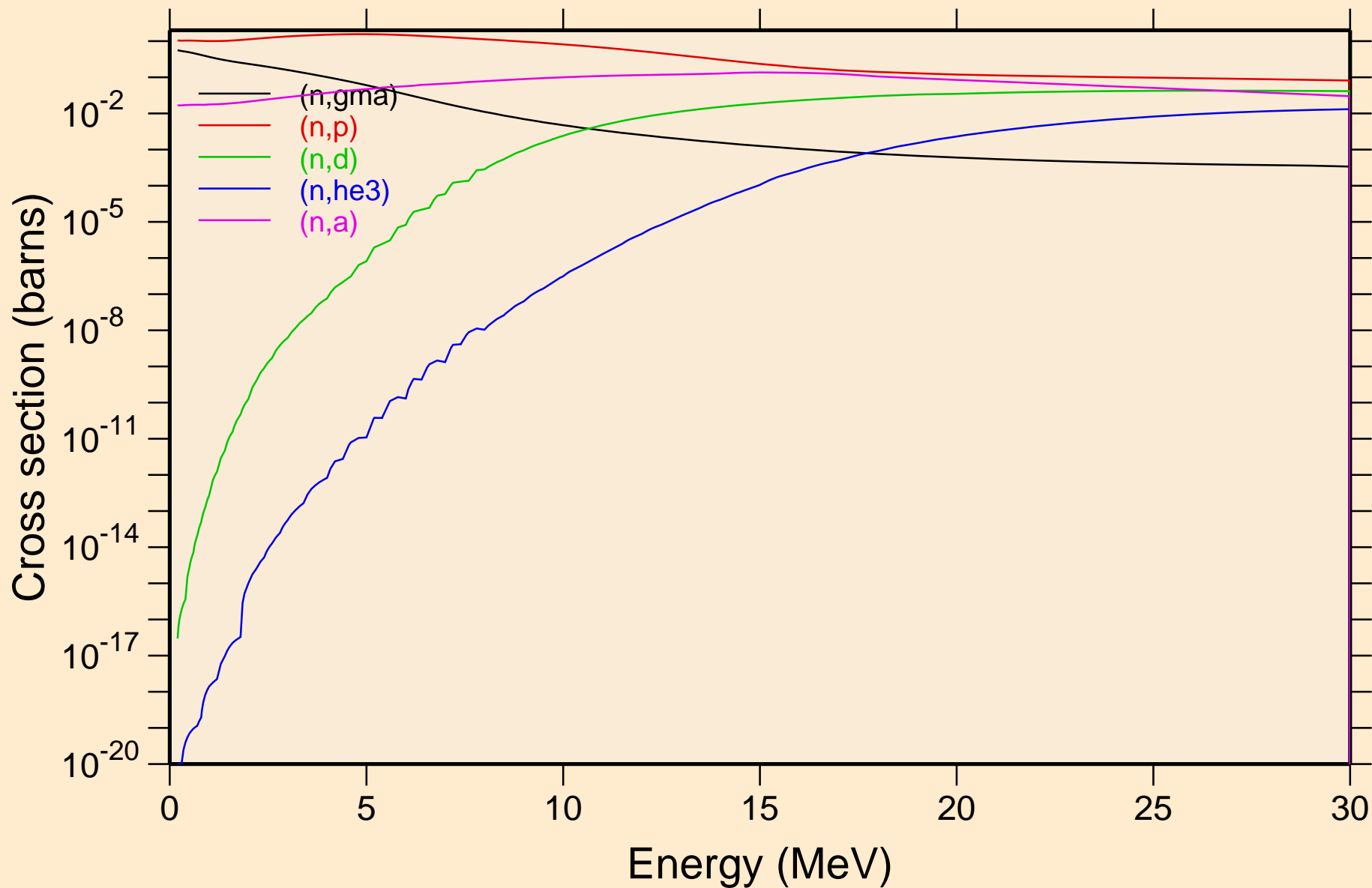

AU178 NEUTRON ACER TENDL-2019 LIBRARY; T=293.16K
Non-threshold reactions

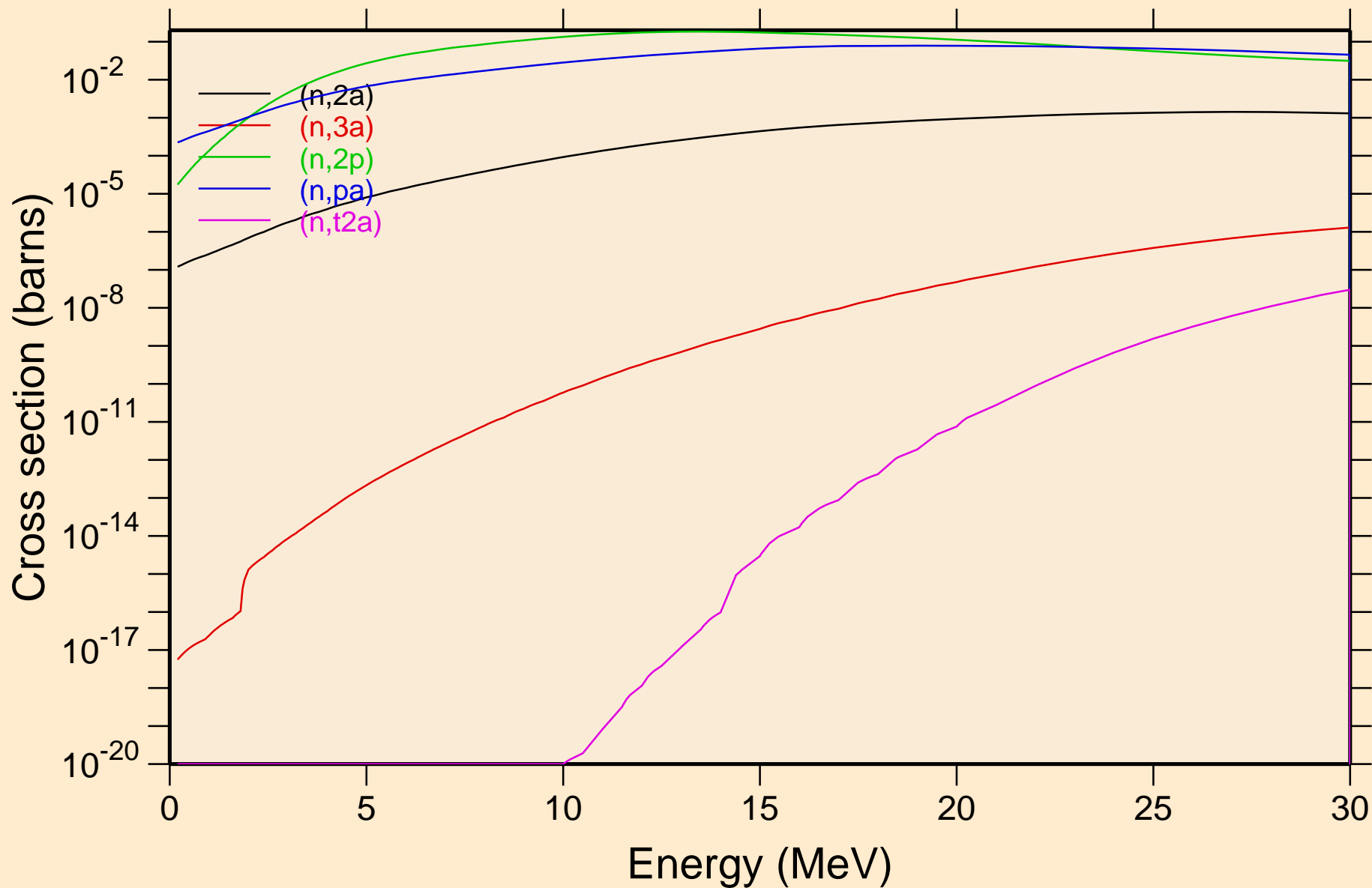

AU178 NEUTRON ACER TENDL-2019 LIBRARY; T=293.16K
Non-threshold reactions

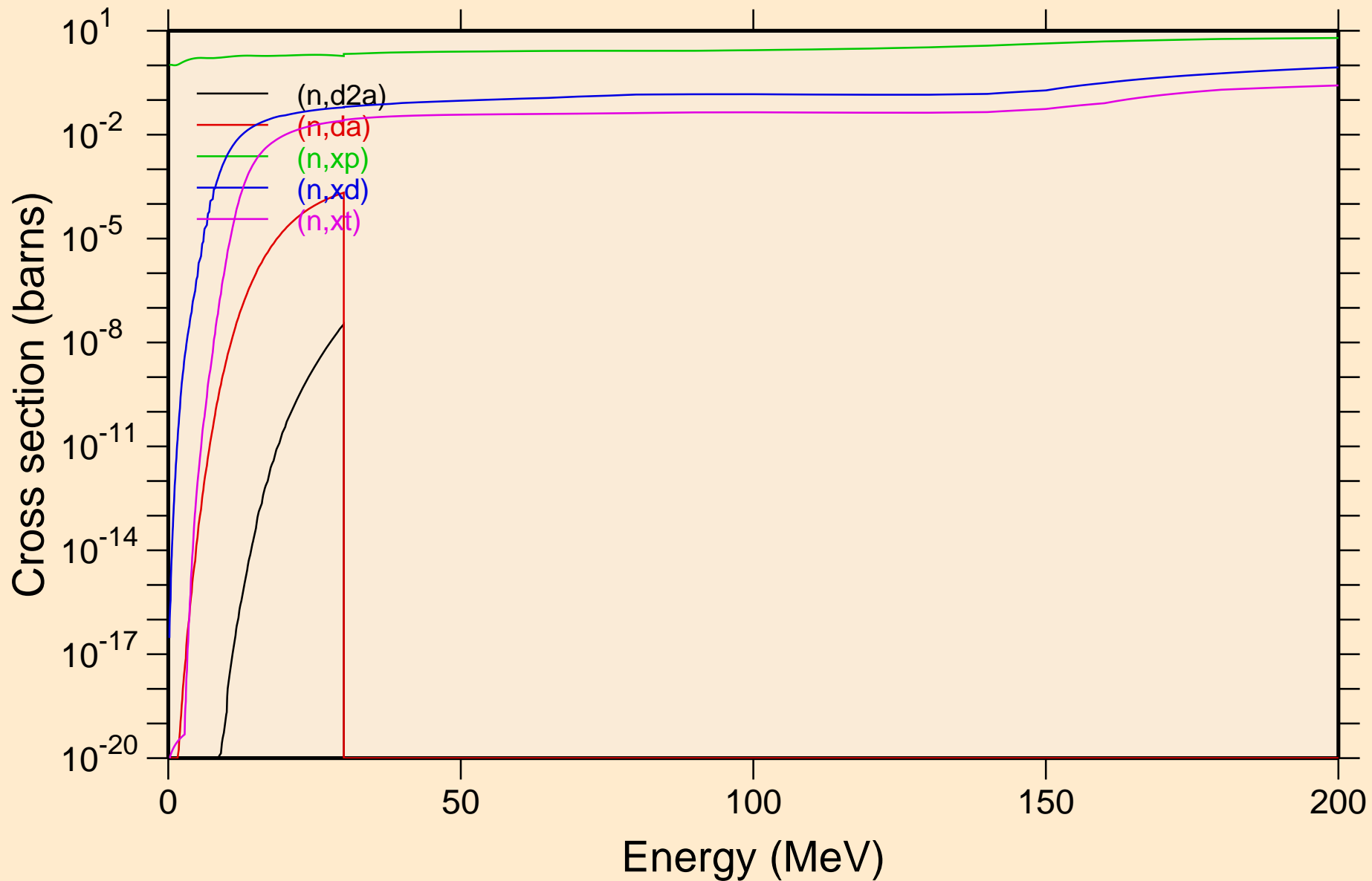

AU178 NEUTRON ACER TENDL-2019 LIBRARY; T=293.16K
Non-threshold reactions

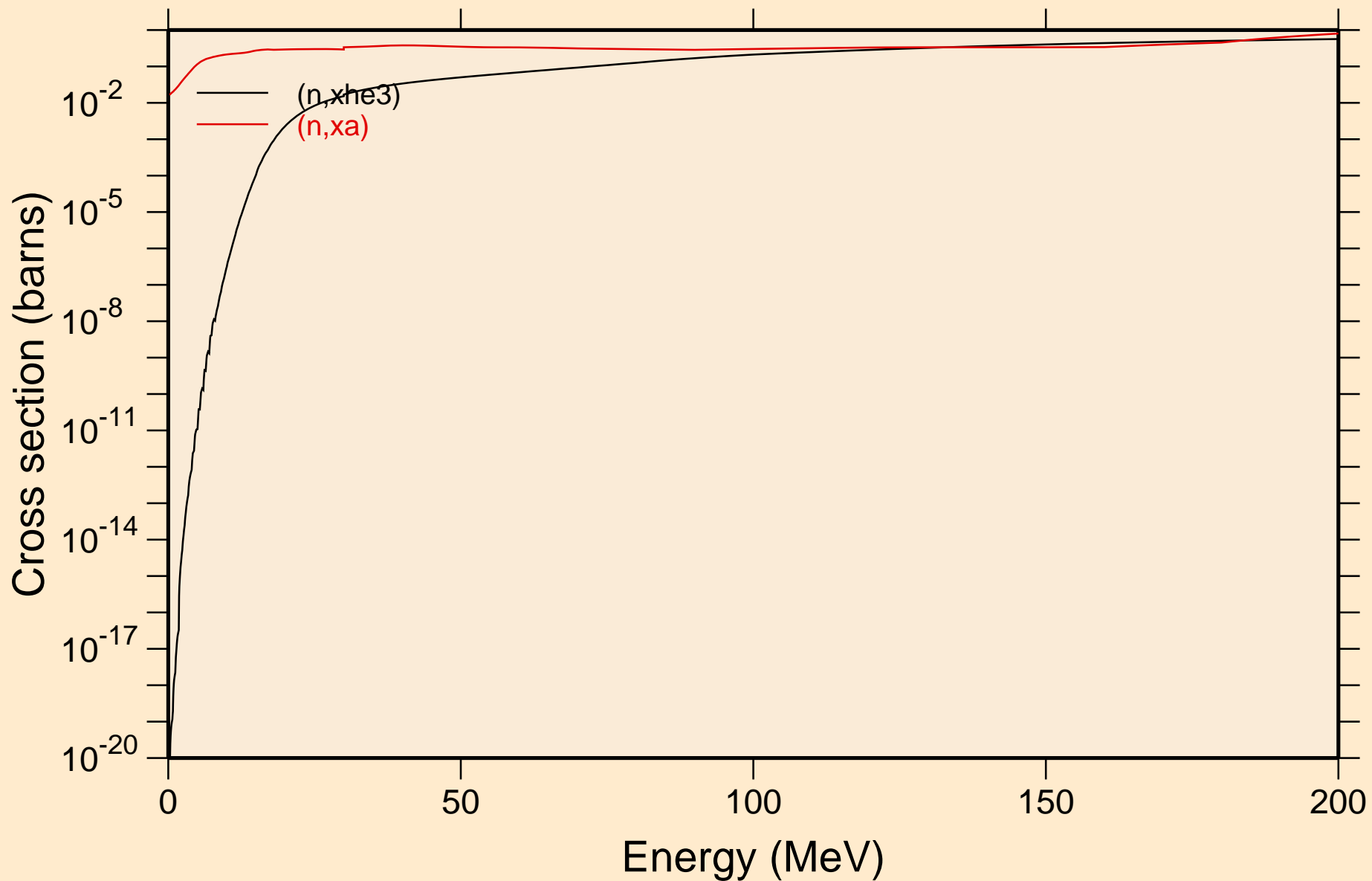

AU178 NEUTRON ACER TENDL-2019 LIBRARY; T=293.16K
Inelastic levels

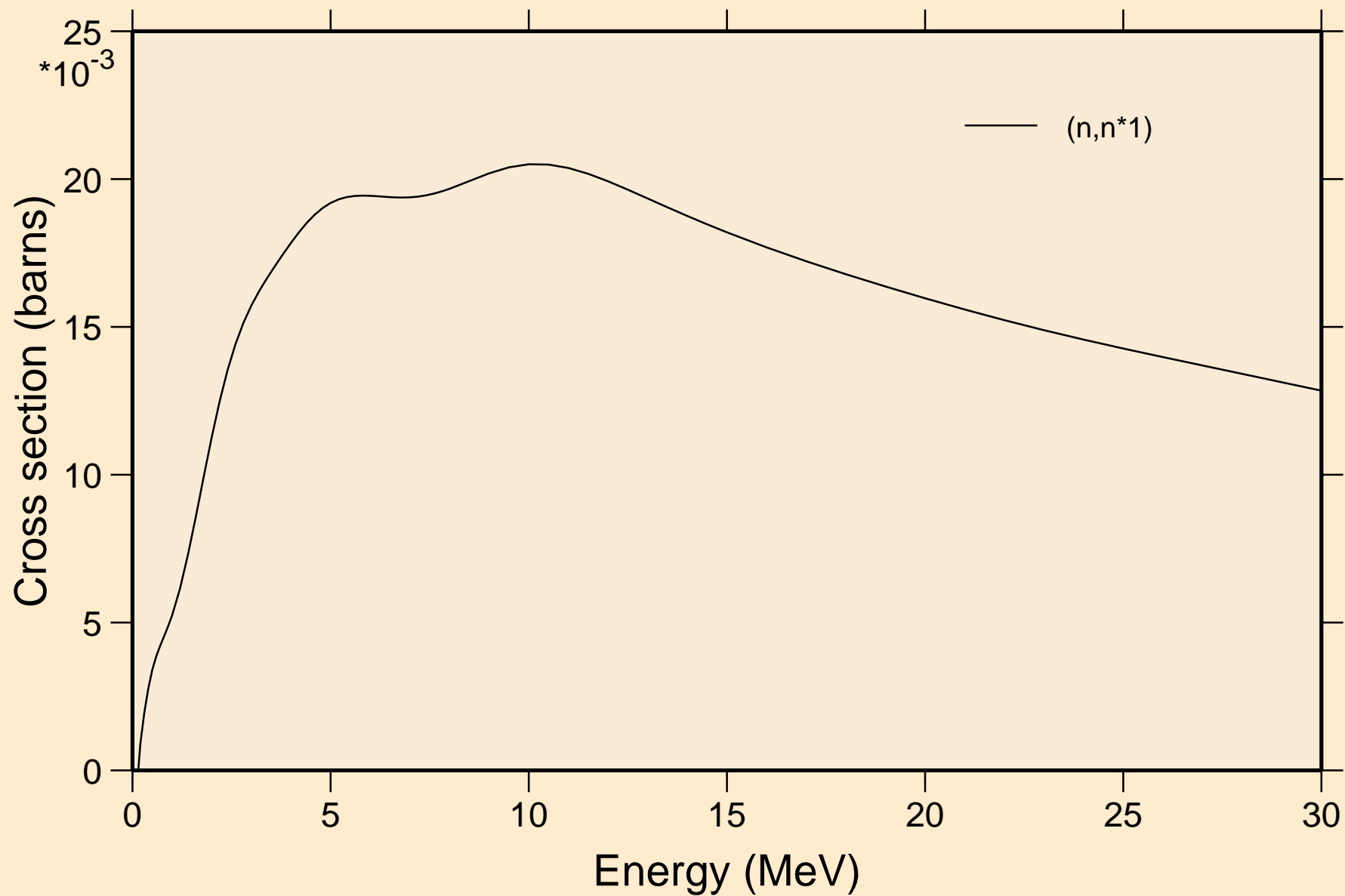

AU178 NEUTRON ACER TENDL-2019 LIBRARY; T=293.16K
Threshold reactions

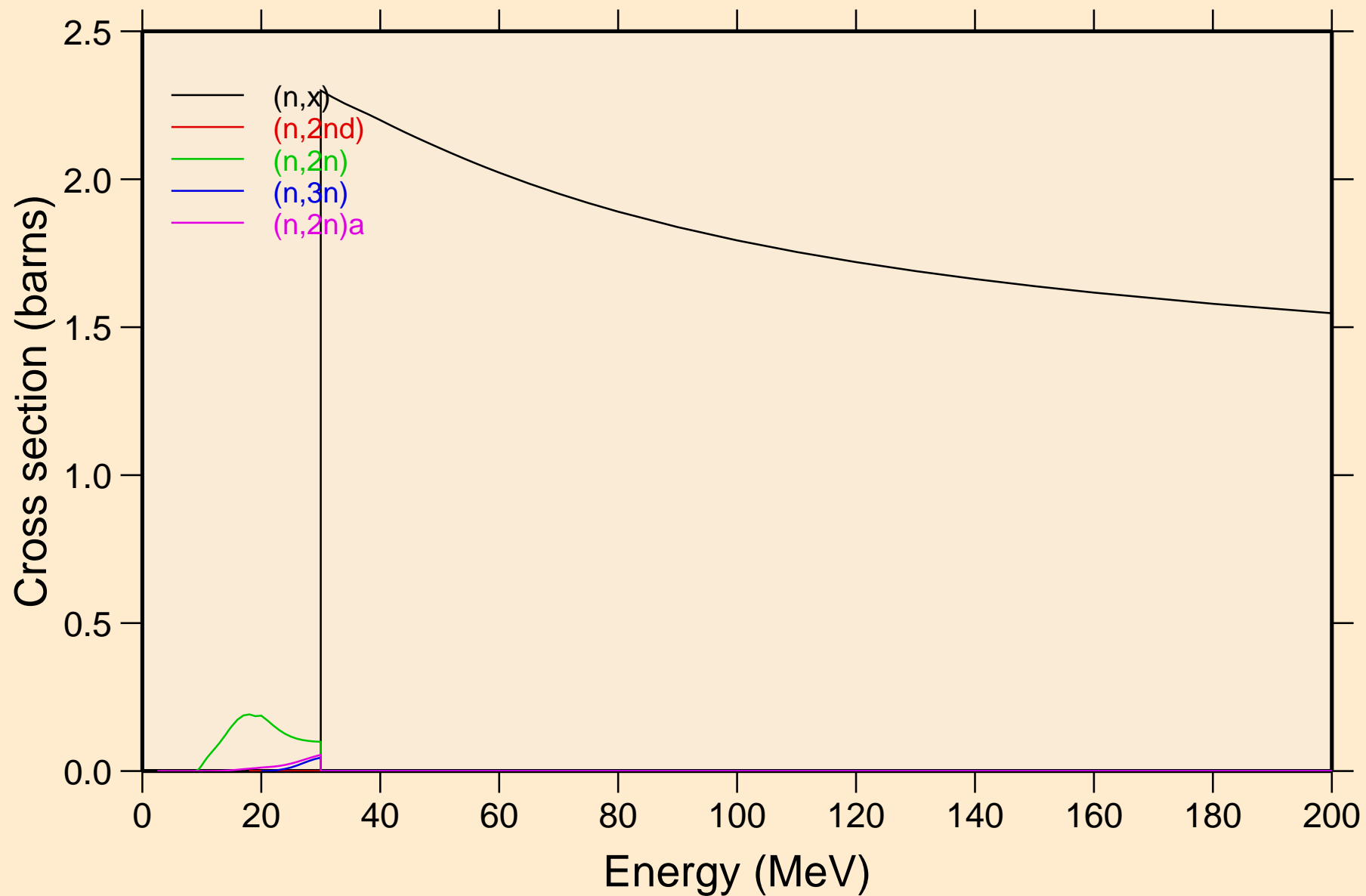

AU178 NEUTRON ACER TENDL-2019 LIBRARY; T=293.16K
Threshold reactions

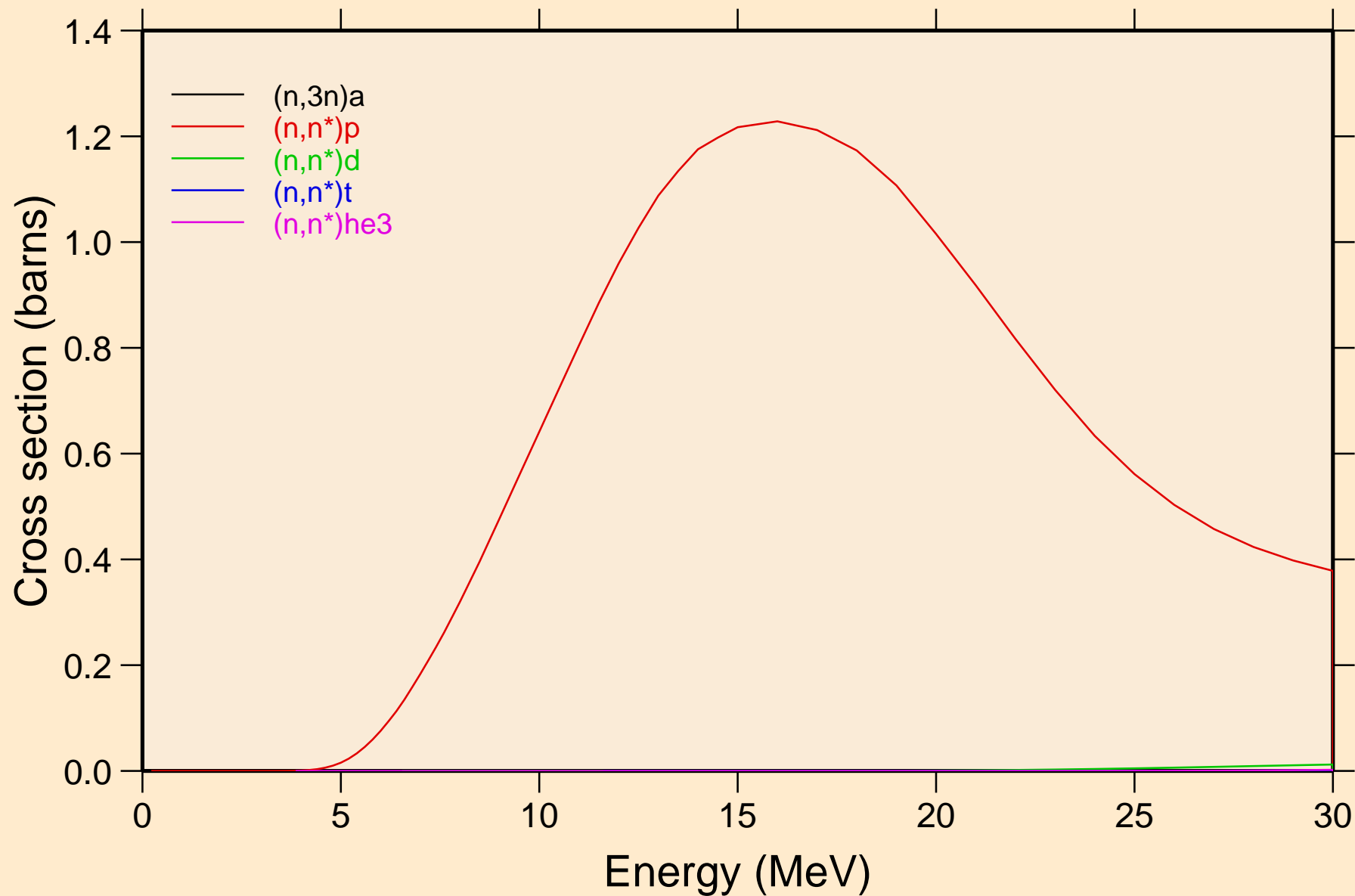

AU178 NEUTRON ACER TENDL-2019 LIBRARY; T=293.16K
Threshold reactions

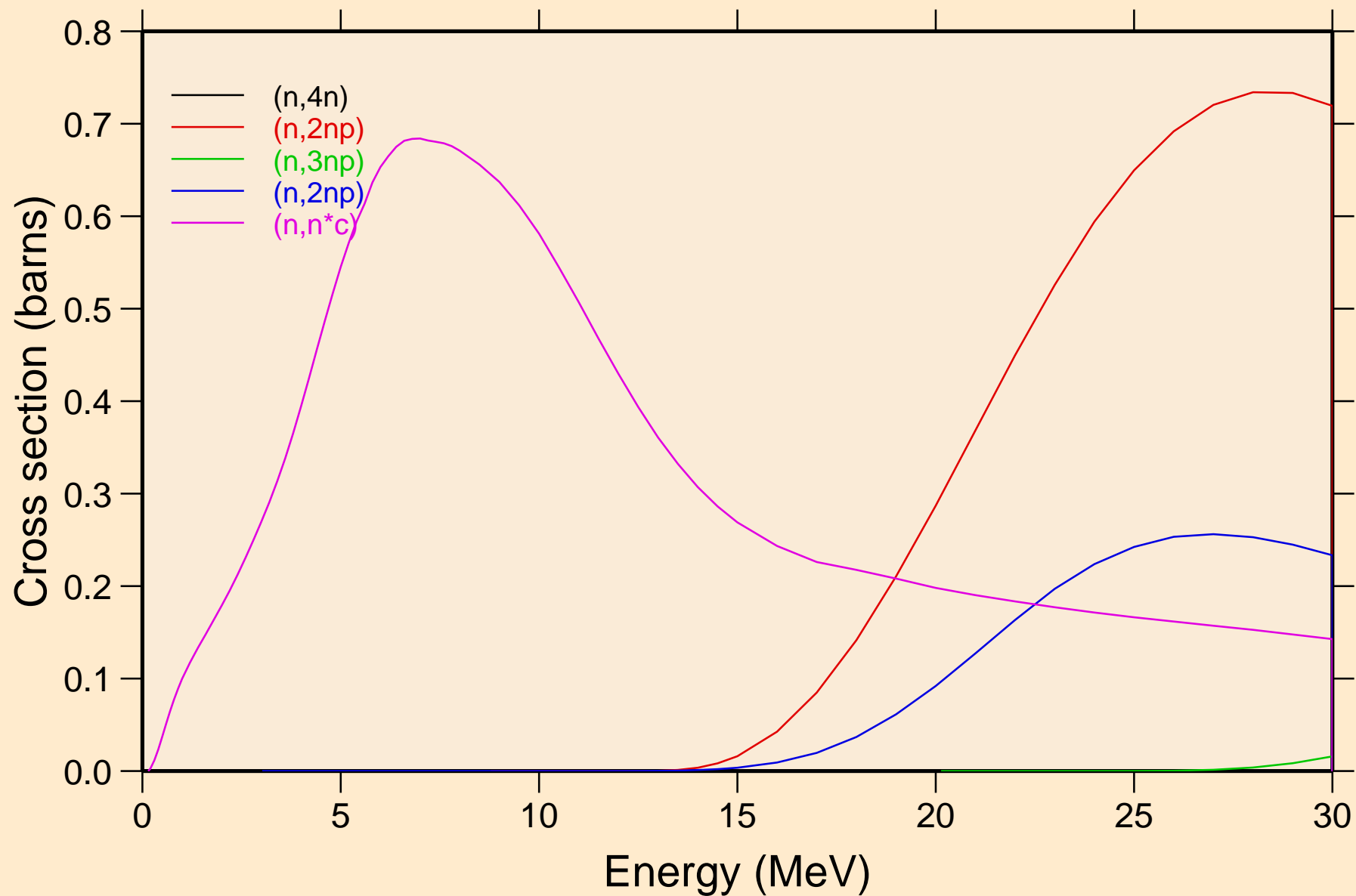

AU178 NEUTRON ACER TENDL-2019 LIBRARY; T=293.16K
Threshold reactions

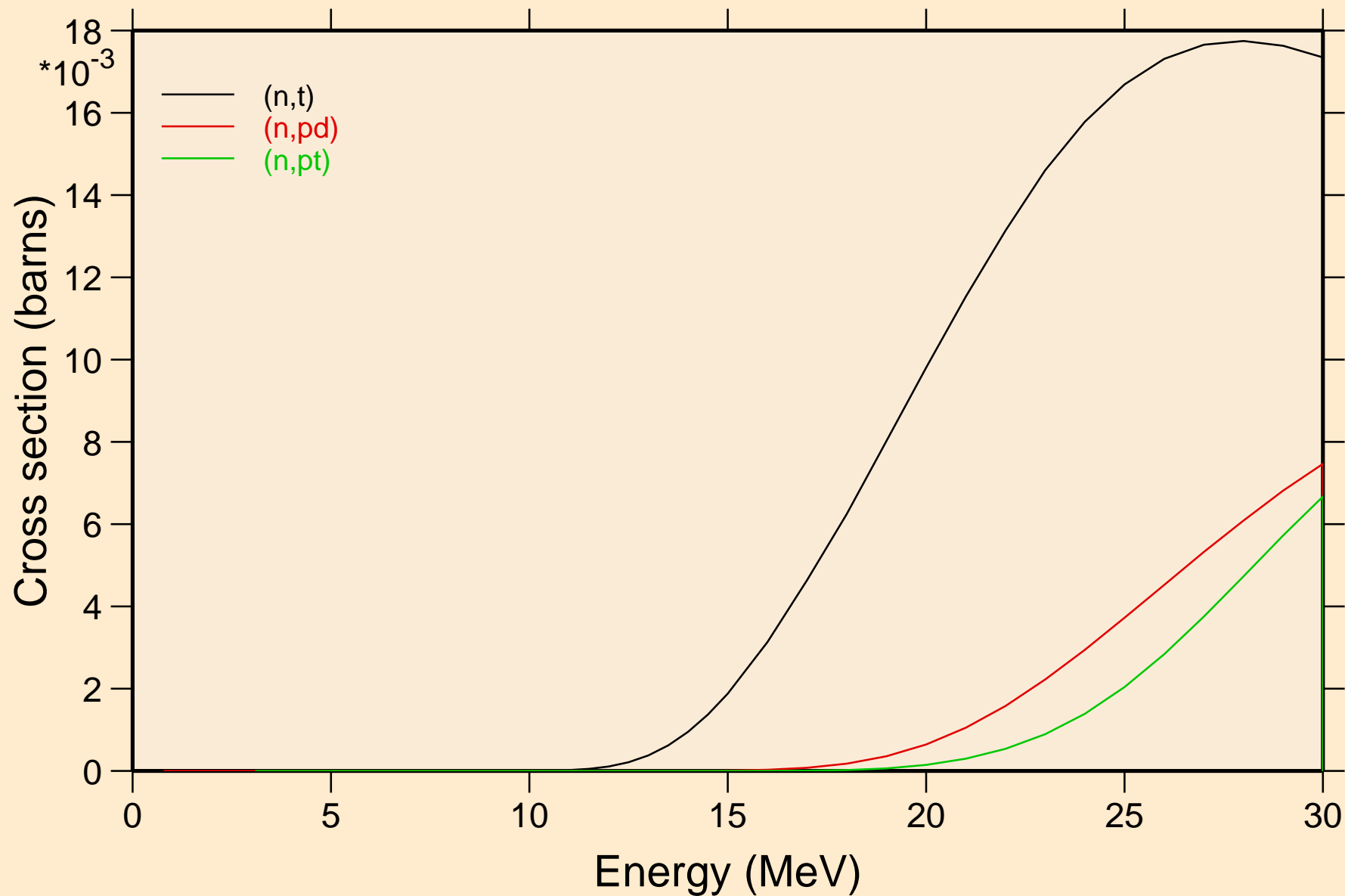

AU178 NEUTRON ACER TENDL-2019 LIBRARY; T=293.16K
angular distribution for elastic

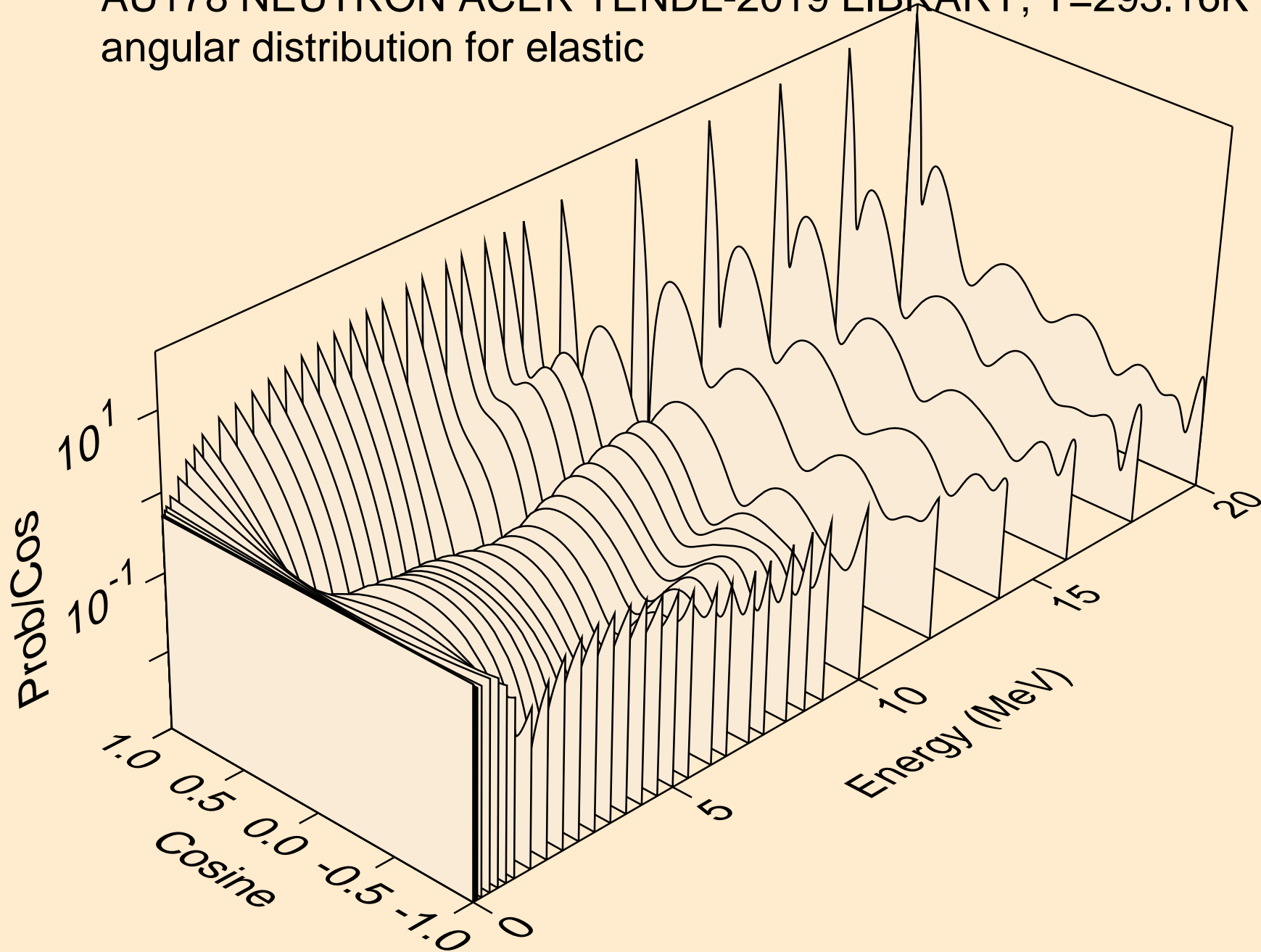

AU178 NEUTRON ACER TENDL-2019 LIBRARY; T=293.16K
angular distribution for elastic

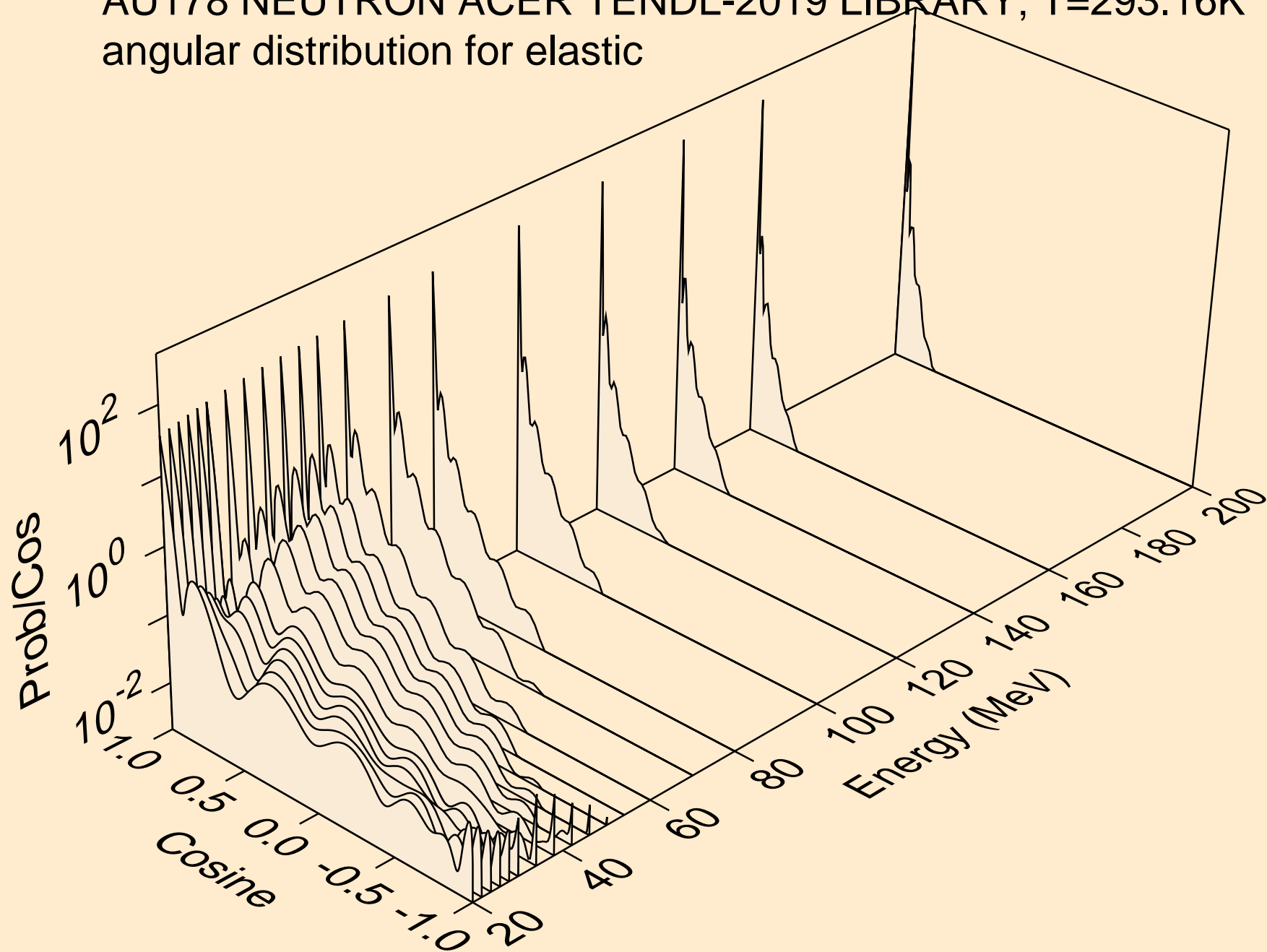

AU178 NEUTRON ACER TENDL-2019 LIBRARY; T=293.16K
angular distribution for (n,n*1)

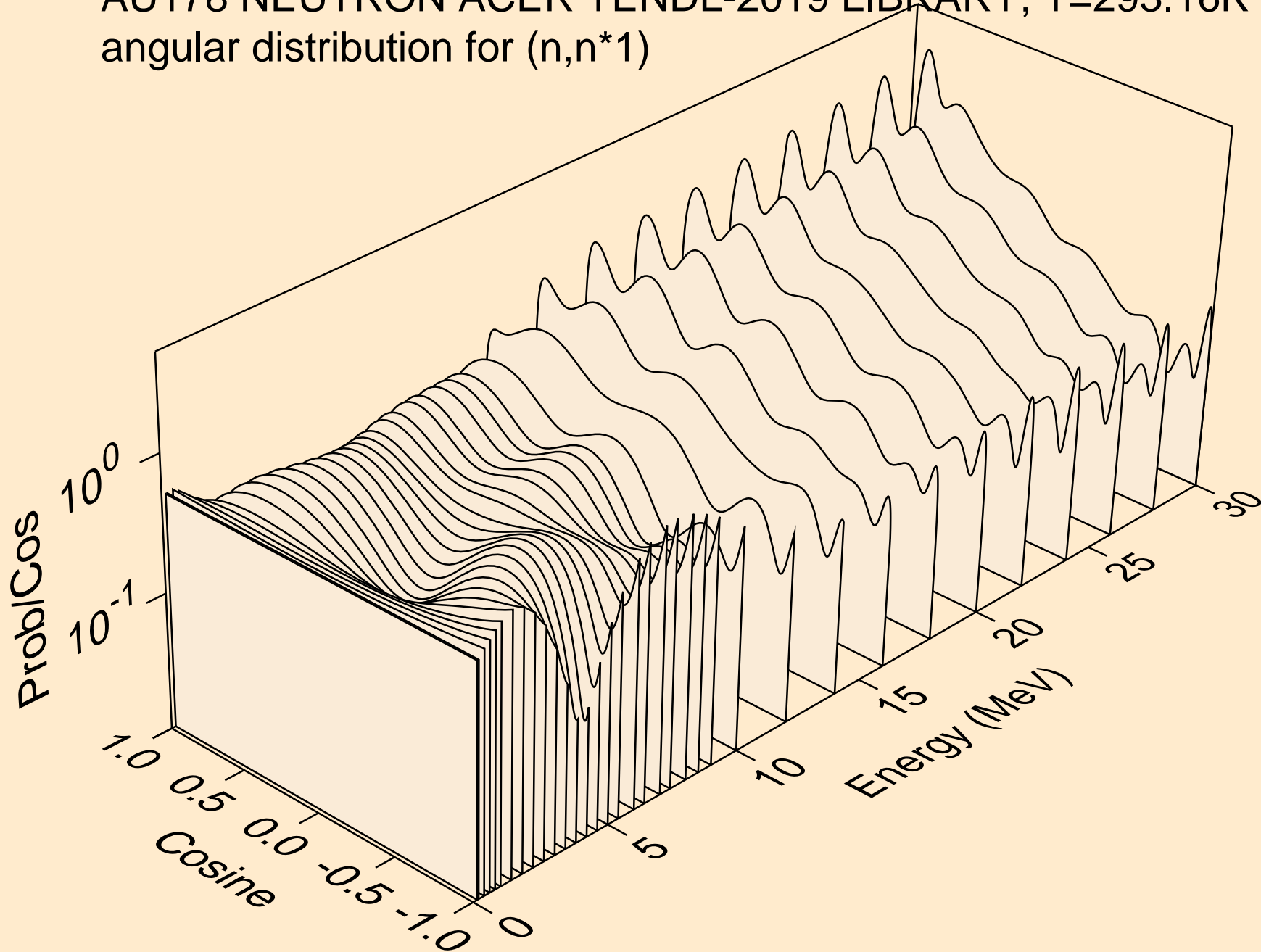

AU178 NEUTRON ACER TENDL-2019 LIBRARY; T=293.16K
Neutron emission for (n,x)

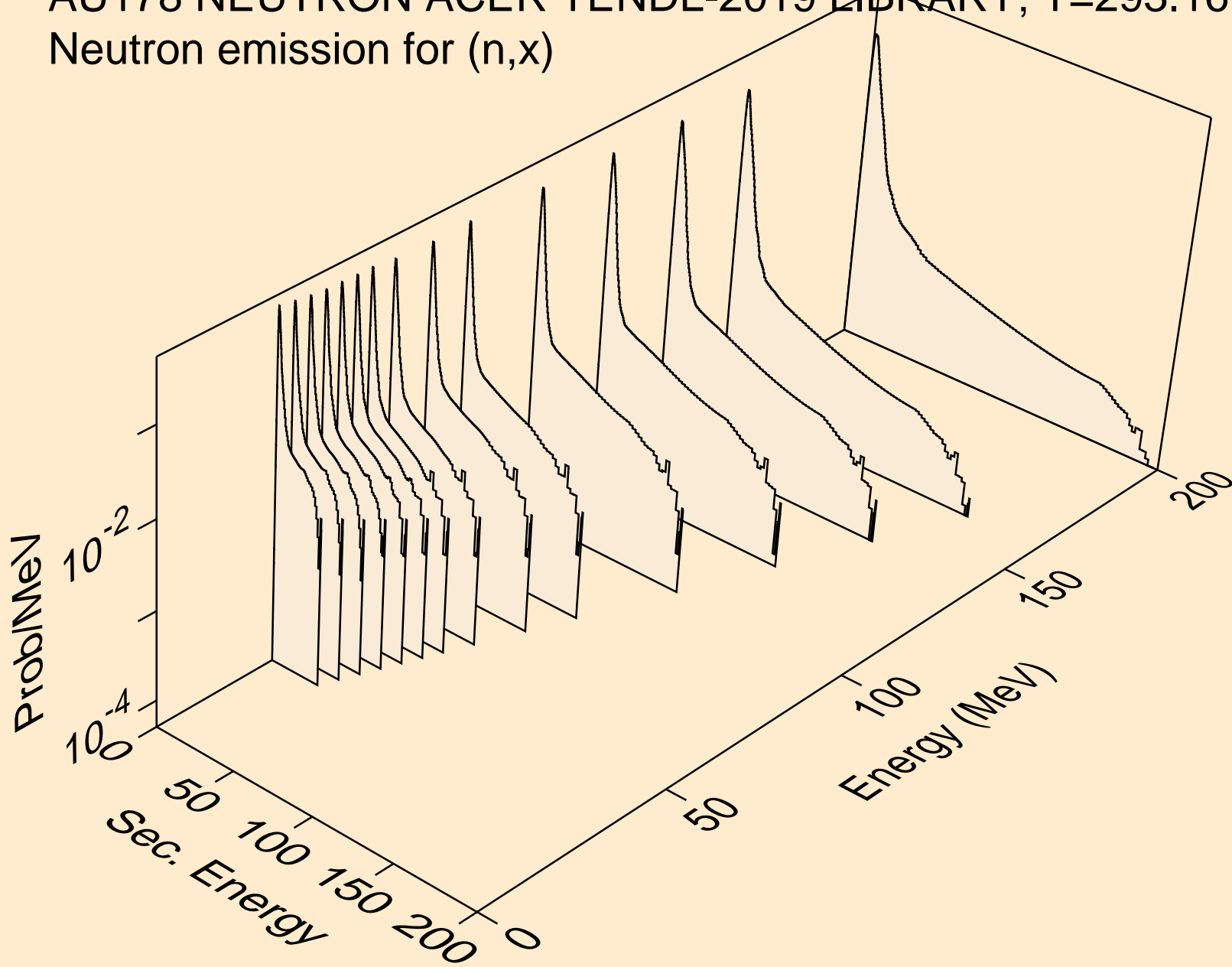

AU178 NEUTRON ACER TENDL-2019 LIBRARY; T=293.16K
Neutron emission for (n,2nd)

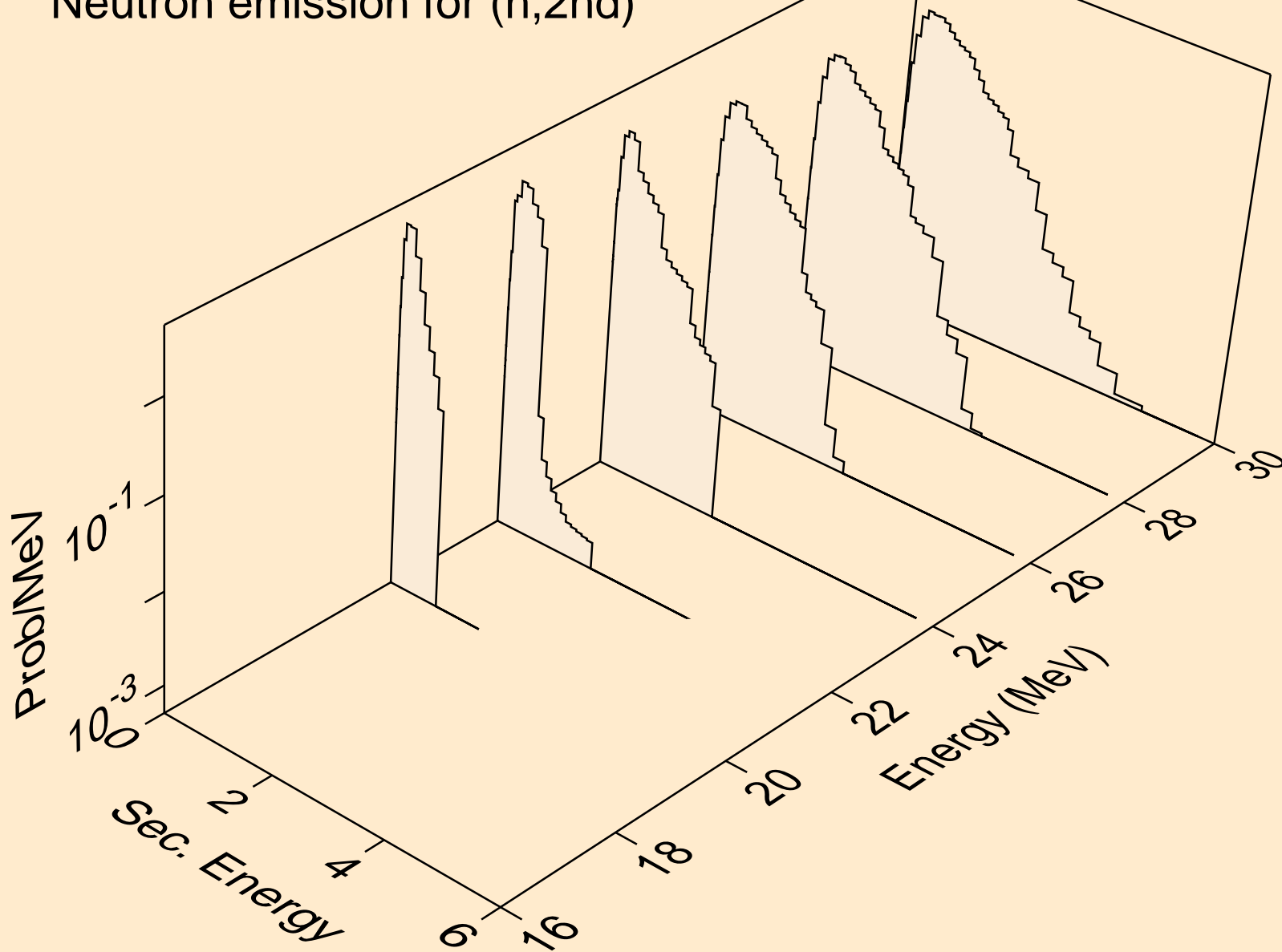

AU178 NEUTRON ACER TENDL-2019 LIBRARY; T=293.16K
Neutron emission for (n,2n)

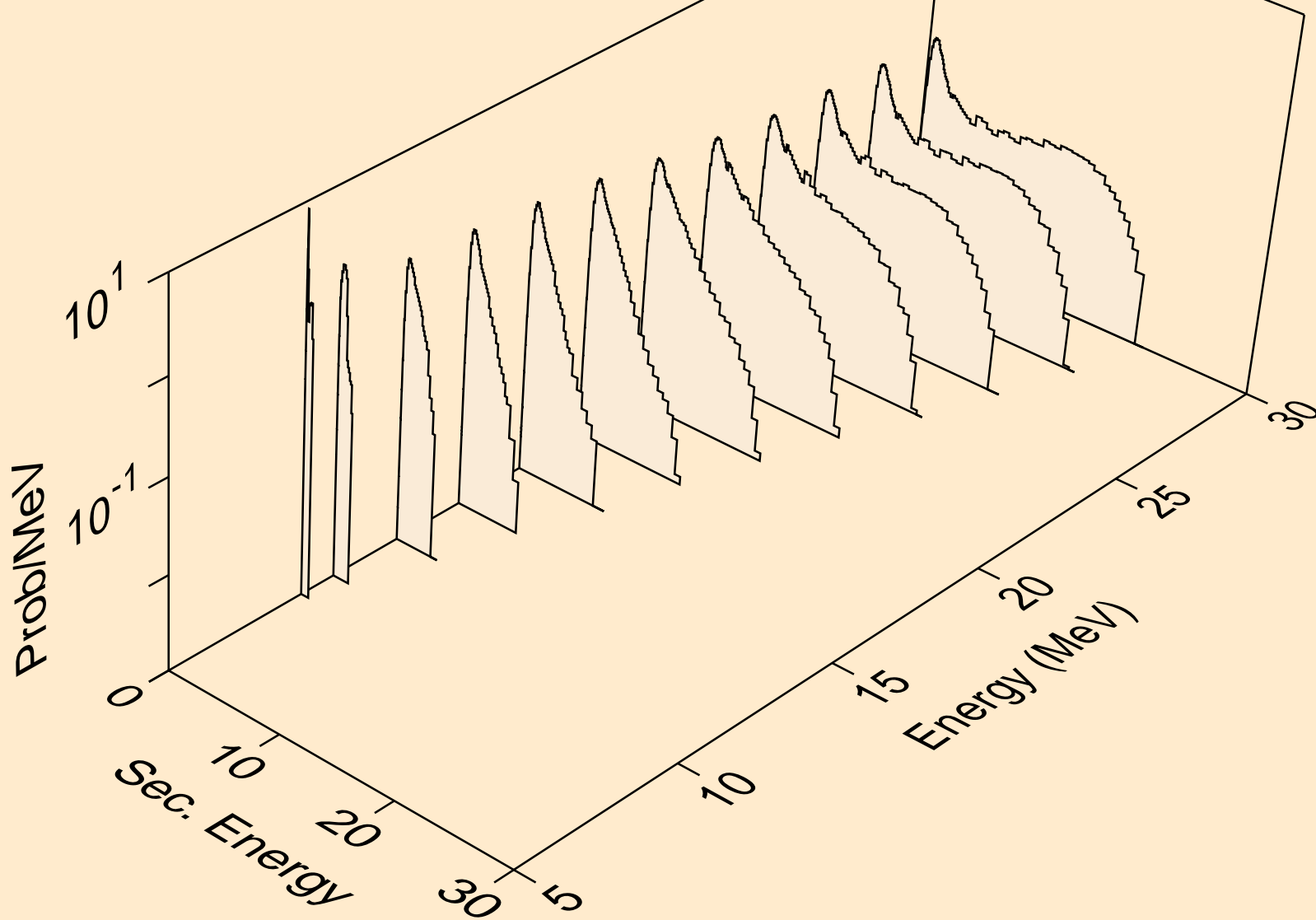

AU178 NEUTRON ACER TENDL-2019 LIBRARY; T=293.16K
Neutron emission for (n,3n)

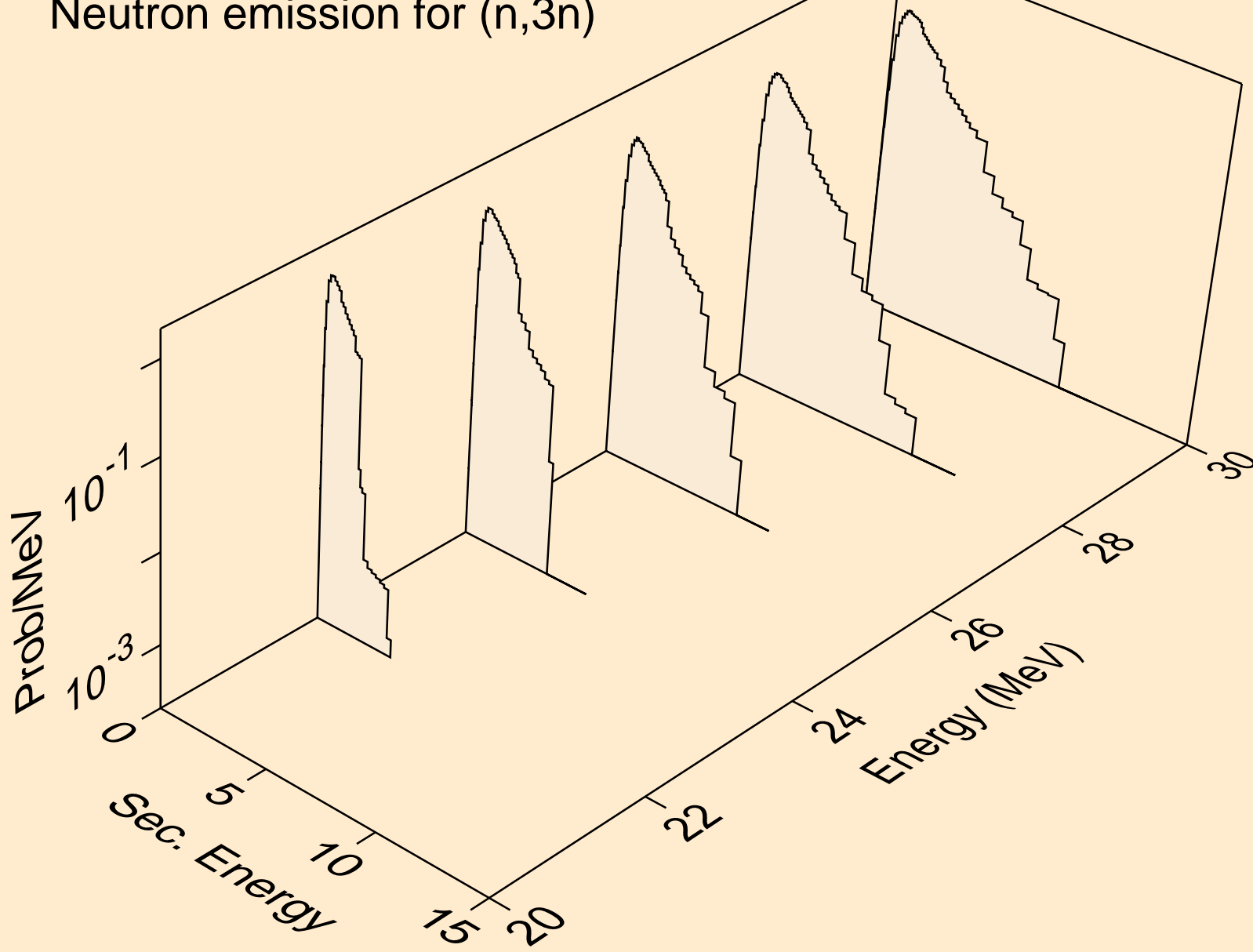

AU178 NEUTRON ACER TENDL-2019 LIBRARY; T=293.16K
Neutron emission for (n,n*)a

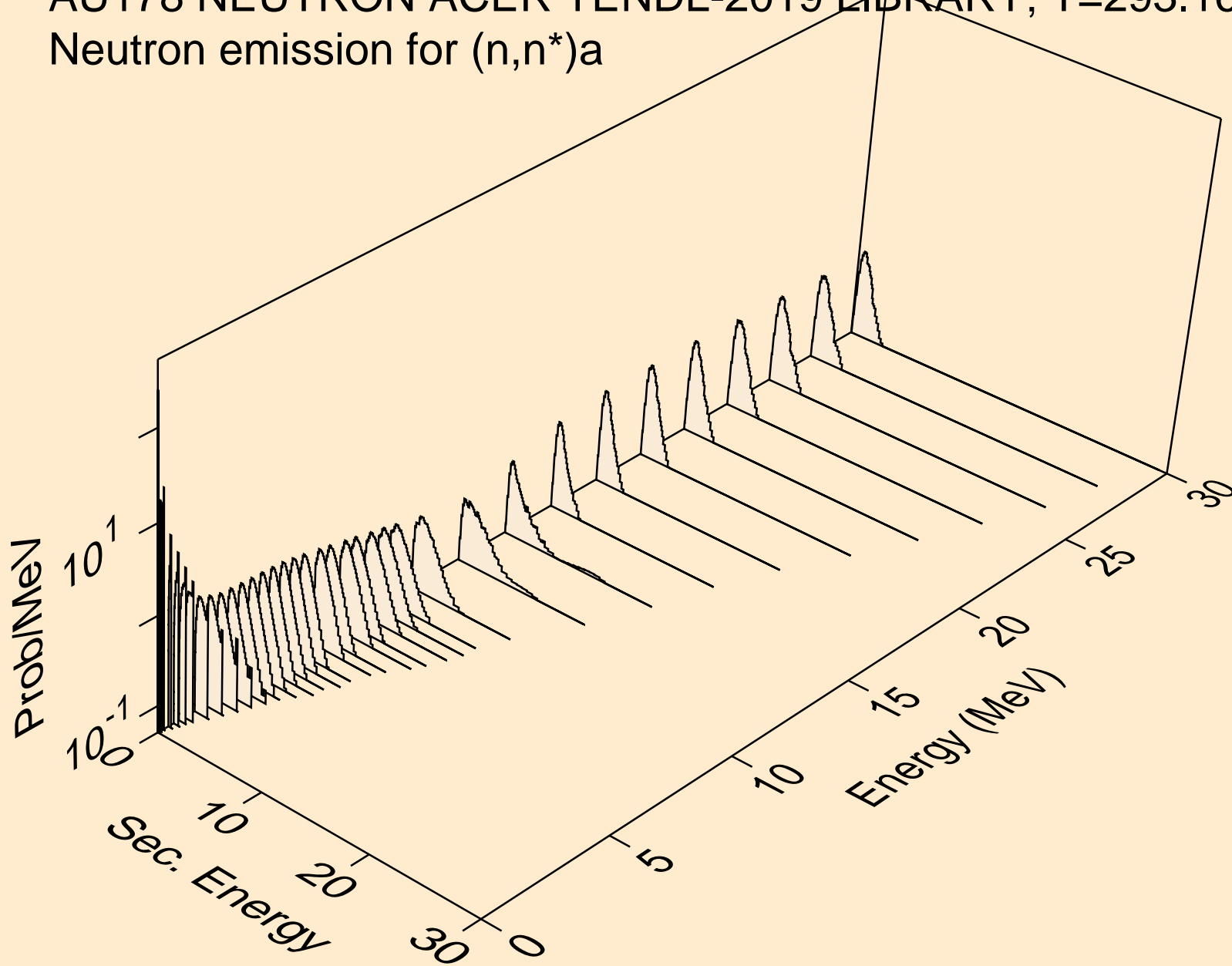

AU178 NEUTRON ACER TENDL-2019 LIBRARY; T=293.16K
Neutron emission for (n,n*)3a

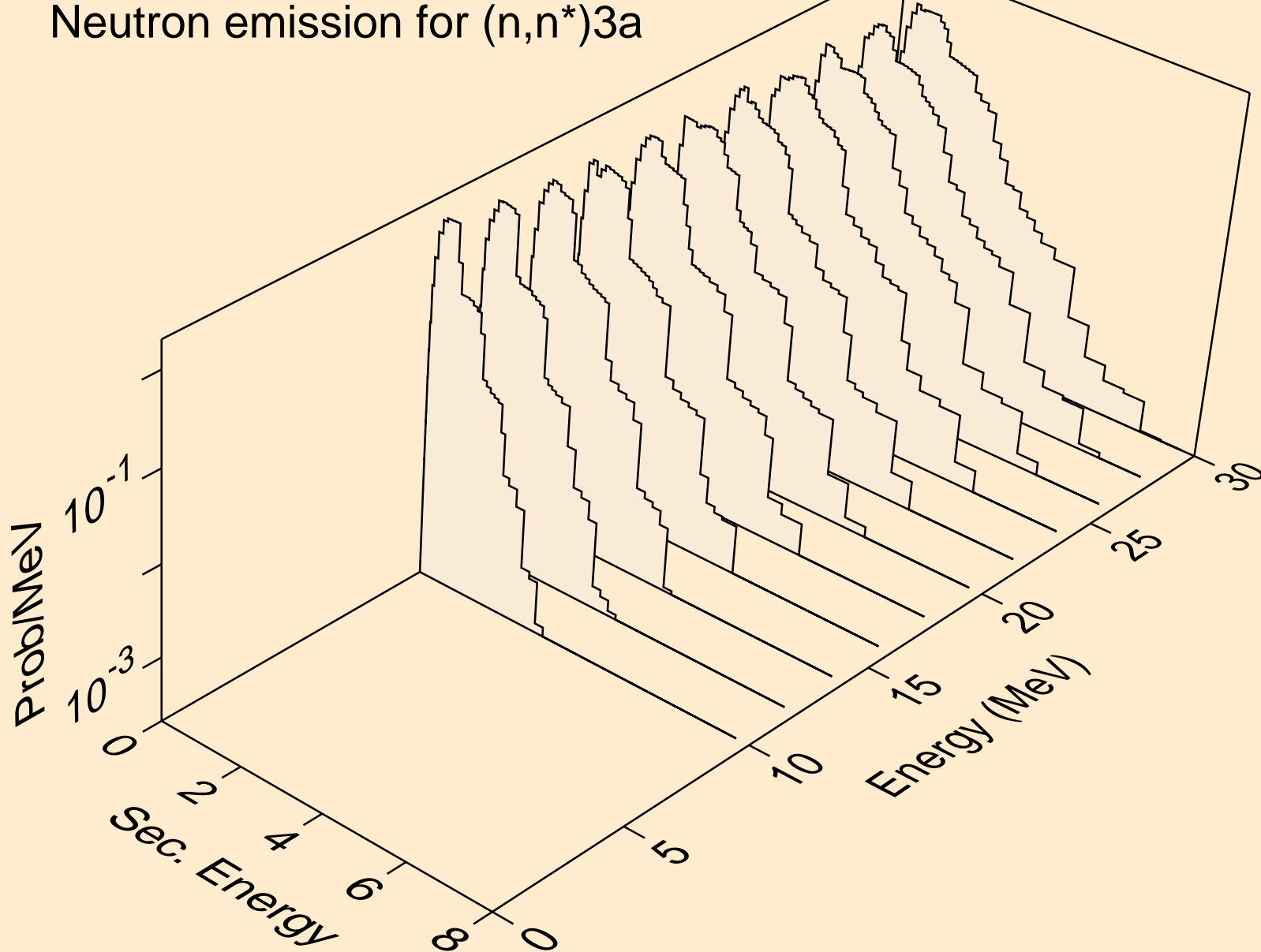

AU178 NEUTRON ACER TENDL-2019 LIBRARY; T=293.16K
Neutron emission for (n,2n)a

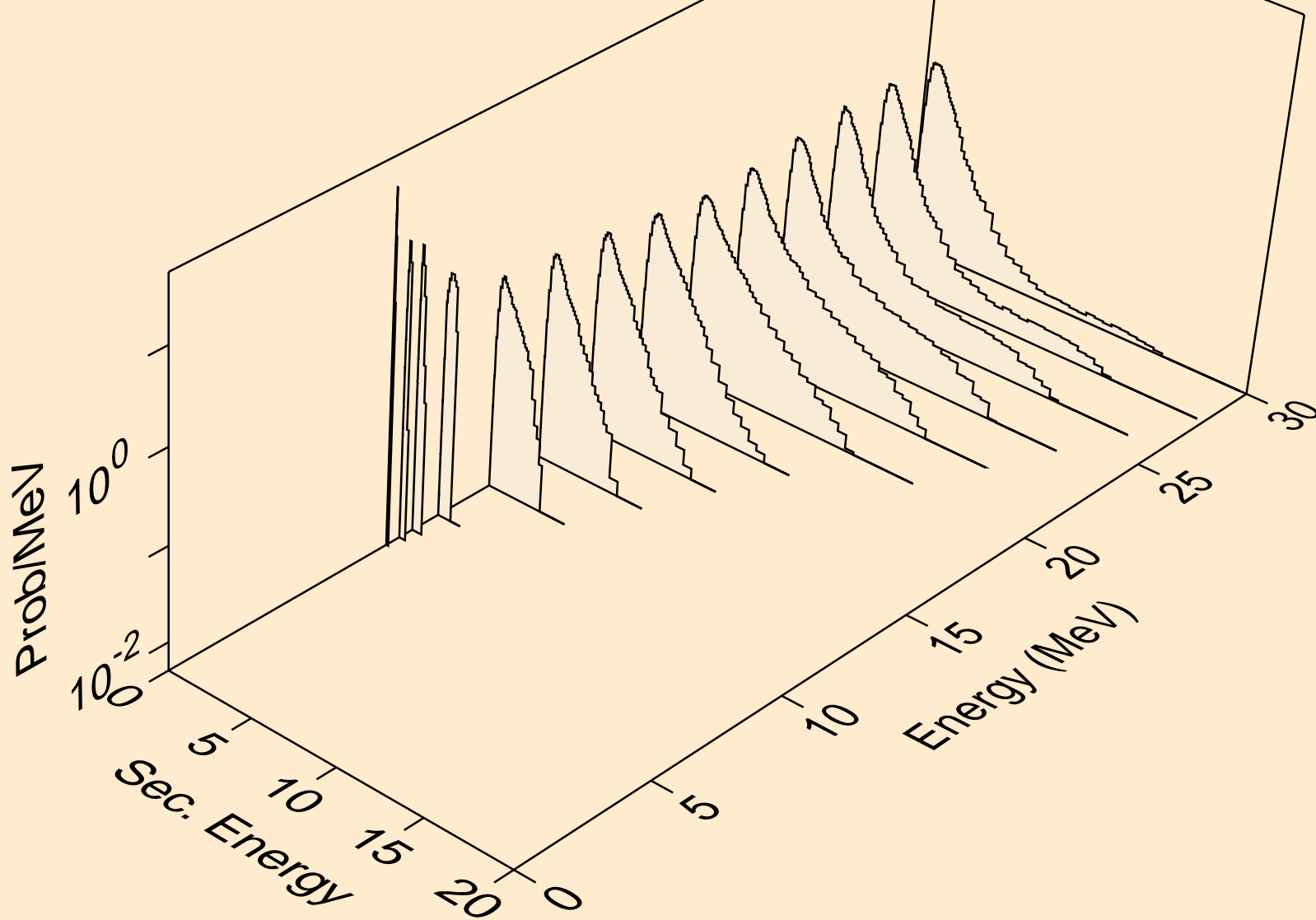

AU178 NEUTRON ACER TENDL-2019 LIBRARY; T=293.16K
Neutron emission for (n,3n)a

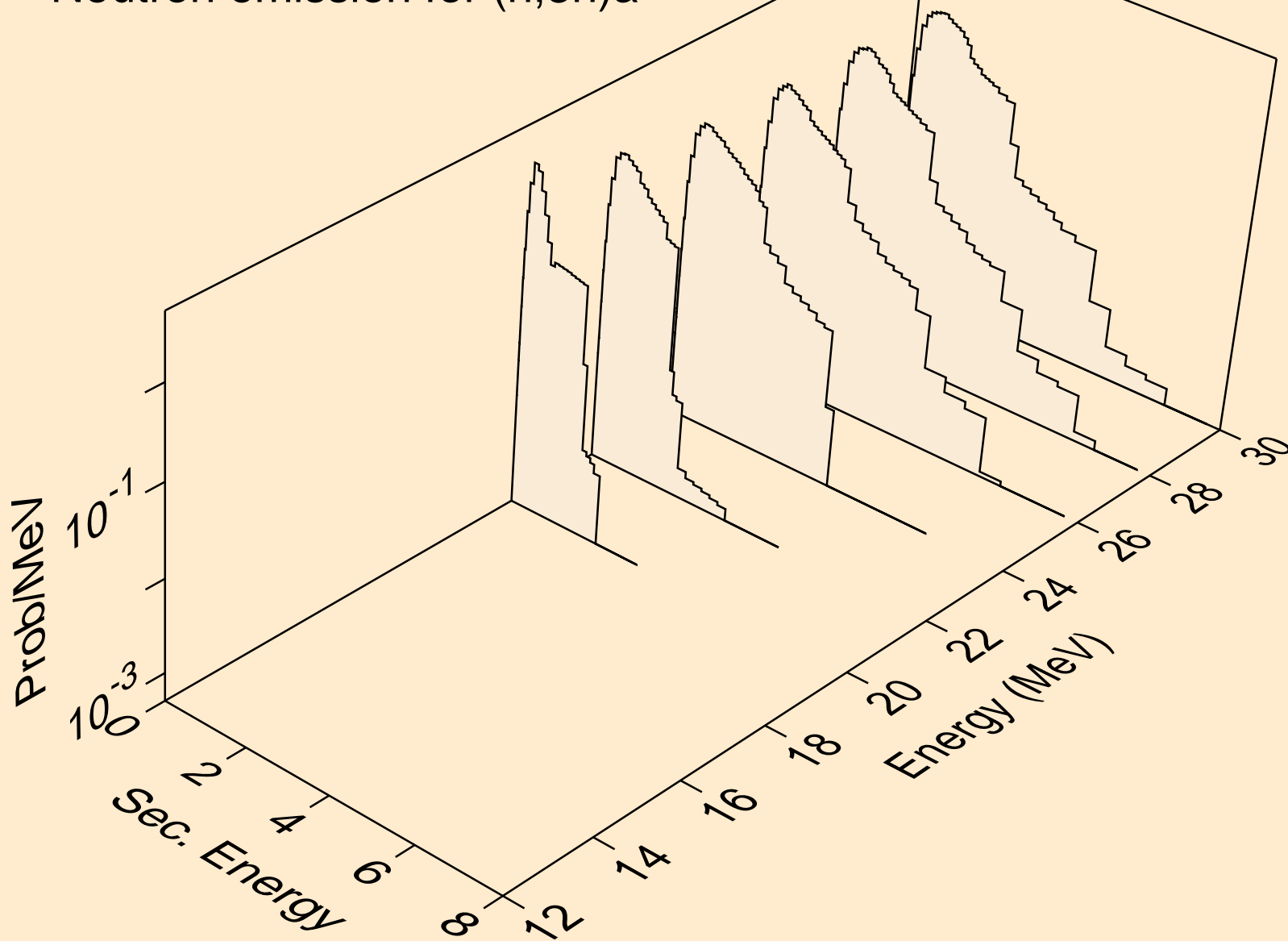

AU178 NEUTRON ACER TENDL-2019 LIBRARY; T=293.16K
Neutron emission for (n,n*)p

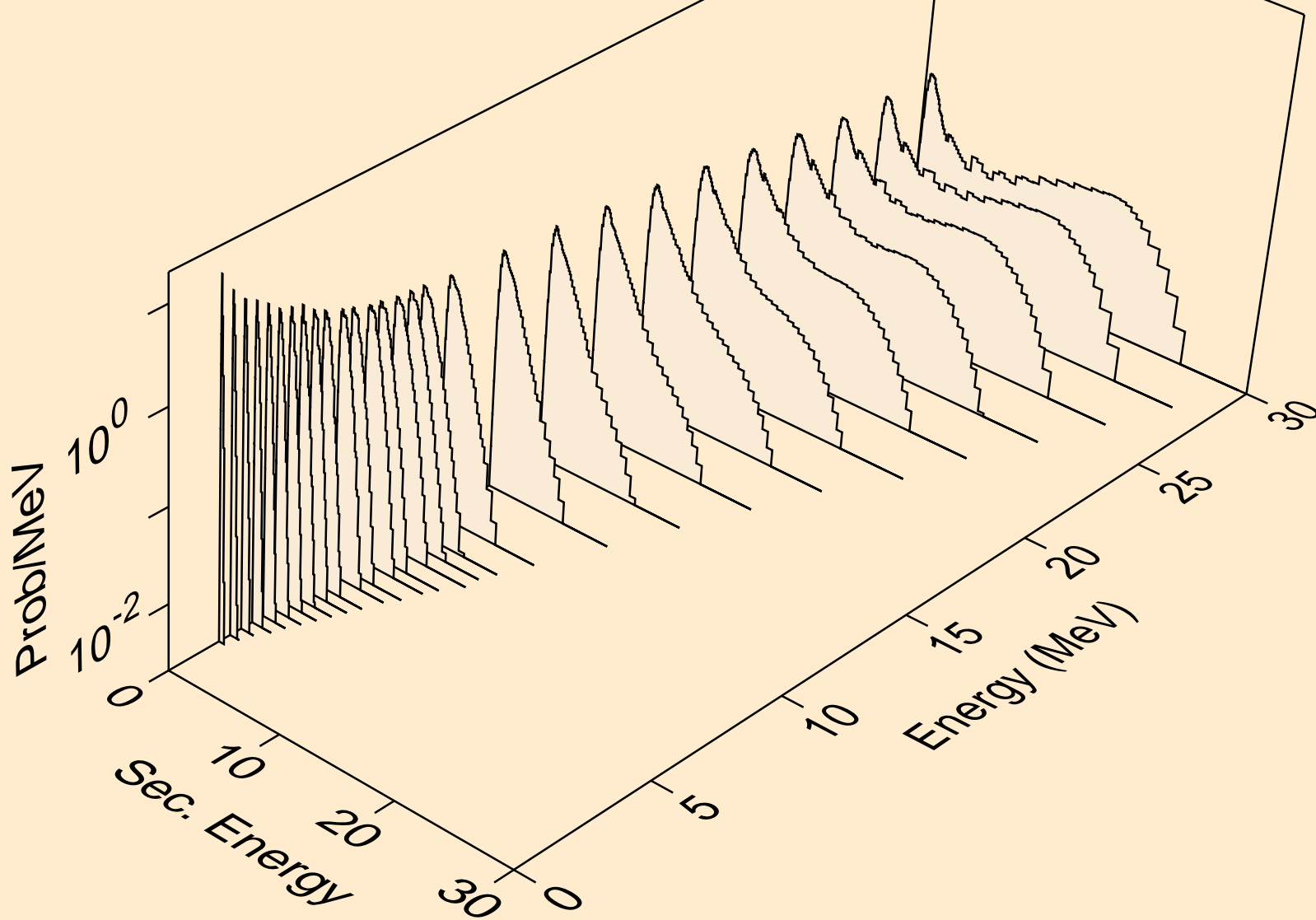

AU178 NEUTRON ACER TENDL-2019 LIBRARY; T=293.16K
Neutron emission for (n,n*)2a

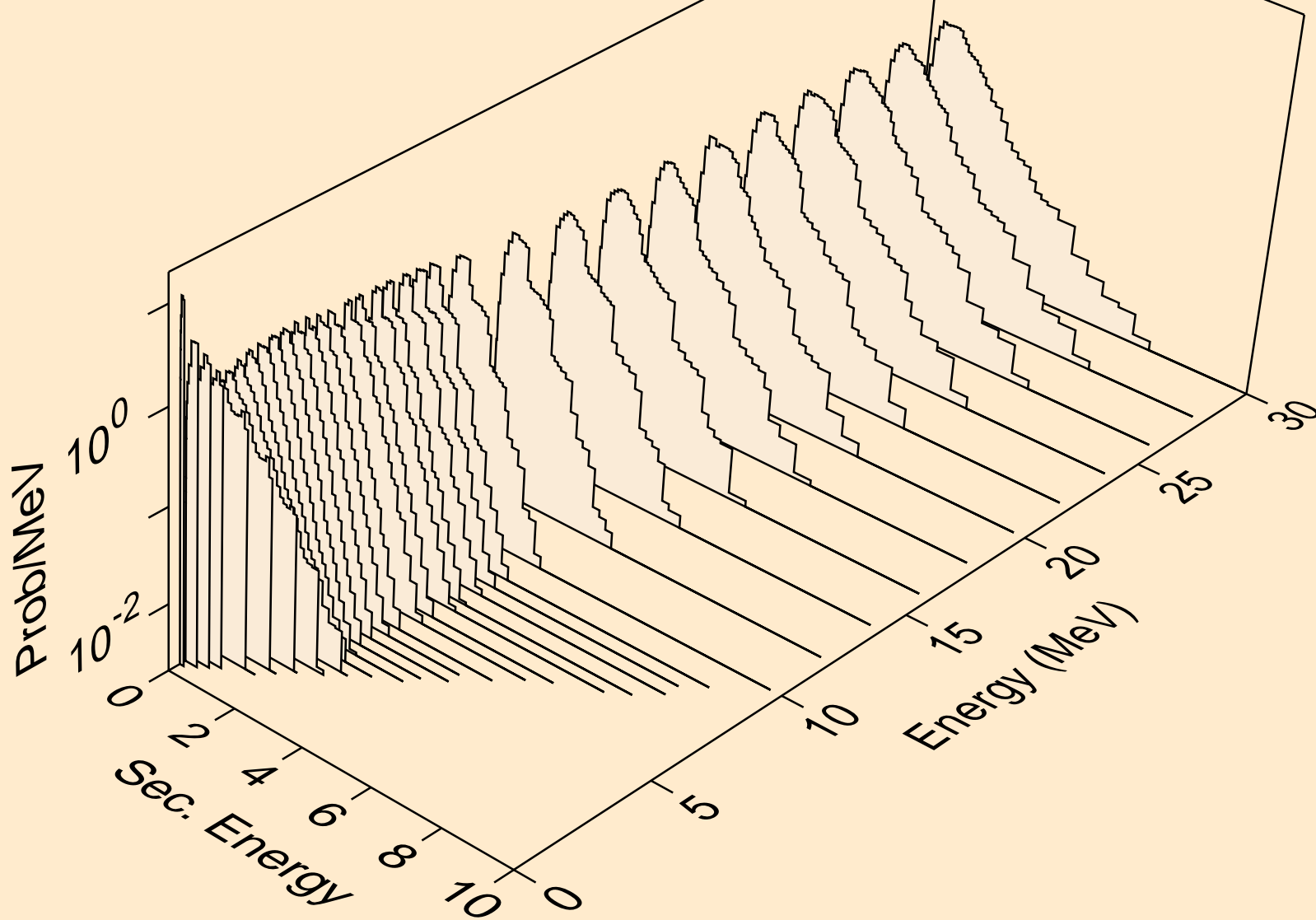

AU178 NEUTRON ACER TENDL-2019 LIBRARY; T=293.16K
Neutron emission for (n,2n)2a

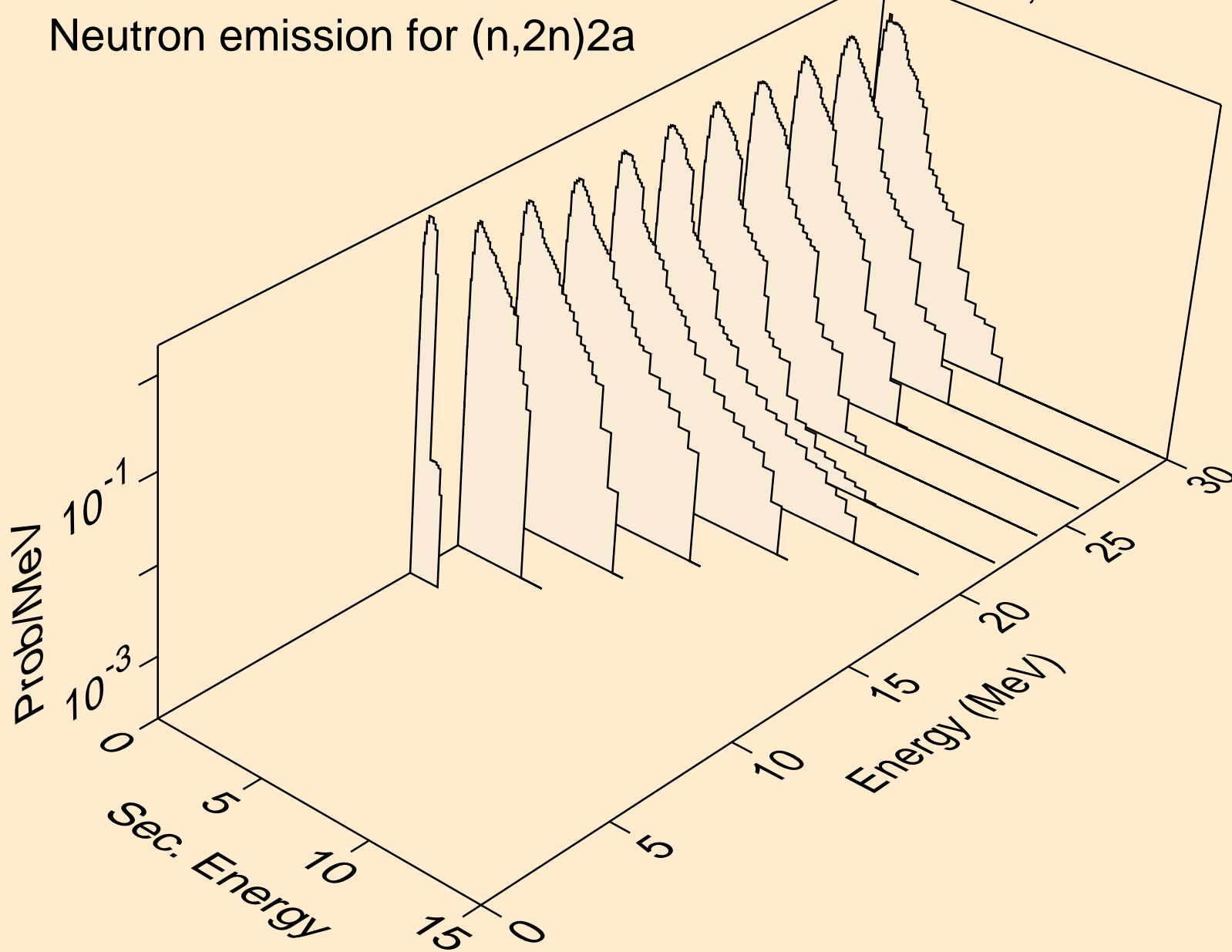

AU178 NEUTRON ACER TENDL-2019 LIBRARY; T=293.16K
Neutron emission for (n,n*)d

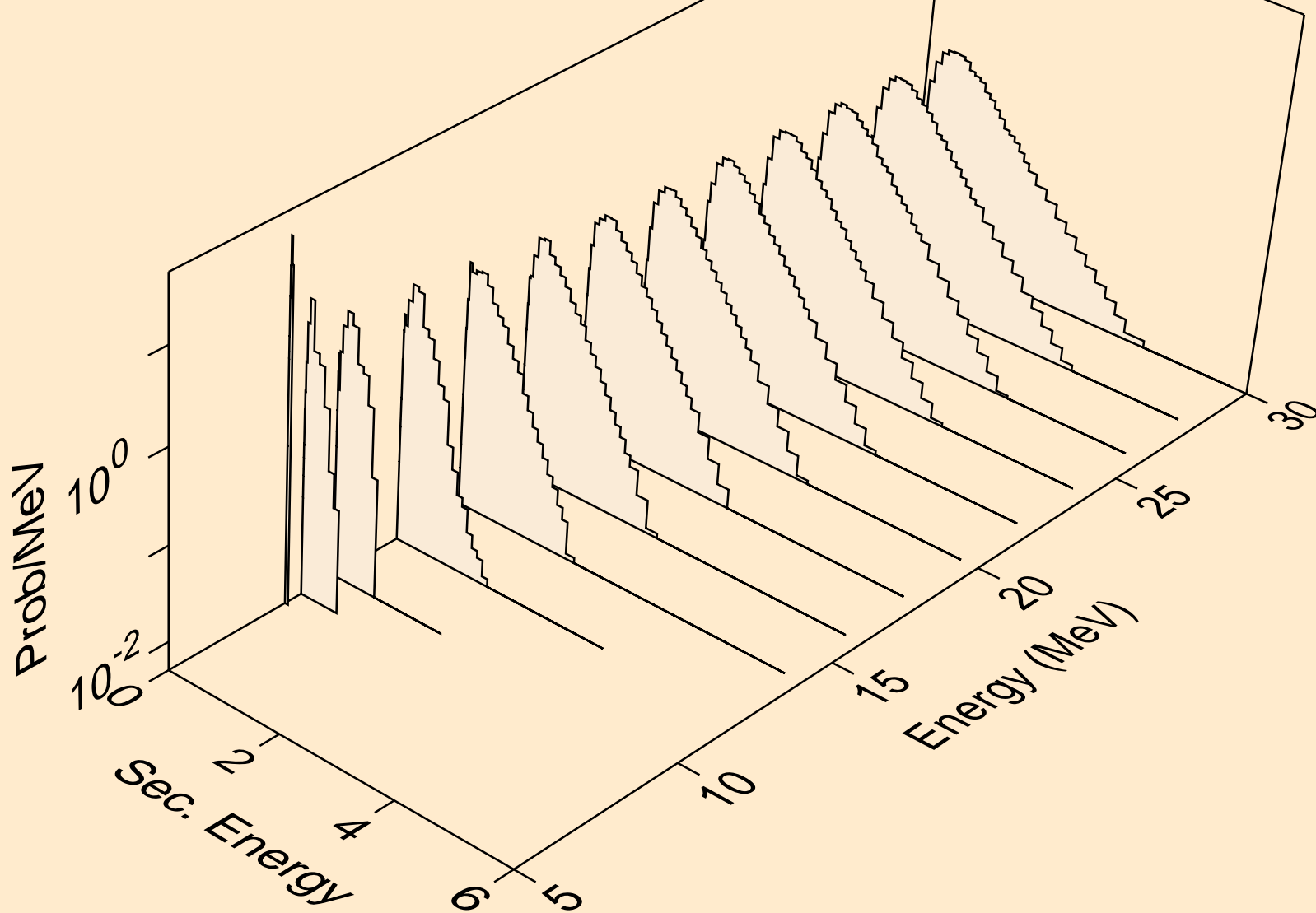

AU178 NEUTRON ACER TENDL-2019 LIBRARY; T=293.16K
Neutron emission for (n,n*)t

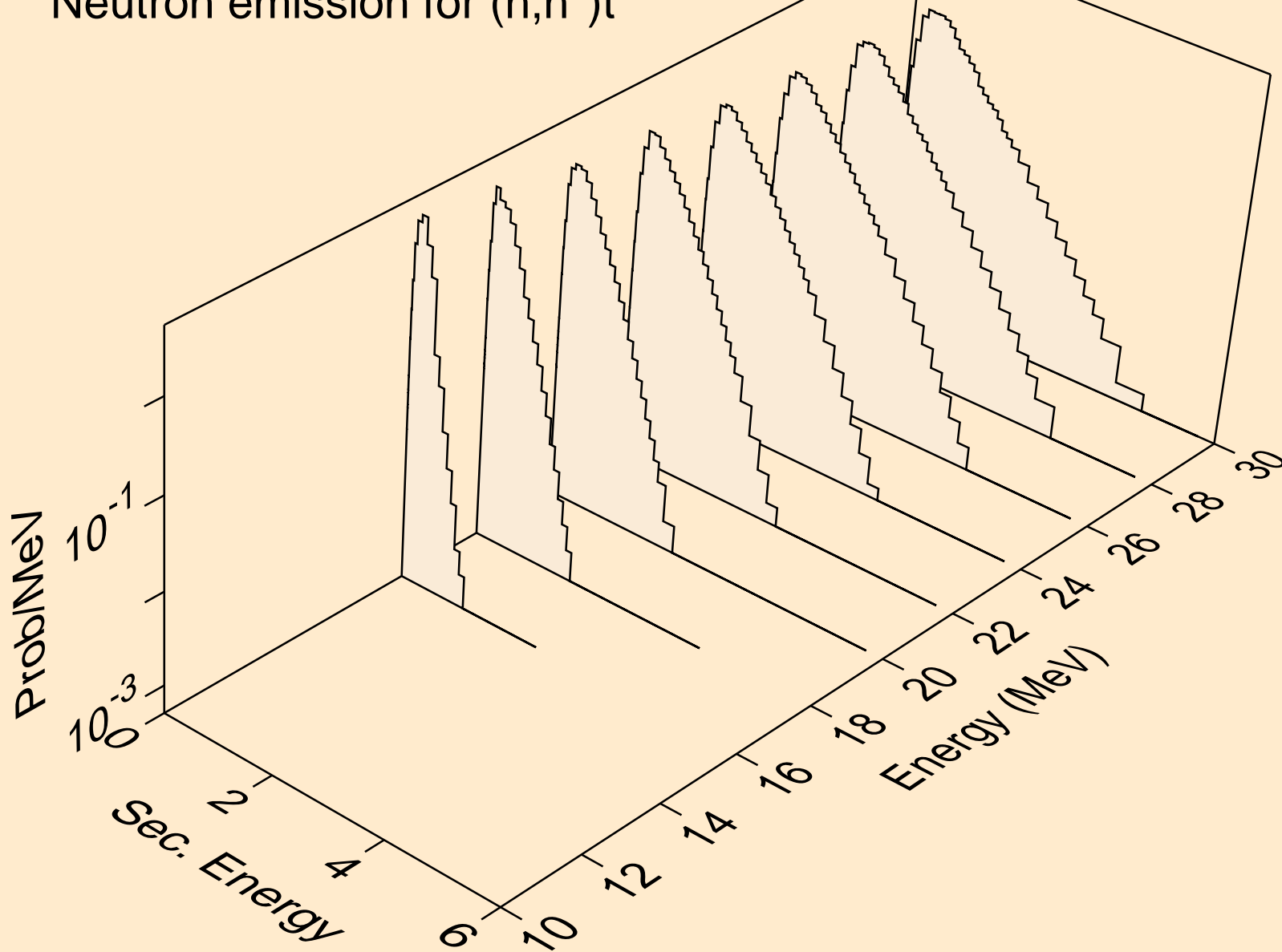

AU178 NEUTRON ACER TENDL-2019 LIBRARY; T=293.16K
Neutron emission for (n,n*)he3

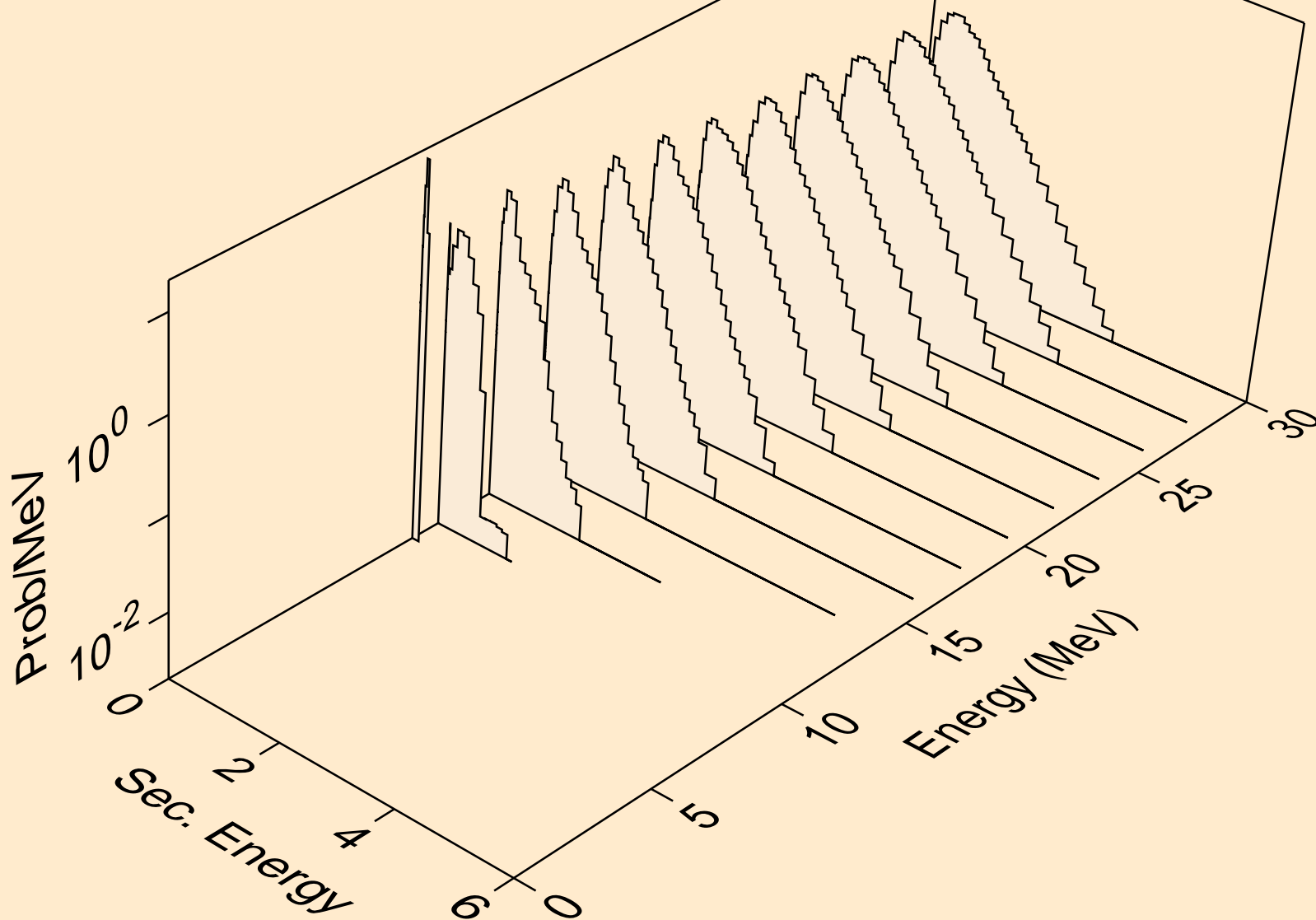

AU178 NEUTRON ACER TENDL-2019 LIBRARY; T=293.16K
Neutron emission for (n,4n)

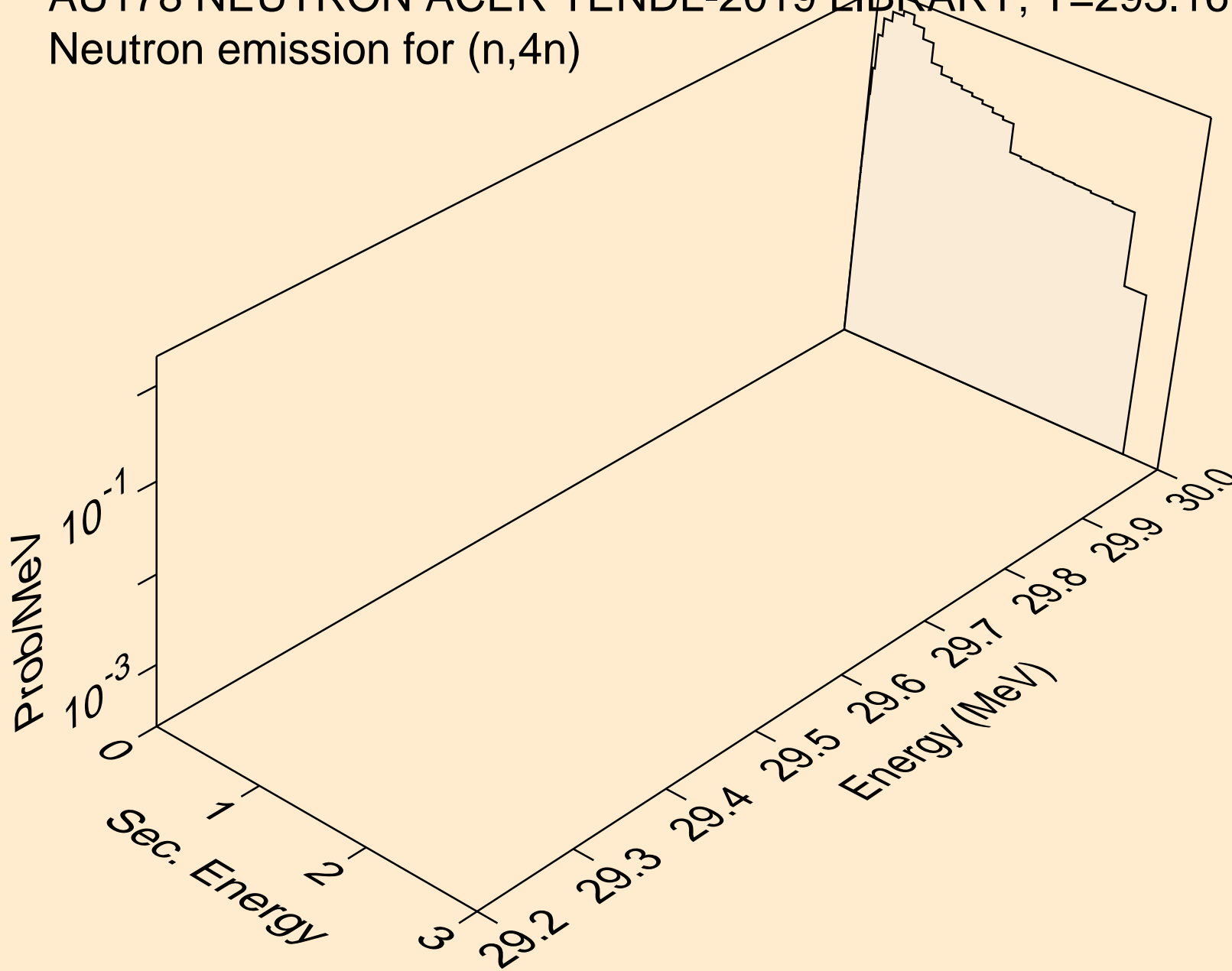

AU178 NEUTRON ACER TENDL-2019 LIBRARY; T=293.16K
Neutron emission for (n,2np)

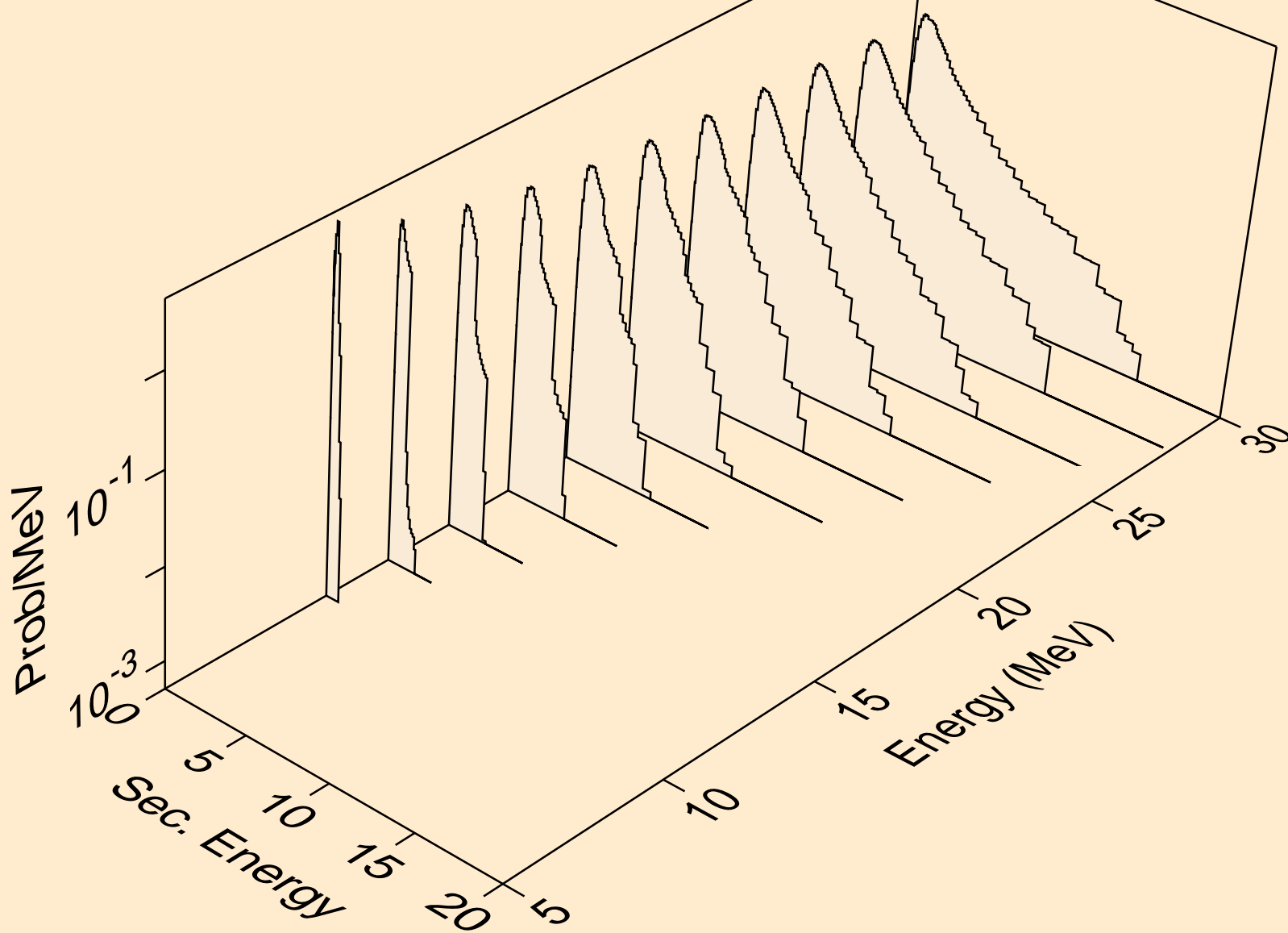

AU178 NEUTRON ACER TENDL-2019 LIBRARY; T=293.16K
Neutron emission for (n,3np)

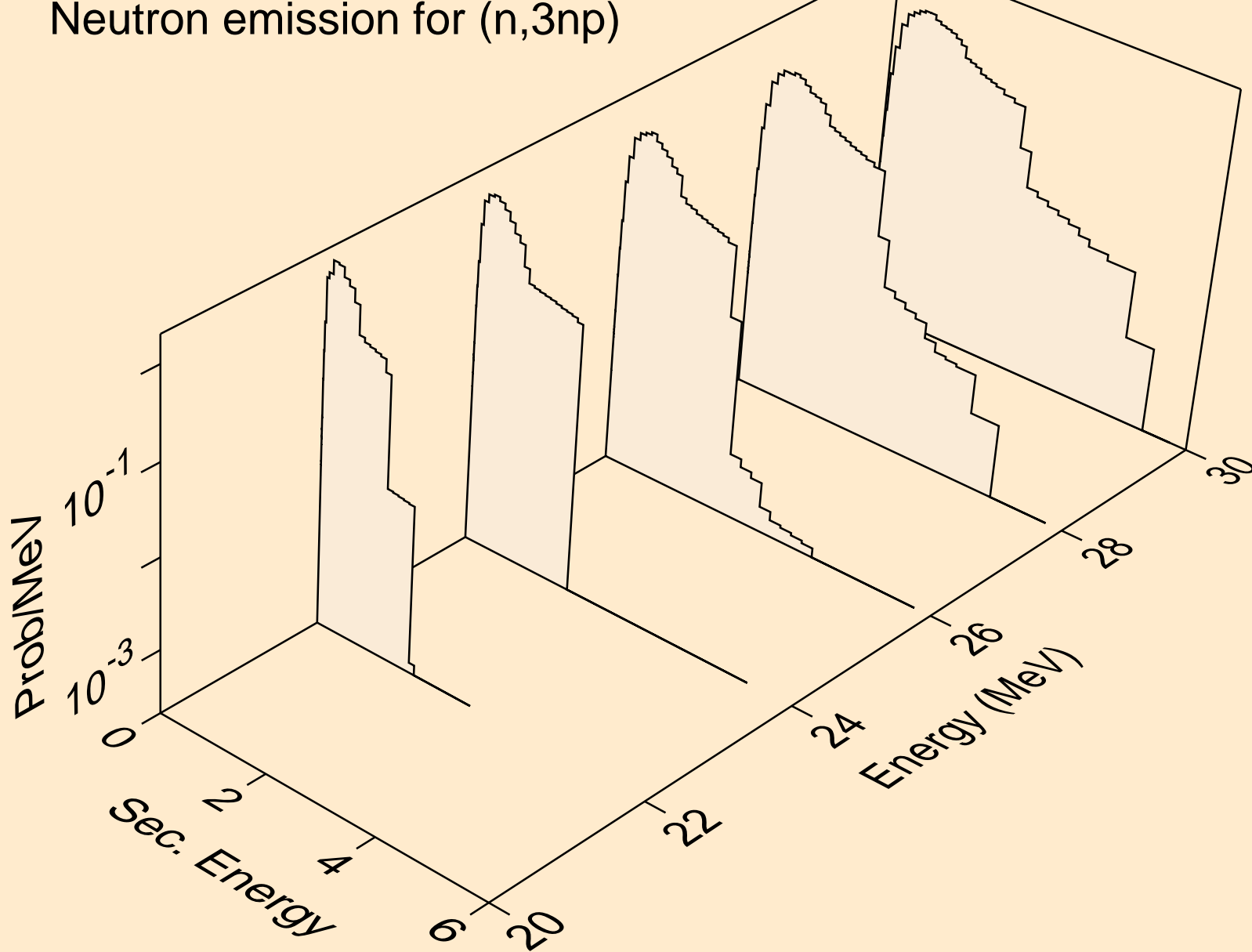

AU178 NEUTRON ACER TENDL-2019 LIBRARY; T=293.16K
Neutron emission for (n,2np)

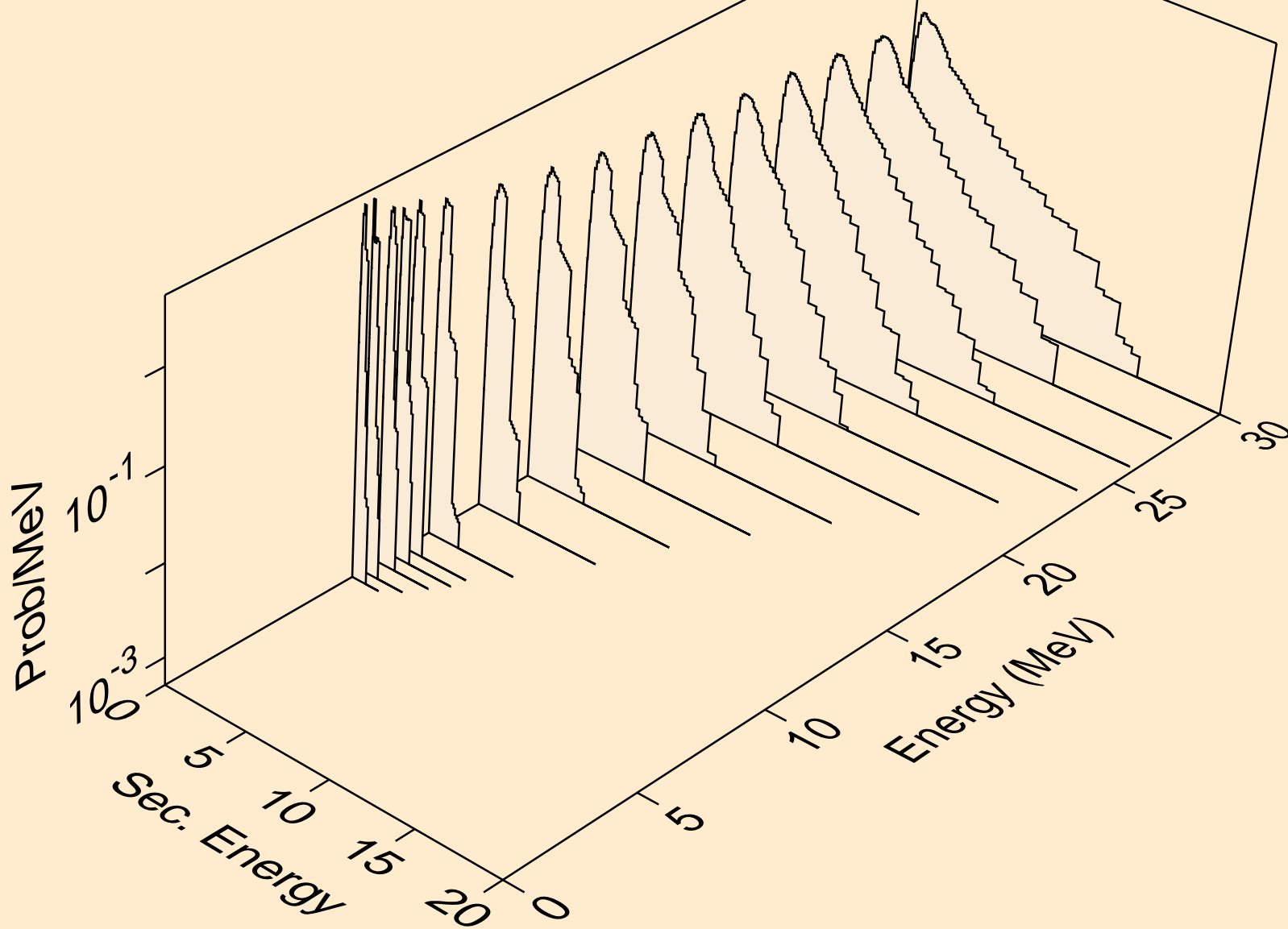

AU178 NEUTRON ACER TENDL-2019 LIBRARY; T=293.16K
Neutron emission for (n,npa)

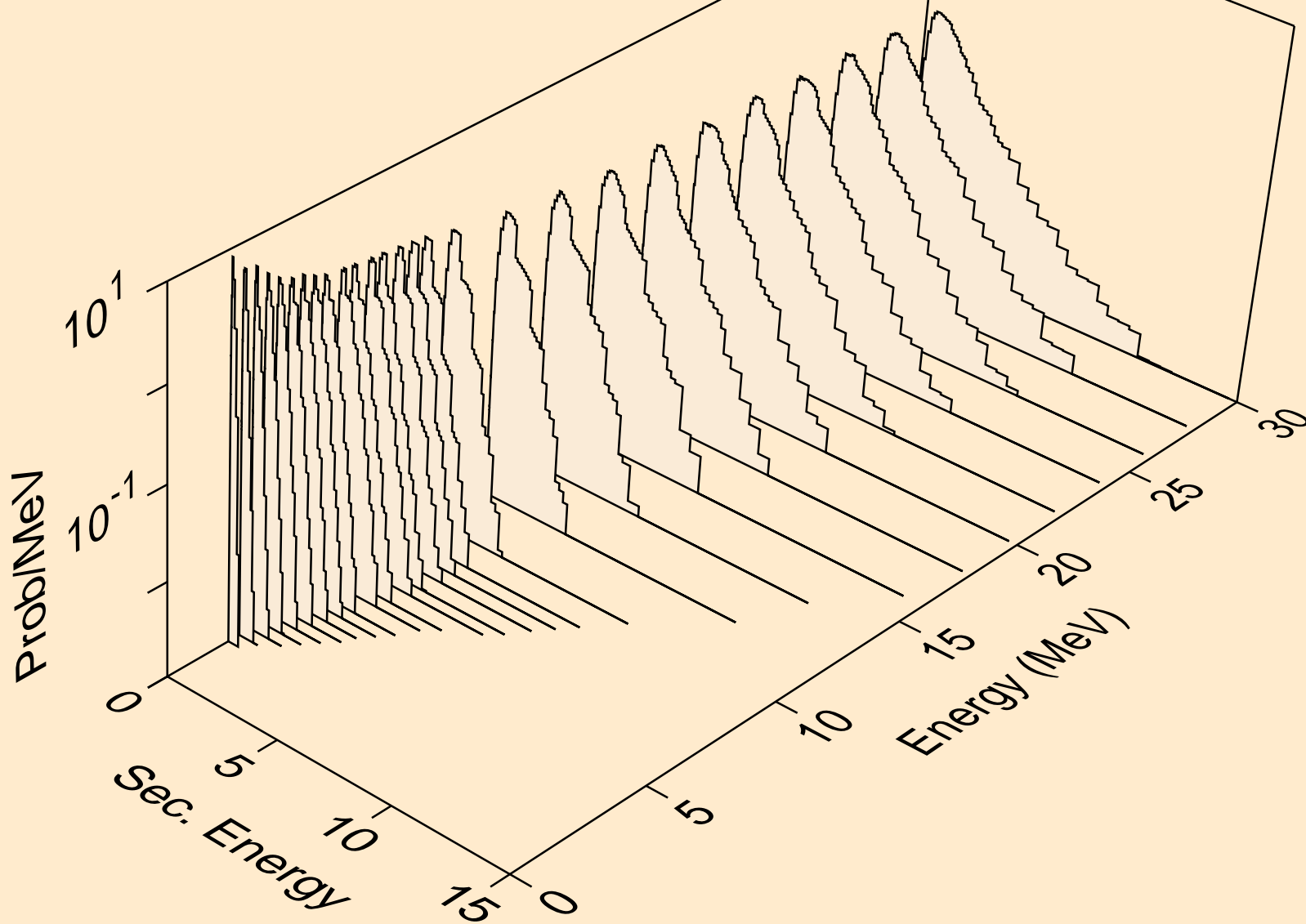

AU178 NEUTRON ACER TENDL-2019 LIBRARY; T=293.16K
Neutron emission for (n,n*c)

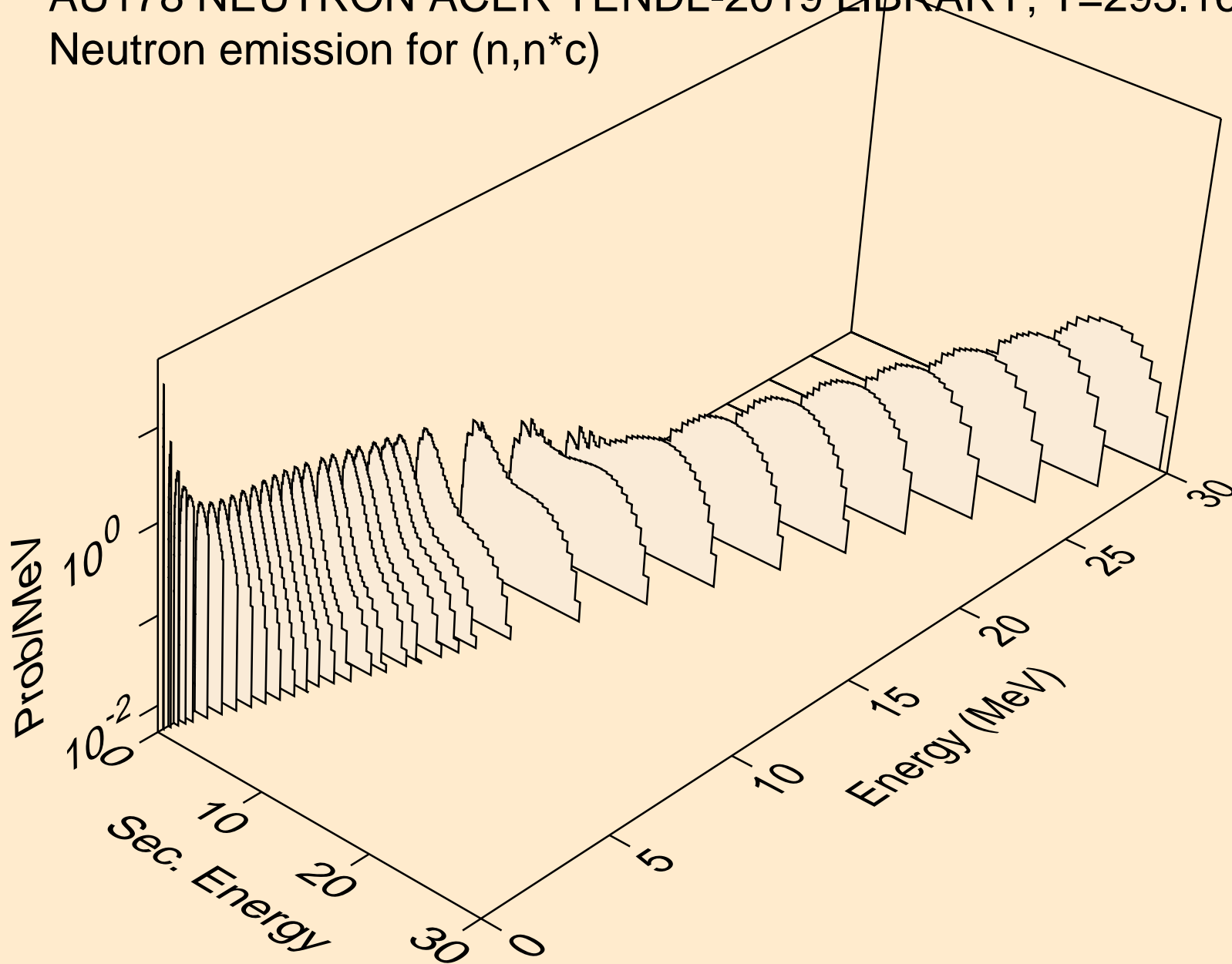

AU178 NEUTRON ACER TENDL-2019 LIBRARY; T=293.16K
Photon emission for (n,x)

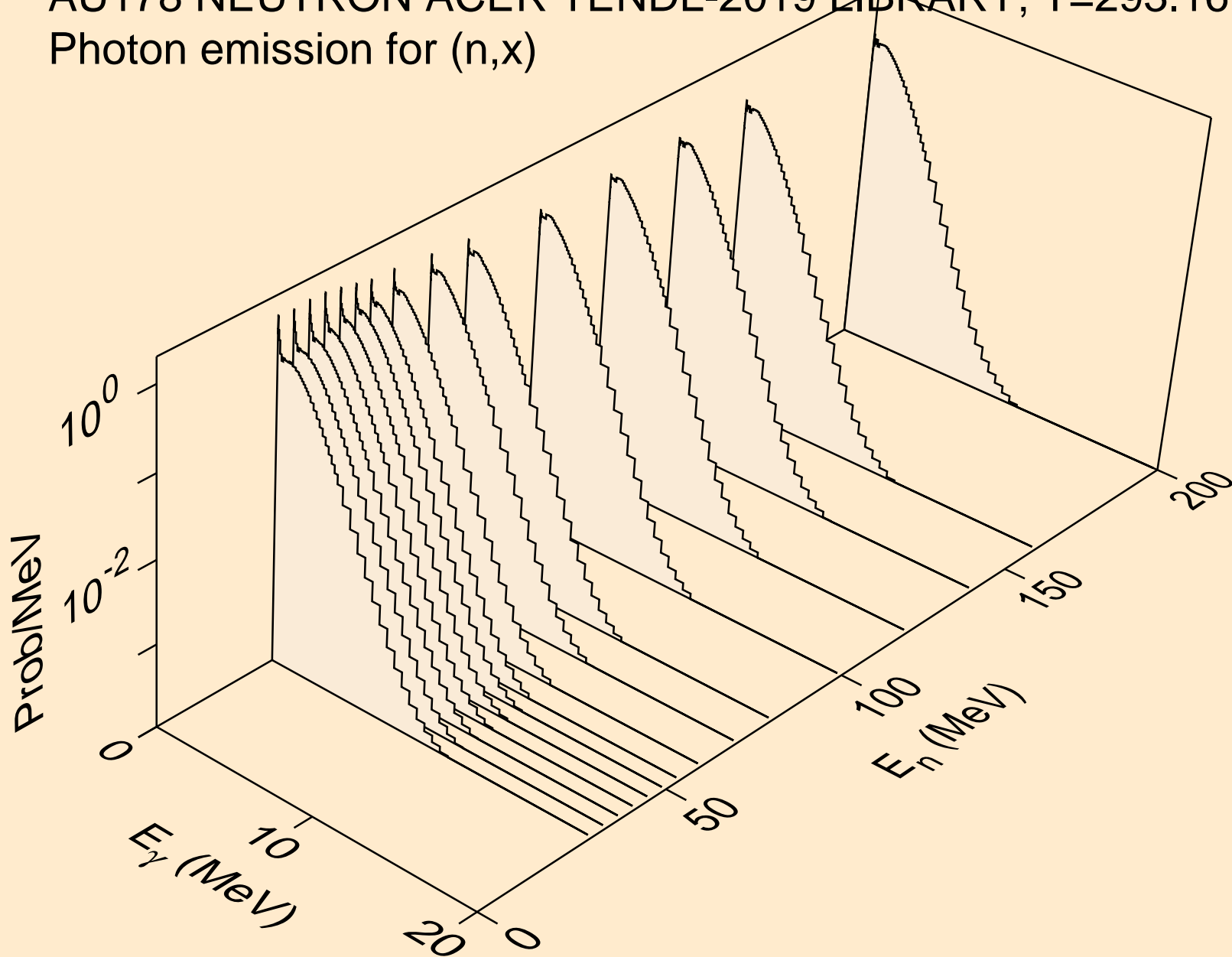

AU178 NEUTRON ACER TENDL-2019 LIBRARY; T=293.16K
Photon emission for (n,2nd)

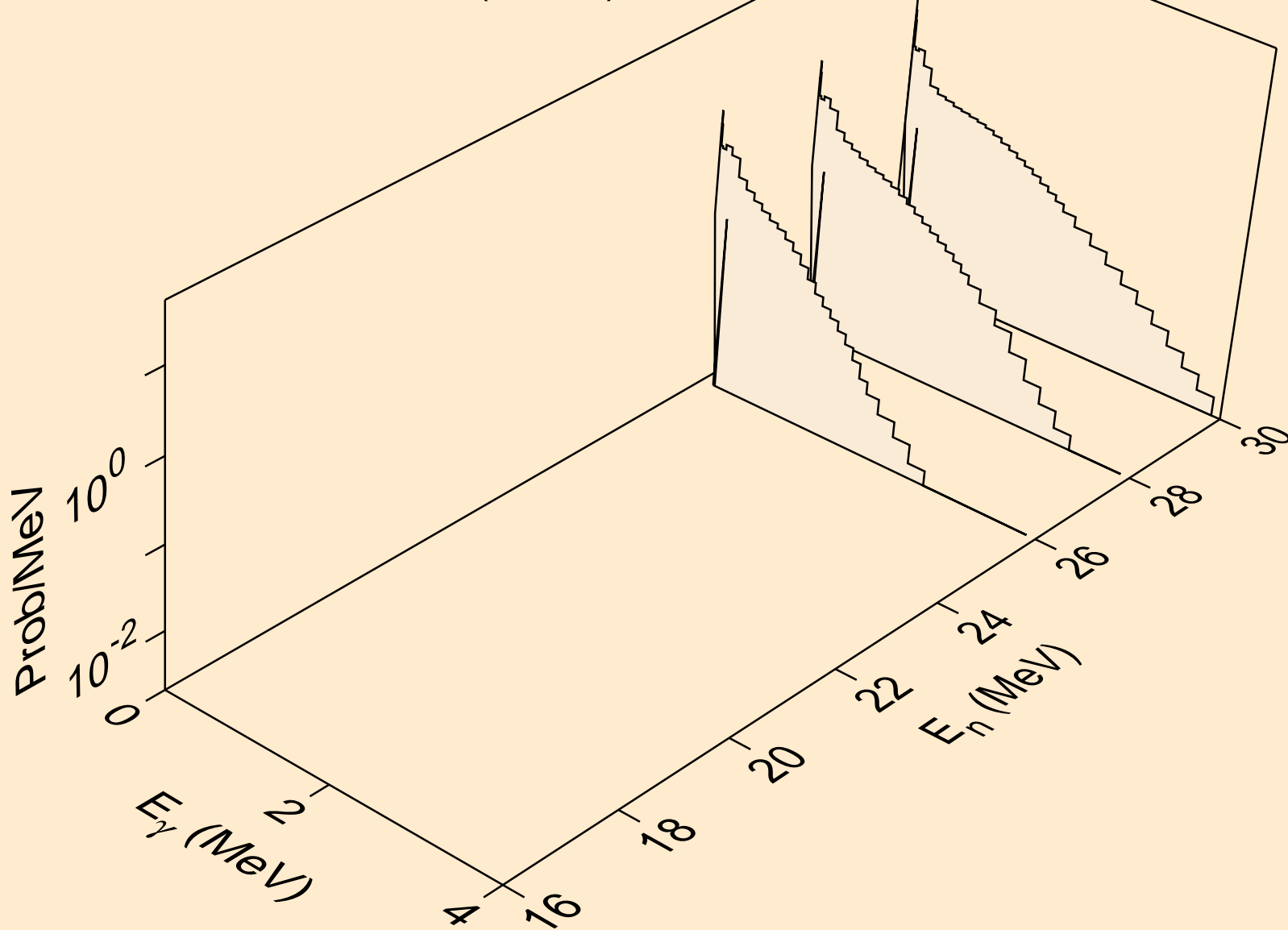

AU178 NEUTRON ACER TENDL-2019 LIBRARY; T=293.16K
Photon emission for (n,2n)

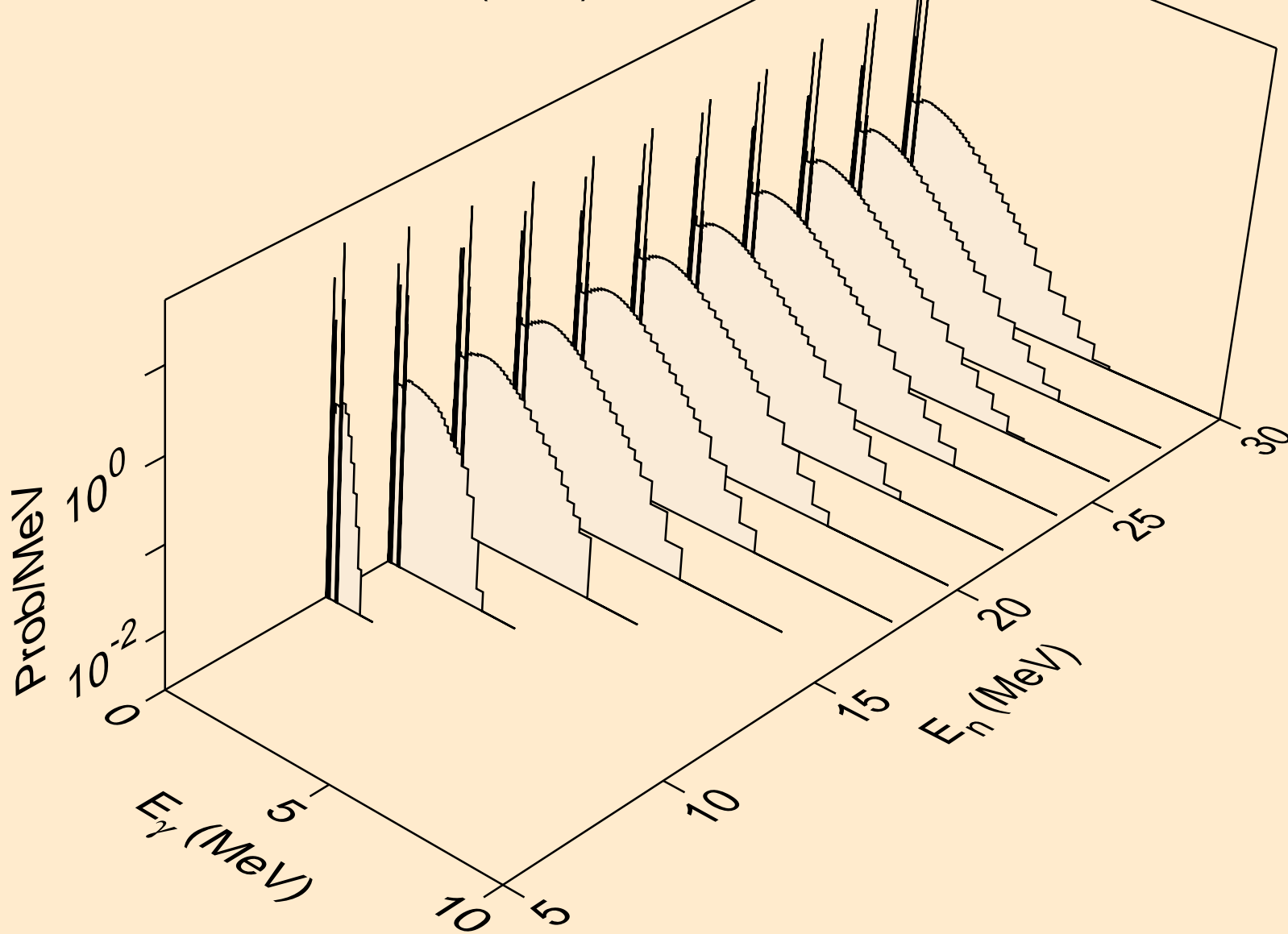

AU178 NEUTRON ACER TENDL-2019 LIBRARY; T=293.16K
Photon emission for (n,3n)

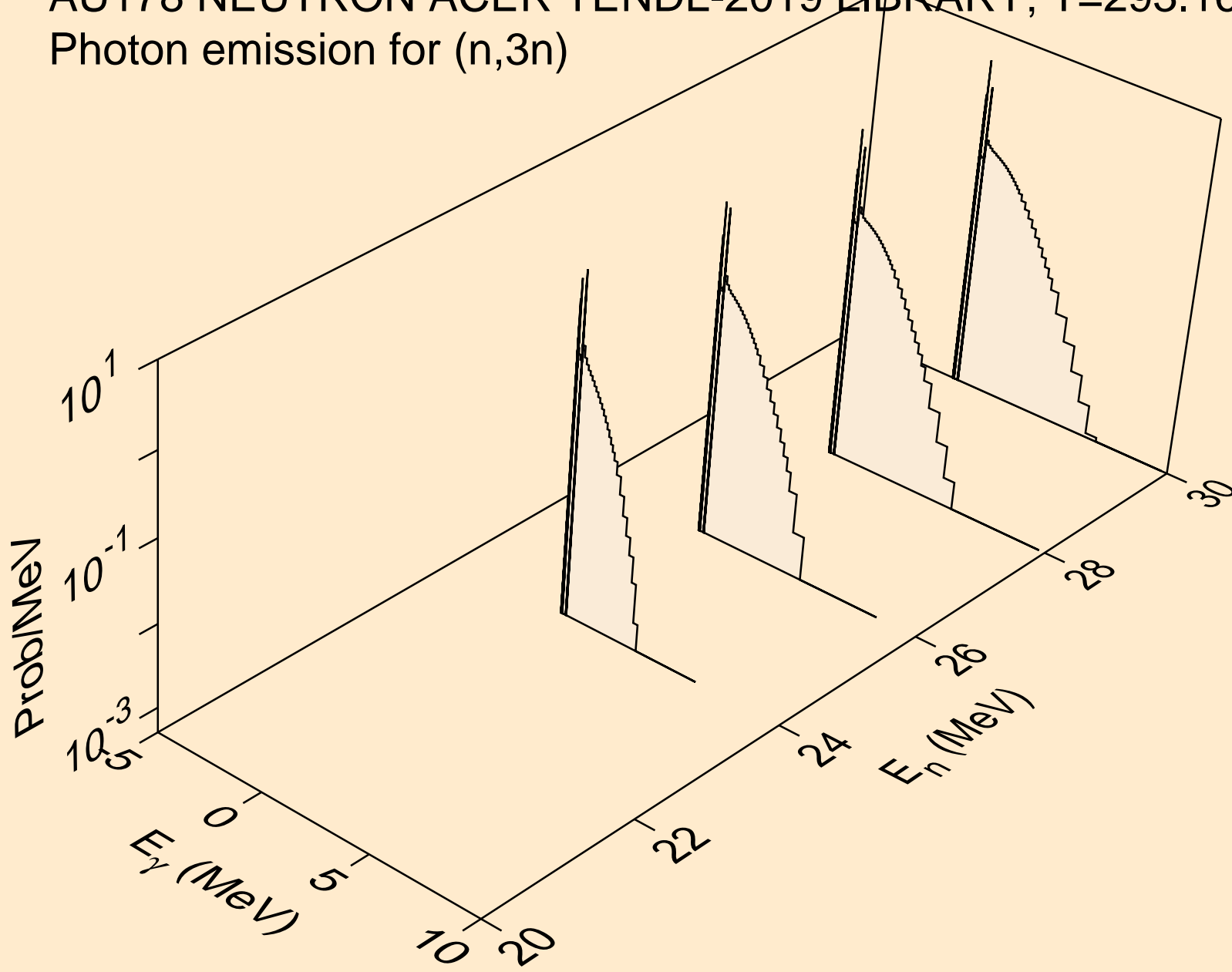

AU178 NEUTRON ACER TENDL-2019 LIBRARY; T=293.16K
Photon emission for (n,n*)a

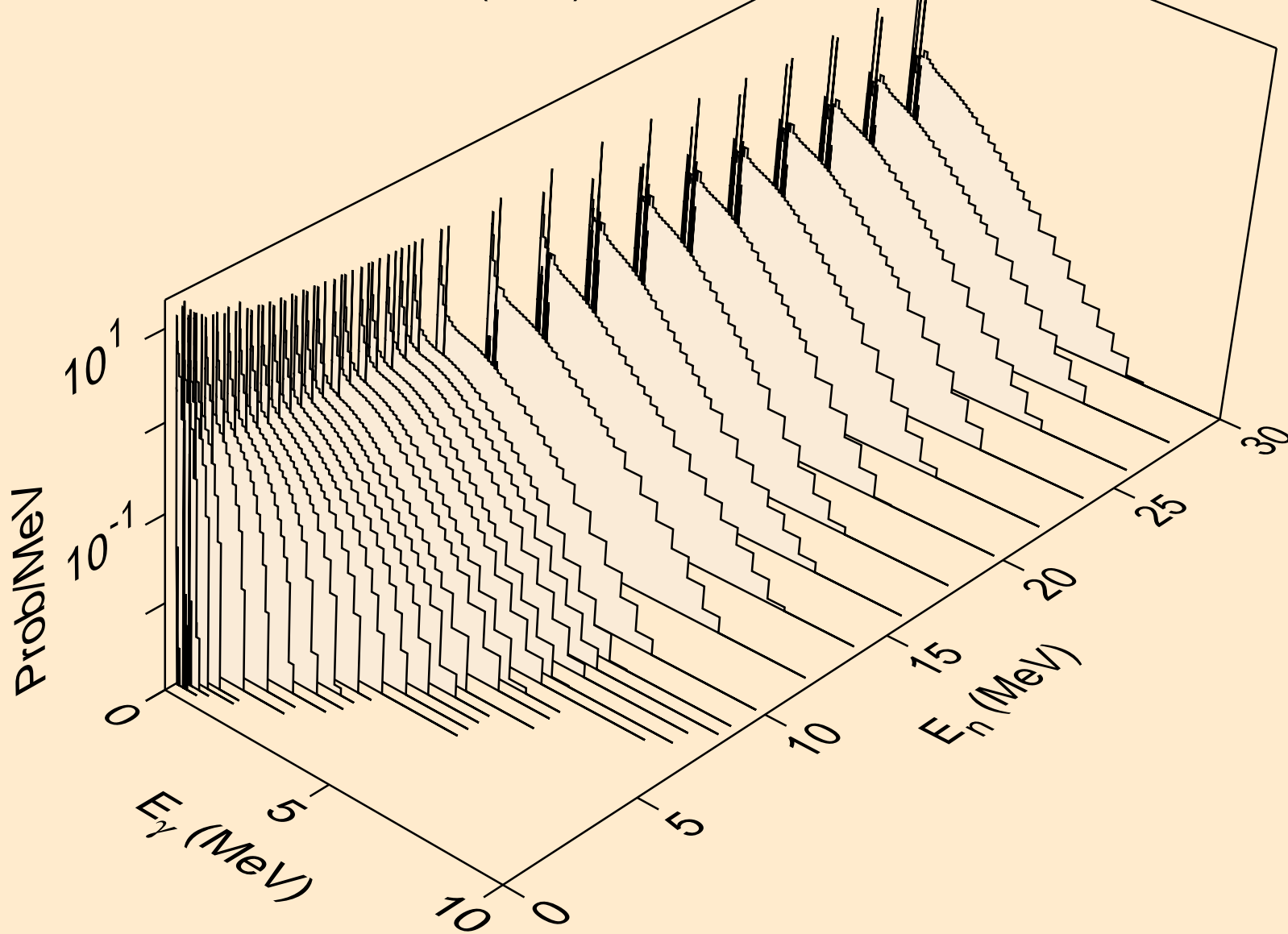

AU178 NEUTRON ACER TENDL-2019 LIBRARY; T=293.16K
Photon emission for (n,n*)3a

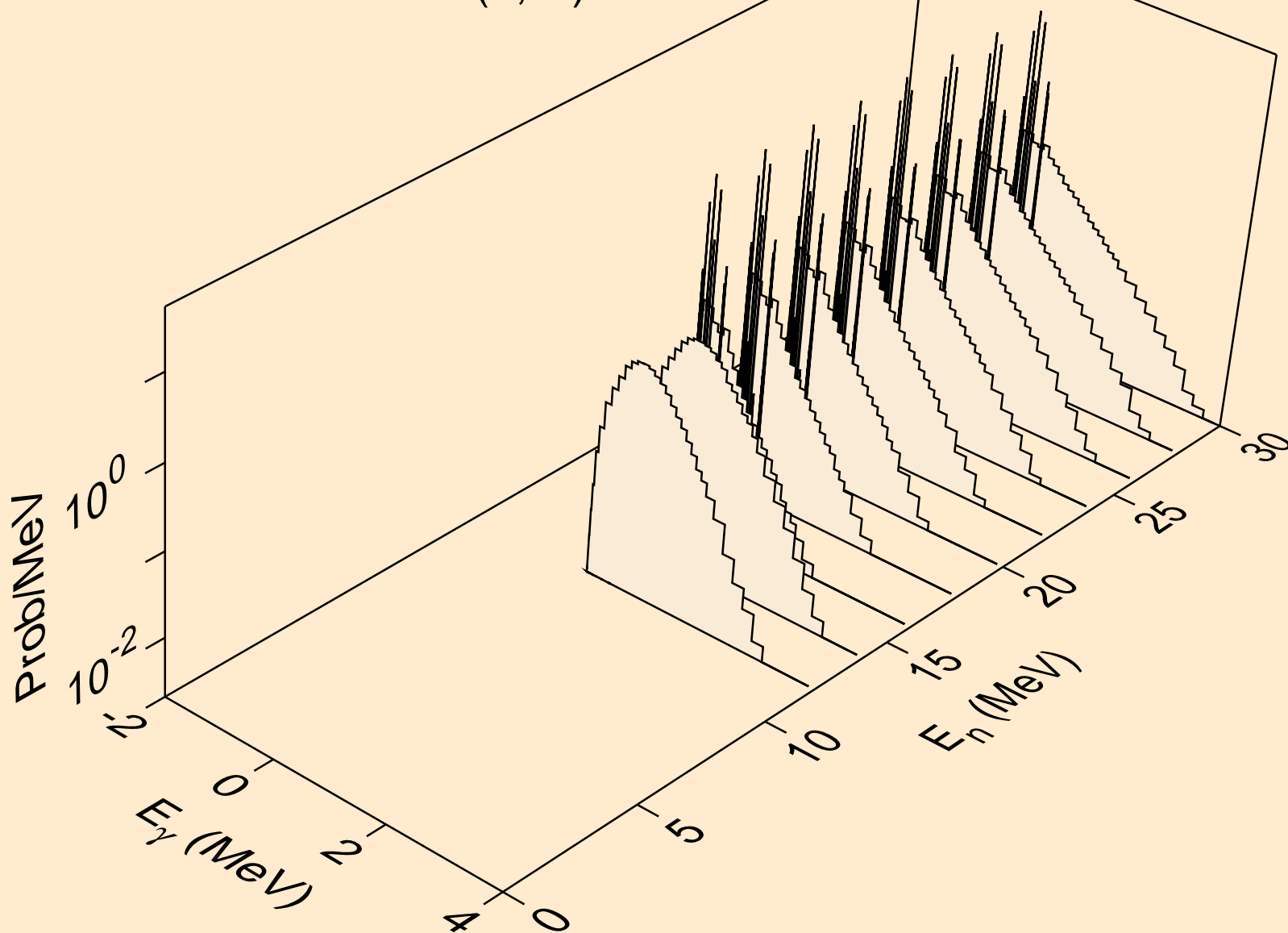

AU178 NEUTRON ACER TENDL-2019 LIBRARY; T=293.16K
Photon emission for (n,2n) α

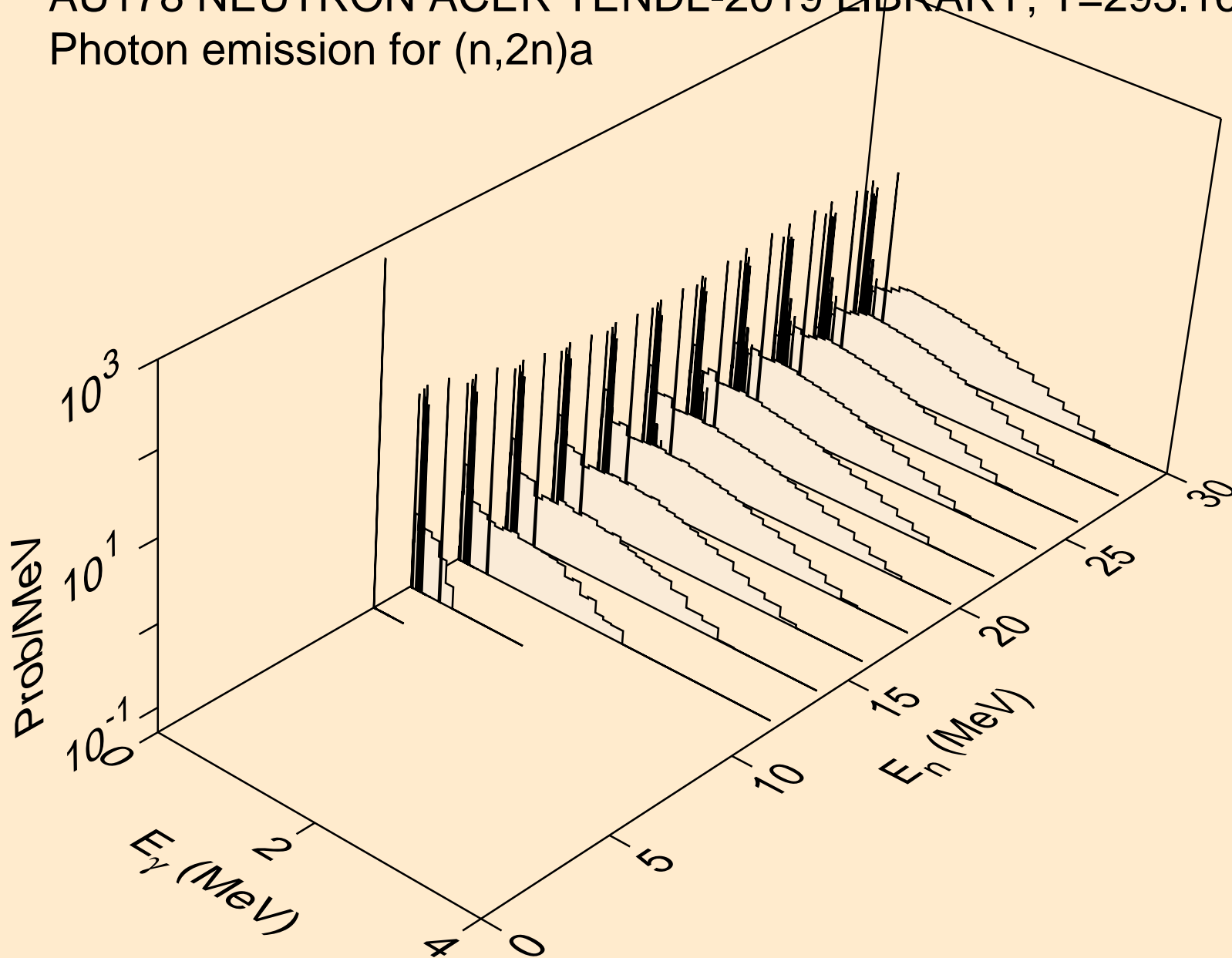

AU178 NEUTRON ACER TENDL-2019 LIBRARY; T=293.16K
Photon emission for (n,3n)a

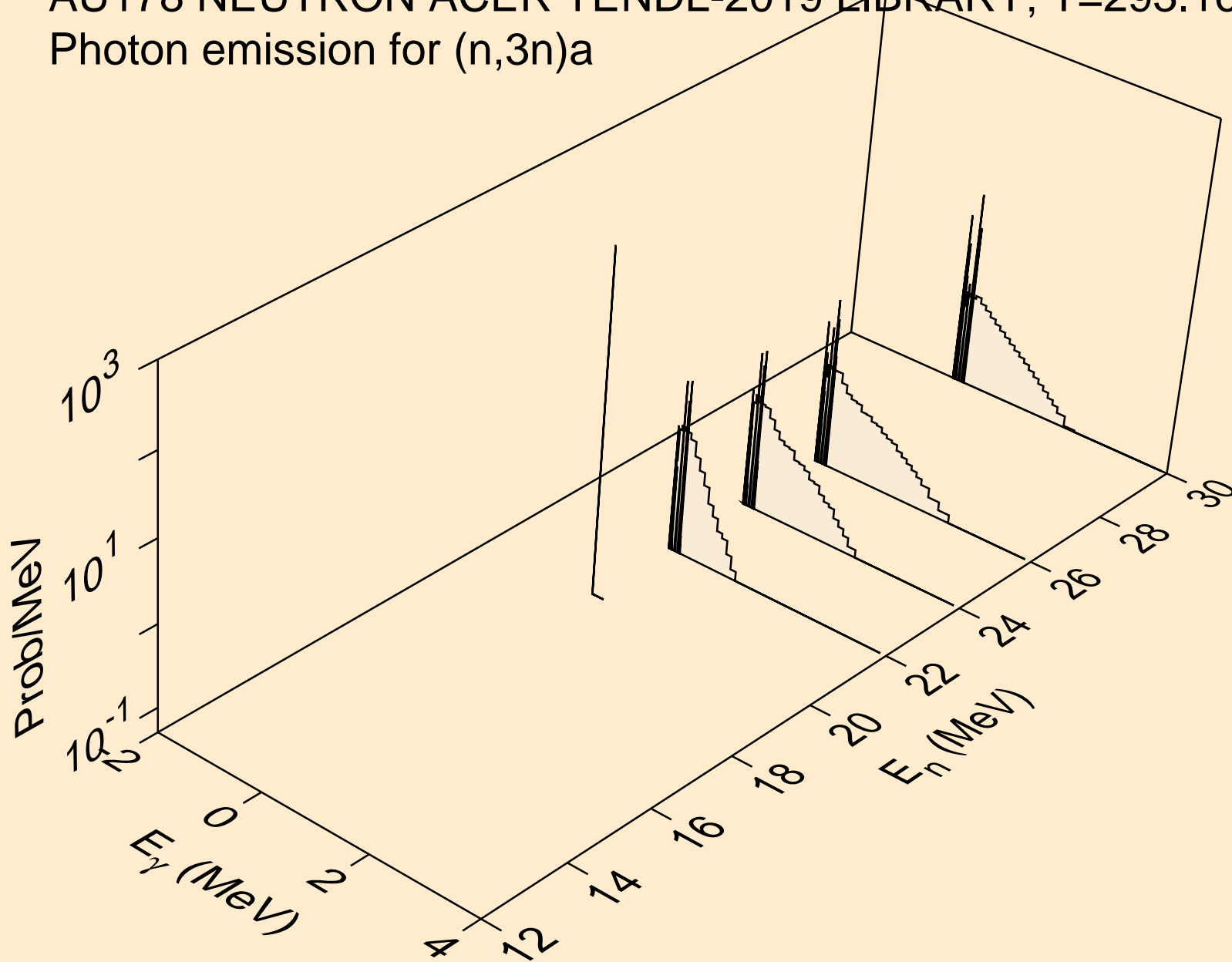

AU178 NEUTRON ACER TENDL-2019 LIBRARY; T=293.16K
Photon emission for (n,n*)p

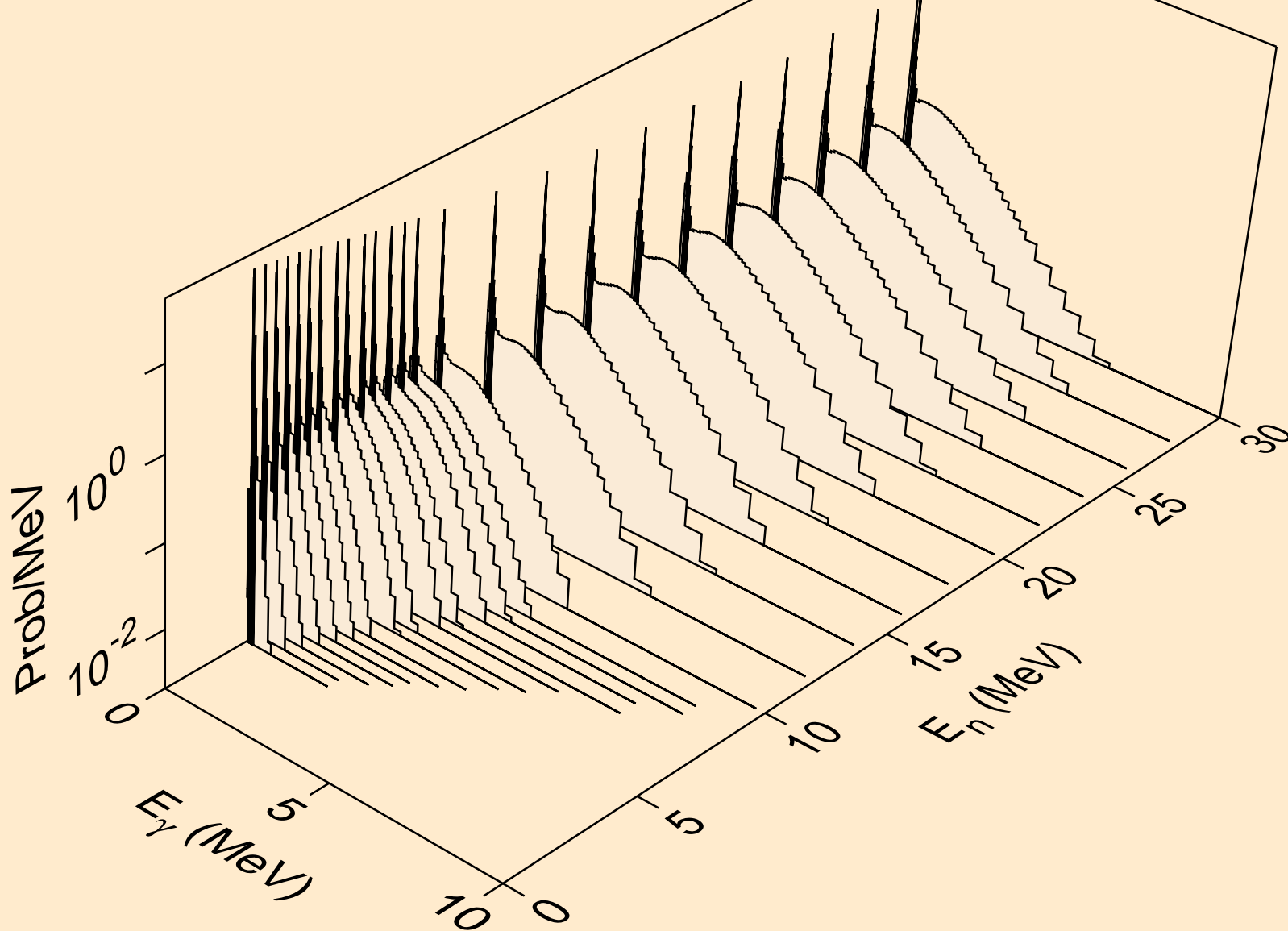

AU178 NEUTRON ACER TENDL-2019 LIBRARY; T=293.16K
Photon emission for (n,n*)2a

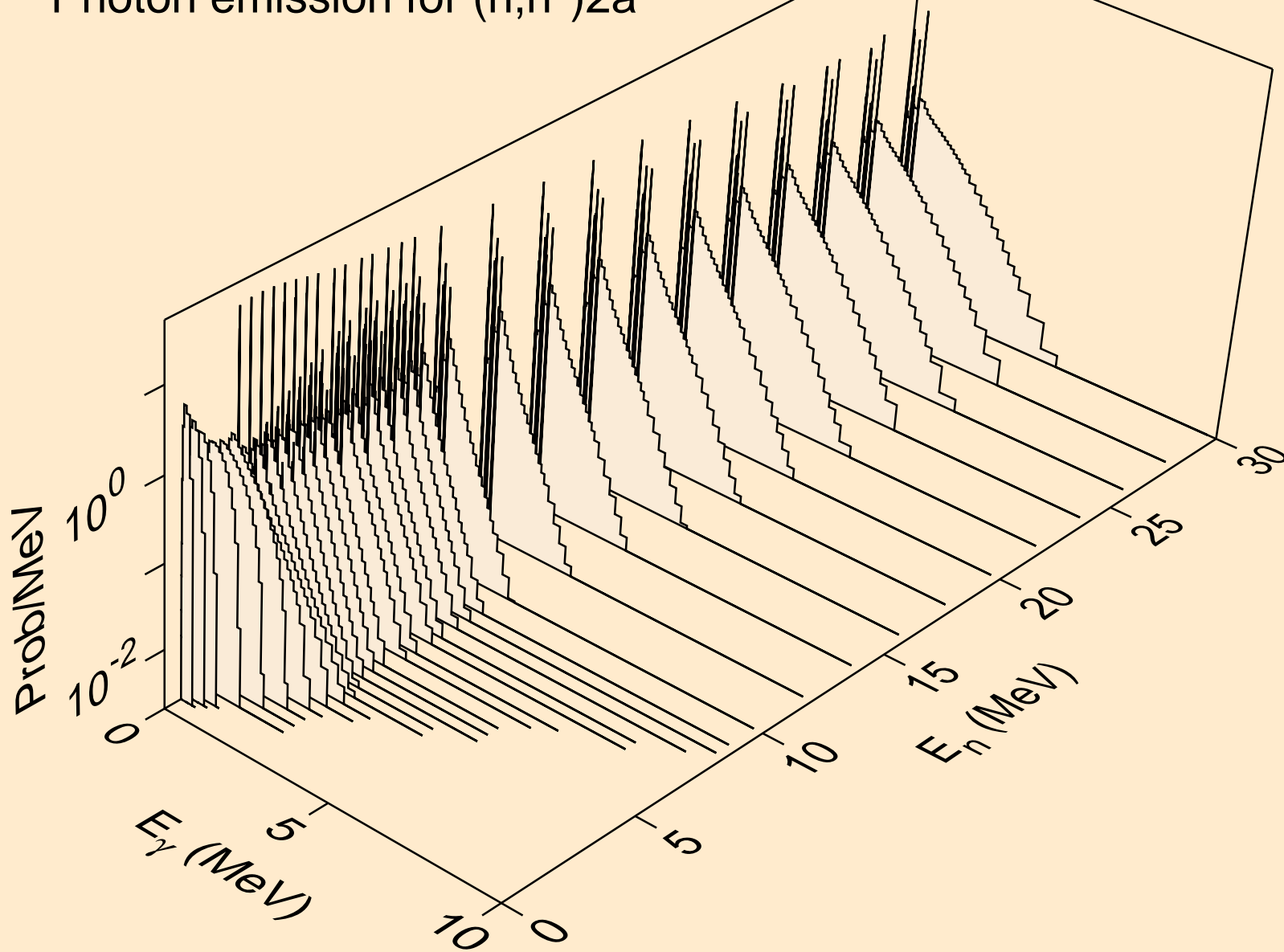

AU178 NEUTRON ACER TENDL-2019 LIBRARY; T=293.16K
Photon emission for (n,2n)2a

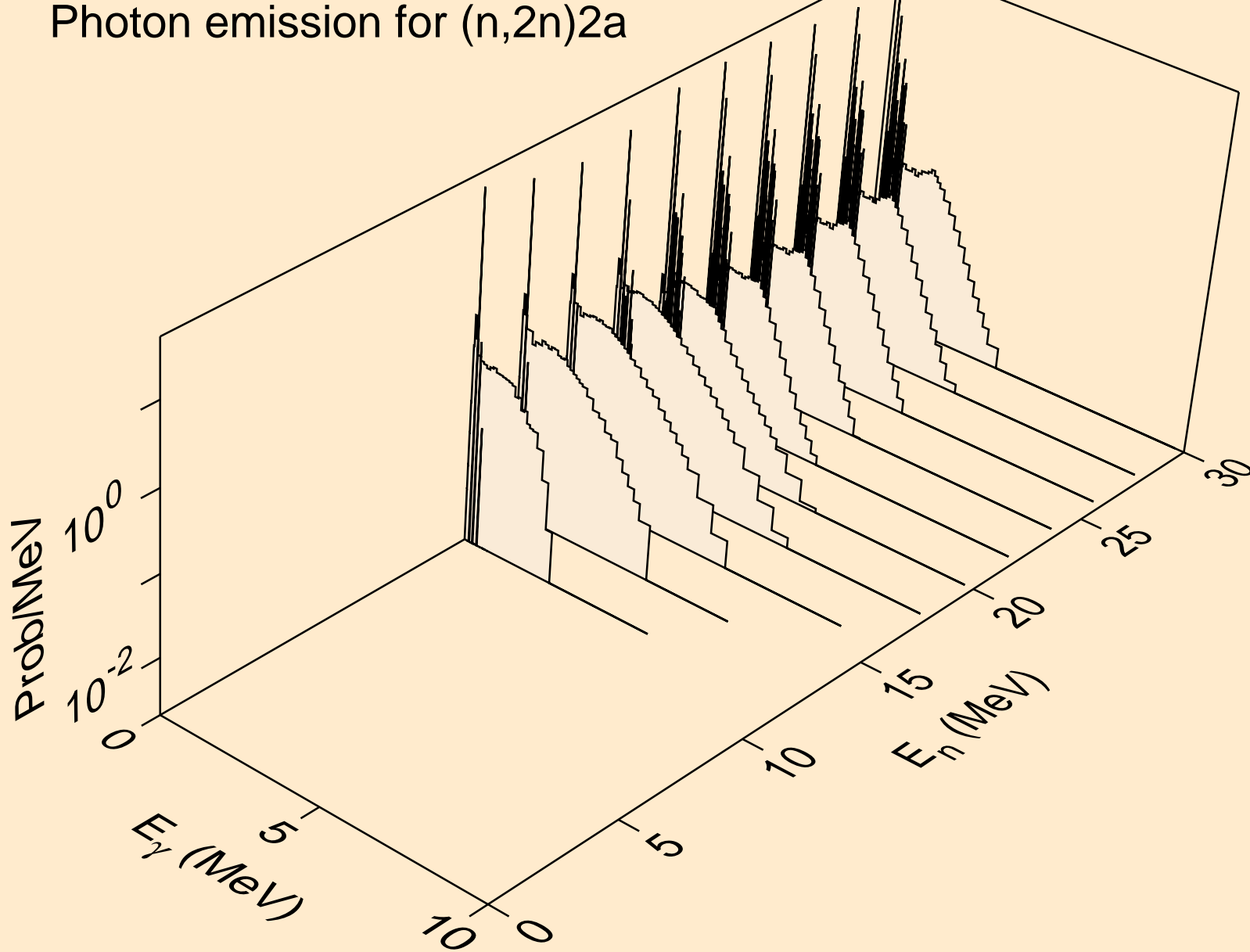

AU178 NEUTRON ACER TENDL-2019 LIBRARY; T=293.16K
Photon emission for (n,n*)d

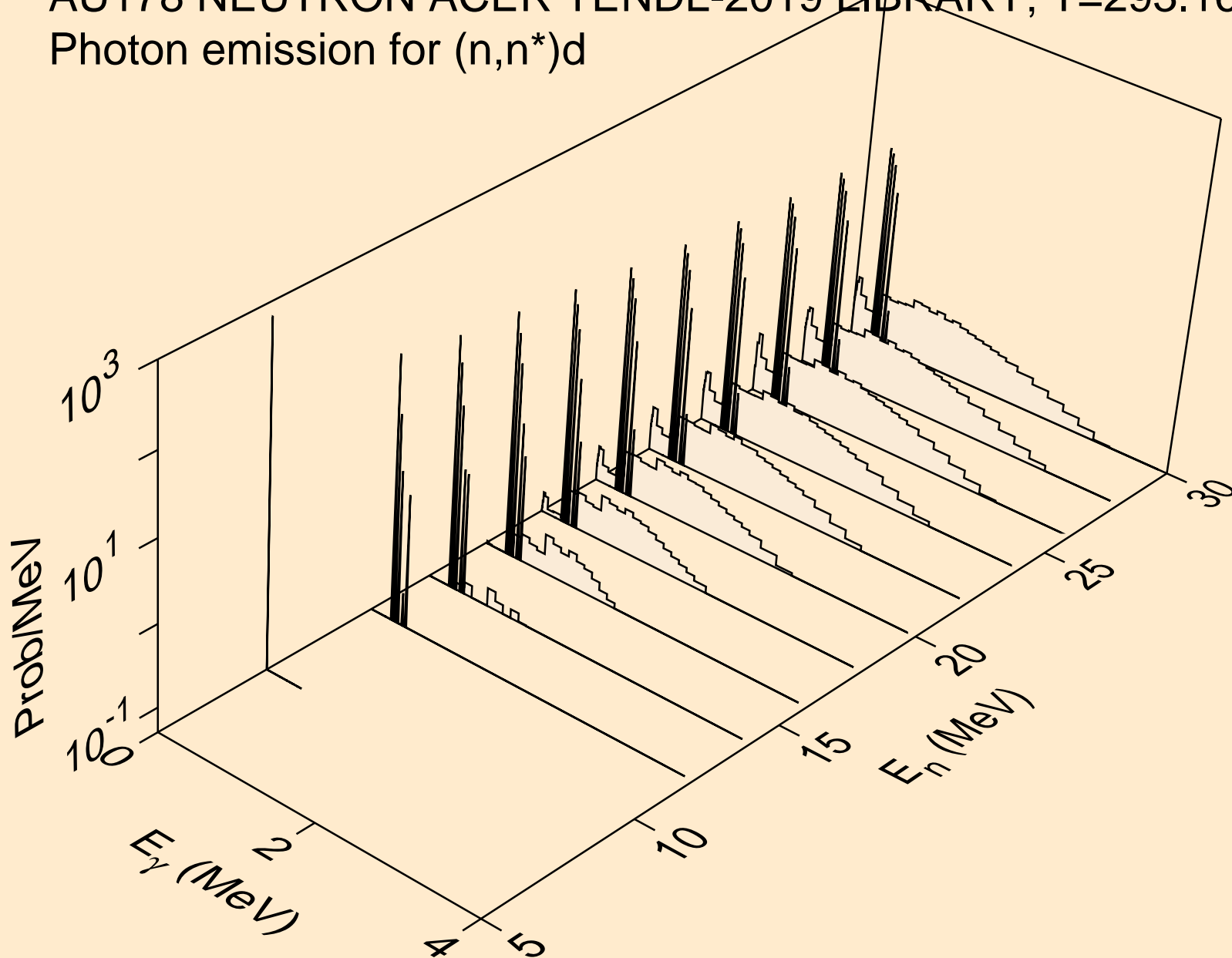

AU178 NEUTRON ACER TENDL-2019 LIBRARY; T=293.16K
Photon emission for (n,n*)t

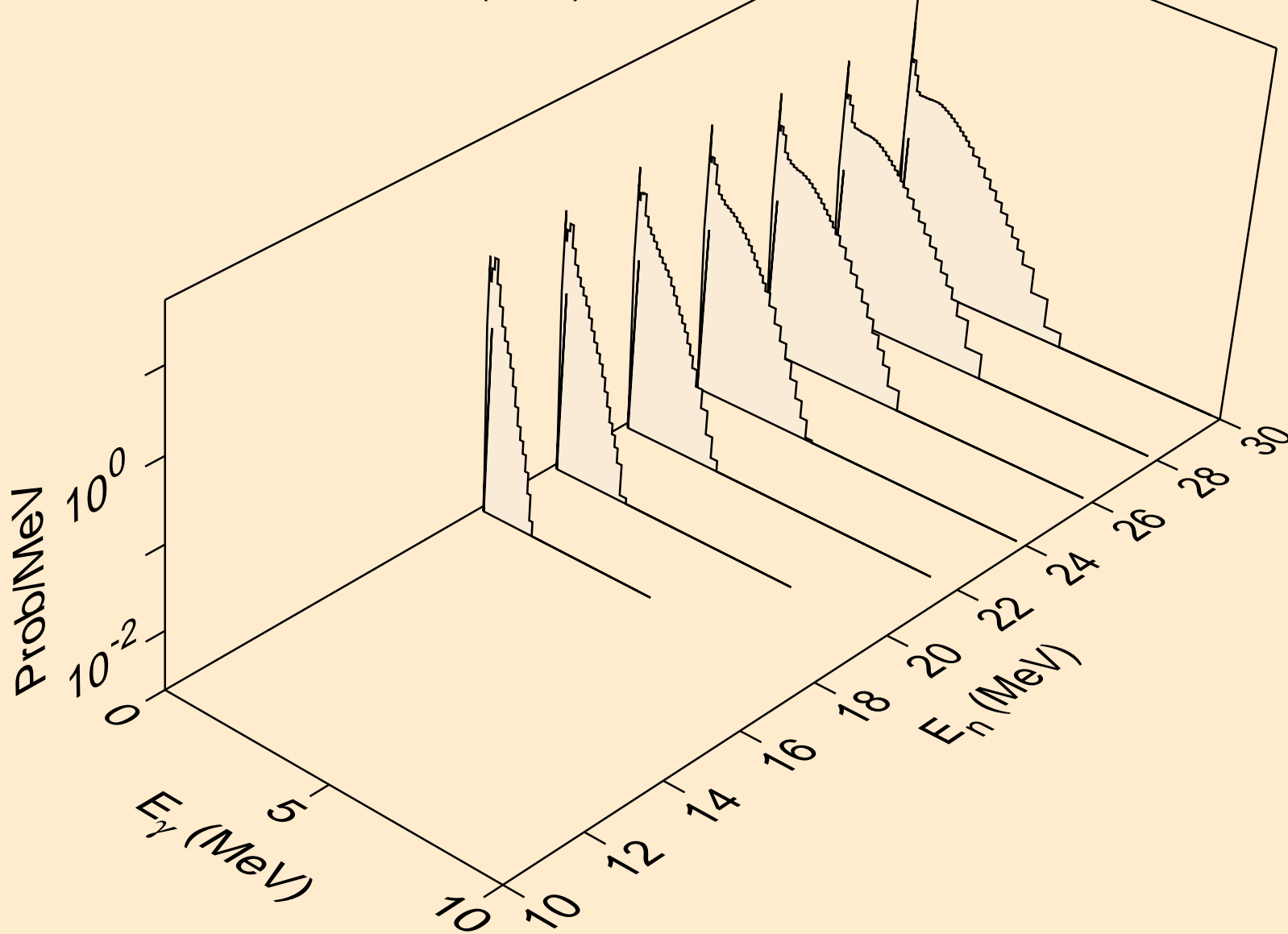

AU178 NEUTRON ACER TENDL-2019 LIBRARY; T=293.16K
Photon emission for (n,n*)he3

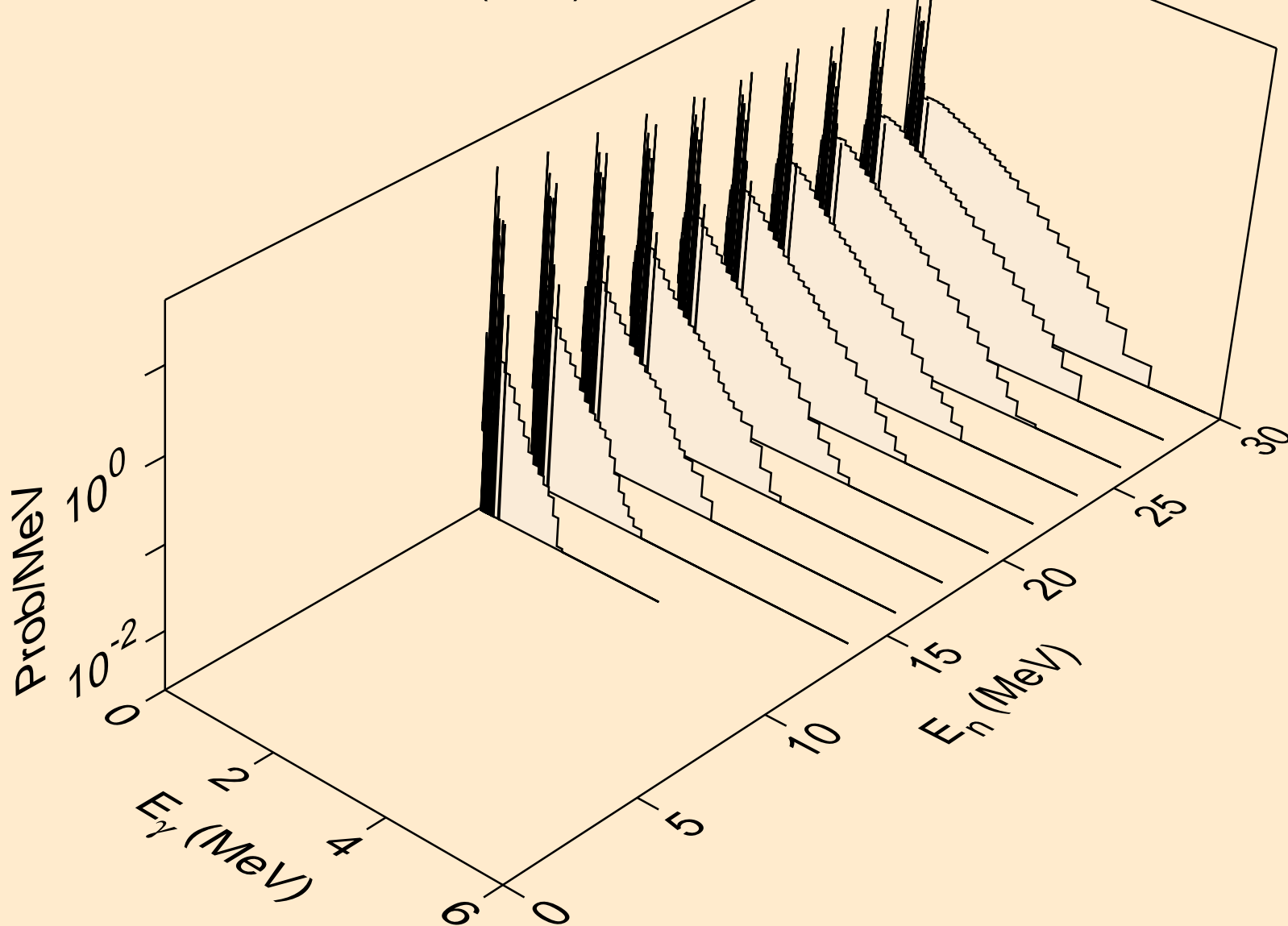

AU178 NEUTRON ACER TENDL-2019 LIBRARY; T=293.16K
Photon emission for (n,4n)

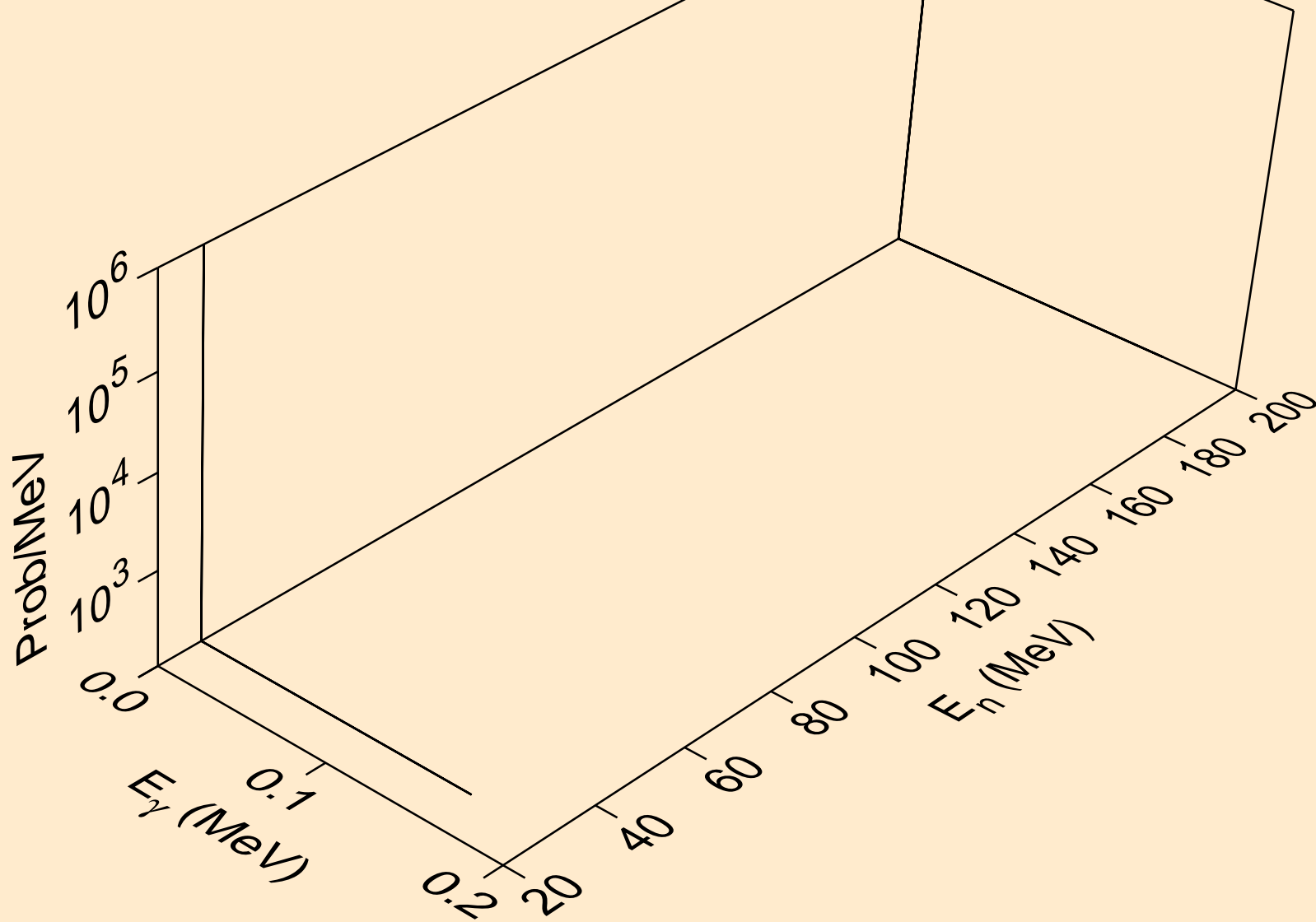

AU178 NEUTRON ACER TENDL-2019 LIBRARY; T=293.16K
Photon emission for (n,2np)

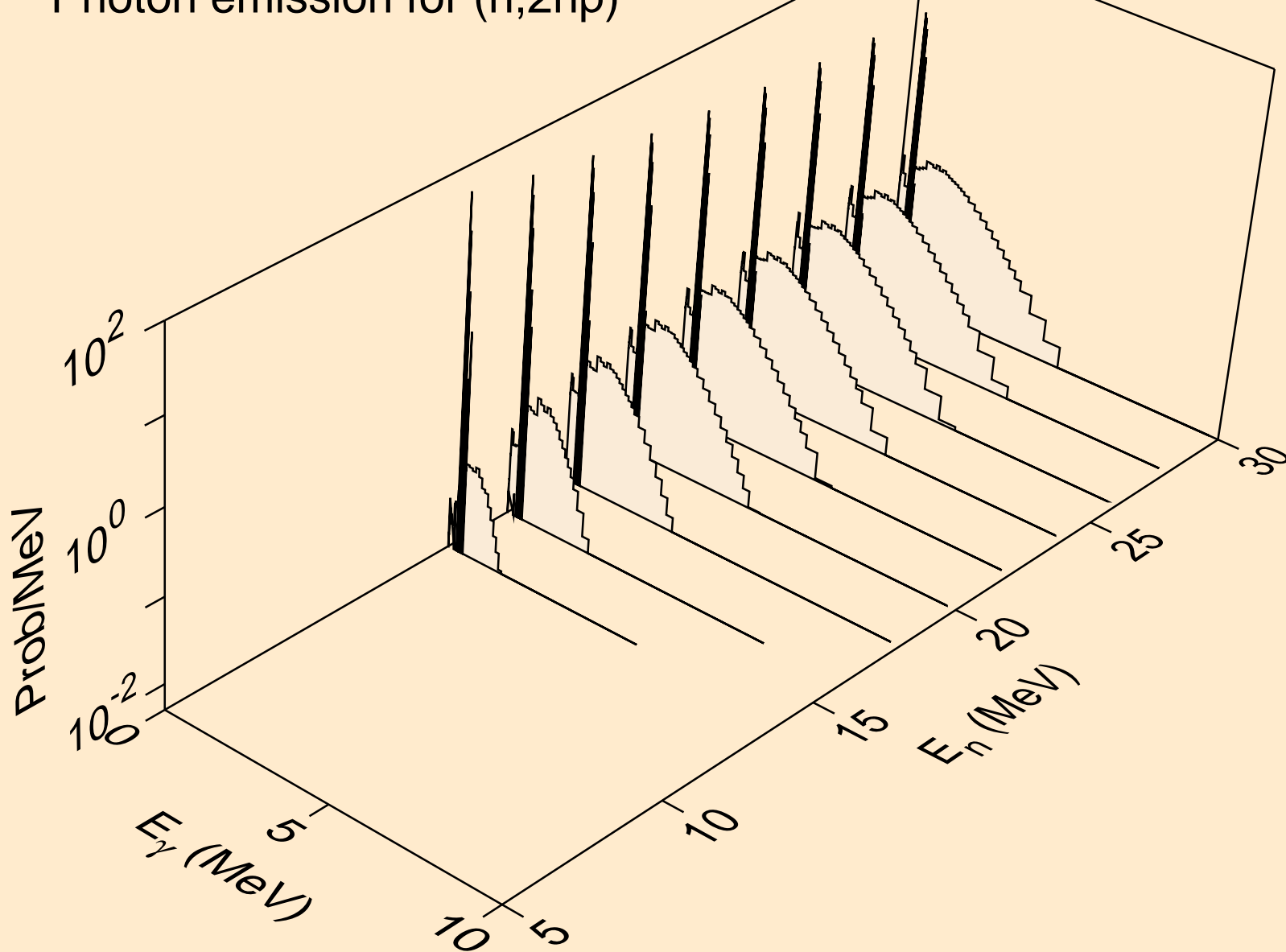

AU178 NEUTRON ACER TENDL-2019 LIBRARY; T=293.16K
Photon emission for (n,3np)

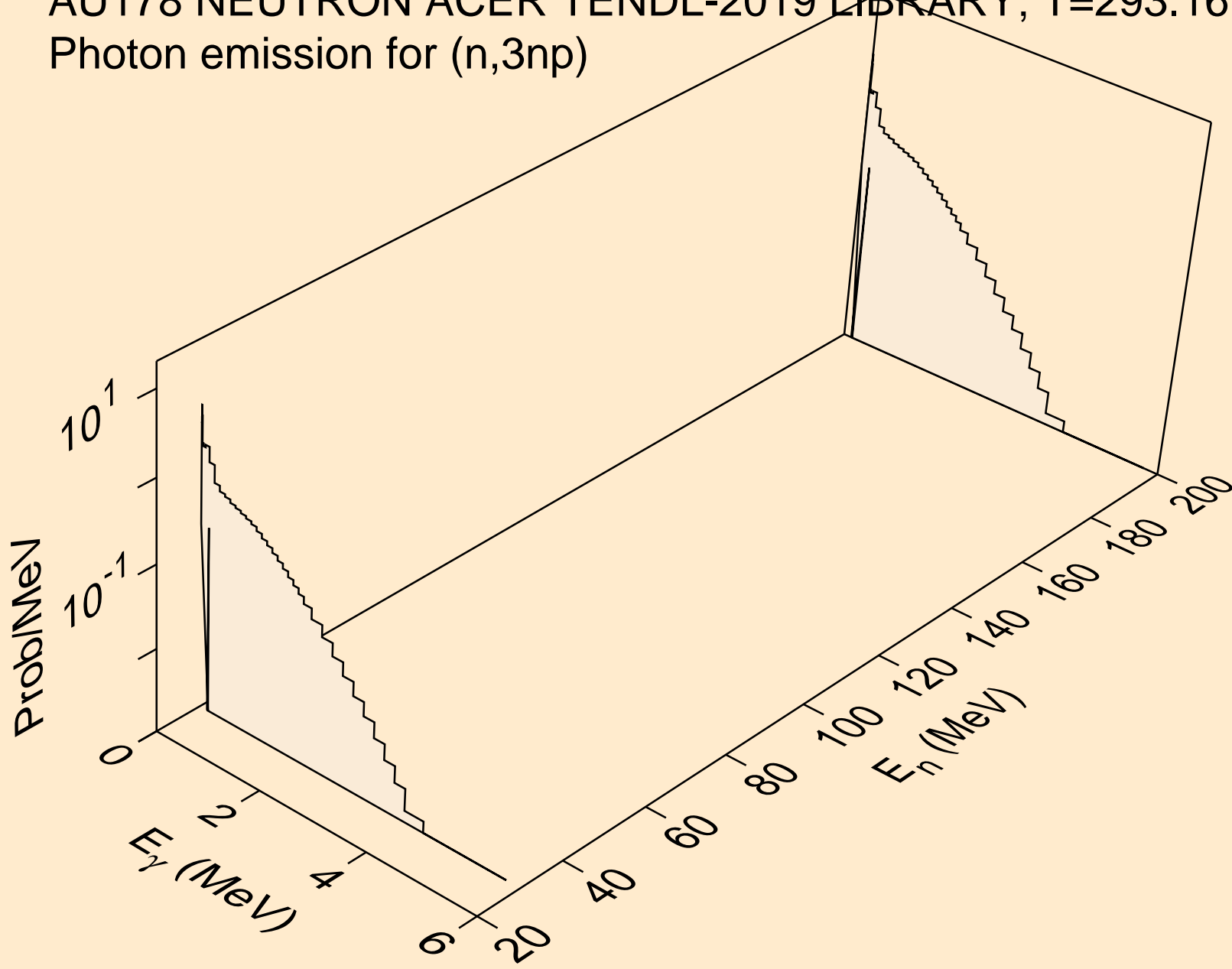

AU178 NEUTRON ACER TENDL-2019 LIBRARY; T=293.16K
Photon emission for (n,2np)

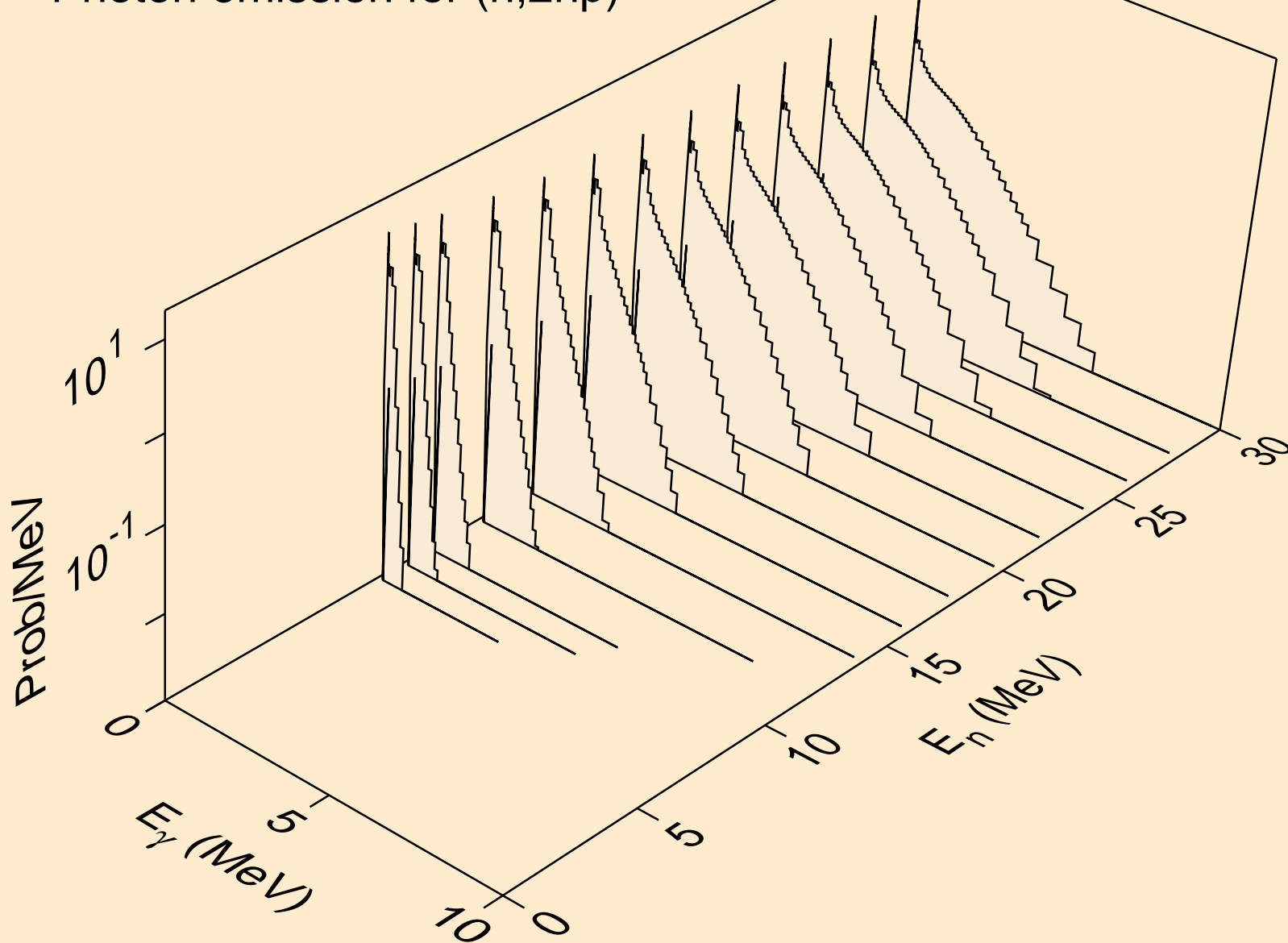

AU178 NEUTRON ACER TENDL-2019 LIBRARY; T=293.16K
Photon emission for (n,npa)

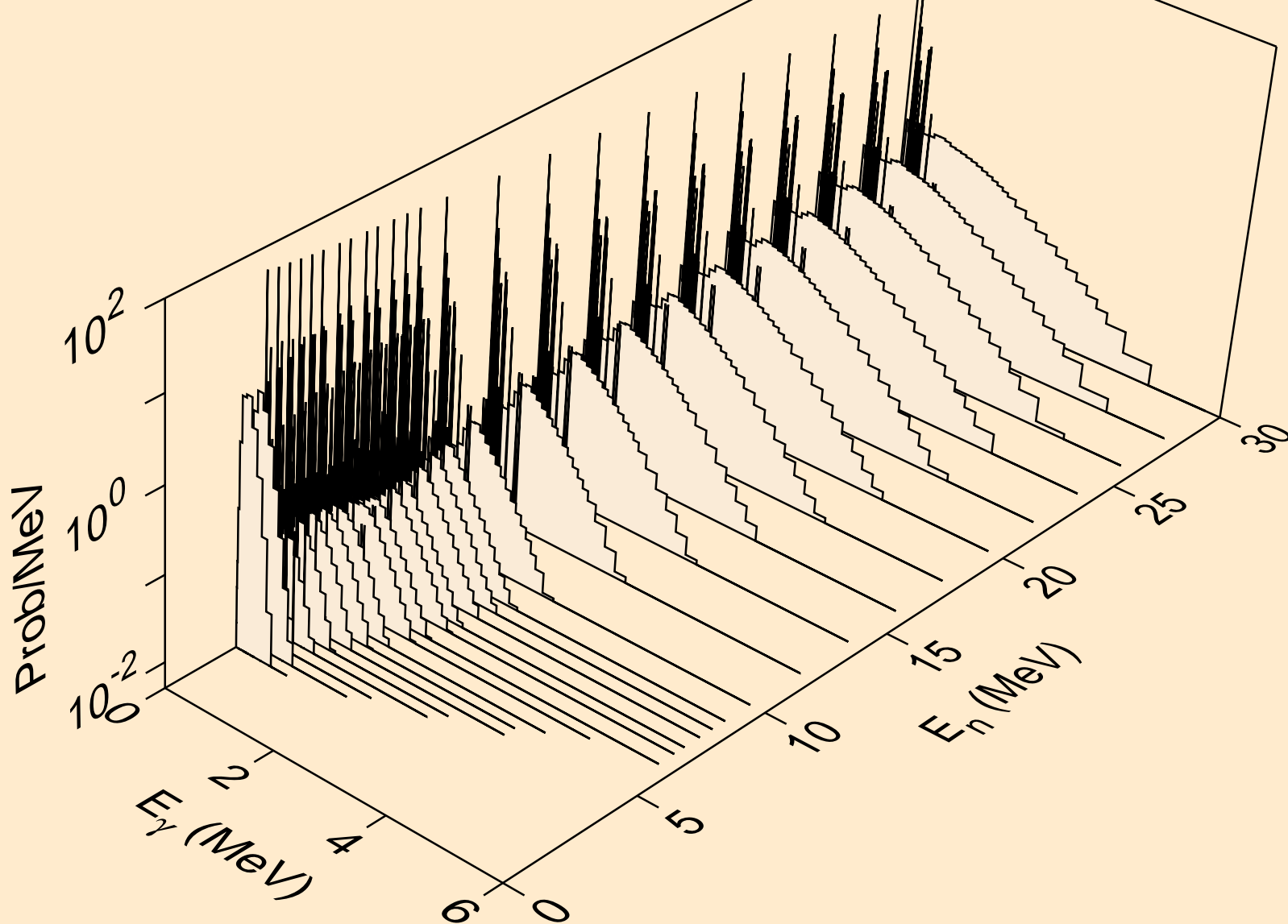

AU178 NEUTRON ACER TENDL-2019 LIBRARY; T=293.16K
Photon emission for (n,n*c)

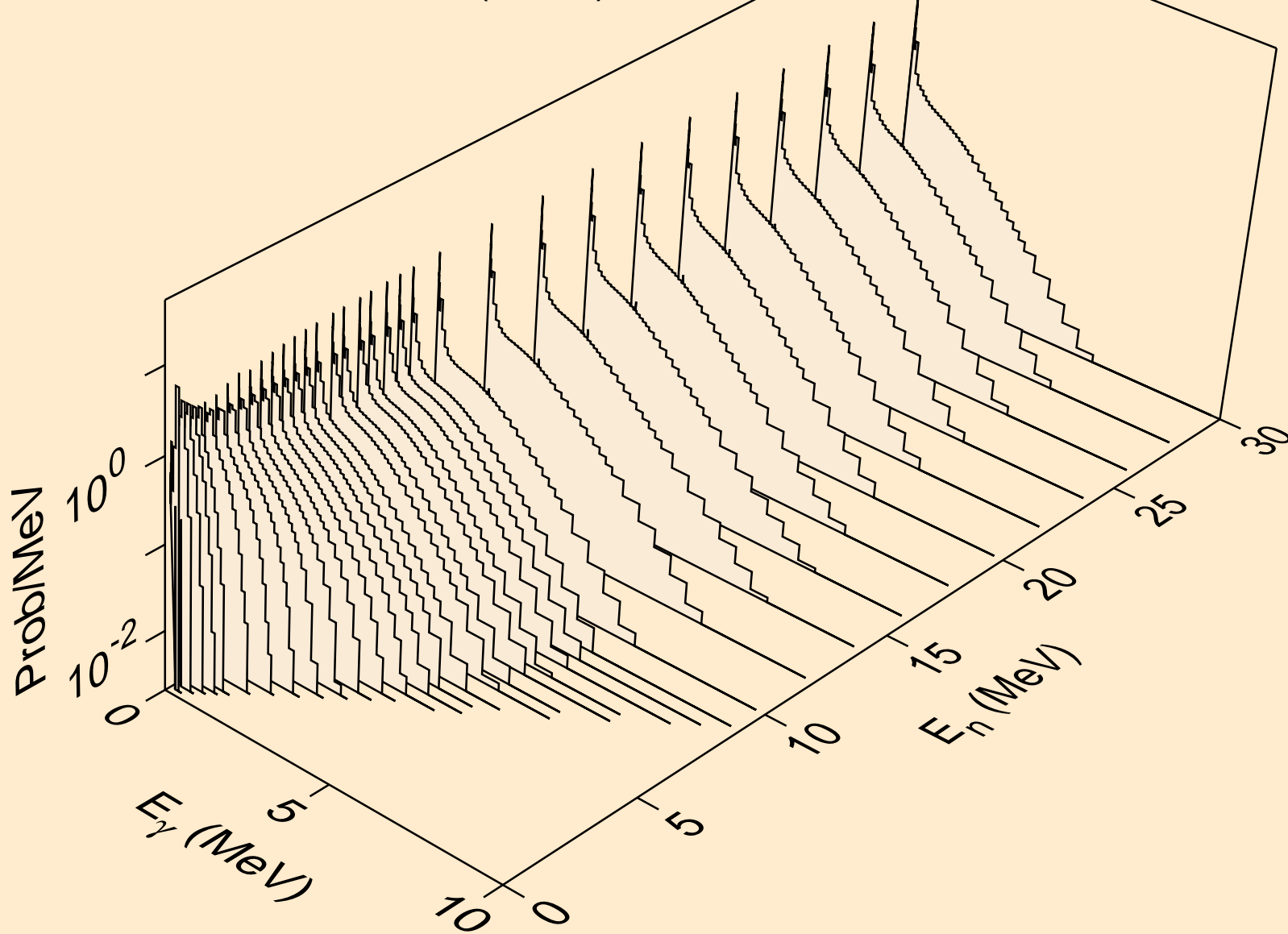

AU178 NEUTRON ACER TENDL-2019 LIBRARY; T=293.16K
Photon emission for (n,gma)

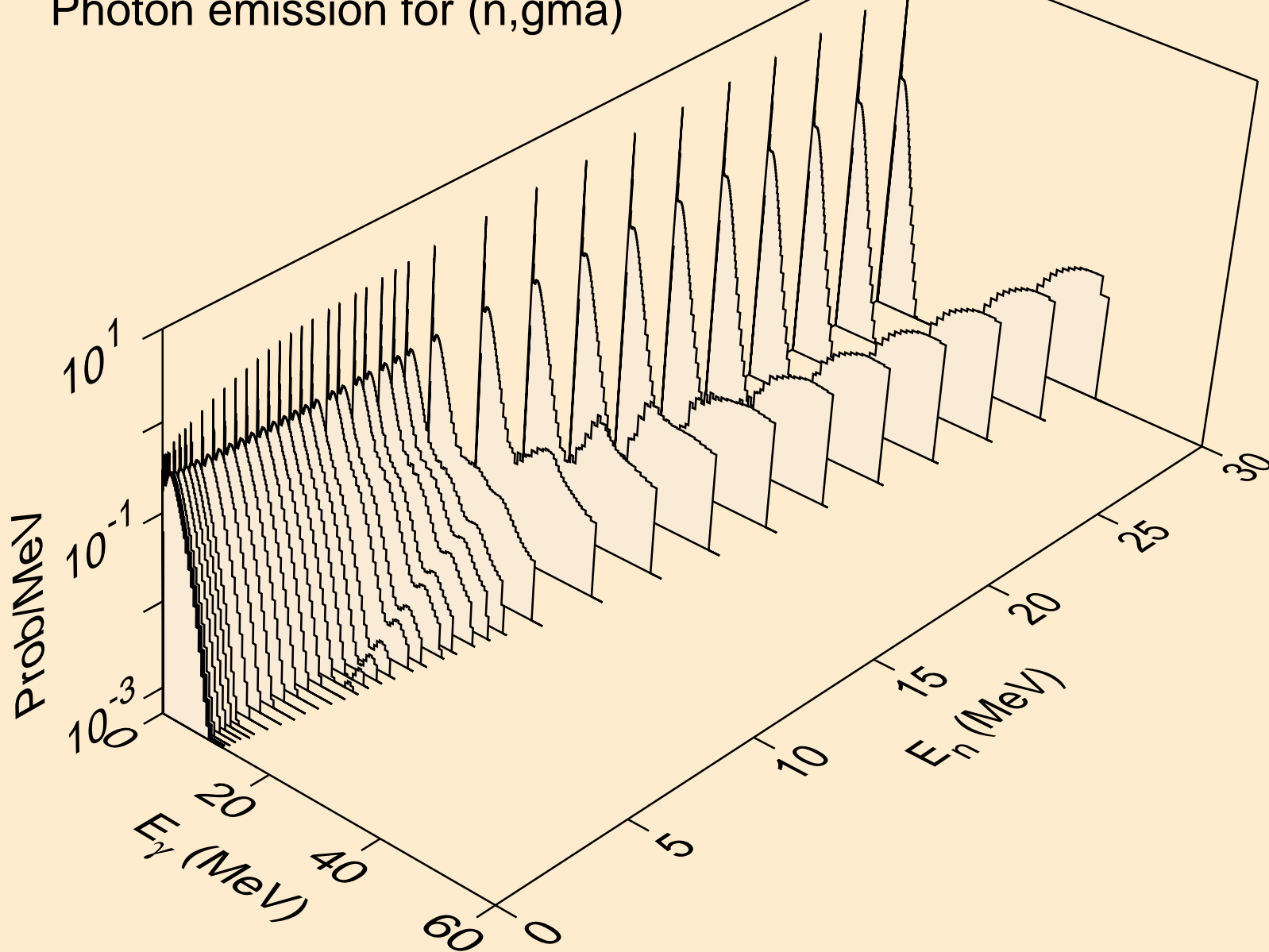

AU178 NEUTRON ACER TENDL-2019 LIBRARY; T=293.16K
Photon emission for (n,p)

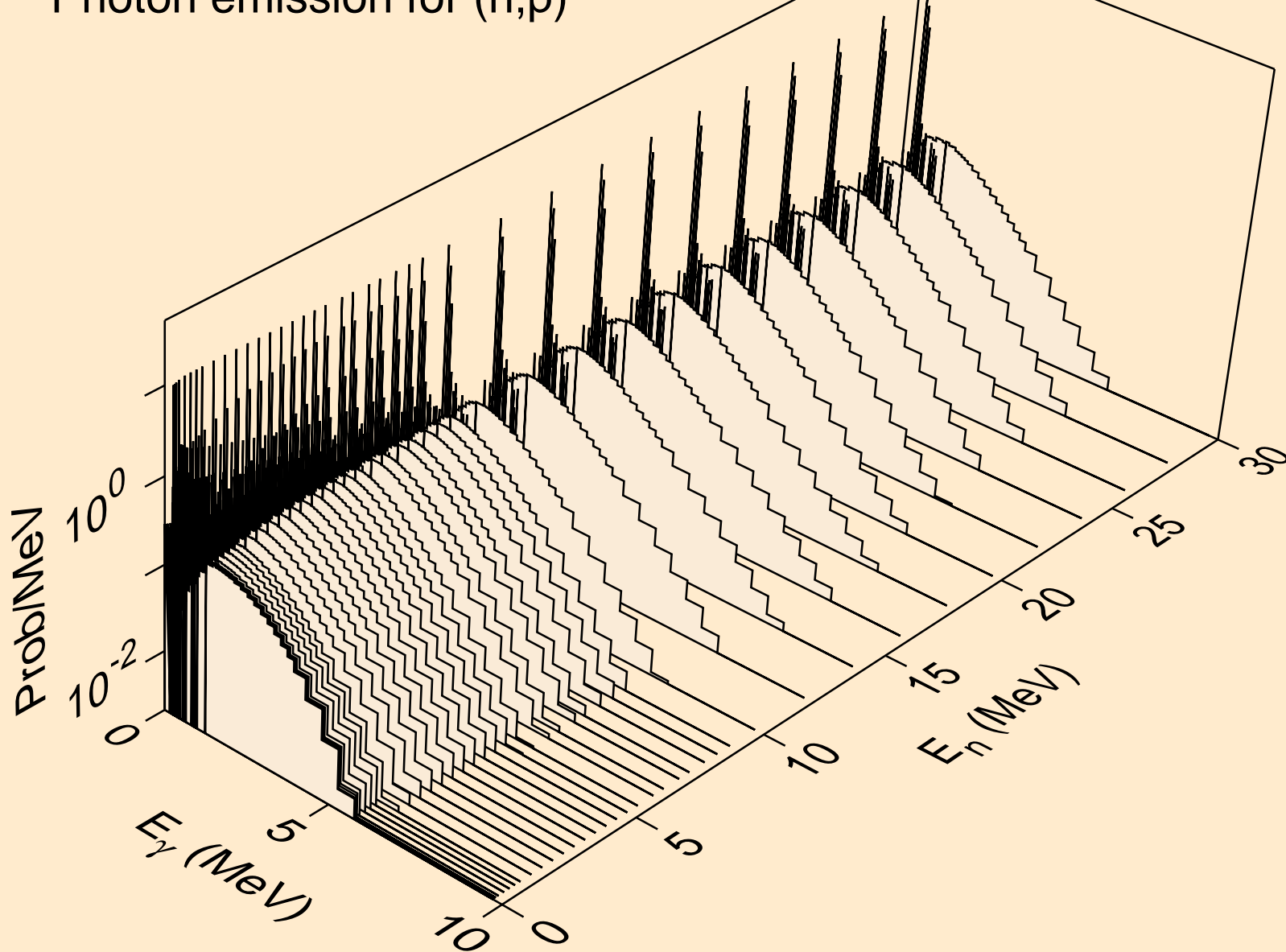

AU178 NEUTRON ACER TENDL-2019 LIBRARY; T=293.16K
Photon emission for (n,d)

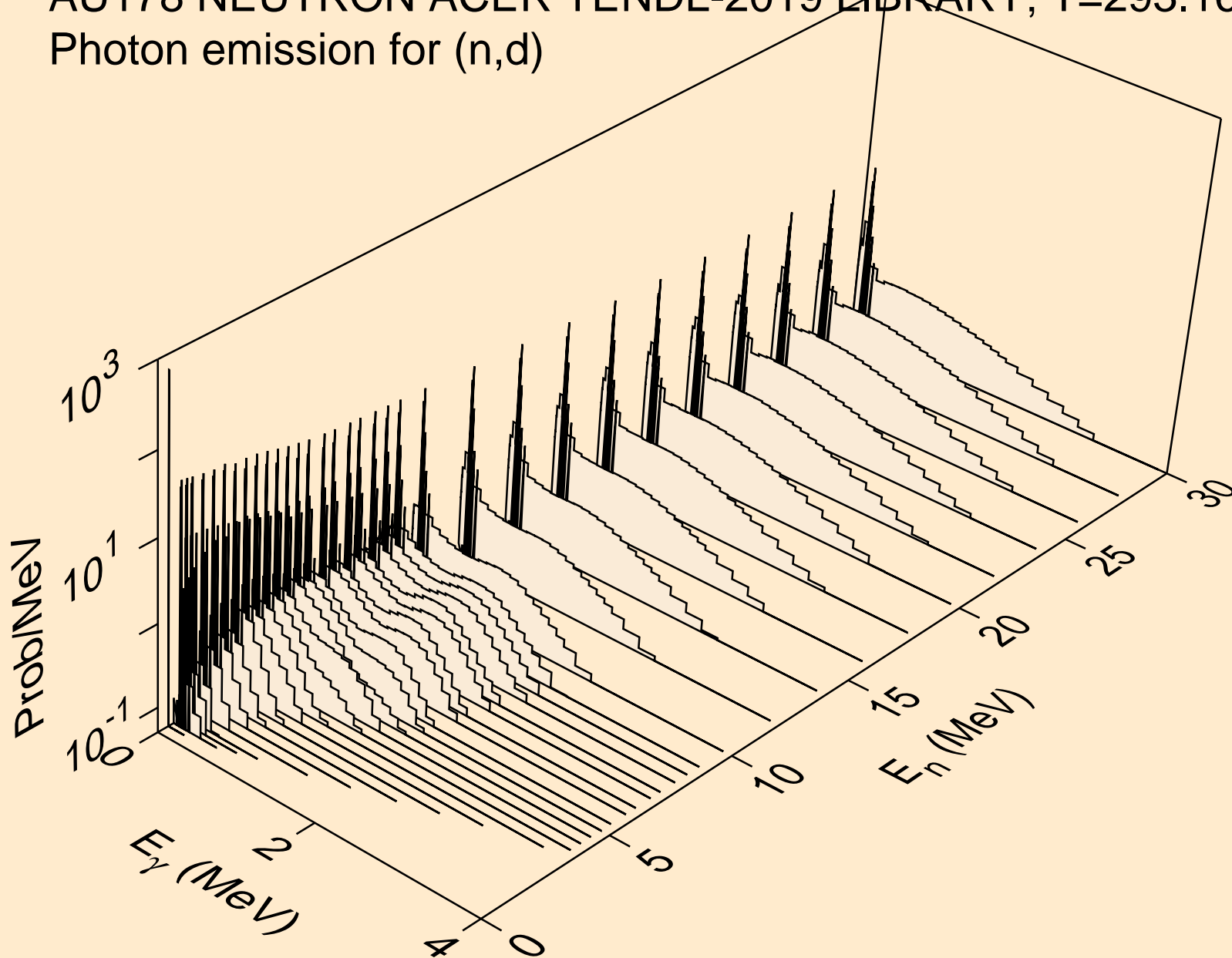

AU178 NEUTRON ACER TENDL-2019 LIBRARY; T=293.16K
Photon emission for (n,t)

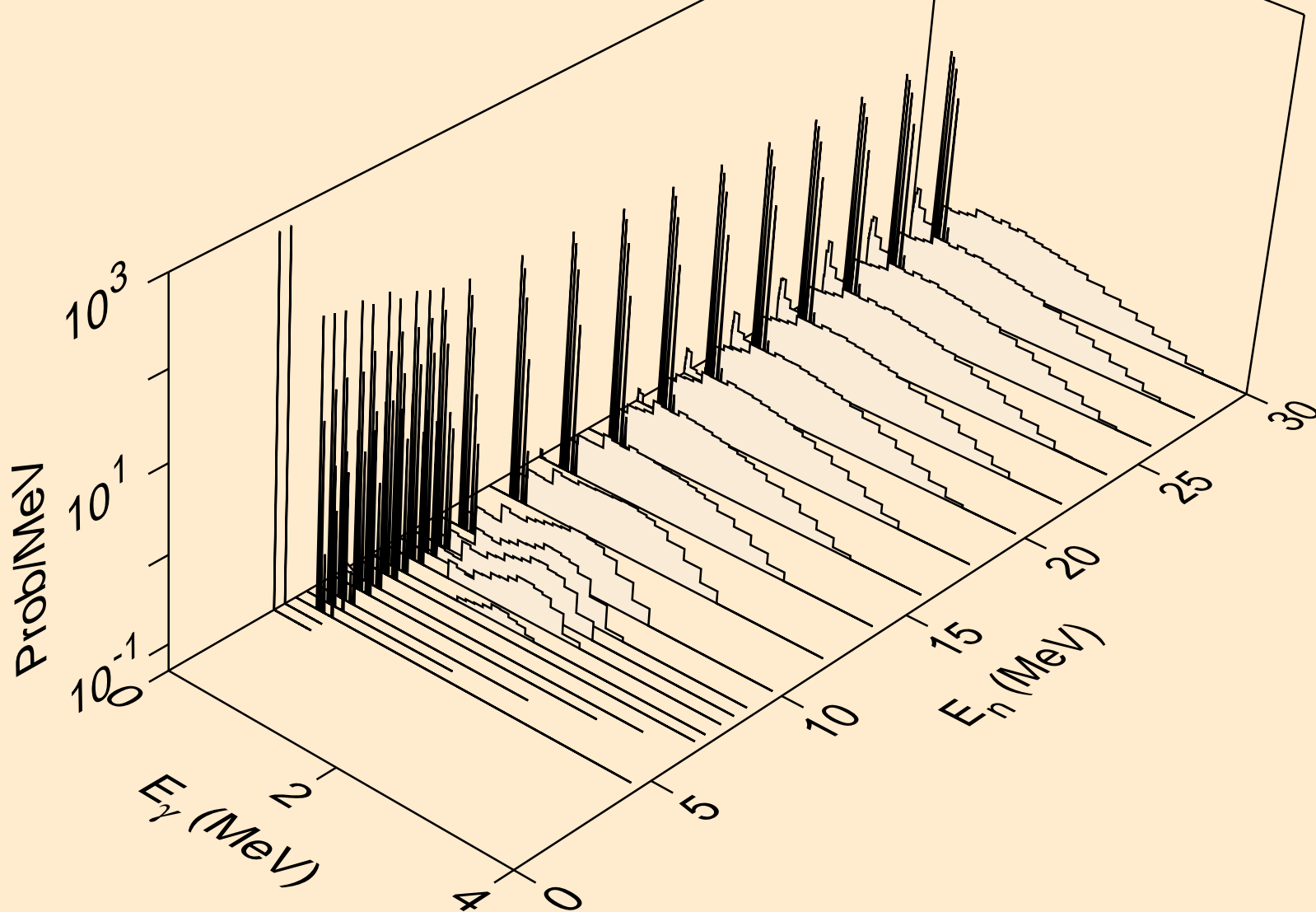

AU178 NEUTRON ACER TENDL-2019 LIBRARY; T=293.16K
Photon emission for (n,he3)

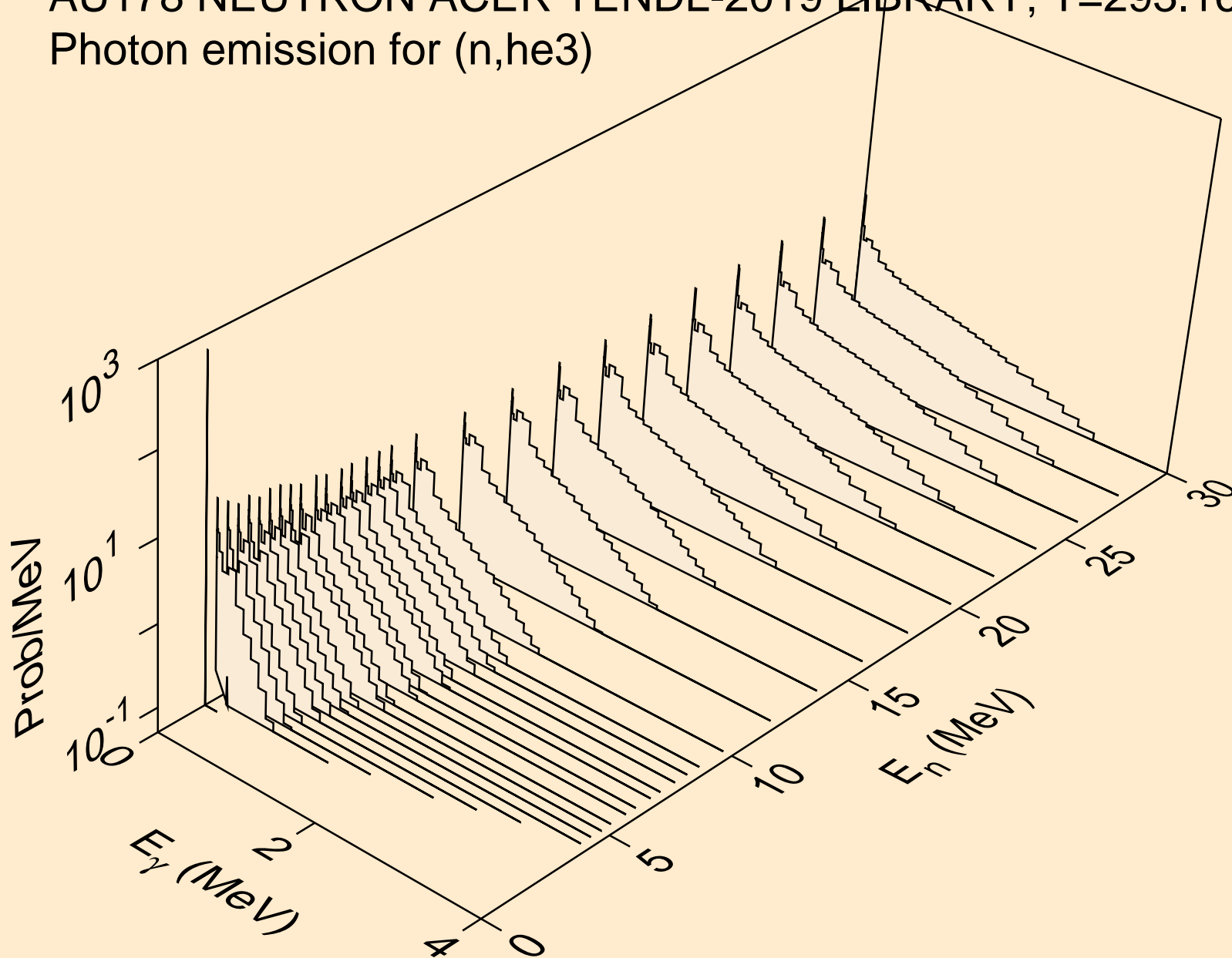

AU178 NEUTRON ACER TENDL-2019 LIBRARY; T=293.16K
Photon emission for (n,a)

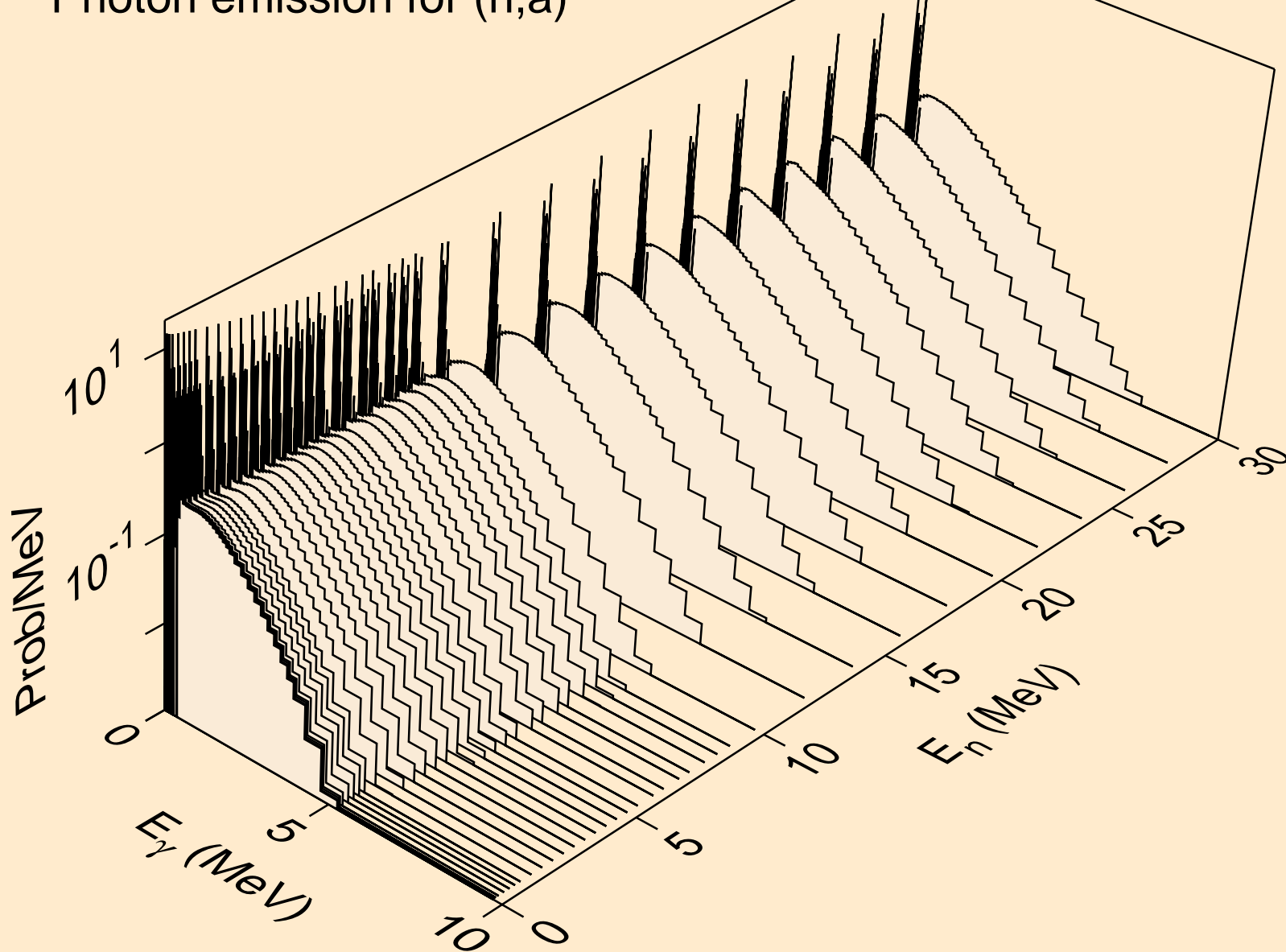

AU178 NEUTRON ACER TENDL-2019 LIBRARY; T=293.16K
Photon emission for (n,2a)

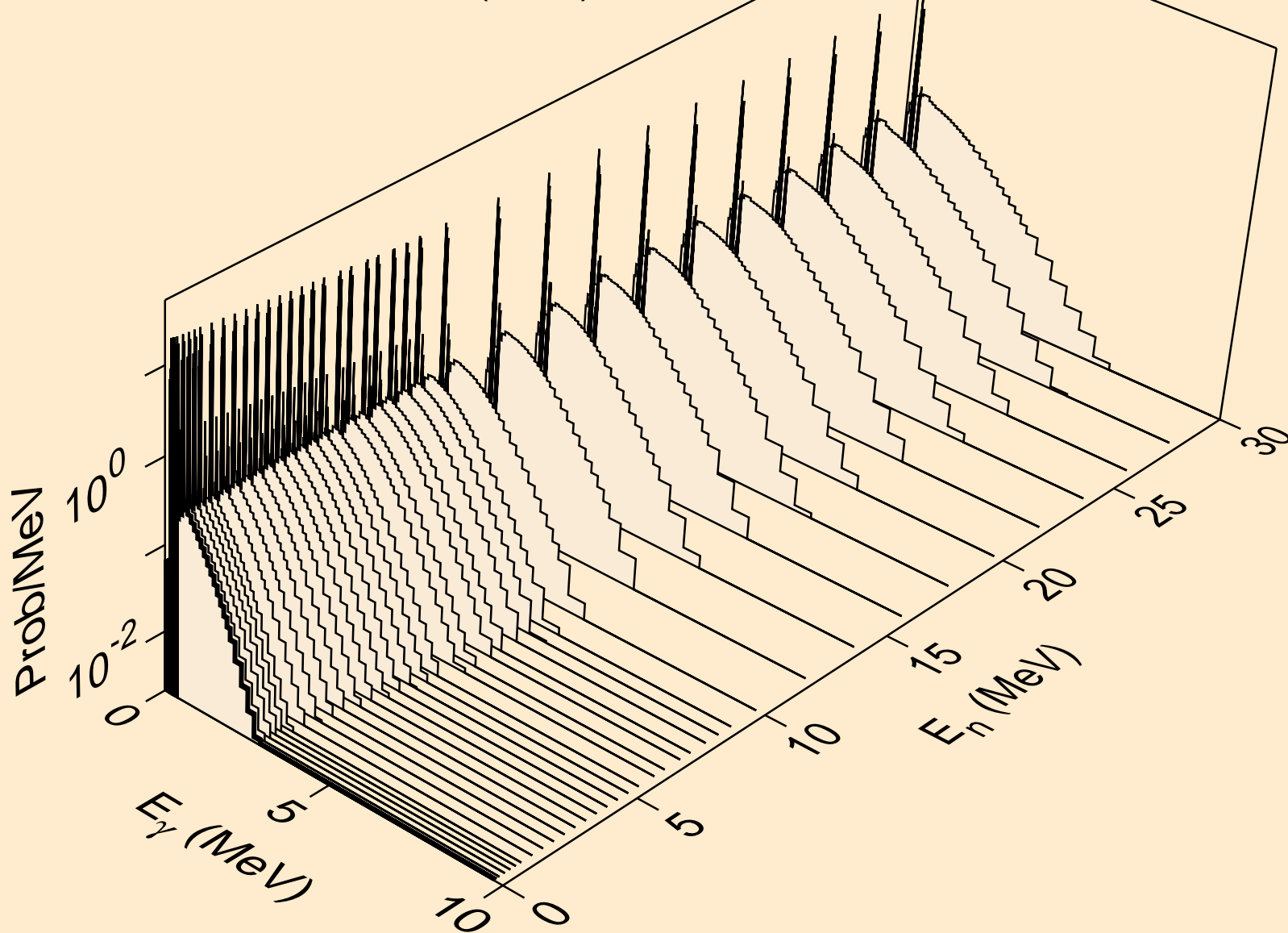

AU178 NEUTRON ACER TENDL-2019 LIBRARY; T=293.16K
Photon emission for (n,3a)

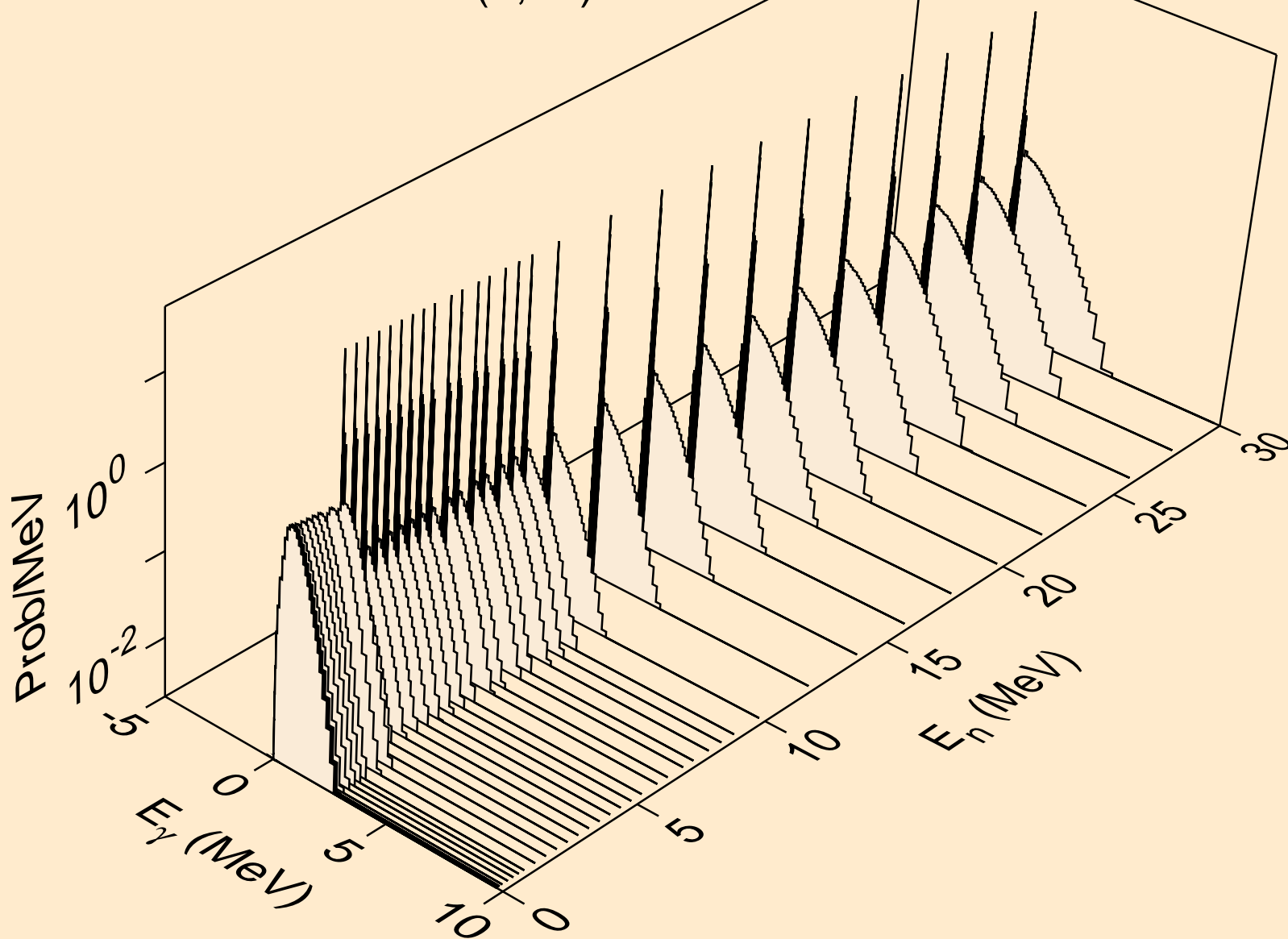

AU178 NEUTRON ACER TENDL-2019 LIBRARY; T=293.16K
Photon emission for (n,2p)

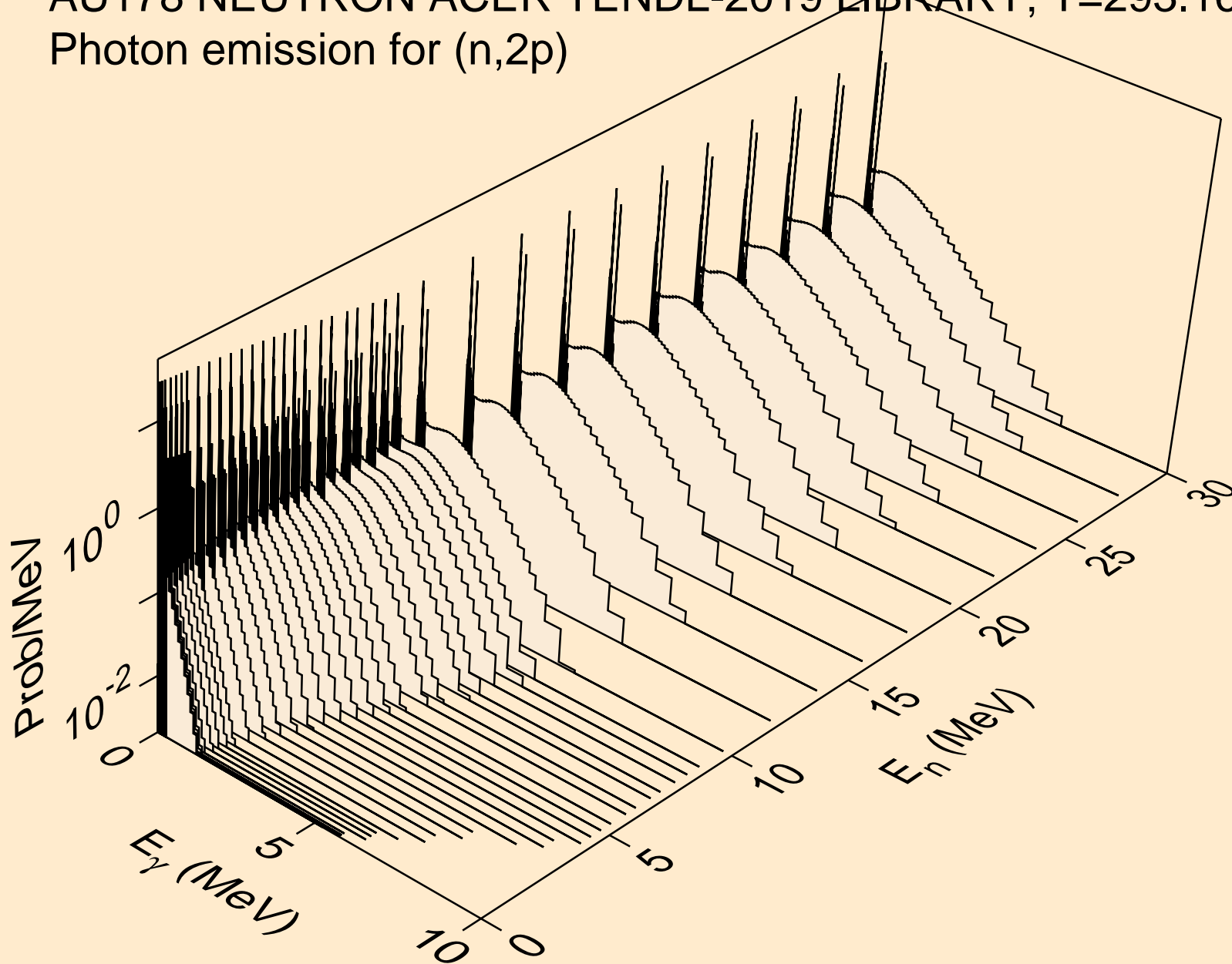

AU178 NEUTRON ACER TENDL-2019 LIBRARY; T=293.16K
Photon emission for (n,p α)

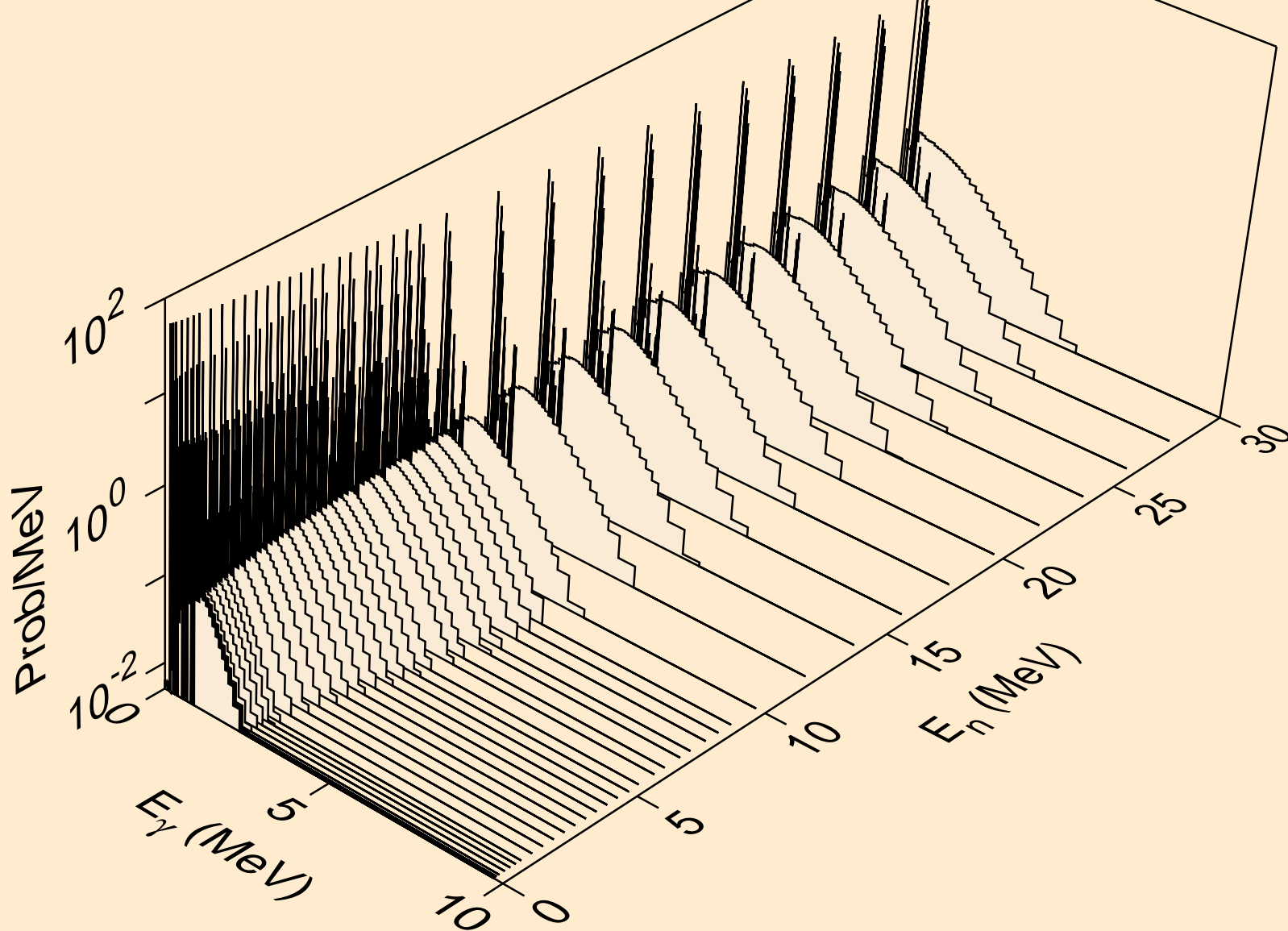

AU178 NEUTRON ACER TENDL-2019 LIBRARY; T=293.16K
Photon emission for (n,t2a)

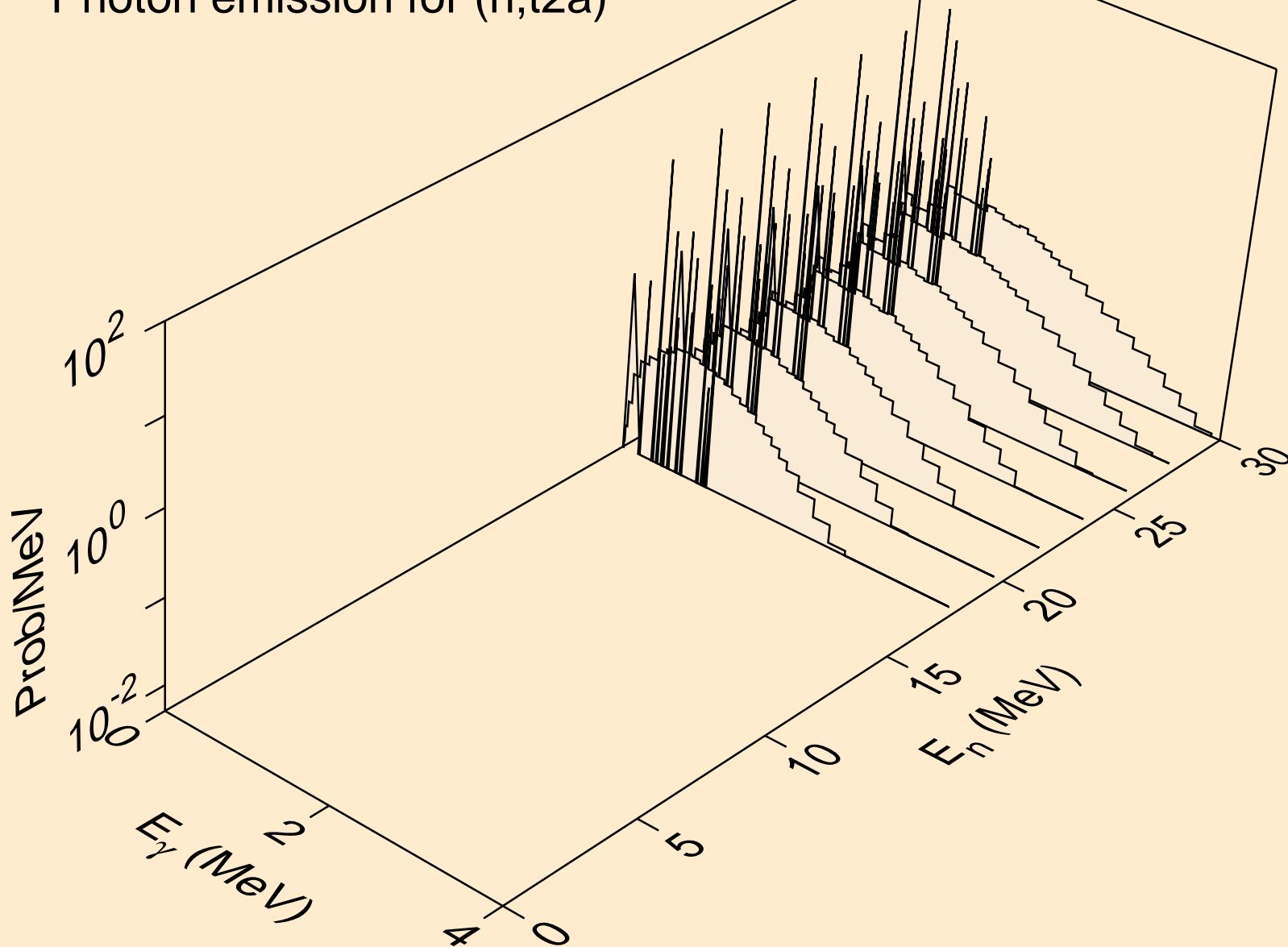

AU178 NEUTRON ACER TENDL-2019 LIBRARY; T=293.16K
Photon emission for (n,d2a)

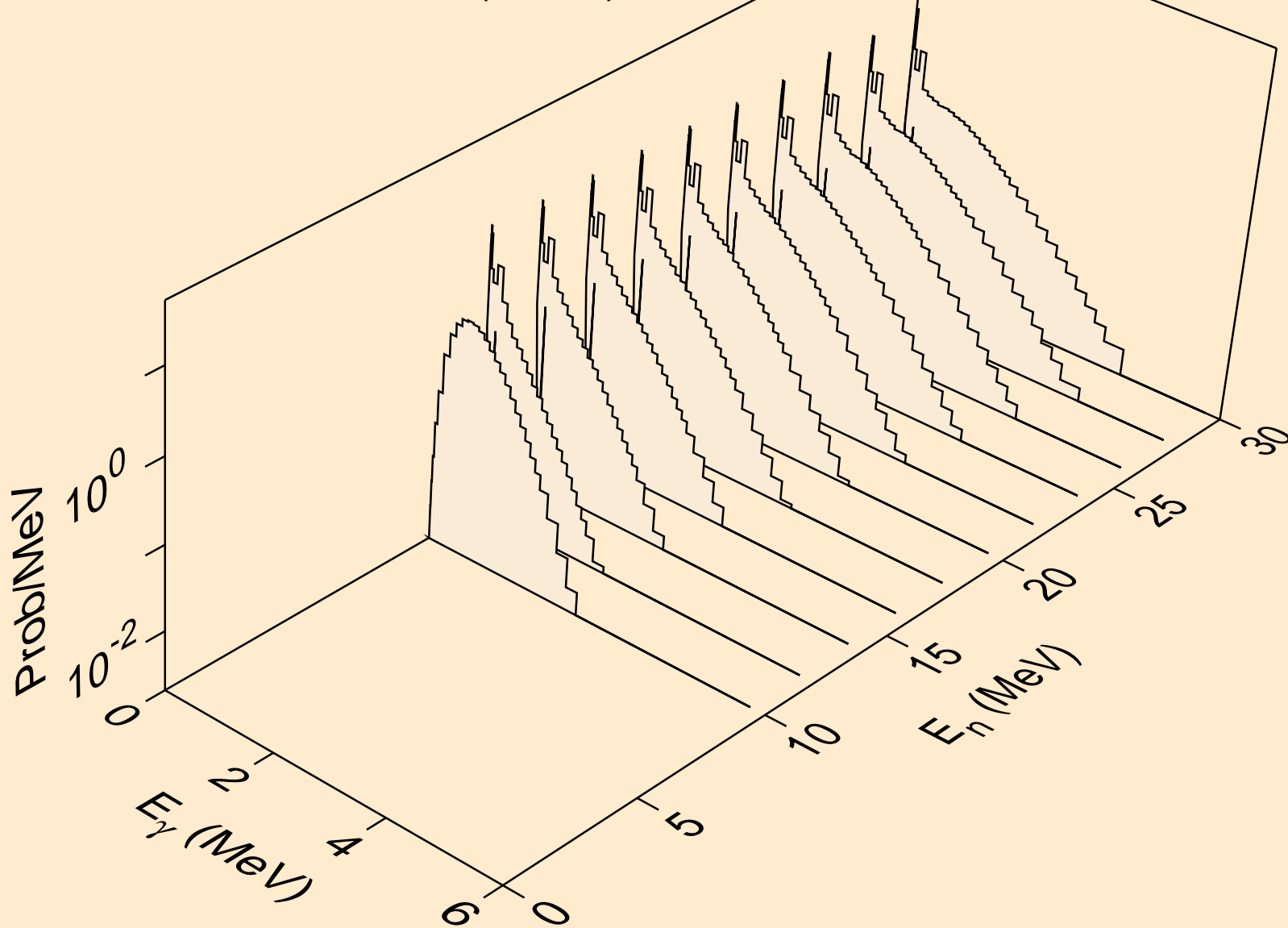

AU178 NEUTRON ACER TENDL-2019 LIBRARY; T=293.16K
Photon emission for (n,pd)

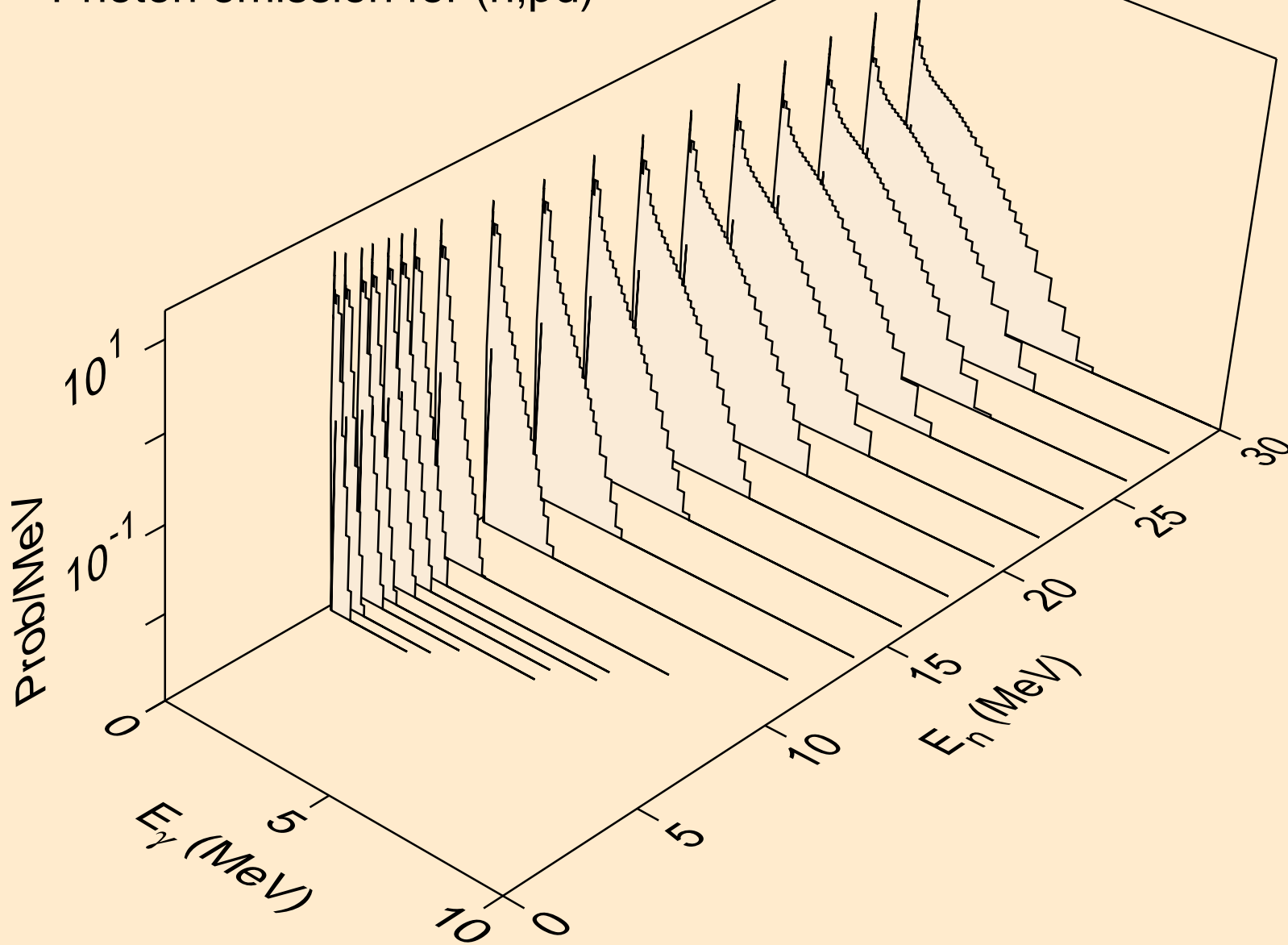

AU178 NEUTRON ACER TENDL-2019 LIBRARY; T=293.16K
Photon emission for (n,pt)

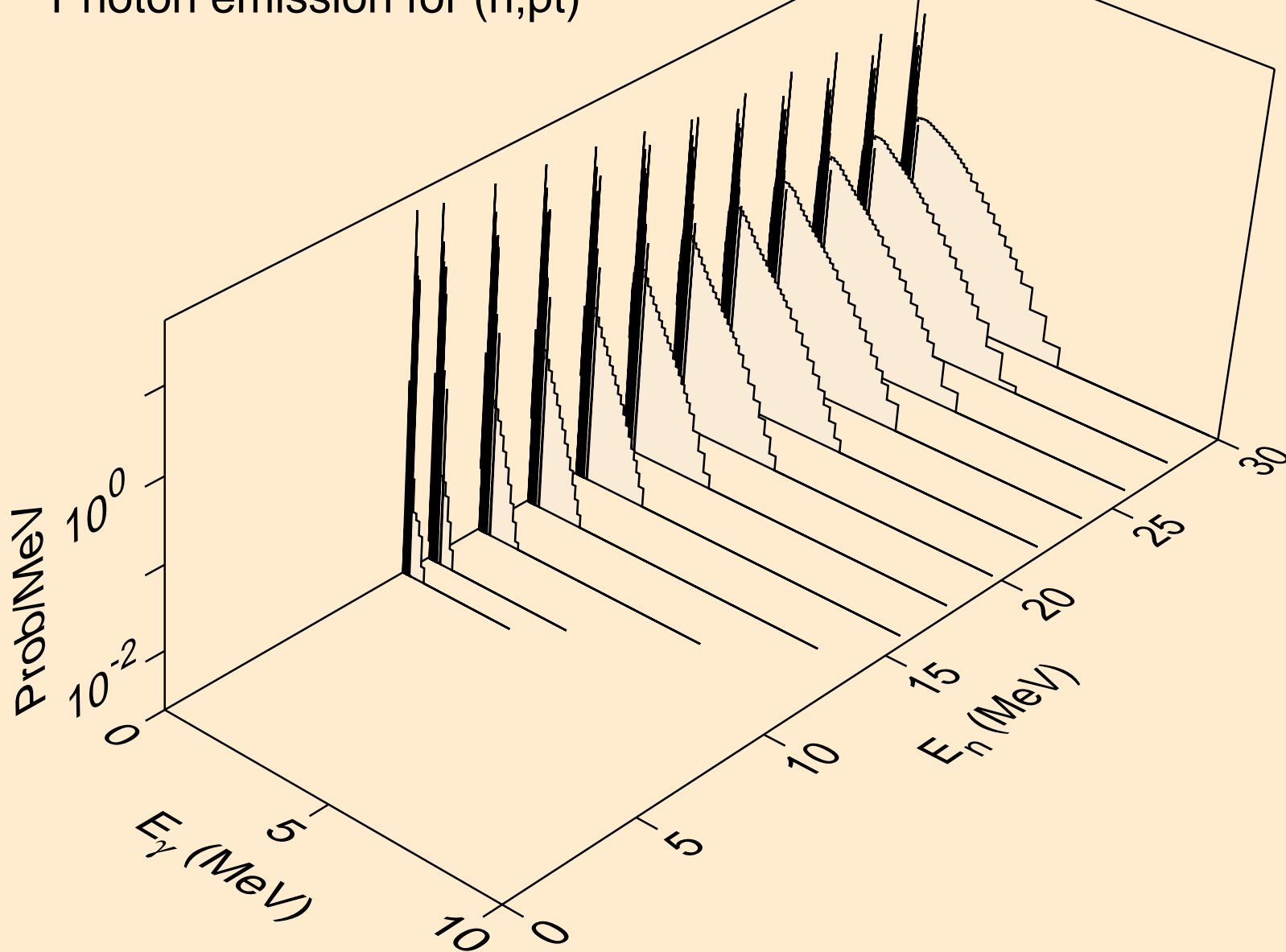

AU178 NEUTRON ACER TENDL-2019 LIBRARY; T=293.16K
Photon emission for (n,da)

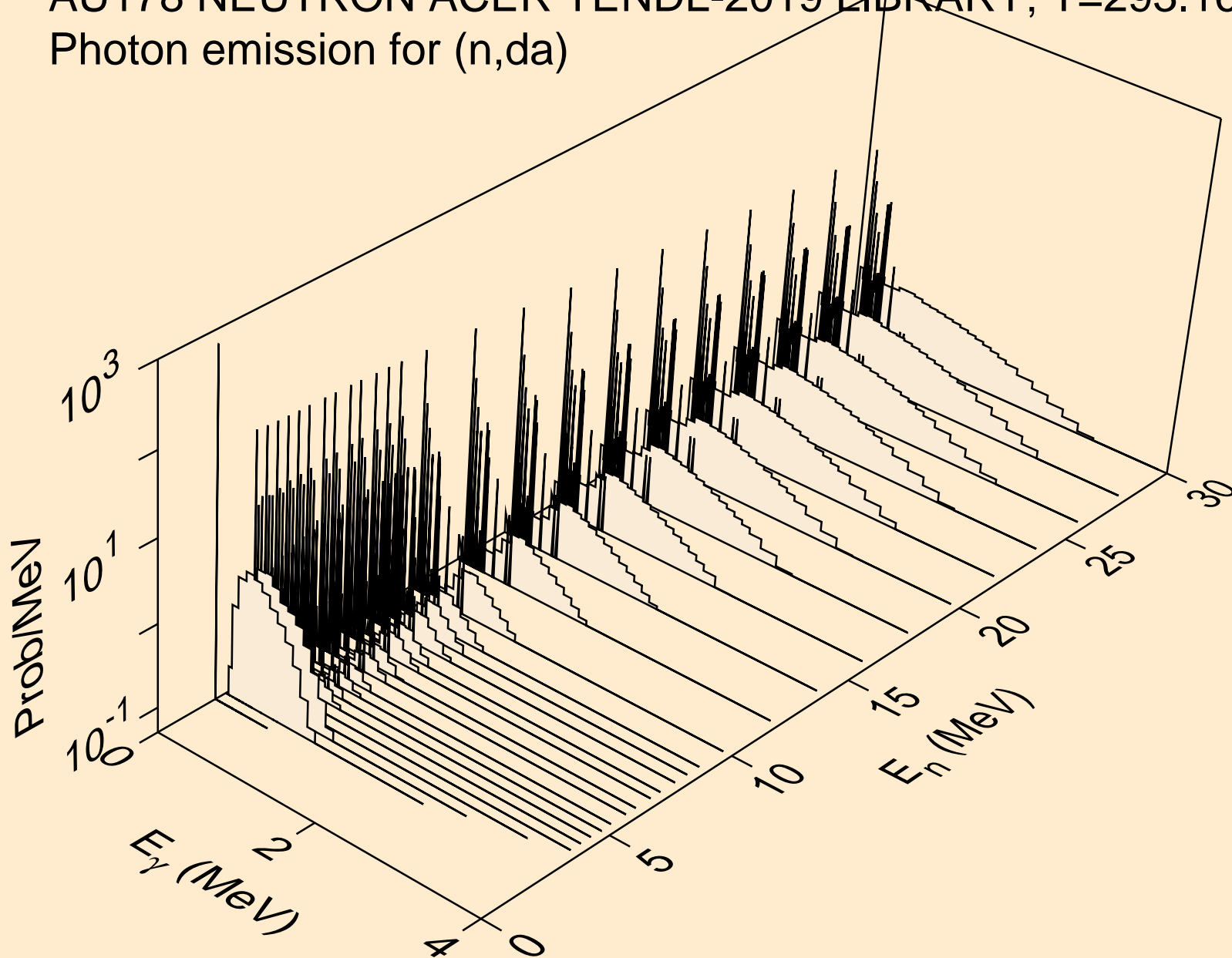

AU178 NEUTRON ACER TENDL-2019 LIBRARY; T=293.16K
thermal capture photon spectrum

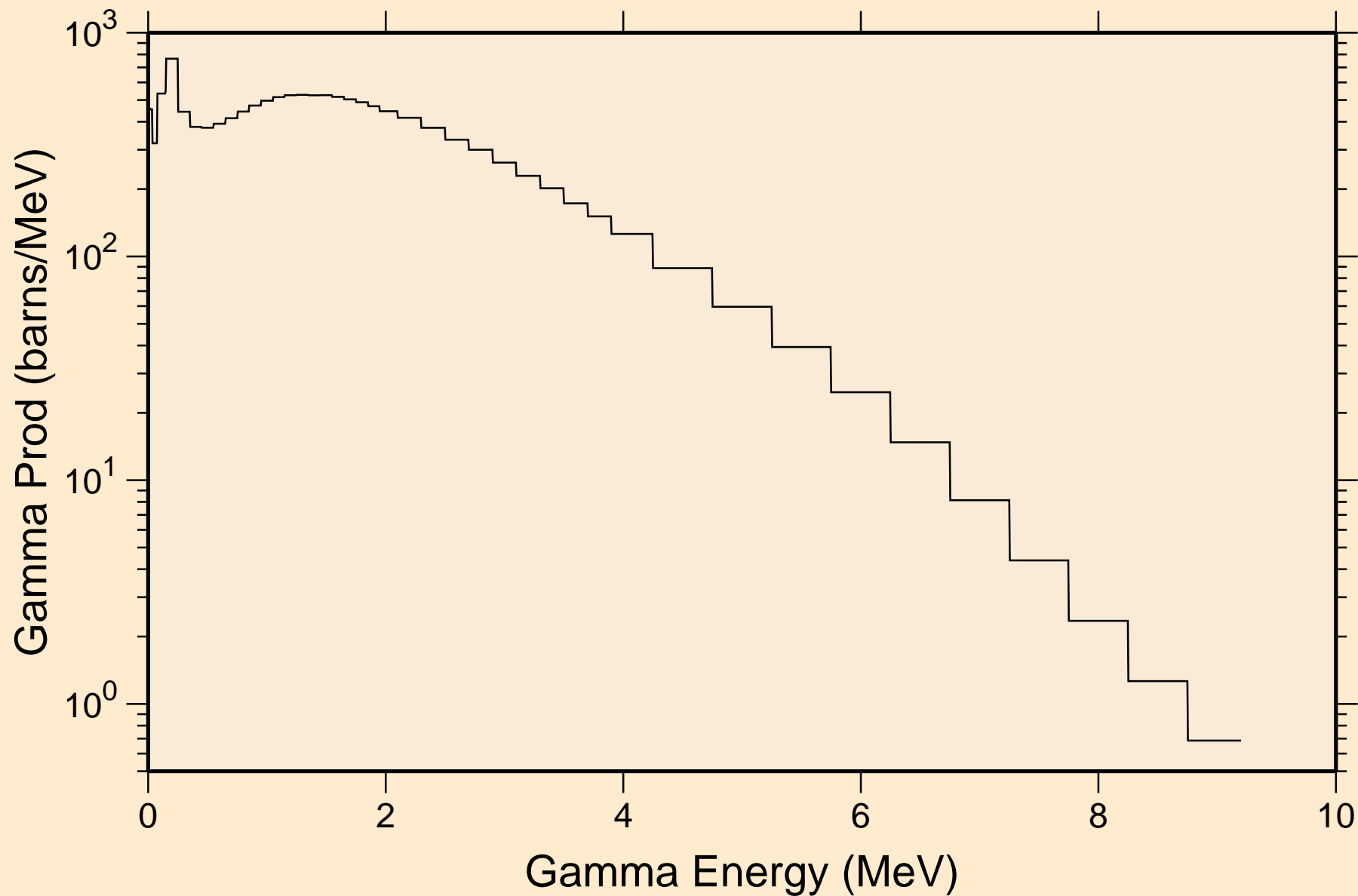

AU178 NEUTRON ACER TENDL-2019 LIBRARY; T=293.16K
14 MeV photon spectrum

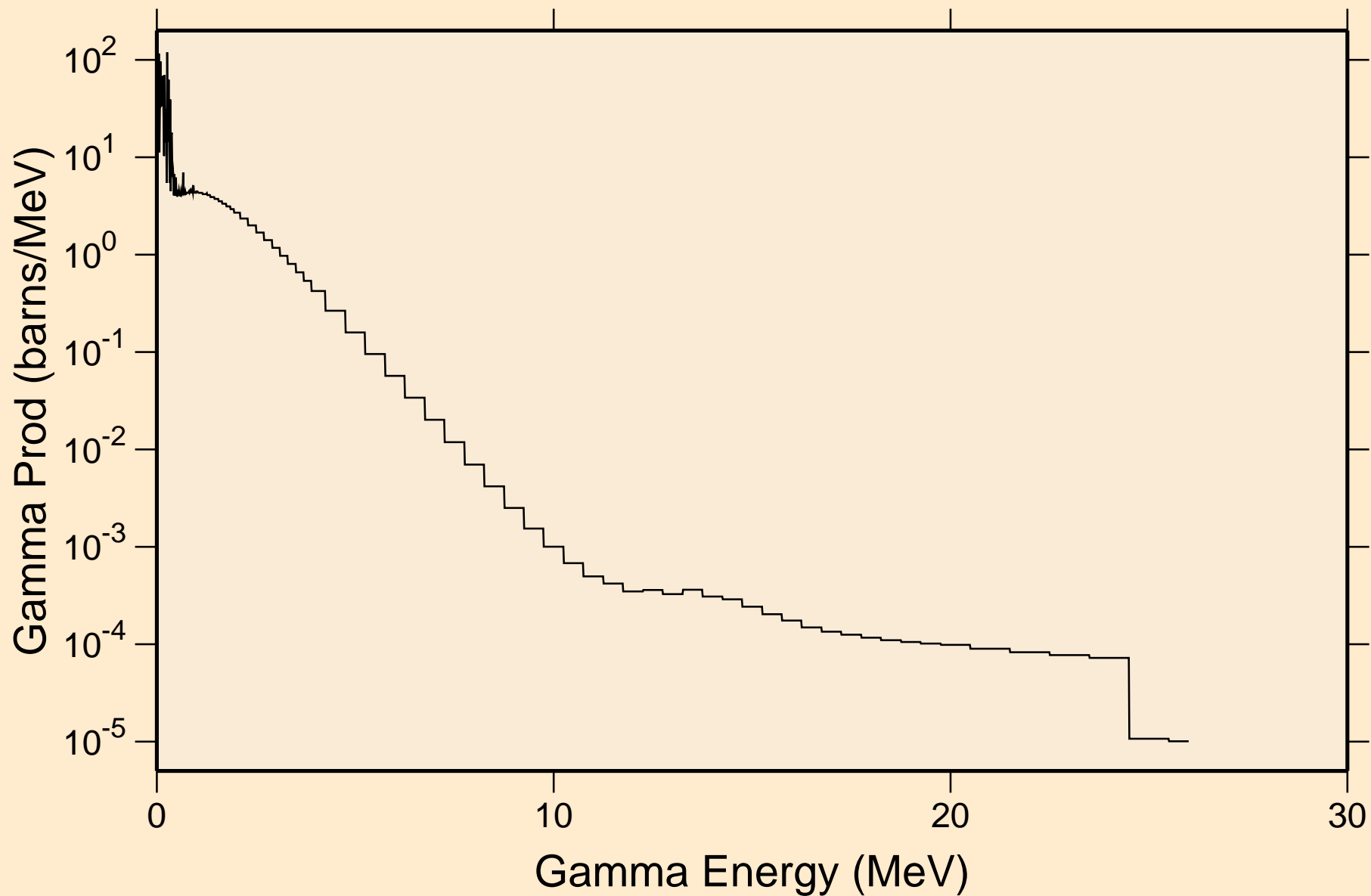

AU178 NEUTRON ACER TENDL-2019 LIBRARY; T=293.16K

Particle heating contributions

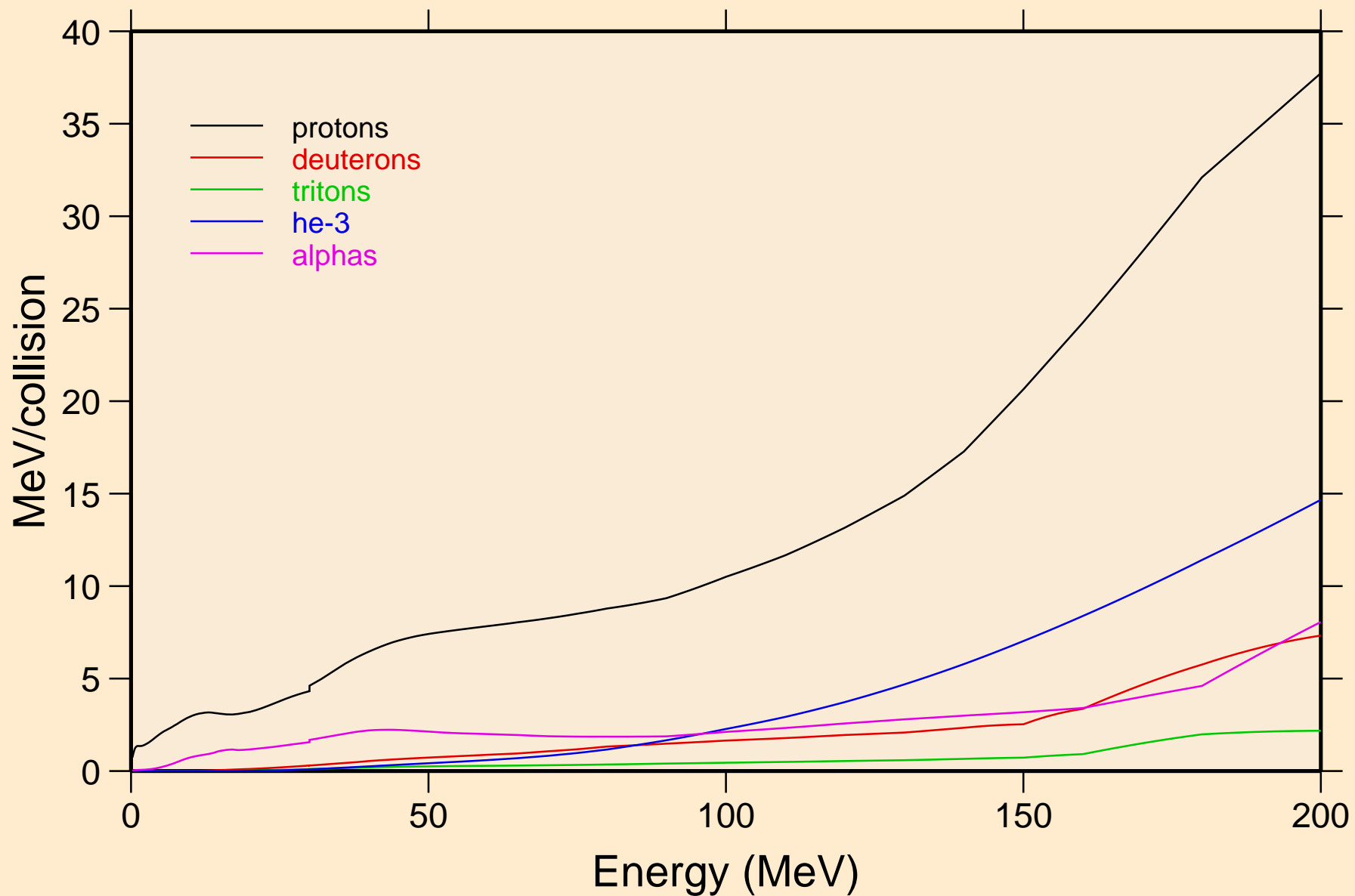

AU178 NEUTRON ACER TENDL-2019 LIBRARY; T=293.16K
Recoil Heating

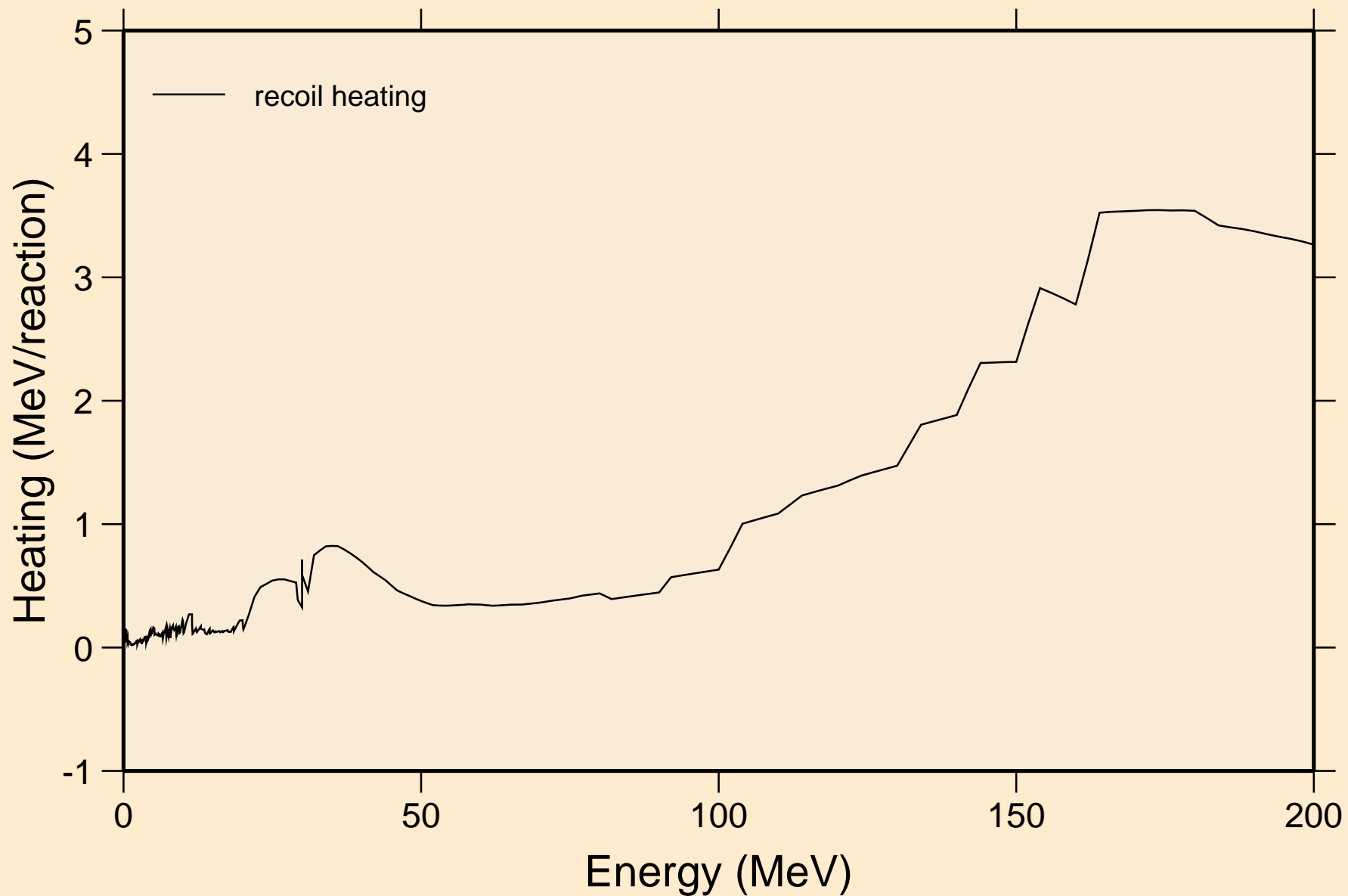

AU178 NEUTRON ACER TENDL-2019 LIBRARY; T=293.16K
Particle production cross sections

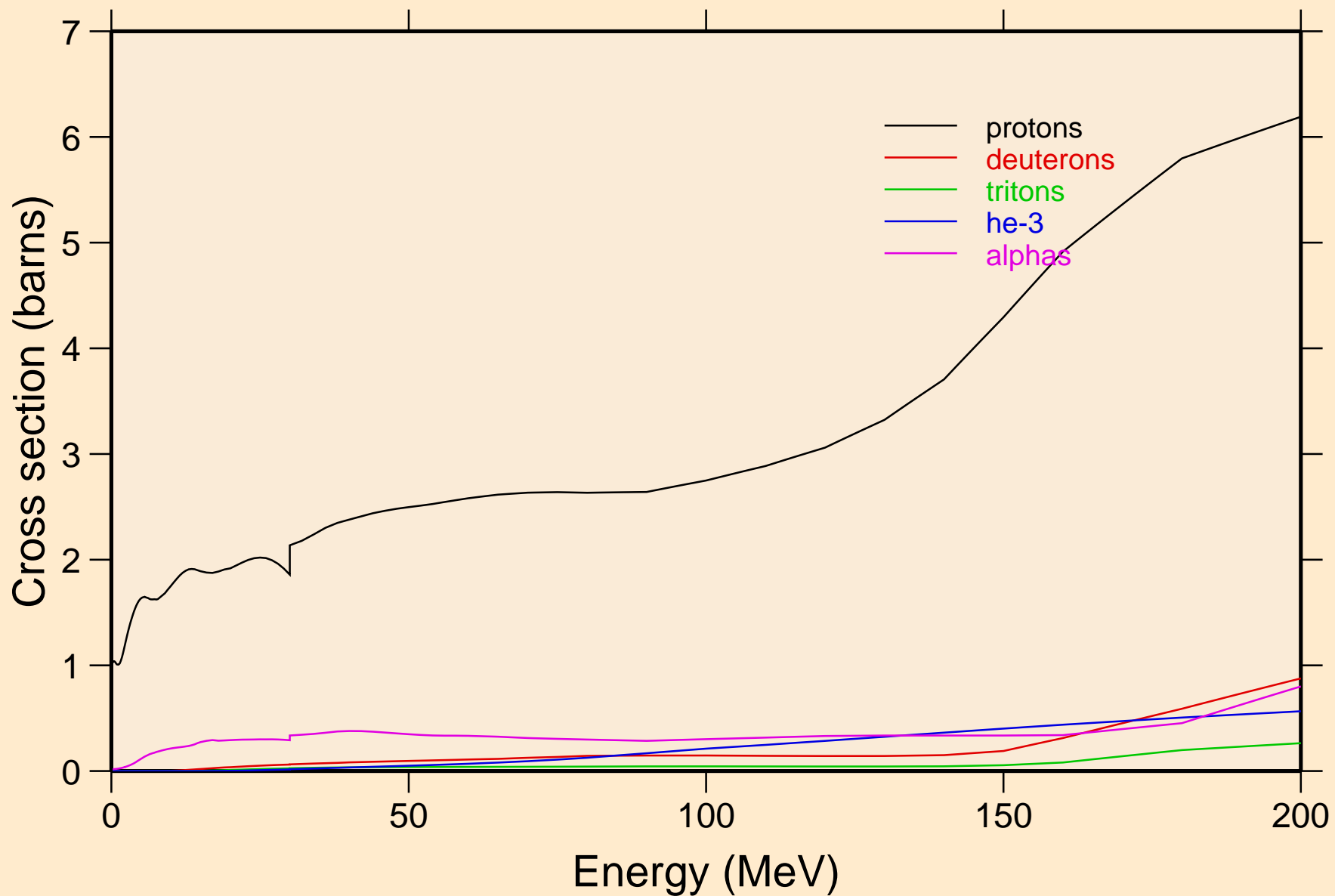

AU178 NEUTRON ACER TENDL-2019 LIBRARY; T=293.16K
protons from (n,x)

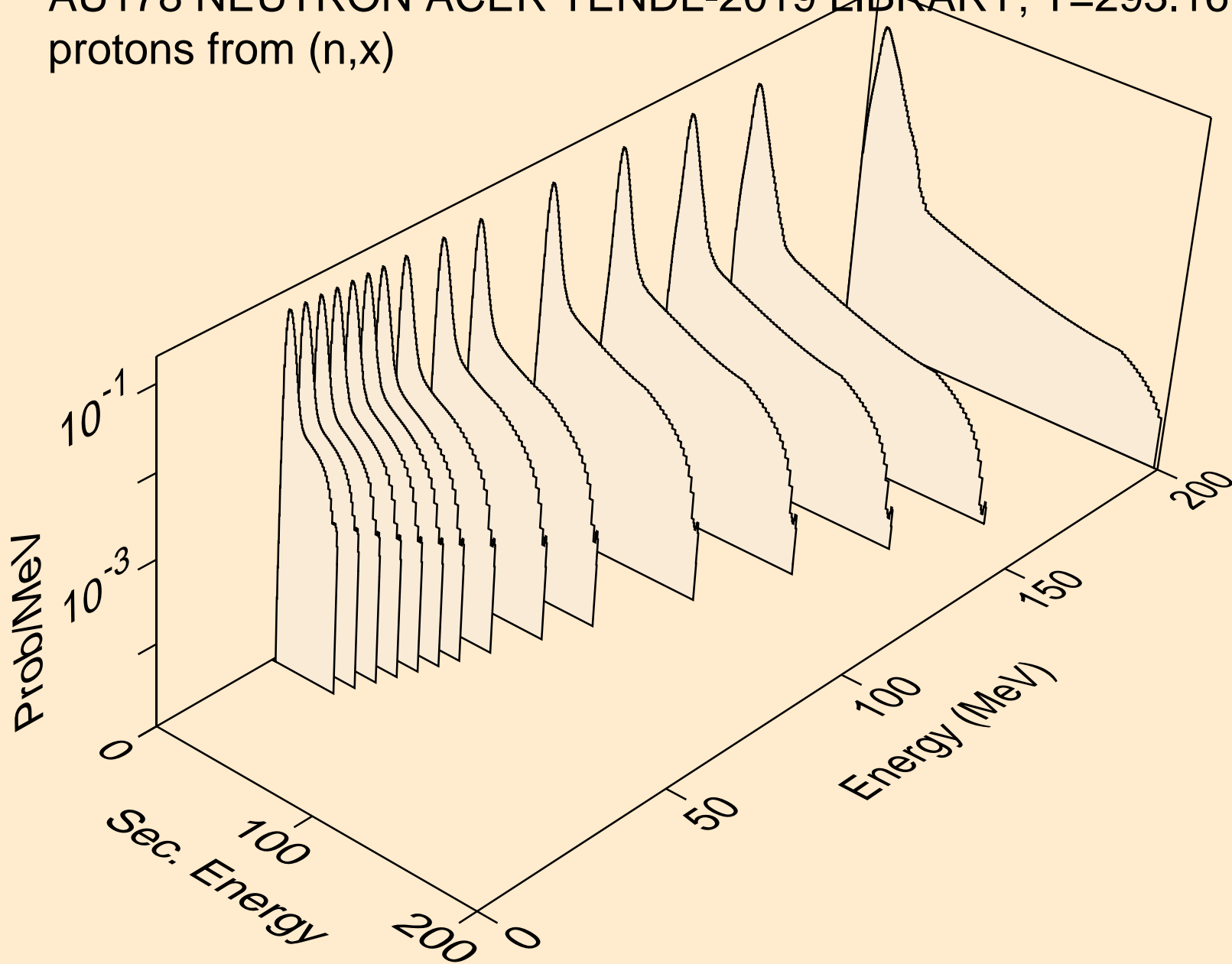

AU178 NEUTRON ACER TENDL-2019 LIBRARY; T=293.16K
protons from (n,n*)p

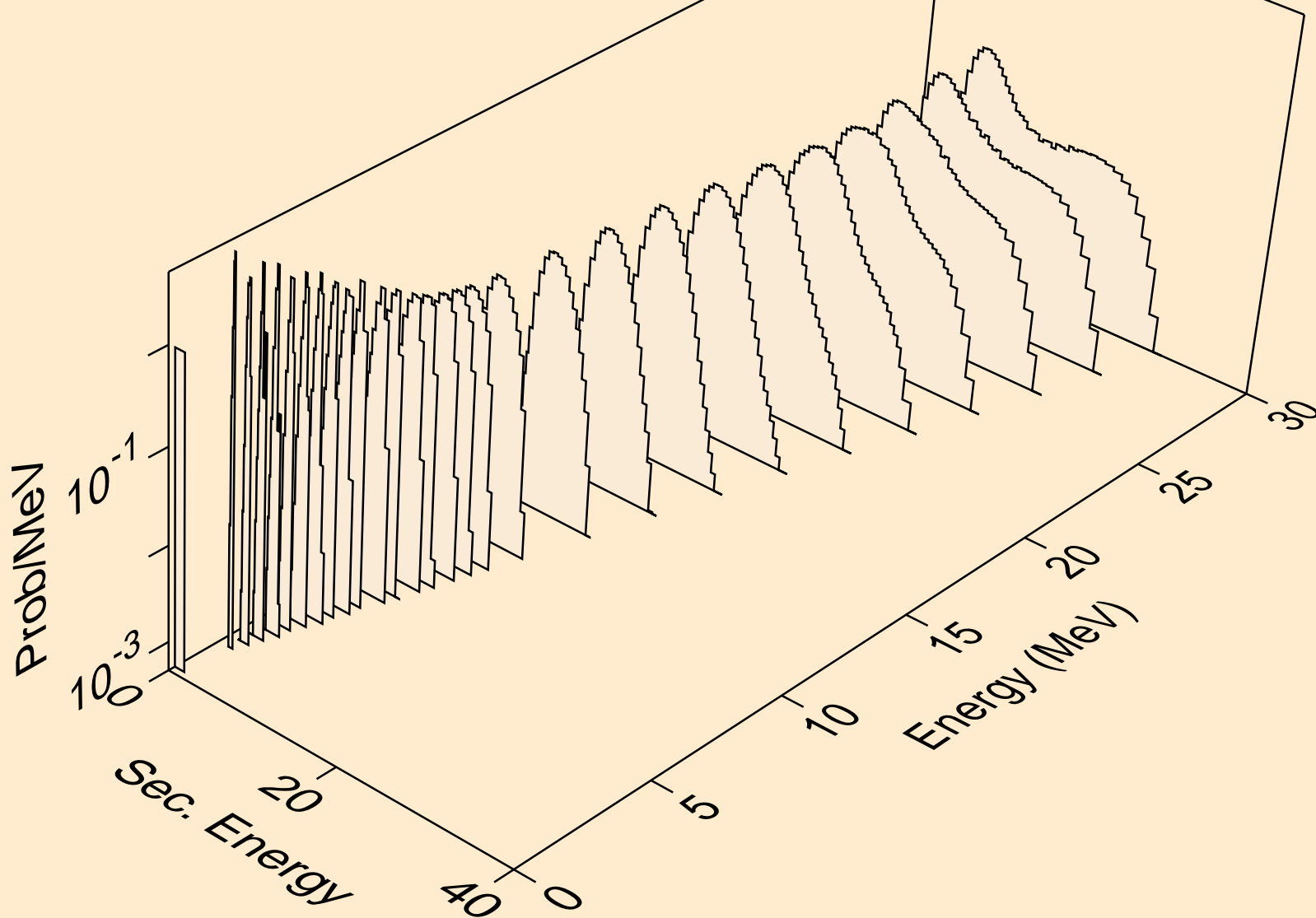

AU178 NEUTRON ACER TENDL-2019 LIBRARY; T=293.16K
protons from (n,2np)

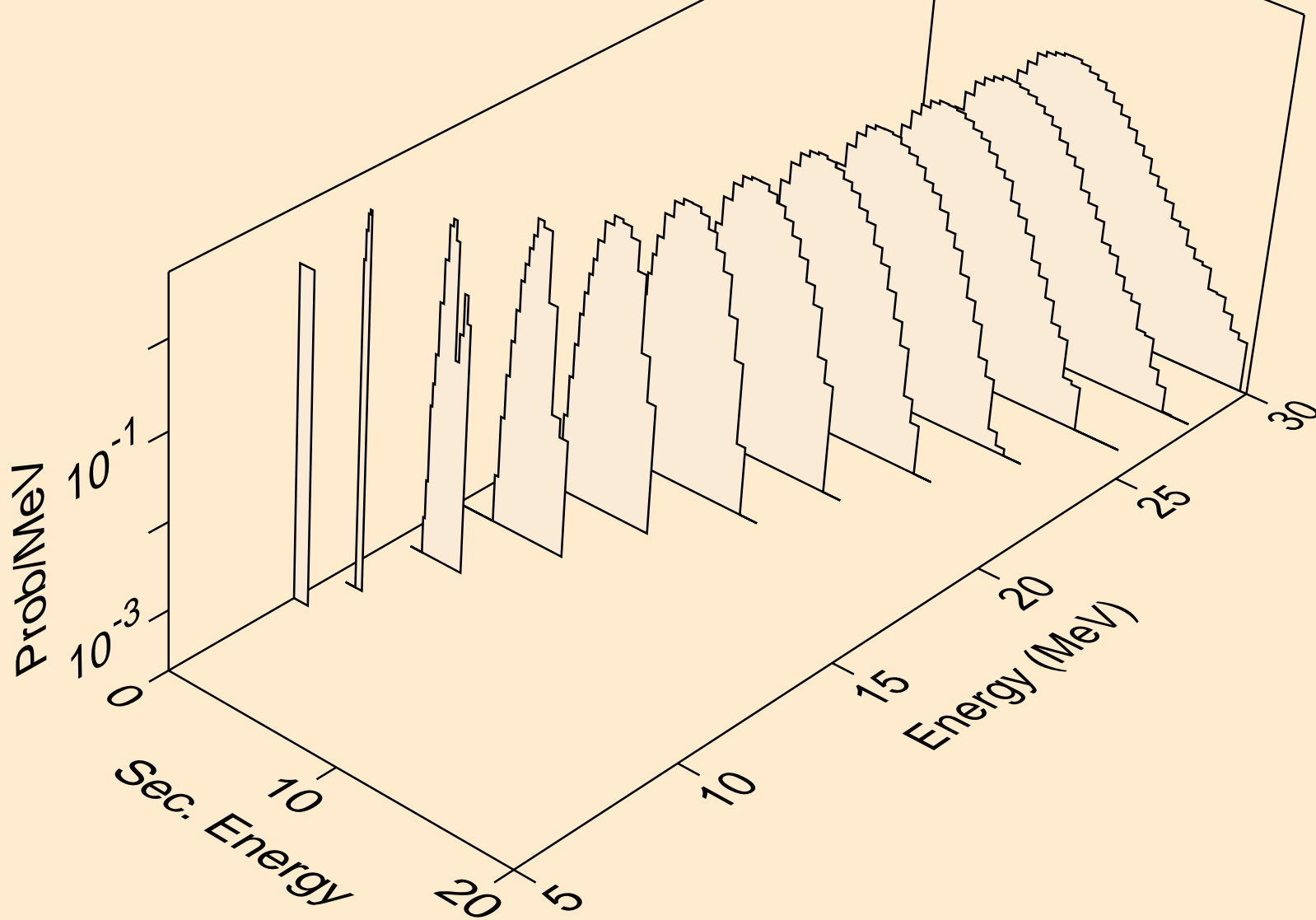

AU178 NEUTRON ACER TENDL-2019 LIBRARY; T=293.16K
protons from (n,3np)

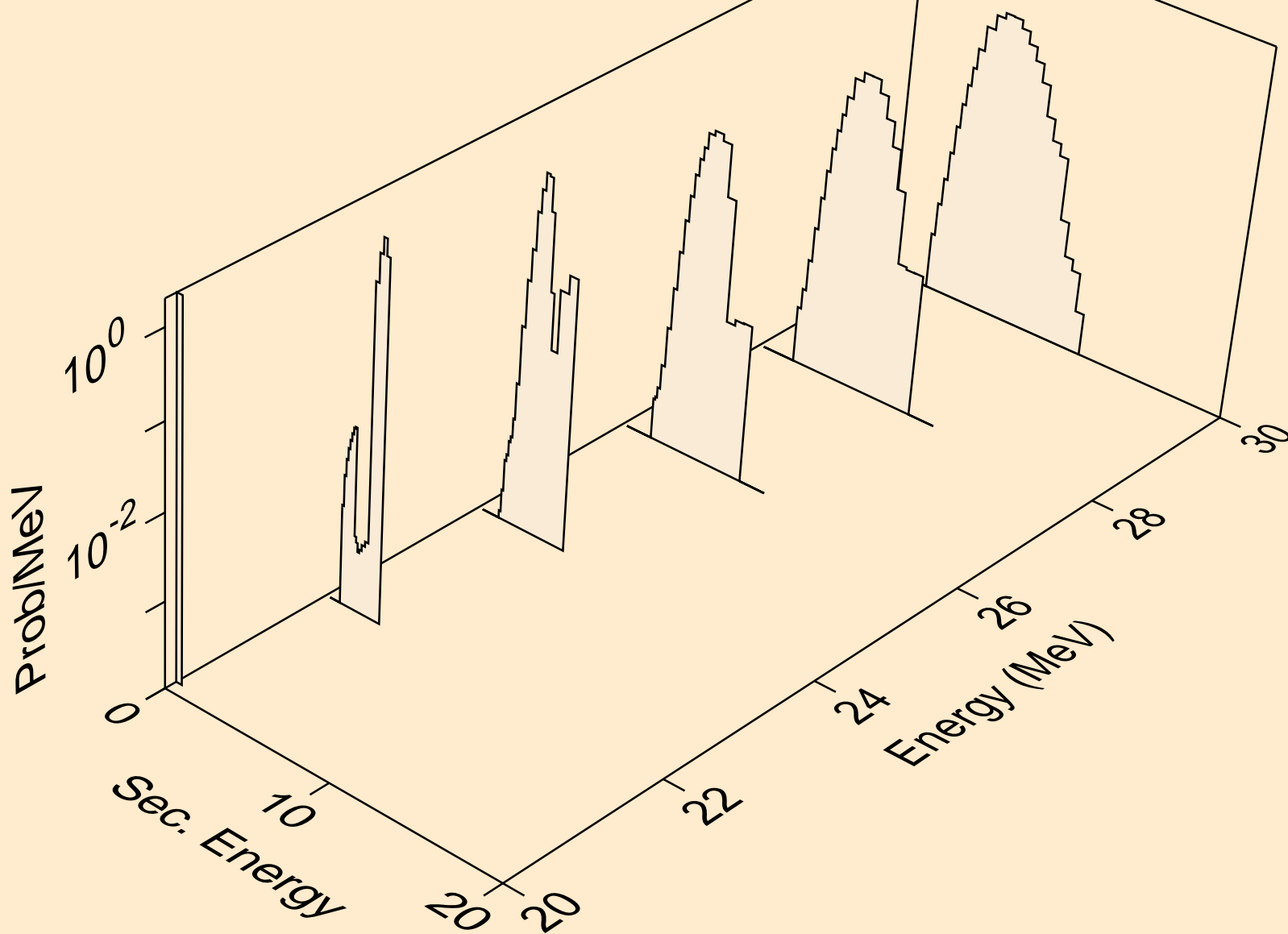

AU178 NEUTRON ACER TENDL-2019 LIBRARY; T=293.16K
protons from (n,2np)

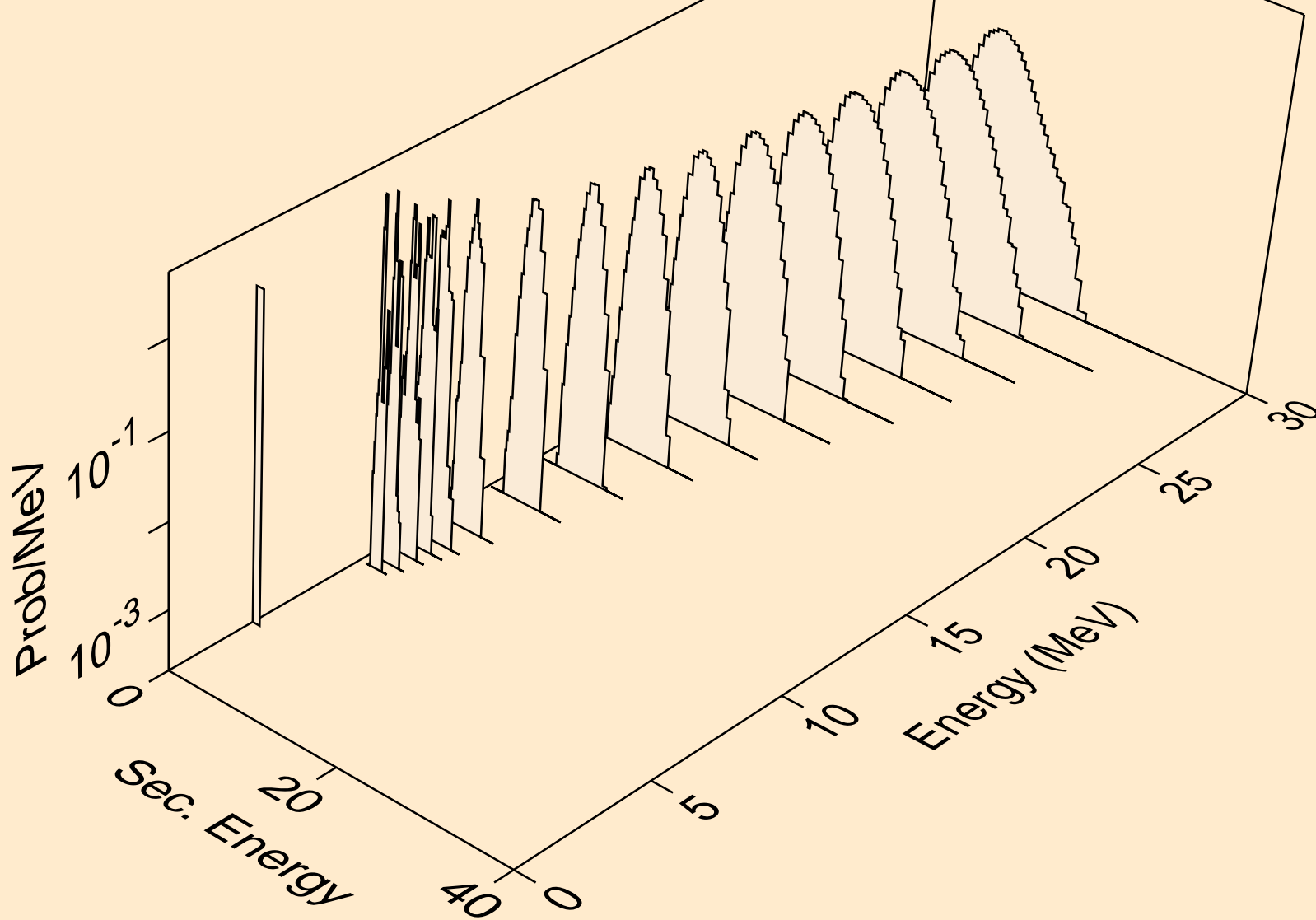

AU178 NEUTRON ACER TENDL-2019 LIBRARY; T=293.16K
protons from (n,npa)

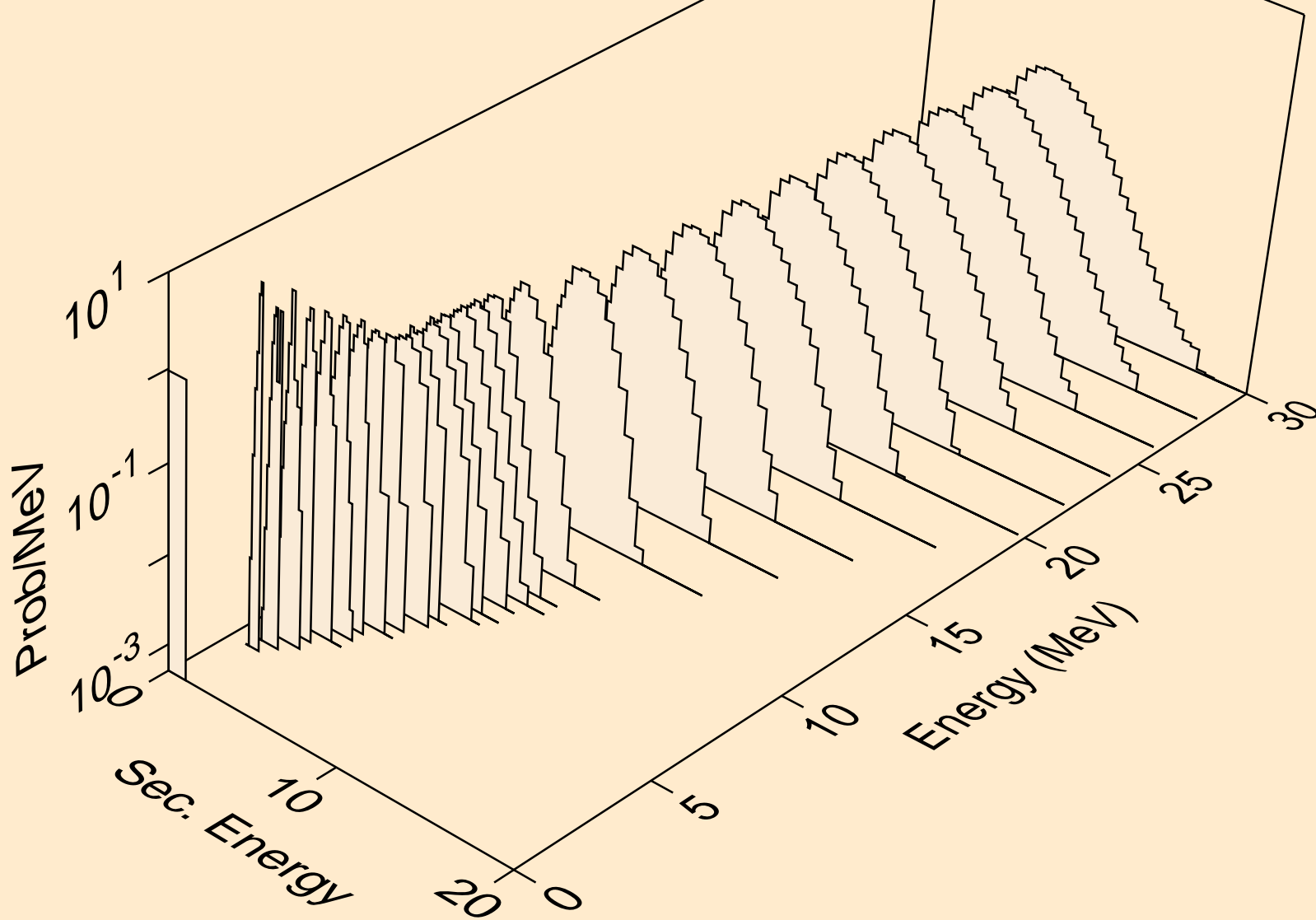

AU178 NEUTRON ACER TENDL-2019 LIBRARY; T=293.16K
protons from (n,p)

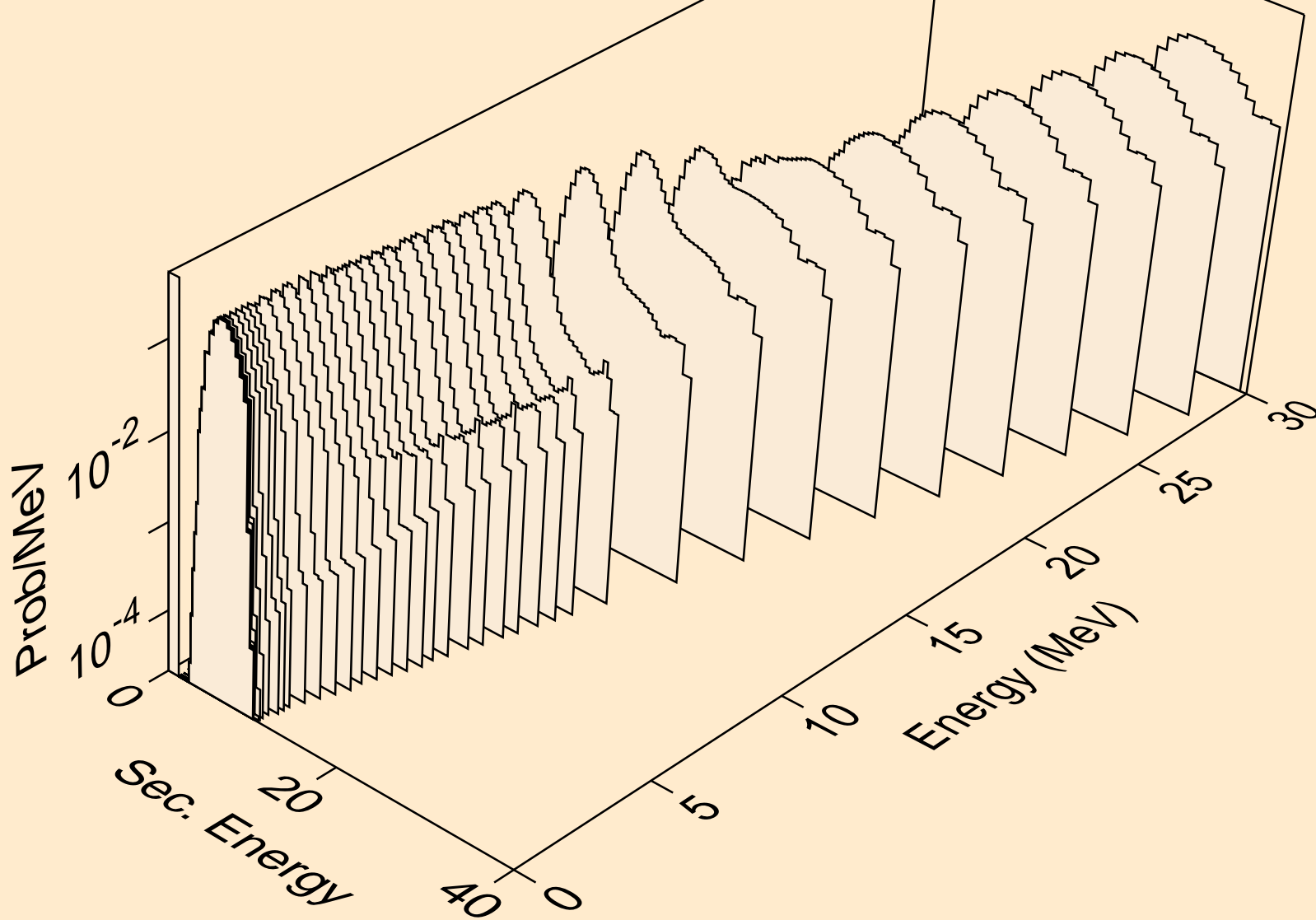

AU178 NEUTRON ACER TENDL-2019 LIBRARY; T=293.16K
protons from (n,2p)

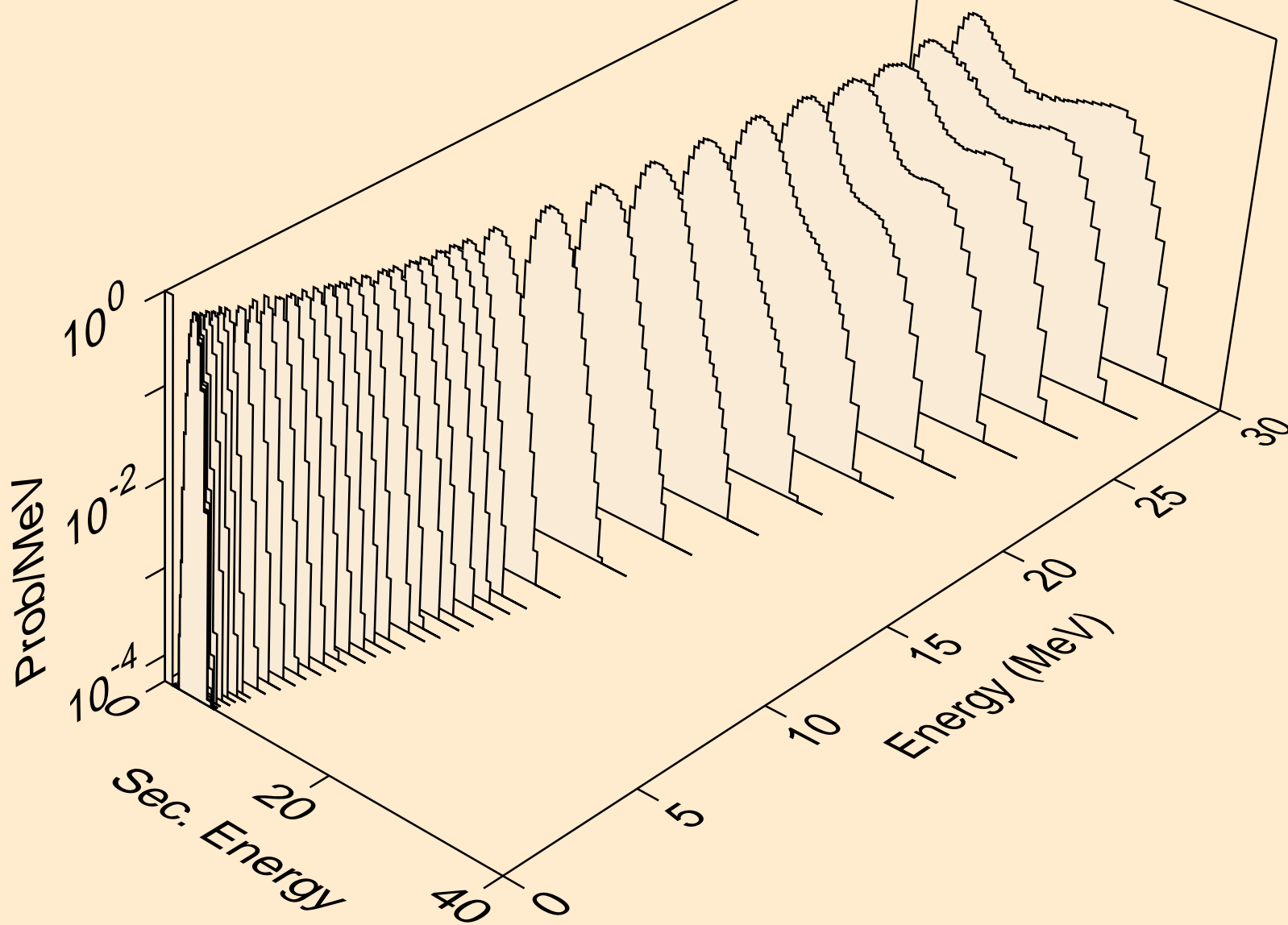

AU178 NEUTRON ACER TENDL-2019 LIBRARY; T=293.16K
protons from (n,p)

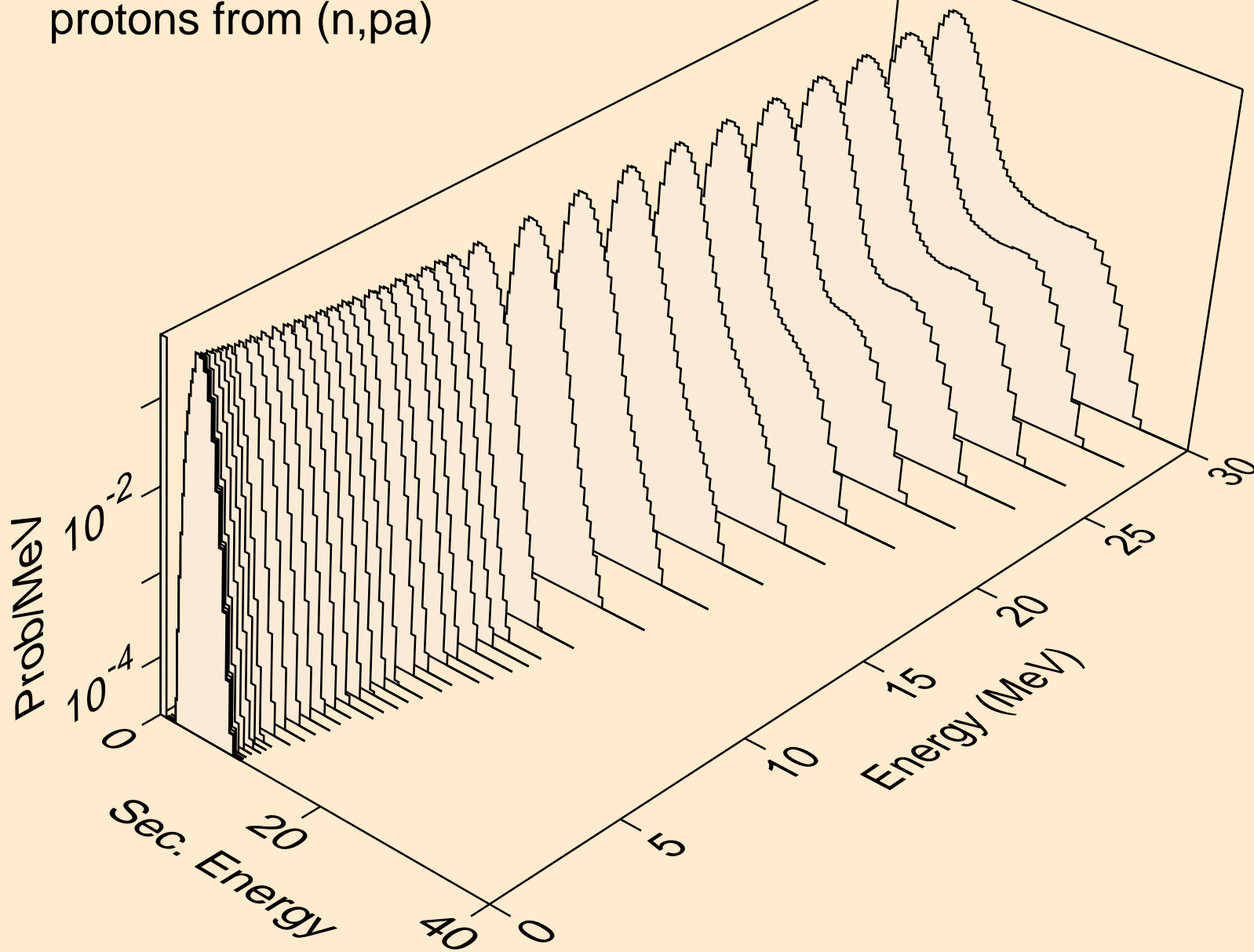

AU178 NEUTRON ACER TENDL-2019 LIBRARY; T=293.16K
protons from (n,pd)

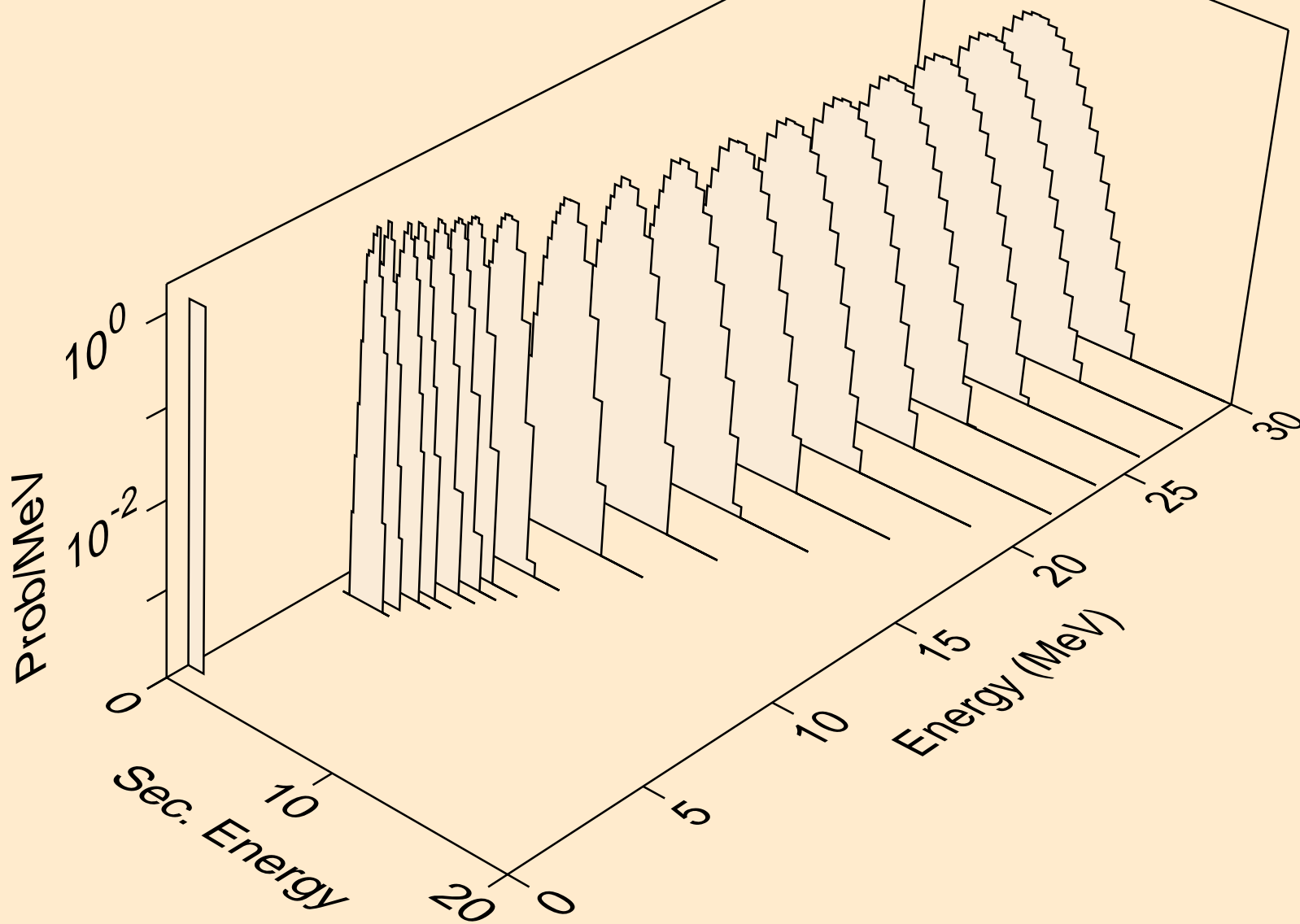

AU178 NEUTRON ACER TENDL-2019 LIBRARY; T=293.16K
protons from (n,pt)

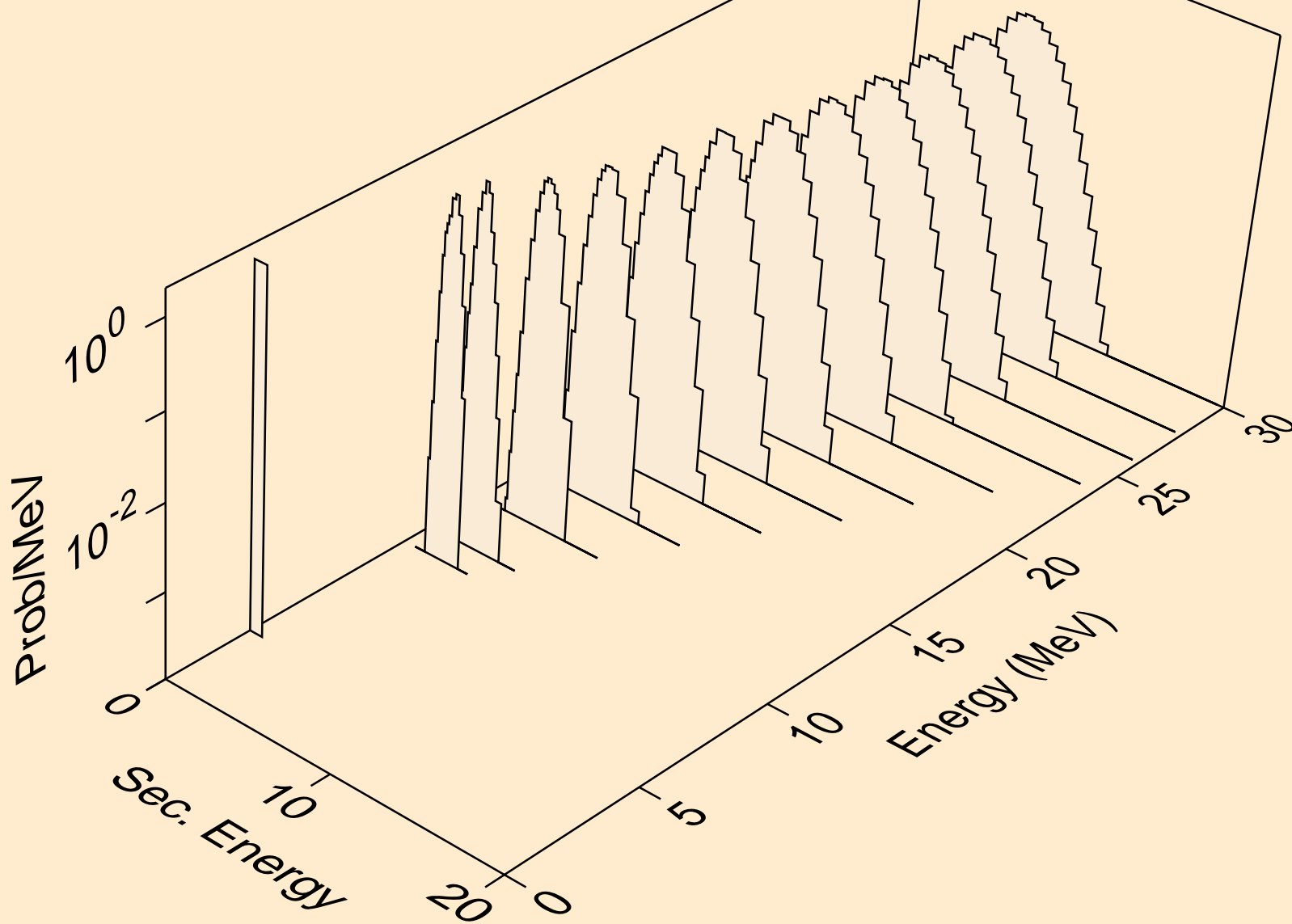

AU178 NEUTRON ACER TENDL-2019 LIBRARY; T=293.16K
deuterons from (n,x)

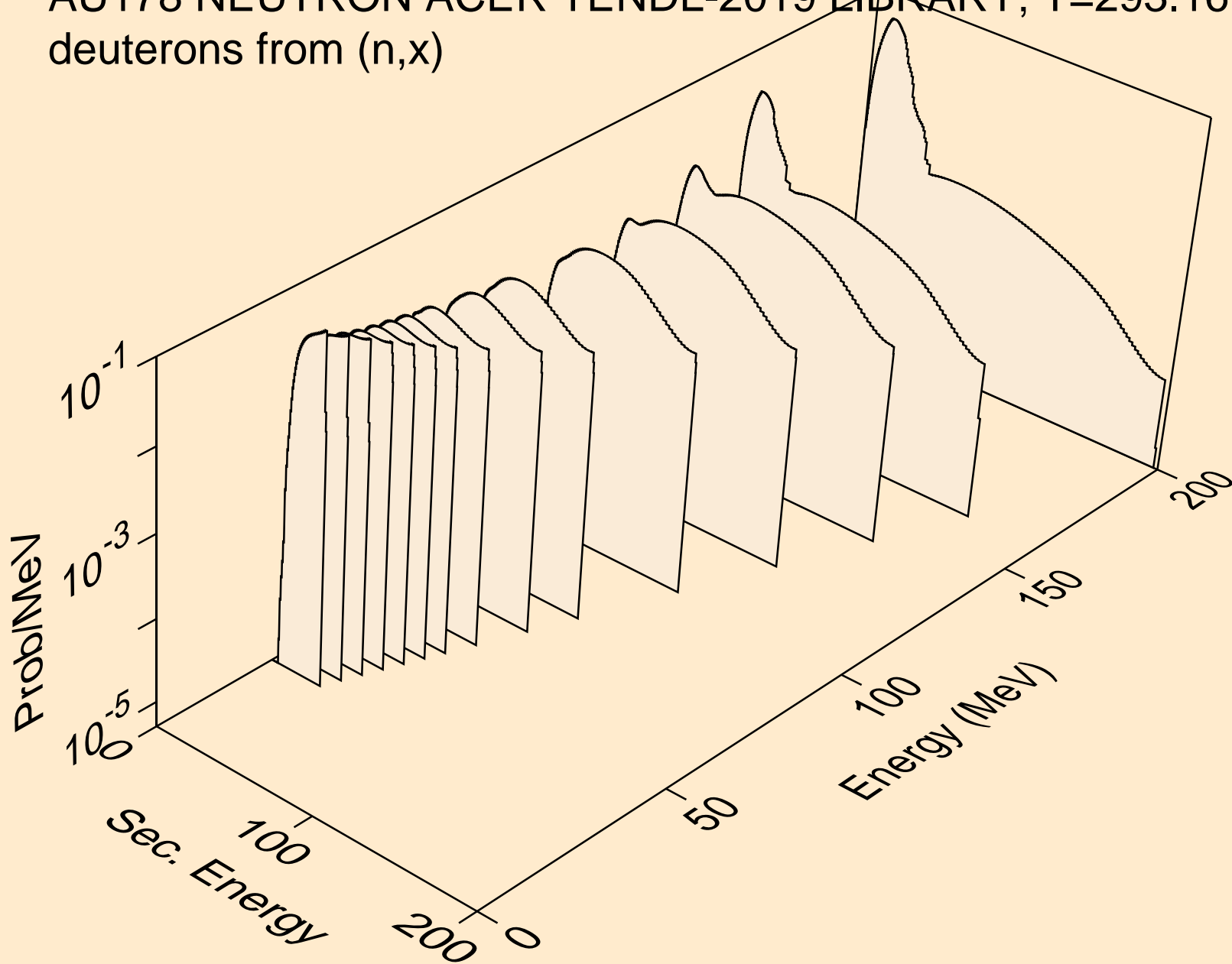

AU178 NEUTRON ACER TENDL-2019 LIBRARY; T=293.16K
deuterons from (n,2nd)

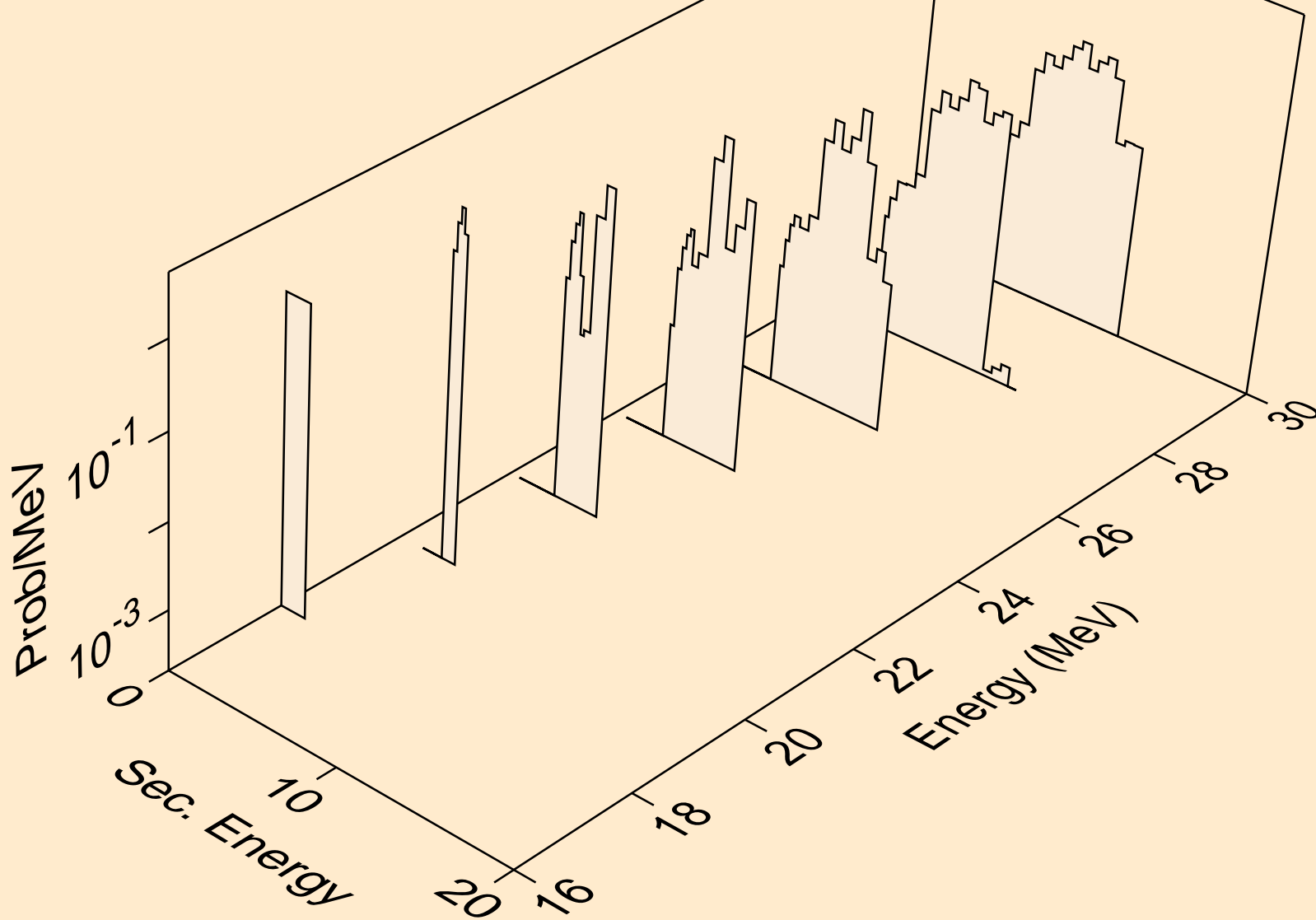

AU178 NEUTRON ACER TENDL-2019 LIBRARY; T=293.16K
deuterons from (n,n*)d

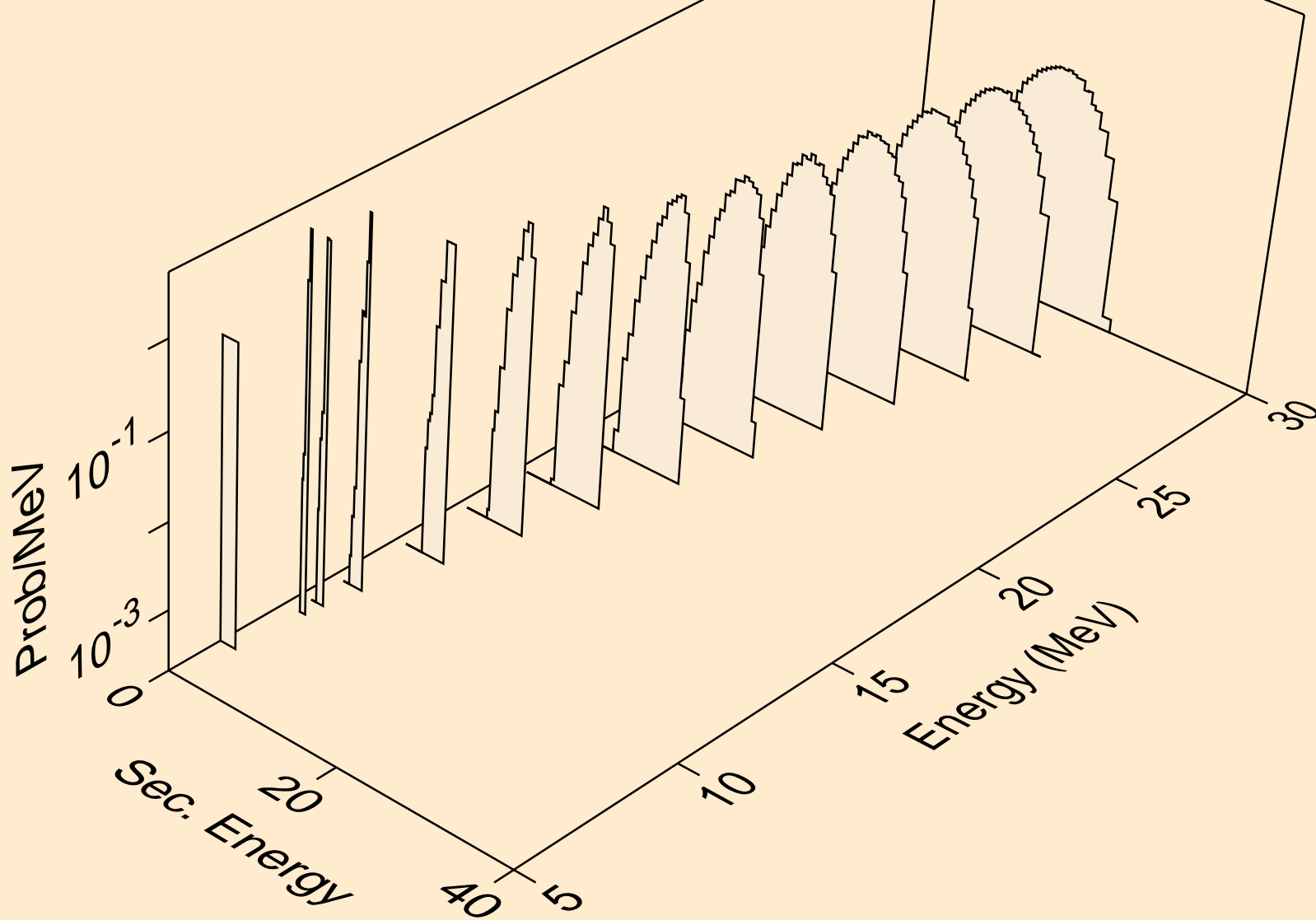

AU178 NEUTRON ACER TENDL-2019 LIBRARY; T=293.16K
deuterons from (n,d)

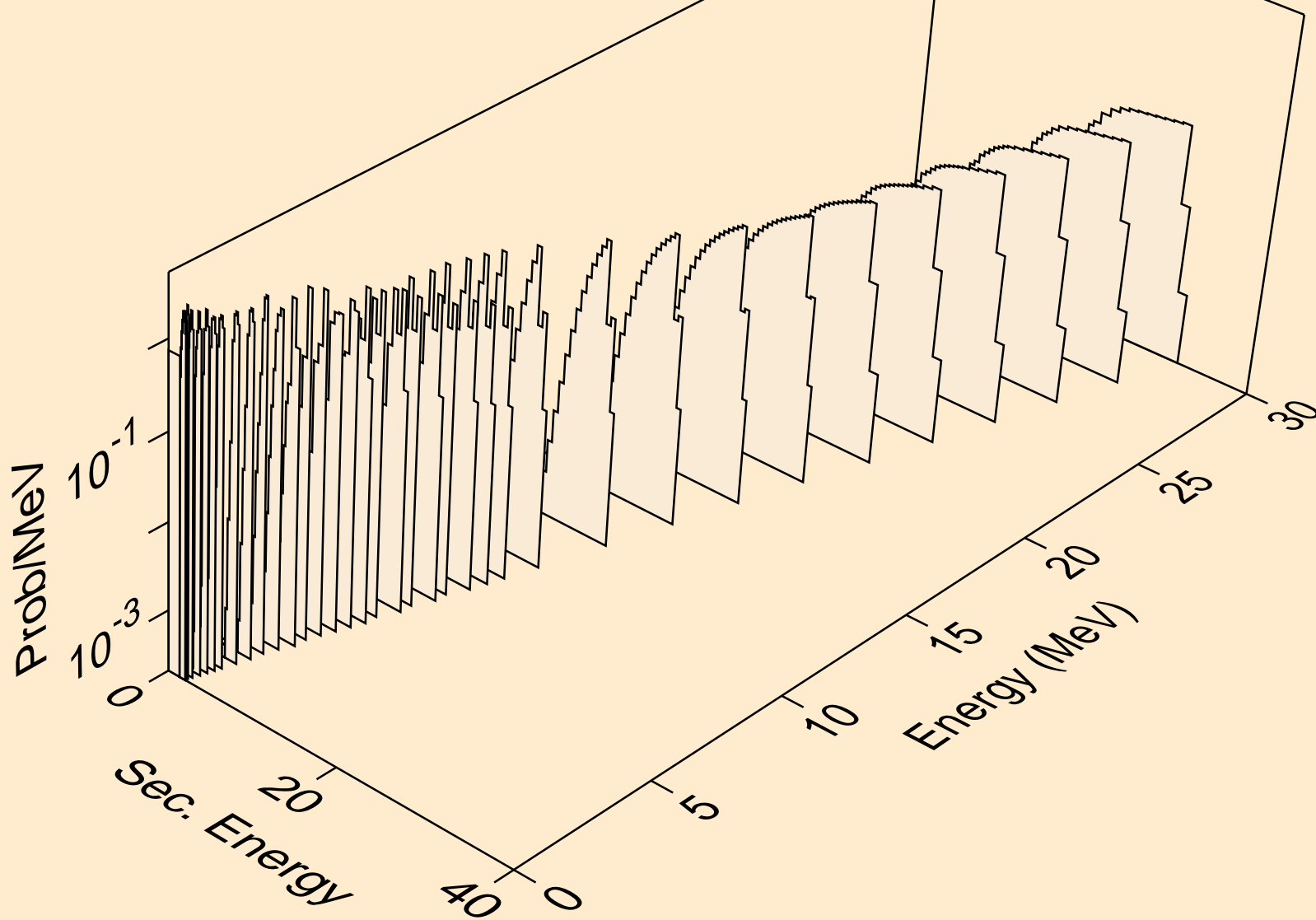

AU178 NEUTRON ACER TENDL-2019 LIBRARY; T=293.16K
deuterons from (n,d2a)

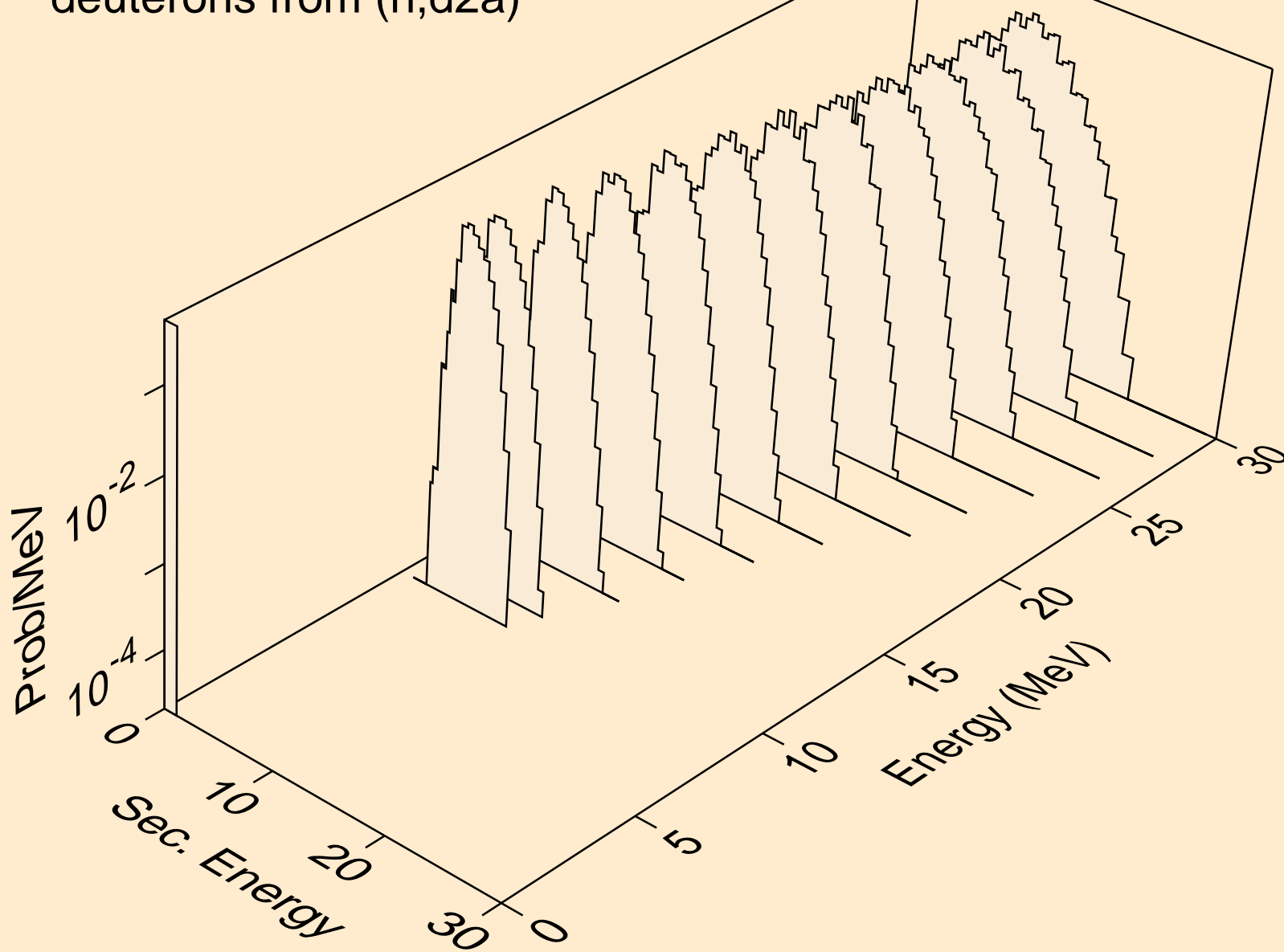

AU178 NEUTRON ACER TENDL-2019 LIBRARY; T=293.16K
deuterons from (n,pd)

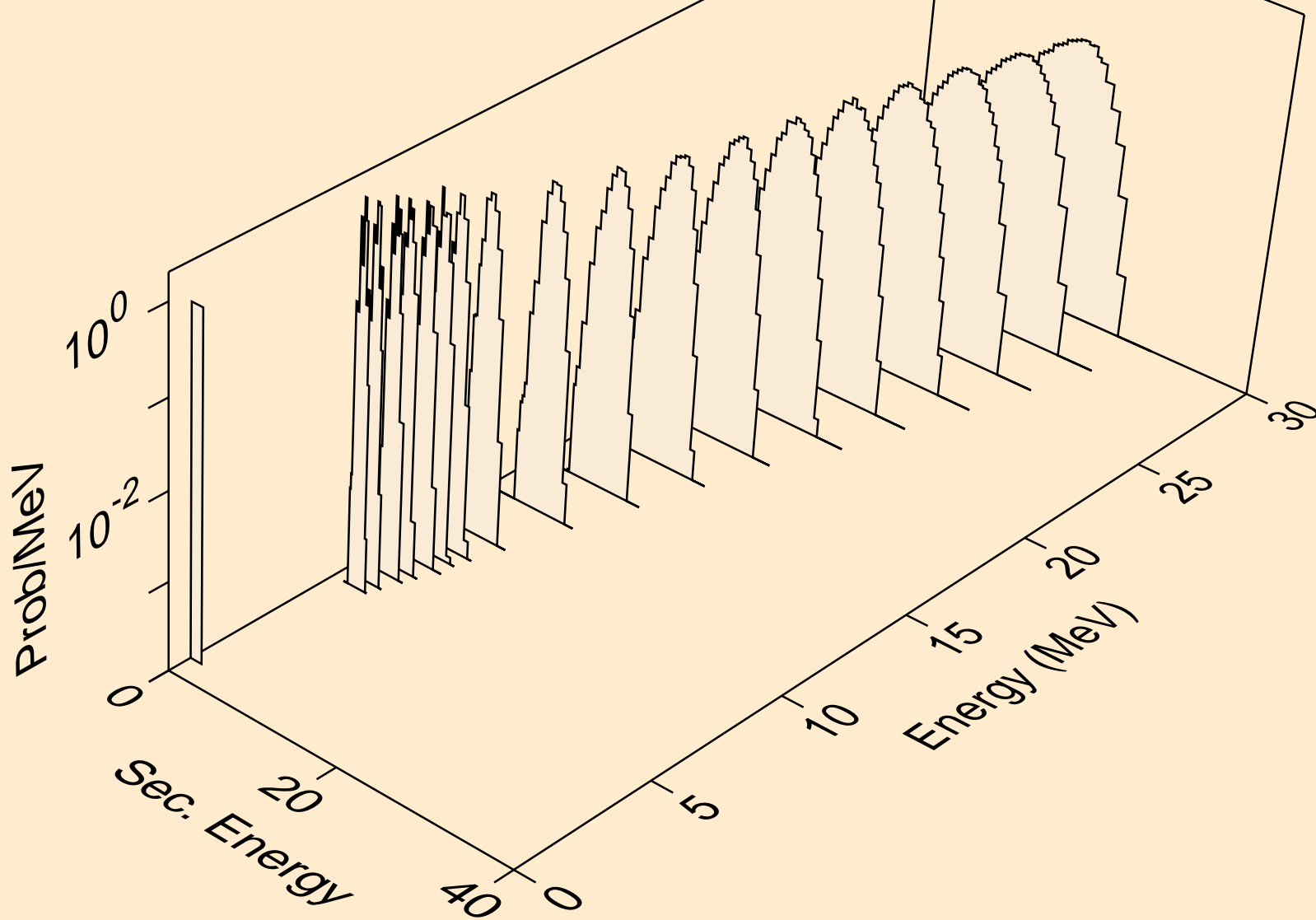

AU178 NEUTRON ACER TENDL-2019 LIBRARY; T=293.16K
deuterons from (n,da)

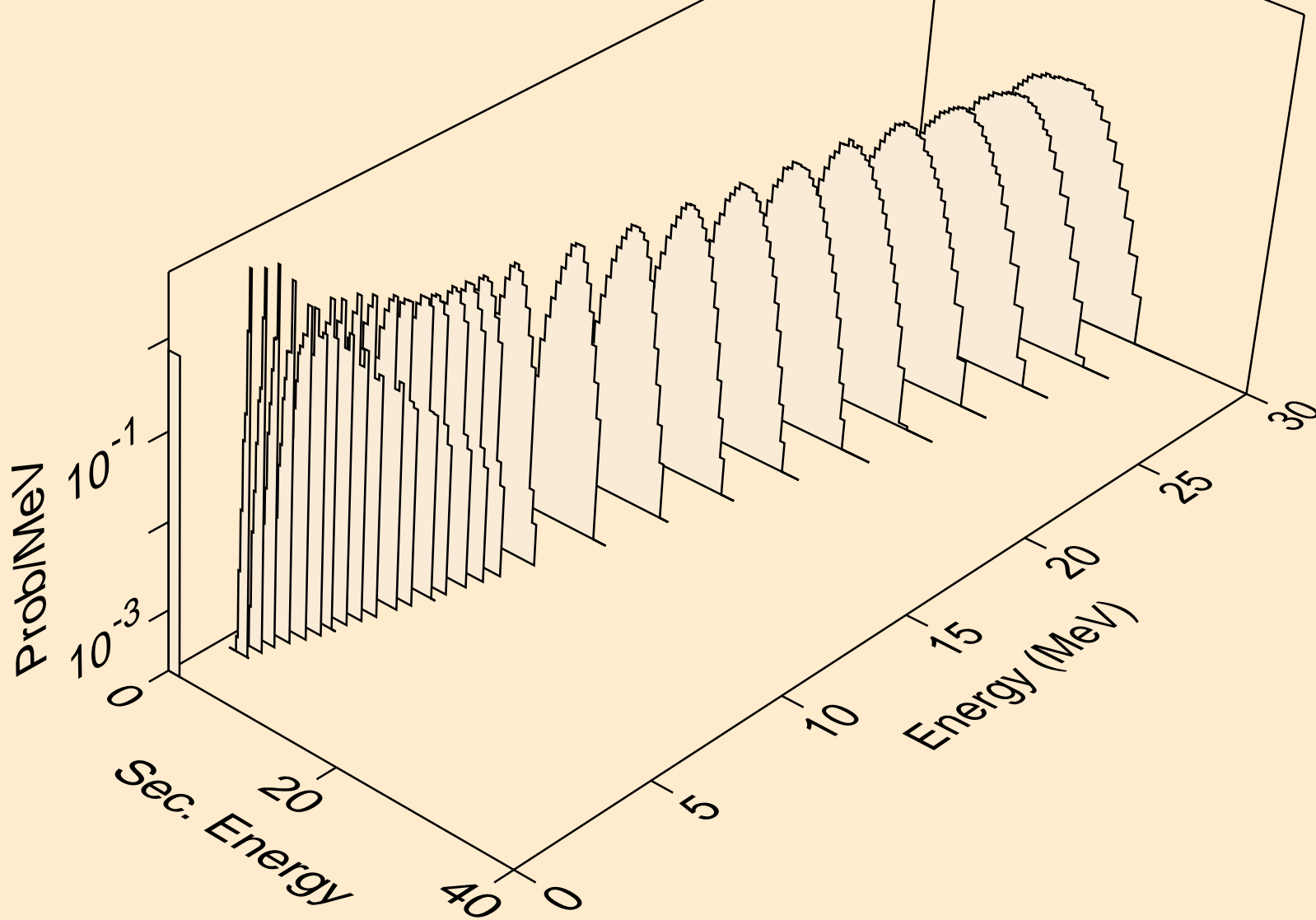

AU178 NEUTRON ACER TENDL-2019 LIBRARY; T=293.16K
tritons from (n,x)

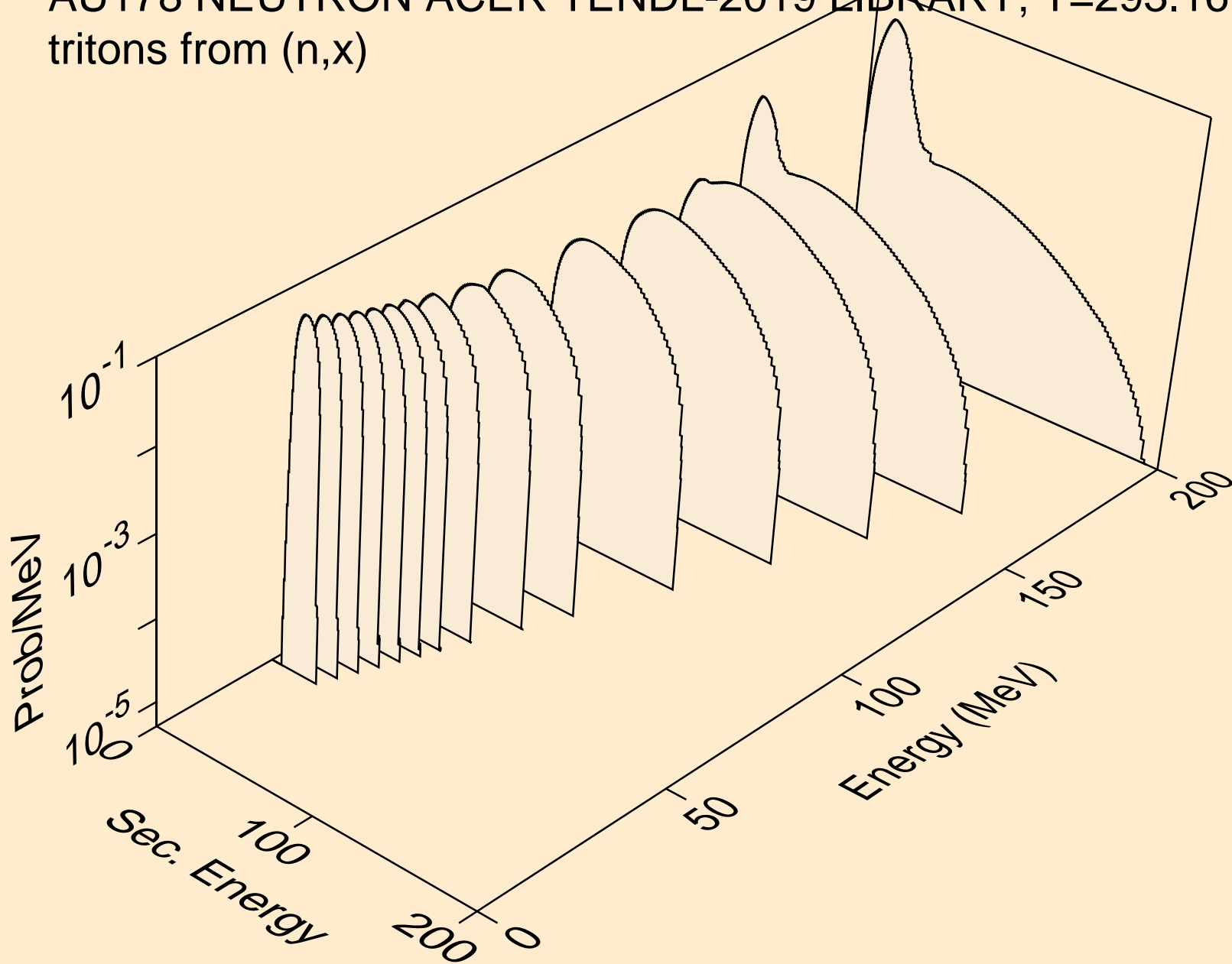

AU178 NEUTRON ACER TENDL-2019 LIBRARY; T=293.16K
tritons from (n,n*)t

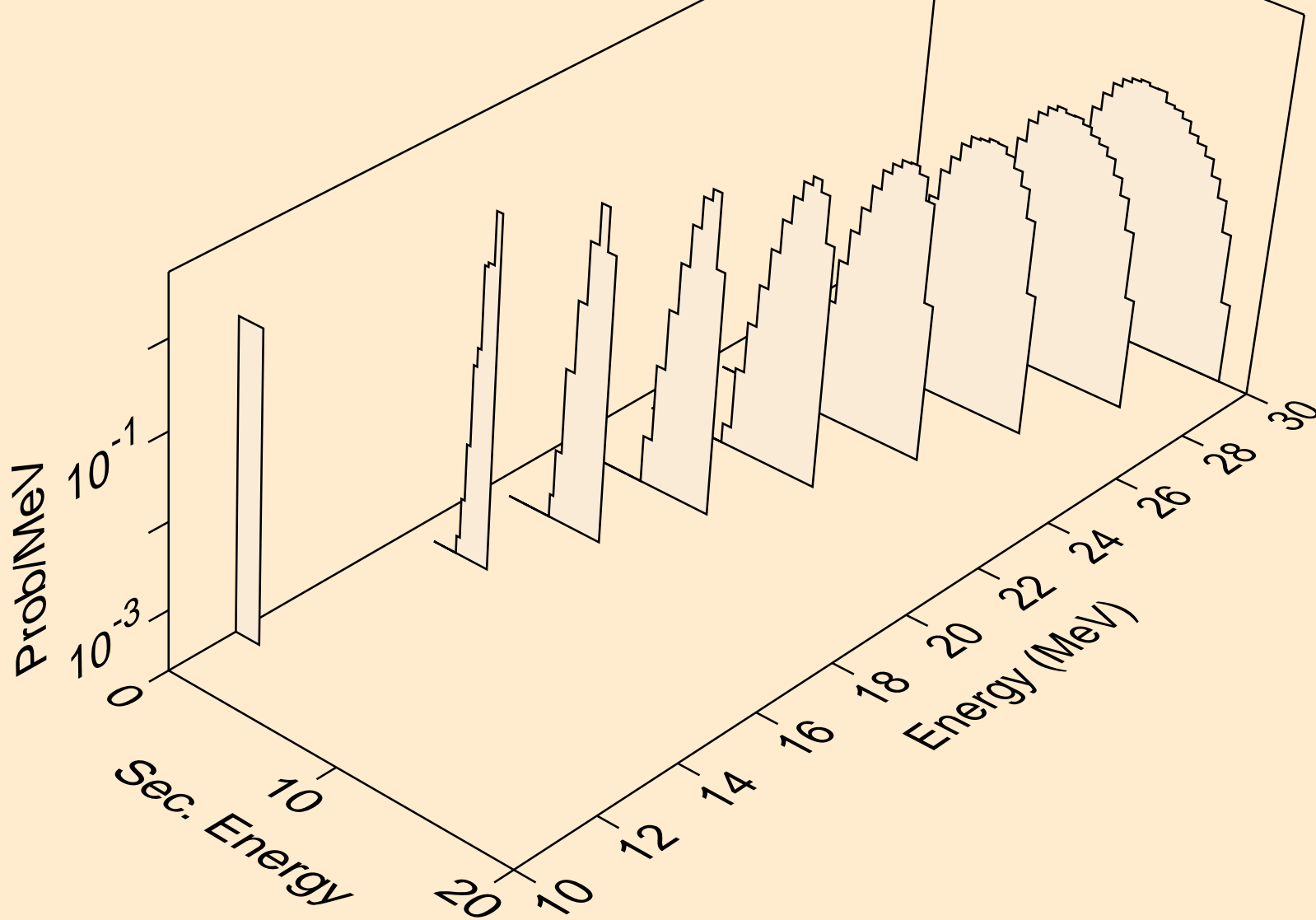

AU178 NEUTRON ACER TENDL-2019 LIBRARY; T=293.16K
tritons from (n,t)

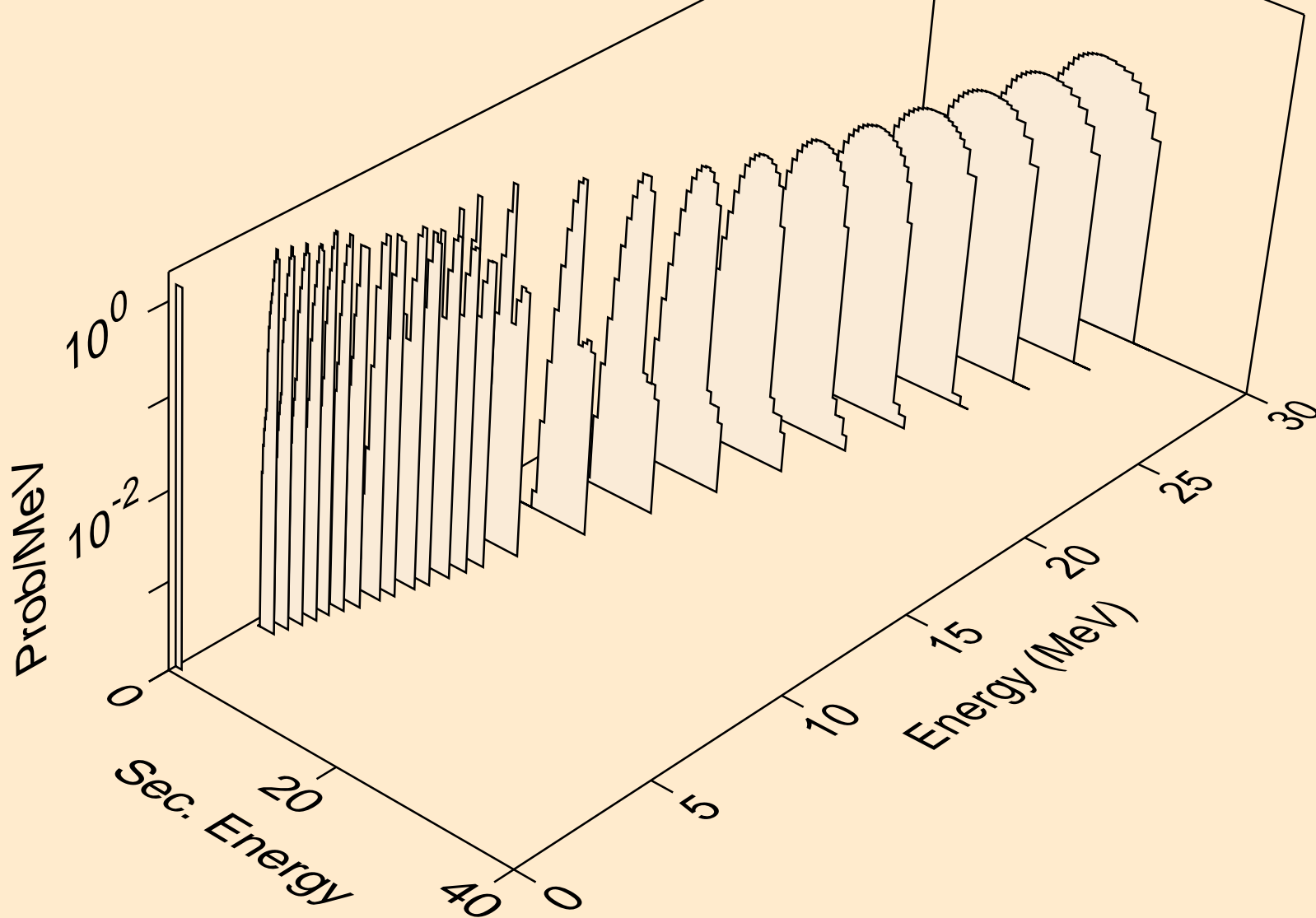

AU178 NEUTRON ACER TENDL-2019 LIBRARY; T=293.16K
tritons from (n,t2a)

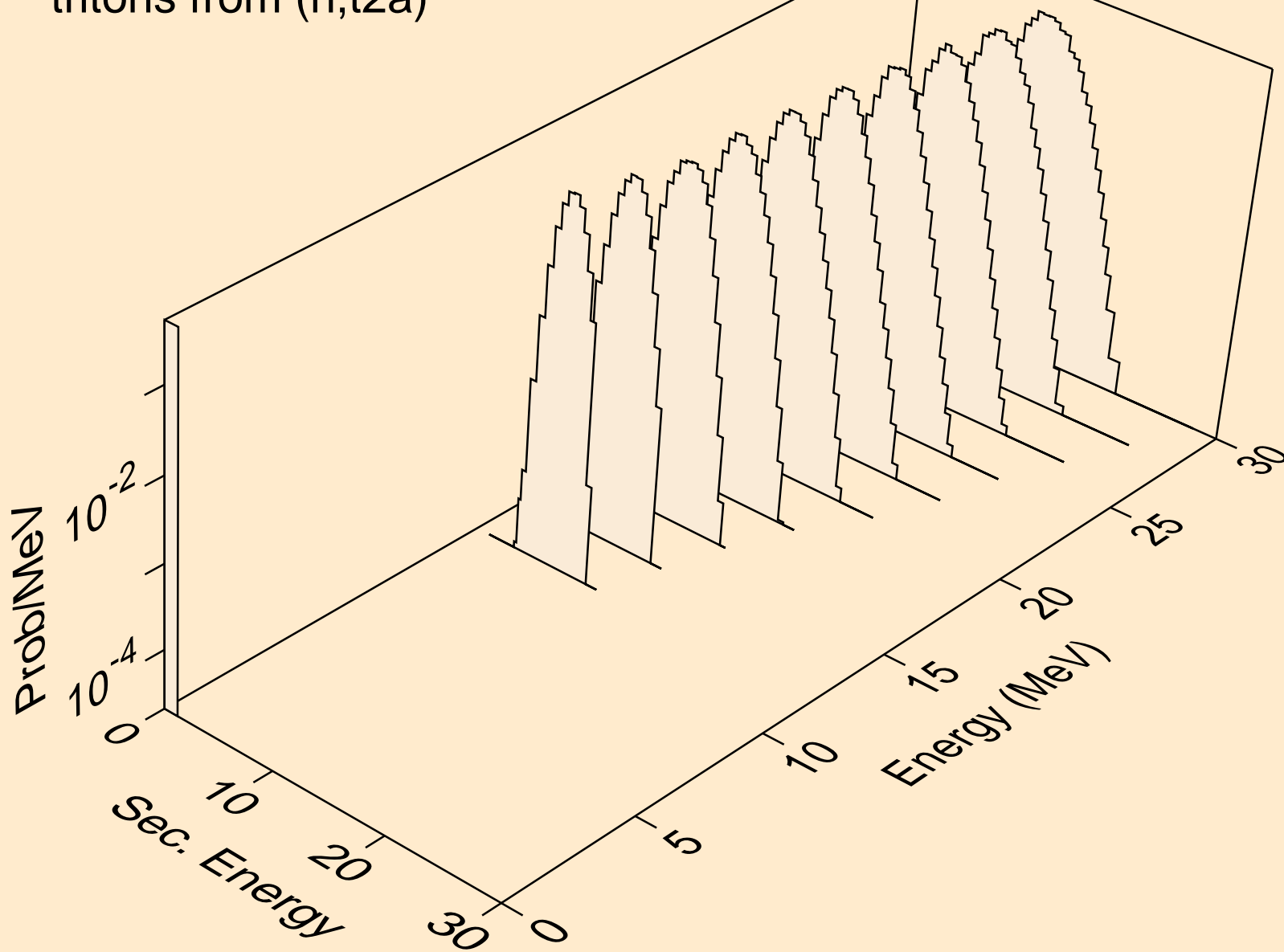

AU178 NEUTRON ACER TENDL-2019 LIBRARY; T=293.16K
tritons from (n,pt)

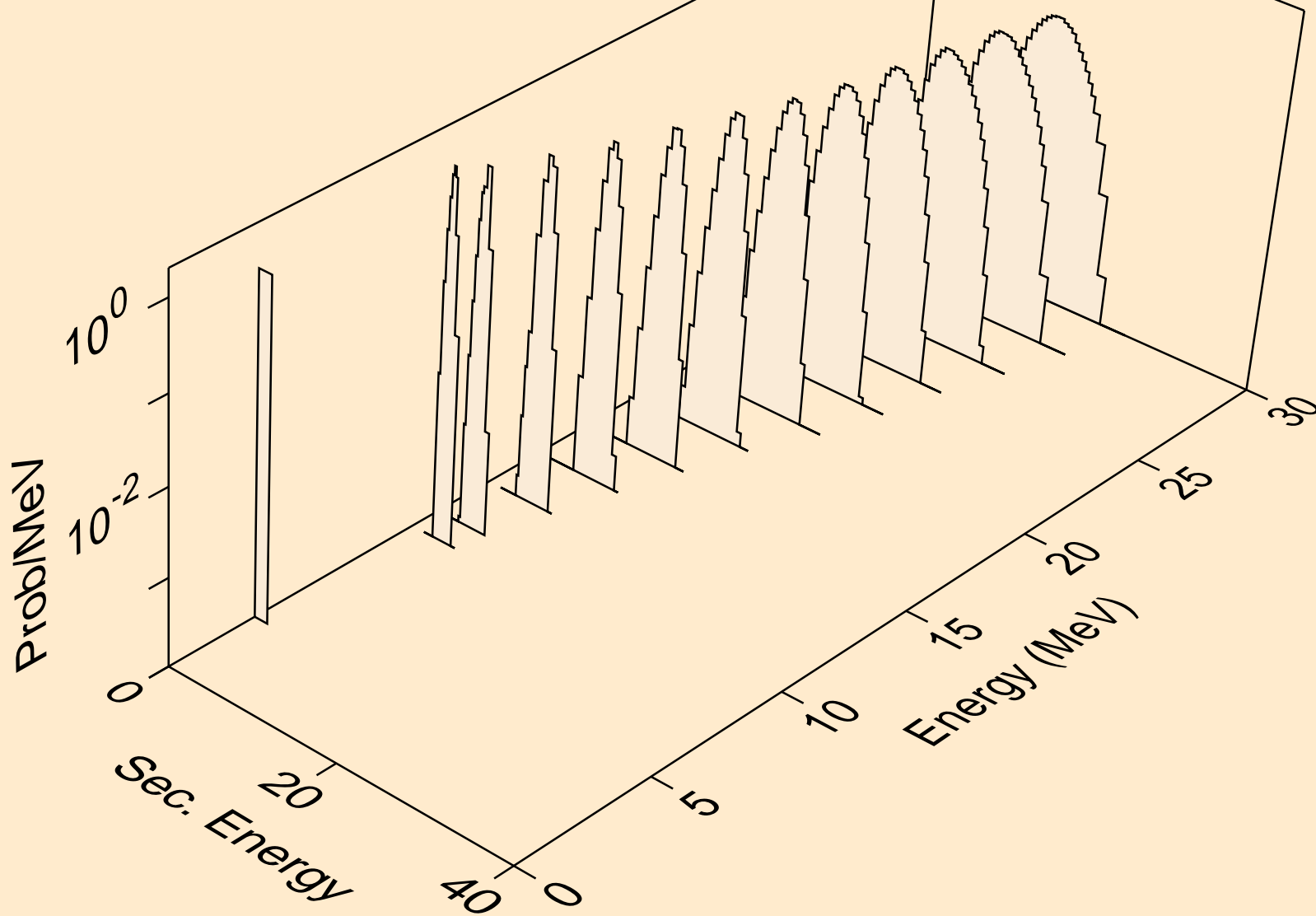

AU178 NEUTRON ACER TENDL-2019 LIBRARY; T=293.16K
he3s from (n,x)

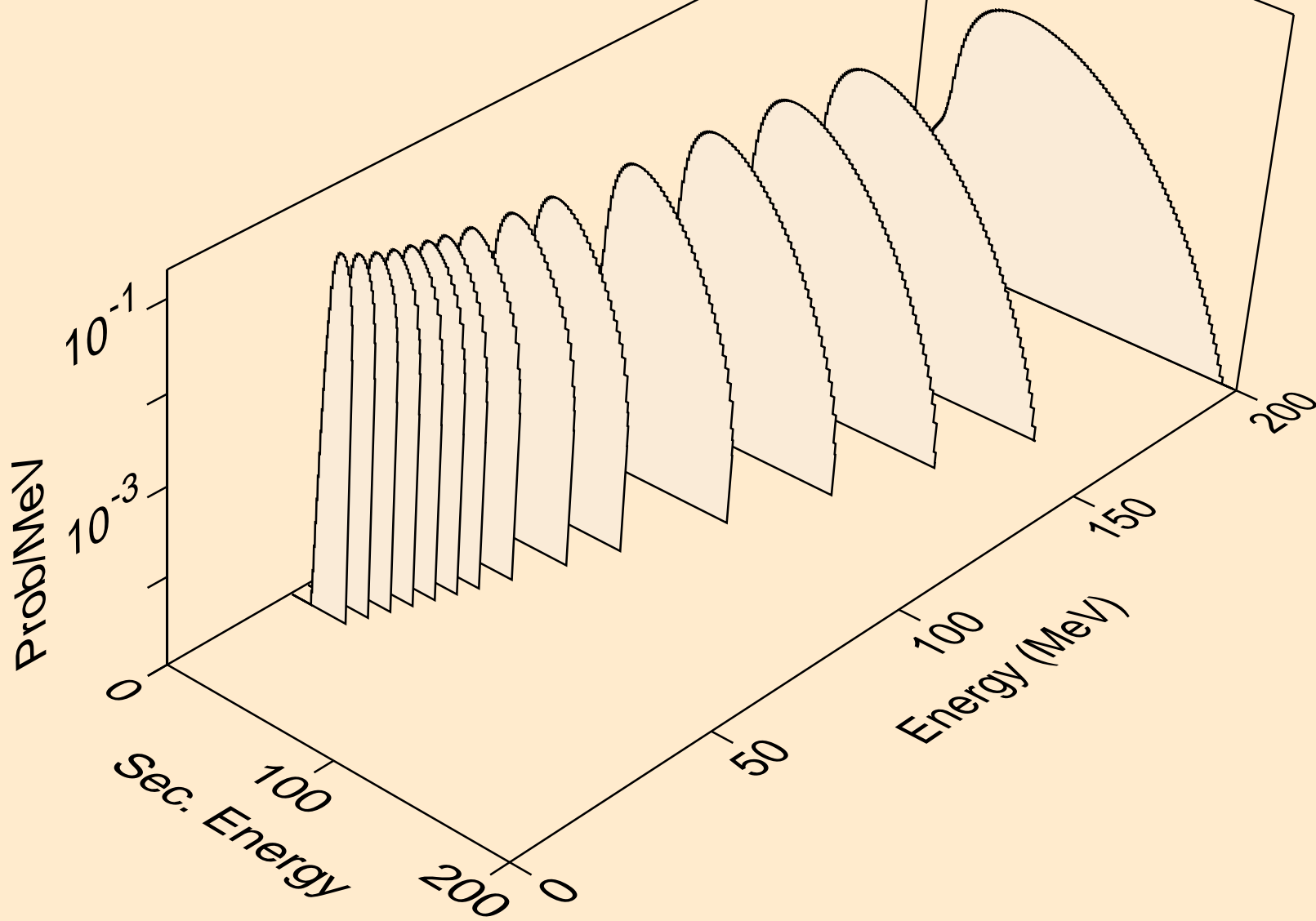

AU178 NEUTRON ACER TENDL-2019 LIBRARY; T=293.16K
he3s from (n,n*)he3

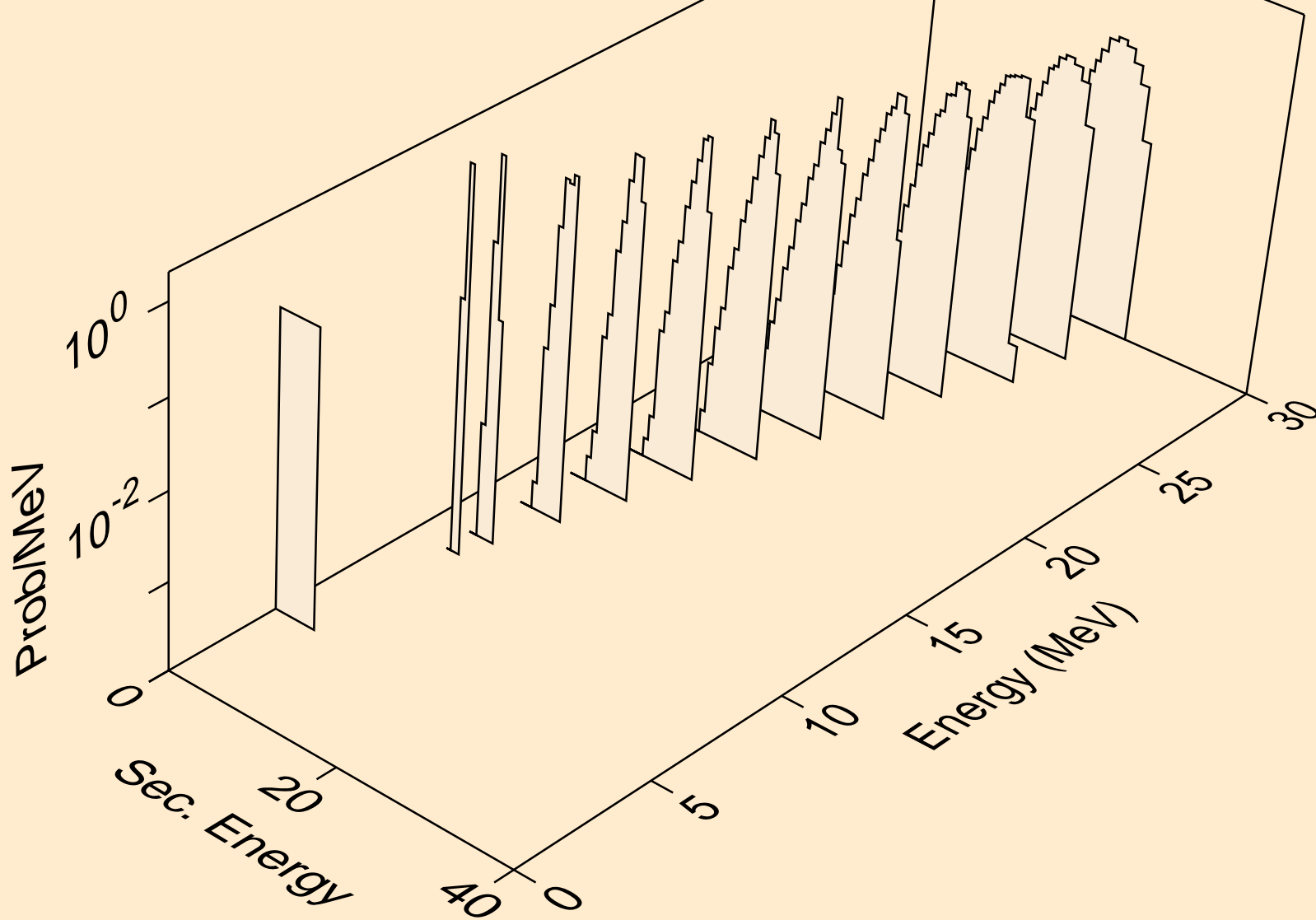

AU178 NEUTRON ACER TENDL-2019 LIBRARY; T=293.16K
he3s from (n,he3)

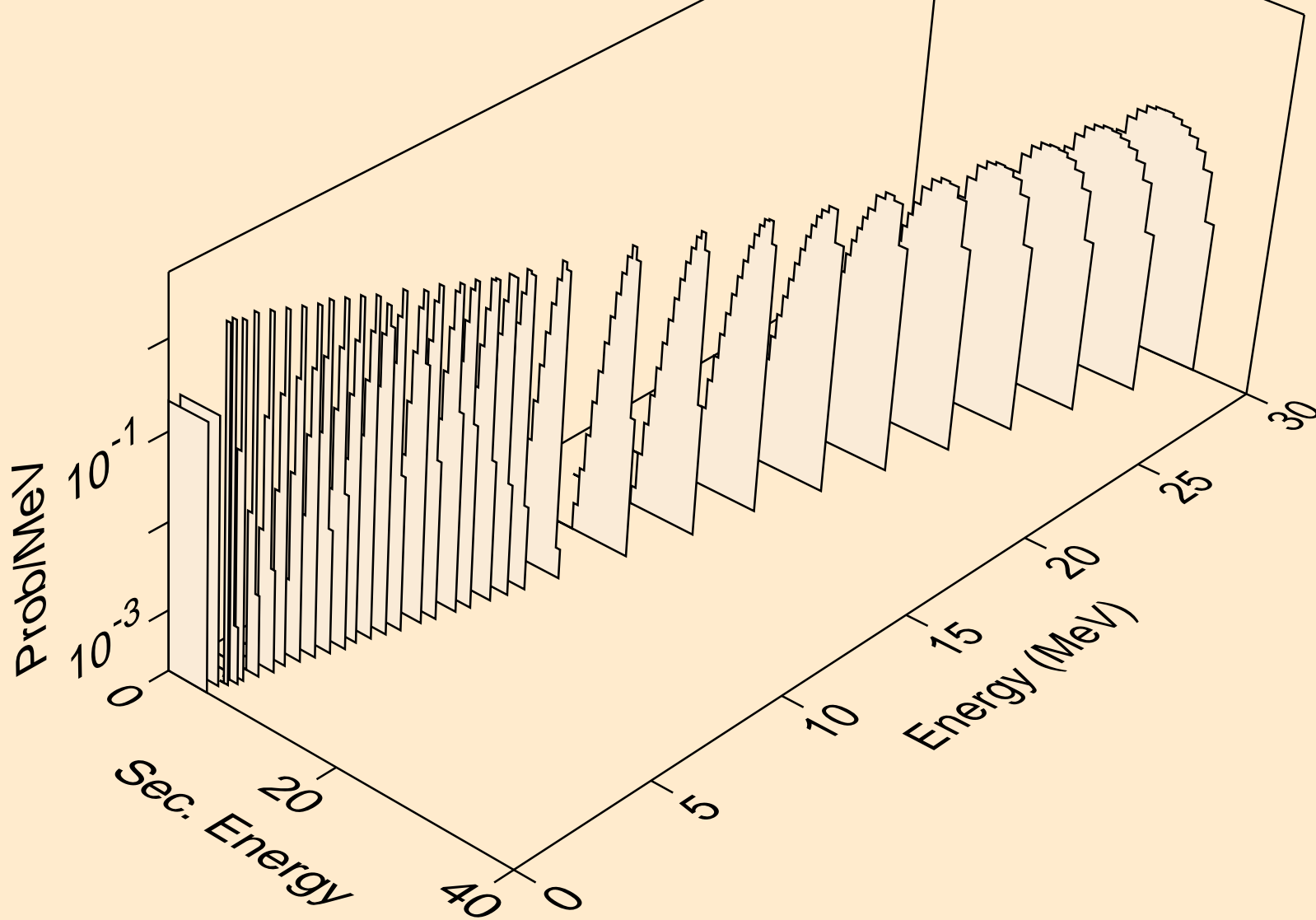

AU178 NEUTRON ACER TENDL-2019 LIBRARY; T=293.16K
alphas from (n,x)

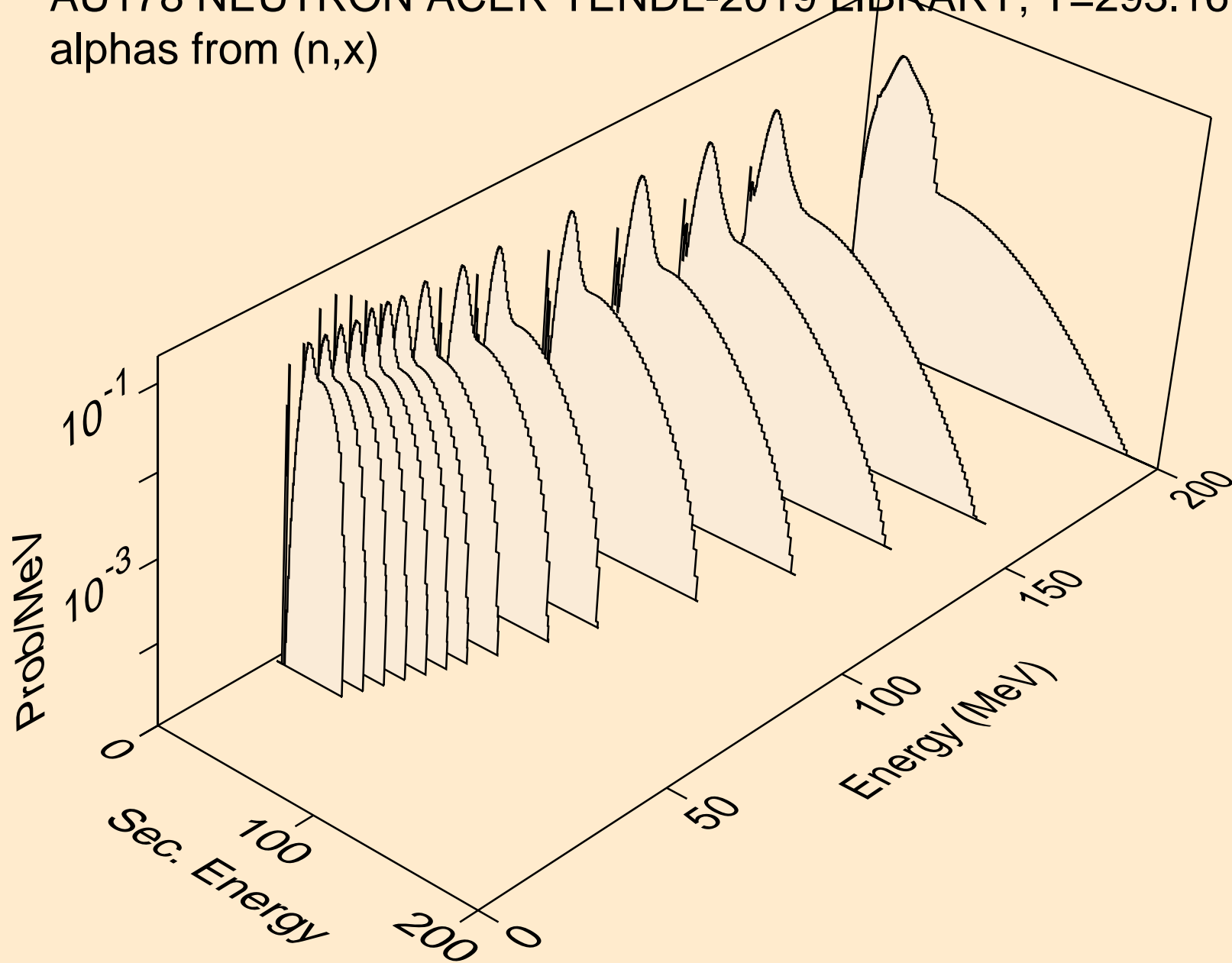

AU178 NEUTRON ACER TENDL-2019 LIBRARY; T=293.16K
alphas from (n,n*)a

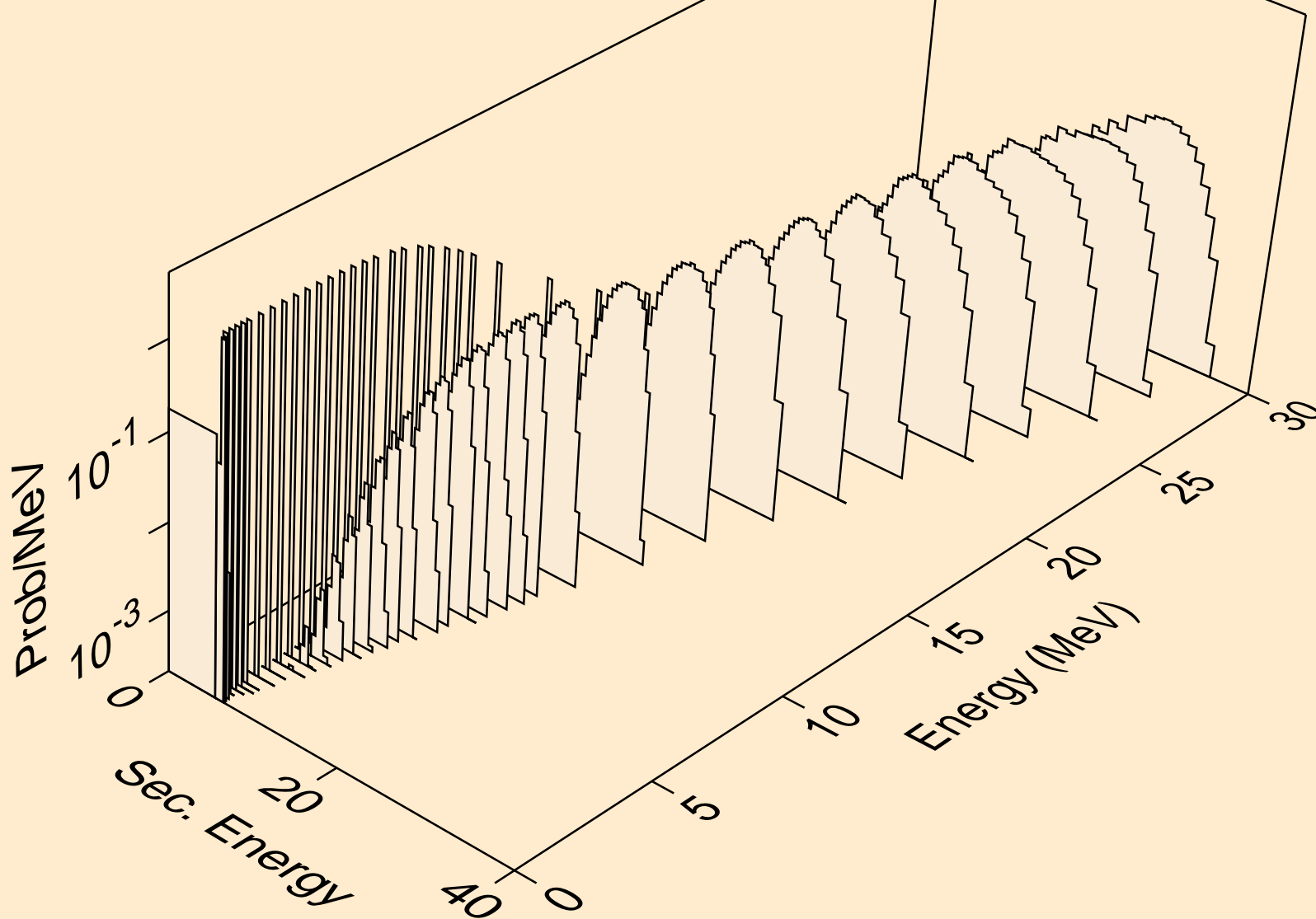

AU178 NEUTRON ACER TENDL-2019 LIBRARY; T=293.16K
alphas from (n,n*)3a

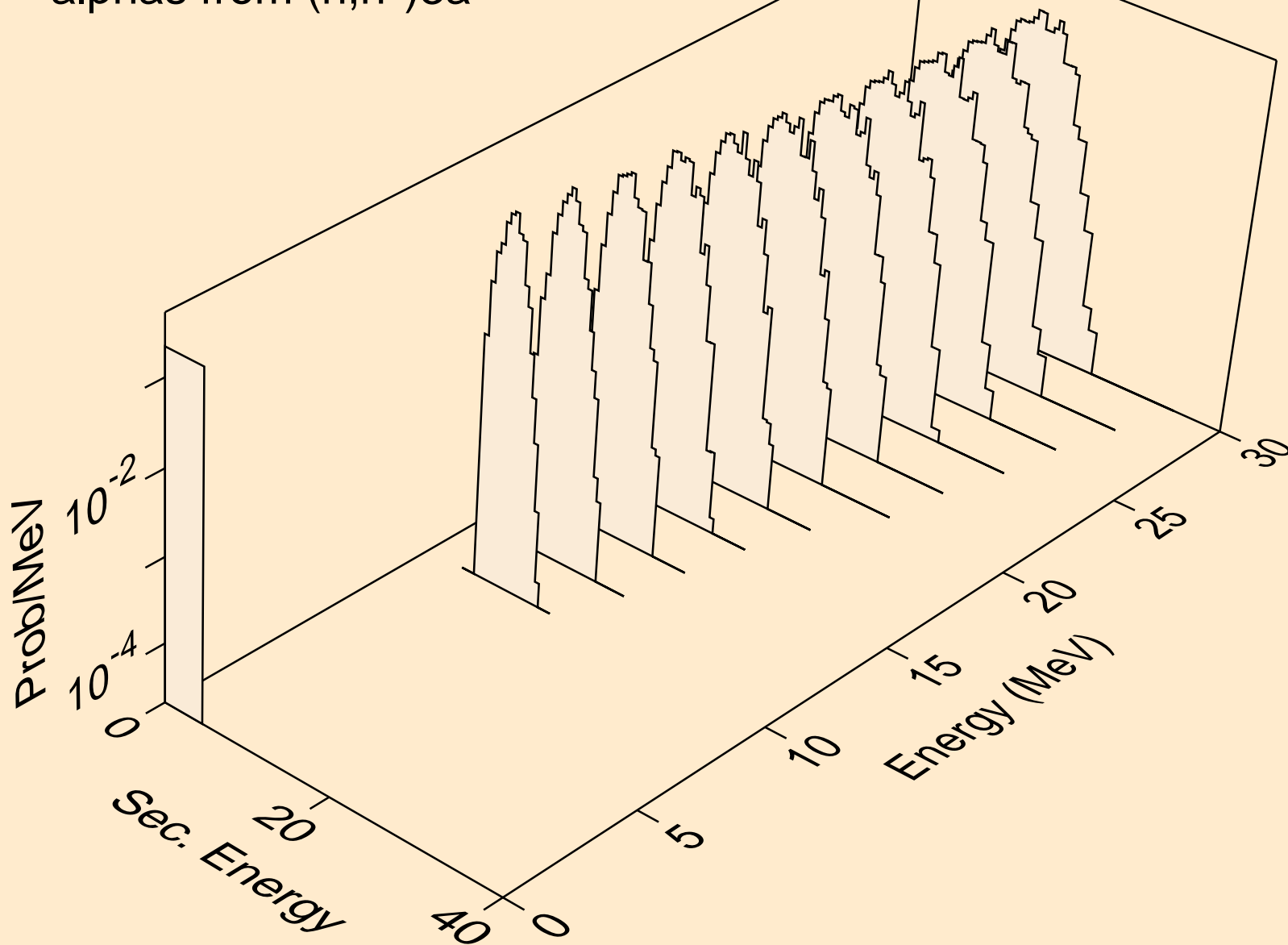

AU178 NEUTRON ACER TENDL-2019 LIBRARY; T=293.16K
alphas from (n,2n)a

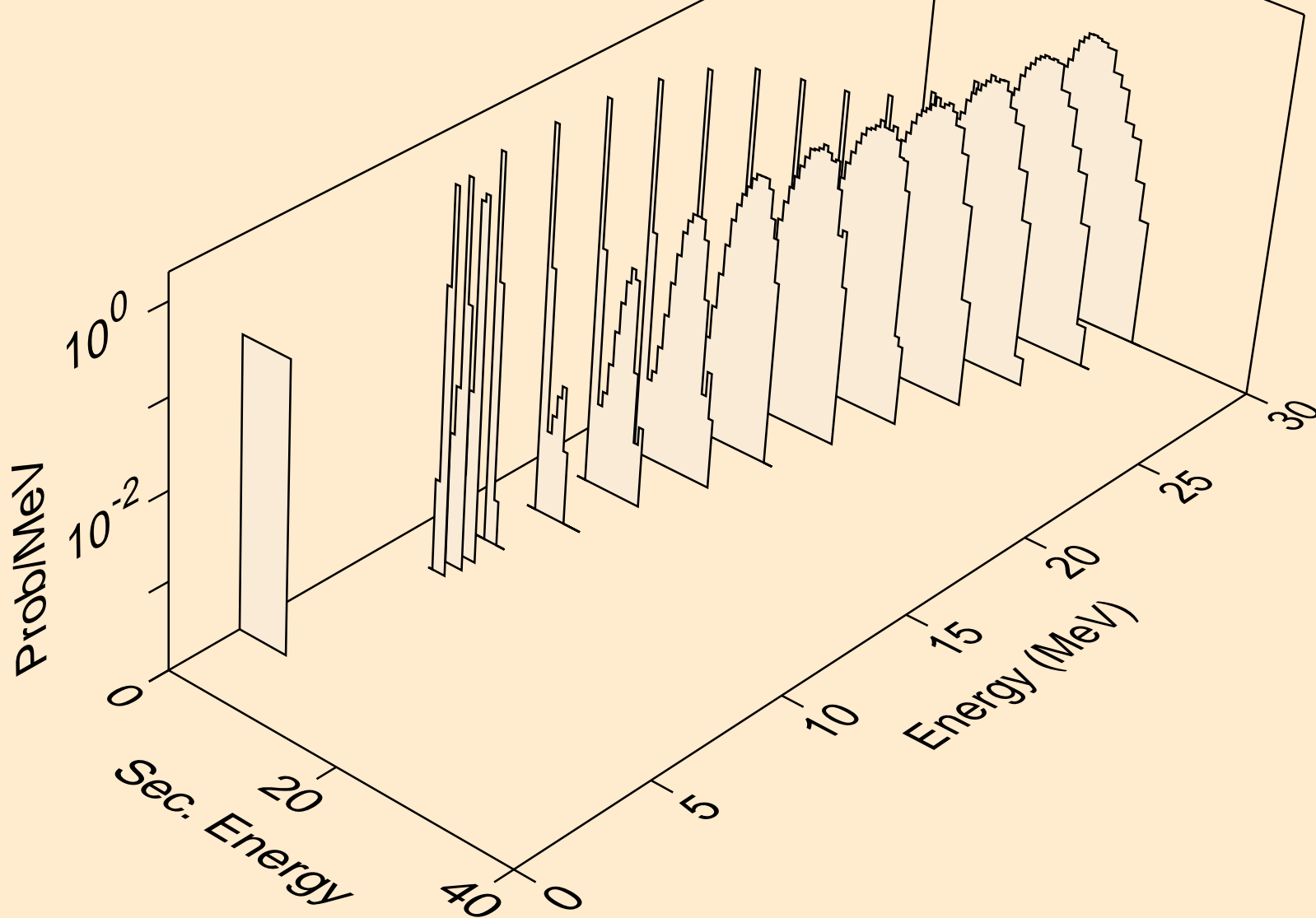

AU178 NEUTRON ACER TENDL-2019 LIBRARY; T=293.16K
alphas from (n,3n)a

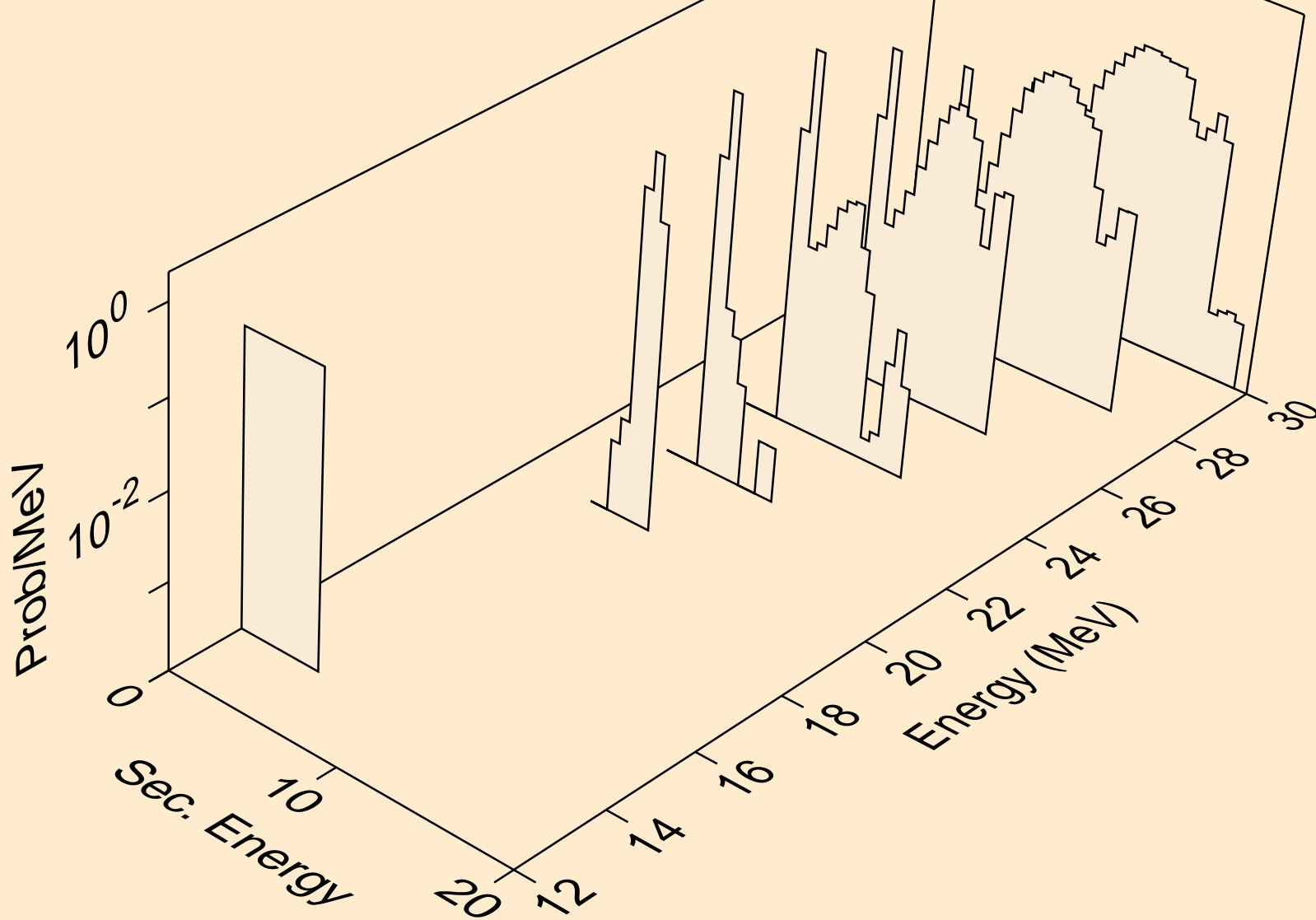

AU178 NEUTRON ACER TENDL-2019 LIBRARY; T=293.16K
alphas from (n,n*)2a

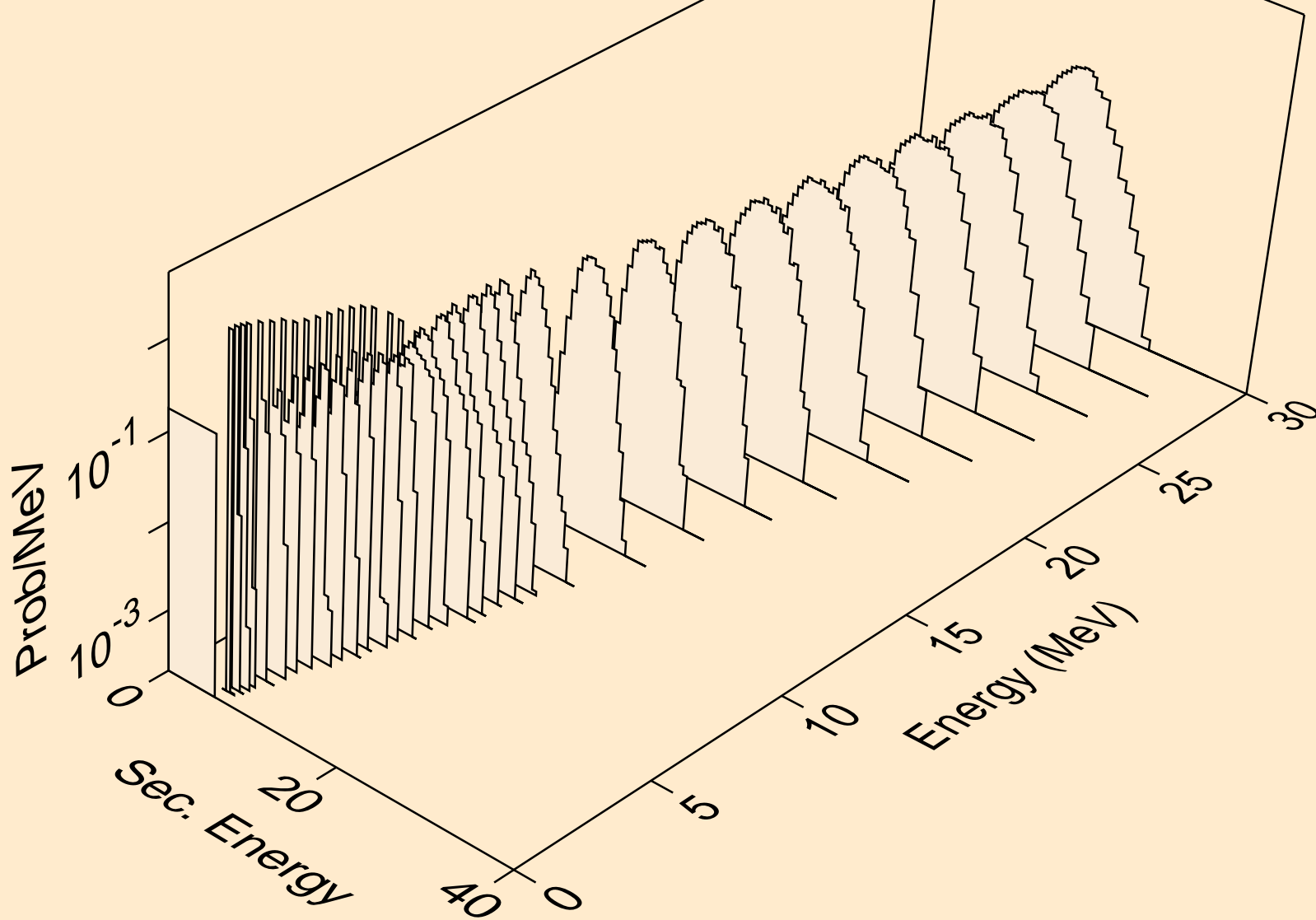

AU178 NEUTRON ACER TENDL-2019 LIBRARY; T=293.16K
alphas from (n,2n)2a

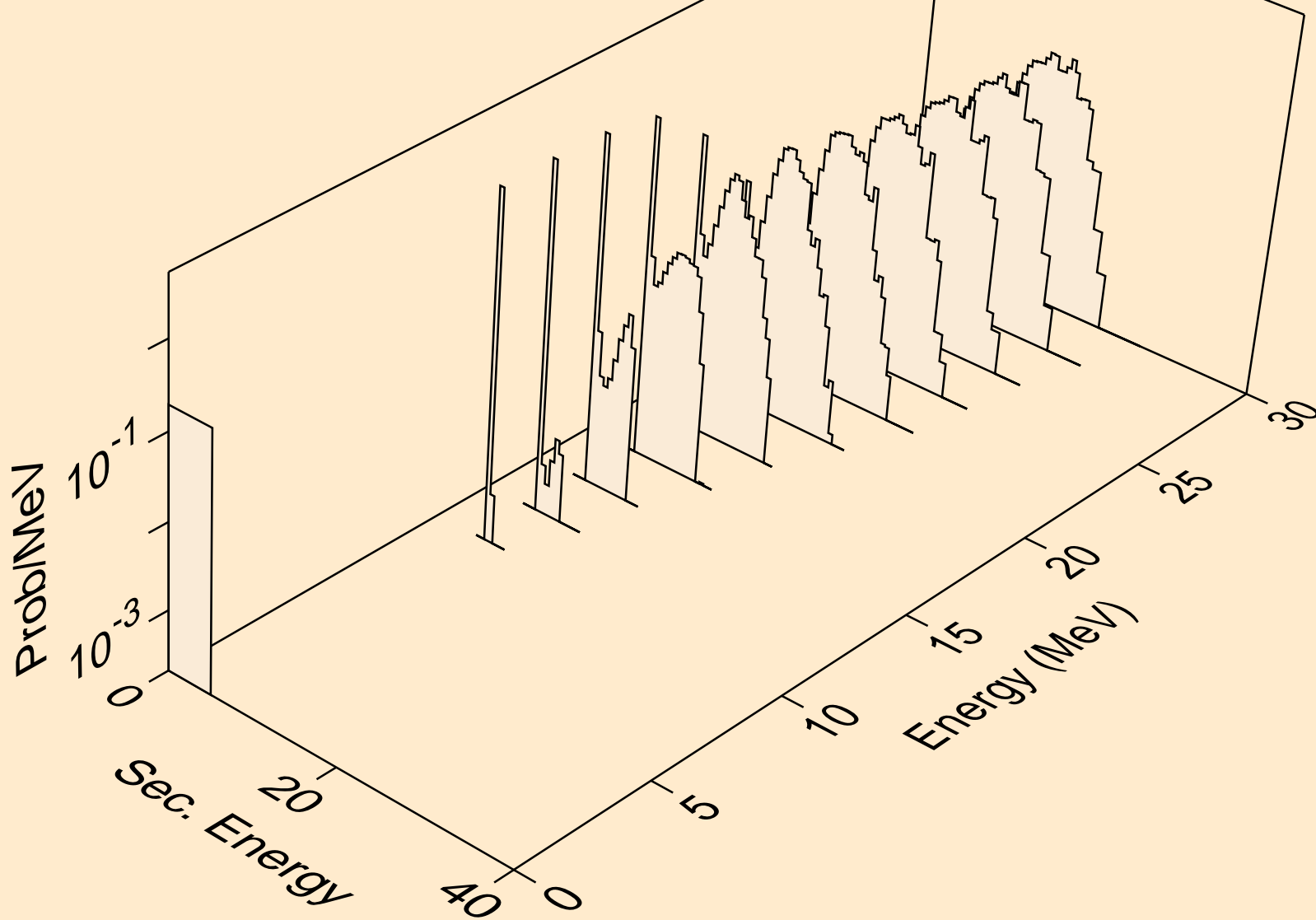

AU178 NEUTRON ACER TENDL-2019 LIBRARY; T=293.16K
alphas from (n,npa)

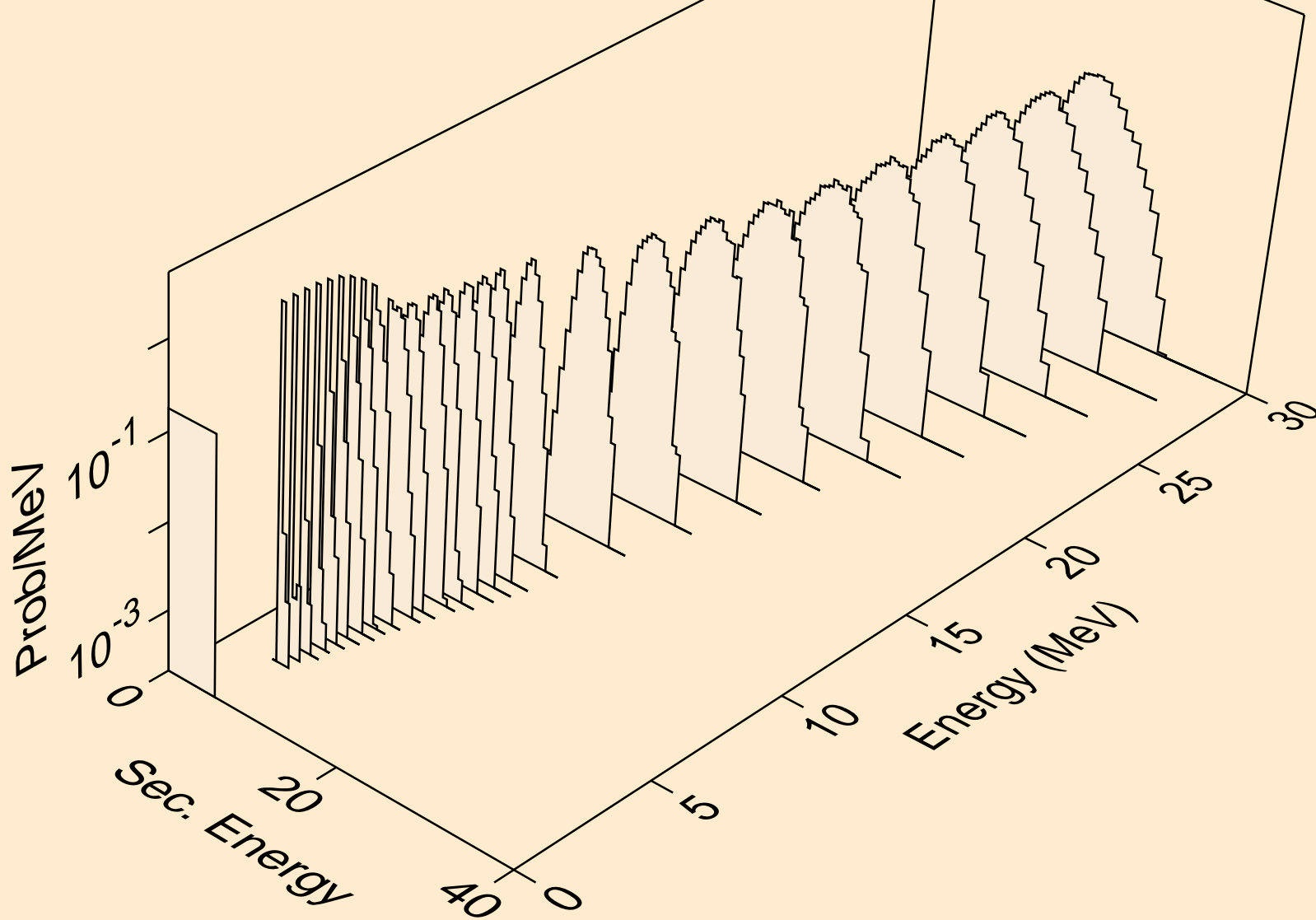

AU178 NEUTRON ACER TENDL-2019 LIBRARY; T=293.16K
alphas from (n,a)

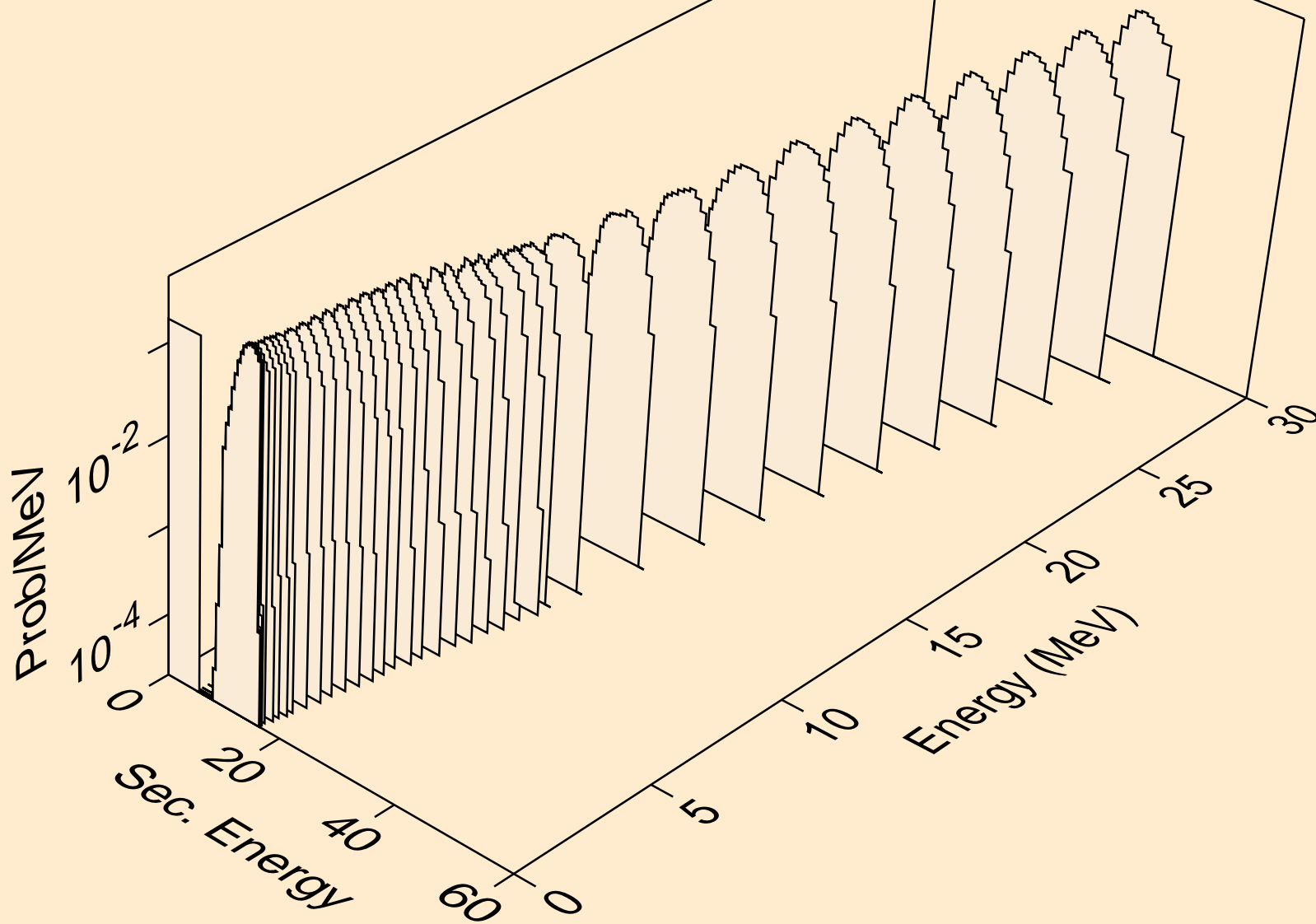

AU178 NEUTRON ACER TENDL-2019 LIBRARY; T=293.16K
alphas from (n,2a)

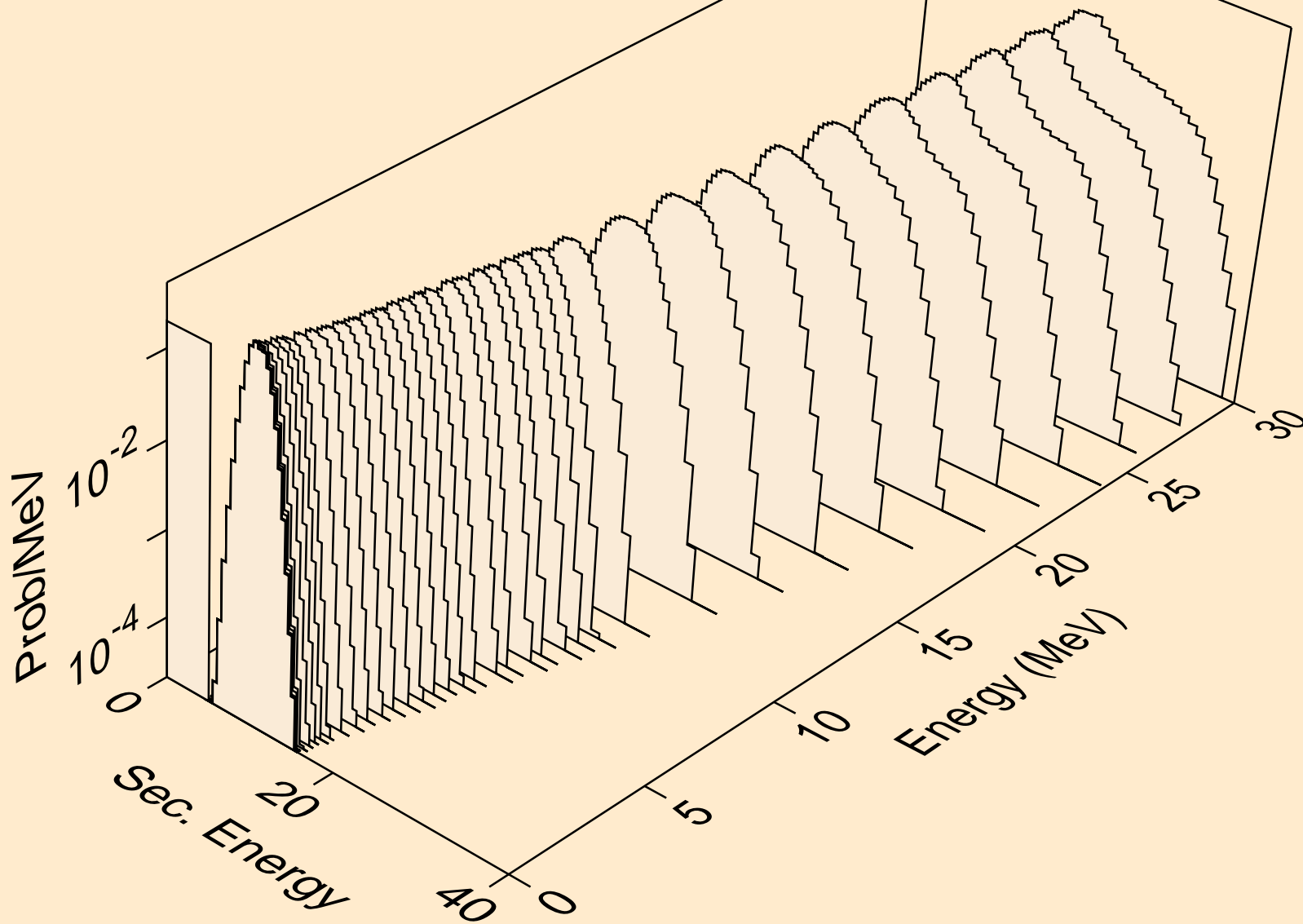

AU178 NEUTRON ACER TENDL-2019 LIBRARY; T=293.16K
alphas from (n,3a)

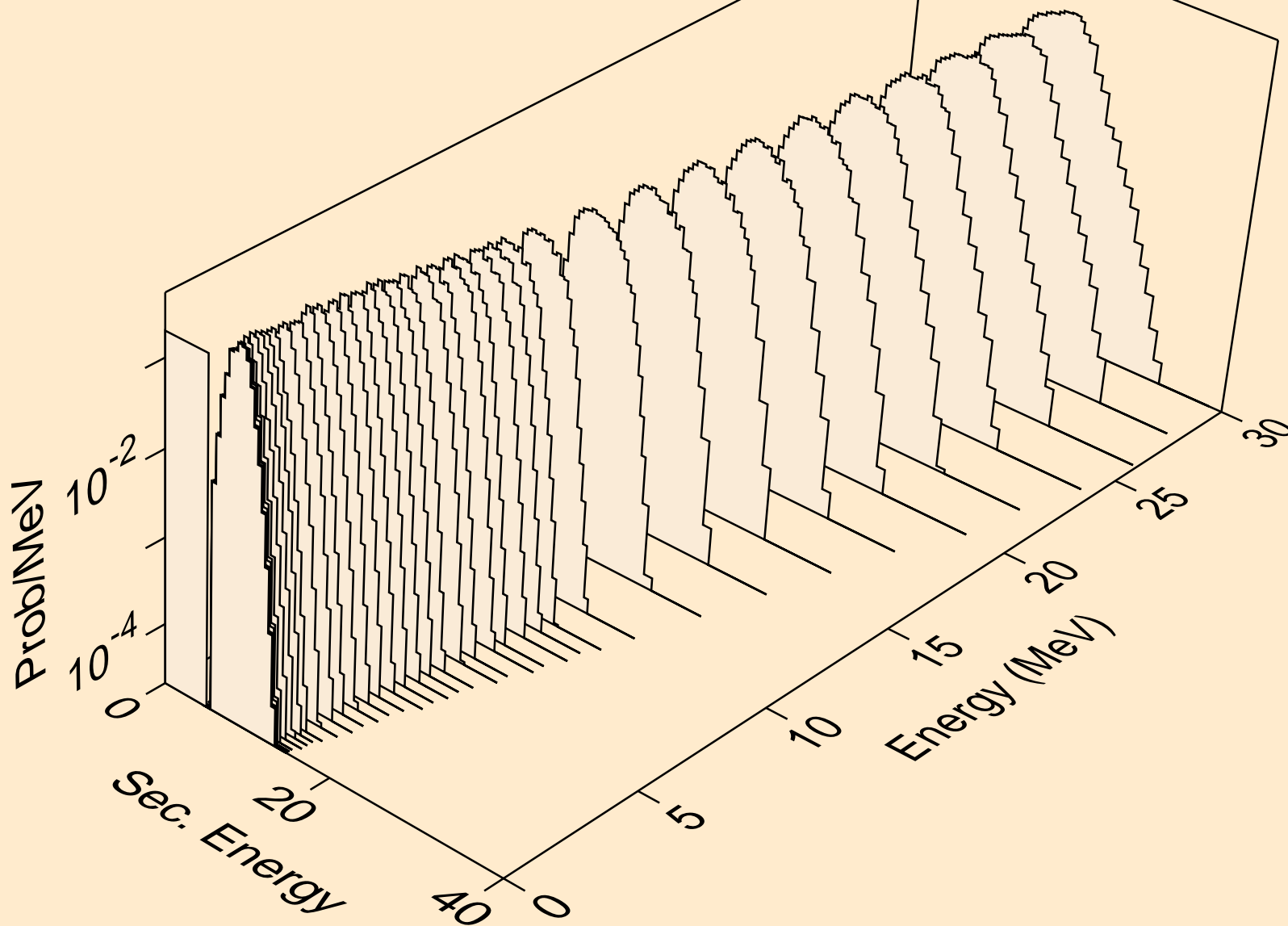

AU178 NEUTRON ACER TENDL-2019 LIBRARY; T=293.16K
alphas from (n,pa)

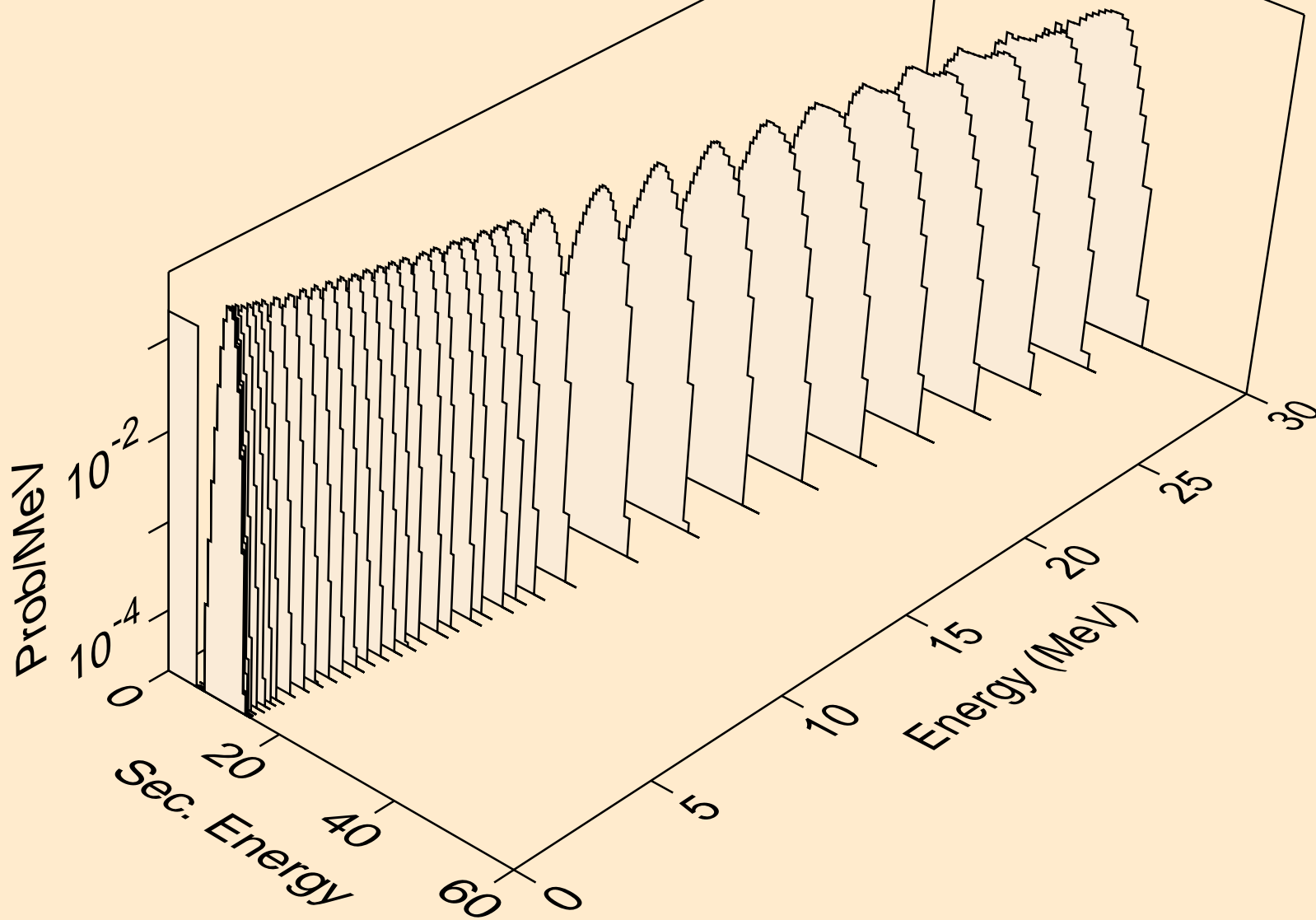

AU178 NEUTRON ACER TENDL-2019 LIBRARY; T=293.16K
alphas from (n,t2a)

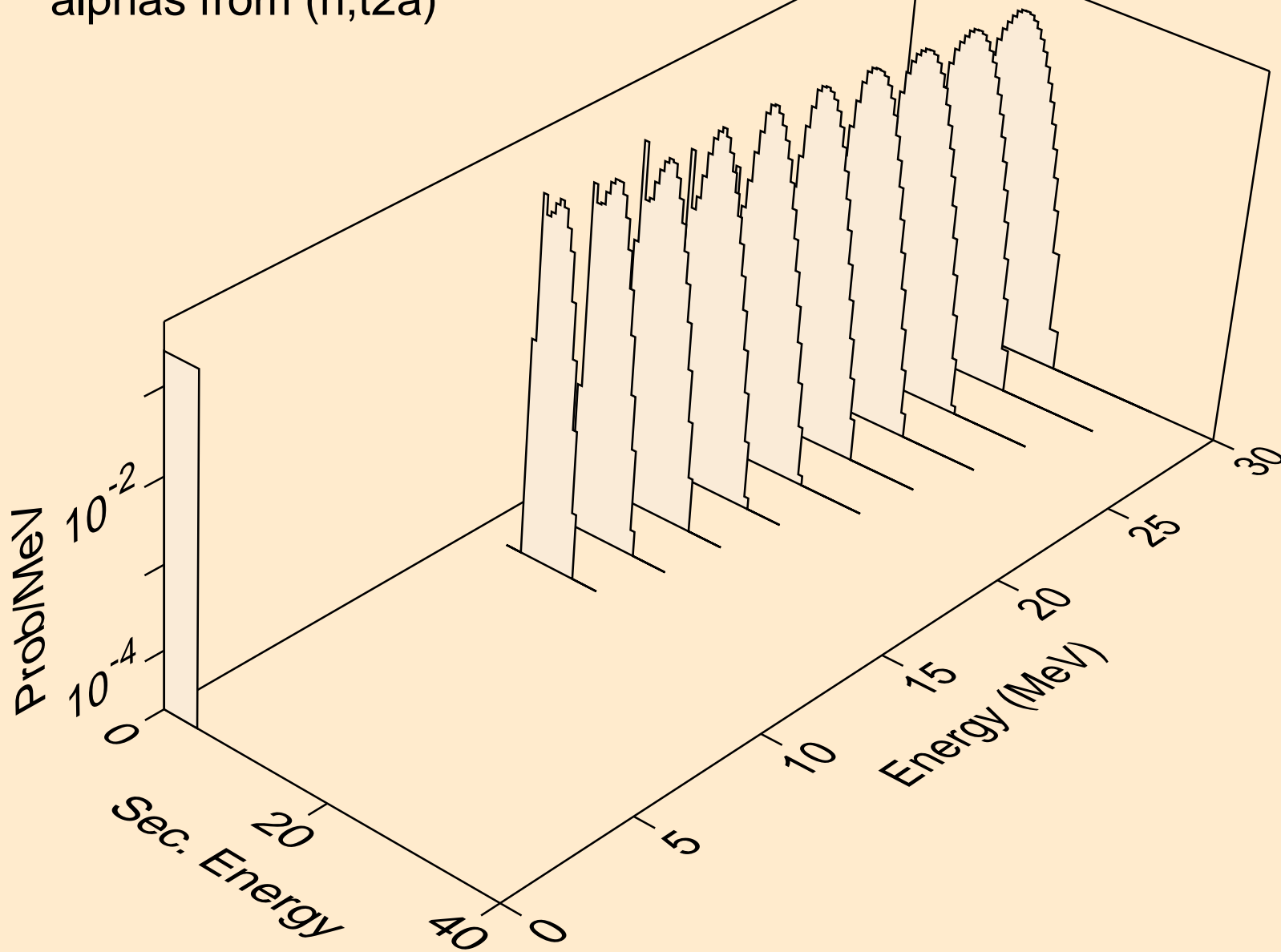

AU178 NEUTRON ACER TENDL-2019 LIBRARY; T=293.16K
alphas from (n,d2a)

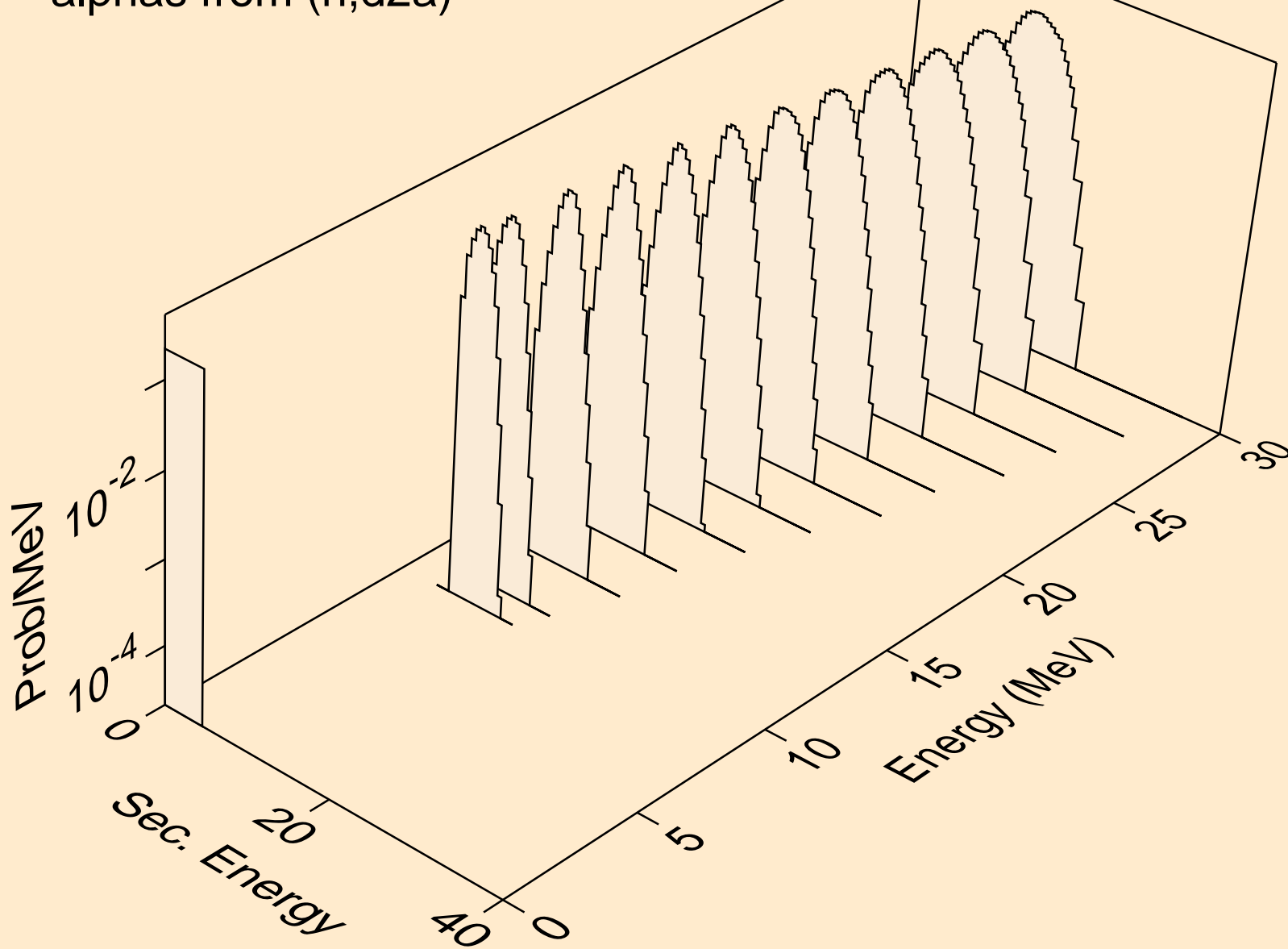

AU178 NEUTRON ACER TENDL-2019 LIBRARY; T=293.16K
alphas from (n,da)

