

AU185 NEUTRON ACER TENDL-2019 LIBRARY; T=293.16K
Principal cross sections

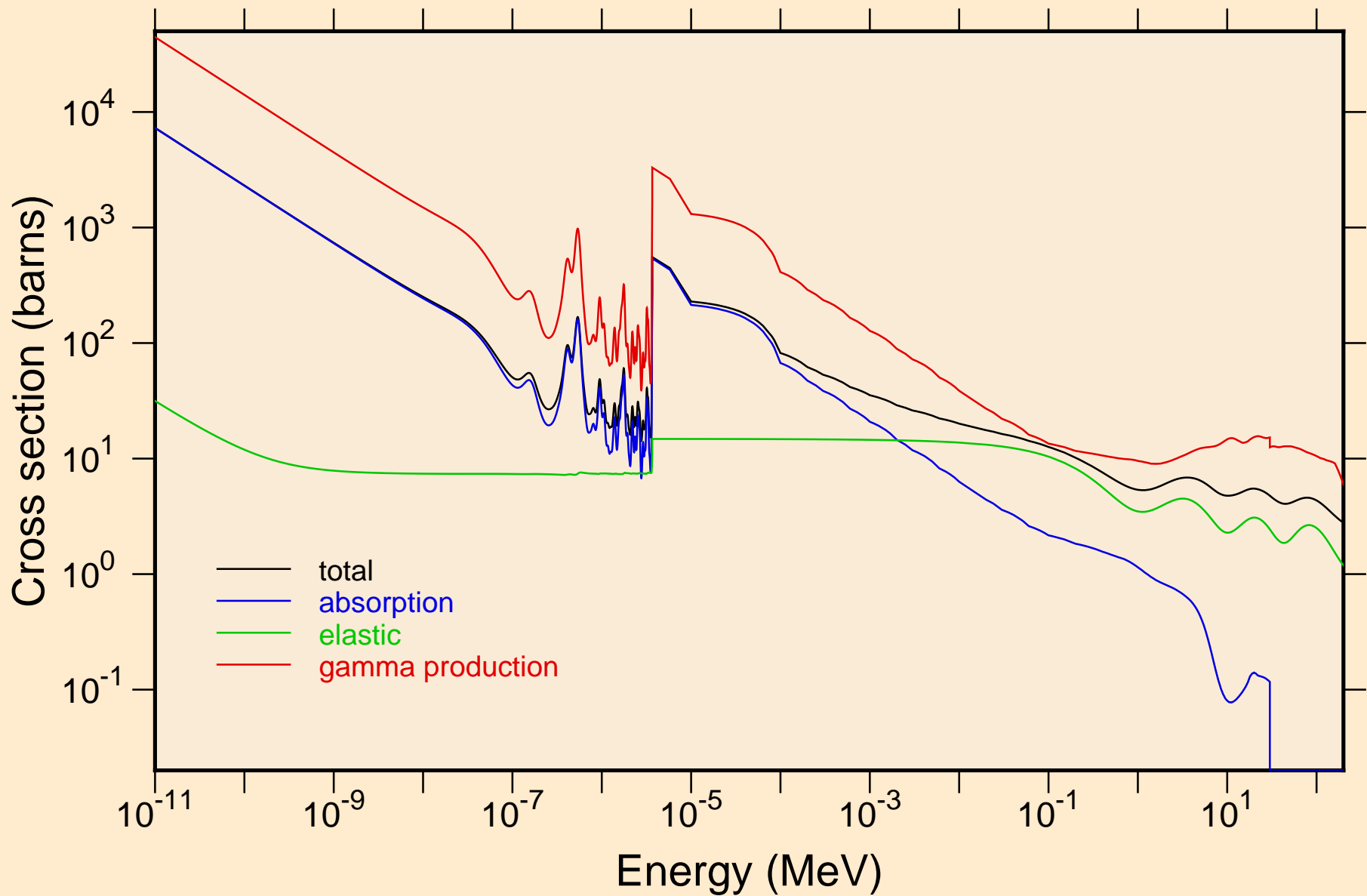

AU185 NEUTRON ACER TENDL-2019 LIBRARY; T=293.16K
resonance total cross section

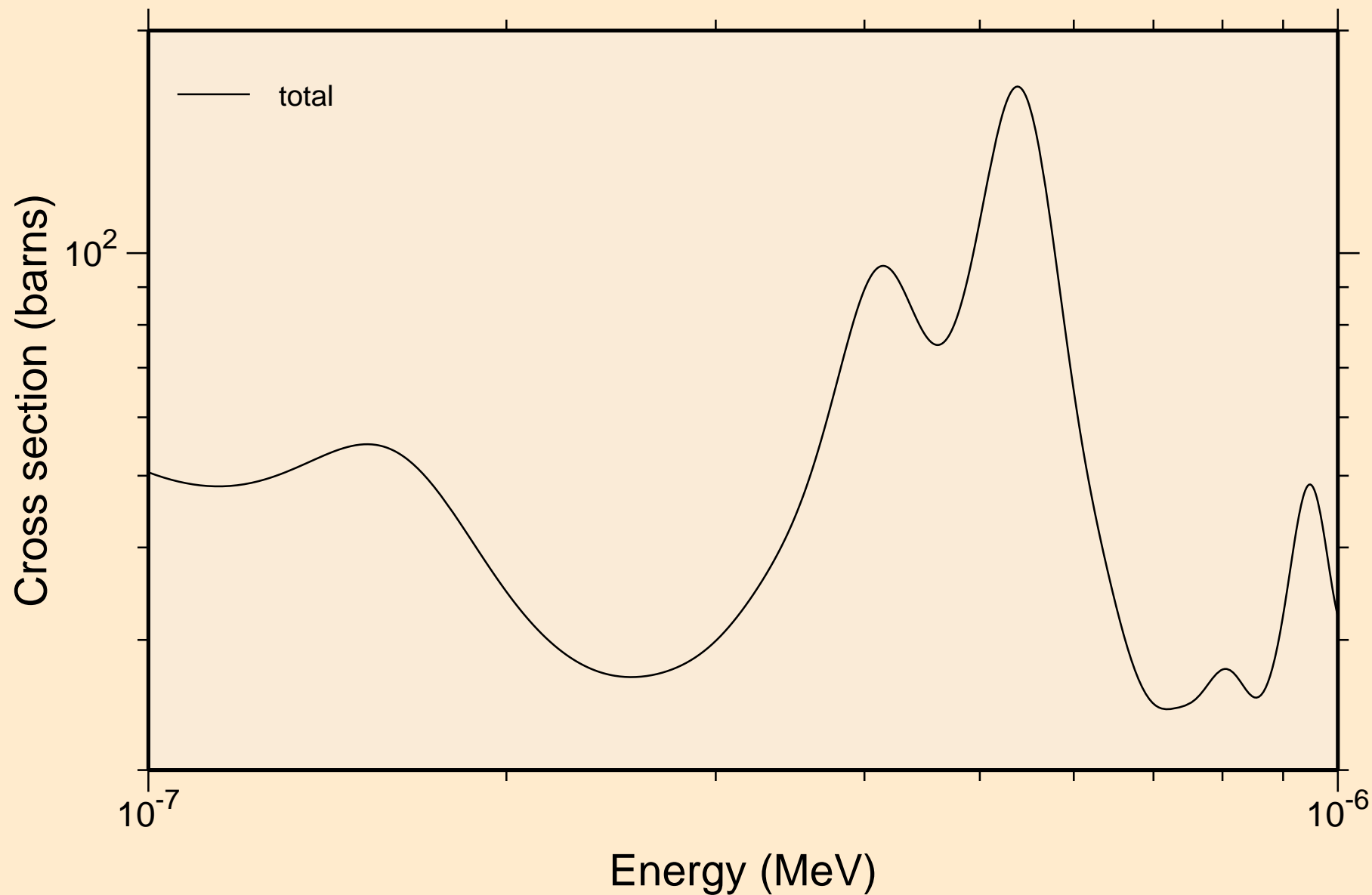

AU185 NEUTRON ACER TENDL-2019 LIBRARY; T=293.16K
resonance total cross section

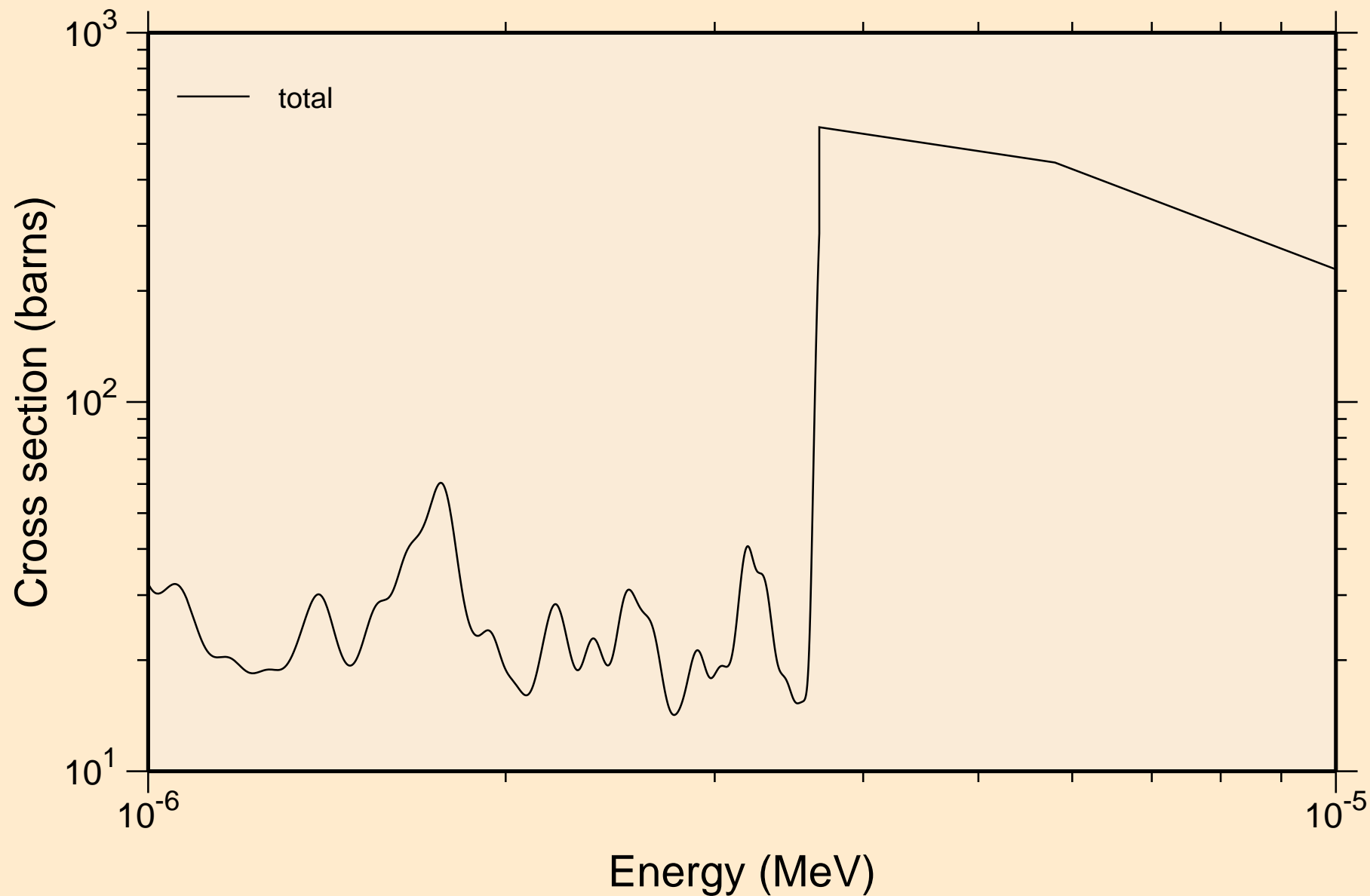

AU185 NEUTRON ACER TENDL-2019 LIBRARY; T=293.16K
resonance total cross section

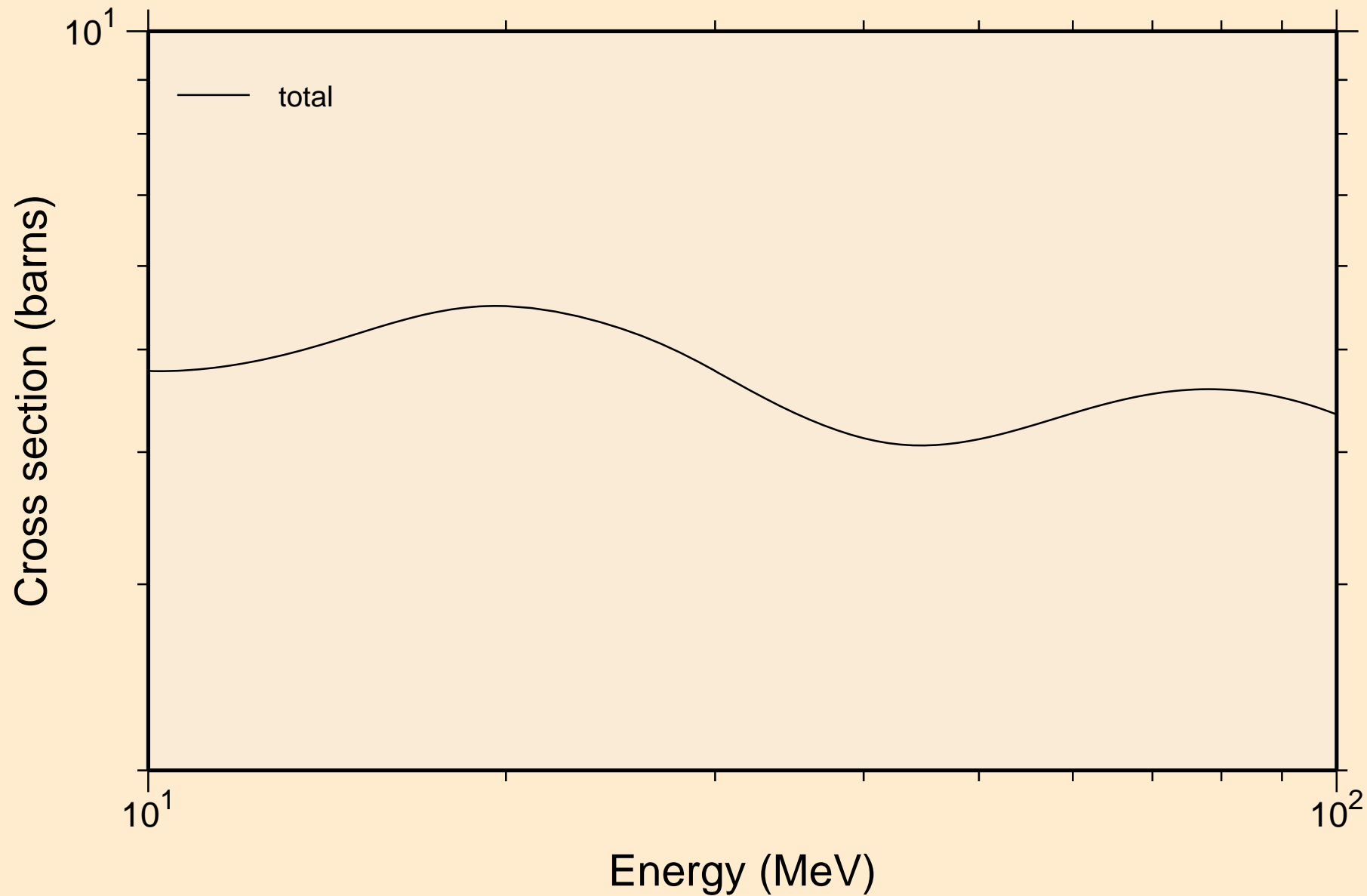

AU185 NEUTRON ACER TENDL-2019 LIBRARY; T=293.16K
resonance absorption cross sections

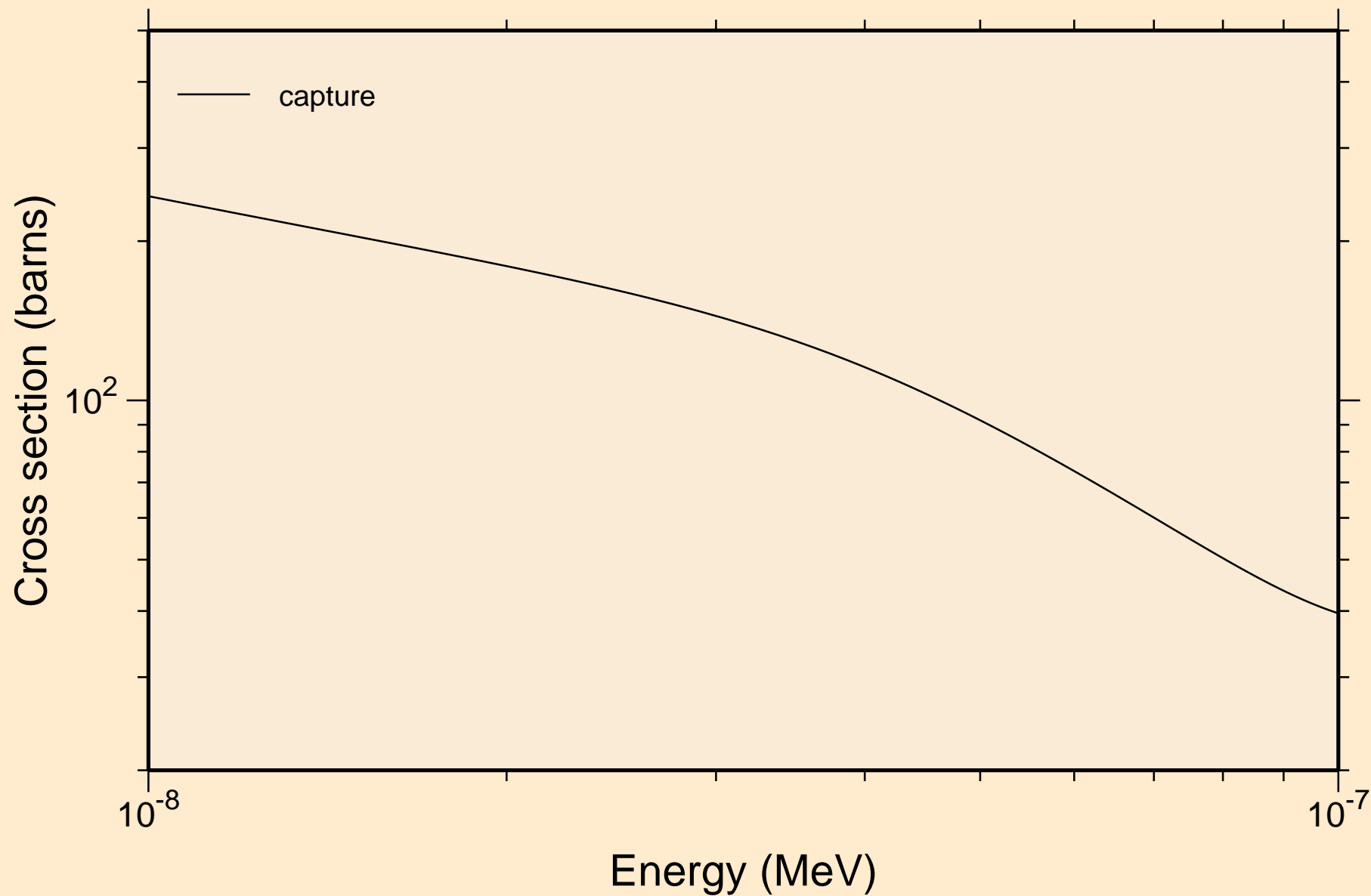

AU185 NEUTRON ACER TENDL-2019 LIBRARY; T=293.16K
resonance absorption cross sections

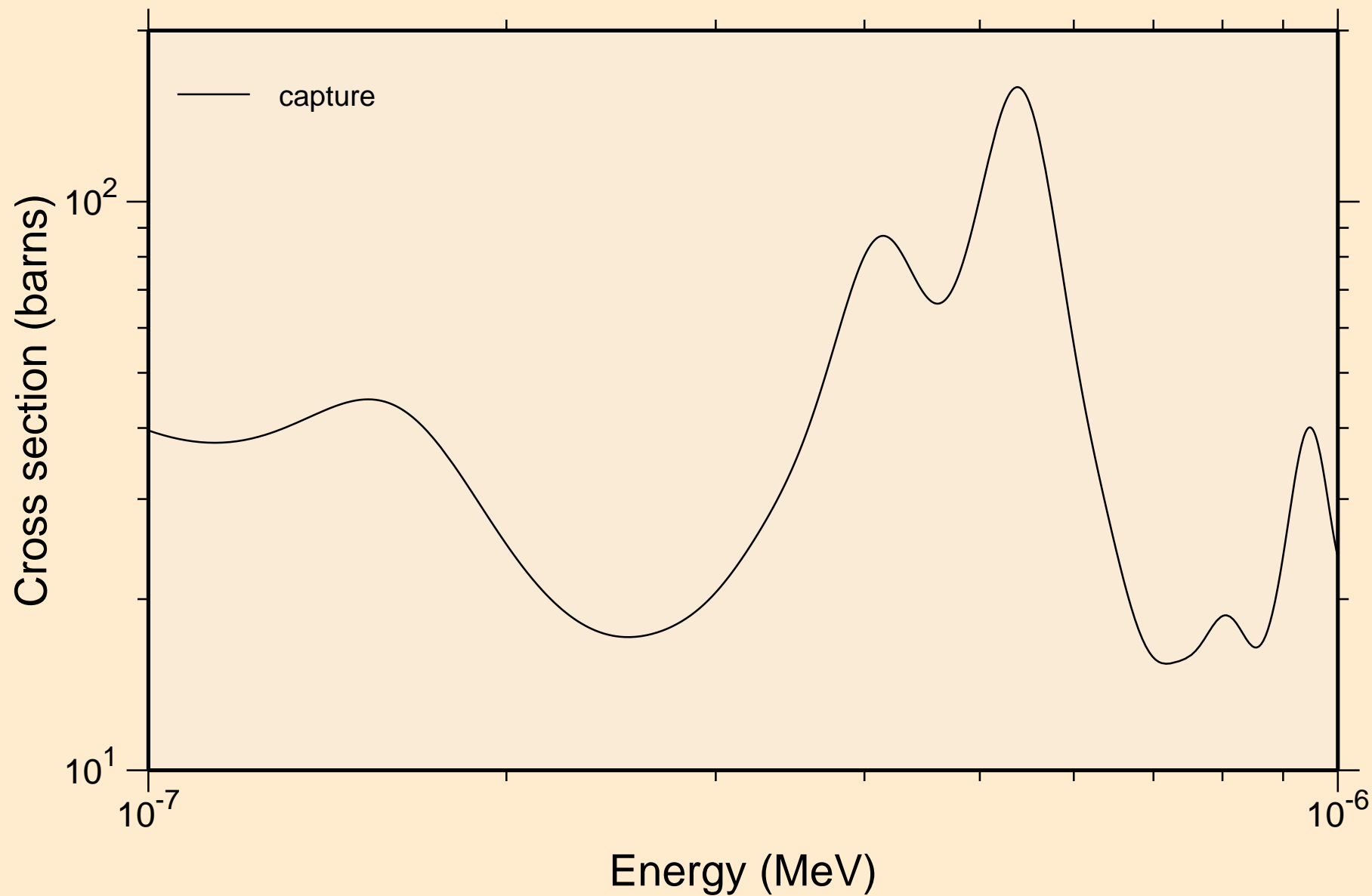

AU185 NEUTRON ACER TENDL-2019 LIBRARY; T=293.16K
resonance absorption cross sections

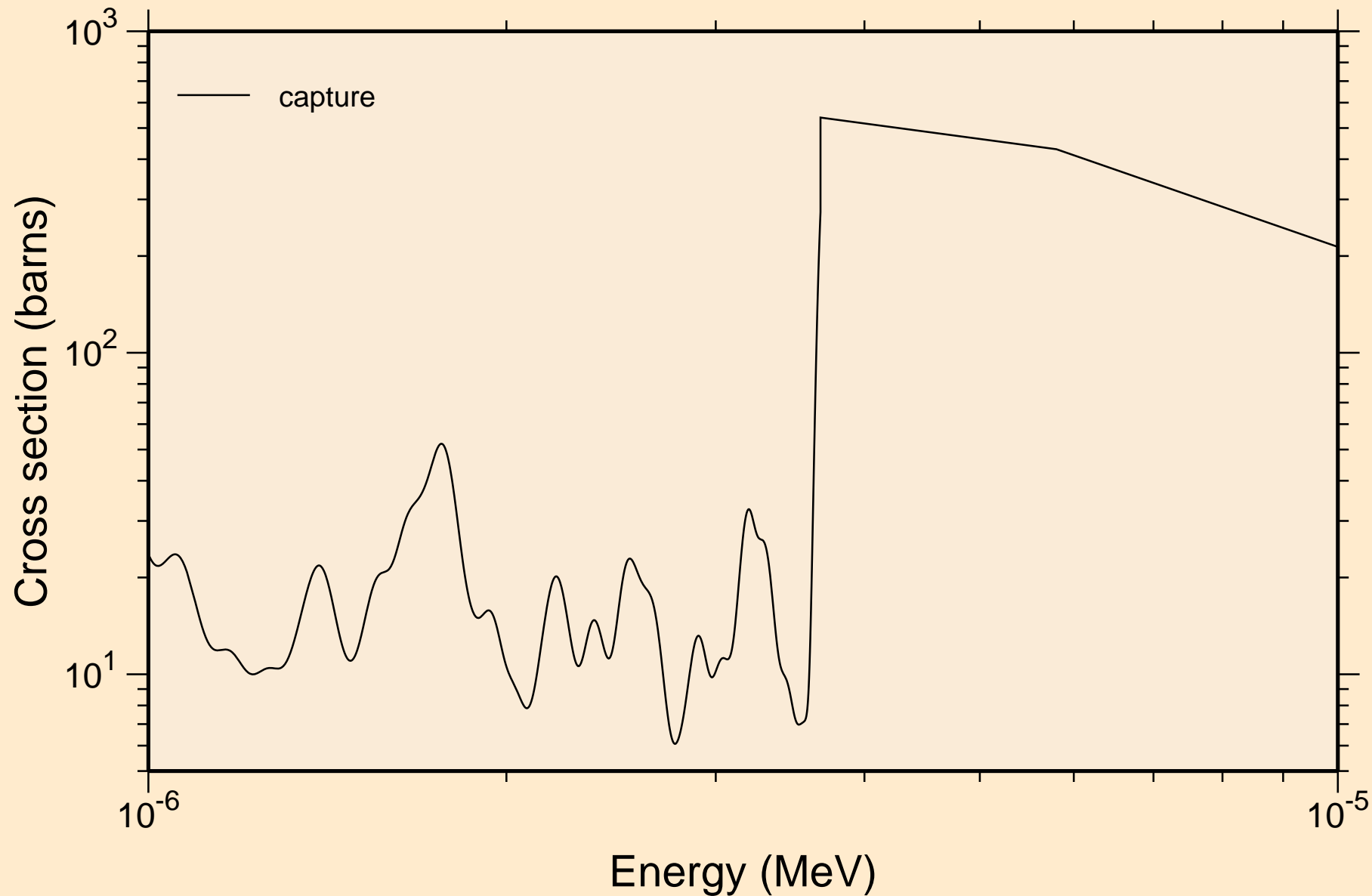

AU185 NEUTRON ACER TENDL-2019 LIBRARY; T=293.16K
resonance absorption cross sections

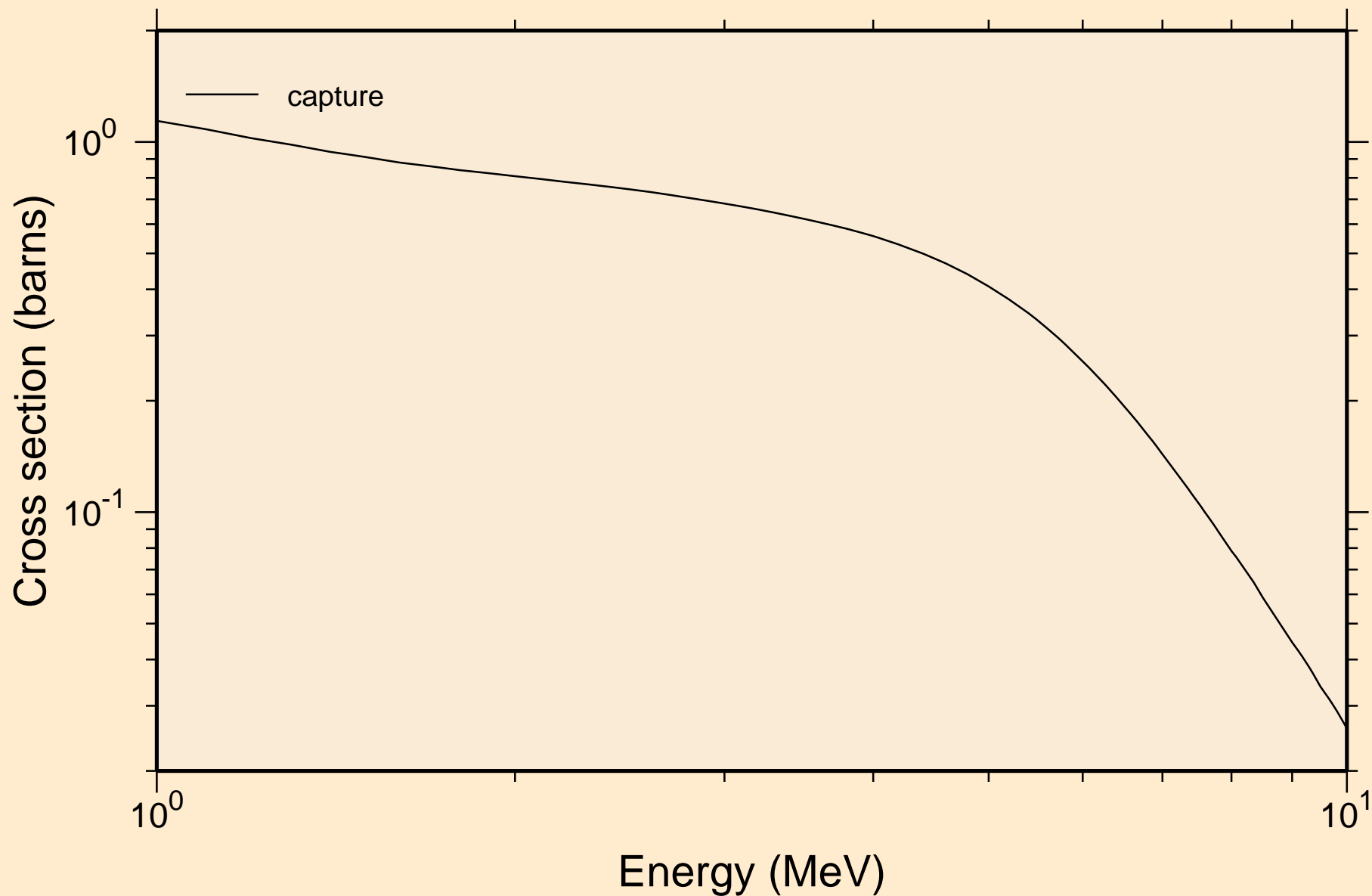

AU185 NEUTRON ACER TENDL-2019 LIBRARY; T=293.16K
Heating

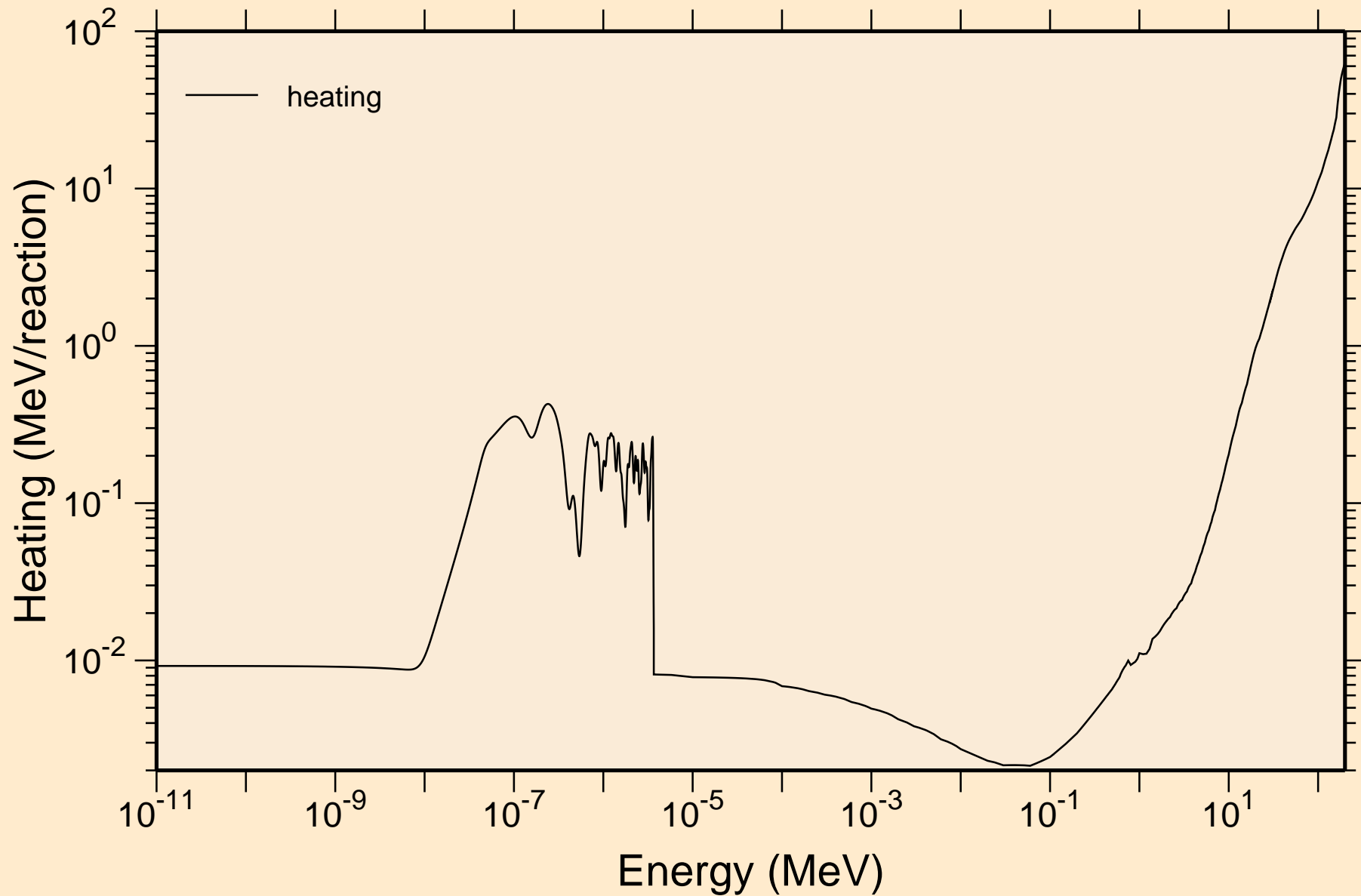

AU185 NEUTRON ACER TENDL-2019 LIBRARY; T=293.16K
Damage

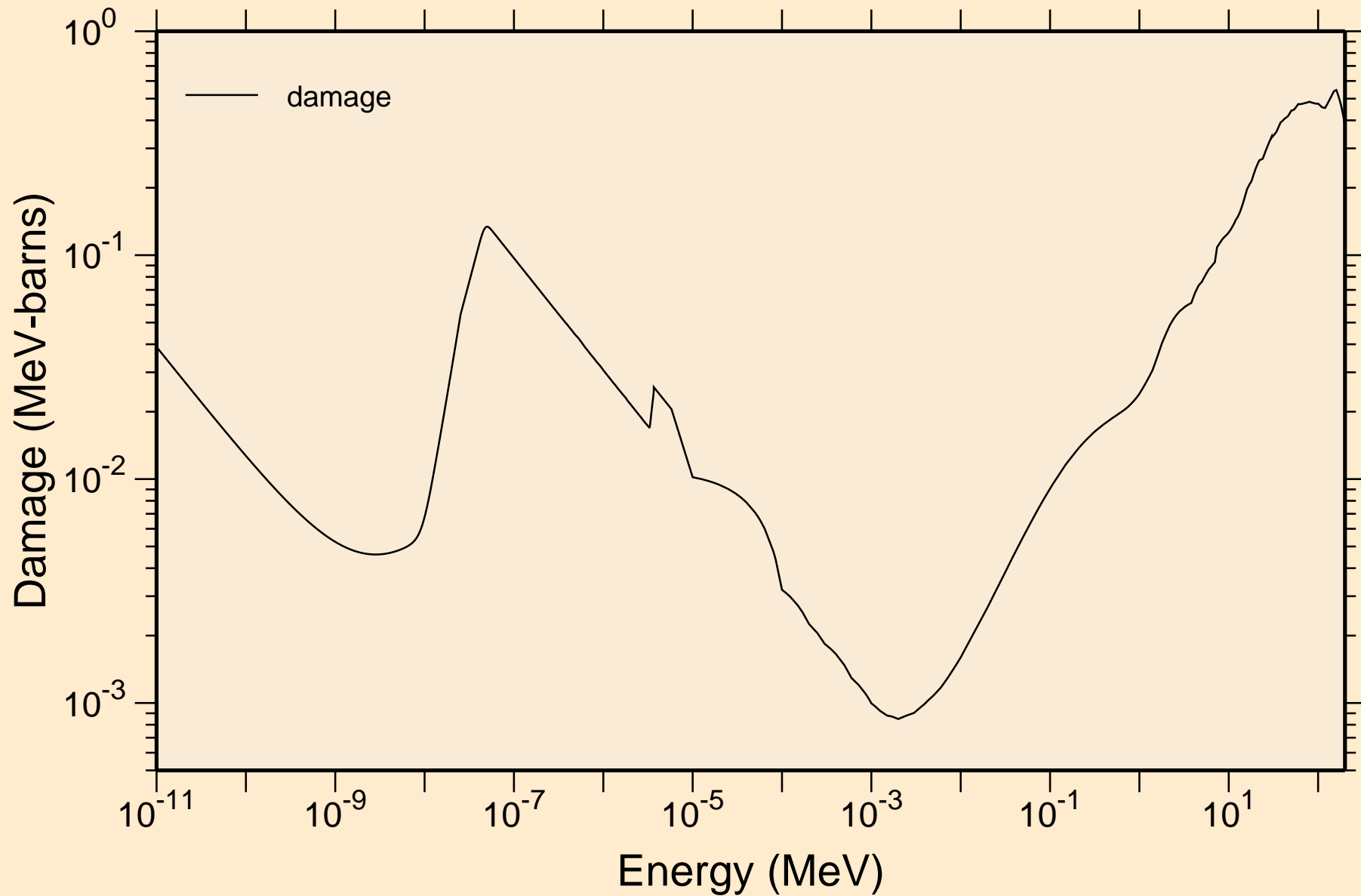

AU185 NEUTRON ACER TENDL-2019 LIBRARY; T=293.16K
Non-threshold reactions

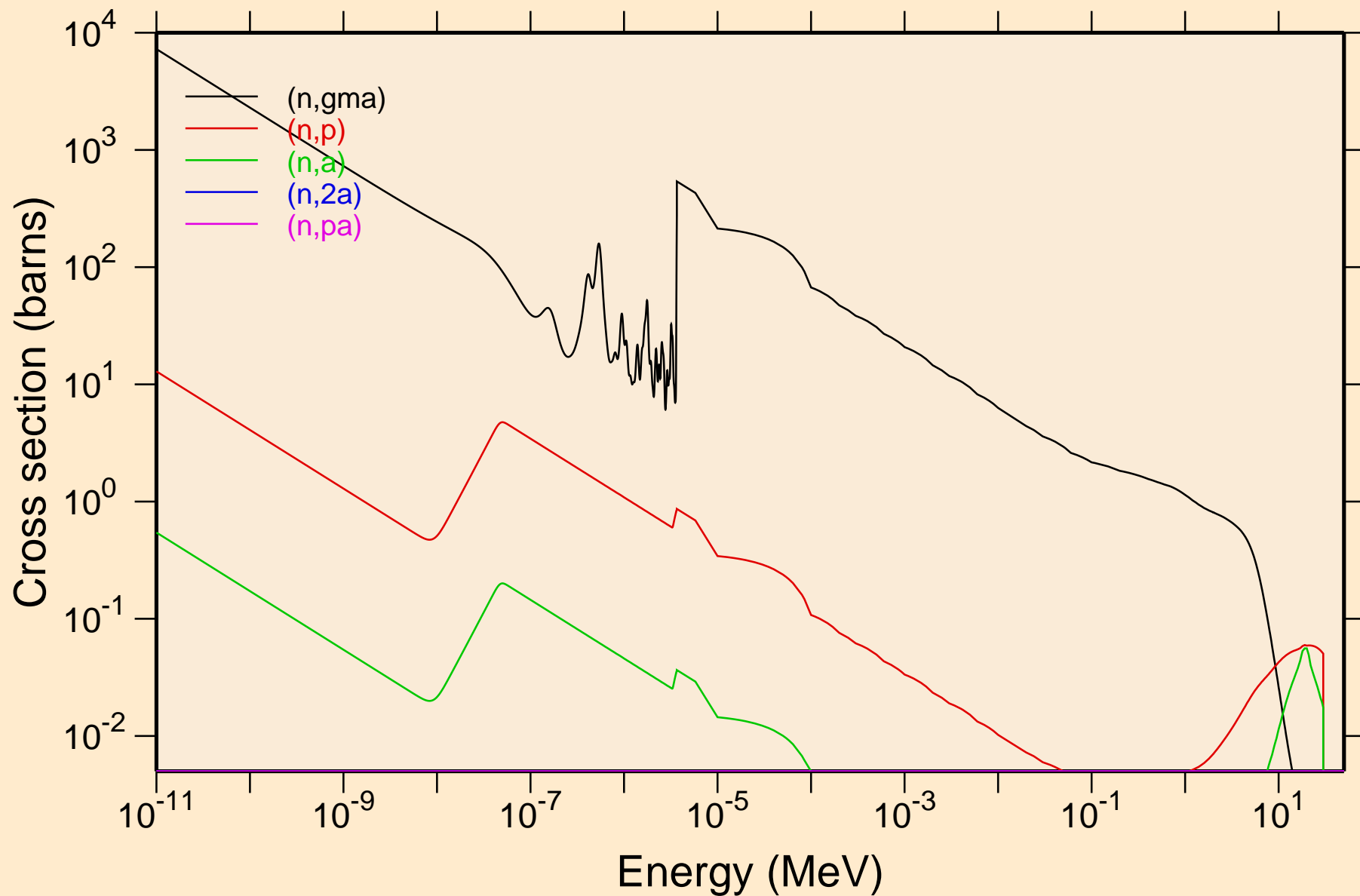

AU185 NEUTRON ACER TENDL-2019 LIBRARY; T=293.16K
Non-threshold reactions

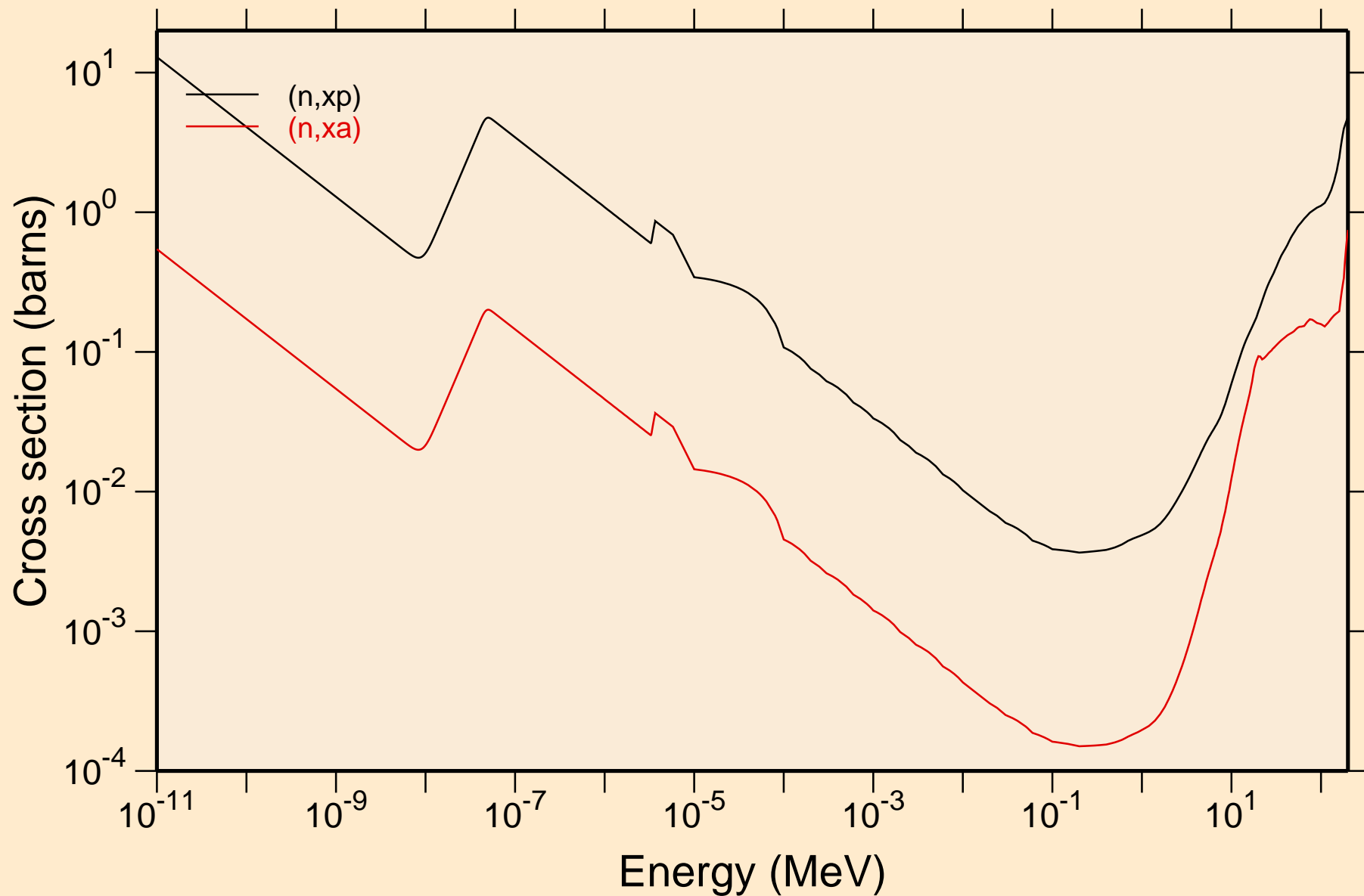

AU185 NEUTRON ACER TENDL-2019 LIBRARY; T=293.16K

Principal cross sections

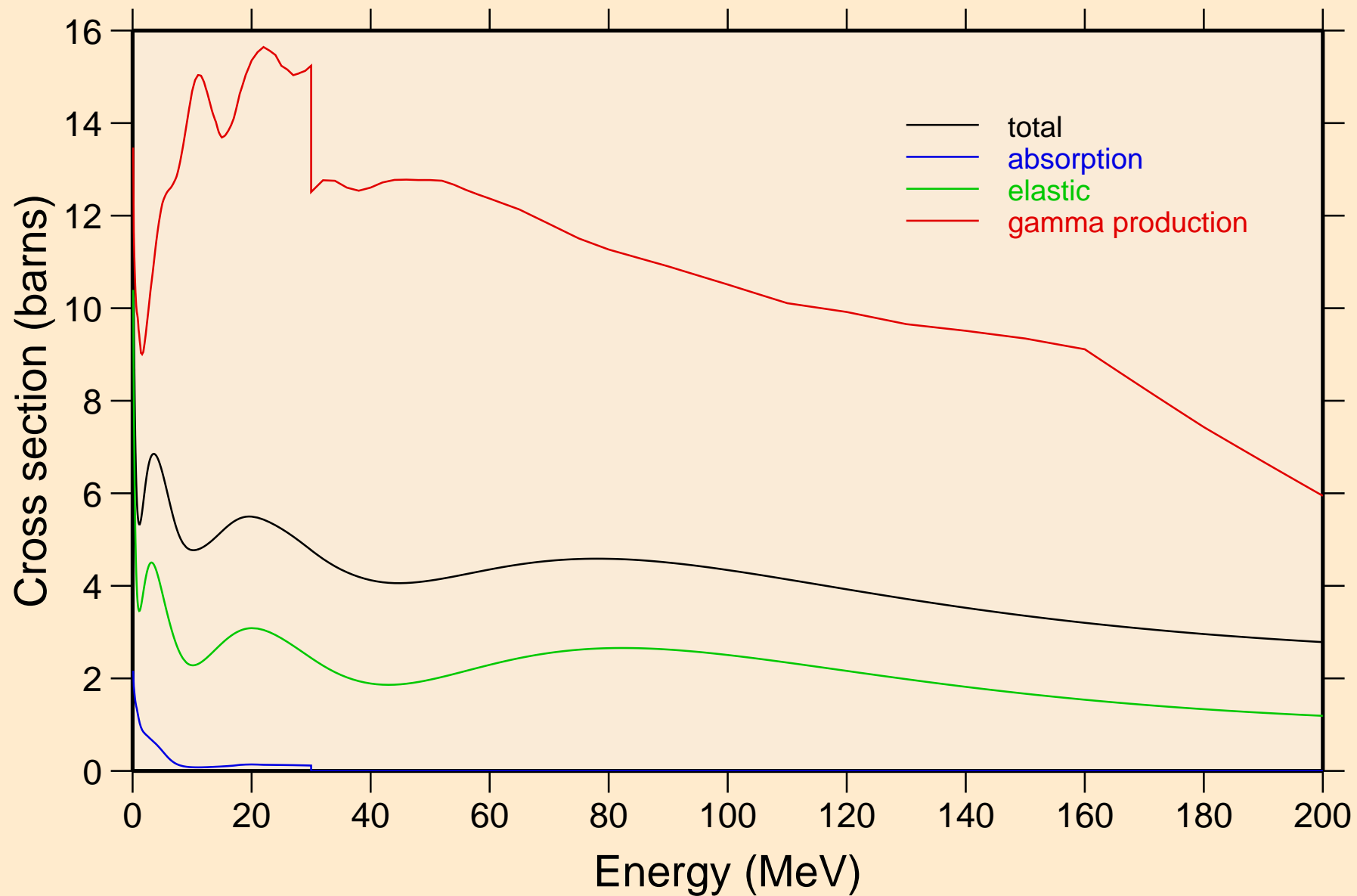

AU185 NEUTRON ACER TENDL-2019 LIBRARY; T=293.16K
Heating

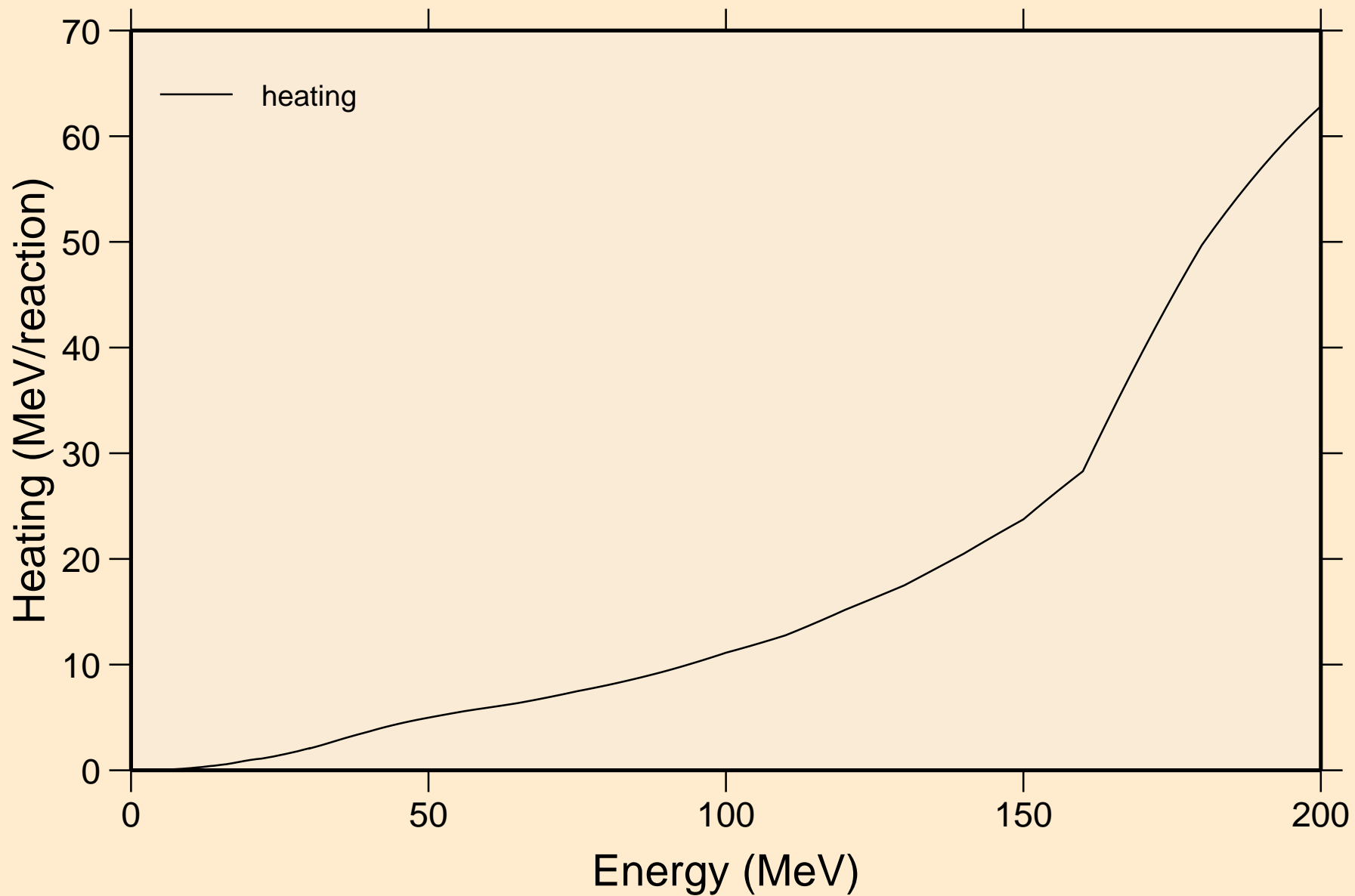

AU185 NEUTRON ACER TENDL-2019 LIBRARY; T=293.16K
Damage

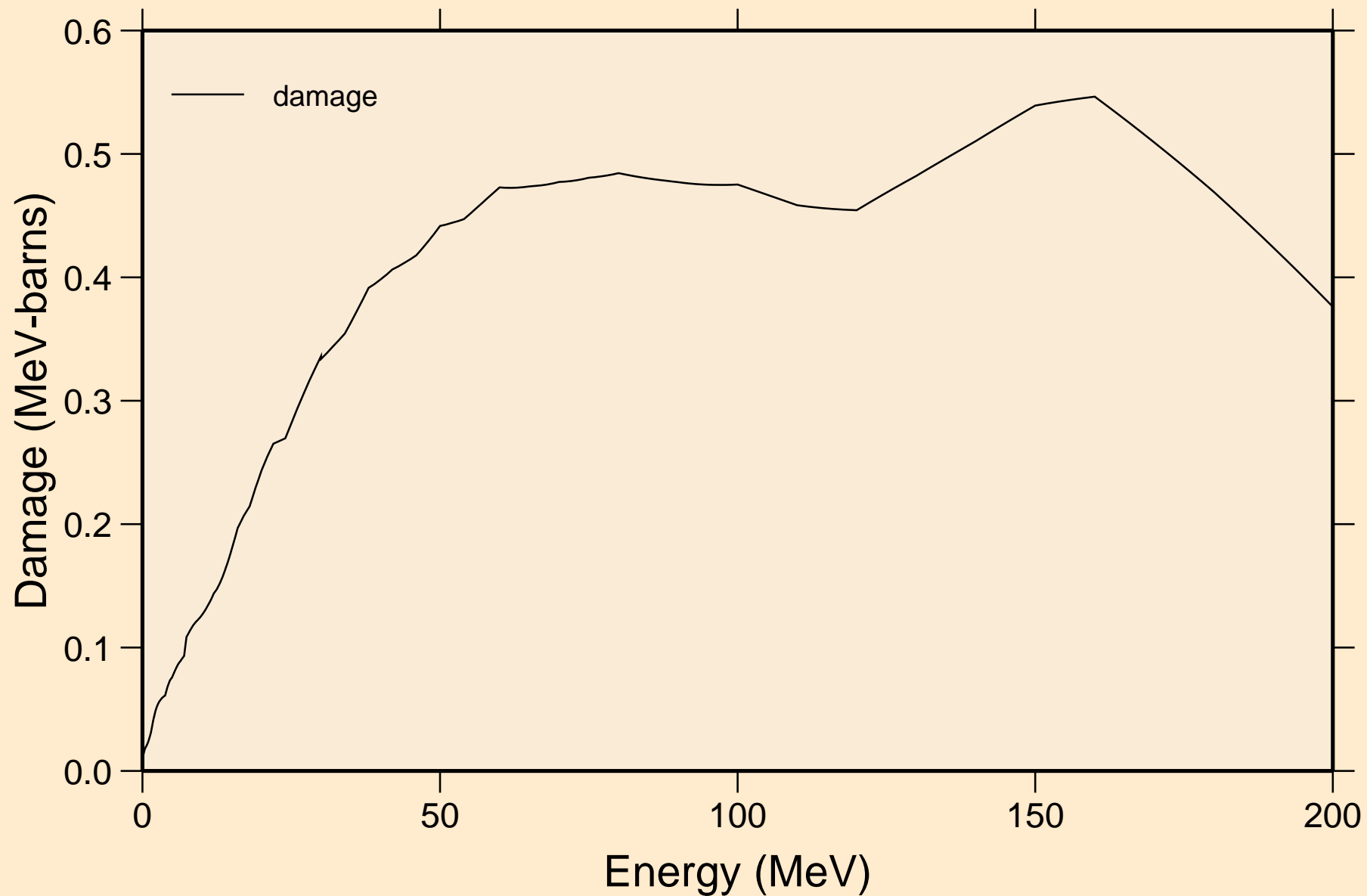

AU185 NEUTRON ACER TENDL-2019 LIBRARY; T=293.16K
Non-threshold reactions

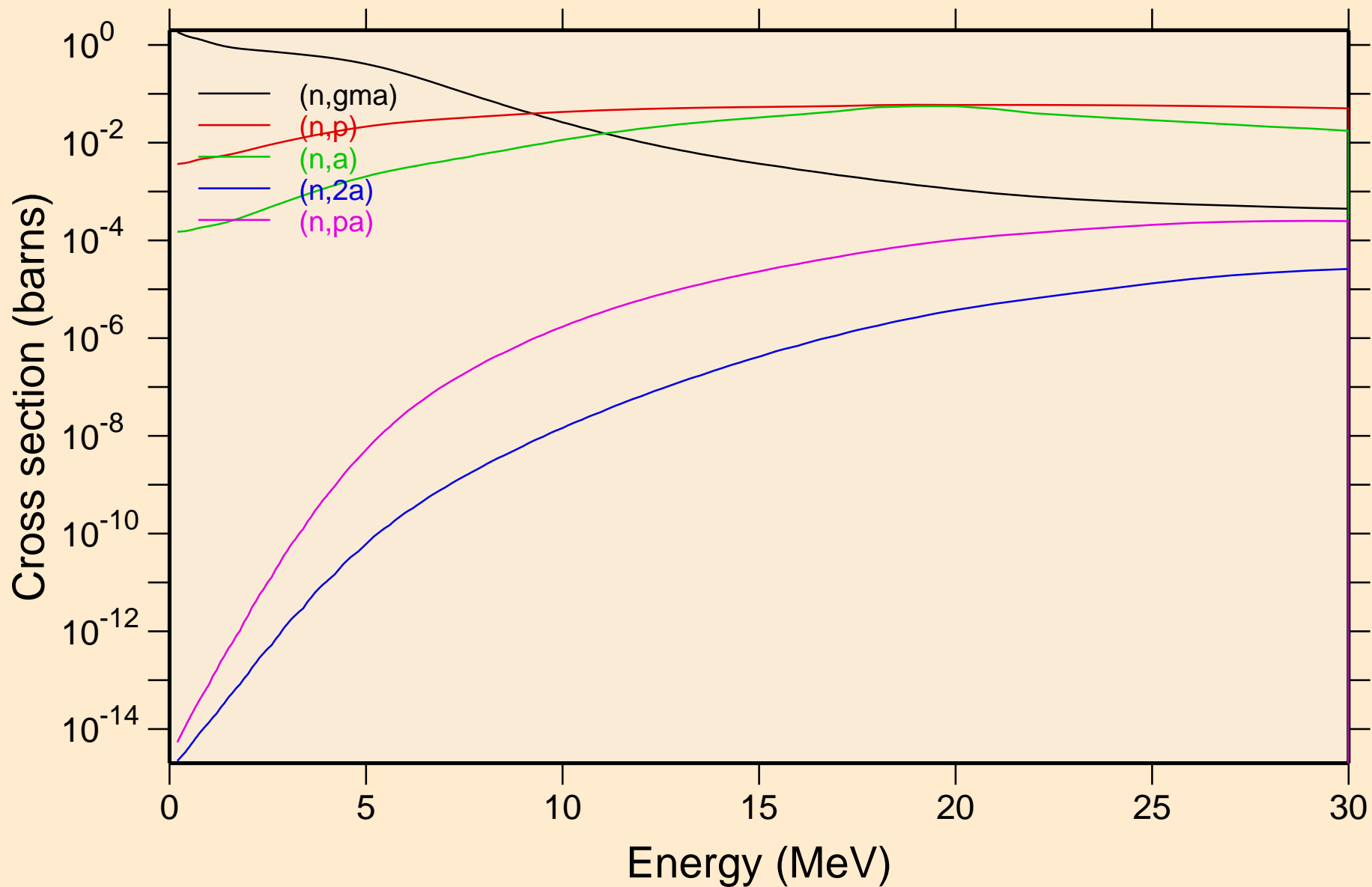

AU185 NEUTRON ACER TENDL-2019 LIBRARY; T=293.16K
Non-threshold reactions

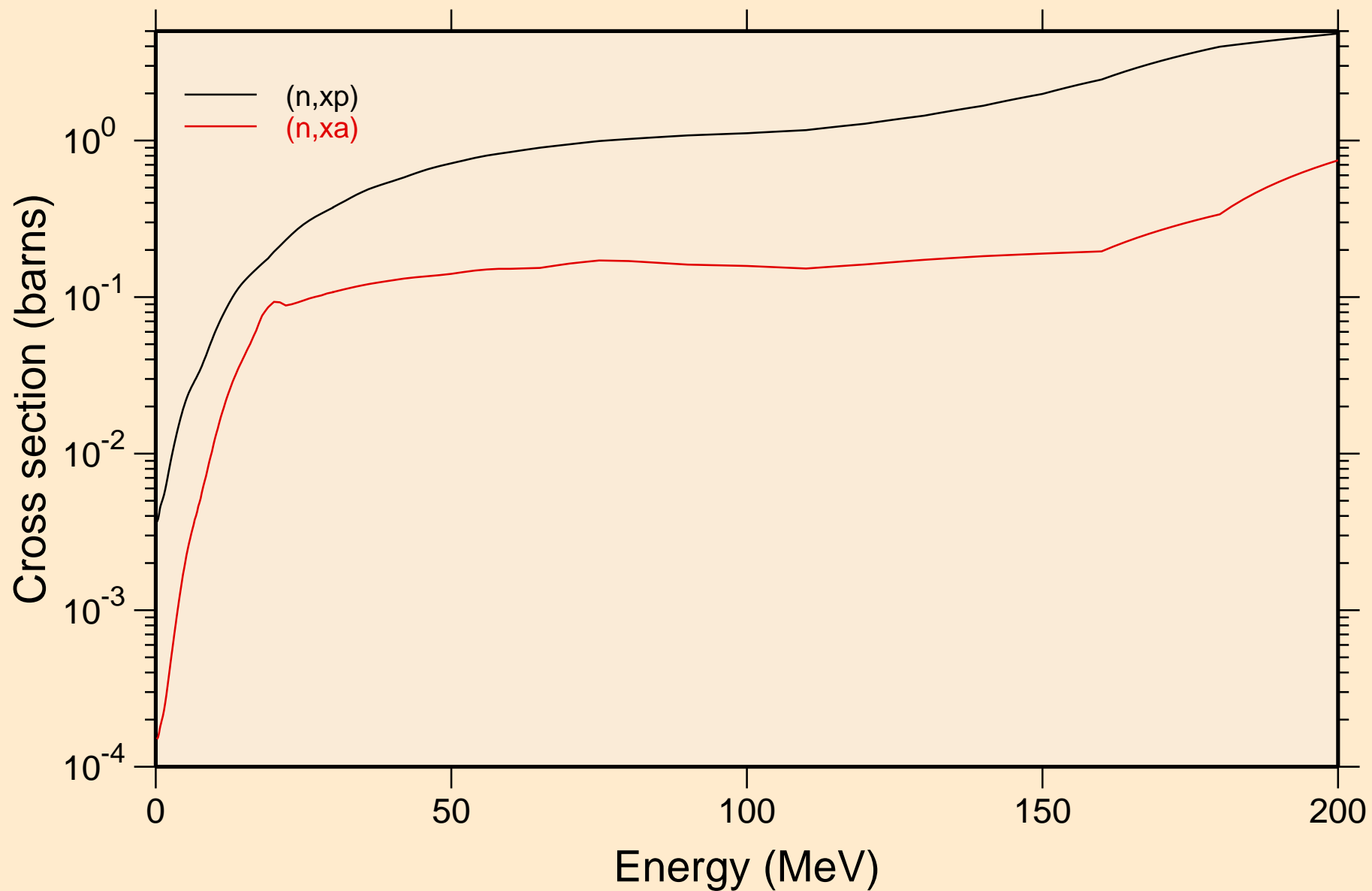

AU185 NEUTRON ACER TENDL-2019 LIBRARY; T=293.16K
Inelastic levels

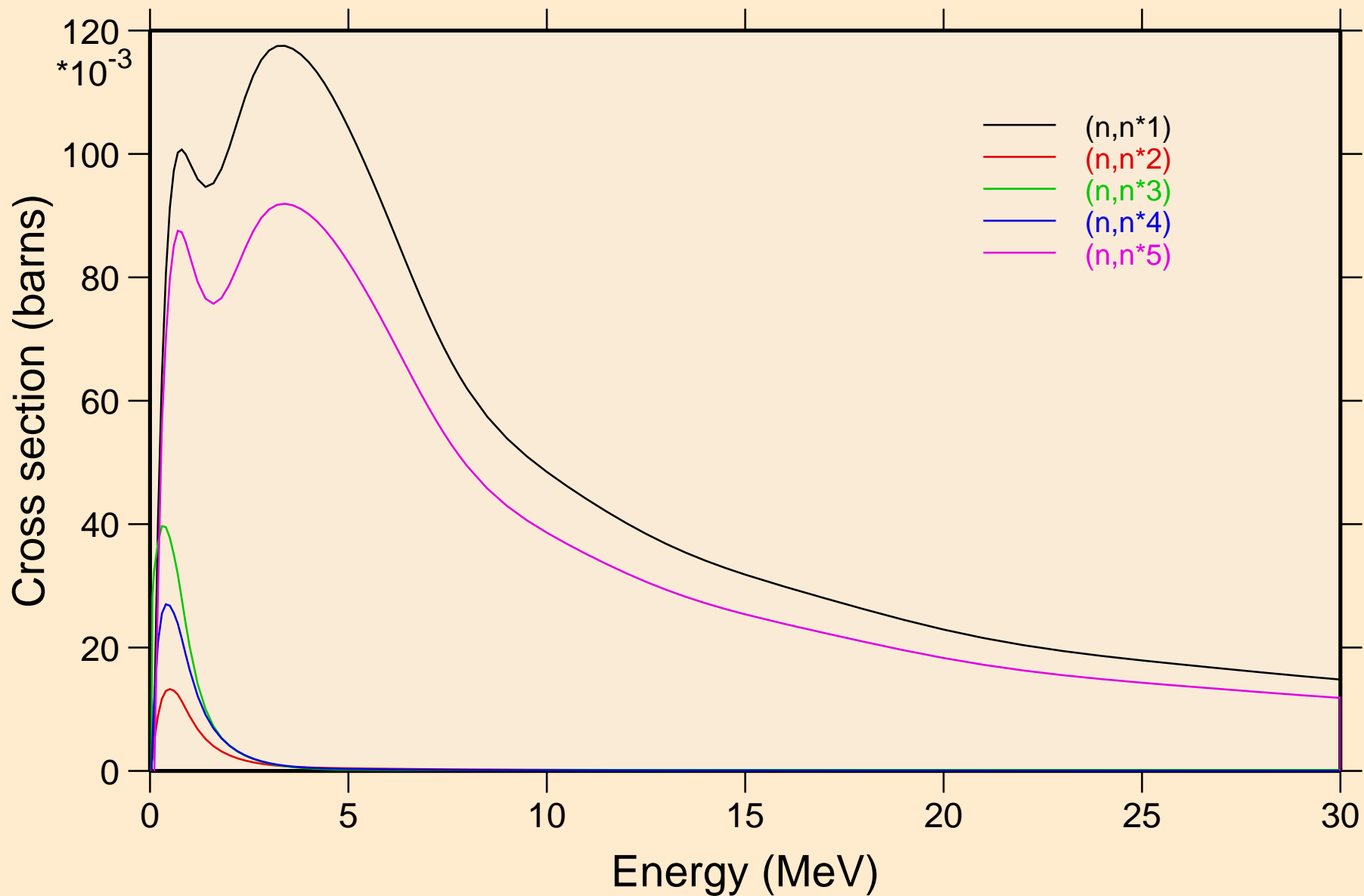

AU185 NEUTRON ACER TENDL-2019 LIBRARY; T=293.16K
Inelastic levels

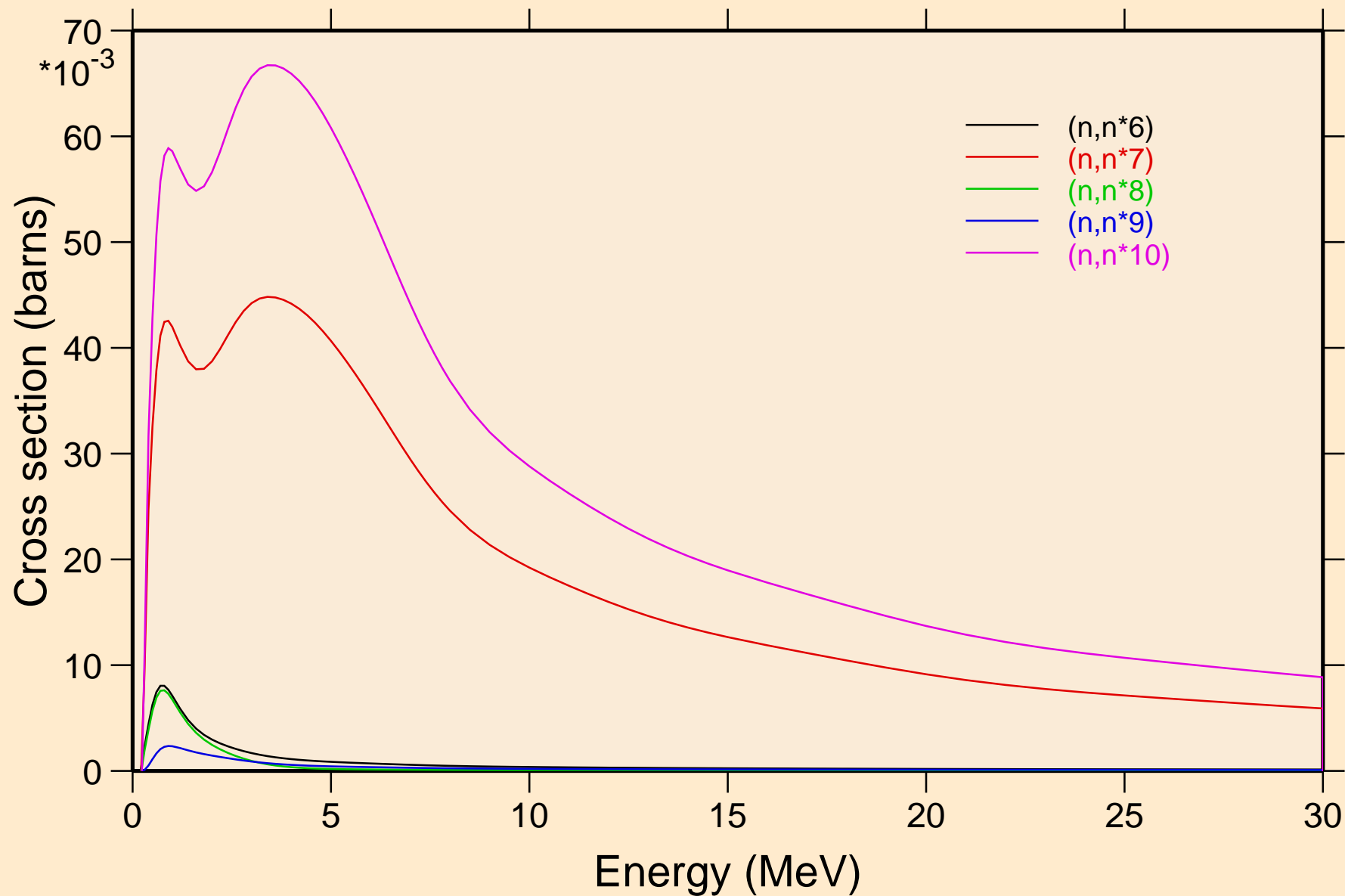

AU185 NEUTRON ACER TENDL-2019 LIBRARY; T=293.16K
Inelastic levels

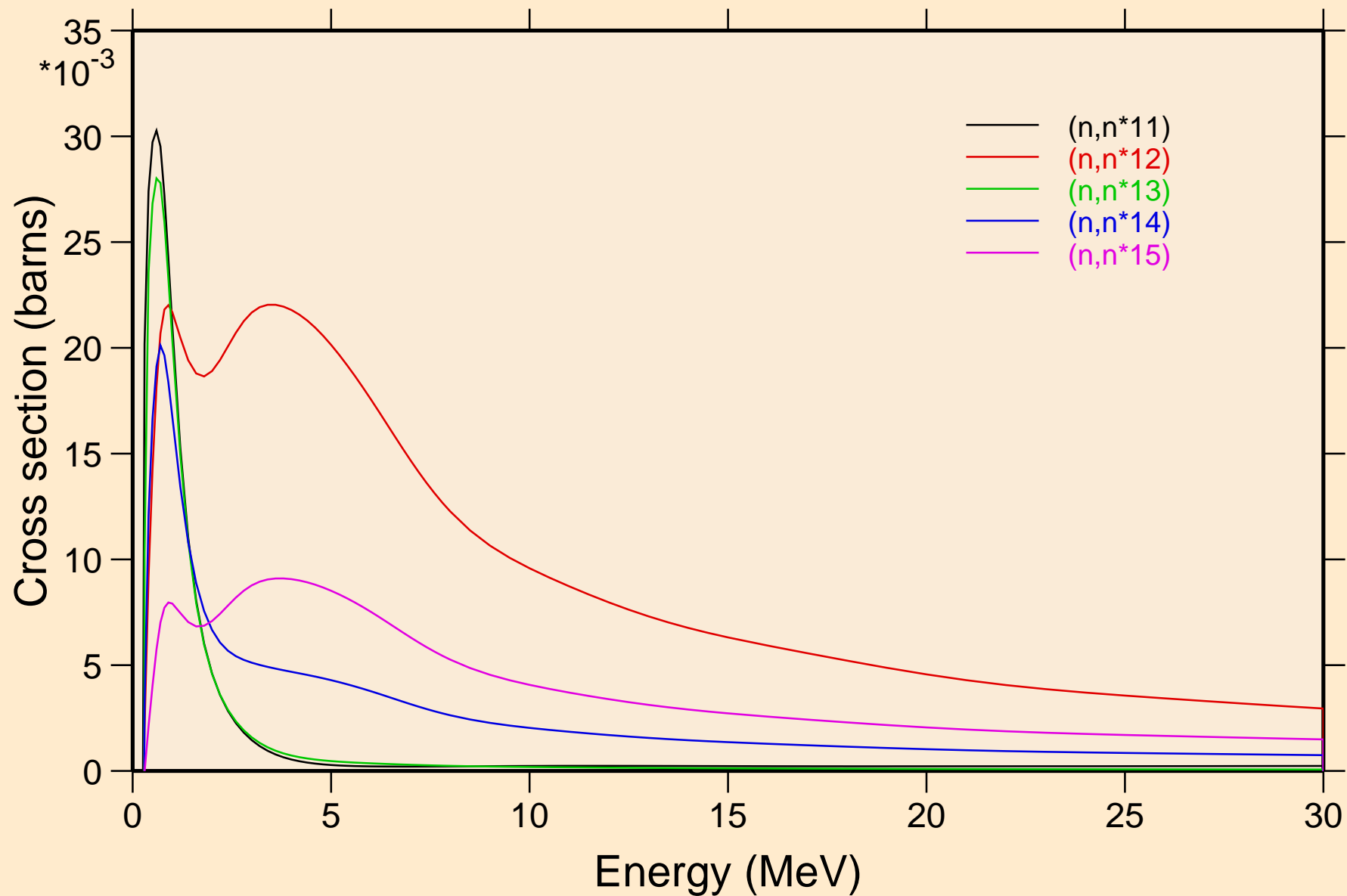

AU185 NEUTRON ACER TENDL-2019 LIBRARY; T=293.16K
Inelastic levels

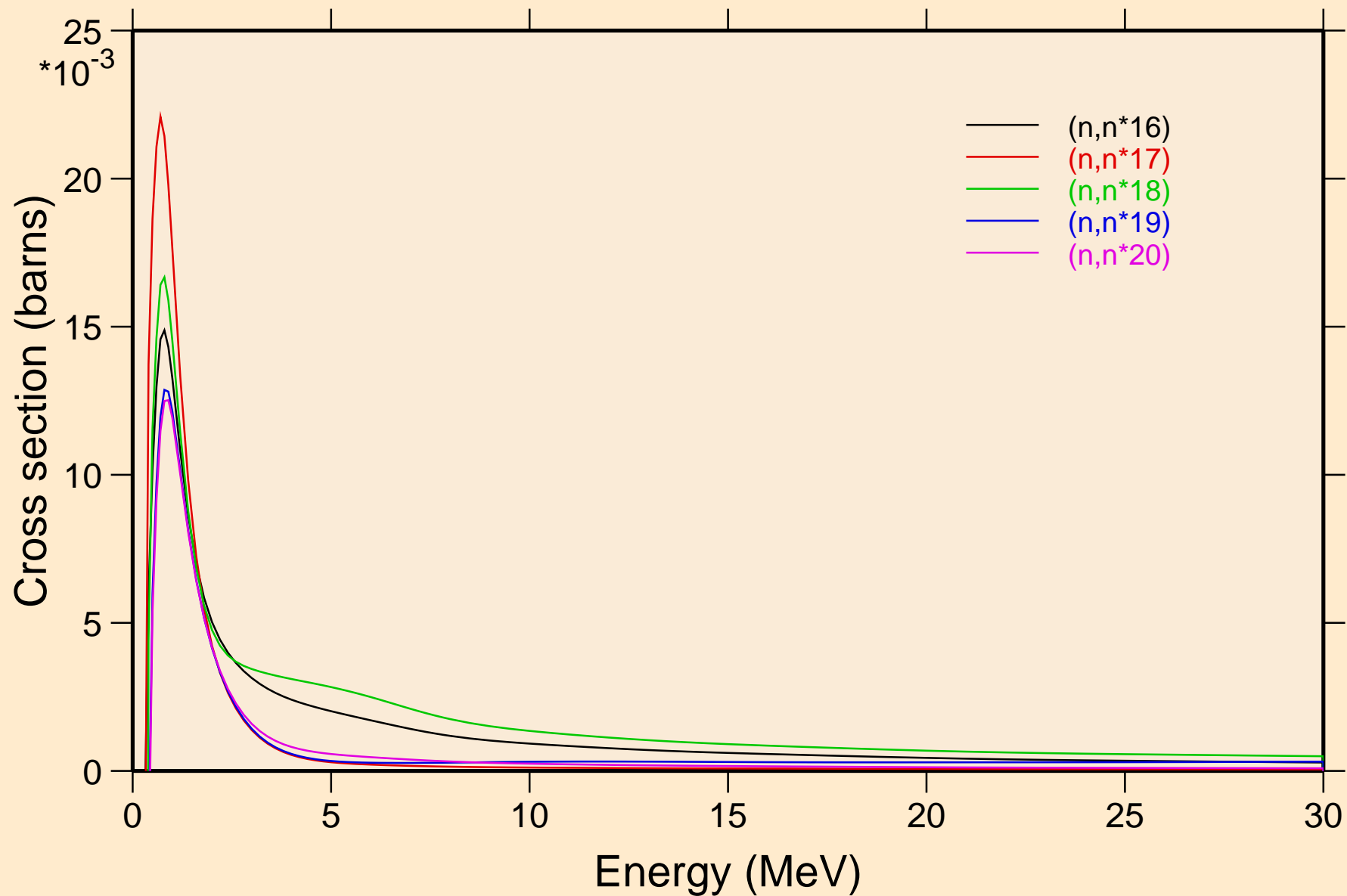

AU185 NEUTRON ACER TENDL-2019 LIBRARY; T=293.16K
Inelastic levels

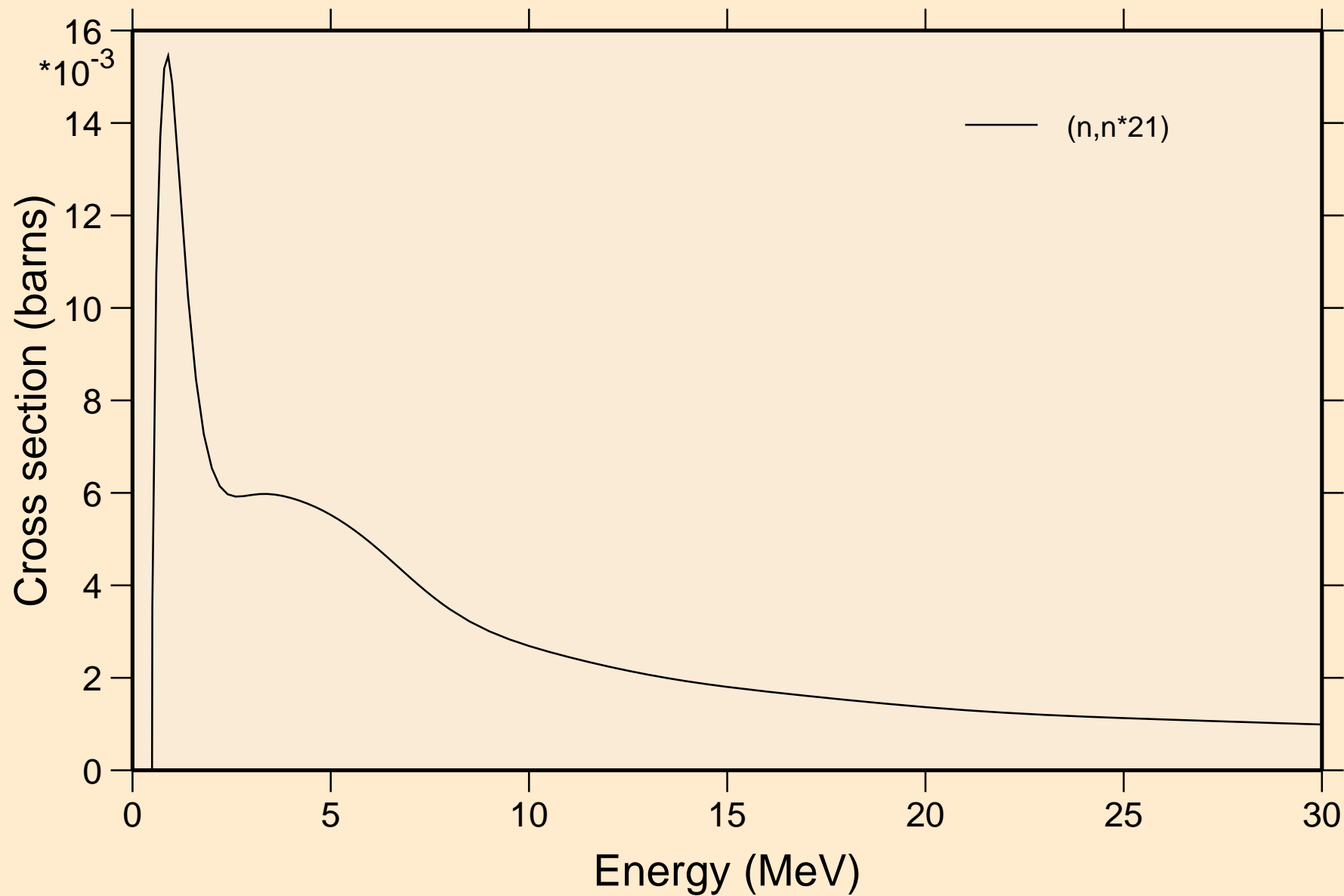

AU185 NEUTRON ACER TENDL-2019 LIBRARY; T=293.16K
Threshold reactions

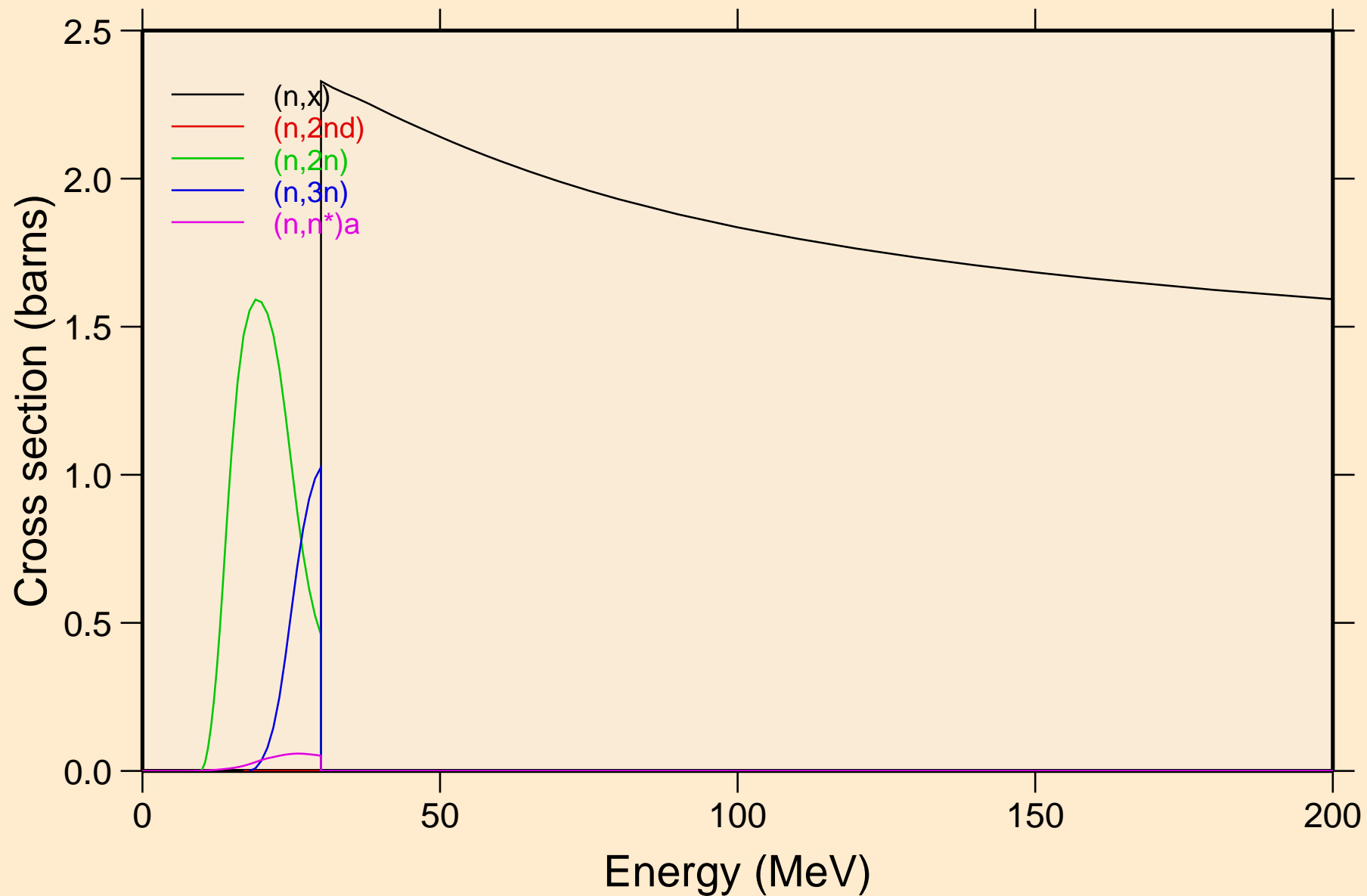

AU185 NEUTRON ACER TENDL-2019 LIBRARY; T=293.16K
Threshold reactions

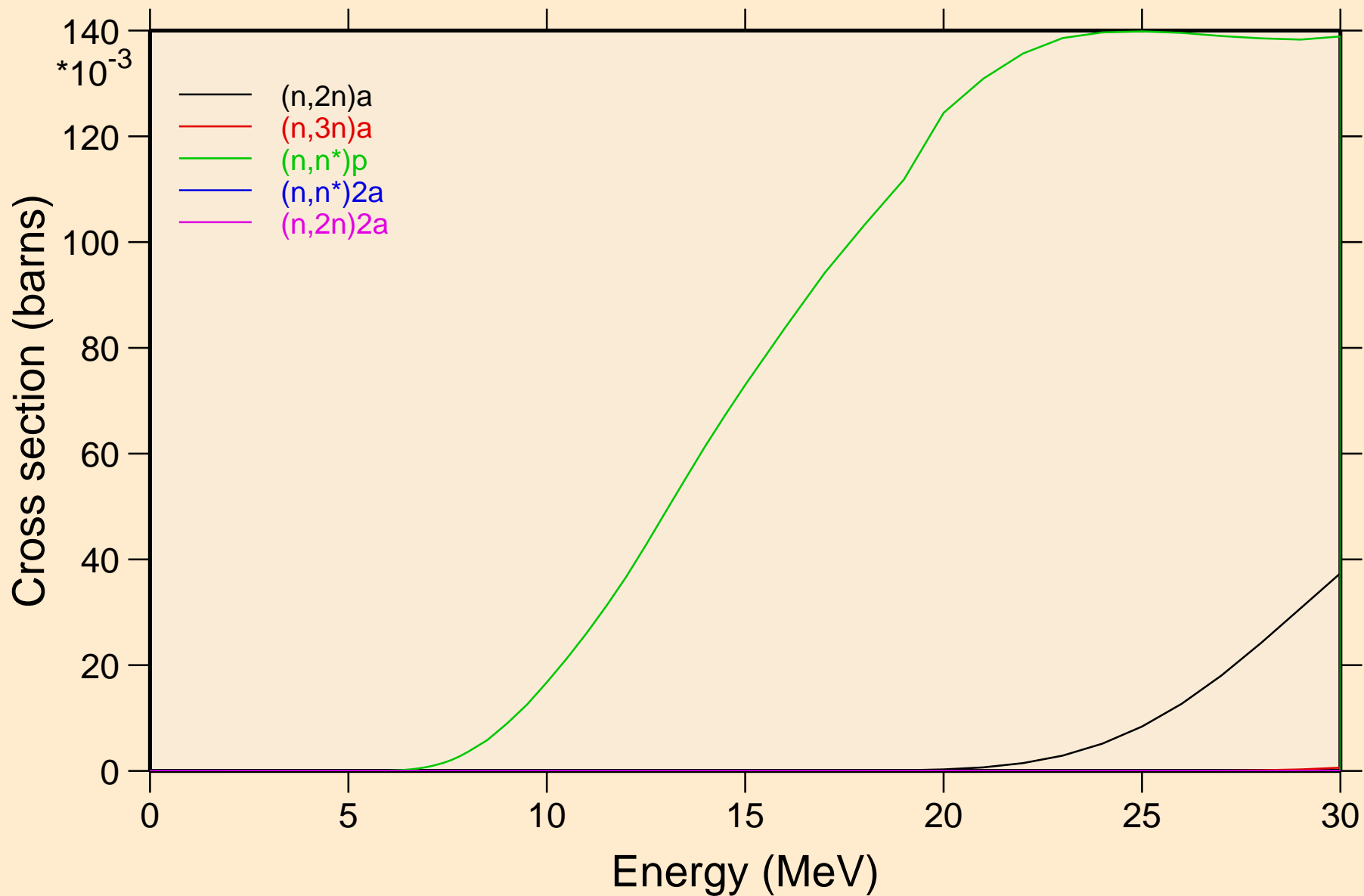

AU185 NEUTRON ACER TENDL-2019 LIBRARY; T=293.16K
Threshold reactions

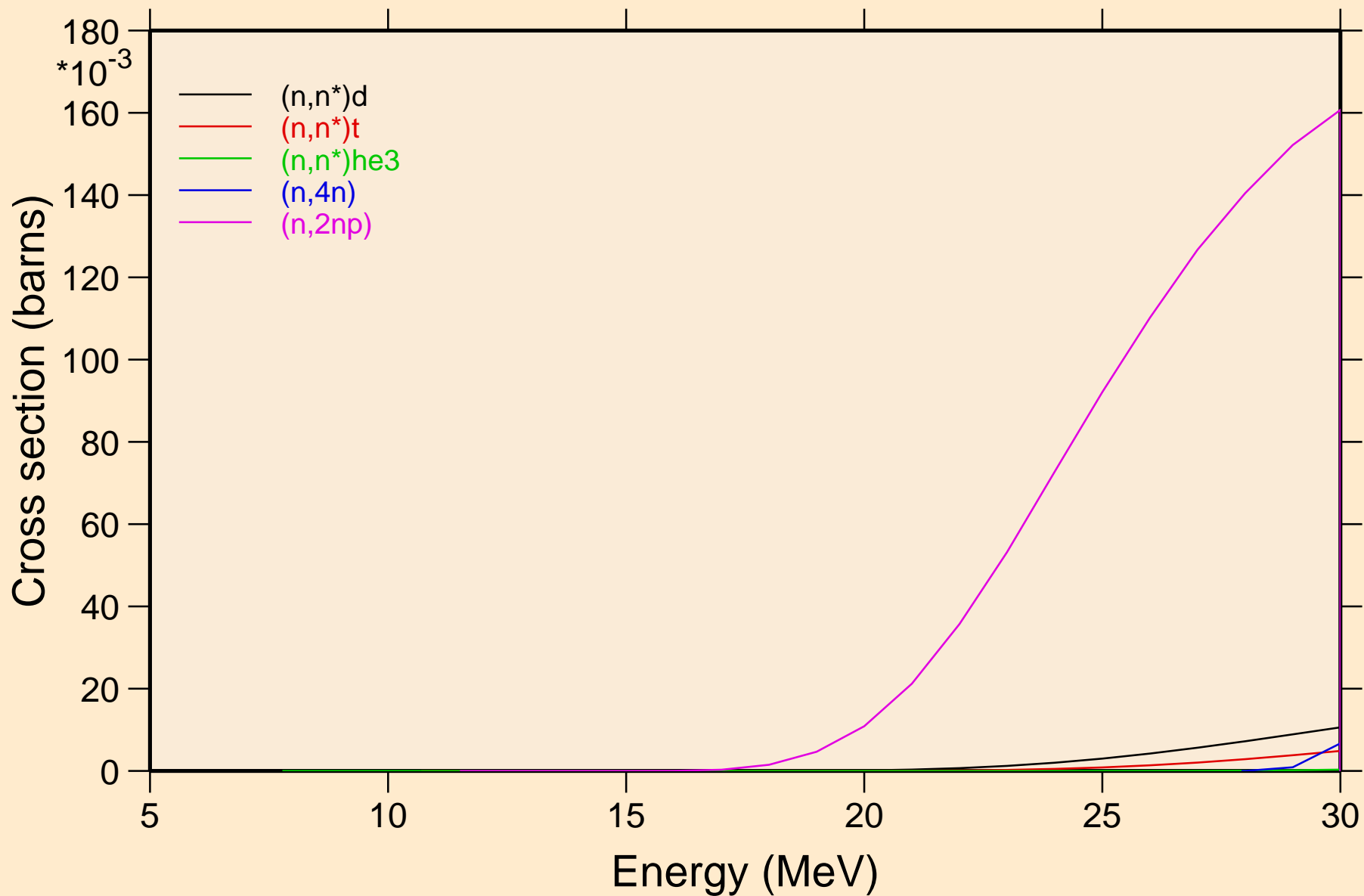

AU185 NEUTRON ACER TENDL-2019 LIBRARY; T=293.16K
Threshold reactions

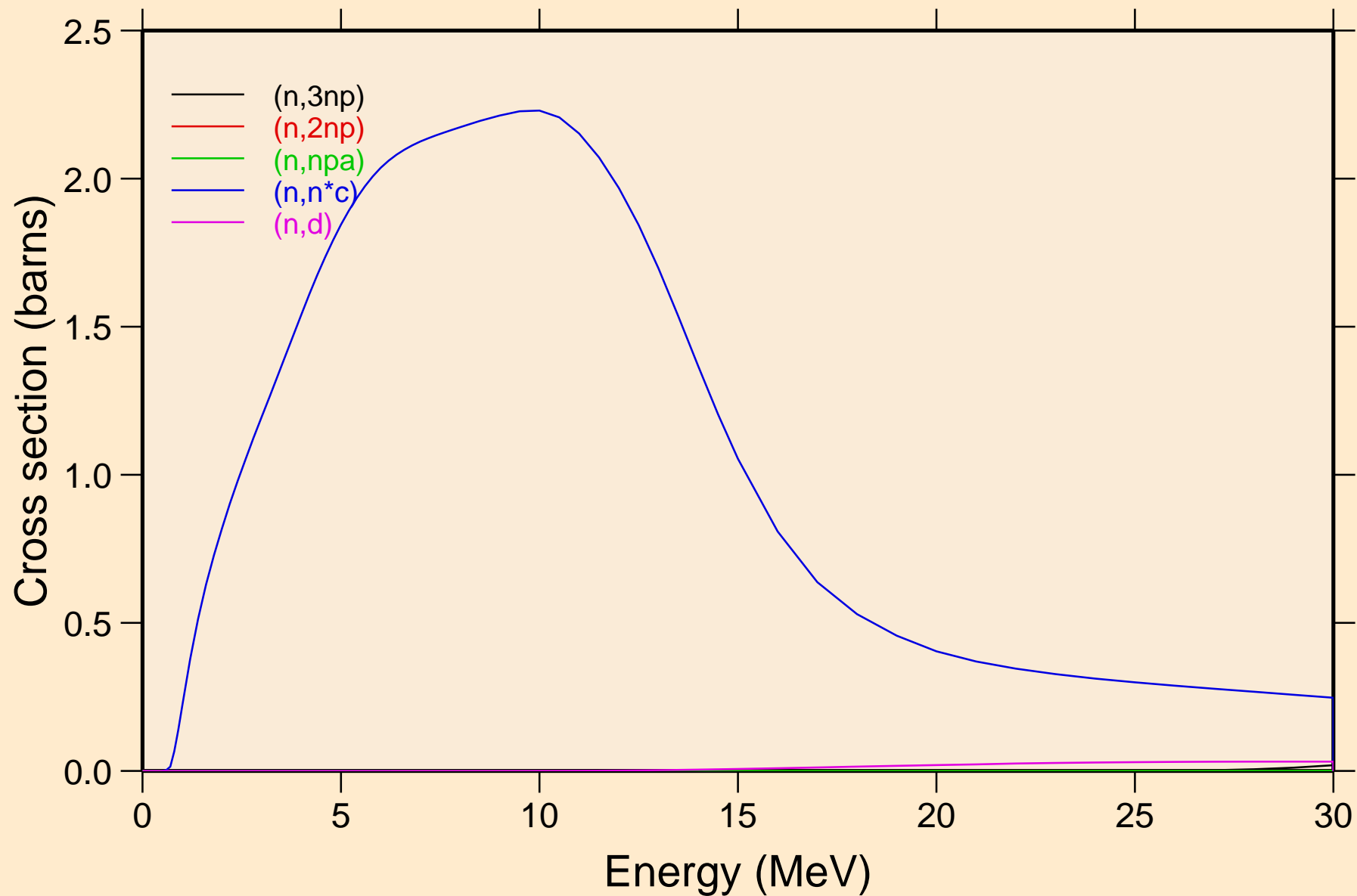

AU185 NEUTRON ACER TENDL-2019 LIBRARY; T=293.16K
Threshold reactions

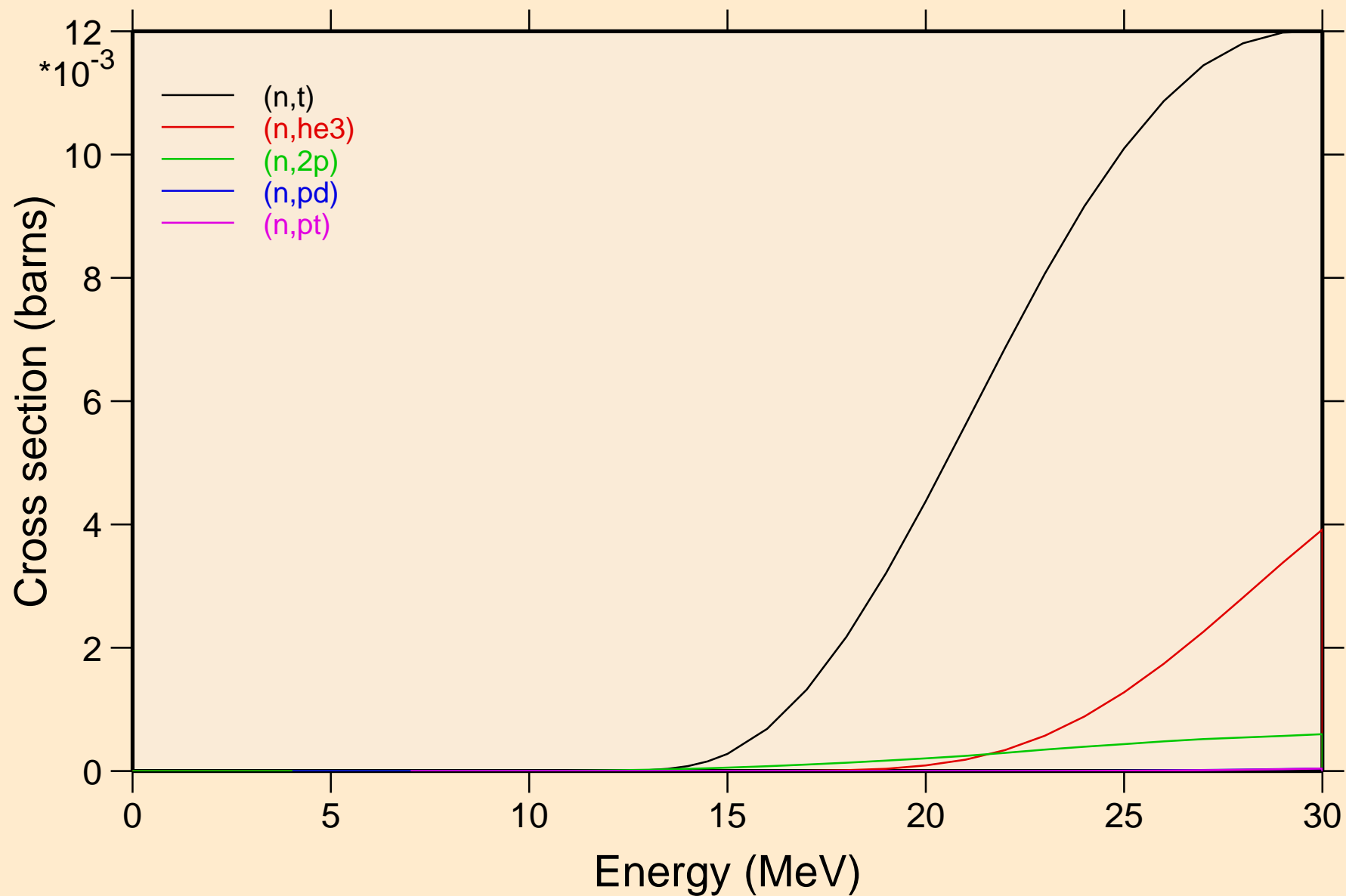

AU185 NEUTRON ACER TENDL-2019 LIBRARY; T=293.16K
Threshold reactions

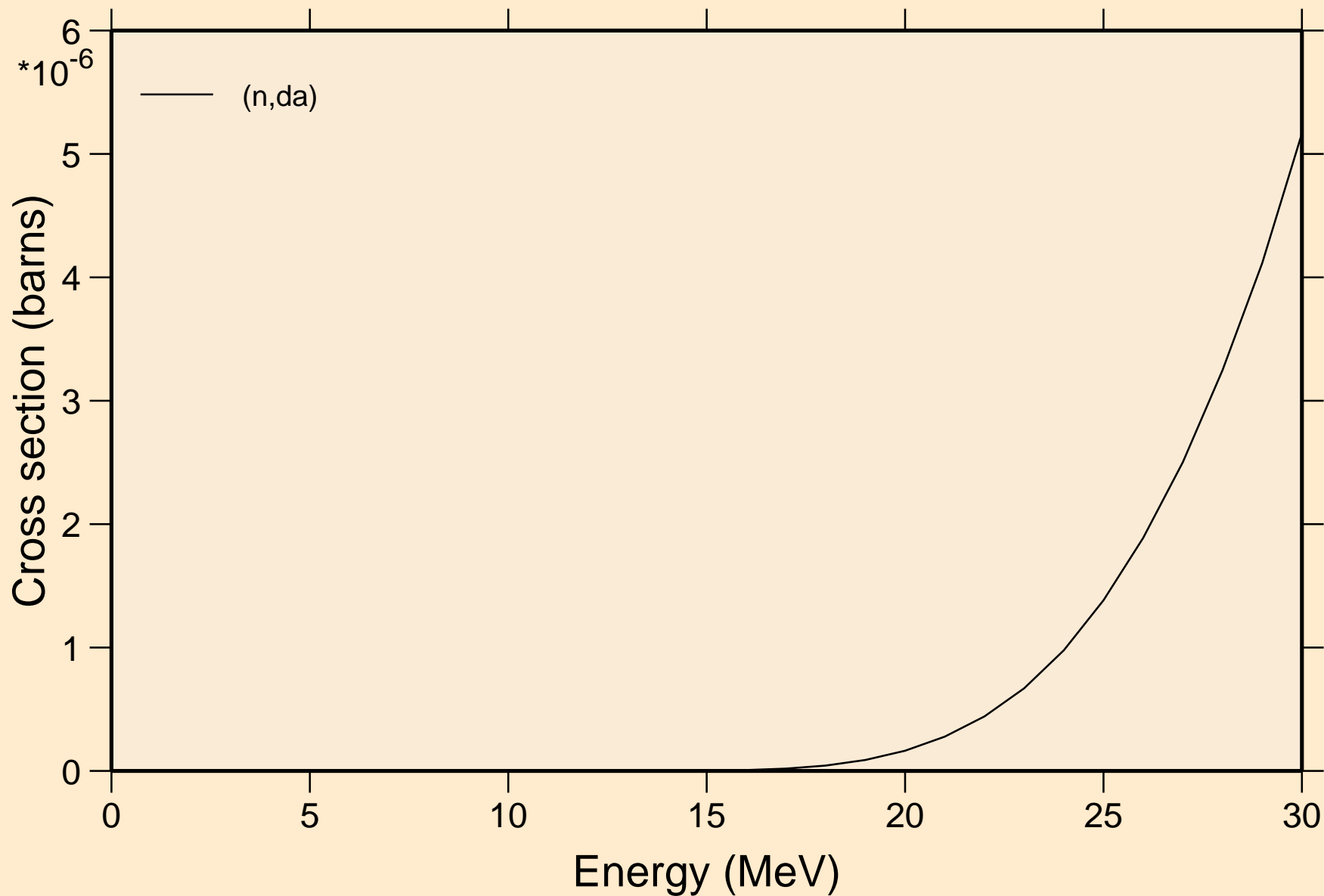

AU185 NEUTRON ACER TENDL-2019 LIBRARY; T=293.16K
Threshold reactions

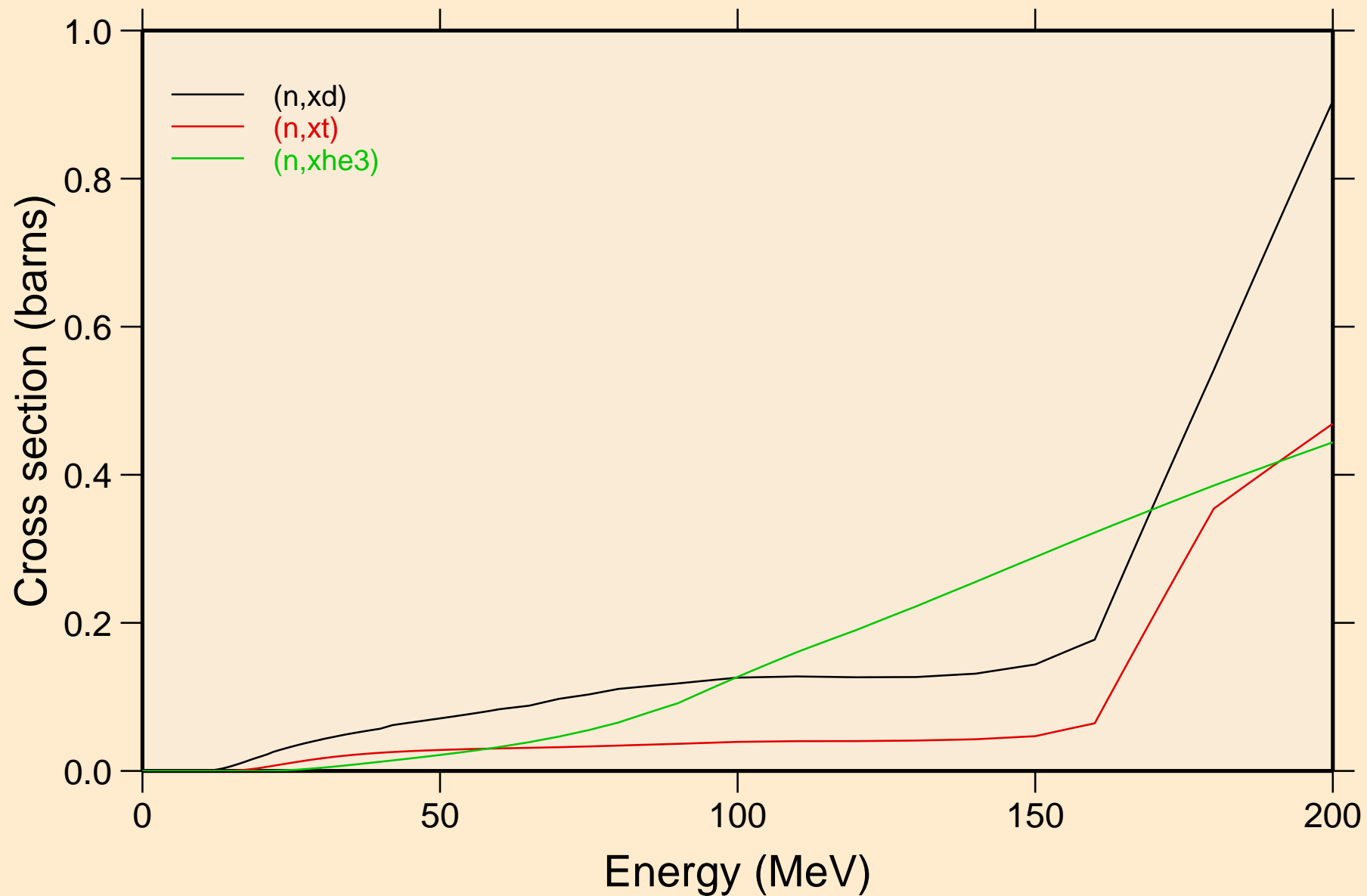

AU185 NEUTRON ACER TENDL-2019 LIBRARY; T=293.16K
angular distribution for elastic

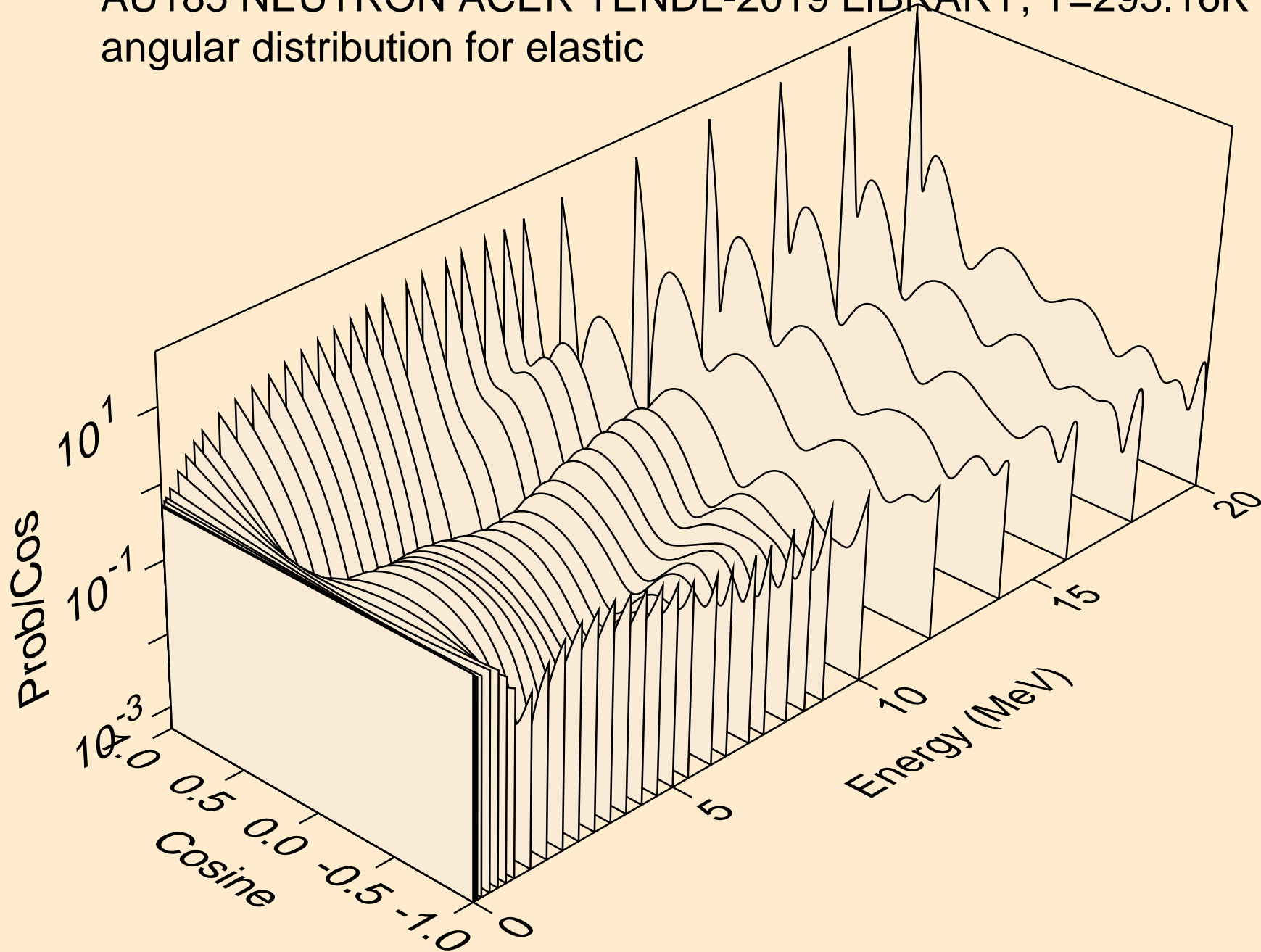

AU185 NEUTRON ACER TENDL-2019 LIBRARY; T=293.16K
angular distribution for elastic

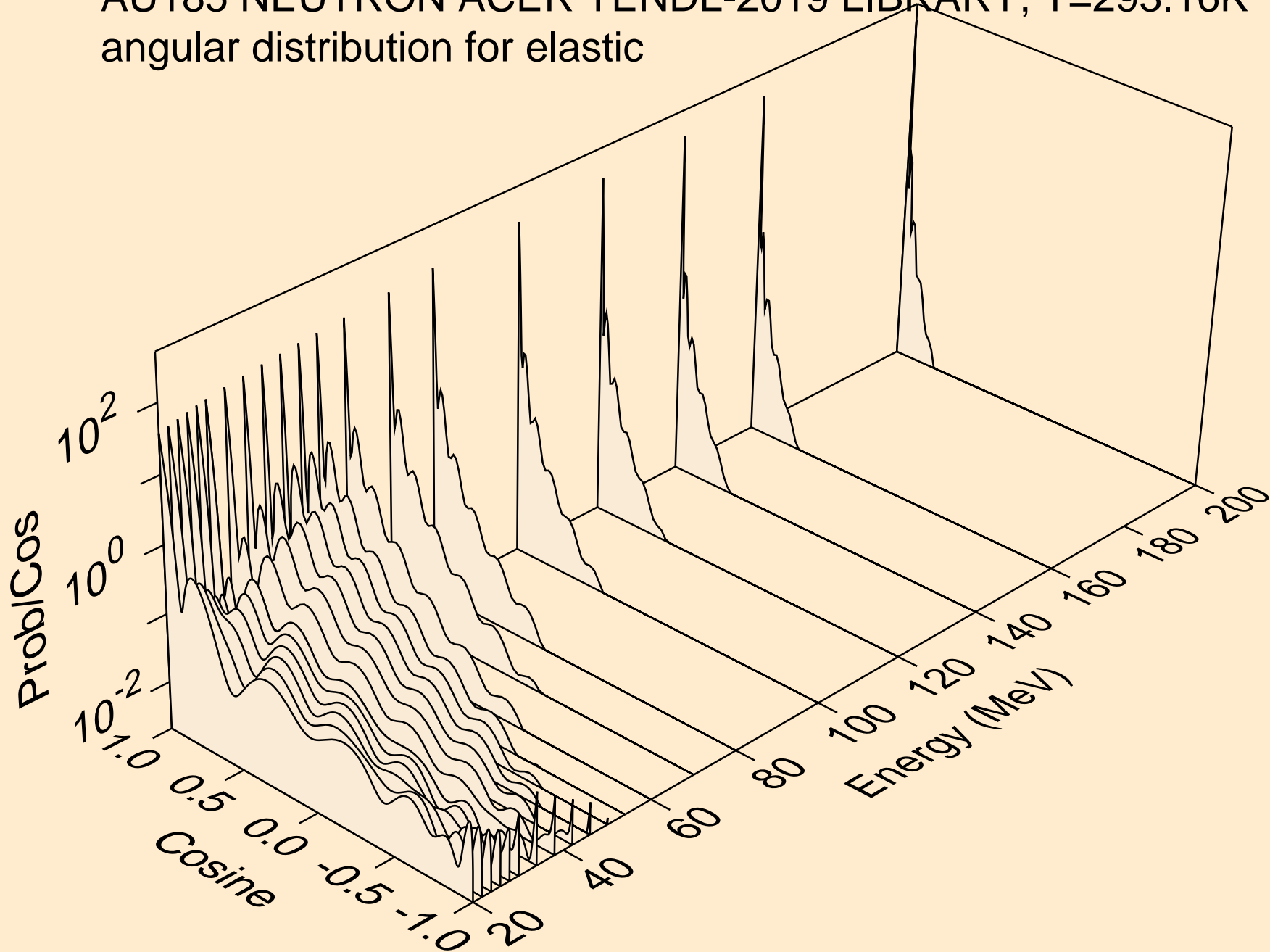

AU185 NEUTRON ACER TENDL-2019 LIBRARY; T=293.16K
angular distribution for (n,n*1)

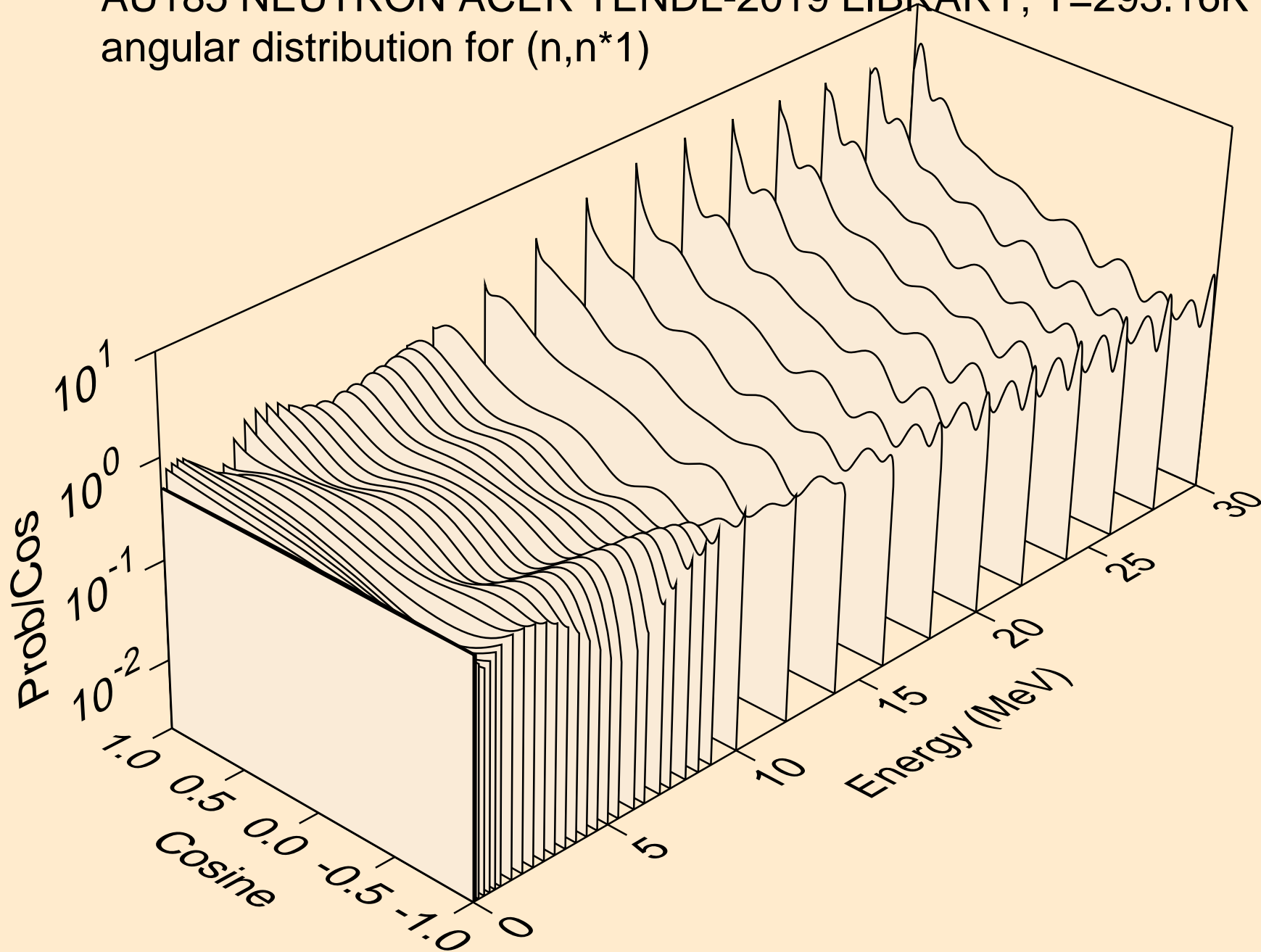

AU185 NEUTRON ACER TENDL-2019 LIBRARY; T=293.16K
angular distribution for (n,n*2)

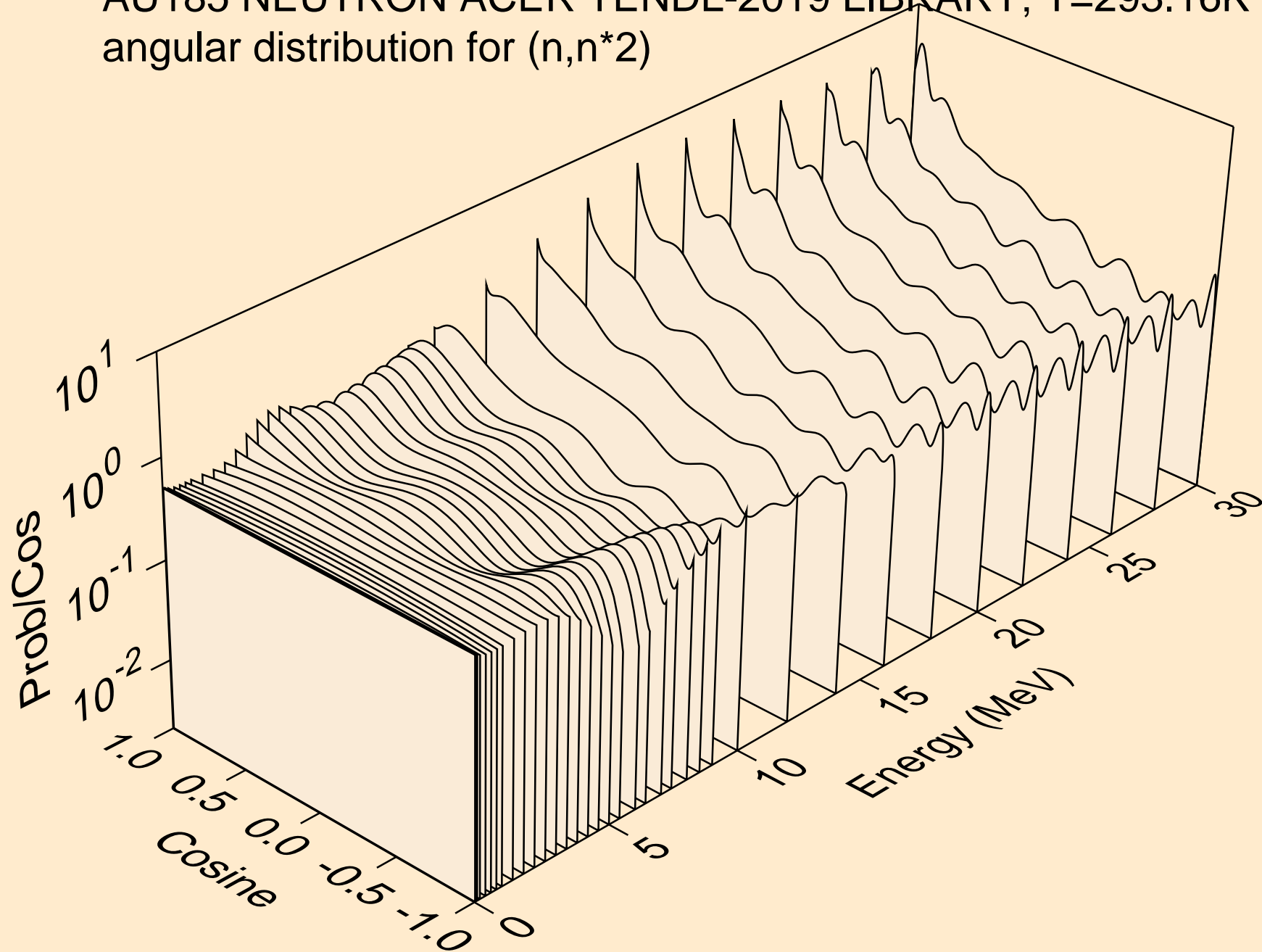

AU185 NEUTRON ACER TENDL-2019 LIBRARY; T=293.16K
angular distribution for (n,n*3)

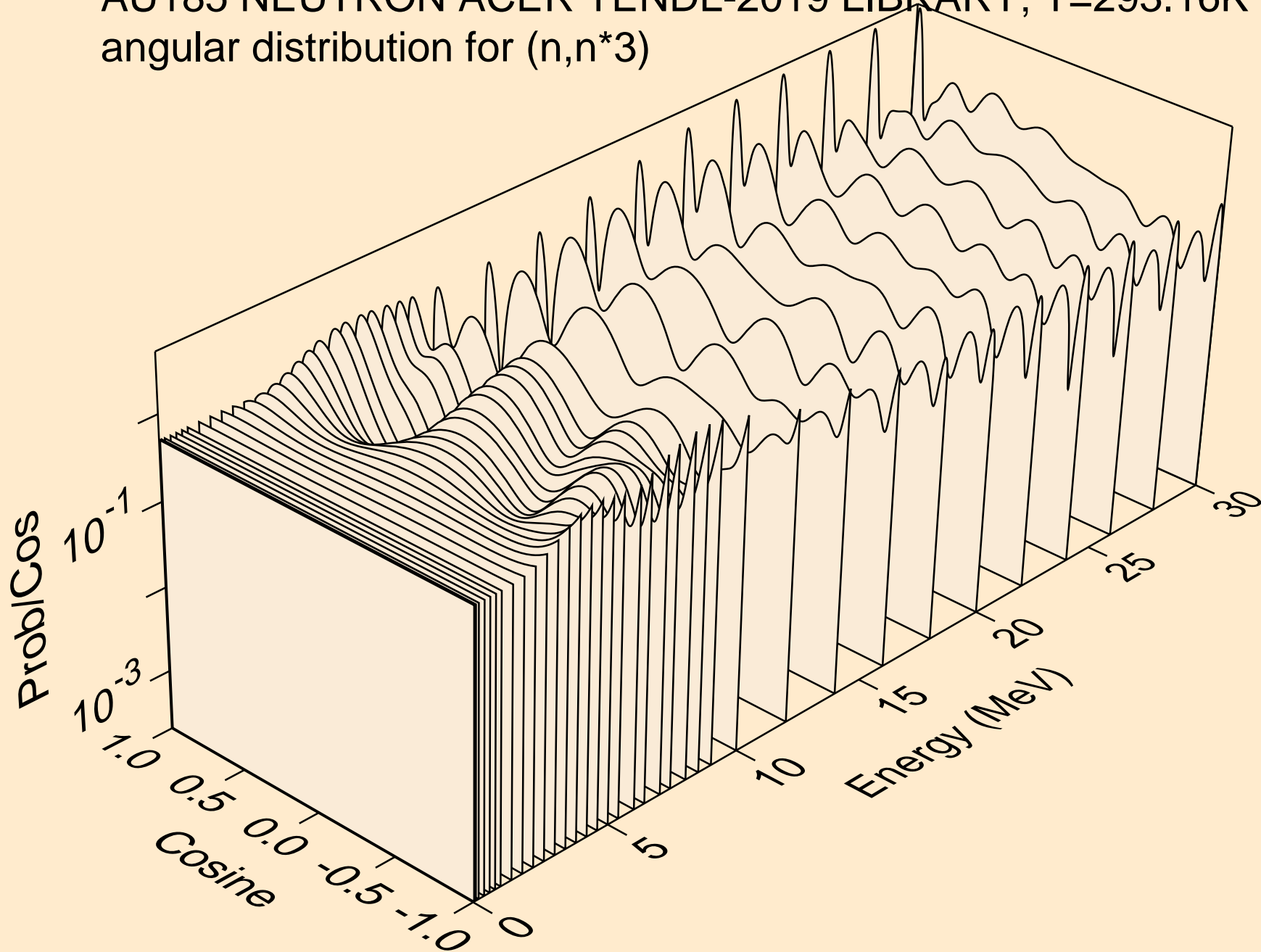

AU185 NEUTRON ACER TENDL-2019 LIBRARY; T=293.16K
angular distribution for (n,n*4)

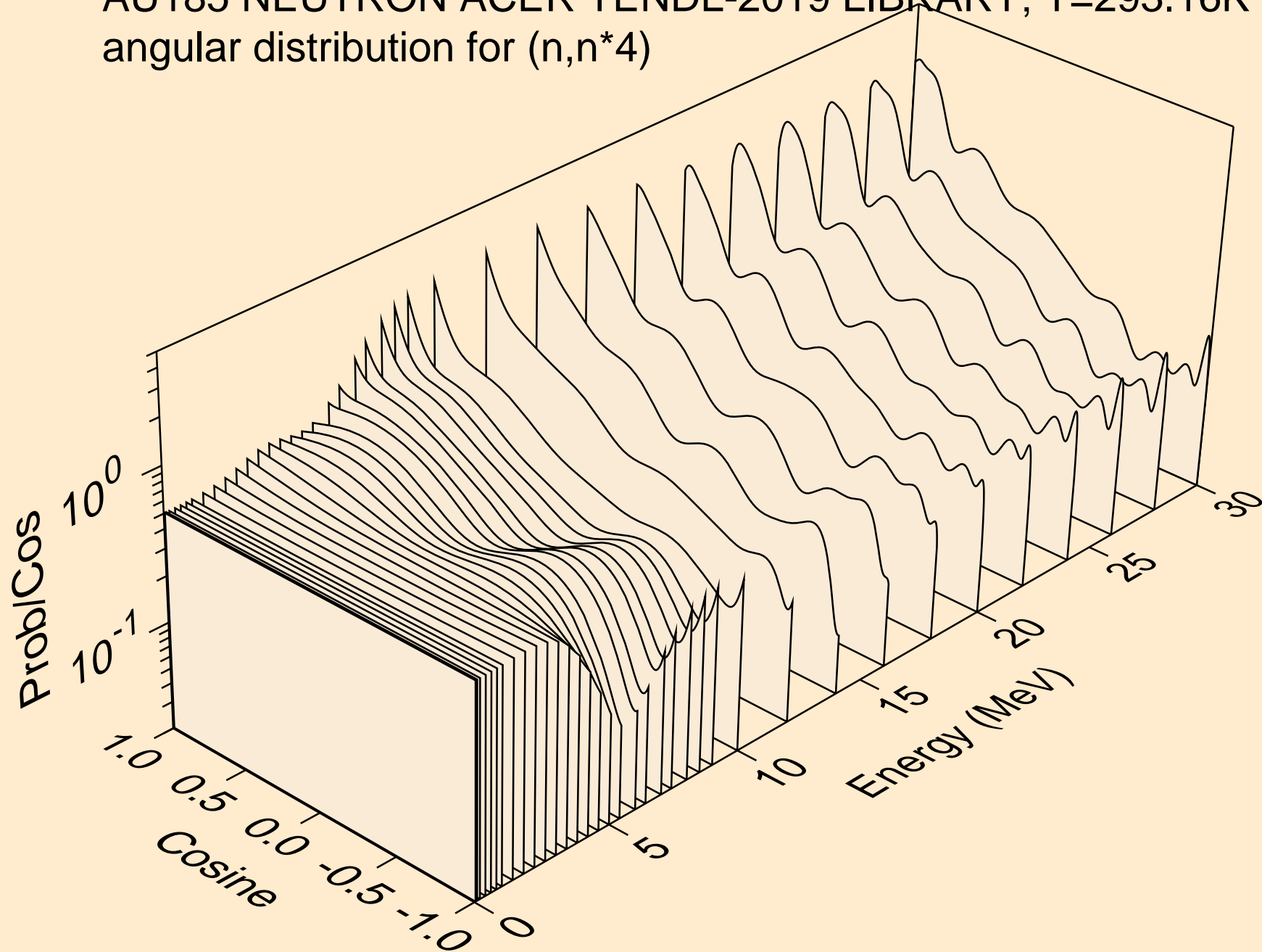

AU185 NEUTRON ACER TENDL-2019 LIBRARY; T=293.16K
angular distribution for (n,n*5)

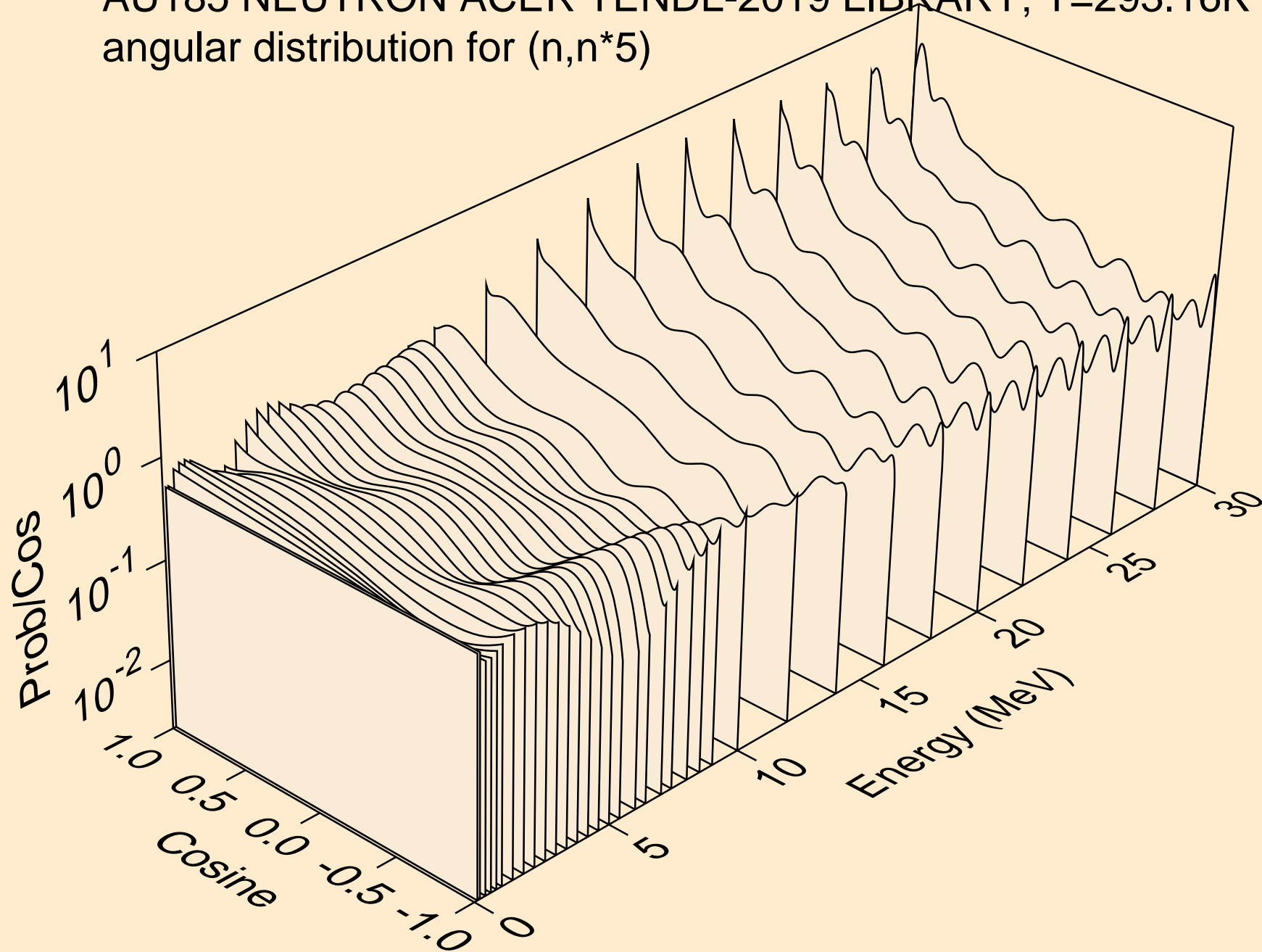

AU185 NEUTRON ACER TENDL-2019 LIBRARY; T=293.16K
angular distribution for (n,n*6)

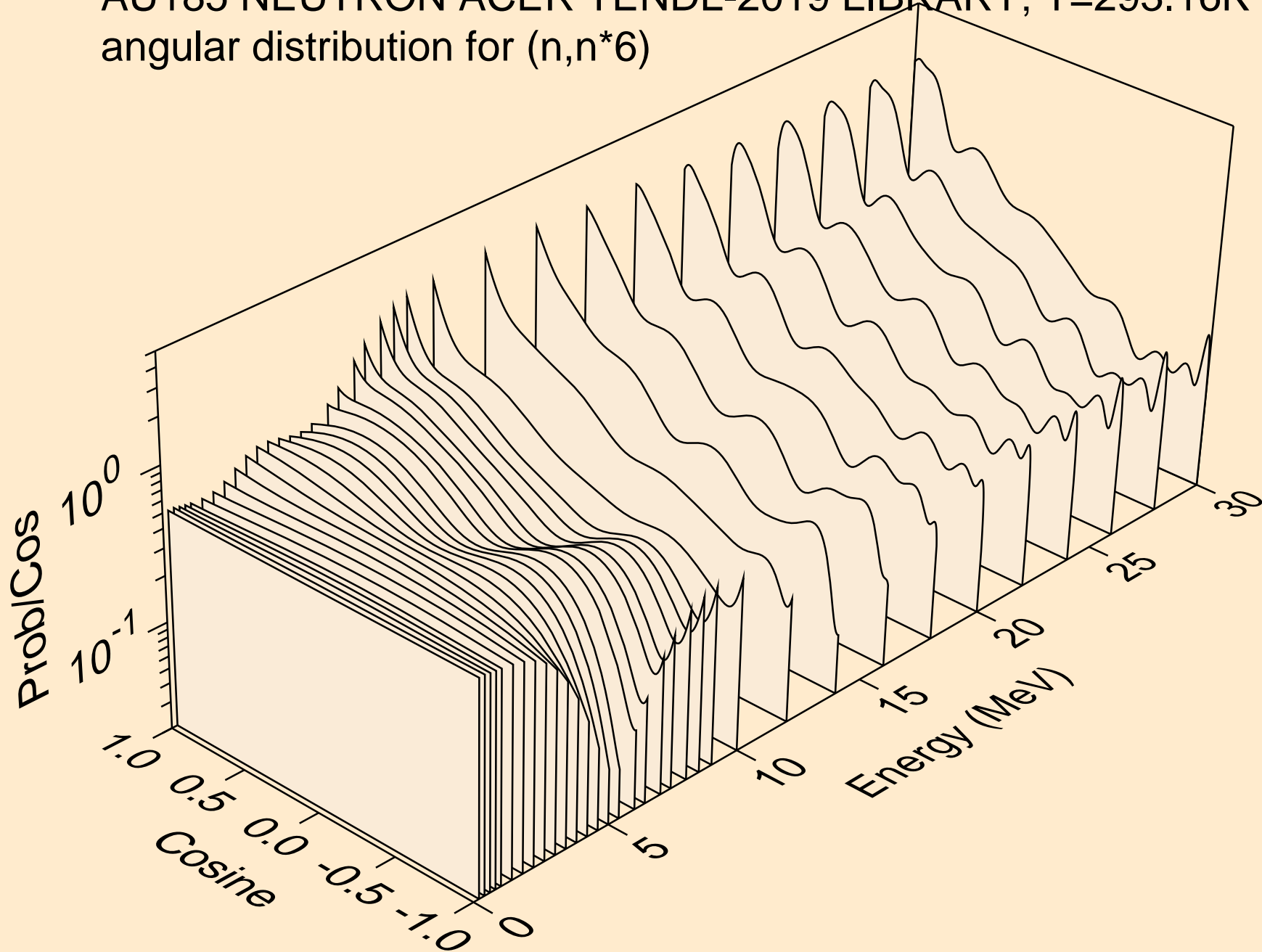

AU185 NEUTRON ACER TENDL-2019 LIBRARY; T=293.16K
angular distribution for (n,n*7)

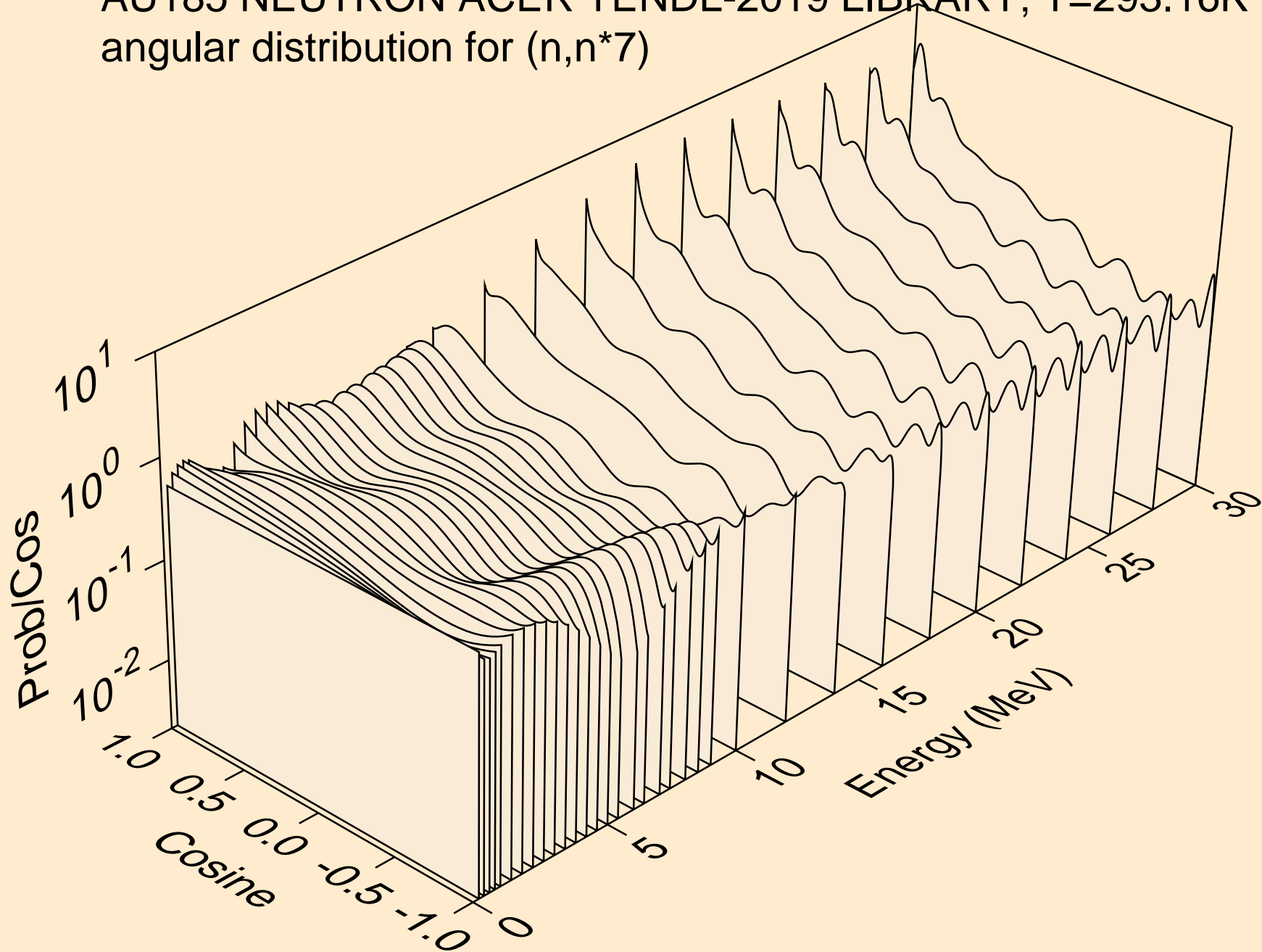

AU185 NEUTRON ACER TENDL-2019 LIBRARY; T=293.16K
angular distribution for (n,n*8)

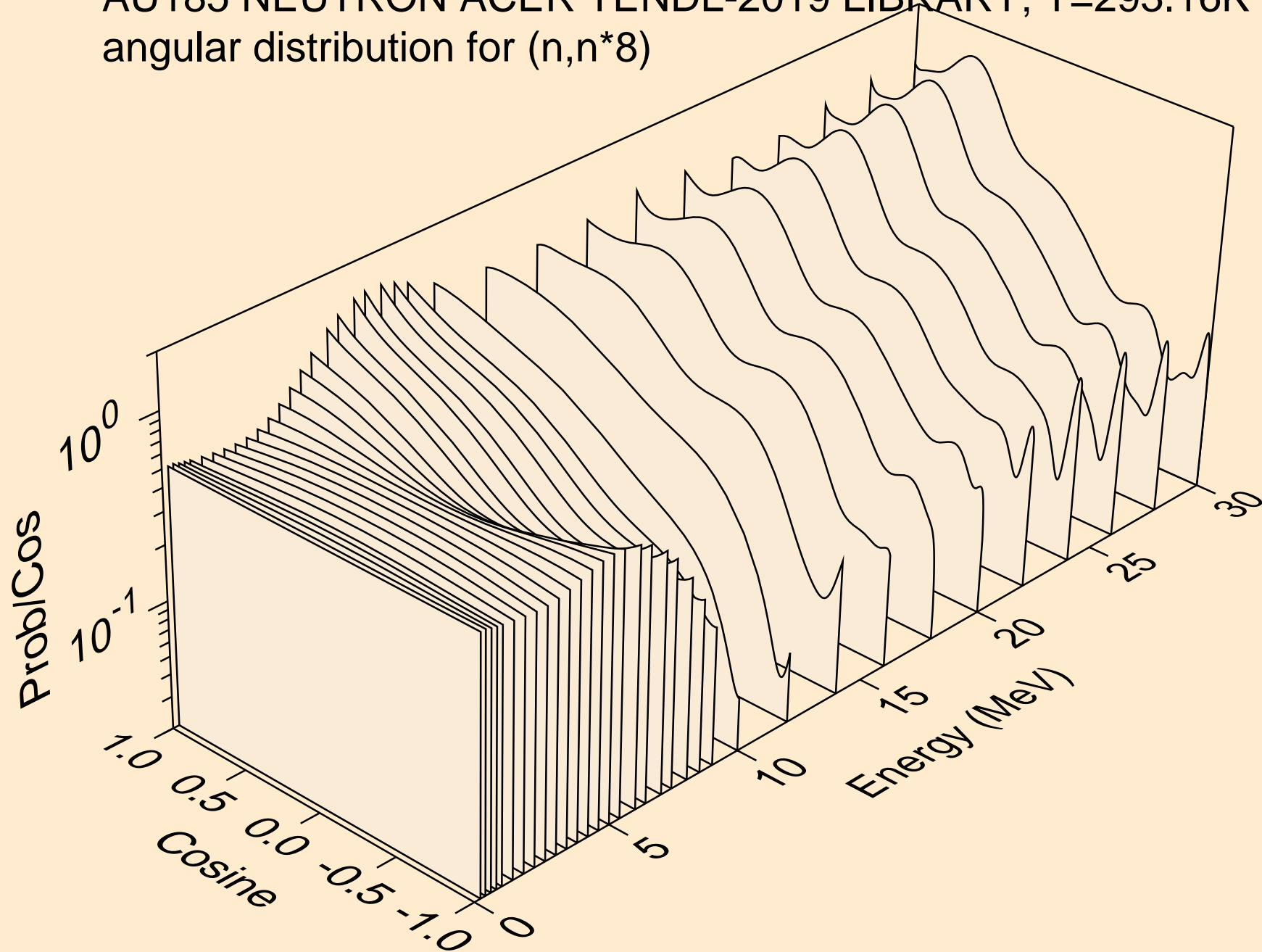

AU185 NEUTRON ACER TENDL-2019 LIBRARY; T=293.16K
angular distribution for (n,n*9)

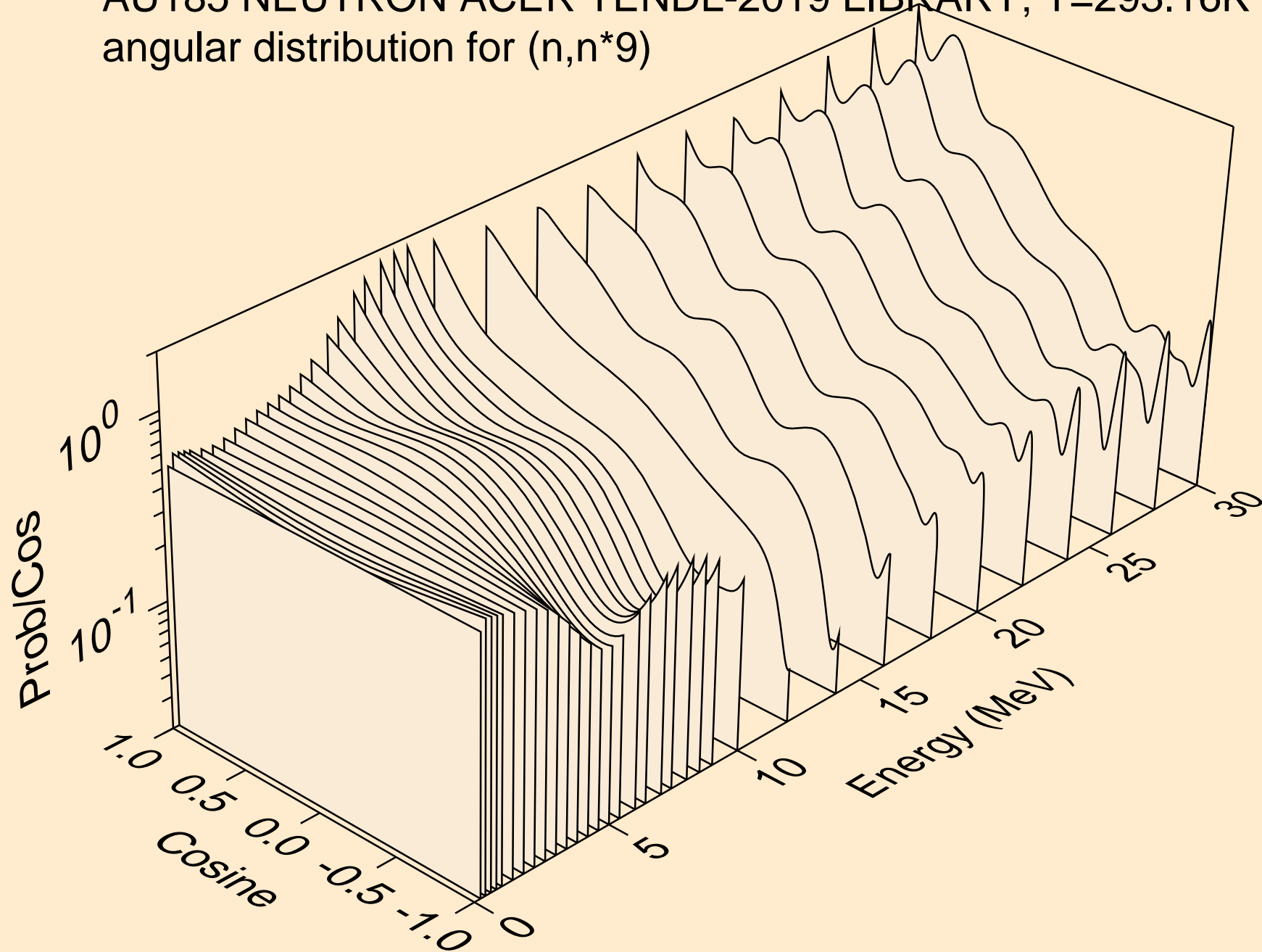

AU185 NEUTRON ACER TENDL-2019 LIBRARY; T=293.16K
angular distribution for (n,n*10)

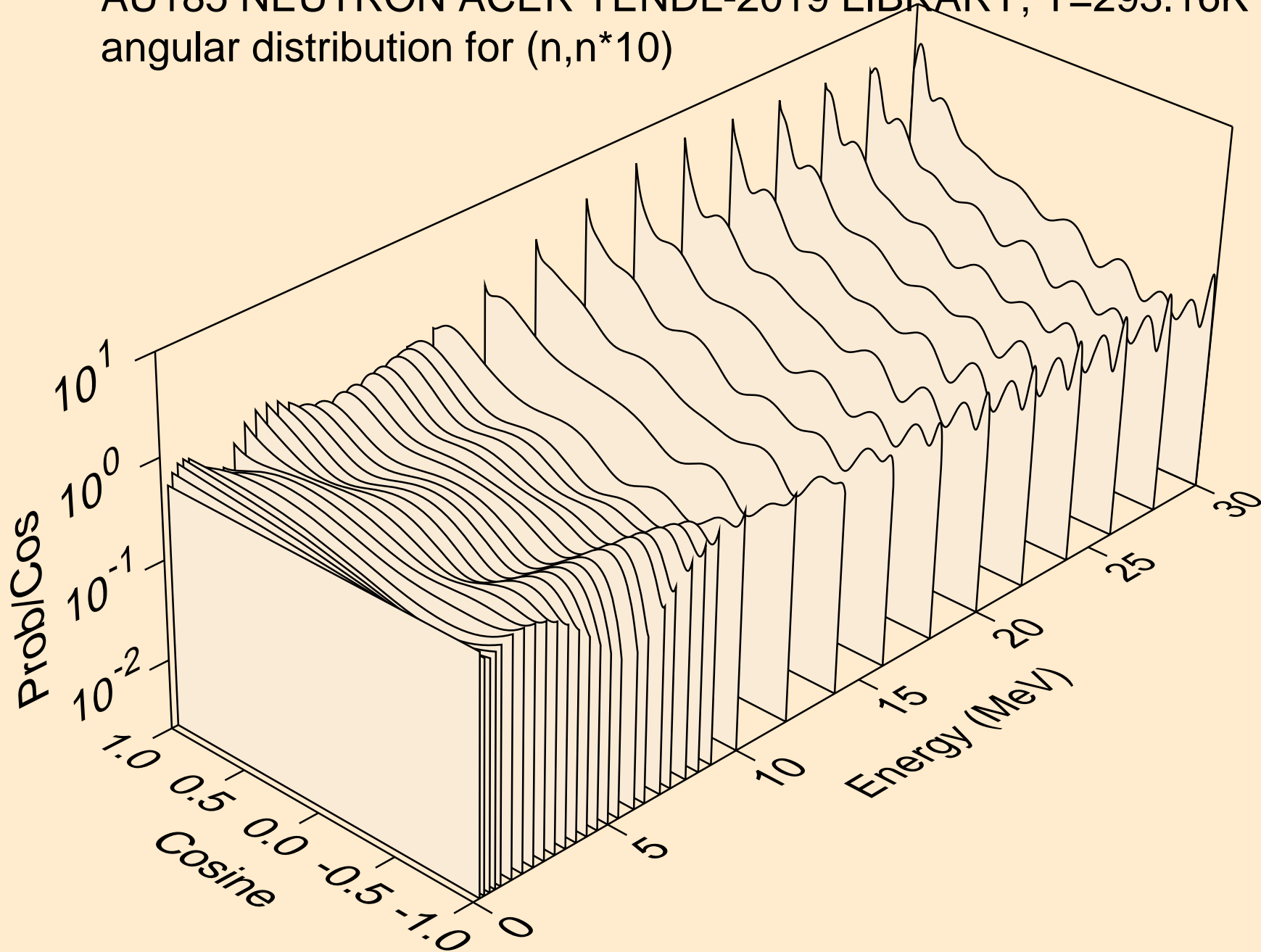

AU185 NEUTRON ACER TENDL-2019 LIBRARY; T=293.16K
angular distribution for (n,n*11)

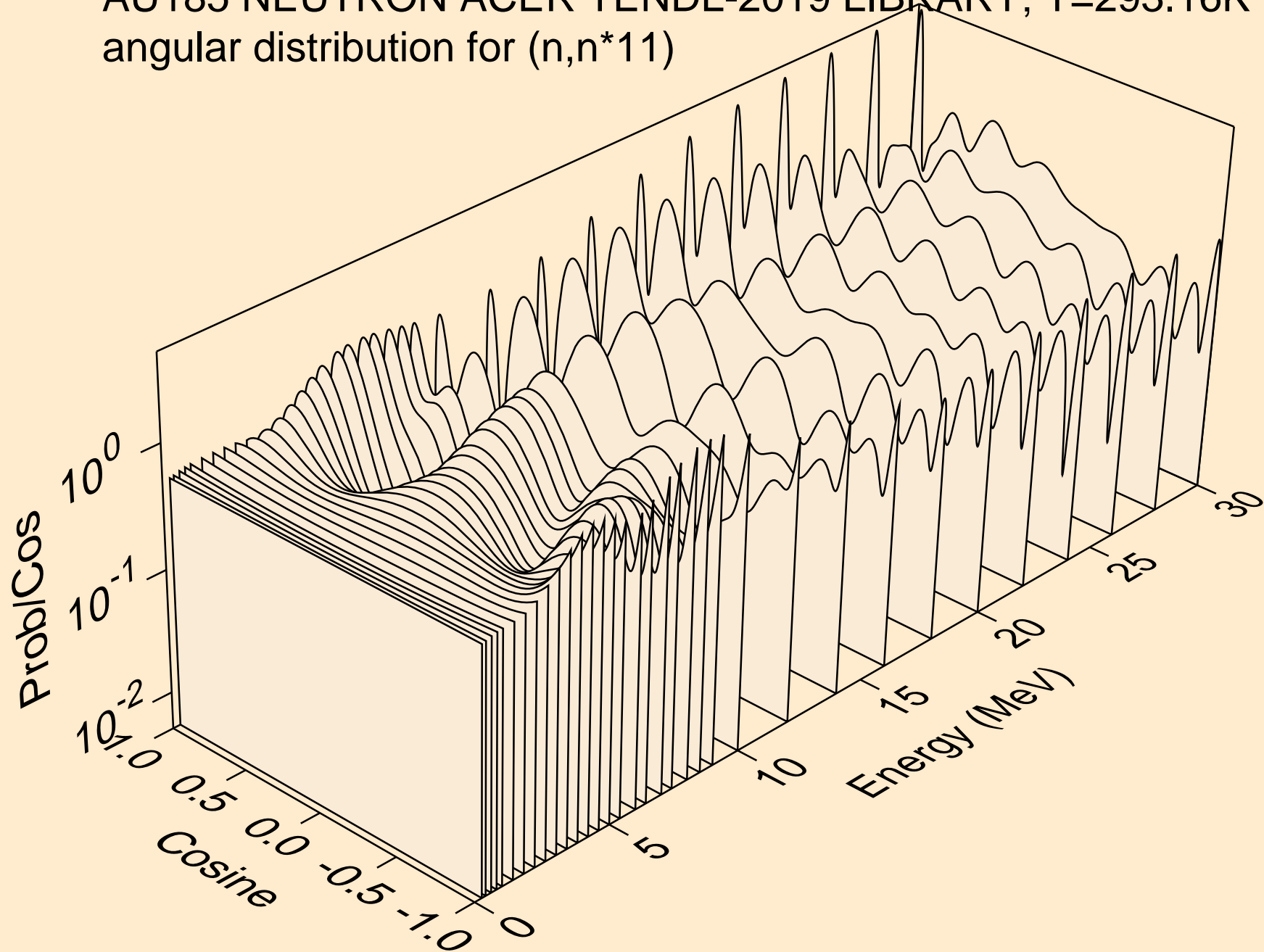

AU185 NEUTRON ACER TENDL-2019 LIBRARY; T=293.16K
angular distribution for (n,n*12)

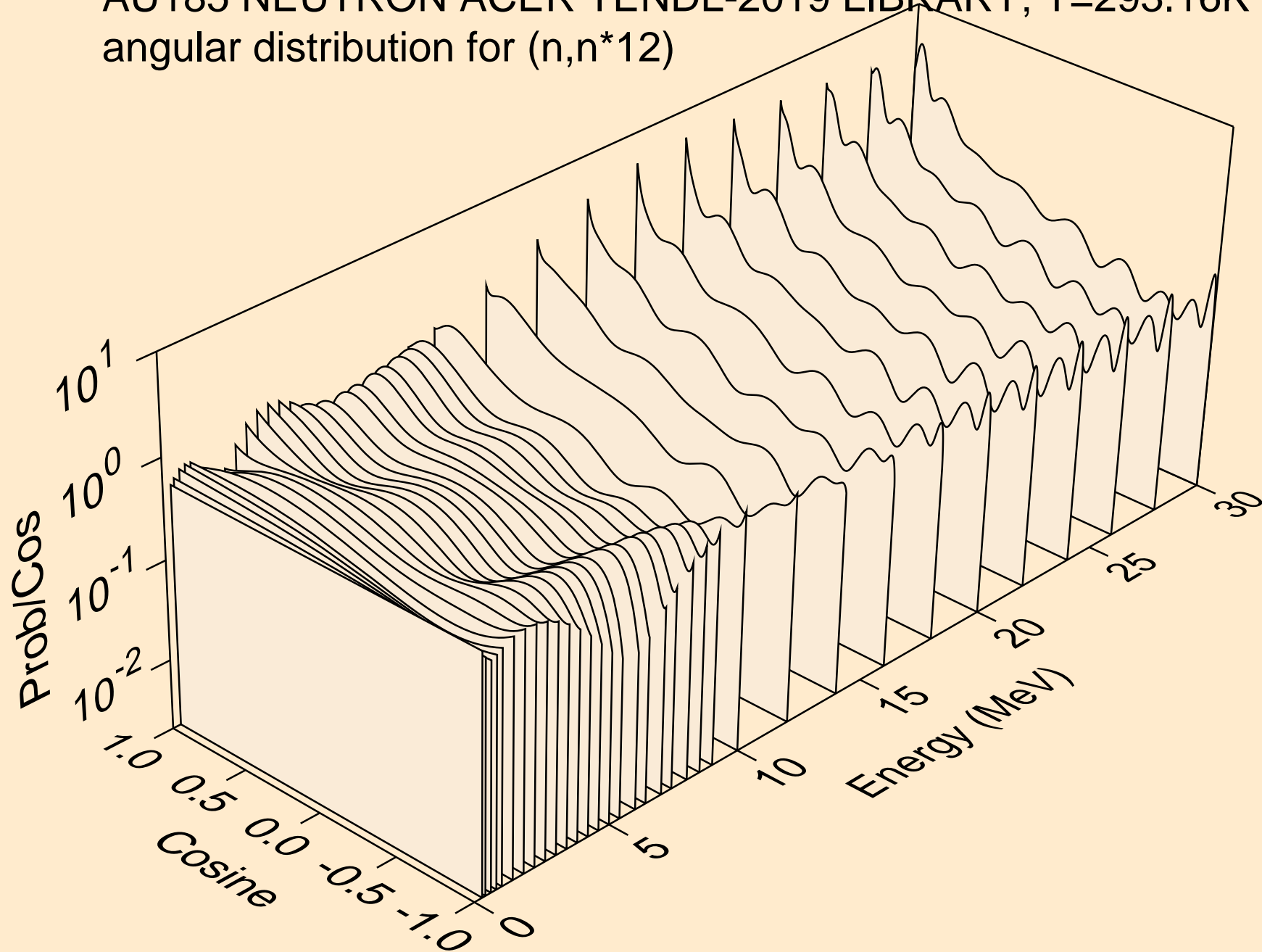

AU185 NEUTRON ACER TENDL-2019 LIBRARY; T=293.16K
angular distribution for (n,n*13)

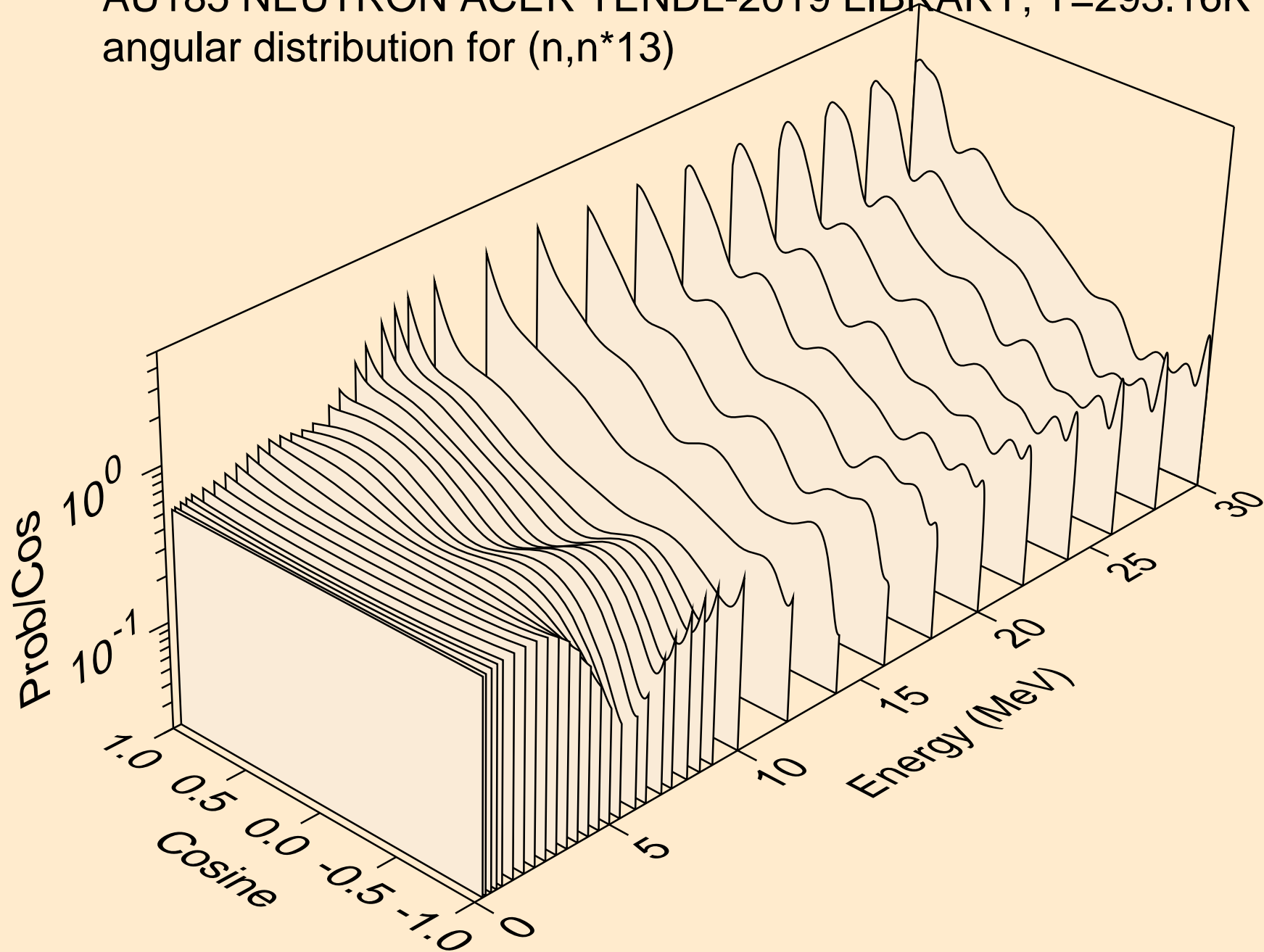

AU185 NEUTRON ACER TENDL-2019 LIBRARY; T=293.16K
angular distribution for (n,n*14)

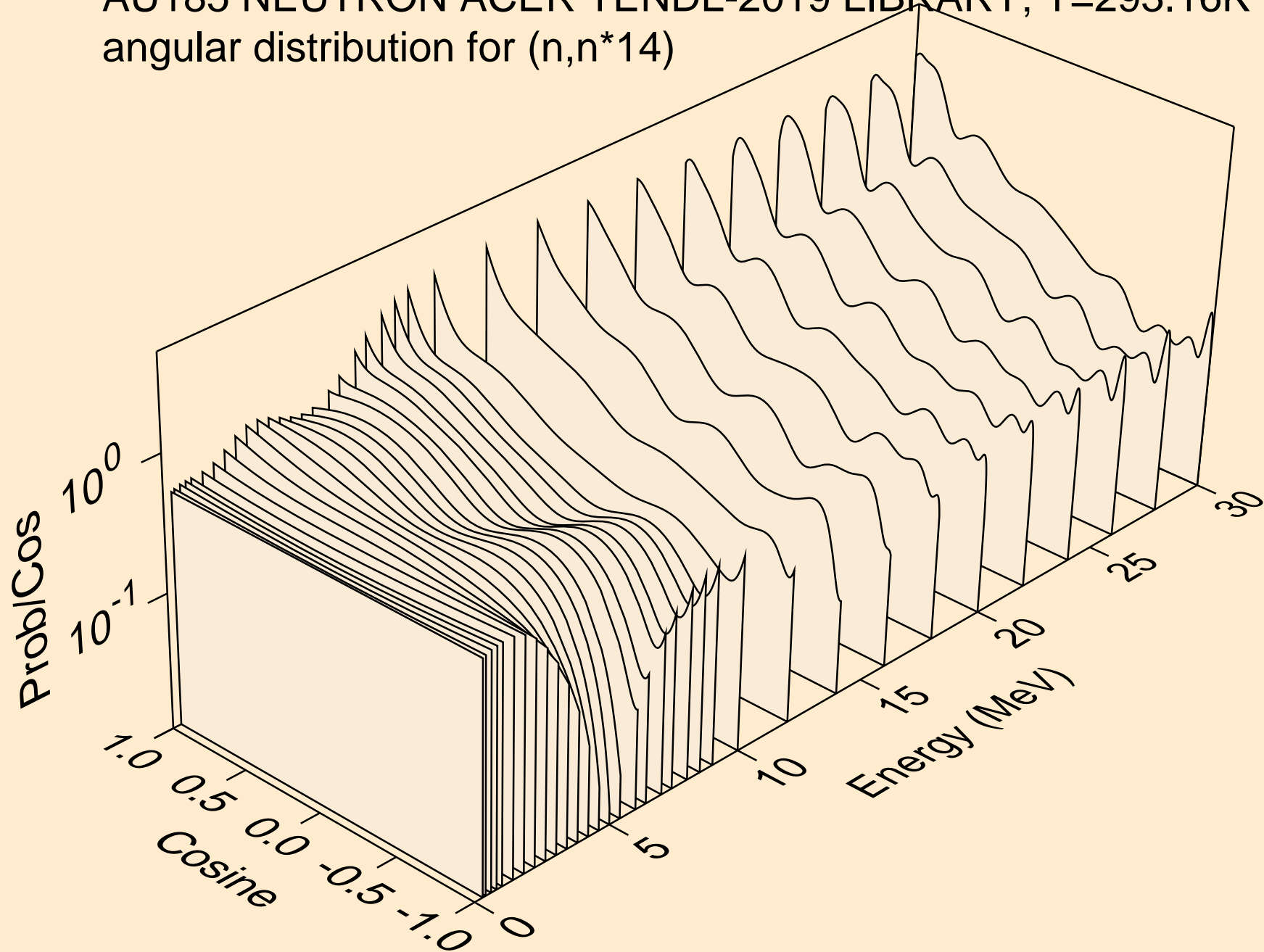

AU185 NEUTRON ACER TENDL-2019 LIBRARY; T=293.16K
angular distribution for (n,n*15)

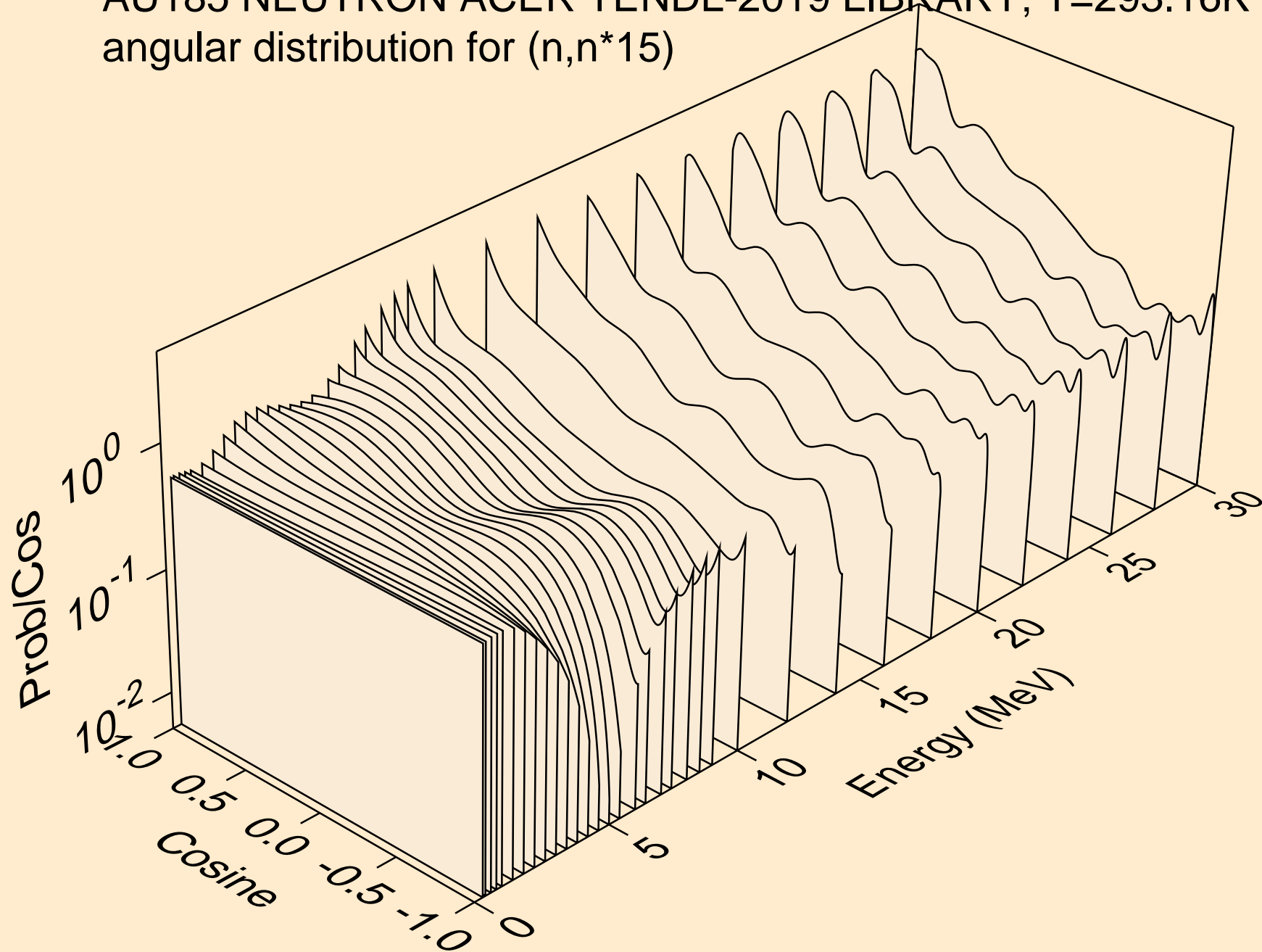

AU185 NEUTRON ACER TENDL-2019 LIBRARY; T=293.16K
angular distribution for (n,n*16)

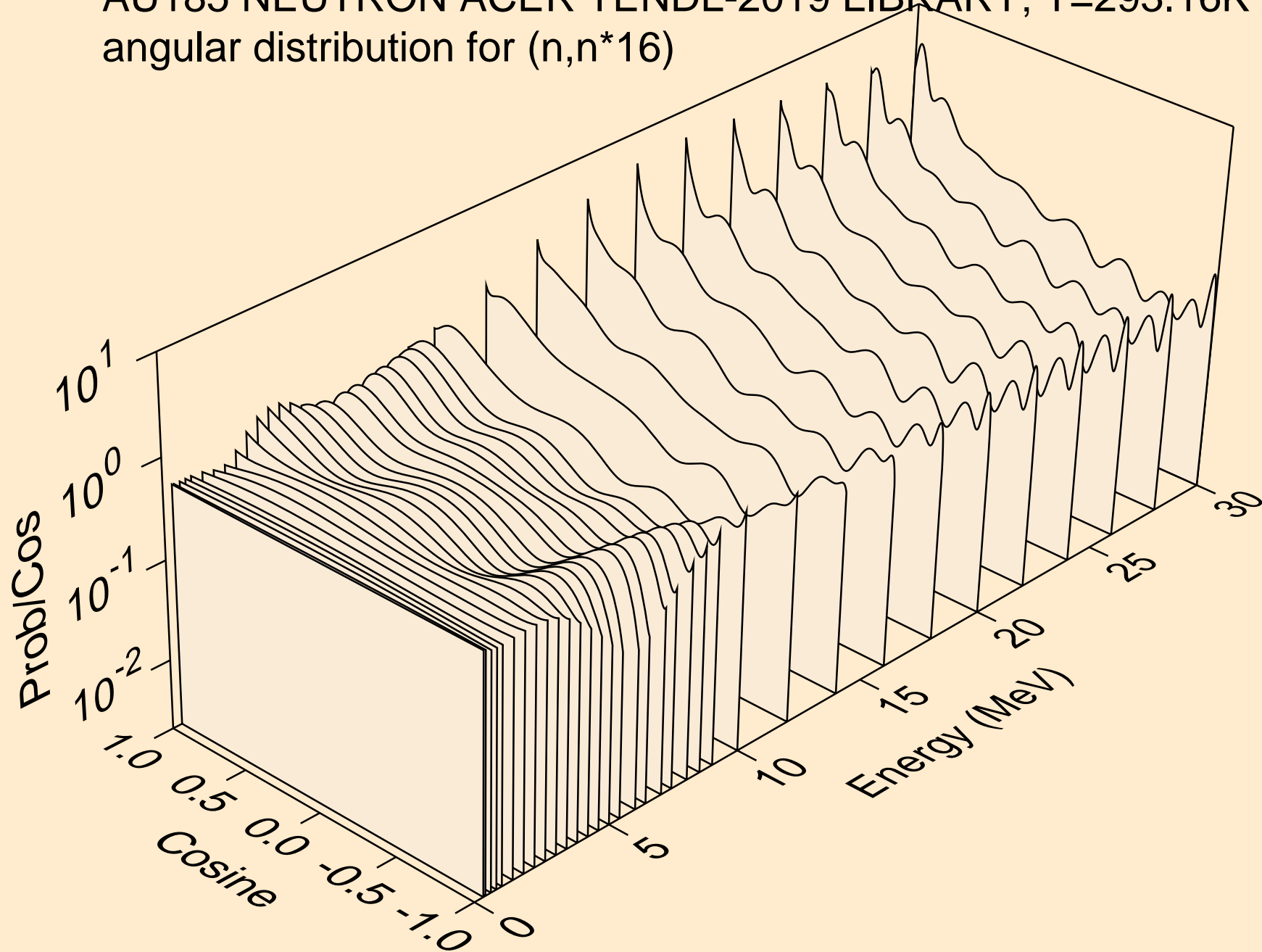

AU185 NEUTRON ACER TENDL-2019 LIBRARY; T=293.16K
angular distribution for (n,n*17)

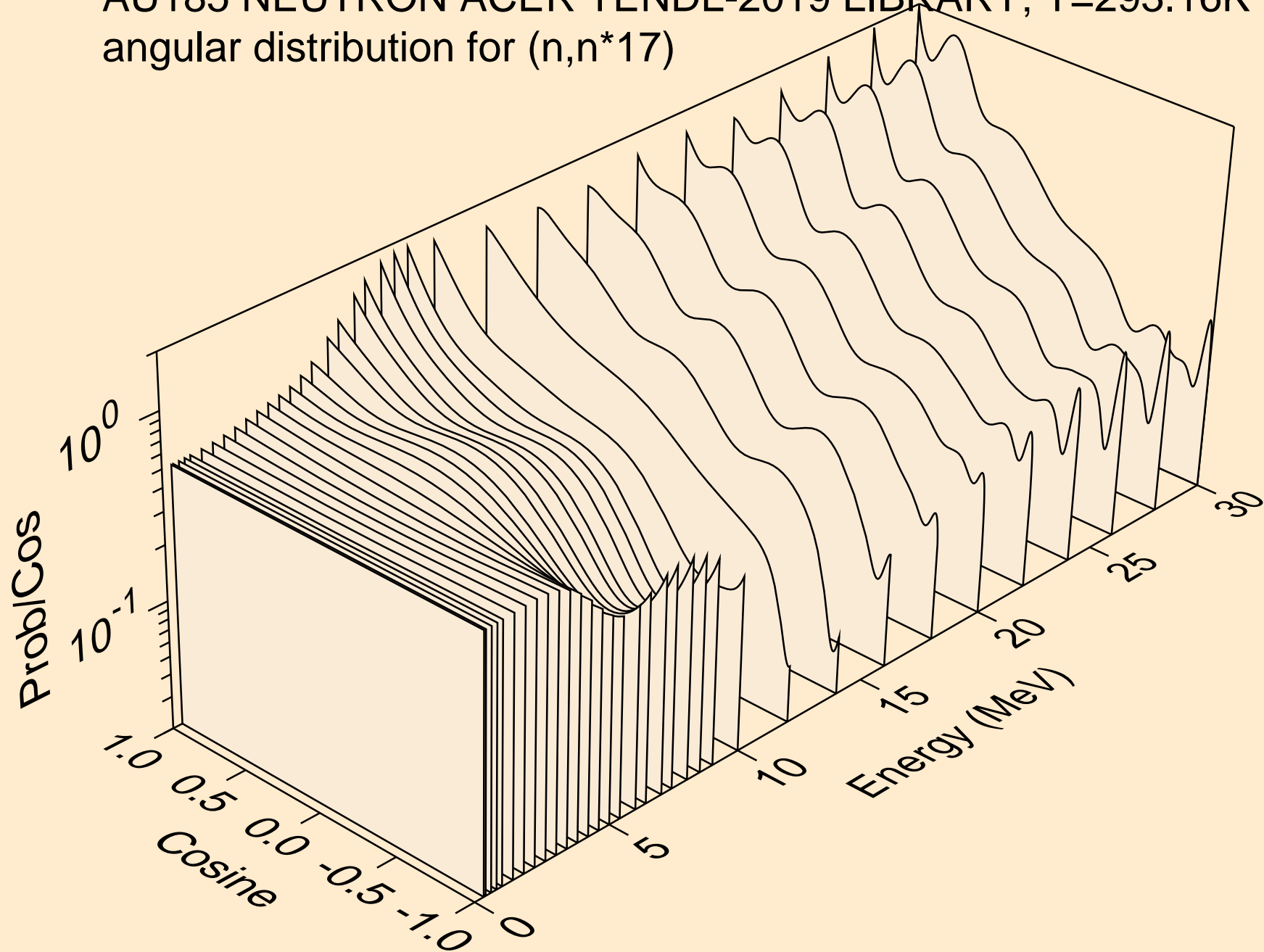

AU185 NEUTRON ACER TENDL-2019 LIBRARY; T=293.16K
angular distribution for (n,n*18)

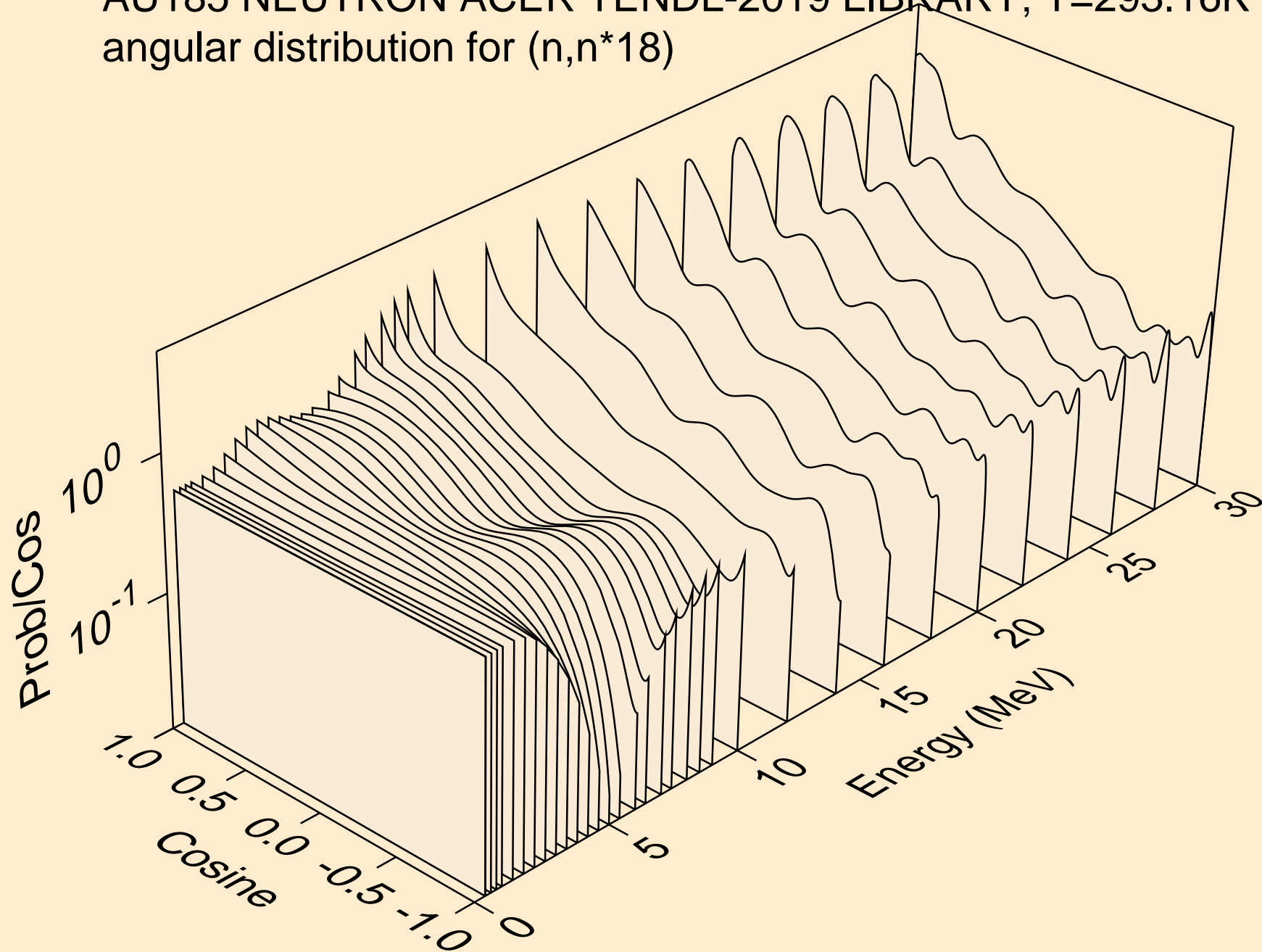

AU185 NEUTRON ACER TENDL-2019 LIBRARY; T=293.16K
angular distribution for (n,n*19)

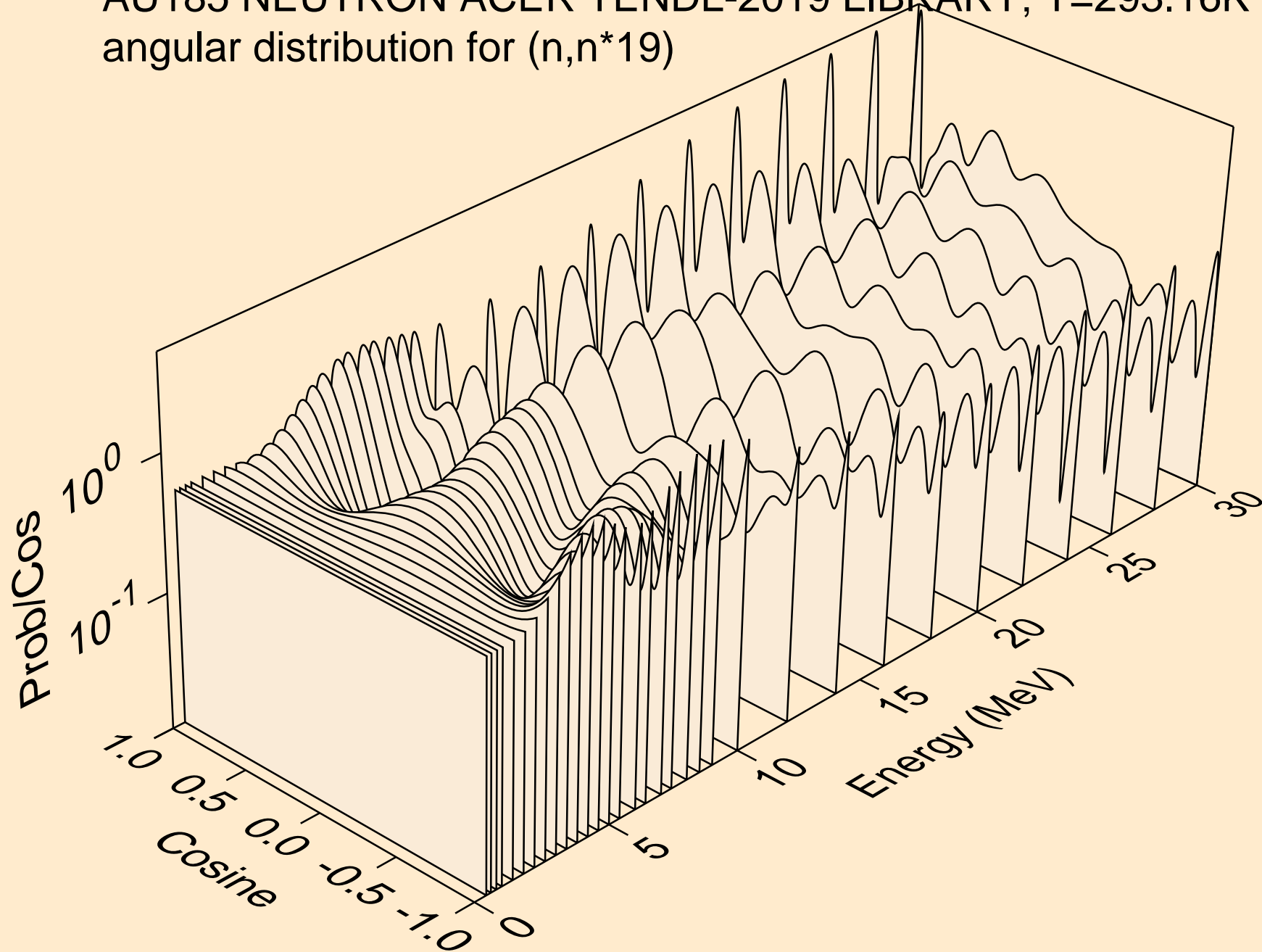

AU185 NEUTRON ACER TENDL-2019 LIBRARY; T=293.16K
angular distribution for (n,n*20)

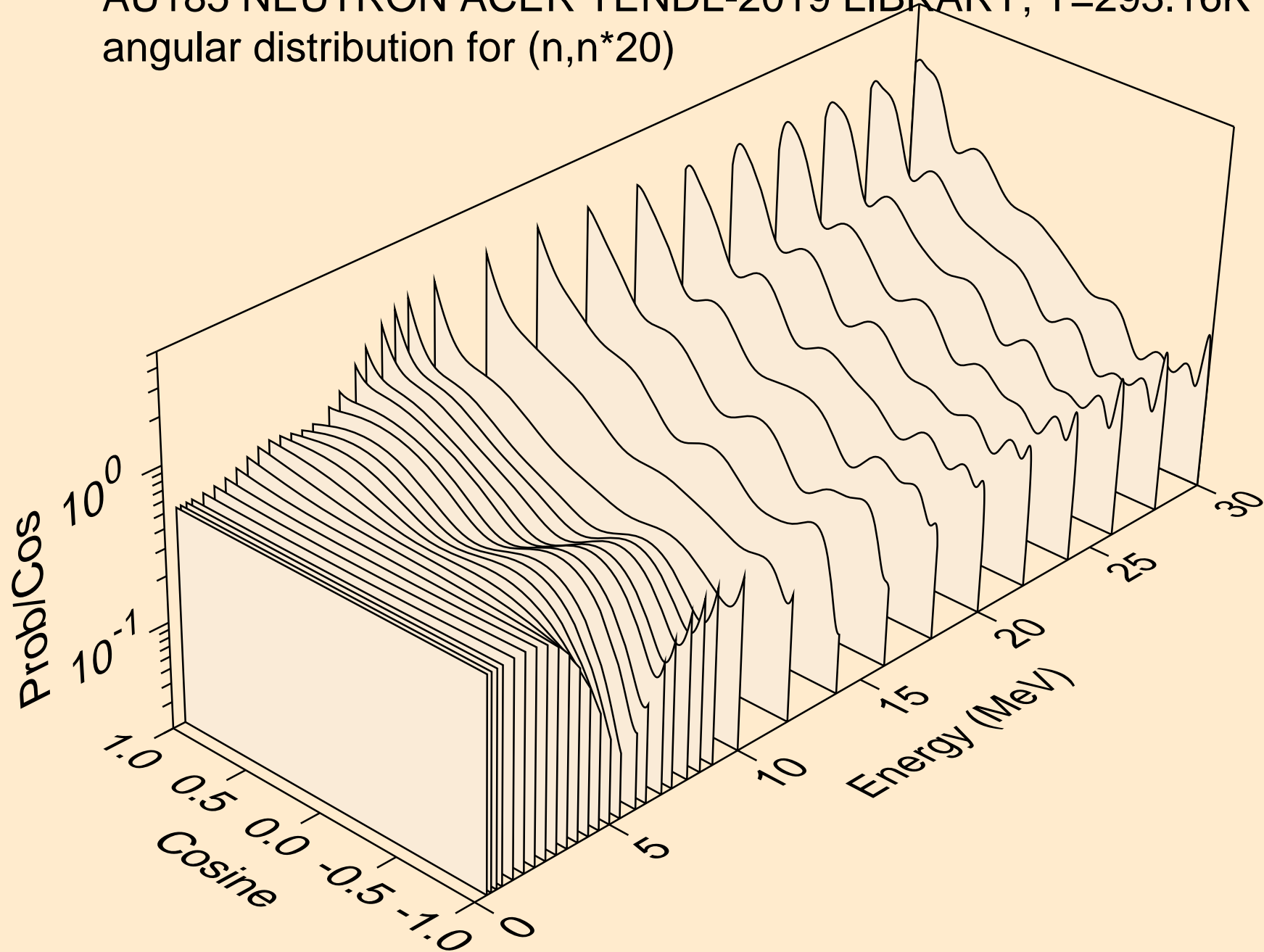

AU185 NEUTRON ACER TENDL-2019 LIBRARY; T=293.16K
angular distribution for (n,n*21)

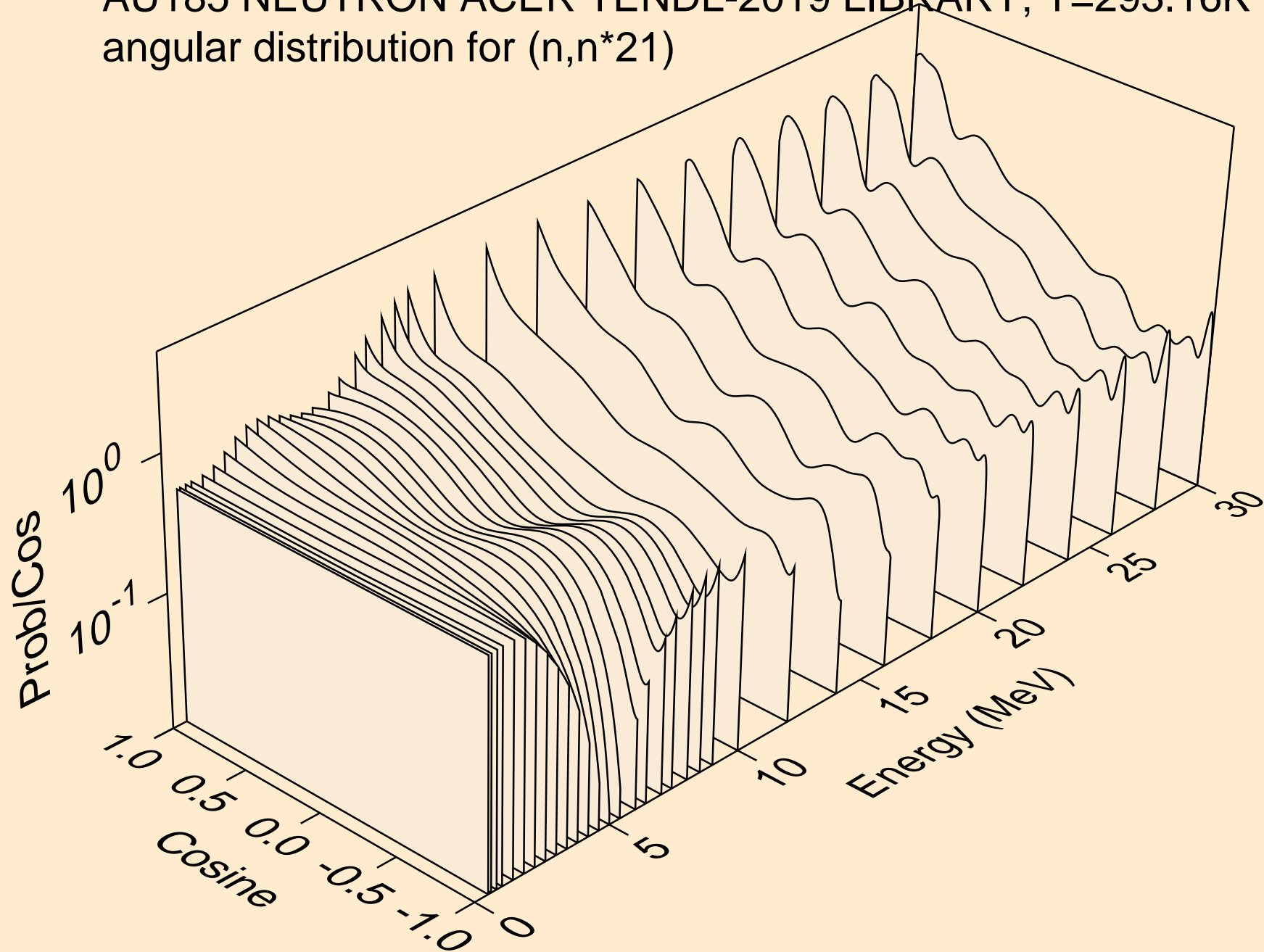

AU185 NEUTRON ACER TENDL-2019 LIBRARY; T=293.16K
Neutron emission for (n,x)

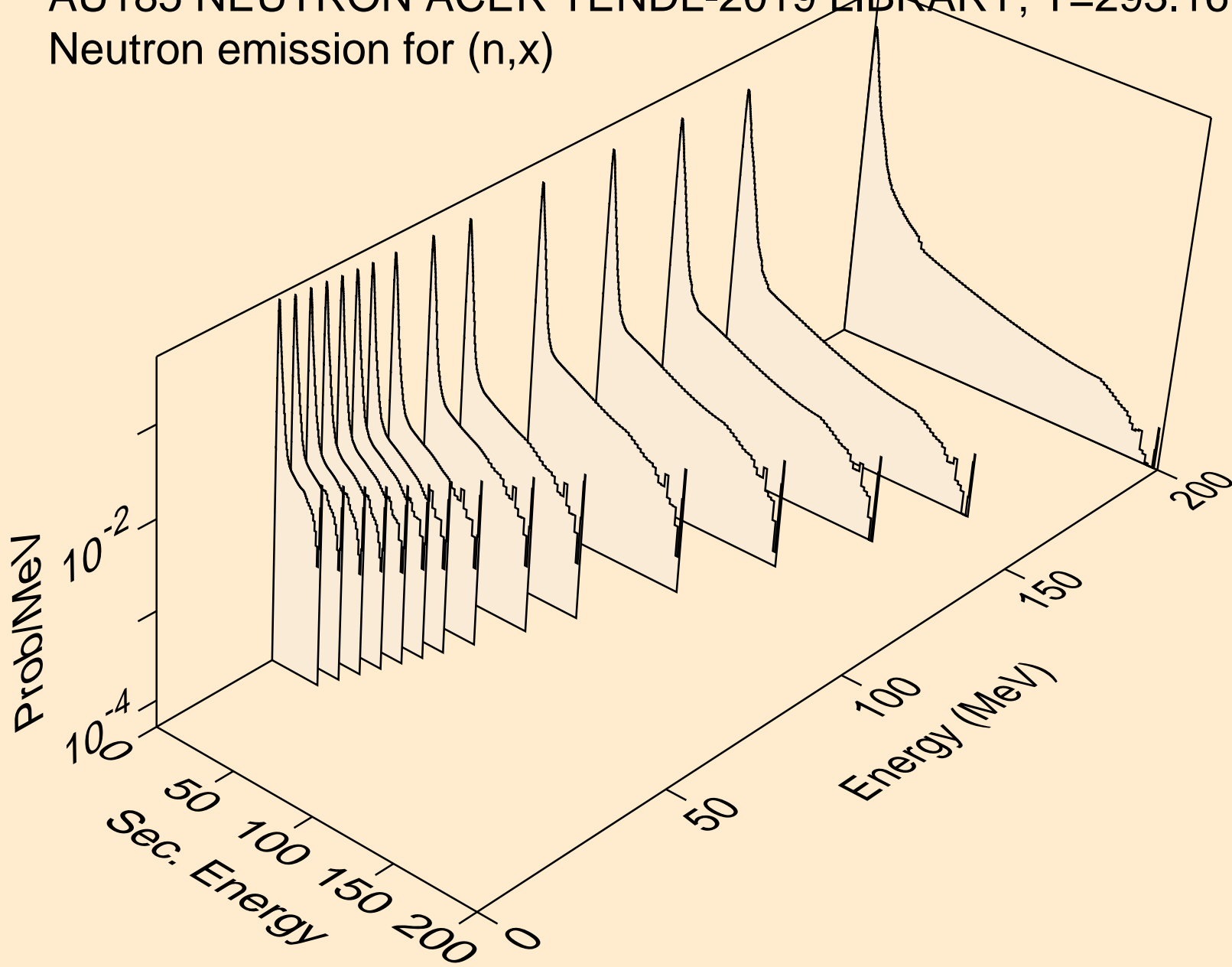

AU185 NEUTRON ACER TENDL-2019 LIBRARY; T=293.16K
Neutron emission for (n,2nd)

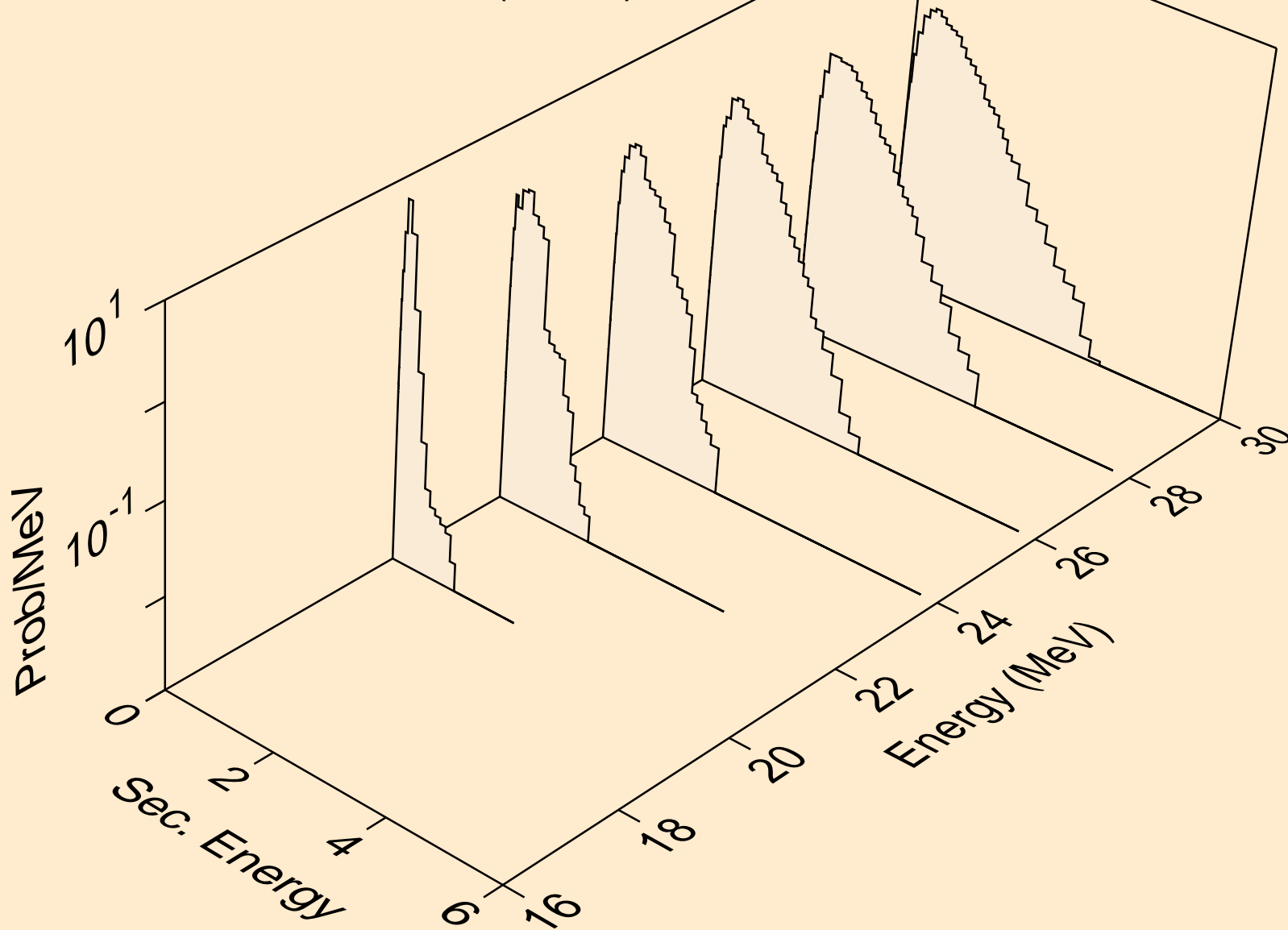

AU185 NEUTRON ACER TENDL-2019 LIBRARY; T=293.16K
Neutron emission for (n,2n)

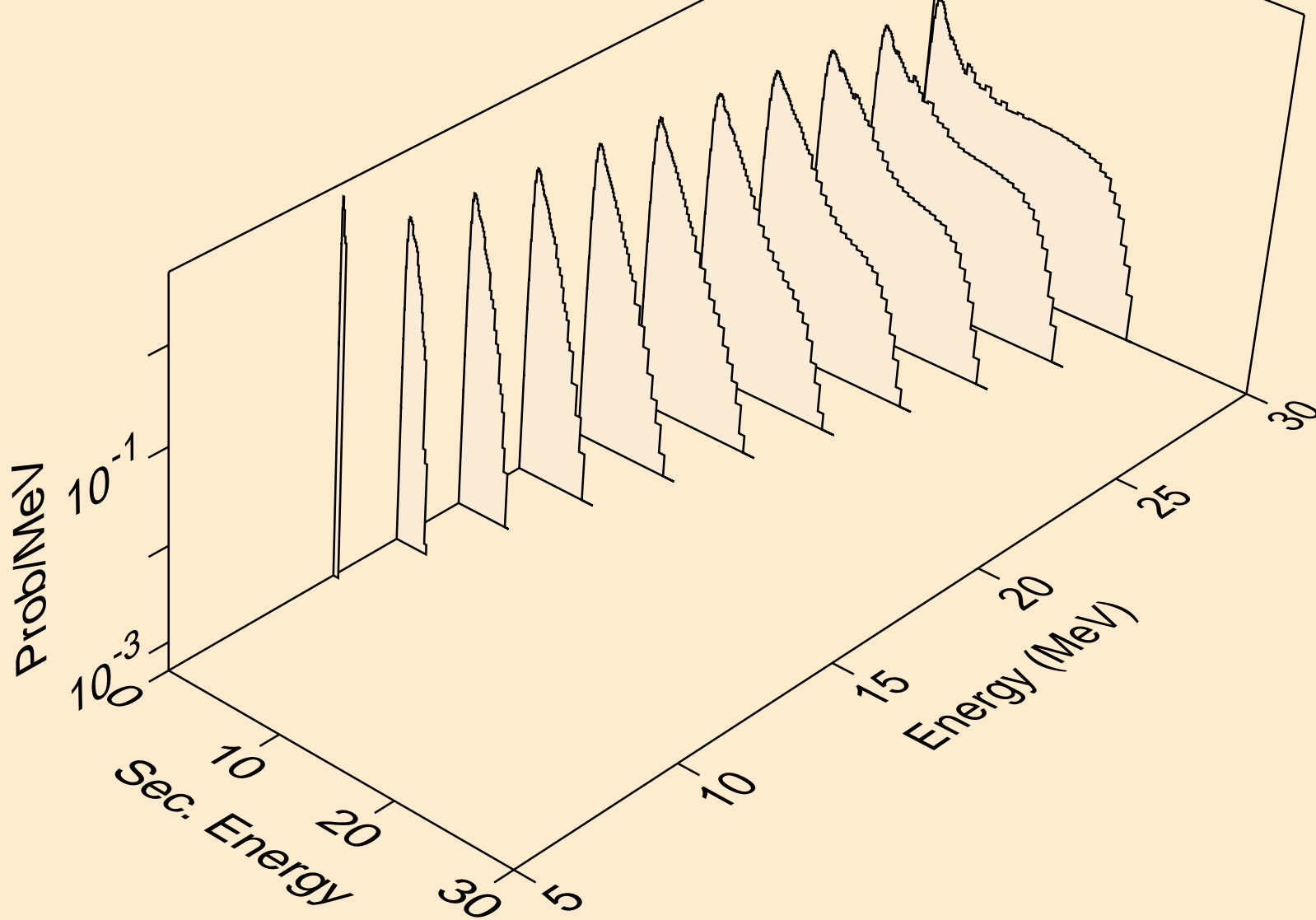

AU185 NEUTRON ACER TENDL-2019 LIBRARY; T=293.16K
Neutron emission for (n,3n)

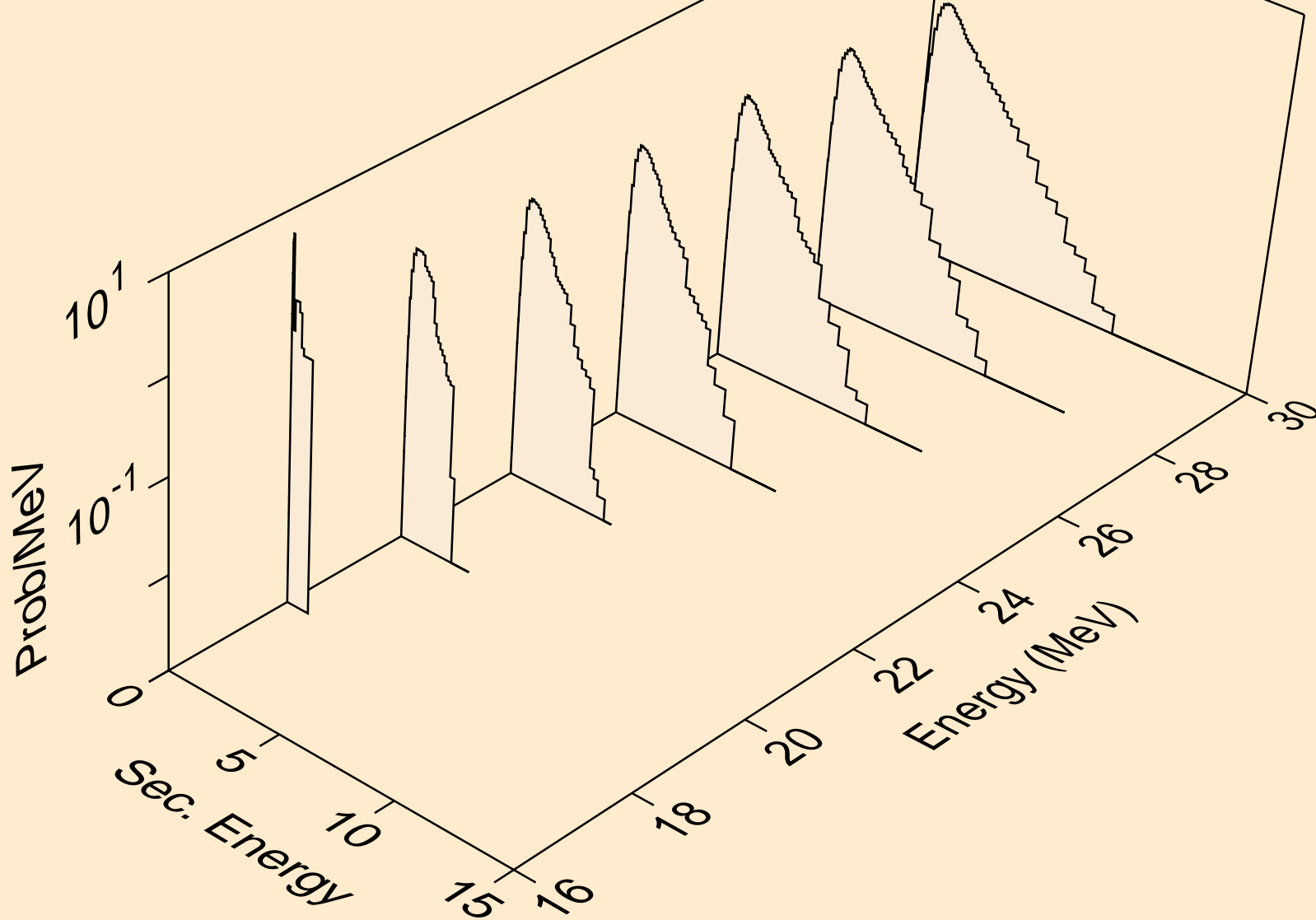

AU185 NEUTRON ACER TENDL-2019 LIBRARY; T=293.16K
Neutron emission for (n,n*)a

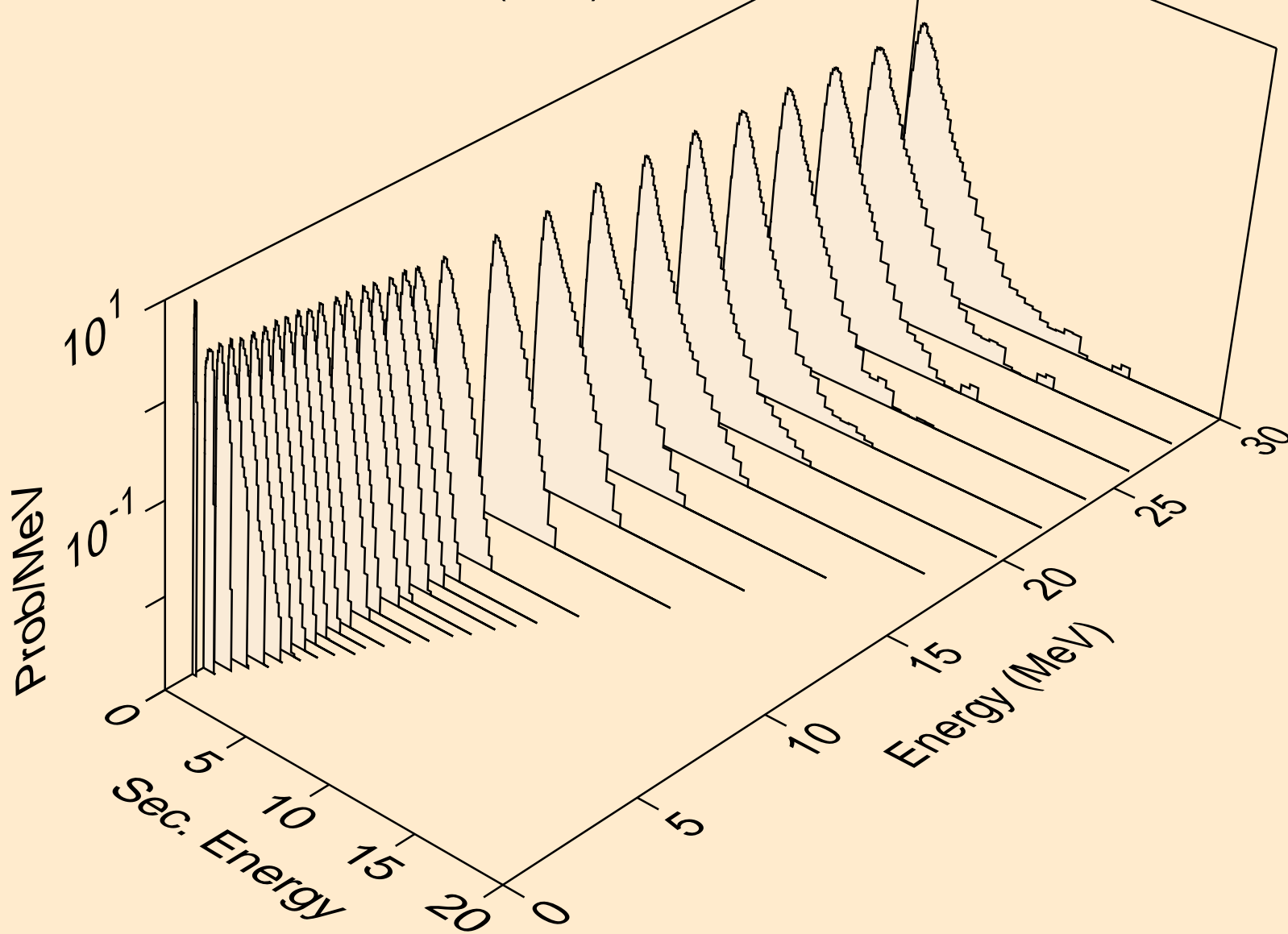

AU185 NEUTRON ACER TENDL-2019 LIBRARY; T=293.16K
Neutron emission for (n,2n)a

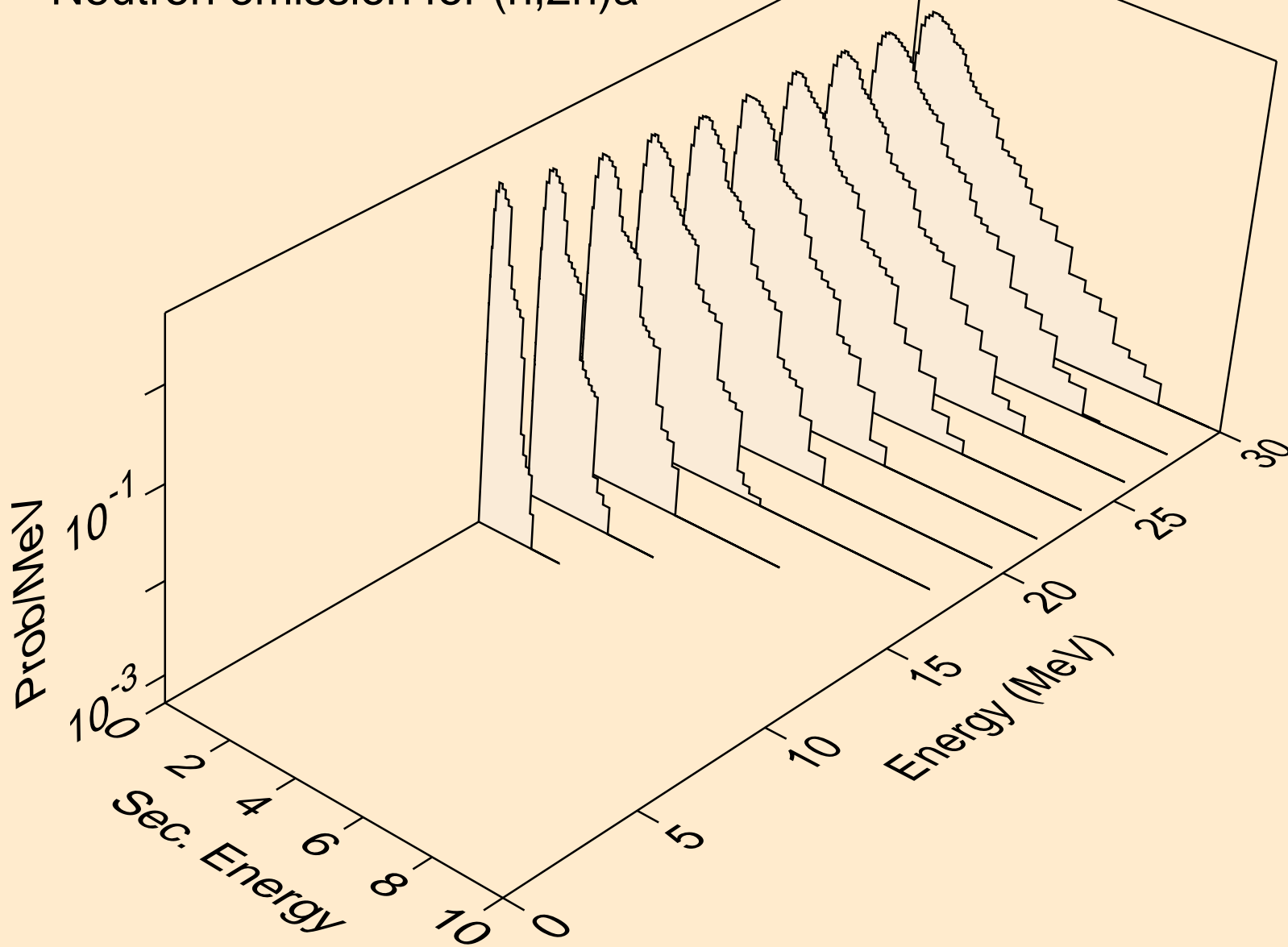

AU185 NEUTRON ACER TENDL-2019 LIBRARY; T=293.16K
Neutron emission for (n,3n)a

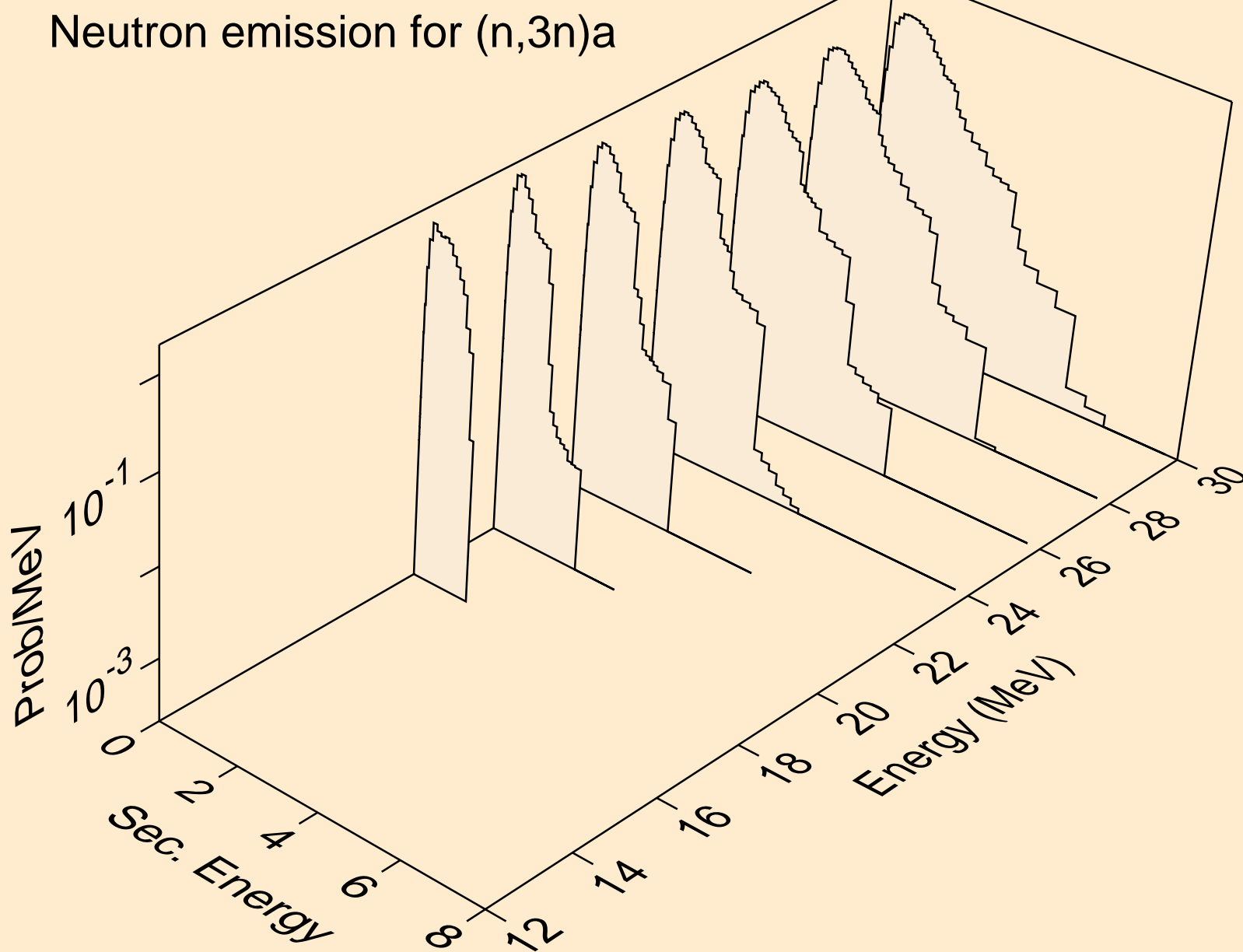

AU185 NEUTRON ACER TENDL-2019 LIBRARY; T=293.16K
Neutron emission for (n,n*)p

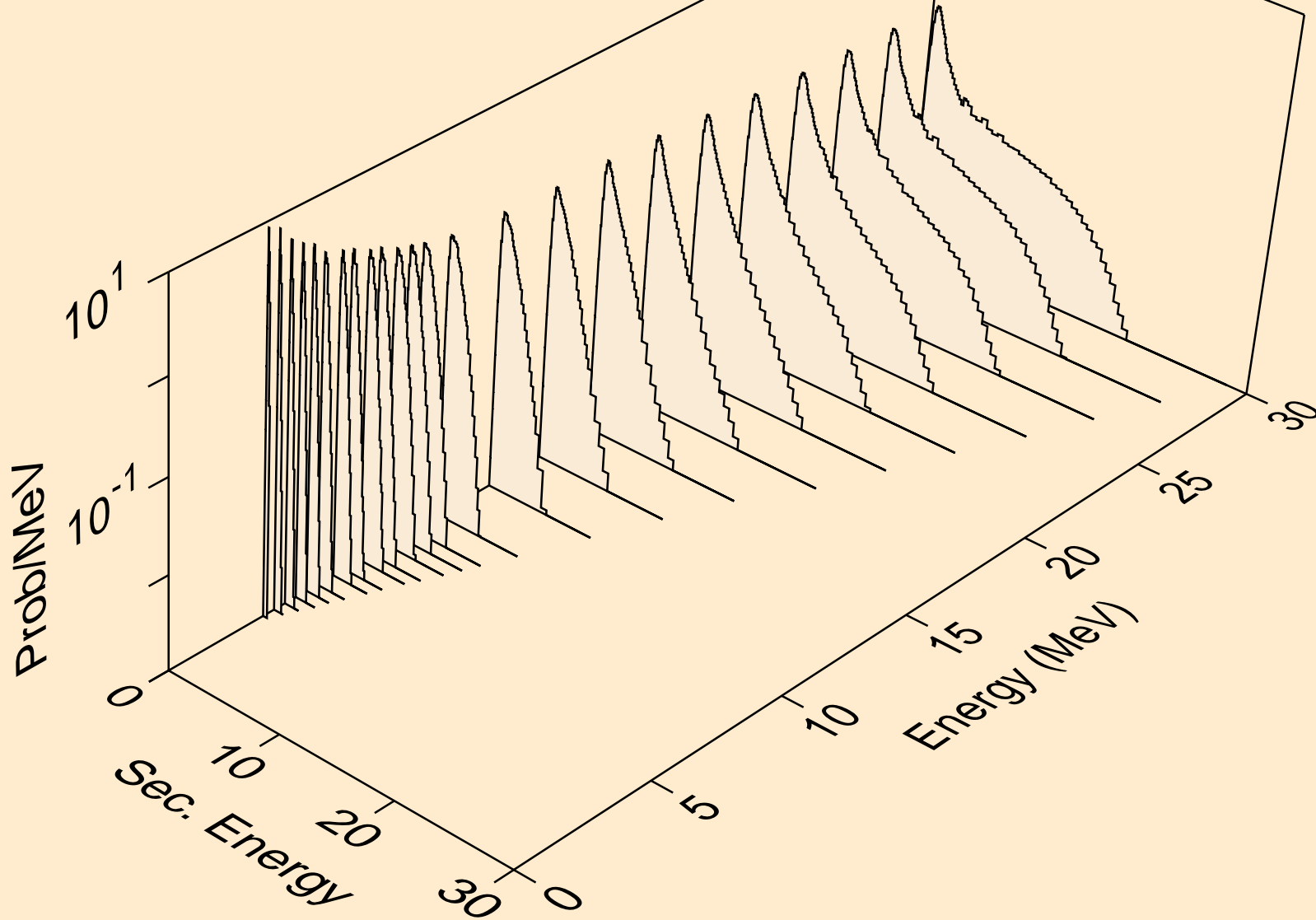

AU185 NEUTRON ACER TENDL-2019 LIBRARY; T=293.16K
Neutron emission for (n,n*)2a

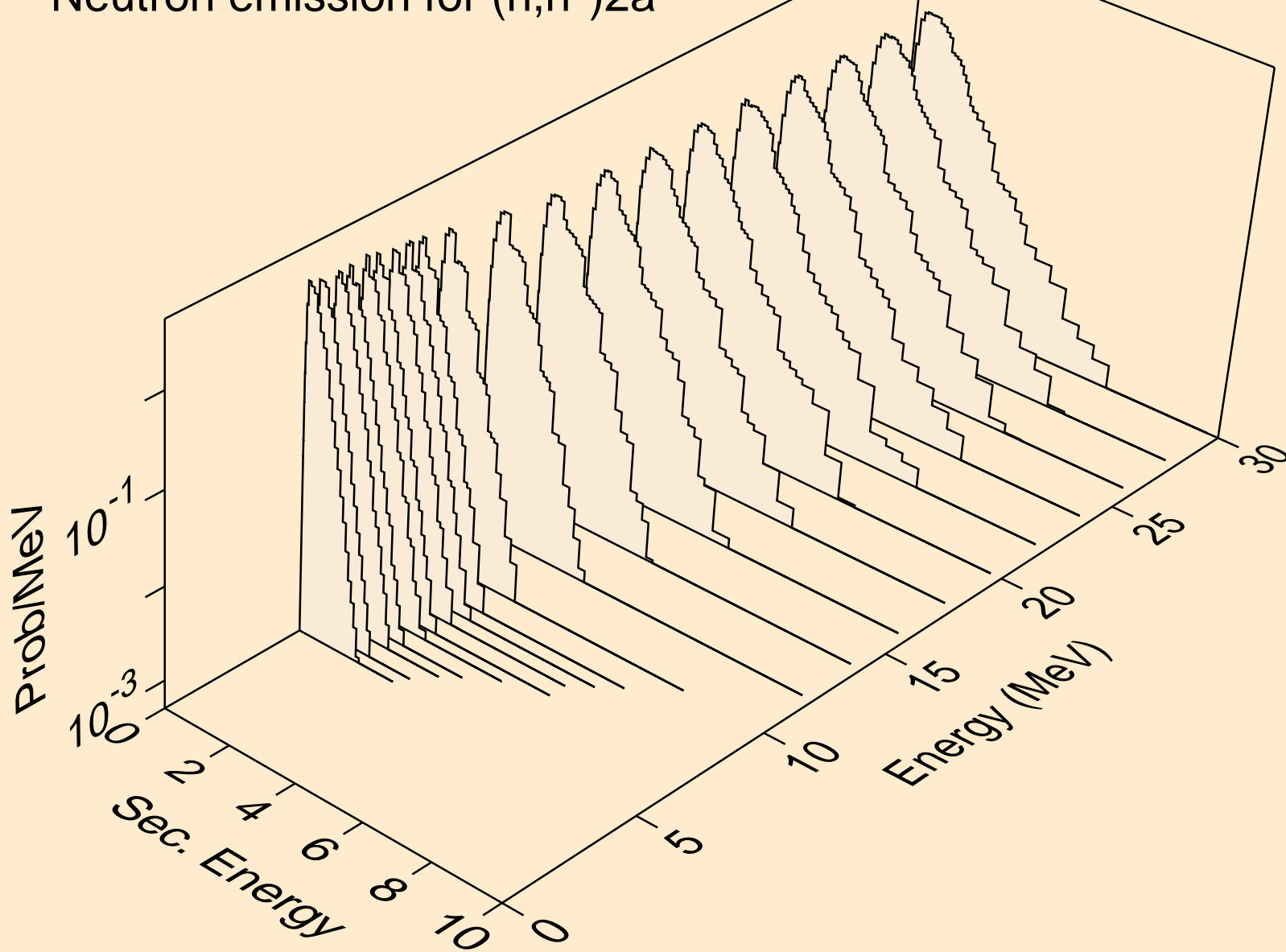

AU185 NEUTRON ACER TENDL-2019 LIBRARY; T=293.16K
Neutron emission for (n,2n)2a

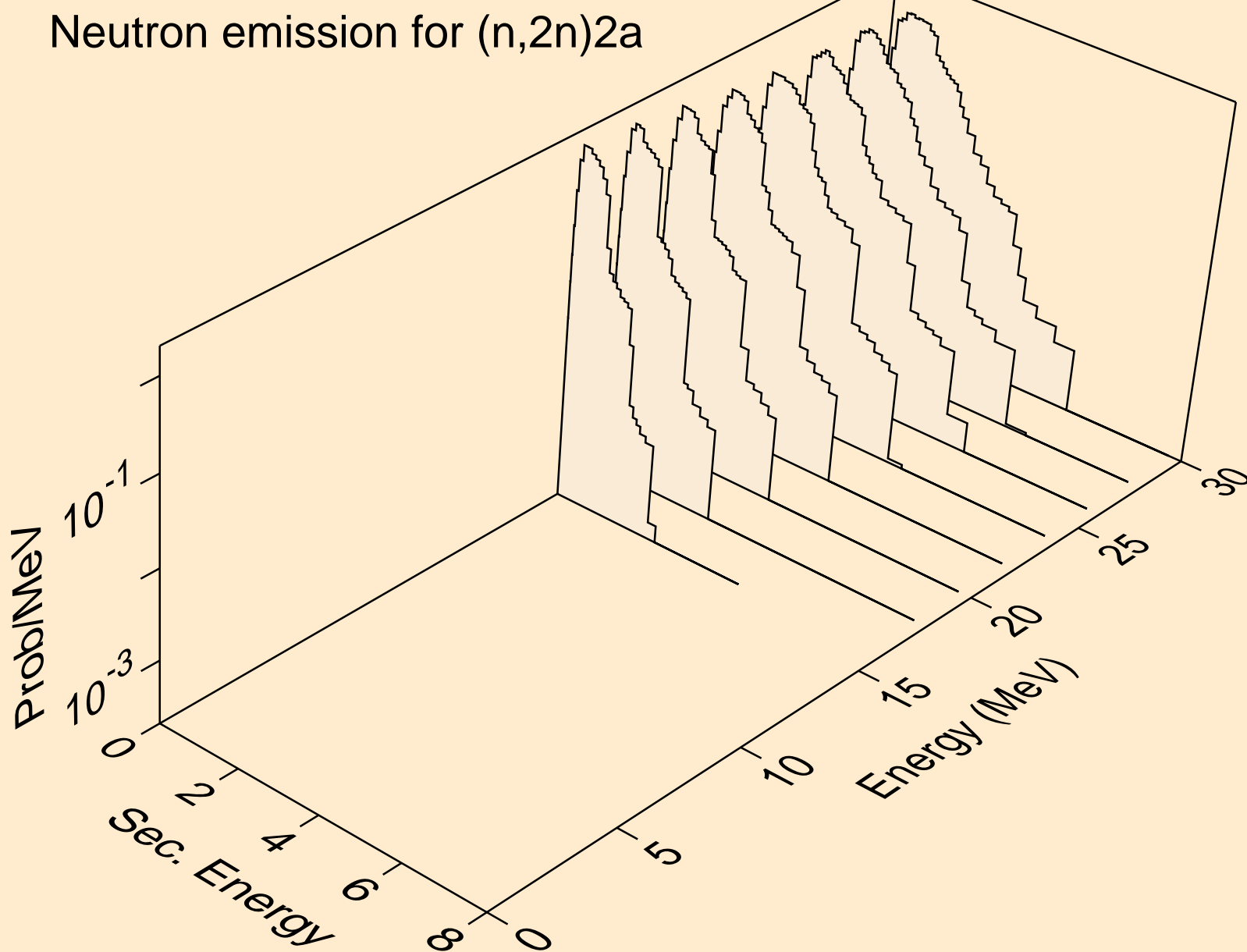

AU185 NEUTRON ACER TENDL-2019 LIBRARY; T=293.16K
Neutron emission for (n,n*)d

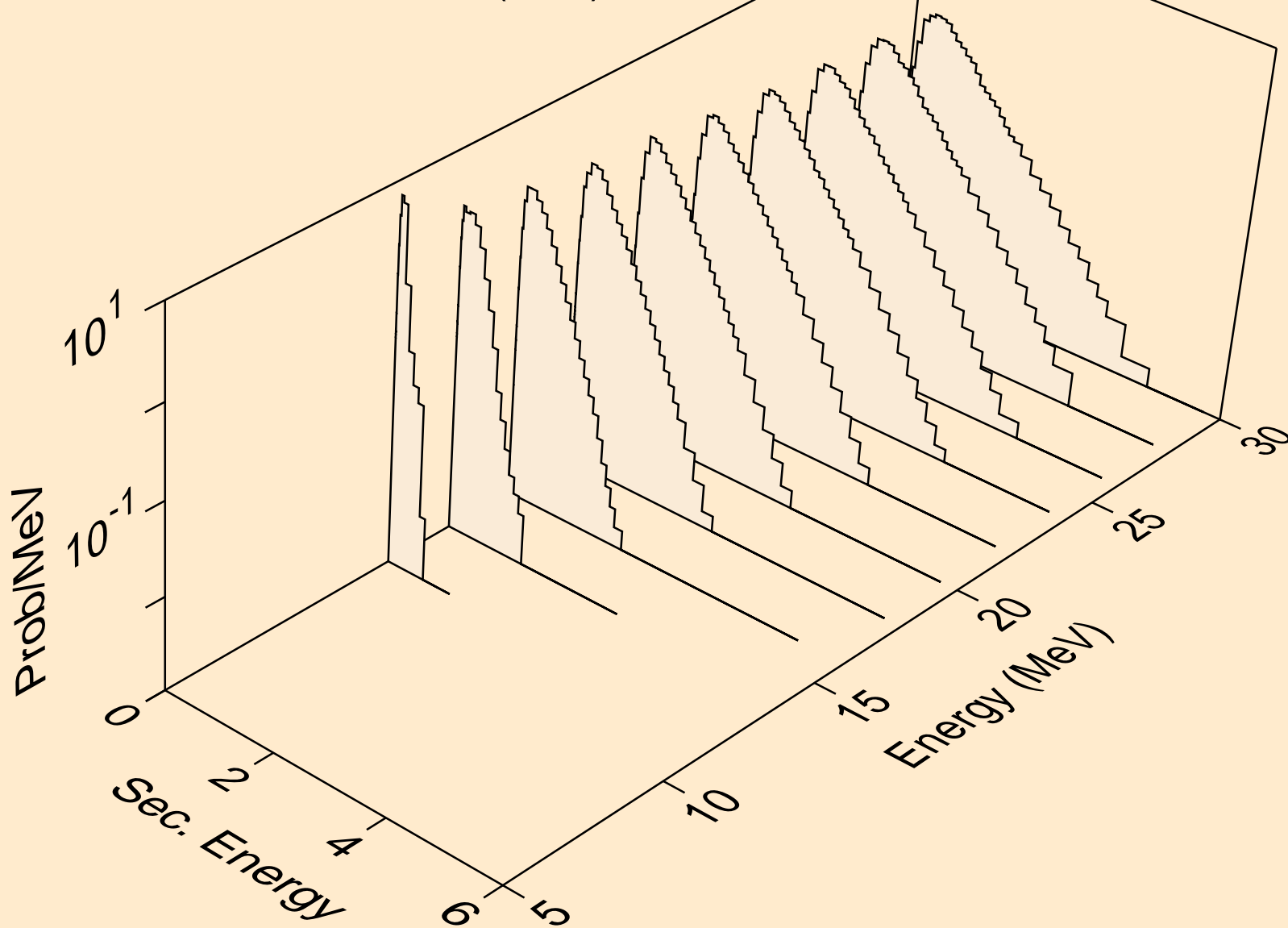

AU185 NEUTRON ACER TENDL-2019 LIBRARY; T=293.16K
Neutron emission for (n,n*)t

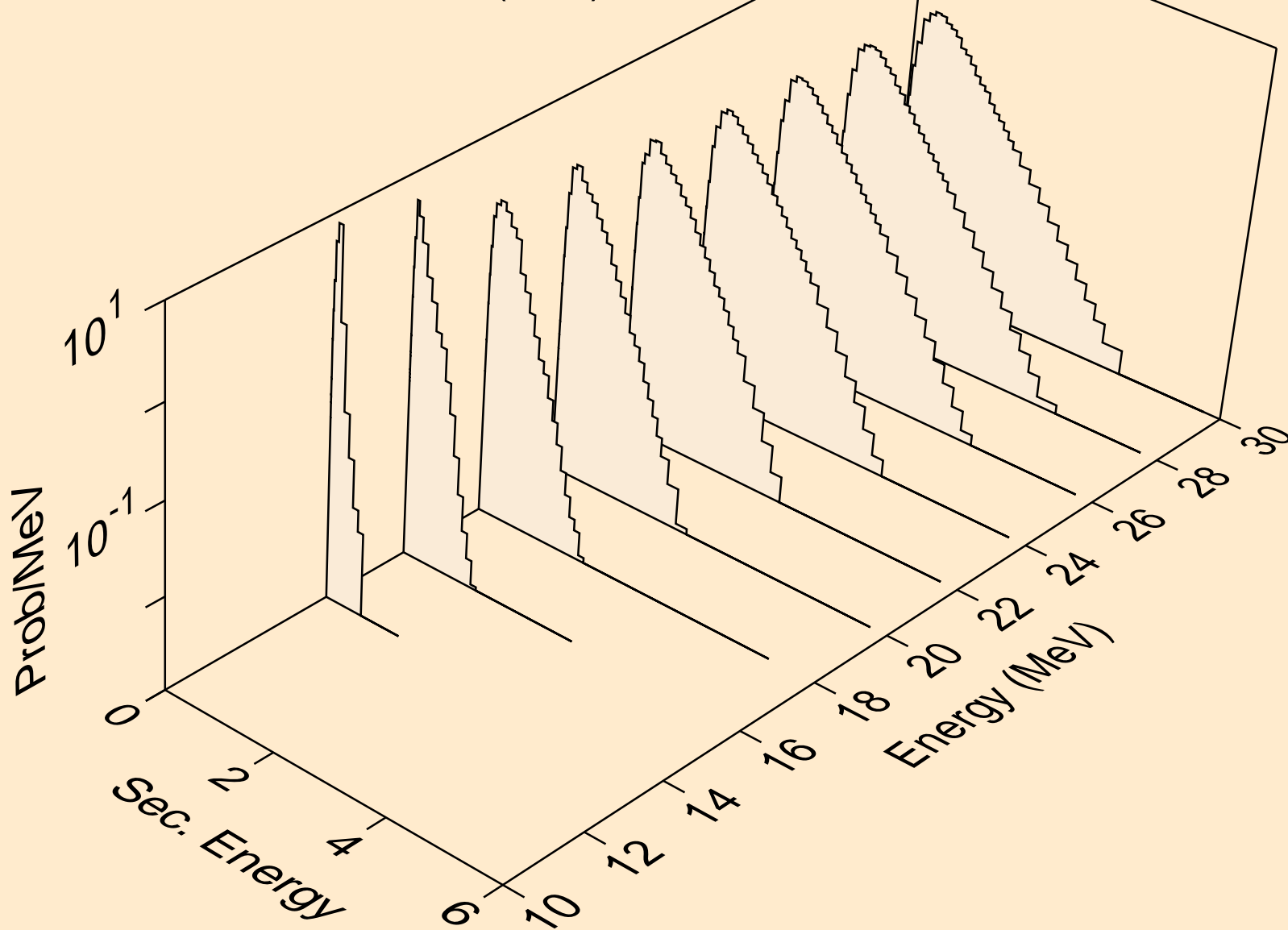

AU185 NEUTRON ACER TENDL-2019 LIBRARY; T=293.16K
Neutron emission for (n,n*)he3

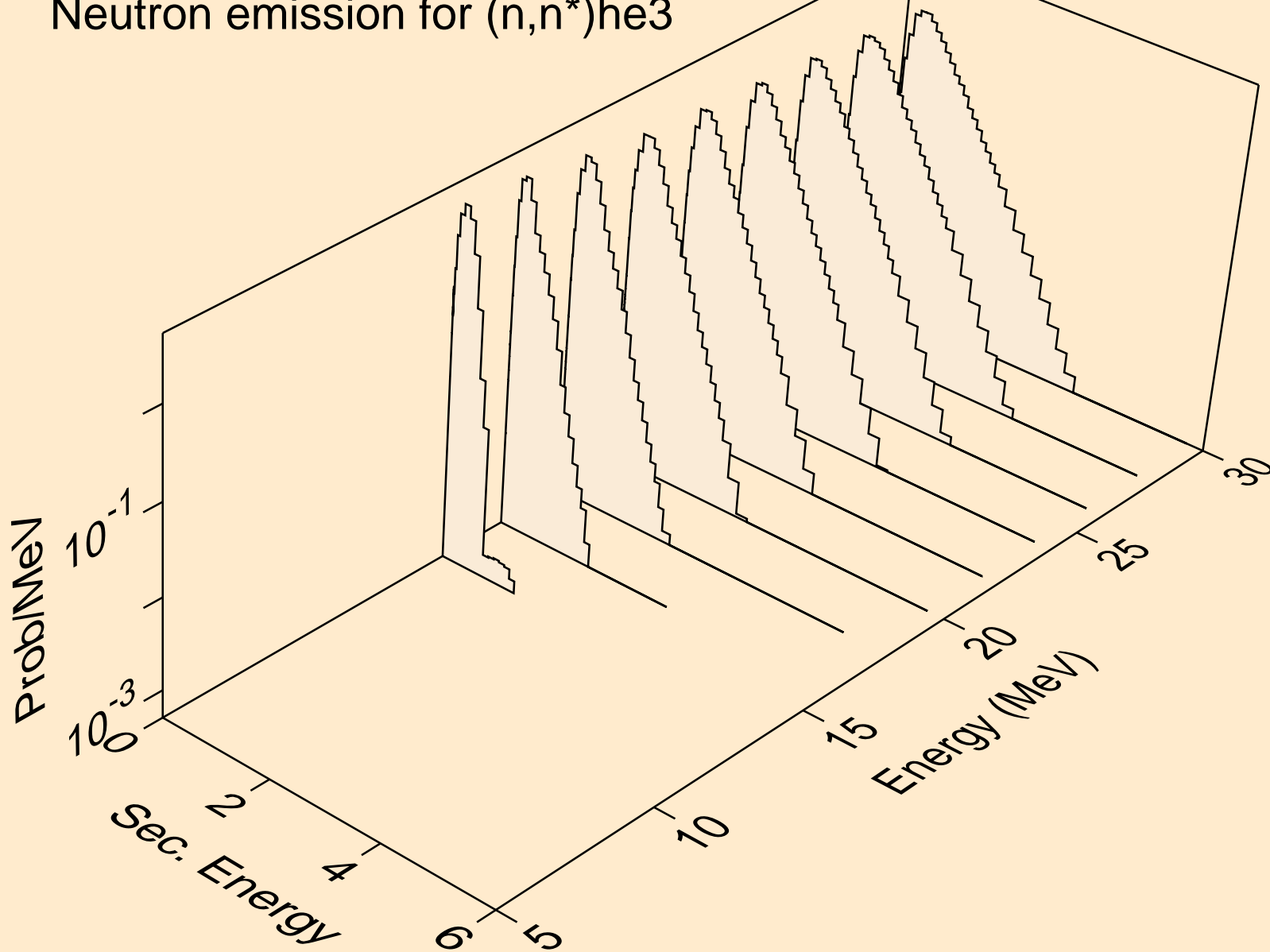

AU185 NEUTRON ACER TENDL-2019 LIBRARY; T=293.16K
Neutron emission for (n,4n)

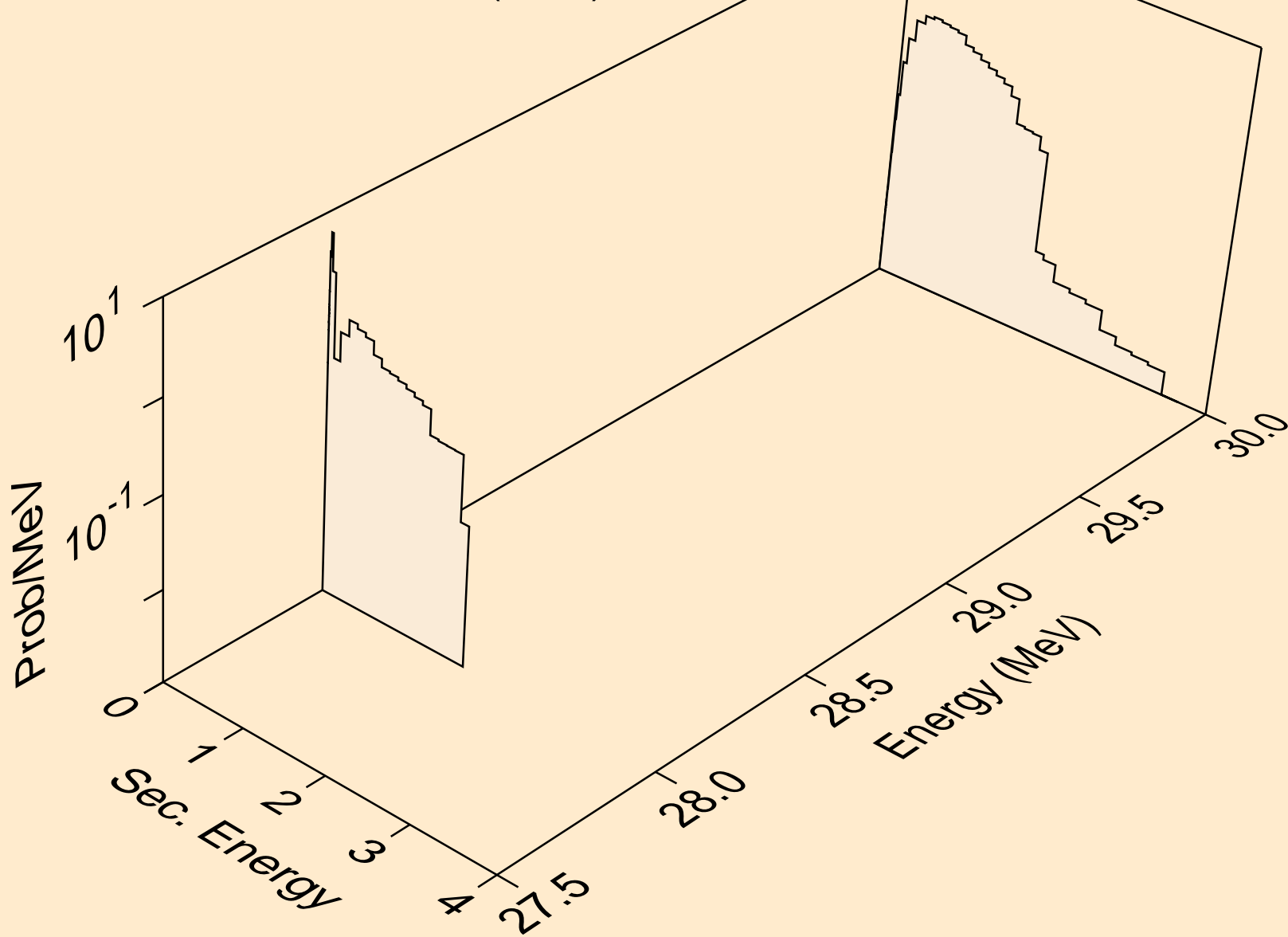

AU185 NEUTRON ACER TENDL-2019 LIBRARY; T=293.16K
Neutron emission for (n,2np)

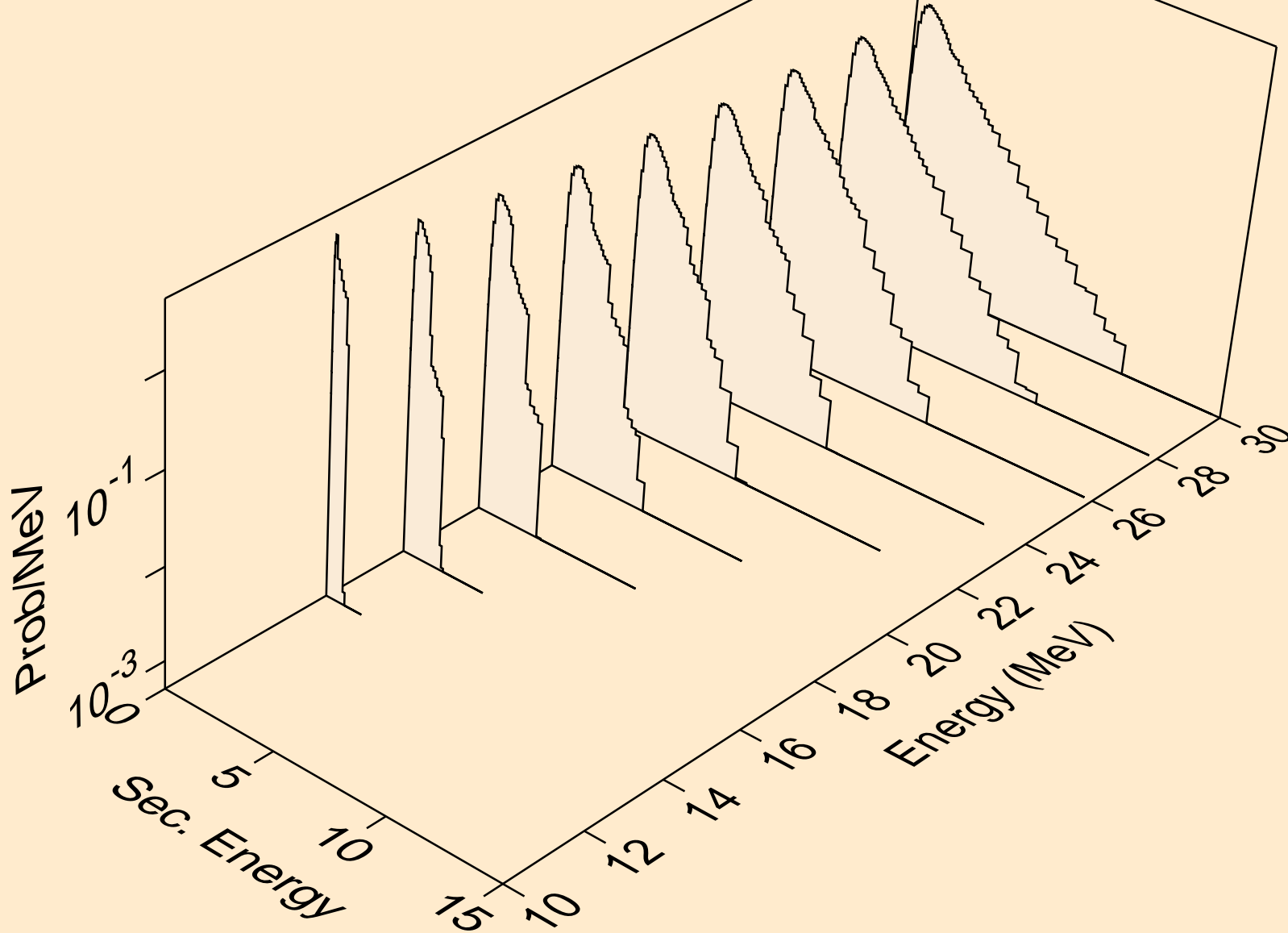

AU185 NEUTRON ACER TENDL-2019 LIBRARY; T=293.16K
Neutron emission for (n,3np)

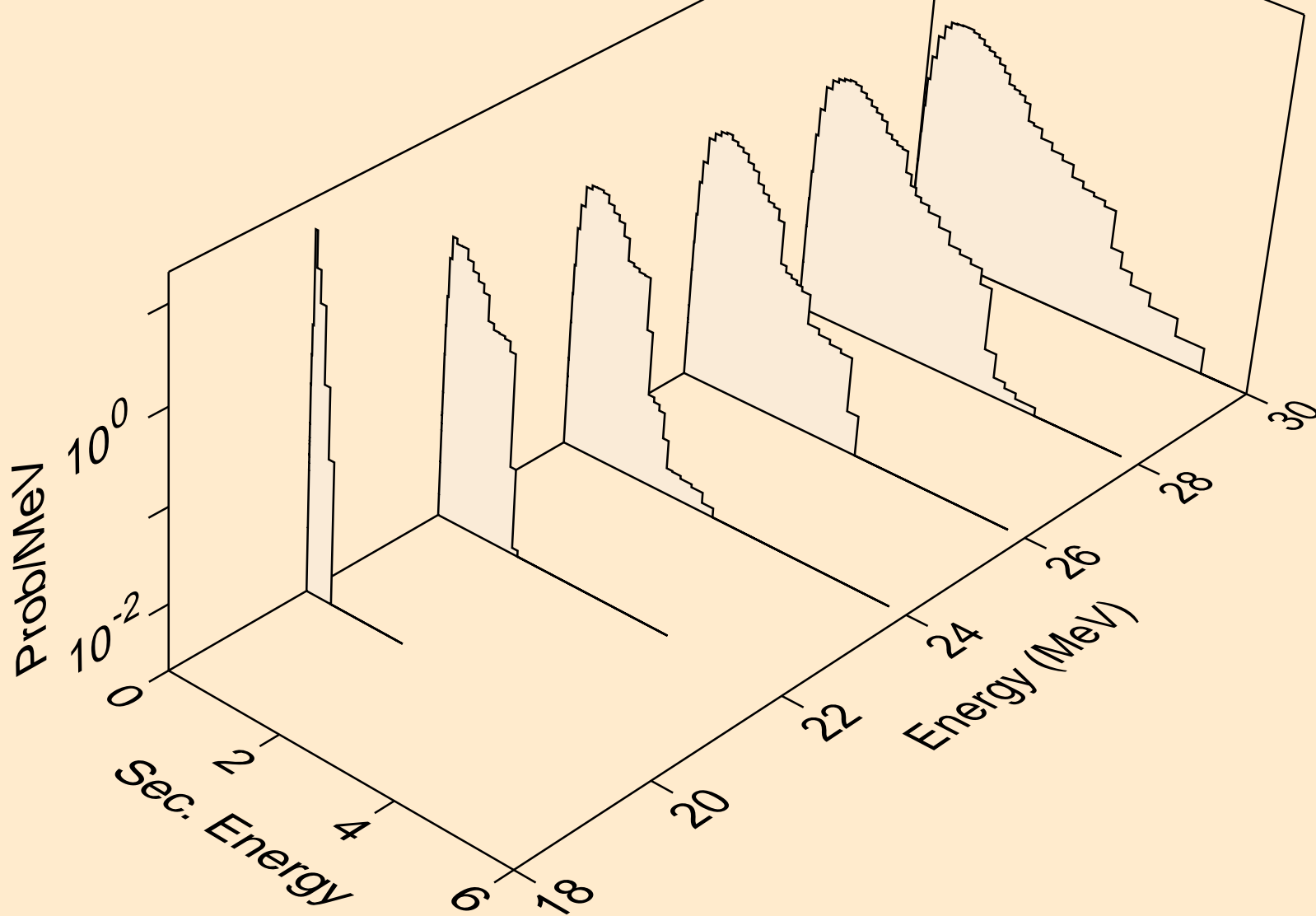

AU185 NEUTRON ACER TENDL-2019 LIBRARY; T=293.16K
Neutron emission for (n,2np)

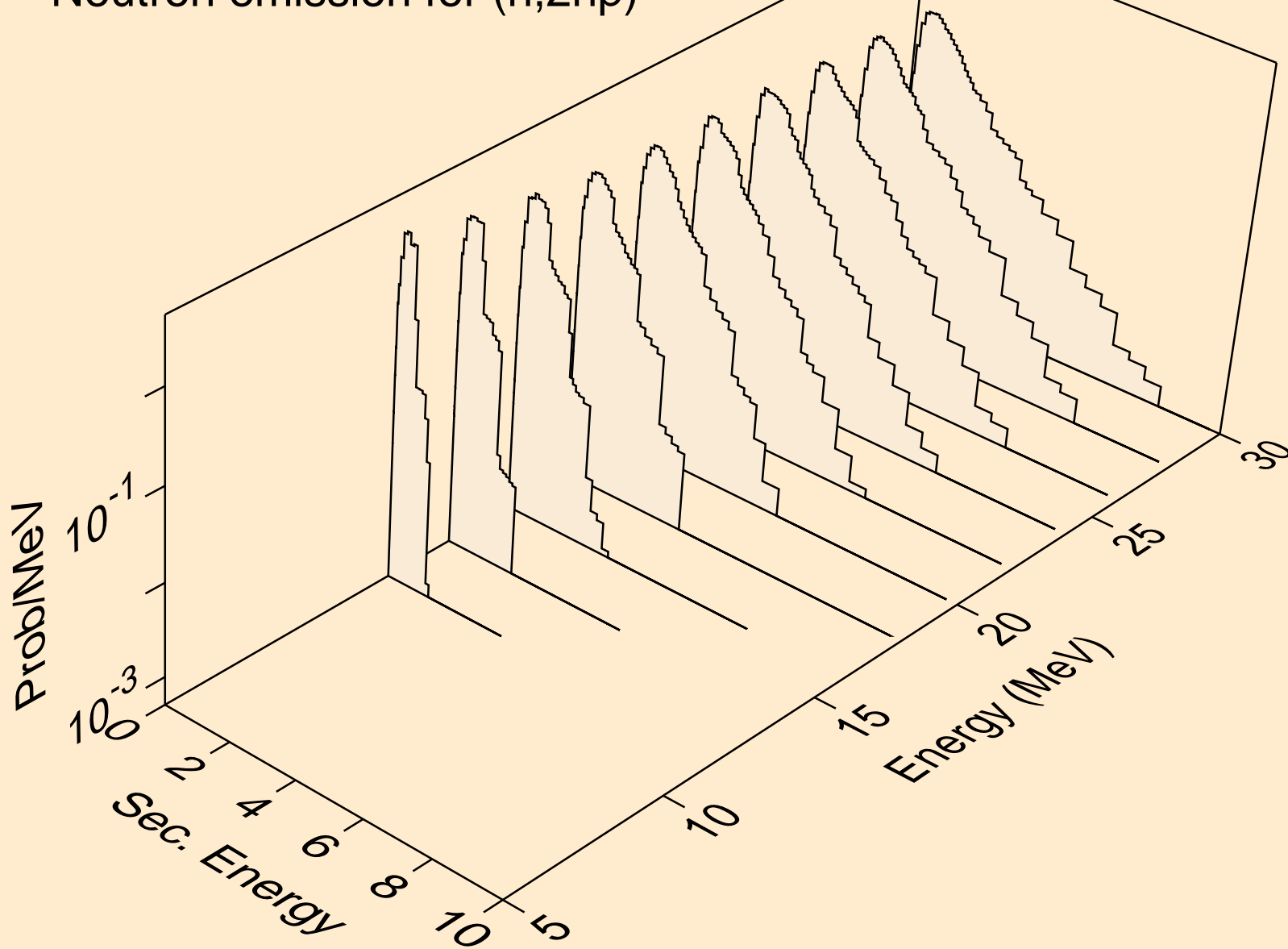

AU185 NEUTRON ACER TENDL-2019 LIBRARY; T=293.16K
Neutron emission for (n,npa)

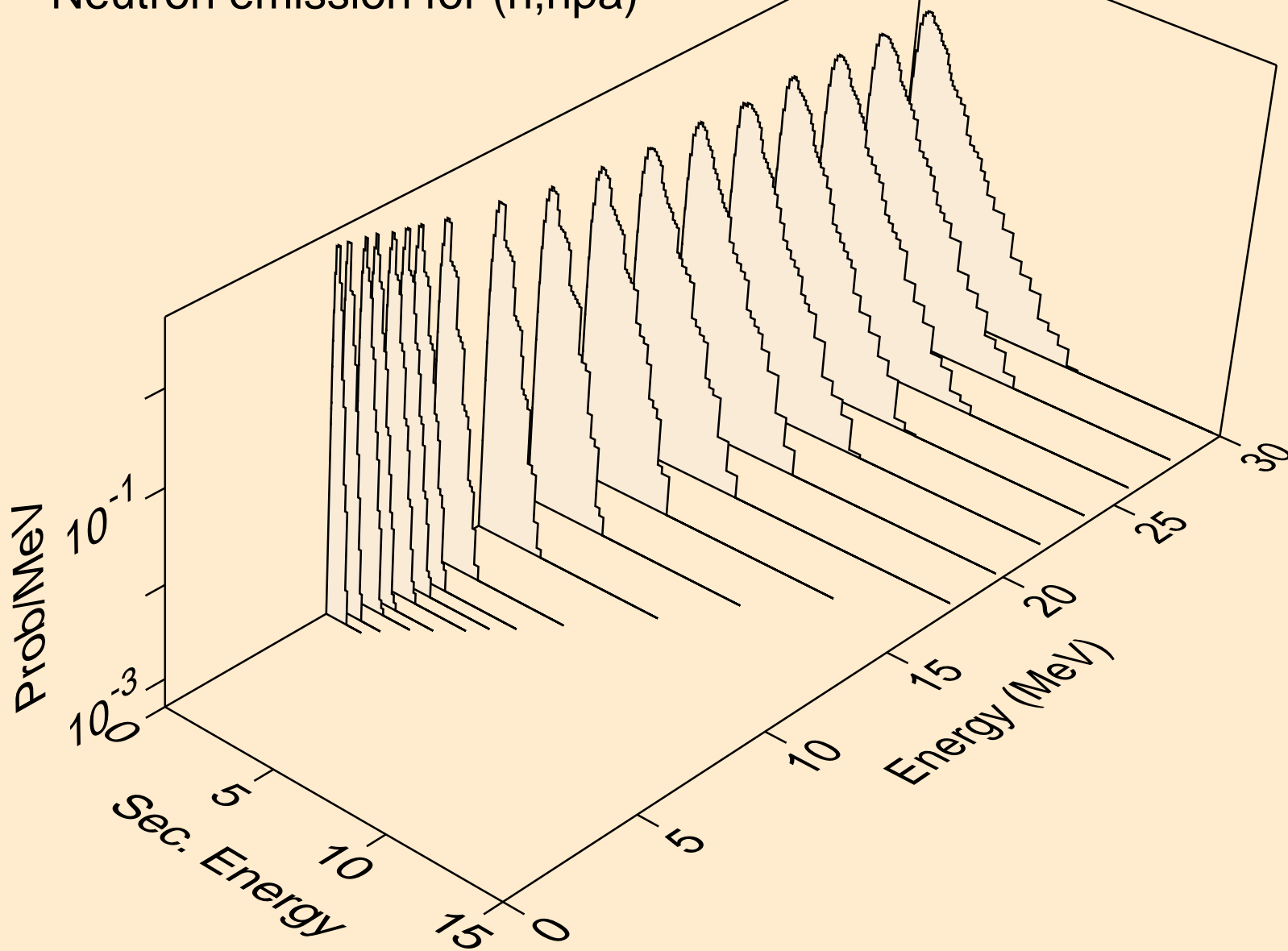

AU185 NEUTRON ACER TENDL-2019 LIBRARY; T=293.16K
Neutron emission for (n,n*c)

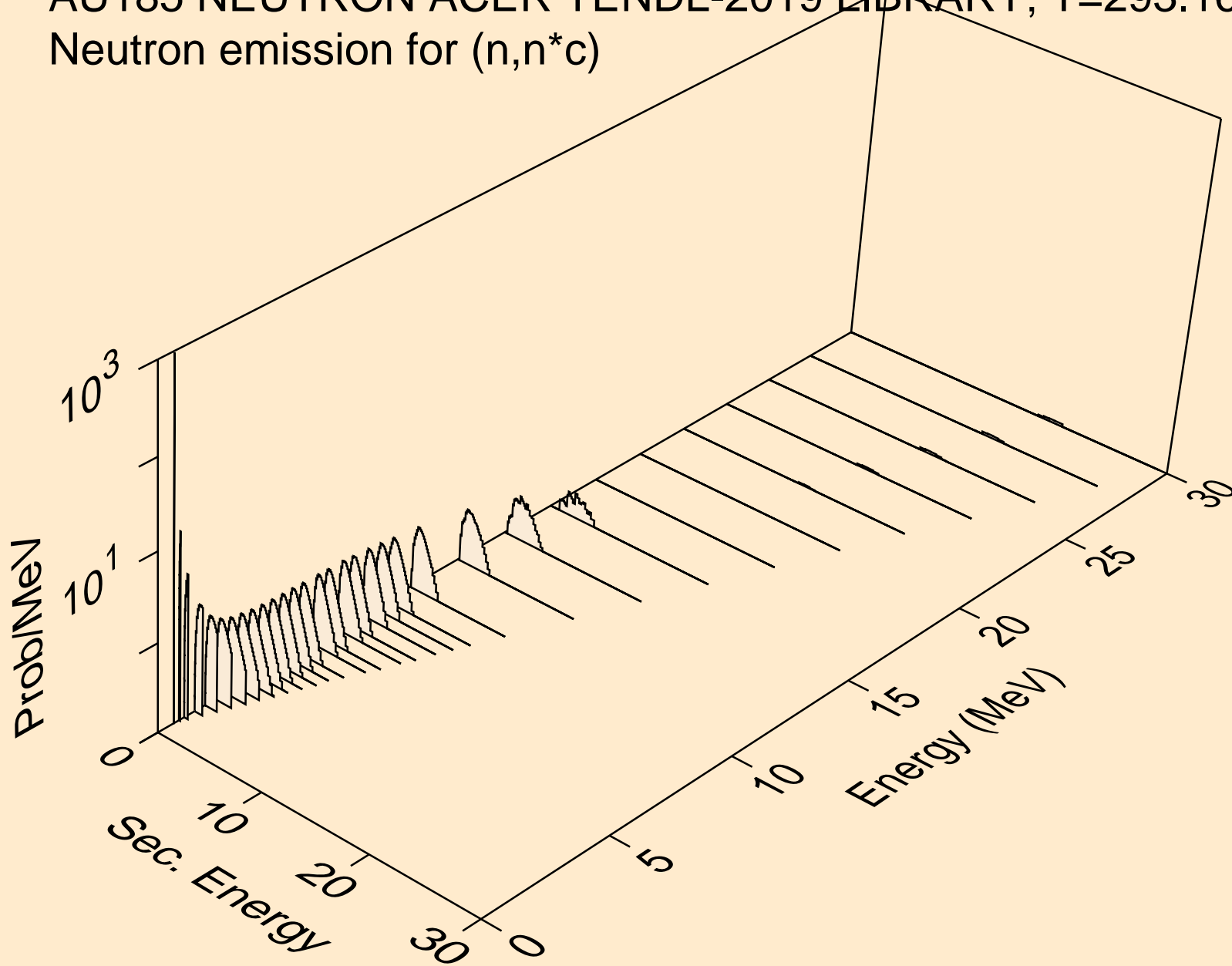

AU185 NEUTRON ACER TENDL-2019 LIBRARY; T=293.16K
Photon emission for (n,x)

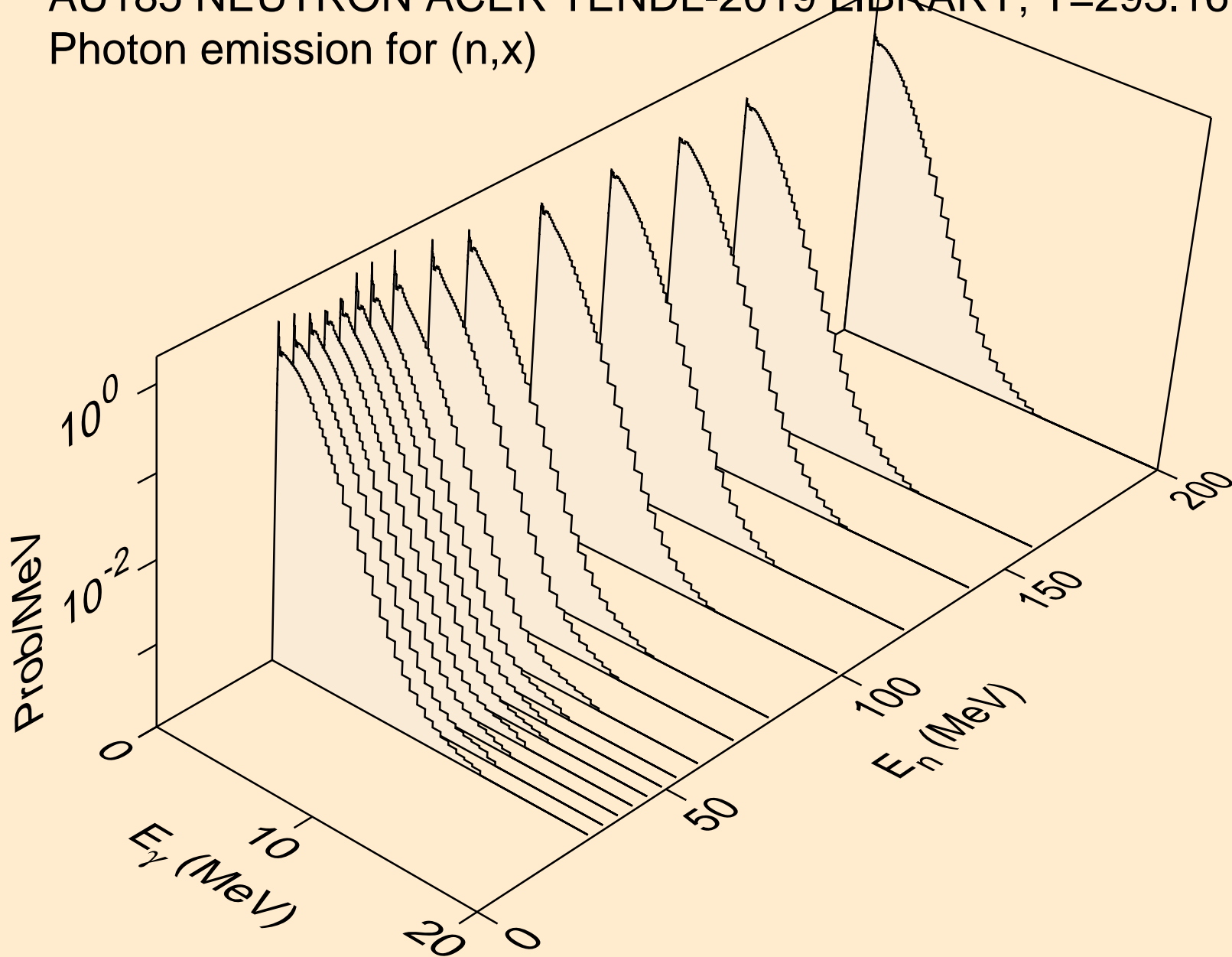

AU185 NEUTRON ACER TENDL-2019 LIBRARY; T=293.16K
Photon emission for (n,2nd)

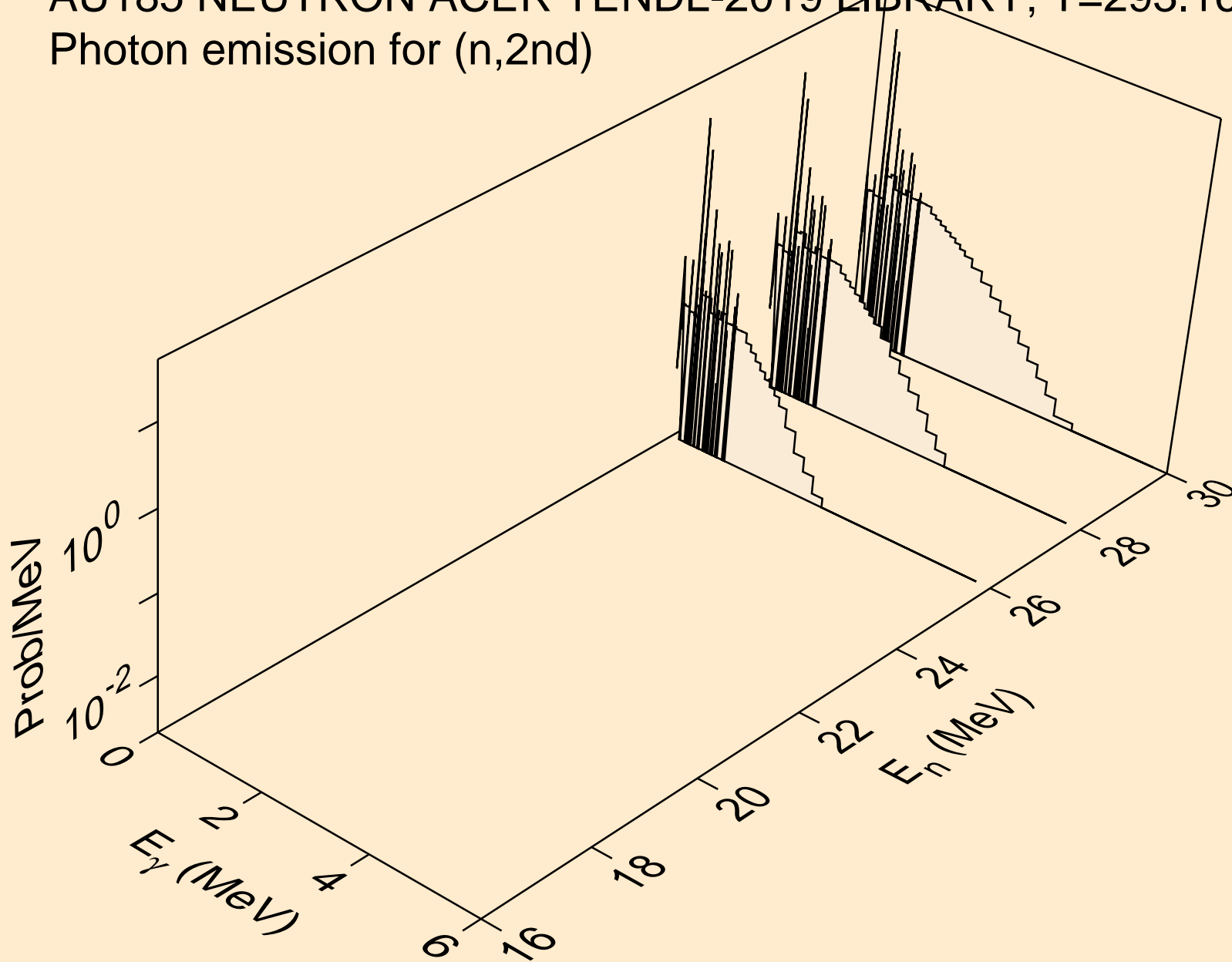

AU185 NEUTRON ACER TENDL-2019 LIBRARY; T=293.16K
Photon emission for (n,2n)

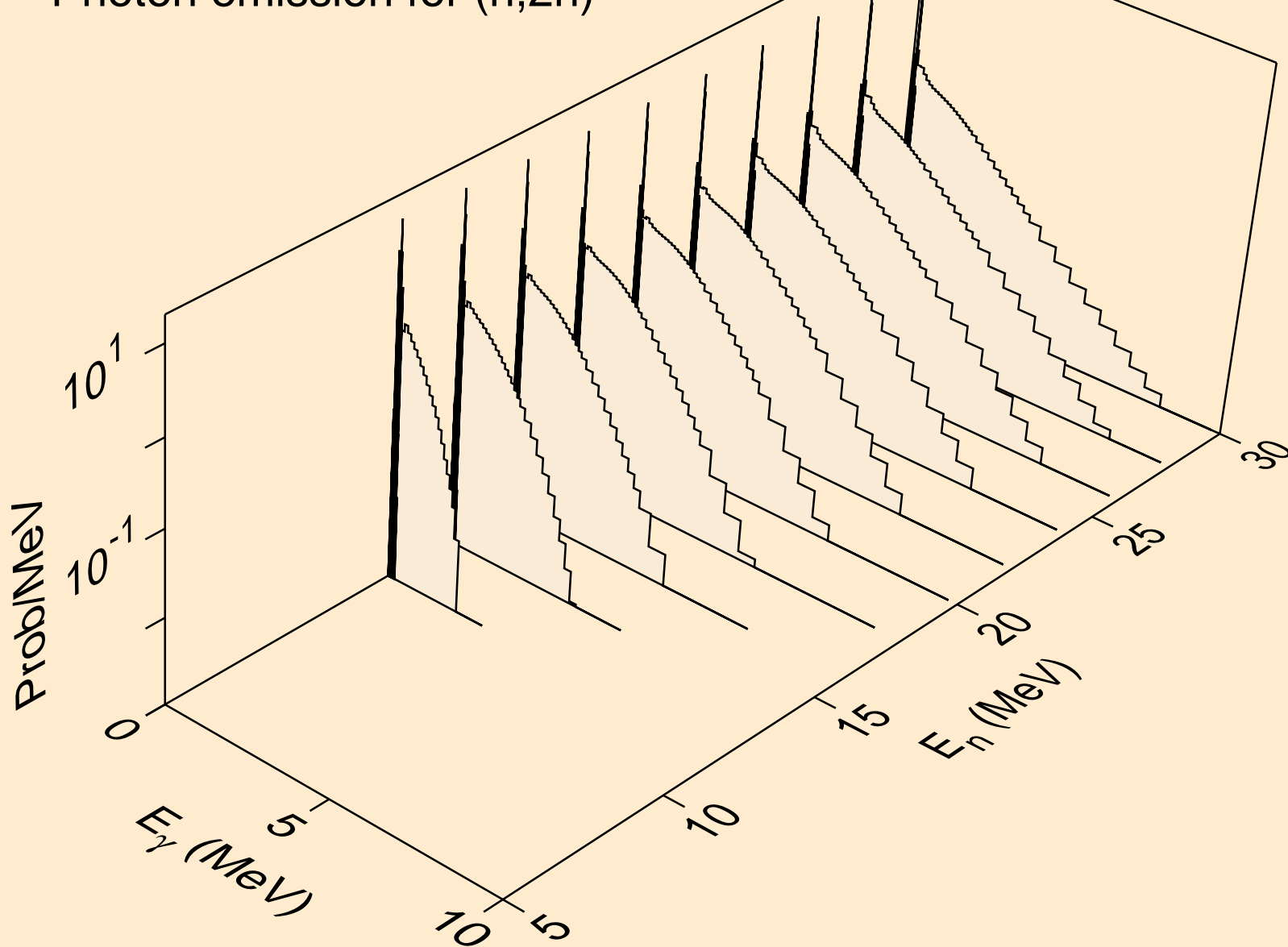

AU185 NEUTRON ACER TENDL-2019 LIBRARY; T=293.16K
Photon emission for (n,3n)

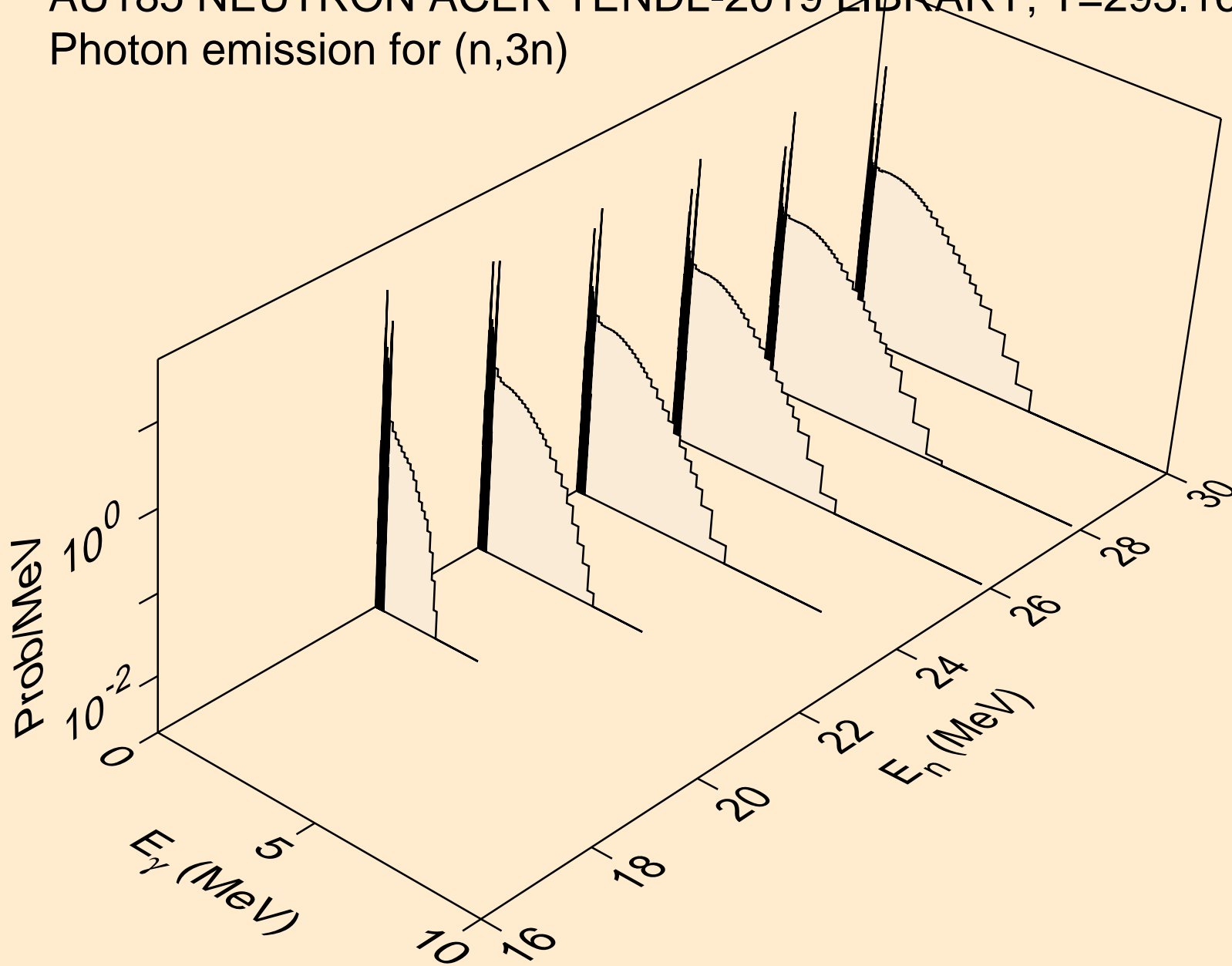

AU185 NEUTRON ACER TENDL-2019 LIBRARY; T=293.16K
Photon emission for (n,n*)a

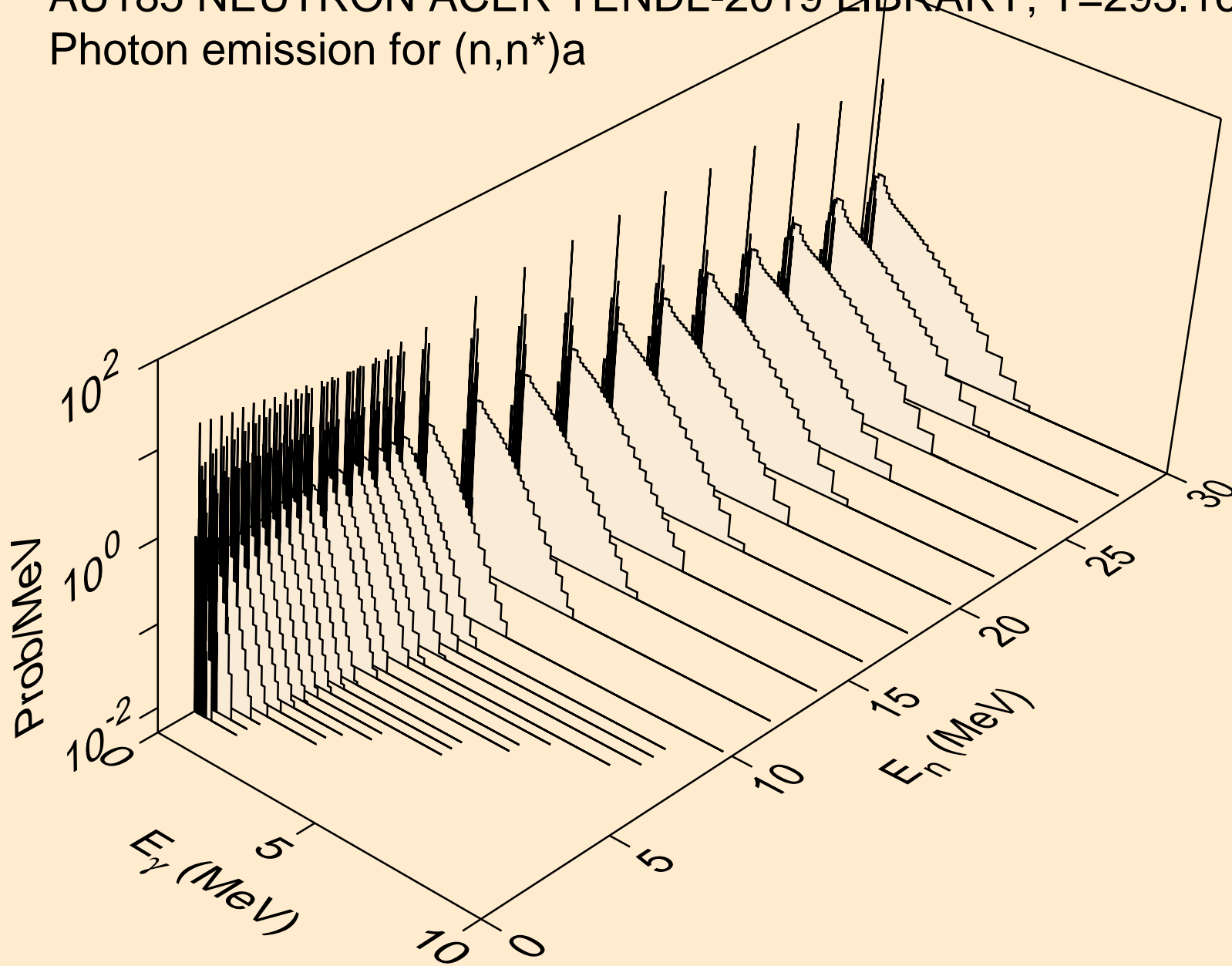

AU185 NEUTRON ACER TENDL-2019 LIBRARY; T=293.16K
Photon emission for (n,2n)a

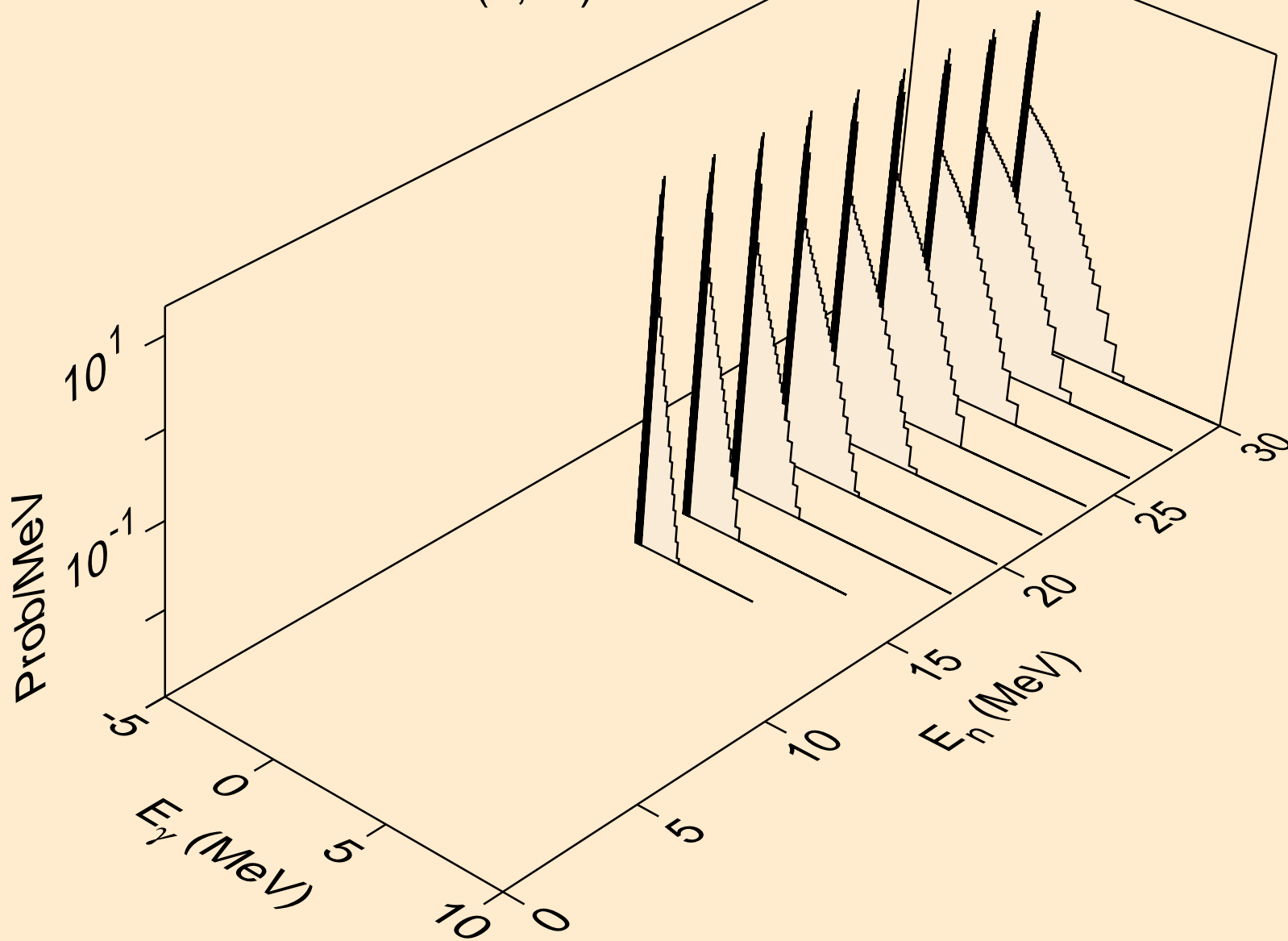

AU185 NEUTRON ACER TENDL-2019 LIBRARY; T=293.16K
Photon emission for (n,3n)a

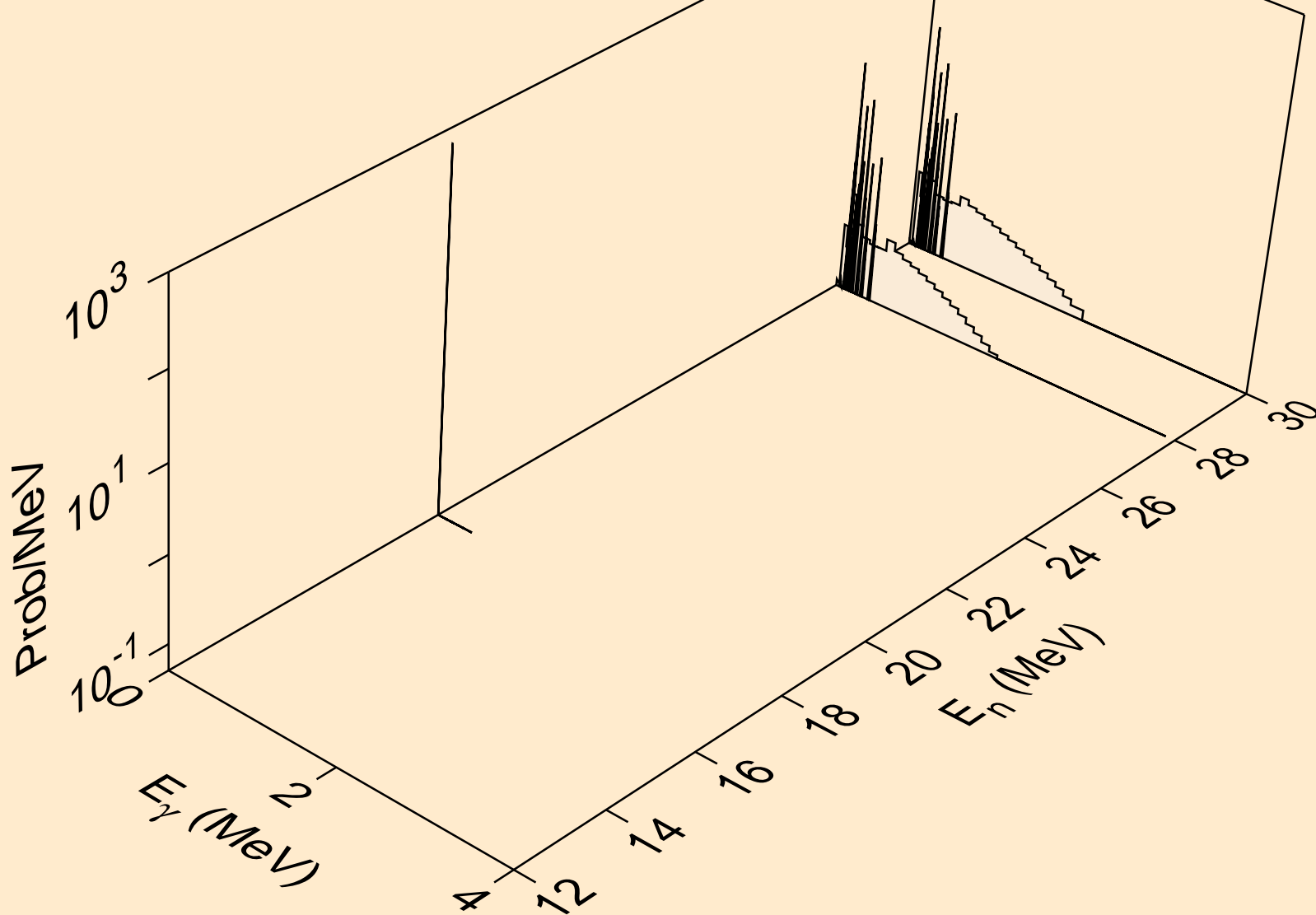

AU185 NEUTRON ACER TENDL-2019 LIBRARY; T=293.16K
Photon emission for (n,n*)p

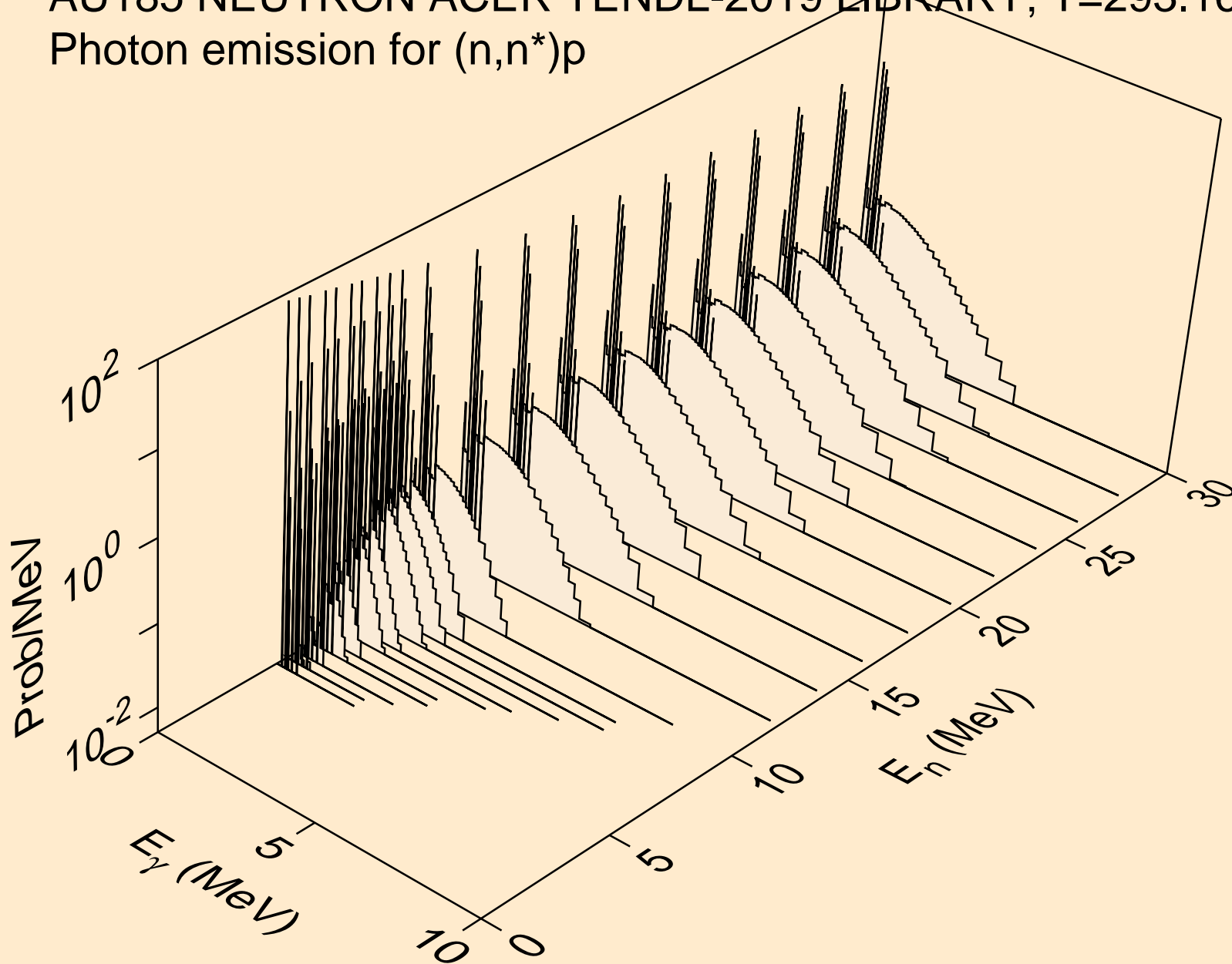

AU185 NEUTRON ACER TENDL-2019 LIBRARY; T=293.16K
Photon emission for (n,n*)2a

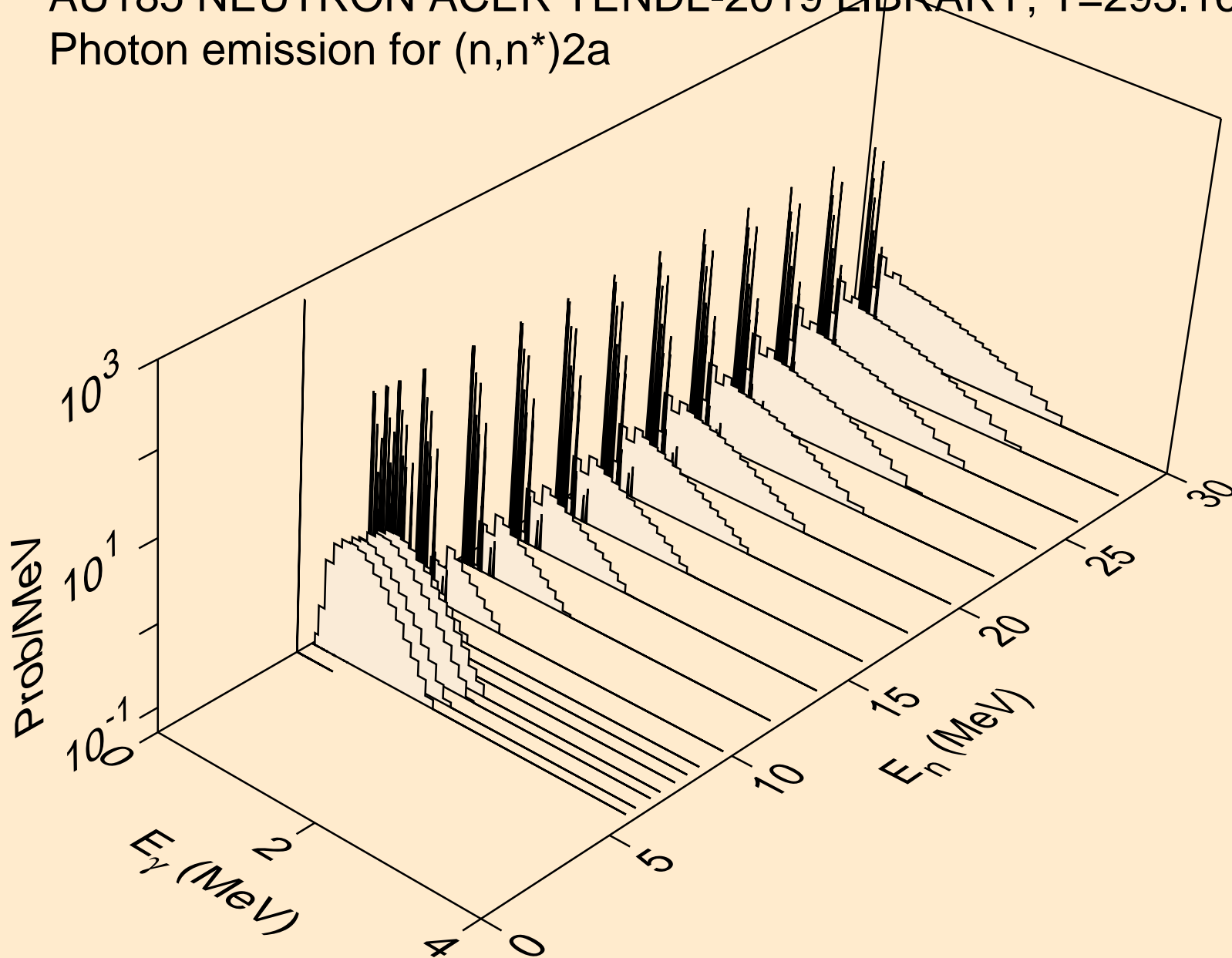

AU185 NEUTRON ACER TENDL-2019 LIBRARY; T=293.16K
Photon emission for (n,2n)2a

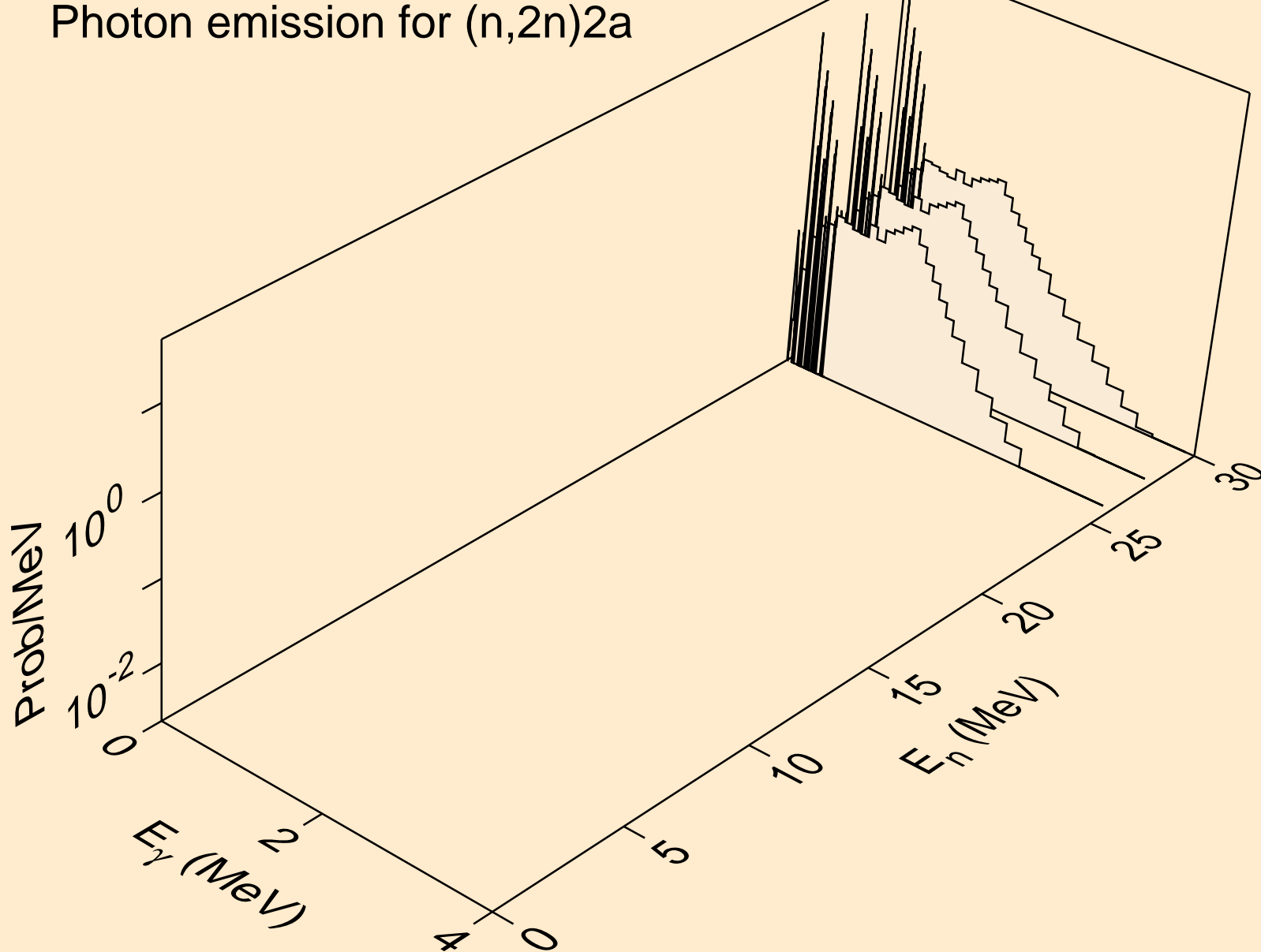

AU185 NEUTRON ACER TENDL-2019 LIBRARY; T=293.16K
Photon emission for (n,n*)d

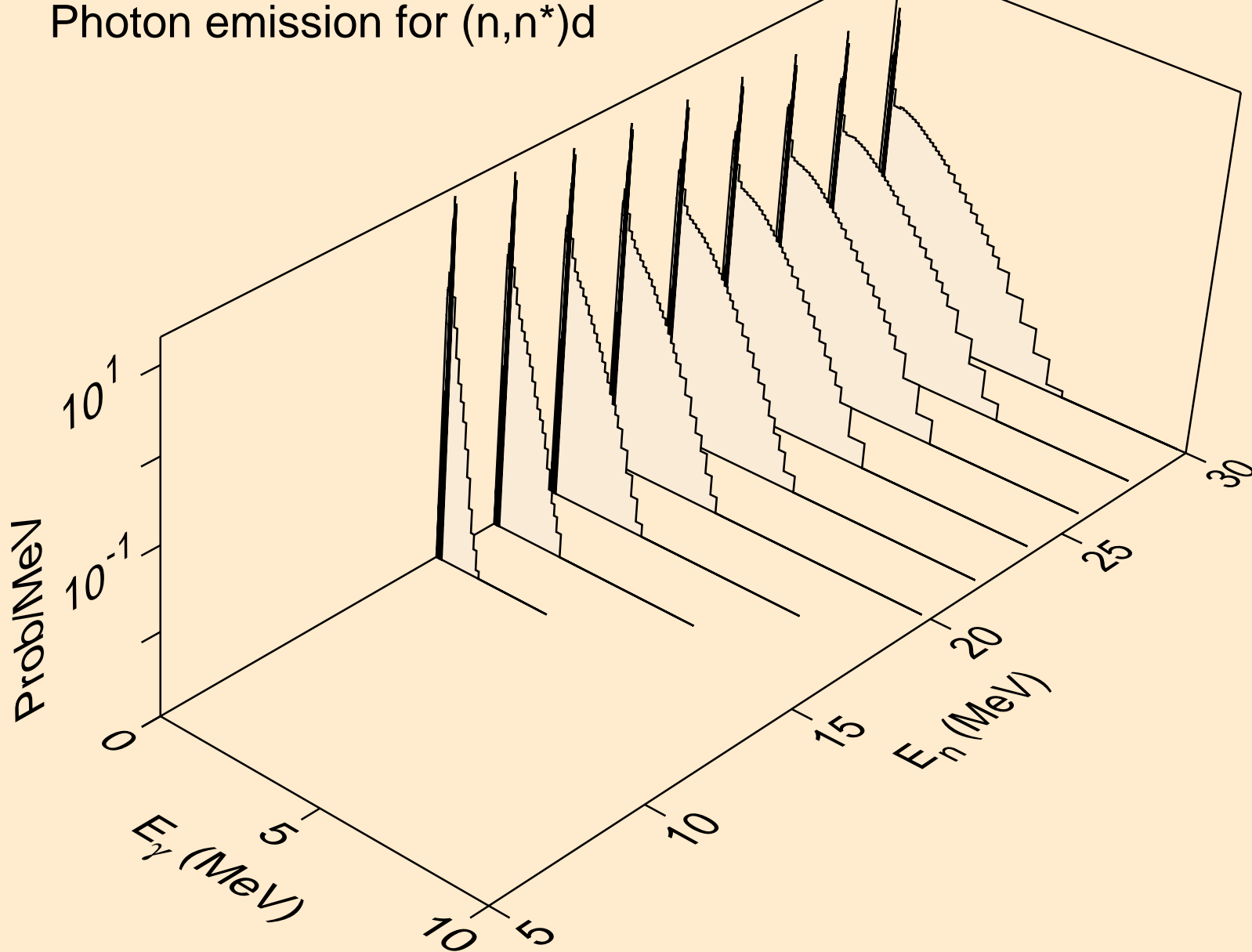

AU185 NEUTRON ACER TENDL-2019 LIBRARY; T=293.16K
Photon emission for (n,n*)t

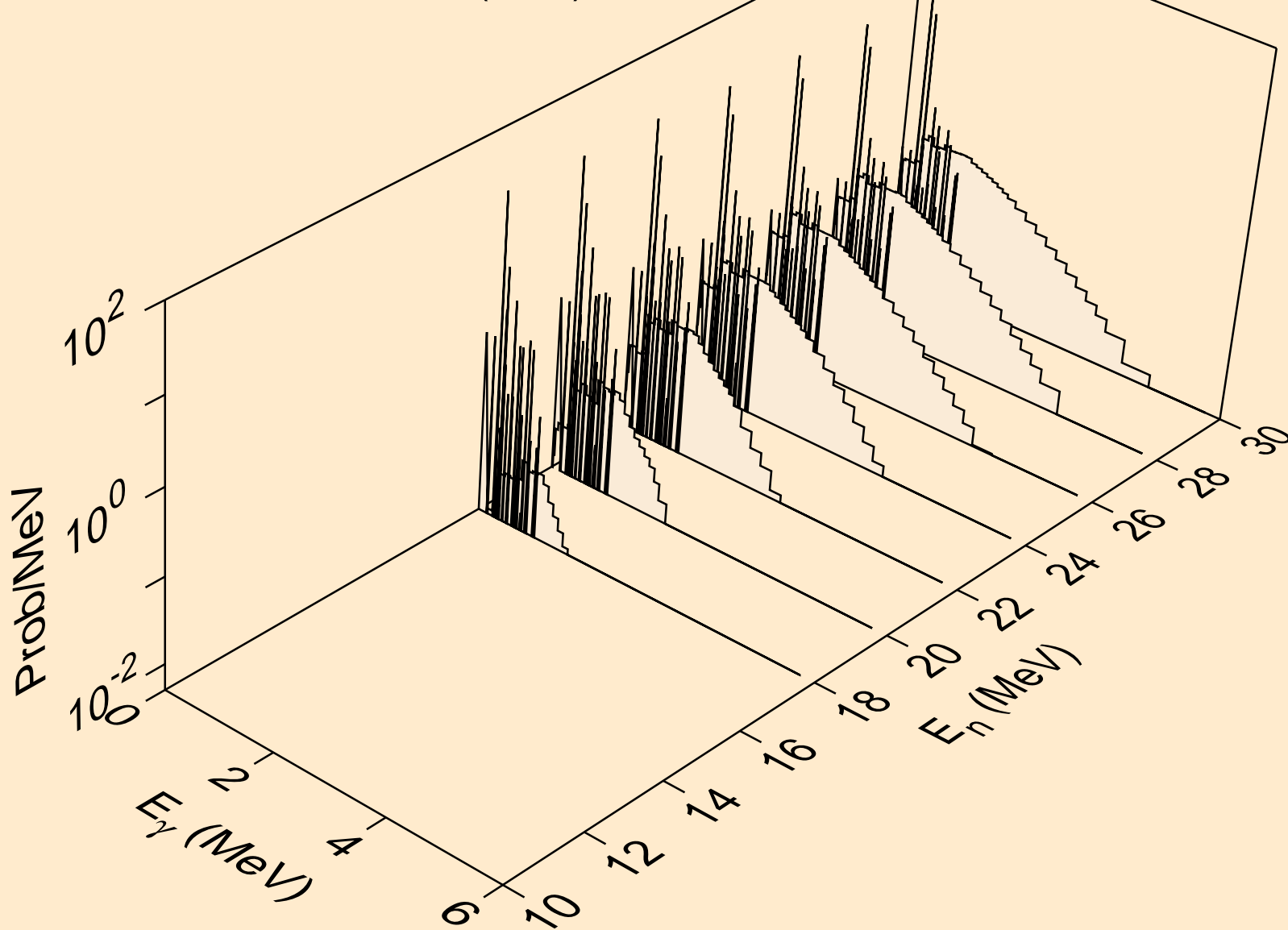

AU185 NEUTRON ACER TENDL-2019 LIBRARY; T=293.16K
Photon emission for (n,n*)he3

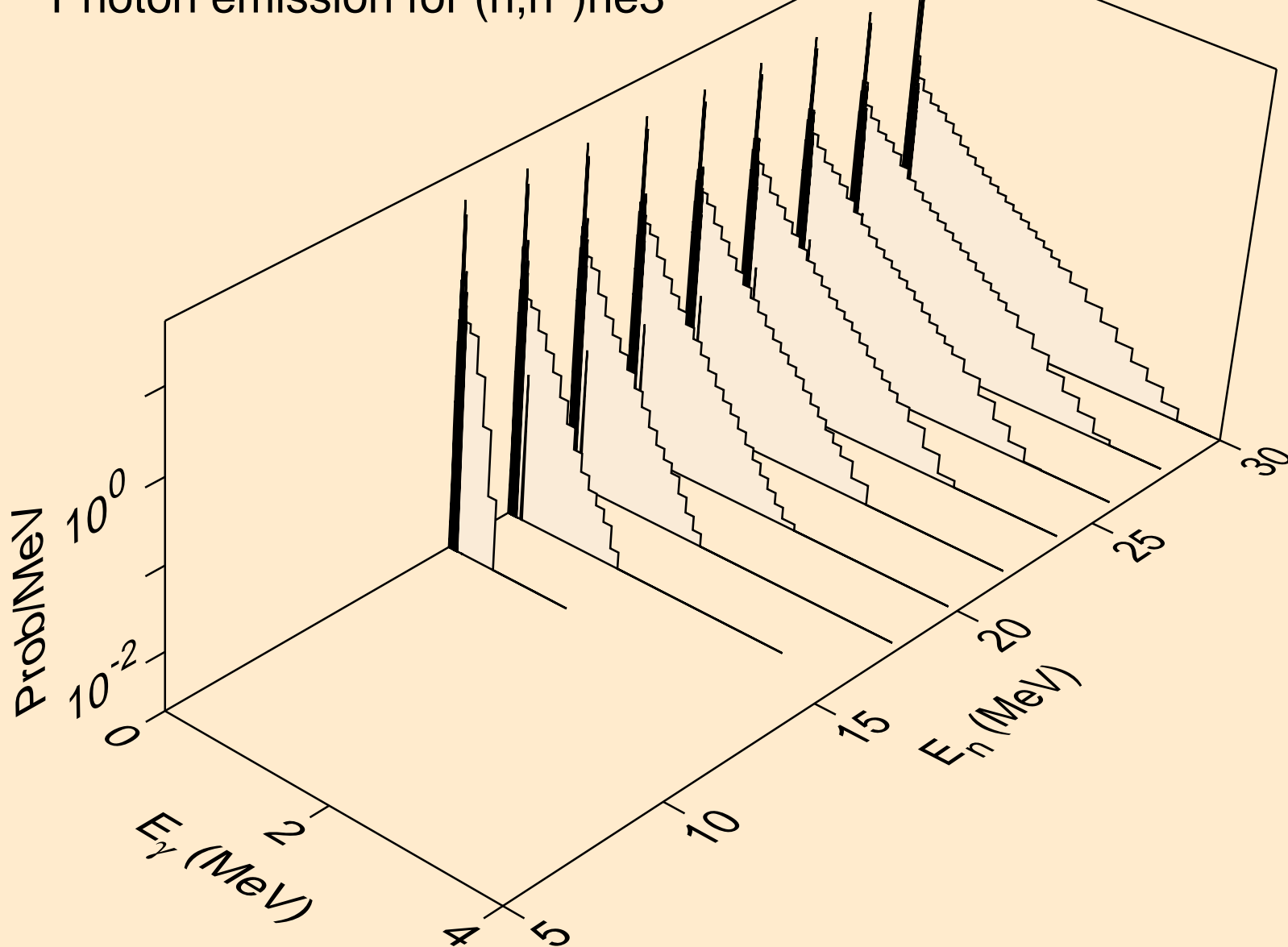

AU185 NEUTRON ACER TENDL-2019 LIBRARY; T=293.16K
Photon emission for (n,4n)

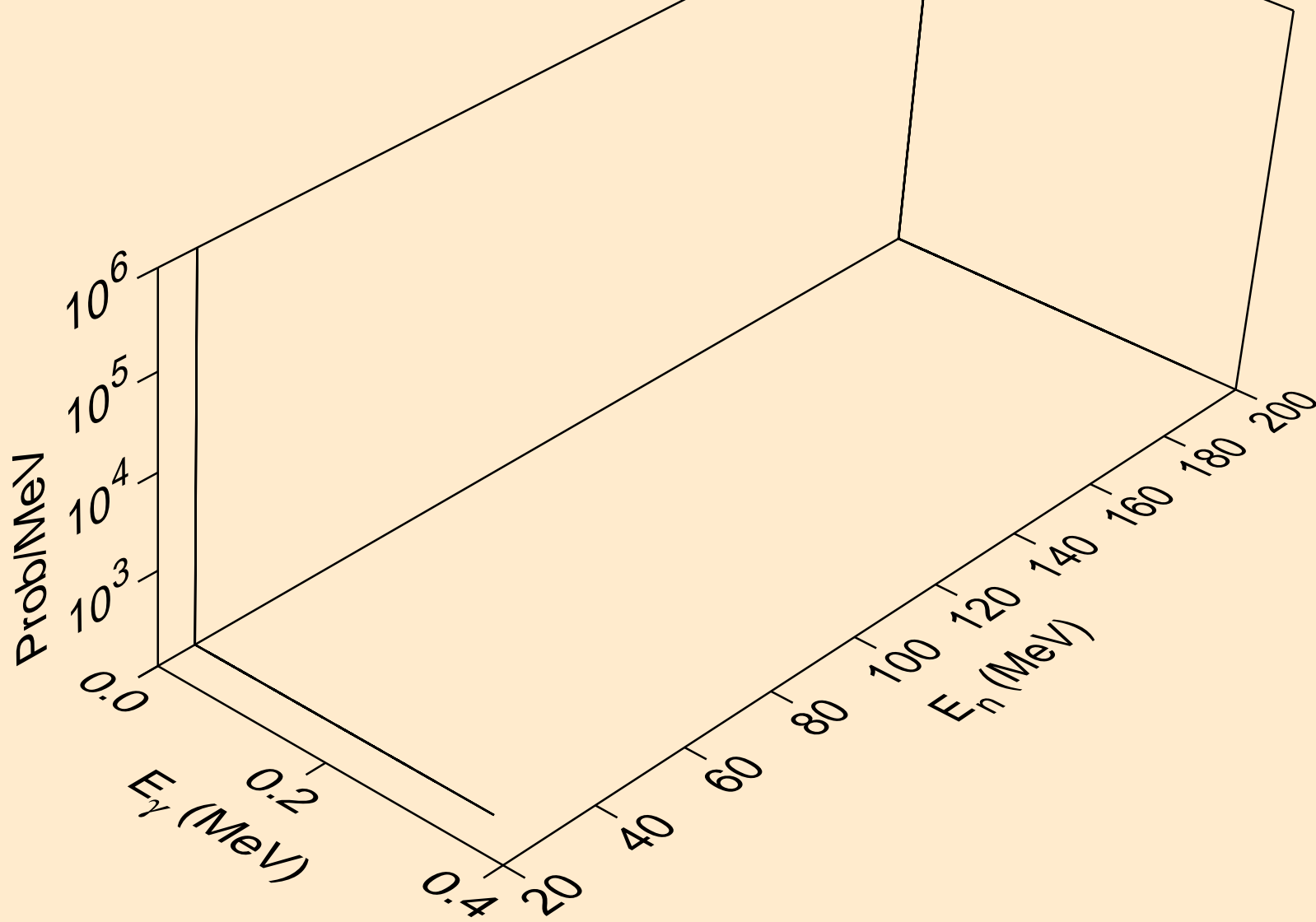

AU185 NEUTRON ACER TENDL-2019 LIBRARY; T=293.16K
Photon emission for (n,2np)

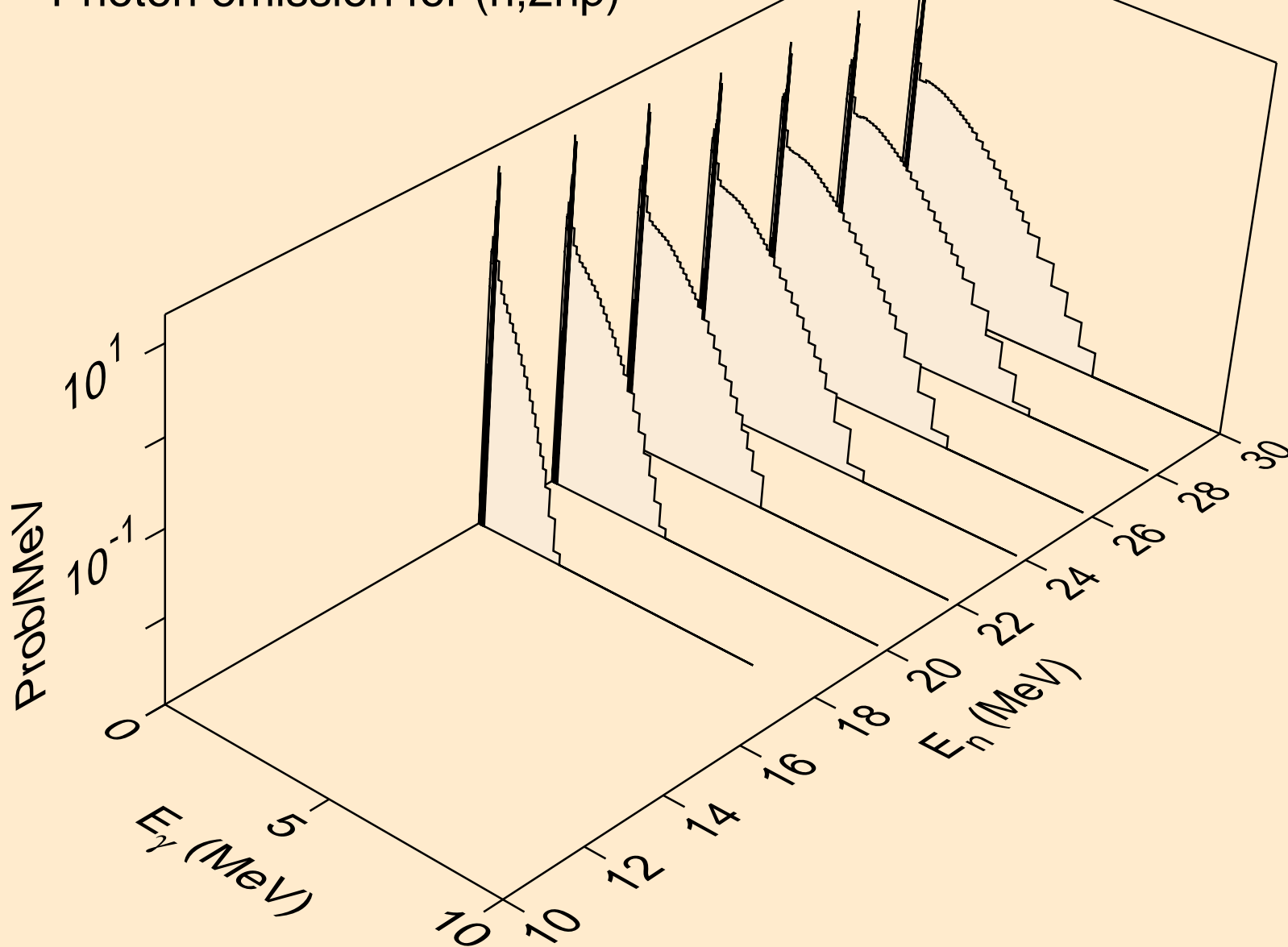

AU185 NEUTRON ACER TENDL-2019 LIBRARY; T=293.16K
Photon emission for (n,3np)

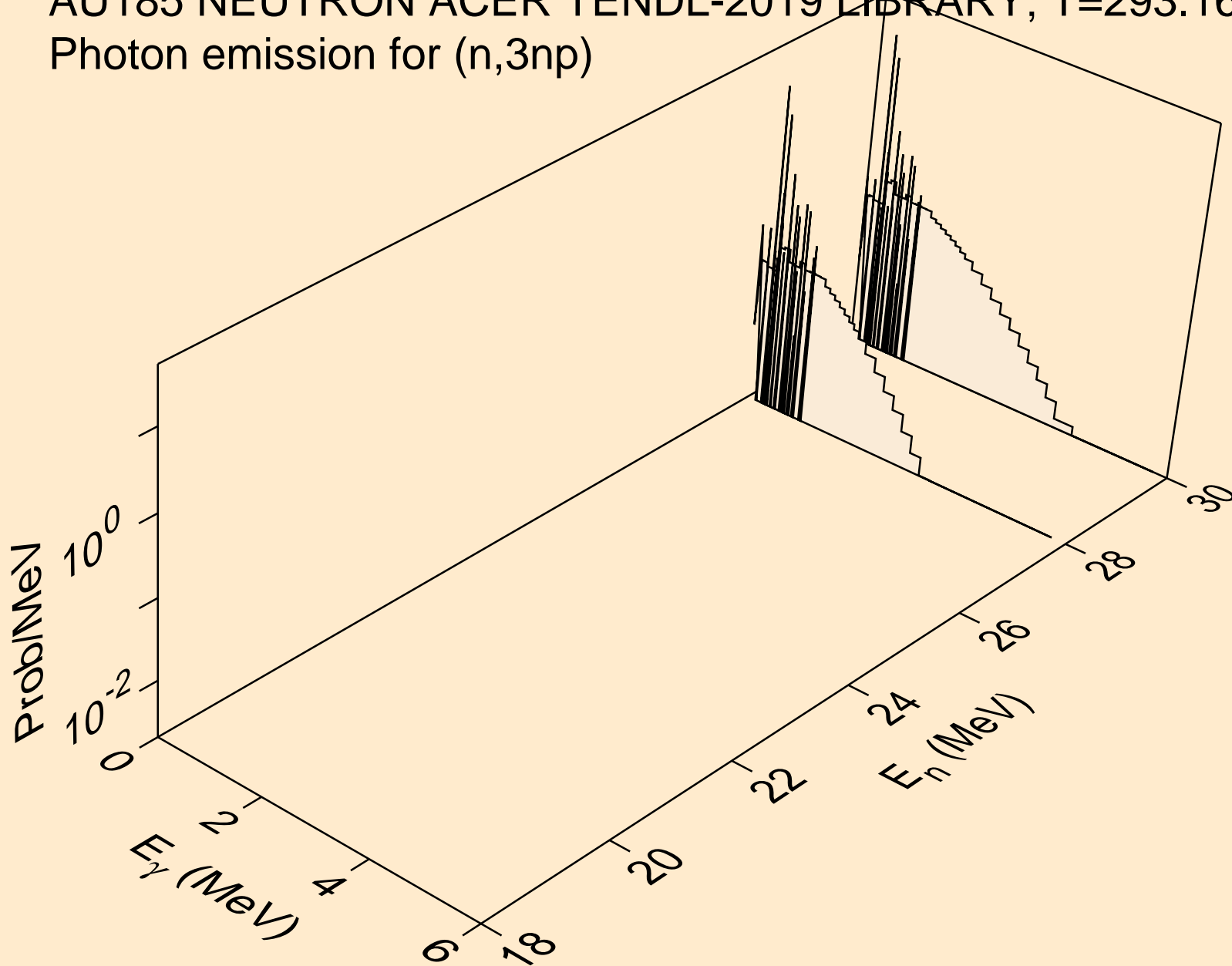

AU185 NEUTRON ACER TENDL-2019 LIBRARY; T=293.16K
Photon emission for (n,2np)

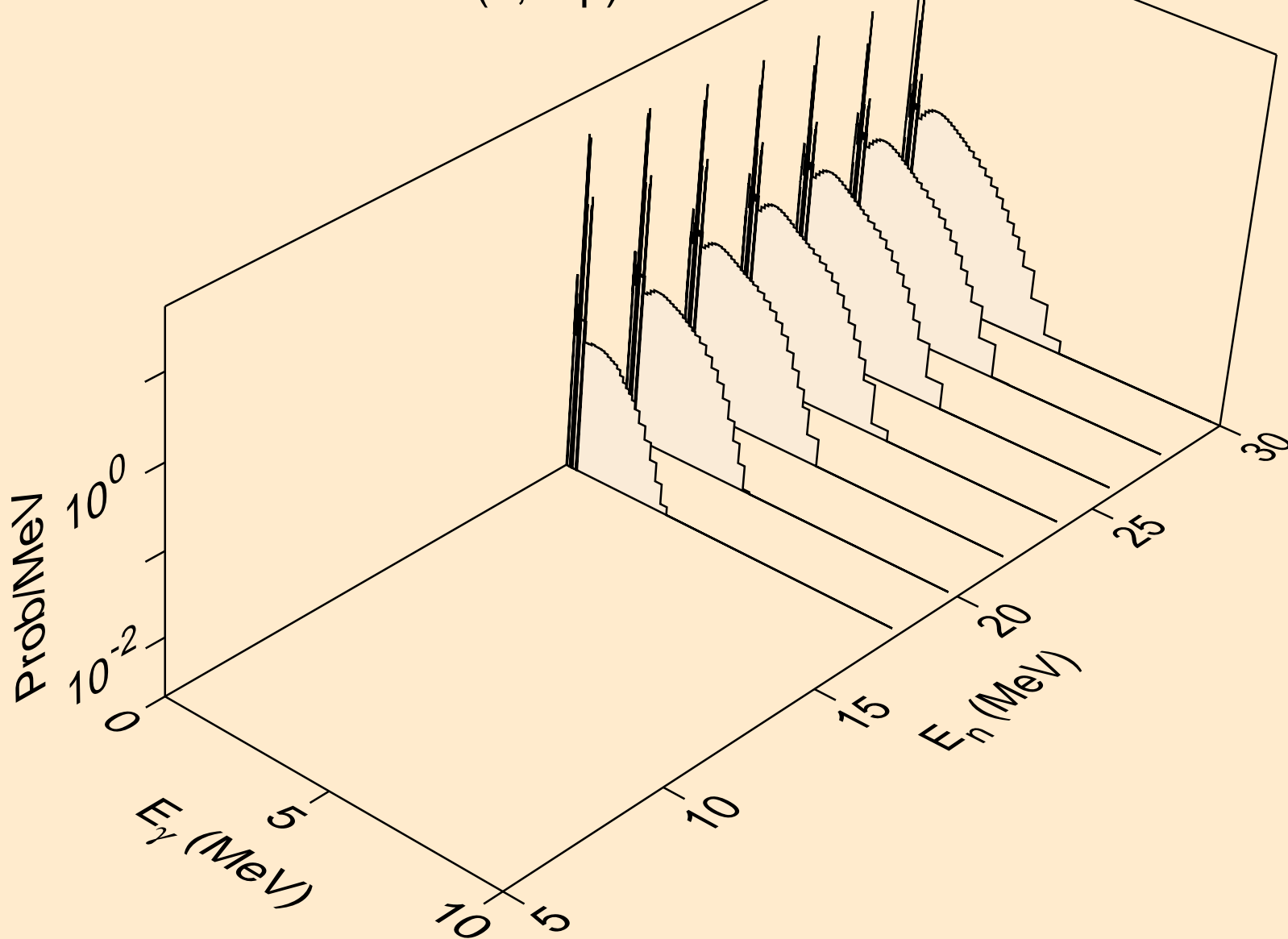

AU185 NEUTRON ACER TENDL-2019 LIBRARY; T=293.16K
Photon emission for (n,npa)

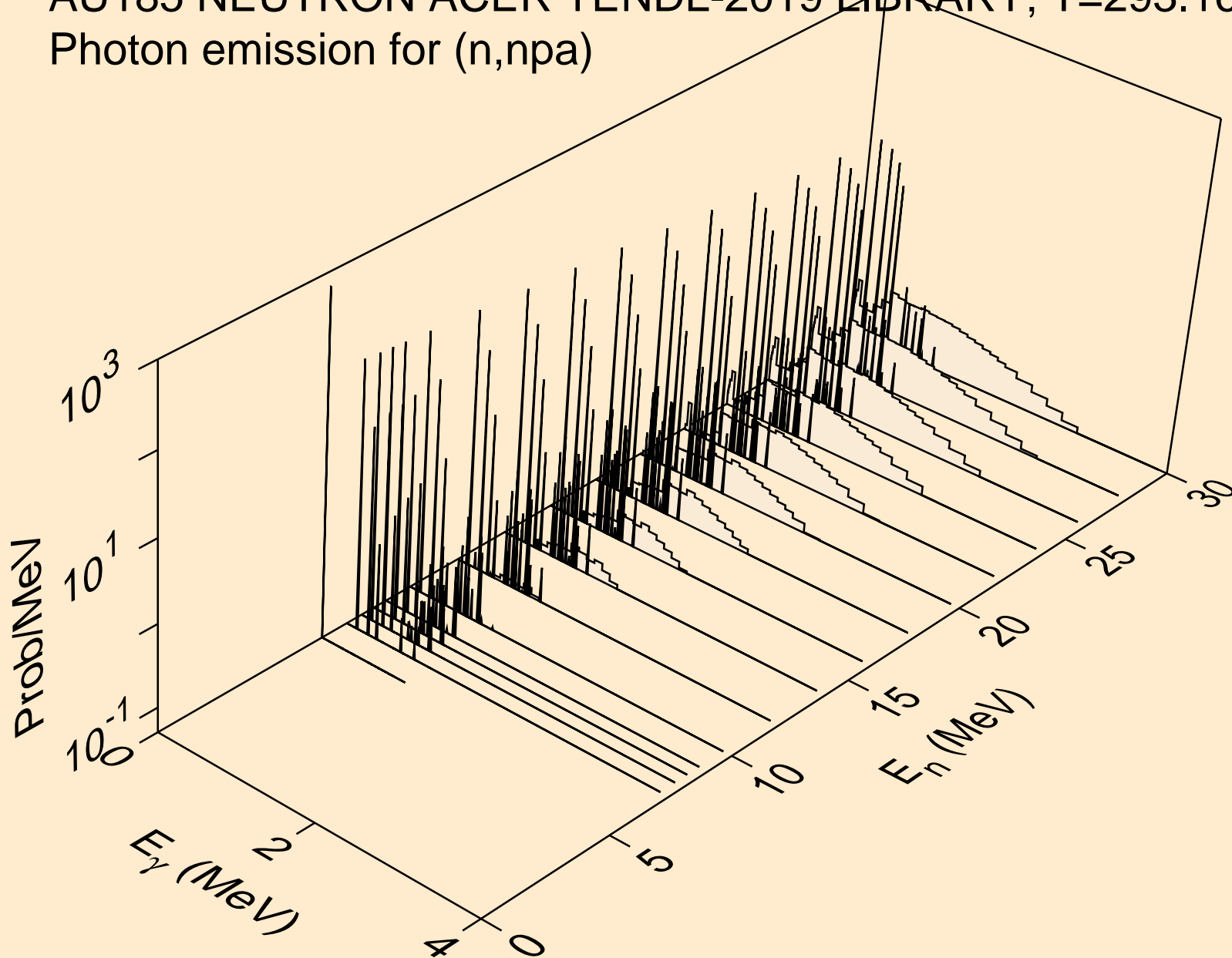

AU185 NEUTRON ACER TENDL-2019 LIBRARY; T=293.16K
Photon emission for (n,n*c)

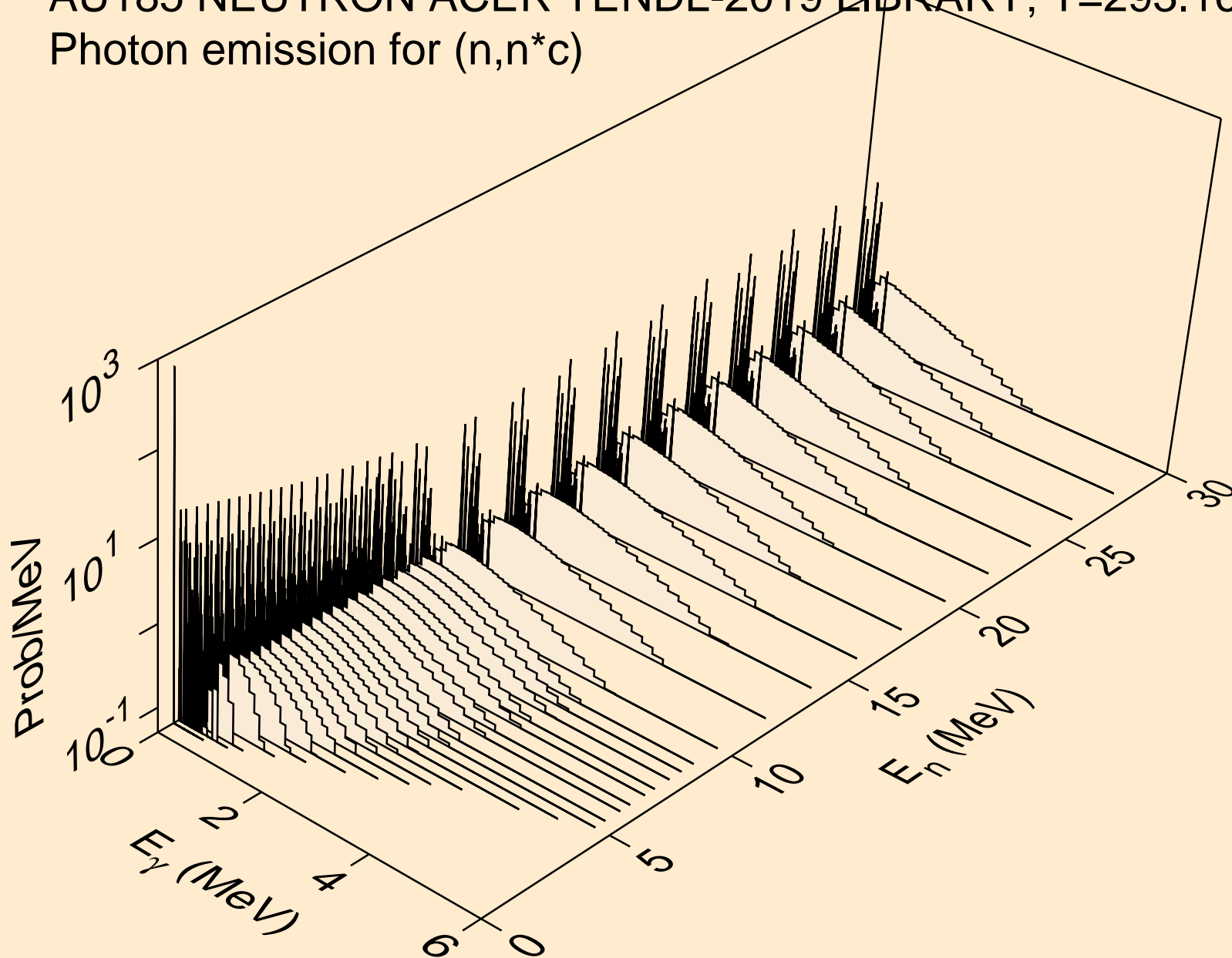

AU185 NEUTRON ACER TENDL-2019 LIBRARY; T=293.16K
Photon emission for (n,gma)

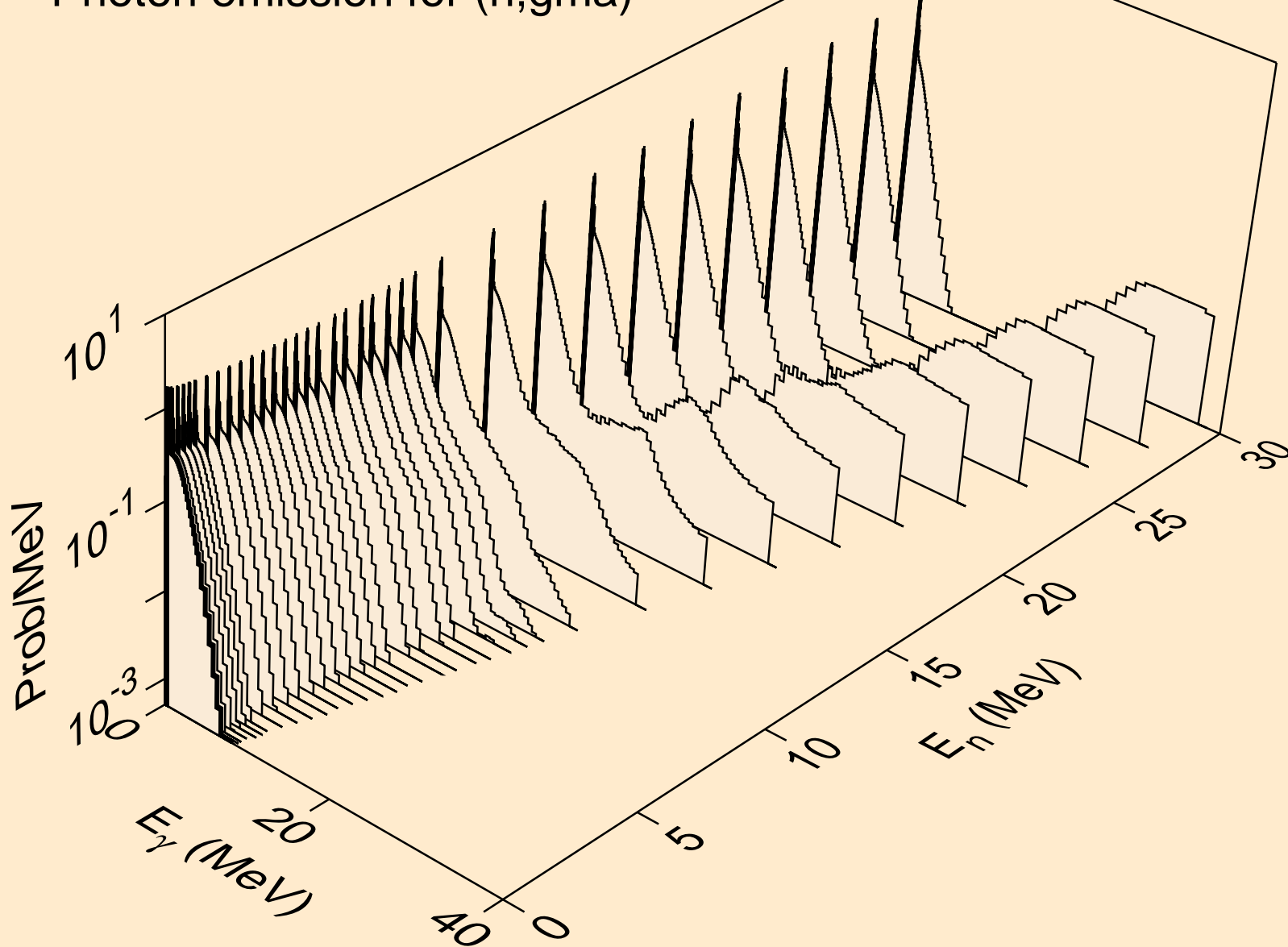

AU185 NEUTRON ACER TENDL-2019 LIBRARY; T=293.16K
Photon emission for (n,p)

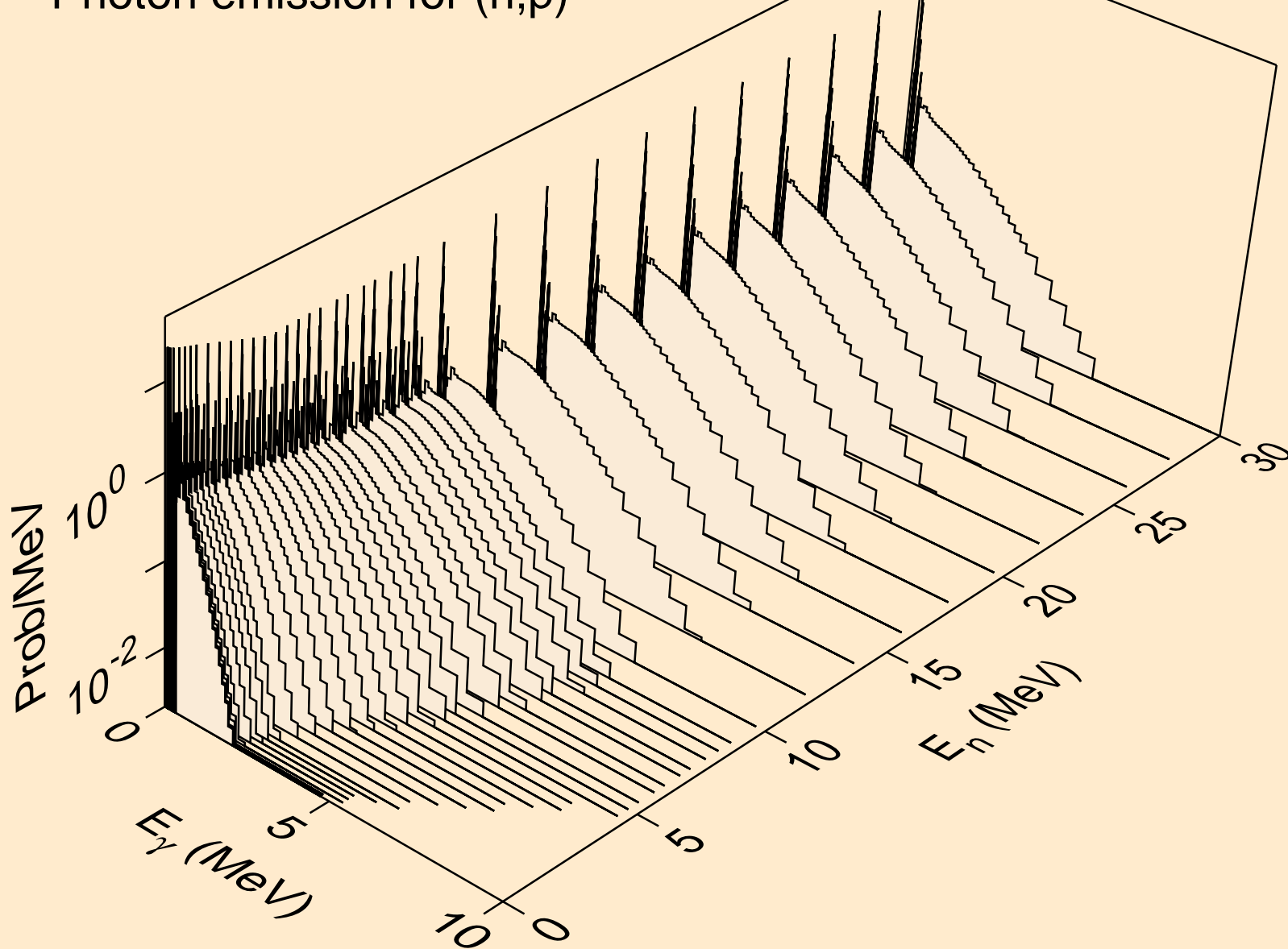

AU185 NEUTRON ACER TENDL-2019 LIBRARY; T=293.16K
Photon emission for (n,d)

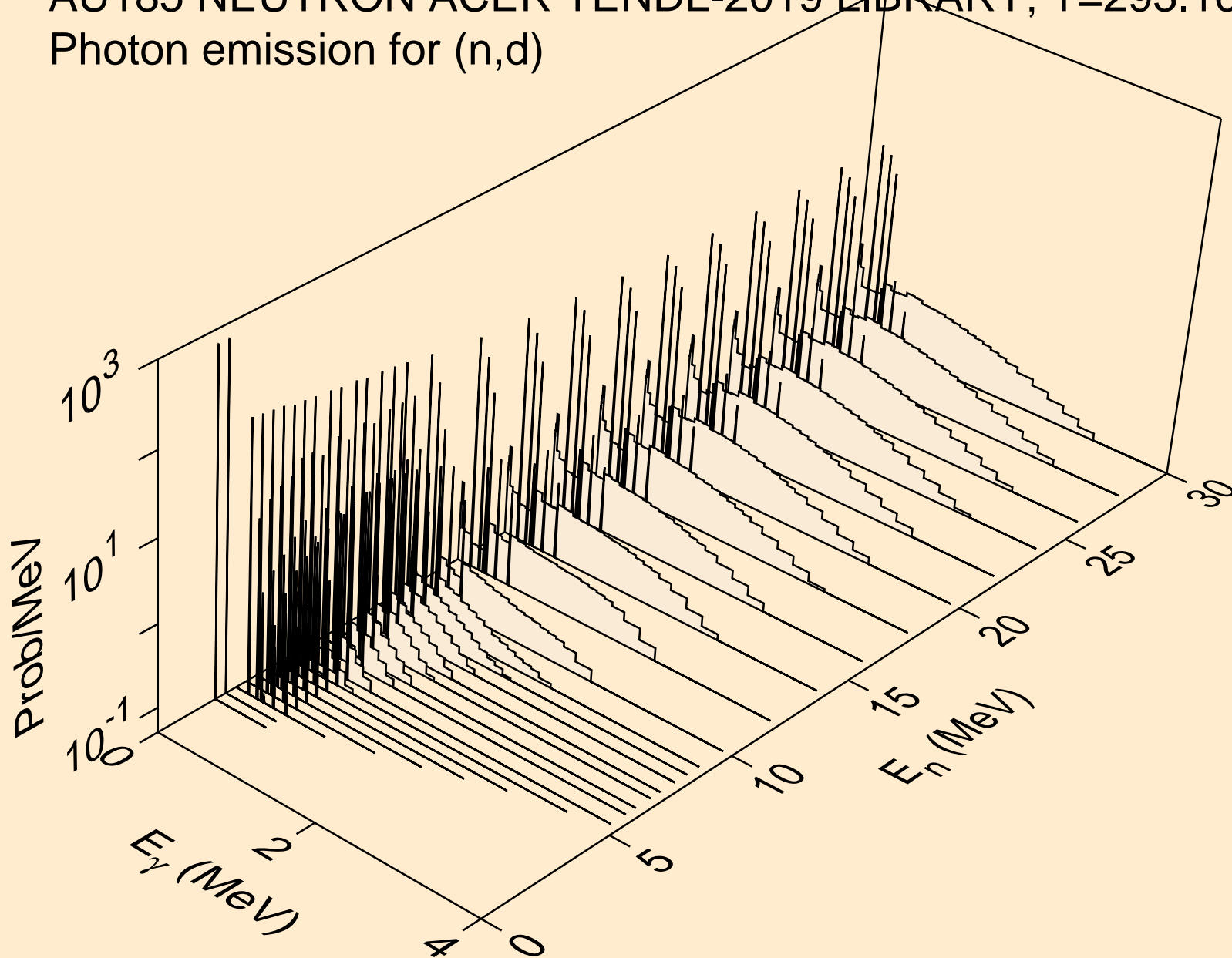

AU185 NEUTRON ACER TENDL-2019 LIBRARY; T=293.16K
Photon emission for (n,t)

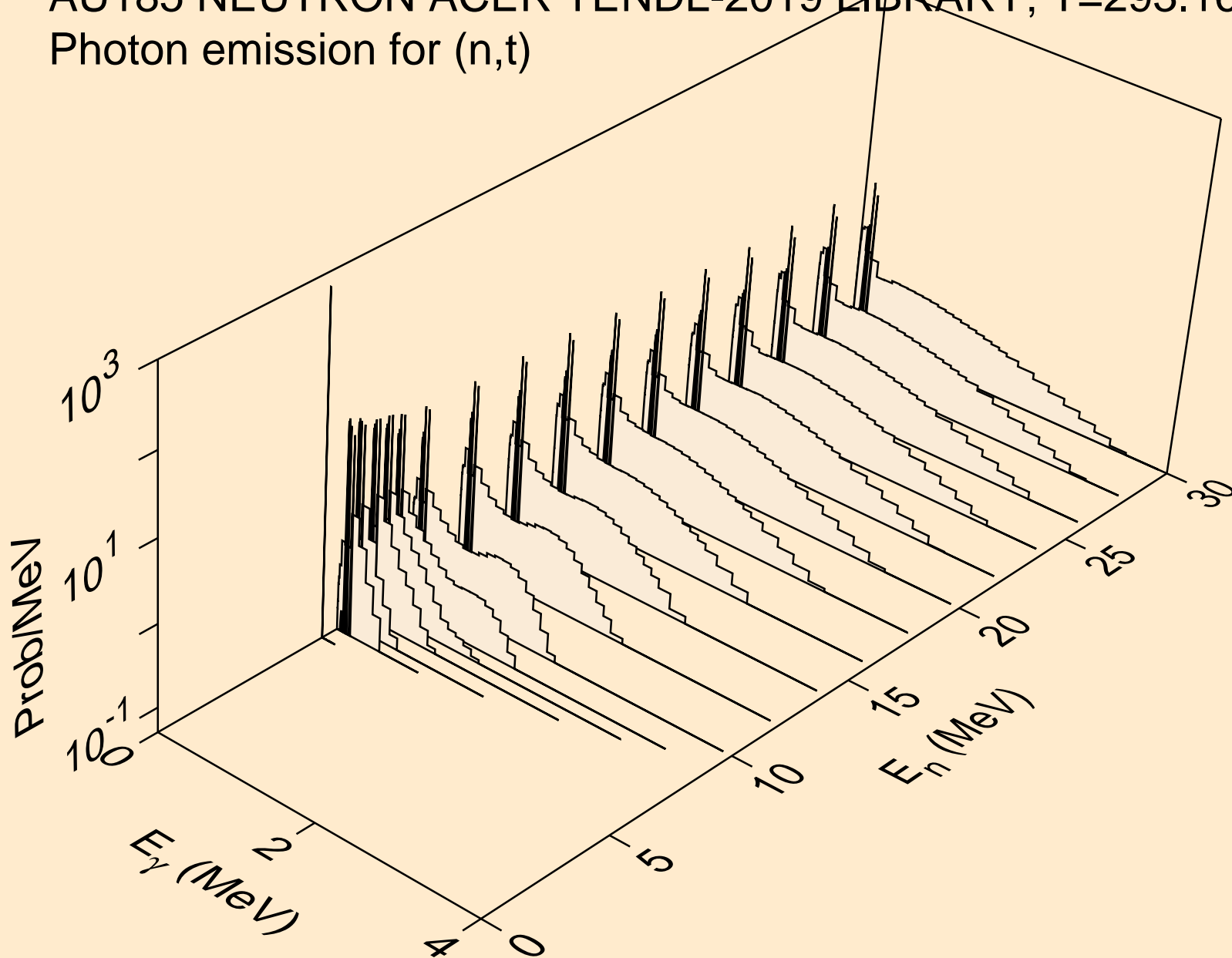

AU185 NEUTRON ACER TENDL-2019 LIBRARY; T=293.16K
Photon emission for (n,he3)

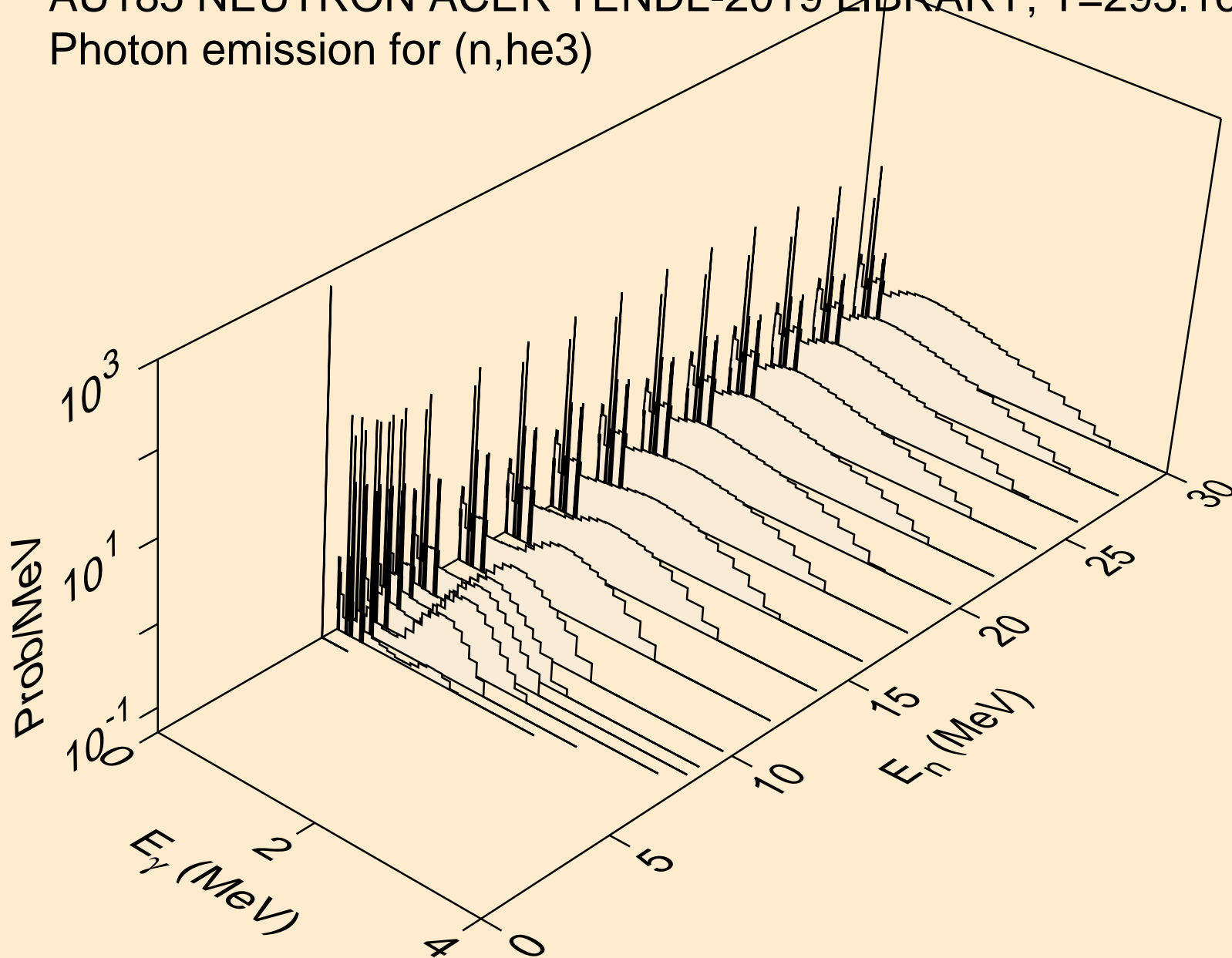

AU185 NEUTRON ACER TENDL-2019 LIBRARY; T=293.16K
Photon emission for (n,a)

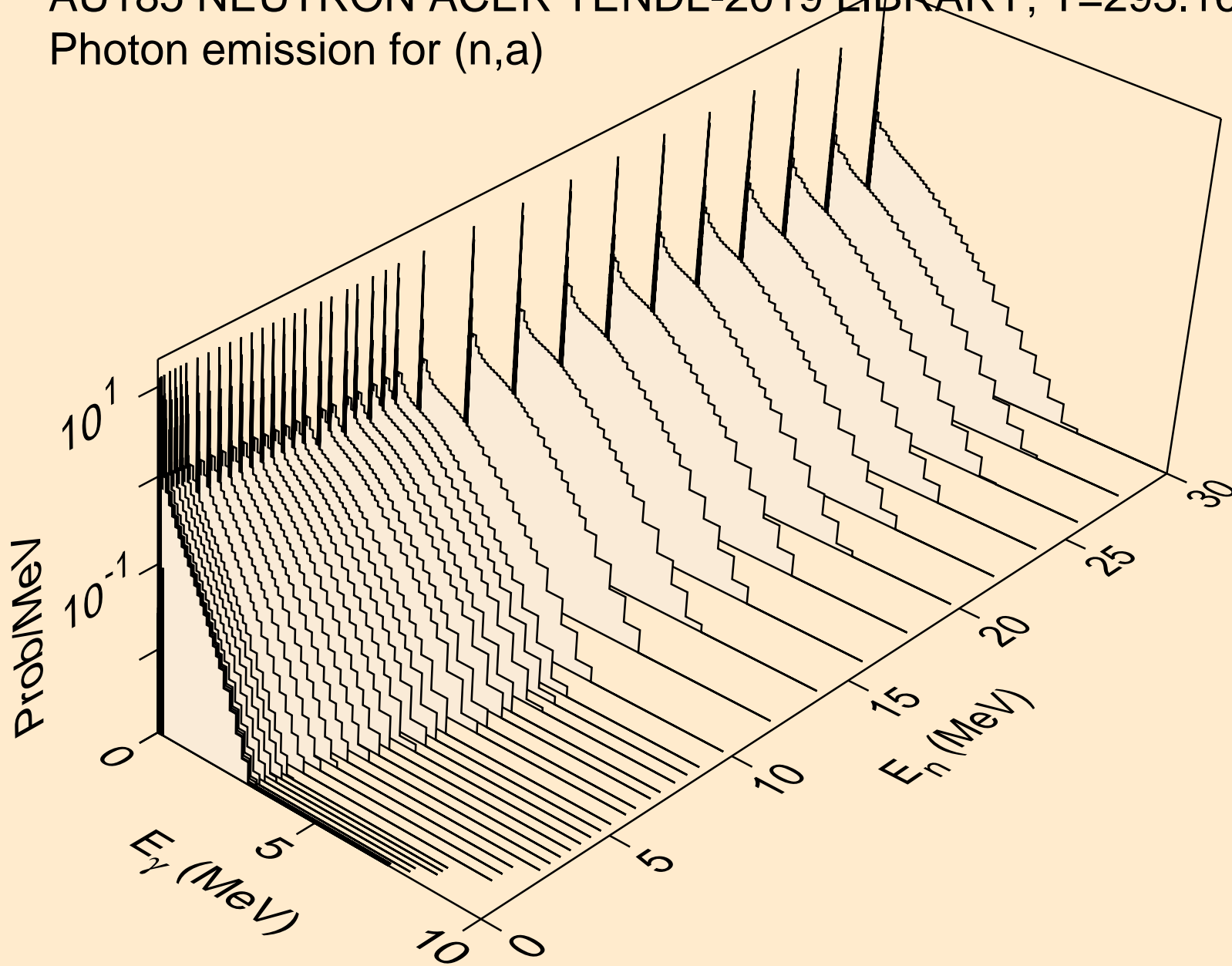

AU185 NEUTRON ACER TENDL-2019 LIBRARY; T=293.16K
Photon emission for (n,2a)

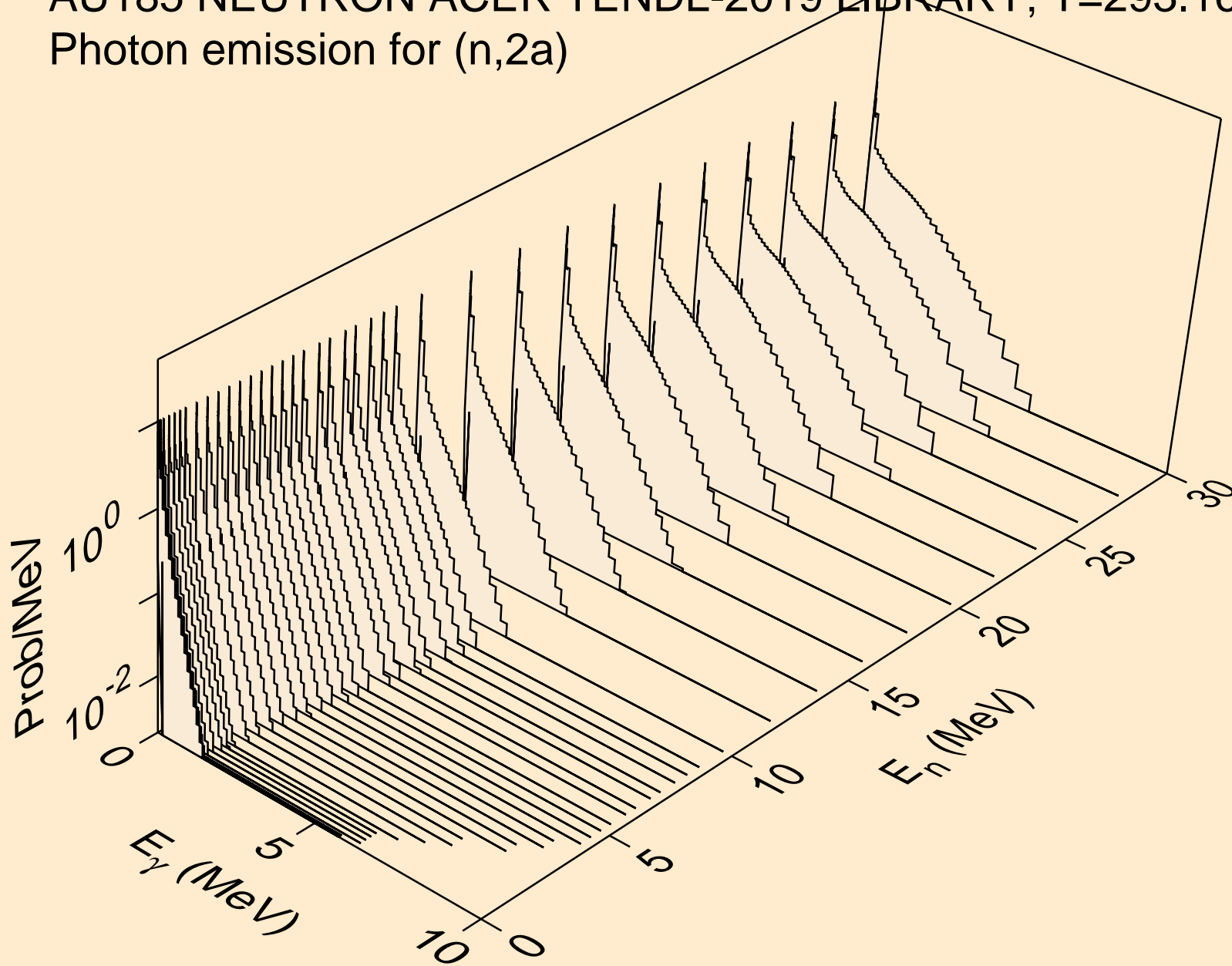

AU185 NEUTRON ACER TENDL-2019 LIBRARY; T=293.16K
Photon emission for (n,2p)

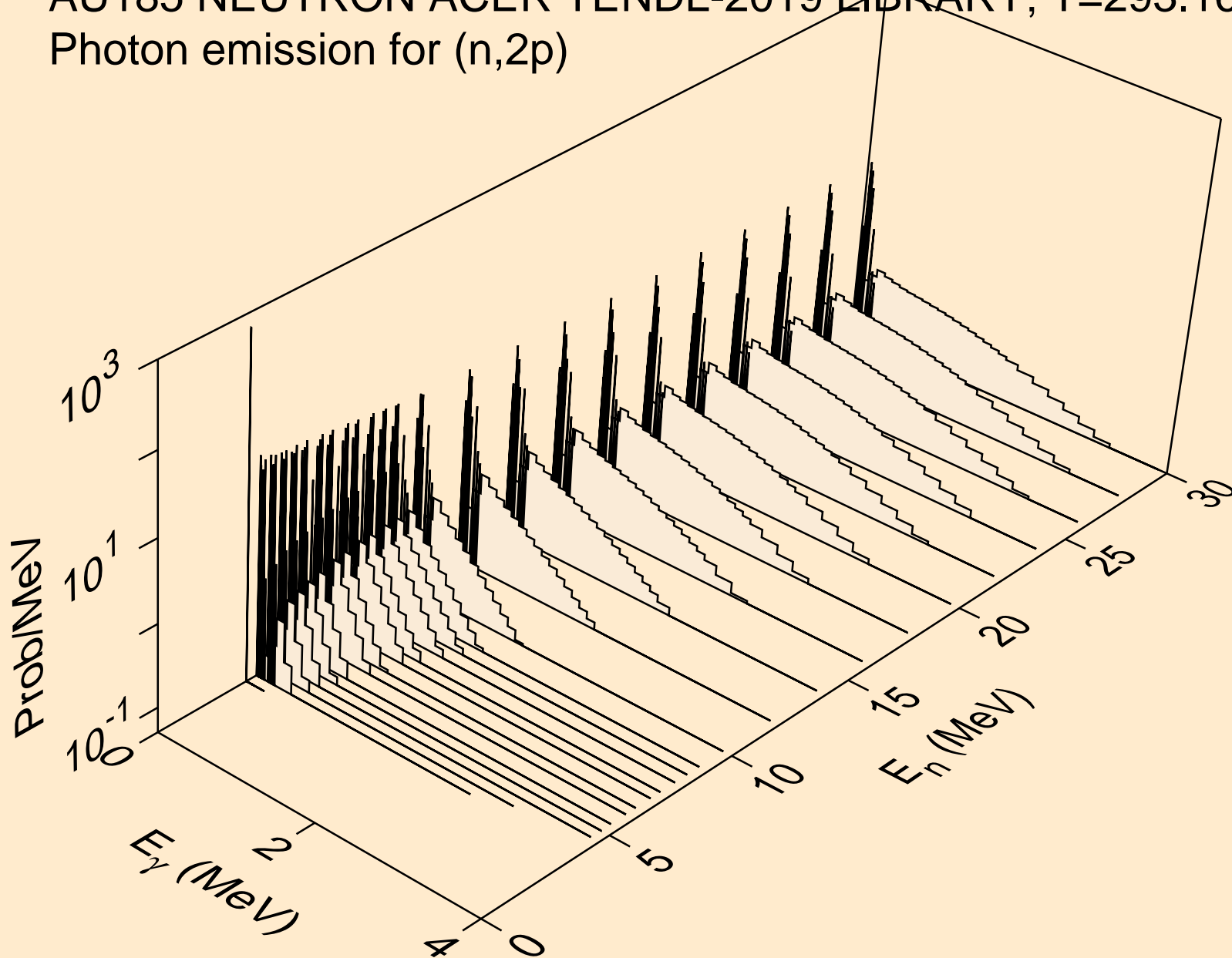

AU185 NEUTRON ACER TENDL-2019 LIBRARY; T=293.16K
Photon emission for (n,p α)

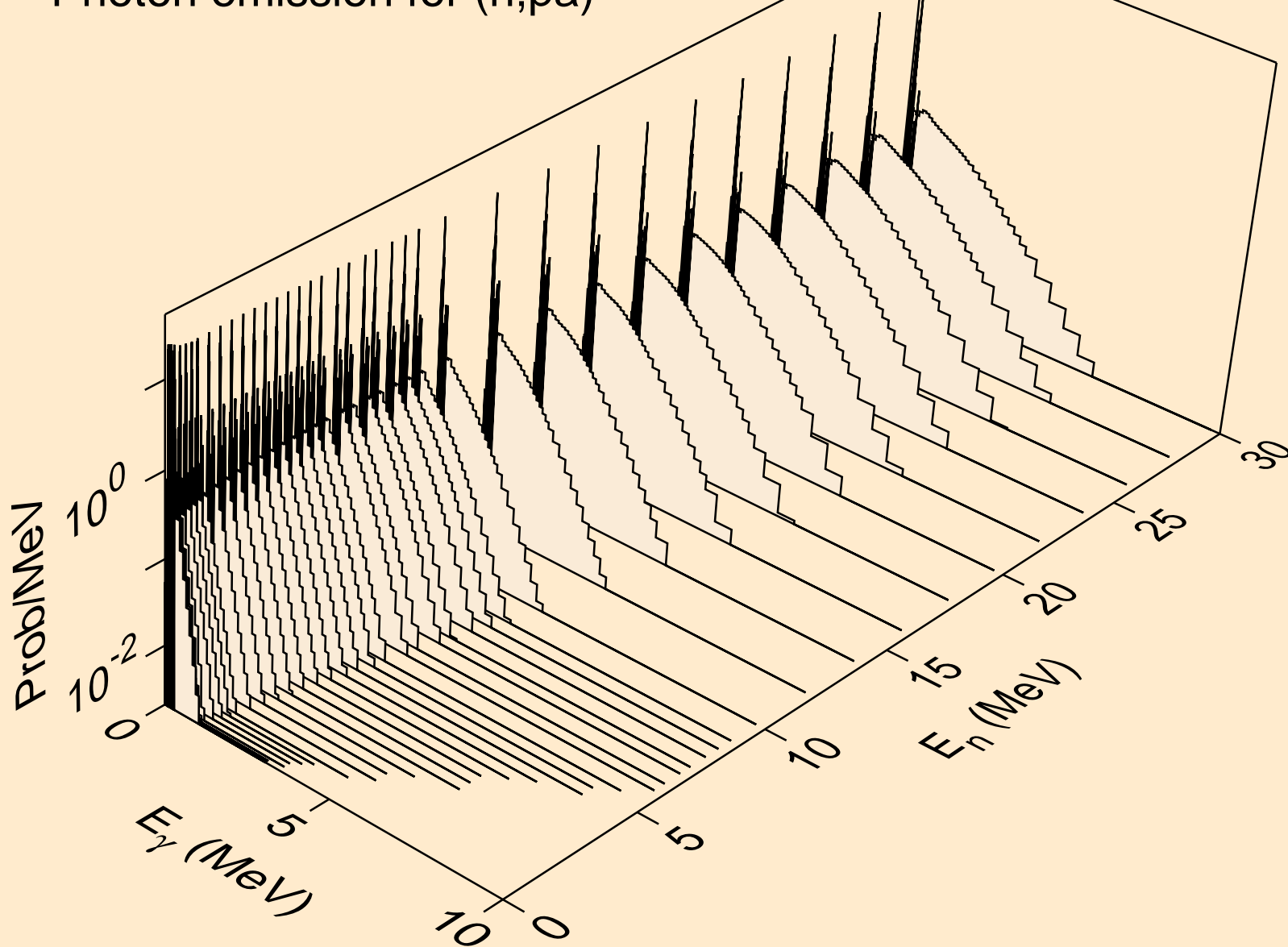

AU185 NEUTRON ACER TENDL-2019 LIBRARY; T=293.16K
Photon emission for (n,pd)

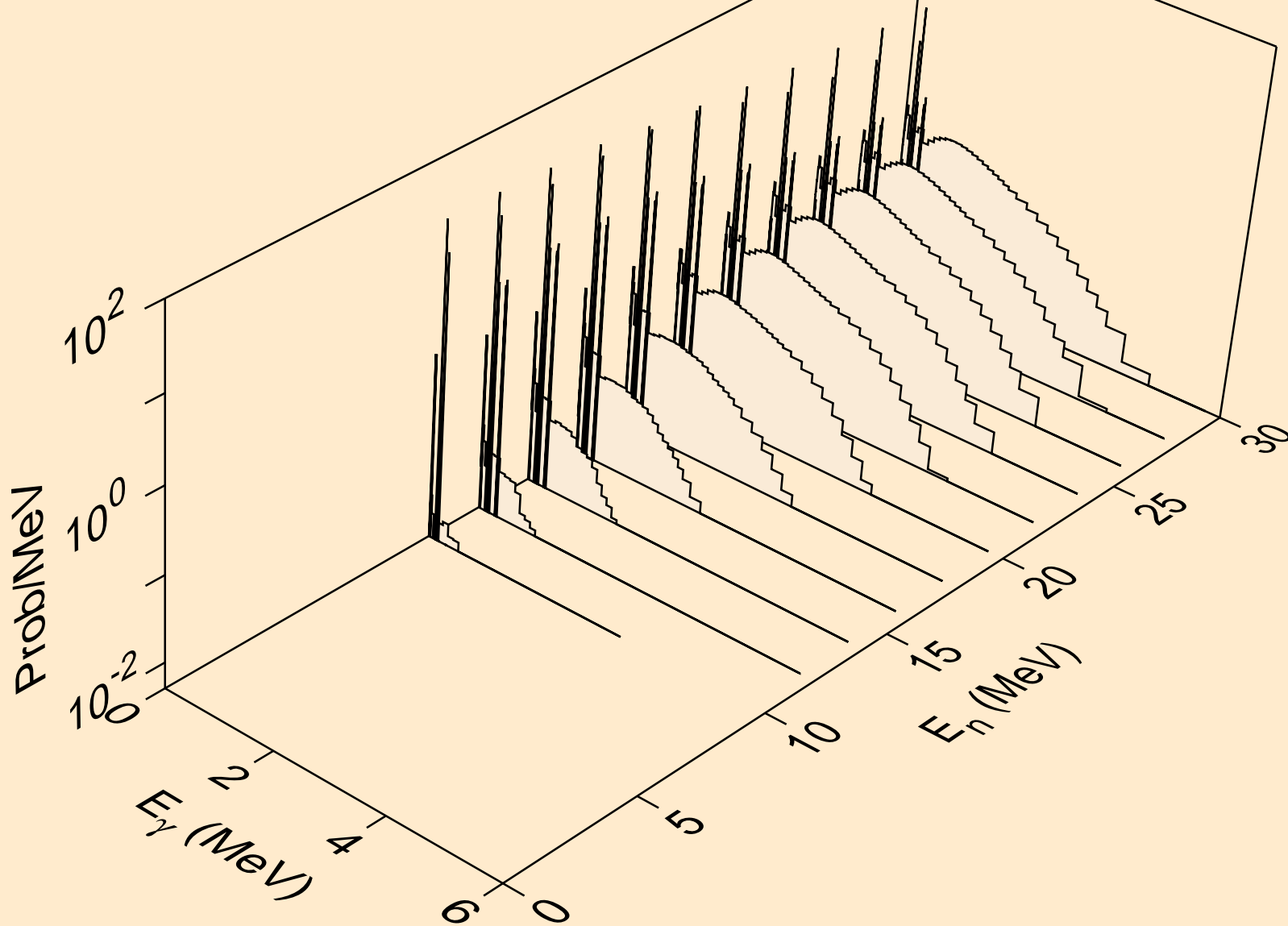

AU185 NEUTRON ACER TENDL-2019 LIBRARY; T=293.16K
Photon emission for (n,pt)

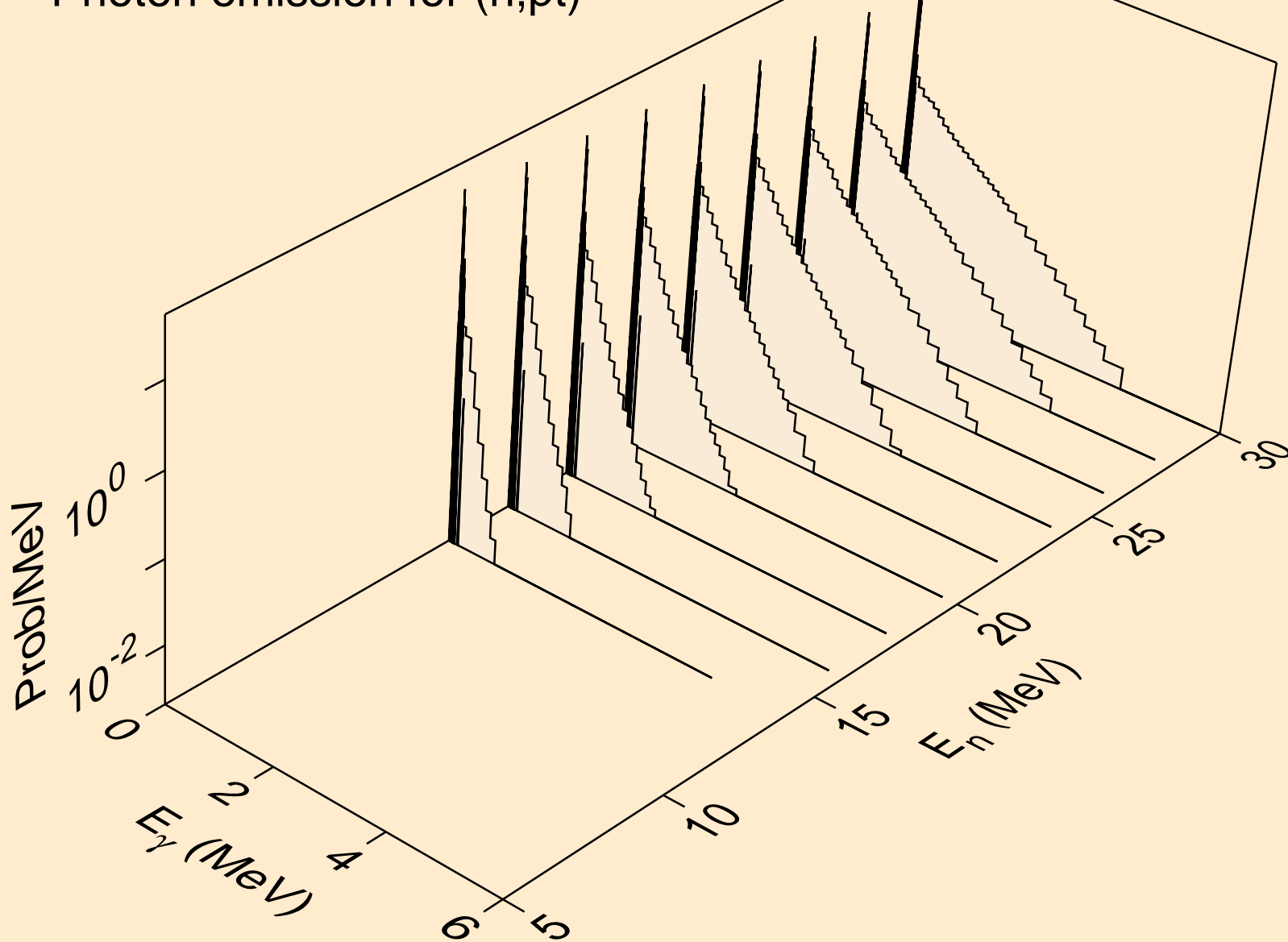

AU185 NEUTRON ACER TENDL-2019 LIBRARY; T=293.16K
Photon emission for (n,da)

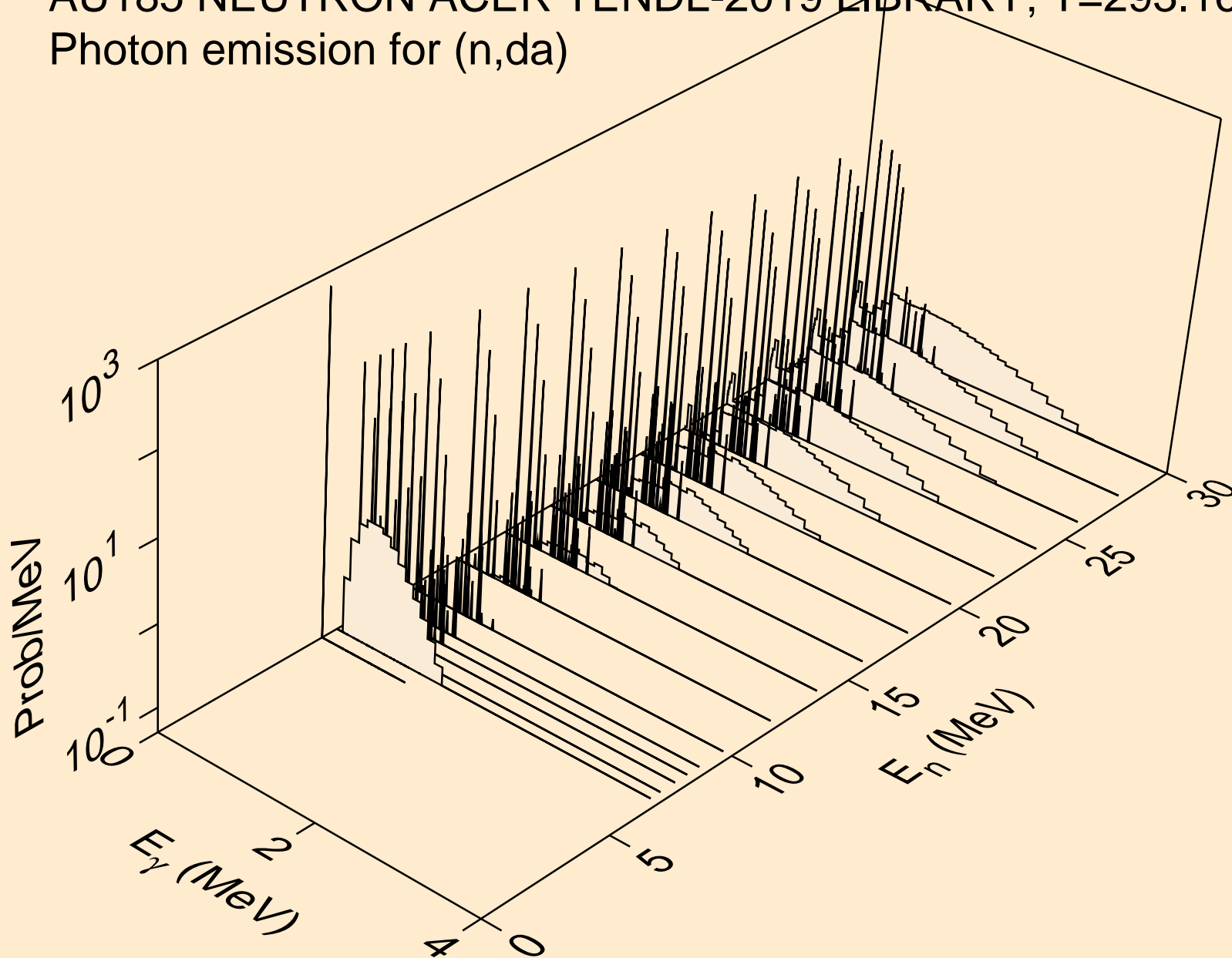

AU185 NEUTRON ACER TENDL-2019 LIBRARY; T=293.16K
thermal capture photon spectrum

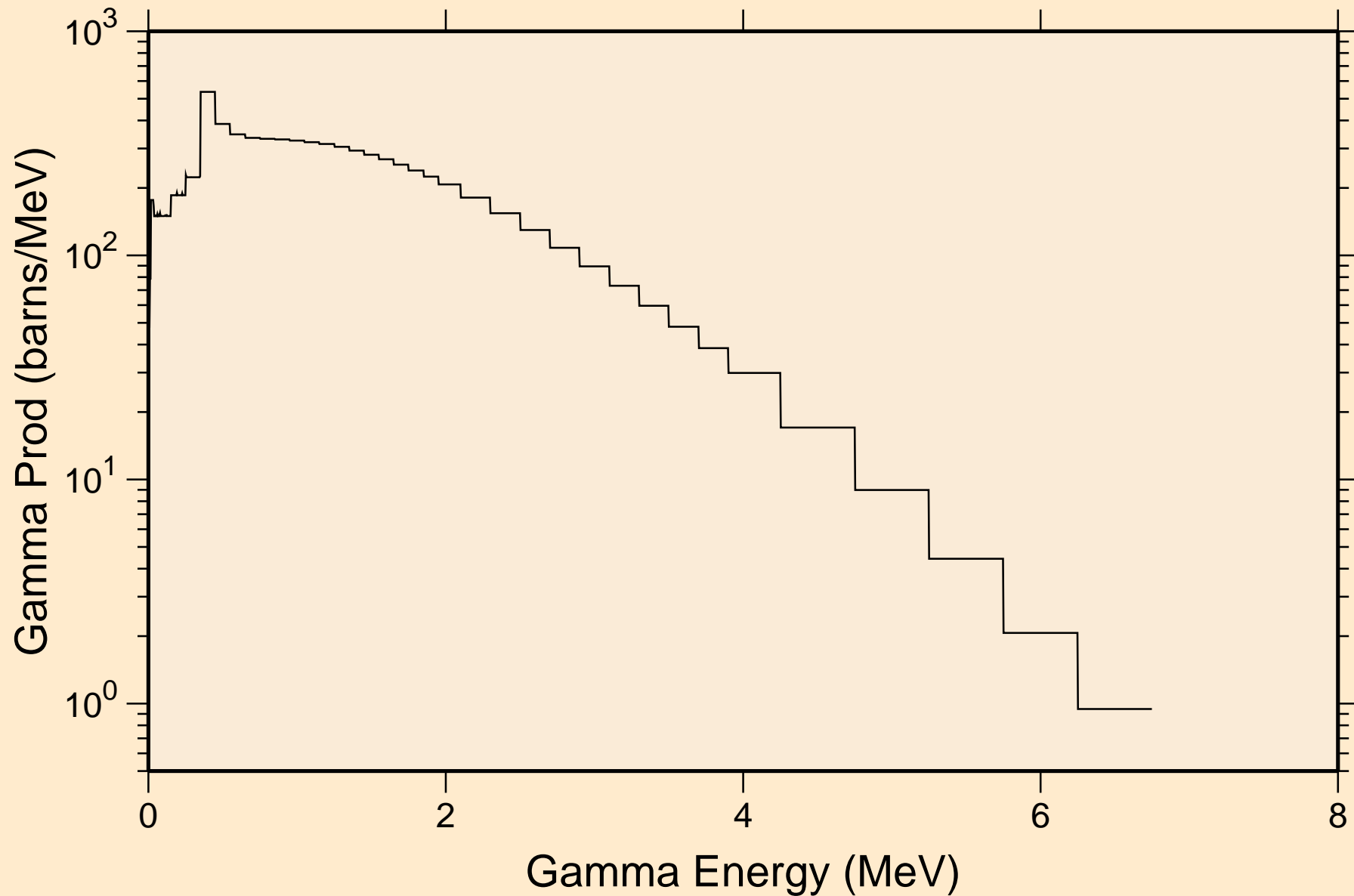

AU185 NEUTRON ACER TENDL-2019 LIBRARY; T=293.16K
14 MeV photon spectrum

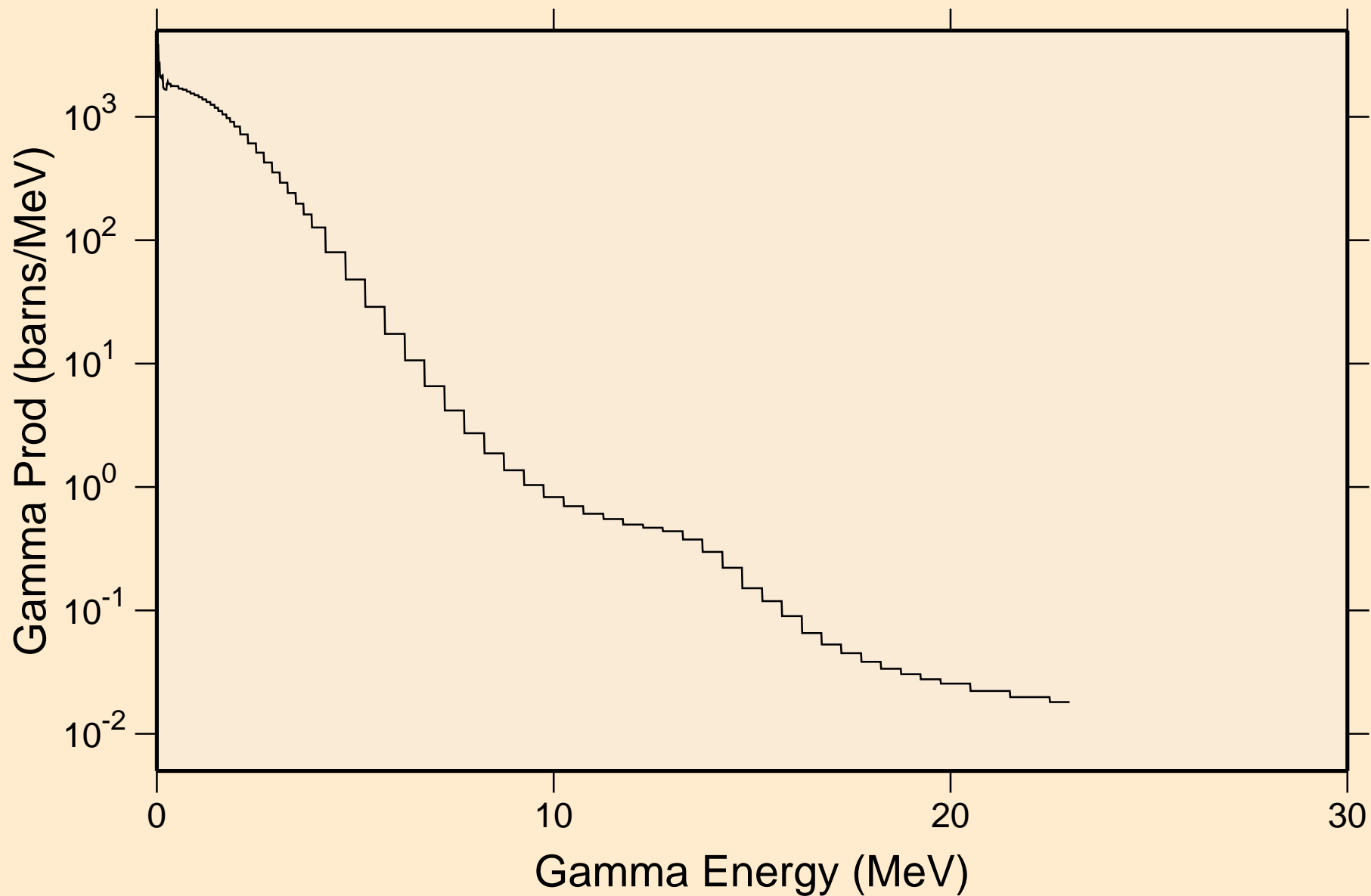

AU185 NEUTRON ACER TENDL-2019 LIBRARY; T=293.16K
Particle heating contributions

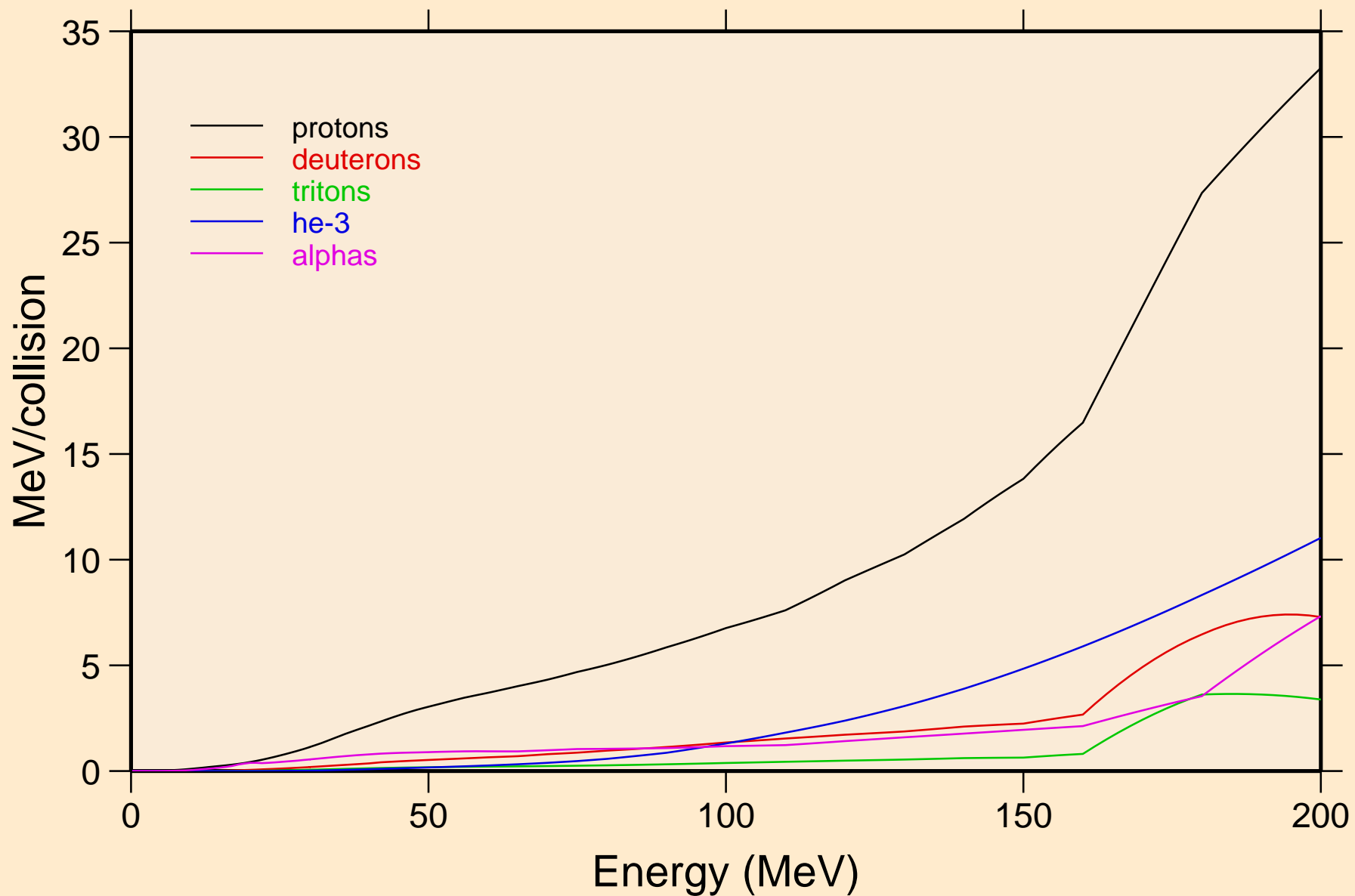

AU185 NEUTRON ACER TENDL-2019 LIBRARY; T=293.16K
Recoil Heating

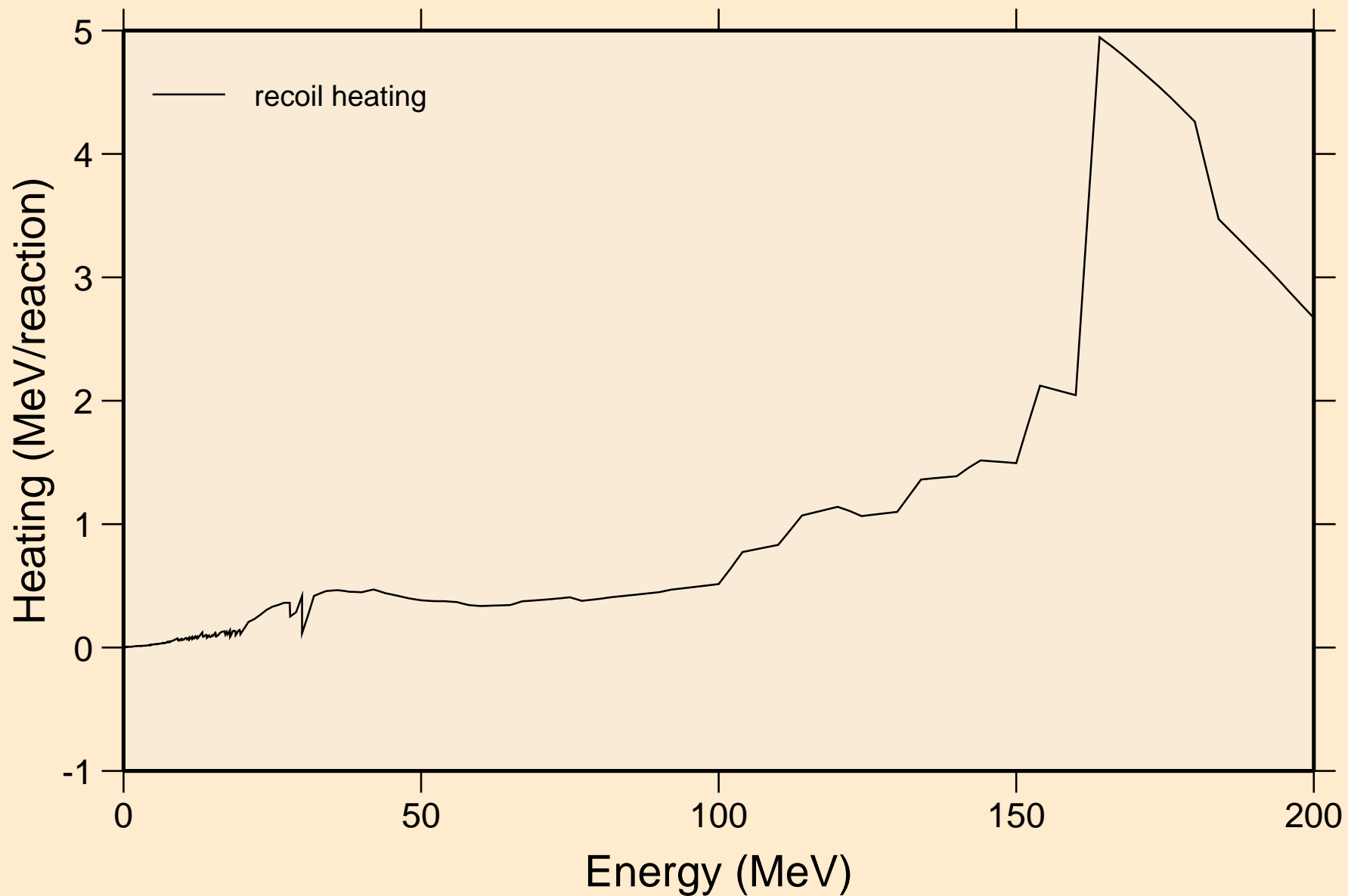

AU185 NEUTRON ACER TENDL-2019 LIBRARY; T=293.16K
Particle production cross sections

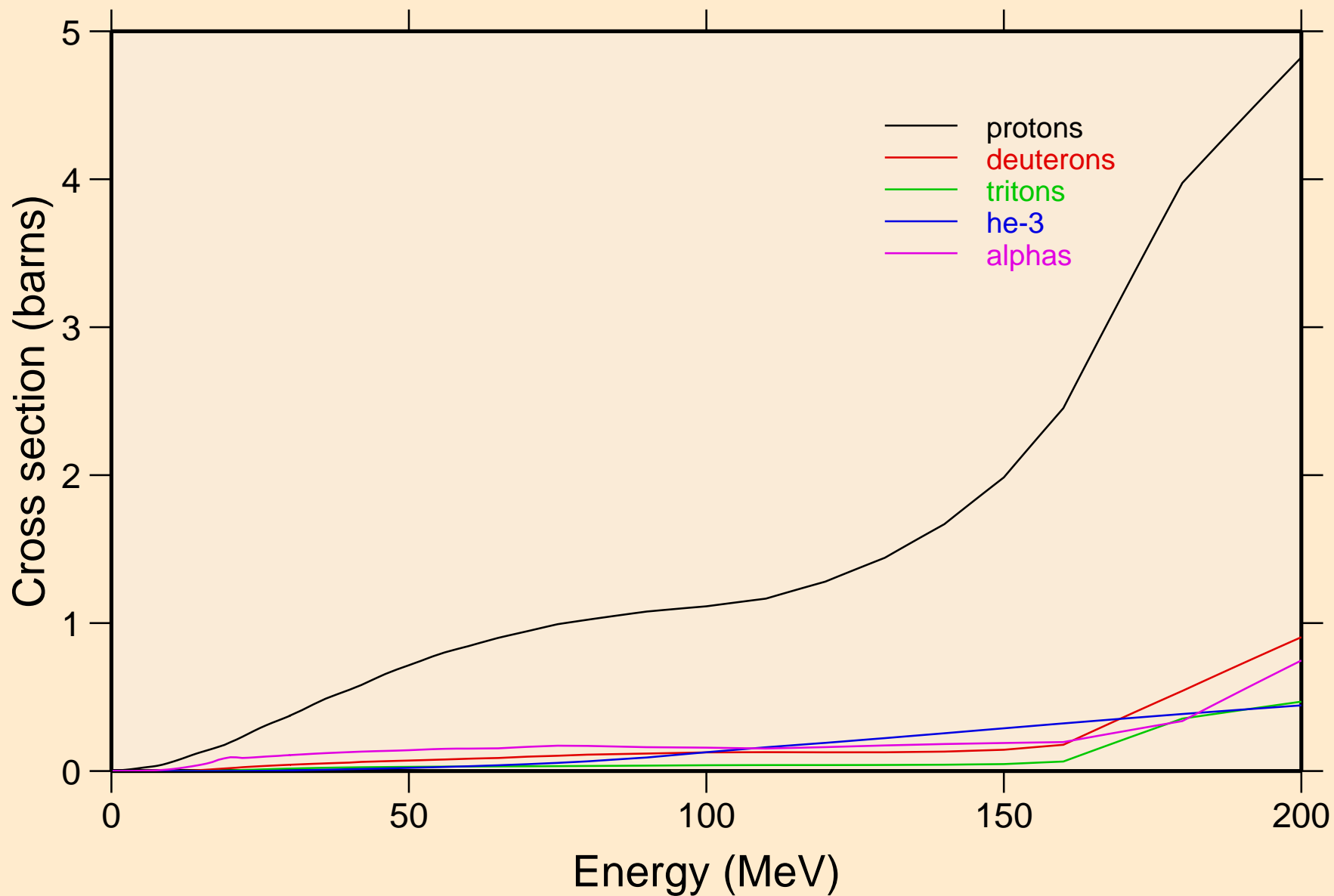

AU185 NEUTRON ACER TENDL-2019 LIBRARY; T=293.16K
protons from (n,x)

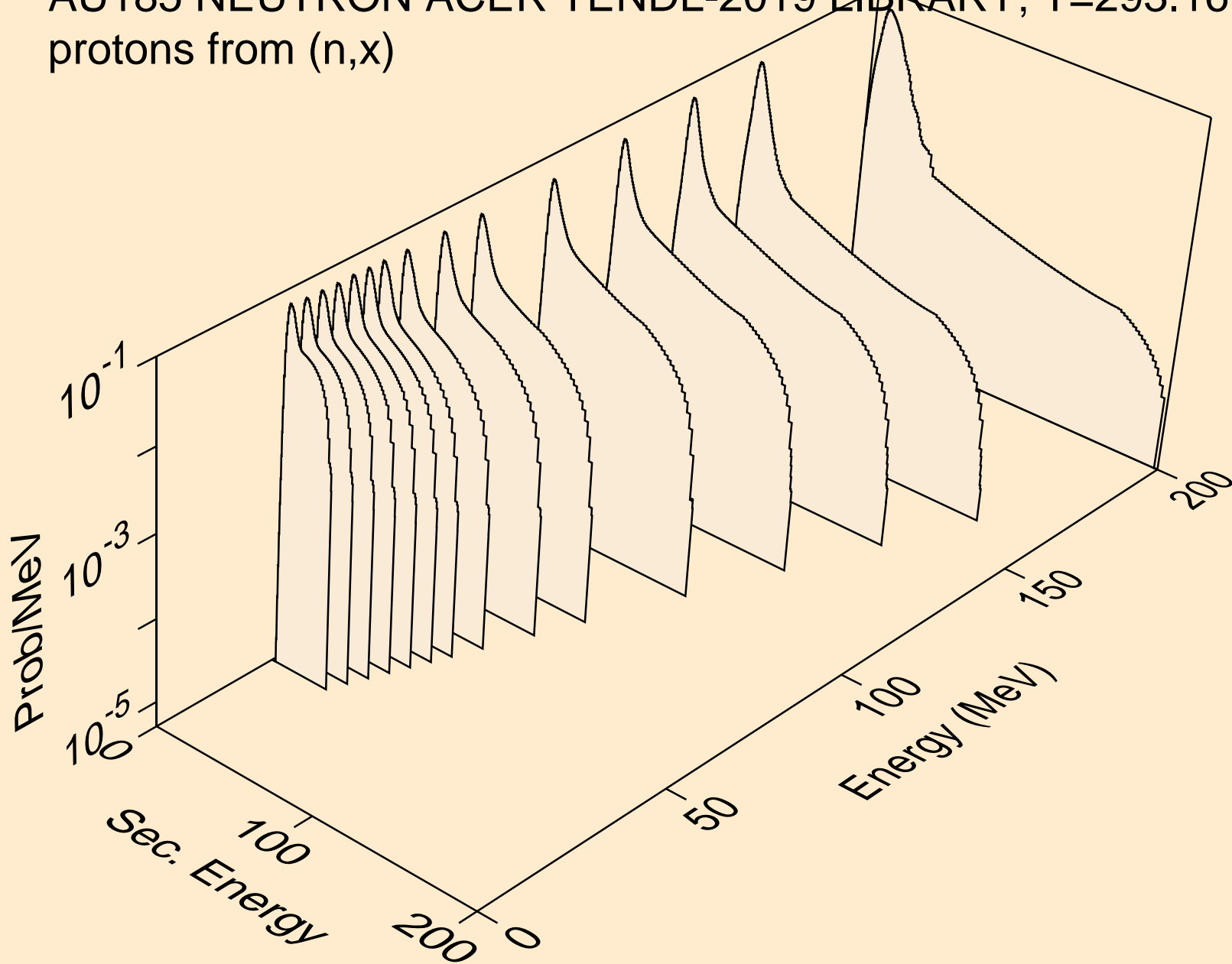

AU185 NEUTRON ACER TENDL-2019 LIBRARY; T=293.16K
protons from (n,n*)p

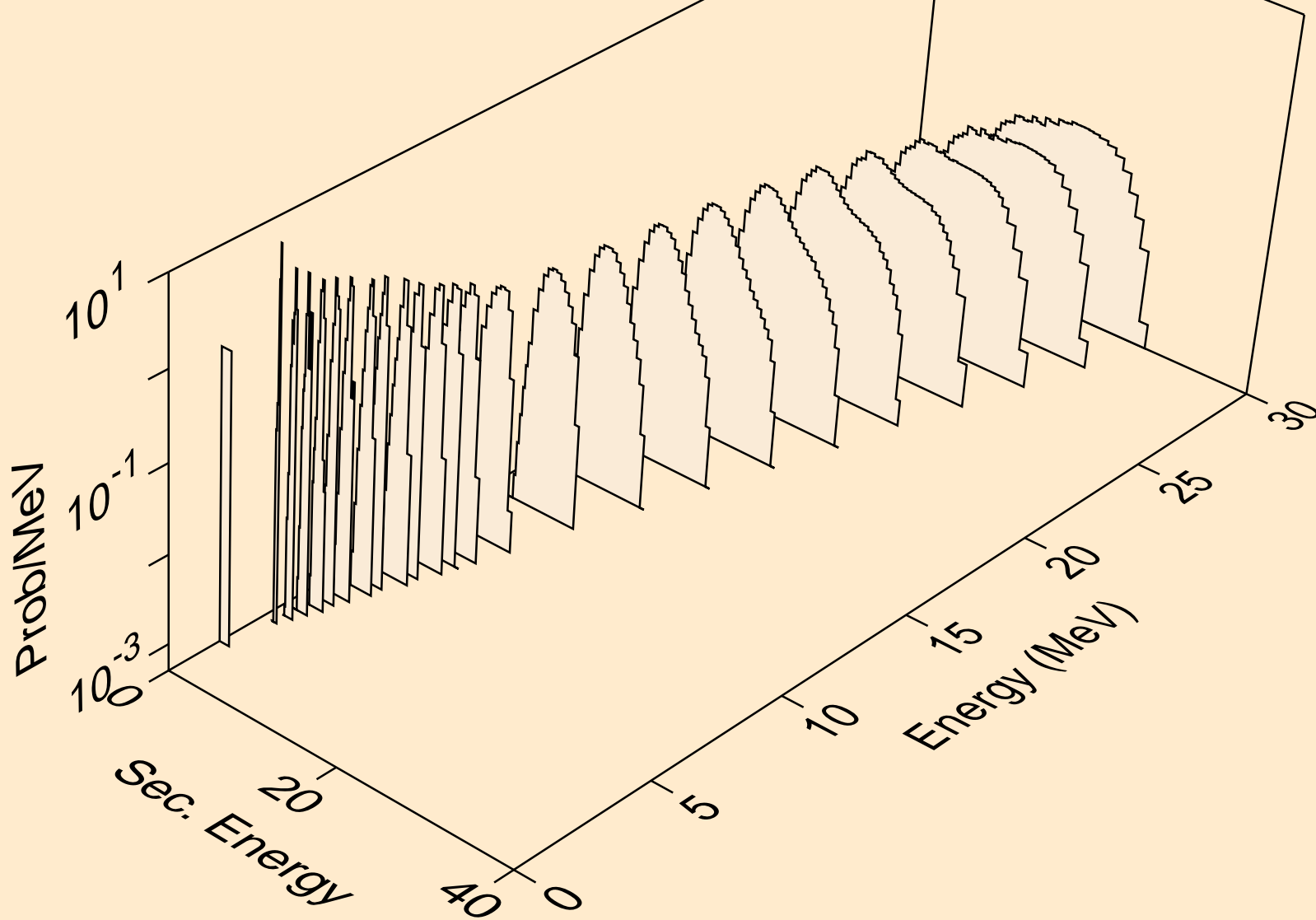

AU185 NEUTRON ACER TENDL-2019 LIBRARY; T=293.16K
protons from (n,2np)

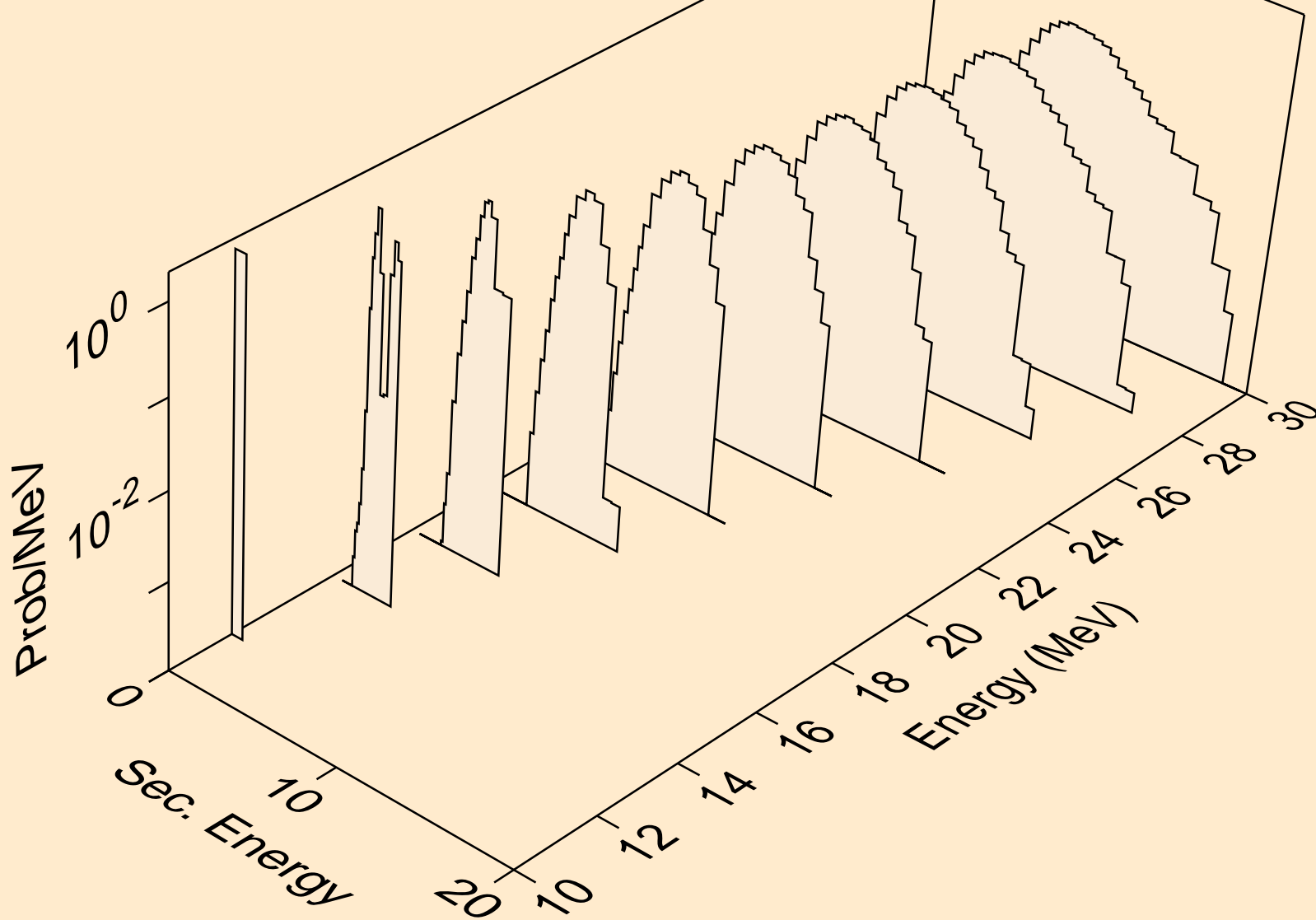

AU185 NEUTRON ACER TENDL-2019 LIBRARY; T=293.16K
protons from (n,3np)

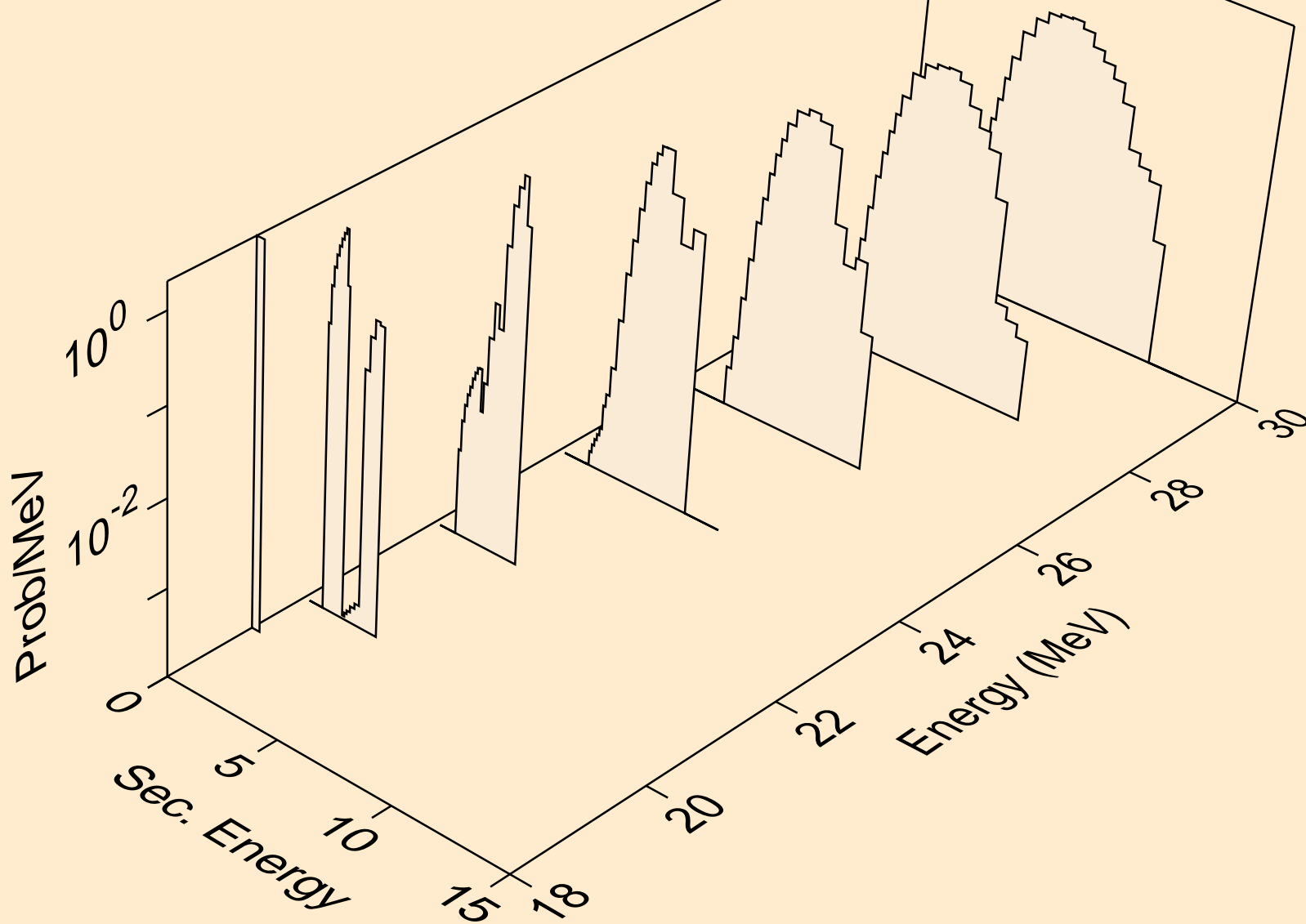

AU185 NEUTRON ACER TENDL-2019 LIBRARY; T=293.16K
protons from (n,2np)

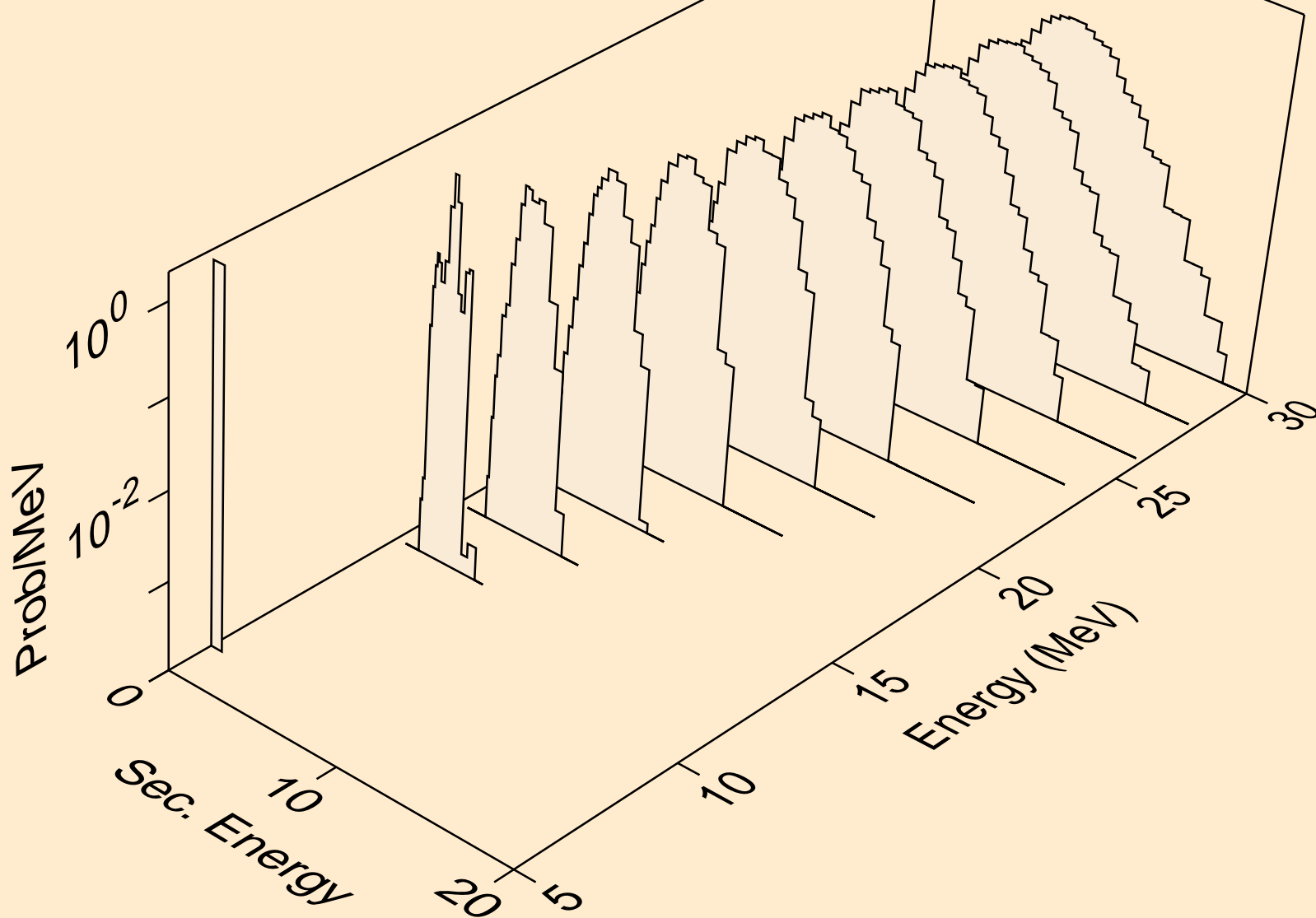

AU185 NEUTRON ACER TENDL-2019 LIBRARY; T=293.16K
protons from (n,npa)

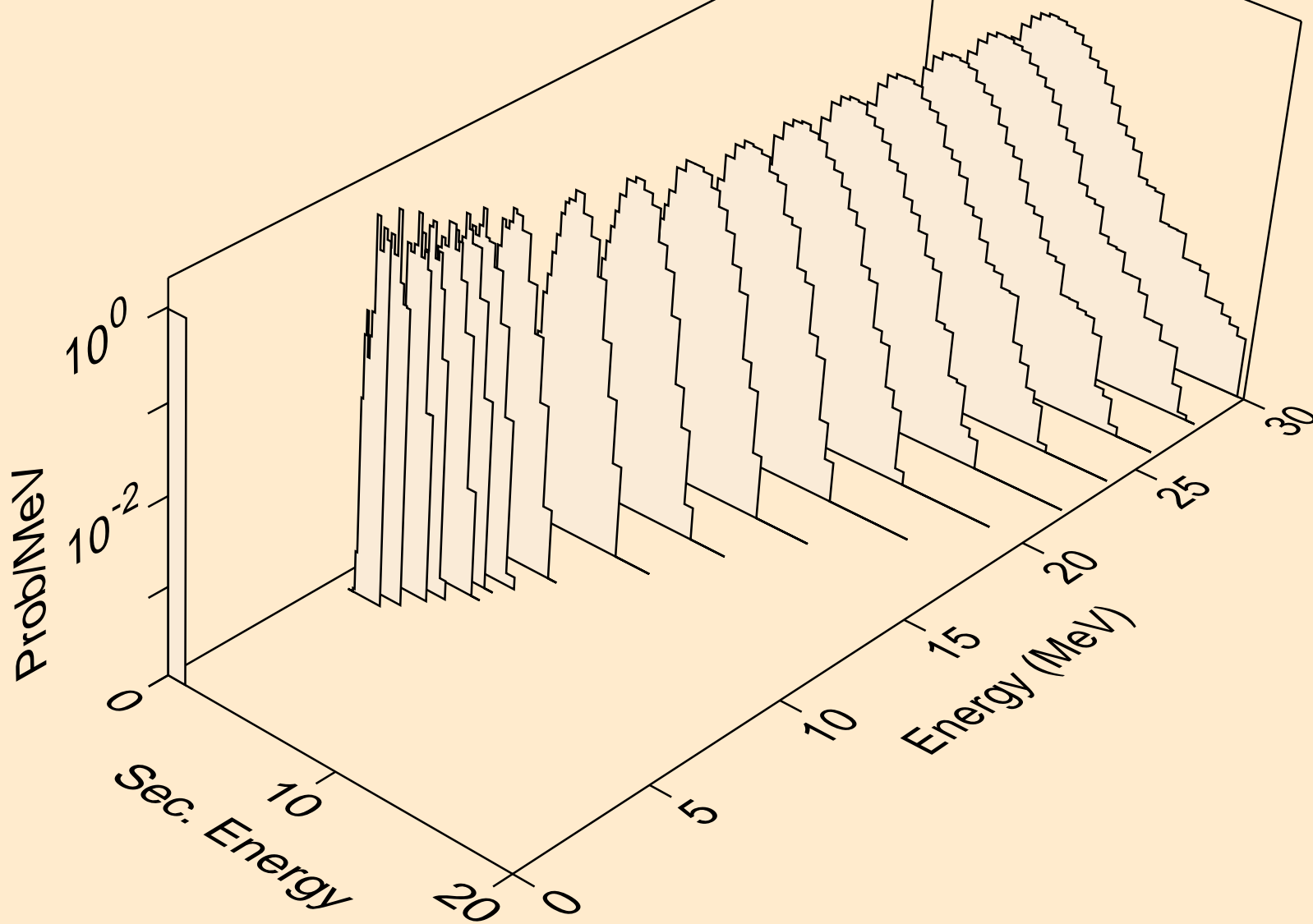

AU185 NEUTRON ACER TENDL-2019 LIBRARY; T=293.16K
protons from (n,p)

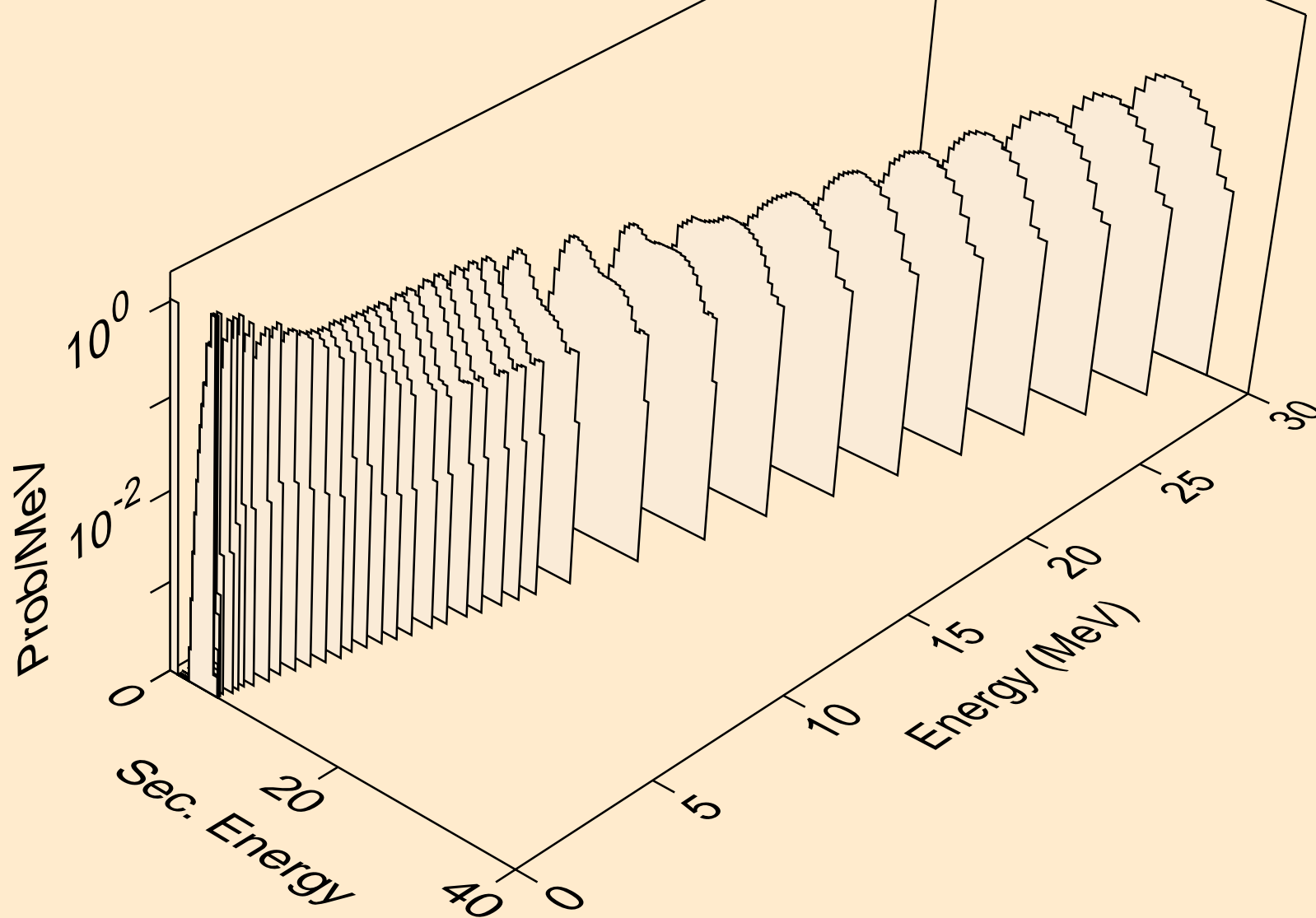

AU185 NEUTRON ACER TENDL-2019 LIBRARY; T=293.16K
protons from (n,2p)

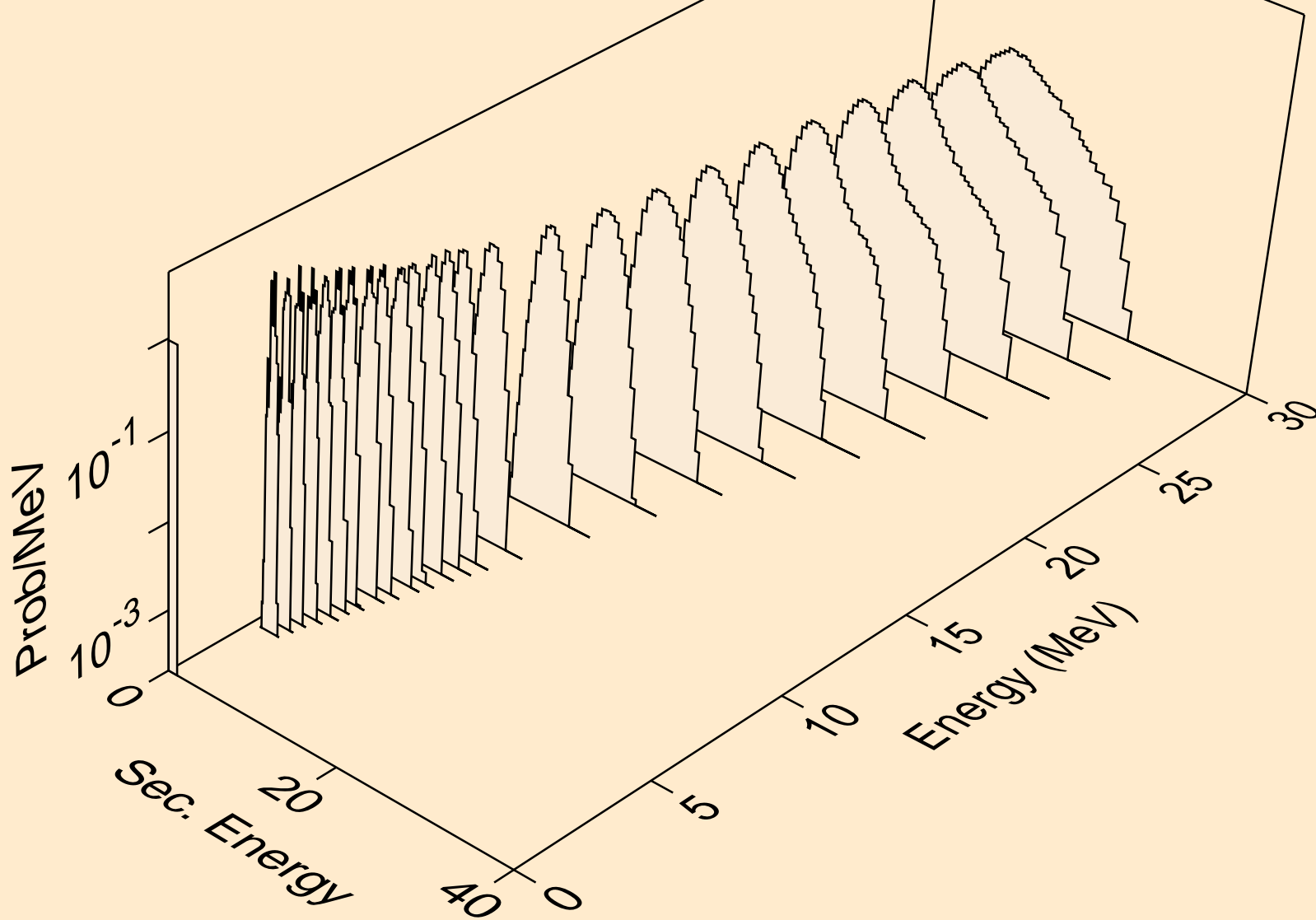

AU185 NEUTRON ACER TENDL-2019 LIBRARY; T=293.16K
protons from (n,p)

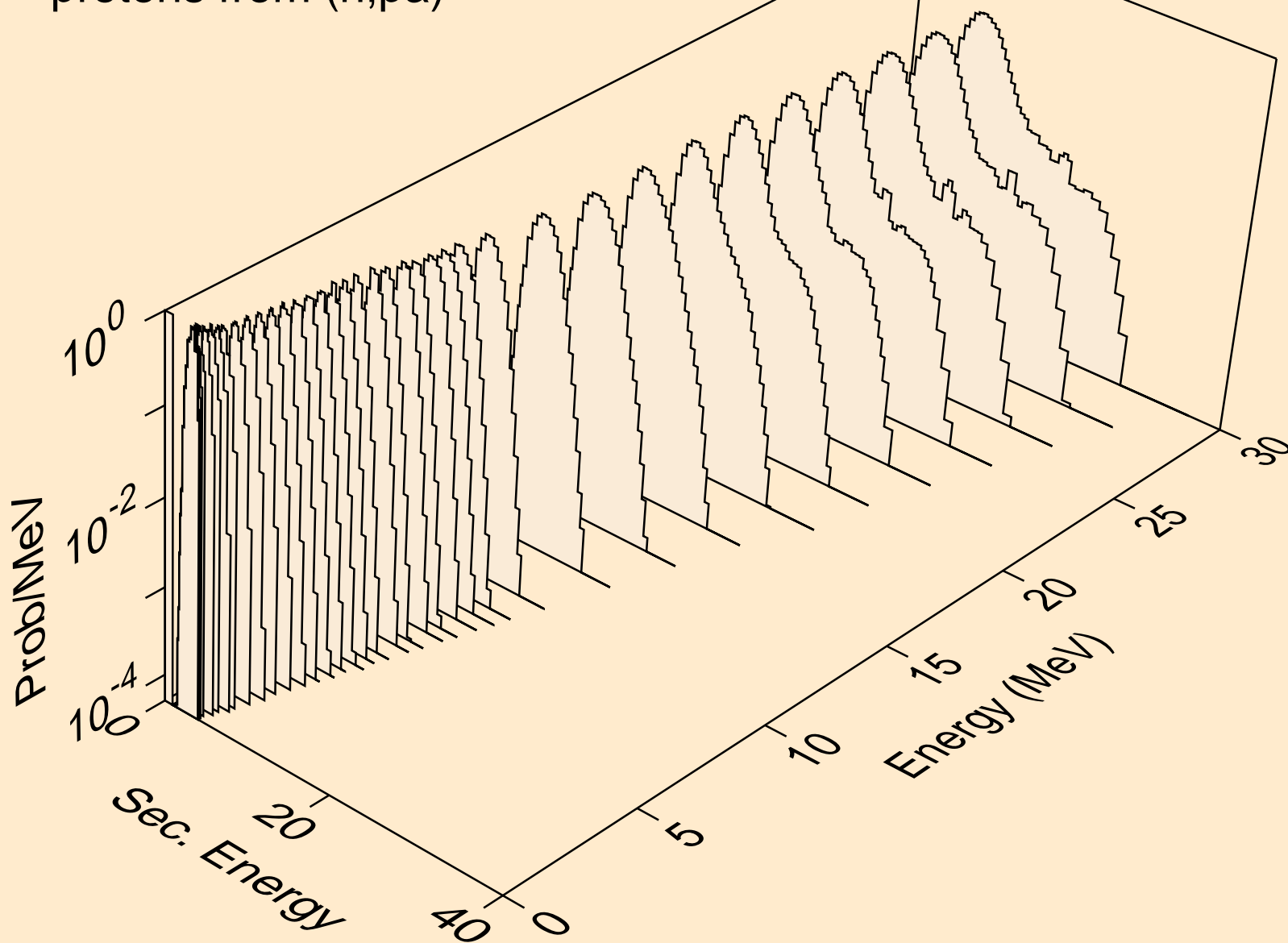

AU185 NEUTRON ACER TENDL-2019 LIBRARY; T=293.16K
protons from (n,pd)

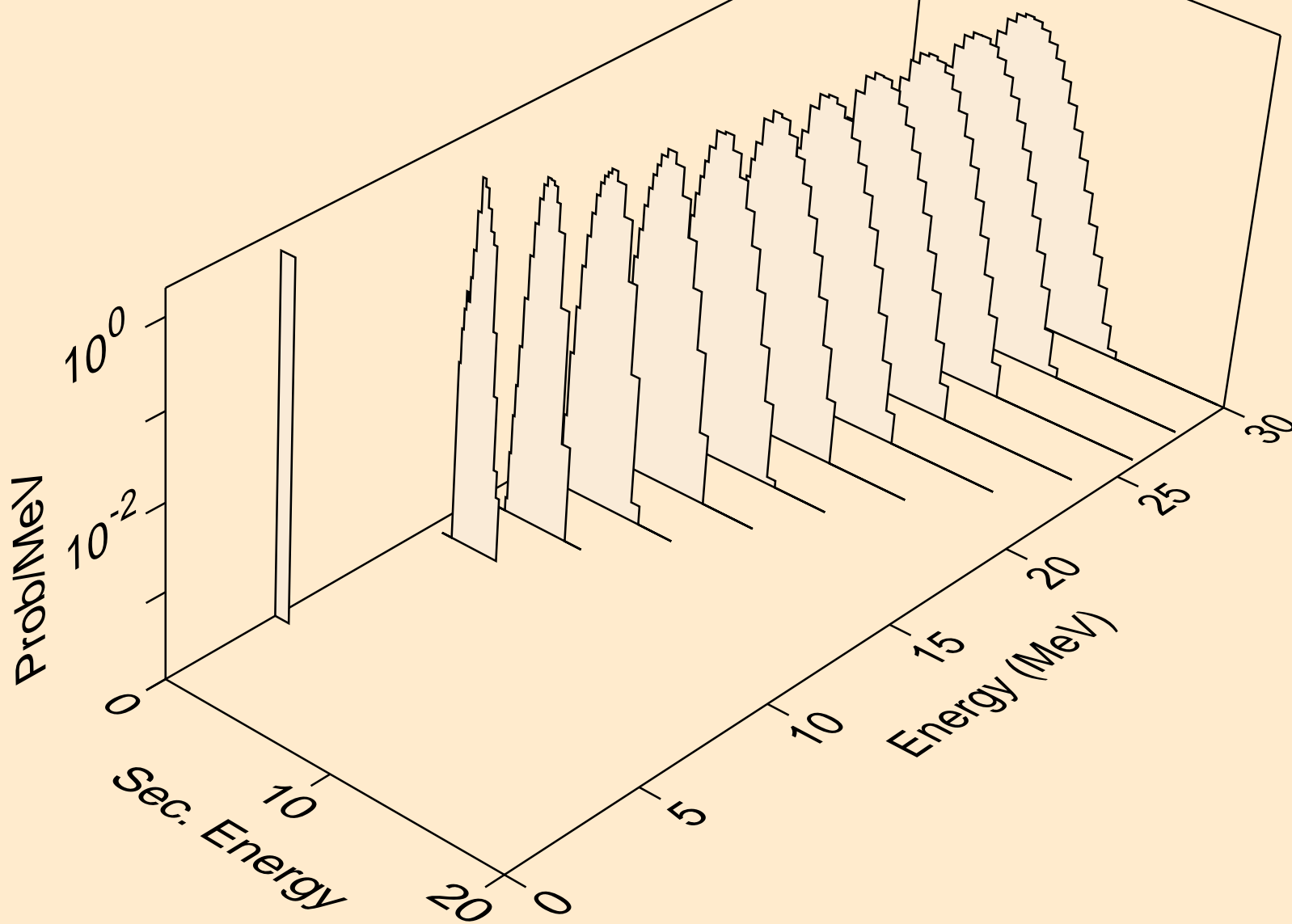

AU185 NEUTRON ACER TENDL-2019 LIBRARY; T=293.16K
protons from (n,pt)

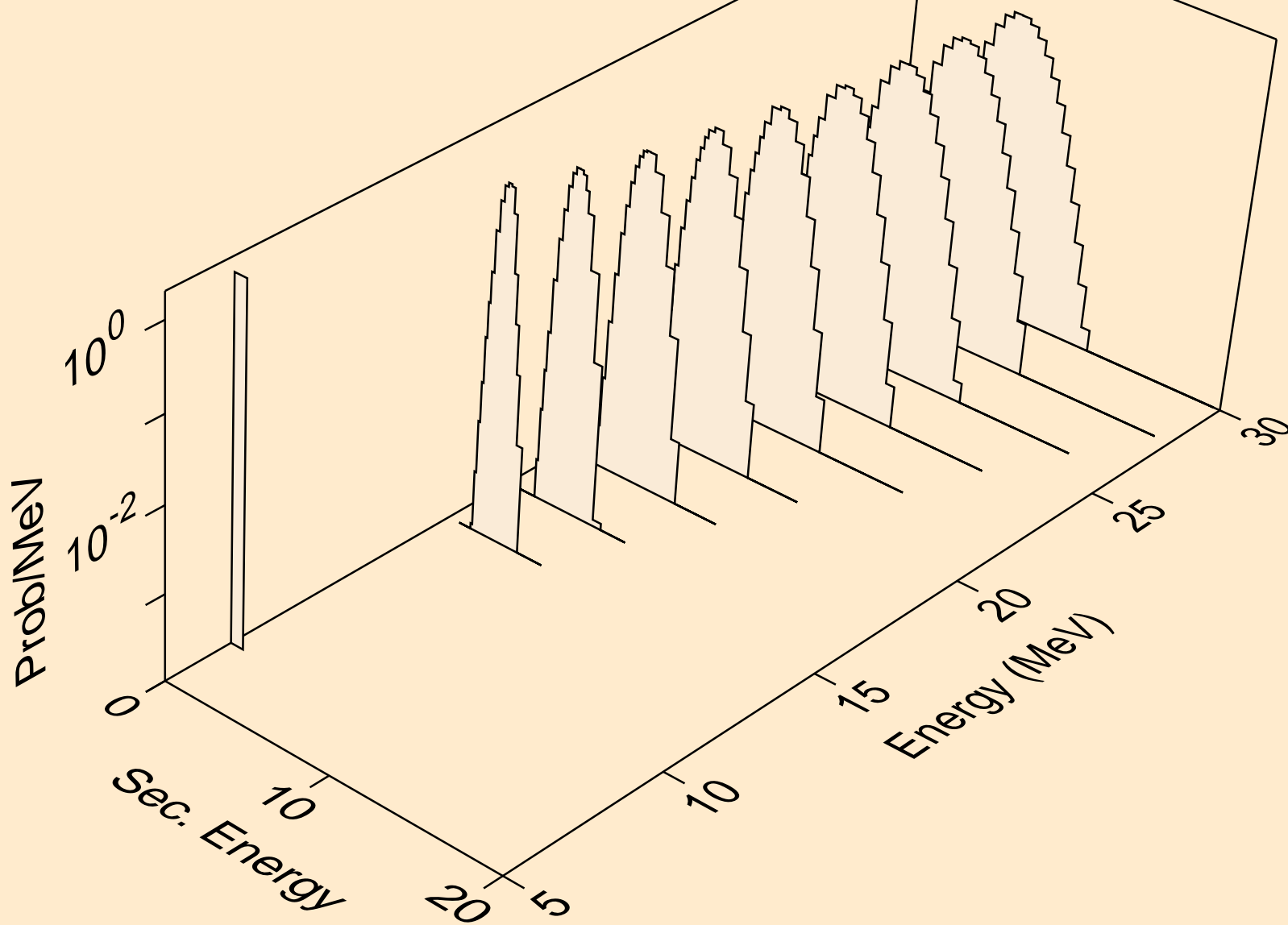

AU185 NEUTRON ACER TENDL-2019 LIBRARY; T=293.16K
deuterons from (n,x)

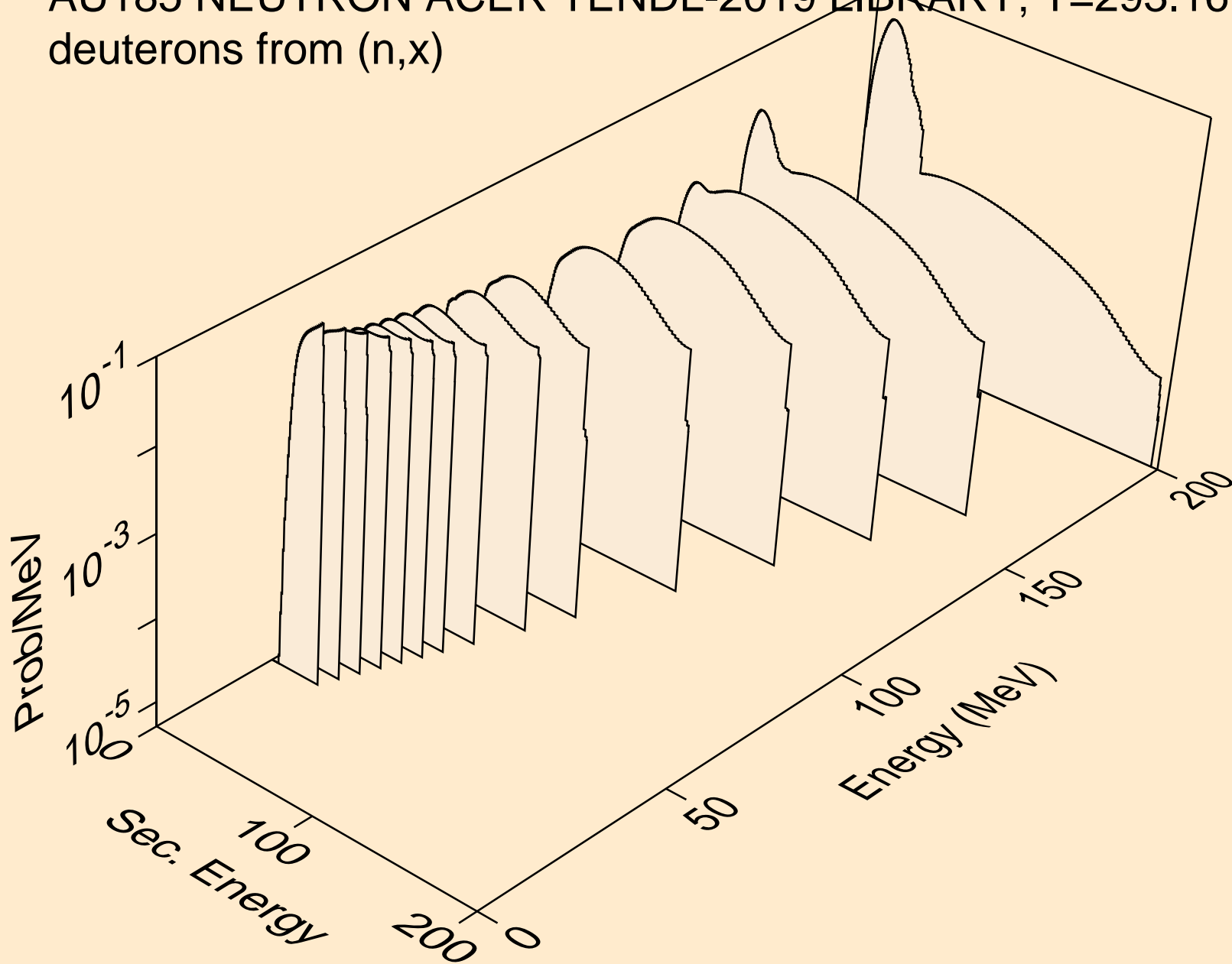

AU185 NEUTRON ACER TENDL-2019 LIBRARY; T=293.16K
deuterons from (n,2nd)

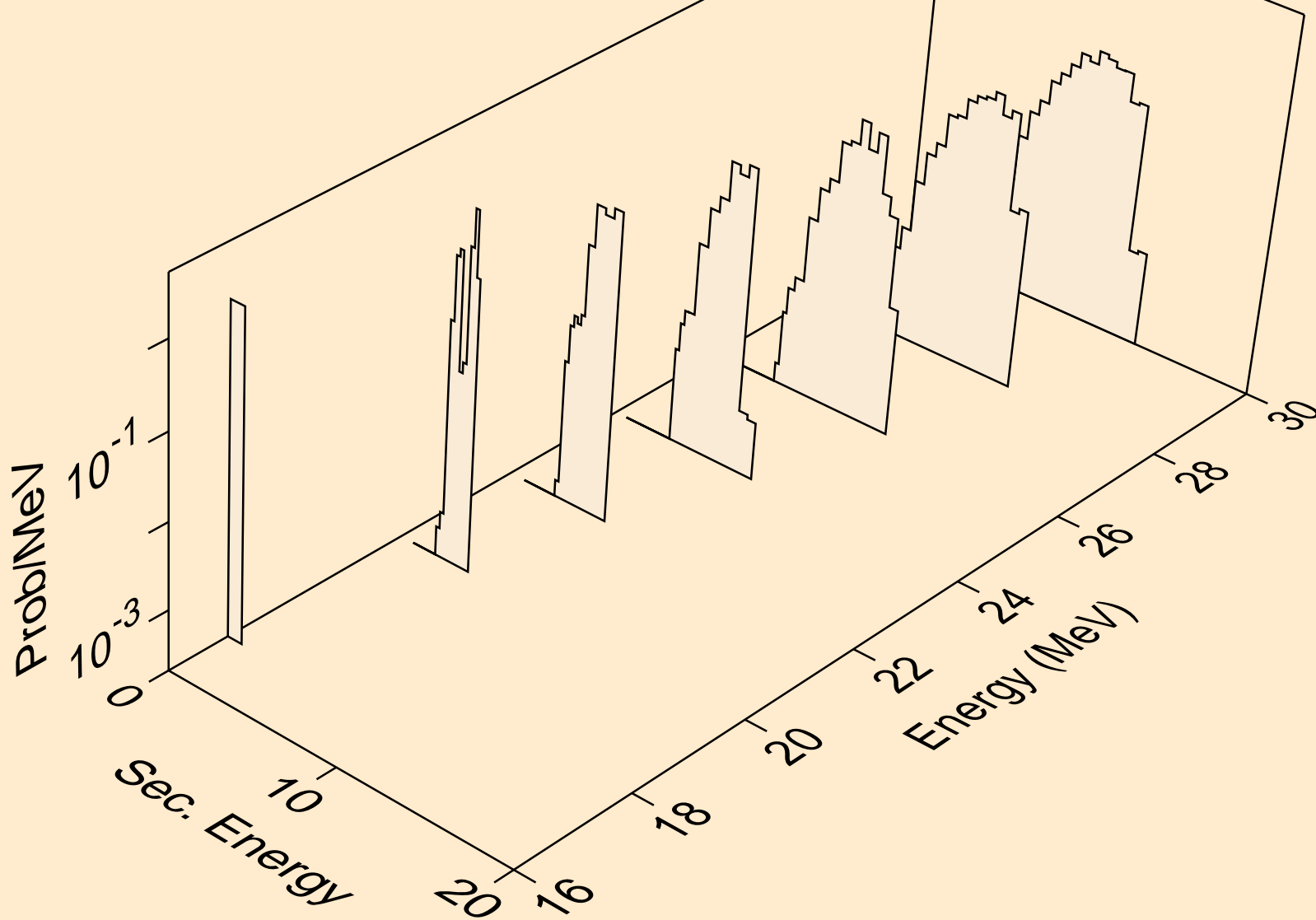

AU185 NEUTRON ACER TENDL-2019 LIBRARY; T=293.16K
deuterons from (n,n*)d

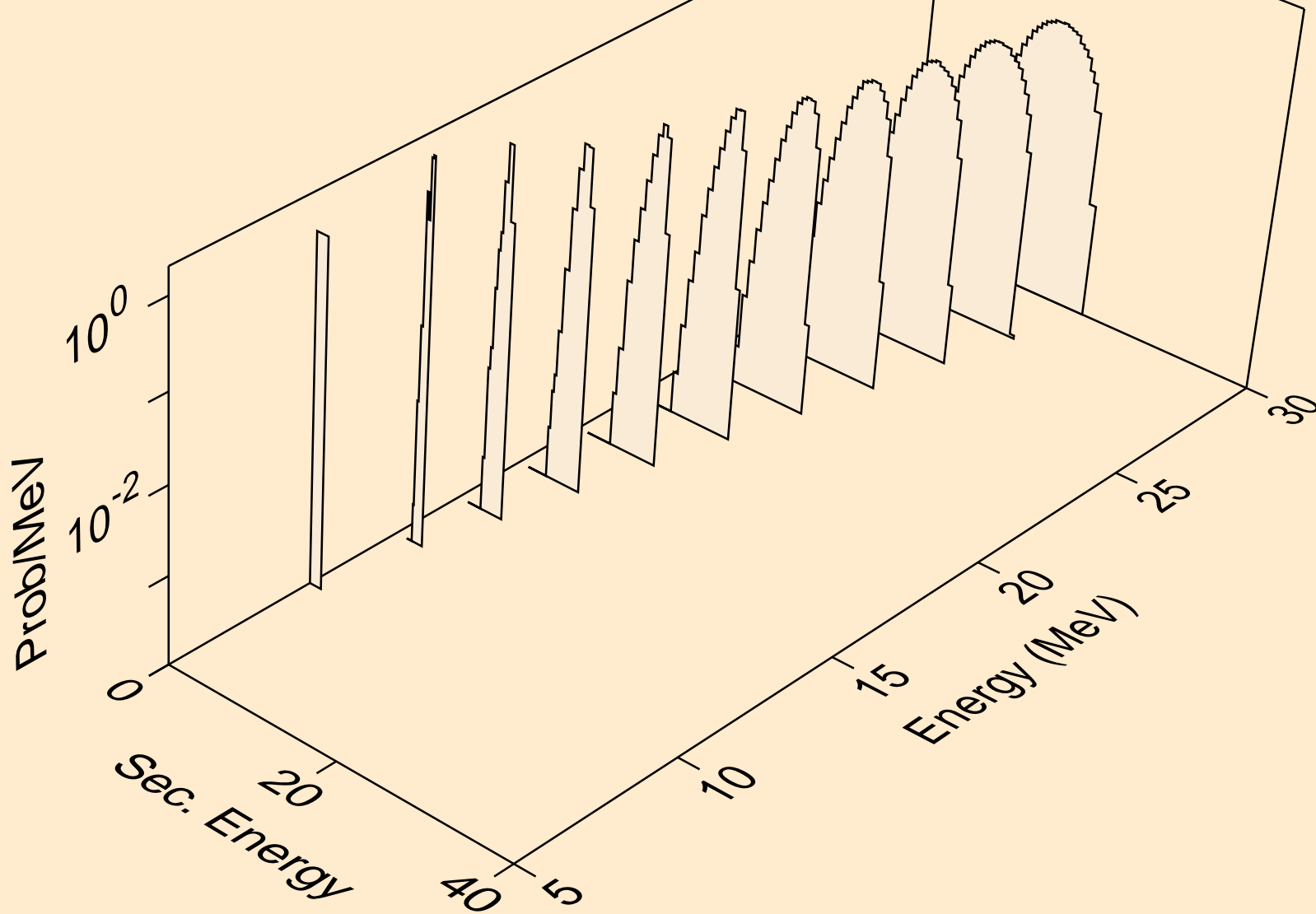

AU185 NEUTRON ACER TENDL-2019 LIBRARY; T=293.16K
deuterons from (n,d)

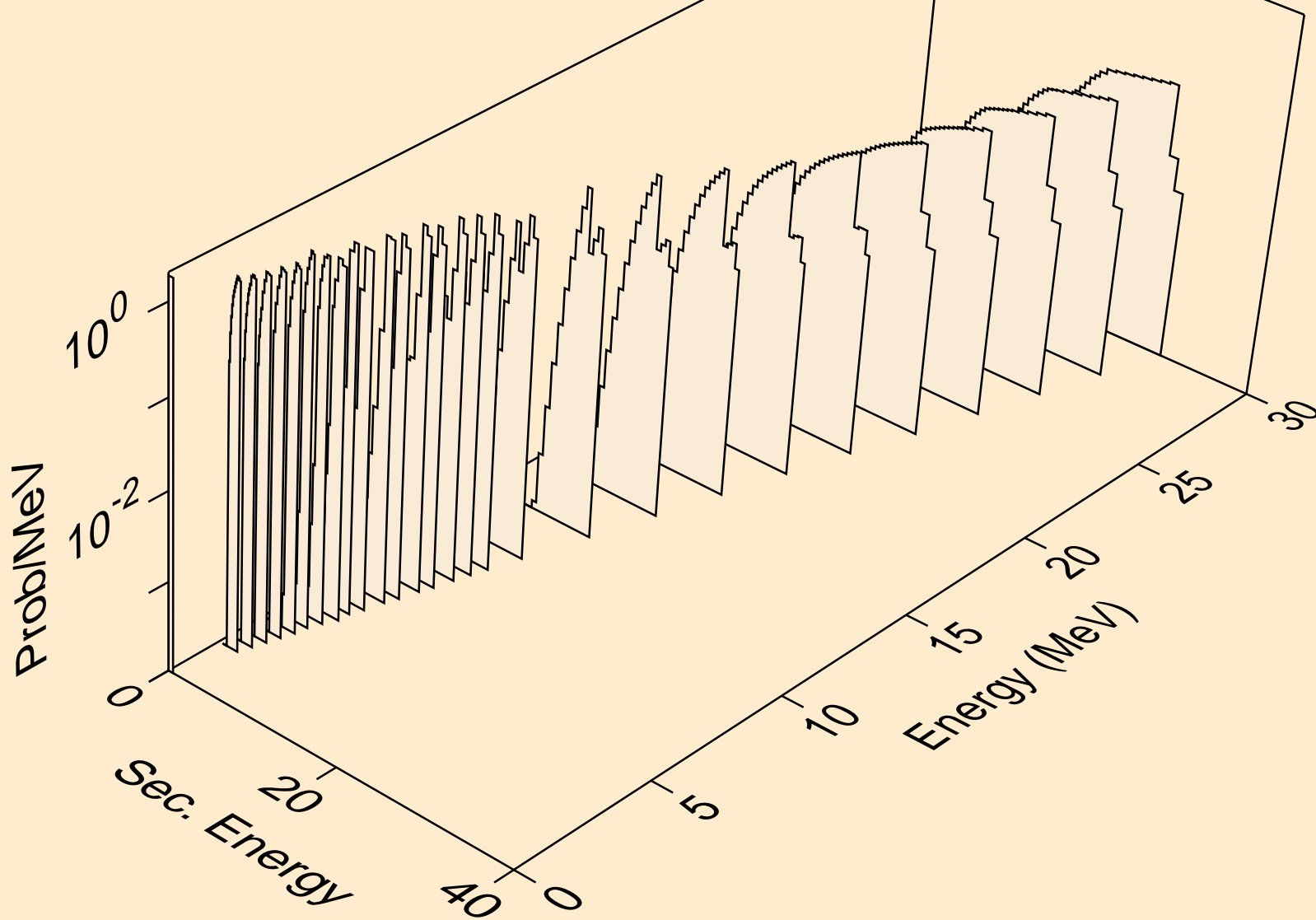

AU185 NEUTRON ACER TENDL-2019 LIBRARY; T=293.16K
deuterons from (n,pd)

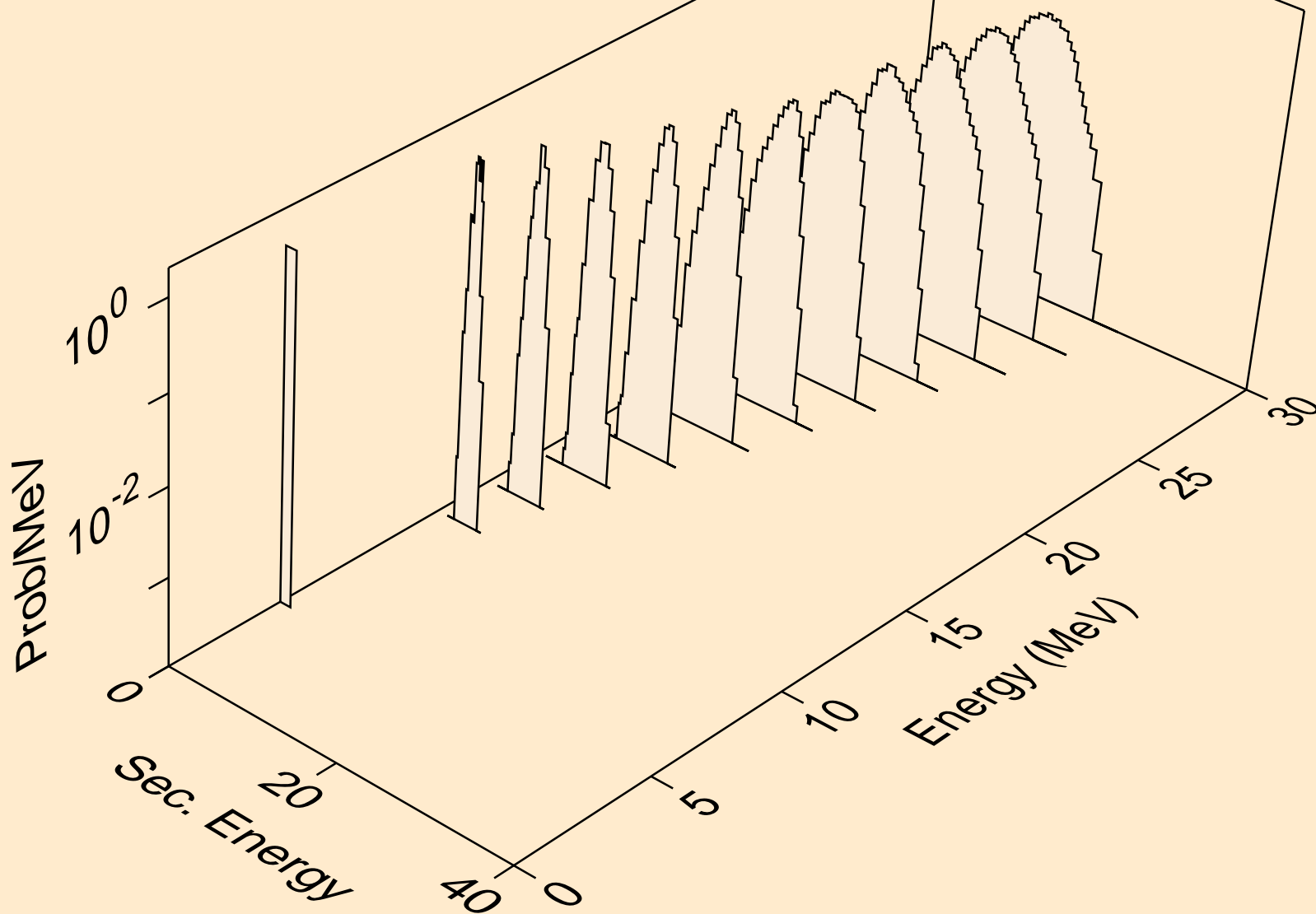

AU185 NEUTRON ACER TENDL-2019 LIBRARY; T=293.16K
deuterons from (n,da)

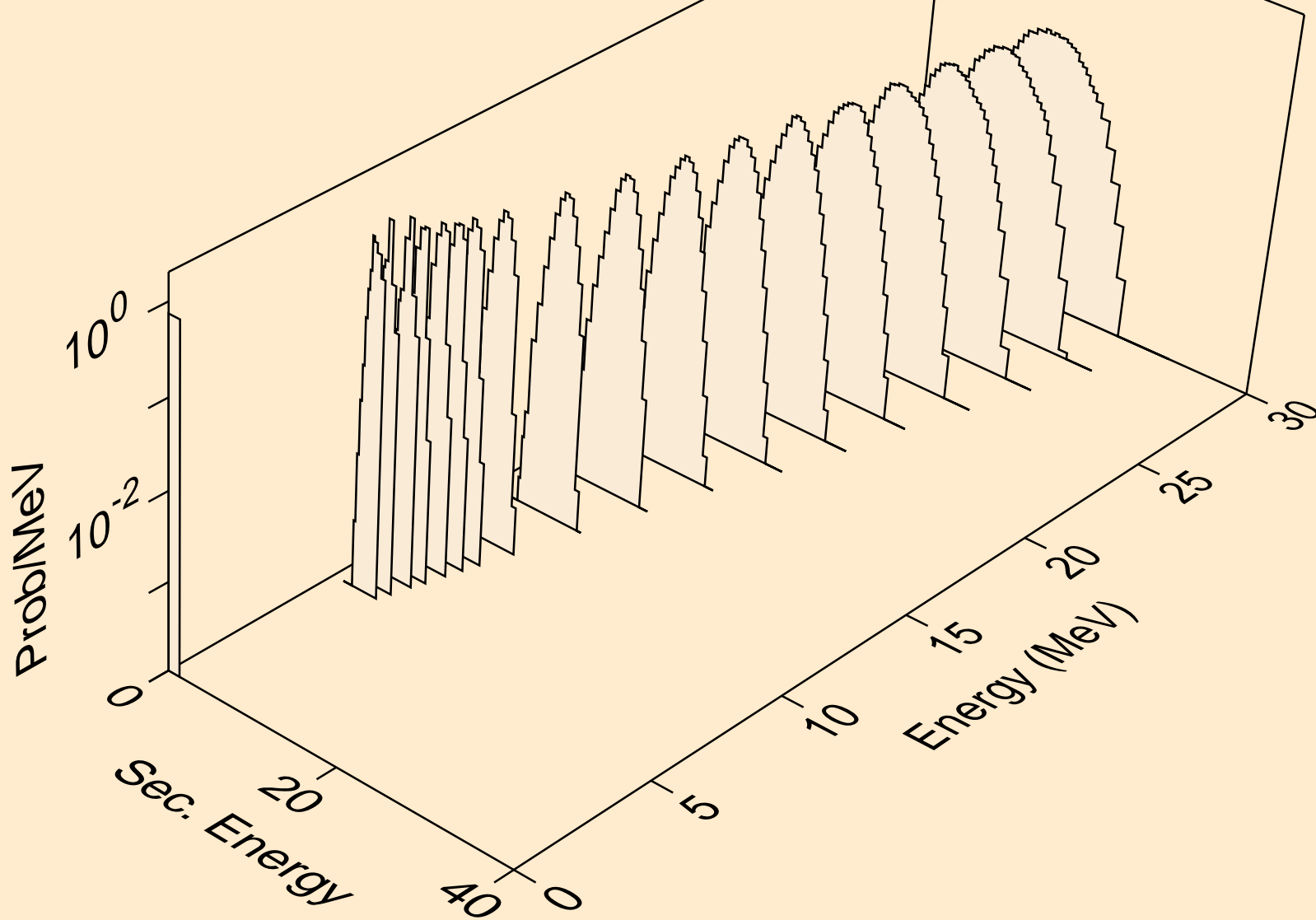

AU185 NEUTRON ACER TENDL-2019 LIBRARY; T=293.16K
tritons from (n,x)

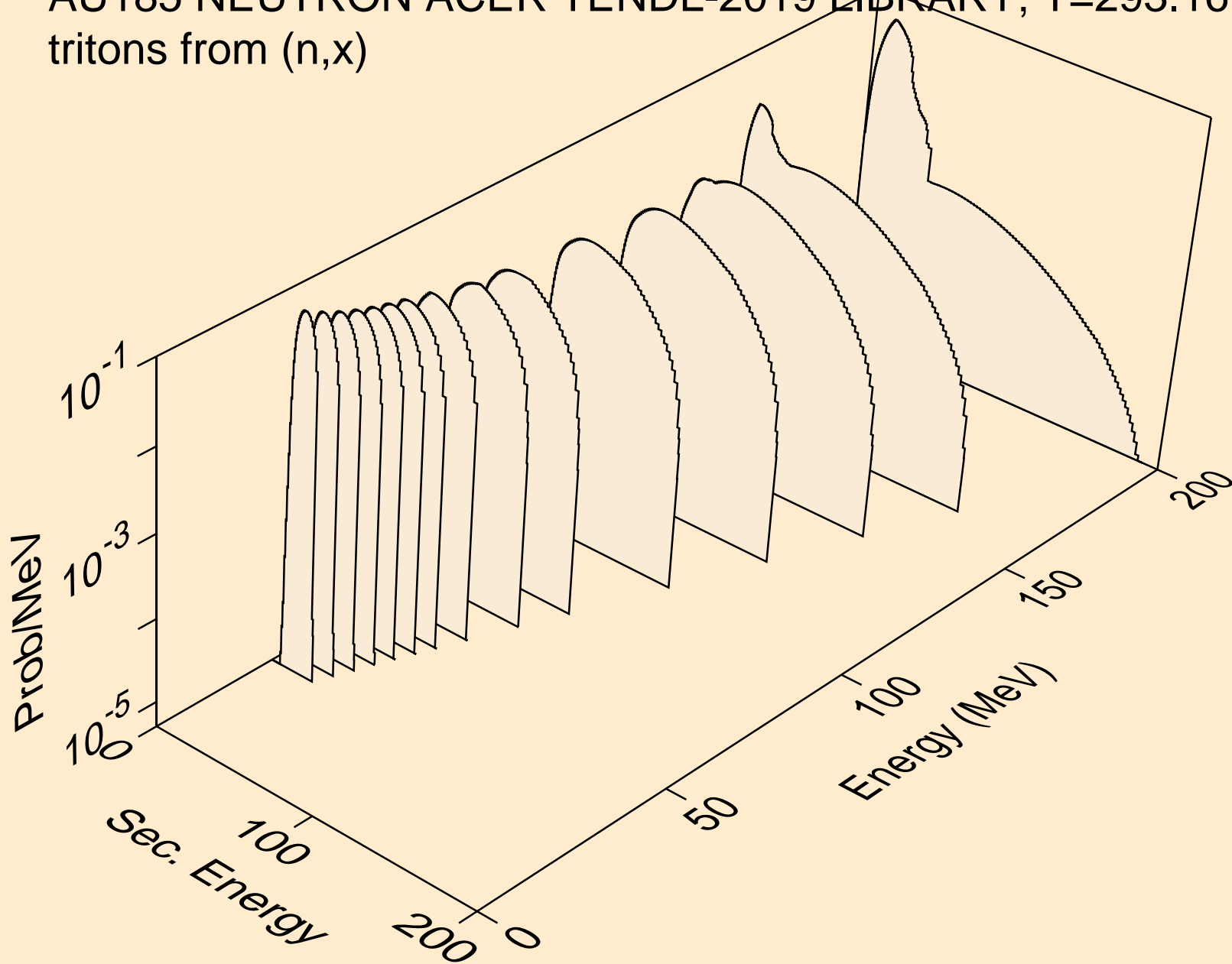

AU185 NEUTRON ACER TENDL-2019 LIBRARY; T=293.16K
tritons from (n,n*)t

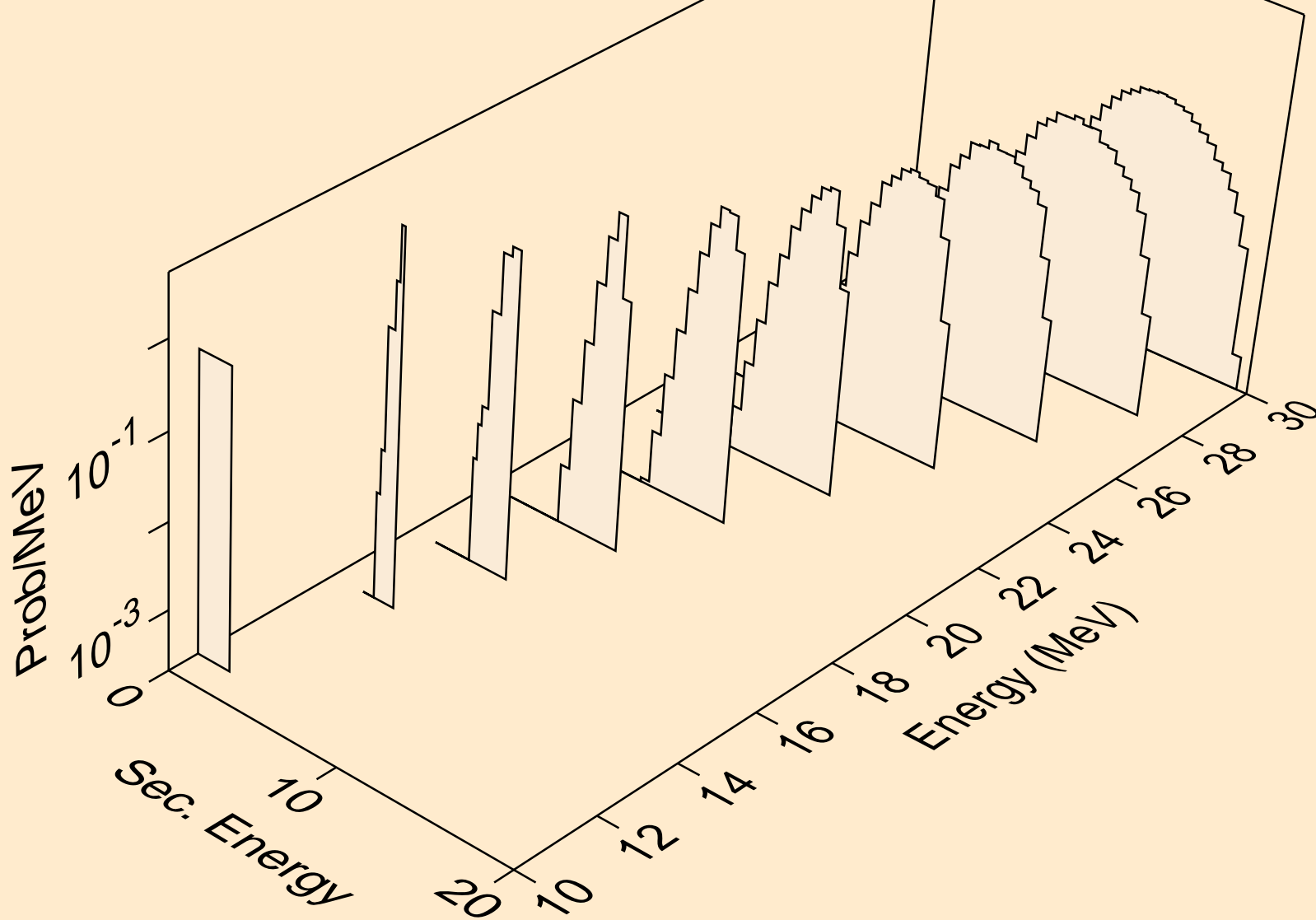

AU185 NEUTRON ACER TENDL-2019 LIBRARY; T=293.16K
tritons from (n,t)

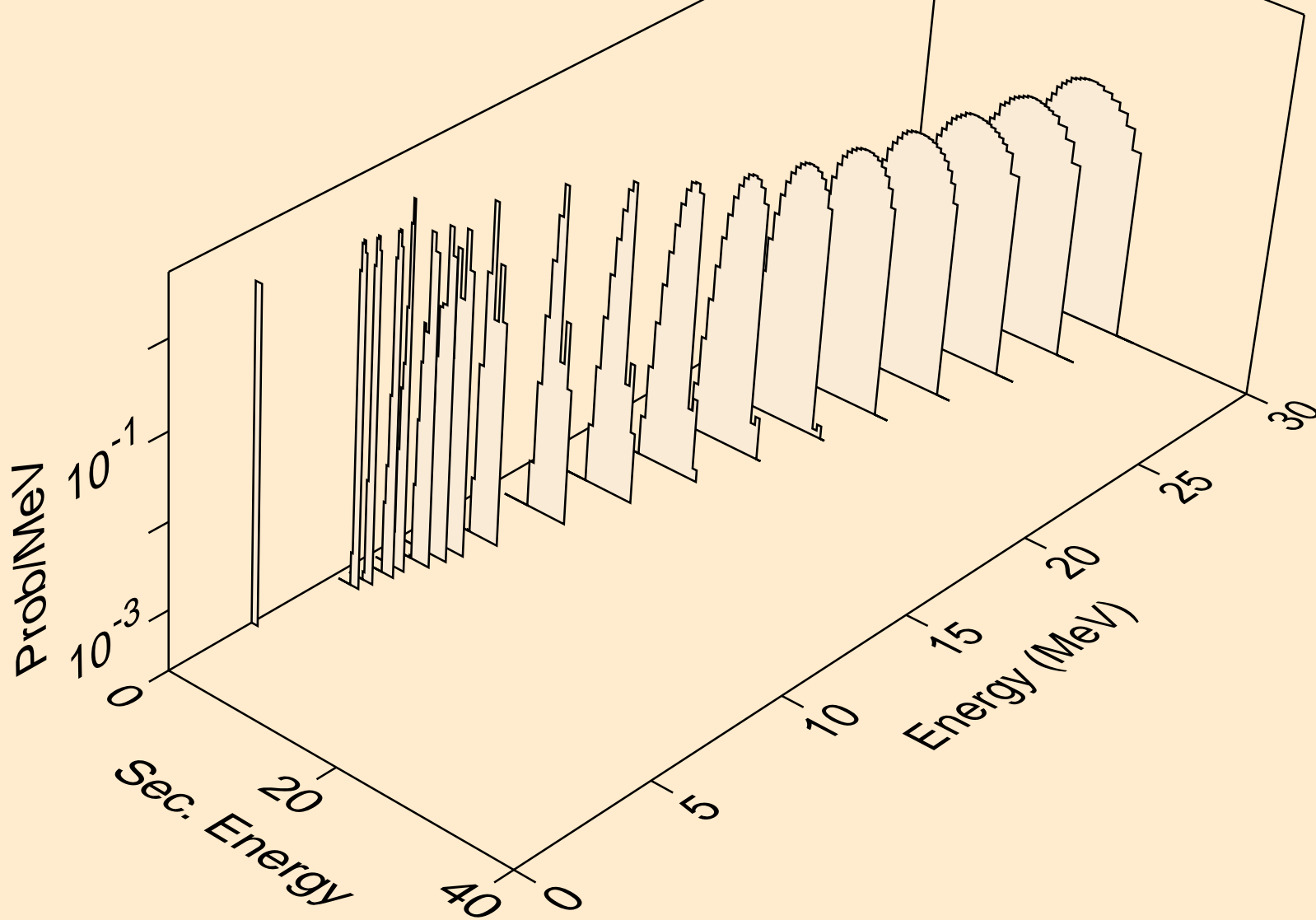

AU185 NEUTRON ACER TENDL-2019 LIBRARY; T=293.16K
tritons from (n,pt)

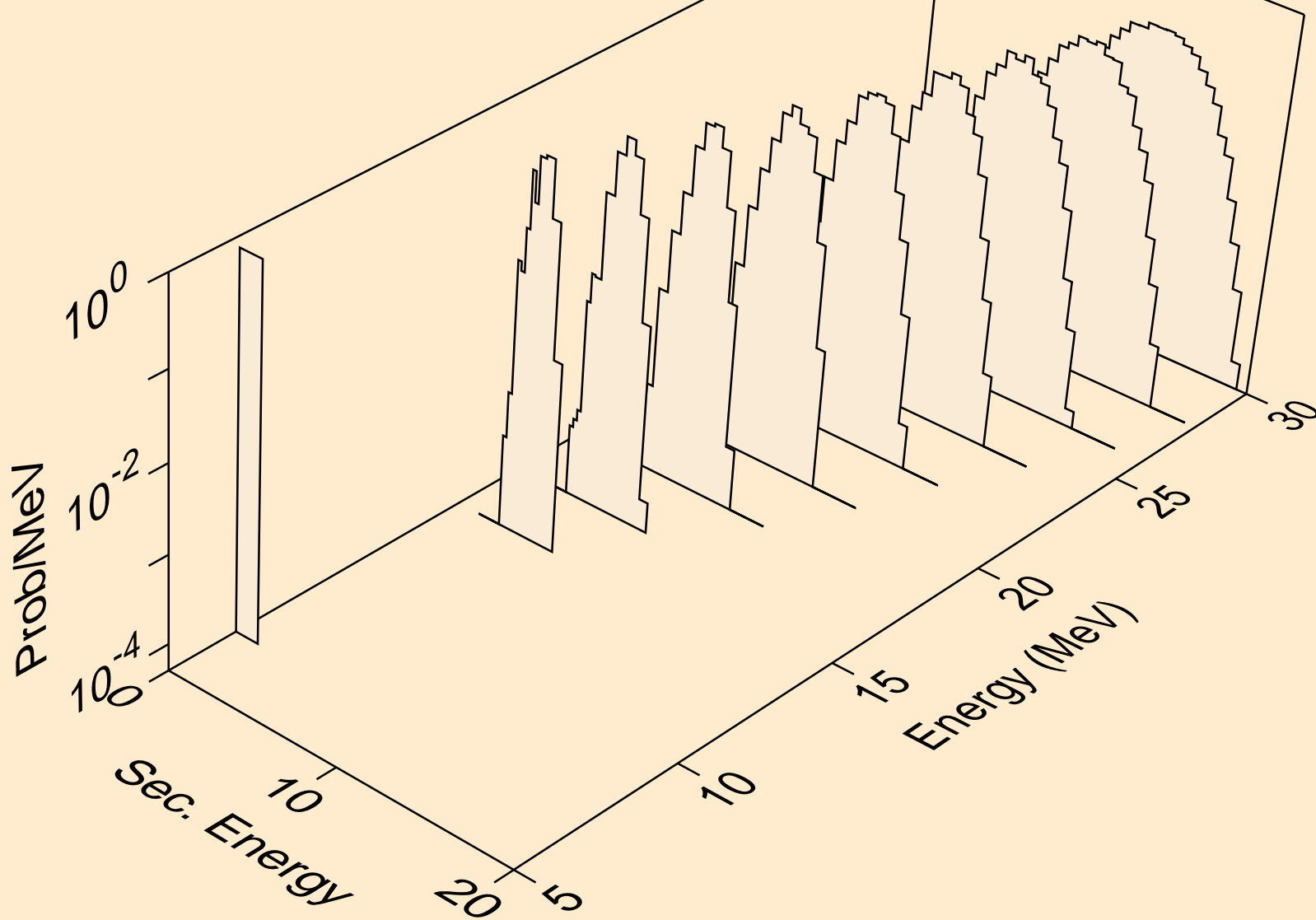

AU185 NEUTRON ACER TENDL-2019 LIBRARY; T=293.16K
he3s from (n,x)

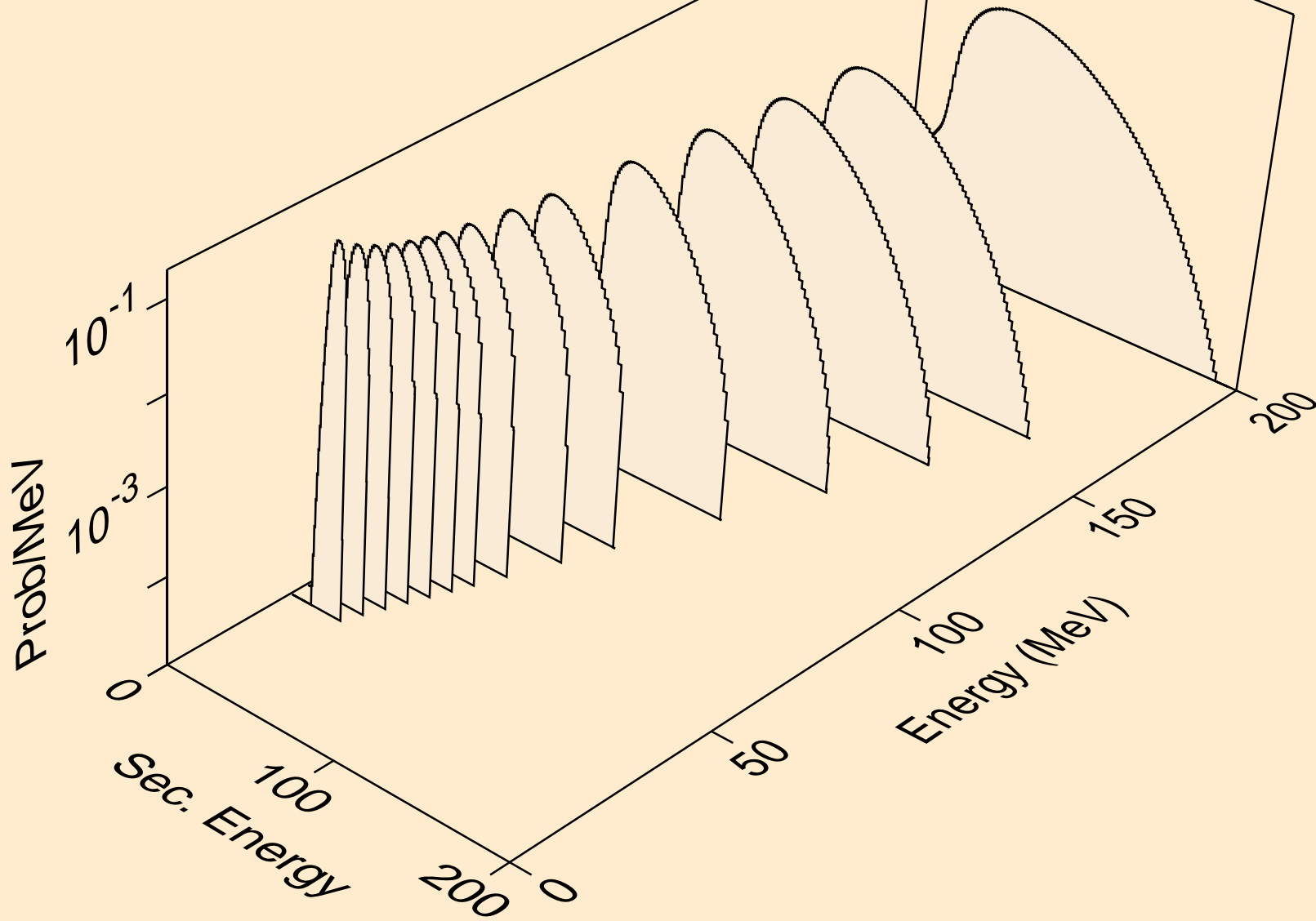

AU185 NEUTRON ACER TENDL-2019 LIBRARY; T=293.16K
he3s from (n,n*)he3

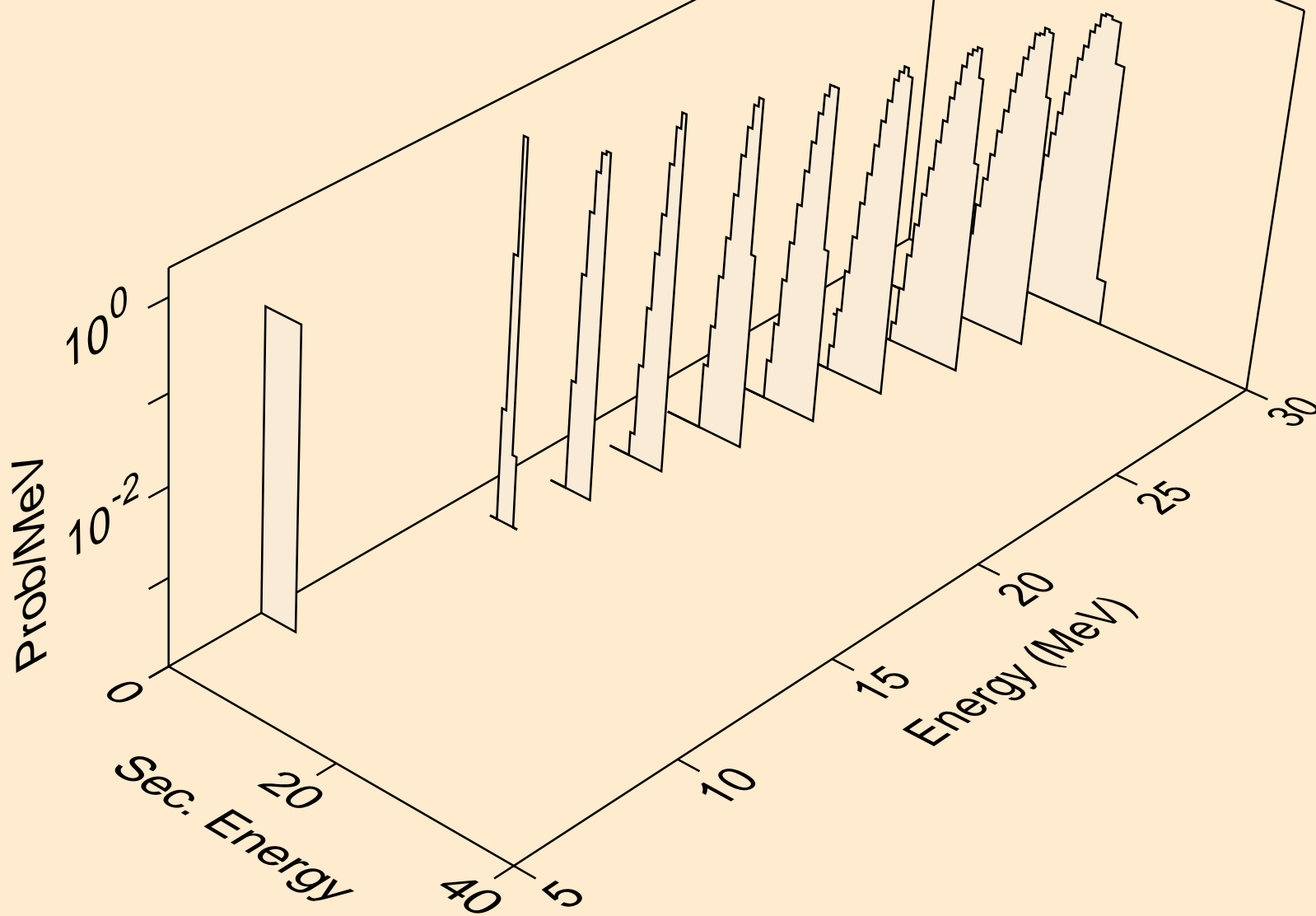

AU185 NEUTRON ACER TENDL-2019 LIBRARY; T=293.16K
he3s from (n,he3)

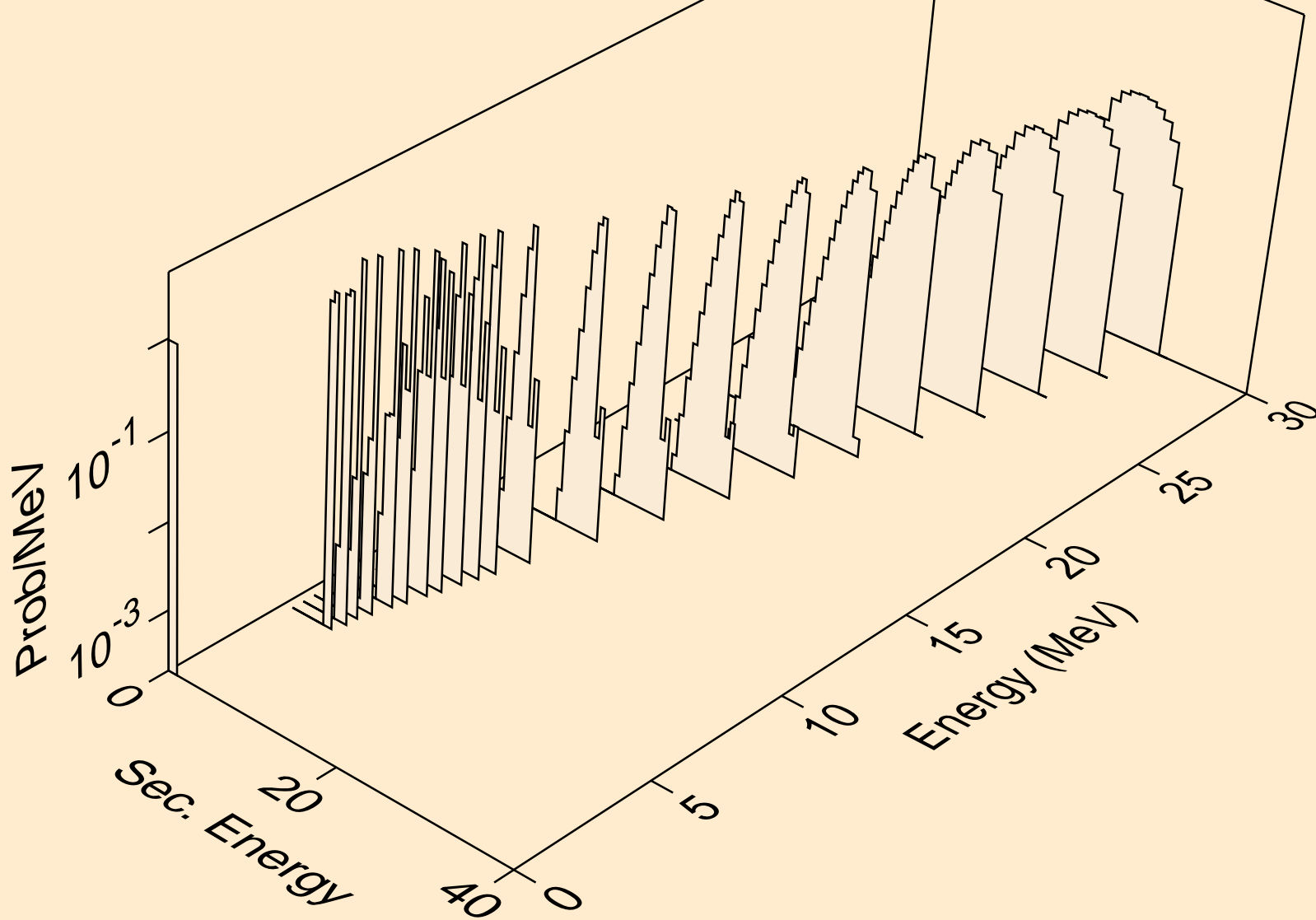

AU185 NEUTRON ACER TENDL-2019 LIBRARY; T=293.16K
alphas from (n,x)

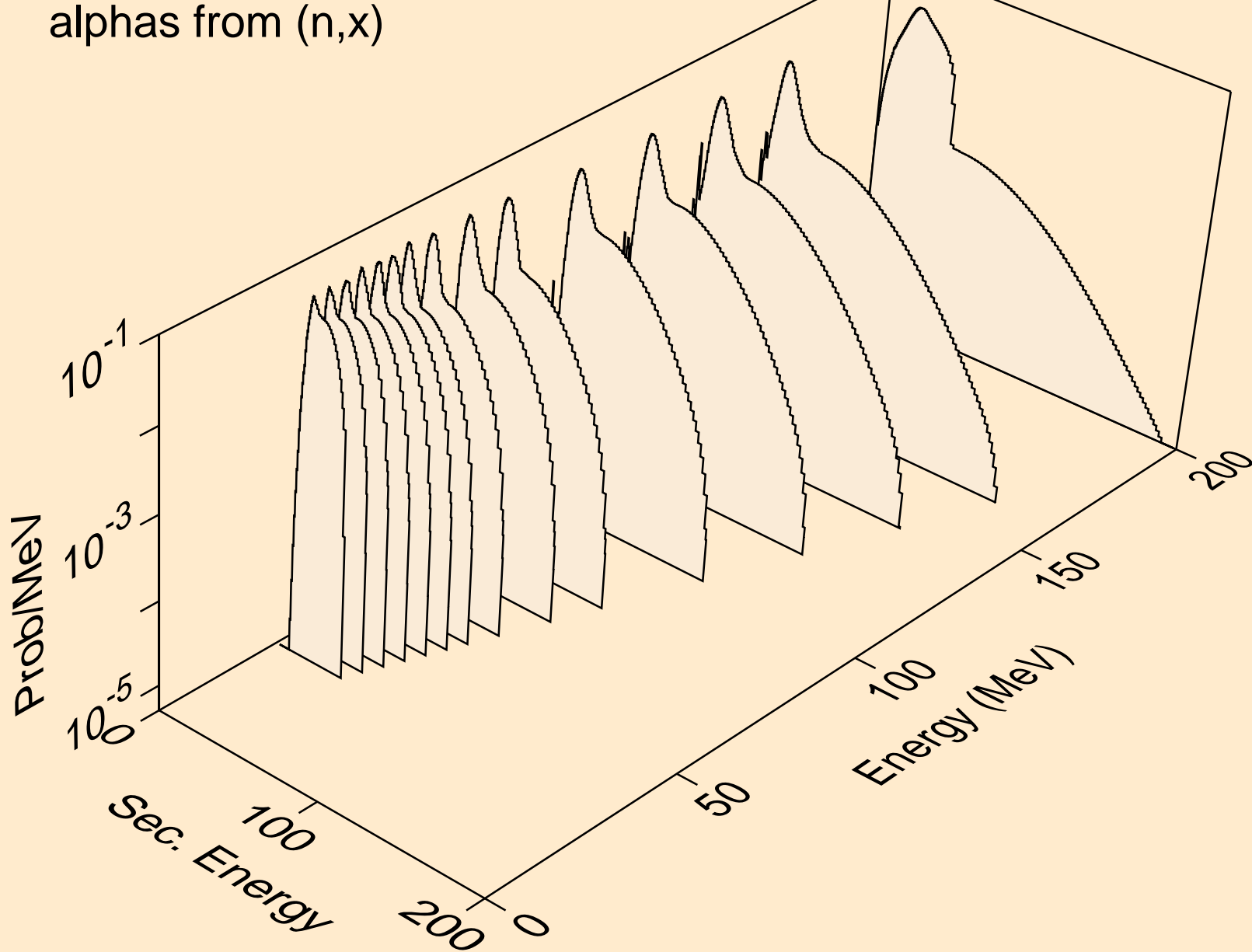

AU185 NEUTRON ACER TENDL-2019 LIBRARY; T=293.16K
alphas from (n,n*)a

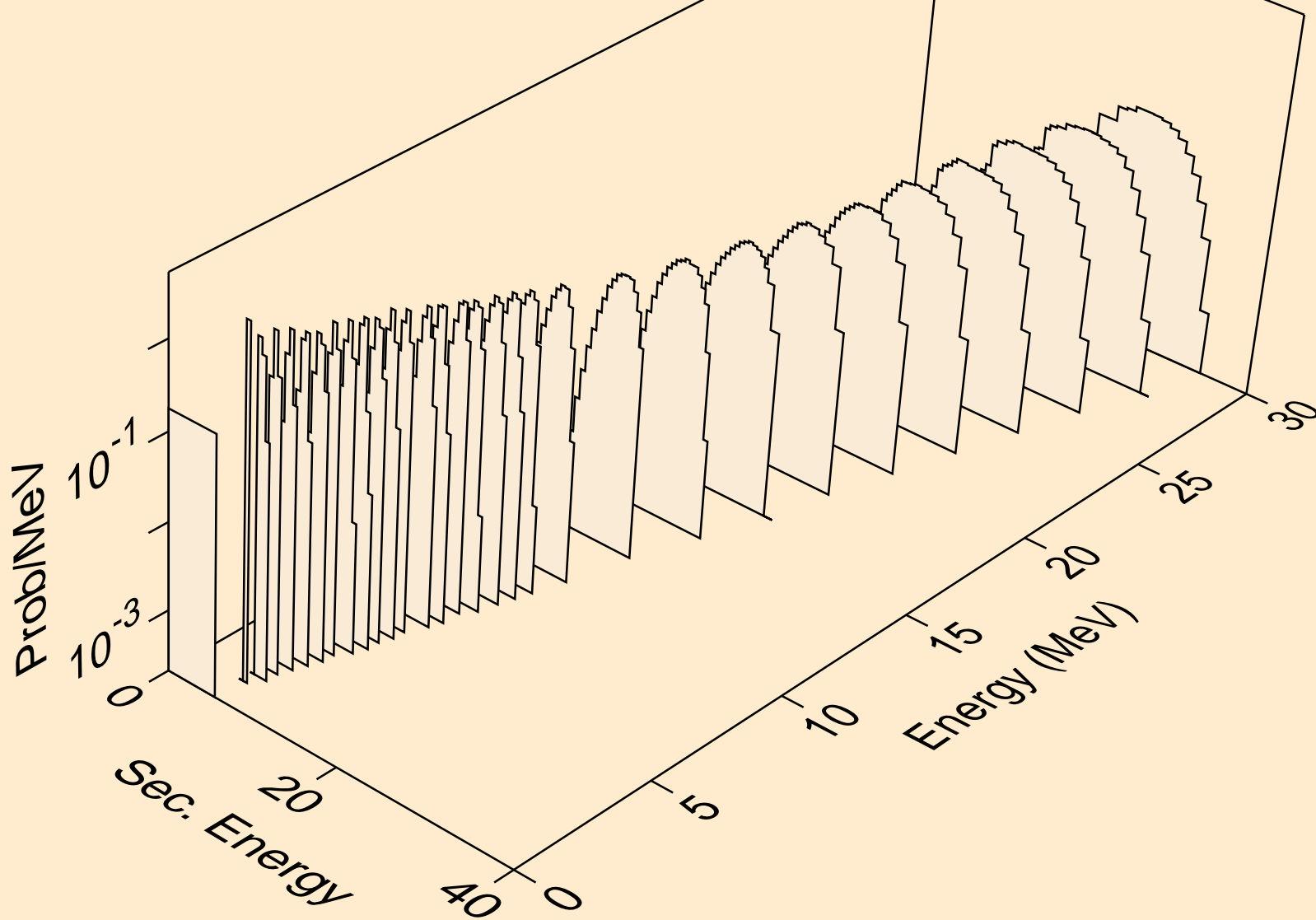

AU185 NEUTRON ACER TENDL-2019 LIBRARY; T=293.16K
alphas from (n,2n)a

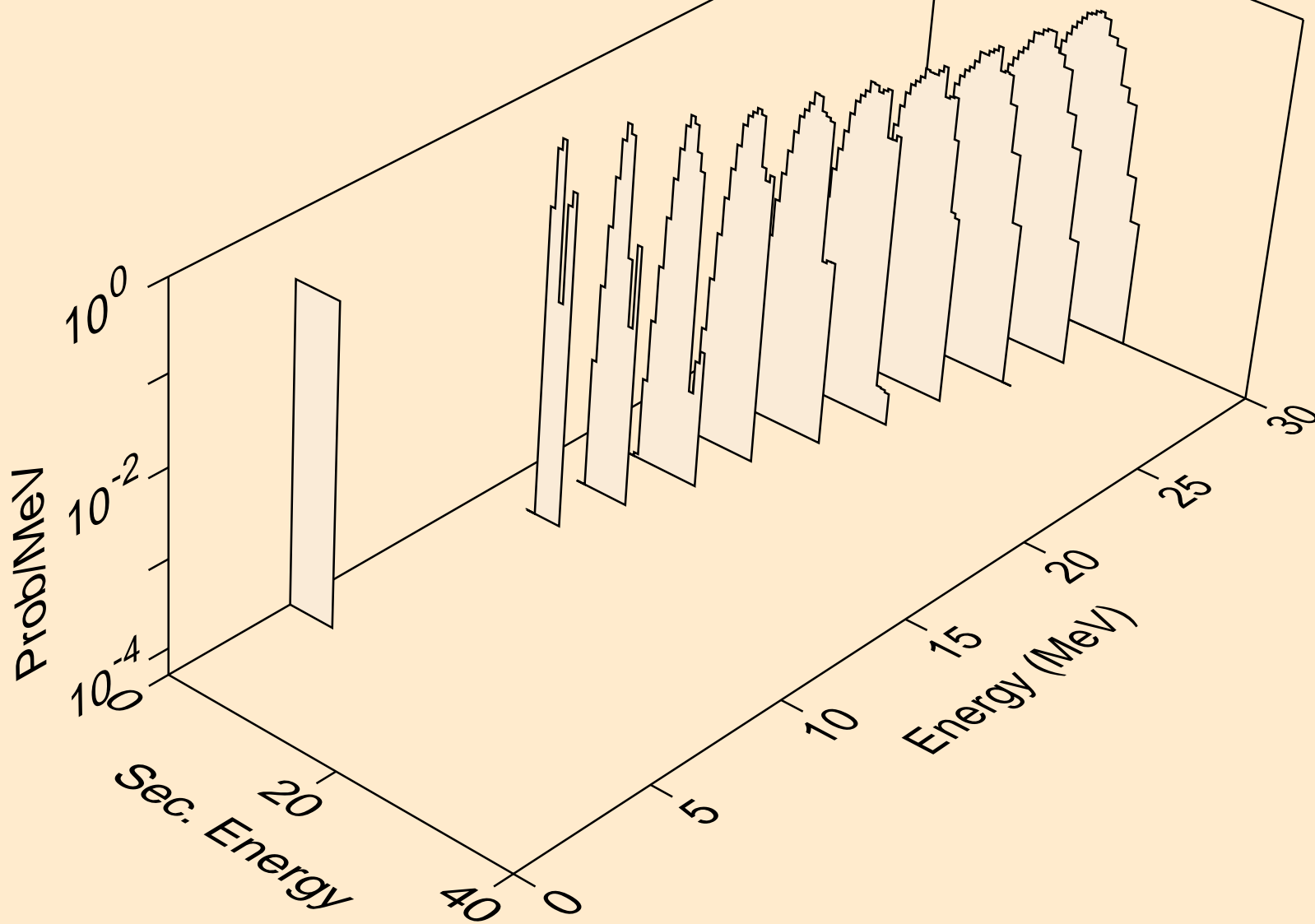

AU185 NEUTRON ACER TENDL-2019 LIBRARY; T=293.16K
alphas from (n,3n)a

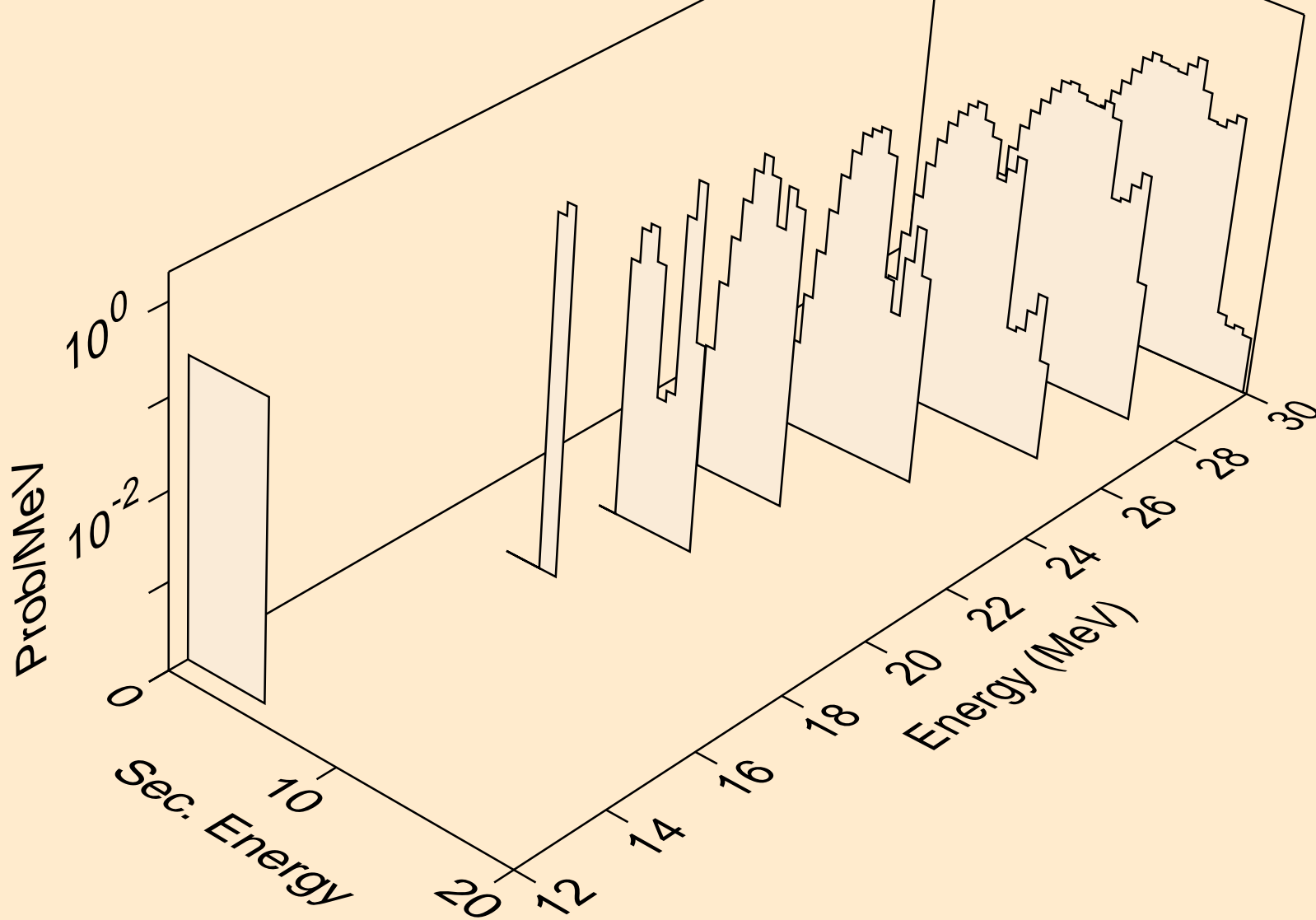

AU185 NEUTRON ACER TENDL-2019 LIBRARY; T=293.16K
alphas from (n,n*)2a

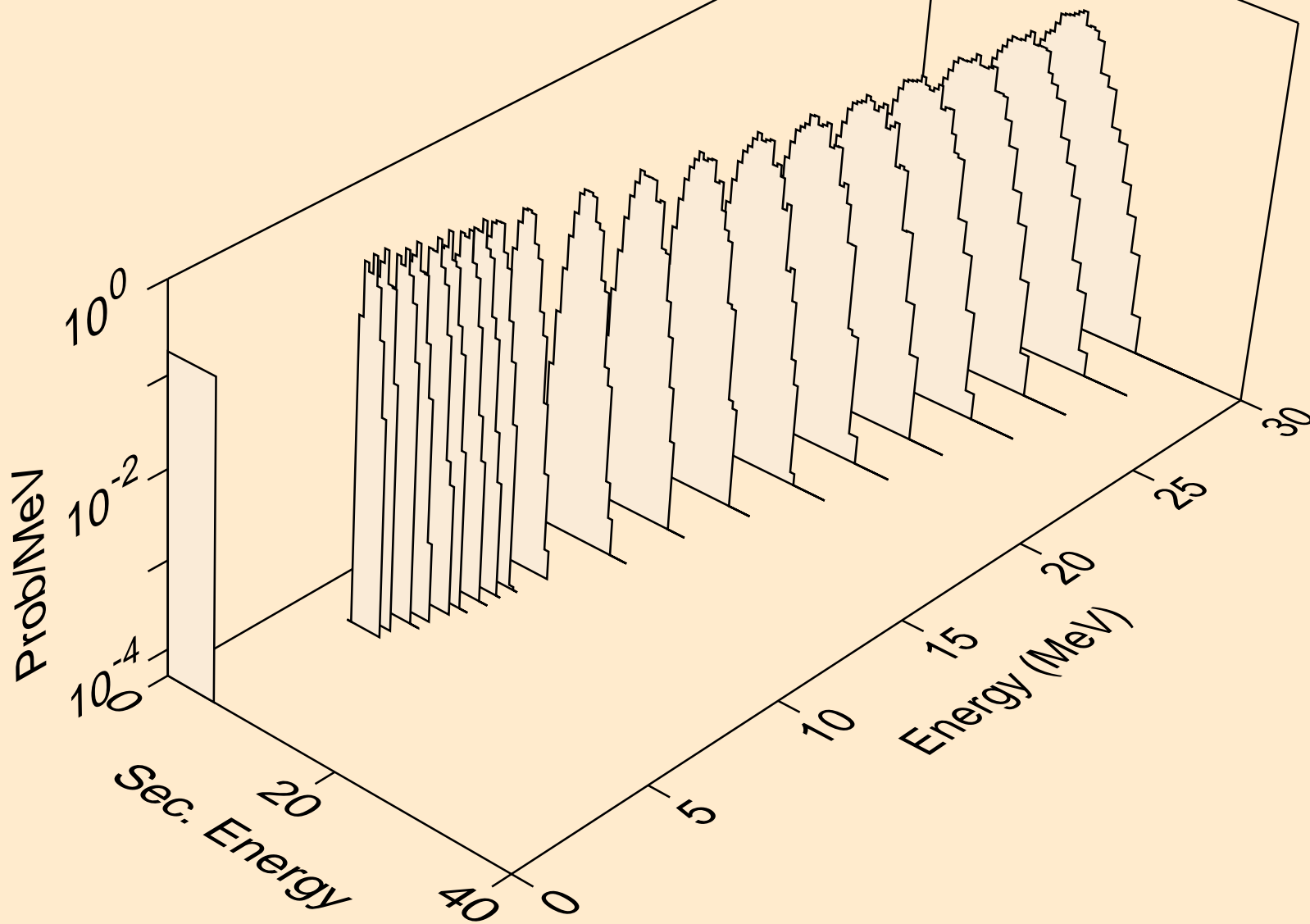

AU185 NEUTRON ACER TENDL-2019 LIBRARY; T=293.16K
alphas from (n,2n)2a

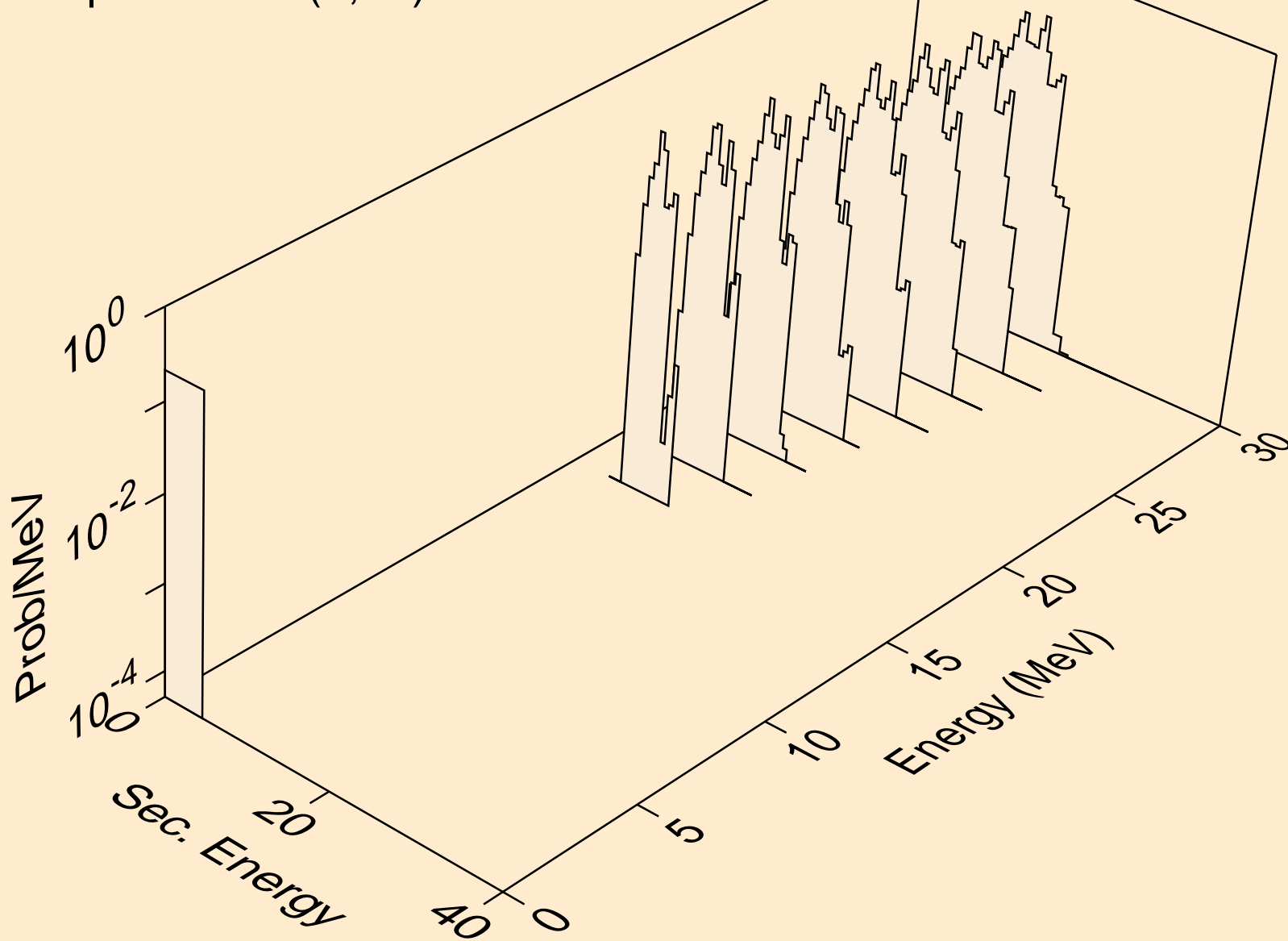

AU185 NEUTRON ACER TENDL-2019 LIBRARY; T=293.16K
alphas from (n,npa)

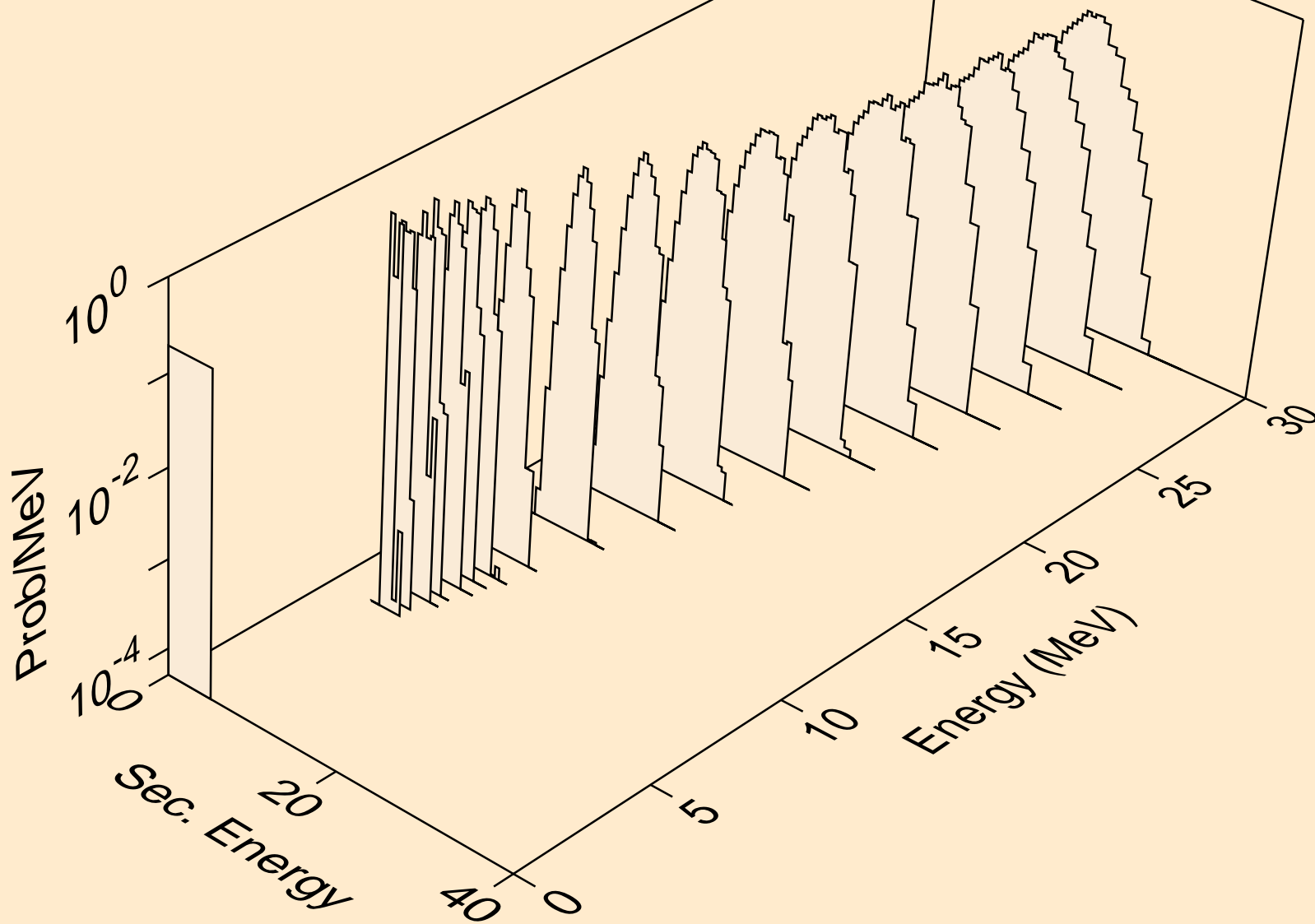

AU185 NEUTRON ACER TENDL-2019 LIBRARY; T=293.16K
alphas from (n,a)

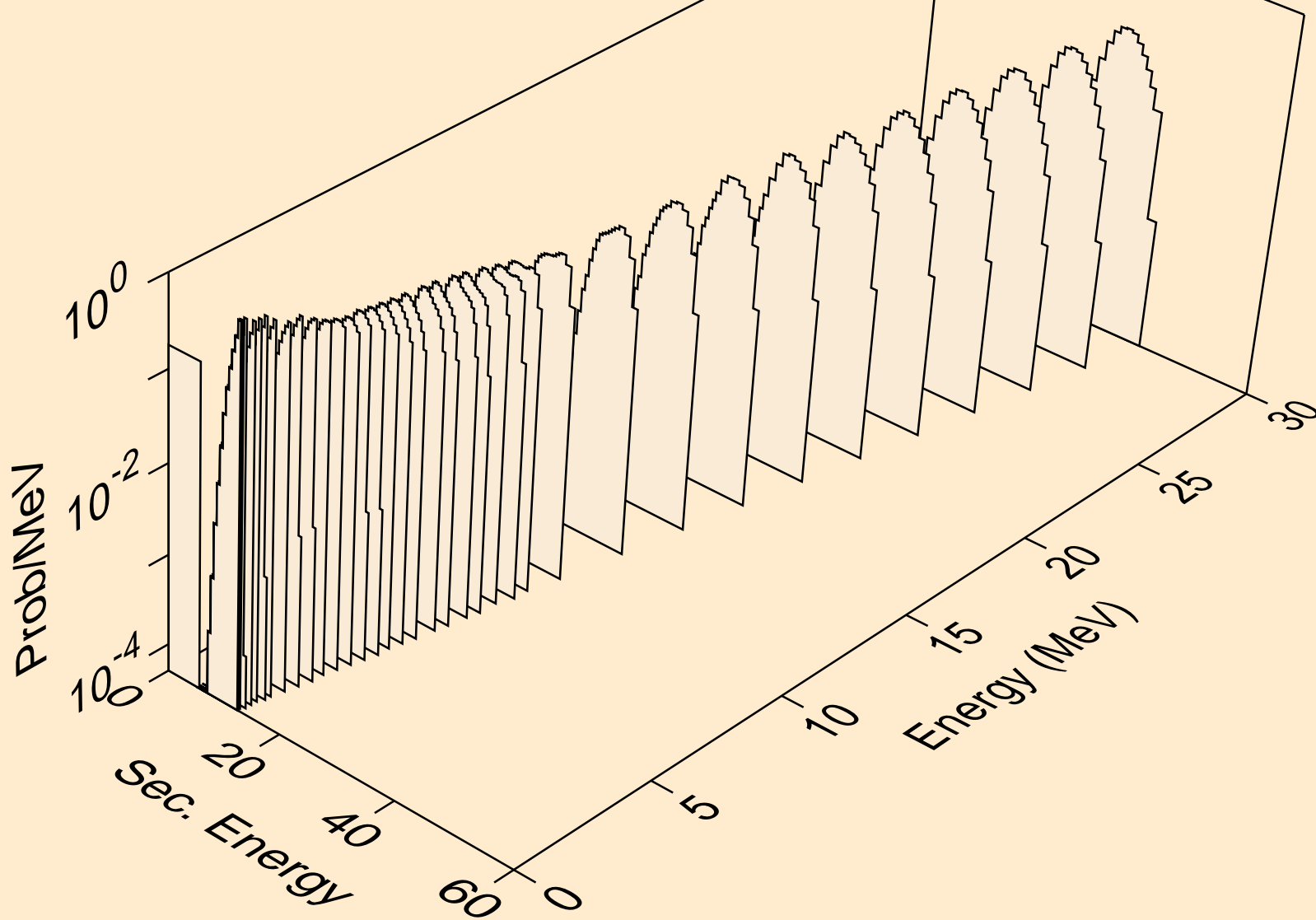

AU185 NEUTRON ACER TENDL-2019 LIBRARY; T=293.16K
alphas from (n,2a)

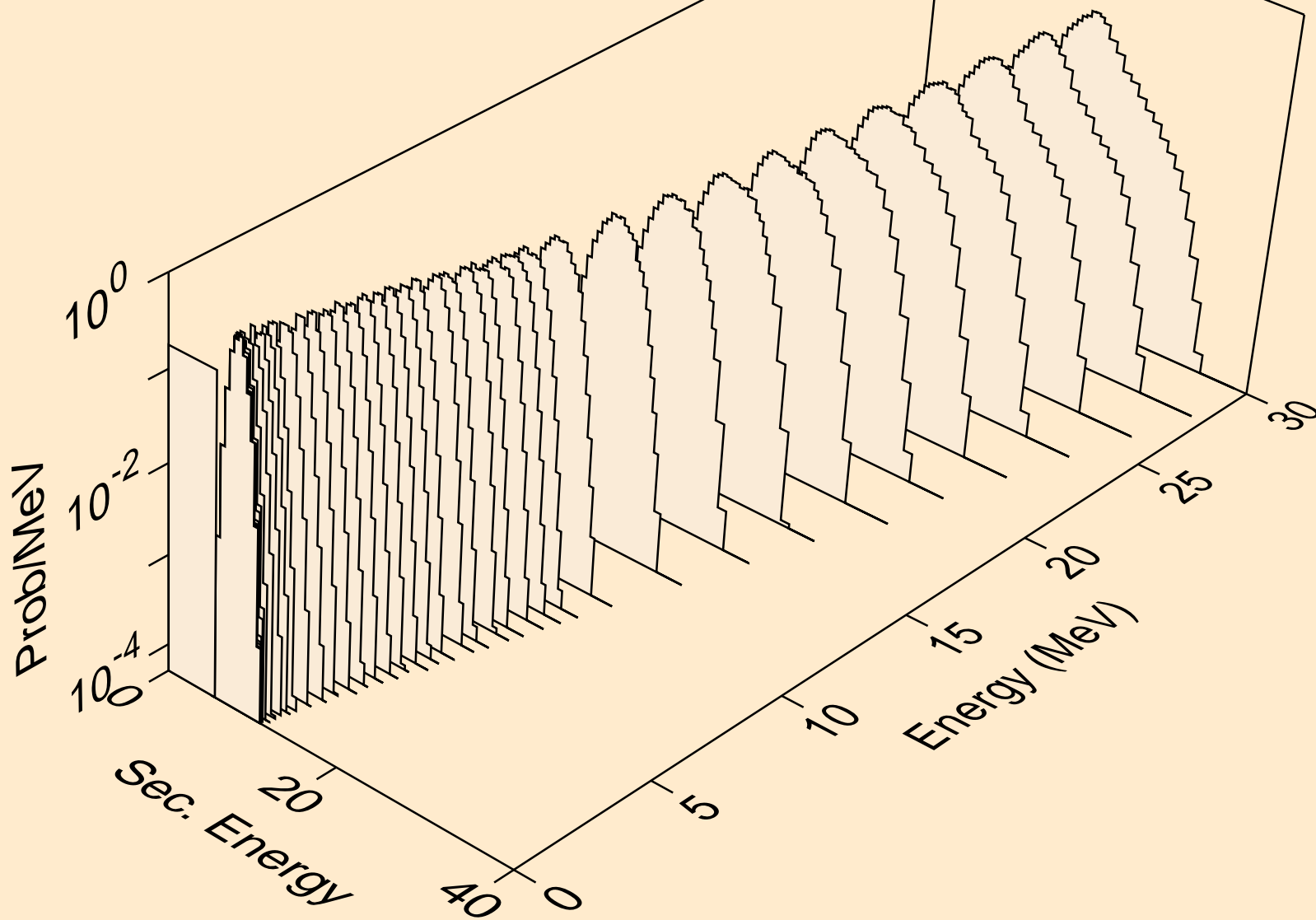

AU185 NEUTRON ACER TENDL-2019 LIBRARY; T=293.16K
alphas from (n,pa)

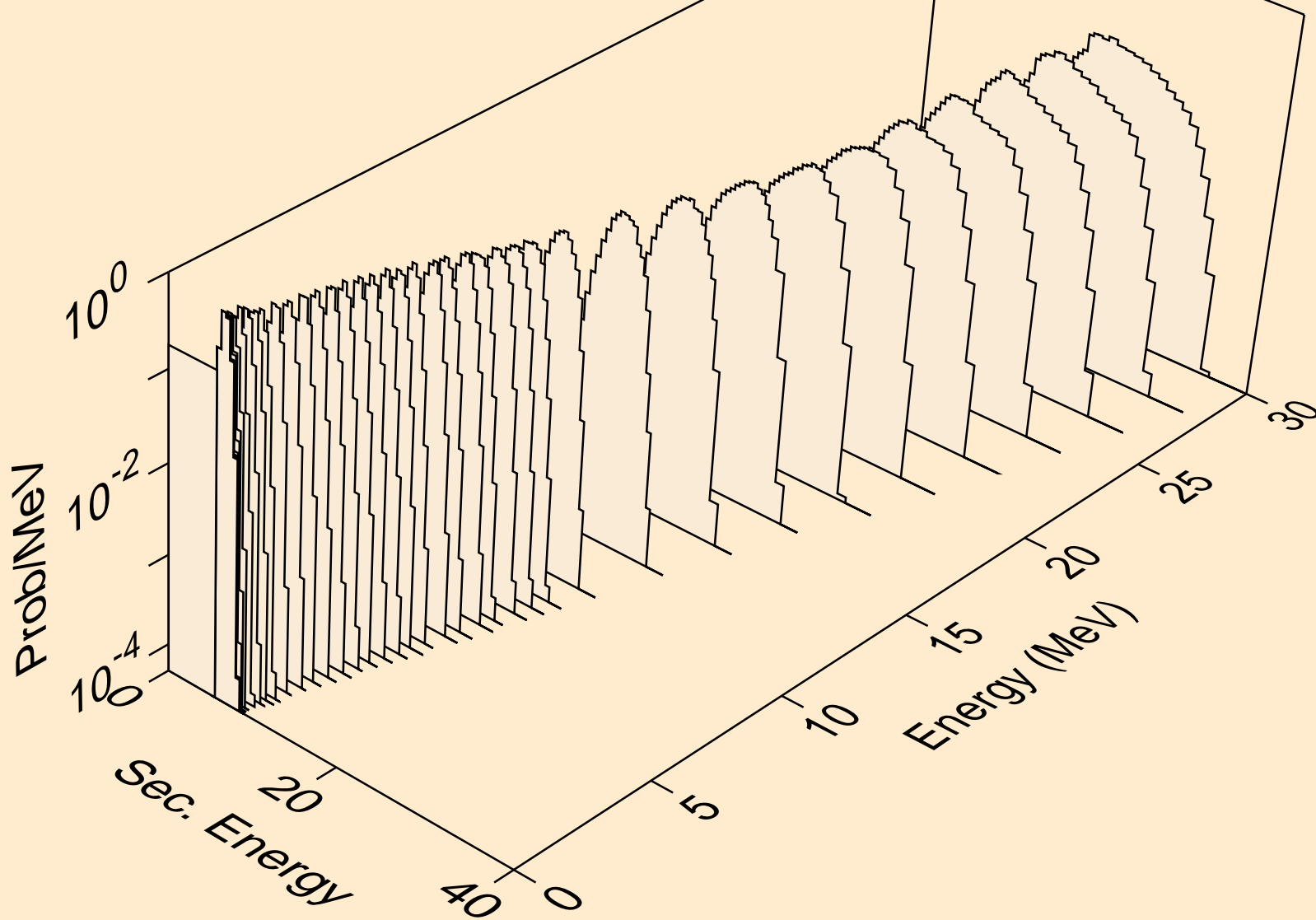

AU185 NEUTRON ACER TENDL-2019 LIBRARY; T=293.16K
alphas from (n,da)

