

AU196 NEUTRON ACER TENDL-2019 LIBRARY; T=293.16K  
Principal cross sections

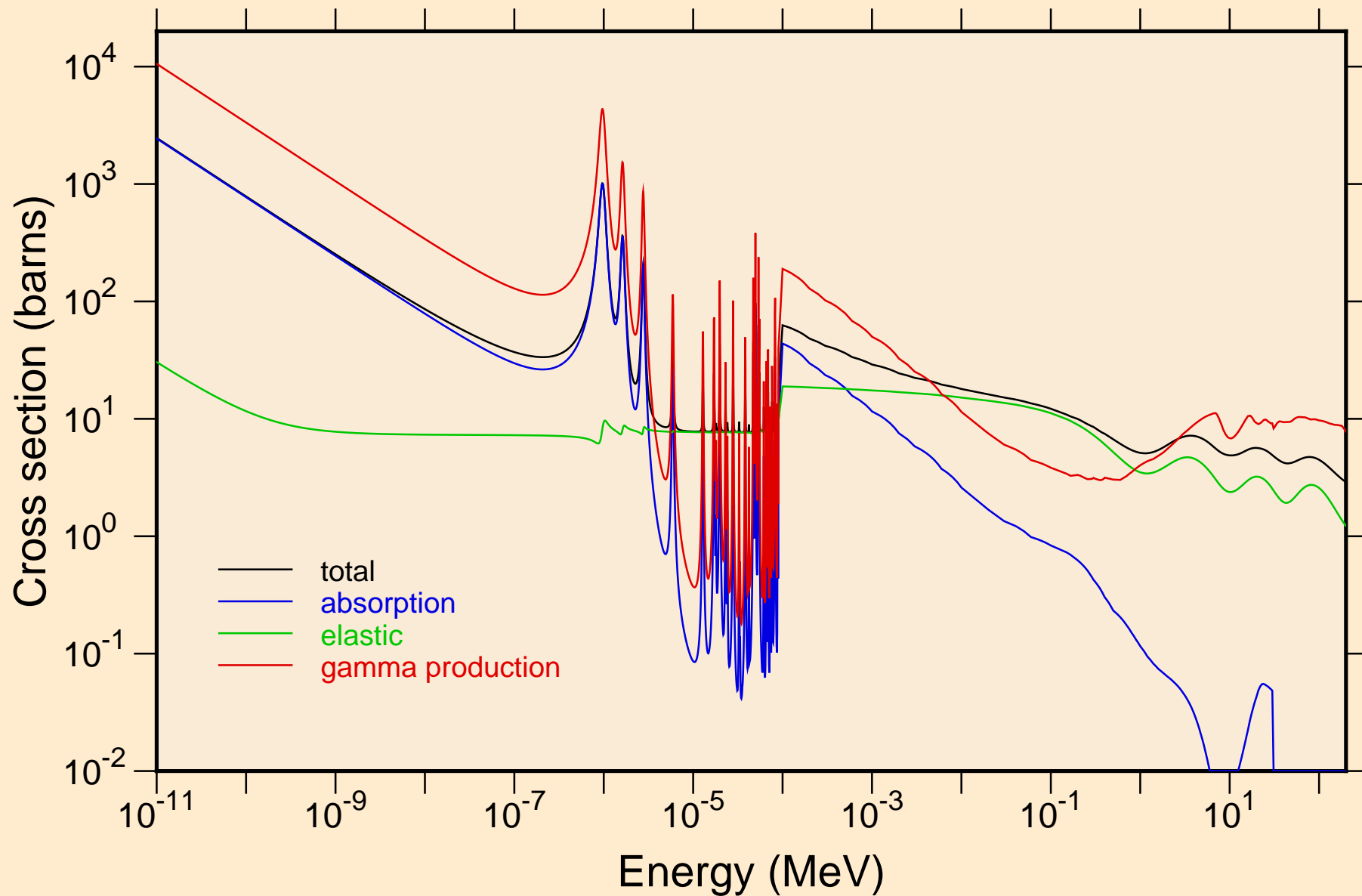

AU196 NEUTRON ACER TENDL-2019 LIBRARY; T=293.16K  
resonance total cross section

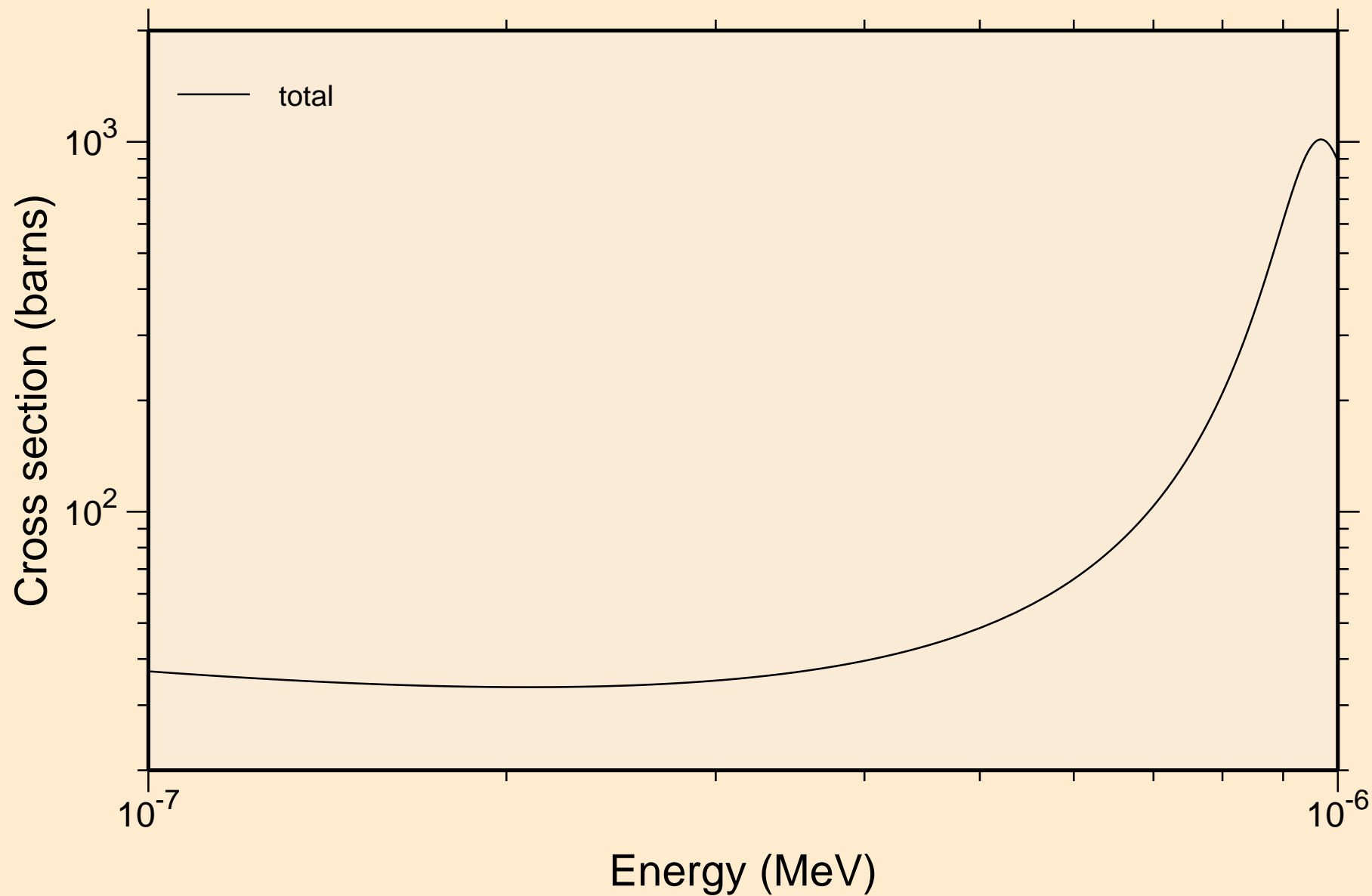

AU196 NEUTRON ACER TENDL-2019 LIBRARY; T=293.16K  
resonance total cross section

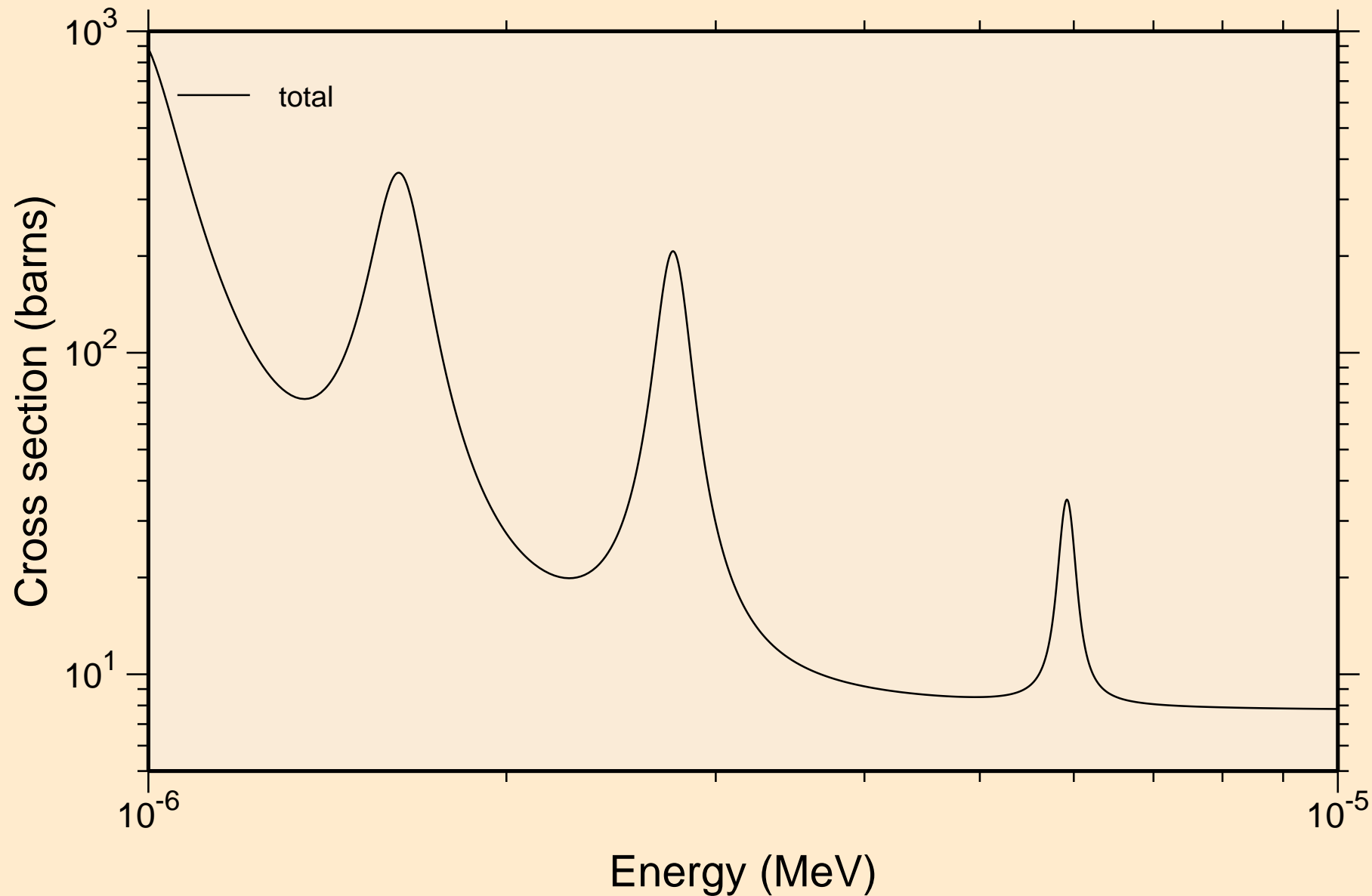

AU196 NEUTRON ACER TENDL-2019 LIBRARY; T=293.16K  
resonance total cross section

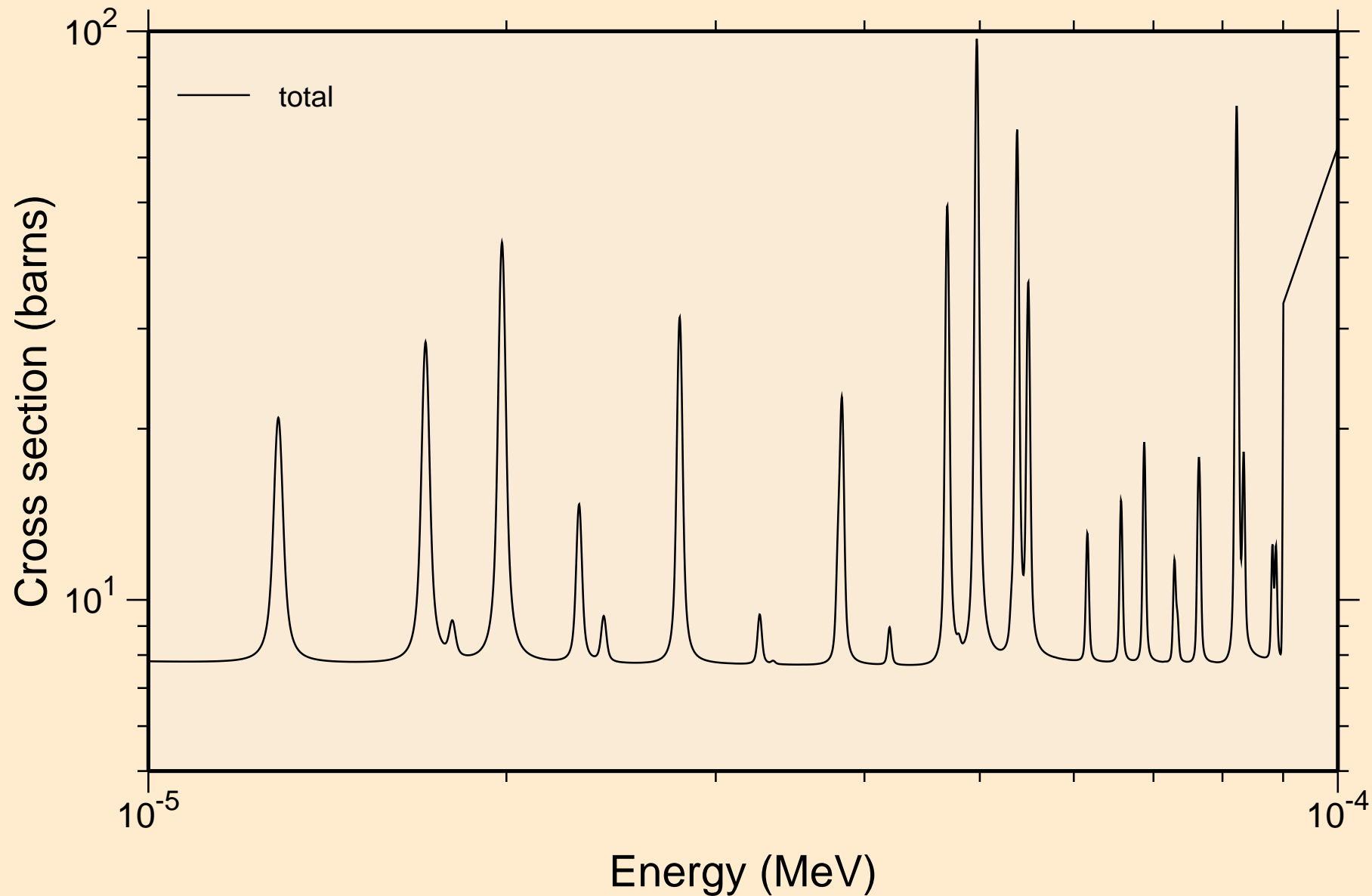

AU196 NEUTRON ACER TENDL-2019 LIBRARY; T=293.16K  
resonance total cross section

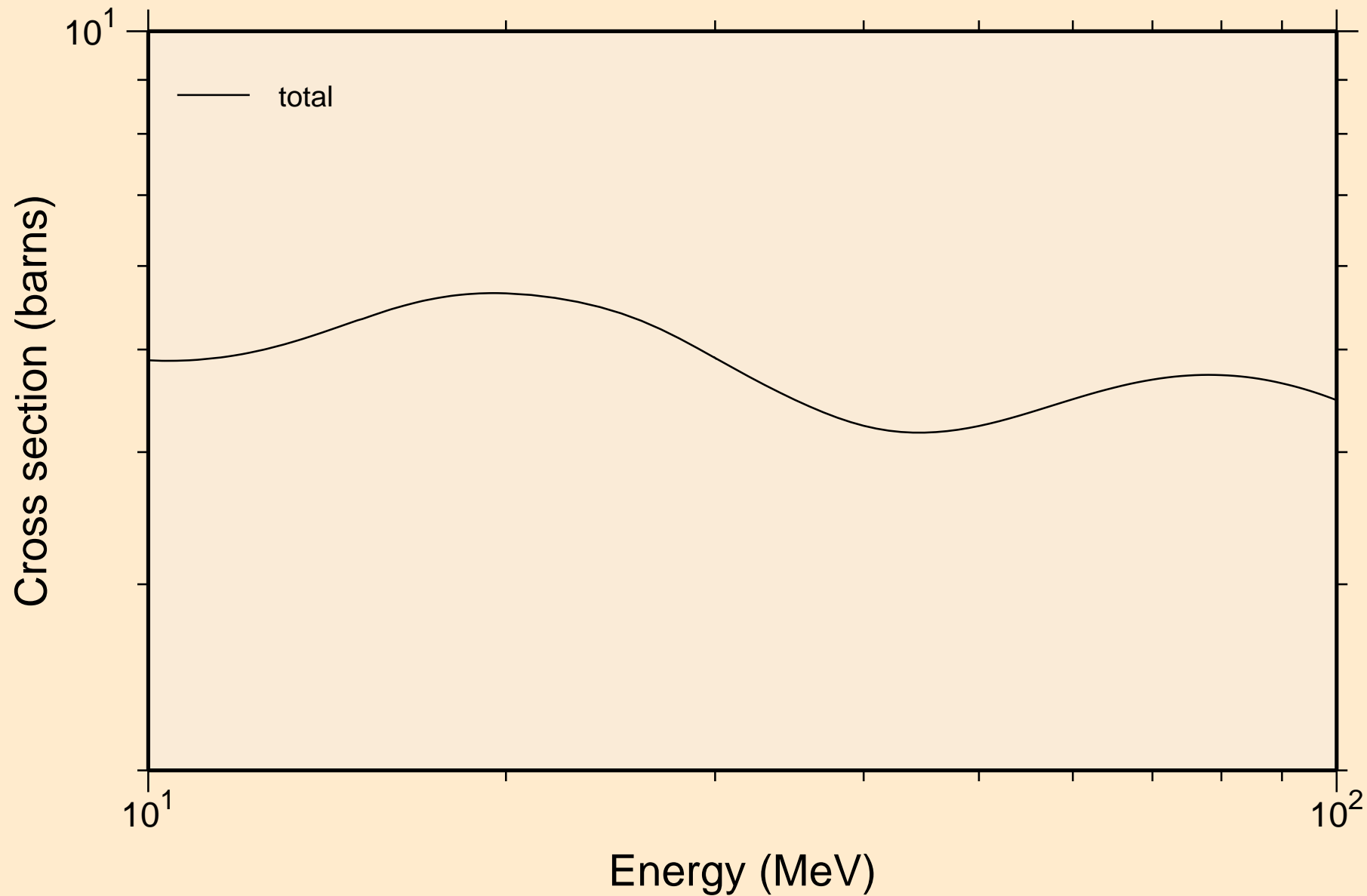

AU196 NEUTRON ACER TENDL-2019 LIBRARY; T=293.16K  
resonance absorption cross sections

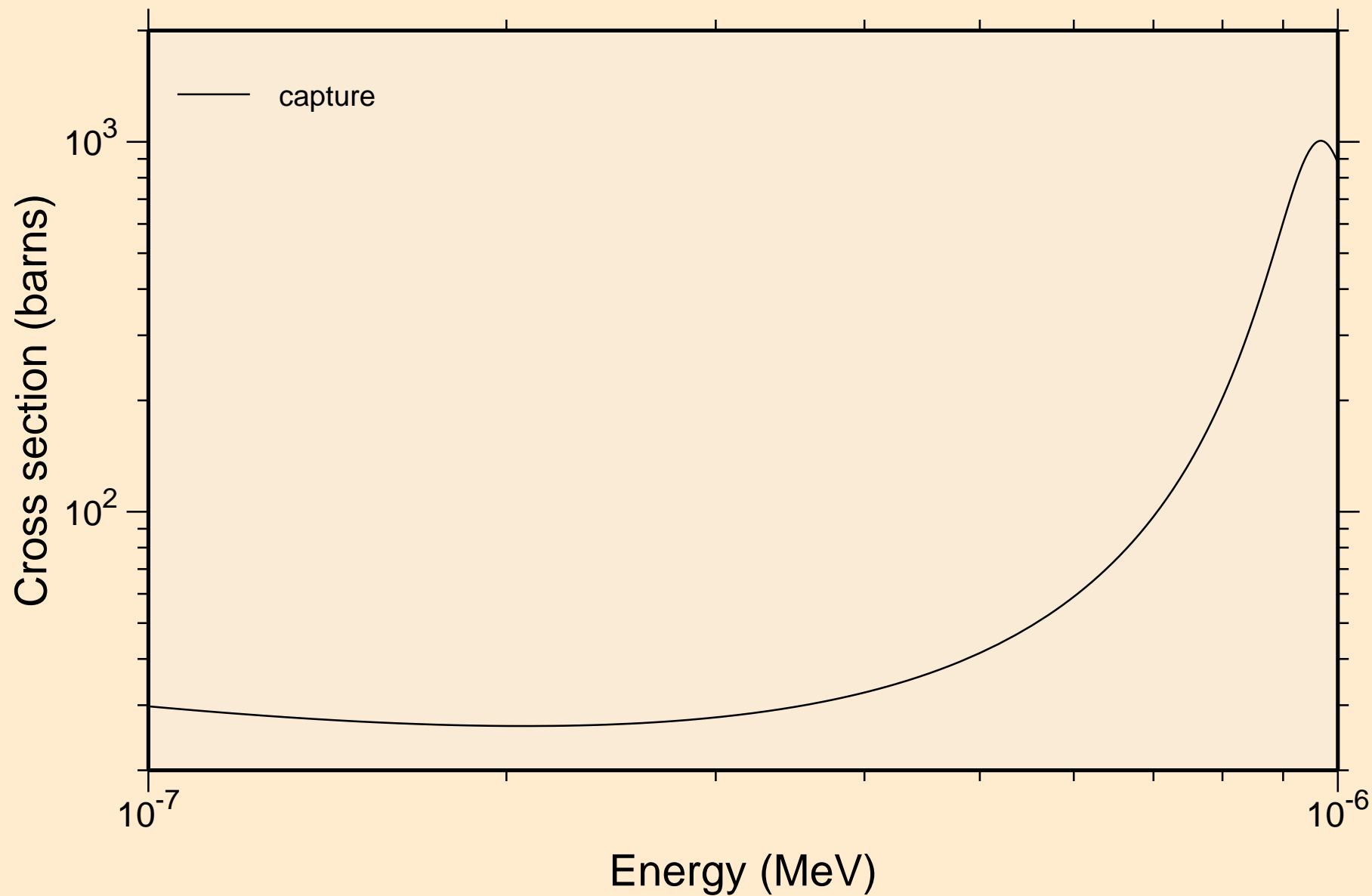

AU196 NEUTRON ACER TENDL-2019 LIBRARY; T=293.16K  
resonance absorption cross sections

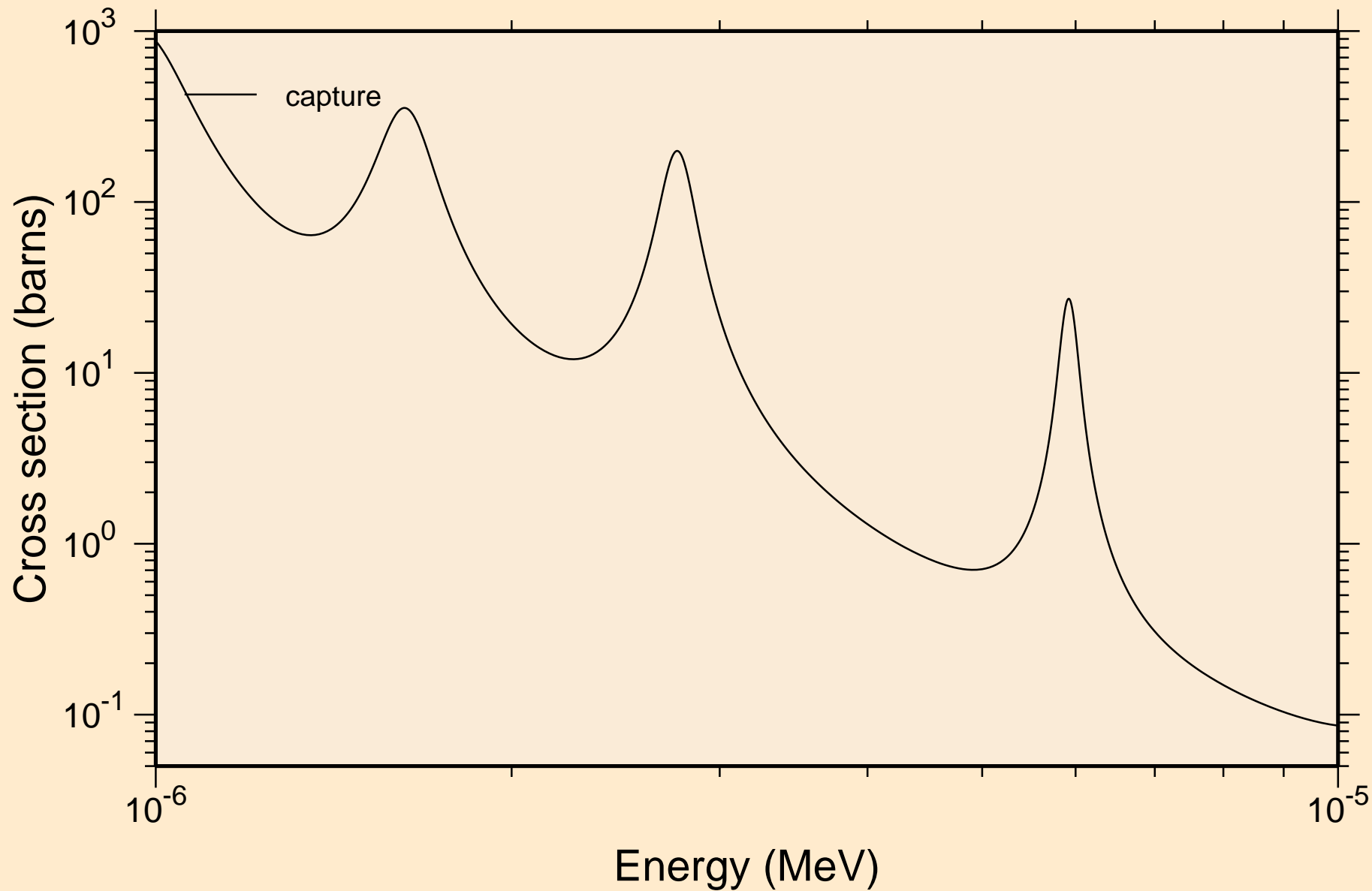

AU196 NEUTRON ACER TENDL-2019 LIBRARY; T=293.16K  
resonance absorption cross sections

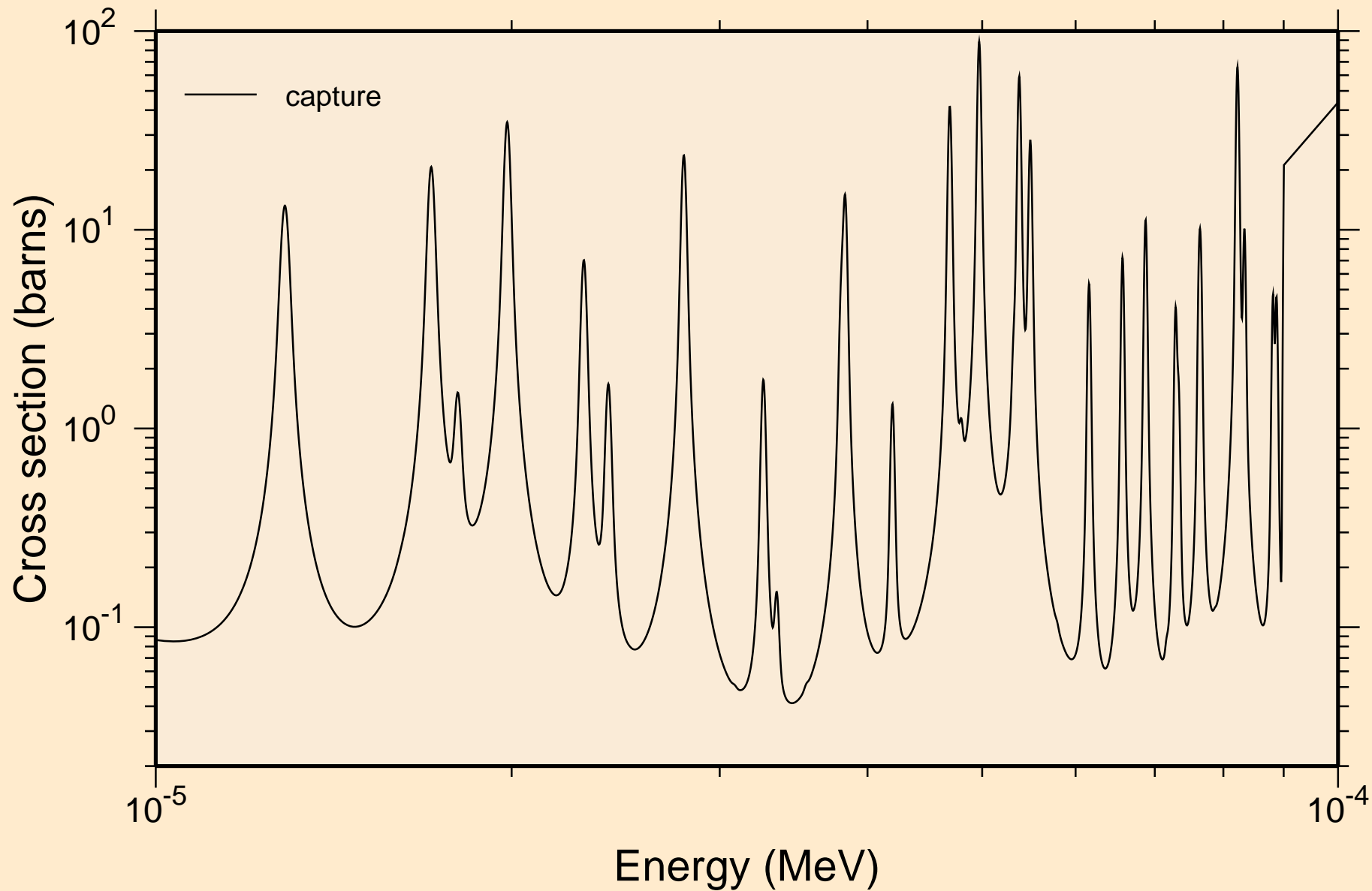



AU196 NEUTRON ACER TENDL-2019 LIBRARY; T=293.16K  
resonance absorption cross sections

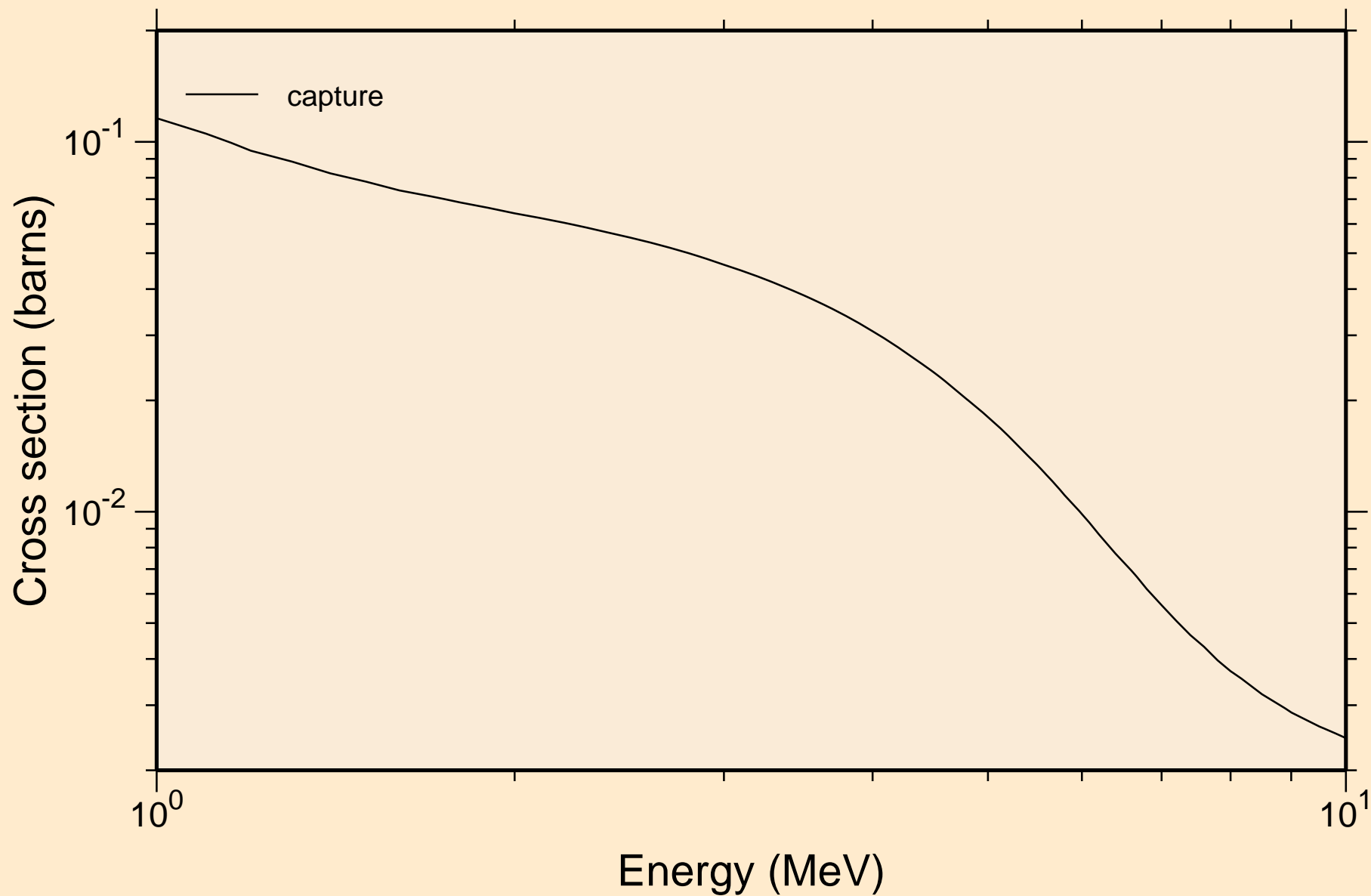

AU196 NEUTRON ACER TENDL-2019 LIBRARY; T=293.16K  
Heating

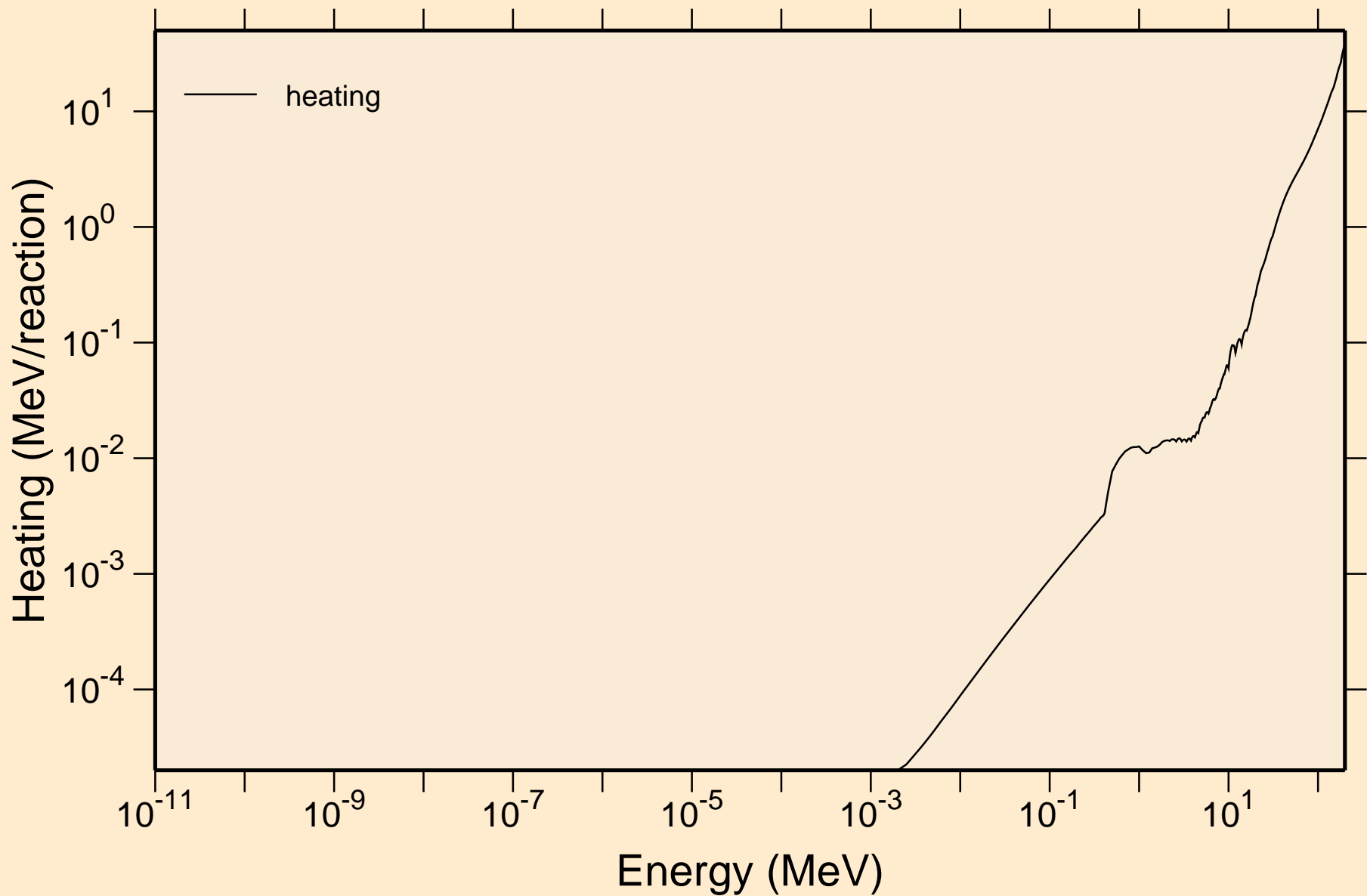

# AU196 NEUTRON ACER TENDL-2019 LIBRARY; T=293.16K

## Damage

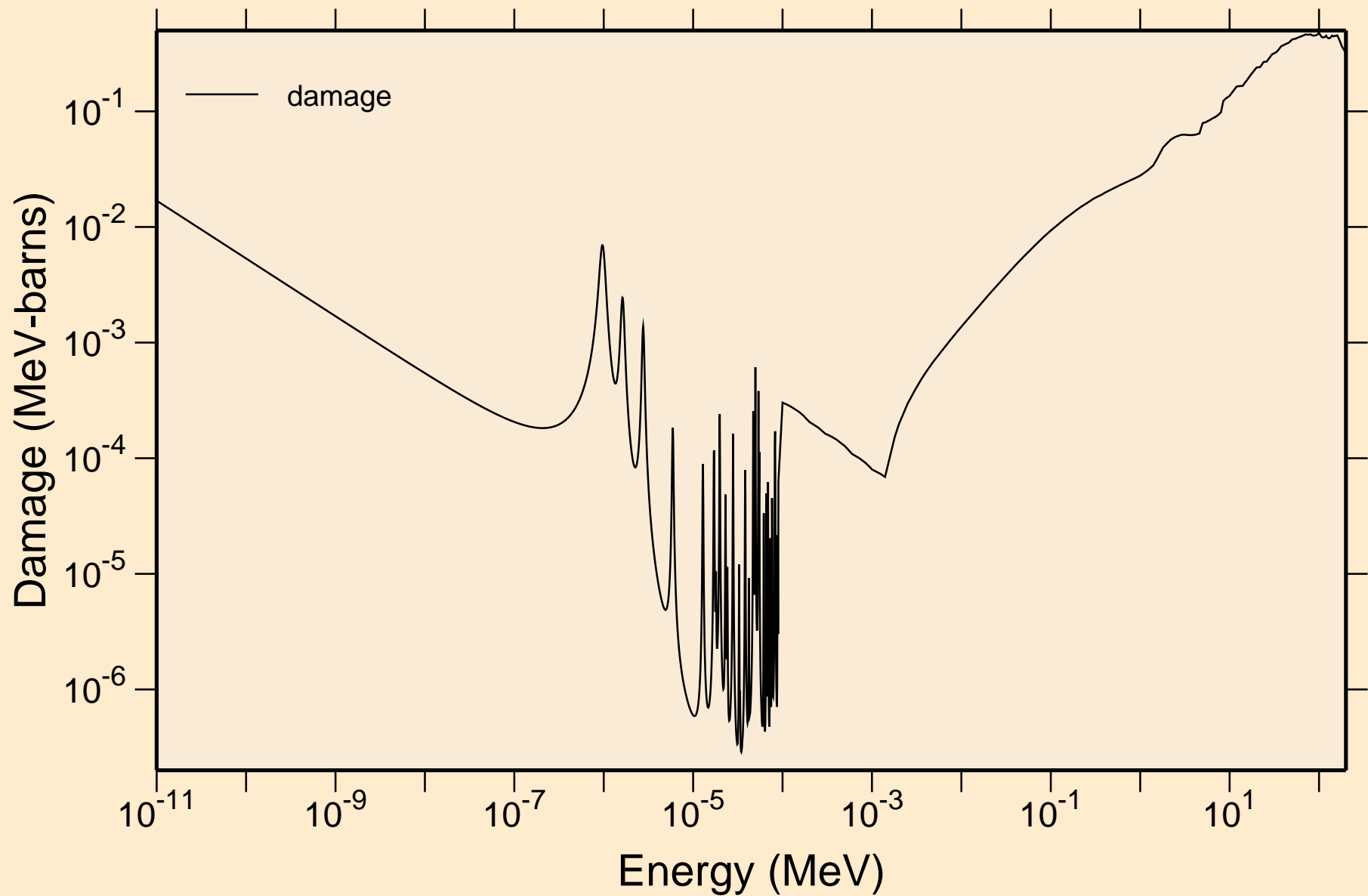

AU196 NEUTRON ACER TENDL-2019 LIBRARY; T=293.16K  
Non-threshold reactions

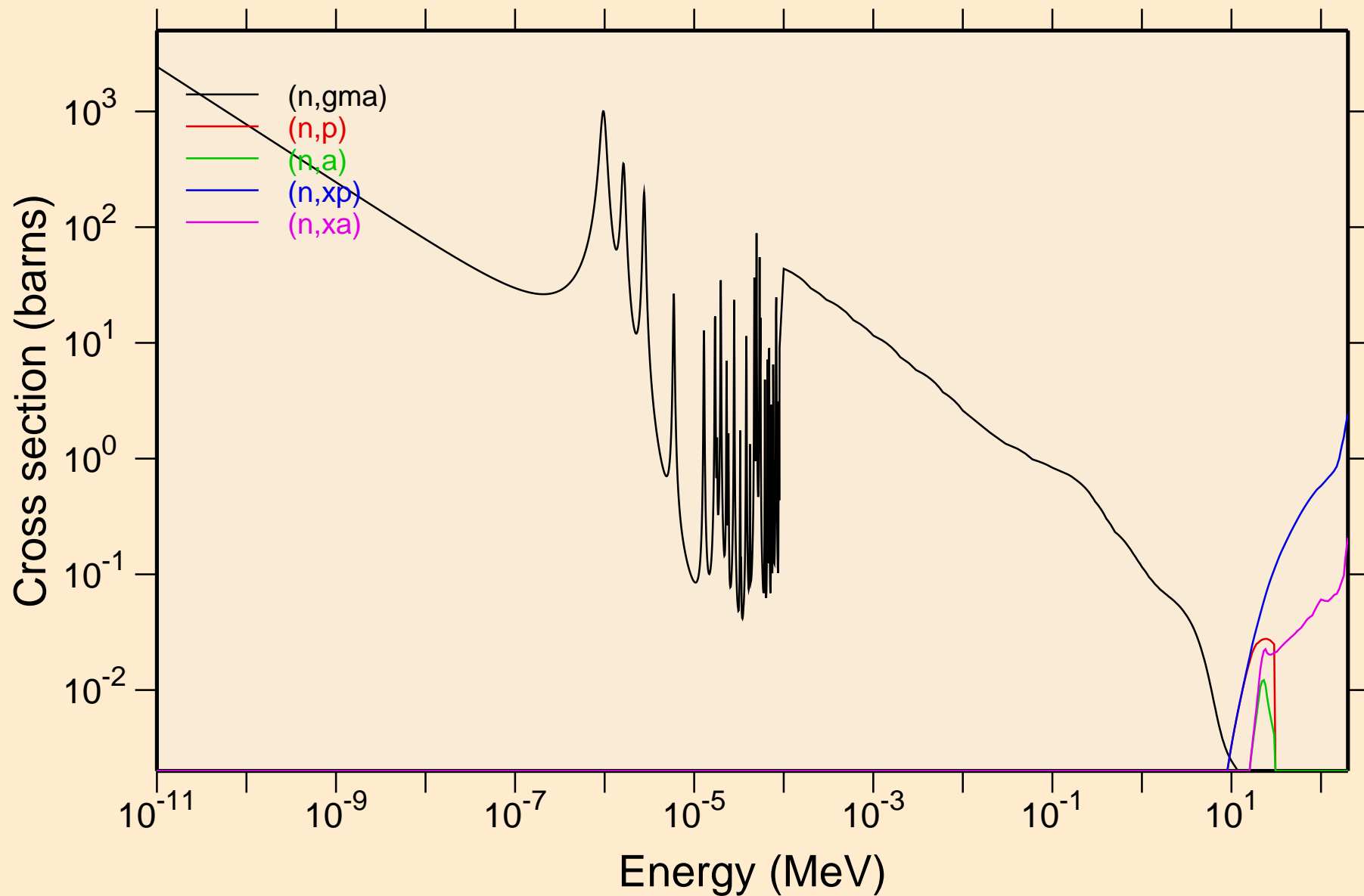

AU196 NEUTRON ACER TENDL-2019 LIBRARY; T=293.16K  
Principal cross sections

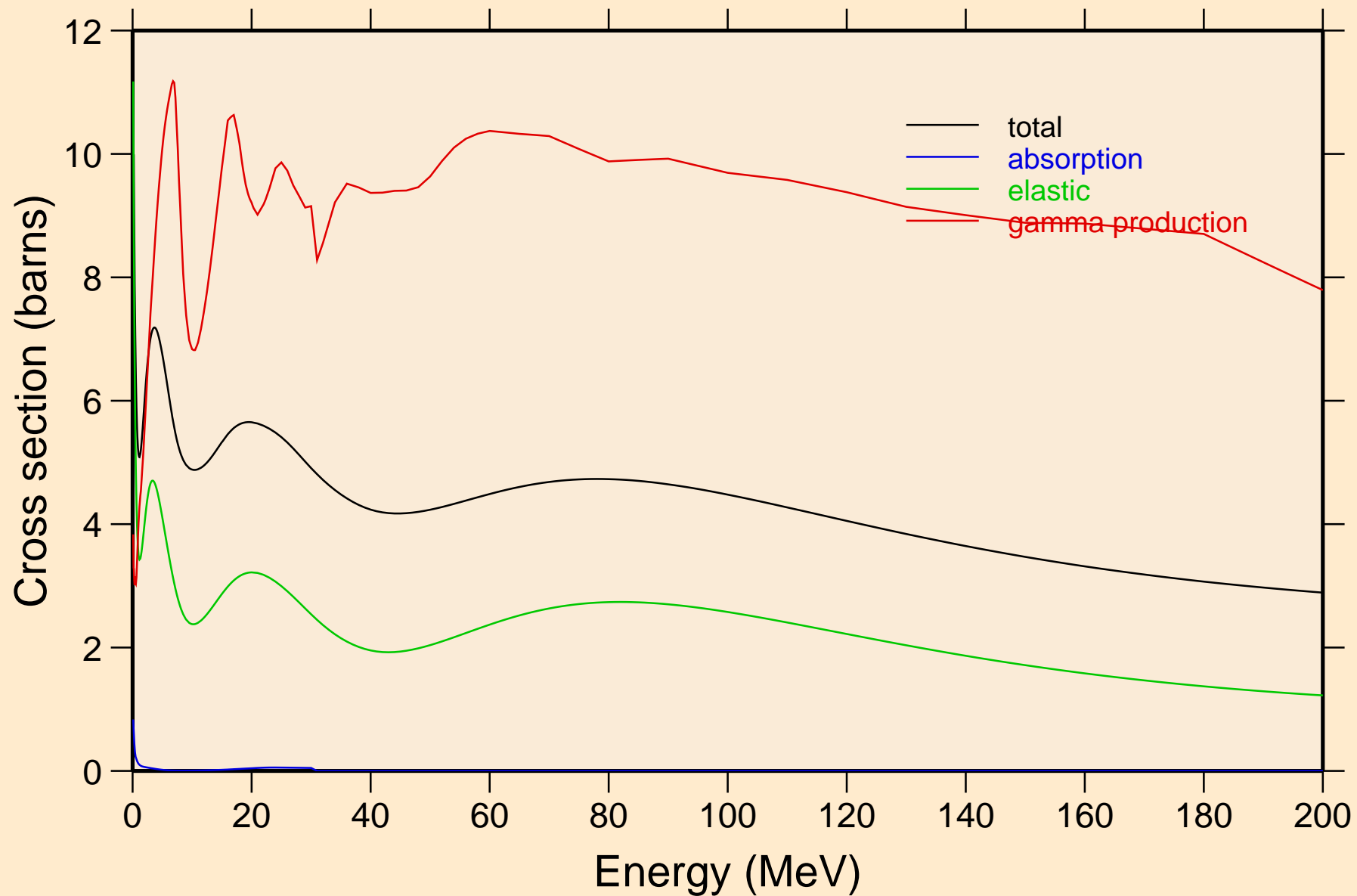

AU196 NEUTRON ACER TENDL-2019 LIBRARY; T=293.16K  
Heating

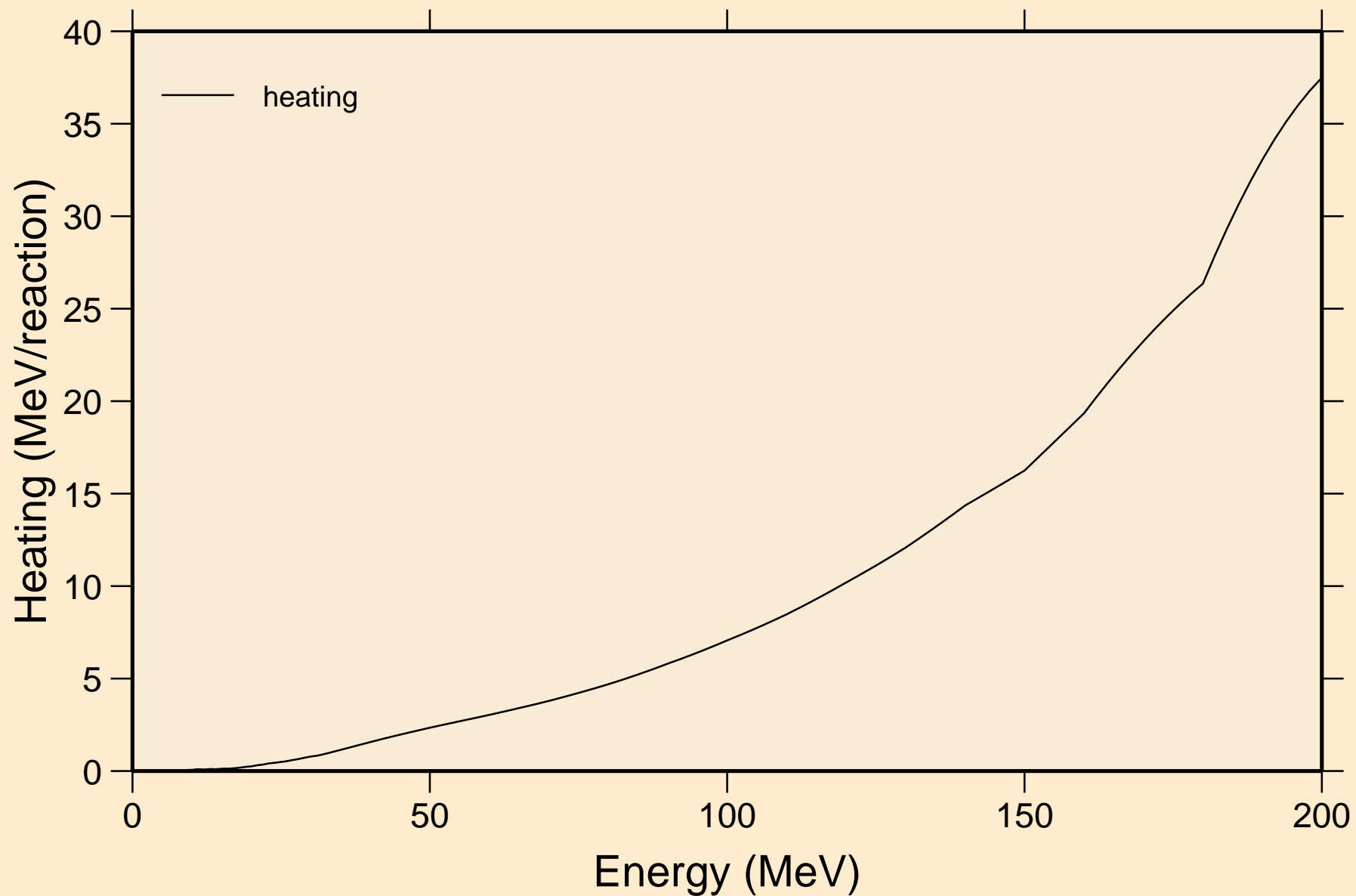

AU196 NEUTRON ACER TENDL-2019 LIBRARY; T=293.16K  
Damage

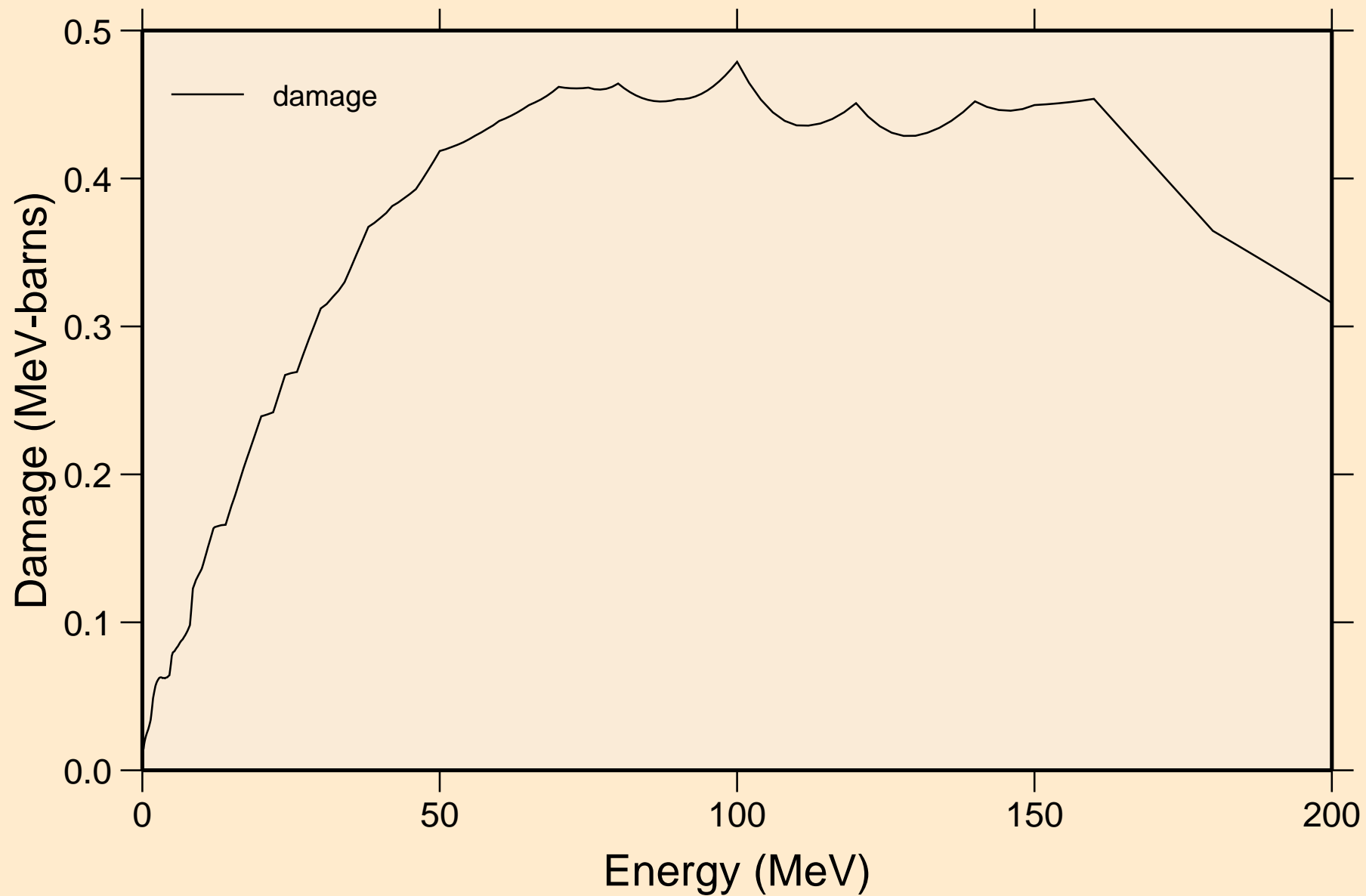

AU196 NEUTRON ACER TENDL-2019 LIBRARY; T=293.16K  
Non-threshold reactions

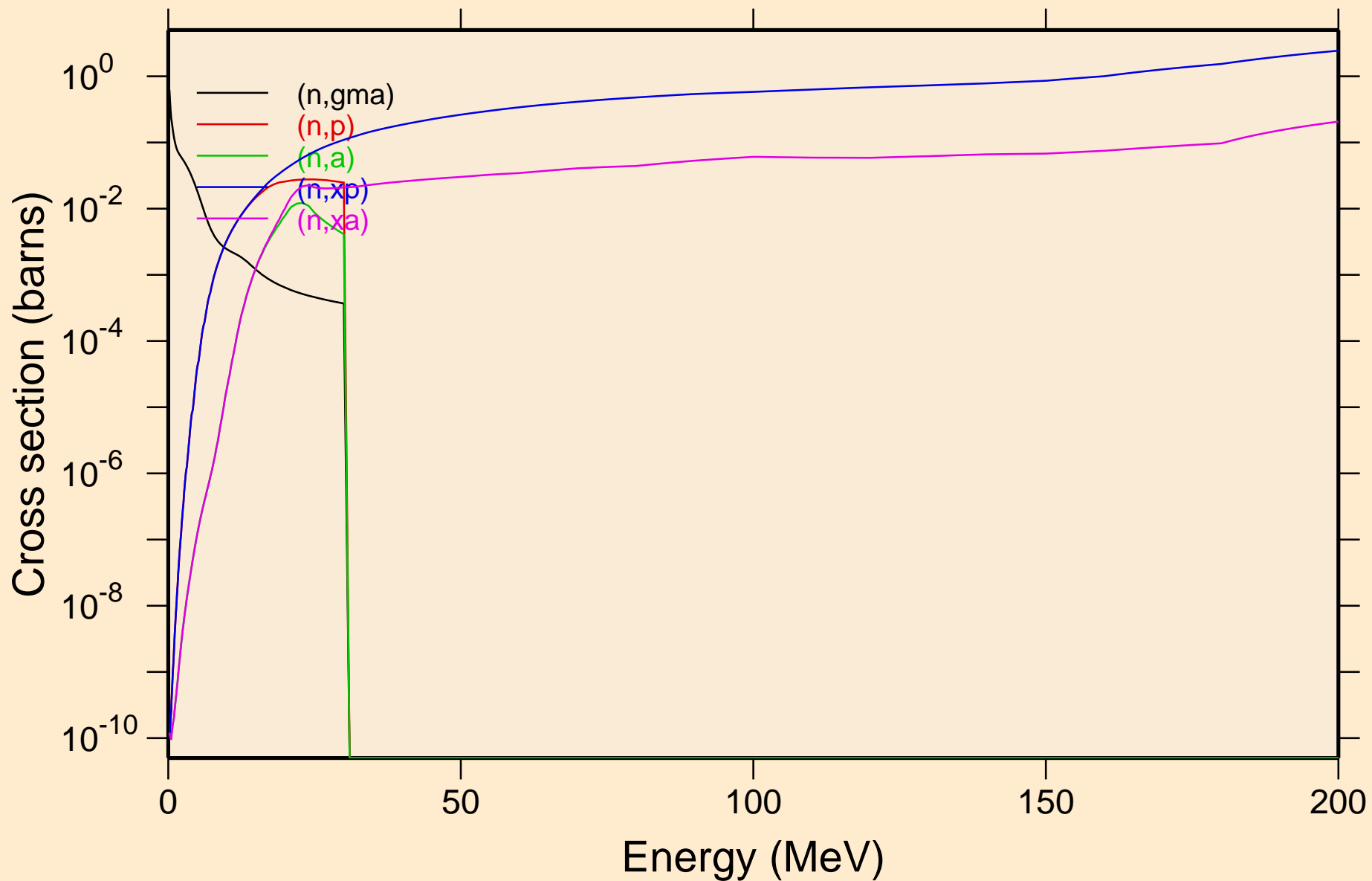



AU196 NEUTRON ACER TENDL-2019 LIBRARY; T=293.16K  
Inelastic levels

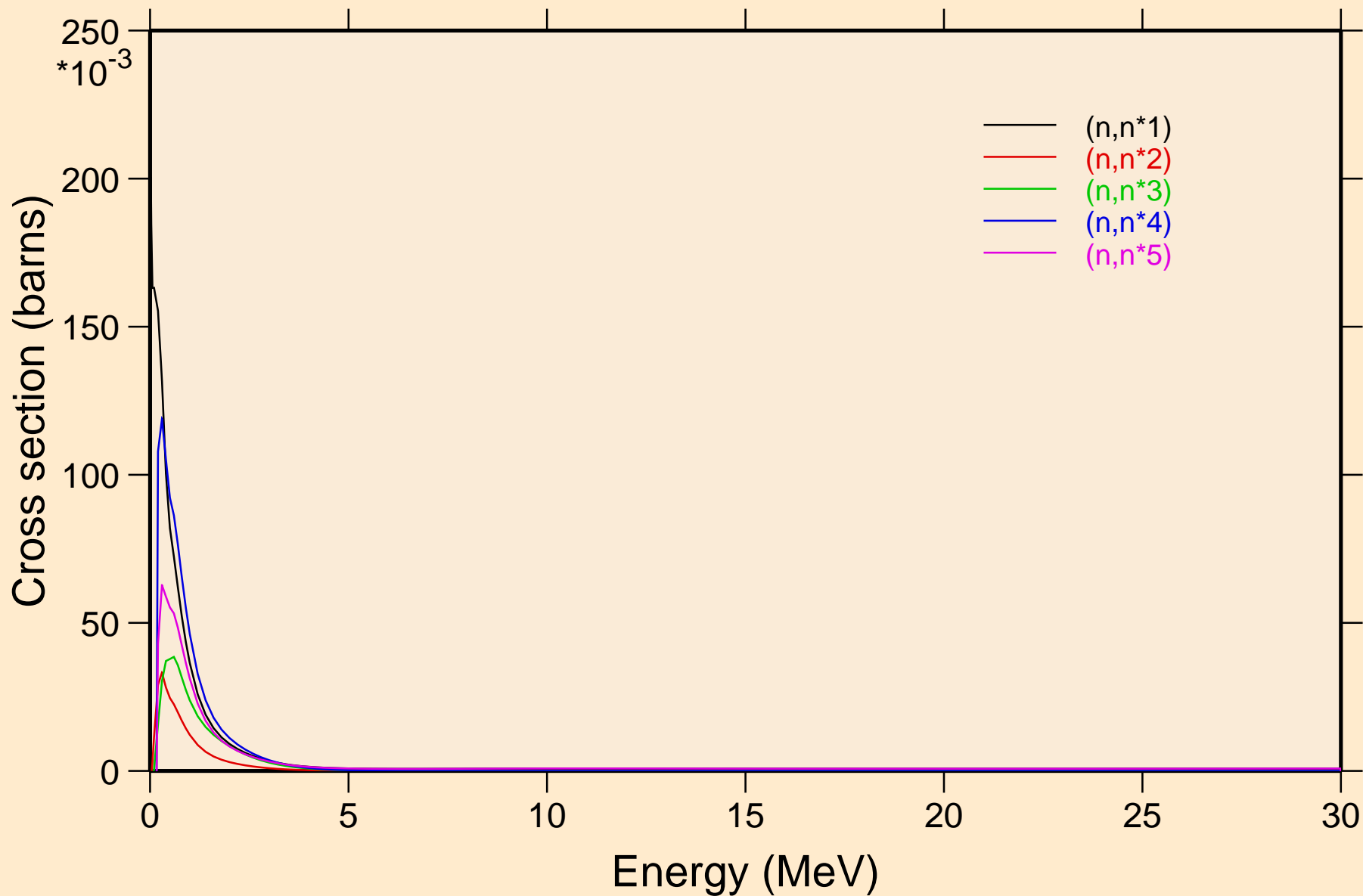

AU196 NEUTRON ACER TENDL-2019 LIBRARY; T=293.16K  
Inelastic levels

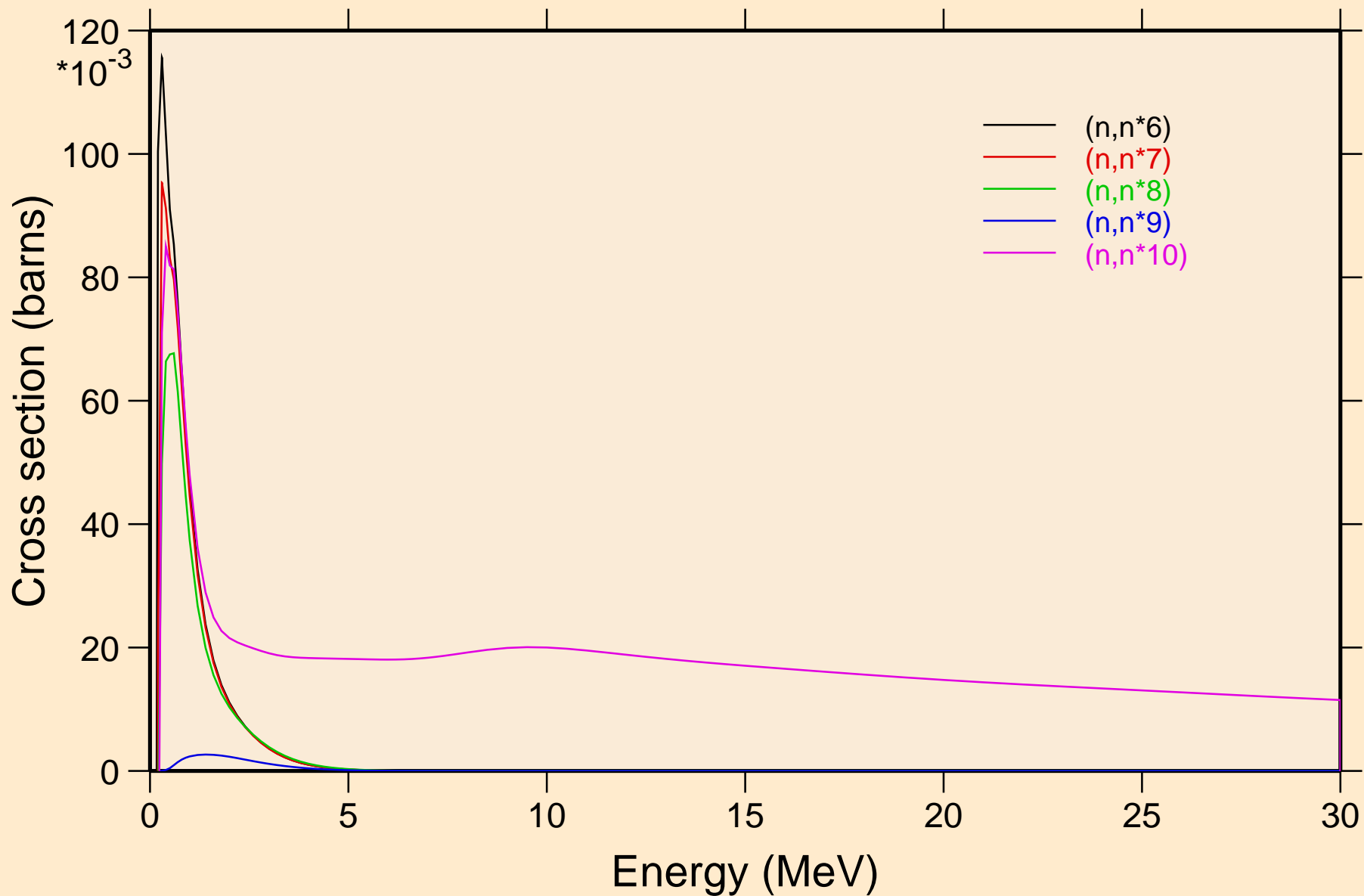

AU196 NEUTRON ACER TENDL-2019 LIBRARY; T=293.16K  
Inelastic levels

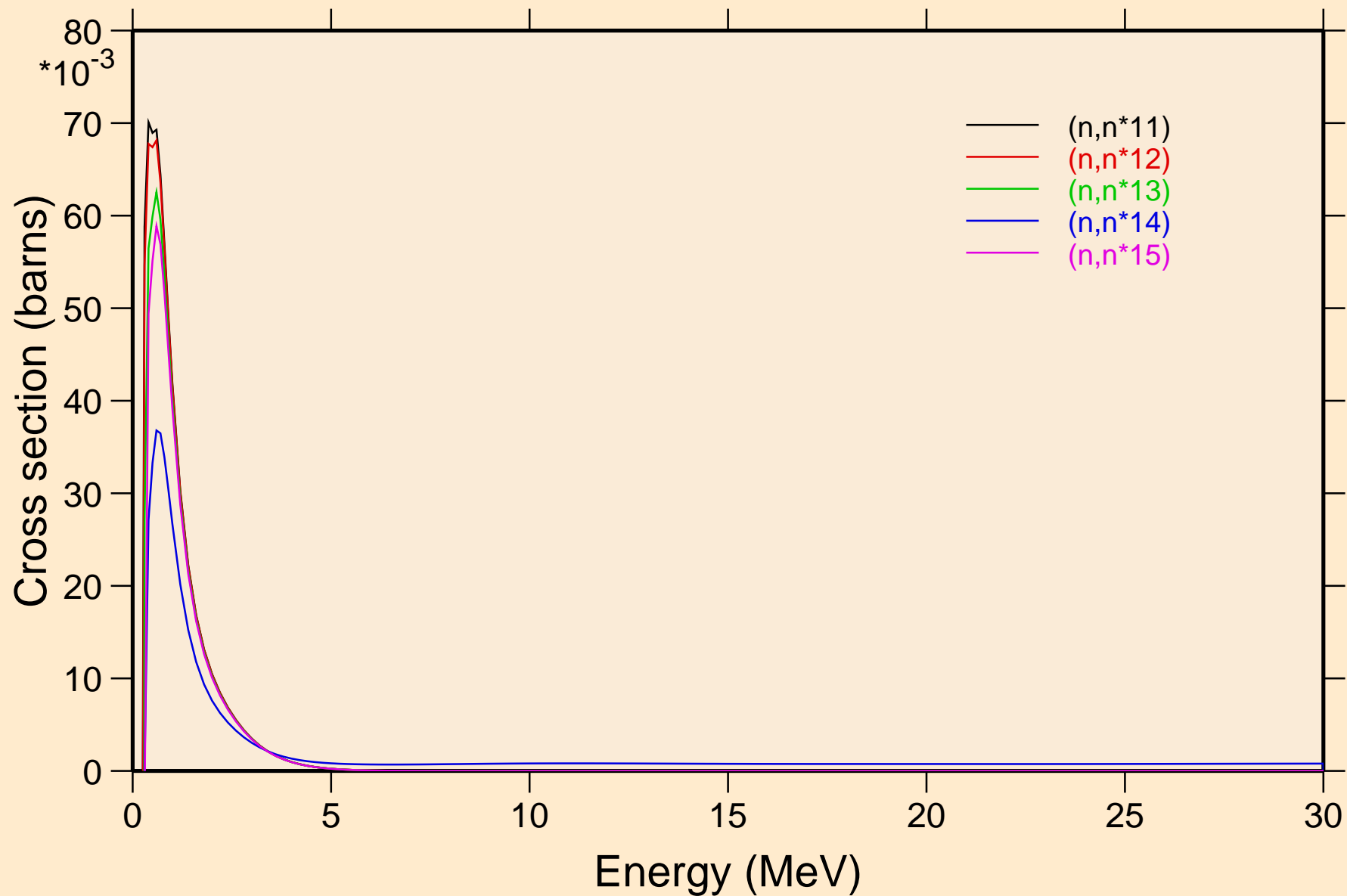

AU196 NEUTRON ACER TENDL-2019 LIBRARY; T=293.16K  
Inelastic levels

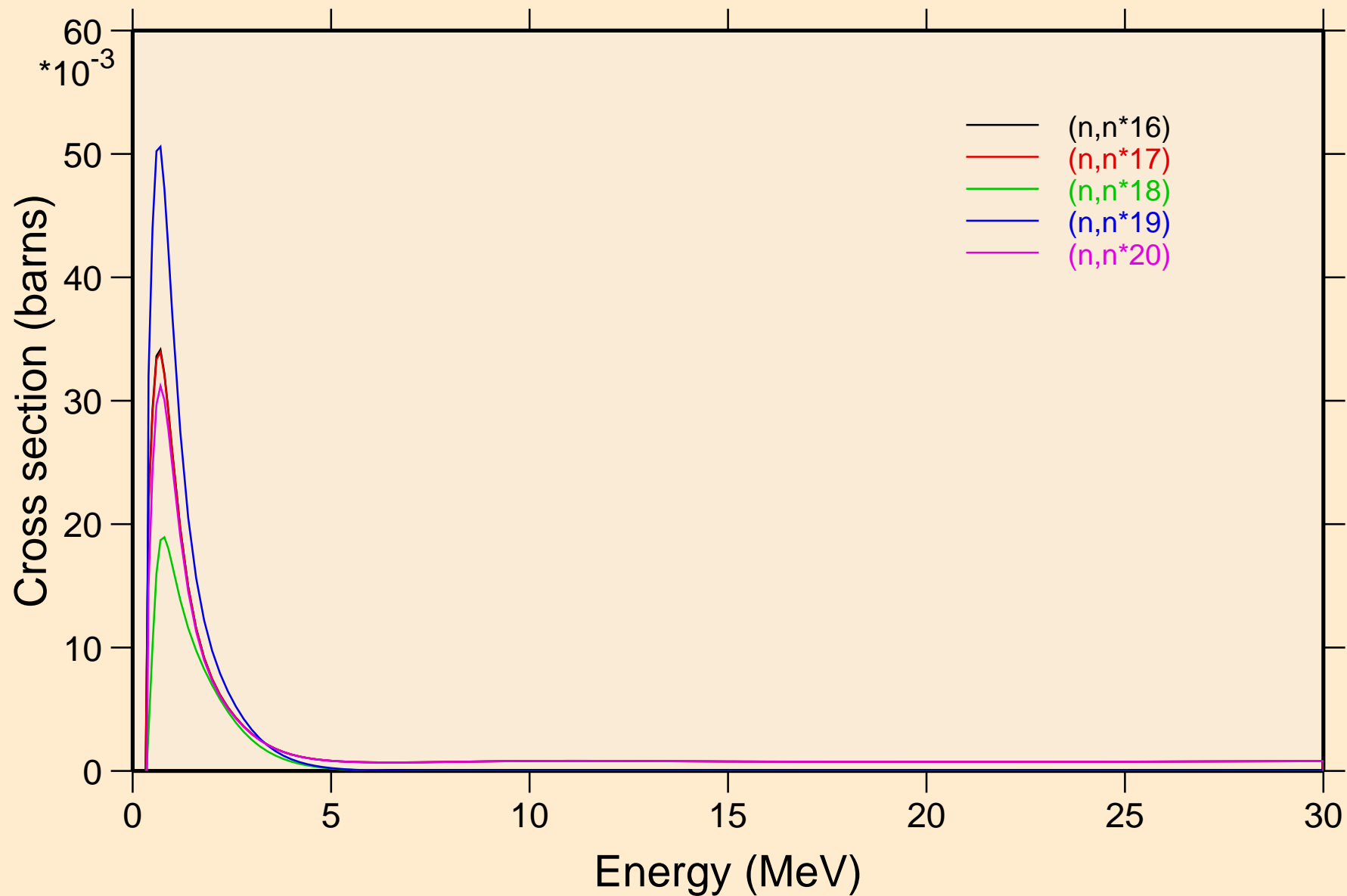

AU196 NEUTRON ACER TENDL-2019 LIBRARY; T=293.16K  
Inelastic levels

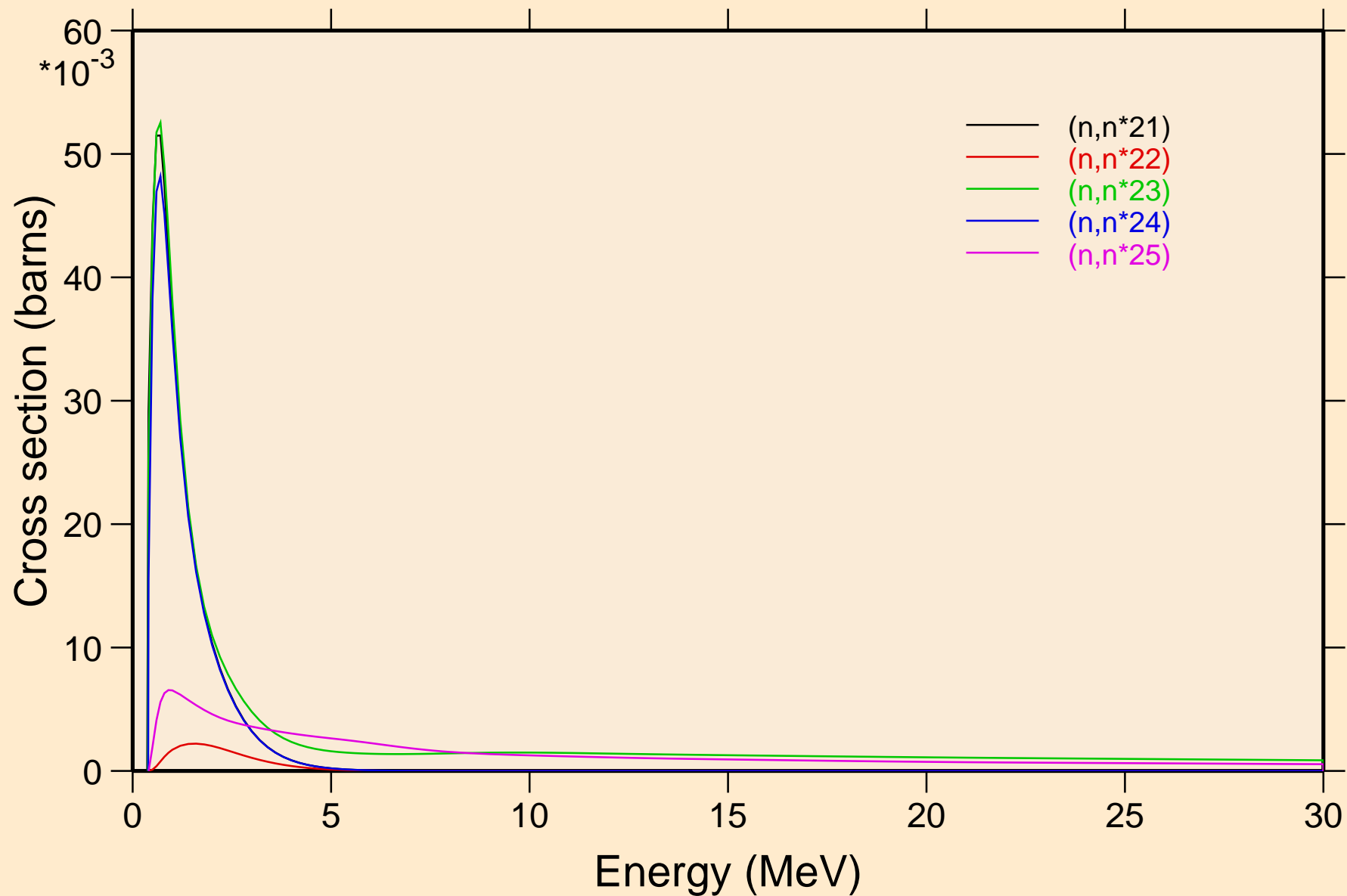

AU196 NEUTRON ACER TENDL-2019 LIBRARY; T=293.16K  
Inelastic levels

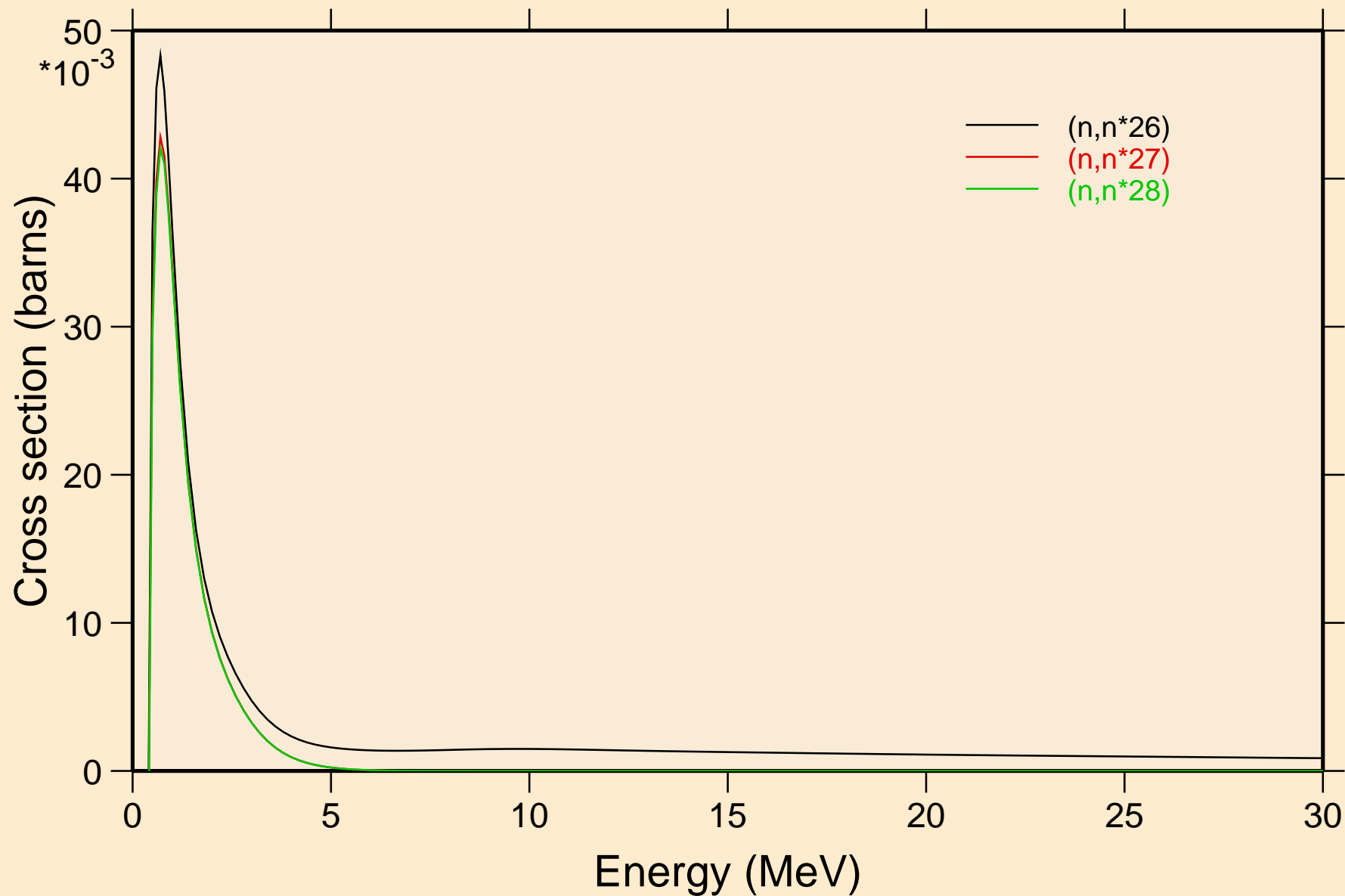

AU196 NEUTRON ACER TENDL-2019 LIBRARY; T=293.16K  
Threshold reactions

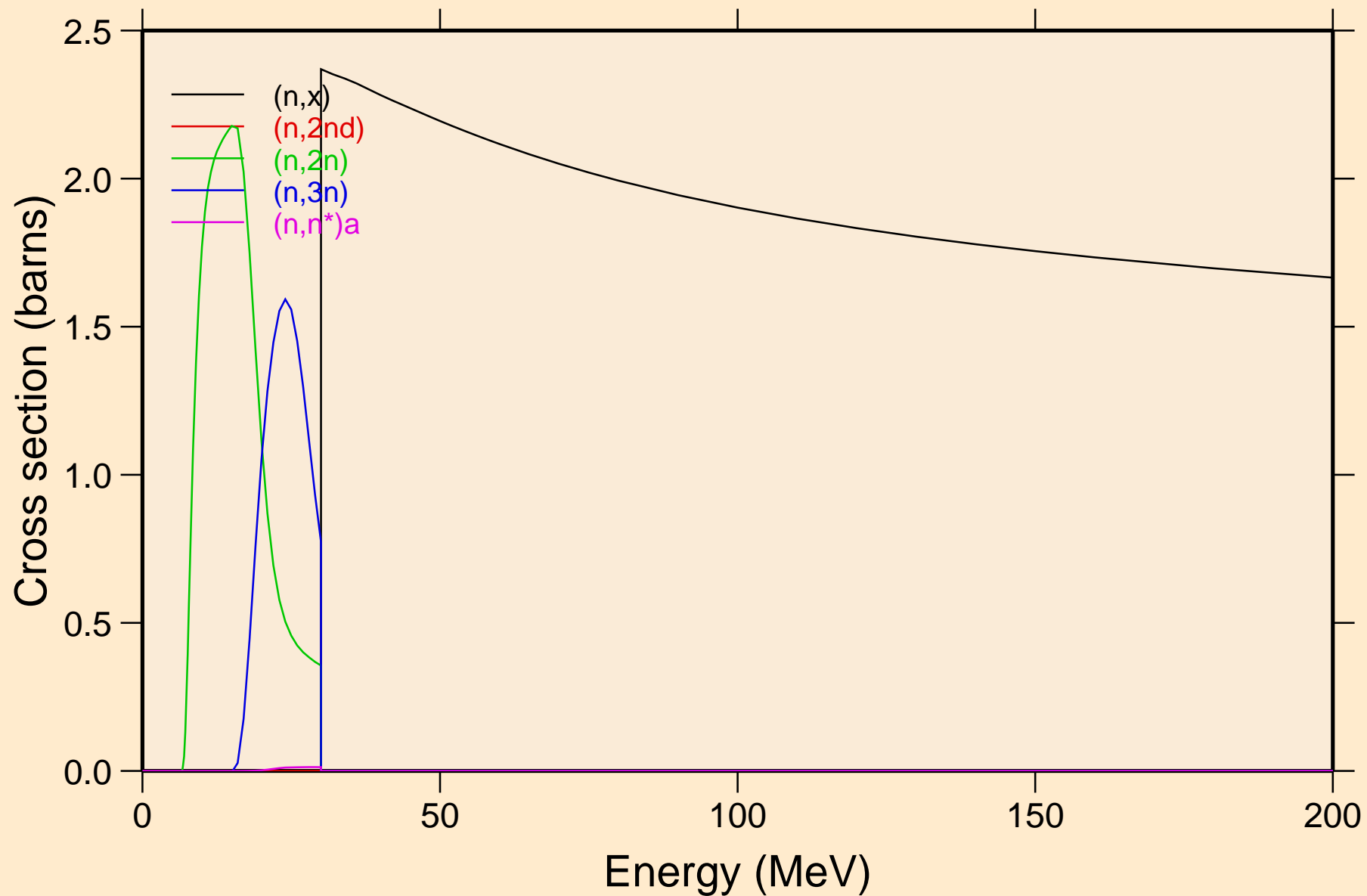

AU196 NEUTRON ACER TENDL-2019 LIBRARY; T=293.16K  
Threshold reactions

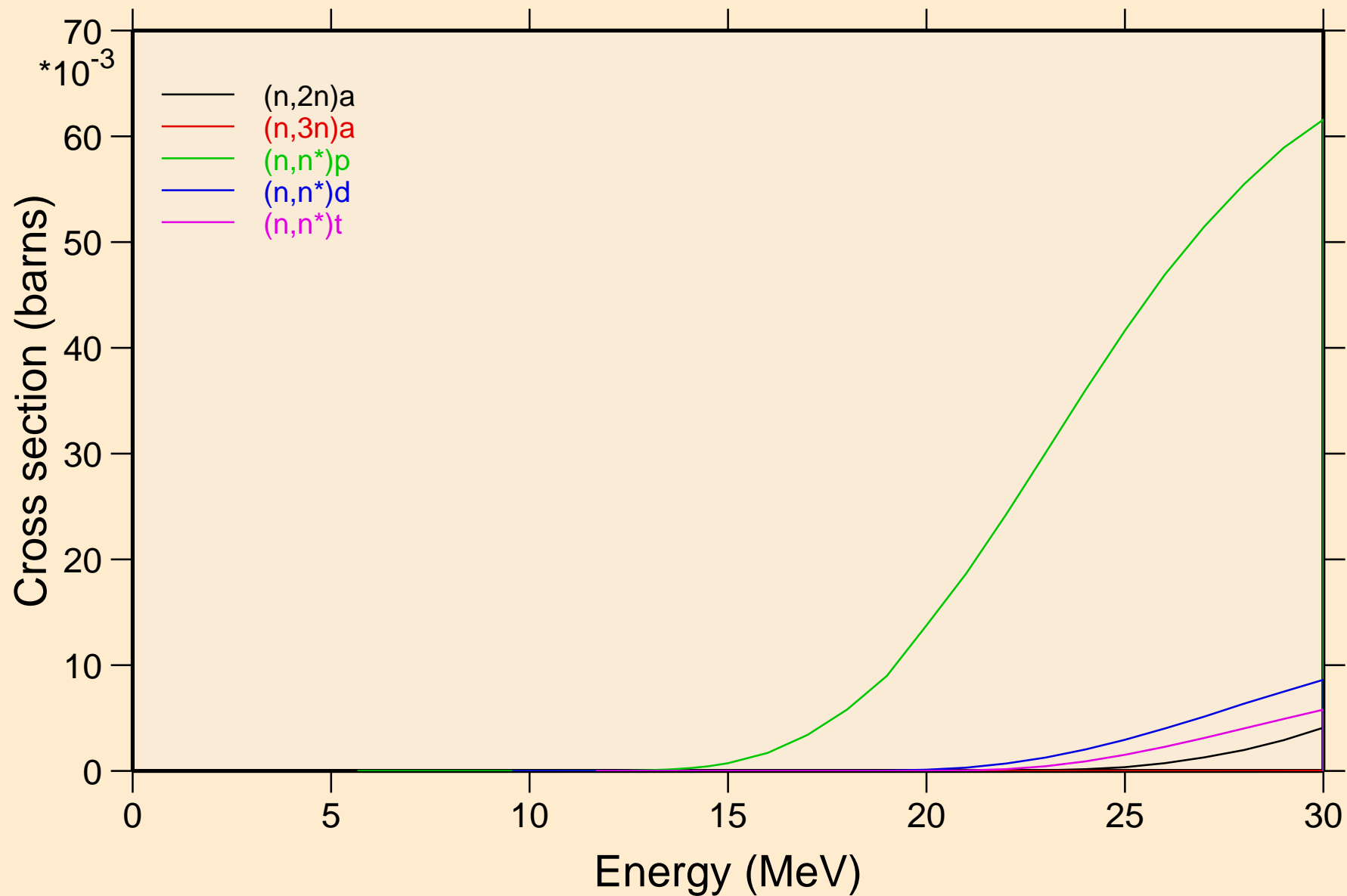



AU196 NEUTRON ACER TENDL-2019 LIBRARY; T=293.16K  
Threshold reactions

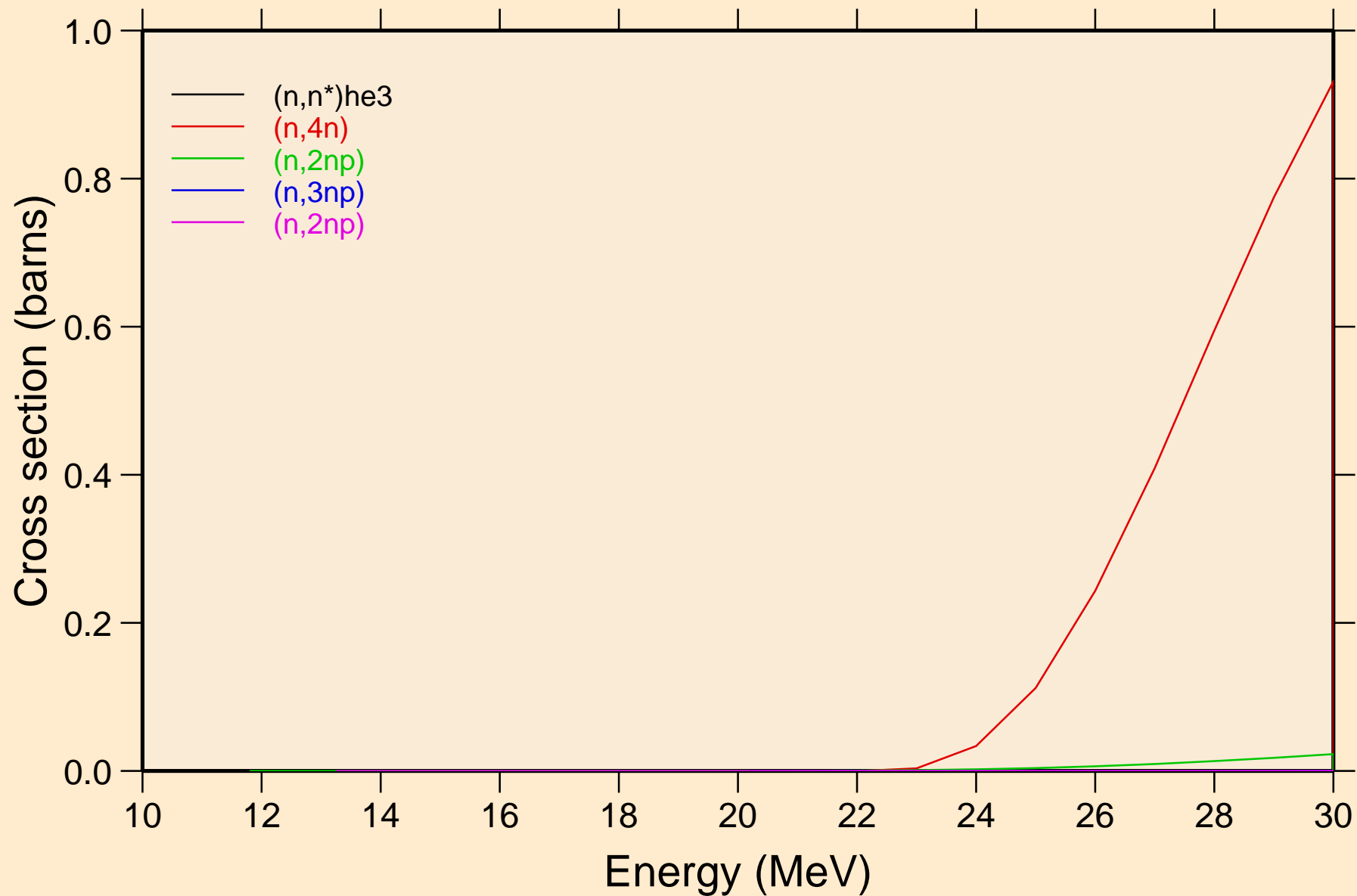

AU196 NEUTRON ACER TENDL-2019 LIBRARY; T=293.16K  
Threshold reactions

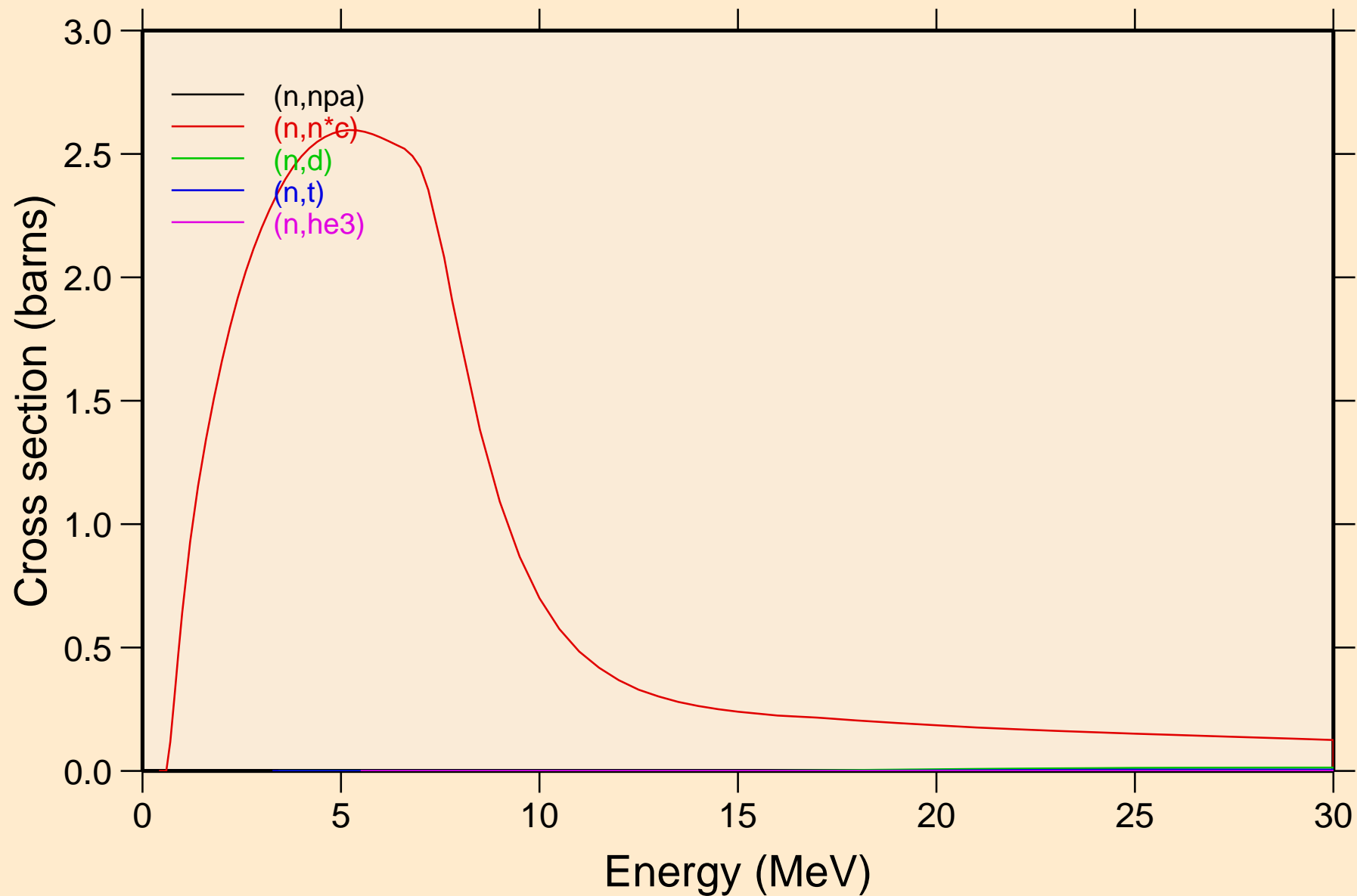

AU196 NEUTRON ACER TENDL-2019 LIBRARY; T=293.16K  
Threshold reactions

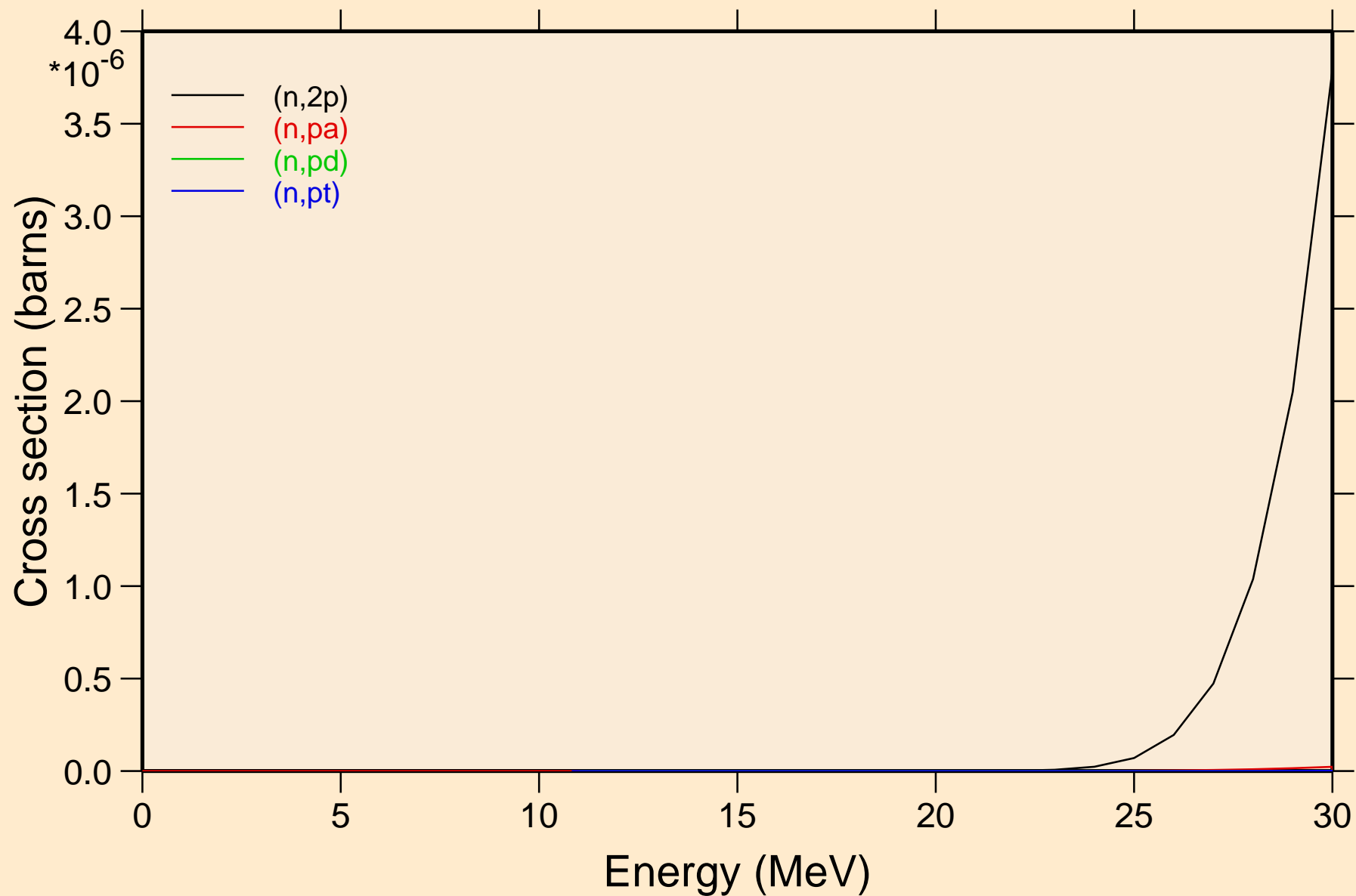

AU196 NEUTRON ACER TENDL-2019 LIBRARY; T=293.16K  
Threshold reactions

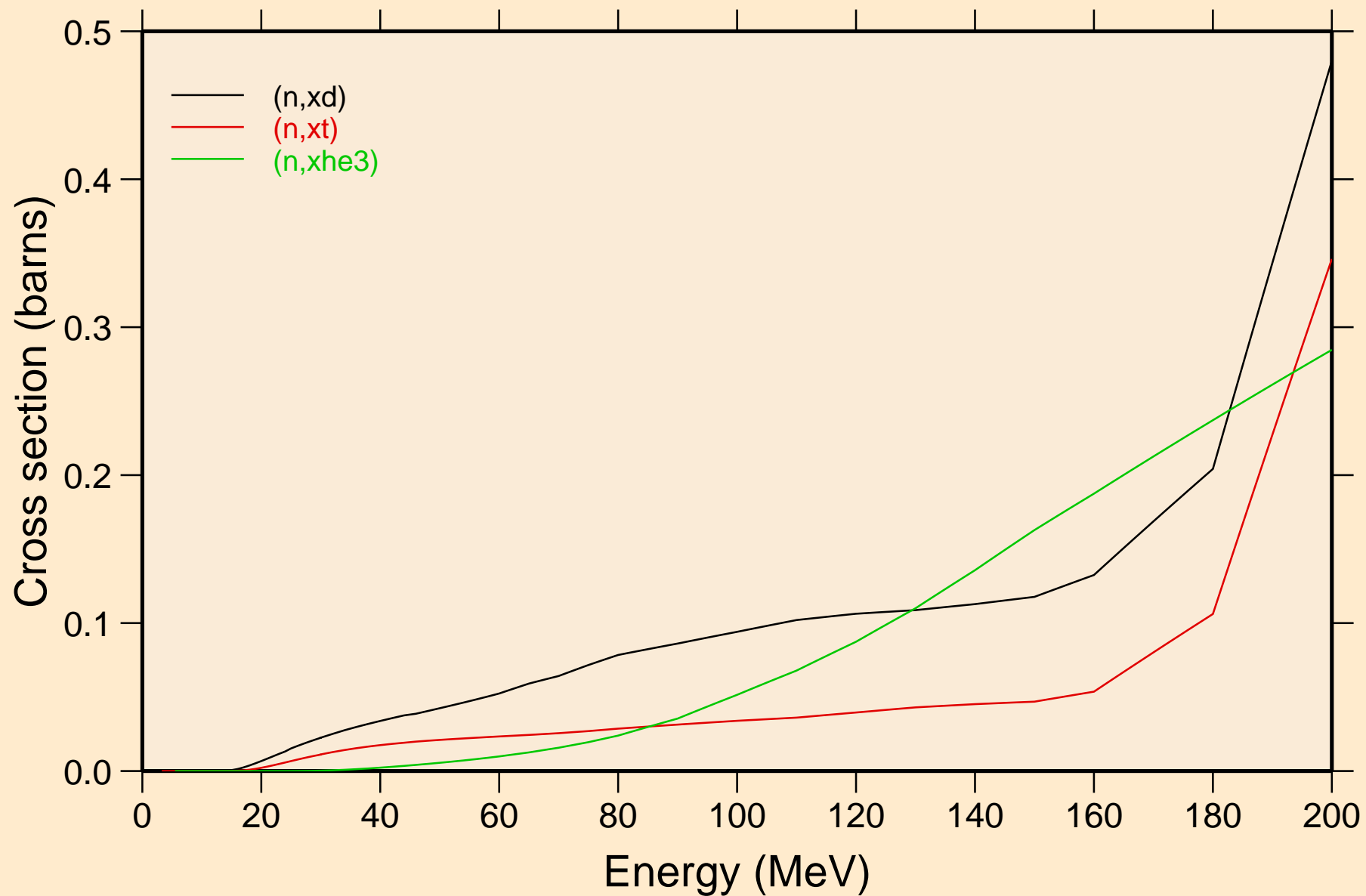

AU196 NEUTRON ACER TENDL-2019 LIBRARY; T=293.16K  
angular distribution for elastic

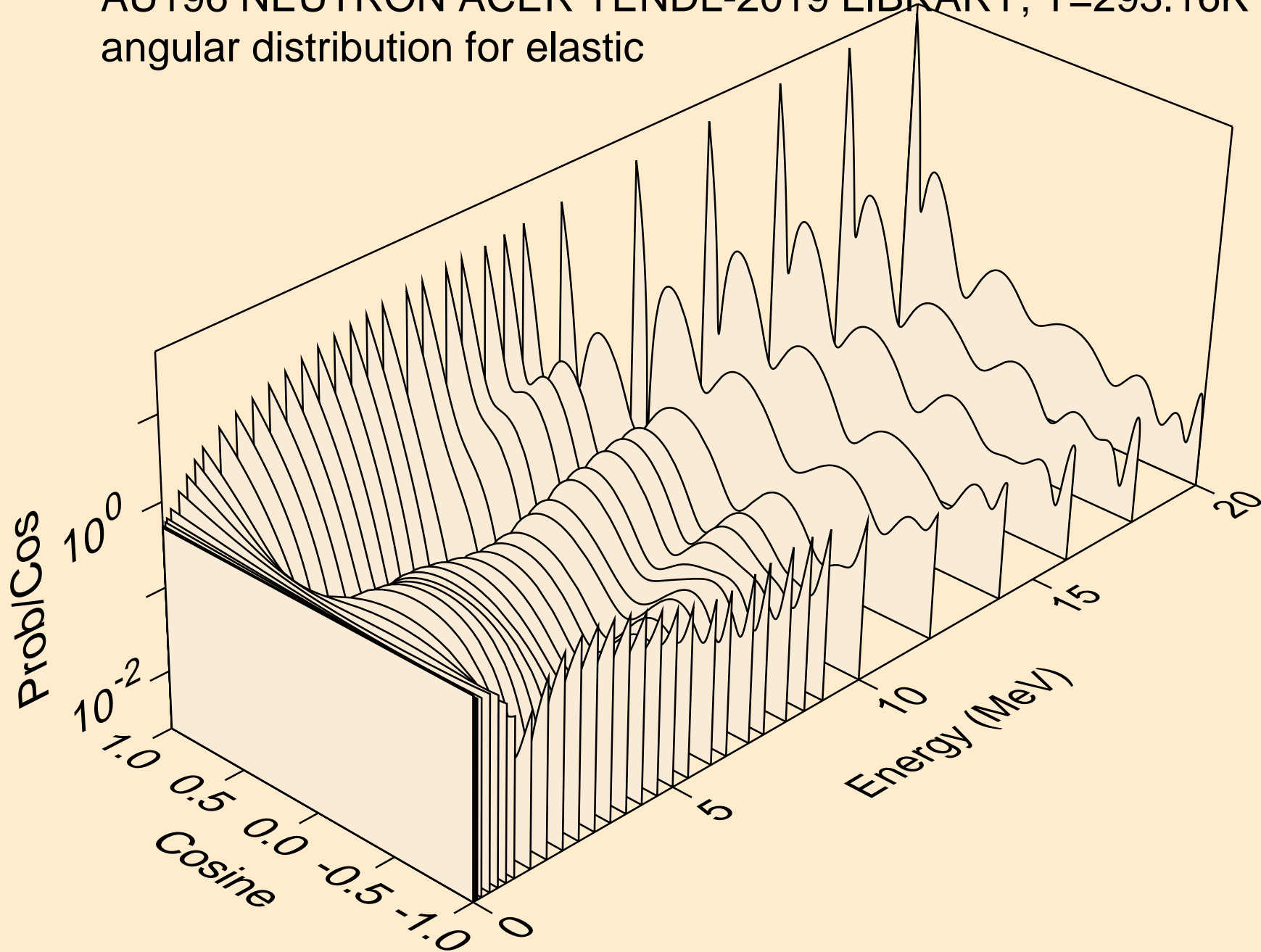

AU196 NEUTRON ACER TENDL-2019 LIBRARY; T=293.16K  
angular distribution for elastic

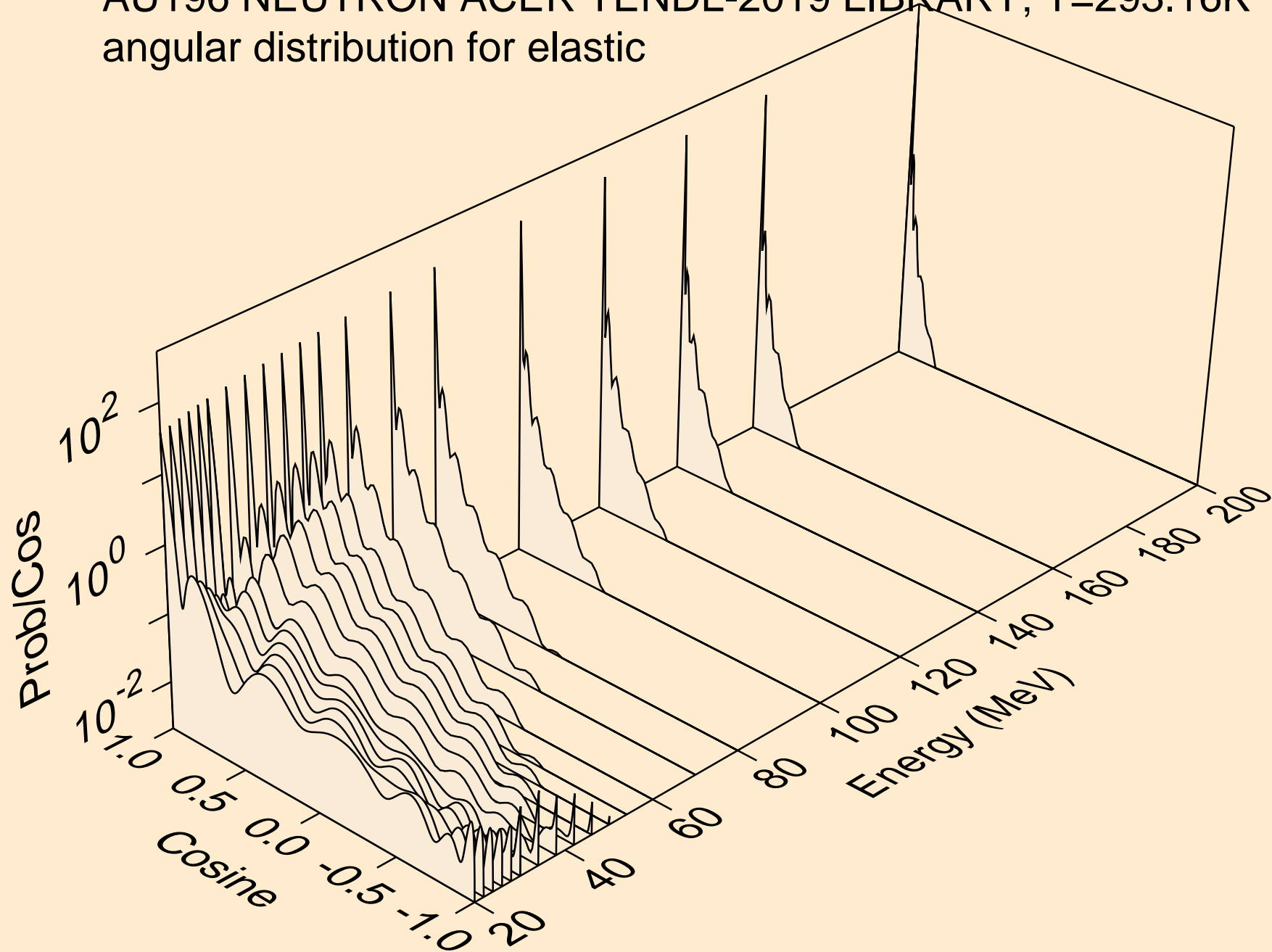

AU196 NEUTRON ACER TENDL-2019 LIBRARY; T=293.16K  
angular distribution for (n,n\*1)

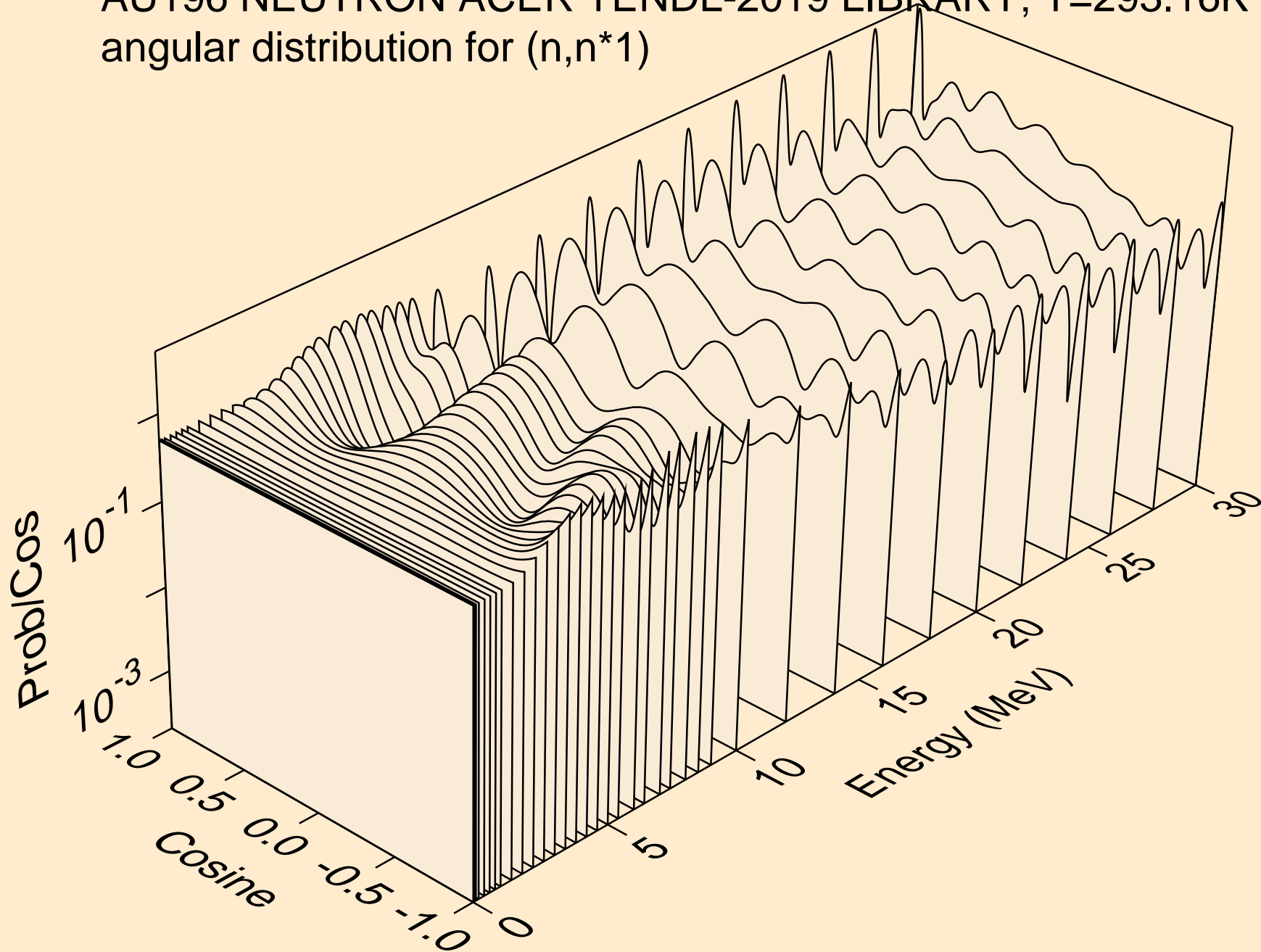

AU196 NEUTRON ACER TENDL-2019 LIBRARY; T=293.16K  
angular distribution for (n,n\*2)

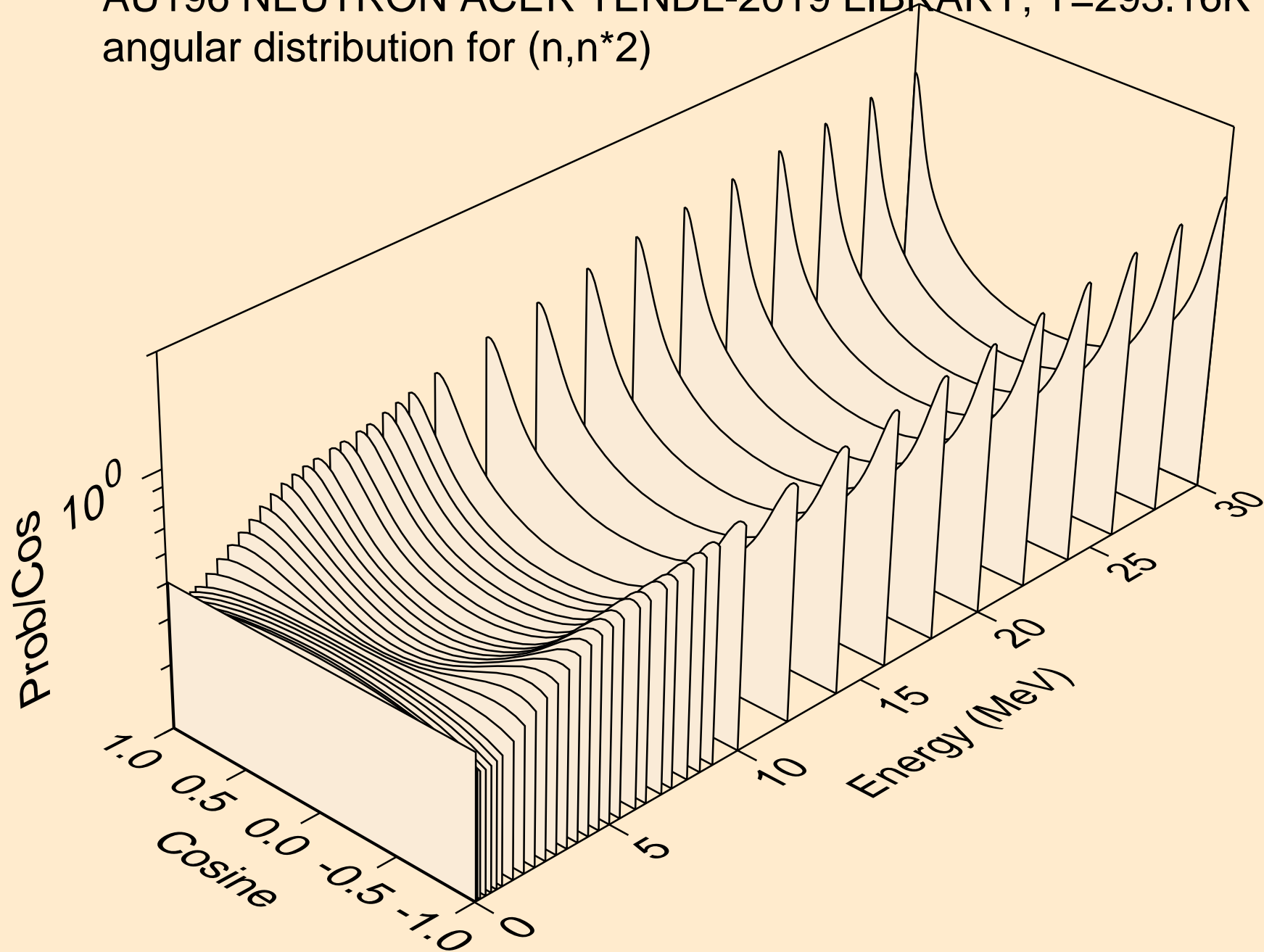



AU196 NEUTRON ACER TENDL-2019 LIBRARY; T=293.16K  
angular distribution for (n,n\*3)

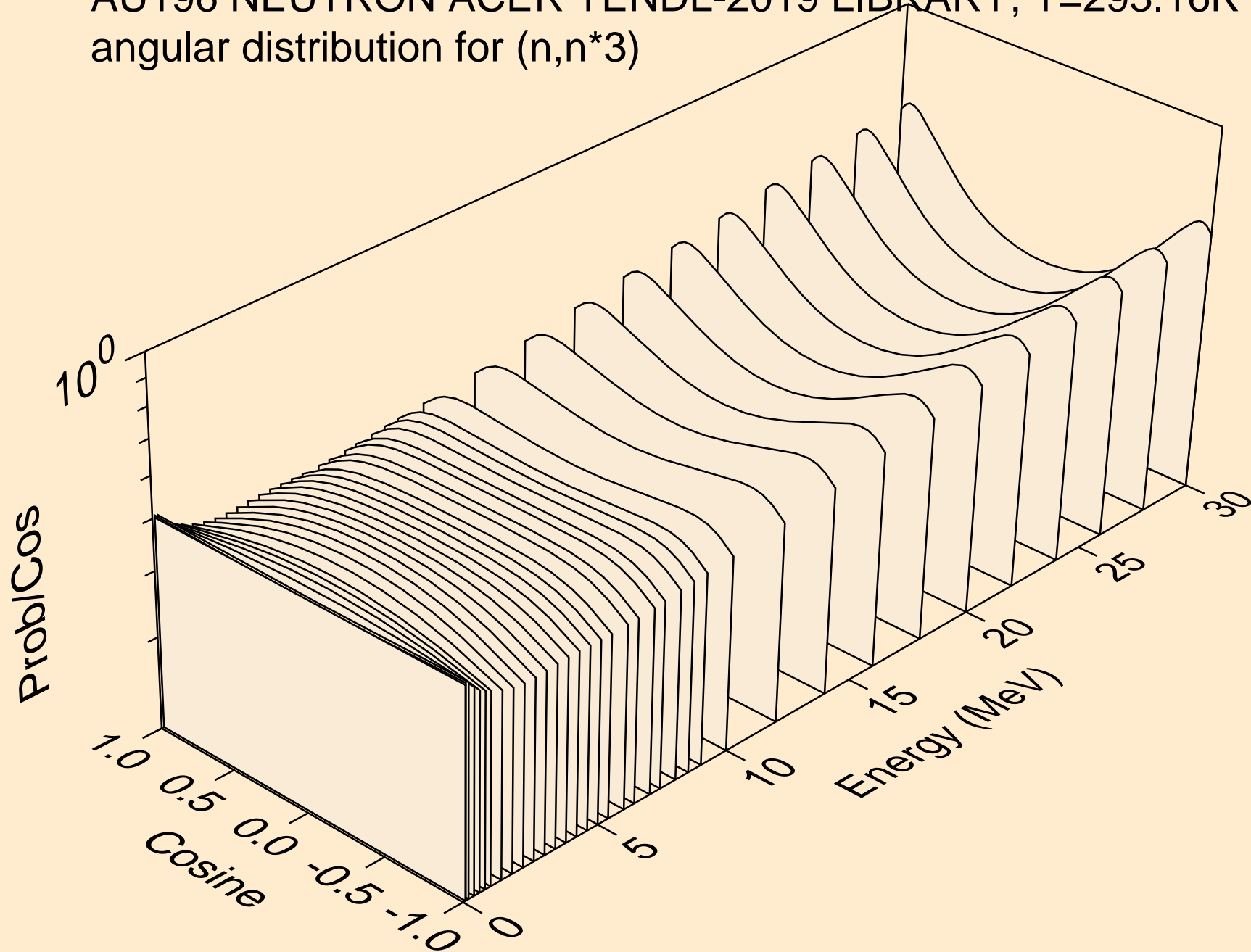

AU196 NEUTRON ACER TENDL-2019 LIBRARY; T=293.16K  
angular distribution for (n,n\*4)

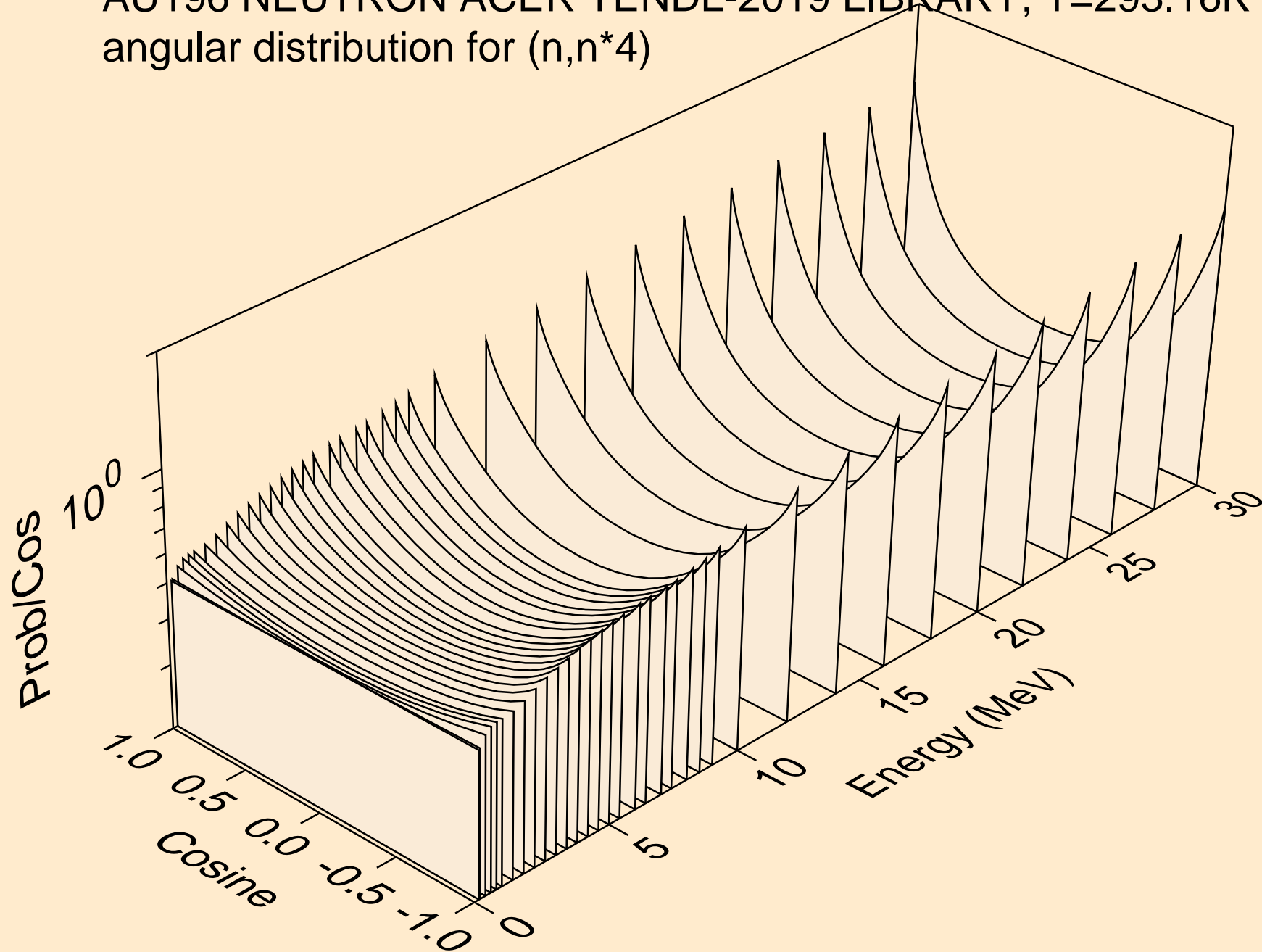

AU196 NEUTRON ACER TENDL-2019 LIBRARY; T=293.16K  
angular distribution for (n,n\*5)

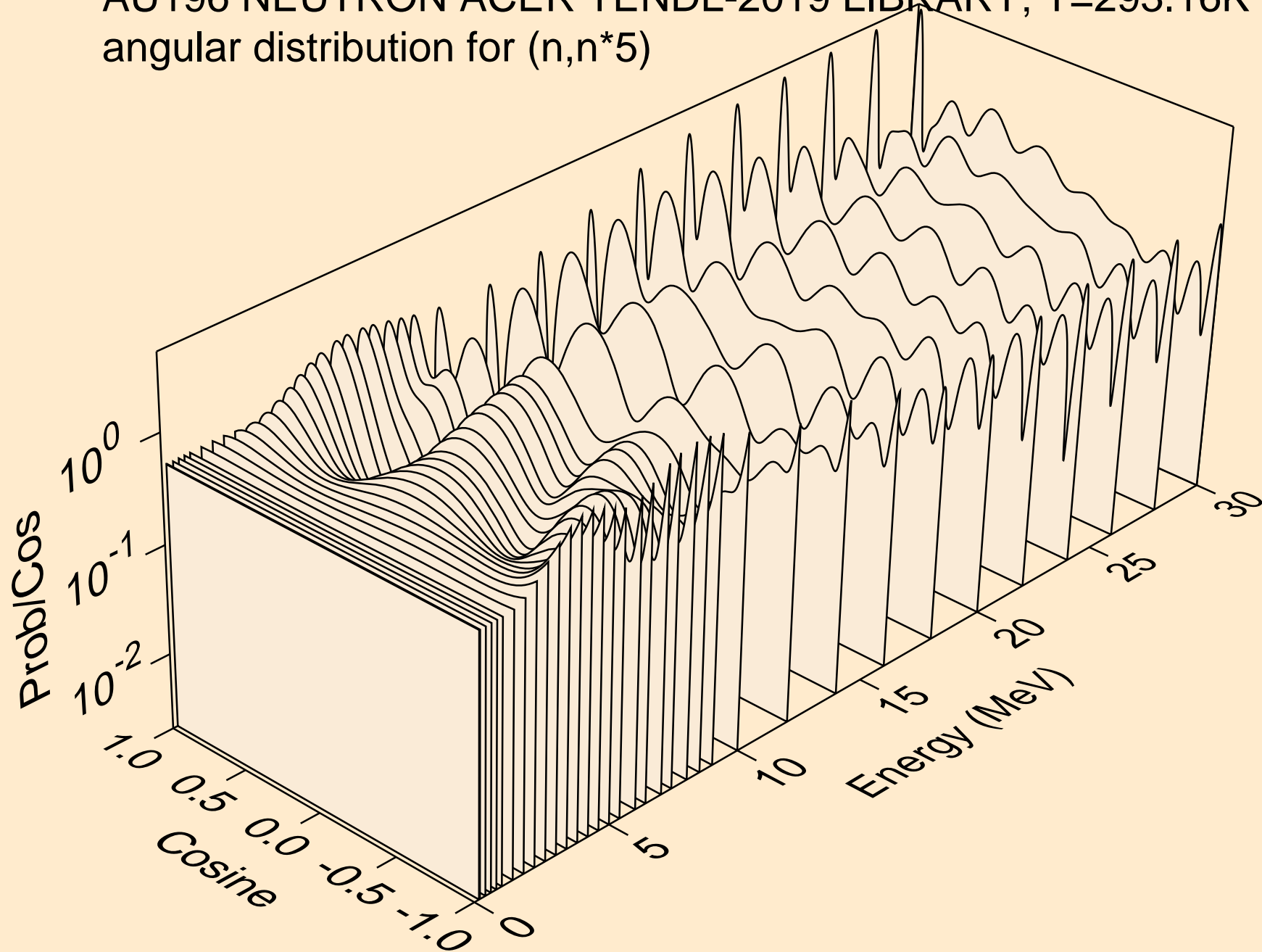

AU196 NEUTRON ACER TENDL-2019 LIBRARY; T=293.16K  
angular distribution for (n,n\*6)

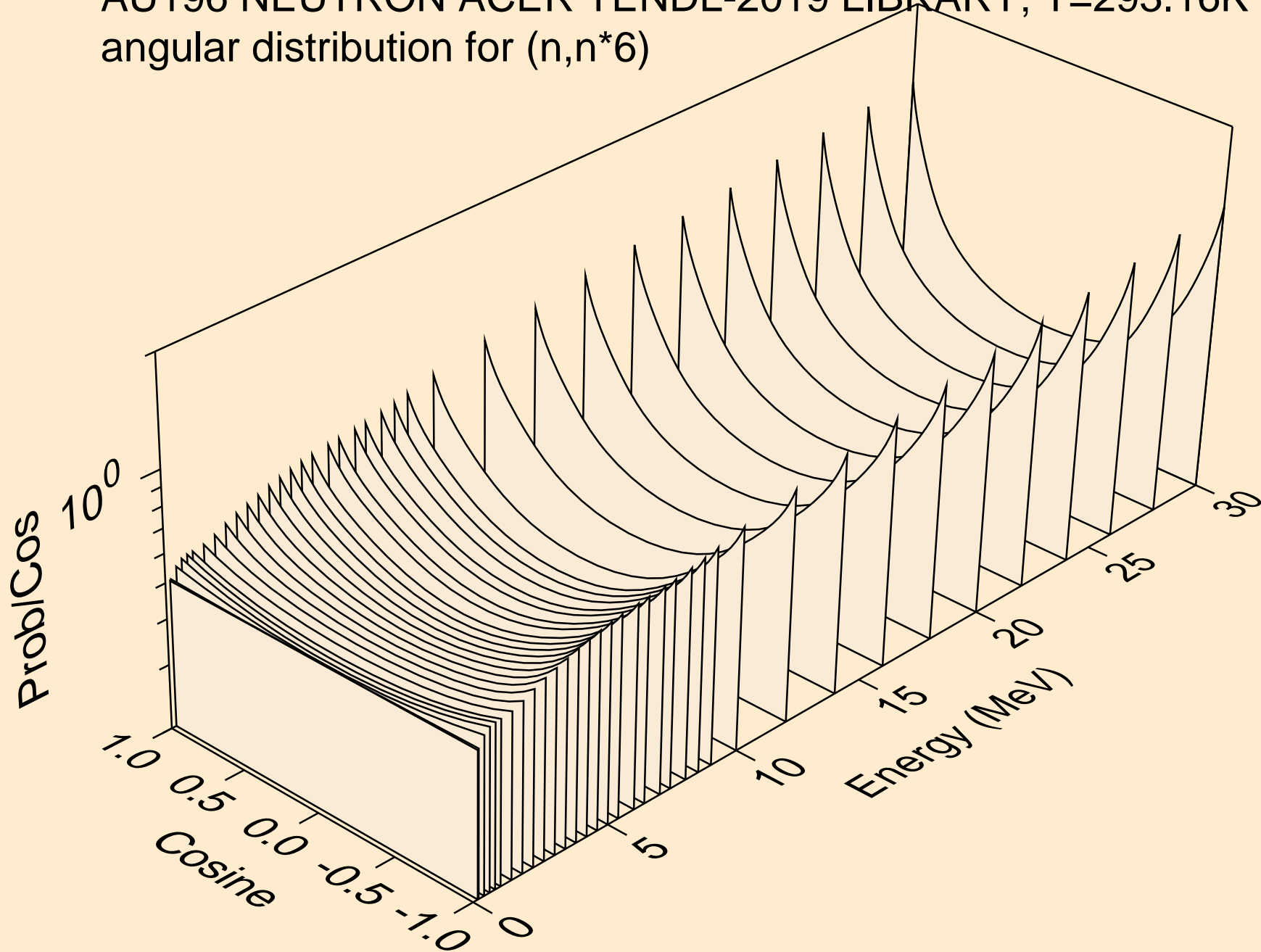

AU196 NEUTRON ACER TENDL-2019 LIBRARY; T=293.16K  
angular distribution for (n,n\*7)

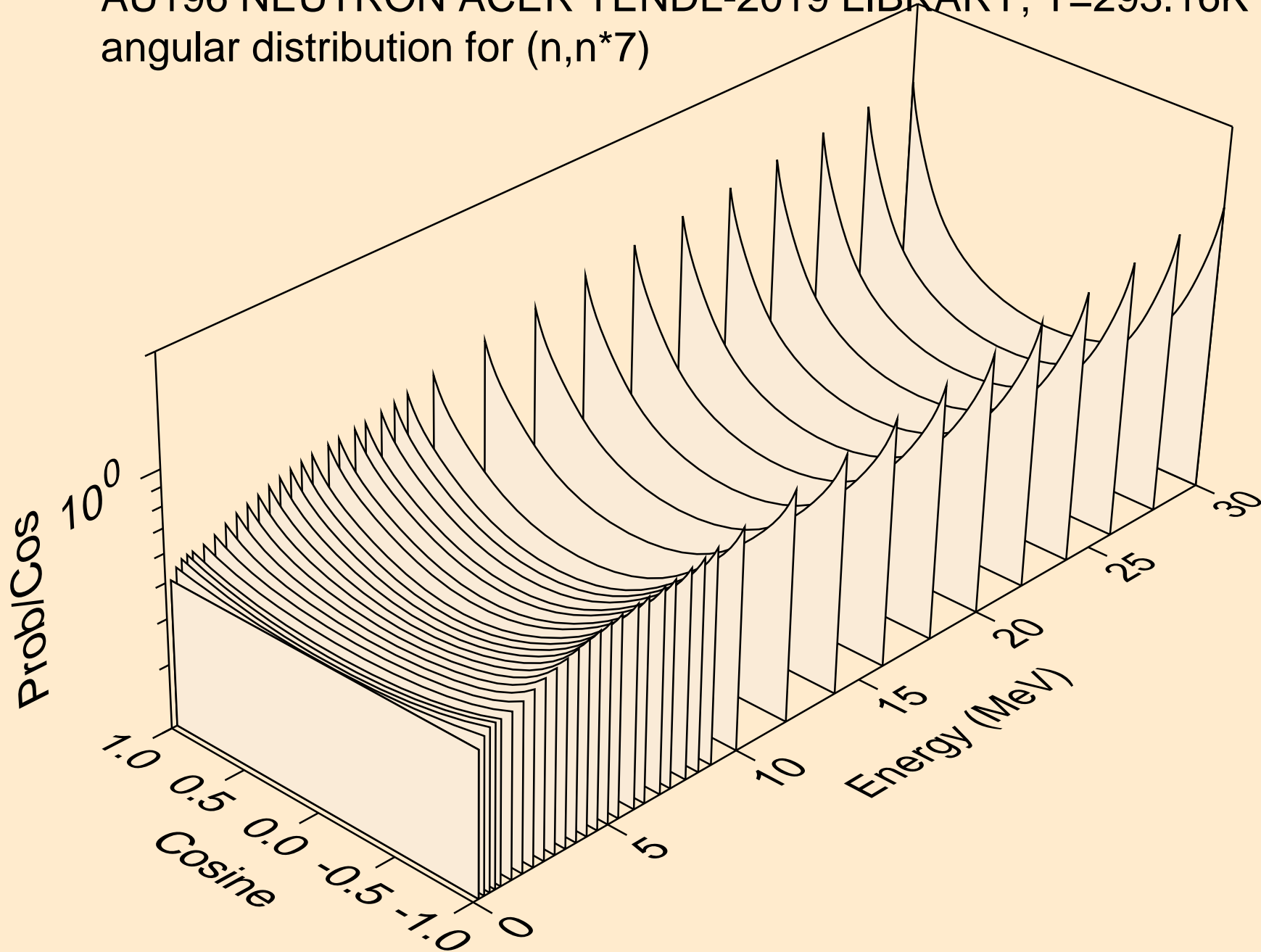

AU196 NEUTRON ACER TENDL-2019 LIBRARY; T=293.16K  
angular distribution for (n,n\*8)

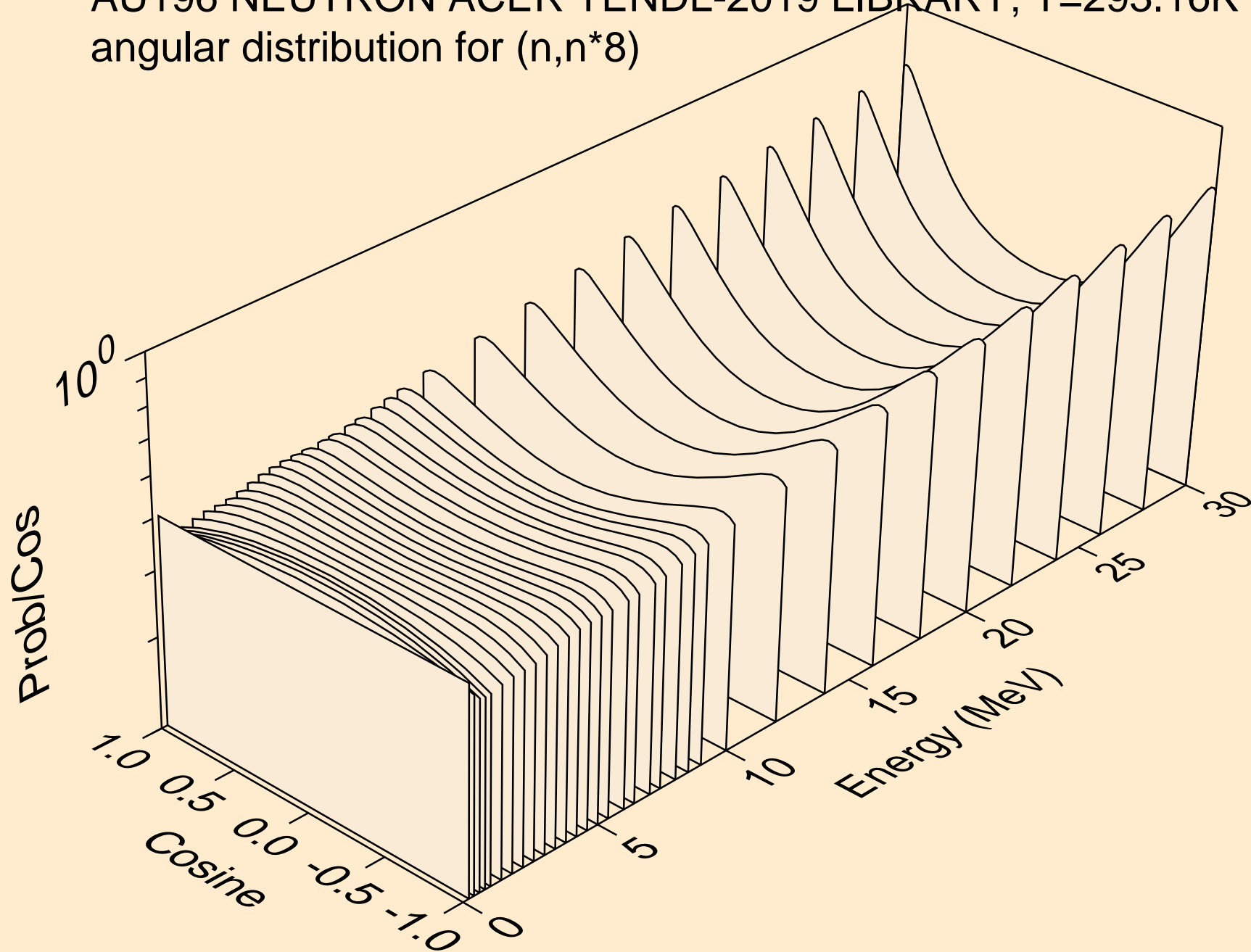

AU196 NEUTRON ACER TENDL-2019 LIBRARY; T=293.16K  
angular distribution for (n,n\*9)

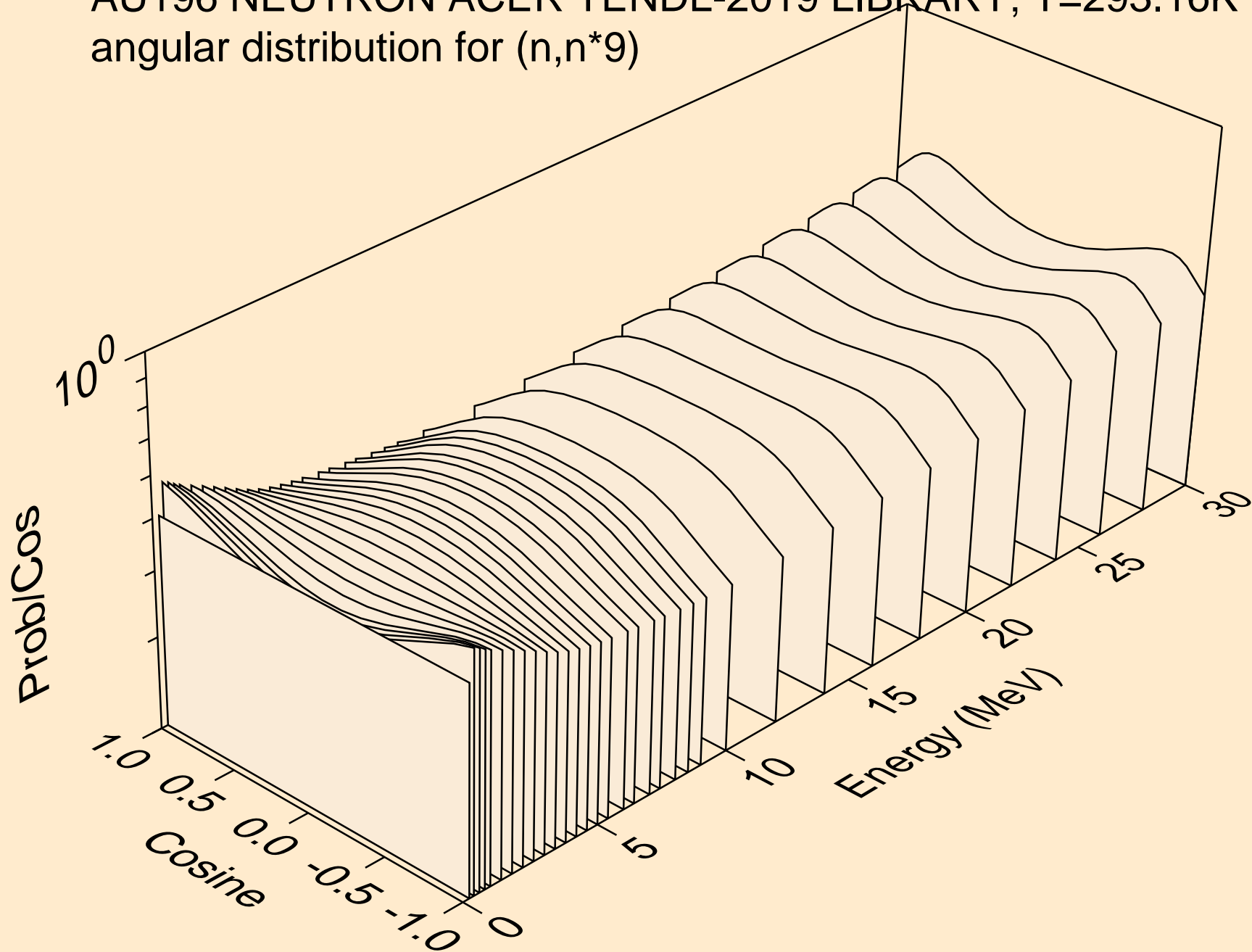

AU196 NEUTRON ACER TENDL-2019 LIBRARY; T=293.16K  
angular distribution for (n,n\*10)

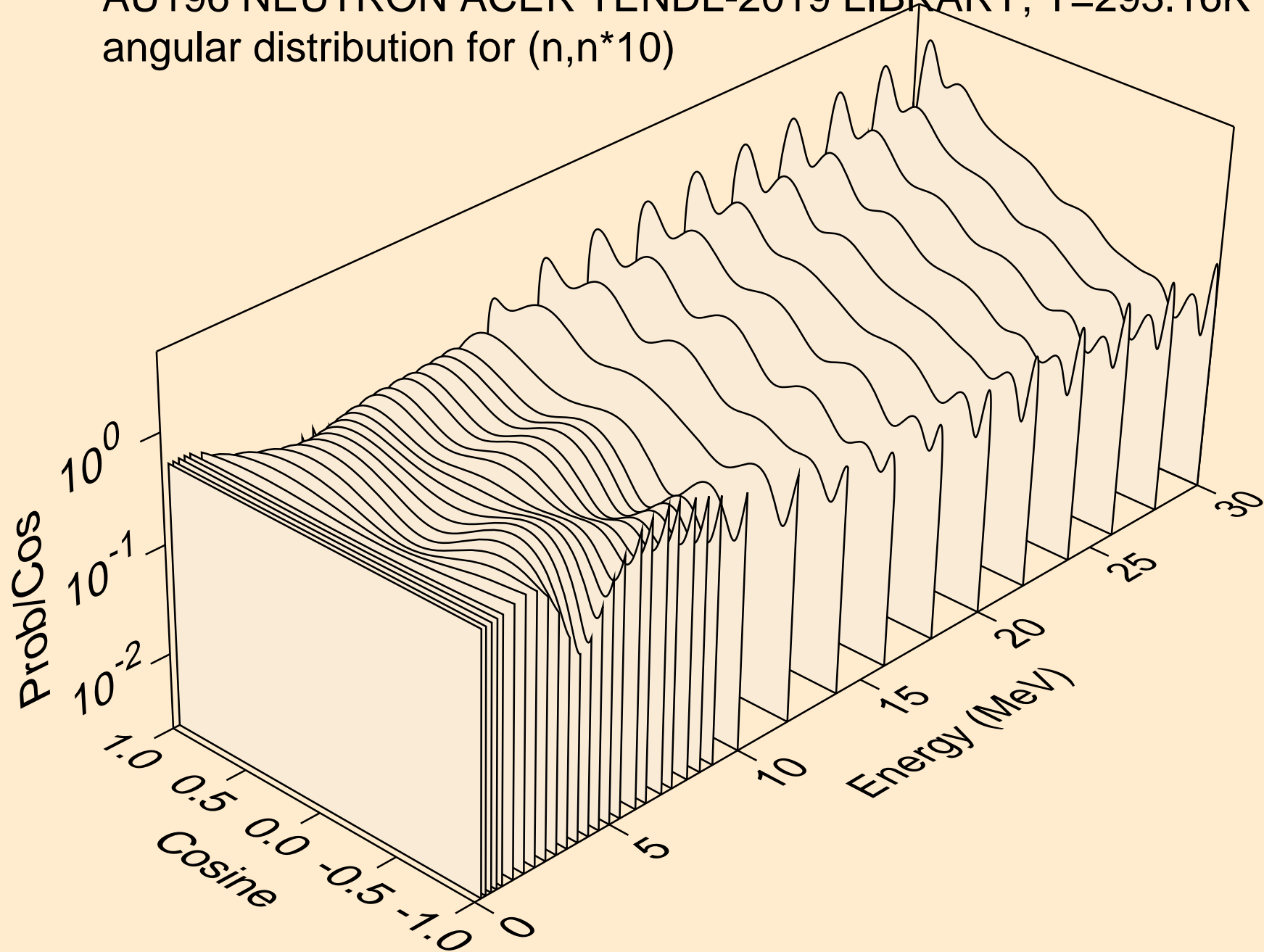



AU196 NEUTRON ACER TENDL-2019 LIBRARY; T=293.16K  
angular distribution for (n,n\*11)

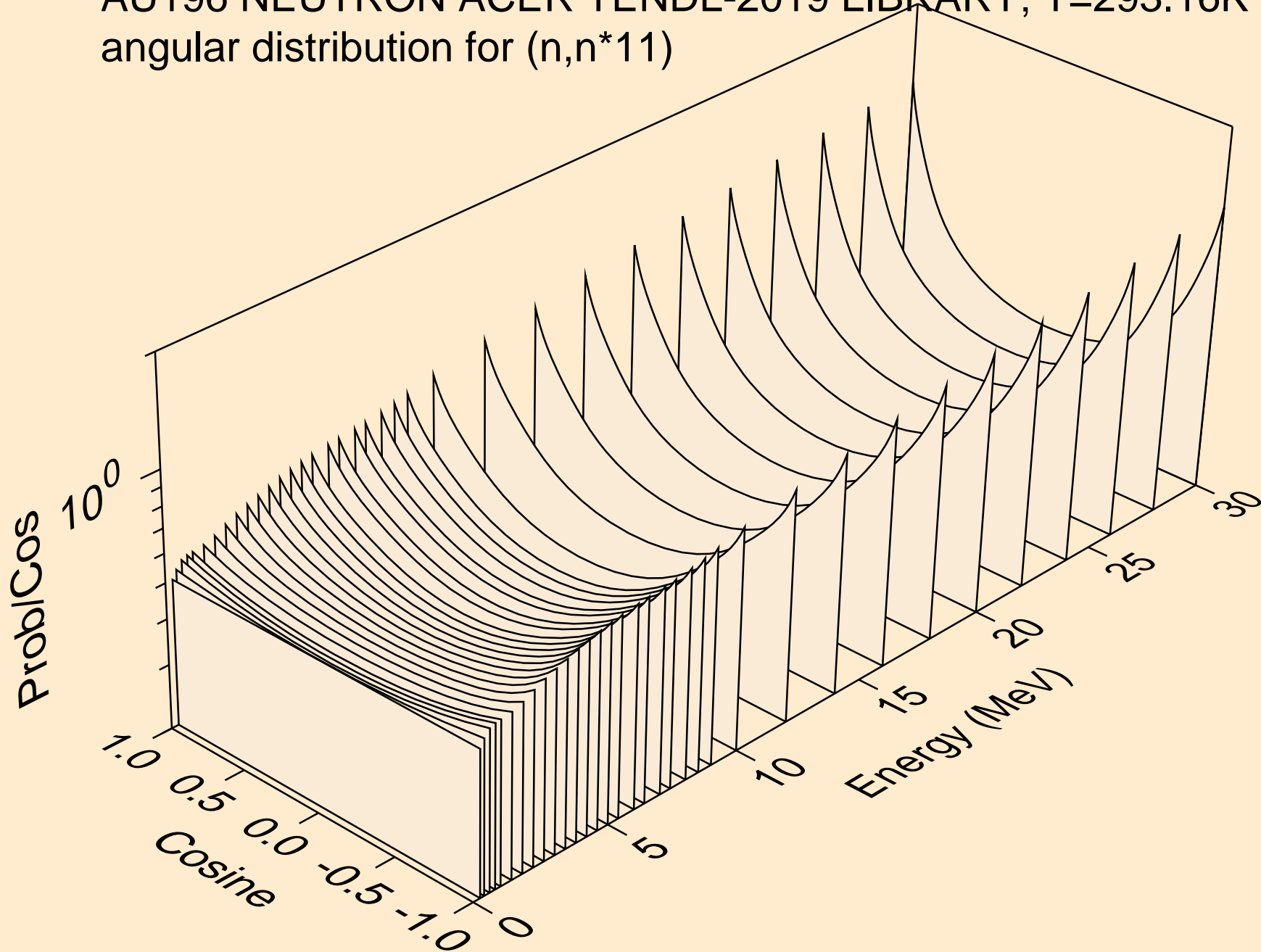

AU196 NEUTRON ACER TENDL-2019 LIBRARY; T=293.16K  
angular distribution for (n,n\*12)

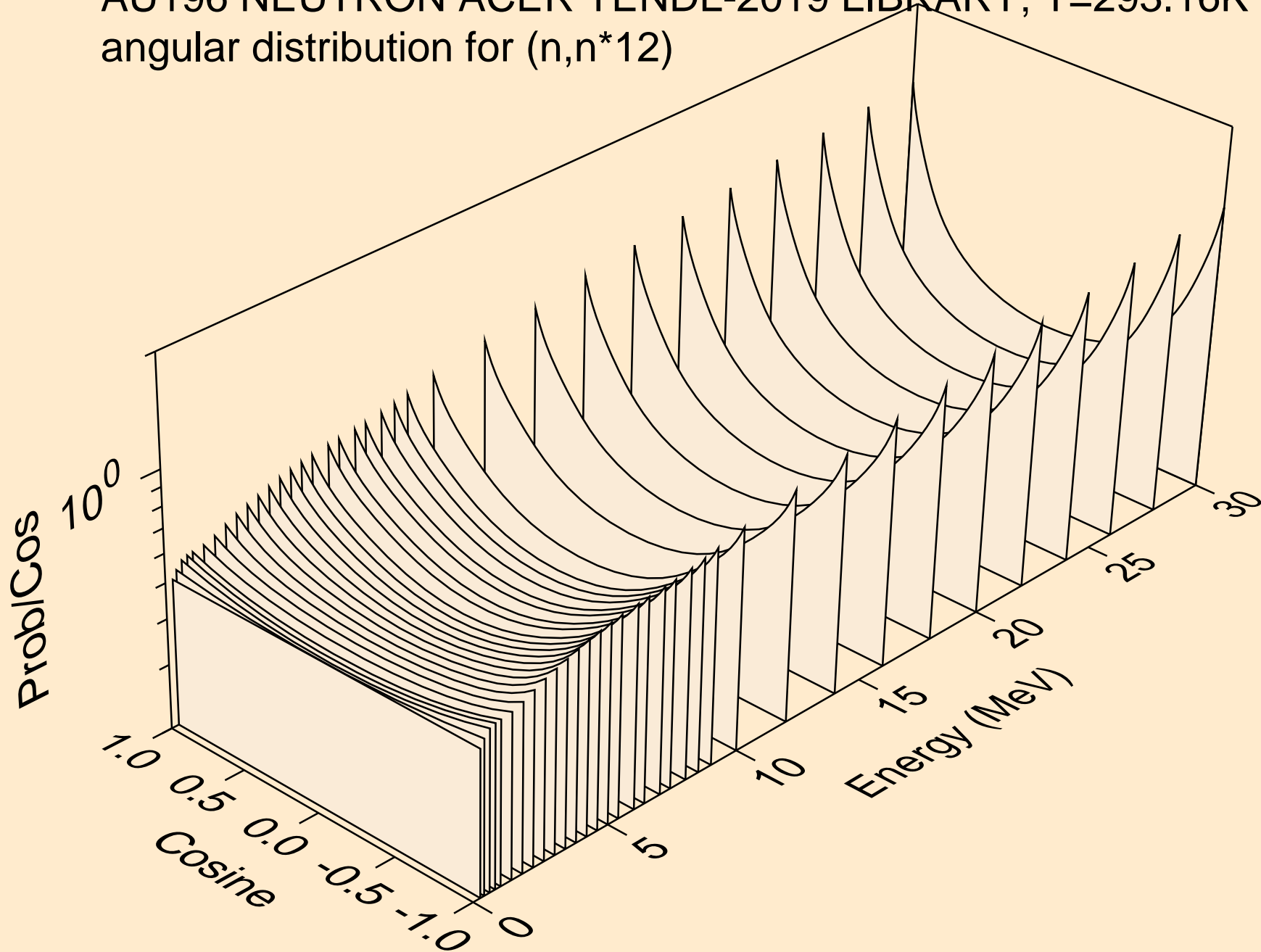

AU196 NEUTRON ACER TENDL-2019 LIBRARY; T=293.16K  
angular distribution for (n,n\*13)

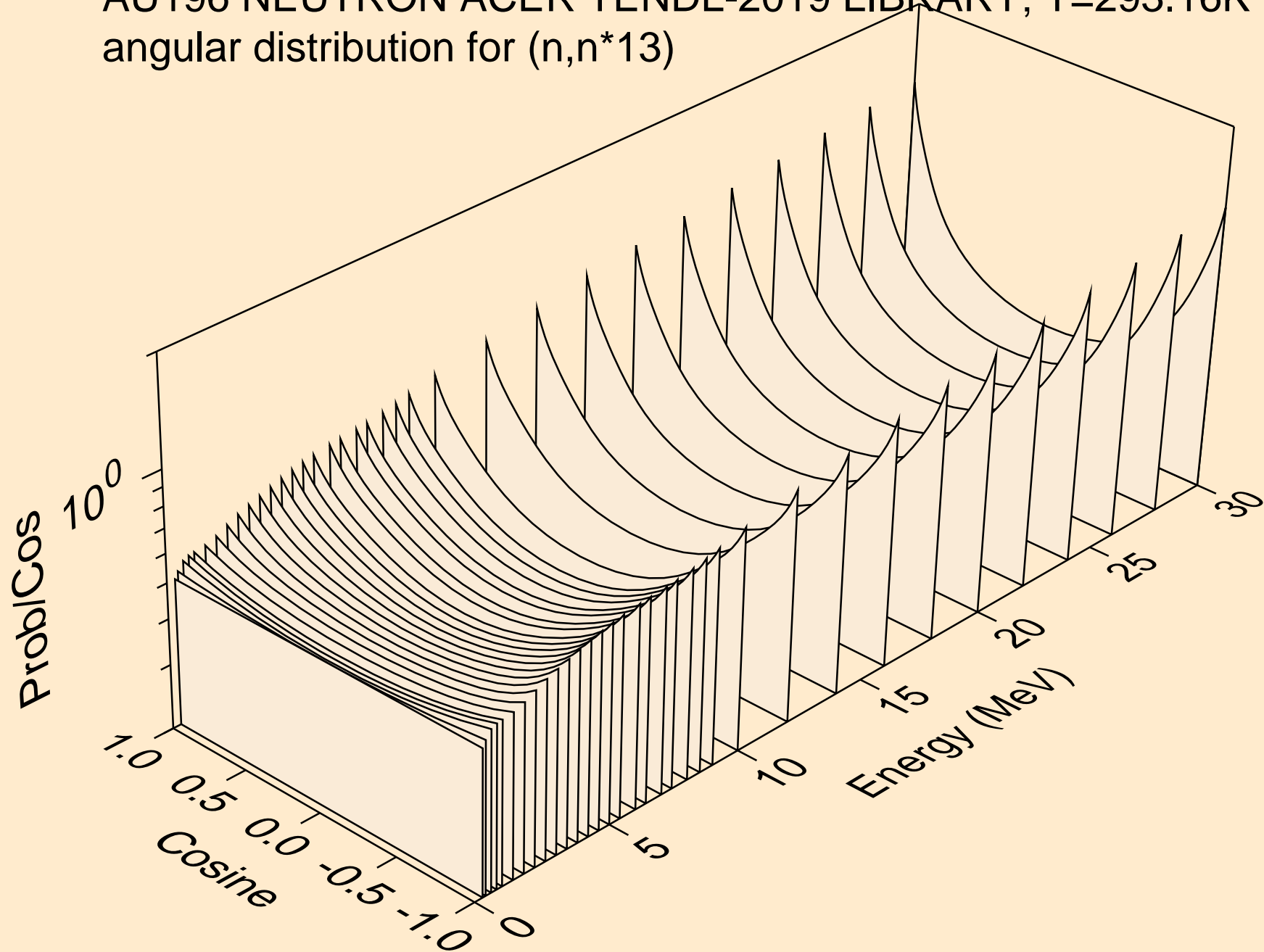

AU196 NEUTRON ACER TENDL-2019 LIBRARY; T=293.16K  
angular distribution for (n,n\*14)

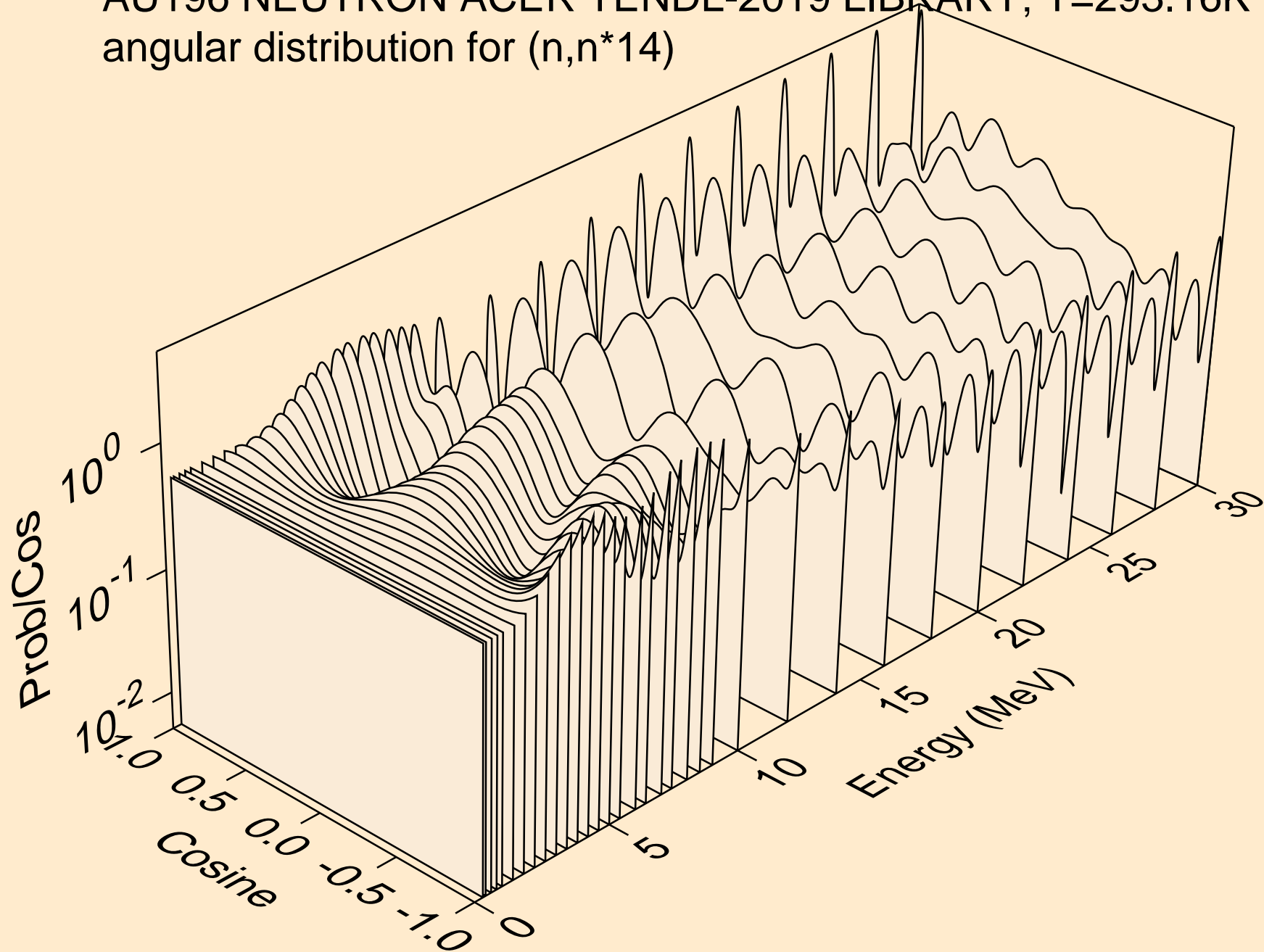

AU196 NEUTRON ACER TENDL-2019 LIBRARY; T=293.16K  
angular distribution for (n,n\*15)

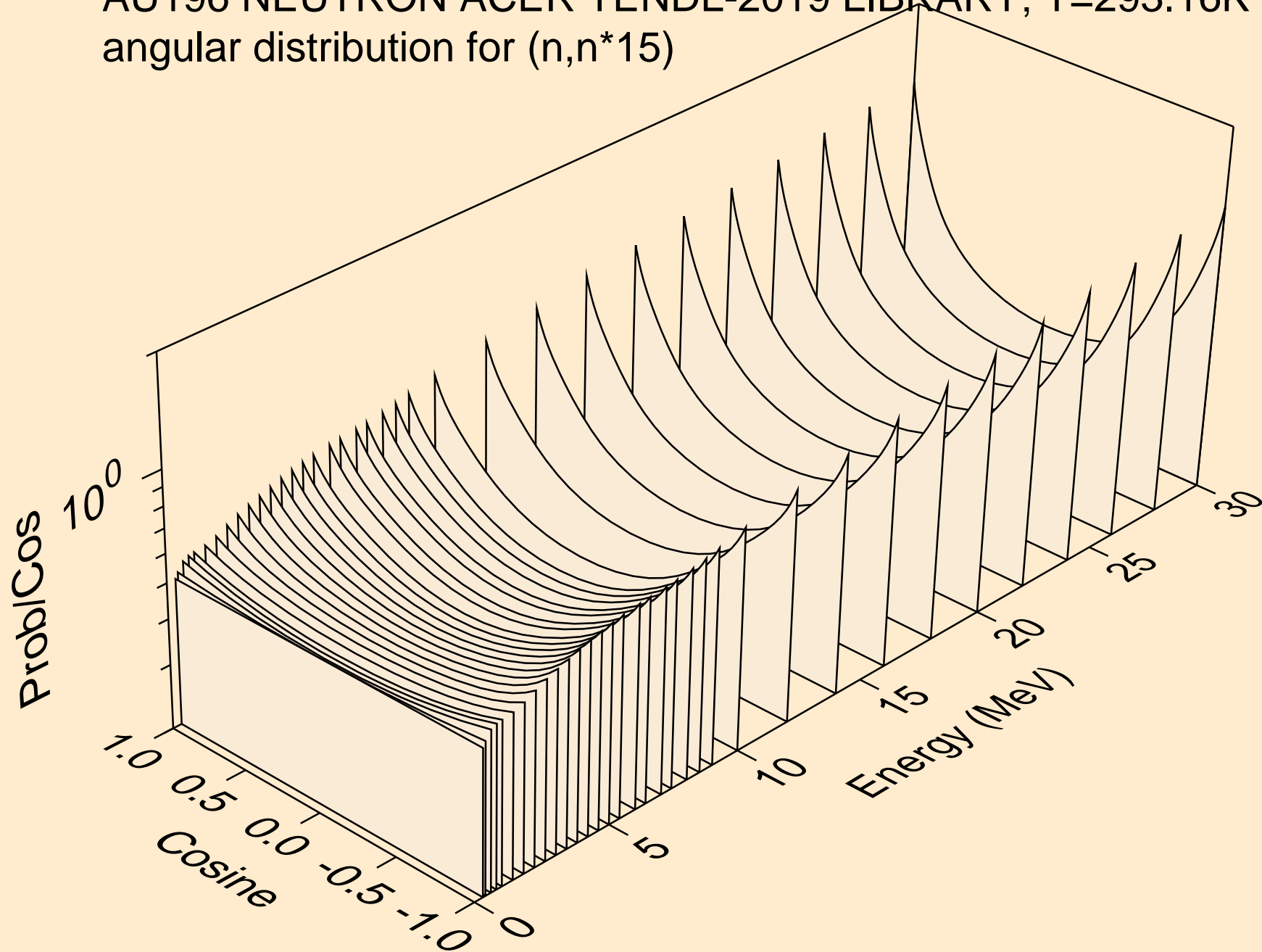

AU196 NEUTRON ACER TENDL-2019 LIBRARY; T=293.16K  
angular distribution for (n,n\*16)

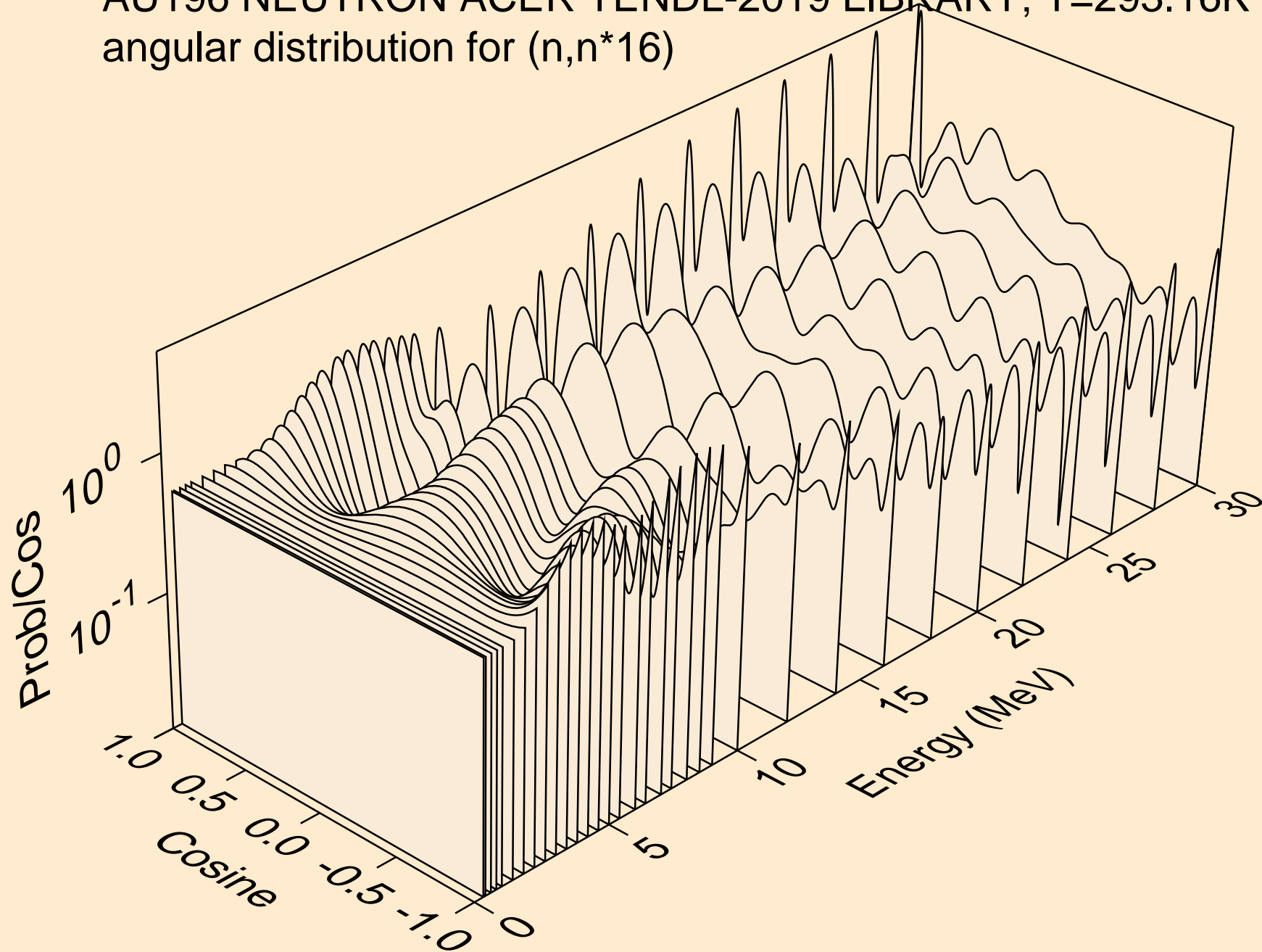

AU196 NEUTRON ACER TENDL-2019 LIBRARY; T=293.16K  
angular distribution for (n,n\*17)

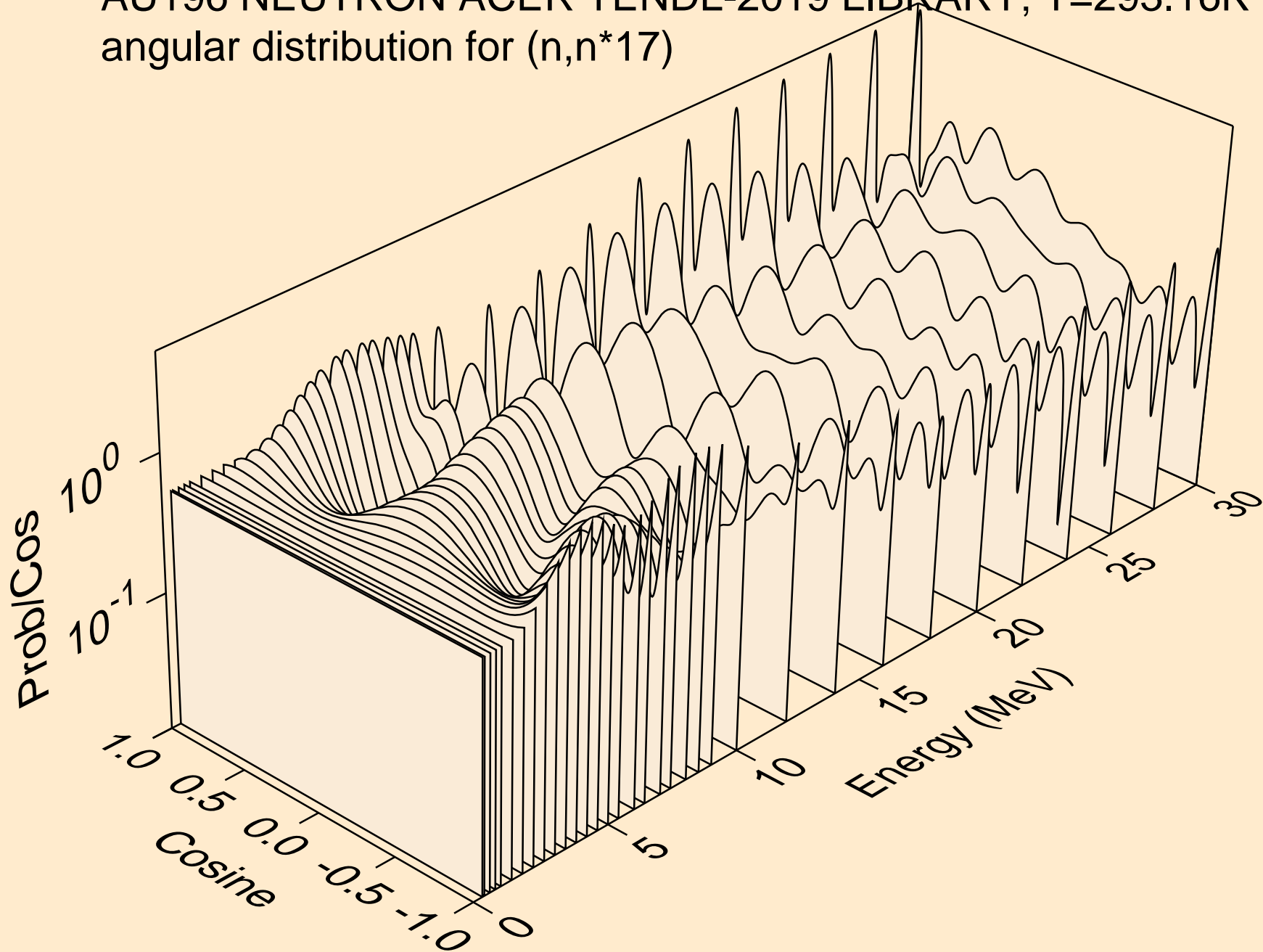

AU196 NEUTRON ACER TENDL-2019 LIBRARY; T=293.16K  
angular distribution for (n,n\*18)

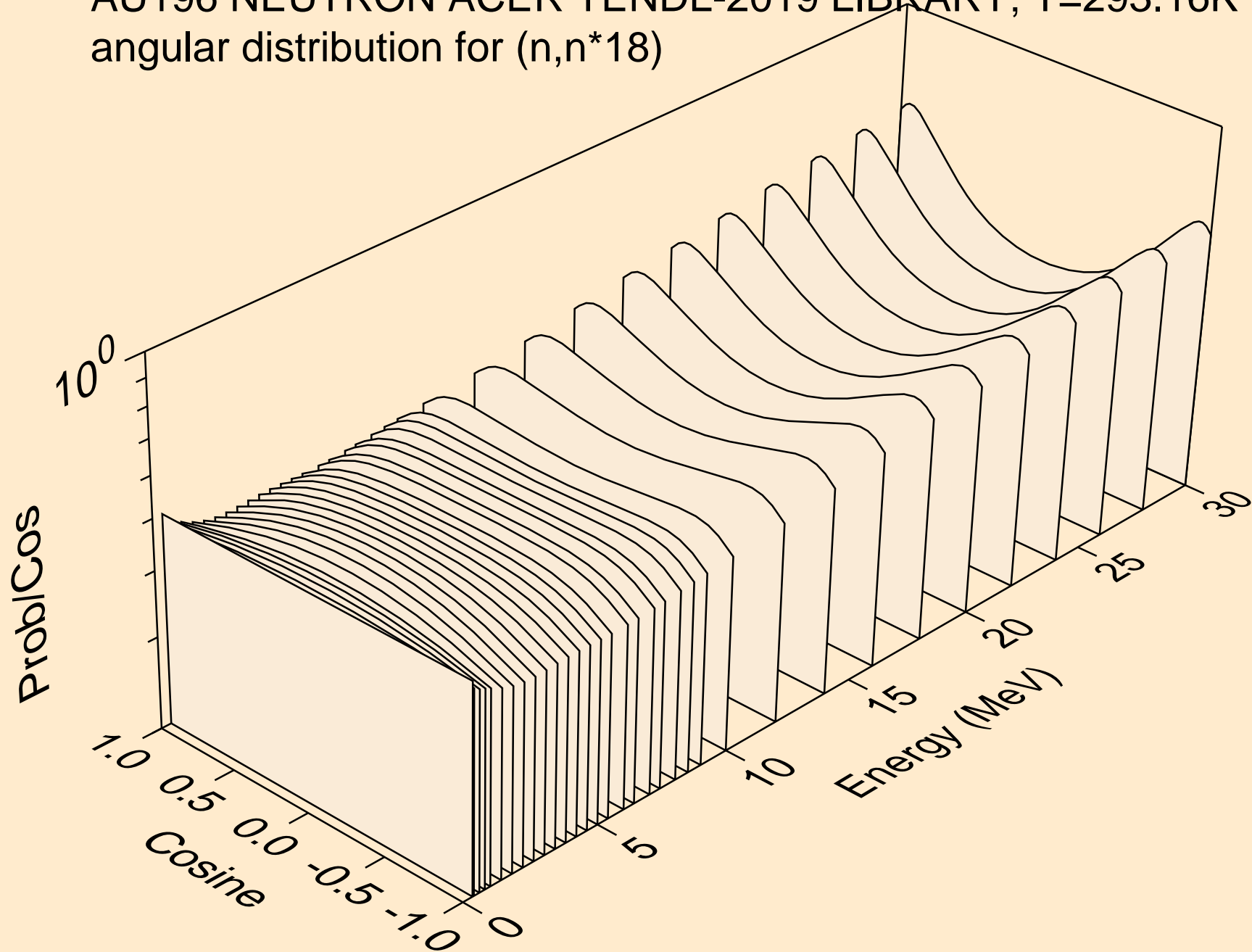



AU196 NEUTRON ACER TENDL-2019 LIBRARY; T=293.16K  
angular distribution for (n,n\*19)

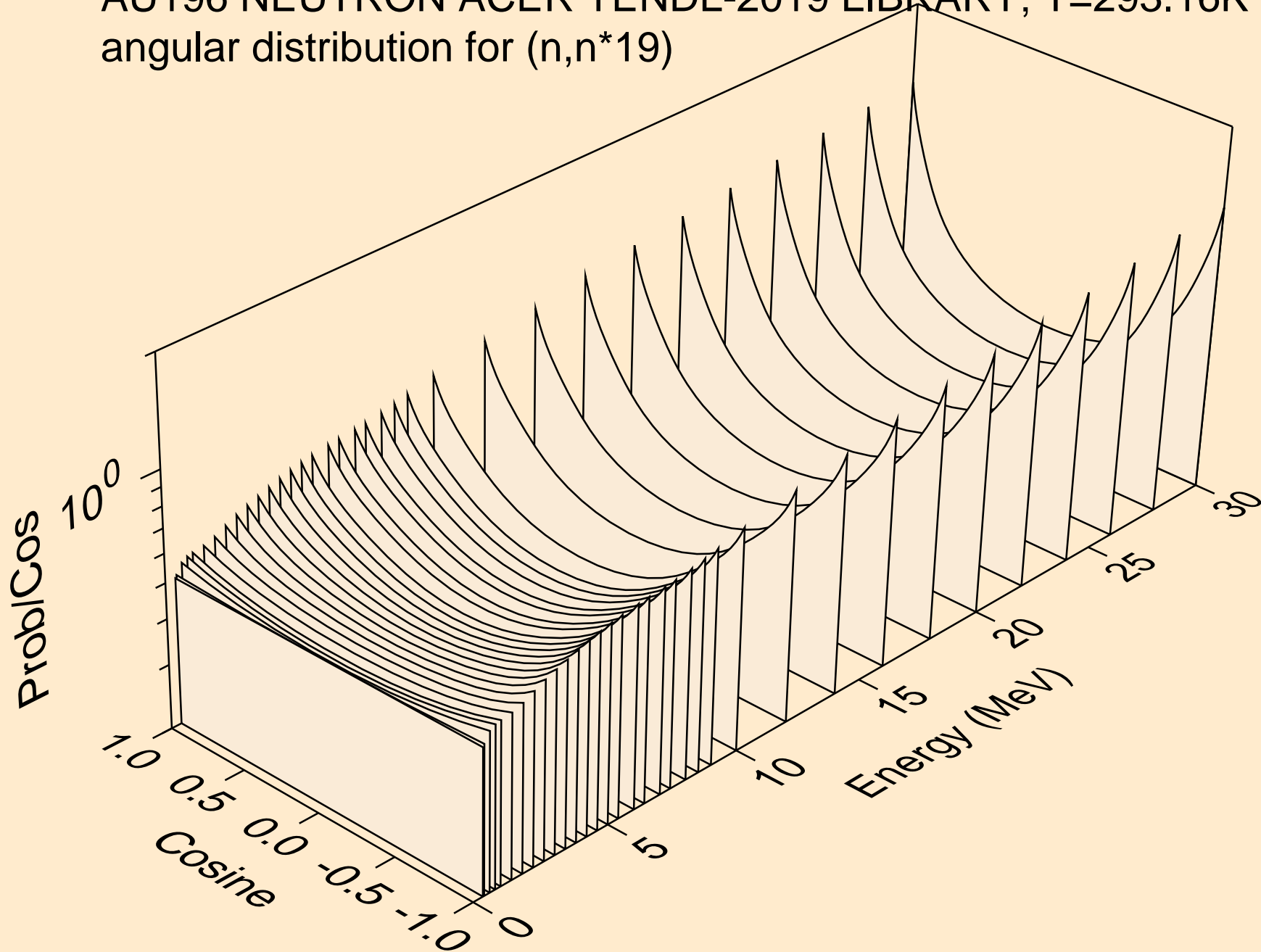

AU196 NEUTRON ACER TENDL-2019 LIBRARY; T=293.16K  
angular distribution for (n,n\*20)

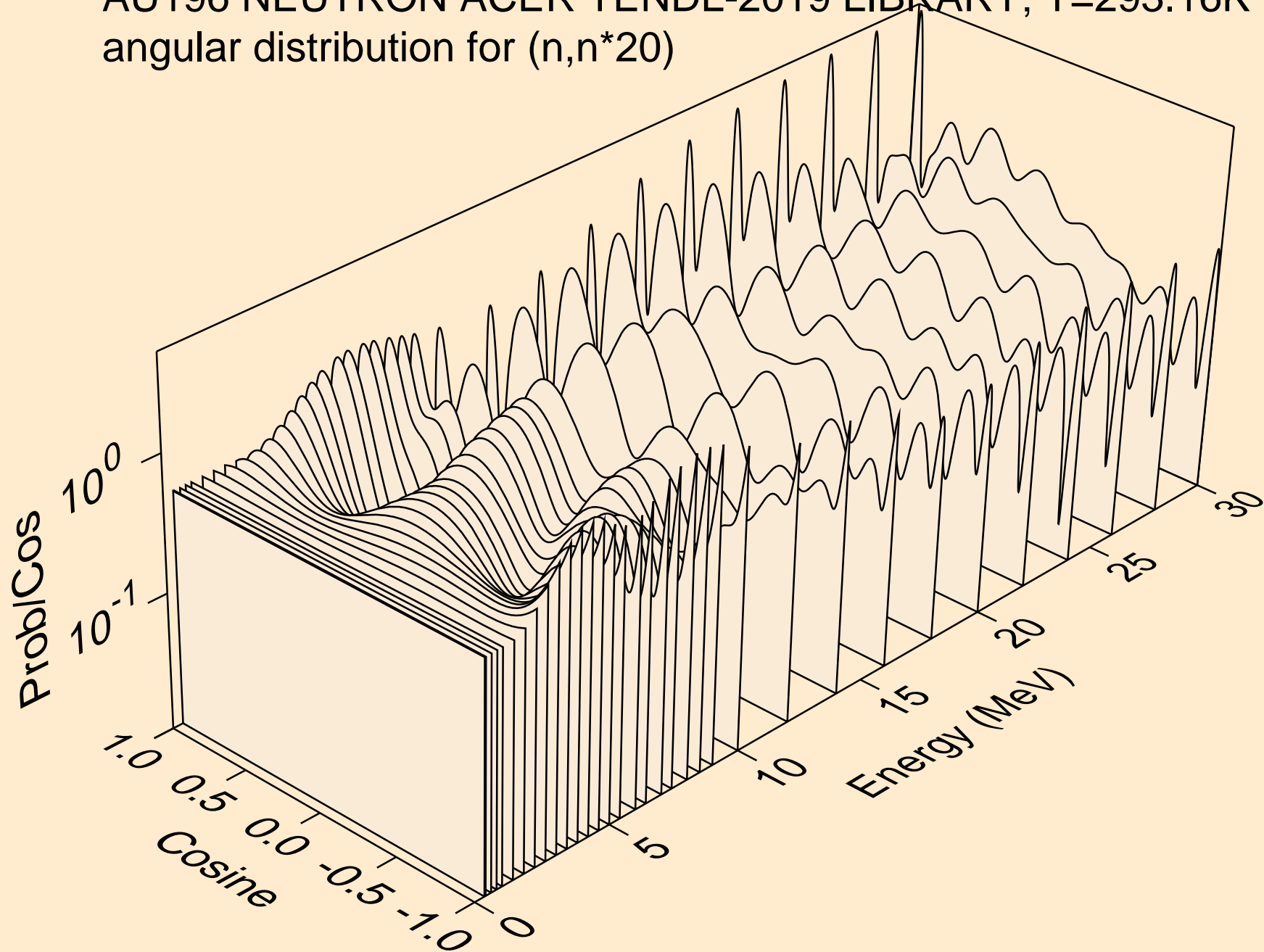

AU196 NEUTRON ACER TENDL-2019 LIBRARY; T=293.16K  
angular distribution for (n,n\*21)

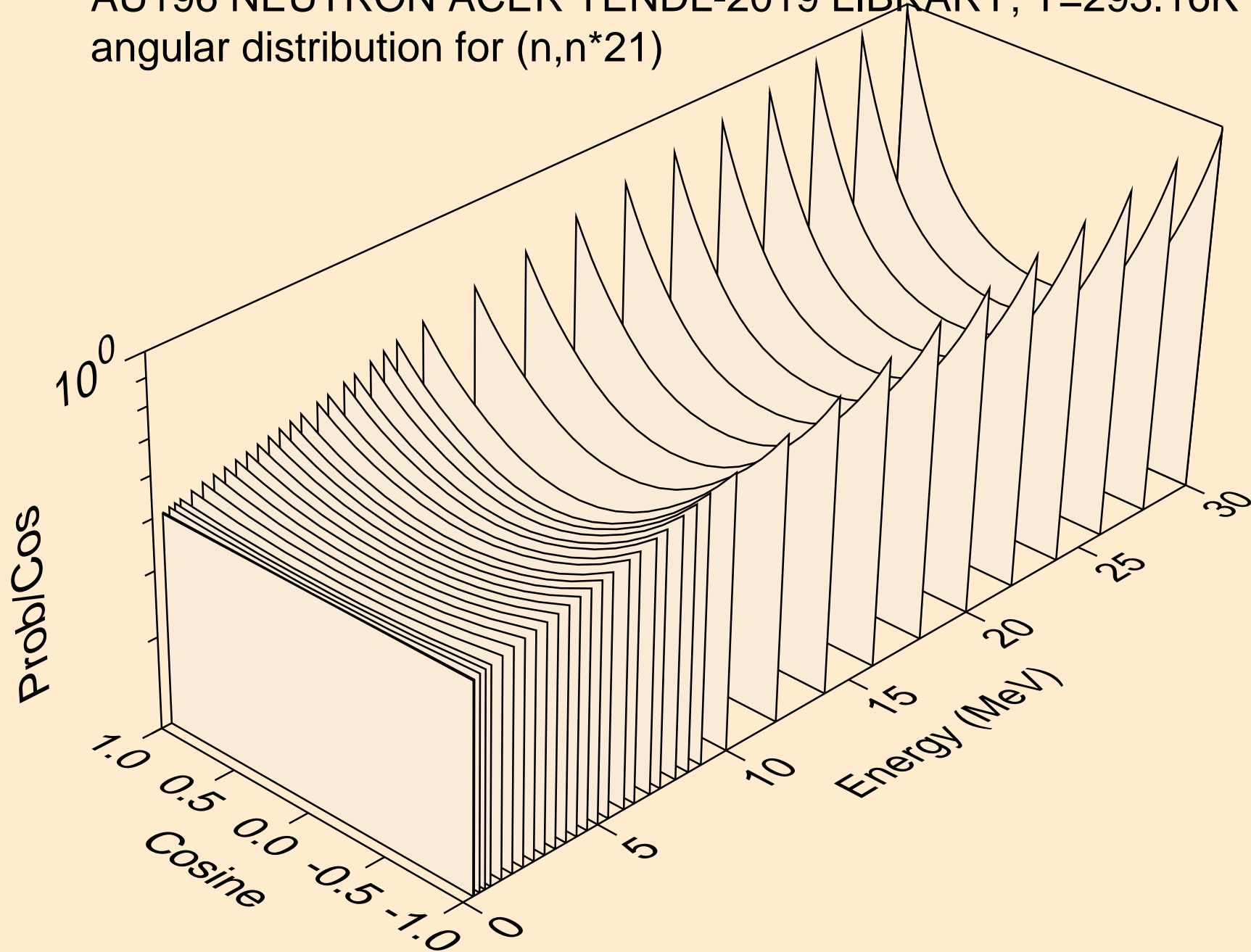

AU196 NEUTRON ACER TENDL-2019 LIBRARY; T=293.16K  
angular distribution for (n,n\*22)

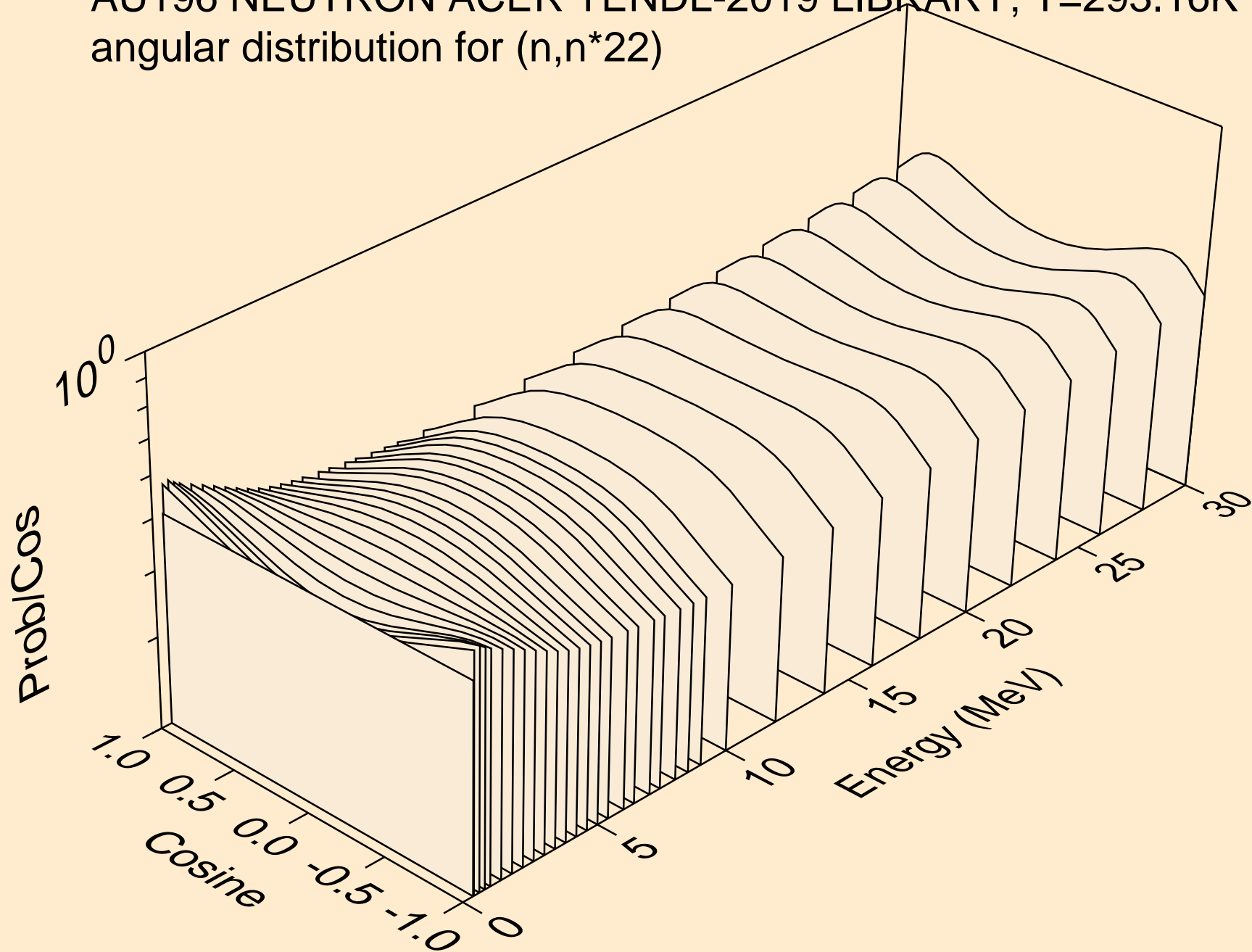

AU196 NEUTRON ACER TENDL-2019 LIBRARY; T=293.16K  
angular distribution for (n,n\*23)

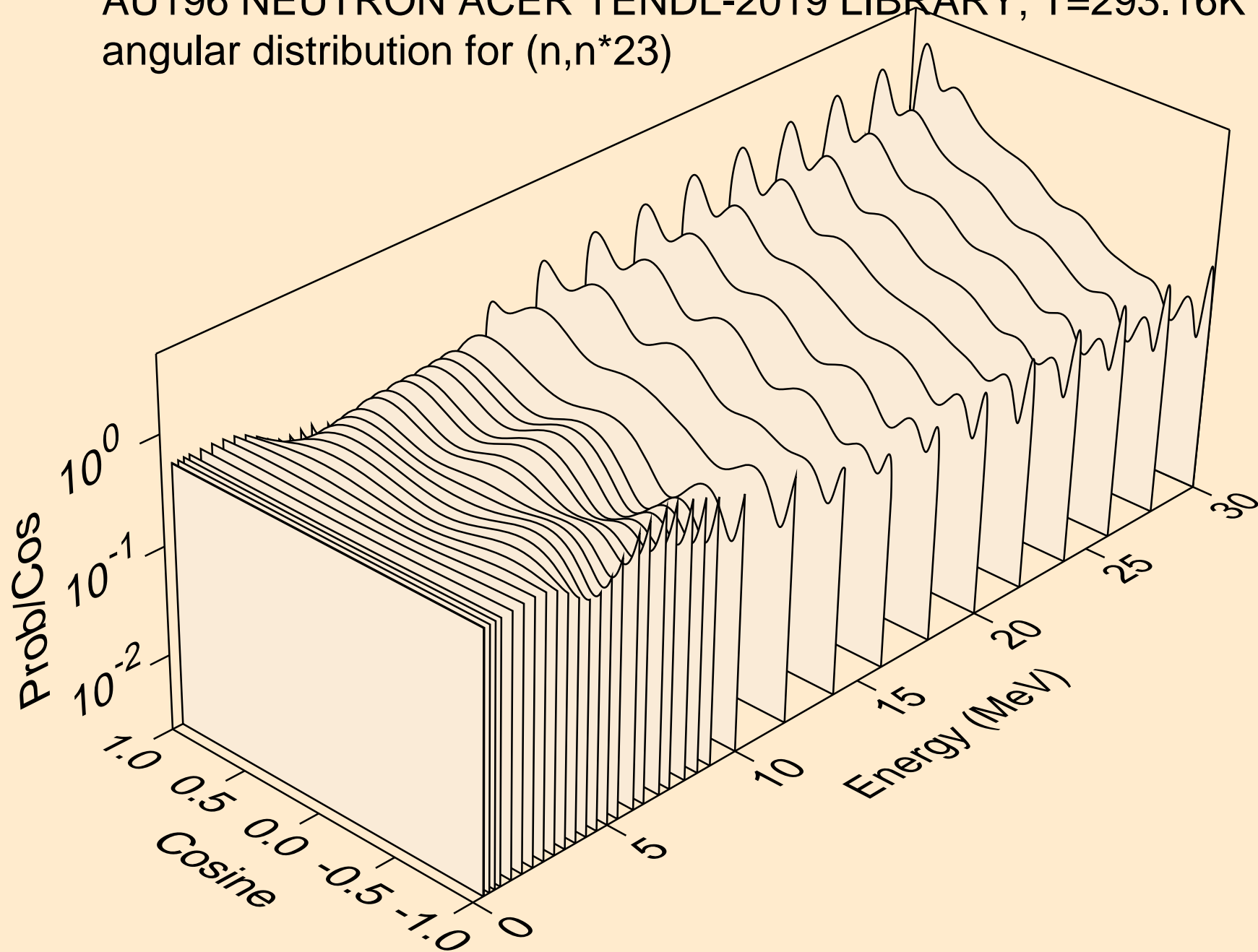

AU196 NEUTRON ACER TENDL-2019 LIBRARY; T=293.16K  
angular distribution for (n,n\*24)

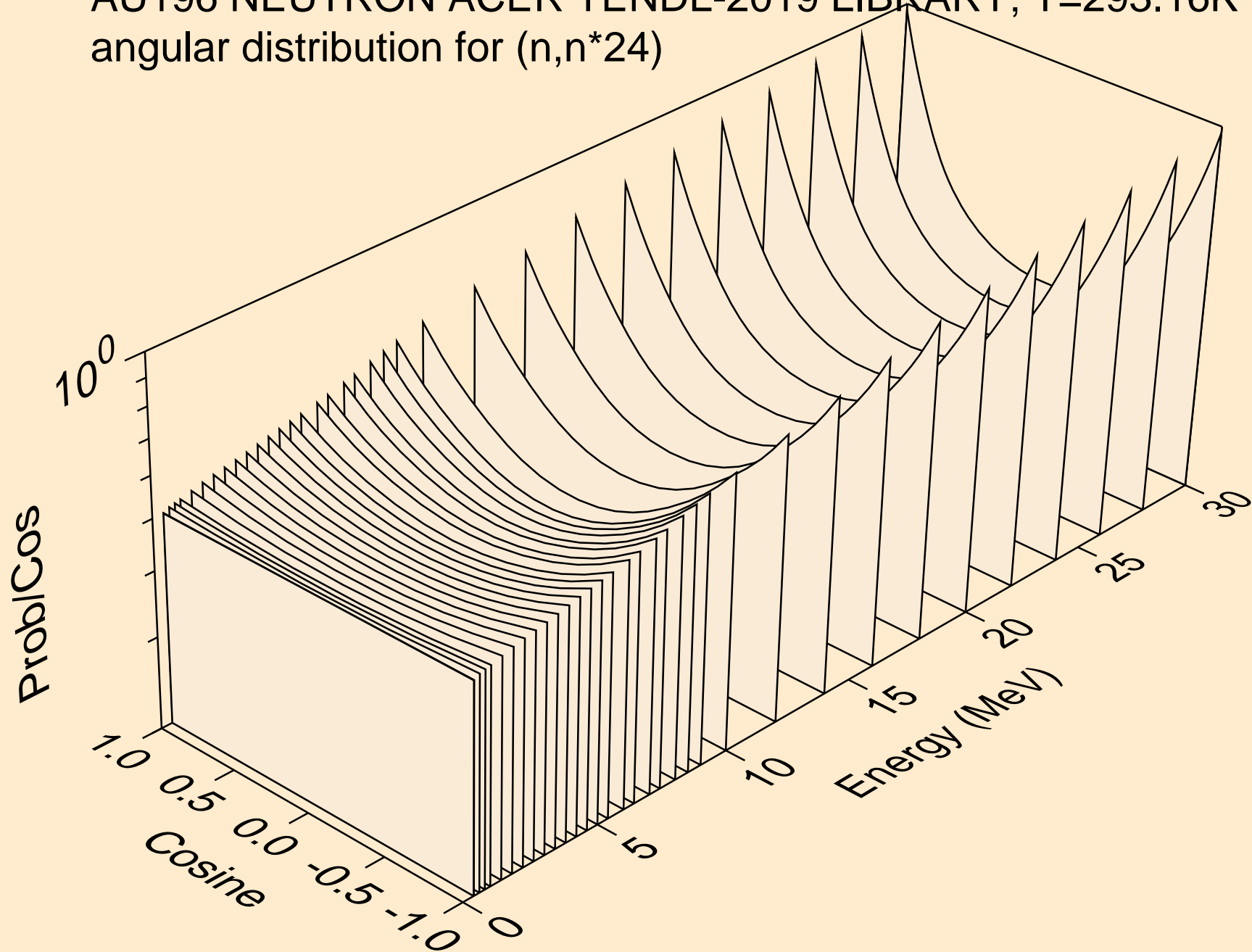

AU196 NEUTRON ACER TENDL-2019 LIBRARY; T=293.16K  
angular distribution for (n,n\*25)

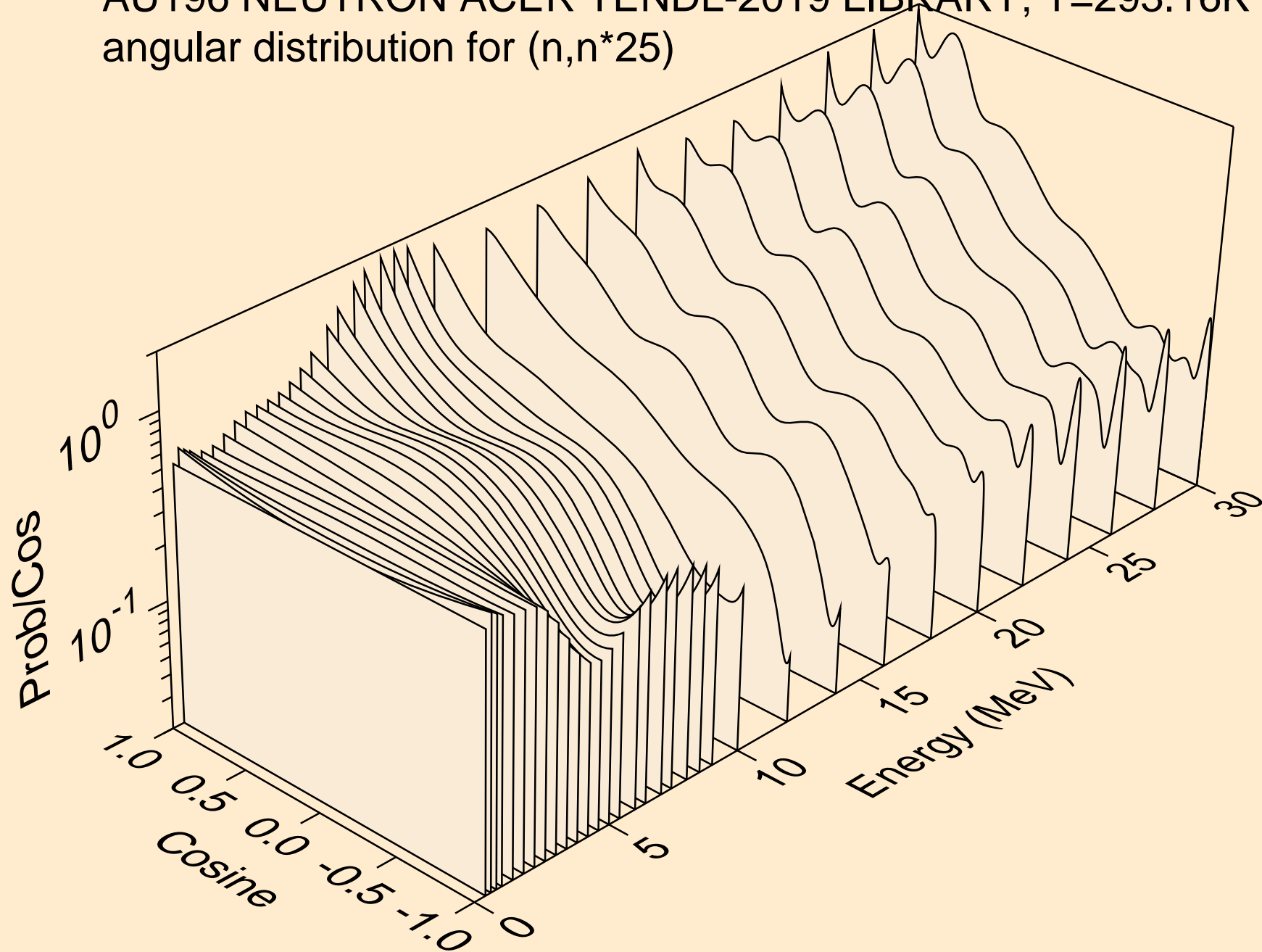

AU196 NEUTRON ACER TENDL-2019 LIBRARY; T=293.16K  
angular distribution for (n,n\*26)

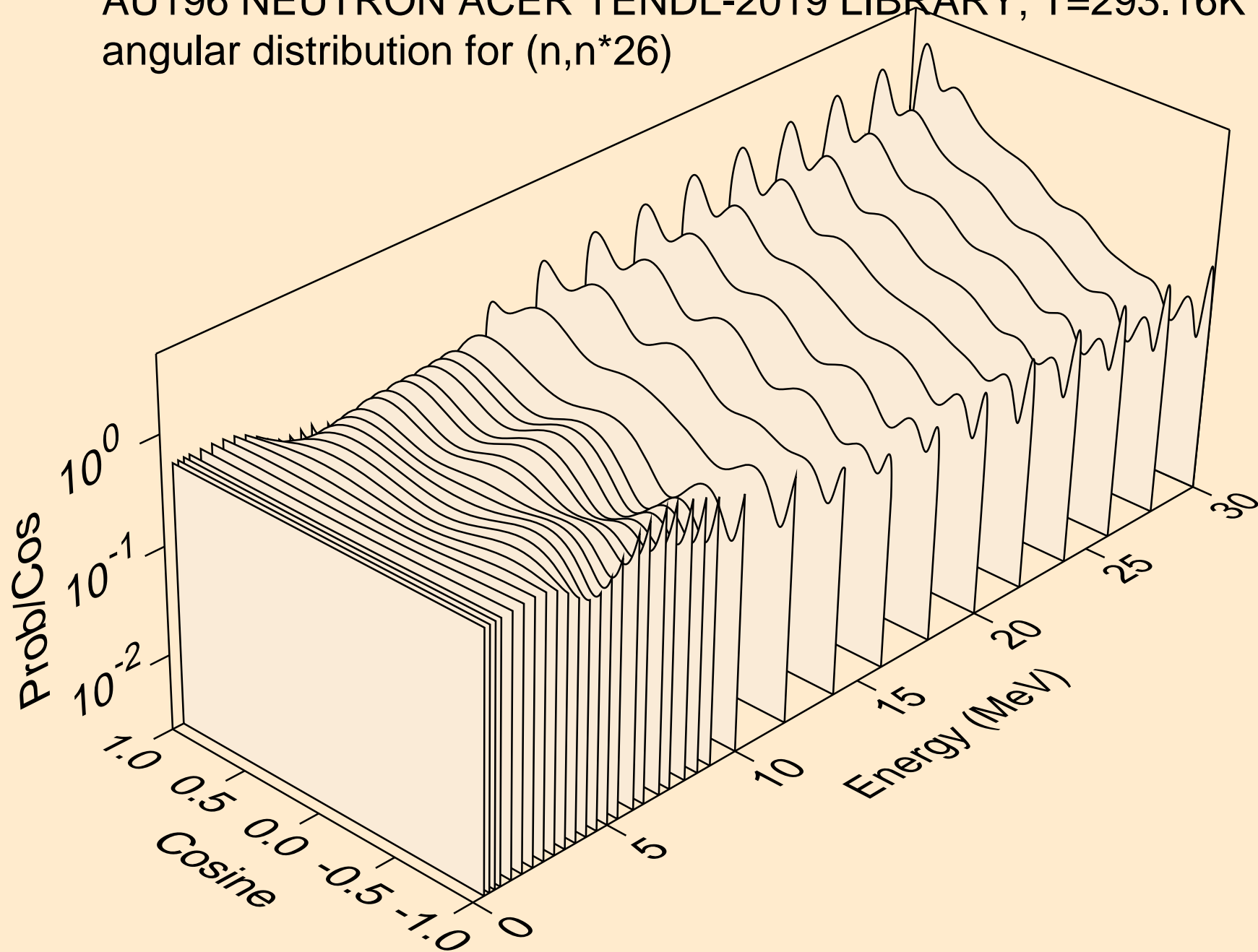



AU196 NEUTRON ACER TENDL-2019 LIBRARY; T=293.16K  
angular distribution for (n,n\*27)

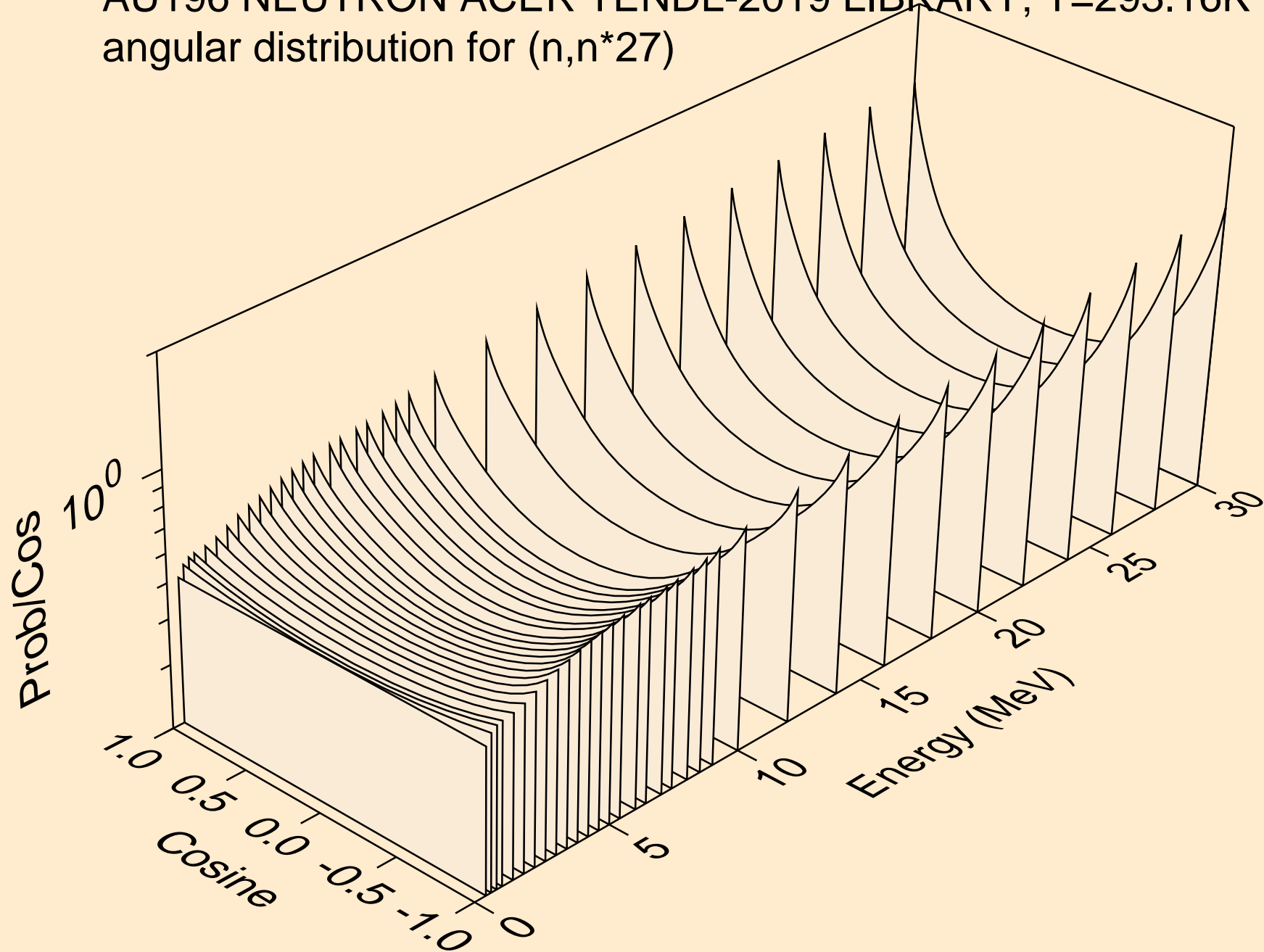

AU196 NEUTRON ACER TENDL-2019 LIBRARY; T=293.16K  
angular distribution for (n,n\*28)

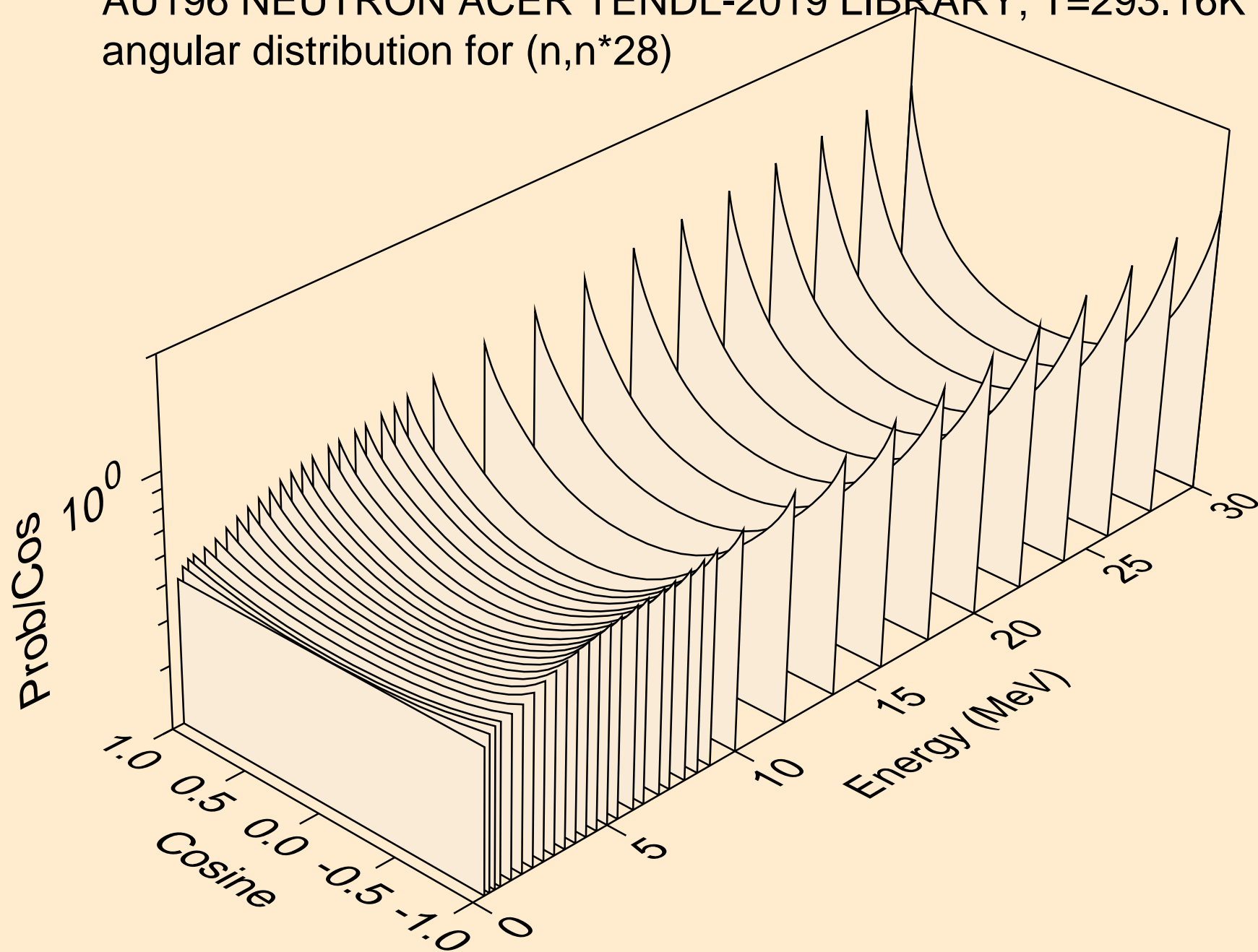

AU196 NEUTRON ACER TENDL-2019 LIBRARY; T=293.16K  
Neutron emission for (n,x)

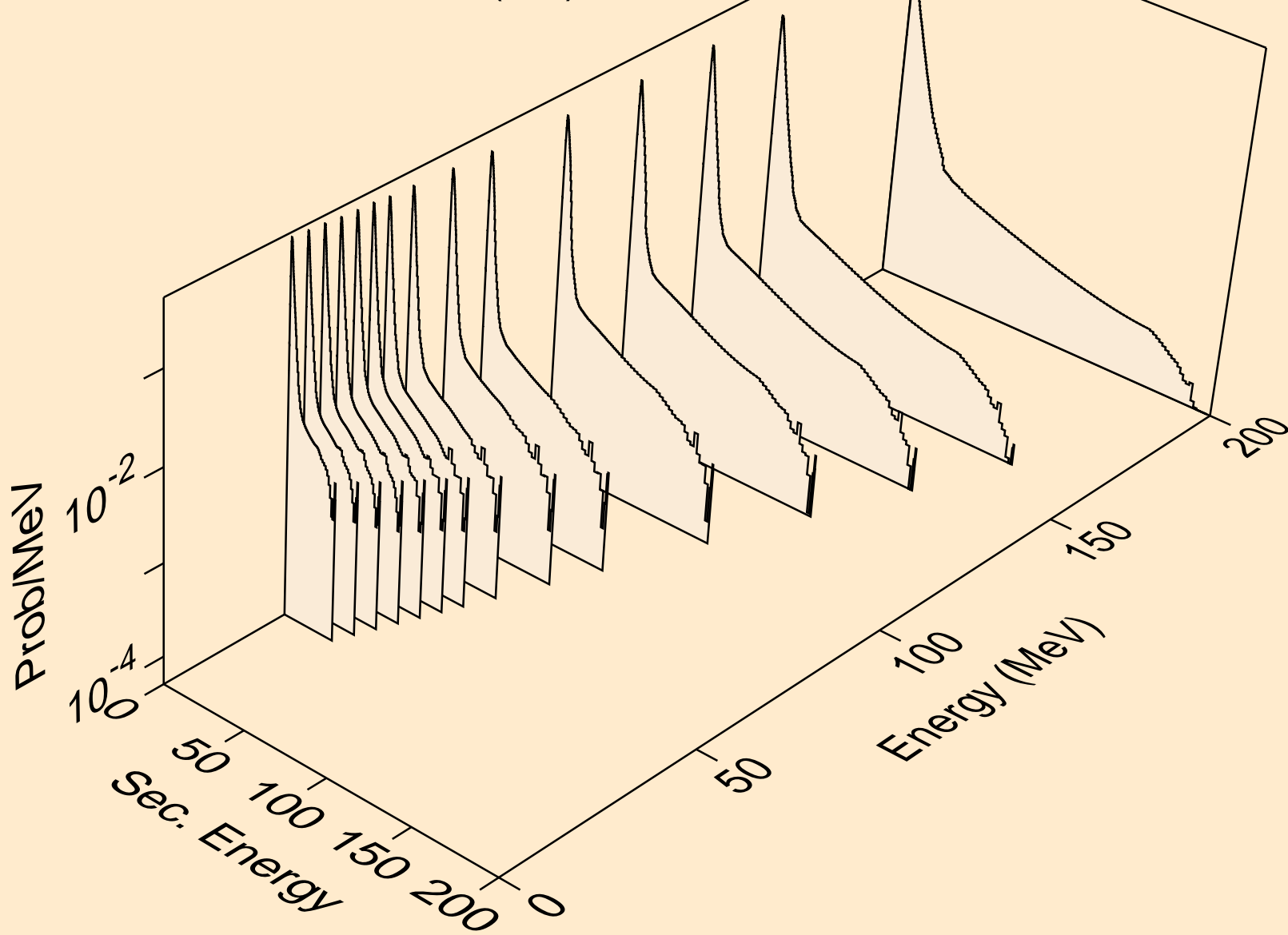

AU196 NEUTRON ACER TENDL-2019 LIBRARY; T=293.16K  
Neutron emission for (n,2nd)

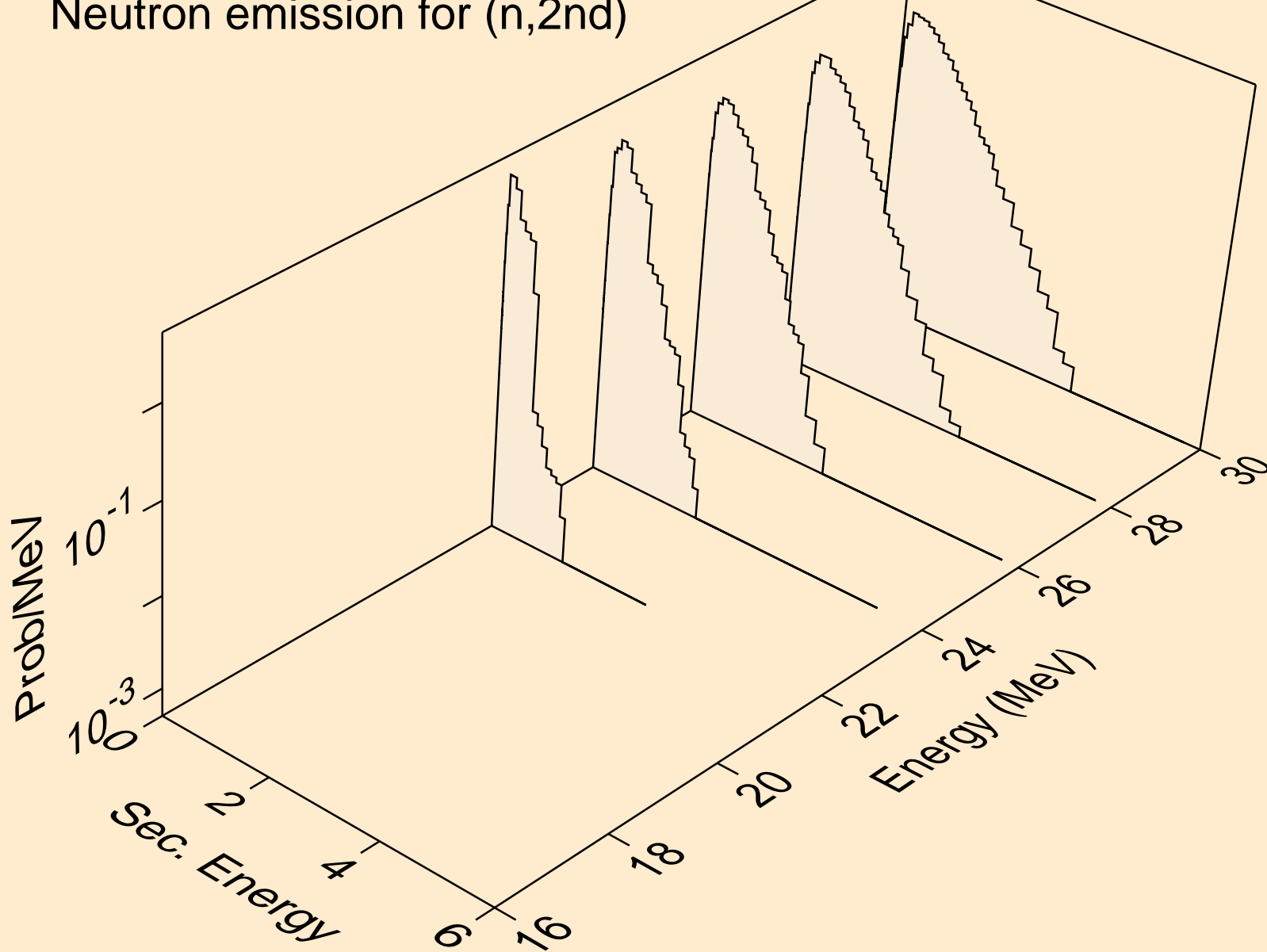

AU196 NEUTRON ACER TENDL-2019 LIBRARY; T=293.16K  
Neutron emission for (n,2n)

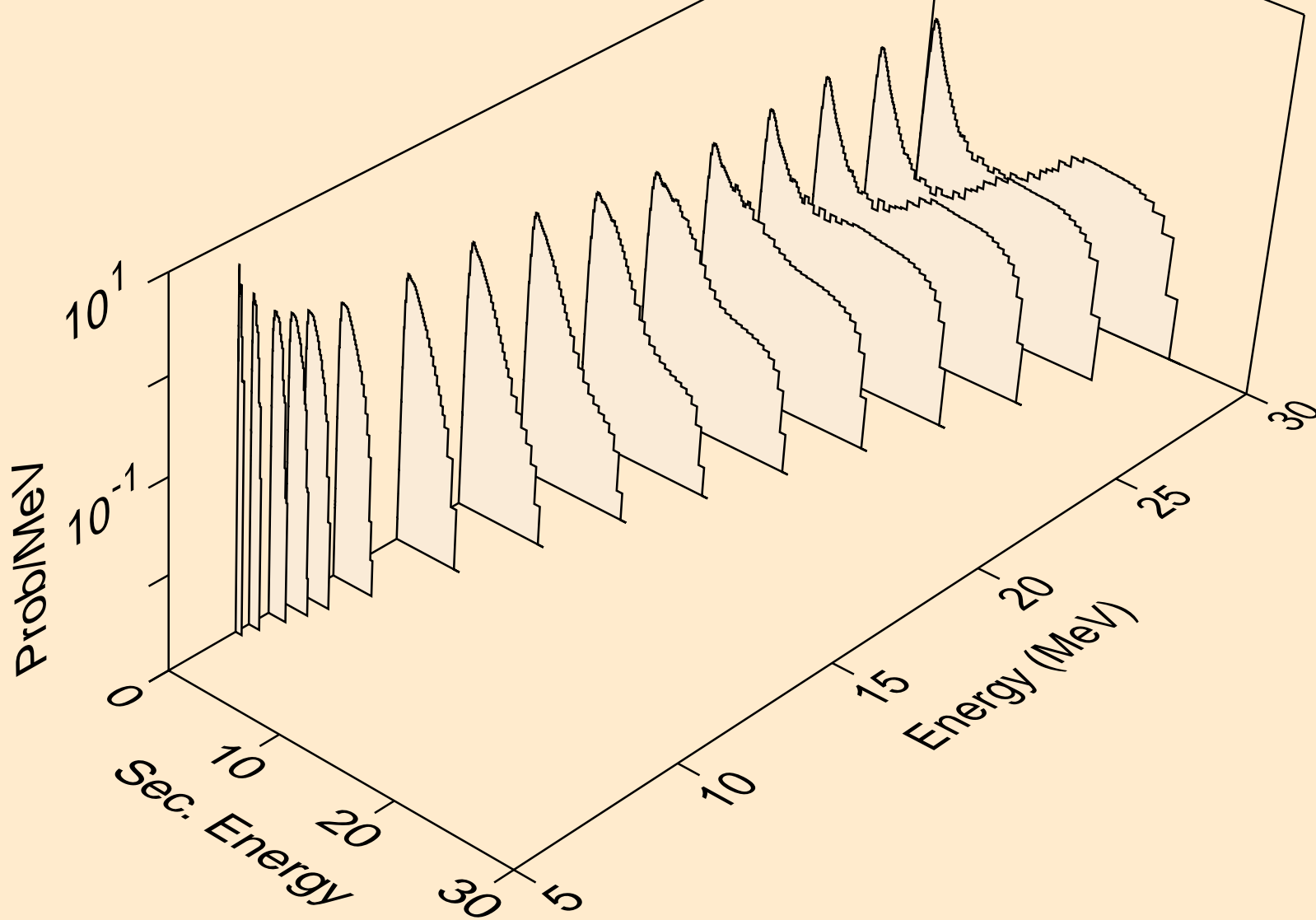

AU196 NEUTRON ACER TENDL-2019 LIBRARY; T=293.16K  
Neutron emission for (n,3n)

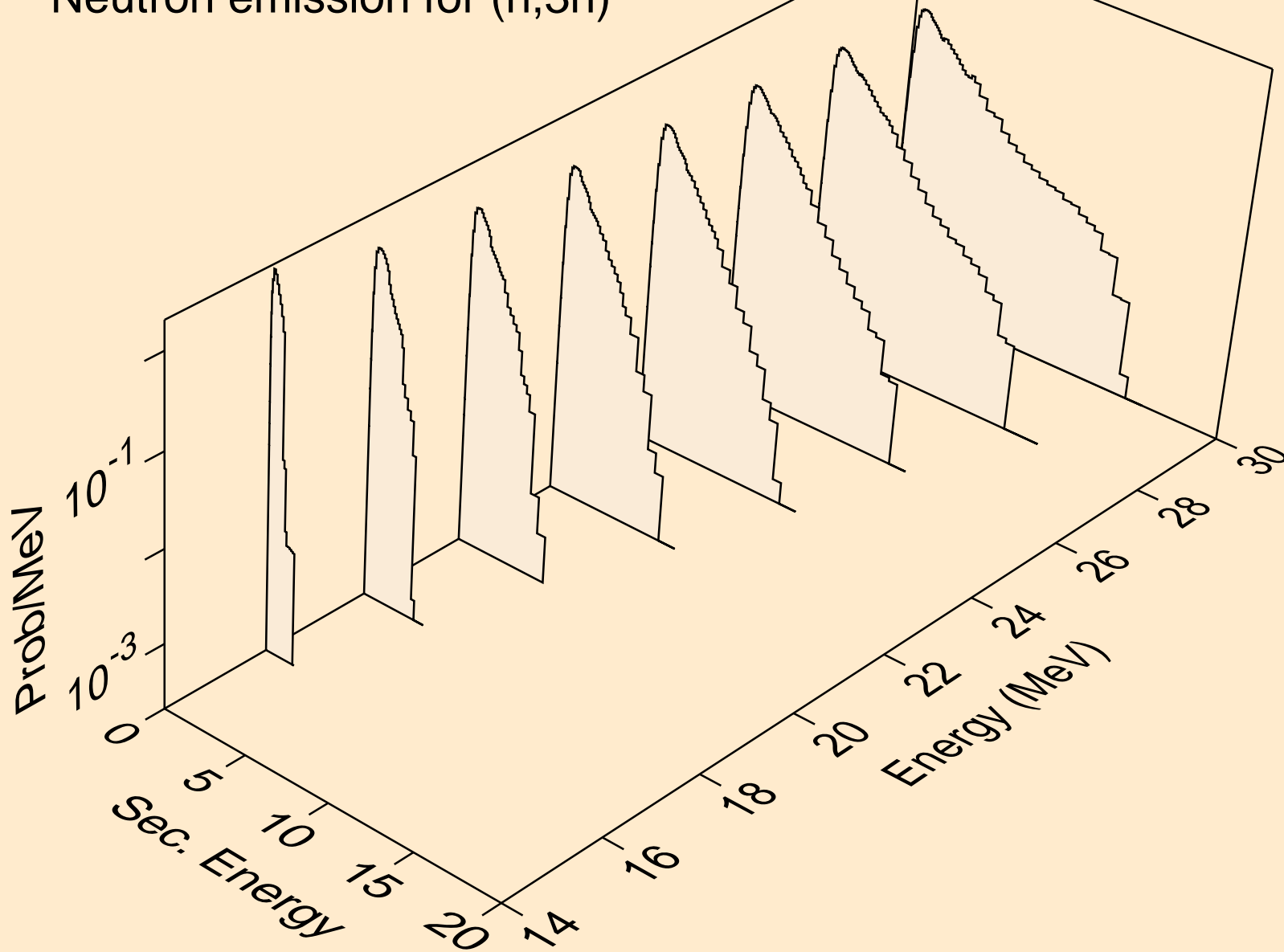

AU196 NEUTRON ACER TENDL-2019 LIBRARY; T=293.16K  
Neutron emission for (n,n\*)a

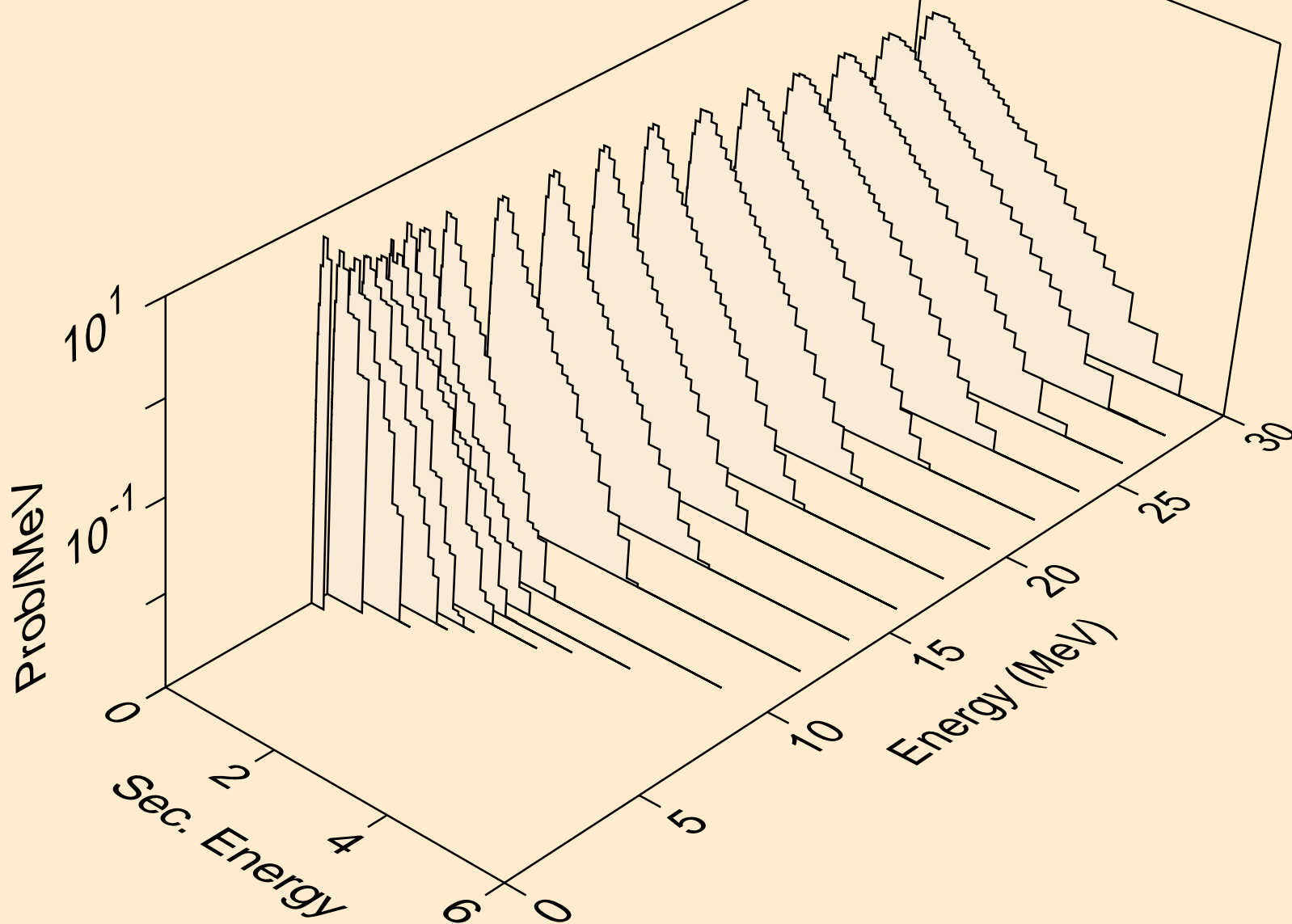

AU196 NEUTRON ACER TENDL-2019 LIBRARY; T=293.16K  
Neutron emission for (n,2n)a

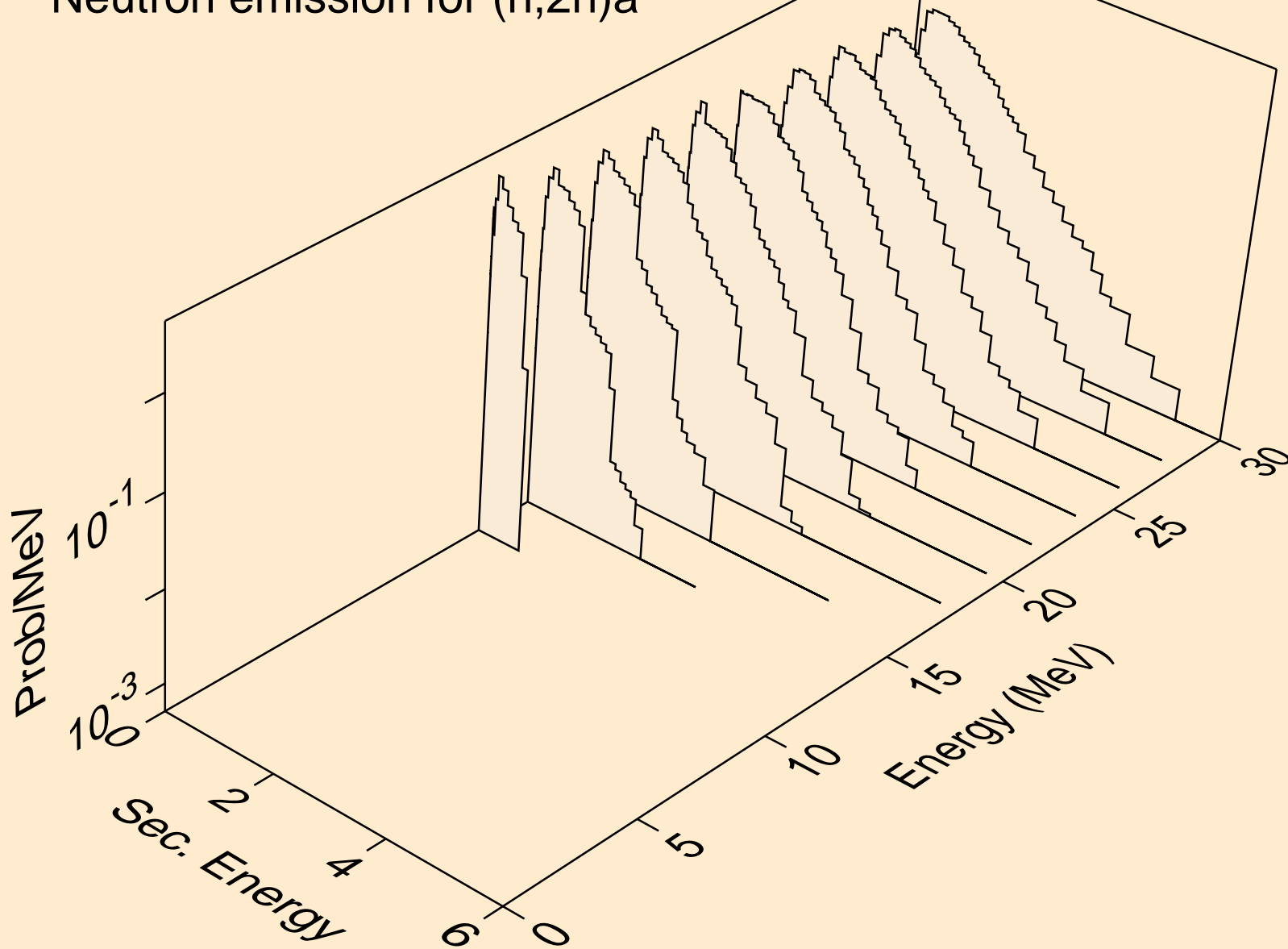



AU196 NEUTRON ACER TENDL-2019 LIBRARY; T=293.16K  
Neutron emission for (n,3n)a

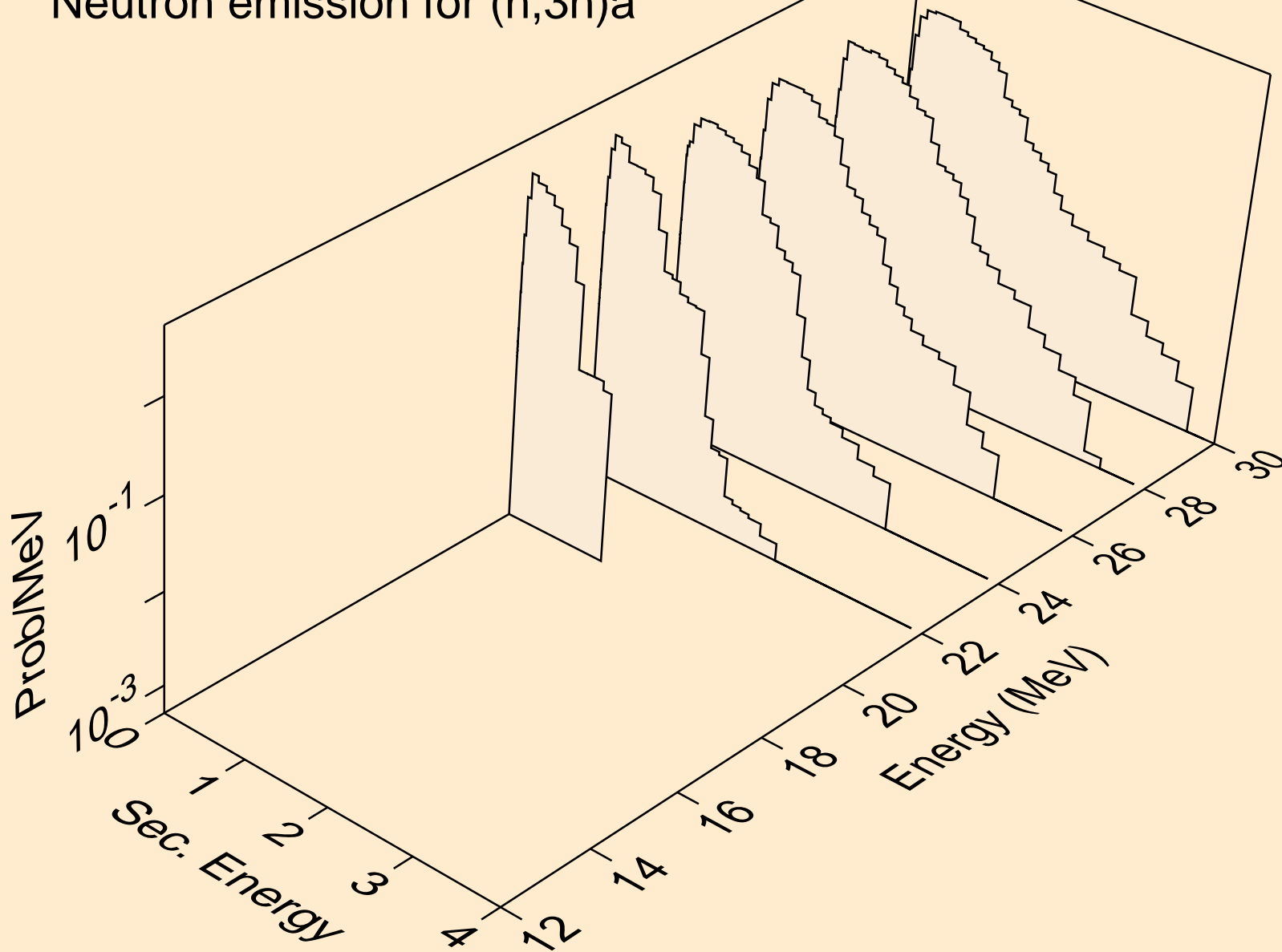

AU196 NEUTRON ACER TENDL-2019 LIBRARY; T=293.16K  
Neutron emission for (n,n\*)p

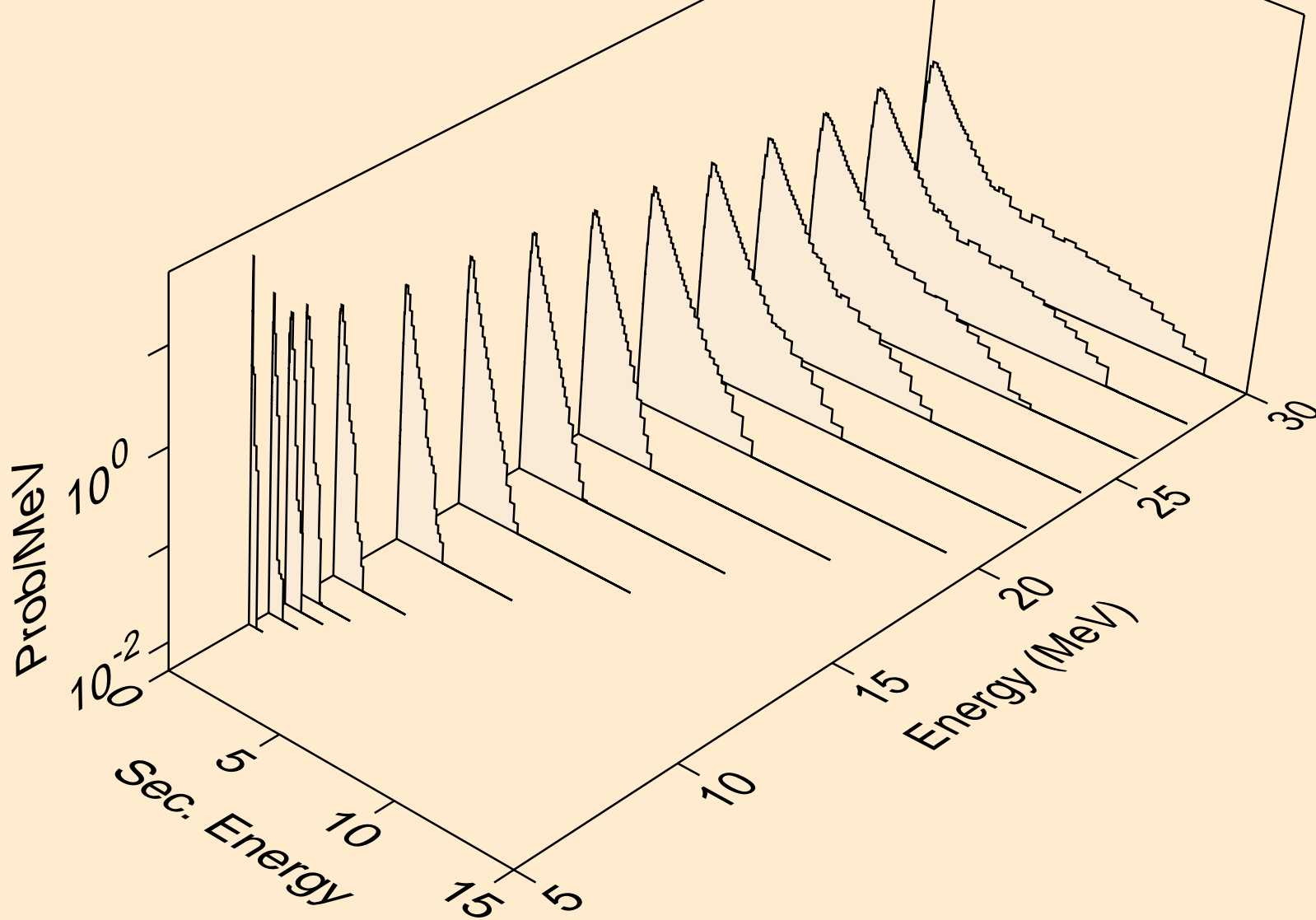

AU196 NEUTRON ACER TENDL-2019 LIBRARY; T=293.16K  
Neutron emission for (n,n\*)d

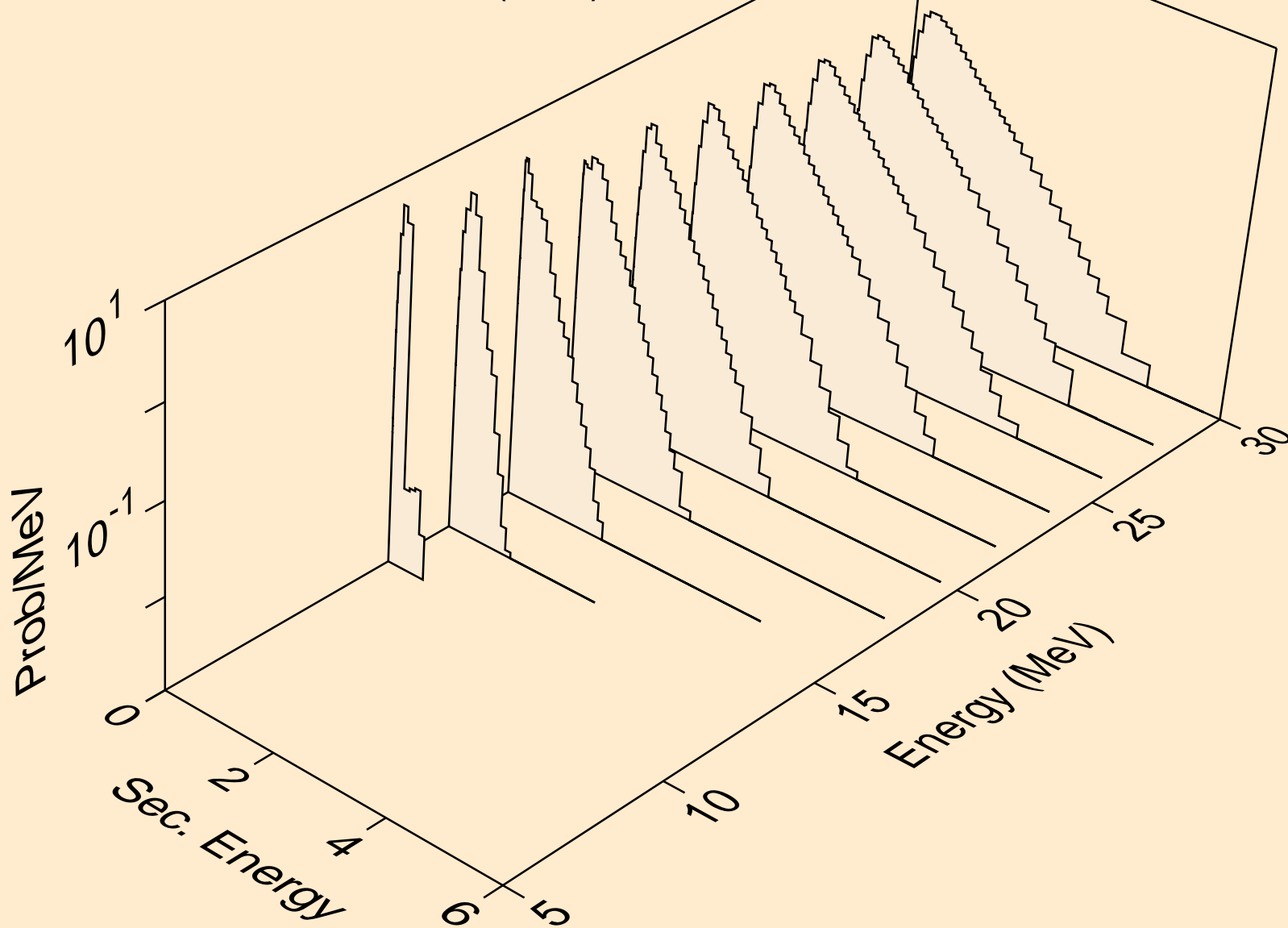

AU196 NEUTRON ACER TENDL-2019 LIBRARY; T=293.16K  
Neutron emission for (n,n\*)t

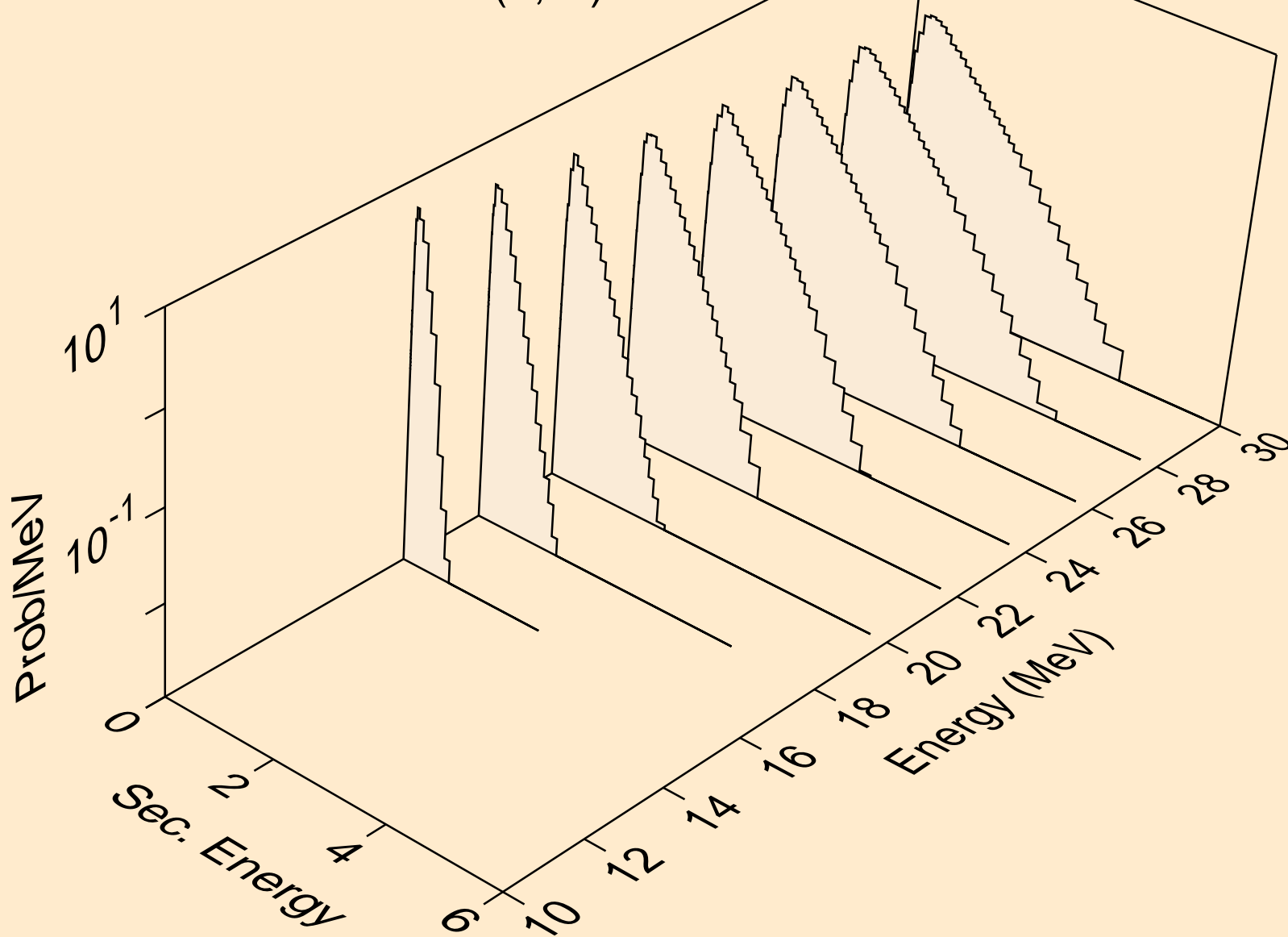

AU196 NEUTRON ACER TENDL-2019 LIBRARY; T=293.16K  
Neutron emission for (n,n\*)he3

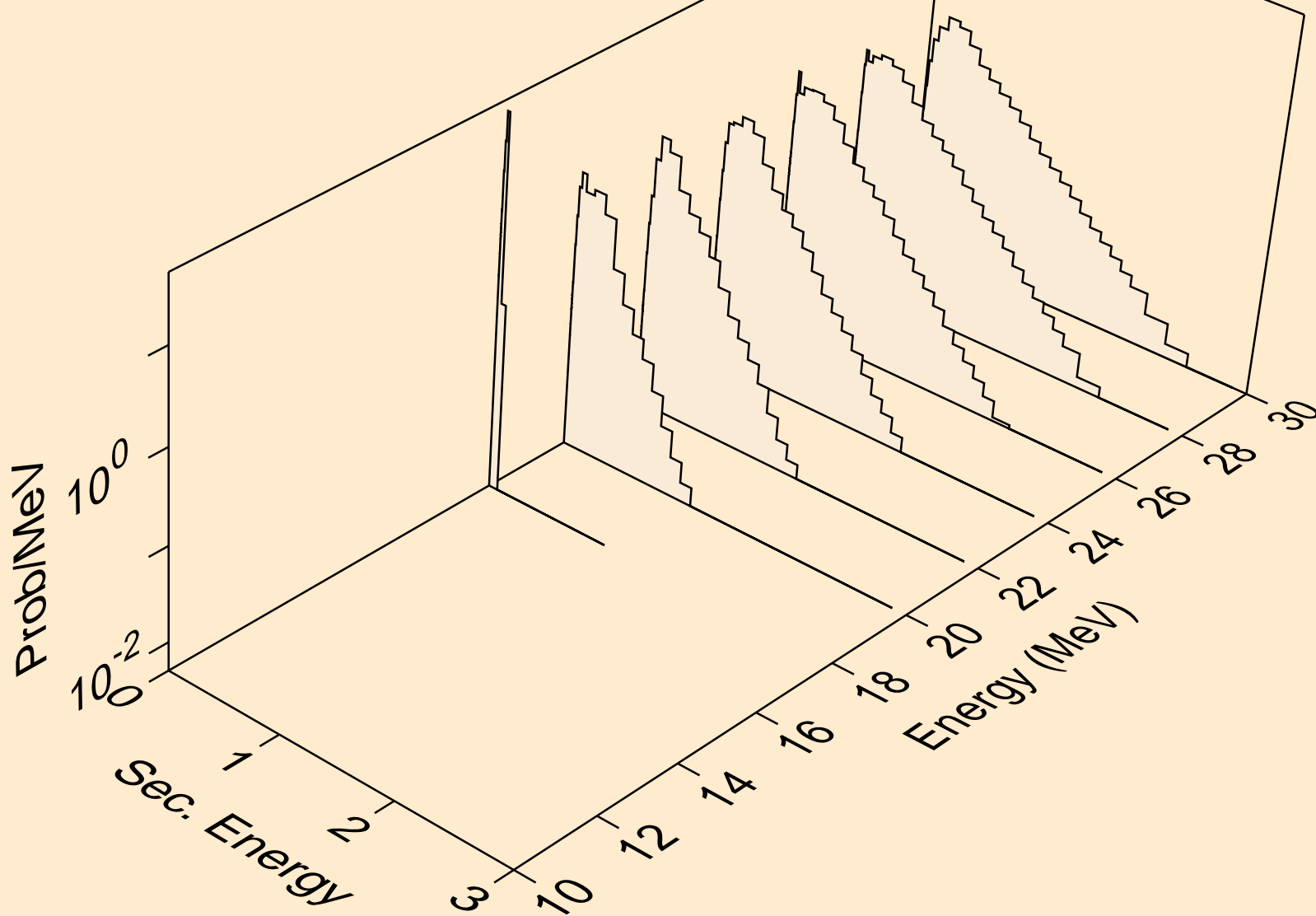

AU196 NEUTRON ACER TENDL-2019 LIBRARY; T=293.16K  
Neutron emission for (n,4n)

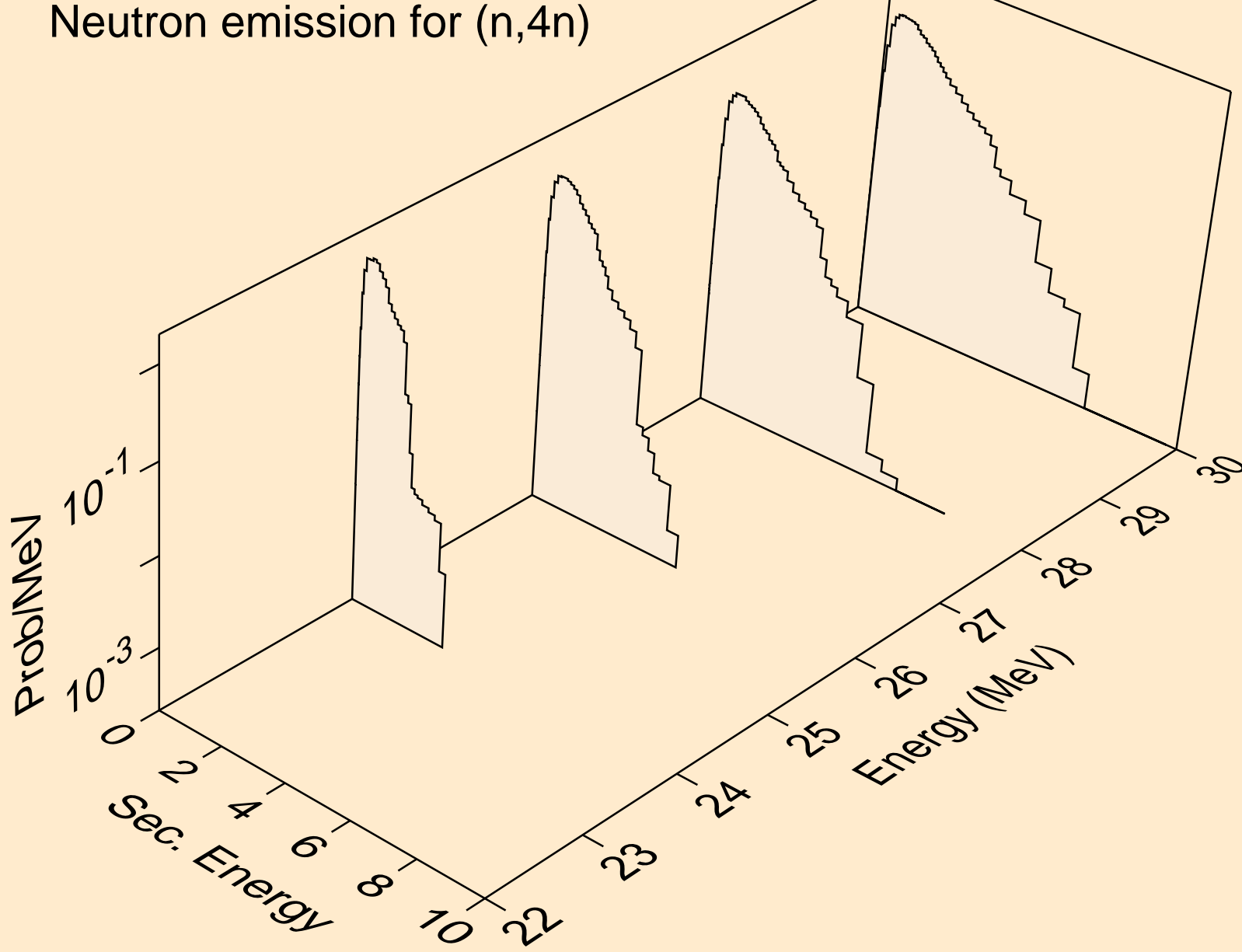

AU196 NEUTRON ACER TENDL-2019 LIBRARY; T=293.16K  
Neutron emission for (n,2np)

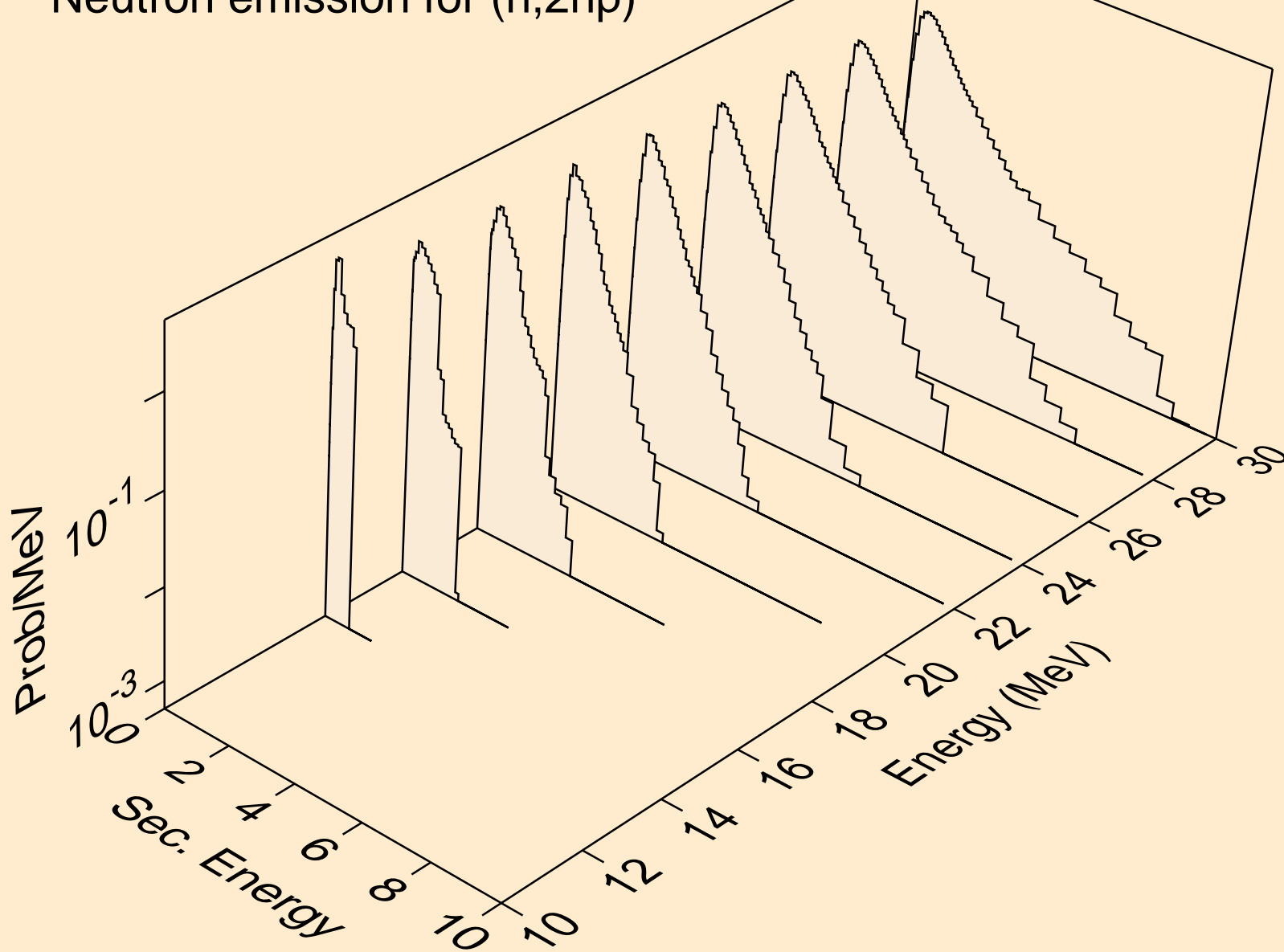

AU196 NEUTRON ACER TENDL-2019 LIBRARY; T=293.16K  
Neutron emission for (n,3np)

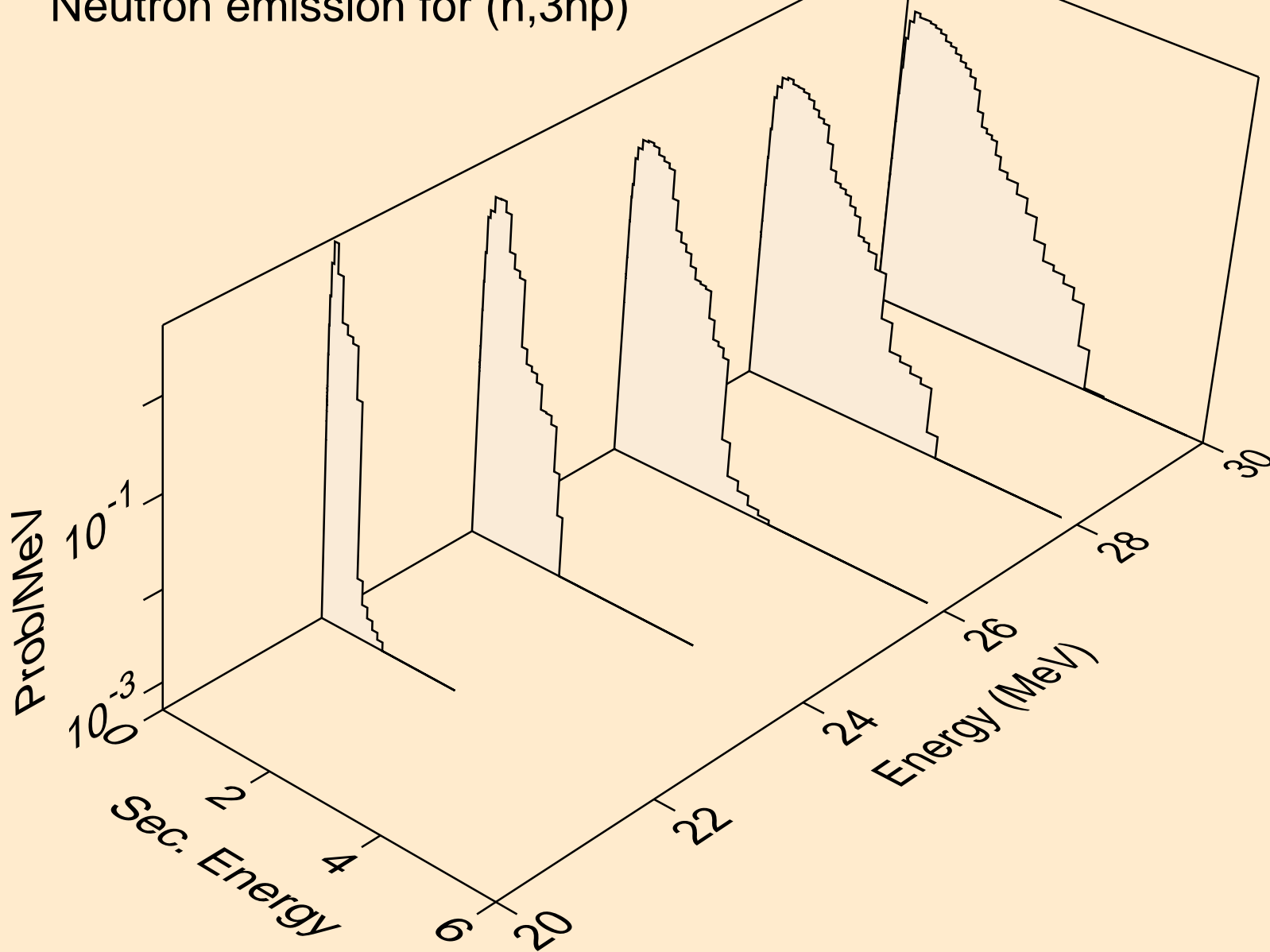



AU196 NEUTRON ACER TENDL-2019 LIBRARY; T=293.16K  
Neutron emission for (n,2np)

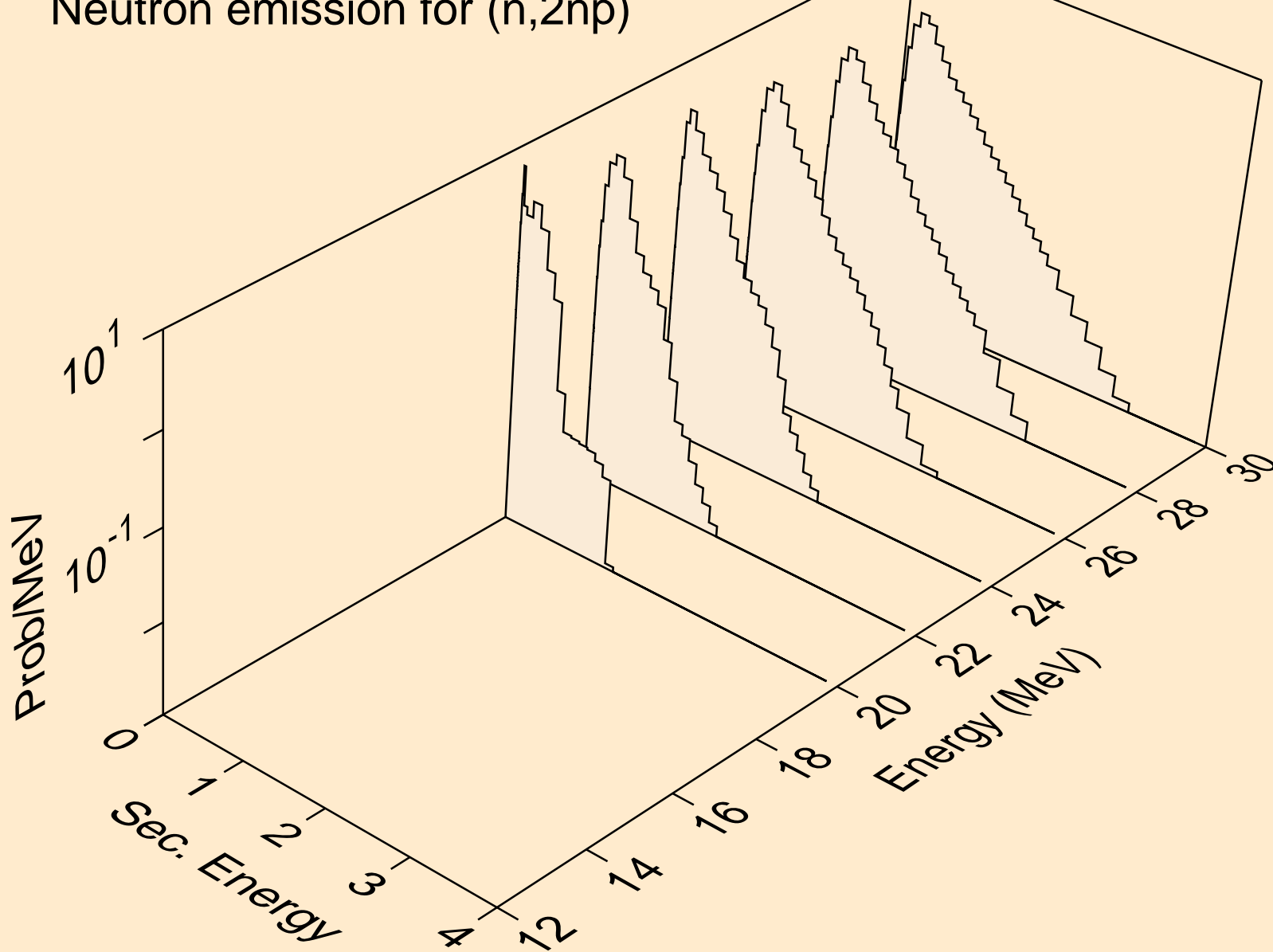

AU196 NEUTRON ACER TENDL-2019 LIBRARY; T=293.16K  
Neutron emission for (n,npa)

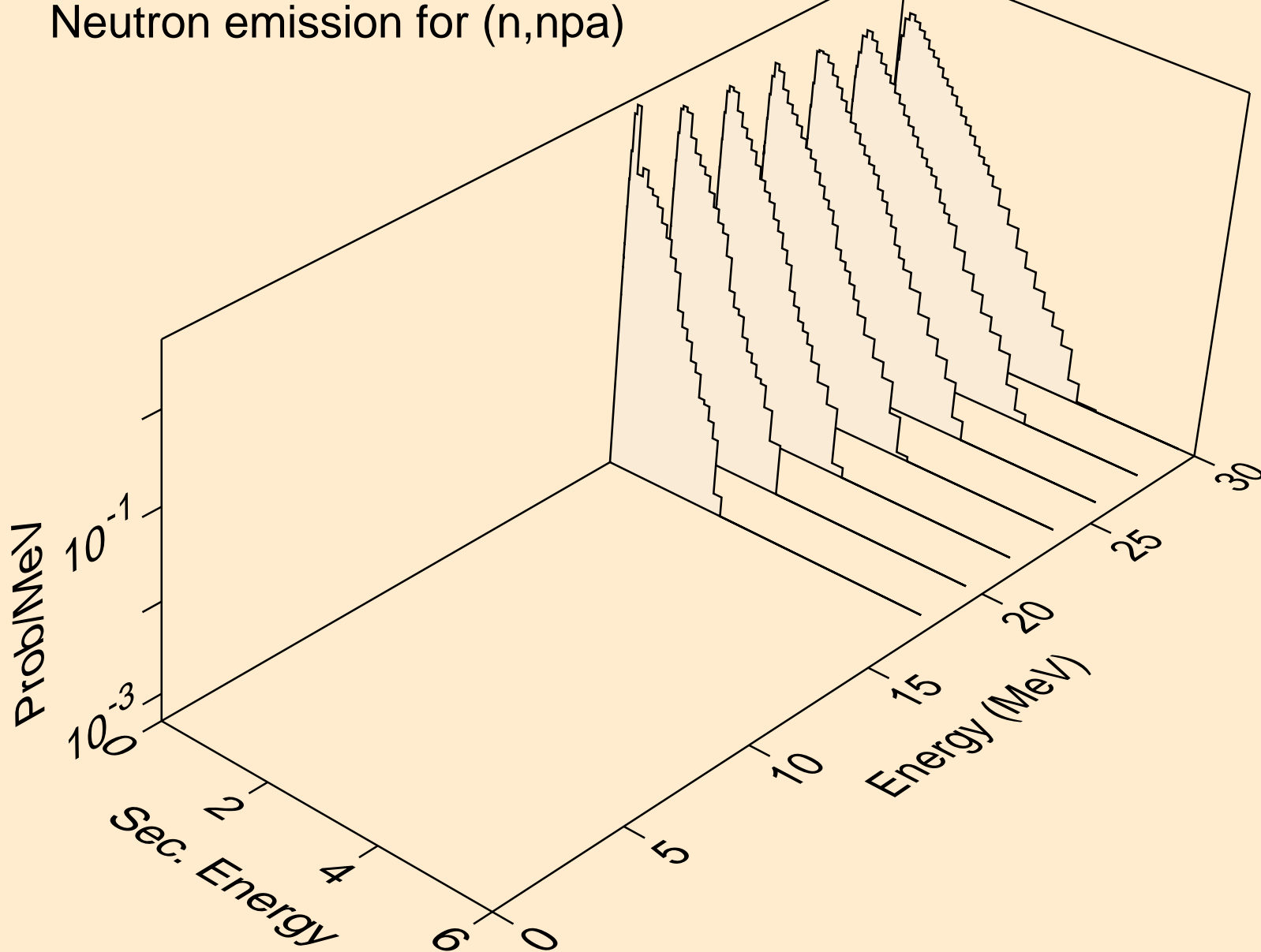

AU196 NEUTRON ACER TENDL-2019 LIBRARY; T=293.16K  
Neutron emission for (n,n\*c)

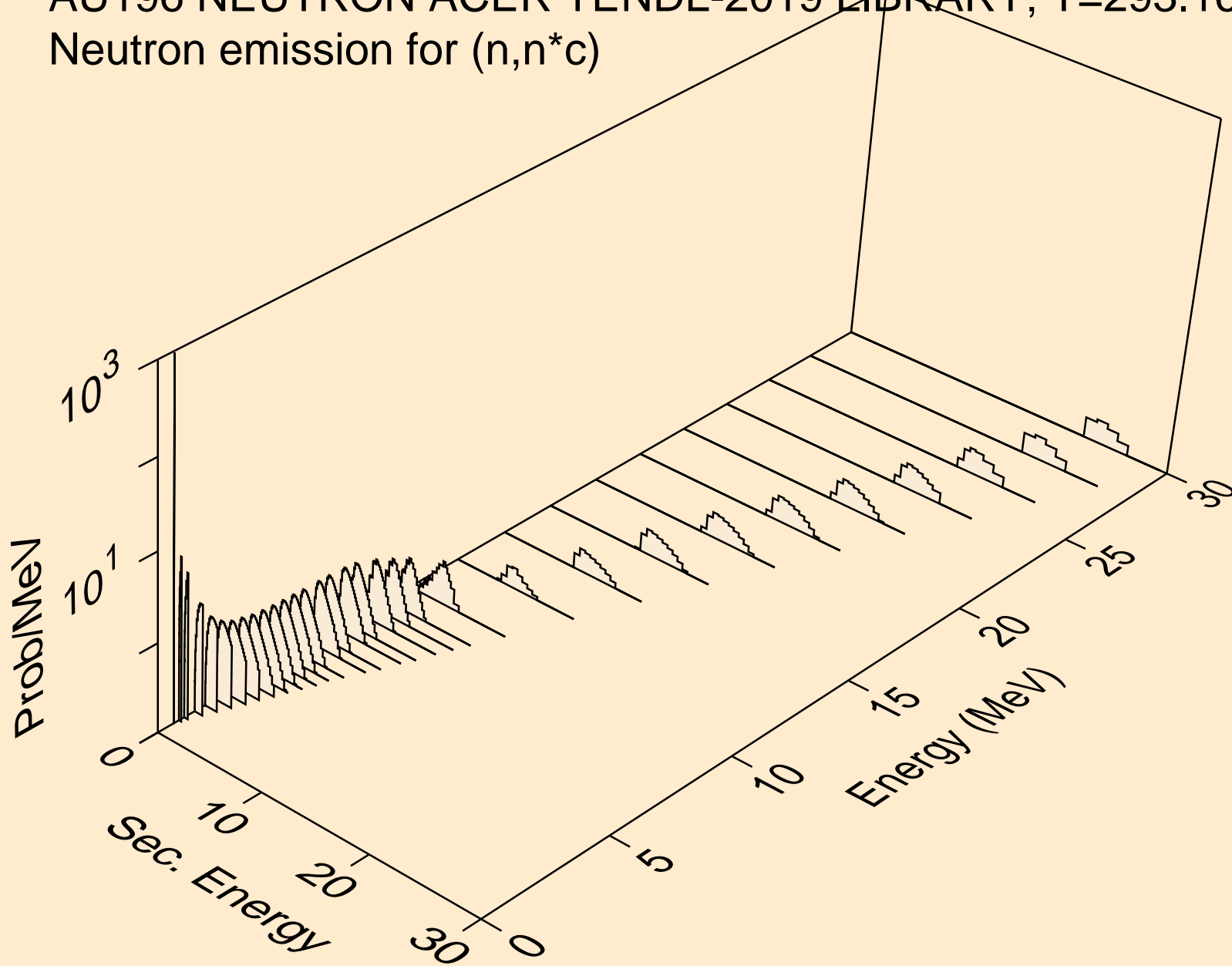

AU196 NEUTRON ACER TENDL-2019 LIBRARY; T=293.16K  
Photon emission for (n,x)

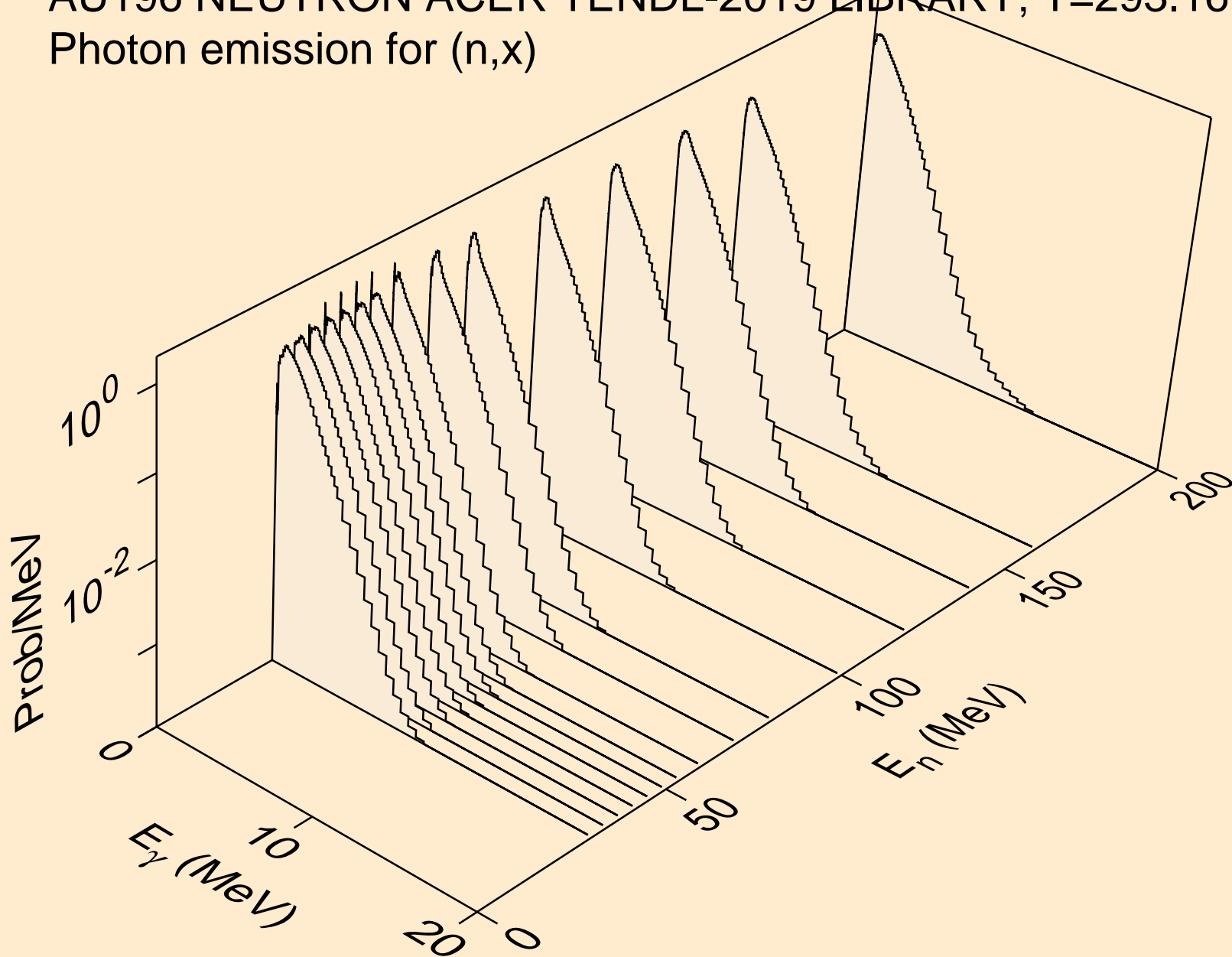

AU196 NEUTRON ACER TENDL-2019 LIBRARY; T=293.16K  
Photon emission for (n,2nd)

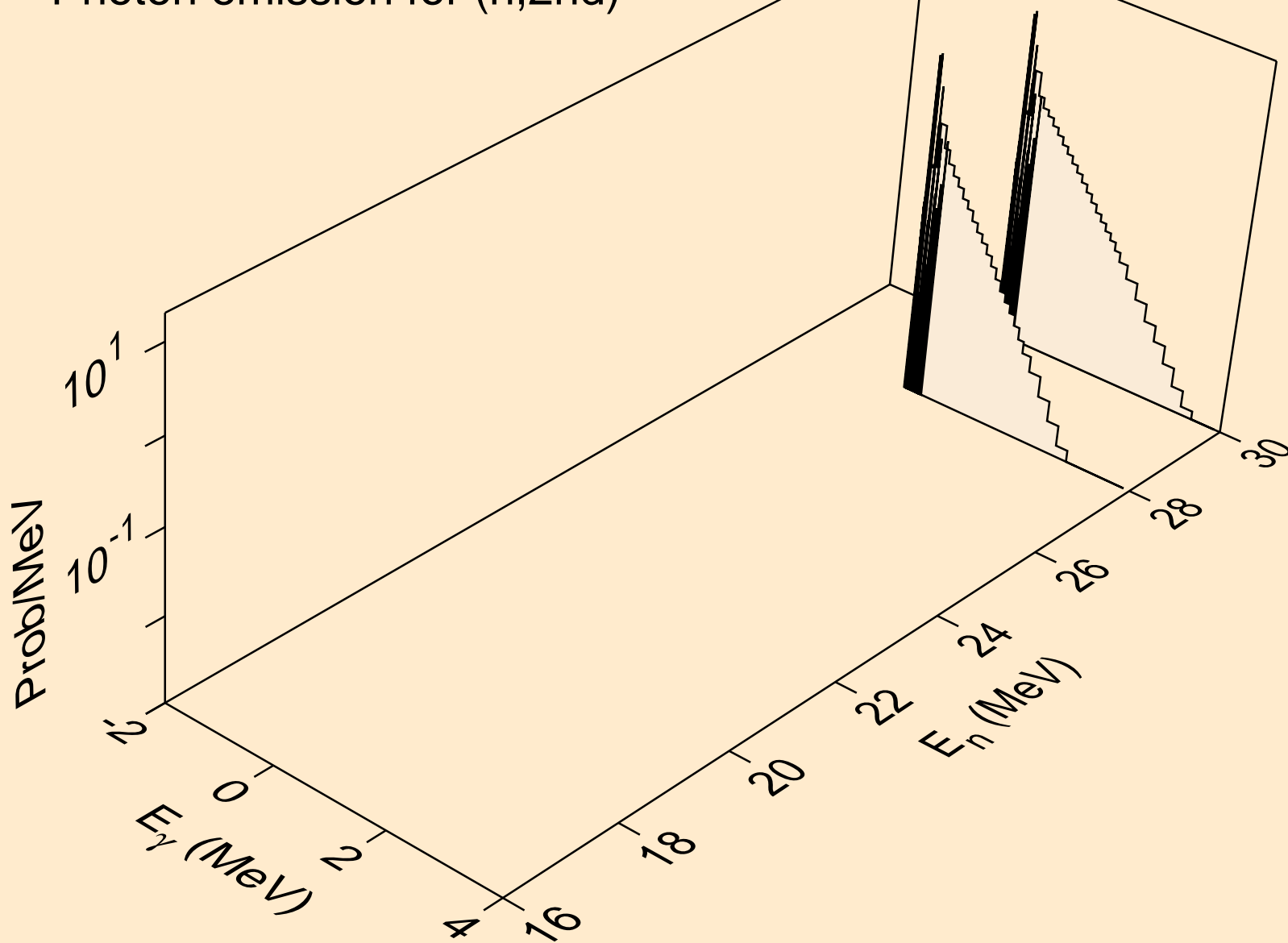

AU196 NEUTRON ACER TENDL-2019 LIBRARY; T=293.16K  
Photon emission for (n,2n)

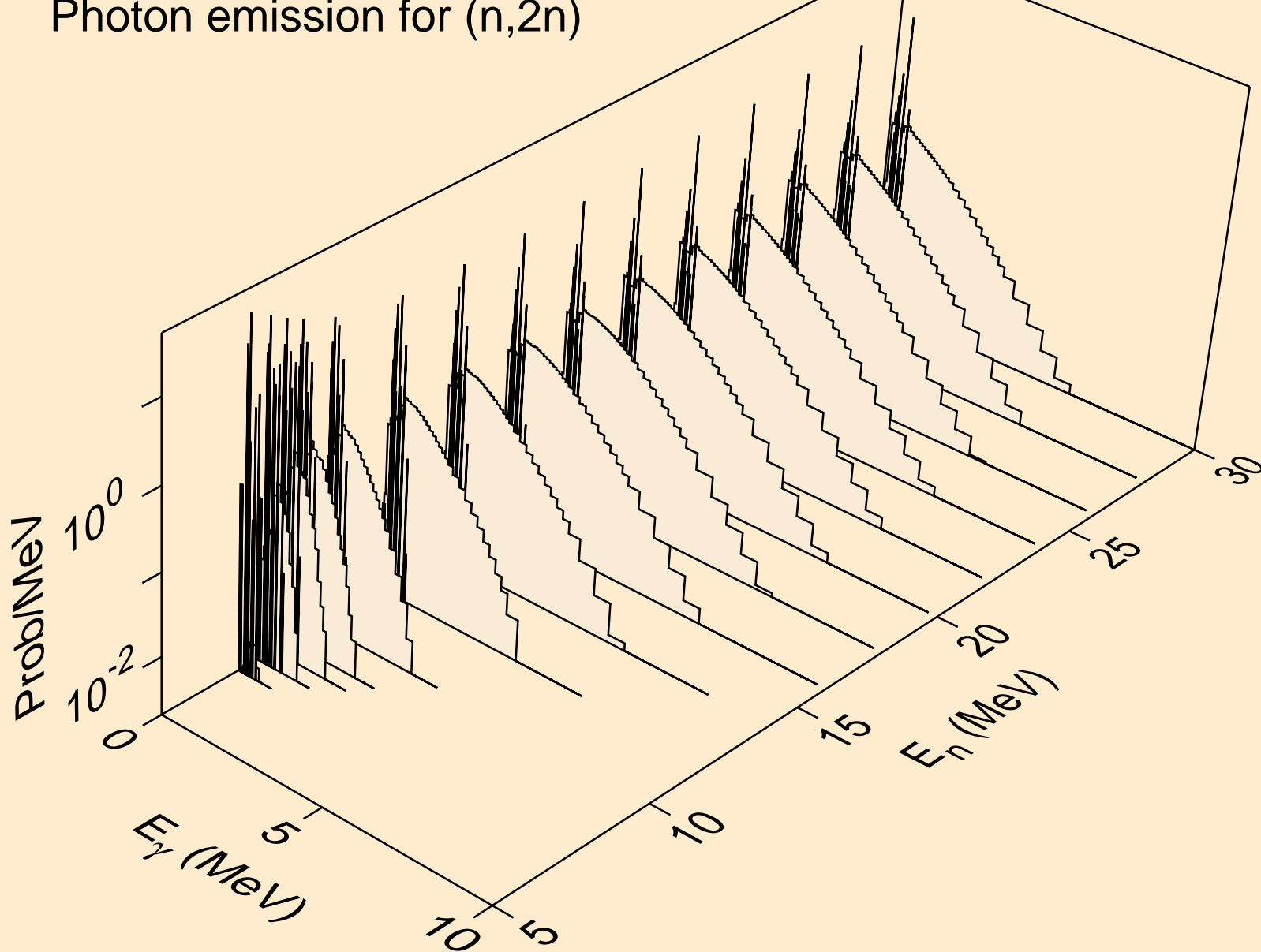

AU196 NEUTRON ACER TENDL-2019 LIBRARY; T=293.16K  
Photon emission for (n,3n)

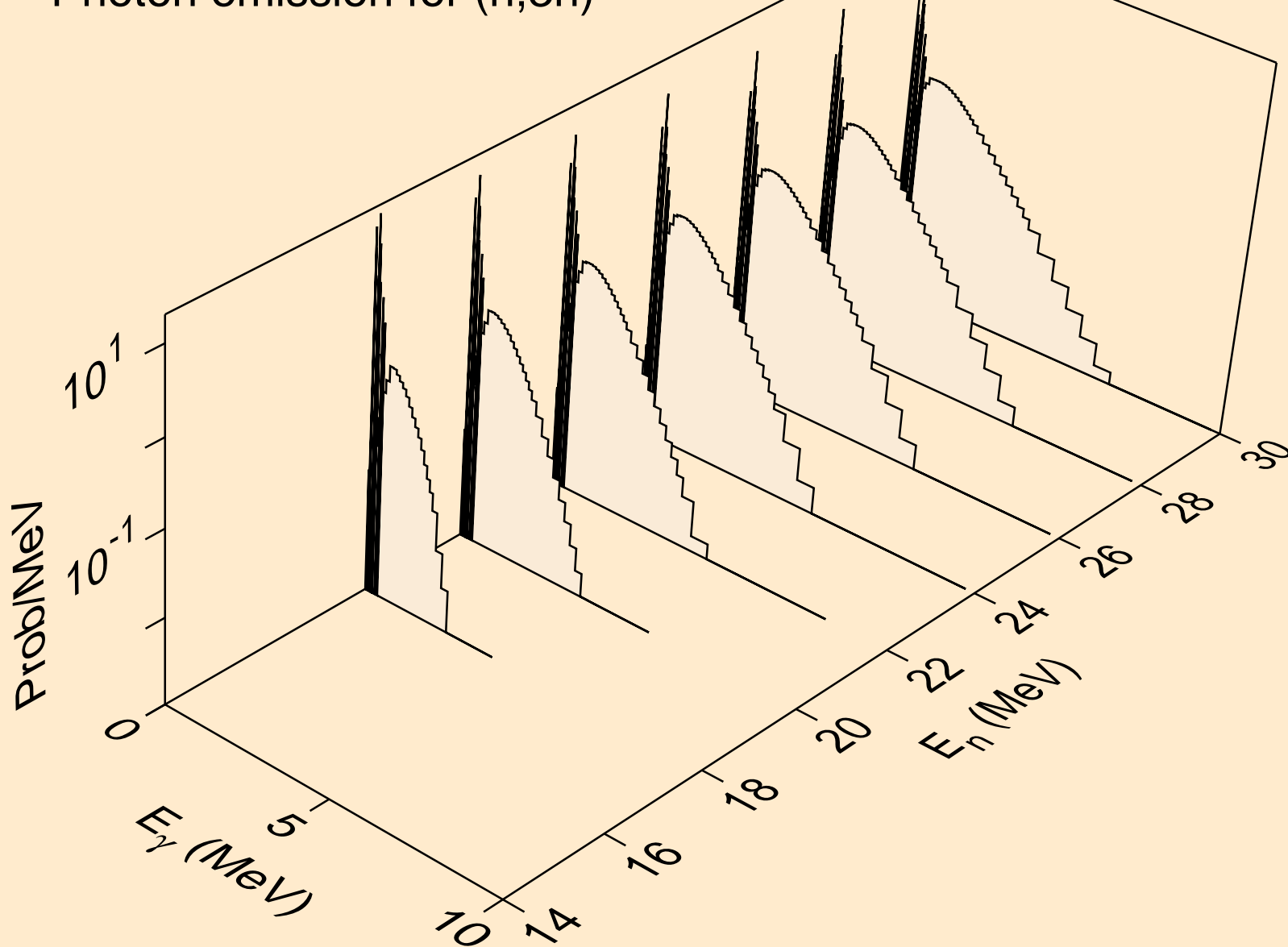

AU196 NEUTRON ACER TENDL-2019 LIBRARY; T=293.16K  
Photon emission for (n,n\*)a

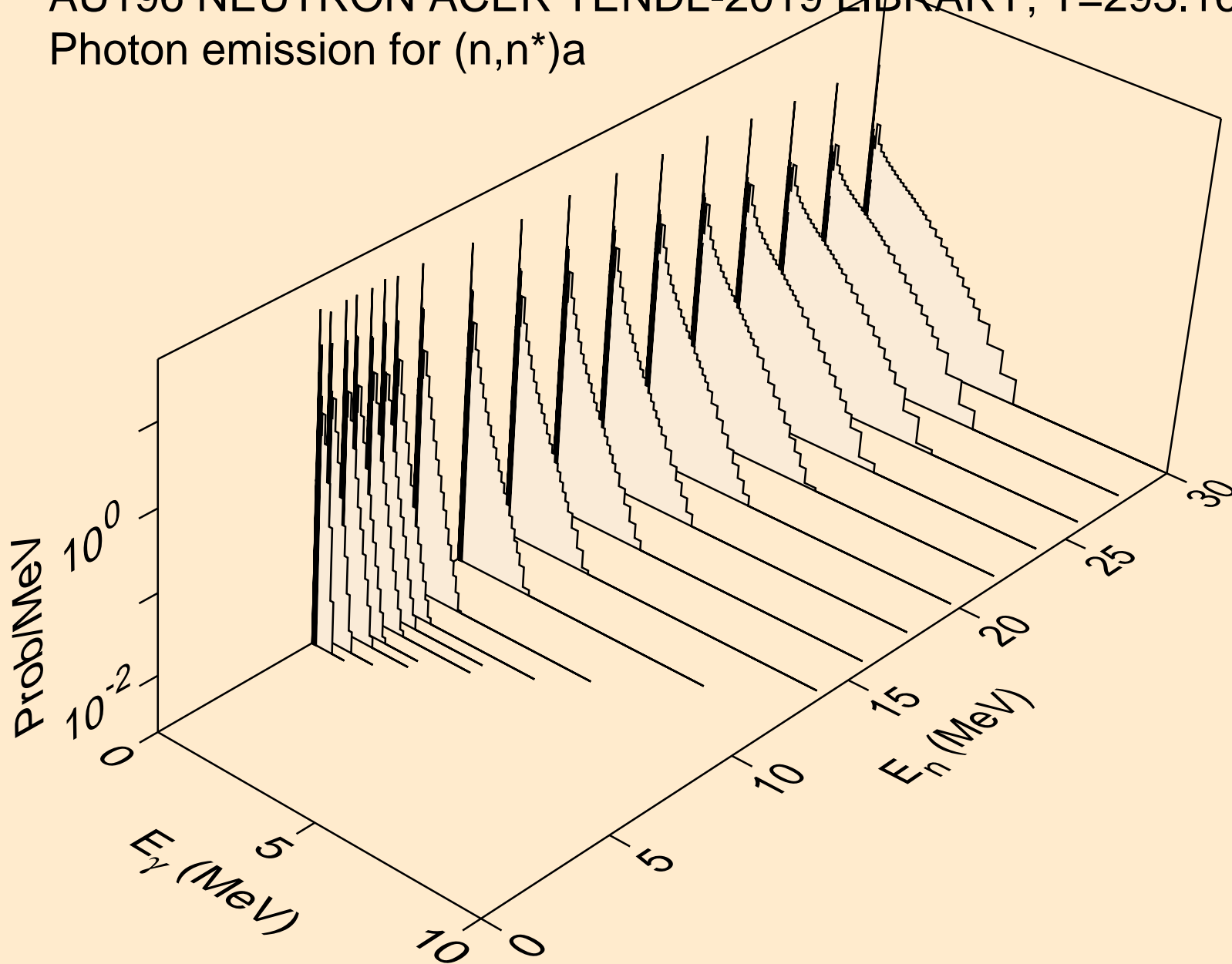



AU196 NEUTRON ACER TENDL-2019 LIBRARY; T=293.16K  
Photon emission for (n,2n)a

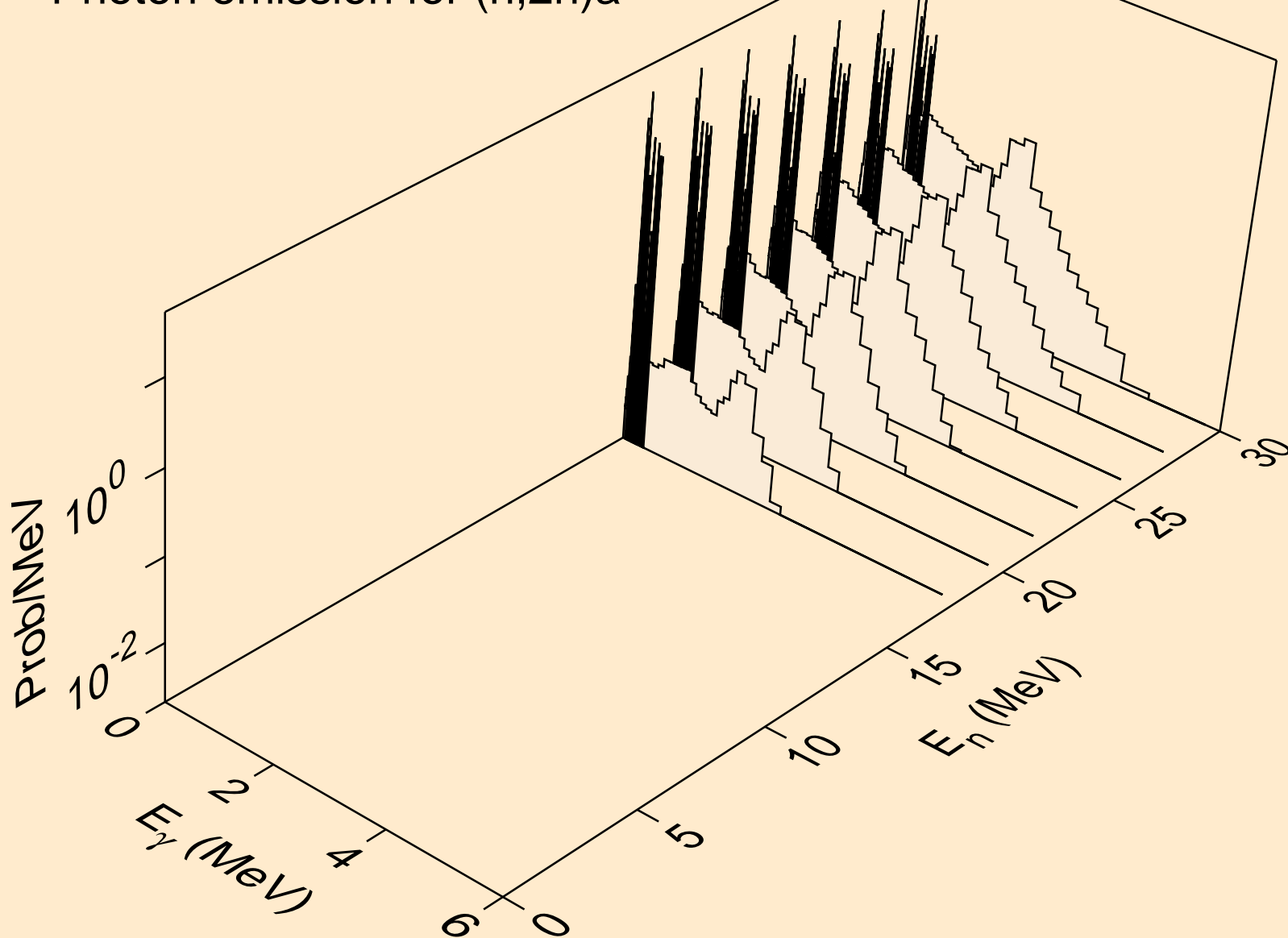

AU196 NEUTRON ACER TENDL-2019 LIBRARY; T=293.16K  
Photon emission for (n,3n)a

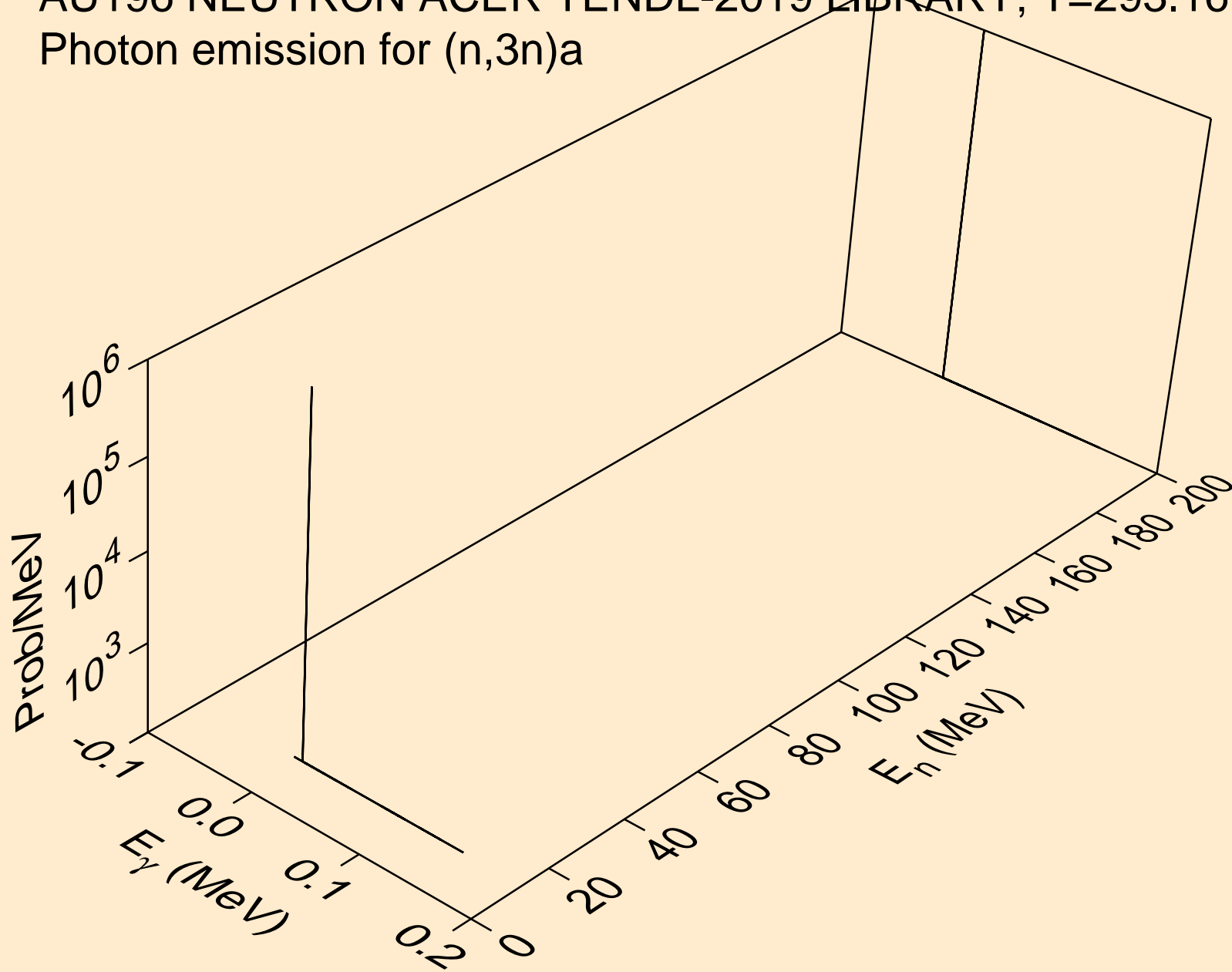

AU196 NEUTRON ACER TENDL-2019 LIBRARY; T=293.16K  
Photon emission for (n,n\*)p

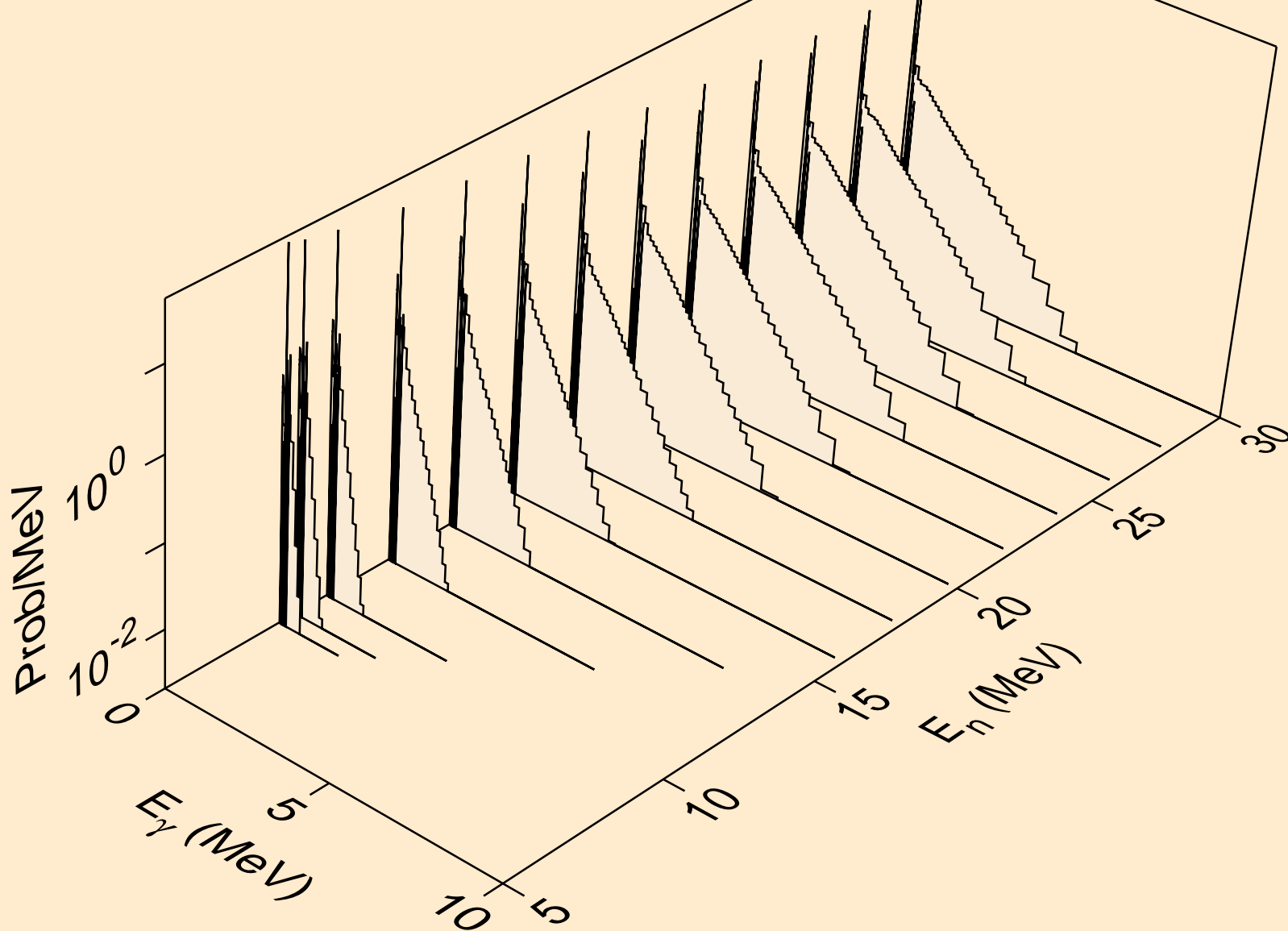

AU196 NEUTRON ACER TENDL-2019 LIBRARY; T=293.16K  
Photon emission for (n,n\*)d

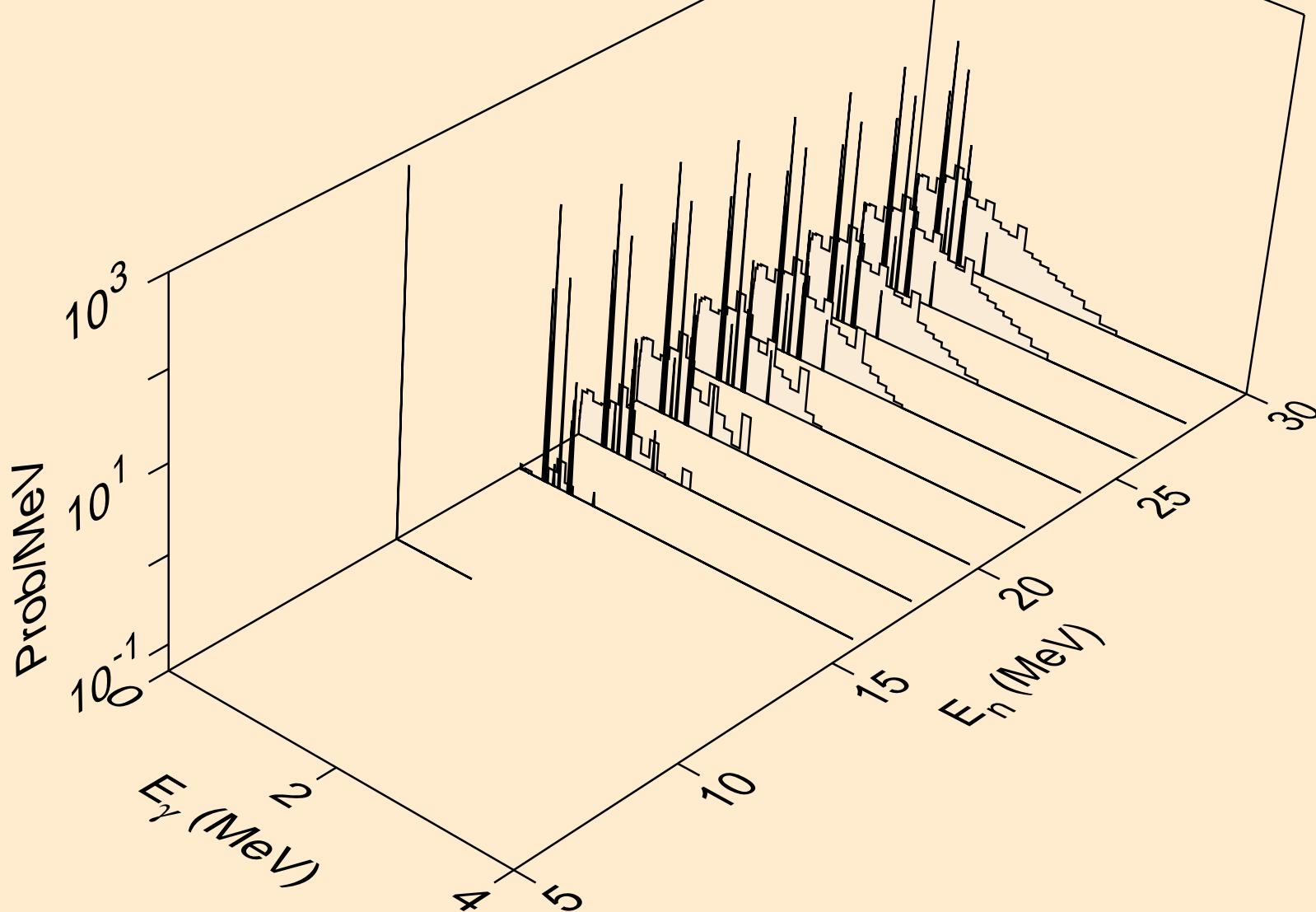

AU196 NEUTRON ACER TENDL-2019 LIBRARY; T=293.16K  
Photon emission for (n,n\*)t

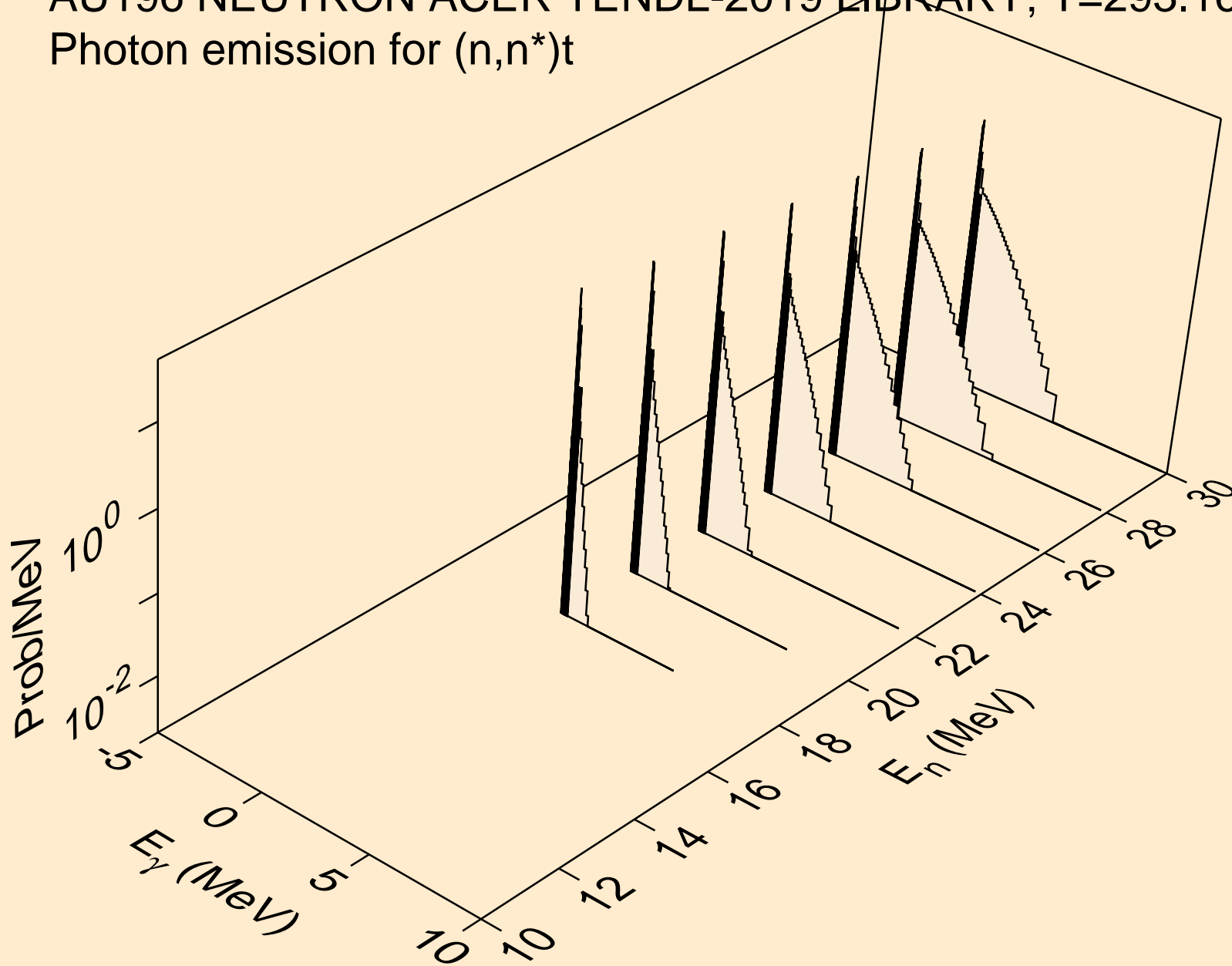

AU196 NEUTRON ACER TENDL-2019 LIBRARY; T=293.16K  
Photon emission for (n,n\*)he3

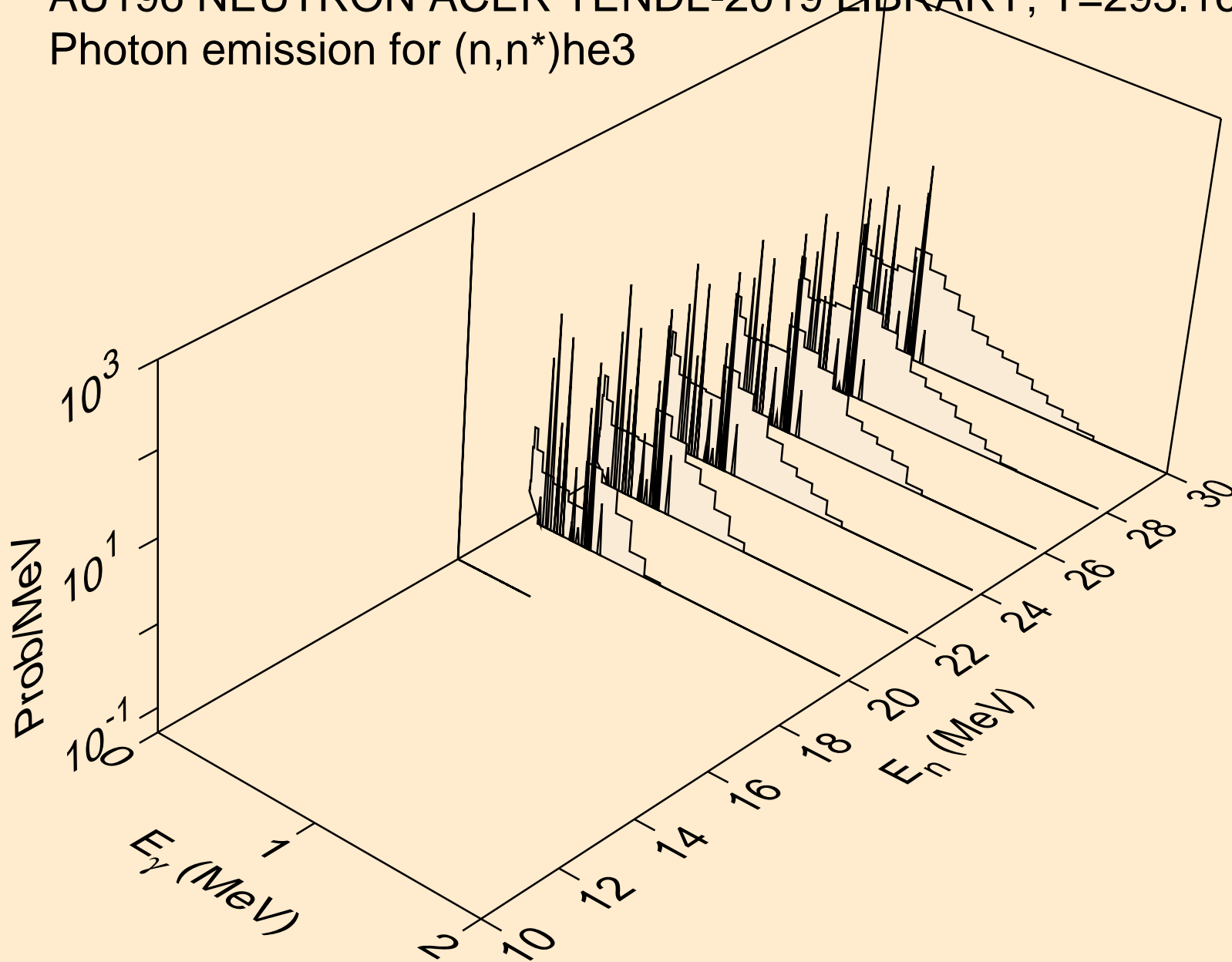

AU196 NEUTRON ACER TENDL-2019 LIBRARY; T=293.16K  
Photon emission for (n,4n)

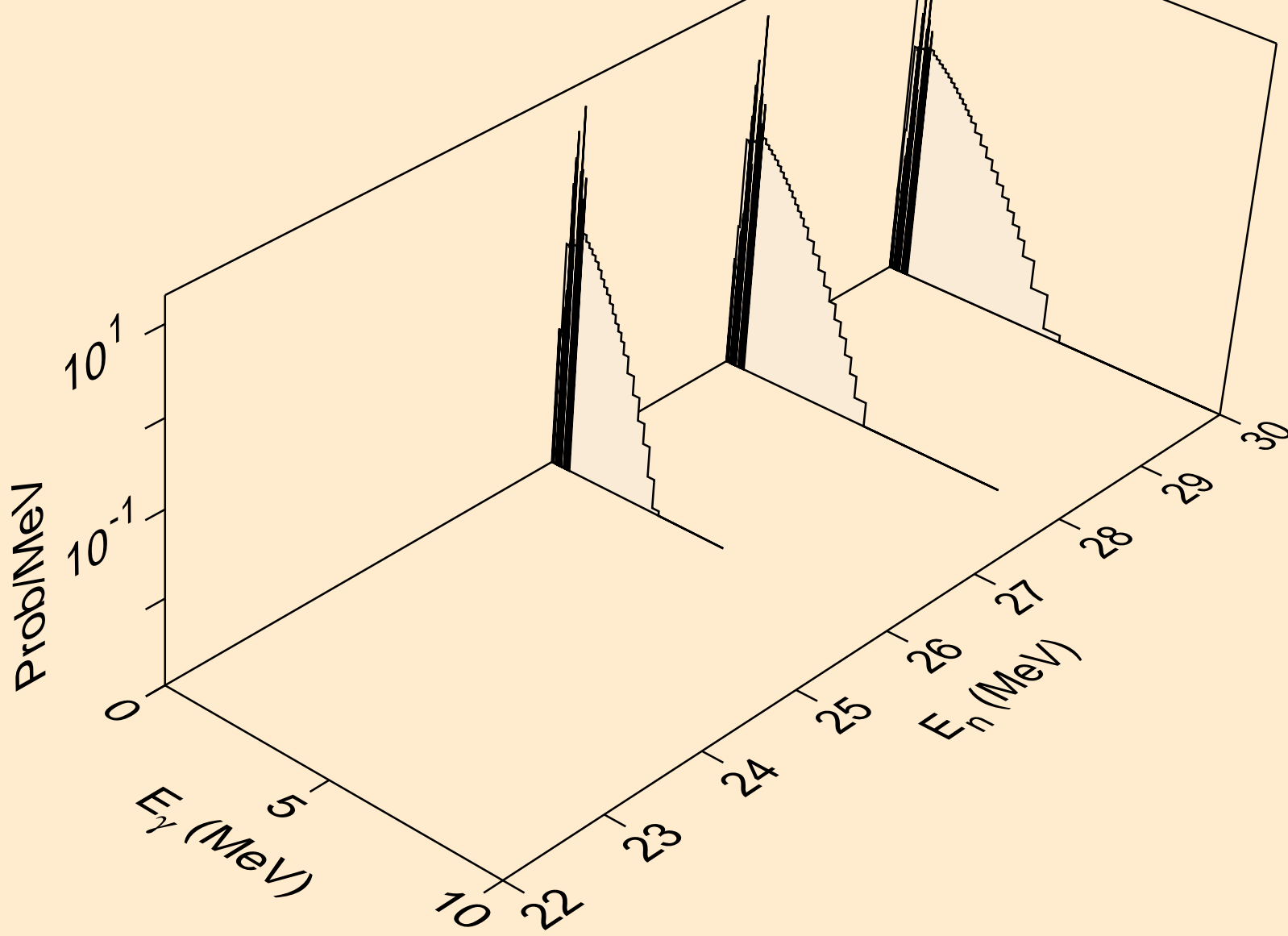

AU196 NEUTRON ACER TENDL-2019 LIBRARY; T=293.16K  
Photon emission for (n,2np)

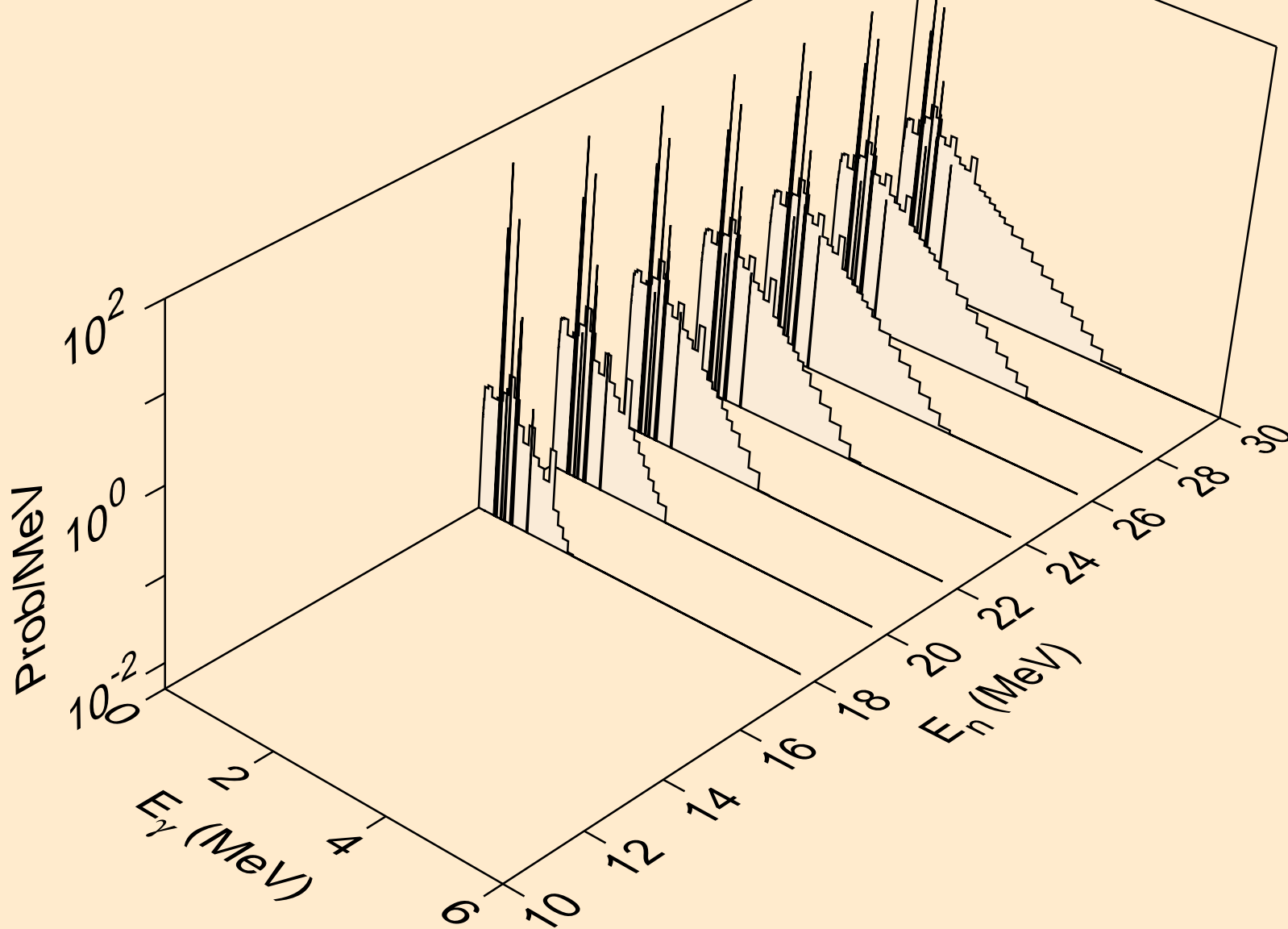



AU196 NEUTRON ACER TENDL-2019 LIBRARY; T=293.16K  
Photon emission for (n,3np)

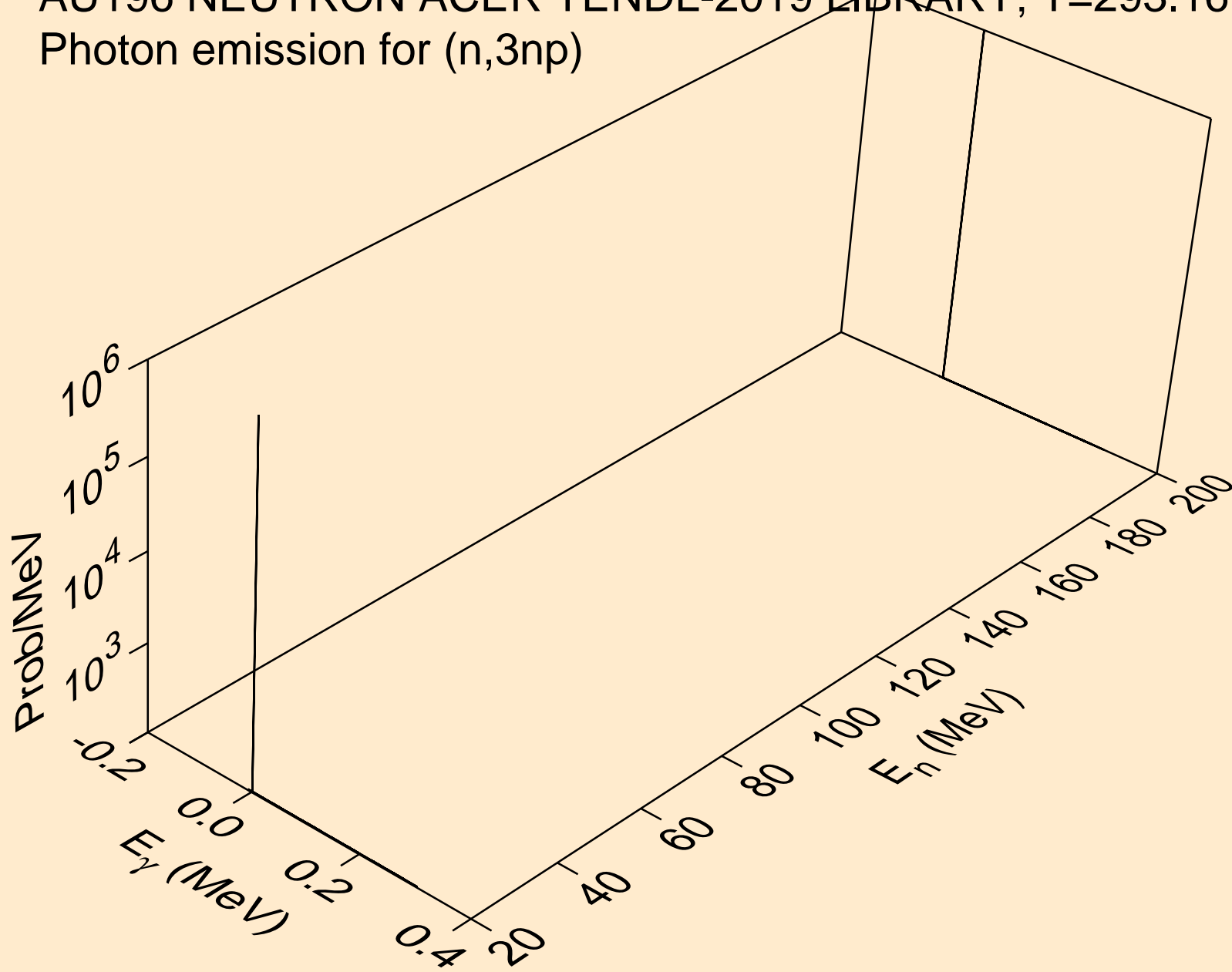

AU196 NEUTRON ACER TENDL-2019 LIBRARY; T=293.16K  
Photon emission for (n,2np)

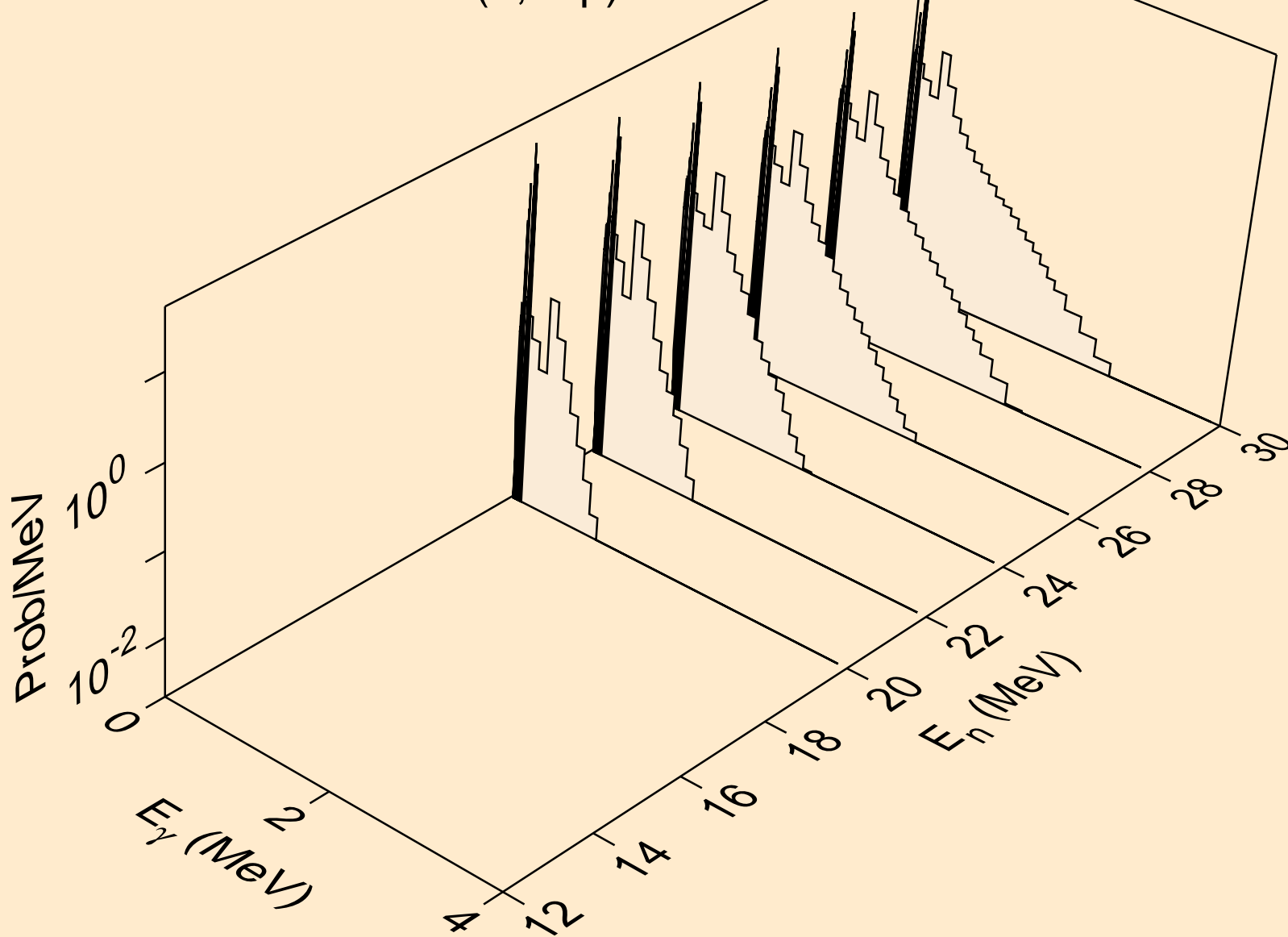

AU196 NEUTRON ACER TENDL-2019 LIBRARY; T=293.16K  
Photon emission for (n,npa)

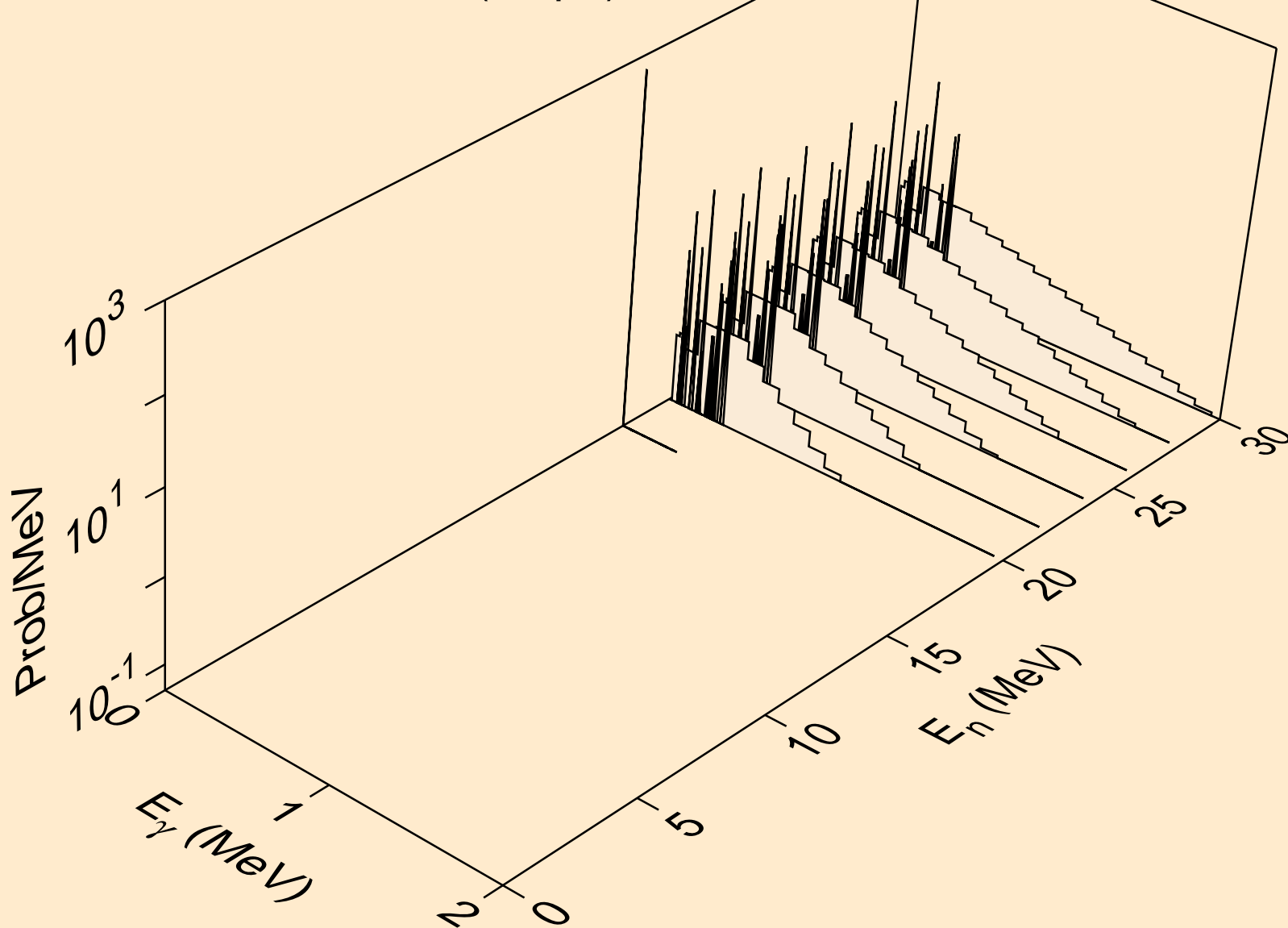

AU196 NEUTRON ACER TENDL-2019 LIBRARY; T=293.16K  
Photon emission for (n,n\*c)

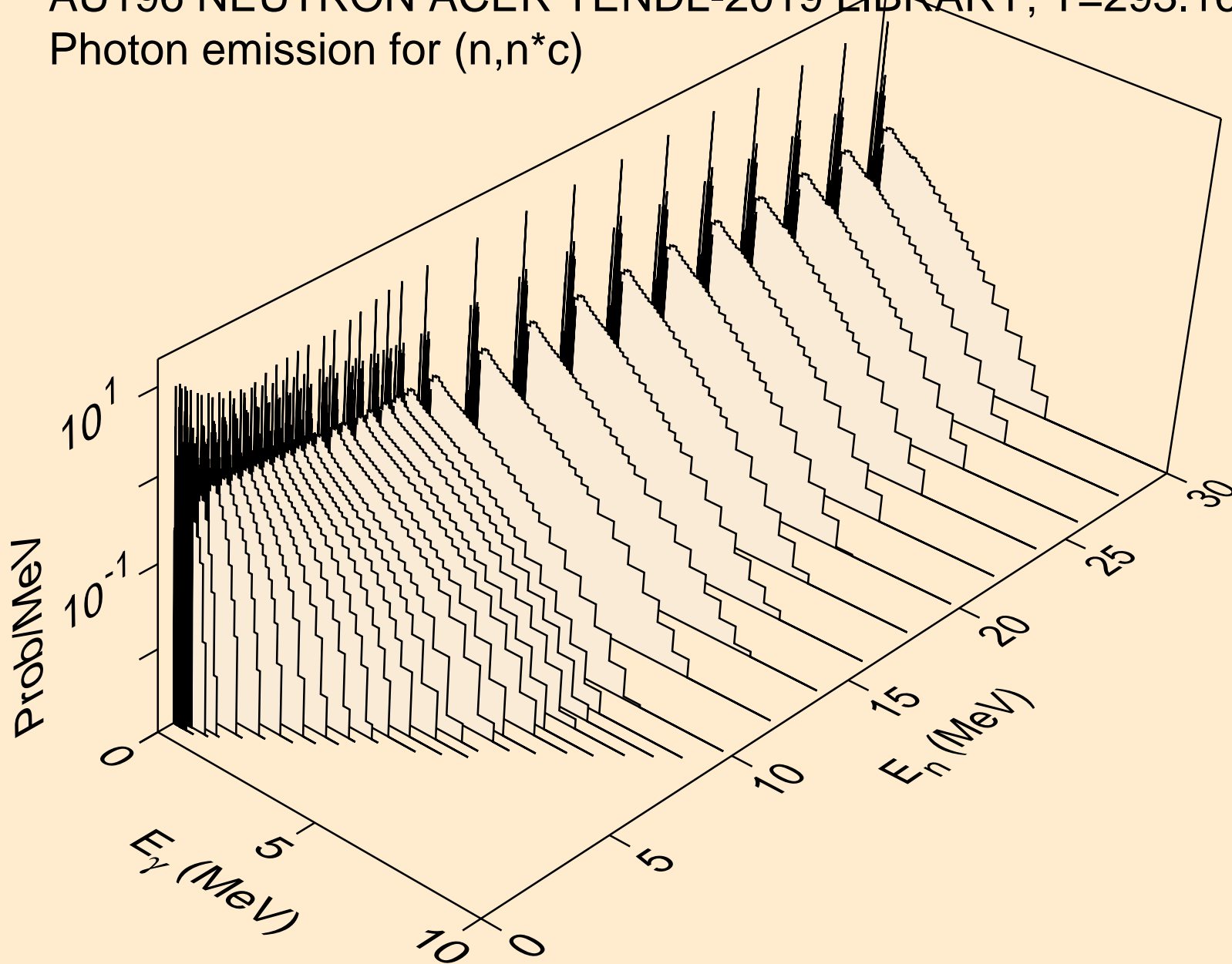

AU196 NEUTRON ACER TENDL-2019 LIBRARY; T=293.16K  
Photon emission for (n,gma)

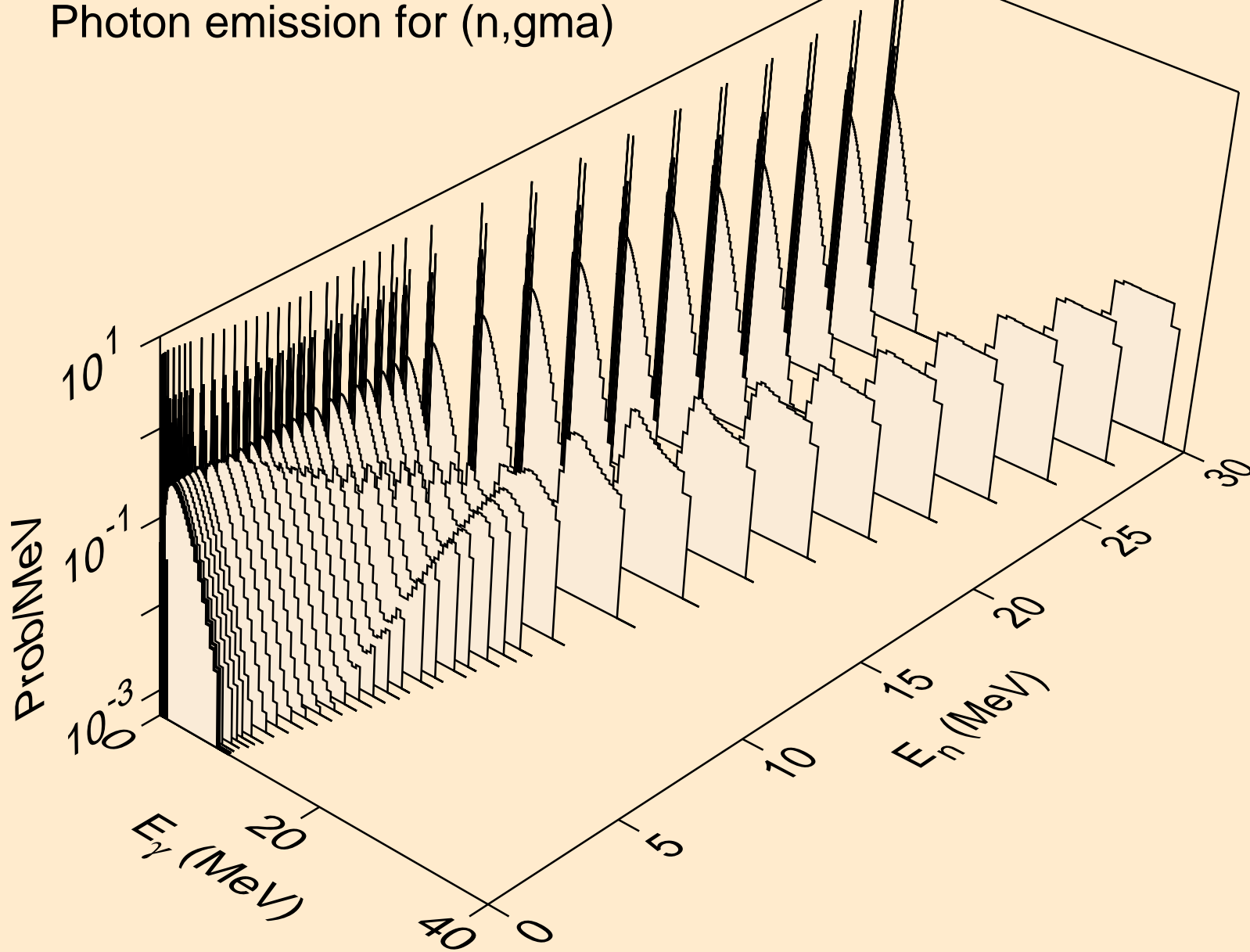

AU196 NEUTRON ACER TENDL-2019 LIBRARY; T=293.16K  
Photon emission for (n,p)

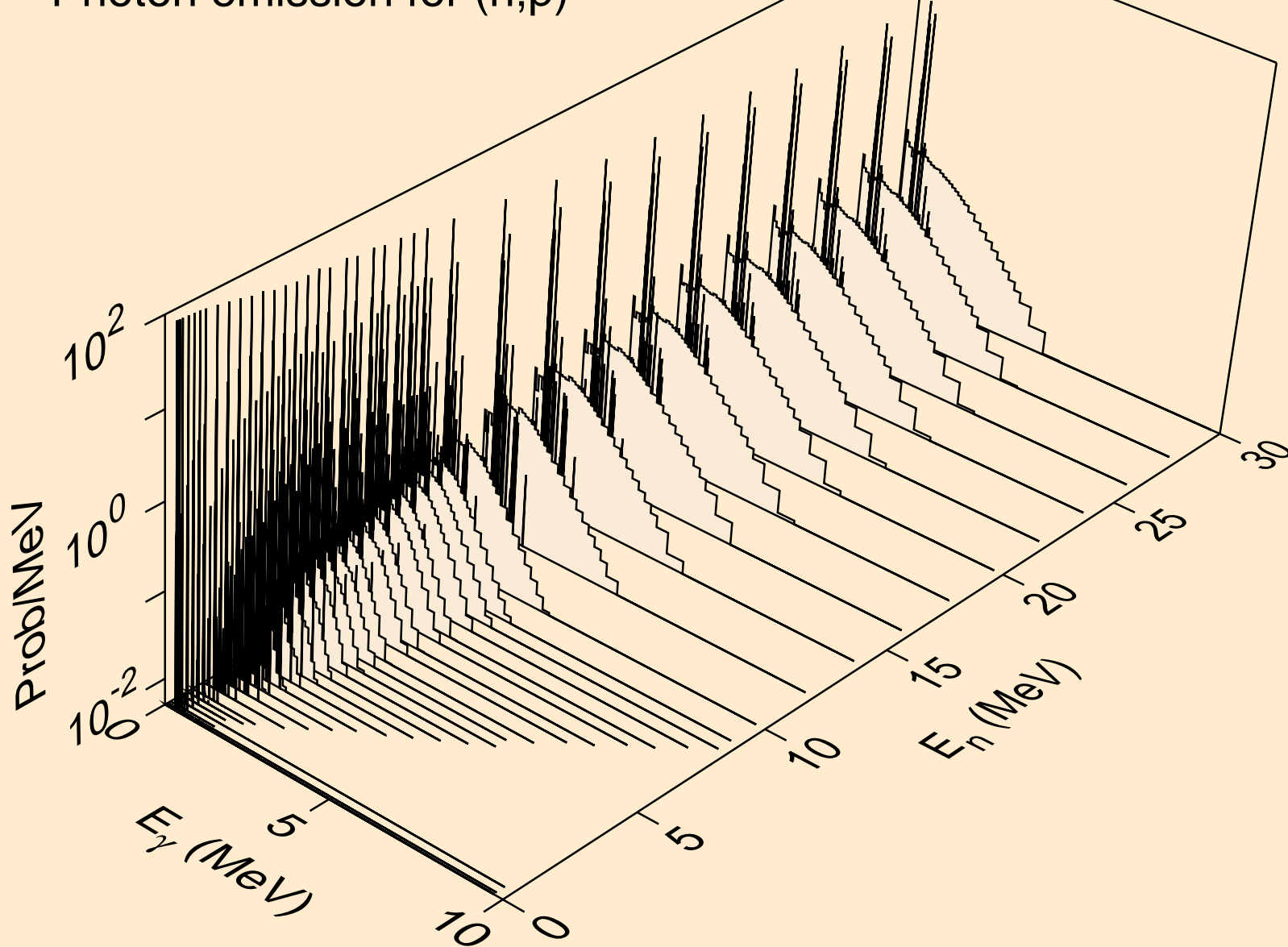

AU196 NEUTRON ACER TENDL-2019 LIBRARY; T=293.16K  
Photon emission for (n,d)

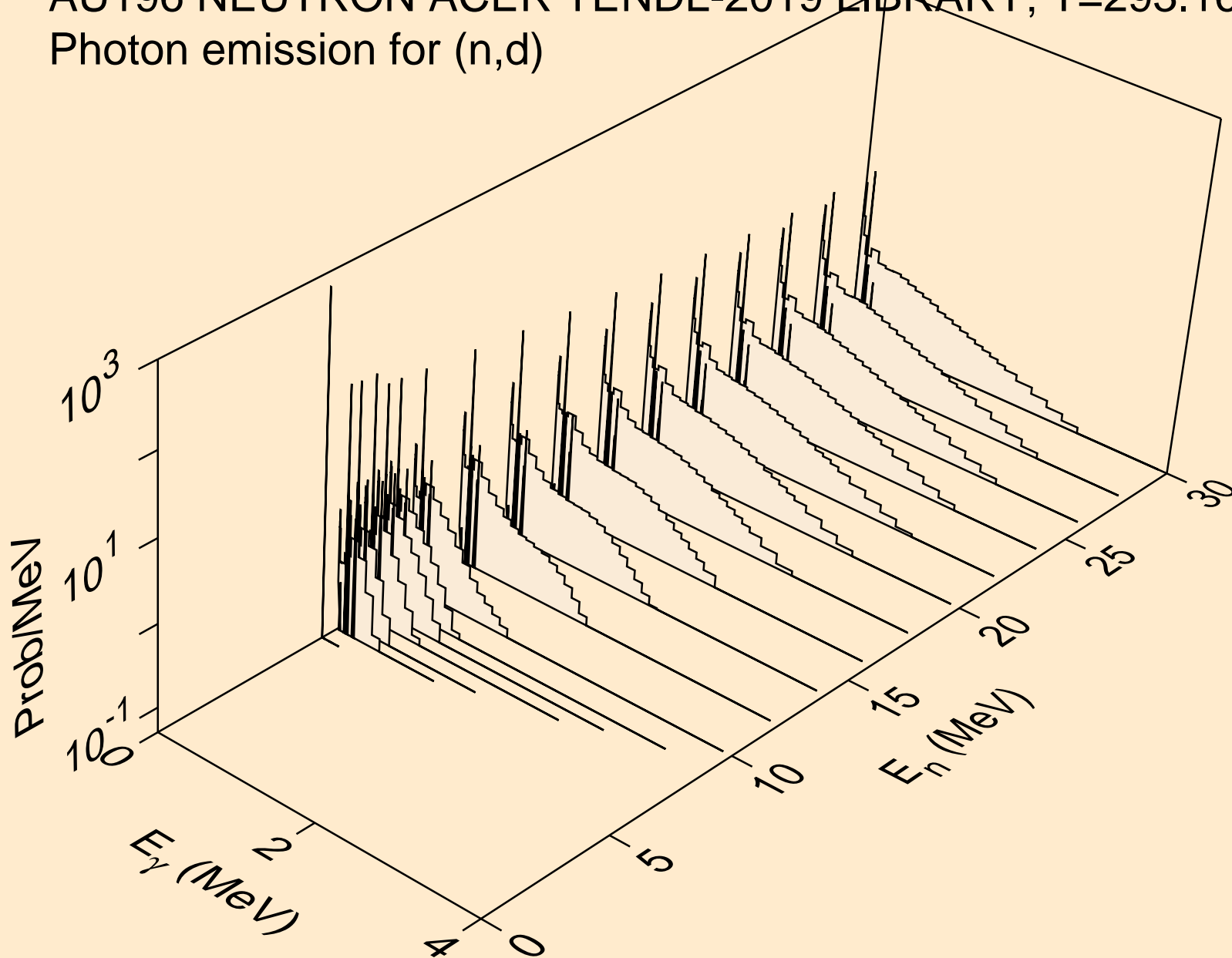

AU196 NEUTRON ACER TENDL-2019 LIBRARY; T=293.16K  
Photon emission for (n,t)

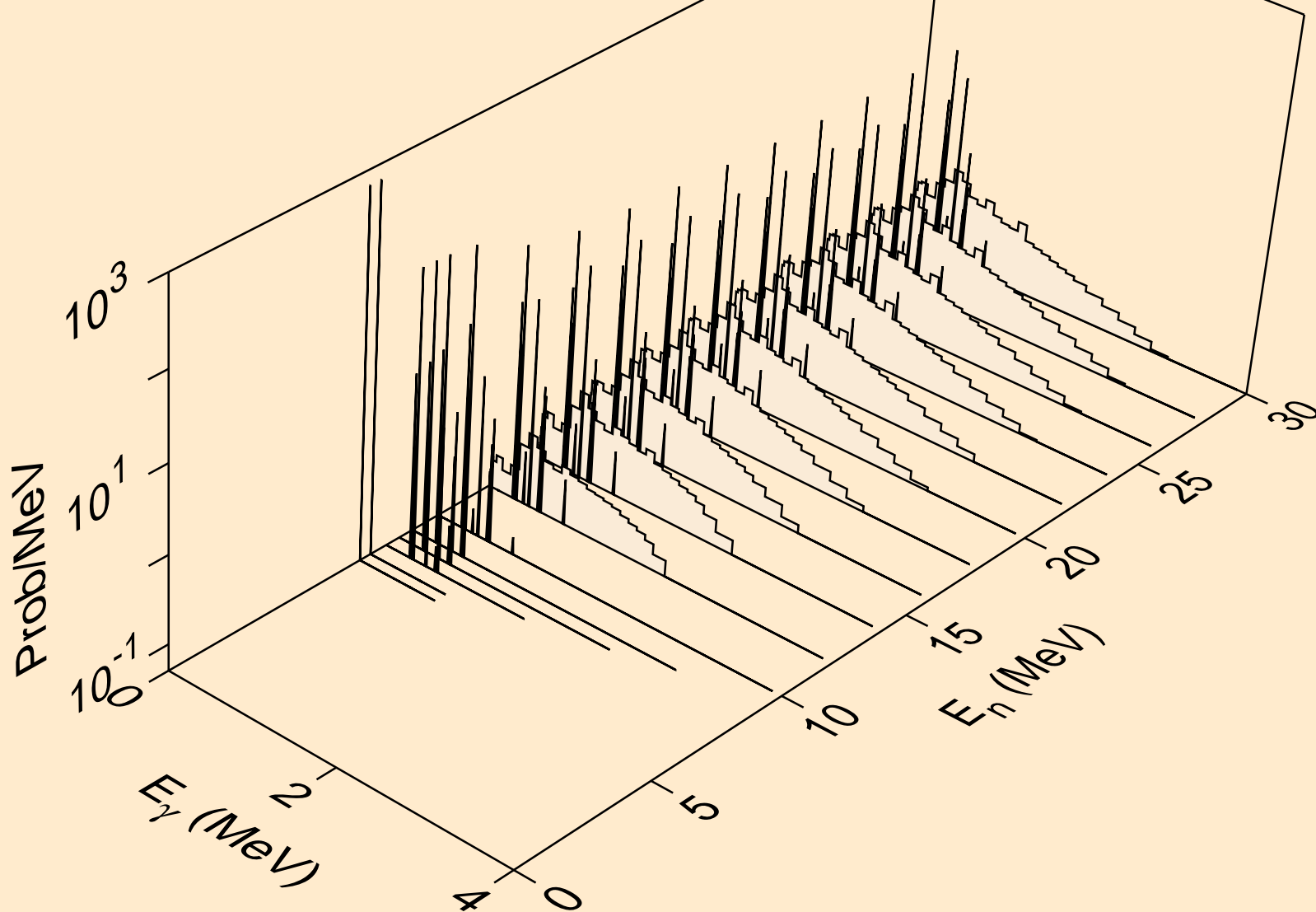



AU196 NEUTRON ACER TENDL-2019 LIBRARY; T=293.16K  
Photon emission for (n,he3)

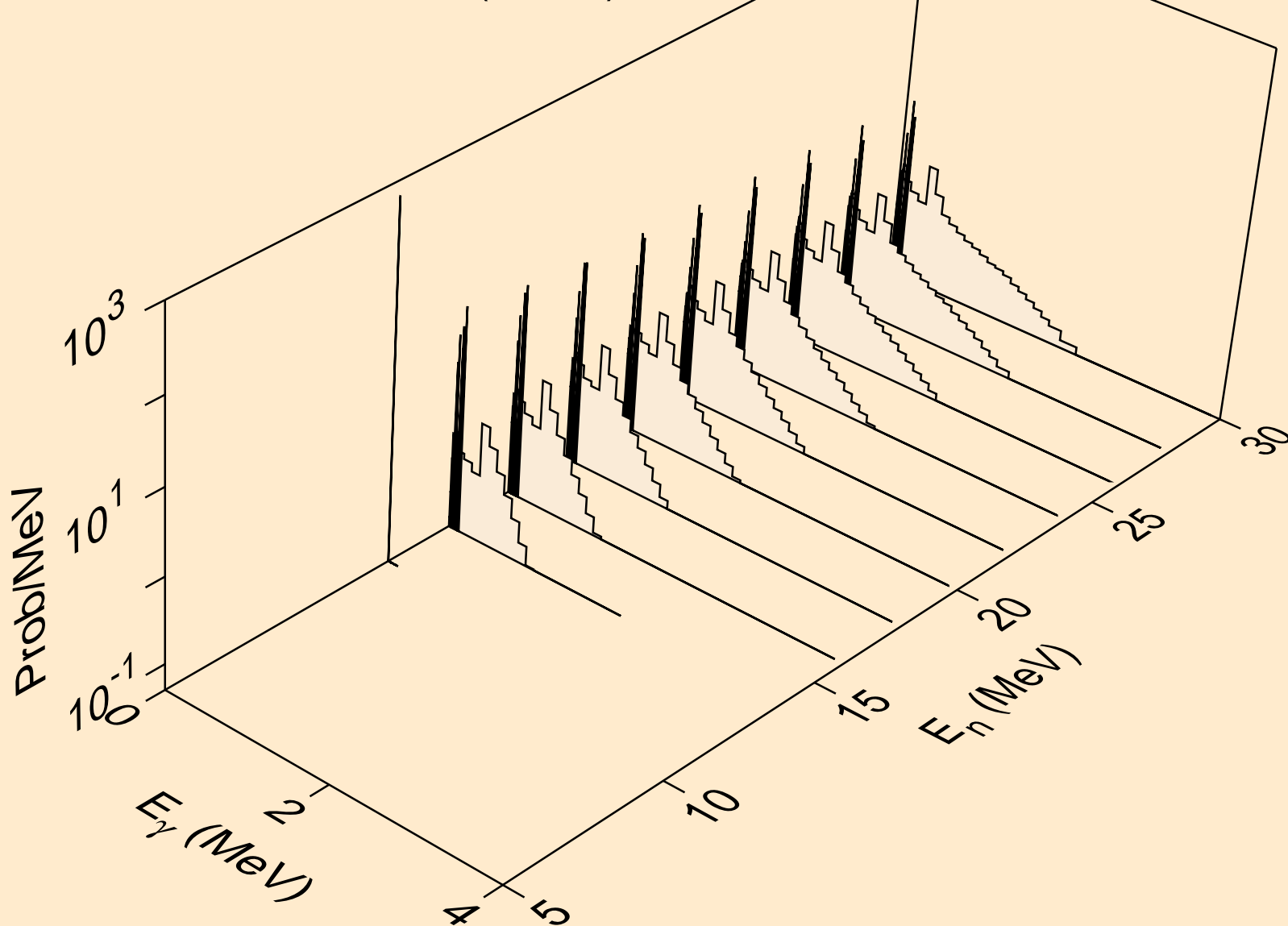

AU196 NEUTRON ACER TENDL-2019 LIBRARY; T=293.16K  
Photon emission for (n,a)

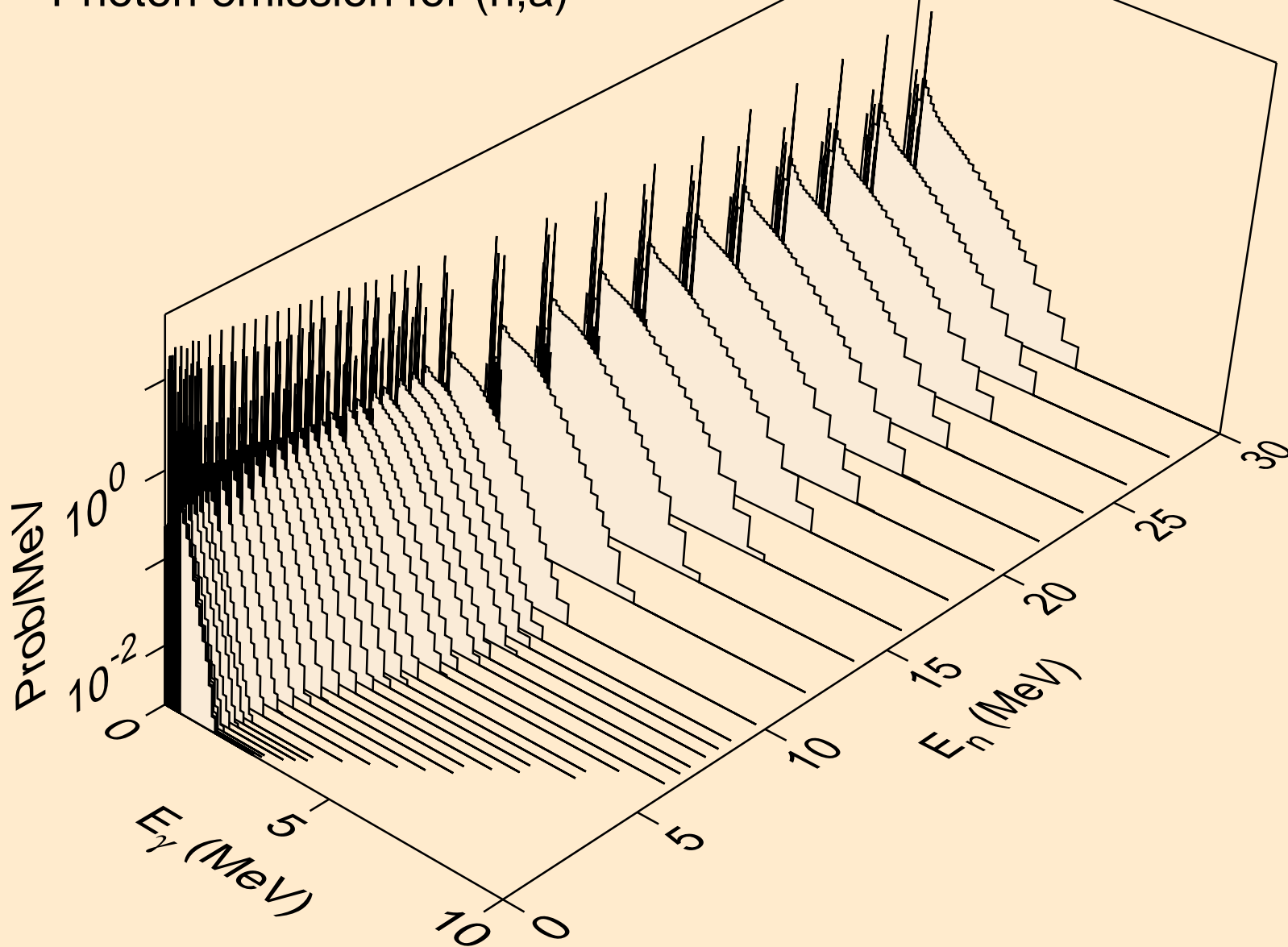

AU196 NEUTRON ACER TENDL-2019 LIBRARY; T=293.16K  
Photon emission for (n,2p)

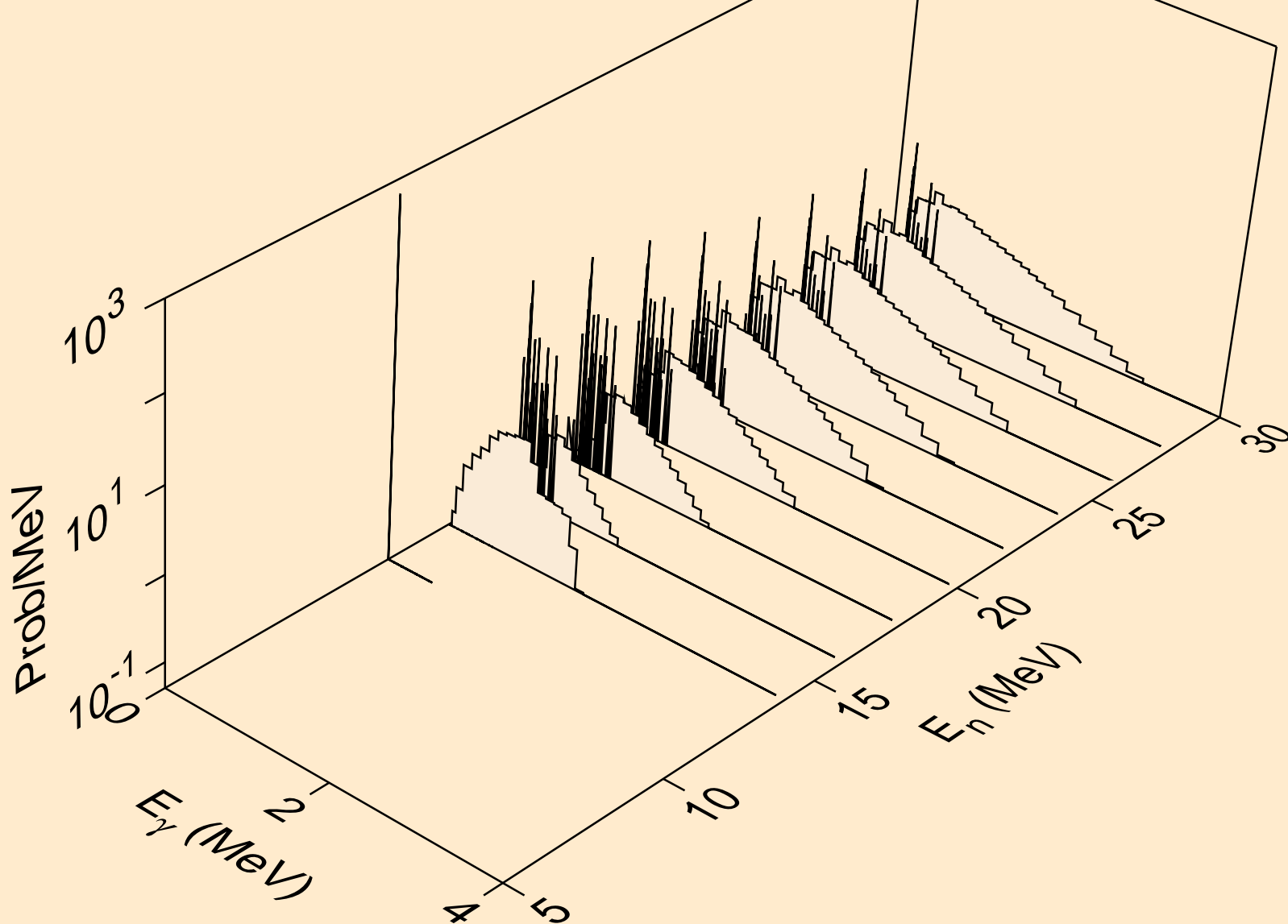

AU196 NEUTRON ACER TENDL-2019 LIBRARY; T=293.16K  
Photon emission for (n,p $\alpha$ )

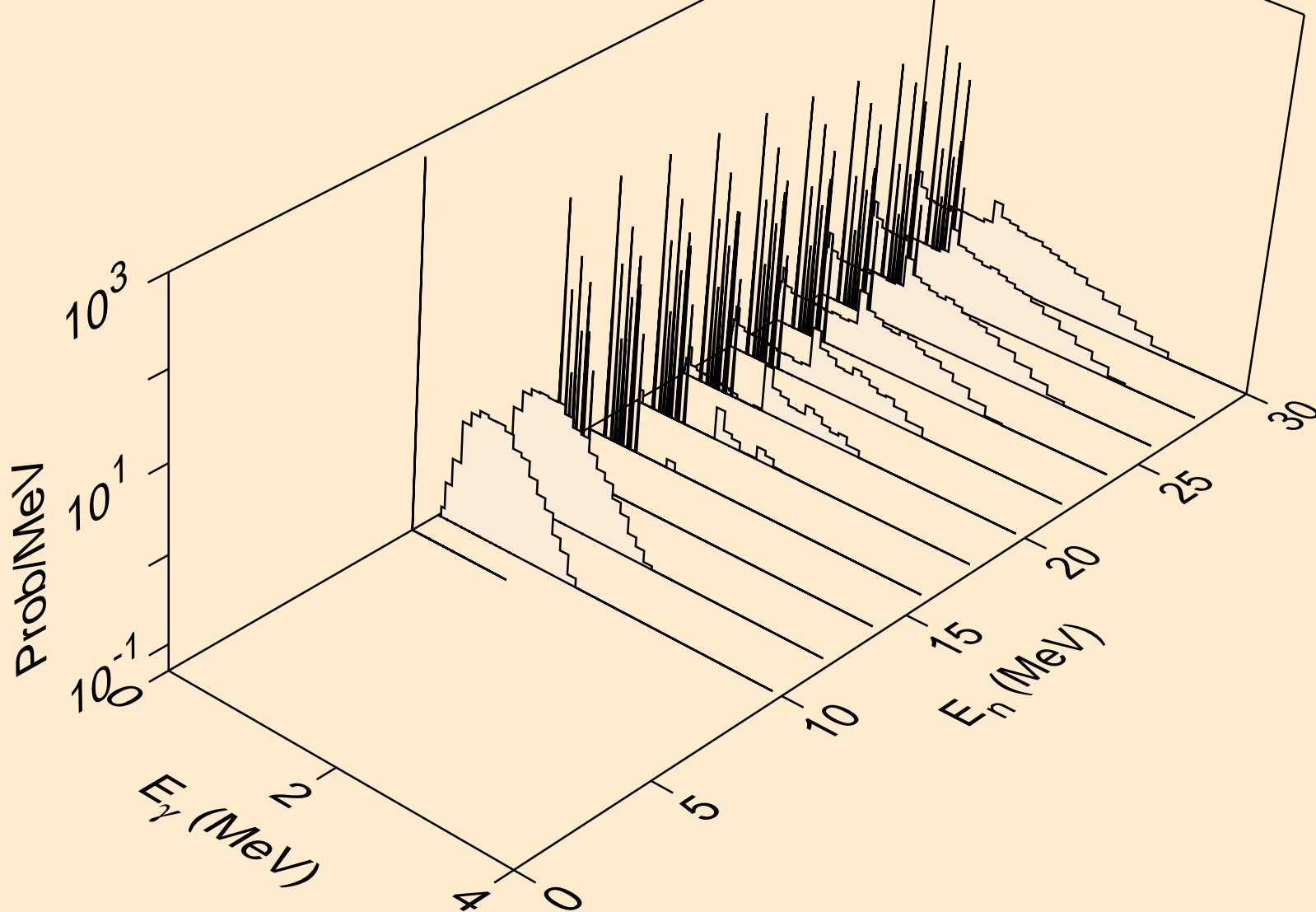

AU196 NEUTRON ACER TENDL-2019 LIBRARY; T=293.16K  
Photon emission for (n,pd)

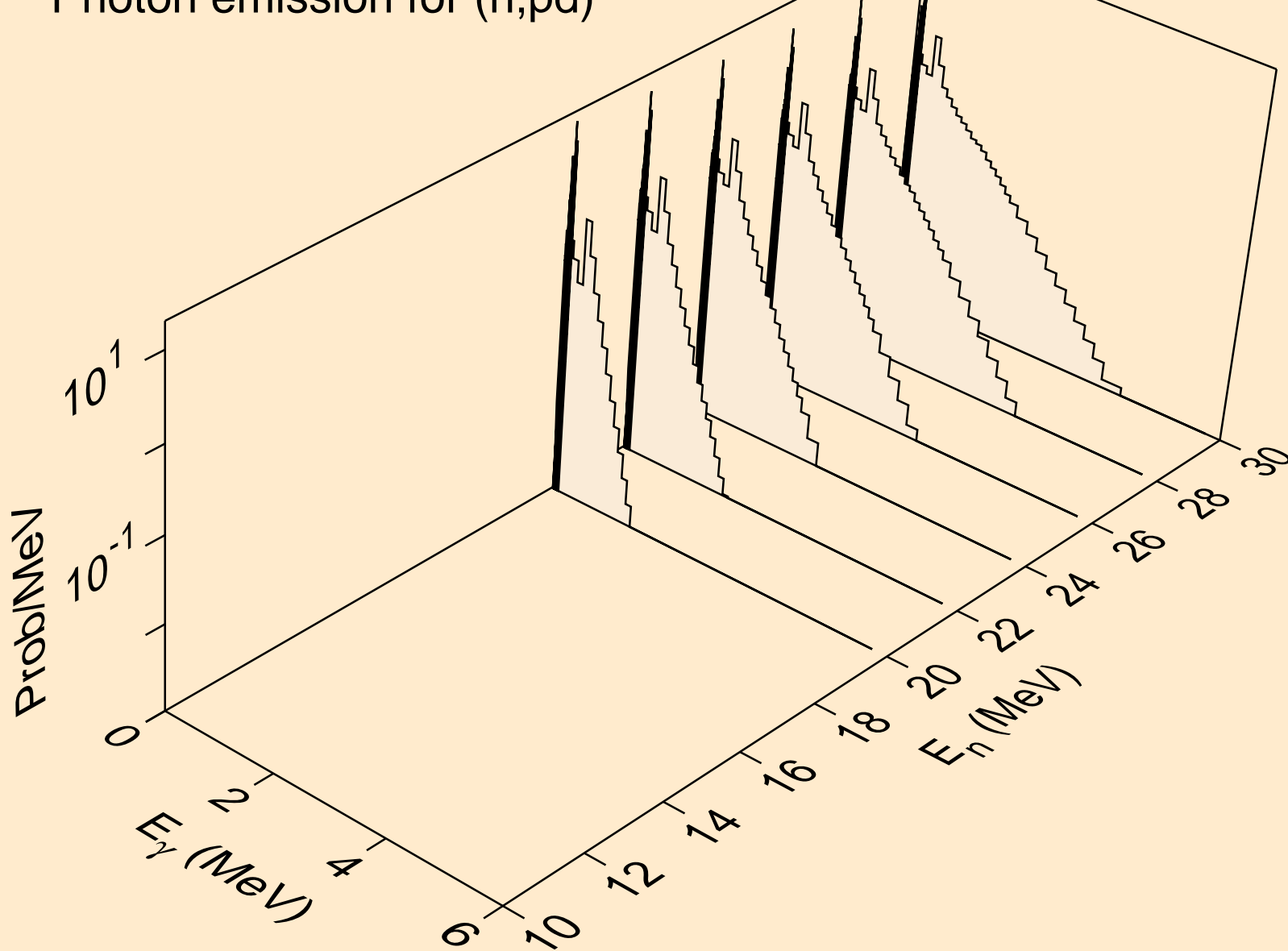

AU196 NEUTRON ACER TENDL-2019 LIBRARY; T=293.16K  
Photon emission for (n,pt)

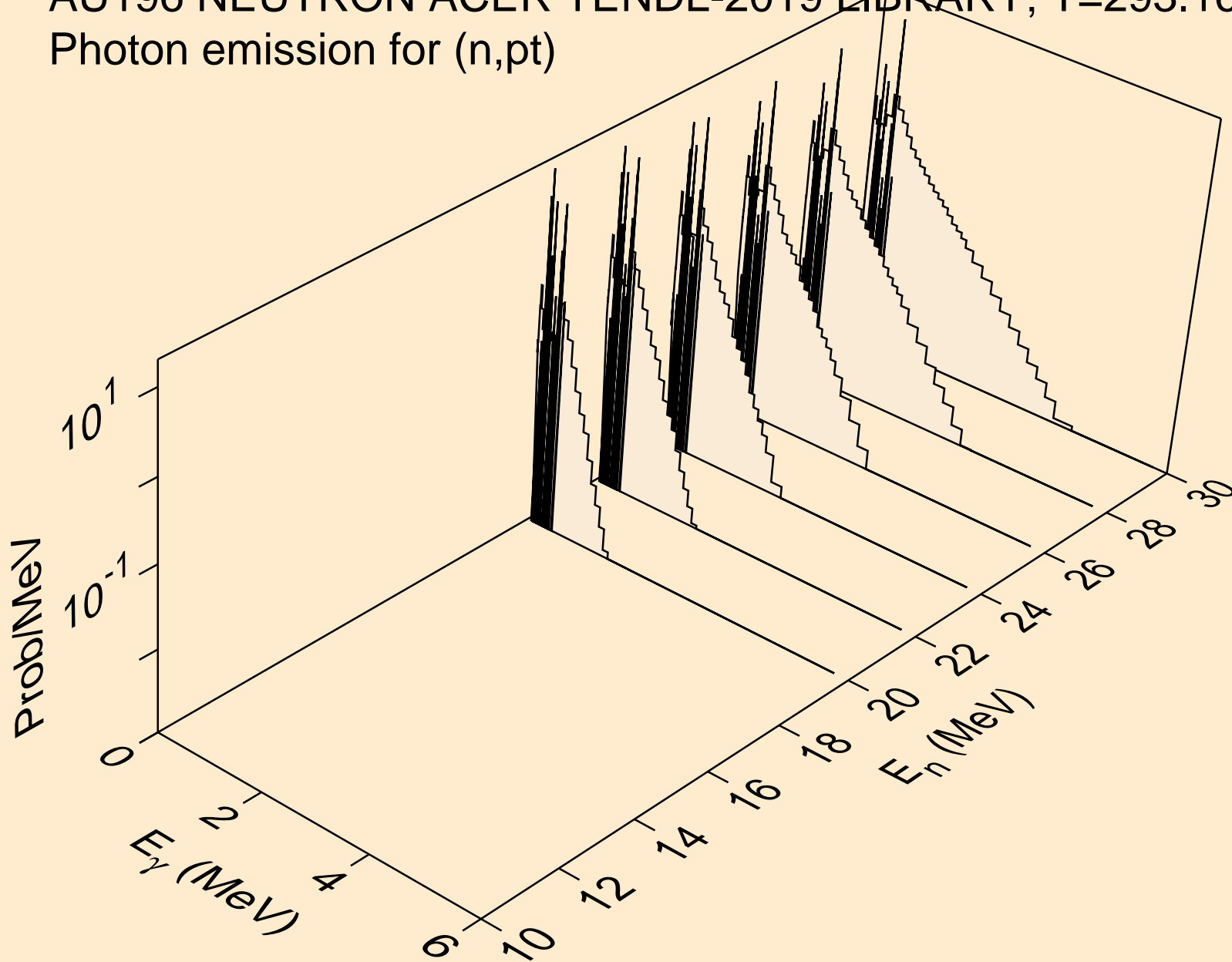

AU196 NEUTRON ACER TENDL-2019 LIBRARY; T=293.16K  
thermal capture photon spectrum

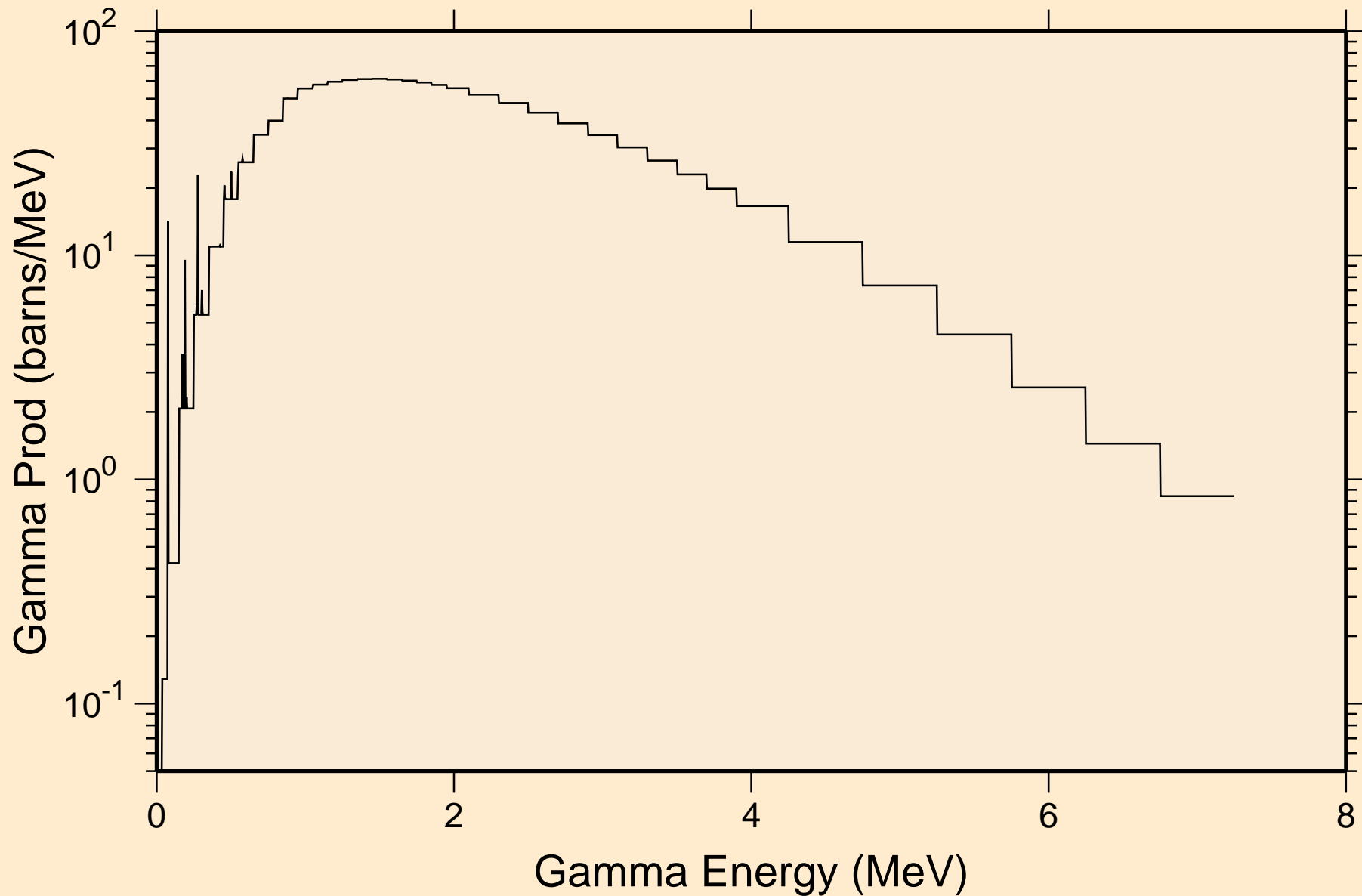

AU196 NEUTRON ACER TENDL-2019 LIBRARY; T=293.16K  
14 MeV photon spectrum

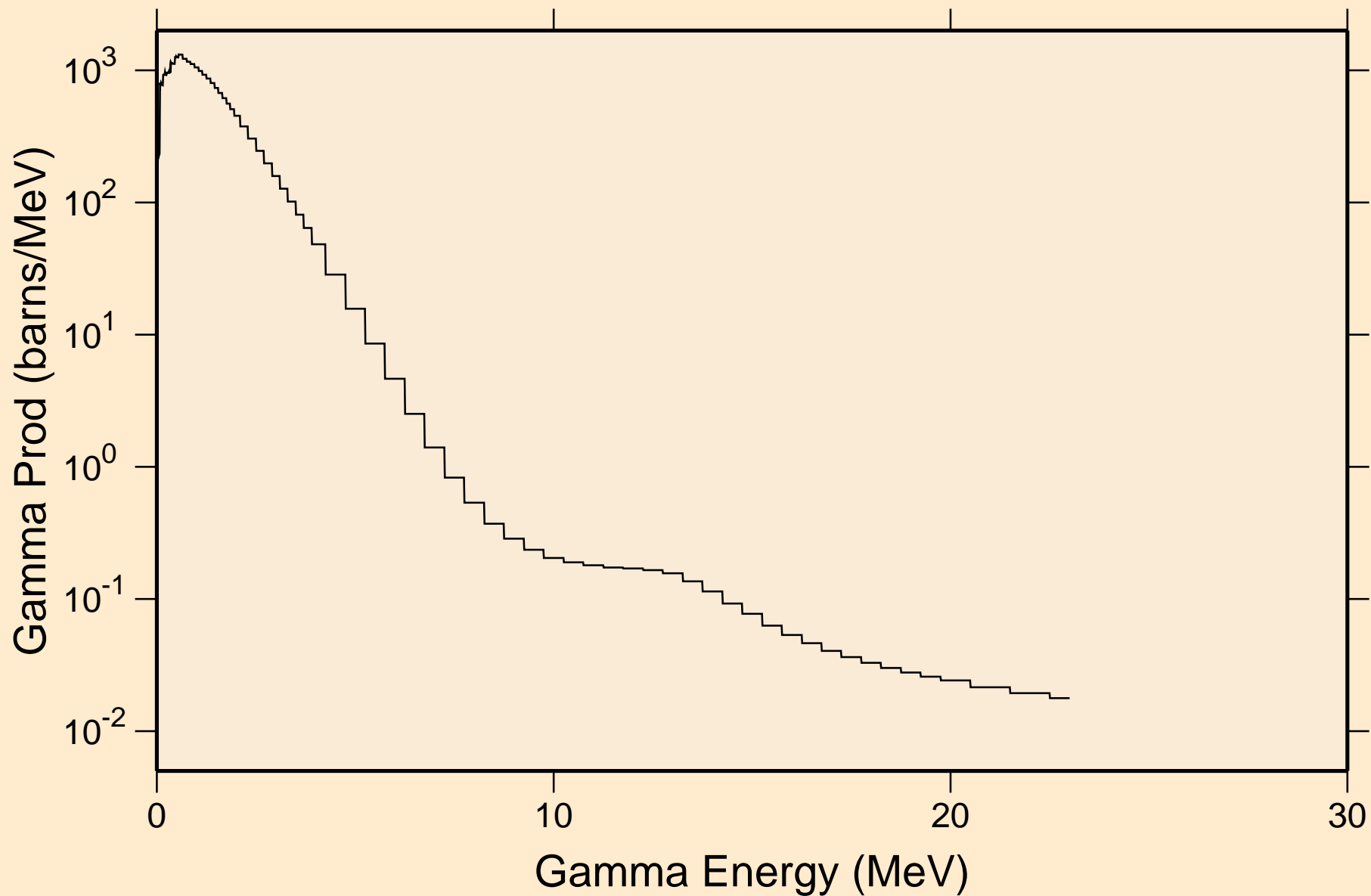



# AU196 NEUTRON ACER TENDL-2019 LIBRARY; T=293.16K

## Particle heating contributions

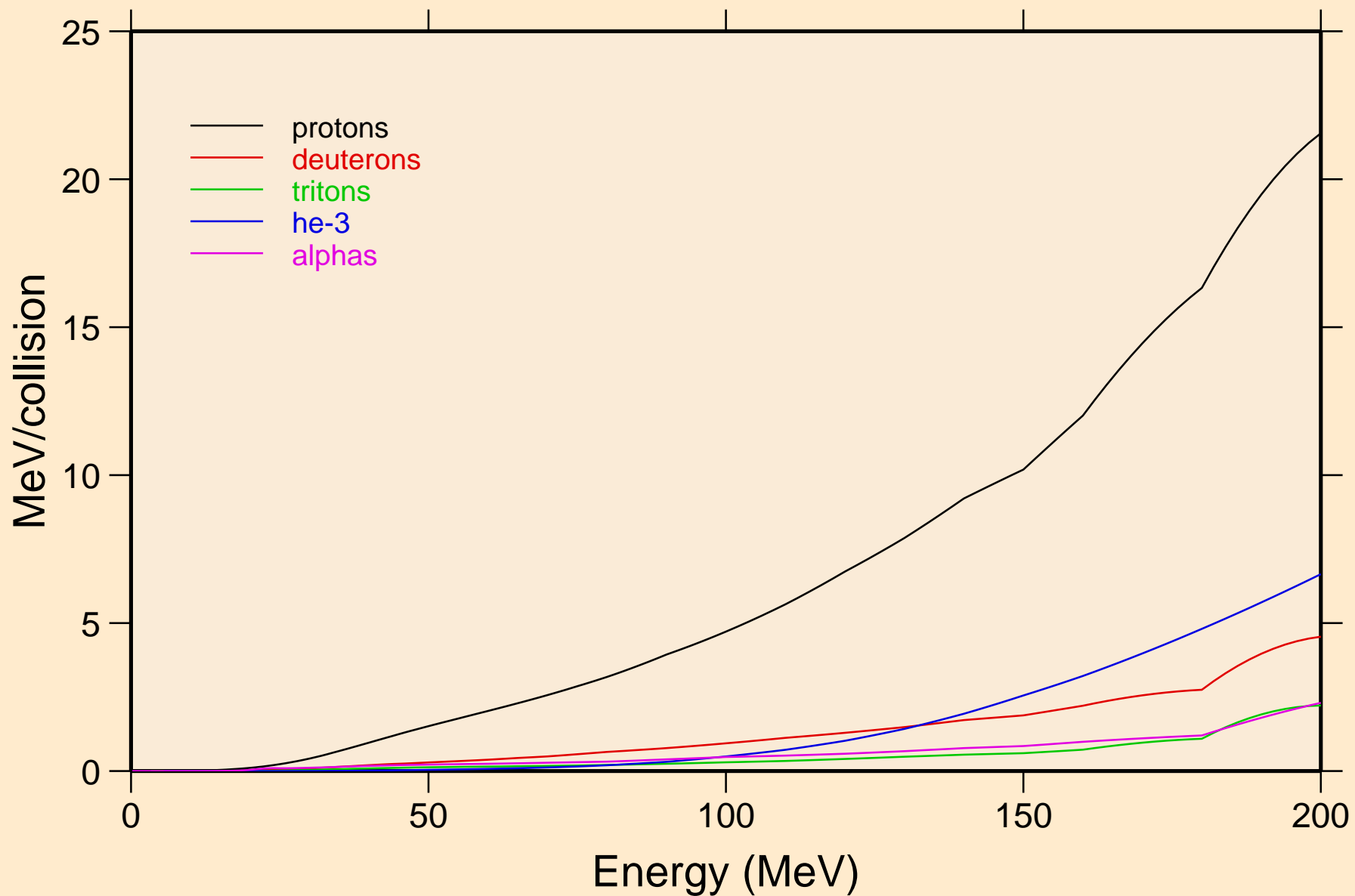

AU196 NEUTRON ACER TENDL-2019 LIBRARY; T=293.16K  
Recoil Heating

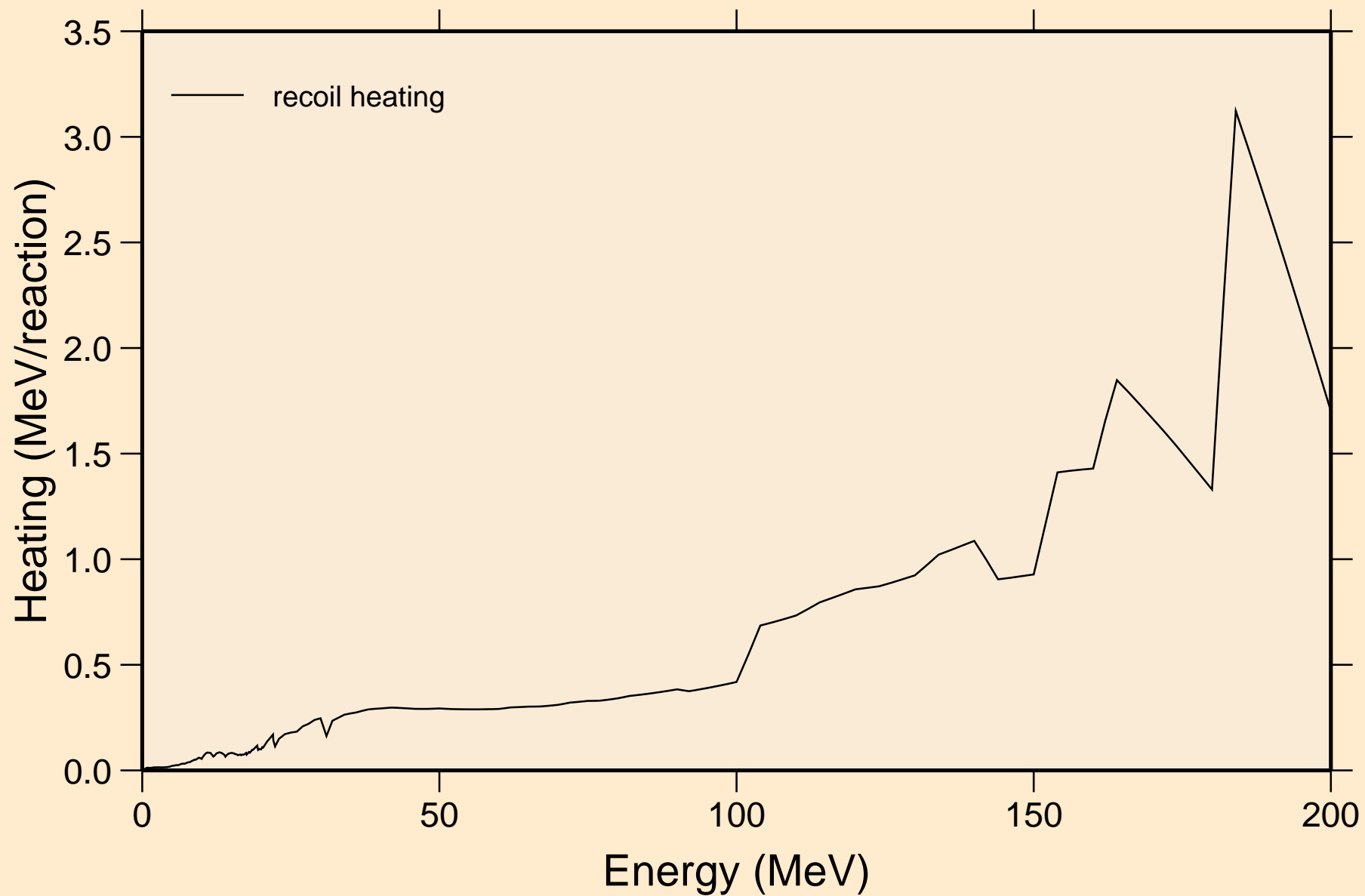

AU196 NEUTRON ACER TENDL-2019 LIBRARY; T=293.16K  
Particle production cross sections

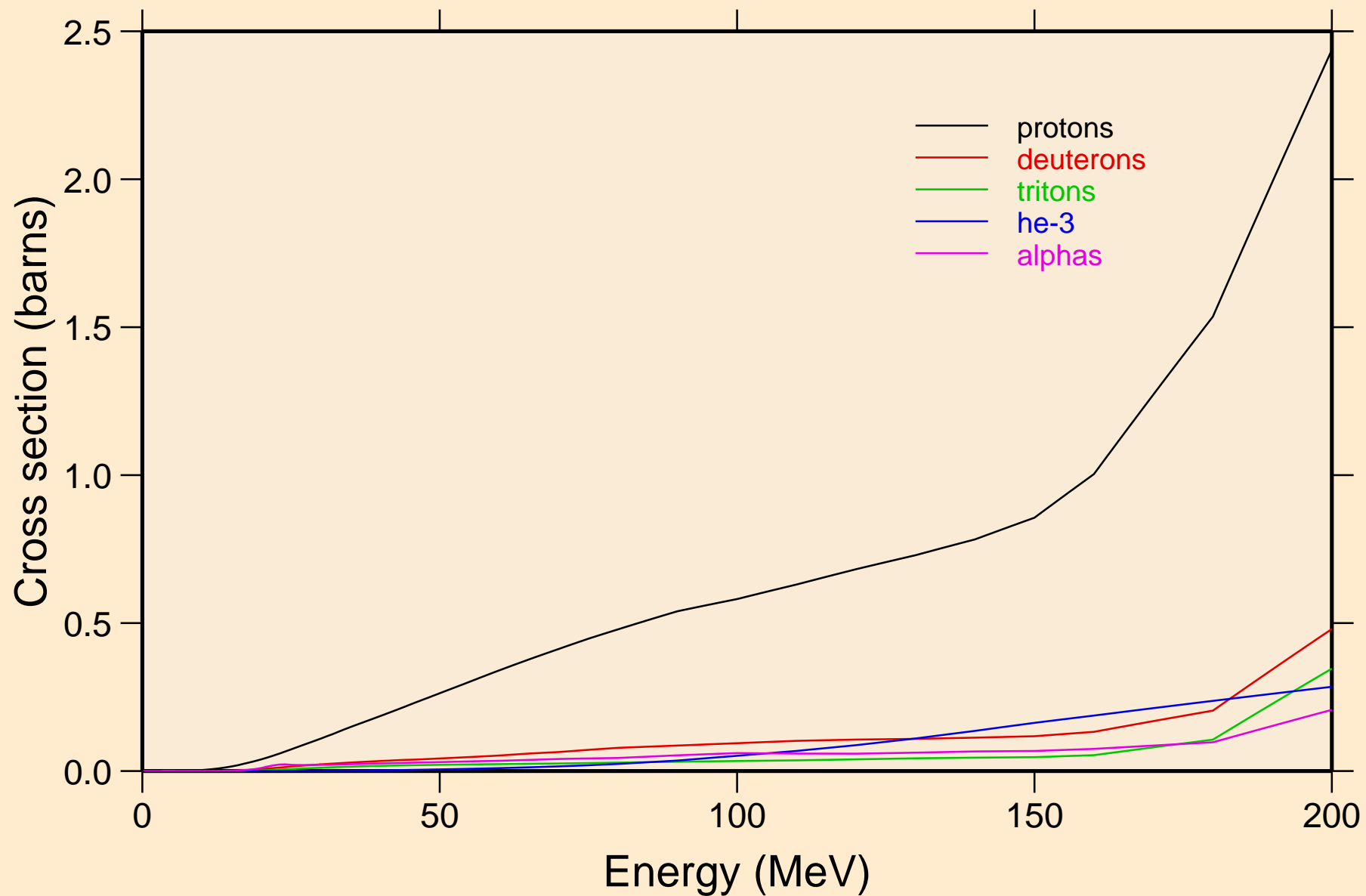

AU196 NEUTRON ACER TENDL-2019 LIBRARY; T=293.16K  
protons from (n,x)

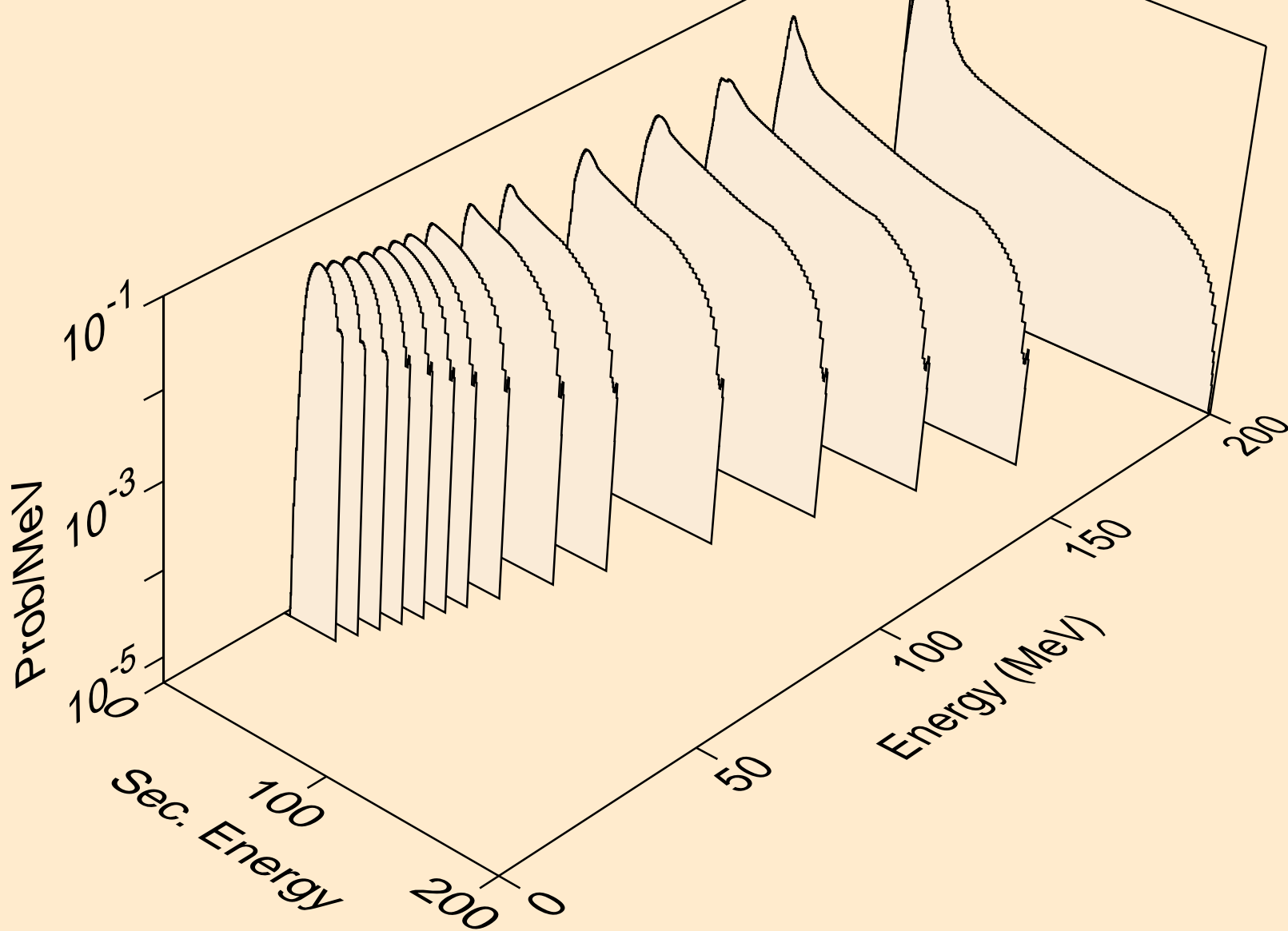

AU196 NEUTRON ACER TENDL-2019 LIBRARY; T=293.16K  
protons from (n,n\*)p

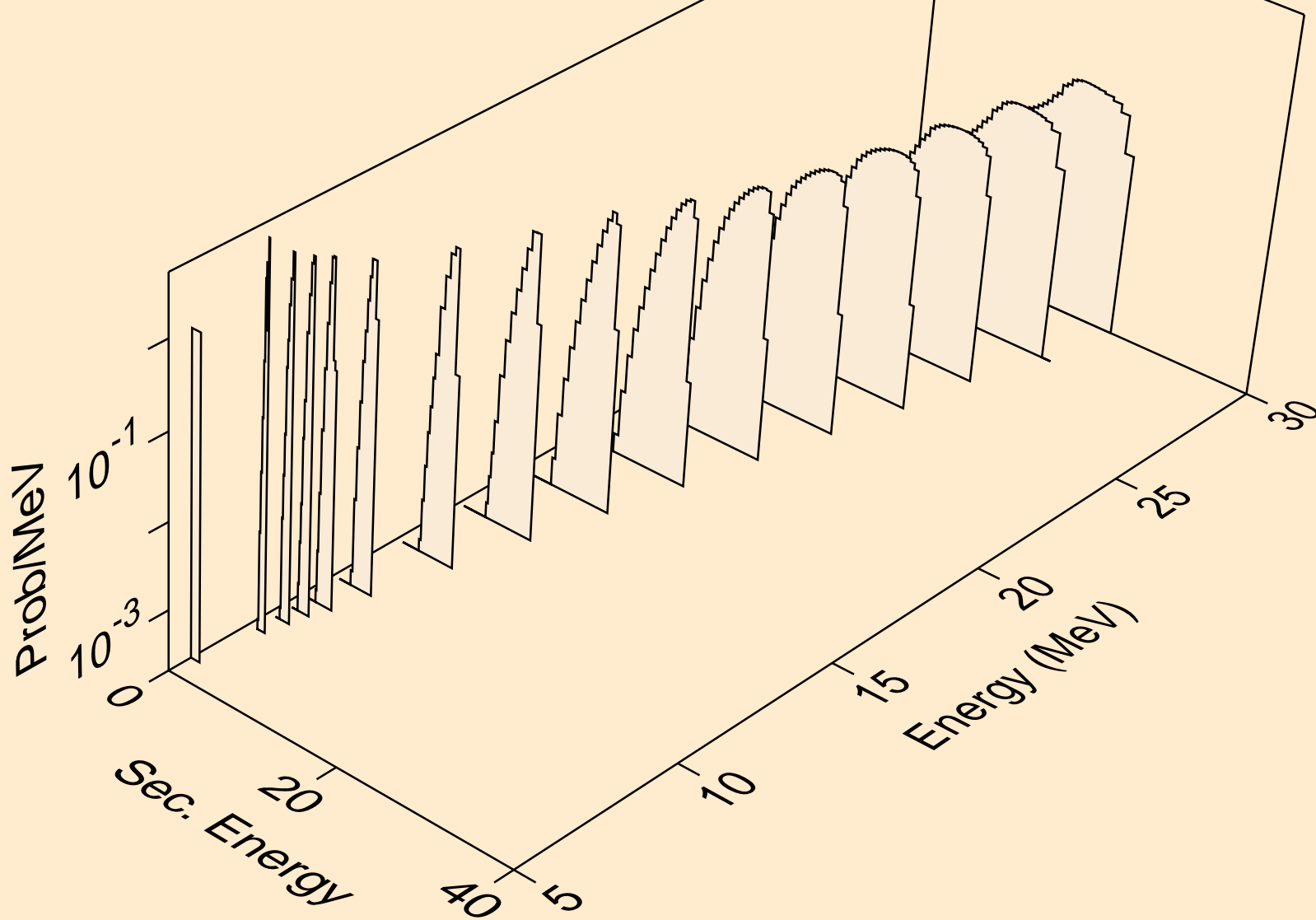

AU196 NEUTRON ACER TENDL-2019 LIBRARY; T=293.16K  
protons from (n,2np)

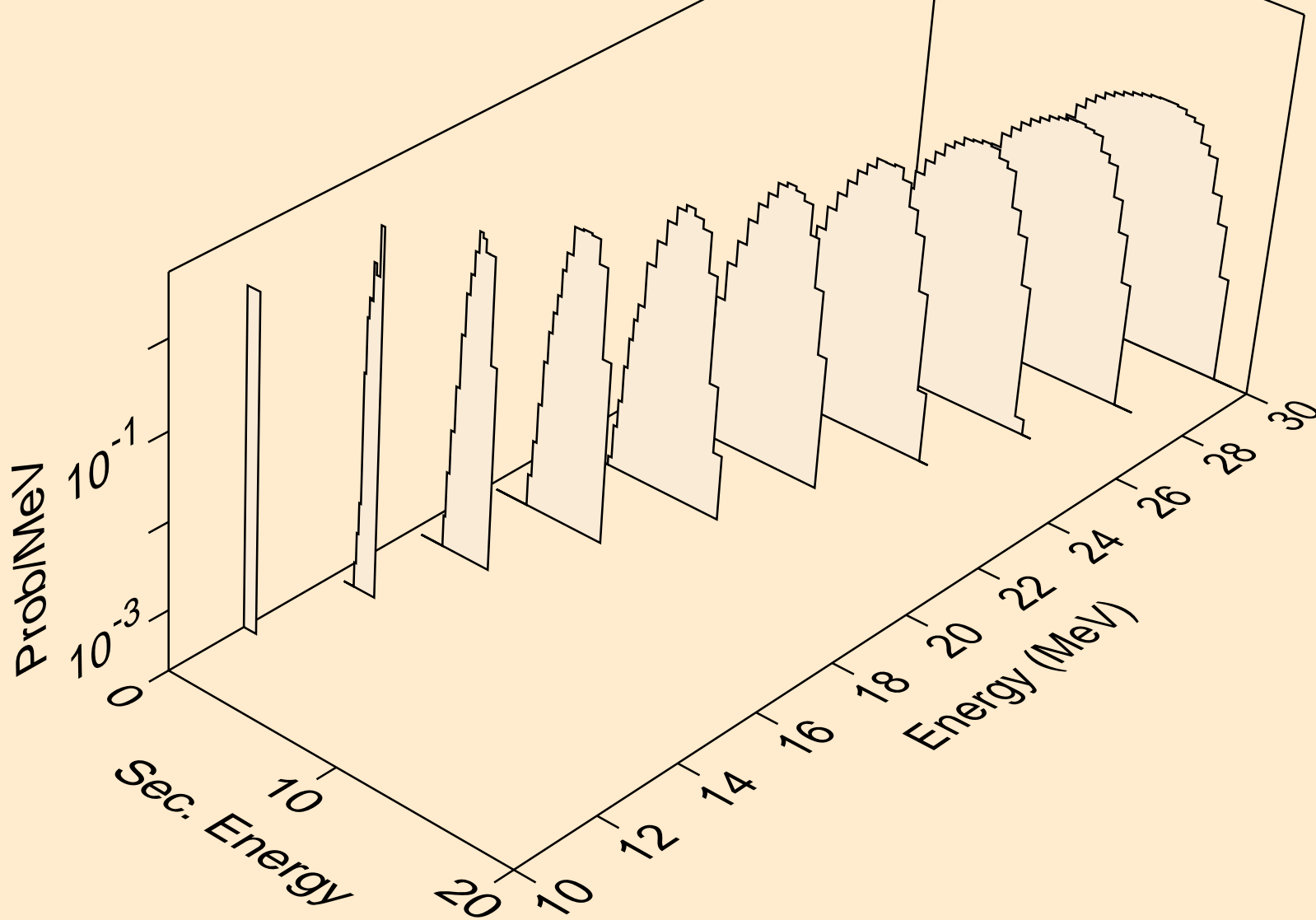

AU196 NEUTRON ACER TENDL-2019 LIBRARY; T=293.16K  
protons from (n,3np)

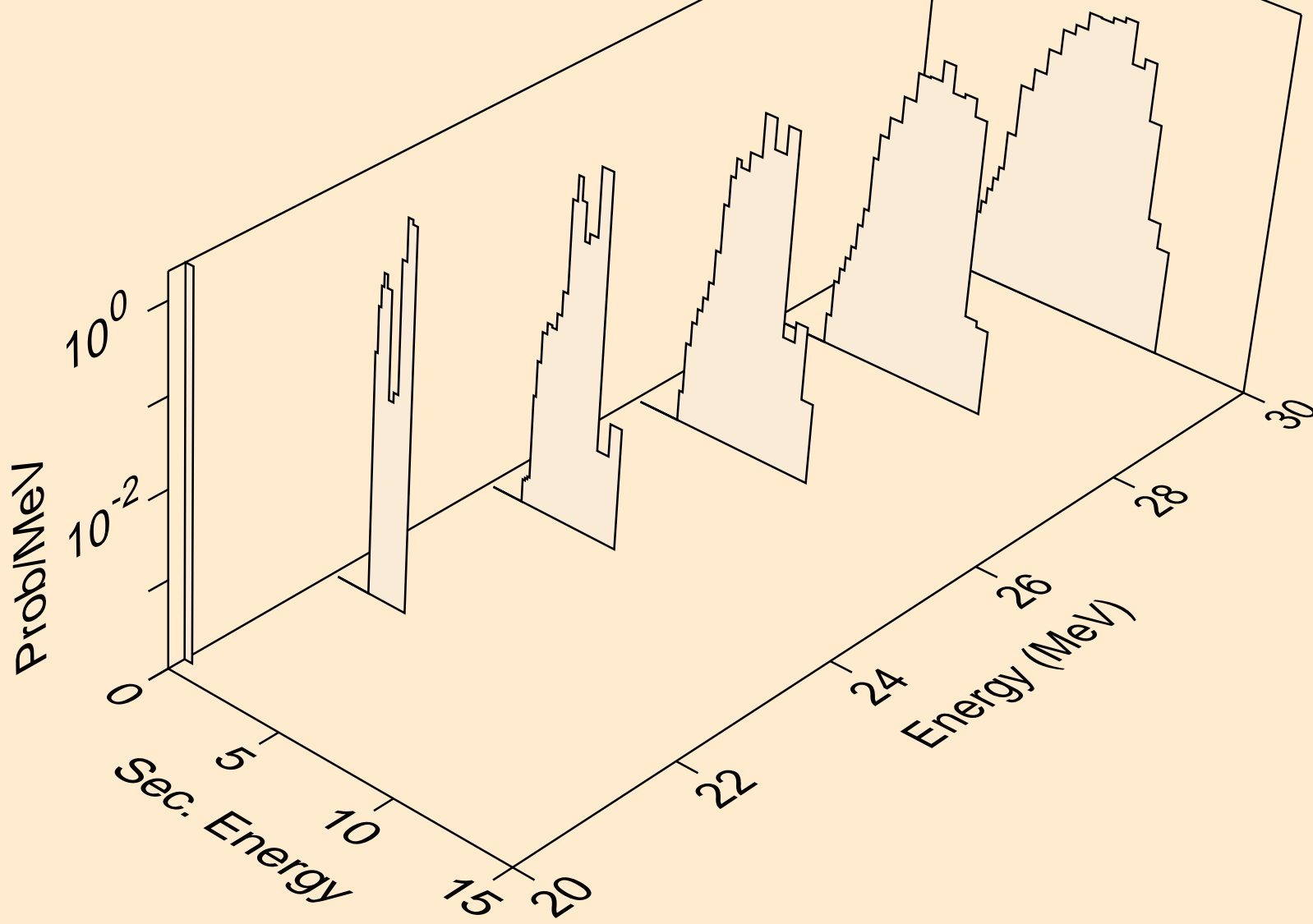

AU196 NEUTRON ACER TENDL-2019 LIBRARY; T=293.16K  
protons from (n,2np)

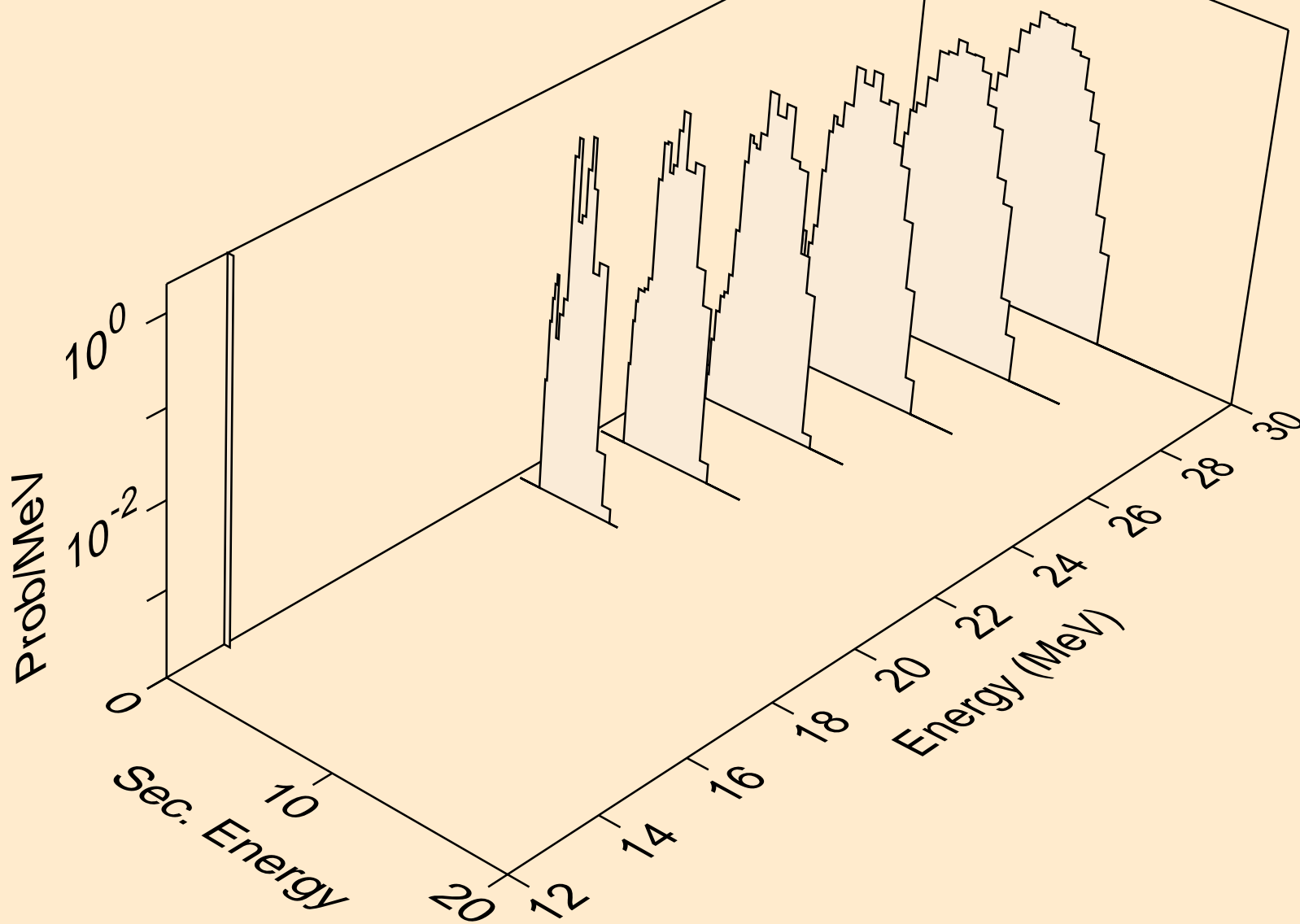



AU196 NEUTRON ACER TENDL-2019 LIBRARY; T=293.16K  
protons from (n,npa)

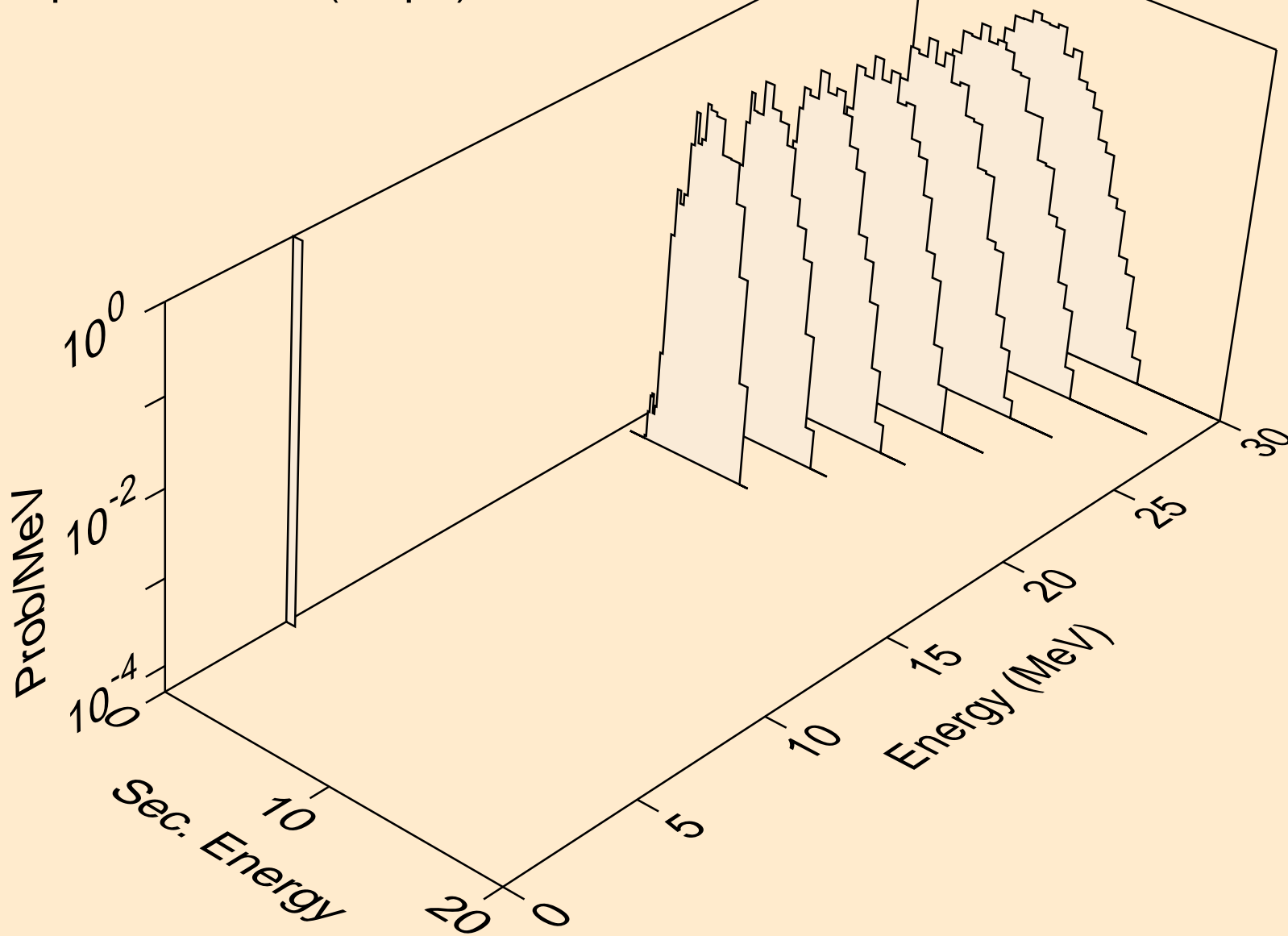

AU196 NEUTRON ACER TENDL-2019 LIBRARY; T=293.16K  
protons from (n,p)

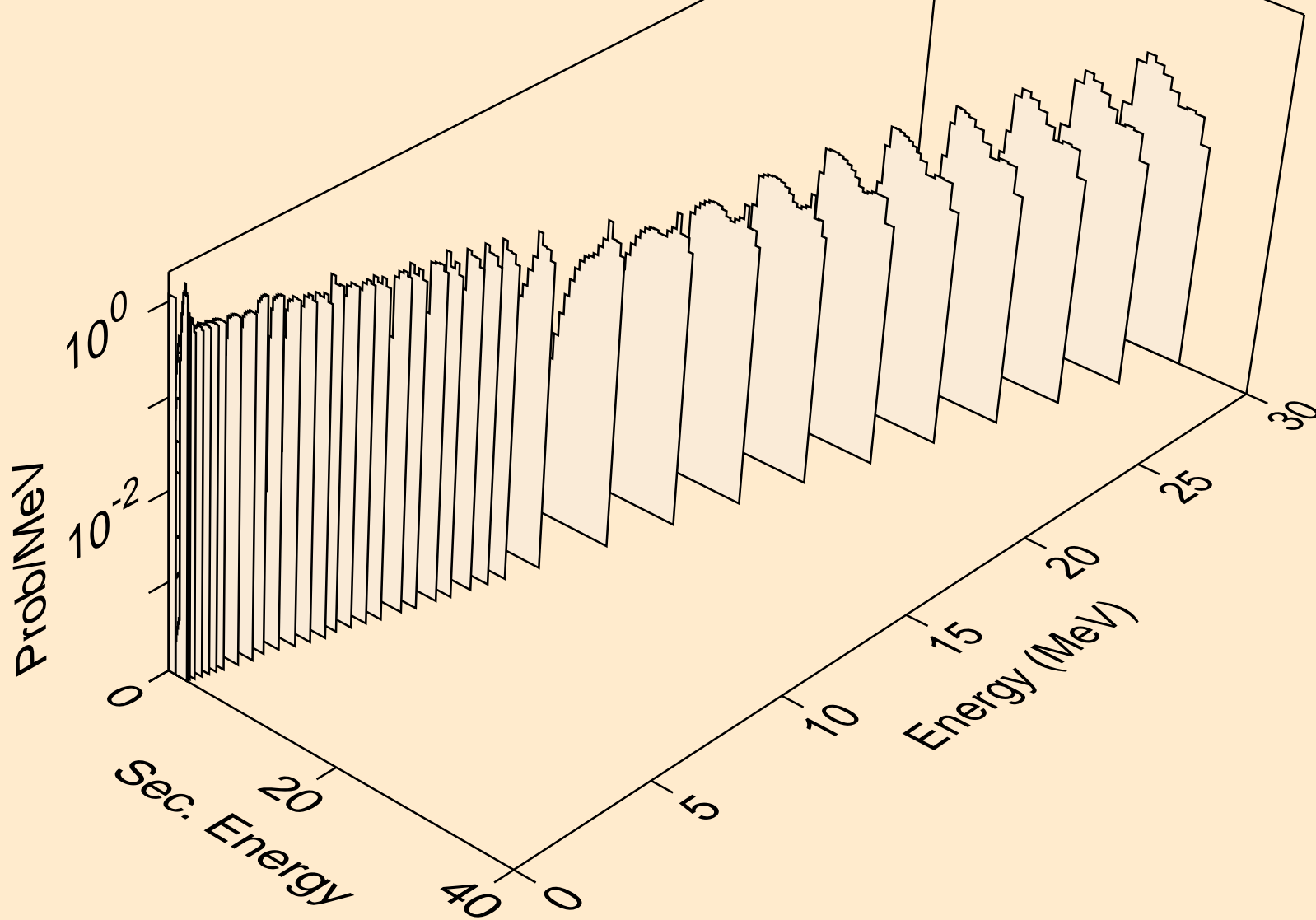

AU196 NEUTRON ACER TENDL-2019 LIBRARY; T=293.16K  
protons from (n,2p)

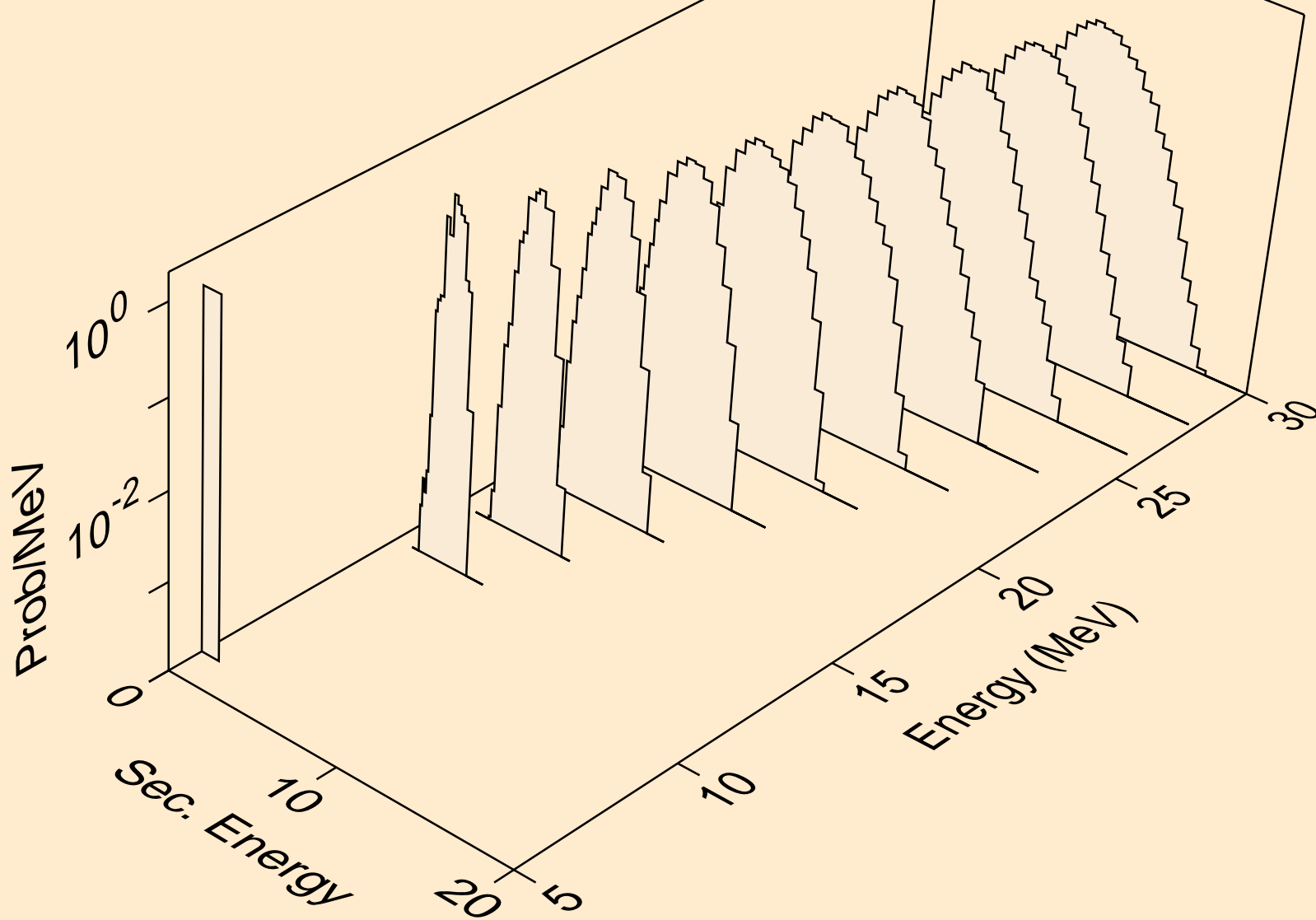

AU196 NEUTRON ACER TENDL-2019 LIBRARY; T=293.16K  
protons from (n,p)

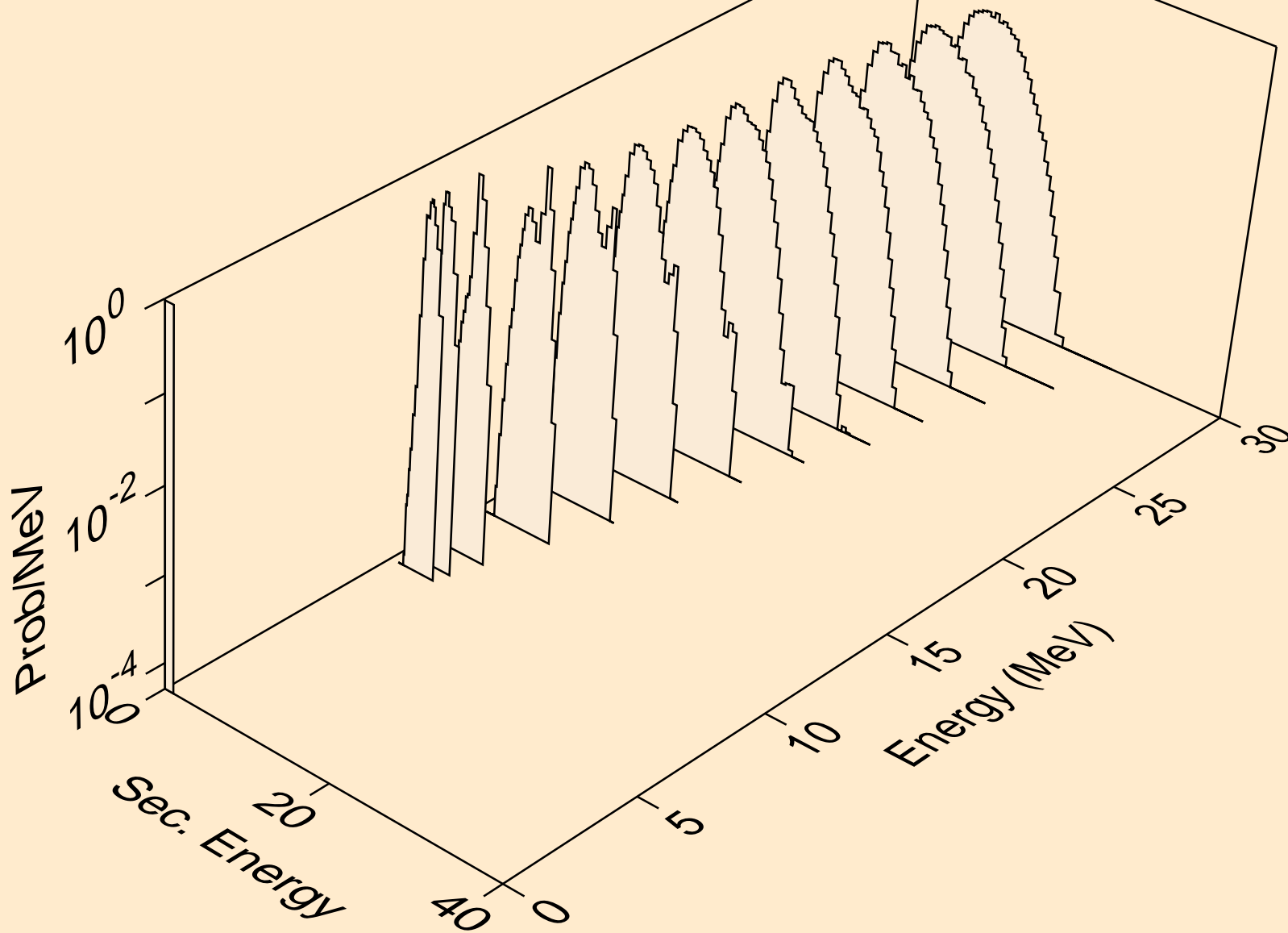

AU196 NEUTRON ACER TENDL-2019 LIBRARY; T=293.16K  
protons from (n,pd)

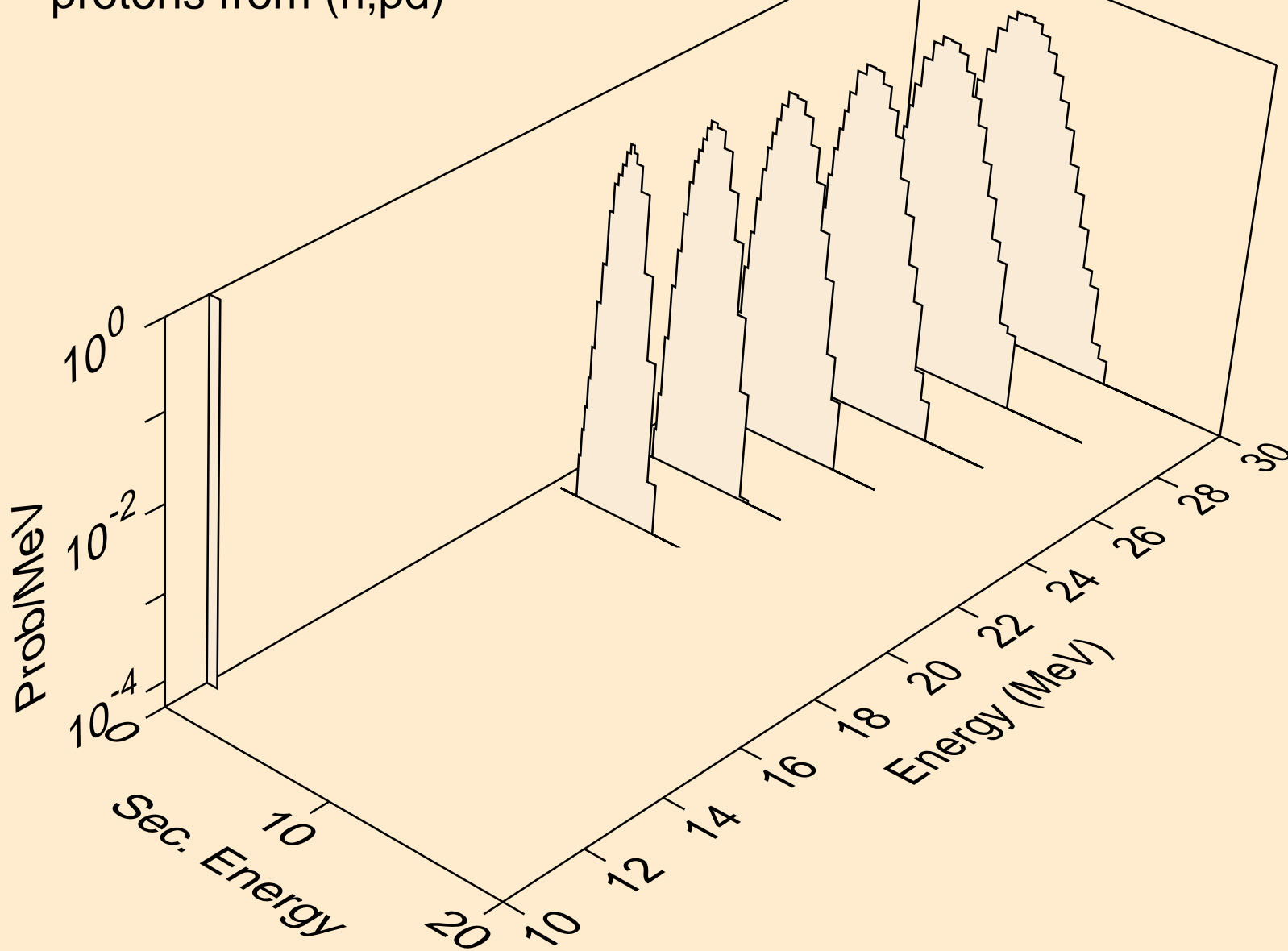

AU196 NEUTRON ACER TENDL-2019 LIBRARY; T=293.16K  
protons from (n,pt)

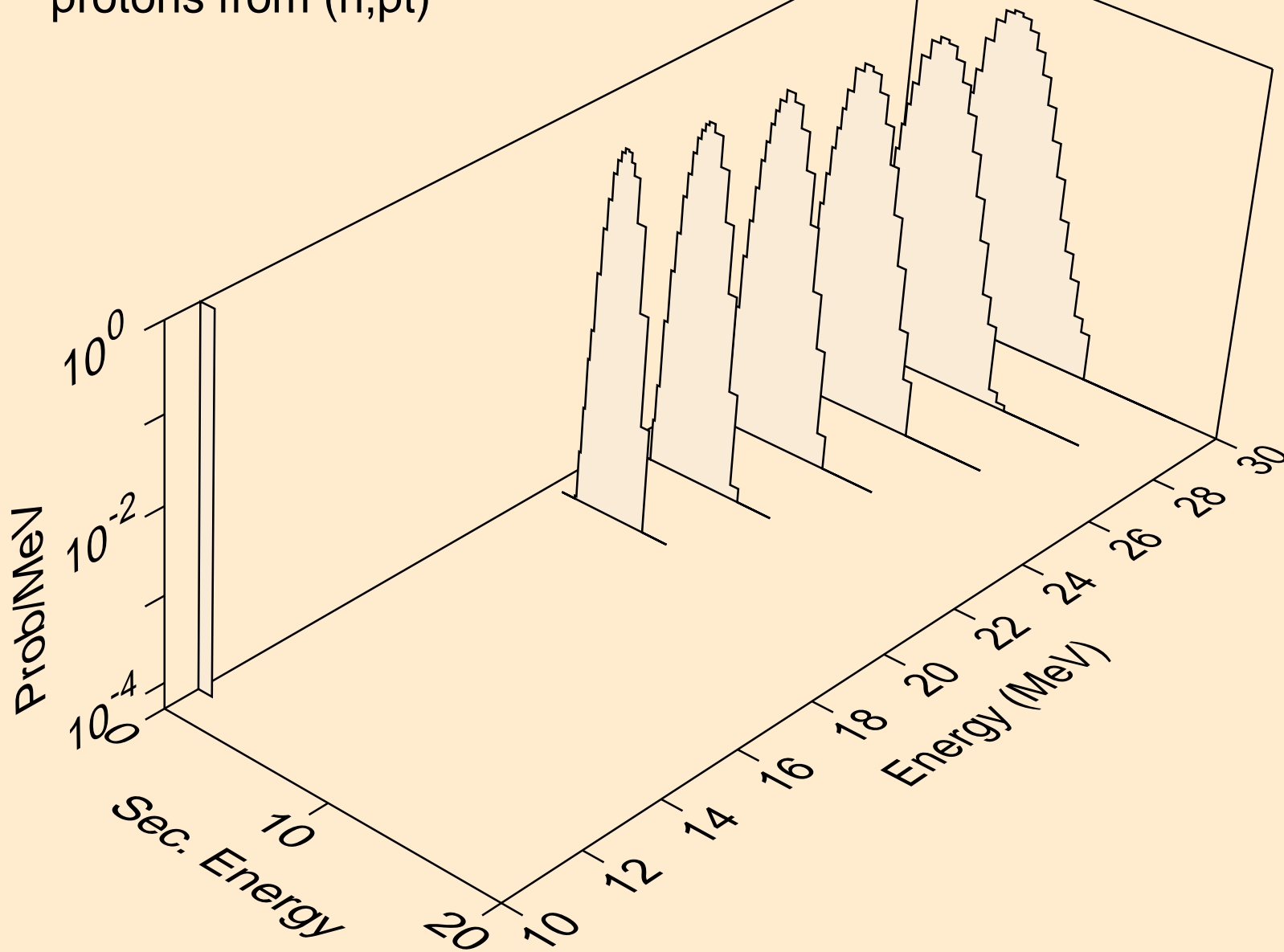

AU196 NEUTRON ACER TENDL-2019 LIBRARY; T=293.16K  
deuterons from (n,x)

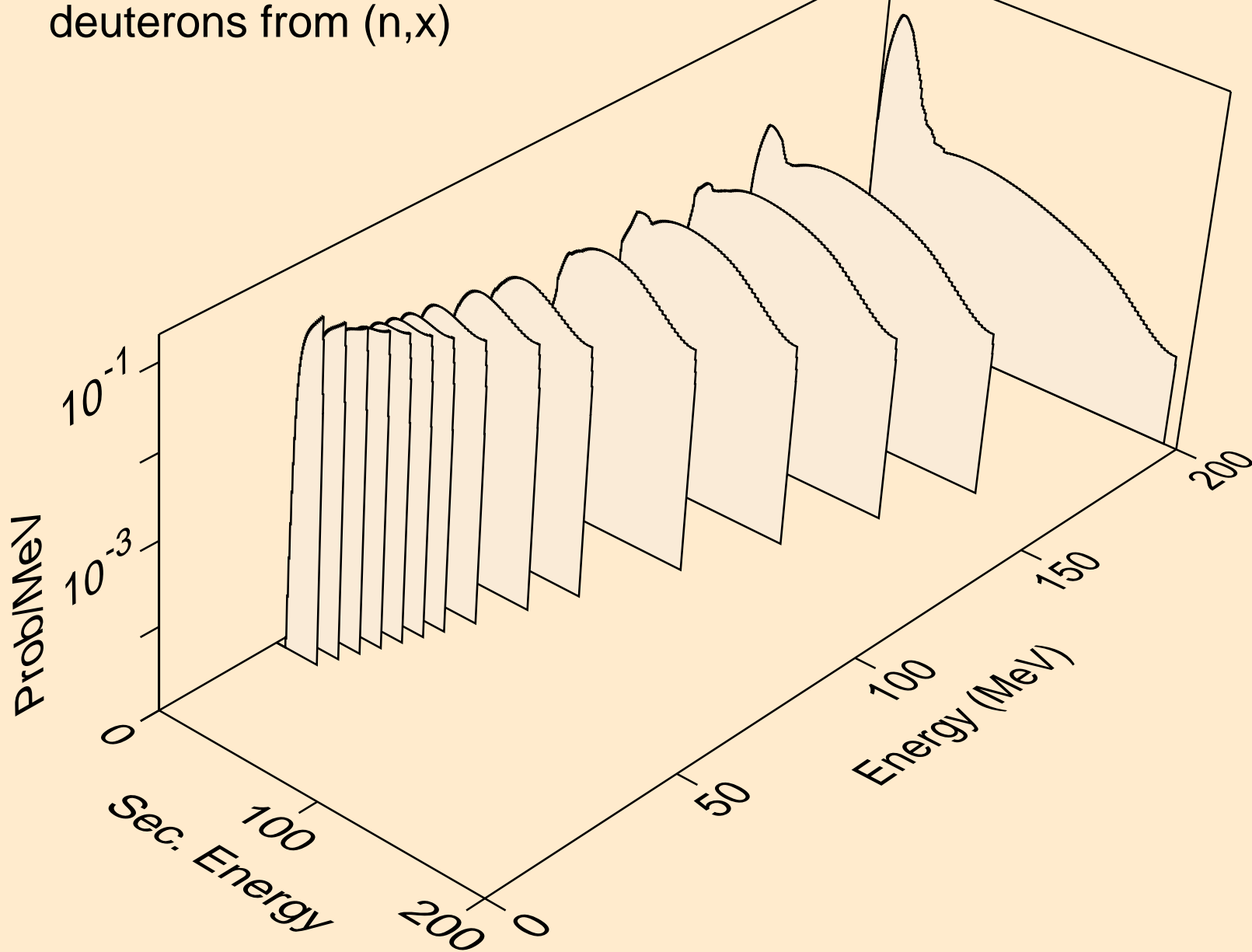

AU196 NEUTRON ACER TENDL-2019 LIBRARY; T=293.16K  
deuterons from (n,2nd)

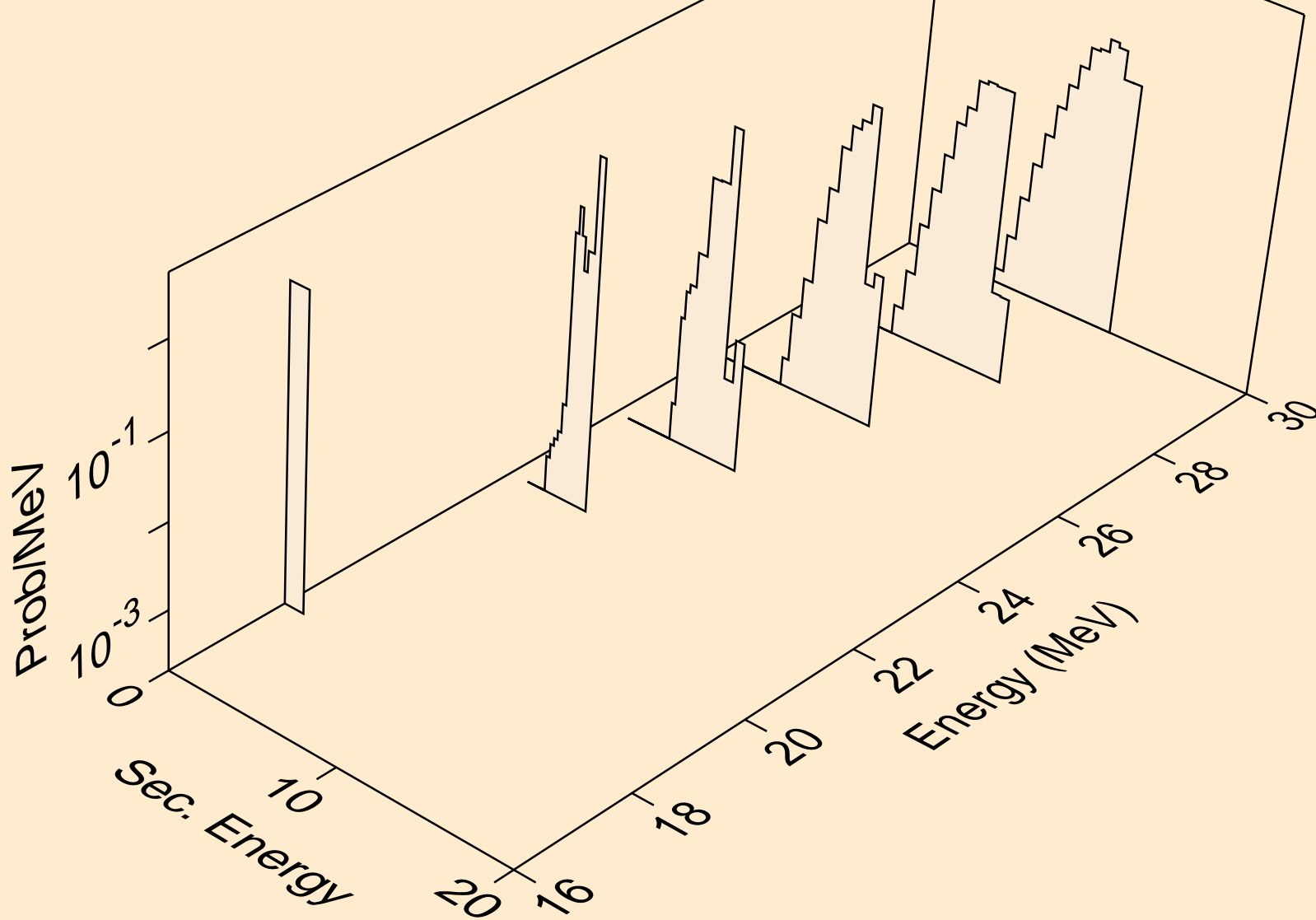



AU196 NEUTRON ACER TENDL-2019 LIBRARY; T=293.16K  
deuterons from (n,n\*)d

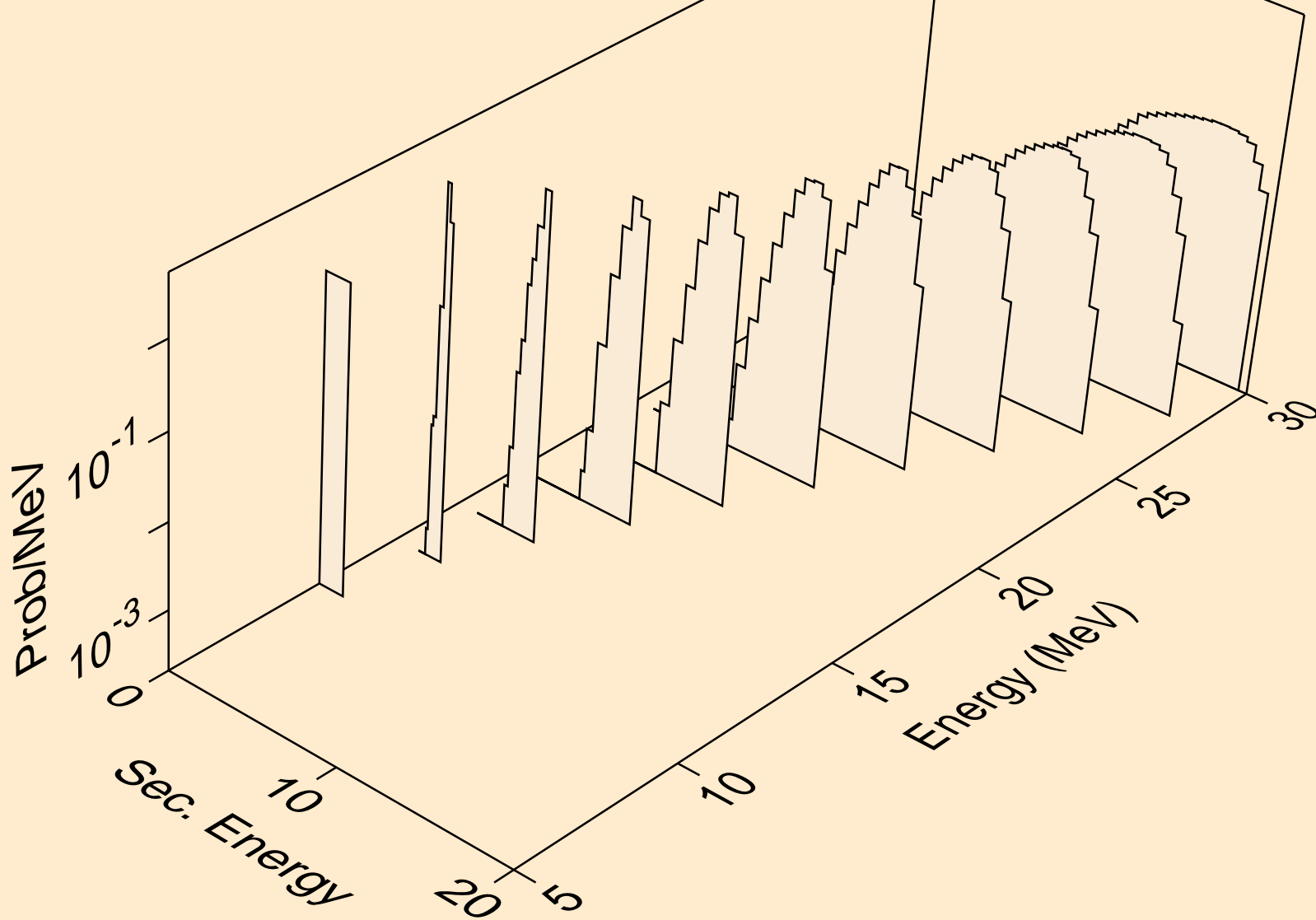

AU196 NEUTRON ACER TENDL-2019 LIBRARY; T=293.16K  
deuterons from (n,d)

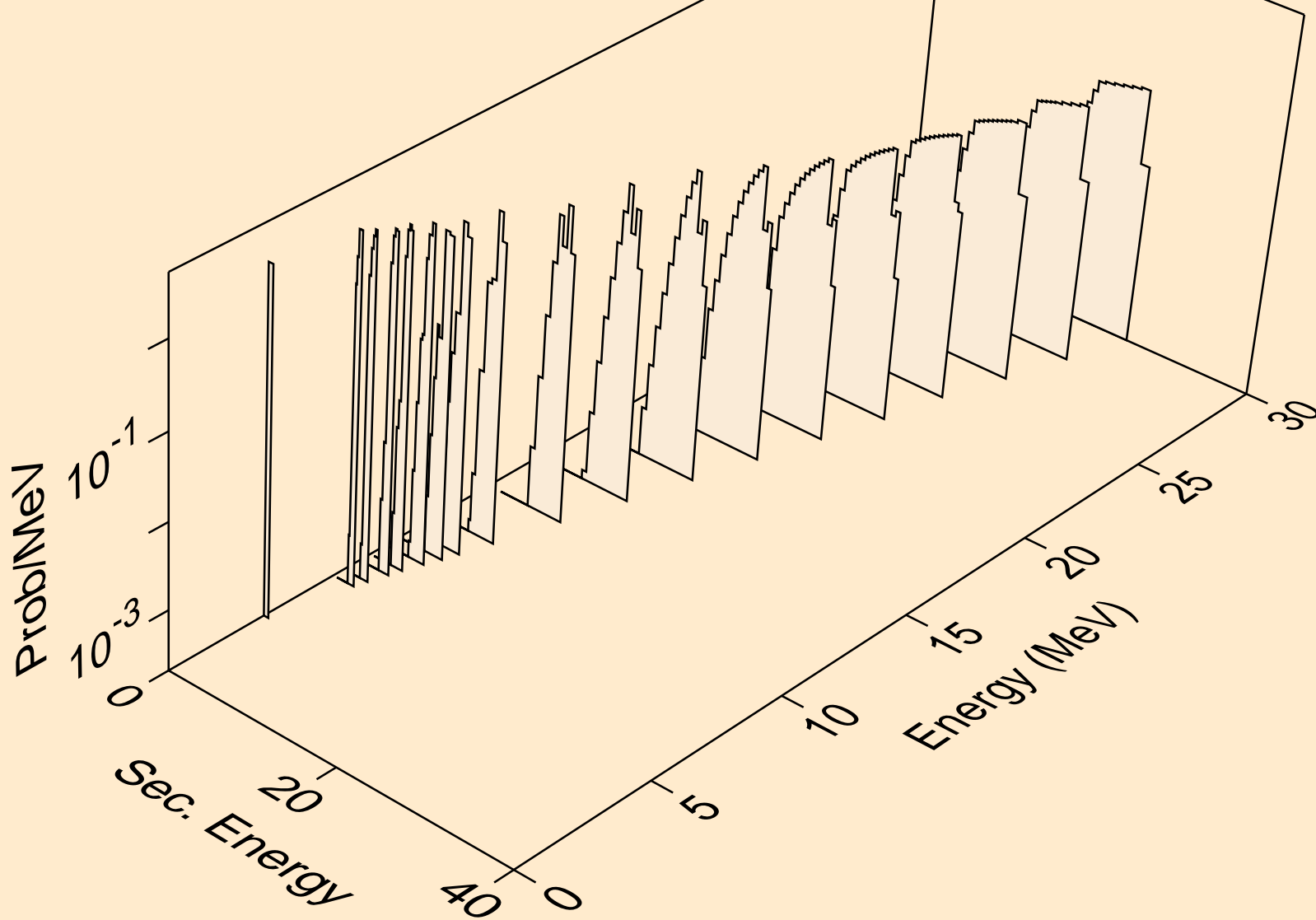

AU196 NEUTRON ACER TENDL-2019 LIBRARY; T=293.16K  
deuterons from (n,pd)

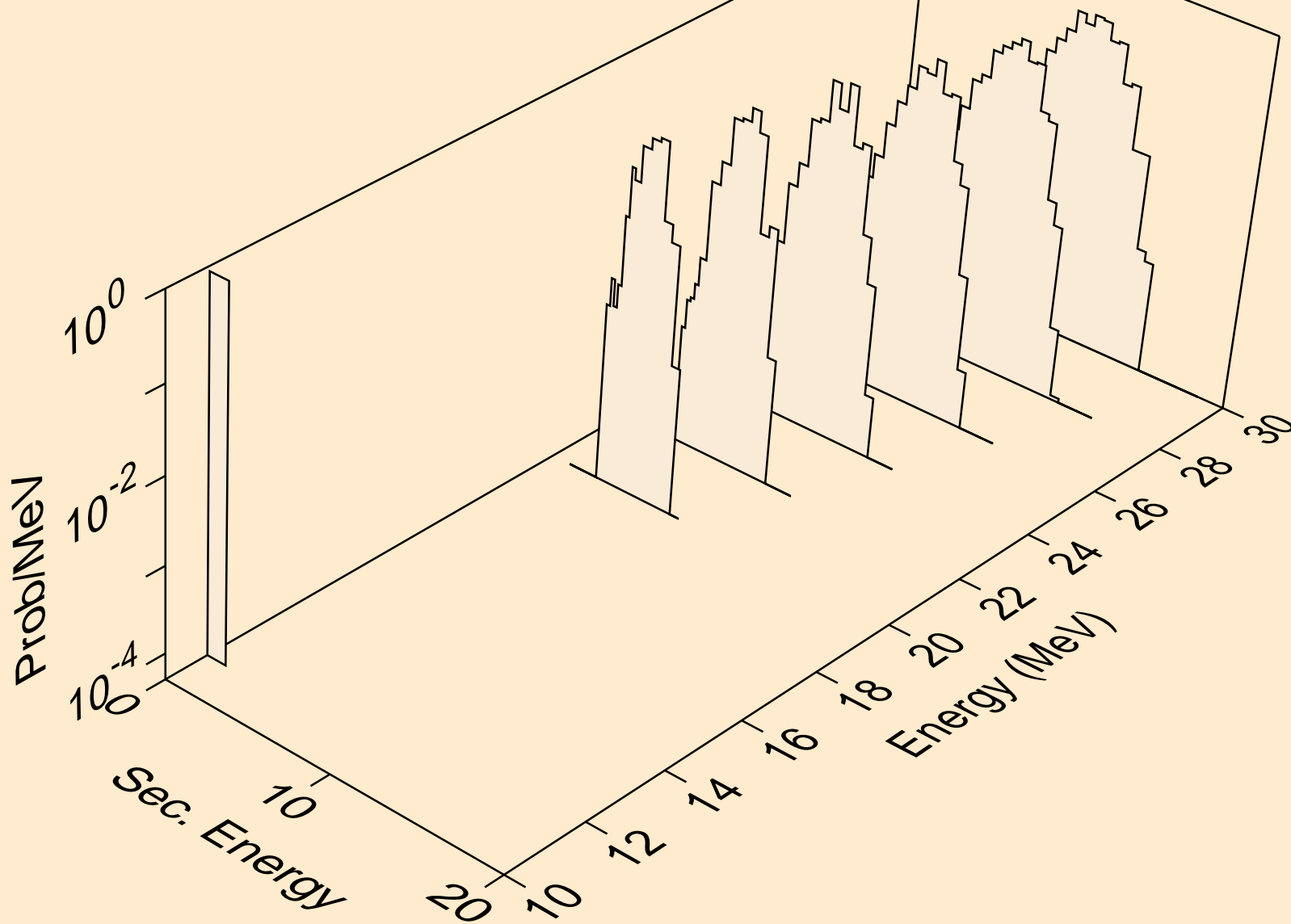

AU196 NEUTRON ACER TENDL-2019 LIBRARY; T=293.16K  
tritons from (n,x)

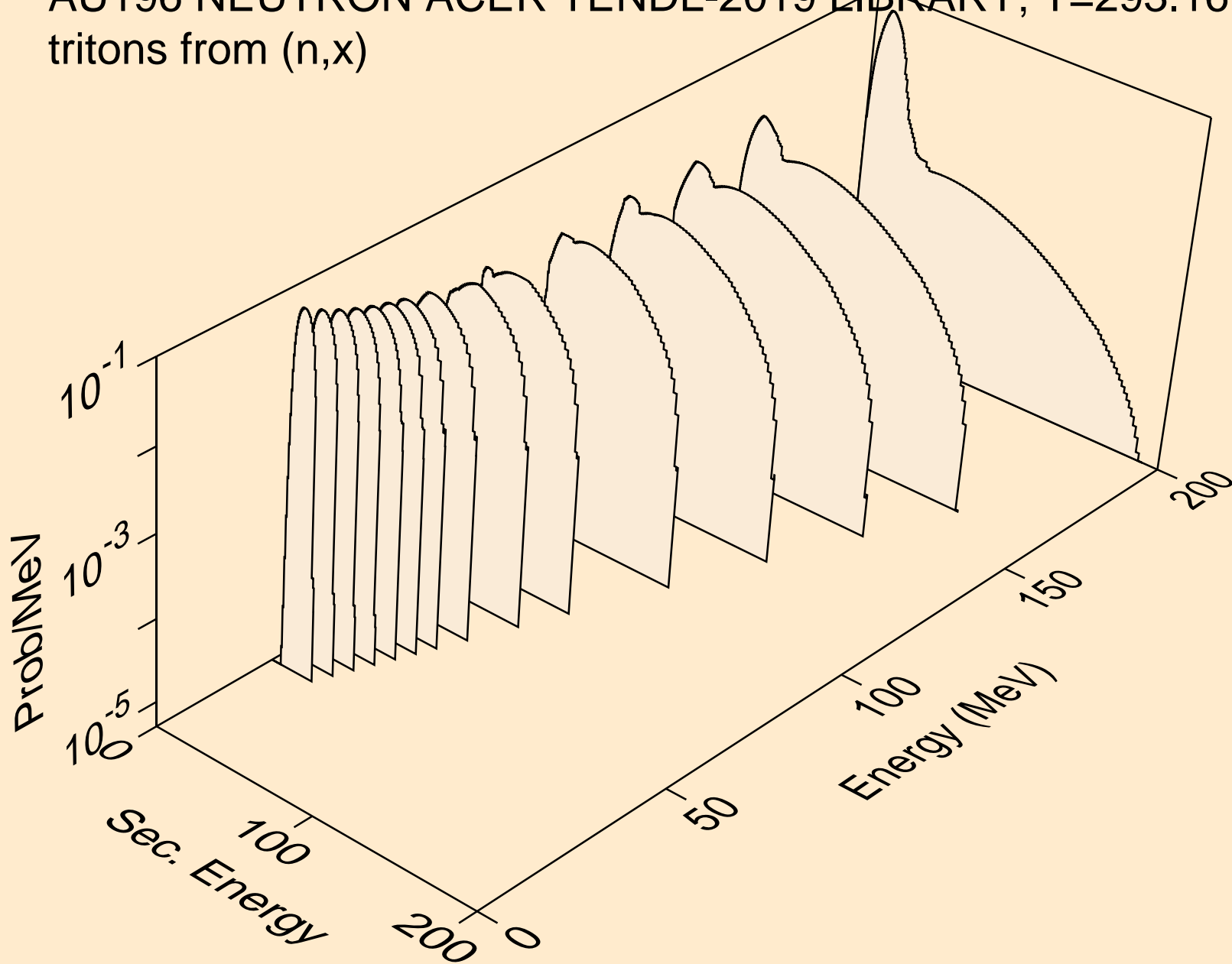

AU196 NEUTRON ACER TENDL-2019 LIBRARY; T=293.16K  
tritons from (n,n\*)t

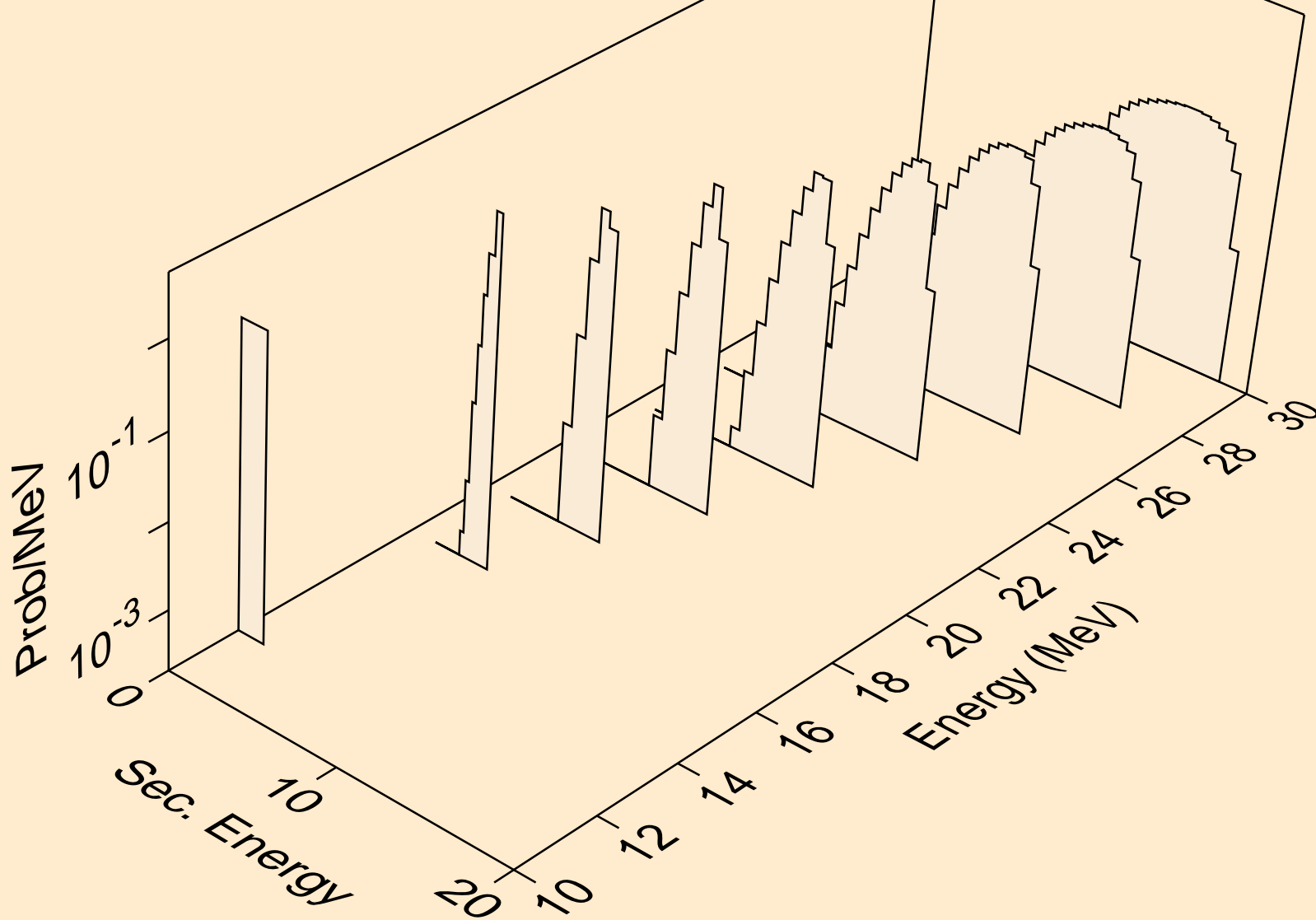

AU196 NEUTRON ACER TENDL-2019 LIBRARY; T=293.16K  
tritons from (n,t)

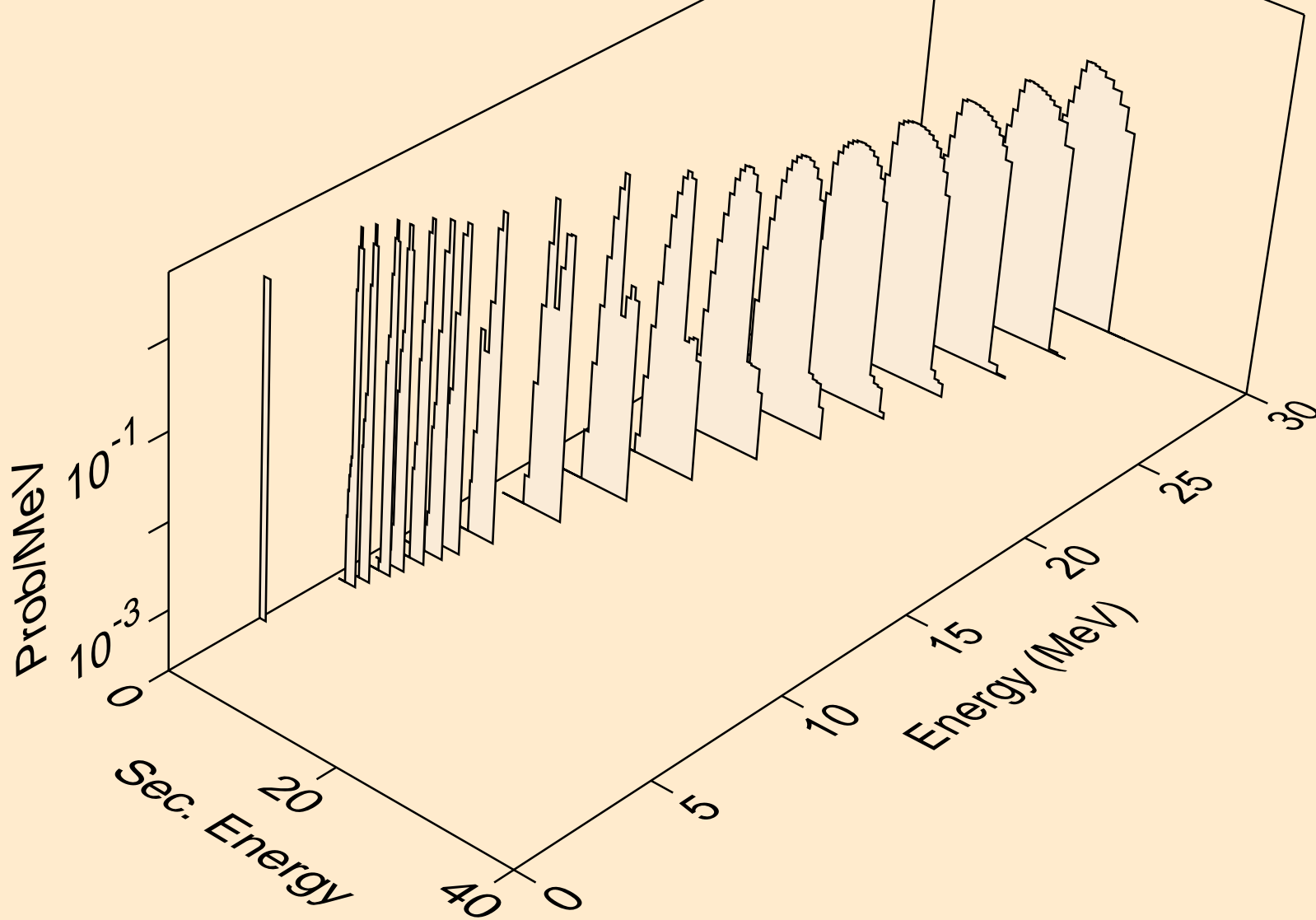

AU196 NEUTRON ACER TENDL-2019 LIBRARY; T=293.16K  
tritons from (n,pt)

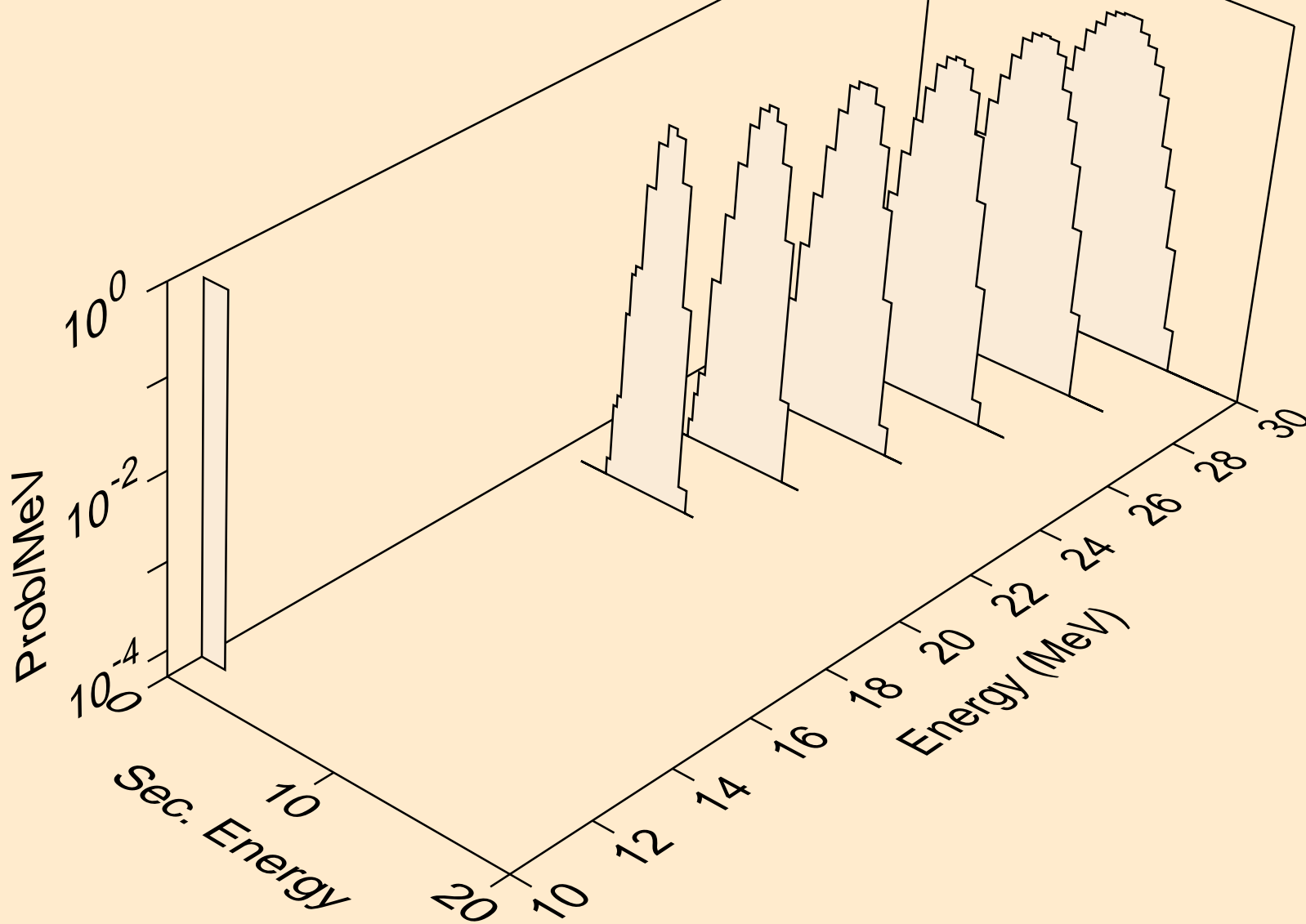

AU196 NEUTRON ACER TENDL-2019 LIBRARY; T=293.16K  
he3s from (n,x)

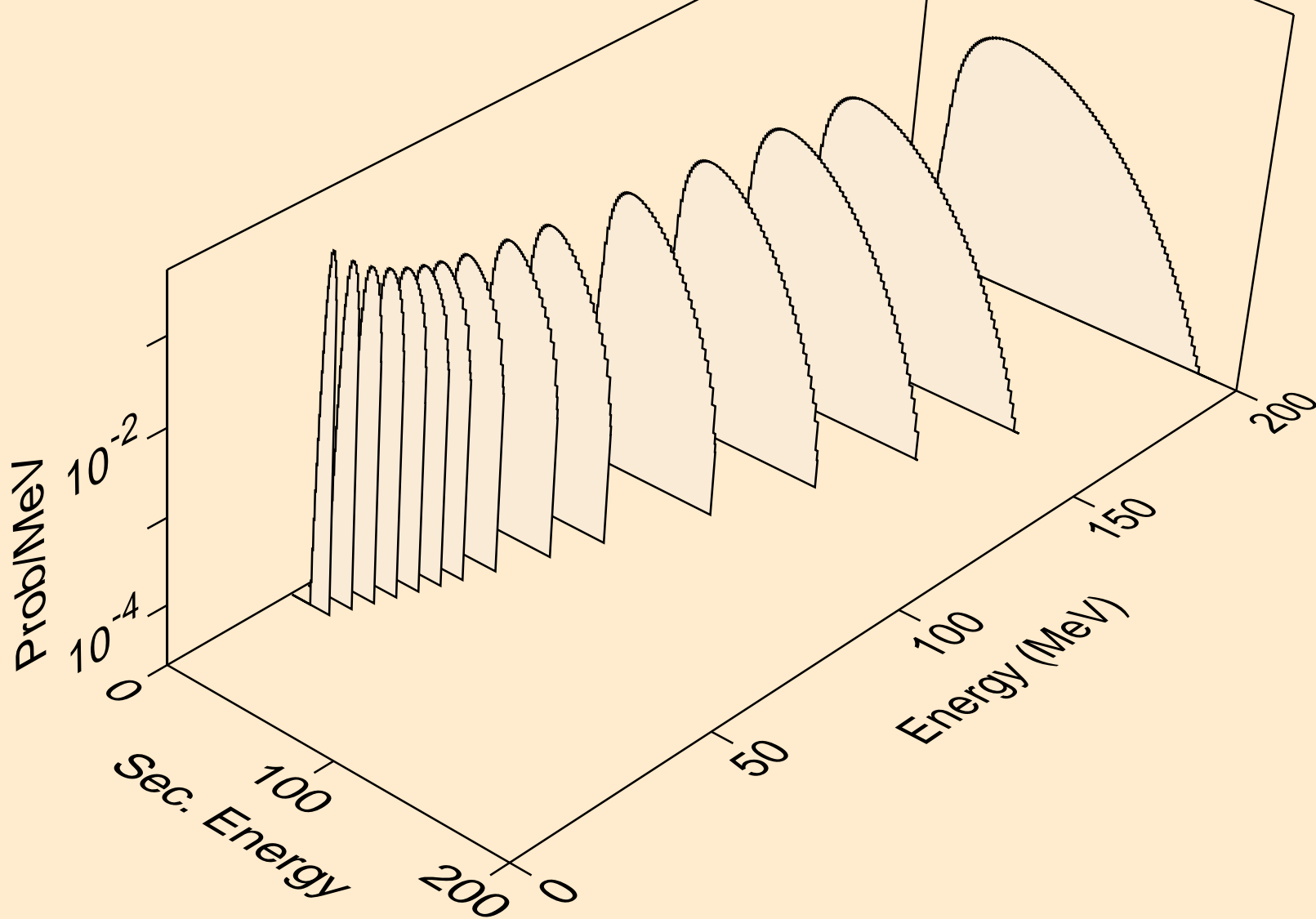



AU196 NEUTRON ACER TENDL-2019 LIBRARY; T=293.16K  
he3s from (n,n\*)he3

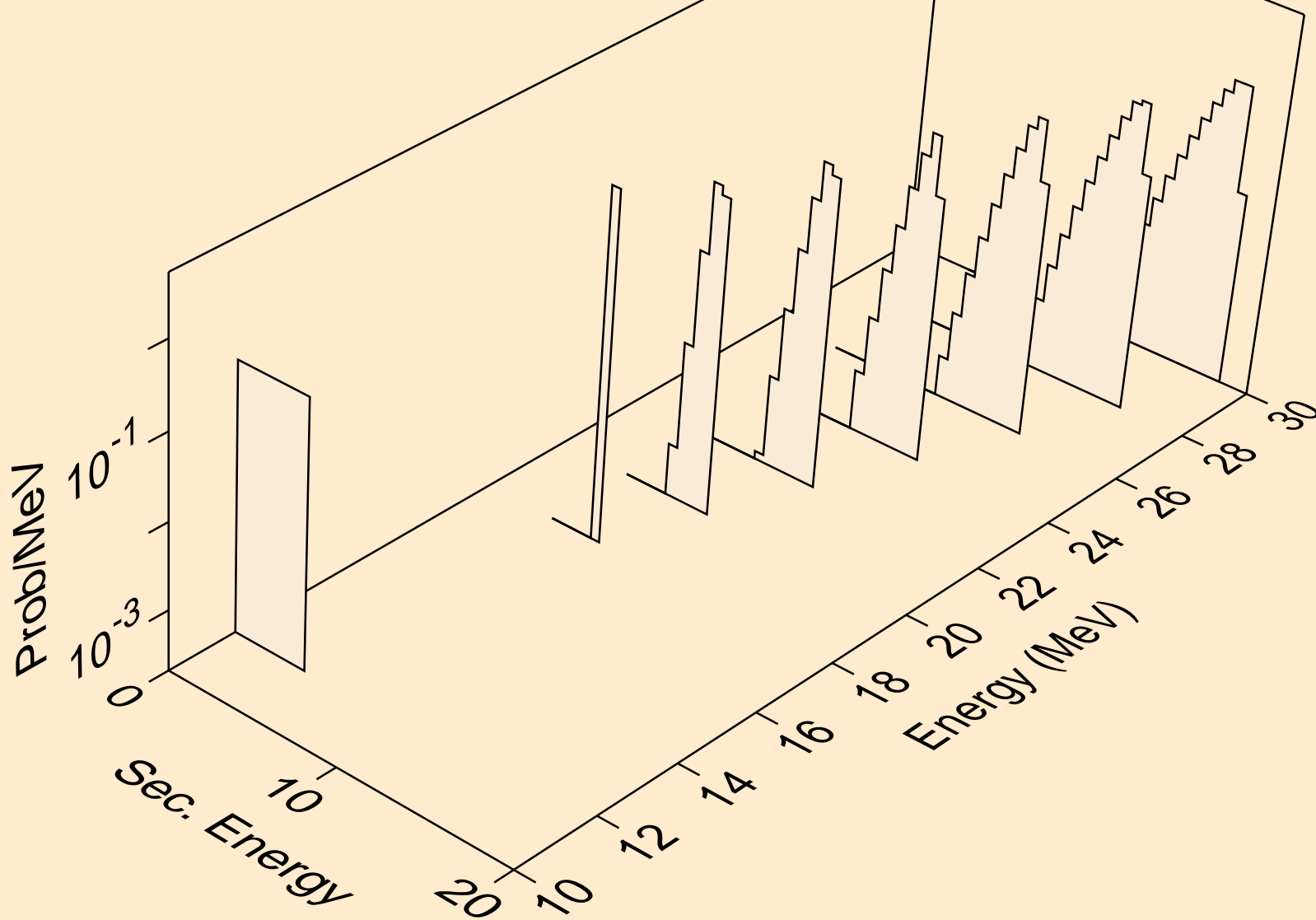

AU196 NEUTRON ACER TENDL-2019 LIBRARY; T=293.16K  
he3s from (n,he3)

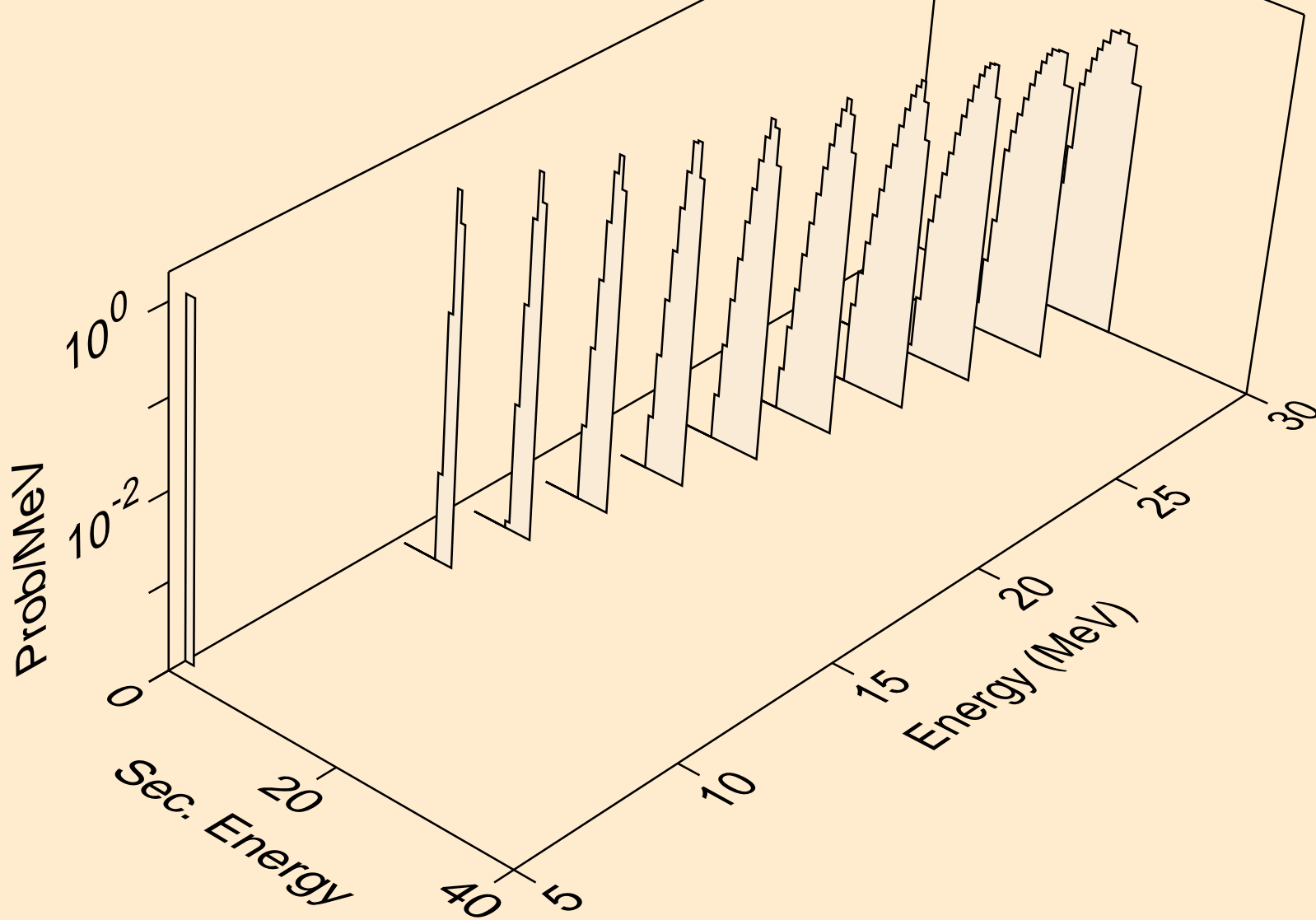

AU196 NEUTRON ACER TENDL-2019 LIBRARY; T=293.16K  
alphas from (n,x)

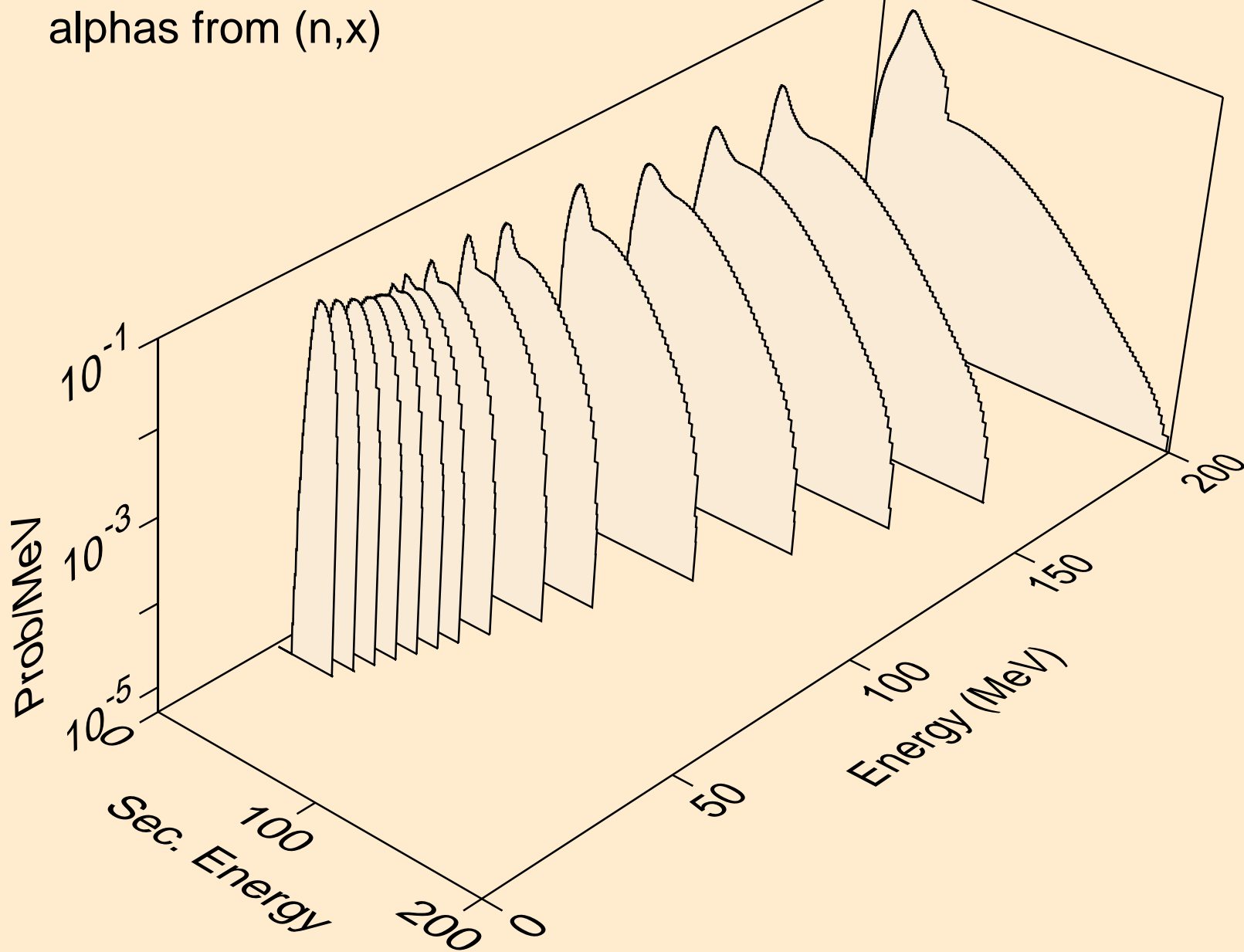

AU196 NEUTRON ACER TENDL-2019 LIBRARY; T=293.16K  
alphas from (n,n\*)a

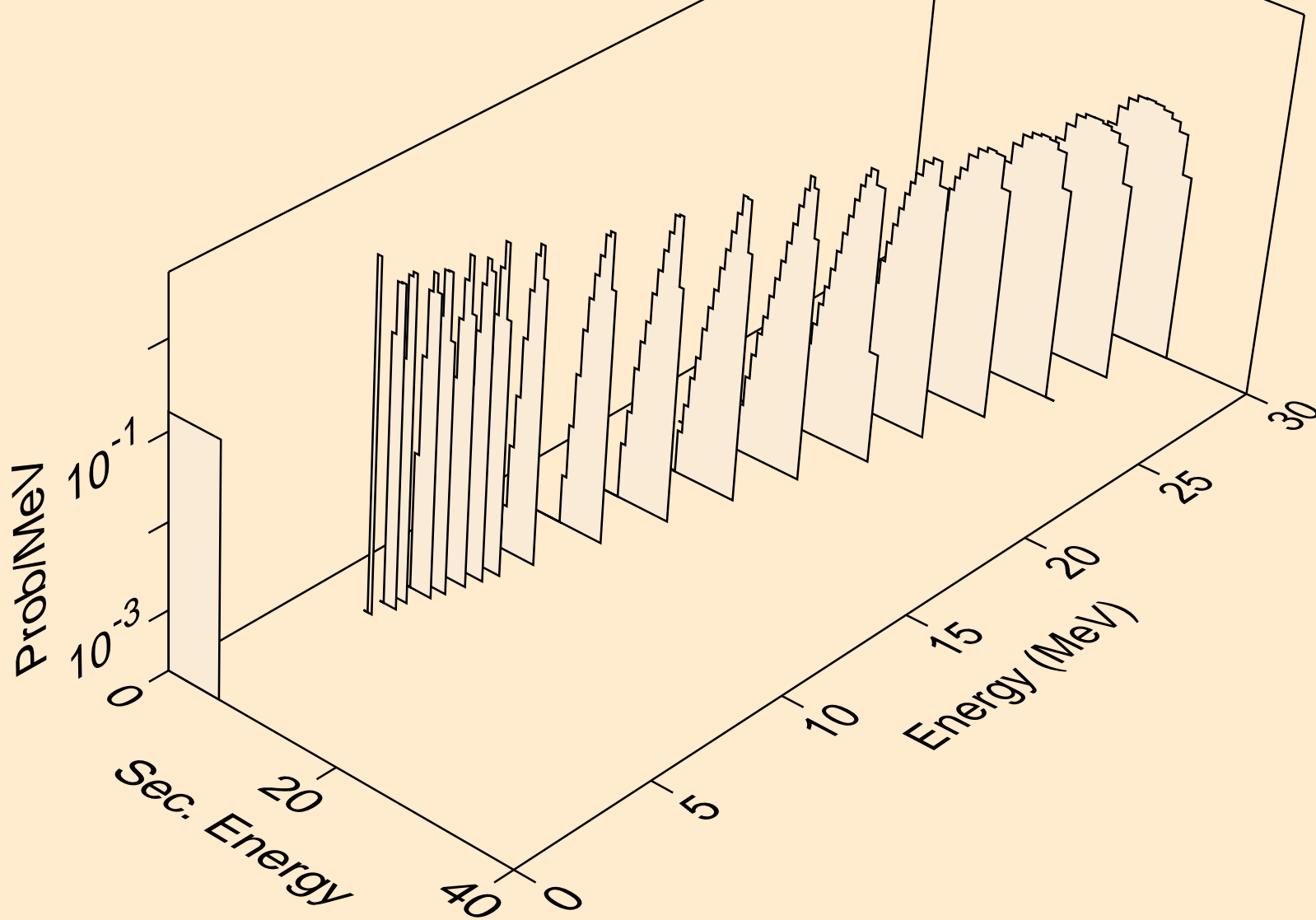

AU196 NEUTRON ACER TENDL-2019 LIBRARY; T=293.16K  
alphas from (n,2n)a

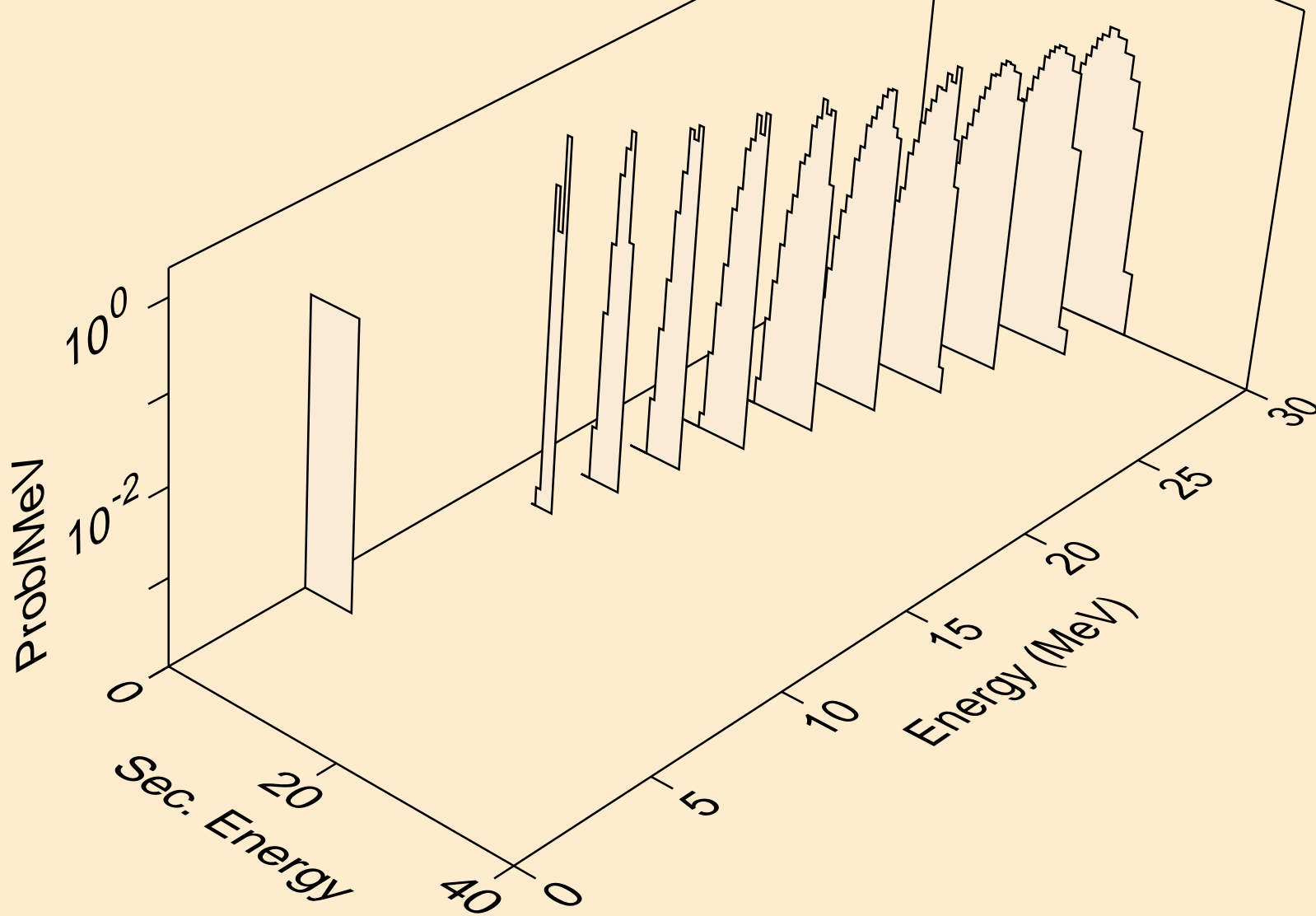

AU196 NEUTRON ACER TENDL-2019 LIBRARY; T=293.16K  
alphas from (n,3n)a

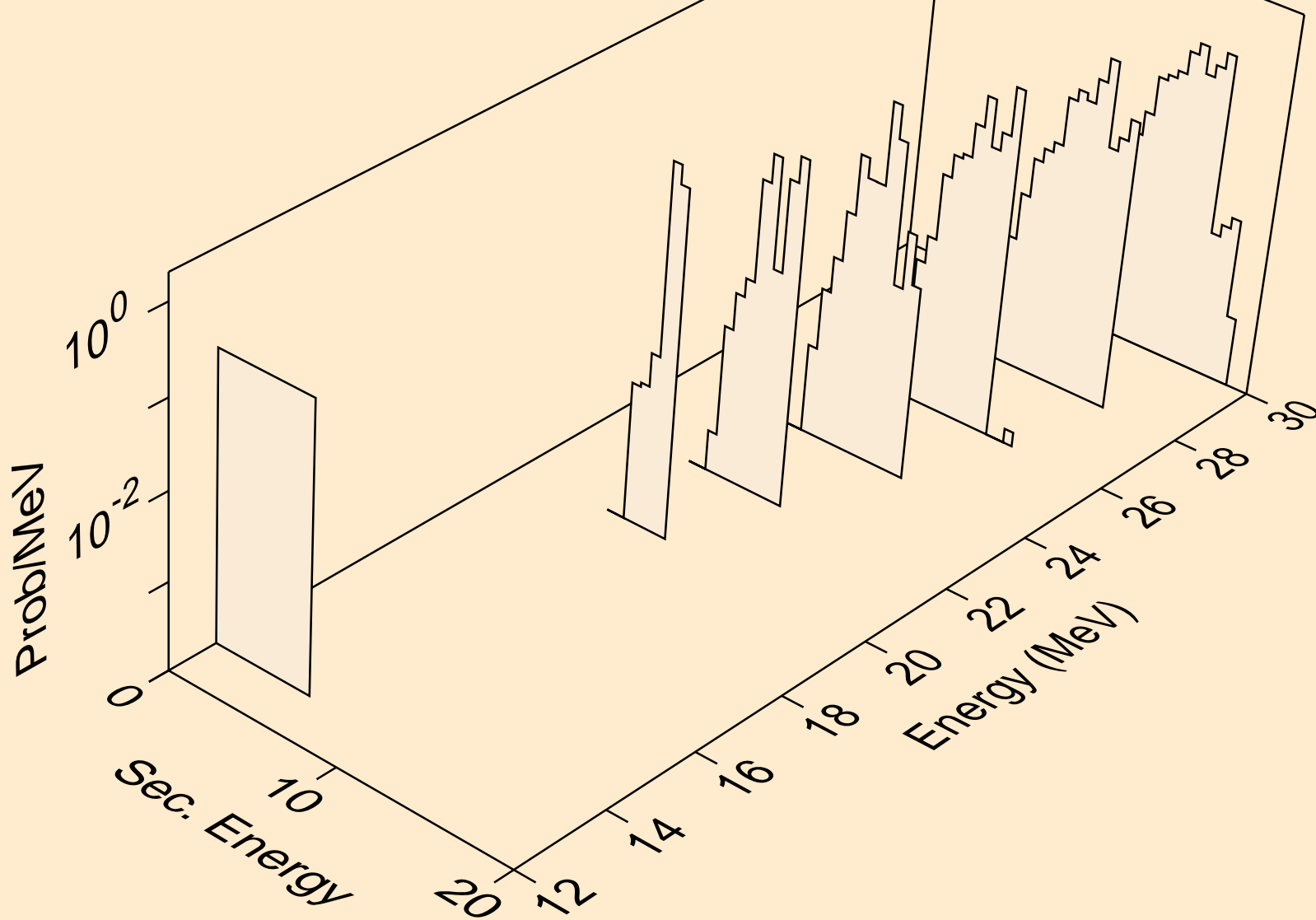

AU196 NEUTRON ACER TENDL-2019 LIBRARY; T=293.16K  
alphas from (n,npa)

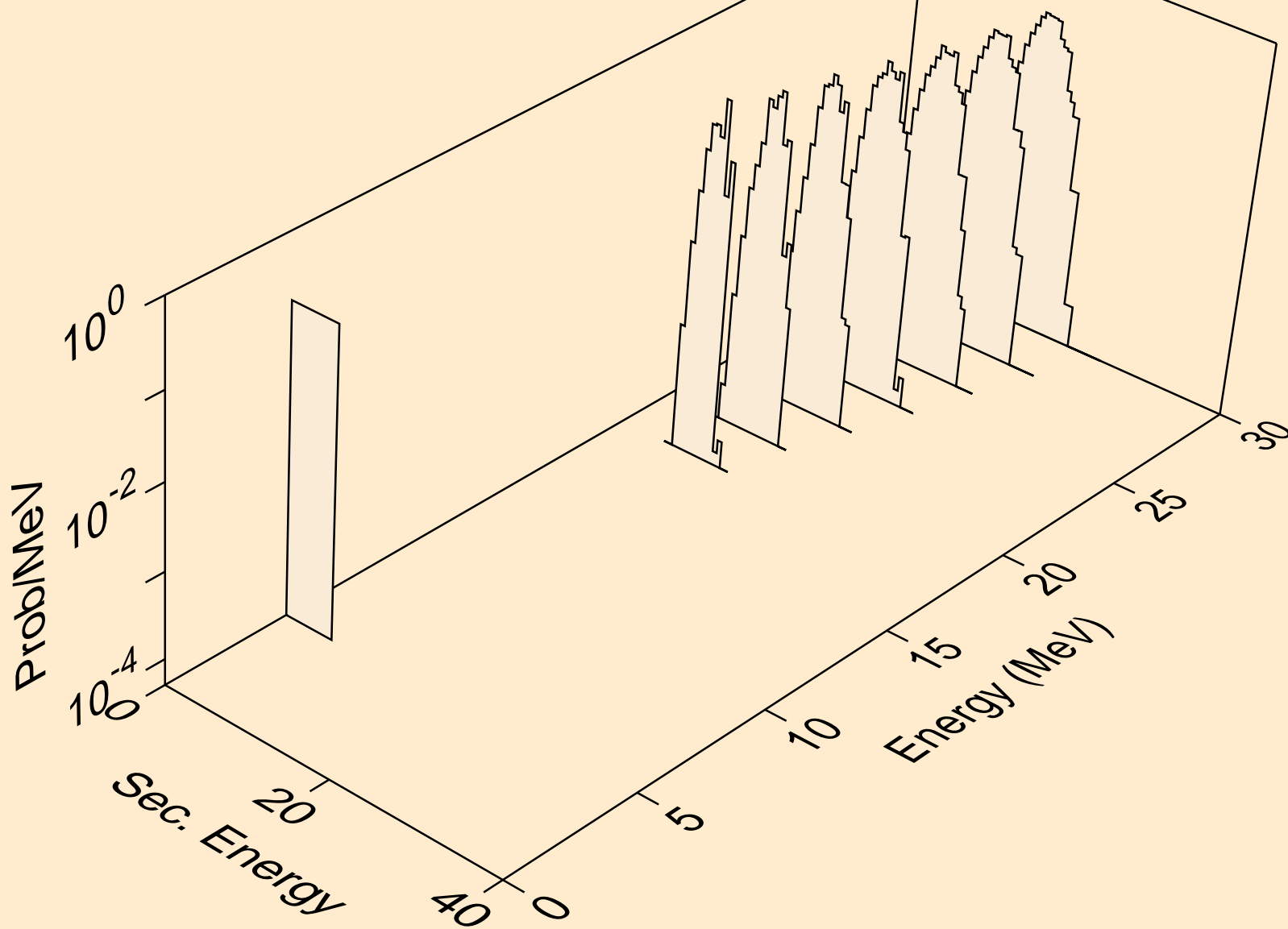

AU196 NEUTRON ACER TENDL-2019 LIBRARY; T=293.16K  
alphas from (n,a)

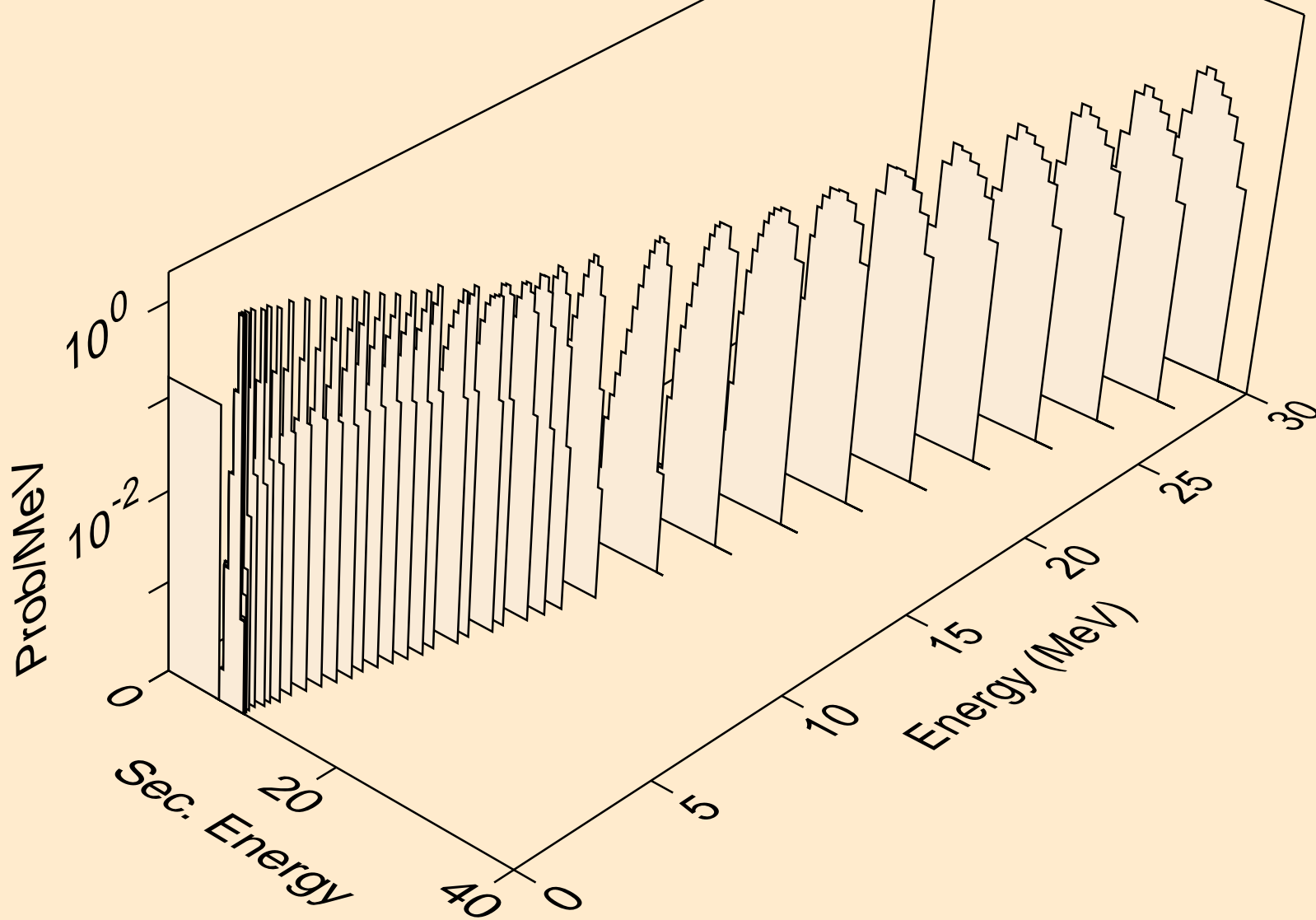



AU196 NEUTRON ACER TENDL-2019 LIBRARY; T=293.16K  
alphas from (n,pa)

