

BA117 NEUTRON ACER TENDL-2019 LIBRARY; T=293.16K  
Principal cross sections

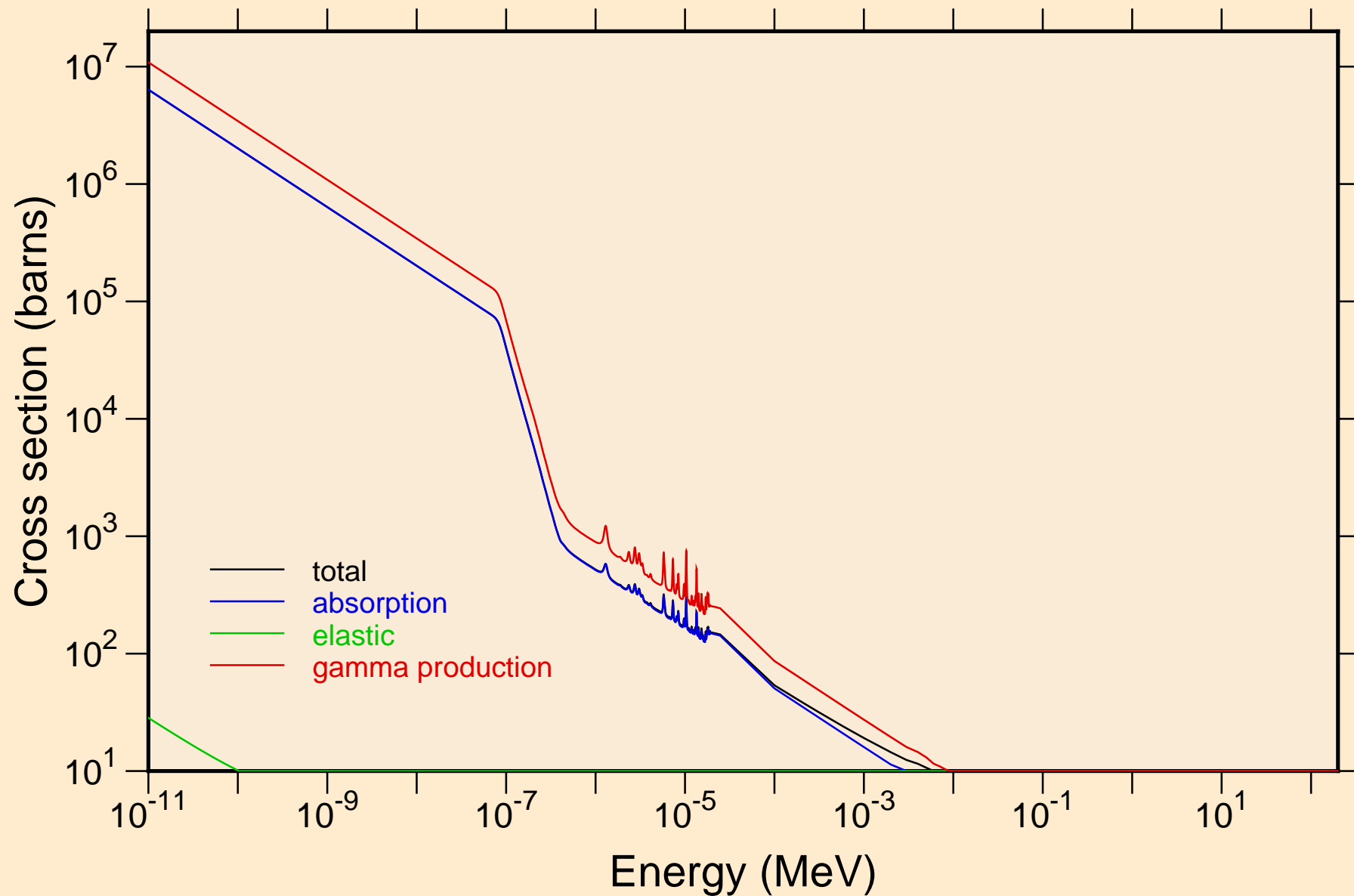

BA117 NEUTRON ACER TENDL-2019 LIBRARY; T=293.16K  
resonance total cross section

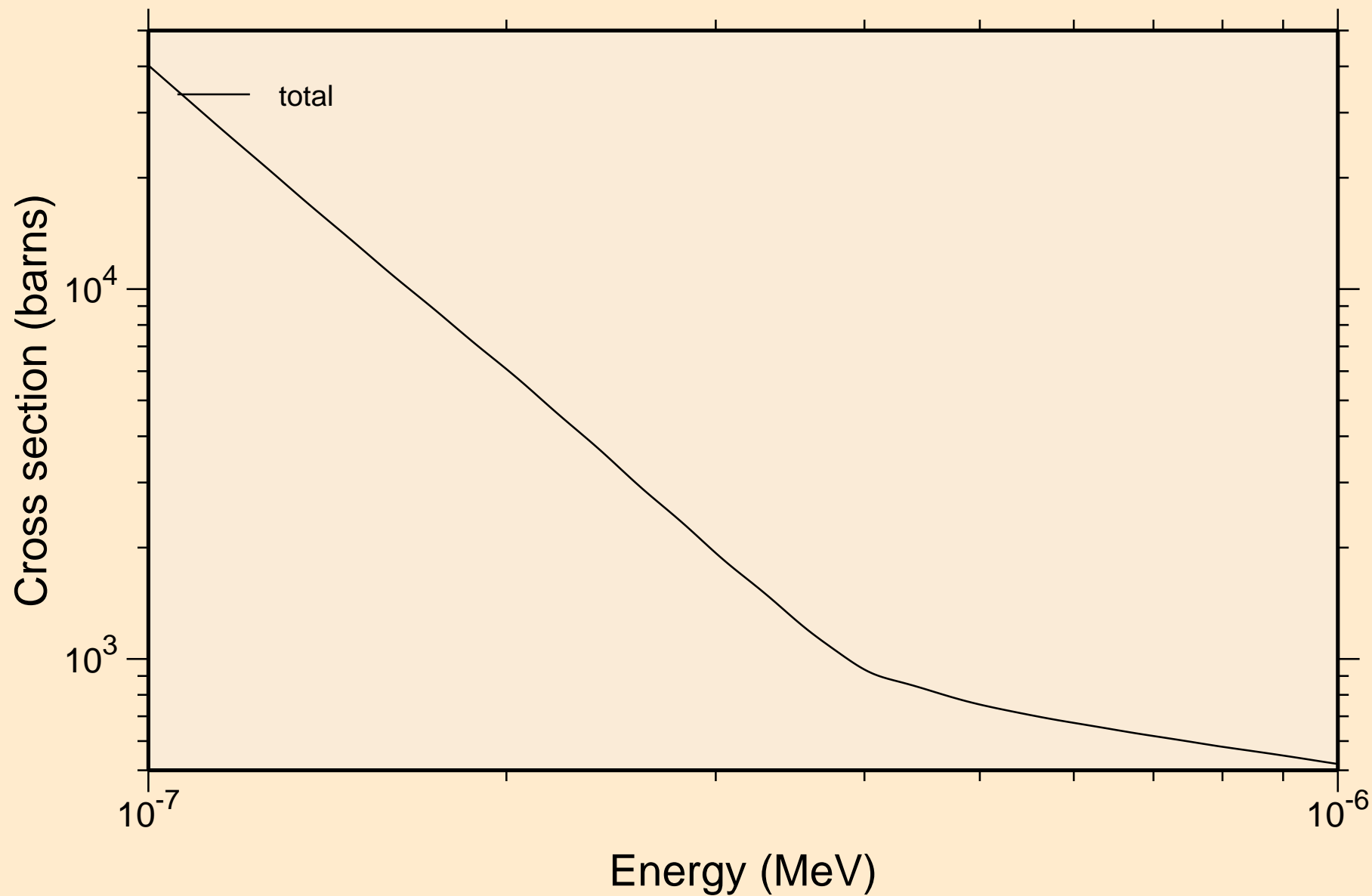

BA117 NEUTRON ACER TENDL-2019 LIBRARY; T=293.16K  
resonance total cross section

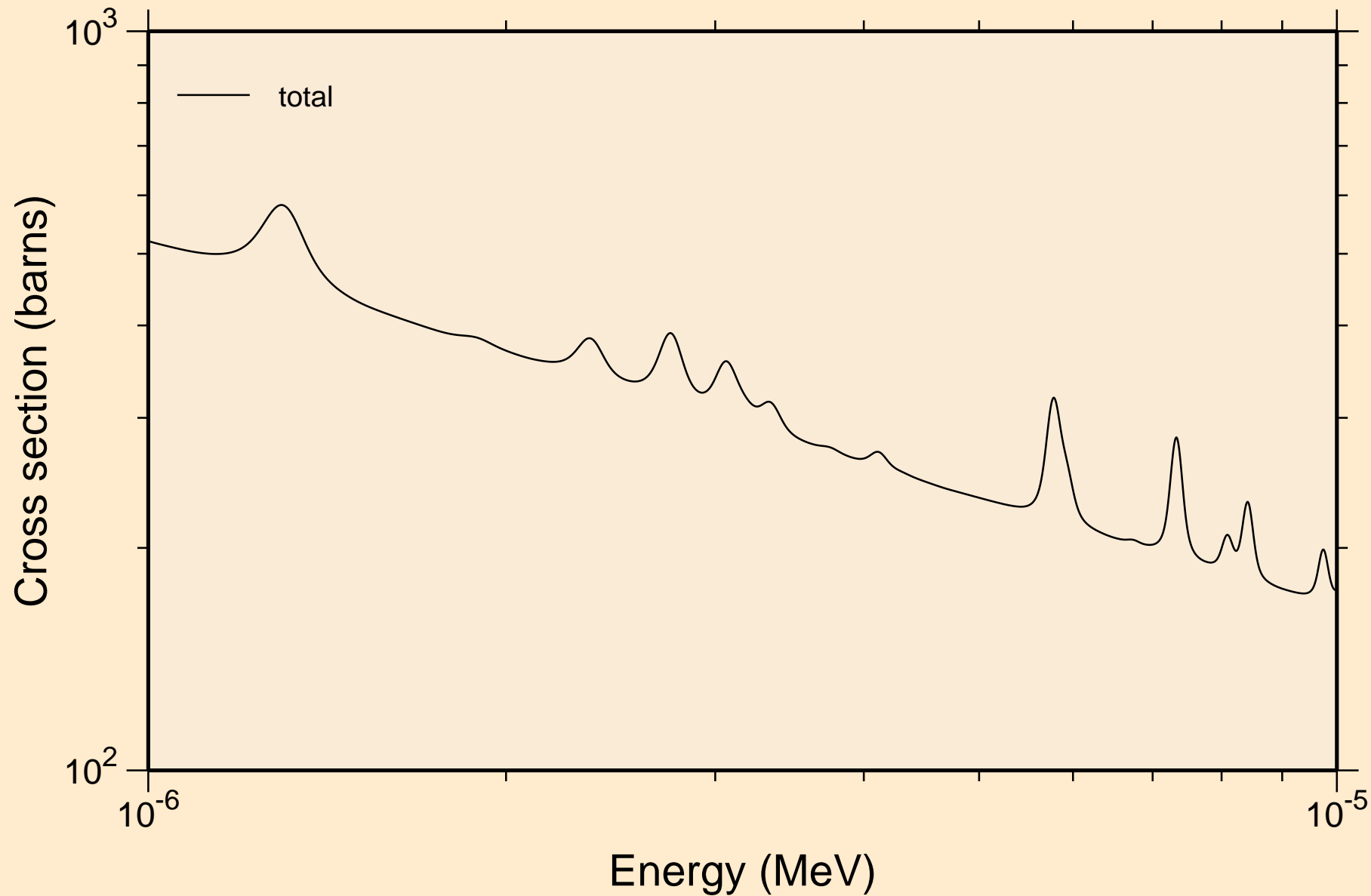

BA117 NEUTRON ACER TENDL-2019 LIBRARY; T=293.16K  
resonance total cross section

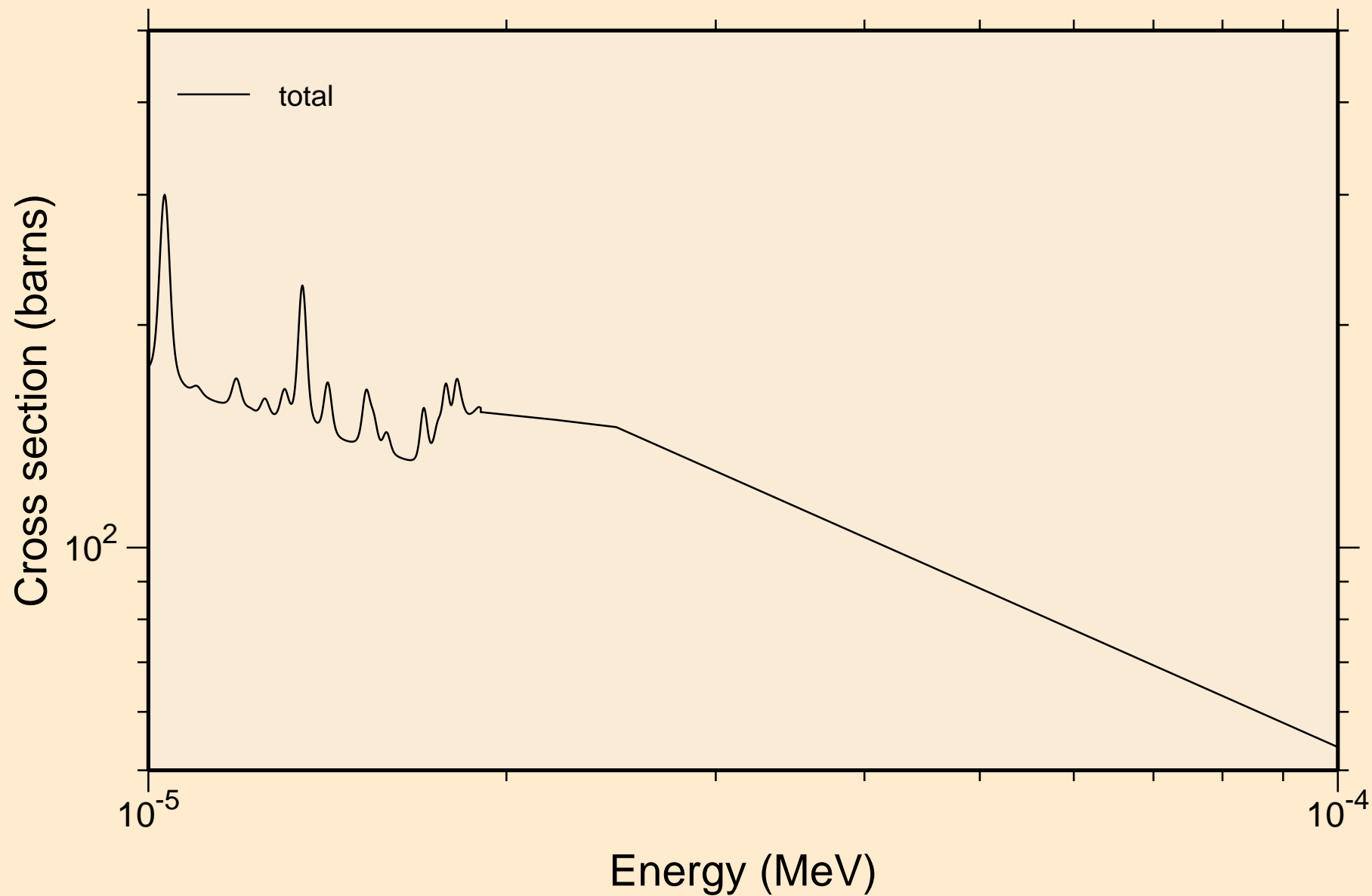

B̄A117 NEUTRON ACER TENDL-2019 LIBRARY; T=293.16K  
resonance total cross section

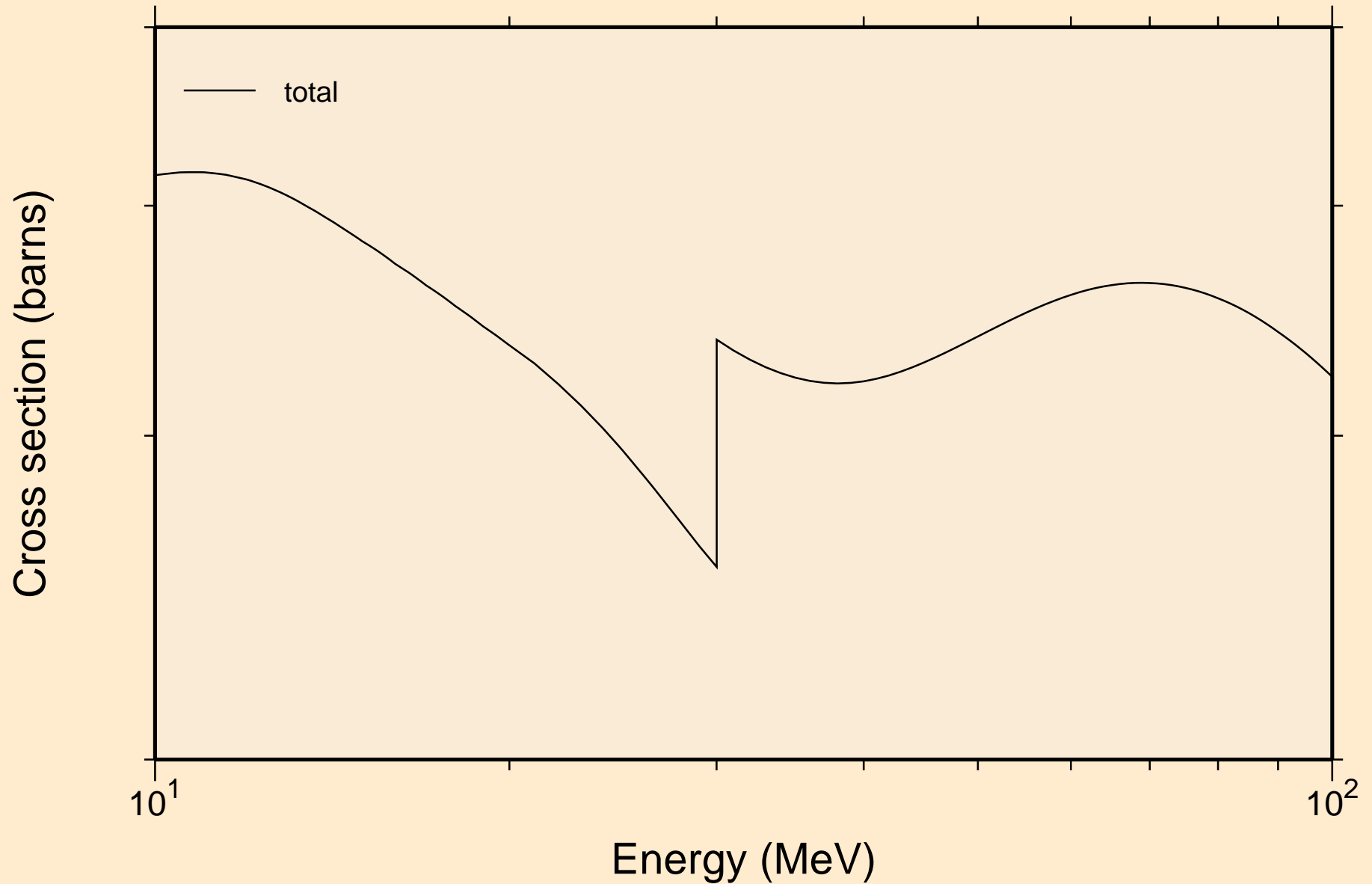

BA117 NEUTRON ACER TENDL-2019 LIBRARY; T=293.16K  
resonance absorption cross sections

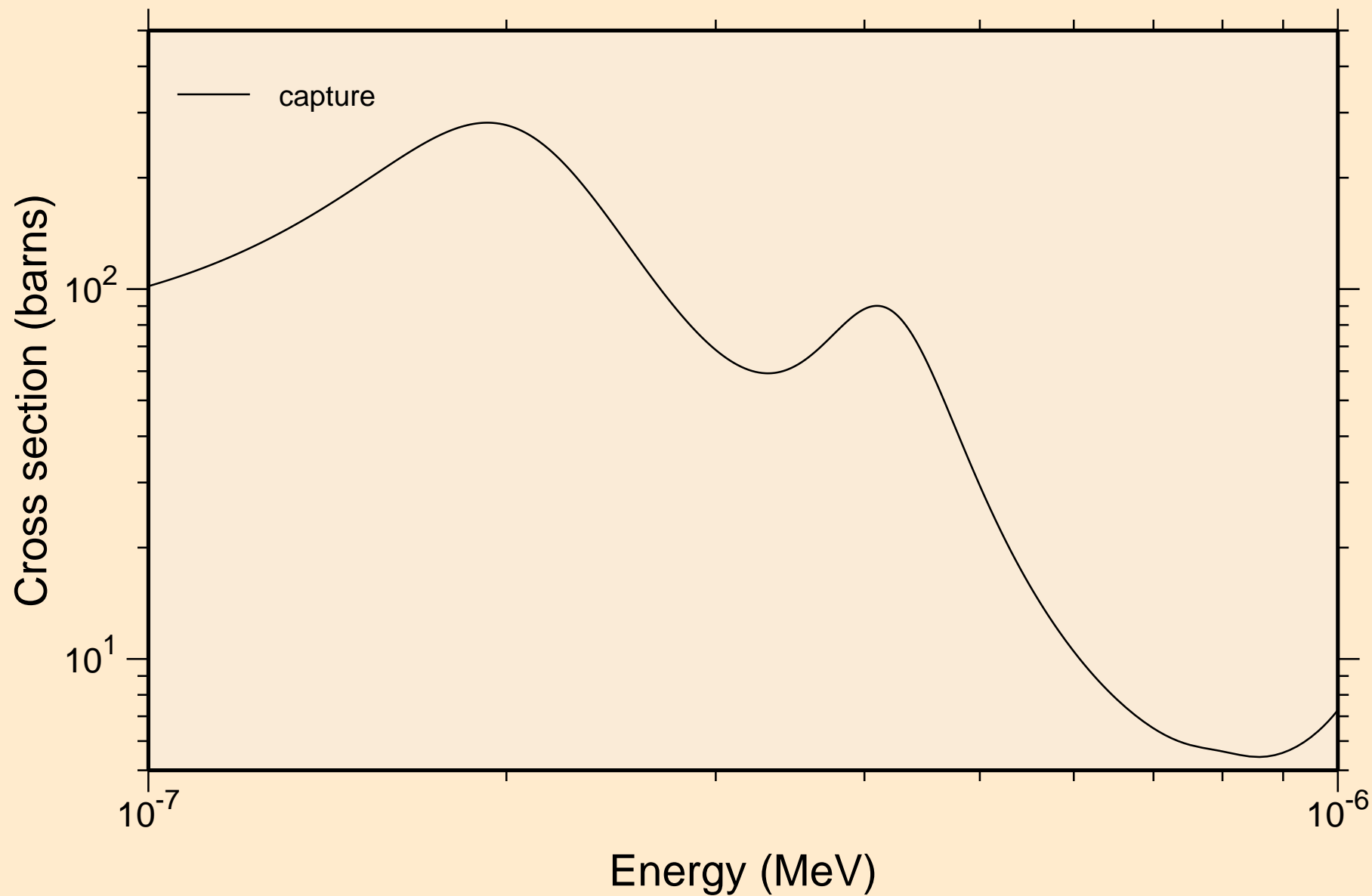

BA117 NEUTRON ACER TENDL-2019 LIBRARY; T=293.16K  
resonance absorption cross sections

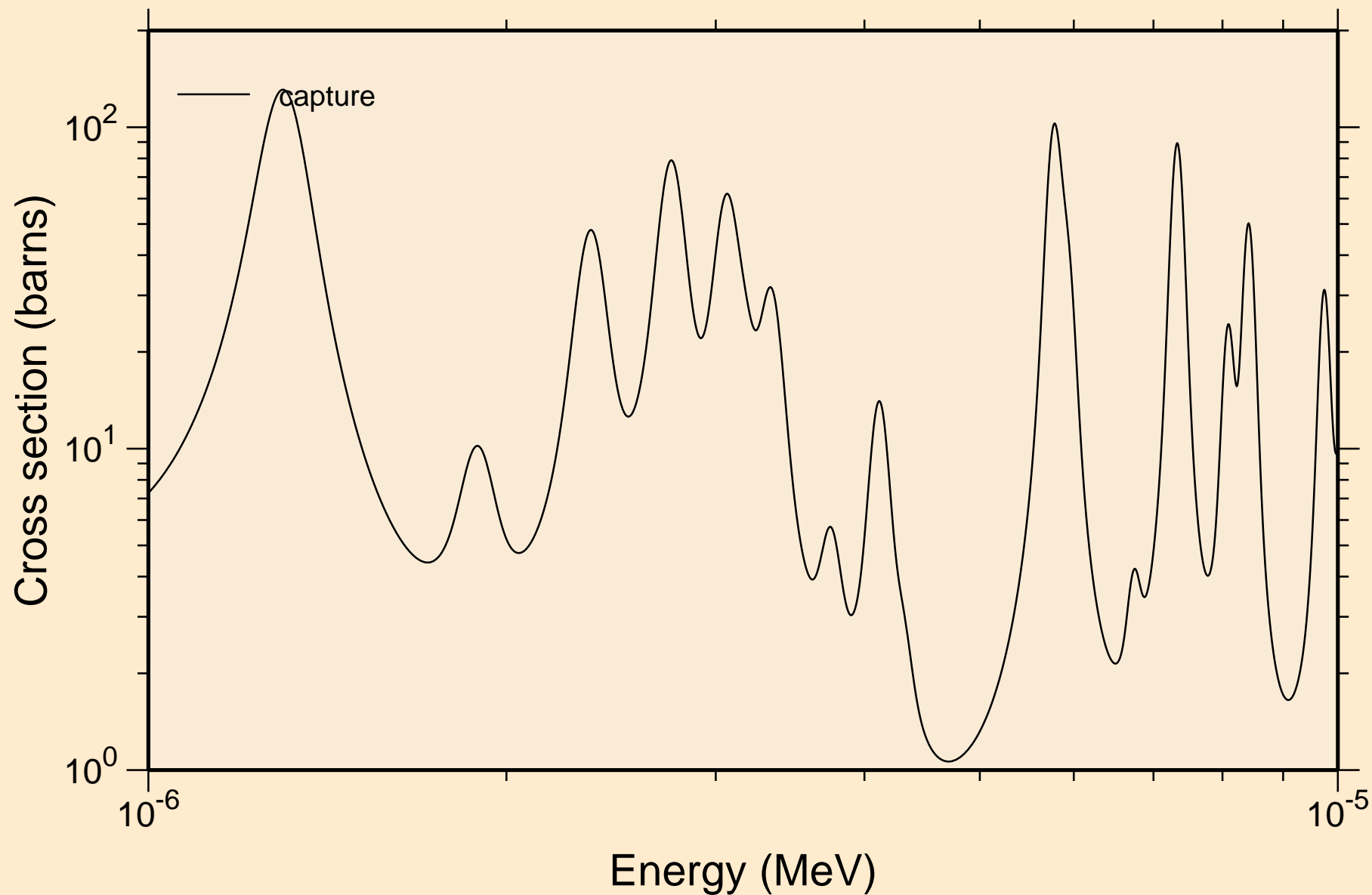

BA117 NEUTRON ACER TENDL-2019 LIBRARY; T=293.16K  
resonance absorption cross sections

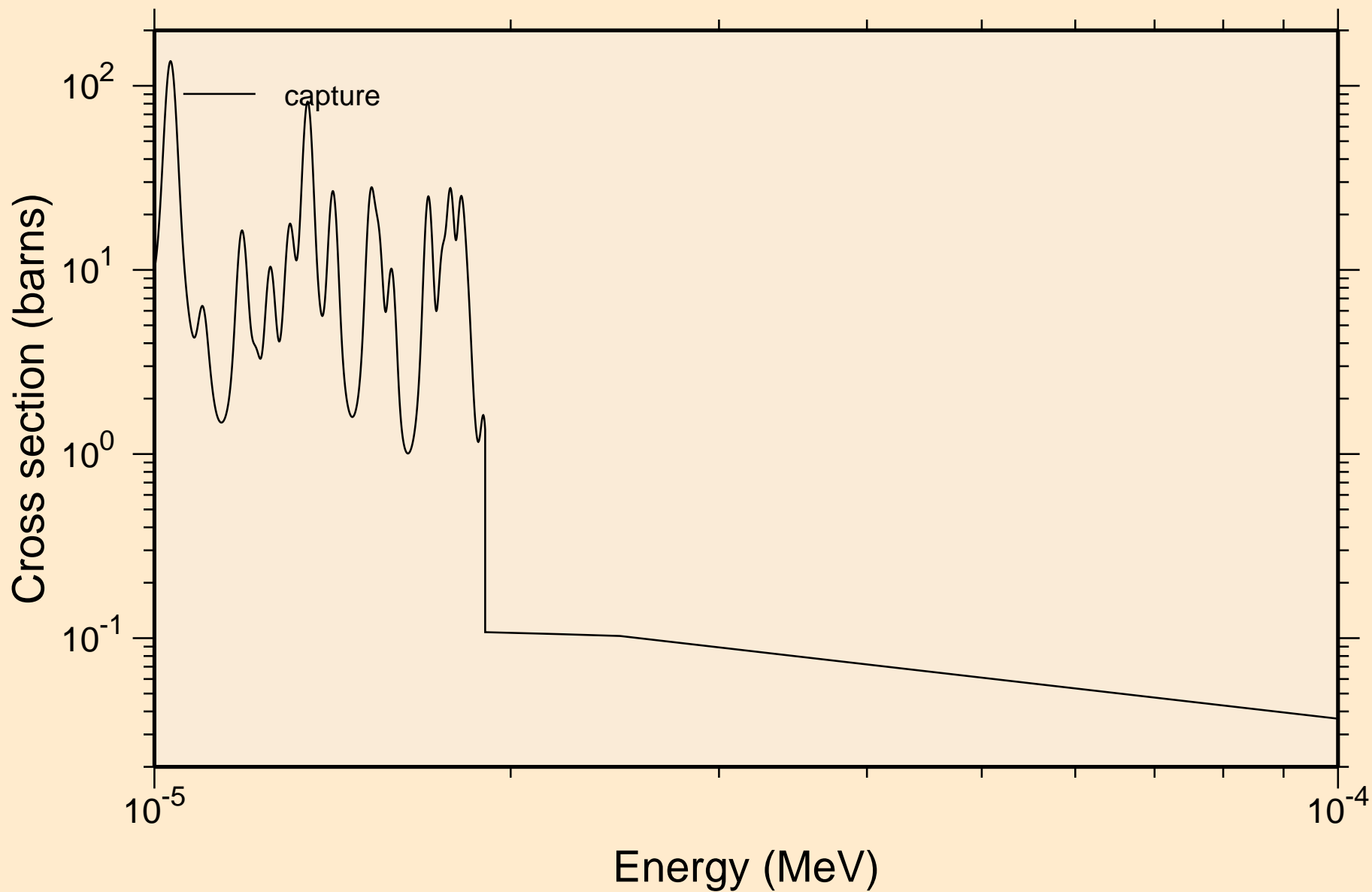



BA117 NEUTRON ACER TENDL-2019 LIBRARY; T=293.16K  
resonance absorption cross sections

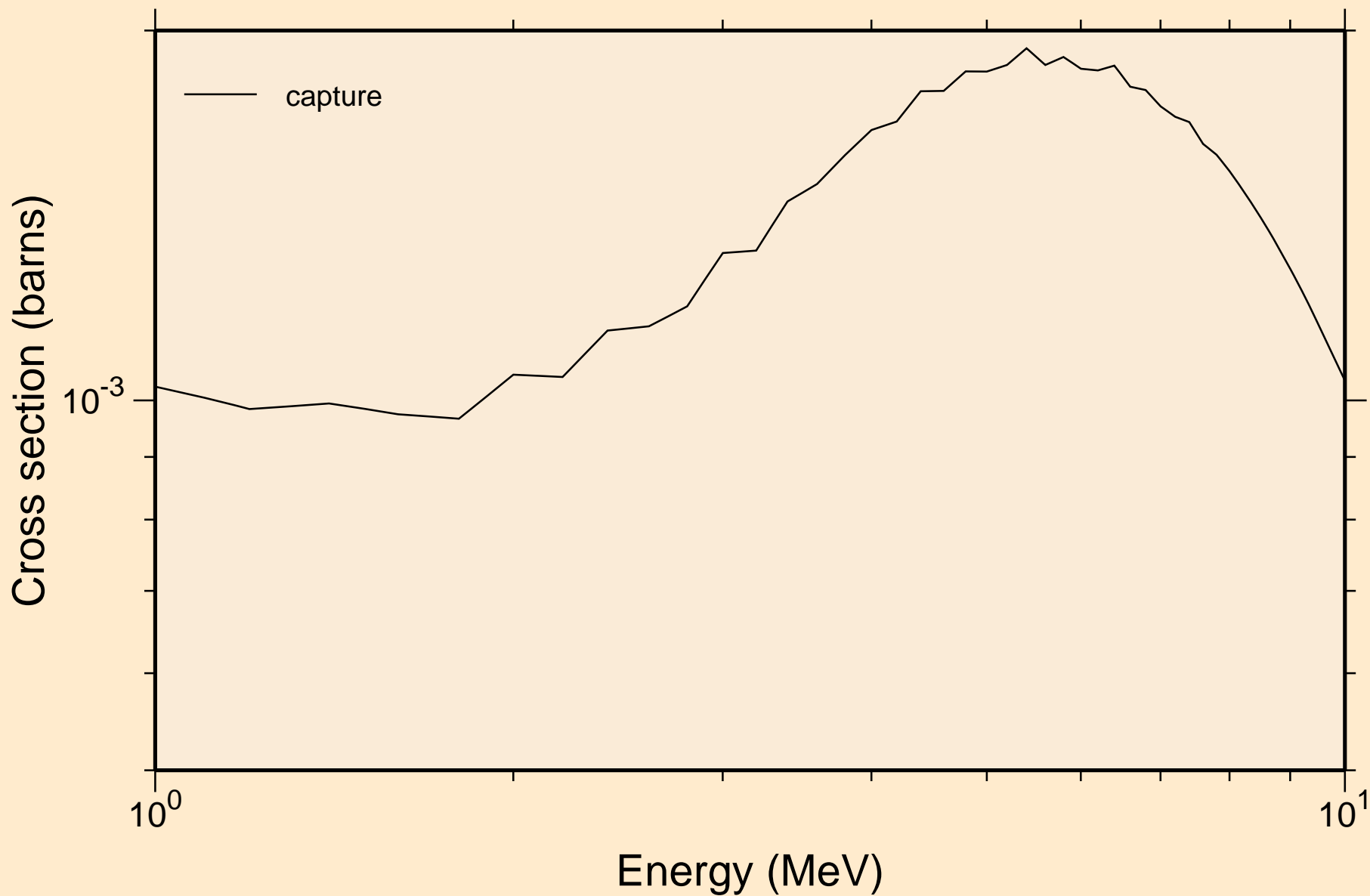

BA117 NEUTRON ACER TENDL-2019 LIBRARY; T=293.16K  
Heating

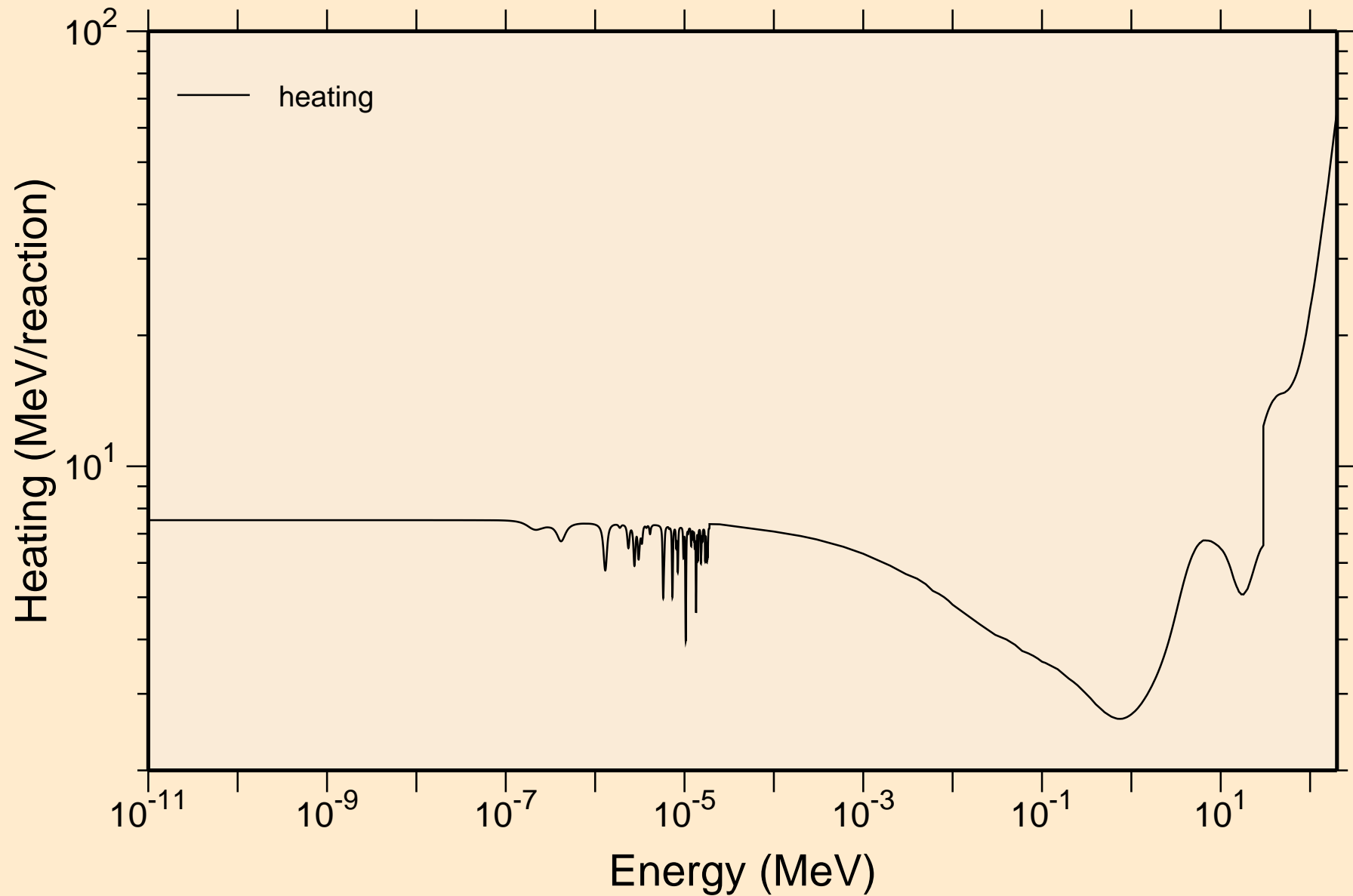

BA117 NEUTRON ACER TENDL-2019 LIBRARY; T=293.16K  
Damage

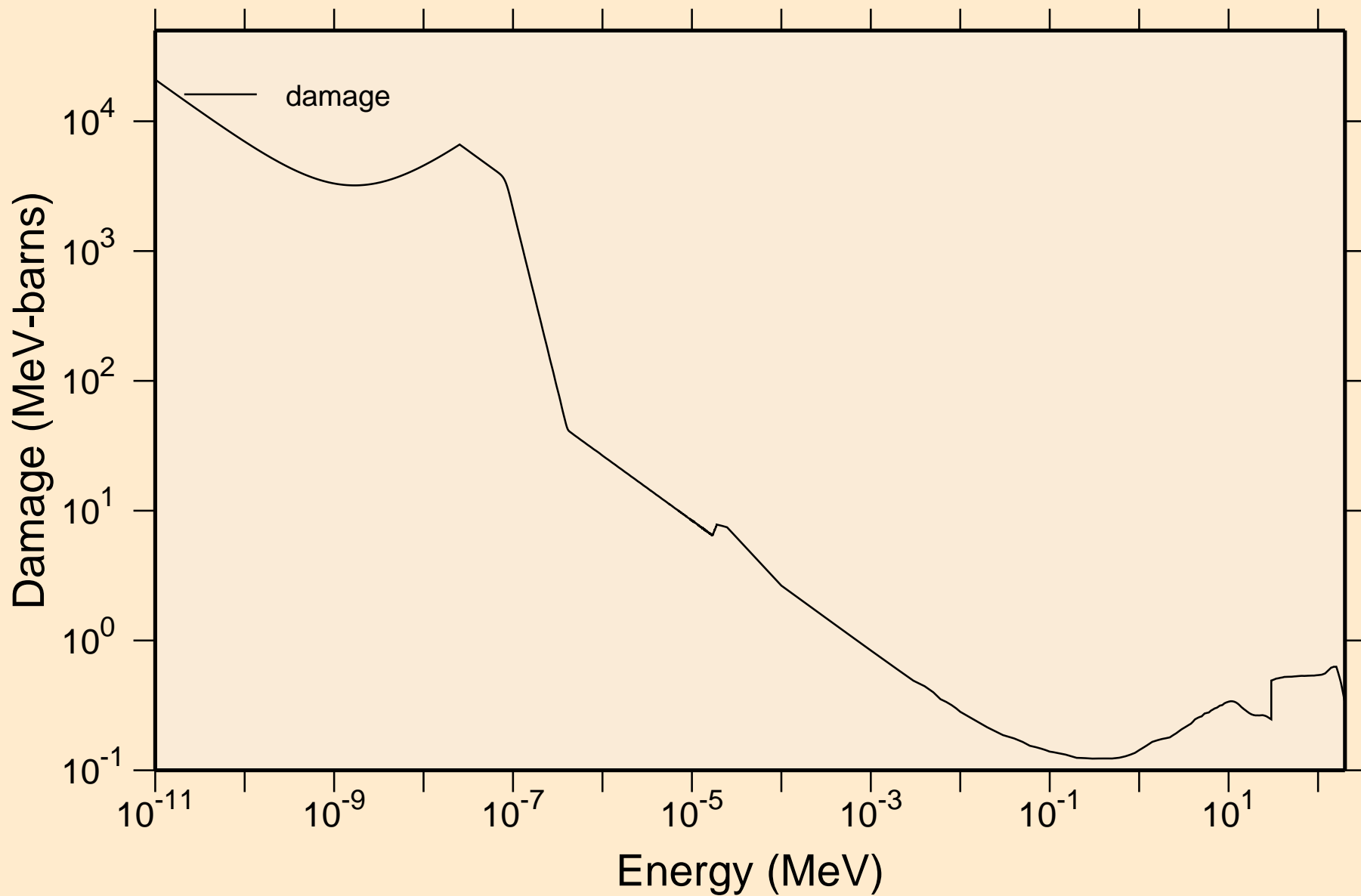

BA117 NEUTRON ACER TENDL-2019 LIBRARY; T=293.16K  
Non-threshold reactions

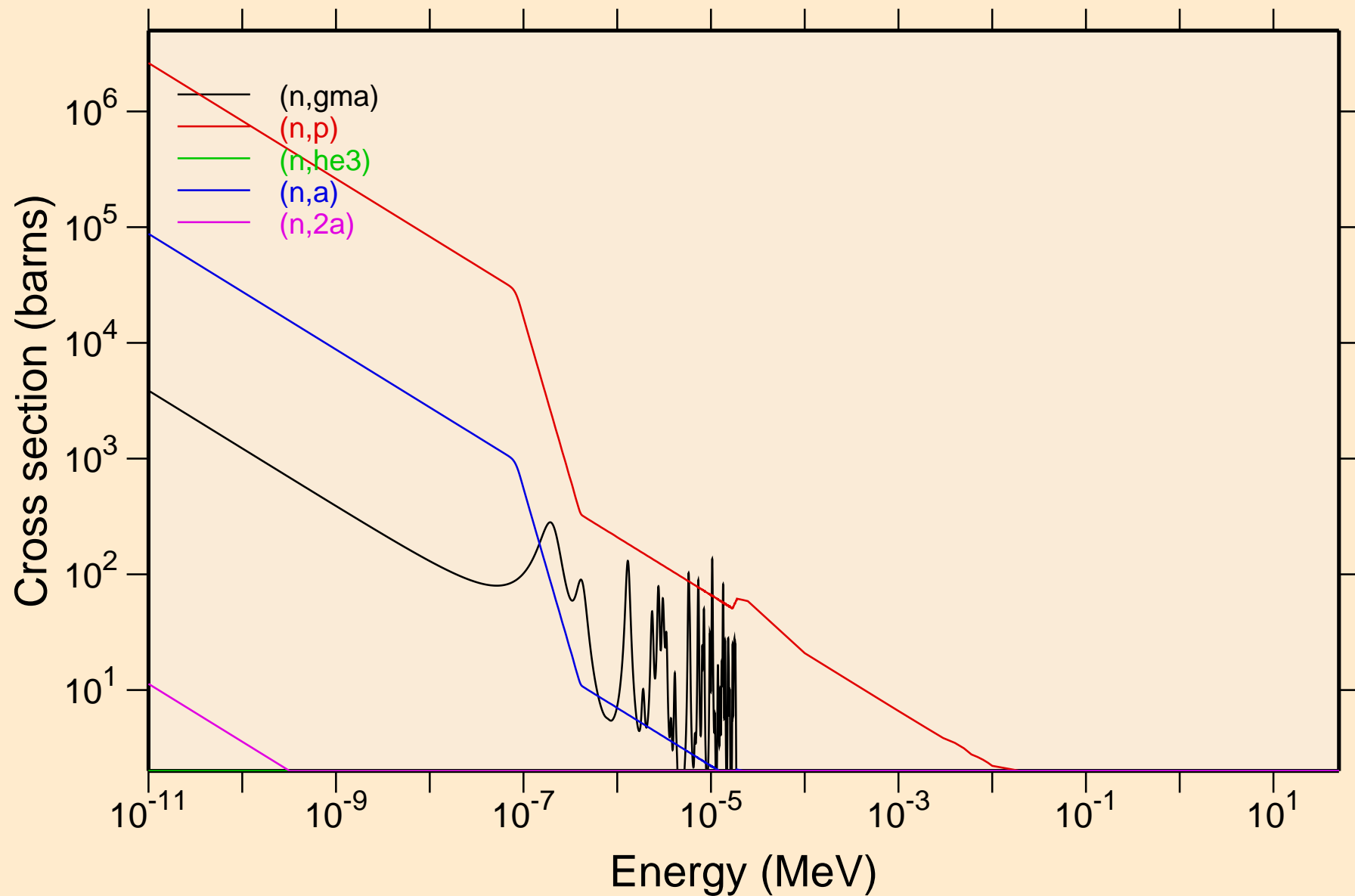

BA117 NEUTRON ACER TENDL-2019 LIBRARY; T=293.16K  
Non-threshold reactions

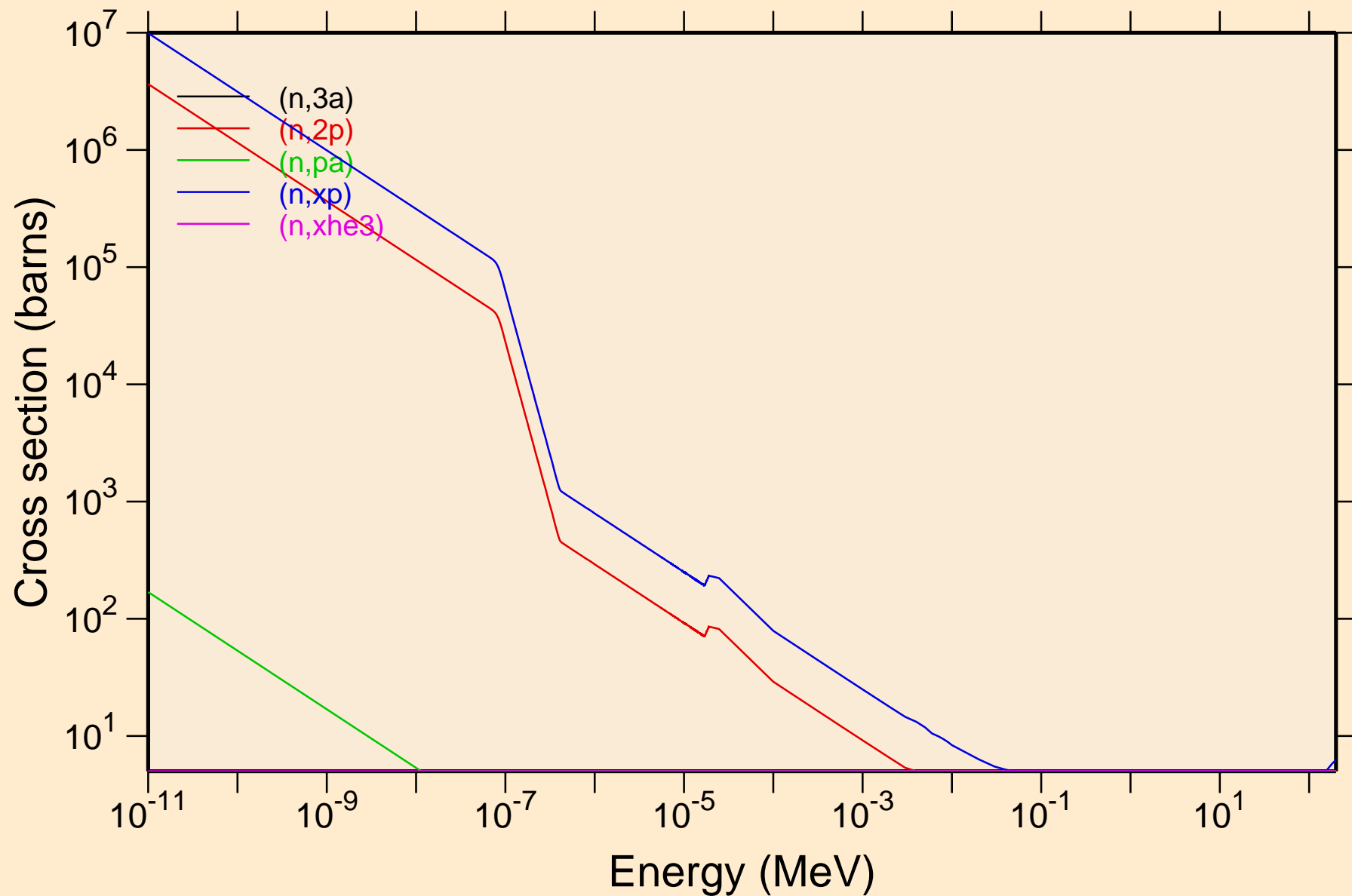

BA117 NEUTRON ACER TENDL-2019 LIBRARY; T=293.16K  
Non-threshold reactions

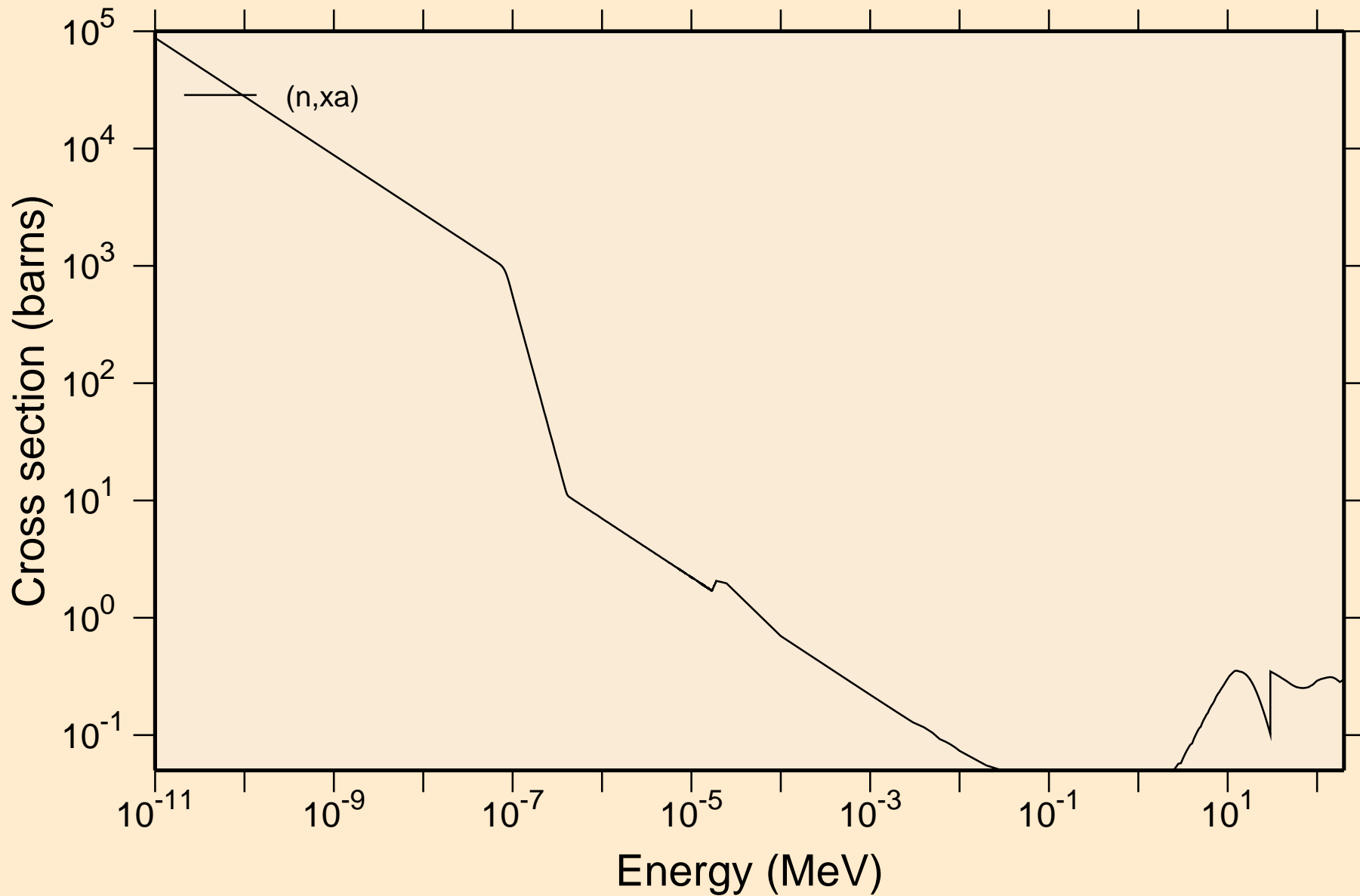

BA117 NEUTRON ACER TENDL-2019 LIBRARY; T=293.16K  
Principal cross sections

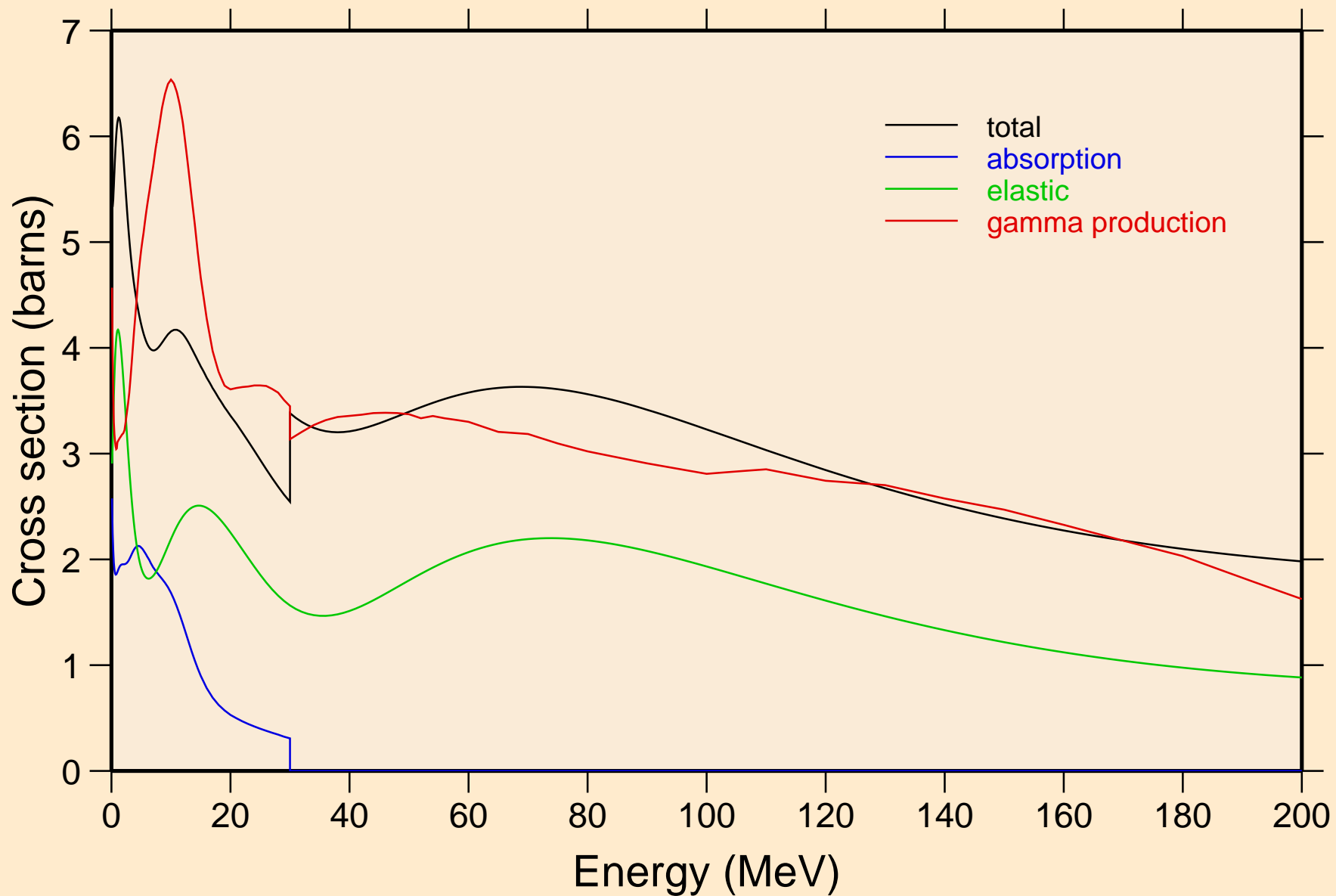

BA117 NEUTRON ACER TENDL-2019 LIBRARY; T=293.16K  
Heating

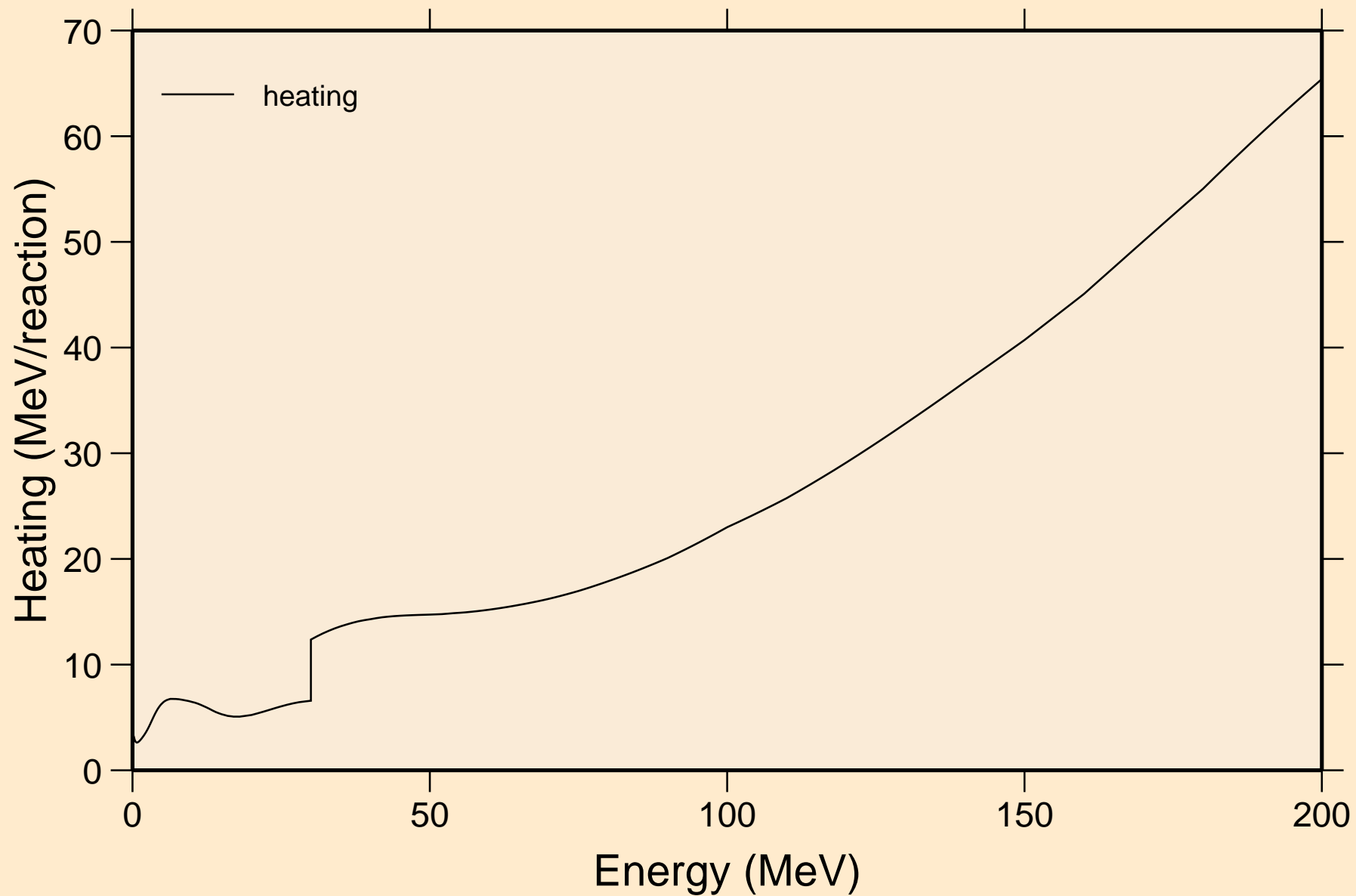



BA117 NEUTRON ACER TENDL-2019 LIBRARY; T=293.16K  
Damage

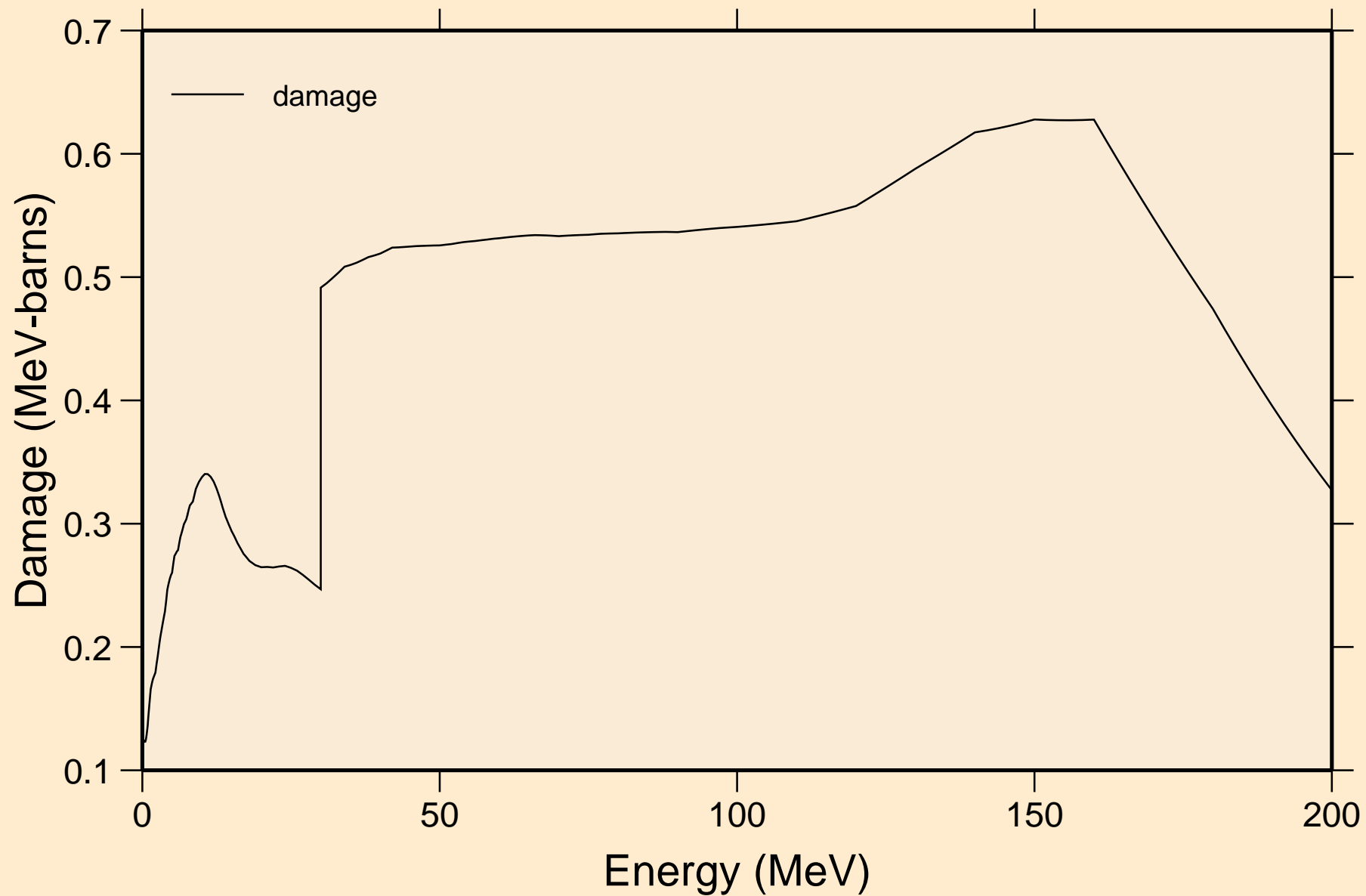

BA117 NEUTRON ACER TENDL-2019 LIBRARY; T=293.16K  
Non-threshold reactions

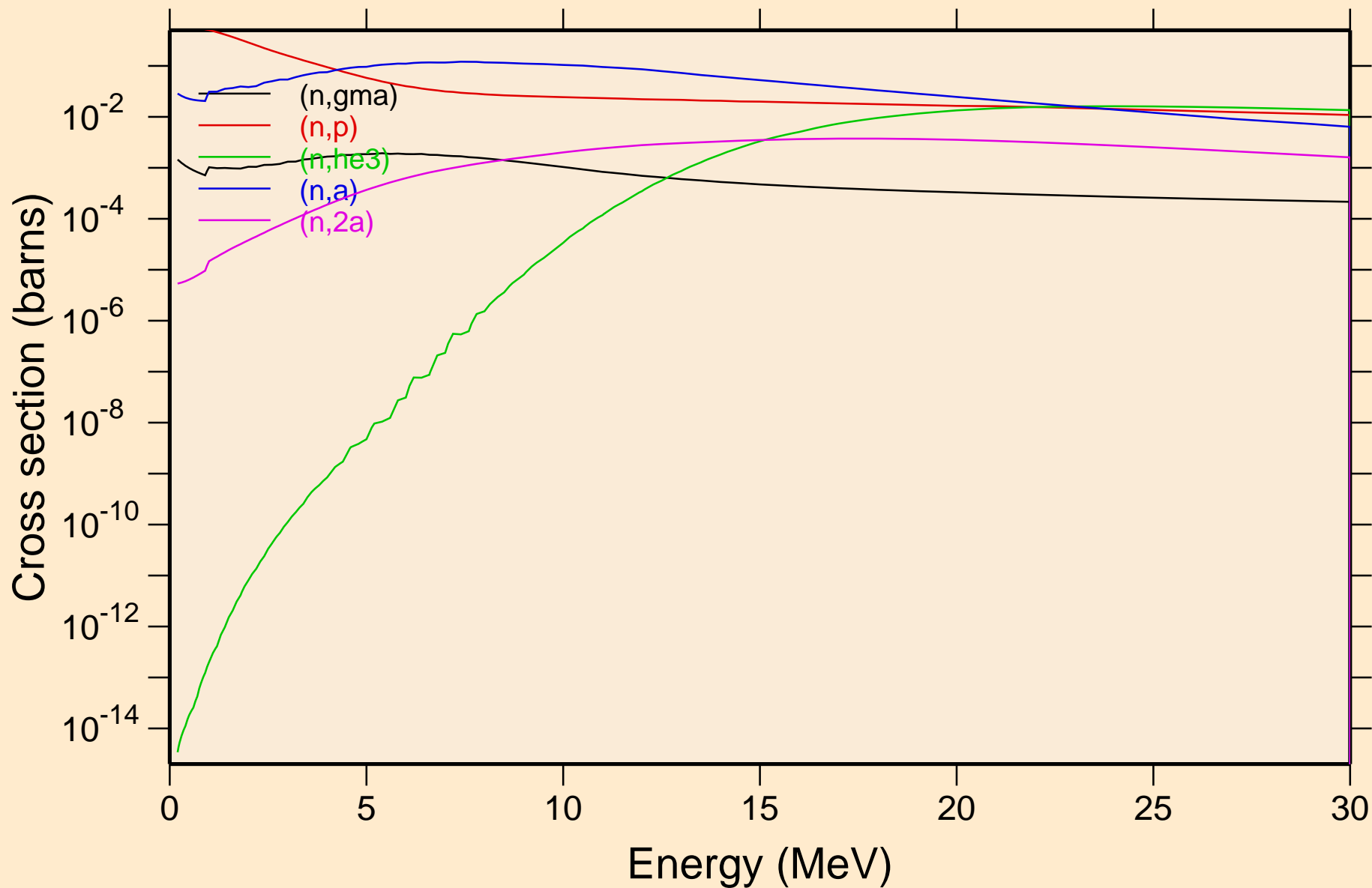

BA117 NEUTRON ACER TENDL-2019 LIBRARY; T=293.16K  
Non-threshold reactions

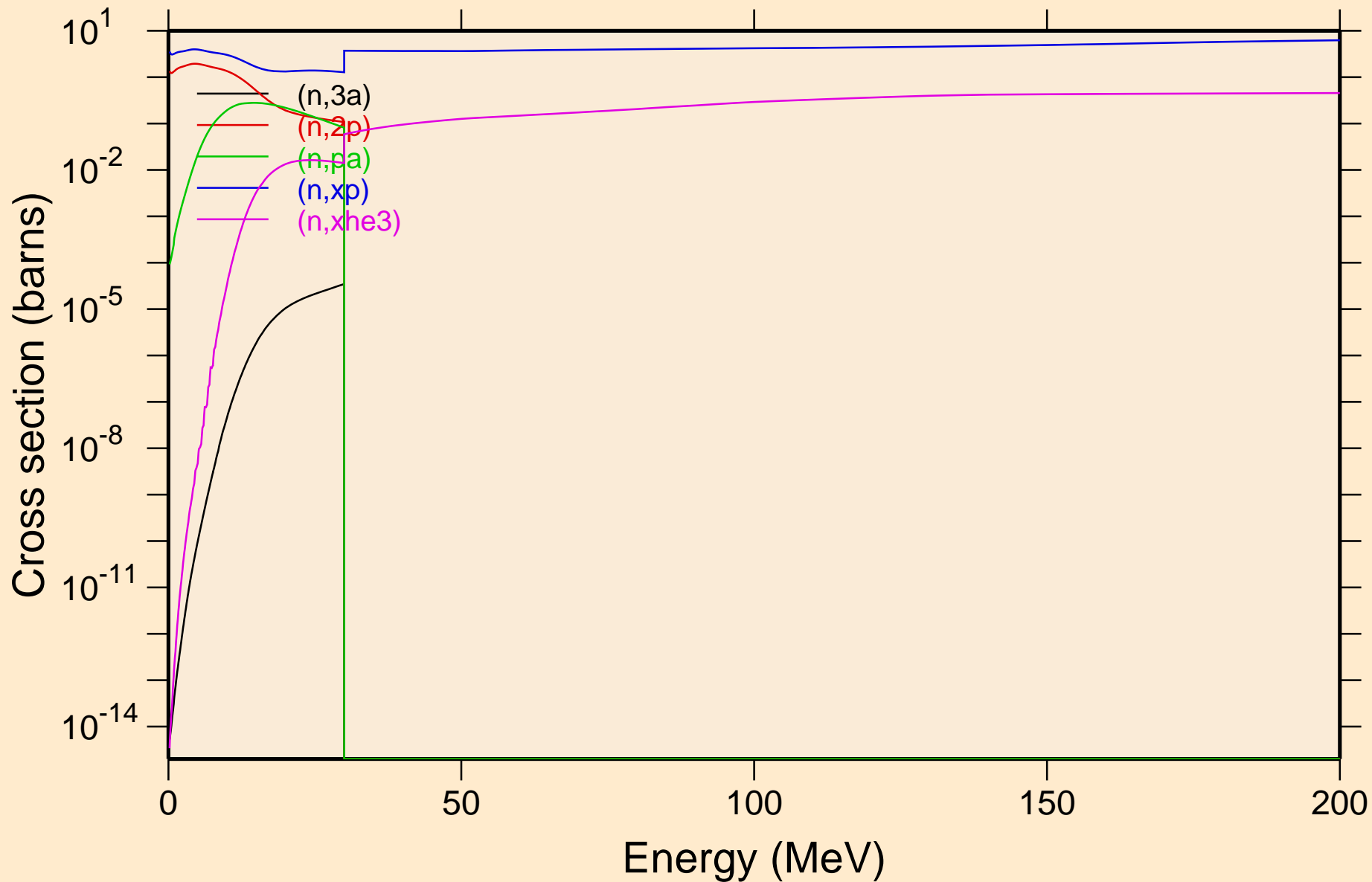

BA117 NEUTRON ACER TENDL-2019 LIBRARY; T=293.16K  
Non-threshold reactions

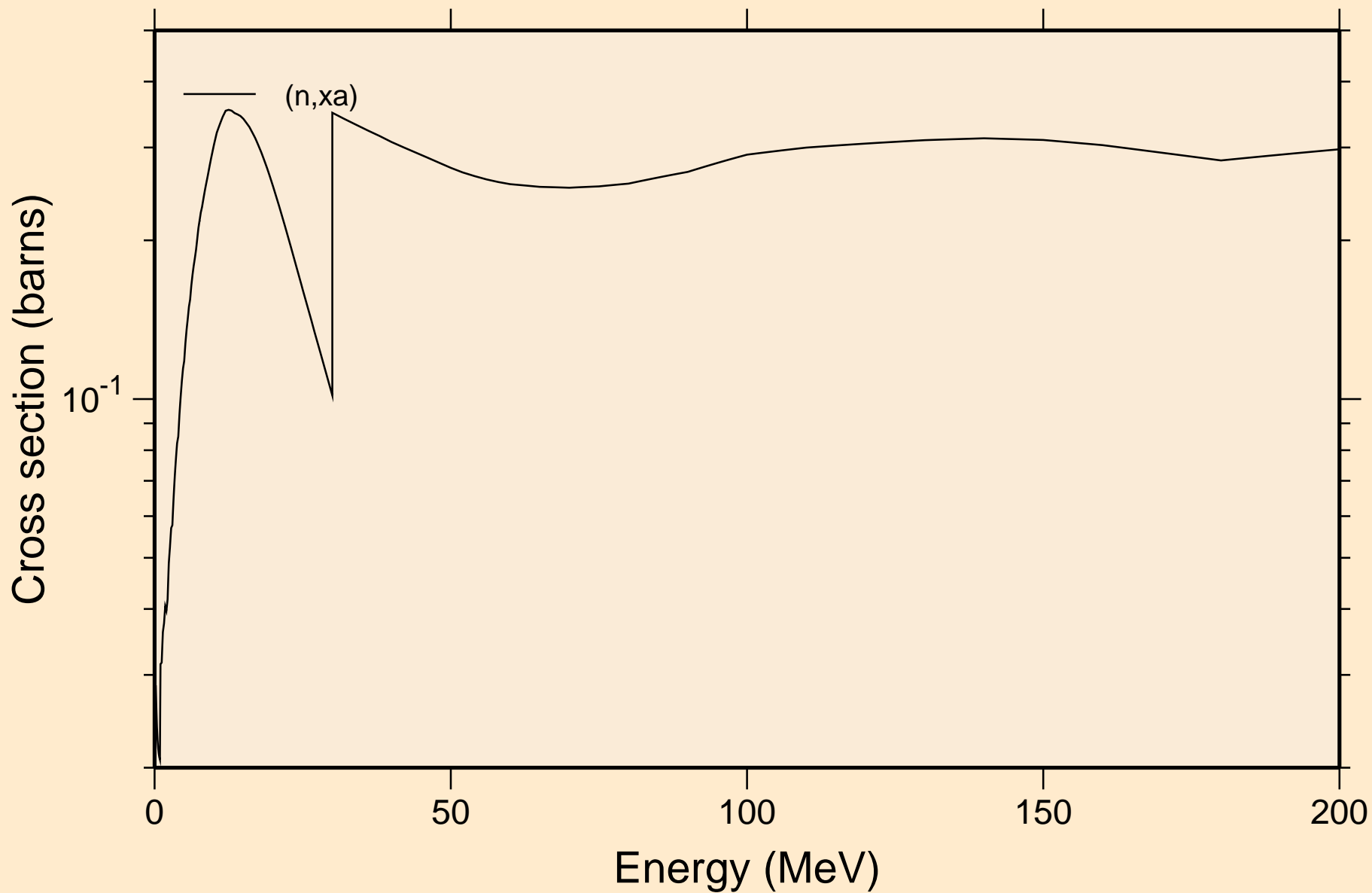

BA117 NEUTRON ACER TENDL-2019 LIBRARY; T=293.16K  
Inelastic levels

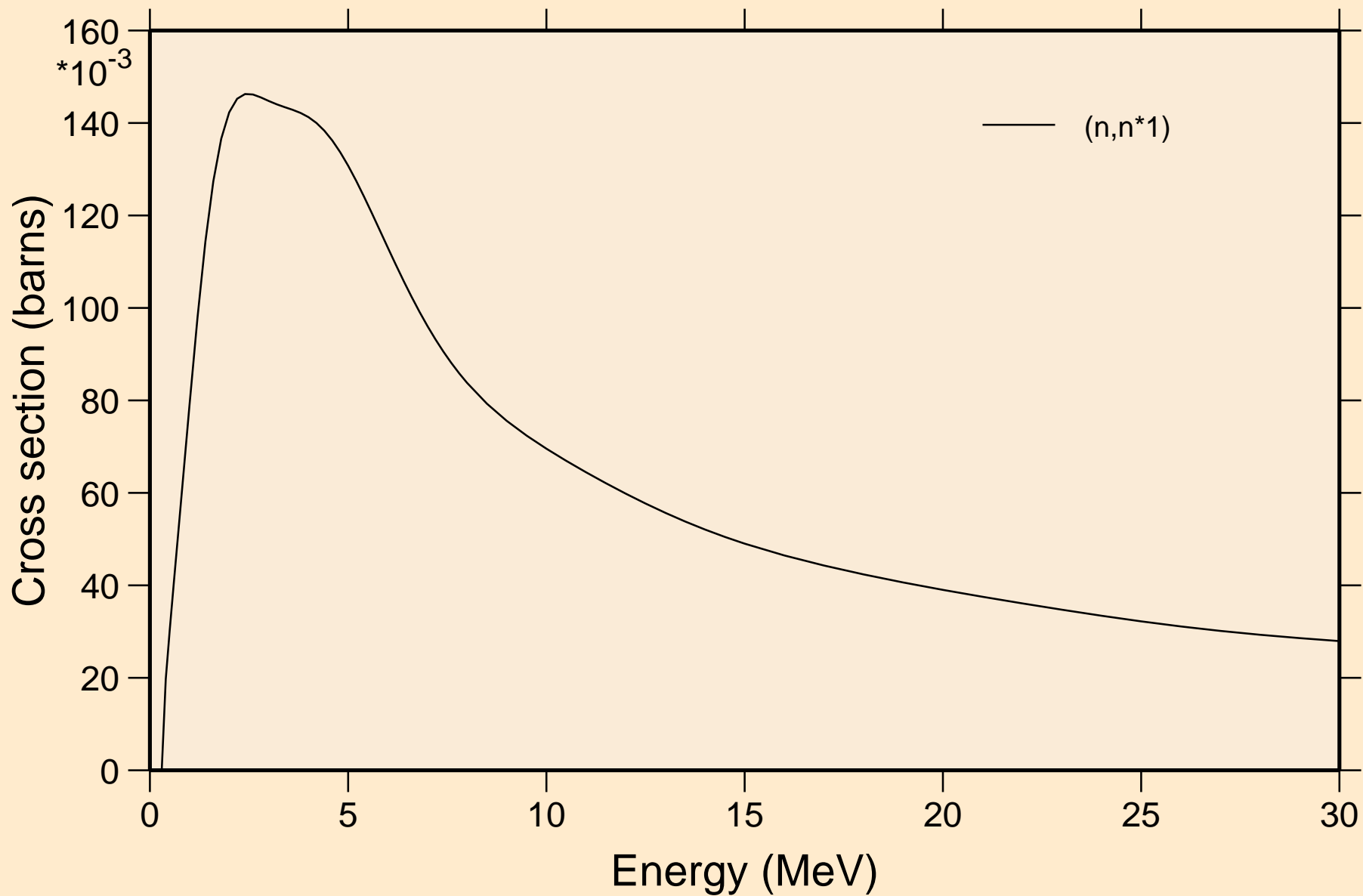

BA117 NEUTRON ACER TENDL-2019 LIBRARY; T=293.16K  
Threshold reactions

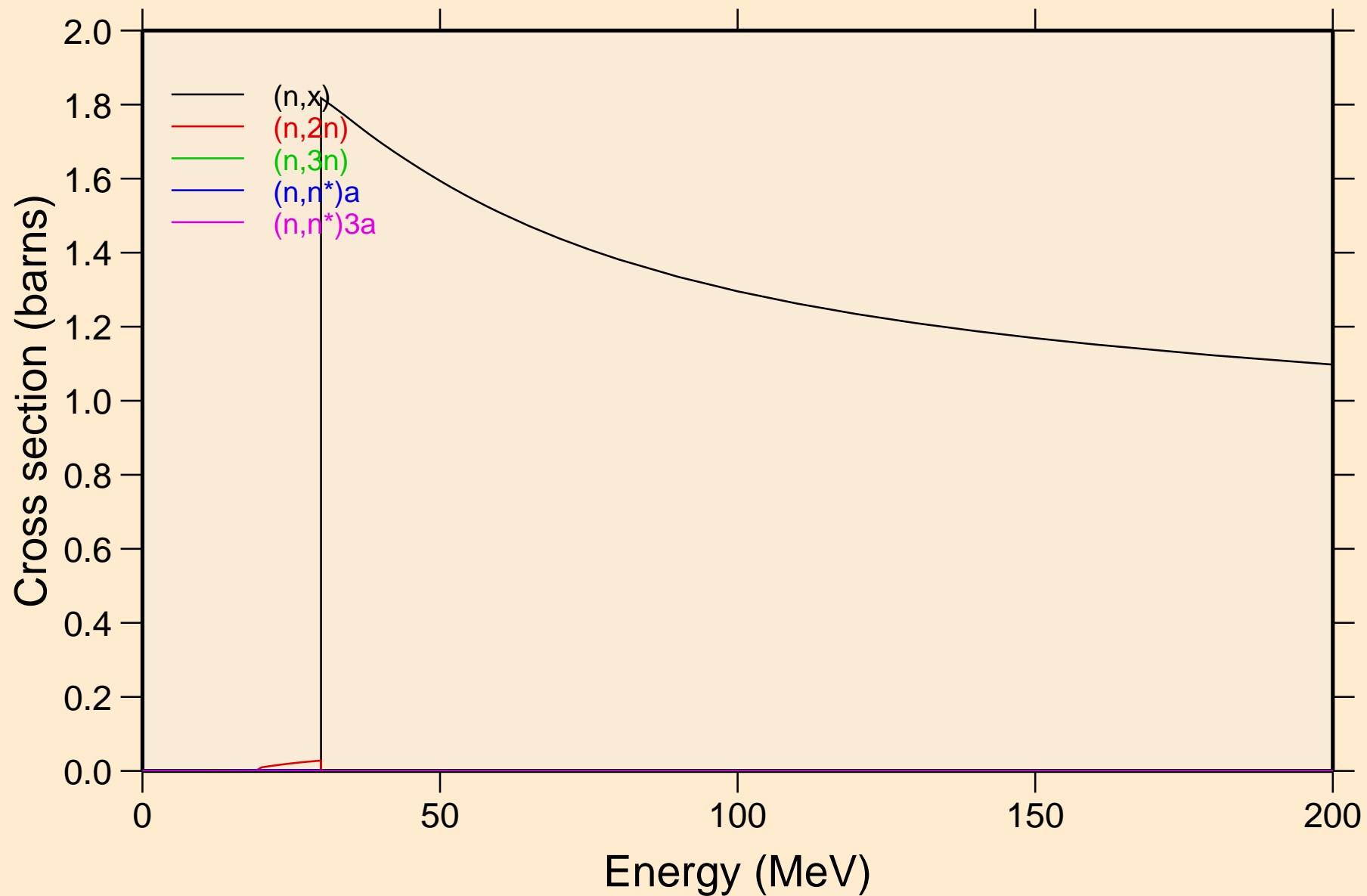

BA117 NEUTRON ACER TENDL-2019 LIBRARY; T=293.16K  
Threshold reactions

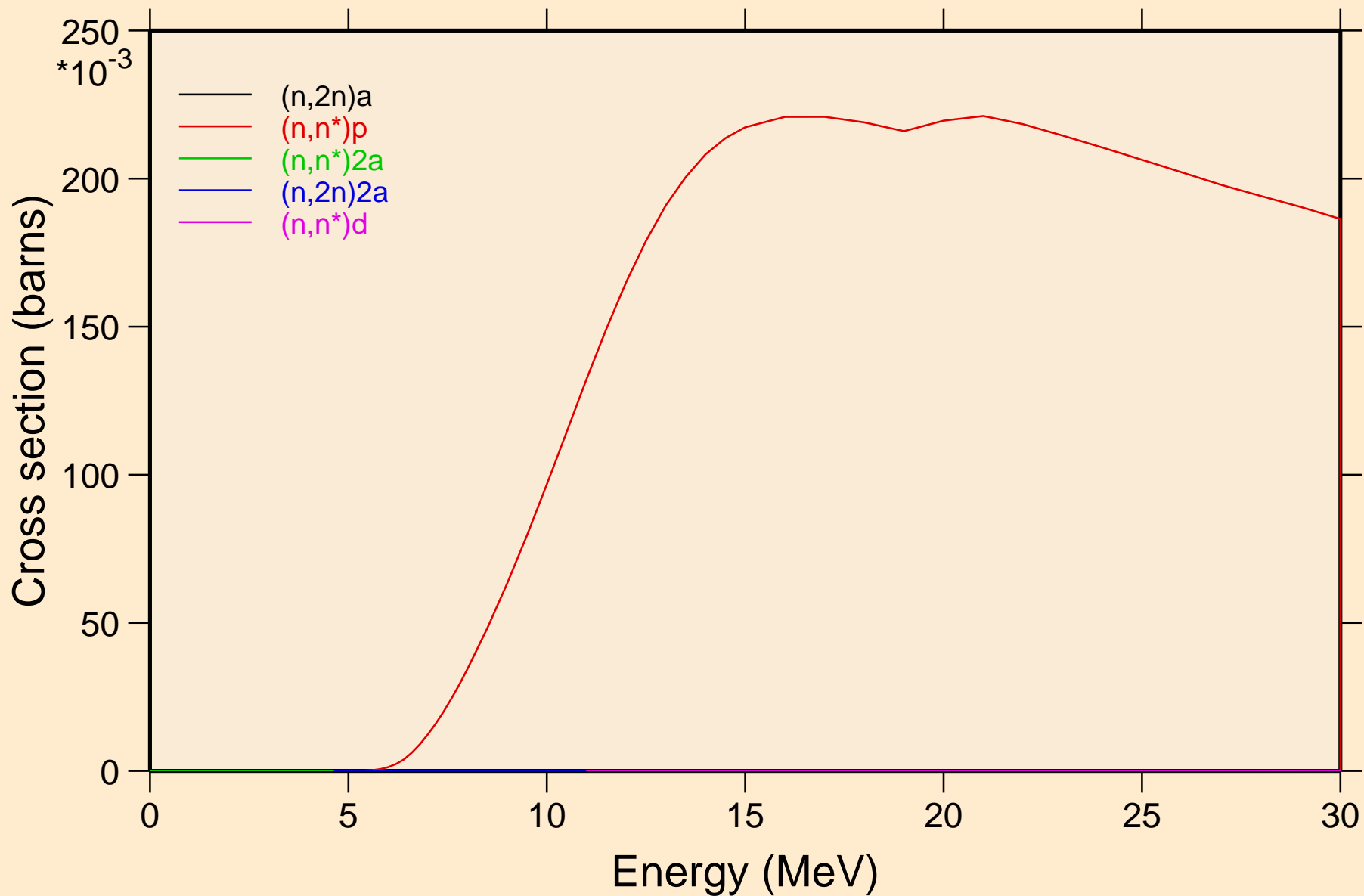

BA117 NEUTRON ACER TENDL-2019 LIBRARY; T=293.16K  
Threshold reactions

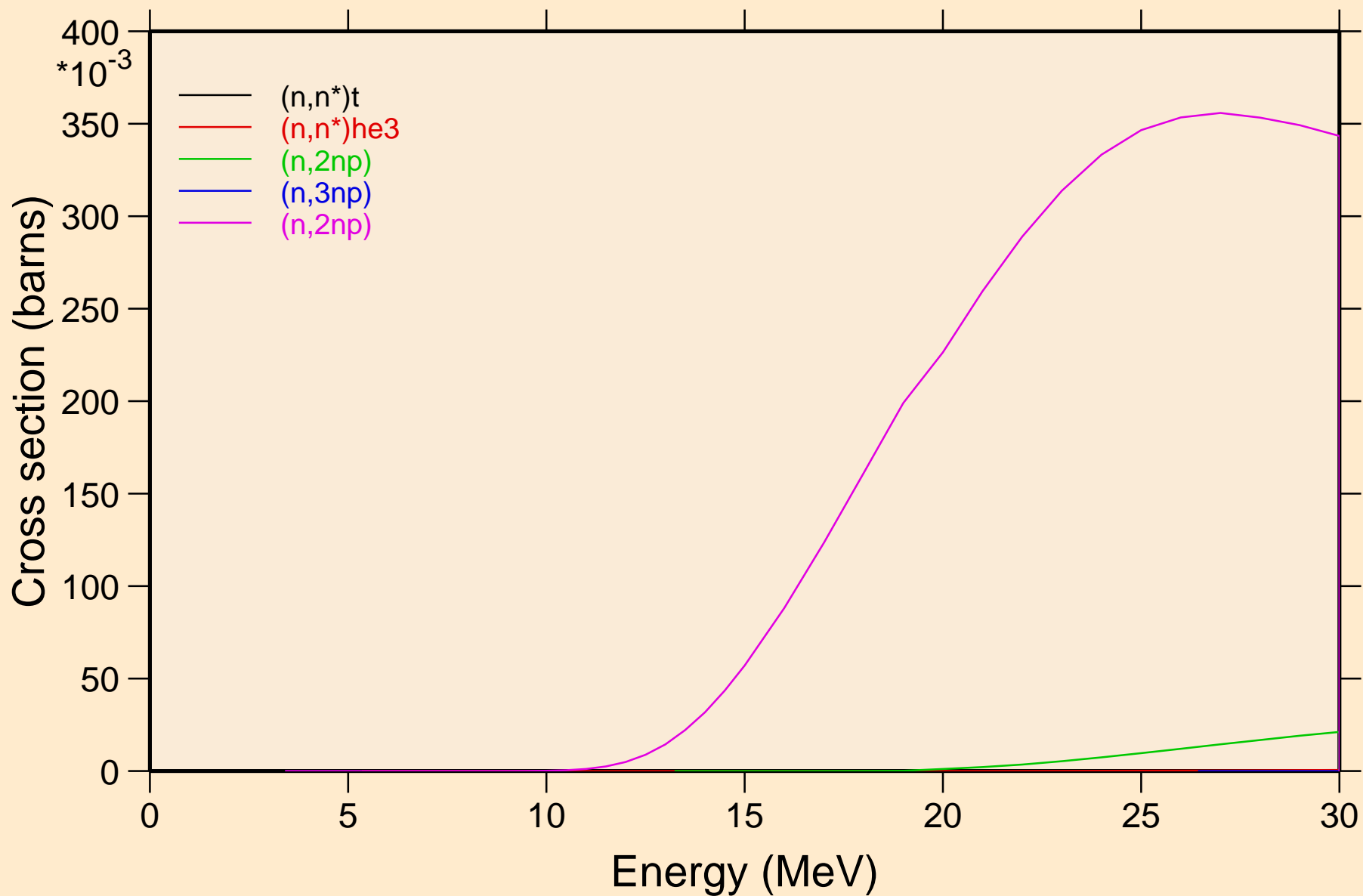



BA117 NEUTRON ACER TENDL-2019 LIBRARY; T=293.16K  
Threshold reactions

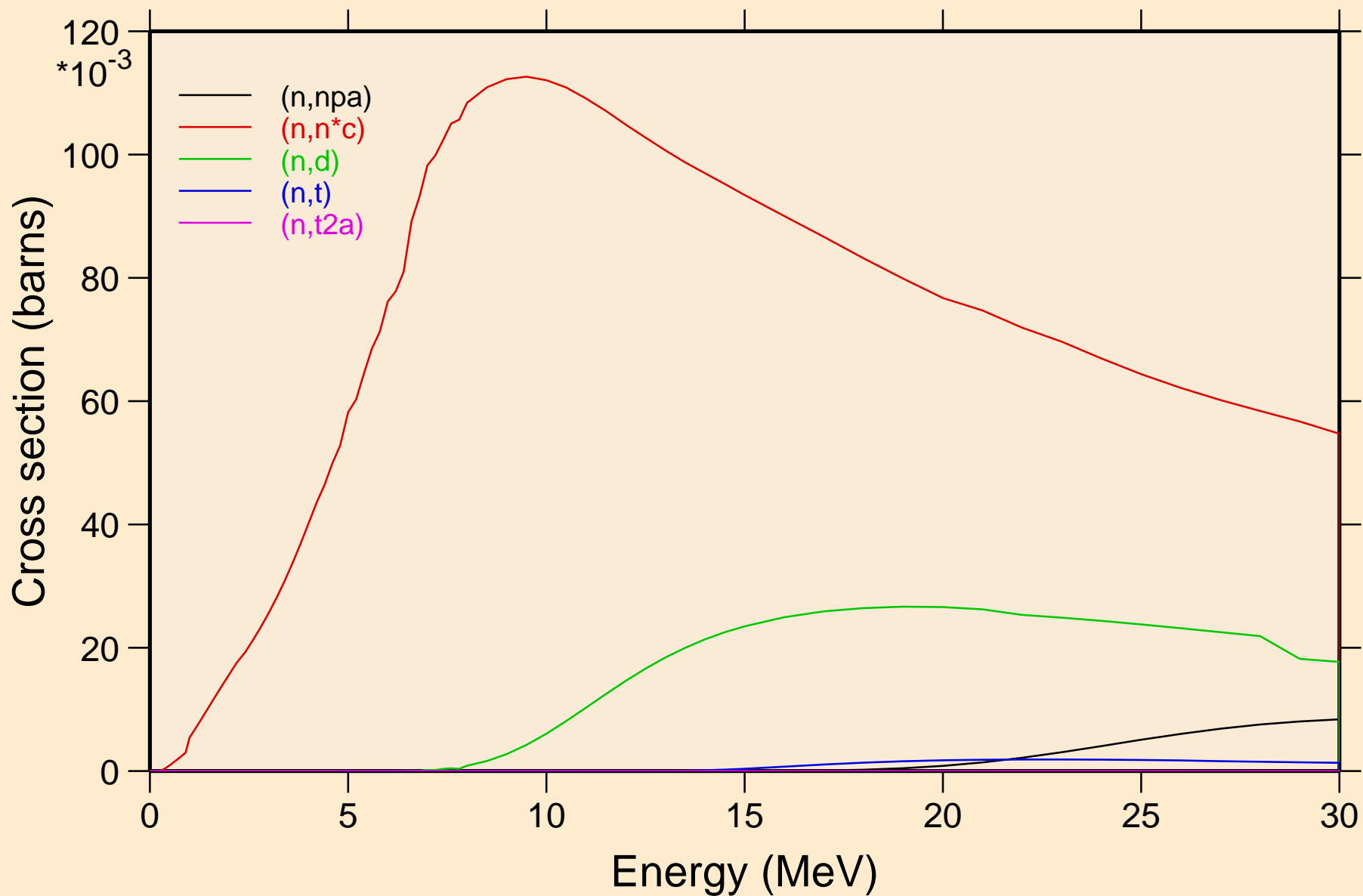

BA117 NEUTRON ACER TENDL-2019 LIBRARY; T=293.16K  
Threshold reactions

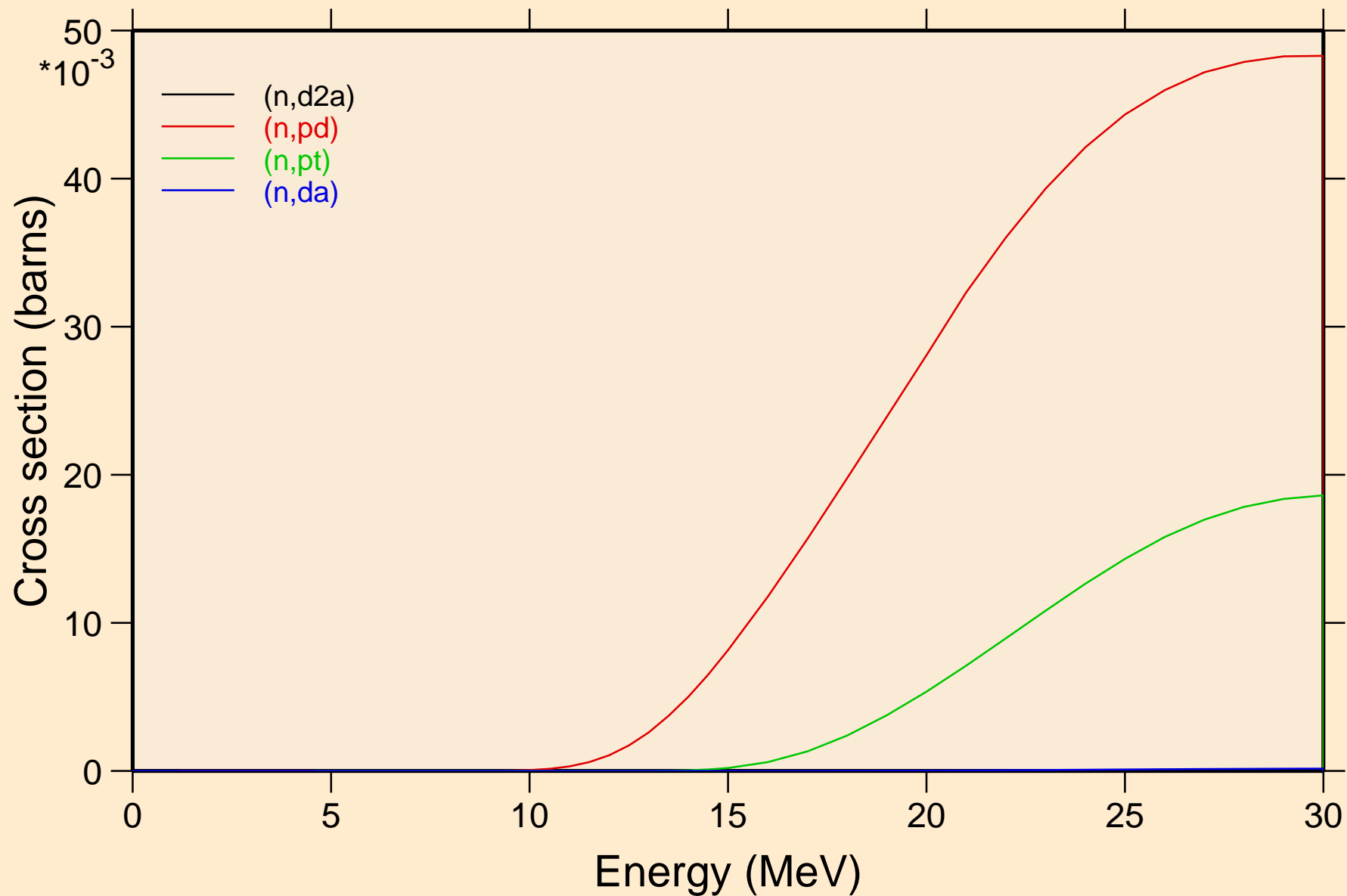

BA117 NEUTRON ACER TENDL-2019 LIBRARY; T=293.16K  
Threshold reactions

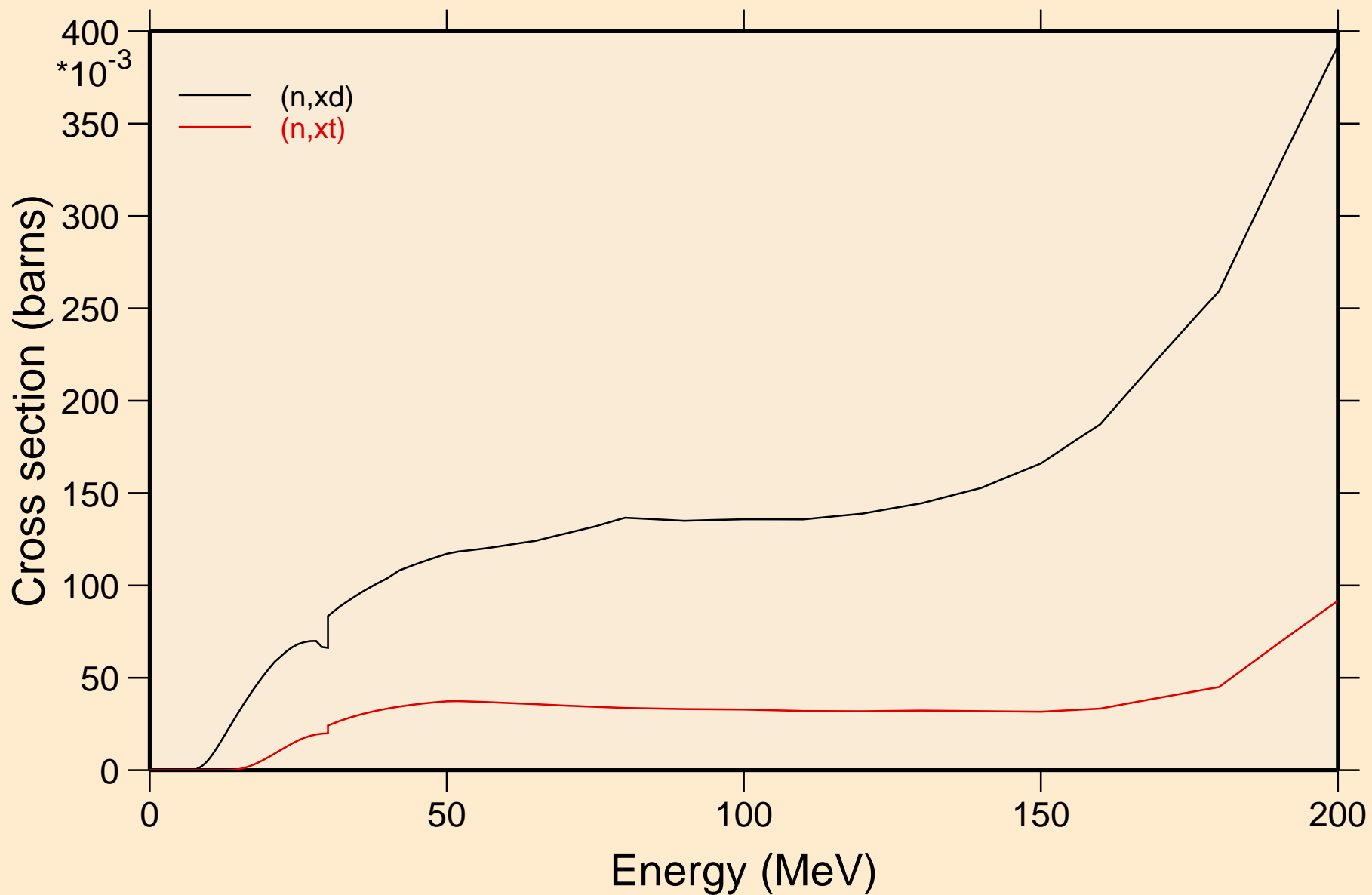

BA117 NEUTRON ACER TENDL-2019 LIBRARY; T=293.16K  
angular distribution for elastic

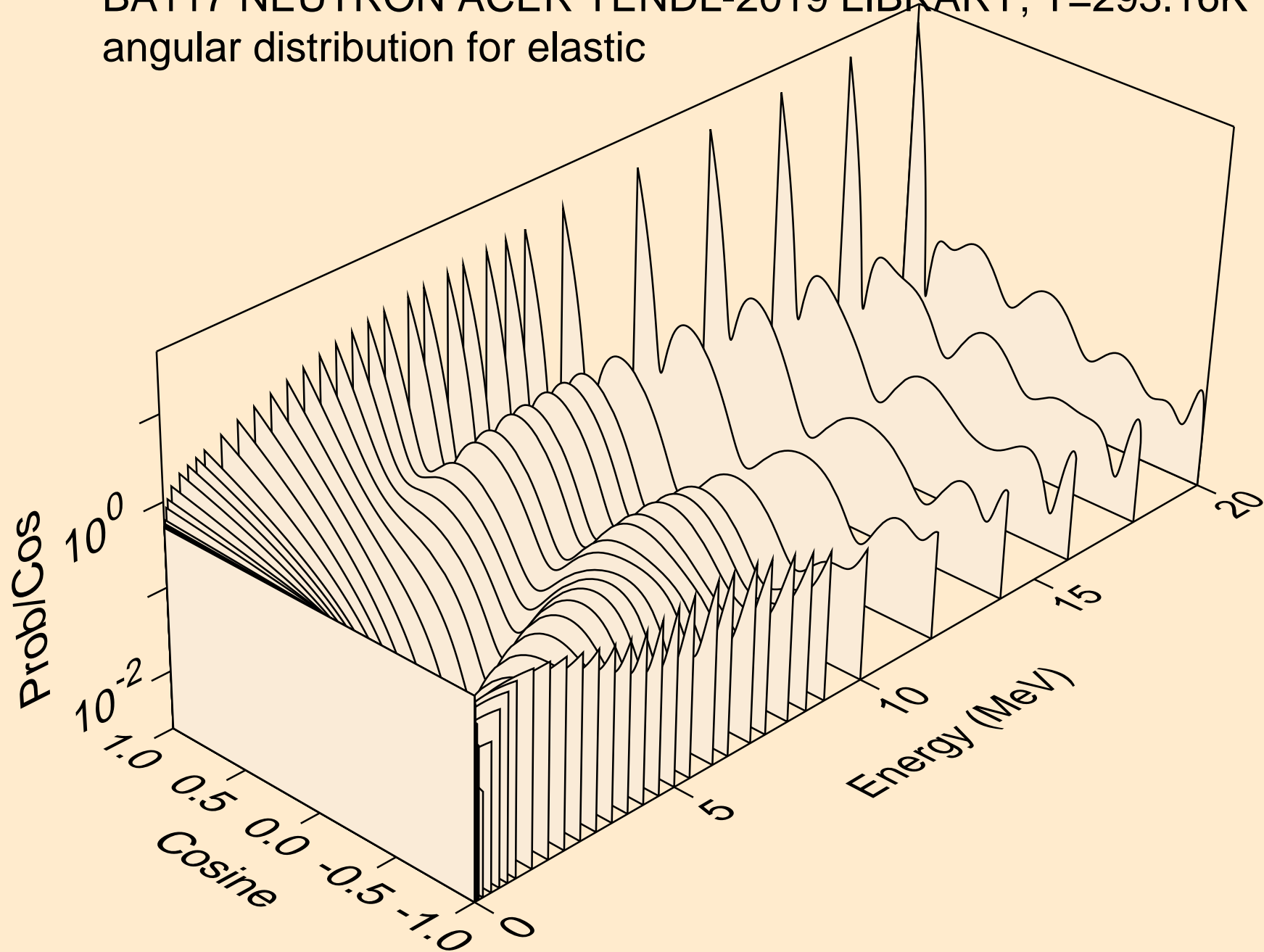

BA117 NEUTRON ACER TENDL-2019 LIBRARY; T=293.16K  
angular distribution for elastic

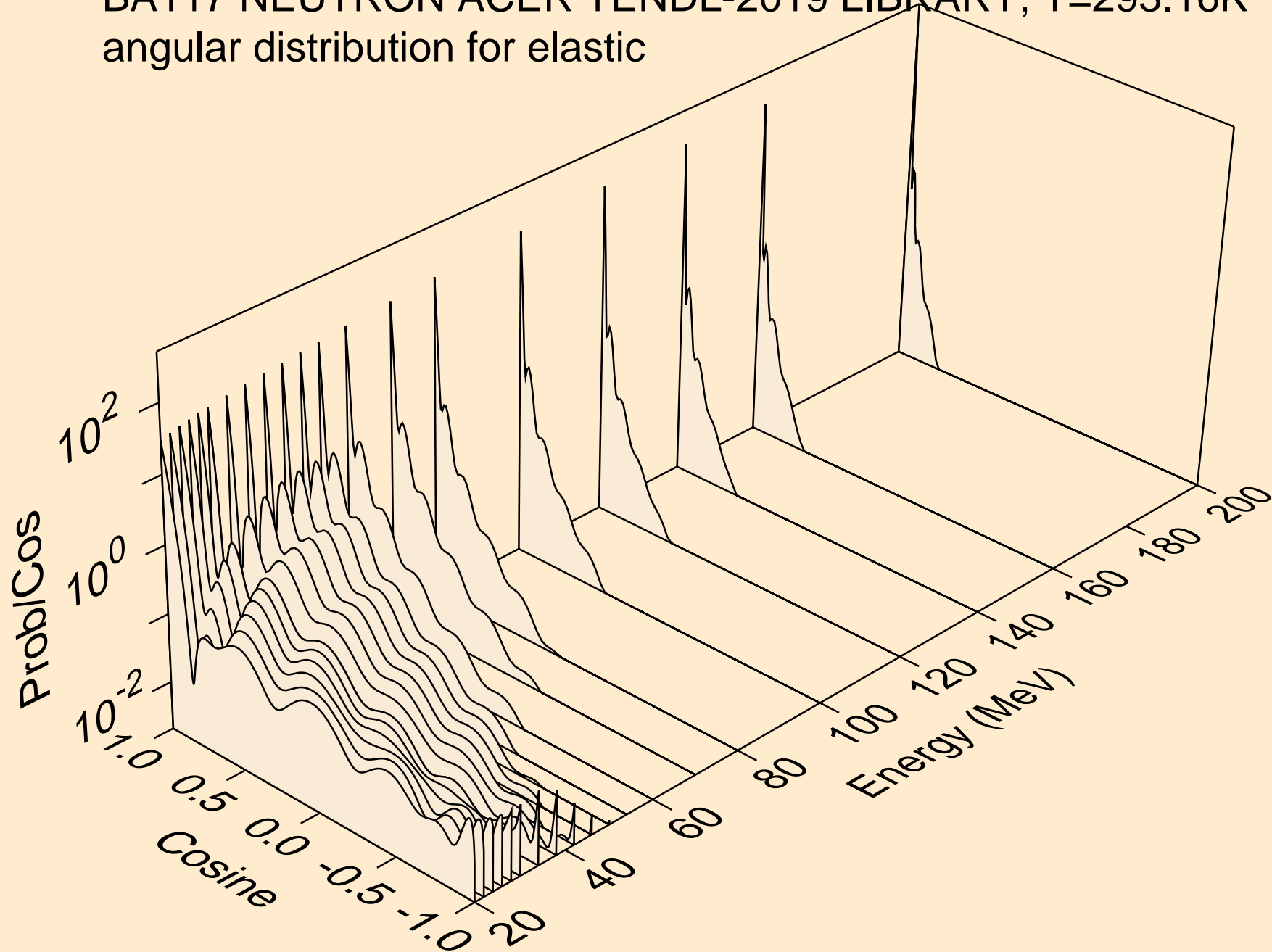

BA117 NEUTRON ACER TENDL-2019 LIBRARY; T=293.16K  
angular distribution for (n,n\*1)

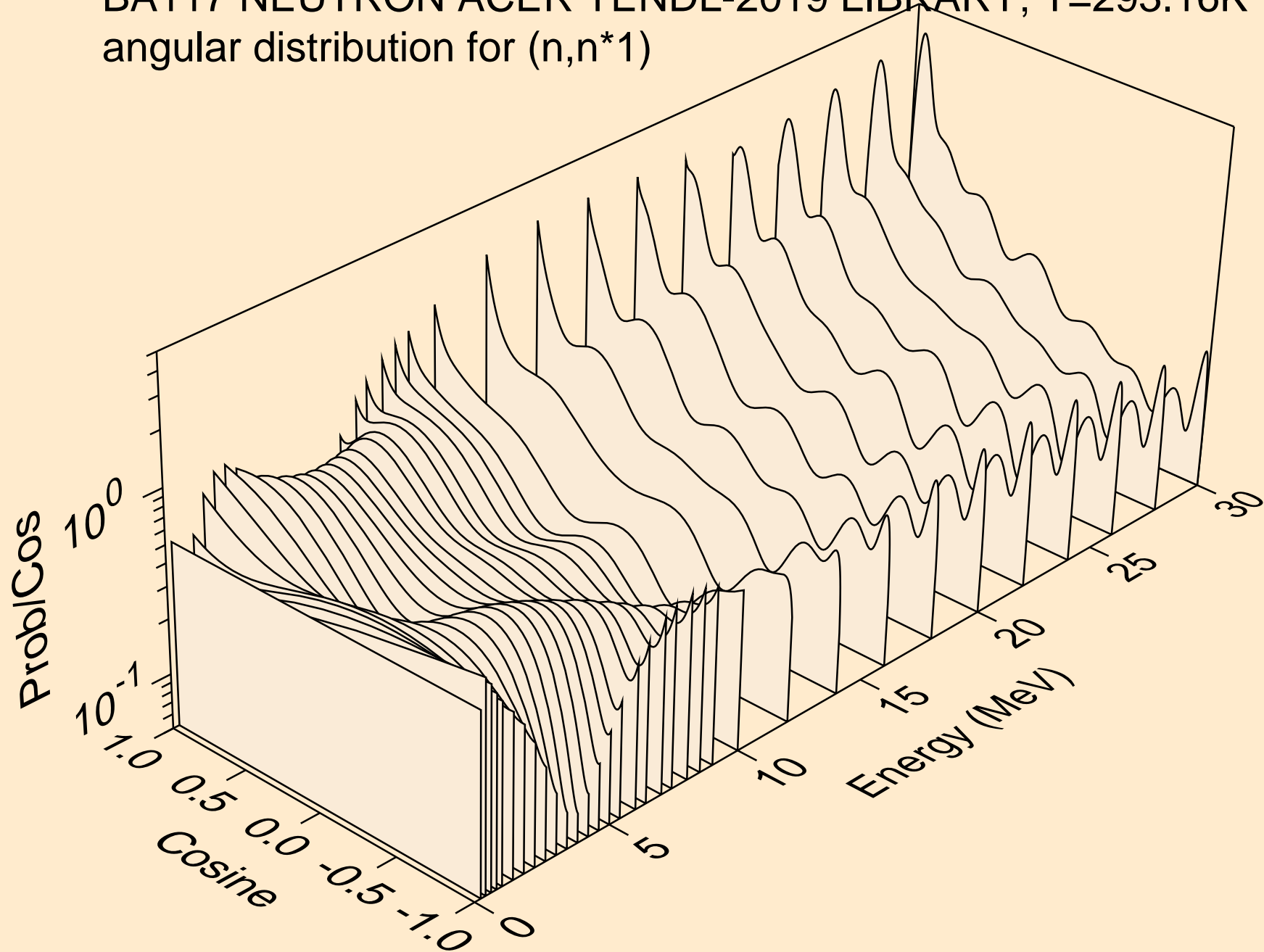

BA117 NEUTRON ACER TENDL-2019 LIBRARY; T=293.16K  
Neutron emission for (n,x)

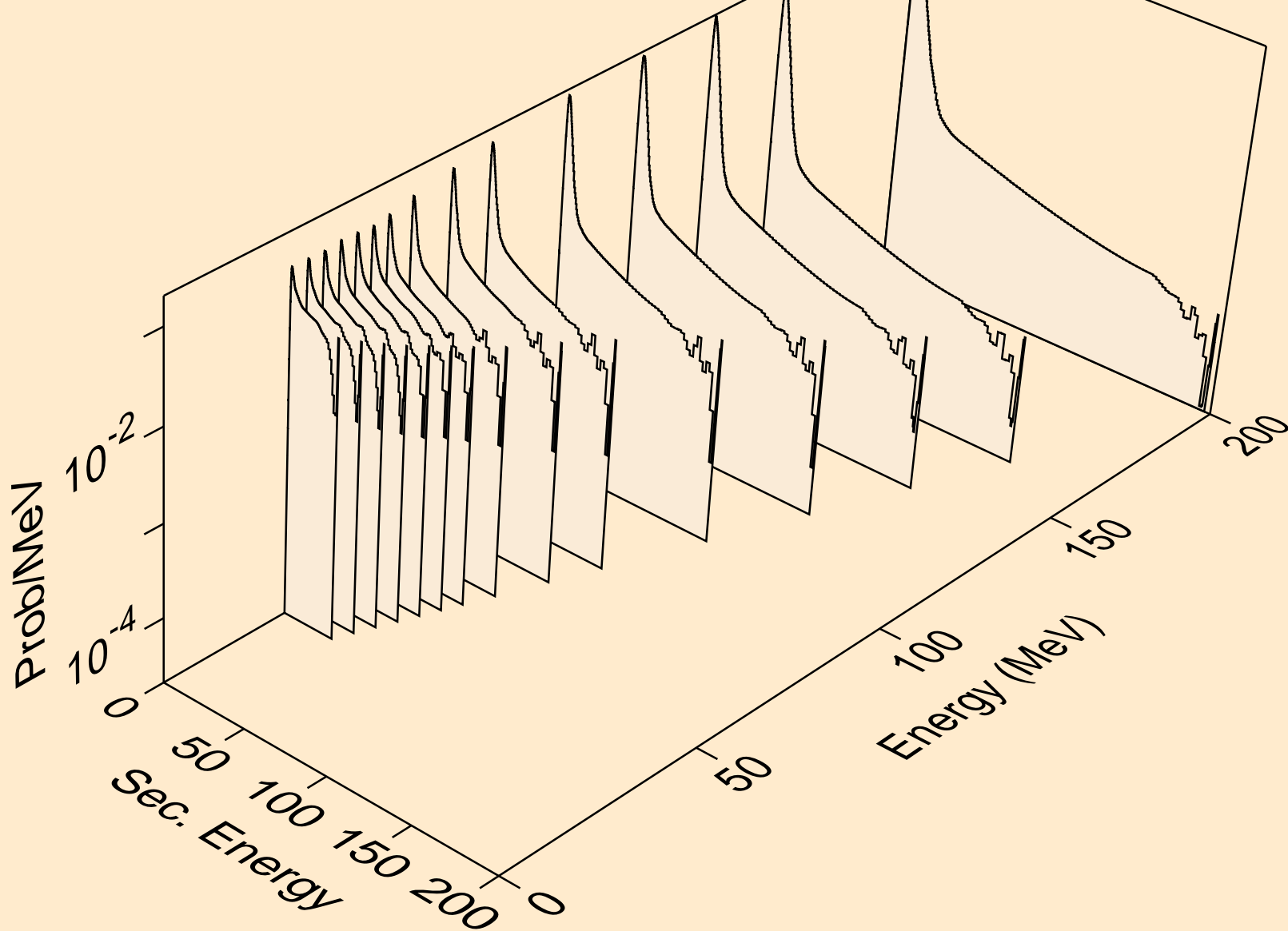

BA117 NEUTRON ACER TENDL-2019 LIBRARY; T=293.16K  
Neutron emission for (n,2n)

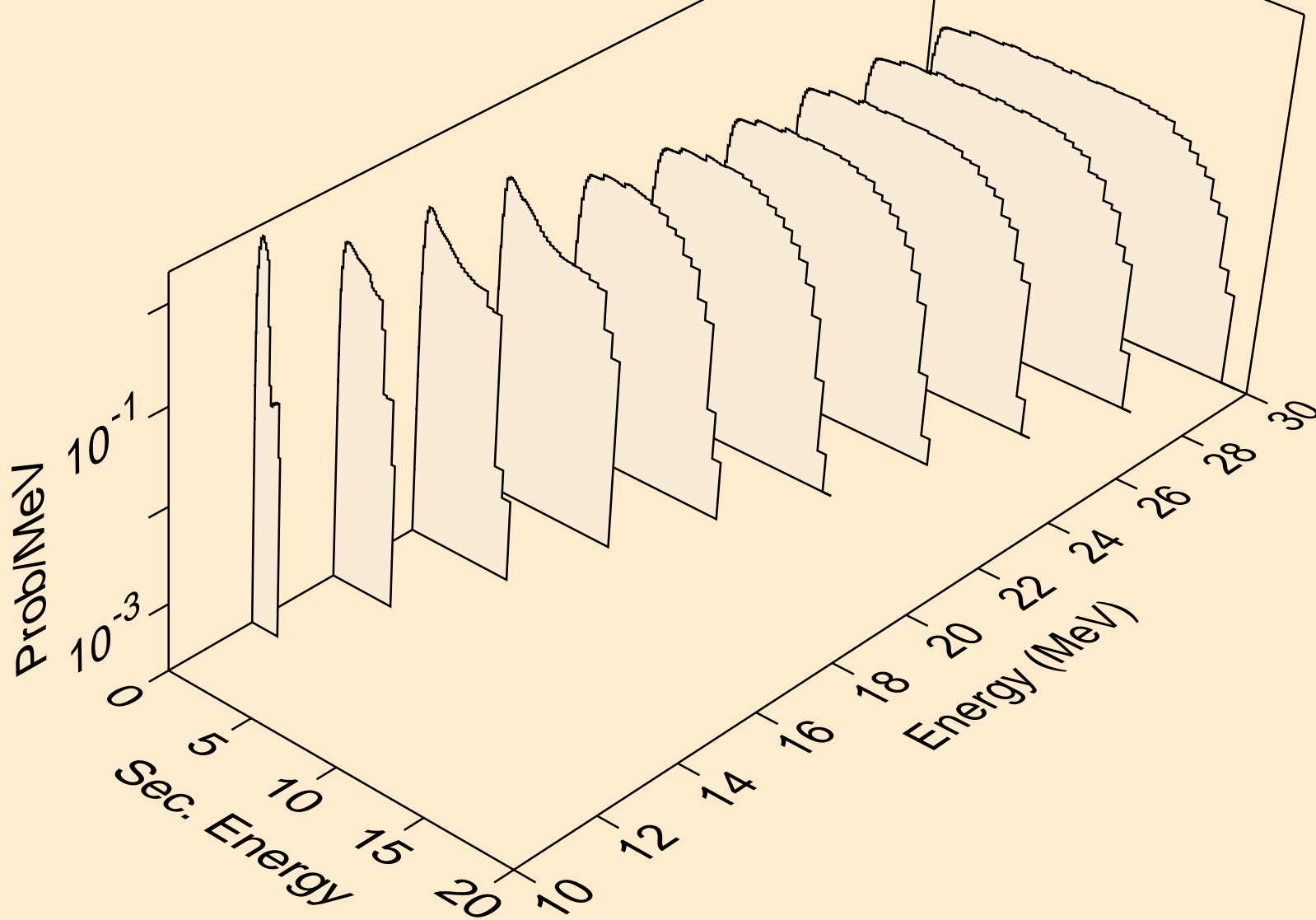



BA117 NEUTRON ACER TENDL-2019 LIBRARY; T=293.16K  
Neutron emission for (n,3n)

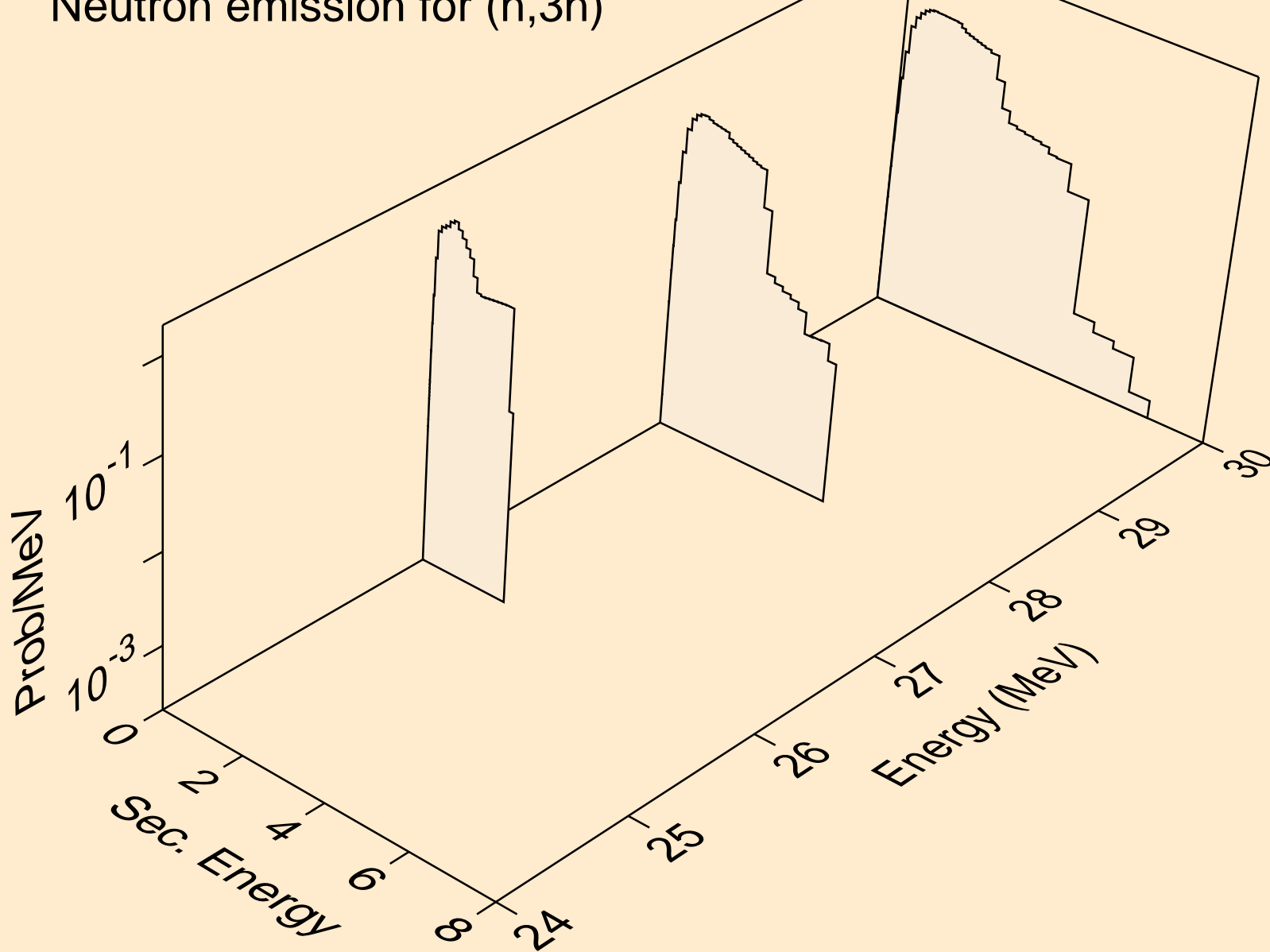

BA117 NEUTRON ACER TENDL-2019 LIBRARY; T=293.16K  
Neutron emission for (n,n\*)a

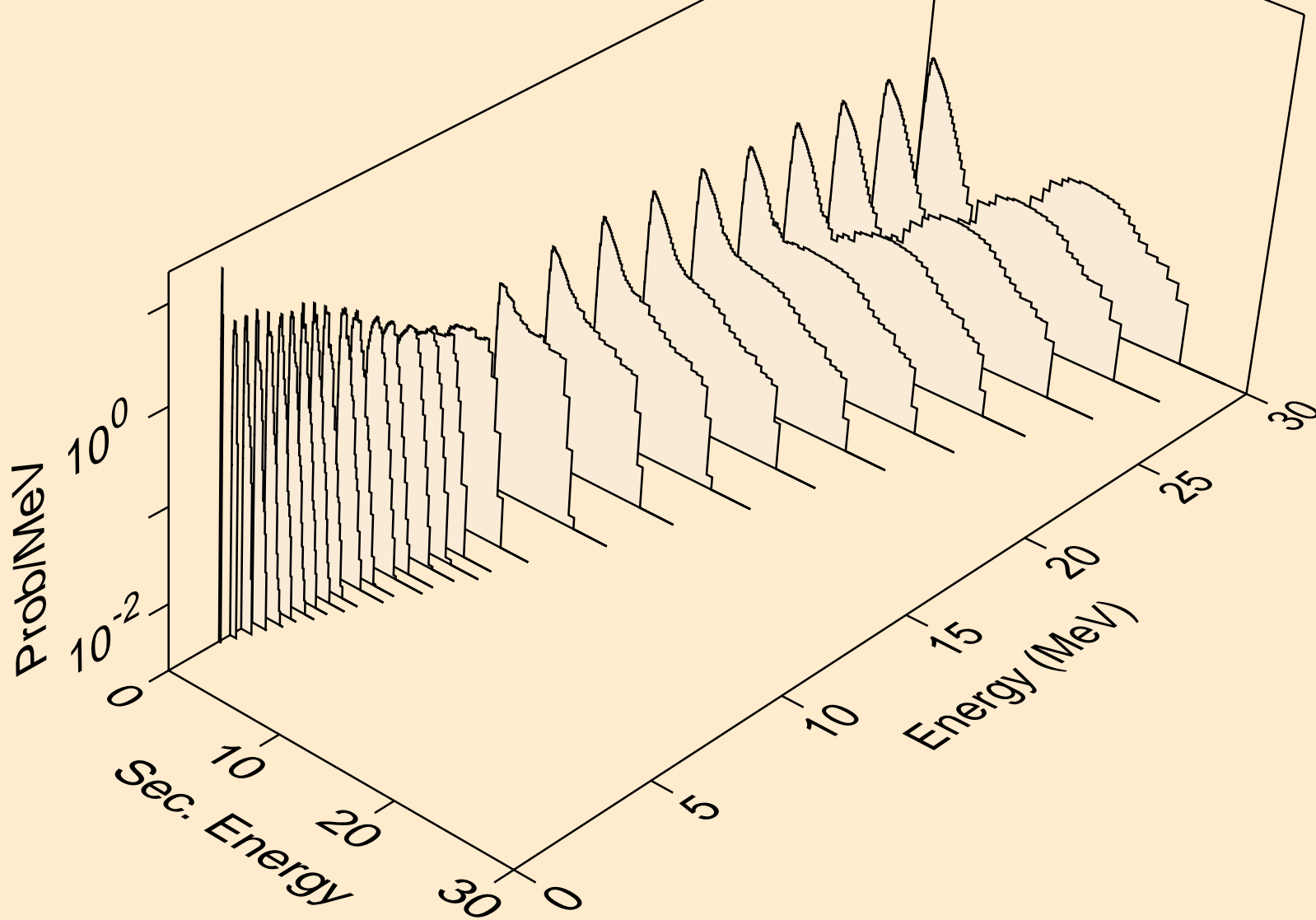

BA117 NEUTRON ACER TENDL-2019 LIBRARY; T=293.16K  
Neutron emission for (n,n\*)3a

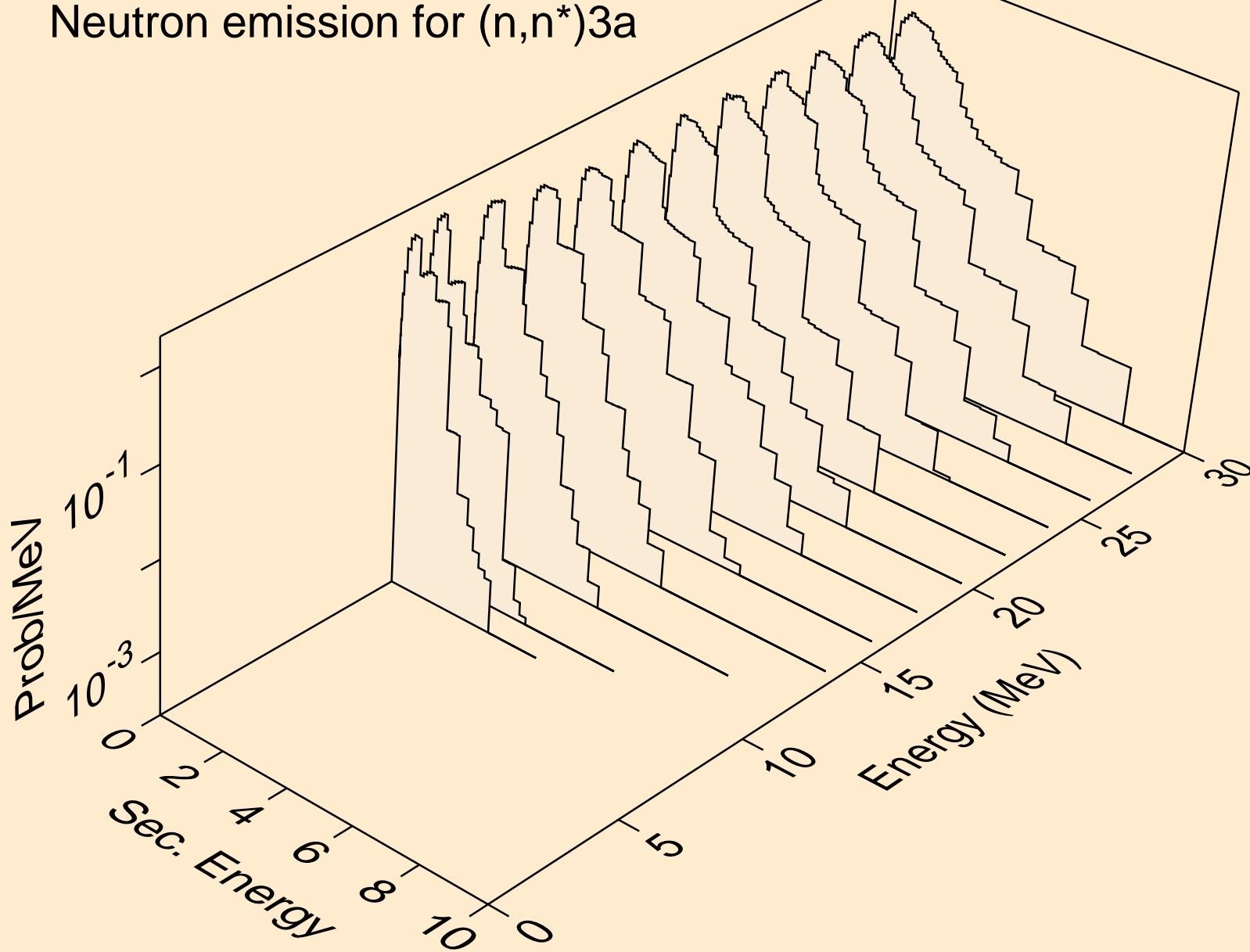

BA117 NEUTRON ACER TENDL-2019 LIBRARY; T=293.16K  
Neutron emission for (n,2n)a

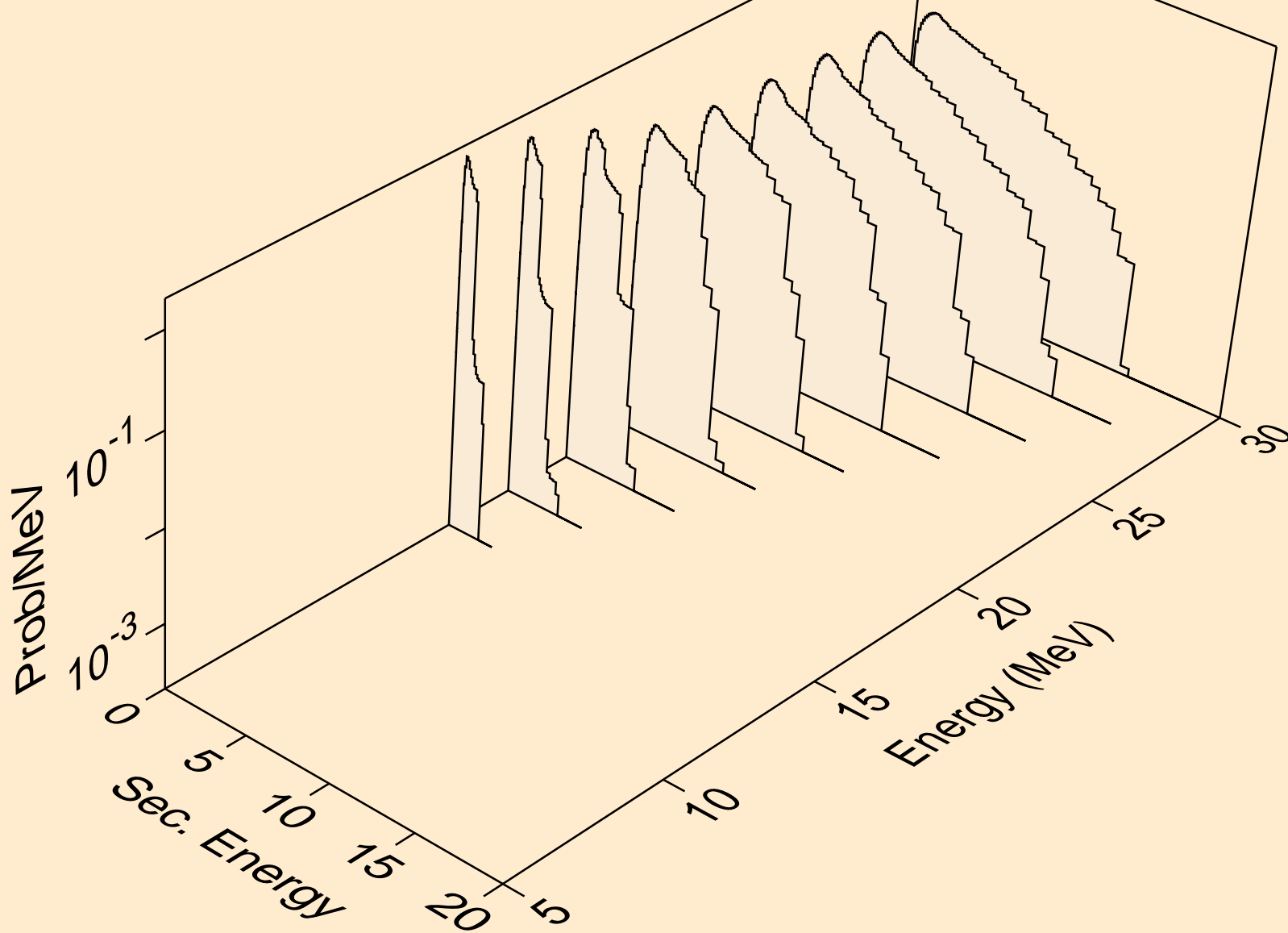

BA117 NEUTRON ACER TENDL-2019 LIBRARY; T=293.16K  
Neutron emission for (n,n\*)p

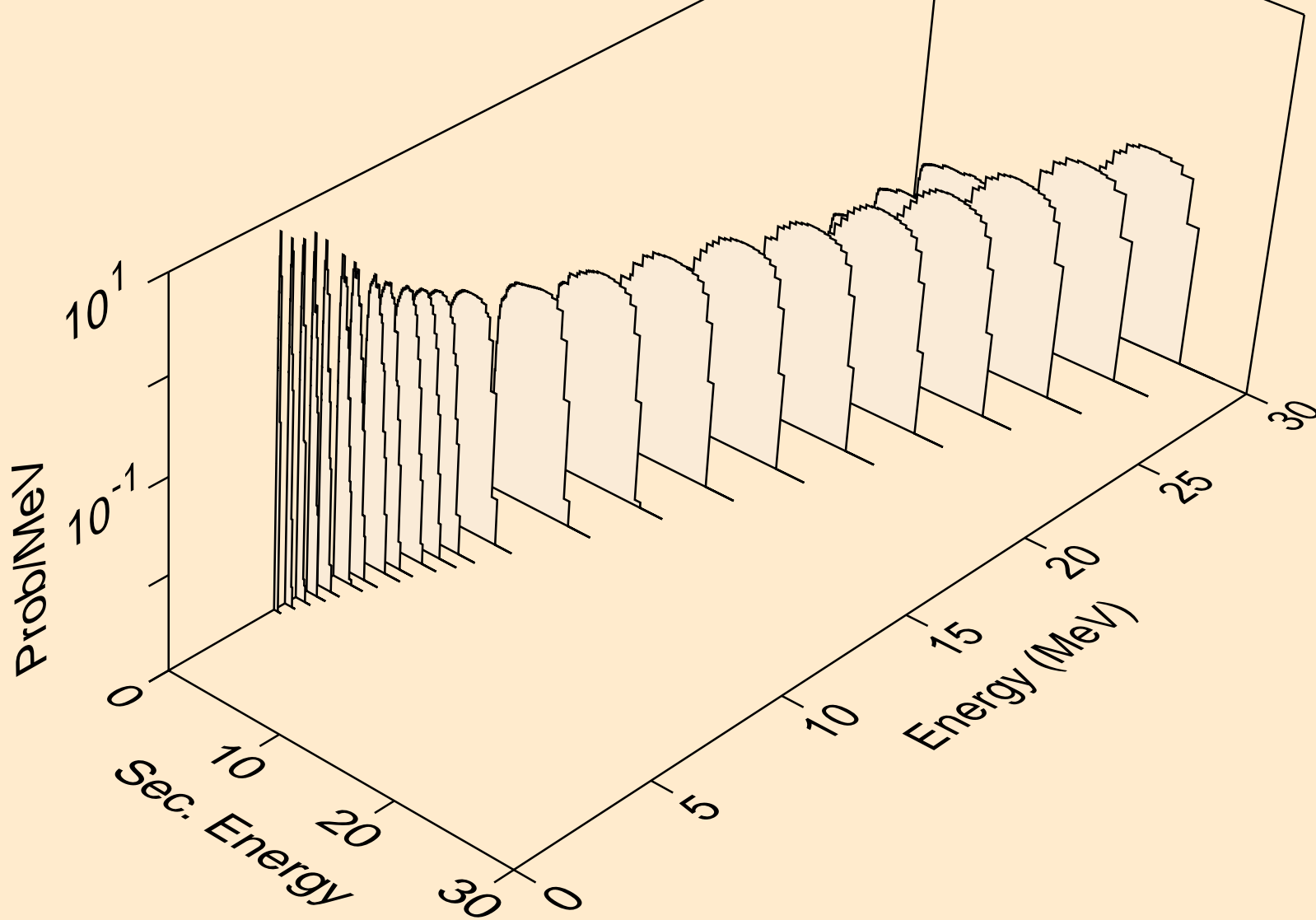

BA117 NEUTRON ACER TENDL-2019 LIBRARY; T=293.16K  
Neutron emission for (n,n\*)2a

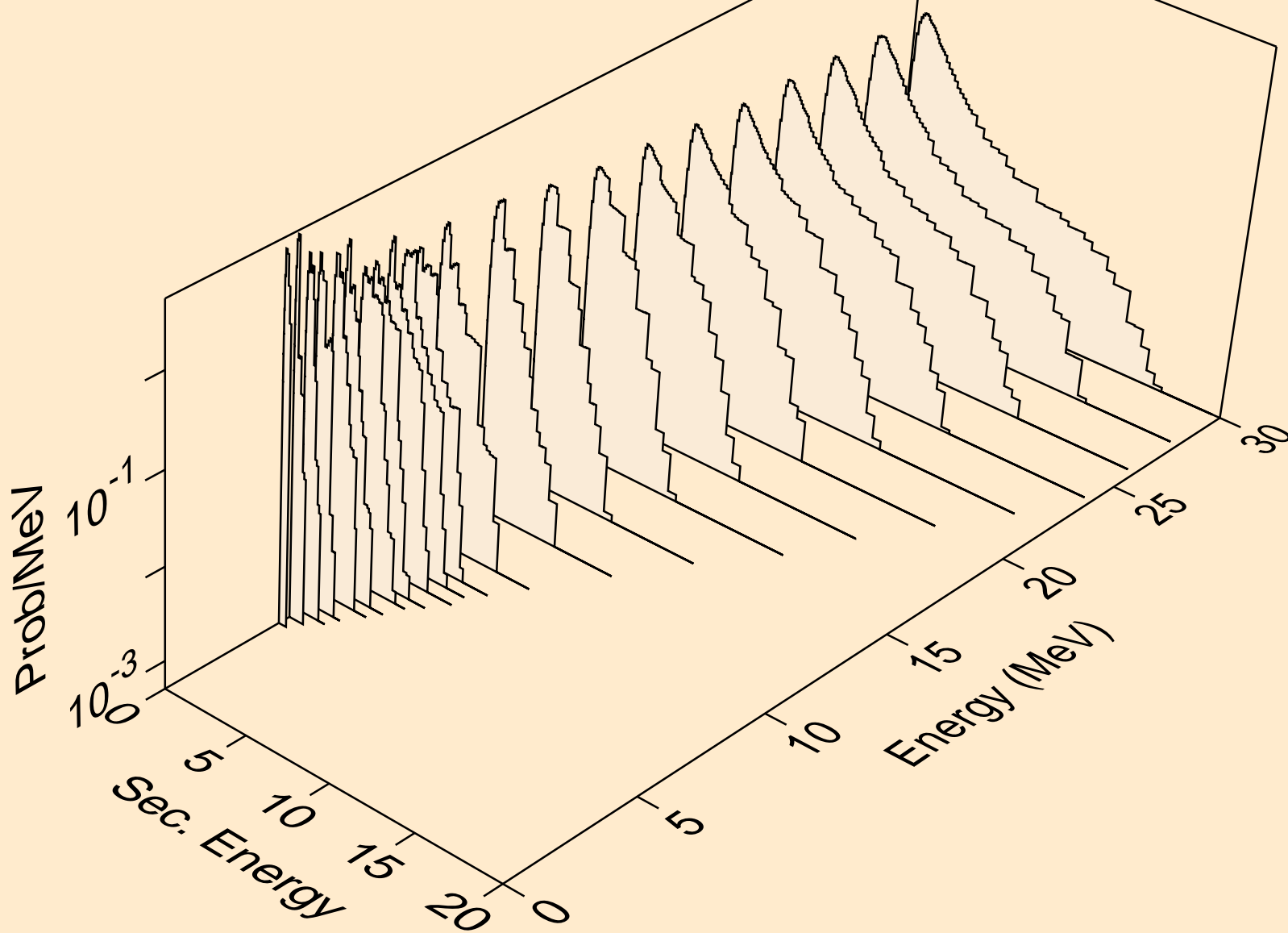

BA117 NEUTRON ACER TENDL-2019 LIBRARY; T=293.16K  
Neutron emission for (n,2n)2a

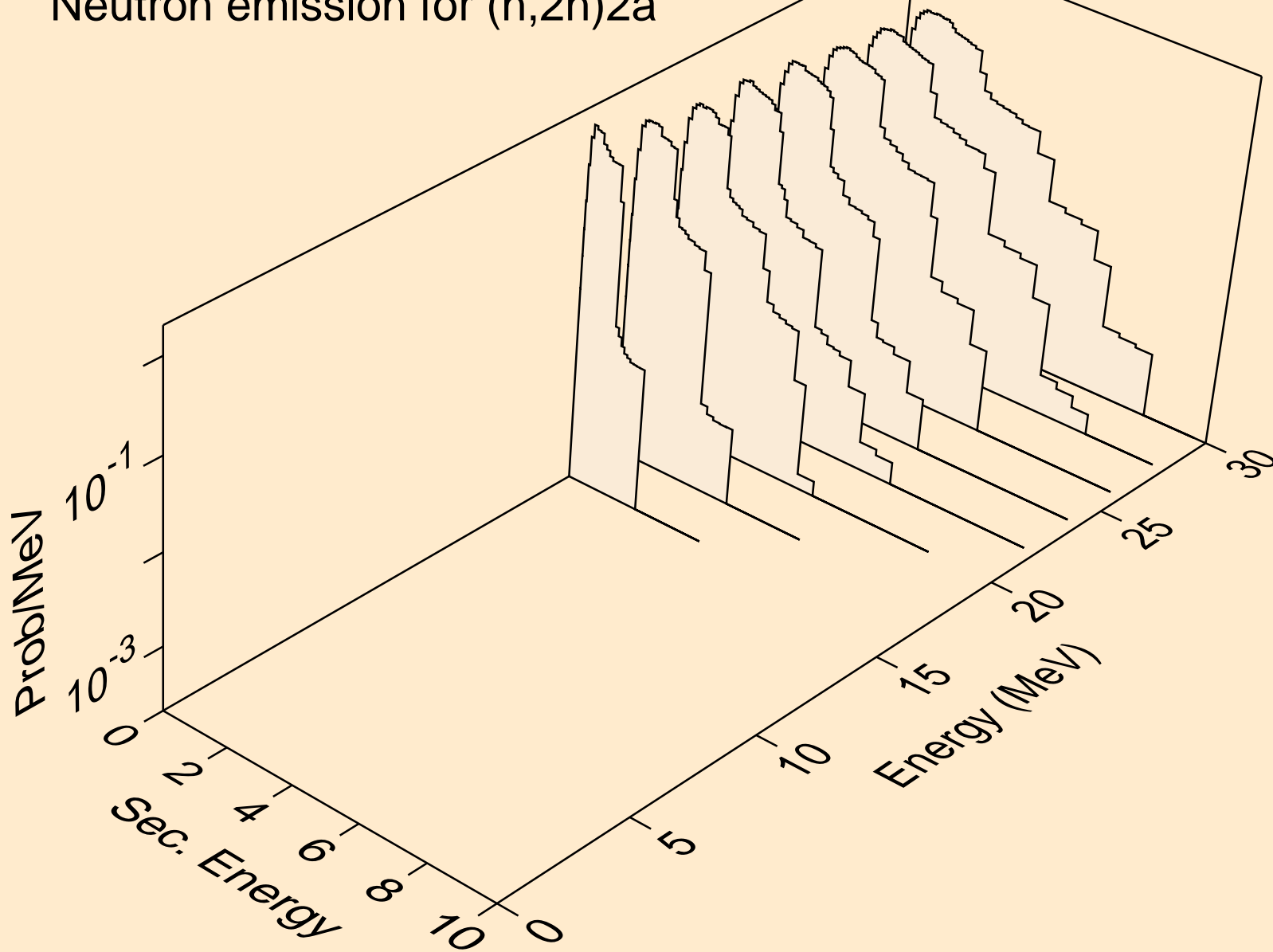

BA117 NEUTRON ACER TENDL-2019 LIBRARY; T=293.16K  
Neutron emission for (n,n\*)d

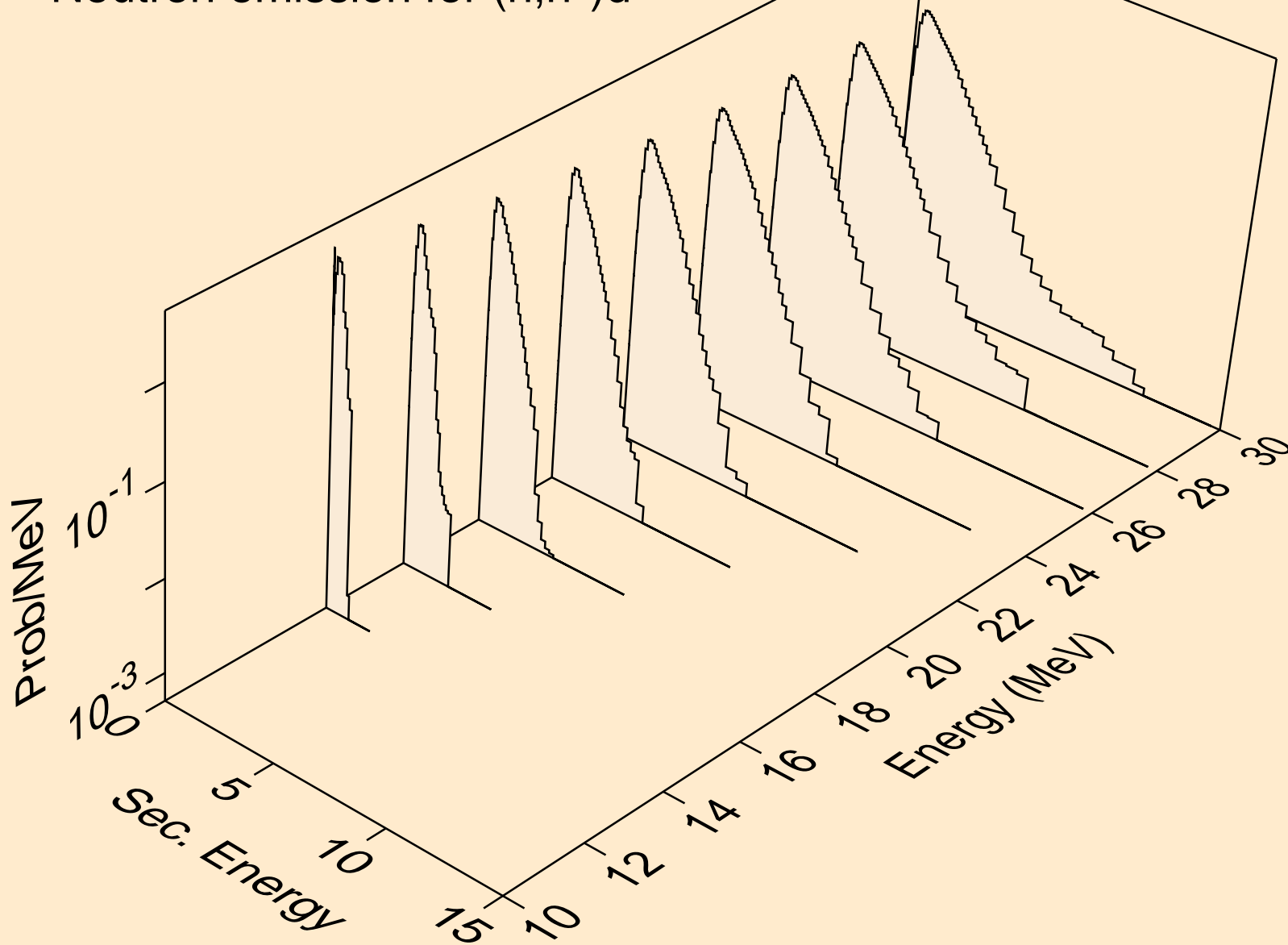



BA117 NEUTRON ACER TENDL-2019 LIBRARY; T=293.16K  
Neutron emission for (n,n\*)t

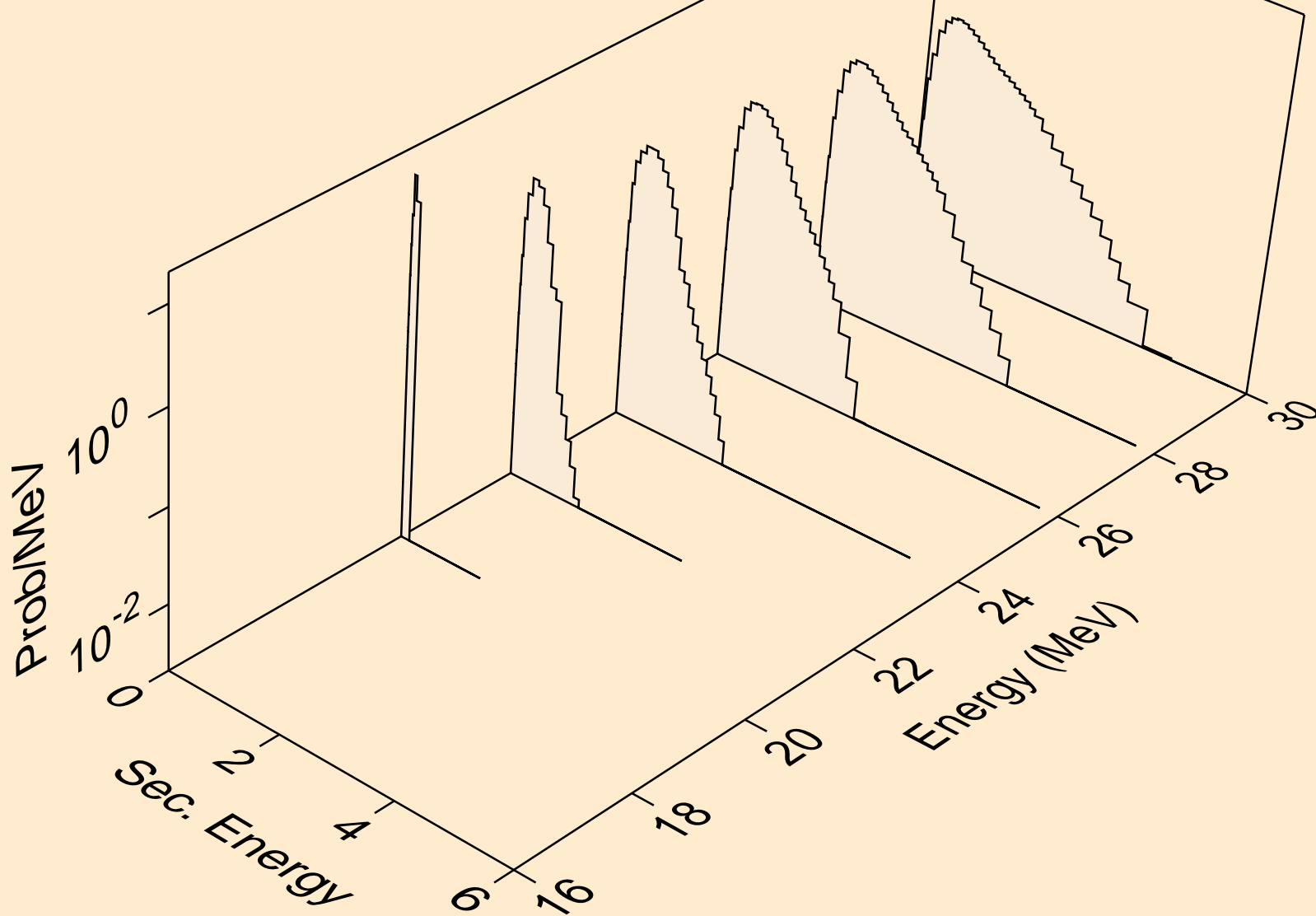

BA117 NEUTRON ACER TENDL-2019 LIBRARY; T=293.16K  
Neutron emission for (n,n\*)he3

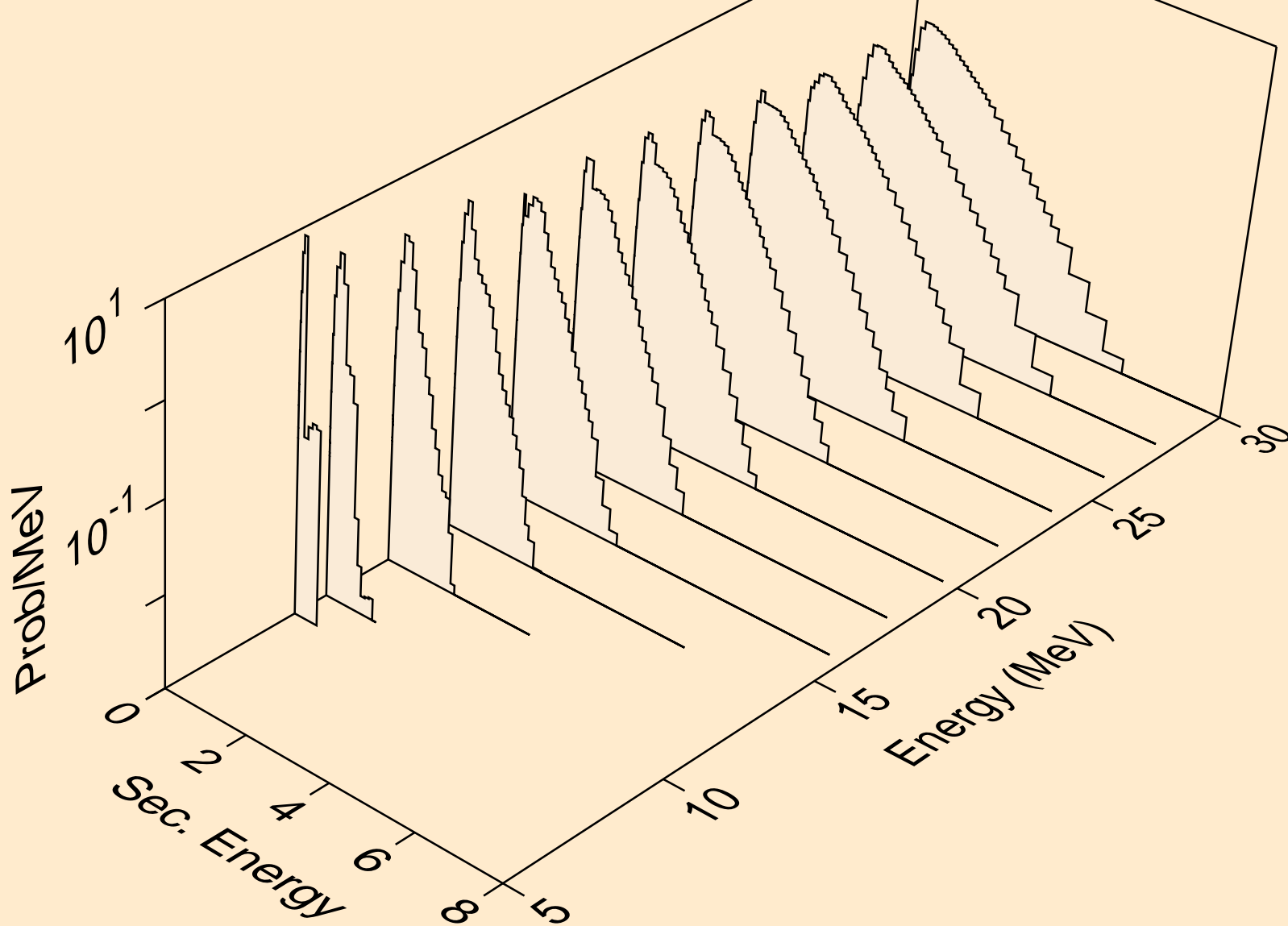

BA117 NEUTRON ACER TENDL-2019 LIBRARY; T=293.16K  
Neutron emission for (n,2np)

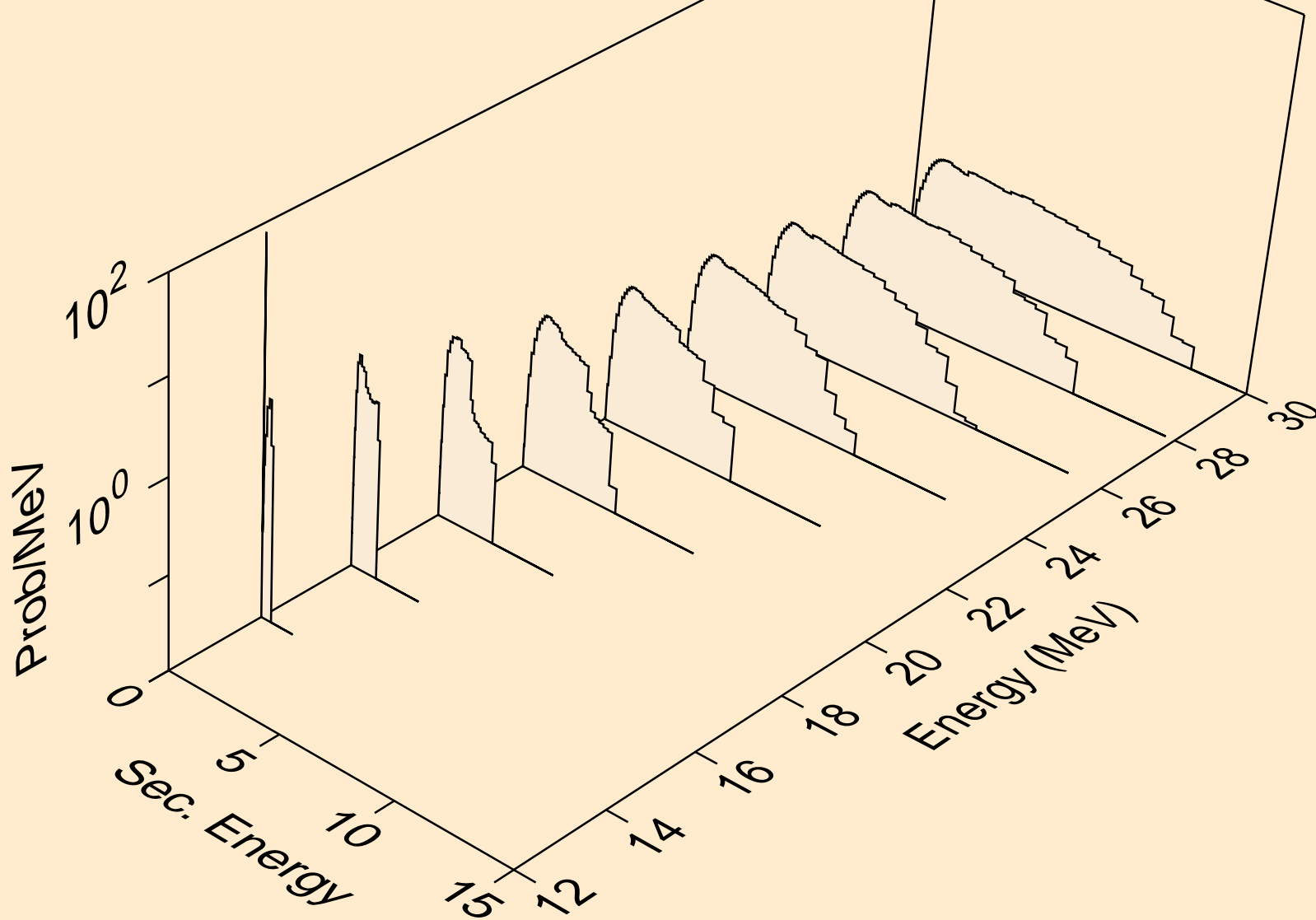

BA117 NEUTRON ACER TENDL-2019 LIBRARY; T=293.16K  
Neutron emission for (n,3np)

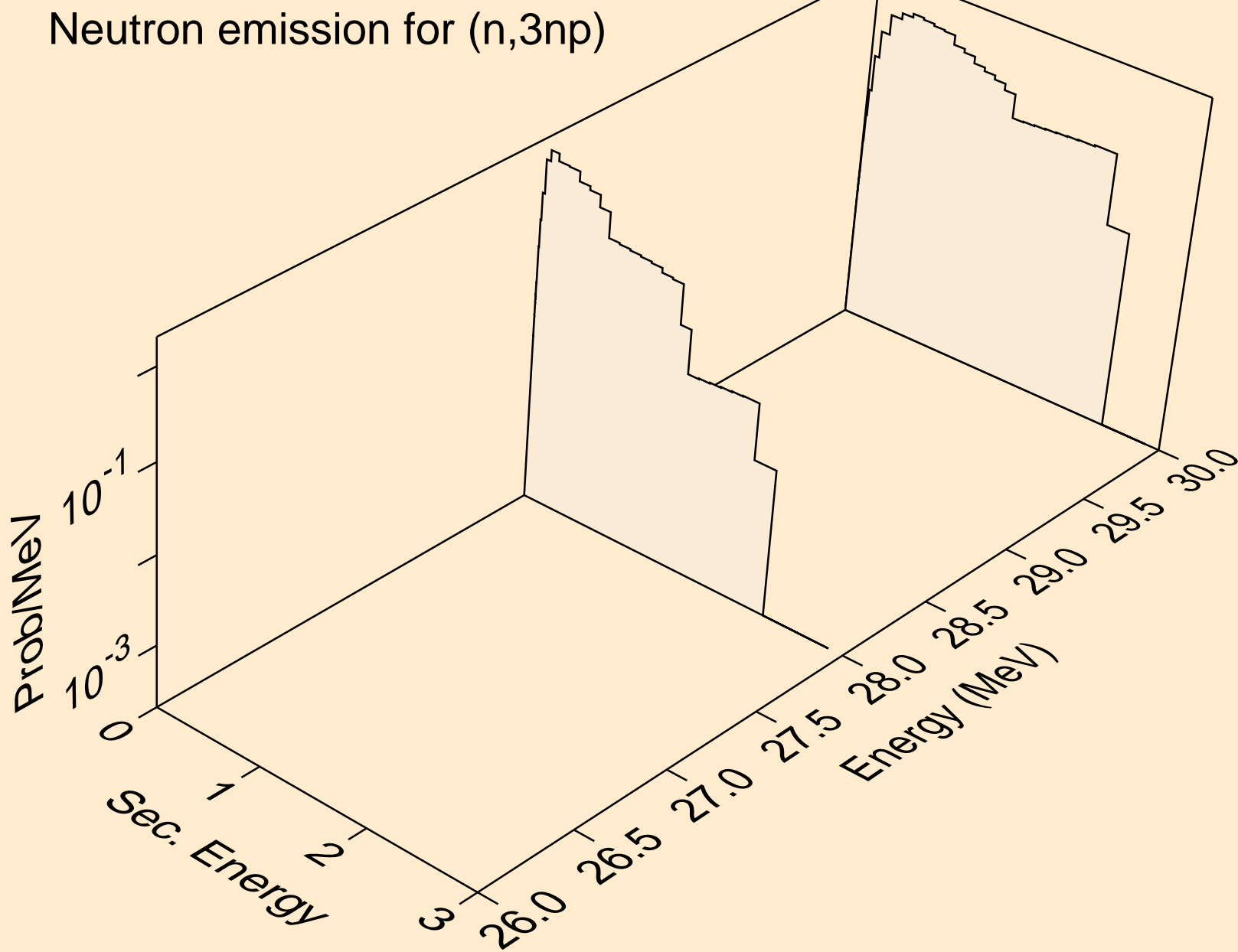

BA117 NEUTRON ACER TENDL-2019 LIBRARY; T=293.16K  
Neutron emission for (n,2np)

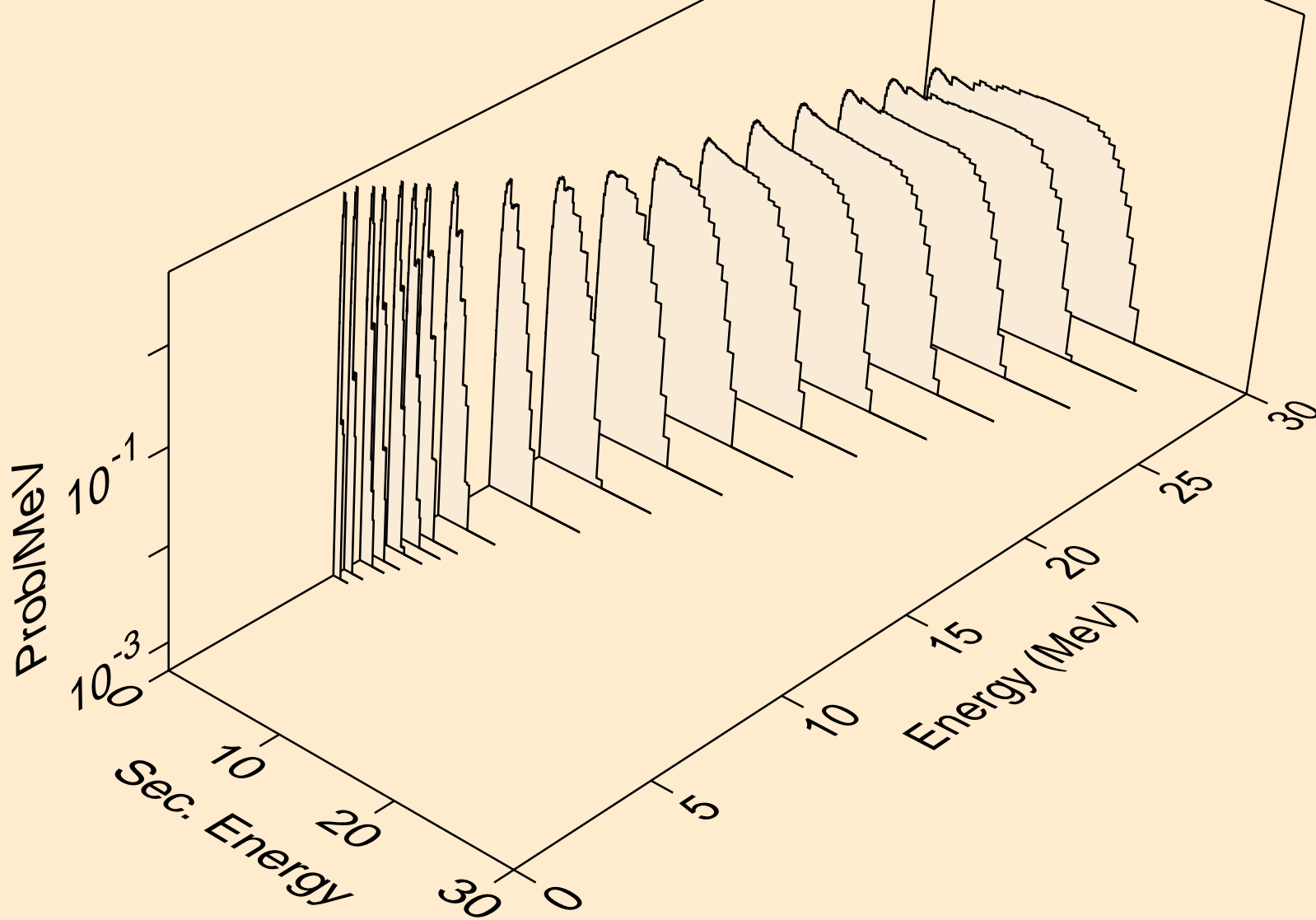

BA117 NEUTRON ACER TENDL-2019 LIBRARY; T=293.16K  
Neutron emission for (n,npa)

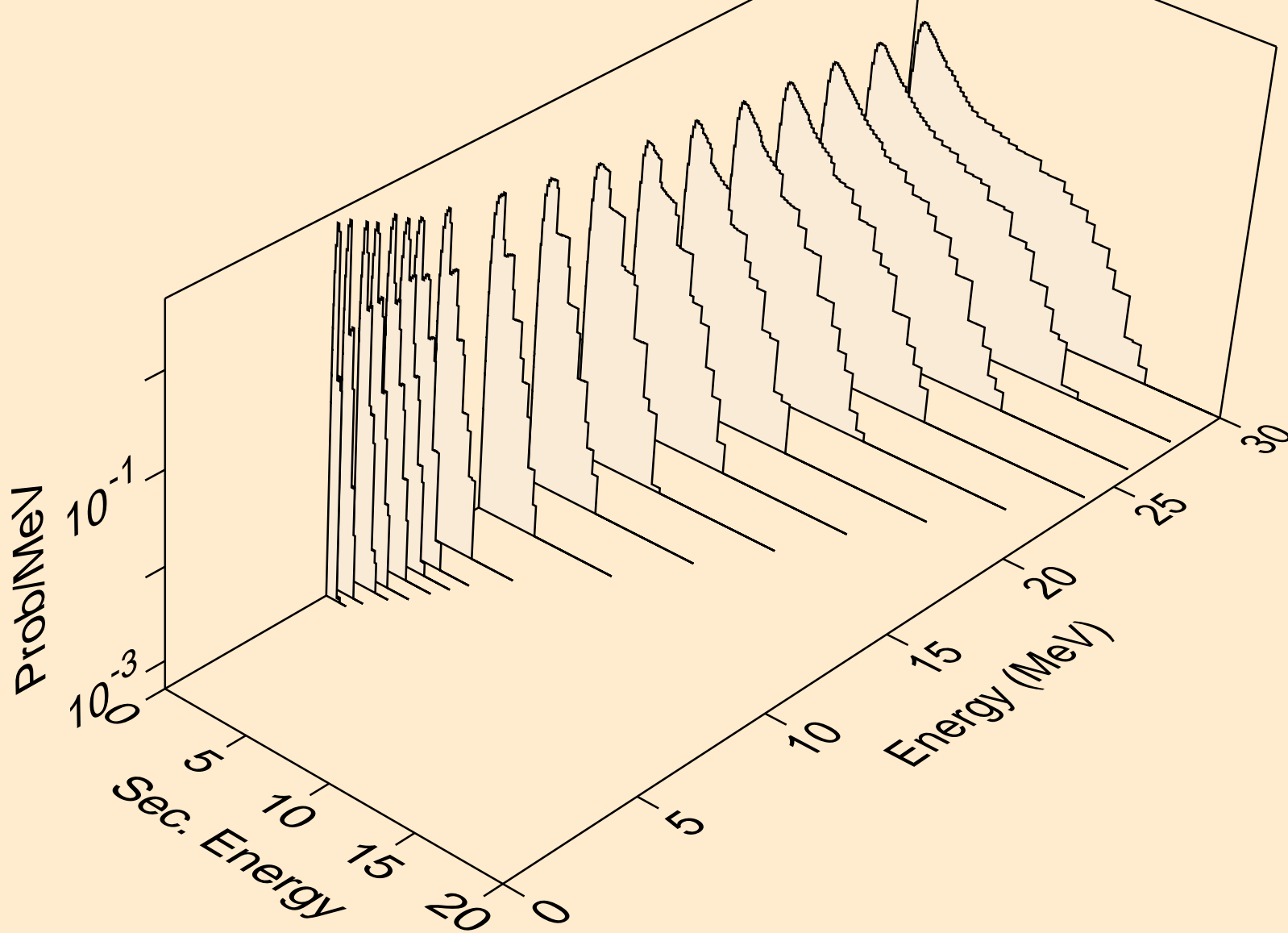

BA117 NEUTRON ACER TENDL-2019 LIBRARY; T=293.16K  
Neutron emission for (n,n\*c)

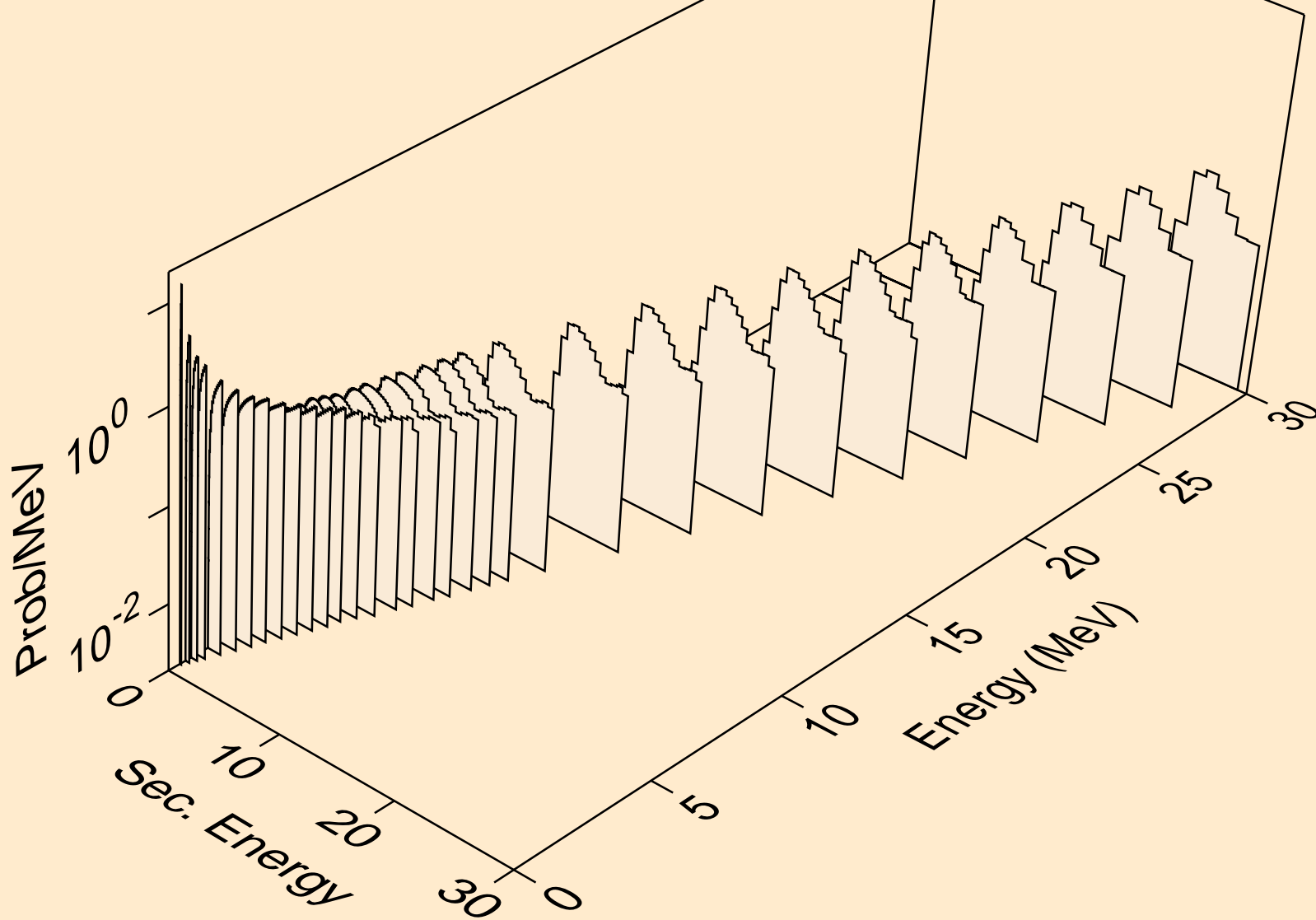

BA117 NEUTRON ACER TENDL-2019 LIBRARY; T=293.16K  
Photon emission for (n,x)

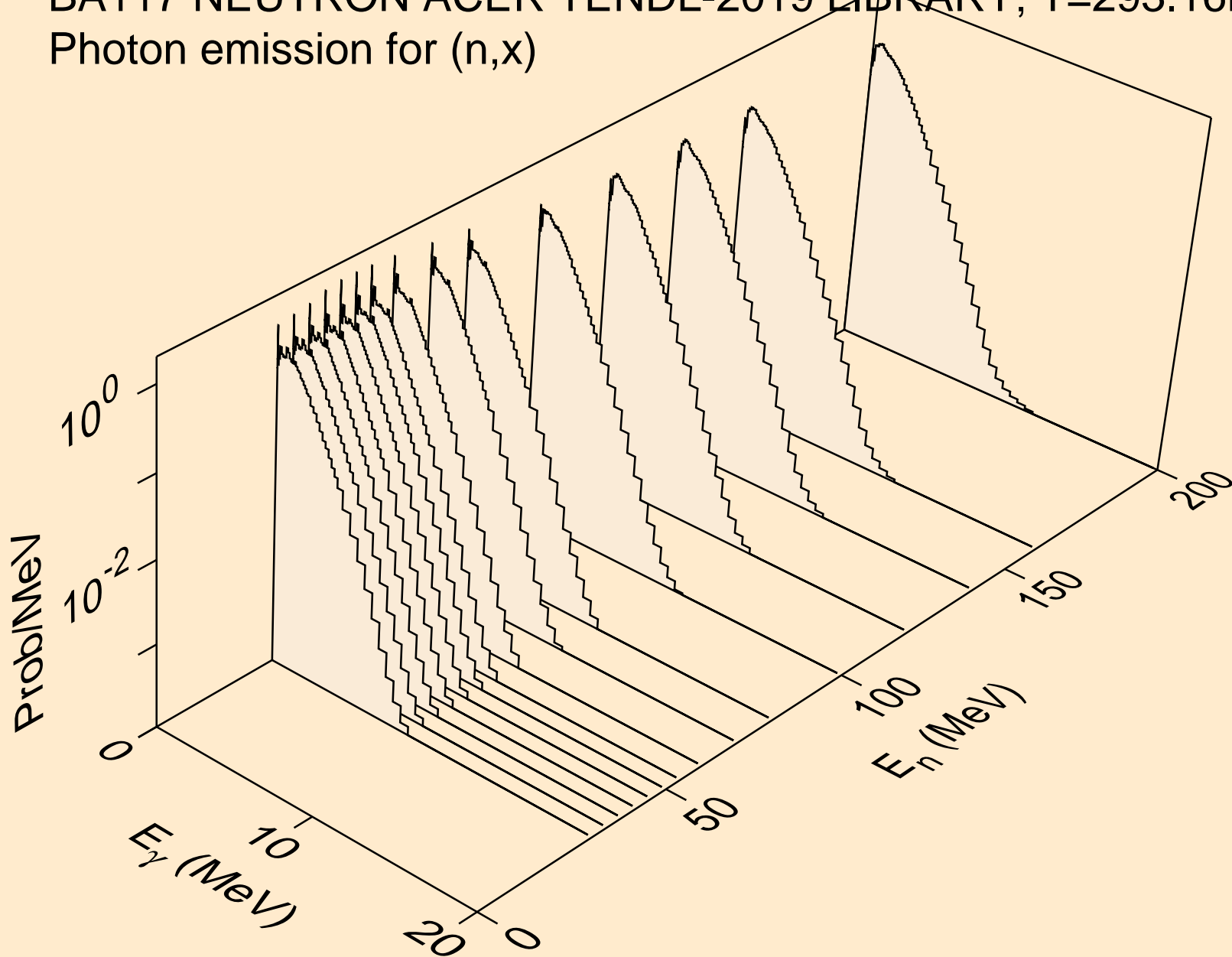



BA117 NEUTRON ACER TENDL-2019 LIBRARY; T=293.16K  
Photon emission for (n,2n)

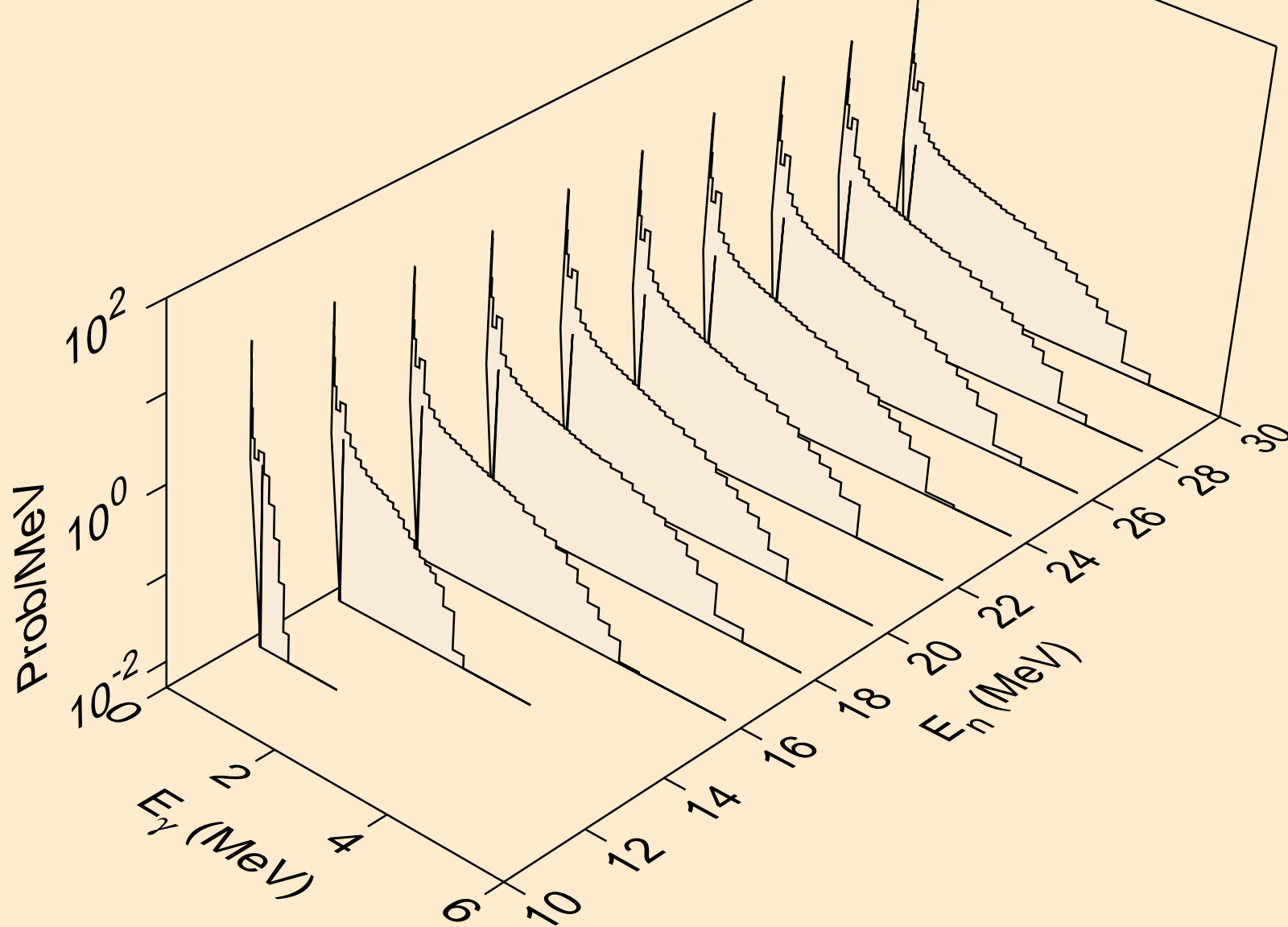

BA117 NEUTRON ACER TENDL-2019 LIBRARY; T=293.16K  
Photon emission for (n,3n)

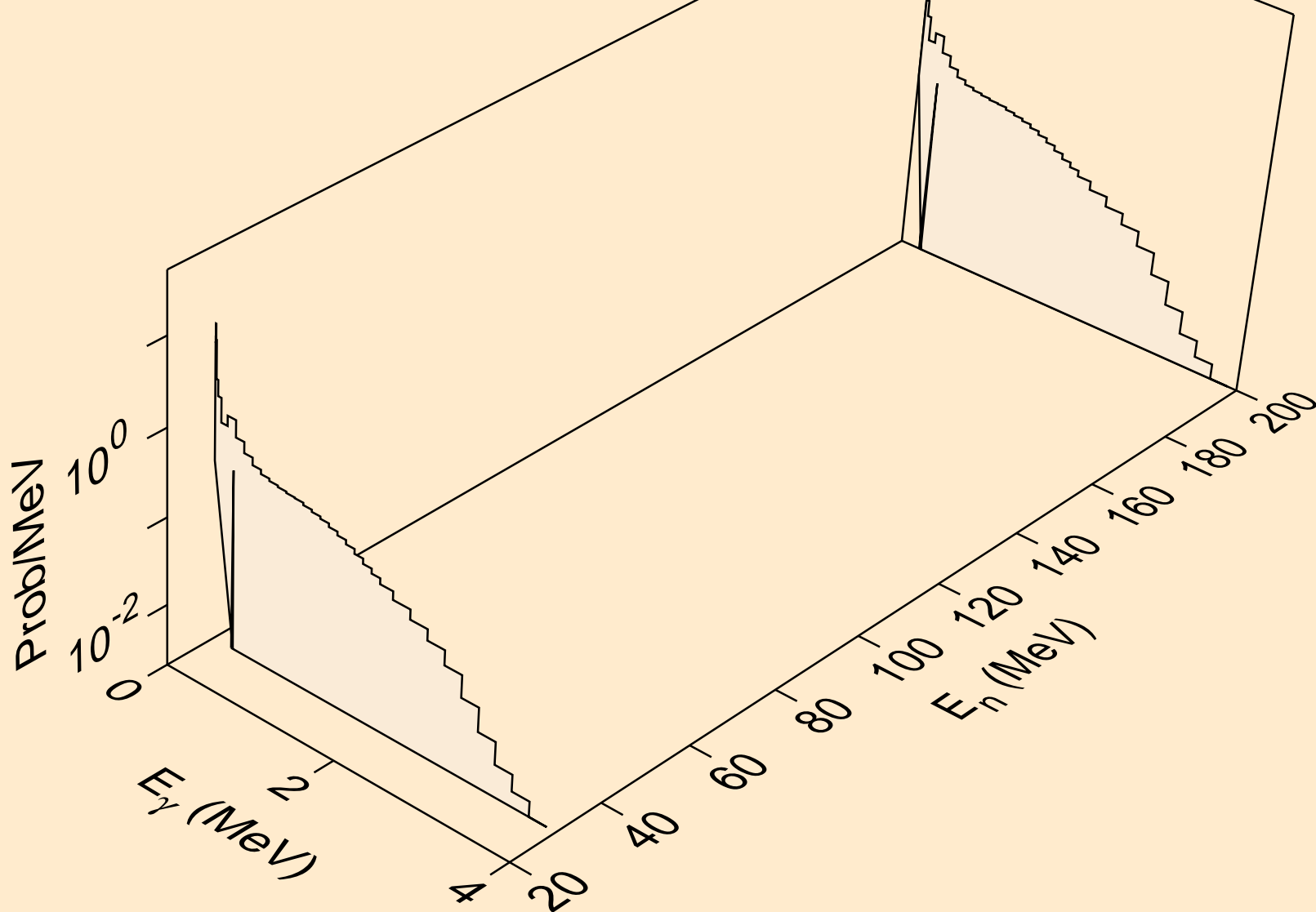

BA117 NEUTRON ACER TENDL-2019 LIBRARY; T=293.16K  
Photon emission for (n,n\*)a

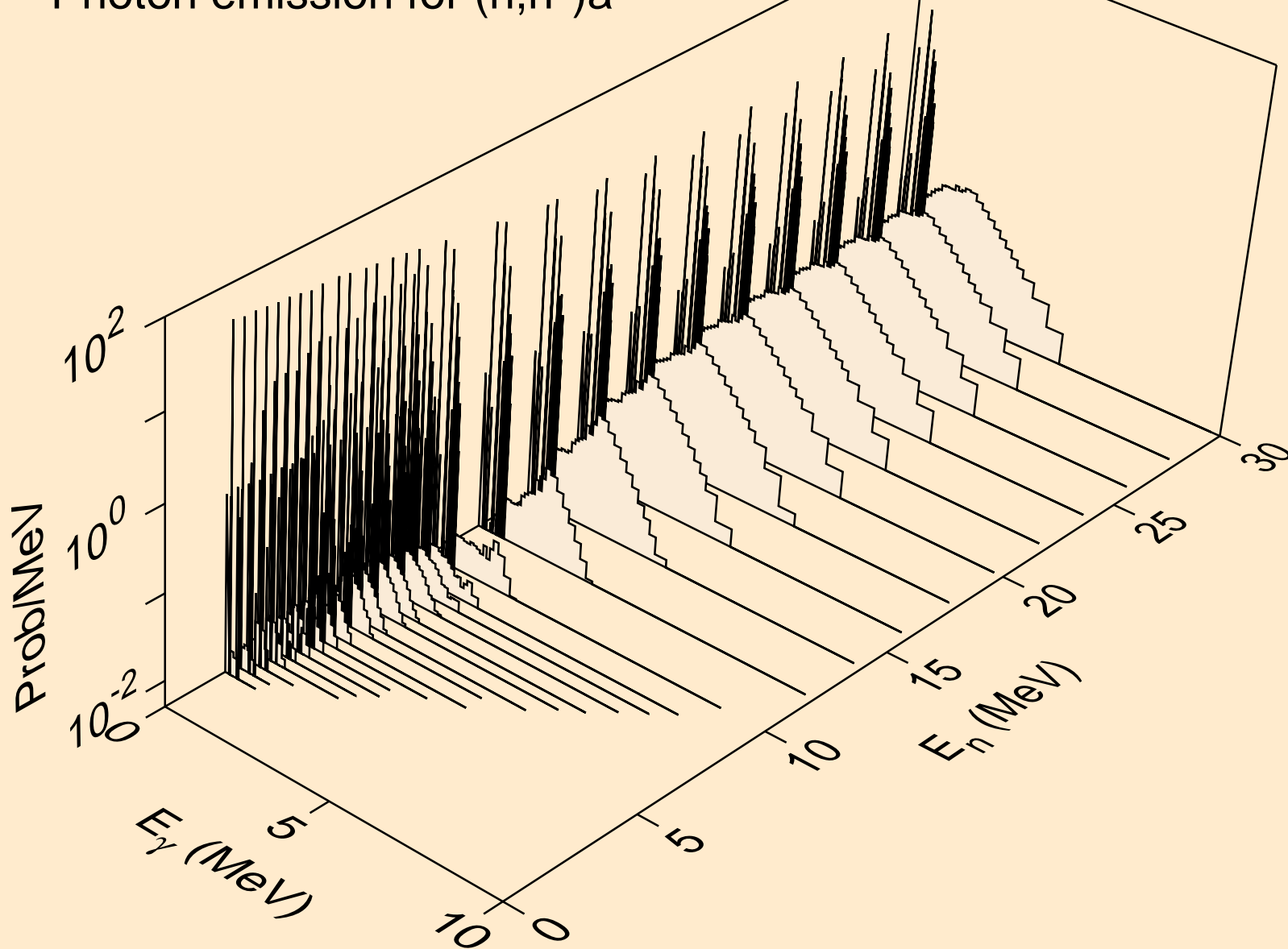

BA117 NEUTRON ACER TENDL-2019 LIBRARY; T=293.16K  
Photon emission for (n,n\*)3a

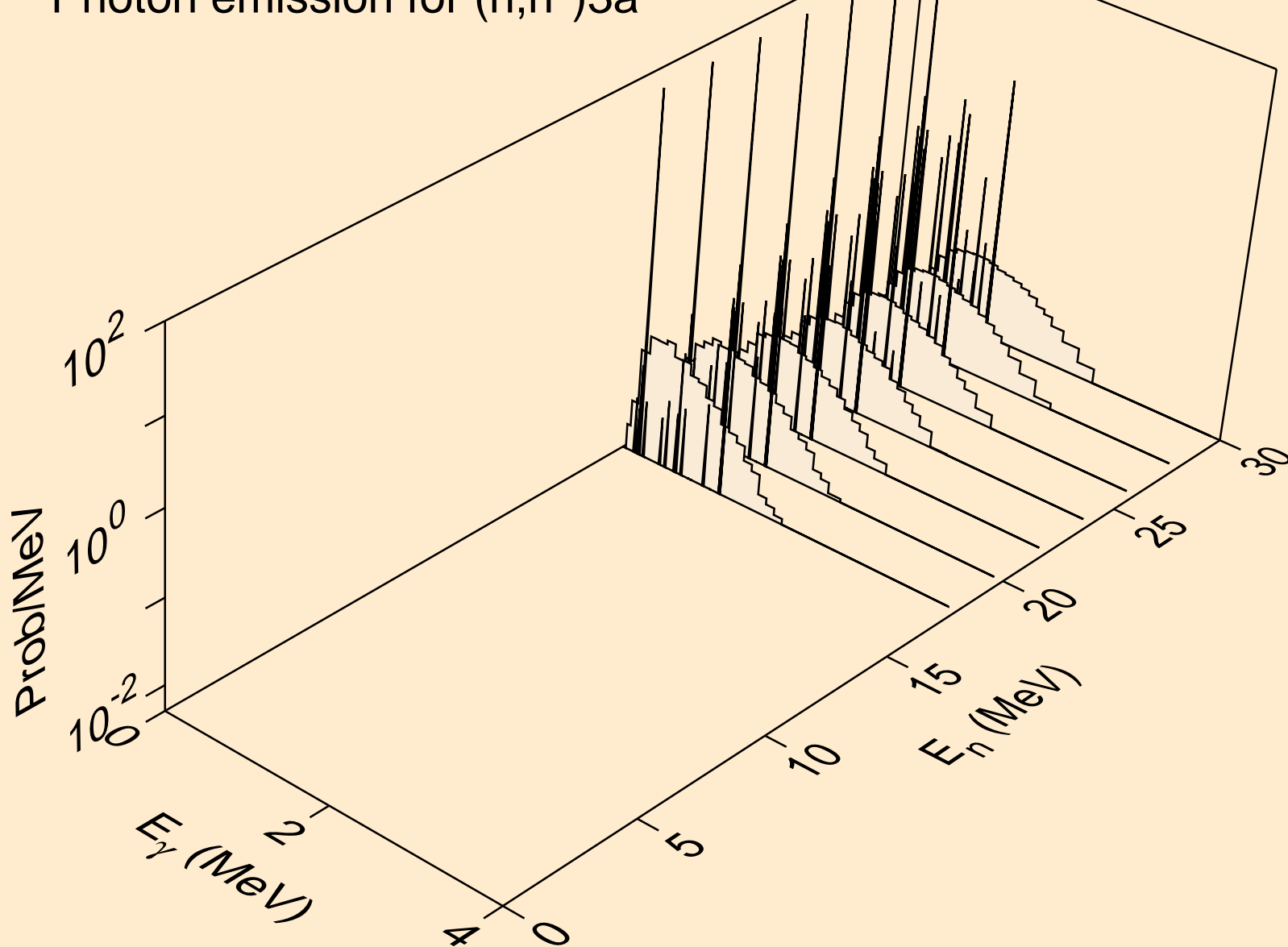

BA117 NEUTRON ACER TENDL-2019 LIBRARY; T=293.16K  
Photon emission for (n,2n)a

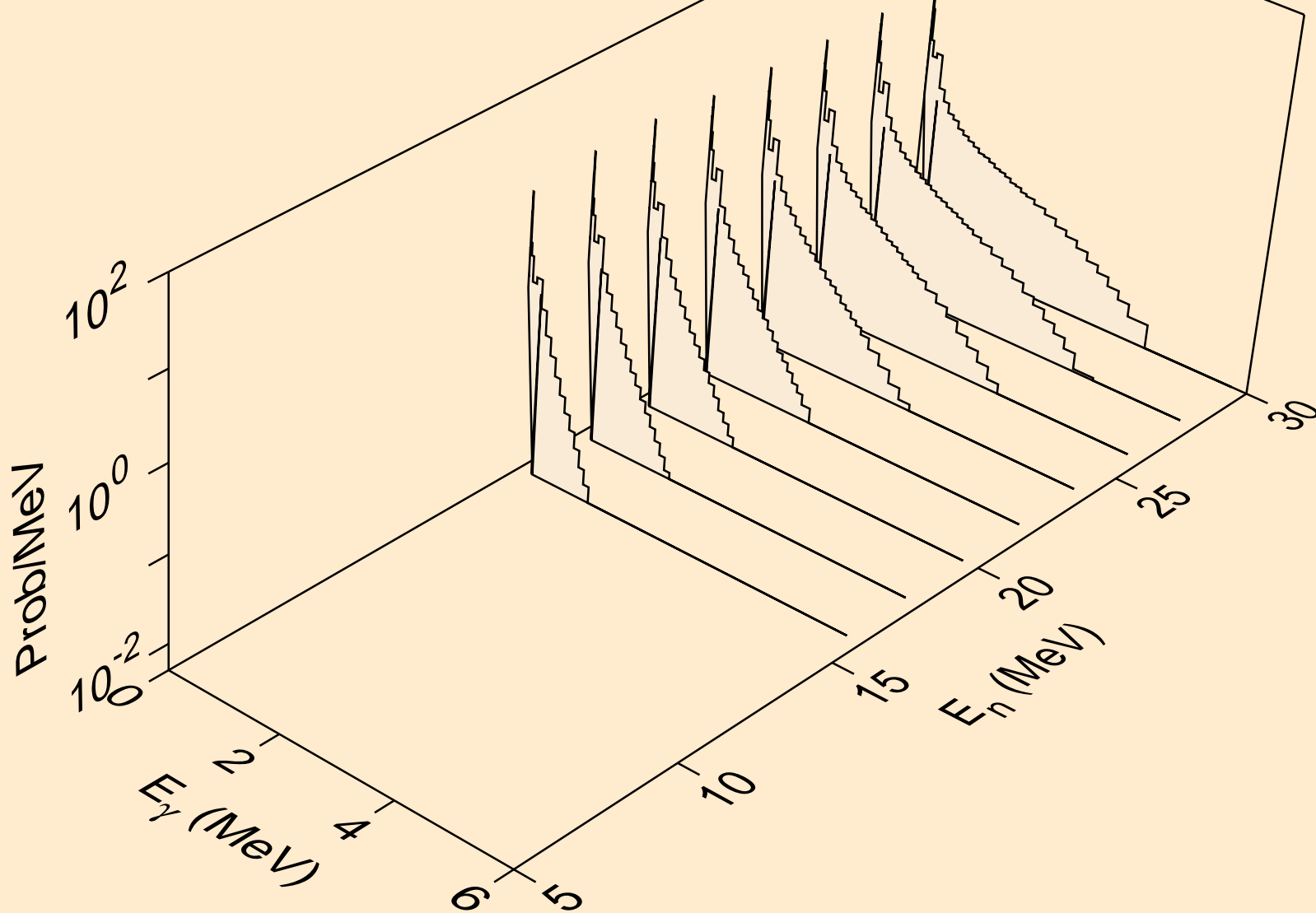

BA117 NEUTRON ACER TENDL-2019 LIBRARY; T=293.16K  
Photon emission for (n,n\*)p

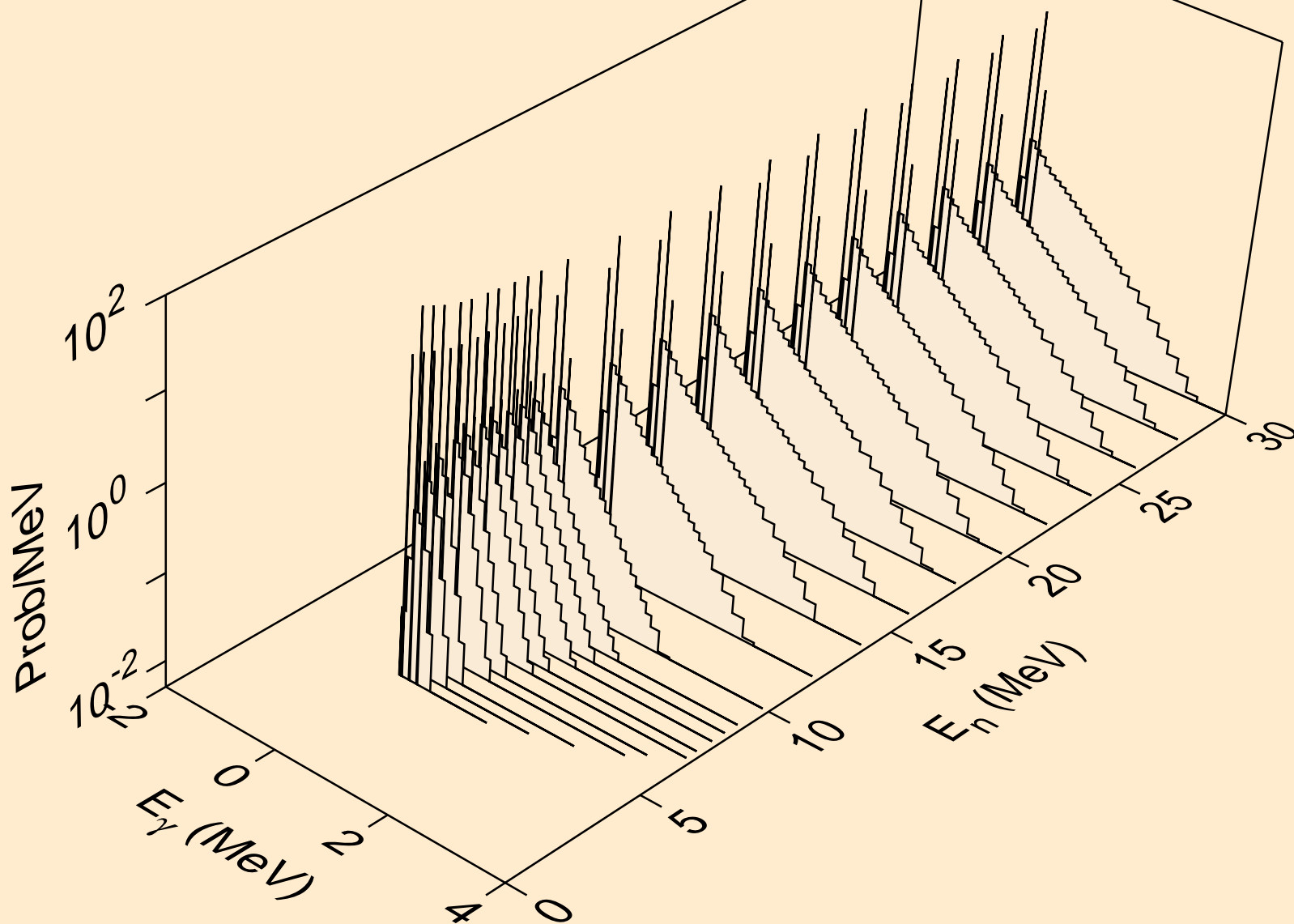

BA117 NEUTRON ACER TENDL-2019 LIBRARY; T=293.16K  
Photon emission for (n,n\*)2a

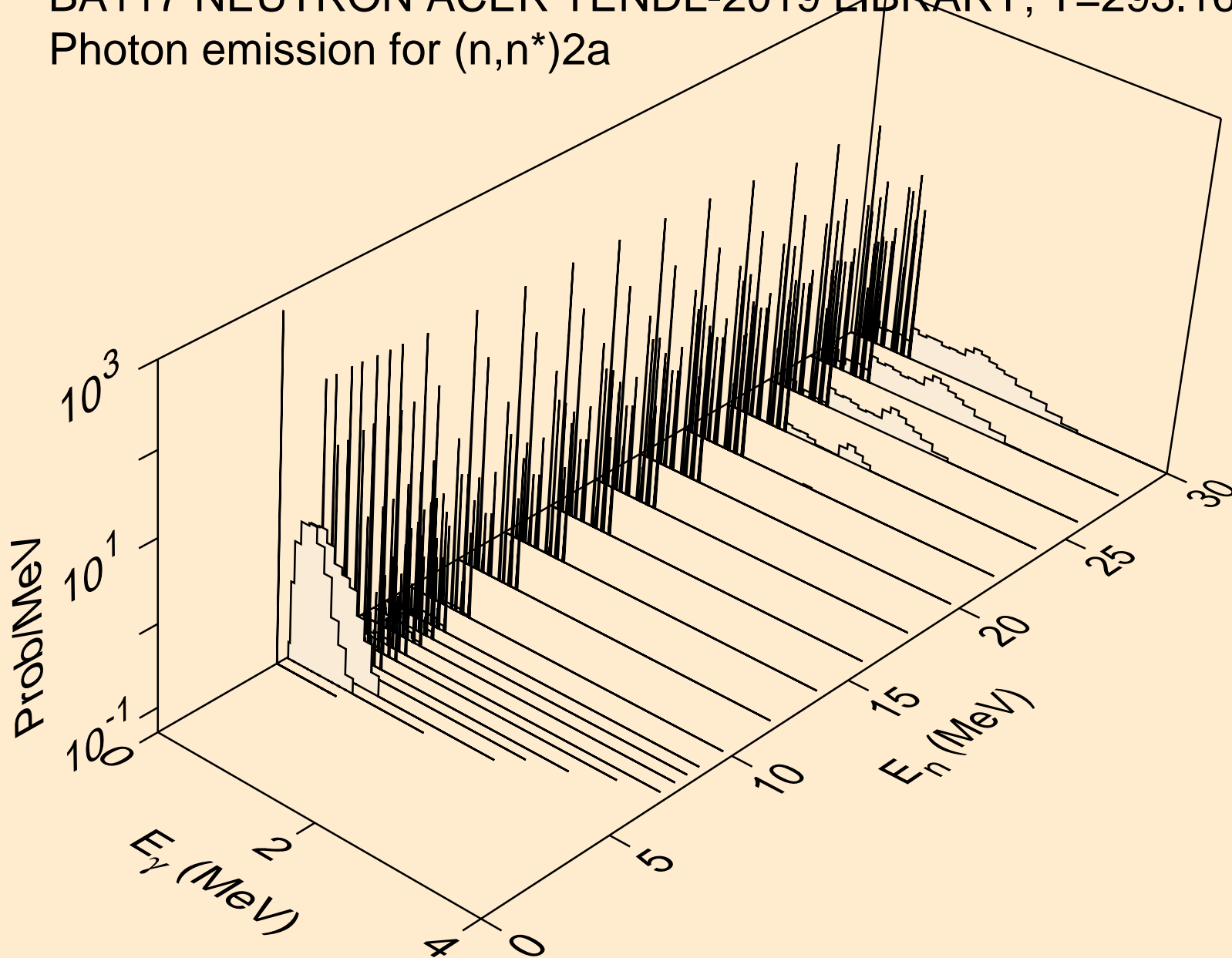

BA117 NEUTRON ACER TENDL-2019 LIBRARY; T=293.16K  
Photon emission for (n,2n)2a

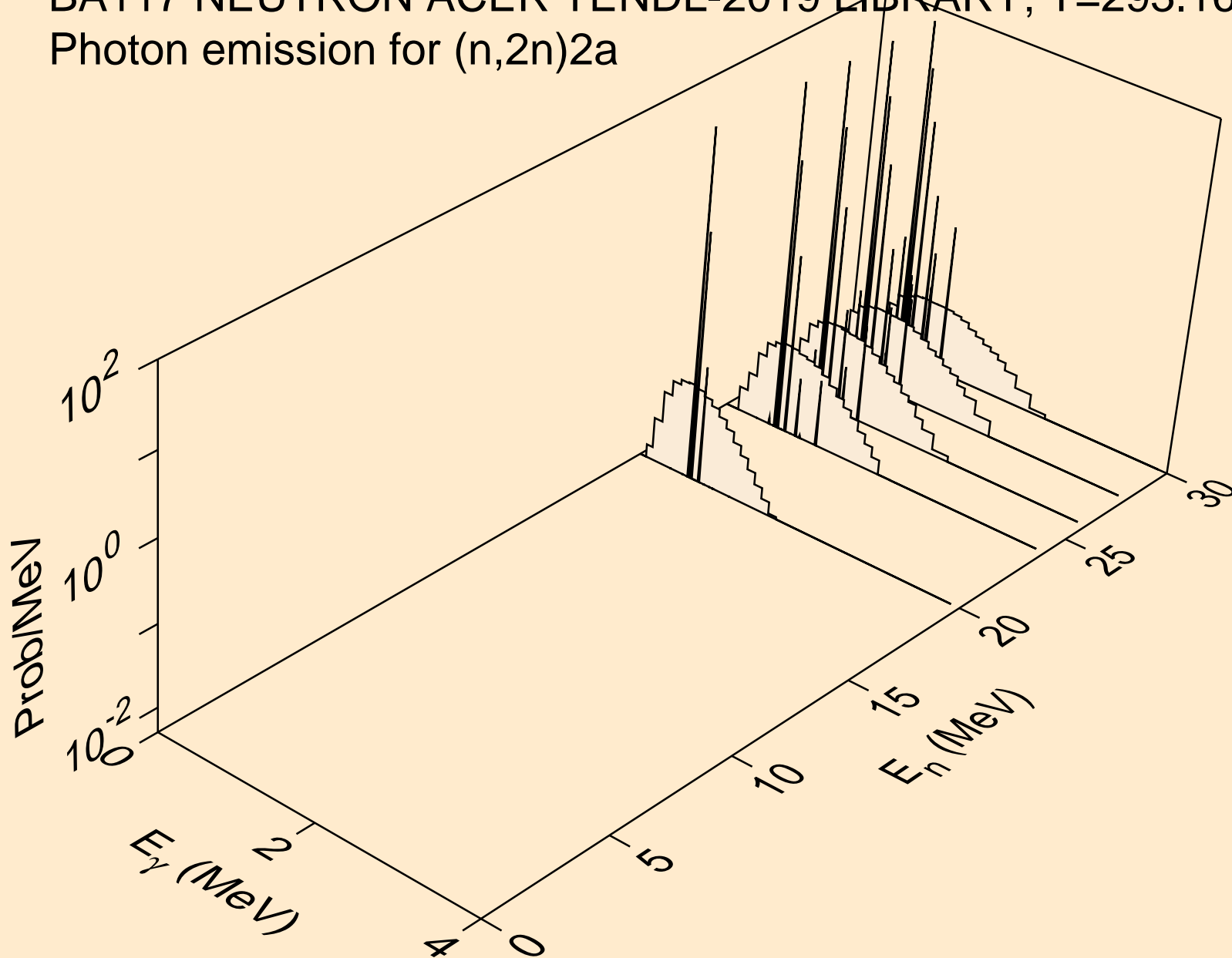



BA117 NEUTRON ACER TENDL-2019 LIBRARY; T=293.16K  
Photon emission for (n,n\*)d

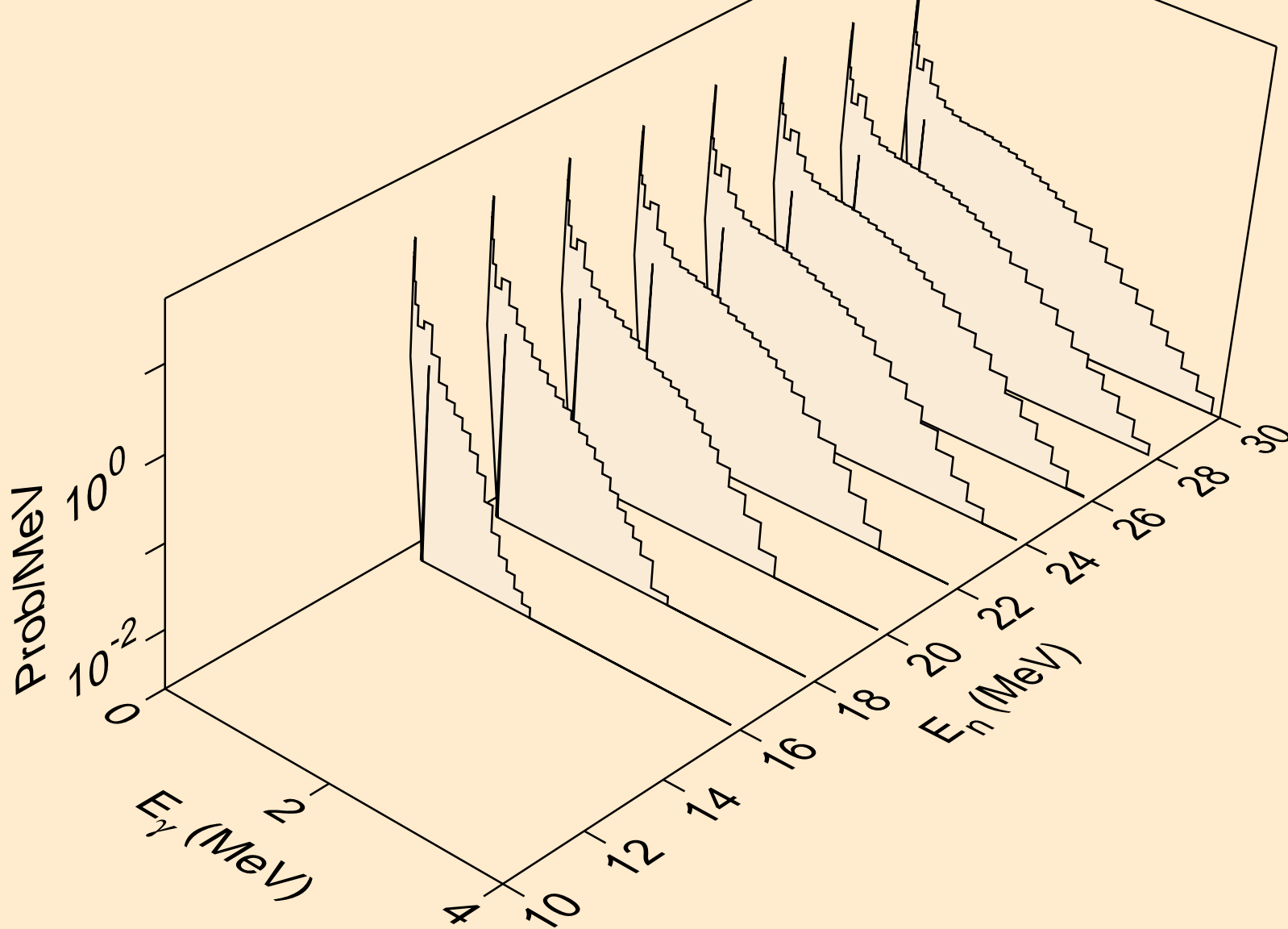

BA117 NEUTRON ACER TENDL-2019 LIBRARY; T=293.16K  
Photon emission for (n,n\*)t

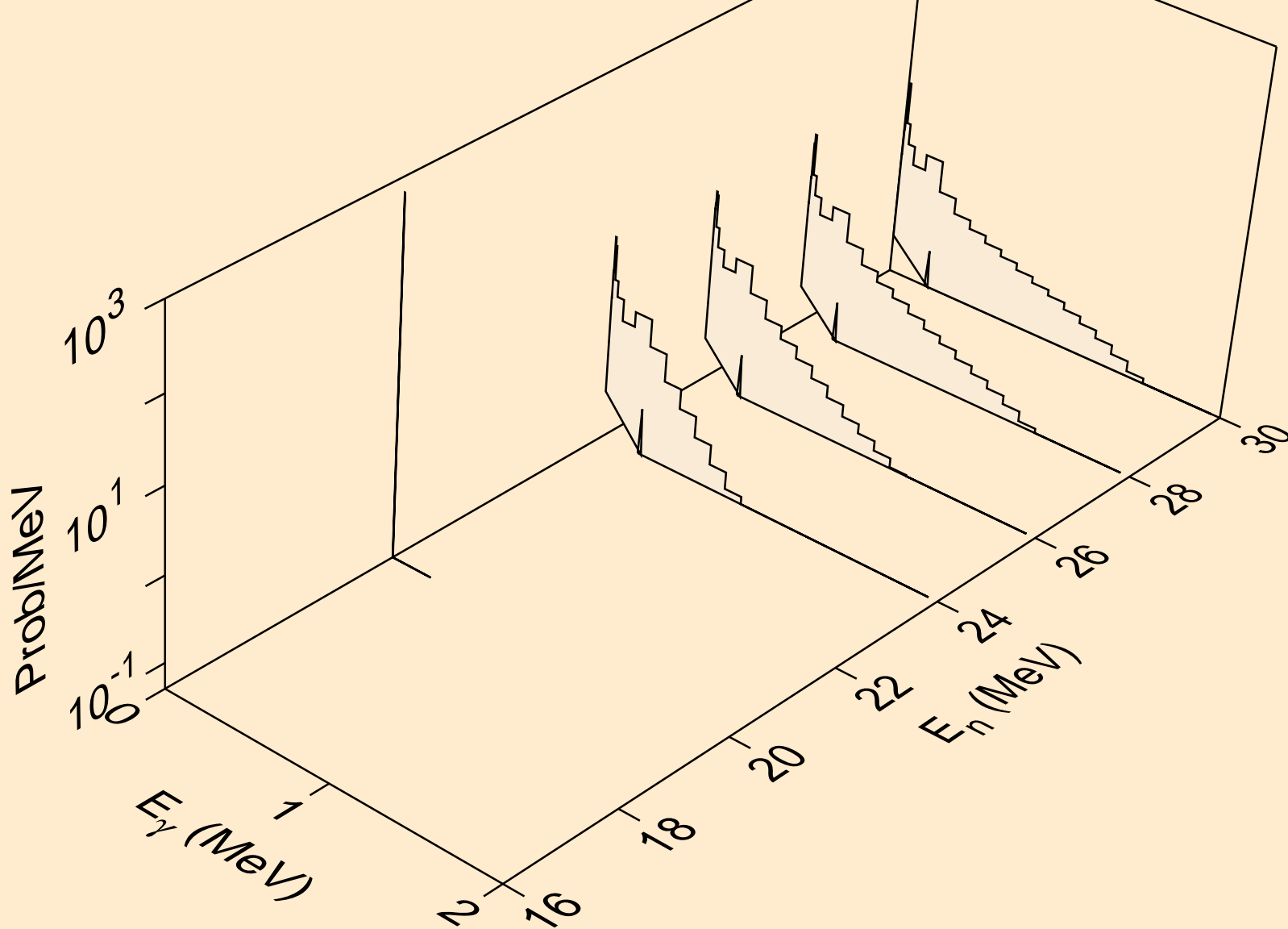

BA117 NEUTRON ACER TENDL-2019 LIBRARY; T=293.16K  
Photon emission for (n,n\*)he3

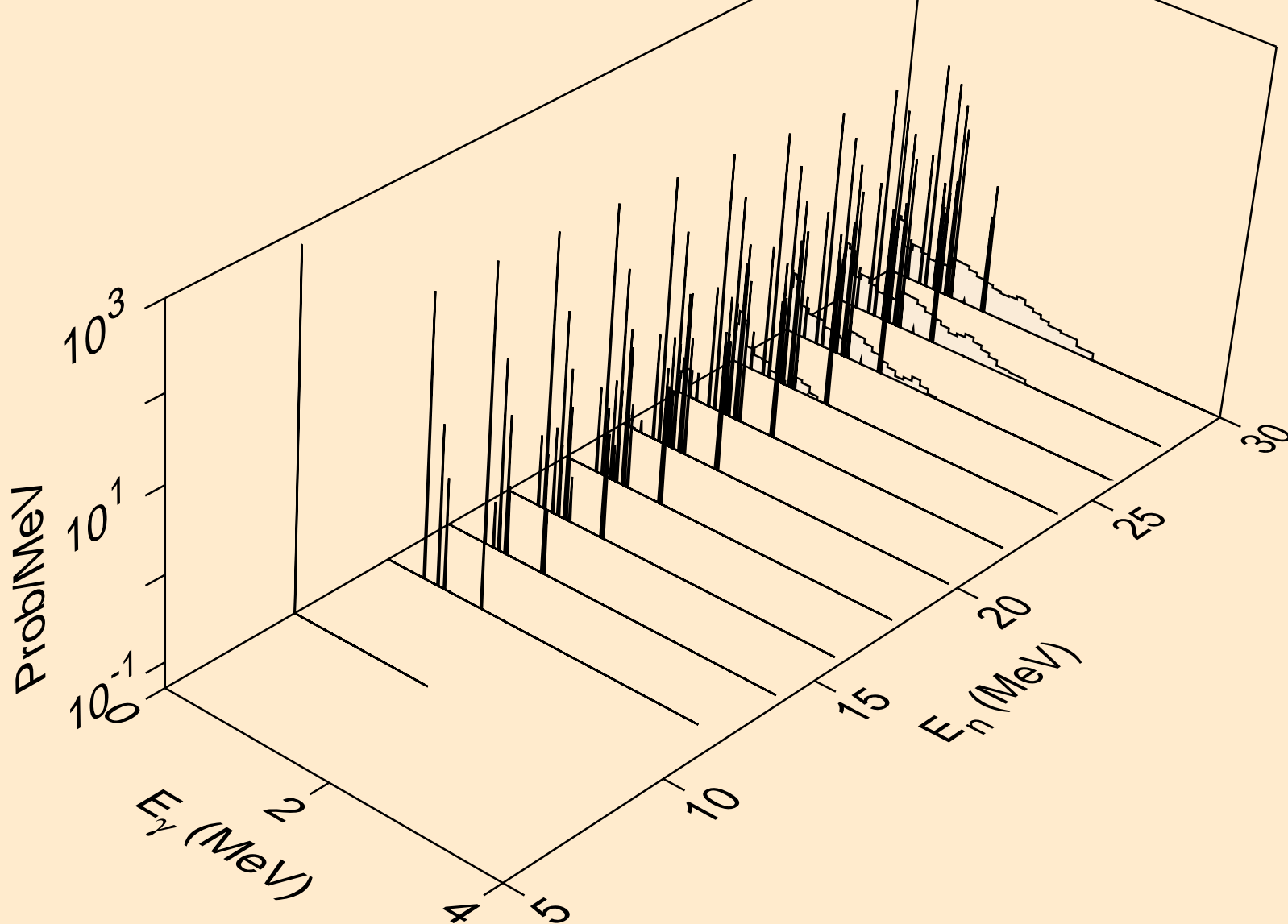

BA117 NEUTRON ACER TENDL-2019 LIBRARY; T=293.16K  
Photon emission for (n,2np)

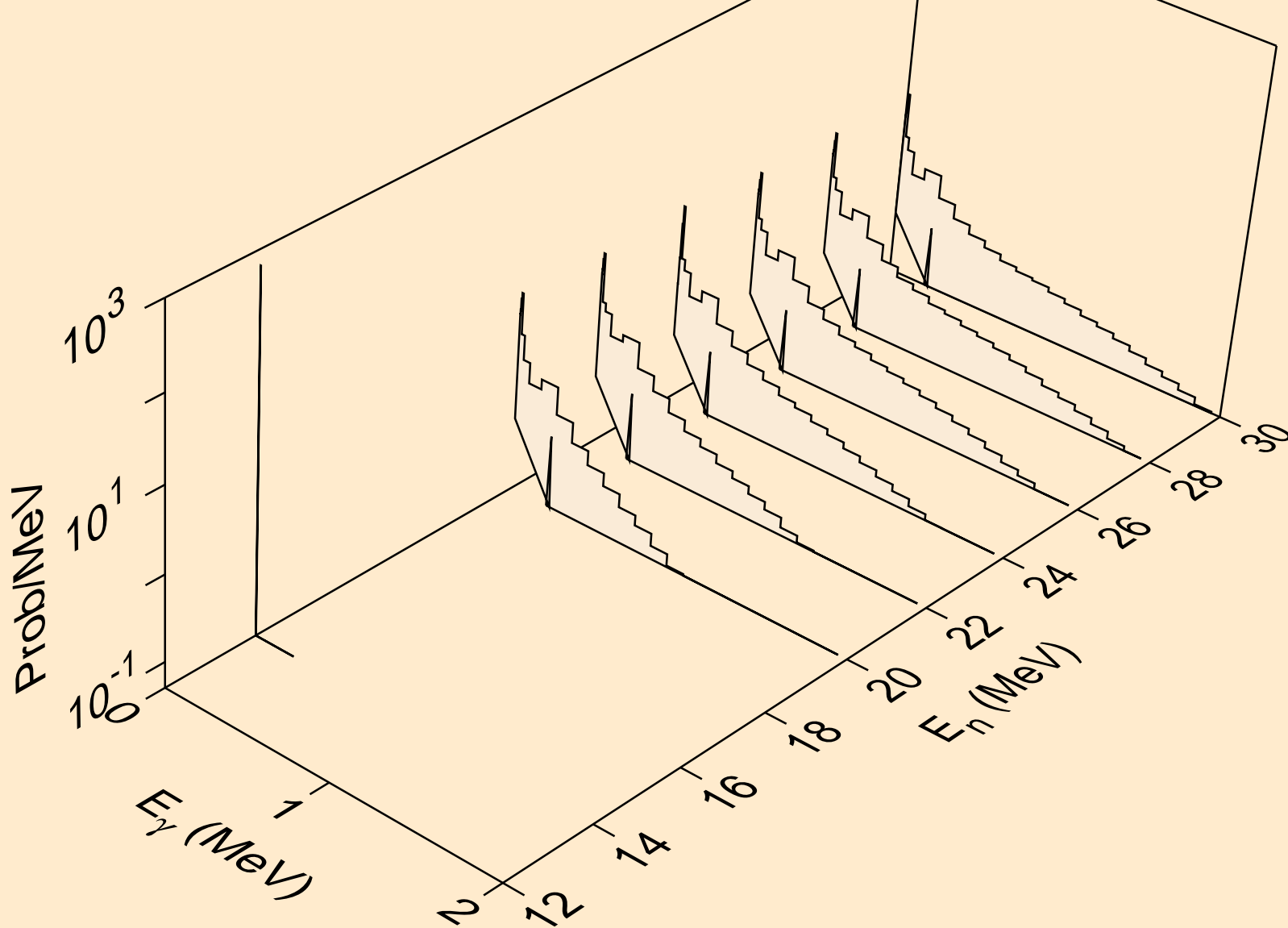

BA117 NEUTRON ACER TENDL-2019 LIBRARY; T=293.16K  
Photon emission for (n,3np)

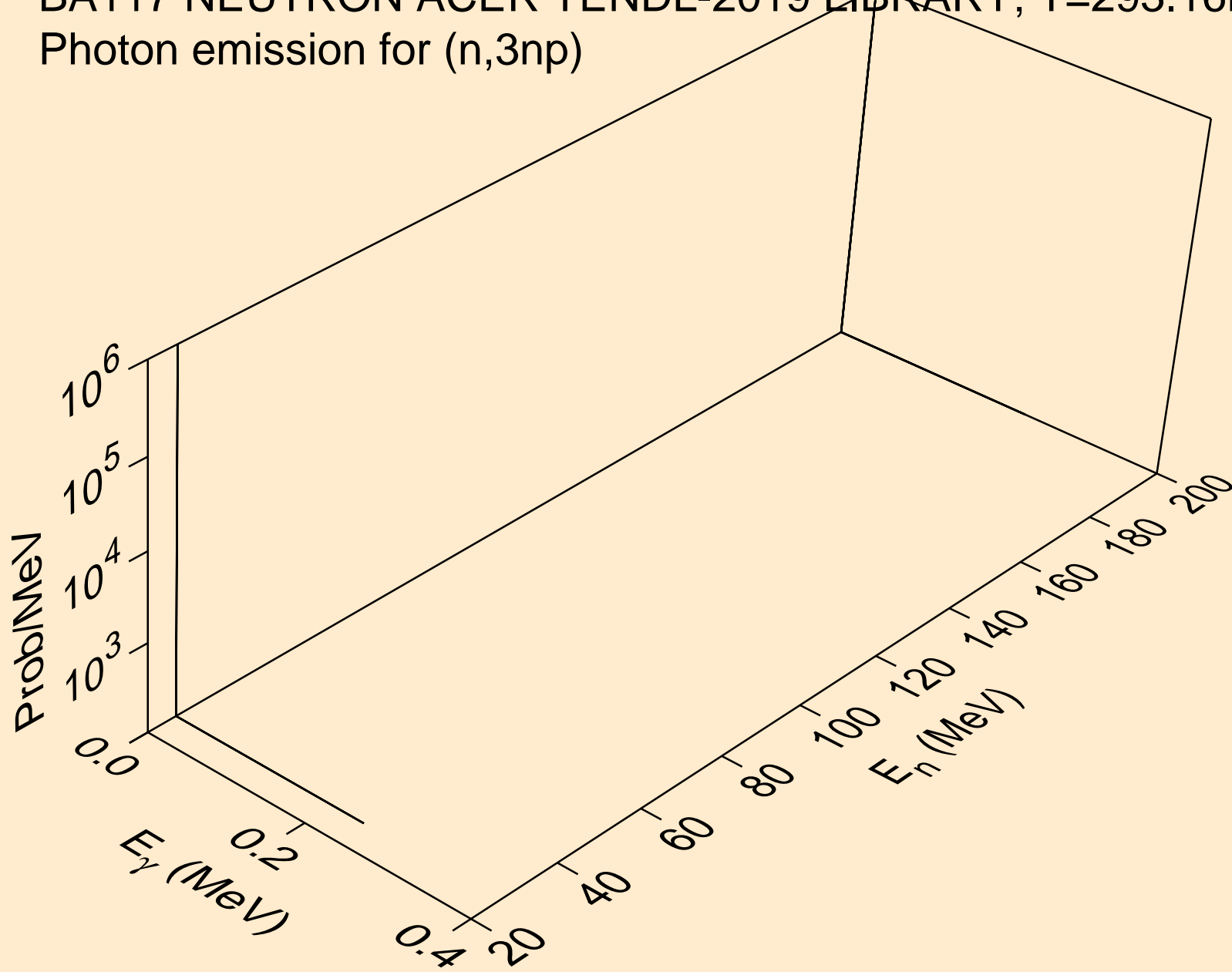

BA117 NEUTRON ACER TENDL-2019 LIBRARY; T=293.16K  
Photon emission for (n,2np)

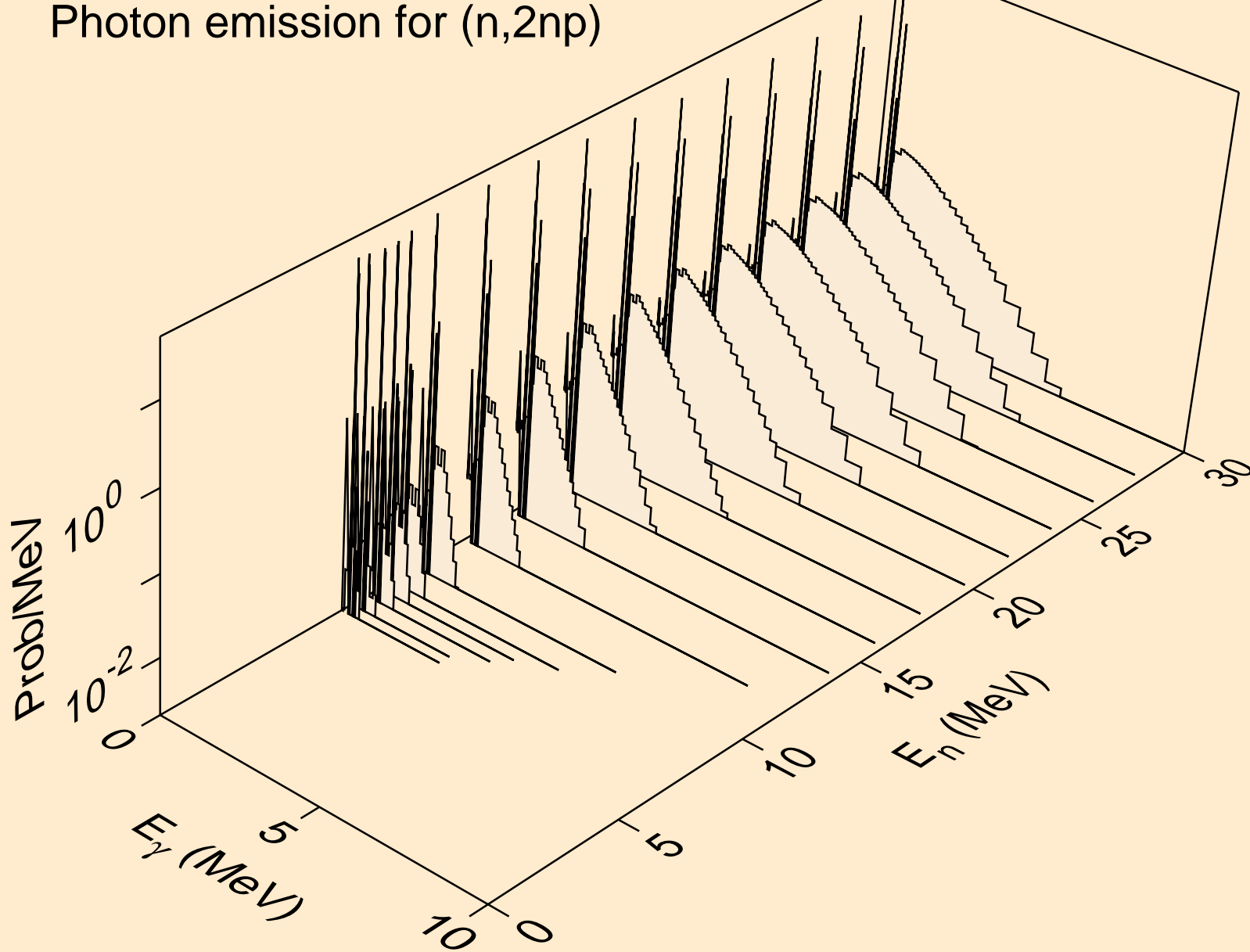

BA117 NEUTRON ACER TENDL-2019 LIBRARY; T=293.16K  
Photon emission for (n,npa)

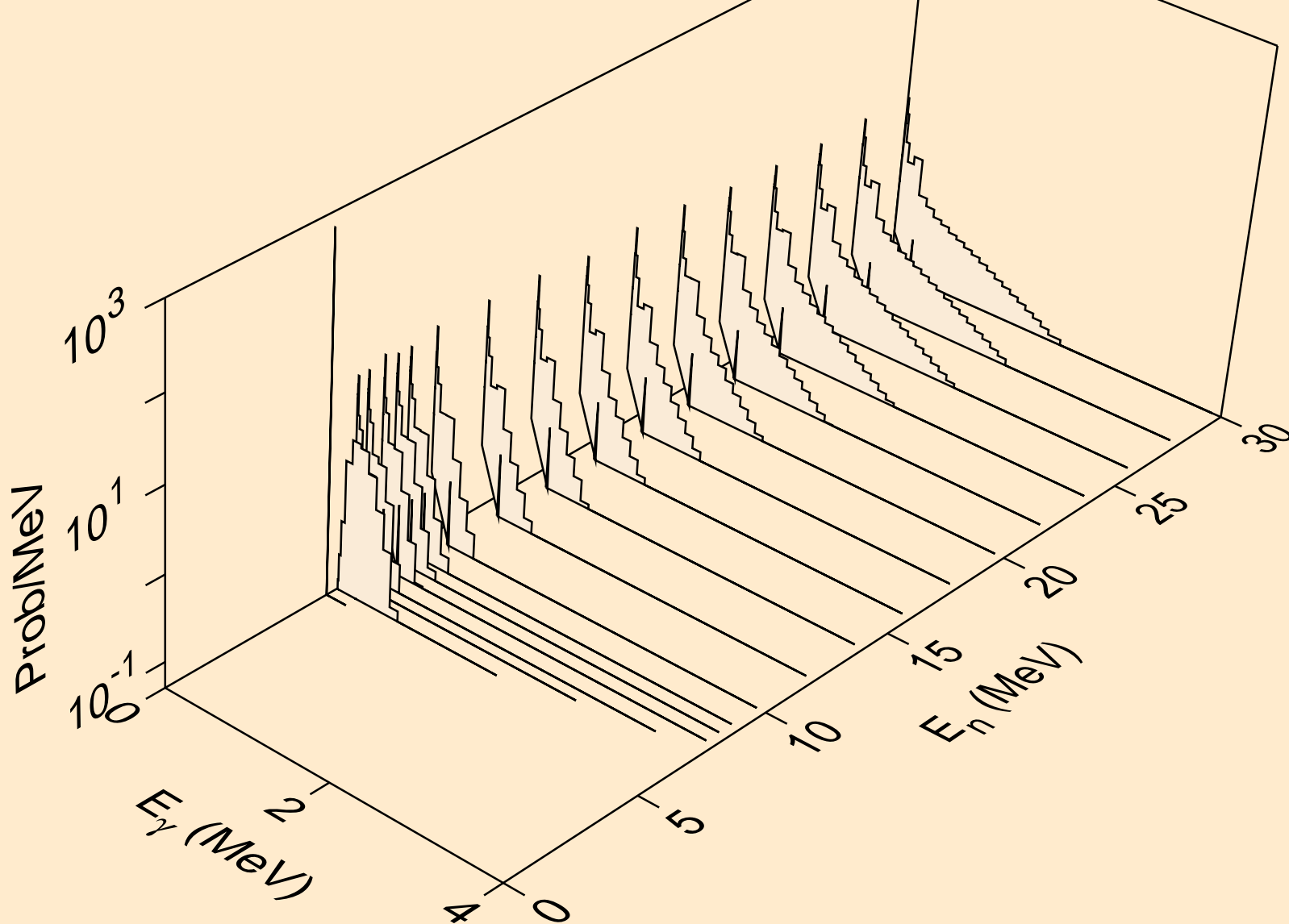

BA117 NEUTRON ACER TENDL-2019 LIBRARY; T=293.16K  
Photon emission for (n,n\*c)

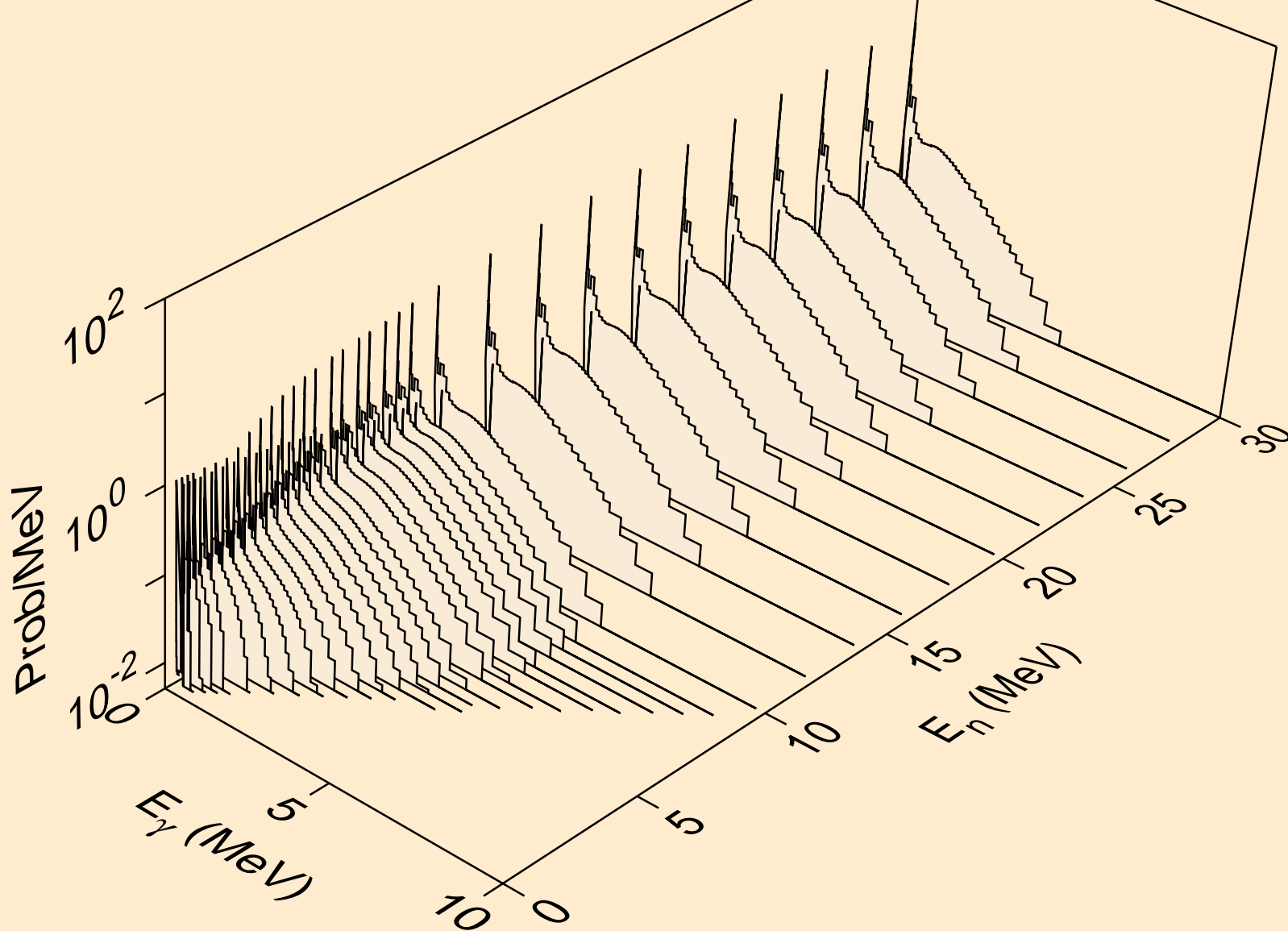



BA117 NEUTRON ACER TENDL-2019 LIBRARY; T=293.16K  
Photon emission for (n,gma)

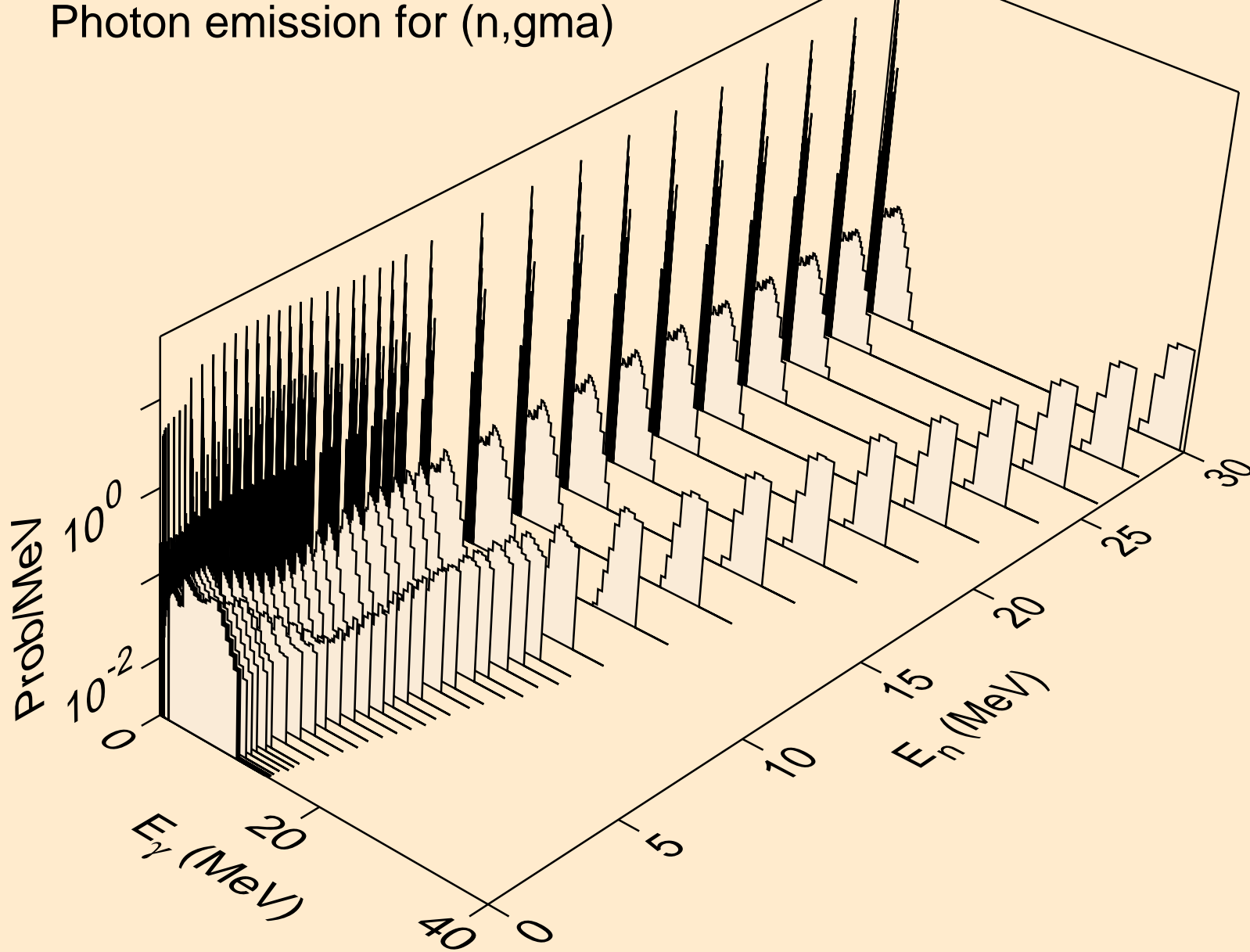

BA117 NEUTRON ACER TENDL-2019 LIBRARY; T=293.16K  
Photon emission for (n,p)

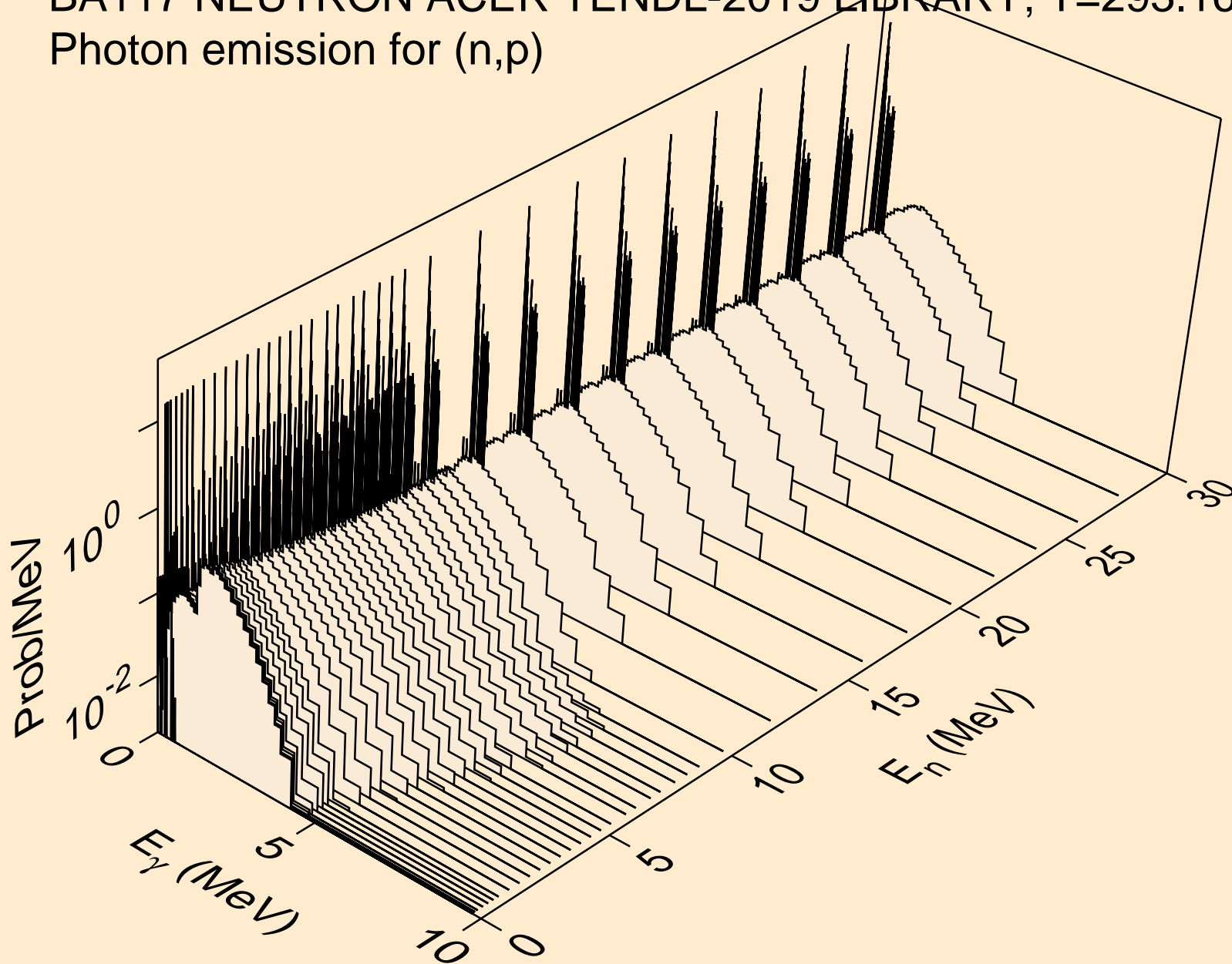

BA117 NEUTRON ACER TENDL-2019 LIBRARY; T=293.16K  
Photon emission for (n,d)

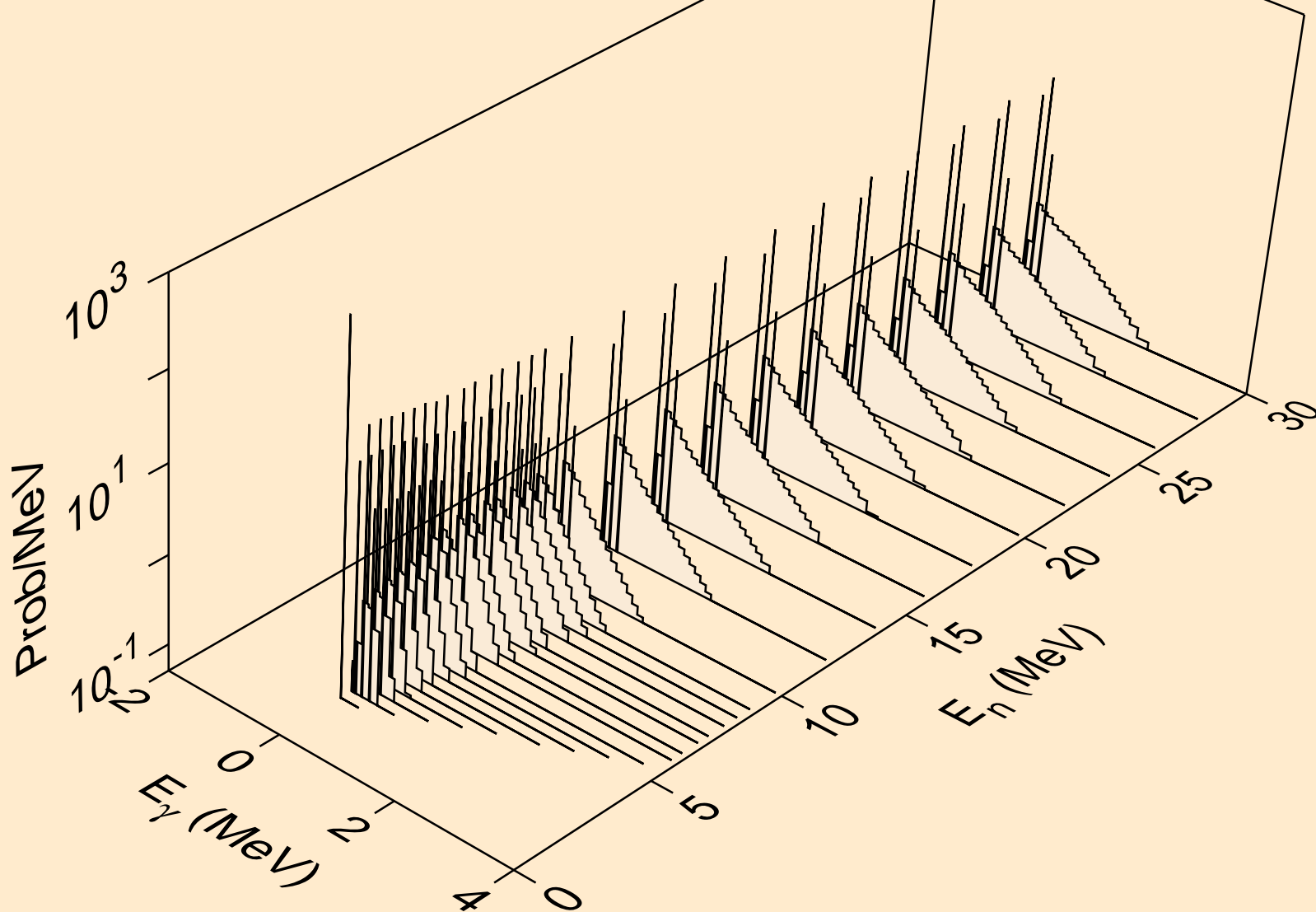

BA117 NEUTRON ACER TENDL-2019 LIBRARY; T=293.16K  
Photon emission for (n,t)

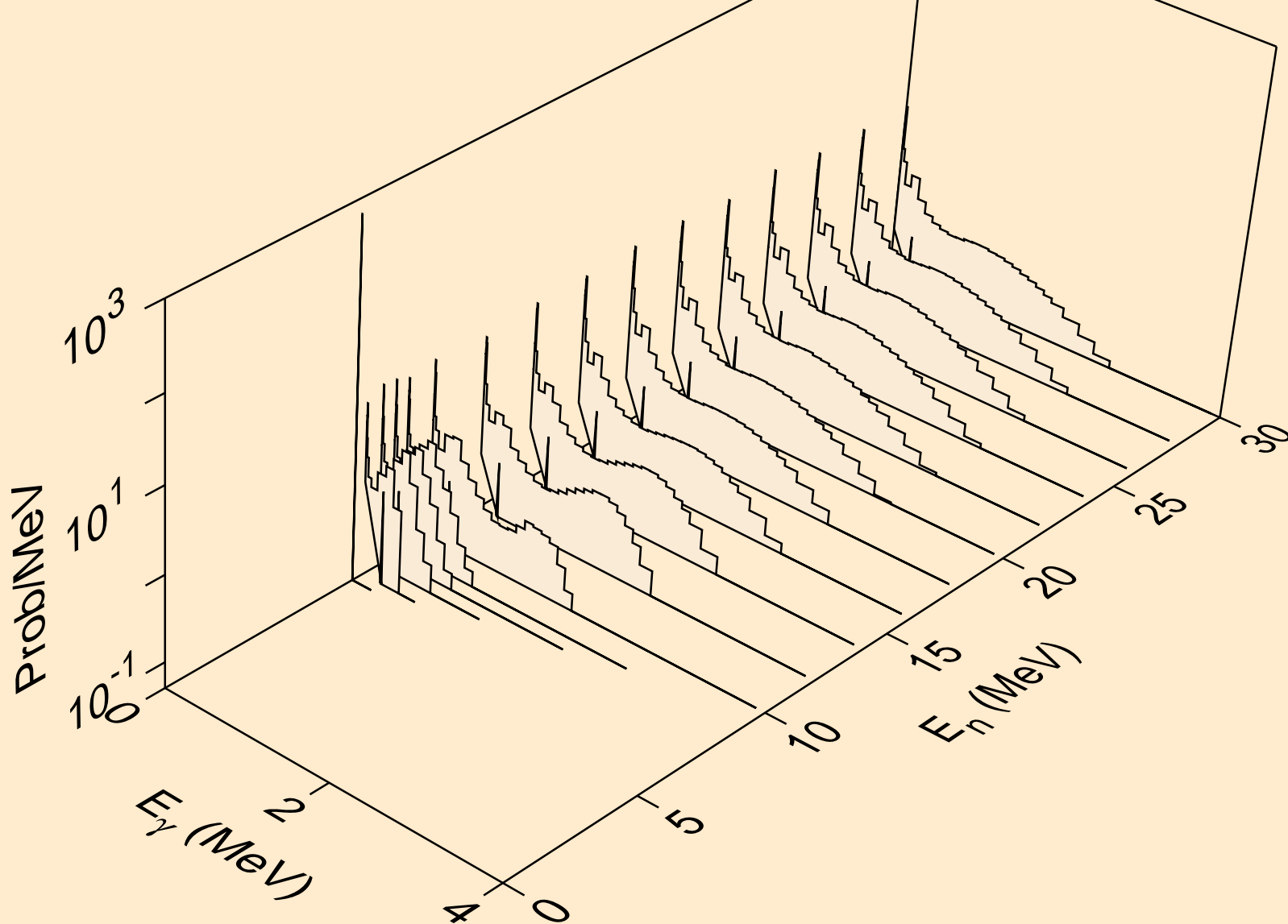

BA117 NEUTRON ACER TENDL-2019 LIBRARY; T=293.16K  
Photon emission for (n,he3)

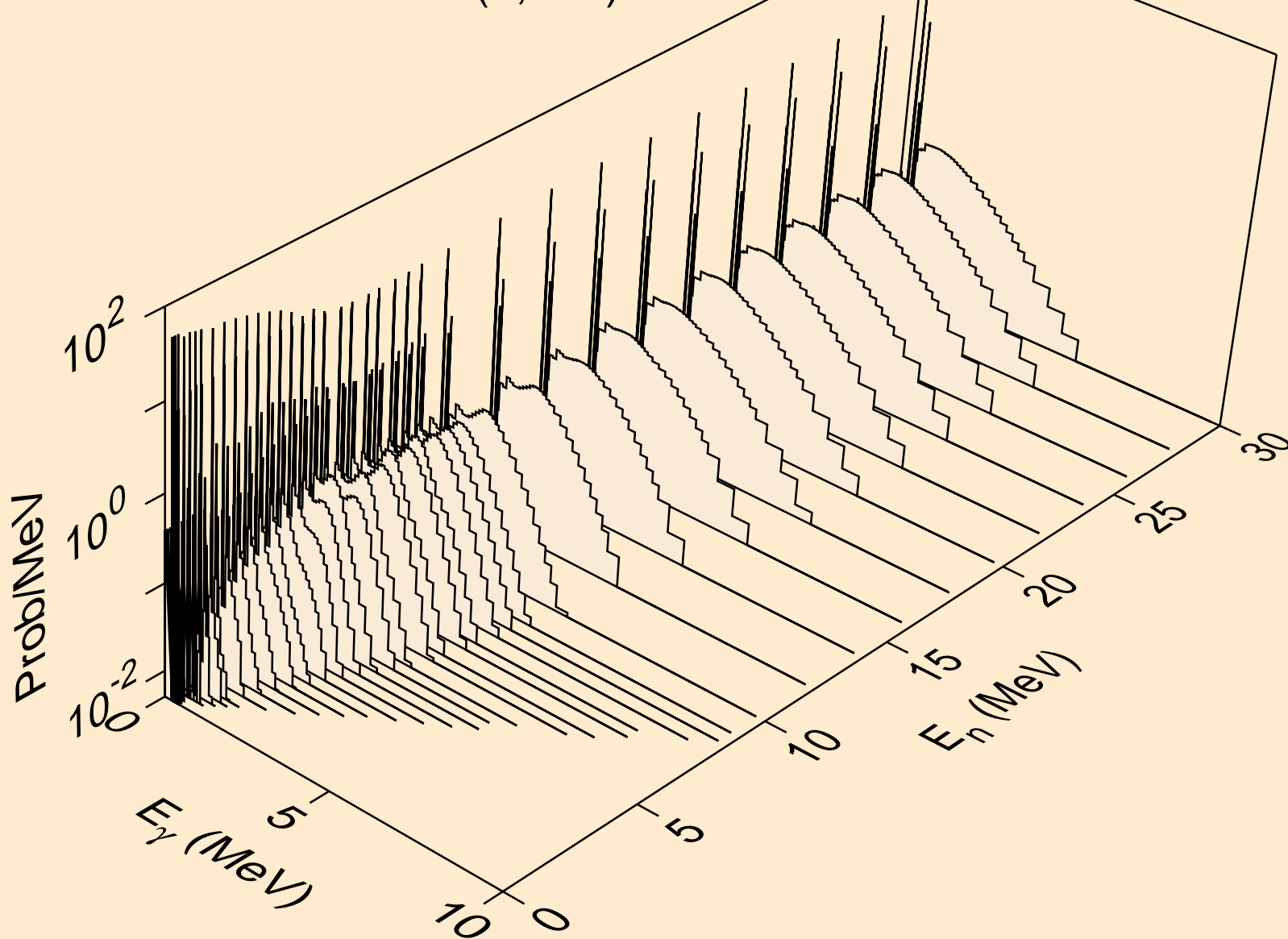

BA117 NEUTRON ACER TENDL-2019 LIBRARY; T=293.16K  
Photon emission for (n,a)

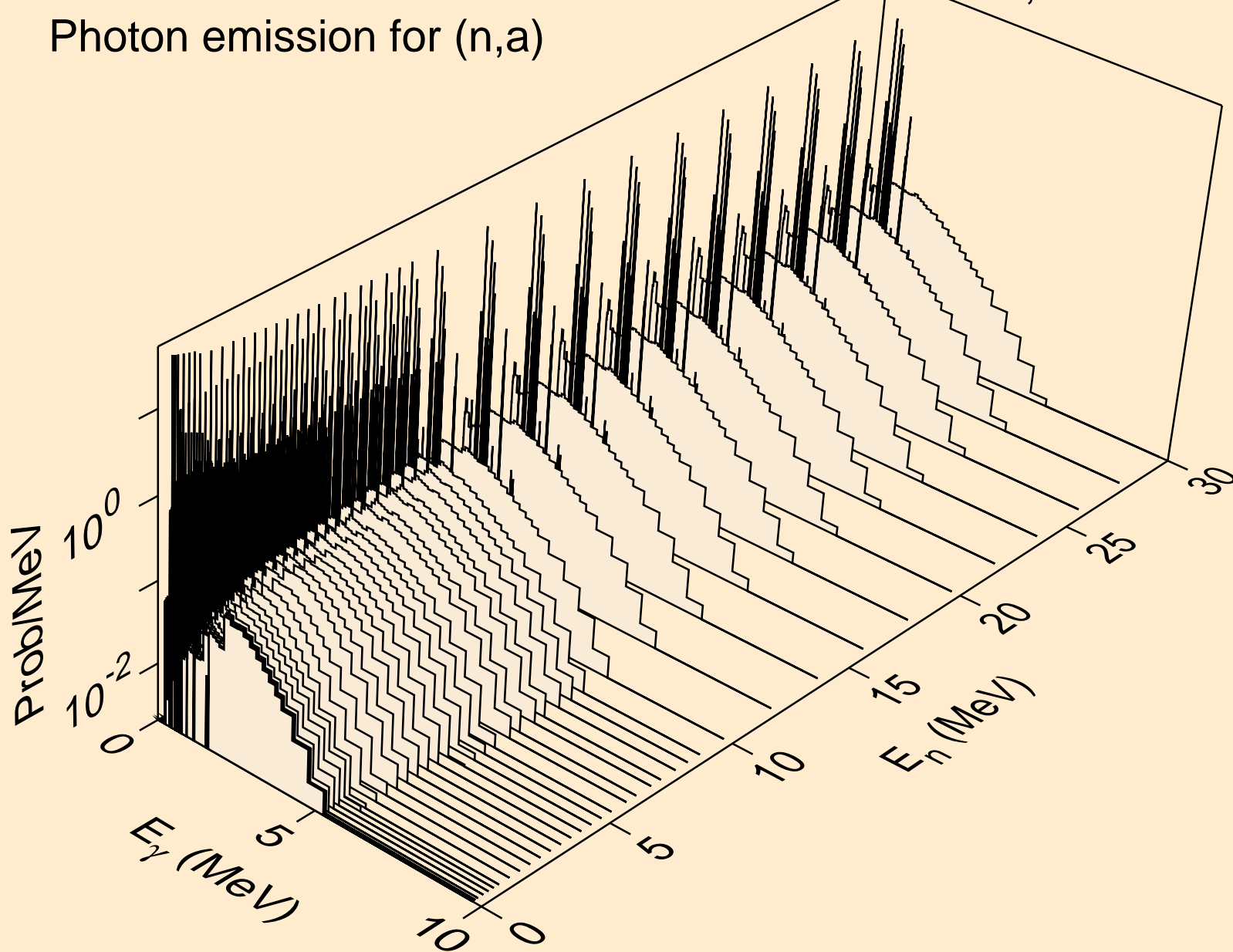

BA117 NEUTRON ACER TENDL-2019 LIBRARY; T=293.16K  
Photon emission for (n,2a)

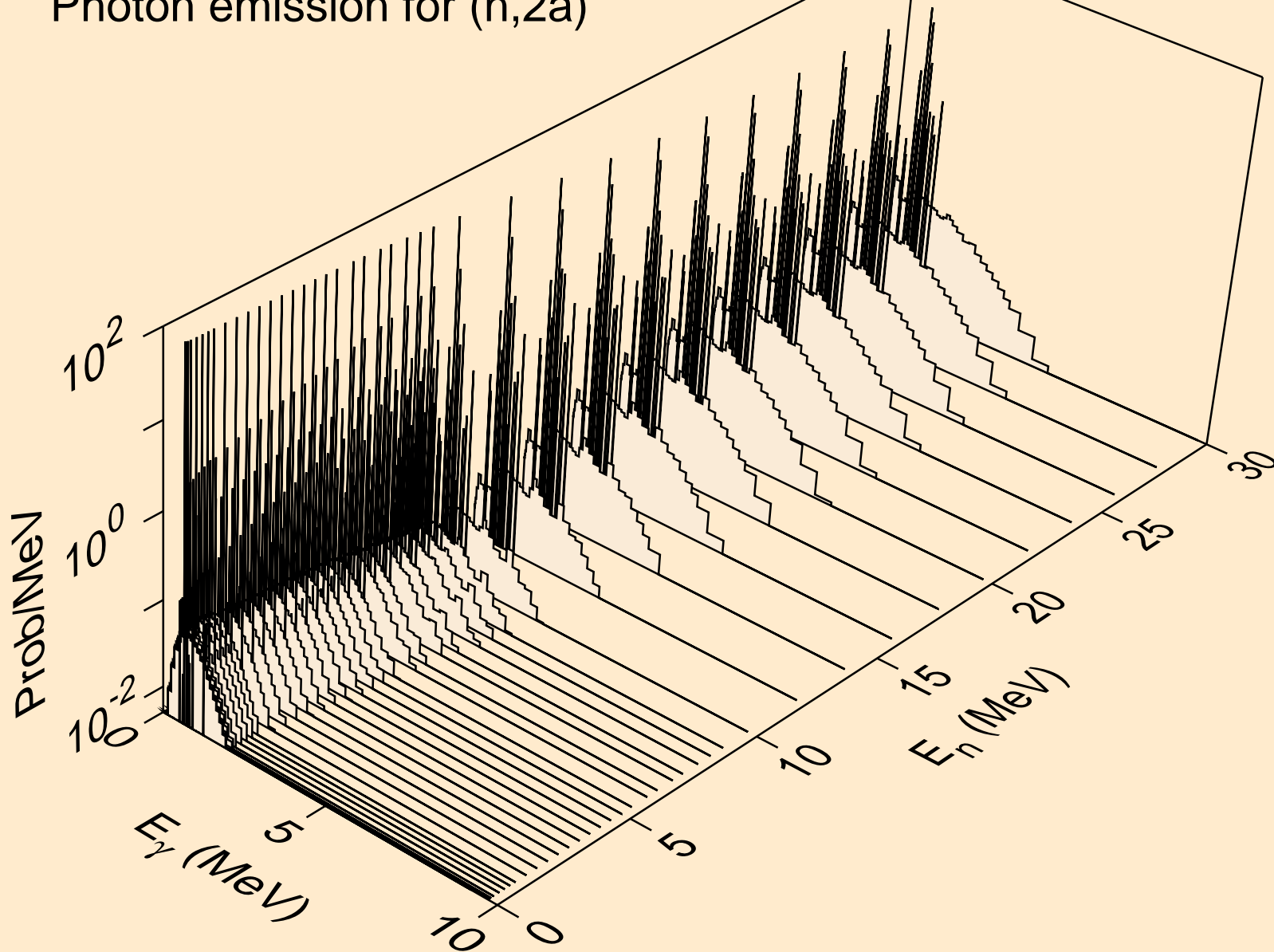

BA117 NEUTRON ACER TENDL-2019 LIBRARY; T=293.16K  
Photon emission for (n,3a)

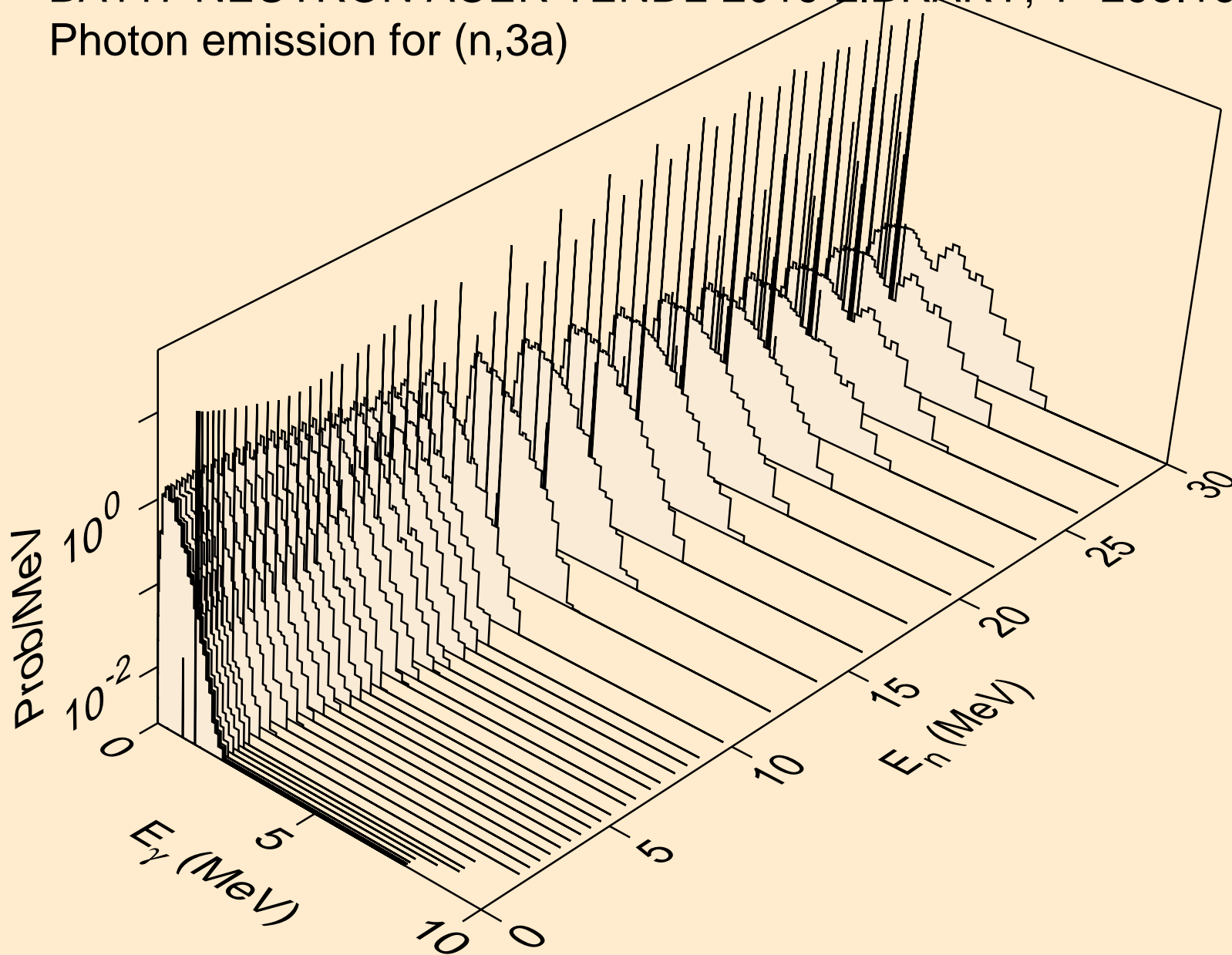



BA117 NEUTRON ACER TENDL-2019 LIBRARY; T=293.16K  
Photon emission for (n,2p)

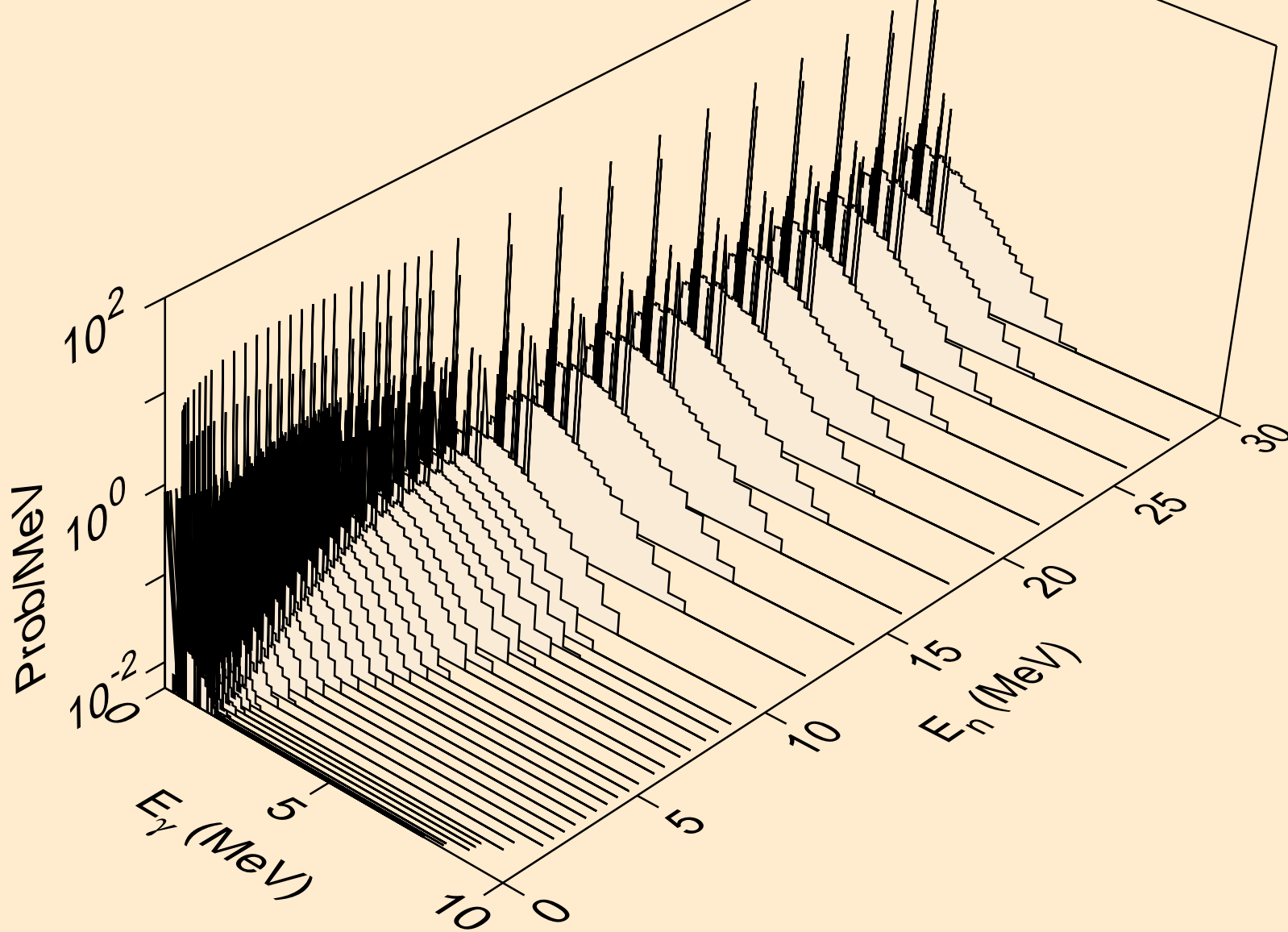

BA117 NEUTRON ACER TENDL-2019 LIBRARY; T=293.16K  
Photon emission for (n,p $\alpha$ )

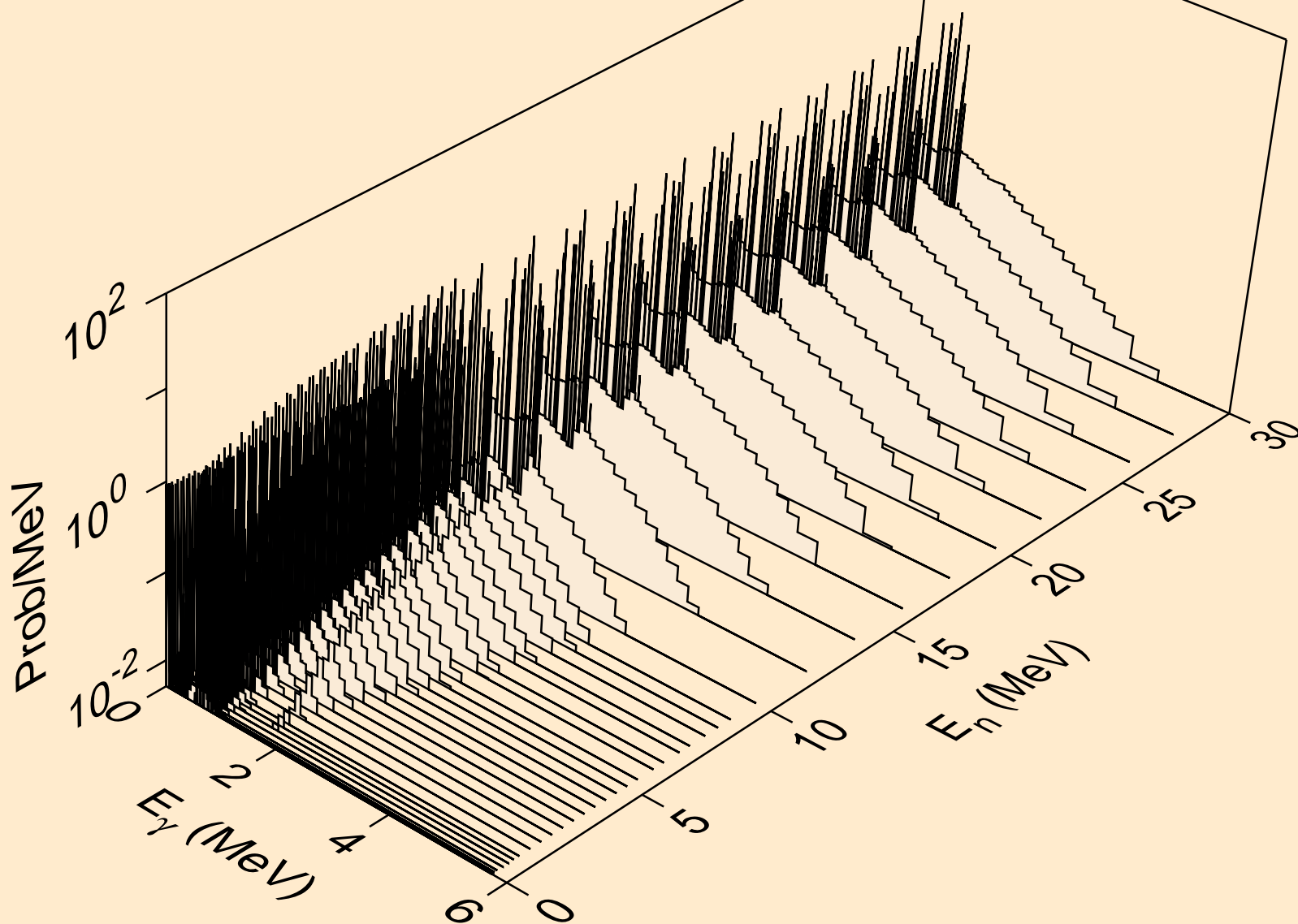

BA117 NEUTRON ACER TENDL-2019 LIBRARY; T=293.16K  
Photon emission for (n,t2a)

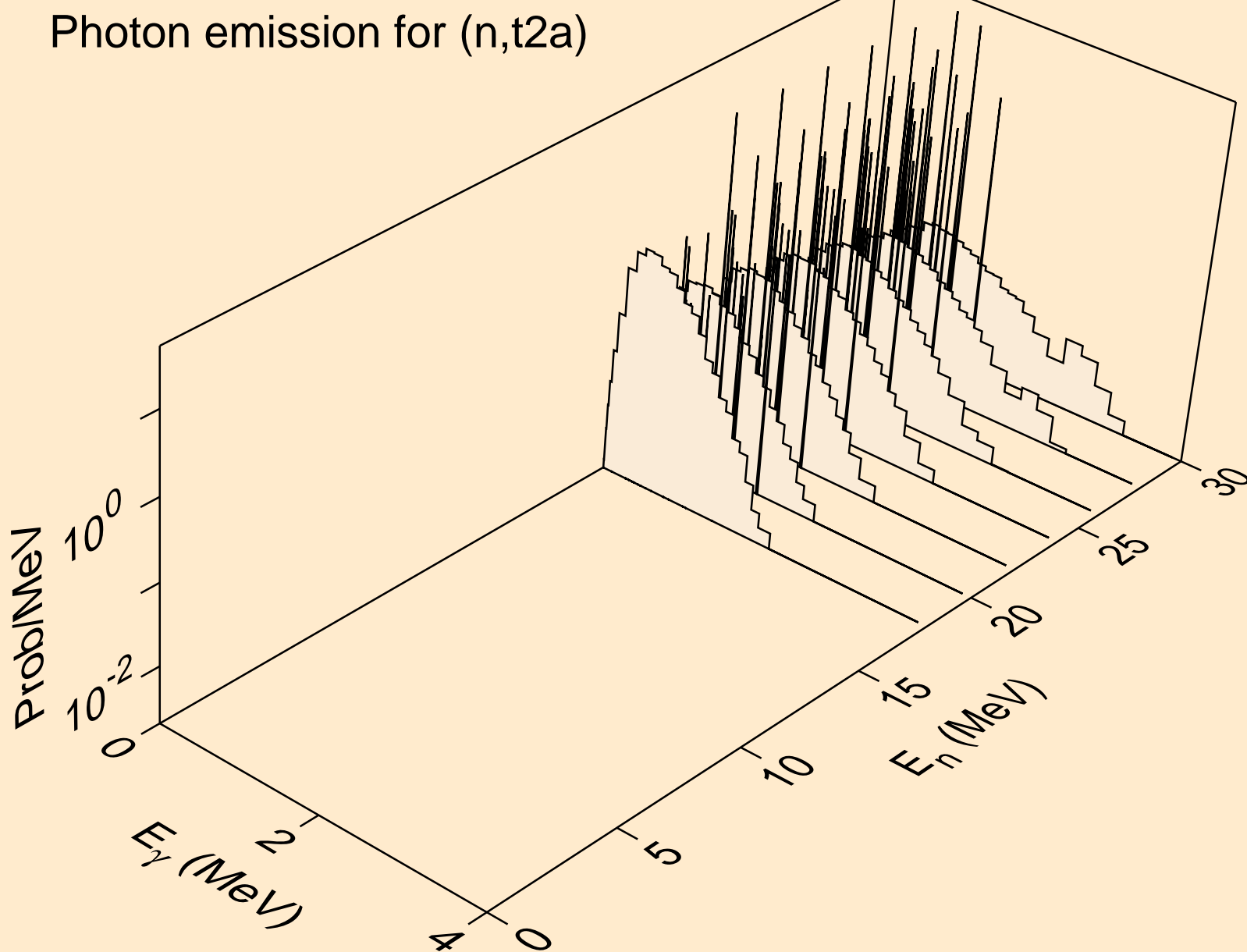

BA117 NEUTRON ACER TENDL-2019 LIBRARY; T=293.16K  
Photon emission for (n,d2a)

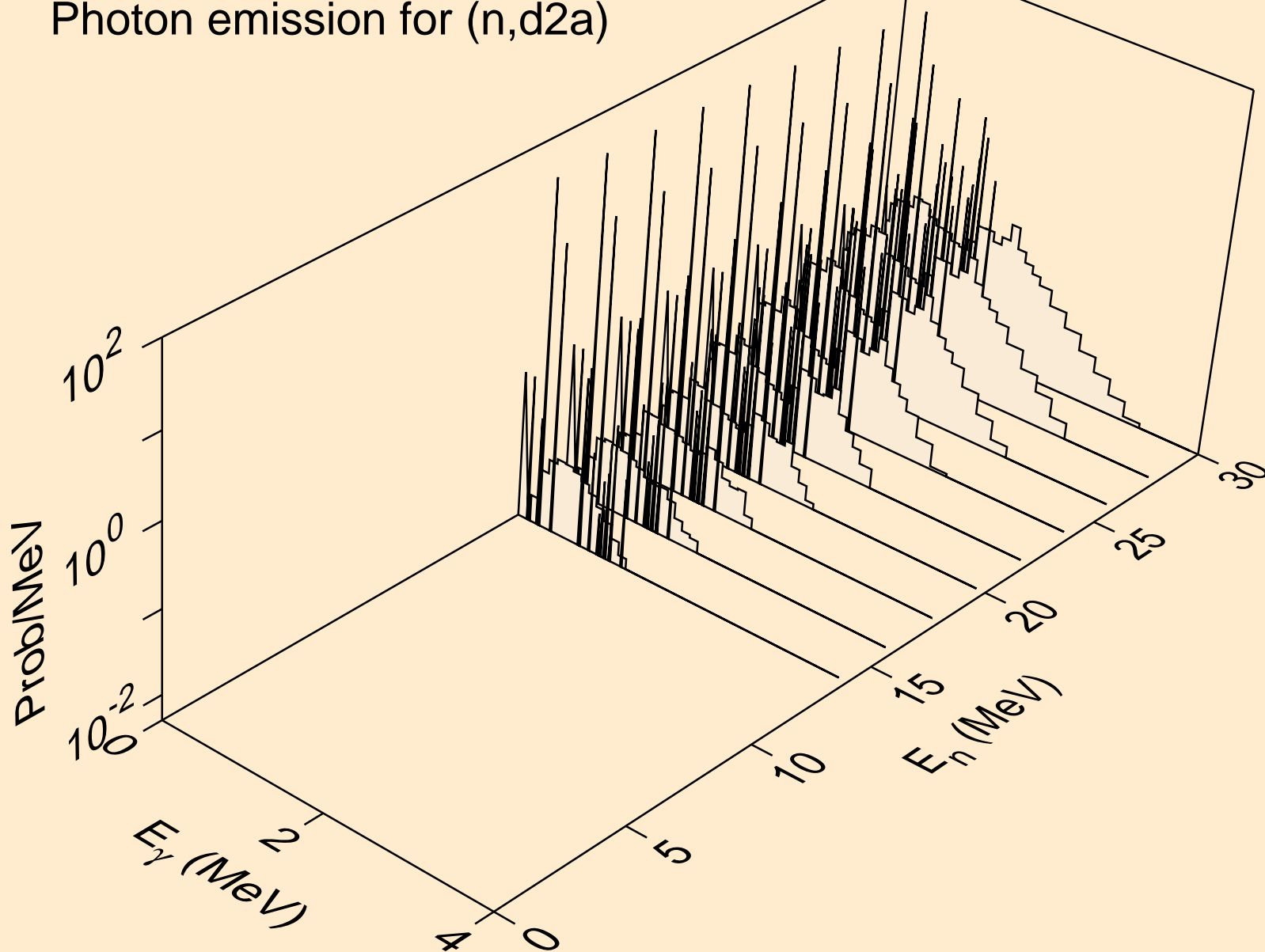

BA117 NEUTRON ACER TENDL-2019 LIBRARY; T=293.16K  
Photon emission for (n,pd)

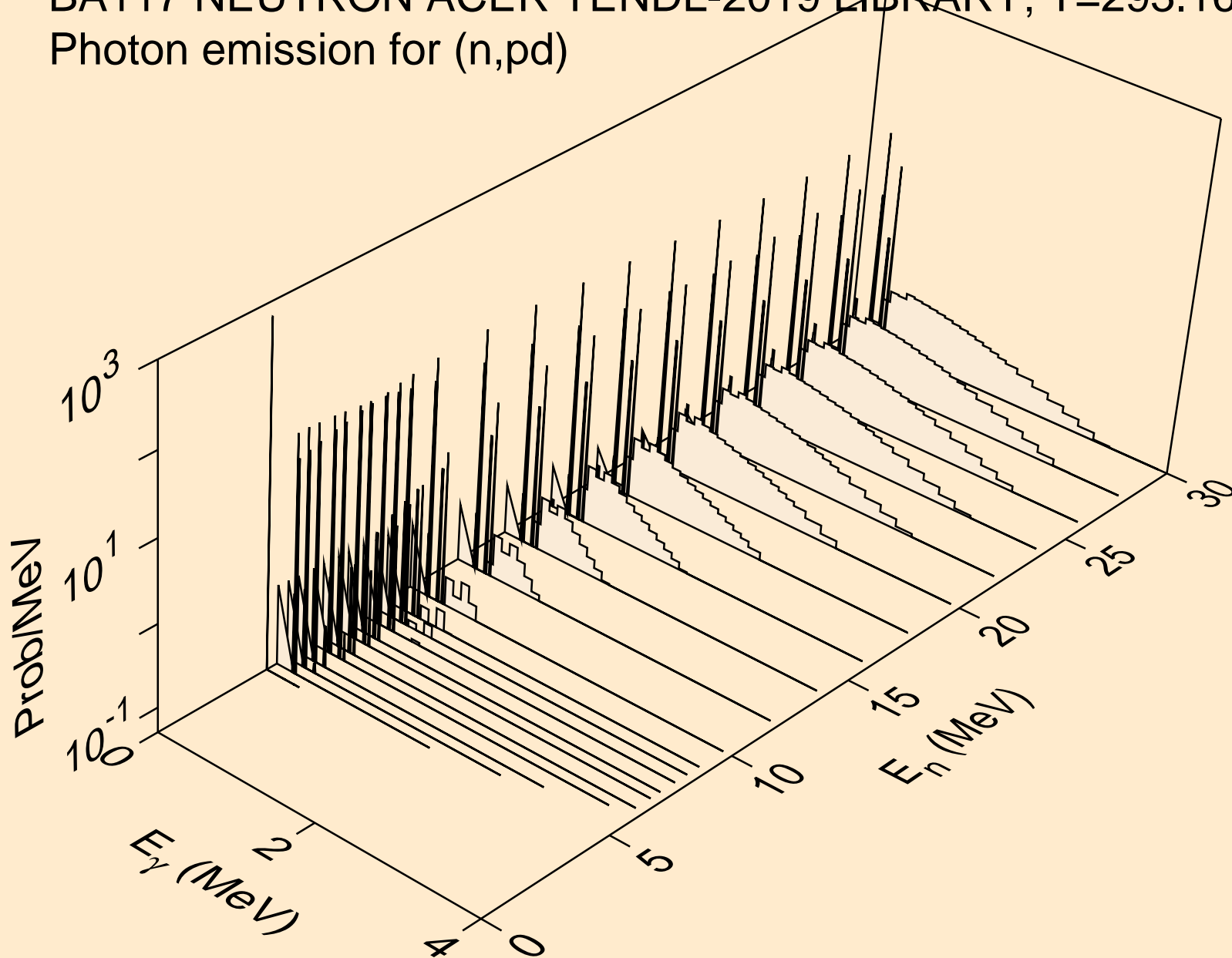

BA117 NEUTRON ACER TENDL-2019 LIBRARY; T=293.16K  
Photon emission for (n,pt)

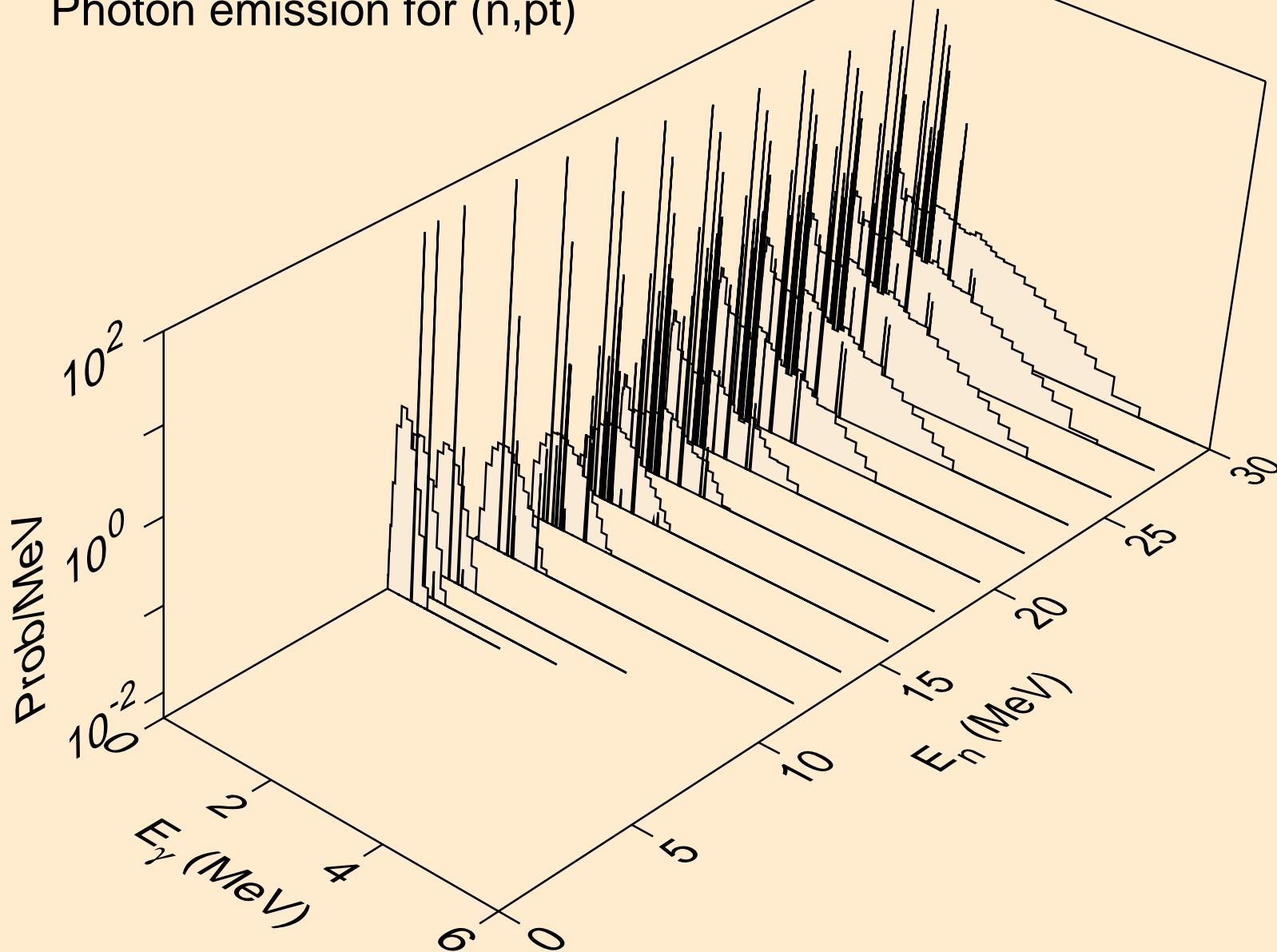

BA117 NEUTRON ACER TENDL-2019 LIBRARY; T=293.16K  
Photon emission for (n,da)

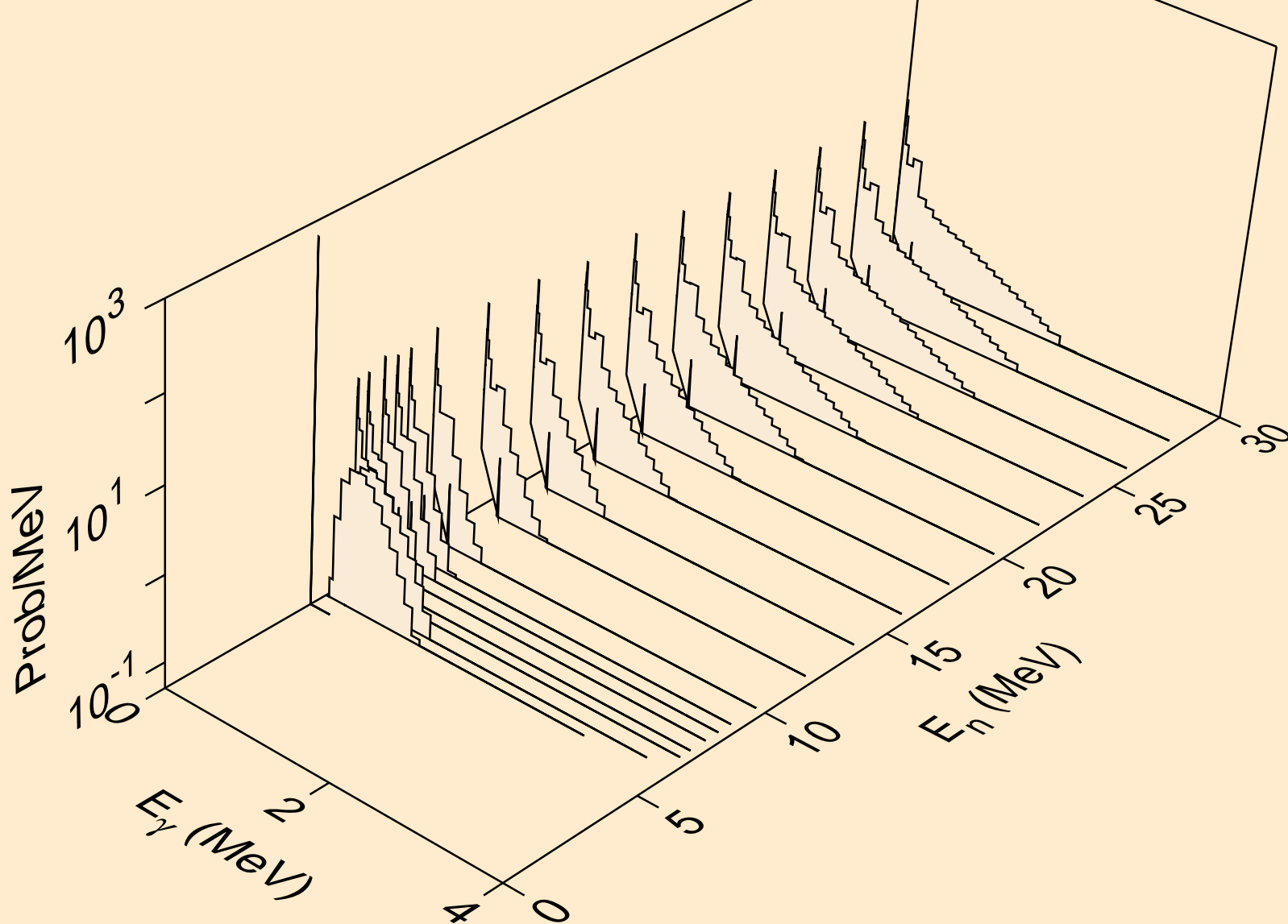

BA117 NEUTRON ACER TENDL-2019 LIBRARY; T=293.16K  
thermal capture photon spectrum

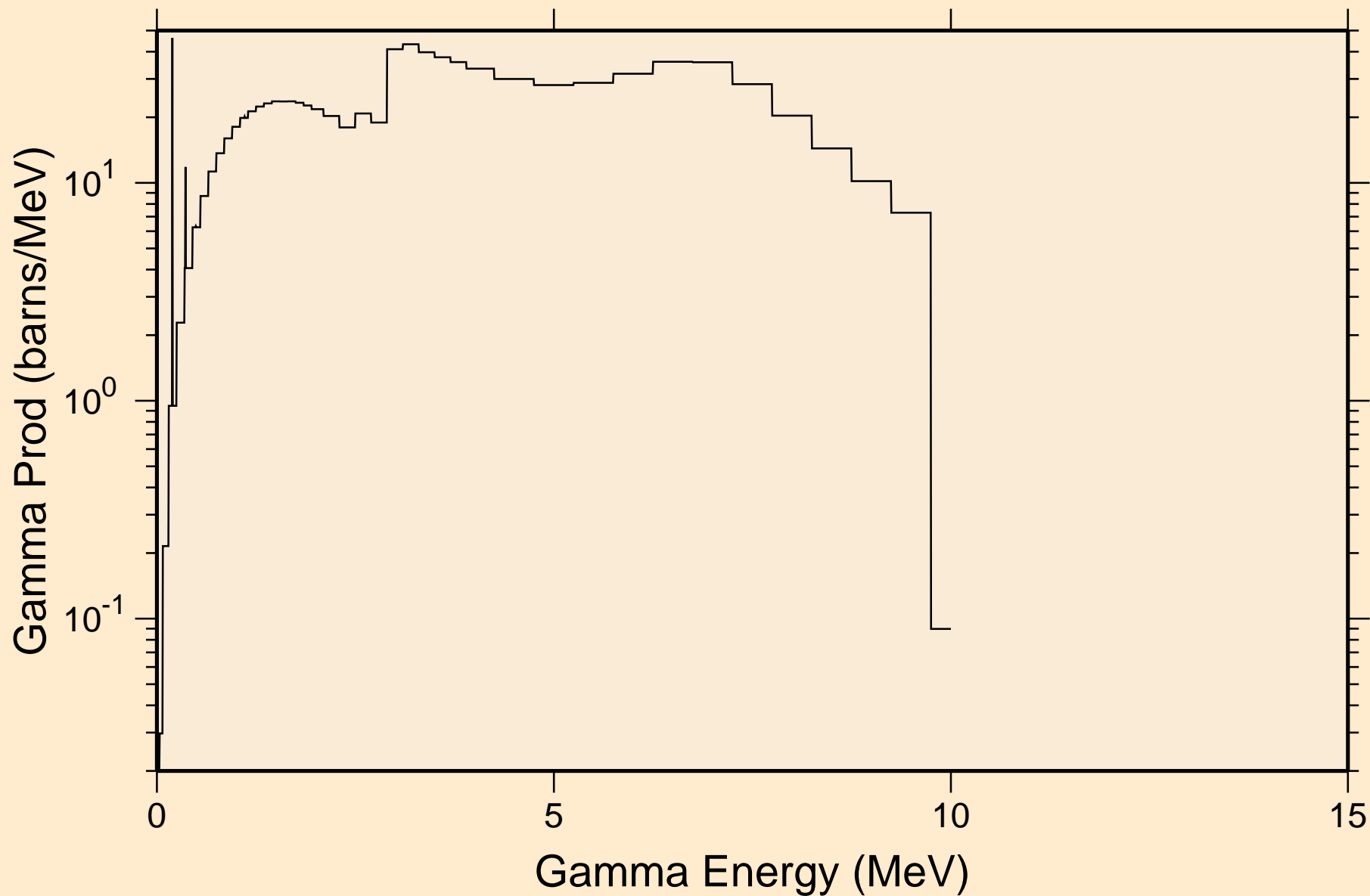



BA117 NEUTRON ACER TENDL-2019 LIBRARY; T=293.16K  
14 MeV photon spectrum

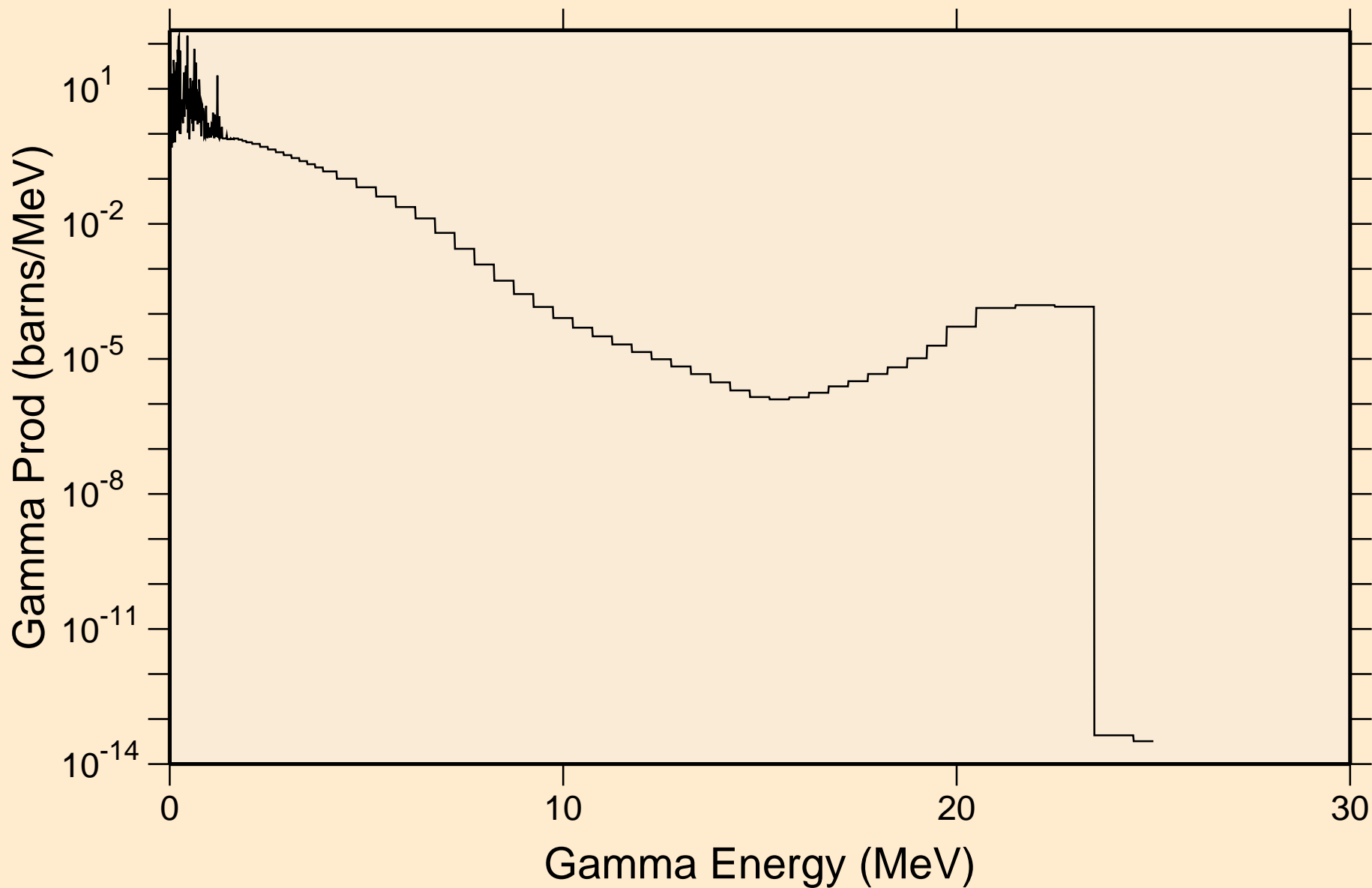

# BA117 NEUTRON ACER TENDL-2019 LIBRARY; T=293.16K

## Particle heating contributions

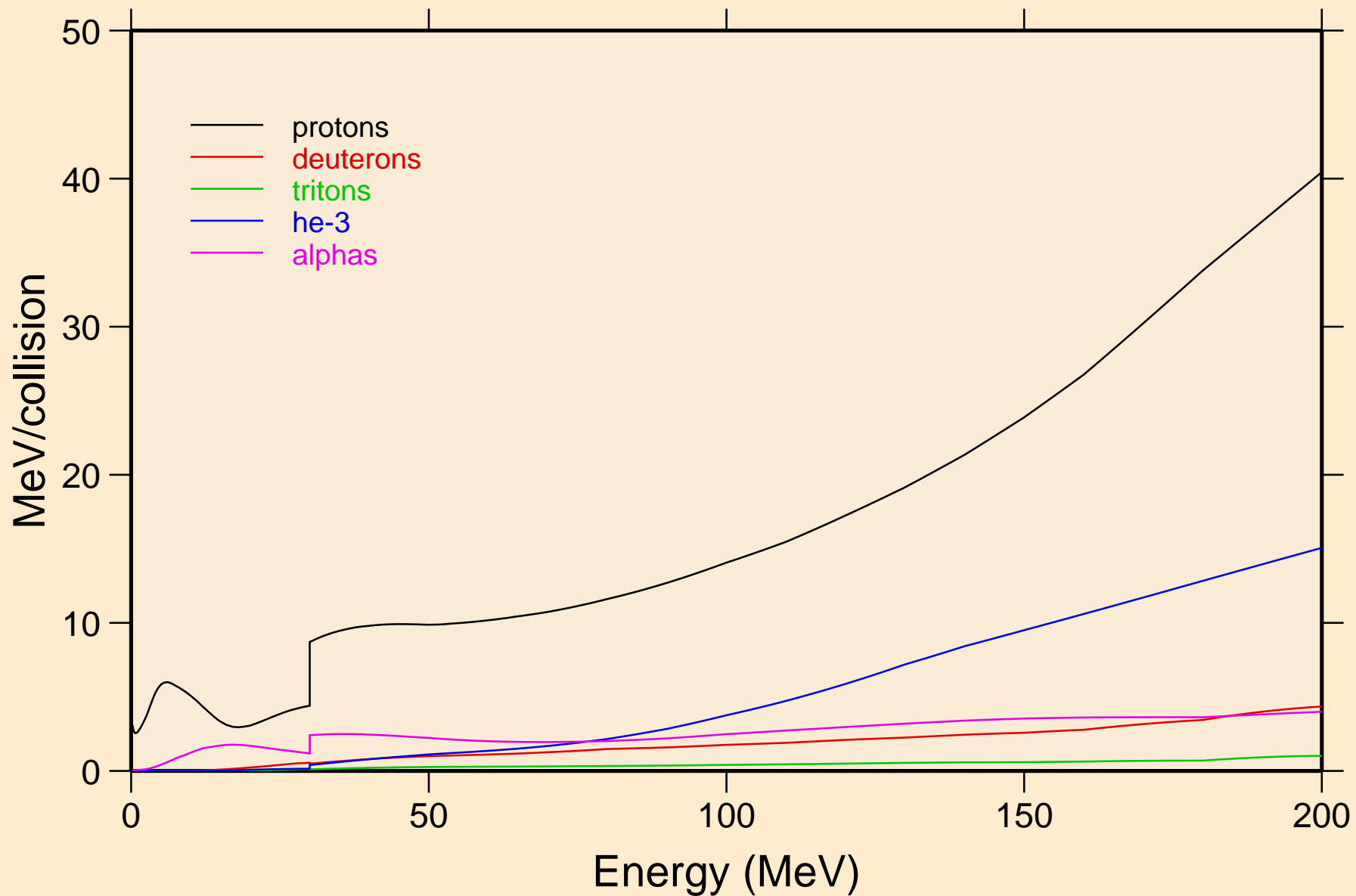

BA117 NEUTRON ACER TENDL-2019 LIBRARY; T=293.16K  
Recoil Heating

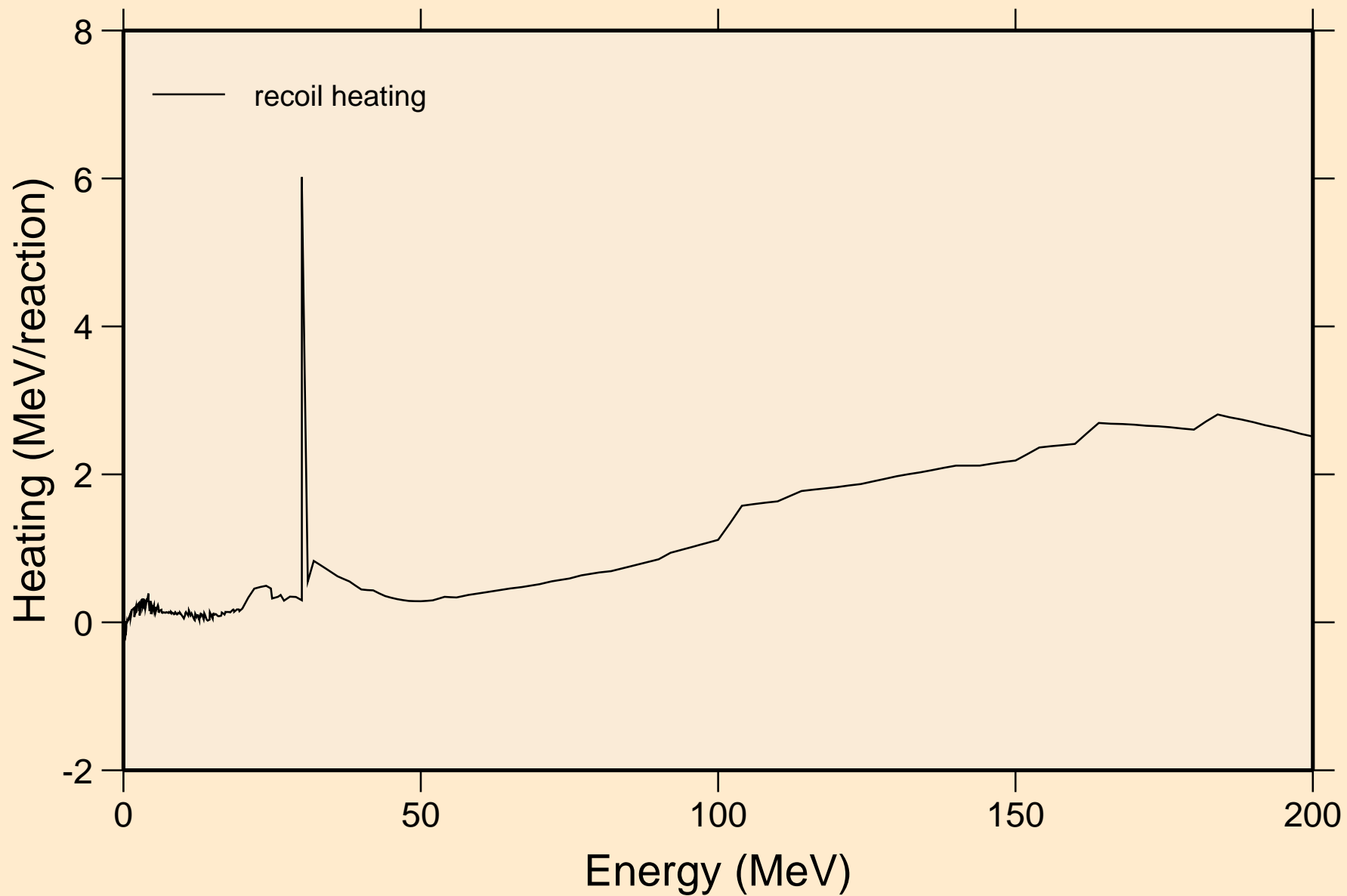

BA117 NEUTRON ACER TENDL-2019 LIBRARY; T=293.16K  
Particle production cross sections

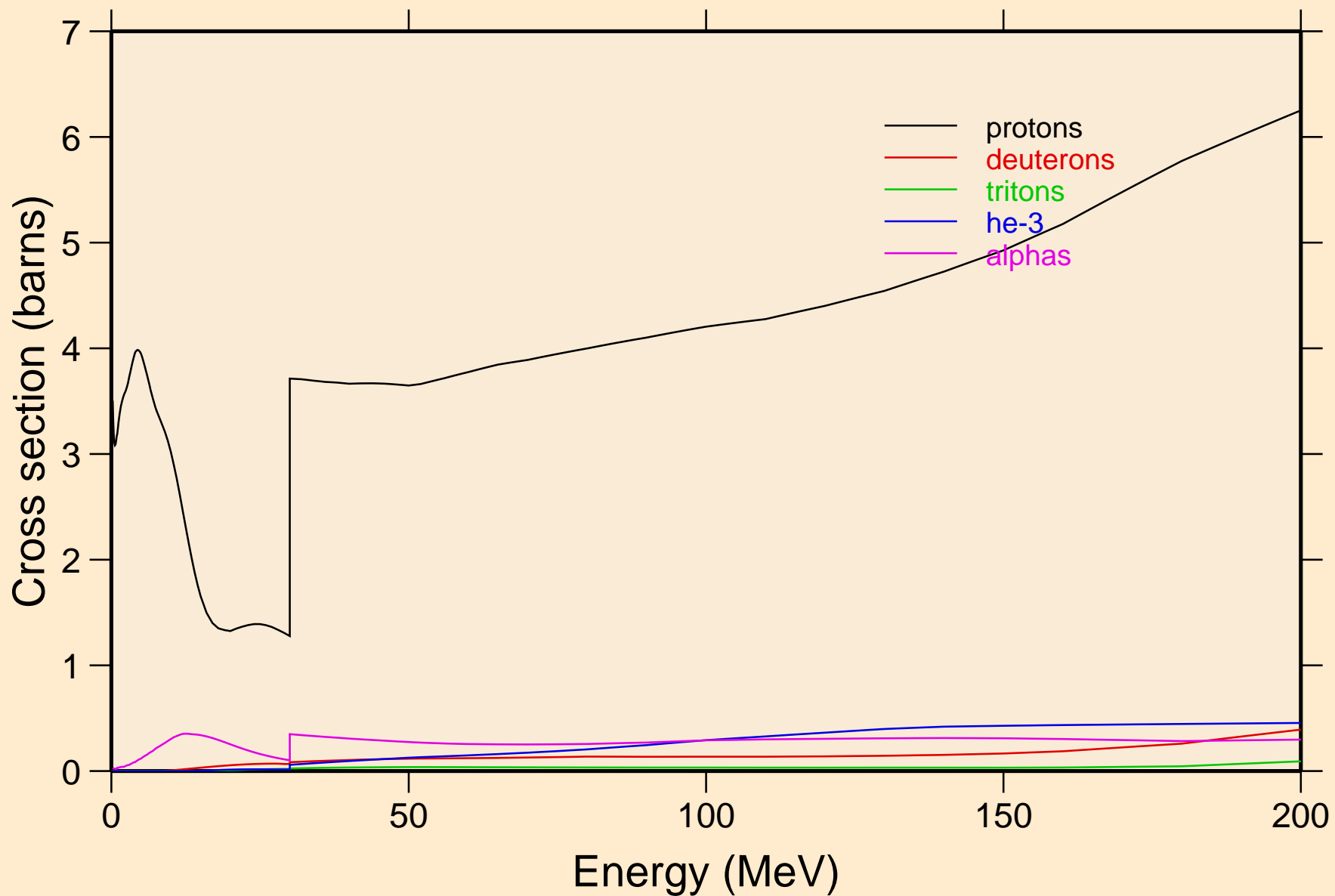

BA117 NEUTRON ACER TENDL-2019 LIBRARY; T=293.16K  
protons from (n,x)

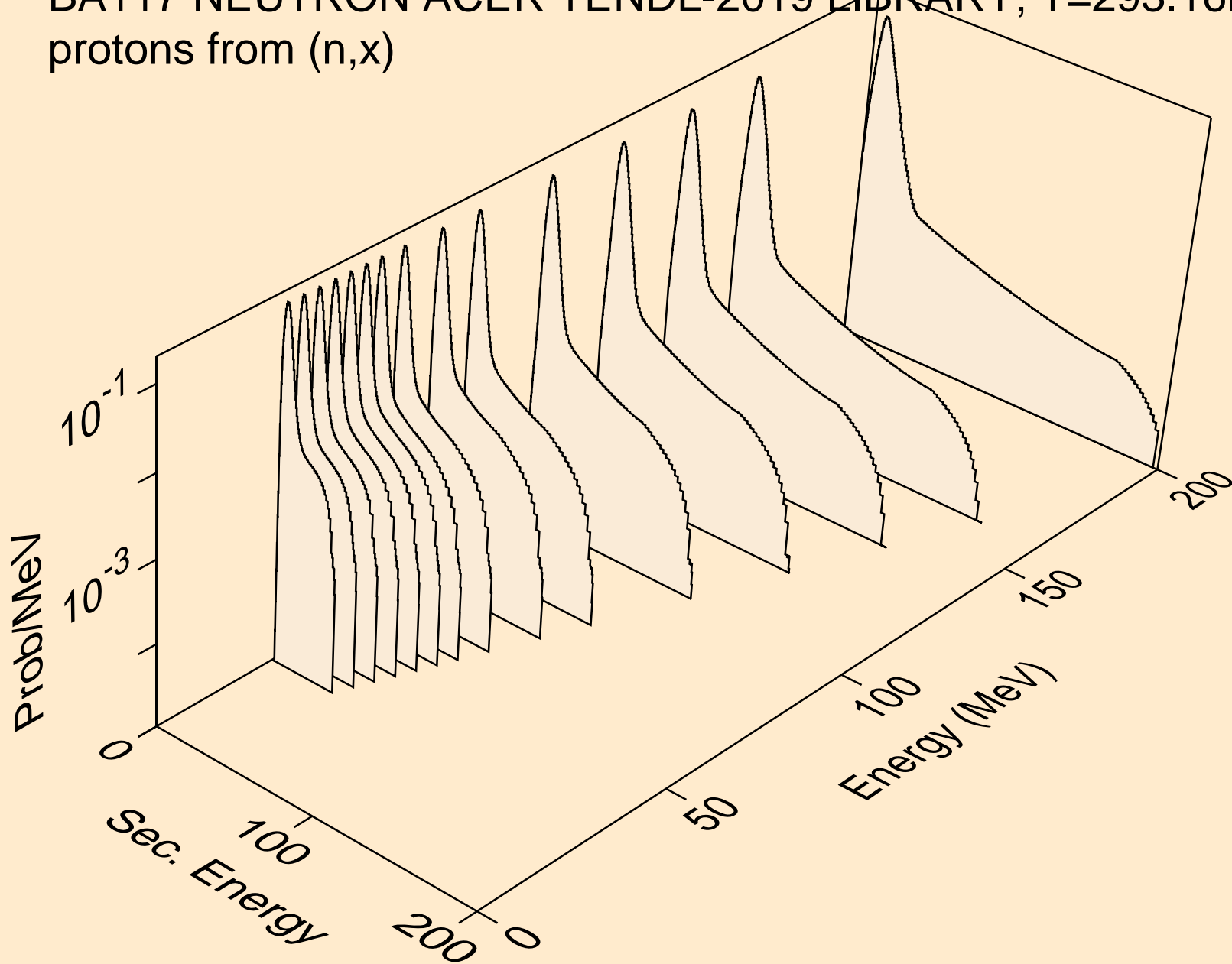

BA117 NEUTRON ACER TENDL-2019 LIBRARY; T=293.16K  
protons from (n,n\*)p

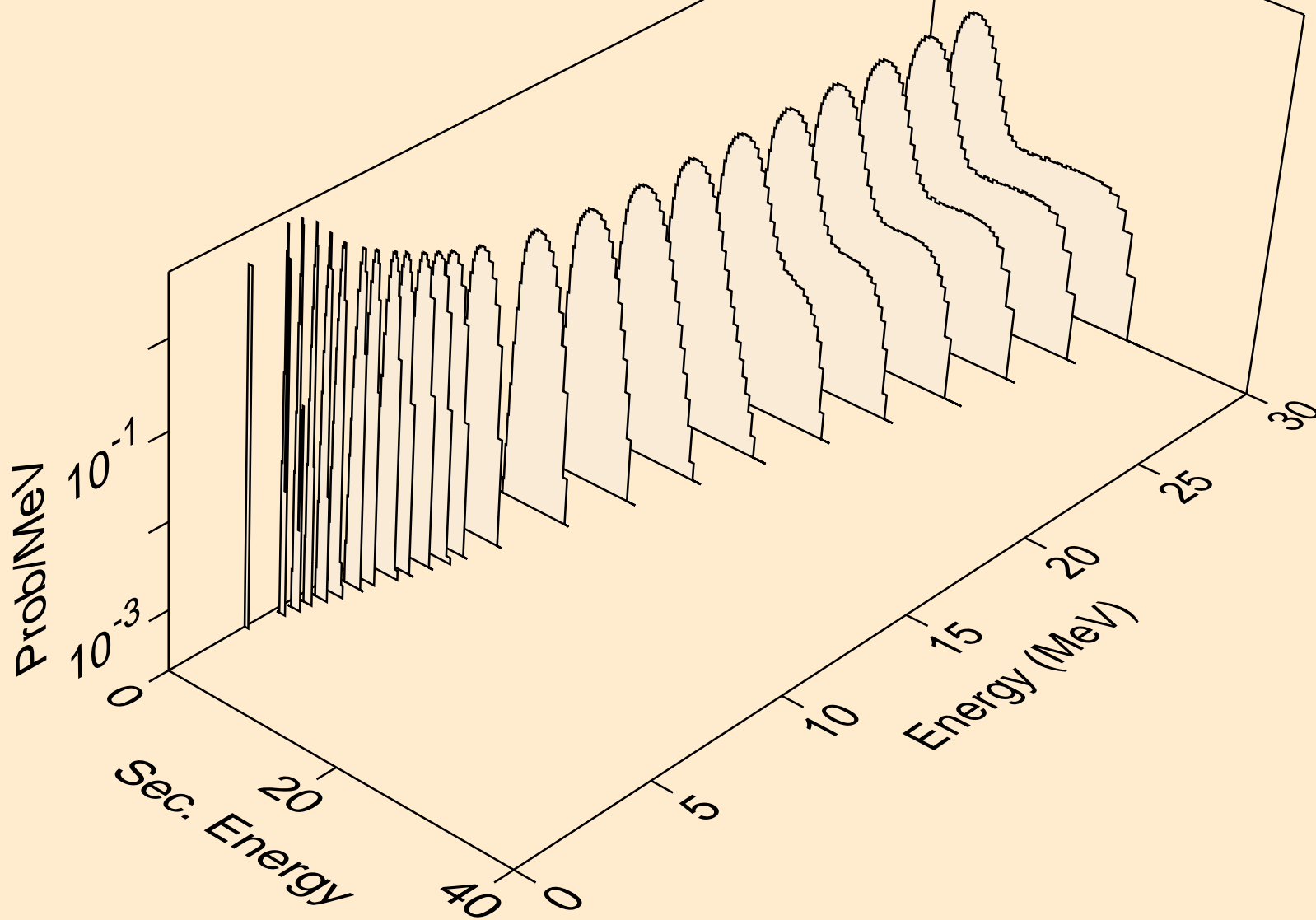

BA117 NEUTRON ACER TENDL-2019 LIBRARY; T=293.16K  
protons from (n,2np)

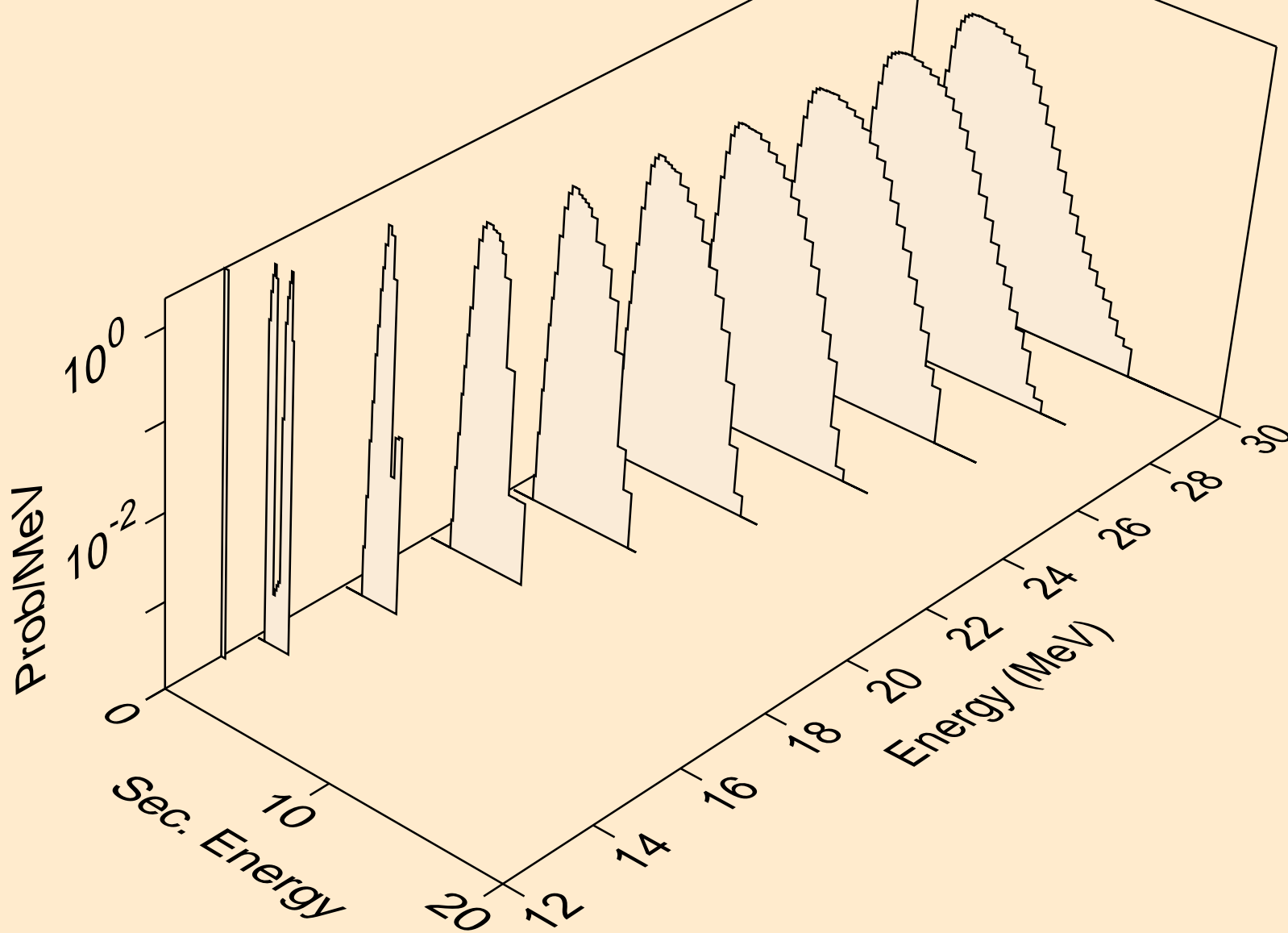

BA117 NEUTRON ACER TENDL-2019 LIBRARY; T=293.16K  
protons from (n,3np)

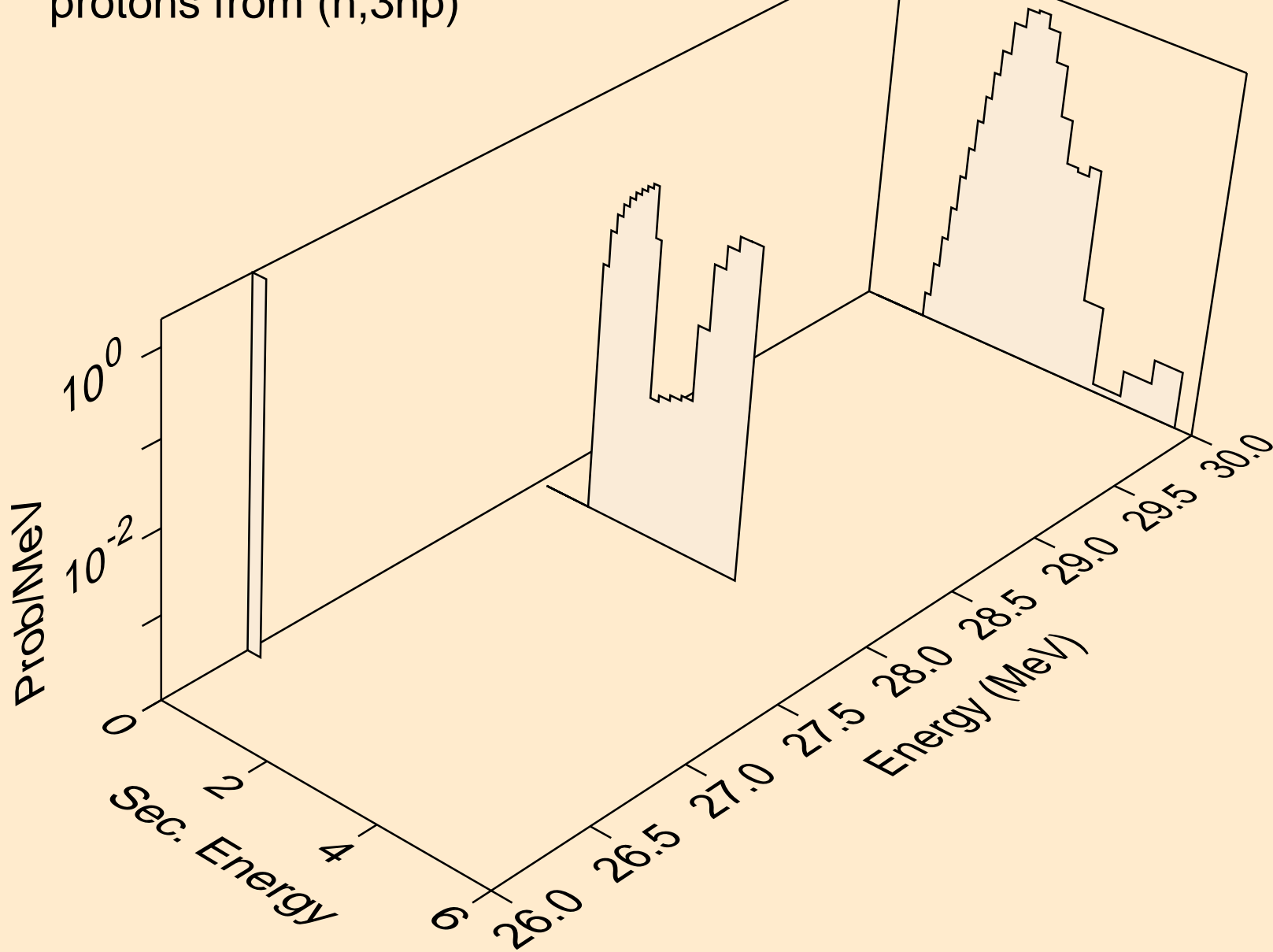



BA117 NEUTRON ACER TENDL-2019 LIBRARY; T=293.16K  
protons from (n,2np)

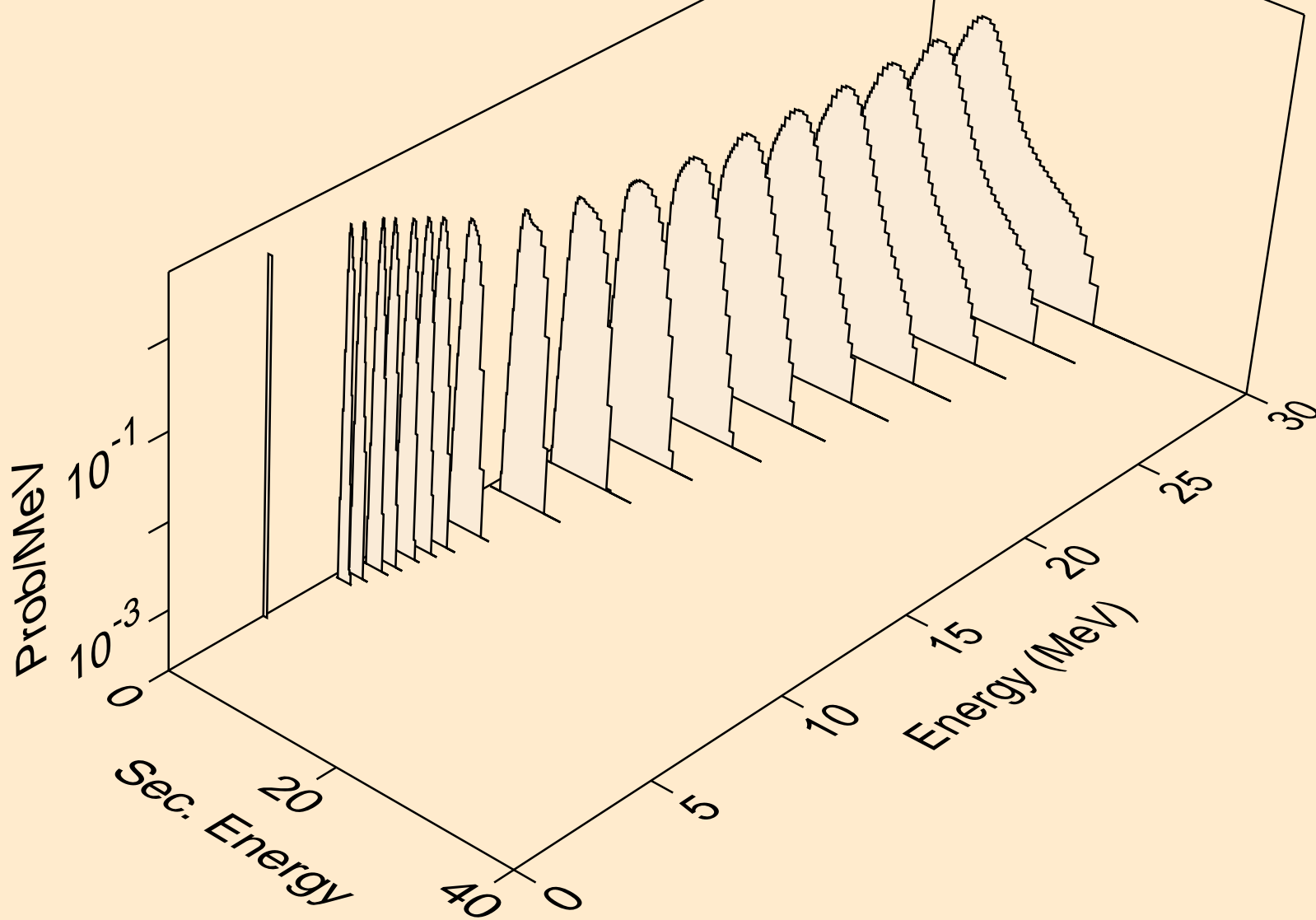

BA117 NEUTRON ACER TENDL-2019 LIBRARY; T=293.16K  
protons from (n,npa)

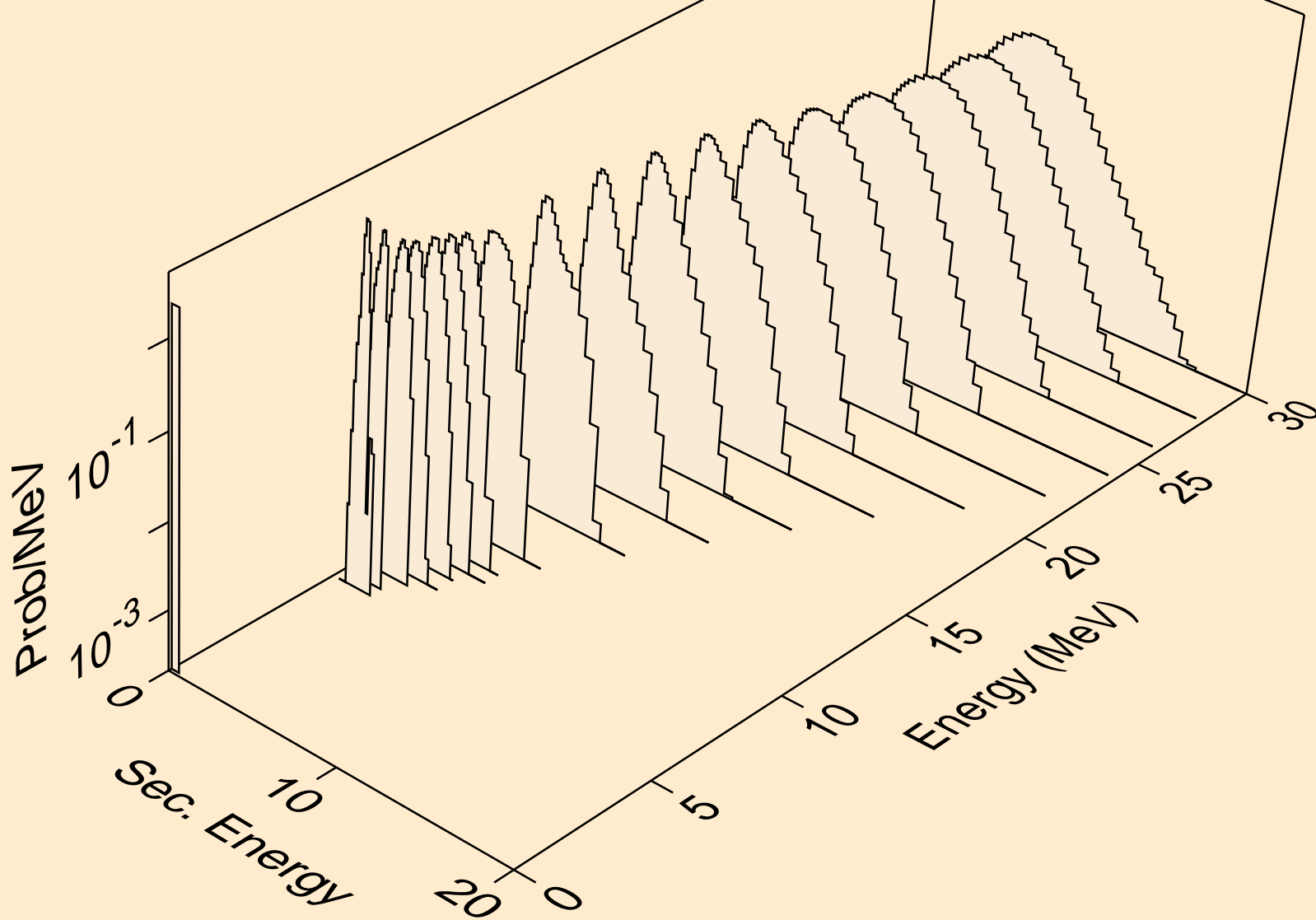

BA117 NEUTRON ACER TENDL-2019 LIBRARY; T=293.16K  
protons from (n,p)

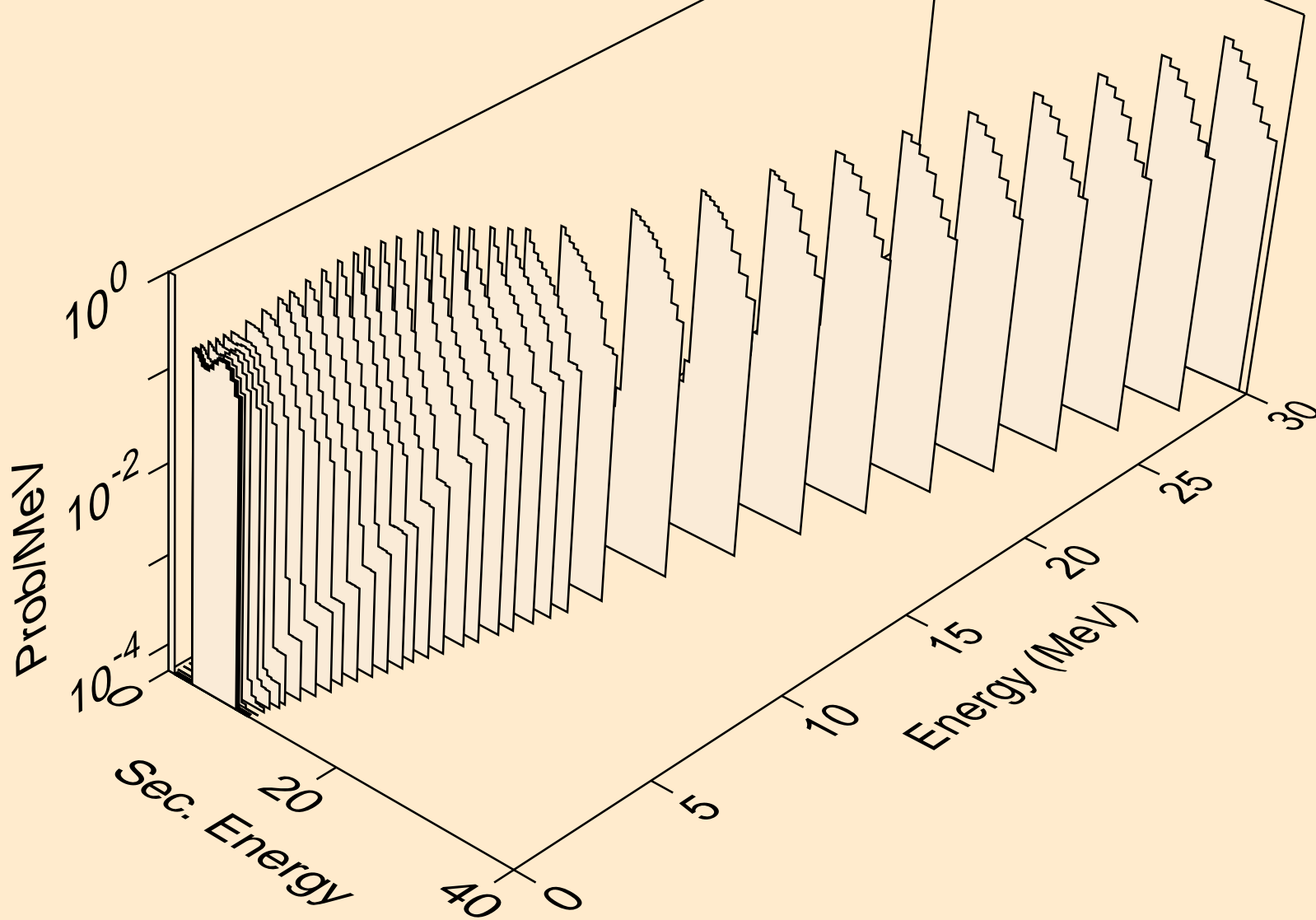

BA117 NEUTRON ACER TENDL-2019 LIBRARY; T=293.16K  
protons from (n,2p)

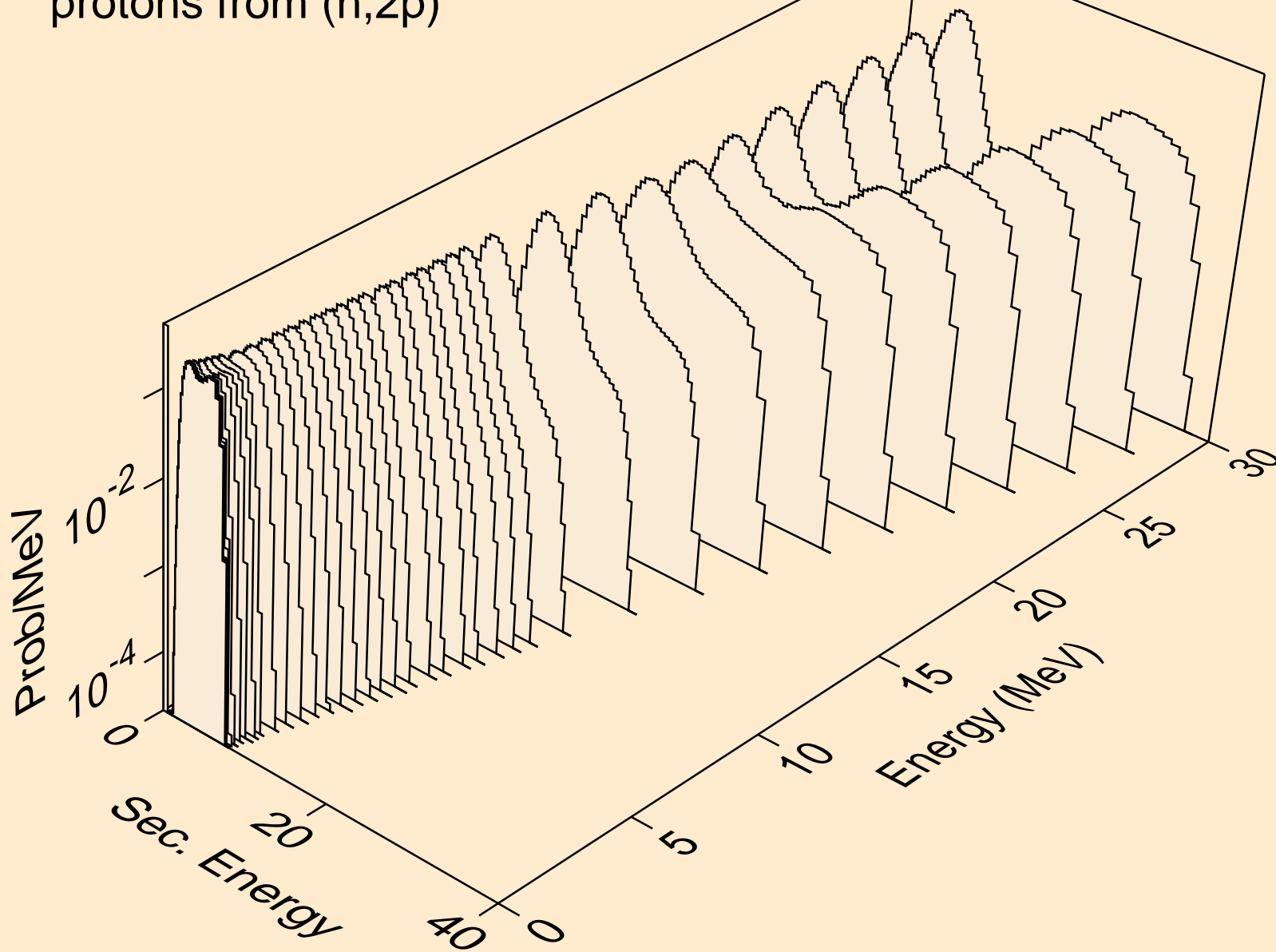

BA117 NEUTRON ACER TENDL-2019 LIBRARY; T=293.16K  
protons from (n,p)

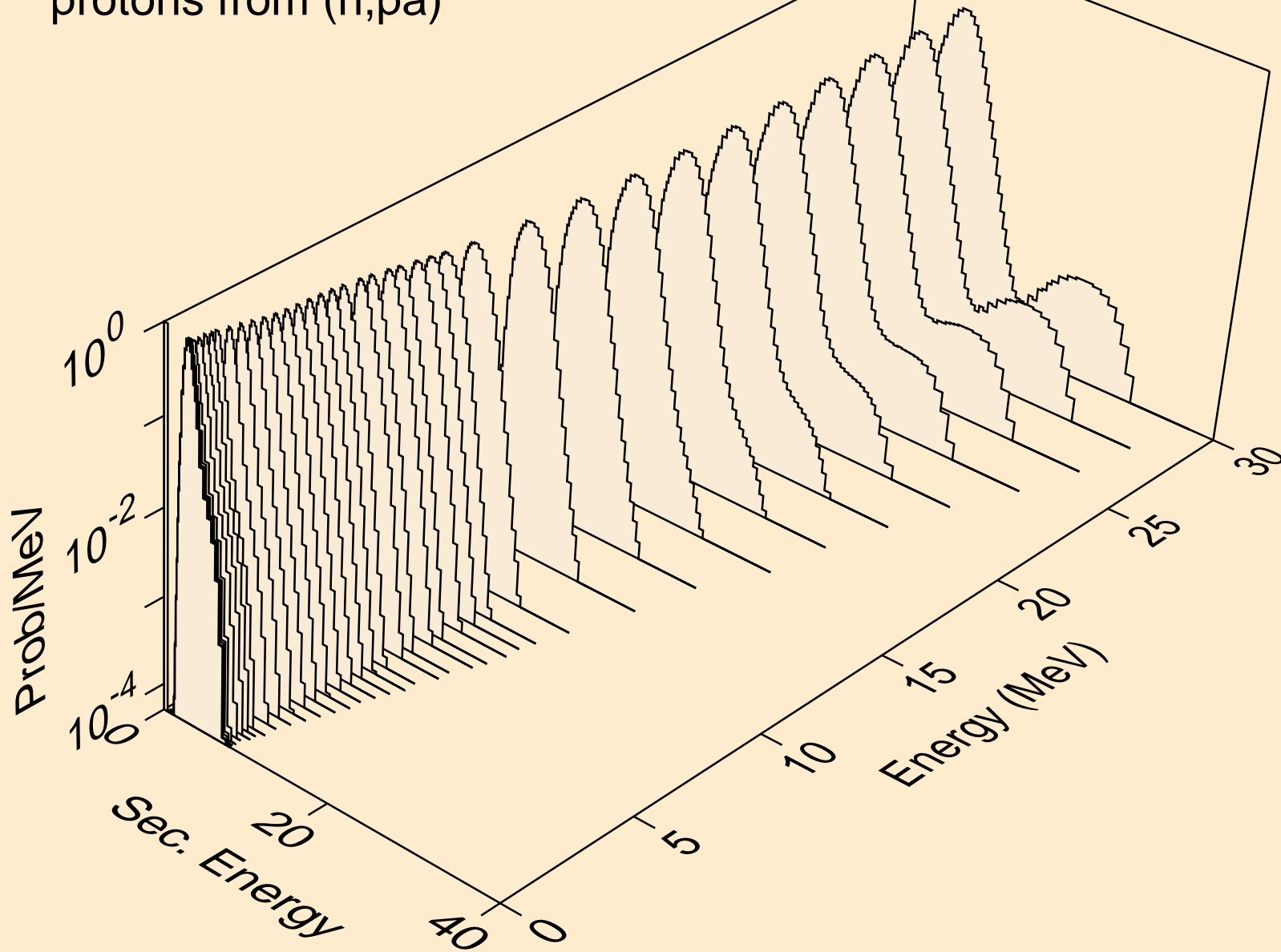

BA117 NEUTRON ACER TENDL-2019 LIBRARY; T=293.16K  
protons from (n,pd)

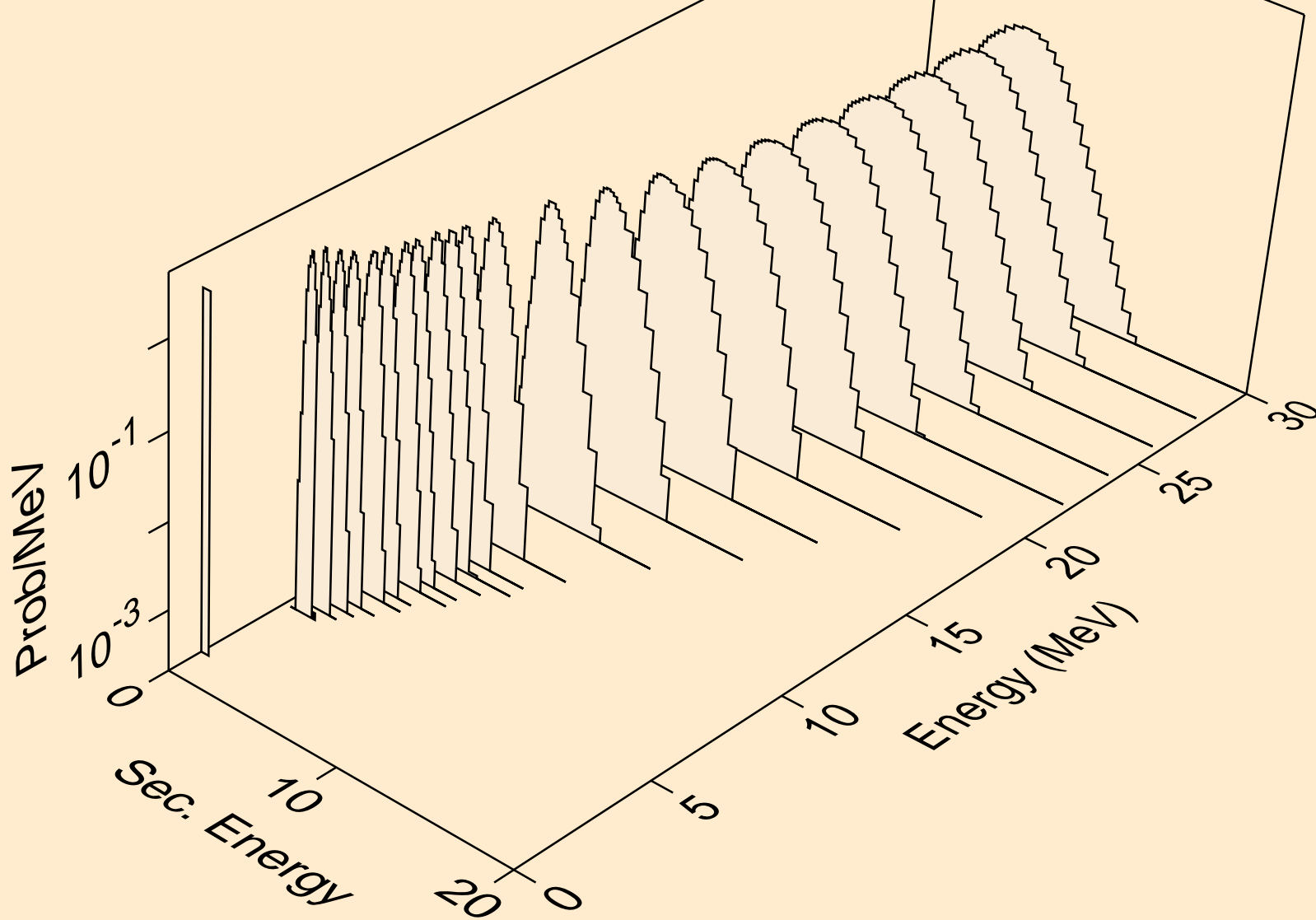

BA117 NEUTRON ACER TENDL-2019 LIBRARY; T=293.16K  
protons from (n,pt)

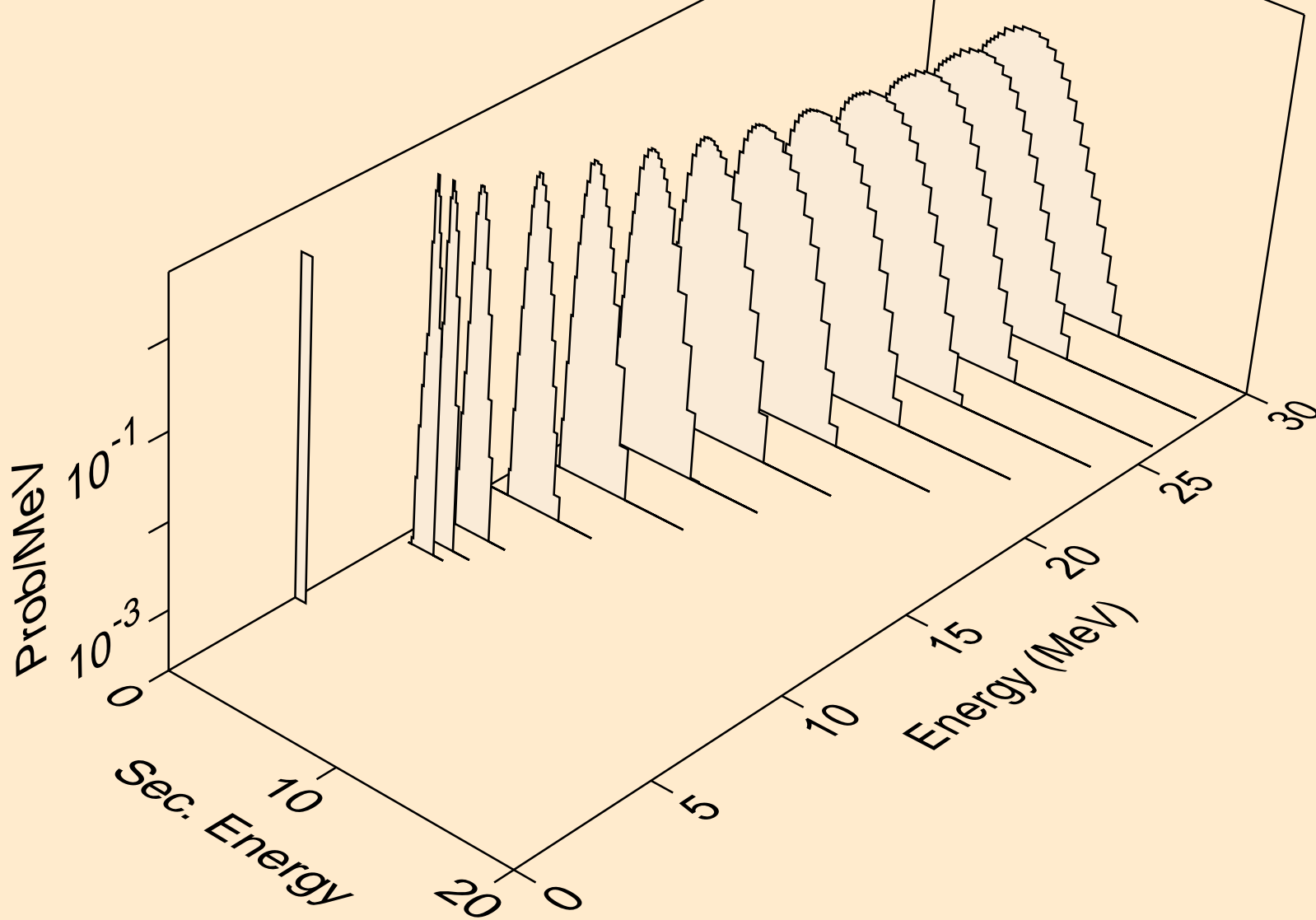

BA117 NEUTRON ACER TENDL-2019 LIBRARY; T=293.16K  
deuterons from (n,x)

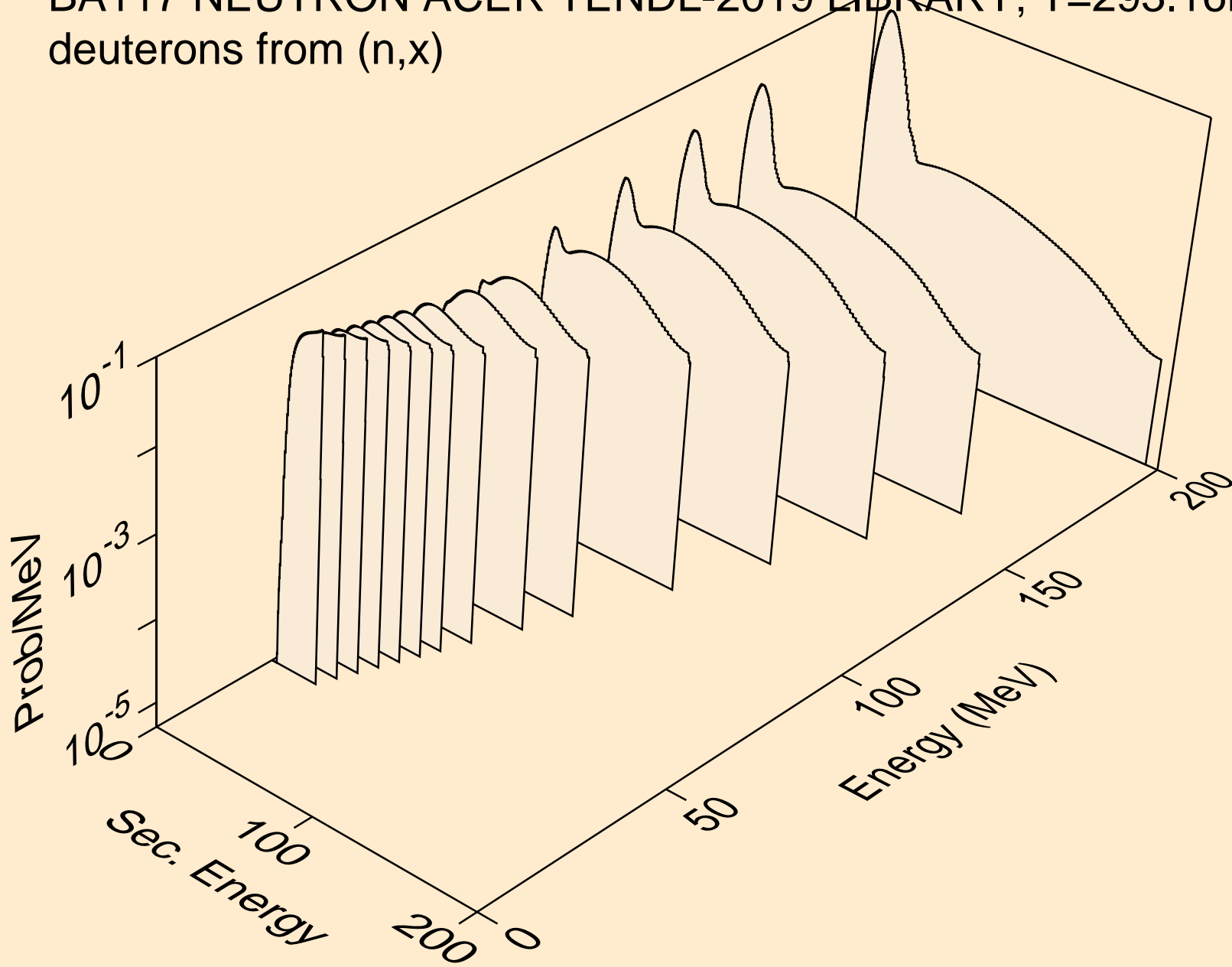



BA117 NEUTRON ACER TENDL-2019 LIBRARY; T=293.16K  
deuterons from (n,n\*)d

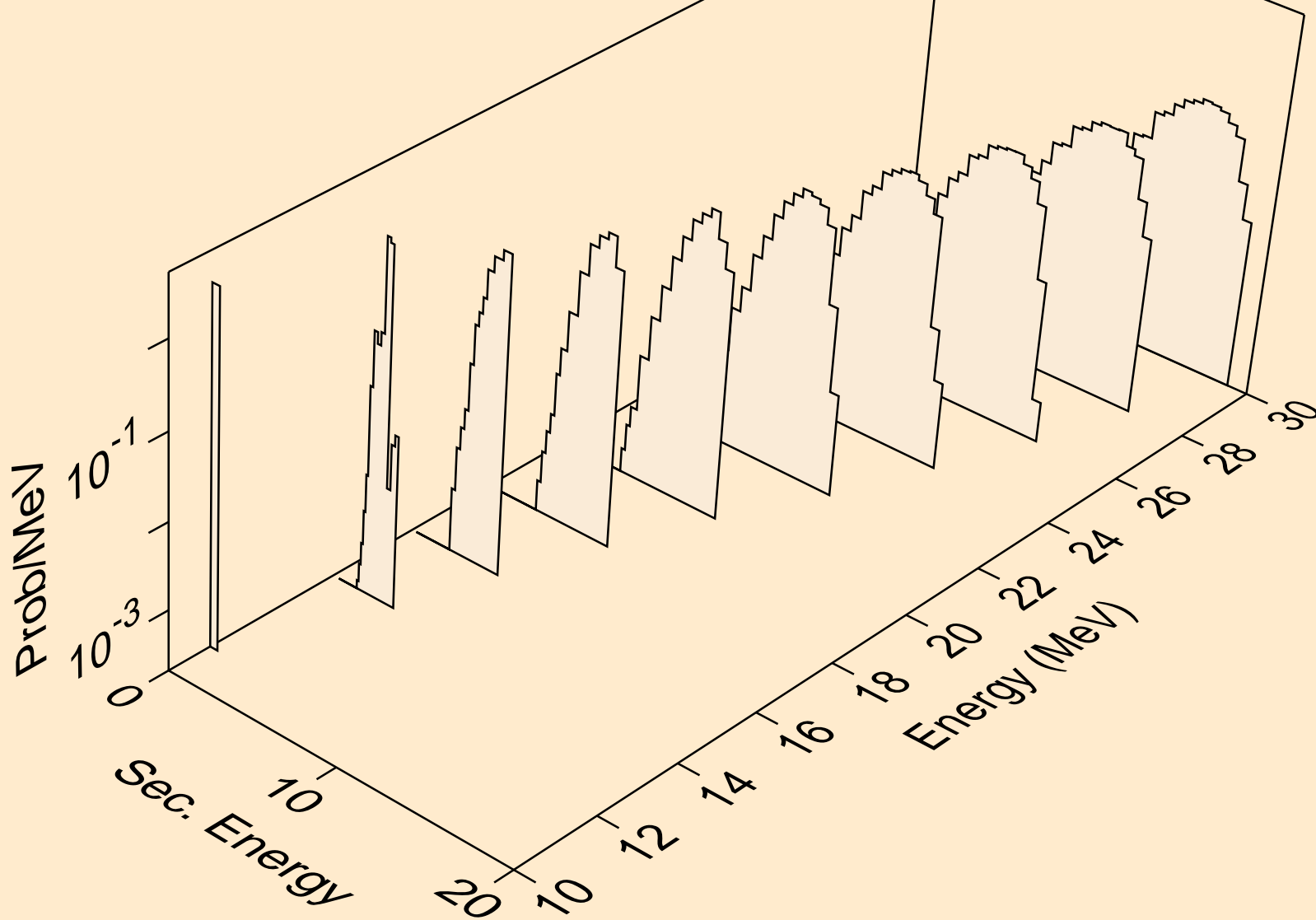

BA117 NEUTRON ACER TENDL-2019 LIBRARY; T=293.16K  
deuterons from (n,d)

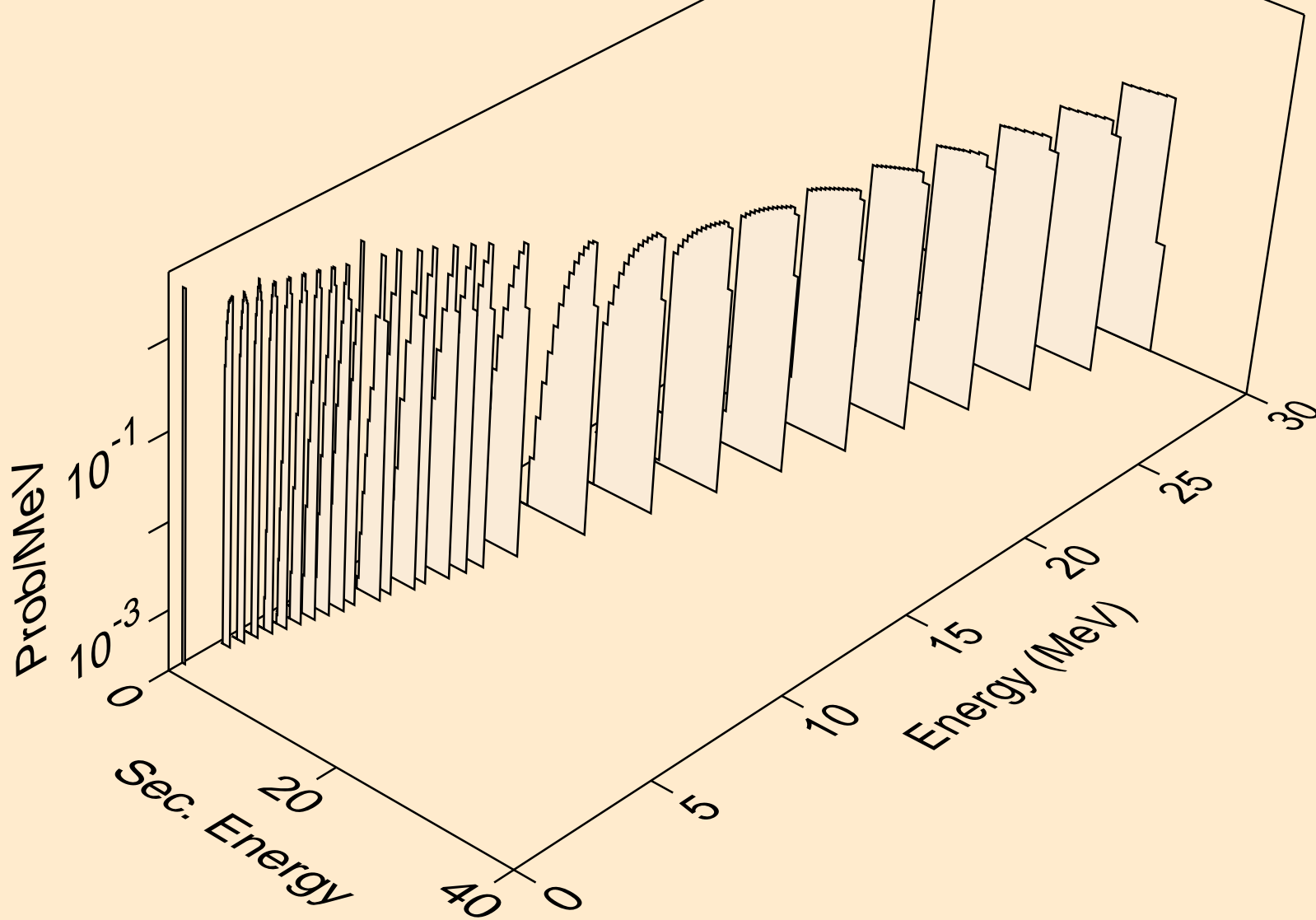

BA117 NEUTRON ACER TENDL-2019 LIBRARY; T=293.16K  
deuterons from (n,d2a)

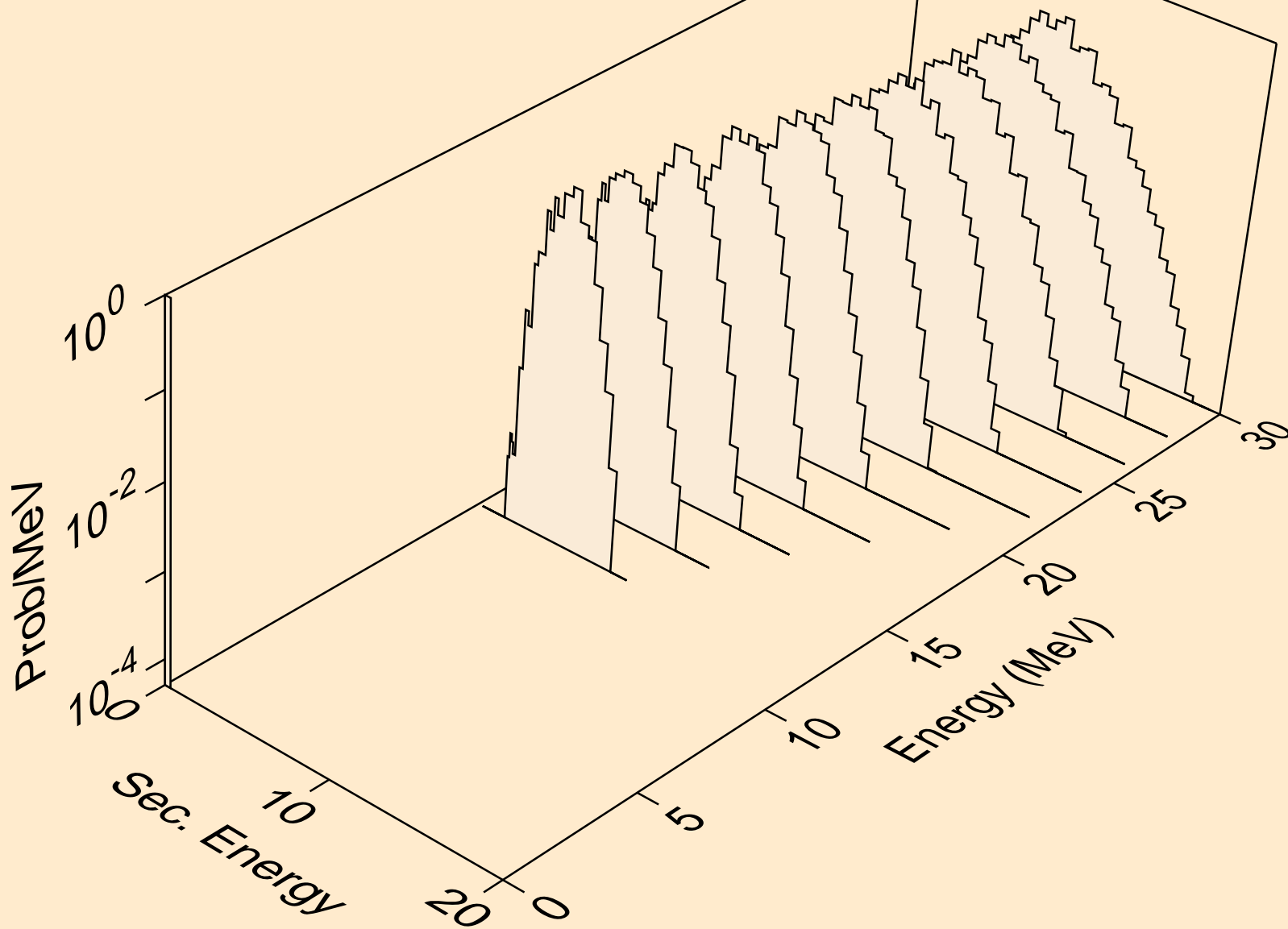

BA117 NEUTRON ACER TENDL-2019 LIBRARY; T=293.16K  
deuterons from (n,pd)

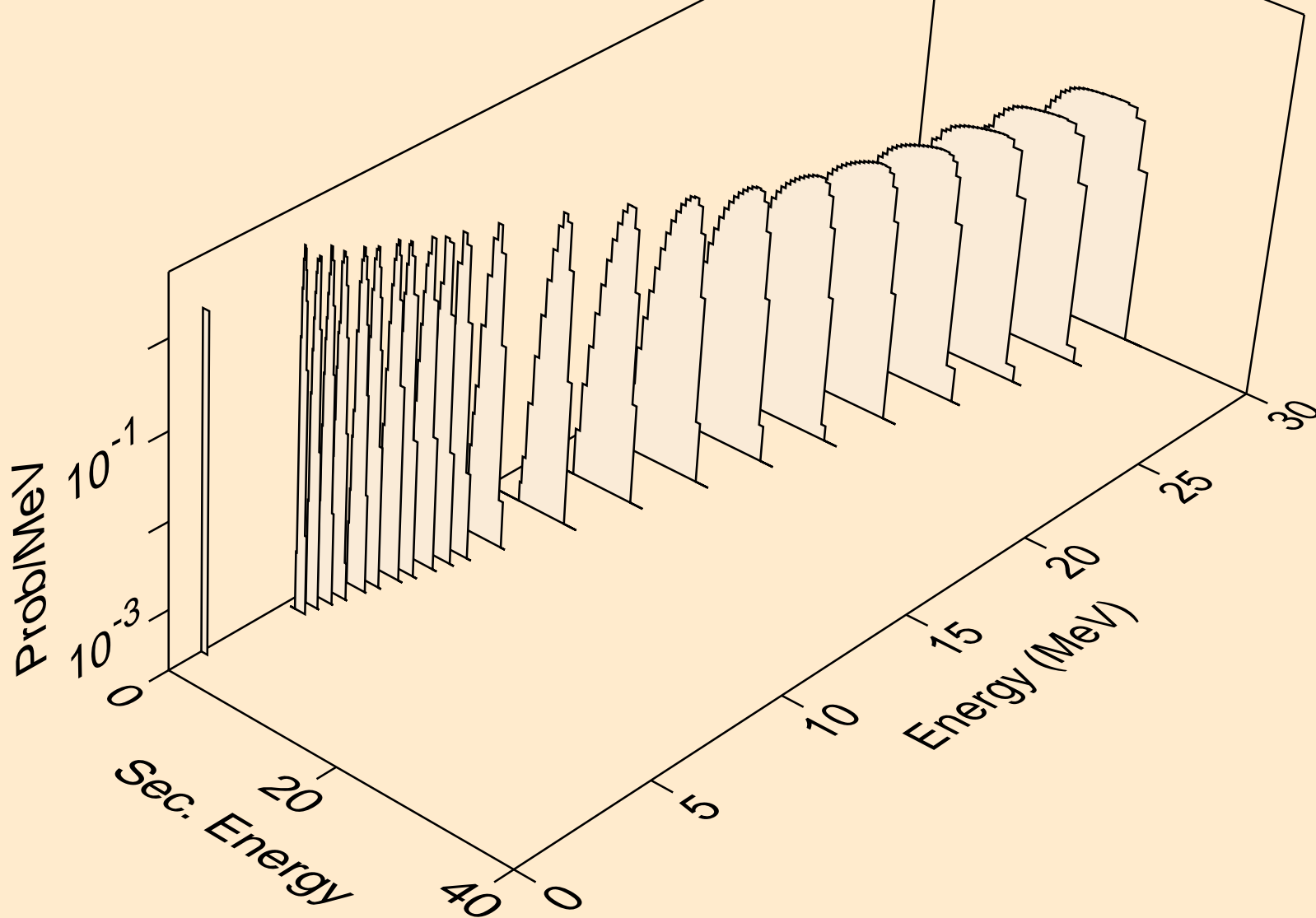

BA117 NEUTRON ACER TENDL-2019 LIBRARY; T=293.16K  
deuterons from (n,da)

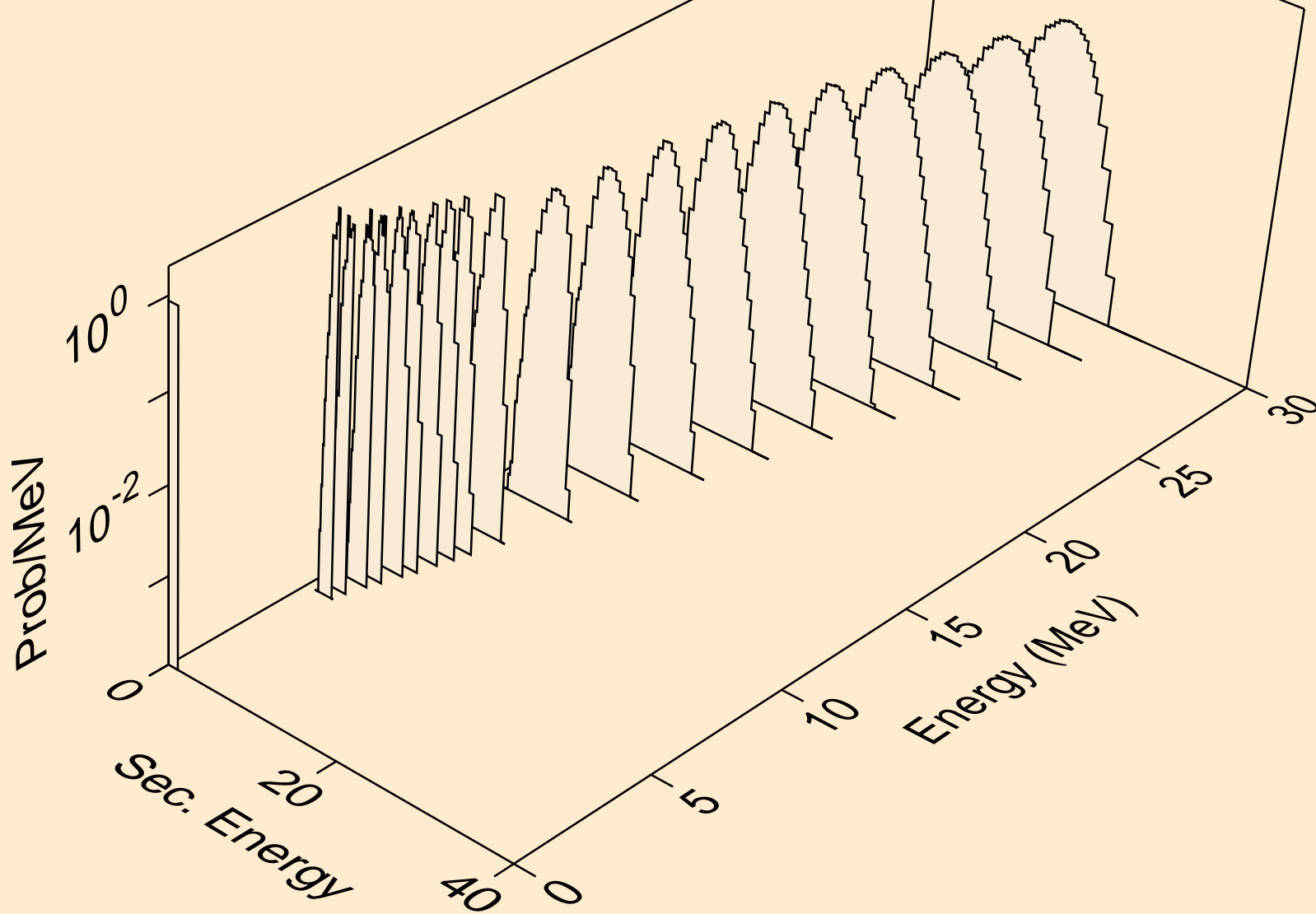

BA117 NEUTRON ACER TENDL-2019 LIBRARY; T=293.16K  
tritons from (n,x)

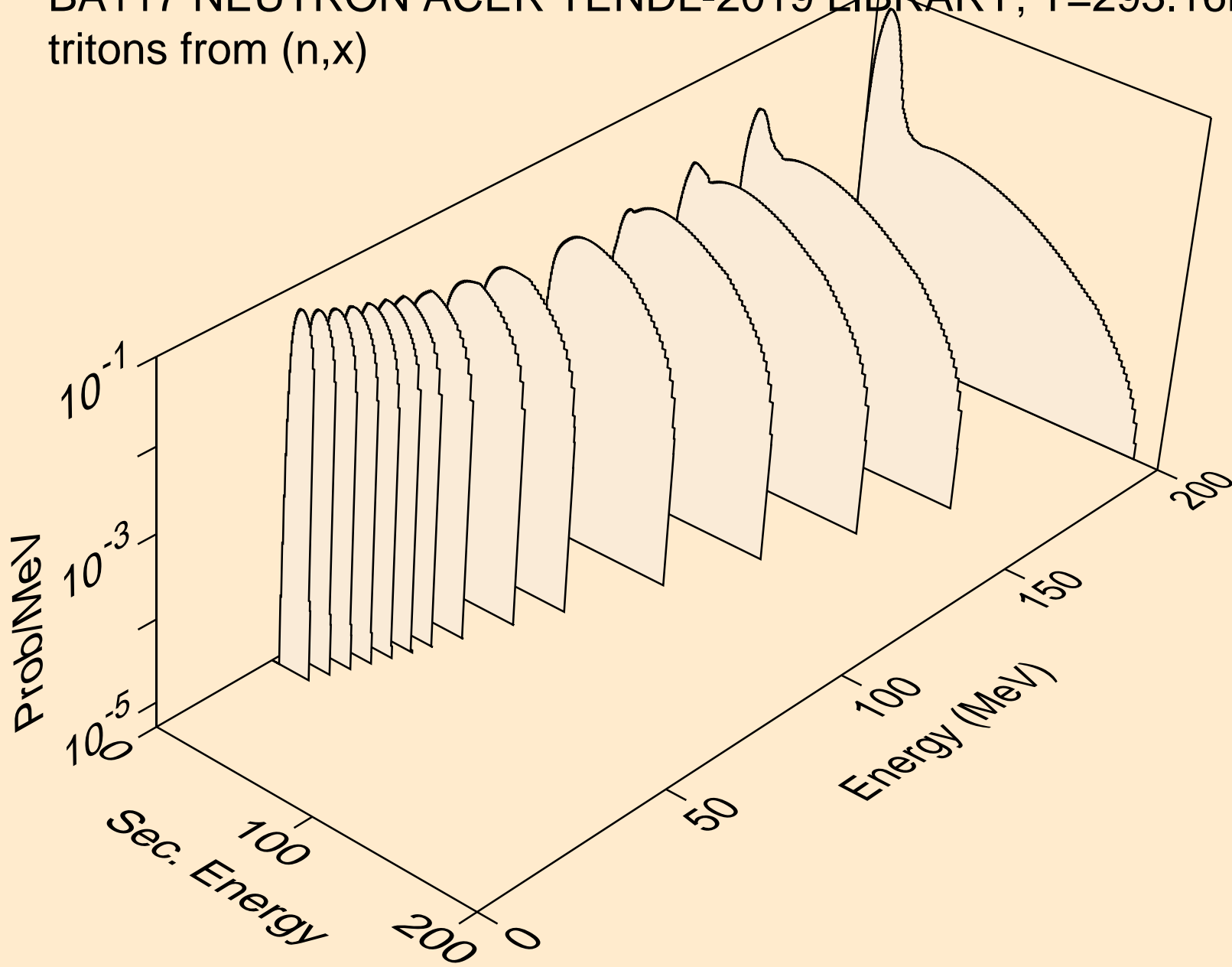

BA117 NEUTRON ACER TENDL-2019 LIBRARY; T=293.16K  
tritons from (n,n\*)t

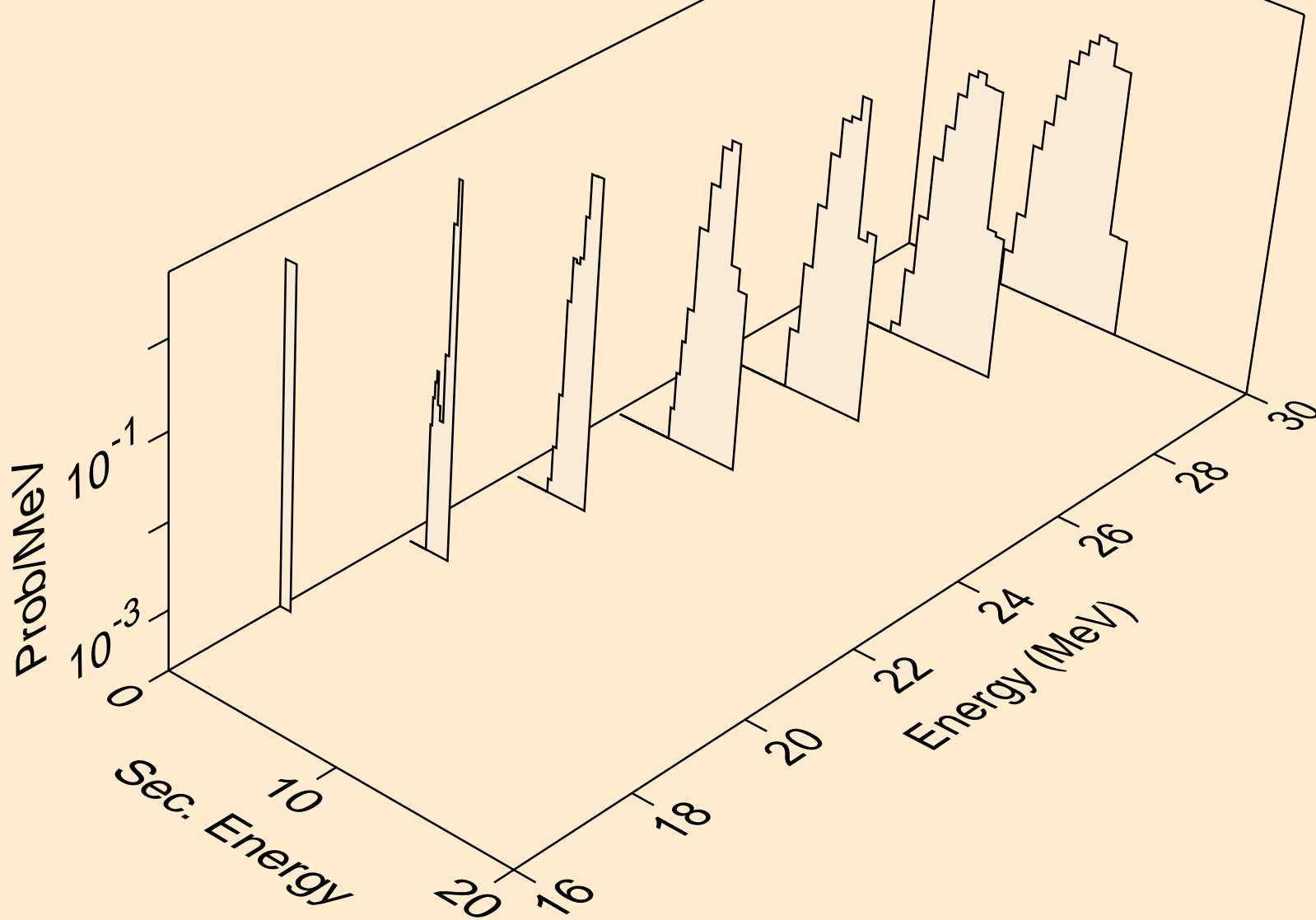

BA117 NEUTRON ACER TENDL-2019 LIBRARY; T=293.16K  
tritons from (n,t)

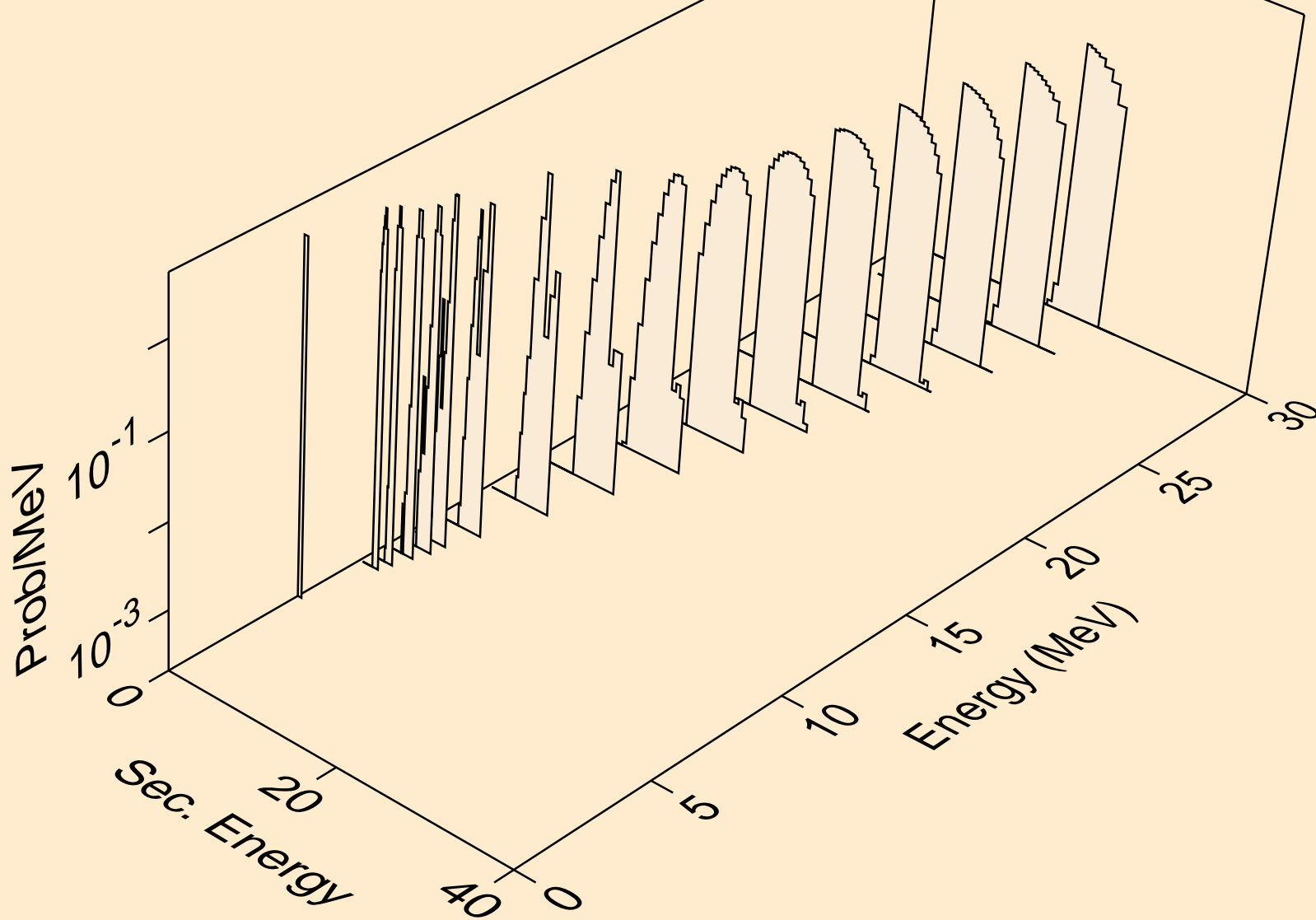



BA117 NEUTRON ACER TENDL-2019 LIBRARY; T=293.16K  
tritons from (n,t2a)

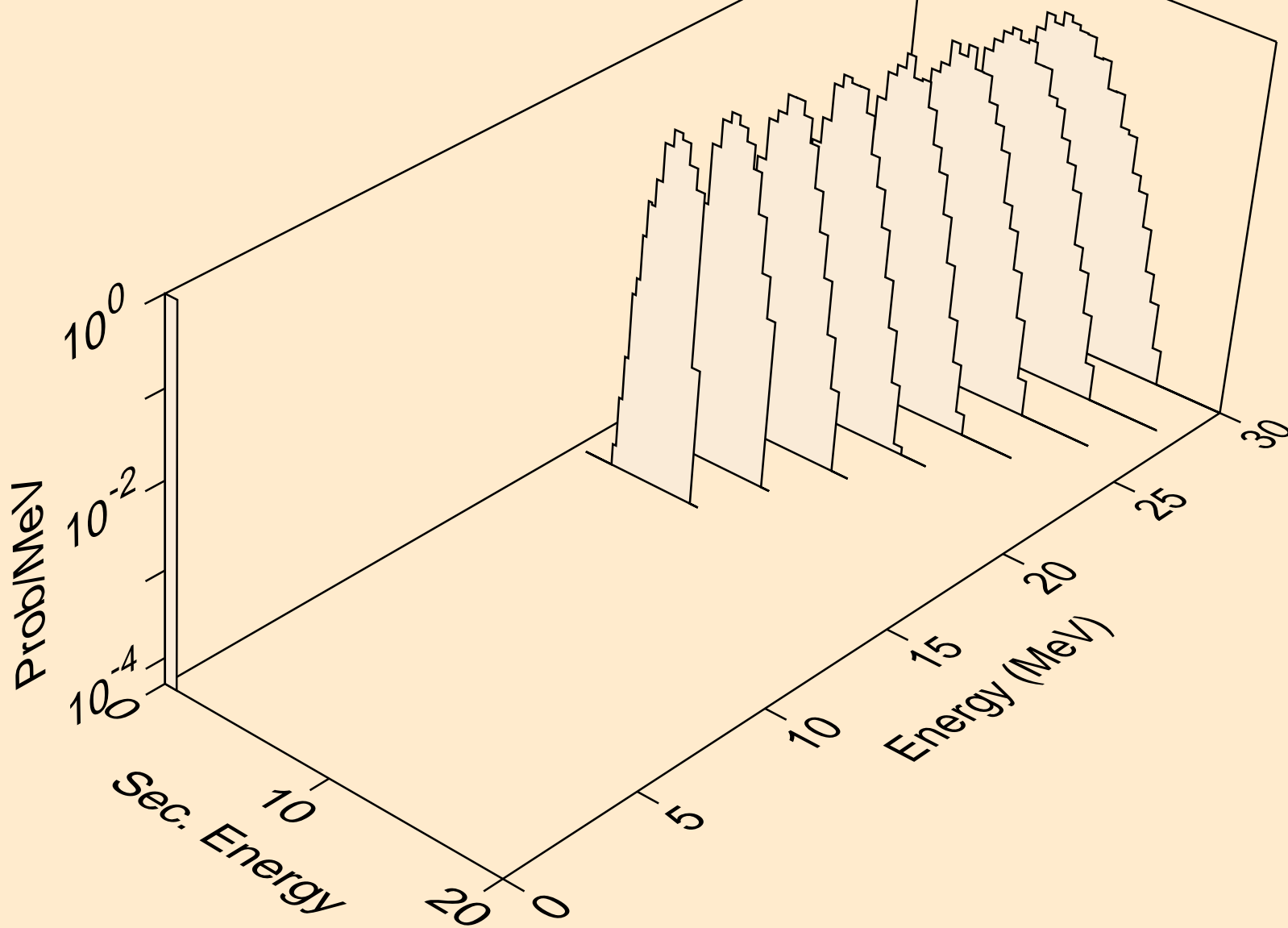

BA117 NEUTRON ACER TENDL-2019 LIBRARY; T=293.16K  
tritons from (n,pt)

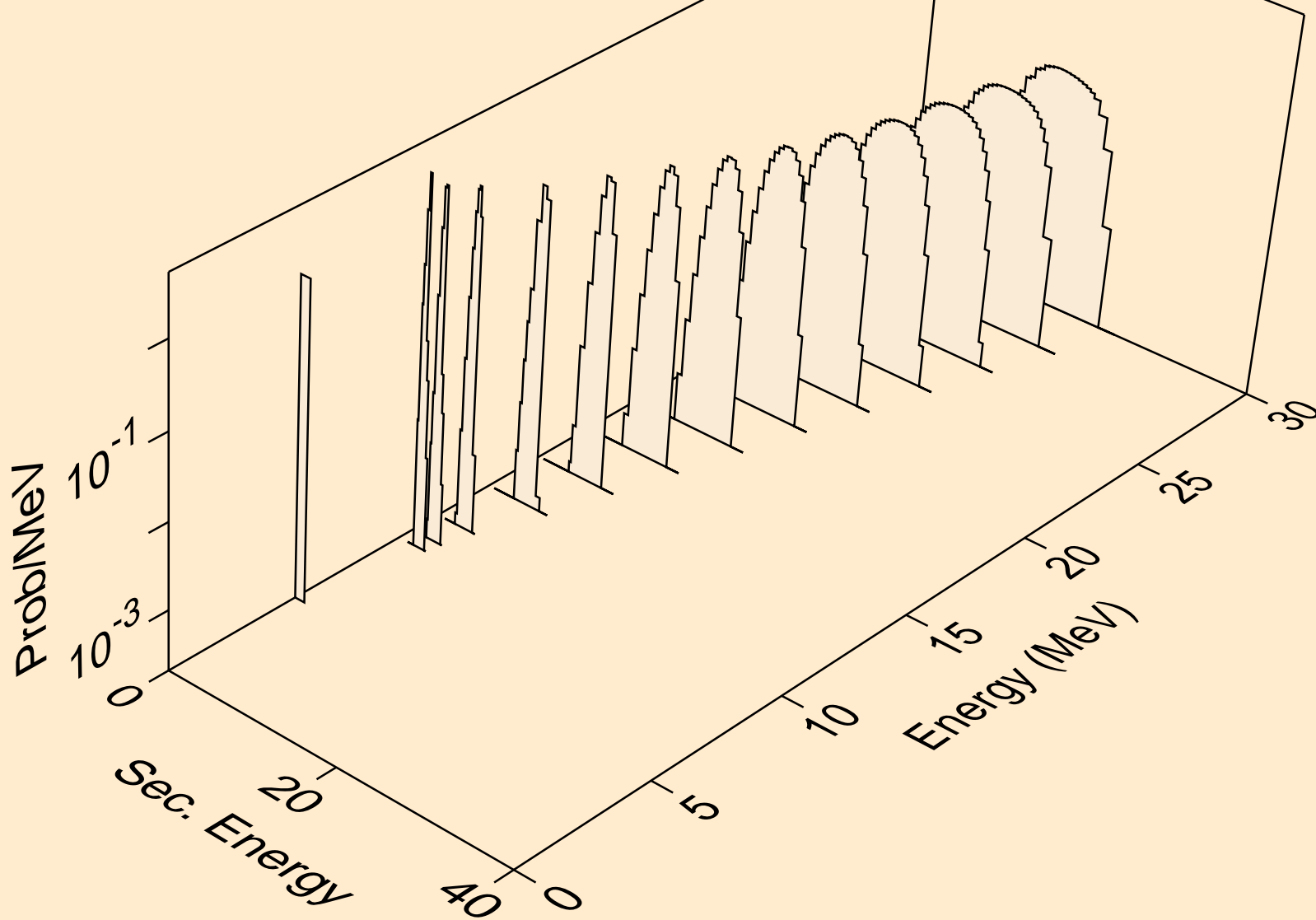

BA117 NEUTRON ACER TENDL-2019 LIBRARY; T=293.16K  
he3s from (n,x)

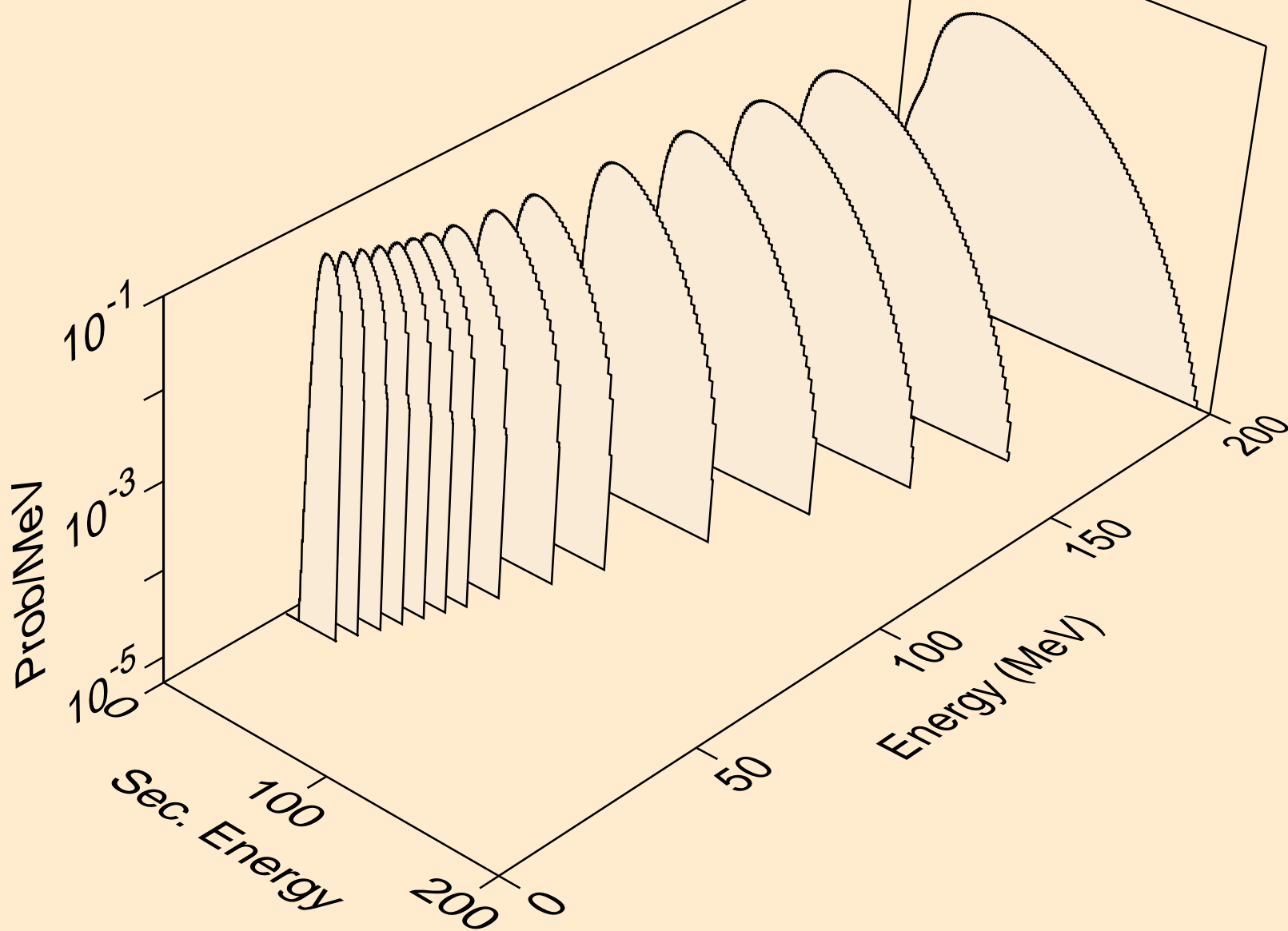

BA117 NEUTRON ACER TENDL-2019 LIBRARY; T=293.16K  
he3s from (n,n\*)he3

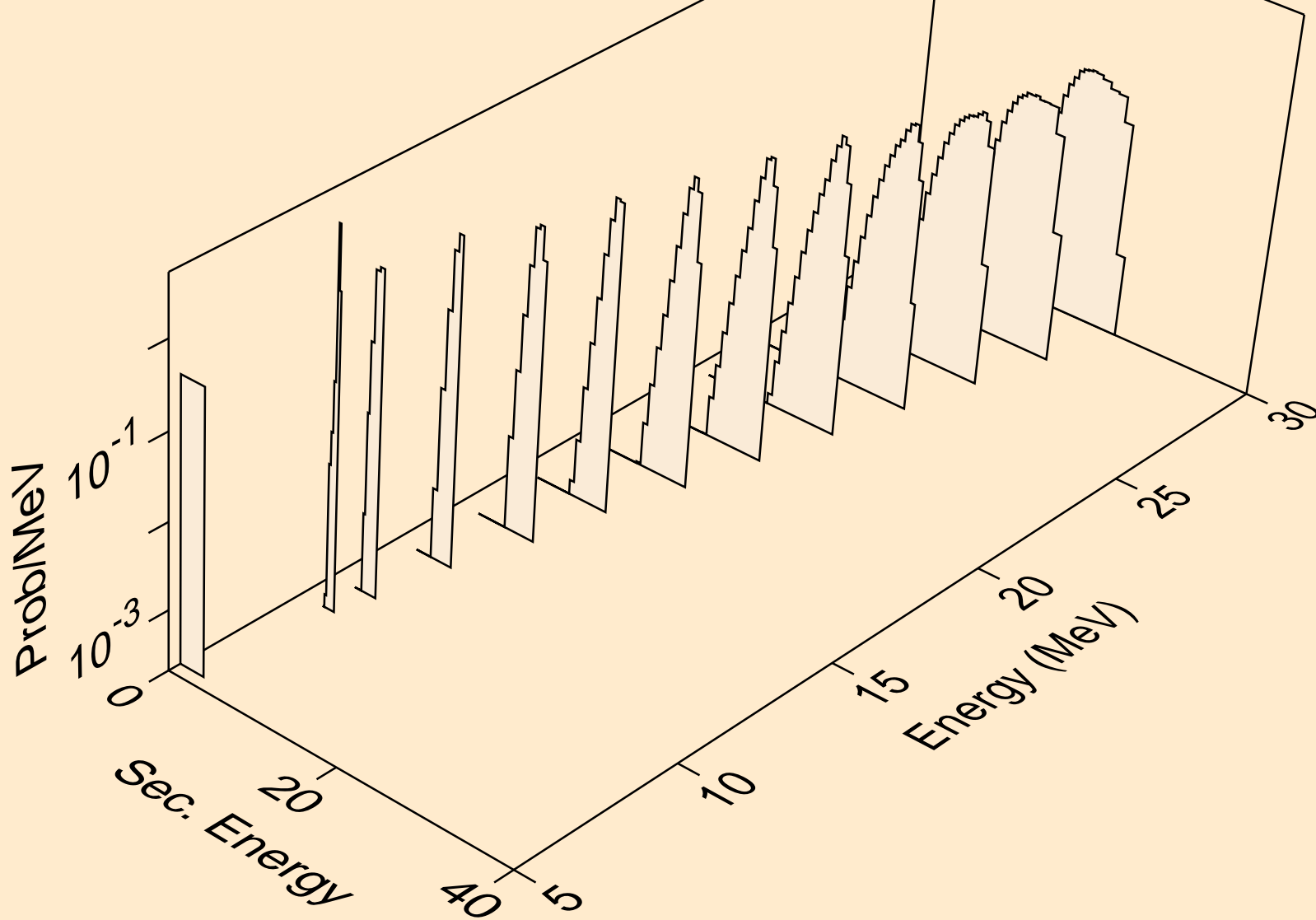

BA117 NEUTRON ACER TENDL-2019 LIBRARY; T=293.16K  
he3s from (n,he3)

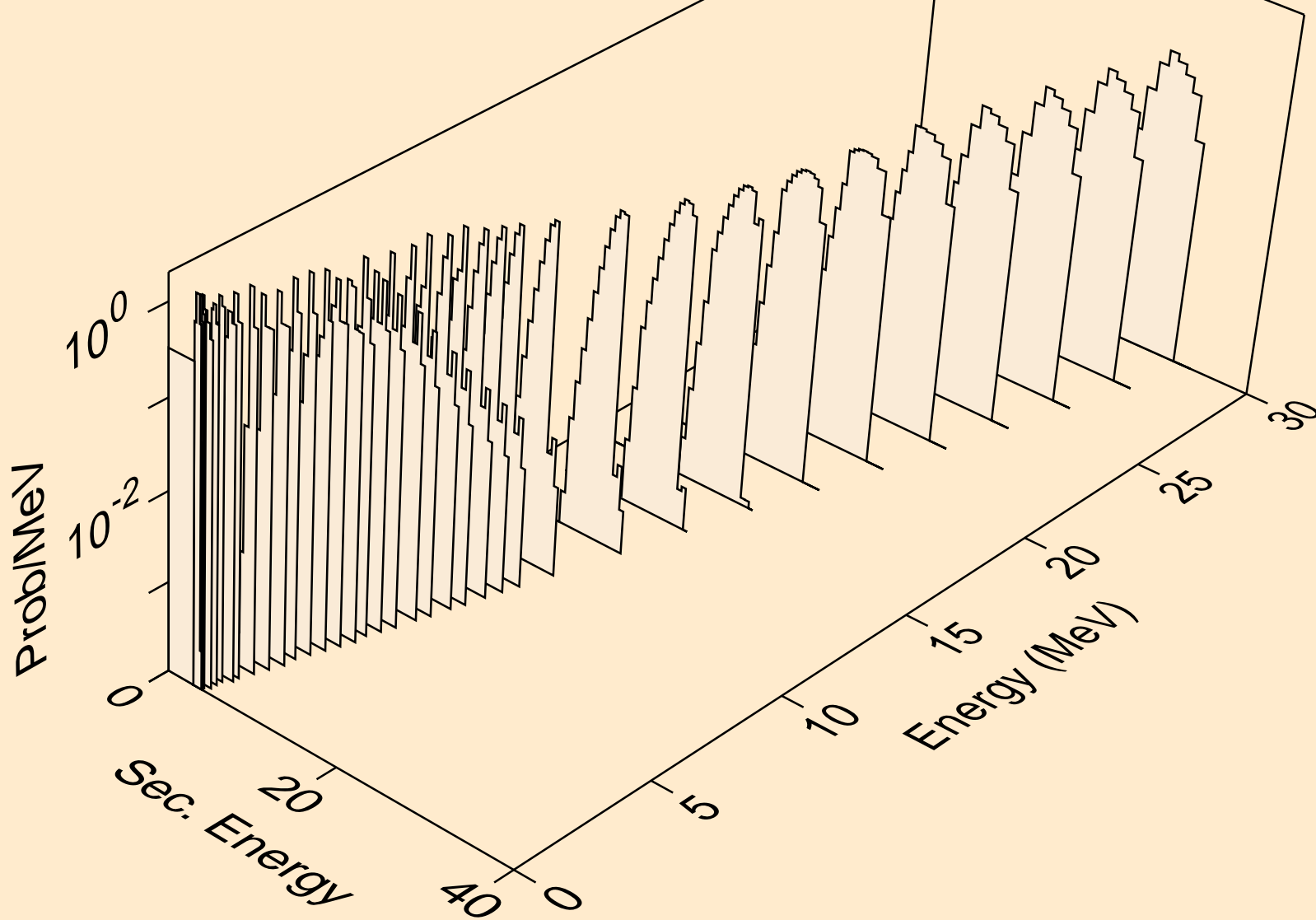

BA117 NEUTRON ACER TENDL-2019 LIBRARY; T=293.16K  
alphas from (n,x)

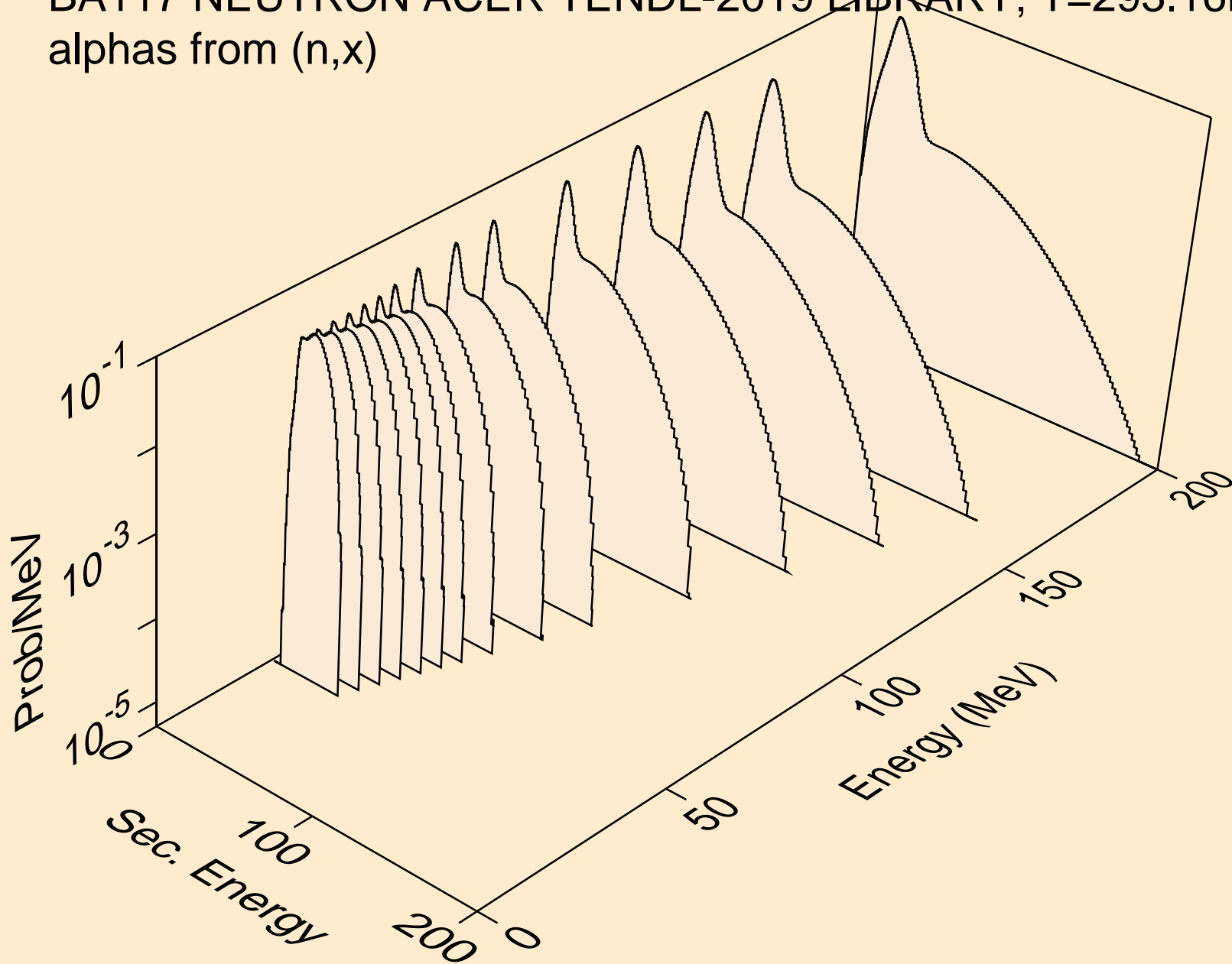

BA117 NEUTRON ACER TENDL-2019 LIBRARY; T=293.16K  
alphas from (n,n\*)a

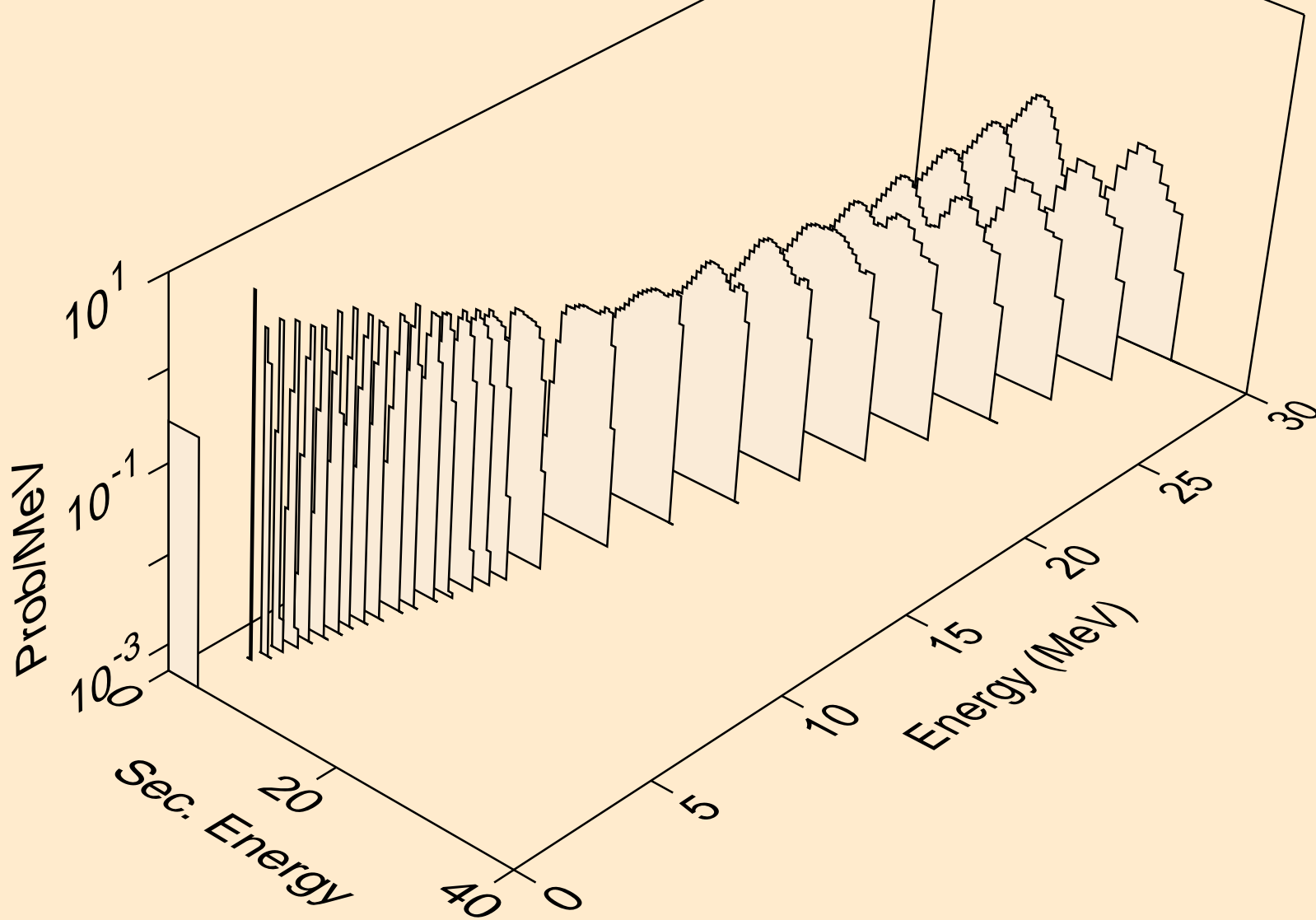

BA117 NEUTRON ACER TENDL-2019 LIBRARY; T=293.16K  
alphas from (n,n\*)3a

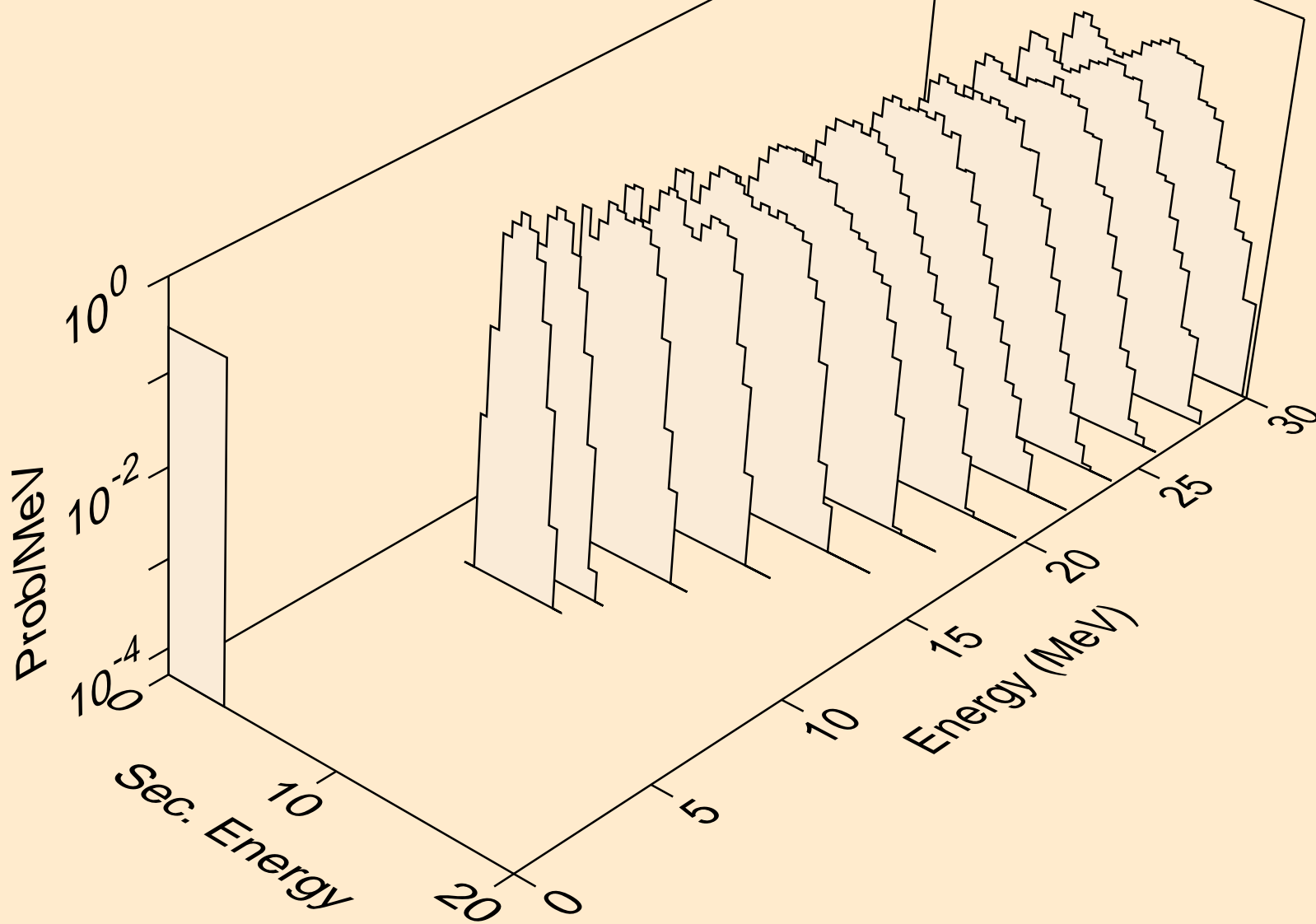



BA117 NEUTRON ACER TENDL-2019 LIBRARY; T=293.16K  
alphas from (n,2n)a

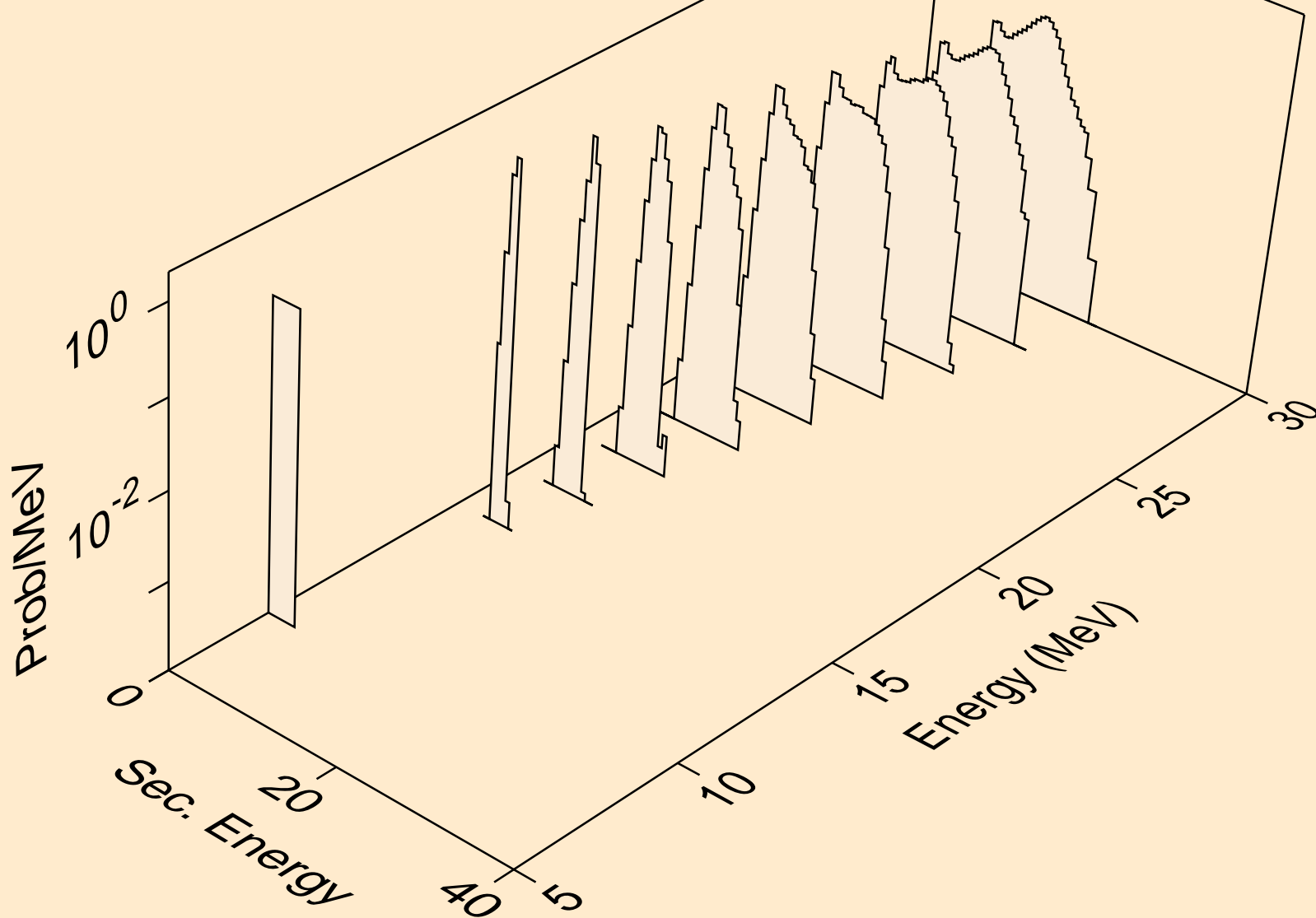

BA117 NEUTRON ACER TENDL-2019 LIBRARY; T=293.16K  
alphas from (n,n\*)2a

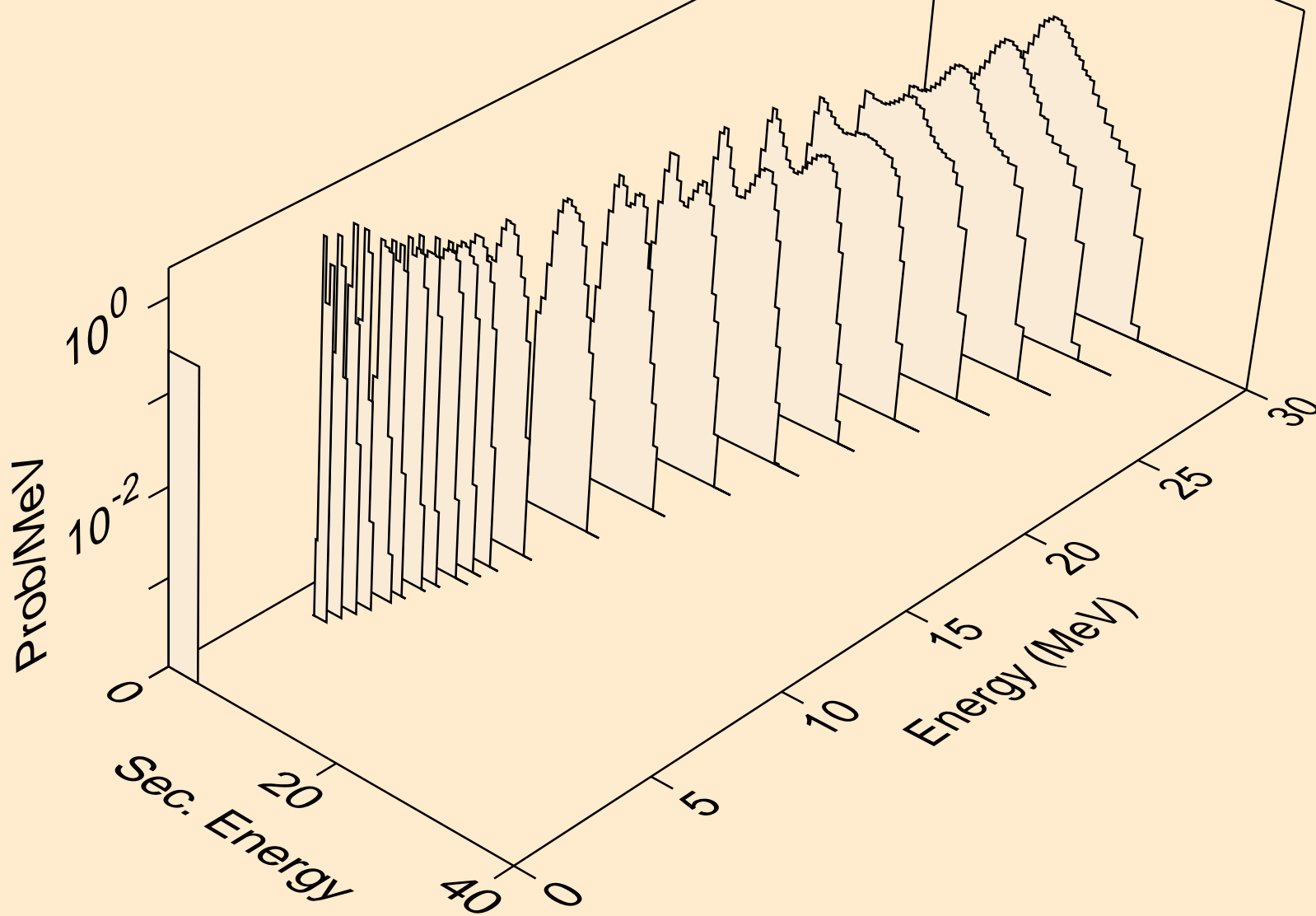

BA117 NEUTRON ACER TENDL-2019 LIBRARY; T=293.16K  
alphas from (n,2n)2a

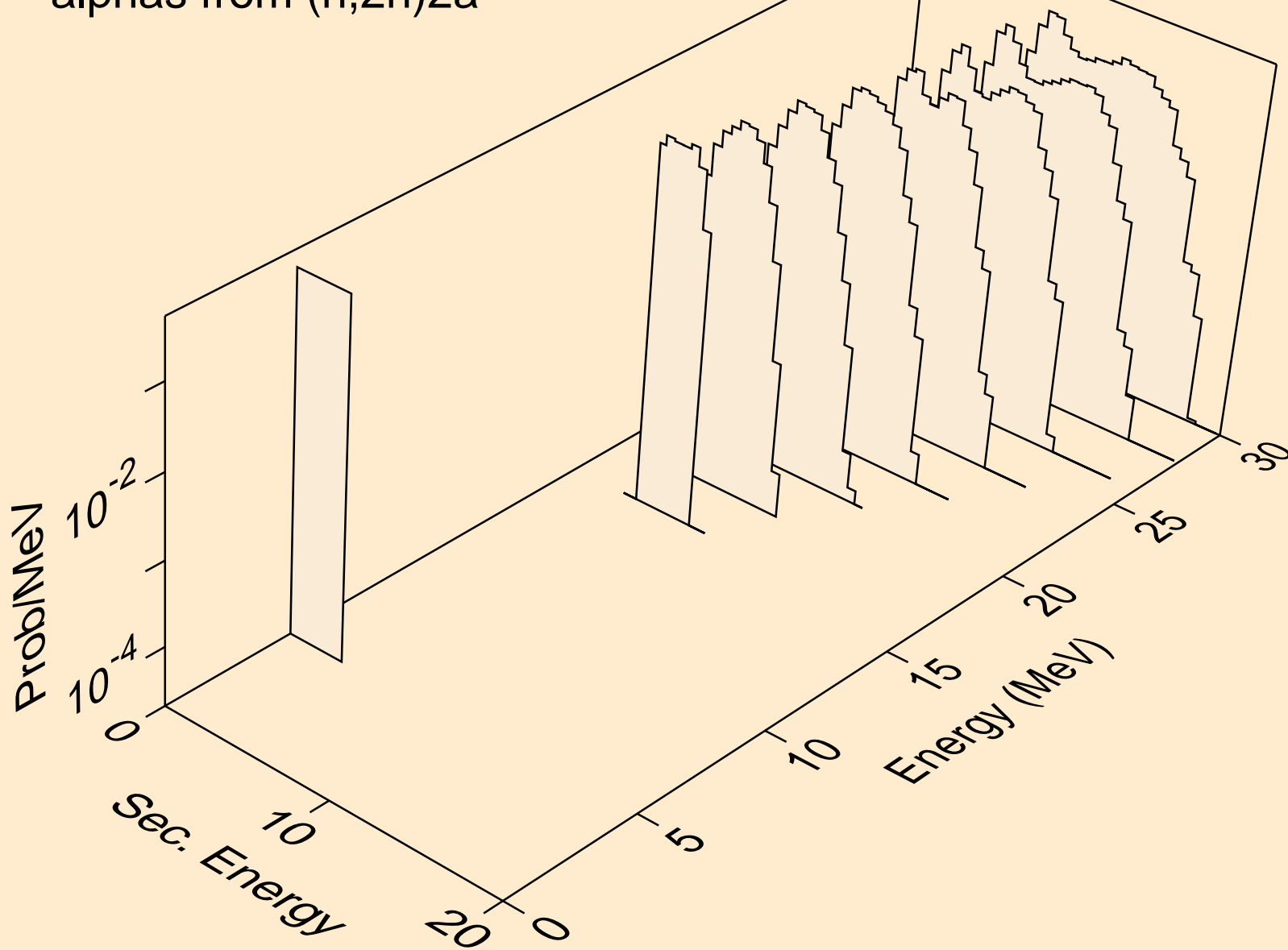

BA117 NEUTRON ACER TENDL-2019 LIBRARY; T=293.16K  
alphas from (n,npa)

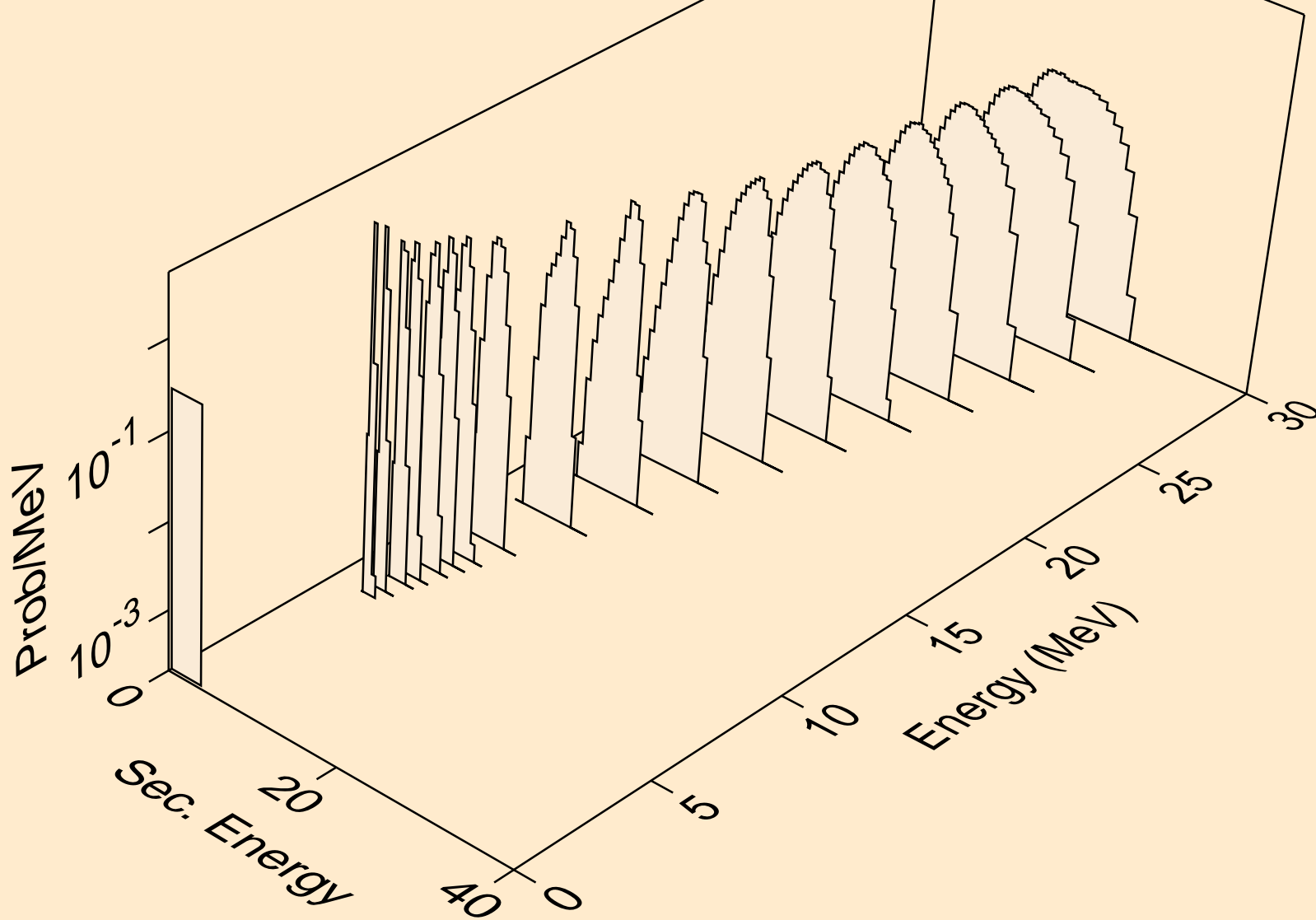

BA117 NEUTRON ACER TENDL-2019 LIBRARY; T=293.16K  
alphas from (n,a)

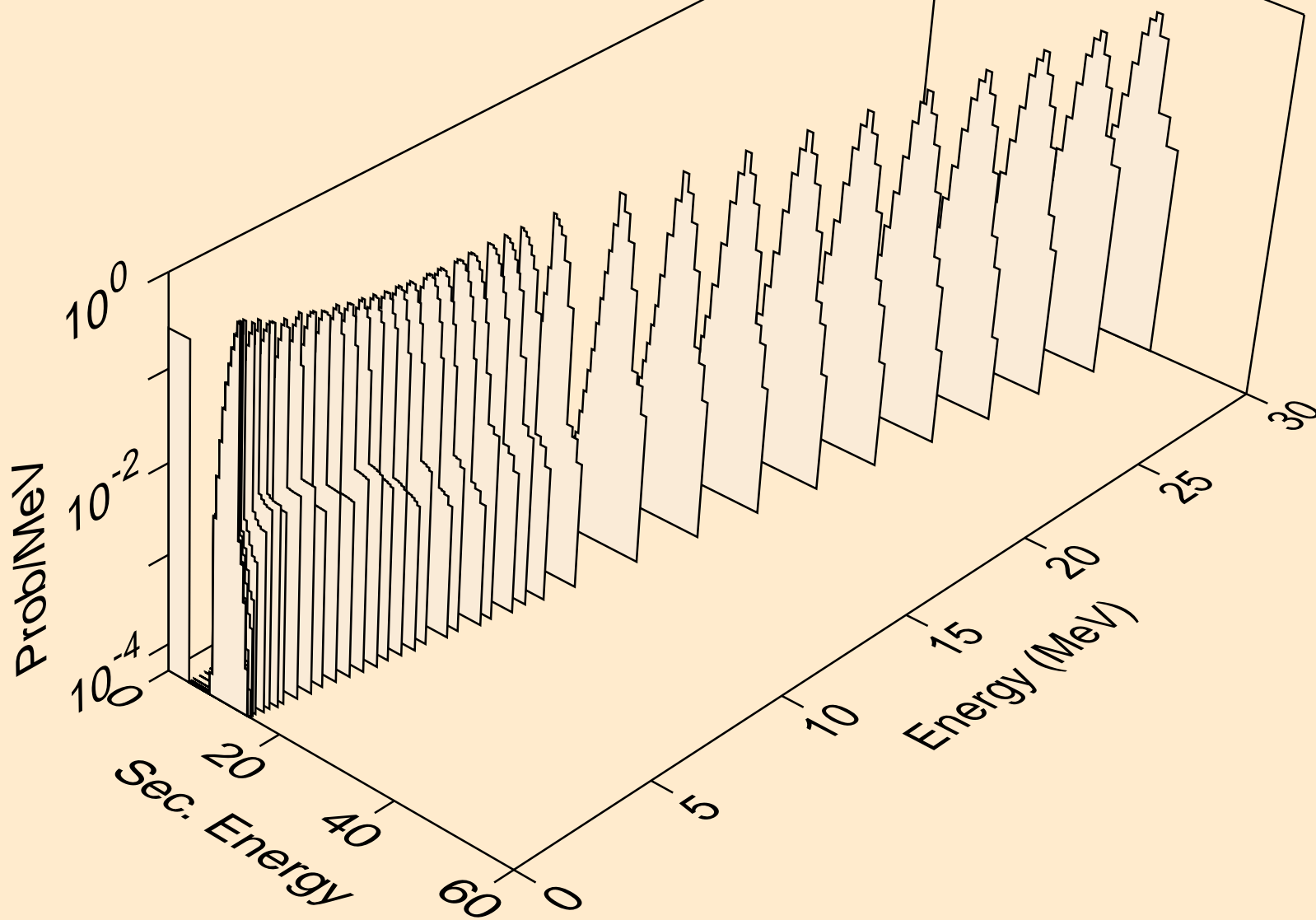

BA117 NEUTRON ACER TENDL-2019 LIBRARY; T=293.16K  
alphas from (n,2a)

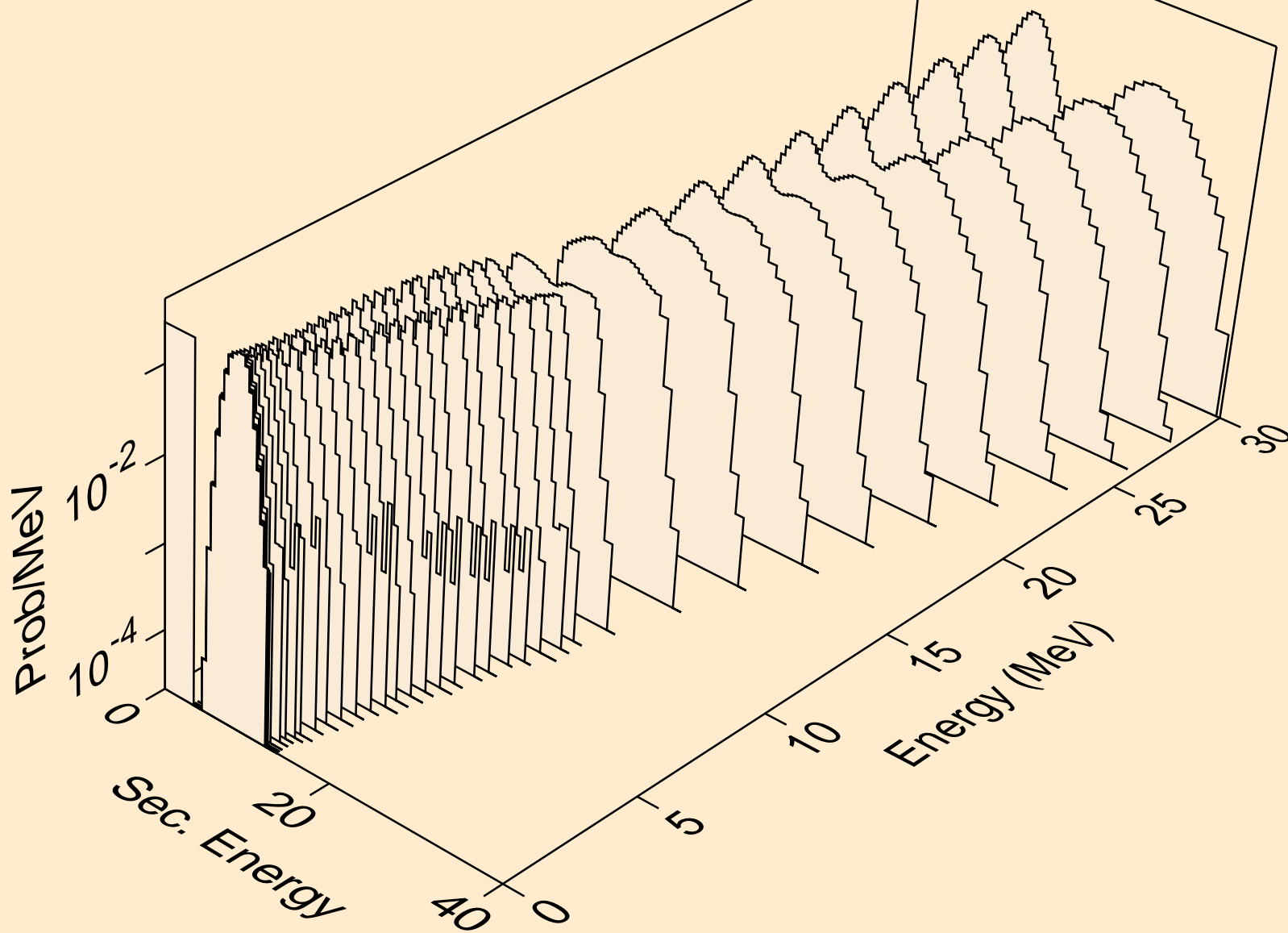

BA117 NEUTRON ACER TENDL-2019 LIBRARY; T=293.16K  
alphas from (n,3a)

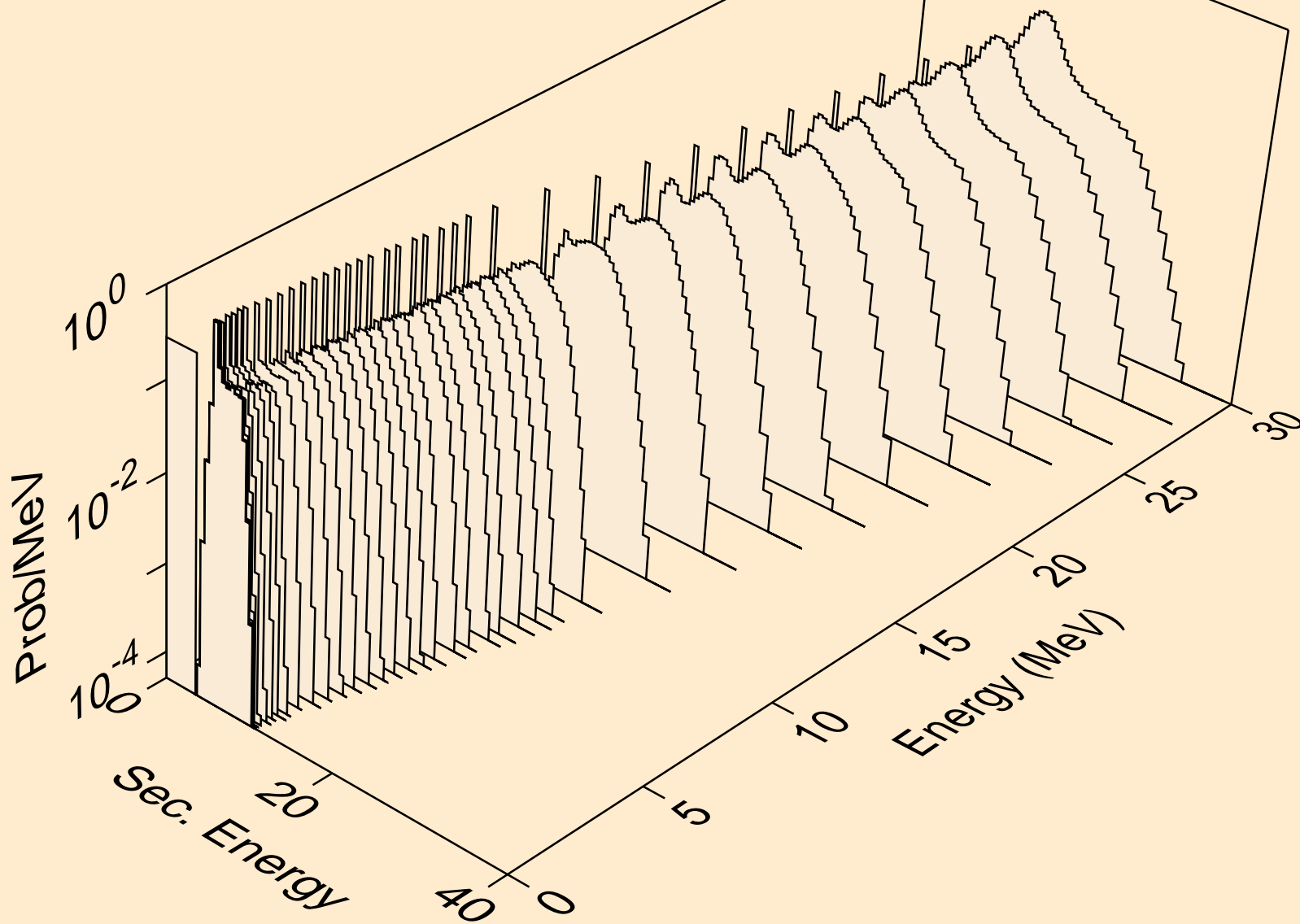

BA117 NEUTRON ACER TENDL-2019 LIBRARY; T=293.16K  
alphas from (n,pa)

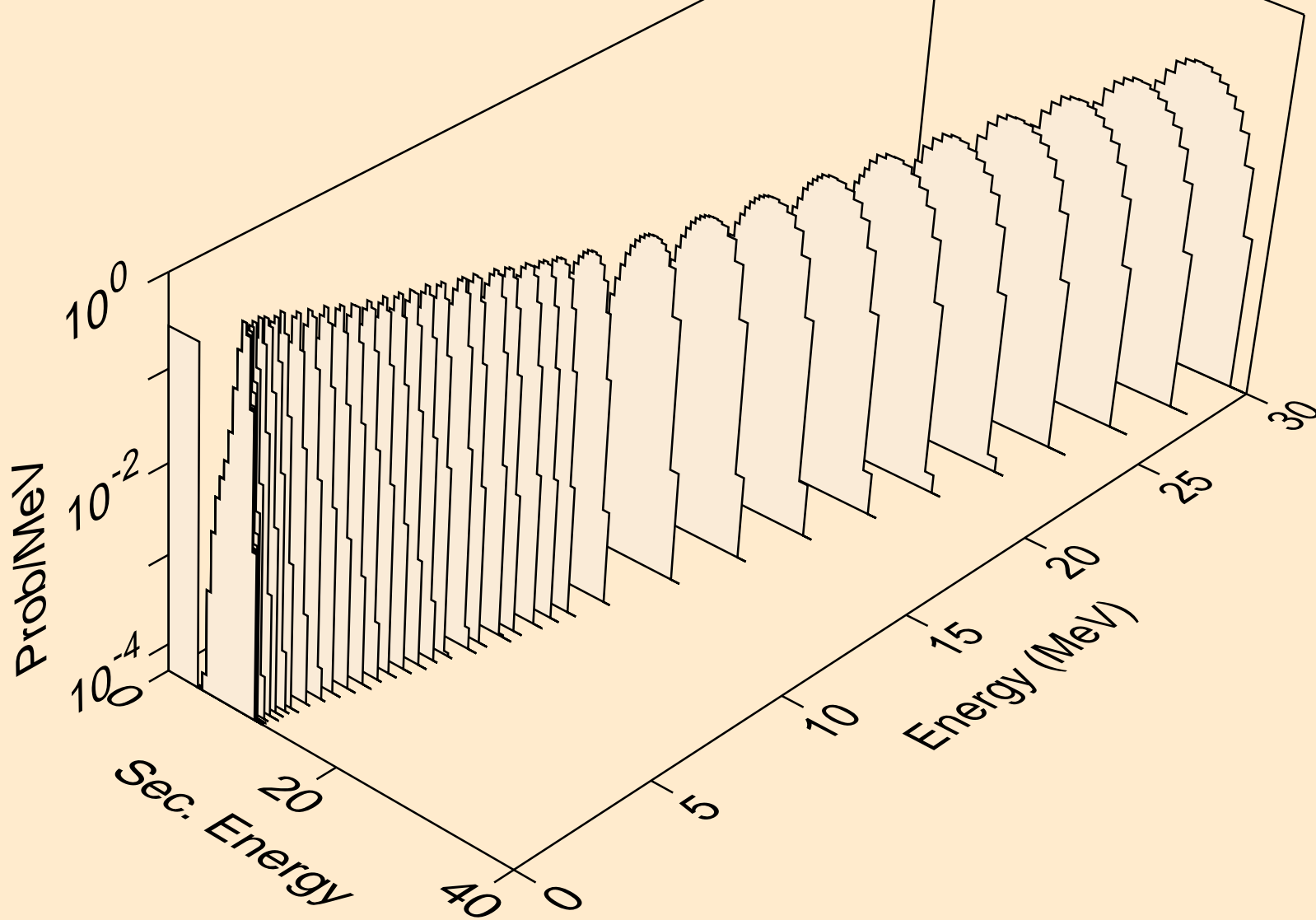



BA117 NEUTRON ACER TENDL-2019 LIBRARY; T=293.16K  
alphas from (n,t2a)

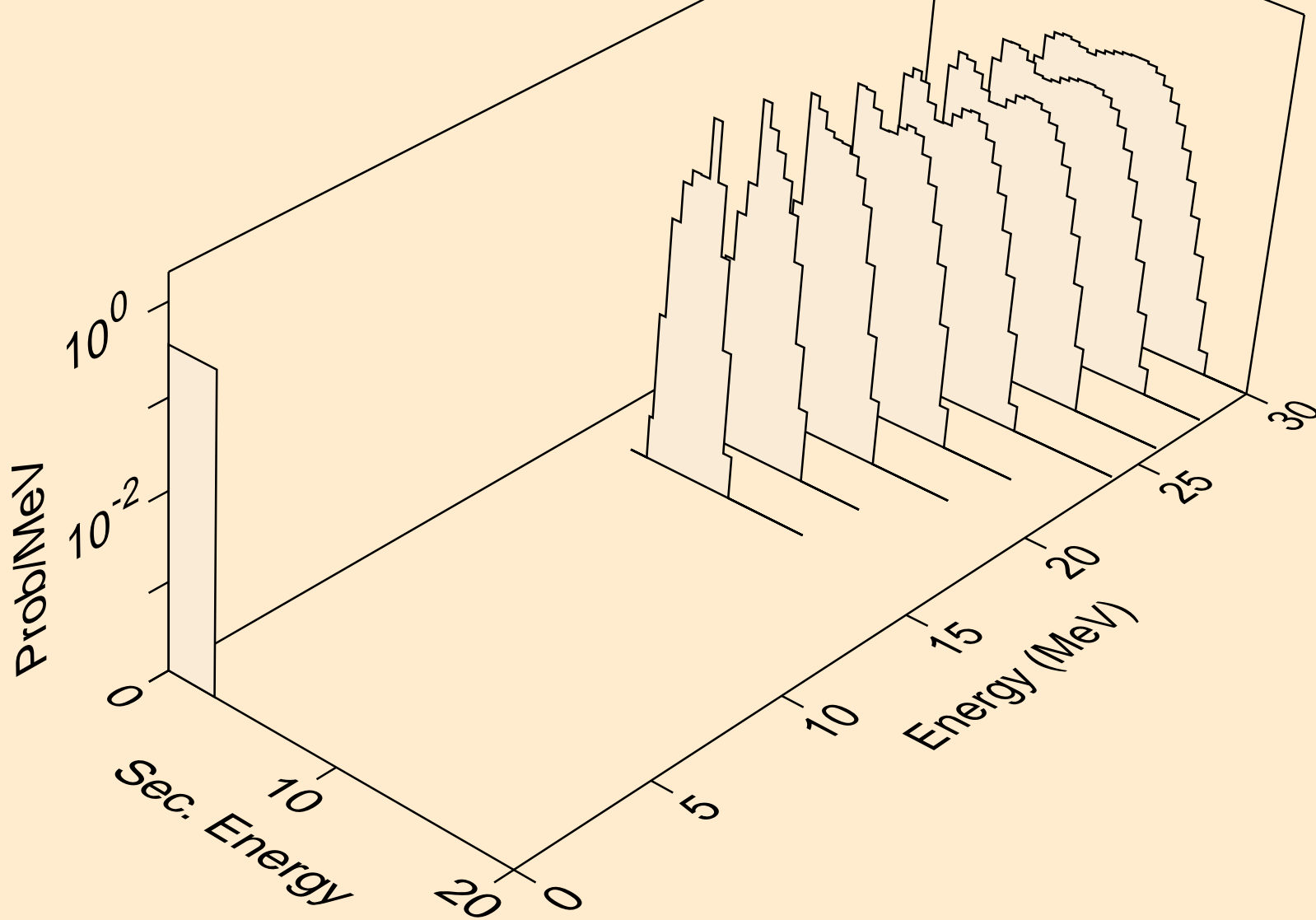

BA117 NEUTRON ACER TENDL-2019 LIBRARY; T=293.16K  
alphas from (n,d2a)

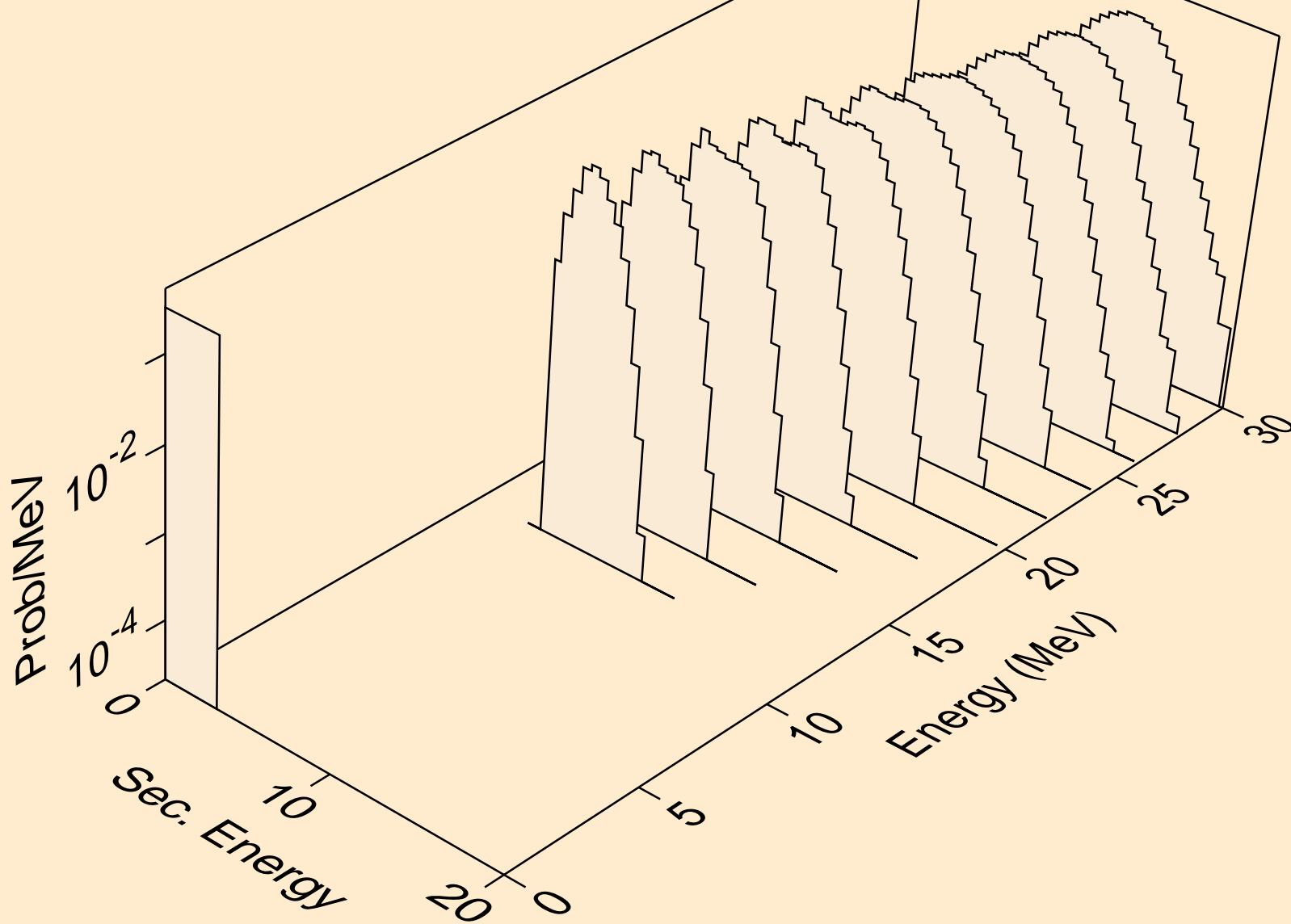

BA117 NEUTRON ACER TENDL-2019 LIBRARY; T=293.16K  
alphas from (n,da)

