

BA121 NEUTRON ACER TENDL-2019 LIBRARY; T=293.16K  
Principal cross sections

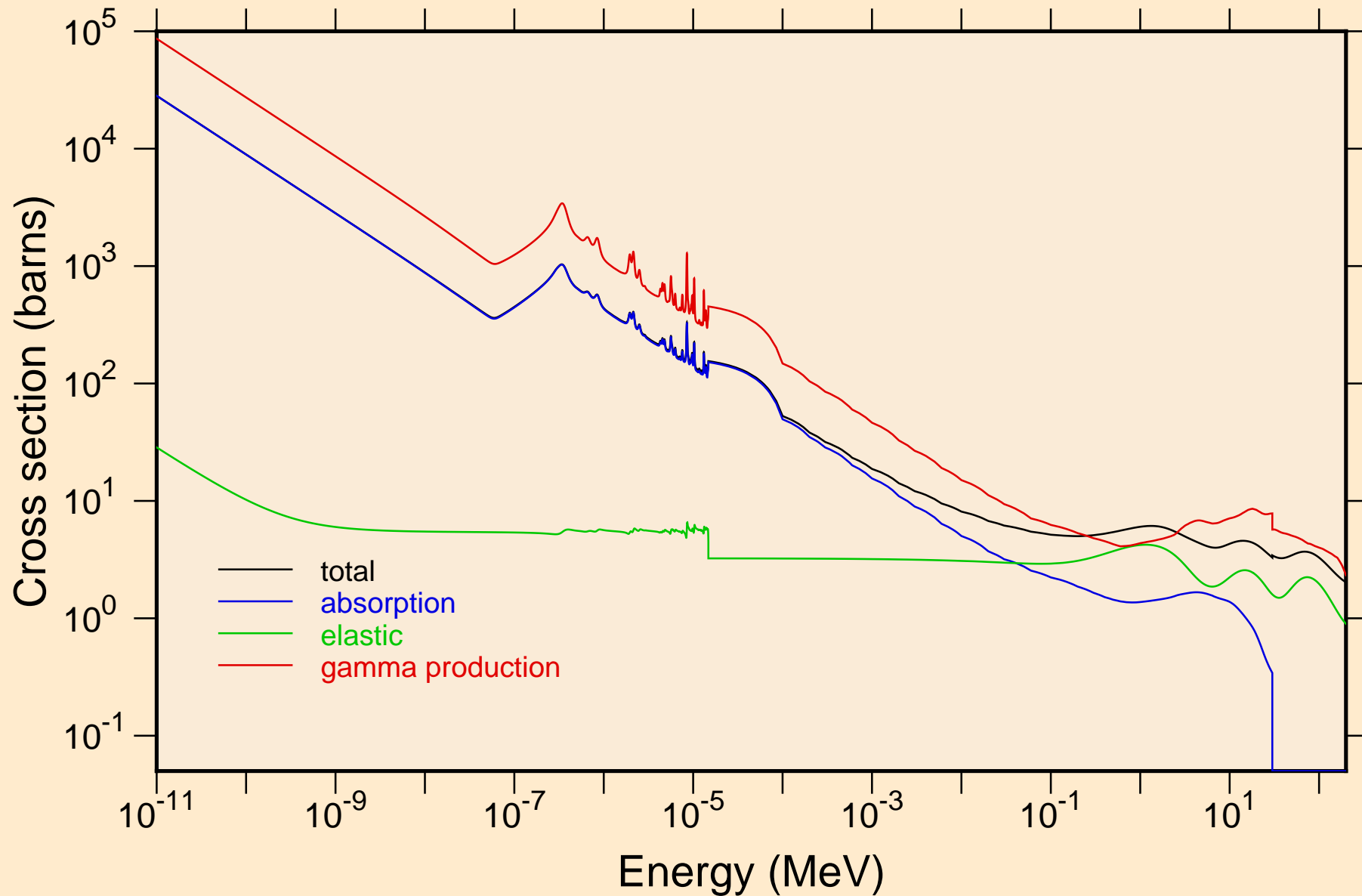

BA121 NEUTRON ACER TENDL-2019 LIBRARY; T=293.16K  
resonance total cross section

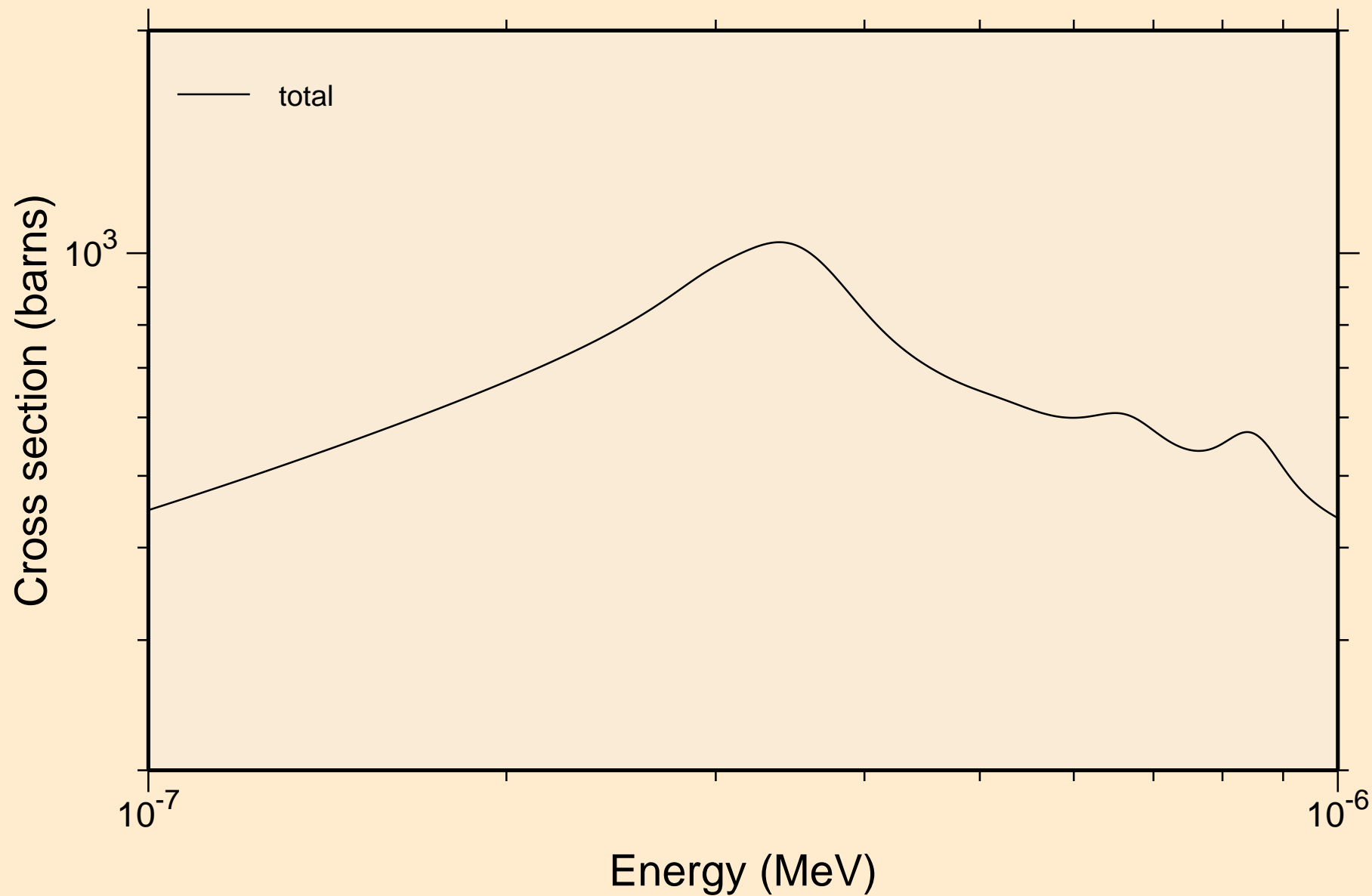

BA121 NEUTRON ACER TENDL-2019 LIBRARY; T=293.16K  
resonance total cross section

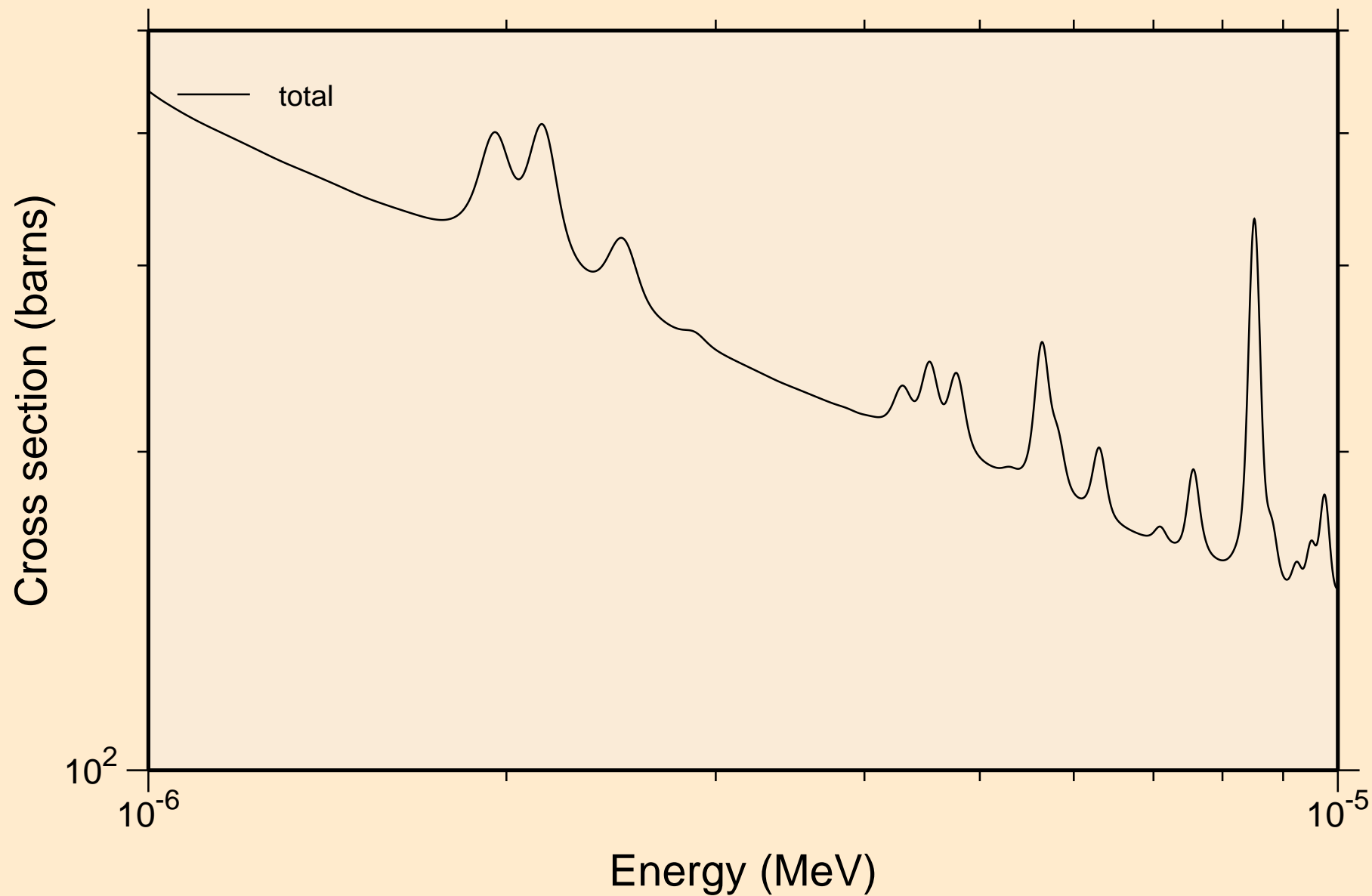

BA121 NEUTRON ACER TENDL-2019 LIBRARY; T=293.16K  
resonance total cross section

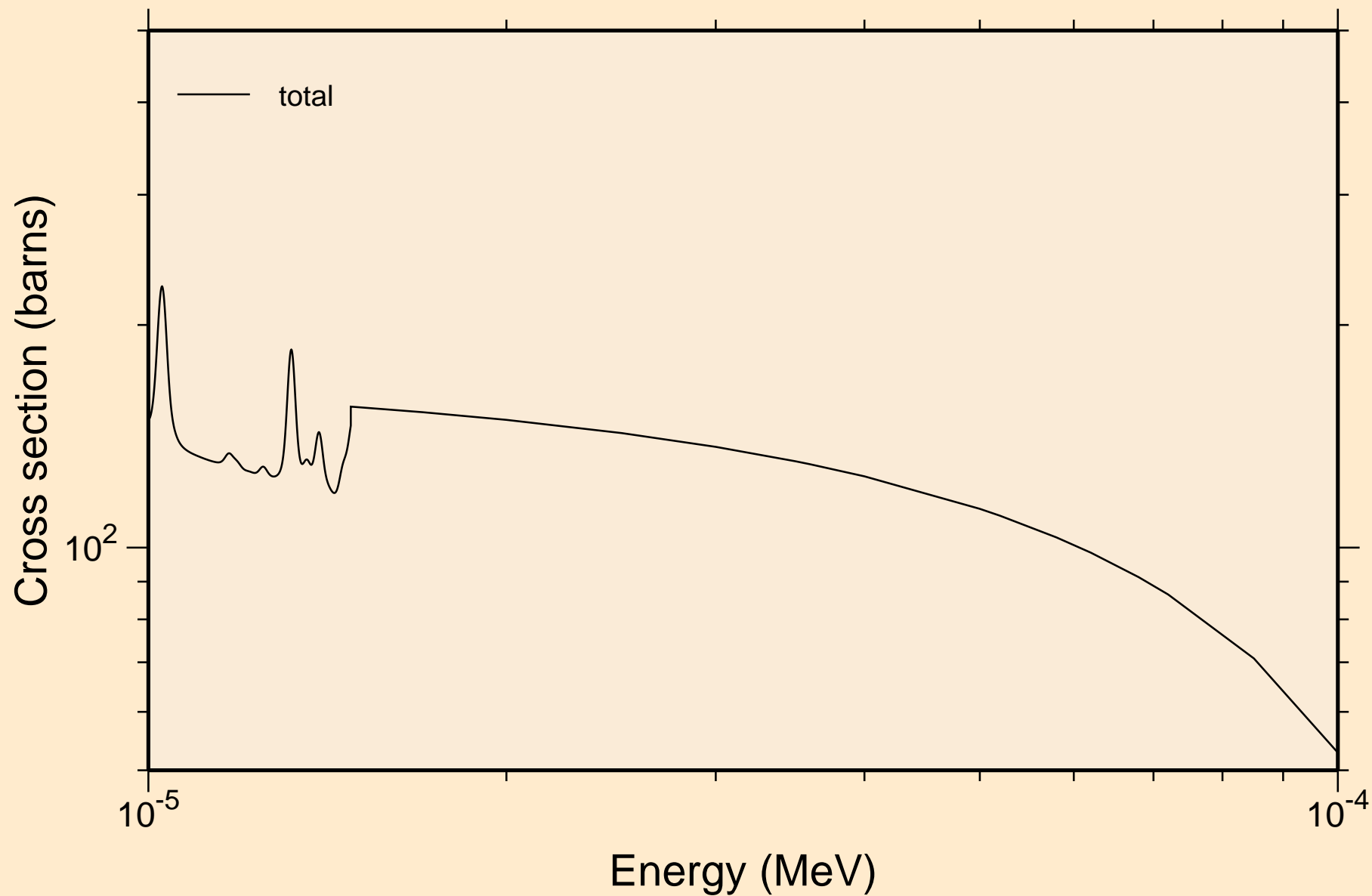

B̄A121 NEUTRON ACER TENDL-2019 LIBRARY; T=293.16K  
resonance total cross section

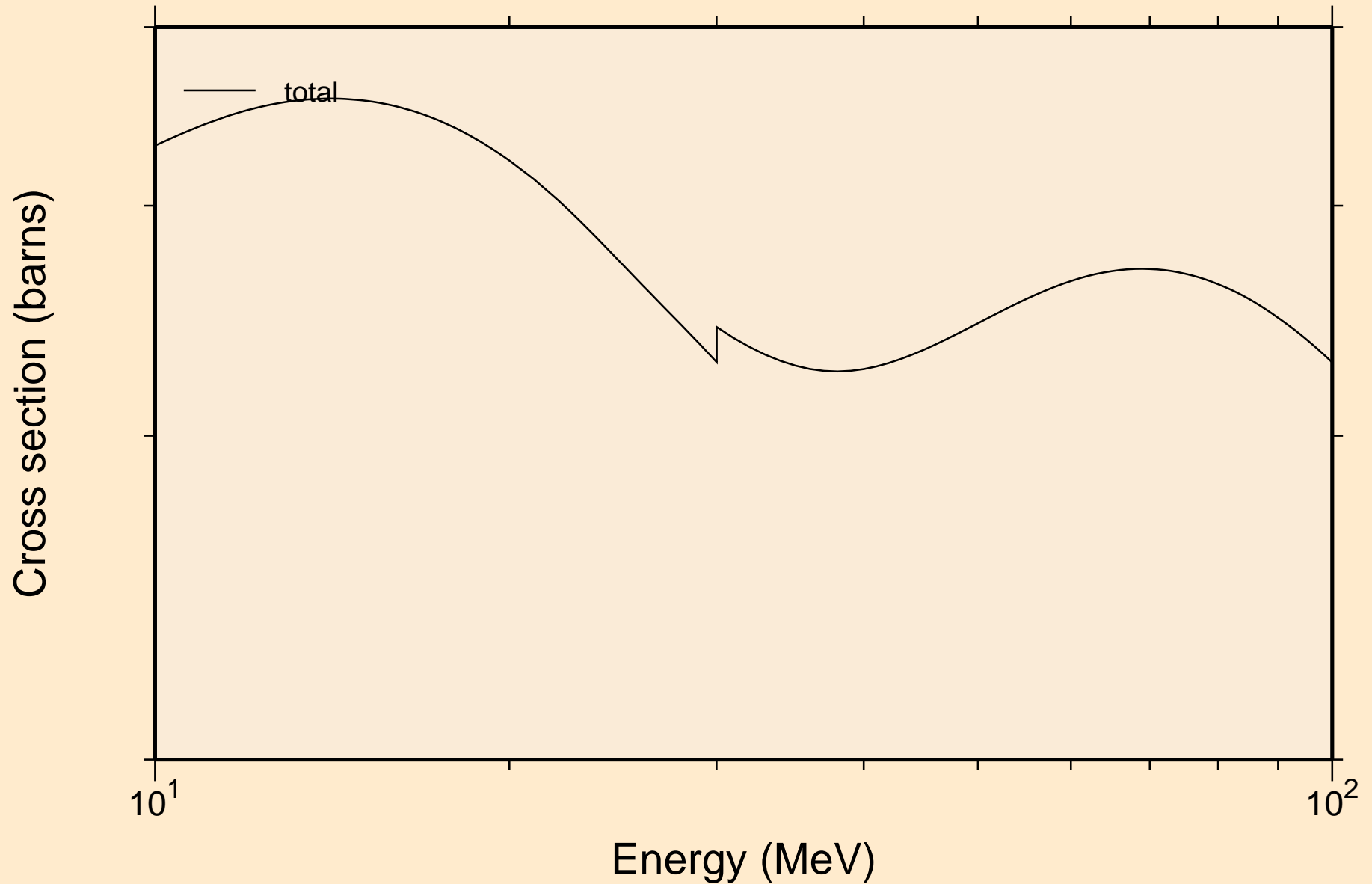

BA121 NEUTRON ACER TENDL-2019 LIBRARY; T=293.16K  
resonance absorption cross sections

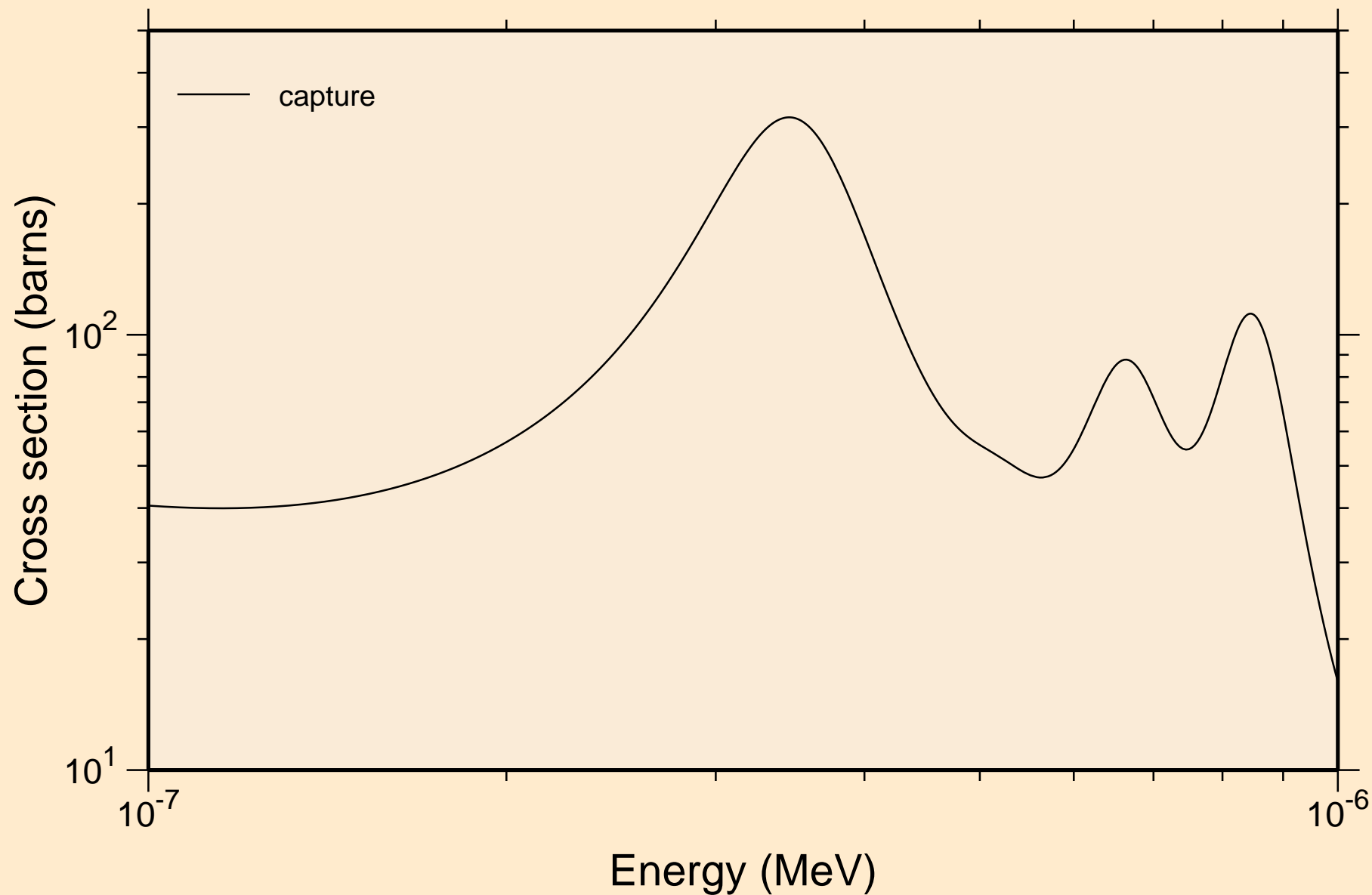

BA121 NEUTRON ACER TENDL-2019 LIBRARY; T=293.16K  
resonance absorption cross sections

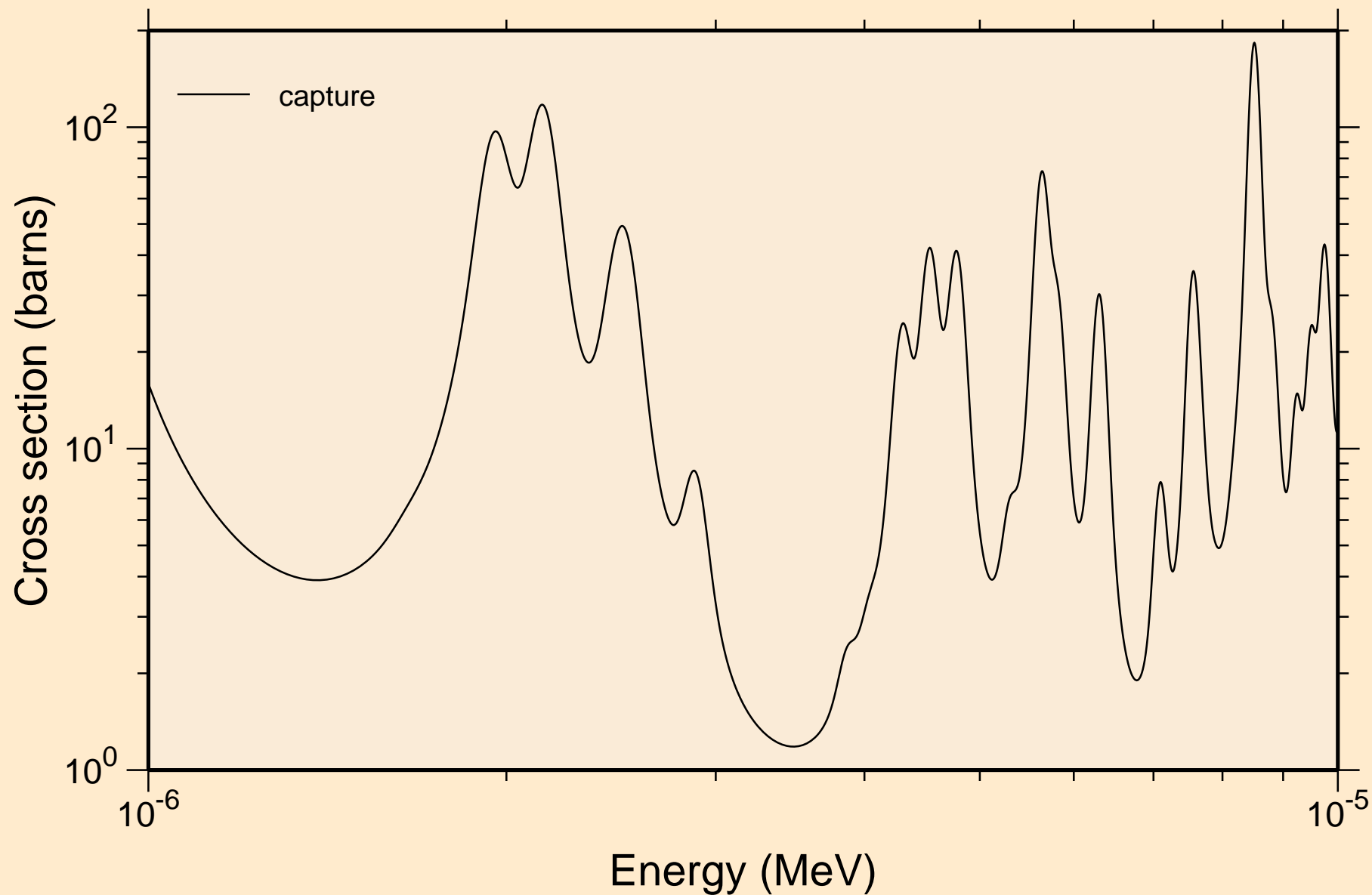

BA121 NEUTRON ACER TENDL-2019 LIBRARY; T=293.16K  
resonance absorption cross sections

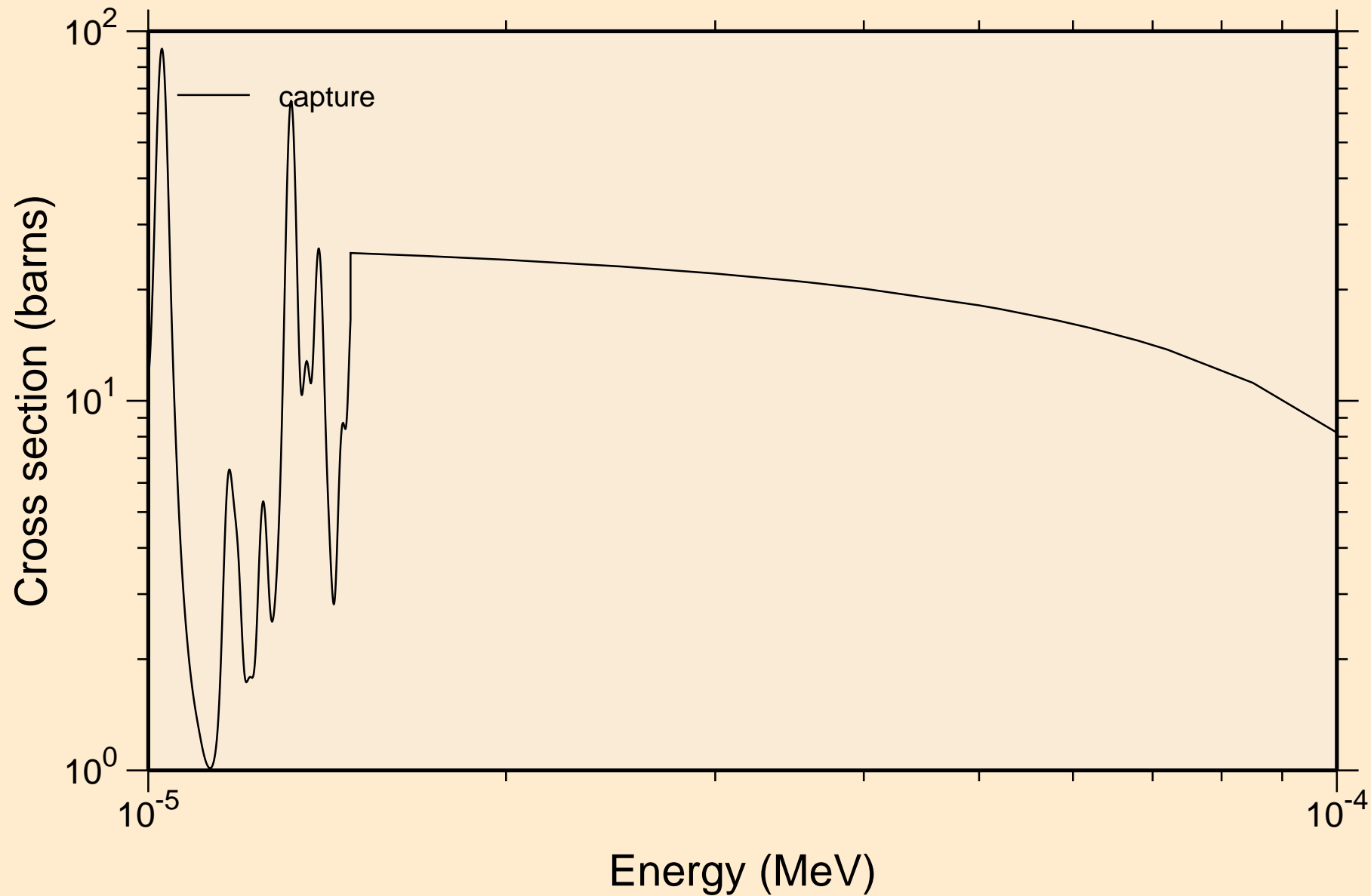



BA121 NEUTRON ACER TENDL-2019 LIBRARY; T=293.16K  
resonance absorption cross sections

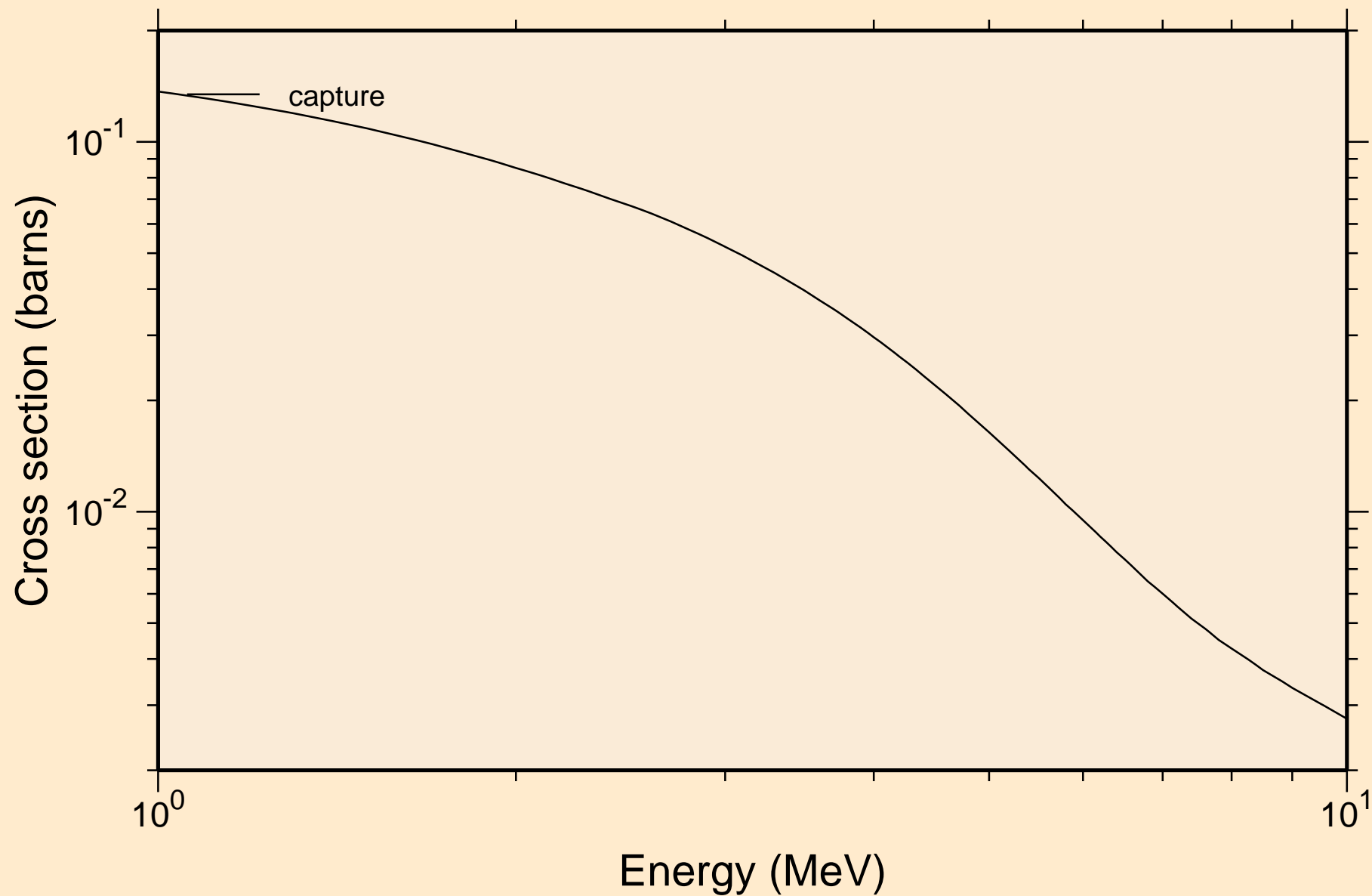

BA121 NEUTRON ACER TENDL-2019 LIBRARY; T=293.16K  
Heating

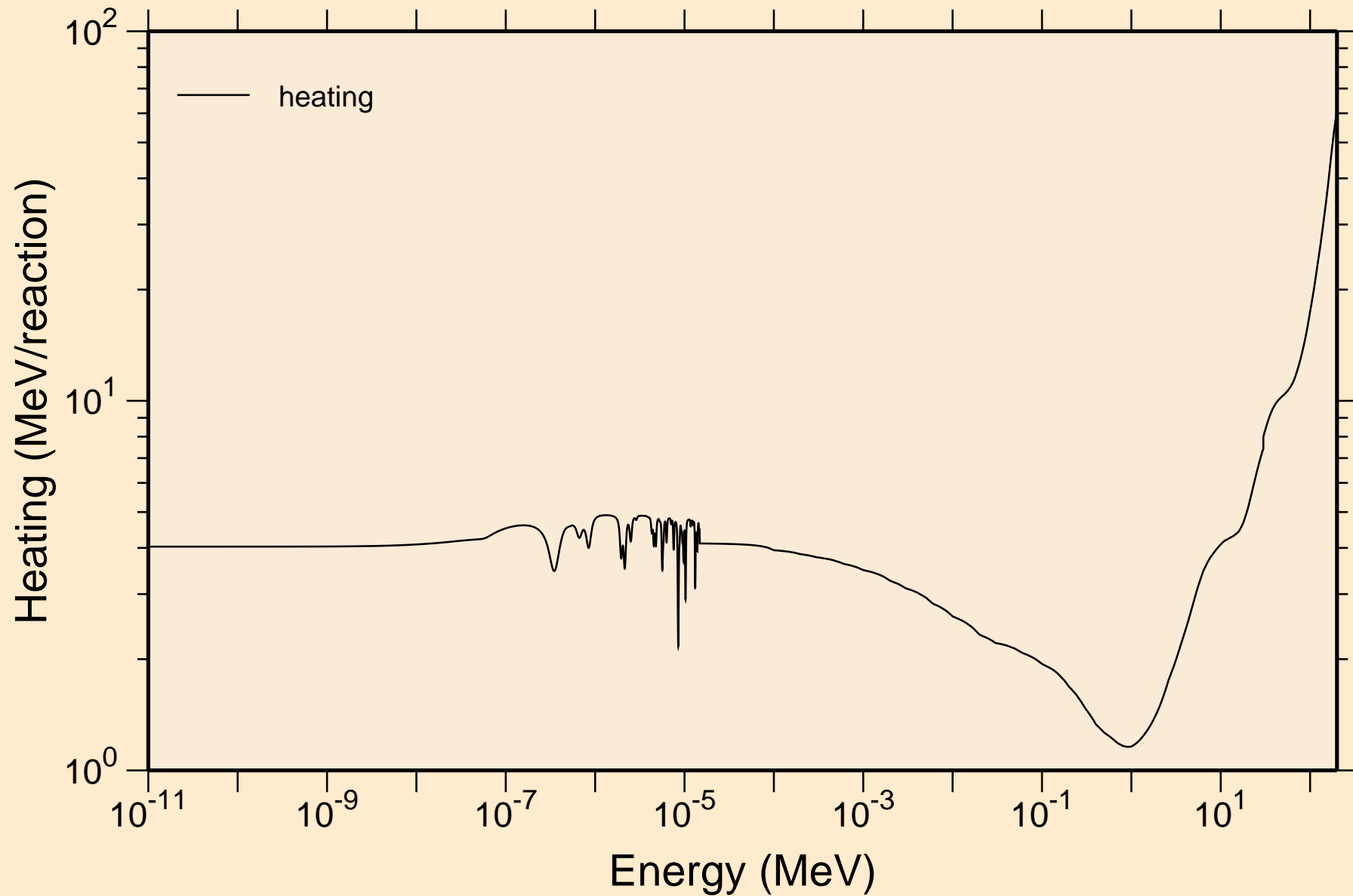

BA121 NEUTRON ACER TENDL-2019 LIBRARY; T=293.16K  
Damage

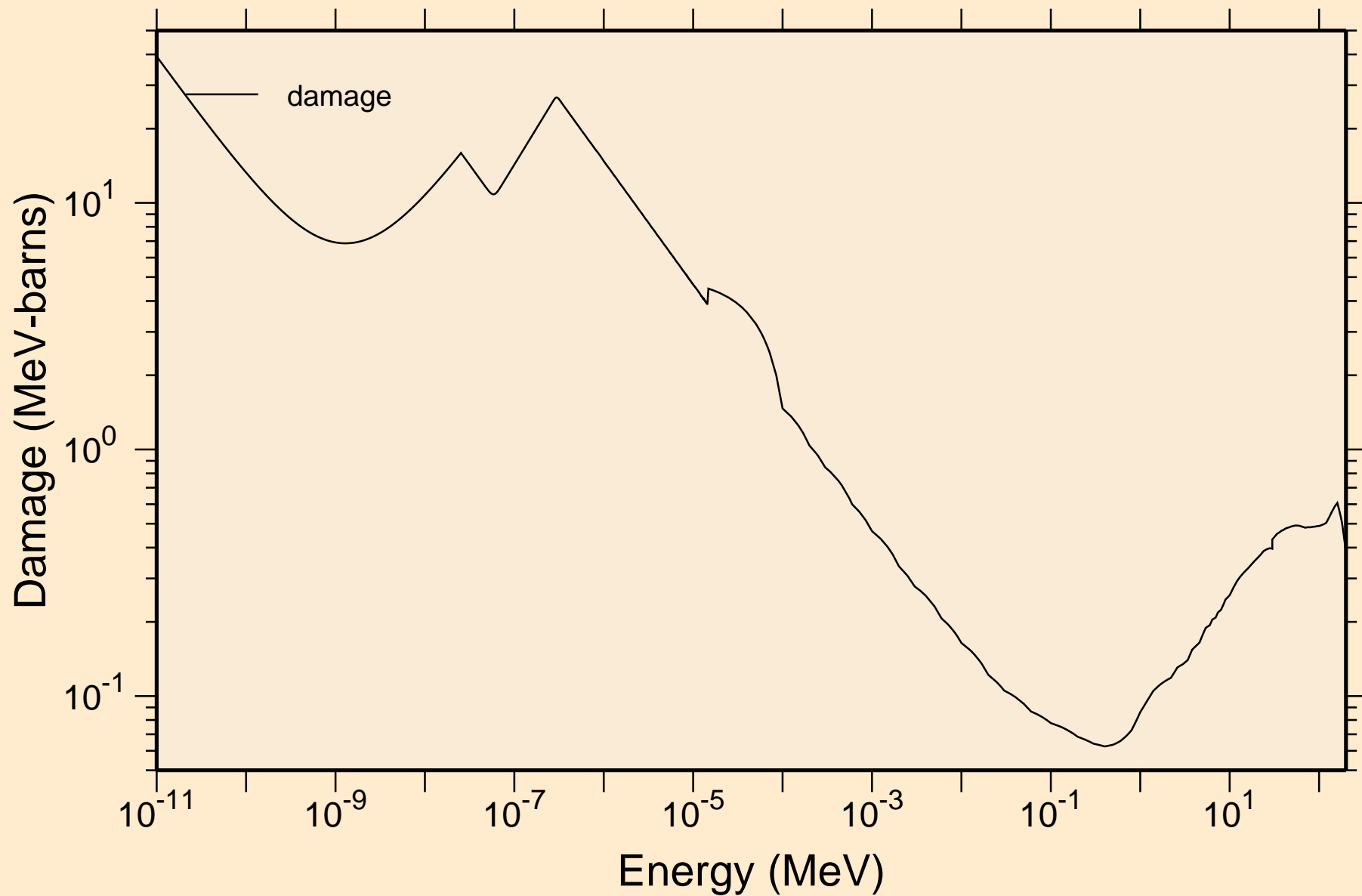

BA121 NEUTRON ACER TENDL-2019 LIBRARY; T=293.16K  
Non-threshold reactions

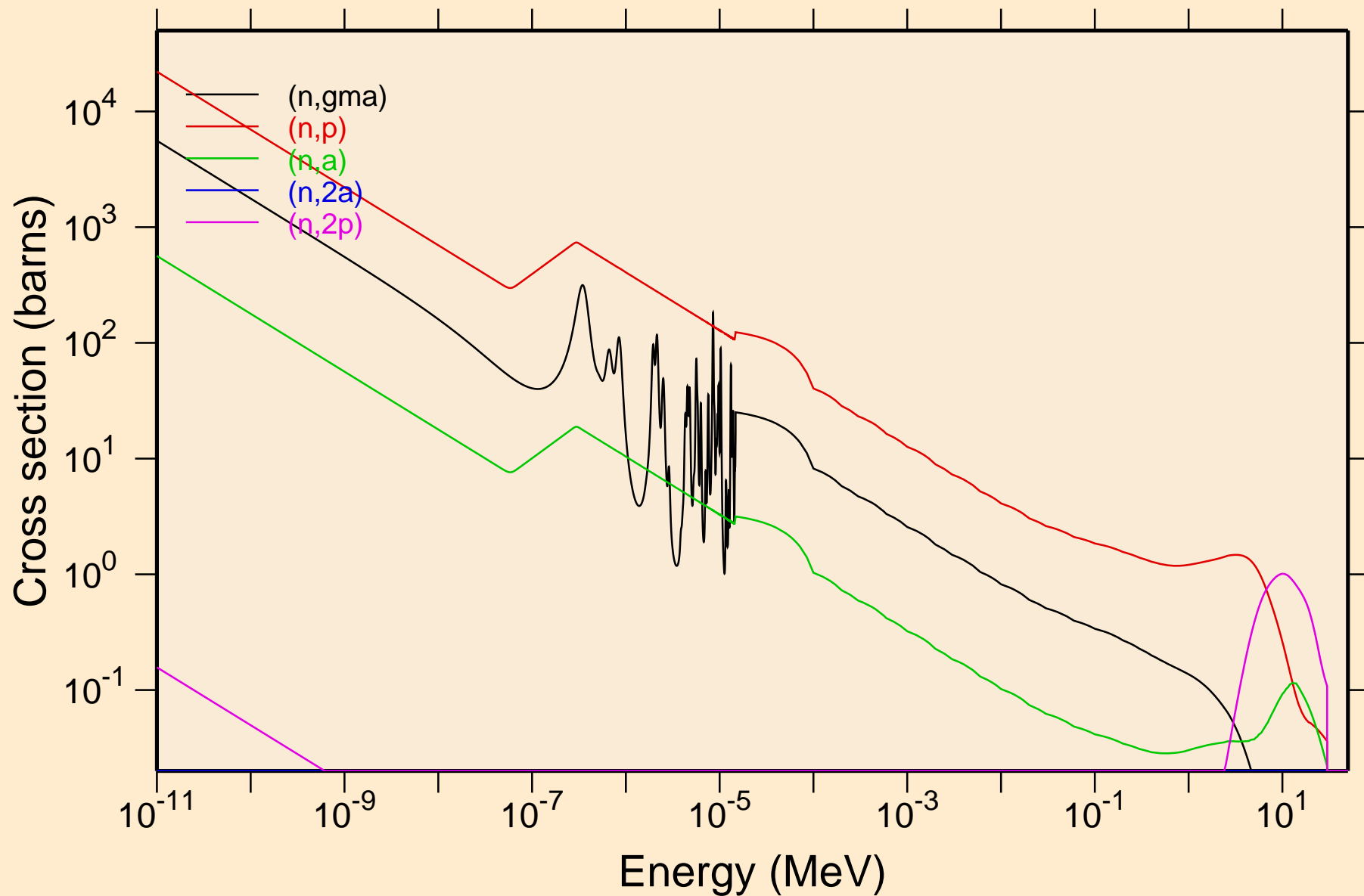

BA121 NEUTRON ACER TENDL-2019 LIBRARY; T=293.16K  
Non-threshold reactions

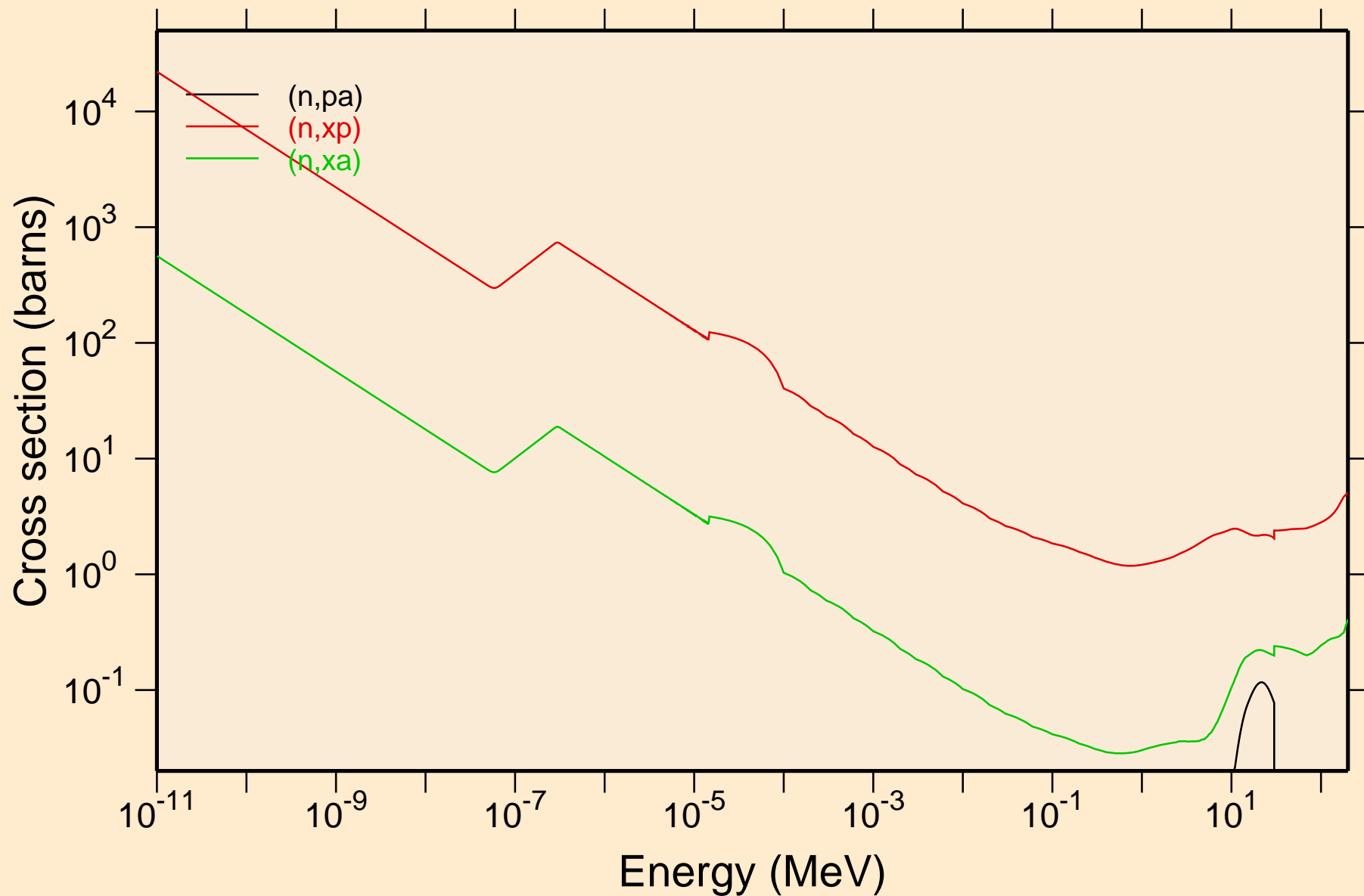

BA121 NEUTRON ACER TENDL-2019 LIBRARY; T=293.16K  
Principal cross sections

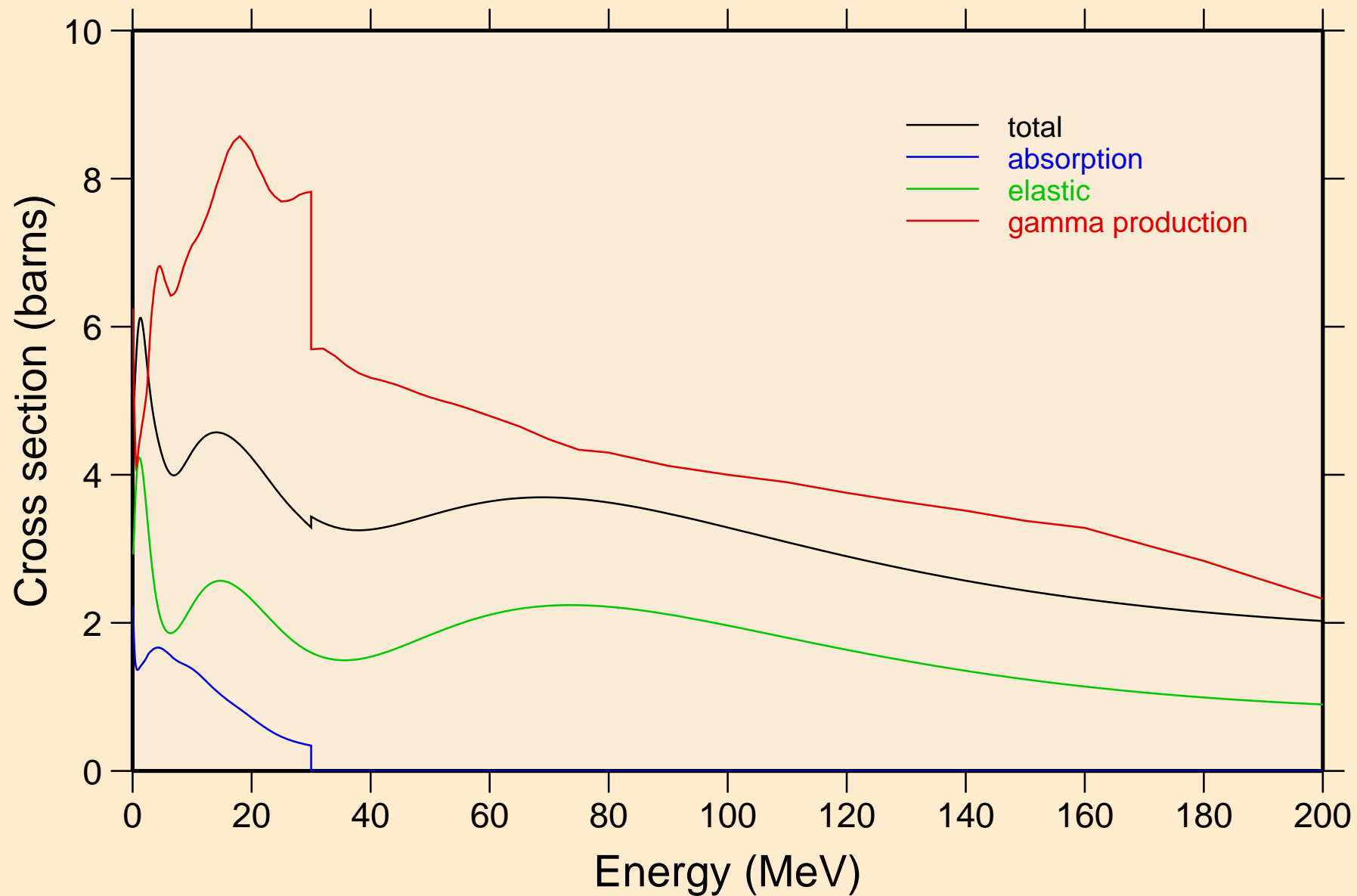

BA121 NEUTRON ACER TENDL-2019 LIBRARY; T=293.16K  
Heating

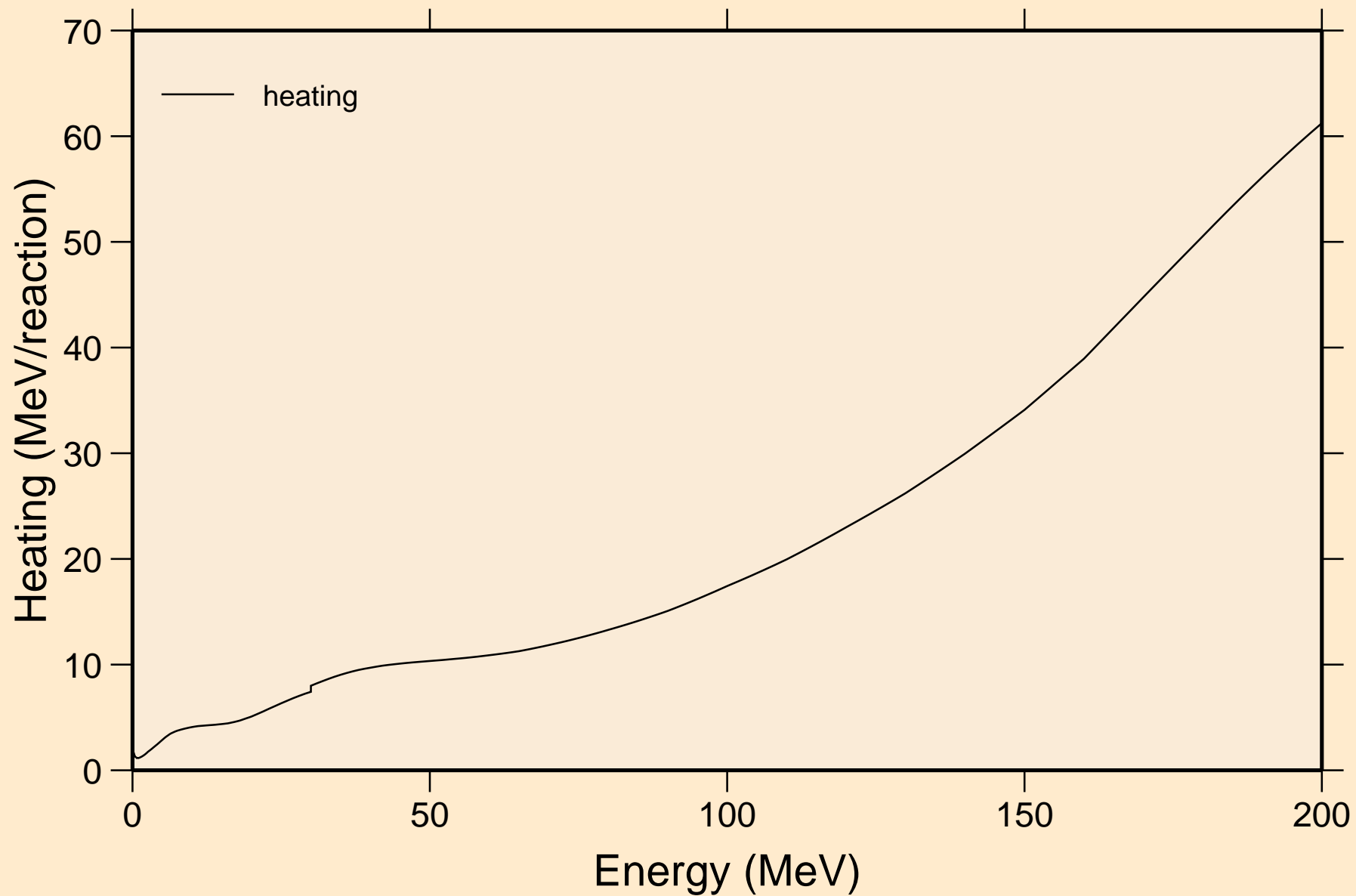

BA121 NEUTRON ACER TENDL-2019 LIBRARY; T=293.16K  
Damage

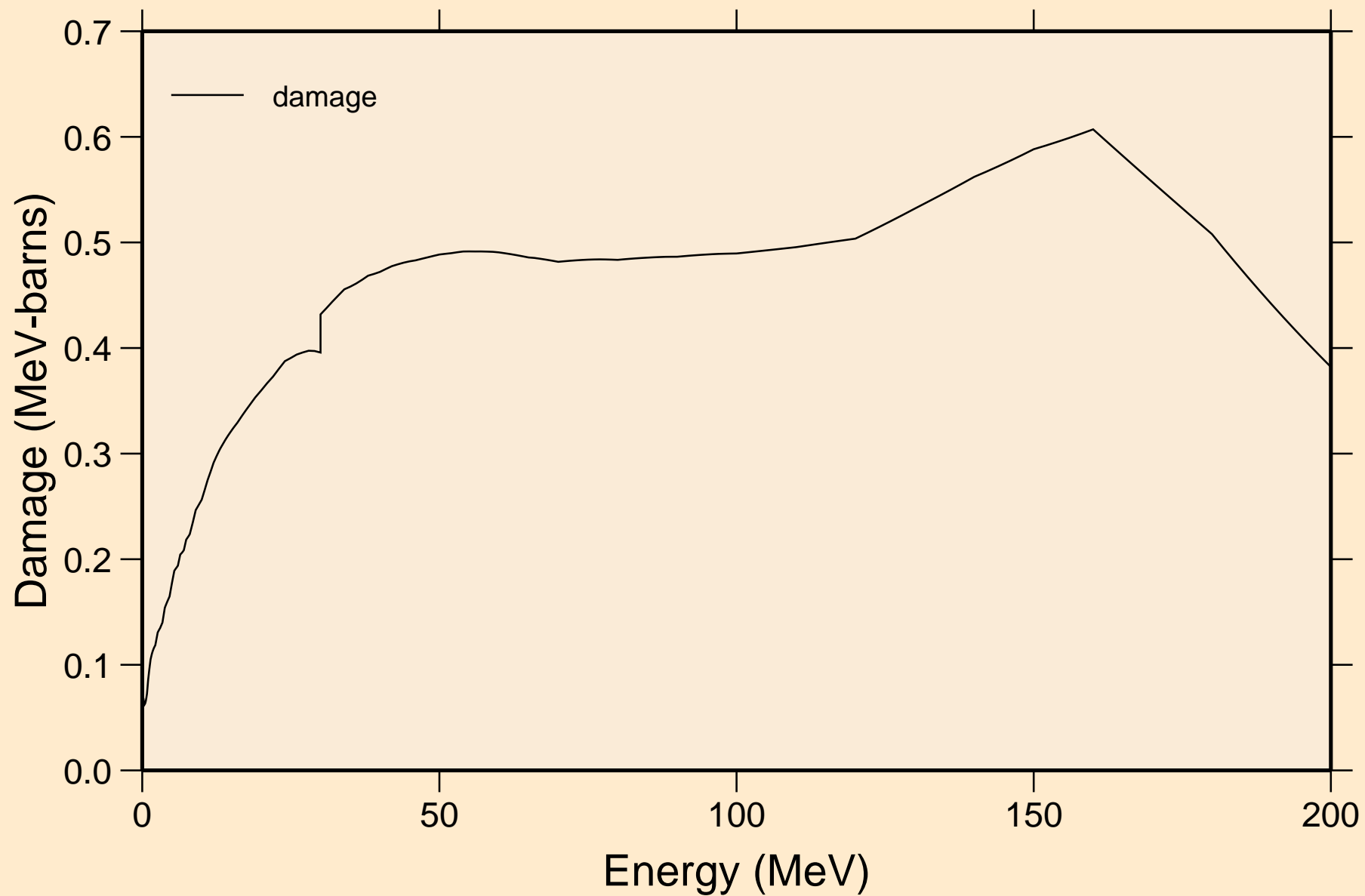



BA121 NEUTRON ACER TENDL-2019 LIBRARY; T=293.16K  
Non-threshold reactions

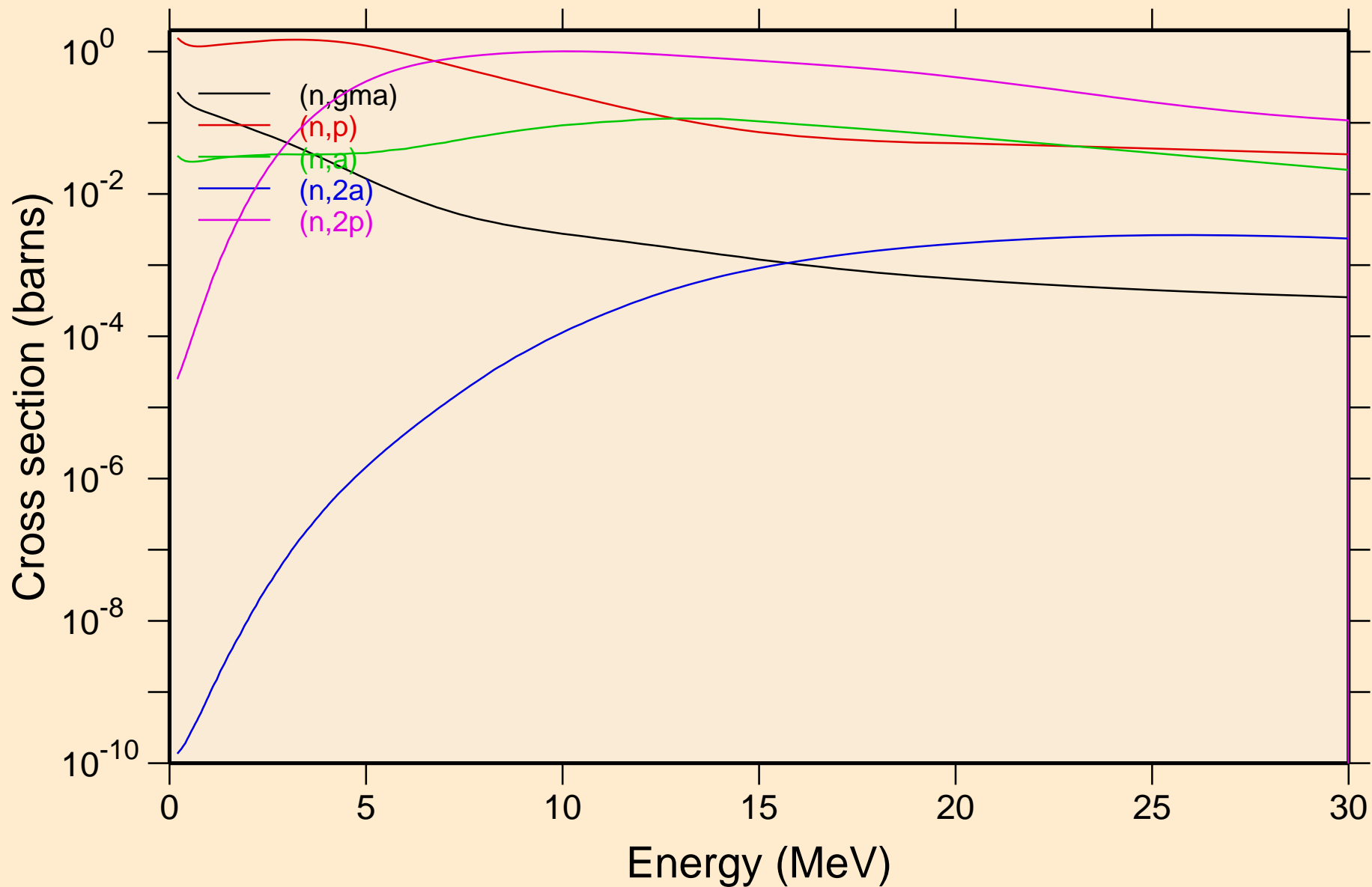

BA121 NEUTRON ACER TENDL-2019 LIBRARY; T=293.16K  
Non-threshold reactions

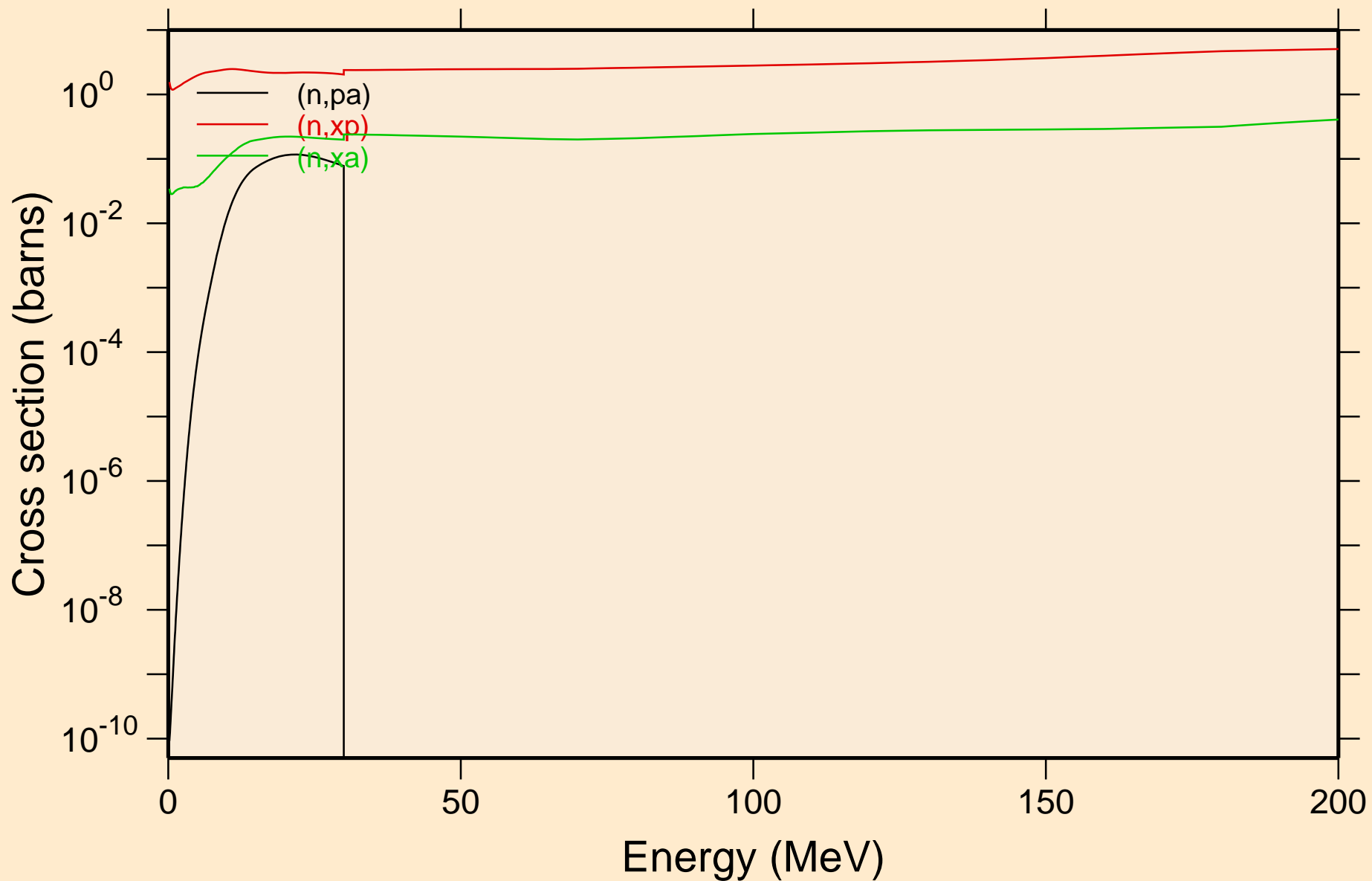

BA121 NEUTRON ACER TENDL-2019 LIBRARY; T=293.16K  
Inelastic levels

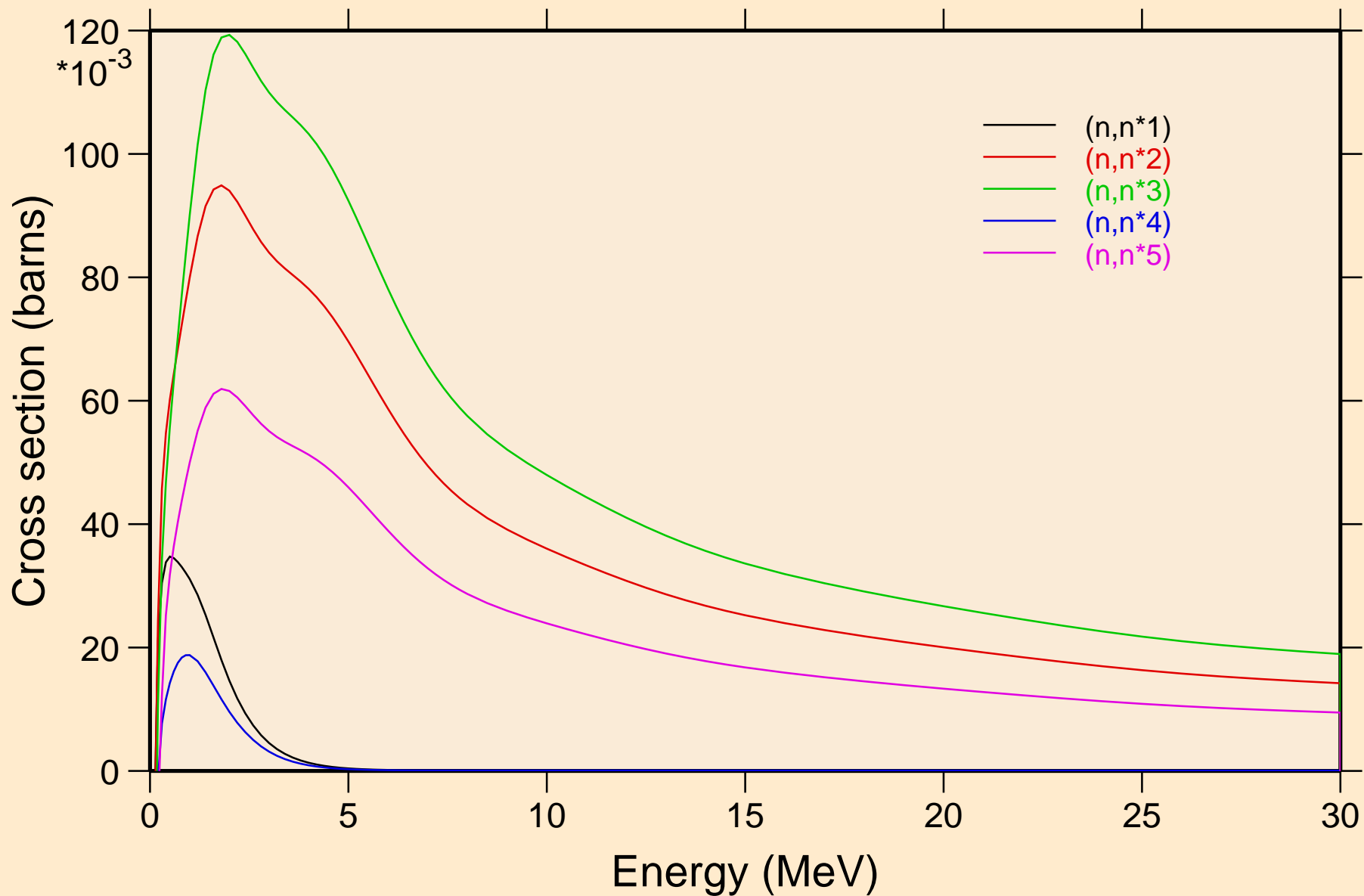

BA121 NEUTRON ACER TENDL-2019 LIBRARY; T=293.16K  
Inelastic levels

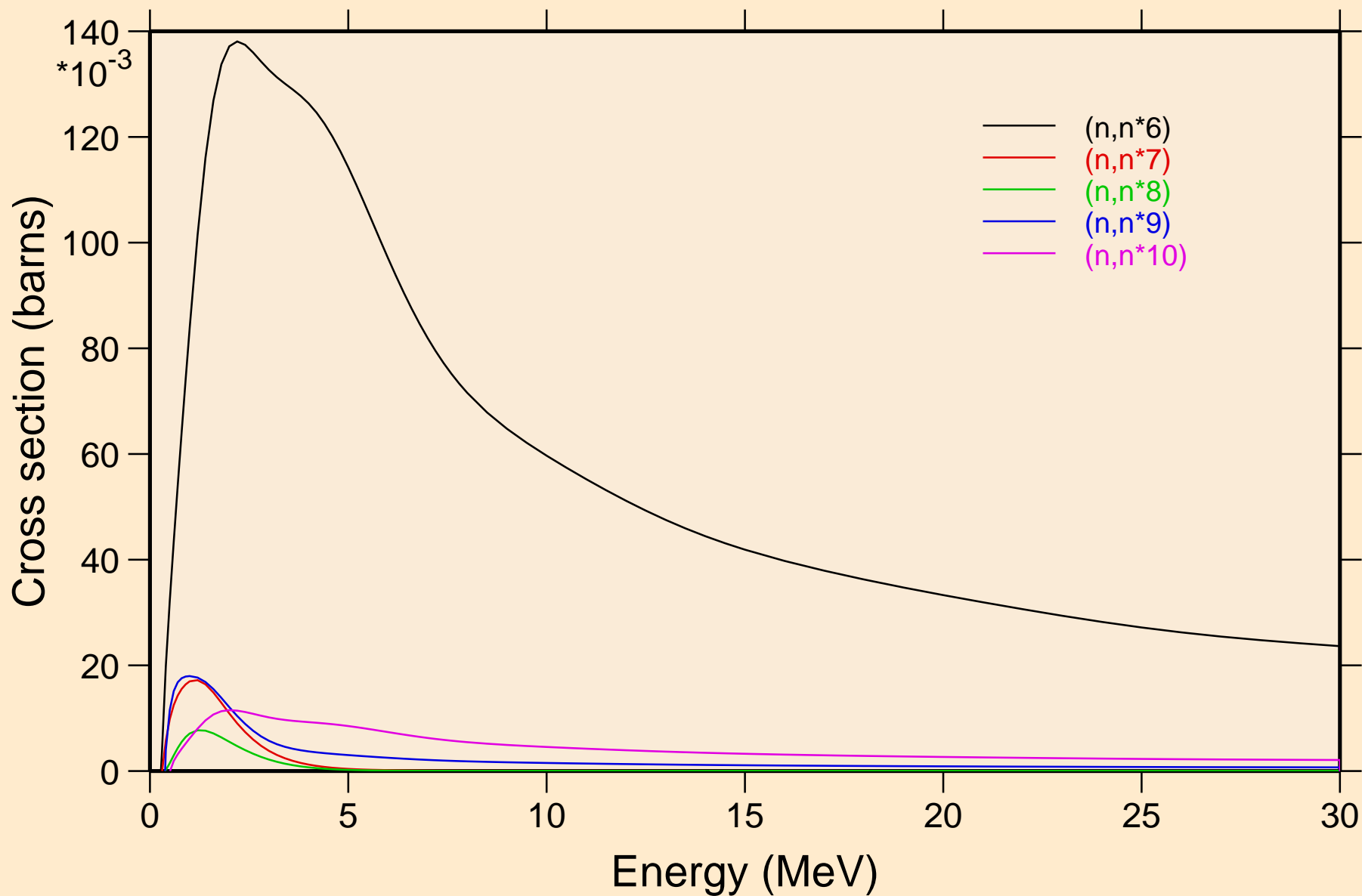

BA121 NEUTRON ACER TENDL-2019 LIBRARY; T=293.16K  
Inelastic levels

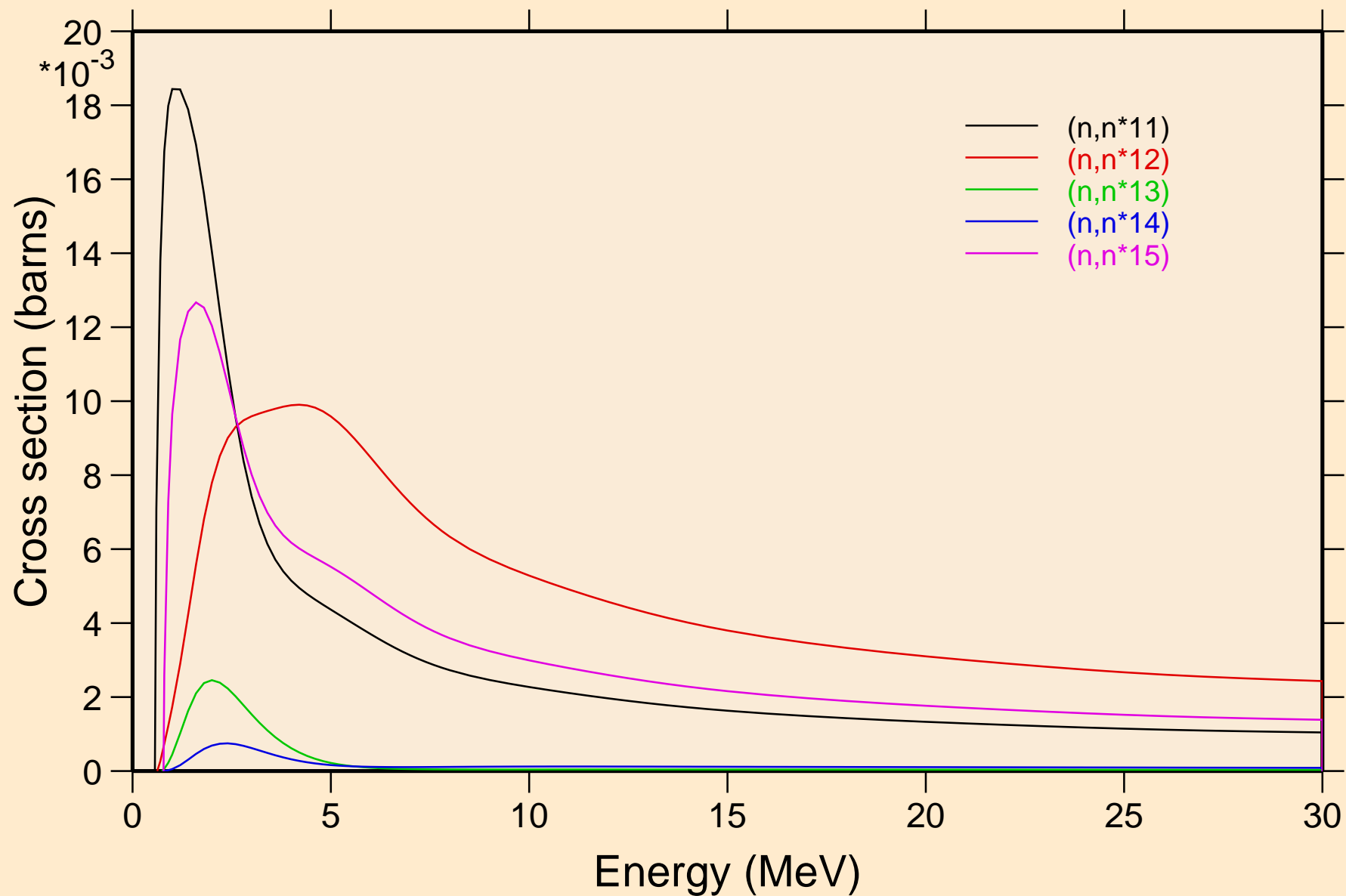

BA121 NEUTRON ACER TENDL-2019 LIBRARY; T=293.16K  
Threshold reactions

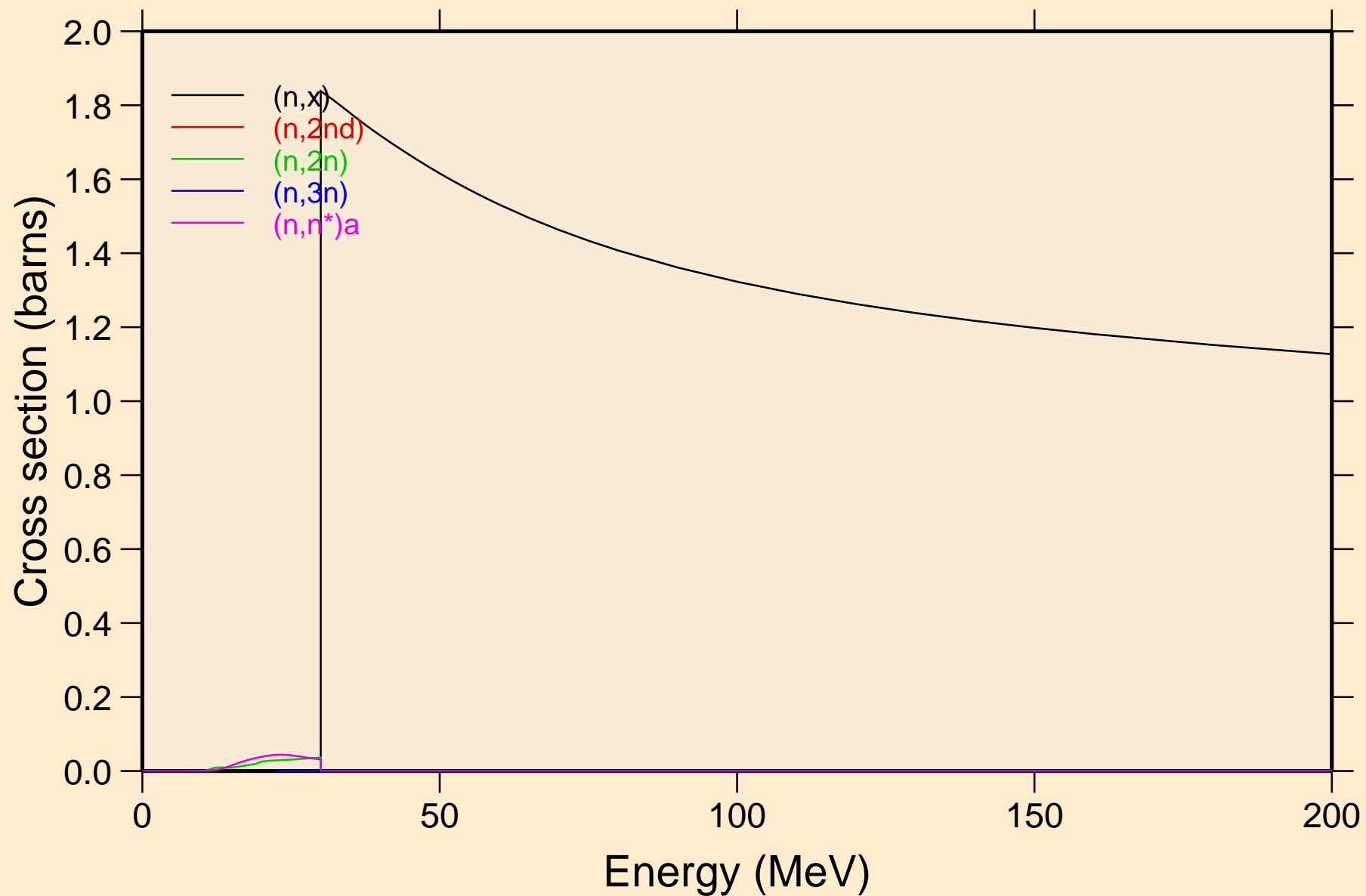

BA121 NEUTRON ACER TENDL-2019 LIBRARY; T=293.16K  
Threshold reactions

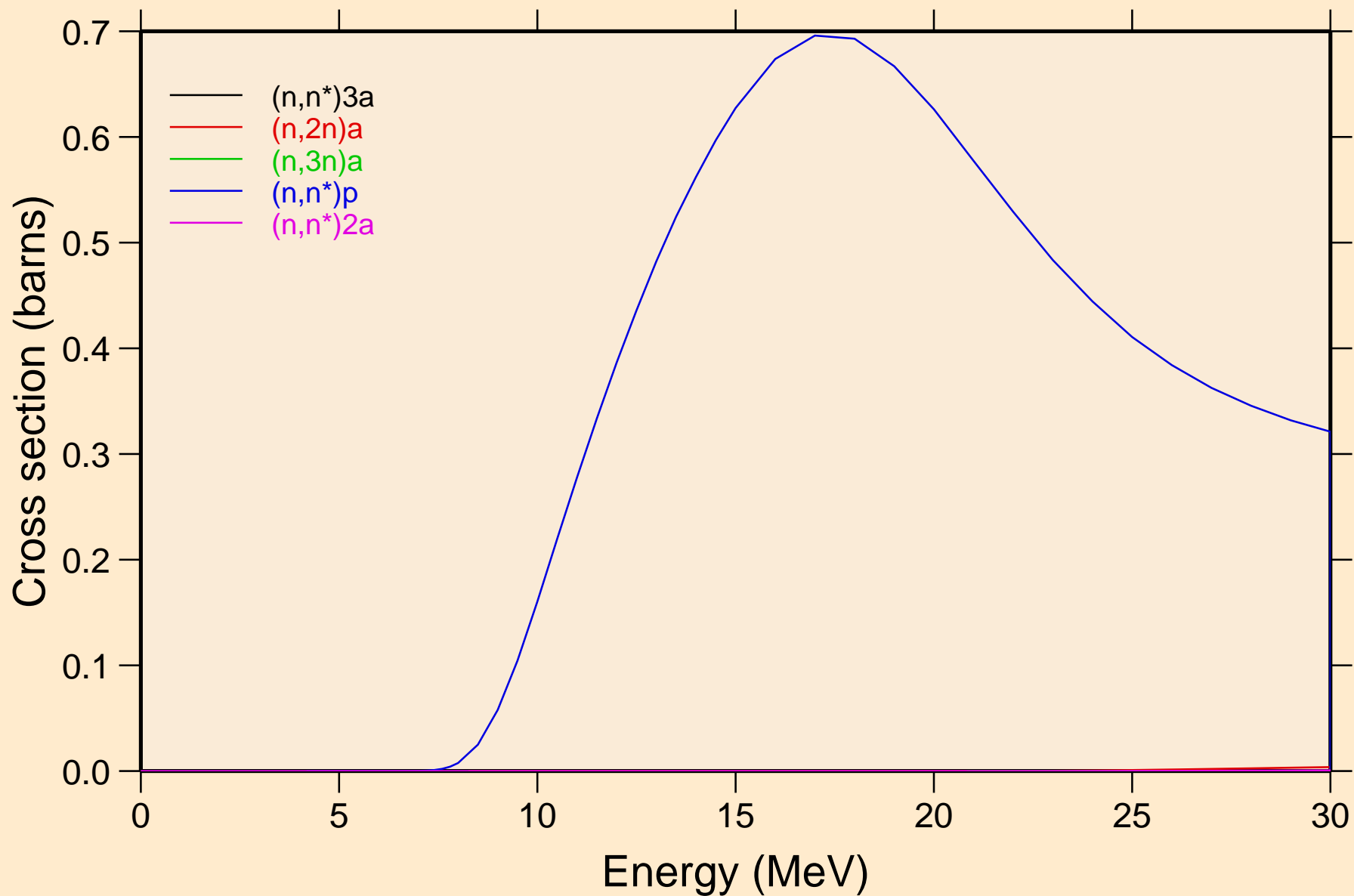

BA121 NEUTRON ACER TENDL-2019 LIBRARY; T=293.16K  
Threshold reactions

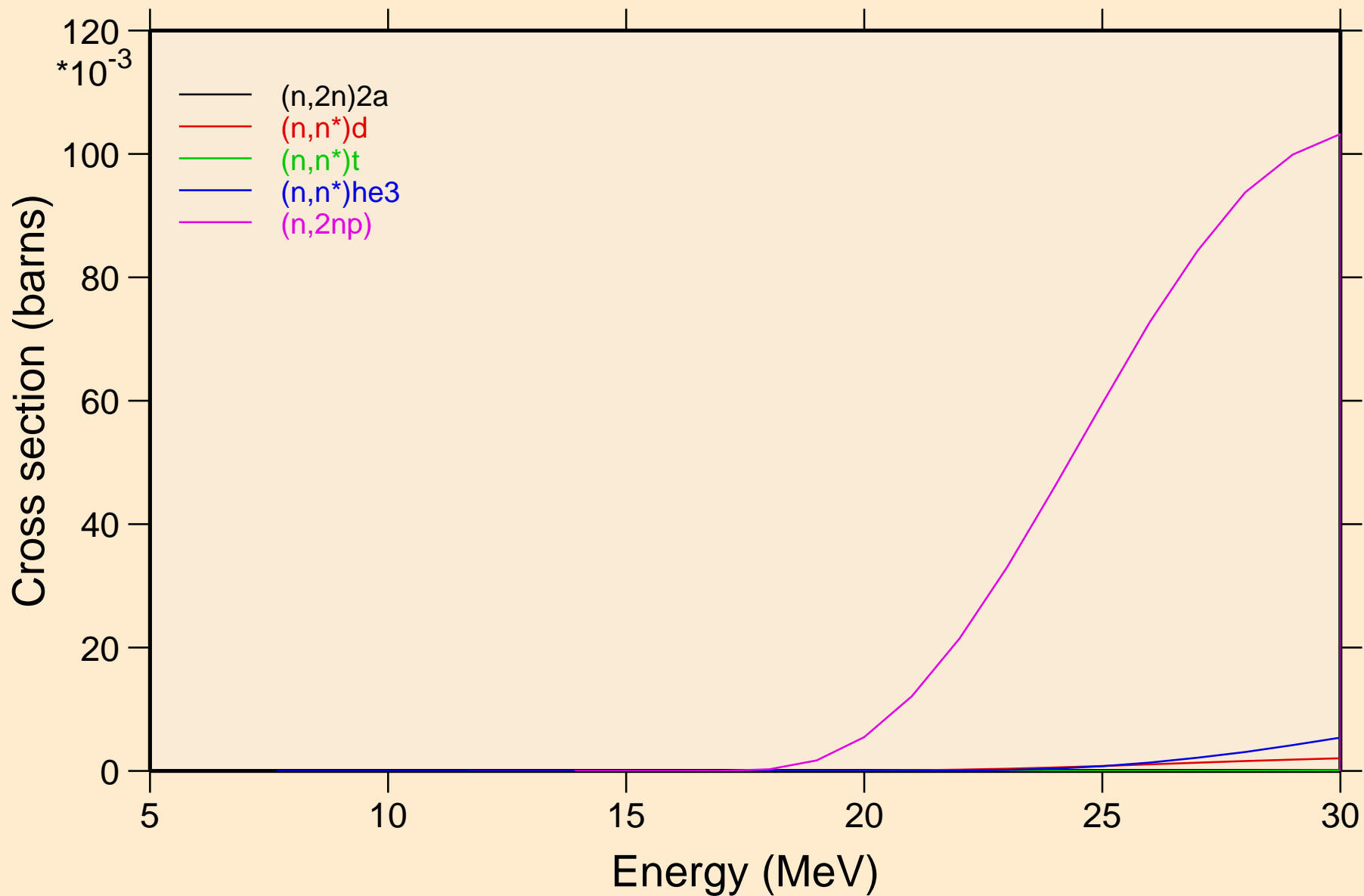



BA121 NEUTRON ACER TENDL-2019 LIBRARY; T=293.16K  
Threshold reactions

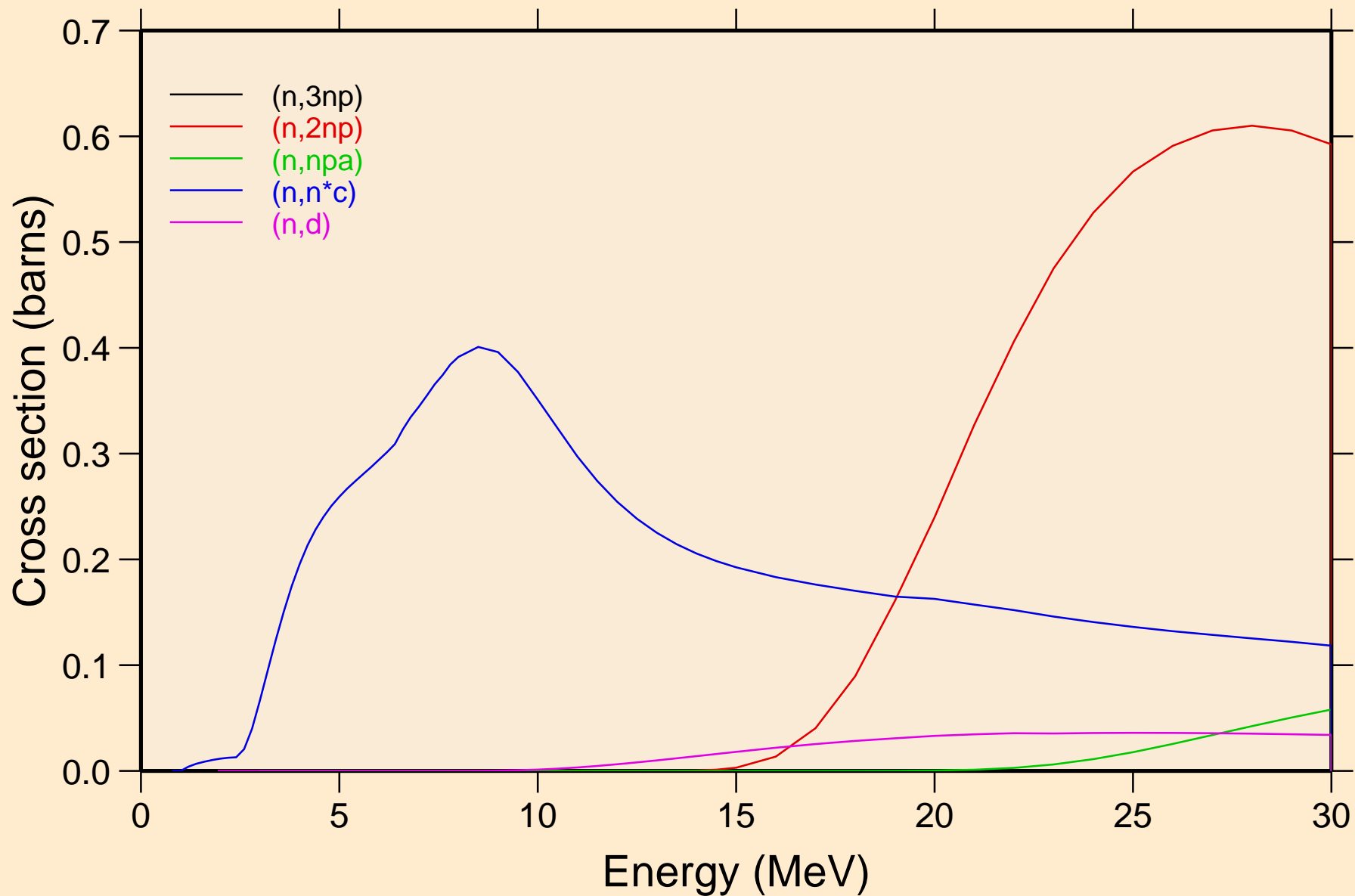

BA121 NEUTRON ACER TENDL-2019 LIBRARY; T=293.16K  
Threshold reactions

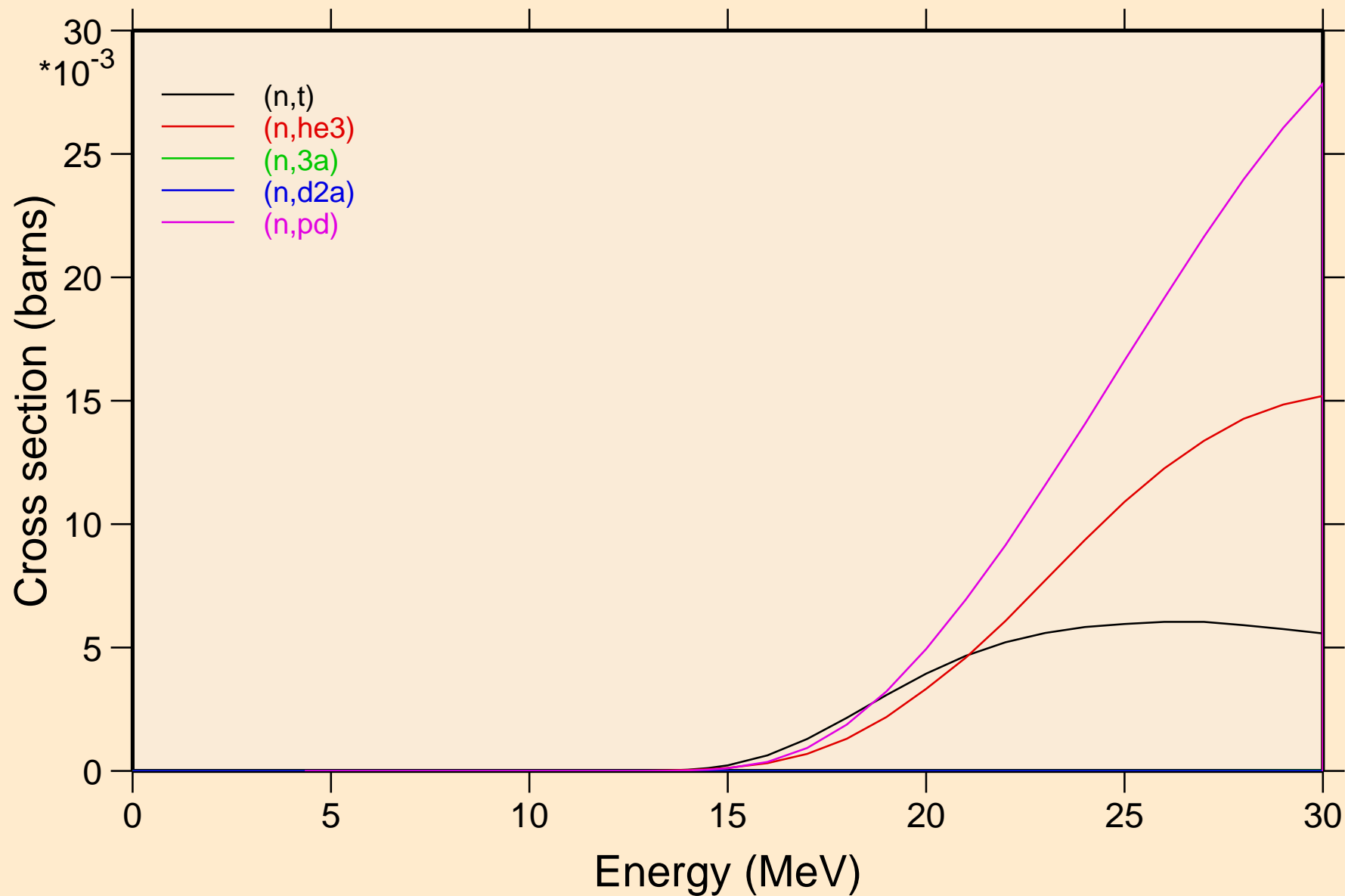

BA121 NEUTRON ACER TENDL-2019 LIBRARY; T=293.16K  
Threshold reactions

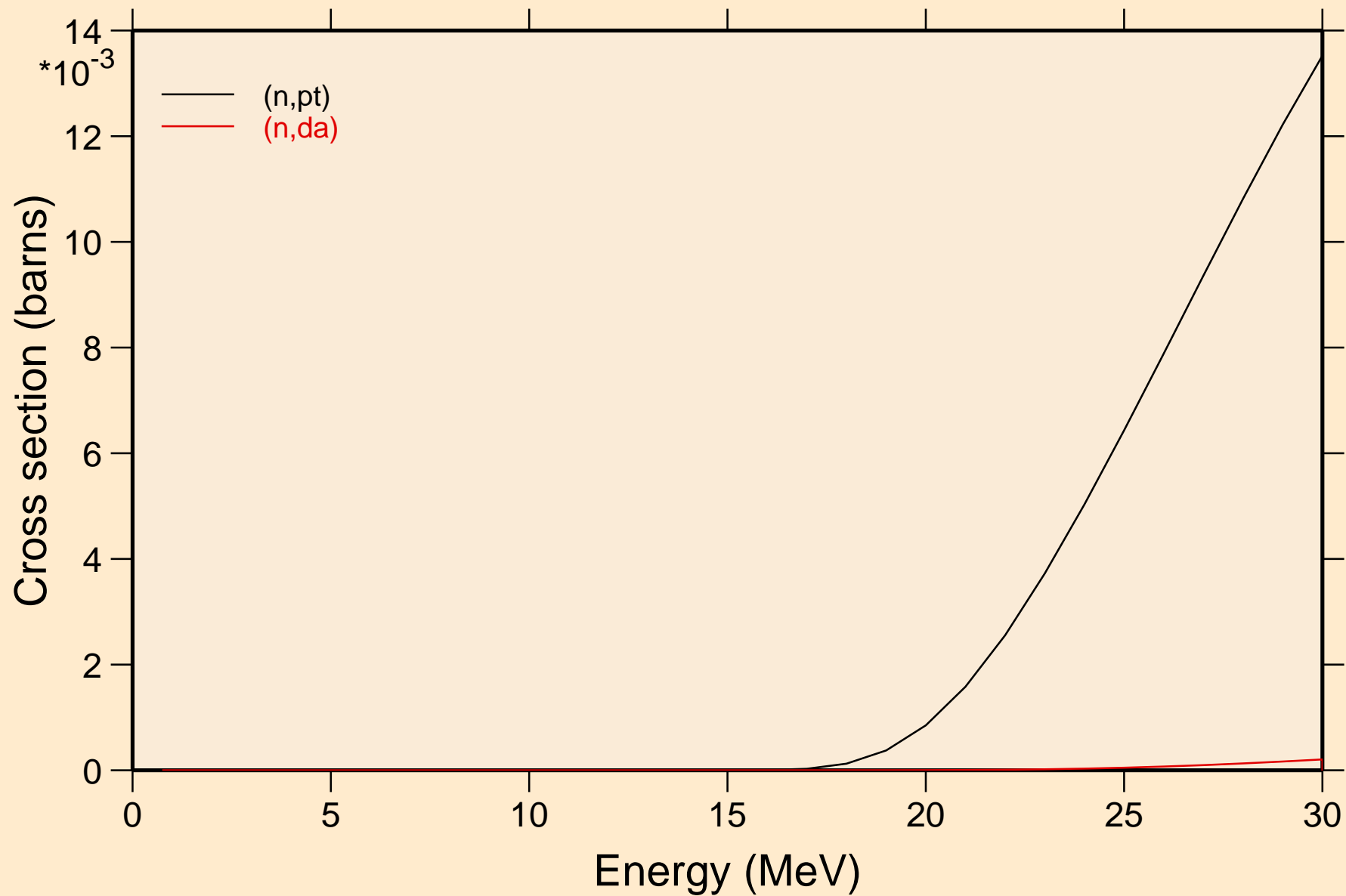

BA121 NEUTRON ACER TENDL-2019 LIBRARY; T=293.16K  
Threshold reactions

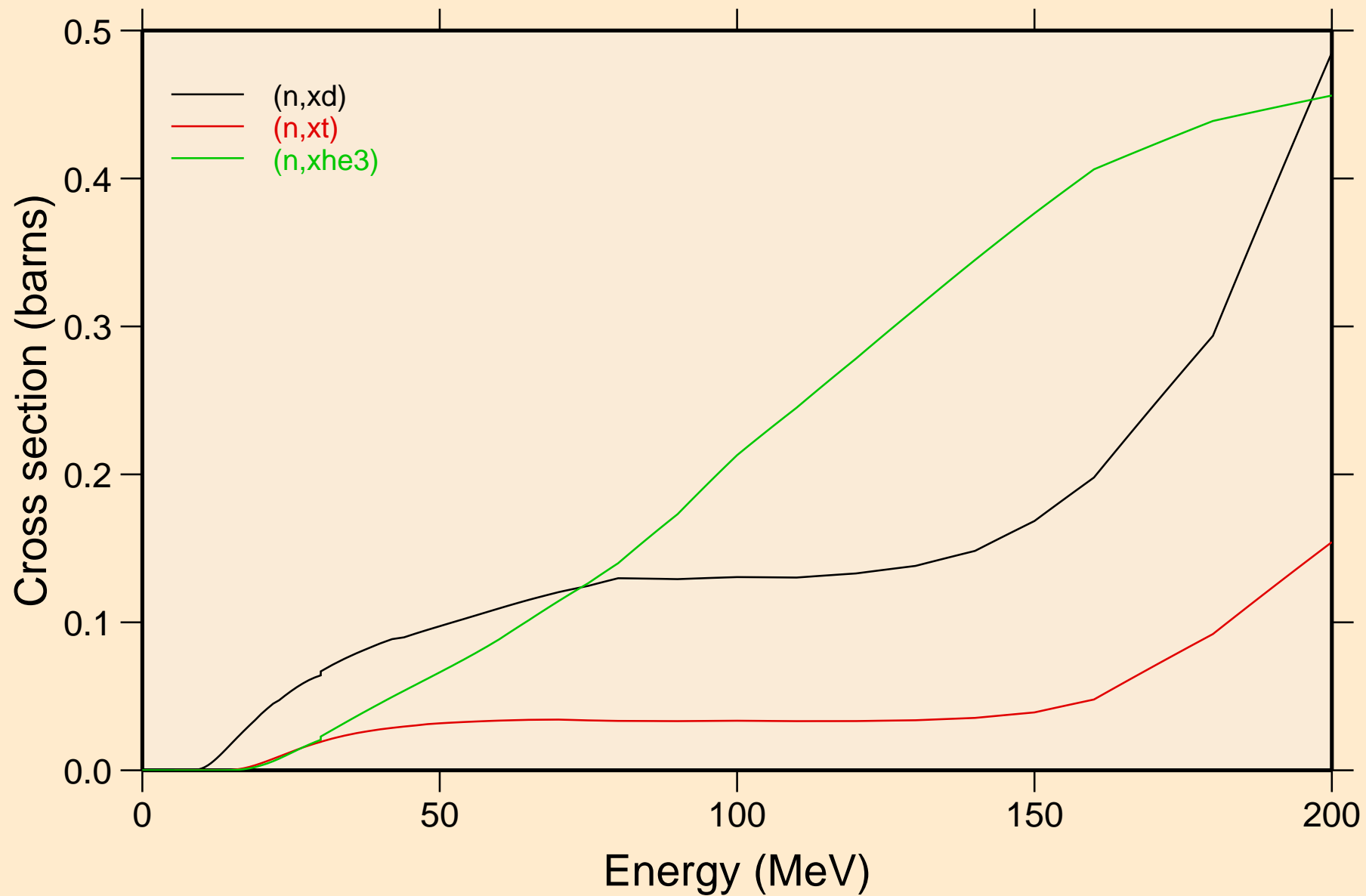

BA121 NEUTRON ACER TENDL-2019 LIBRARY; T=293.16K  
angular distribution for elastic

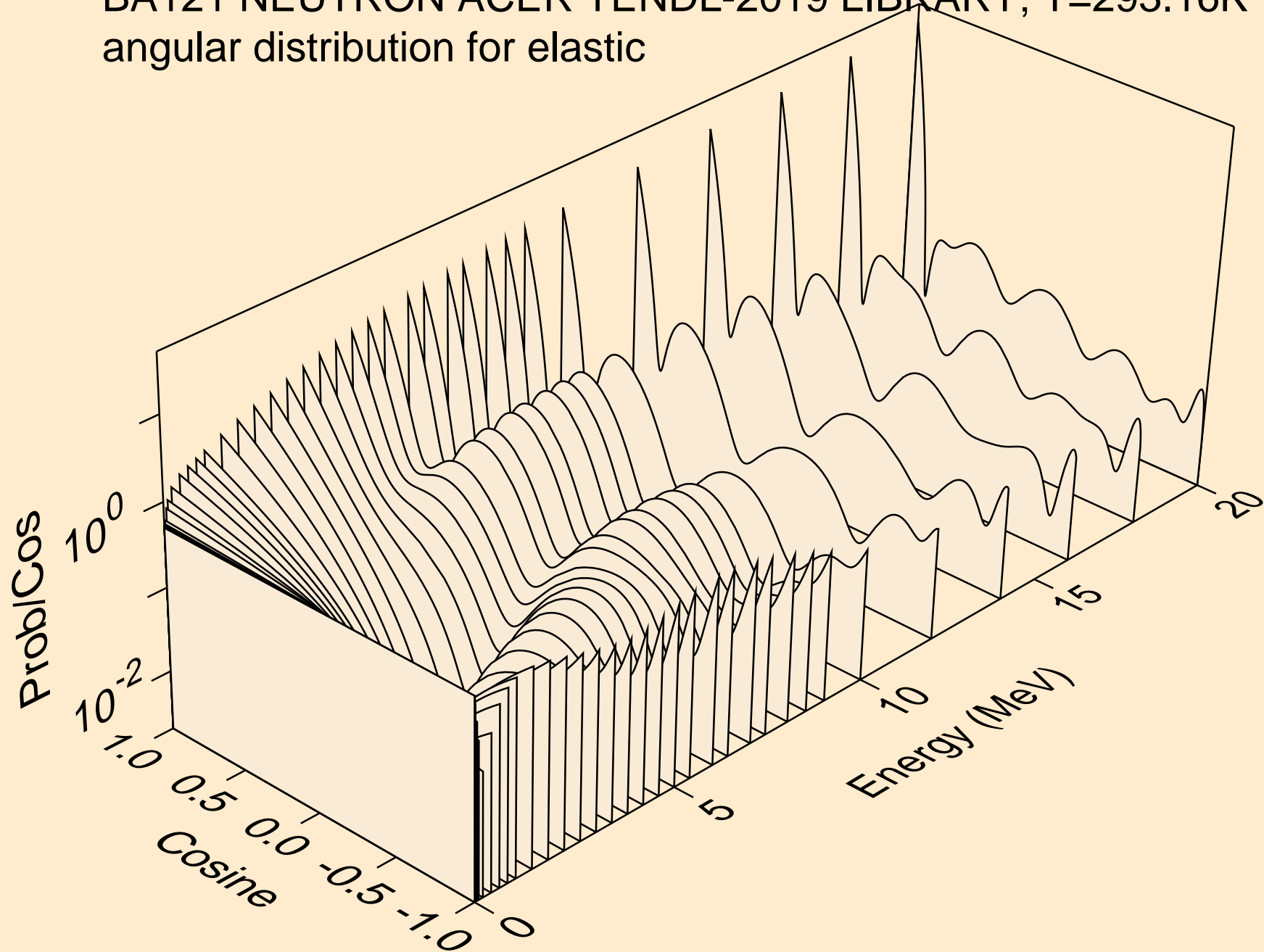

BA121 NEUTRON ACER TENDL-2019 LIBRARY; T=293.16K  
angular distribution for elastic

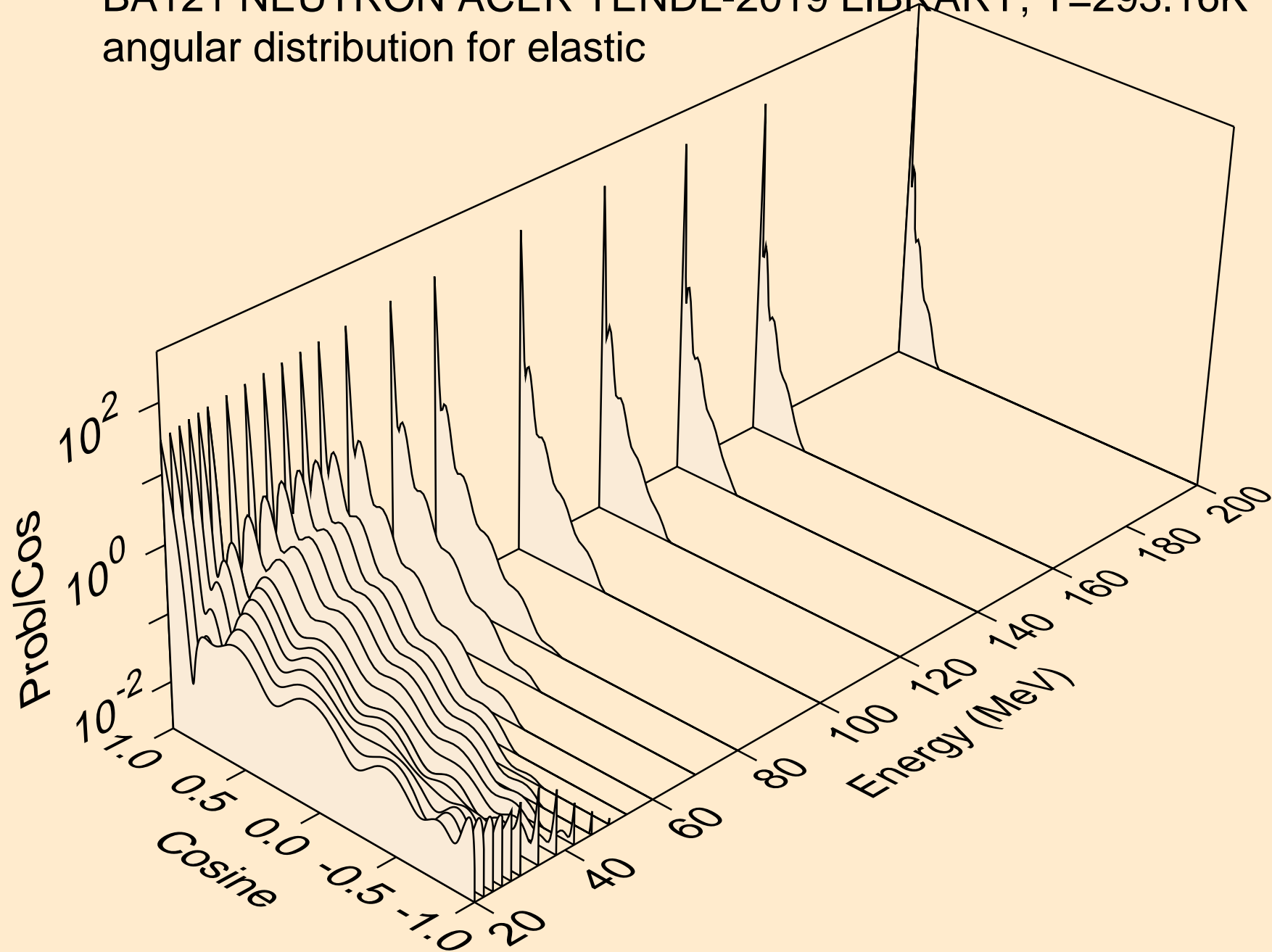

BA121 NEUTRON ACER TENDL-2019 LIBRARY; T=293.16K  
angular distribution for (n,n\*1)

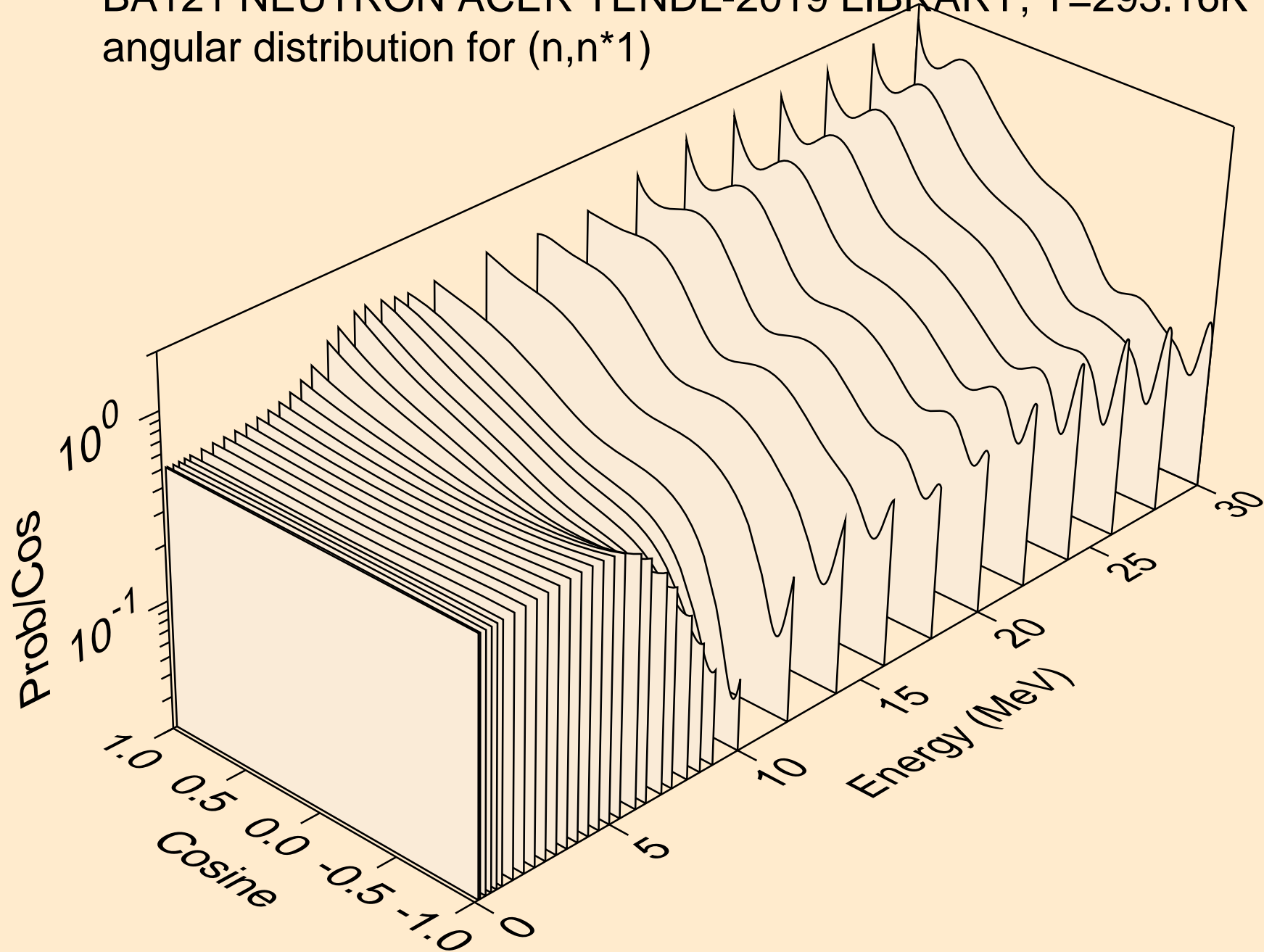

BA121 NEUTRON ACER TENDL-2019 LIBRARY; T=293.16K  
angular distribution for (n,n\*2)

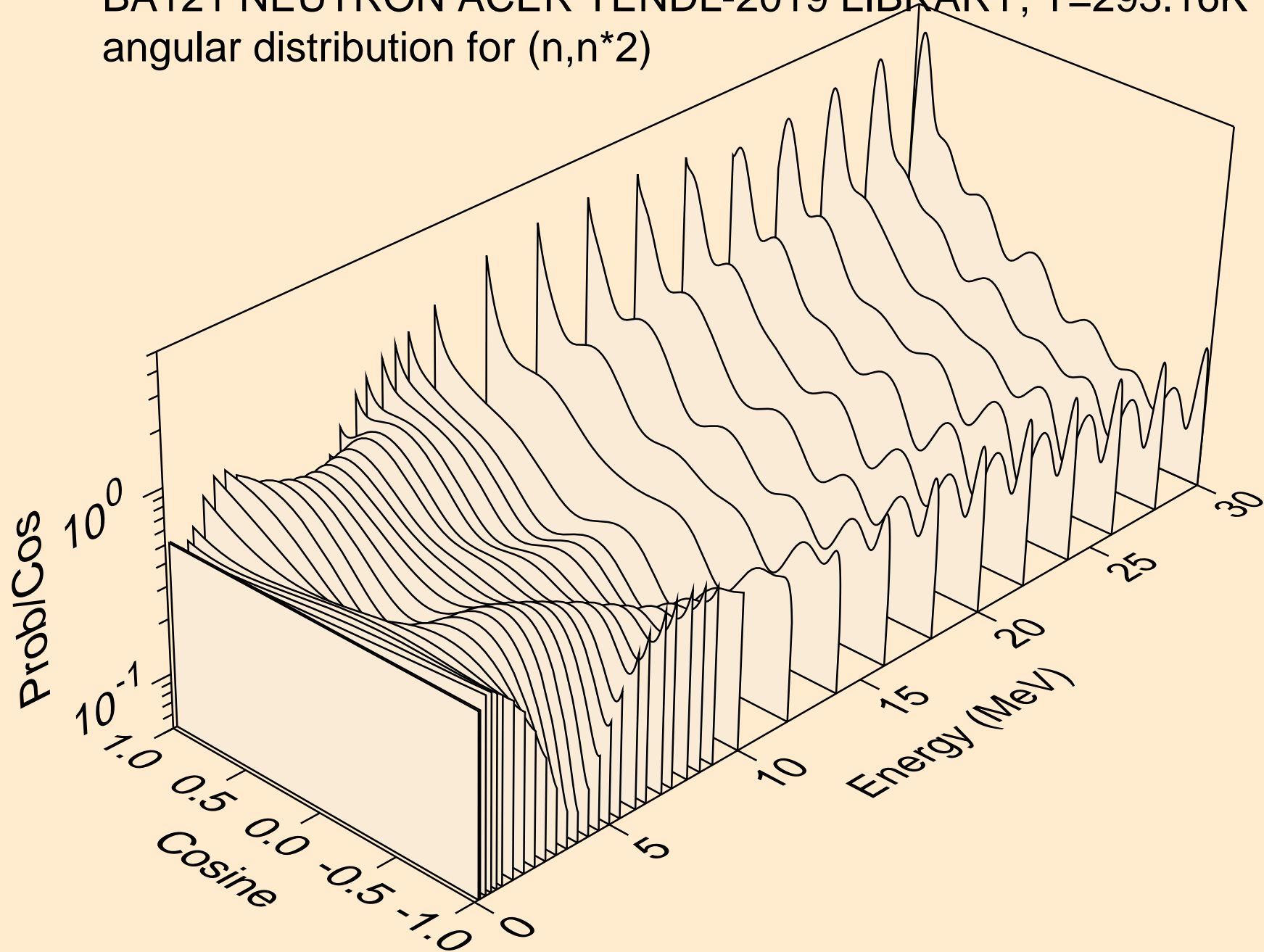



BA121 NEUTRON ACER TENDL-2019 LIBRARY; T=293.16K  
angular distribution for (n,n\*3)

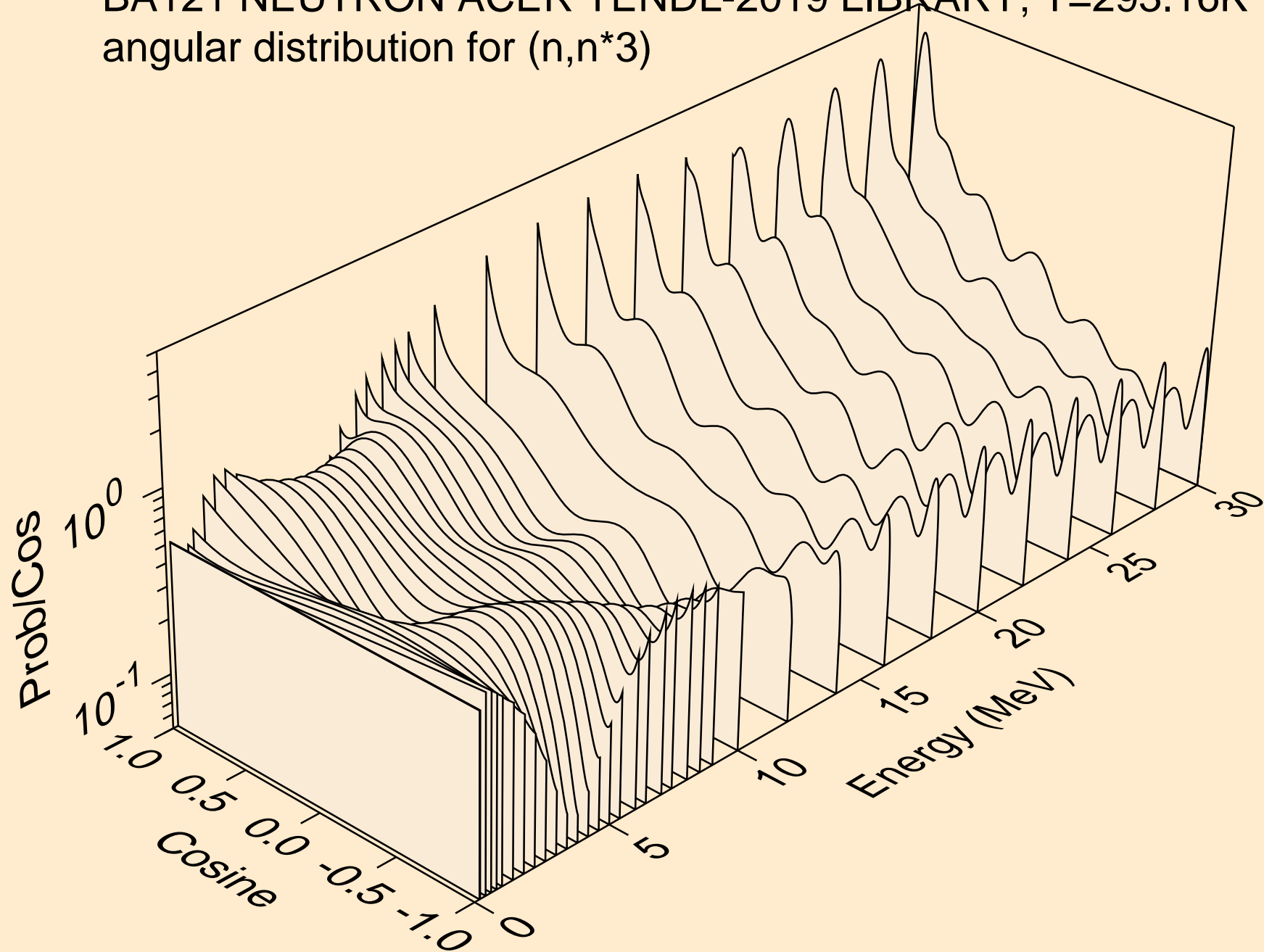

BA121 NEUTRON ACER TENDL-2019 LIBRARY; T=293.16K  
angular distribution for (n,n\*4)

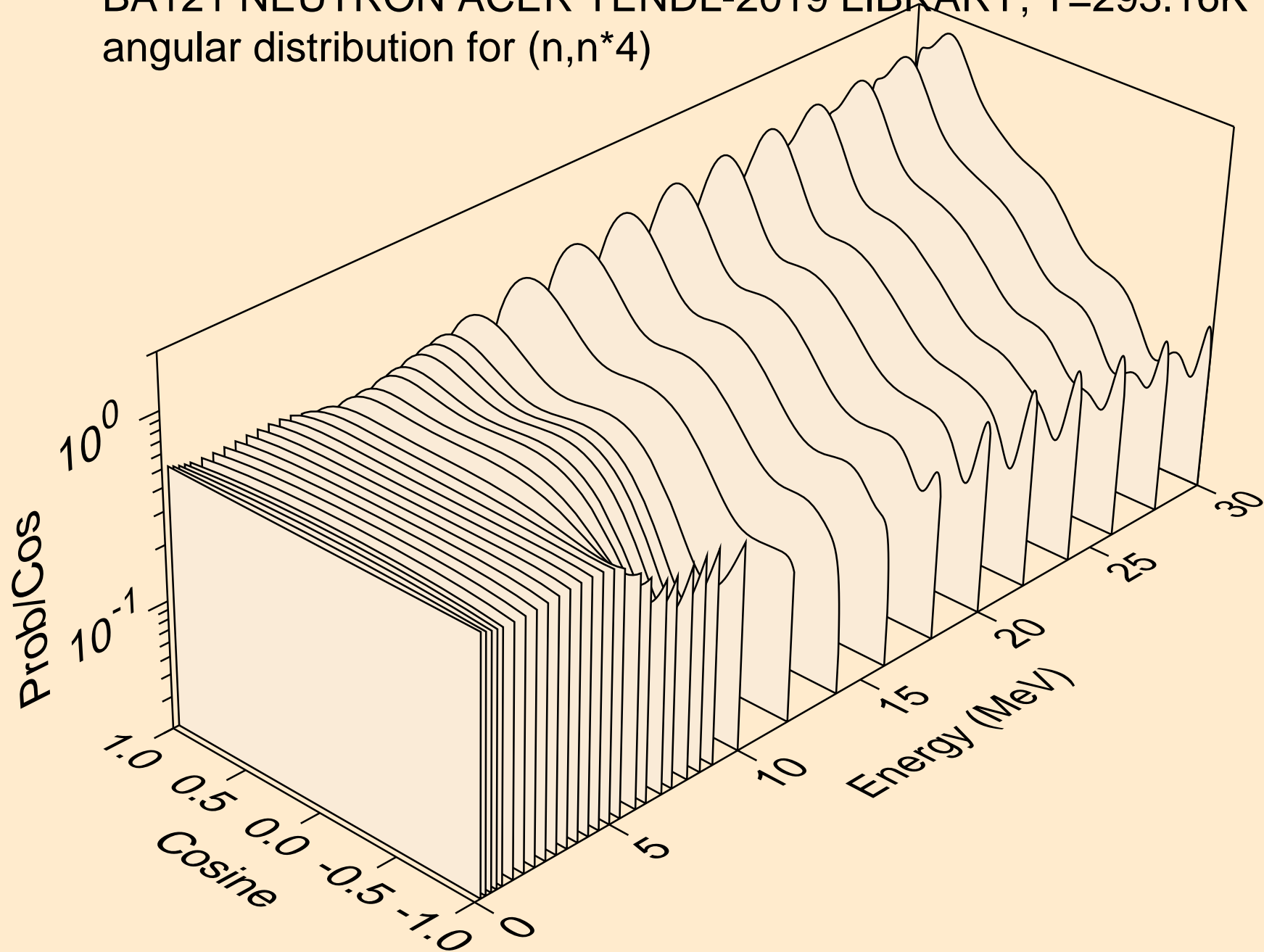

BA121 NEUTRON ACER TENDL-2019 LIBRARY; T=293.16K  
angular distribution for (n,n\*5)

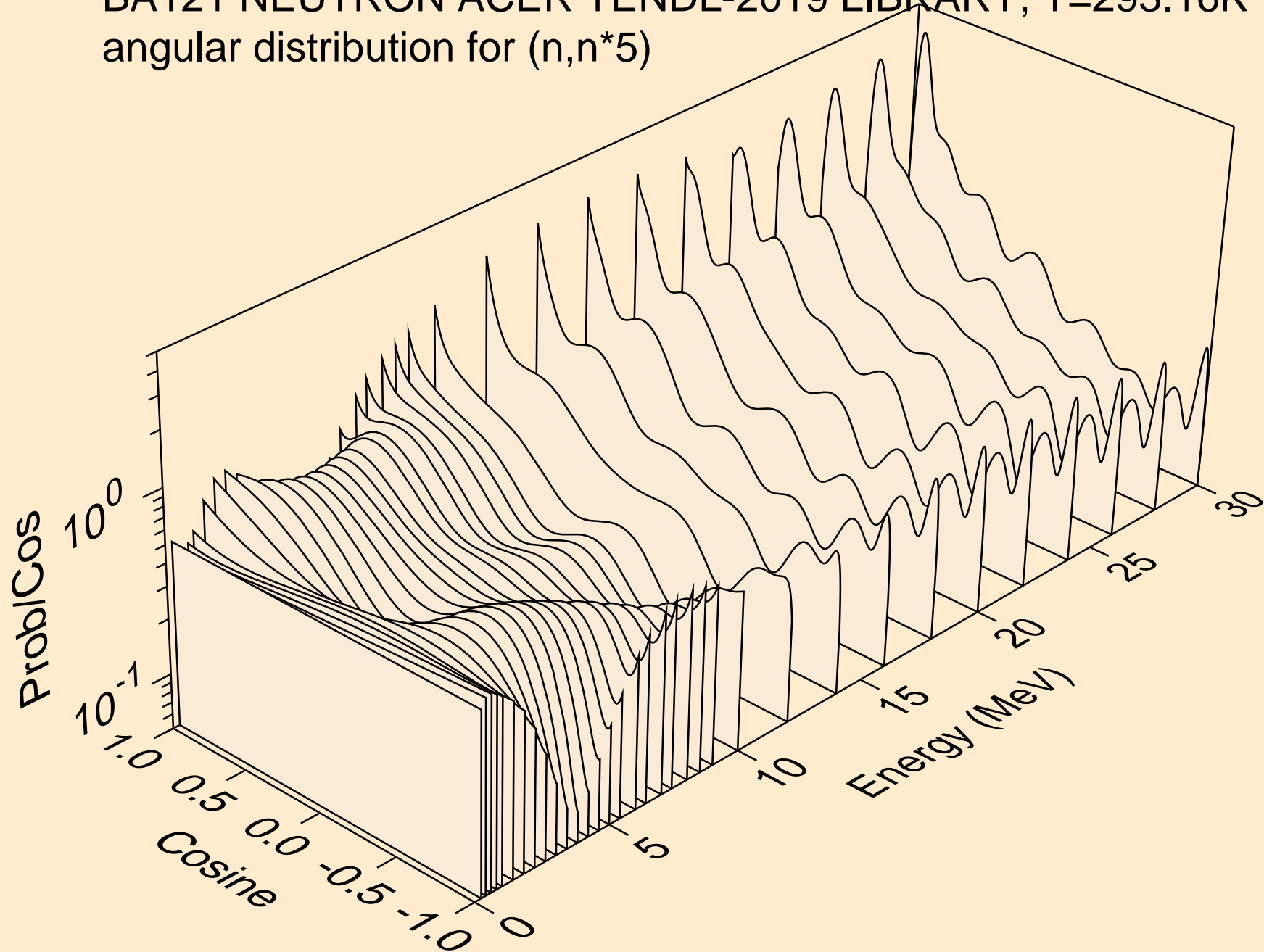

BA121 NEUTRON ACER TENDL-2019 LIBRARY; T=293.16K  
angular distribution for (n,n\*6)

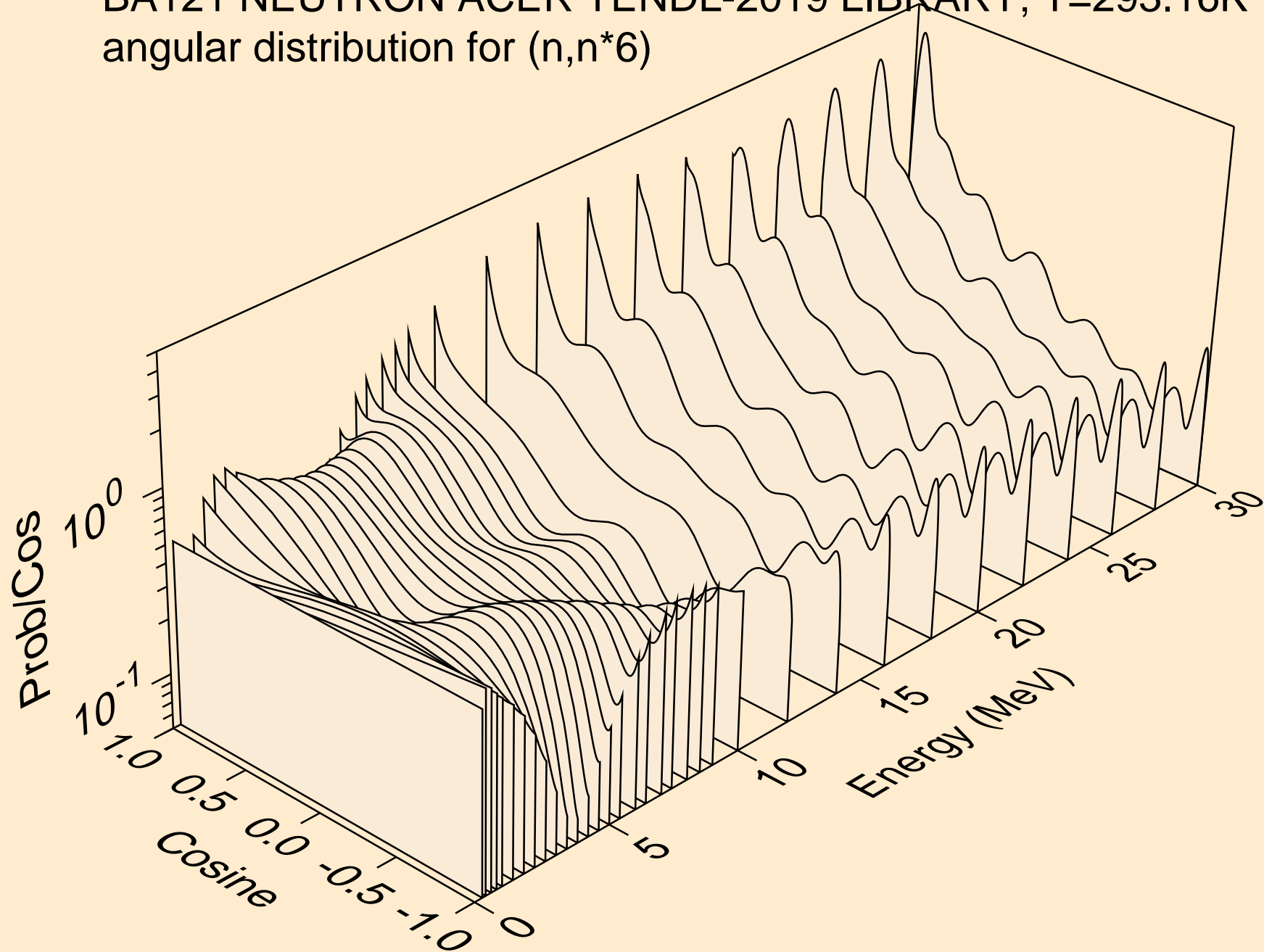

BA121 NEUTRON ACER TENDL-2019 LIBRARY; T=293.16K  
angular distribution for (n,n\*7)

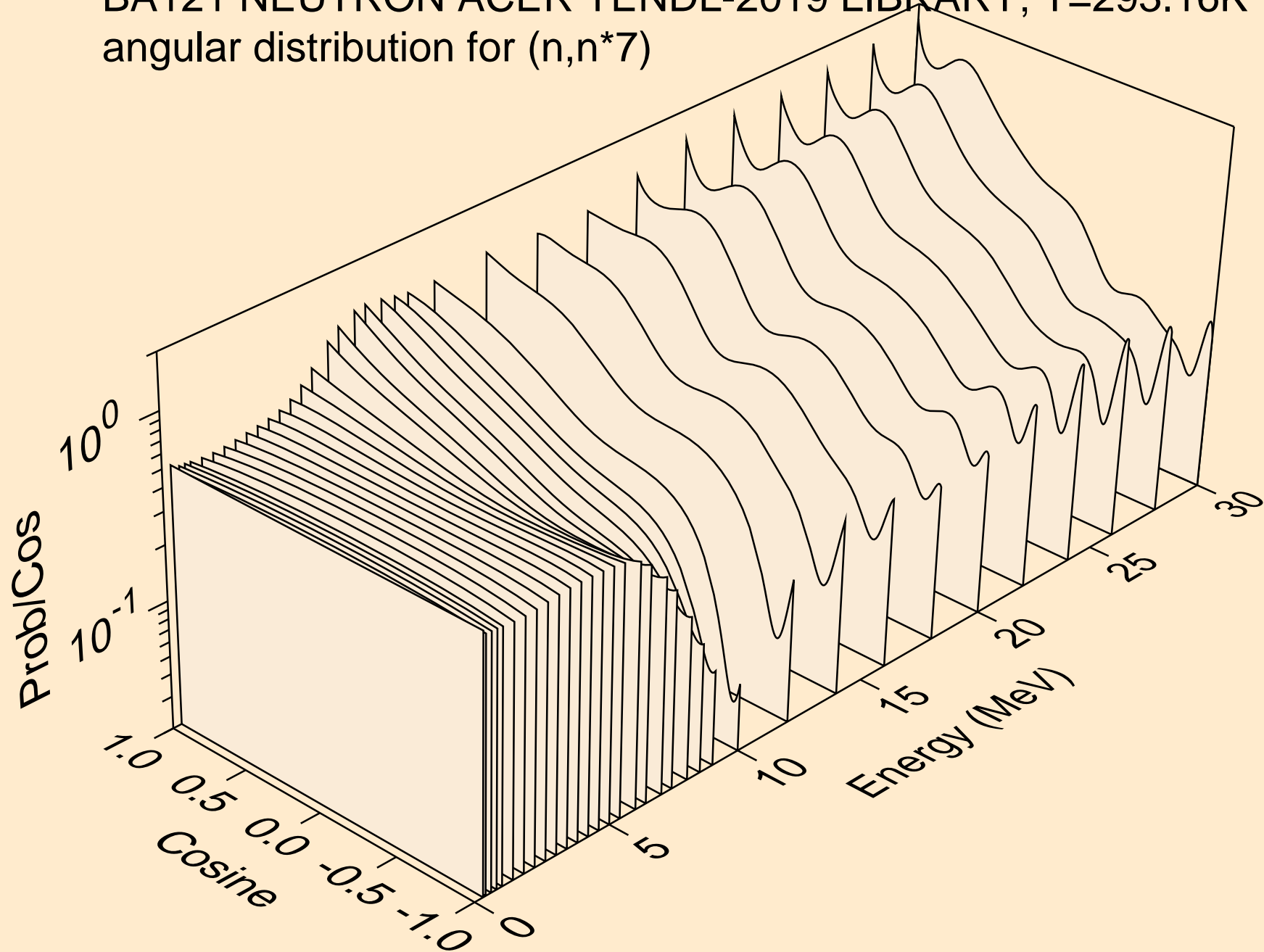

BA121 NEUTRON ACER TENDL-2019 LIBRARY; T=293.16K  
angular distribution for (n,n\*8)

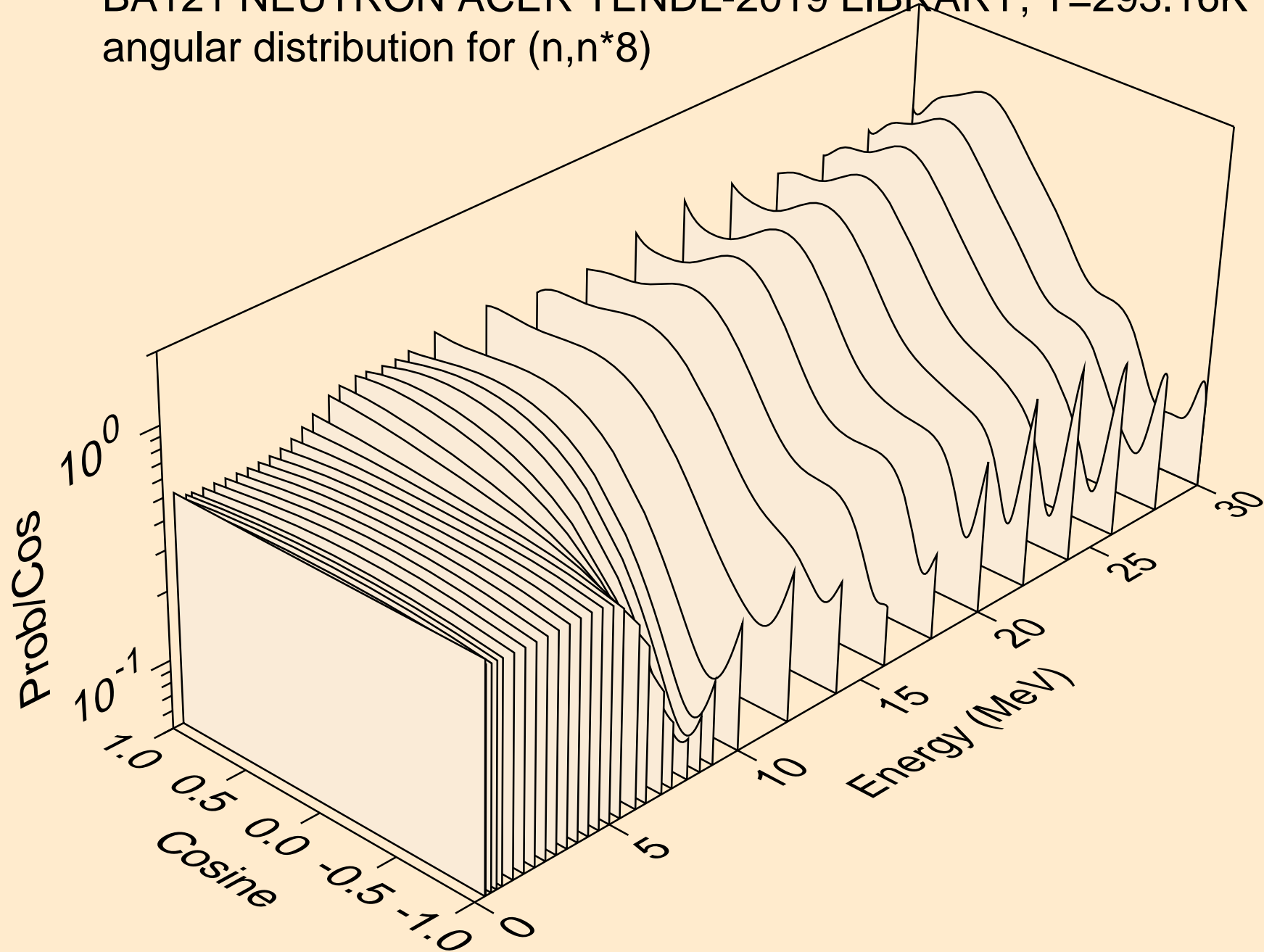

BA121 NEUTRON ACER TENDL-2019 LIBRARY; T=293.16K  
angular distribution for (n,n\*9)

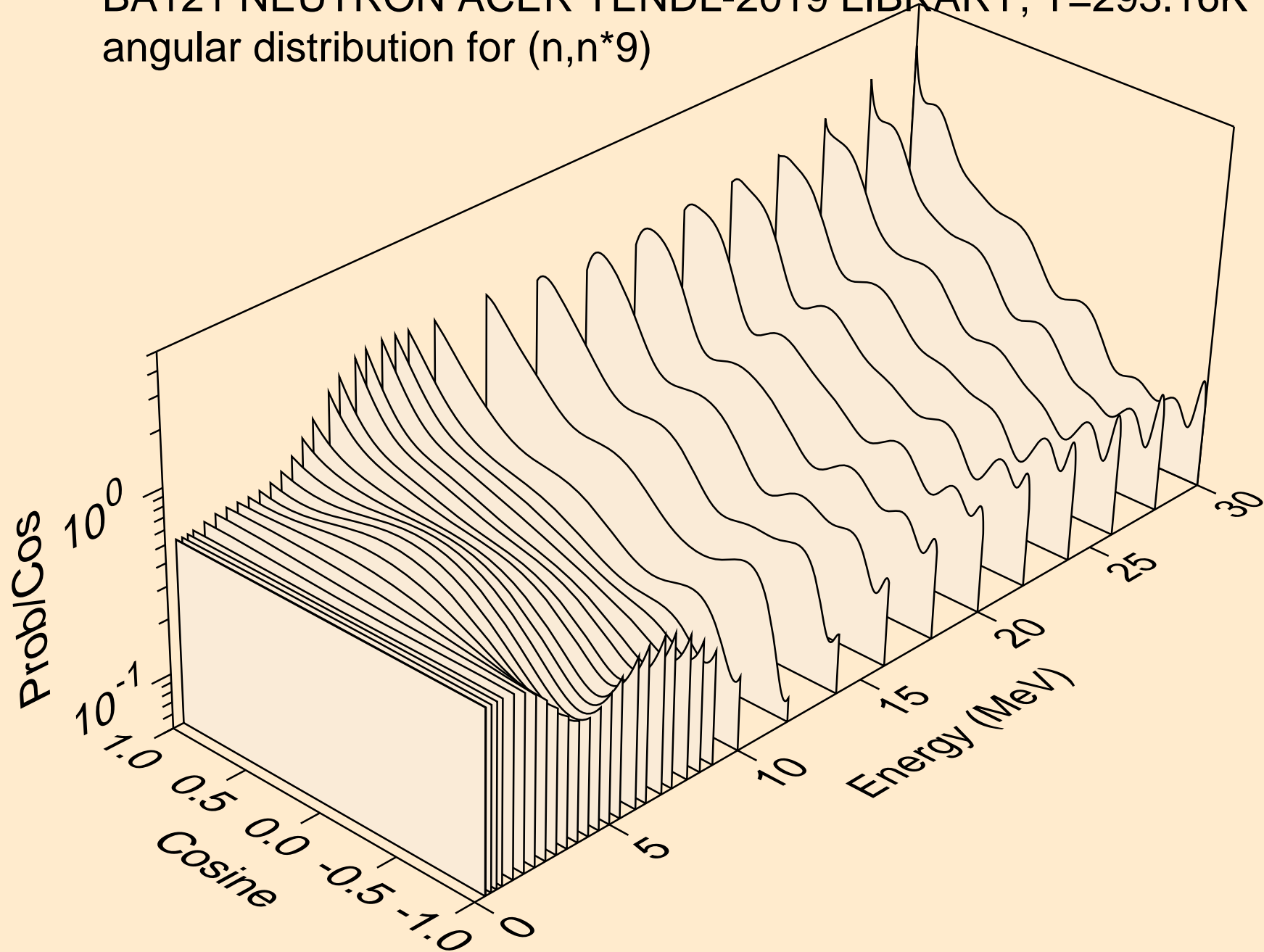

BA121 NEUTRON ACER TENDL-2019 LIBRARY; T=293.16K  
angular distribution for (n,n\*10)

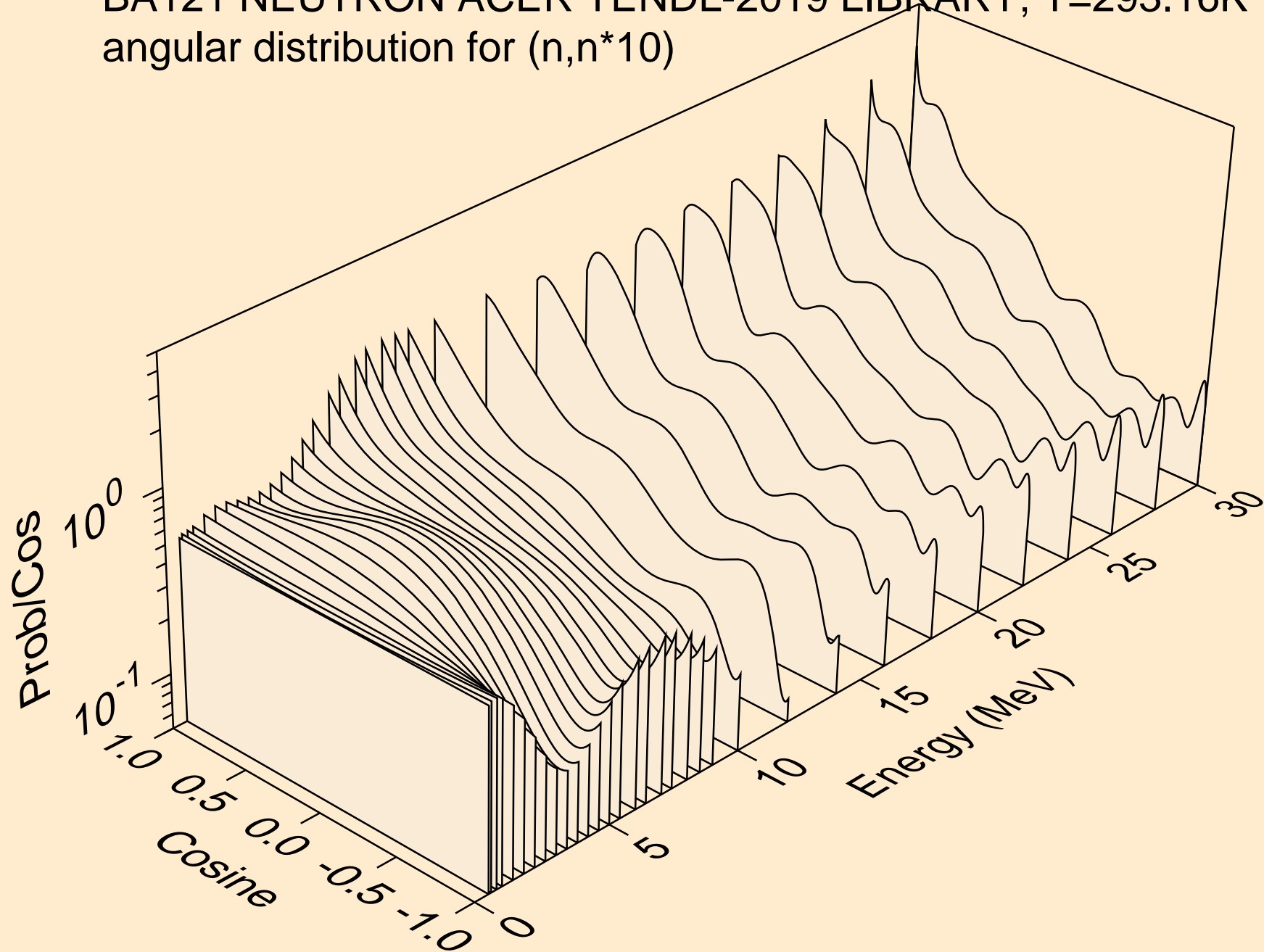



BA121 NEUTRON ACER TENDL-2019 LIBRARY; T=293.16K  
angular distribution for (n,n\*11)

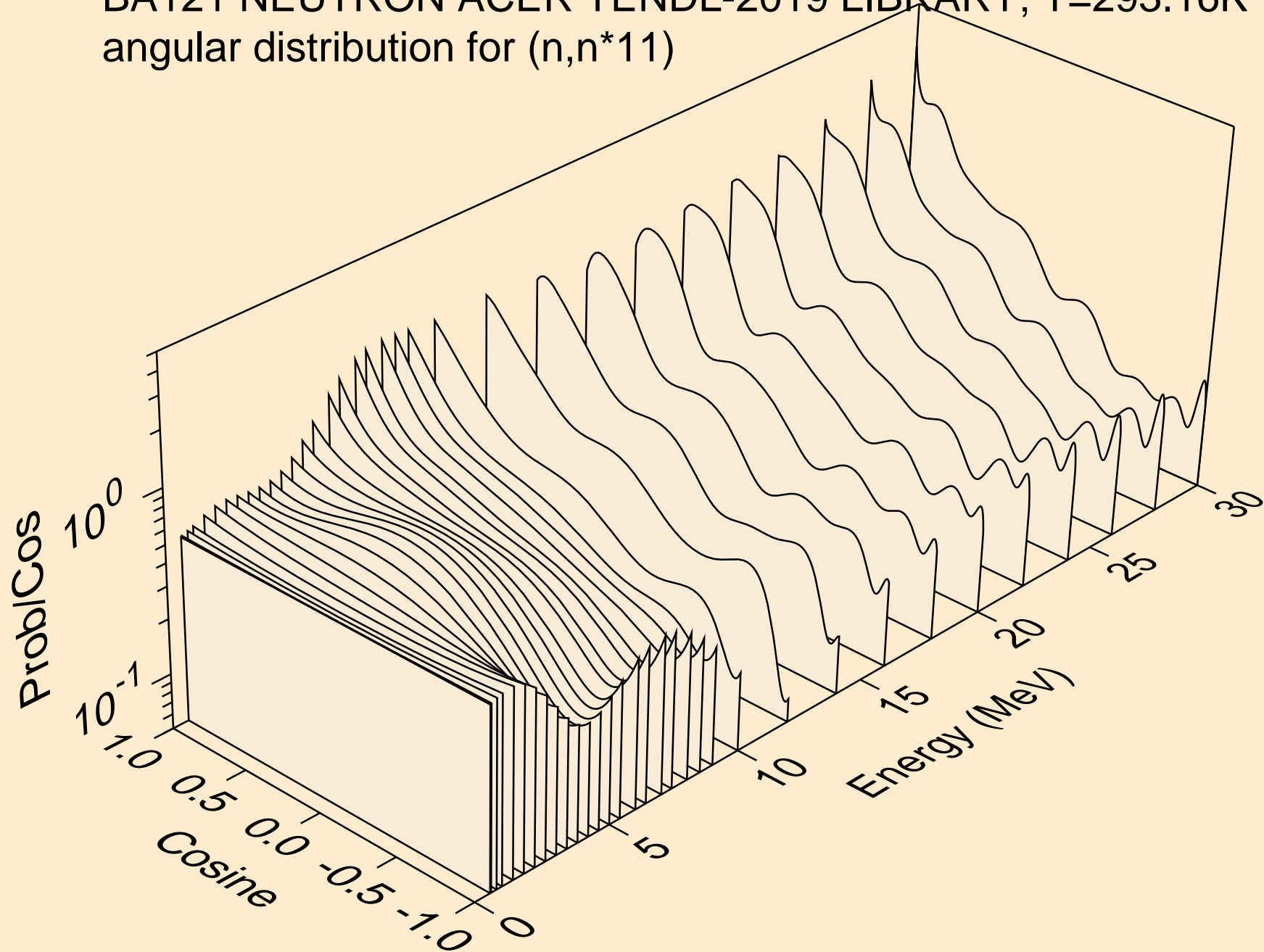

BA121 NEUTRON ACER TENDL-2019 LIBRARY; T=293.16K  
angular distribution for (n,n\*12)

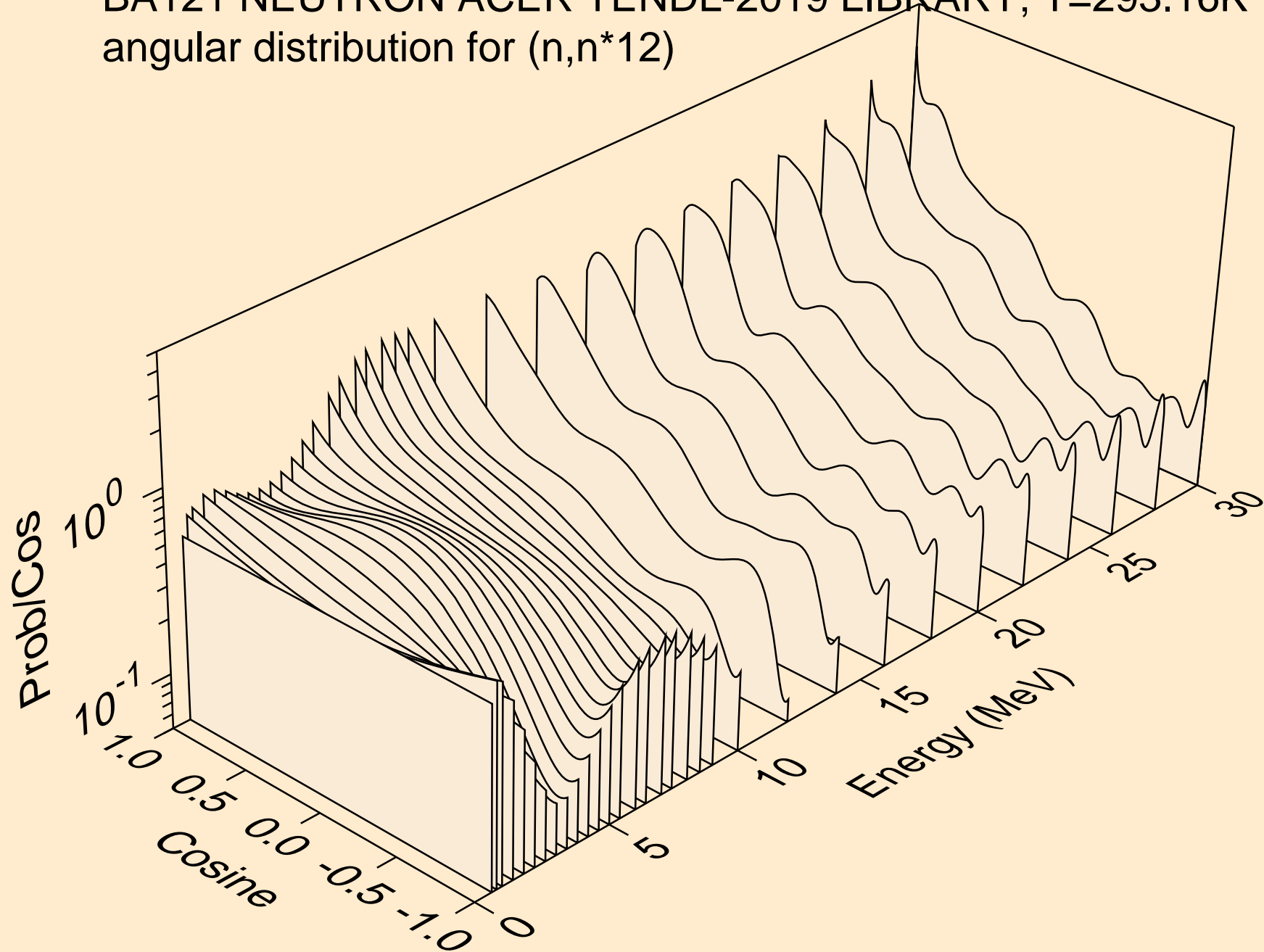

BA121 NEUTRON ACER TENDL-2019 LIBRARY; T=293.16K  
angular distribution for (n,n\*13)

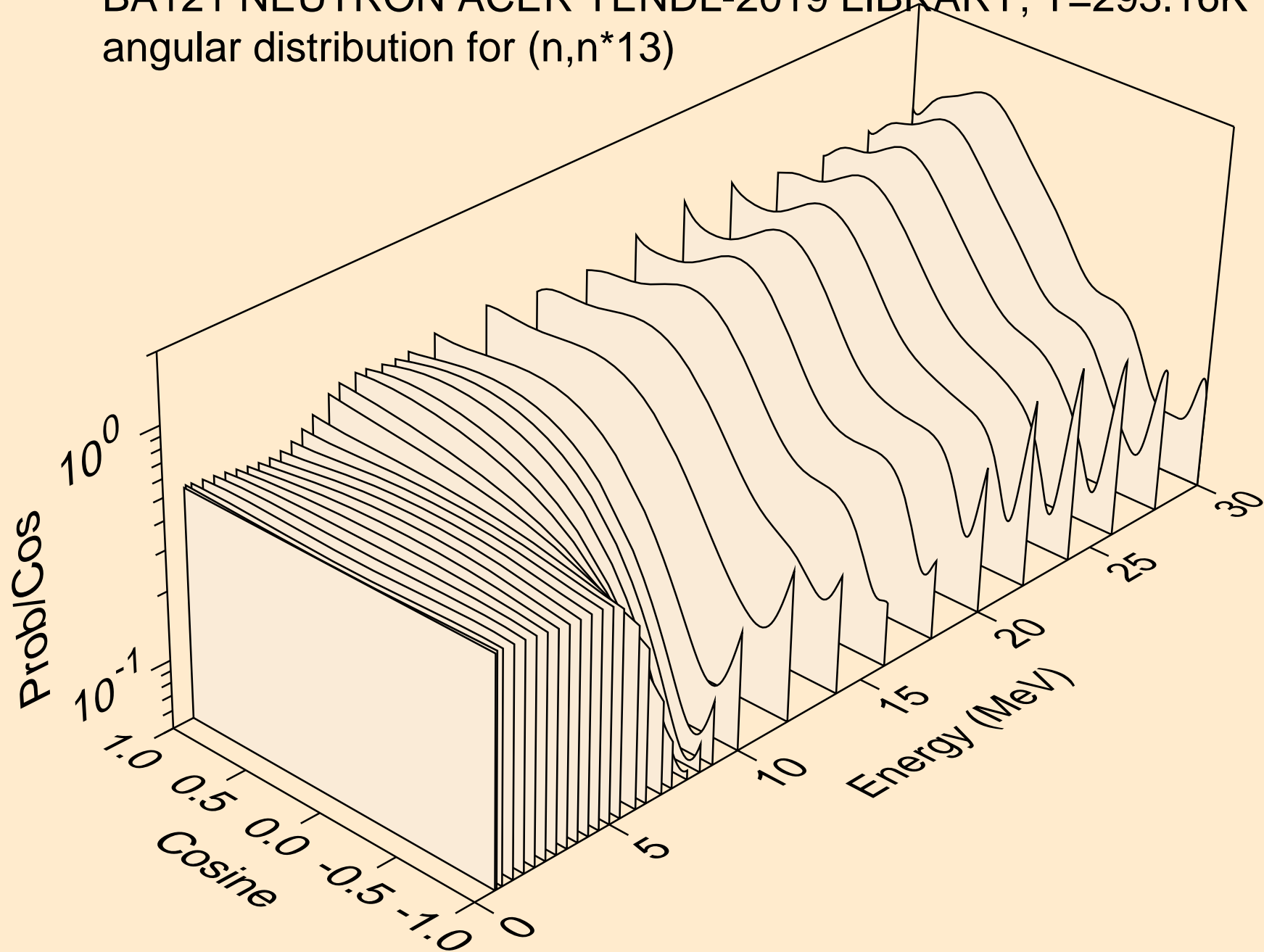

BA121 NEUTRON ACER TENDL-2019 LIBRARY; T=293.16K  
angular distribution for (n,n\*14)

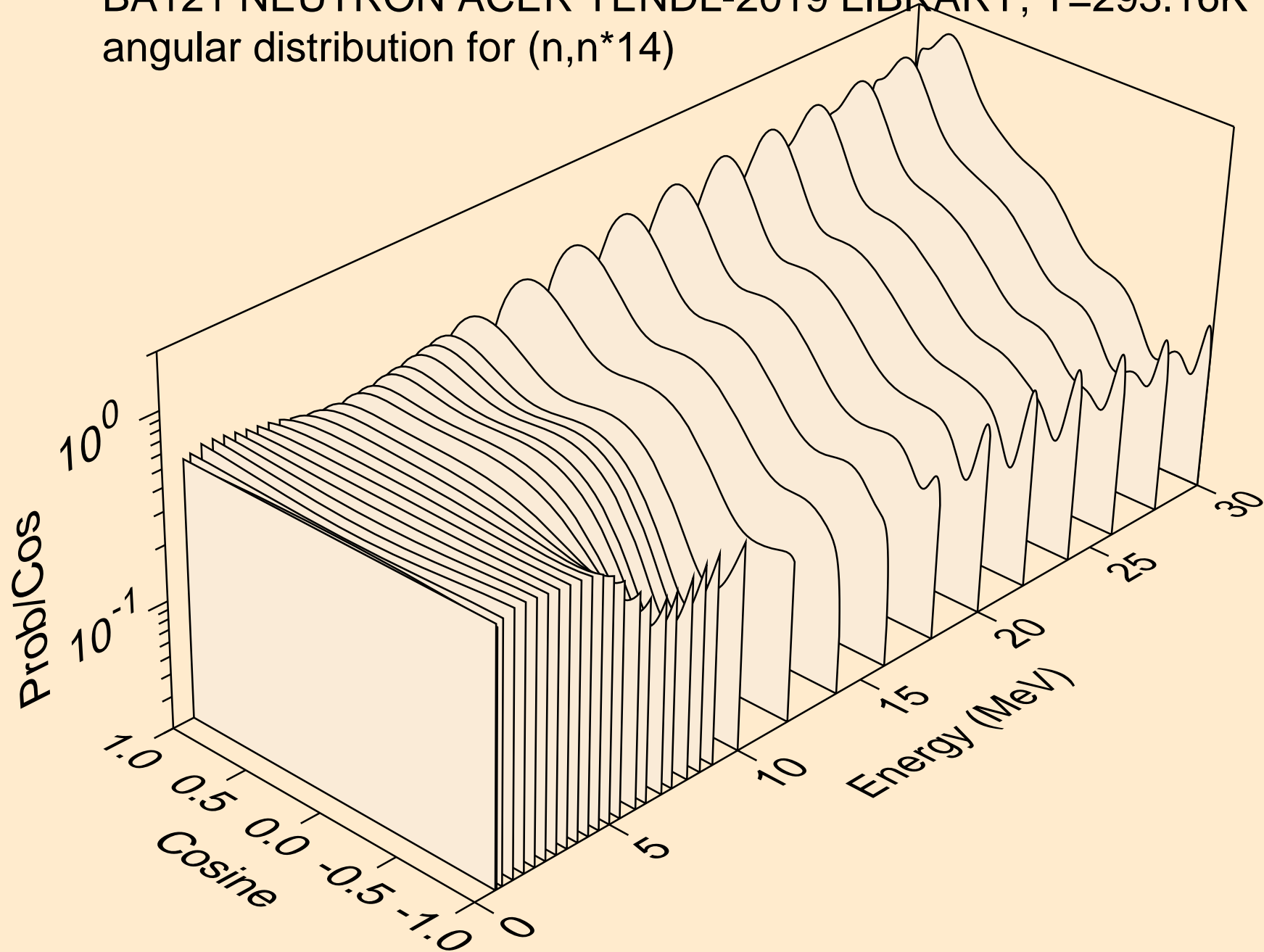

BA121 NEUTRON ACER TENDL-2019 LIBRARY; T=293.16K  
angular distribution for (n,n\*15)

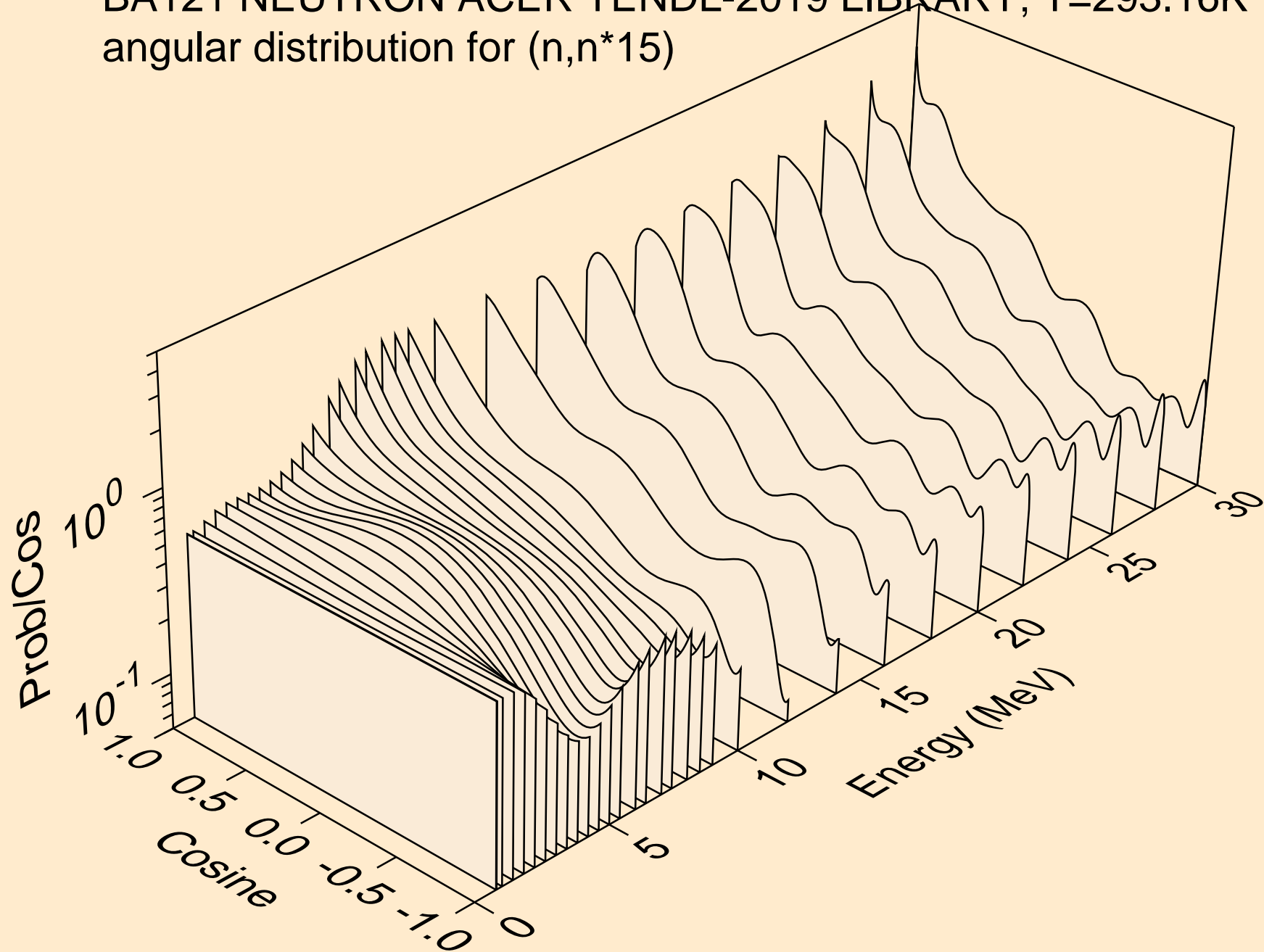

BA121 NEUTRON ACER TENDL-2019 LIBRARY; T=293.16K  
Neutron emission for (n,x)

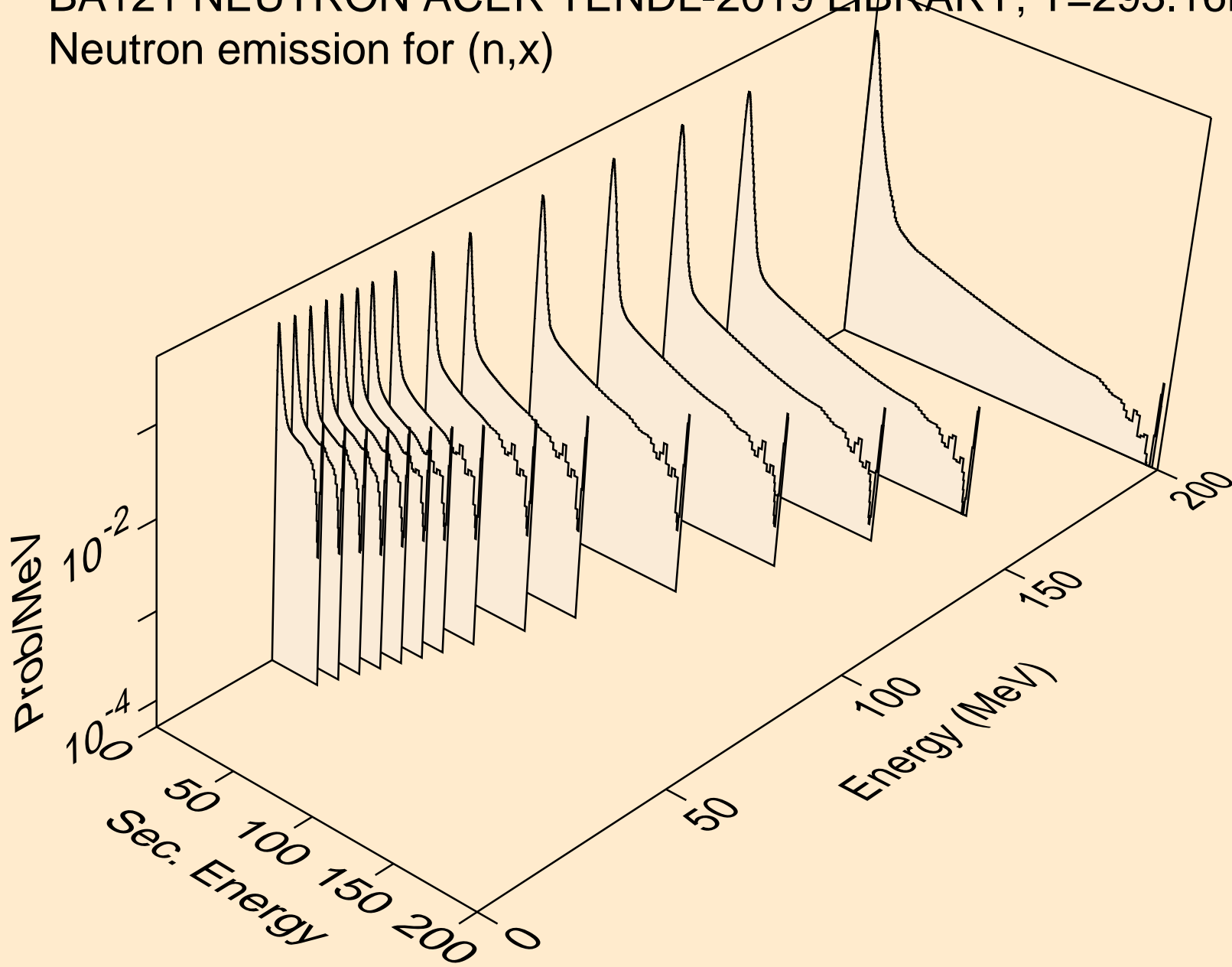

BA121 NEUTRON ACER TENDL-2019 LIBRARY; T=293.16K  
Neutron emission for (n,2nd)

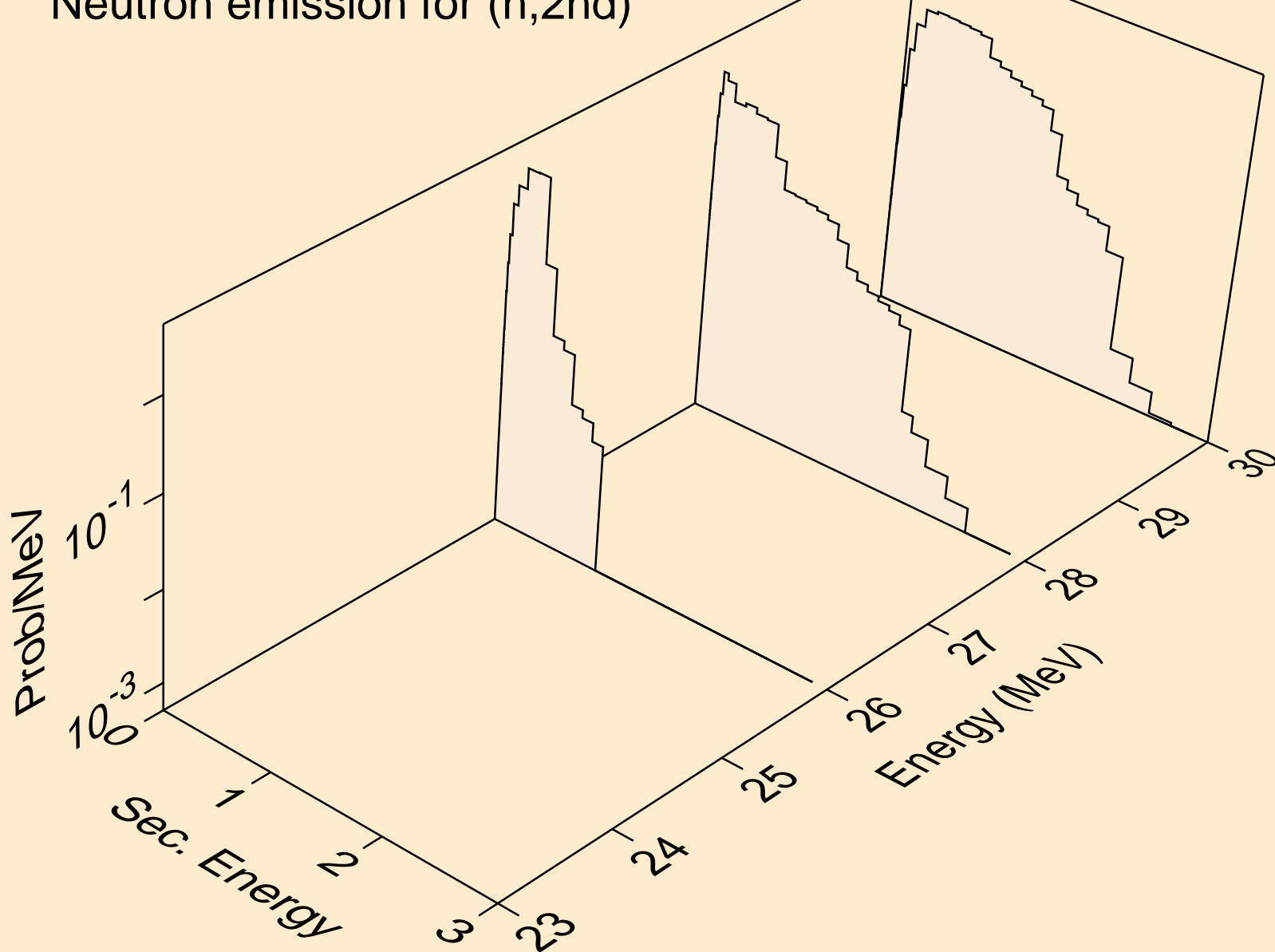

BA121 NEUTRON ACER TENDL-2019 LIBRARY; T=293.16K  
Neutron emission for (n,2n)

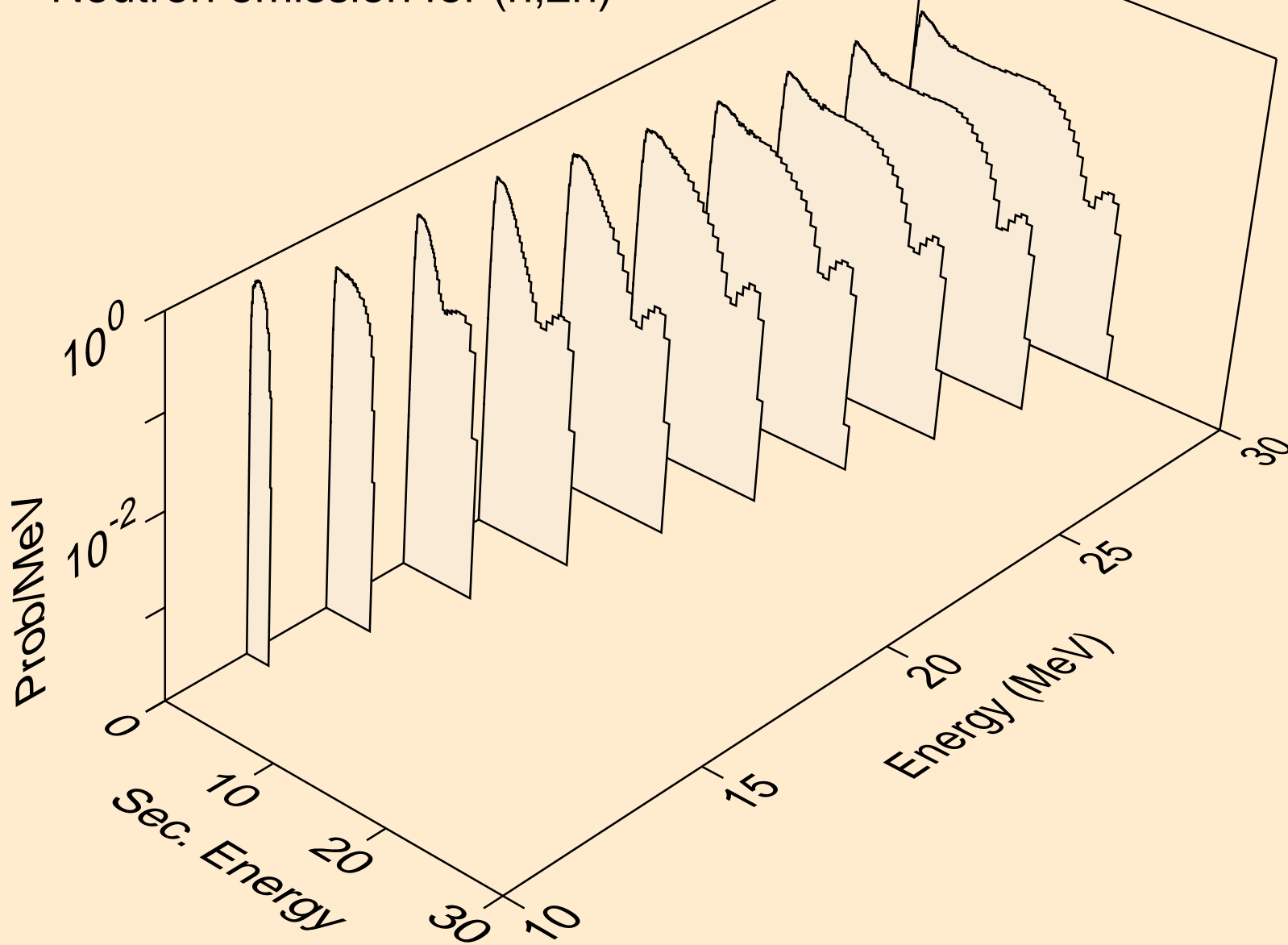



BA121 NEUTRON ACER TENDL-2019 LIBRARY; T=293.16K  
Neutron emission for (n,3n)

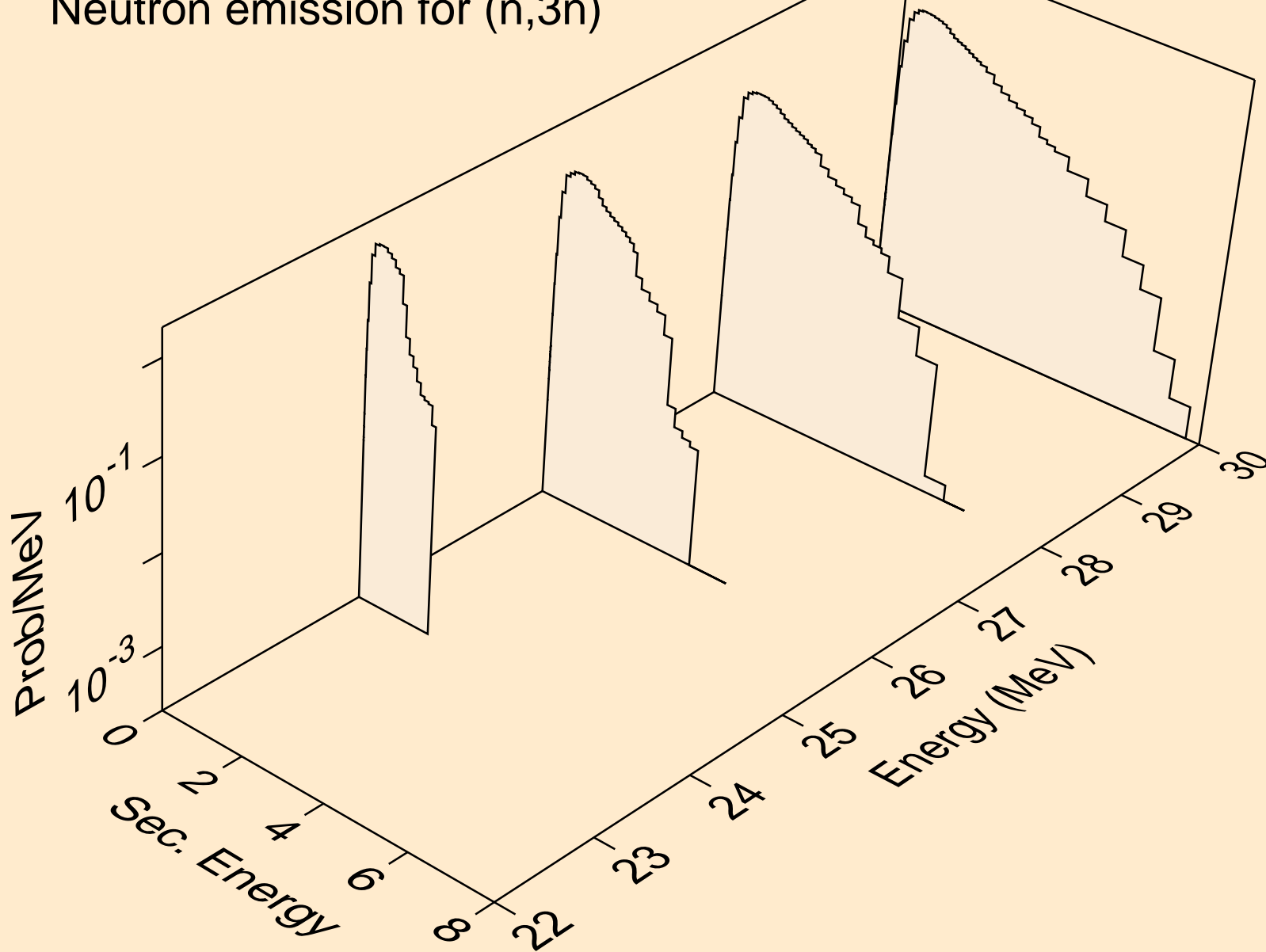

BA121 NEUTRON ACER TENDL-2019 LIBRARY; T=293.16K  
Neutron emission for (n,n\*)a

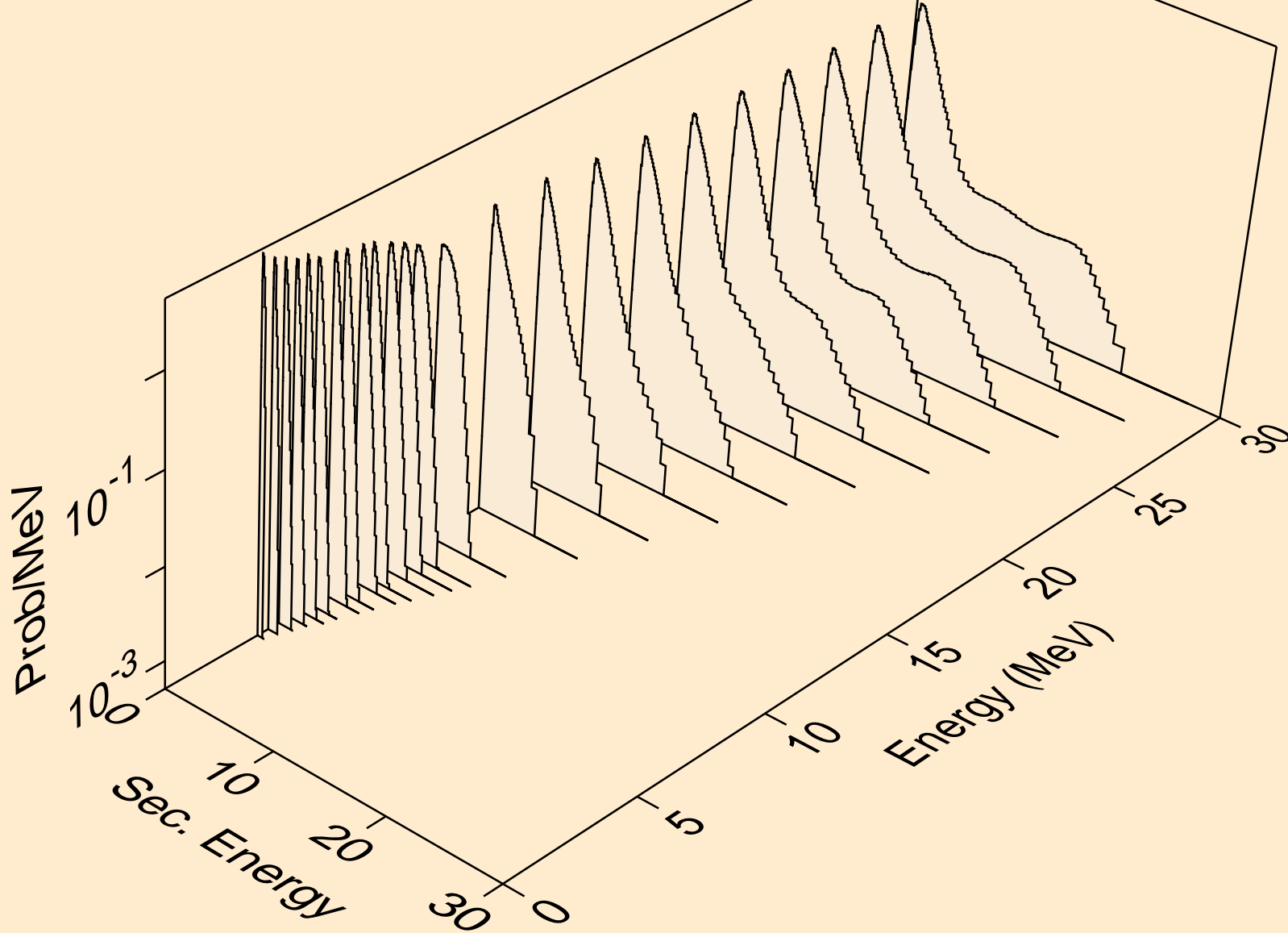

BA121 NEUTRON ACER TENDL-2019 LIBRARY; T=293.16K  
Neutron emission for (n,n\*)3a

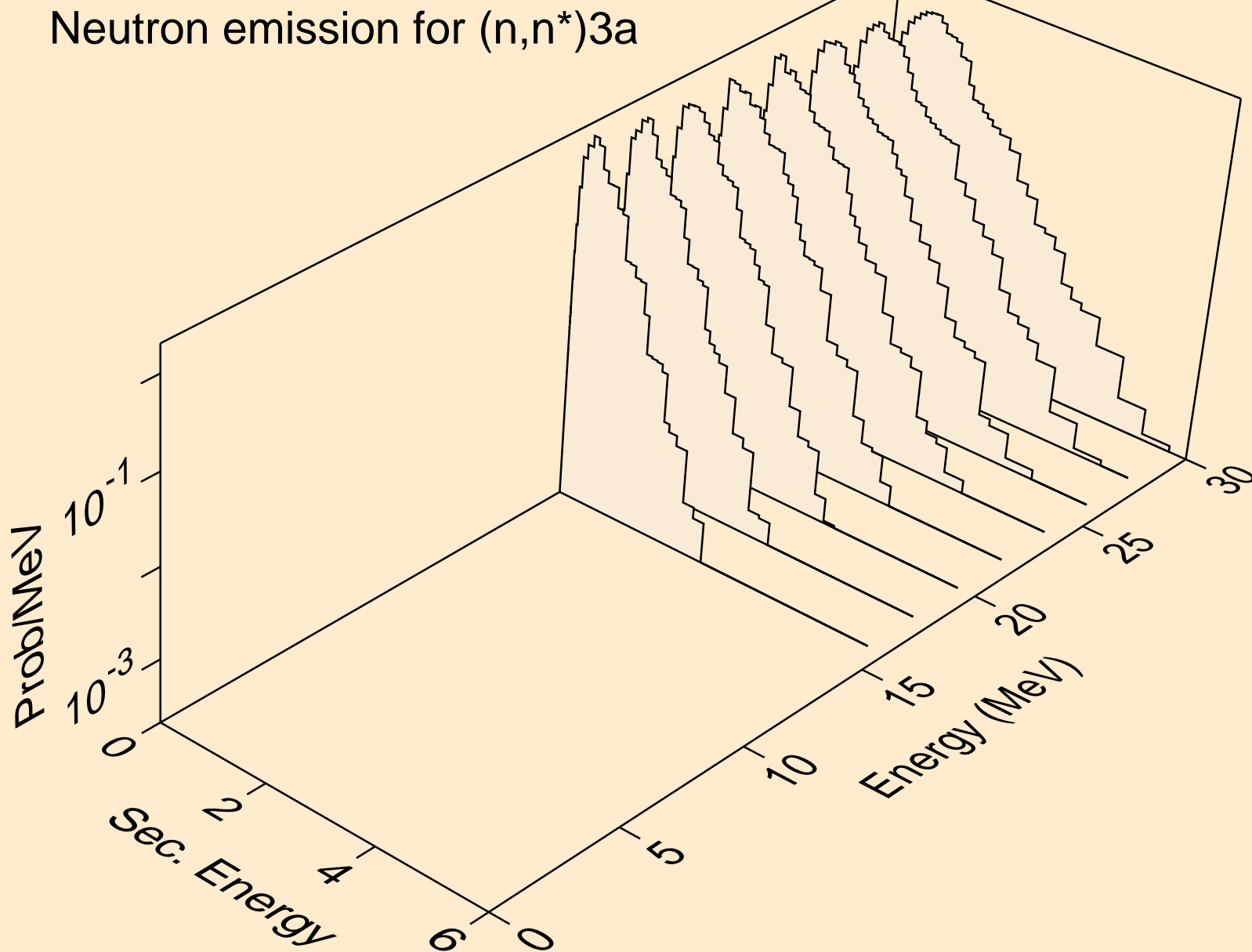

BA121 NEUTRON ACER TENDL-2019 LIBRARY; T=293.16K  
Neutron emission for (n,2n)a

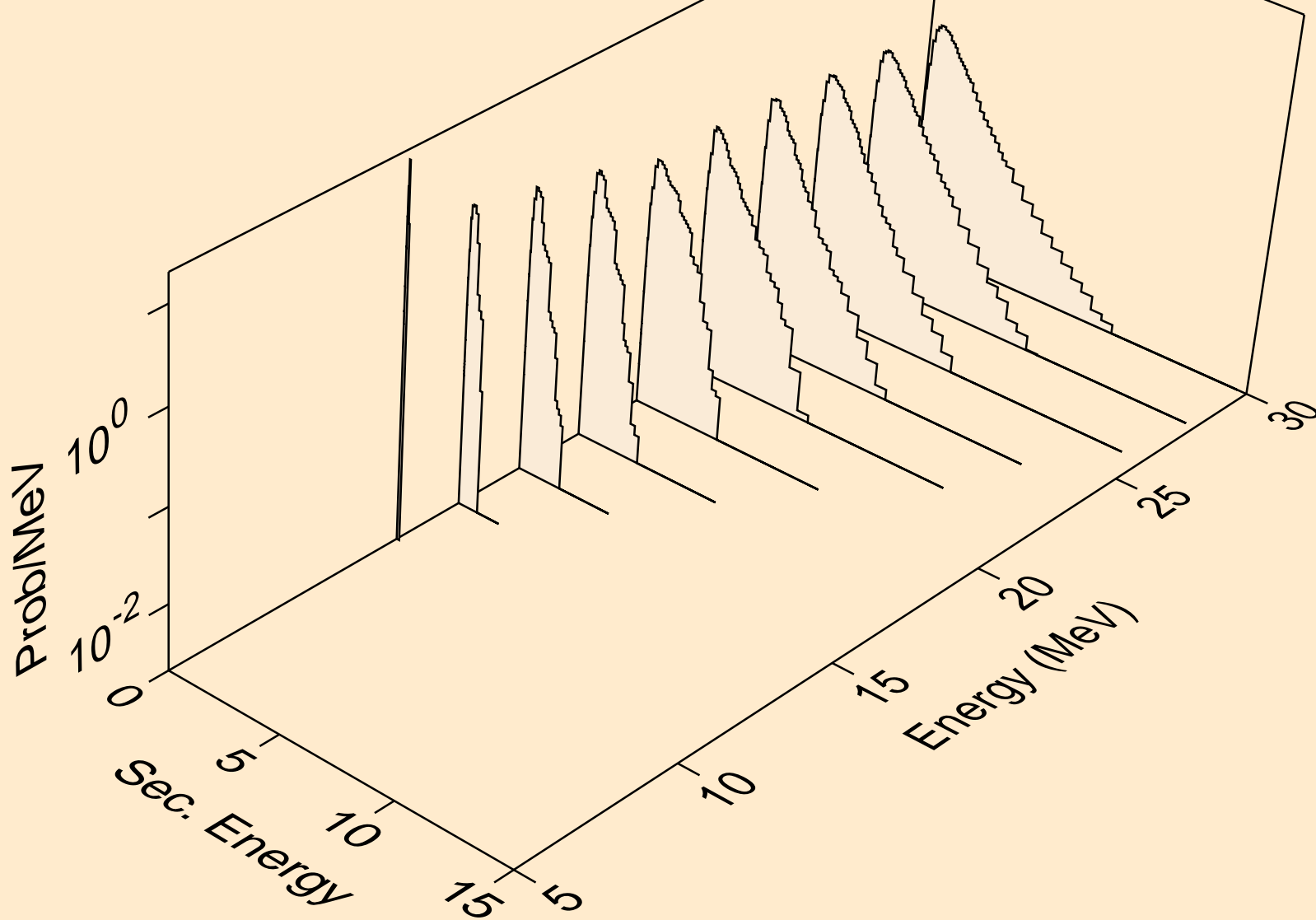

BA121 NEUTRON ACER TENDL-2019 LIBRARY; T=293.16K  
Neutron emission for (n,3n)a

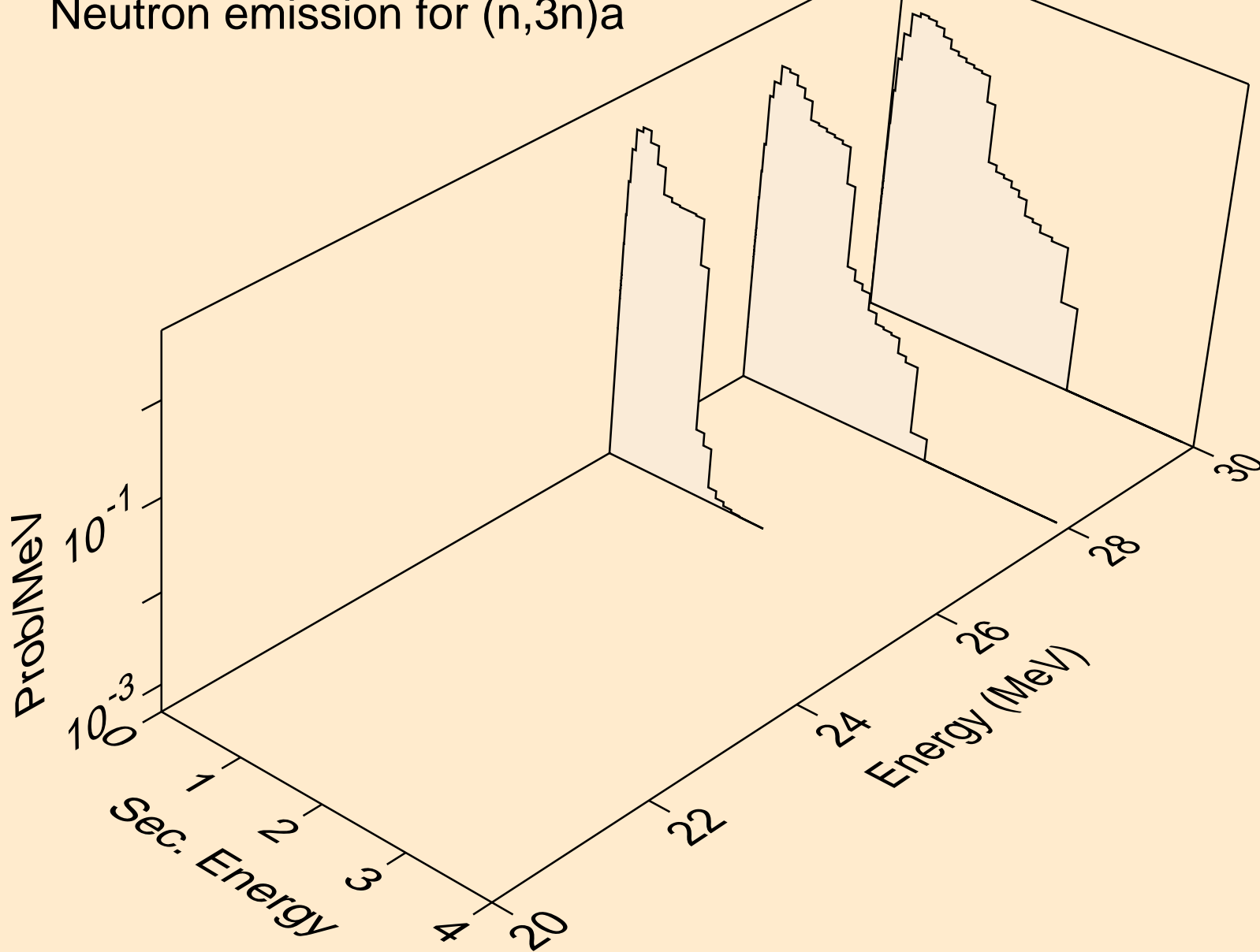

BA121 NEUTRON ACER TENDL-2019 LIBRARY; T=293.16K  
Neutron emission for (n,n\*)p

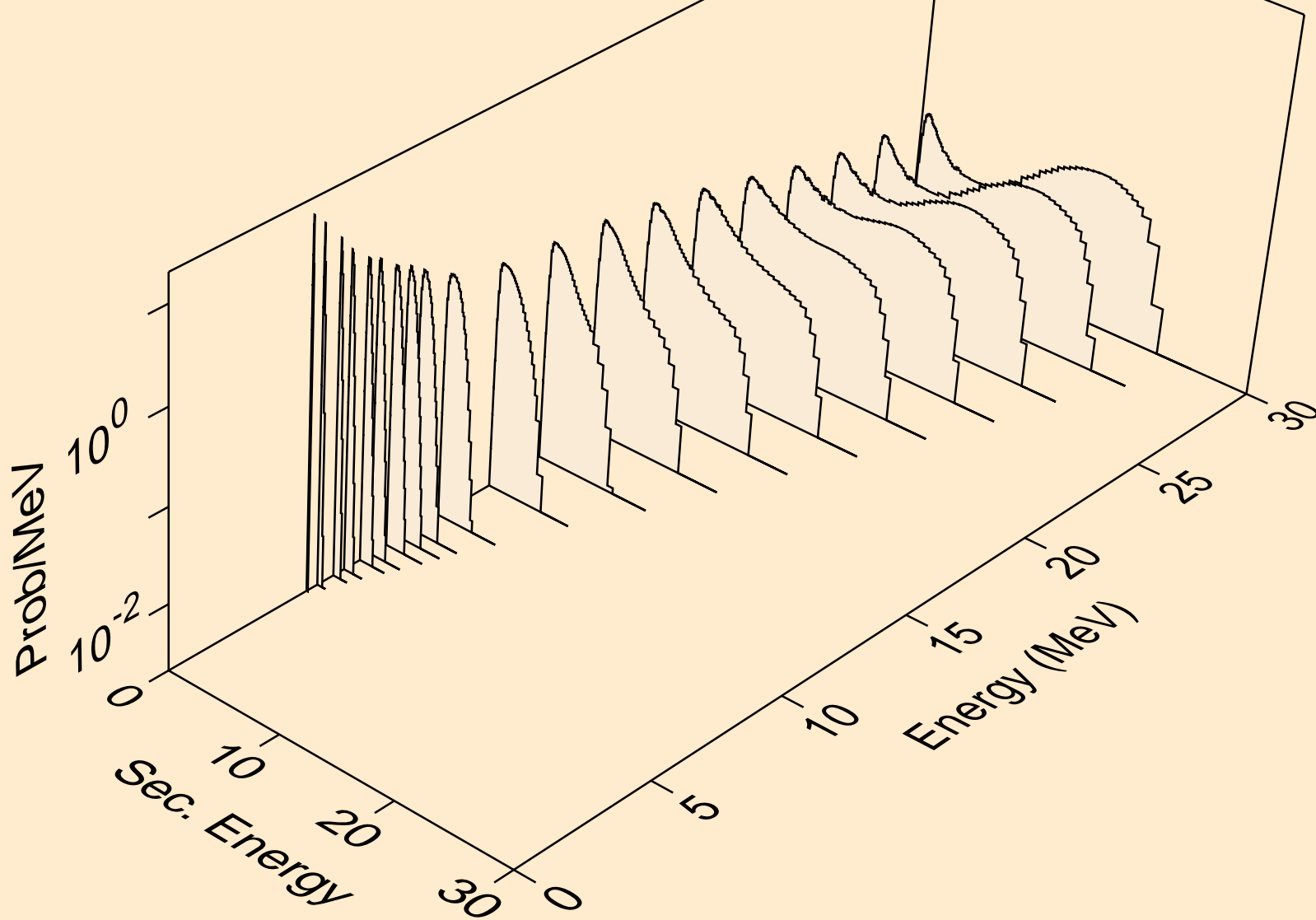

BA121 NEUTRON ACER TENDL-2019 LIBRARY; T=293.16K  
Neutron emission for (n,n\*)2a

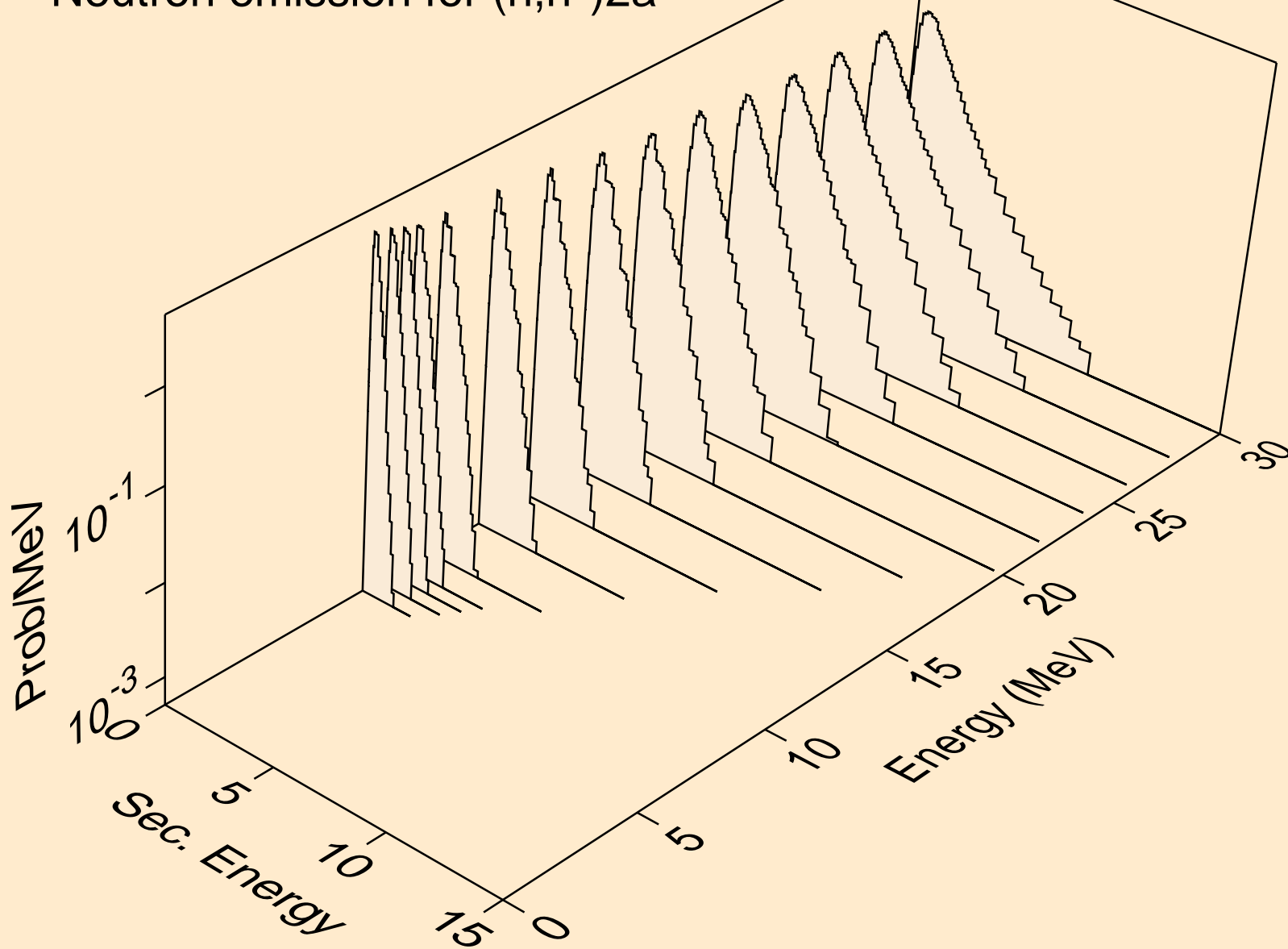

BA121 NEUTRON ACER TENDL-2019 LIBRARY; T=293.16K  
Neutron emission for (n,2n)2a

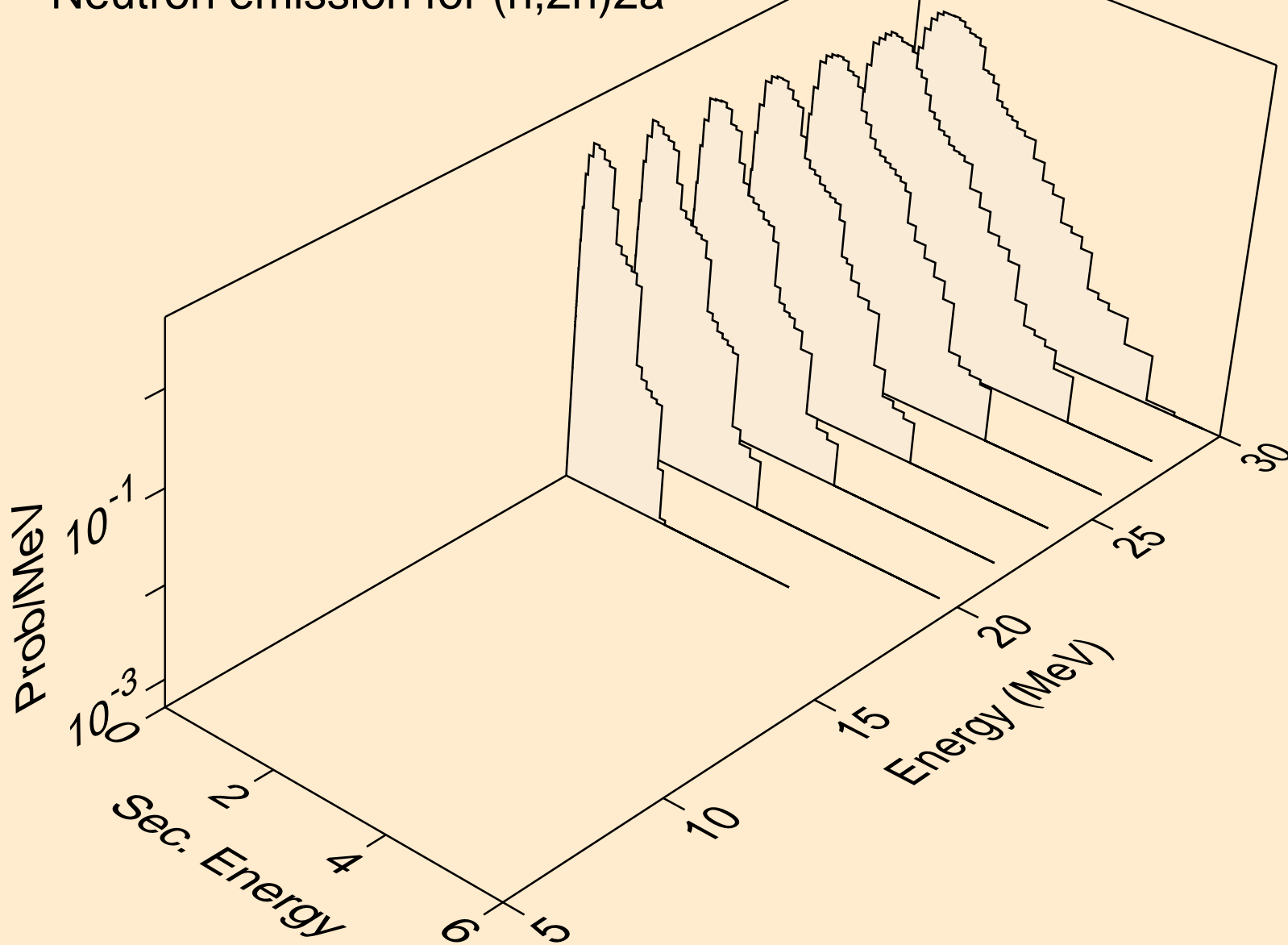



BA121 NEUTRON ACER TENDL-2019 LIBRARY; T=293.16K  
Neutron emission for (n,n\*)d

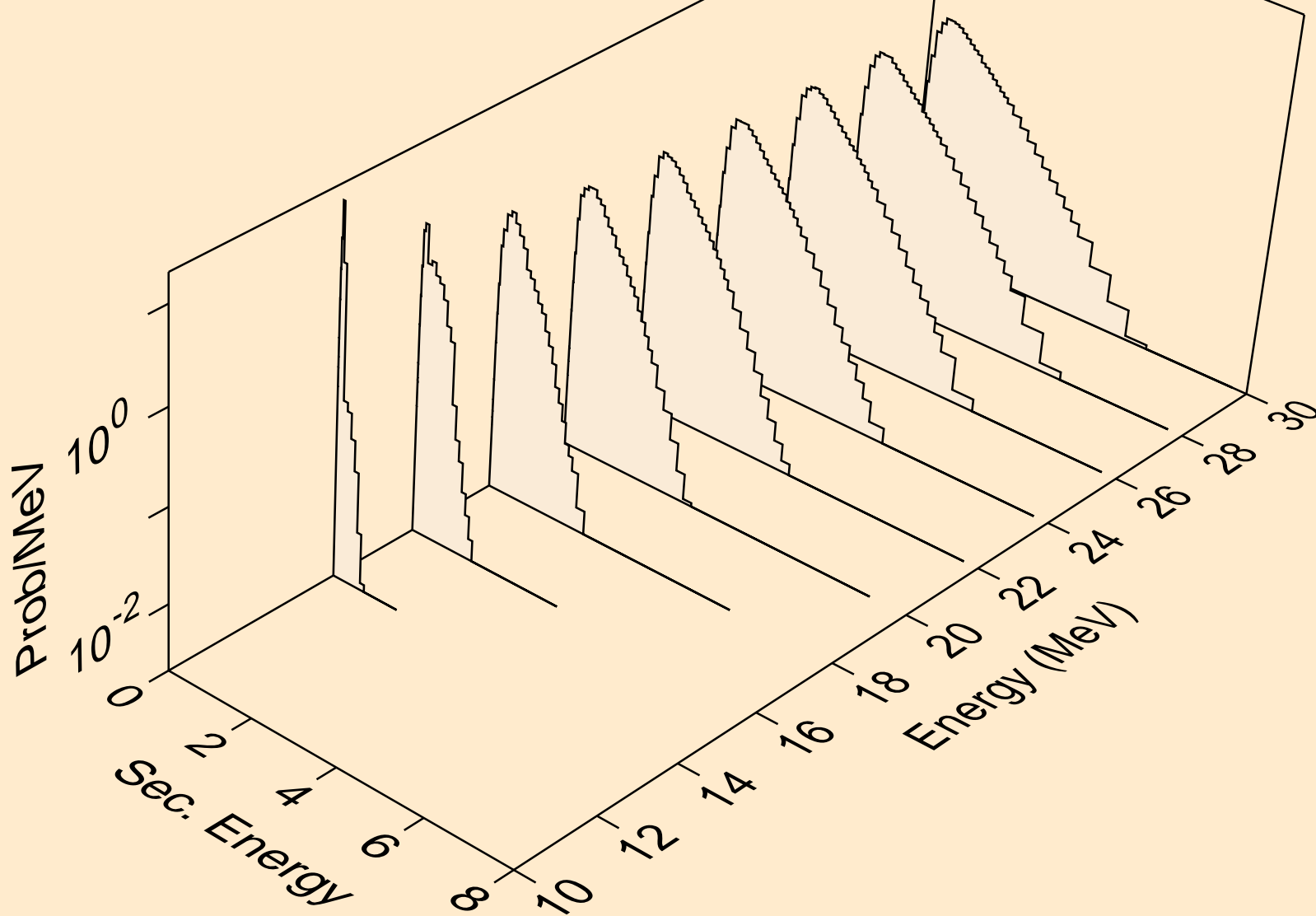

BA121 NEUTRON ACER TENDL-2019 LIBRARY; T=293.16K  
Neutron emission for (n,n\*)t

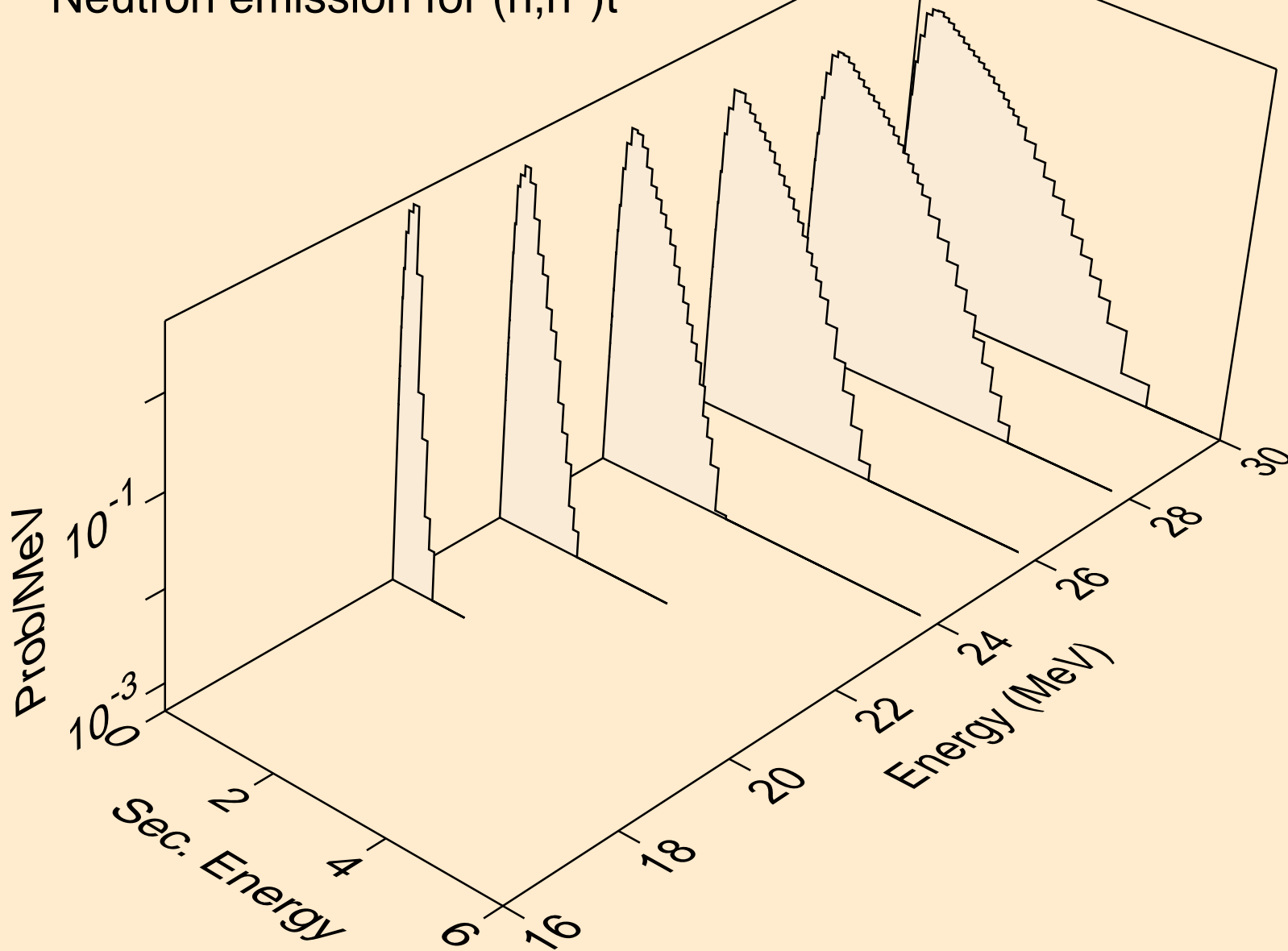

BA121 NEUTRON ACER TENDL-2019 LIBRARY; T=293.16K  
Neutron emission for (n,n\*)he3

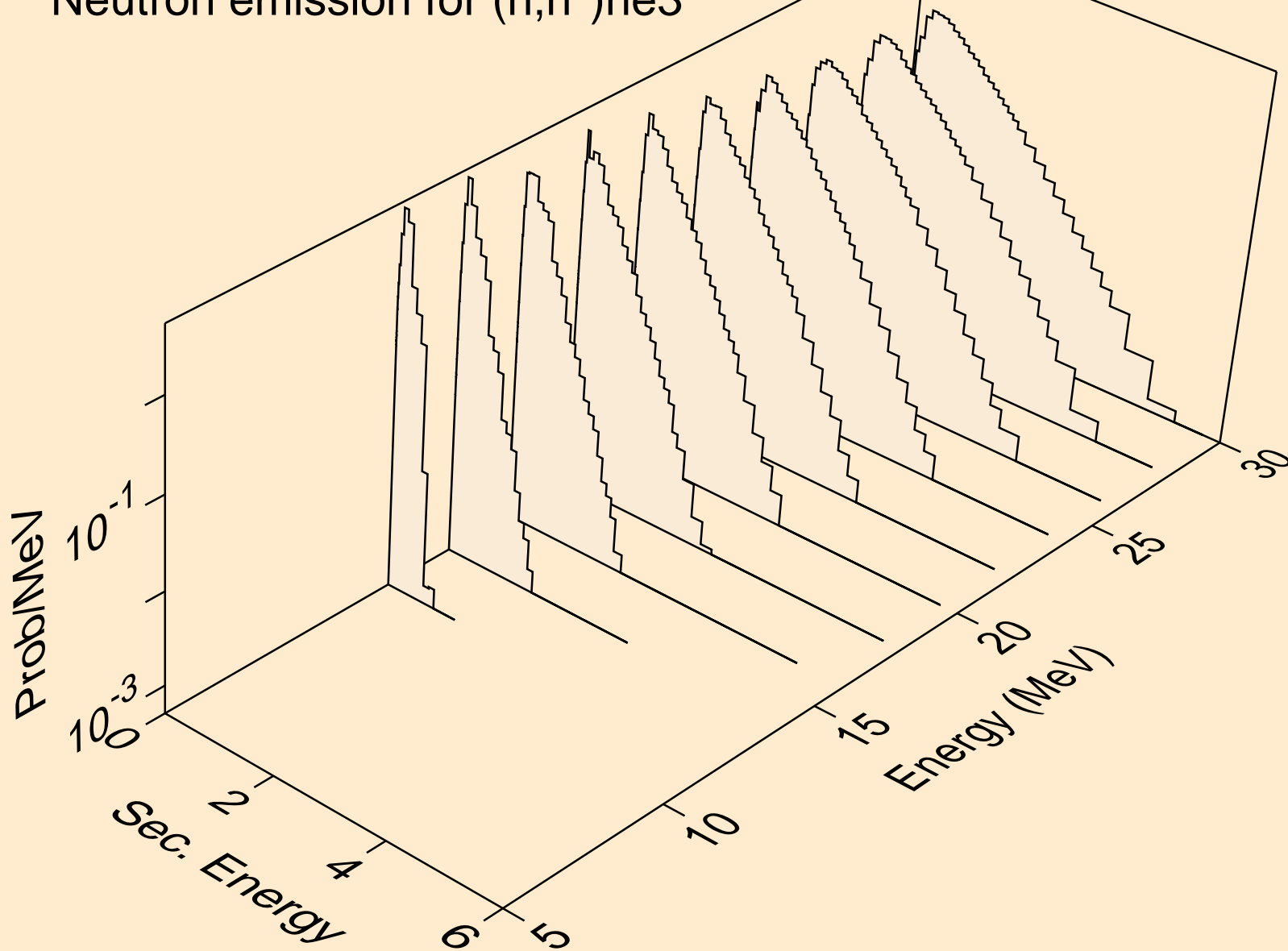

BA121 NEUTRON ACER TENDL-2019 LIBRARY; T=293.16K  
Neutron emission for (n,2np)

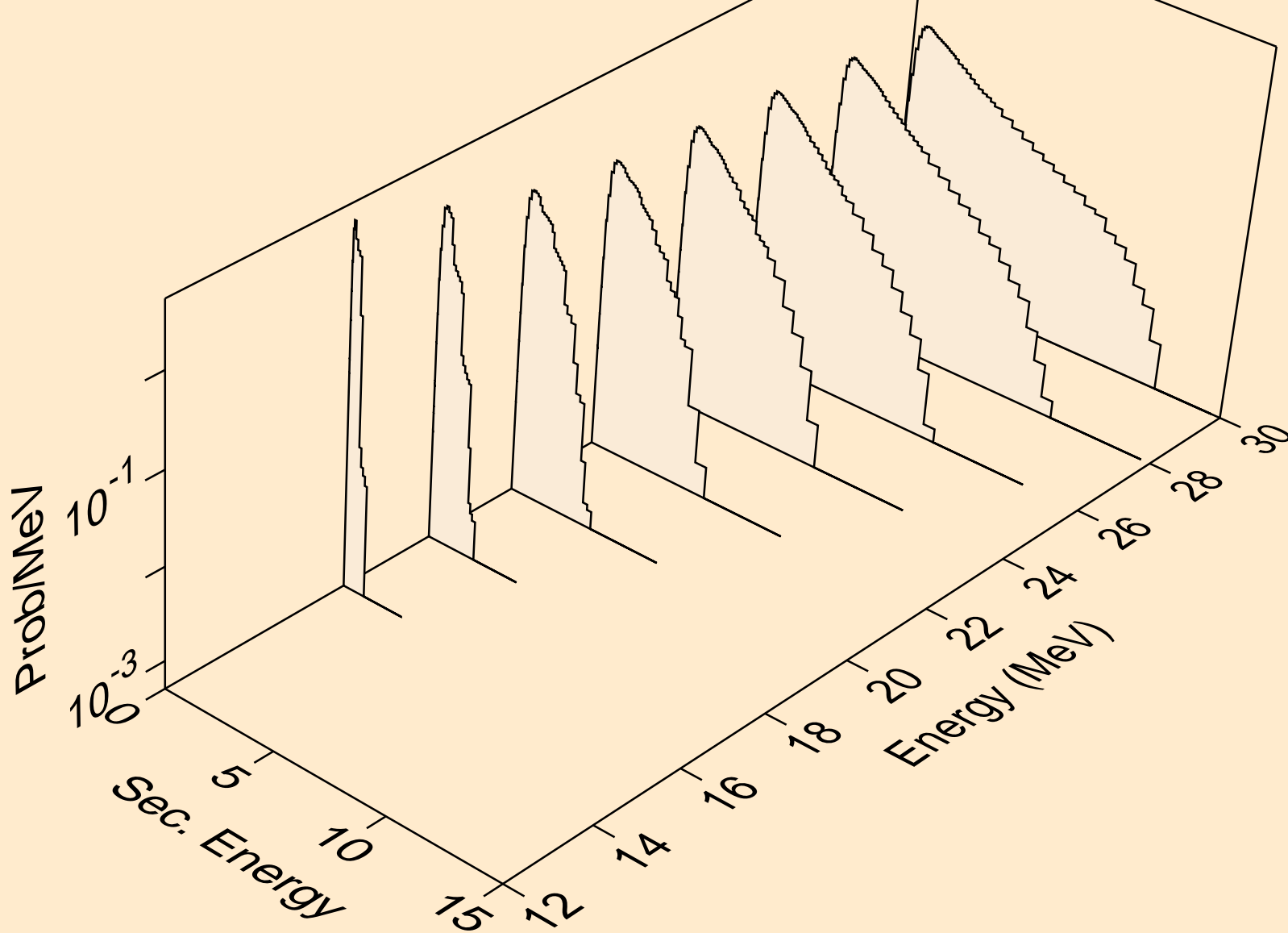

BA121 NEUTRON ACER TENDL-2019 LIBRARY; T=293.16K  
Neutron emission for (n,3np)

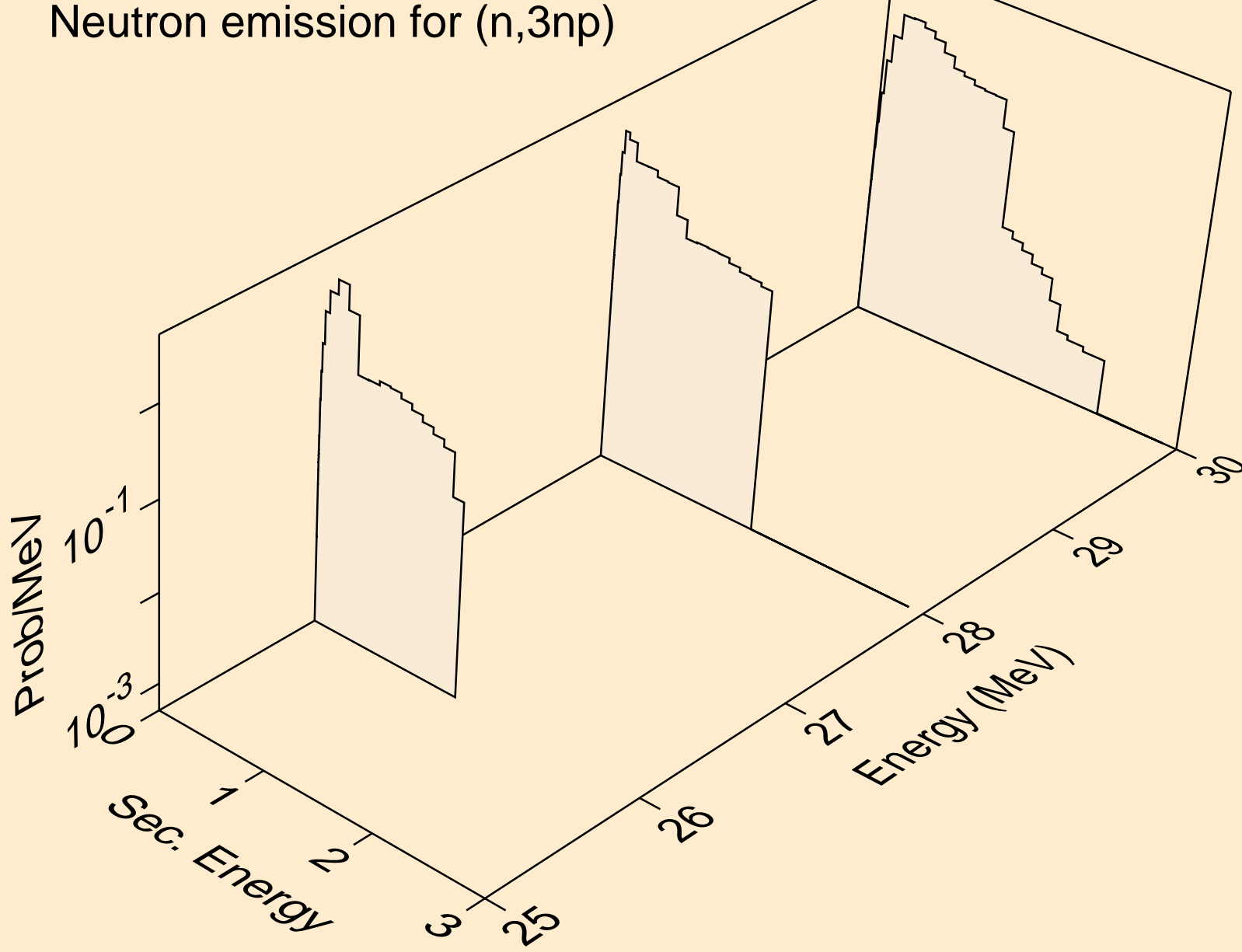

BA121 NEUTRON ACER TENDL-2019 LIBRARY; T=293.16K  
Neutron emission for (n,2np)

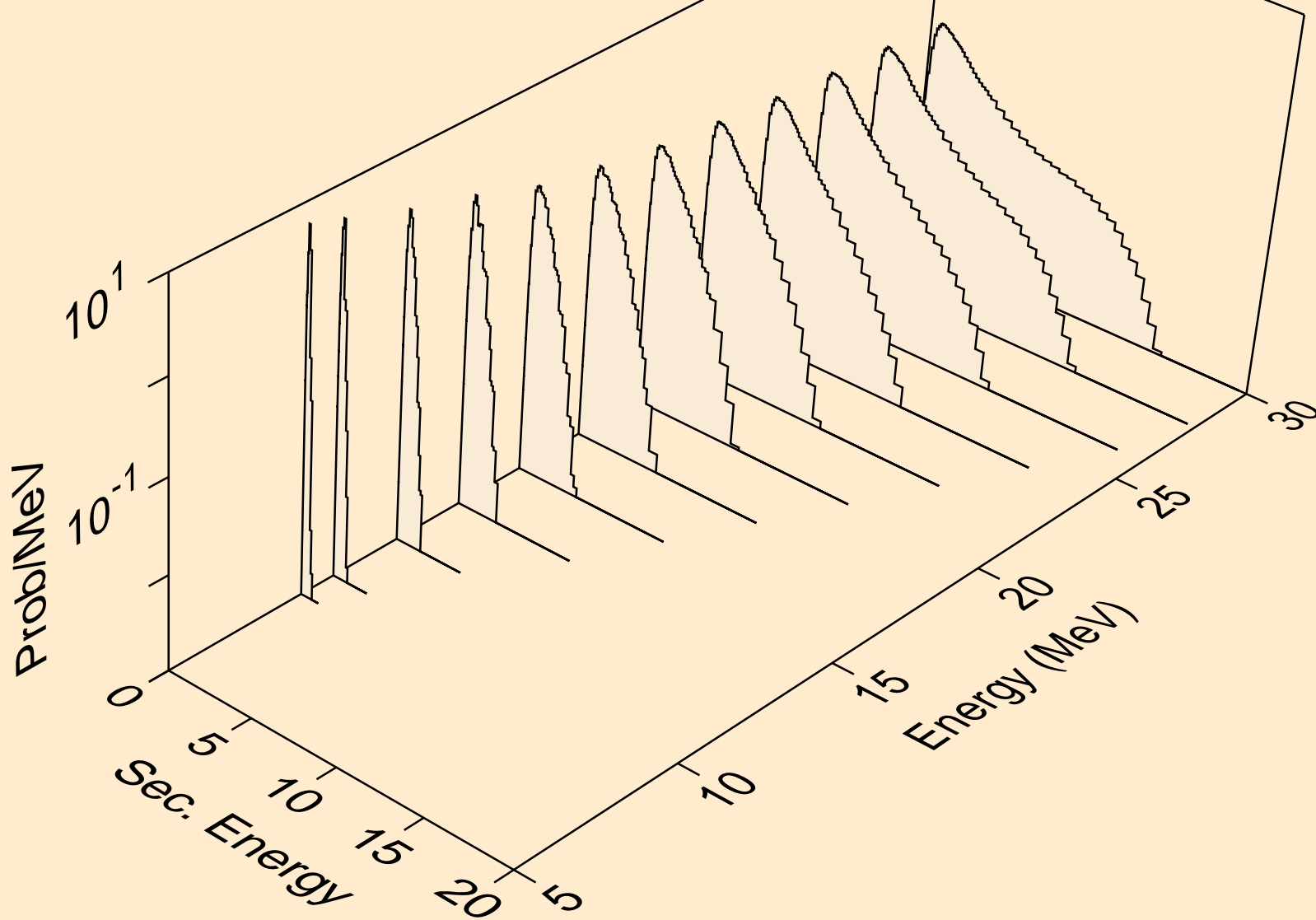

BA121 NEUTRON ACER TENDL-2019 LIBRARY; T=293.16K  
Neutron emission for (n,npa)

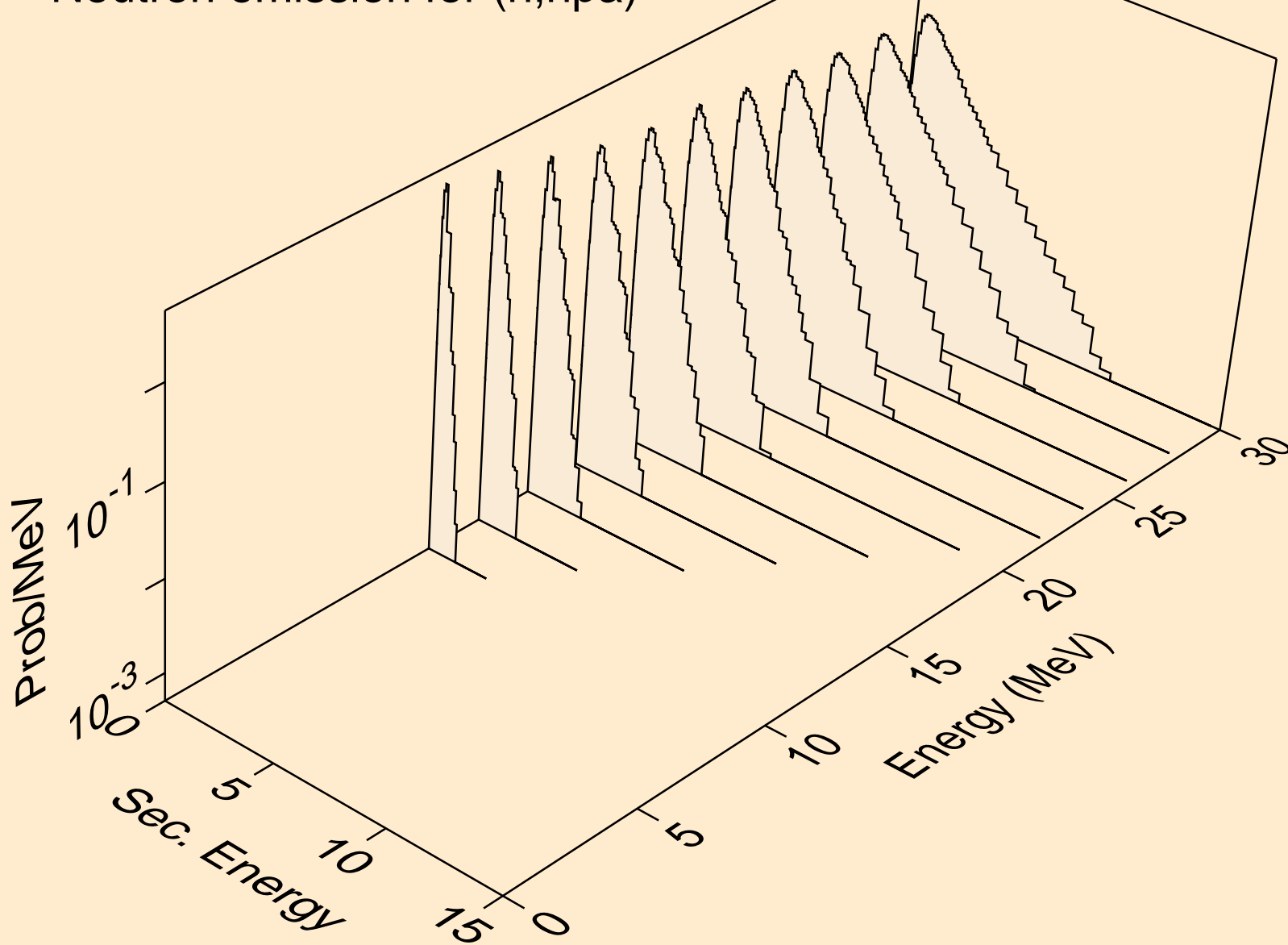

BA121 NEUTRON ACER TENDL-2019 LIBRARY; T=293.16K  
Neutron emission for (n,n\*c)

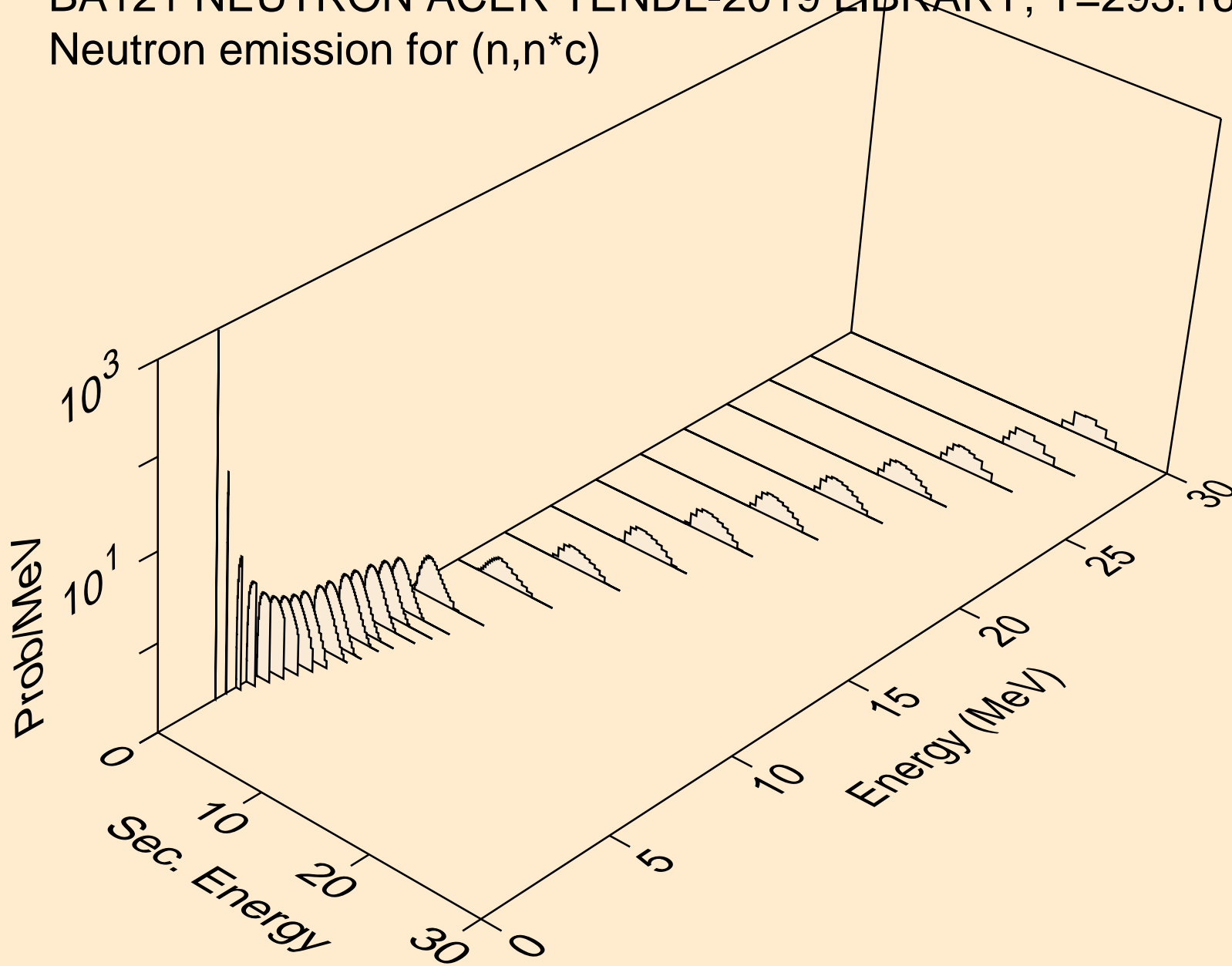



BA121 NEUTRON ACER TENDL-2019 LIBRARY; T=293.16K  
Photon emission for (n,x)

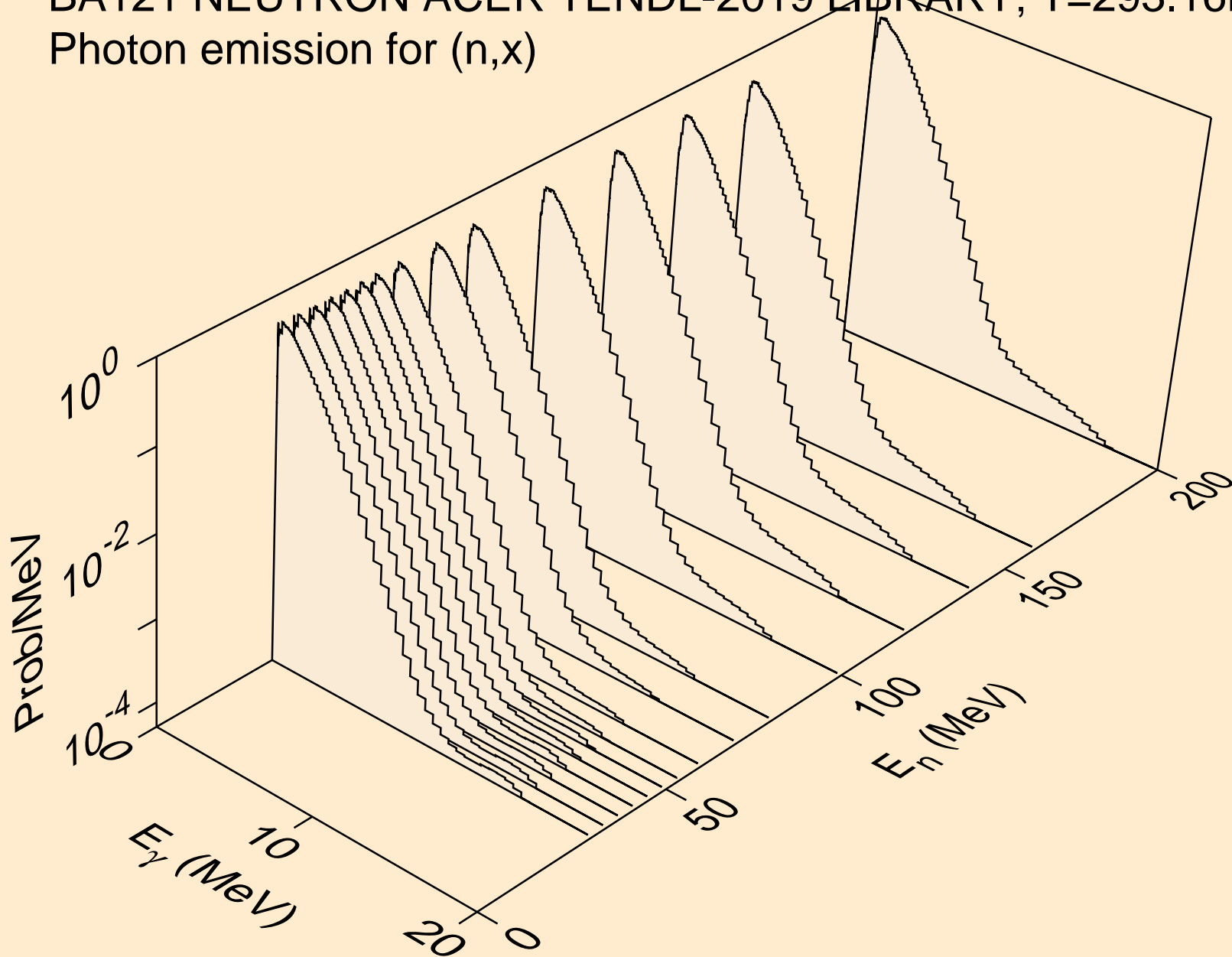

BA121 NEUTRON ACER TENDL-2019 LIBRARY; T=293.16K  
Photon emission for (n,2nd)

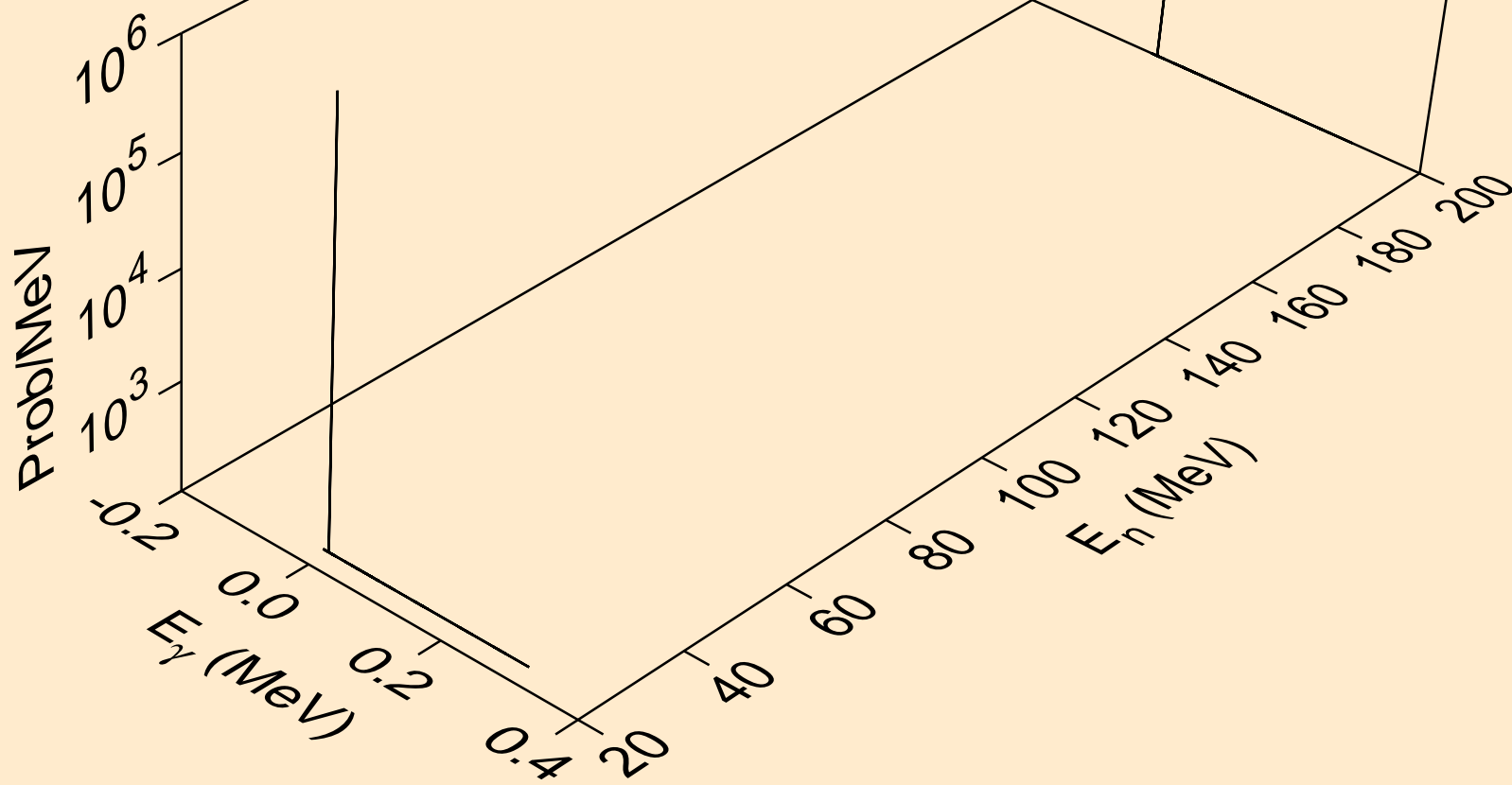

BA121 NEUTRON ACER TENDL-2019 LIBRARY; T=293.16K  
Photon emission for (n,2n)

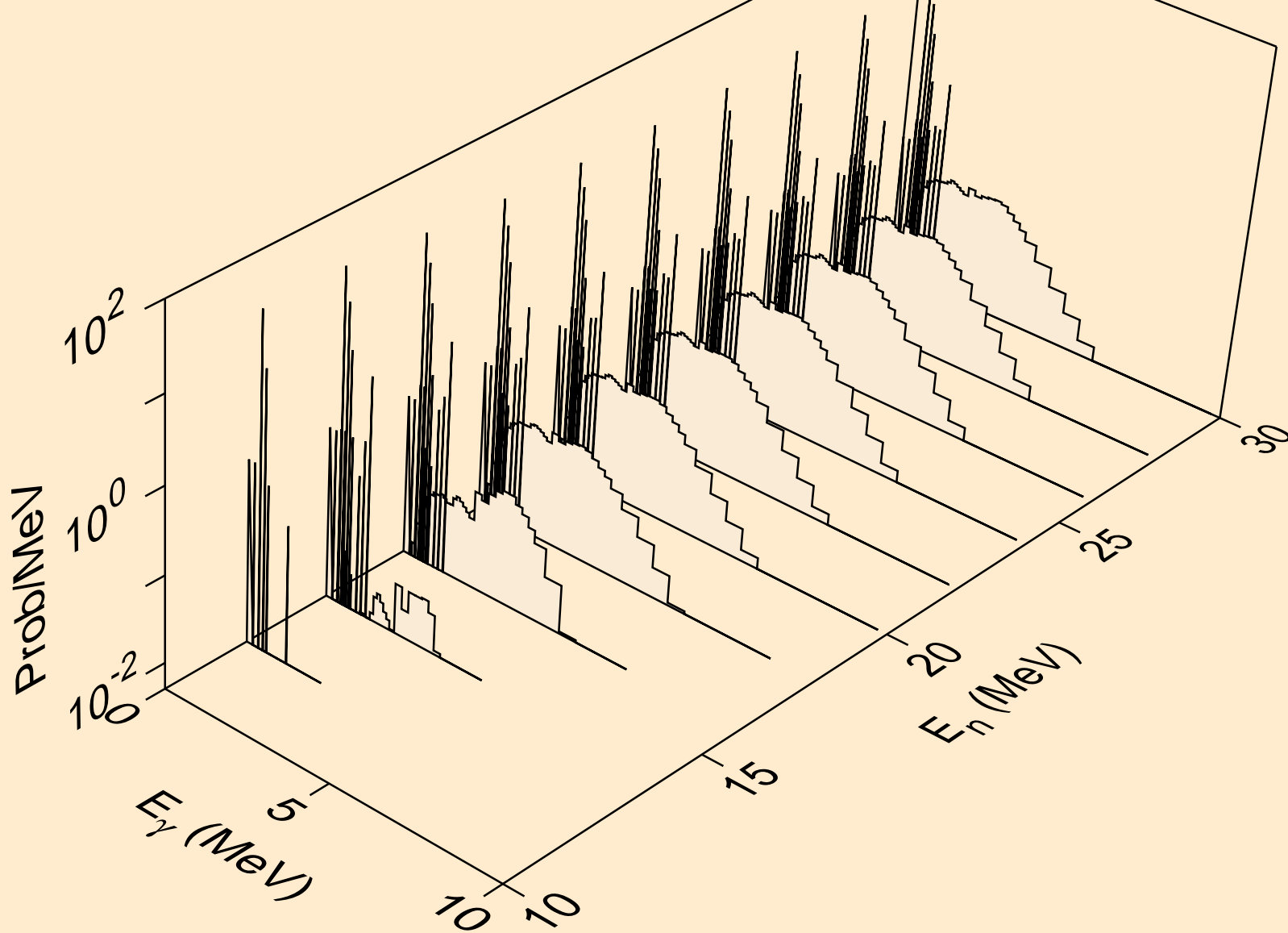

BA121 NEUTRON ACER TENDL-2019 LIBRARY; T=293.16K  
Photon emission for (n,3n)

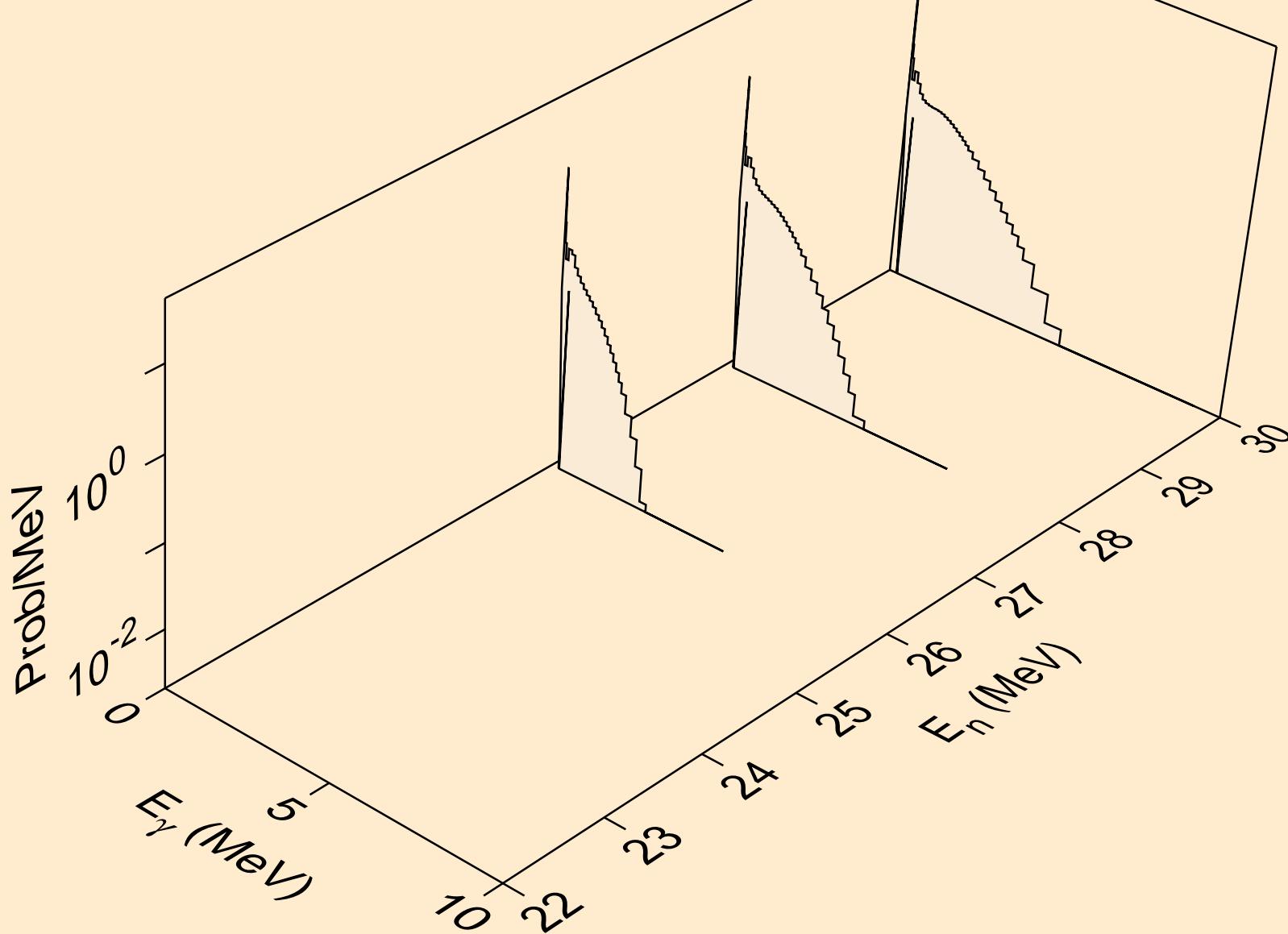

BA121 NEUTRON ACER TENDL-2019 LIBRARY; T=293.16K  
Photon emission for (n,n\*)a

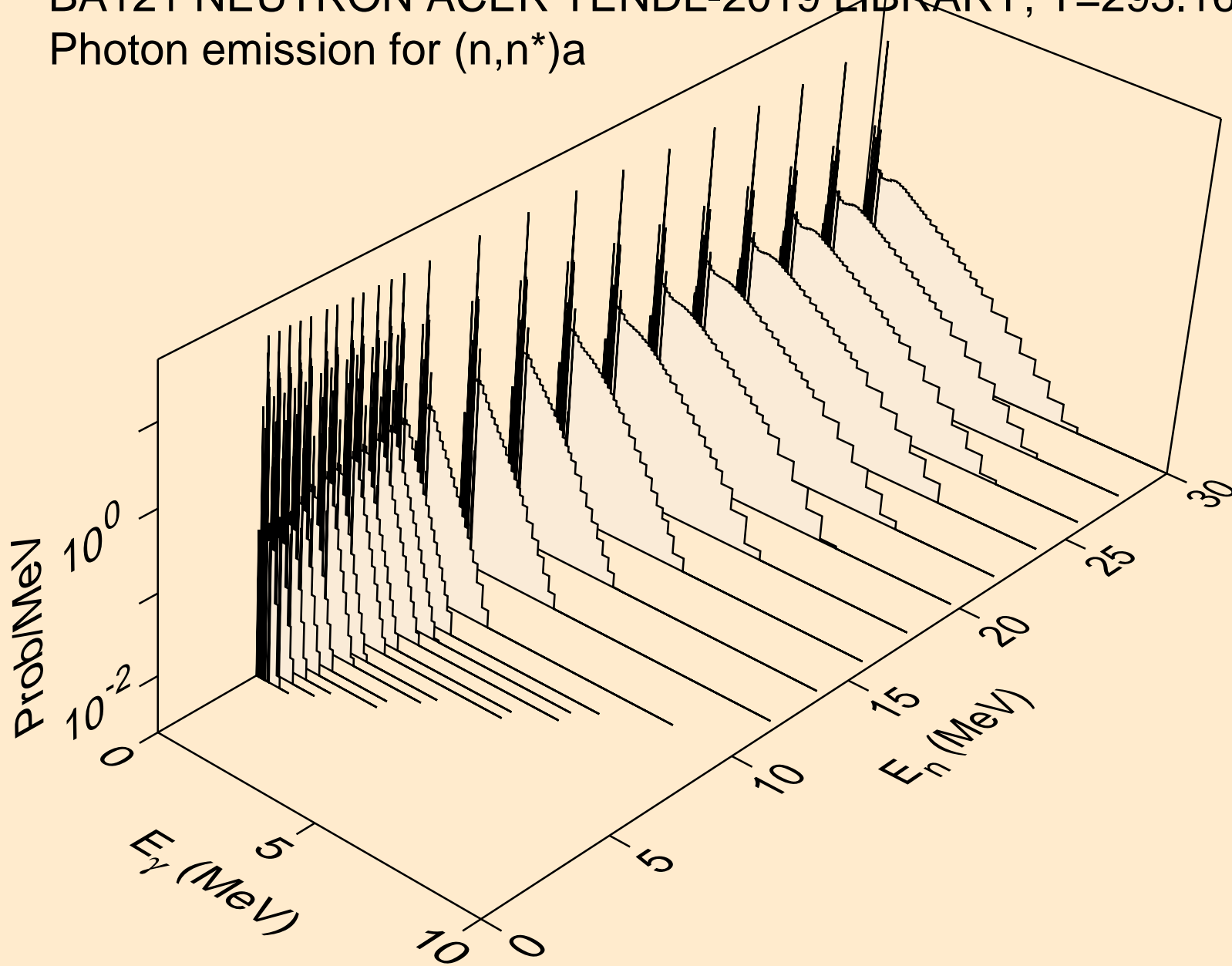

BA121 NEUTRON ACER TENDL-2019 LIBRARY; T=293.16K  
Photon emission for (n,n\*)3a

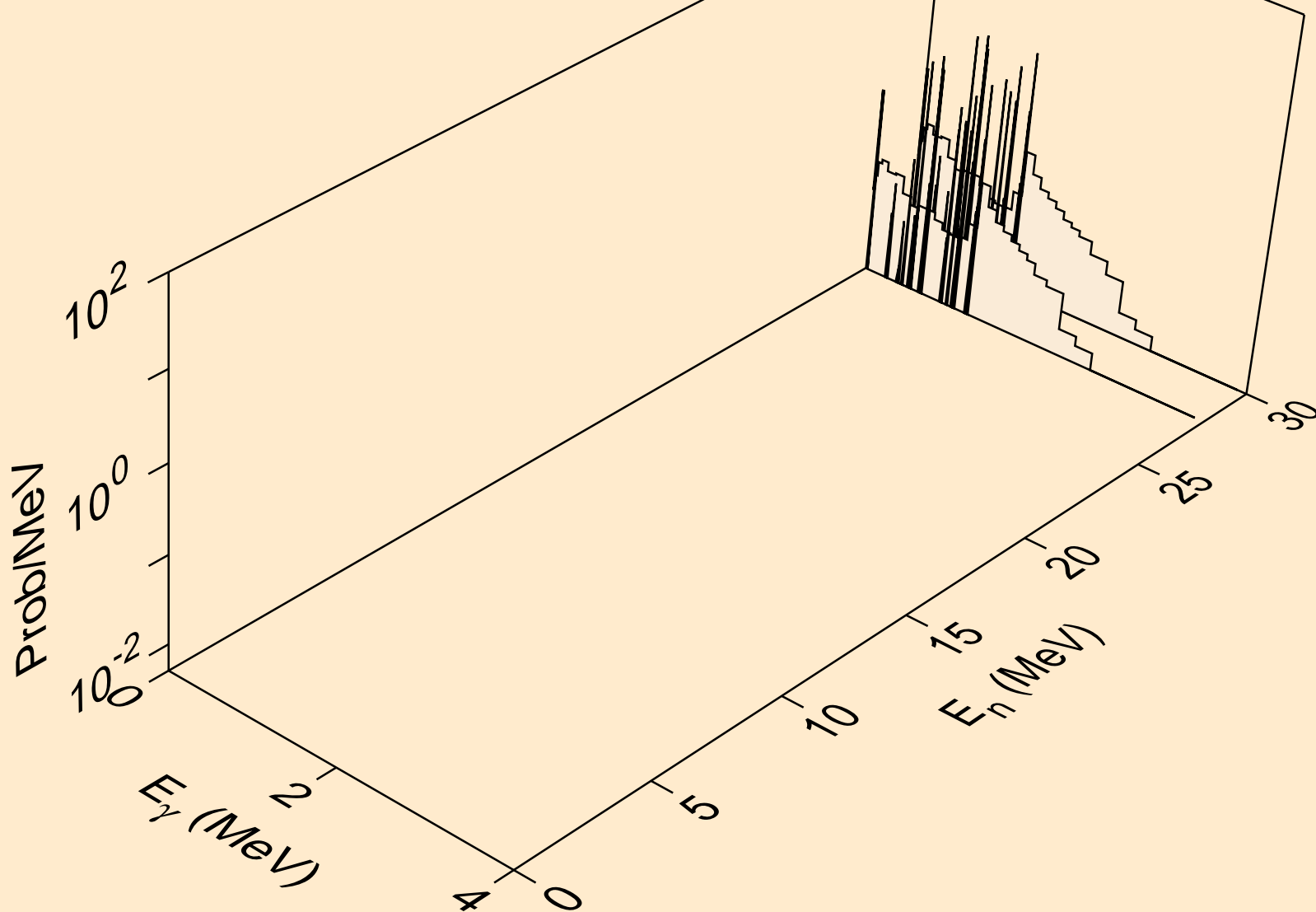

BA121 NEUTRON ACER TENDL-2019 LIBRARY; T=293.16K  
Photon emission for (n,2n)a

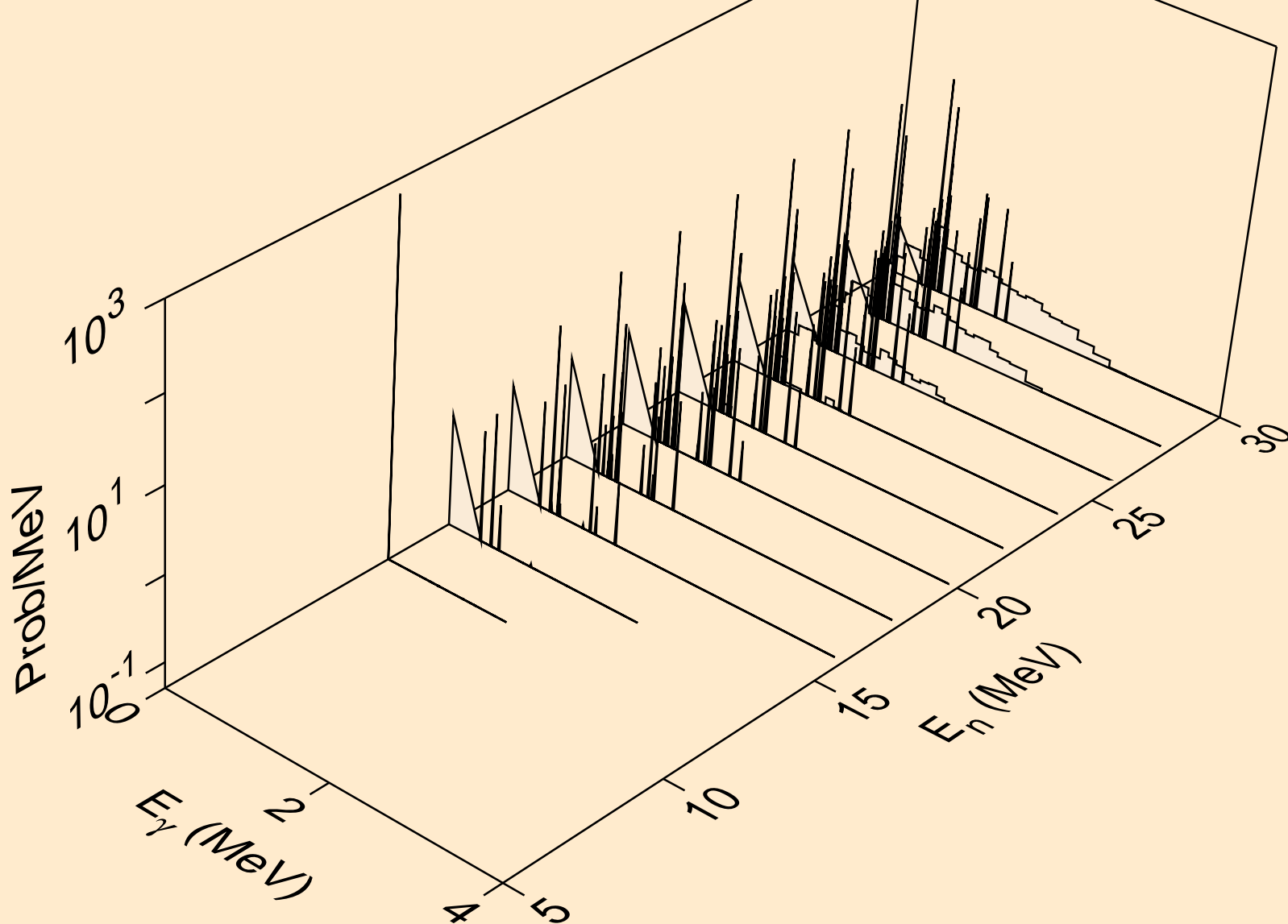

BA121 NEUTRON ACER TENDL-2019 LIBRARY; T=293.16K  
Photon emission for (n,3n)a

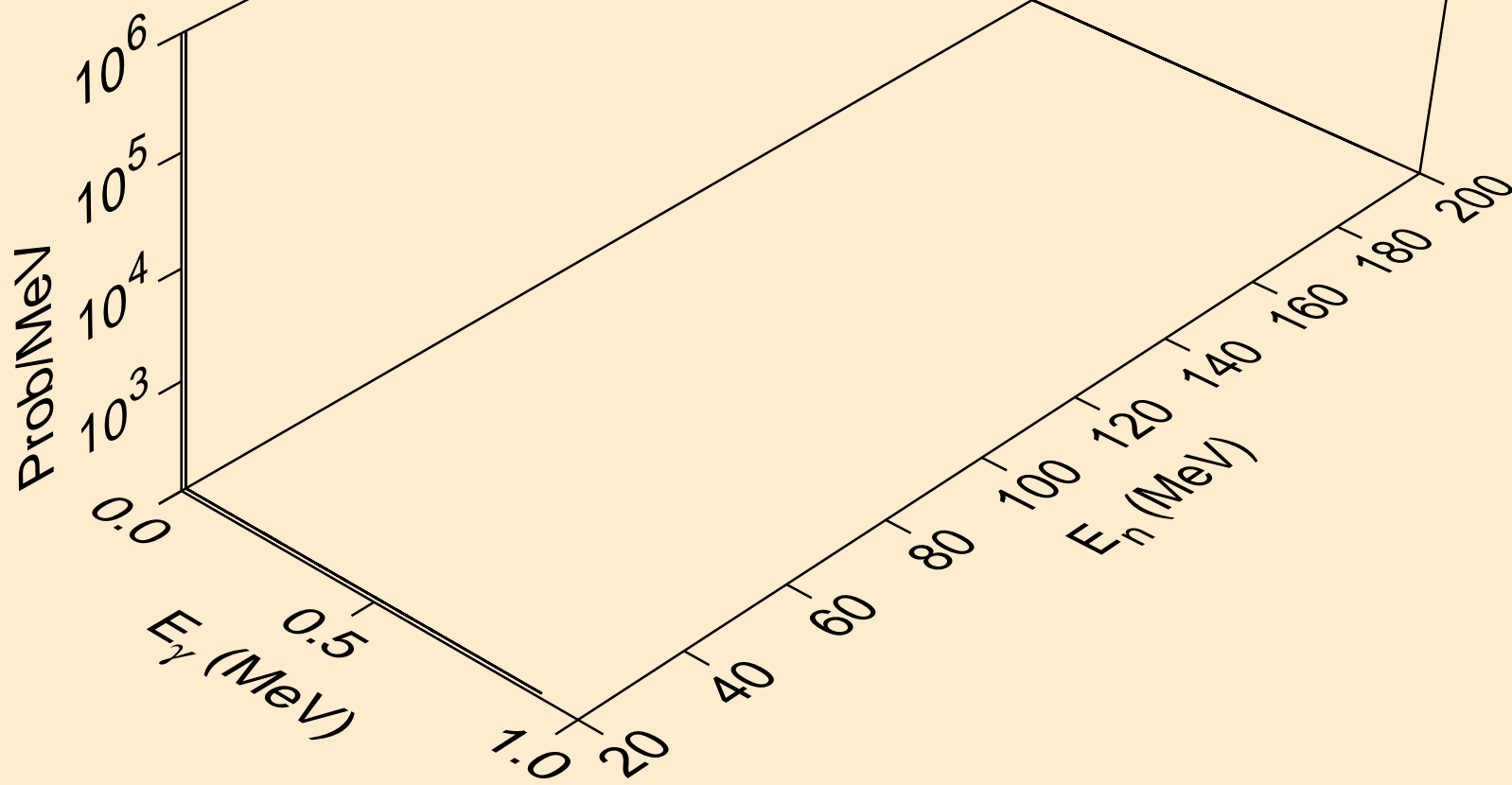



BA121 NEUTRON ACER TENDL-2019 LIBRARY; T=293.16K  
Photon emission for (n,n\*)p

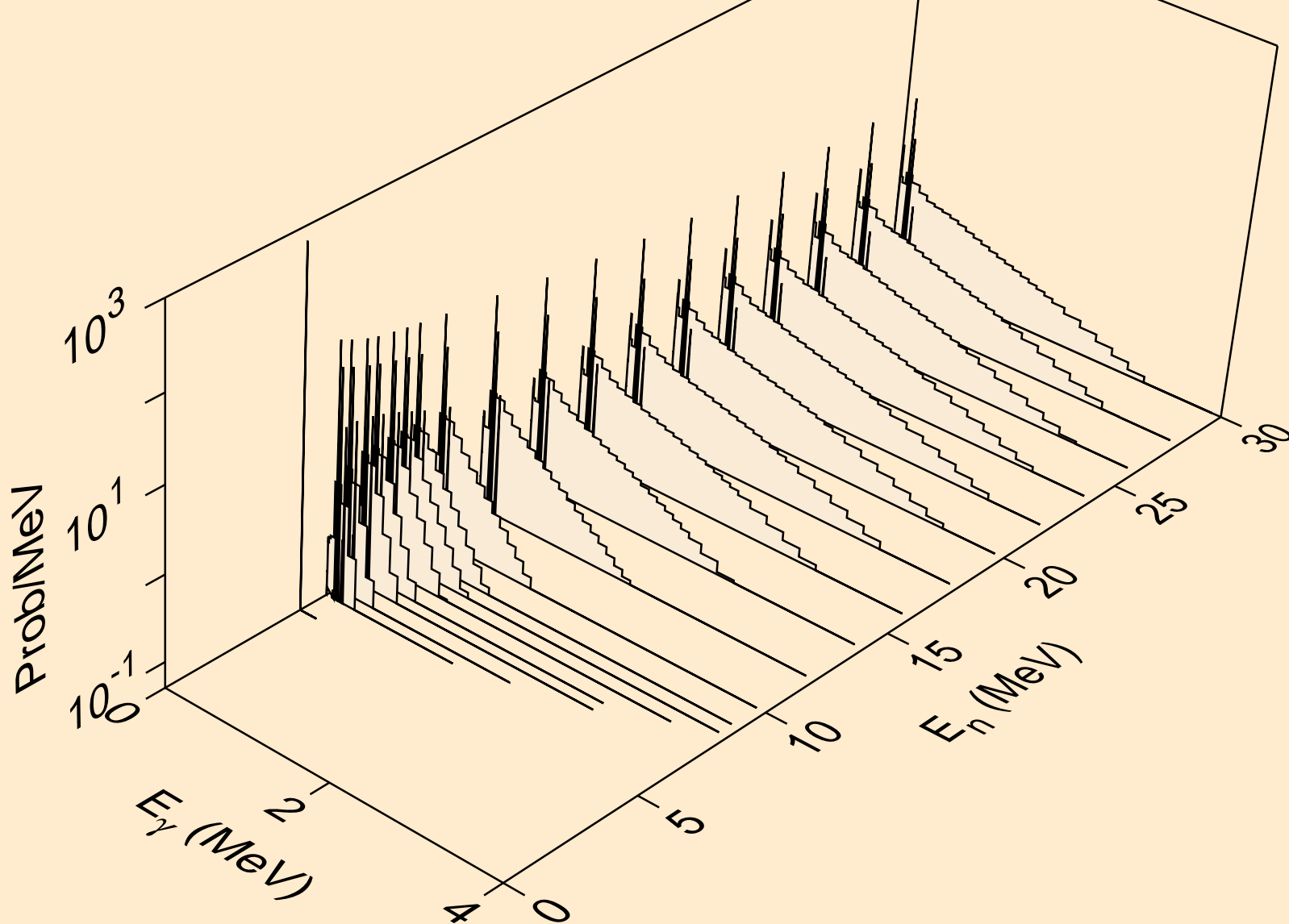

BA121 NEUTRON ACER TENDL-2019 LIBRARY; T=293.16K  
Photon emission for (n,n\*)2a

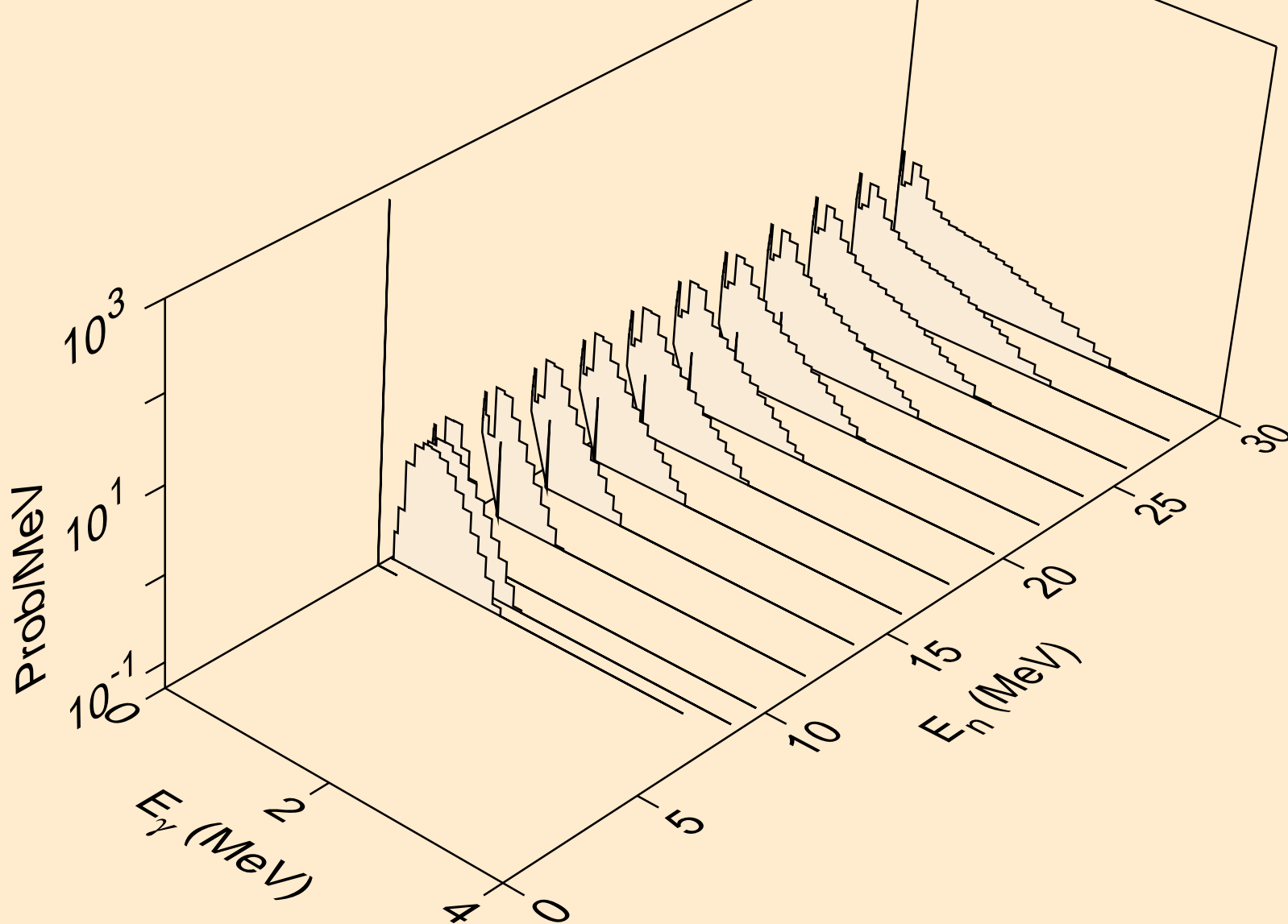

BA121 NEUTRON ACER TENDL-2019 LIBRARY; T=293.16K  
Photon emission for (n,2n)2a

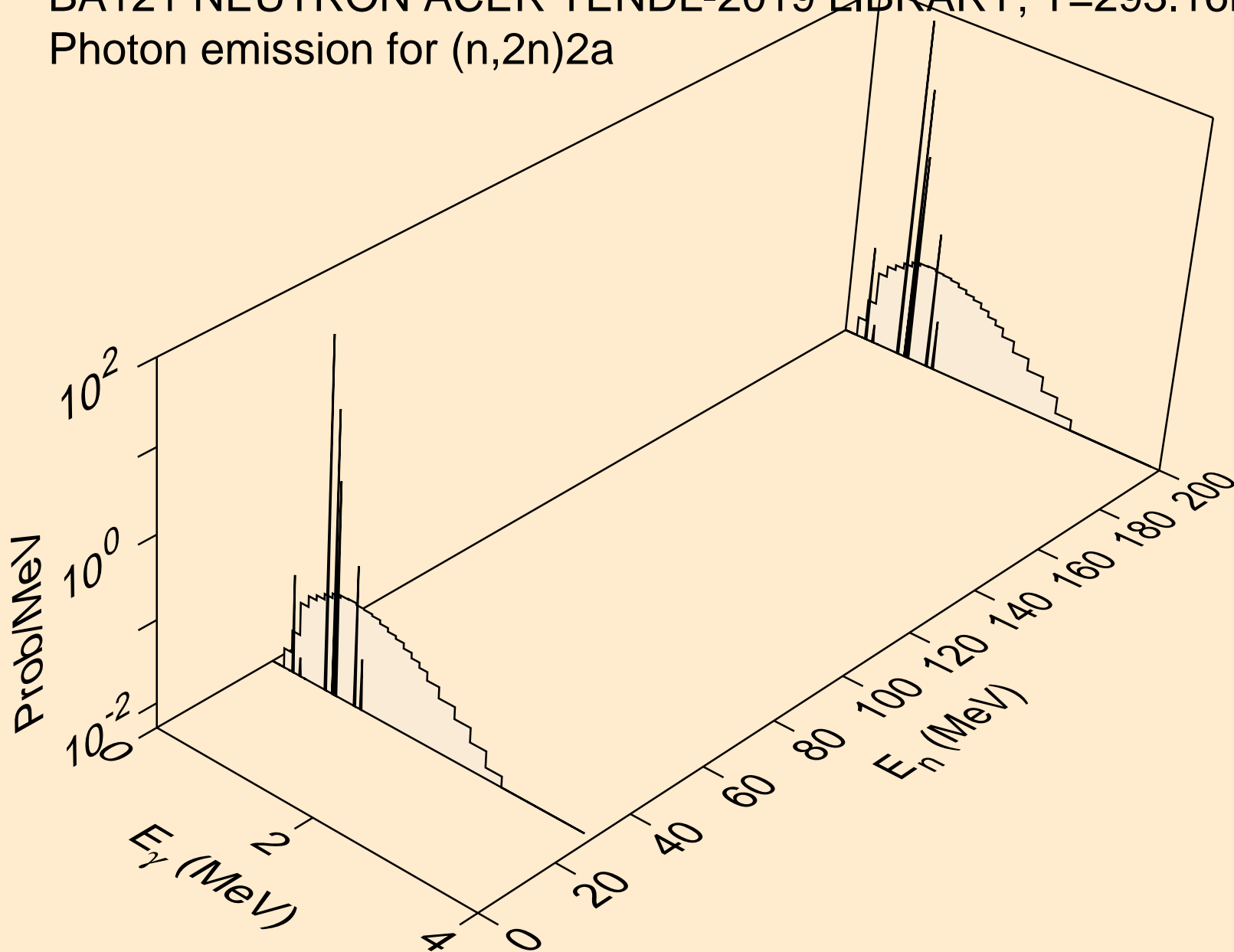

BA121 NEUTRON ACER TENDL-2019 LIBRARY; T=293.16K  
Photon emission for (n,n\*)d

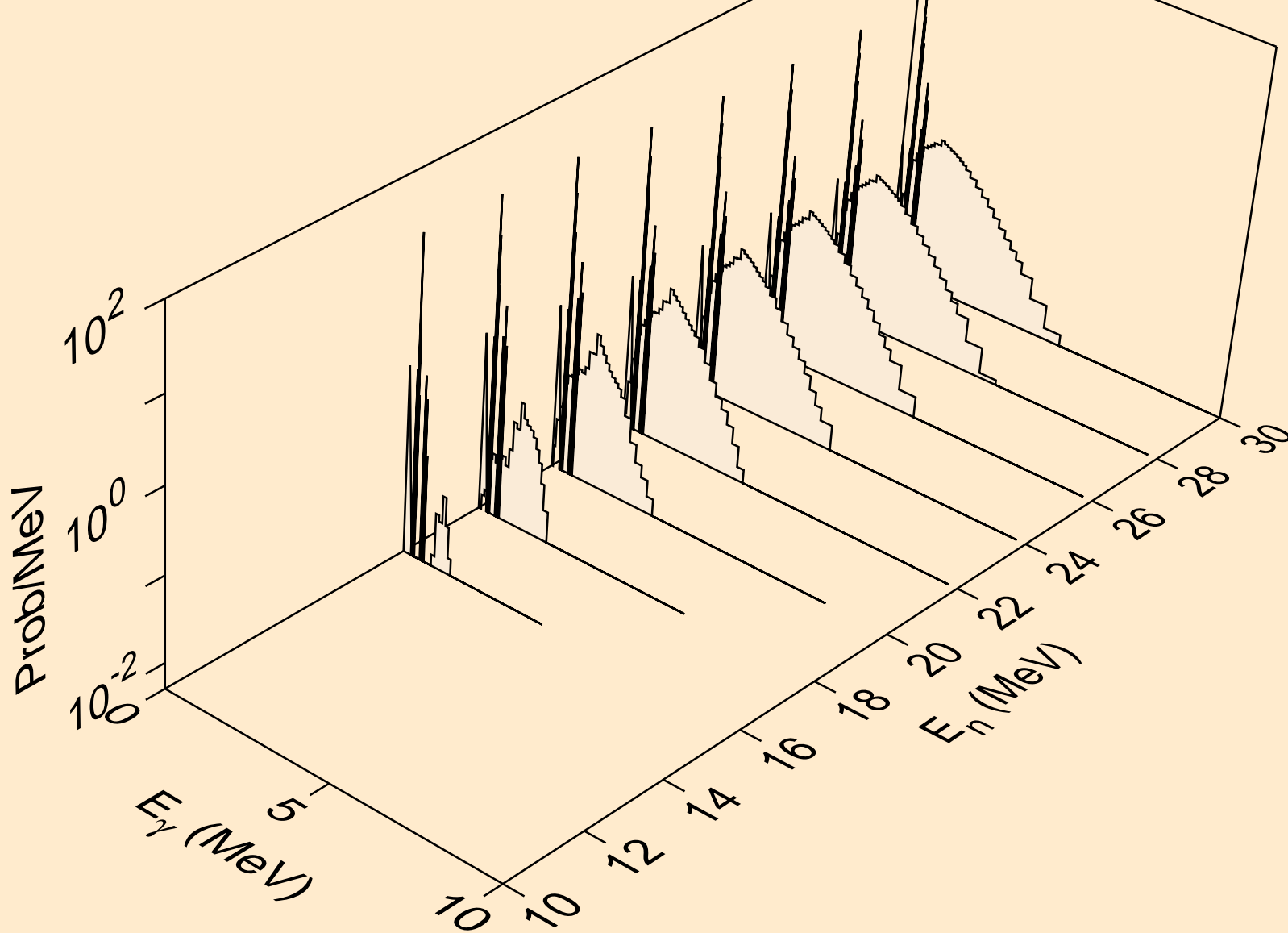

BA121 NEUTRON ACER TENDL-2019 LIBRARY; T=293.16K  
Photon emission for (n,n\*)t

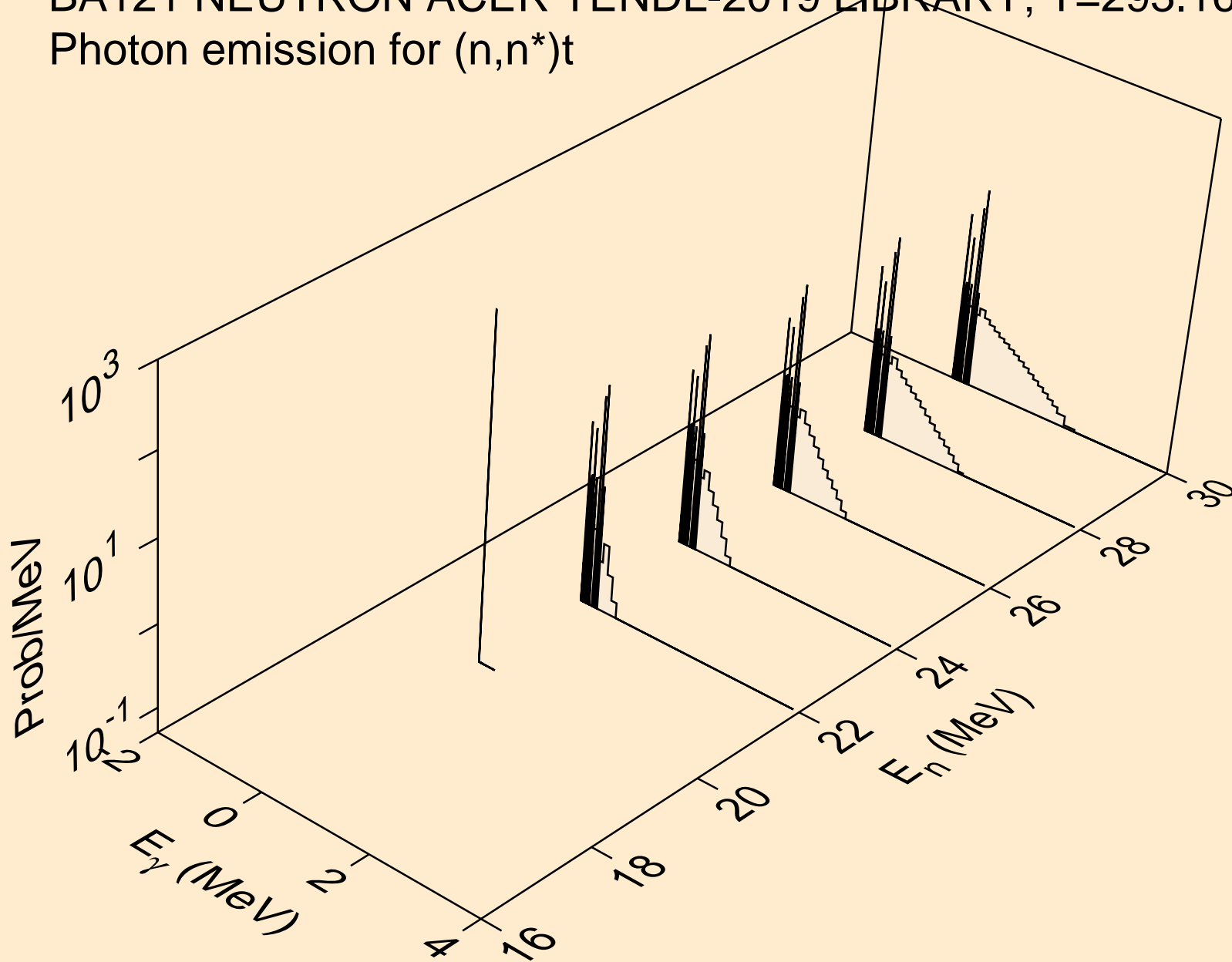

BA121 NEUTRON ACER TENDL-2019 LIBRARY; T=293.16K  
Photon emission for (n,n\*)he3

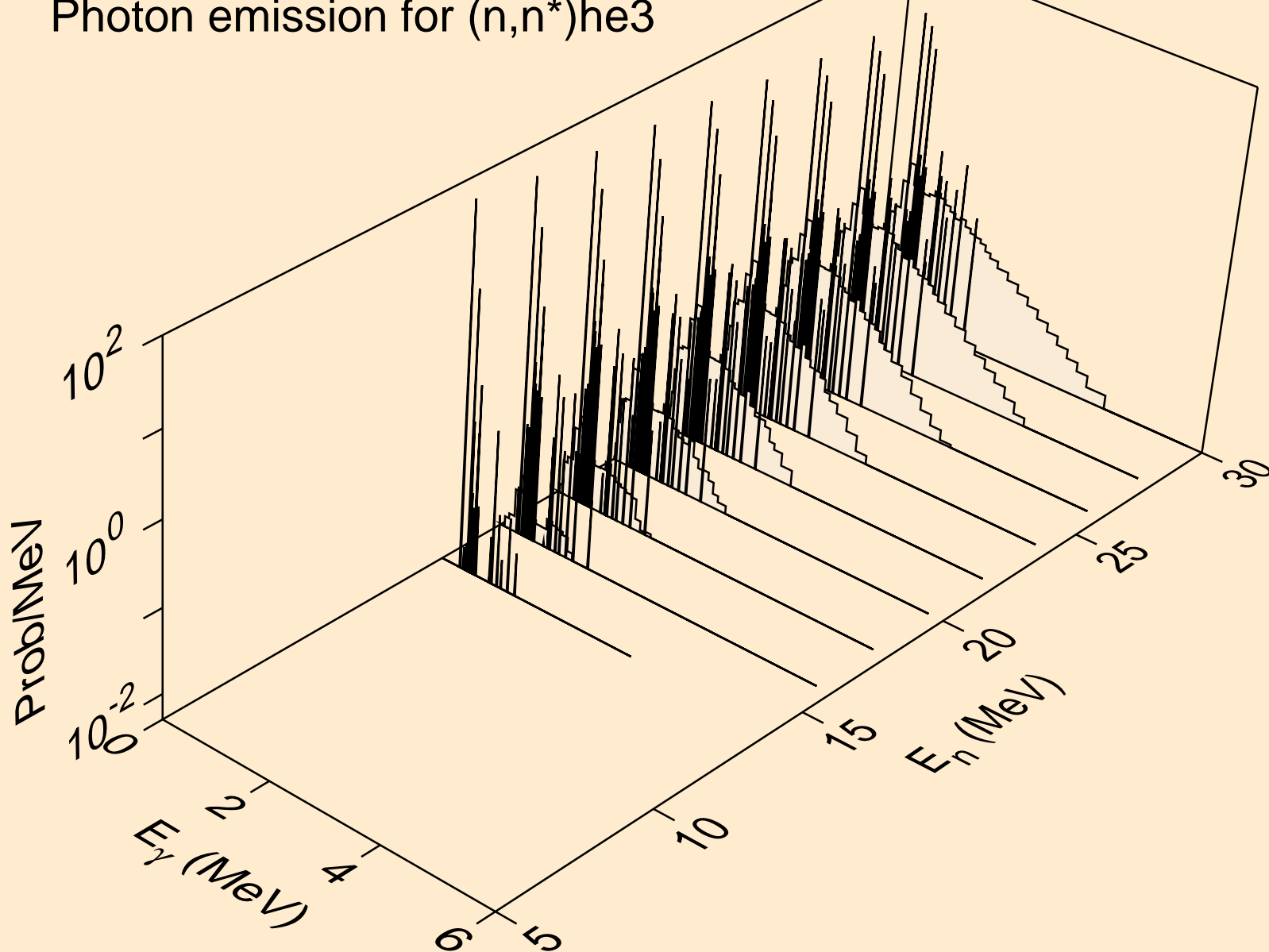

BA121 NEUTRON ACER TENDL-2019 LIBRARY; T=293.16K  
Photon emission for (n,2np)

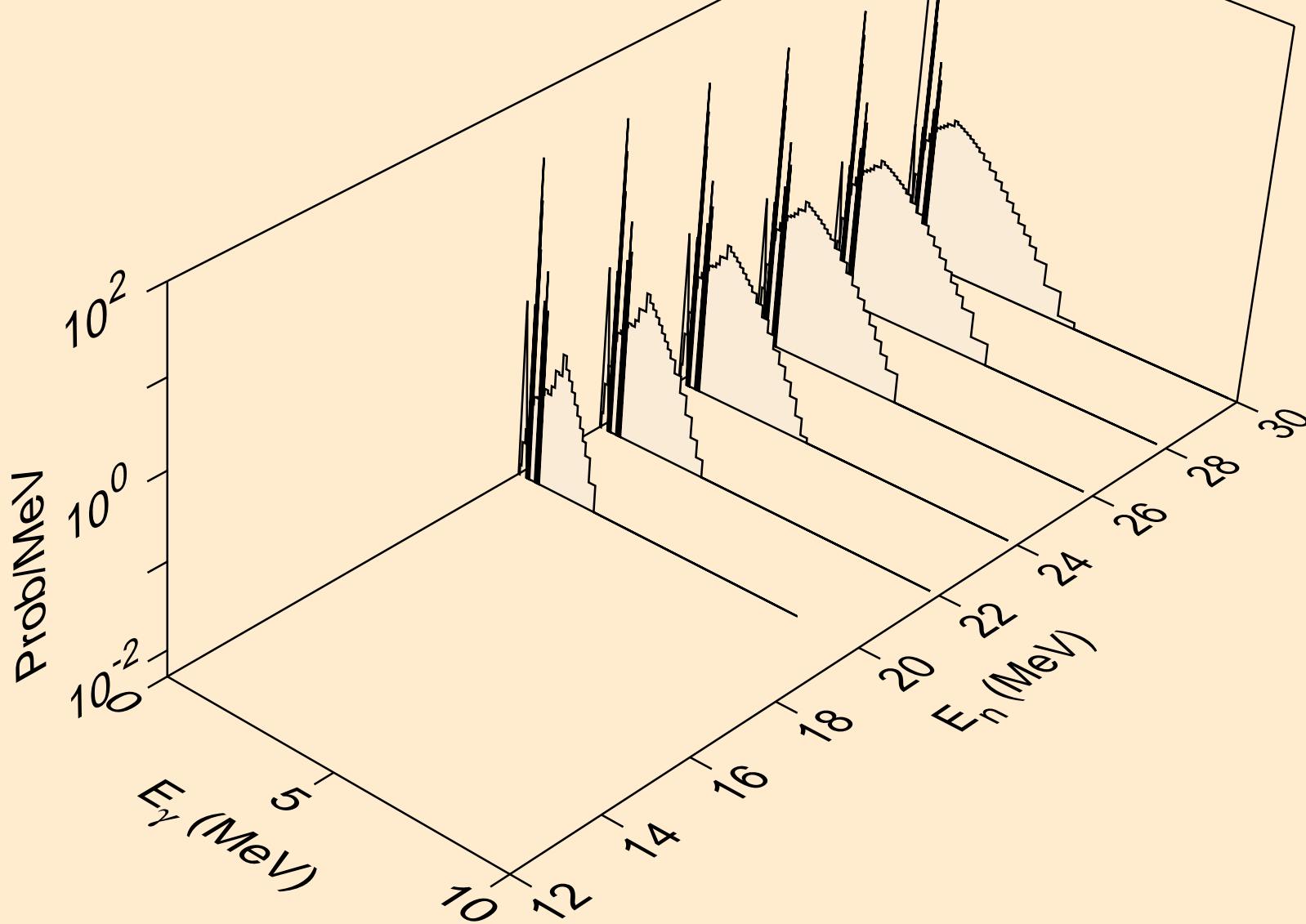

BA121 NEUTRON ACER TENDL-2019 LIBRARY; T=293.16K  
Photon emission for (n,3np)

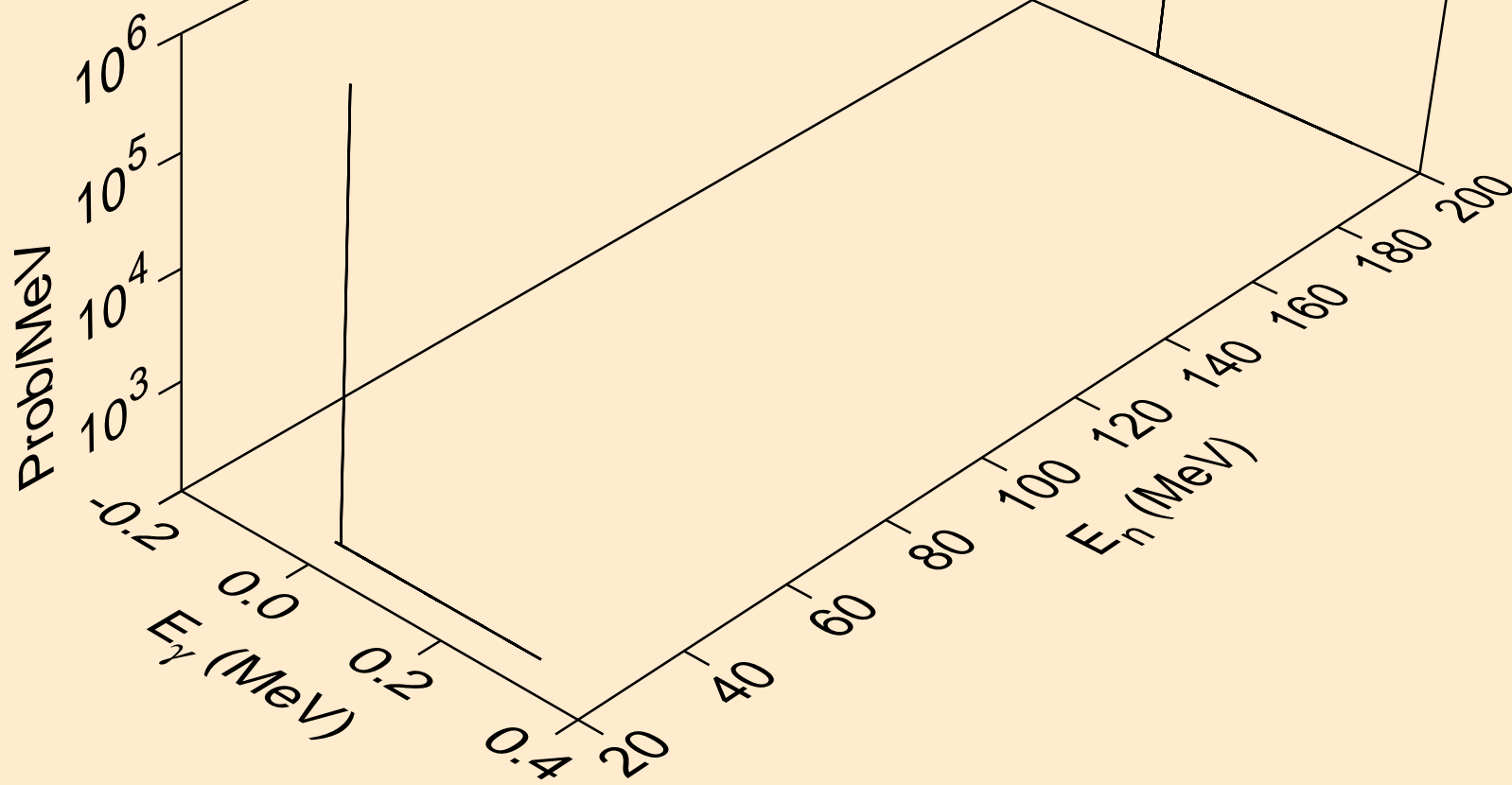



BA121 NEUTRON ACER TENDL-2019 LIBRARY; T=293.16K  
Photon emission for (n,2np)

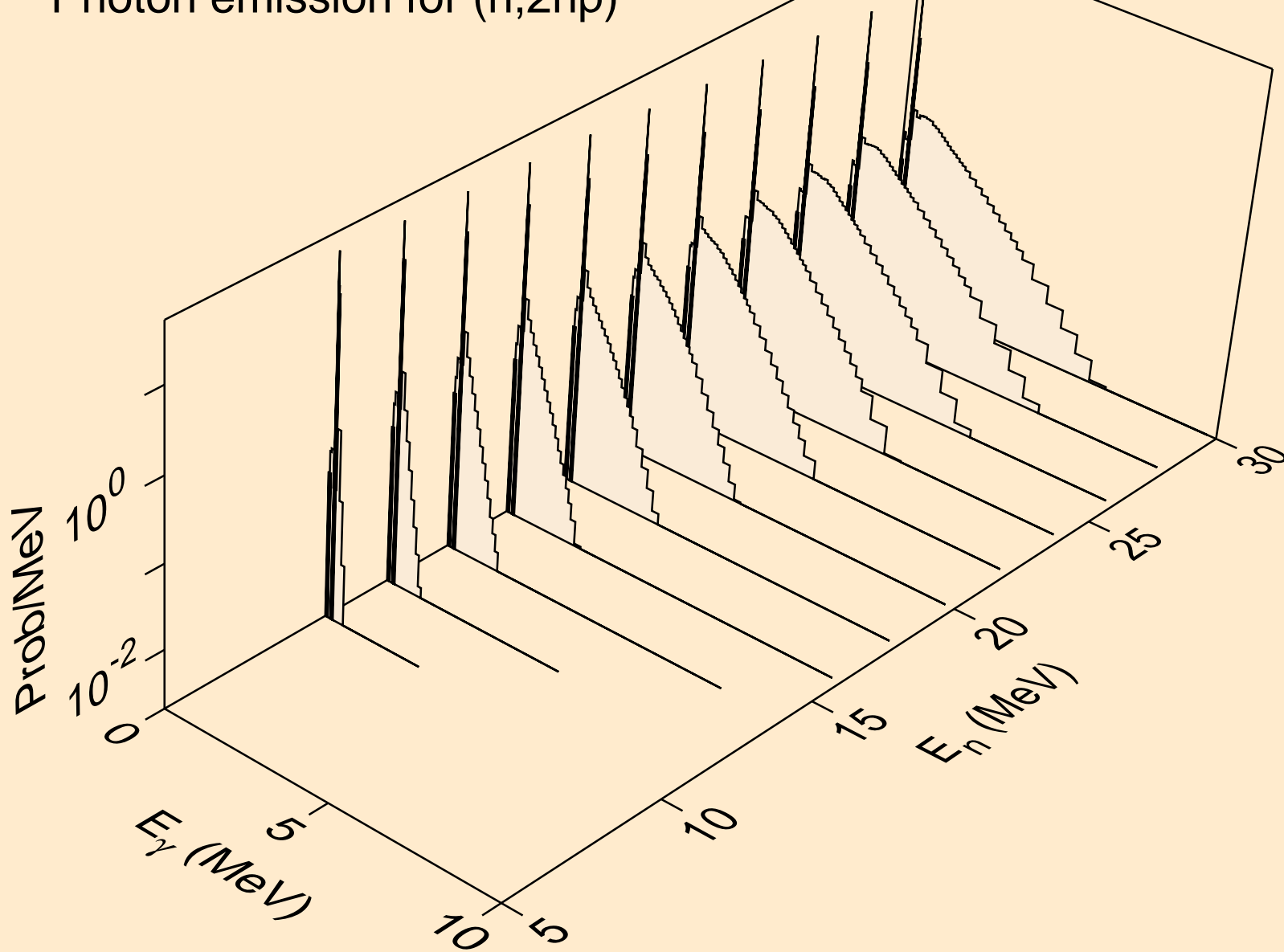

BA121 NEUTRON ACER TENDL-2019 LIBRARY; T=293.16K  
Photon emission for (n,npa)

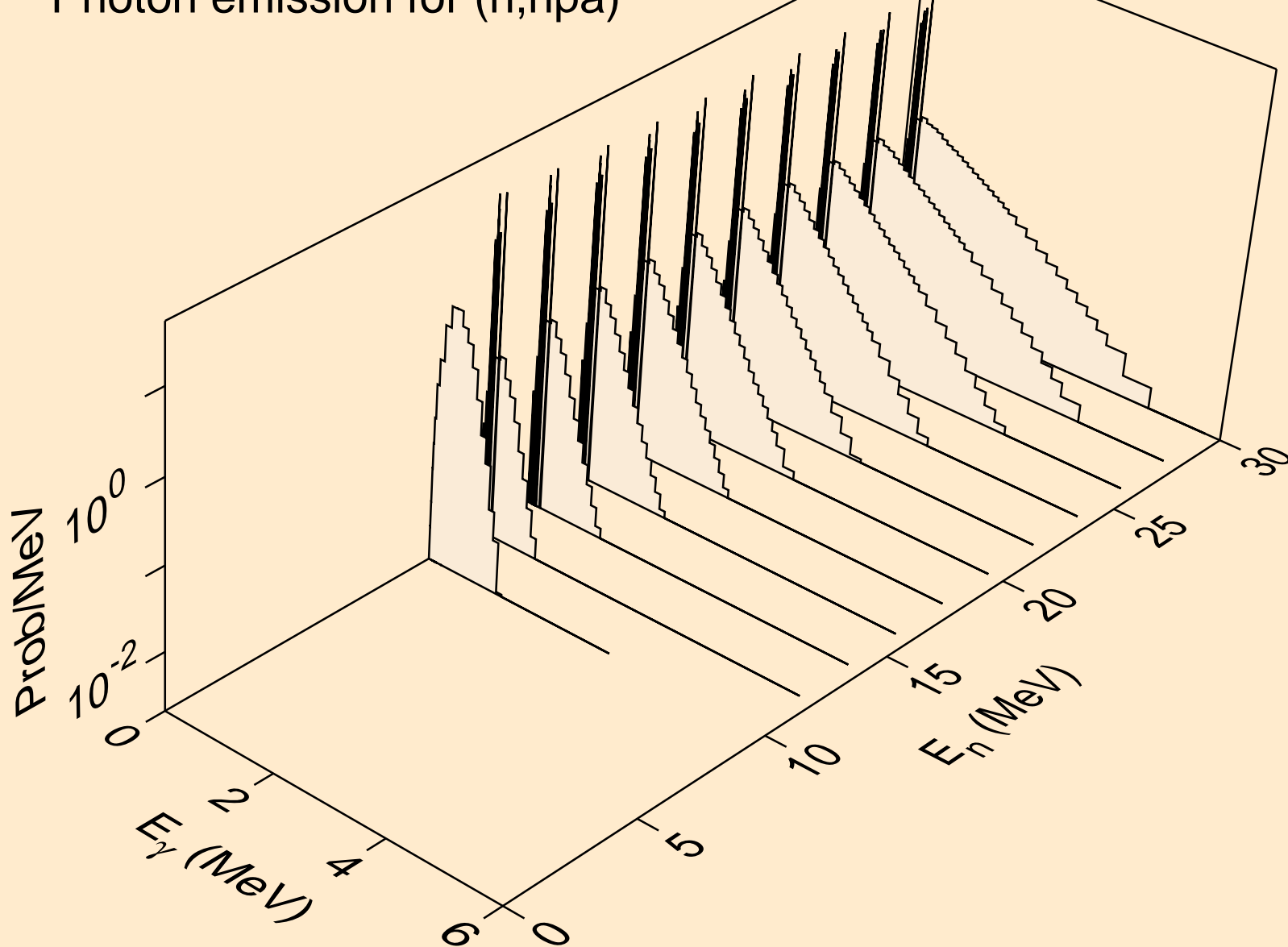

BA121 NEUTRON ACER TENDL-2019 LIBRARY; T=293.16K  
Photon emission for (n,n\*c)

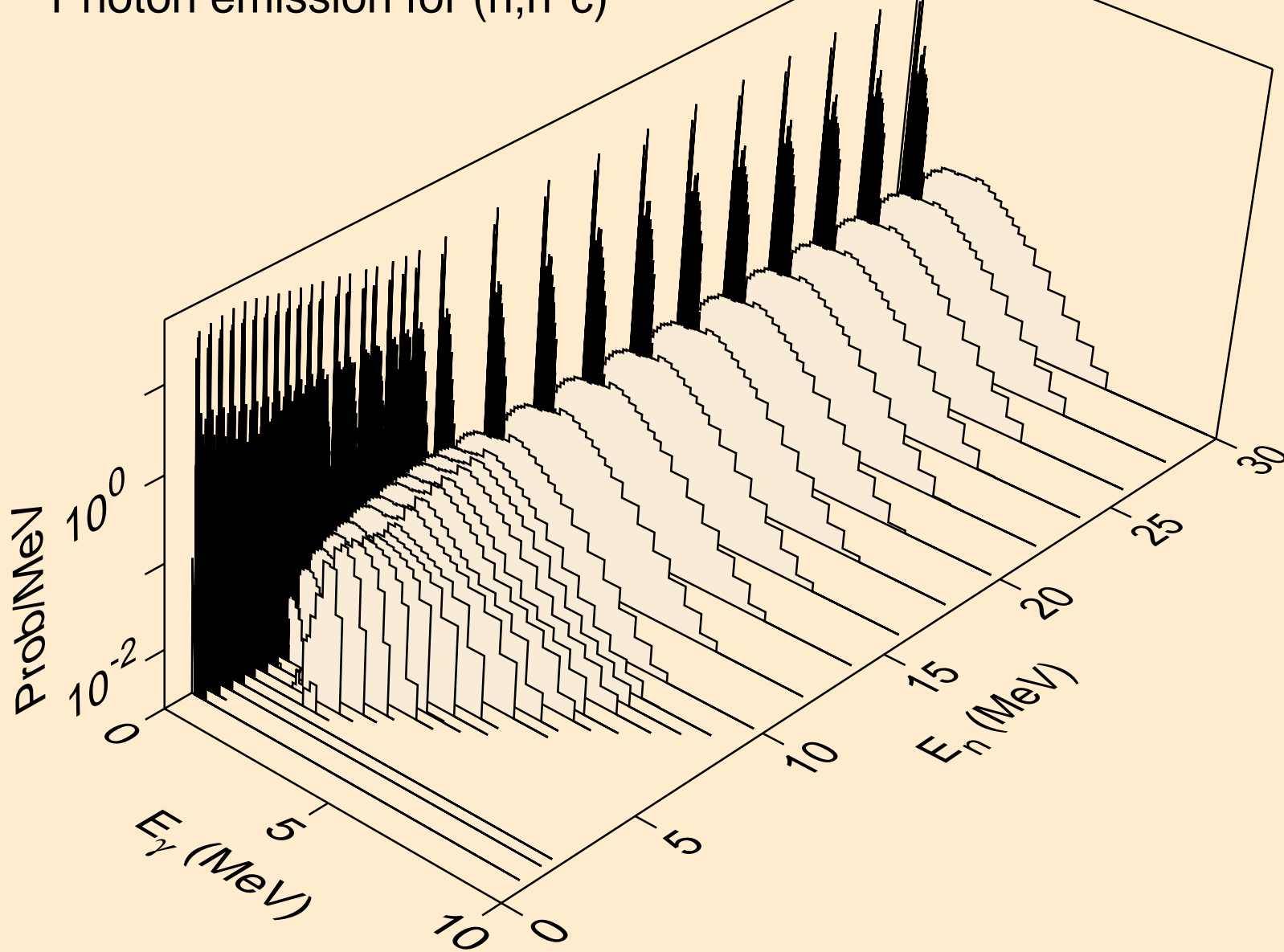

BA121 NEUTRON ACER TENDL-2019 LIBRARY; T=293.16K  
Photon emission for (n,gma)

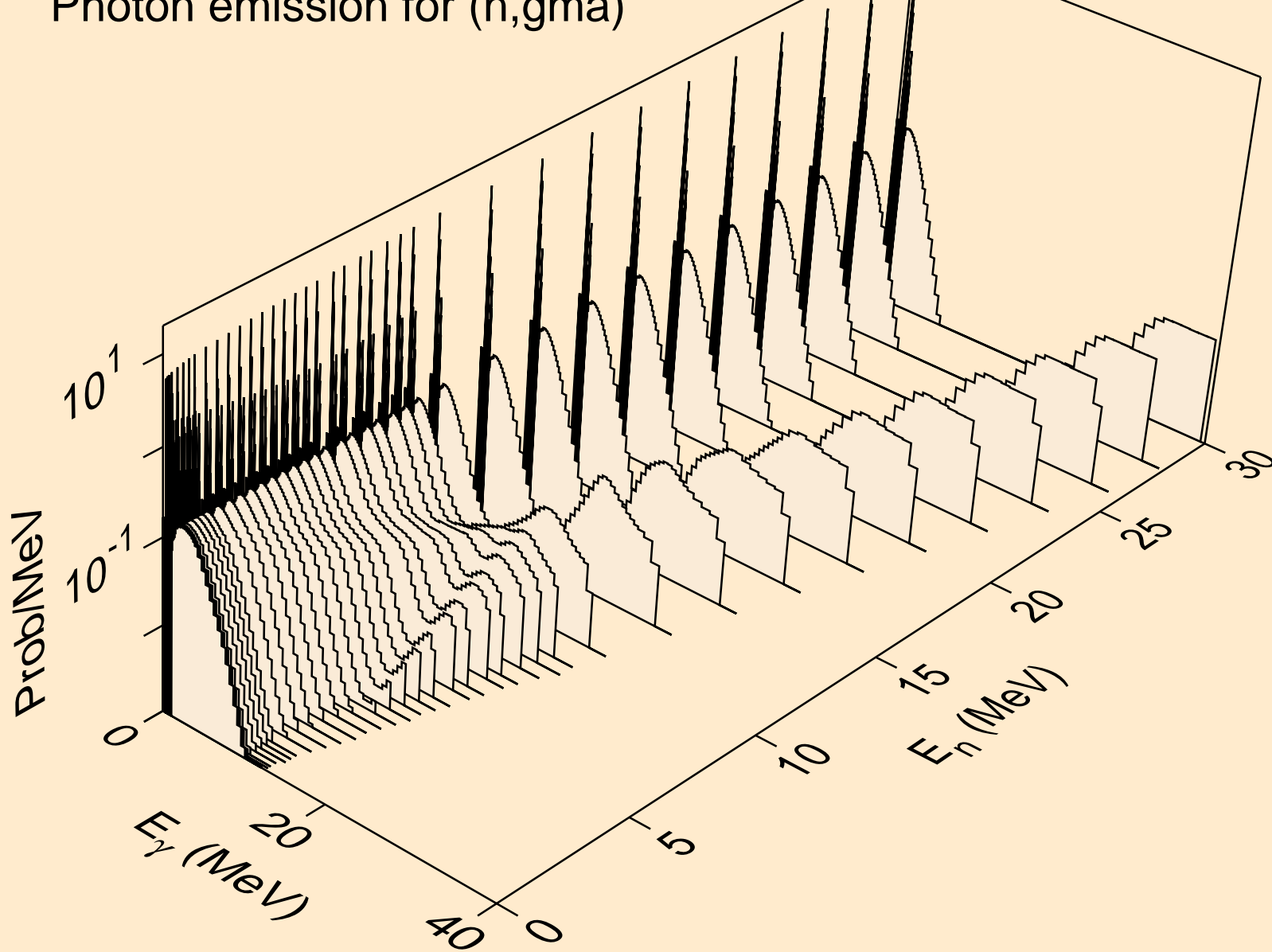

BA121 NEUTRON ACER TENDL-2019 LIBRARY; T=293.16K  
Photon emission for (n,p)

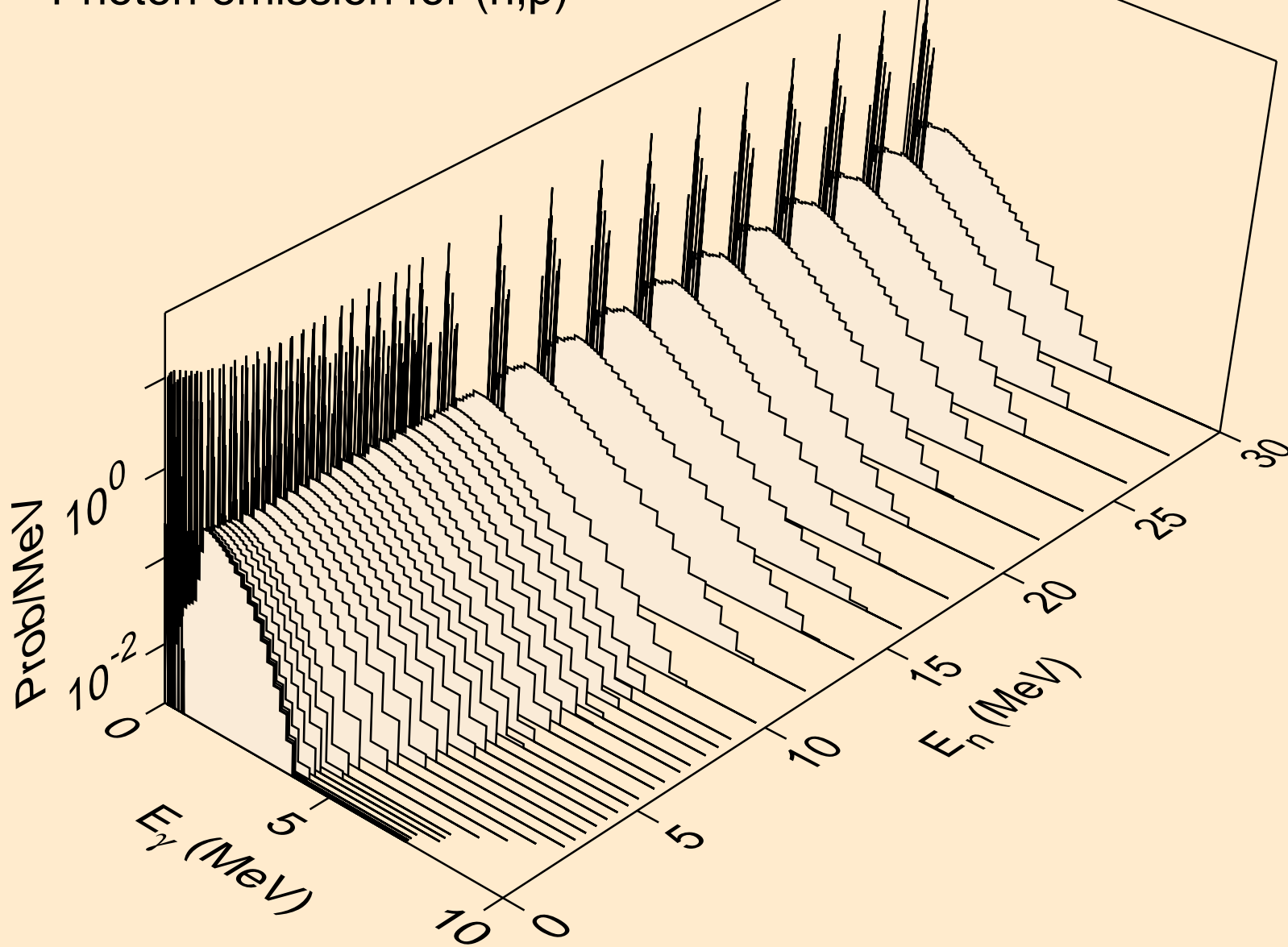

BA121 NEUTRON ACER TENDL-2019 LIBRARY; T=293.16K  
Photon emission for (n,d)

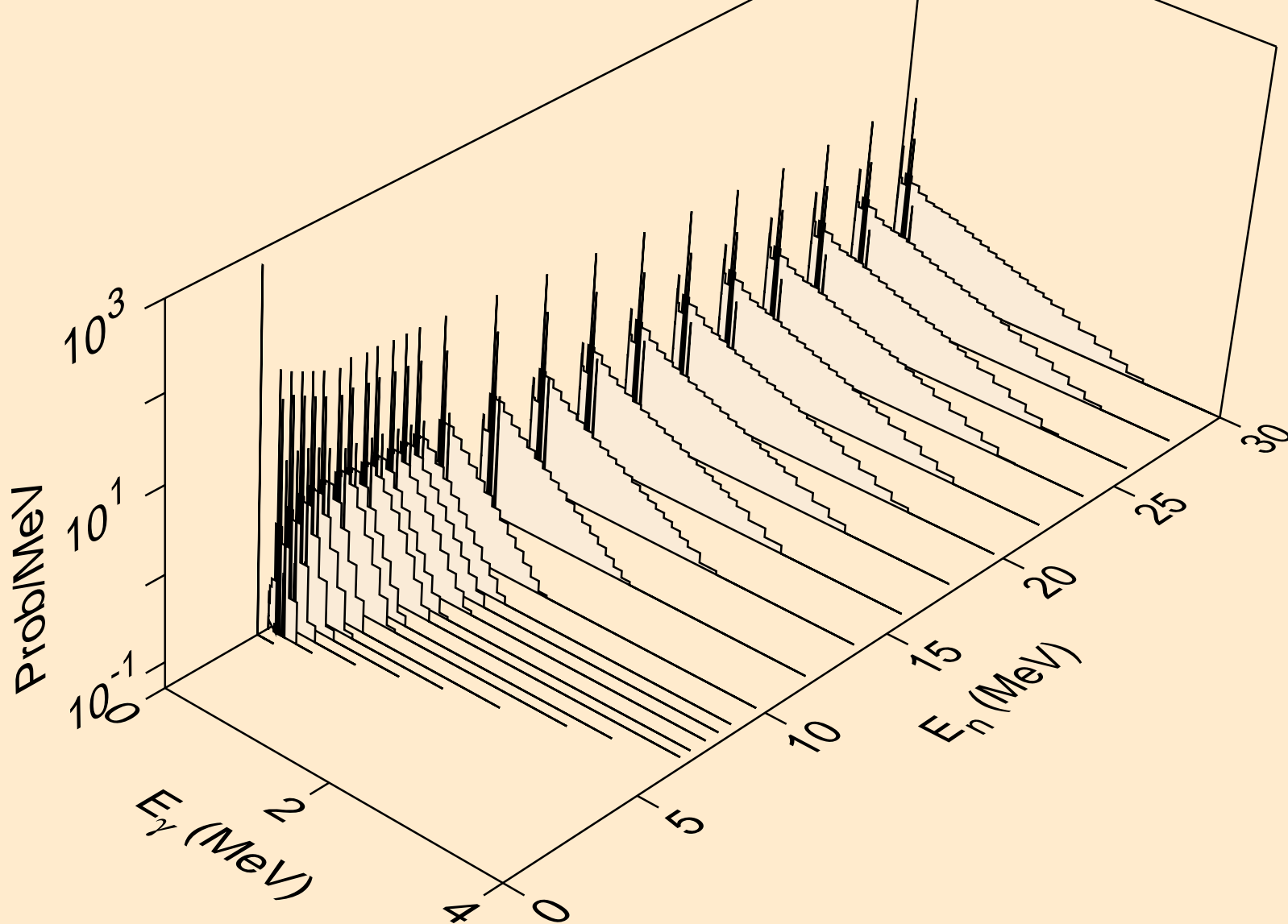

BA121 NEUTRON ACER TENDL-2019 LIBRARY; T=293.16K  
Photon emission for (n,t)

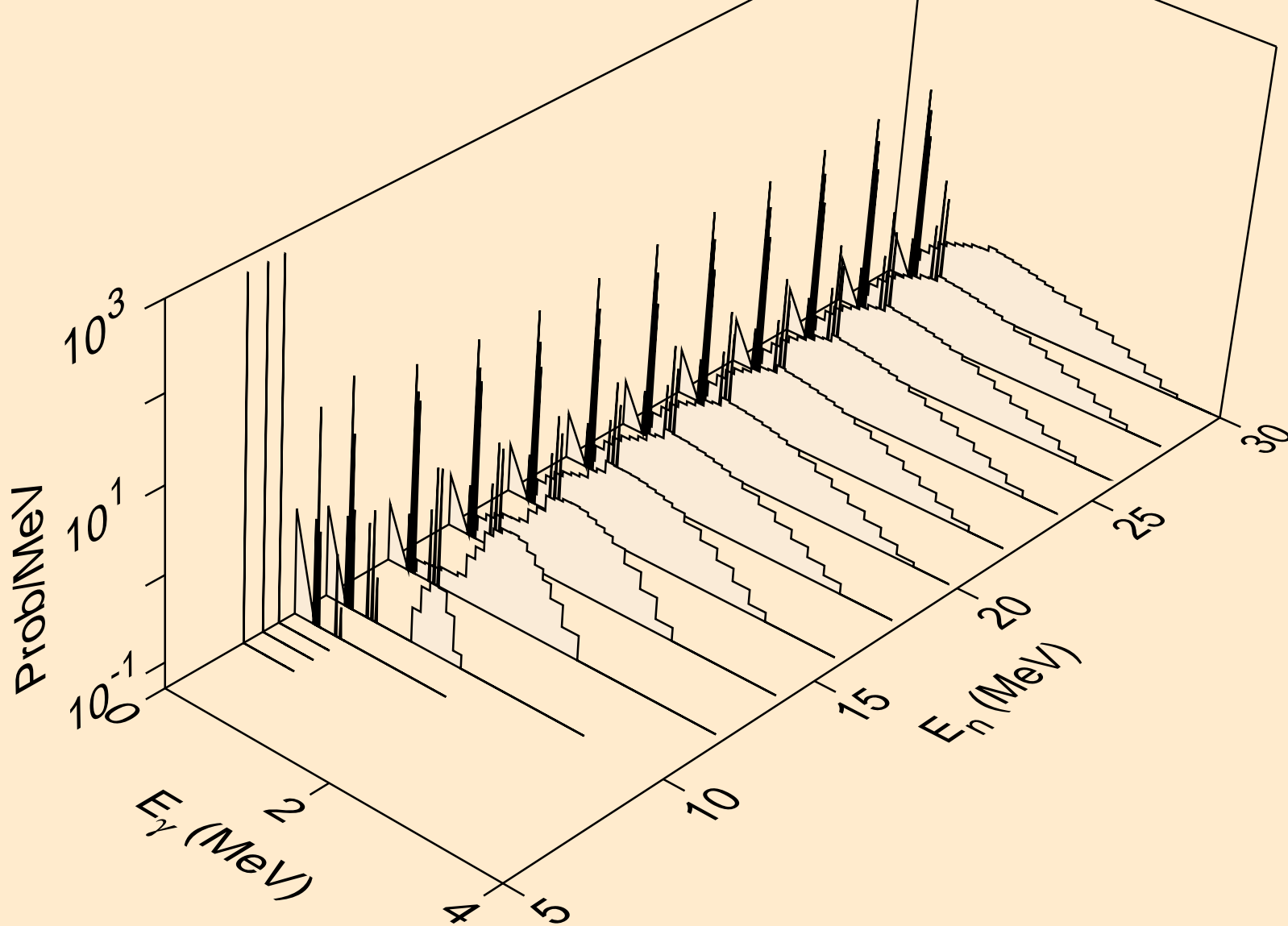

BA121 NEUTRON ACER TENDL-2019 LIBRARY; T=293.16K  
Photon emission for (n,he3)

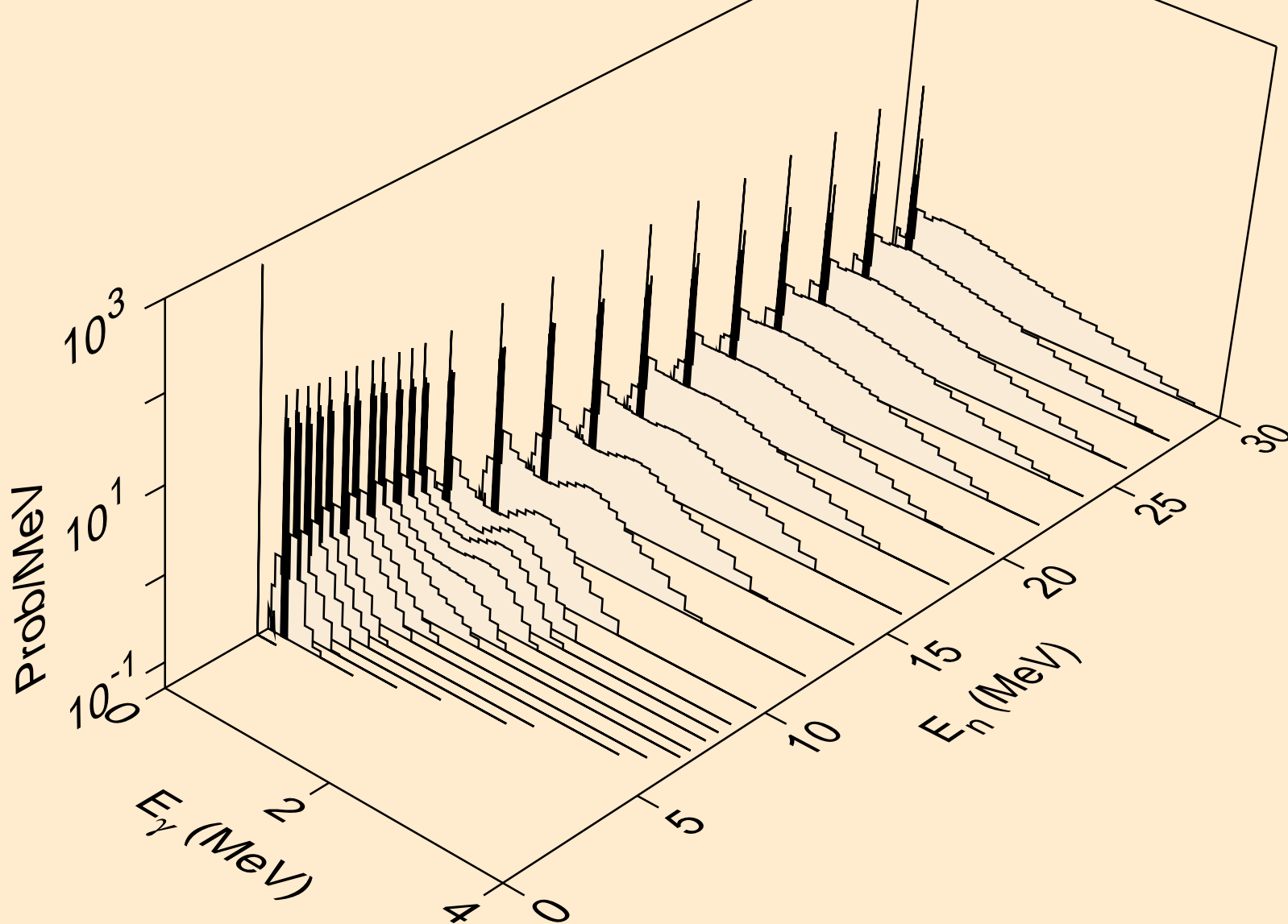



BA121 NEUTRON ACER TENDL-2019 LIBRARY; T=293.16K  
Photon emission for (n,a)

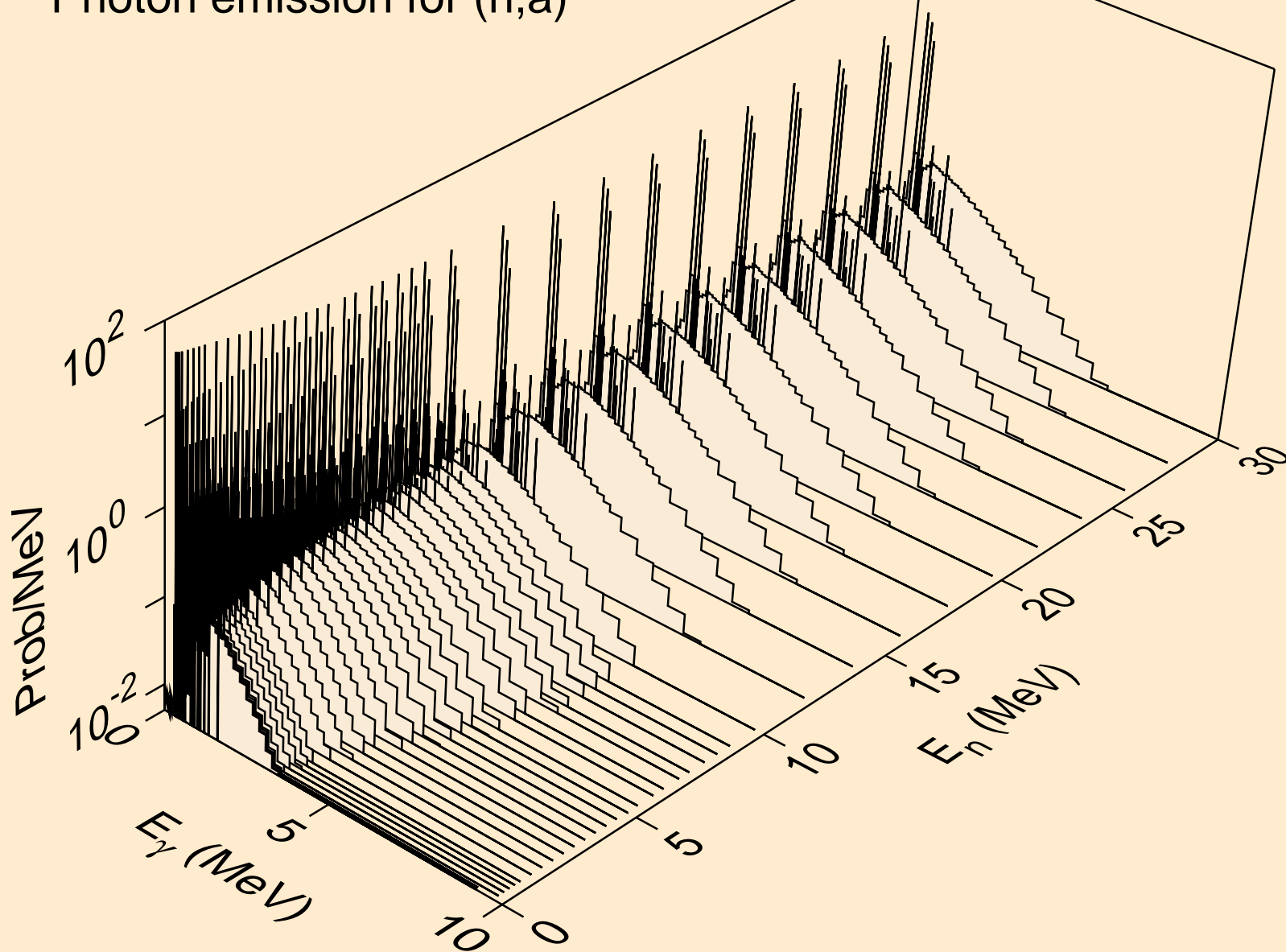

BA121 NEUTRON ACER TENDL-2019 LIBRARY; T=293.16K  
Photon emission for (n,2a)

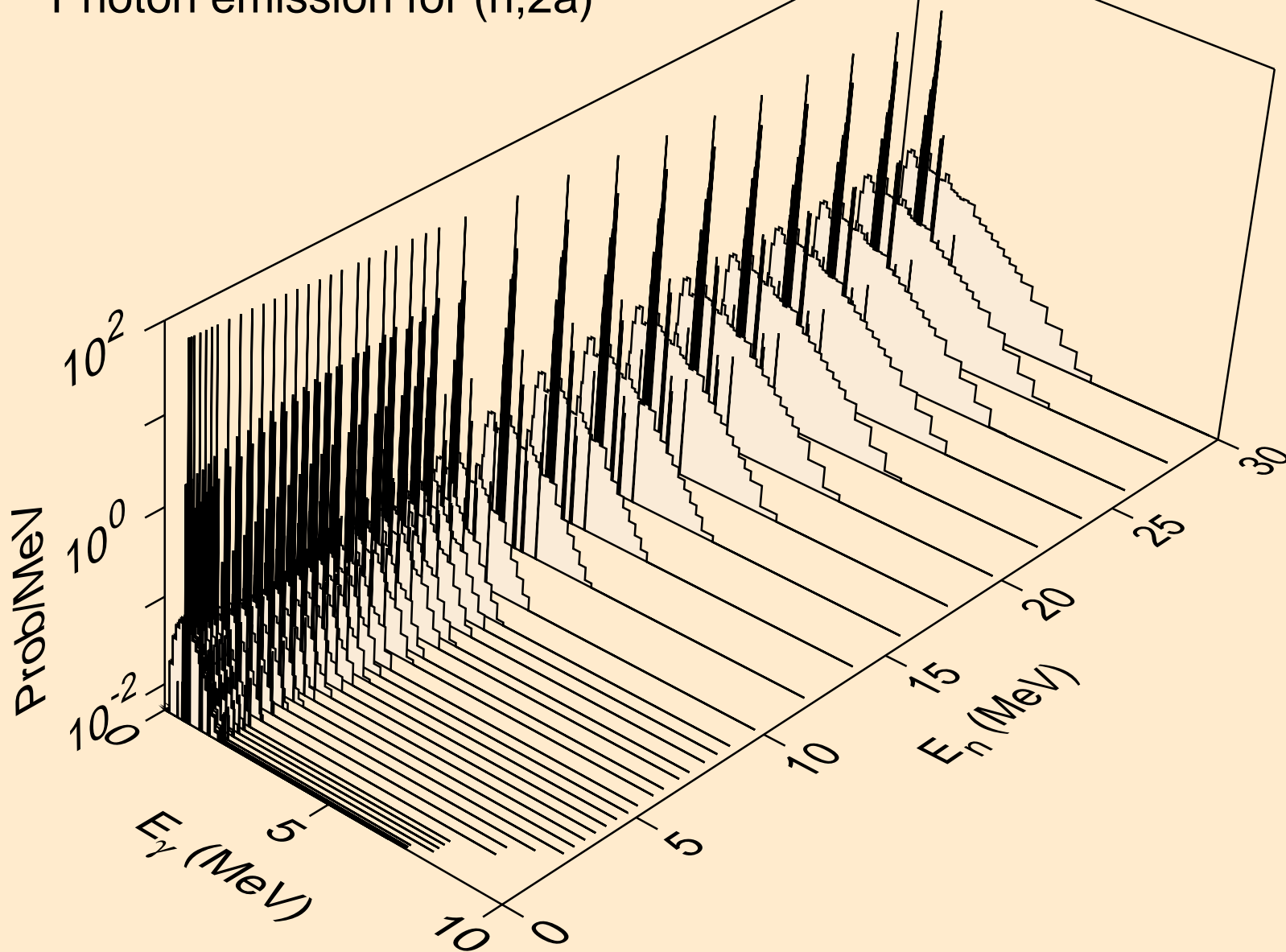

BA121 NEUTRON ACER TENDL-2019 LIBRARY; T=293.16K  
Photon emission for (n,3a)

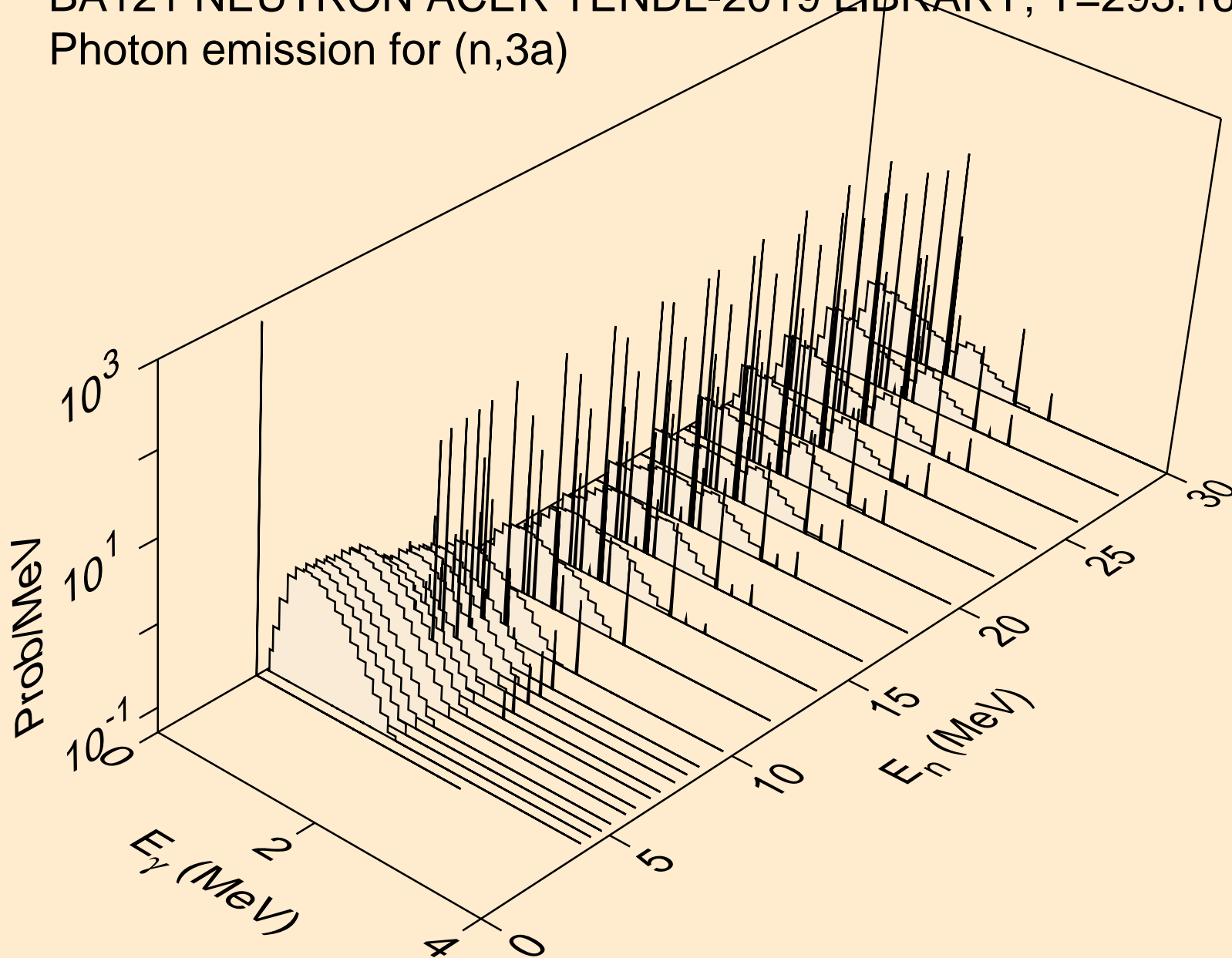

BA121 NEUTRON ACER TENDL-2019 LIBRARY; T=293.16K  
Photon emission for (n,2p)

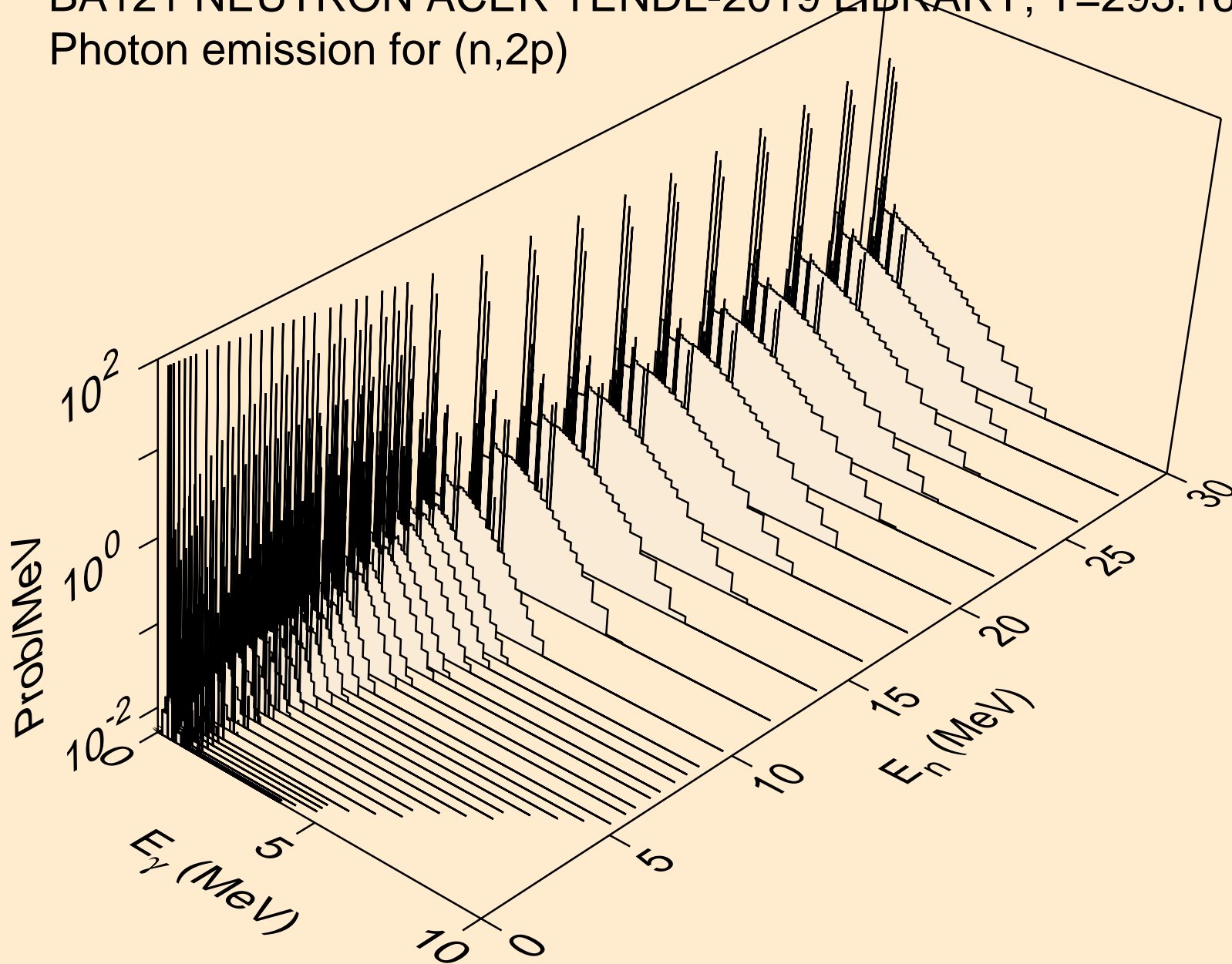

BA121 NEUTRON ACER TENDL-2019 LIBRARY; T=293.16K  
Photon emission for (n,p $\alpha$ )

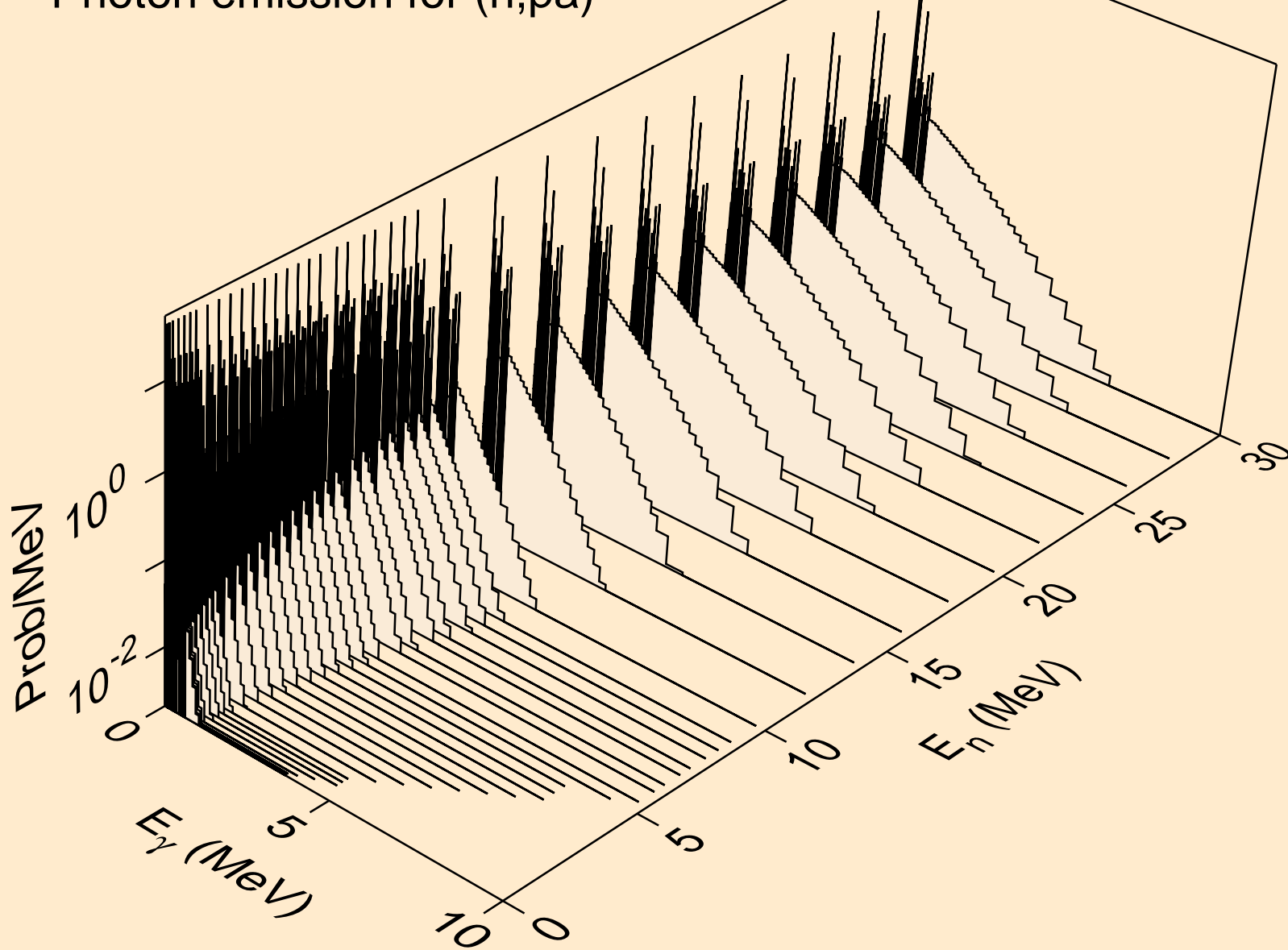

BA121 NEUTRON ACER TENDL-2019 LIBRARY; T=293.16K  
Photon emission for (n,d2a)

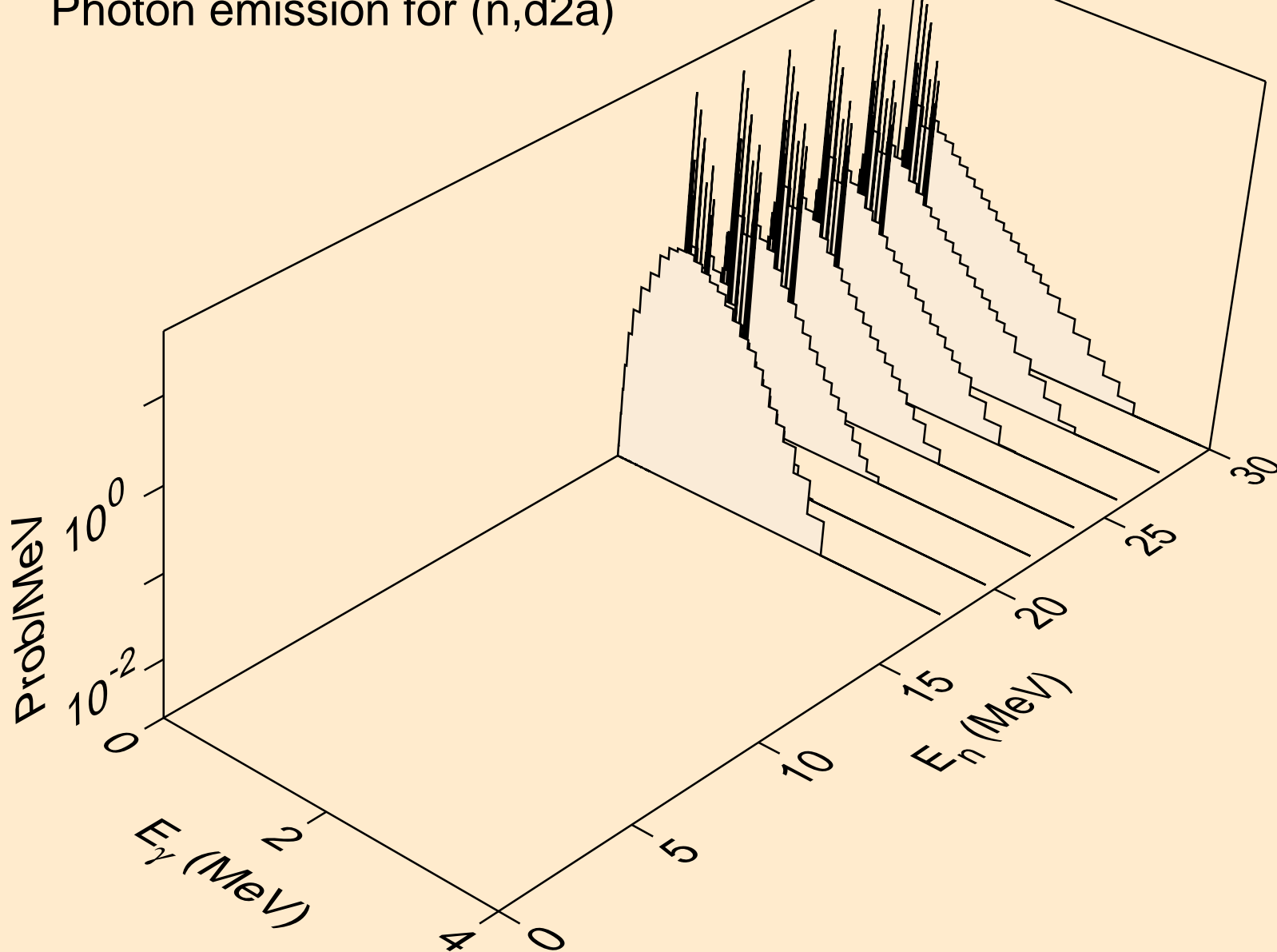

BA121 NEUTRON ACER TENDL-2019 LIBRARY; T=293.16K  
Photon emission for (n,pd)

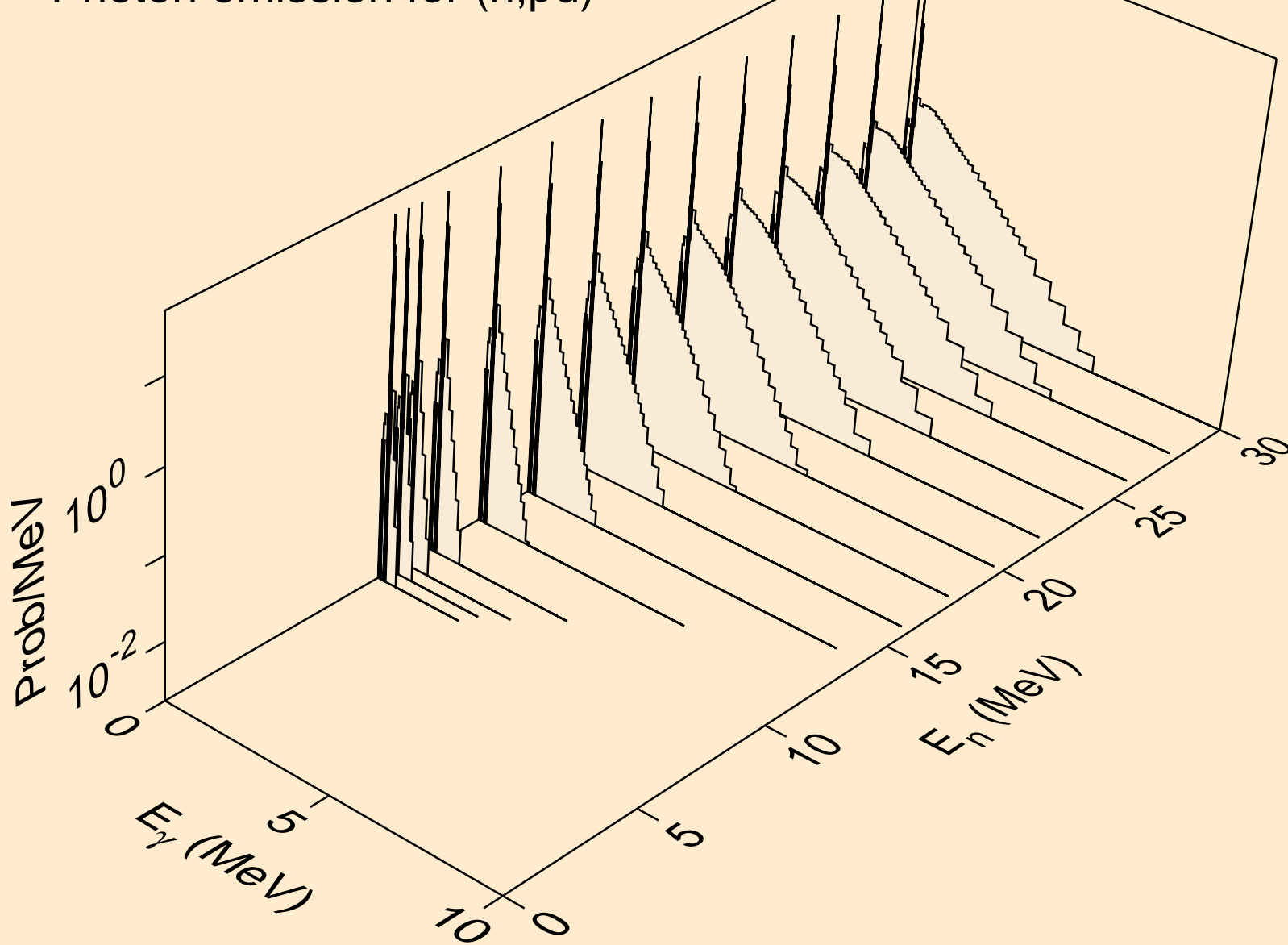

BA121 NEUTRON ACER TENDL-2019 LIBRARY; T=293.16K  
Photon emission for (n,pt)

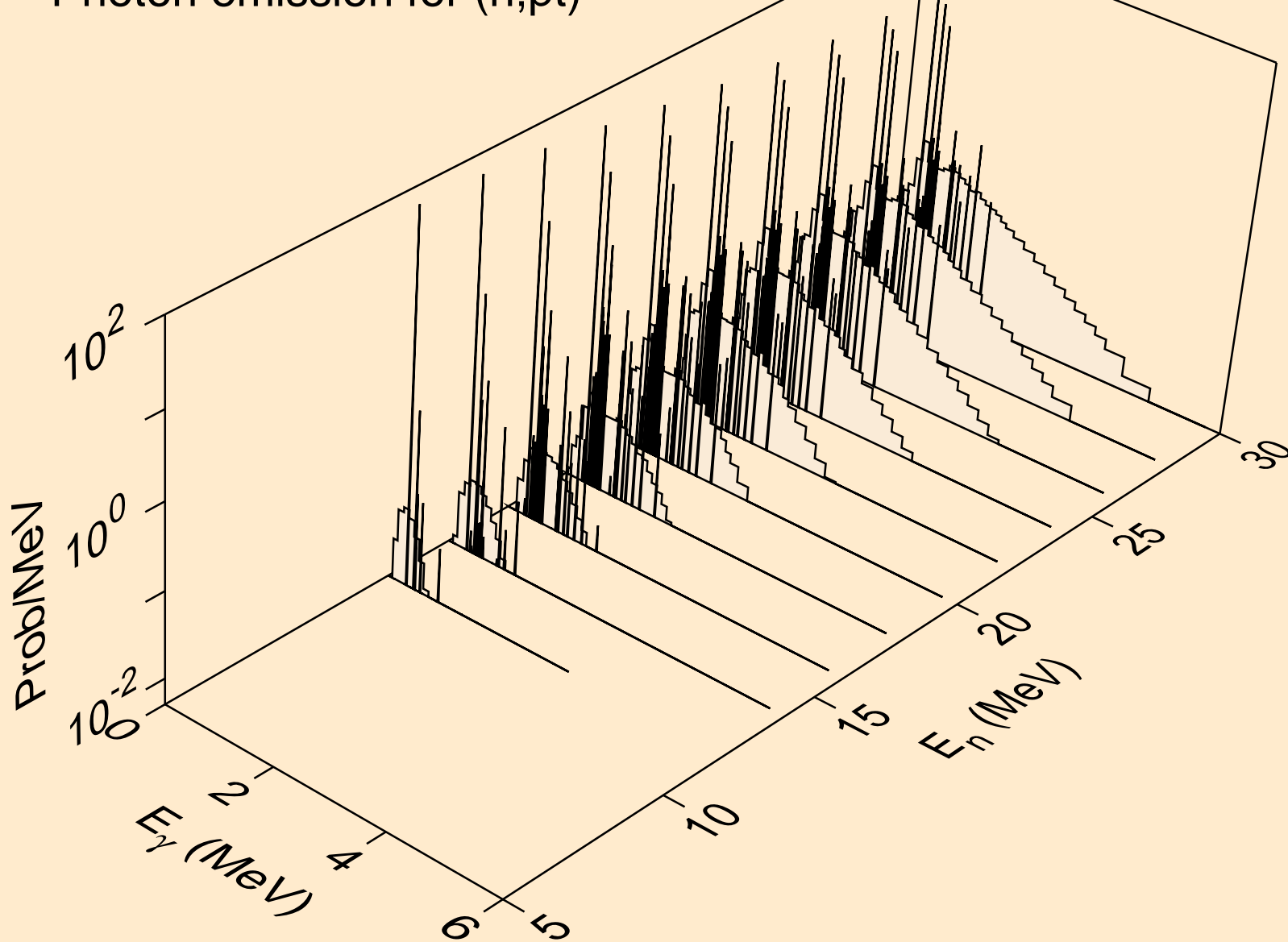



BA121 NEUTRON ACER TENDL-2019 LIBRARY; T=293.16K  
Photon emission for (n,da)

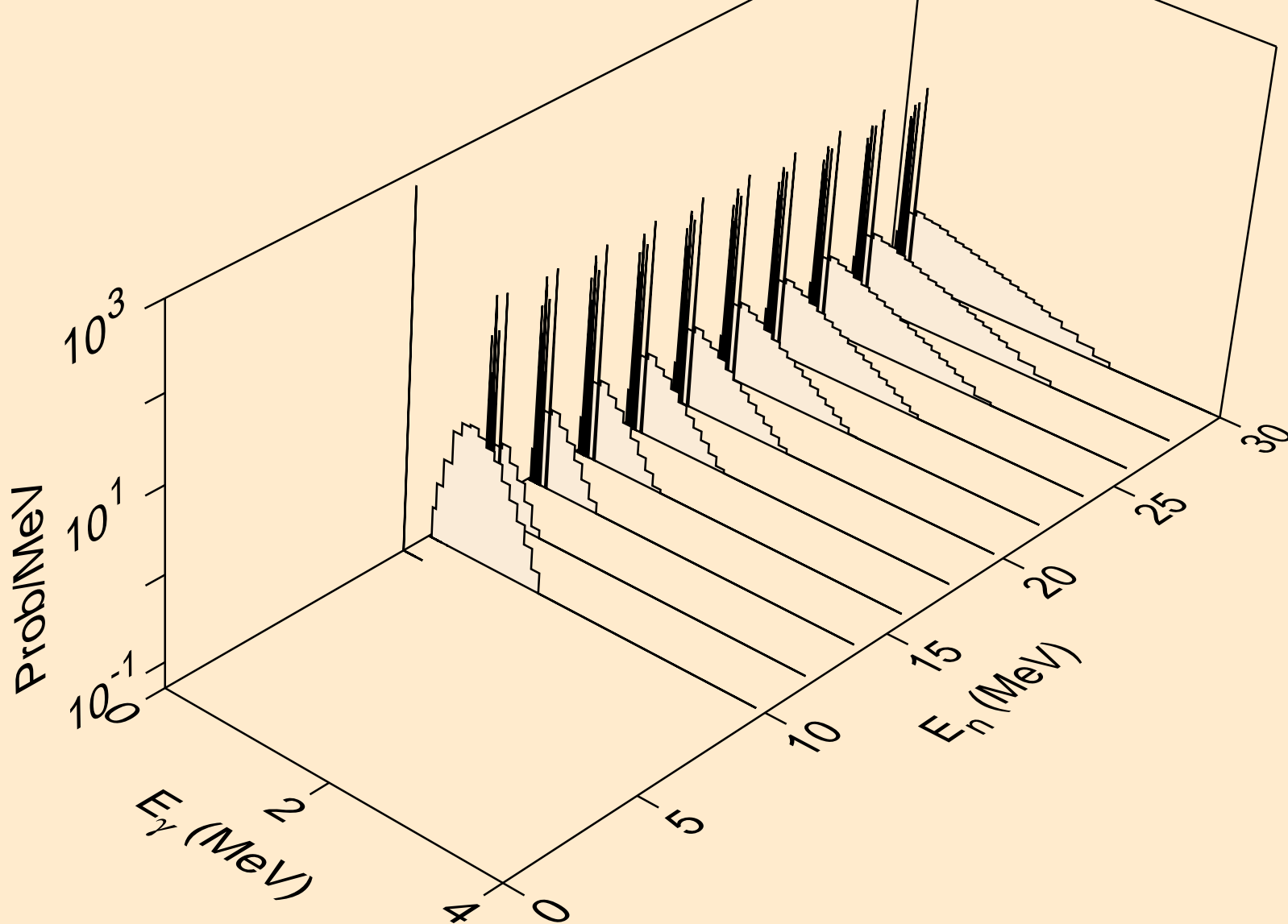

BA121 NEUTRON ACER TENDL-2019 LIBRARY; T=293.16K  
thermal capture photon spectrum

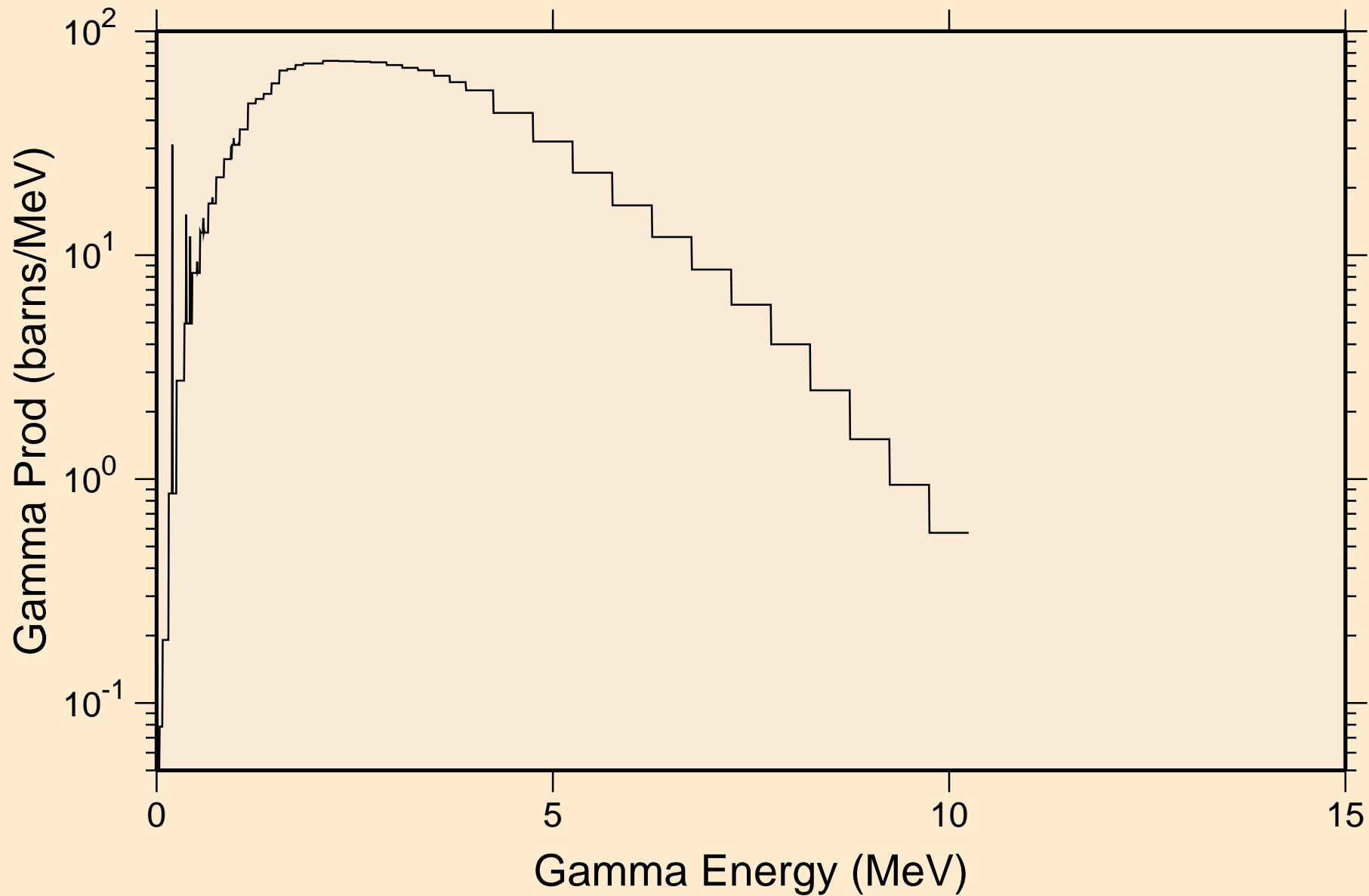

BA121 NEUTRON ACER TENDL-2019 LIBRARY; T=293.16K  
14 MeV photon spectrum

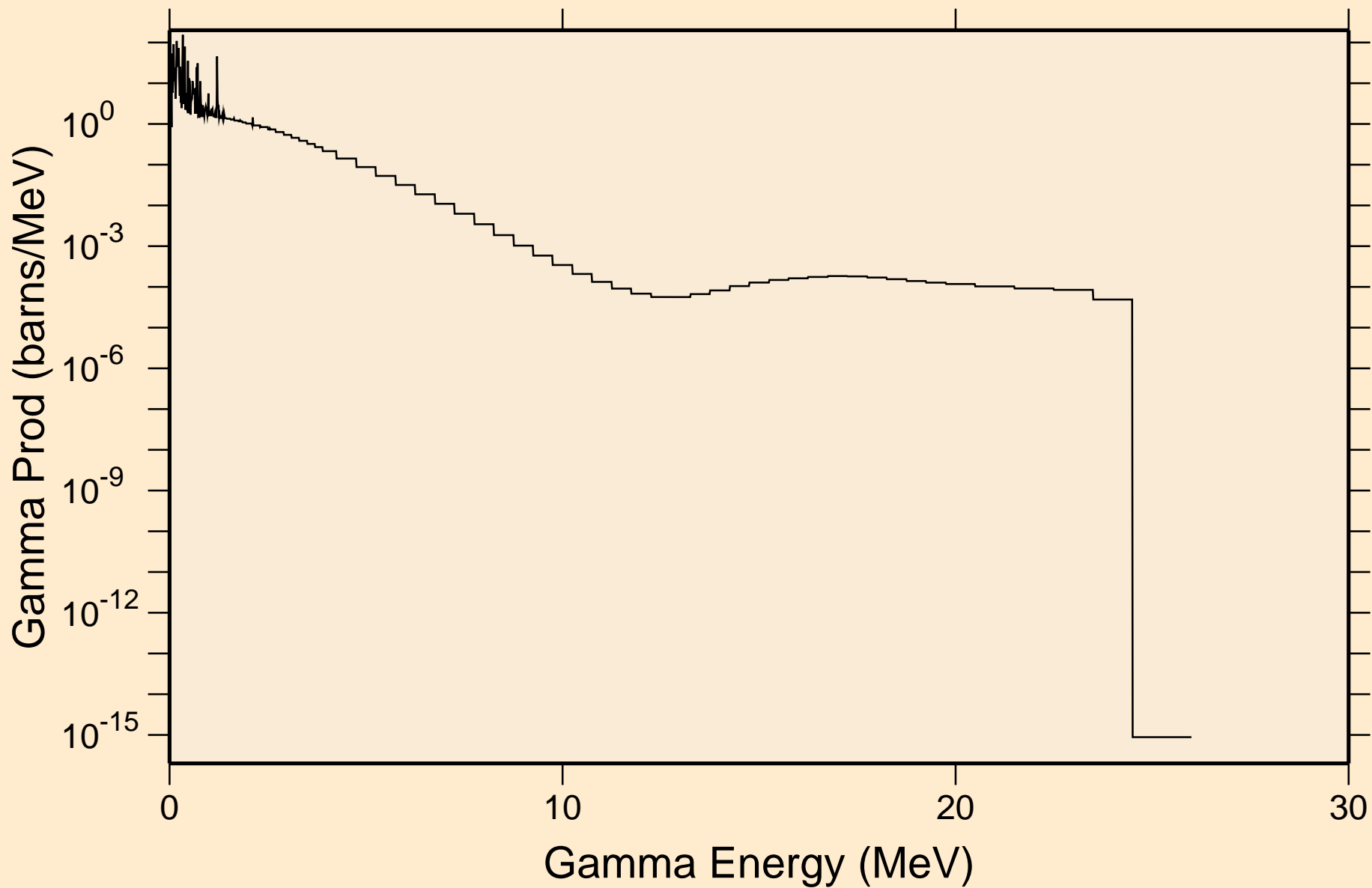

# BA121 NEUTRON ACER TENDL-2019 LIBRARY; T=293.16K

## Particle heating contributions

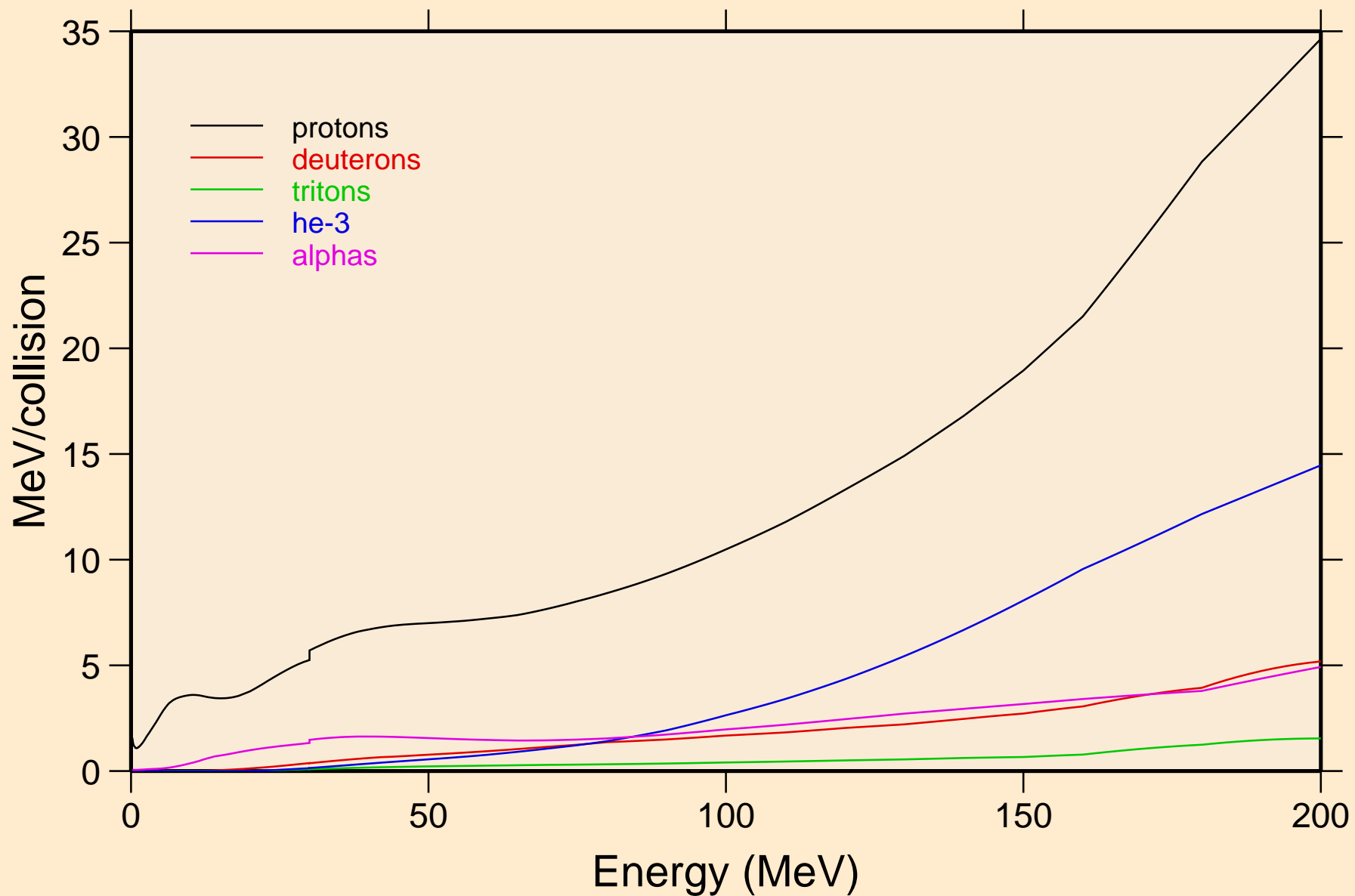

BA121 NEUTRON ACER TENDL-2019 LIBRARY; T=293.16K  
Recoil Heating

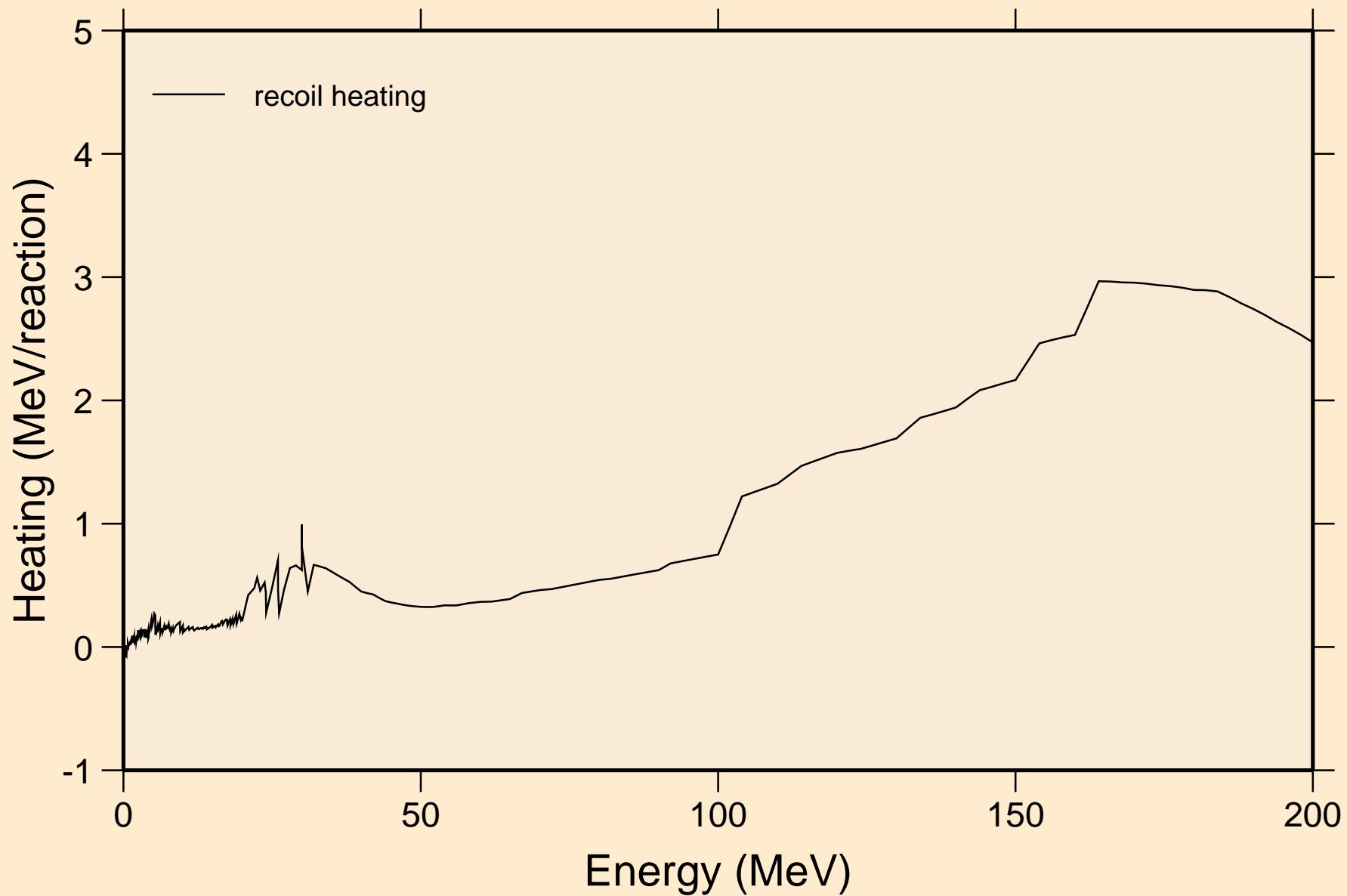

BA121 NEUTRON ACER TENDL-2019 LIBRARY; T=293.16K  
Particle production cross sections

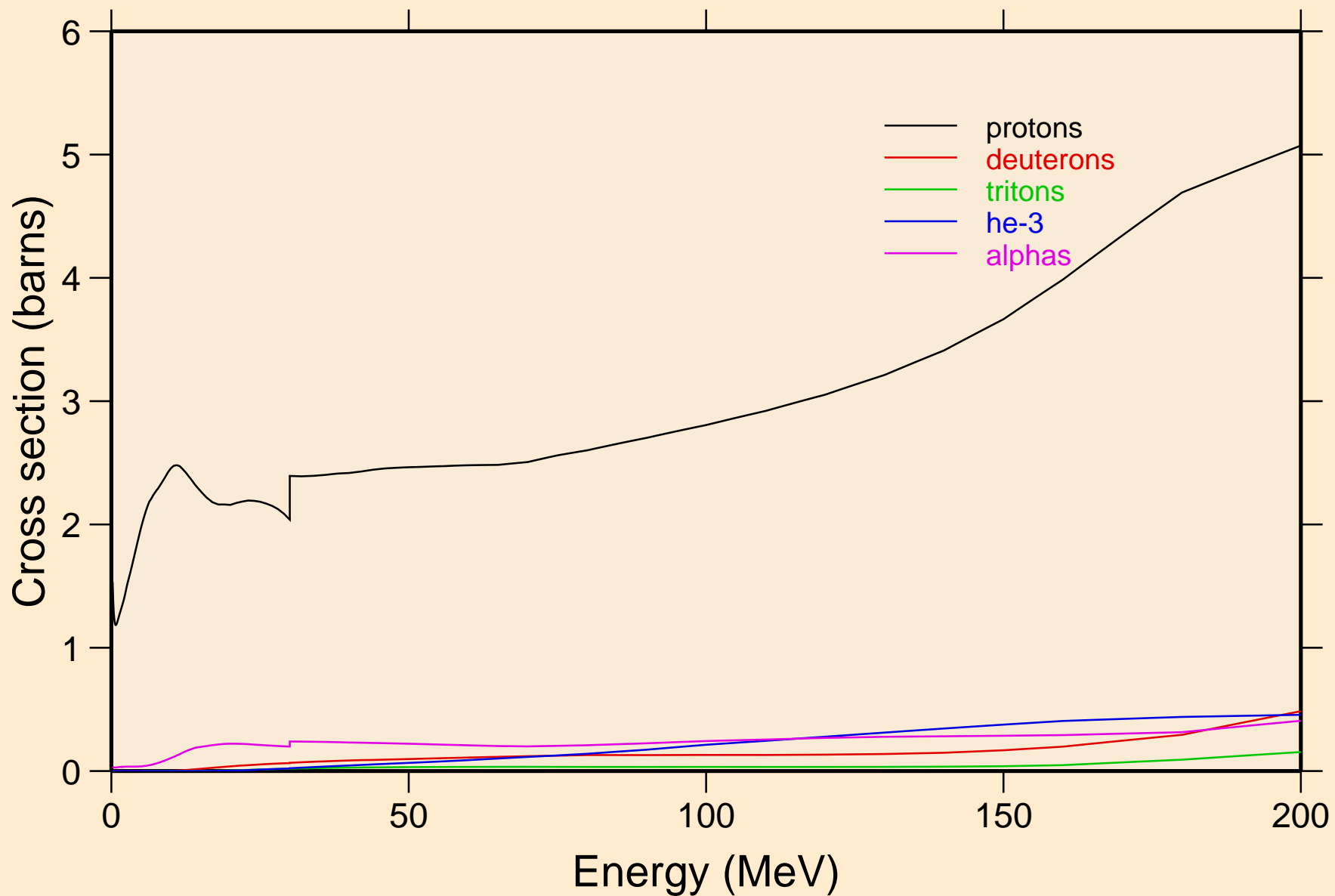

BA121 NEUTRON ACER TENDL-2019 LIBRARY; T=293.16K  
protons from (n,x)

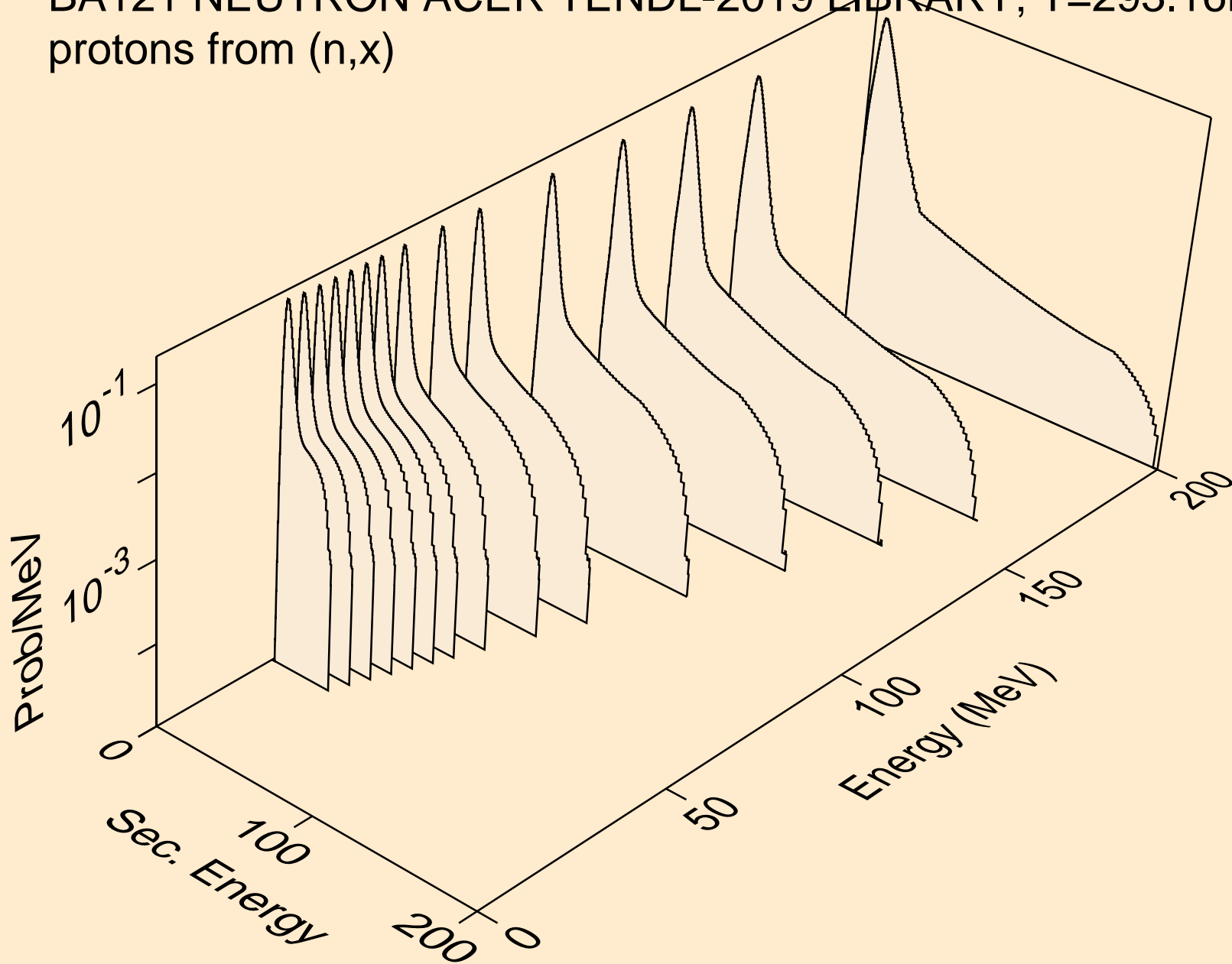

BA121 NEUTRON ACER TENDL-2019 LIBRARY; T=293.16K  
protons from (n,n\*)p

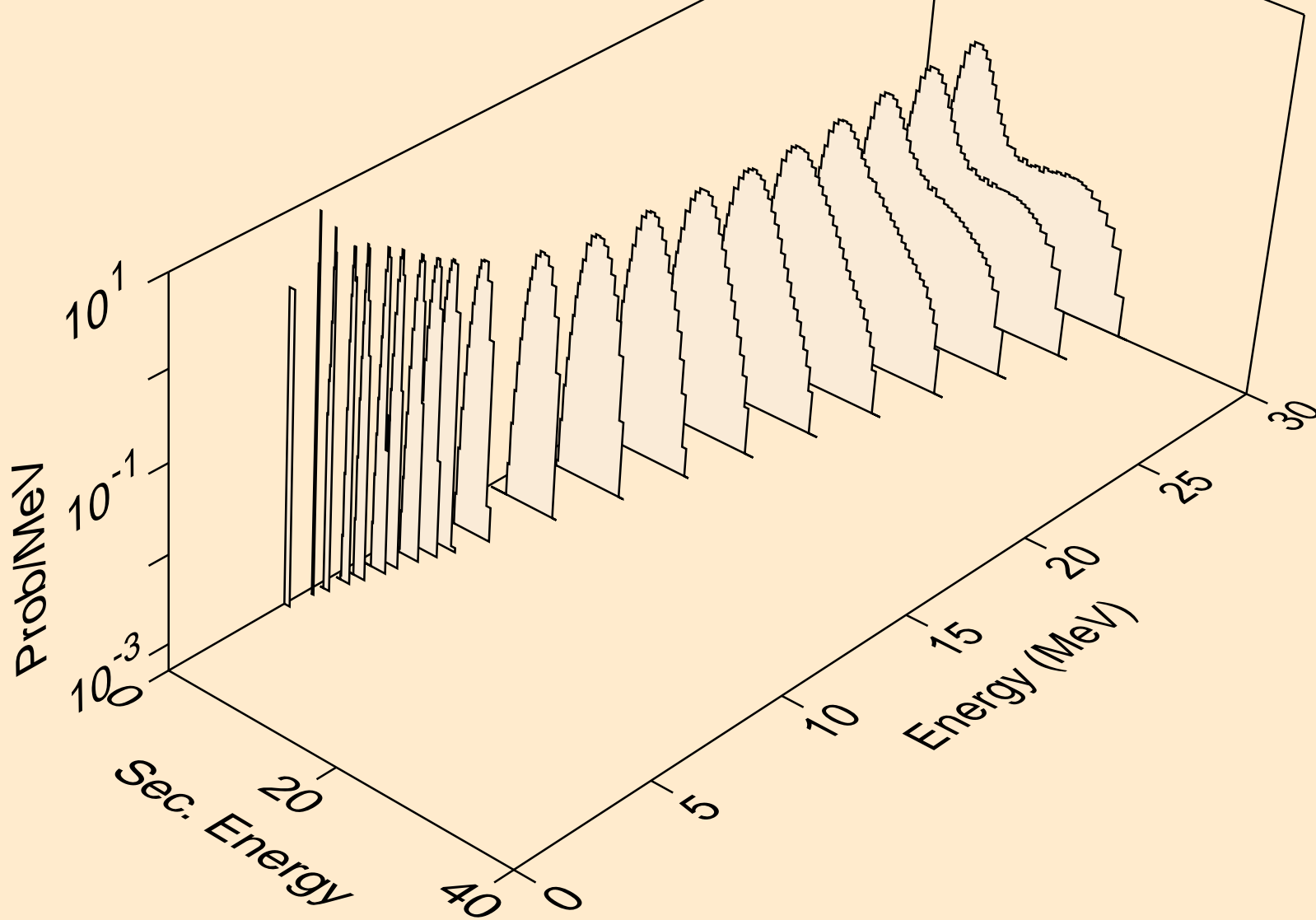



BA121 NEUTRON ACER TENDL-2019 LIBRARY; T=293.16K  
protons from (n,2np)

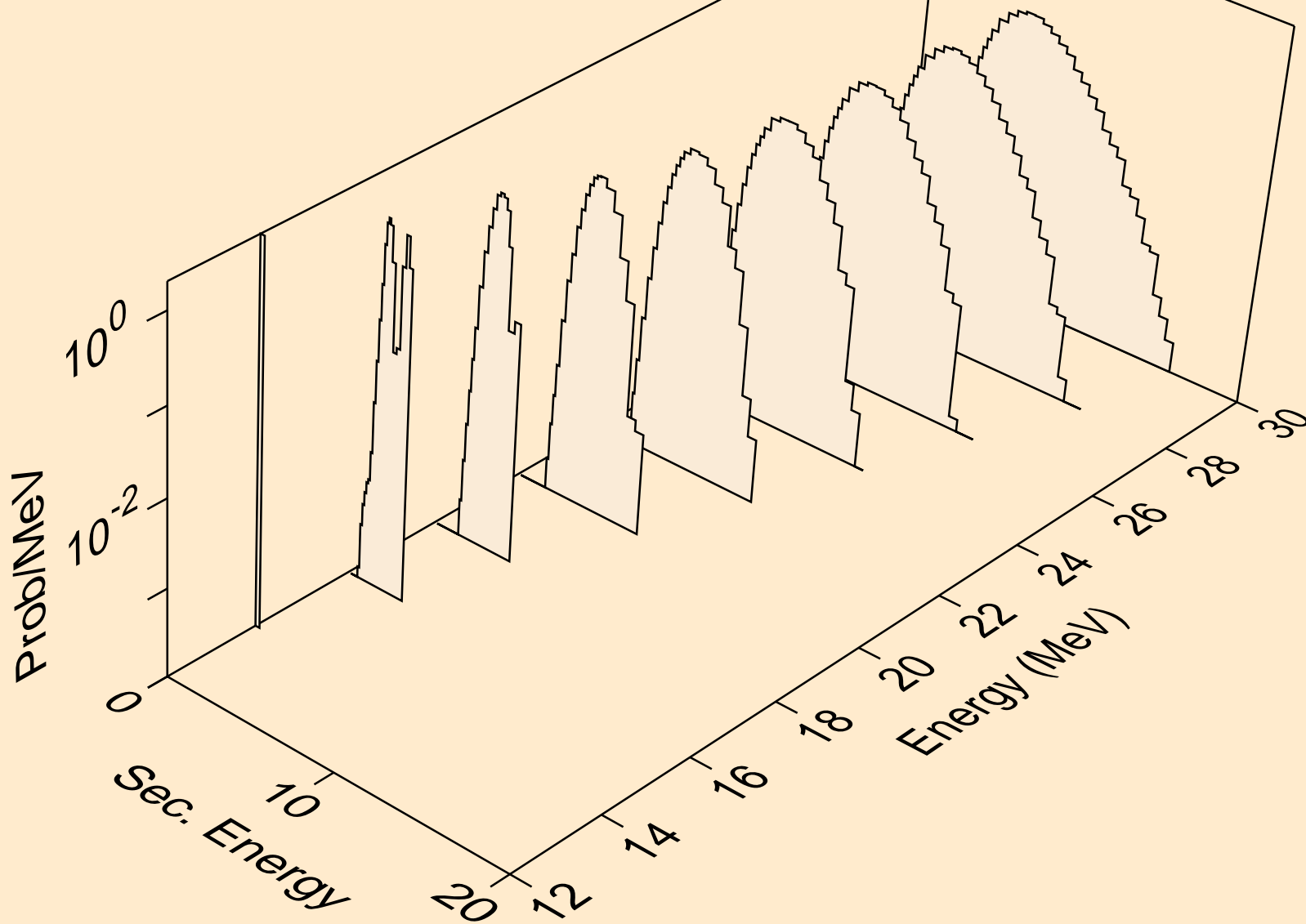

BA121 NEUTRON ACER TENDL-2019 LIBRARY; T=293.16K  
protons from (n,3np)

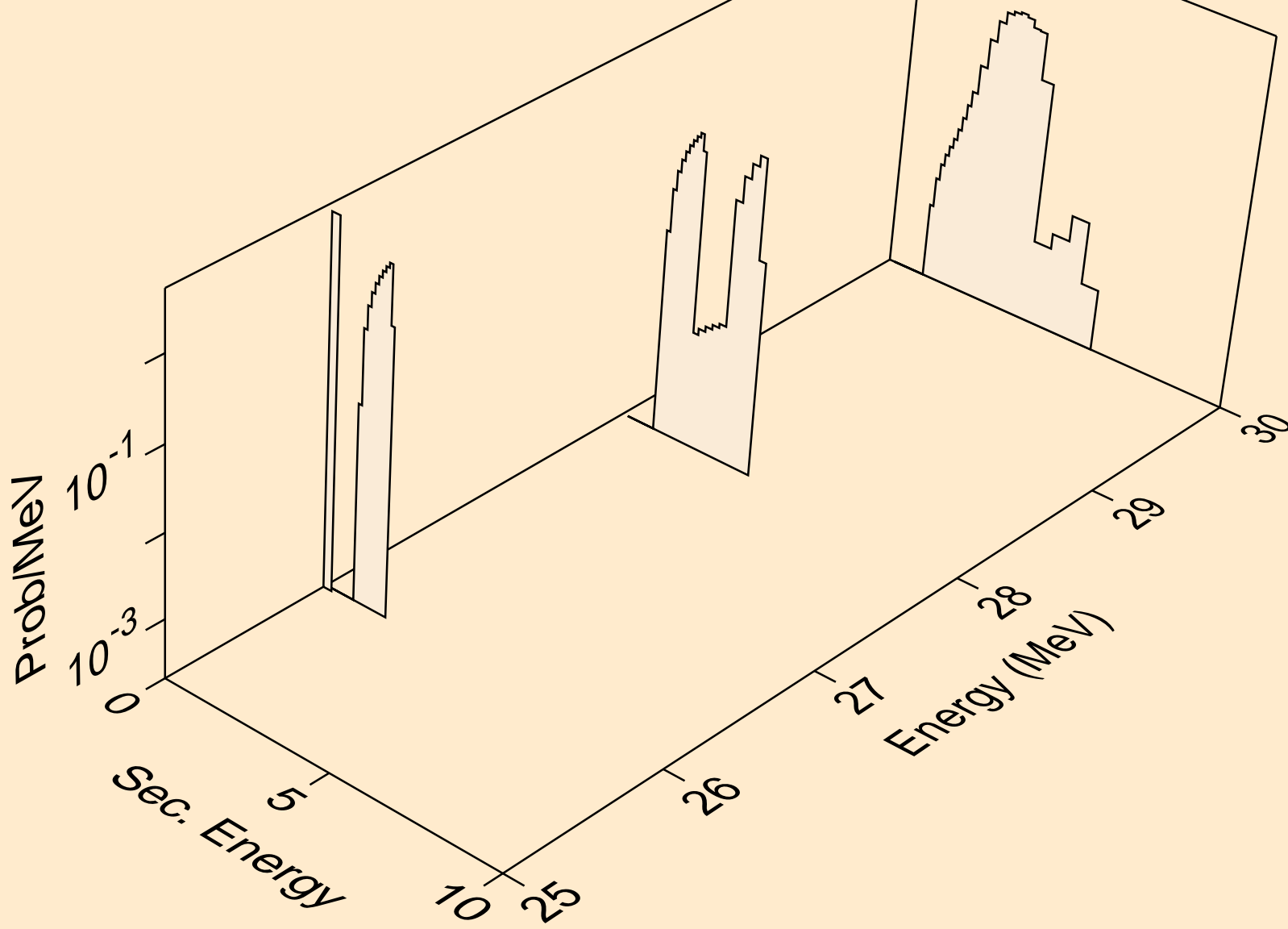

BA121 NEUTRON ACER TENDL-2019 LIBRARY; T=293.16K  
protons from (n,2np)

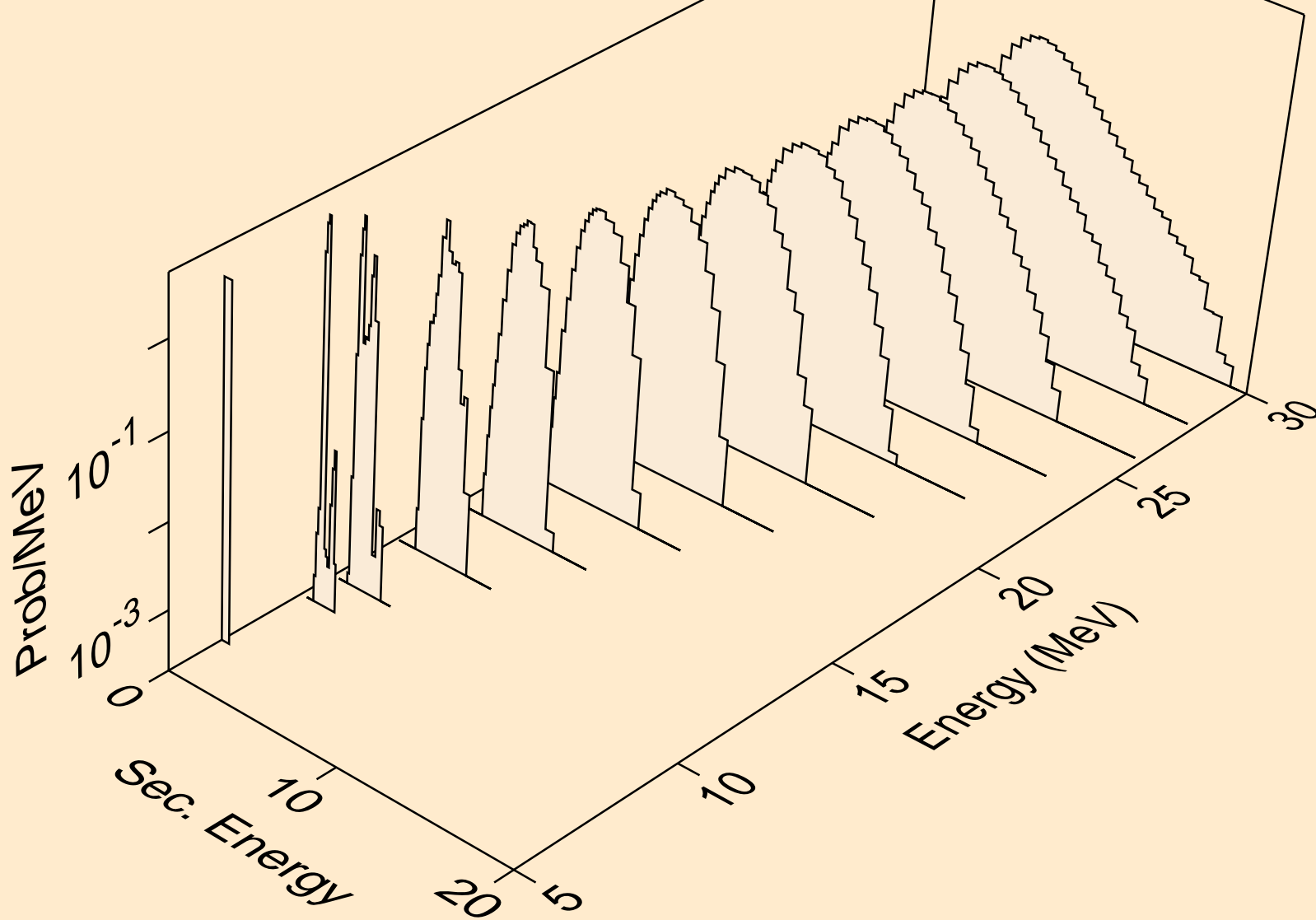

BA121 NEUTRON ACER TENDL-2019 LIBRARY; T=293.16K  
protons from (n,npa)

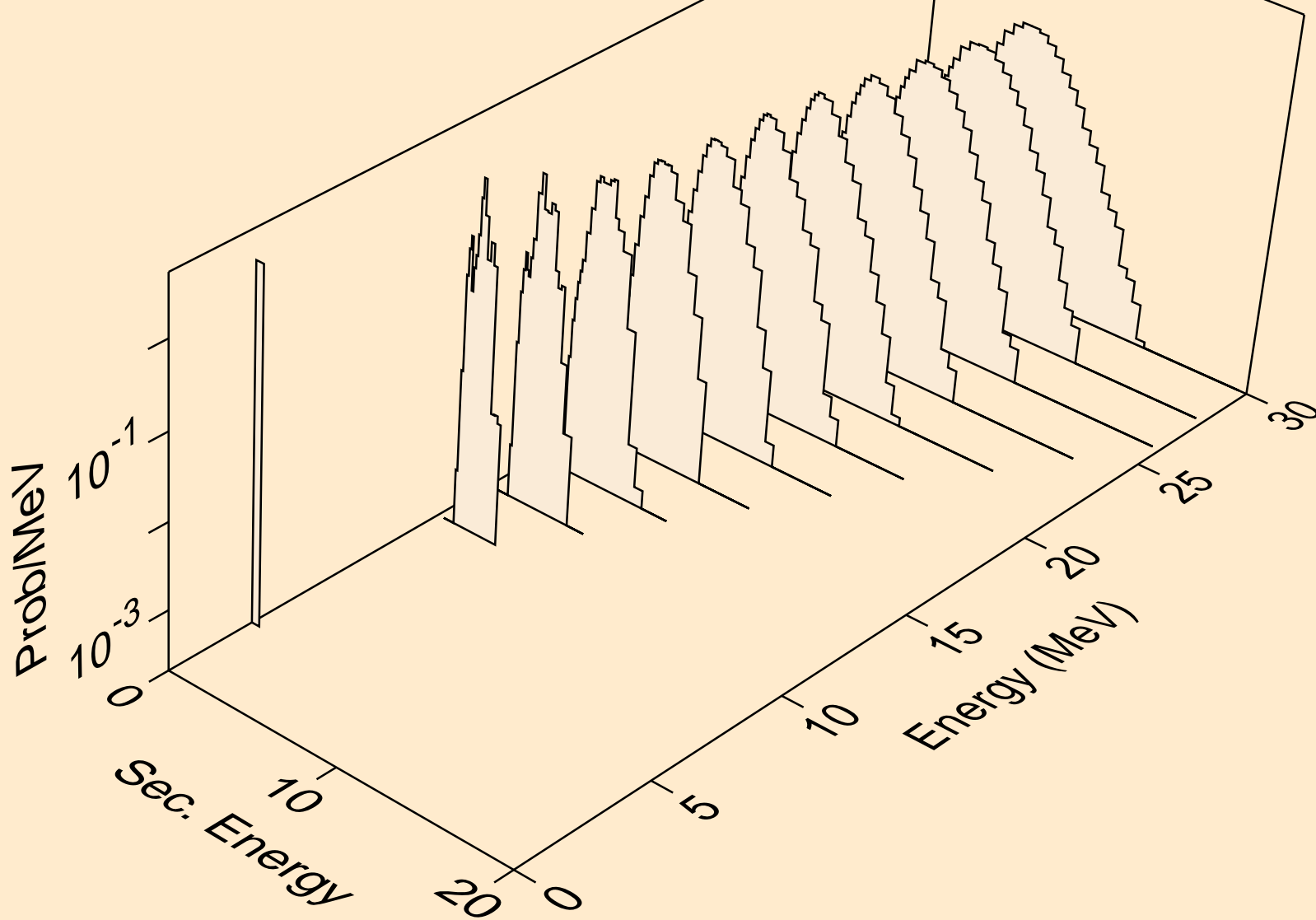

BA121 NEUTRON ACER TENDL-2019 LIBRARY; T=293.16K  
protons from (n,p)

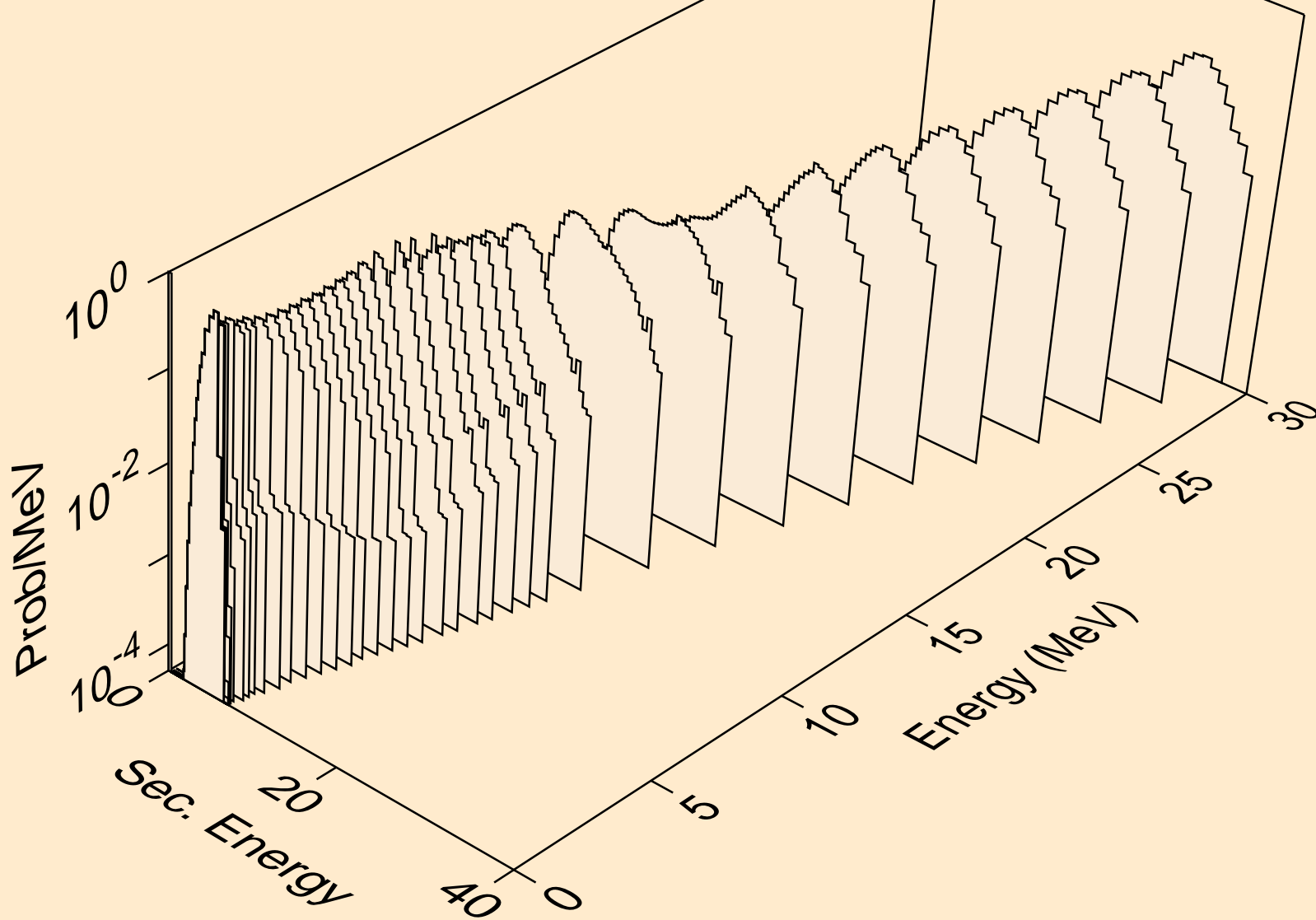

BA121 NEUTRON ACER TENDL-2019 LIBRARY; T=293.16K  
protons from (n,2p)

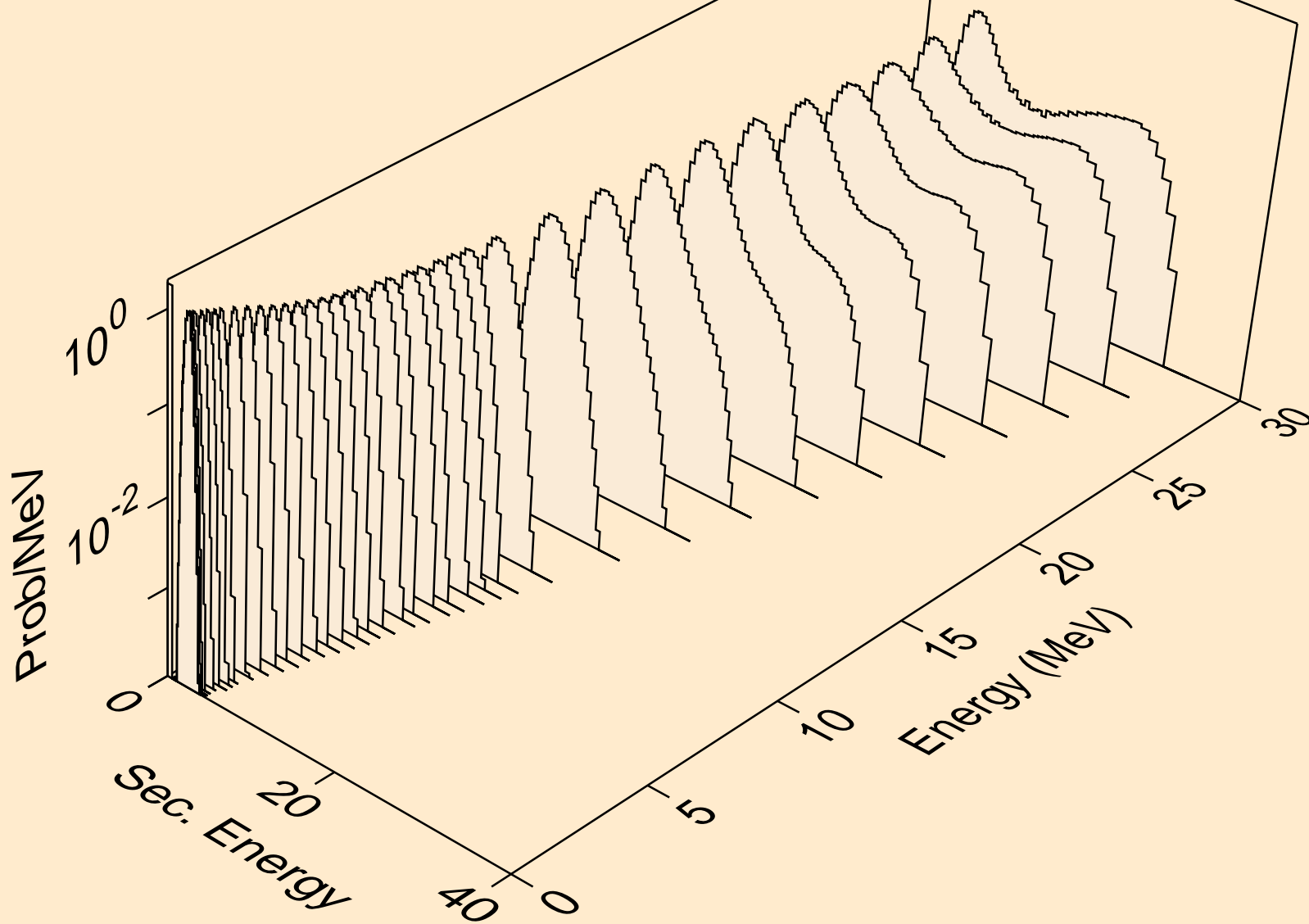

BA121 NEUTRON ACER TENDL-2019 LIBRARY; T=293.16K  
protons from (n,p)

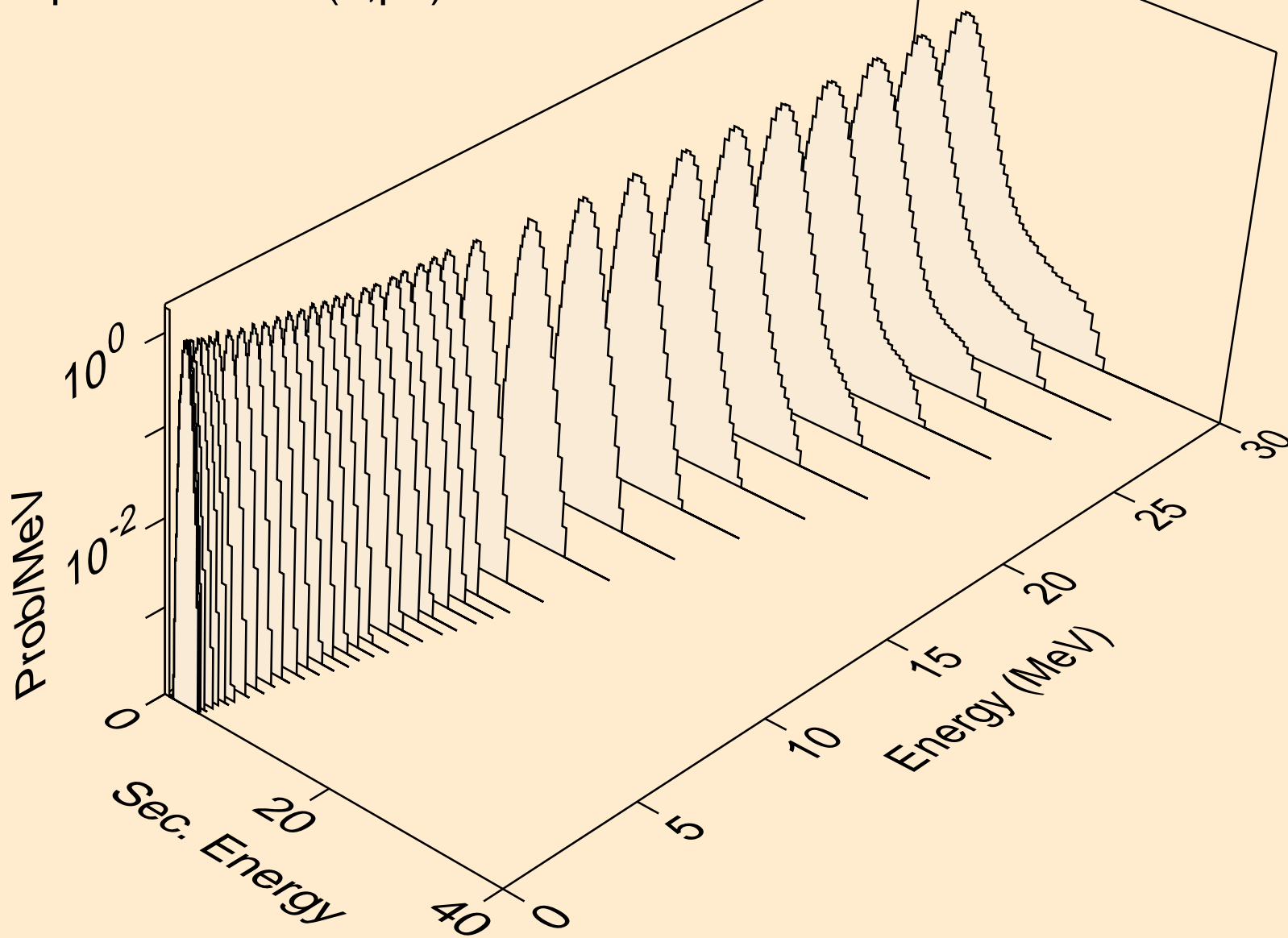

BA121 NEUTRON ACER TENDL-2019 LIBRARY; T=293.16K  
protons from (n,pd)

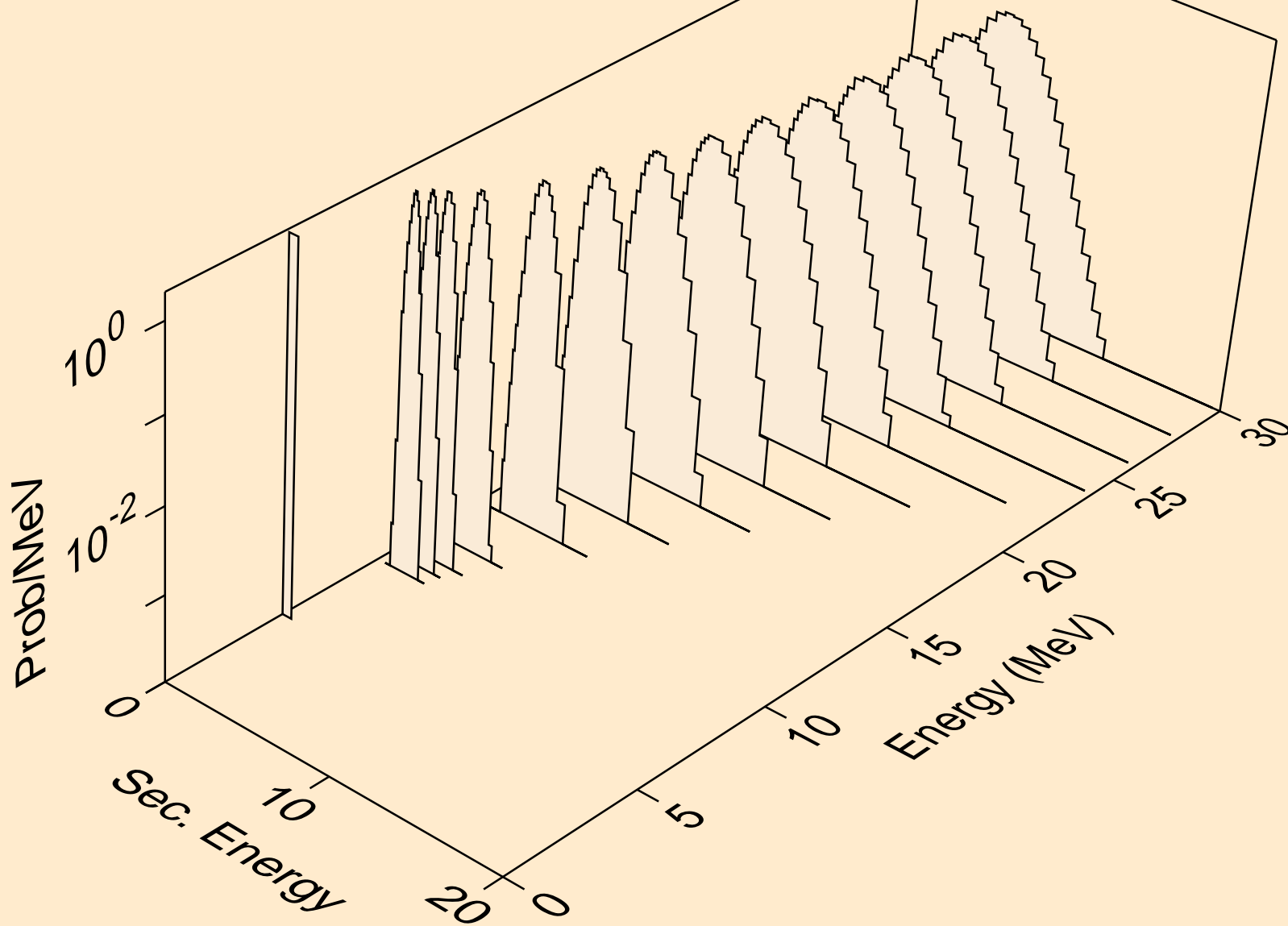



BA121 NEUTRON ACER TENDL-2019 LIBRARY; T=293.16K  
protons from (n,pt)

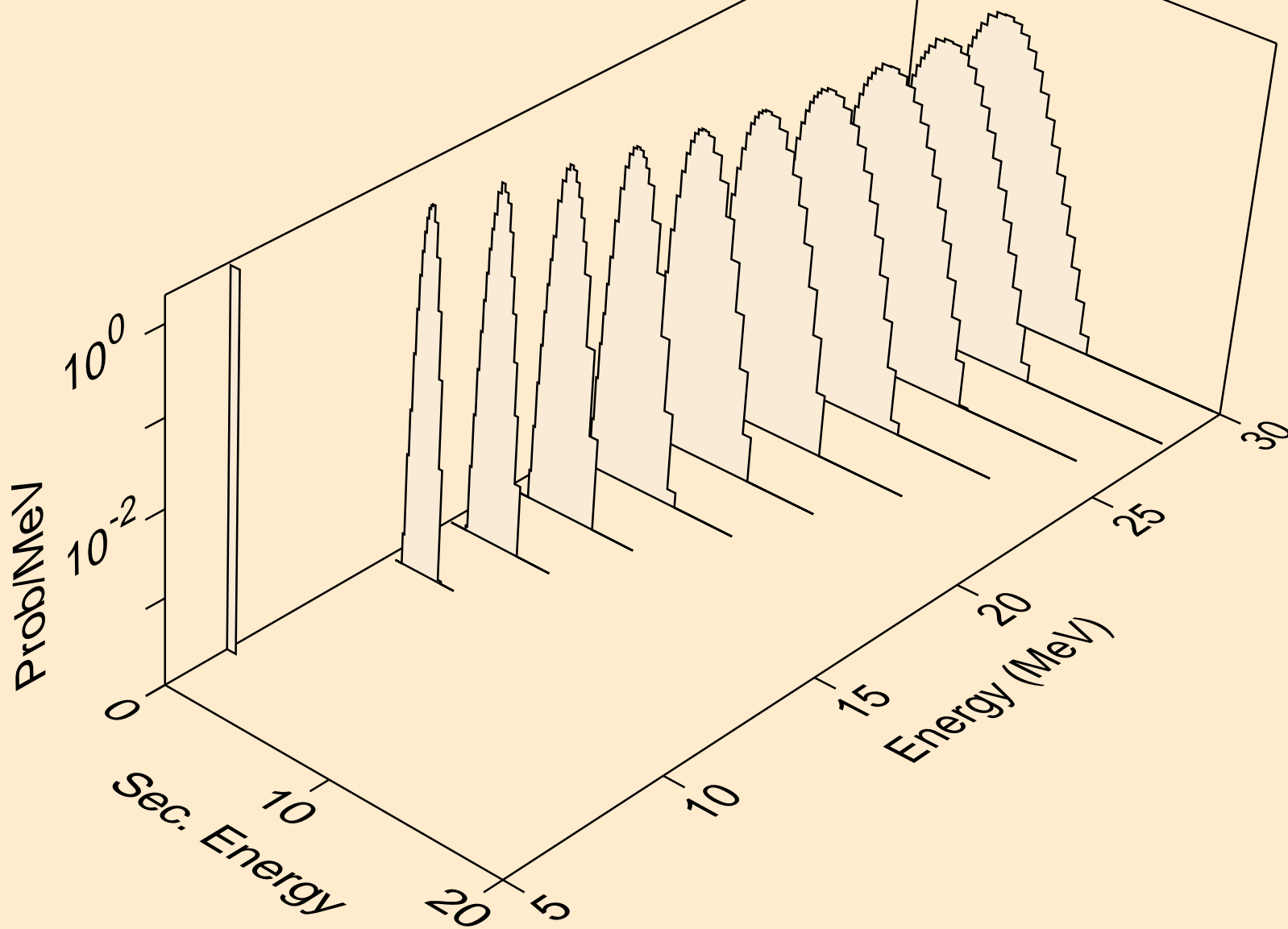

BA121 NEUTRON ACER TENDL-2019 LIBRARY; T=293.16K  
deuterons from (n,x)

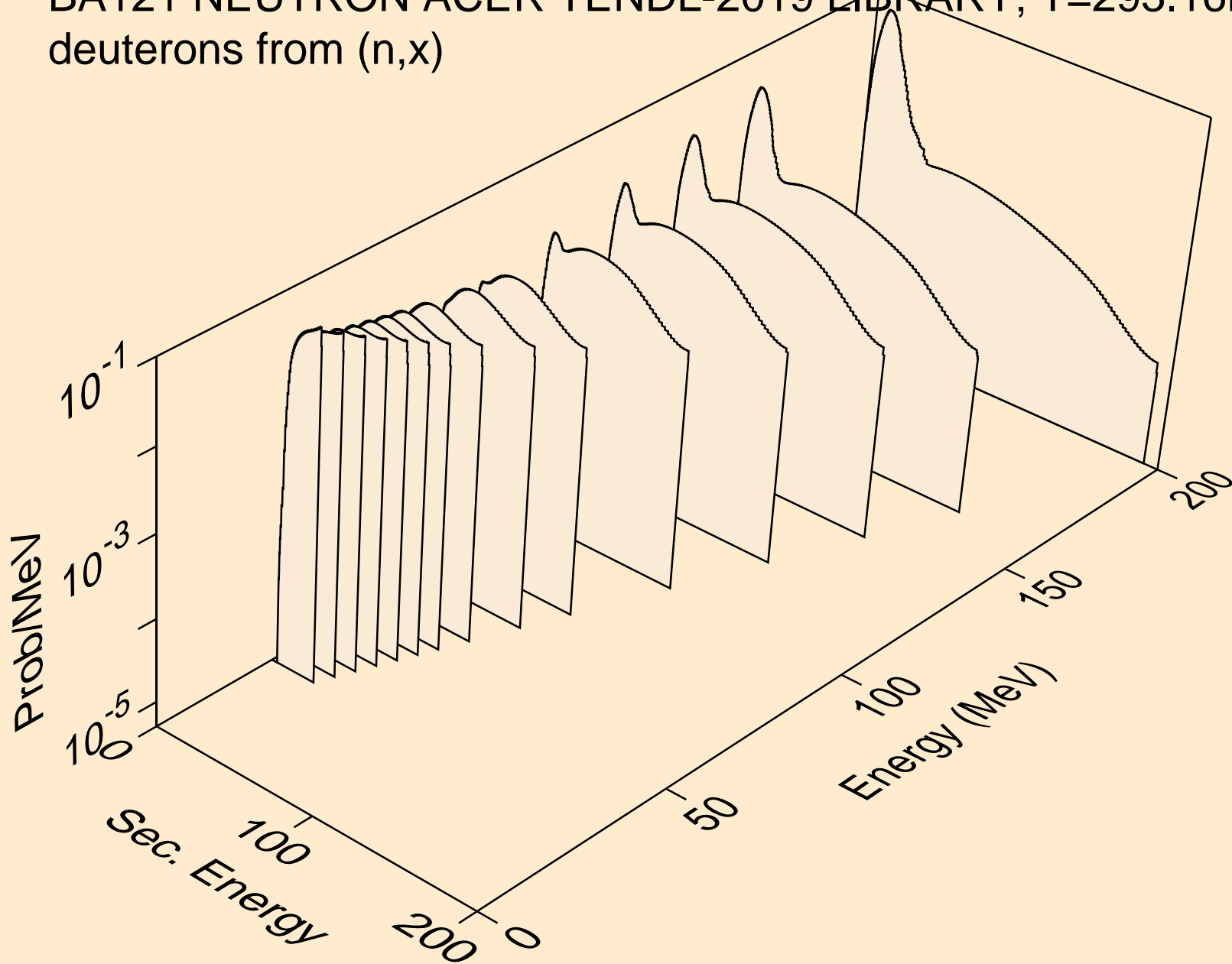

BA121 NEUTRON ACER TENDL-2019 LIBRARY; T=293.16K  
deuterons from (n,2nd)

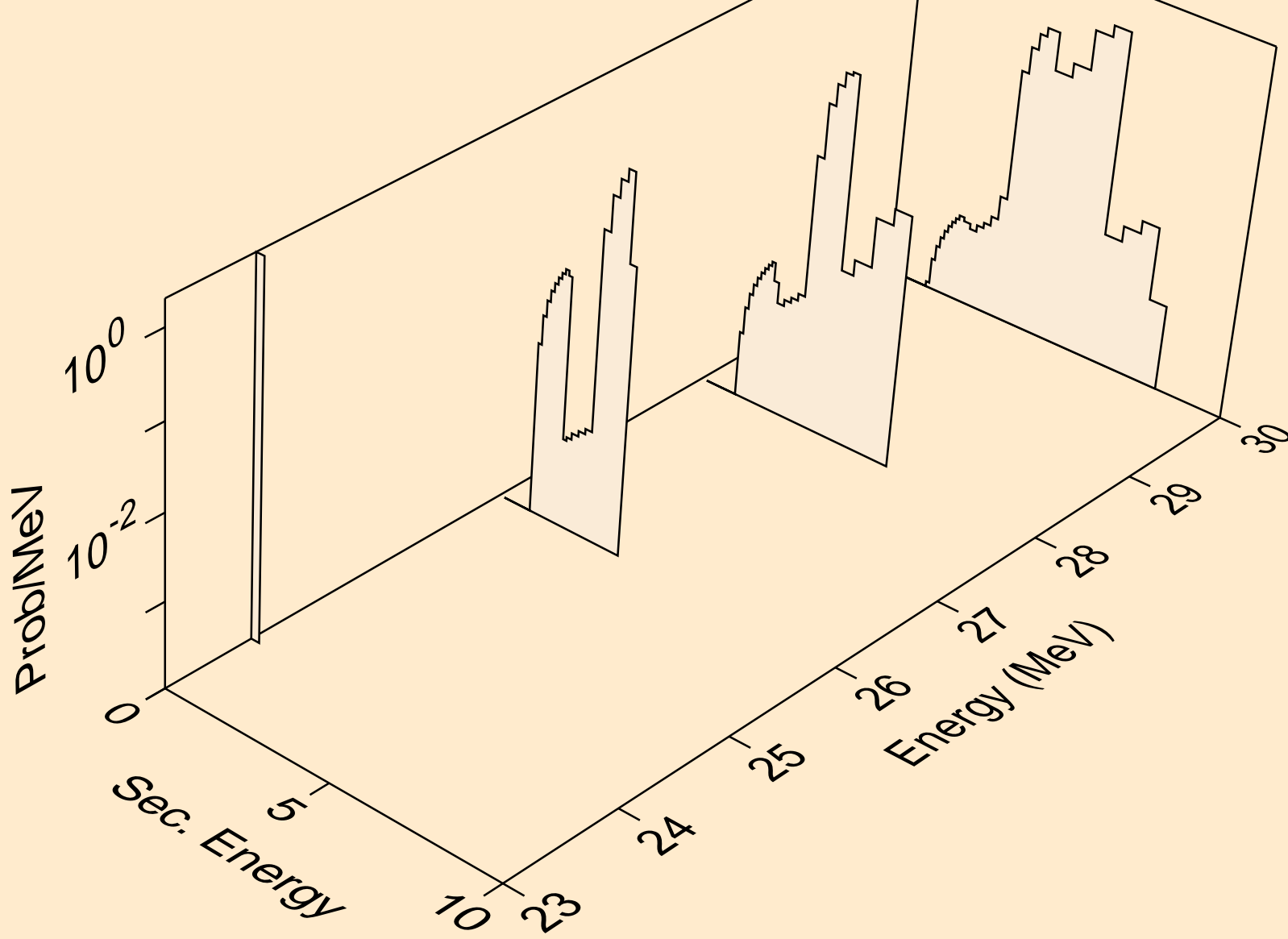

BA121 NEUTRON ACER TENDL-2019 LIBRARY; T=293.16K  
deuterons from (n,n\*)d

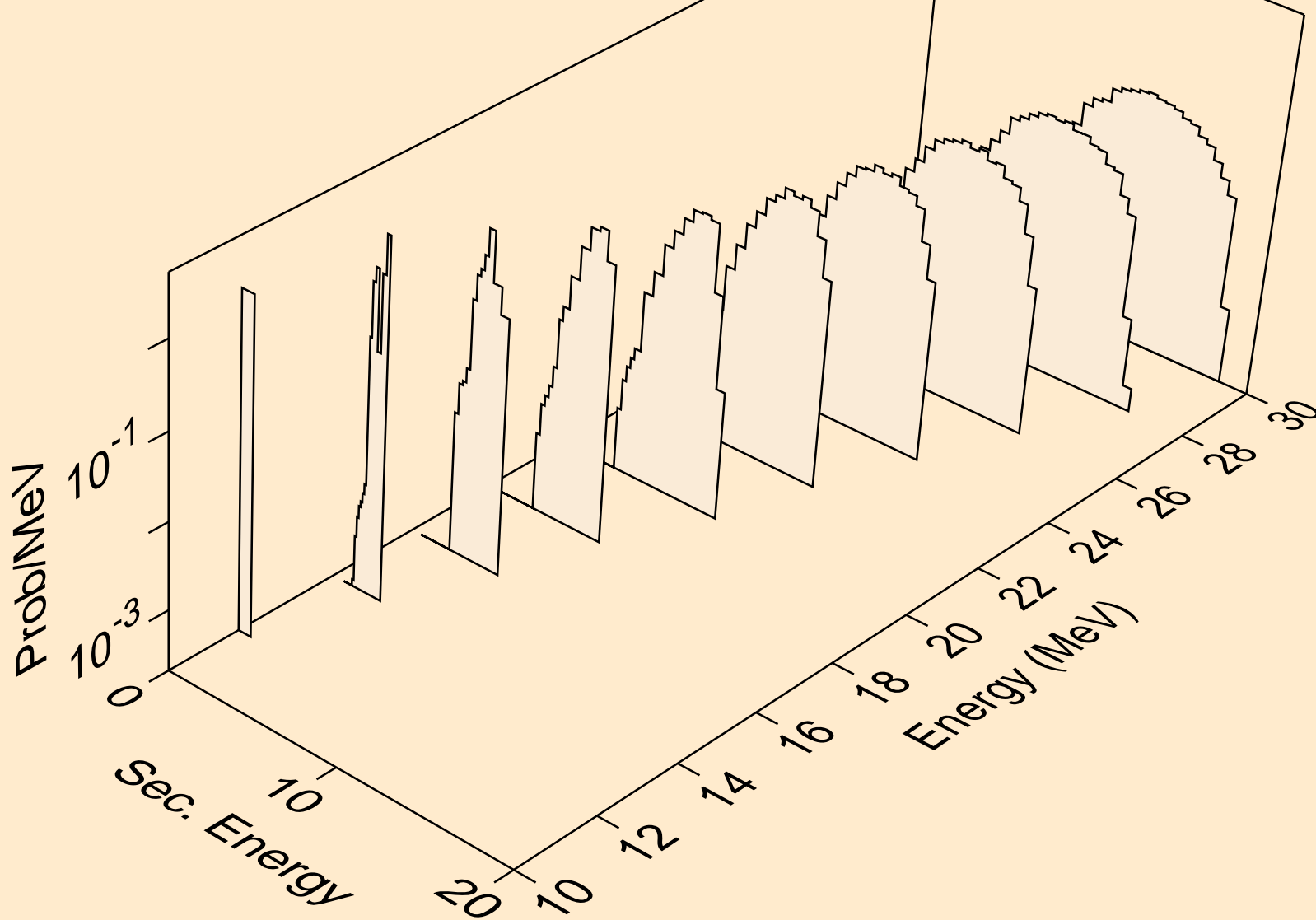

BA121 NEUTRON ACER TENDL-2019 LIBRARY; T=293.16K  
deuterons from (n,d)

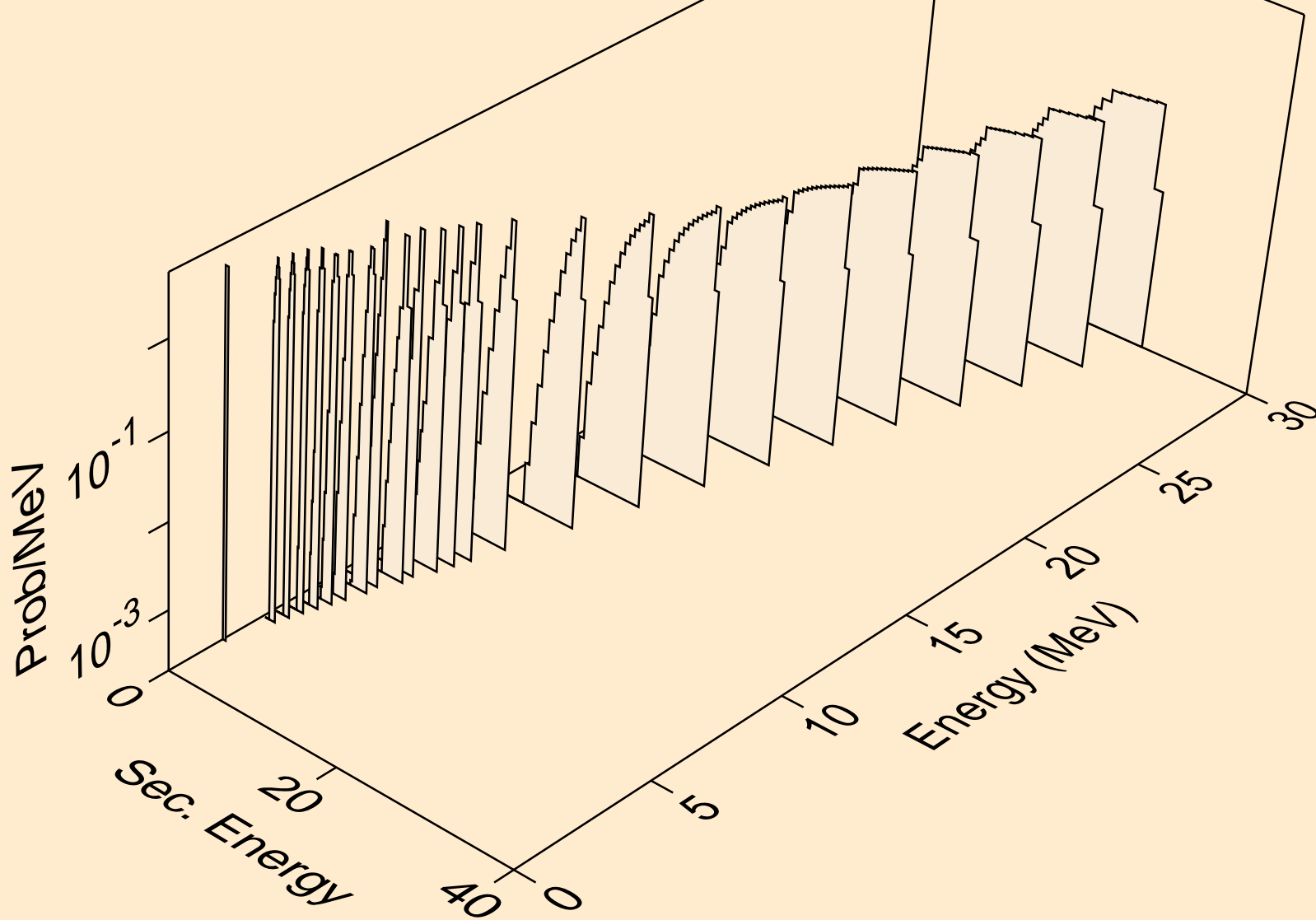

BA121 NEUTRON ACER TENDL-2019 LIBRARY; T=293.16K  
deuterons from (n,d2a)

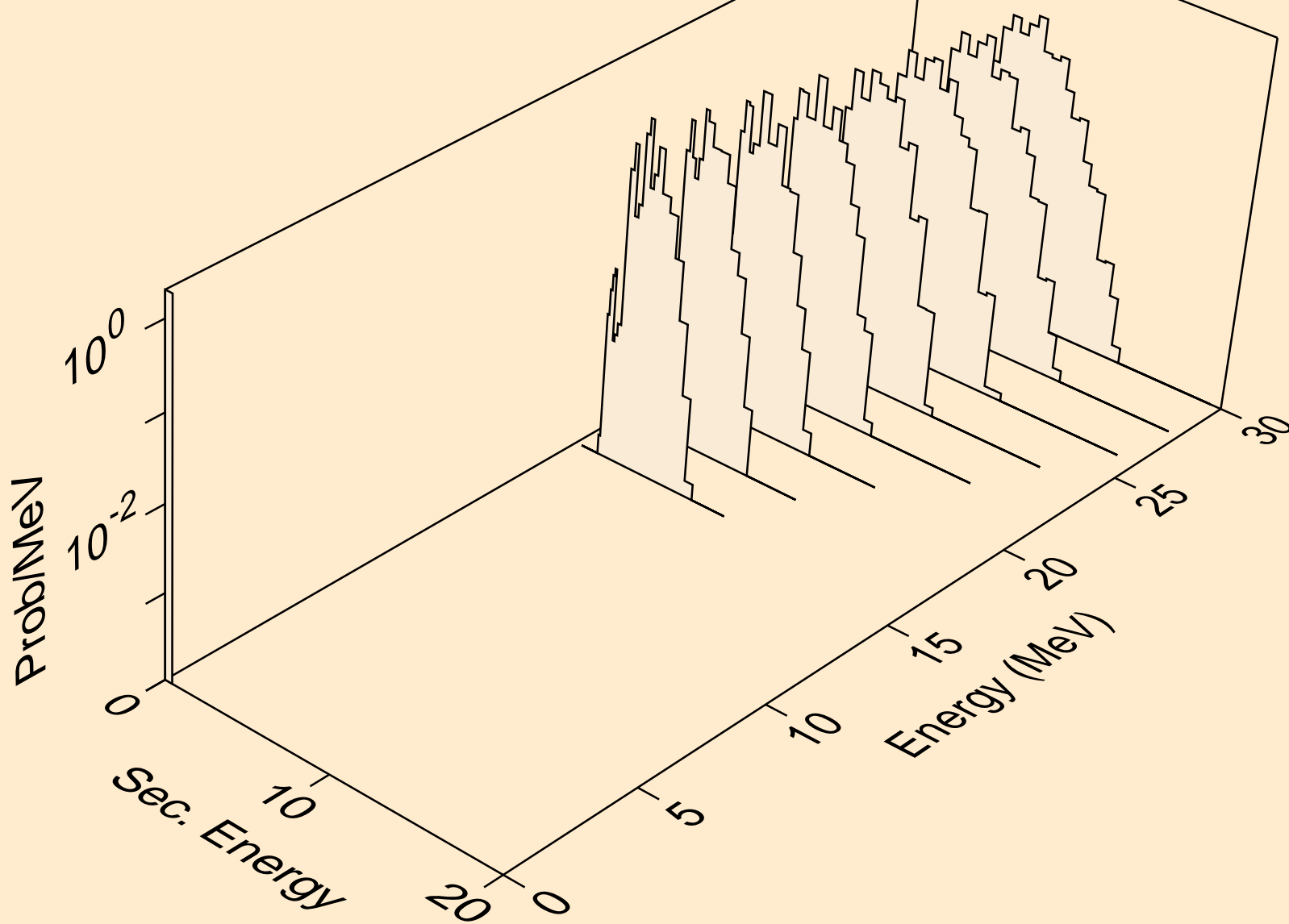

BA121 NEUTRON ACER TENDL-2019 LIBRARY; T=293.16K  
deuterons from (n,pd)

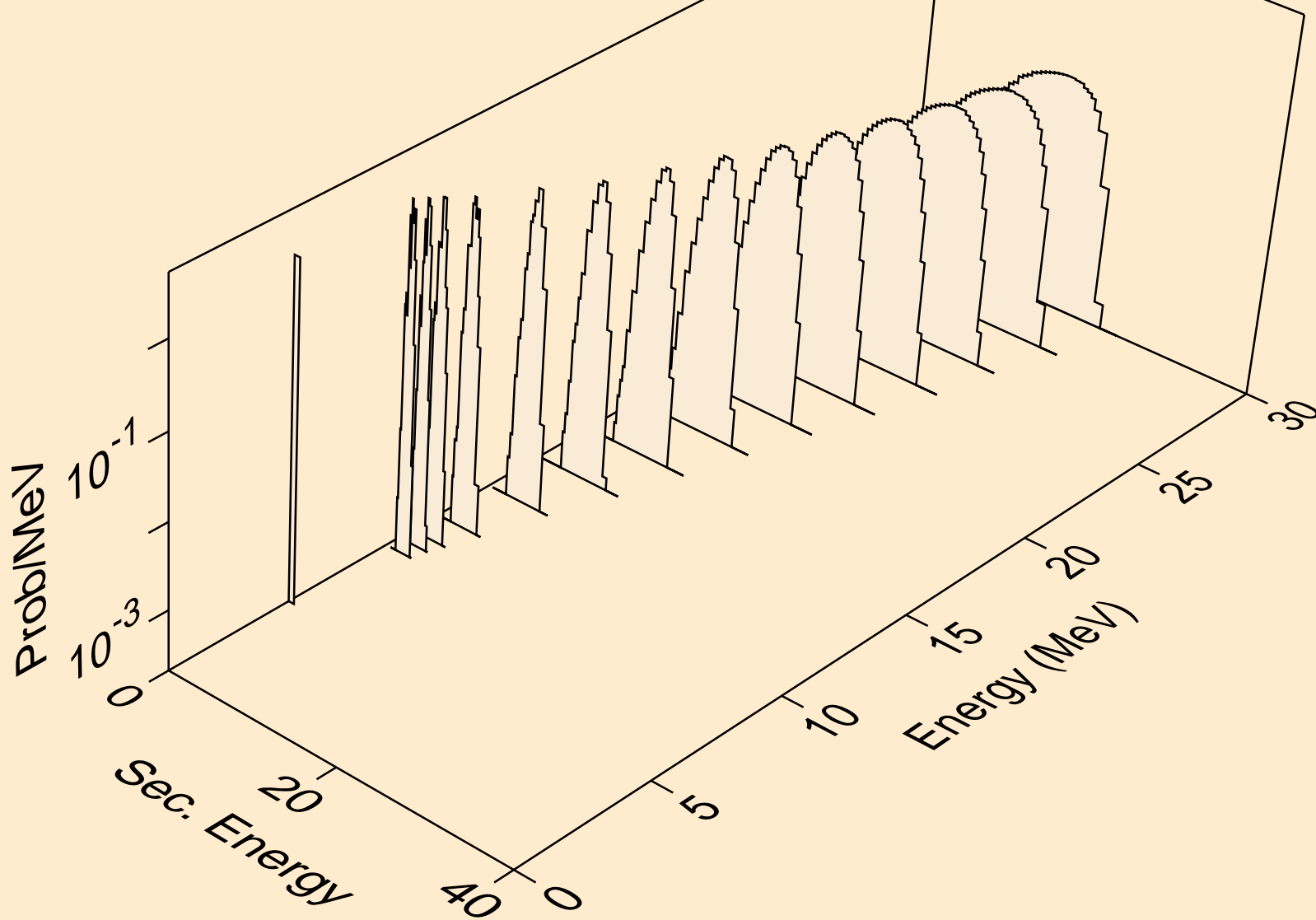

BA121 NEUTRON ACER TENDL-2019 LIBRARY; T=293.16K  
deuterons from (n,da)

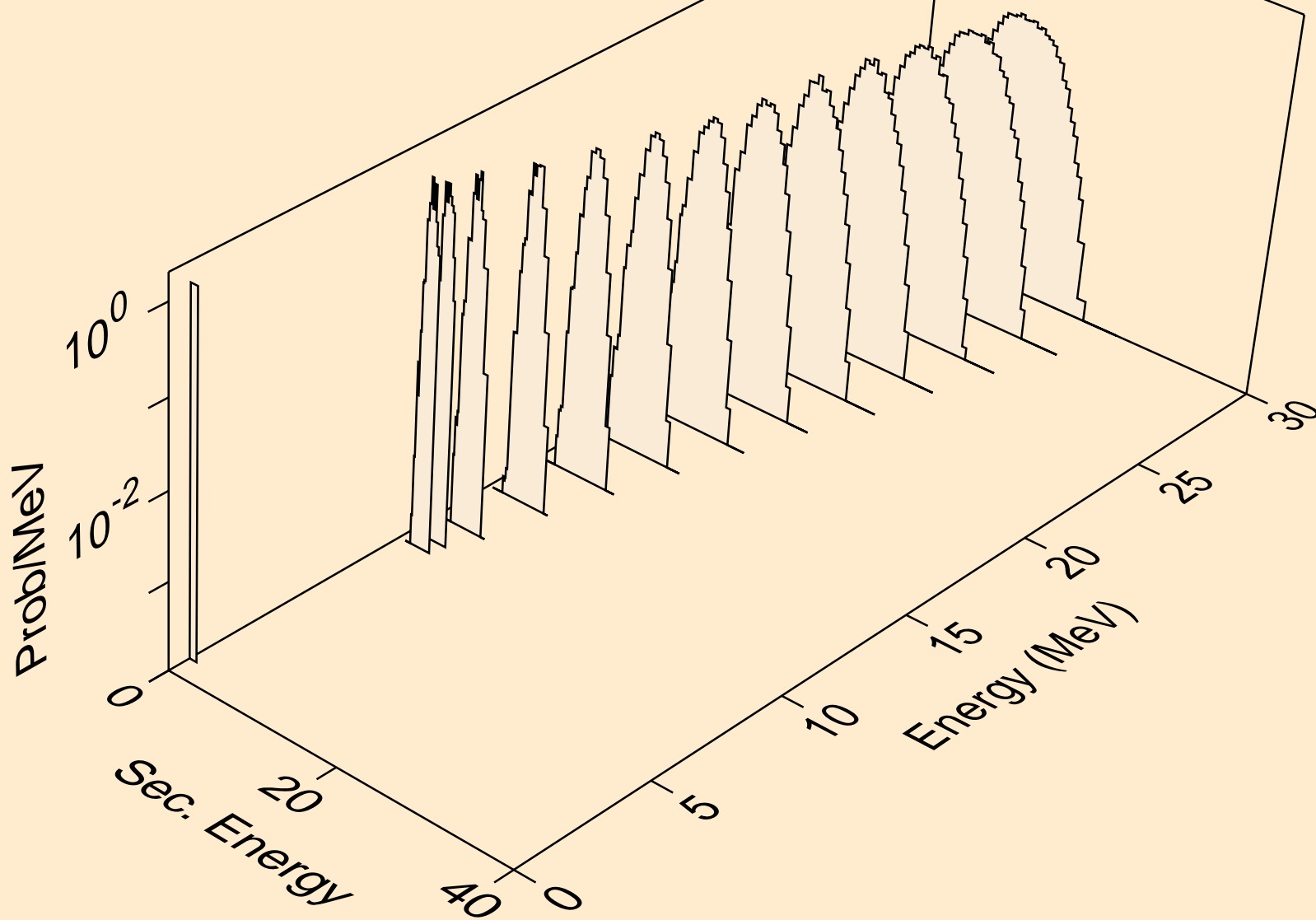



BA121 NEUTRON ACER TENDL-2019 LIBRARY; T=293.16K  
tritons from (n,x)

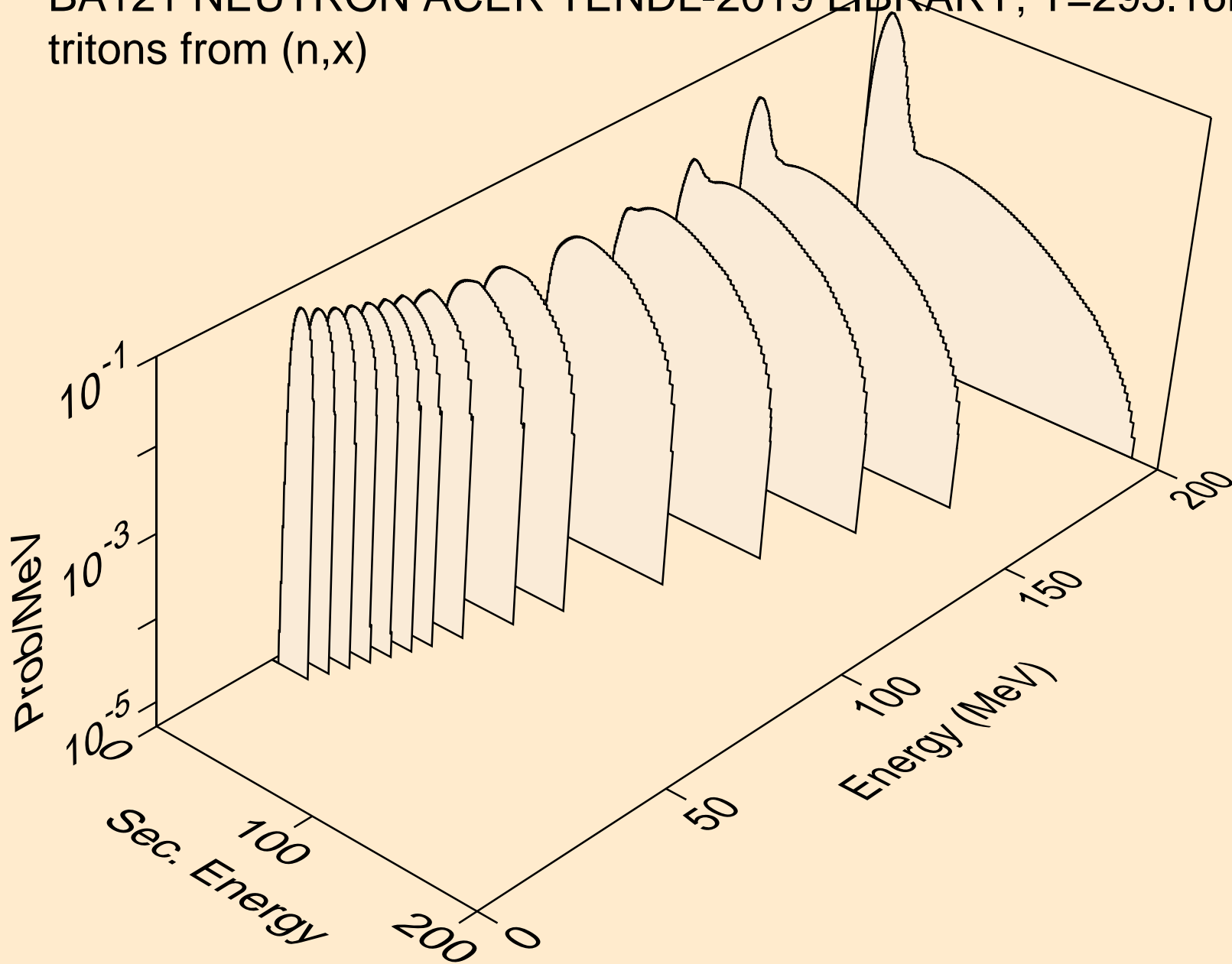

BA121 NEUTRON ACER TENDL-2019 LIBRARY; T=293.16K  
tritons from (n,n\*)t

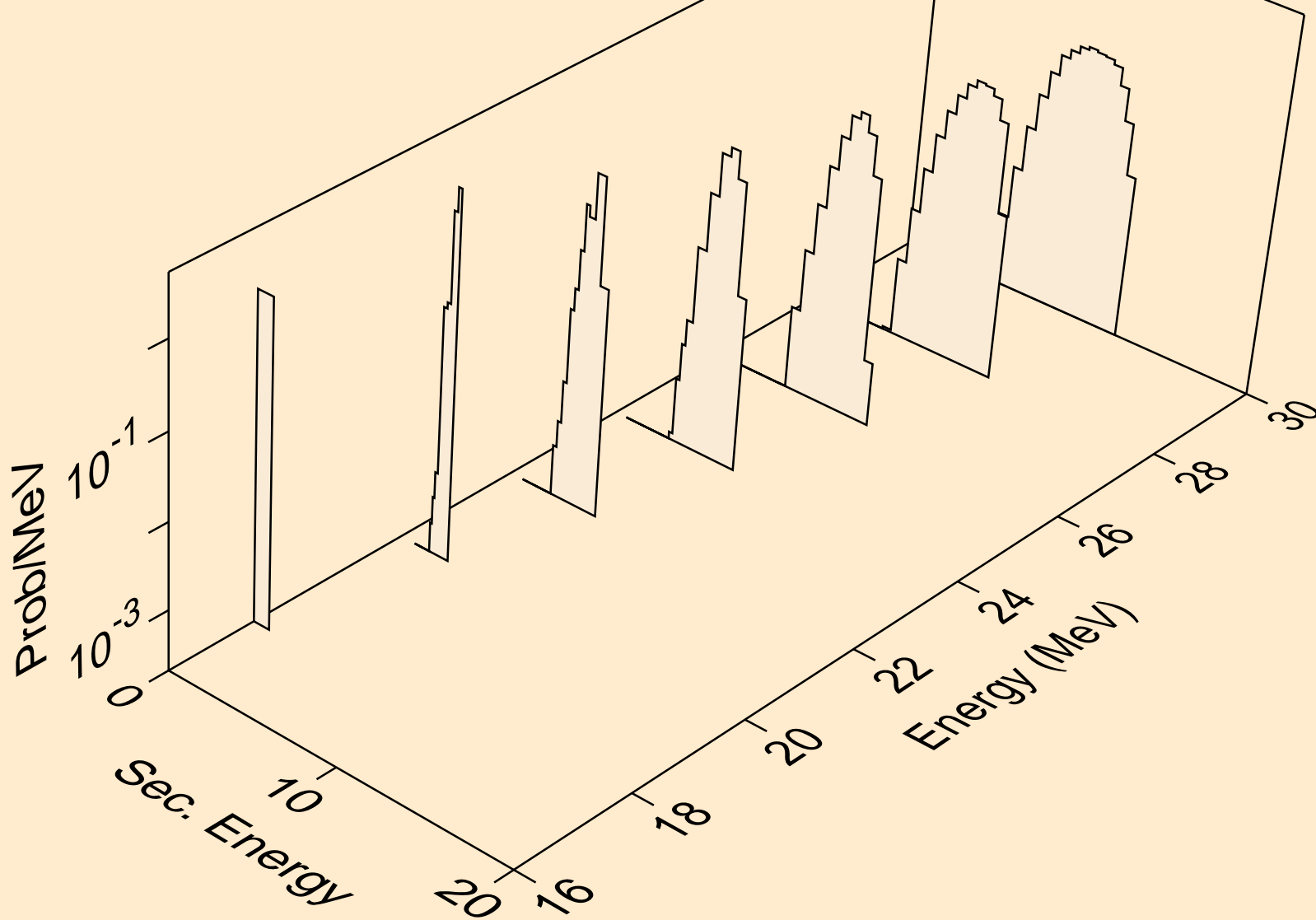

BA121 NEUTRON ACER TENDL-2019 LIBRARY; T=293.16K  
tritons from (n,t)

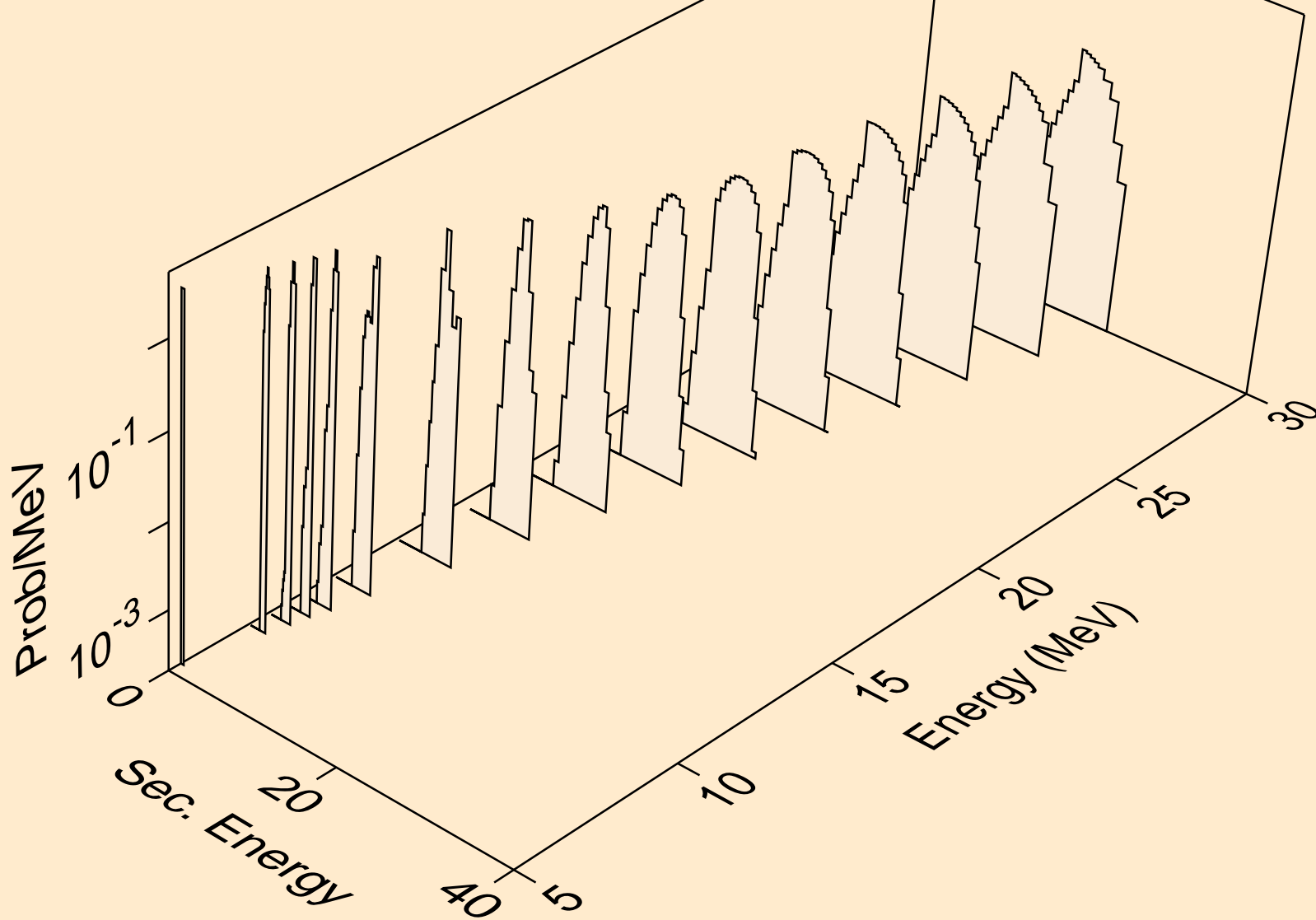

BA121 NEUTRON ACER TENDL-2019 LIBRARY; T=293.16K  
tritons from (n,pt)

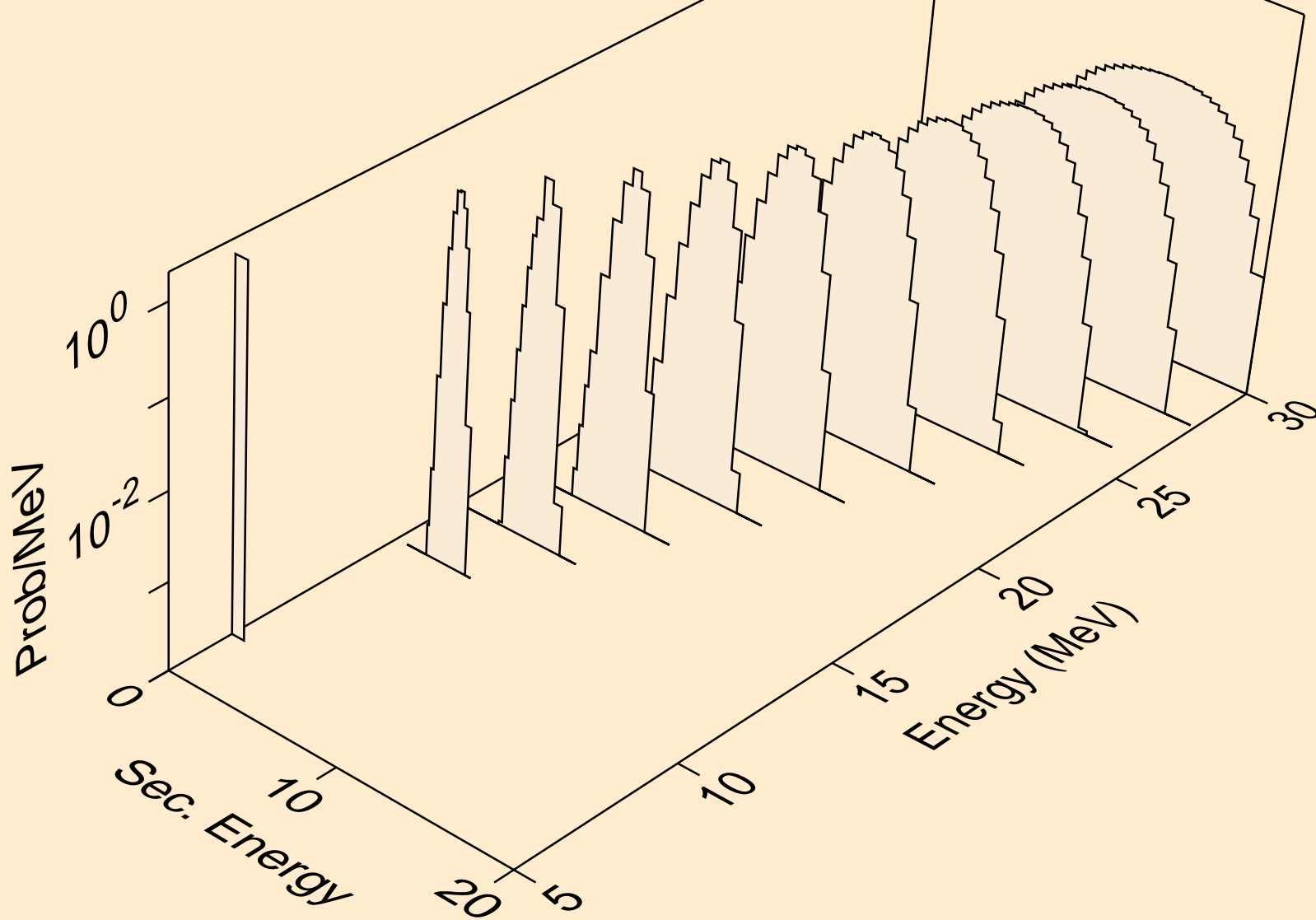

BA121 NEUTRON ACER TENDL-2019 LIBRARY; T=293.16K  
he3s from (n,x)

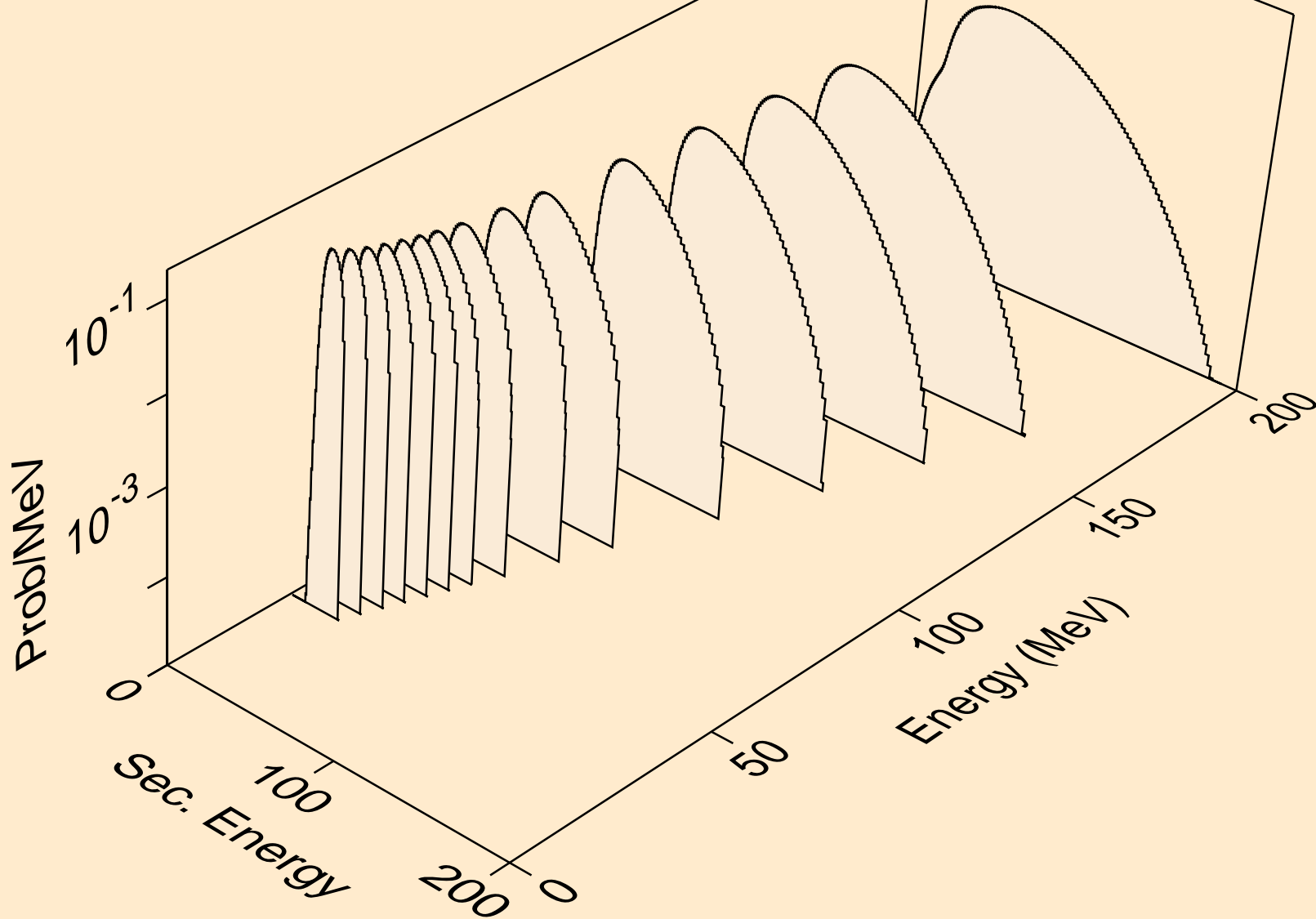

BA121 NEUTRON ACER TENDL-2019 LIBRARY; T=293.16K  
he3s from (n,n\*)he3

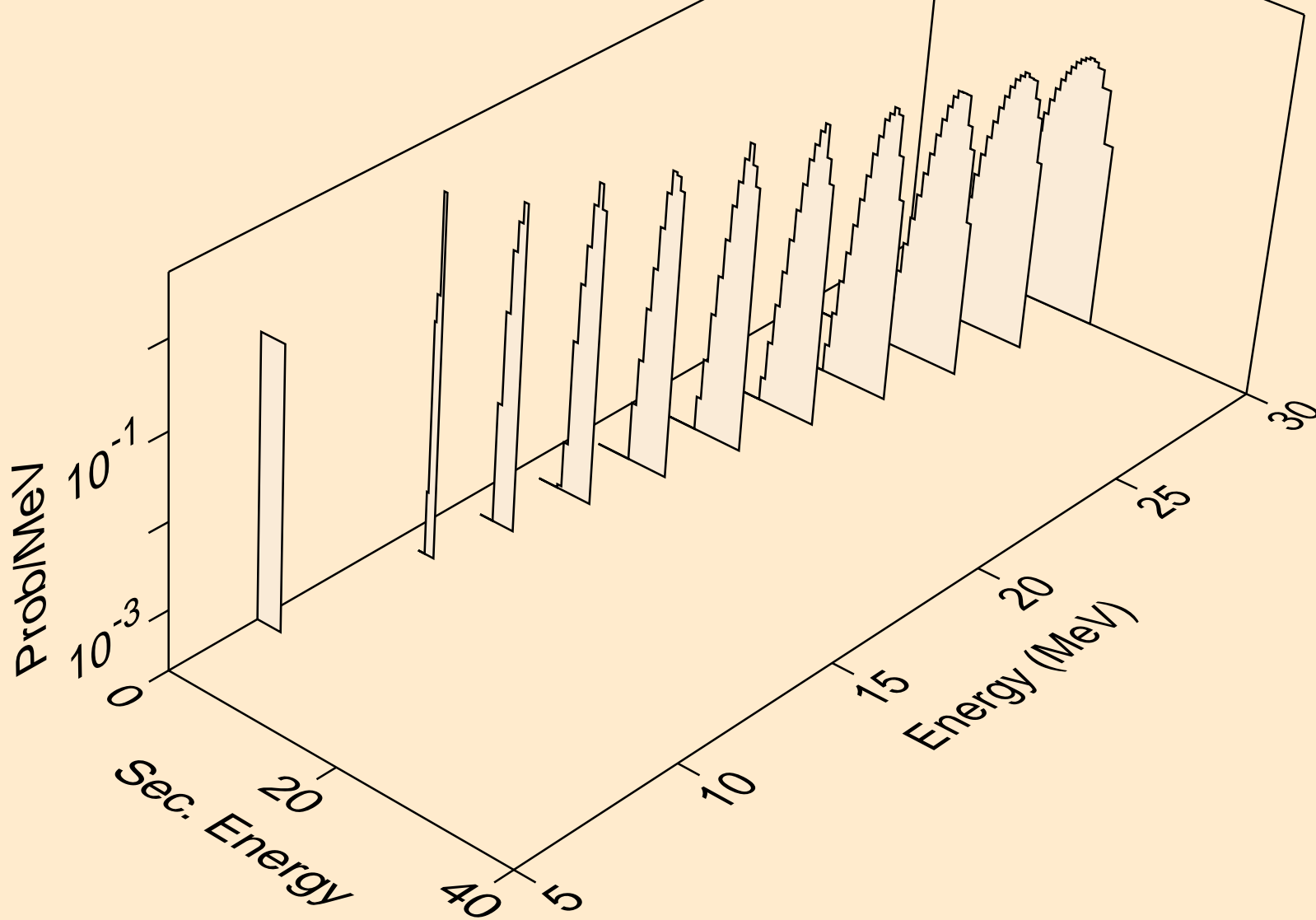

BA121 NEUTRON ACER TENDL-2019 LIBRARY; T=293.16K  
he3s from (n,he3)

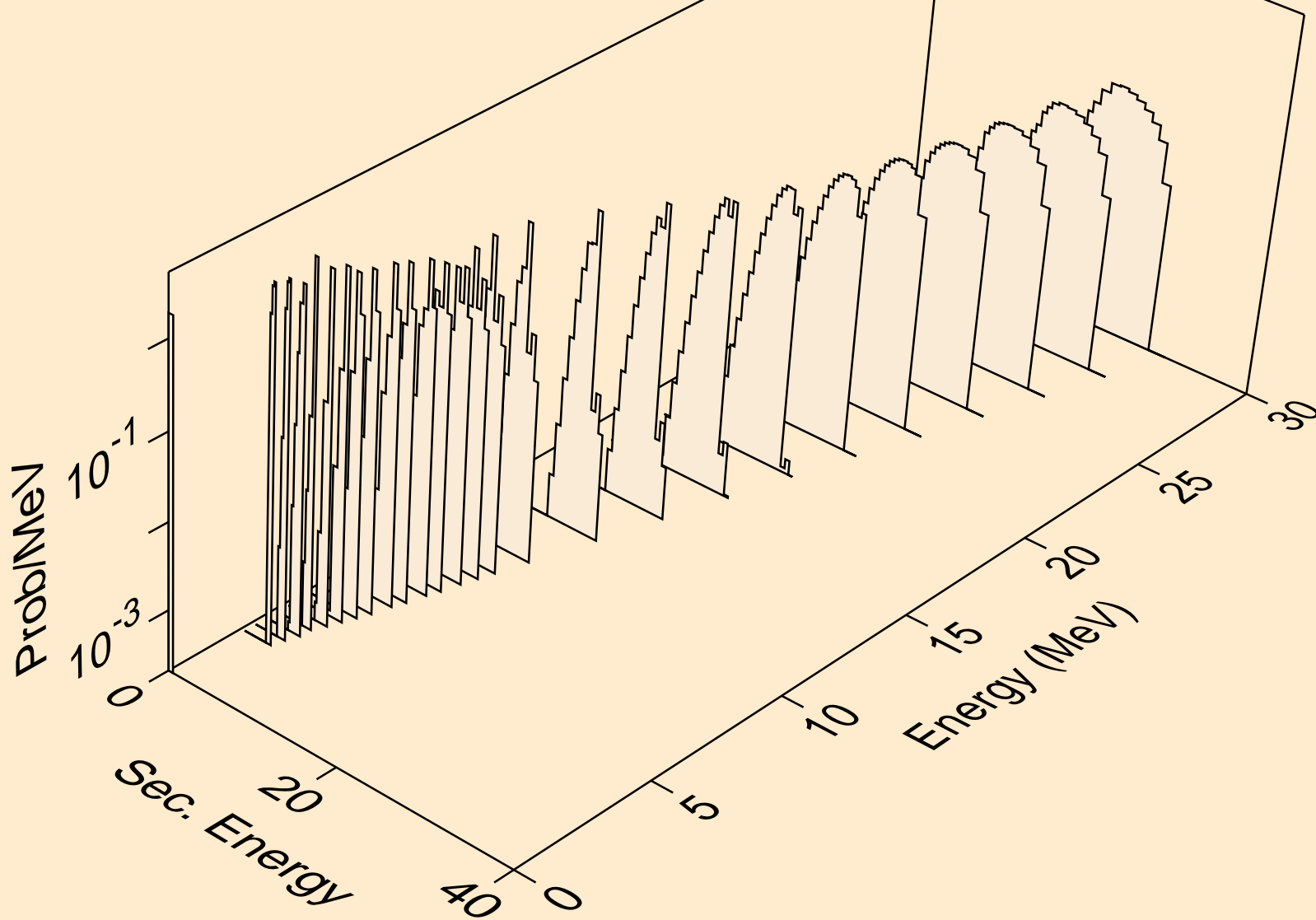

BA121 NEUTRON ACER TENDL-2019 LIBRARY; T=293.16K  
alphas from (n,x)

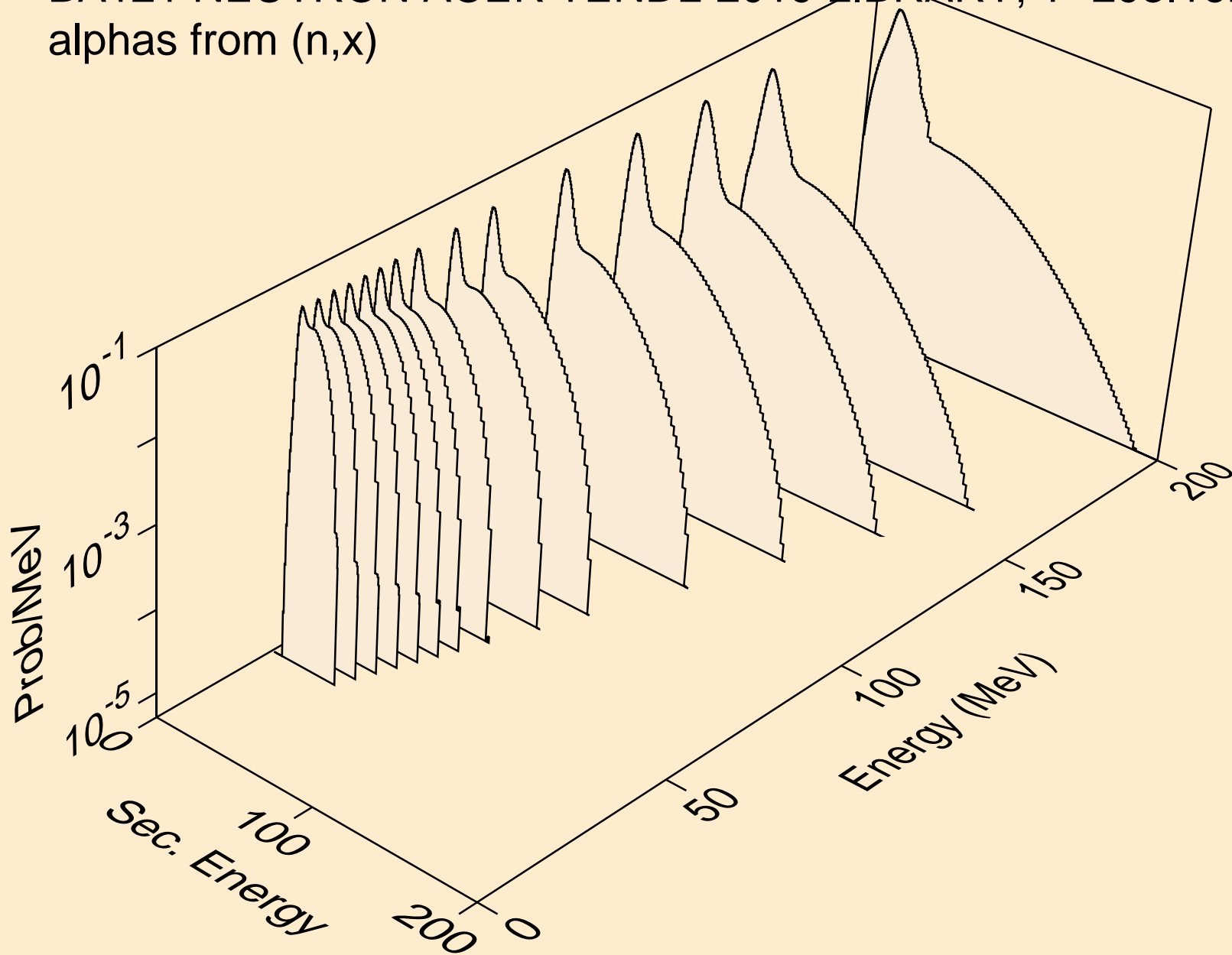



BA121 NEUTRON ACER TENDL-2019 LIBRARY; T=293.16K  
alphas from (n,n\*)a

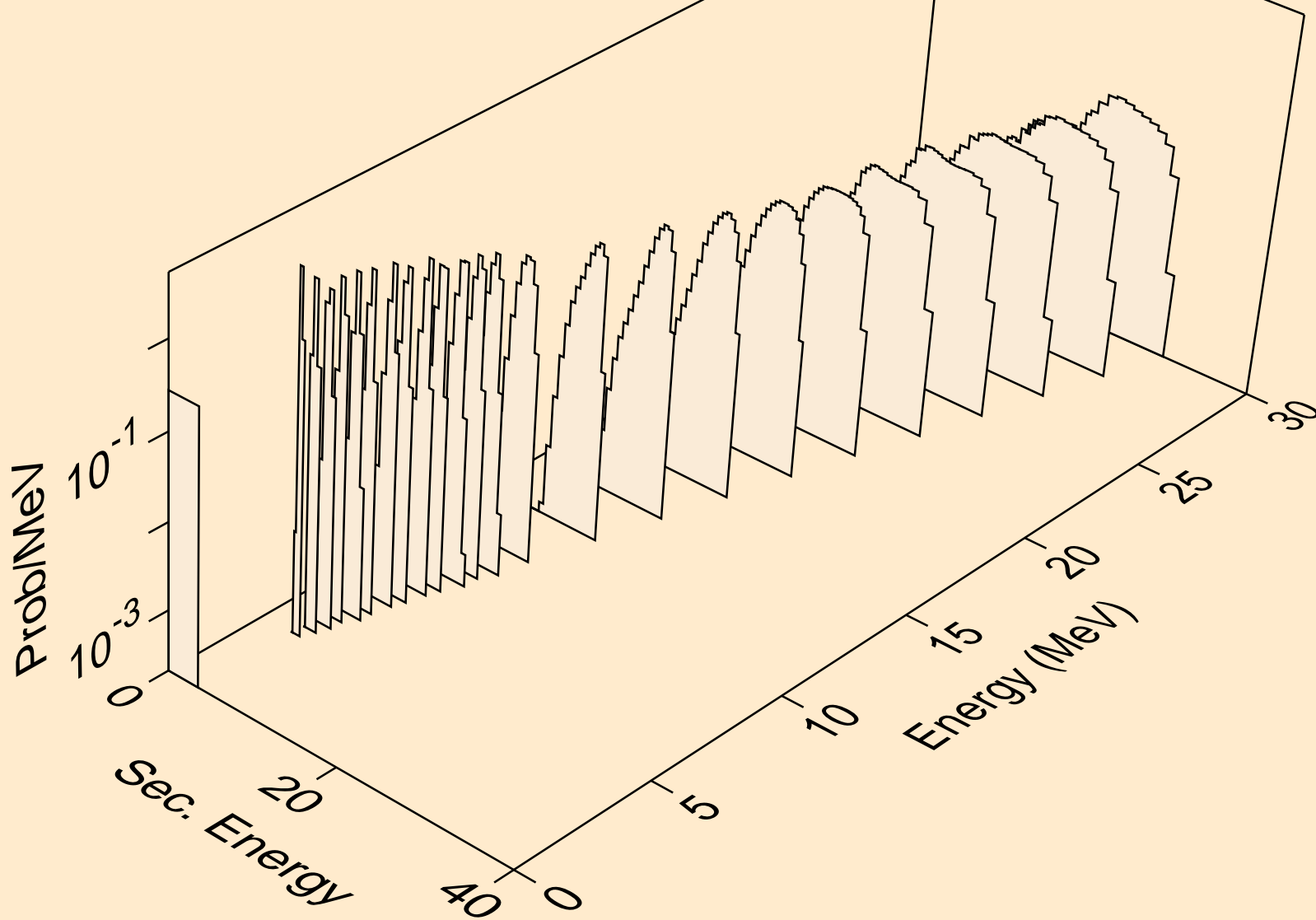

BA121 NEUTRON ACER TENDL-2019 LIBRARY; T=293.16K  
alphas from (n,n\*)3a

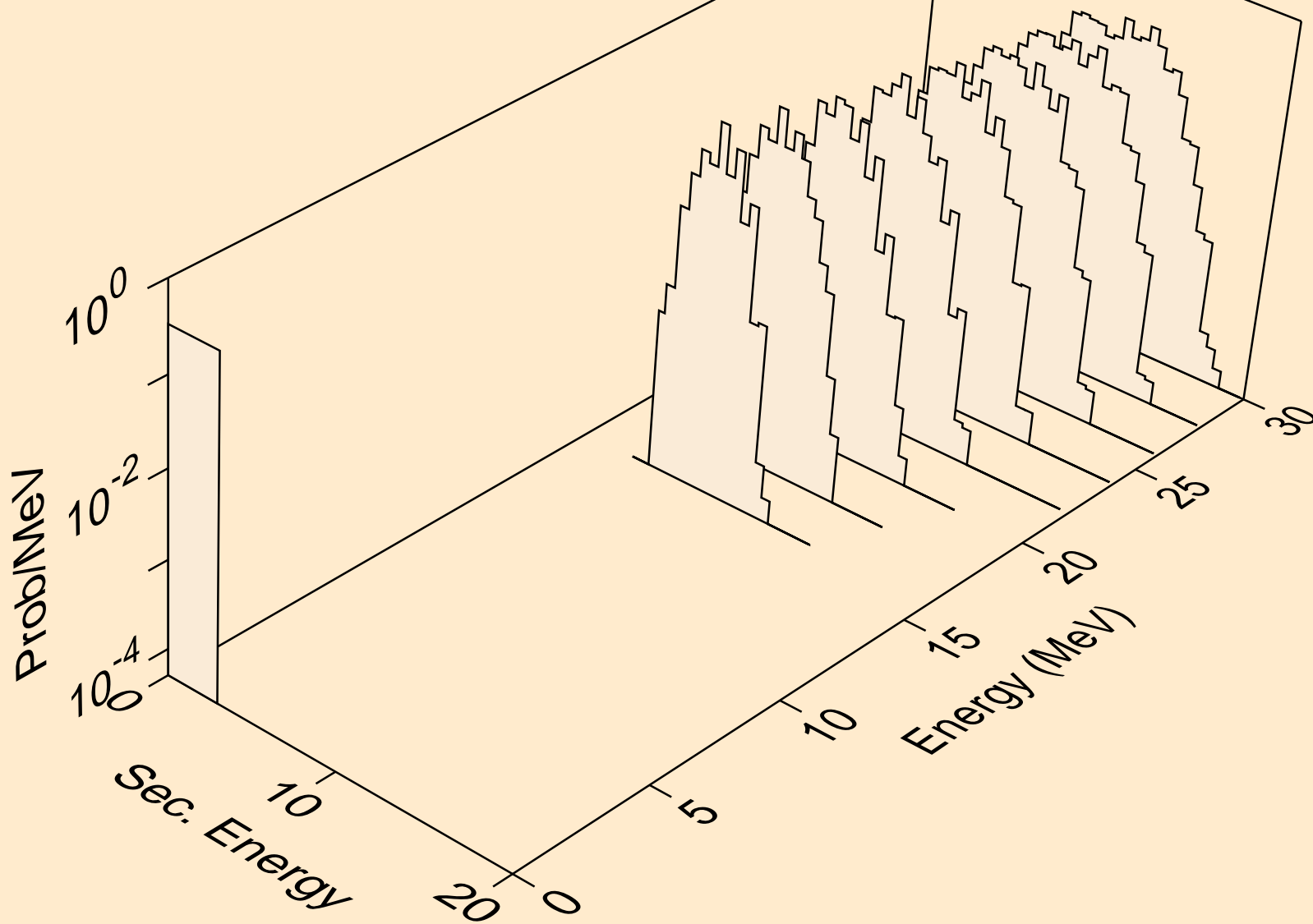

BA121 NEUTRON ACER TENDL-2019 LIBRARY; T=293.16K  
alphas from (n,2n)a

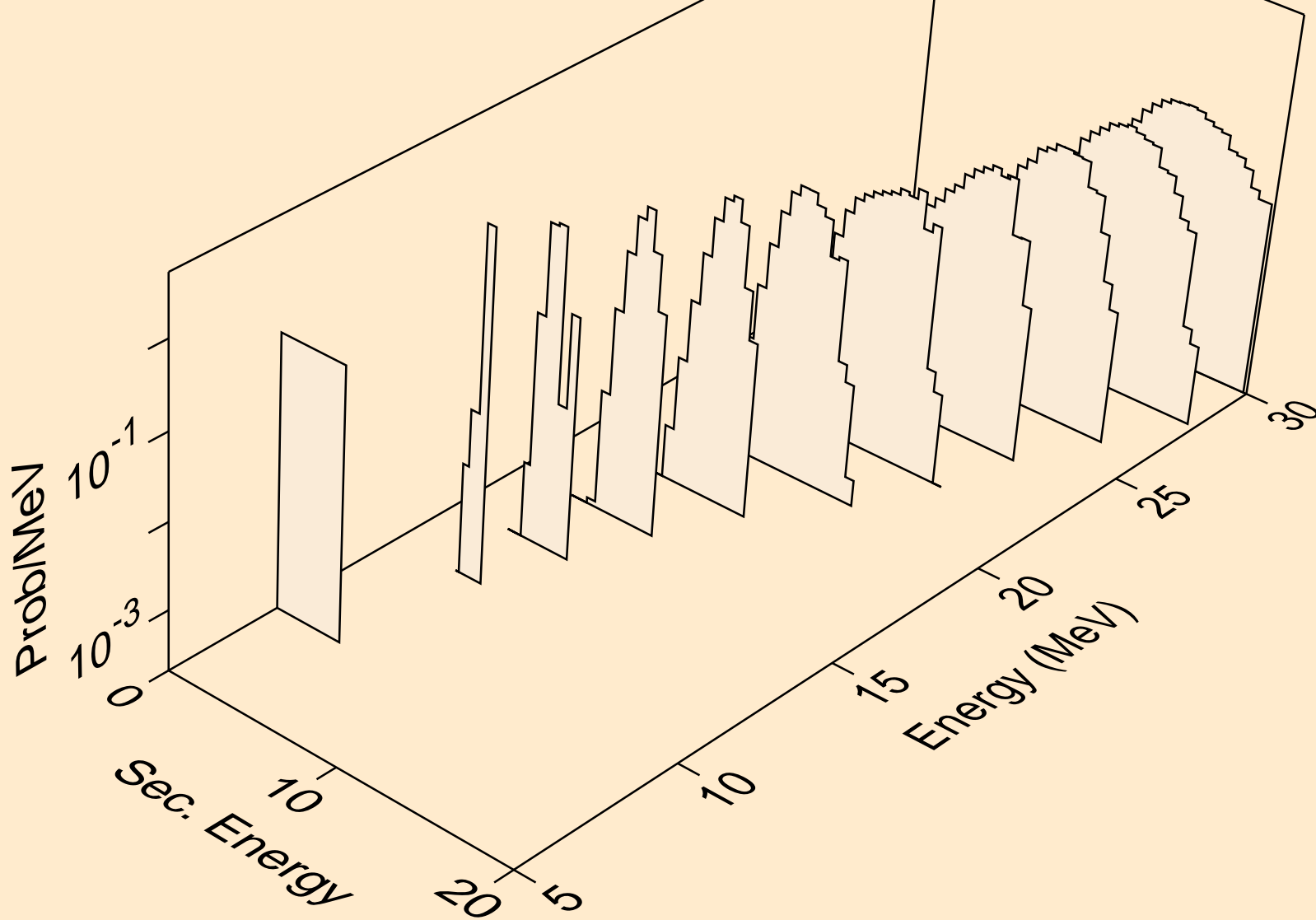

BA121 NEUTRON ACER TENDL-2019 LIBRARY; T=293.16K  
alphas from (n,3n)a

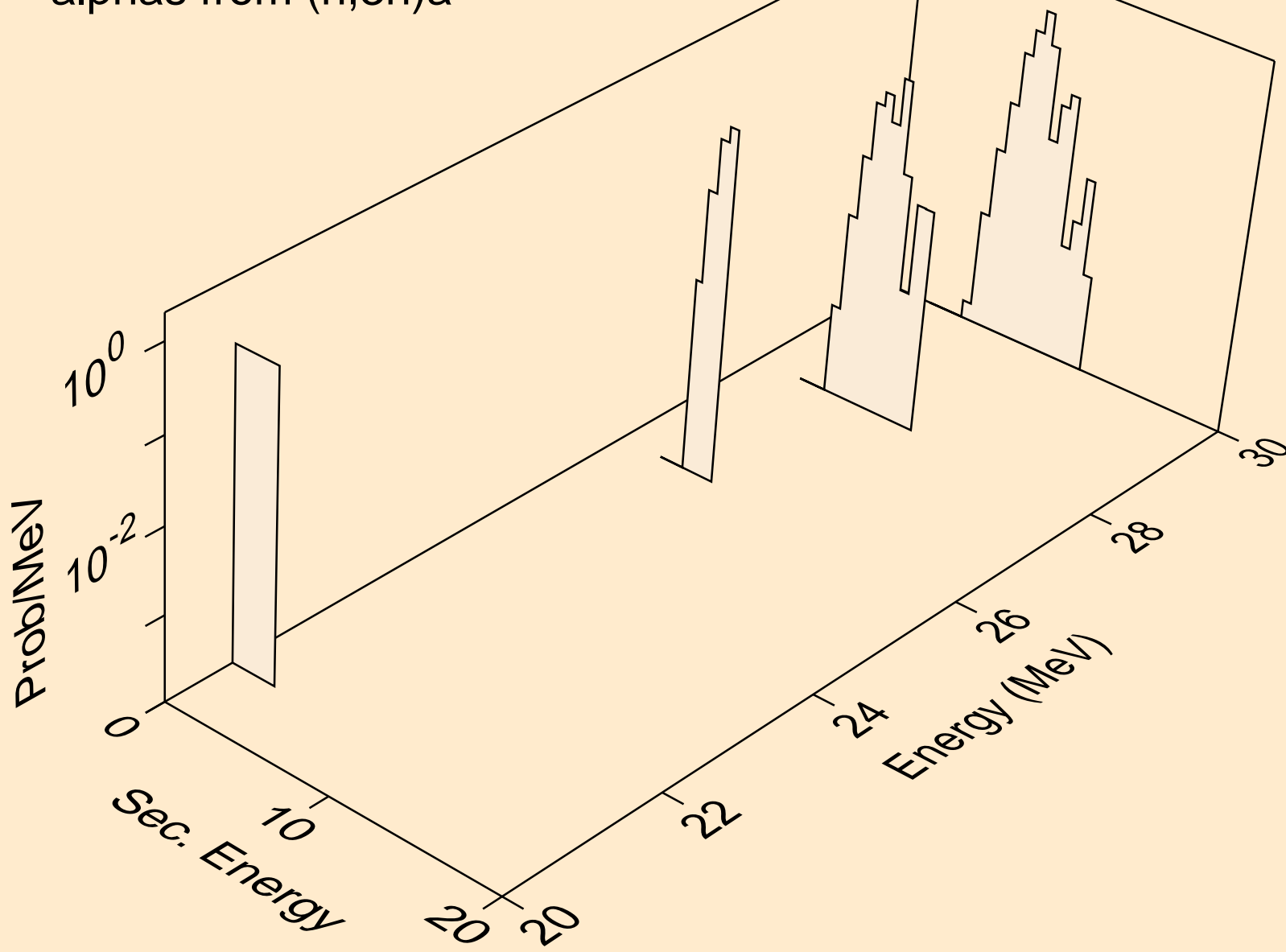

BA121 NEUTRON ACER TENDL-2019 LIBRARY; T=293.16K  
alphas from (n,n\*)2a

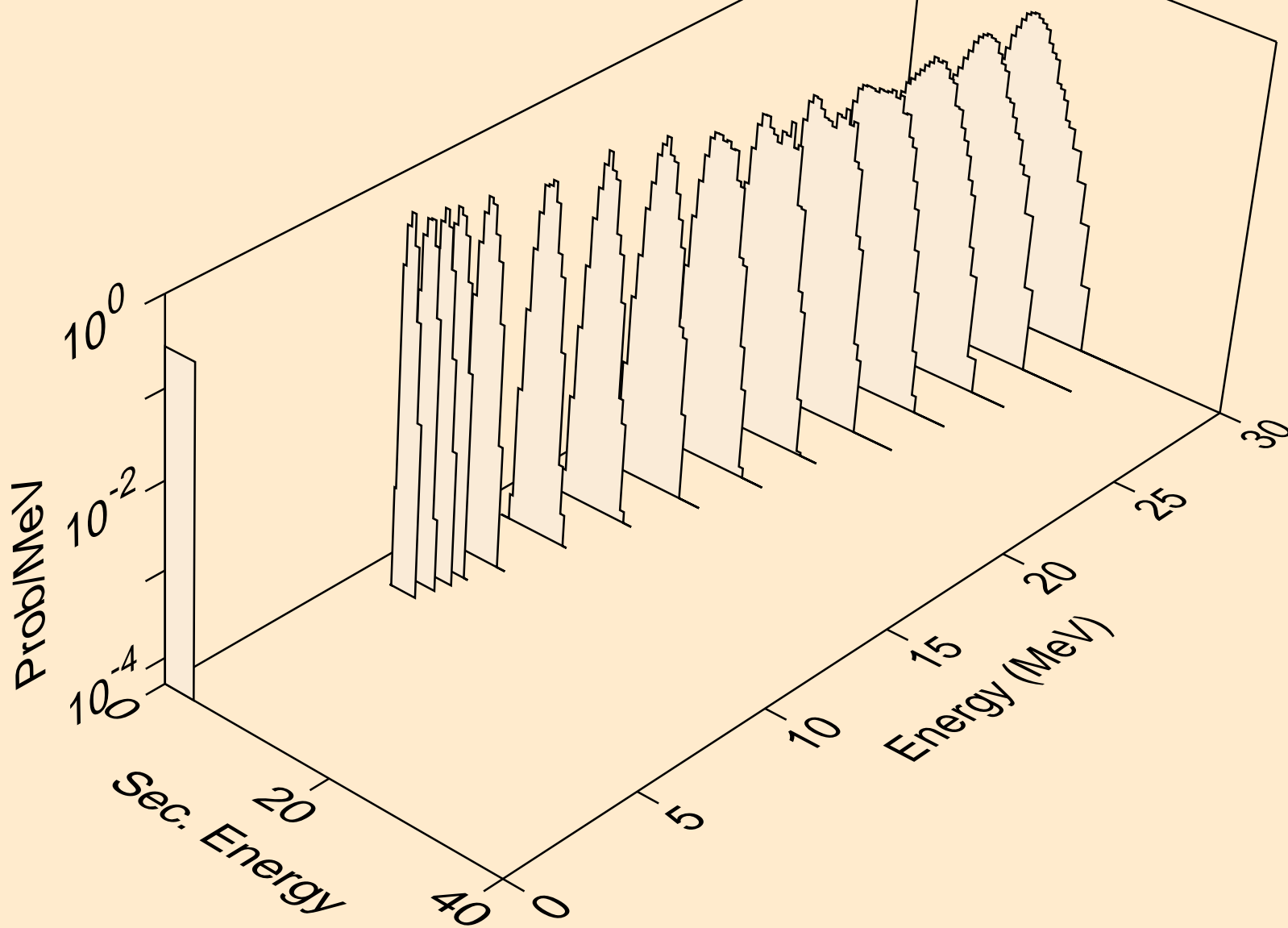

BA121 NEUTRON ACER TENDL-2019 LIBRARY; T=293.16K  
alphas from (n,2n)2a

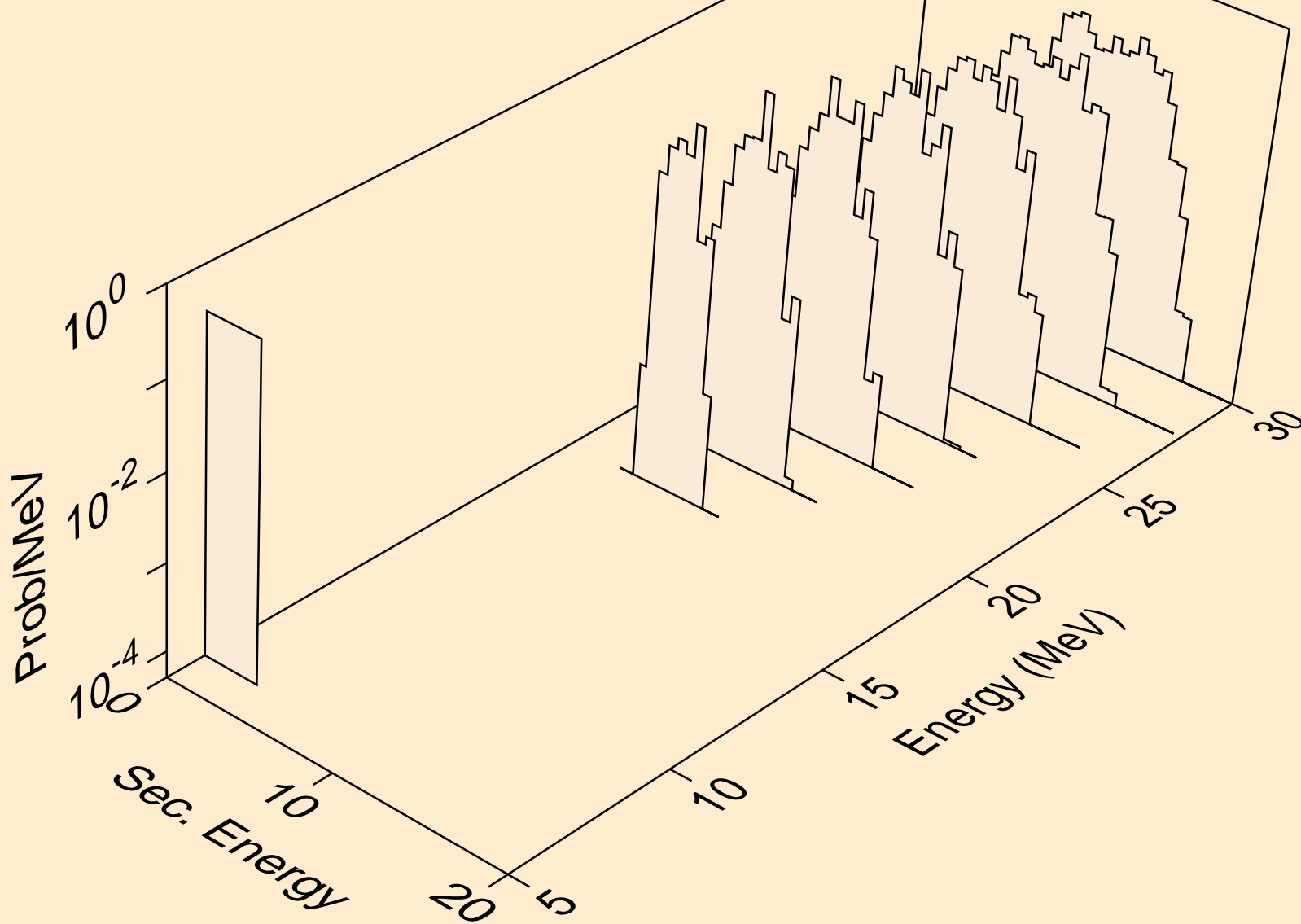

BA121 NEUTRON ACER TENDL-2019 LIBRARY; T=293.16K  
alphas from (n,npa)

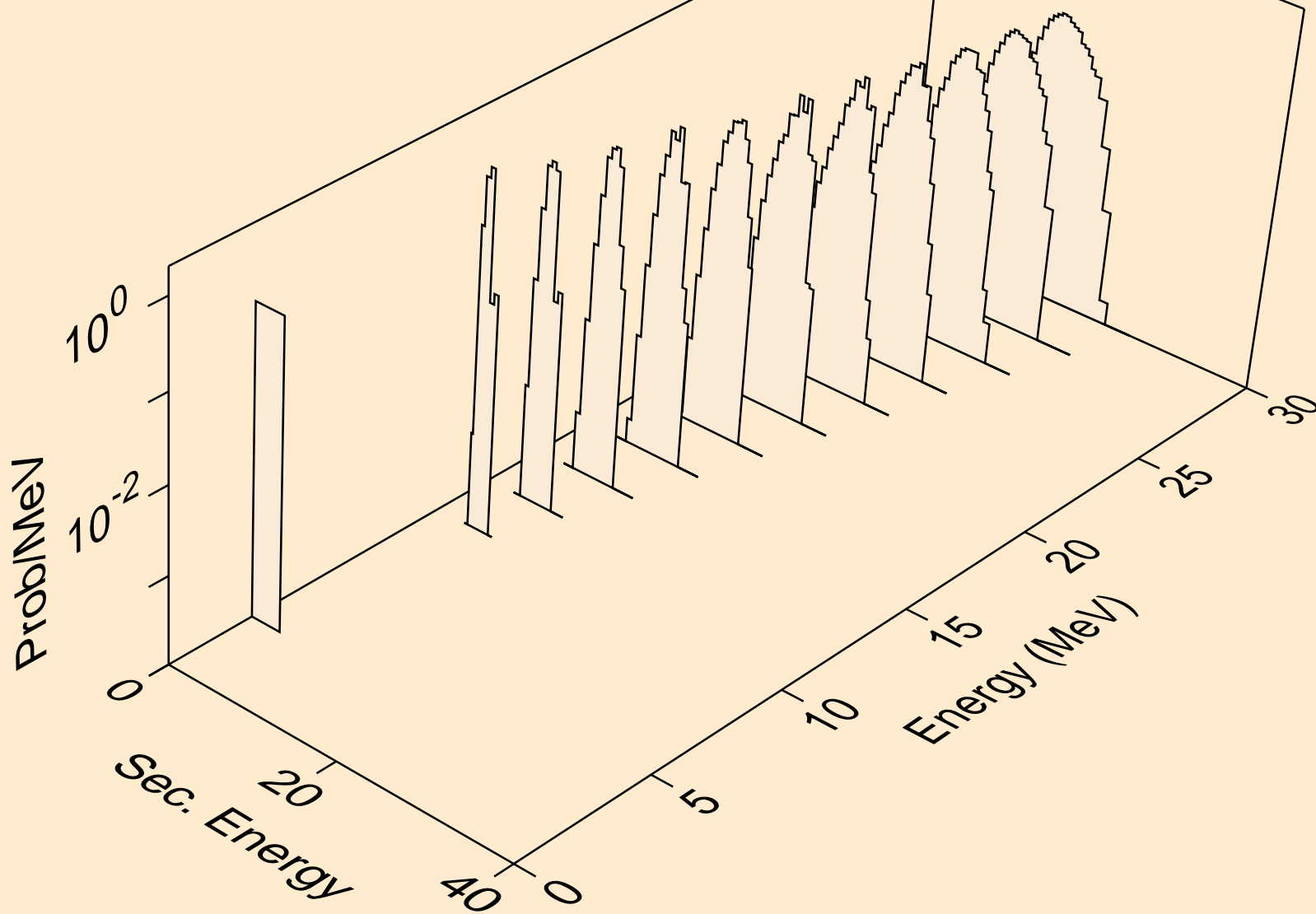

BA121 NEUTRON ACER TENDL-2019 LIBRARY; T=293.16K  
alphas from (n,a)

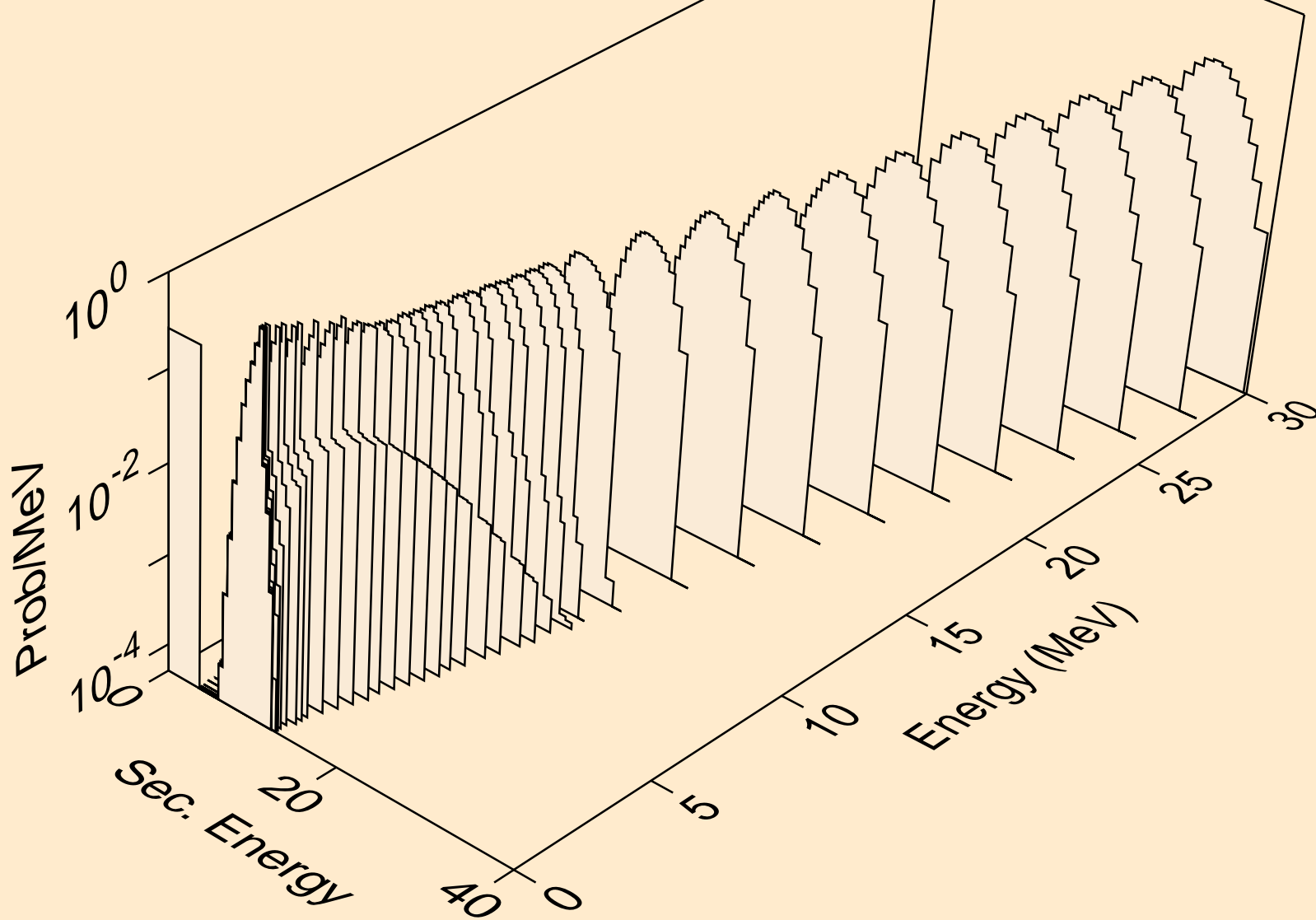



BA121 NEUTRON ACER TENDL-2019 LIBRARY; T=293.16K  
alphas from (n,2a)

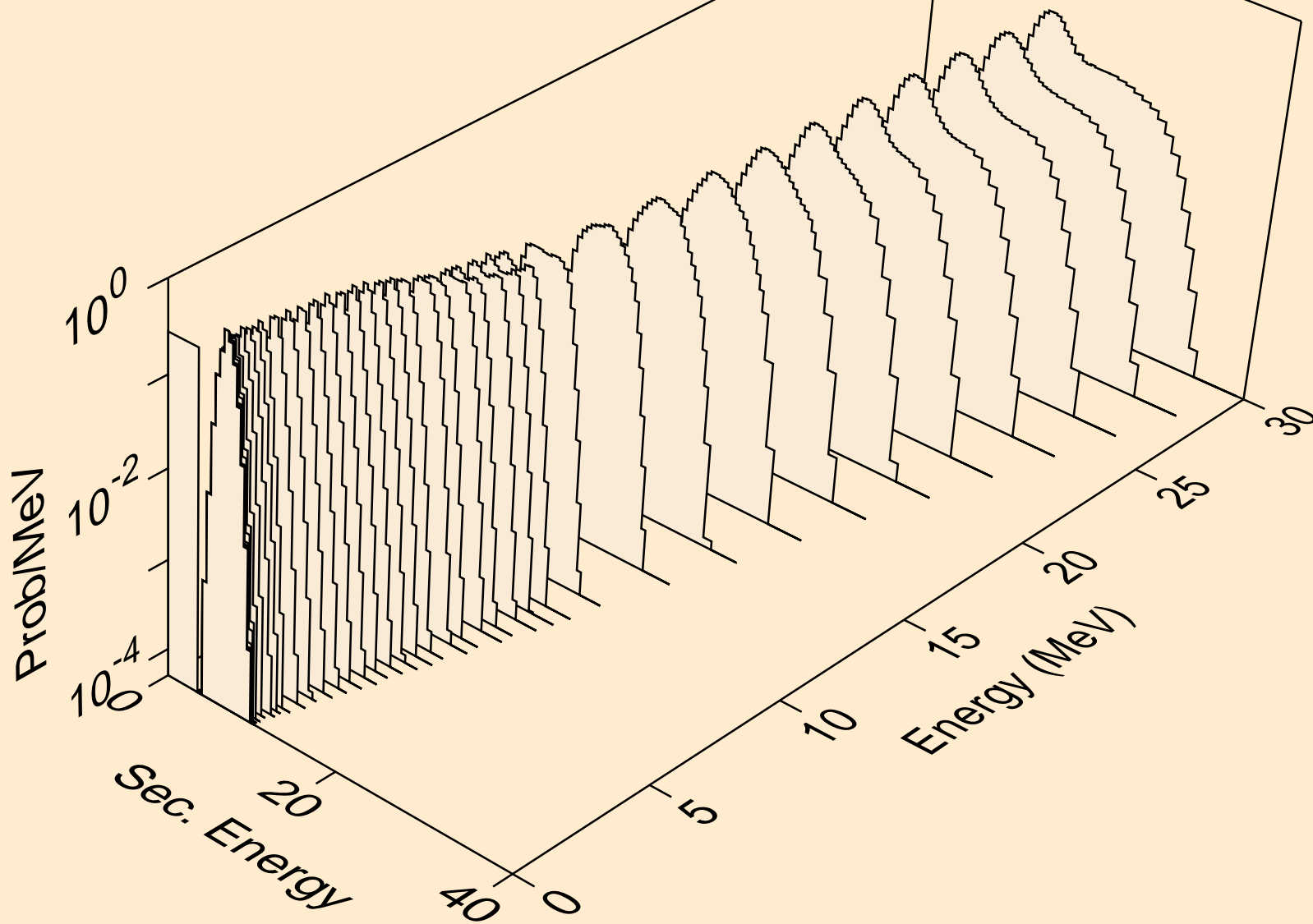

BA121 NEUTRON ACER TENDL-2019 LIBRARY; T=293.16K  
alphas from (n,3a)

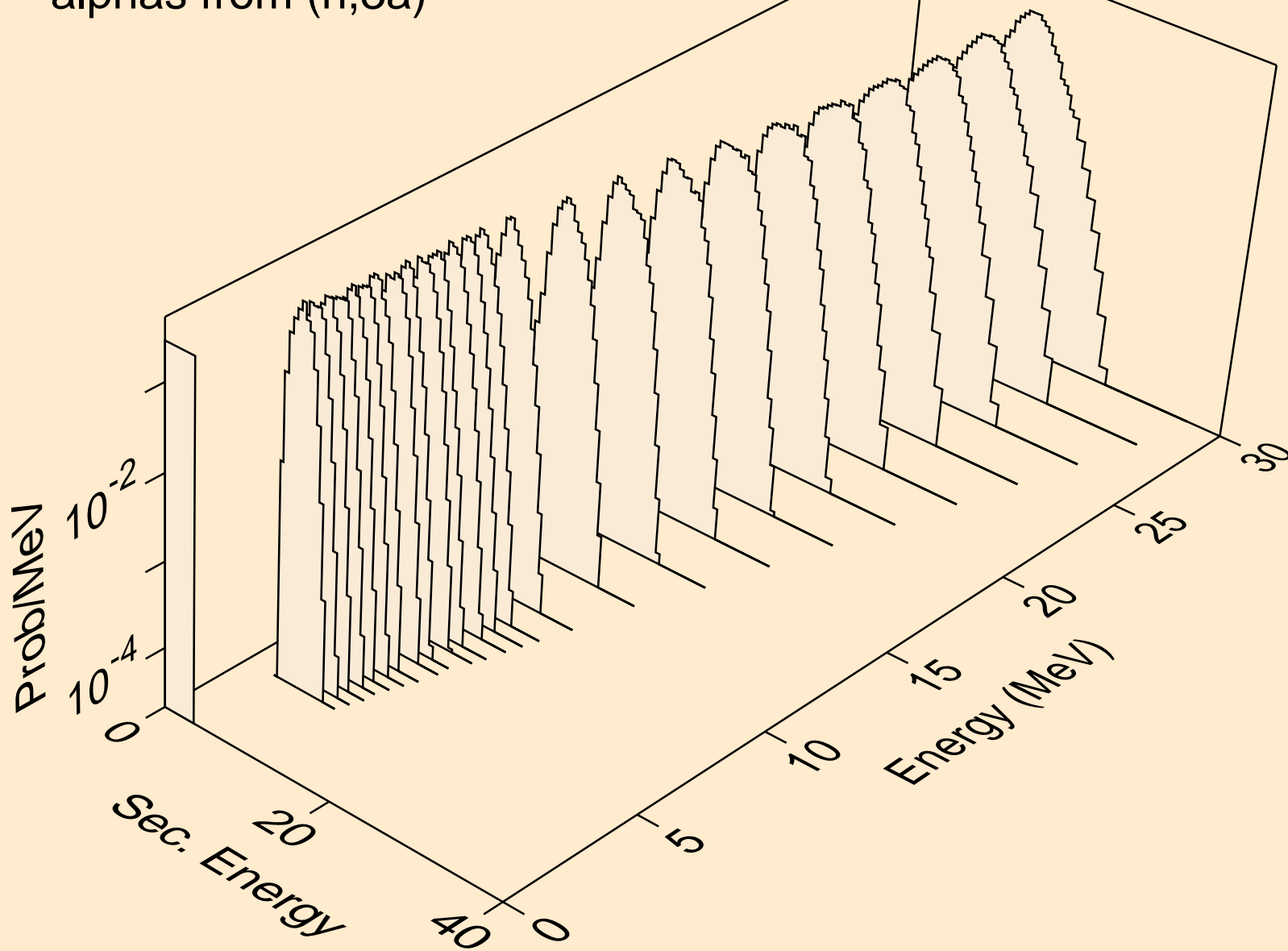

BA121 NEUTRON ACER TENDL-2019 LIBRARY; T=293.16K  
alphas from (n,pa)

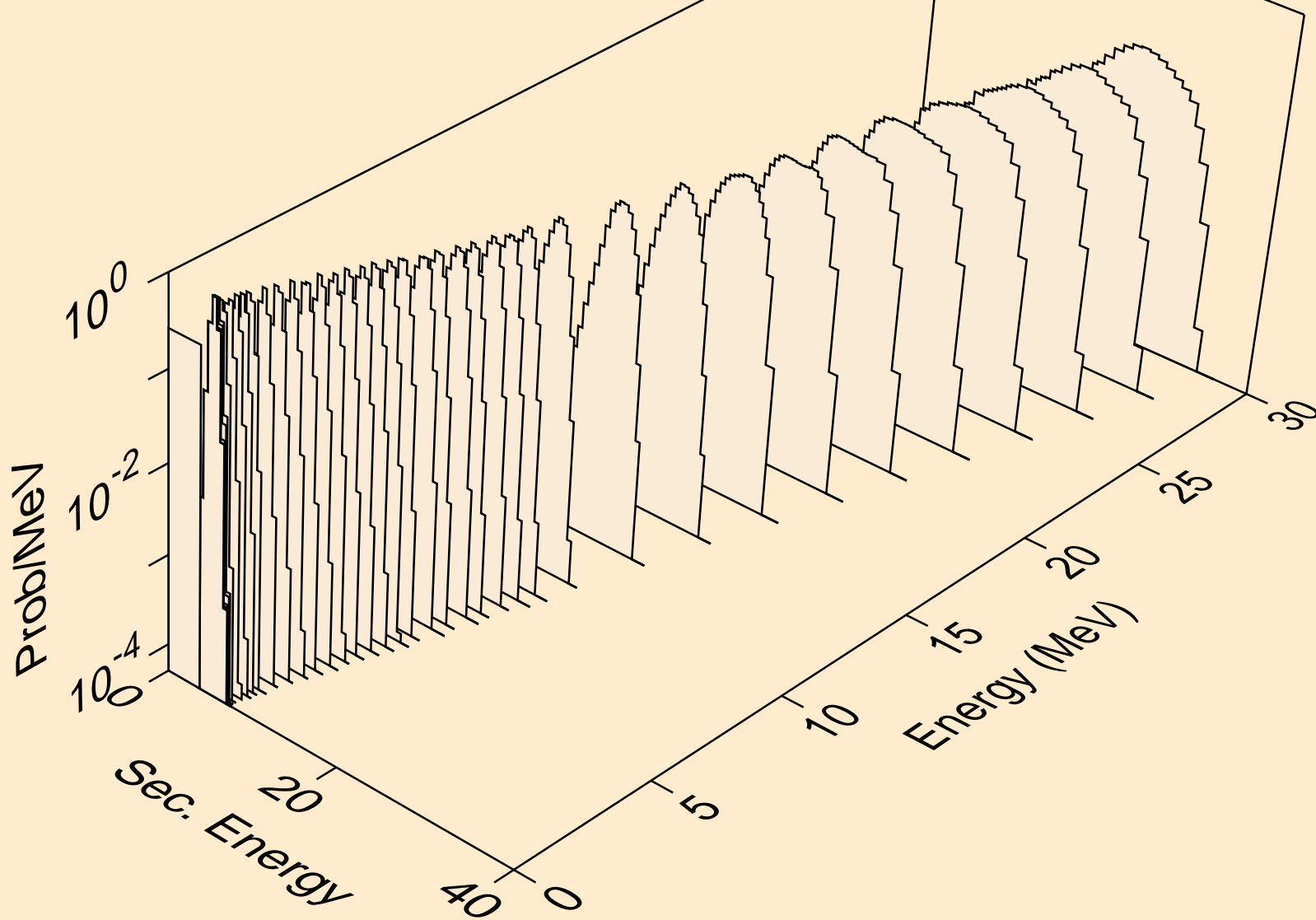

BA121 NEUTRON ACER TENDL-2019 LIBRARY; T=293.16K  
alphas from (n,d2a)

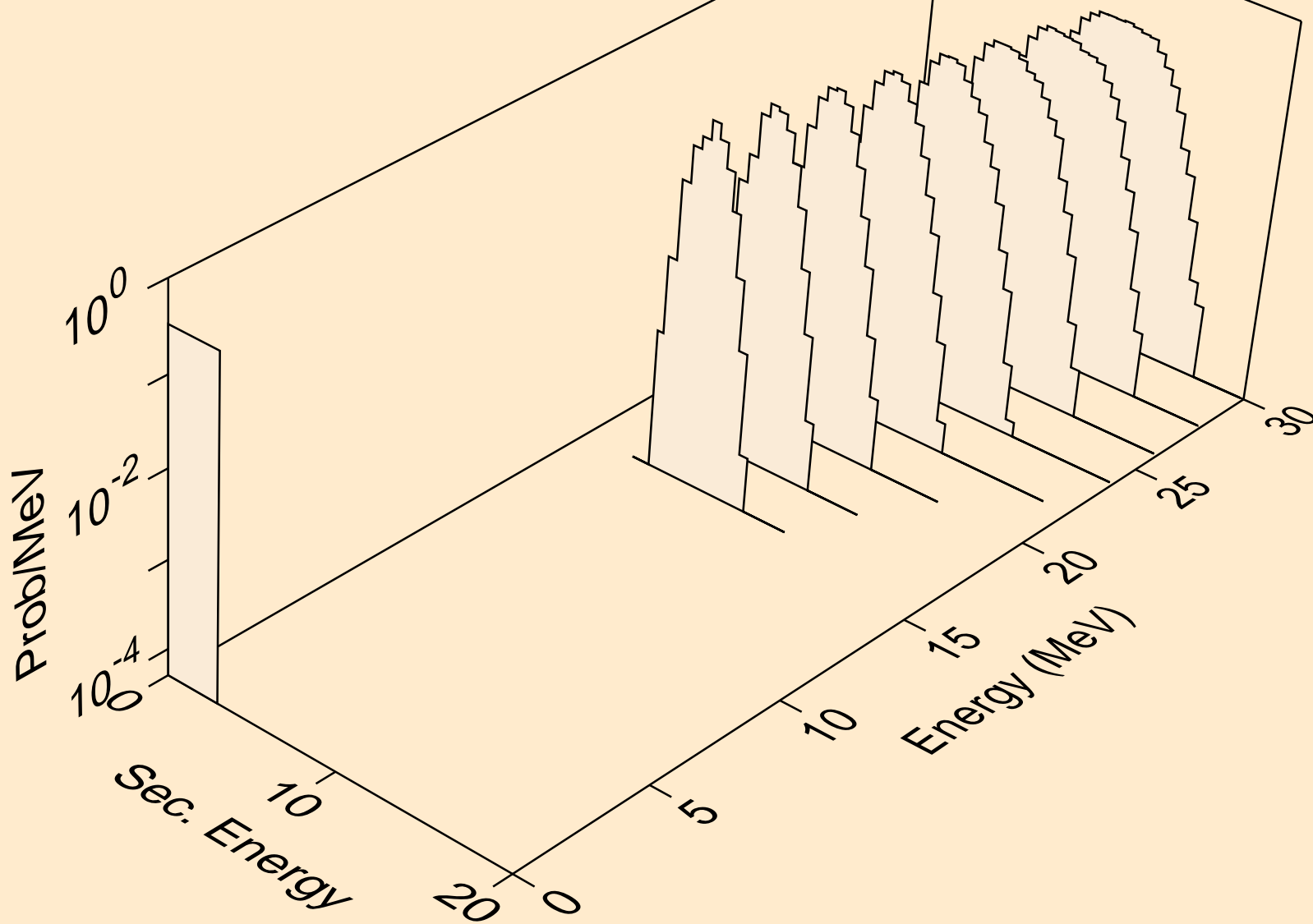

BA121 NEUTRON ACER TENDL-2019 LIBRARY; T=293.16K  
alphas from (n,da)

