

BA122 NEUTRON ACER TENDL-2019 LIBRARY; T=293.16K
Principal cross sections

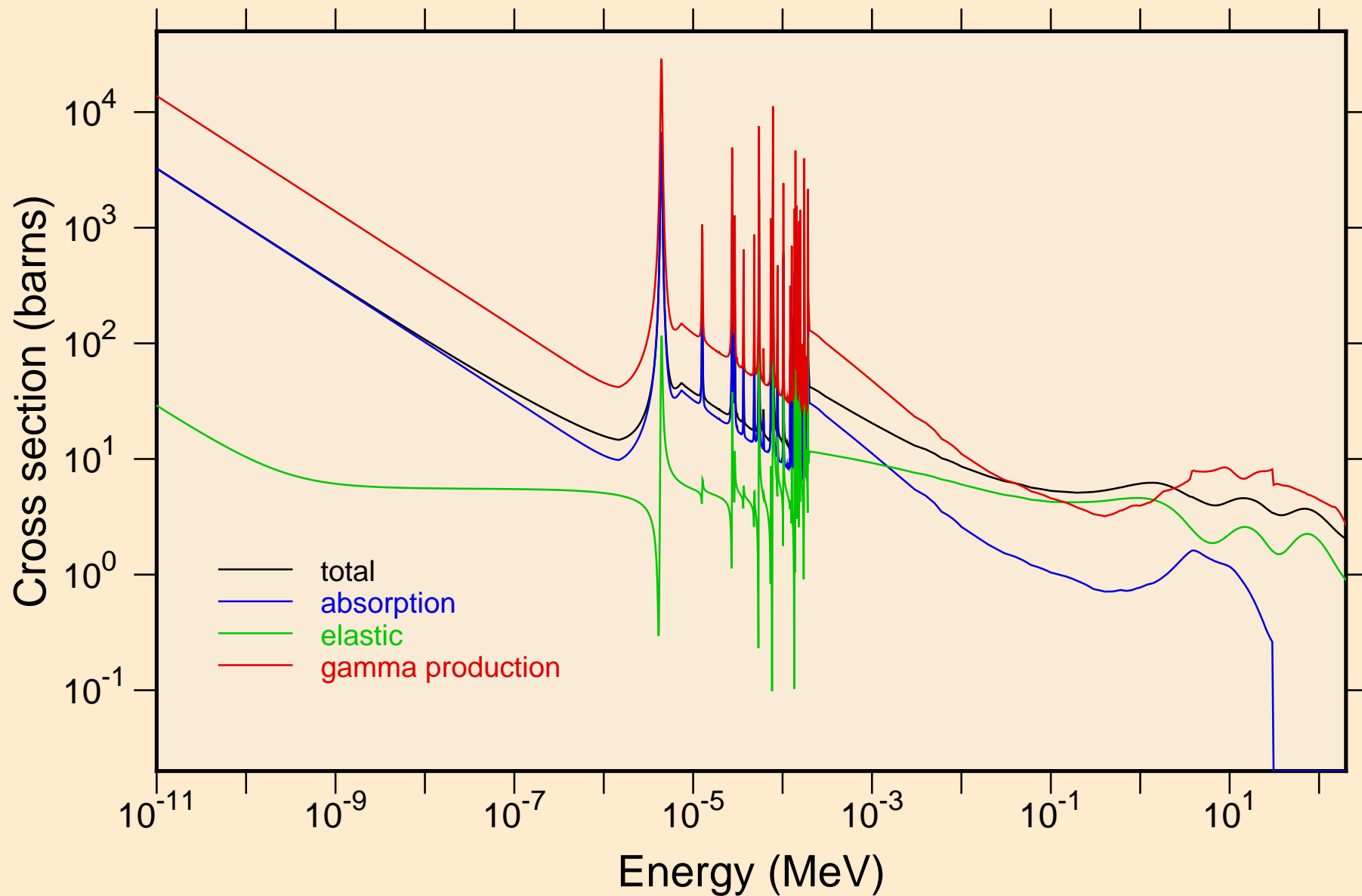

BA122 NEUTRON ACER TENDL-2019 LIBRARY; T=293.16K
resonance total cross section

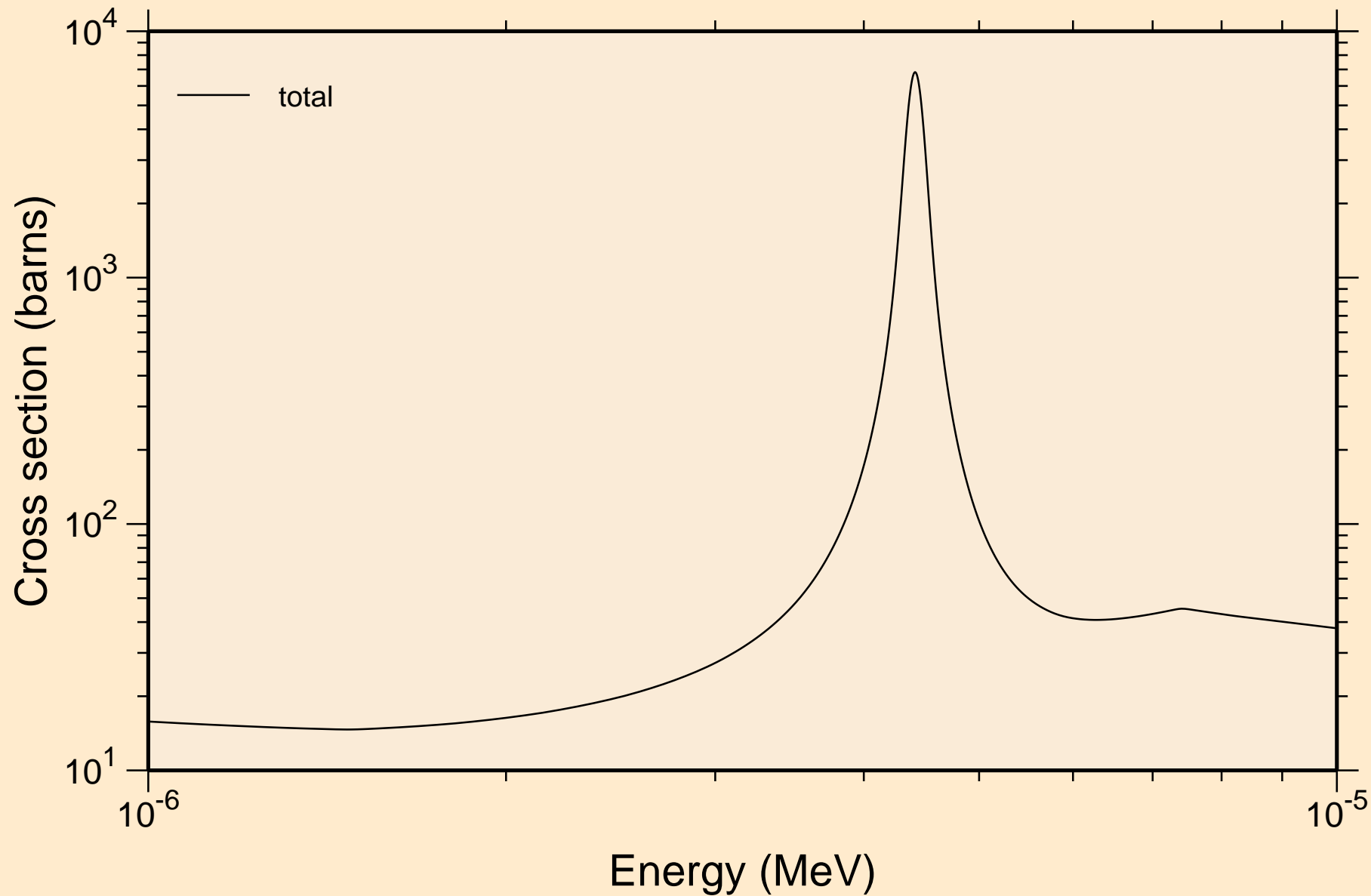

BA122 NEUTRON ACER TENDL-2019 LIBRARY; T=293.16K
resonance total cross section

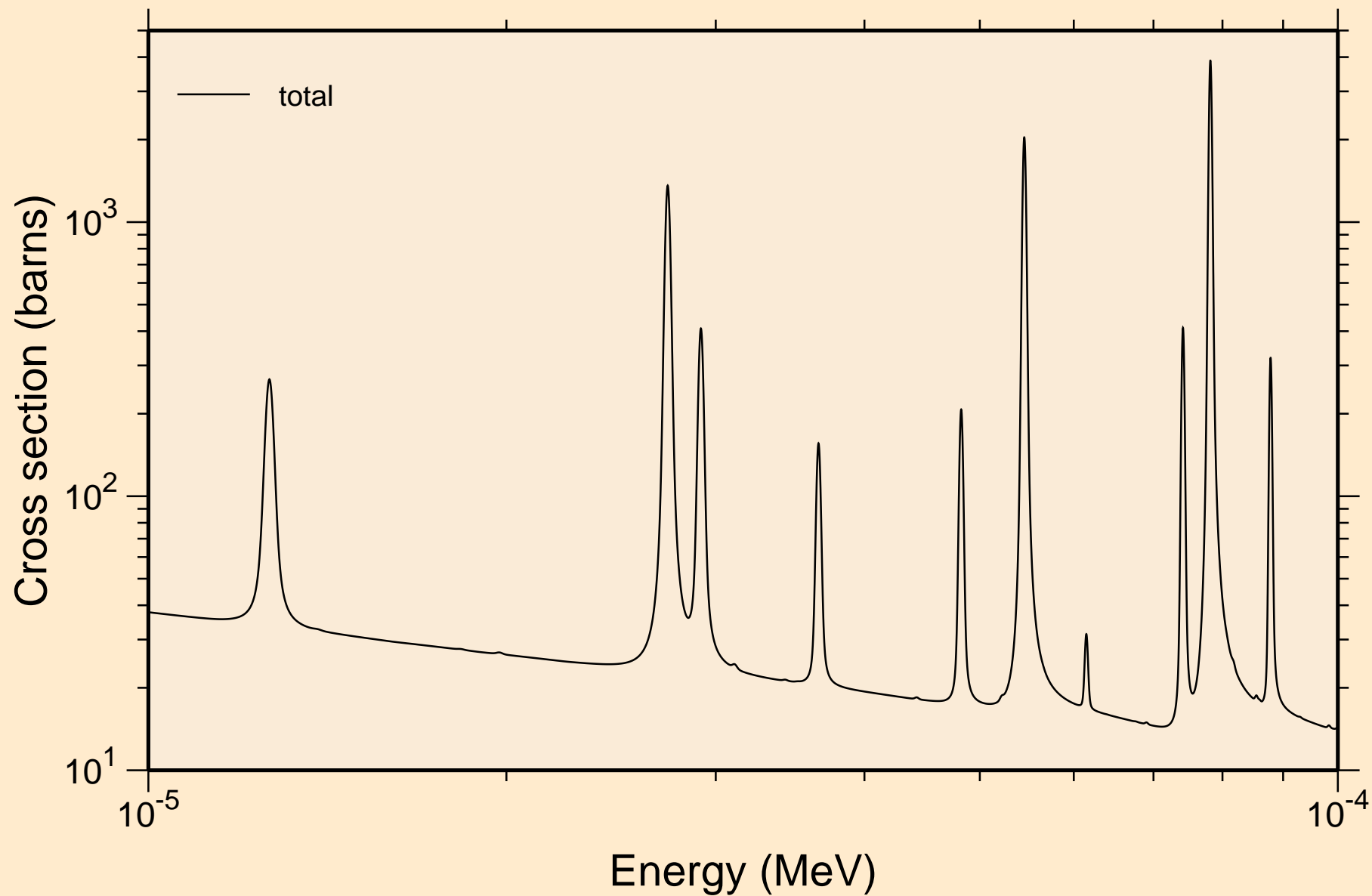

BA122 NEUTRON ACER TENDL-2019 LIBRARY; T=293.16K
resonance total cross section

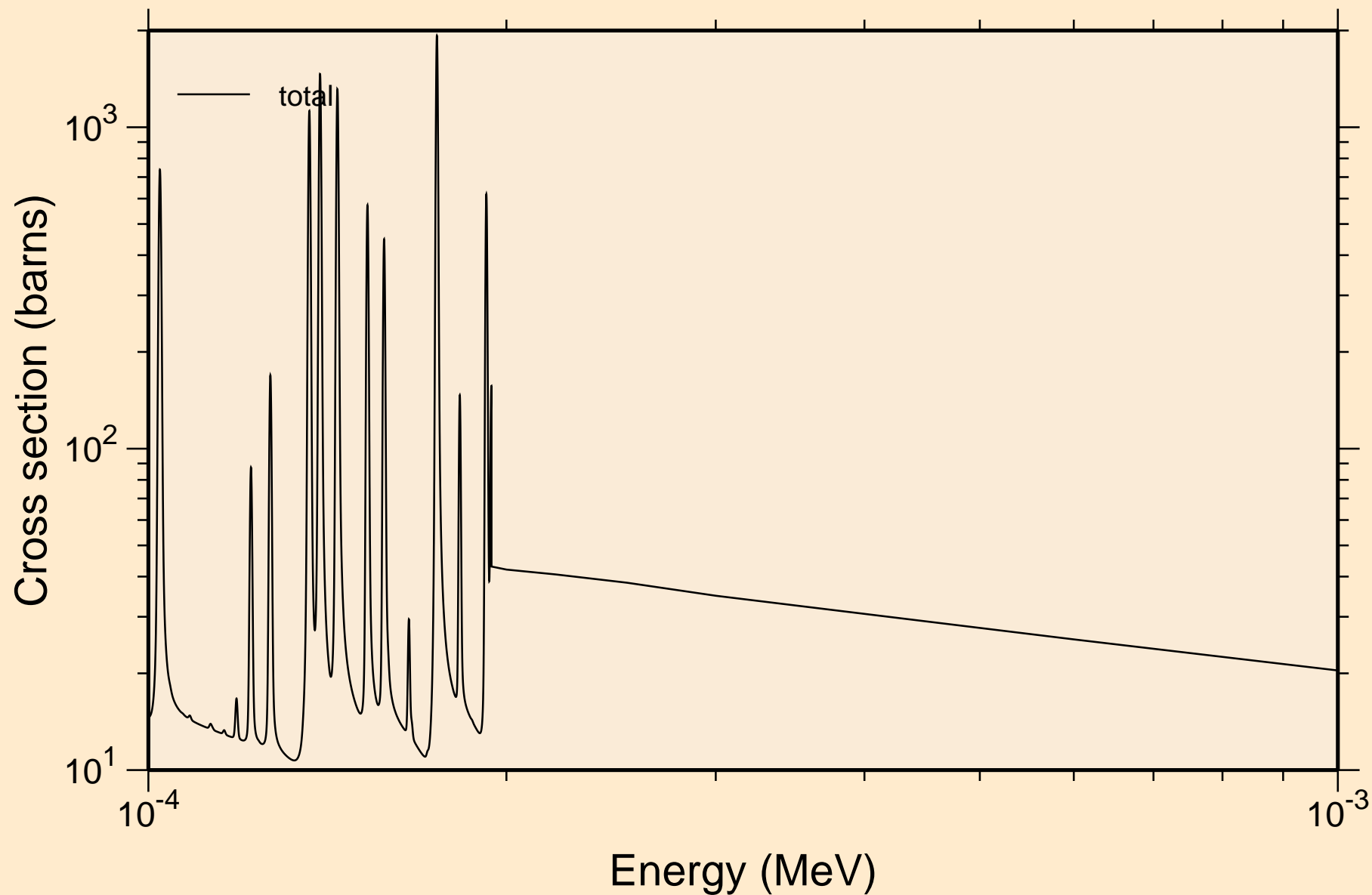

BA122 NEUTRON ACER TENDL-2019 LIBRARY; T=293.16K
resonance total cross section

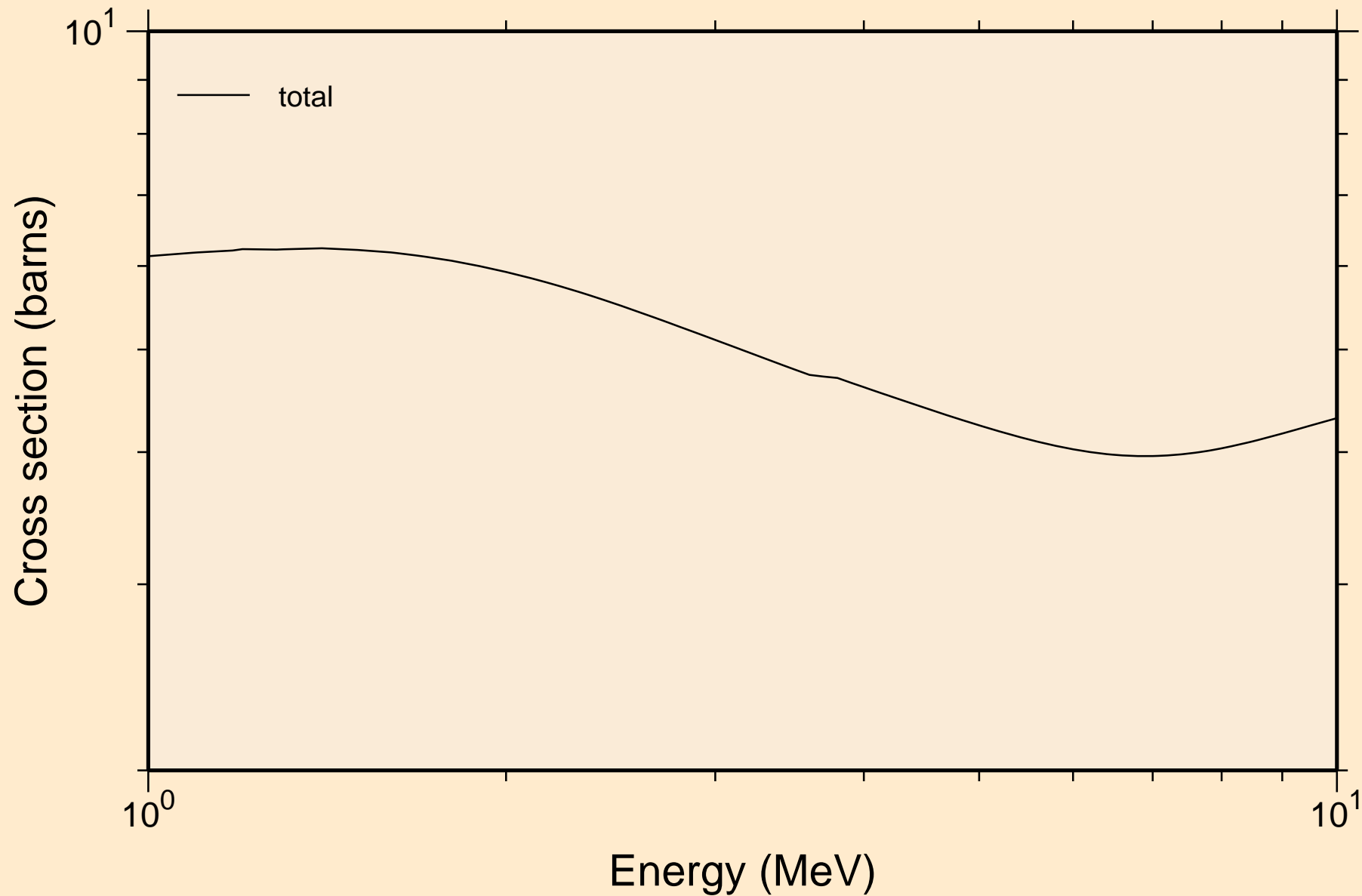

BA122 NEUTRON ACER TENDL-2019 LIBRARY; T=293.16K
resonance absorption cross sections

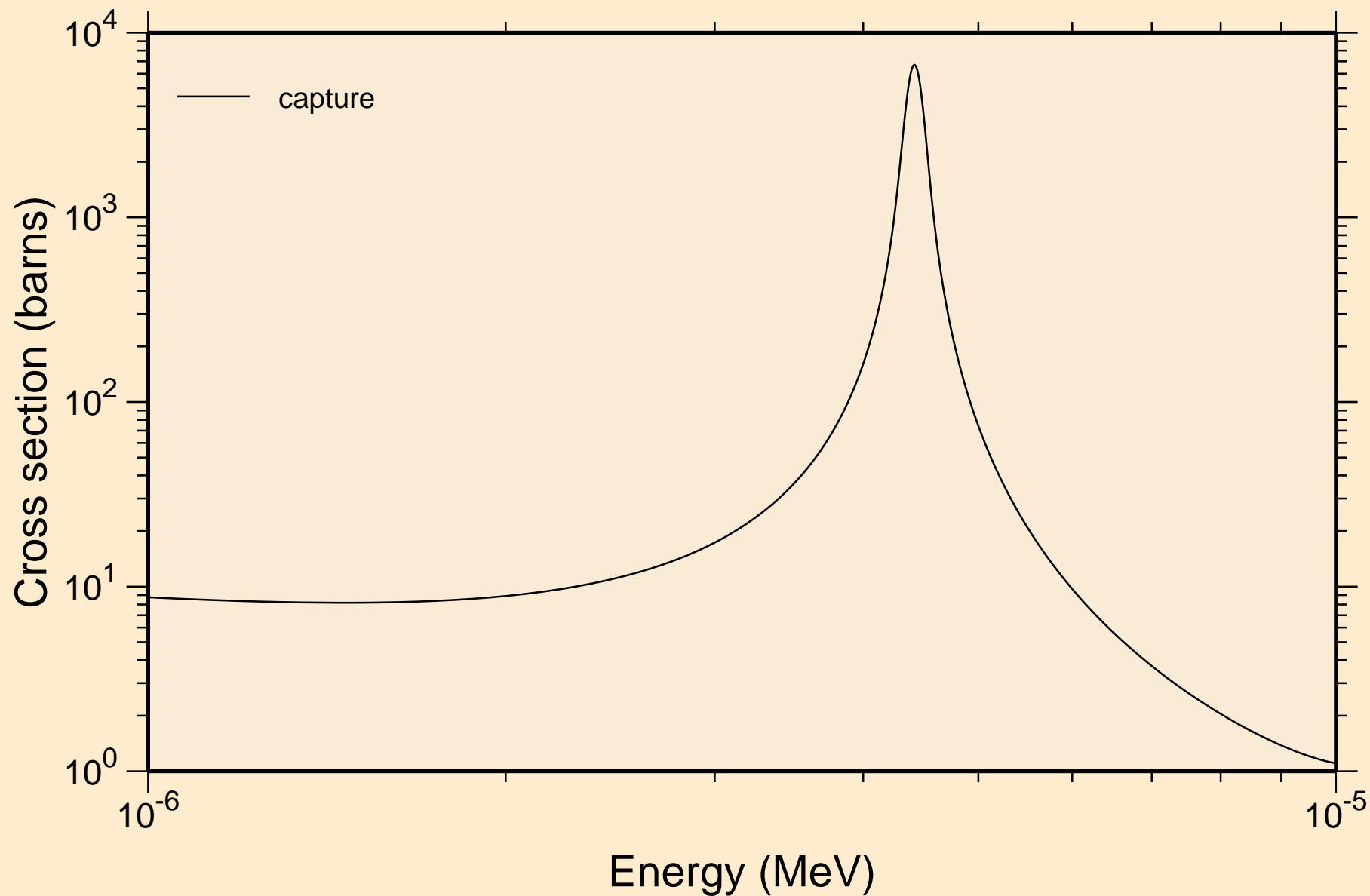

BA122 NEUTRON ACER TENDL-2019 LIBRARY; T=293.16K
resonance absorption cross sections

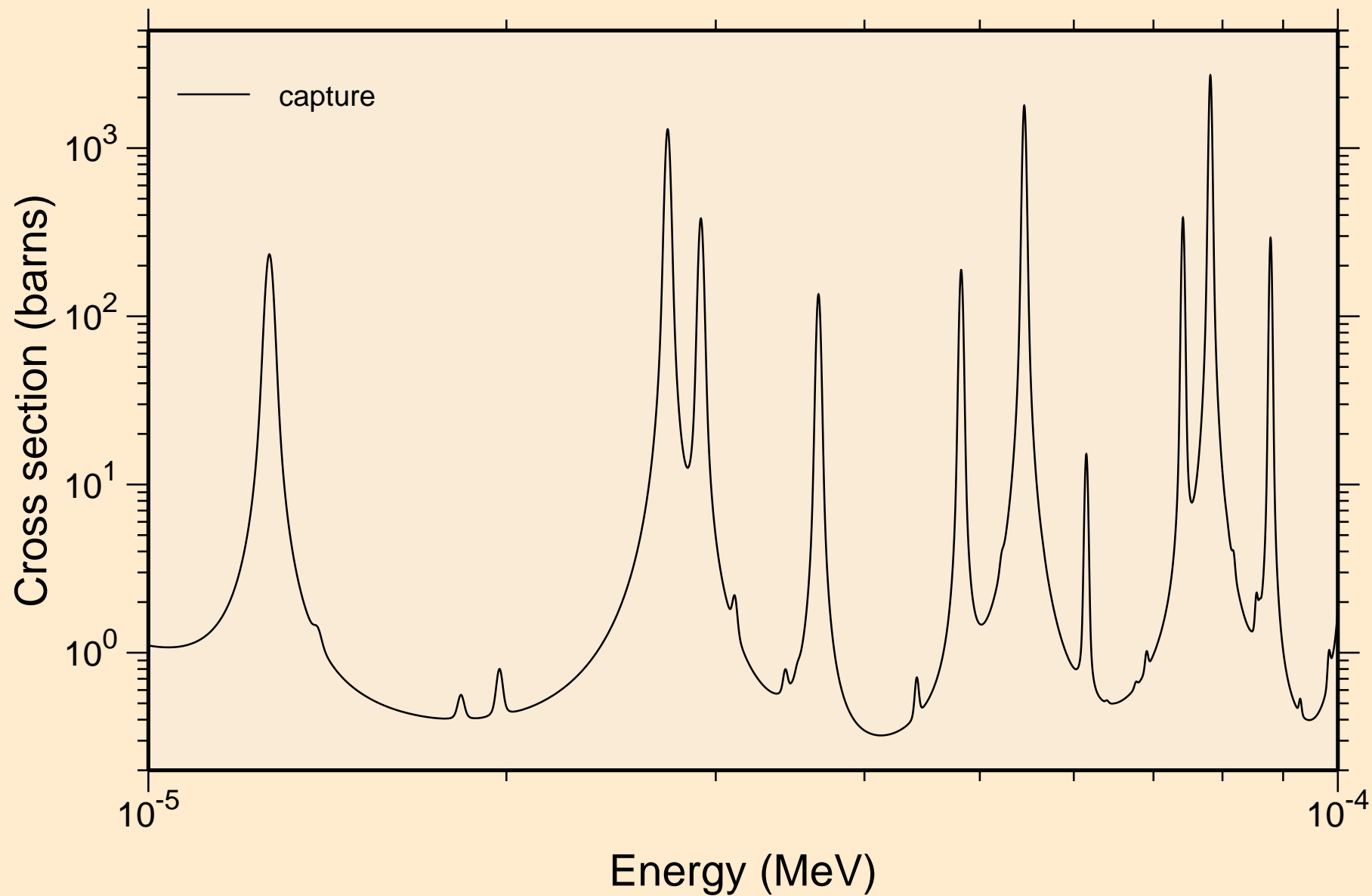

BA122 NEUTRON ACER TENDL-2019 LIBRARY; T=293.16K
resonance absorption cross sections

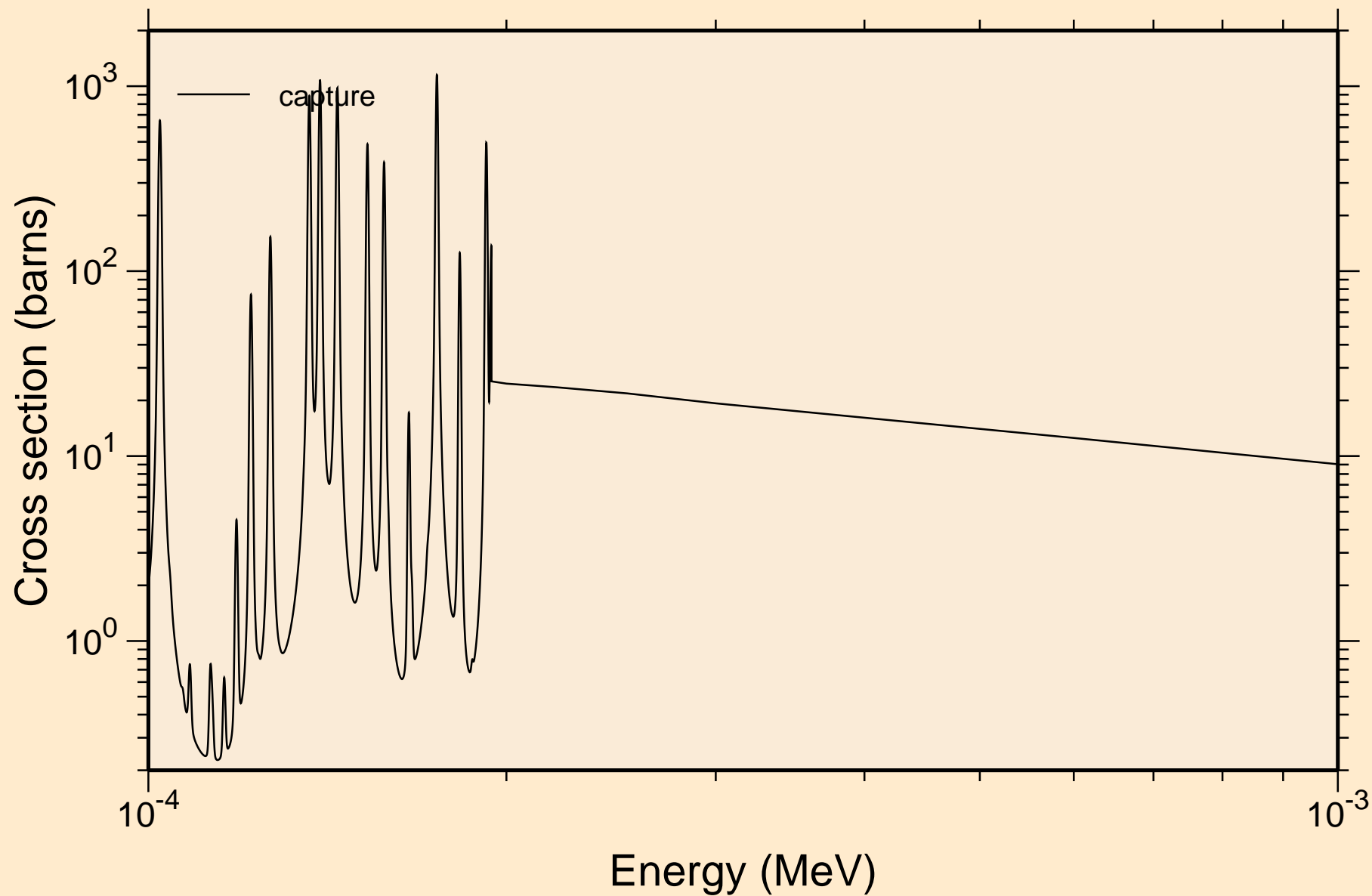

BA122 NEUTRON ACER TENDL-2019 LIBRARY; T=293.16K
resonance absorption cross sections

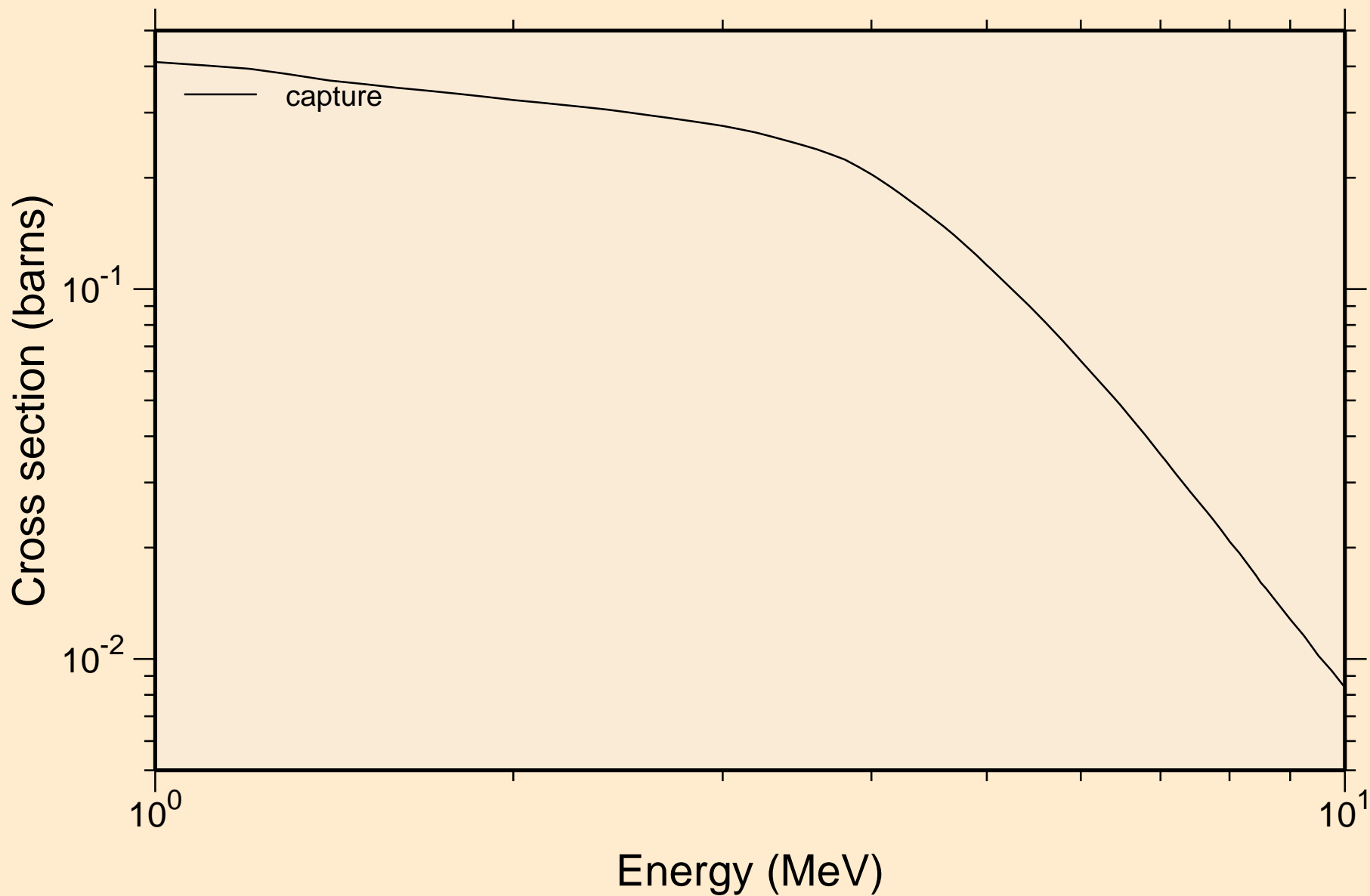

BA122 NEUTRON ACER TENDL-2019 LIBRARY; T=293.16K
Heating

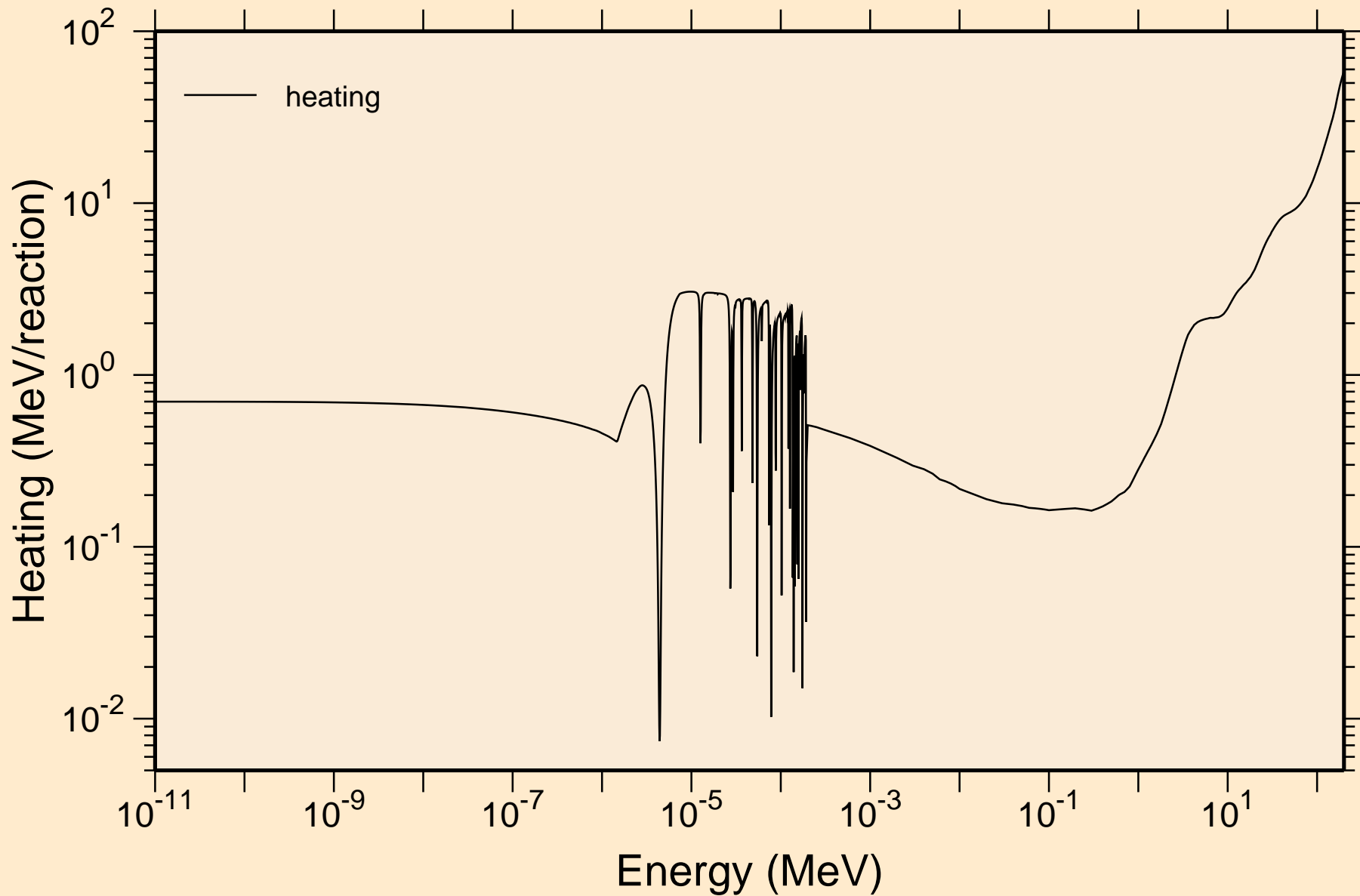

BA122 NEUTRON ACER TENDL-2019 LIBRARY; T=293.16K
Damage

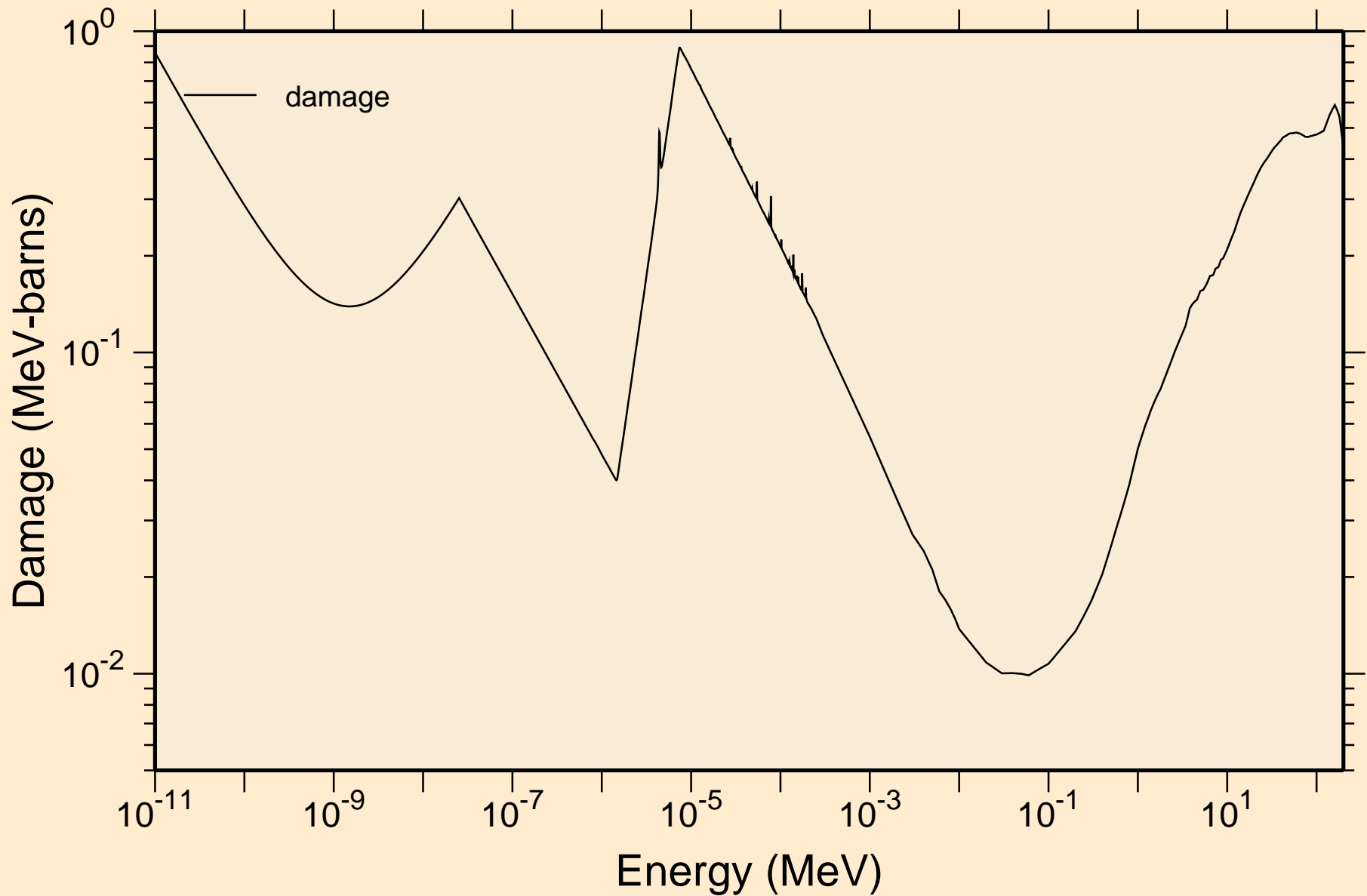

BA122 NEUTRON ACER TENDL-2019 LIBRARY; T=293.16K
Non-threshold reactions

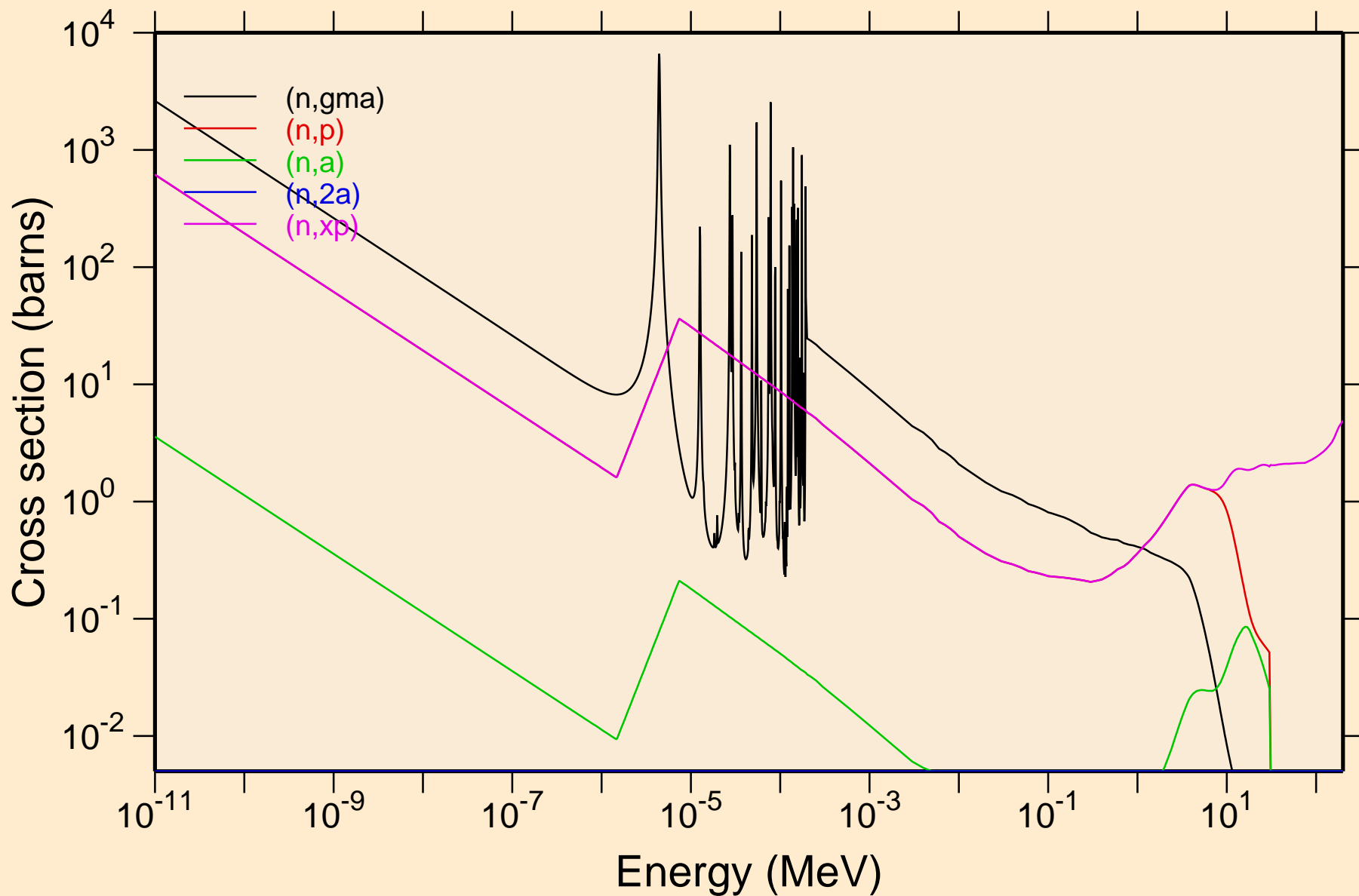

BA122 NEUTRON ACER TENDL-2019 LIBRARY; T=293.16K
Non-threshold reactions

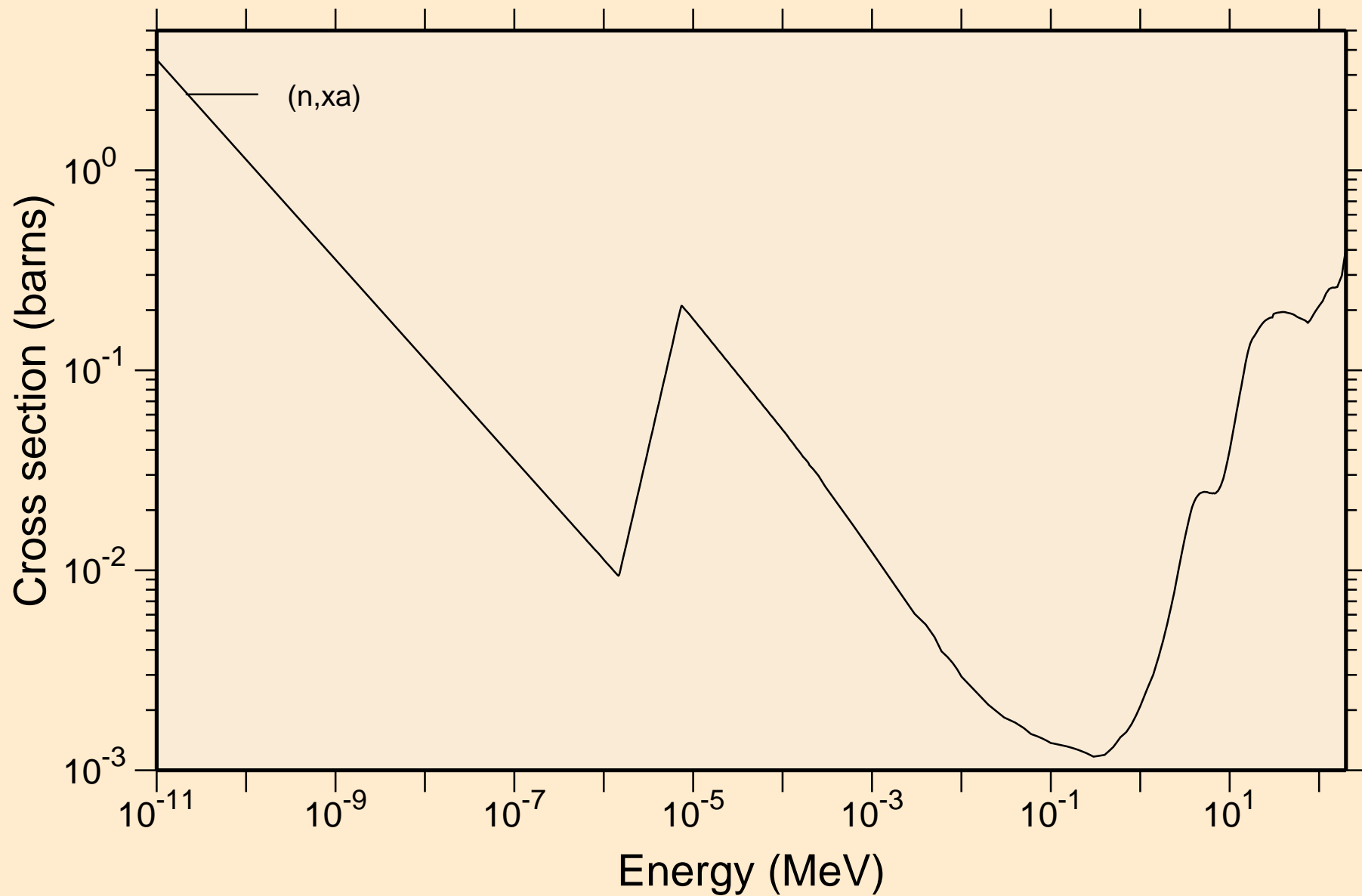

BA122 NEUTRON ACER TENDL-2019 LIBRARY; T=293.16K
Principal cross sections

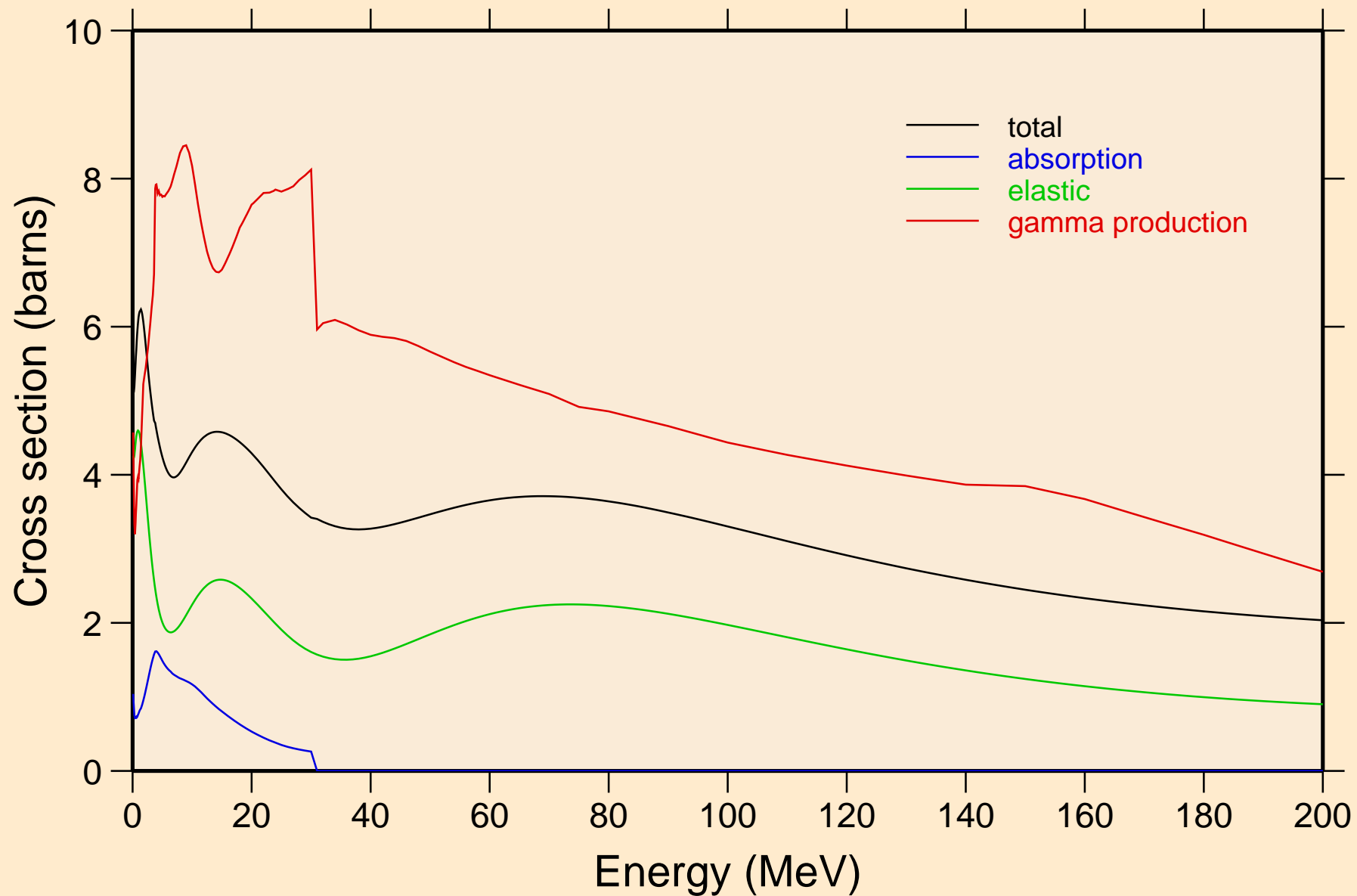

BA122 NEUTRON ACER TENDL-2019 LIBRARY; T=293.16K
Heating

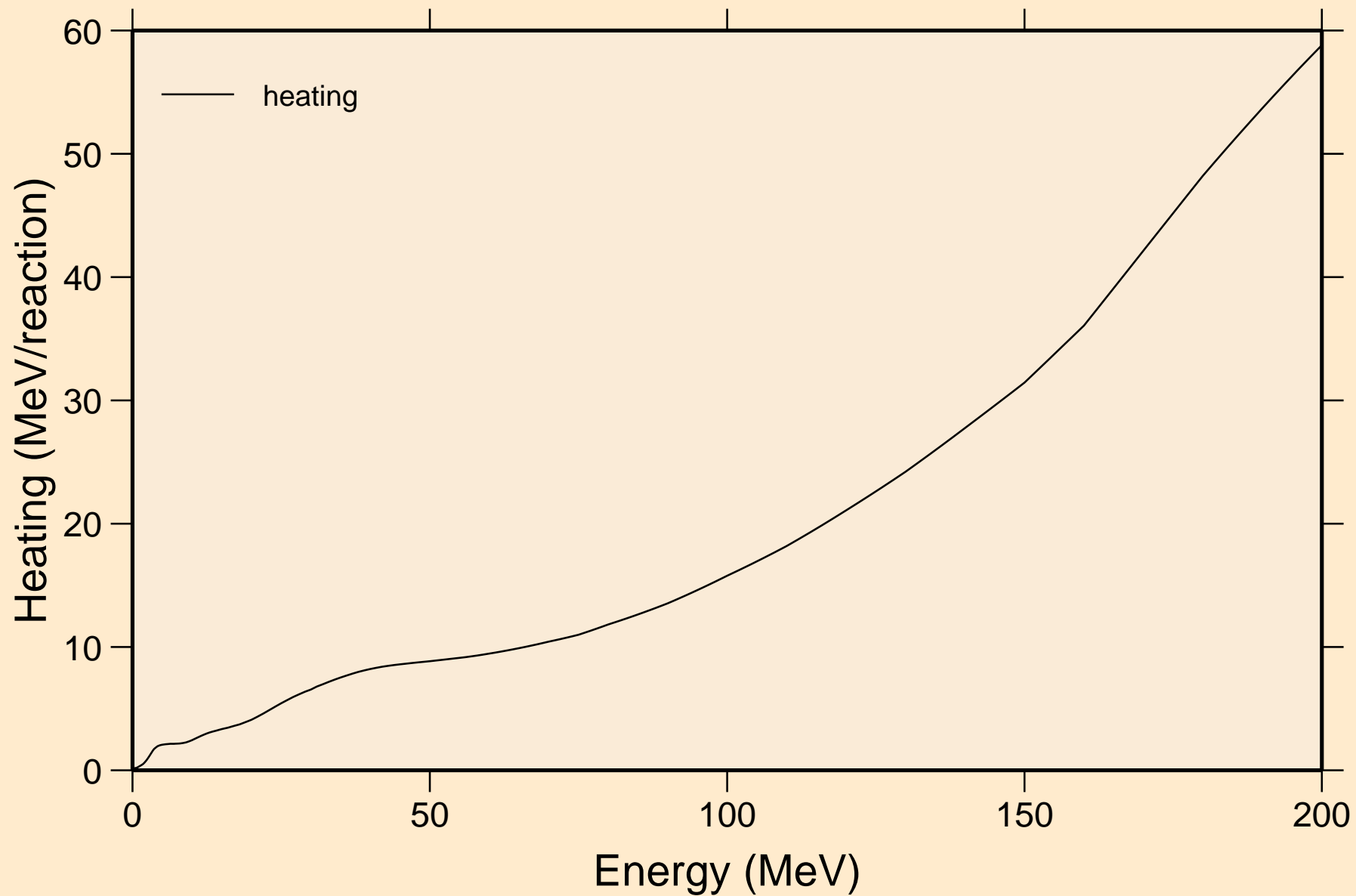

BA122 NEUTRON ACER TENDL-2019 LIBRARY; T=293.16K
Damage

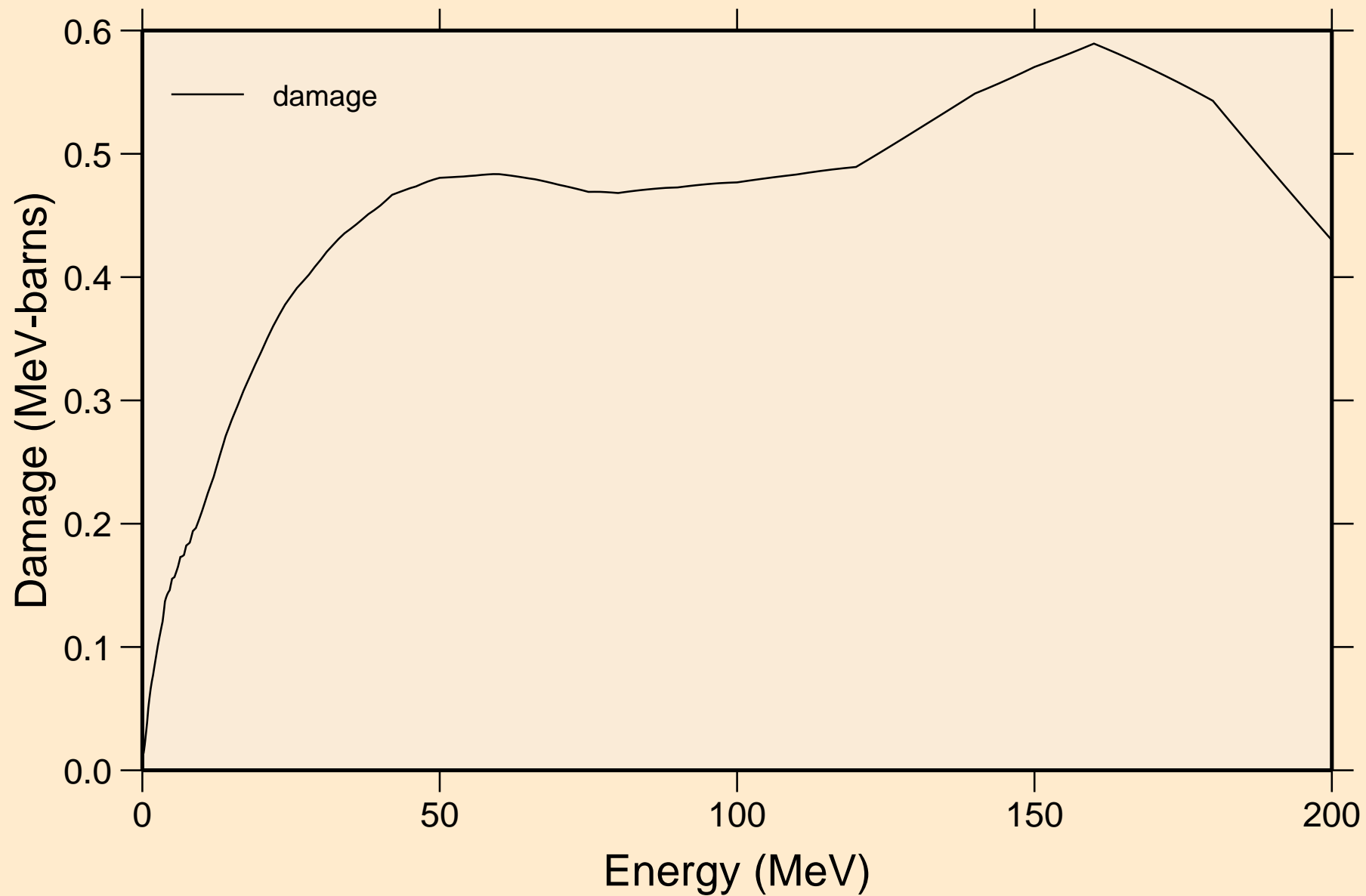

BA122 NEUTRON ACER TENDL-2019 LIBRARY; T=293.16K
Non-threshold reactions

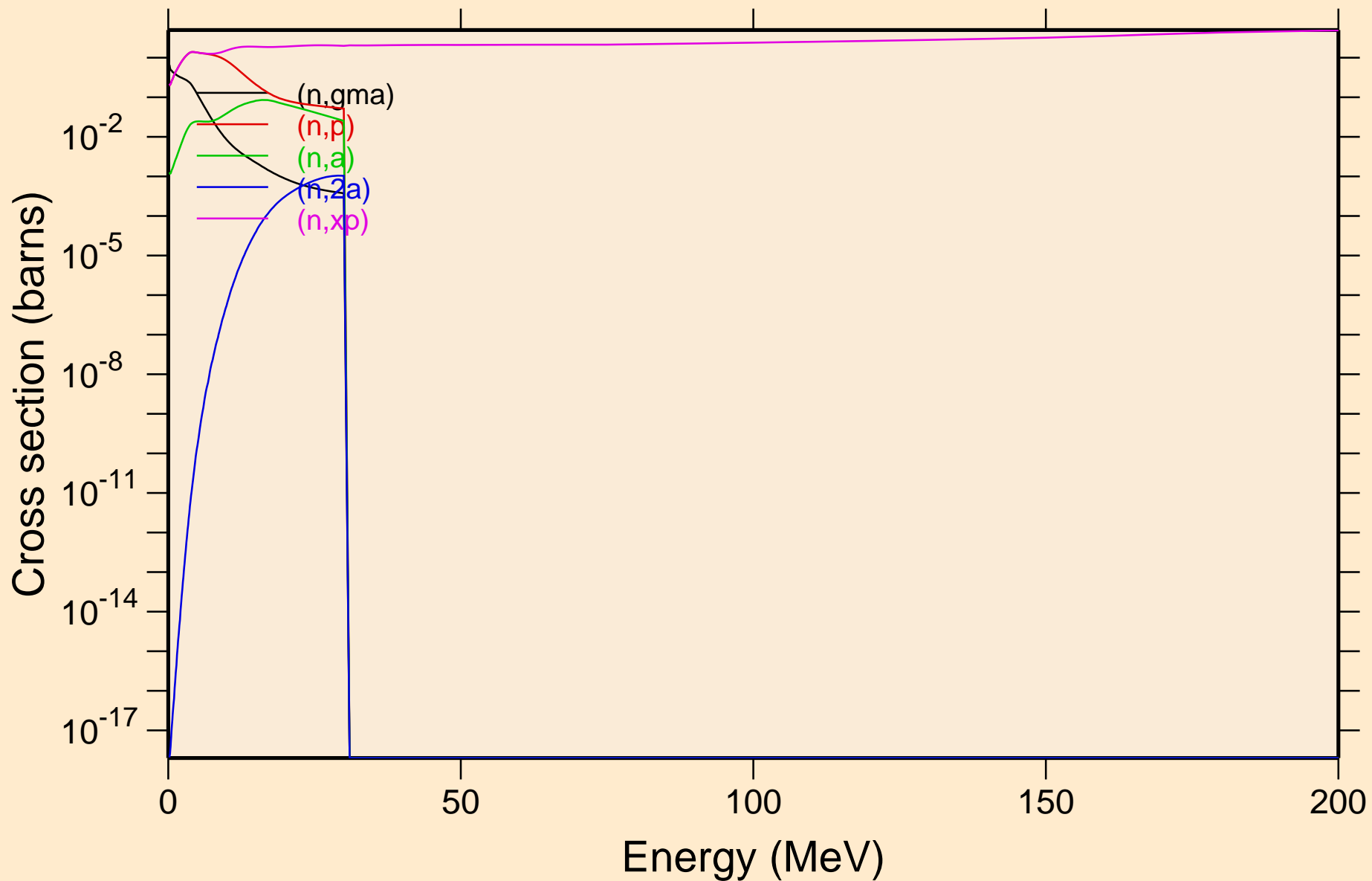

BA122 NEUTRON ACER TENDL-2019 LIBRARY; T=293.16K
Non-threshold reactions

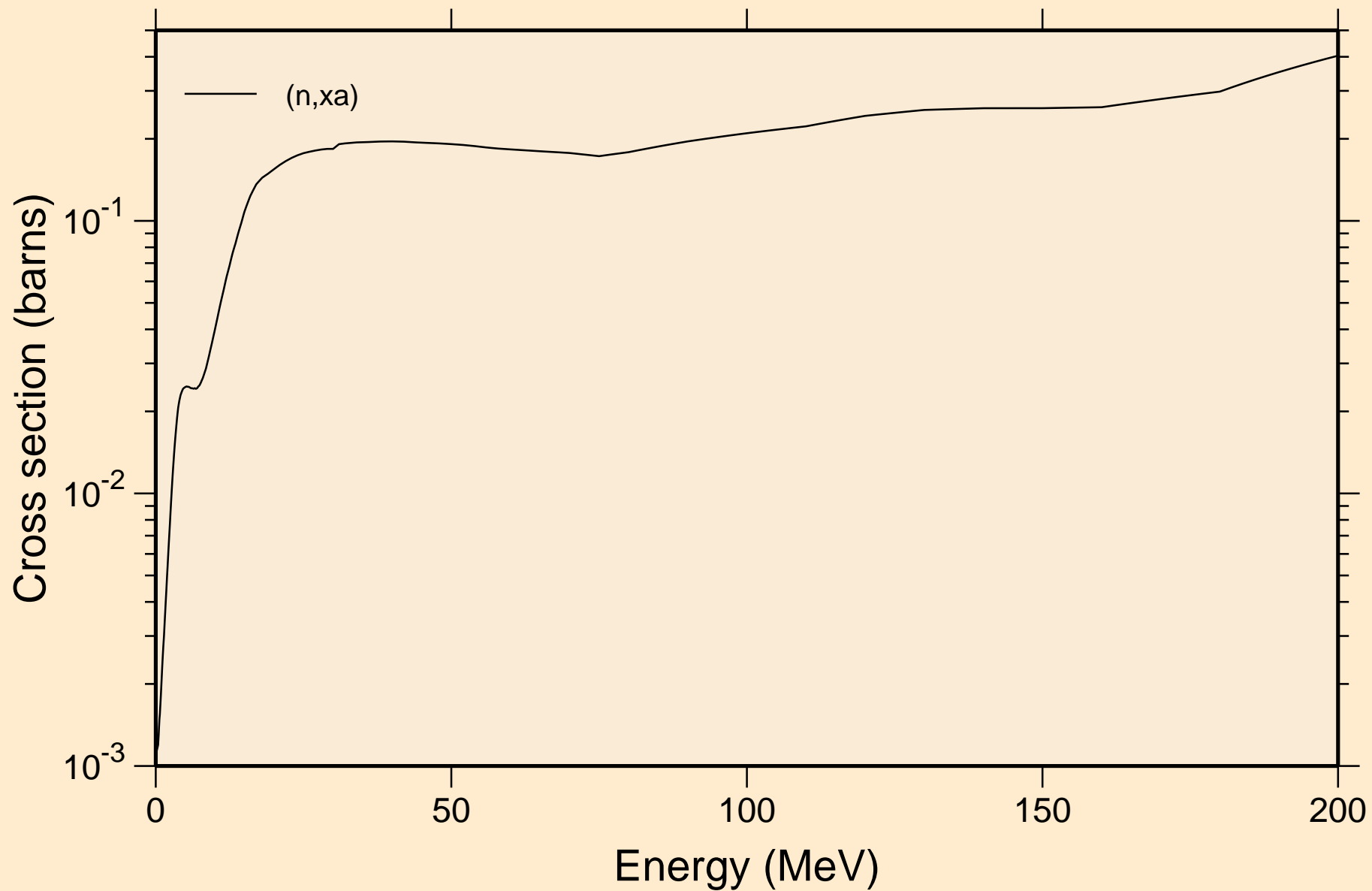

BA122 NEUTRON ACER TENDL-2019 LIBRARY; T=293.16K
Inelastic levels

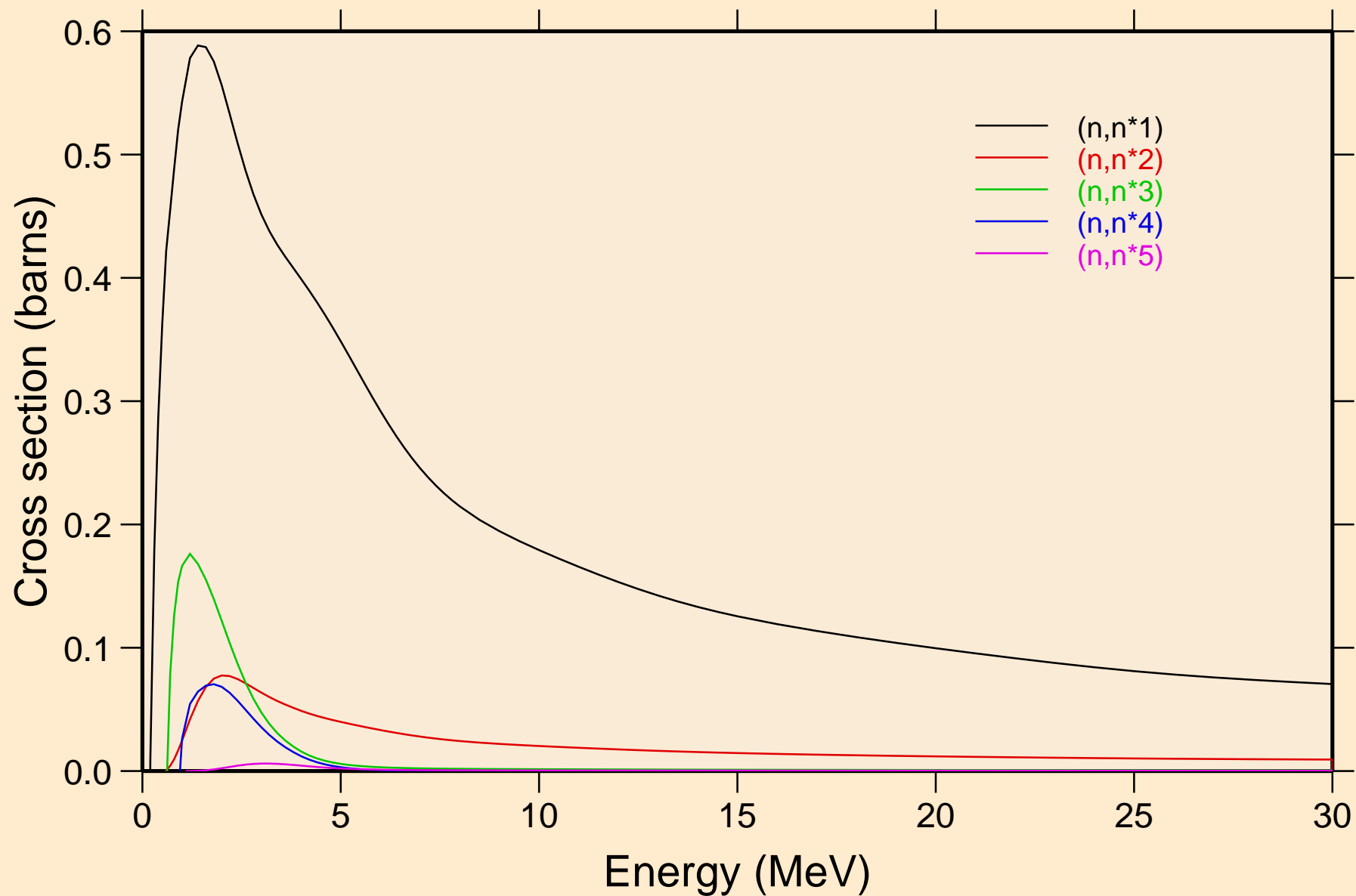

BA122 NEUTRON ACER TENDL-2019 LIBRARY; T=293.16K
Inelastic levels

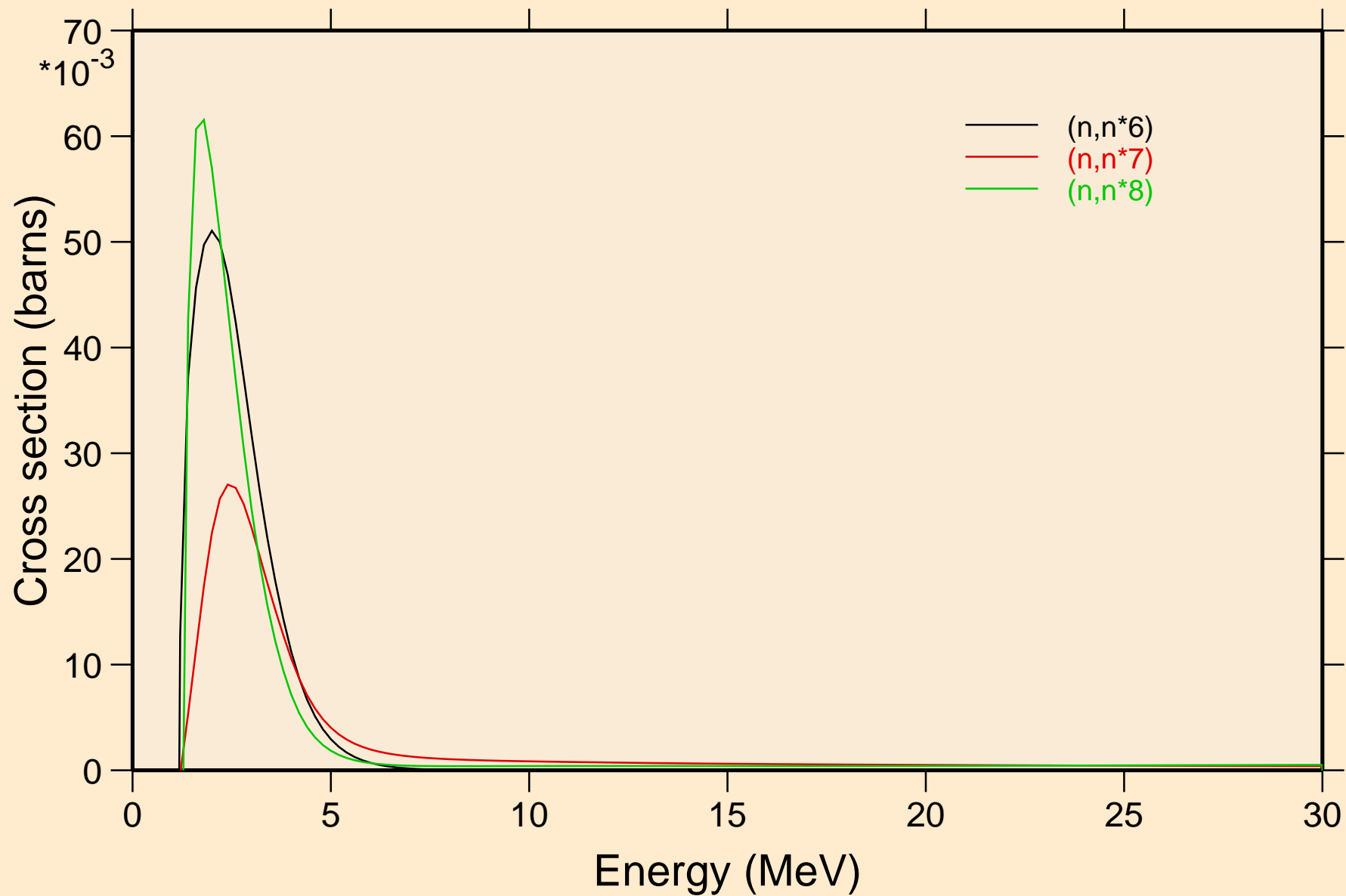

BA122 NEUTRON ACER TENDL-2019 LIBRARY; T=293.16K
Threshold reactions

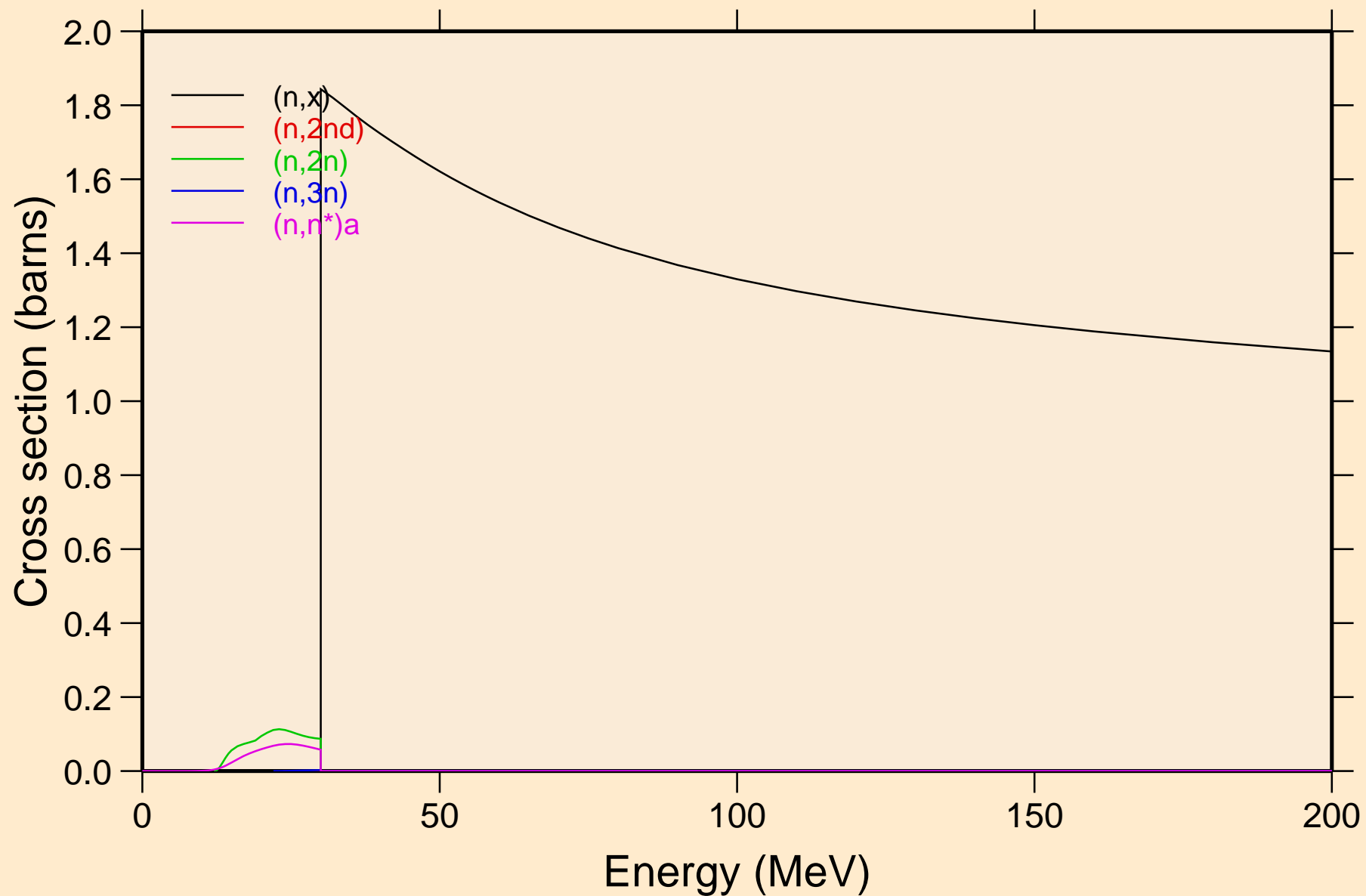

BA122 NEUTRON ACER TENDL-2019 LIBRARY; T=293.16K
Threshold reactions

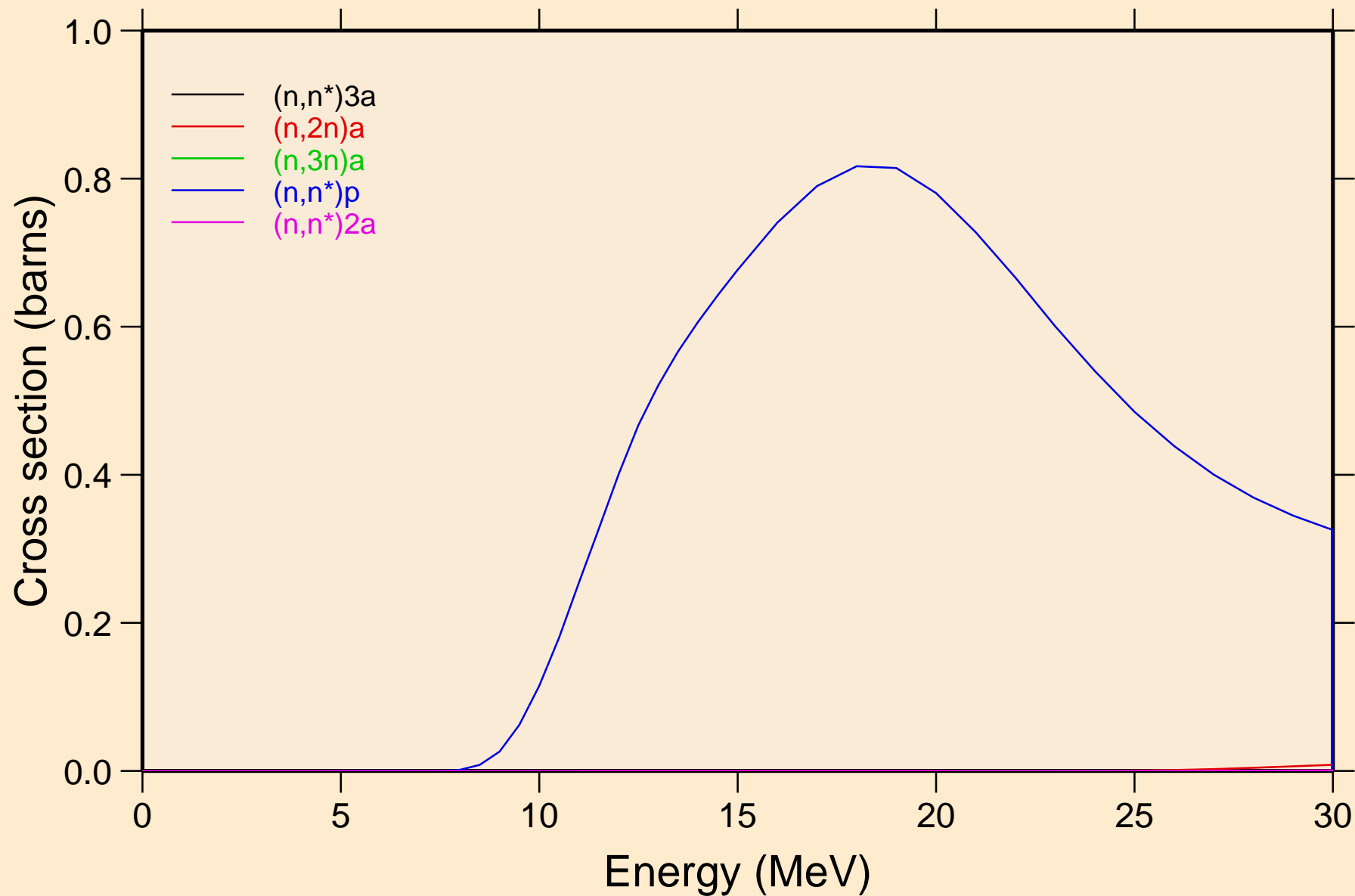

BA122 NEUTRON ACER TENDL-2019 LIBRARY; T=293.16K
Threshold reactions

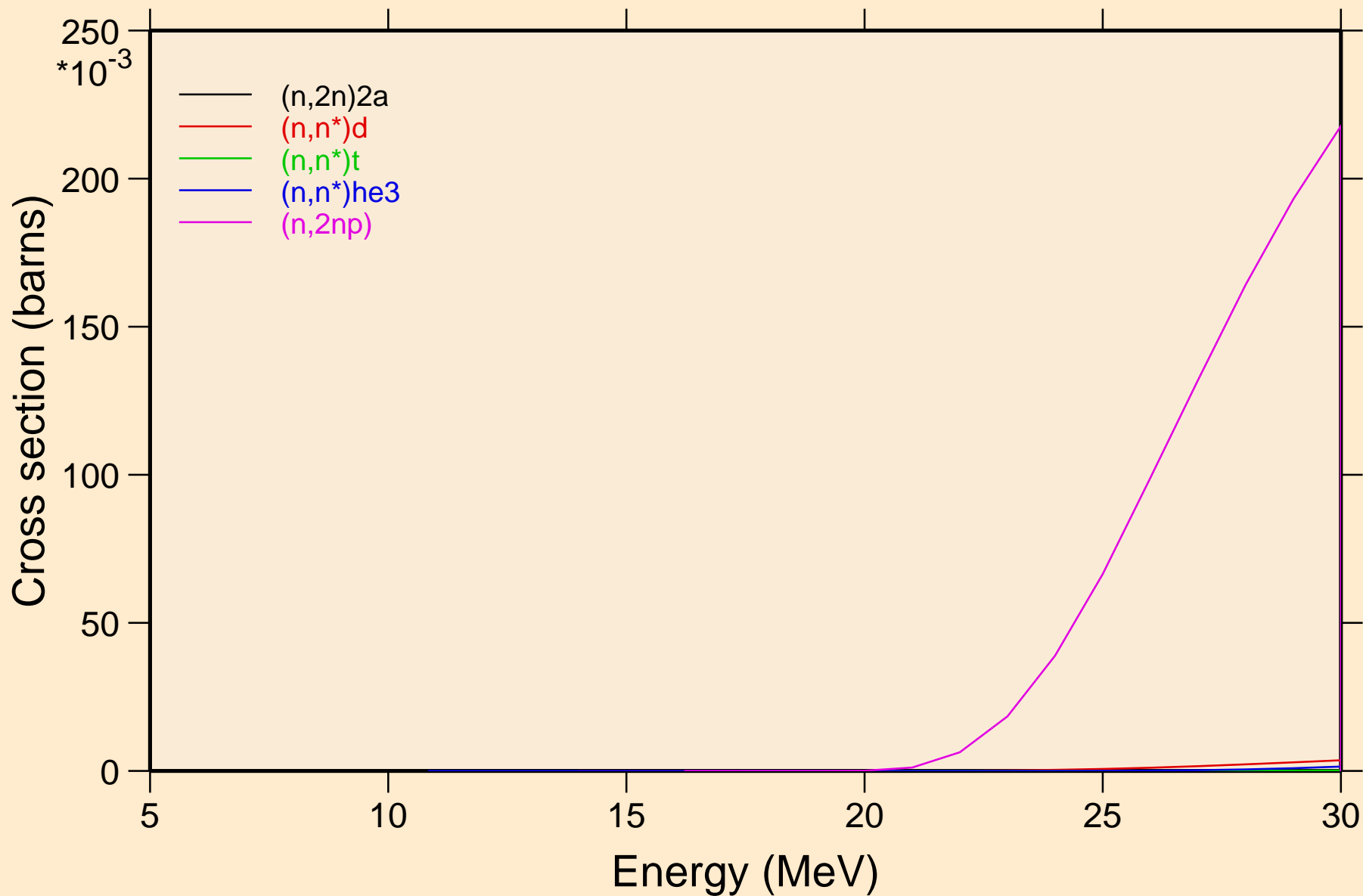

BA122 NEUTRON ACER TENDL-2019 LIBRARY; T=293.16K
Threshold reactions

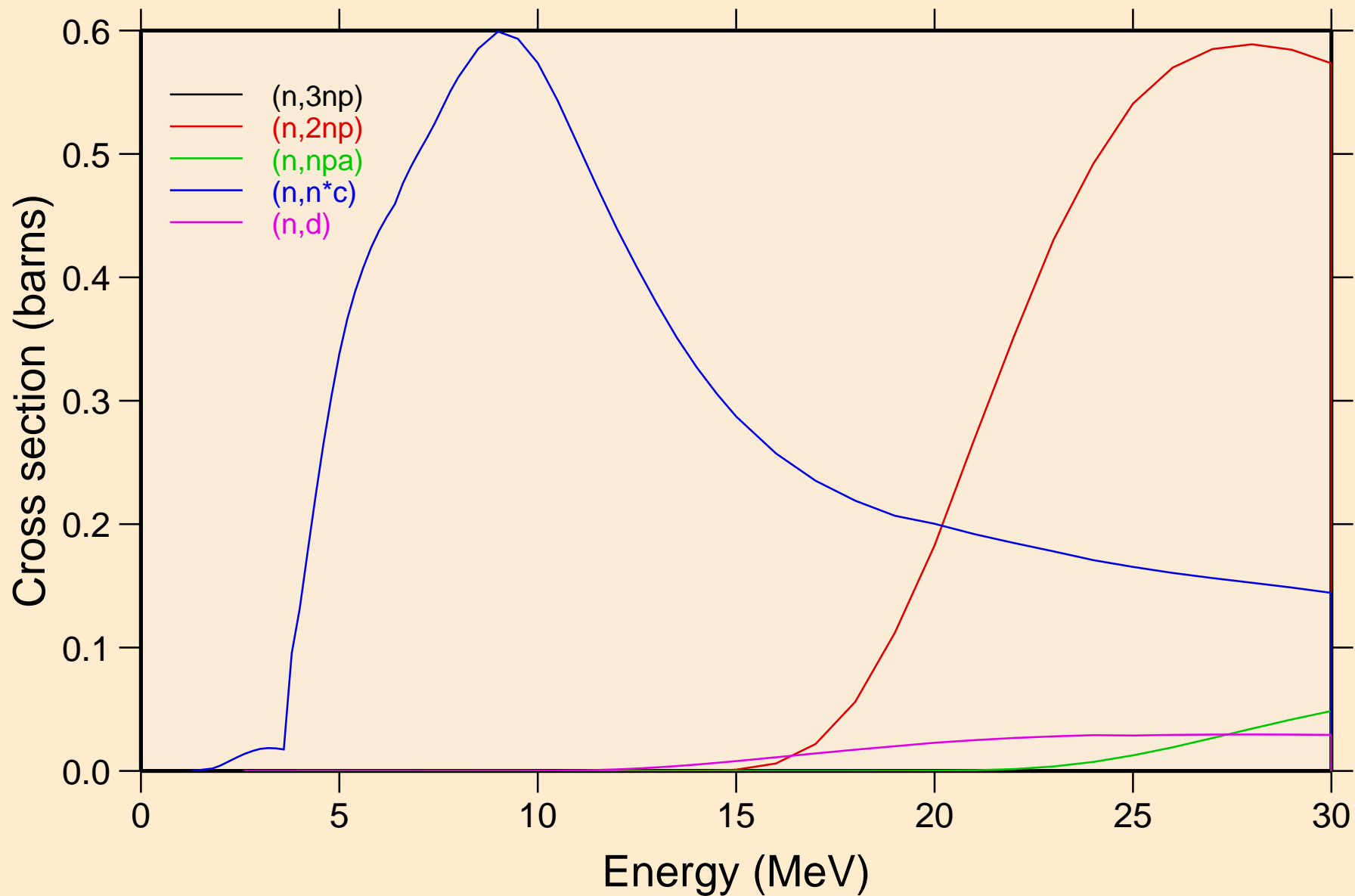

BA122 NEUTRON ACER TENDL-2019 LIBRARY; T=293.16K
Threshold reactions

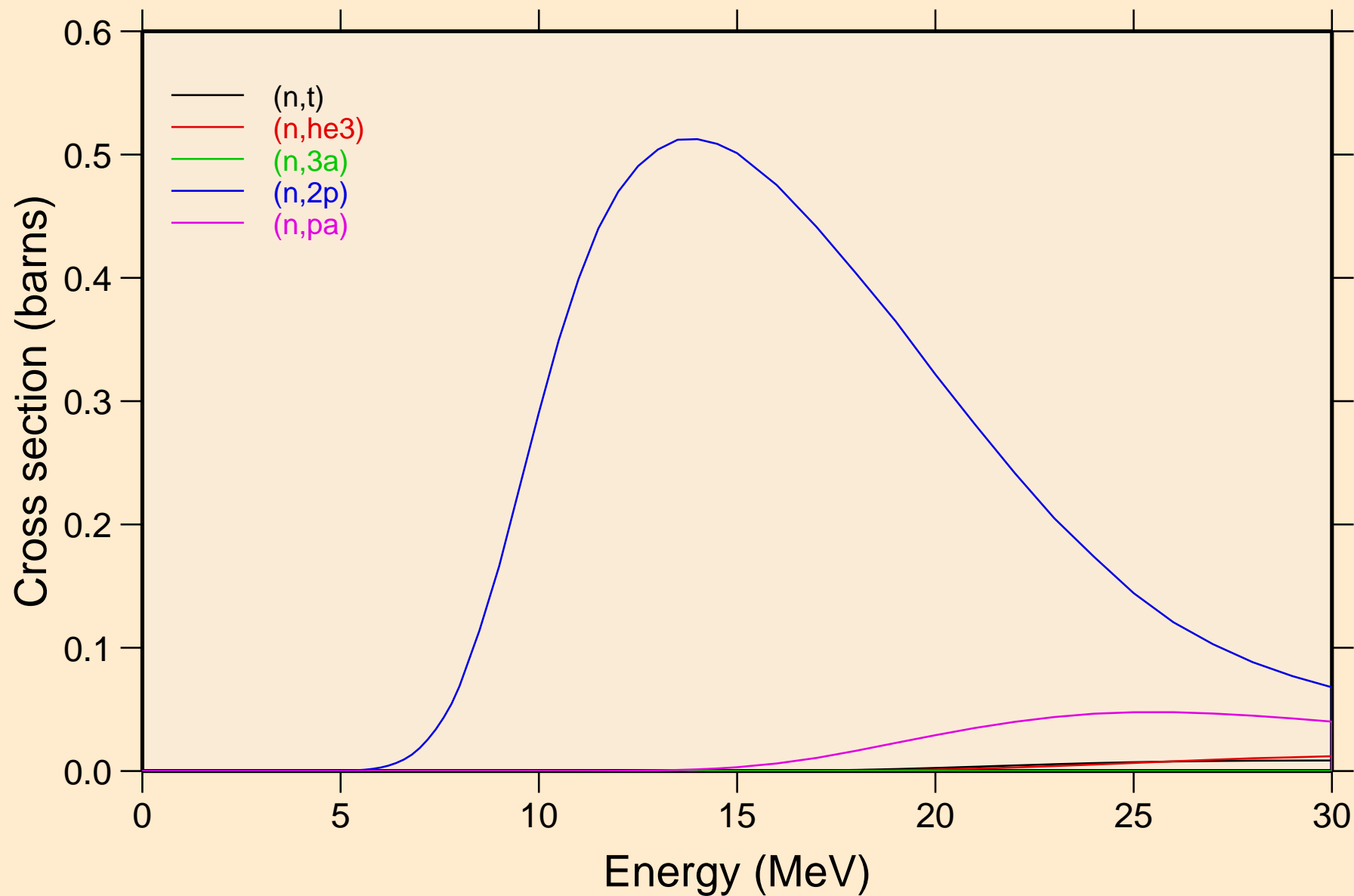

BA122 NEUTRON ACER TENDL-2019 LIBRARY; T=293.16K
Threshold reactions

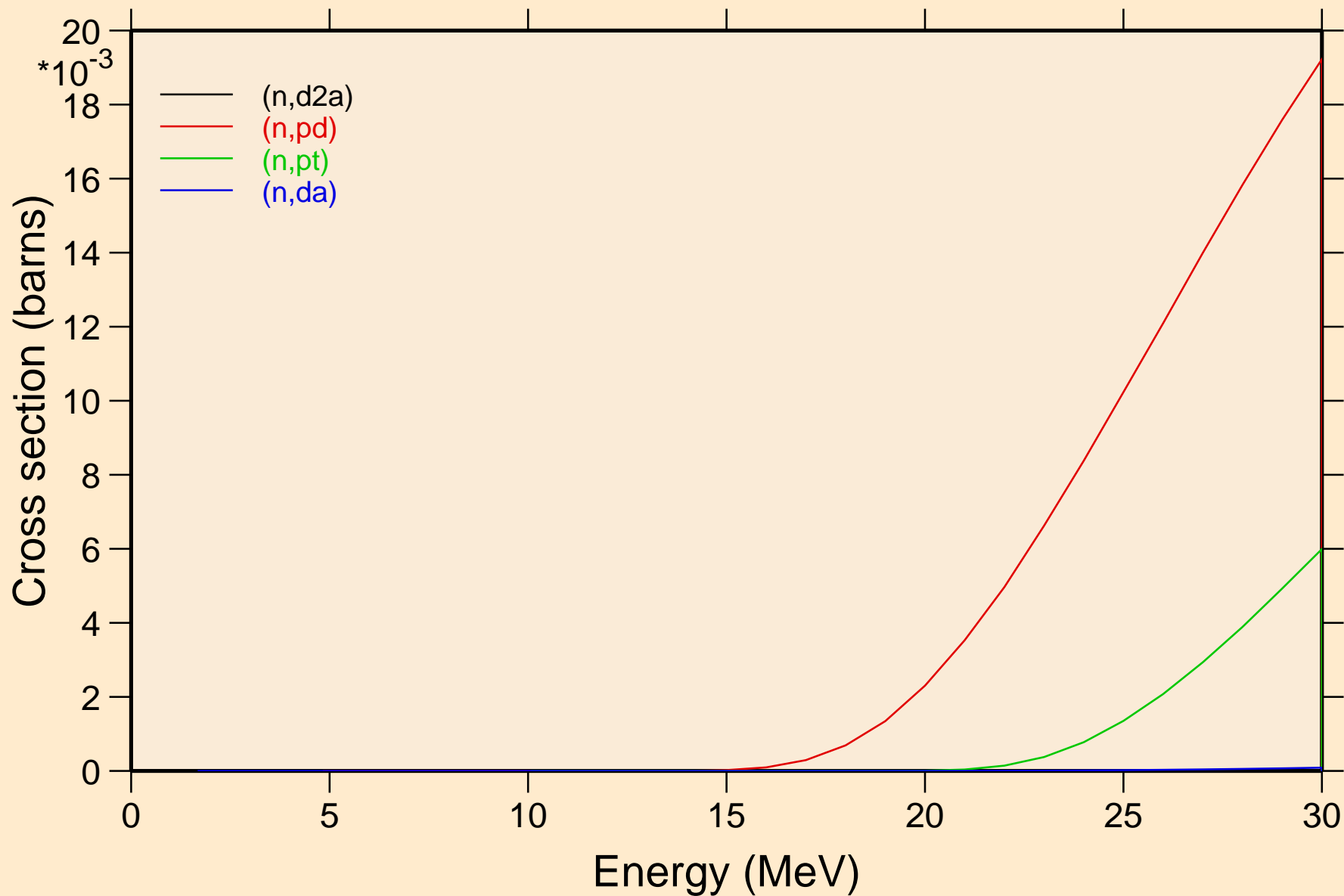

BA122 NEUTRON ACER TENDL-2019 LIBRARY; T=293.16K
Threshold reactions

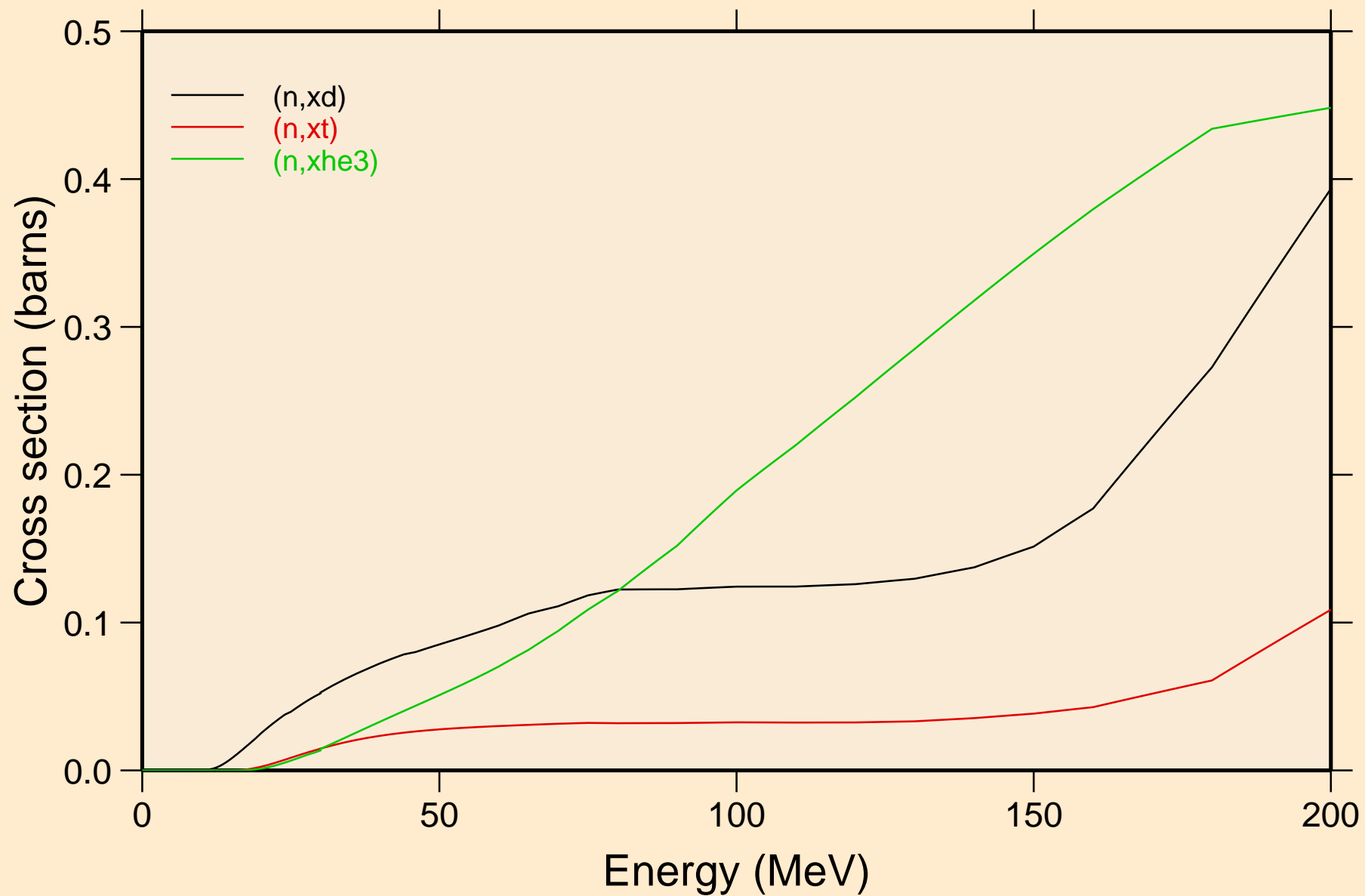

BA122 NEUTRON ACER TENDL-2019 LIBRARY; T=293.16K
angular distribution for elastic

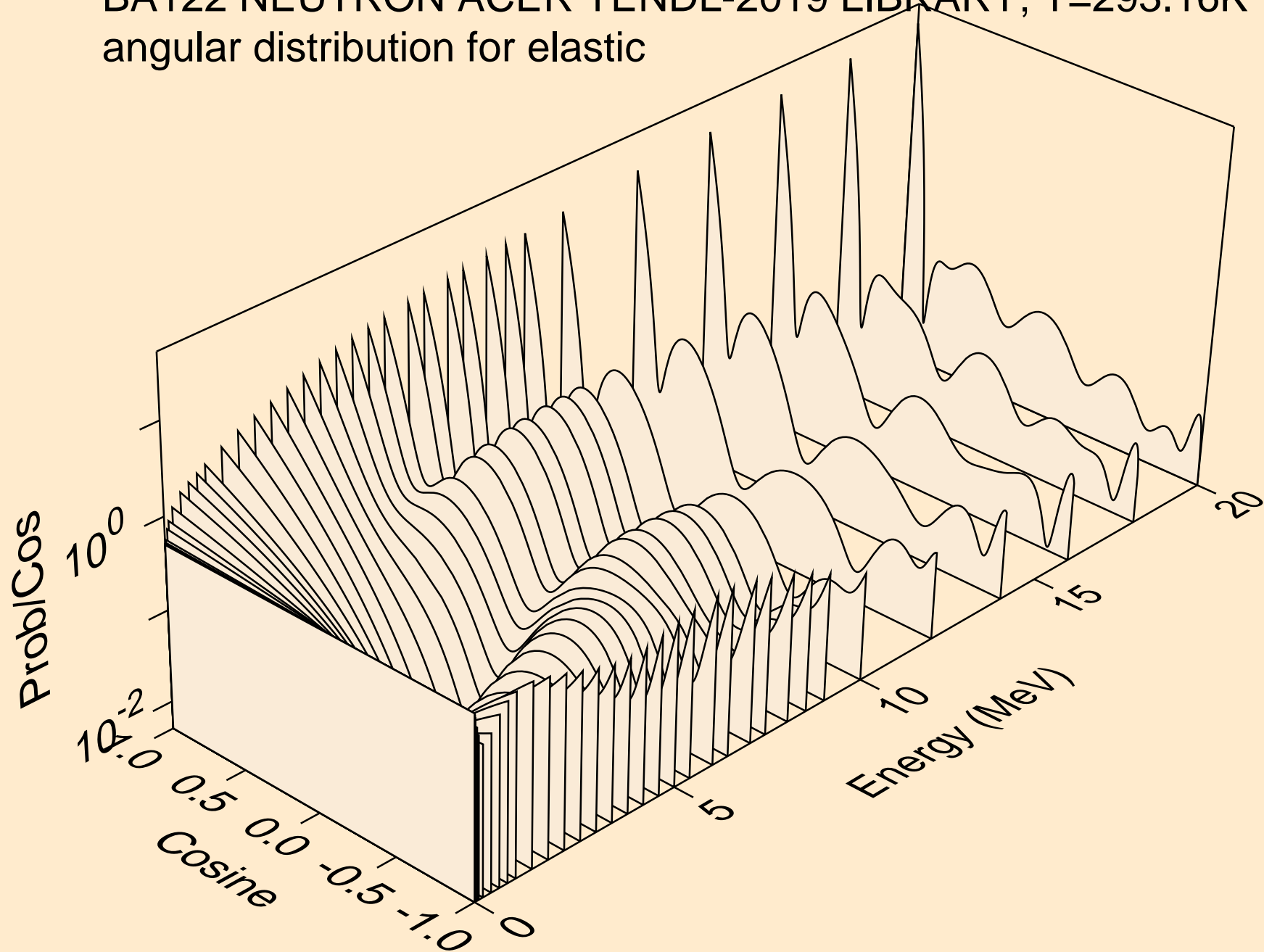

BA122 NEUTRON ACER TENDL-2019 LIBRARY; T=293.16K
angular distribution for elastic

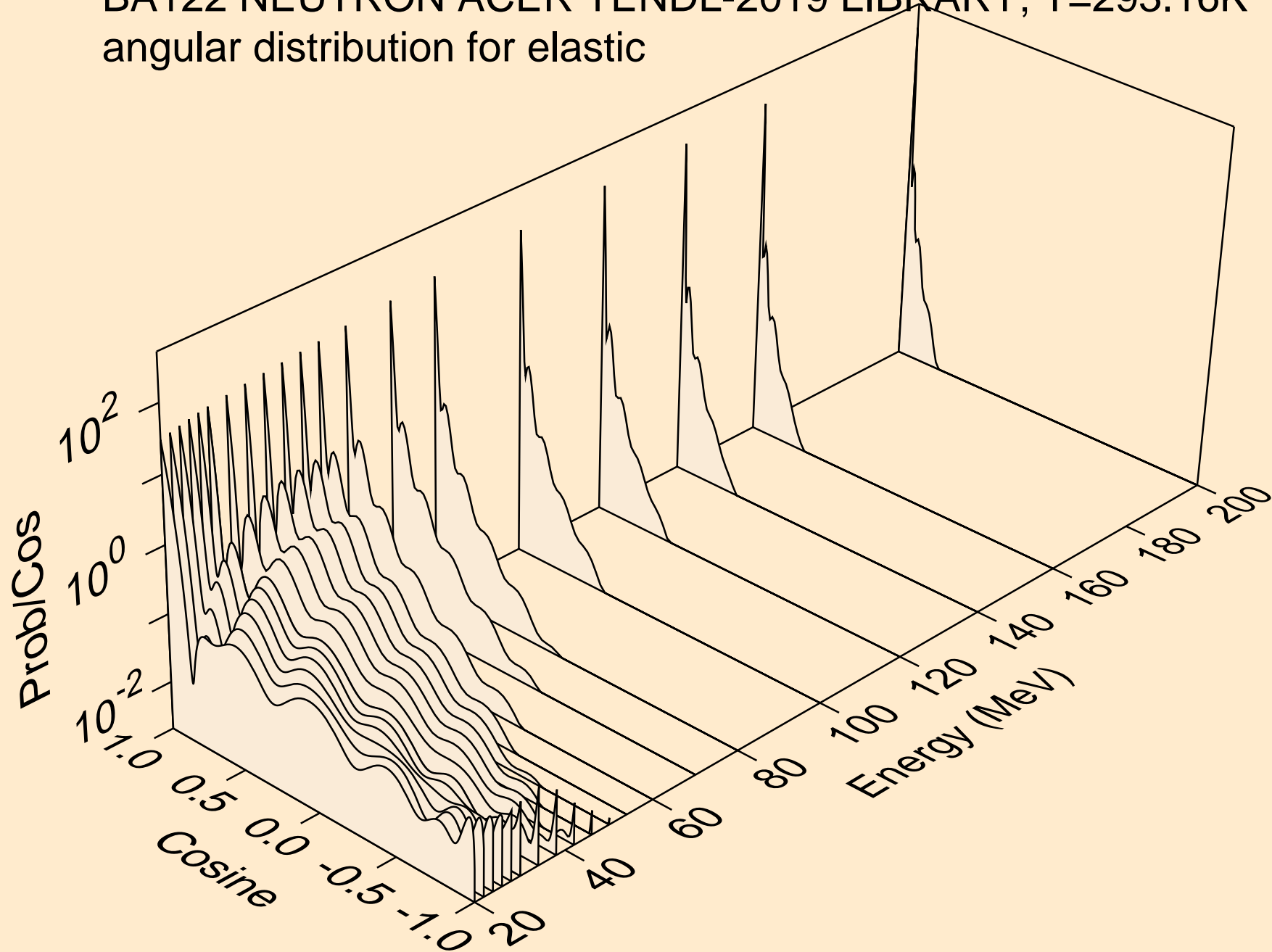

BA122 NEUTRON ACER TENDL-2019 LIBRARY; T=293.16K
angular distribution for (n,n*1)

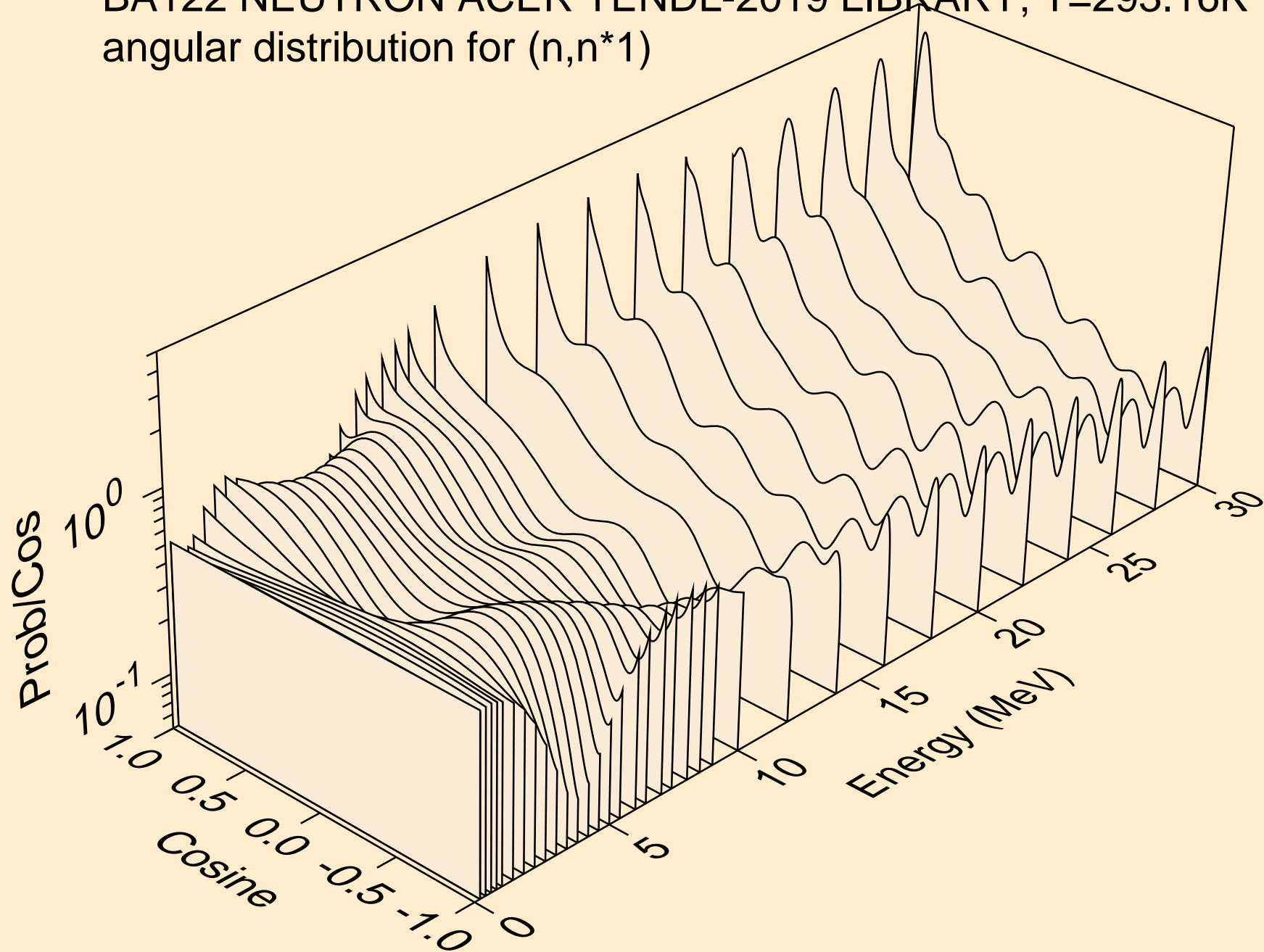

BA122 NEUTRON ACER TENDL-2019 LIBRARY; T=293.16K
angular distribution for (n,n*2)

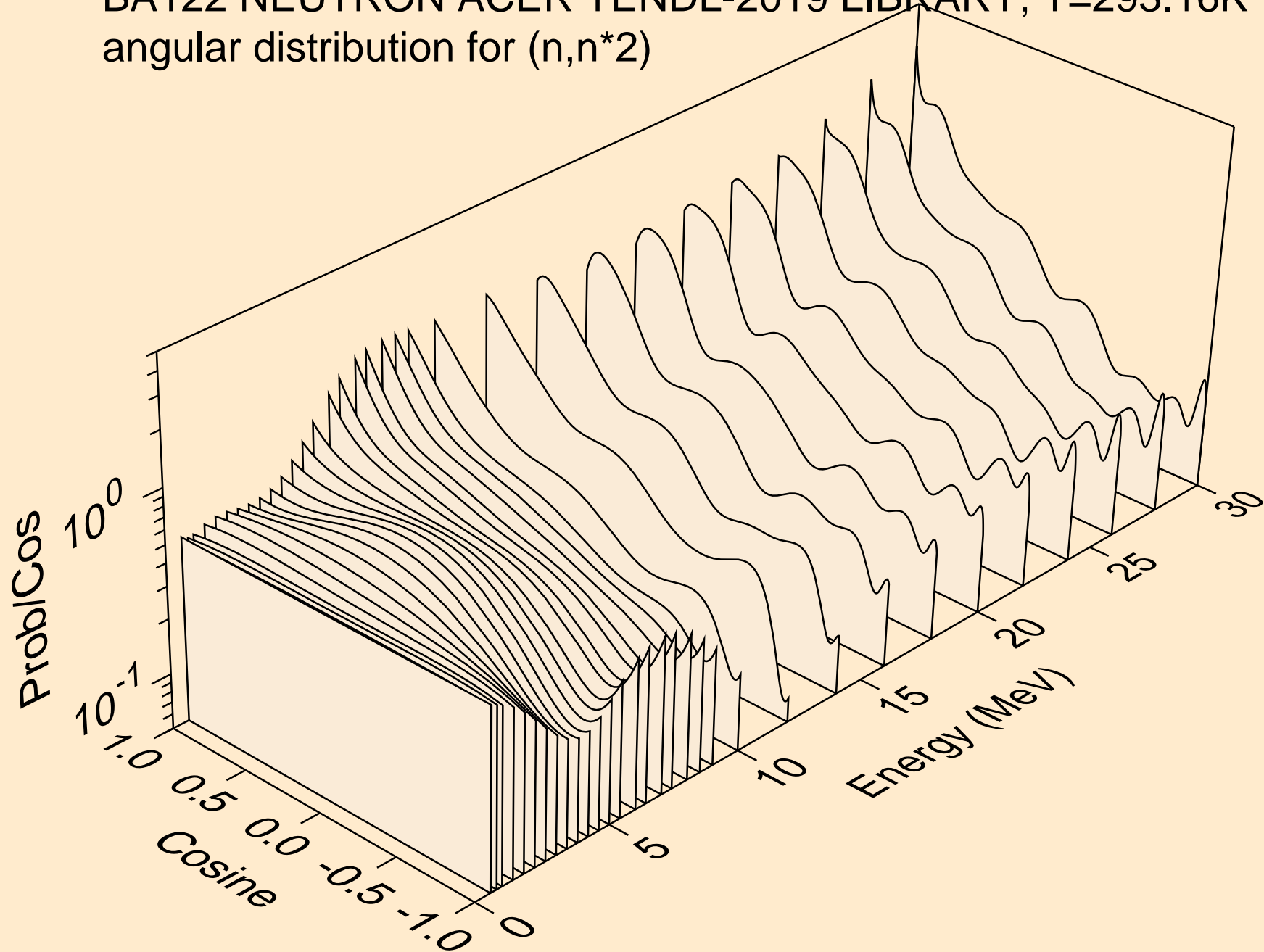

BA122 NEUTRON ACER TENDL-2019 LIBRARY; T=293.16K
angular distribution for (n,n*3)

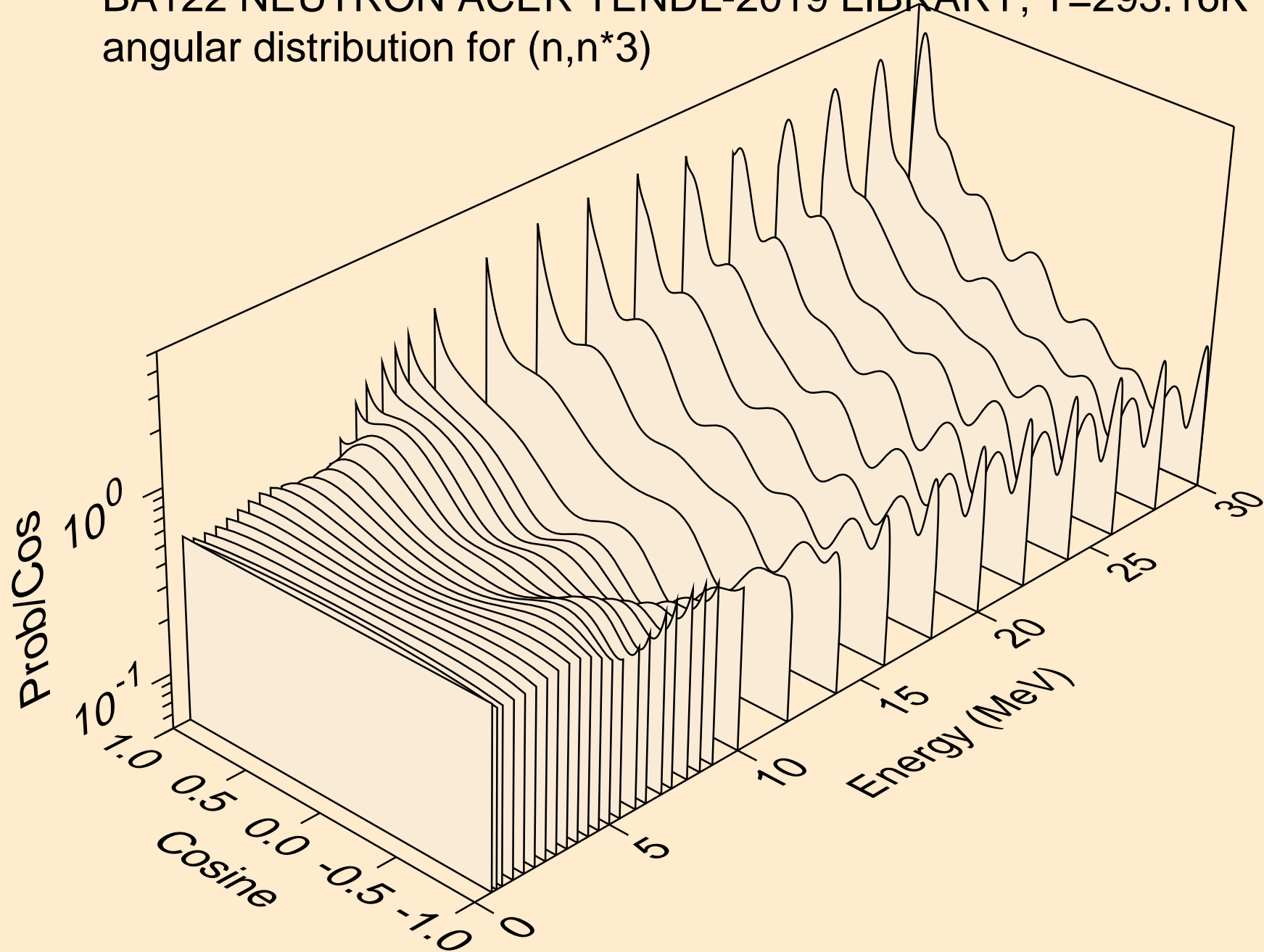

BA122 NEUTRON ACER TENDL-2019 LIBRARY; T=293.16K
angular distribution for (n,n*4)

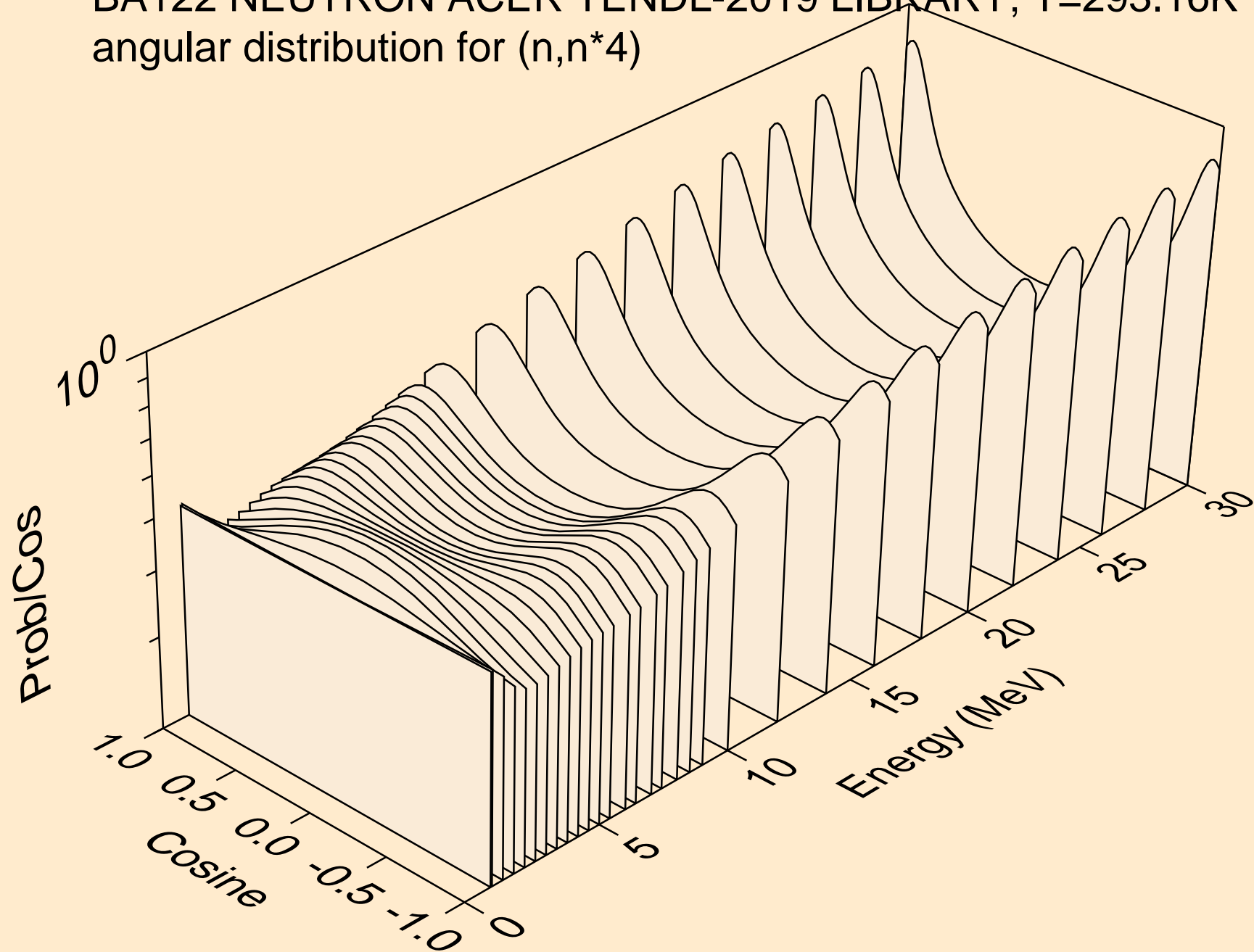

BA122 NEUTRON ACER TENDL-2019 LIBRARY; T=293.16K
angular distribution for (n,n*5)

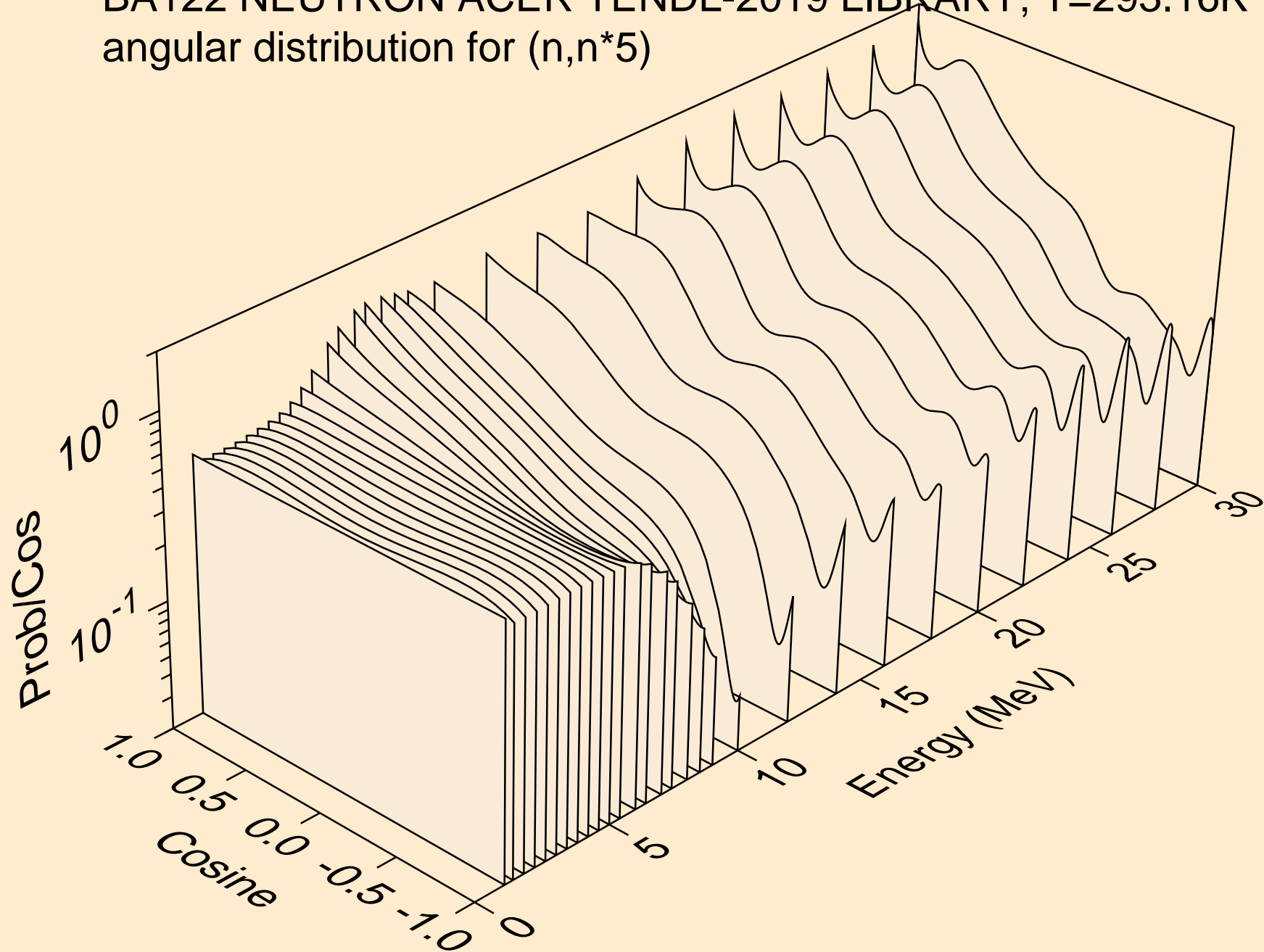

BA122 NEUTRON ACER TENDL-2019 LIBRARY; T=293.16K
angular distribution for (n,n*6)

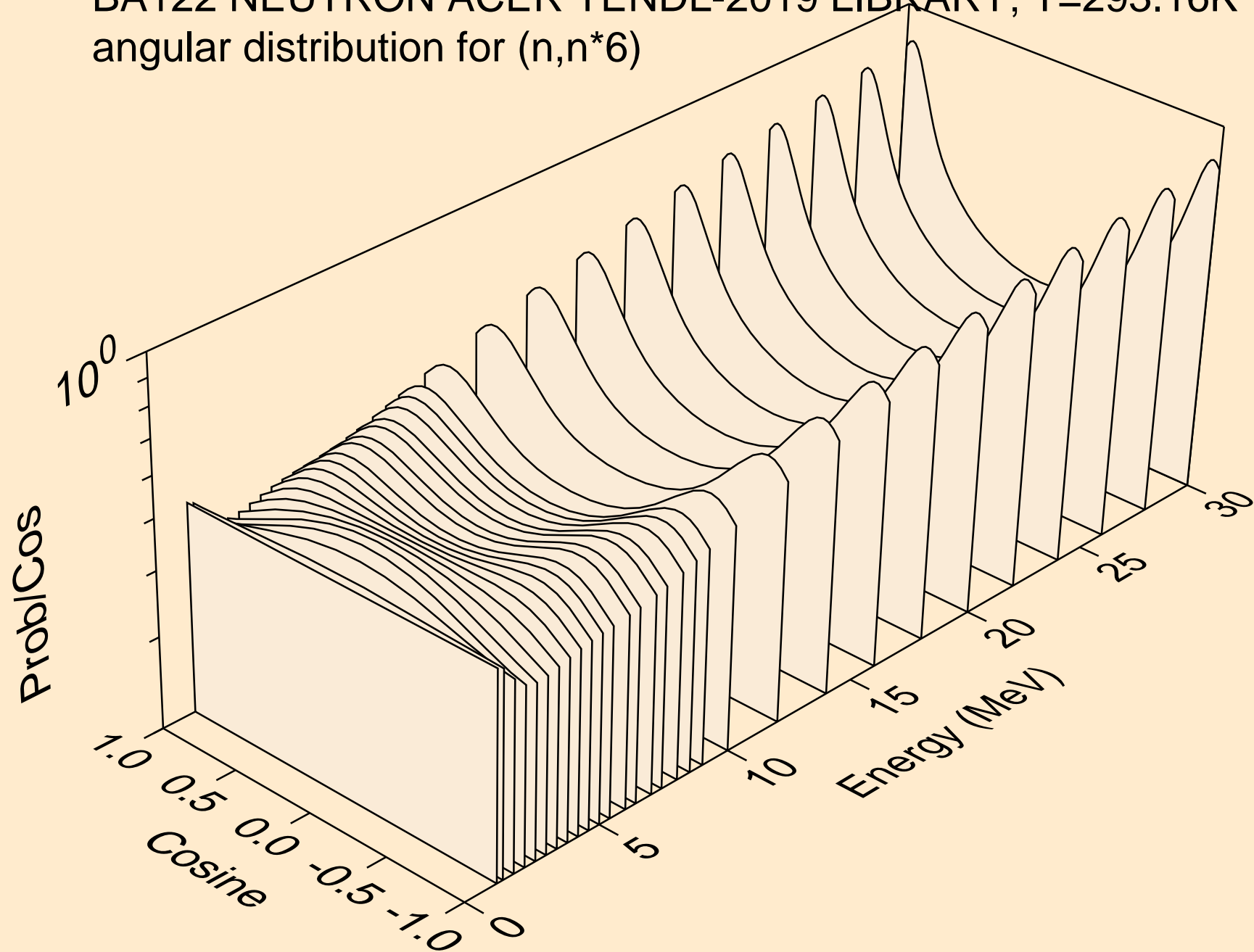

BA122 NEUTRON ACER TENDL-2019 LIBRARY; T=293.16K
angular distribution for (n,n*7)

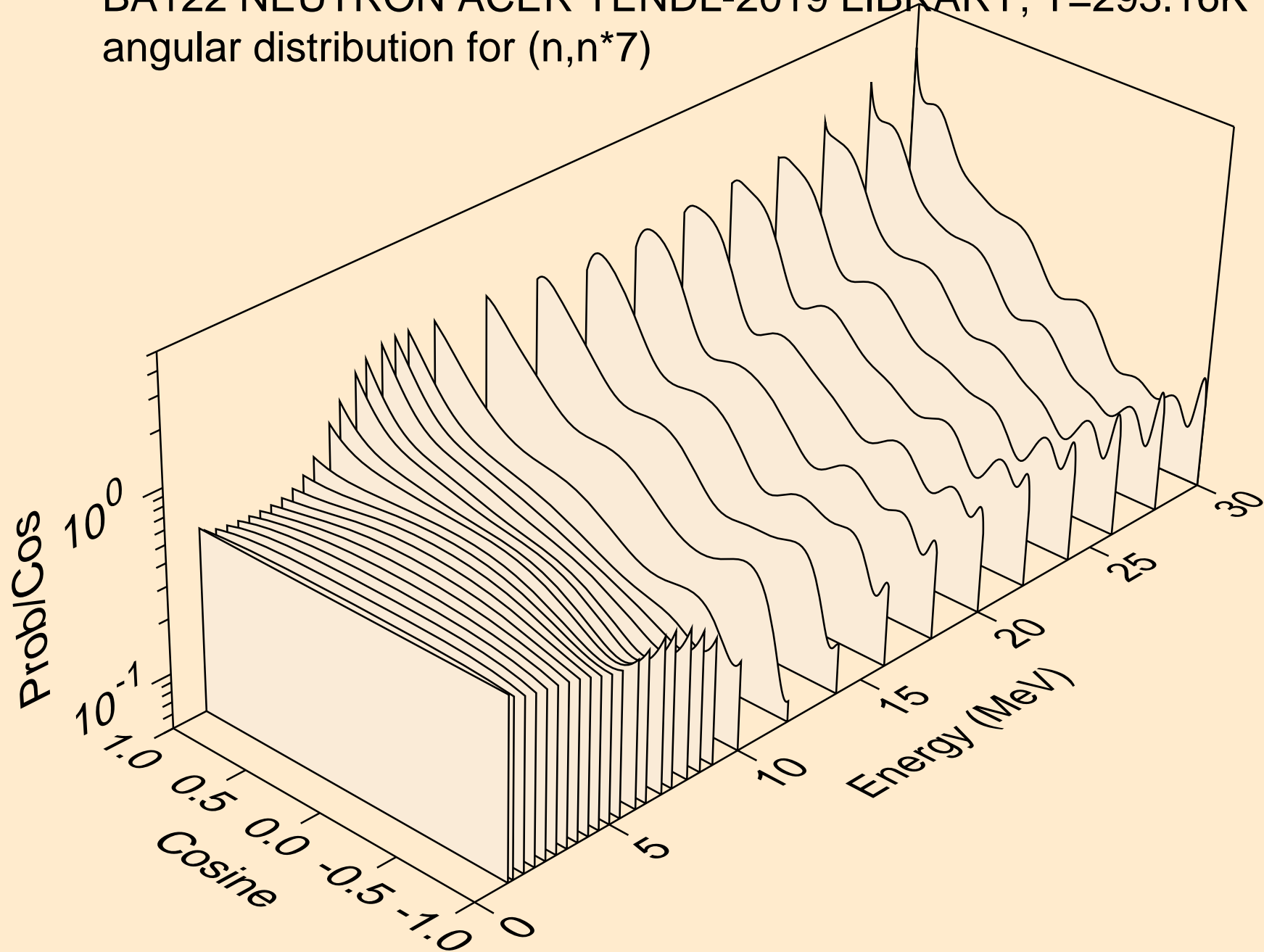

BA122 NEUTRON ACER TENDL-2019 LIBRARY; T=293.16K
angular distribution for (n,n*8)

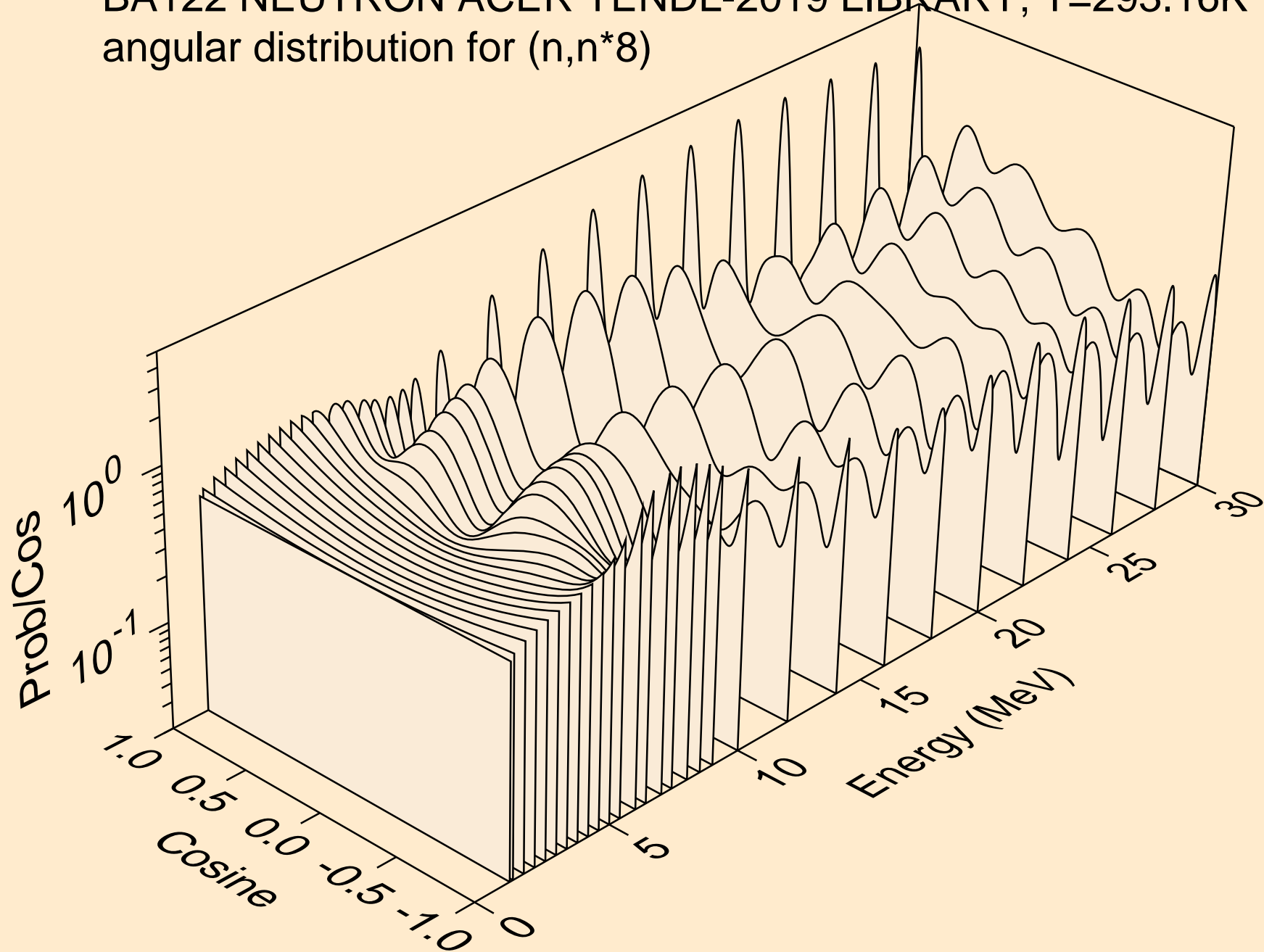

BA122 NEUTRON ACER TENDL-2019 LIBRARY; T=293.16K
Neutron emission for (n,x)

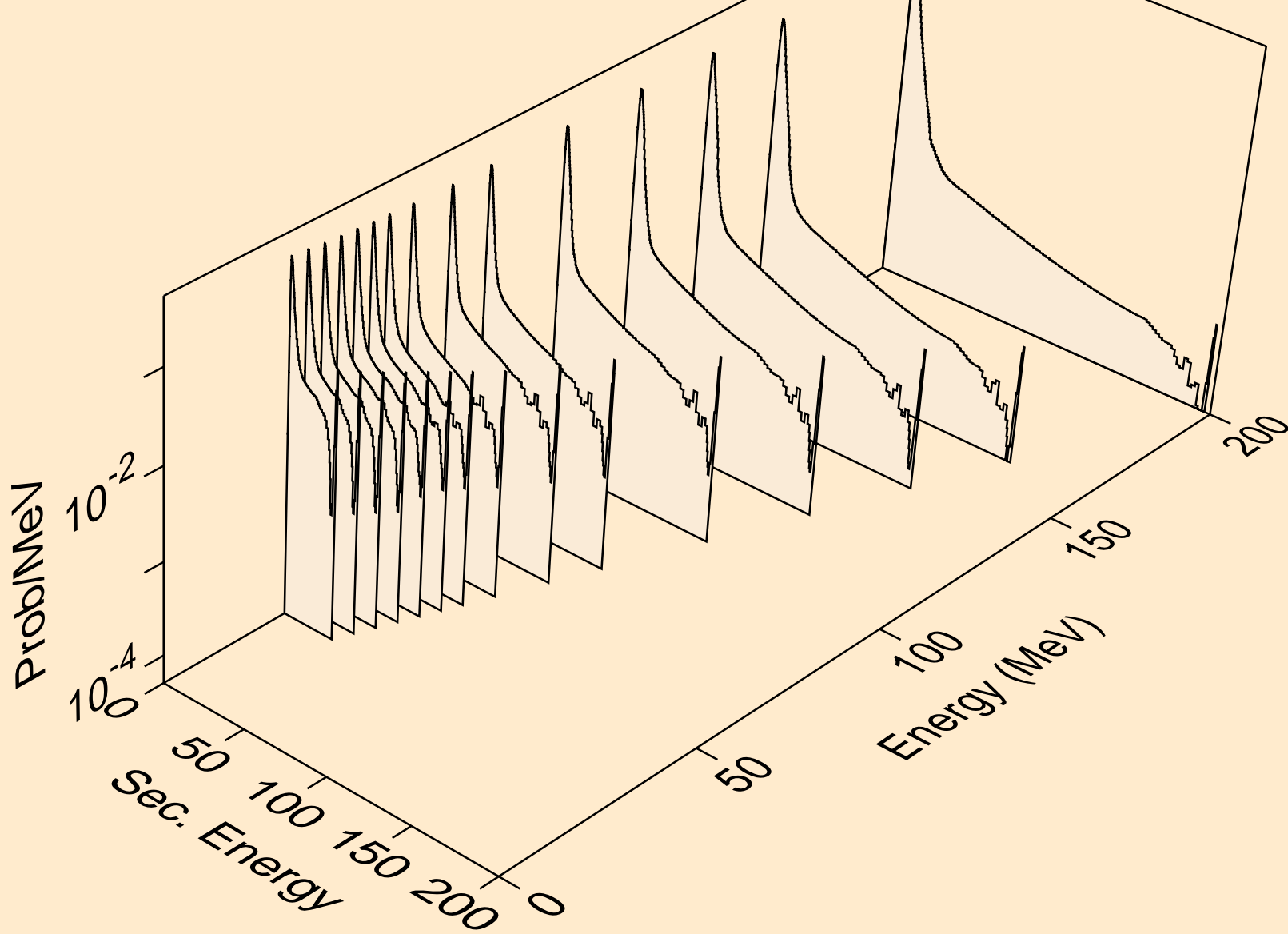

BA122 NEUTRON ACER TENDL-2019 LIBRARY; T=293.16K
Neutron emission for (n,2nd)

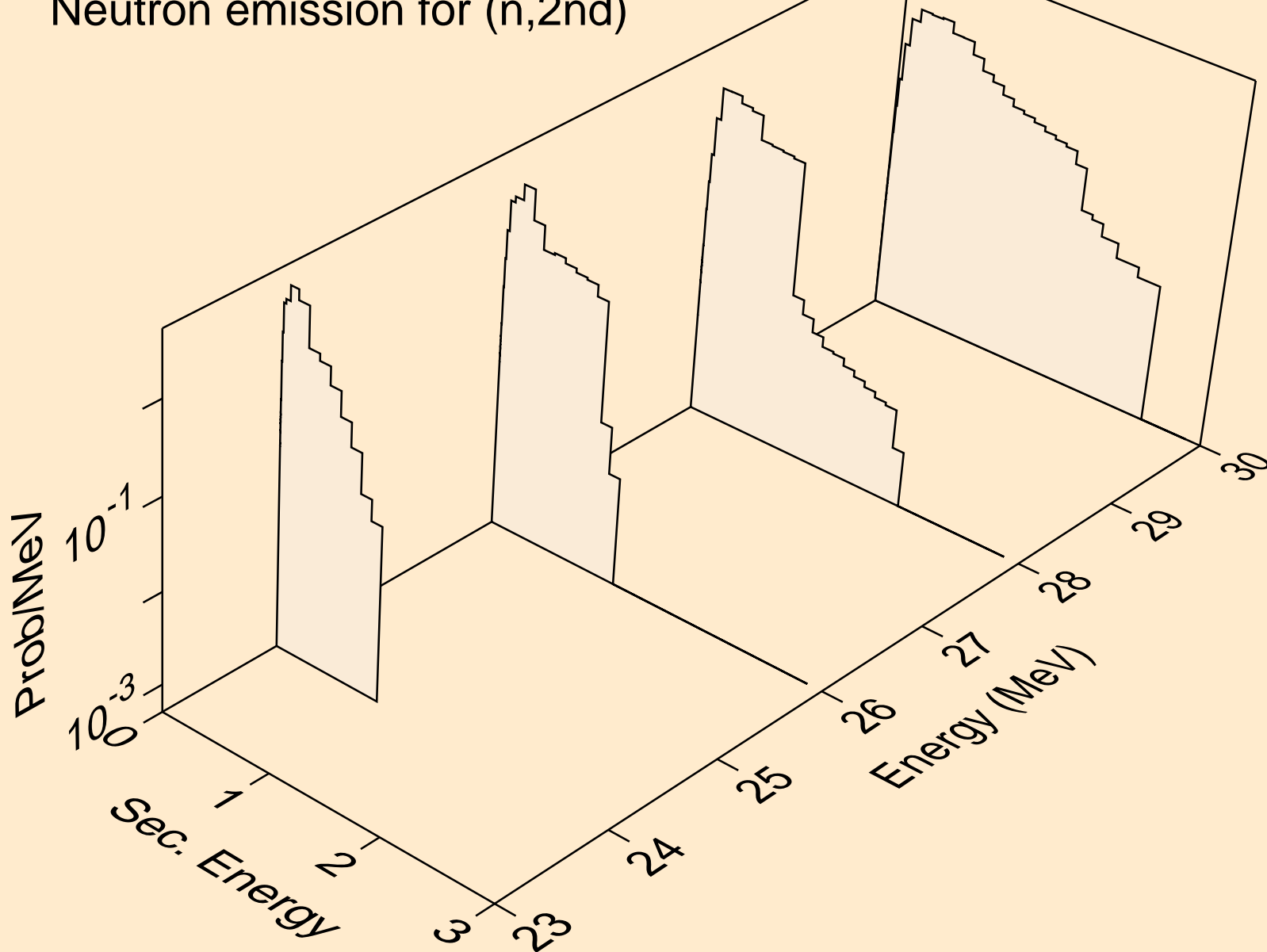

BA122 NEUTRON ACER TENDL-2019 LIBRARY; T=293.16K
Neutron emission for (n,2n)

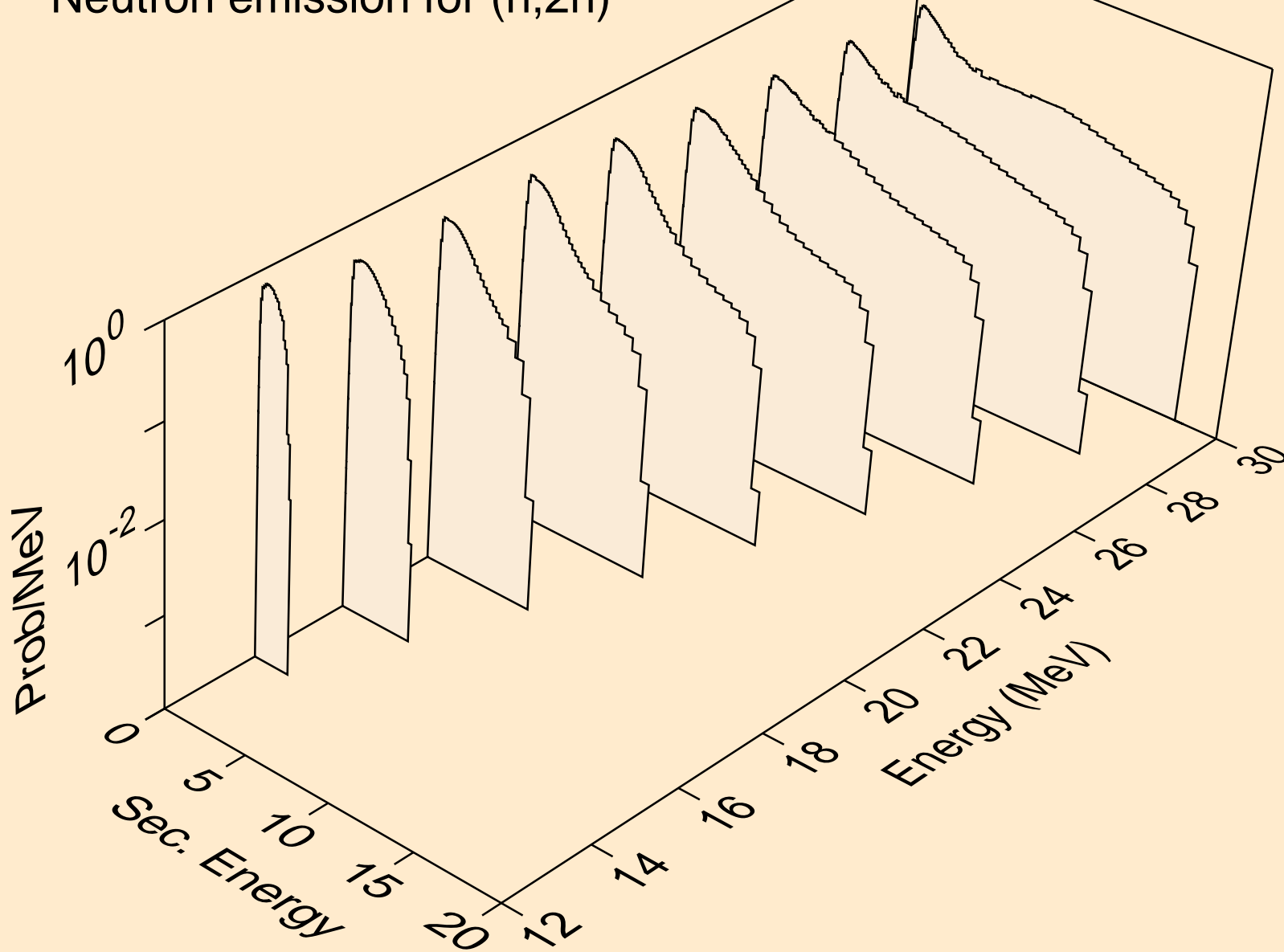

BA122 NEUTRON ACER TENDL-2019 LIBRARY; T=293.16K
Neutron emission for (n,3n)

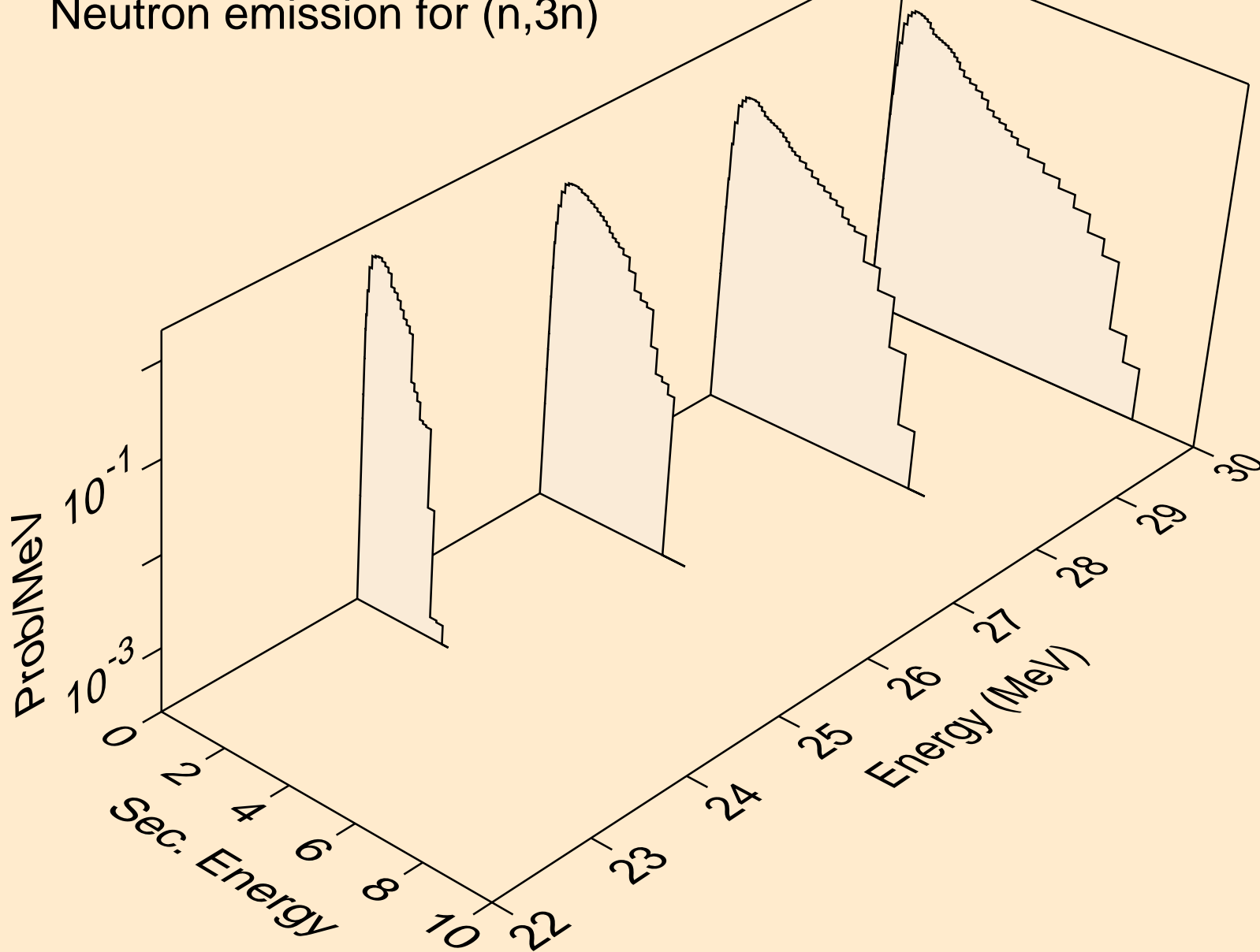

BA122 NEUTRON ACER TENDL-2019 LIBRARY; T=293.16K
Neutron emission for (n,n*)a

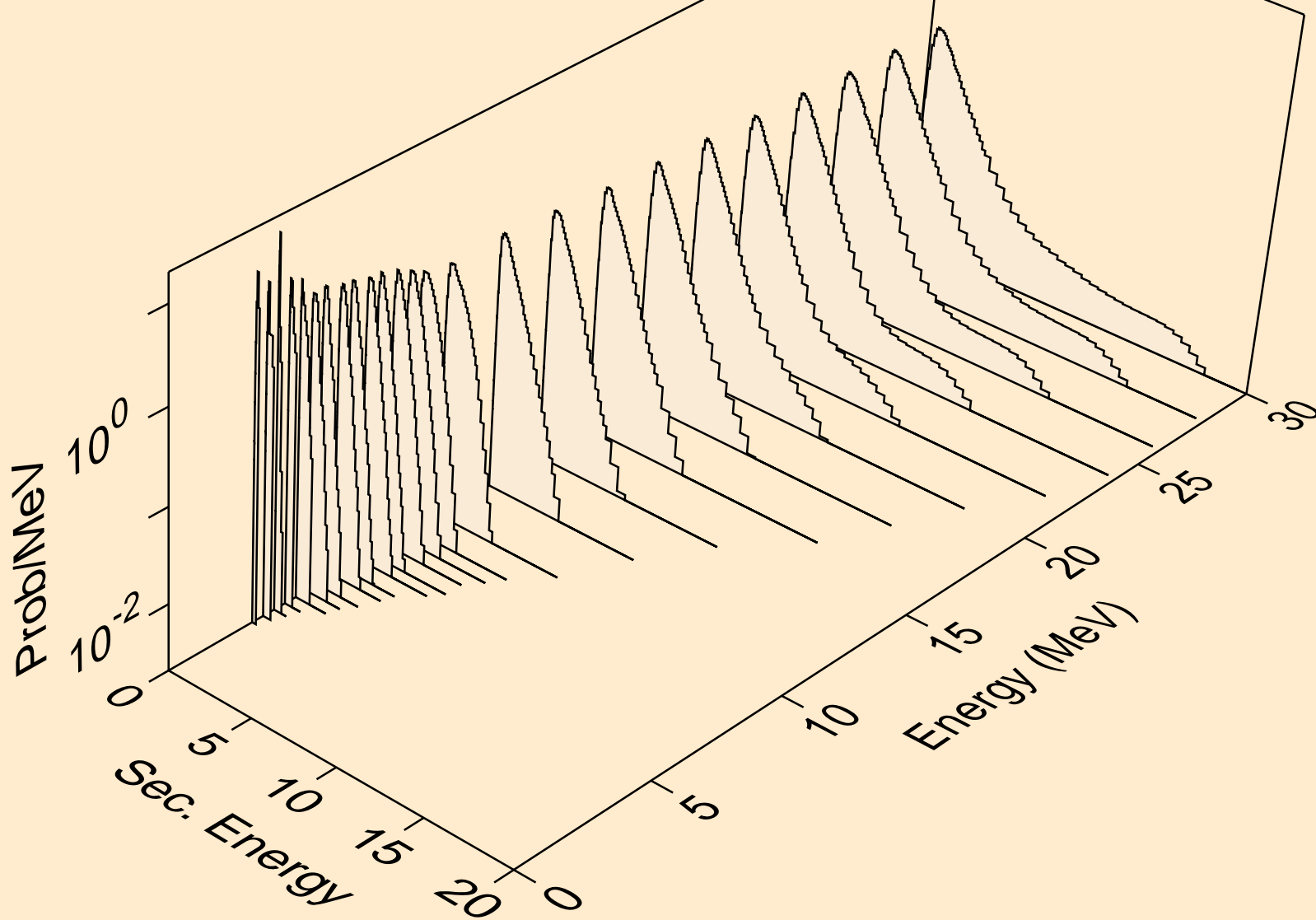

BA122 NEUTRON ACER TENDL-2019 LIBRARY; T=293.16K
Neutron emission for (n,n*)3a

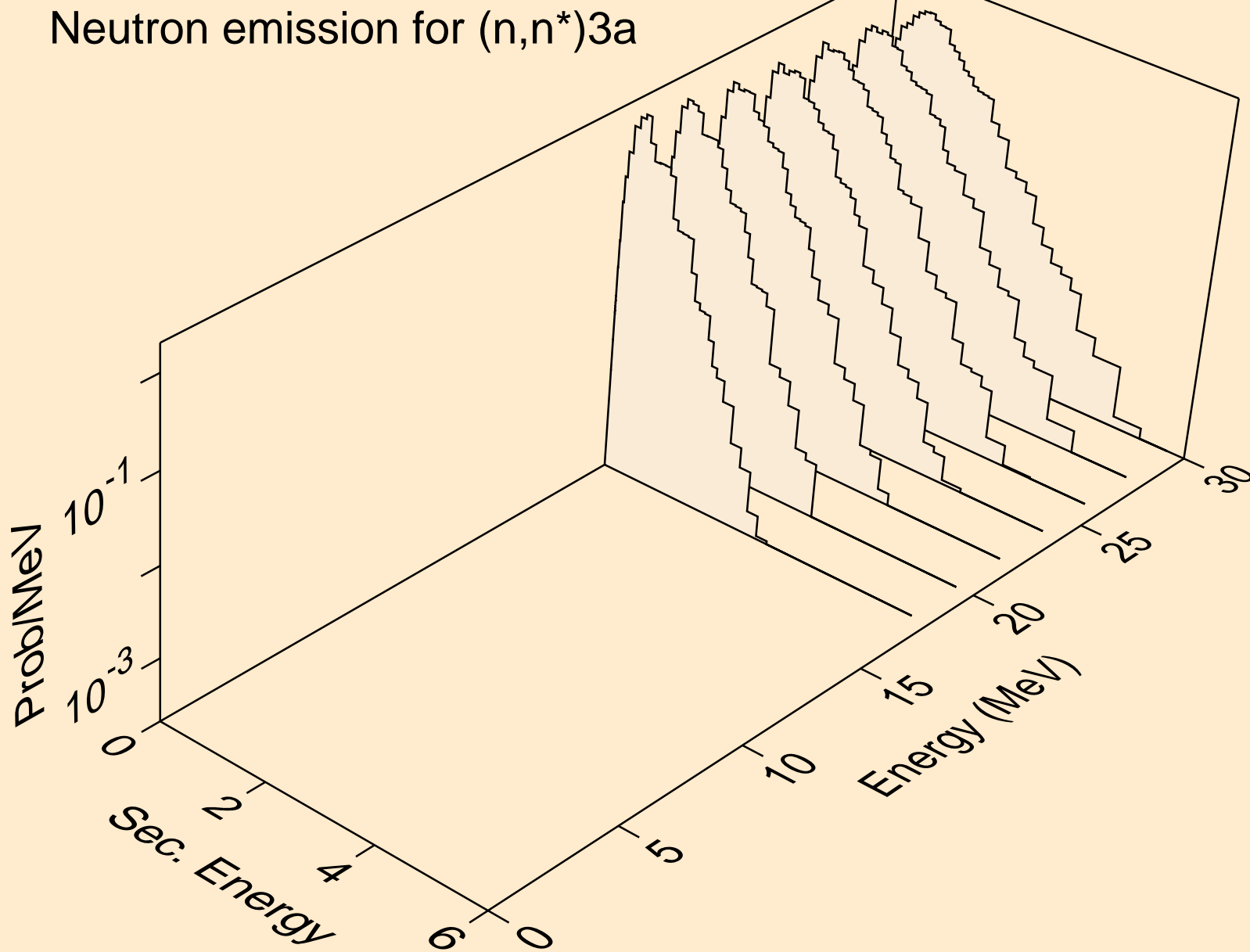

BA122 NEUTRON ACER TENDL-2019 LIBRARY; T=293.16K
Neutron emission for (n,2n)a

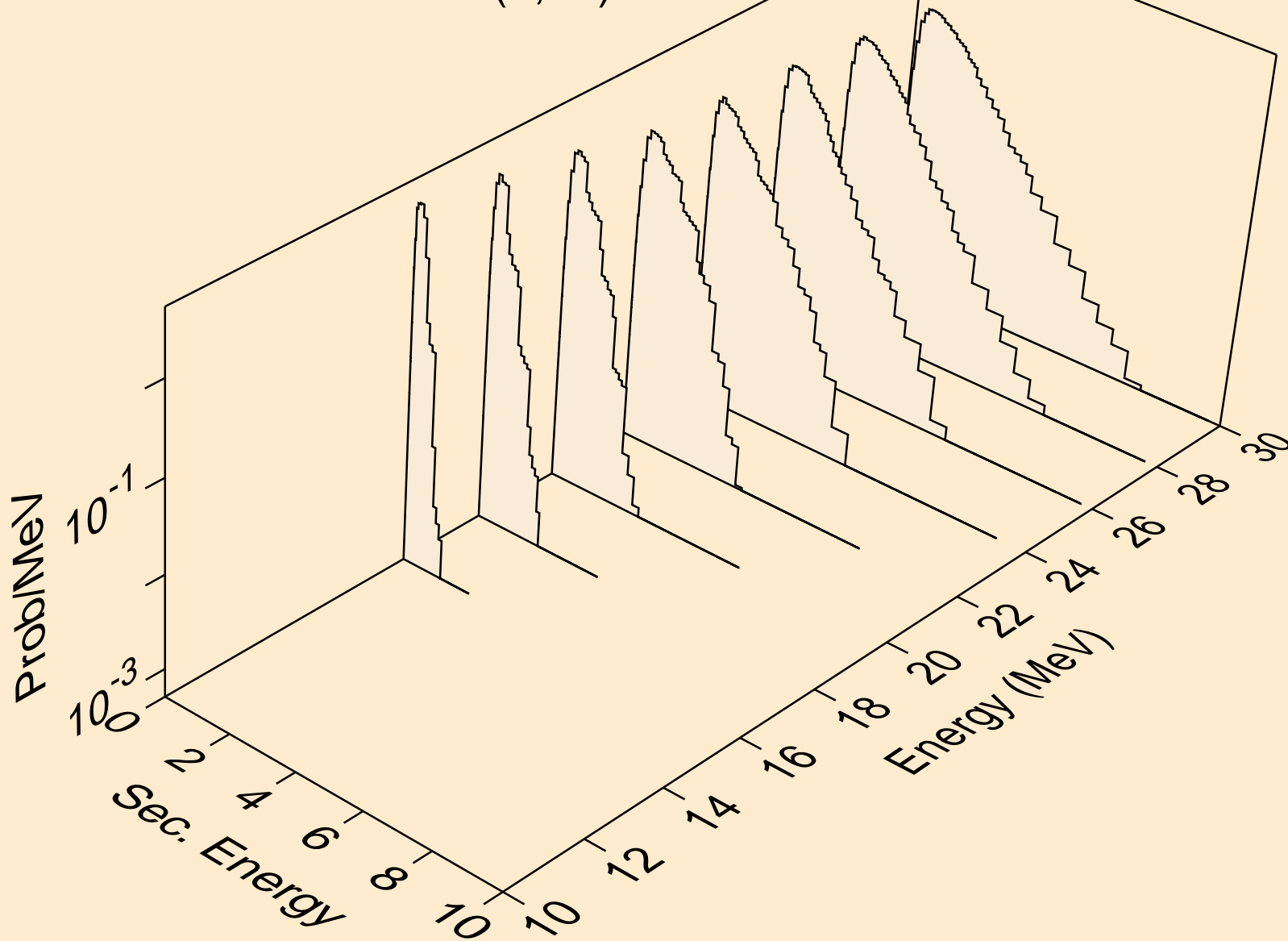

BA122 NEUTRON ACER TENDL-2019 LIBRARY; T=293.16K
Neutron emission for (n,3n)a

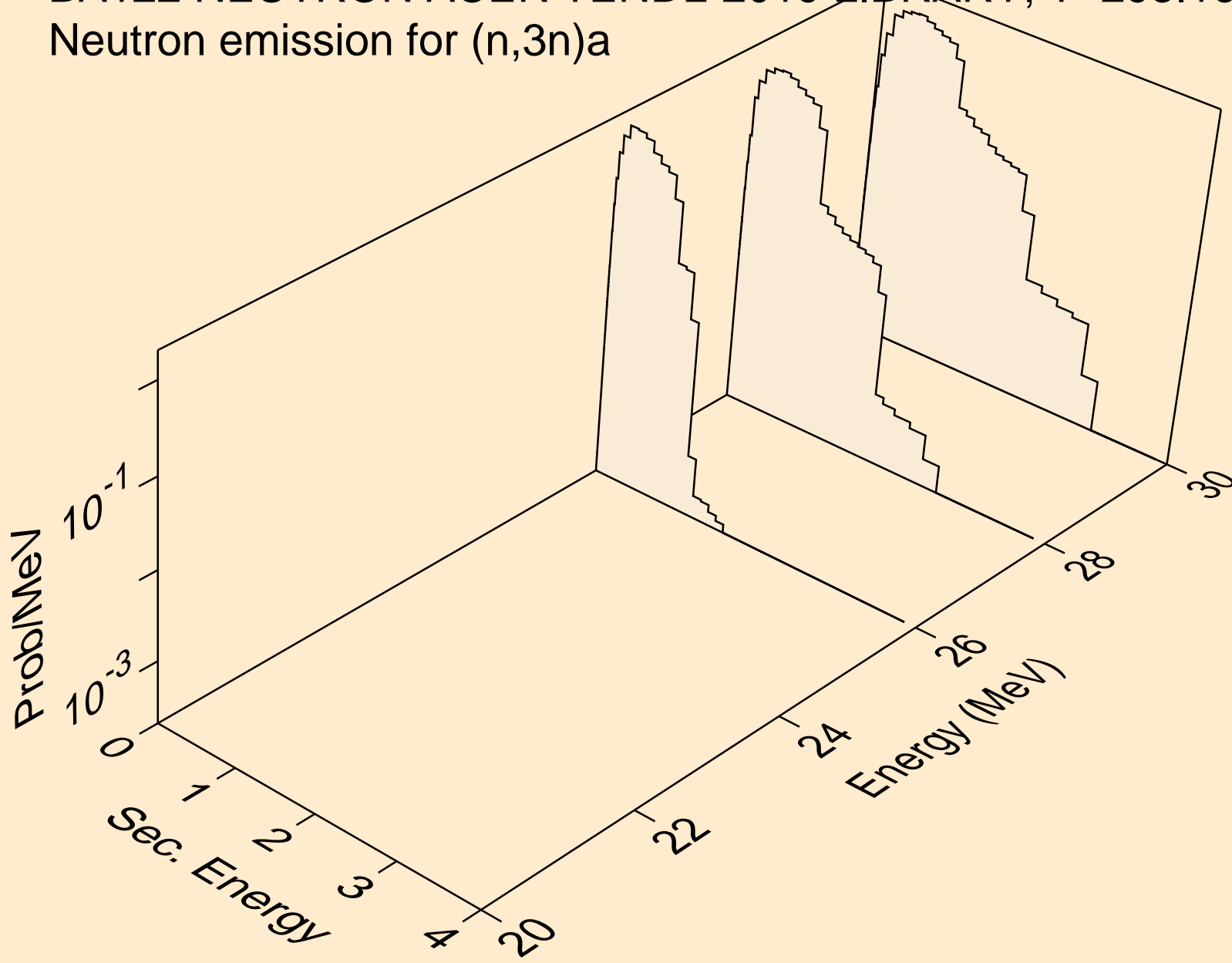

BA122 NEUTRON ACER TENDL-2019 LIBRARY; T=293.16K
Neutron emission for (n,n*)p

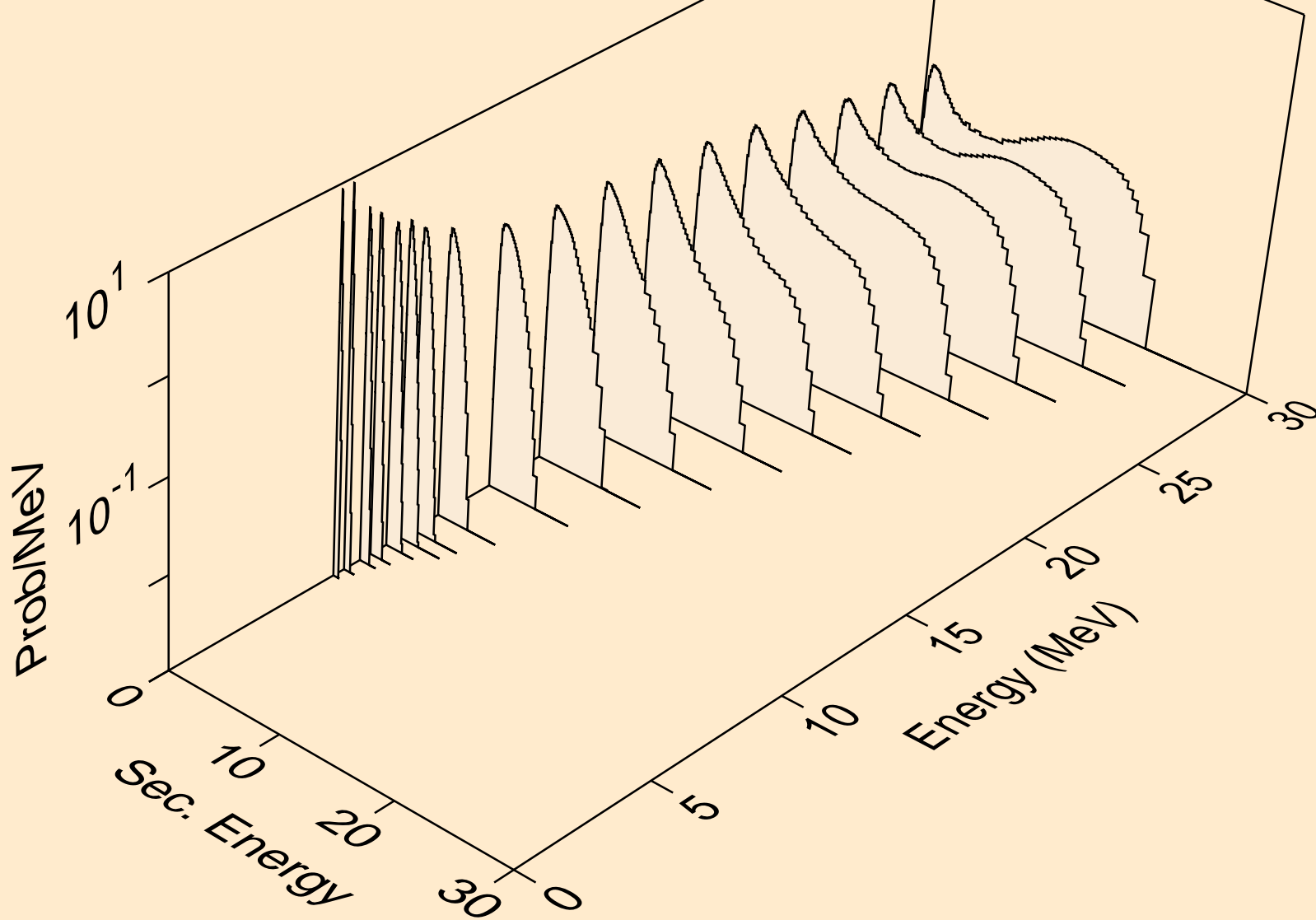

BA122 NEUTRON ACER TENDL-2019 LIBRARY; T=293.16K
Neutron emission for (n,n*)2a

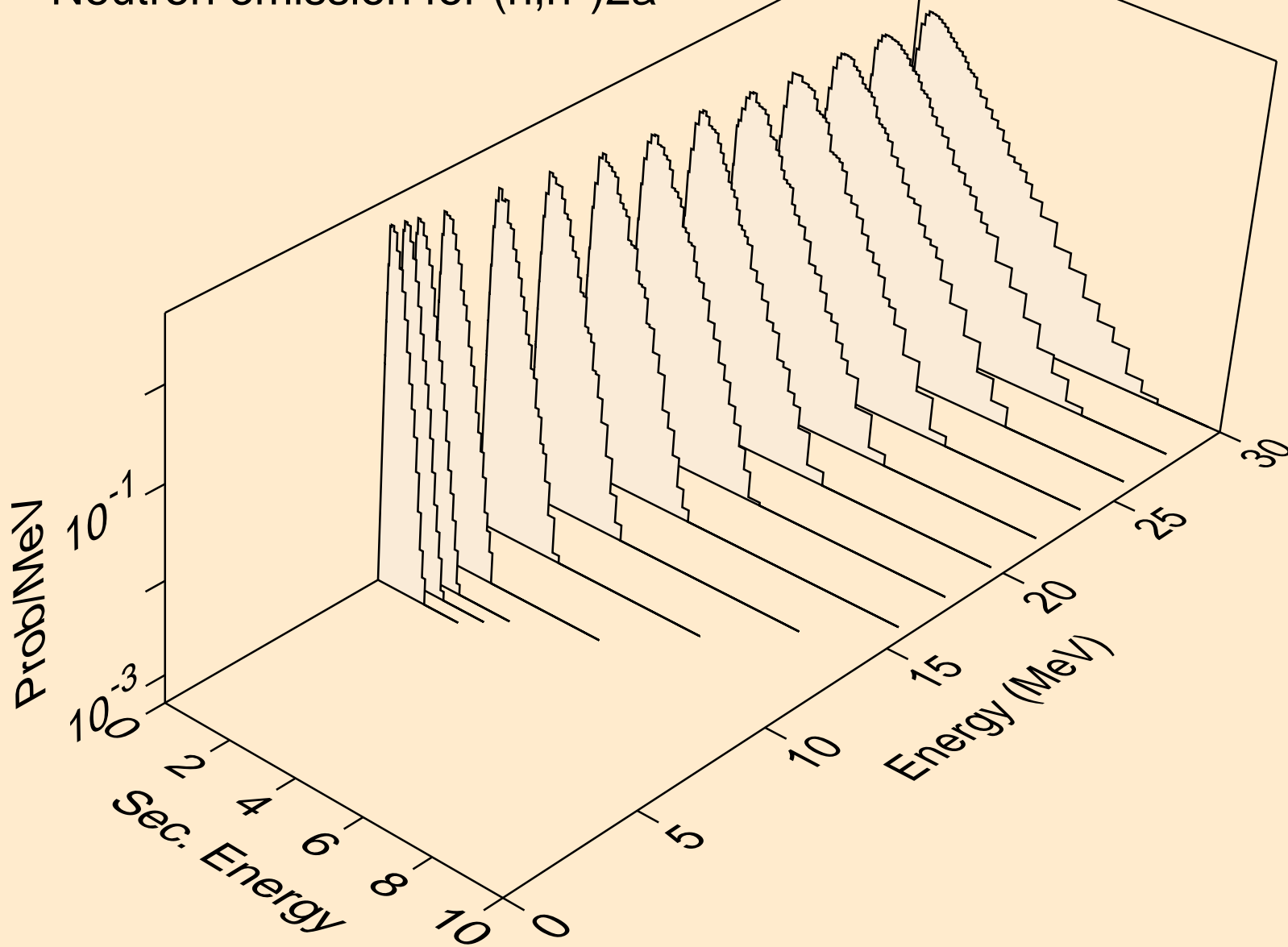

BA122 NEUTRON ACER TENDL-2019 LIBRARY; T=293.16K
Neutron emission for (n,2n)2a

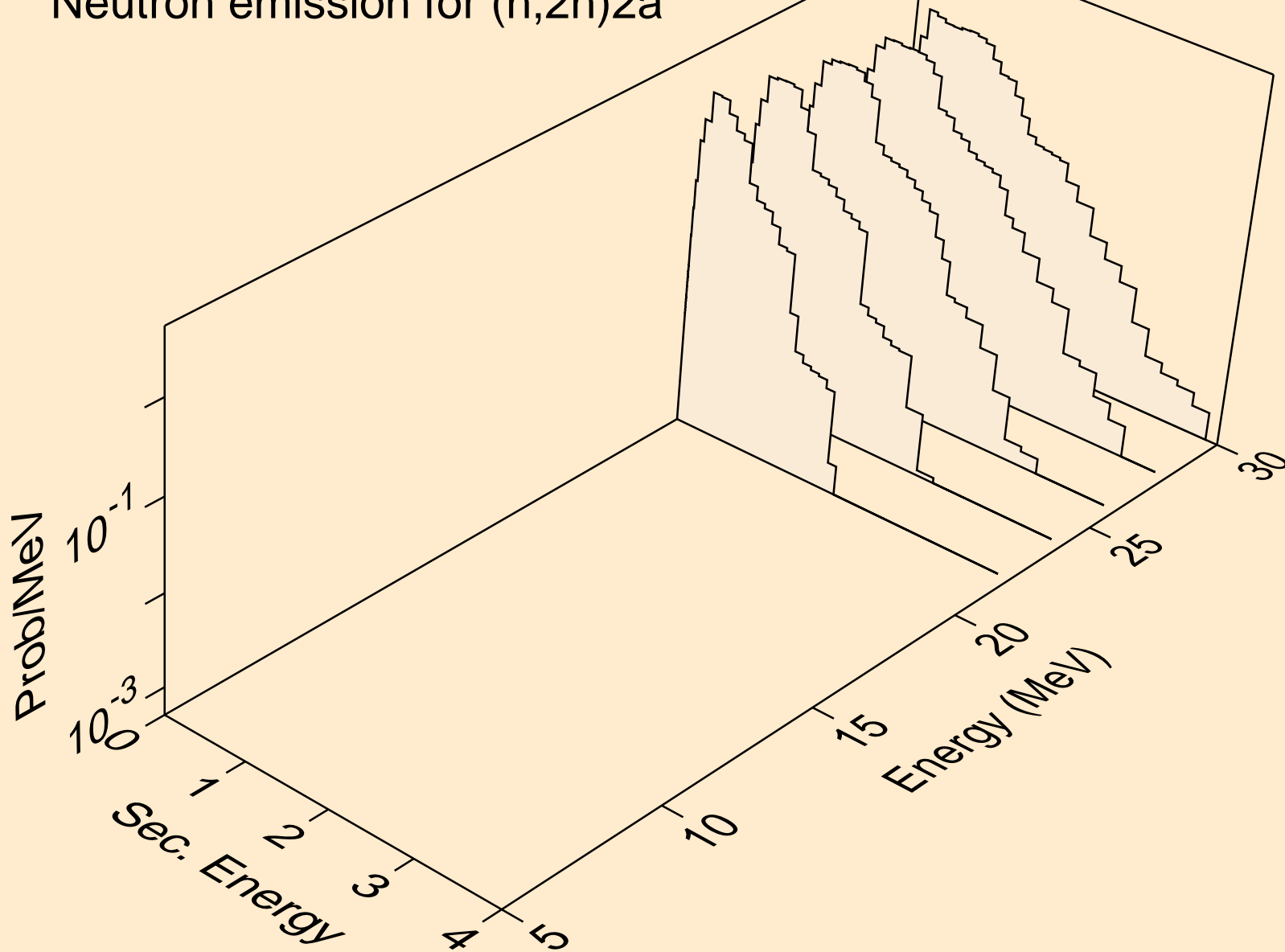

BA122 NEUTRON ACER TENDL-2019 LIBRARY; T=293.16K
Neutron emission for (n,n*)d

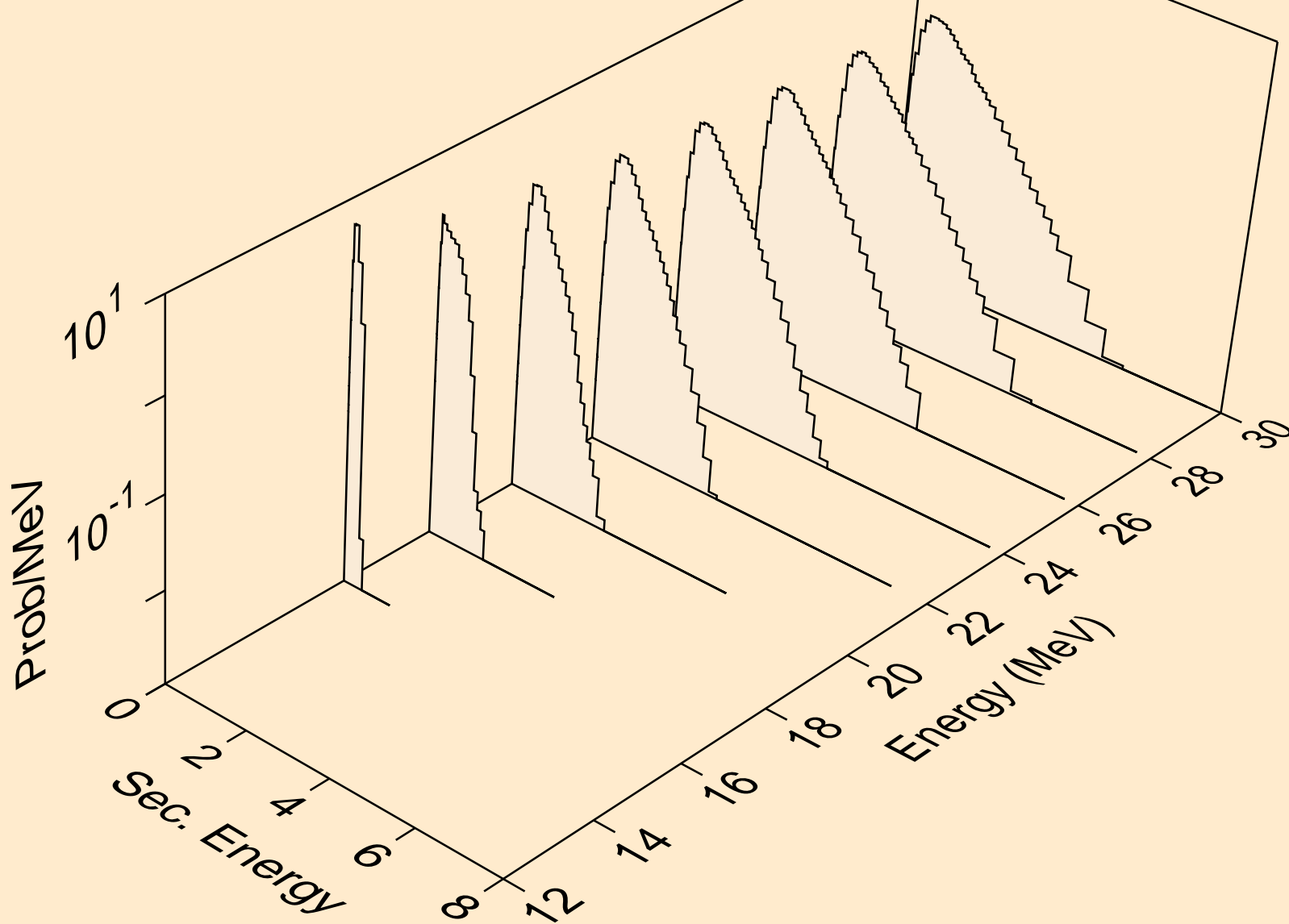

BA122 NEUTRON ACER TENDL-2019 LIBRARY; T=293.16K
Neutron emission for (n,n*)t

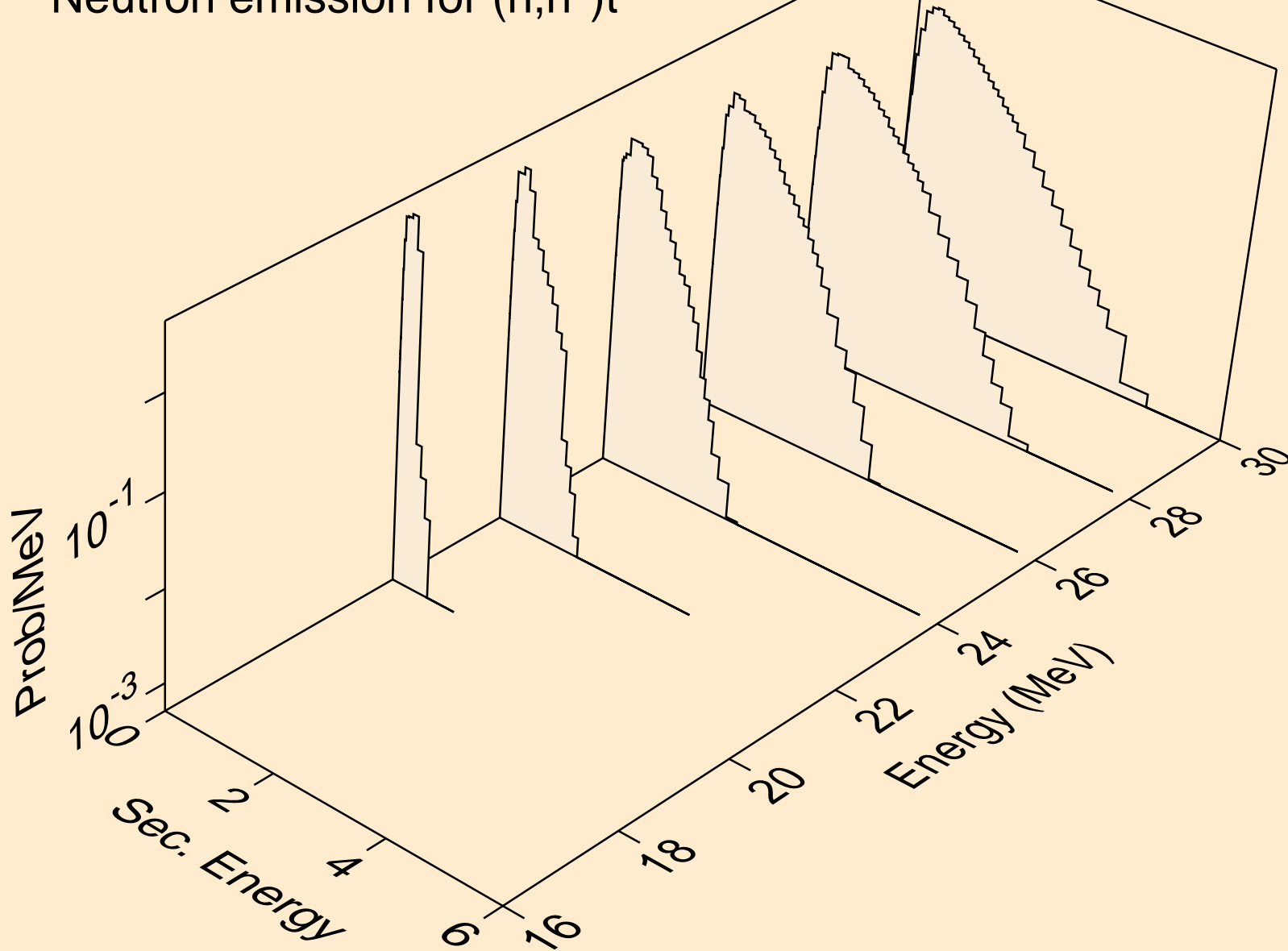

BA122 NEUTRON ACER TENDL-2019 LIBRARY; T=293.16K
Neutron emission for (n,n*)he3

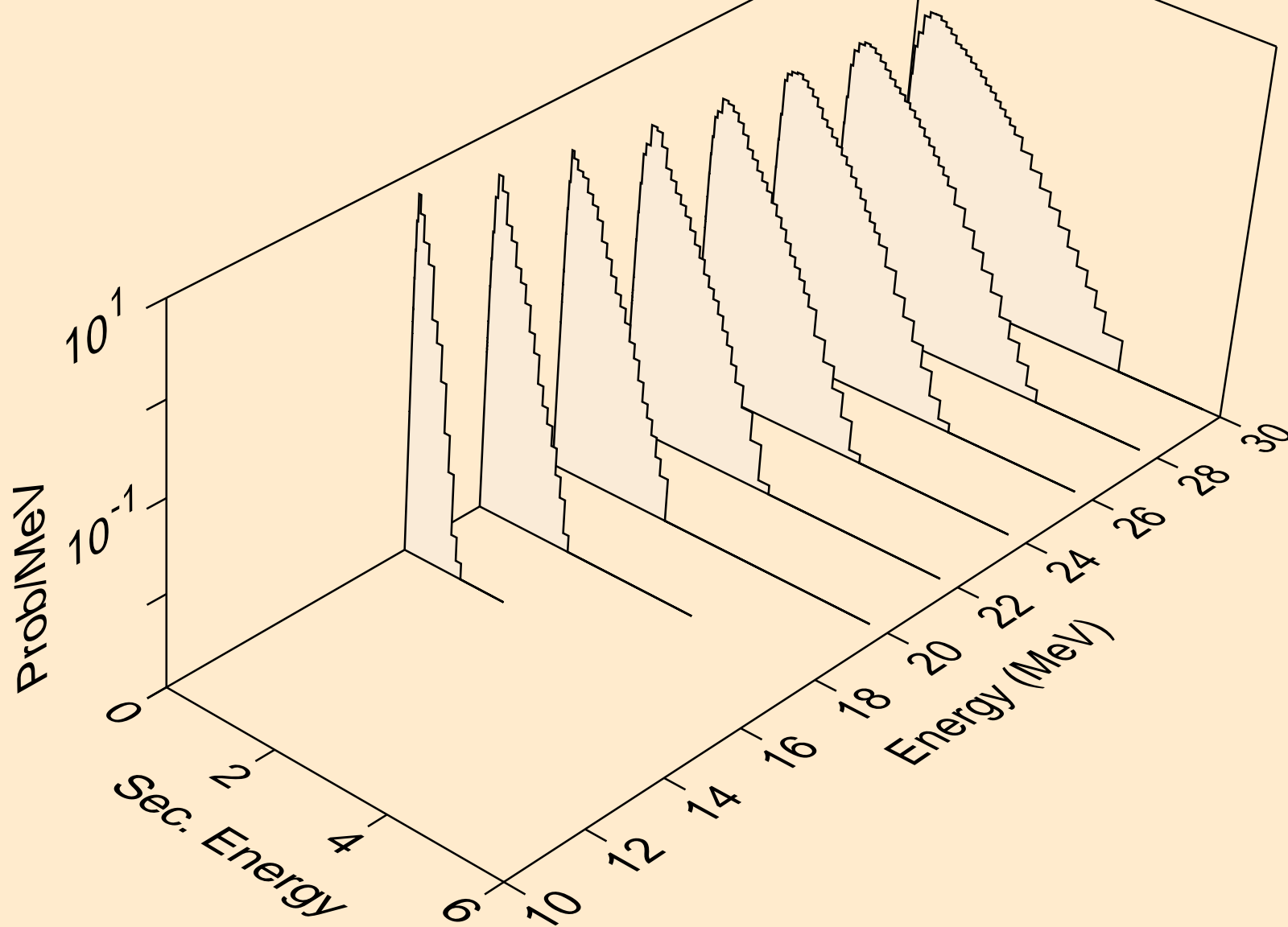

BA122 NEUTRON ACER TENDL-2019 LIBRARY; T=293.16K
Neutron emission for (n,2np)

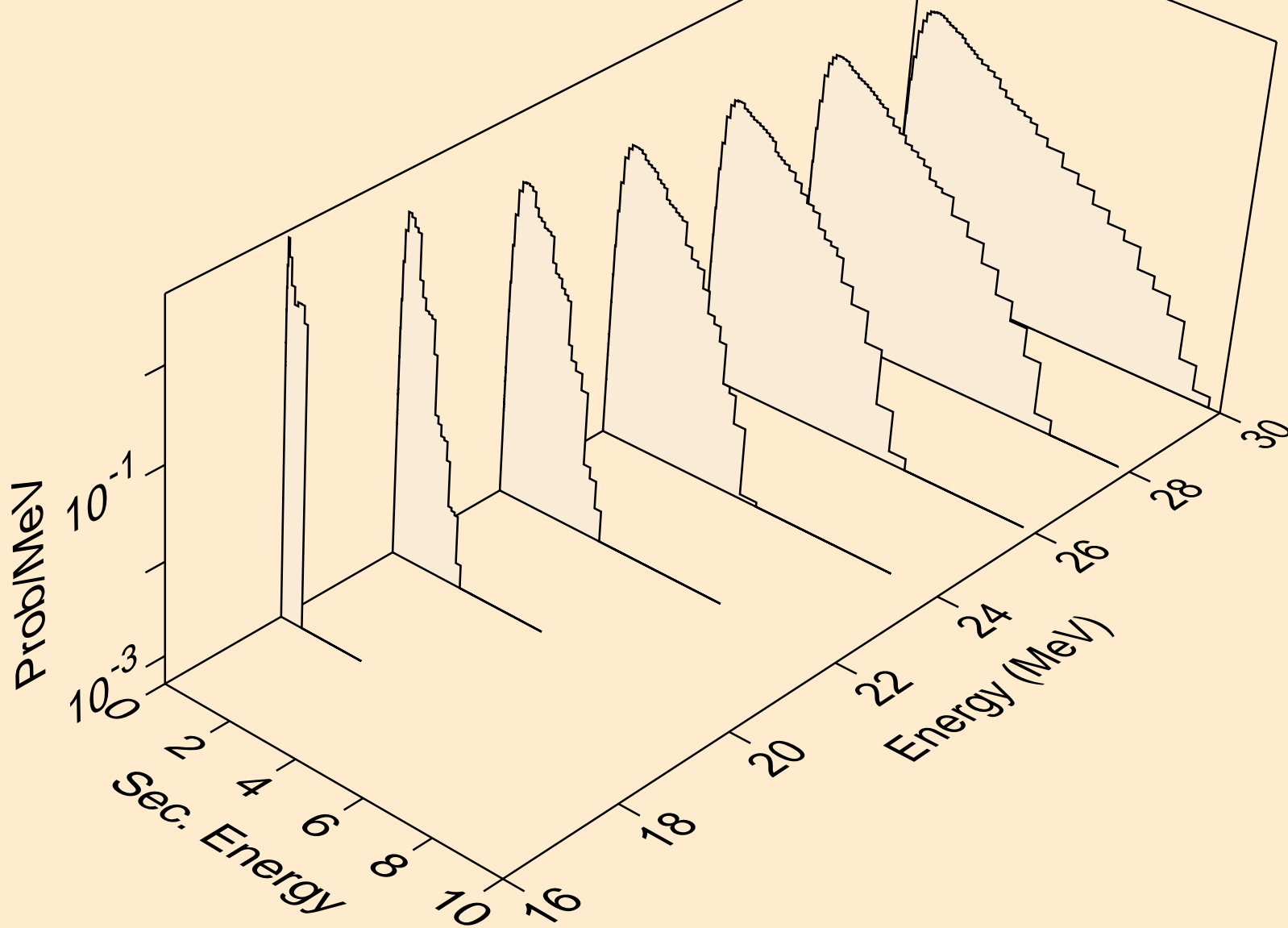

BA122 NEUTRON ACER TENDL-2019 LIBRARY; T=293.16K
Neutron emission for (n,3np)

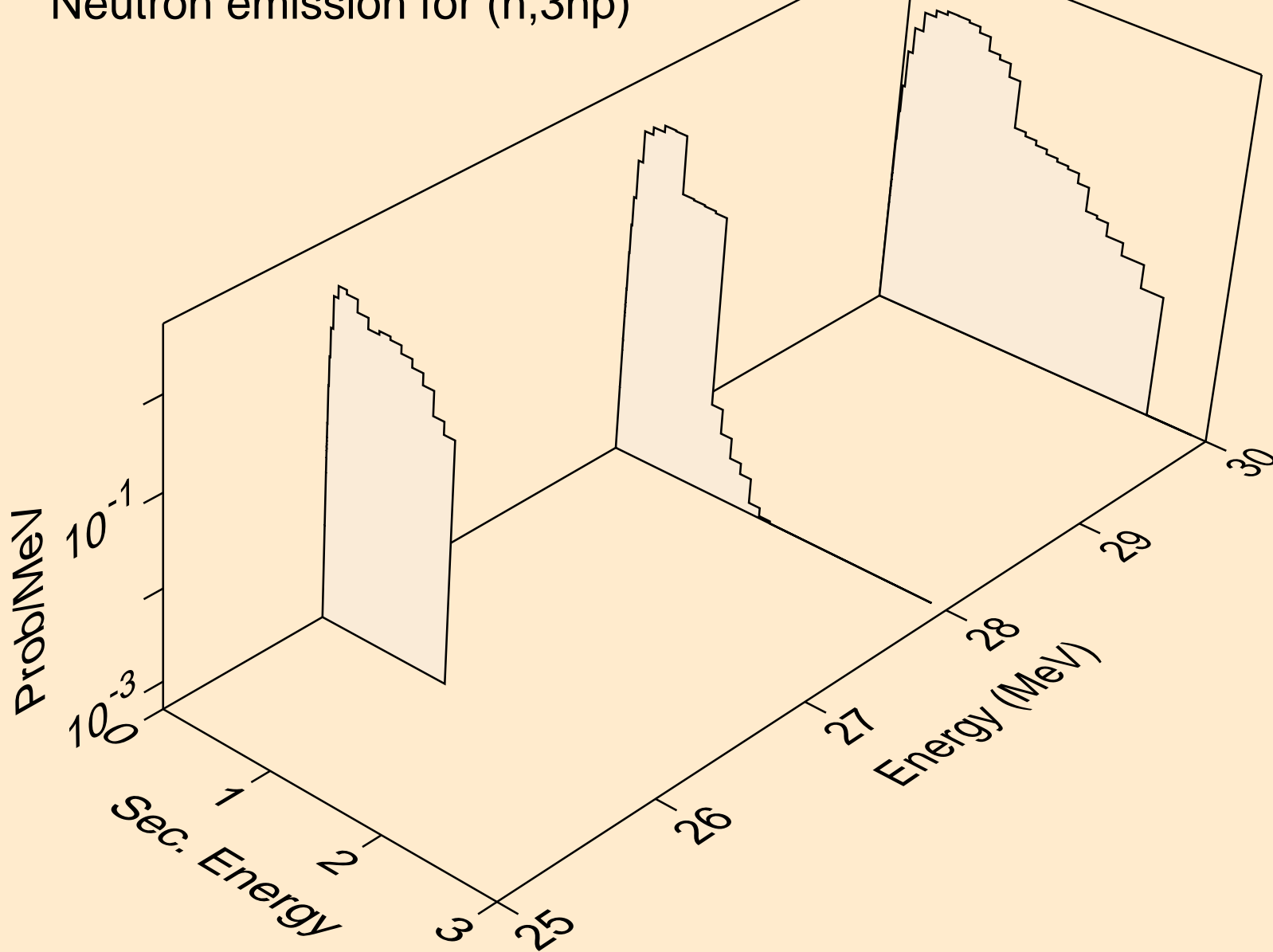

BA122 NEUTRON ACER TENDL-2019 LIBRARY; T=293.16K
Neutron emission for (n,2np)

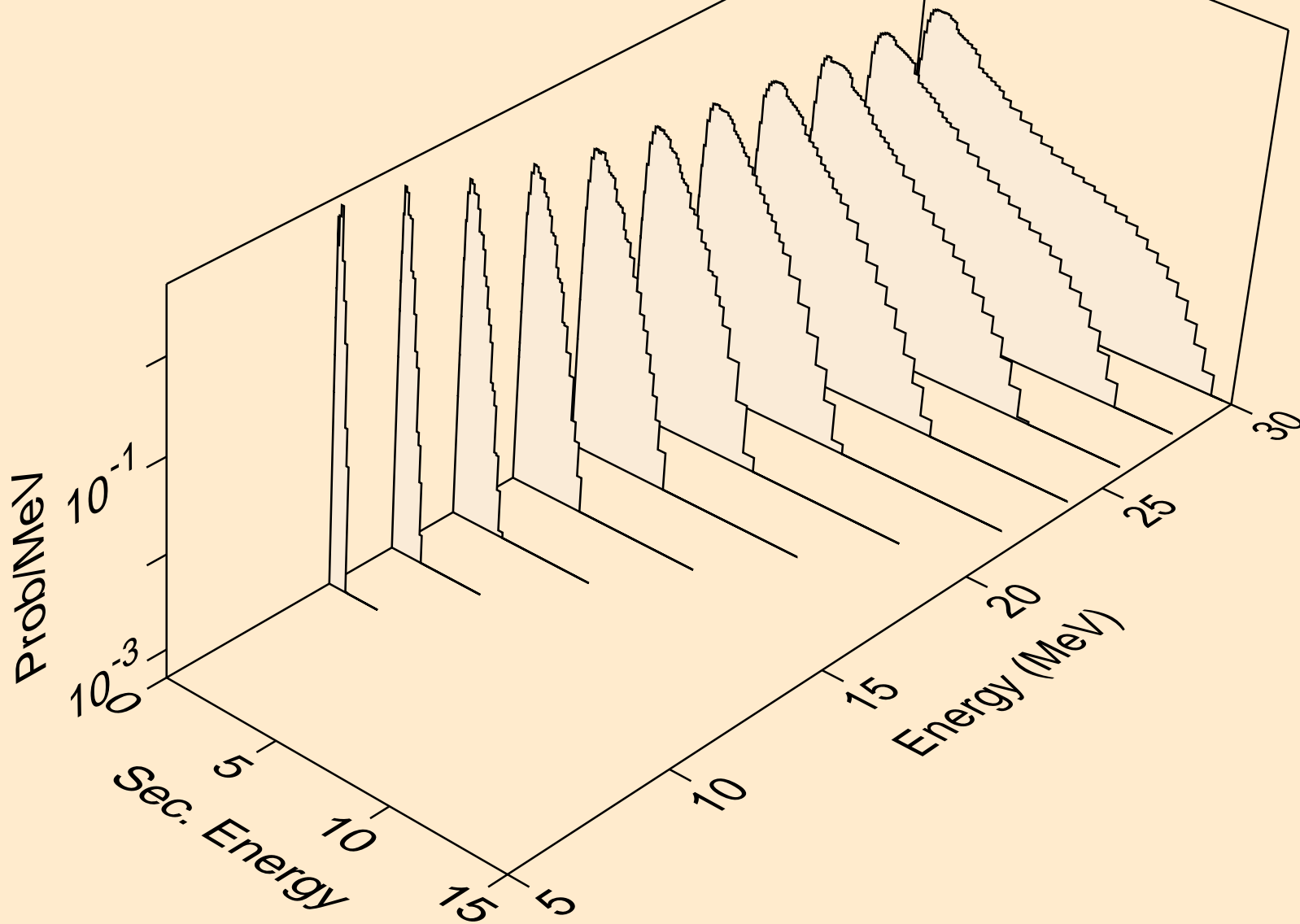

BA122 NEUTRON ACER TENDL-2019 LIBRARY; T=293.16K
Neutron emission for (n,npa)

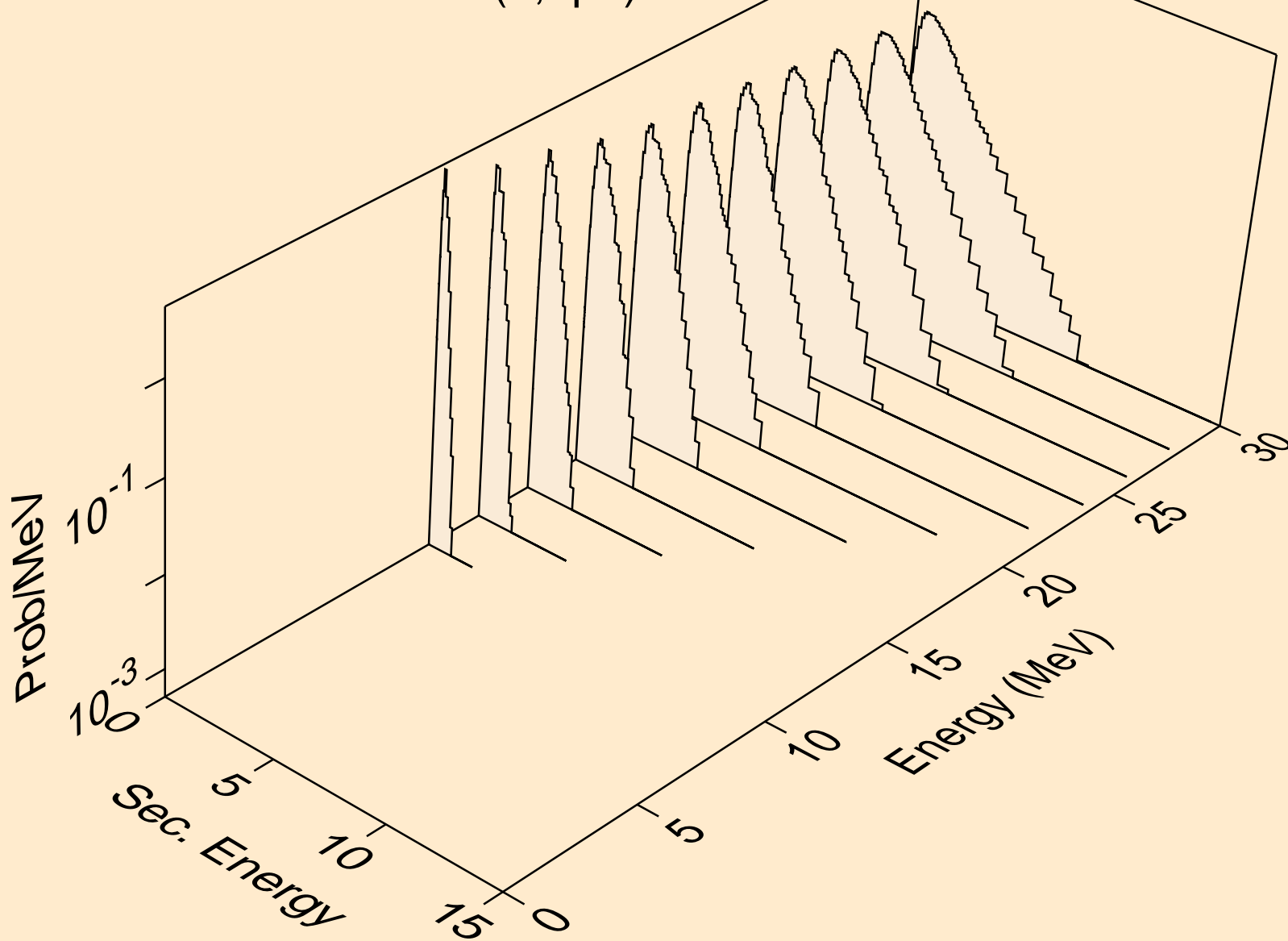

BA122 NEUTRON ACER TENDL-2019 LIBRARY; T=293.16K
Neutron emission for (n,n*c)

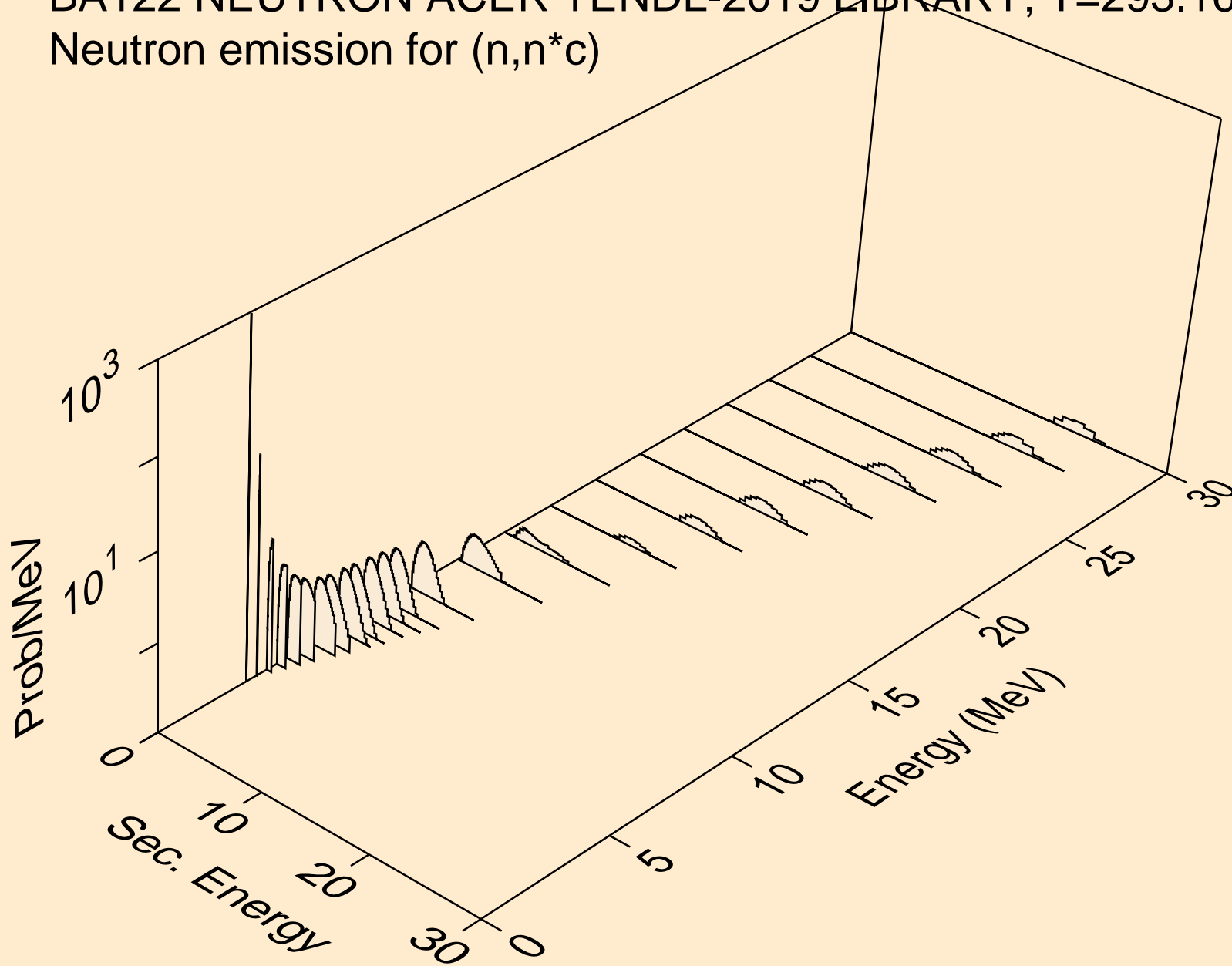

BA122 NEUTRON ACER TENDL-2019 LIBRARY; T=293.16K
Photon emission for (n,x)

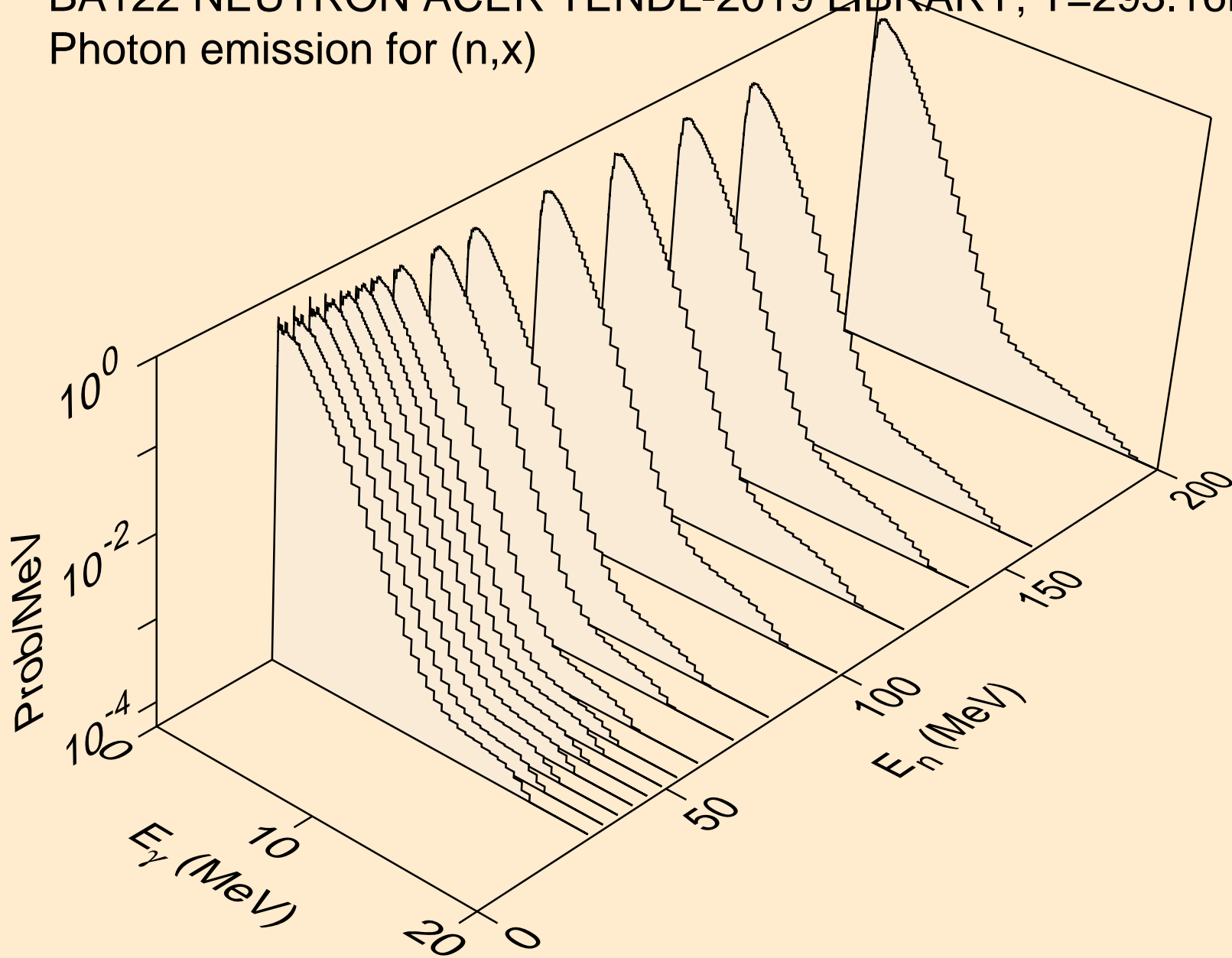

BA122 NEUTRON ACER TENDL-2019 LIBRARY; T=293.16K
Photon emission for (n,2nd)

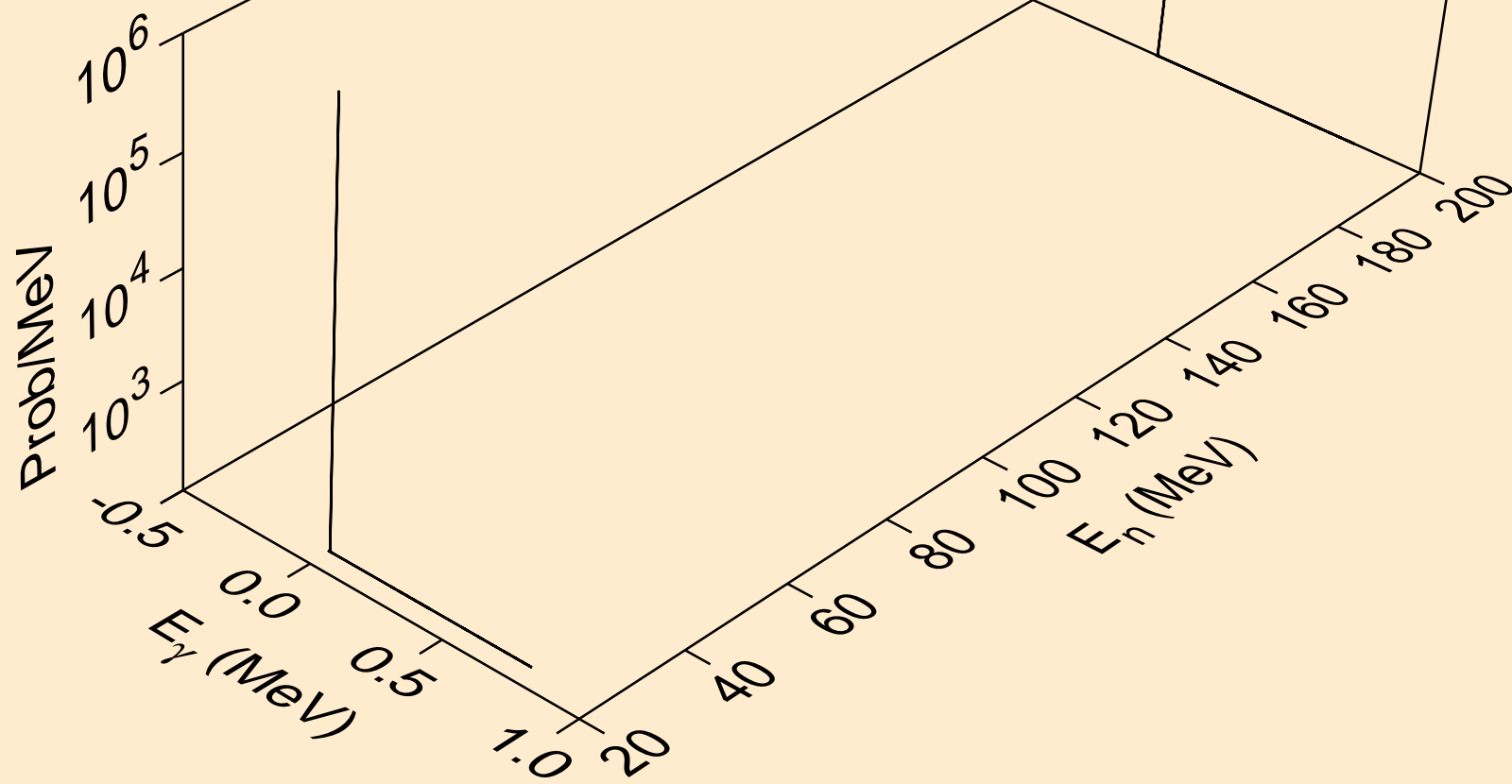

BA122 NEUTRON ACER TENDL-2019 LIBRARY; T=293.16K
Photon emission for (n,2n)

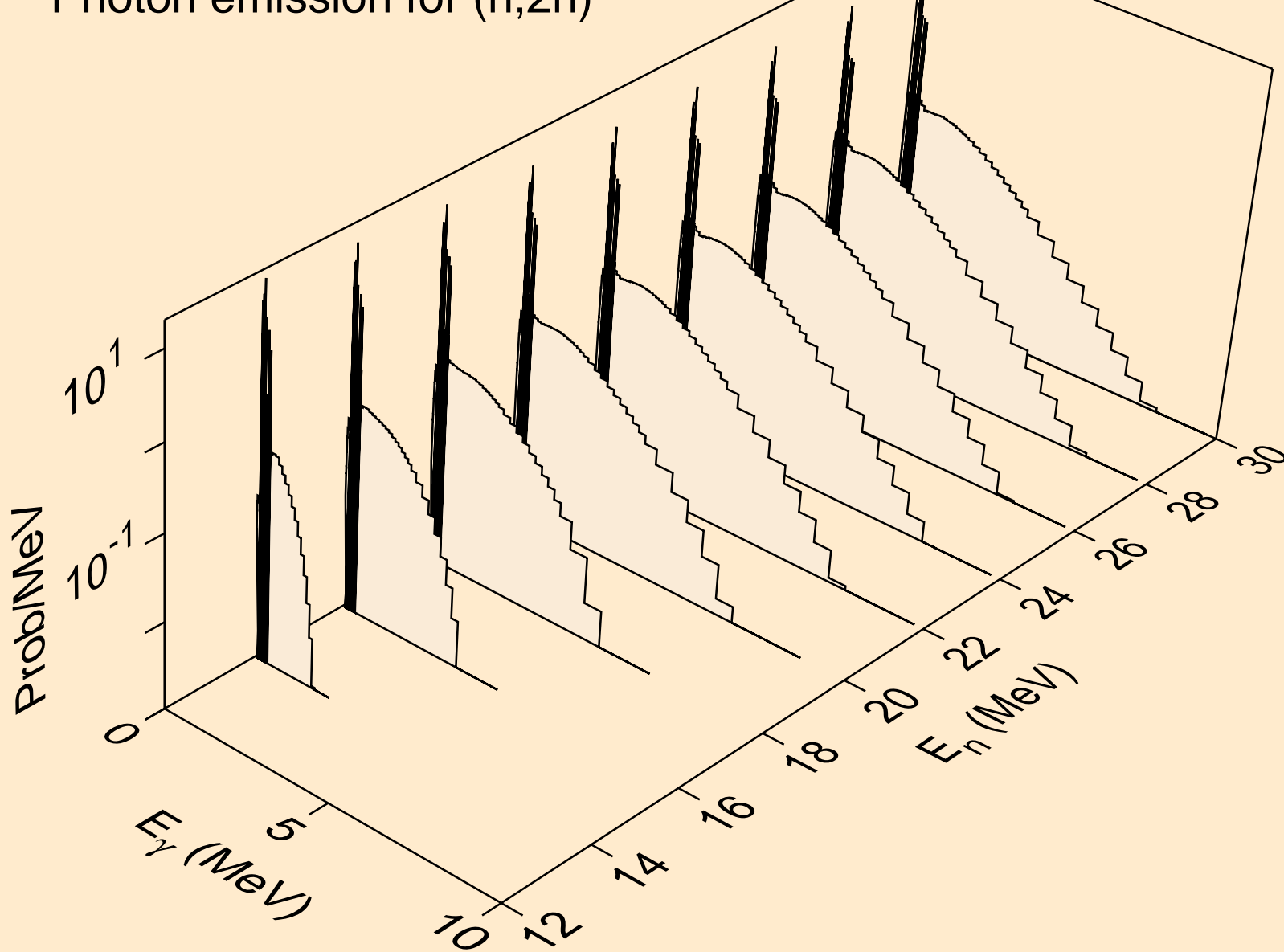

BA122 NEUTRON ACER TENDL-2019 LIBRARY; T=293.16K
Photon emission for (n,3n)

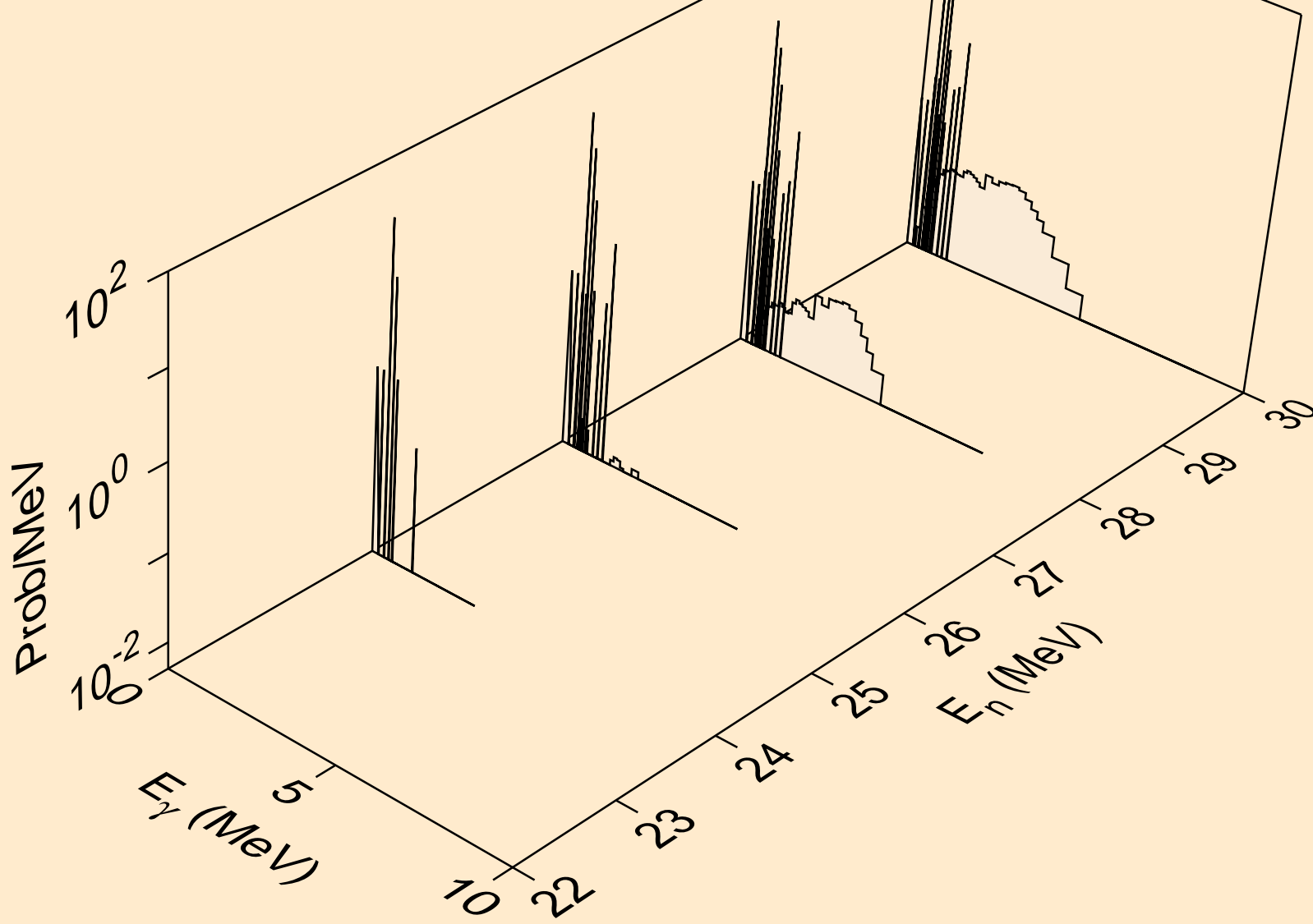

BA122 NEUTRON ACER TENDL-2019 LIBRARY; T=293.16K
Photon emission for (n,n*)a

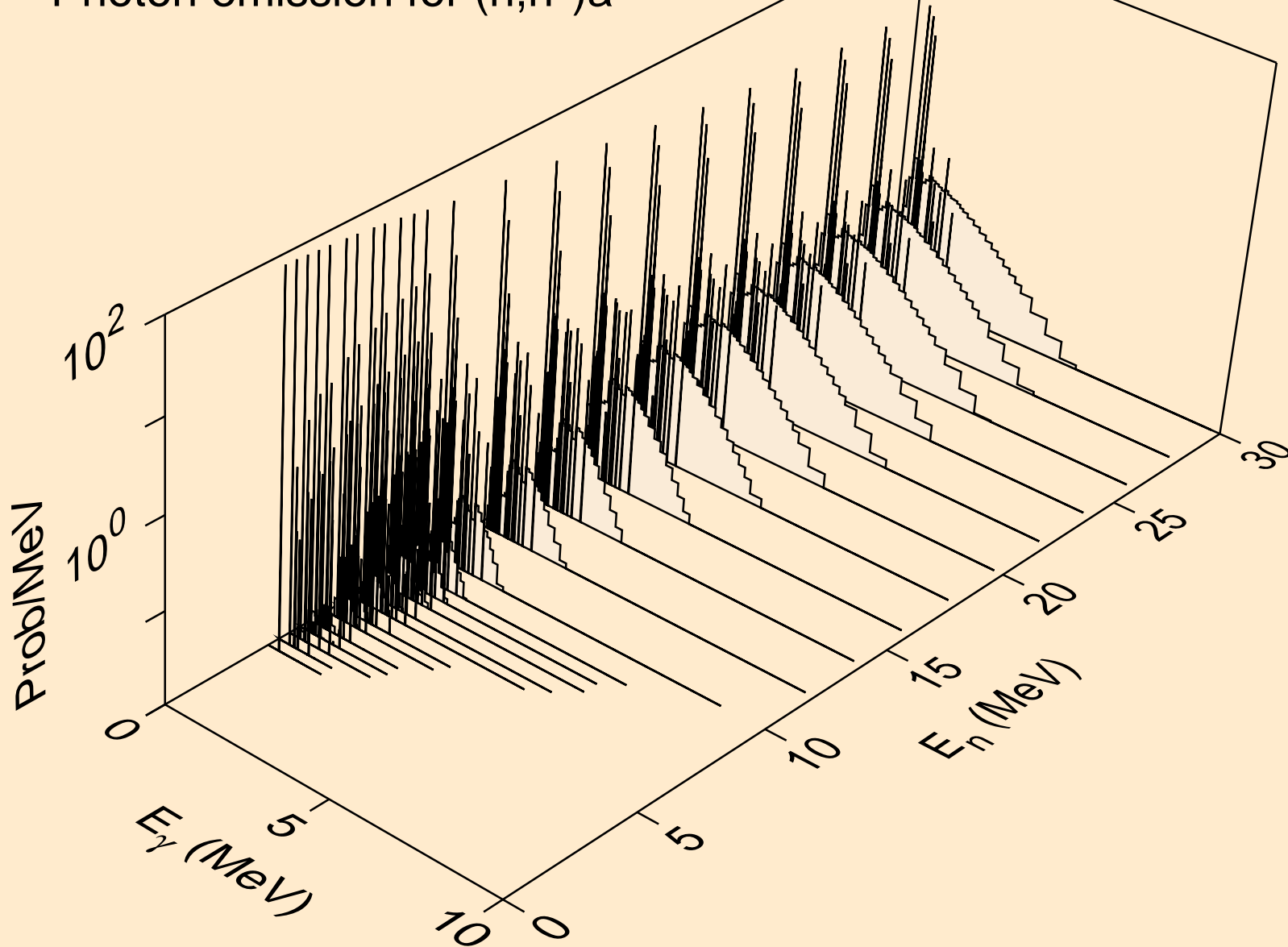

BA122 NEUTRON ACER TENDL-2019 LIBRARY; T=293.16K
Photon emission for (n,n*)3a

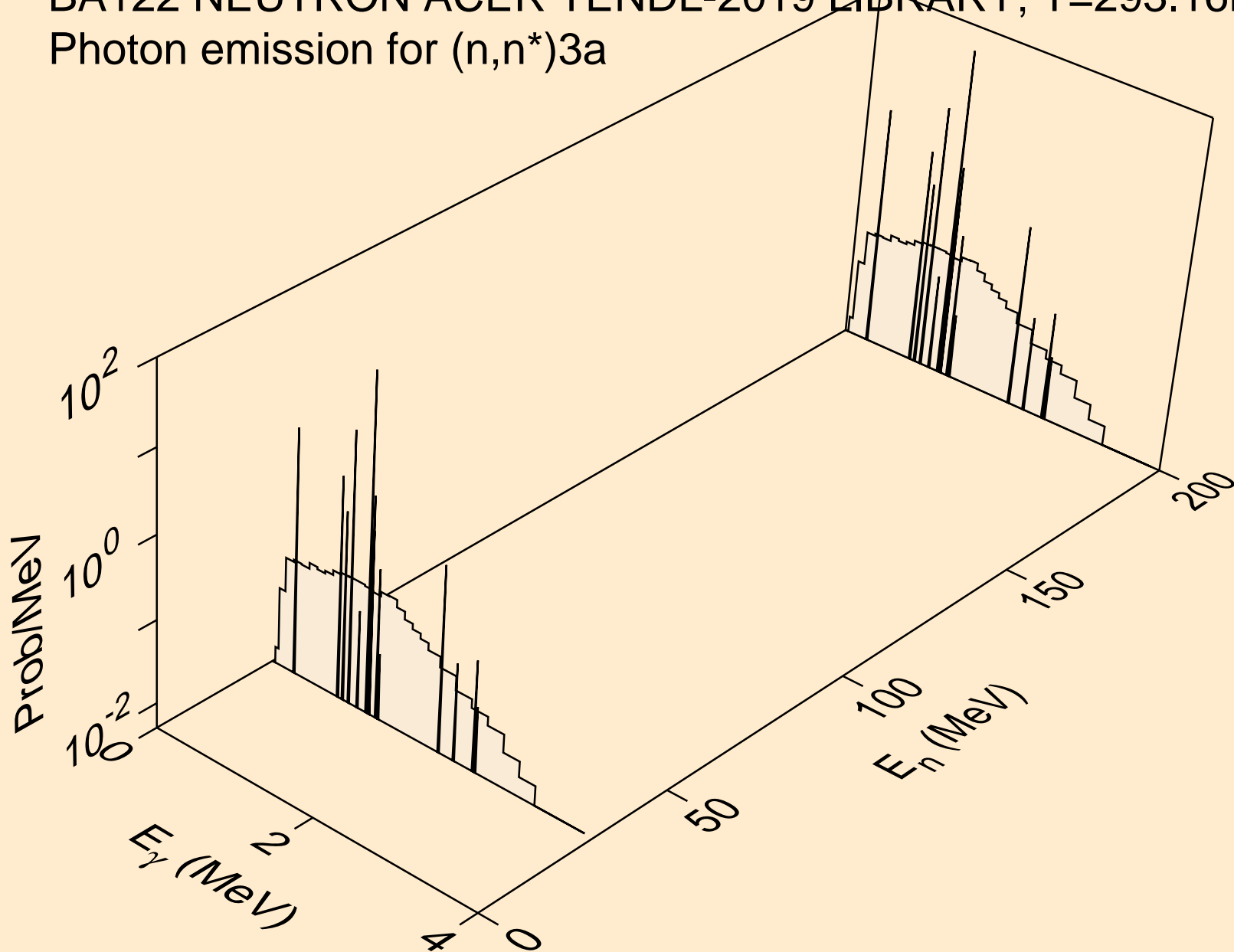

BA122 NEUTRON ACER TENDL-2019 LIBRARY; T=293.16K
Photon emission for (n,2n)a

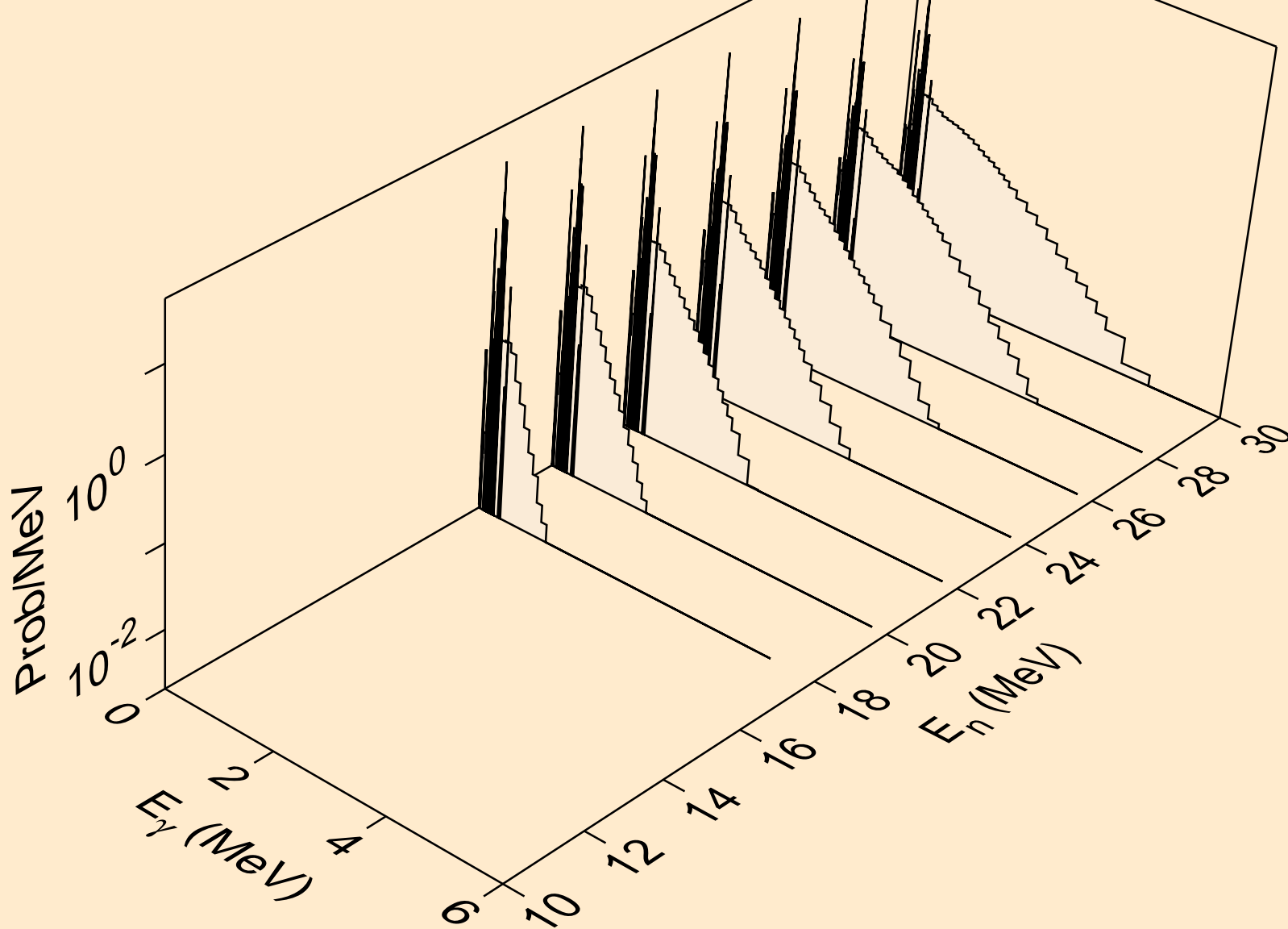

BA122 NEUTRON ACER TENDL-2019 LIBRARY; T=293.16K
Photon emission for (n,3n)a

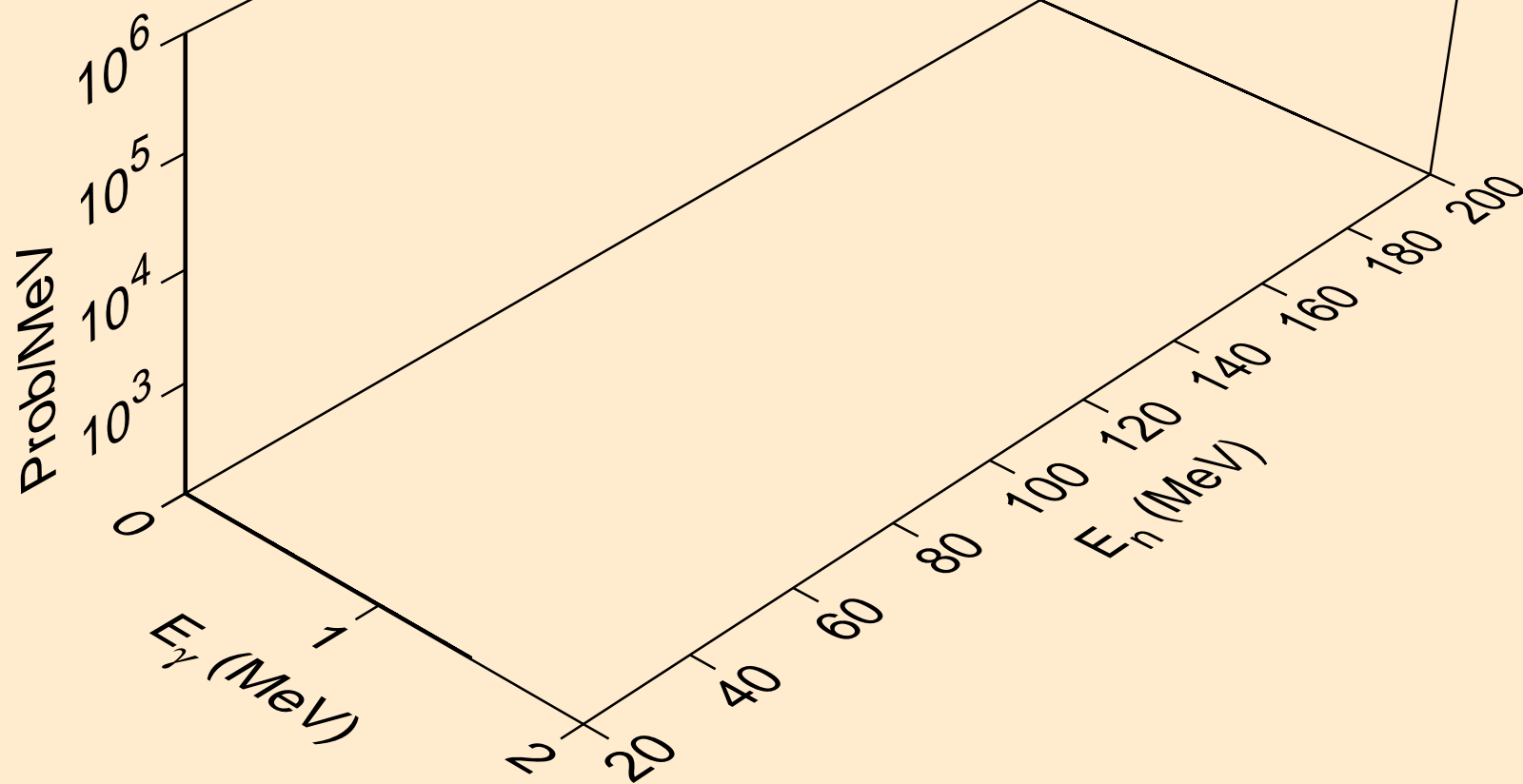

BA122 NEUTRON ACER TENDL-2019 LIBRARY; T=293.16K
Photon emission for (n,n*)p

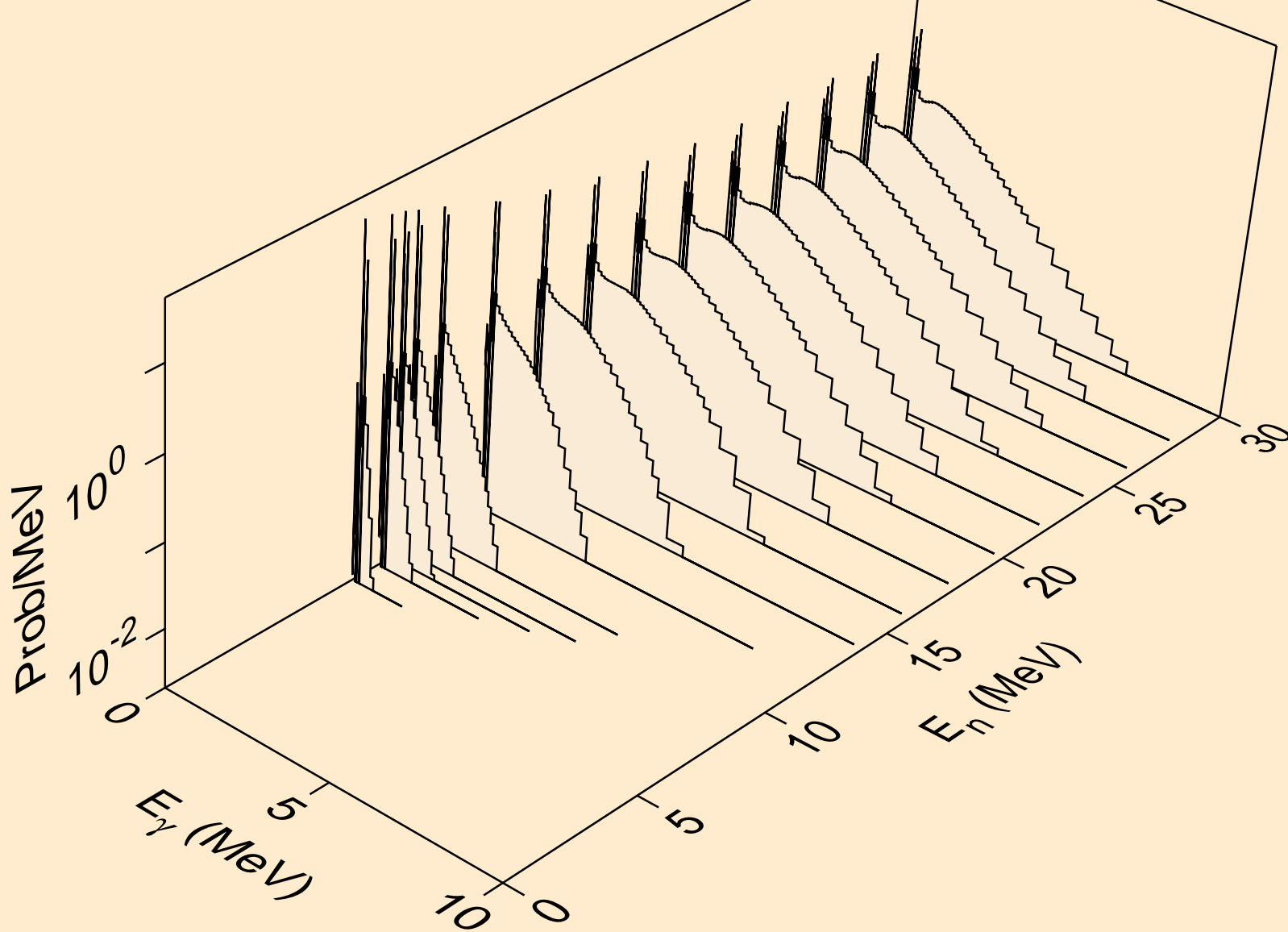

BA122 NEUTRON ACER TENDL-2019 LIBRARY; T=293.16K
Photon emission for (n,n*)2a

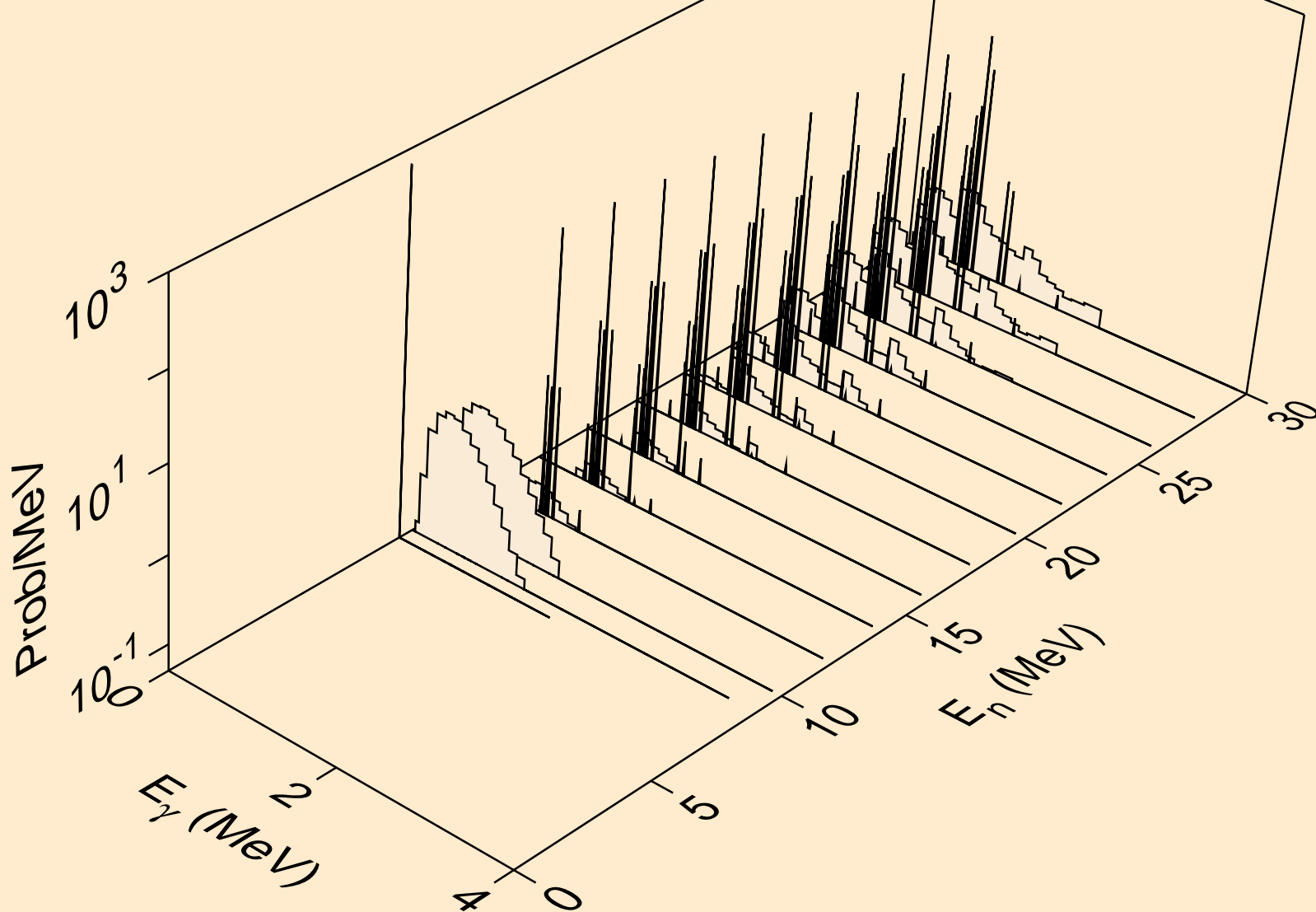

BA122 NEUTRON ACER TENDL-2019 LIBRARY; T=293.16K
Photon emission for (n,2n)2a

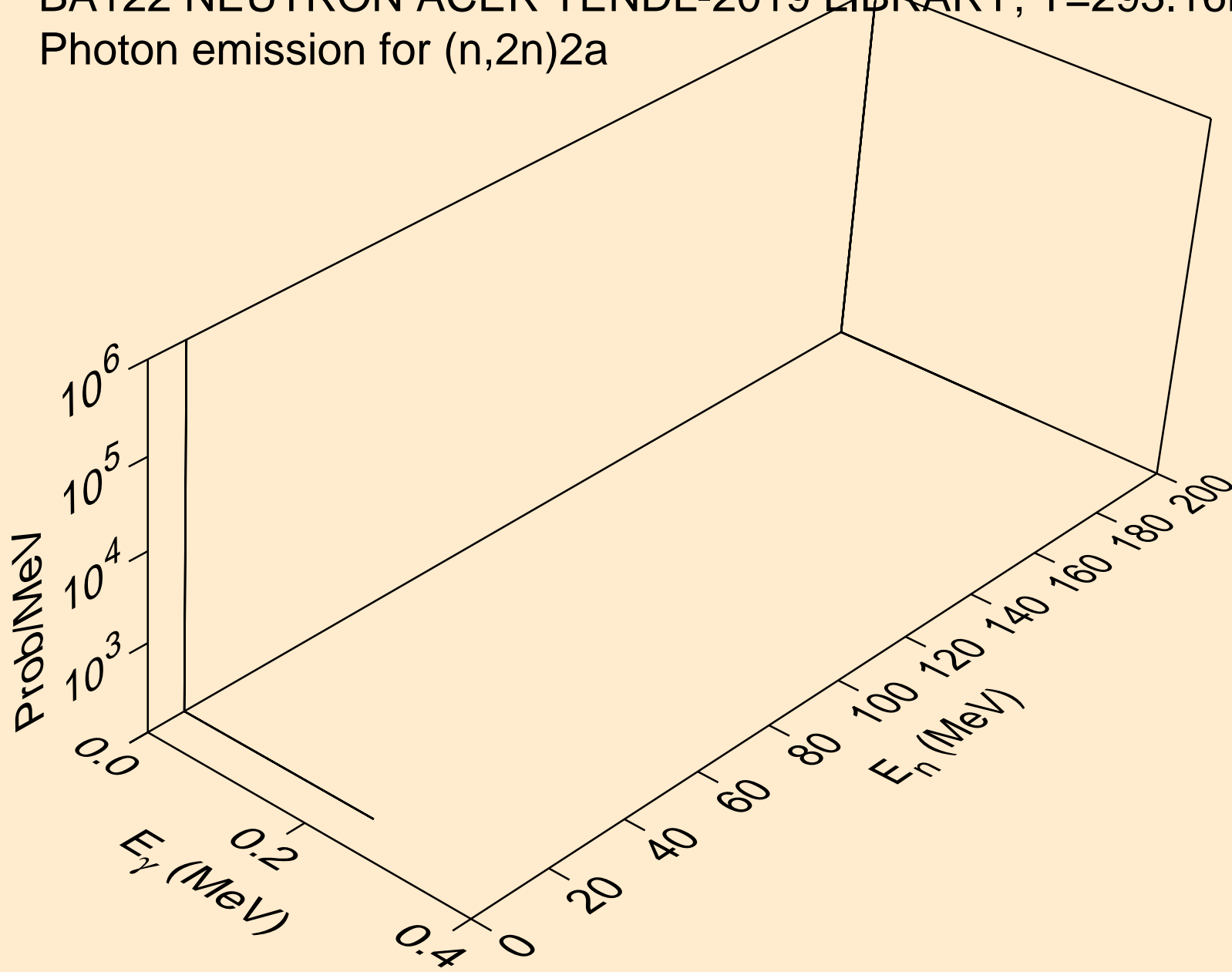

BA122 NEUTRON ACER TENDL-2019 LIBRARY; T=293.16K
Photon emission for (n,n*)d

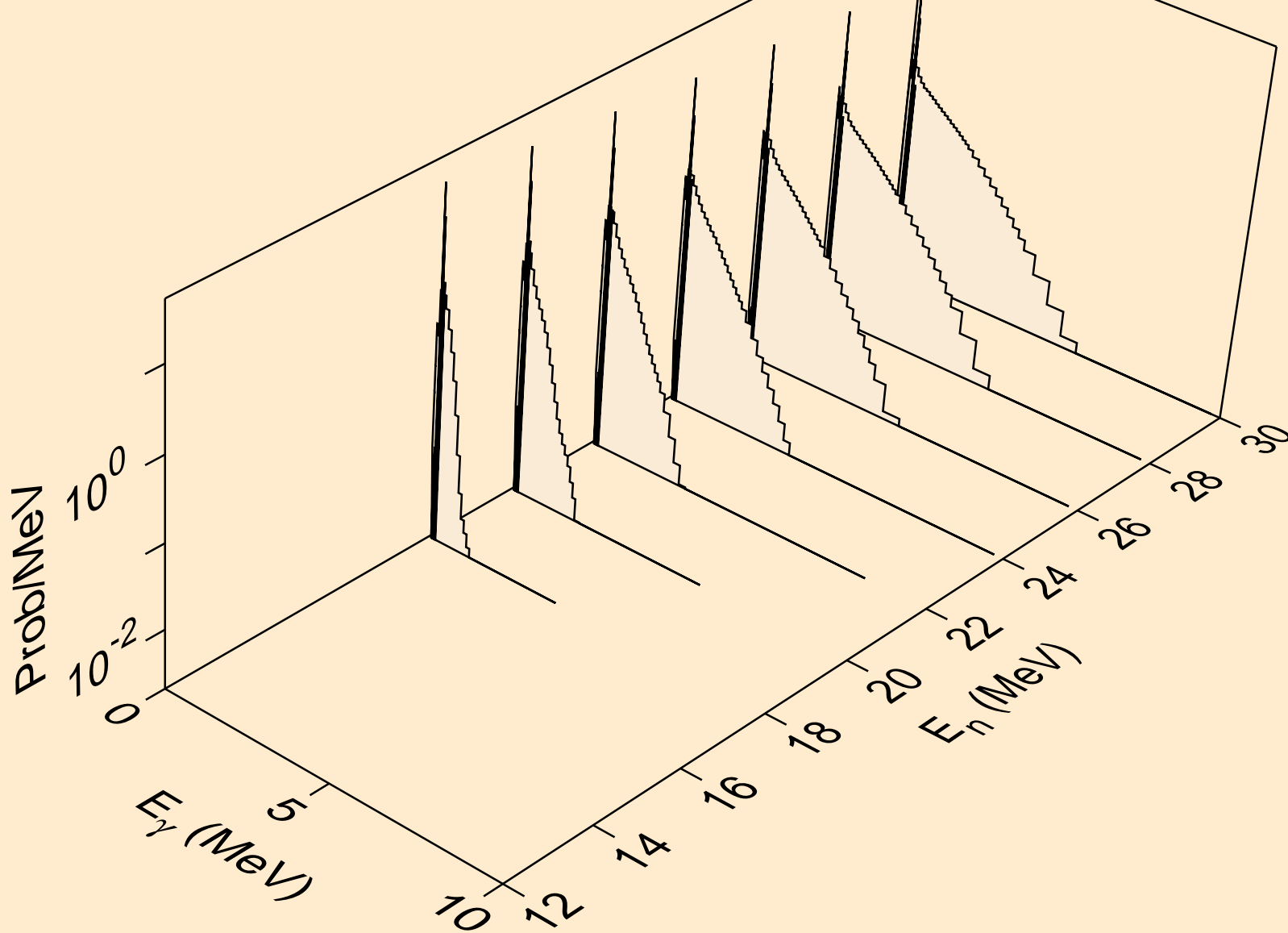

BA122 NEUTRON ACER TENDL-2019 LIBRARY; T=293.16K
Photon emission for (n,n*)t

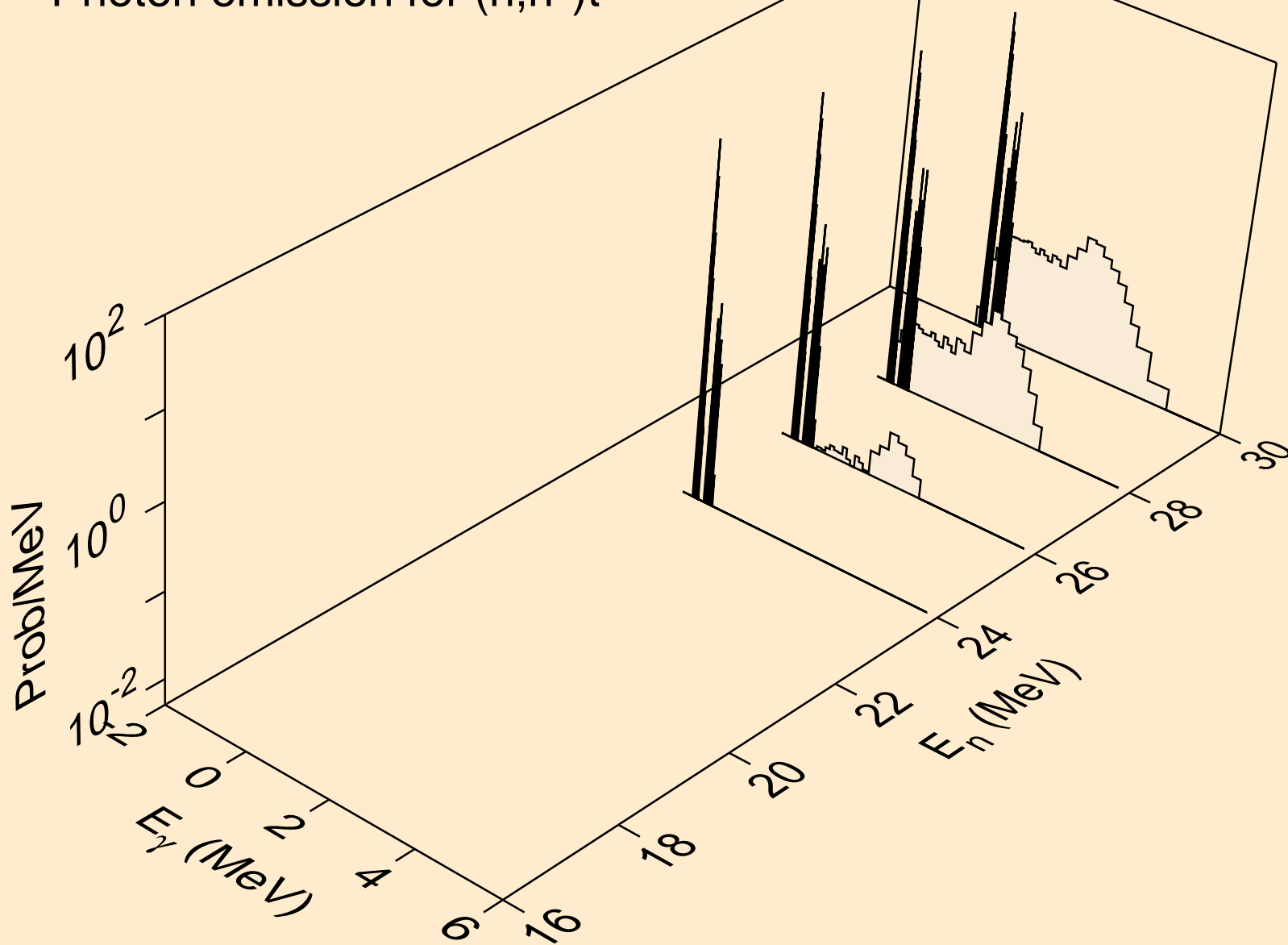

BA122 NEUTRON ACER TENDL-2019 LIBRARY; T=293.16K
Photon emission for (n,n*)he3

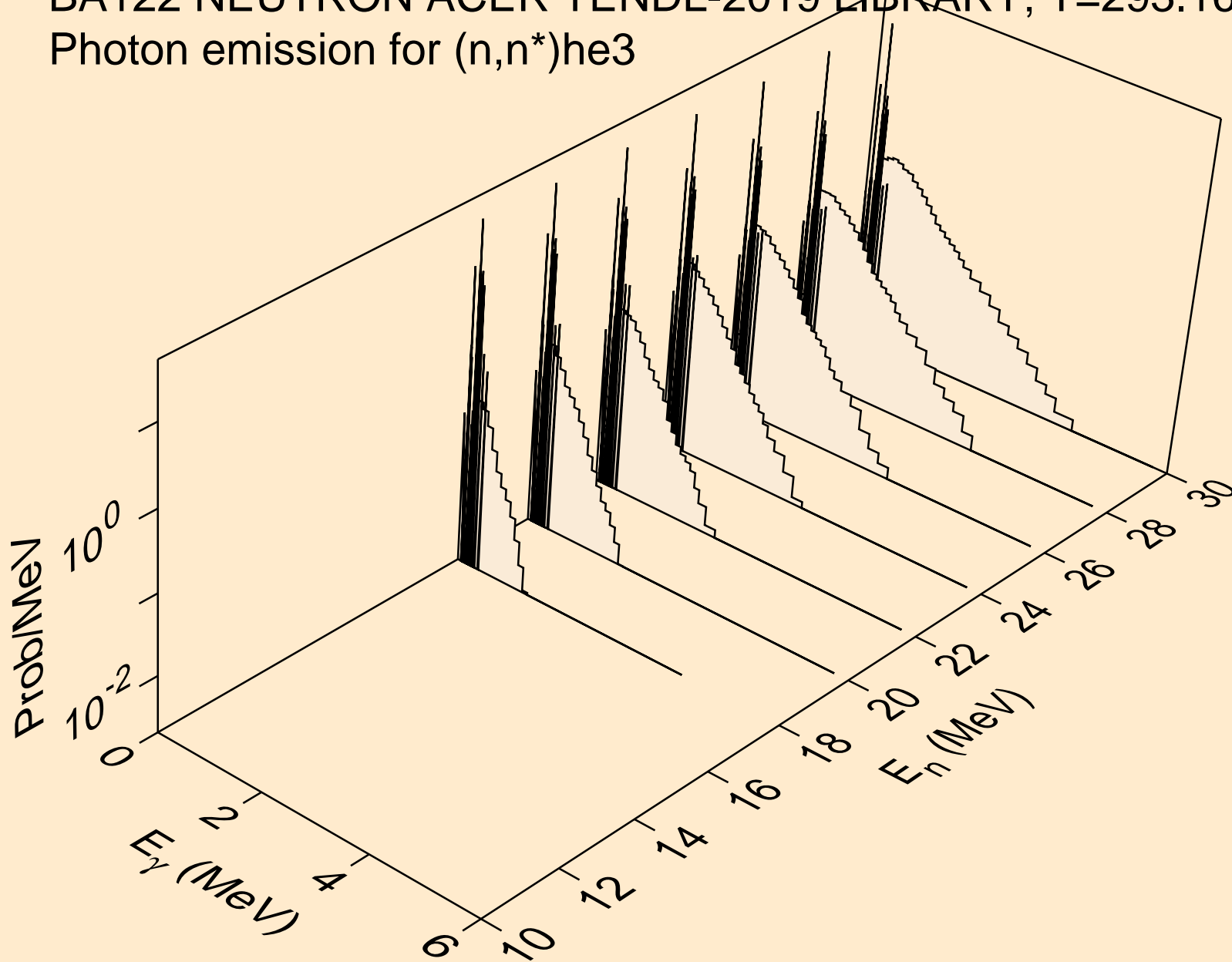

BA122 NEUTRON ACER TENDL-2019 LIBRARY; T=293.16K
Photon emission for (n,2np)

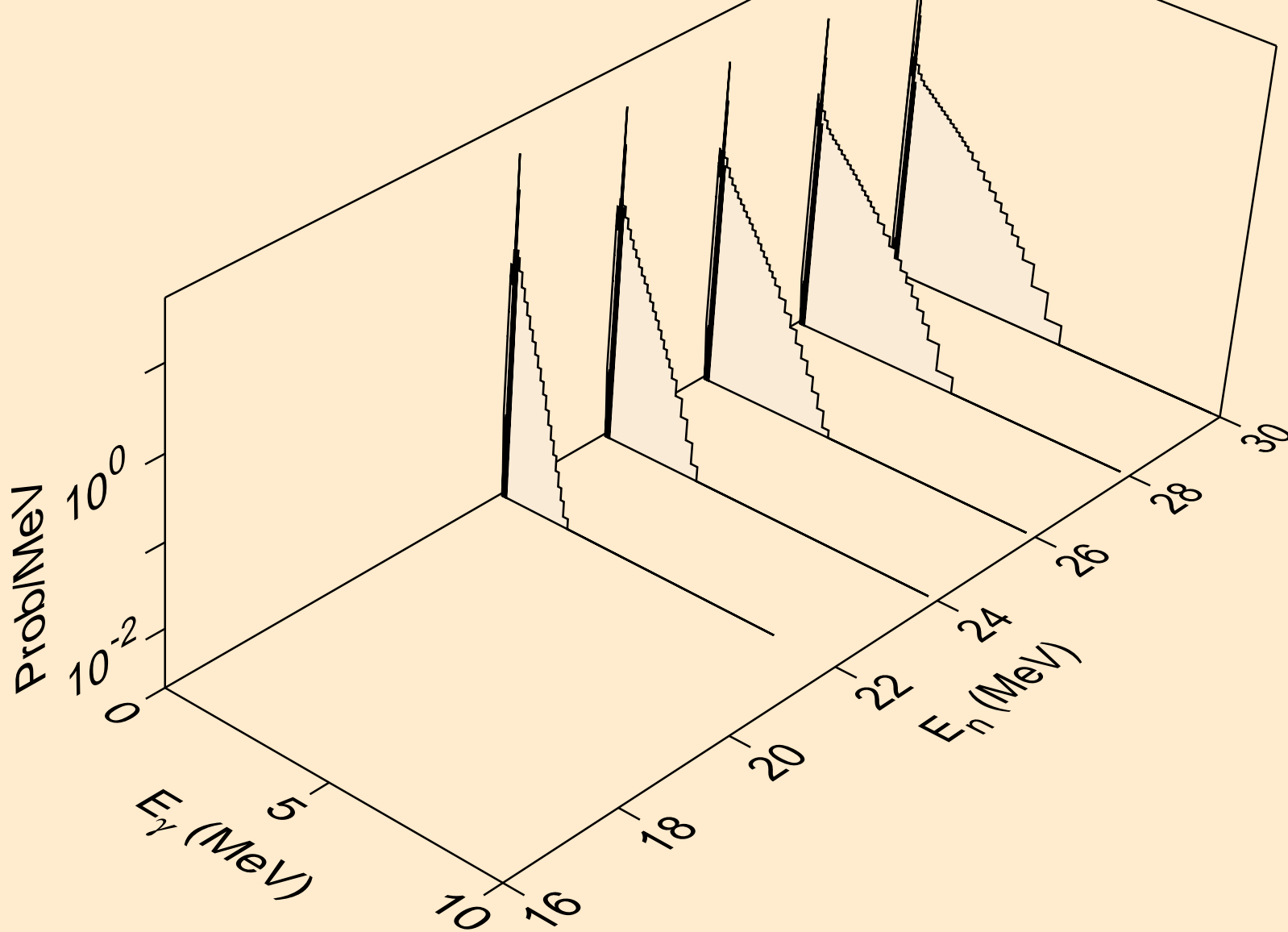

BA122 NEUTRON ACER TENDL-2019 LIBRARY; T=293.16K
Photon emission for (n,3np)

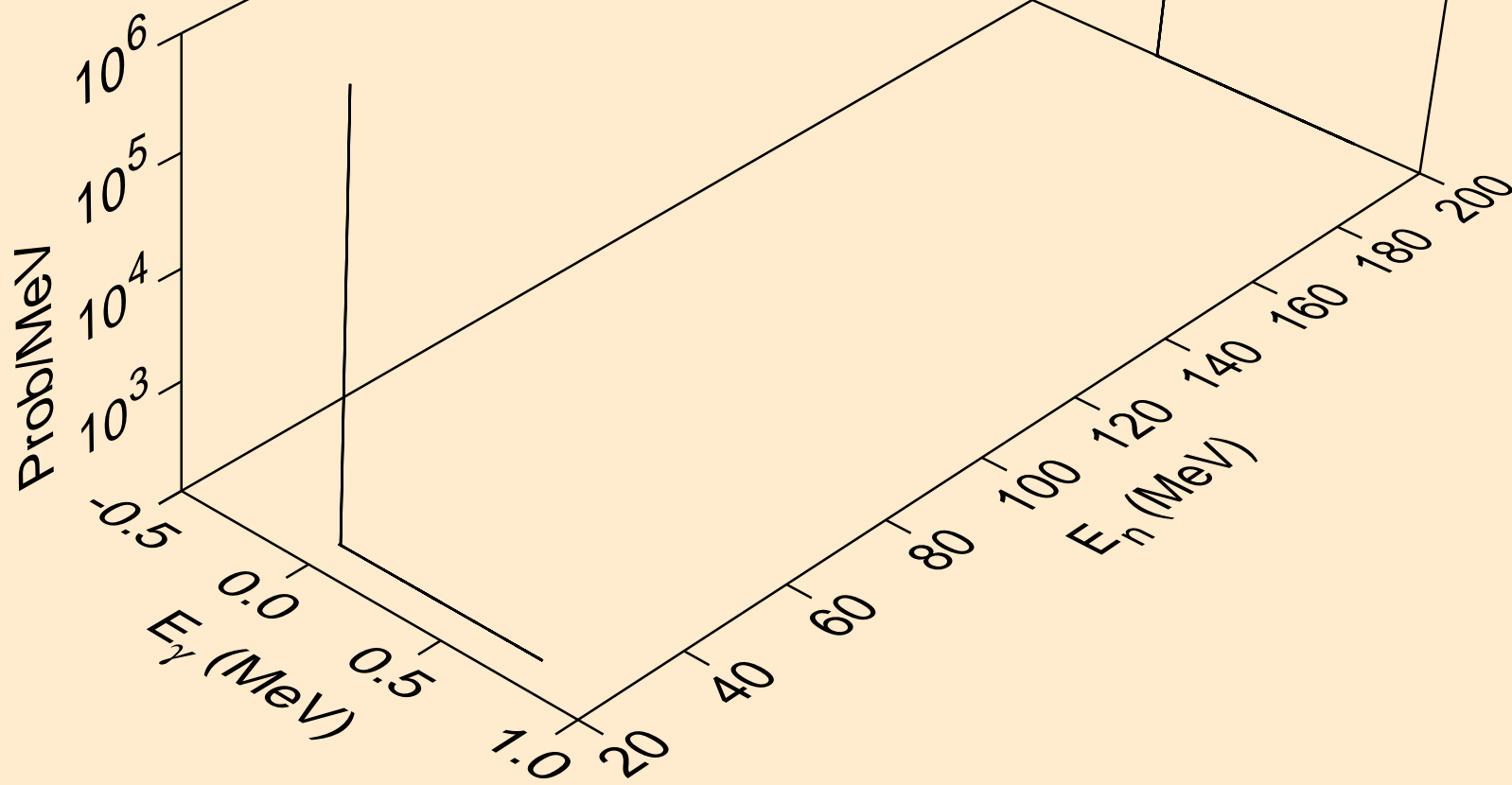

BA122 NEUTRON ACER TENDL-2019 LIBRARY; T=293.16K
Photon emission for (n,2np)

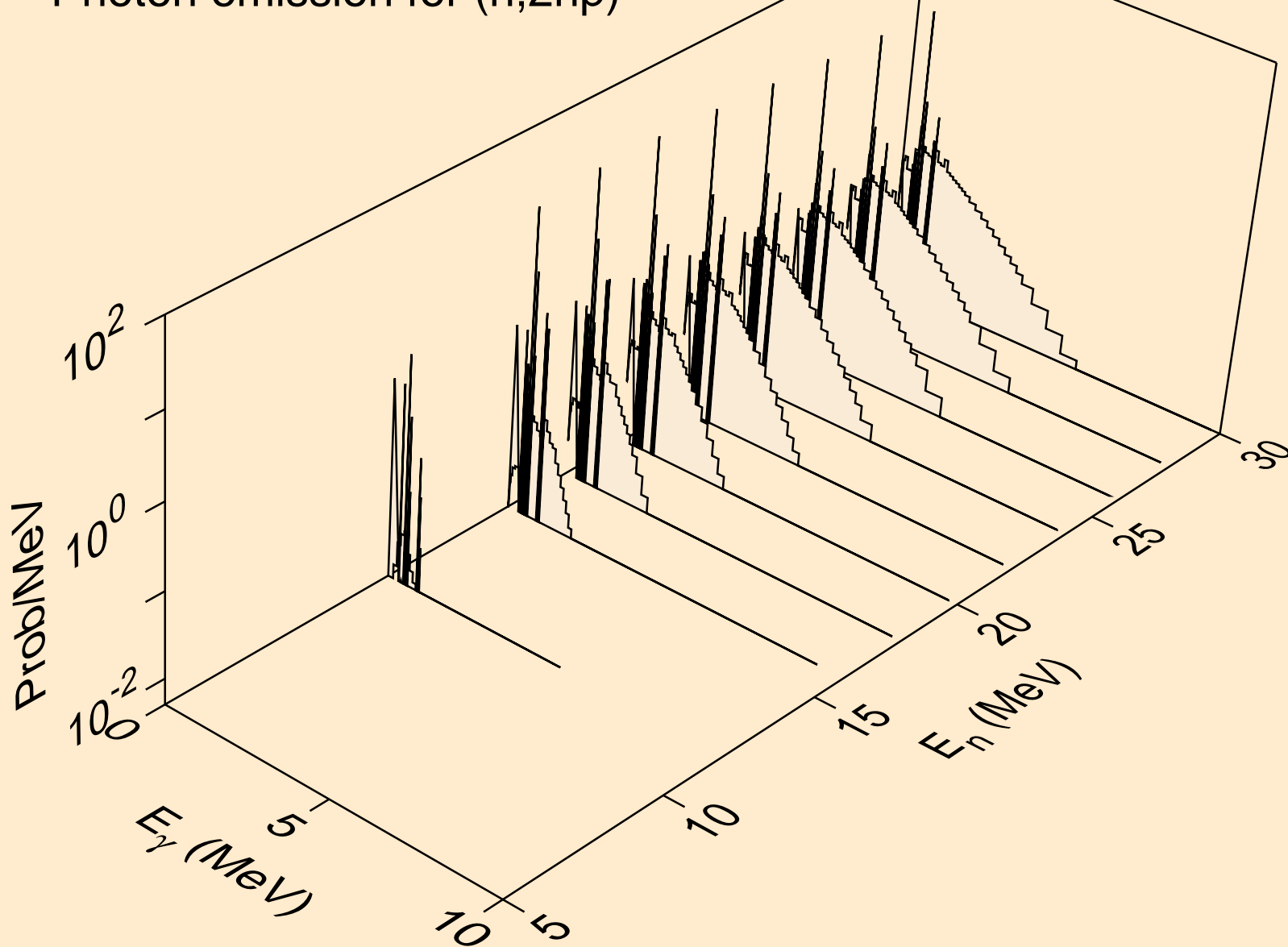

BA122 NEUTRON ACER TENDL-2019 LIBRARY; T=293.16K
Photon emission for (n,npa)

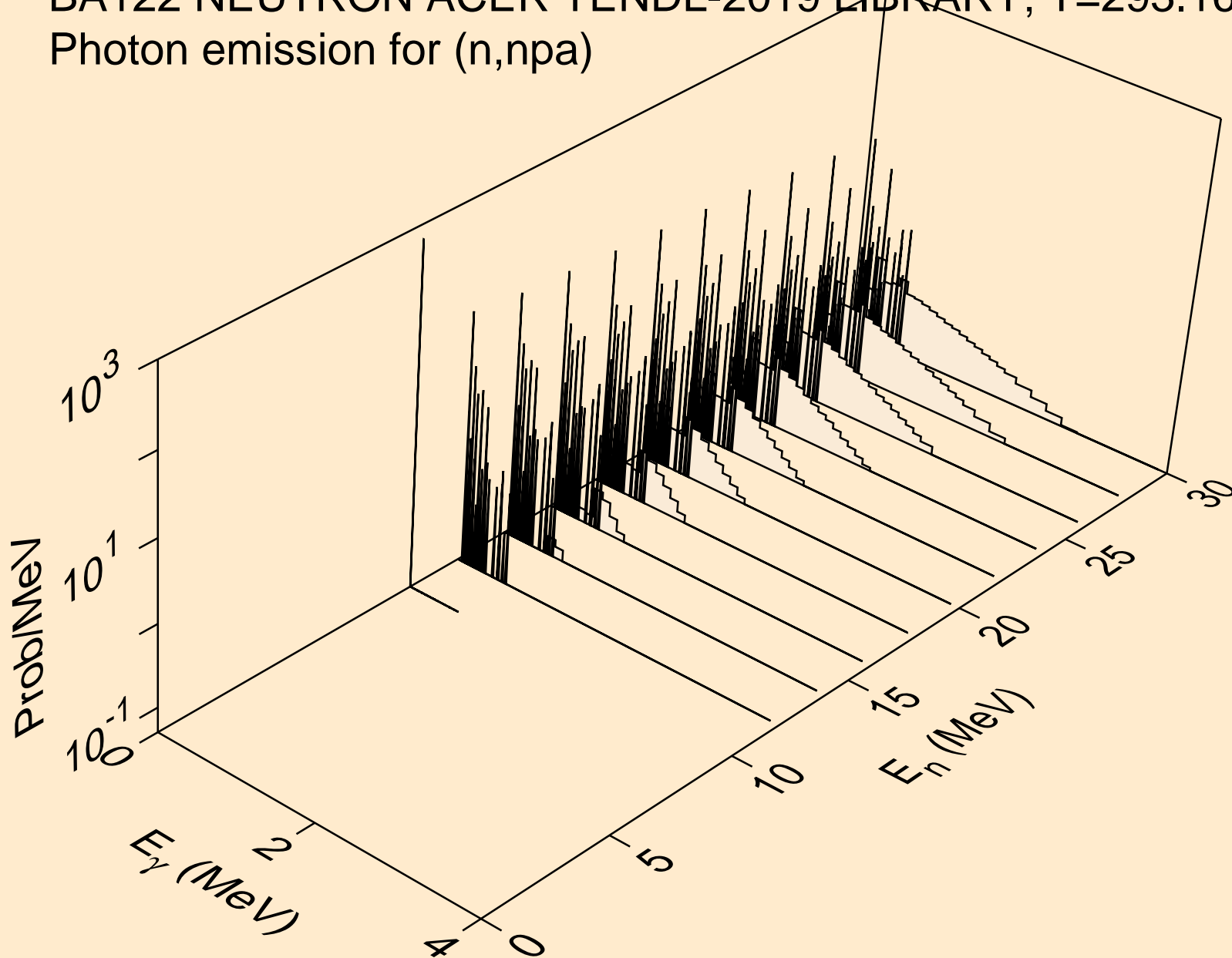

BA122 NEUTRON ACER TENDL-2019 LIBRARY; T=293.16K
Photon emission for (n,n*c)

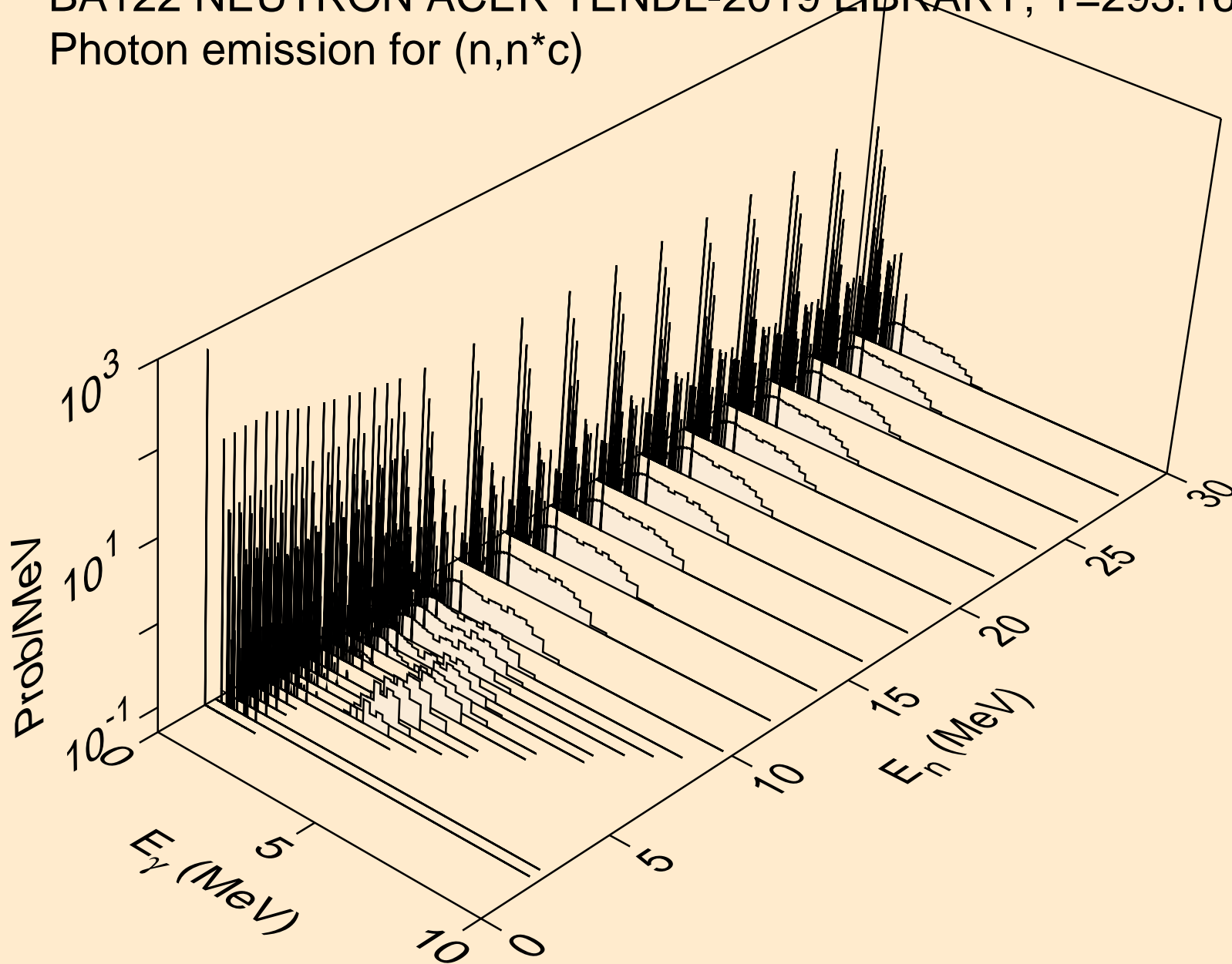

BA122 NEUTRON ACER TENDL-2019 LIBRARY; T=293.16K
Photon emission for (n,gma)

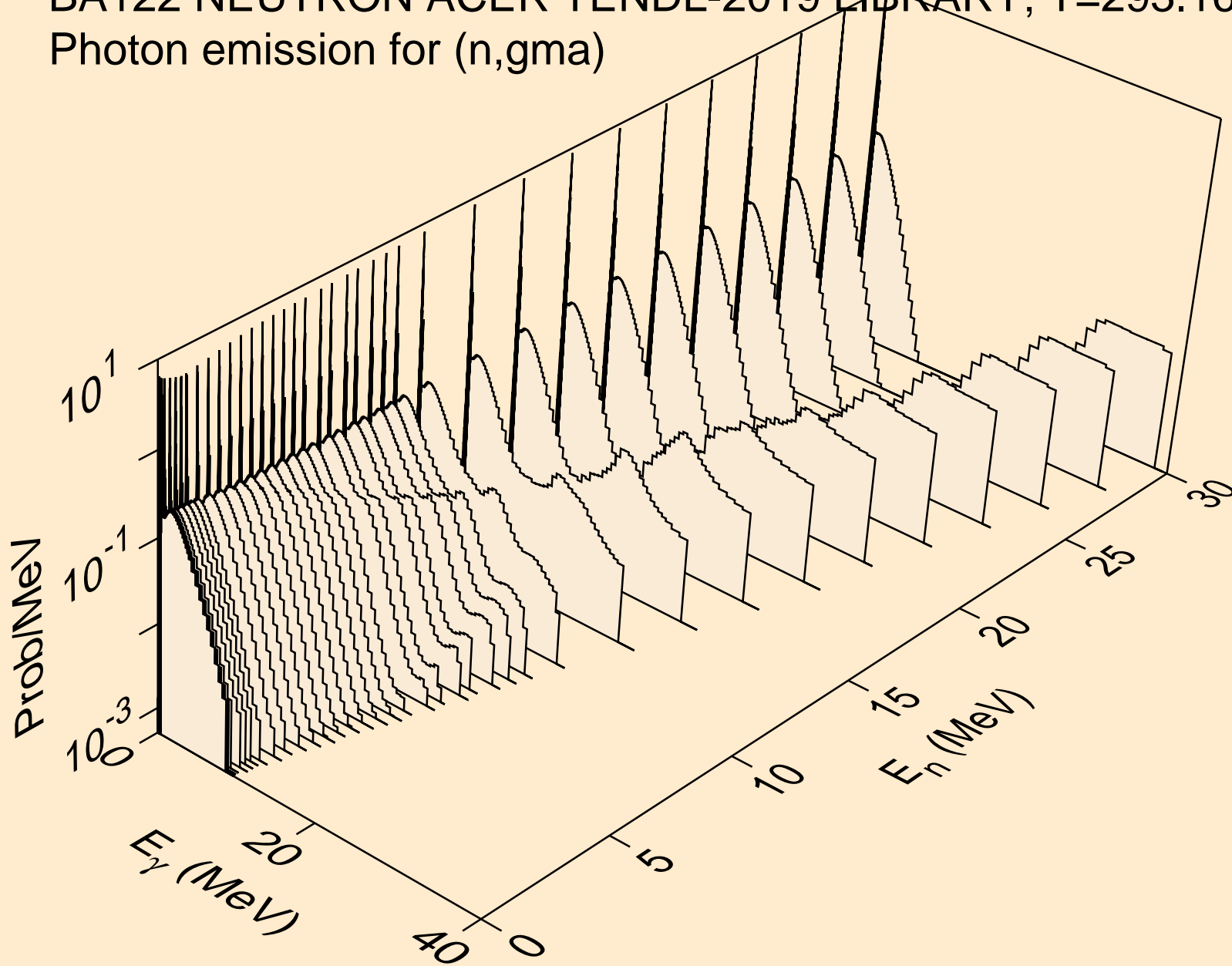

BA122 NEUTRON ACER TENDL-2019 LIBRARY; T=293.16K
Photon emission for (n,p)

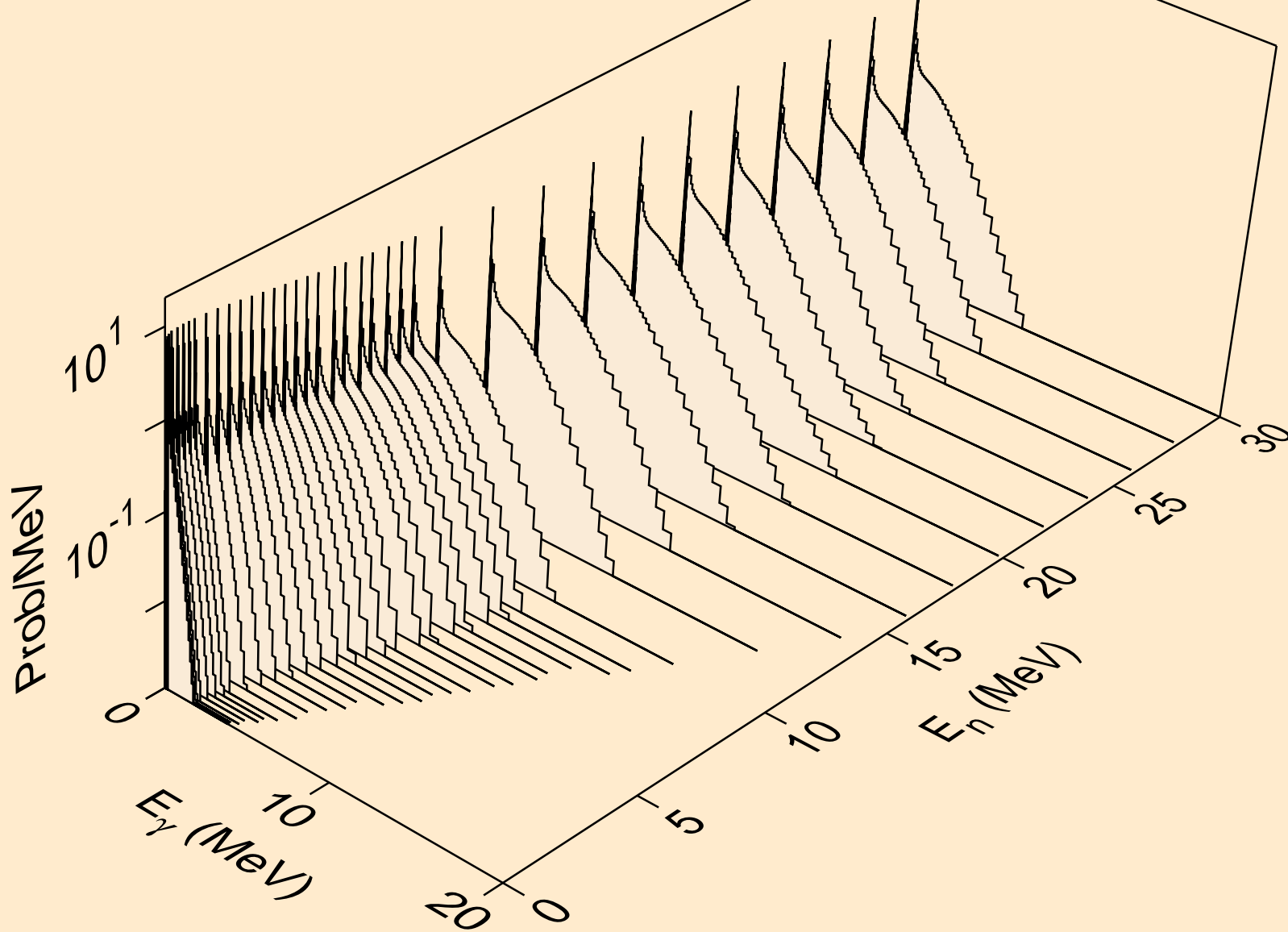

BA122 NEUTRON ACER TENDL-2019 LIBRARY; T=293.16K
Photon emission for (n,d)

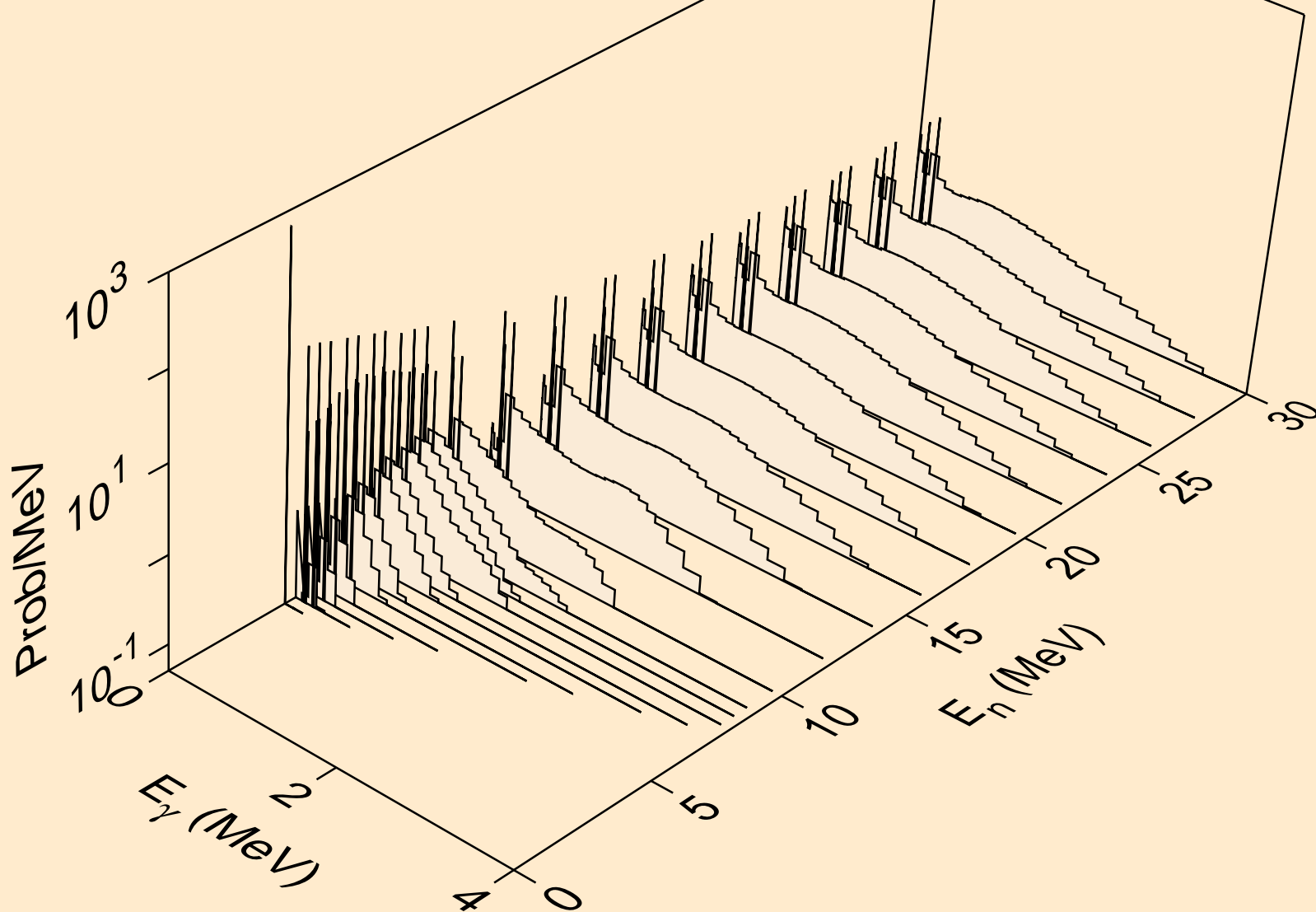

BA122 NEUTRON ACER TENDL-2019 LIBRARY; T=293.16K
Photon emission for (n,t)

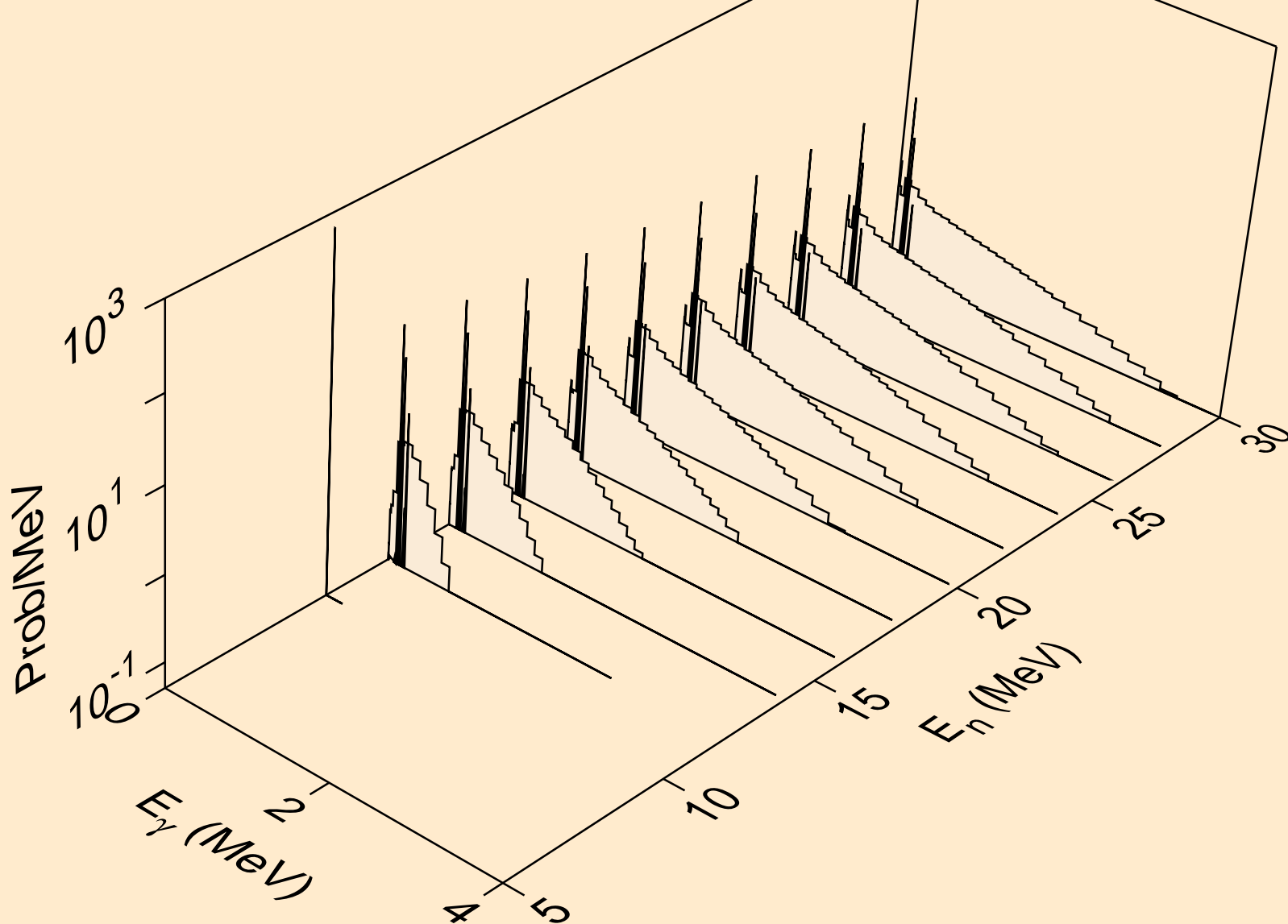

BA122 NEUTRON ACER TENDL-2019 LIBRARY; T=293.16K
Photon emission for (n,he3)

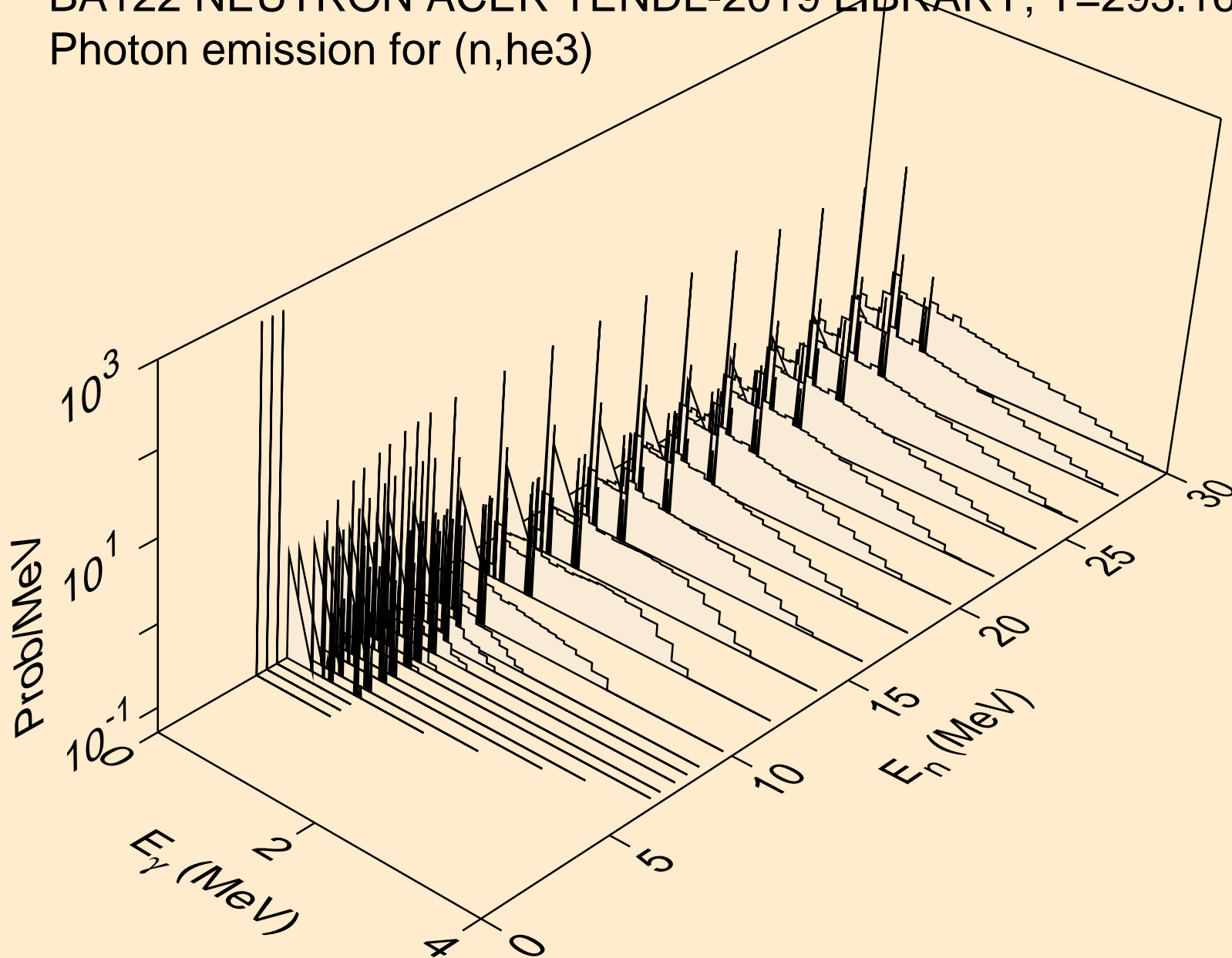

BA122 NEUTRON ACER TENDL-2019 LIBRARY; T=293.16K
Photon emission for (n,a)

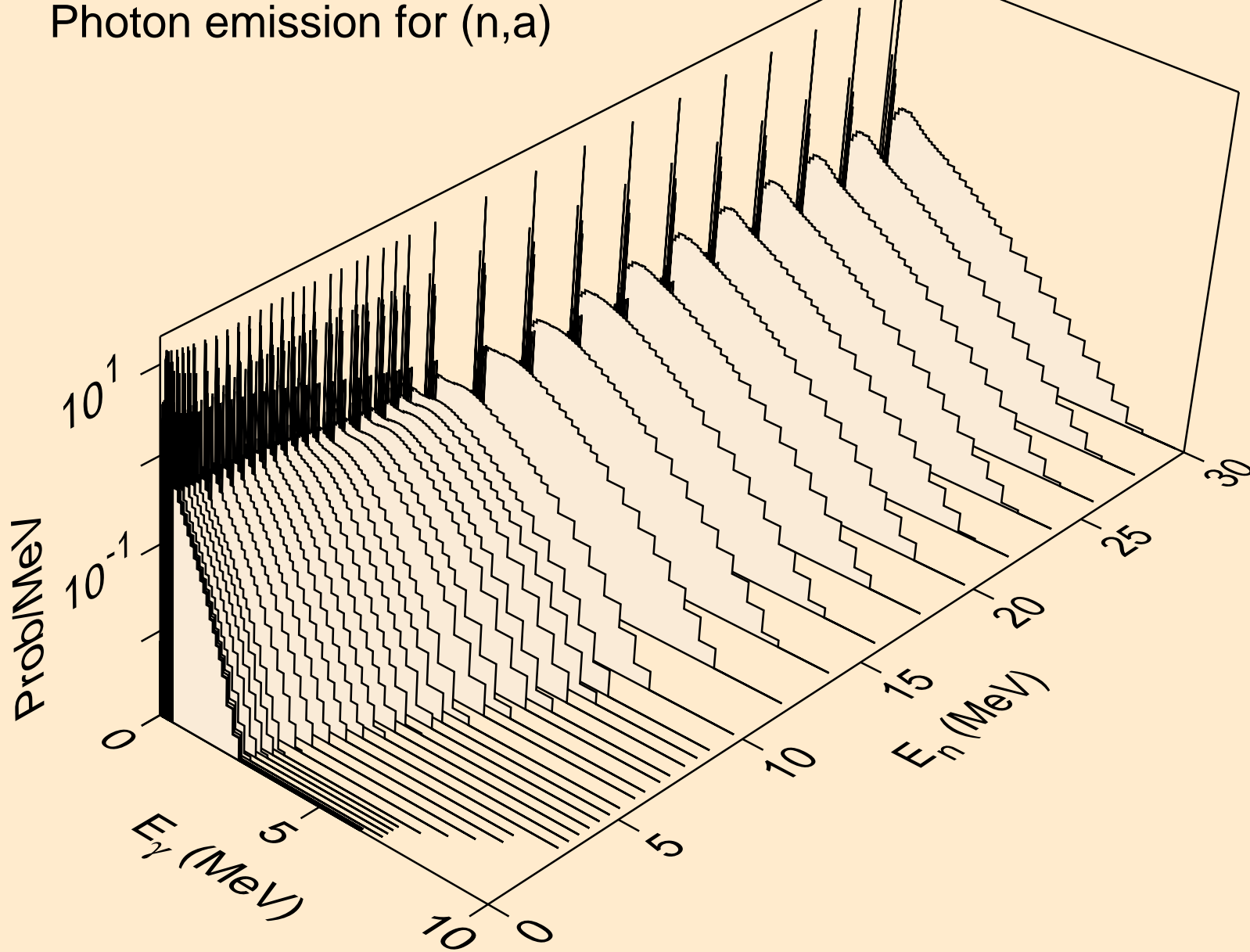

BA122 NEUTRON ACER TENDL-2019 LIBRARY; T=293.16K
Photon emission for (n,2a)

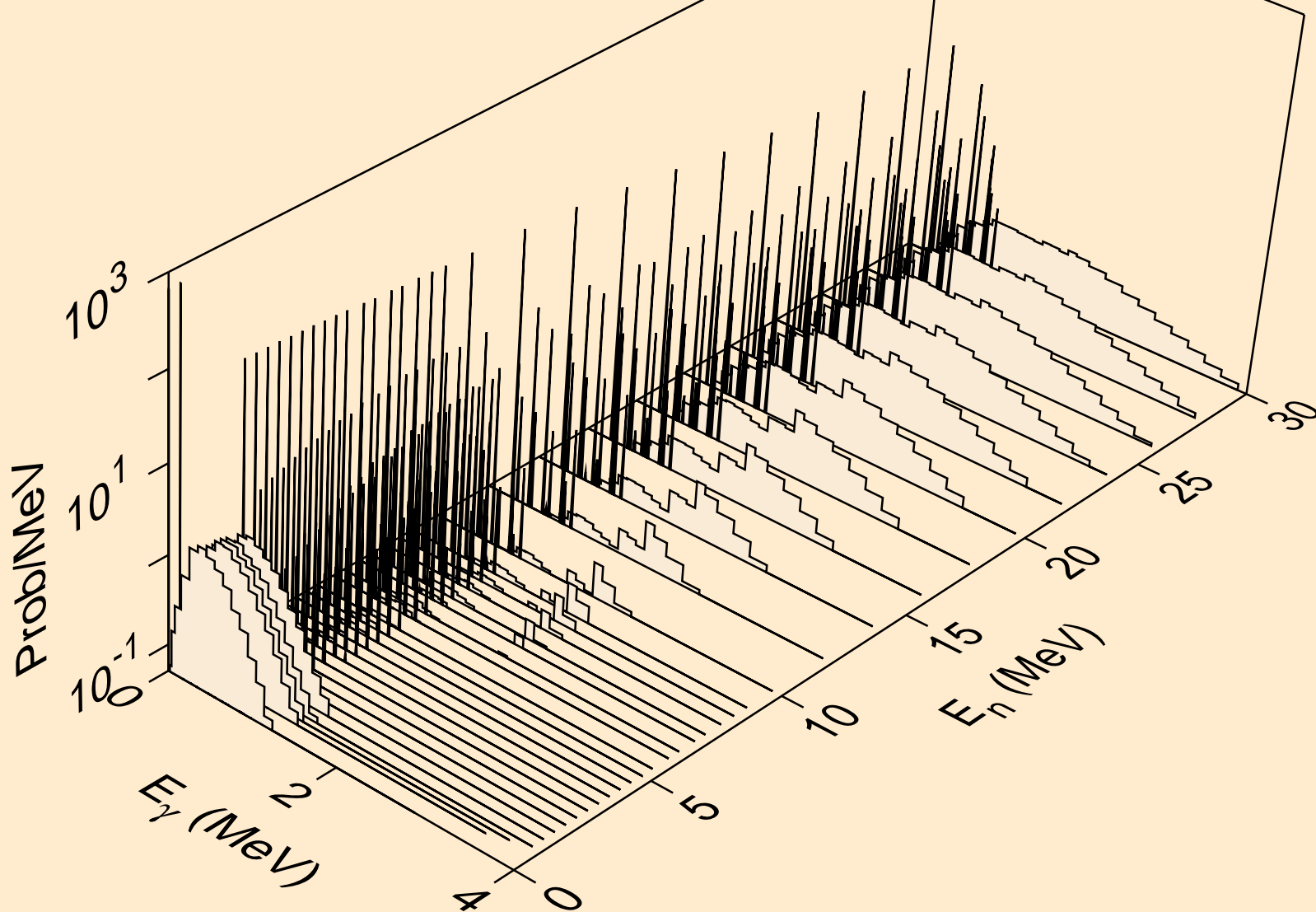

BA122 NEUTRON ACER TENDL-2019 LIBRARY; T=293.16K
Photon emission for (n,3a)

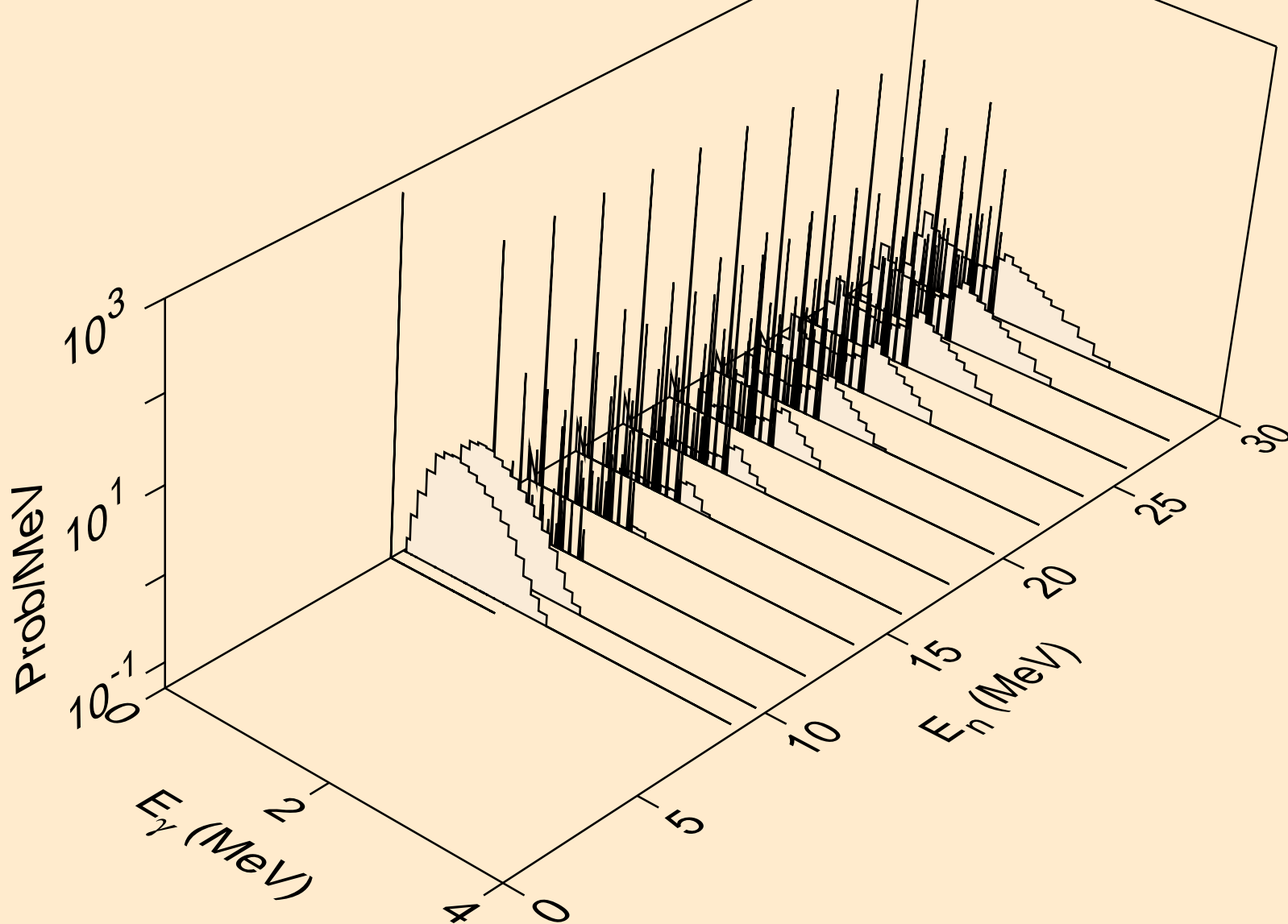

BA122 NEUTRON ACER TENDL-2019 LIBRARY; T=293.16K
Photon emission for (n,2p)

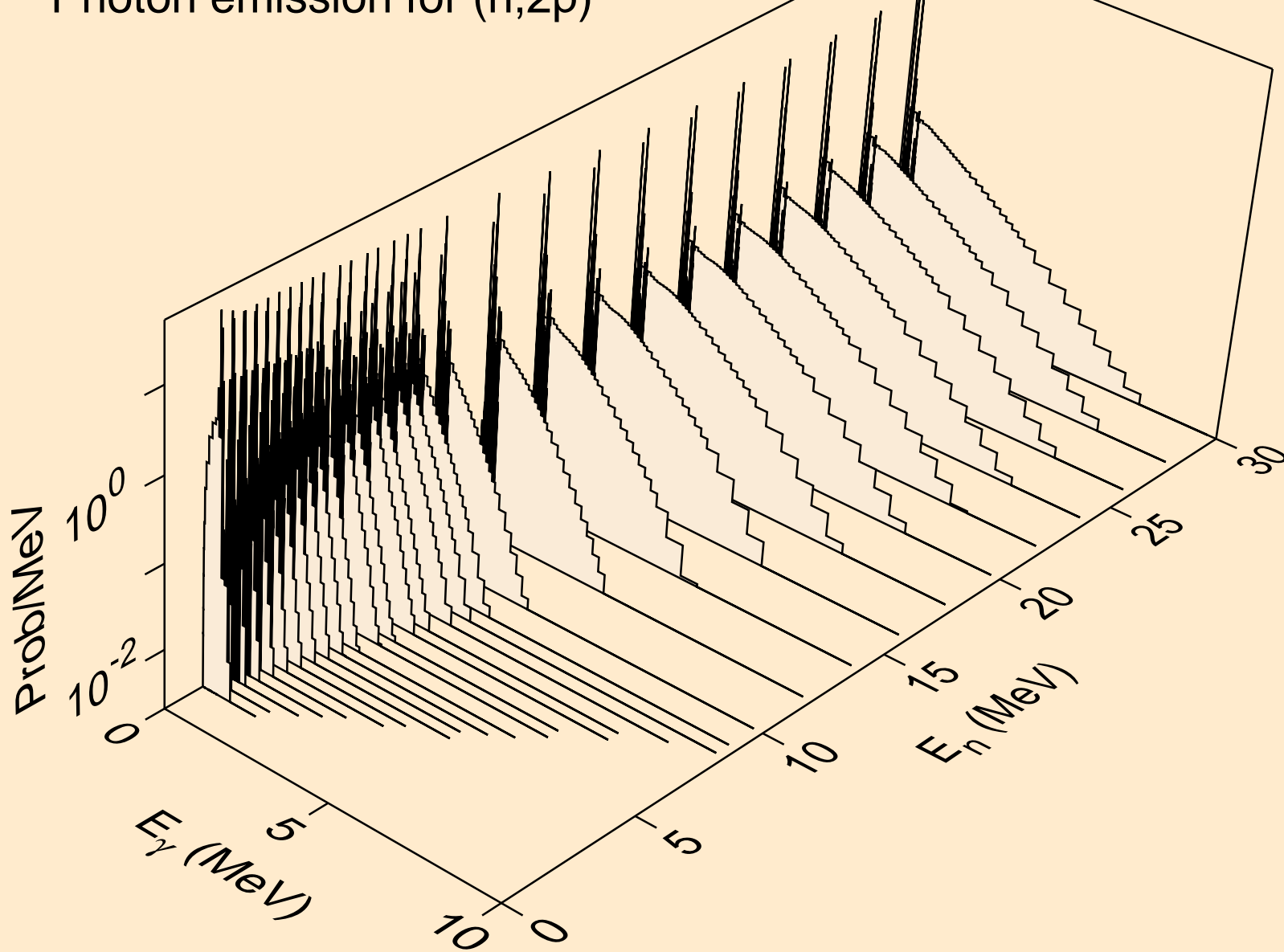

BA122 NEUTRON ACER TENDL-2019 LIBRARY; T=293.16K
Photon emission for (n,p)

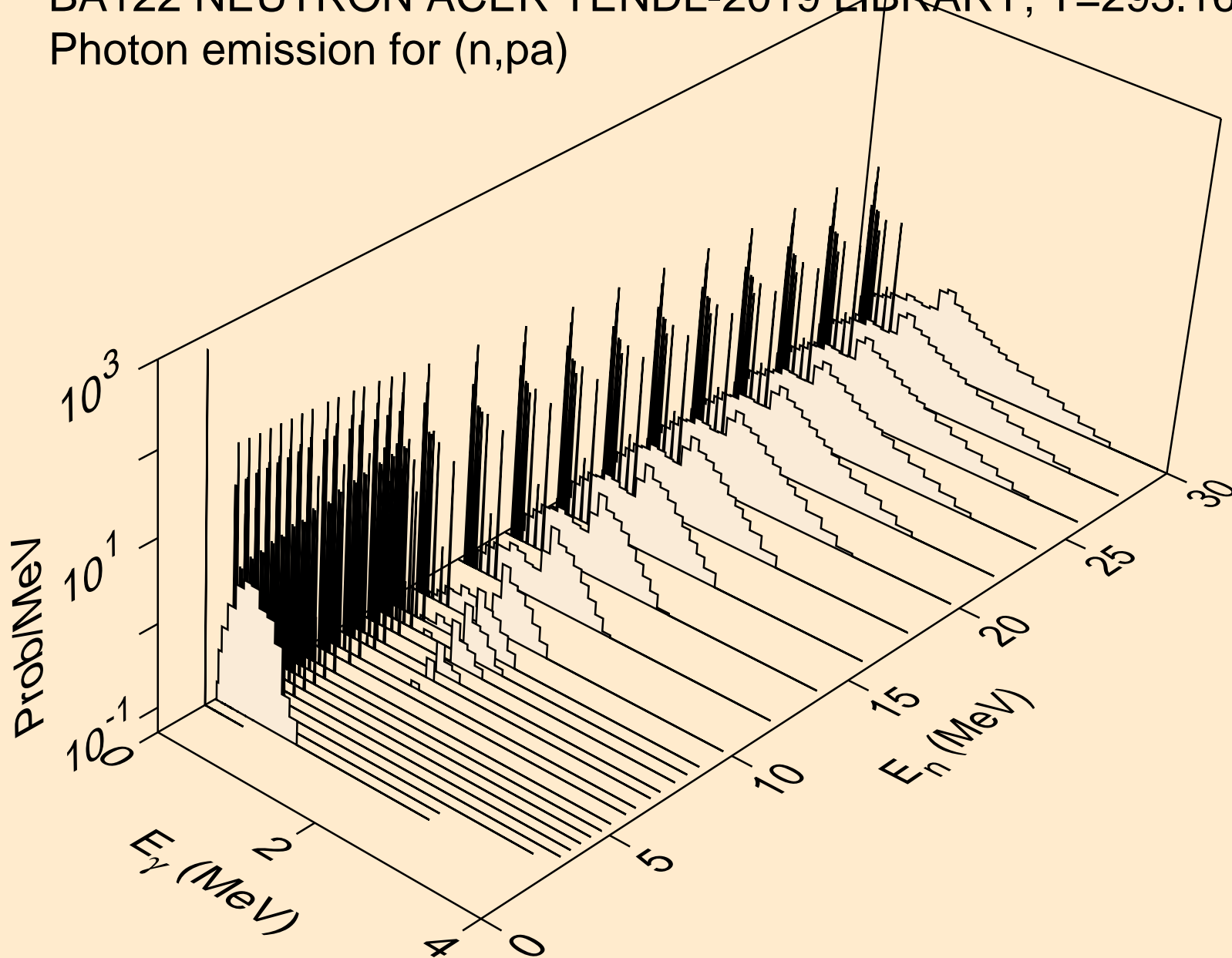

BA122 NEUTRON ACER TENDL-2019 LIBRARY; T=293.16K
Photon emission for (n,d2a)

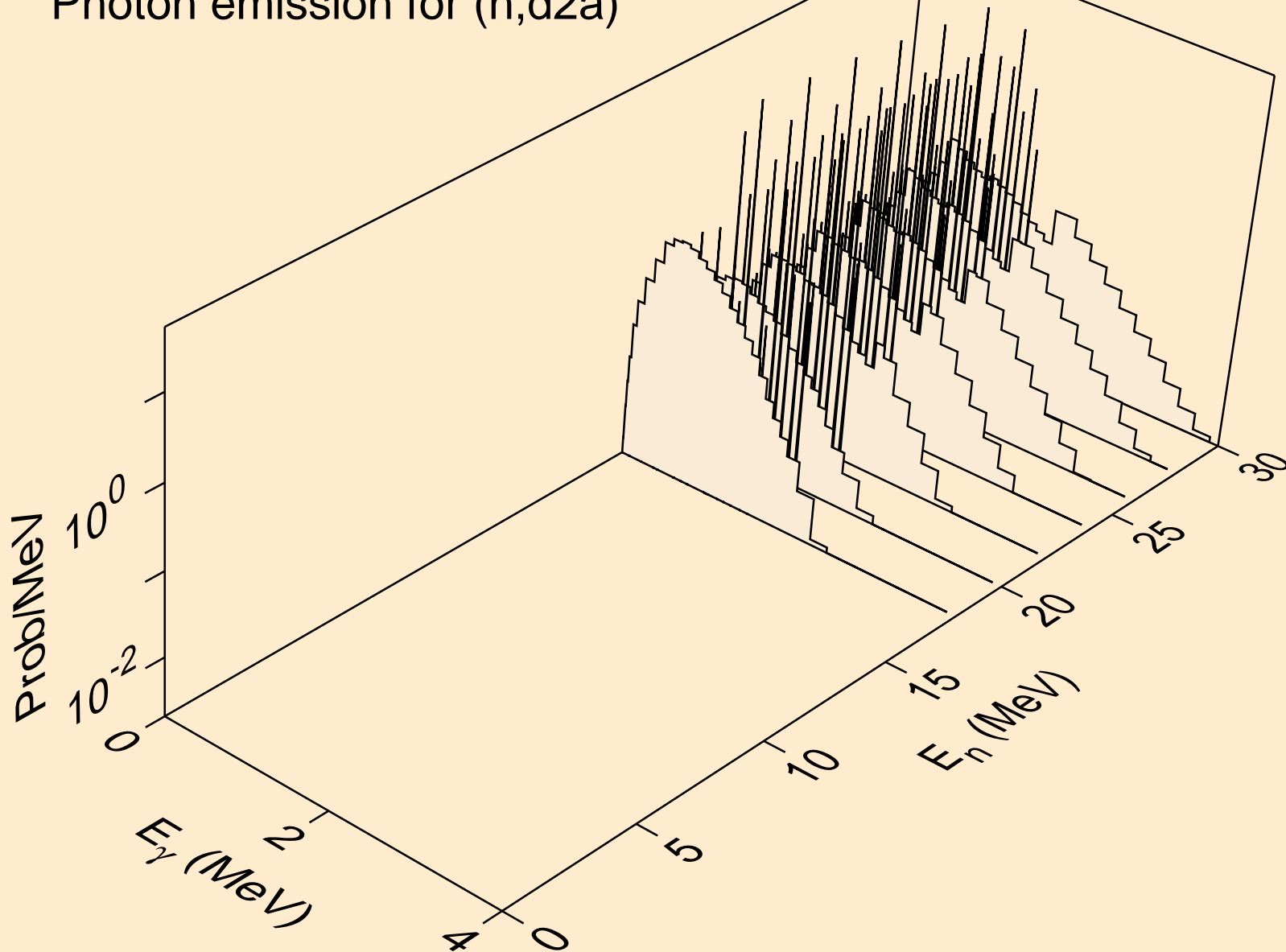

BA122 NEUTRON ACER TENDL-2019 LIBRARY; T=293.16K
Photon emission for (n,pd)

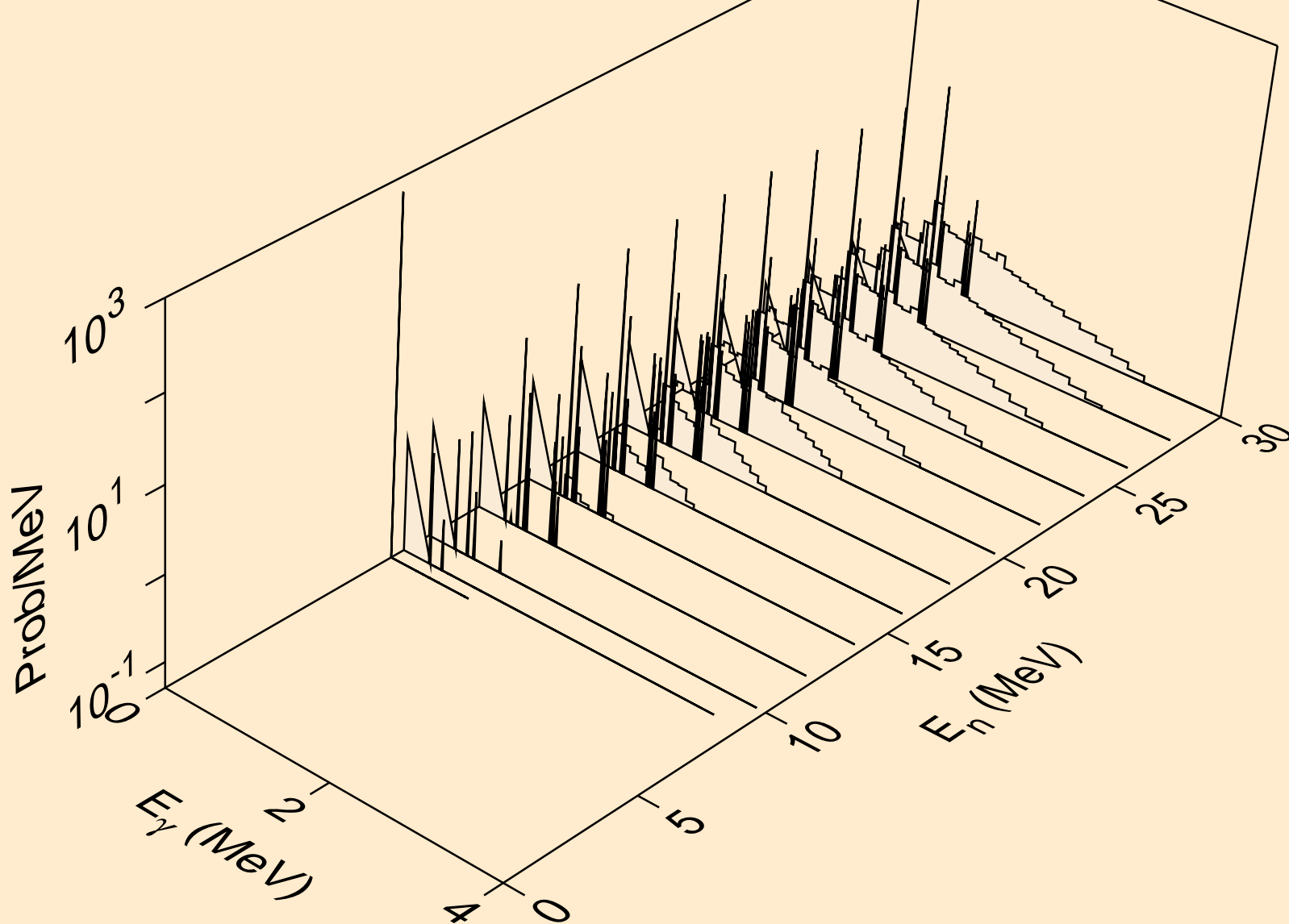

BA122 NEUTRON ACER TENDL-2019 LIBRARY; T=293.16K
Photon emission for (n,pt)

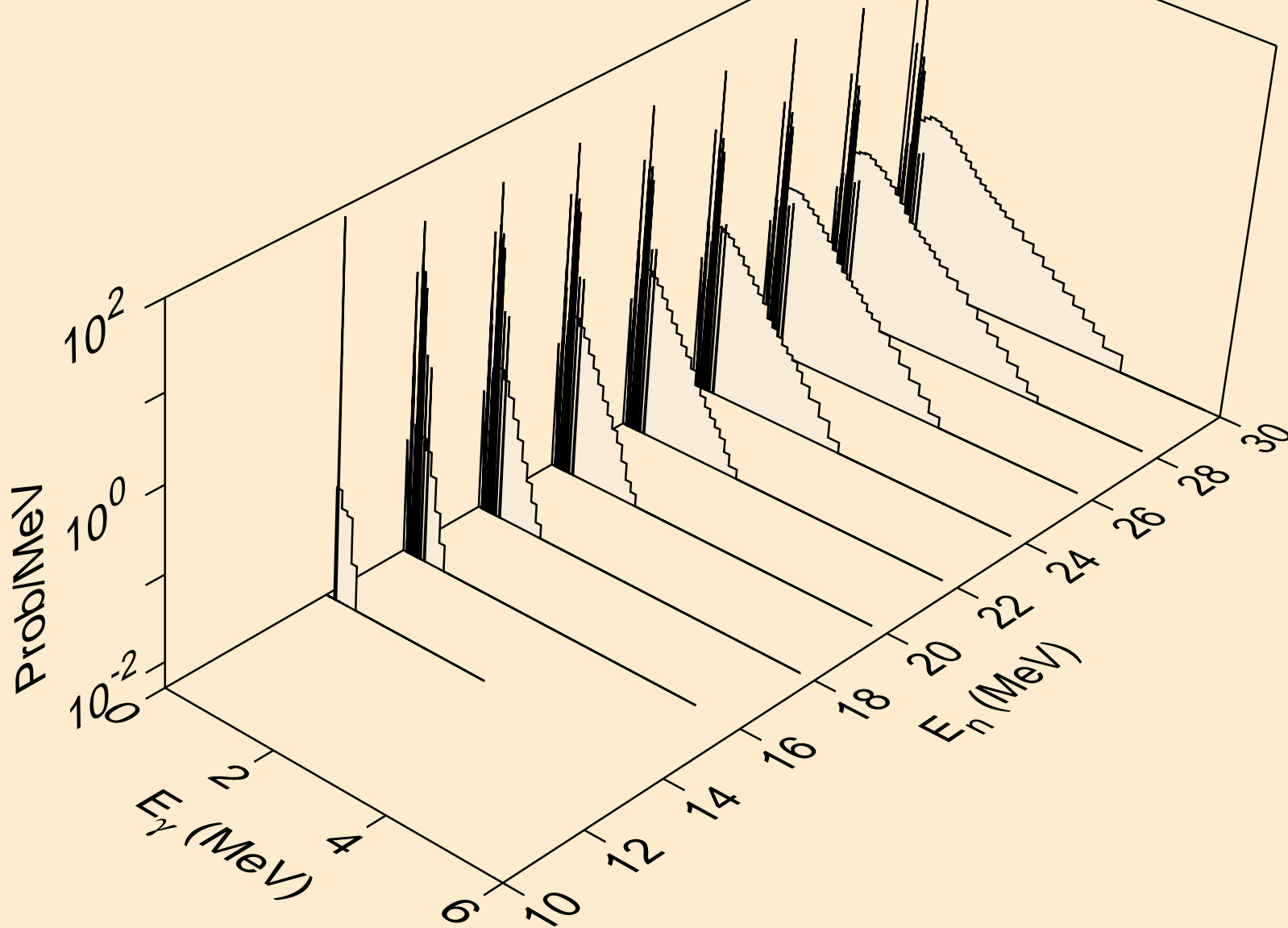

BA122 NEUTRON ACER TENDL-2019 LIBRARY; T=293.16K
Photon emission for (n,da)

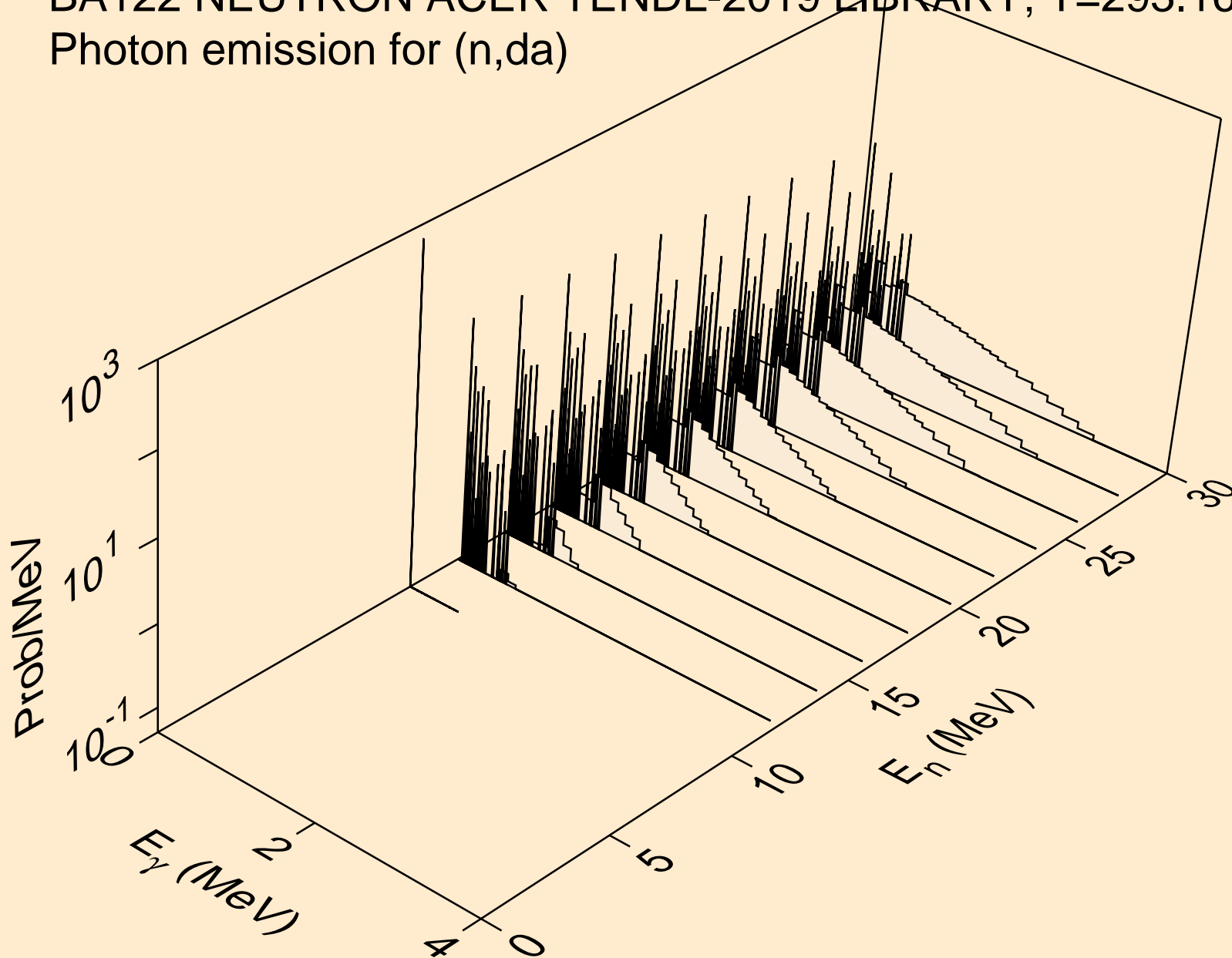

BA122 NEUTRON ACER TENDL-2019 LIBRARY; T=293.16K
thermal capture photon spectrum

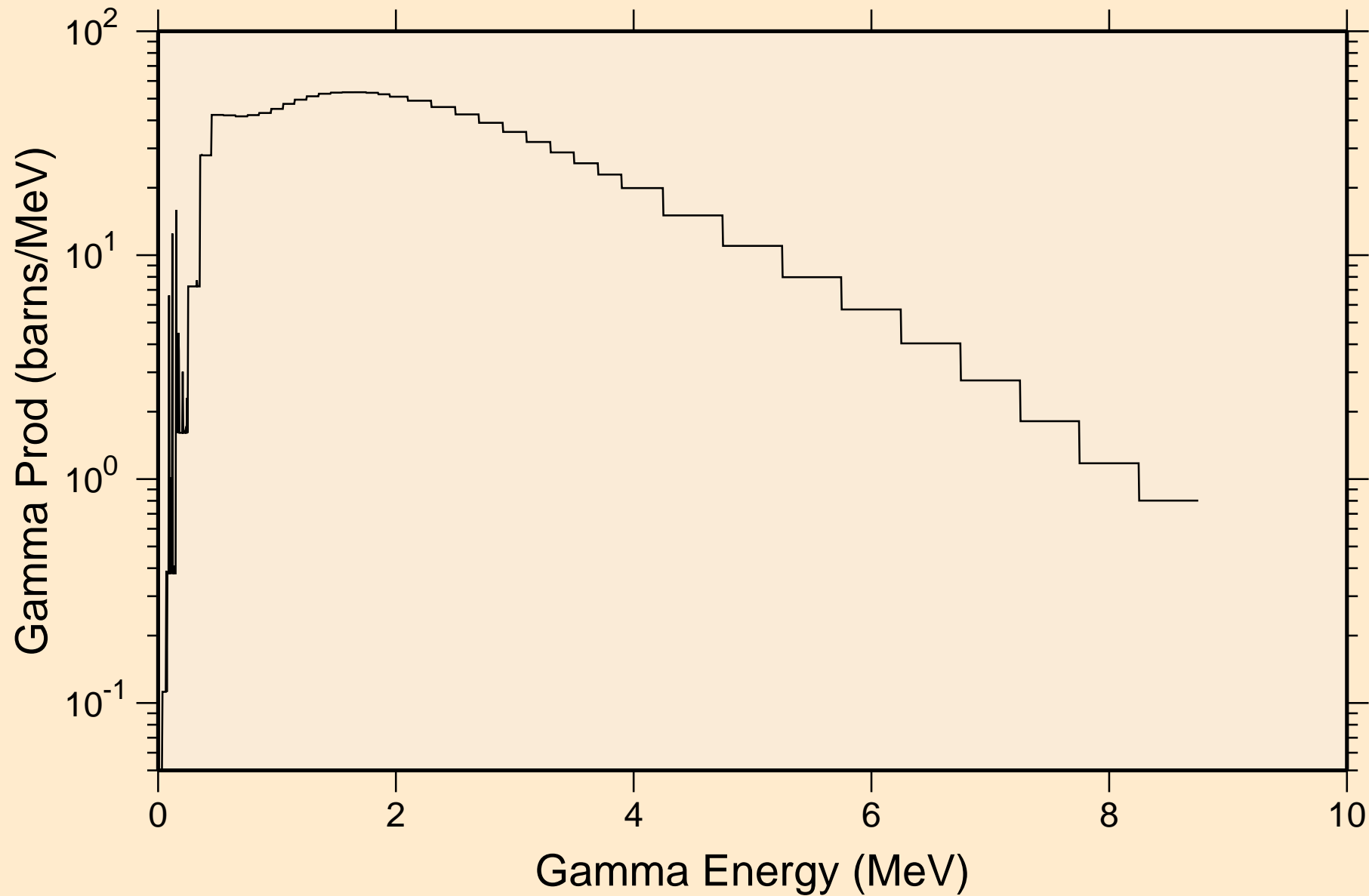

BA122 NEUTRON ACER TENDL-2019 LIBRARY; T=293.16K
14 MeV photon spectrum

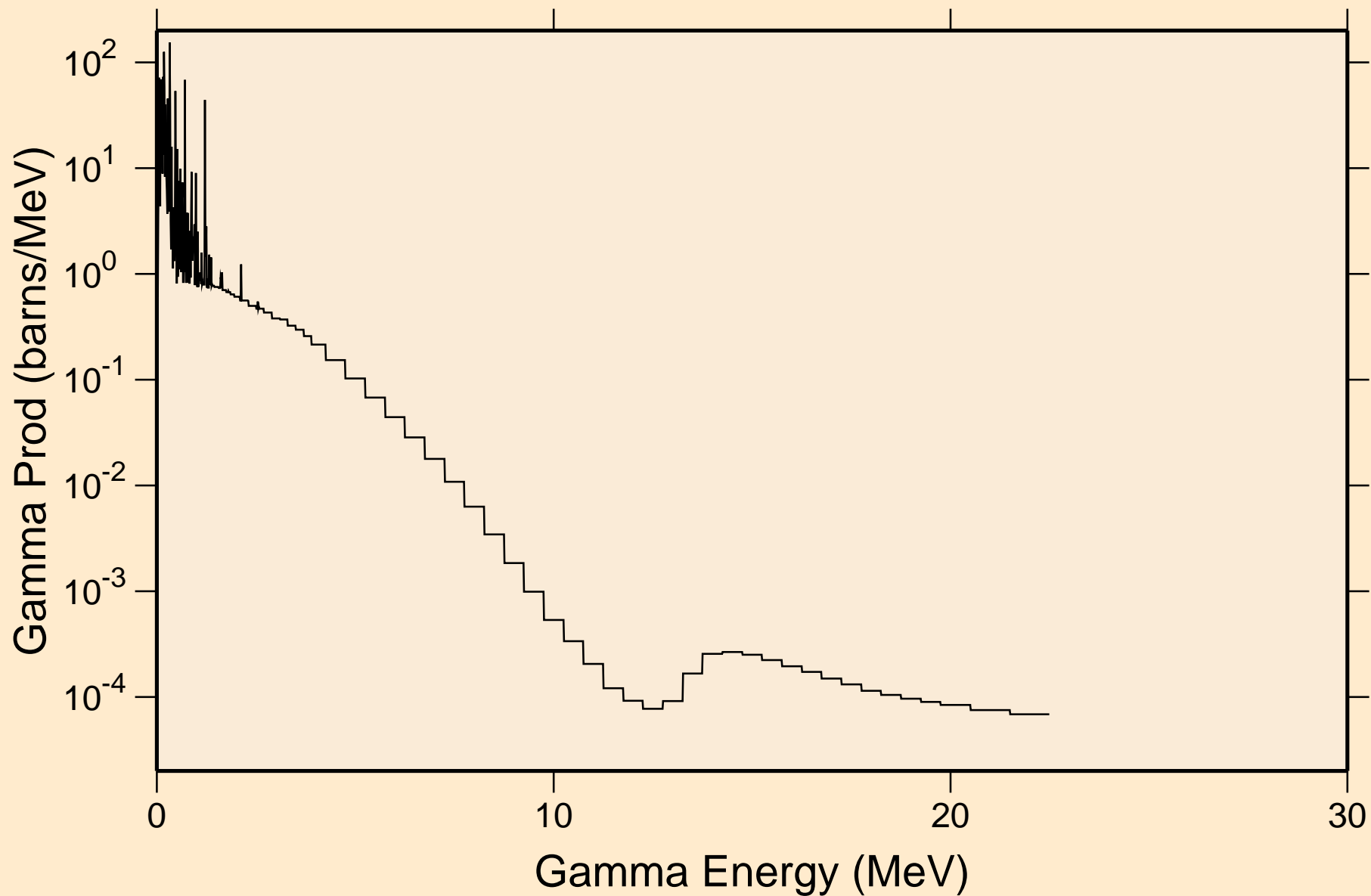

BA122 NEUTRON ACER TENDL-2019 LIBRARY; T=293.16K
Particle heating contributions

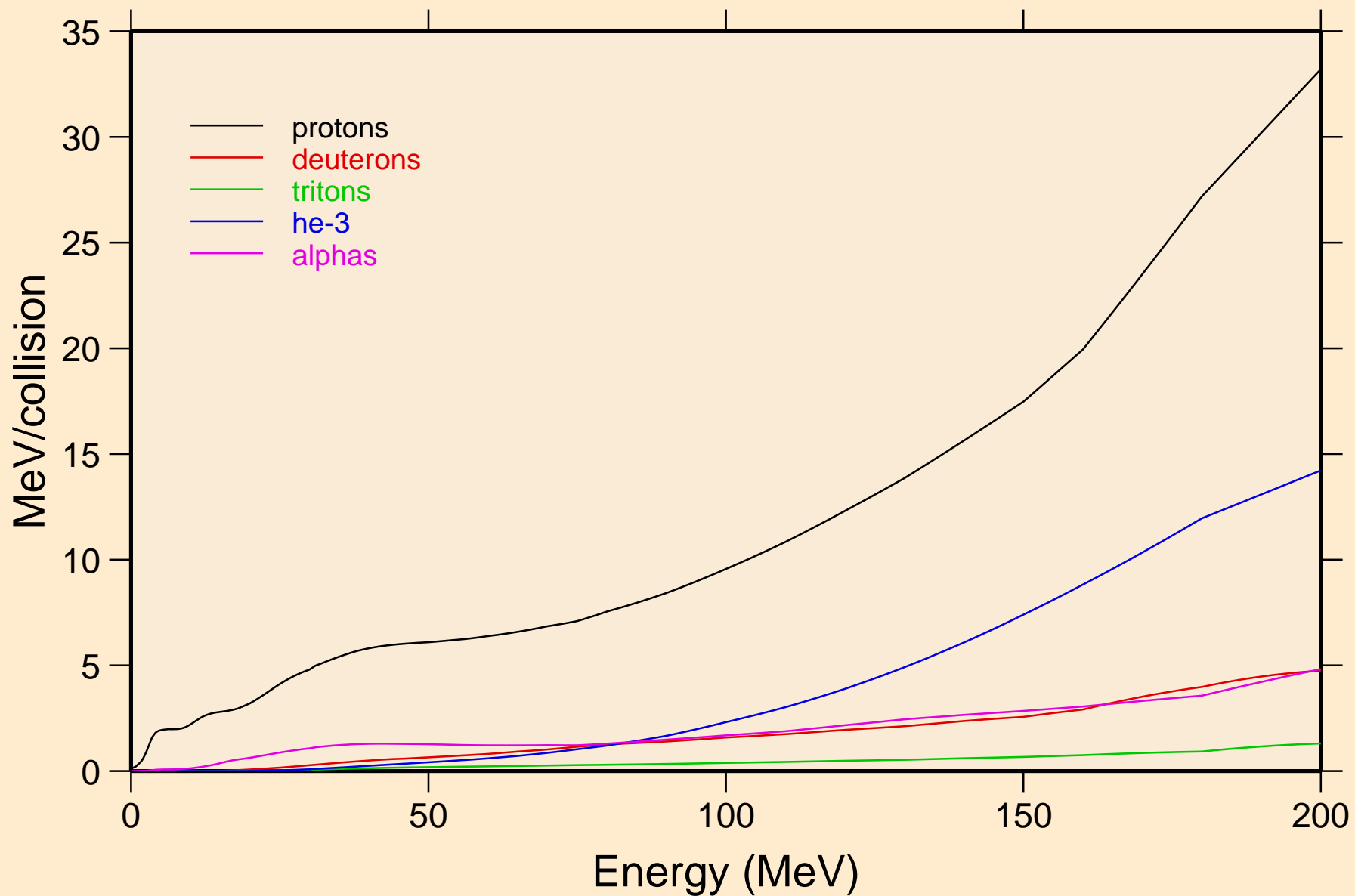

BA122 NEUTRON ACER TENDL-2019 LIBRARY; T=293.16K
Recoil Heating

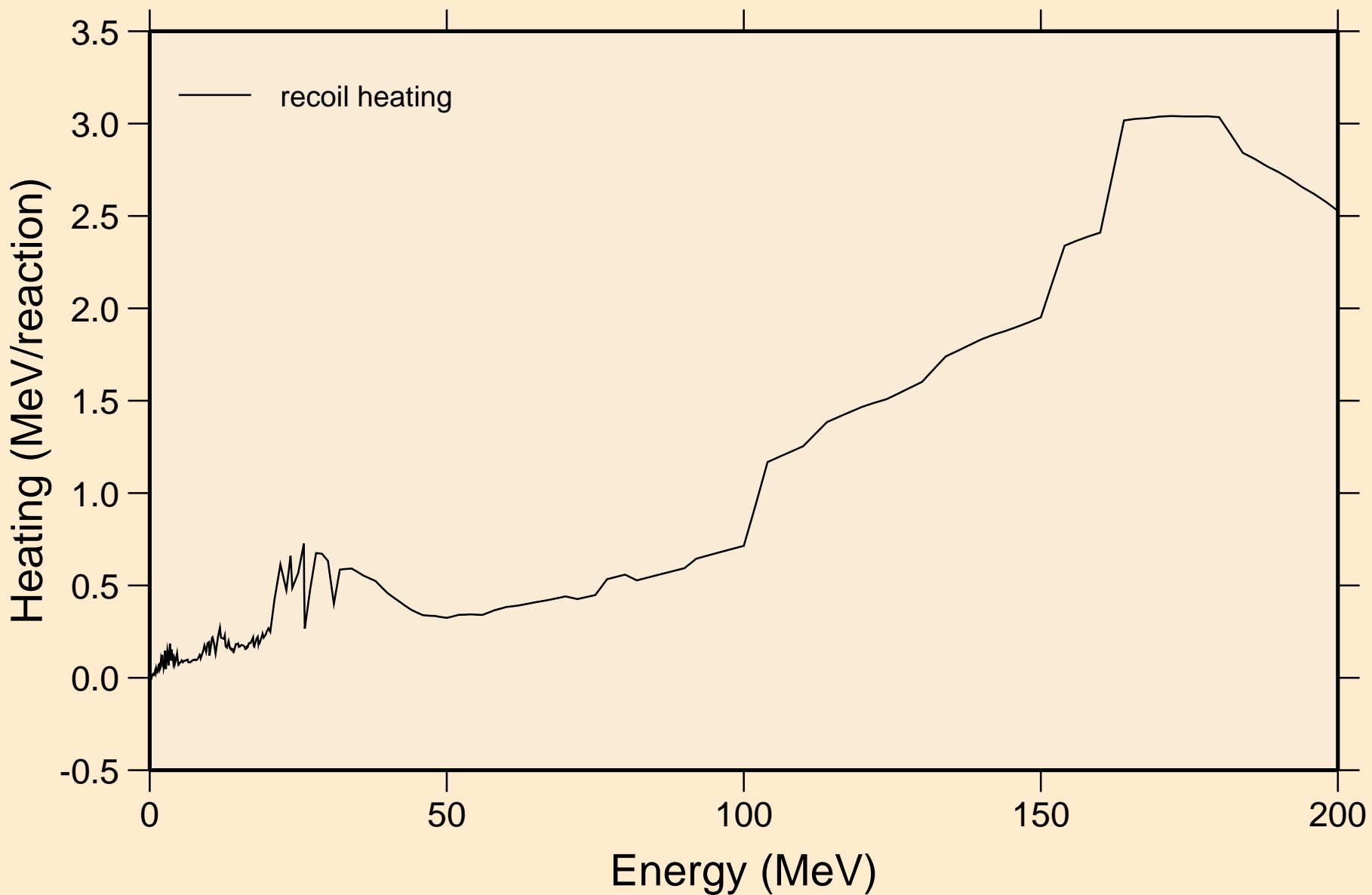

BA122 NEUTRON ACER TENDL-2019 LIBRARY; T=293.16K
Particle production cross sections

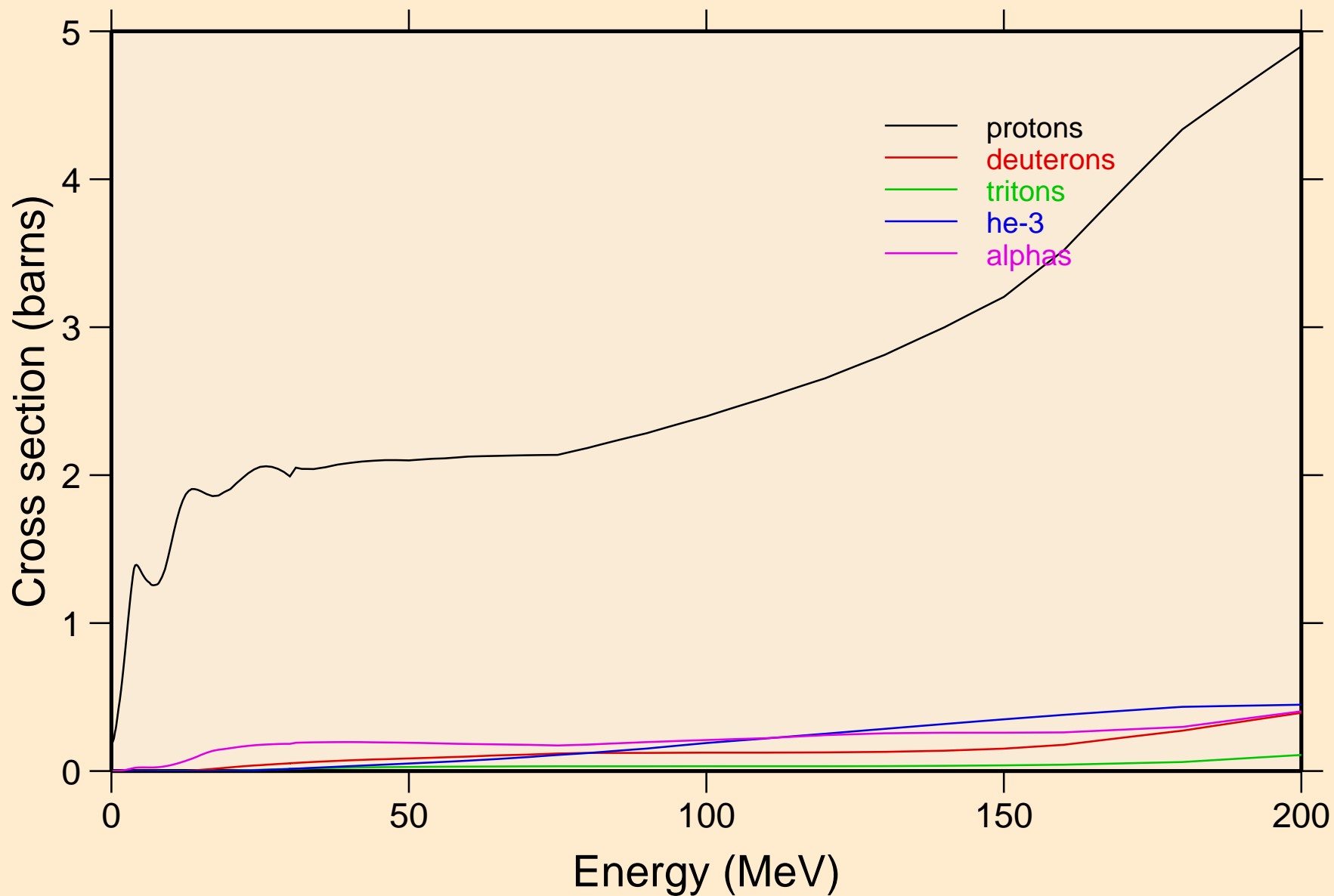

BA122 NEUTRON ACER TENDL-2019 LIBRARY; T=293.16K
protons from (n,x)

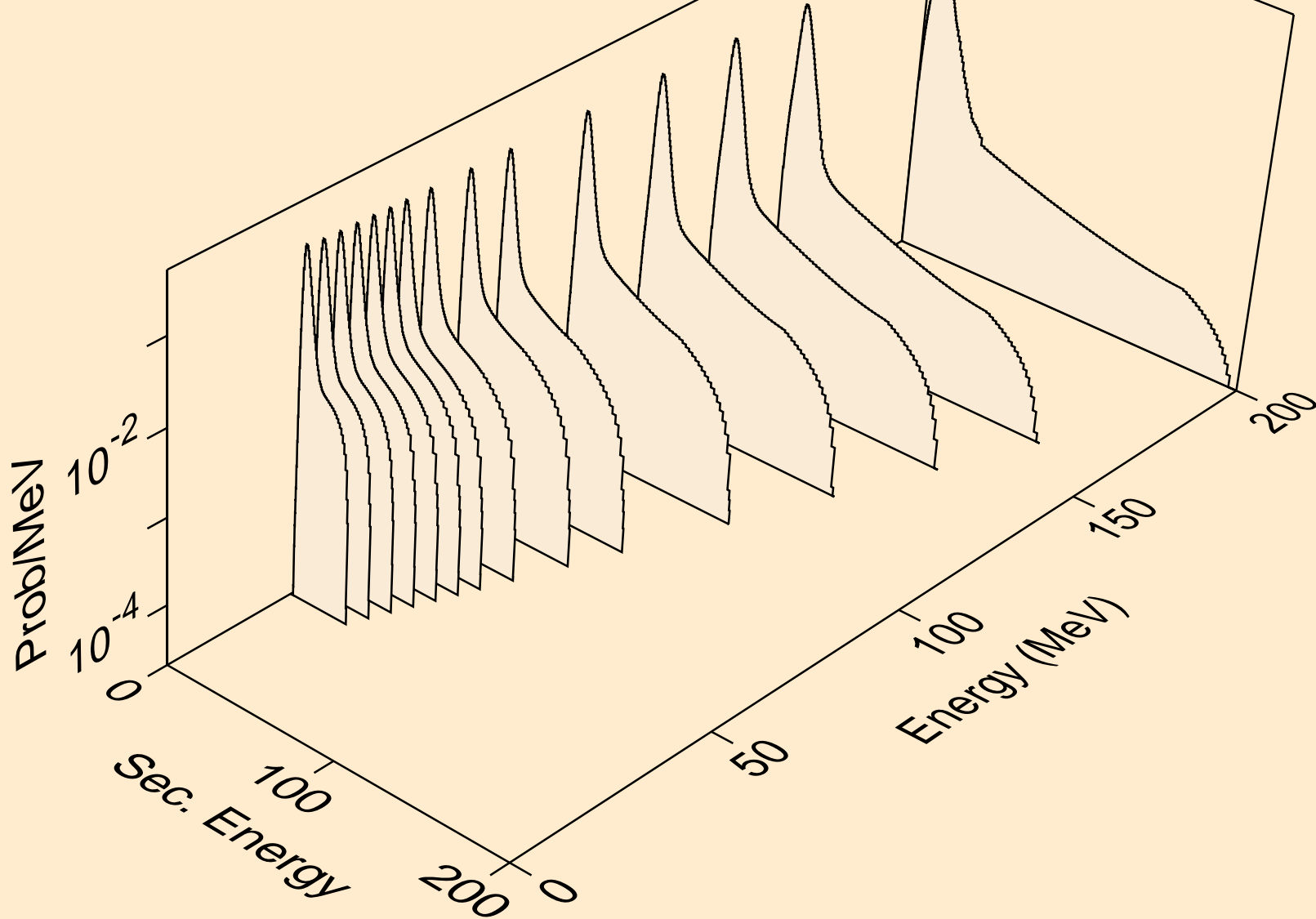

BA122 NEUTRON ACER TENDL-2019 LIBRARY; T=293.16K
protons from (n,n*)p

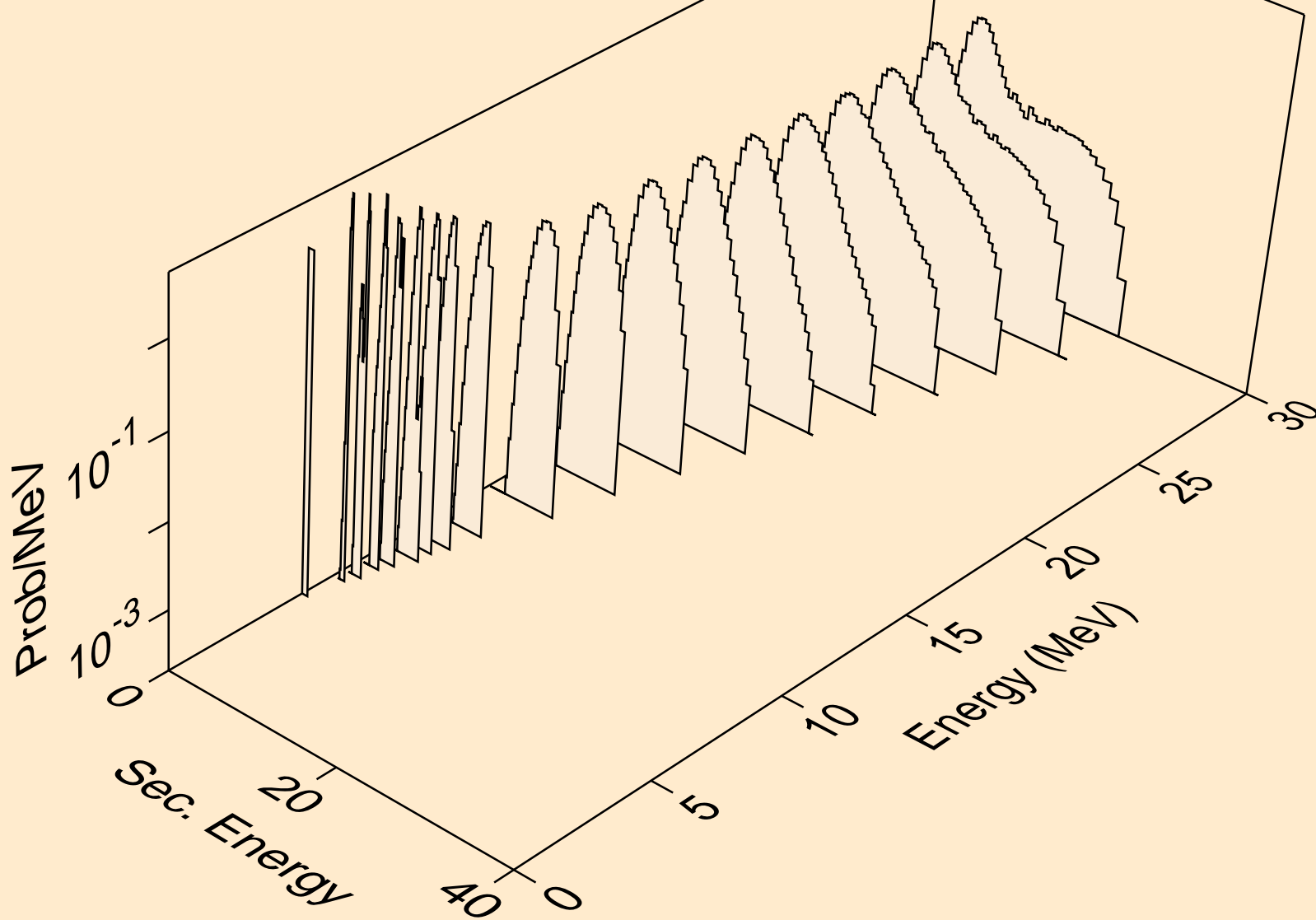

BA122 NEUTRON ACER TENDL-2019 LIBRARY; T=293.16K
protons from (n,2np)

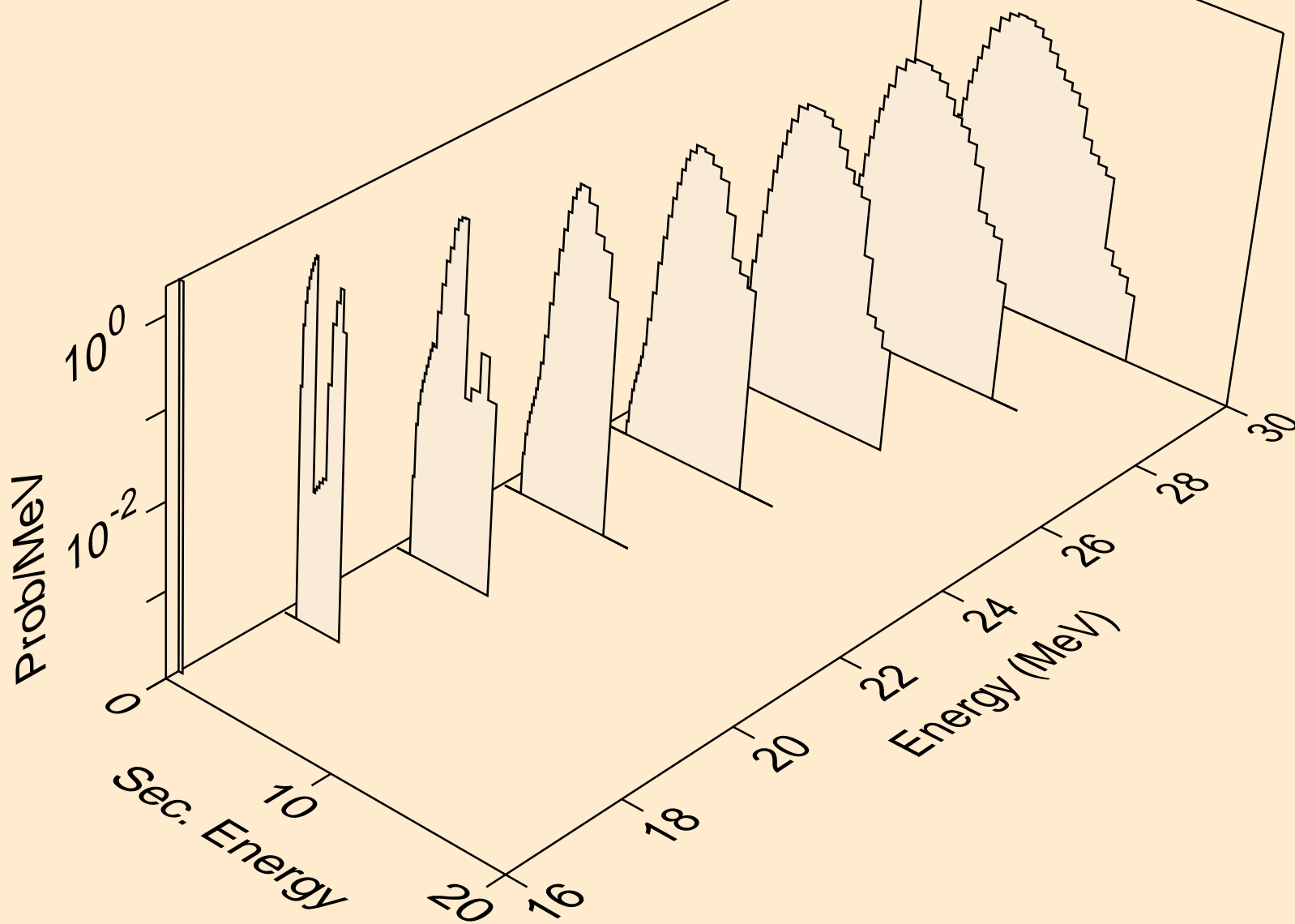

BA122 NEUTRON ACER TENDL-2019 LIBRARY; T=293.16K
protons from (n,3np)

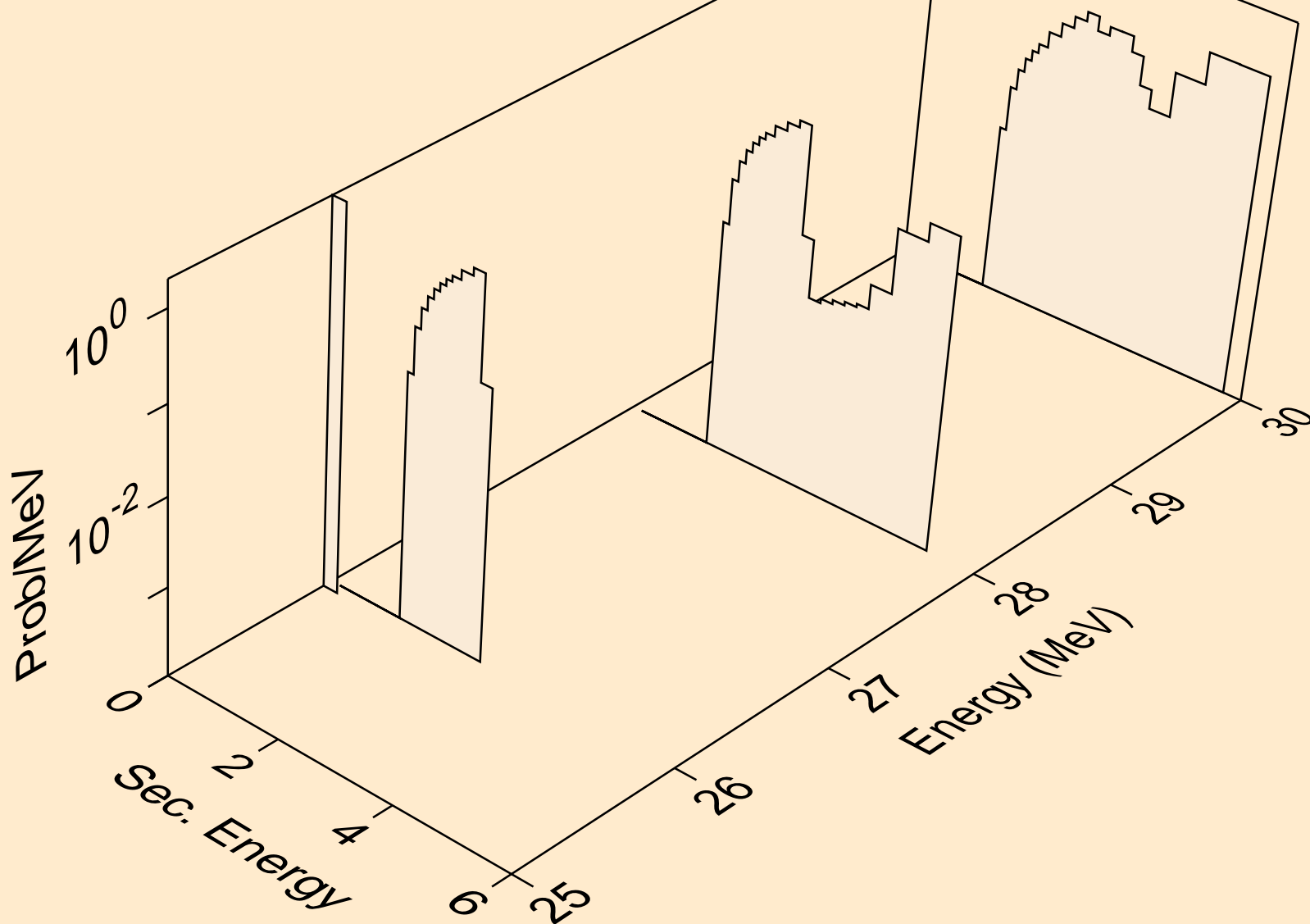

BA122 NEUTRON ACER TENDL-2019 LIBRARY; T=293.16K
protons from (n,2np)

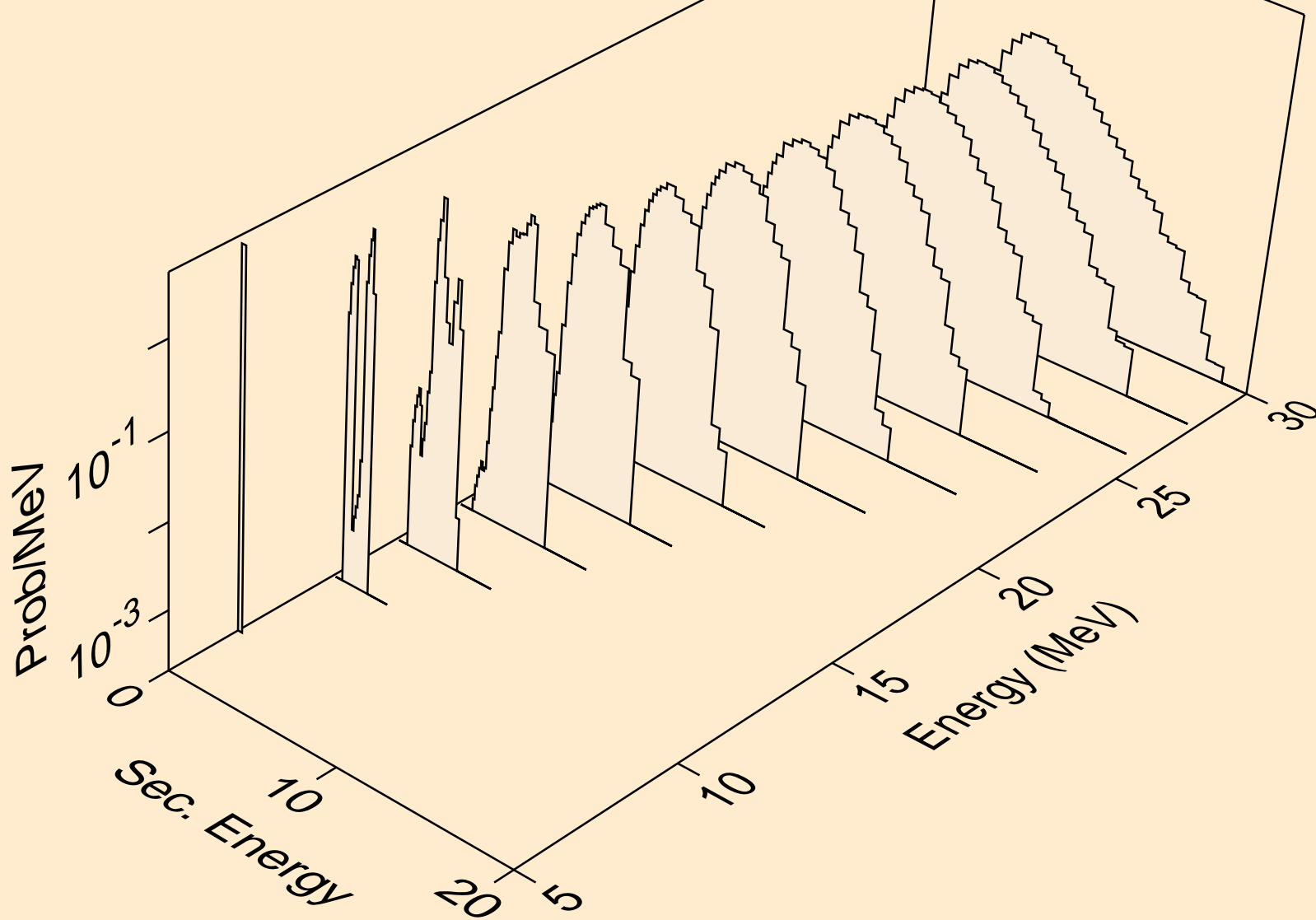

BA122 NEUTRON ACER TENDL-2019 LIBRARY; T=293.16K
protons from (n,npa)

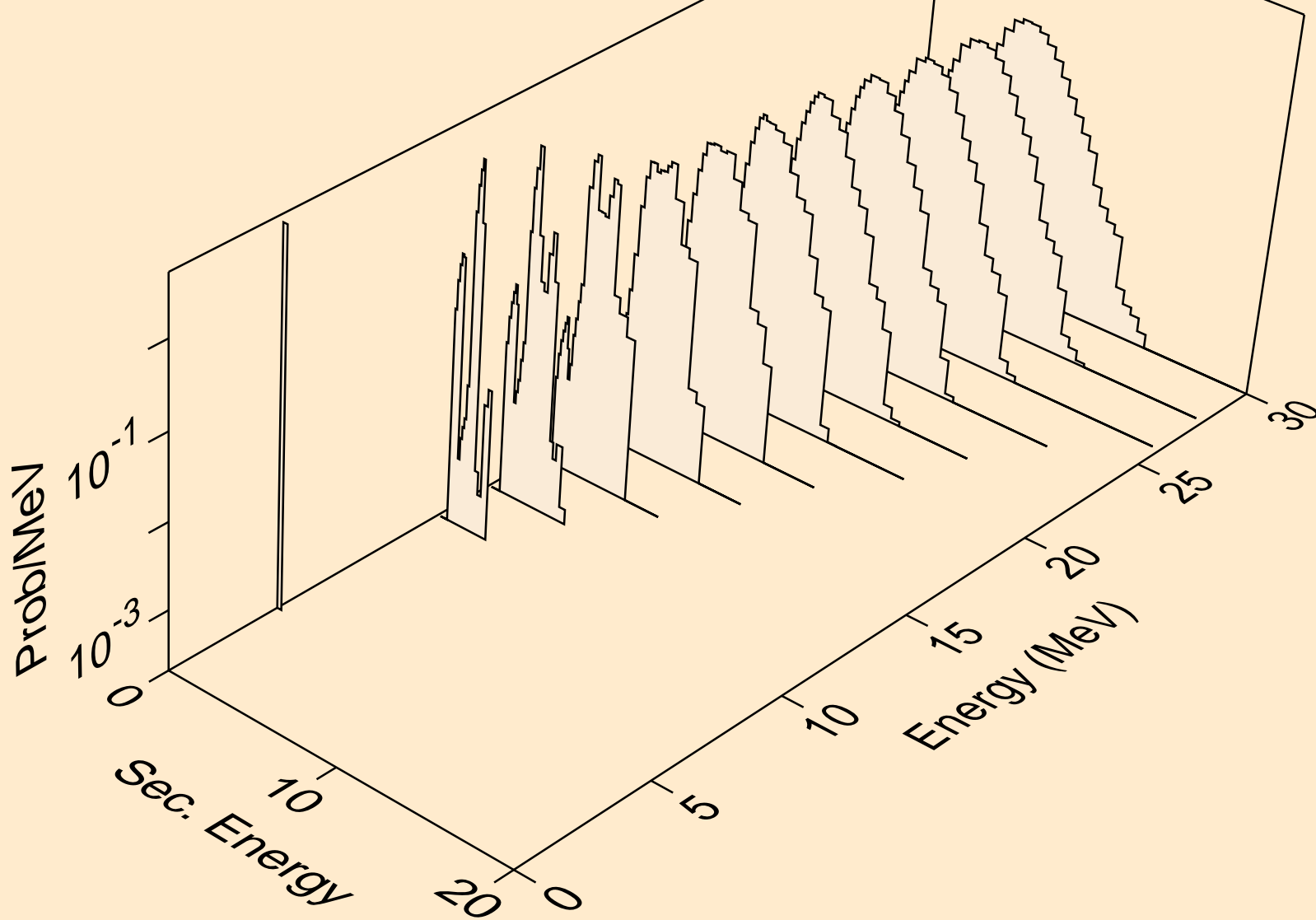

BA122 NEUTRON ACER TENDL-2019 LIBRARY; T=293.16K
protons from (n,p)

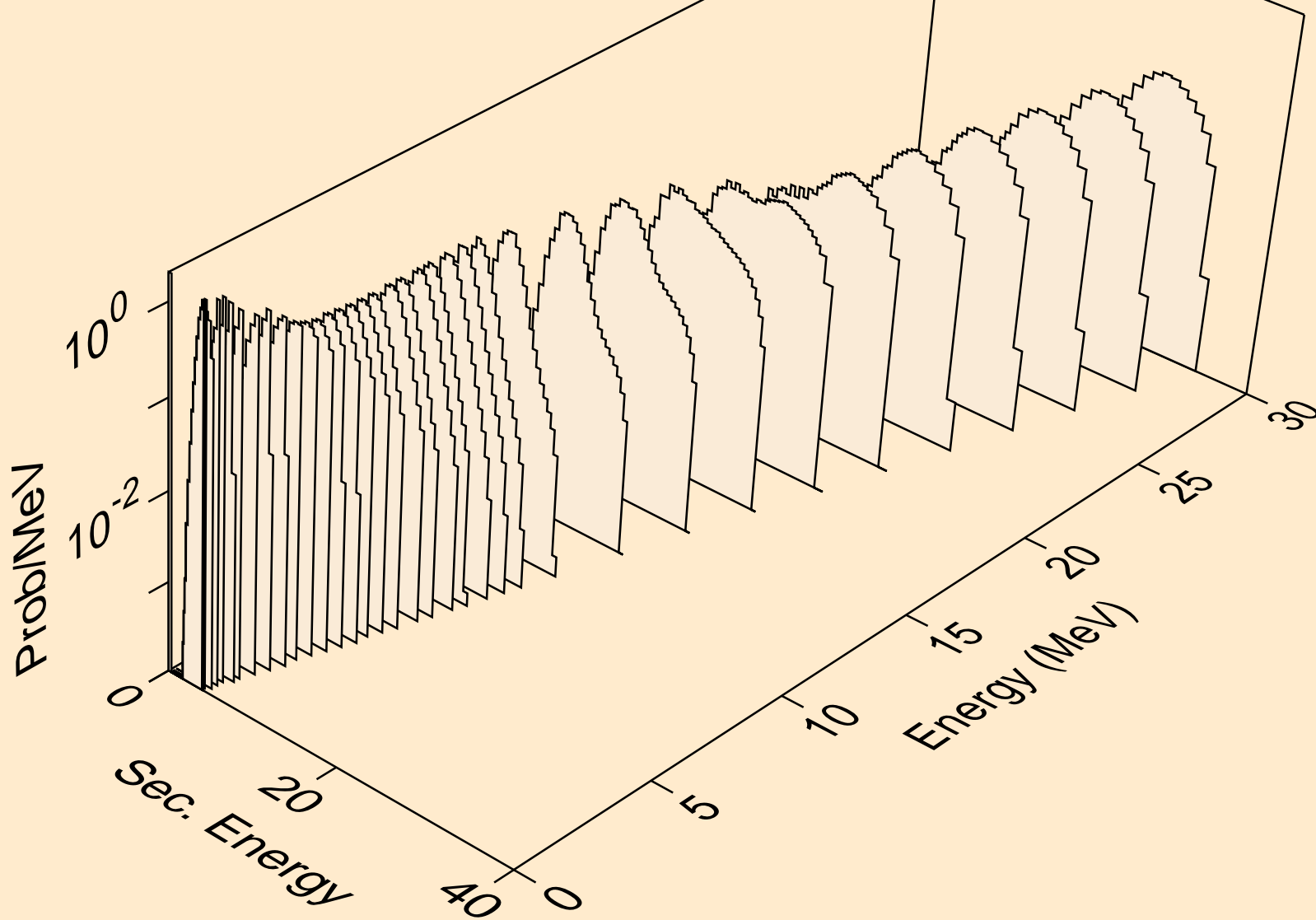

BA122 NEUTRON ACER TENDL-2019 LIBRARY; T=293.16K
protons from (n,2p)

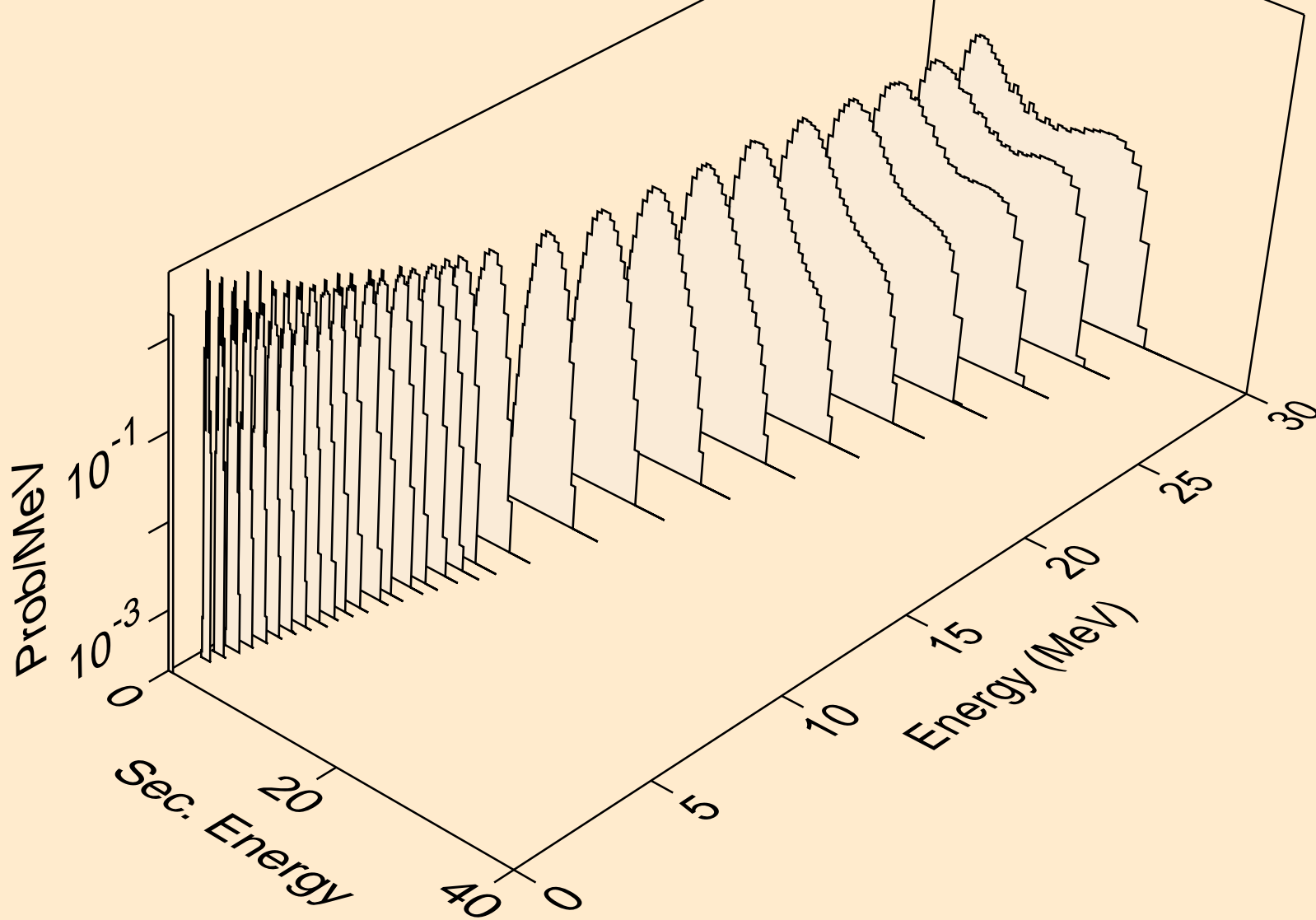

BA122 NEUTRON ACER TENDL-2019 LIBRARY; T=293.16K
protons from (n,p)

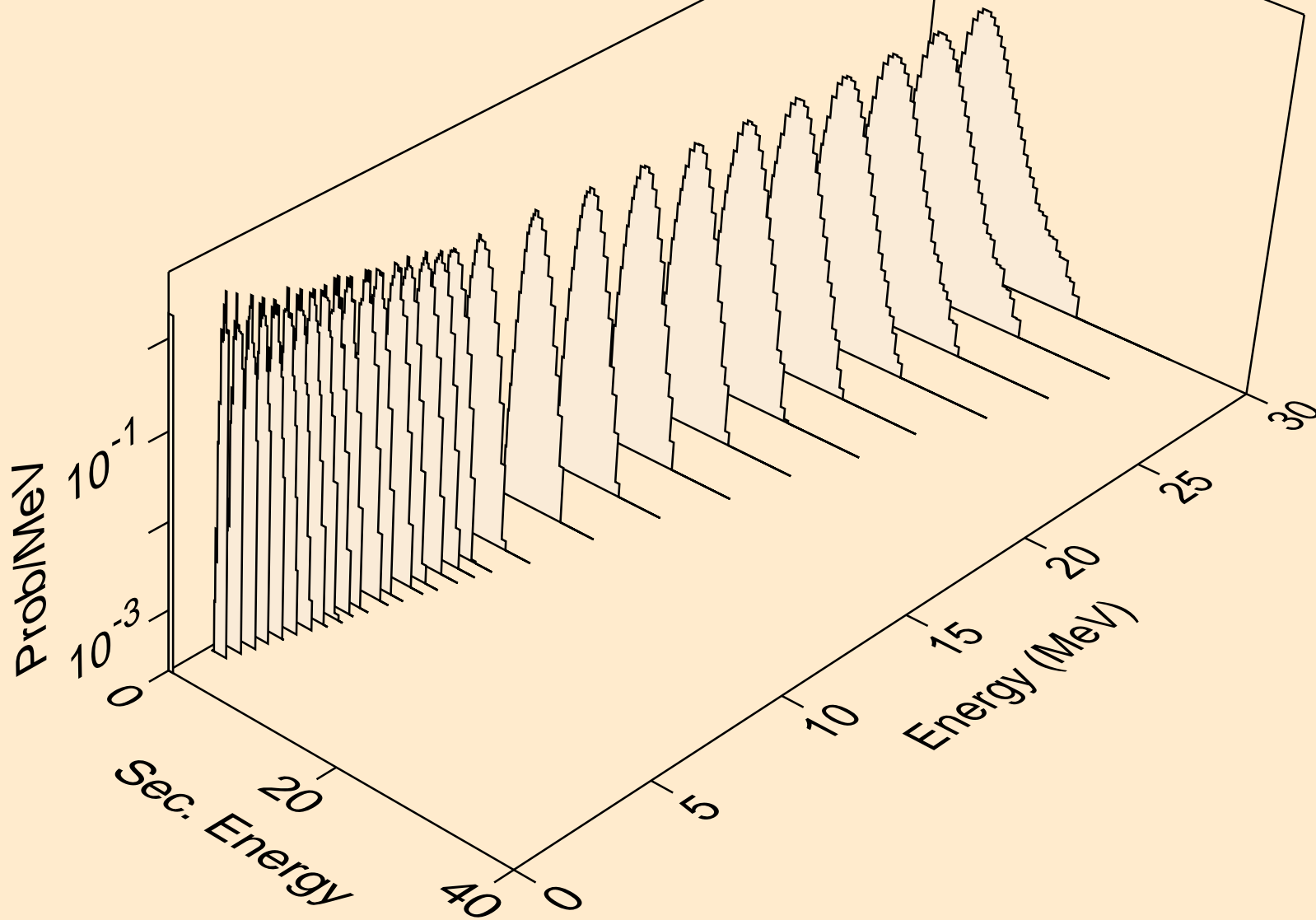

BA122 NEUTRON ACER TENDL-2019 LIBRARY; T=293.16K
protons from (n,pd)

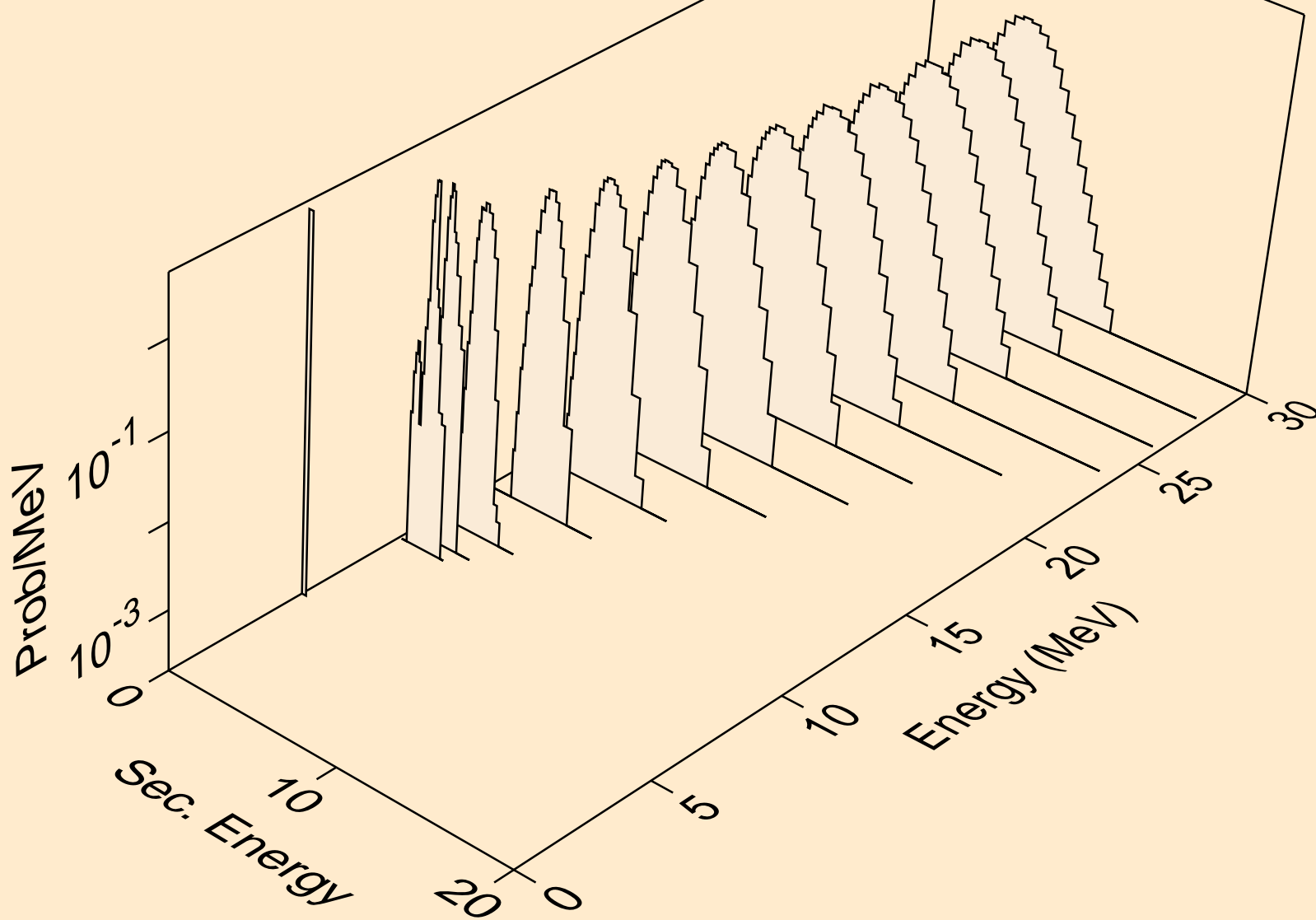

BA122 NEUTRON ACER TENDL-2019 LIBRARY; T=293.16K
protons from (n,pt)

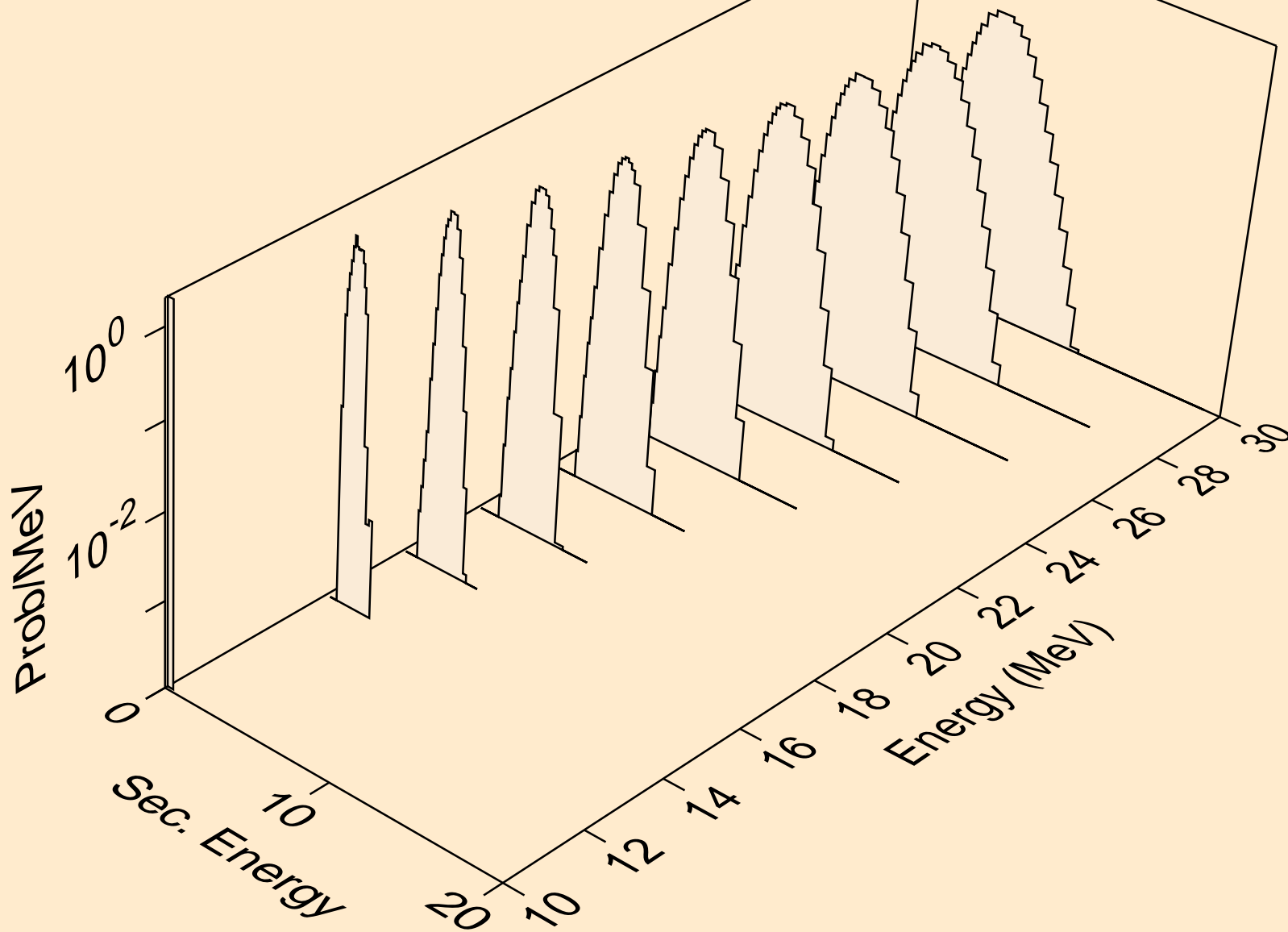

BA122 NEUTRON ACER TENDL-2019 LIBRARY; T=293.16K
deuterons from (n,x)

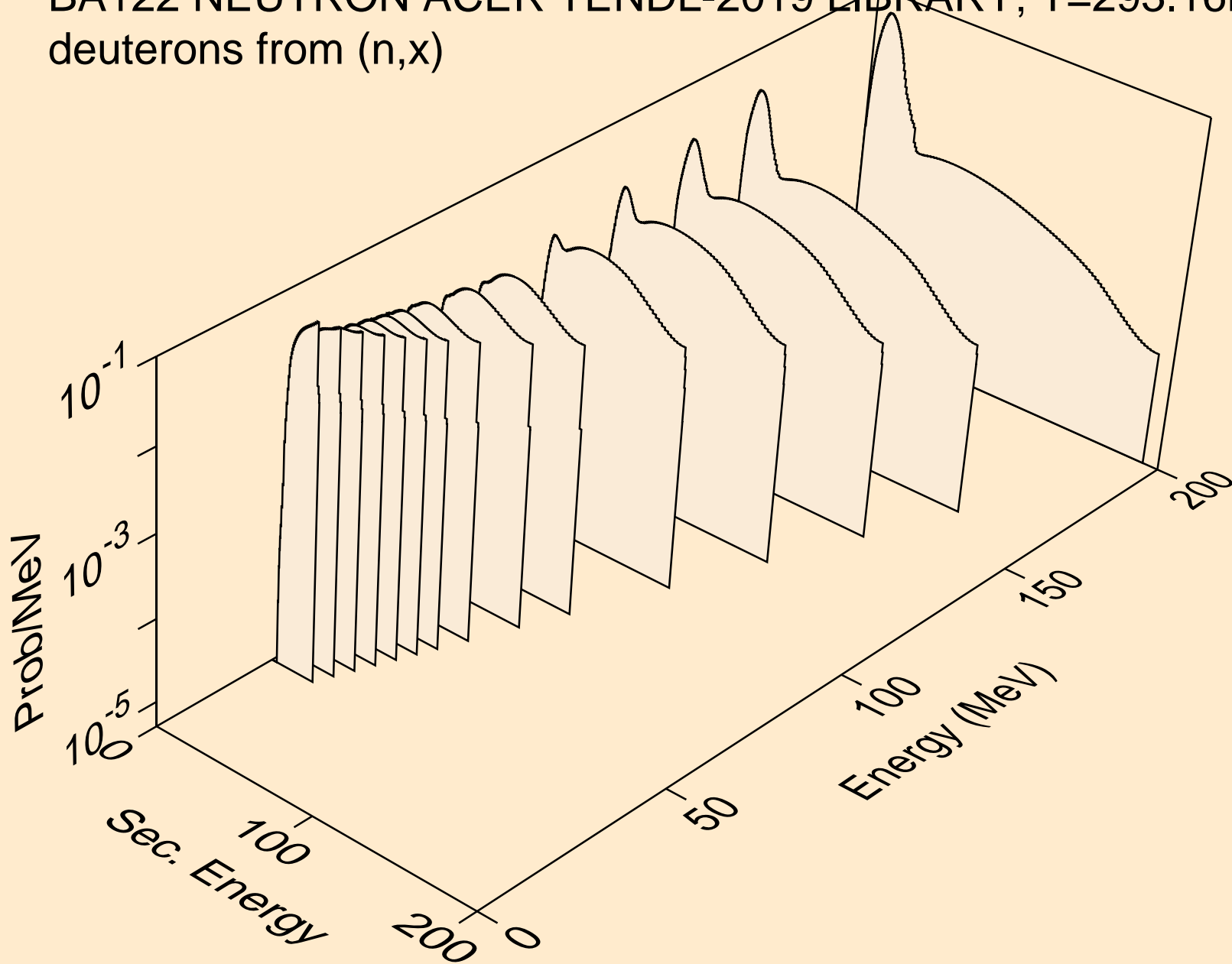

BA122 NEUTRON ACER TENDL-2019 LIBRARY; T=293.16K
deuterons from (n,2nd)

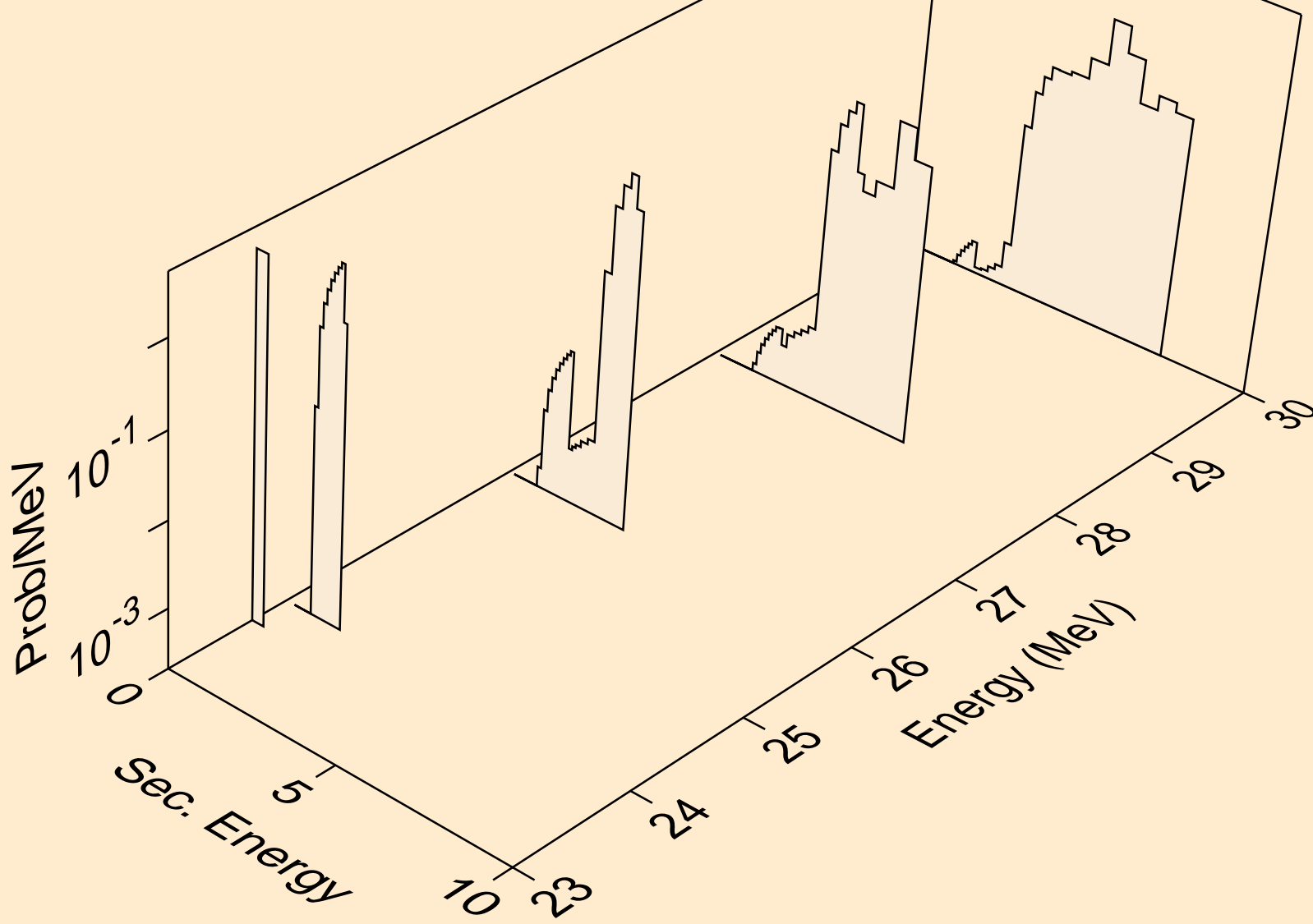

BA122 NEUTRON ACER TENDL-2019 LIBRARY; T=293.16K
deuterons from (n,n*)d

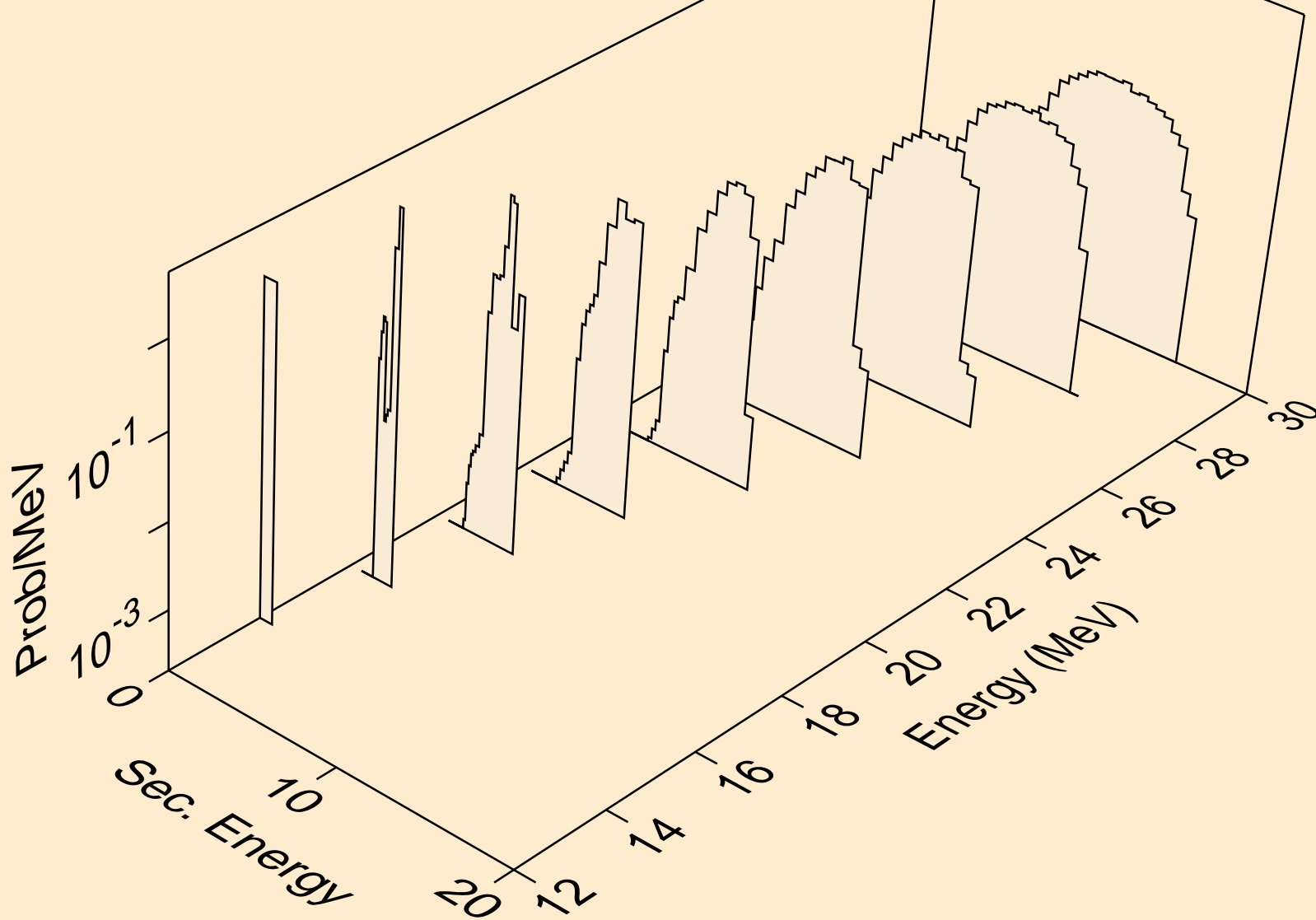

BA122 NEUTRON ACER TENDL-2019 LIBRARY; T=293.16K
deuterons from (n,d)

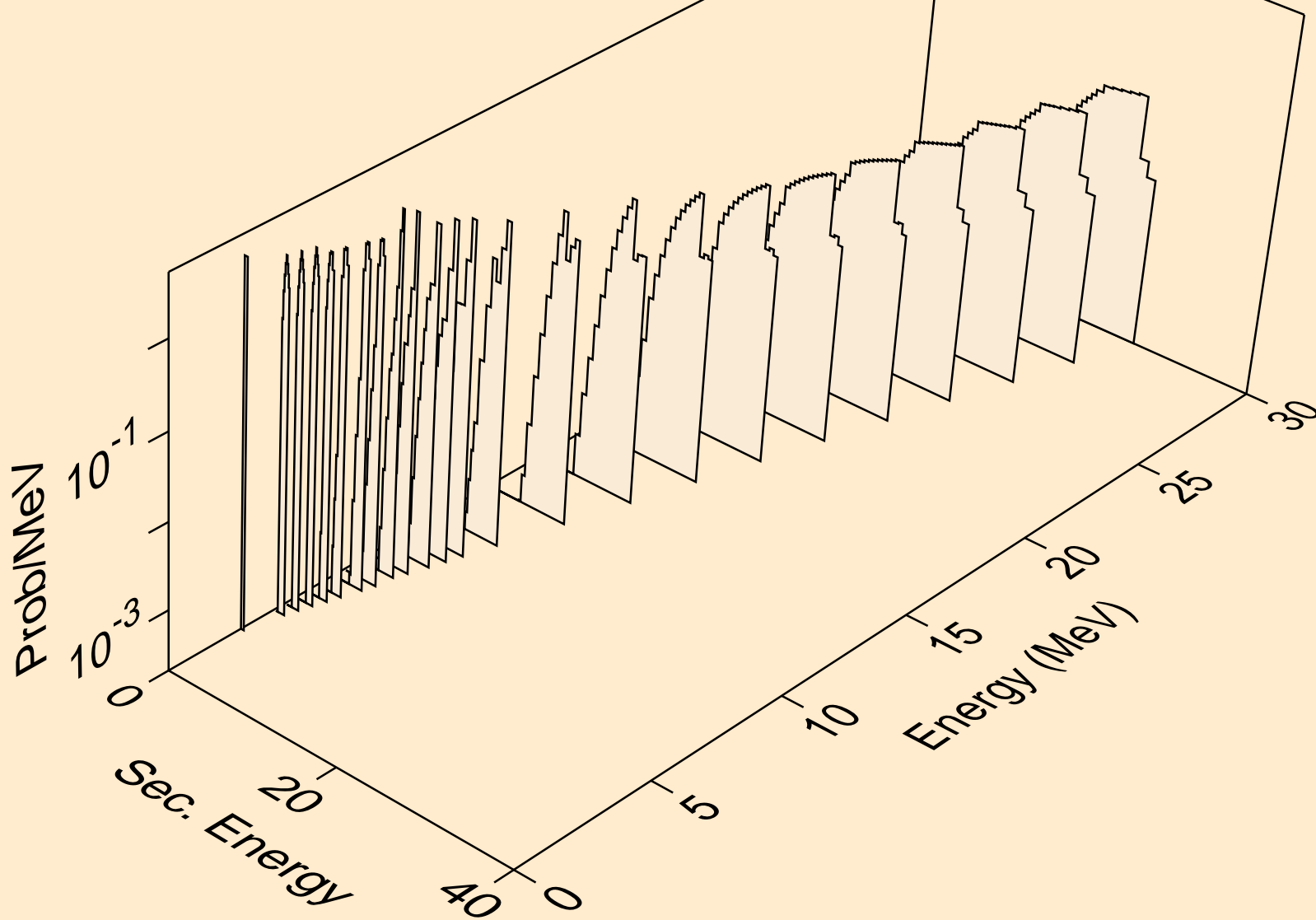

BA122 NEUTRON ACER TENDL-2019 LIBRARY; T=293.16K
deuterons from (n,d2a)

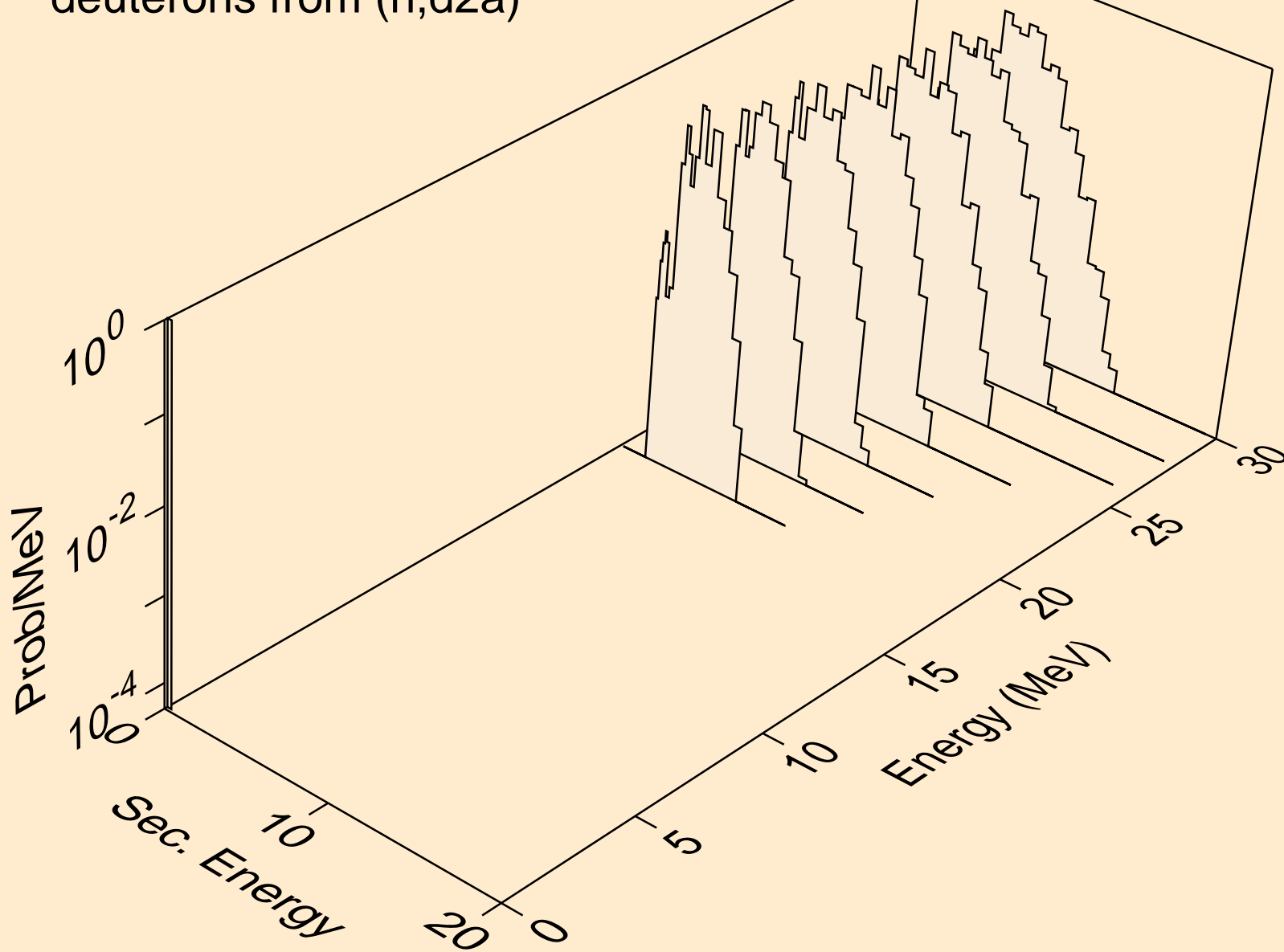

BA122 NEUTRON ACER TENDL-2019 LIBRARY; T=293.16K
deuterons from (n,pd)

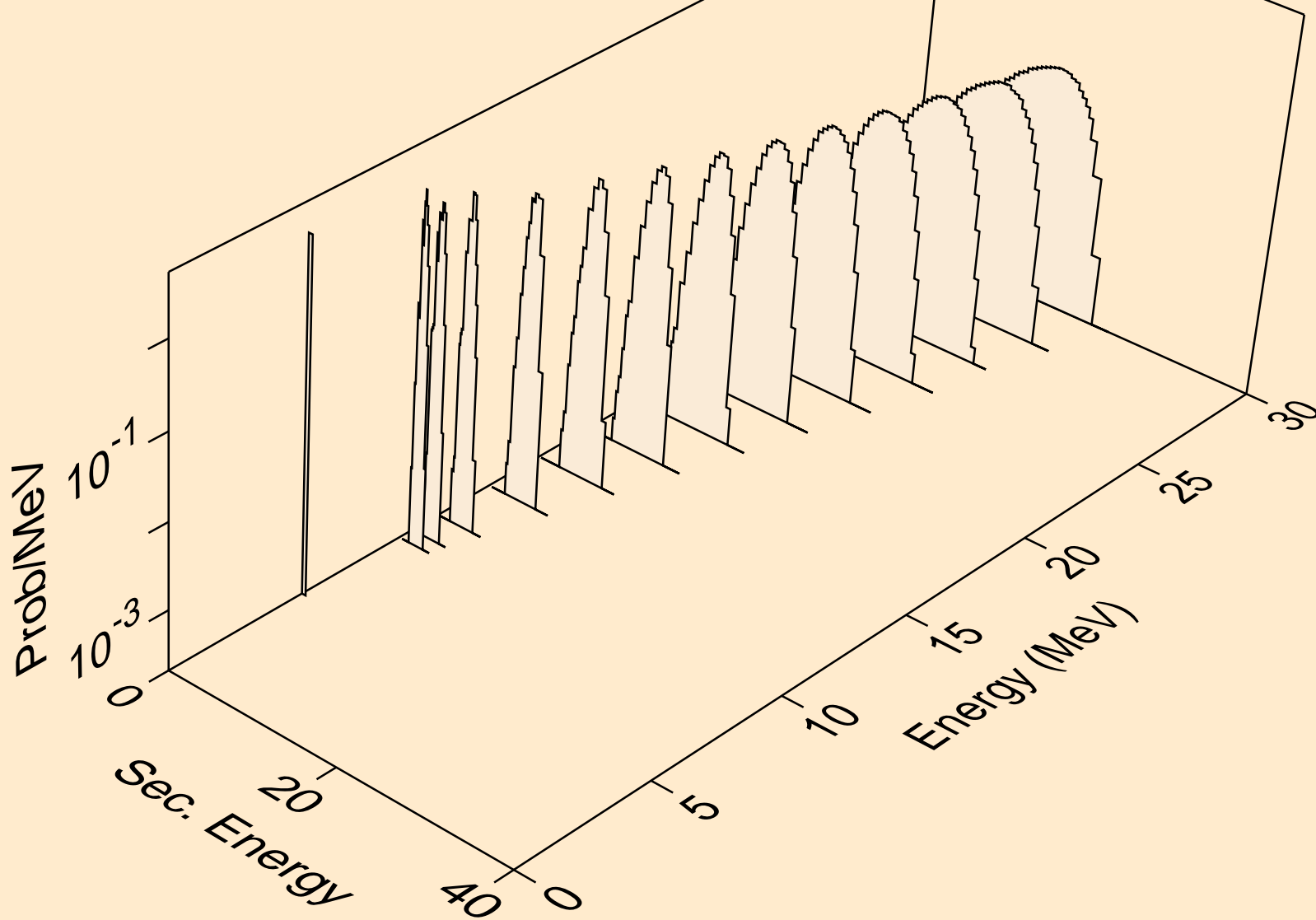

BA122 NEUTRON ACER TENDL-2019 LIBRARY; T=293.16K
deuterons from (n,da)

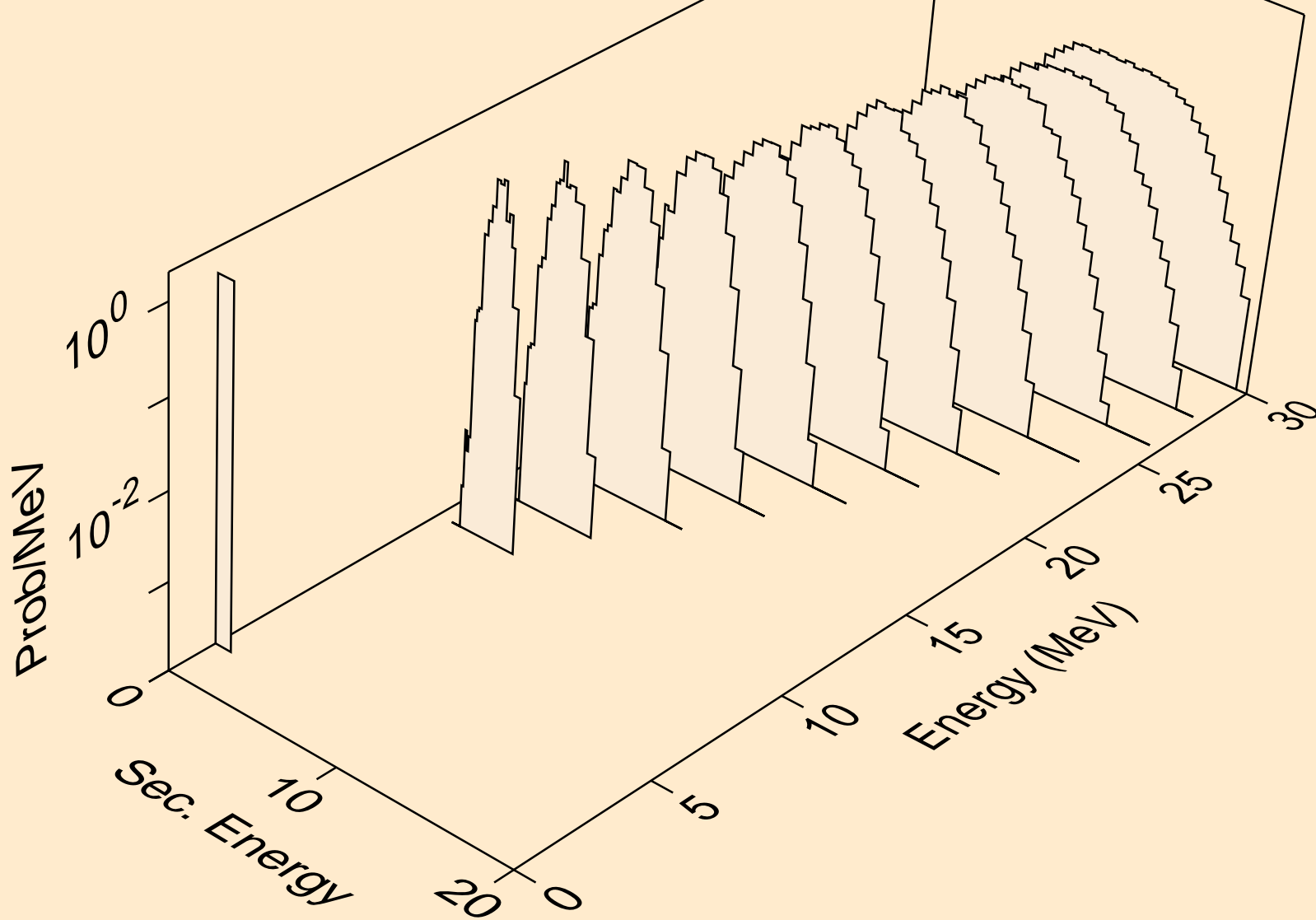

BA122 NEUTRON ACER TENDL-2019 LIBRARY; T=293.16K
tritons from (n,x)

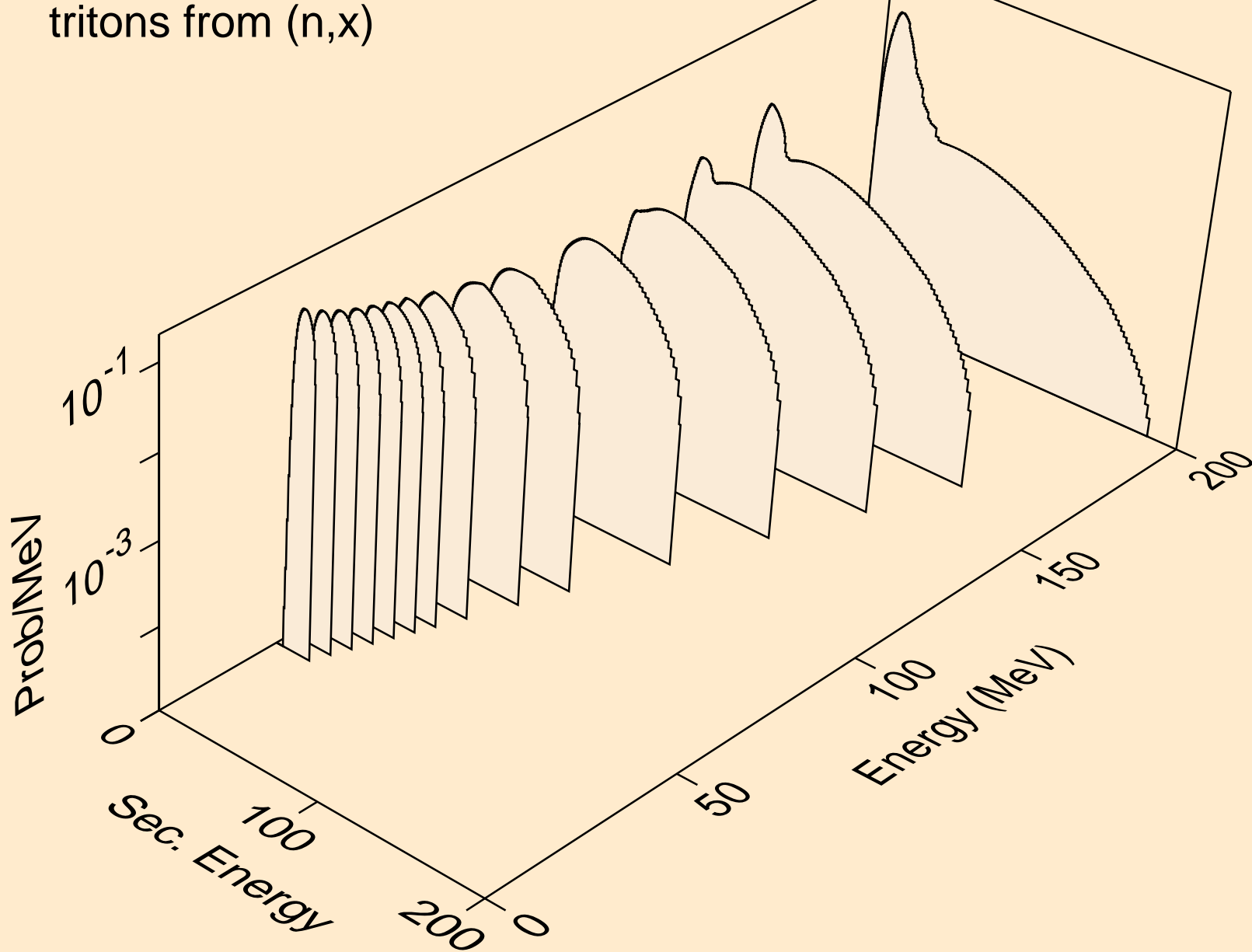

BA122 NEUTRON ACER TENDL-2019 LIBRARY; T=293.16K
tritons from (n,n*)t

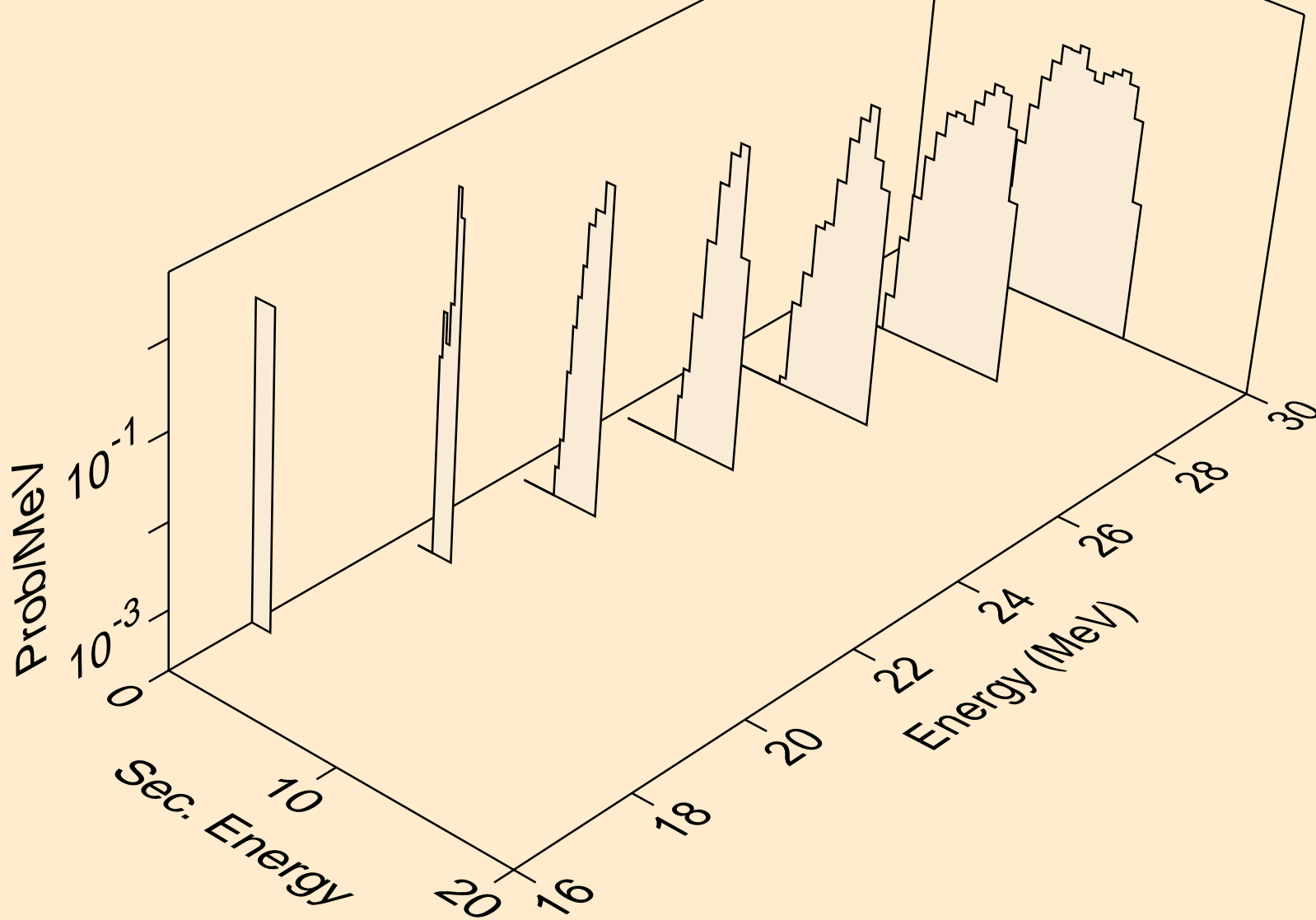

BA122 NEUTRON ACER TENDL-2019 LIBRARY; T=293.16K
tritons from (n,t)

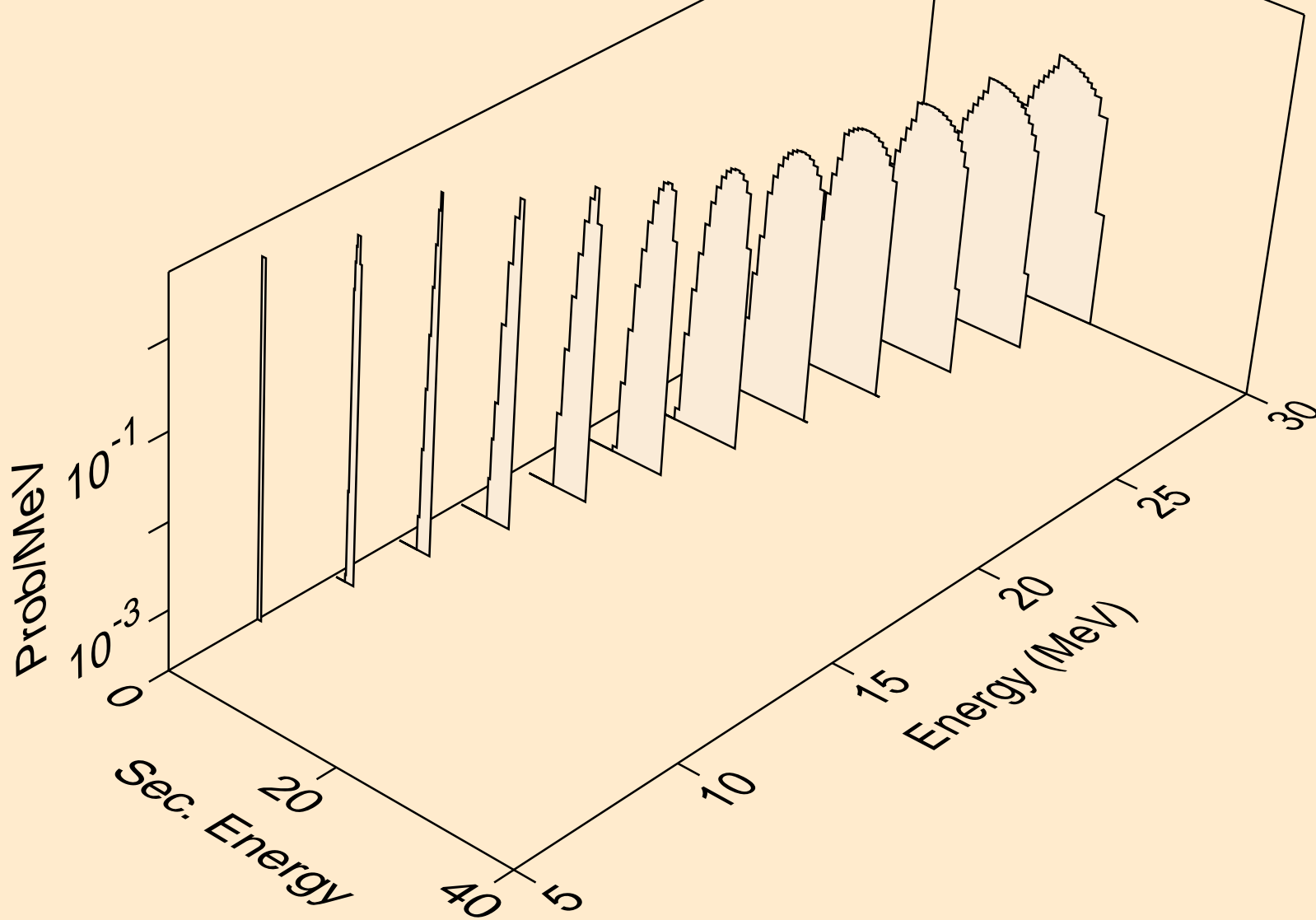

BA122 NEUTRON ACER TENDL-2019 LIBRARY; T=293.16K
tritons from (n,pt)

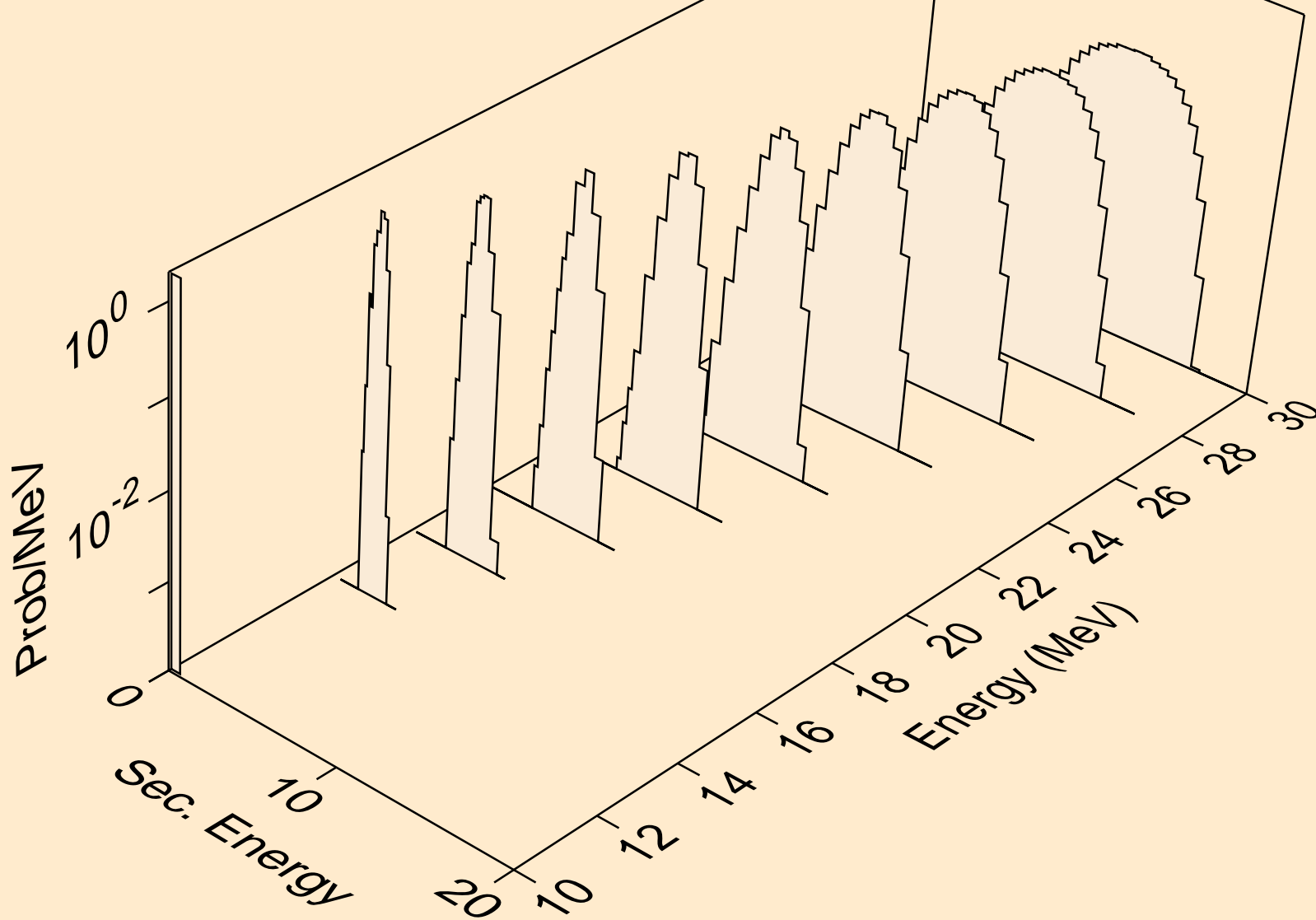

BA122 NEUTRON ACER TENDL-2019 LIBRARY; T=293.16K
he3s from (n,x)

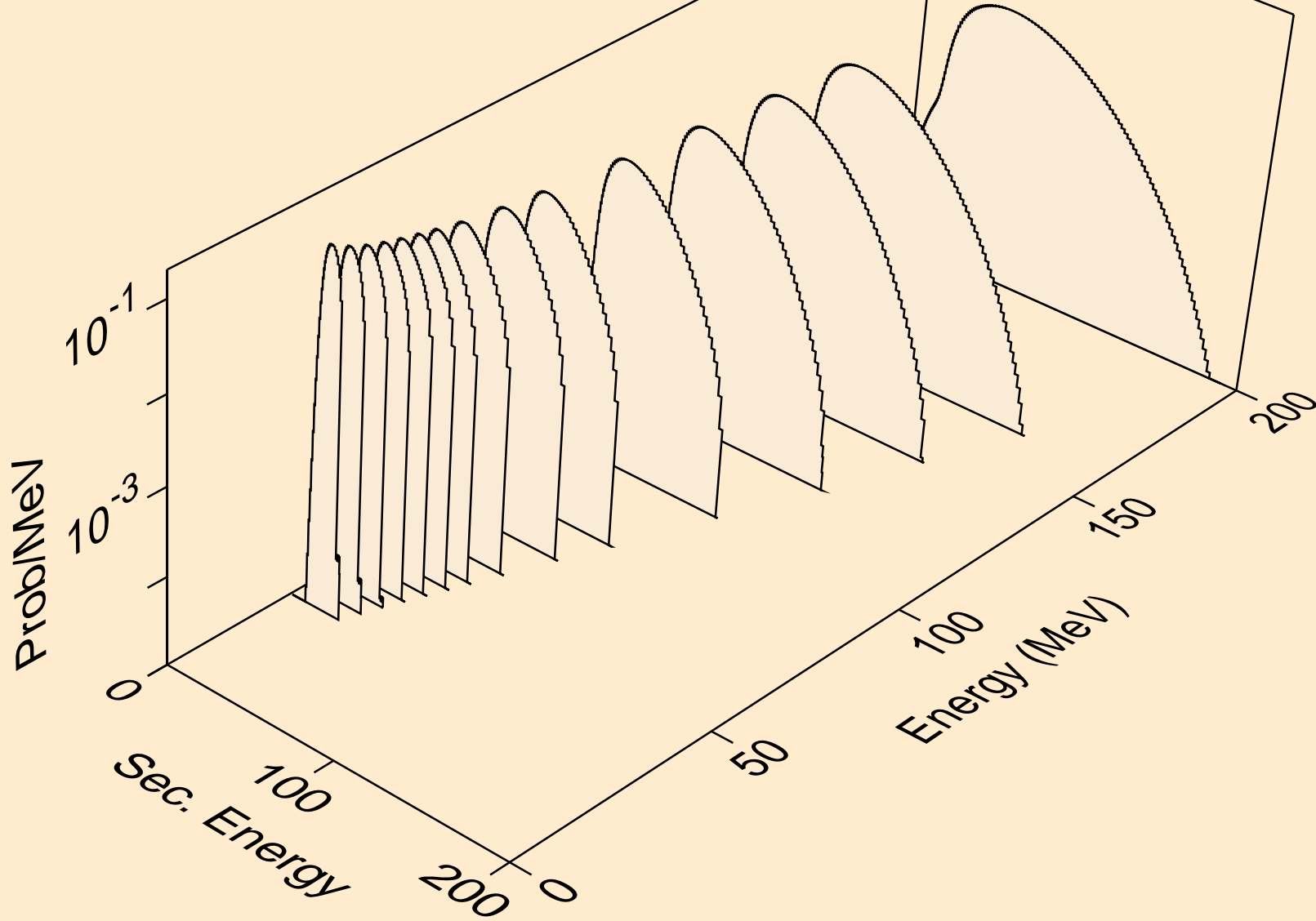

BA122 NEUTRON ACER TENDL-2019 LIBRARY; T=293.16K
he3s from (n,n*)he3

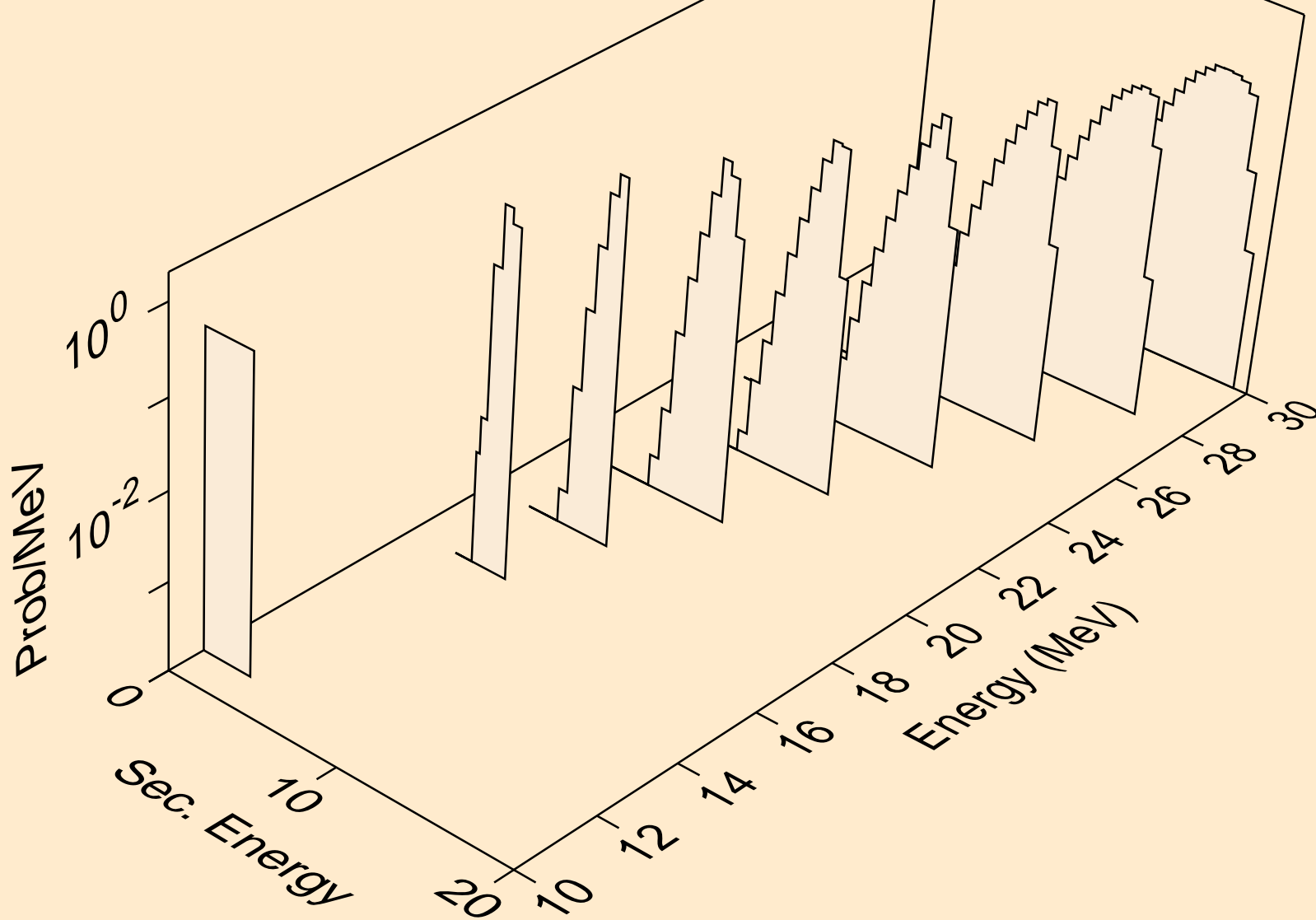

BA122 NEUTRON ACER TENDL-2019 LIBRARY; T=293.16K
he3s from (n,he3)

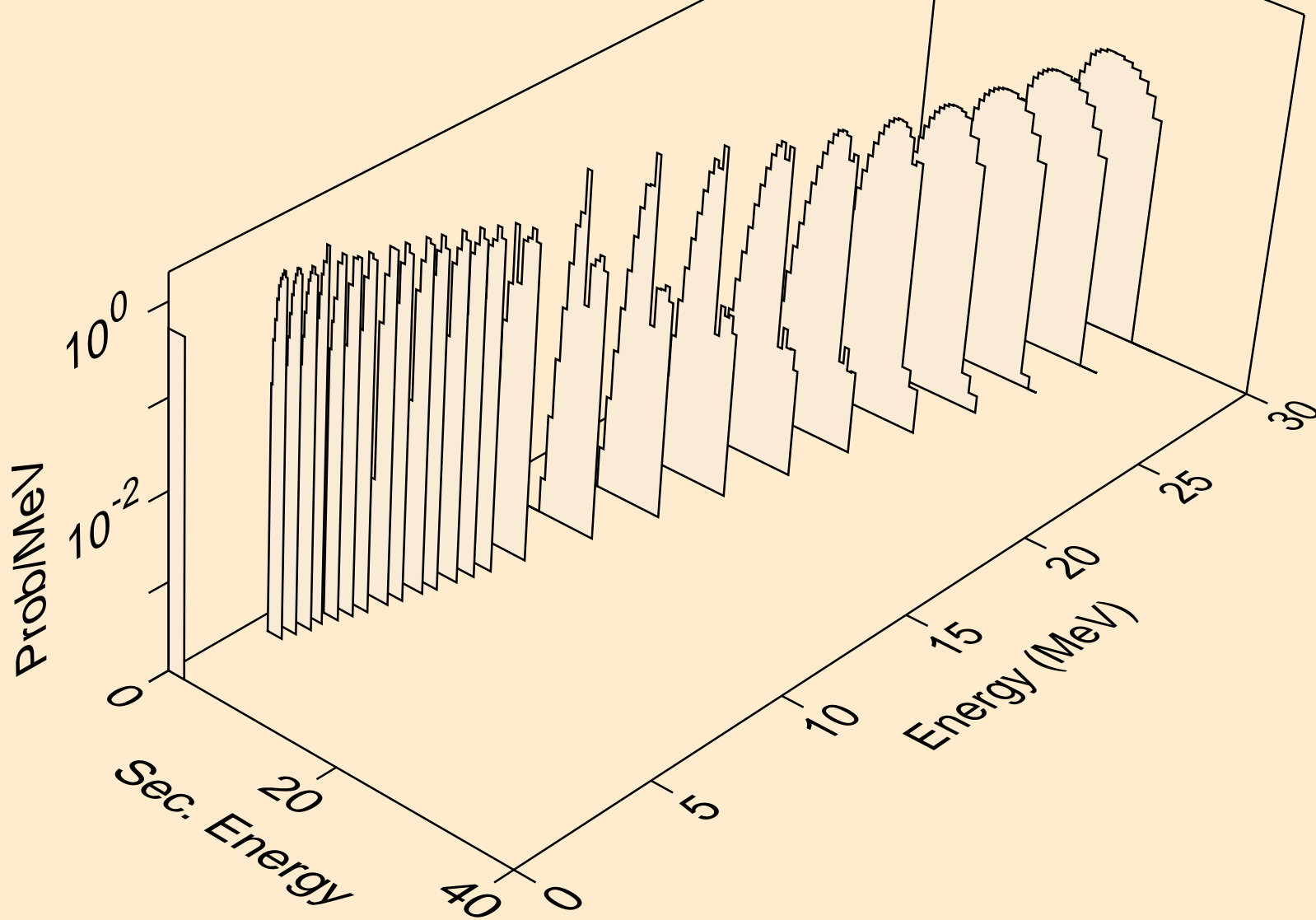

BA122 NEUTRON ACER TENDL-2019 LIBRARY; T=293.16K
alphas from (n,x)

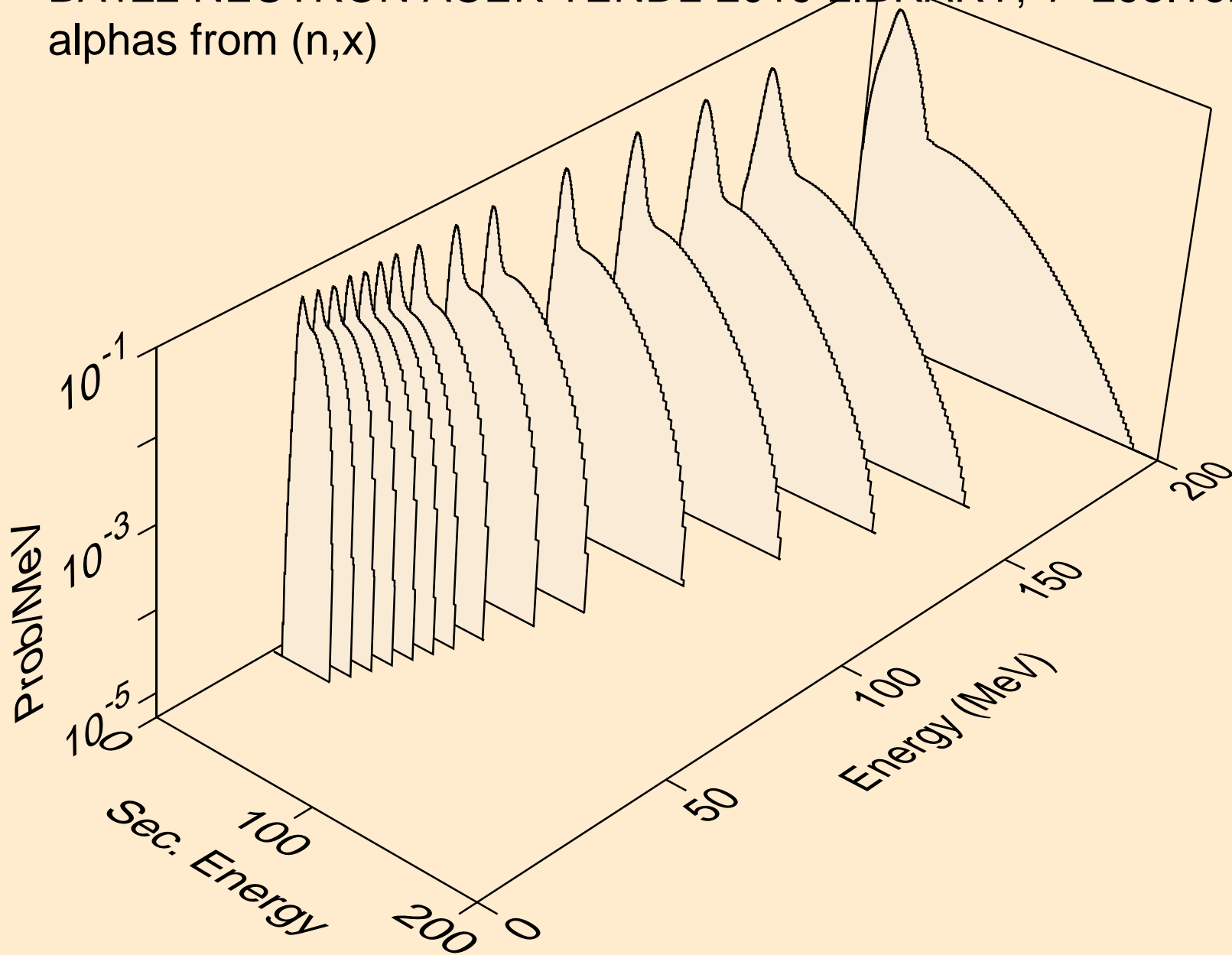

BA122 NEUTRON ACER TENDL-2019 LIBRARY; T=293.16K
alphas from (n,n*)a

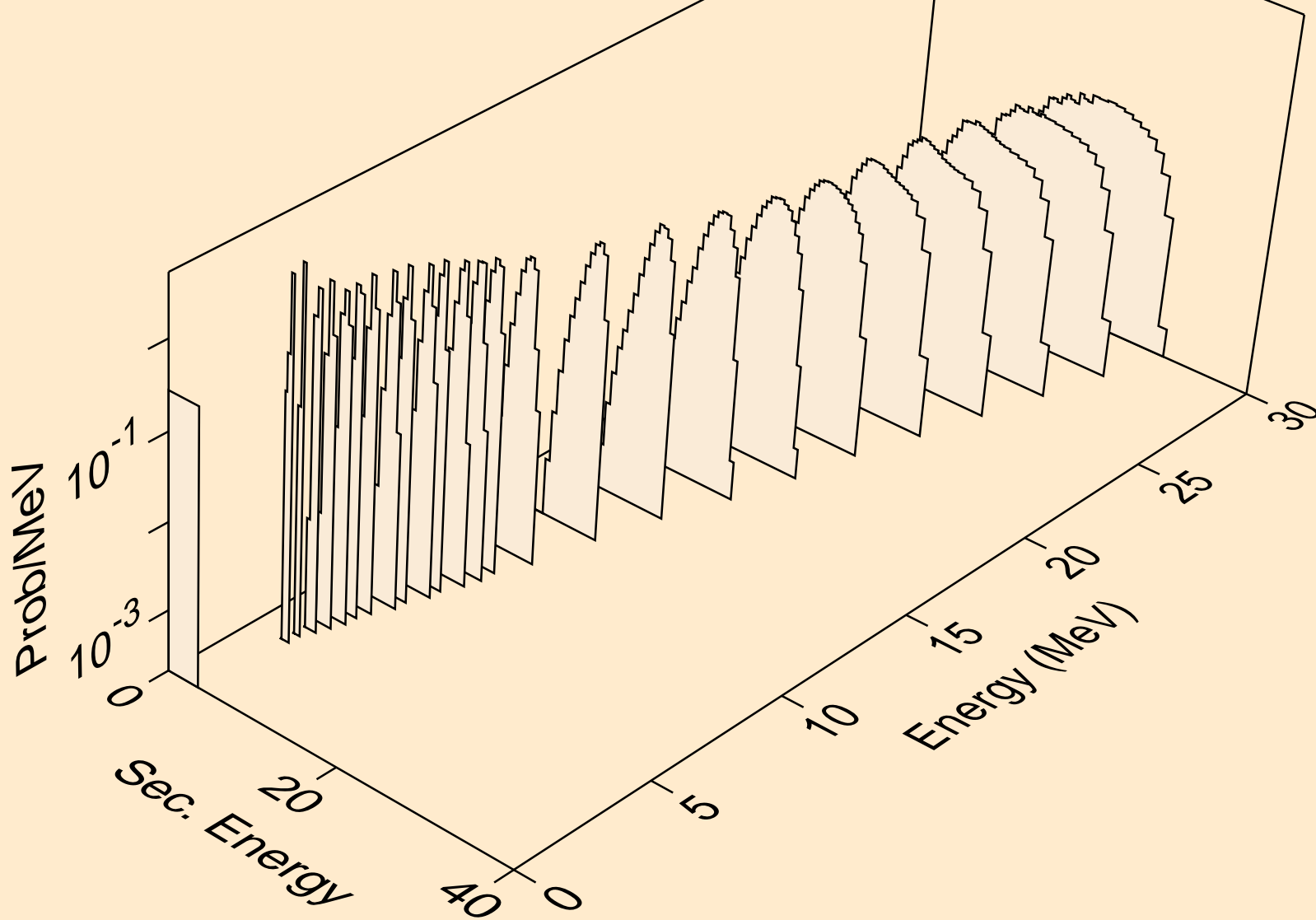

BA122 NEUTRON ACER TENDL-2019 LIBRARY; T=293.16K
alphas from (n,n*)3a

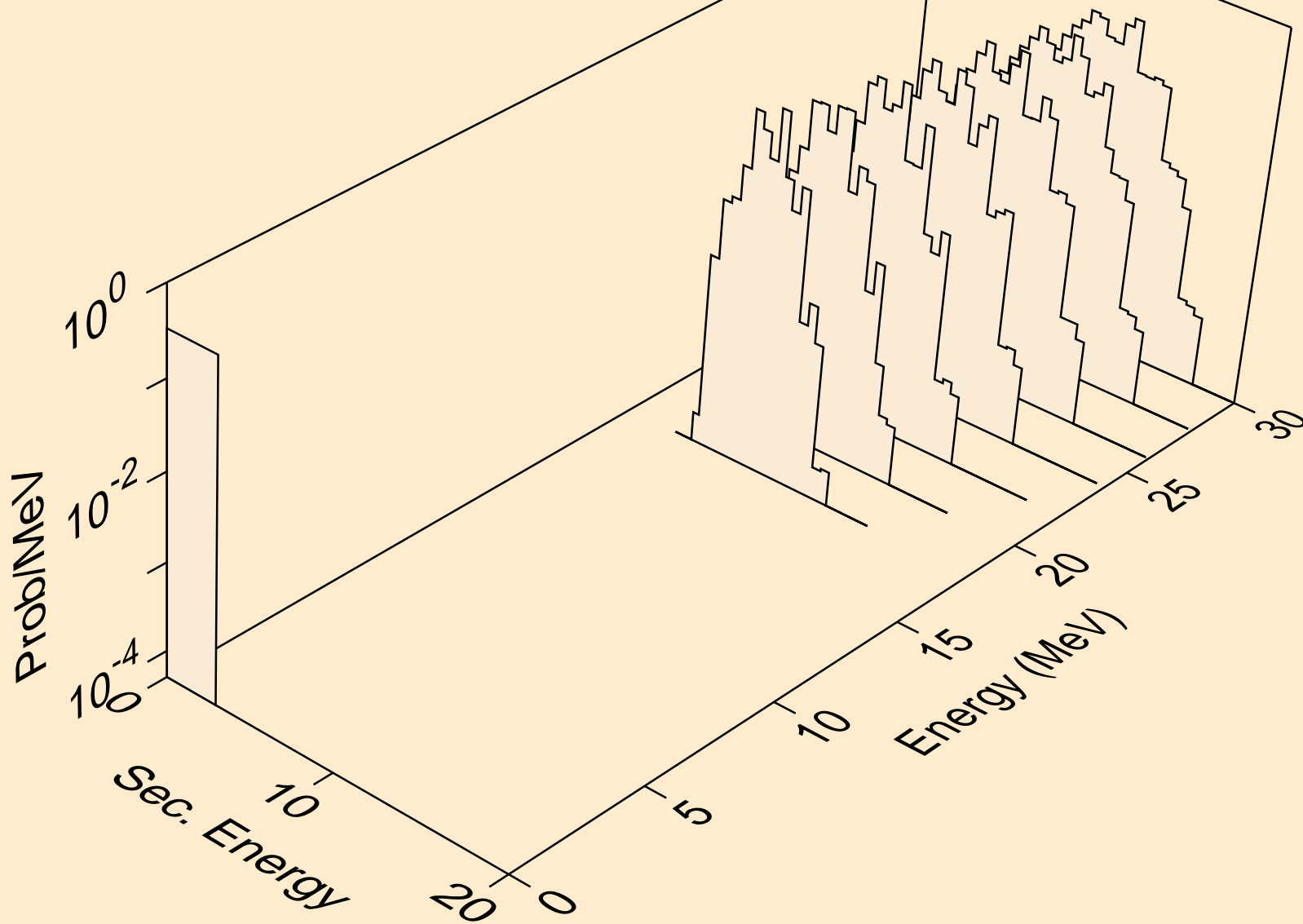

BA122 NEUTRON ACER TENDL-2019 LIBRARY; T=293.16K
alphas from (n,2n)a

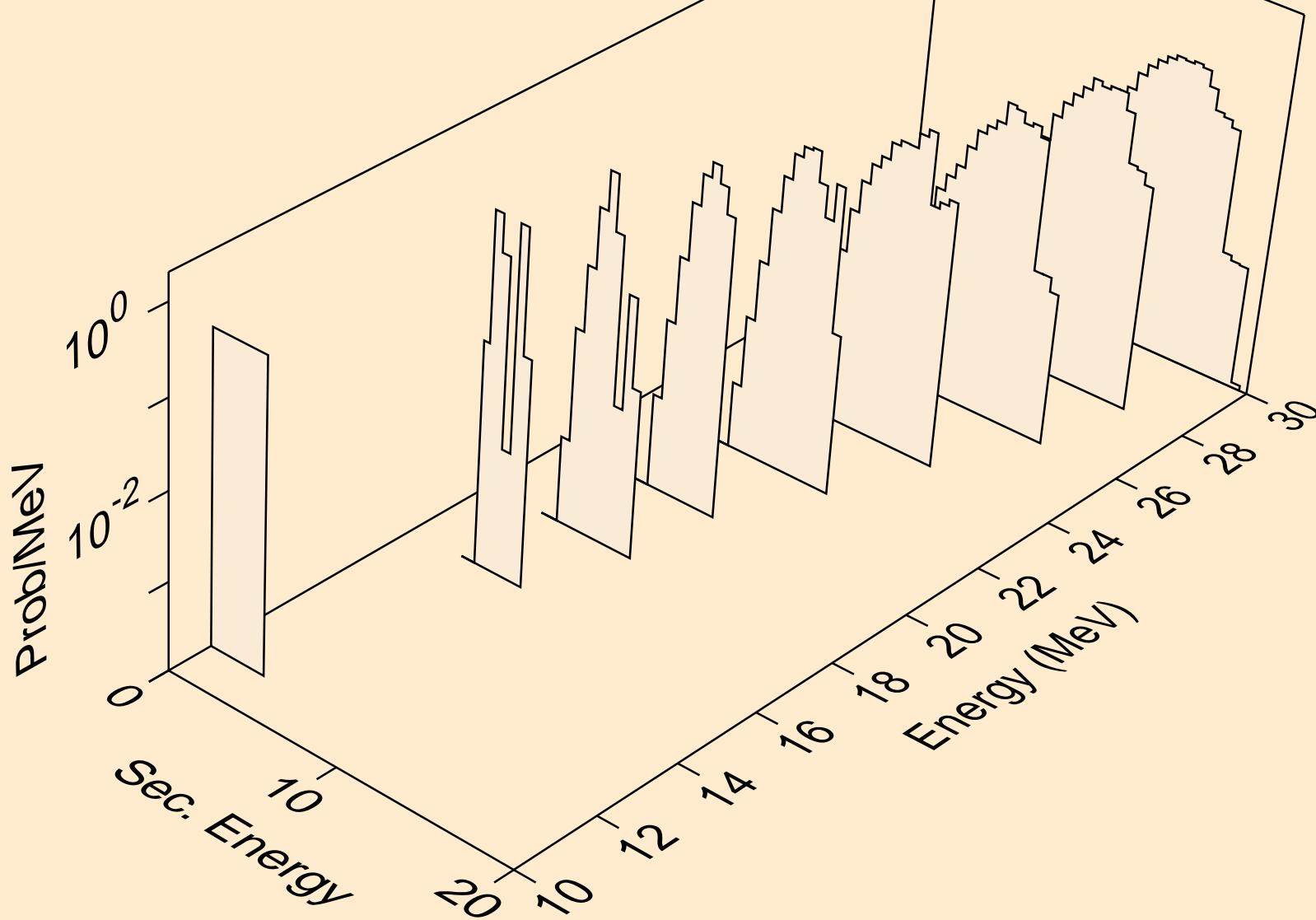

BA122 NEUTRON ACER TENDL-2019 LIBRARY; T=293.16K
alphas from (n,3n)a

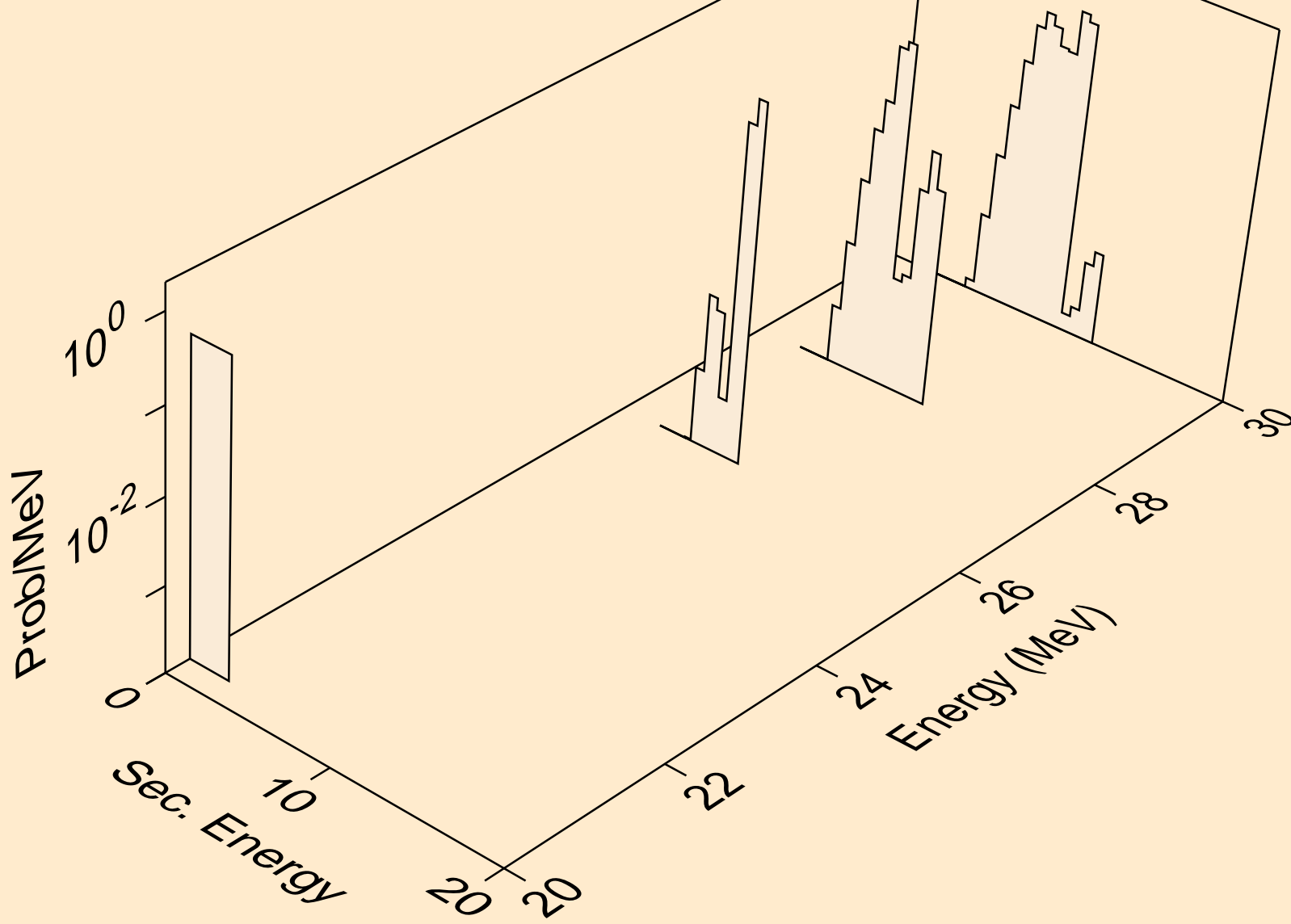

BA122 NEUTRON ACER TENDL-2019 LIBRARY; T=293.16K
alphas from (n,n*)2a

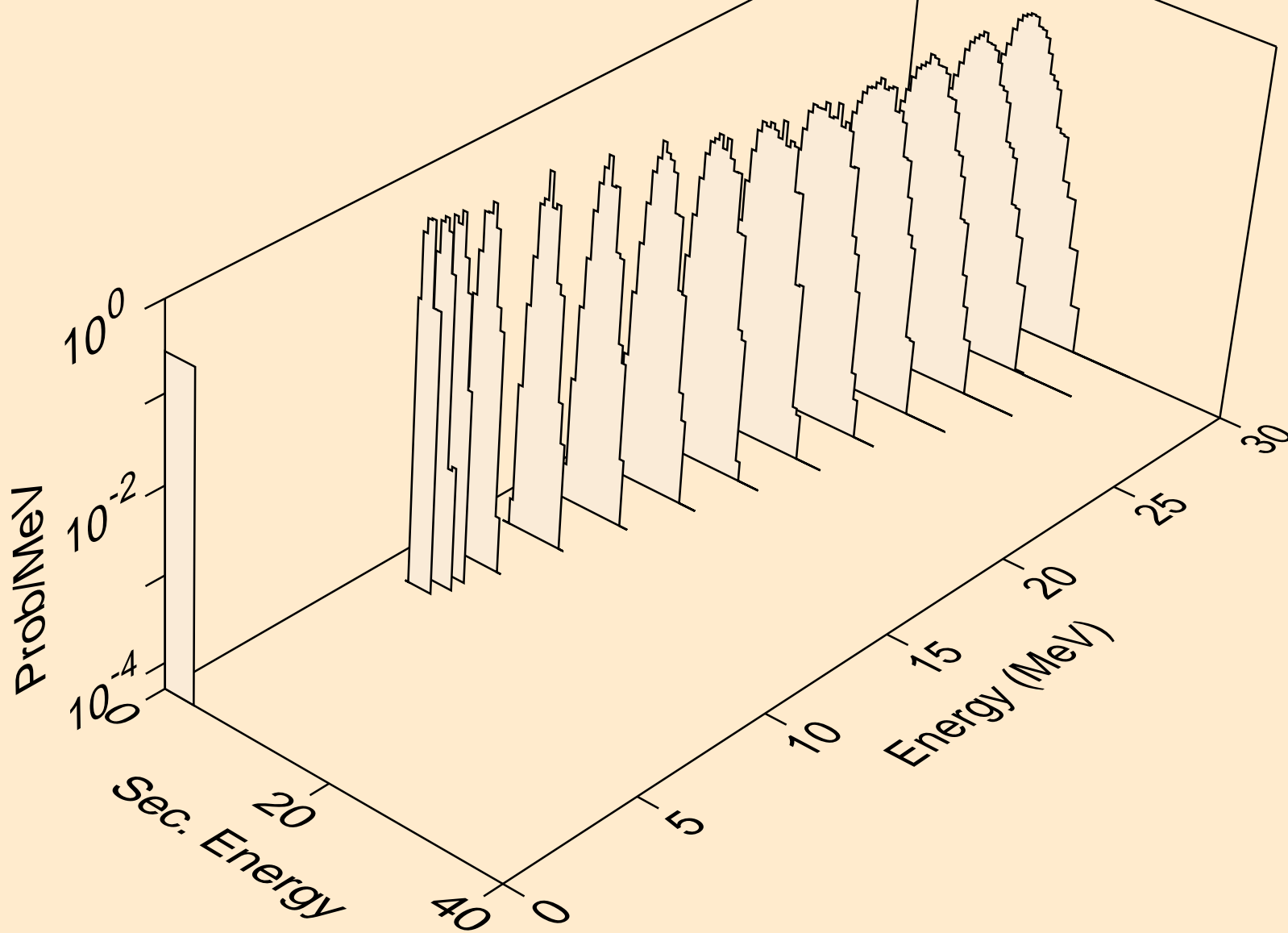

BA122 NEUTRON ACER TENDL-2019 LIBRARY; T=293.16K
alphas from (n,2n)2a

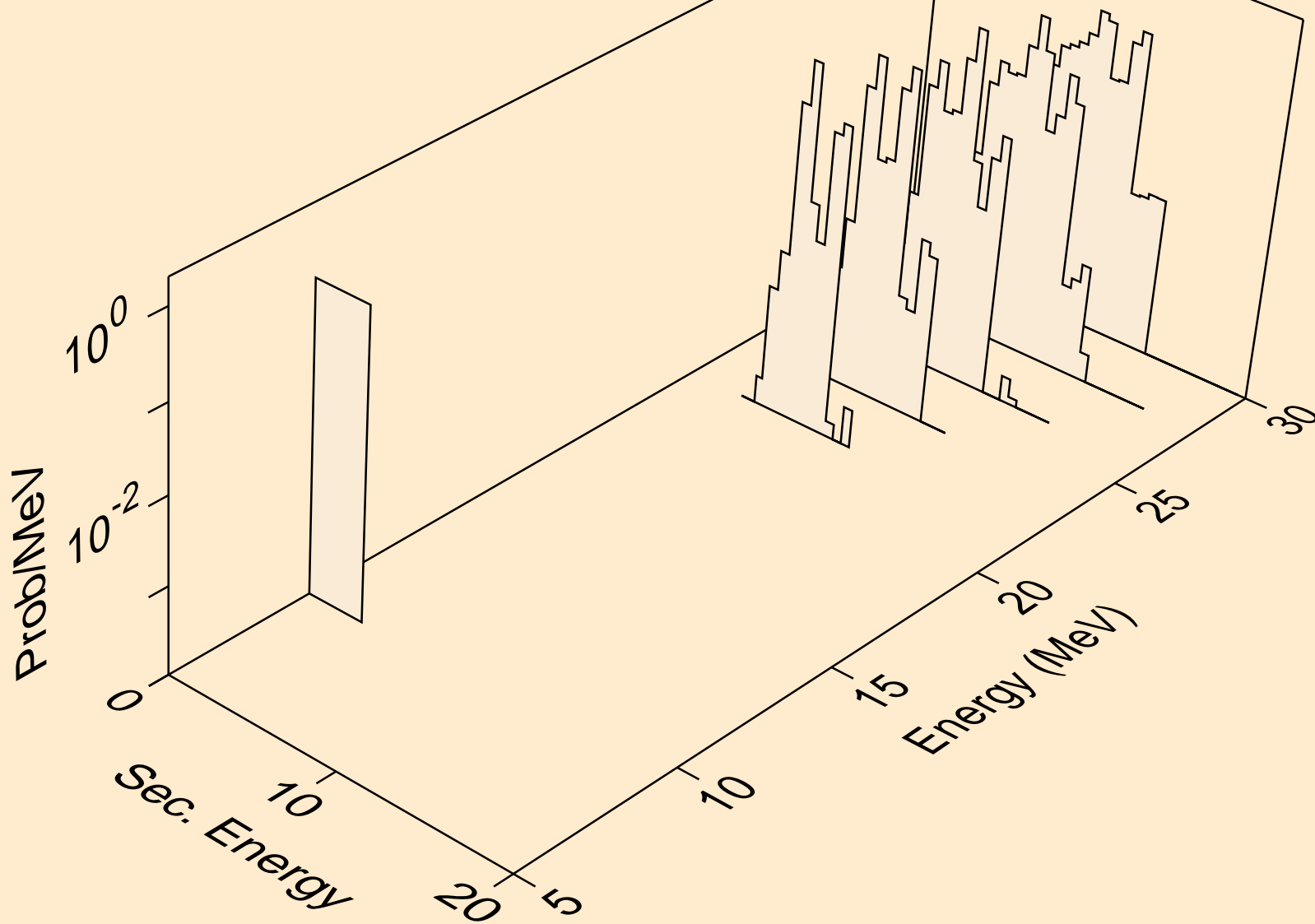

BA122 NEUTRON ACER TENDL-2019 LIBRARY; T=293.16K
alphas from (n,npa)

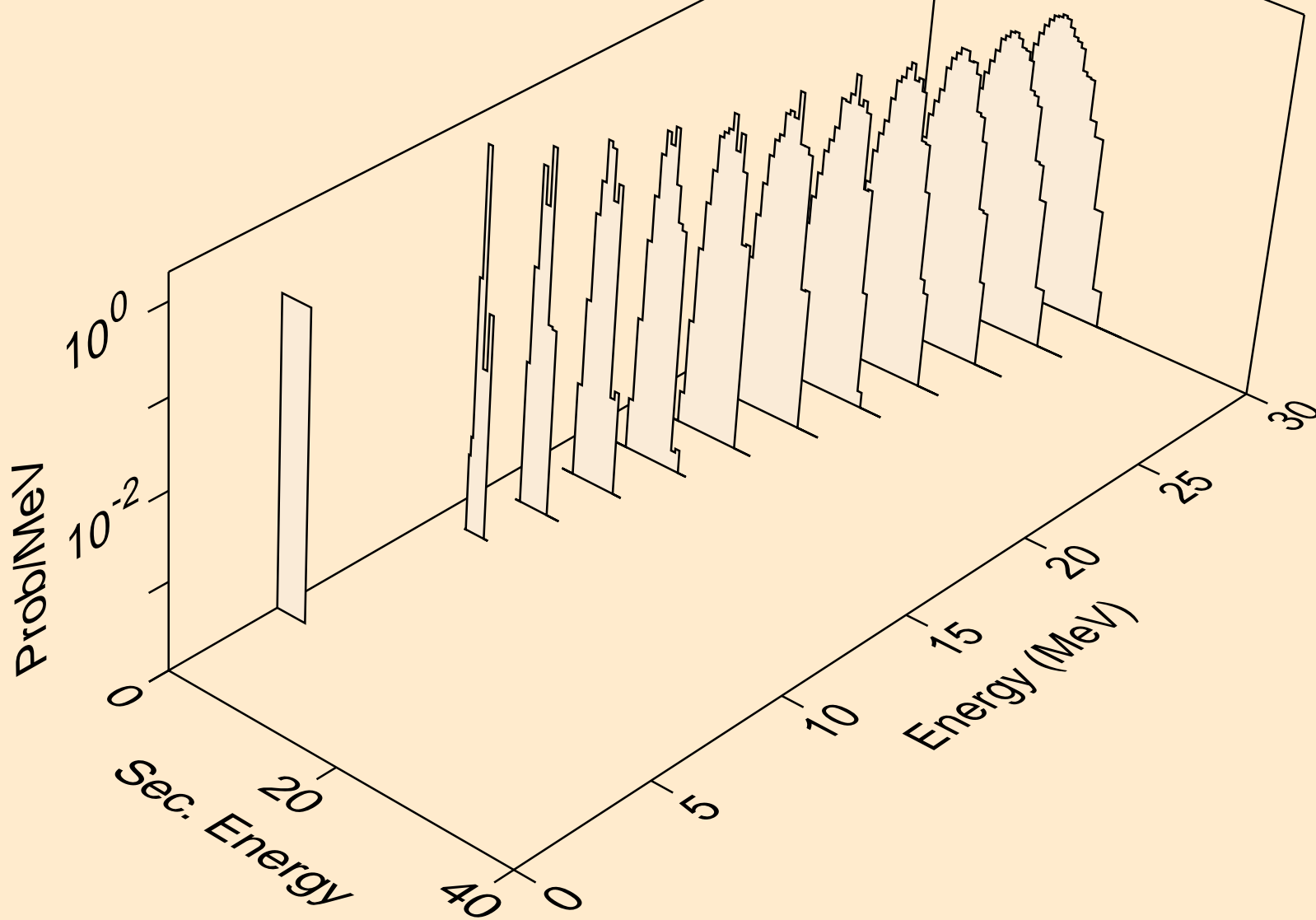

BA122 NEUTRON ACER TENDL-2019 LIBRARY; T=293.16K
alphas from (n,a)

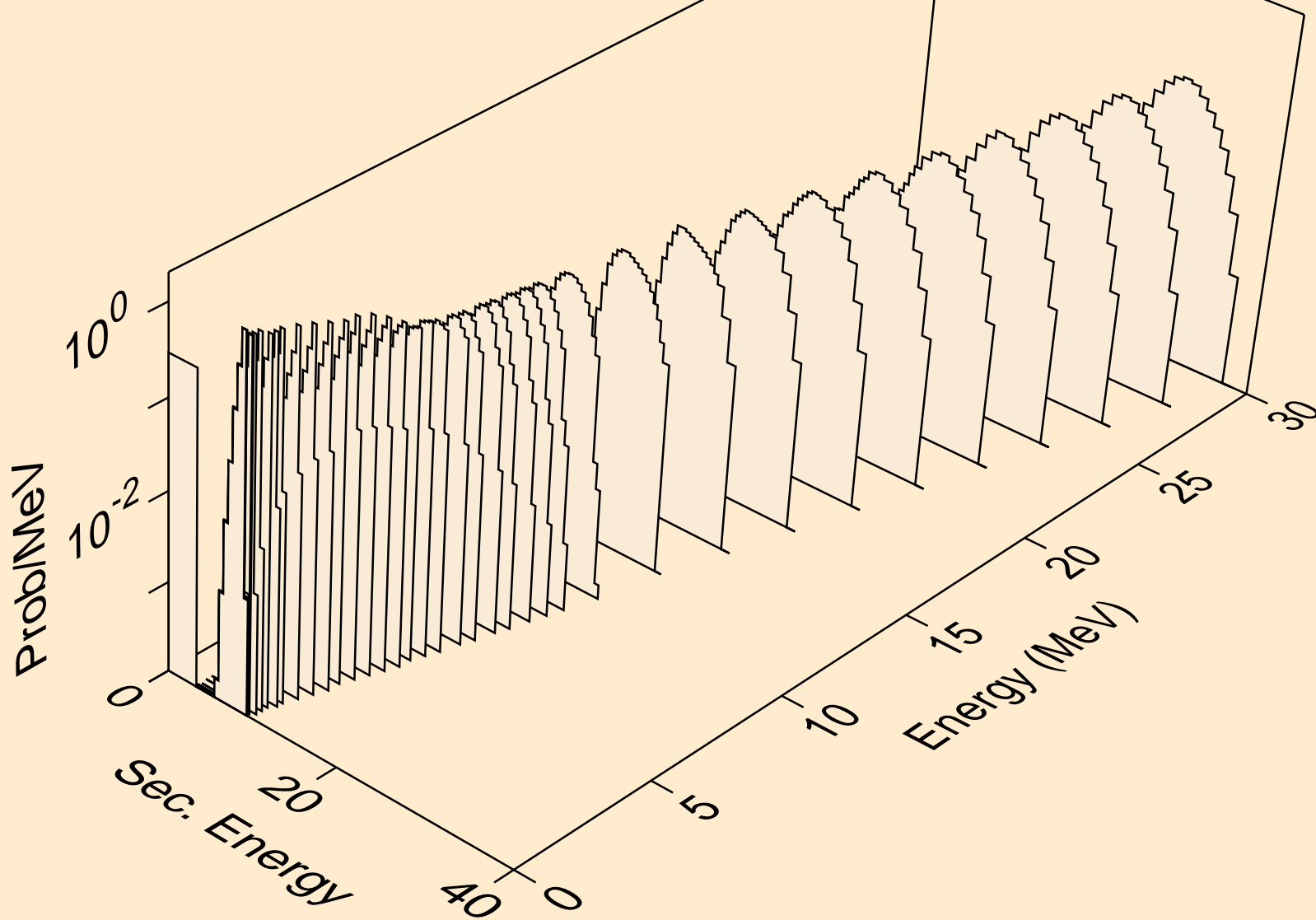

BA122 NEUTRON ACER TENDL-2019 LIBRARY; T=293.16K
alphas from (n,2a)

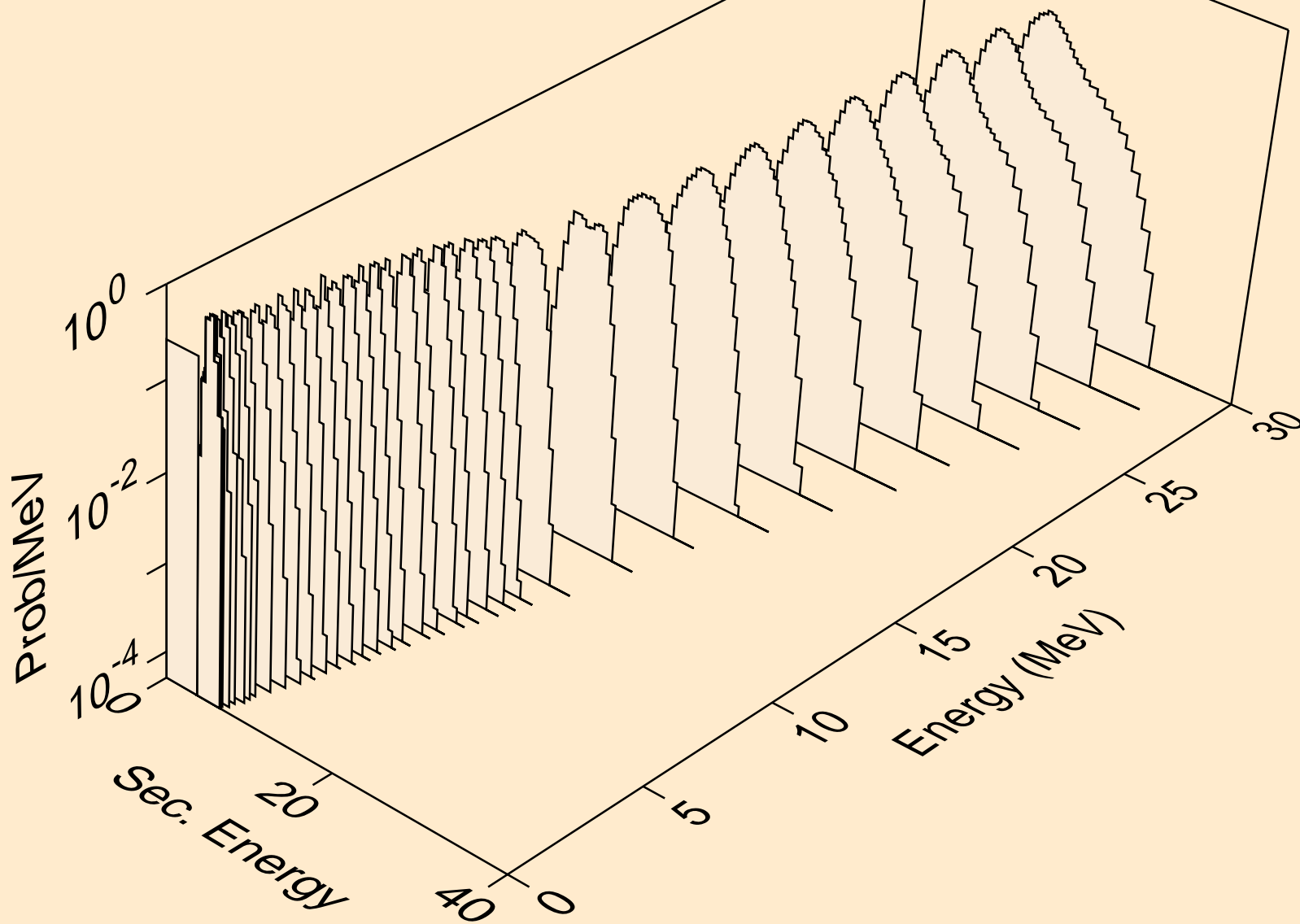

BA122 NEUTRON ACER TENDL-2019 LIBRARY; T=293.16K
alphas from (n,3a)

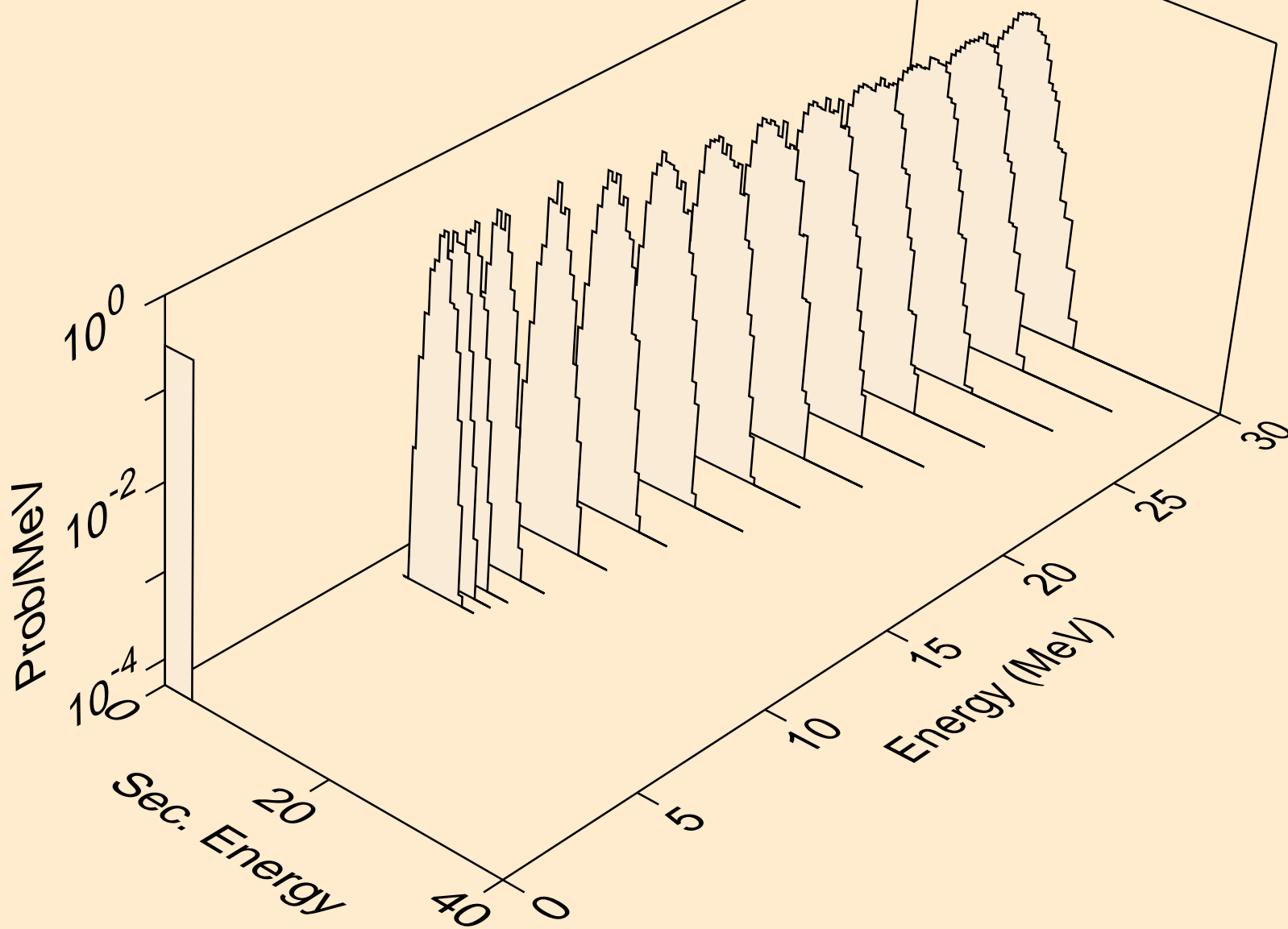

BA122 NEUTRON ACER TENDL-2019 LIBRARY; T=293.16K
alphas from (n,pa)

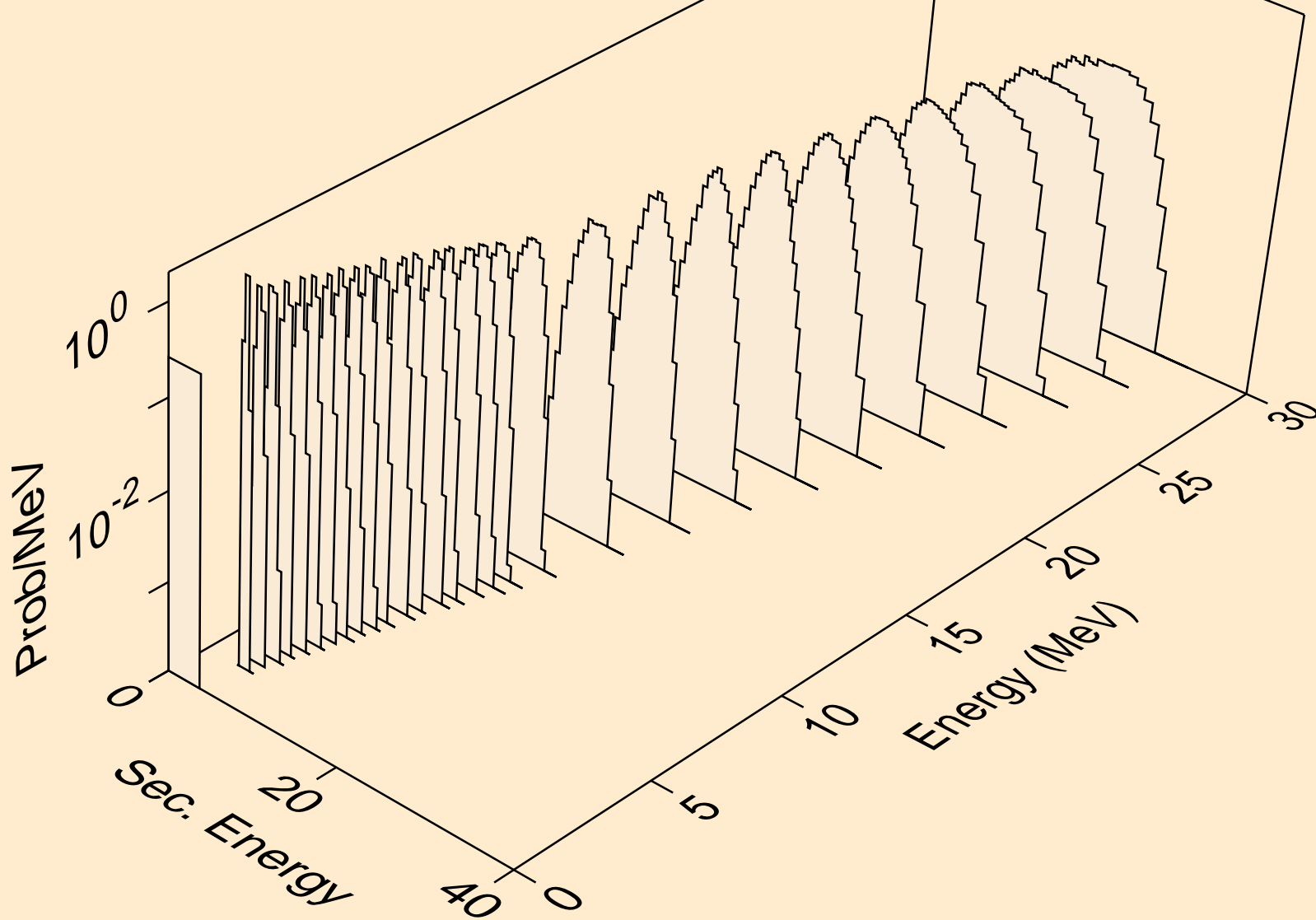

BA122 NEUTRON ACER TENDL-2019 LIBRARY; T=293.16K
alphas from (n,d2a)

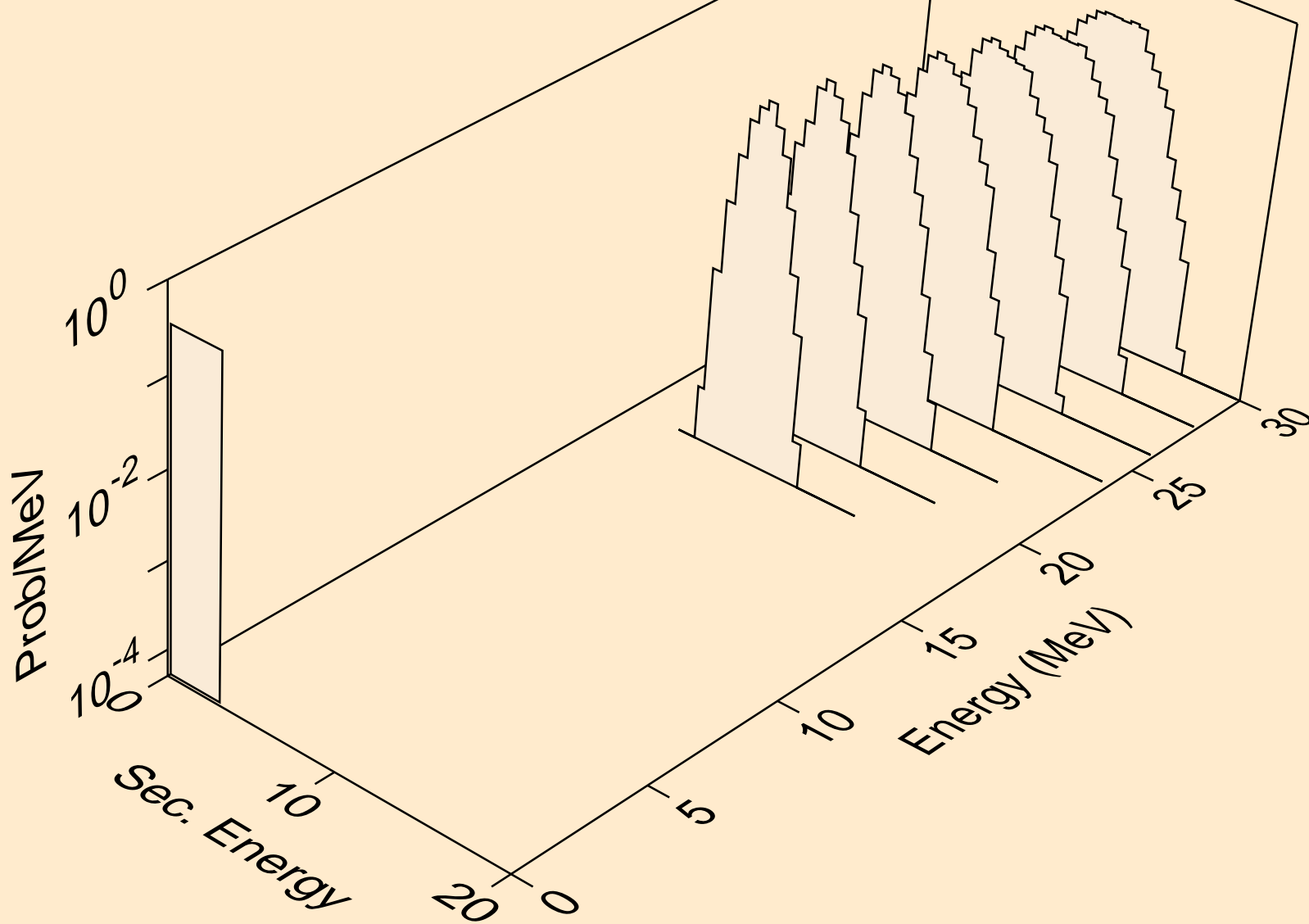

BA122 NEUTRON ACER TENDL-2019 LIBRARY; T=293.16K
alphas from (n,da)

