

BA136 NEUTRON ACER TENDL-2019 LIBRARY; T=293.16K  
Principal cross sections

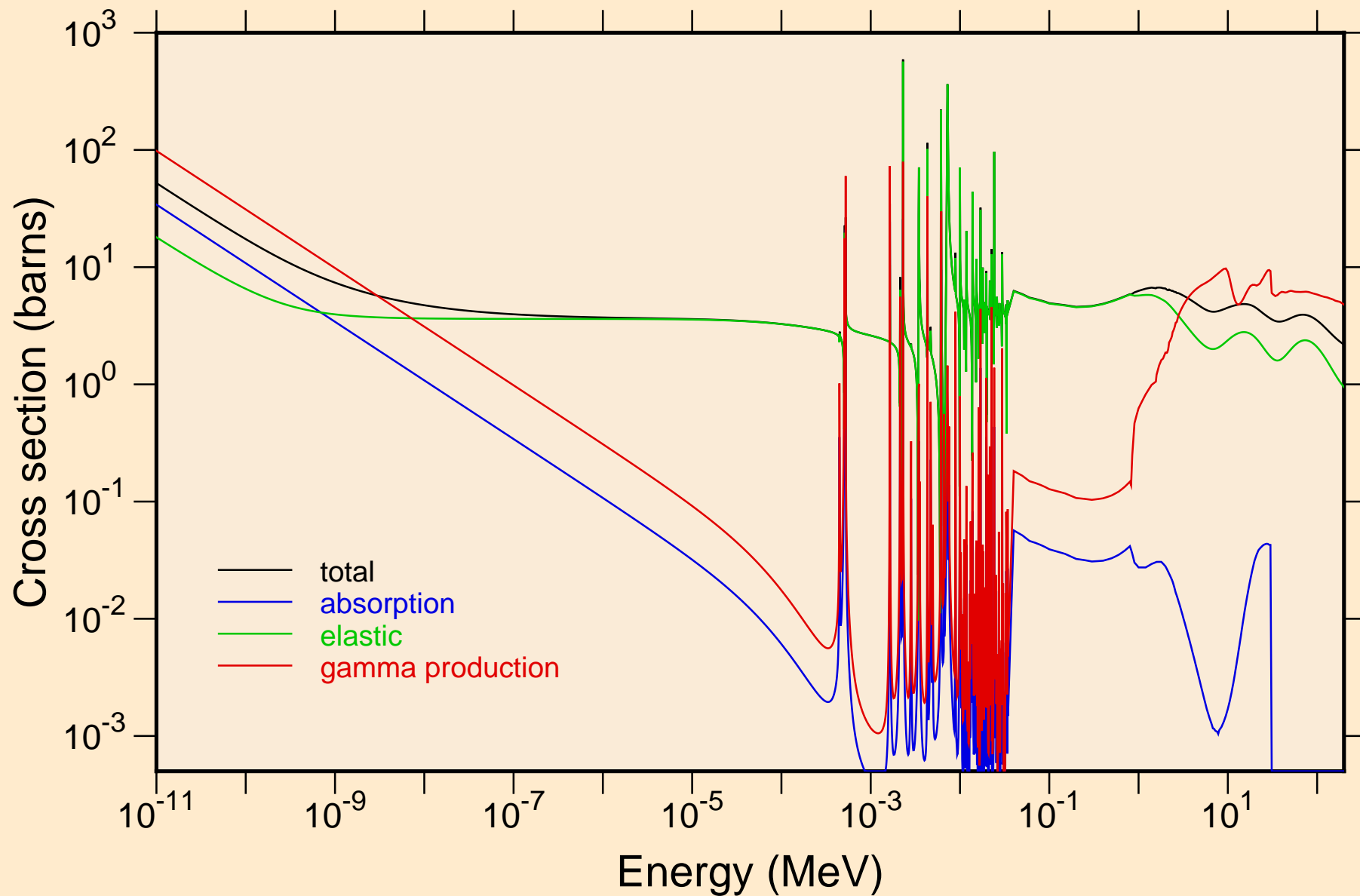

BA136 NEUTRON ACER TENDL-2019 LIBRARY; T=293.16K  
resonance total cross section

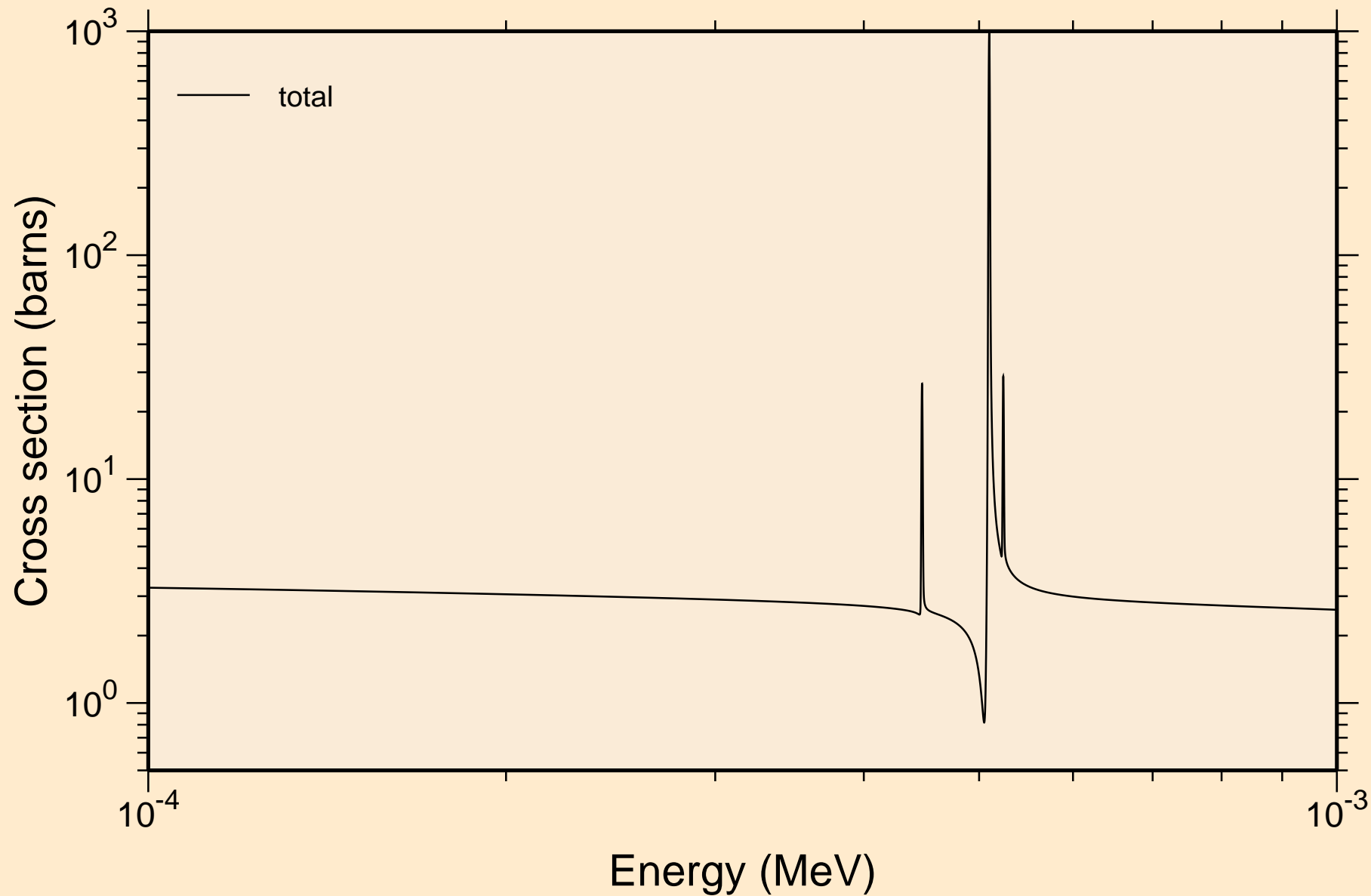

BA136 NEUTRON ACER TENDL-2019 LIBRARY; T=293.16K  
resonance total cross section

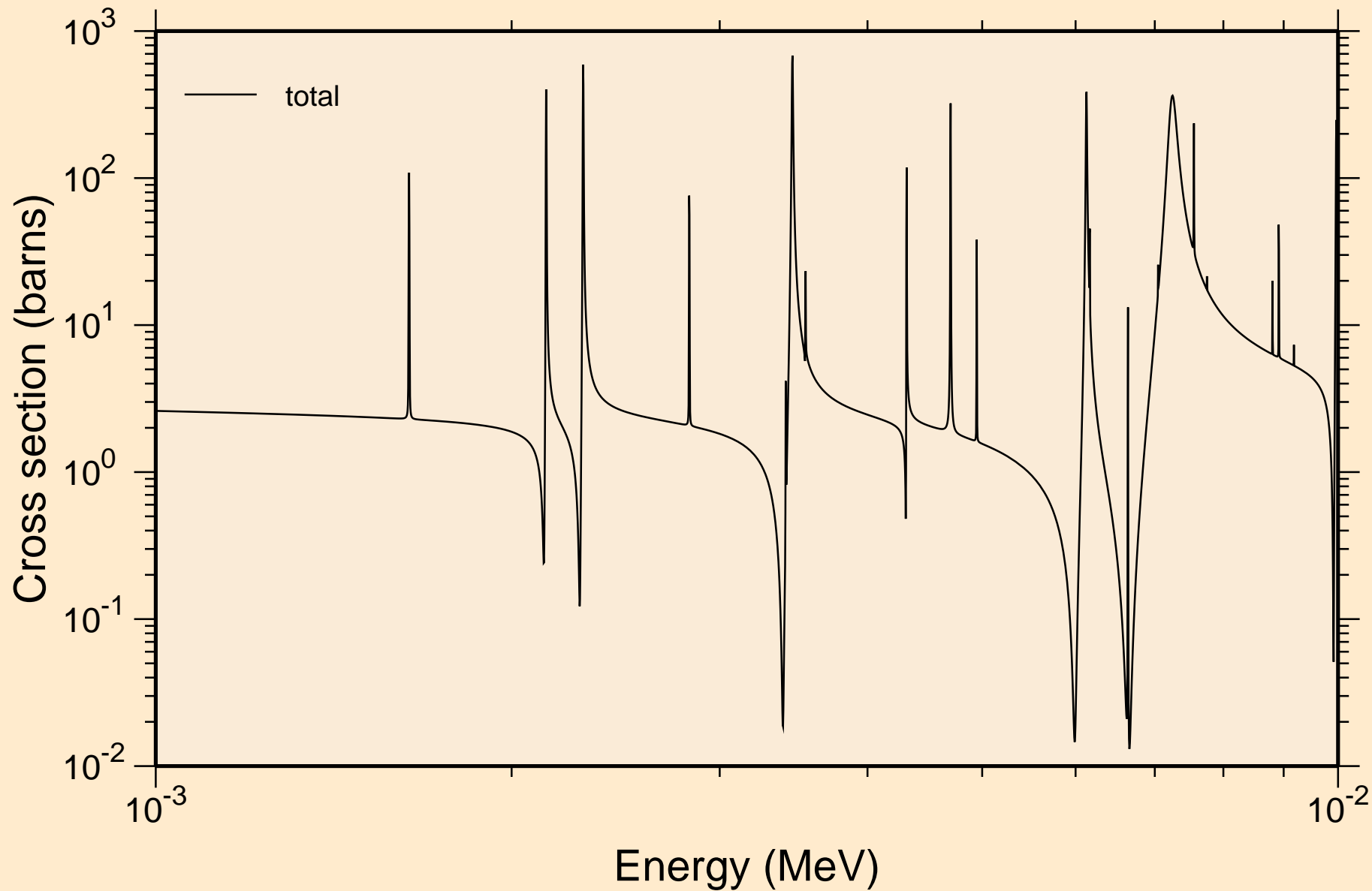

BA136 NEUTRON ACER TENDL-2019 LIBRARY; T=293.16K  
resonance total cross section

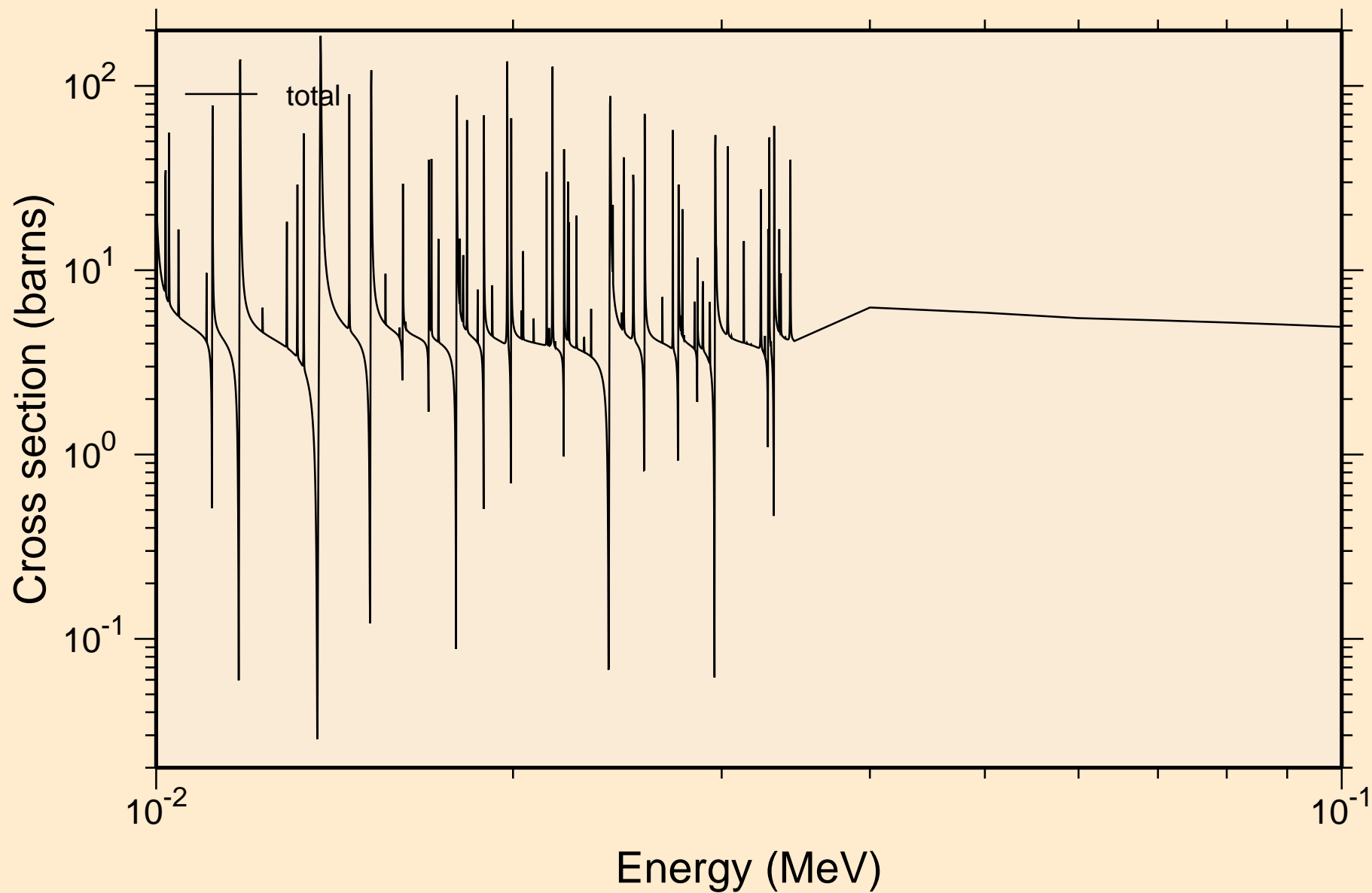

BA136 NEUTRON ACER TENDL-2019 LIBRARY; T=293.16K  
resonance total cross section

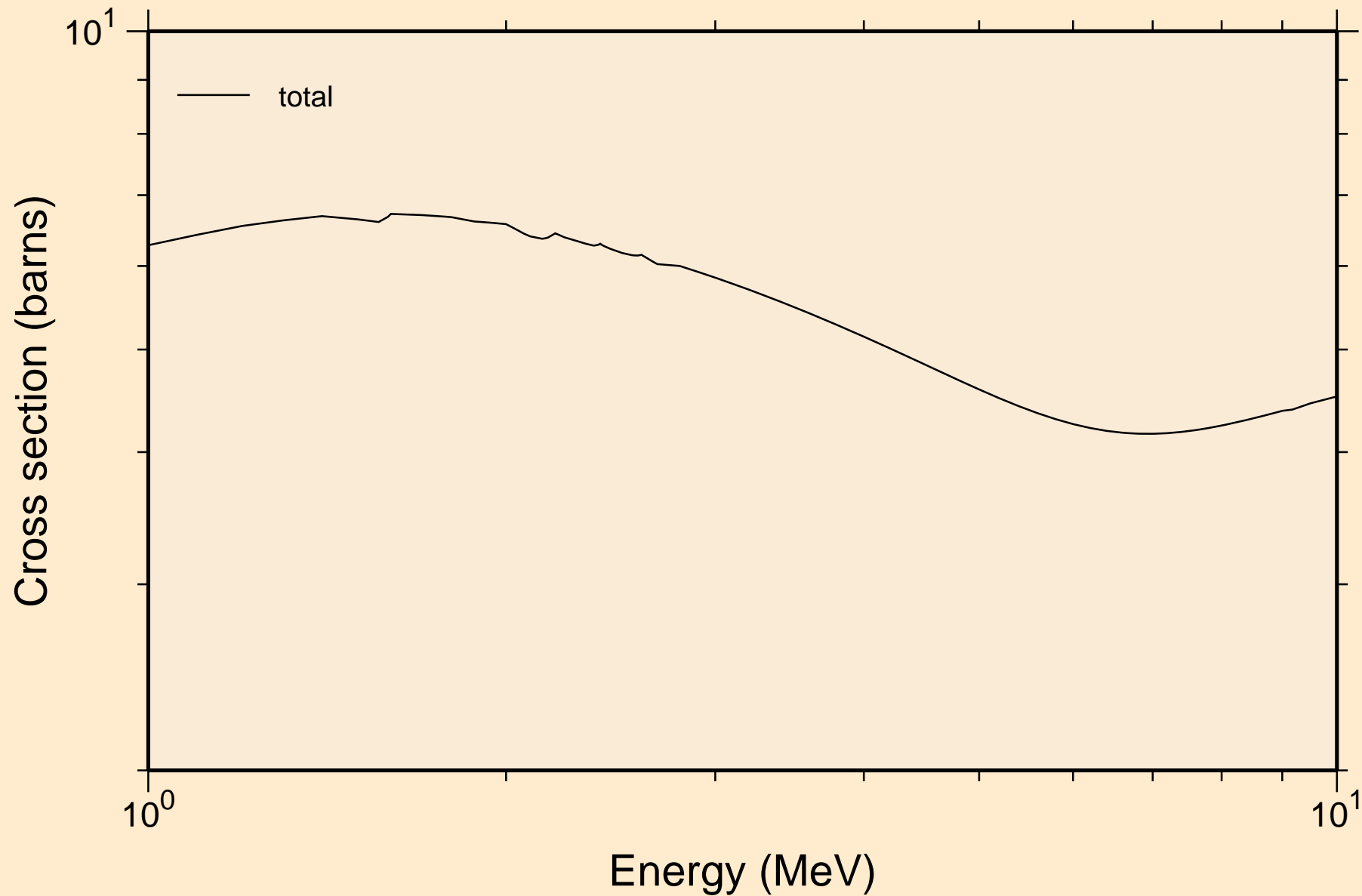

BA136 NEUTRON ACER TENDL-2019 LIBRARY; T=293.16K  
resonance absorption cross sections

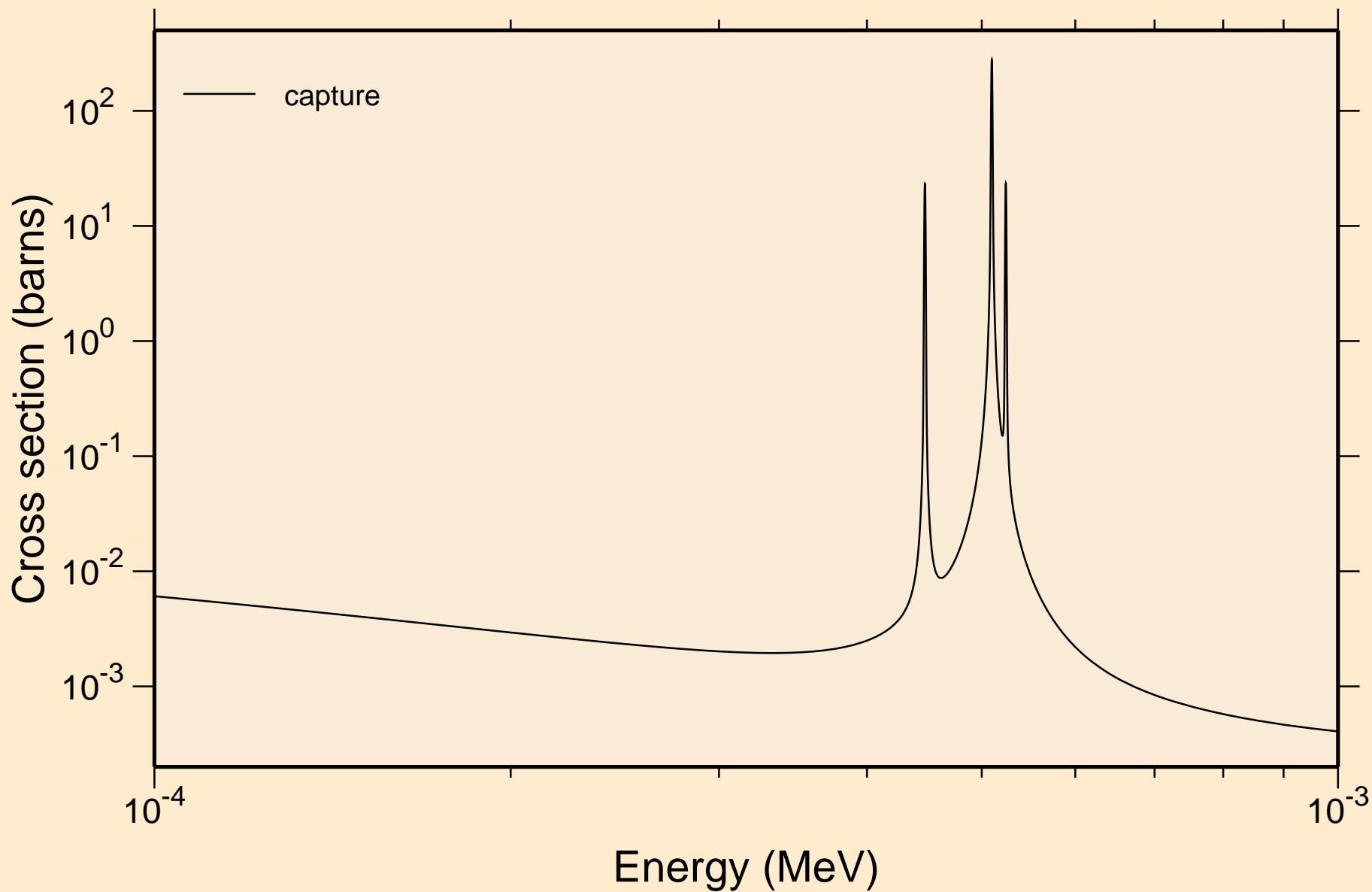

BA136 NEUTRON ACER TENDL-2019 LIBRARY; T=293.16K  
resonance absorption cross sections

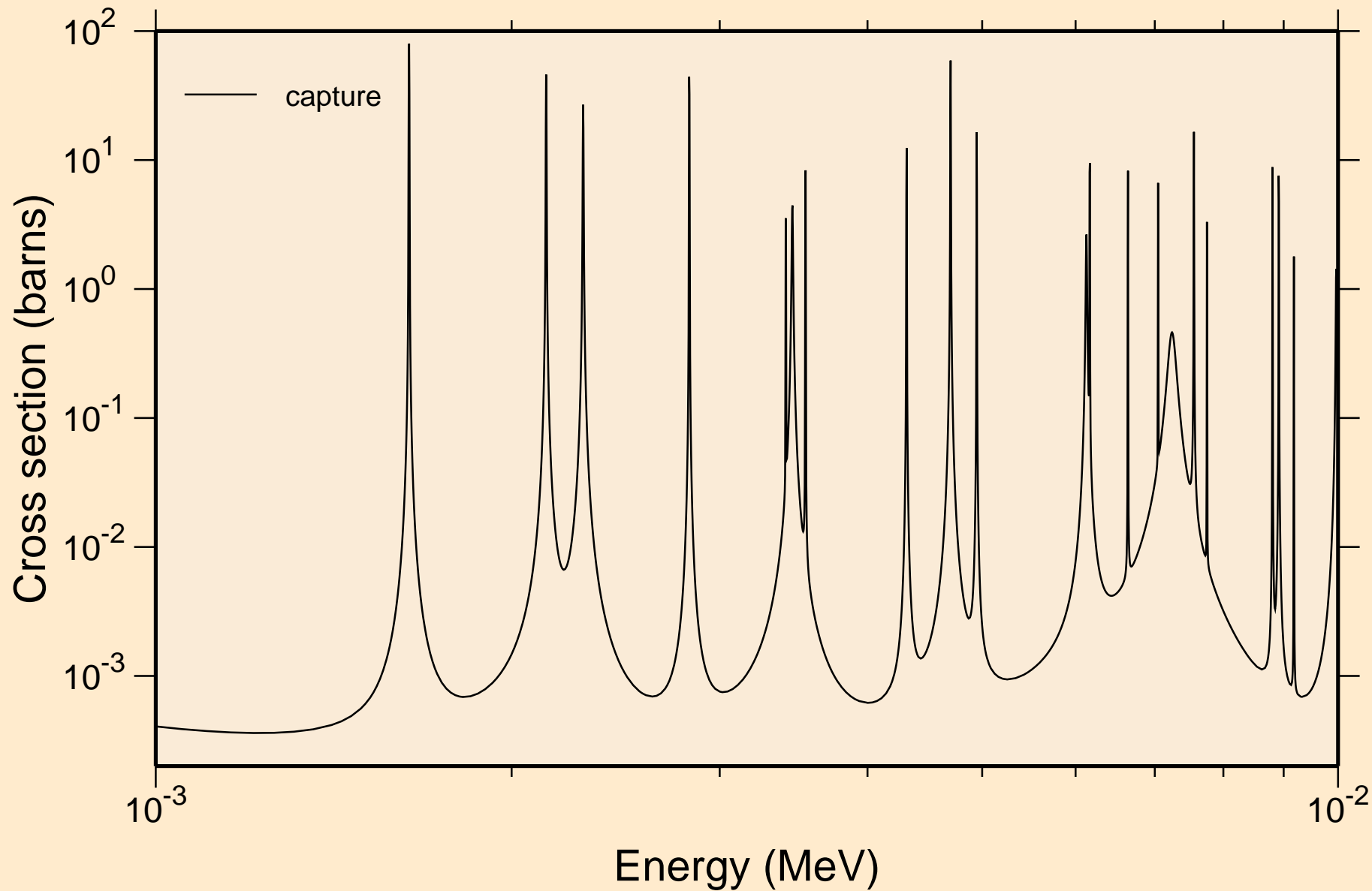

BA136 NEUTRON ACER TENDL-2019 LIBRARY; T=293.16K  
resonance absorption cross sections

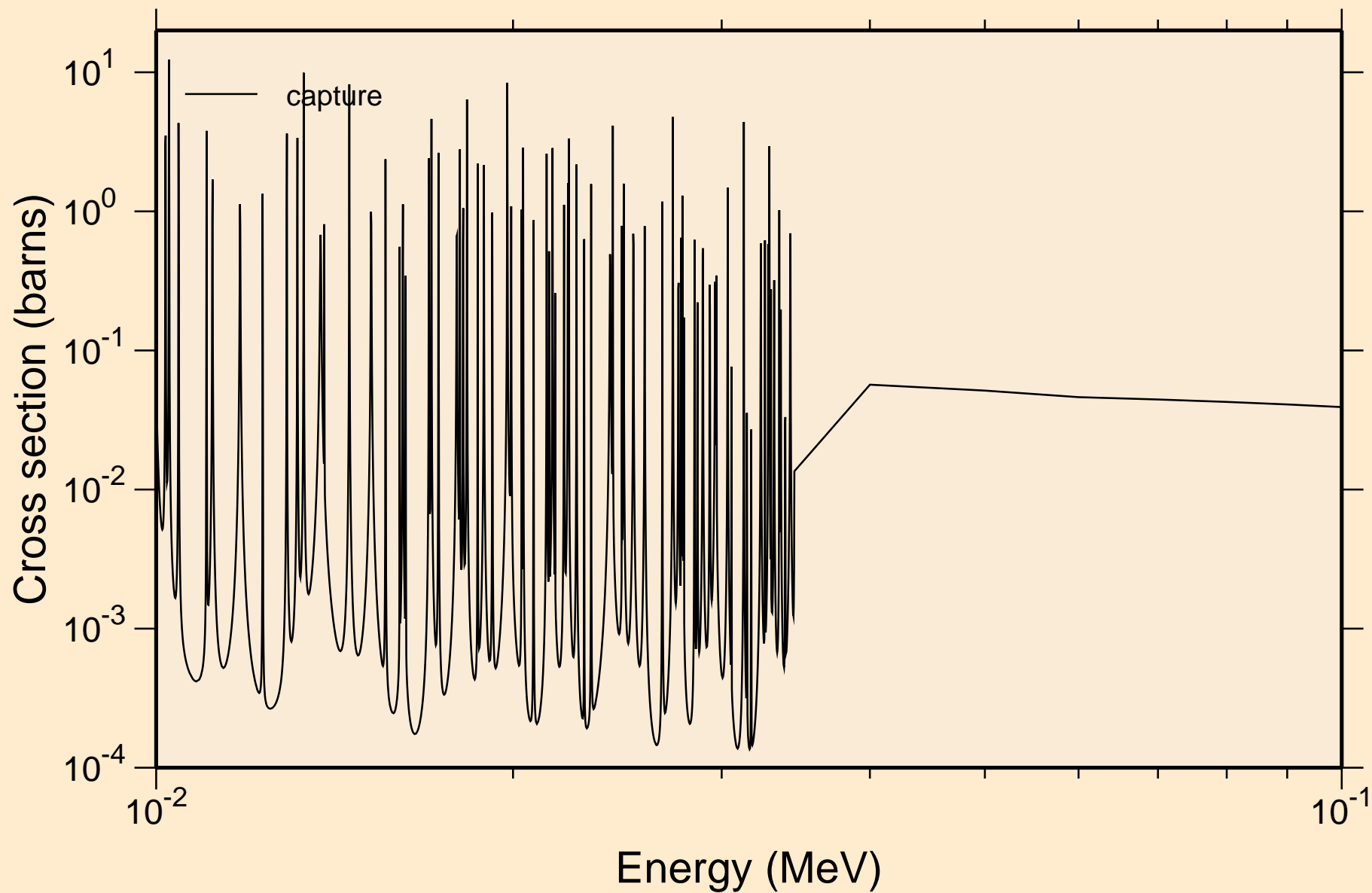



BA136 NEUTRON ACER TENDL-2019 LIBRARY; T=293.16K  
resonance absorption cross sections

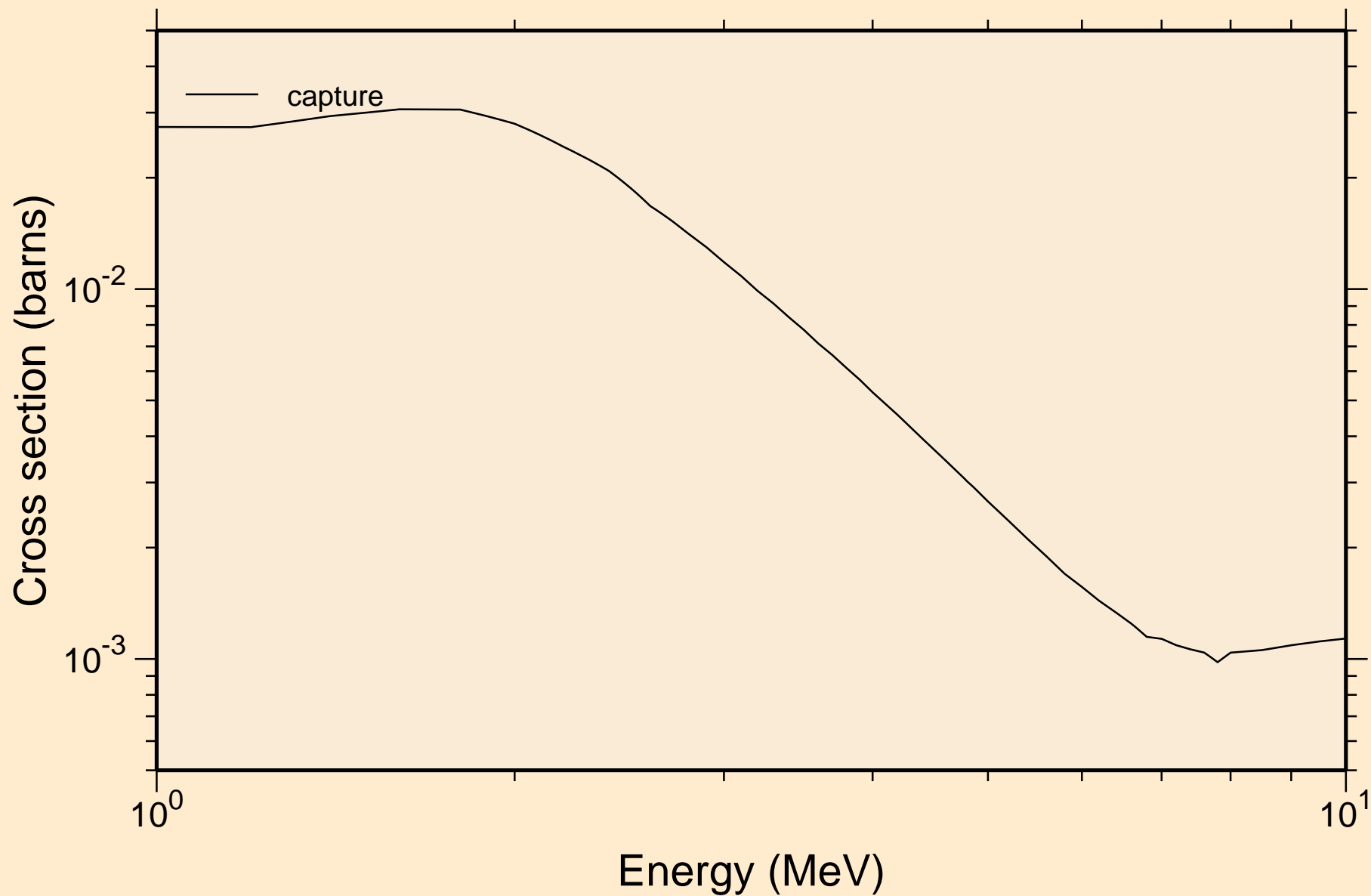

BA136 NEUTRON ACER TENDL-2019 LIBRARY; T=293.16K  
Heating

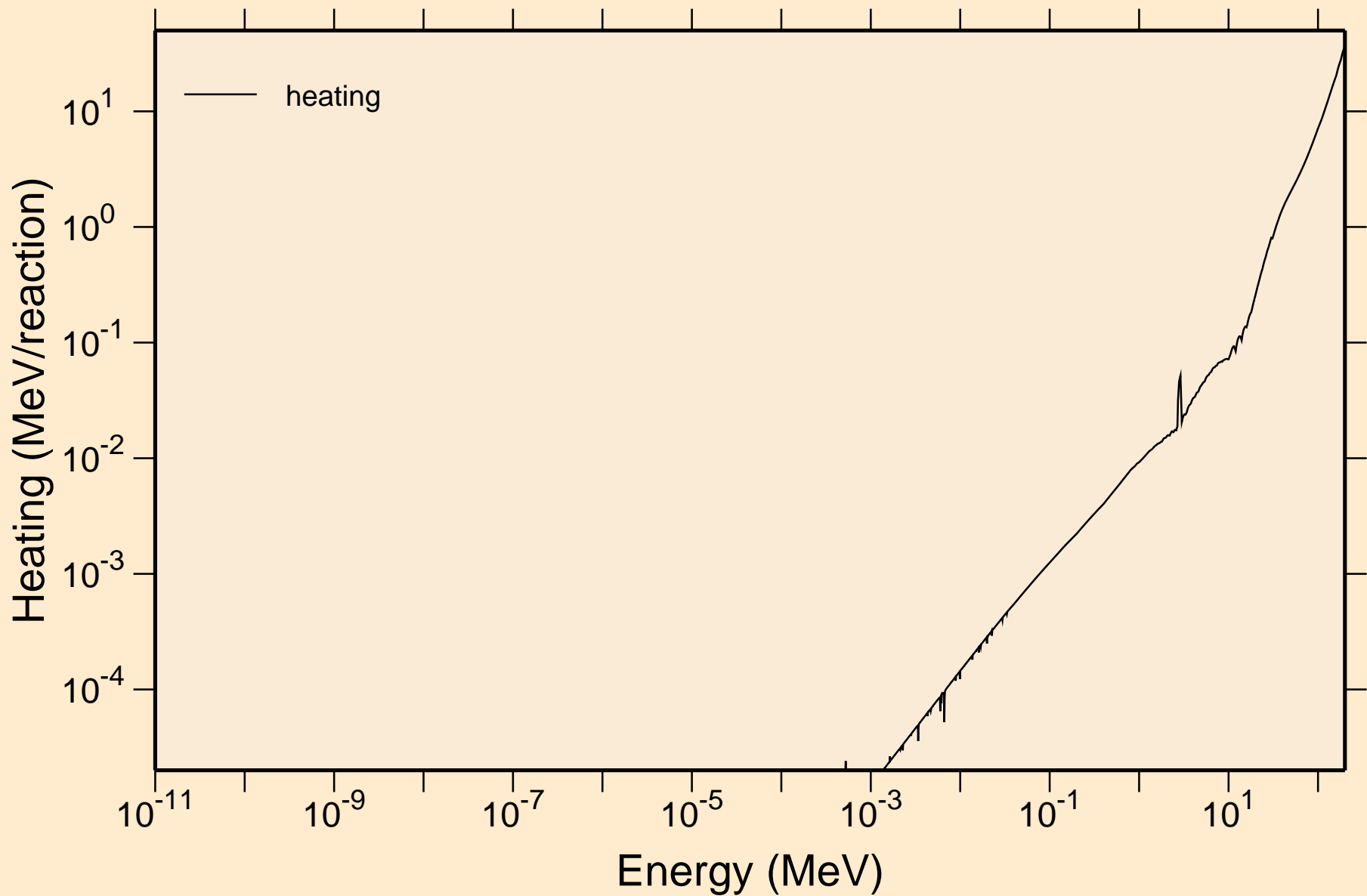

BA136 NEUTRON ACER TENDL-2019 LIBRARY; T=293.16K  
Damage

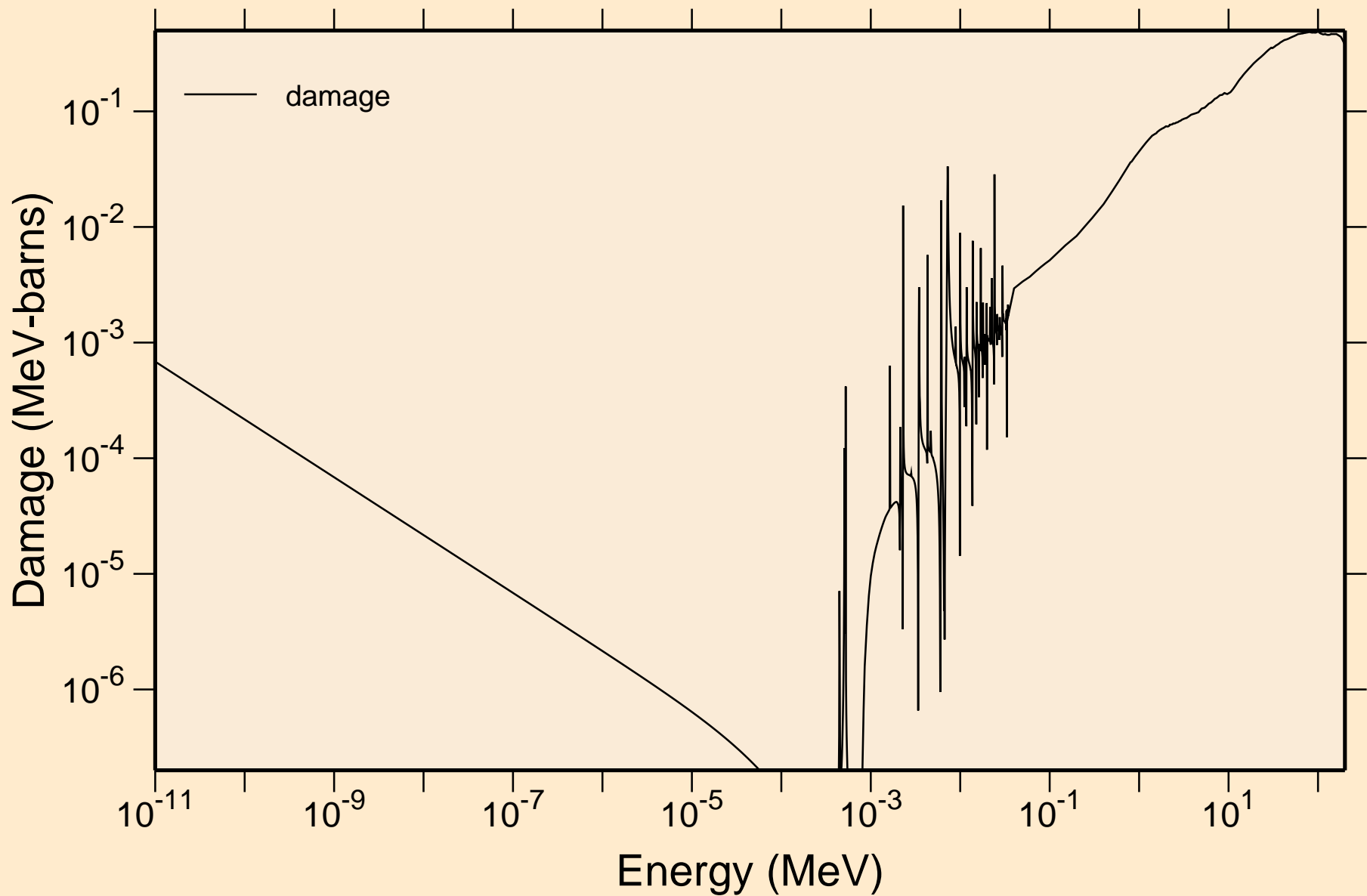

BA136 NEUTRON ACER TENDL-2019 LIBRARY; T=293.16K  
Non-threshold reactions

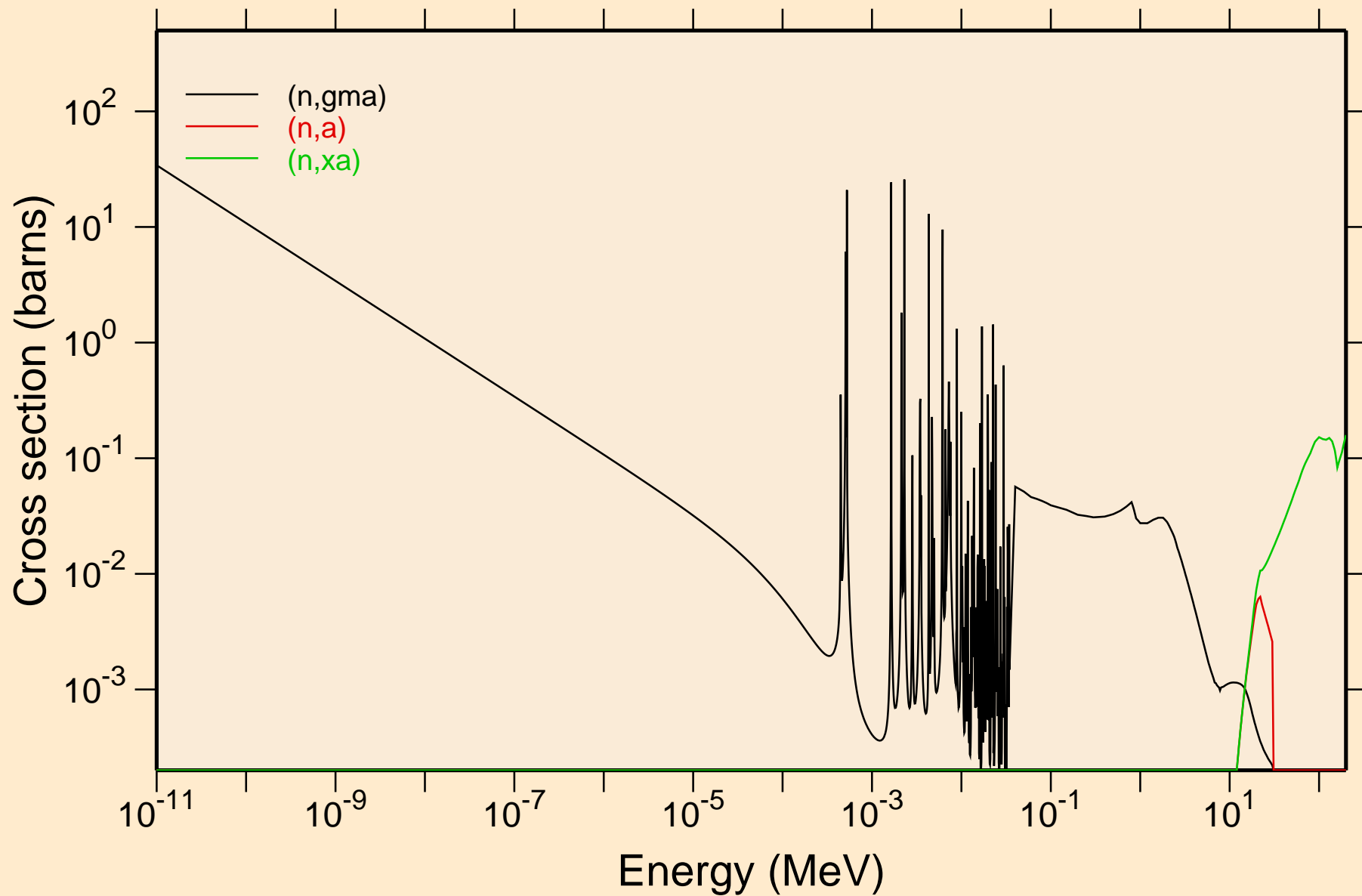

BA136 NEUTRON ACER TENDL-2019 LIBRARY; T=293.16K  
Principal cross sections

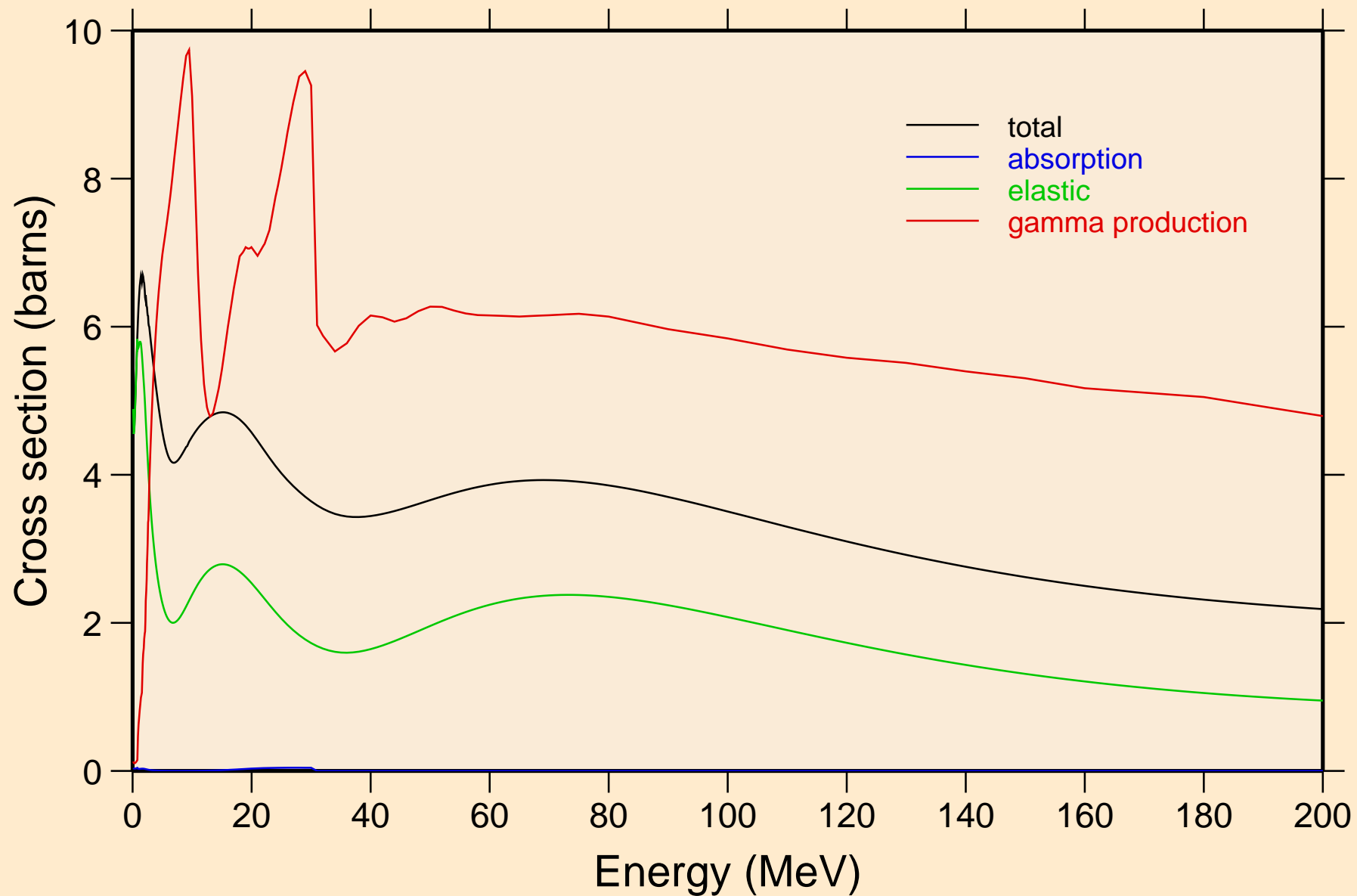

BA136 NEUTRON ACER TENDL-2019 LIBRARY; T=293.16K  
Heating

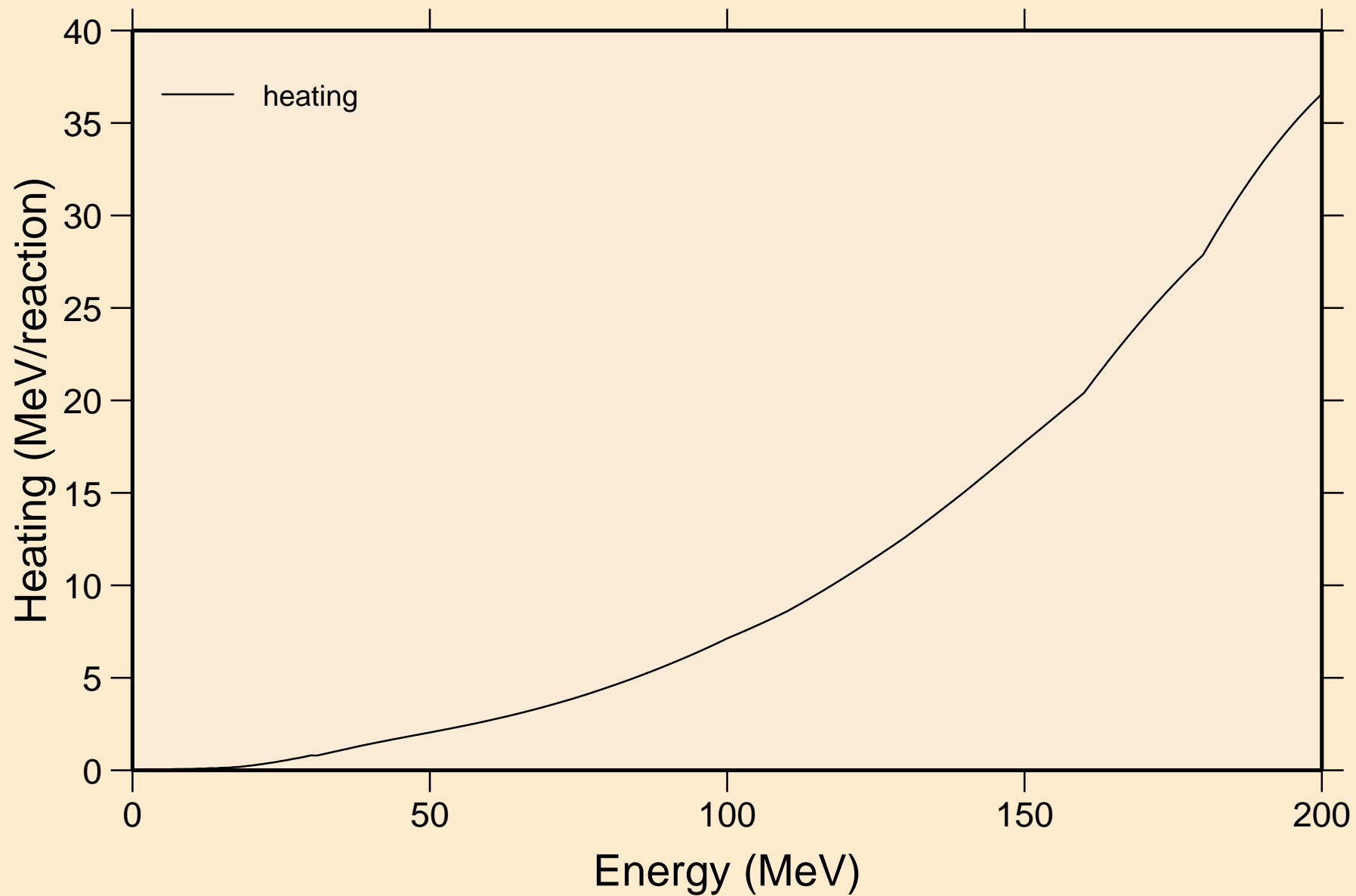

BA136 NEUTRON ACER TENDL-2019 LIBRARY; T=293.16K  
Damage

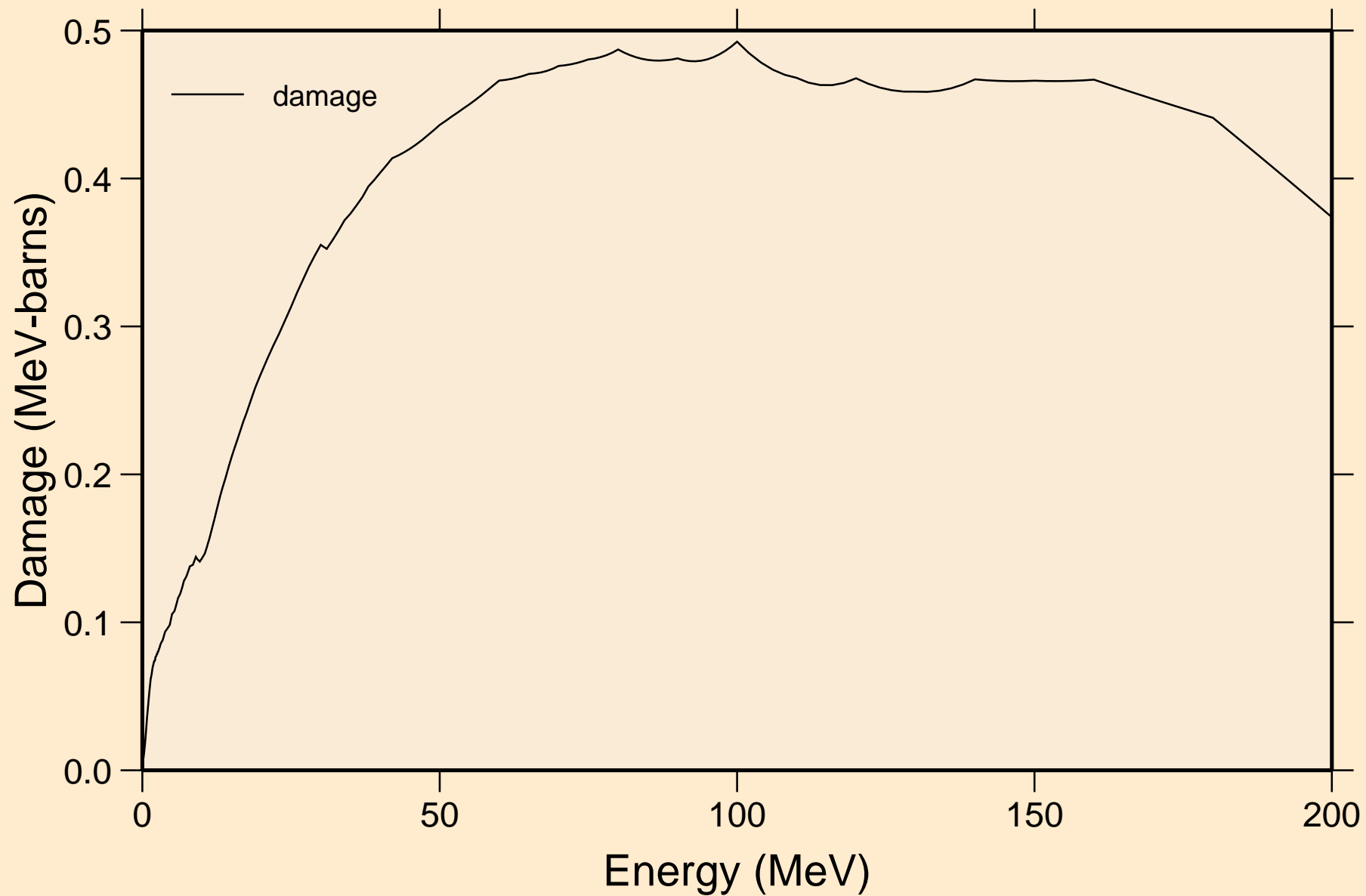

BA136 NEUTRON ACER TENDL-2019 LIBRARY; T=293.16K  
Non-threshold reactions

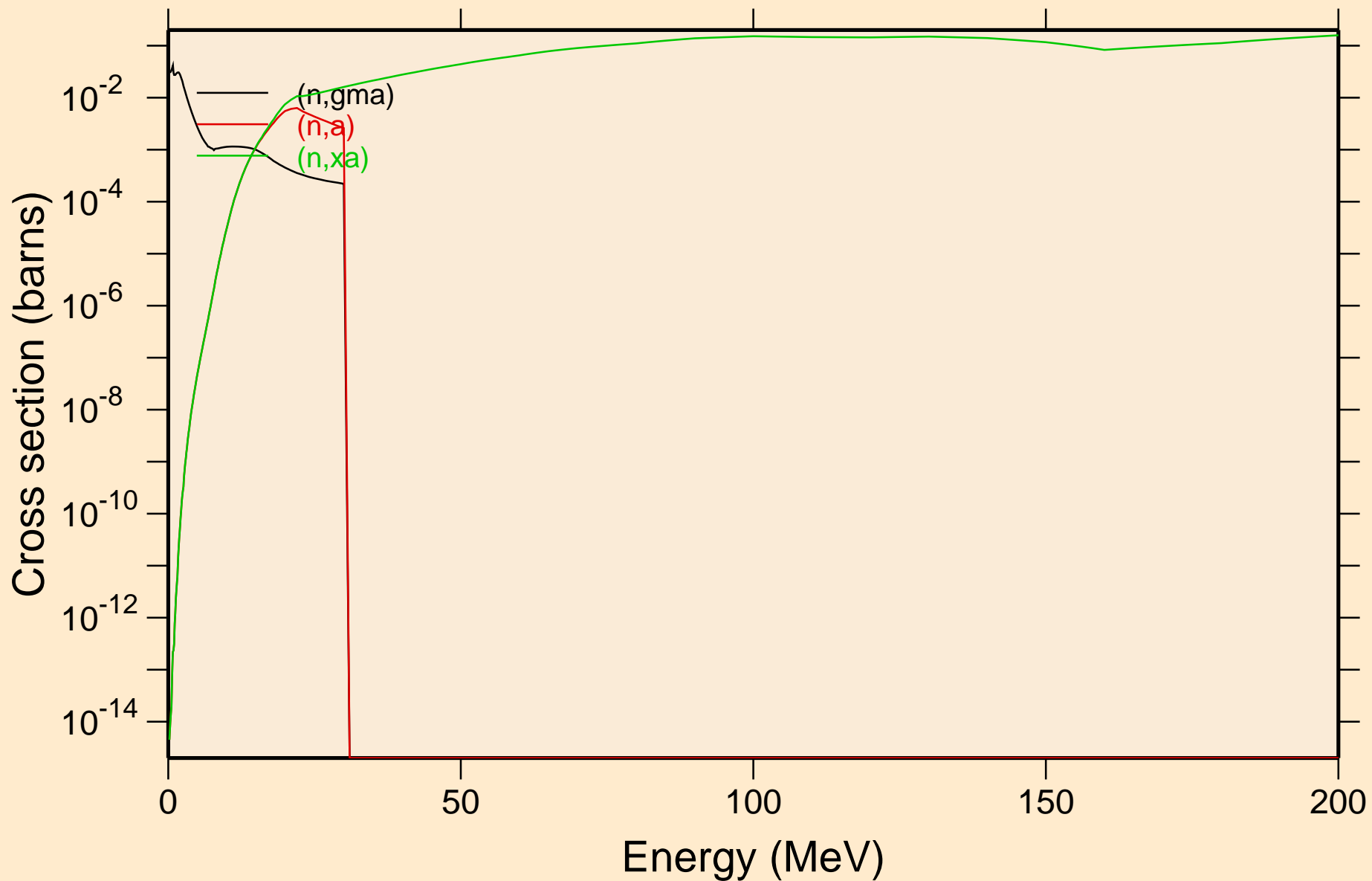



BA136 NEUTRON ACER TENDL-2019 LIBRARY; T=293.16K  
Inelastic levels

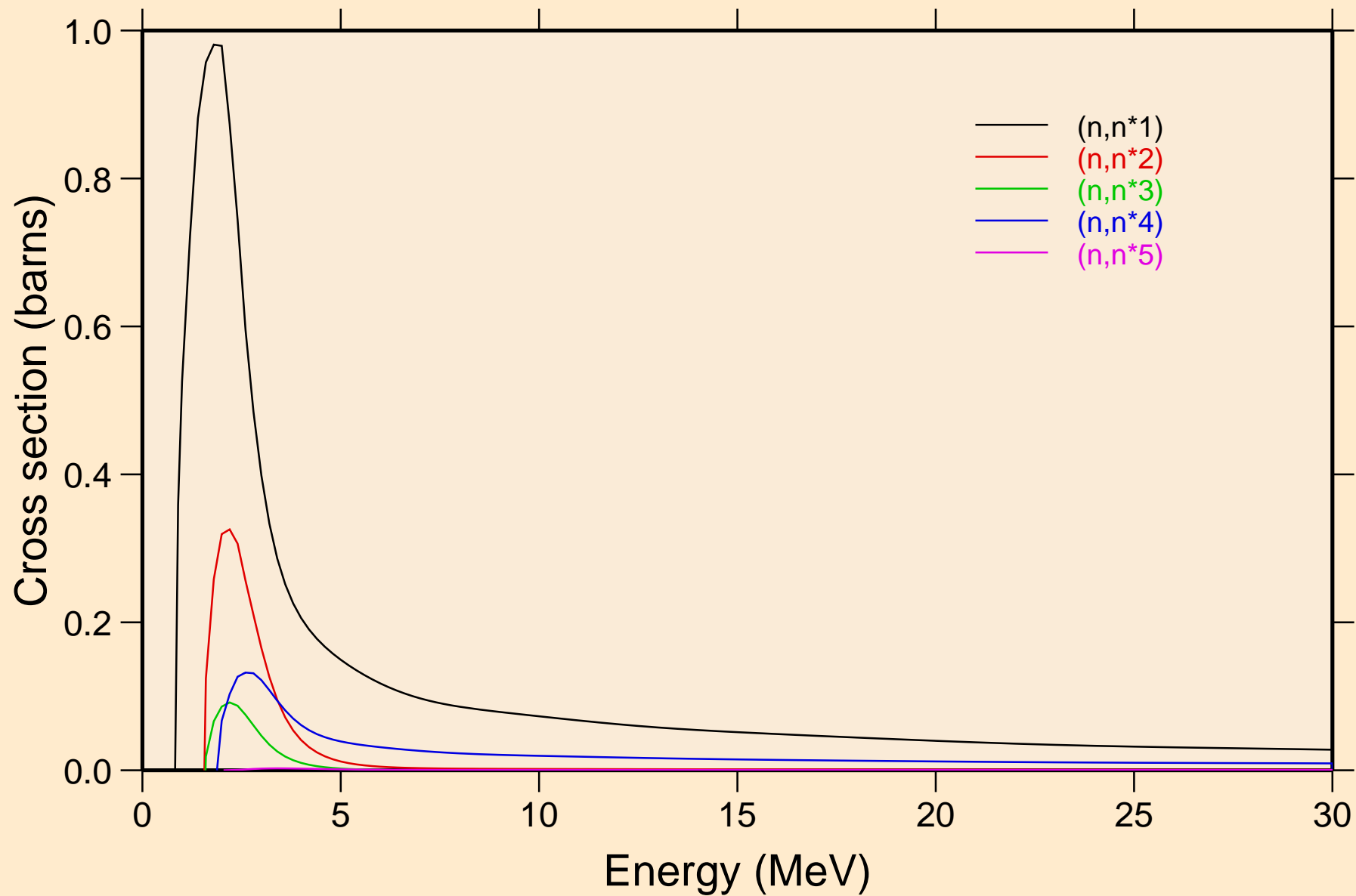

BA136 NEUTRON ACER TENDL-2019 LIBRARY; T=293.16K  
Inelastic levels

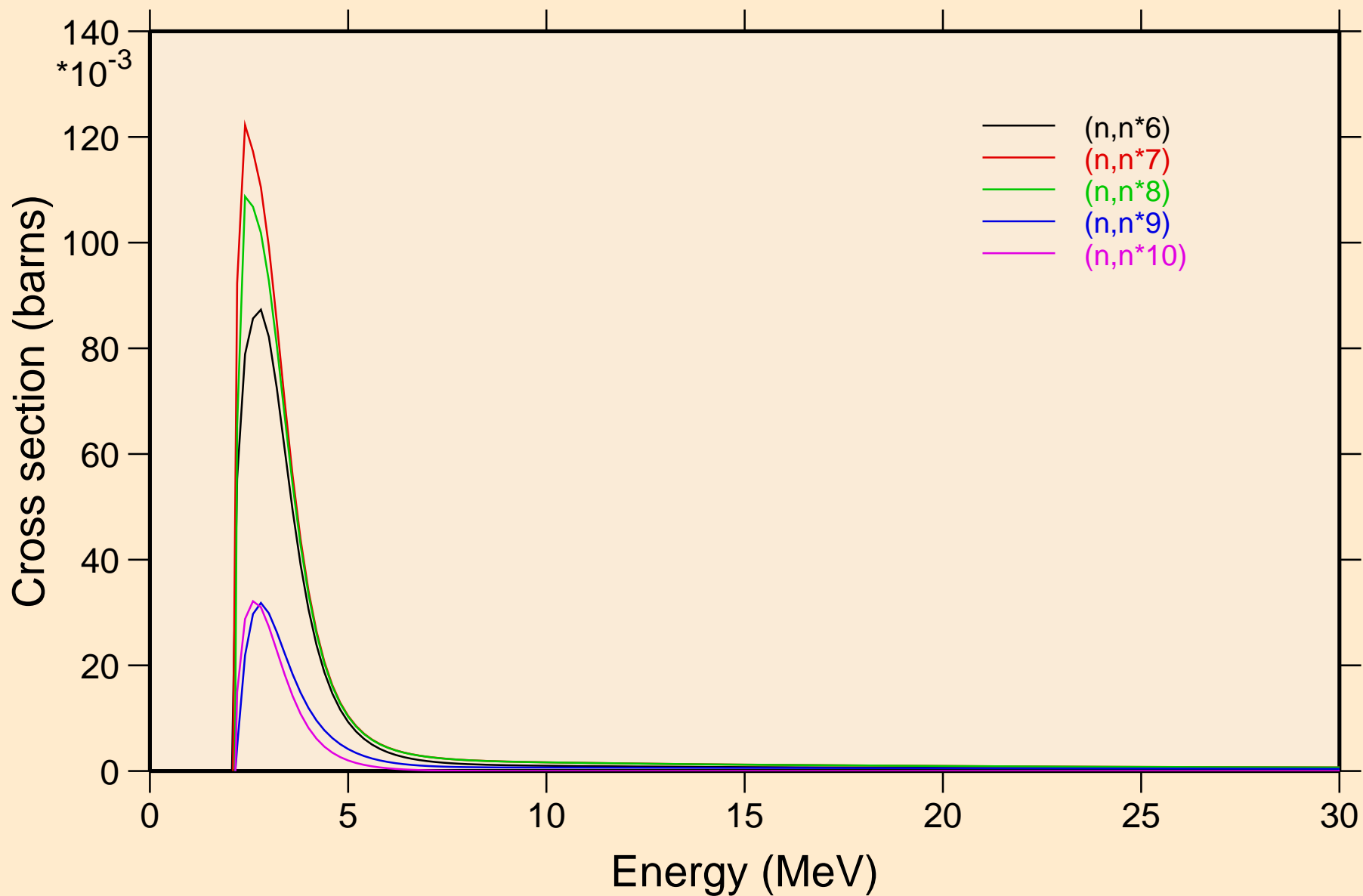

BA136 NEUTRON ACER TENDL-2019 LIBRARY; T=293.16K  
Inelastic levels

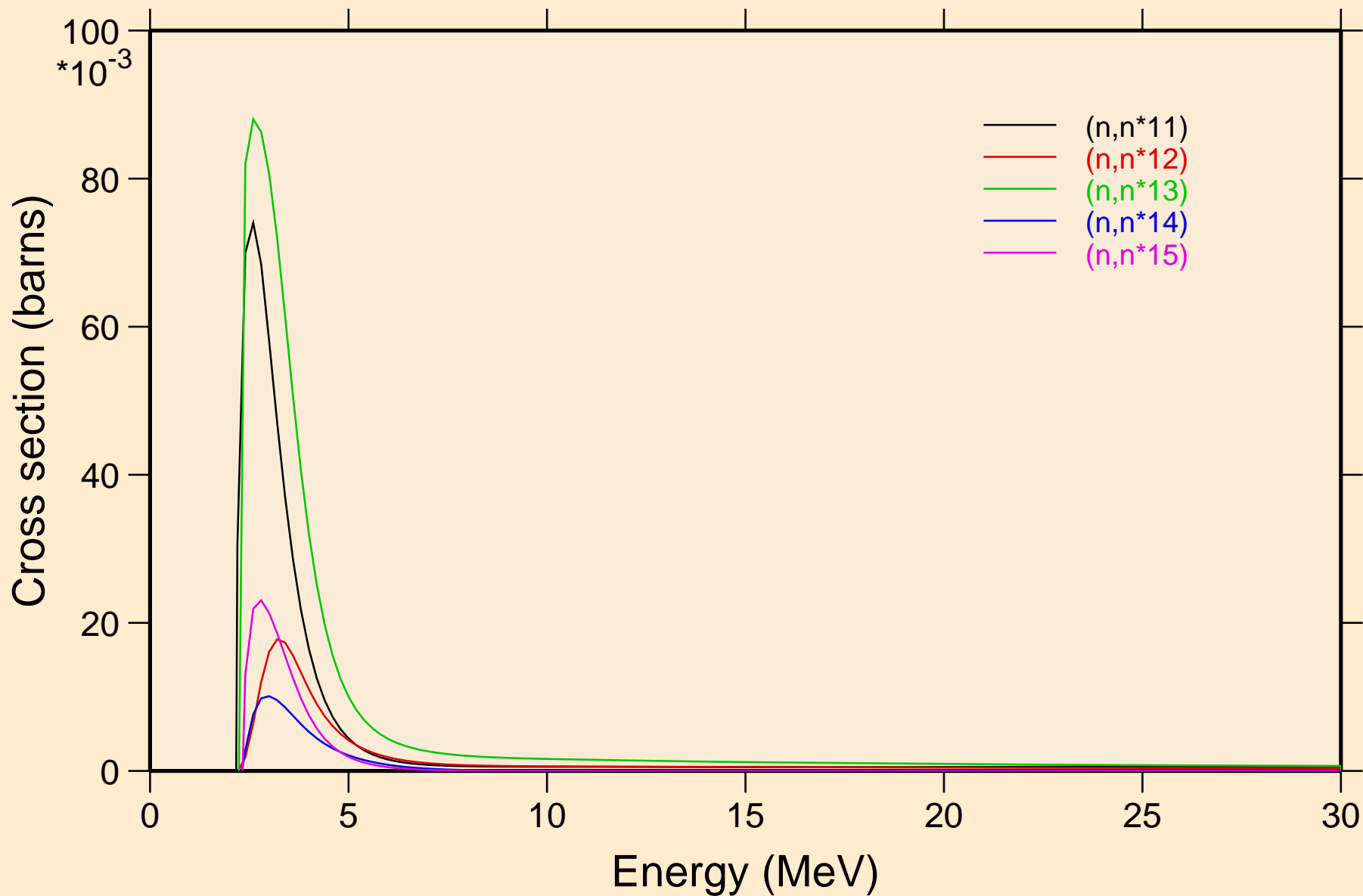

BA136 NEUTRON ACER TENDL-2019 LIBRARY; T=293.16K  
Inelastic levels

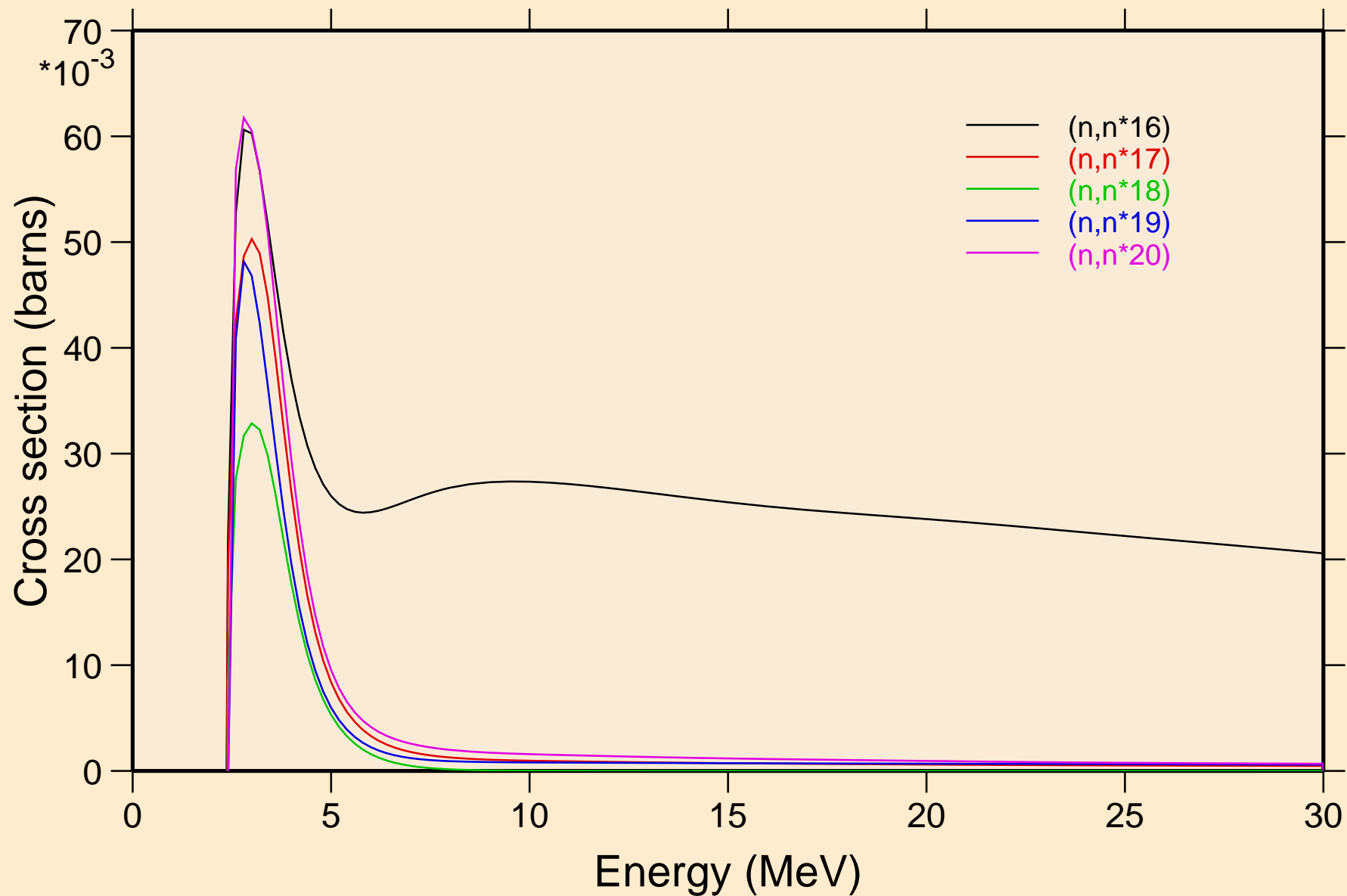

BA136 NEUTRON ACER TENDL-2019 LIBRARY; T=293.16K  
Inelastic levels

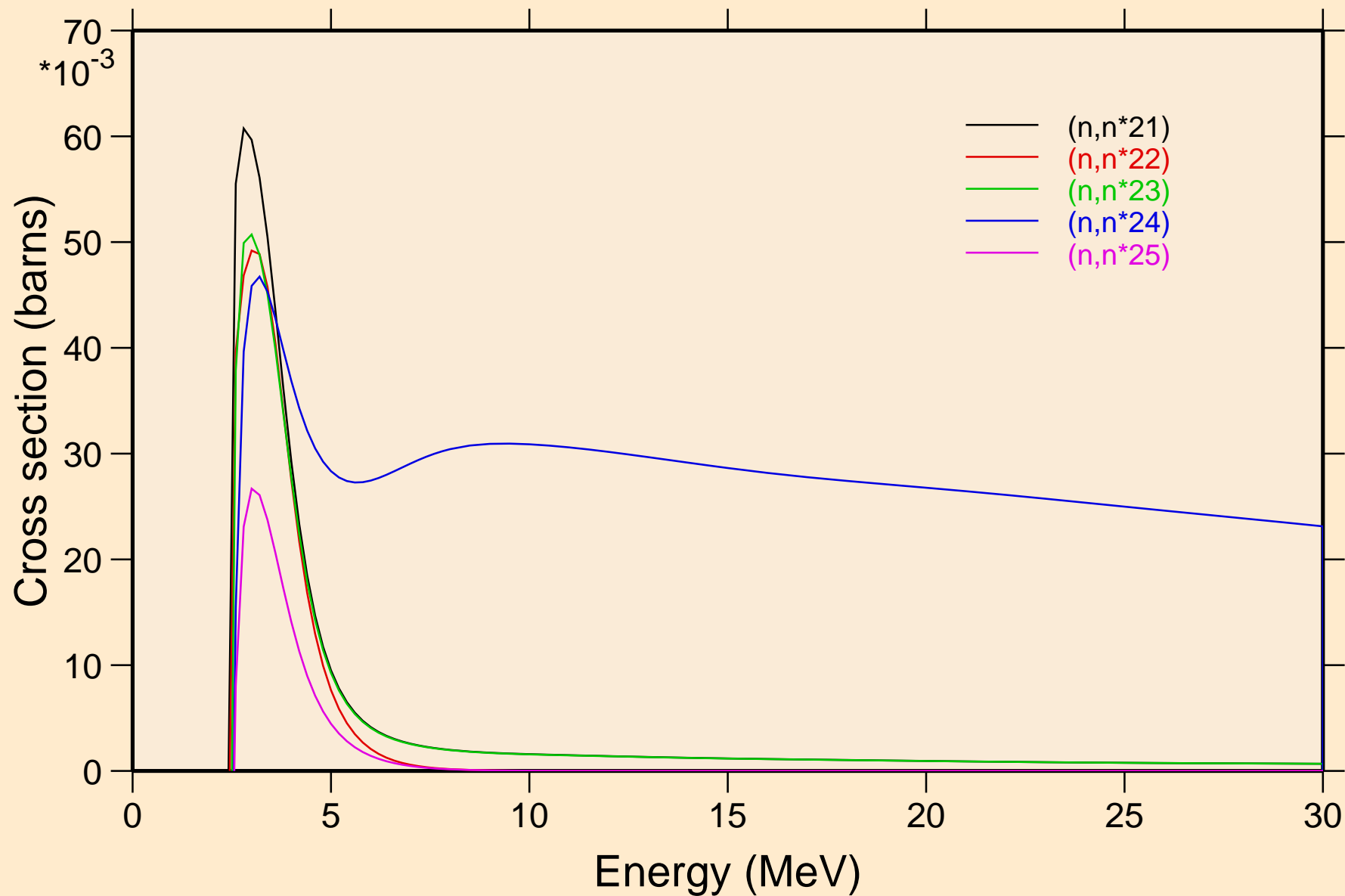

BA136 NEUTRON ACER TENDL-2019 LIBRARY; T=293.16K  
Inelastic levels

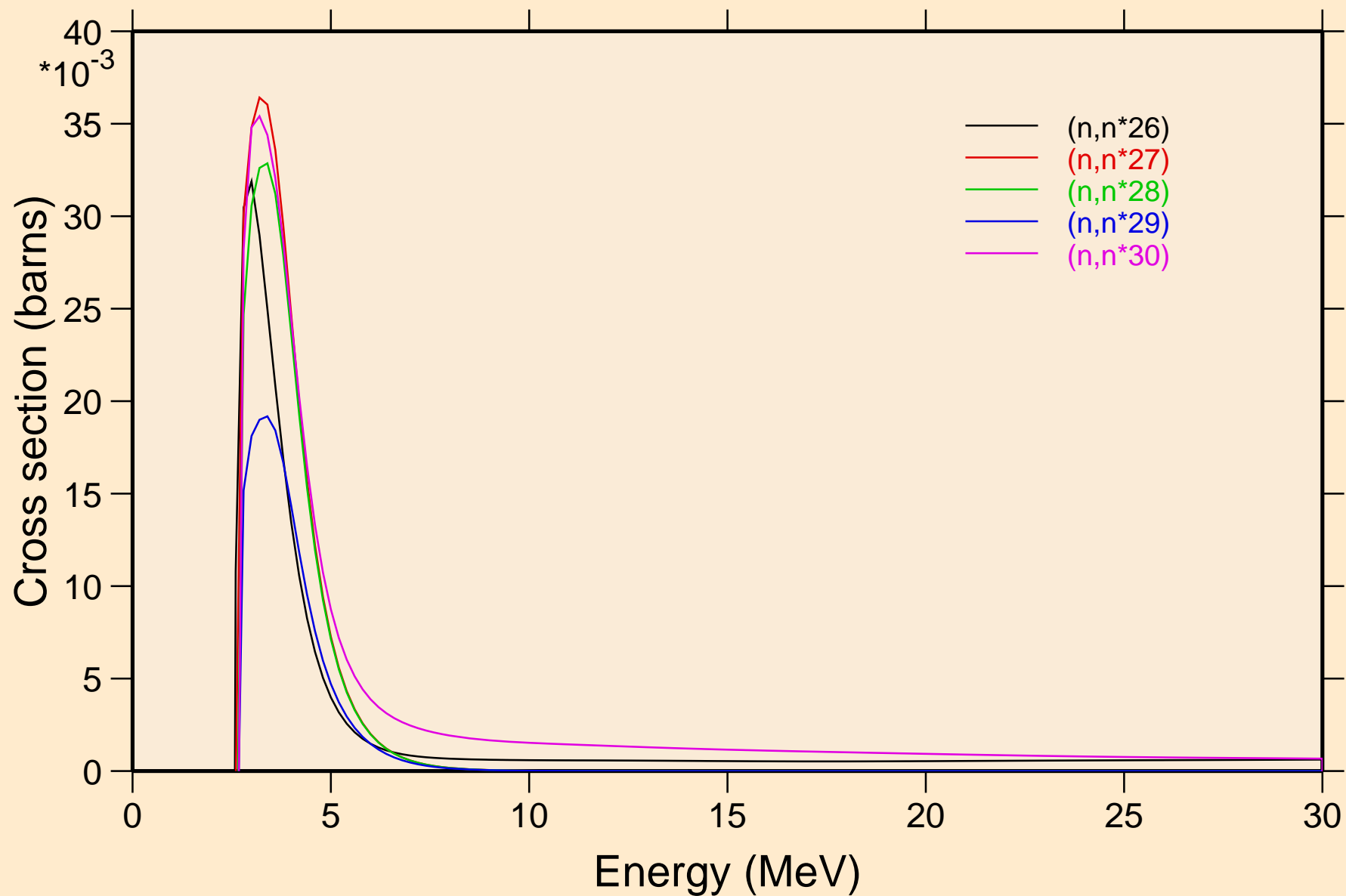

BA136 NEUTRON ACER TENDL-2019 LIBRARY; T=293.16K  
Threshold reactions

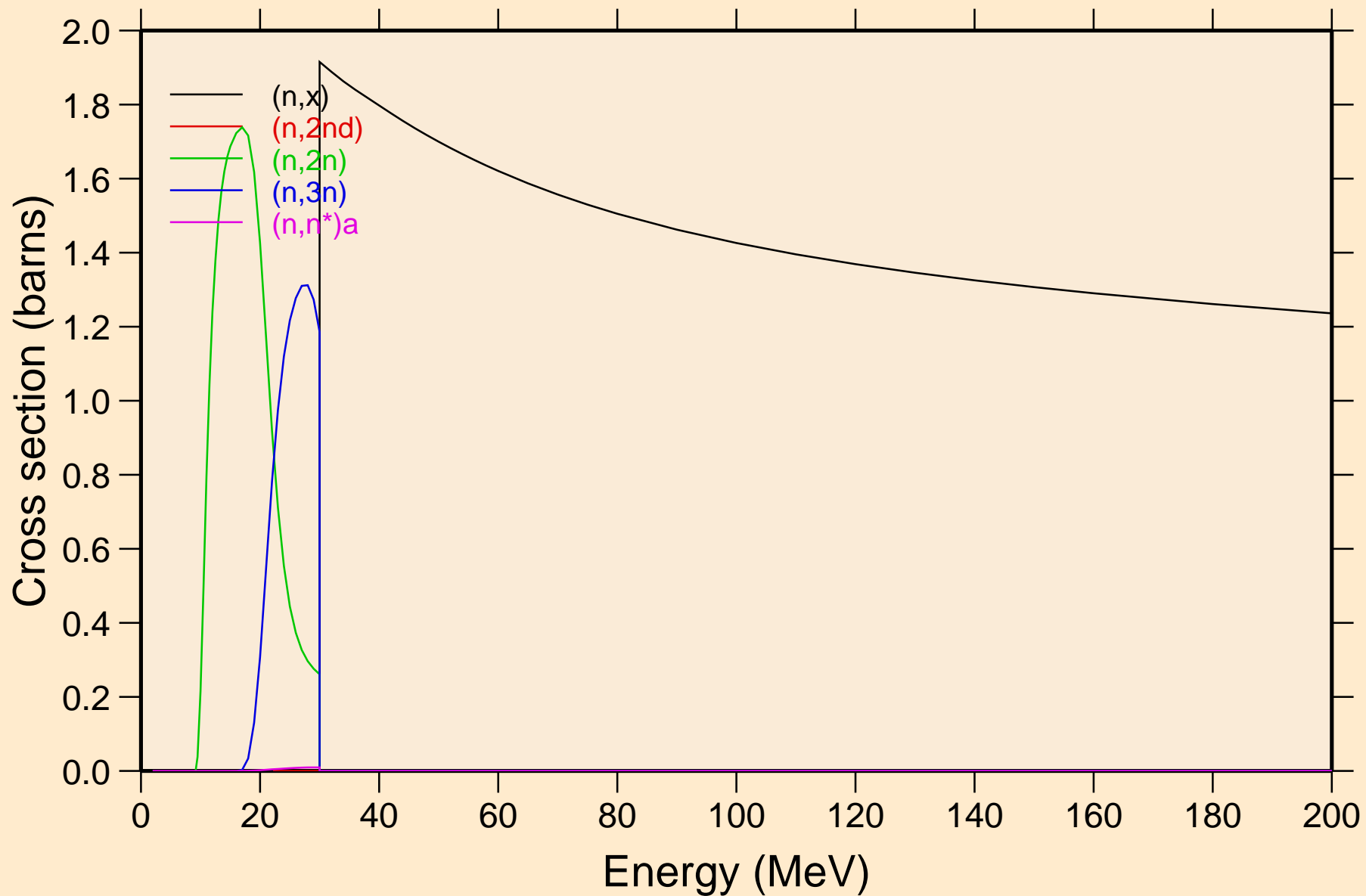

BA136 NEUTRON ACER TENDL-2019 LIBRARY; T=293.16K  
Threshold reactions

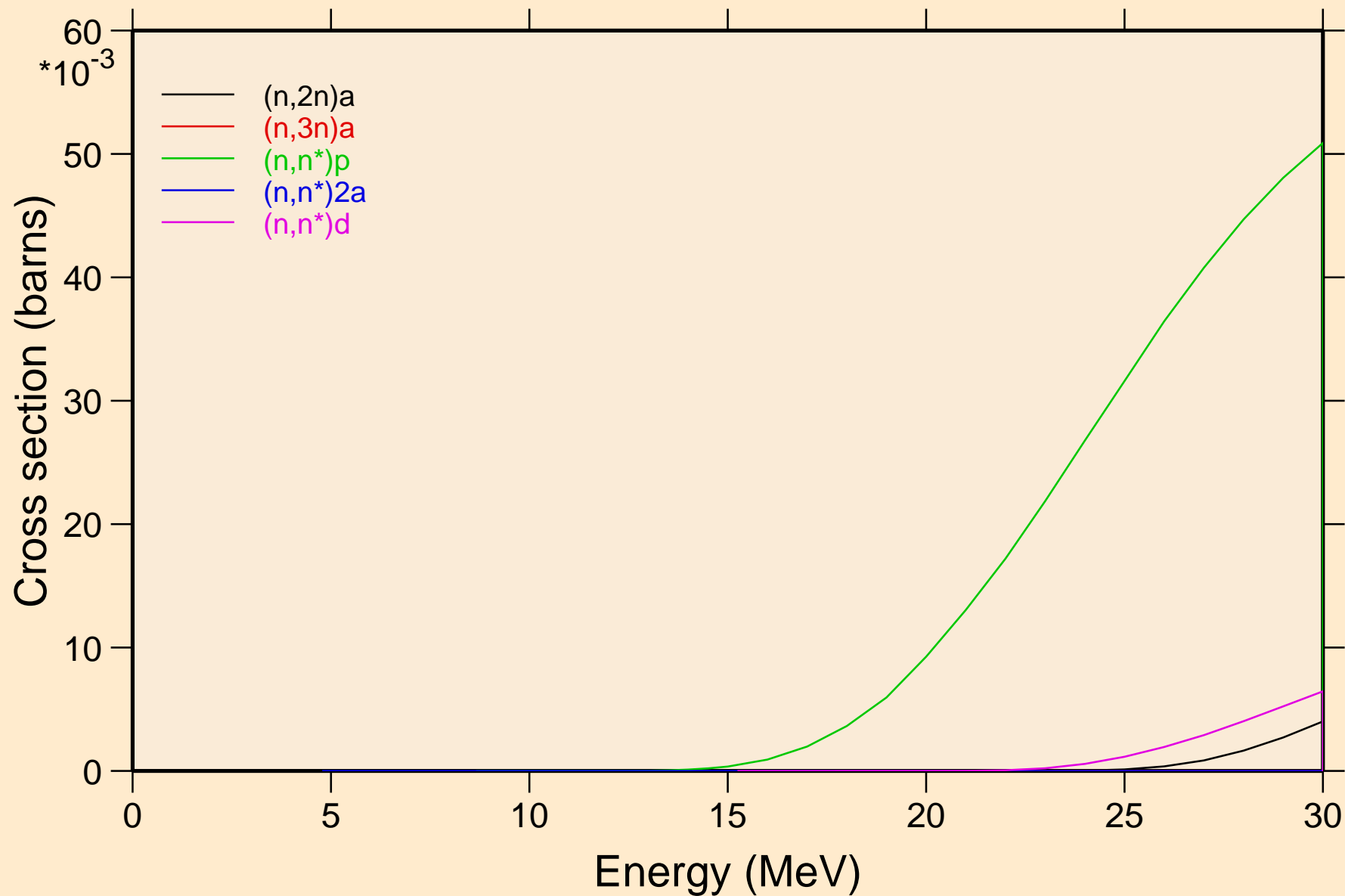



BA136 NEUTRON ACER TENDL-2019 LIBRARY; T=293.16K  
Threshold reactions

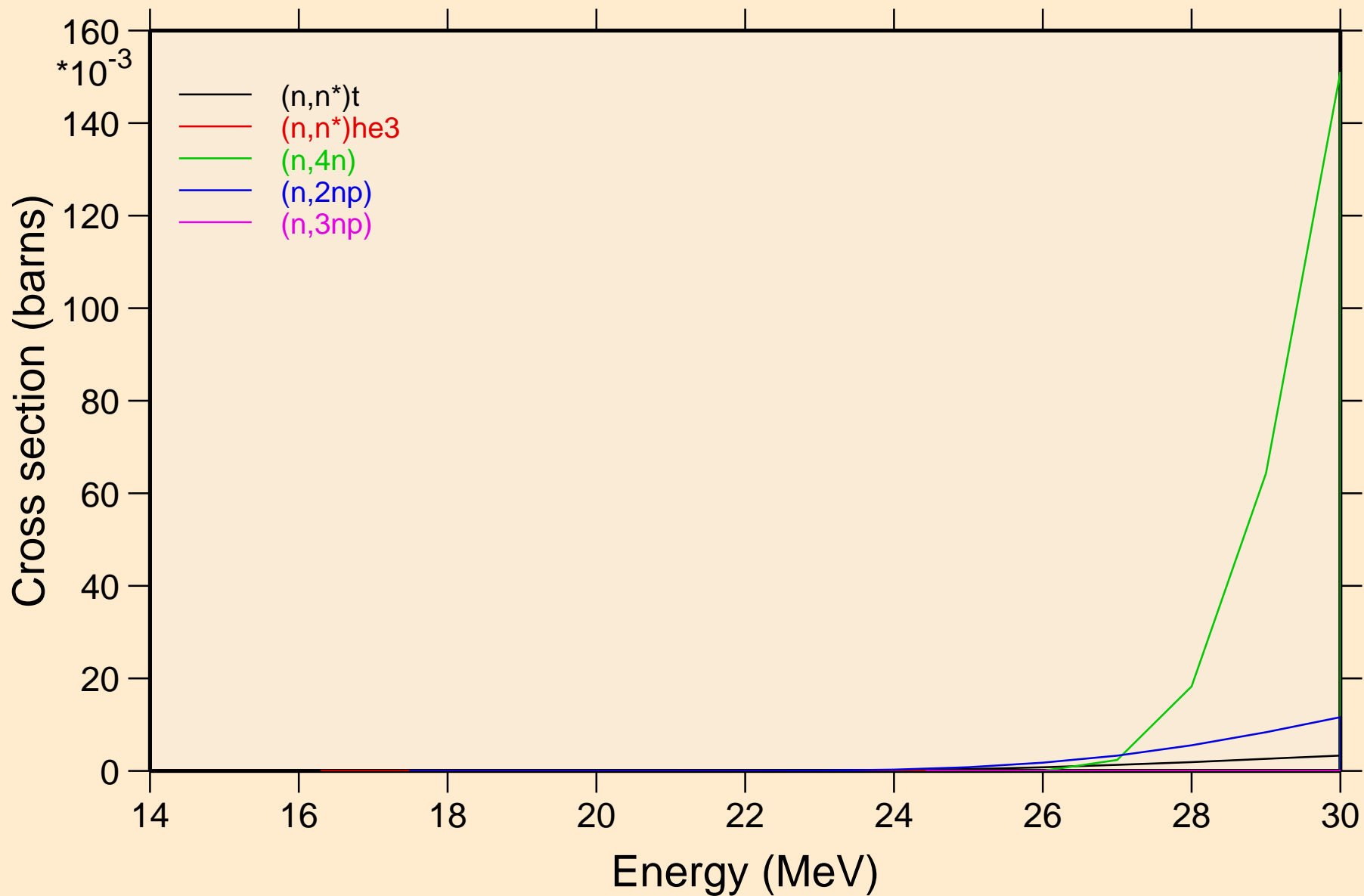

BA136 NEUTRON ACER TENDL-2019 LIBRARY; T=293.16K  
Threshold reactions

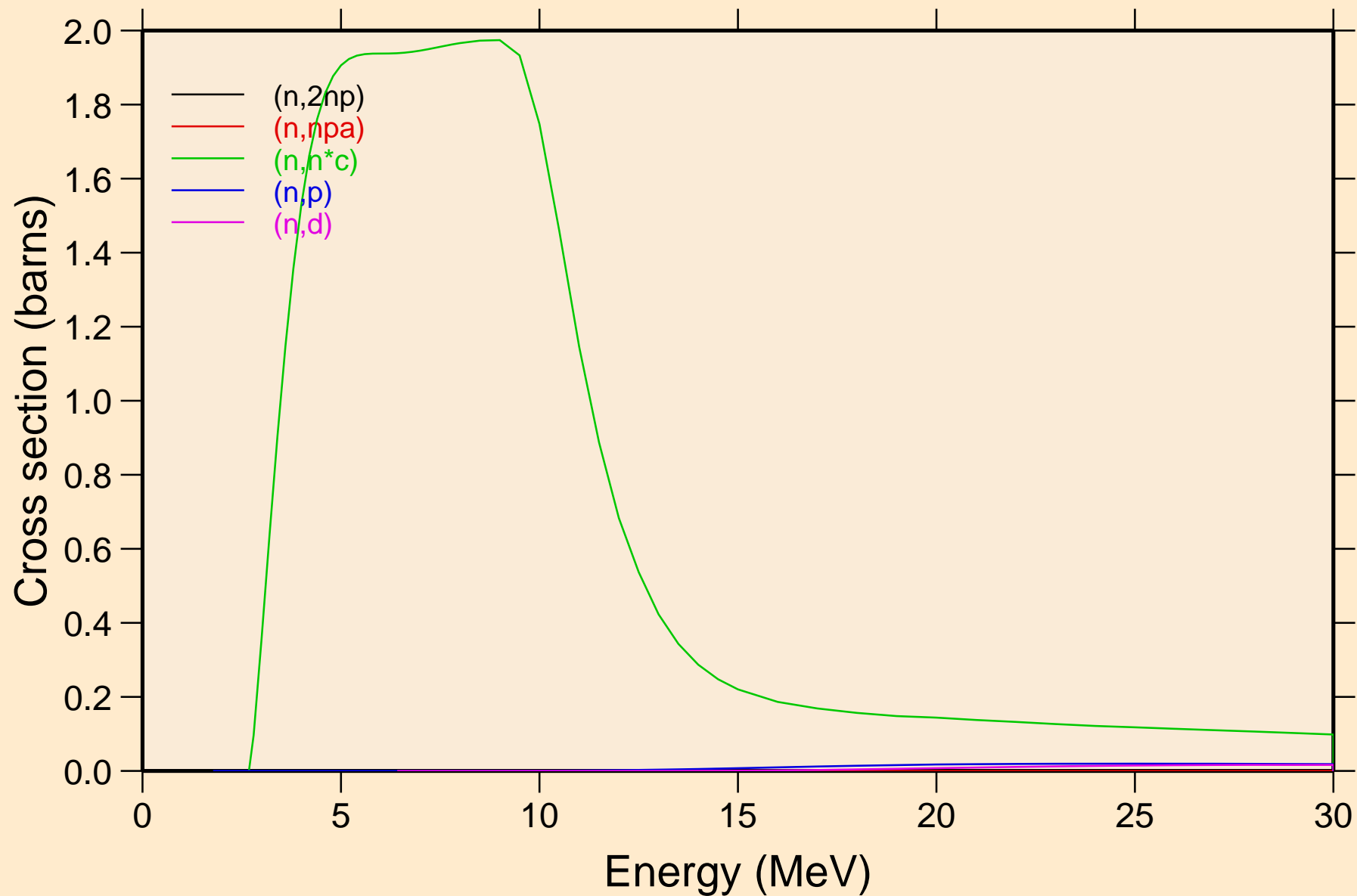

BA136 NEUTRON ACER TENDL-2019 LIBRARY; T=293.16K  
Threshold reactions

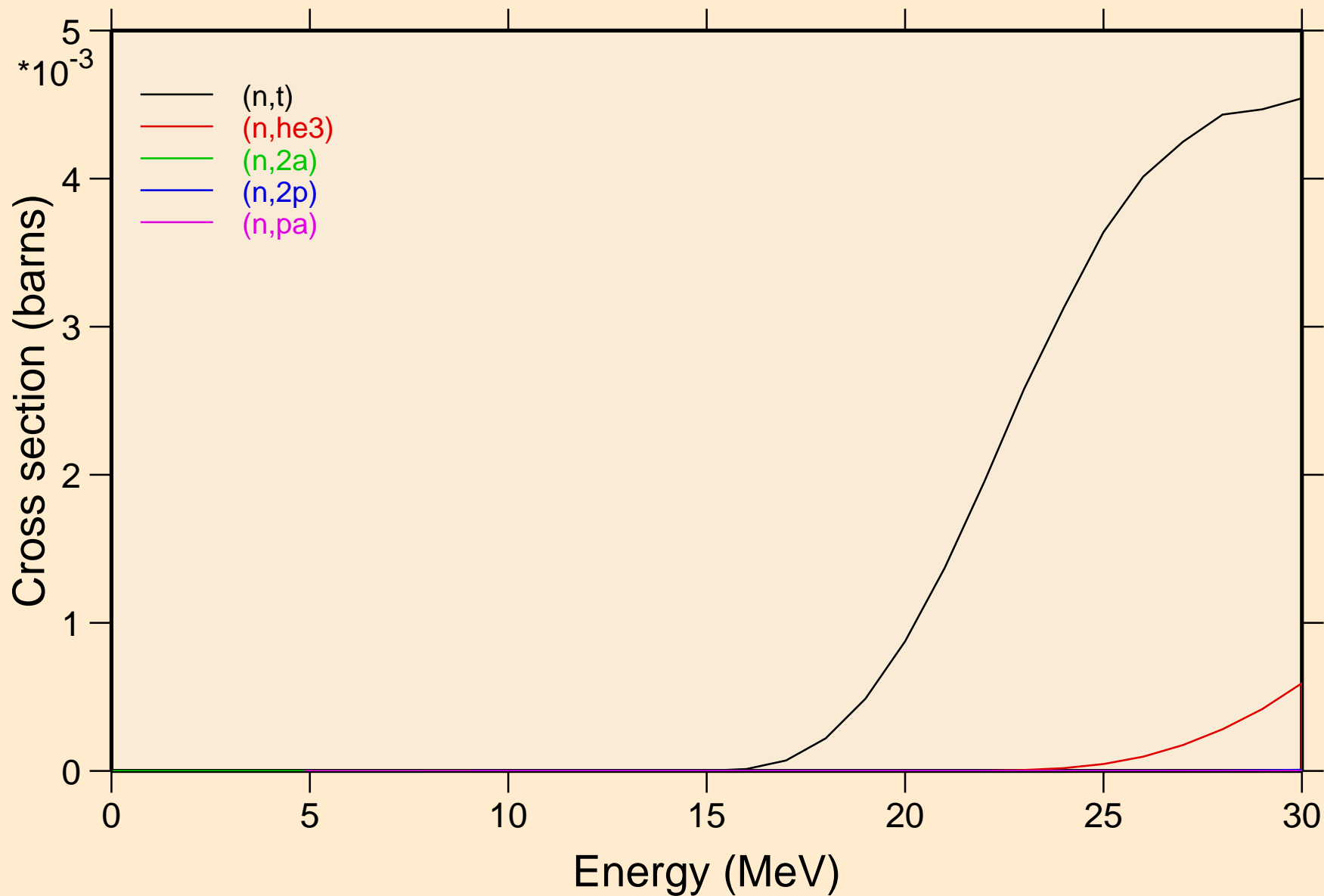

BA136 NEUTRON ACER TENDL-2019 LIBRARY; T=293.16K  
Threshold reactions

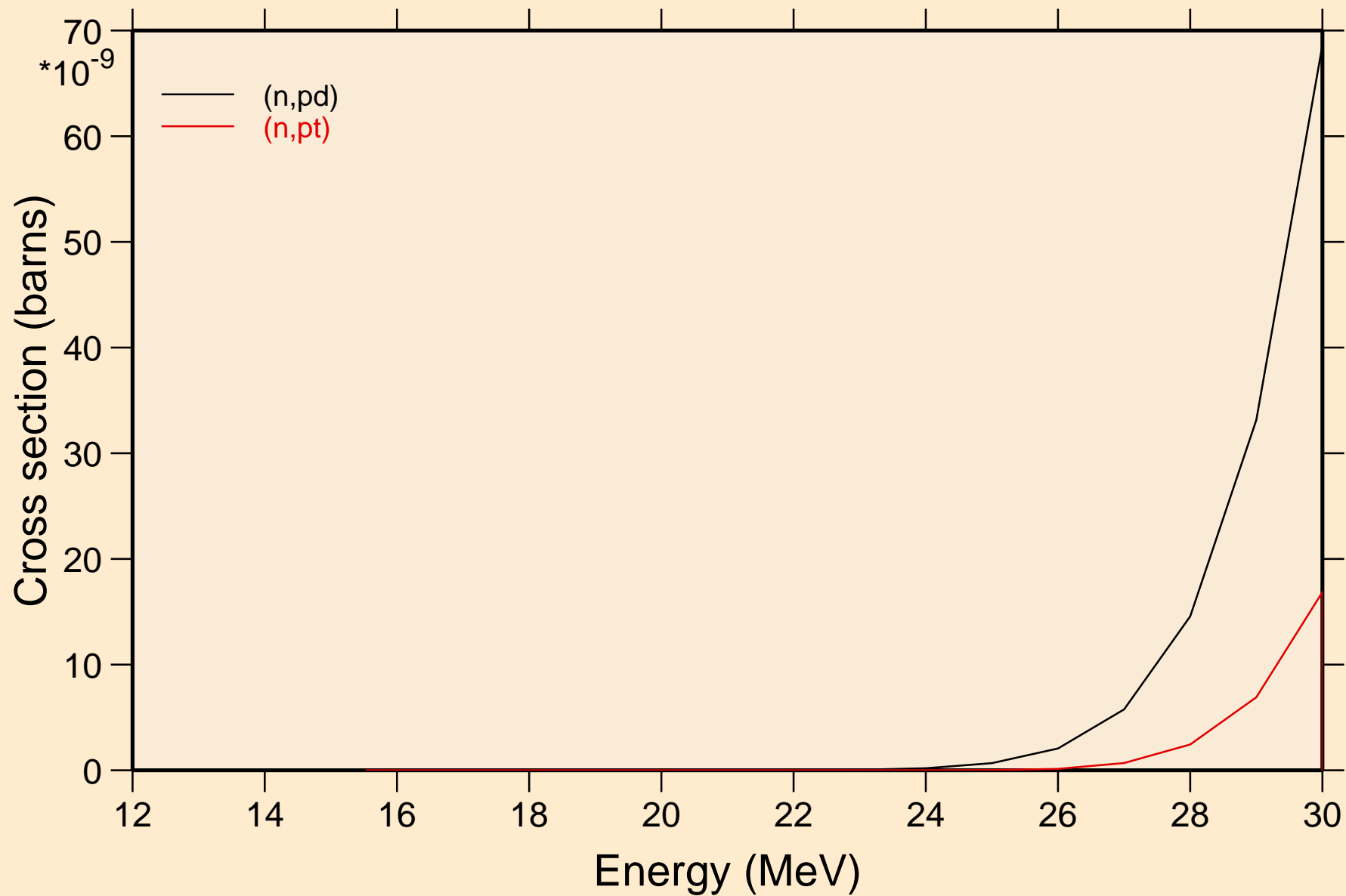

BA136 NEUTRON ACER TENDL-2019 LIBRARY; T=293.16K  
Threshold reactions

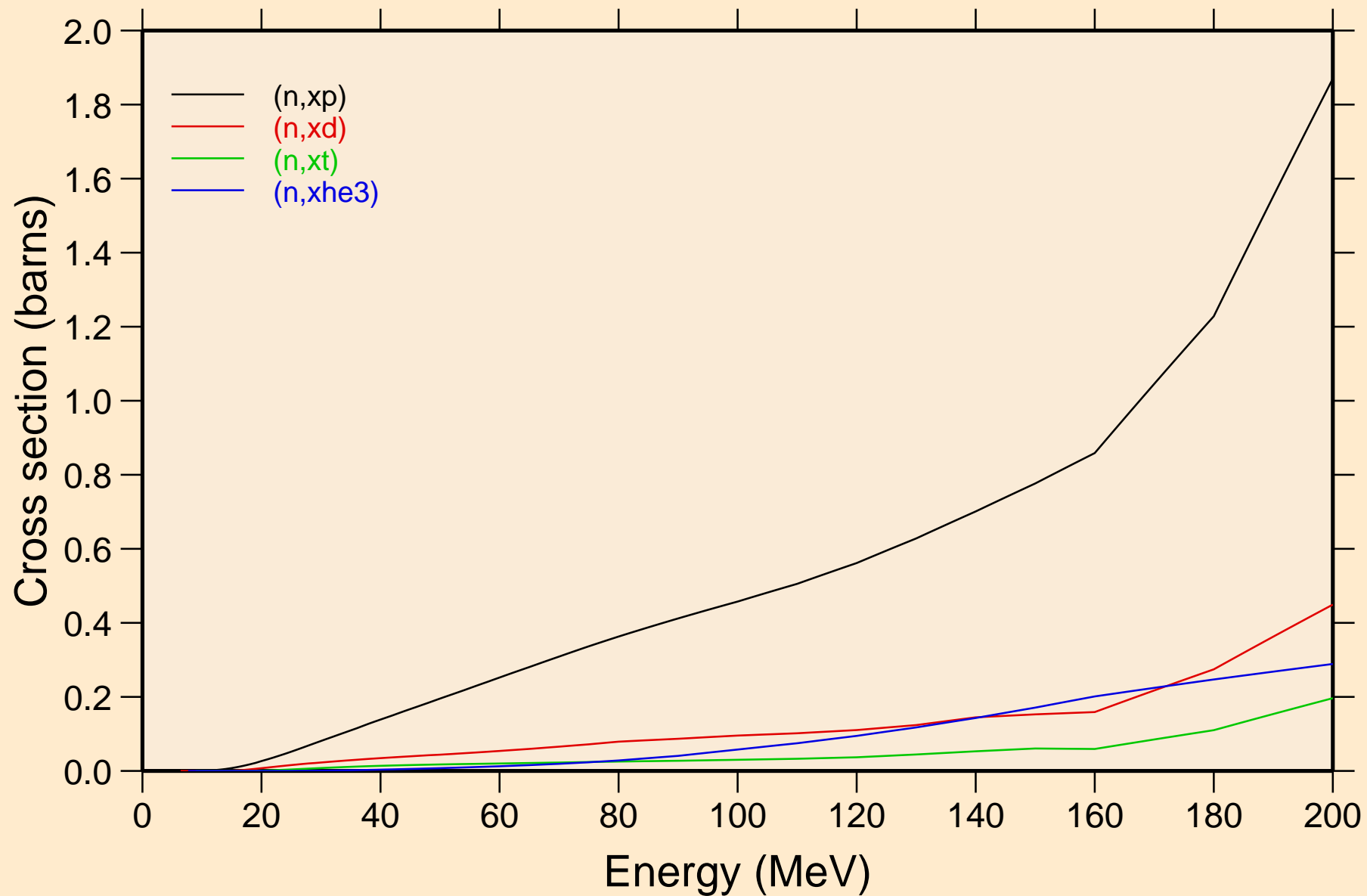

BA136 NEUTRON ACER TENDL-2019 LIBRARY; T=293.16K  
angular distribution for elastic

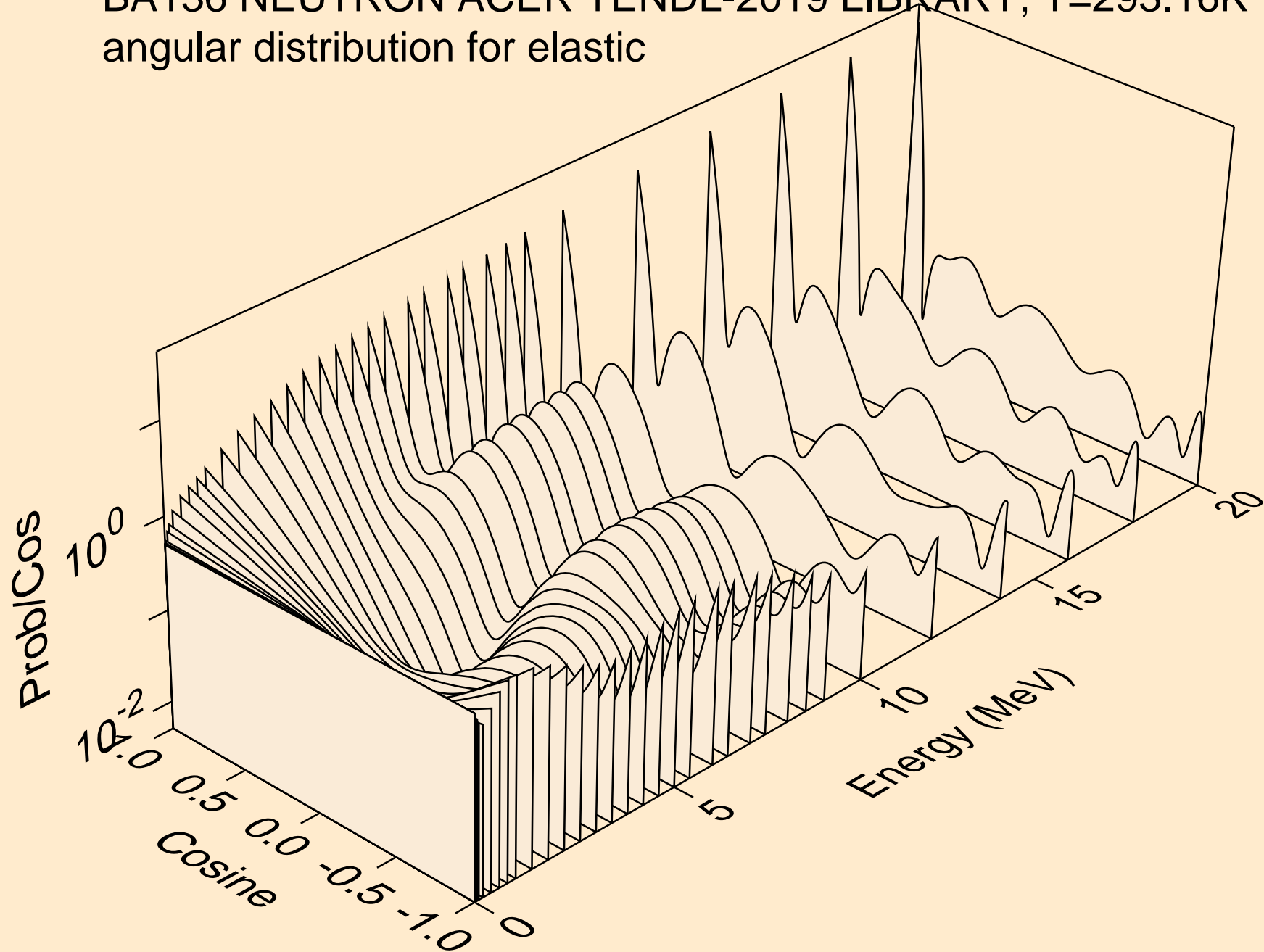

BA136 NEUTRON ACER TENDL-2019 LIBRARY; T=293.16K  
angular distribution for elastic

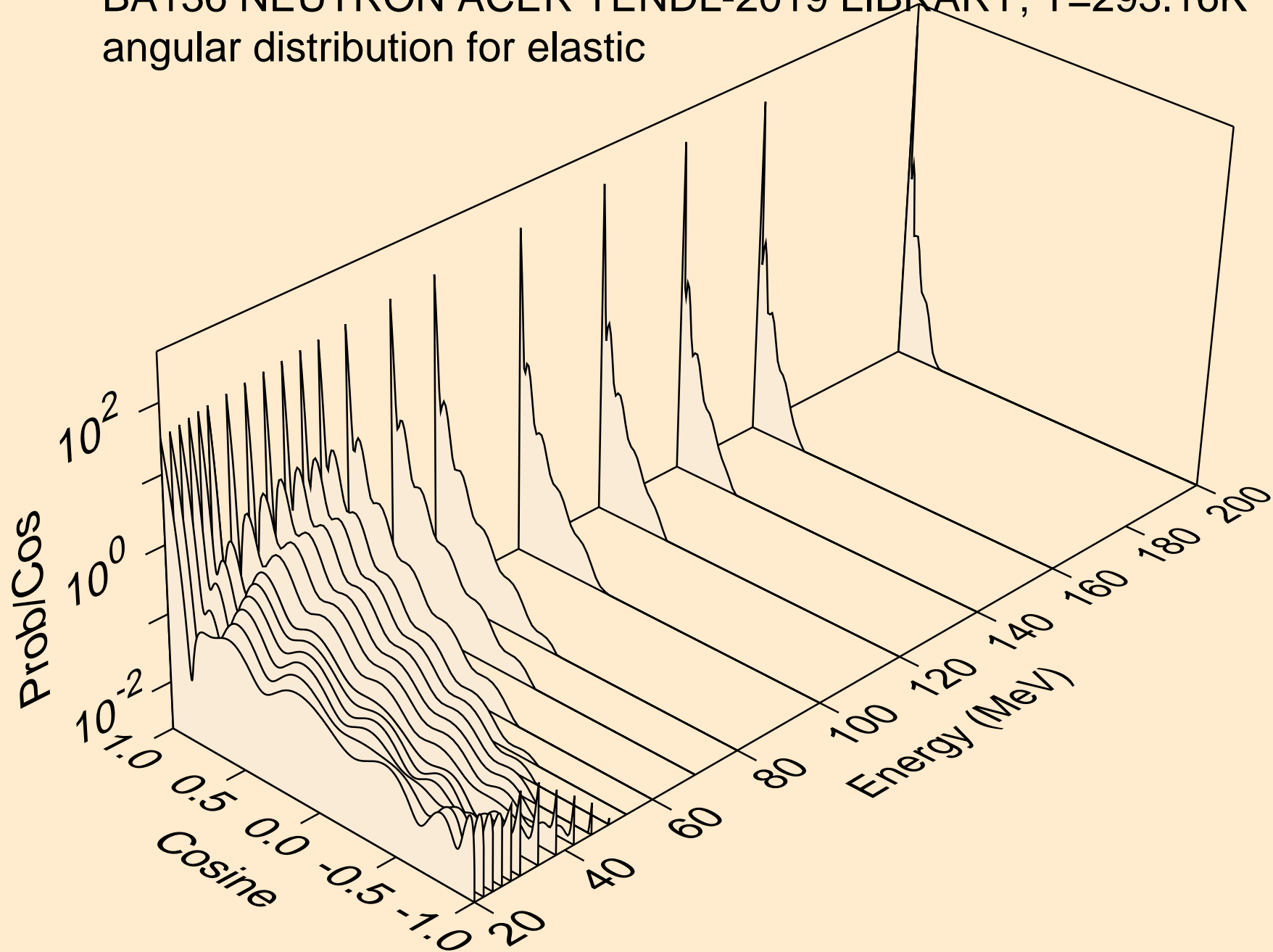

BA136 NEUTRON ACER TENDL-2019 LIBRARY; T=293.16K  
angular distribution for (n,n\*1)

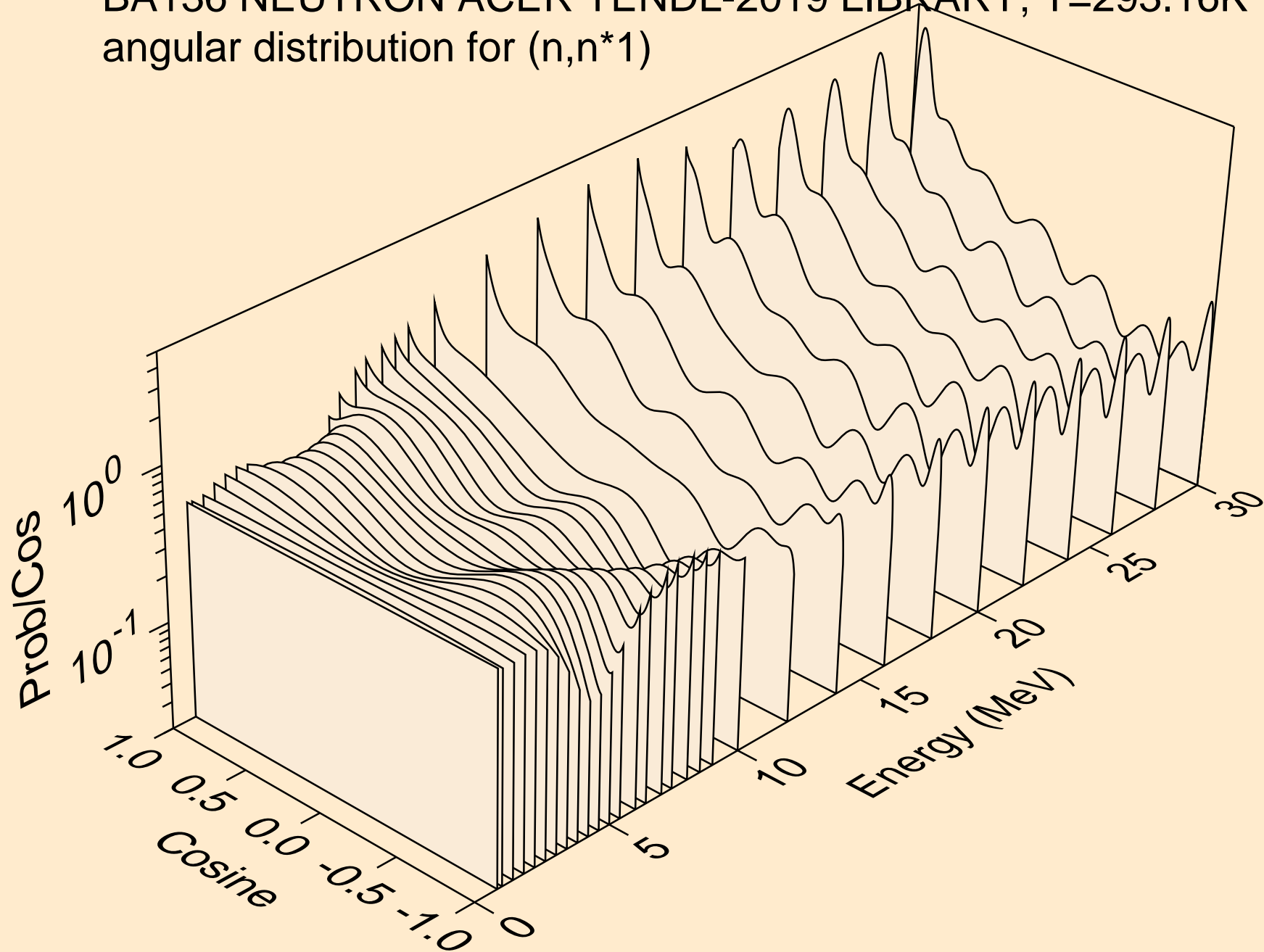



BA136 NEUTRON ACER TENDL-2019 LIBRARY; T=293.16K  
angular distribution for (n,n\*2)

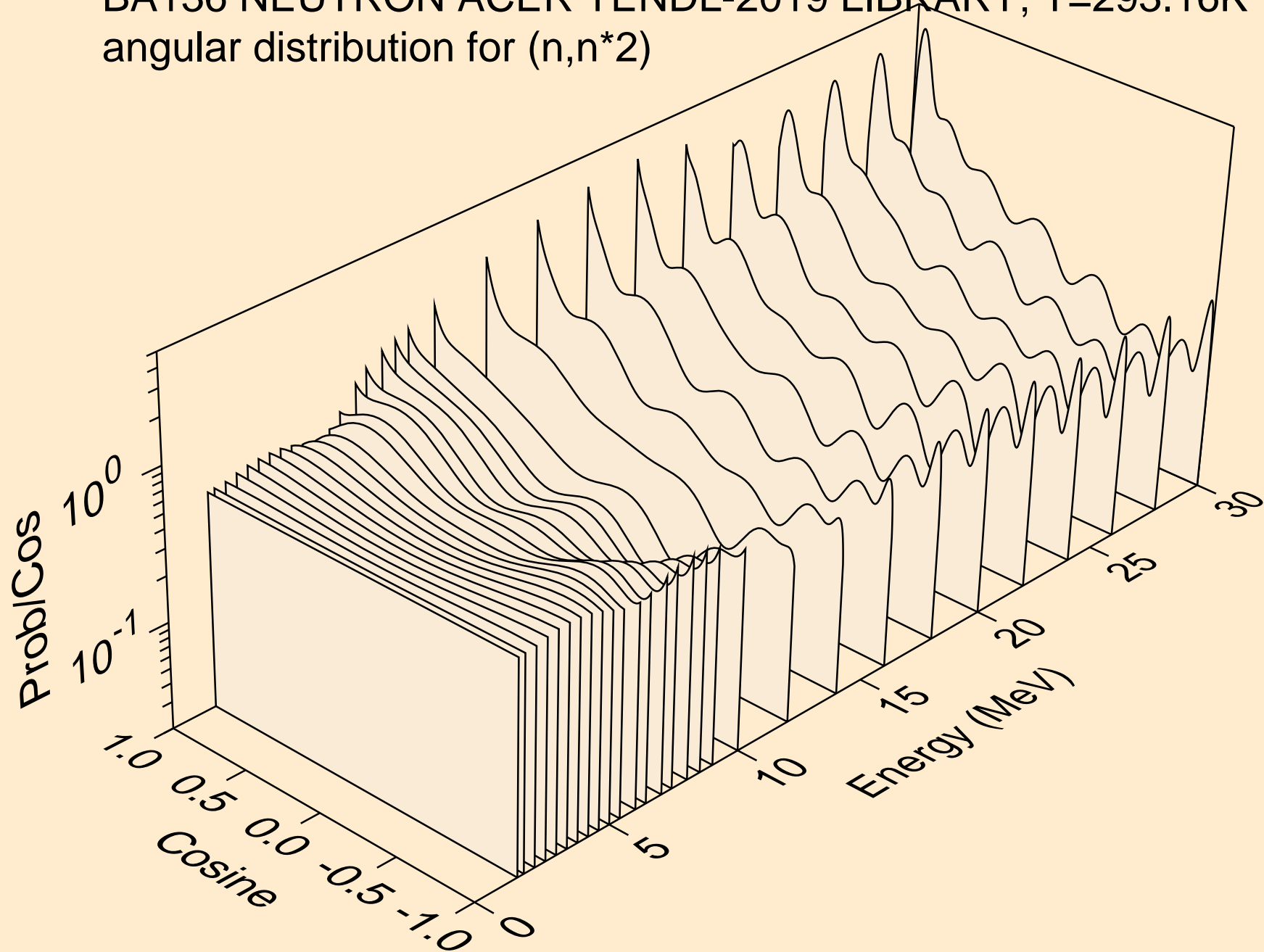

BA136 NEUTRON ACER TENDL-2019 LIBRARY; T=293.16K  
angular distribution for (n,n\*3)

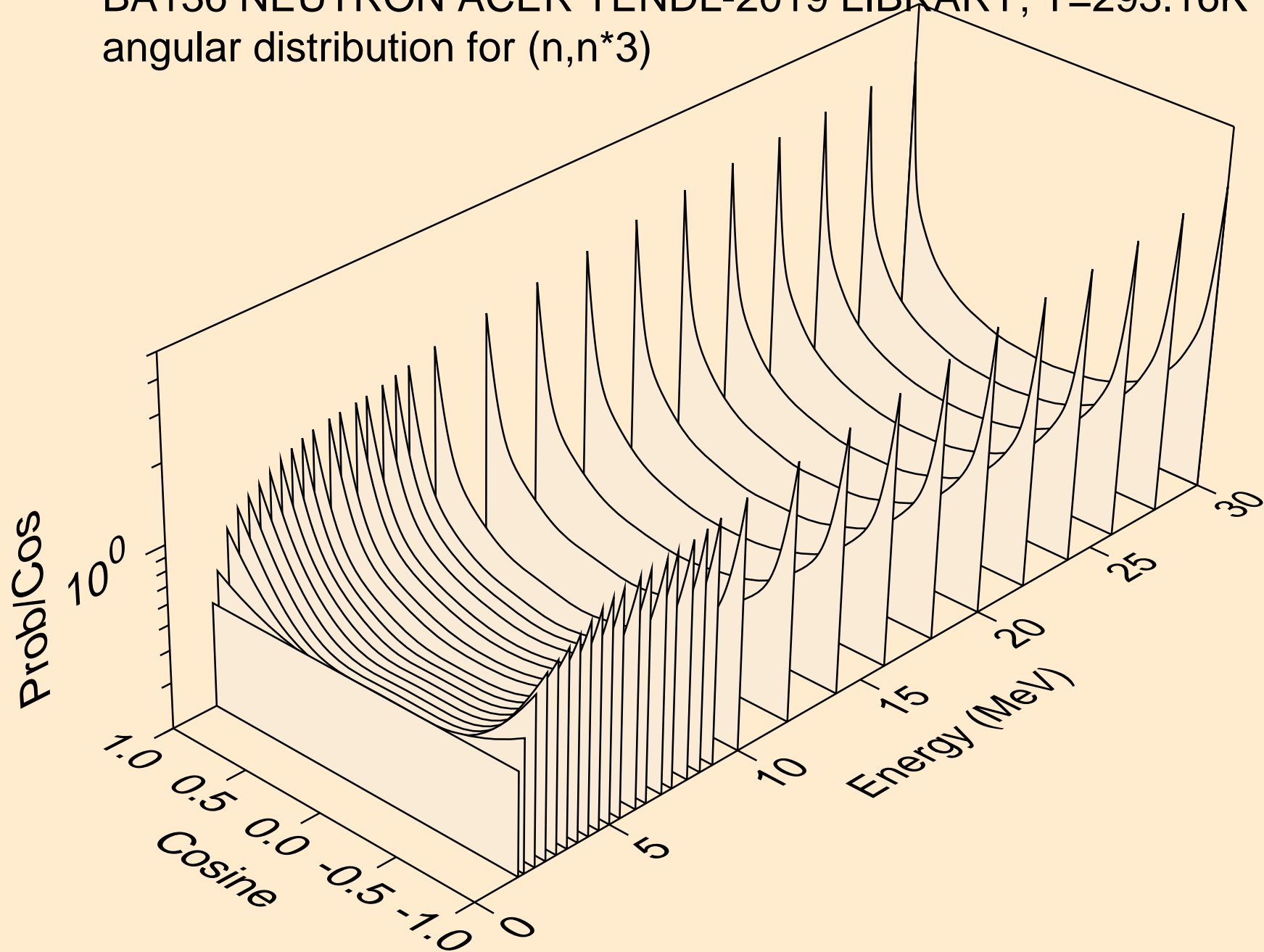

BA136 NEUTRON ACER TENDL-2019 LIBRARY; T=293.16K  
angular distribution for (n,n\*4)

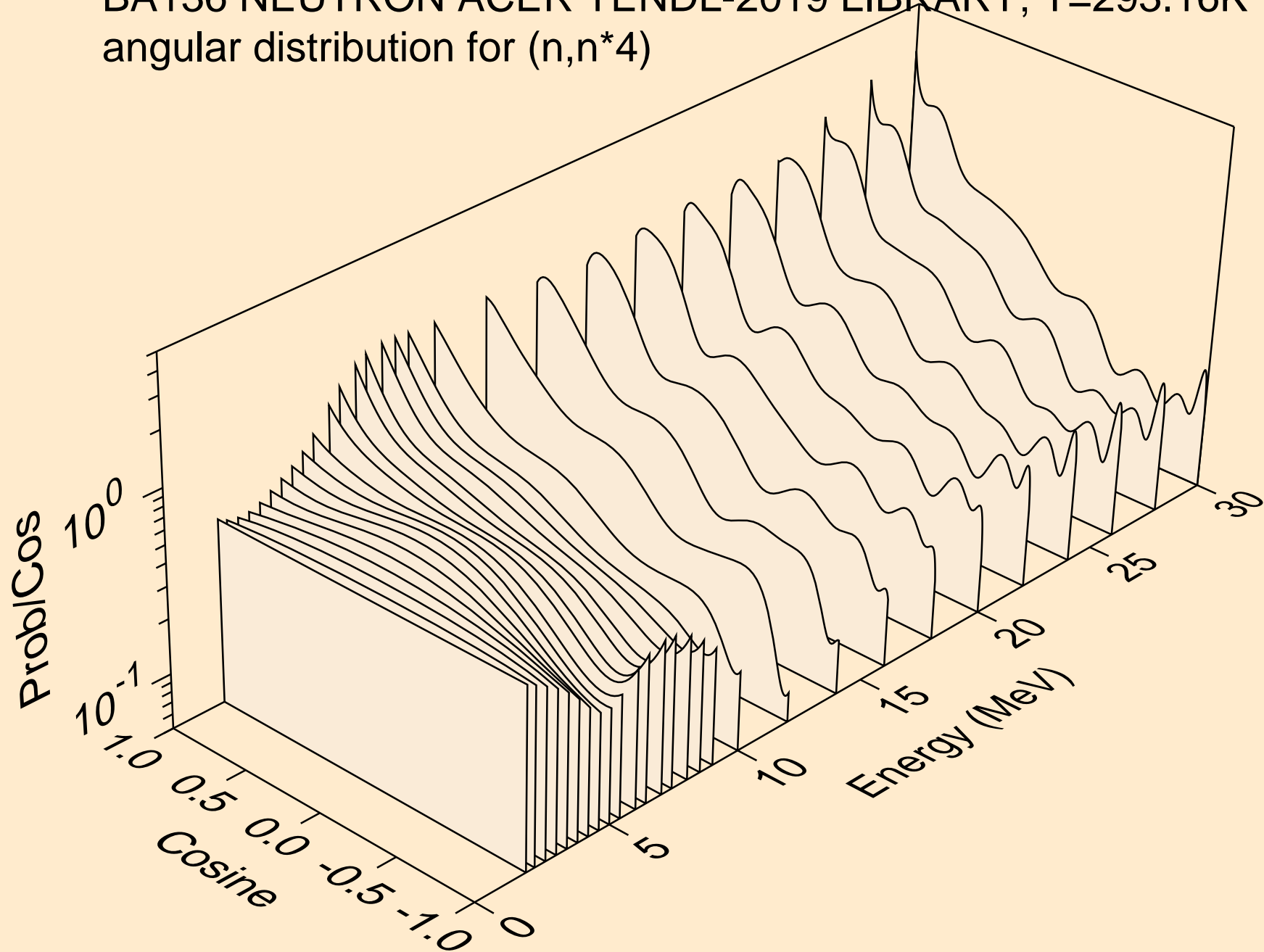

BA136 NEUTRON ACER TENDL-2019 LIBRARY; T=293.16K  
angular distribution for (n,n\*5)

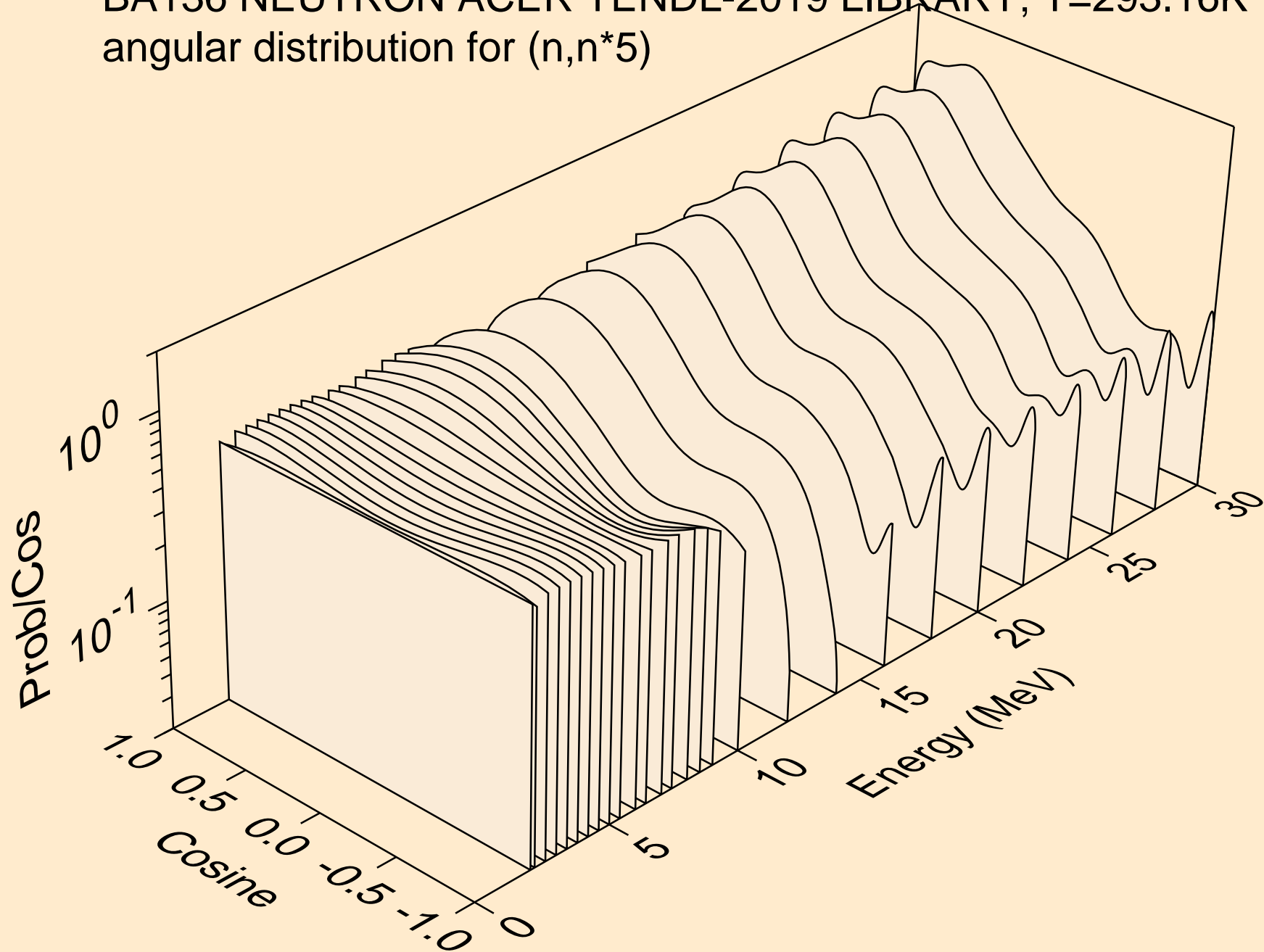

BA136 NEUTRON ACER TENDL-2019 LIBRARY; T=293.16K  
angular distribution for (n,n\*6)

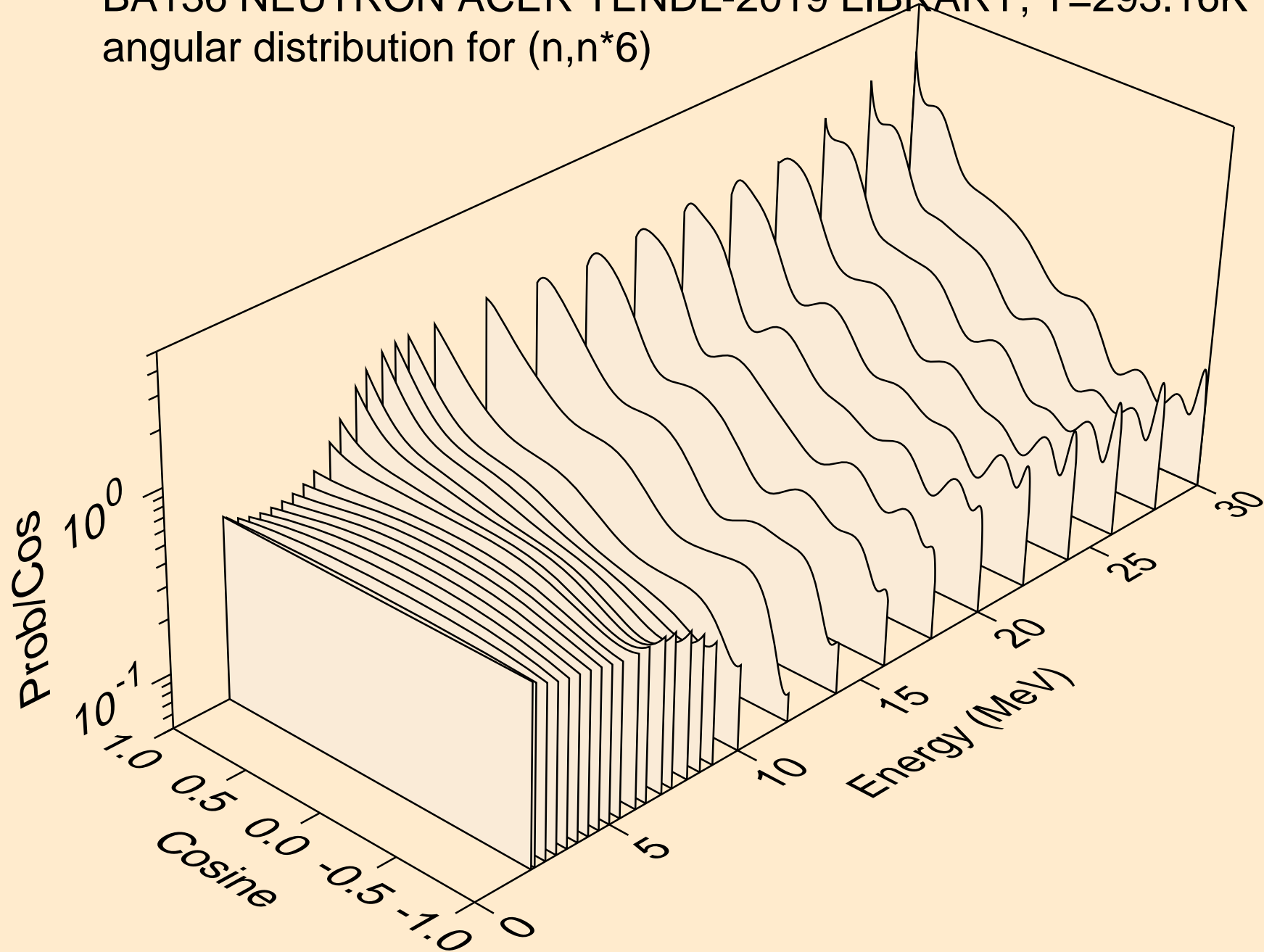

BA136 NEUTRON ACER TENDL-2019 LIBRARY; T=293.16K  
angular distribution for (n,n\*7)

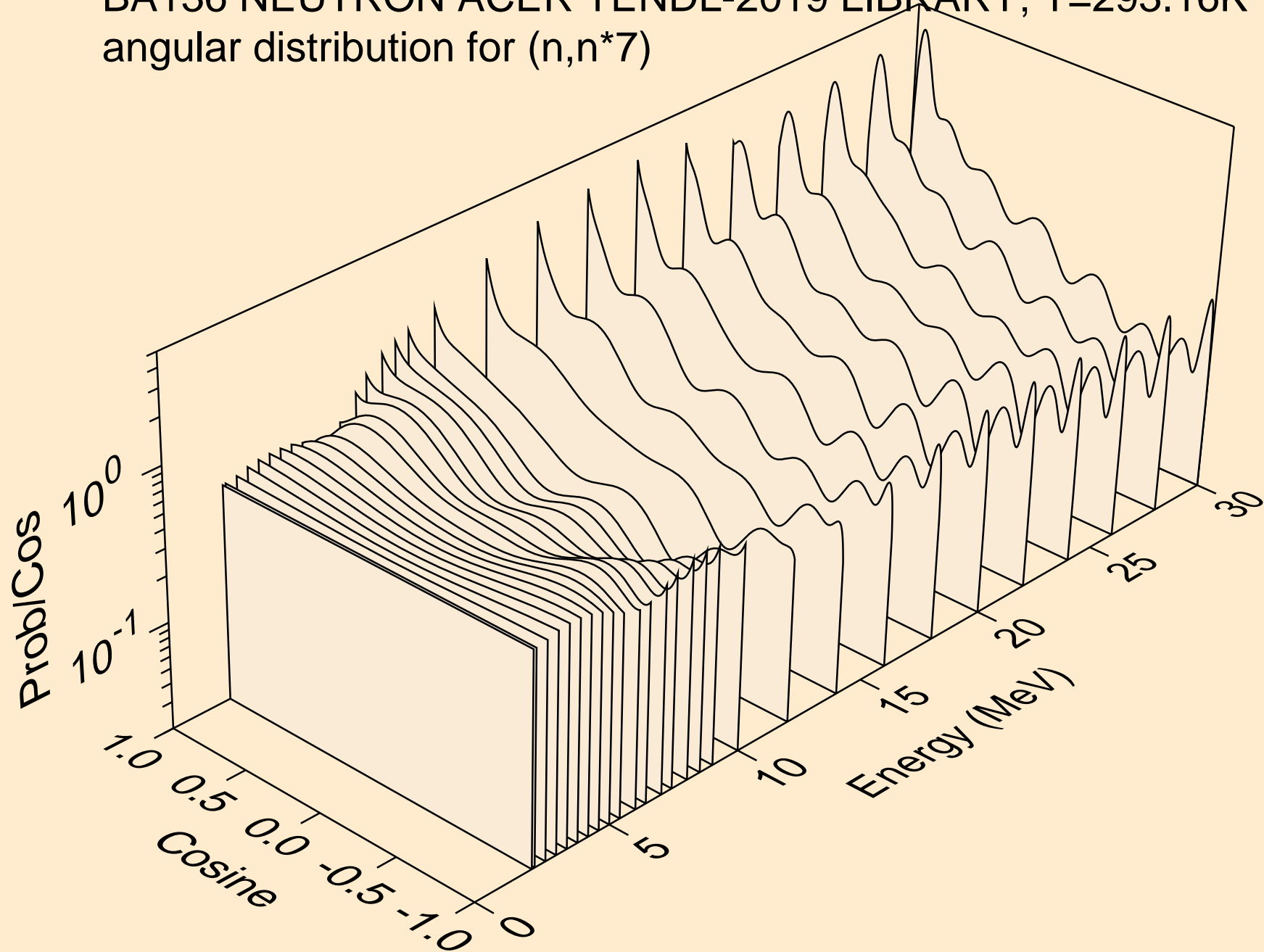

BA136 NEUTRON ACER TENDL-2019 LIBRARY; T=293.16K  
angular distribution for (n,n\*8)

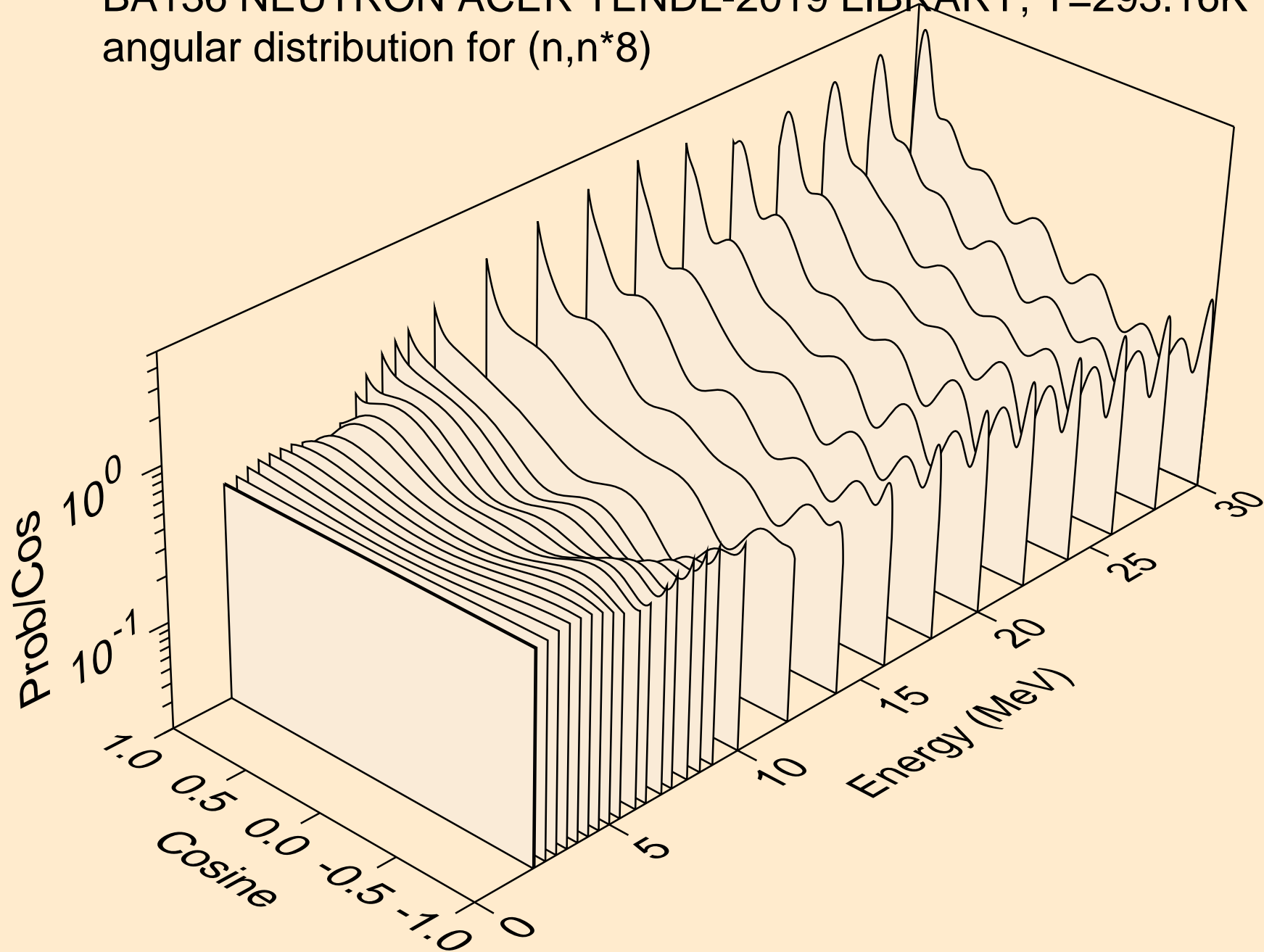

BA136 NEUTRON ACER TENDL-2019 LIBRARY; T=293.16K  
angular distribution for (n,n\*9)

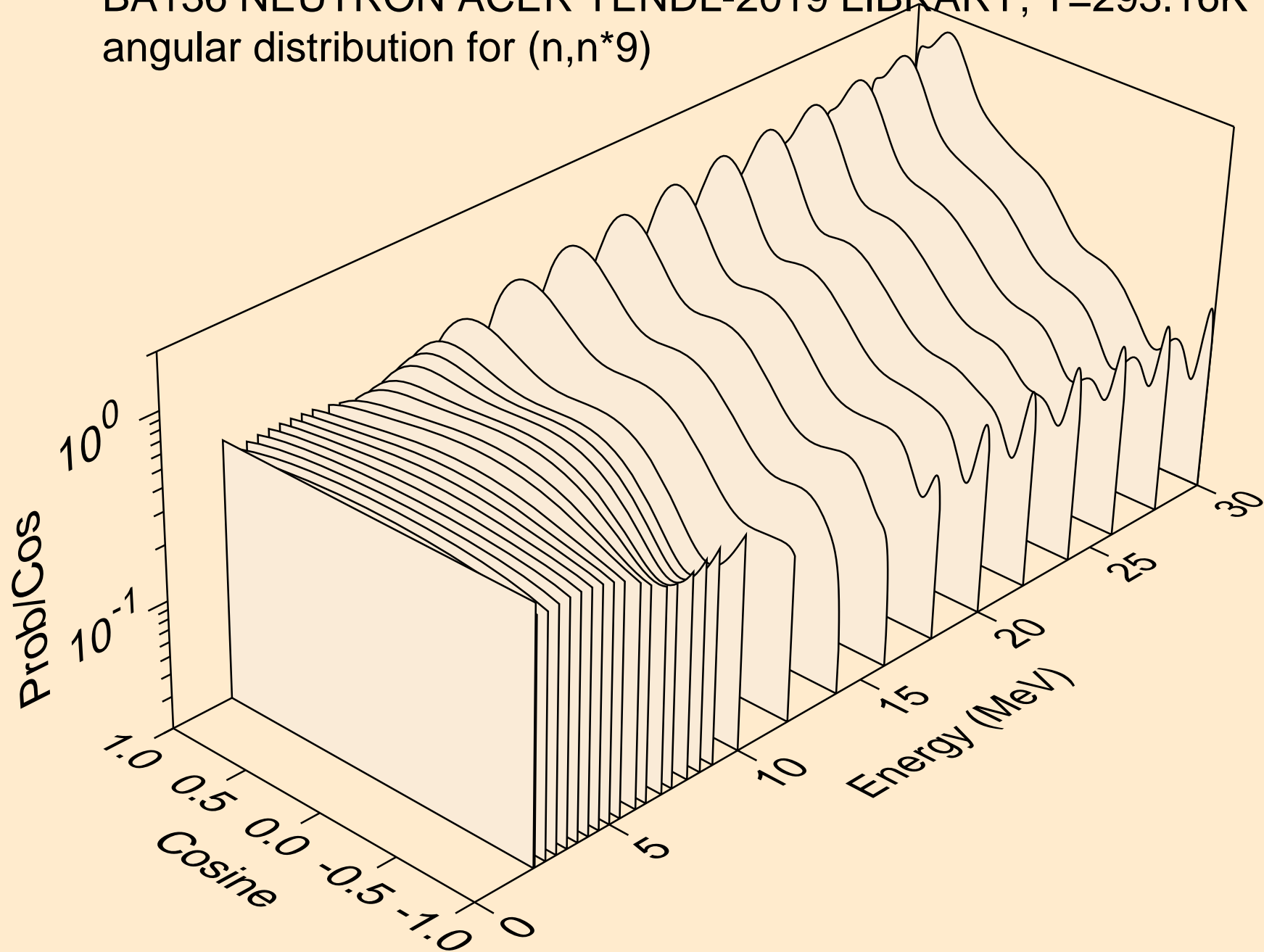



BA136 NEUTRON ACER TENDL-2019 LIBRARY; T=293.16K  
angular distribution for (n,n\*10)

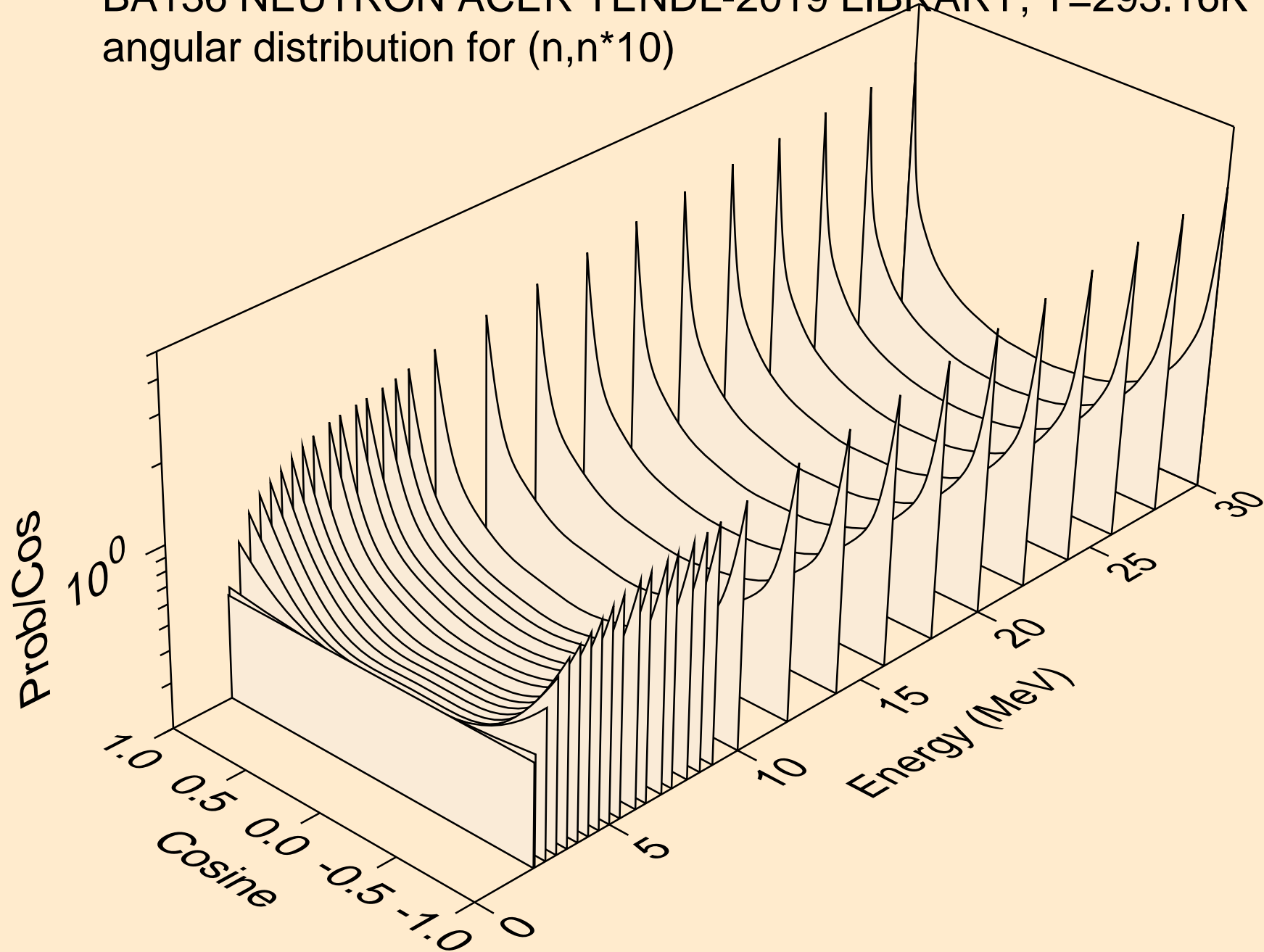

BA136 NEUTRON ACER TENDL-2019 LIBRARY; T=293.16K  
angular distribution for (n,n\*11)

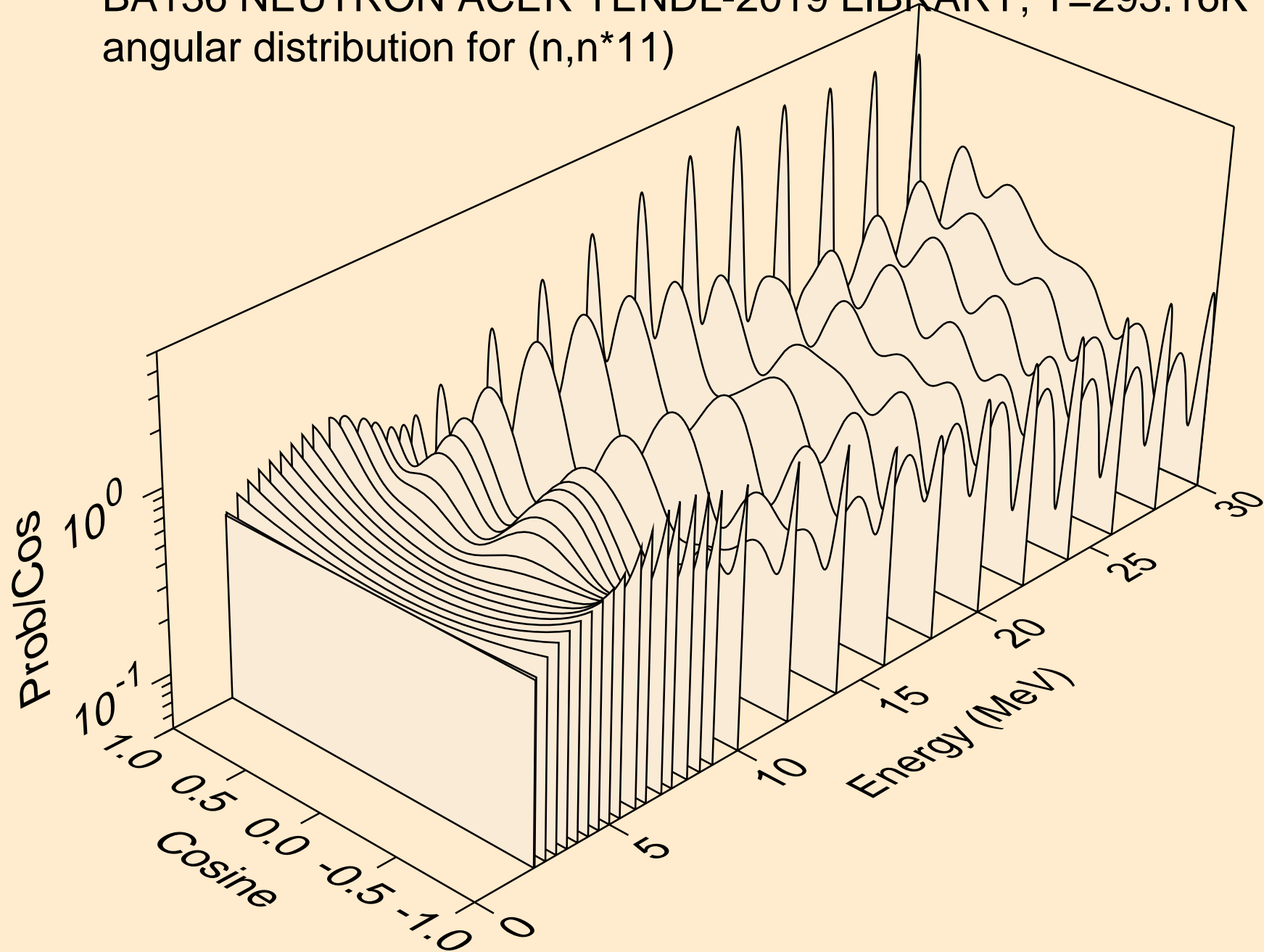

BA136 NEUTRON ACER TENDL-2019 LIBRARY; T=293.16K  
angular distribution for (n,n\*12)

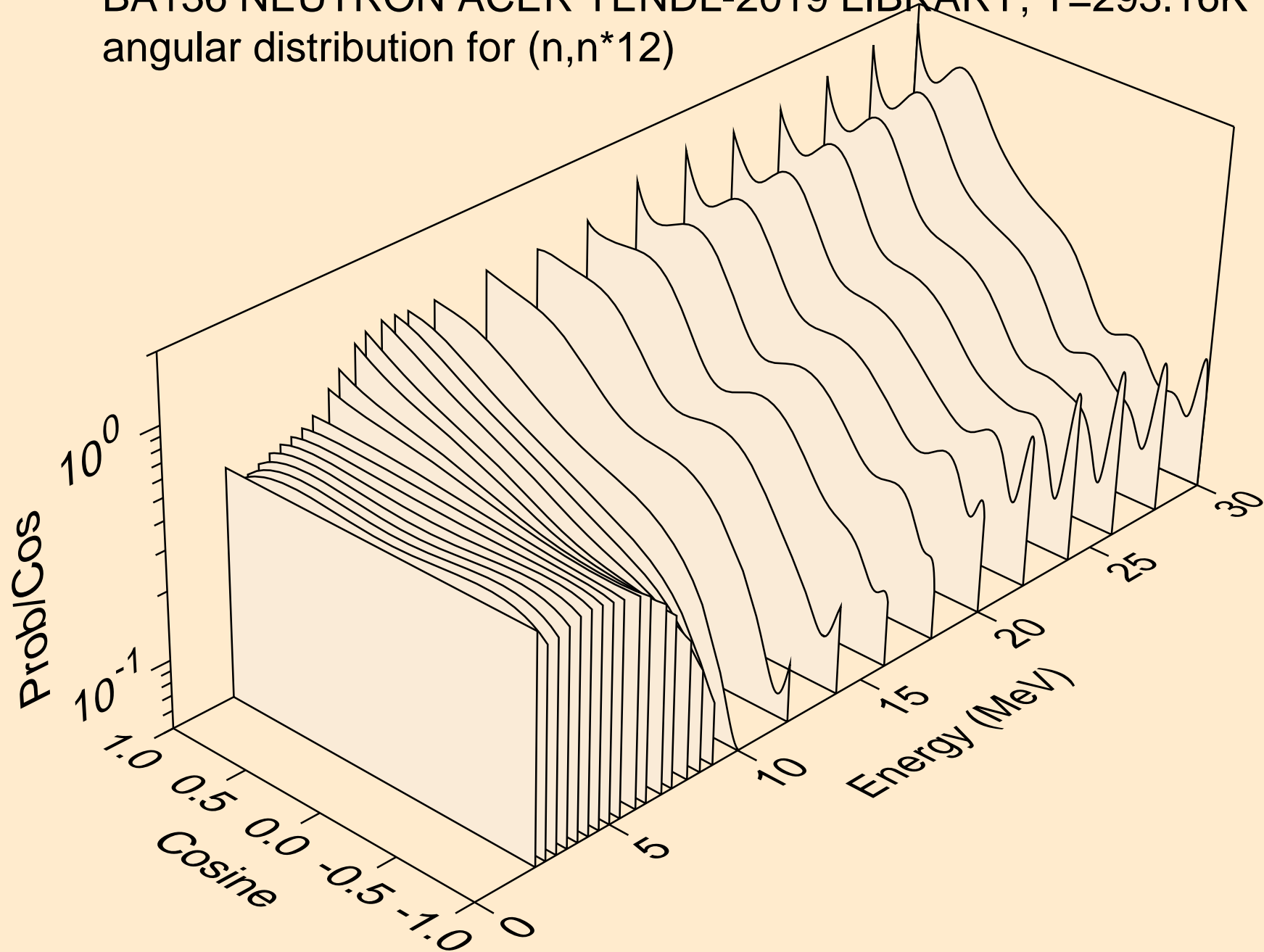

BA136 NEUTRON ACER TENDL-2019 LIBRARY; T=293.16K  
angular distribution for (n,n\*13)

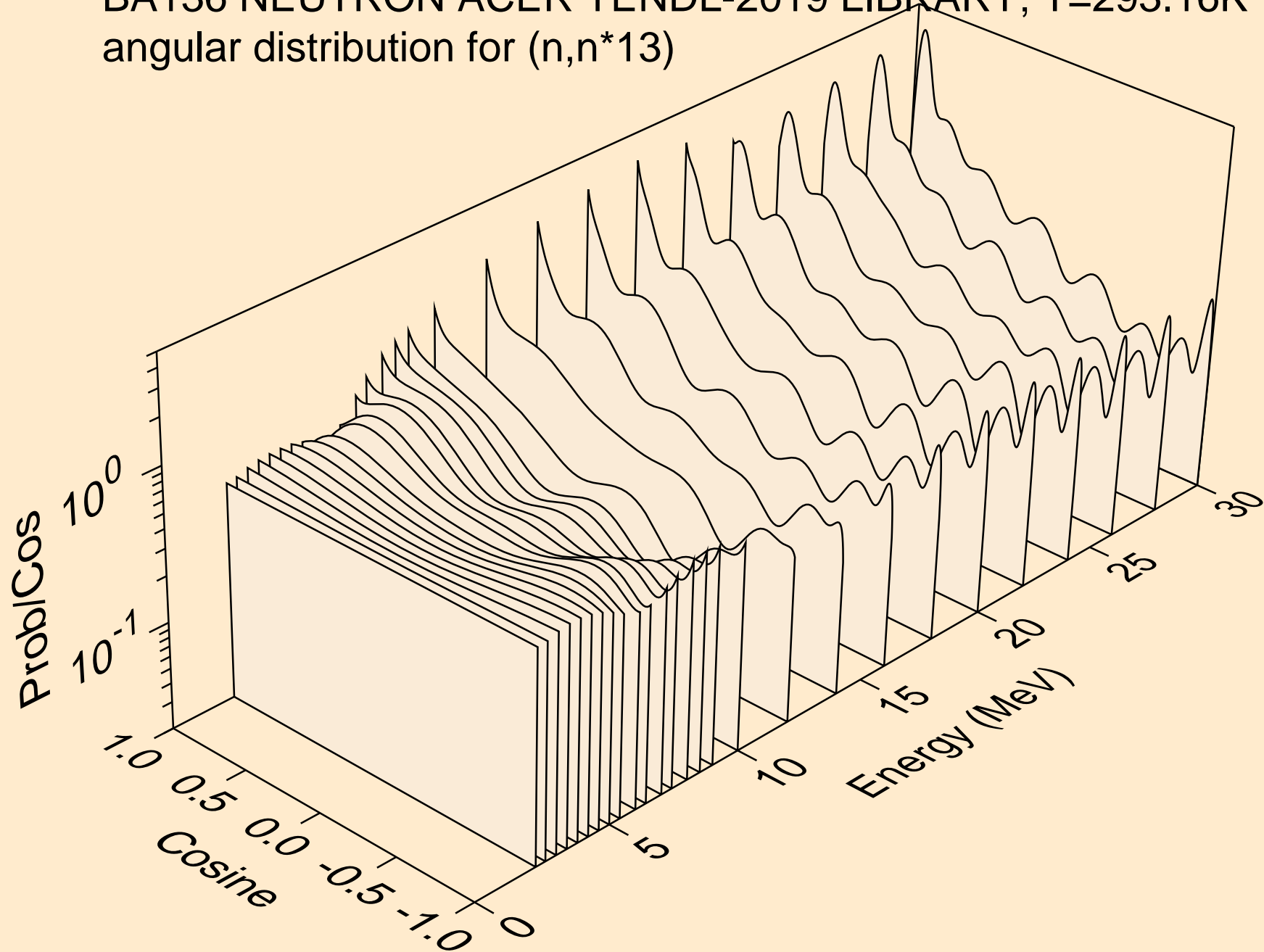

BA136 NEUTRON ACER TENDL-2019 LIBRARY; T=293.16K  
angular distribution for (n,n\*14)

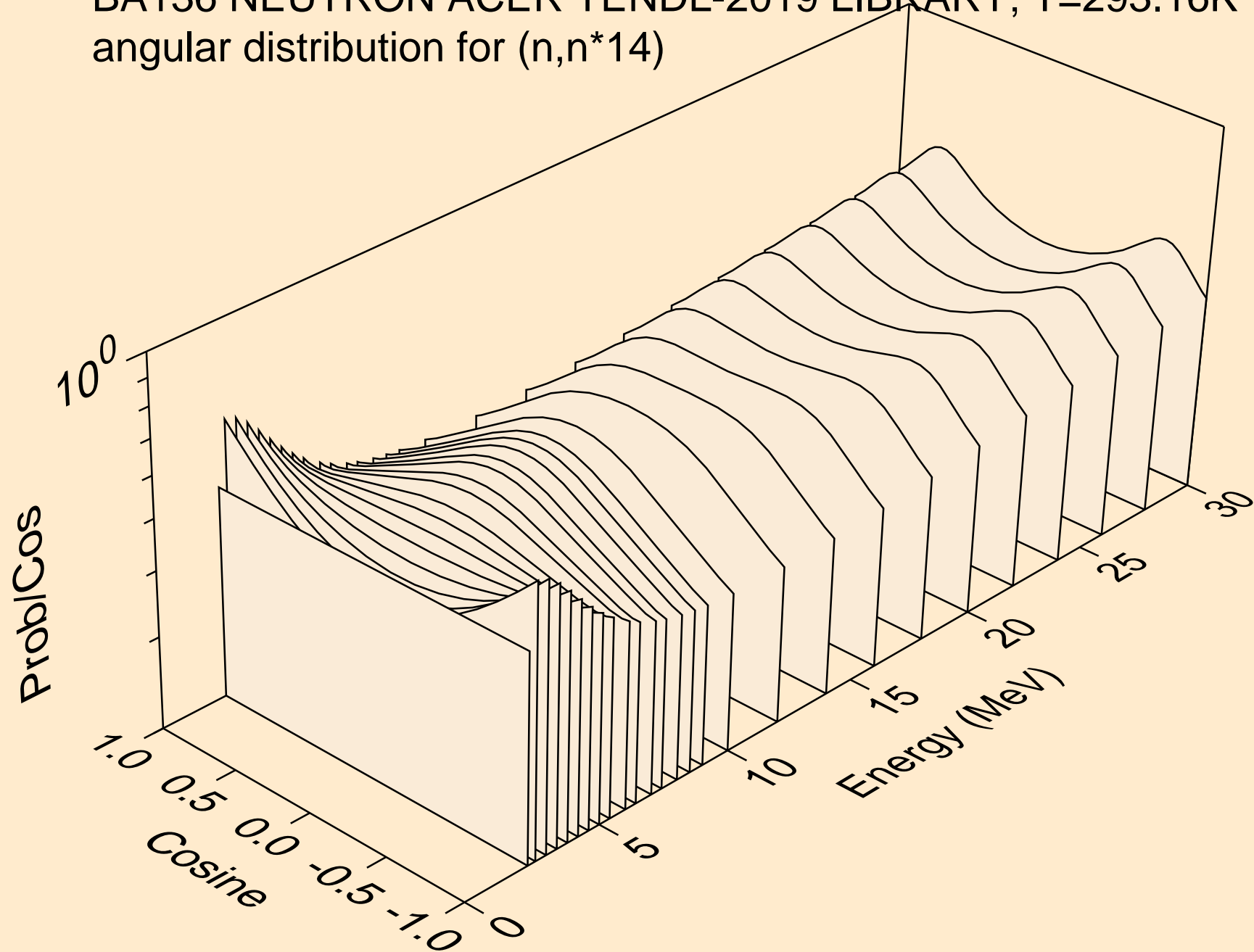

BA136 NEUTRON ACER TENDL-2019 LIBRARY; T=293.16K  
angular distribution for (n,n\*15)

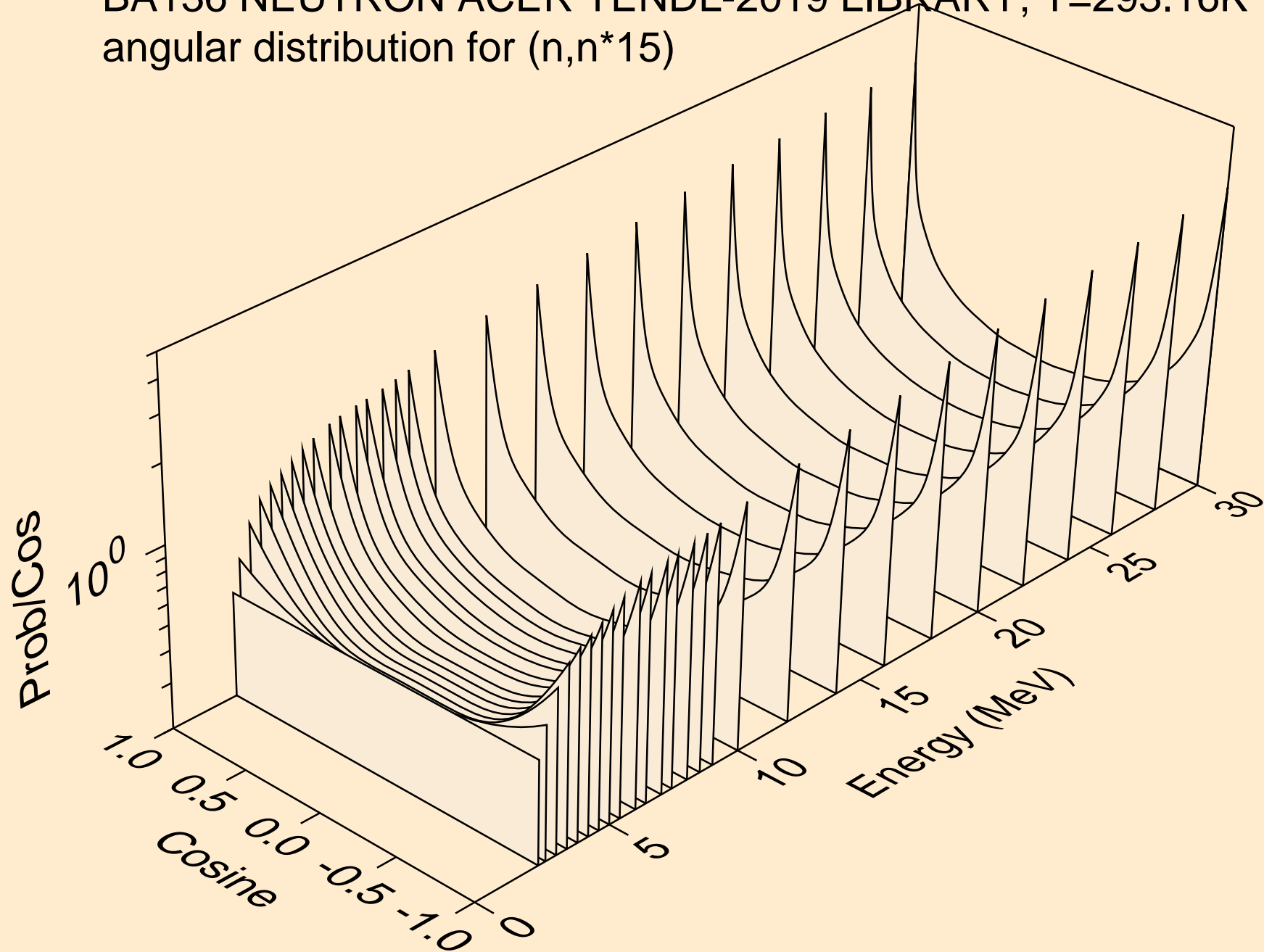

BA136 NEUTRON ACER TENDL-2019 LIBRARY; T=293.16K  
angular distribution for (n,n\*16)

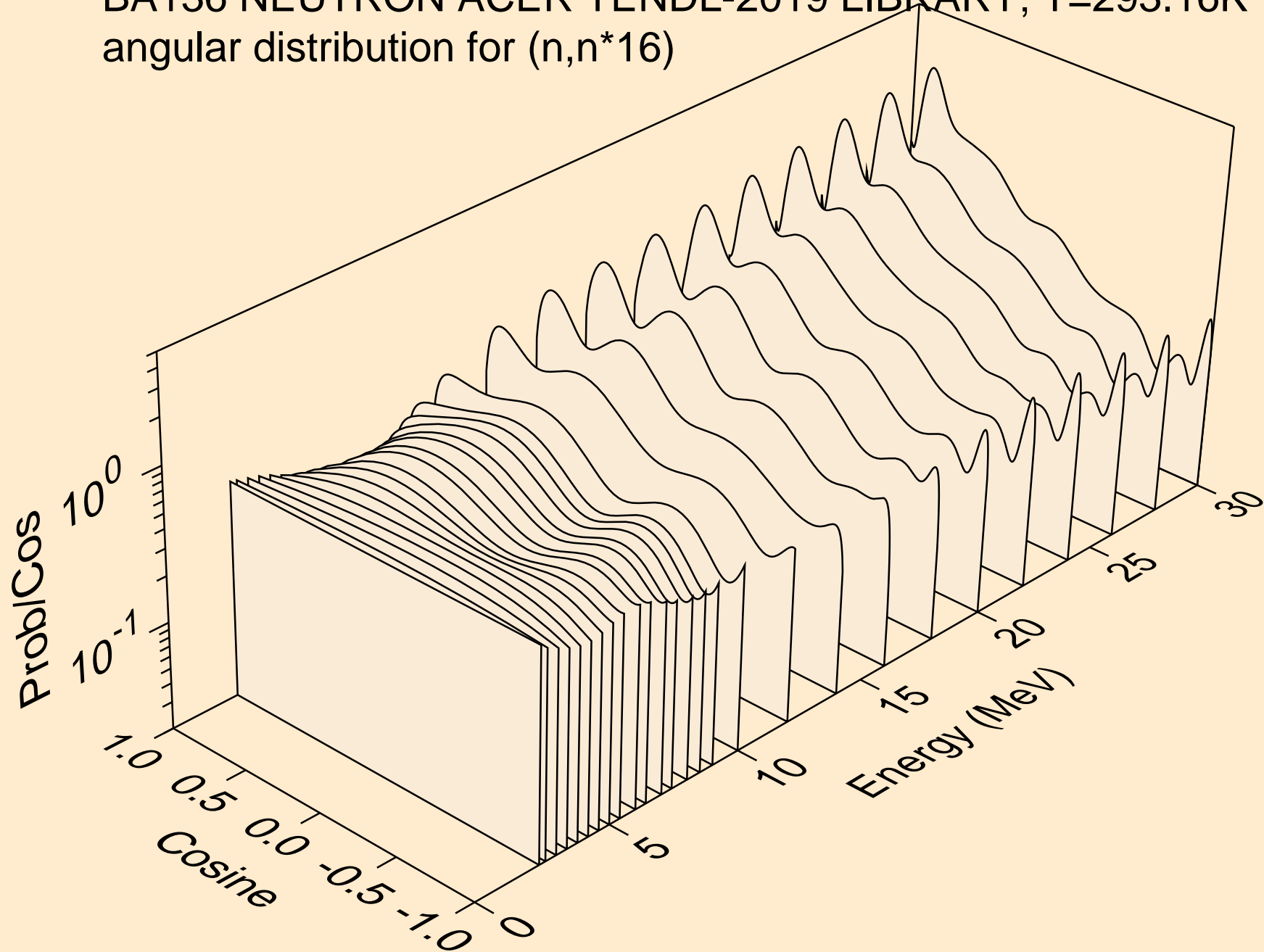

BA136 NEUTRON ACER TENDL-2019 LIBRARY; T=293.16K  
angular distribution for (n,n\*17)

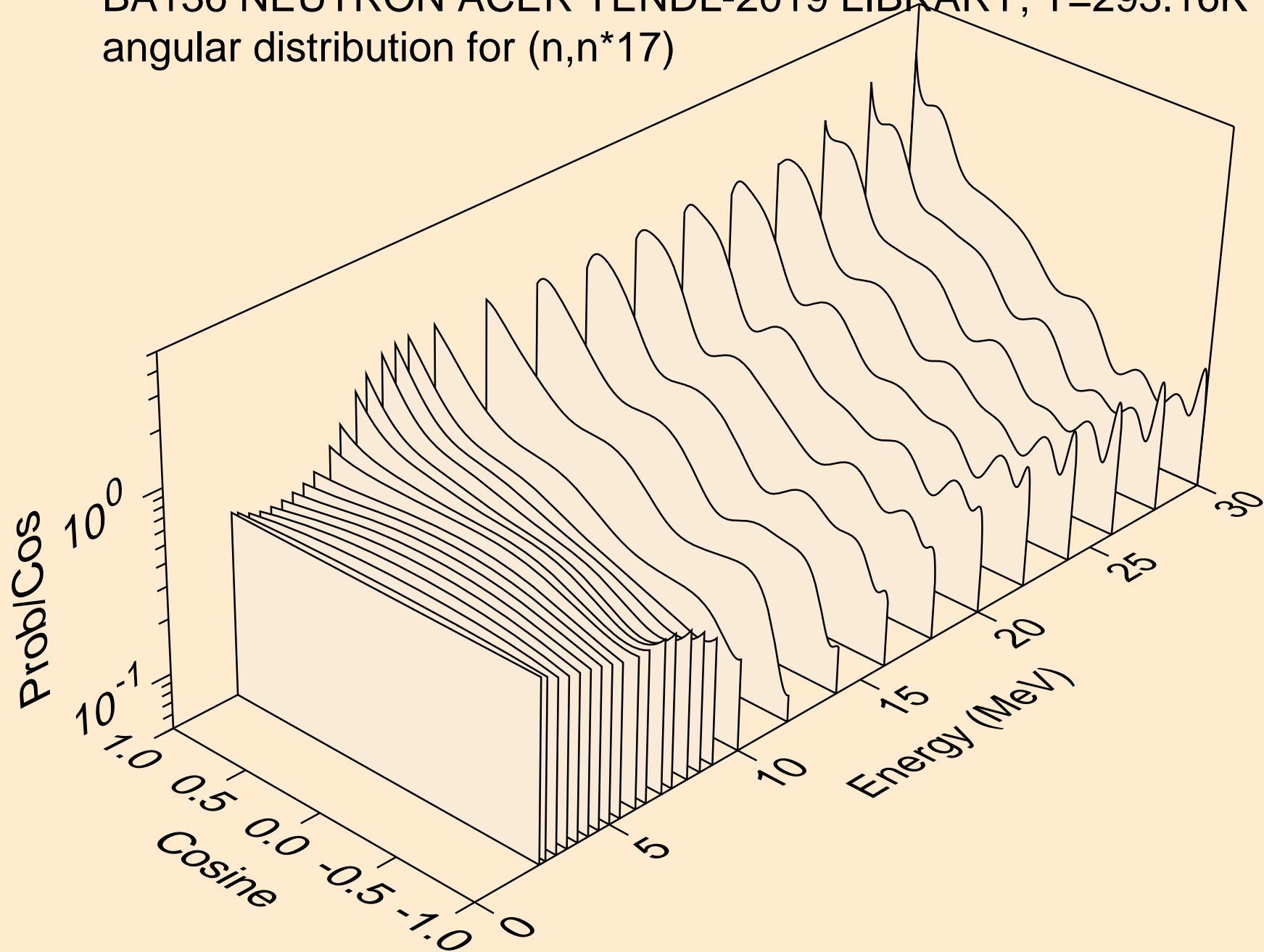



BA136 NEUTRON ACER TENDL-2019 LIBRARY; T=293.16K  
angular distribution for (n,n\*18)

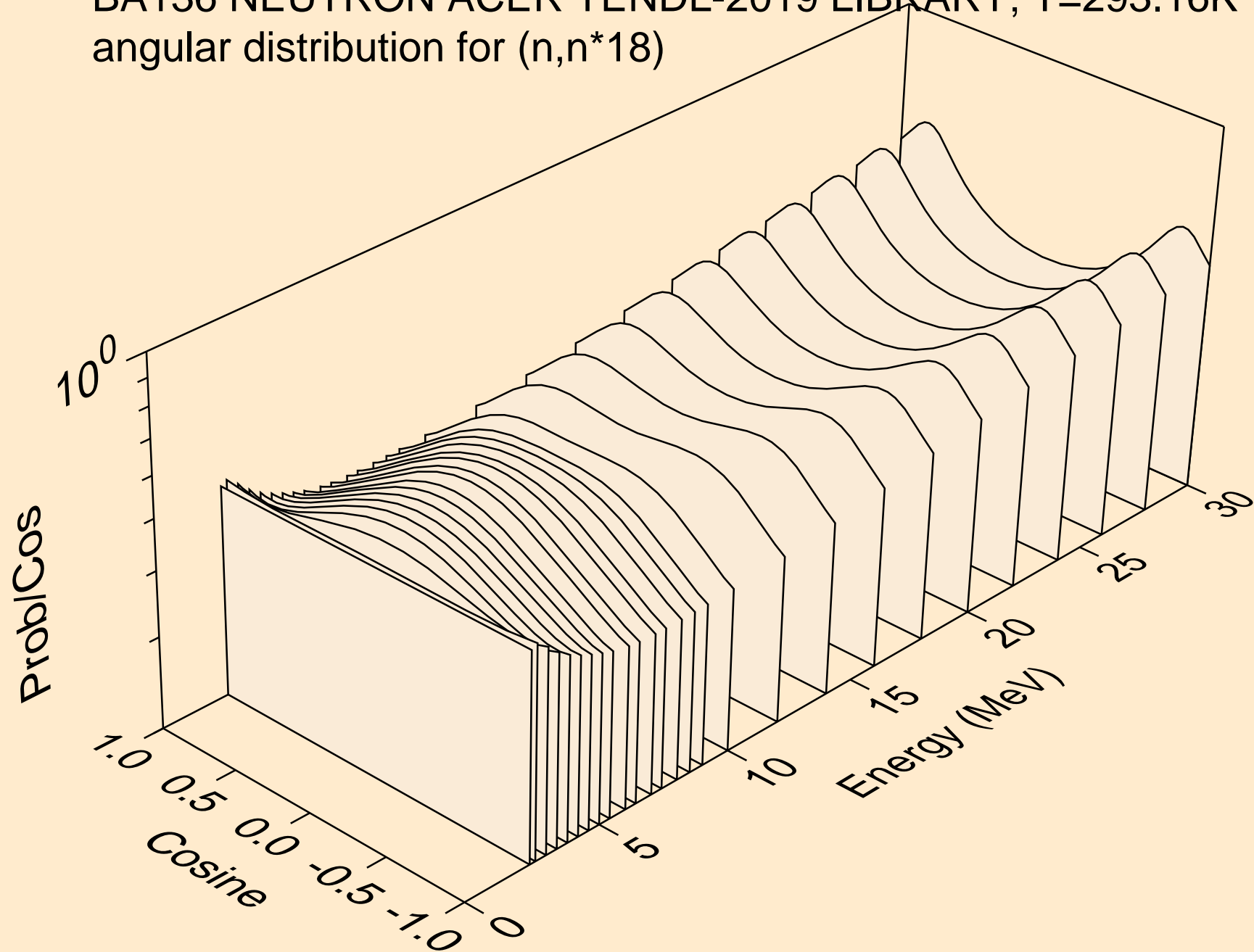

BA136 NEUTRON ACER TENDL-2019 LIBRARY; T=293.16K  
angular distribution for (n,n\*19)

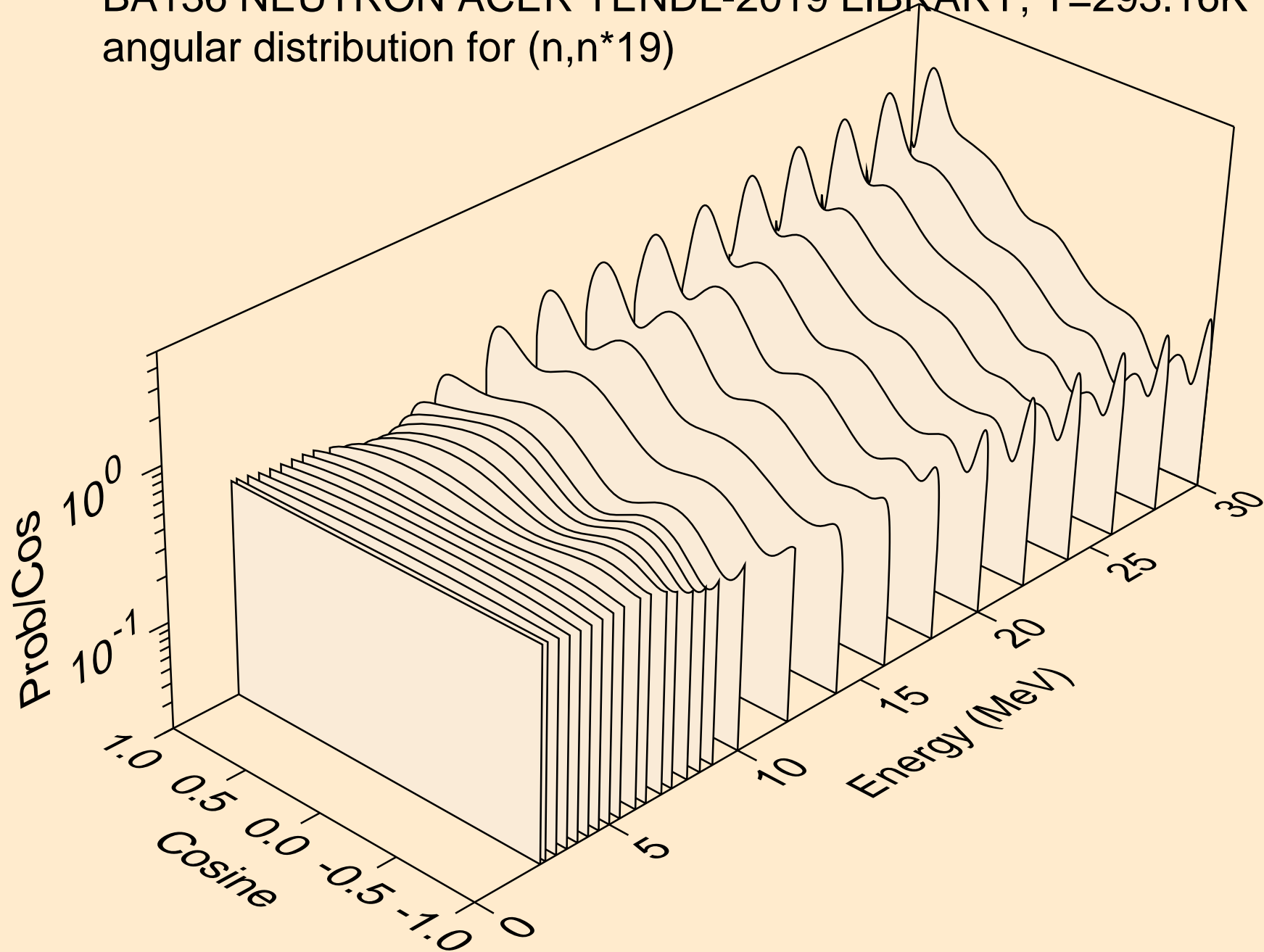

BA136 NEUTRON ACER TENDL-2019 LIBRARY; T=293.16K  
angular distribution for (n,n\*20)

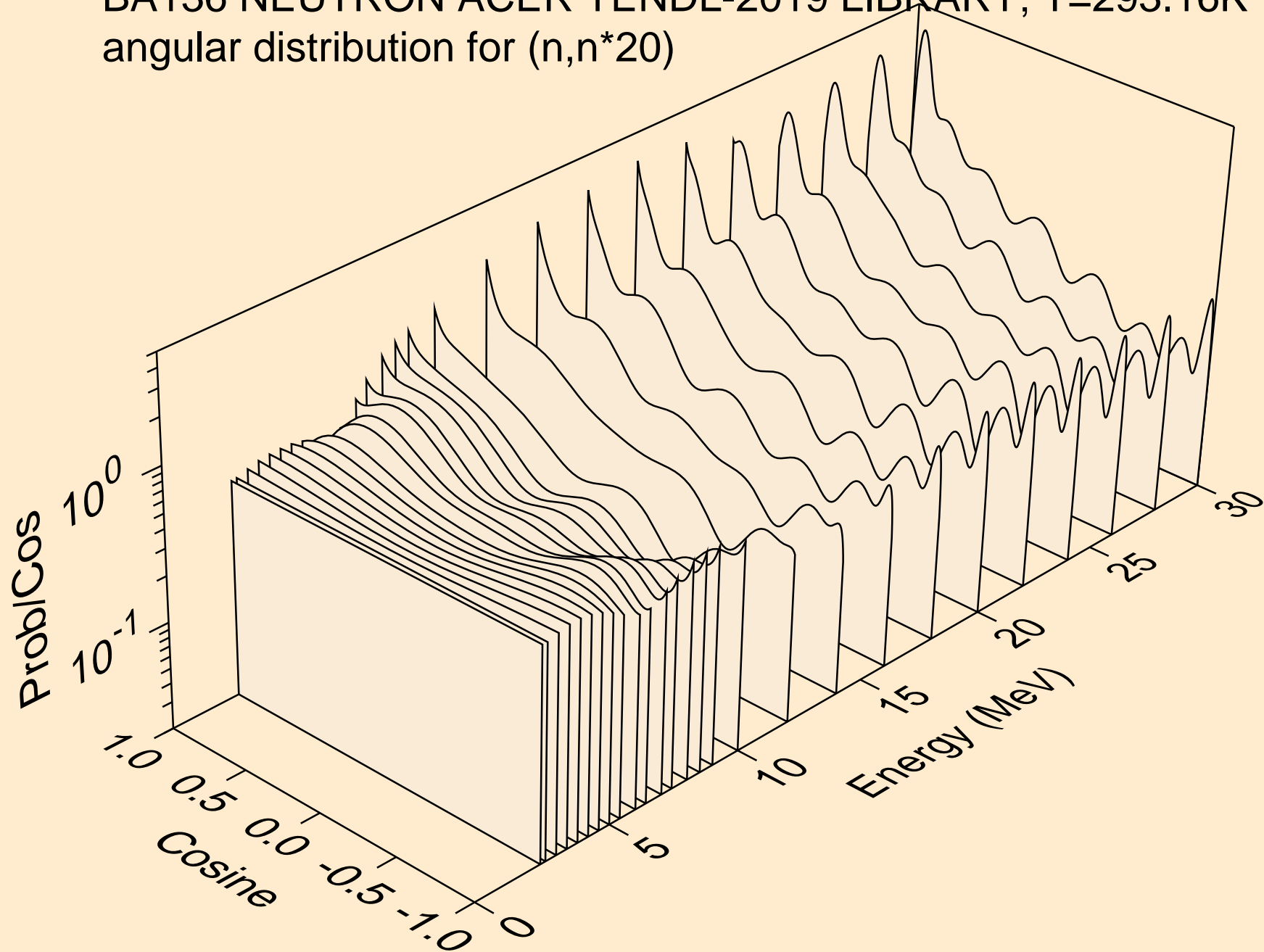

BA136 NEUTRON ACER TENDL-2019 LIBRARY; T=293.16K  
angular distribution for (n,n\*21)

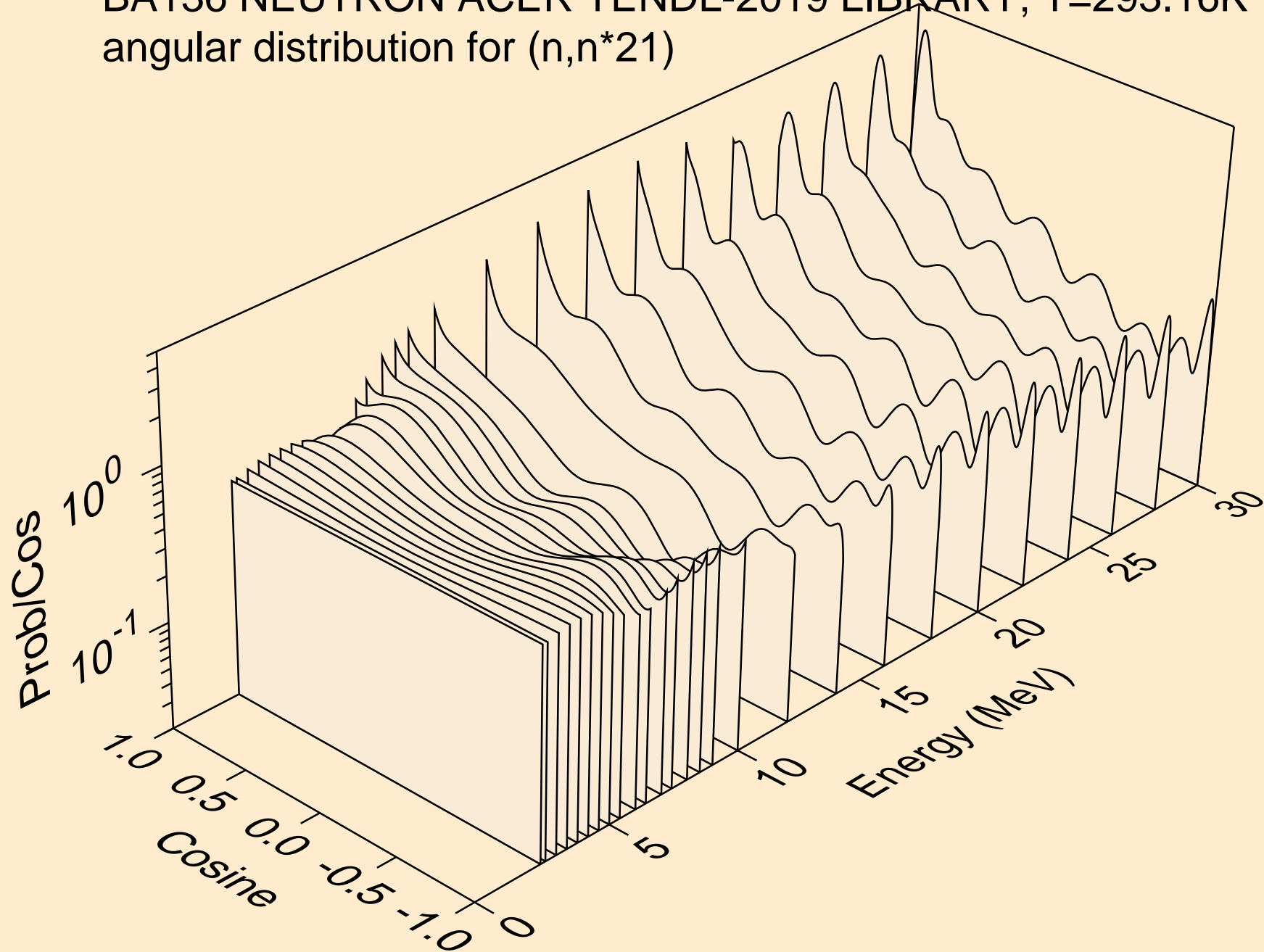

BA136 NEUTRON ACER TENDL-2019 LIBRARY; T=293.16K  
angular distribution for (n,n\*22)

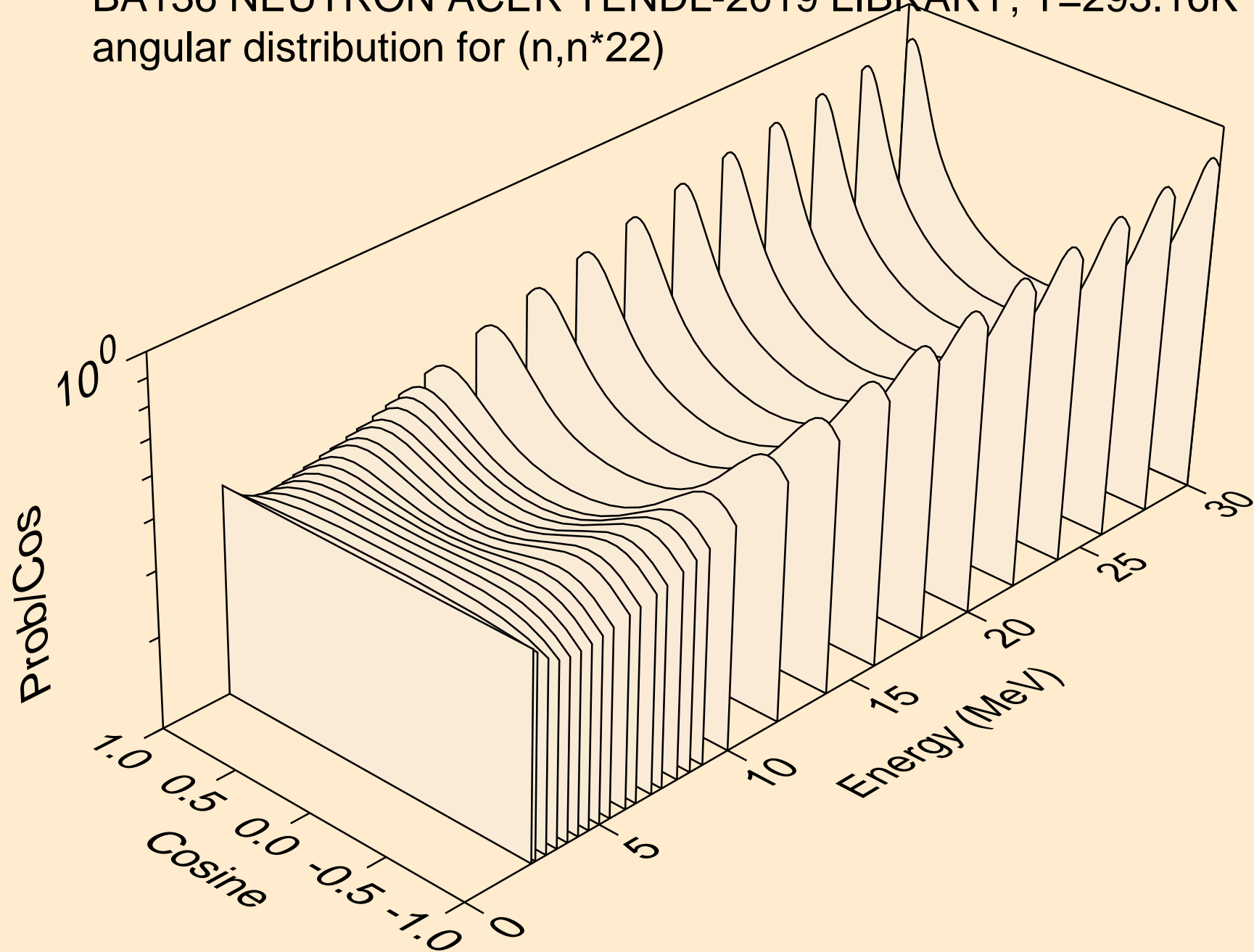

BA136 NEUTRON ACER TENDL-2019 LIBRARY; T=293.16K  
angular distribution for (n,n\*23)

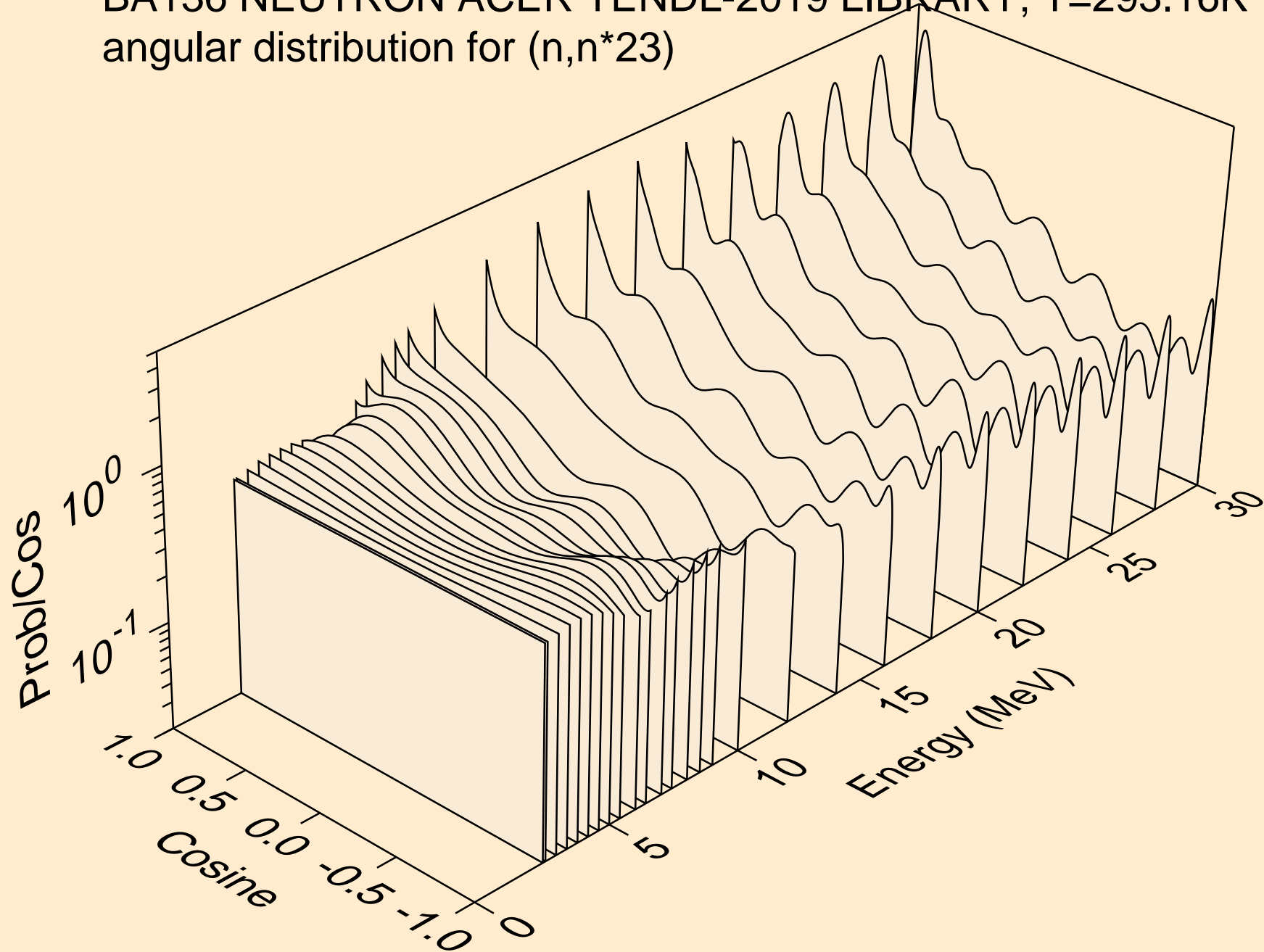

BA136 NEUTRON ACER TENDL-2019 LIBRARY; T=293.16K  
angular distribution for (n,n\*24)

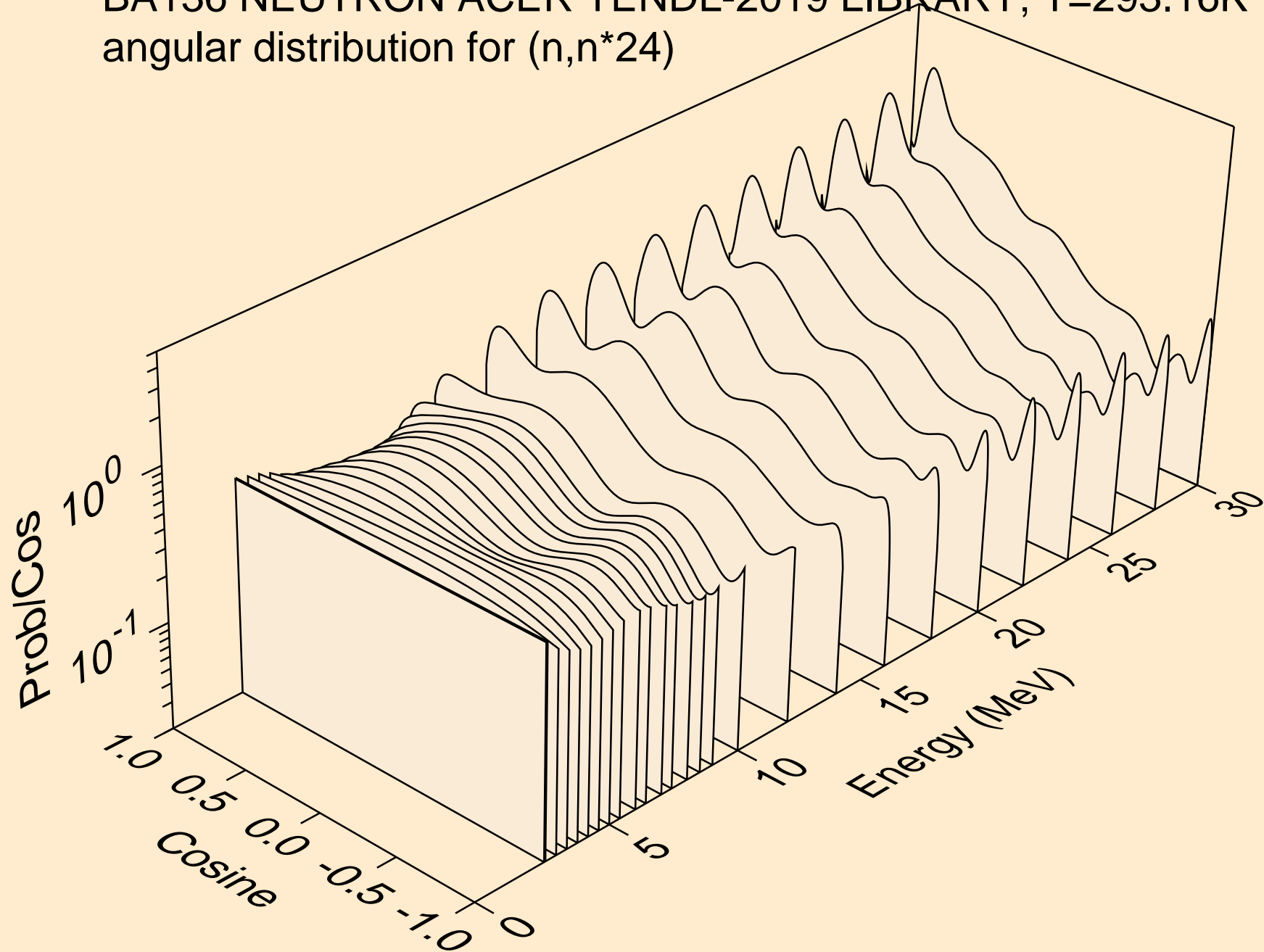

BA136 NEUTRON ACER TENDL-2019 LIBRARY; T=293.16K  
angular distribution for (n,n\*25)

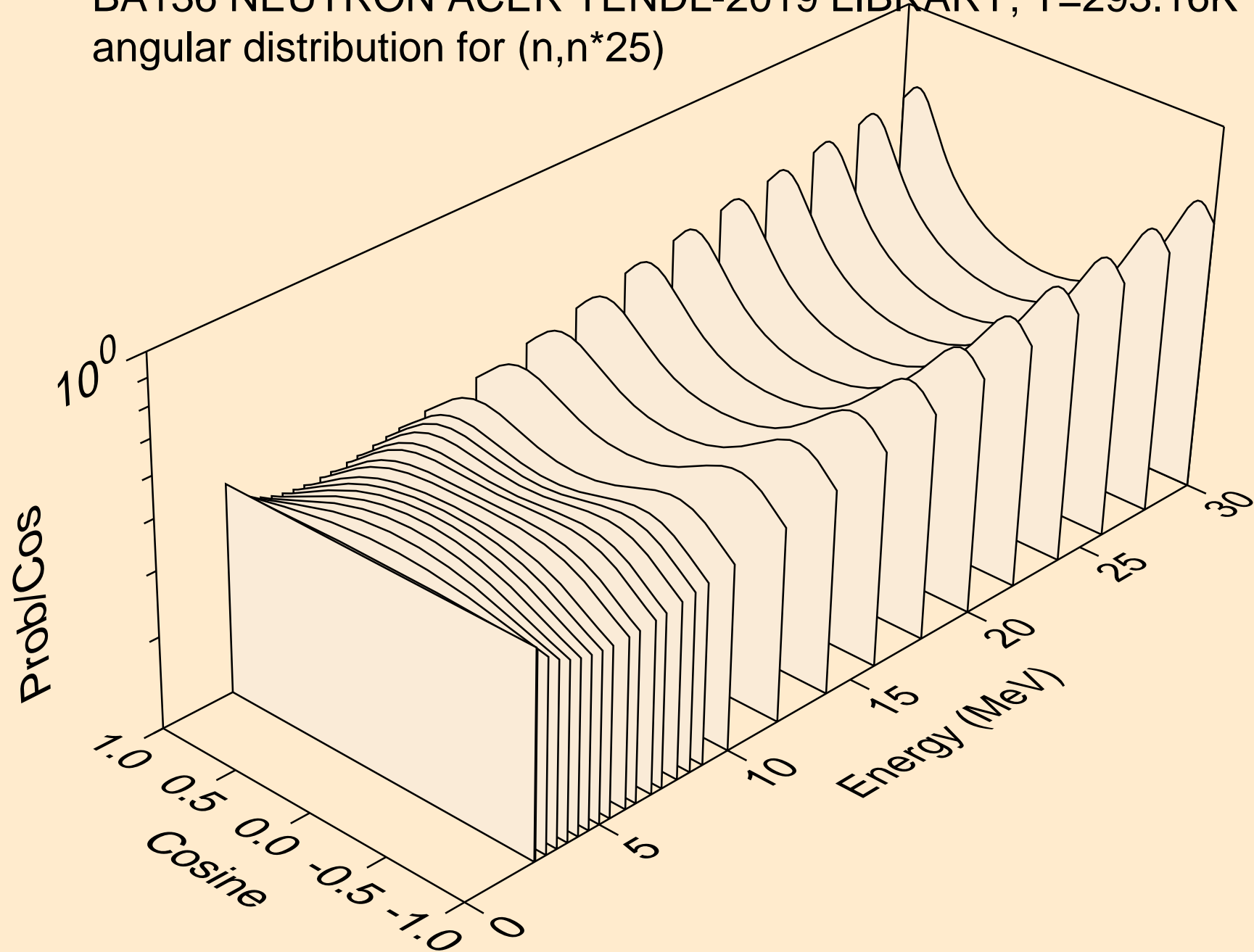



BA136 NEUTRON ACER TENDL-2019 LIBRARY; T=293.16K  
angular distribution for (n,n\*26)

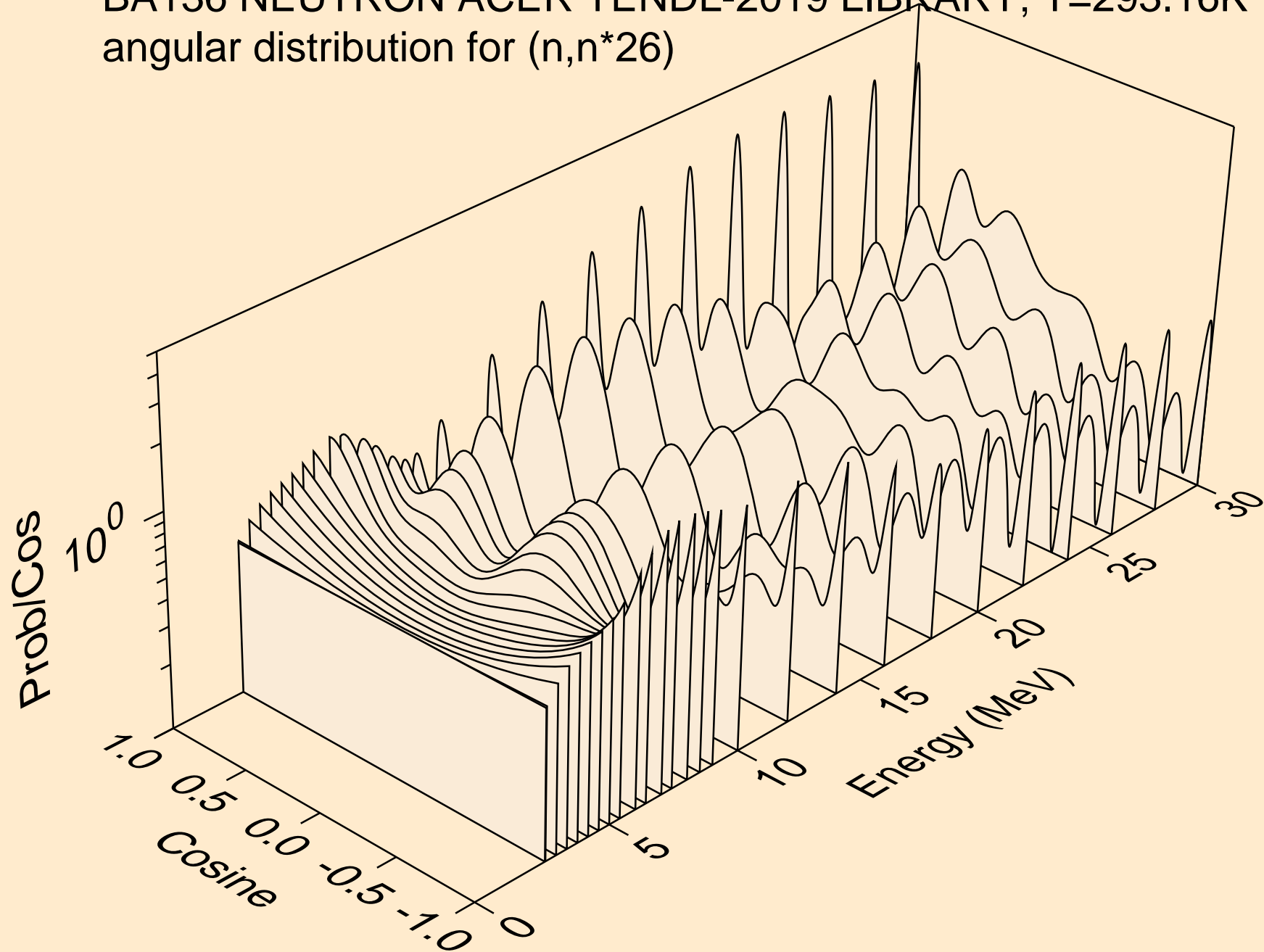

BA136 NEUTRON ACER TENDL-2019 LIBRARY; T=293.16K  
angular distribution for (n,n\*27)

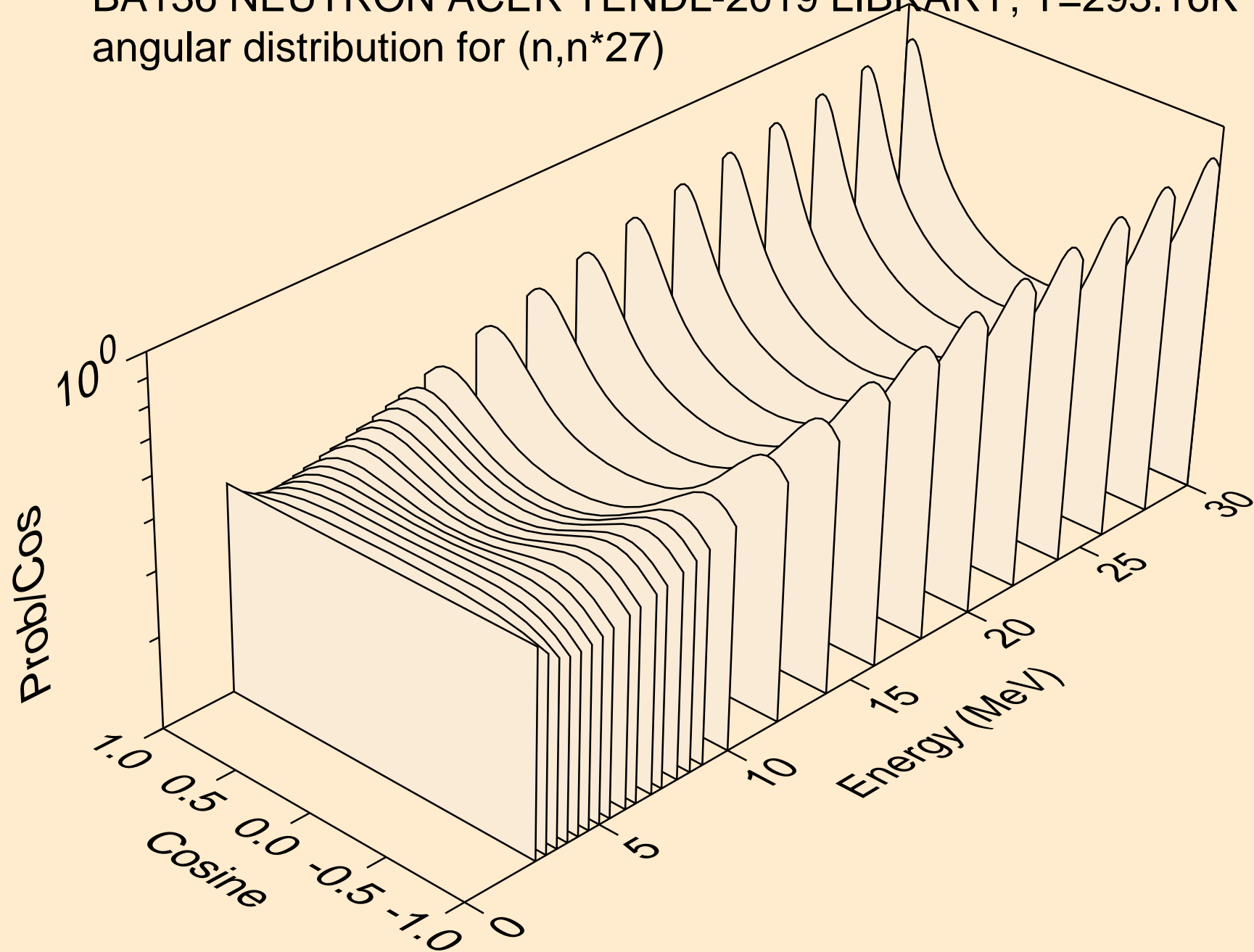

BA136 NEUTRON ACER TENDL-2019 LIBRARY; T=293.16K  
angular distribution for (n,n\*28)

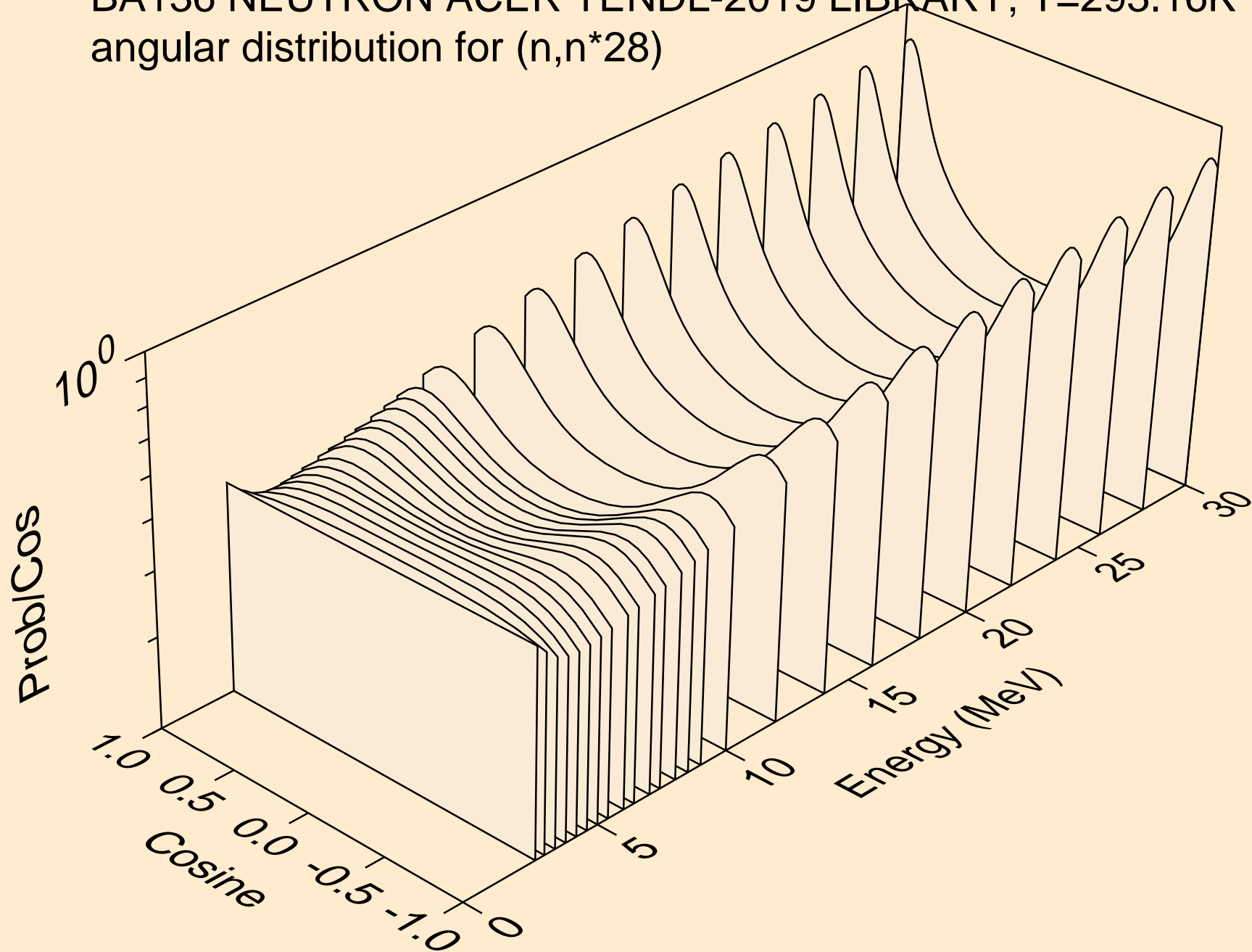

BA136 NEUTRON ACER TENDL-2019 LIBRARY; T=293.16K  
angular distribution for (n,n\*29)

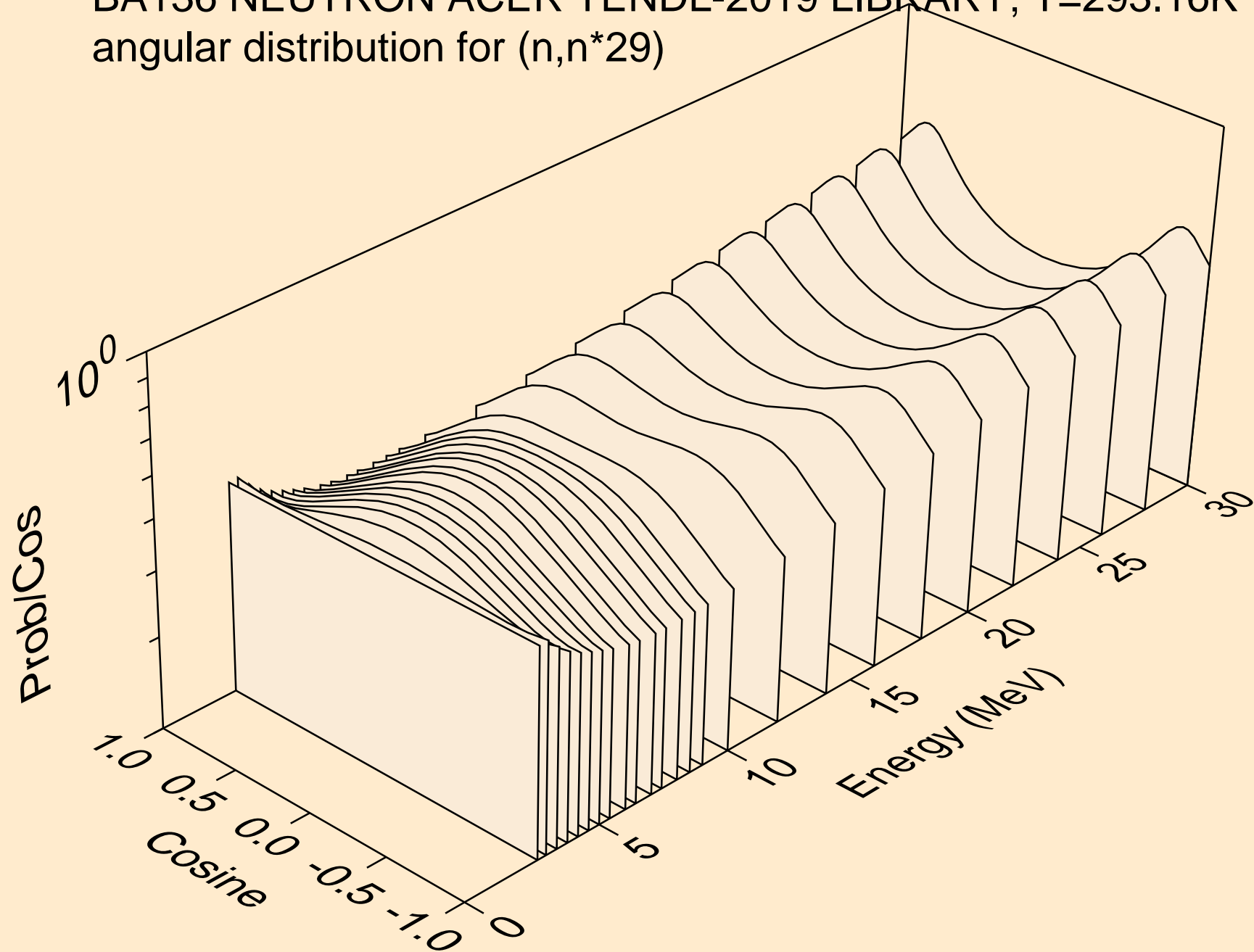

BA136 NEUTRON ACER TENDL-2019 LIBRARY; T=293.16K  
angular distribution for (n,n\*30)

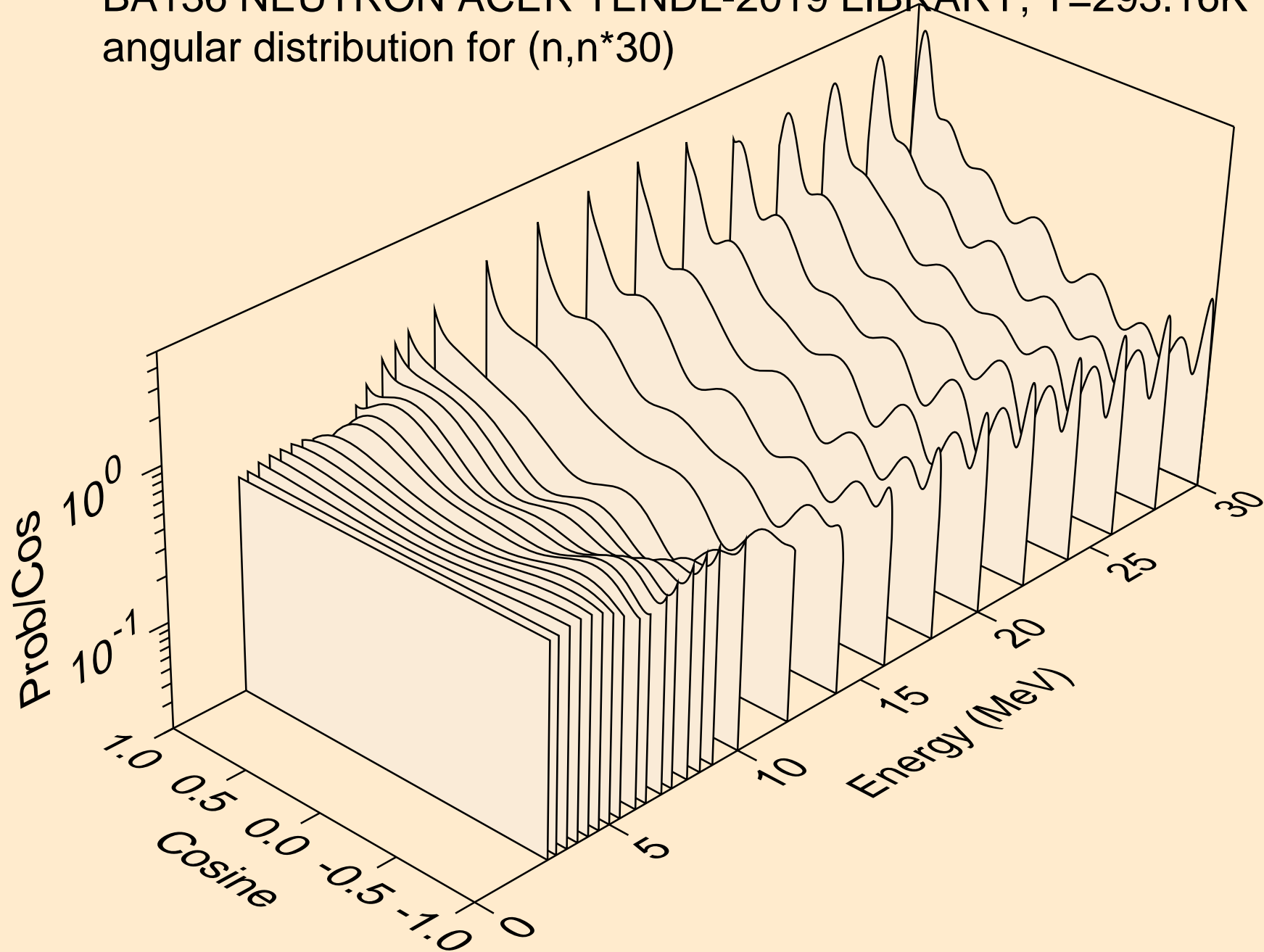

BA136 NEUTRON ACER TENDL-2019 LIBRARY; T=293.16K  
Neutron emission for (n,x)

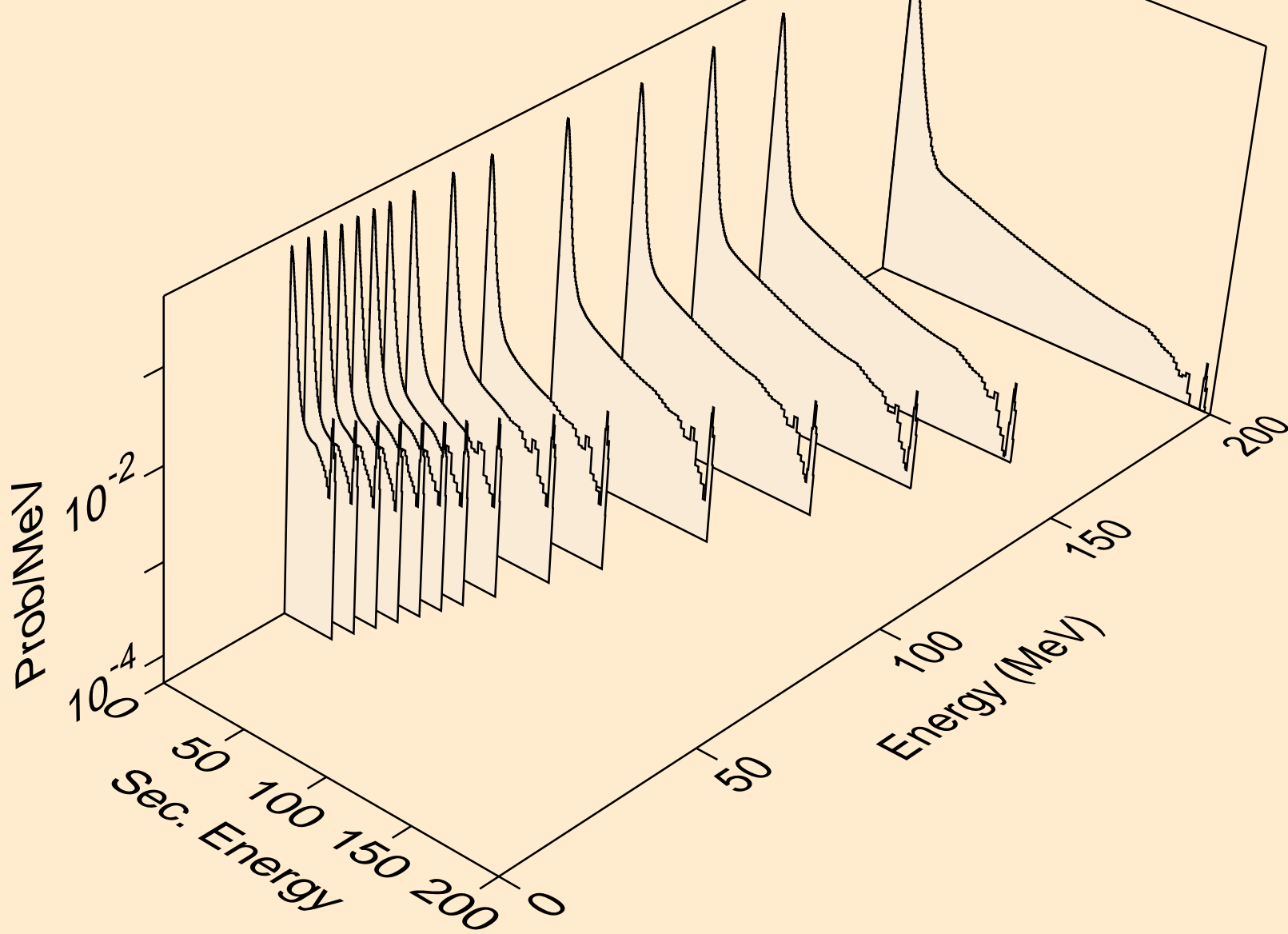

BA136 NEUTRON ACER TENDL-2019 LIBRARY; T=293.16K  
Neutron emission for (n,2nd)

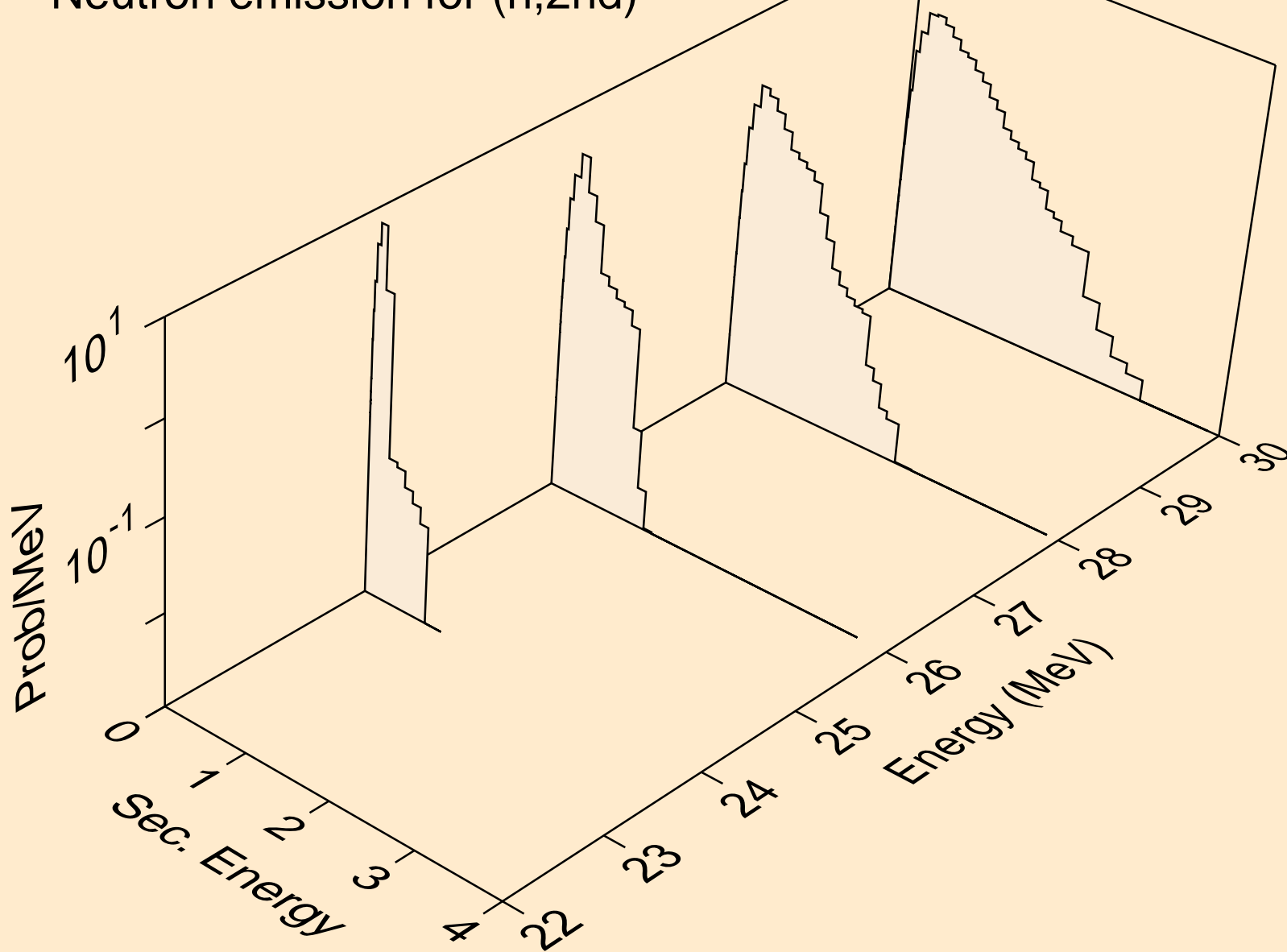

BA136 NEUTRON ACER TENDL-2019 LIBRARY; T=293.16K  
Neutron emission for (n,2n)

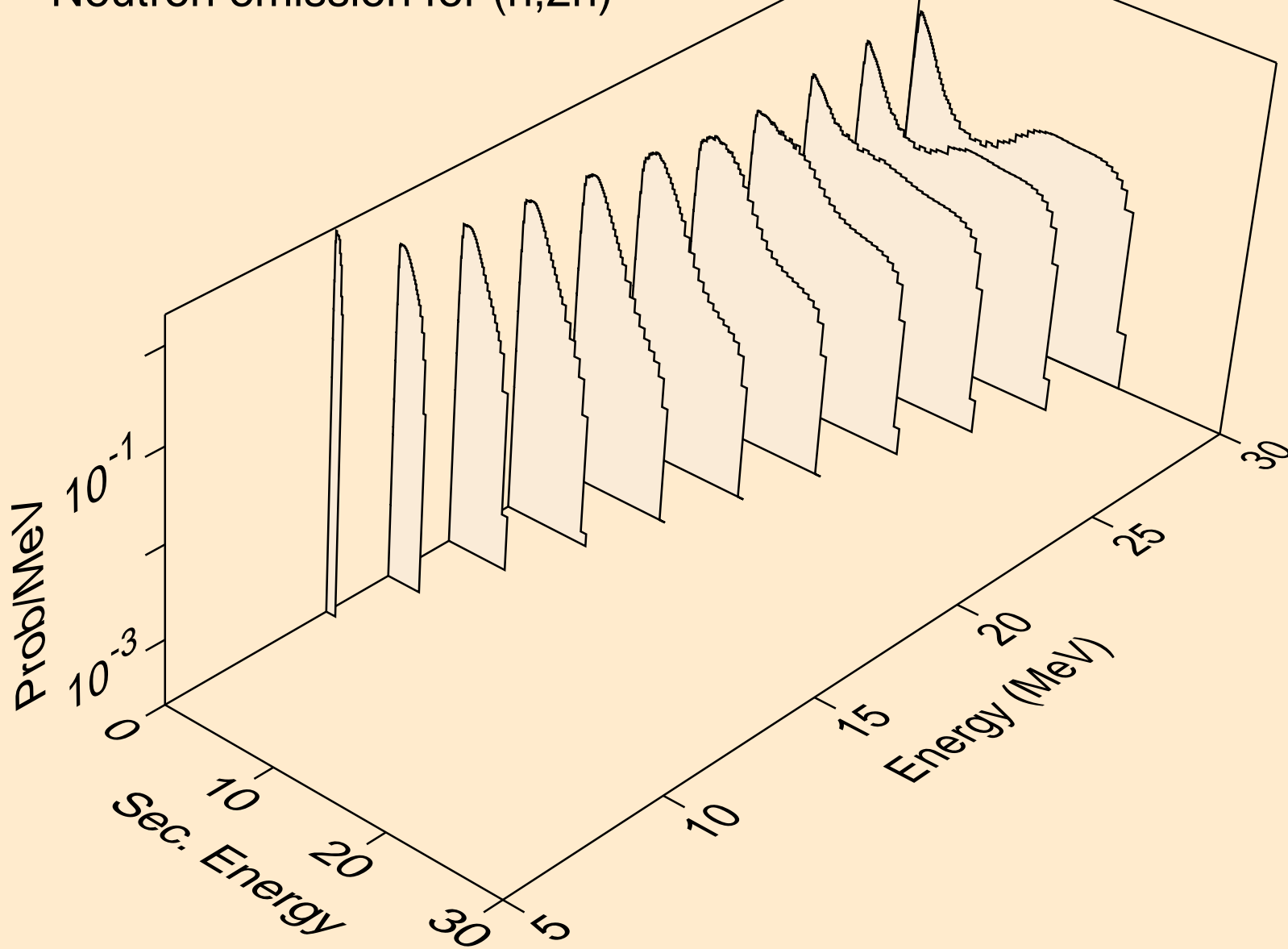



BA136 NEUTRON ACER TENDL-2019 LIBRARY; T=293.16K  
Neutron emission for (n,3n)

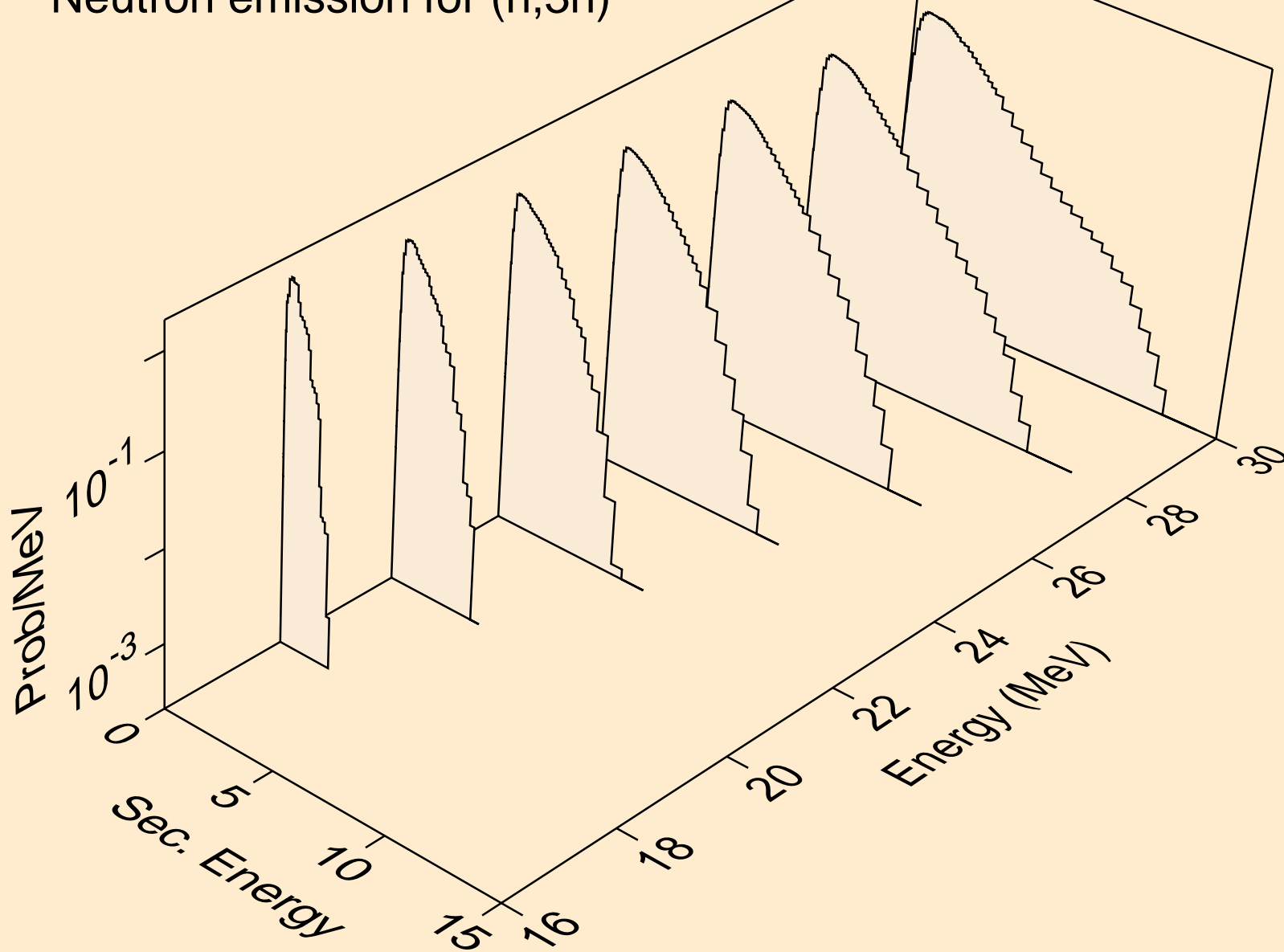

BA136 NEUTRON ACER TENDL-2019 LIBRARY; T=293.16K  
Neutron emission for (n,n\*)a

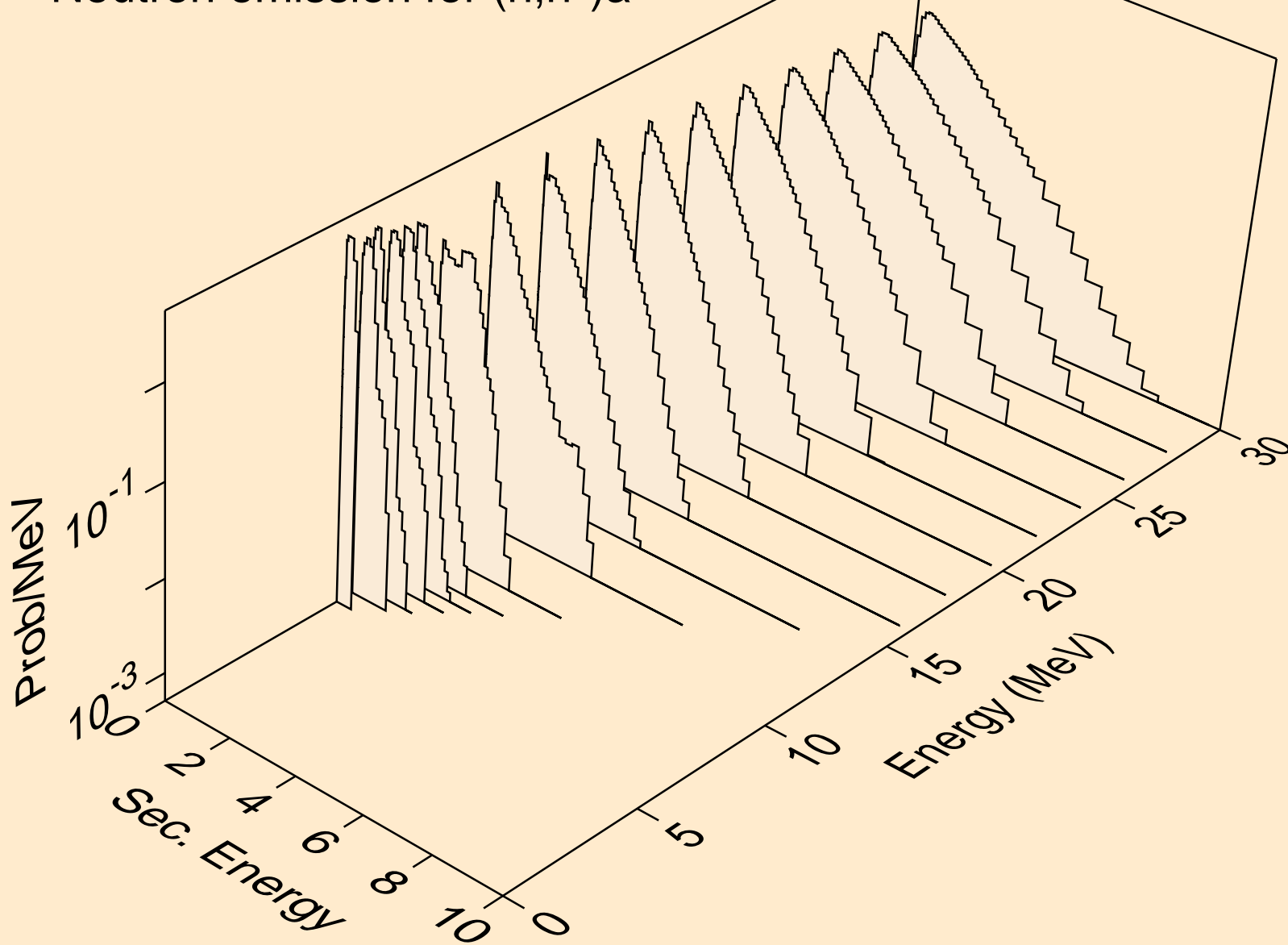

BA136 NEUTRON ACER TENDL-2019 LIBRARY; T=293.16K  
Neutron emission for (n,2n)a

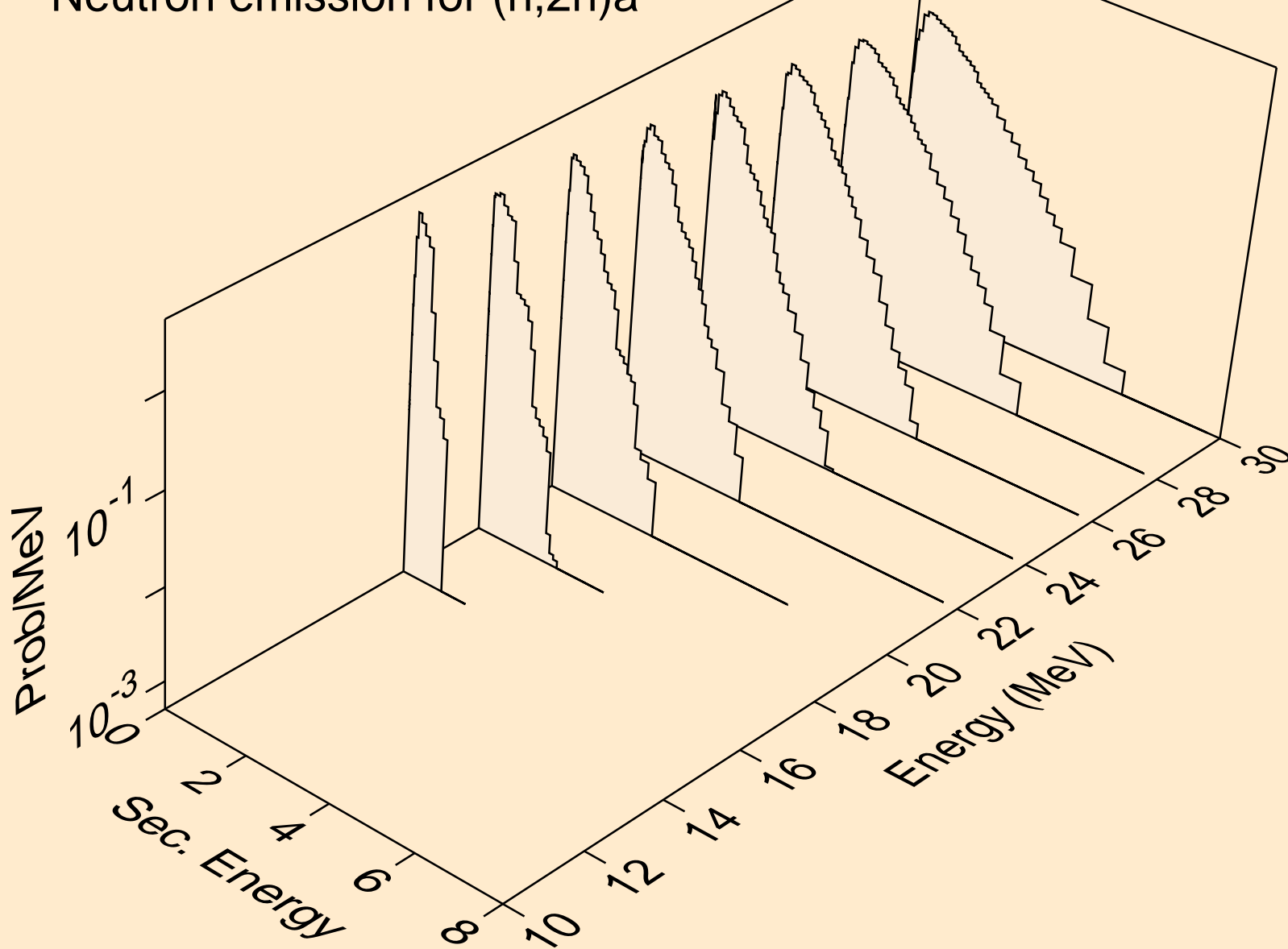

BA136 NEUTRON ACER TENDL-2019 LIBRARY; T=293.16K  
Neutron emission for (n,3n)a

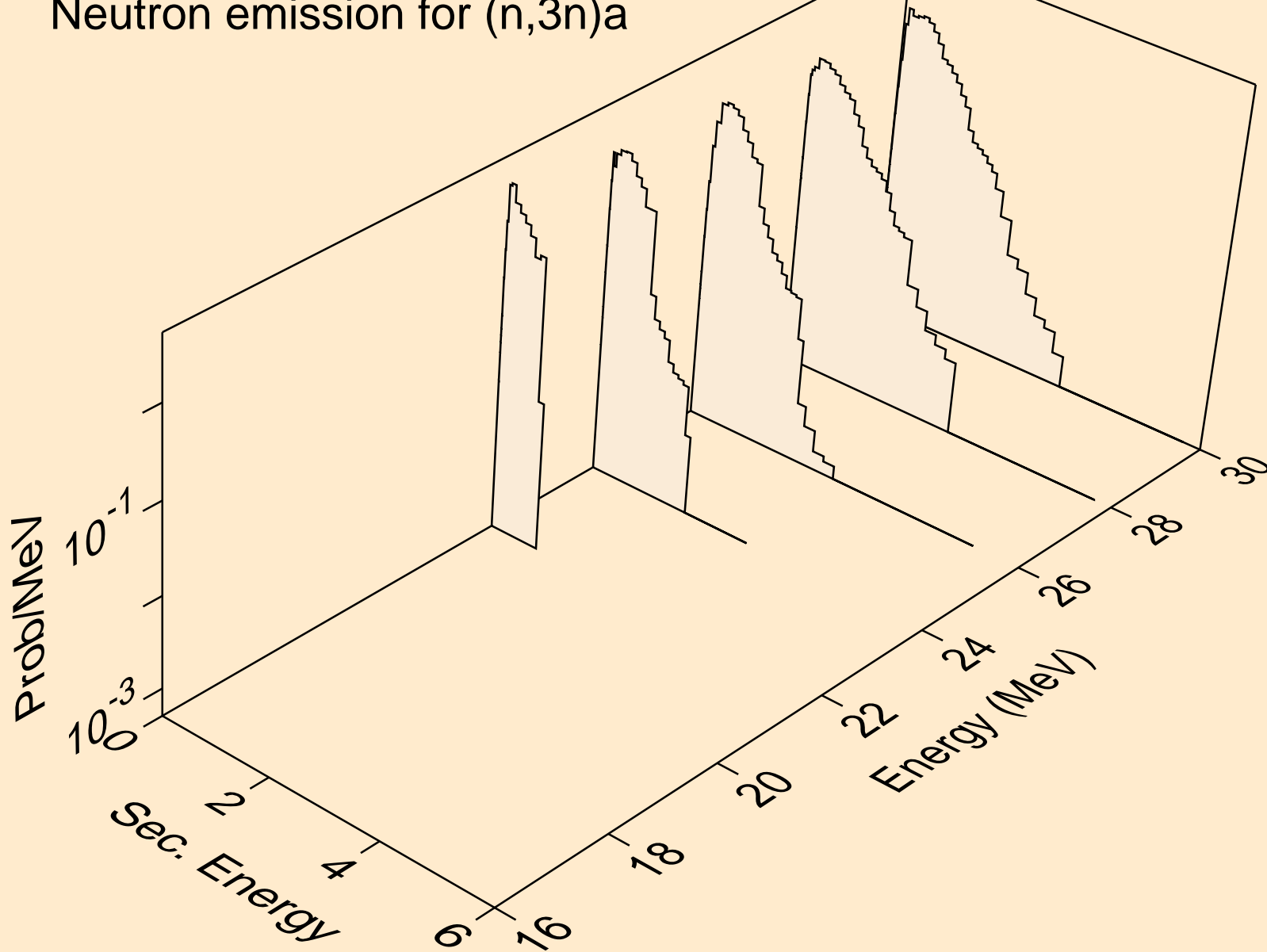

BA136 NEUTRON ACER TENDL-2019 LIBRARY; T=293.16K  
Neutron emission for (n,n\*)p

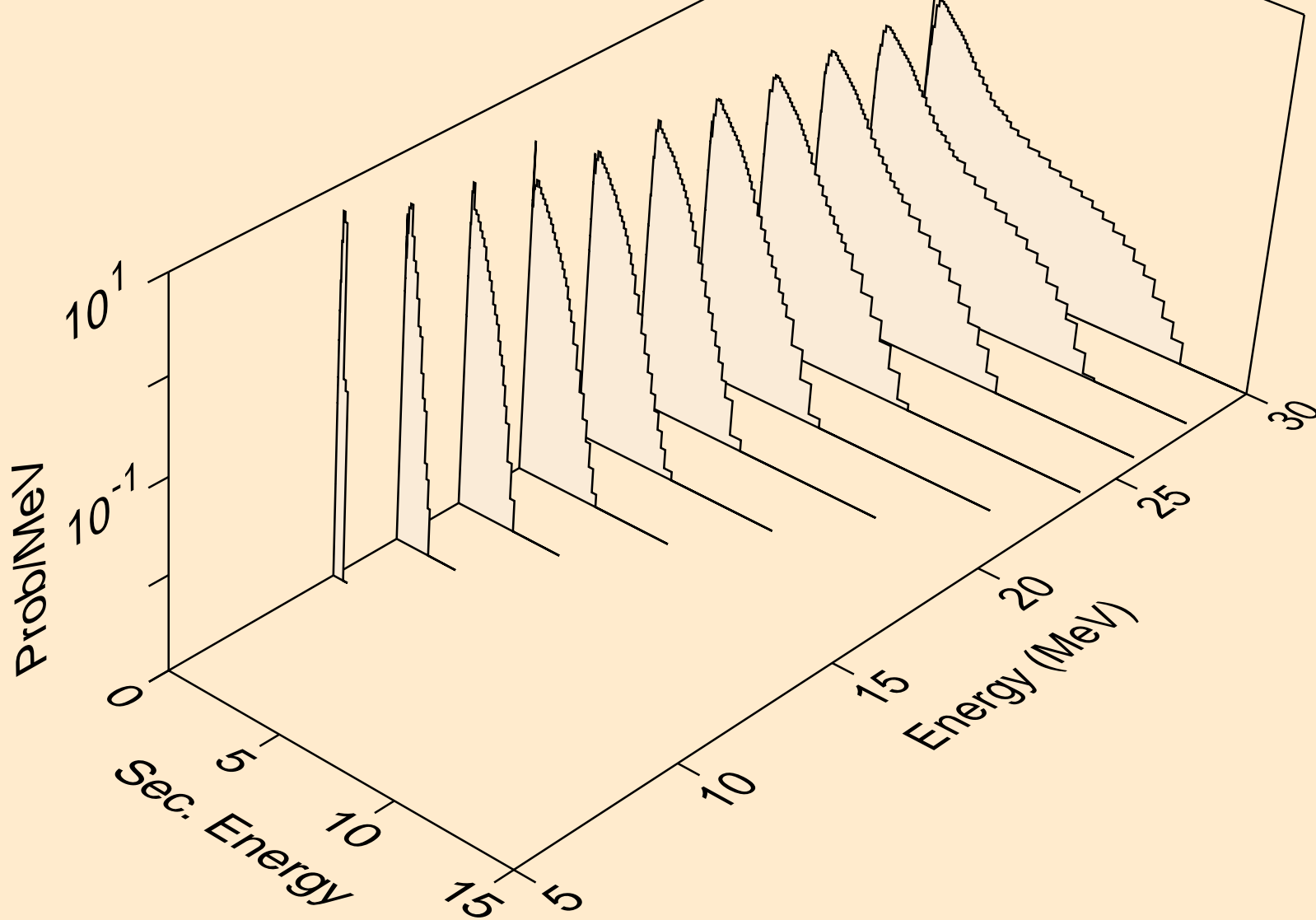

BA136 NEUTRON ACER TENDL-2019 LIBRARY; T=293.16K  
Neutron emission for (n,n\*)2a

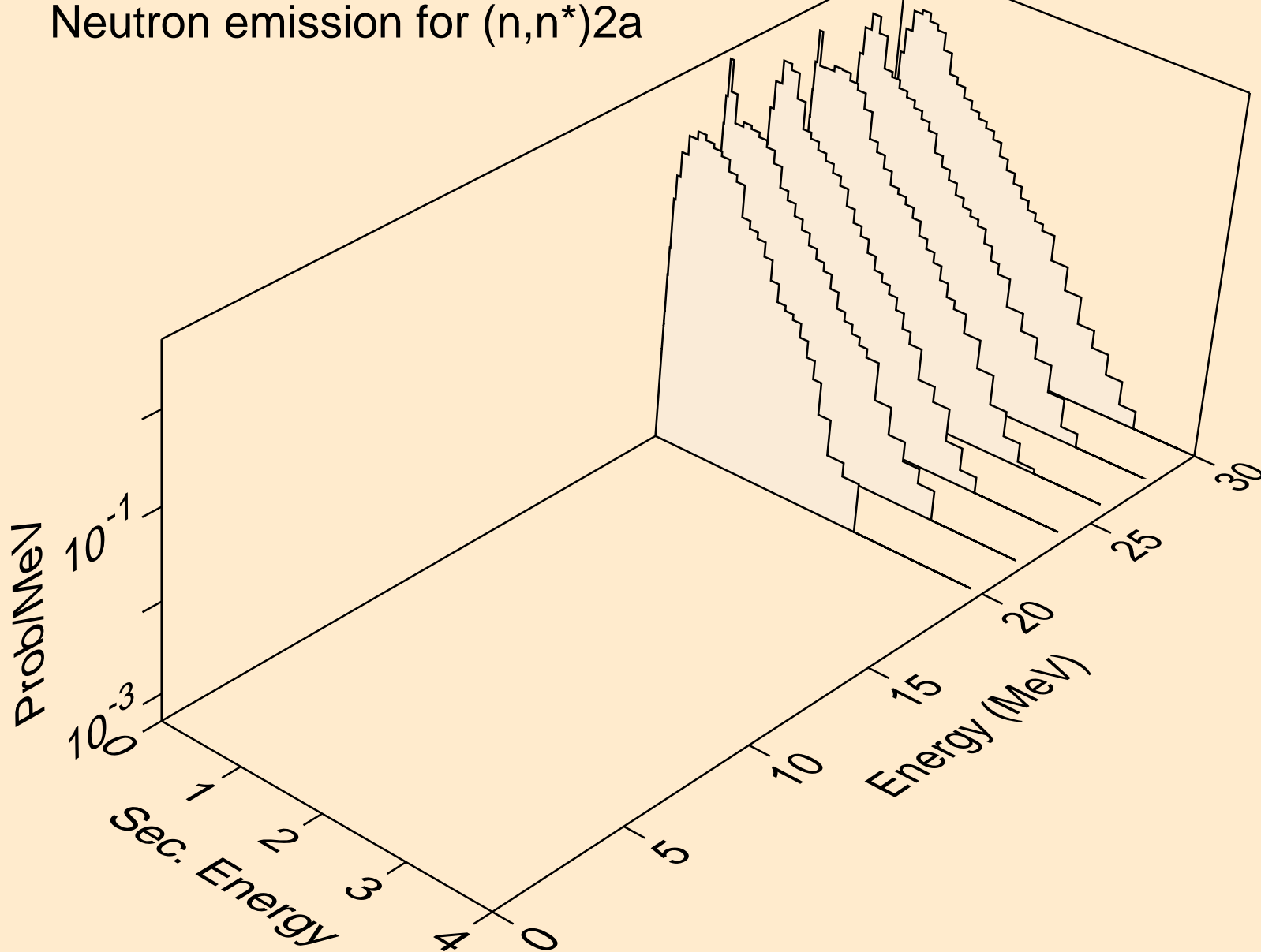

BA136 NEUTRON ACER TENDL-2019 LIBRARY; T=293.16K  
Neutron emission for (n,n\*)d

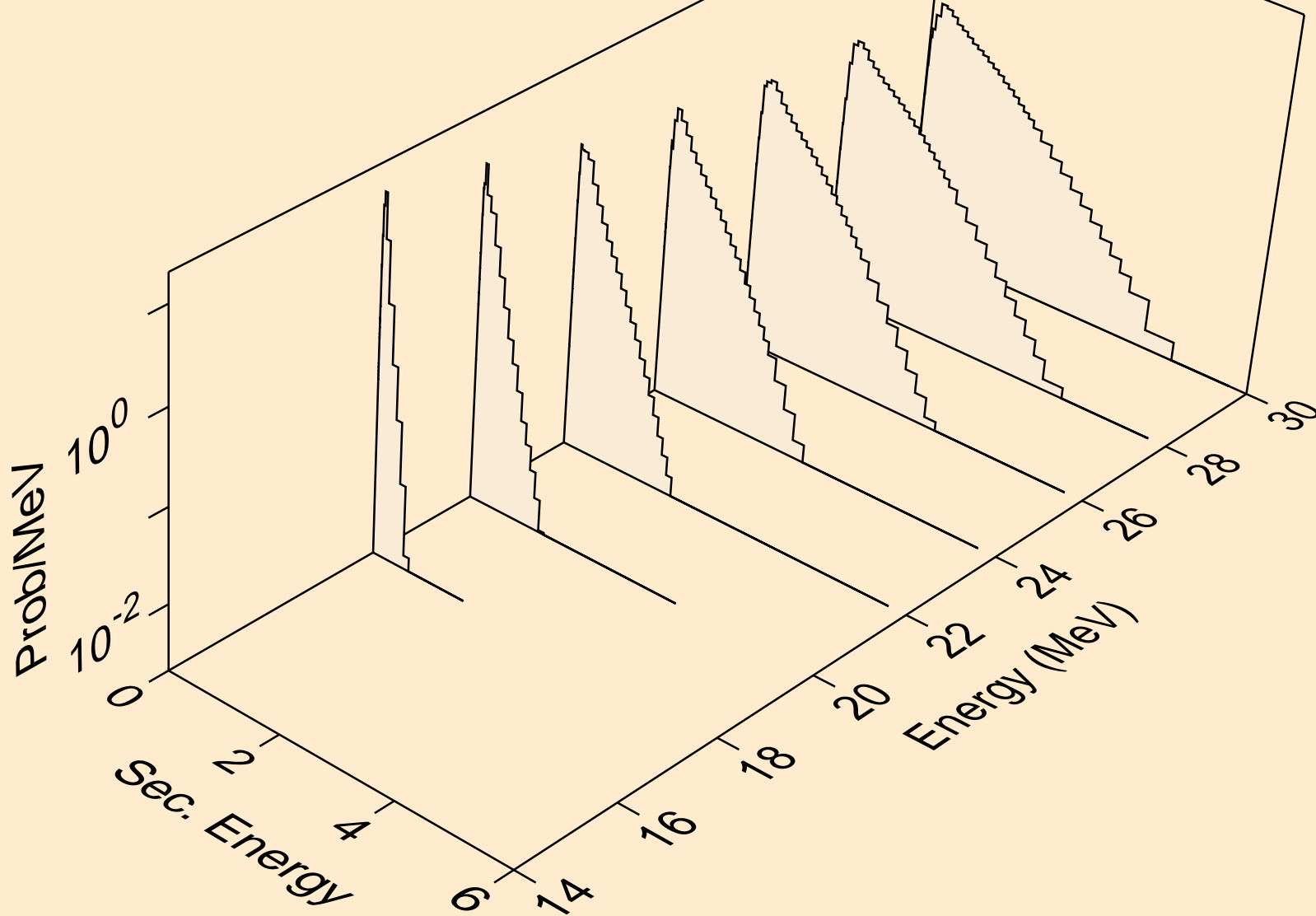

BA136 NEUTRON ACER TENDL-2019 LIBRARY; T=293.16K  
Neutron emission for (n,n\*)t

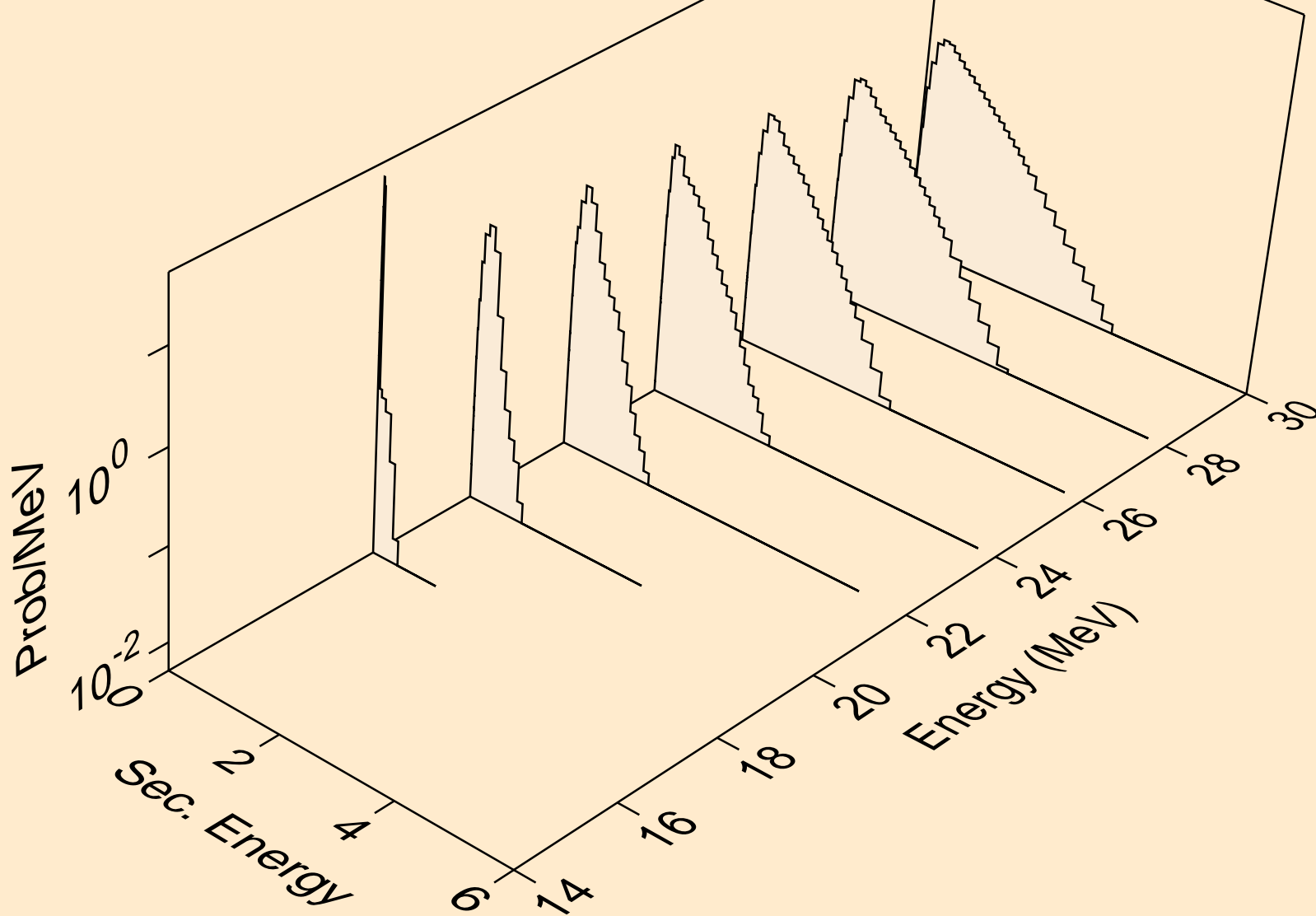



BA136 NEUTRON ACER TENDL-2019 LIBRARY; T=293.16K  
Neutron emission for (n,n\*)he3

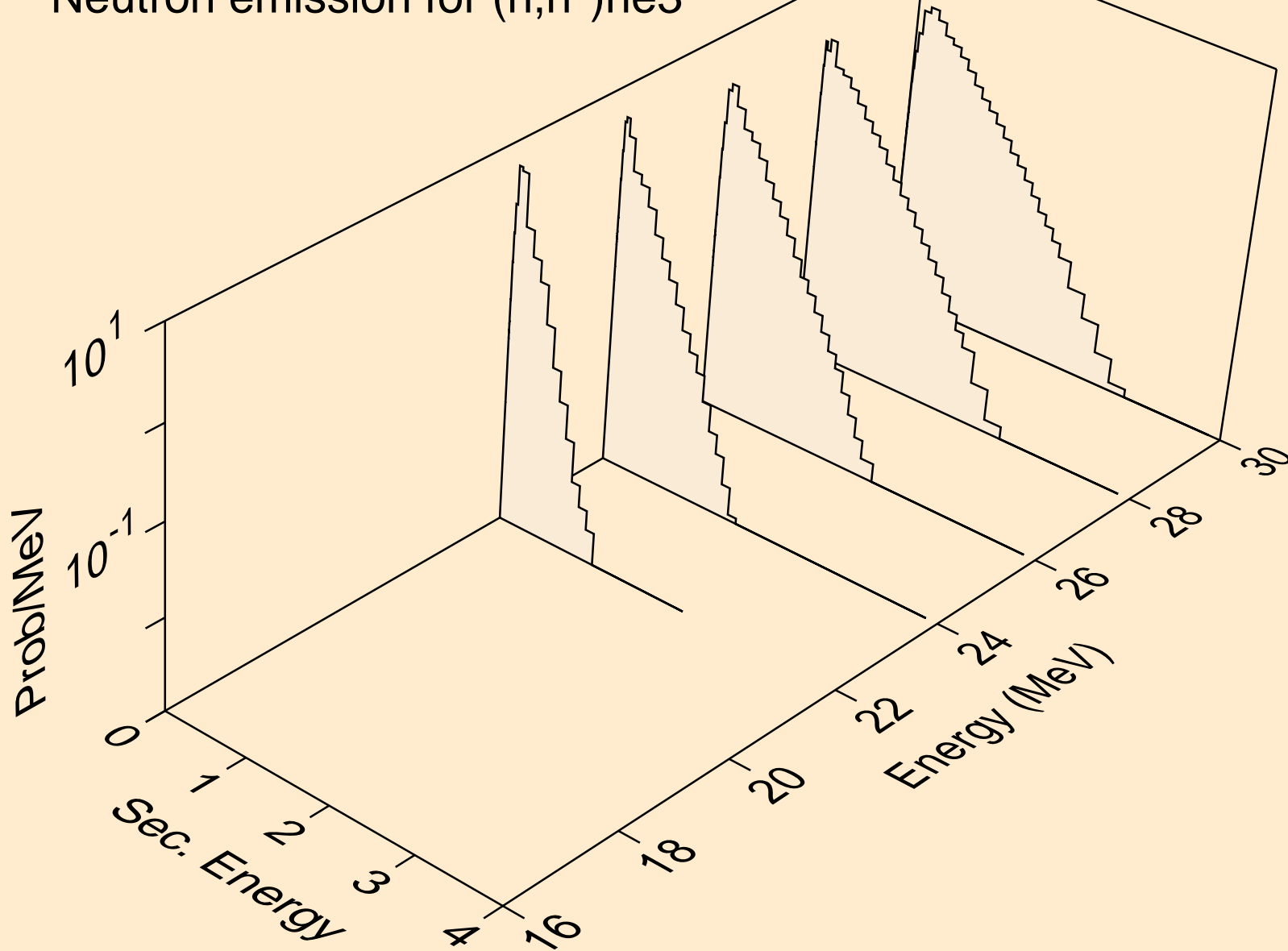

BA136 NEUTRON ACER TENDL-2019 LIBRARY; T=293.16K  
Neutron emission for (n,4n)

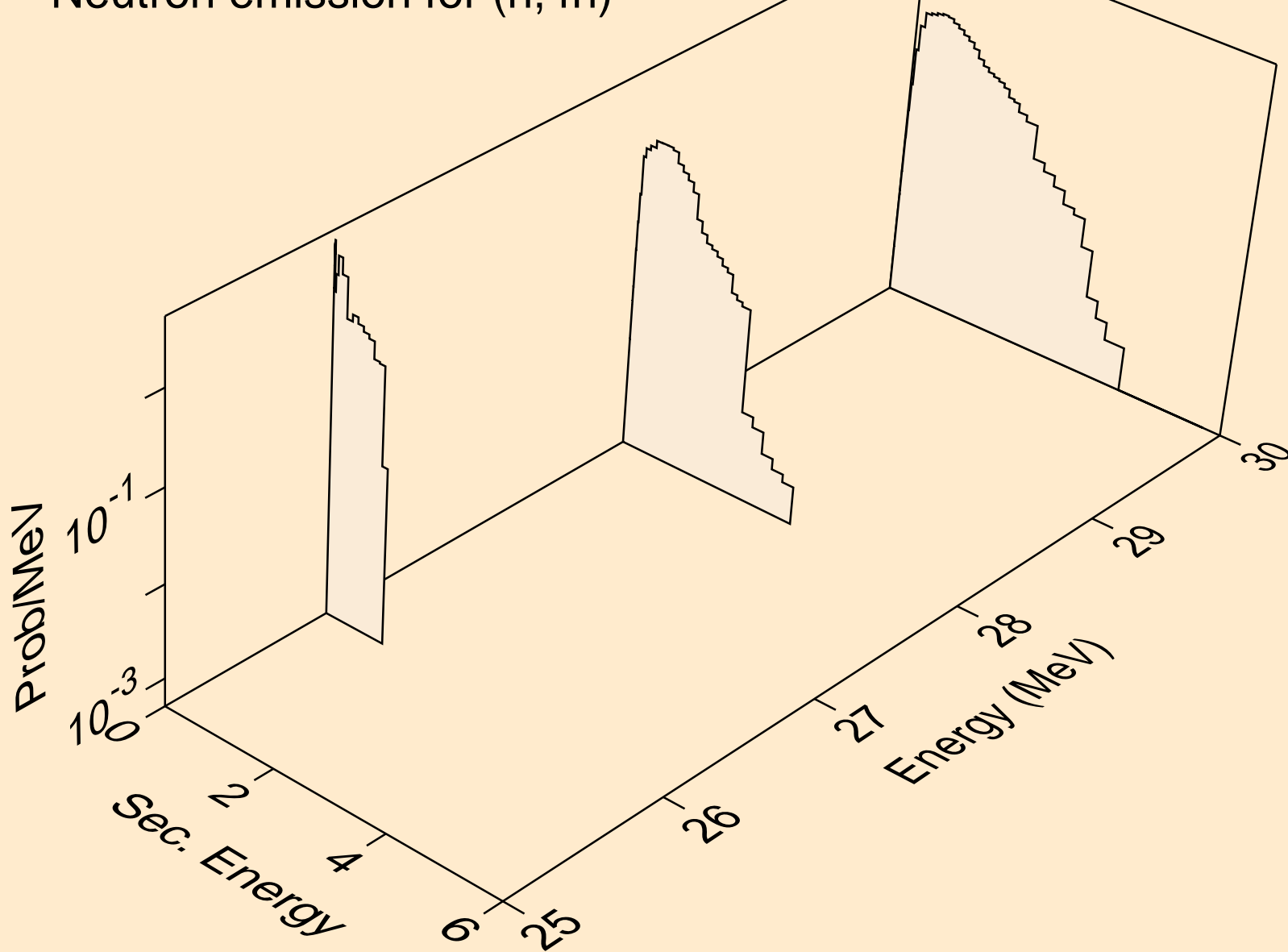

BA136 NEUTRON ACER TENDL-2019 LIBRARY; T=293.16K  
Neutron emission for (n,2np)

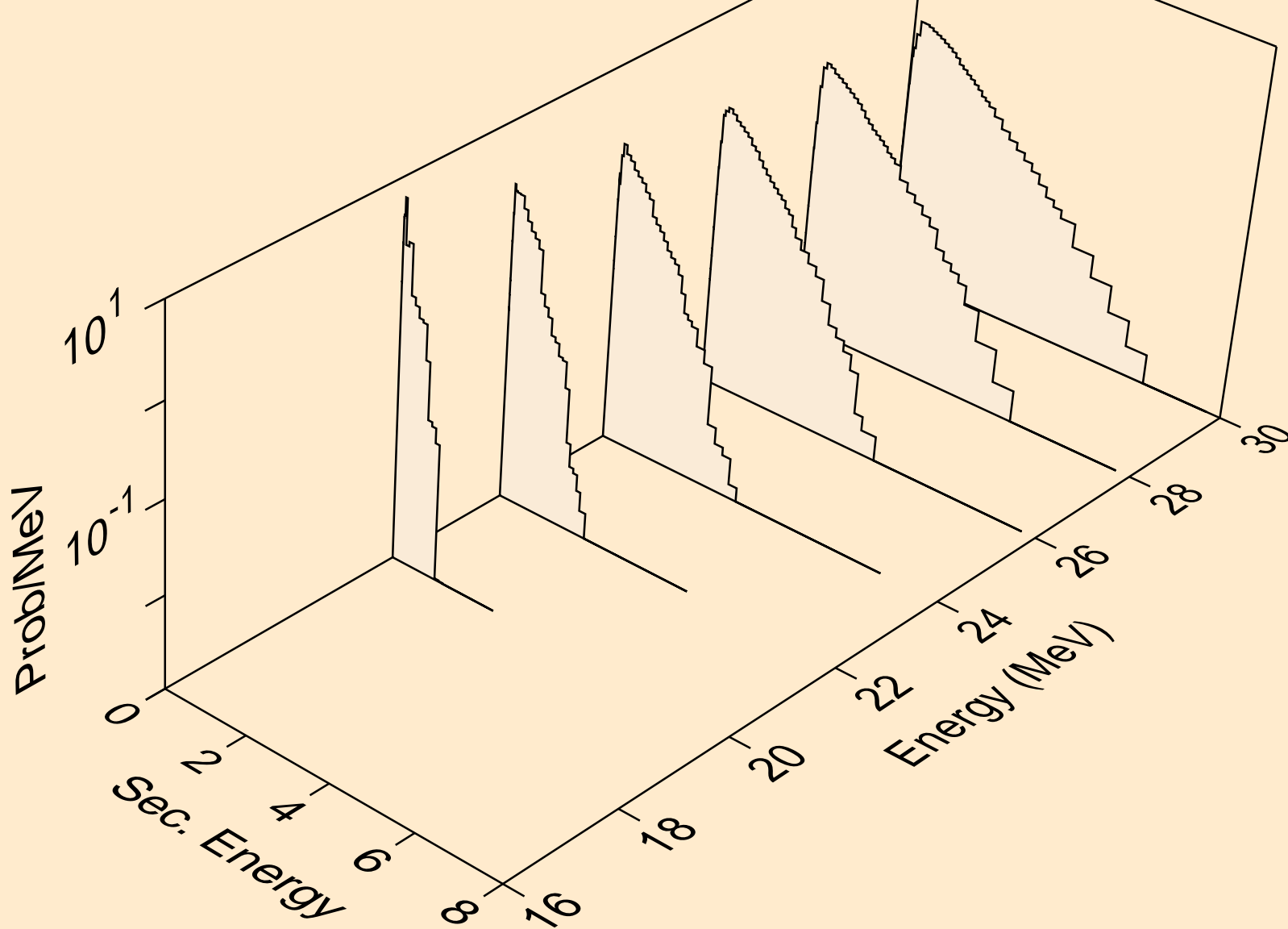

BA136 NEUTRON ACER TENDL-2019 LIBRARY; T=293.16K  
Neutron emission for (n,3np)

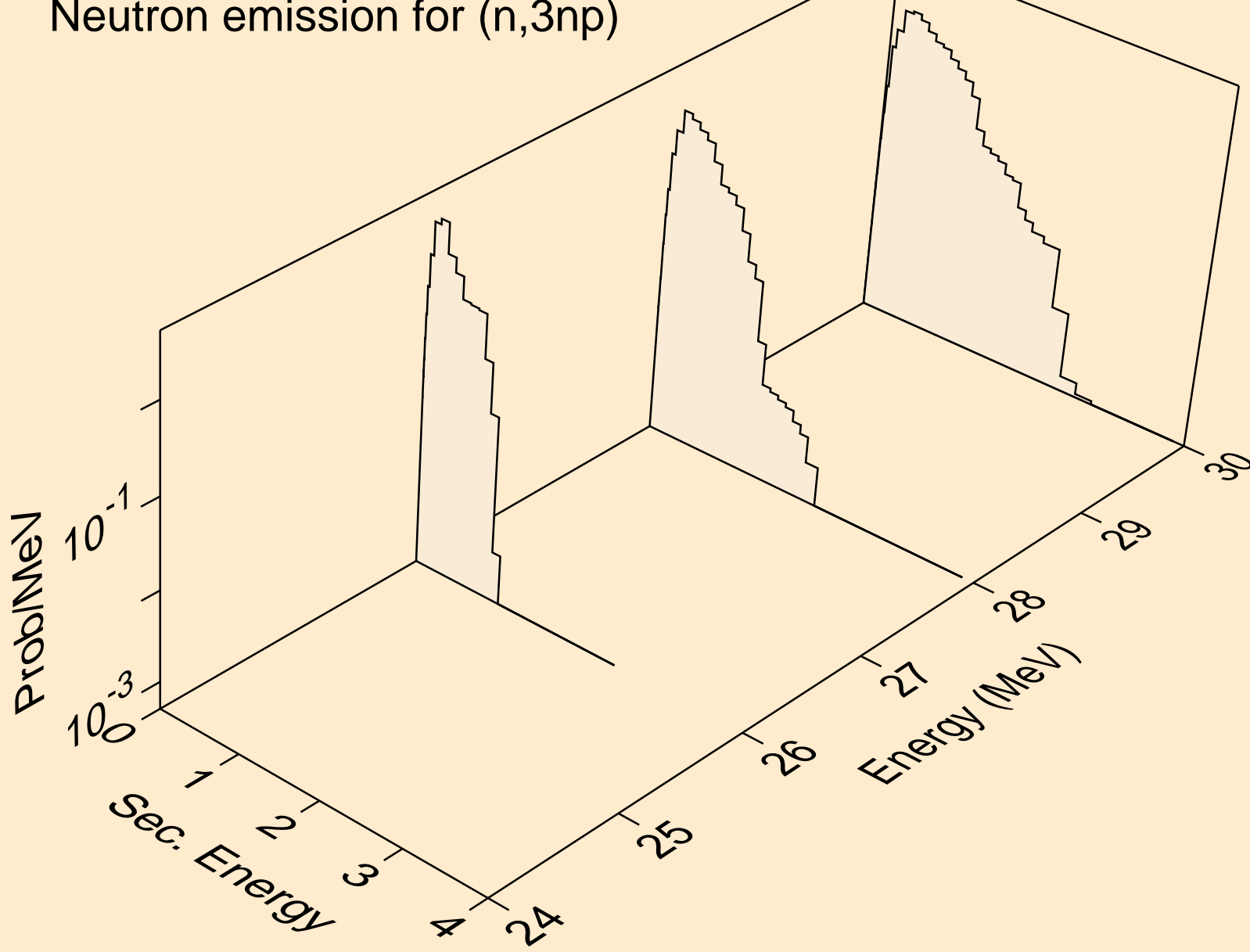

BA136 NEUTRON ACER TENDL-2019 LIBRARY; T=293.16K  
Neutron emission for (n,2np)

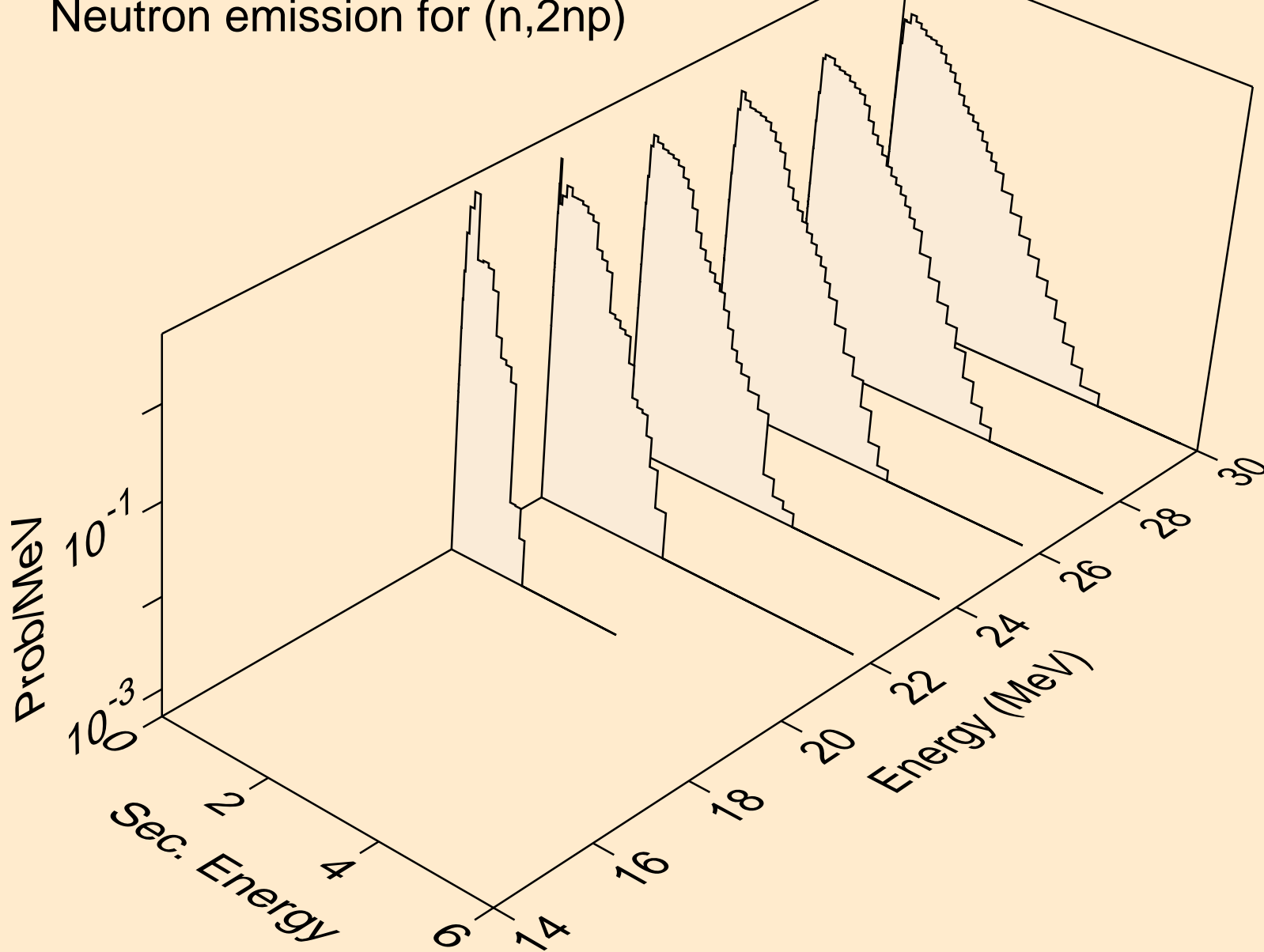

BA136 NEUTRON ACER TENDL-2019 LIBRARY; T=293.16K  
Neutron emission for (n,npa)

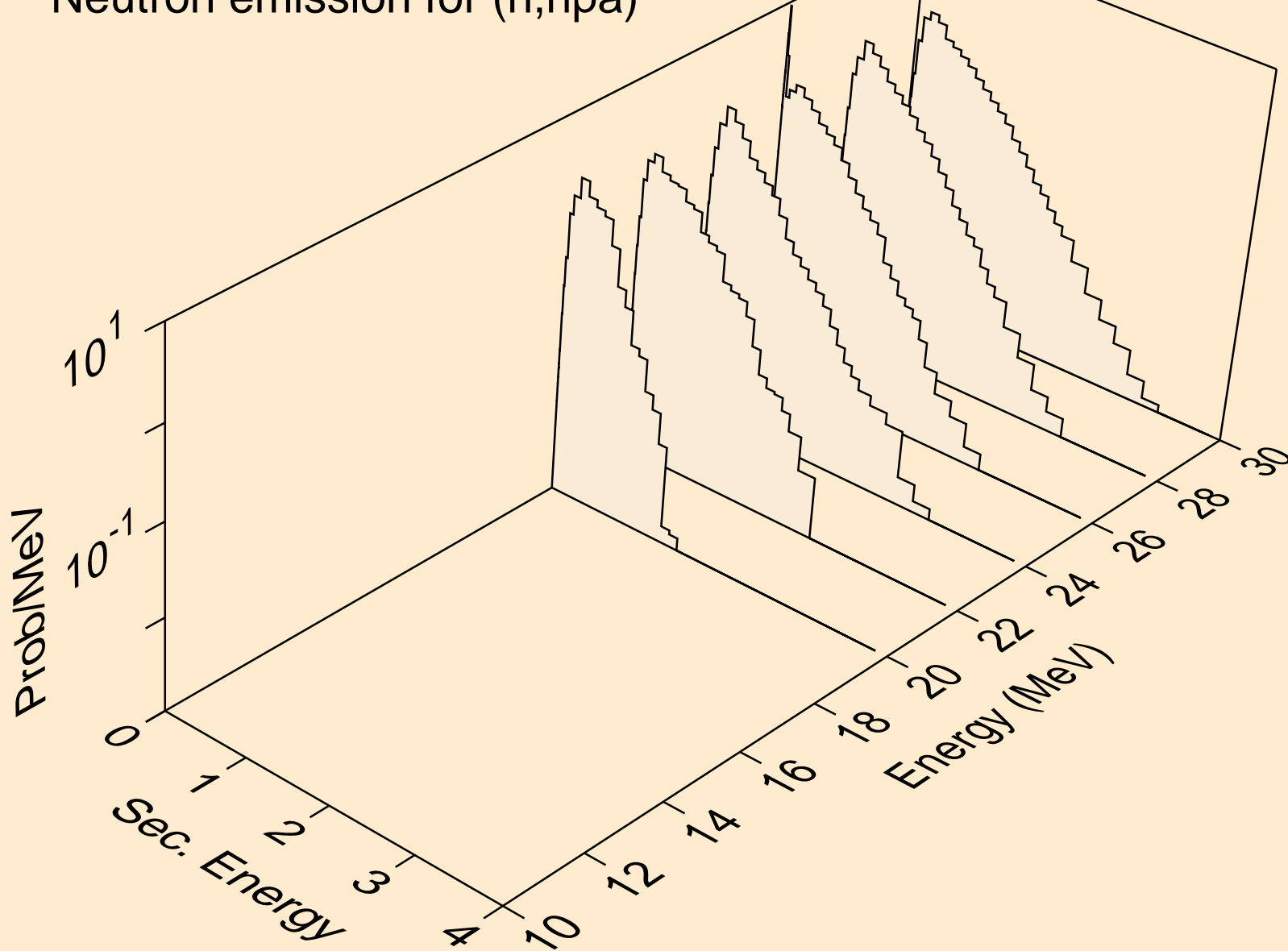

BA136 NEUTRON ACER TENDL-2019 LIBRARY; T=293.16K  
Neutron emission for (n,n\*c)

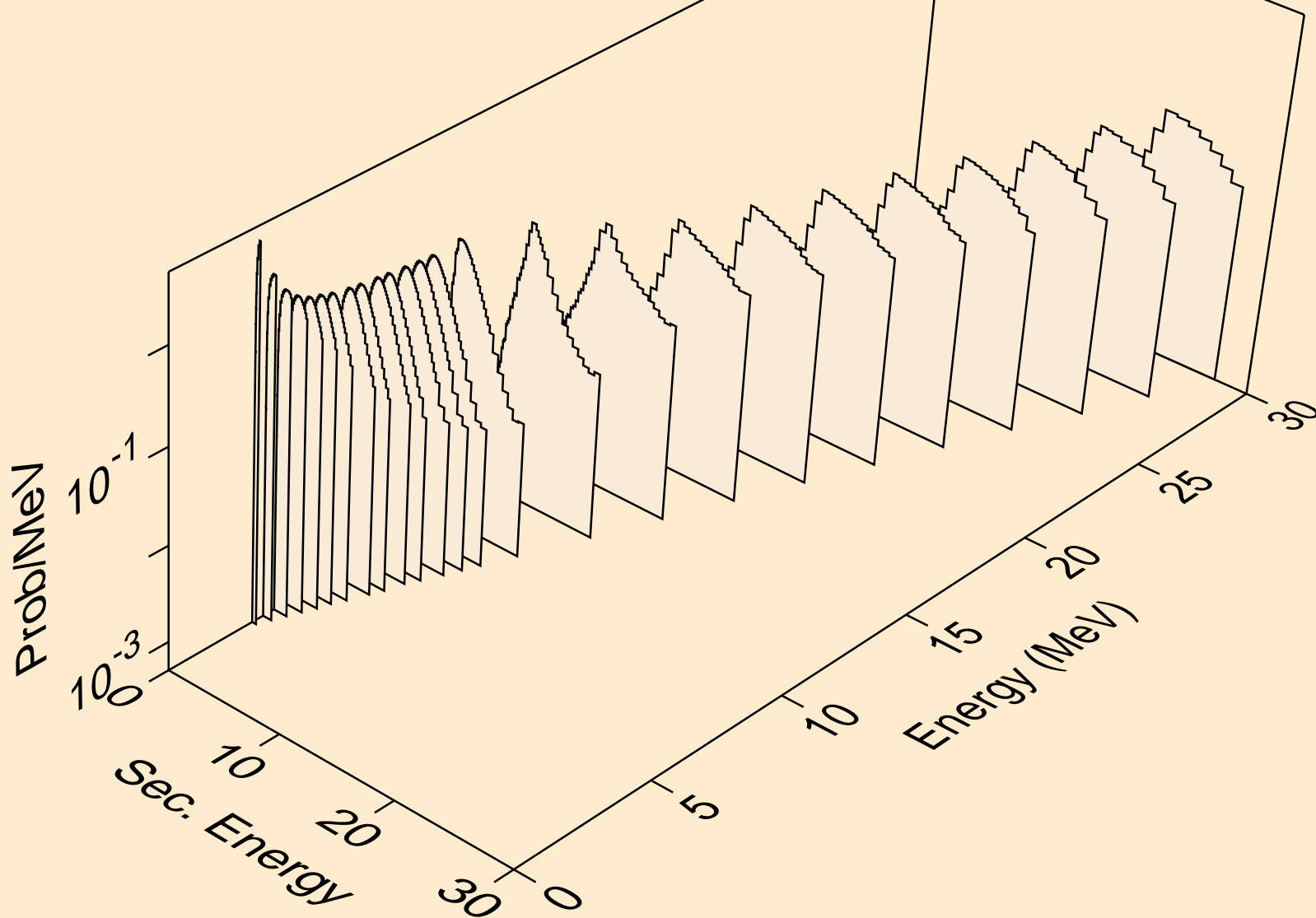

BA136 NEUTRON ACER TENDL-2019 LIBRARY; T=293.16K  
Photon emission for (n,x)

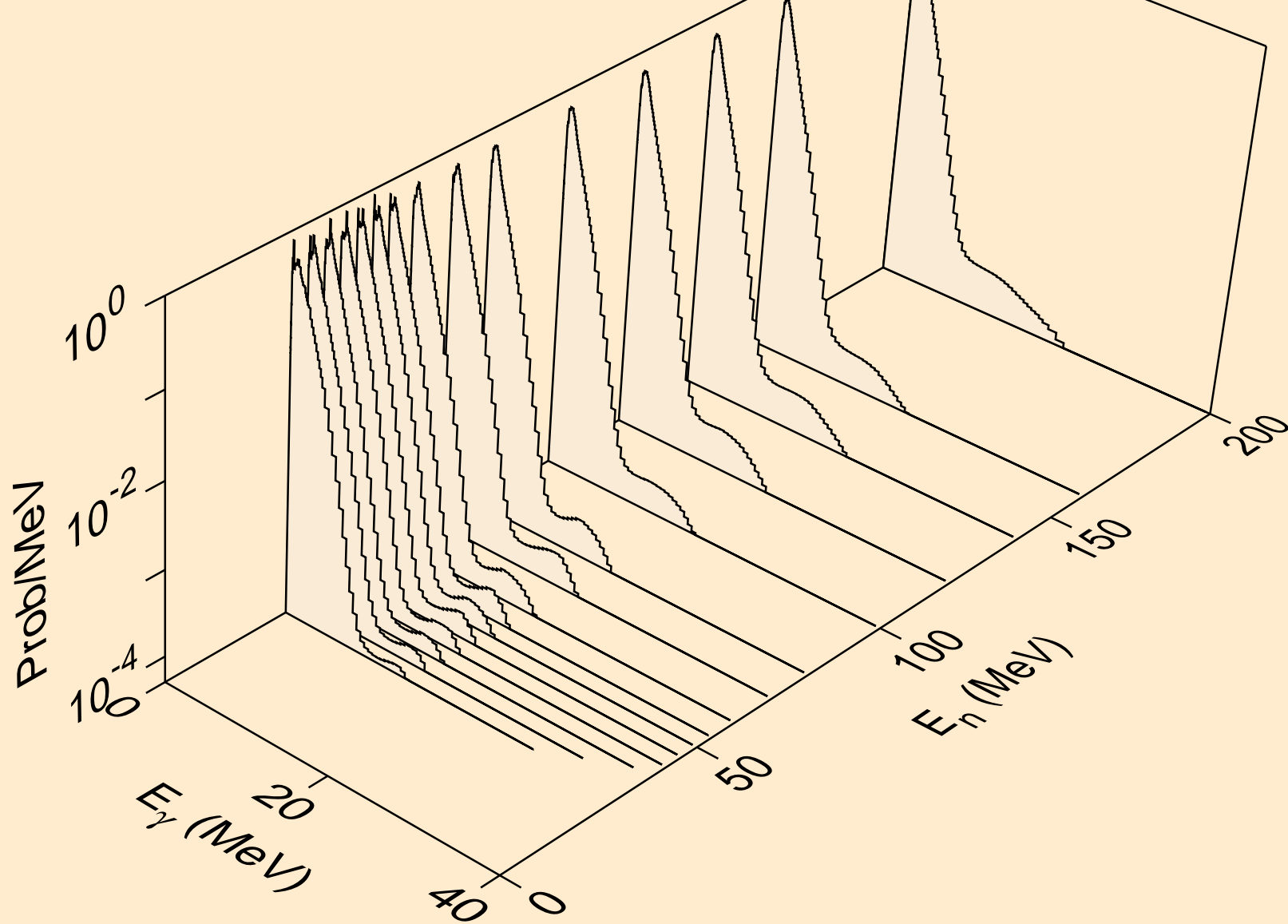



BA136 NEUTRON ACER TENDL-2019 LIBRARY; T=293.16K  
Photon emission for (n,2nd)

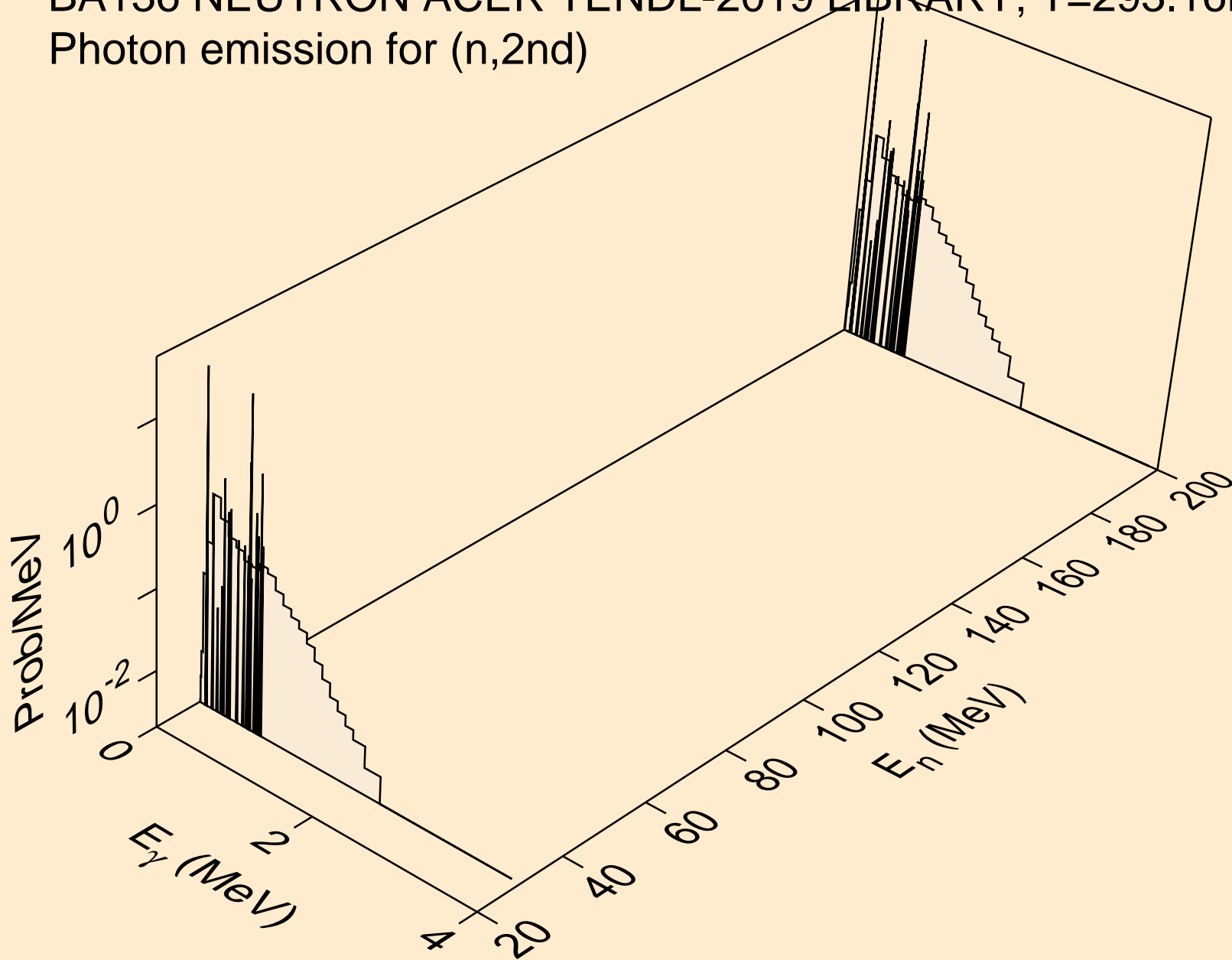

BA136 NEUTRON ACER TENDL-2019 LIBRARY; T=293.16K  
Photon emission for (n,2n)

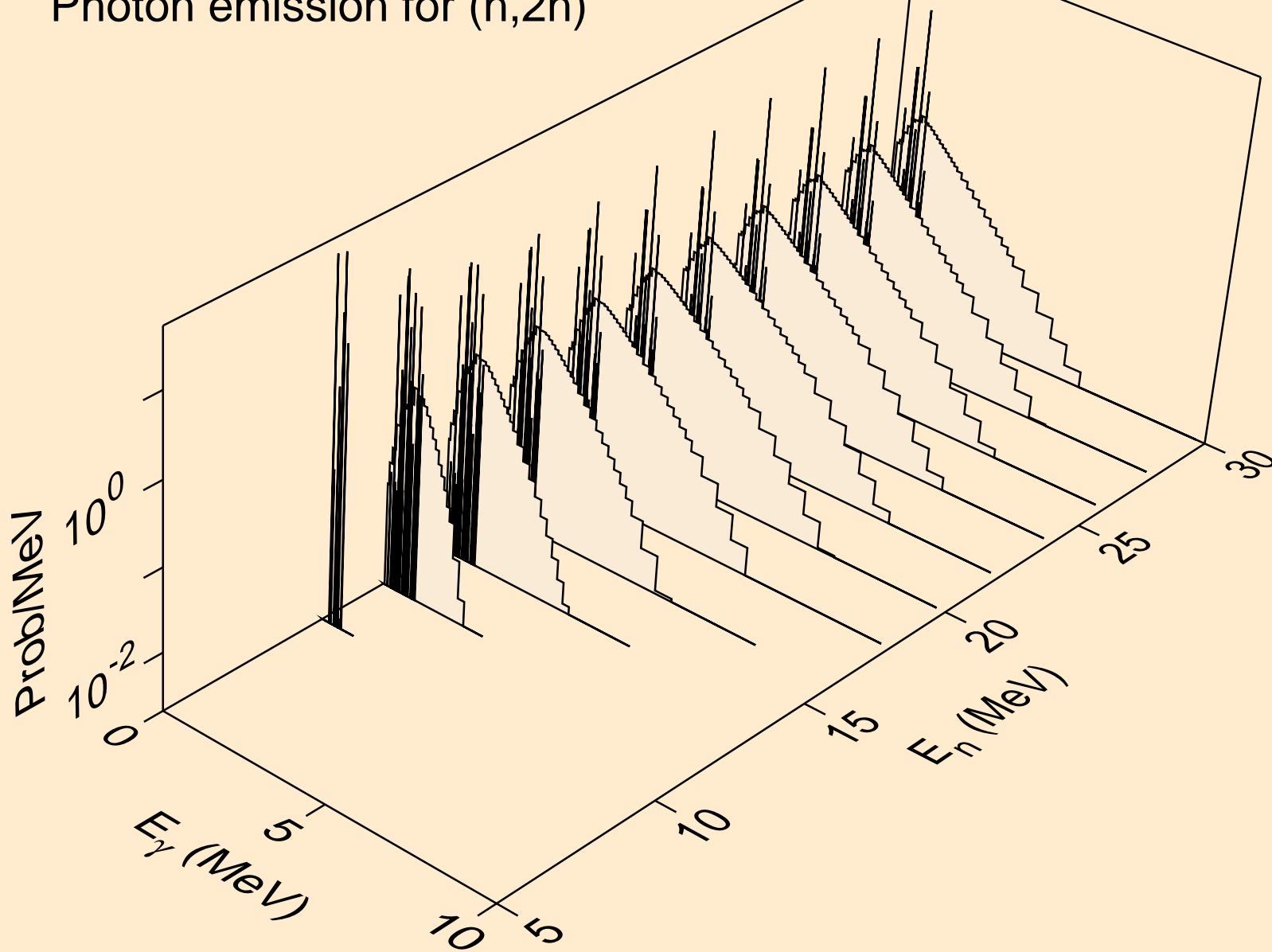

BA136 NEUTRON ACER TENDL-2019 LIBRARY; T=293.16K  
Photon emission for (n,3n)

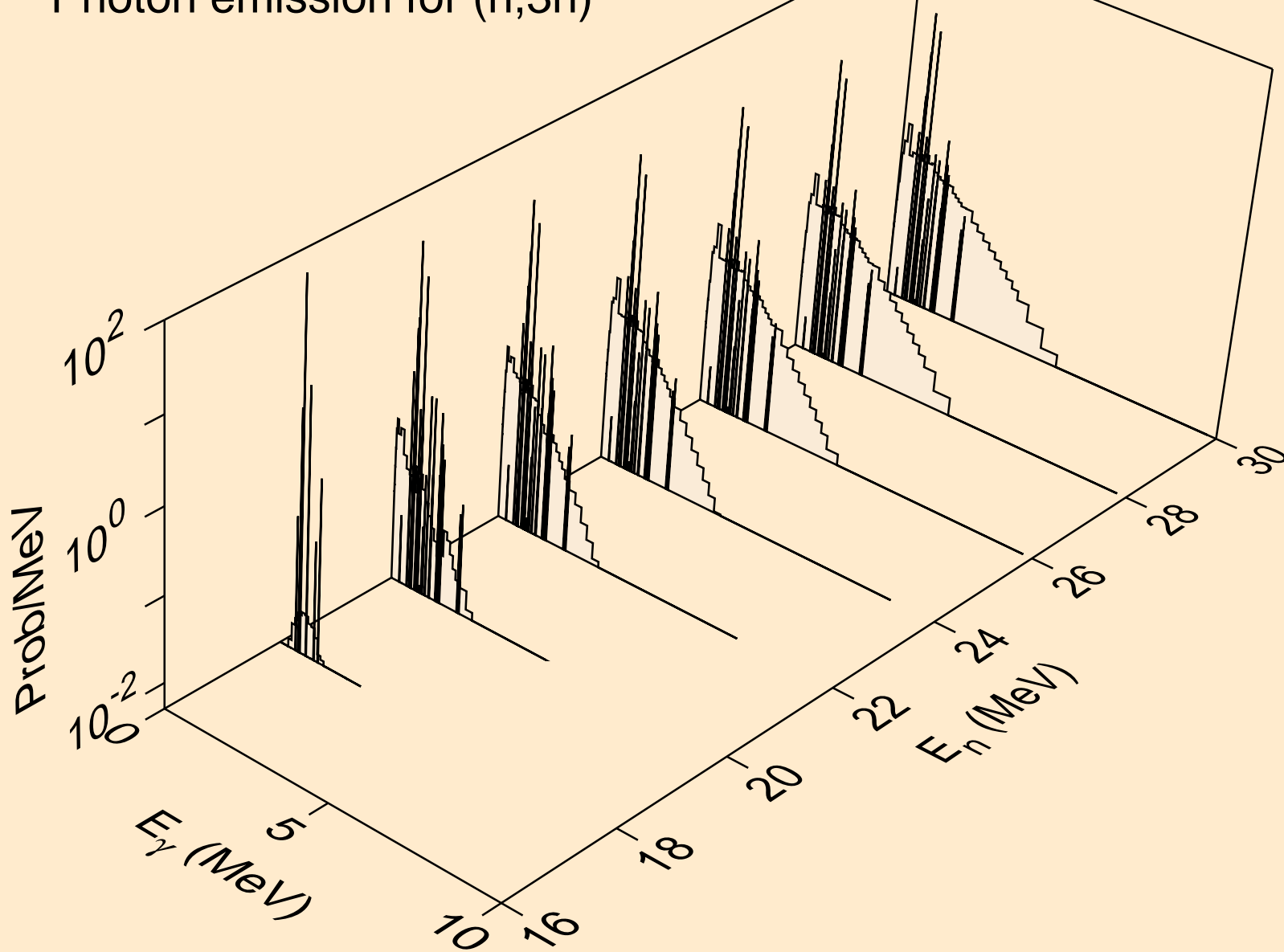

BA136 NEUTRON ACER TENDL-2019 LIBRARY; T=293.16K  
Photon emission for (n,n\*)a

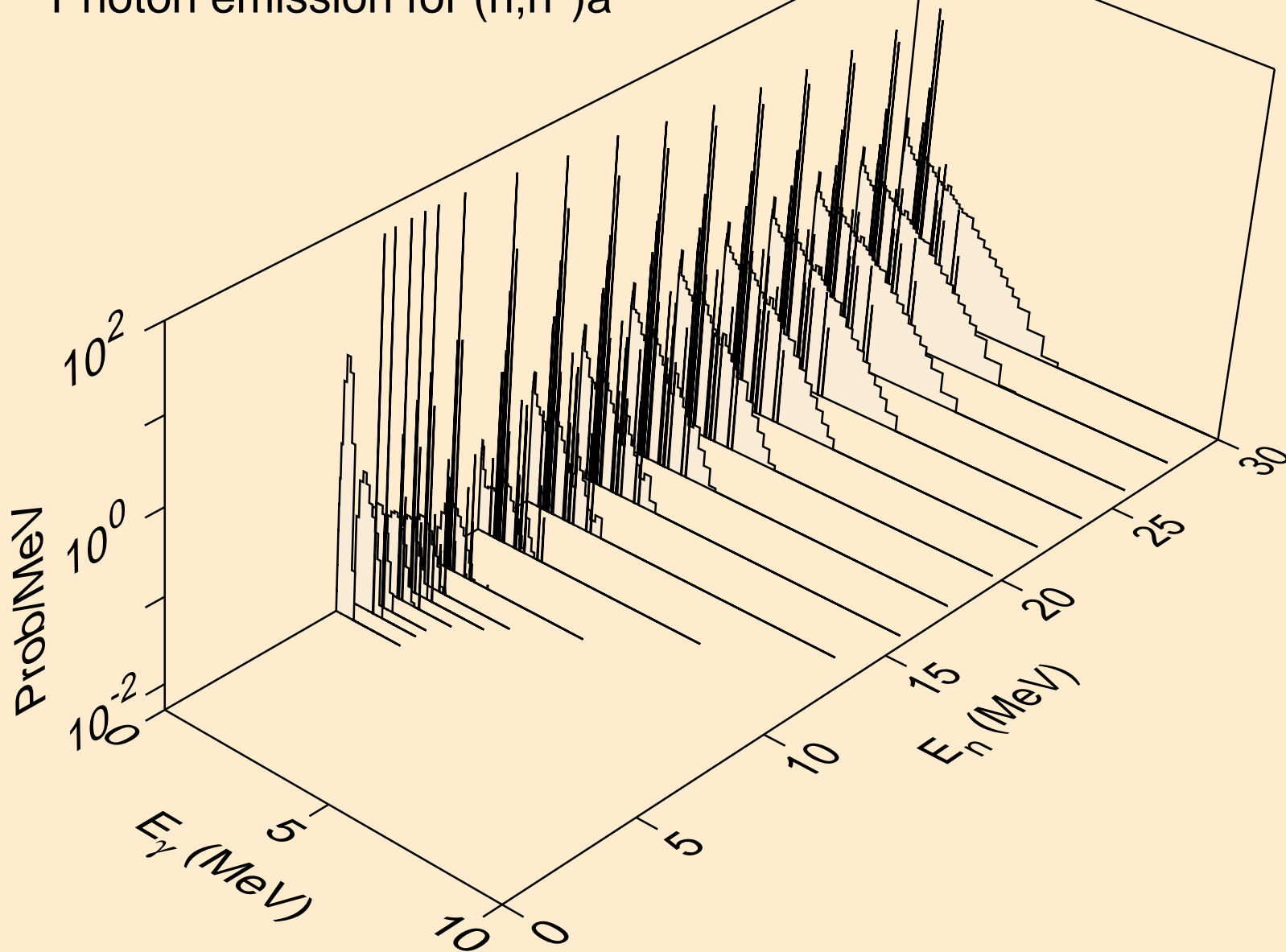

BA136 NEUTRON ACER TENDL-2019 LIBRARY; T=293.16K  
Photon emission for (n,2n)a

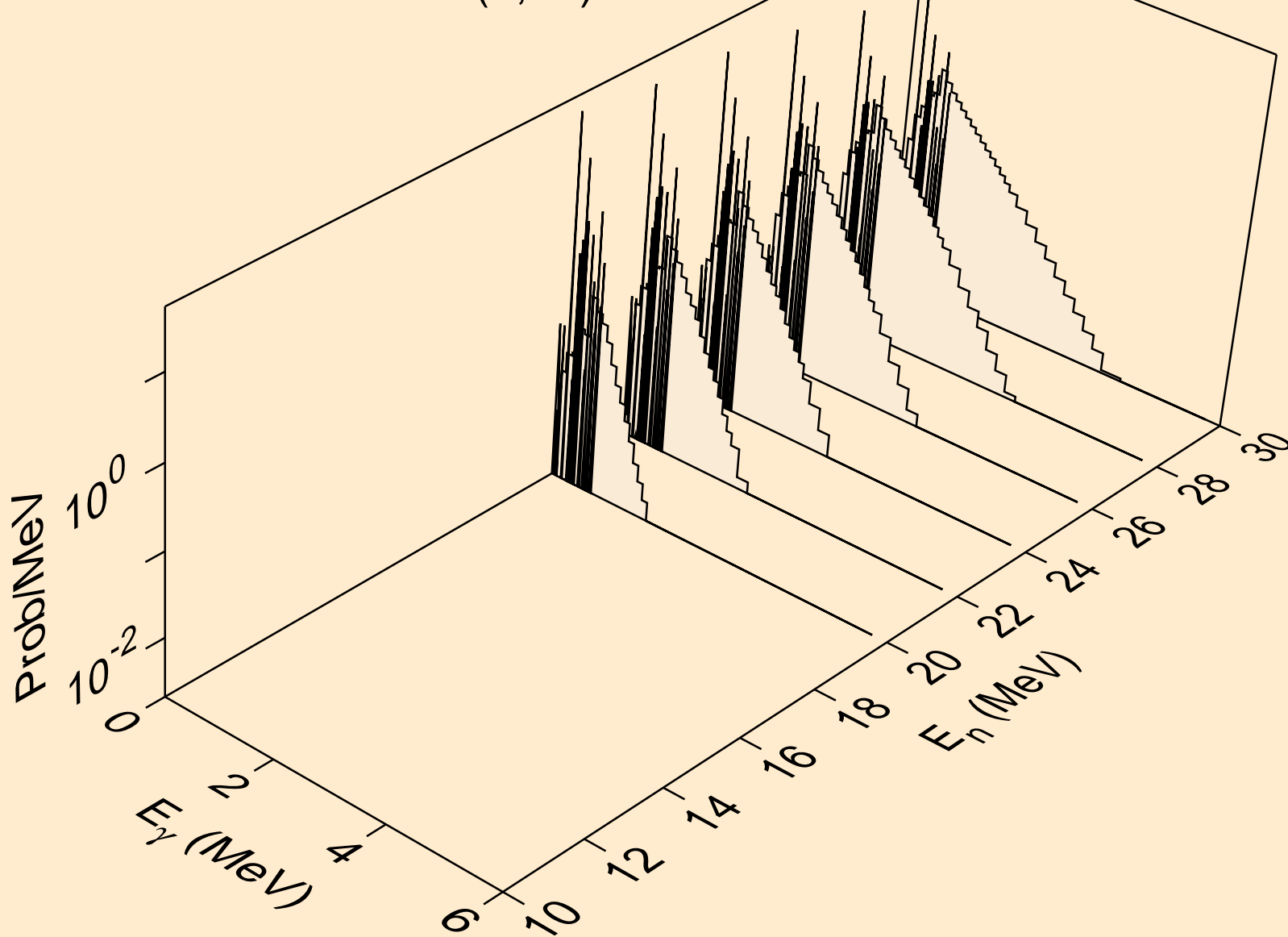

BA136 NEUTRON ACER TENDL-2019 LIBRARY; T=293.16K  
Photon emission for (n,3n)a

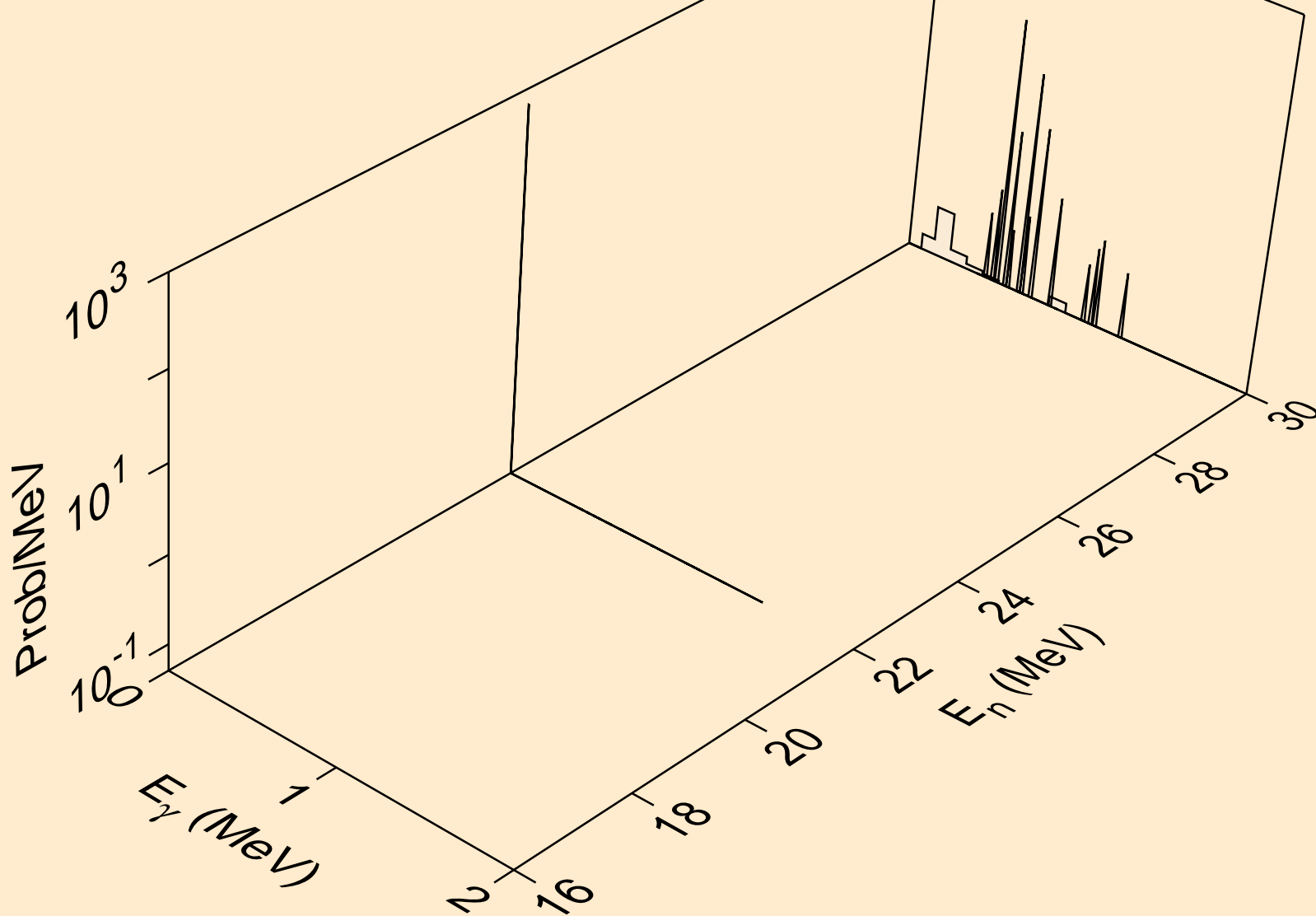

BA136 NEUTRON ACER TENDL-2019 LIBRARY; T=293.16K  
Photon emission for (n,n\*)p

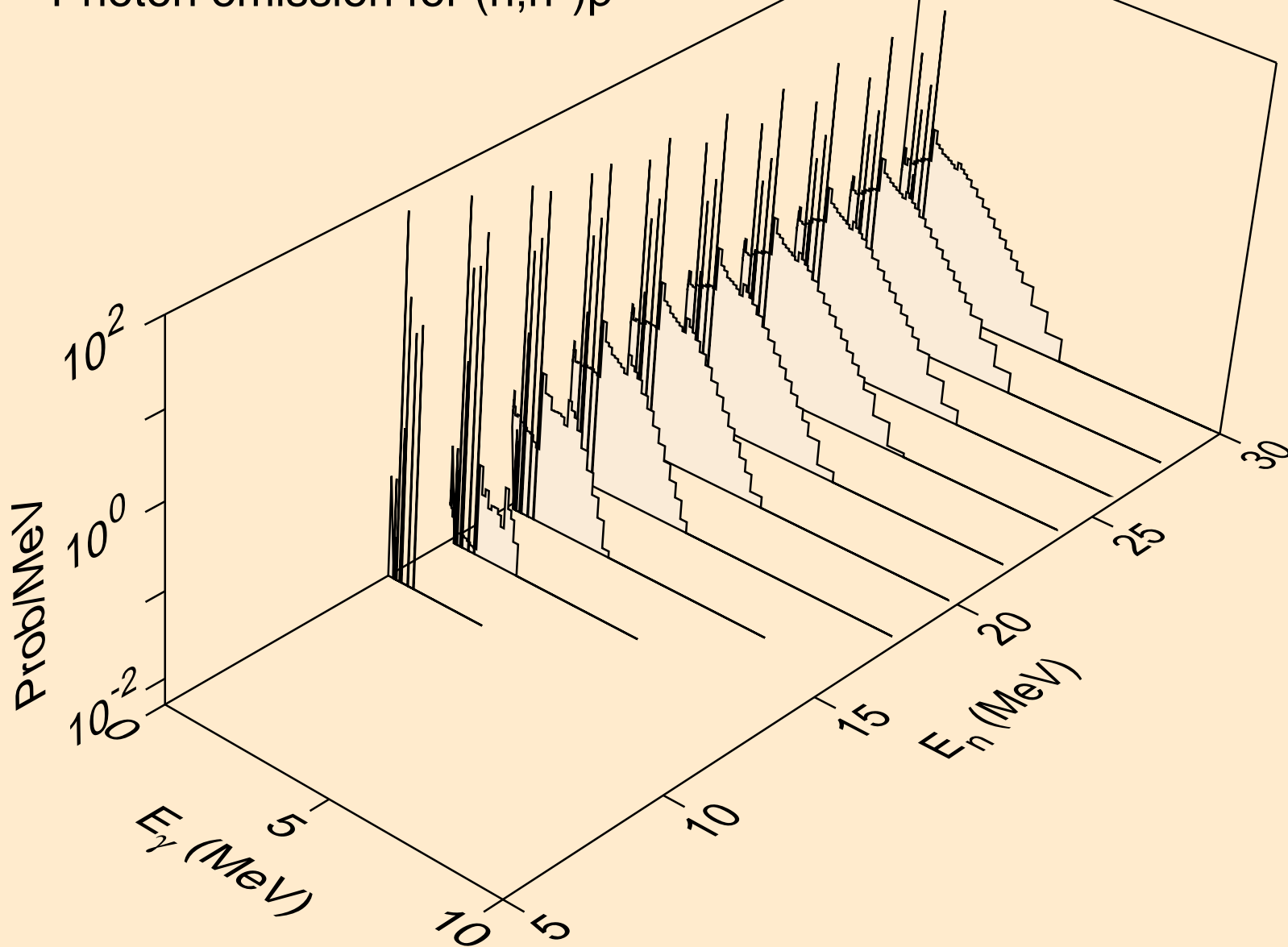

BA136 NEUTRON ACER TENDL-2019 LIBRARY; T=293.16K  
Photon emission for (n,n\*)2a

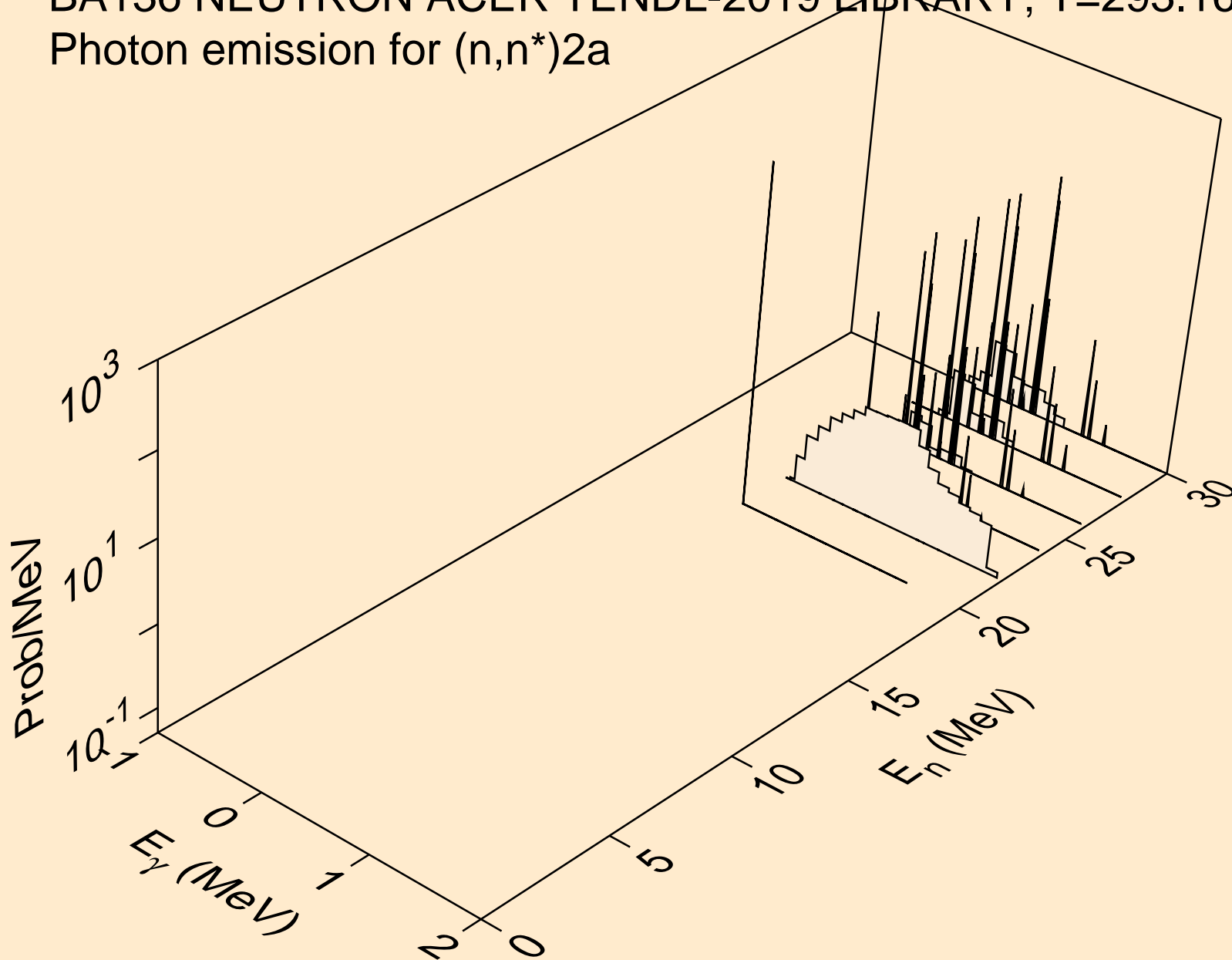



BA136 NEUTRON ACER TENDL-2019 LIBRARY; T=293.16K  
Photon emission for (n,n\*)d

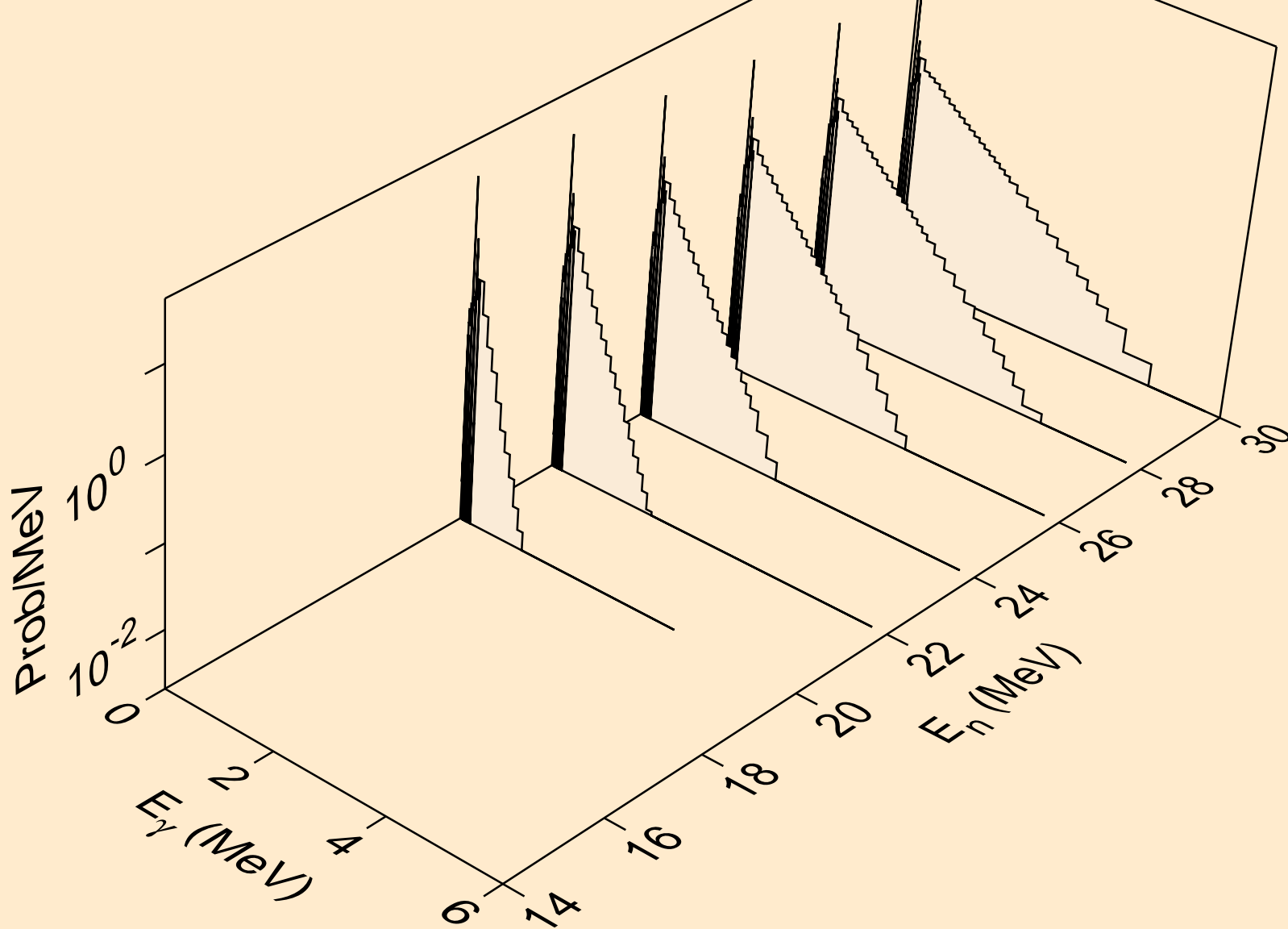

BA136 NEUTRON ACER TENDL-2019 LIBRARY; T=293.16K  
Photon emission for (n,n\*)t

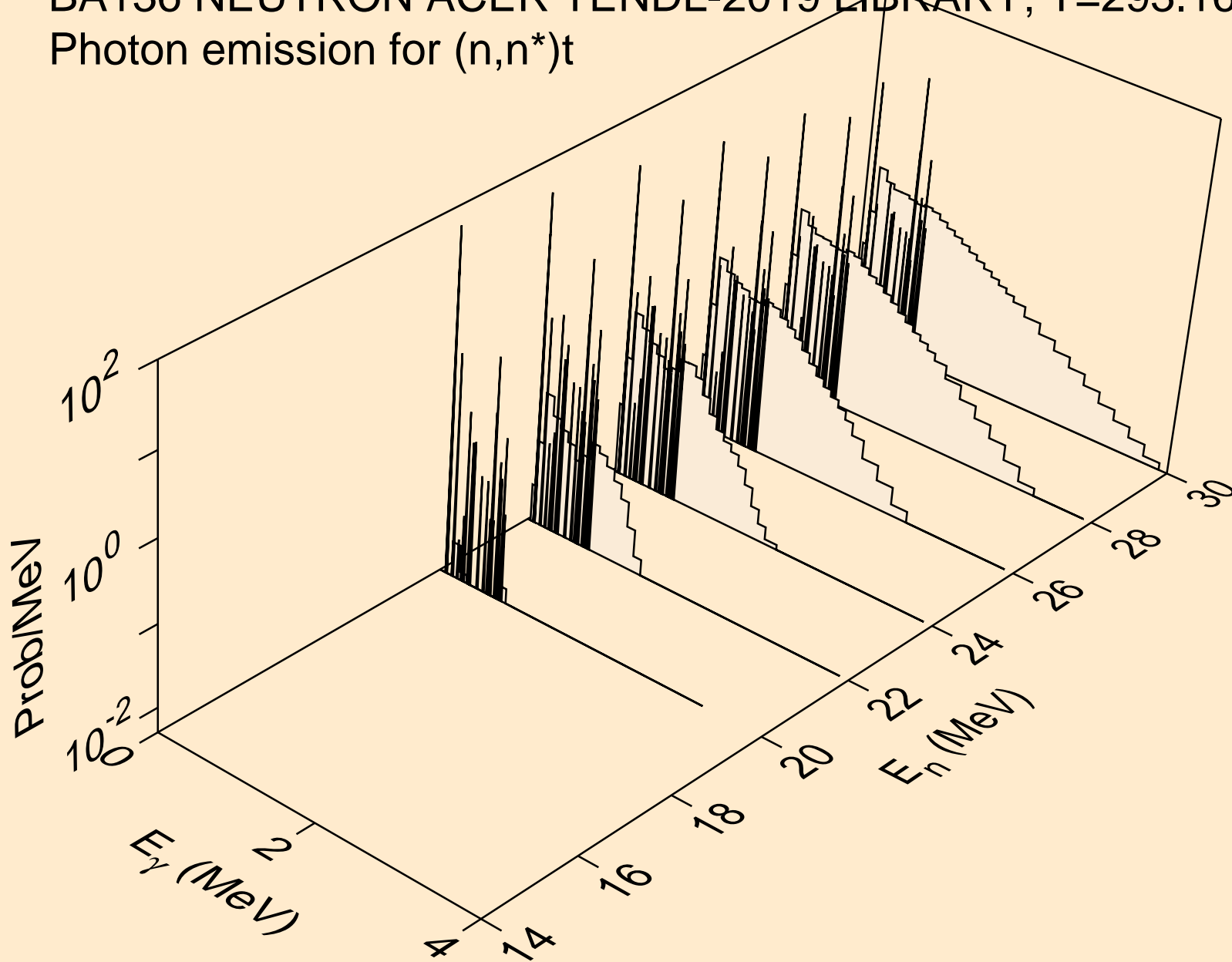

BA136 NEUTRON ACER TENDL-2019 LIBRARY; T=293.16K  
Photon emission for (n,n\*)he3

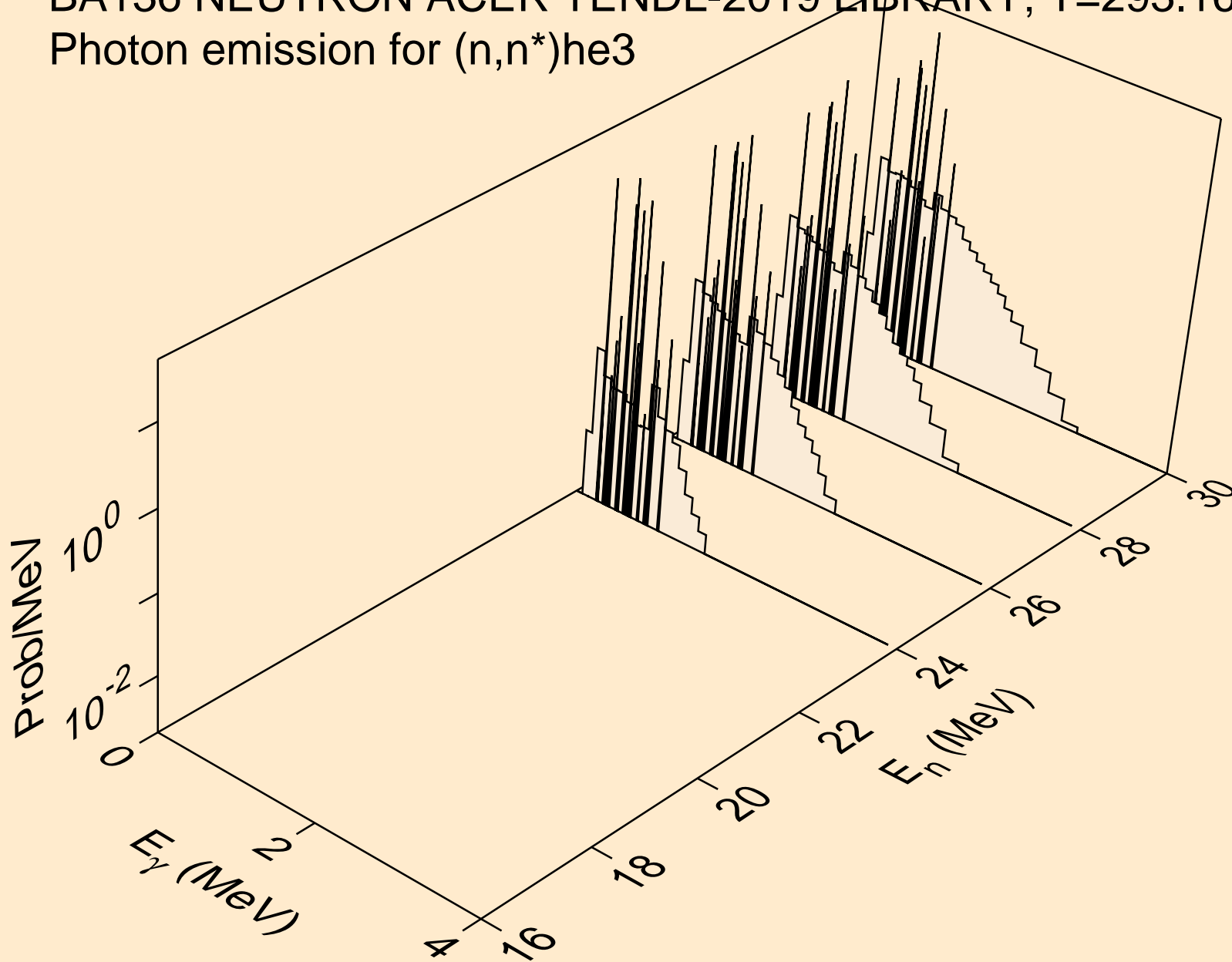

BA136 NEUTRON ACER TENDL-2019 LIBRARY; T=293.16K  
Photon emission for (n,4n)

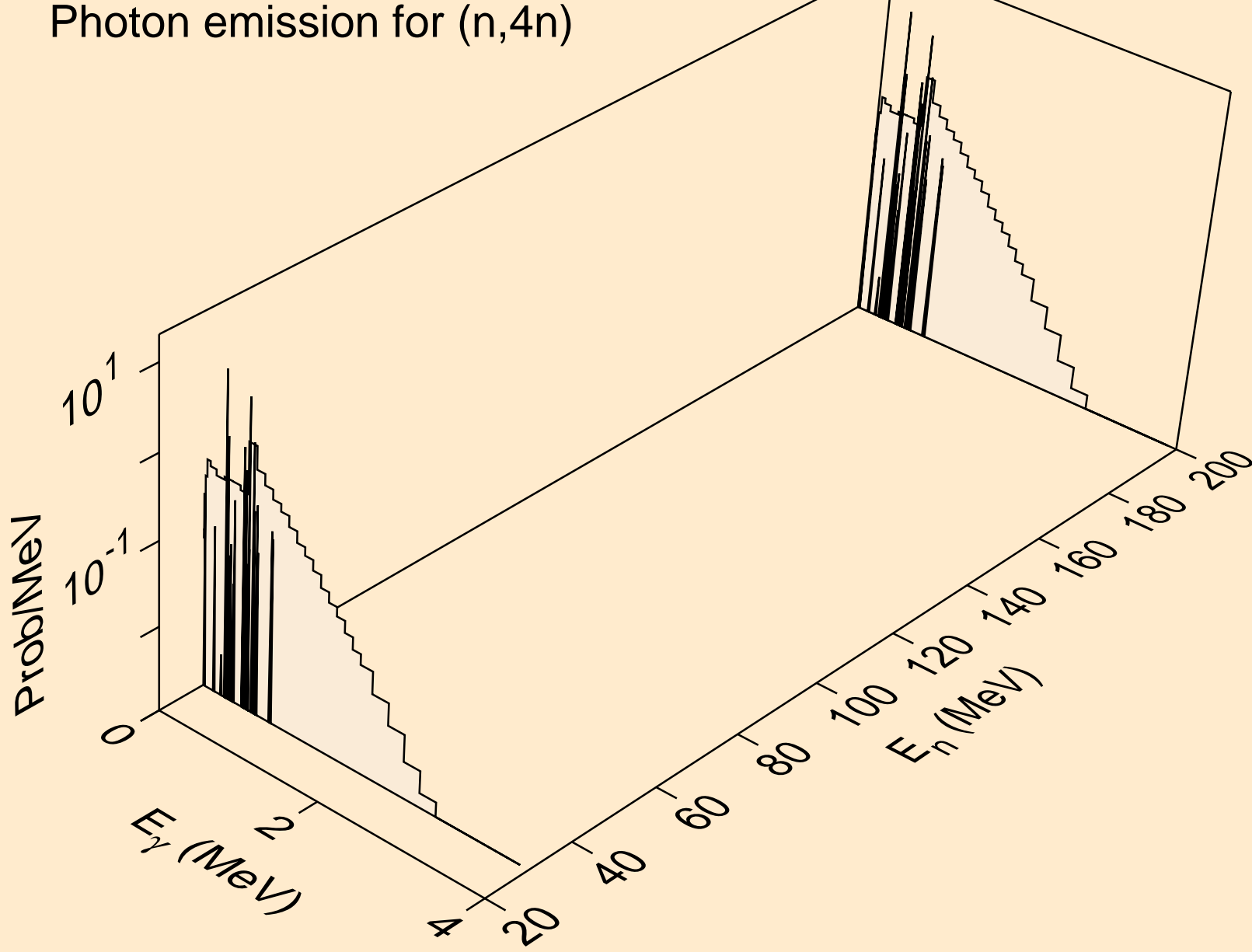

BA136 NEUTRON ACER TENDL-2019 LIBRARY; T=293.16K  
Photon emission for (n,2np)

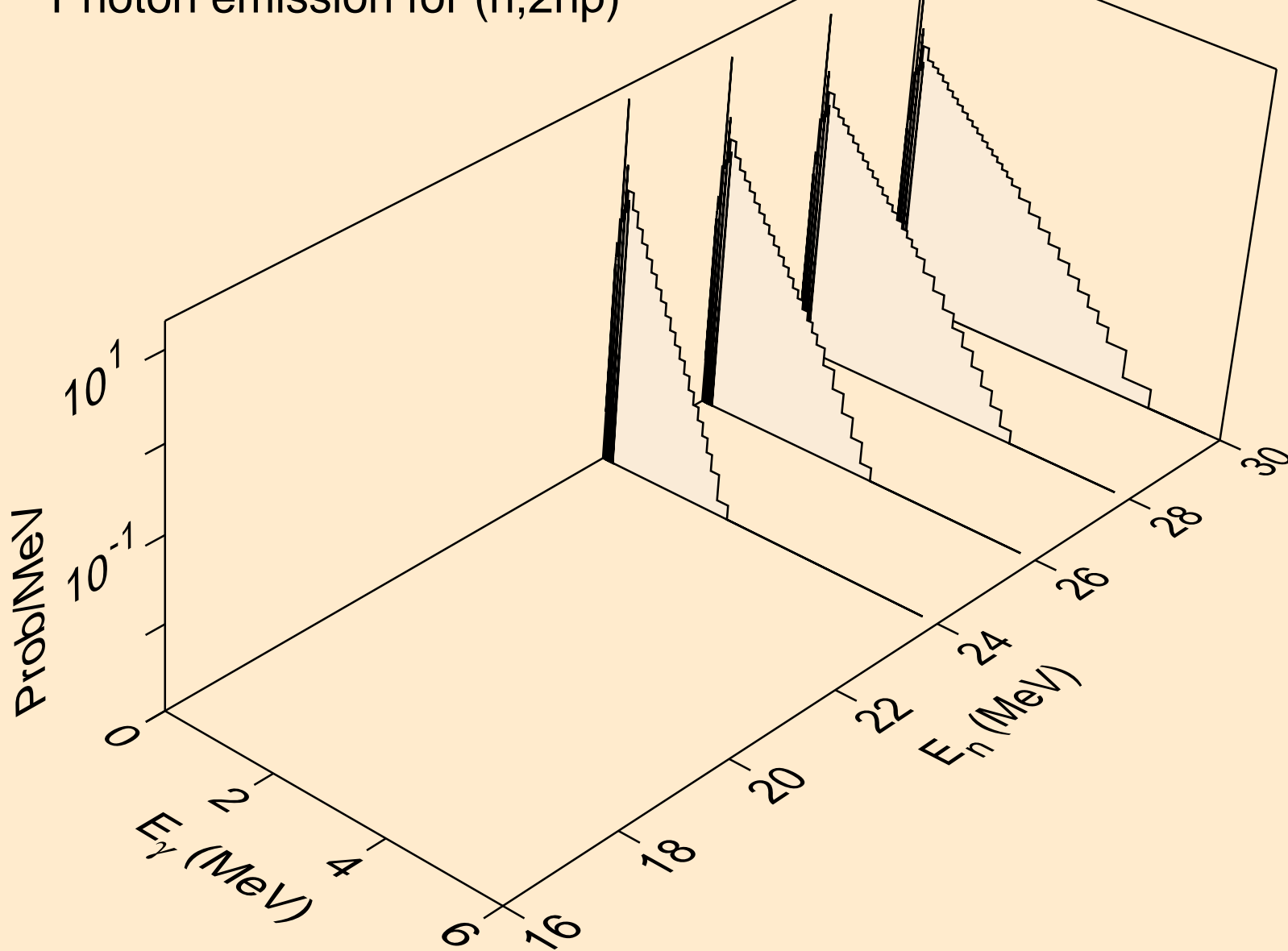

BA136 NEUTRON ACER TENDL-2019 LIBRARY; T=293.16K  
Photon emission for (n,3np)

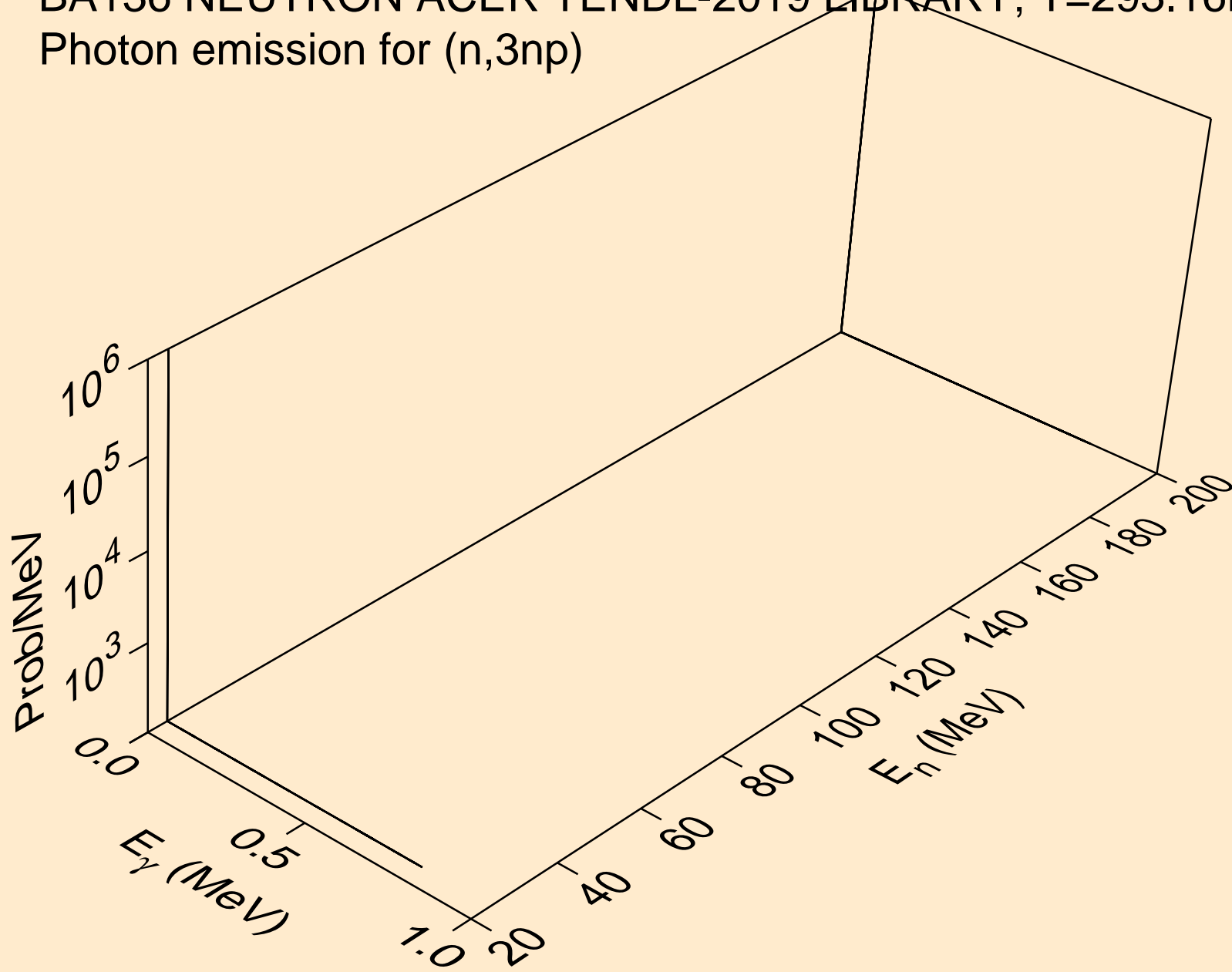

BA136 NEUTRON ACER TENDL-2019 LIBRARY; T=293.16K  
Photon emission for (n,2np)

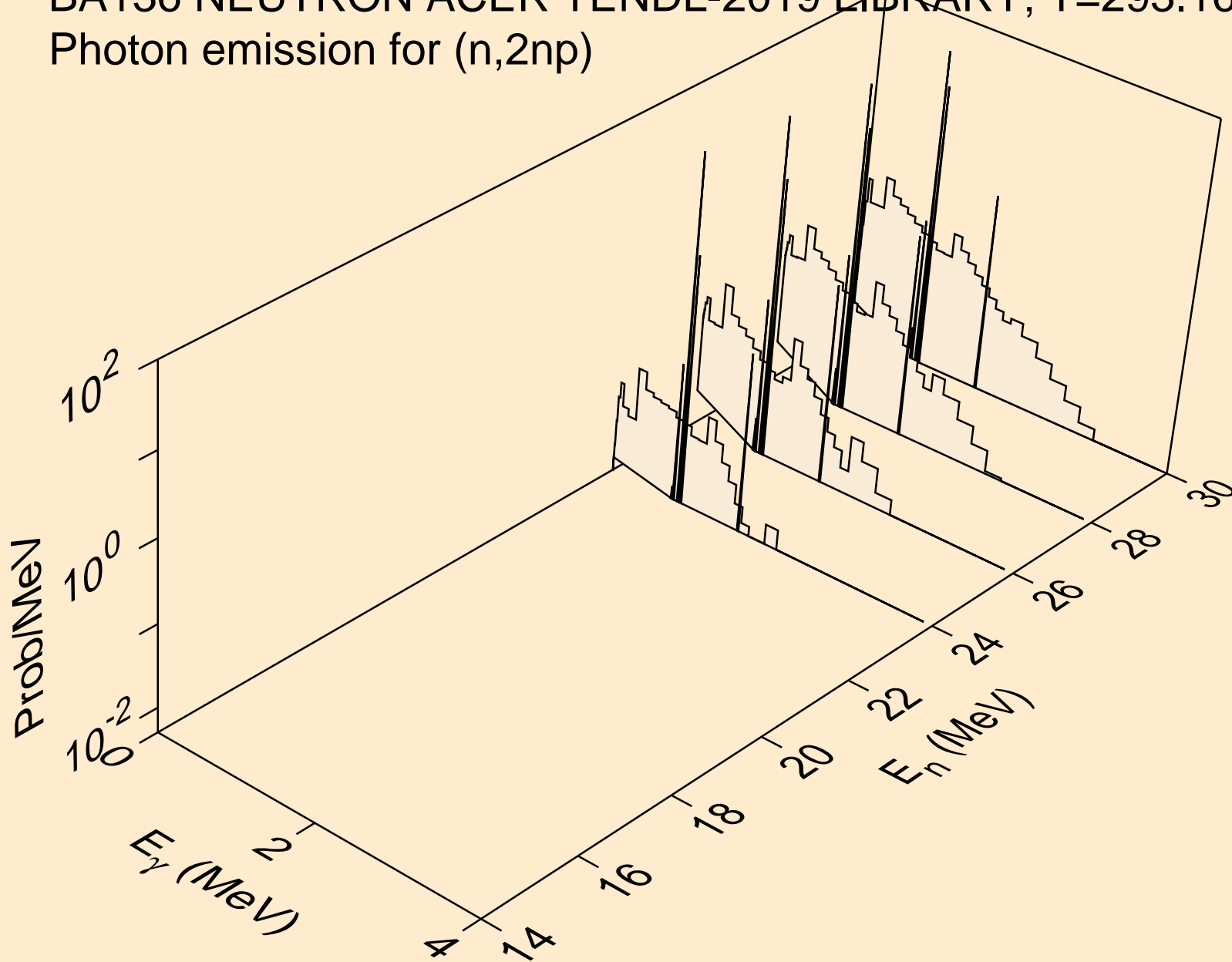

BA136 NEUTRON ACER TENDL-2019 LIBRARY; T=293.16K  
Photon emission for (n,npa)

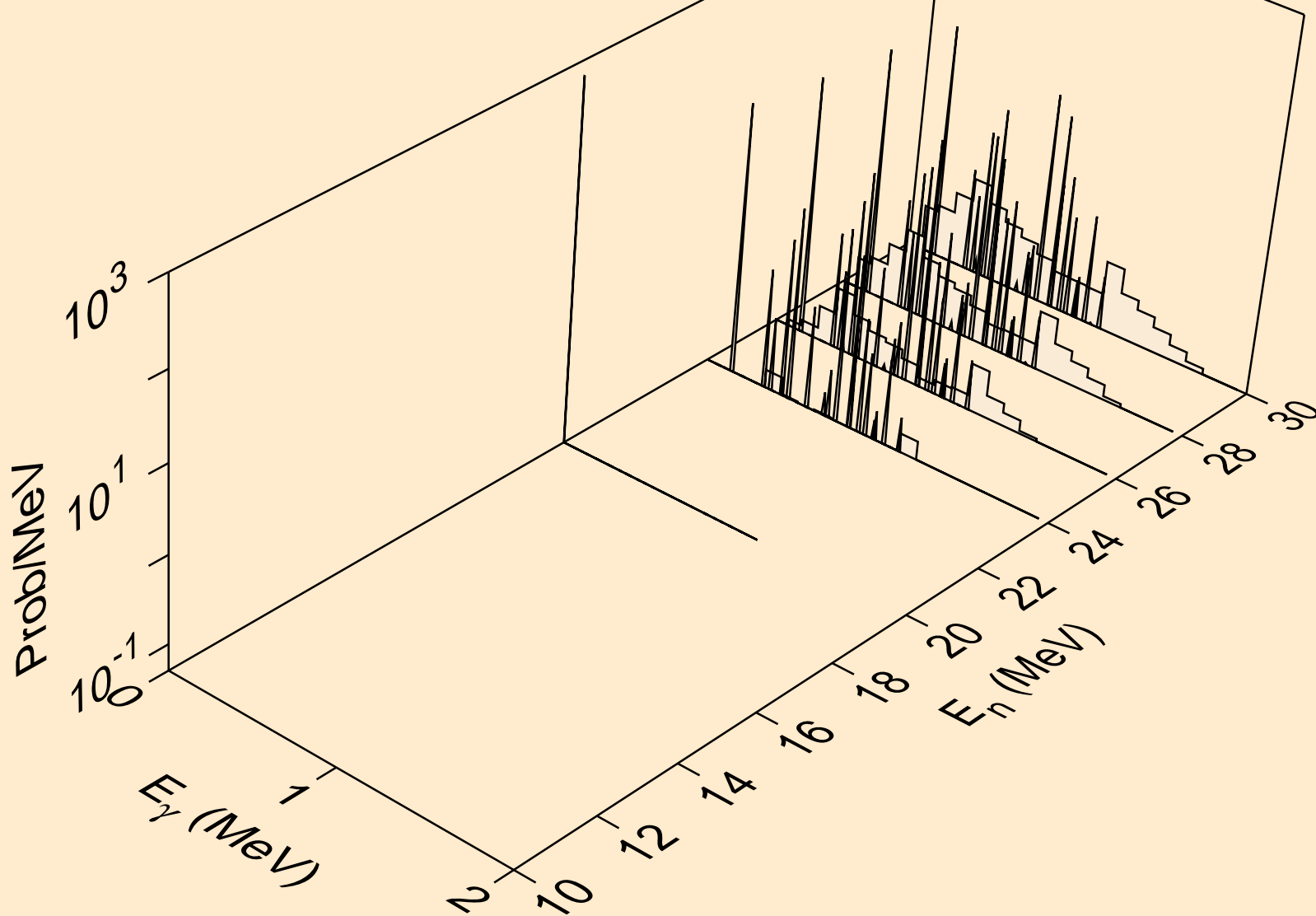



BA136 NEUTRON ACER TENDL-2019 LIBRARY; T=293.16K  
Photon emission for (n,n\*c)

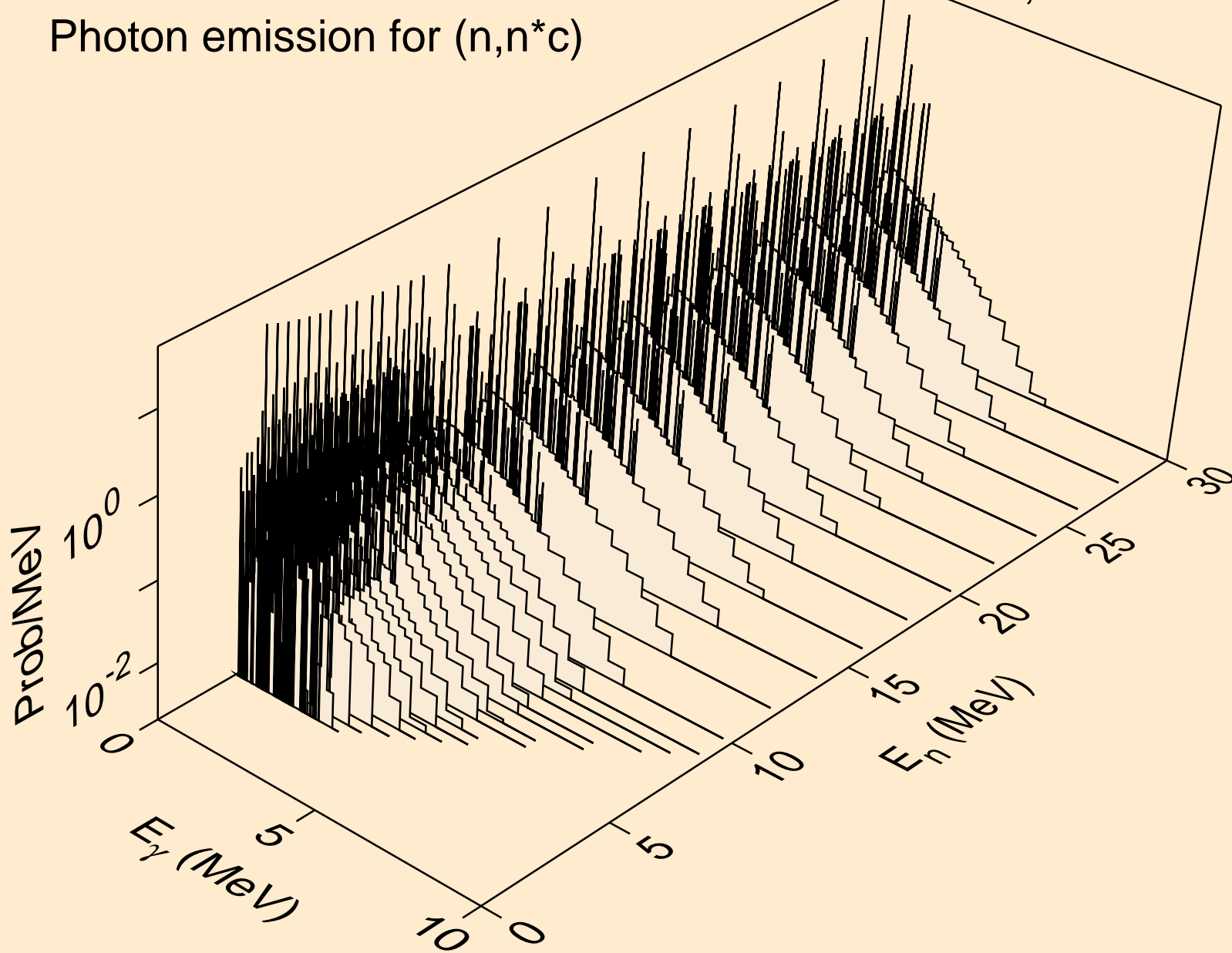

BA136 NEUTRON ACER TENDL-2019 LIBRARY; T=293.16K  
Photon emission for (n,gma)

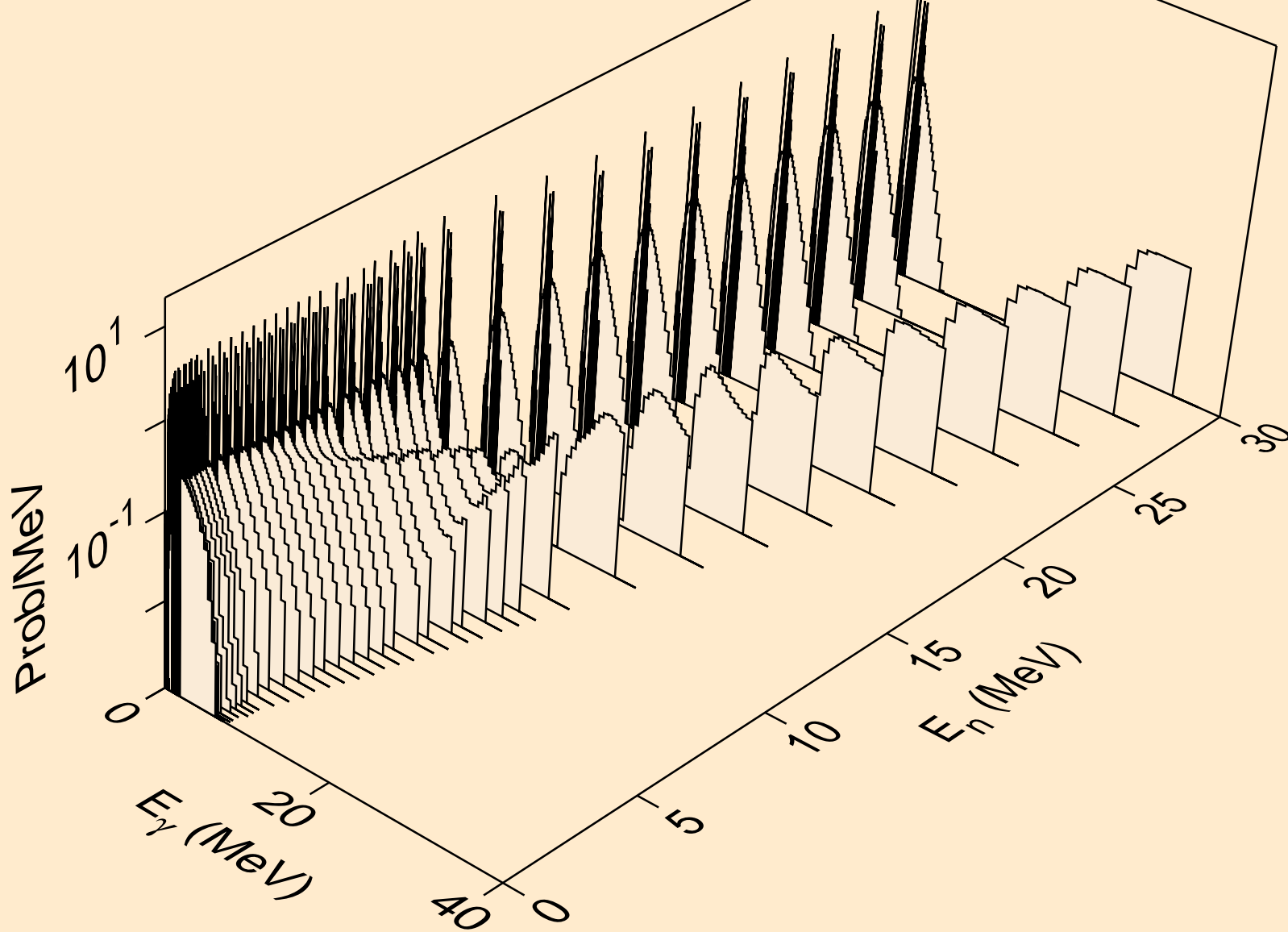

BA136 NEUTRON ACER TENDL-2019 LIBRARY; T=293.16K  
Photon emission for (n,p)

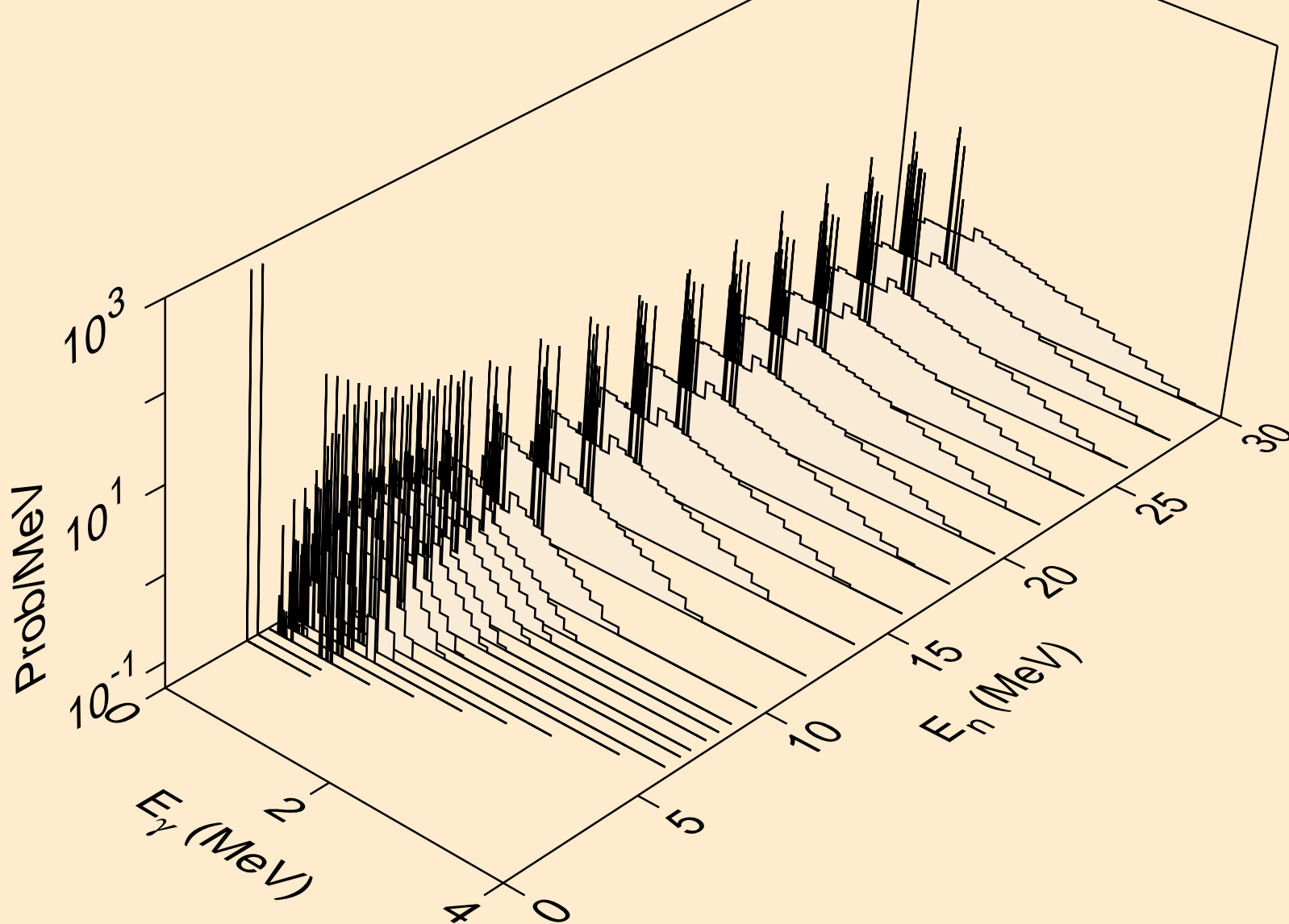

BA136 NEUTRON ACER TENDL-2019 LIBRARY; T=293.16K  
Photon emission for (n,d)

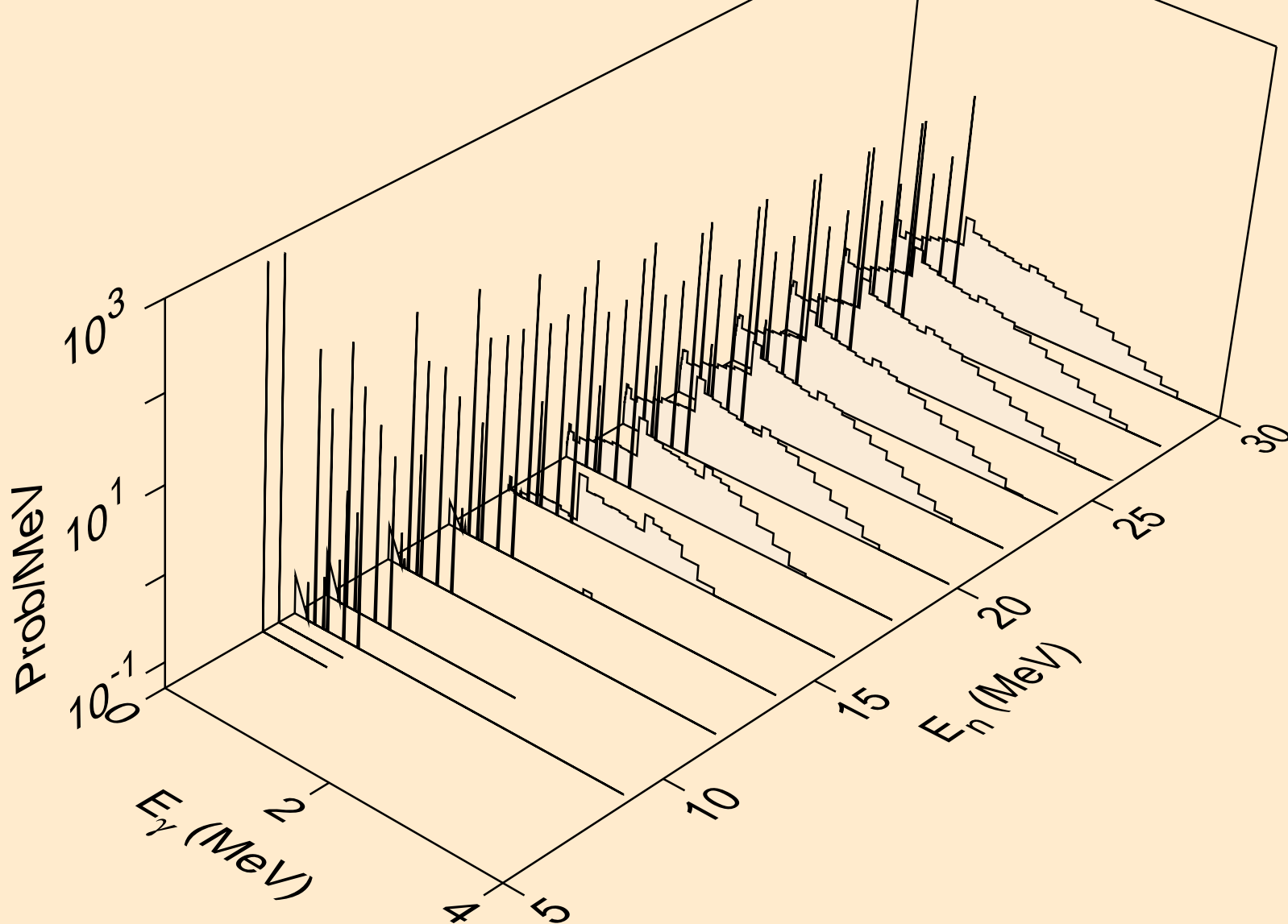

BA136 NEUTRON ACER TENDL-2019 LIBRARY; T=293.16K  
Photon emission for (n,t)

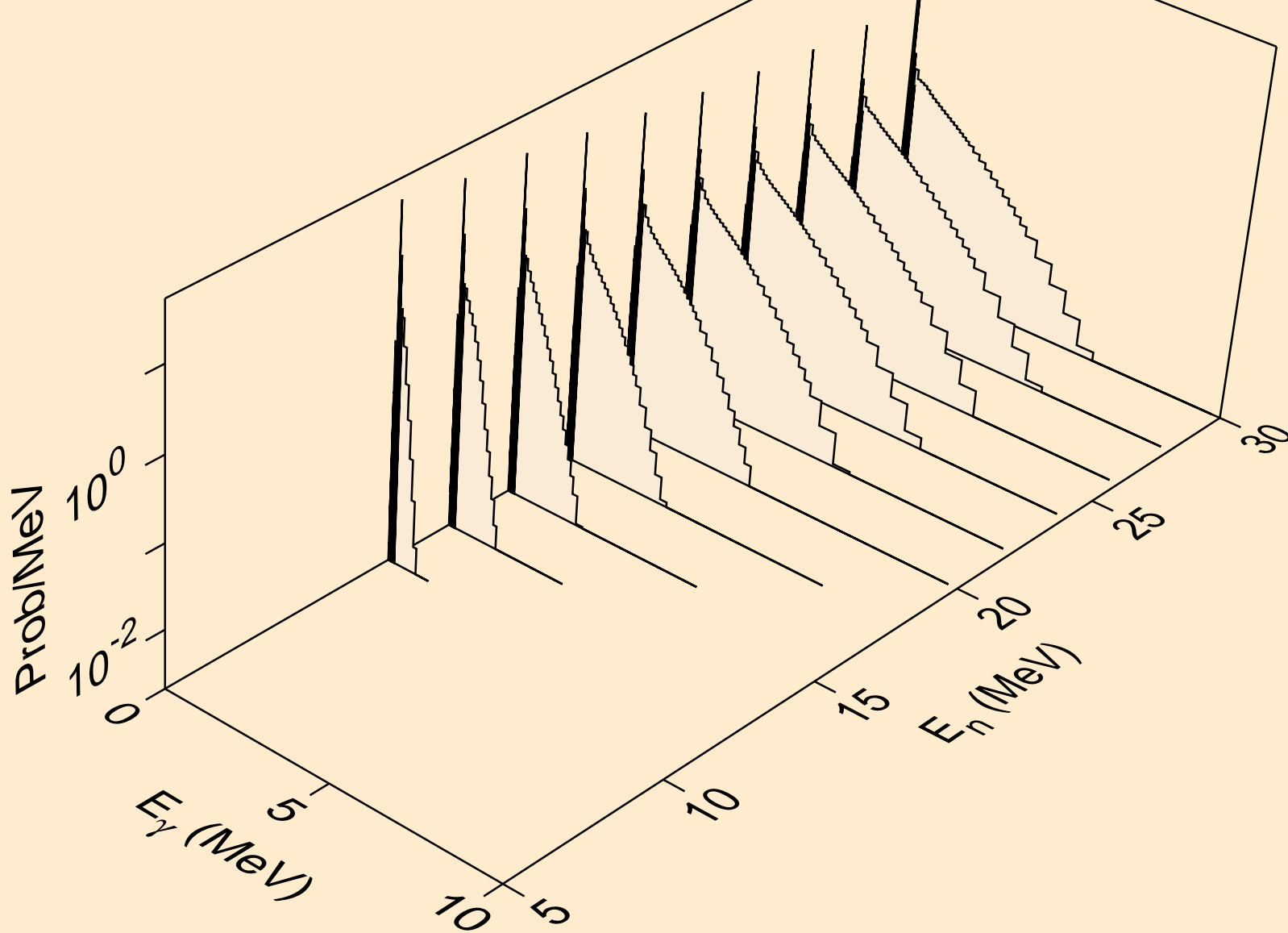

BA136 NEUTRON ACER TENDL-2019 LIBRARY; T=293.16K  
Photon emission for (n,he3)

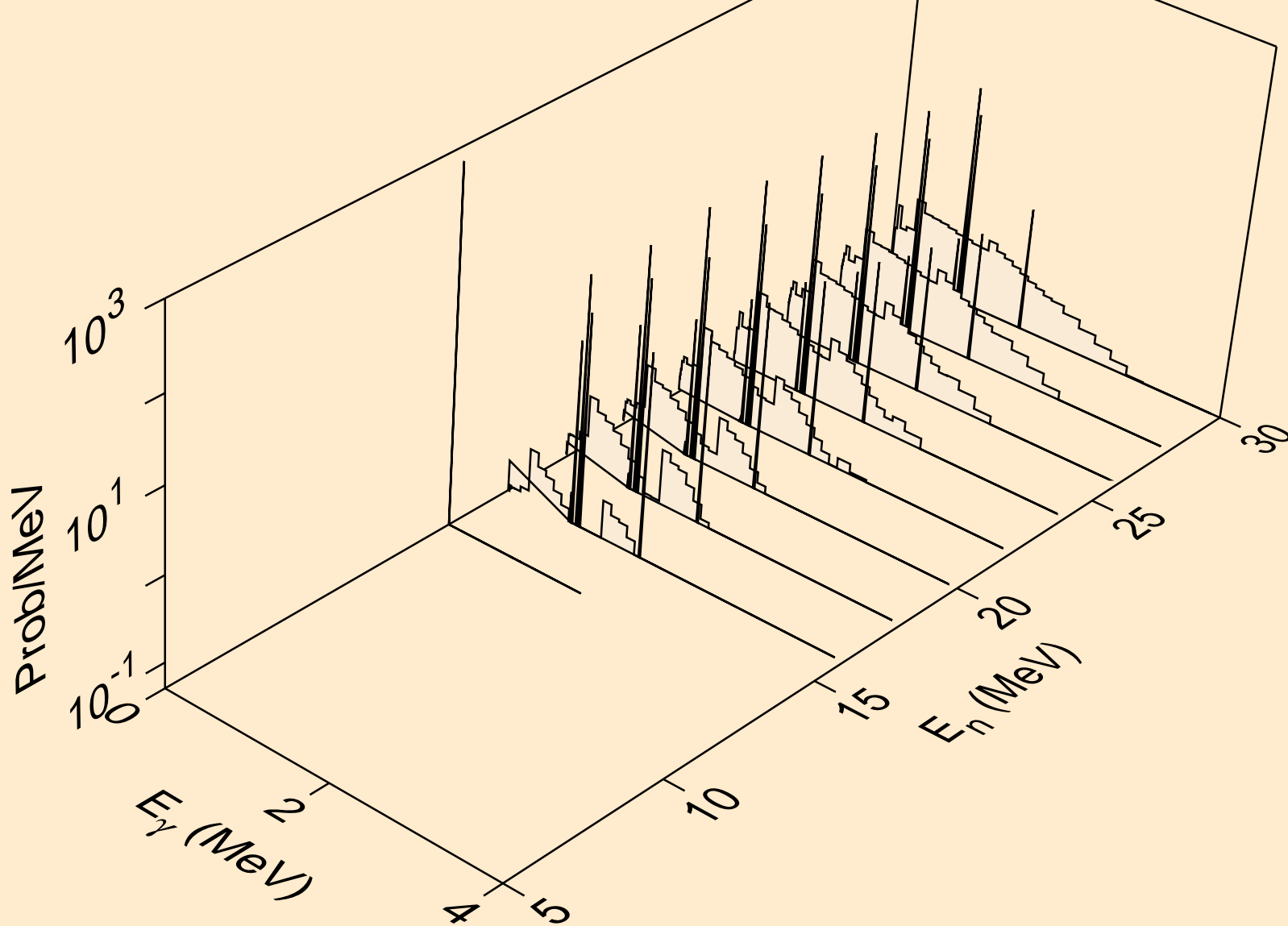

BA136 NEUTRON ACER TENDL-2019 LIBRARY; T=293.16K  
Photon emission for (n,a)

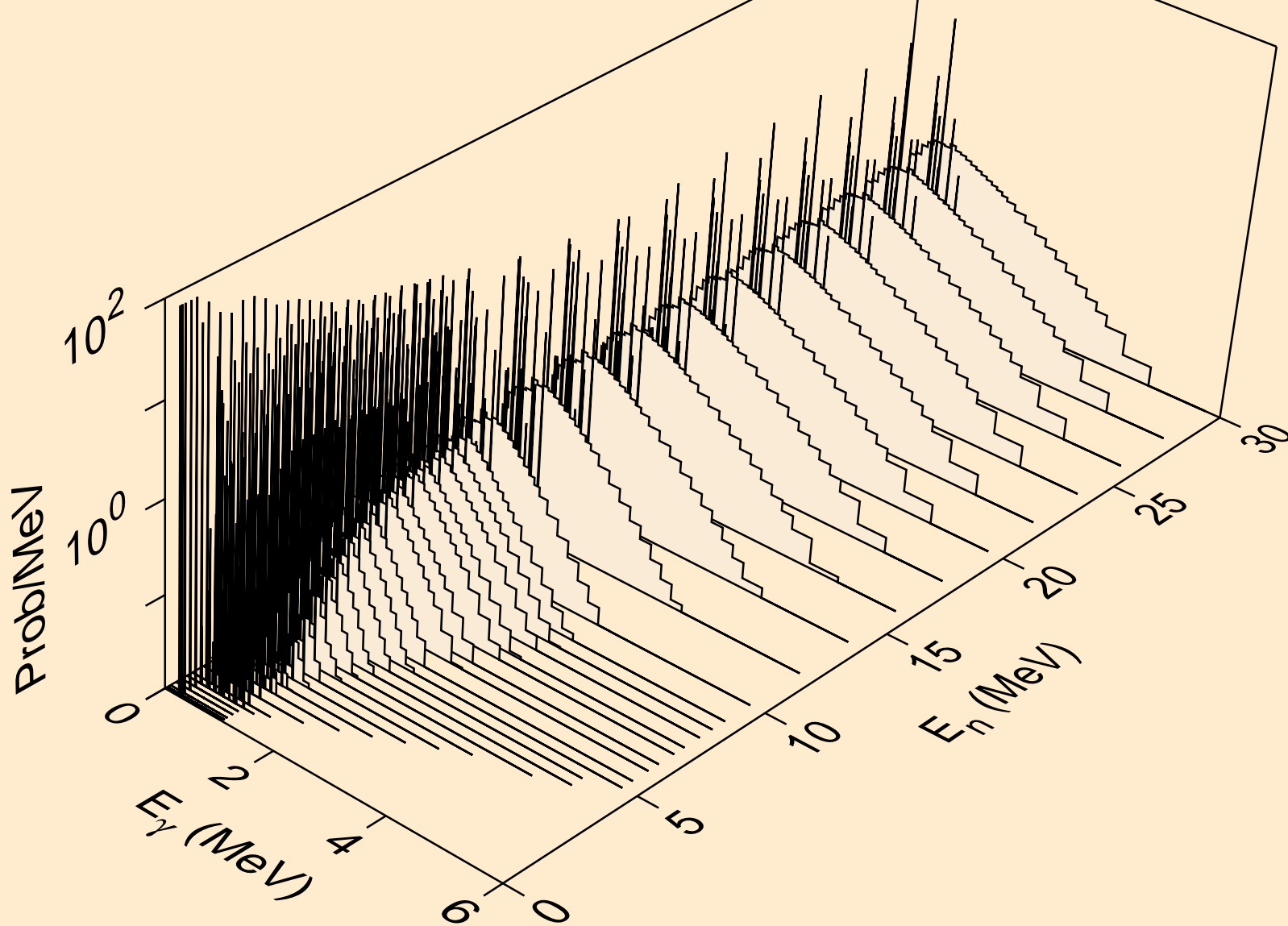

BA136 NEUTRON ACER TENDL-2019 LIBRARY; T=293.16K  
Photon emission for (n,2a)

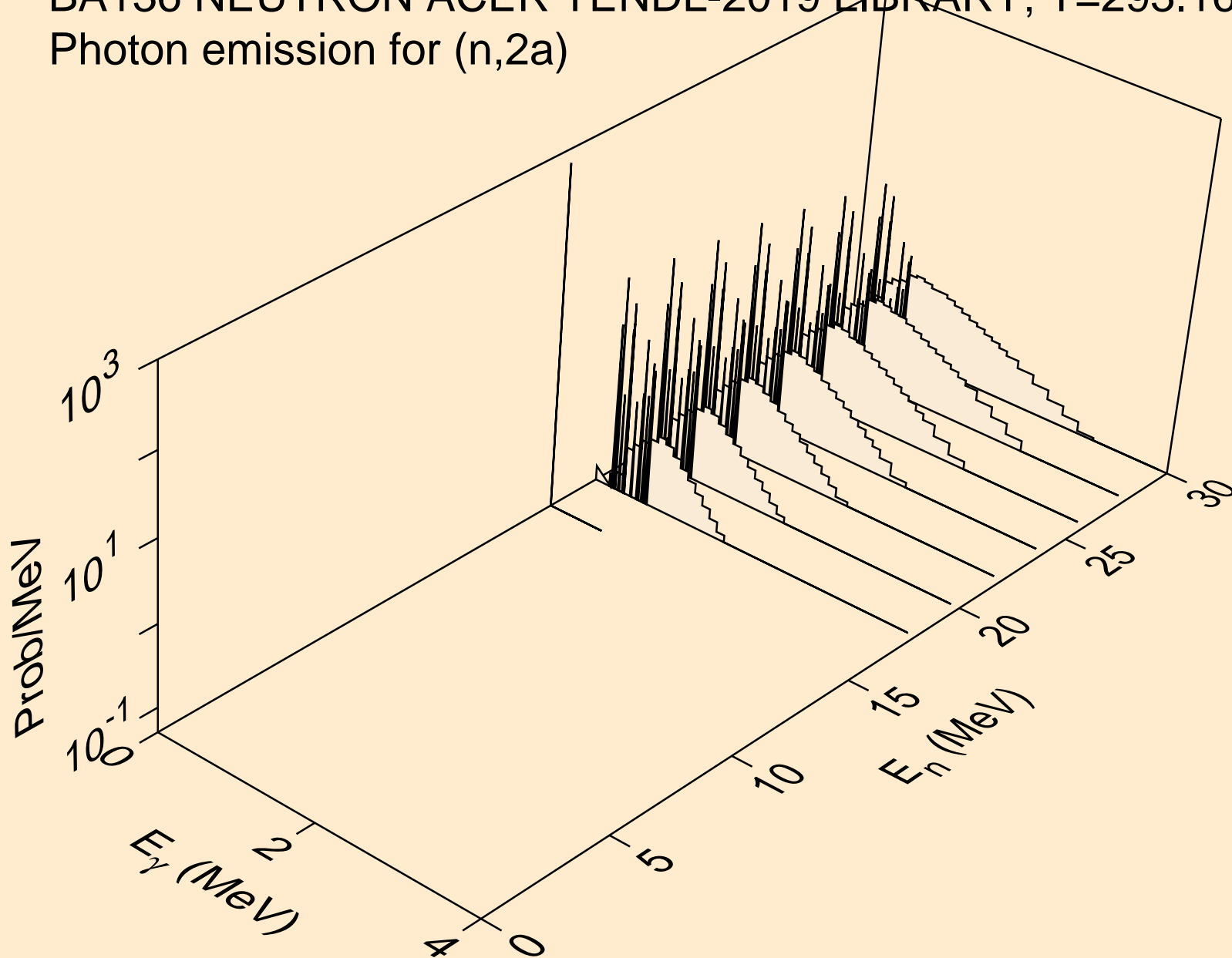



BA136 NEUTRON ACER TENDL-2019 LIBRARY; T=293.16K  
Photon emission for (n,2p)

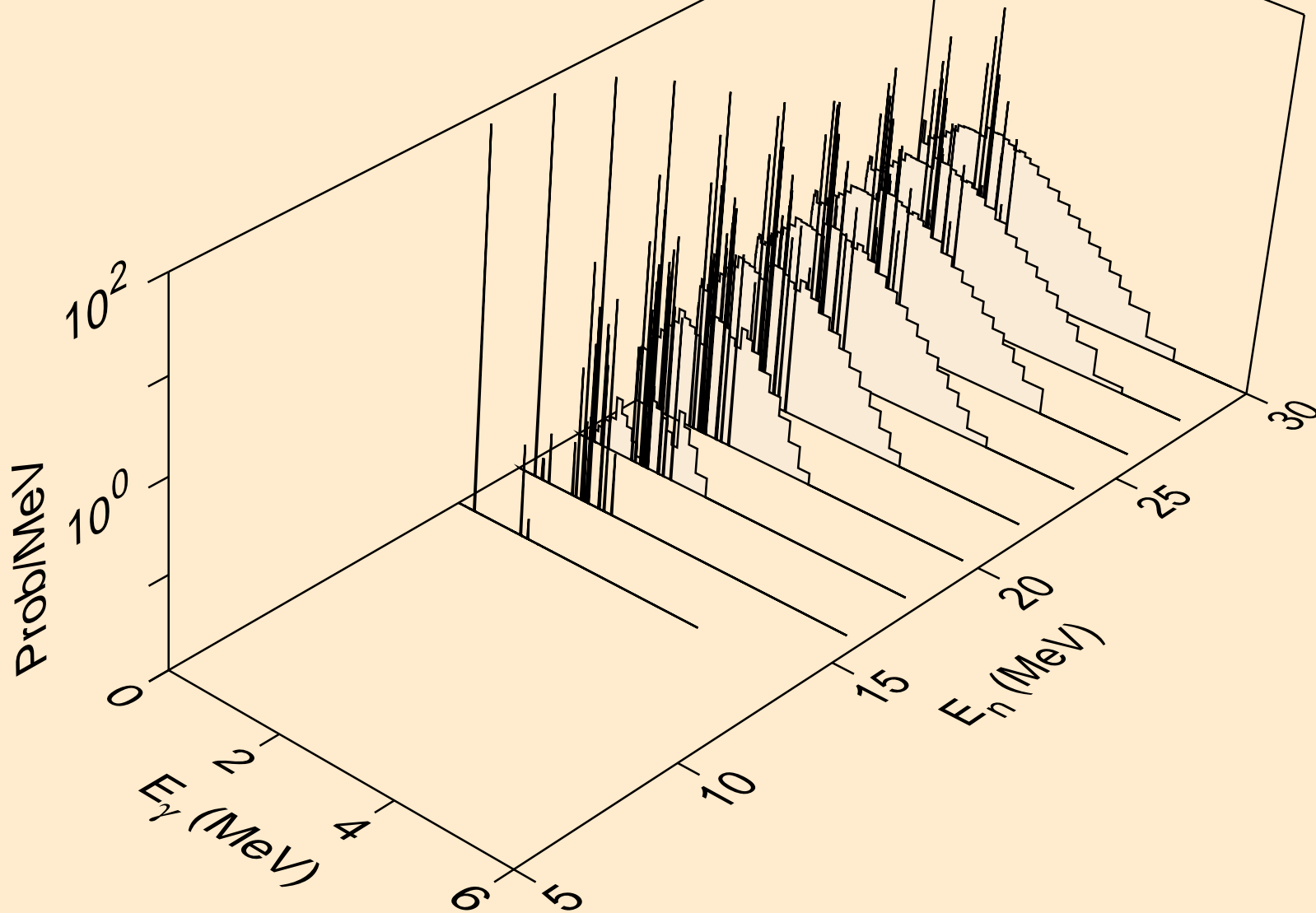

BA136 NEUTRON ACER TENDL-2019 LIBRARY; T=293.16K  
Photon emission for (n,p $\alpha$ )

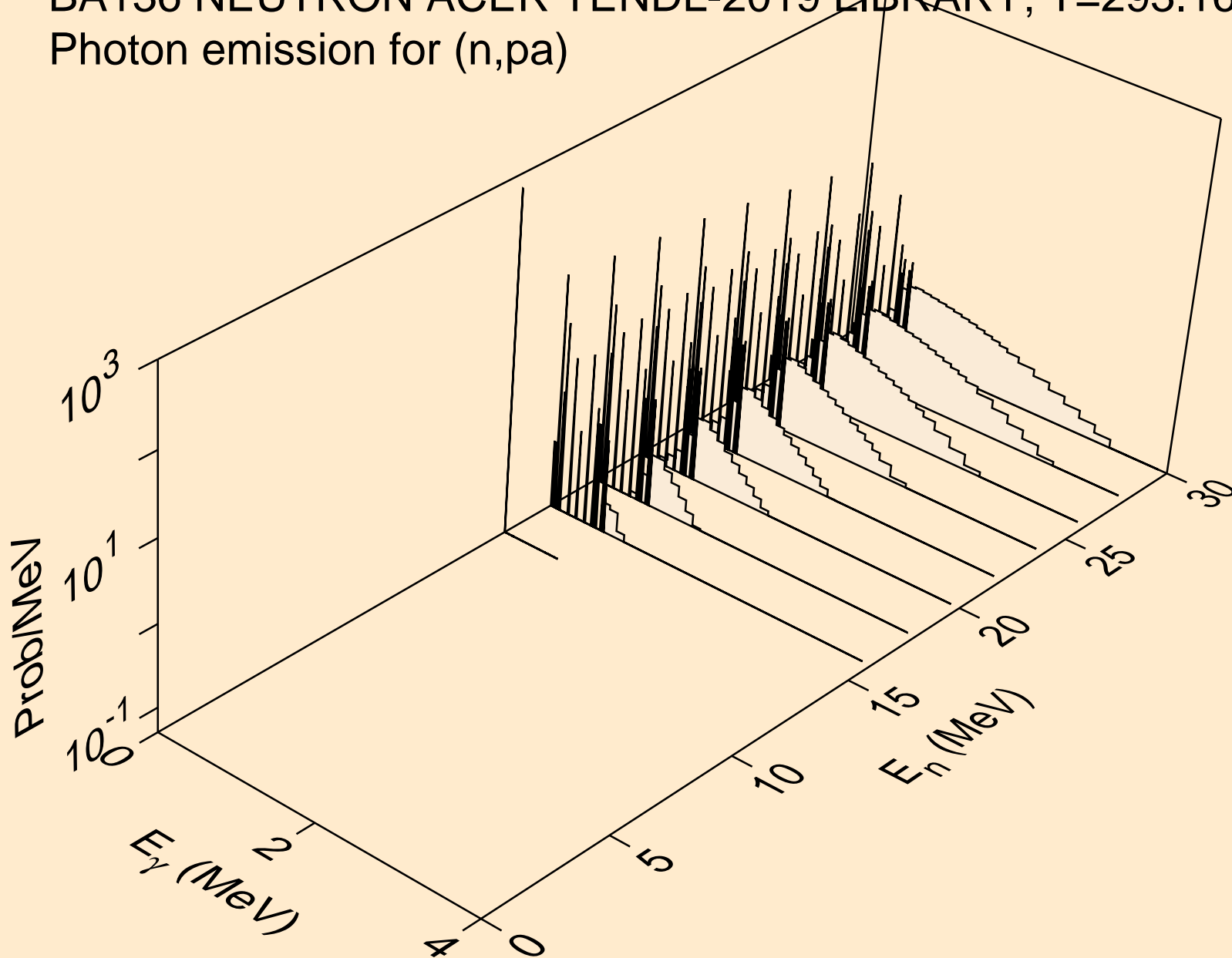

BA136 NEUTRON ACER TENDL-2019 LIBRARY; T=293.16K  
Photon emission for (n,pd)

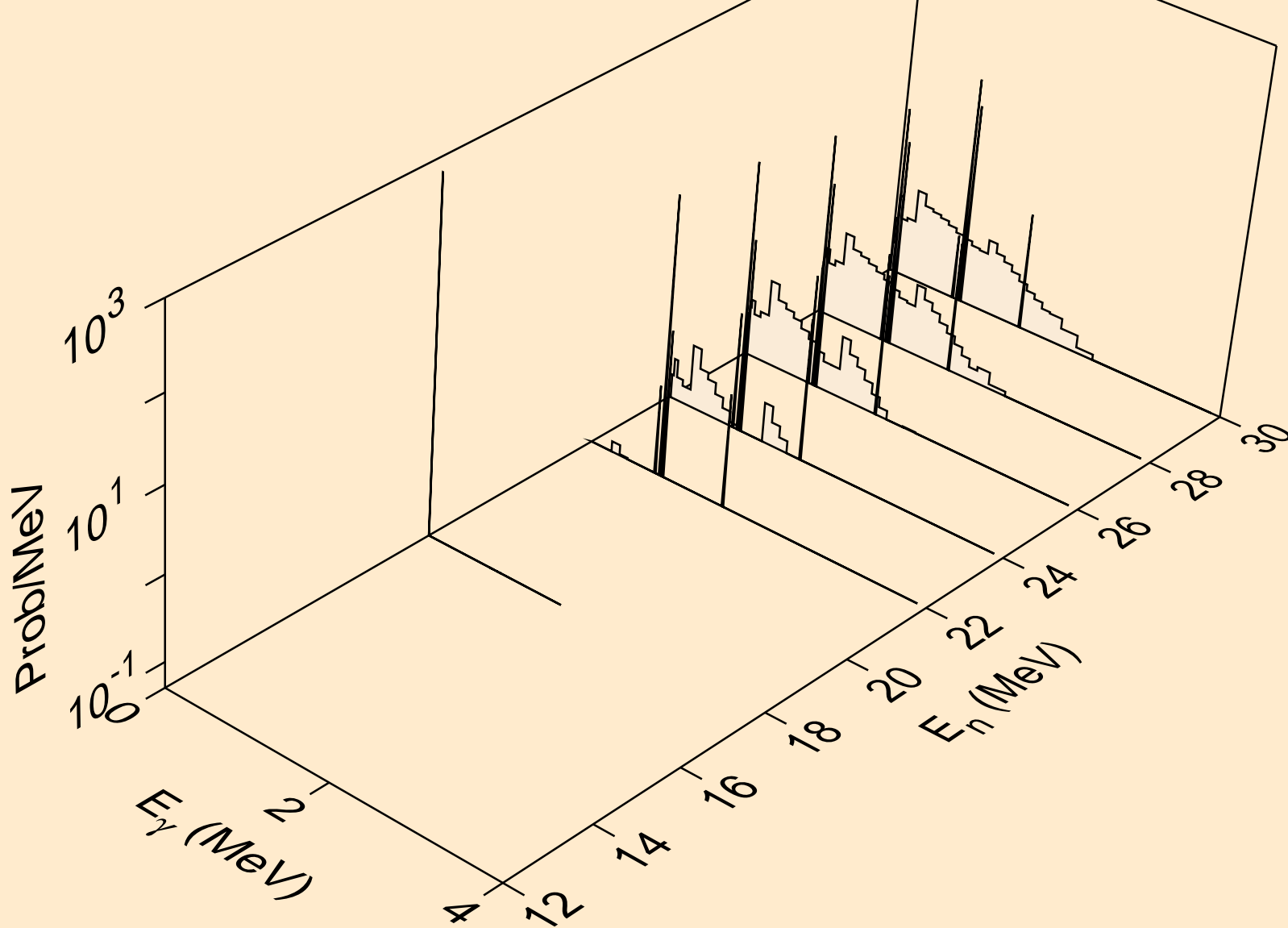

BA136 NEUTRON ACER TENDL-2019 LIBRARY; T=293.16K  
Photon emission for (n,pt)

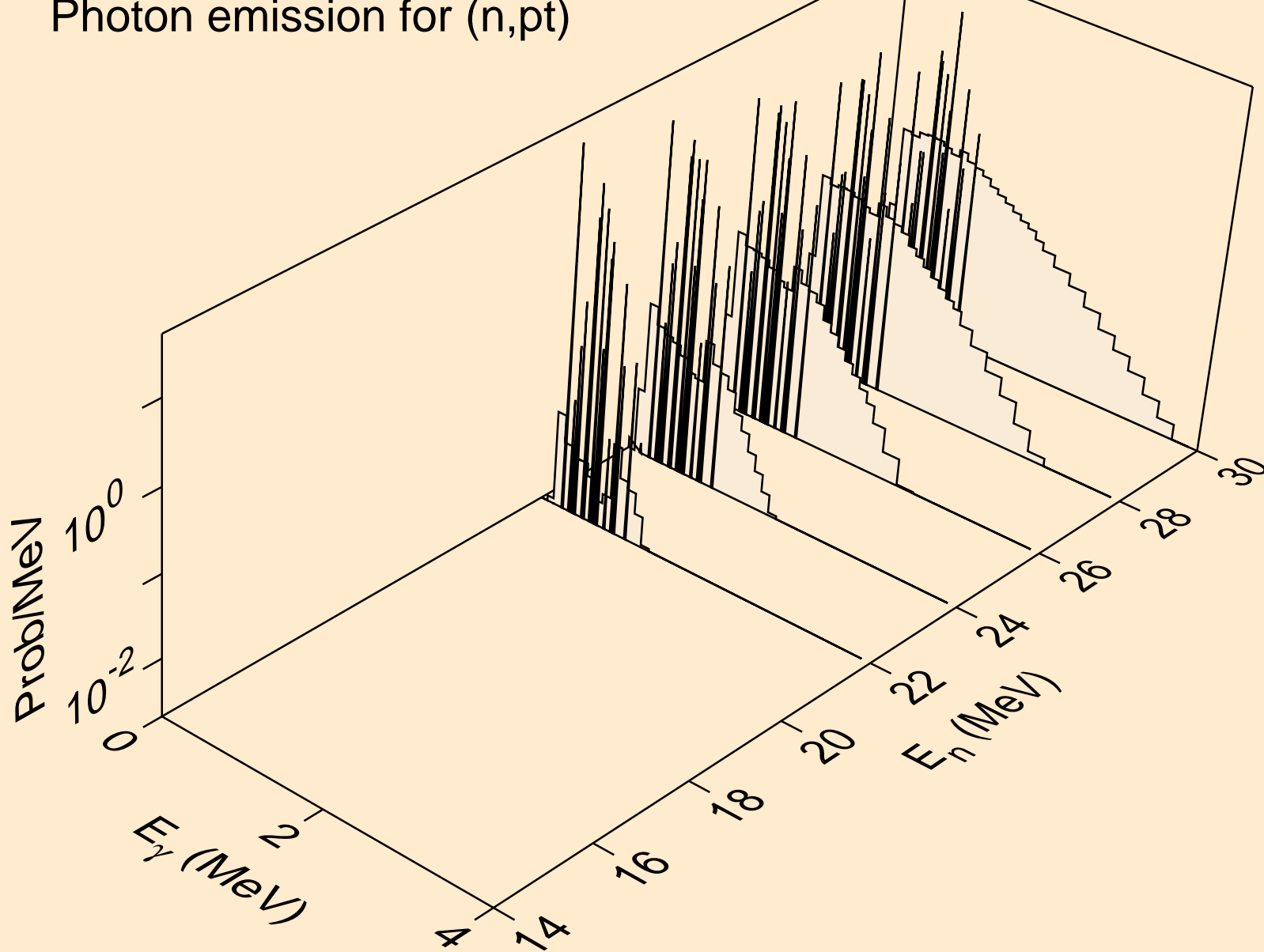

BA136 NEUTRON ACER TENDL-2019 LIBRARY; T=293.16K  
thermal capture photon spectrum

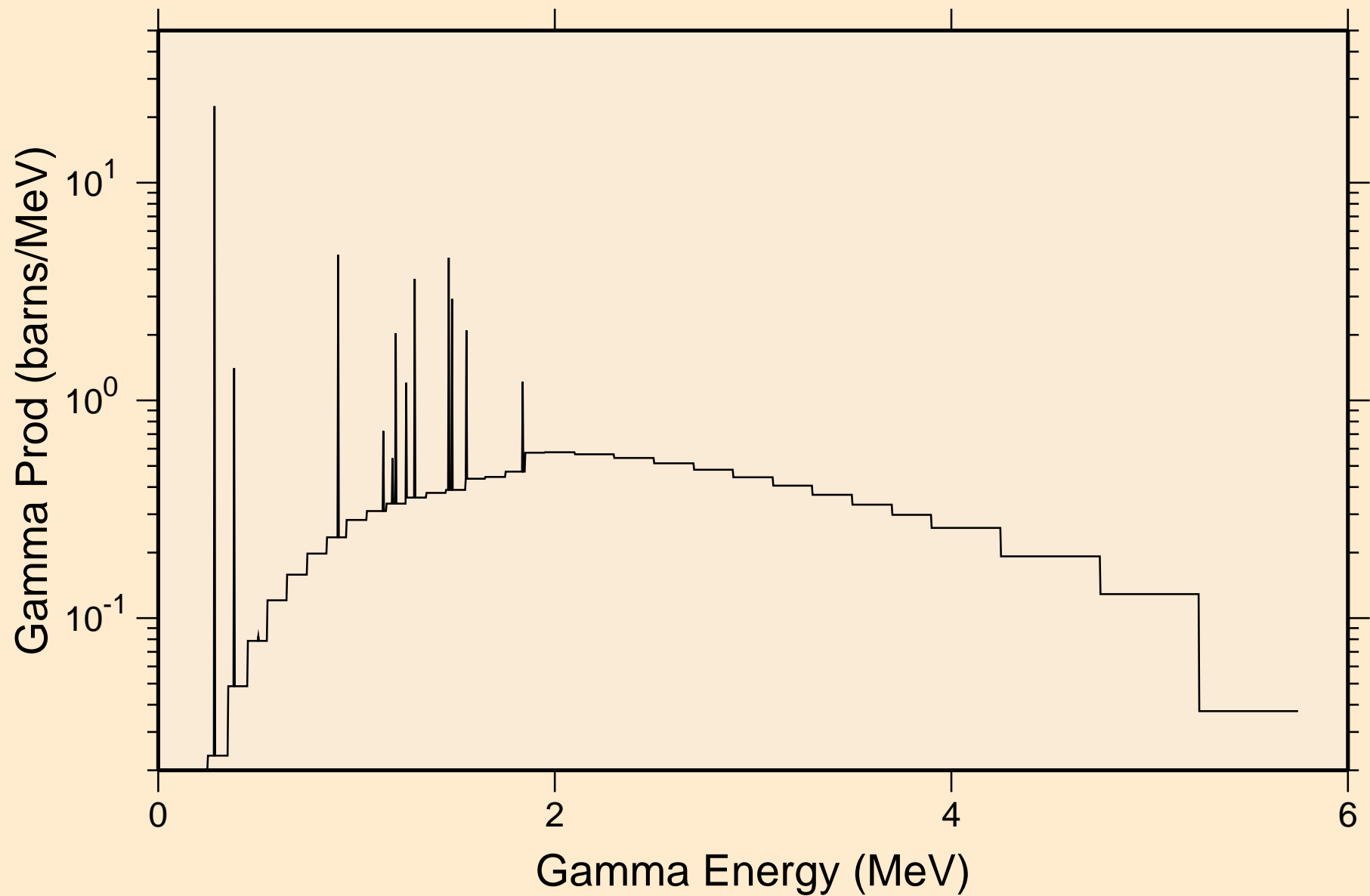

BA136 NEUTRON ACER TENDL-2019 LIBRARY; T=293.16K  
14 MeV photon spectrum

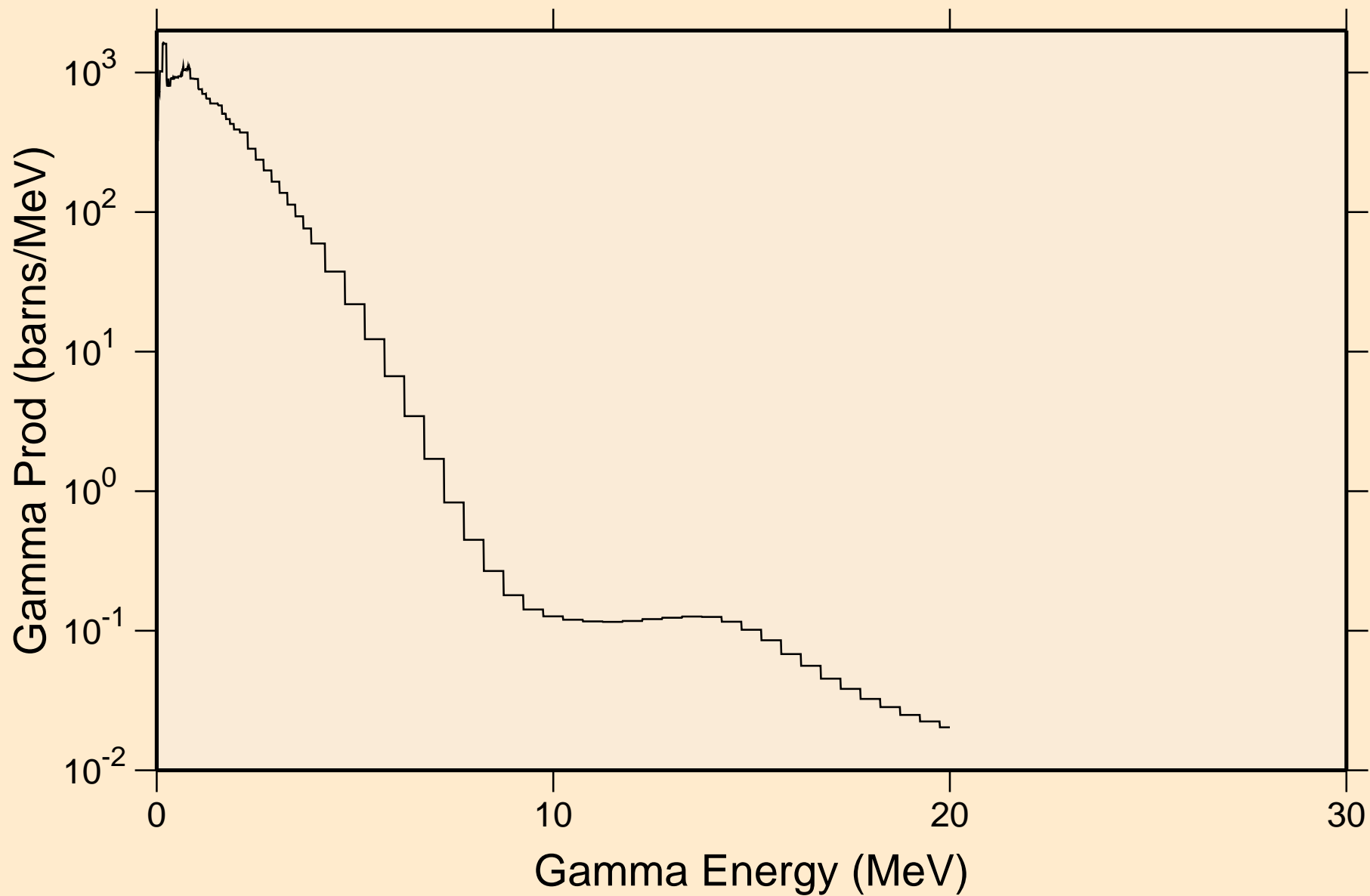

BA136 NEUTRON ACER TENDL-2019 LIBRARY; T=293.16K  
Particle heating contributions

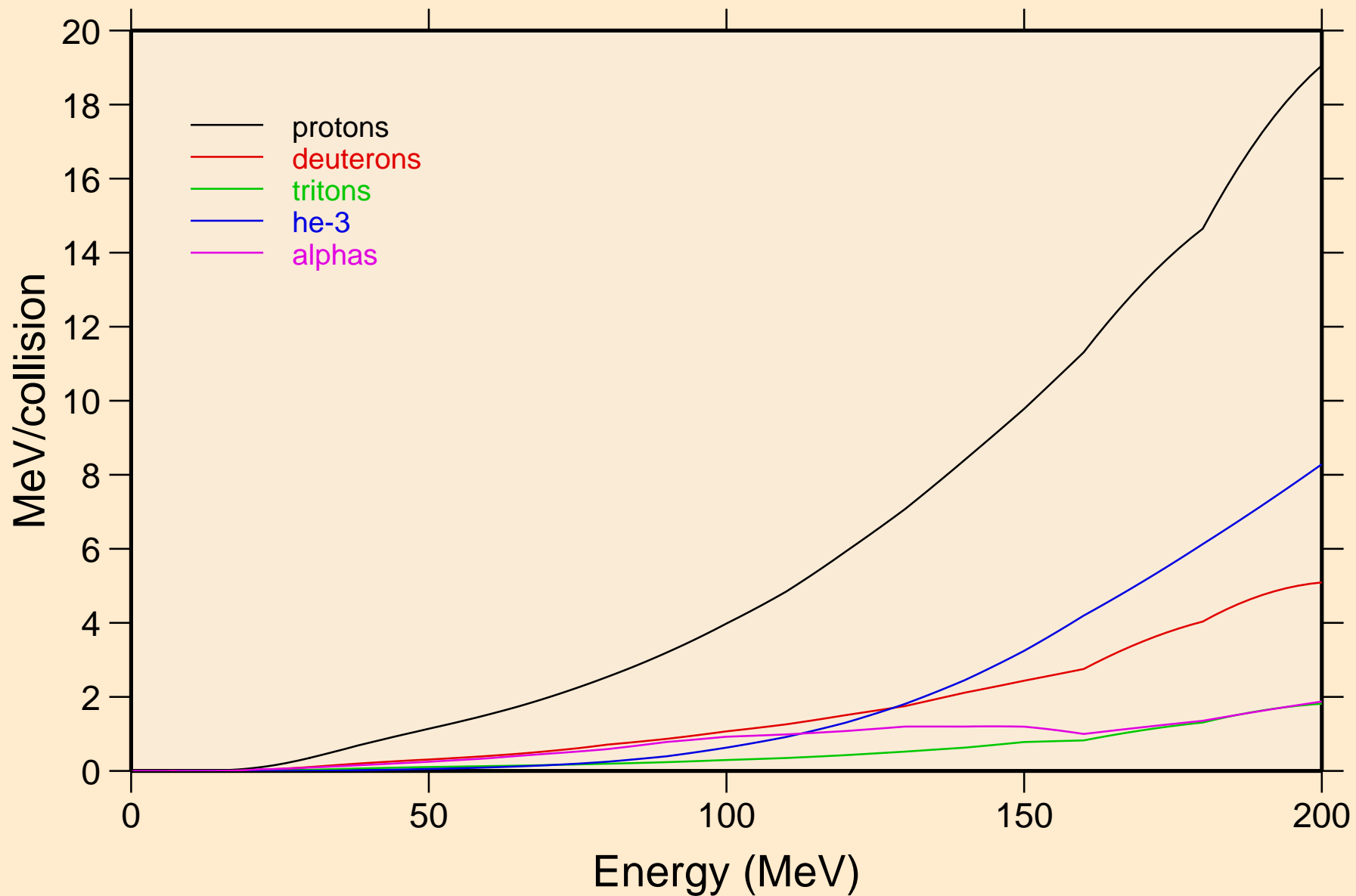

BA136 NEUTRON ACER TENDL-2019 LIBRARY; T=293.16K  
Recoil Heating

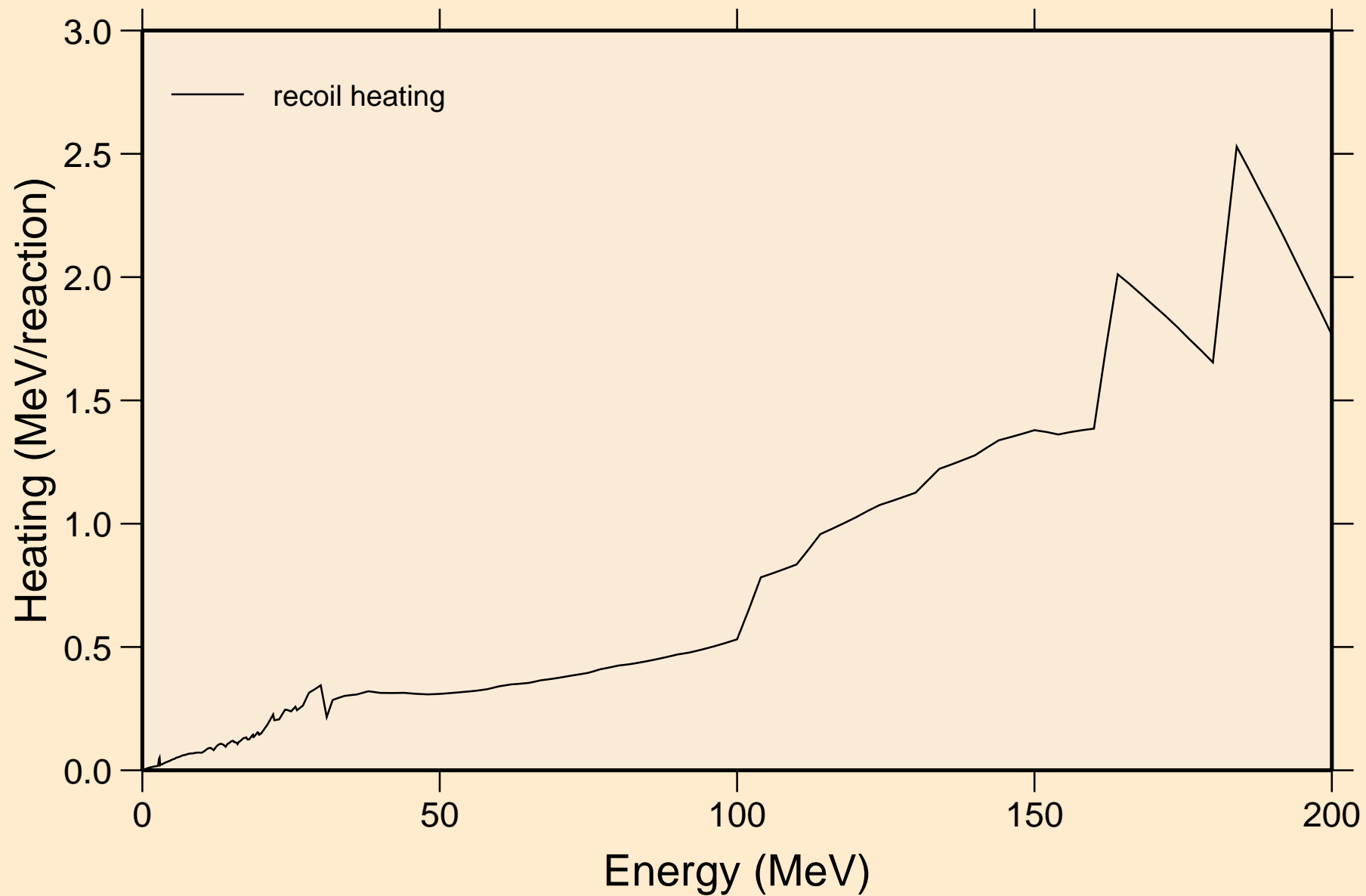



BA136 NEUTRON ACER TENDL-2019 LIBRARY; T=293.16K  
Particle production cross sections

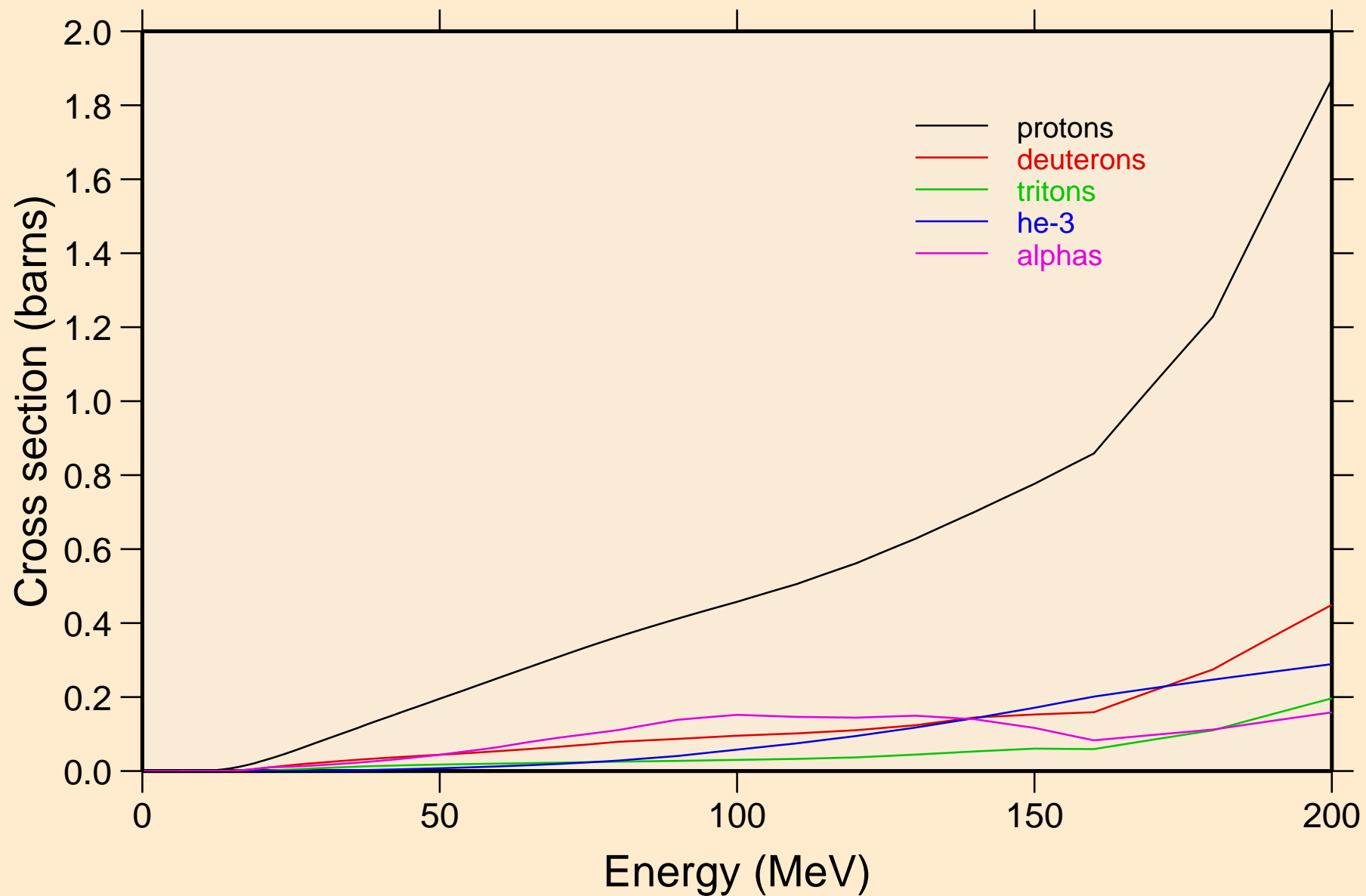

BA136 NEUTRON ACER TENDL-2019 LIBRARY; T=293.16K  
protons from (n,x)

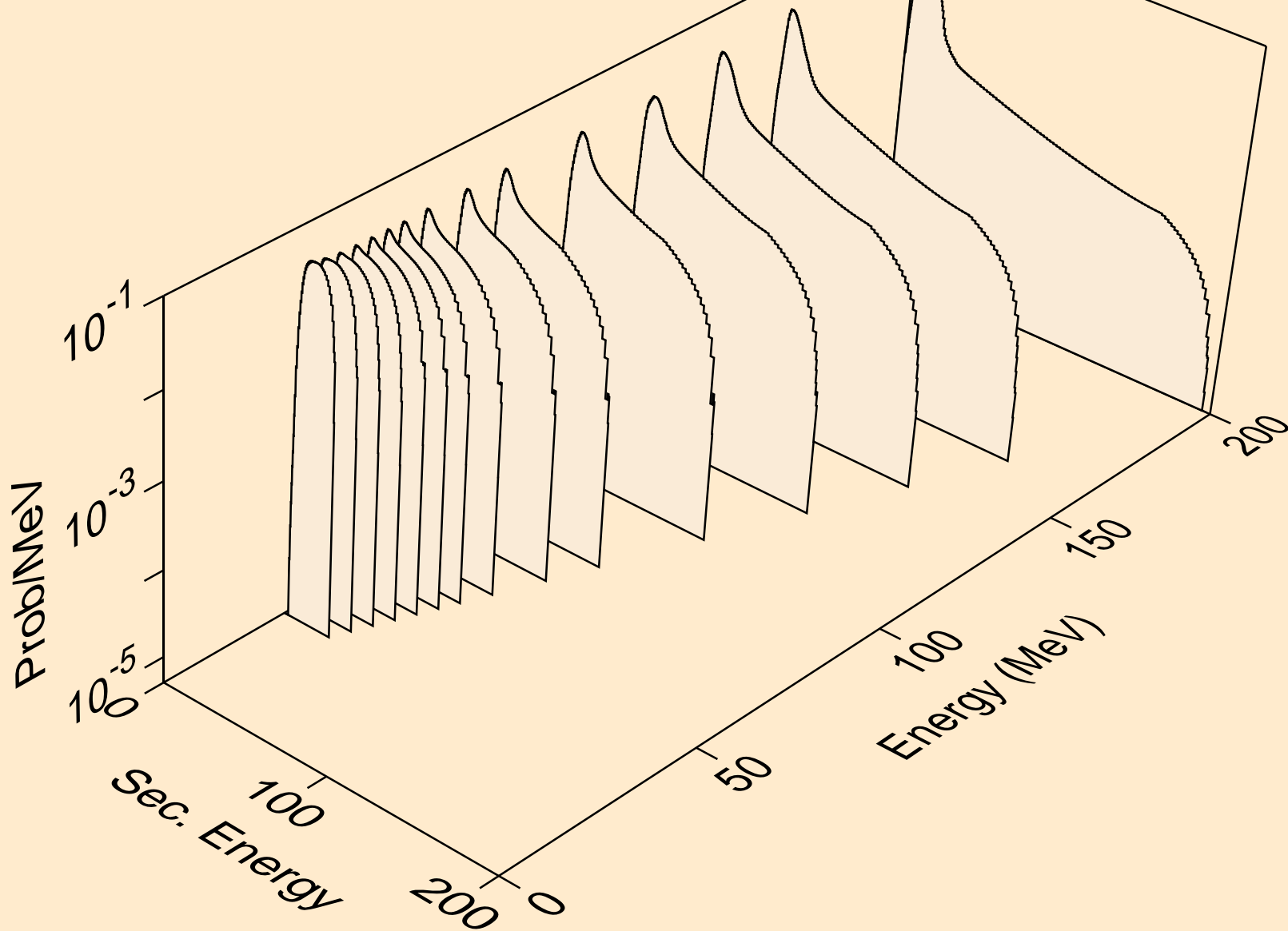

BA136 NEUTRON ACER TENDL-2019 LIBRARY; T=293.16K  
protons from (n,n\*)p

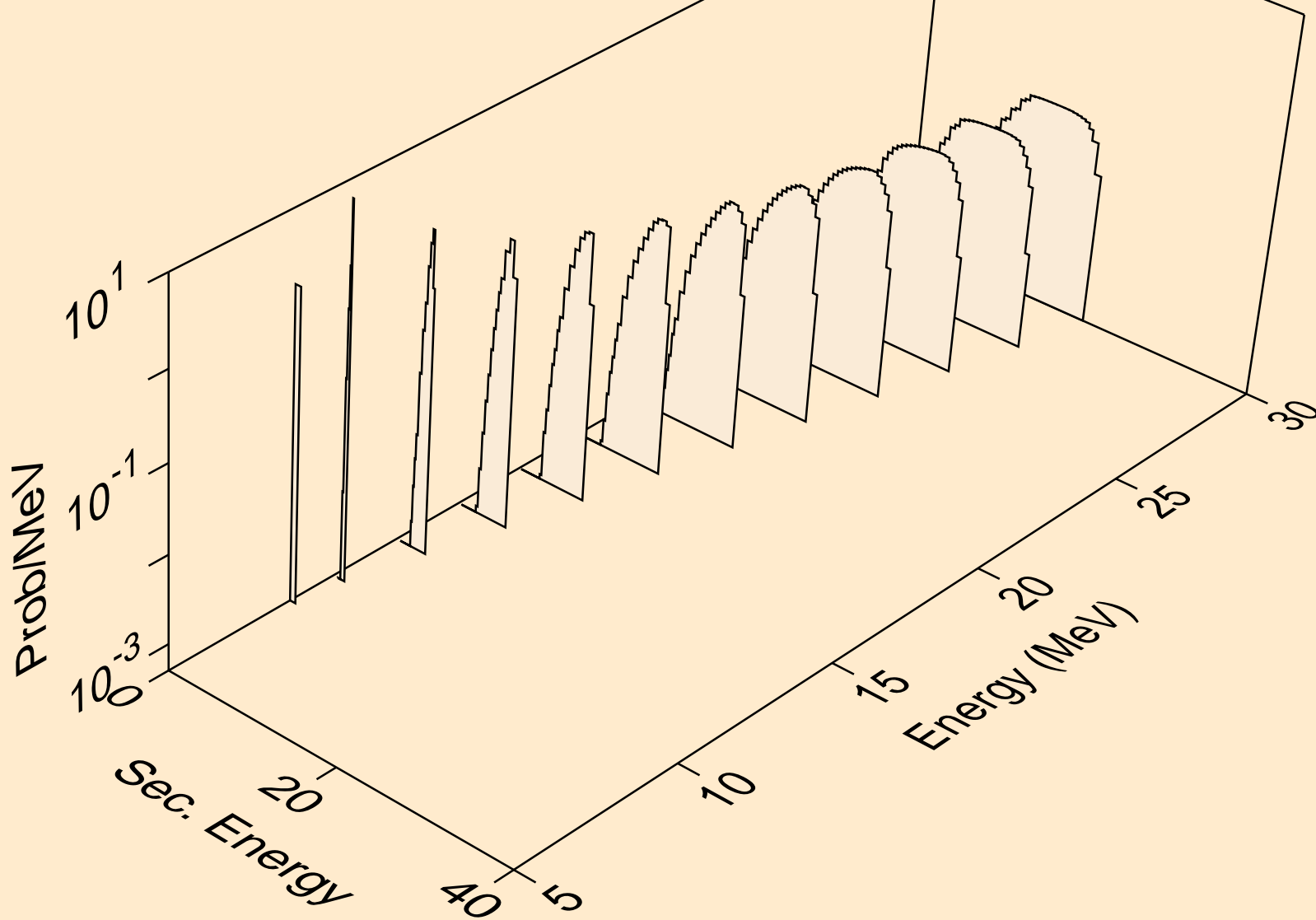

BA136 NEUTRON ACER TENDL-2019 LIBRARY; T=293.16K  
protons from (n,2np)

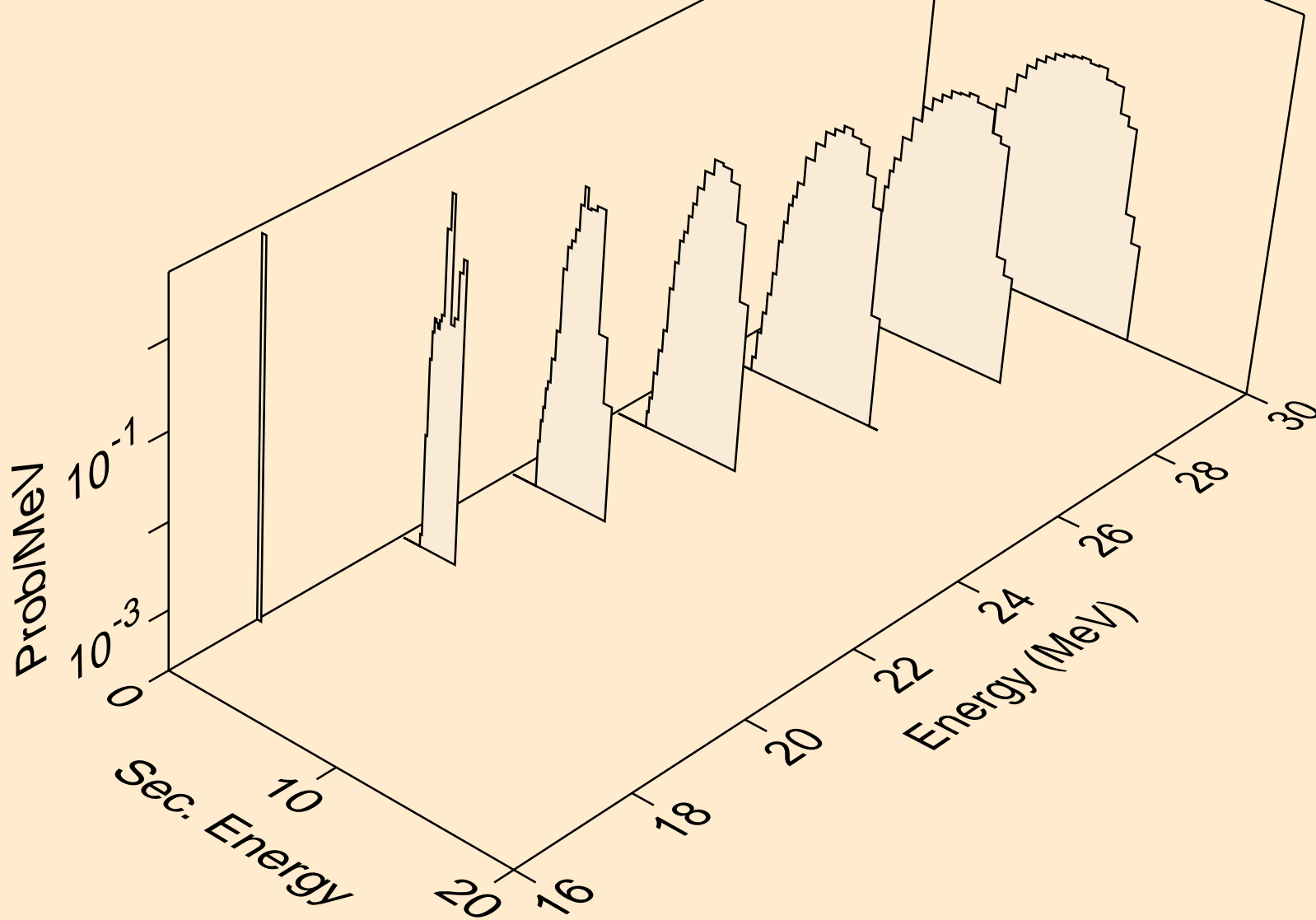

BA136 NEUTRON ACER TENDL-2019 LIBRARY; T=293.16K  
protons from (n,3np)

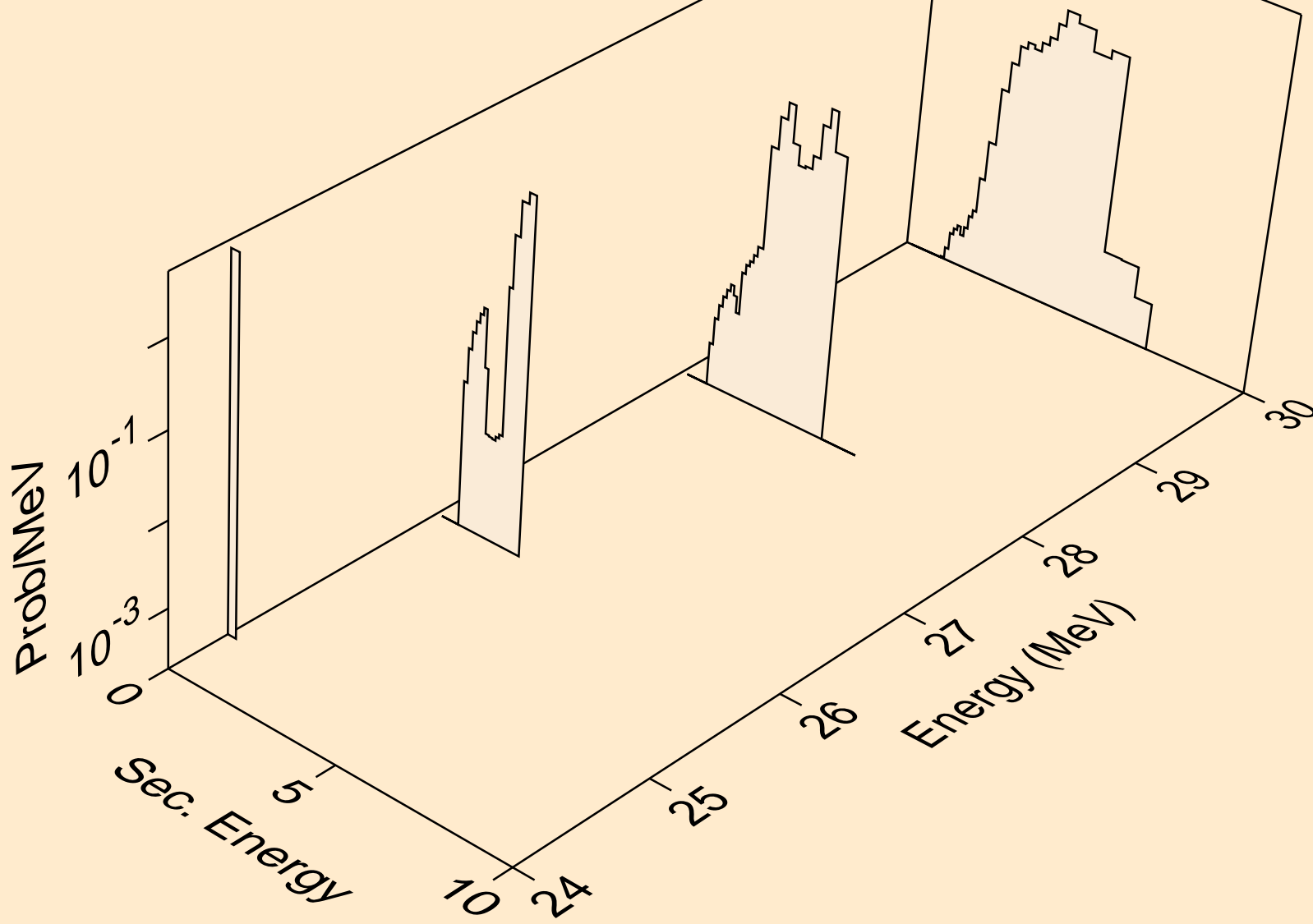

BA136 NEUTRON ACER TENDL-2019 LIBRARY; T=293.16K  
protons from (n,2np)

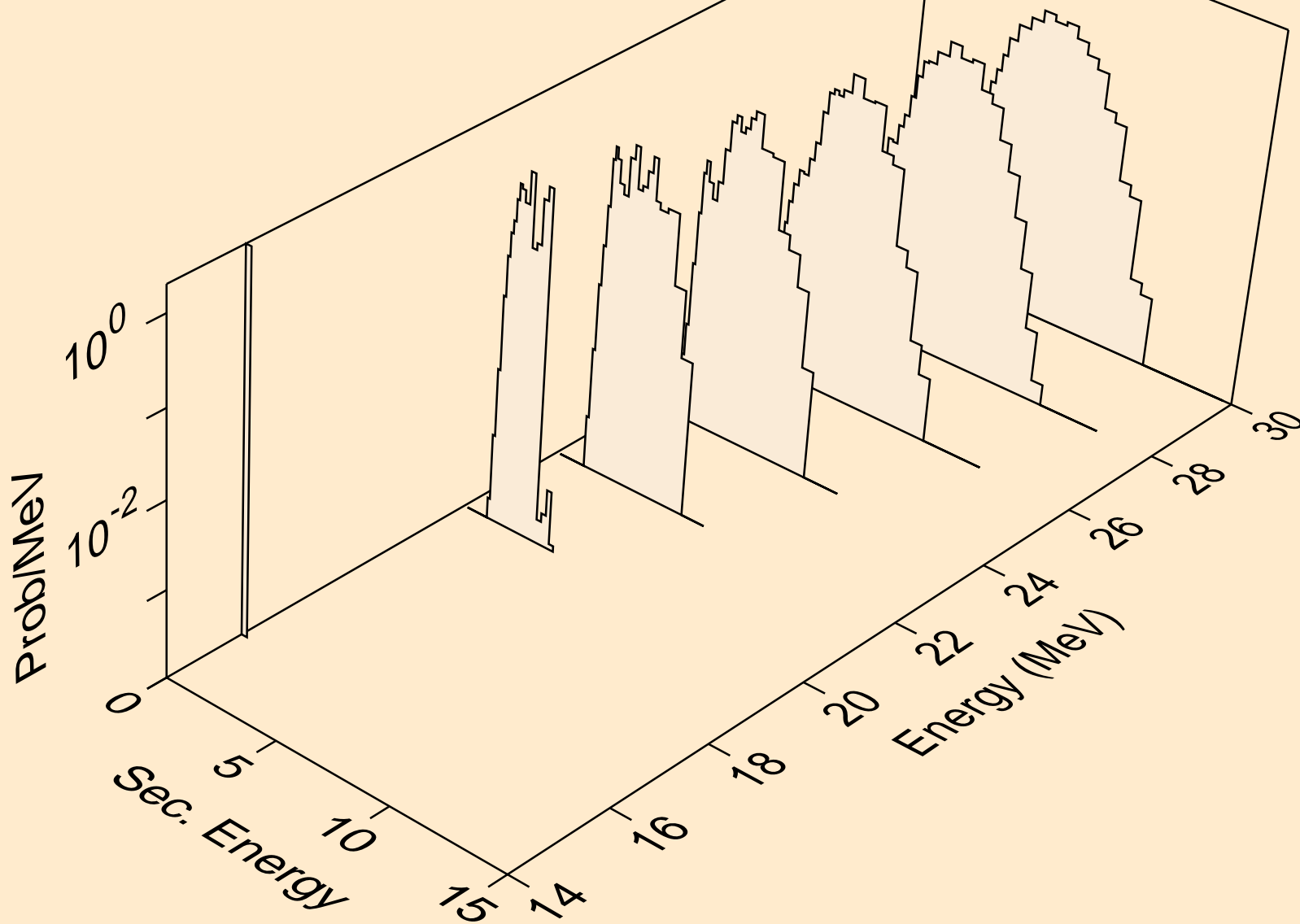

BA136 NEUTRON ACER TENDL-2019 LIBRARY; T=293.16K  
protons from (n,npa)

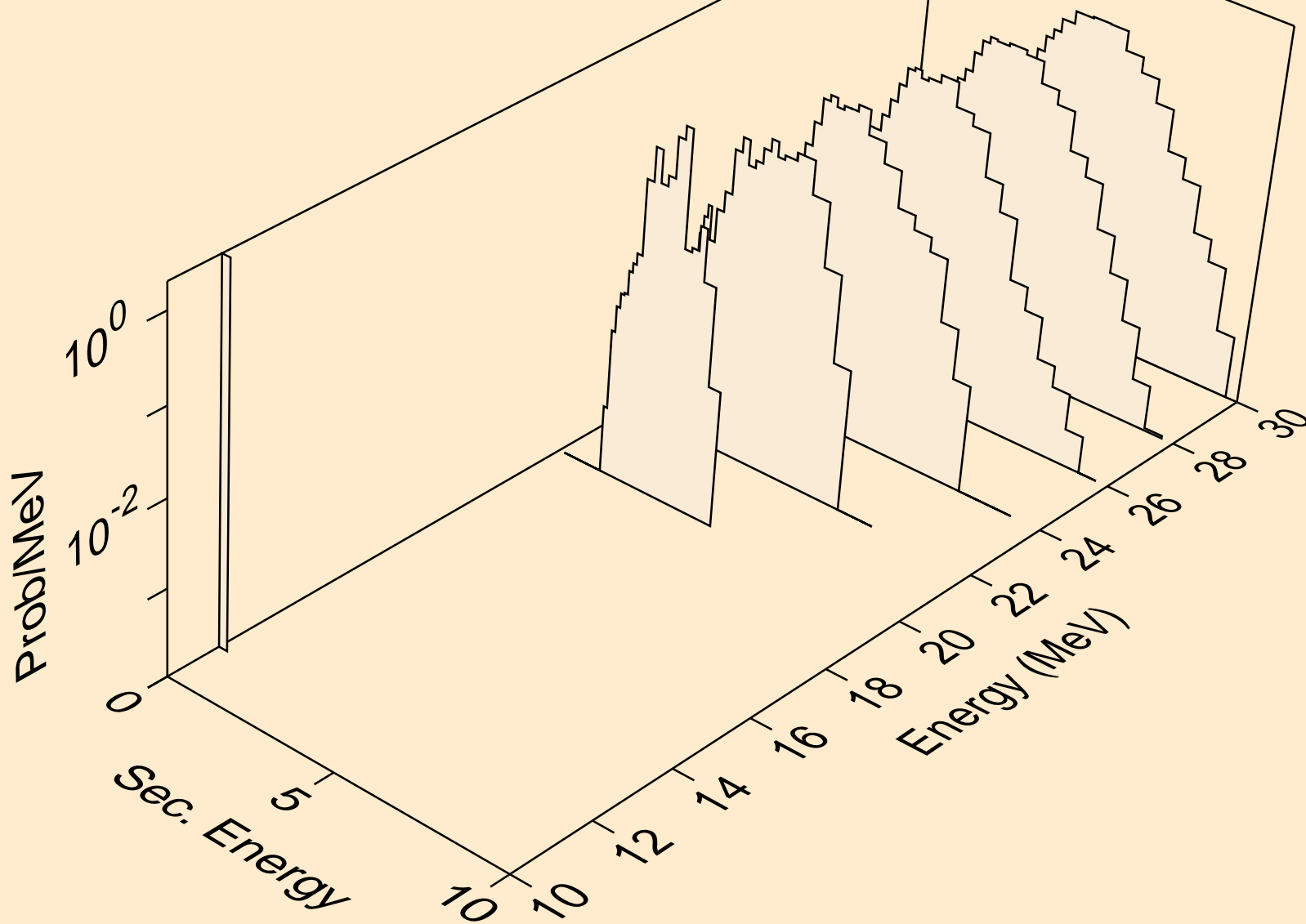

BA136 NEUTRON ACER TENDL-2019 LIBRARY; T=293.16K  
protons from (n,p)

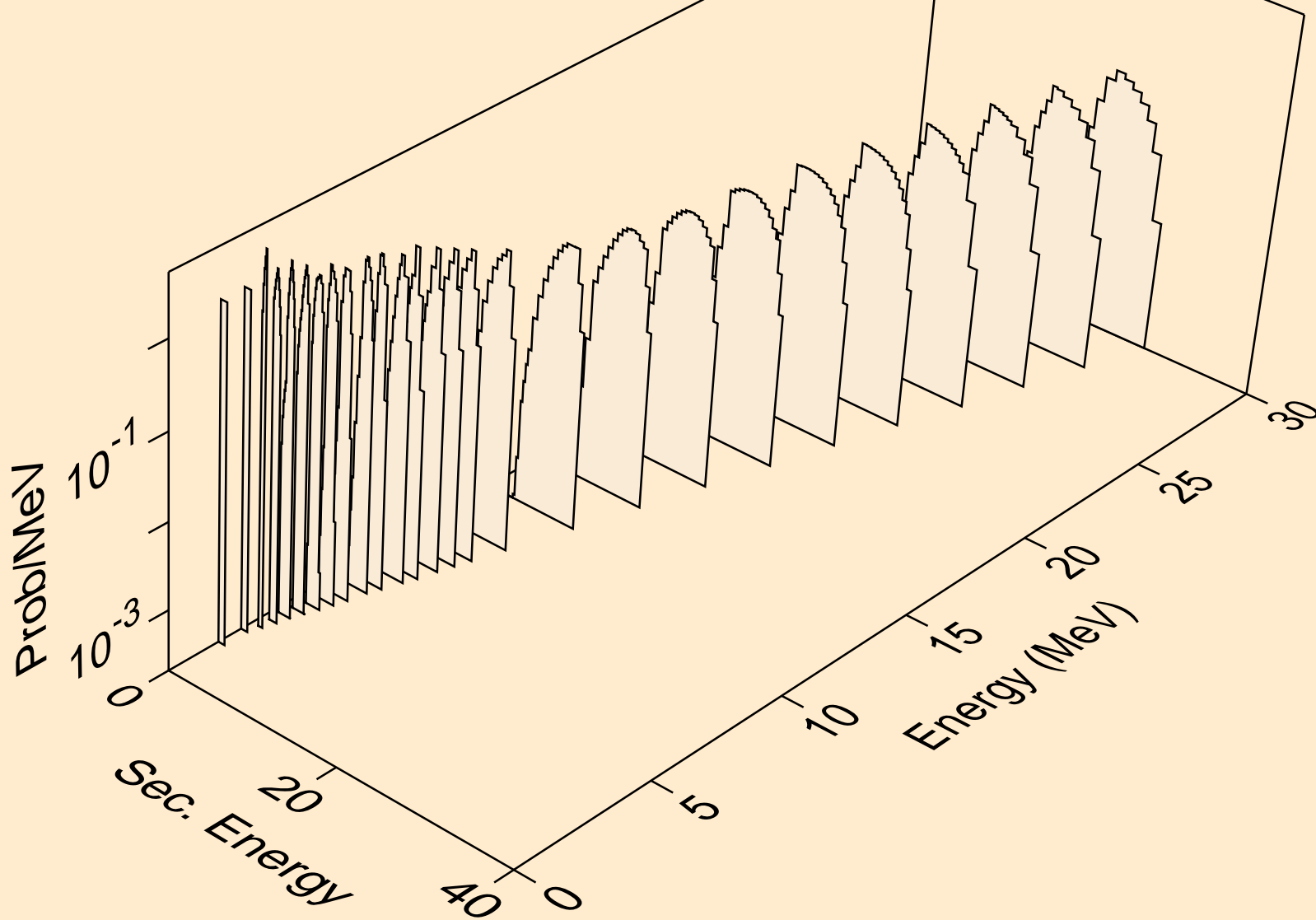



BA136 NEUTRON ACER TENDL-2019 LIBRARY; T=293.16K  
protons from (n,2p)

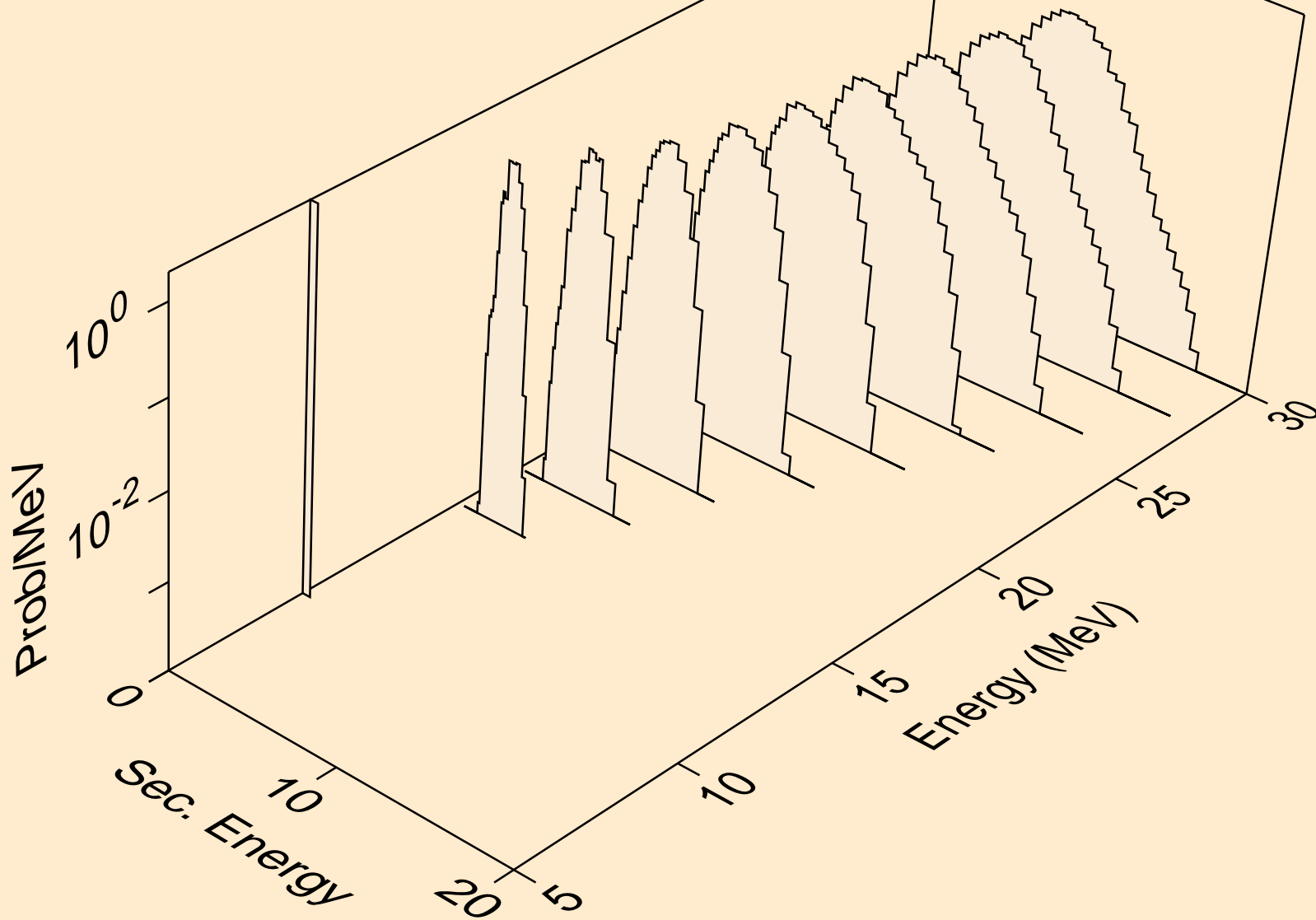

BA136 NEUTRON ACER TENDL-2019 LIBRARY; T=293.16K  
protons from (n,p)

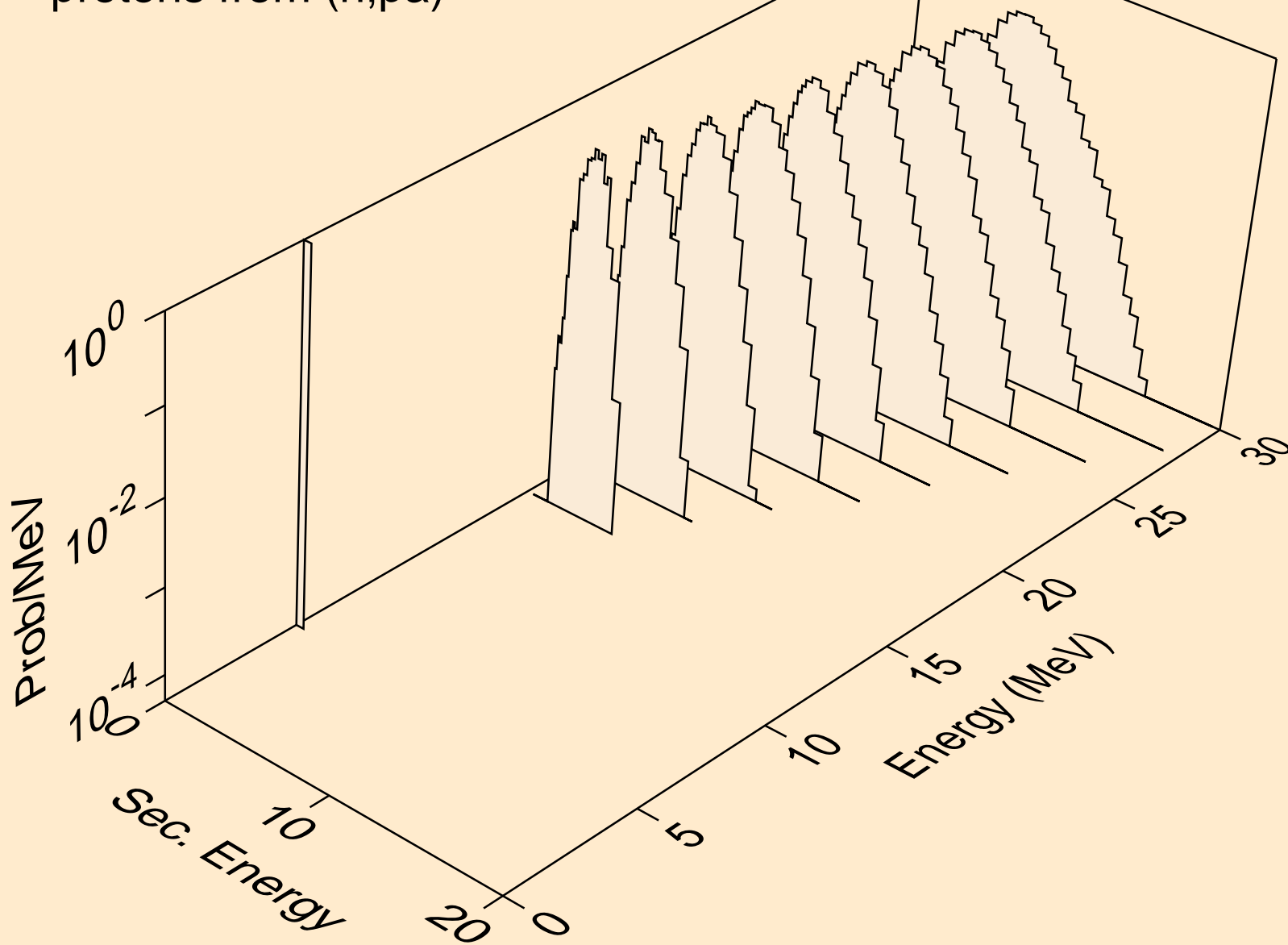

BA136 NEUTRON ACER TENDL-2019 LIBRARY; T=293.16K  
protons from (n,pd)

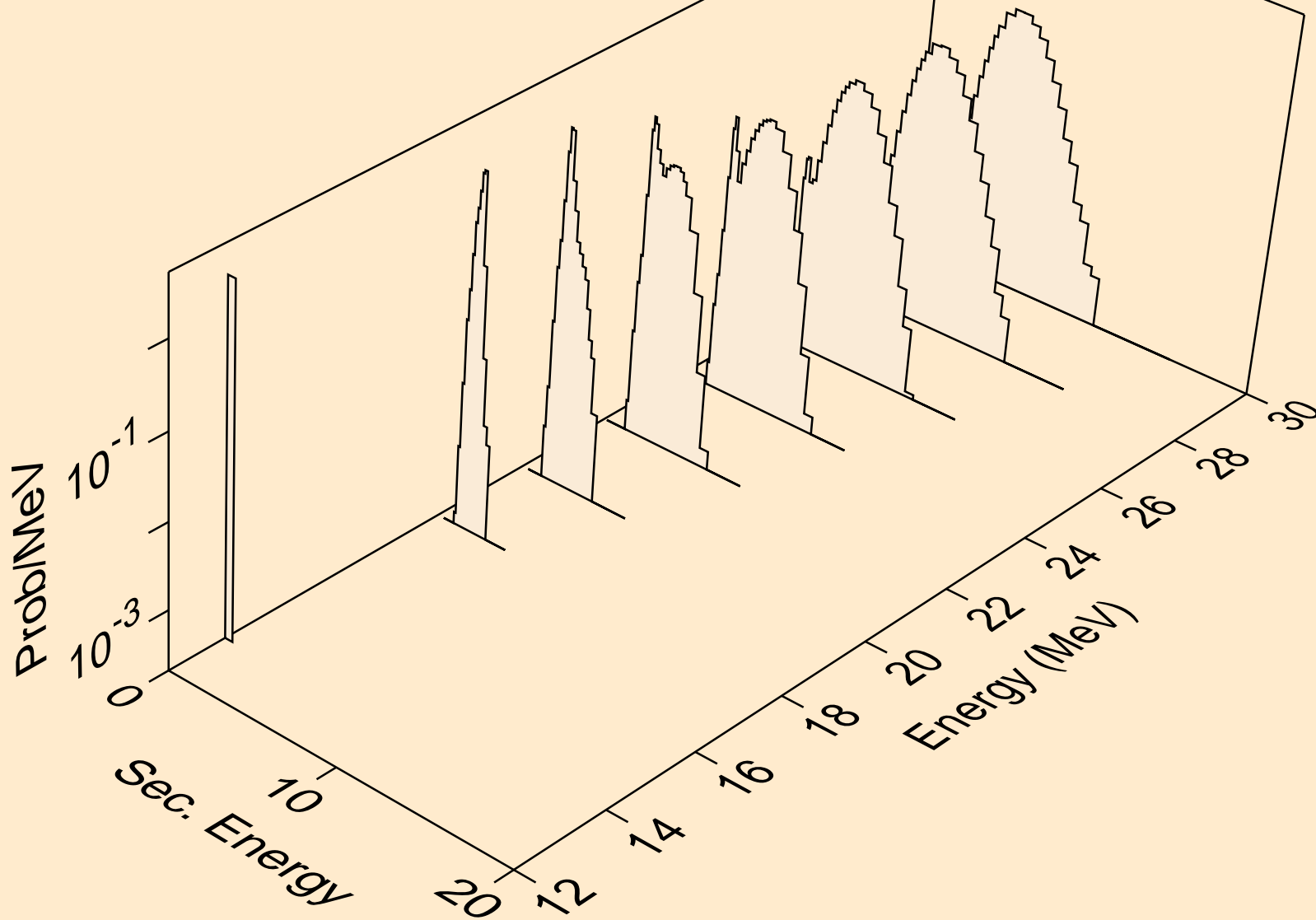

BA136 NEUTRON ACER TENDL-2019 LIBRARY; T=293.16K  
protons from (n,pt)

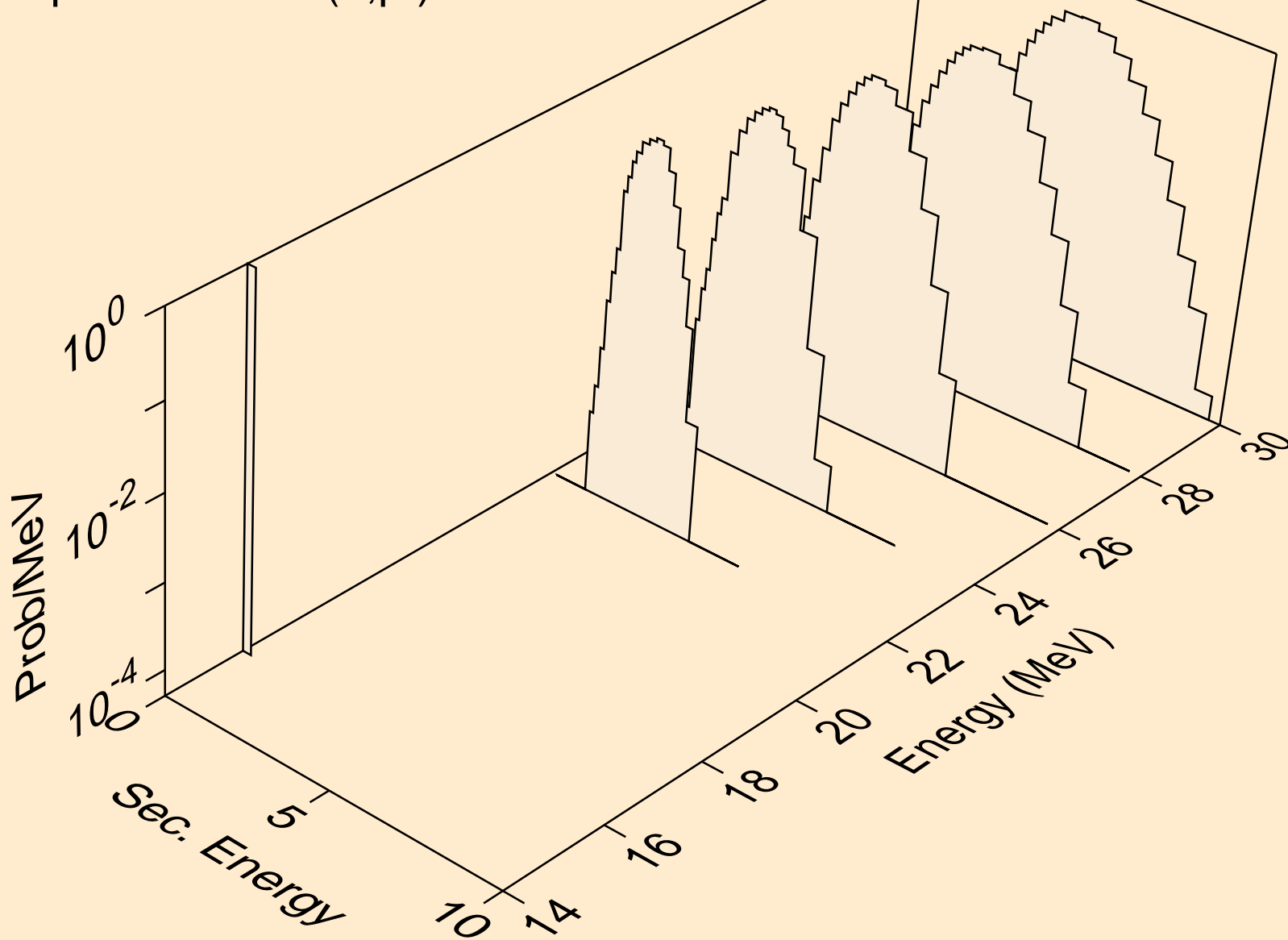

BA136 NEUTRON ACER TENDL-2019 LIBRARY; T=293.16K  
deuterons from (n,x)

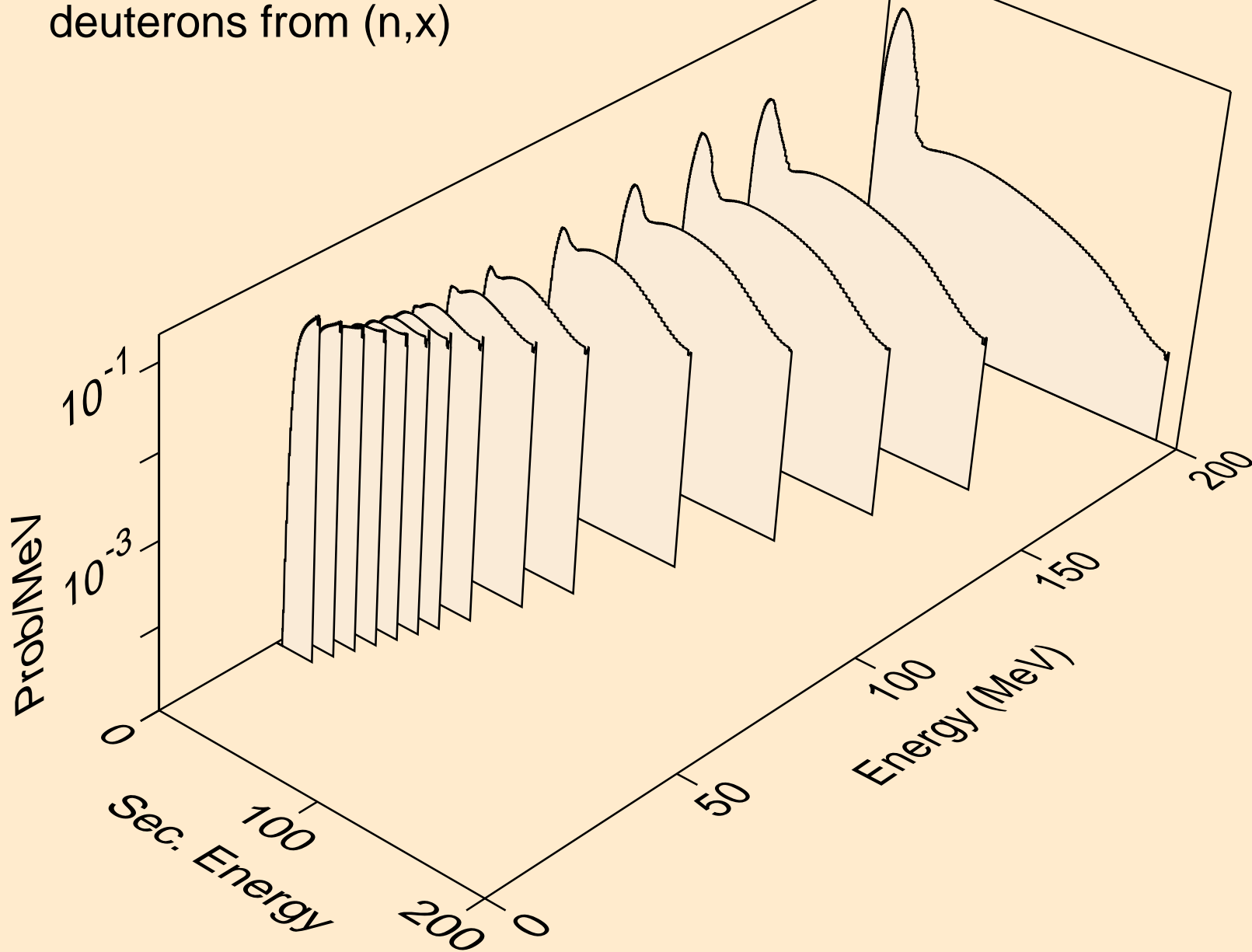

BA136 NEUTRON ACER TENDL-2019 LIBRARY; T=293.16K  
deuterons from (n,2nd)

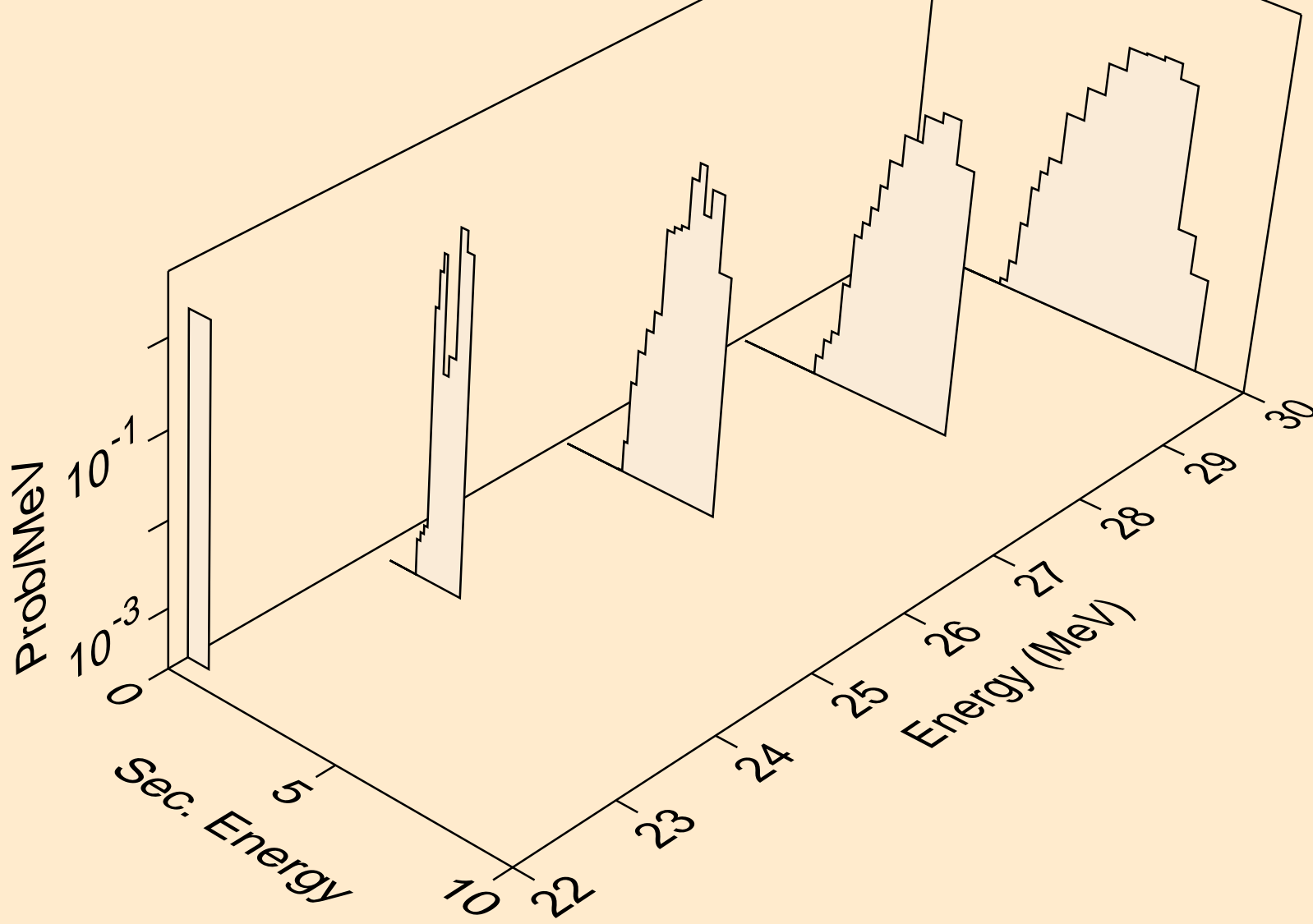

BA136 NEUTRON ACER TENDL-2019 LIBRARY; T=293.16K  
deuterons from (n,n\*)d

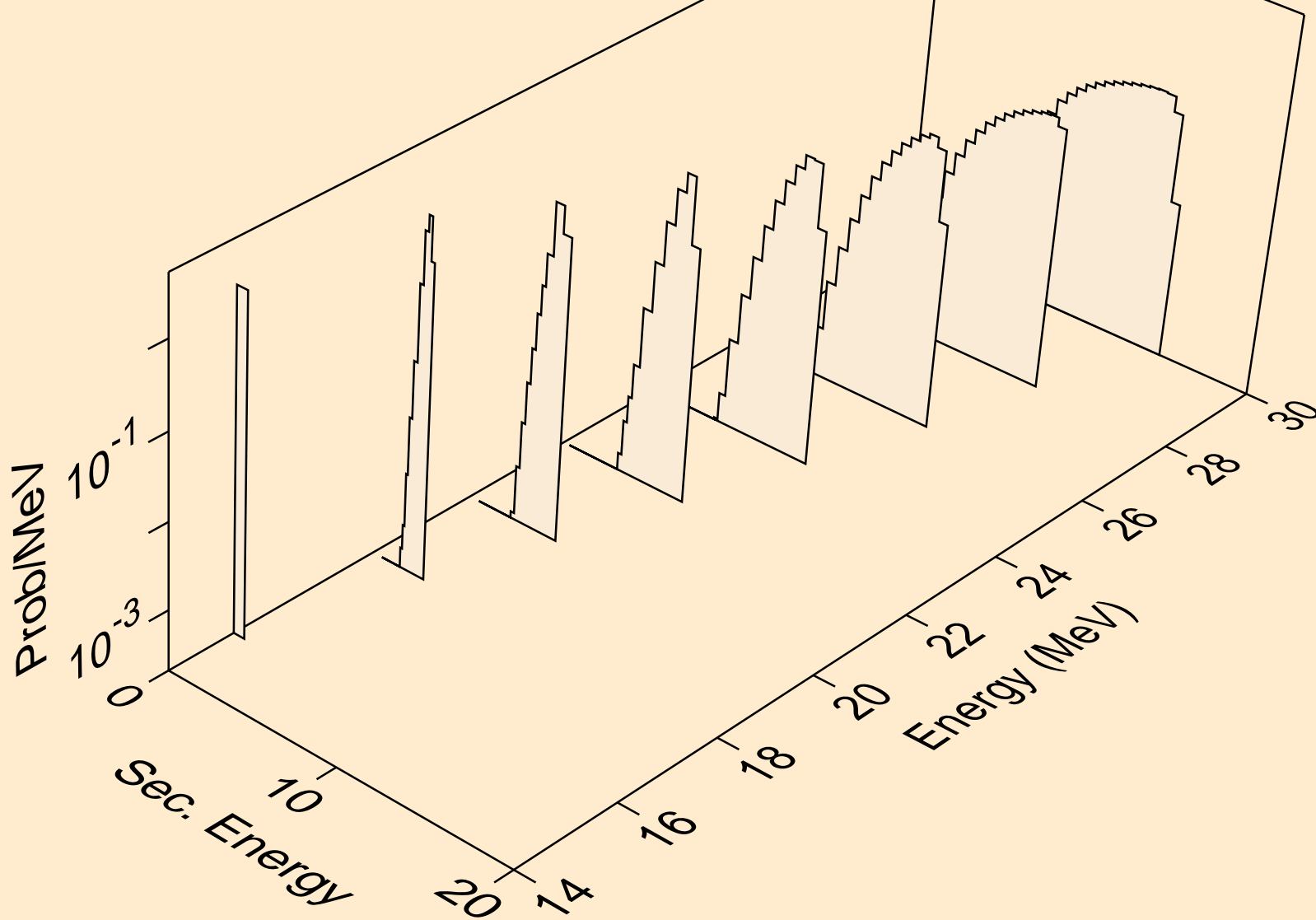

BA136 NEUTRON ACER TENDL-2019 LIBRARY; T=293.16K  
deuterons from (n,d)

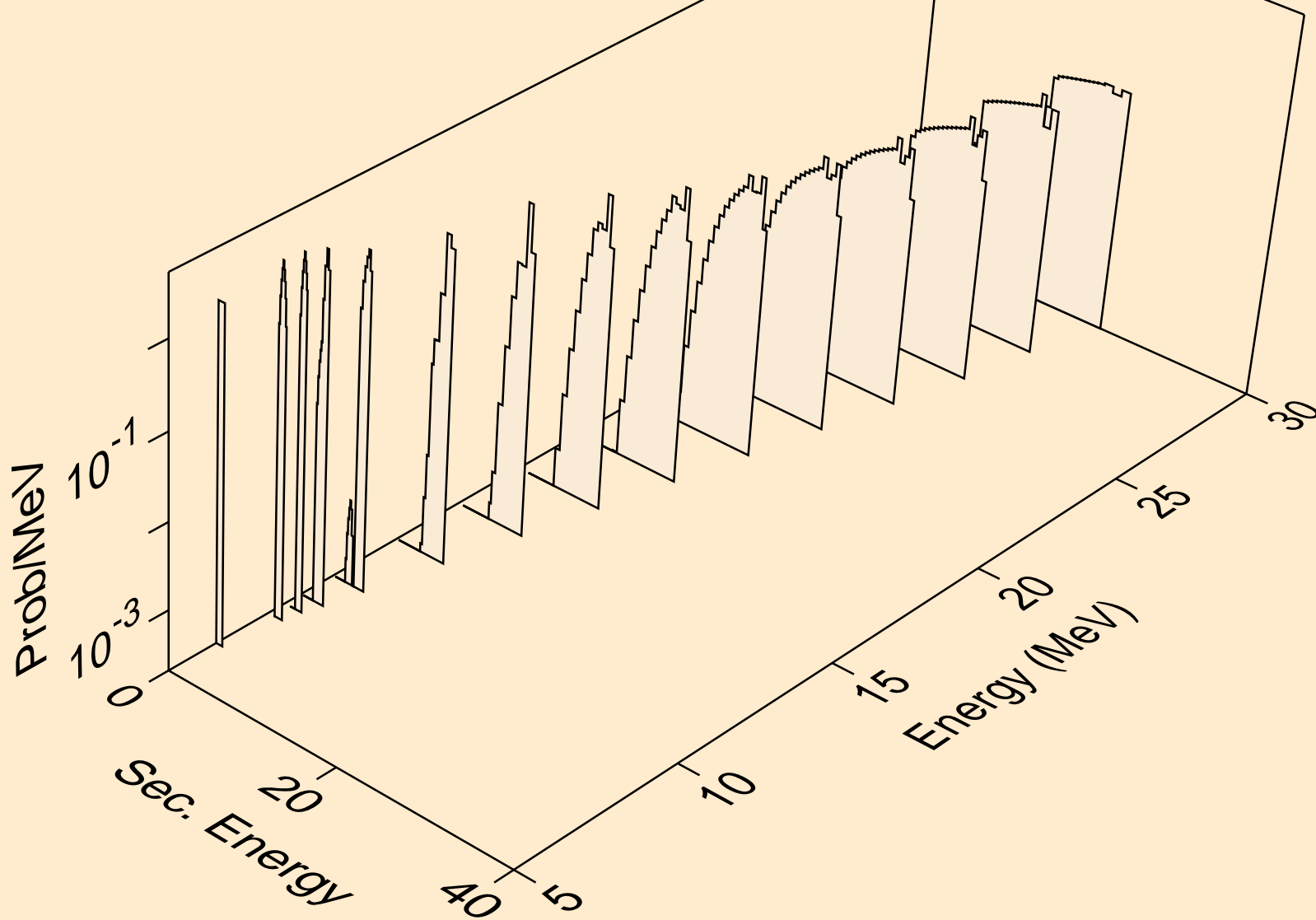



BA136 NEUTRON ACER TENDL-2019 LIBRARY; T=293.16K  
deuterons from (n,pd)

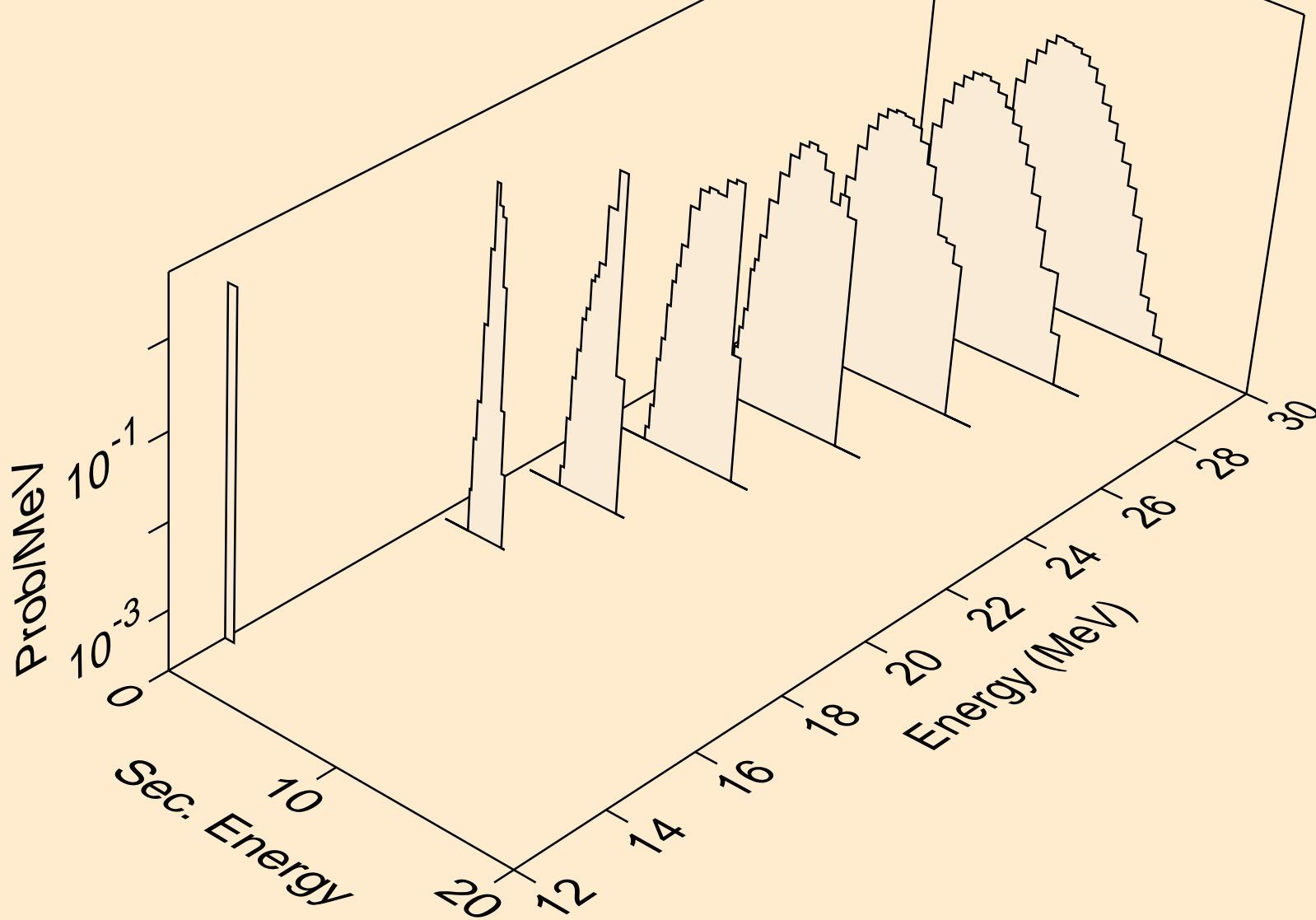

BA136 NEUTRON ACER TENDL-2019 LIBRARY; T=293.16K  
tritons from (n,x)

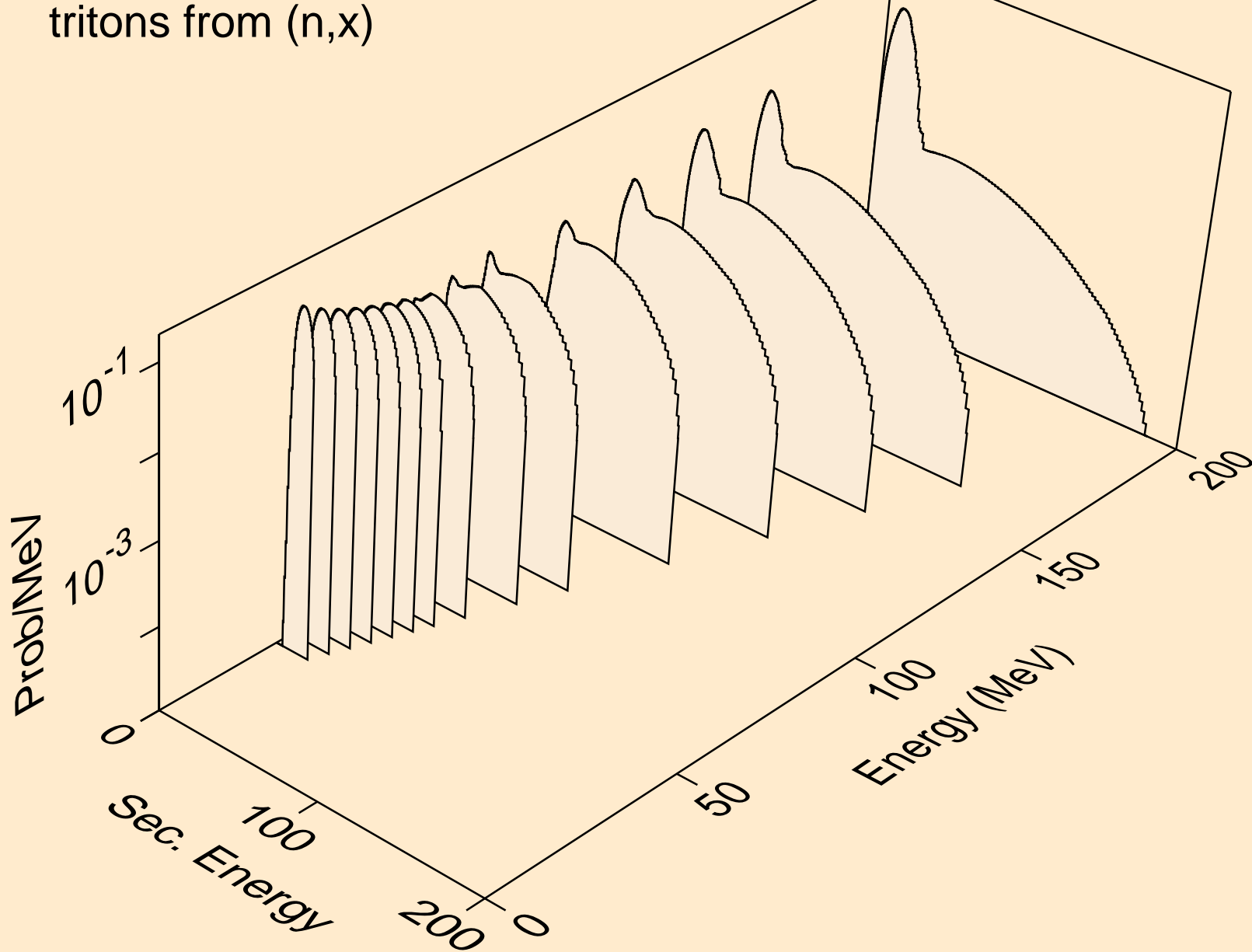

BA136 NEUTRON ACER TENDL-2019 LIBRARY; T=293.16K  
tritons from (n,n\*)t

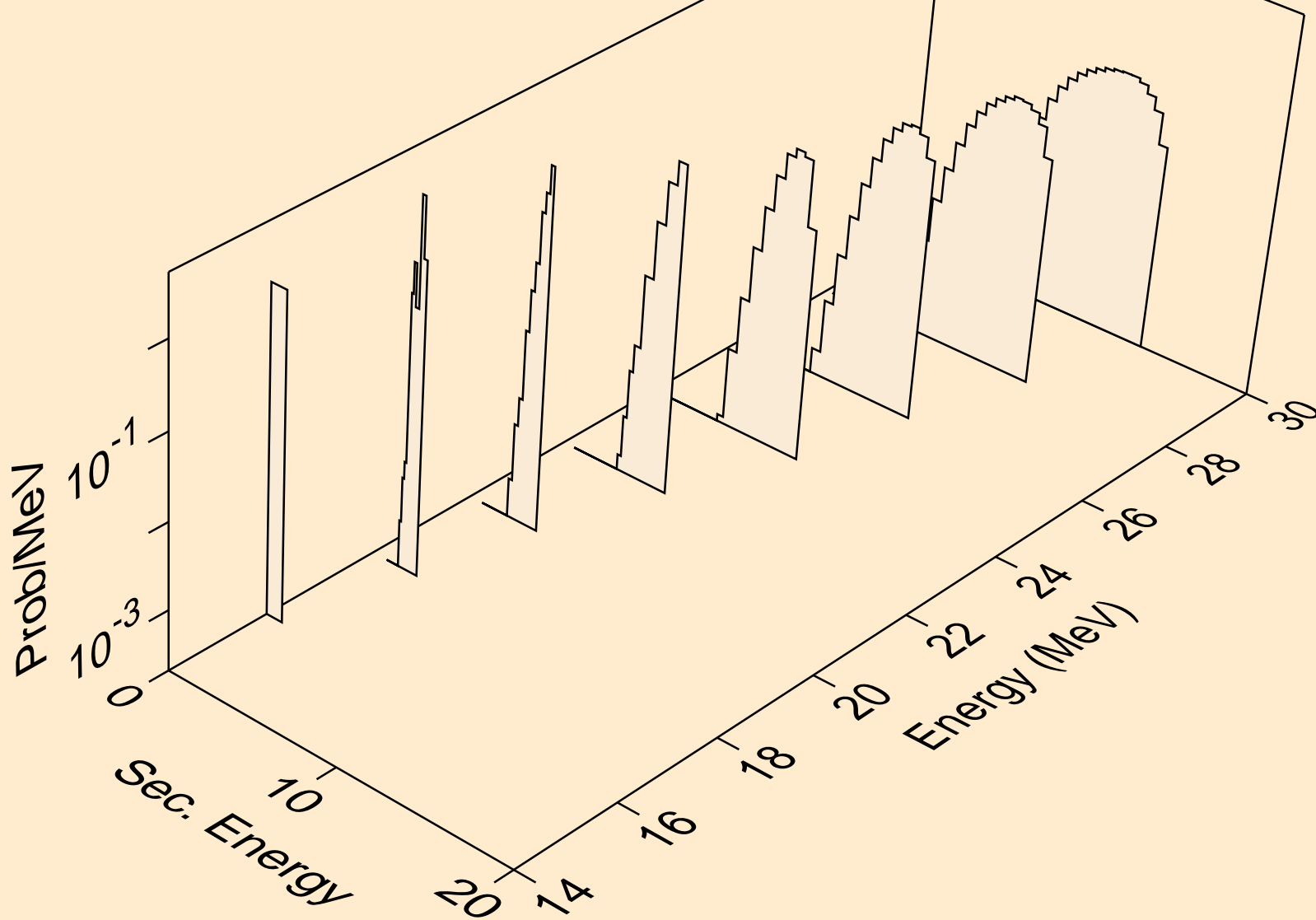

BA136 NEUTRON ACER TENDL-2019 LIBRARY; T=293.16K  
tritons from (n,t)

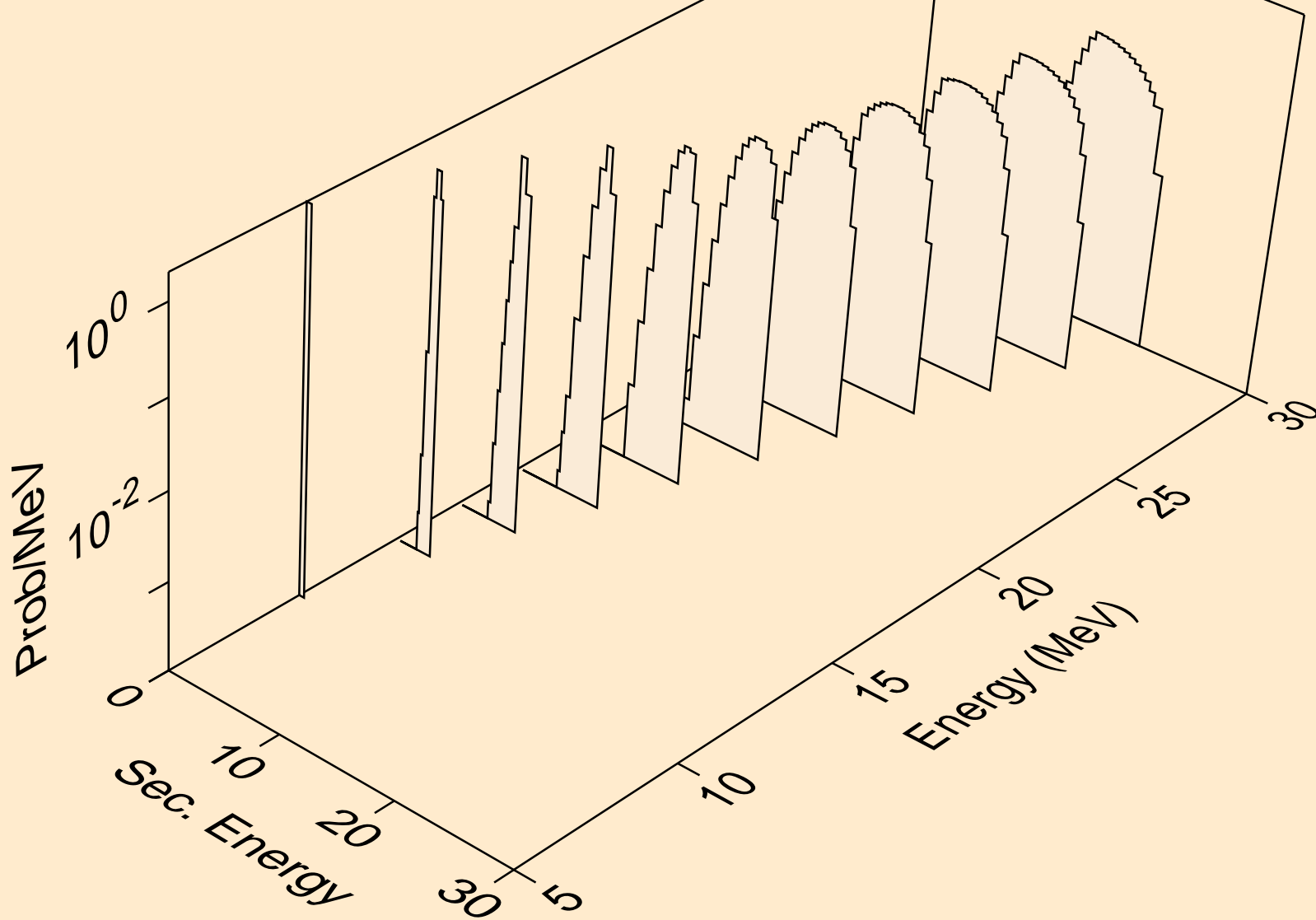

BA136 NEUTRON ACER TENDL-2019 LIBRARY; T=293.16K  
tritons from (n,pt)

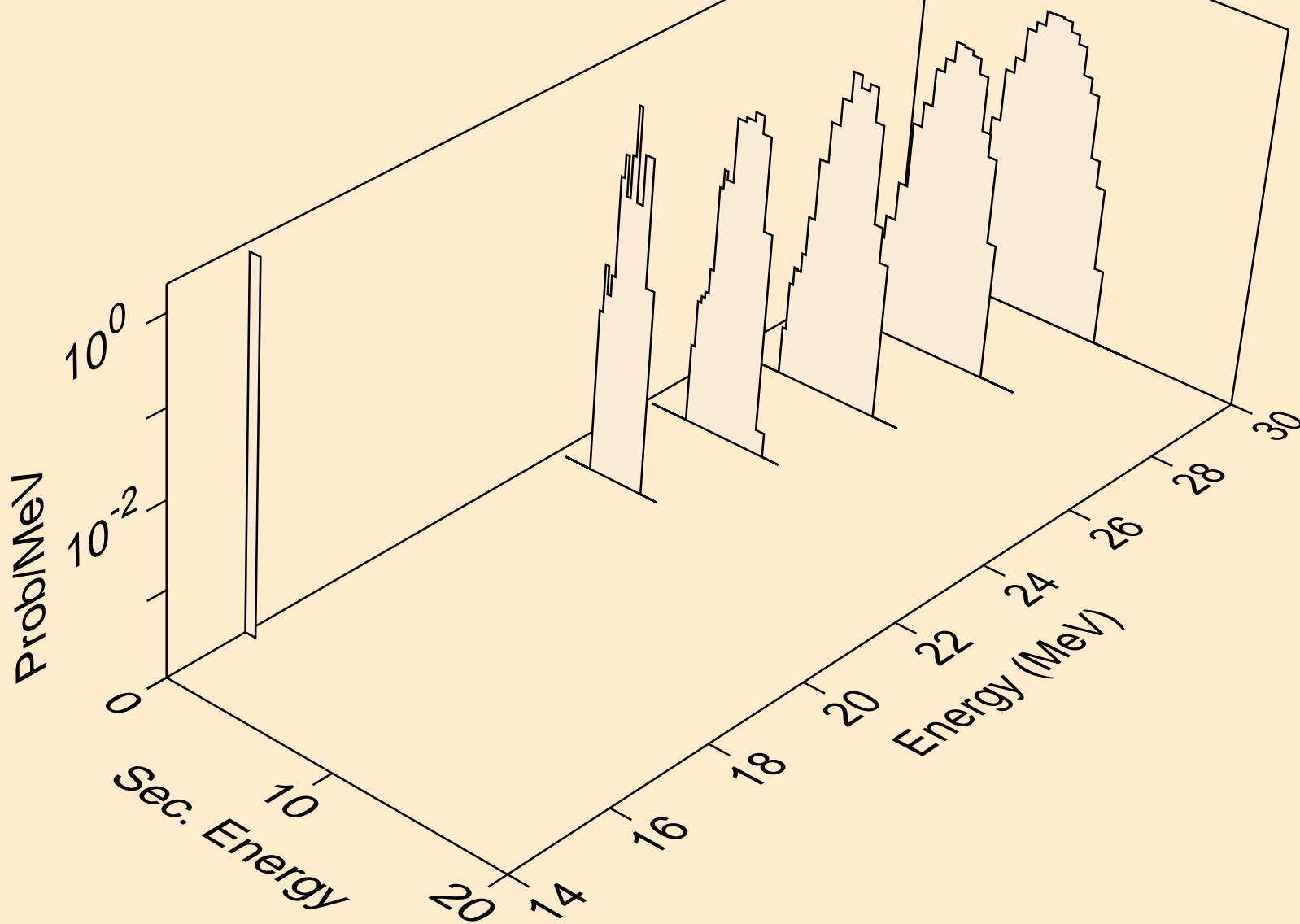

BA136 NEUTRON ACER TENDL-2019 LIBRARY; T=293.16K  
he3s from (n,x)

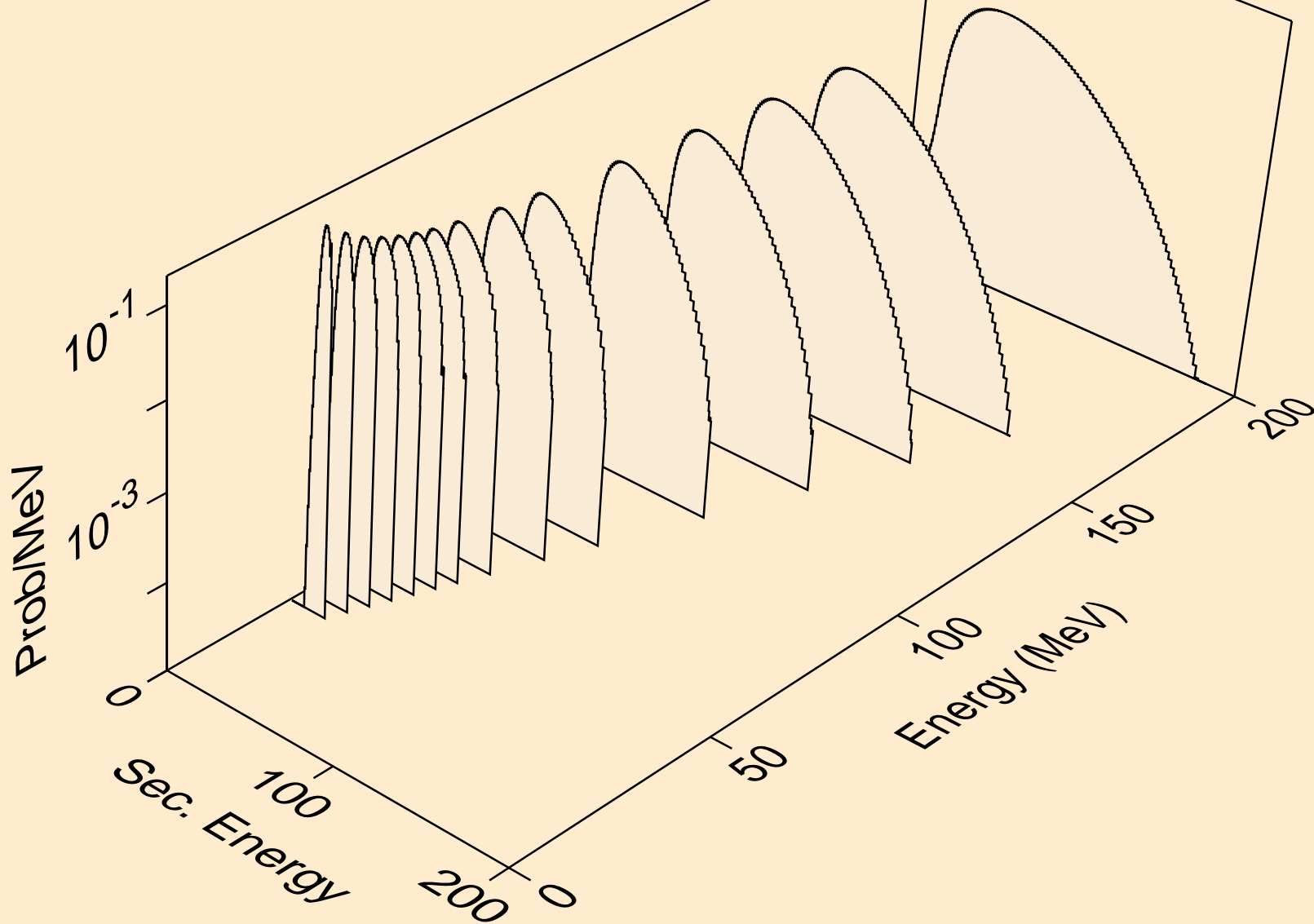

BA136 NEUTRON ACER TENDL-2019 LIBRARY; T=293.16K  
he3s from (n,n\*)he3

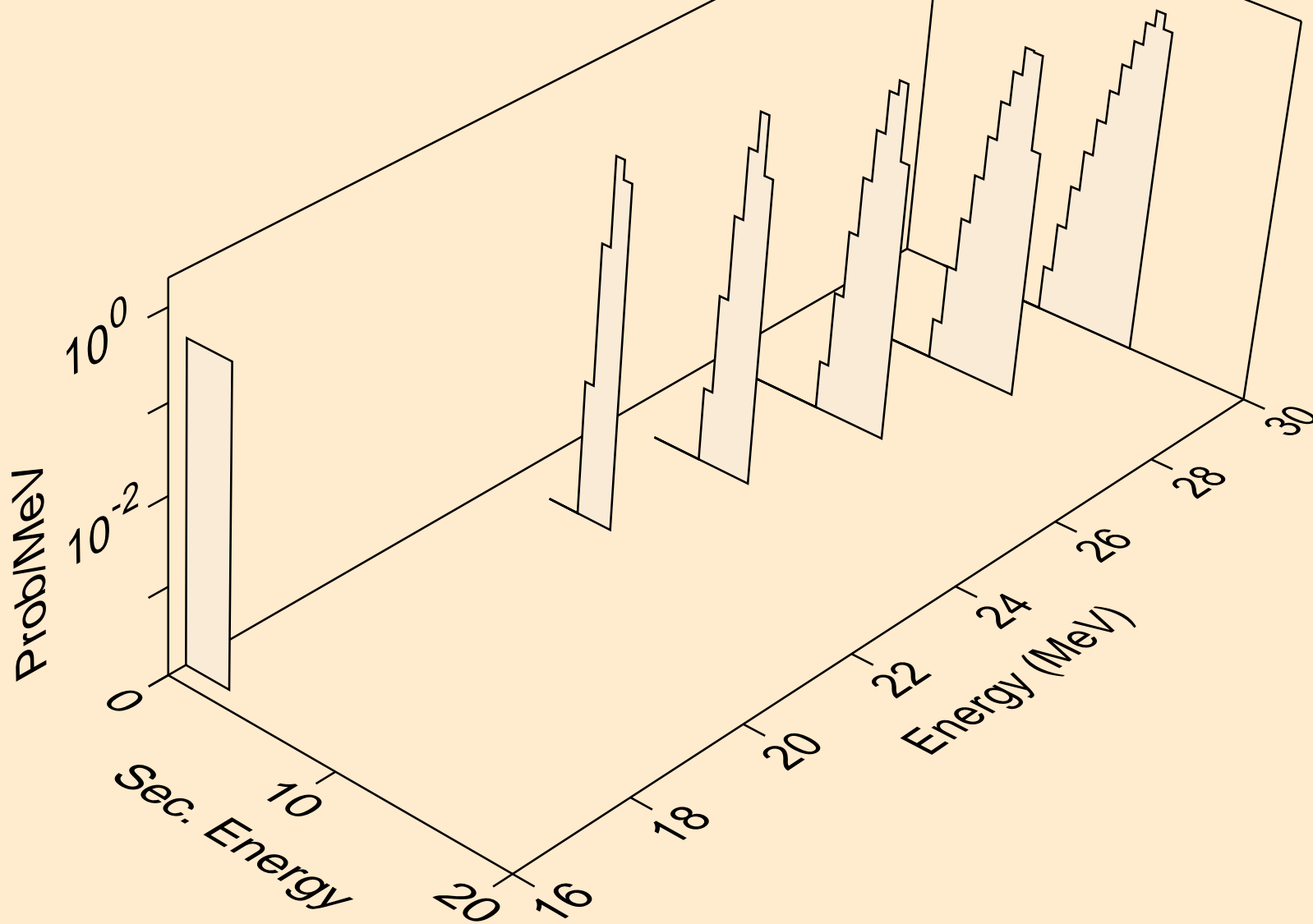

BA136 NEUTRON ACER TENDL-2019 LIBRARY; T=293.16K  
he3s from (n,he3)

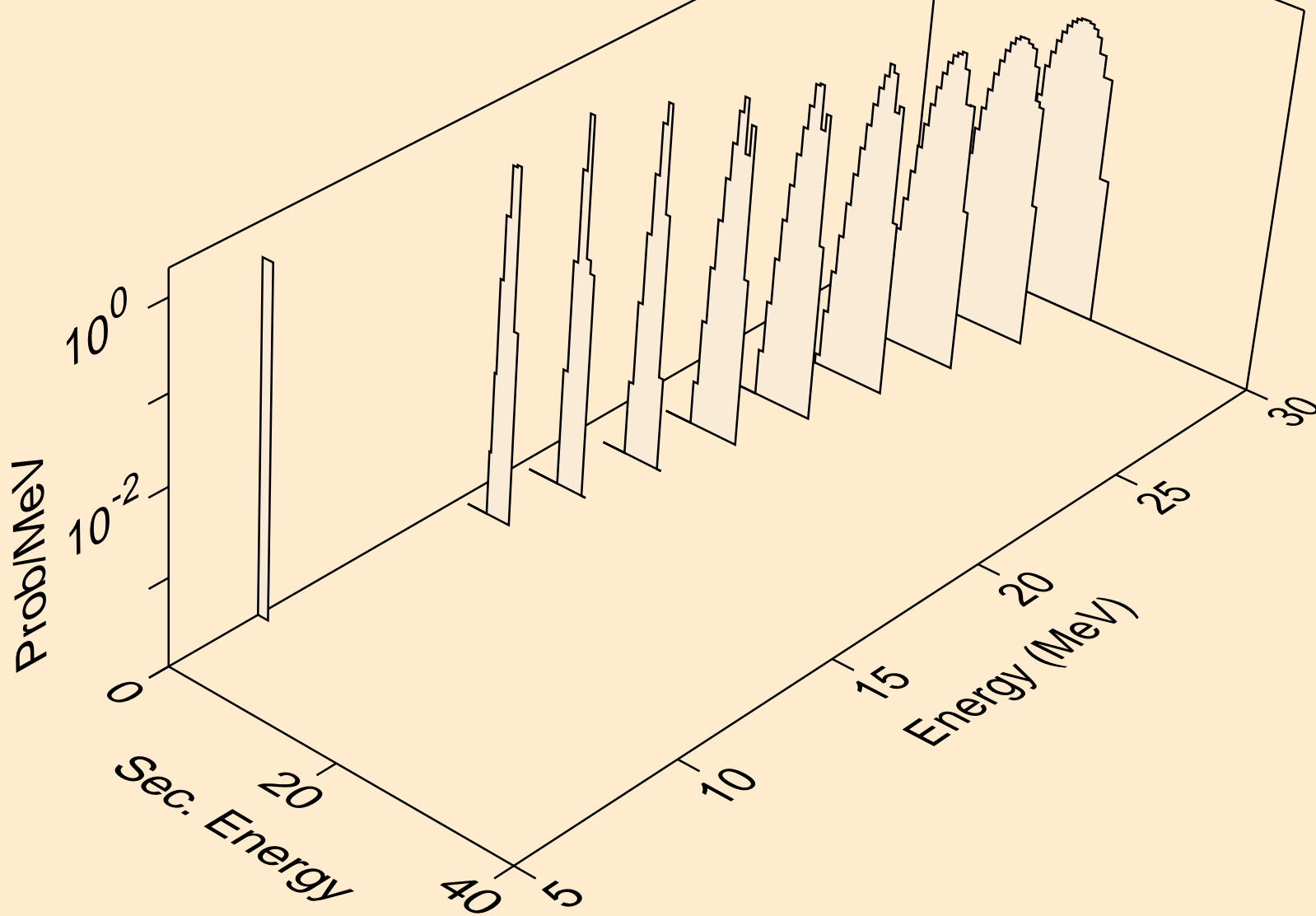



BA136 NEUTRON ACER TENDL-2019 LIBRARY; T=293.16K  
alphas from (n,x)

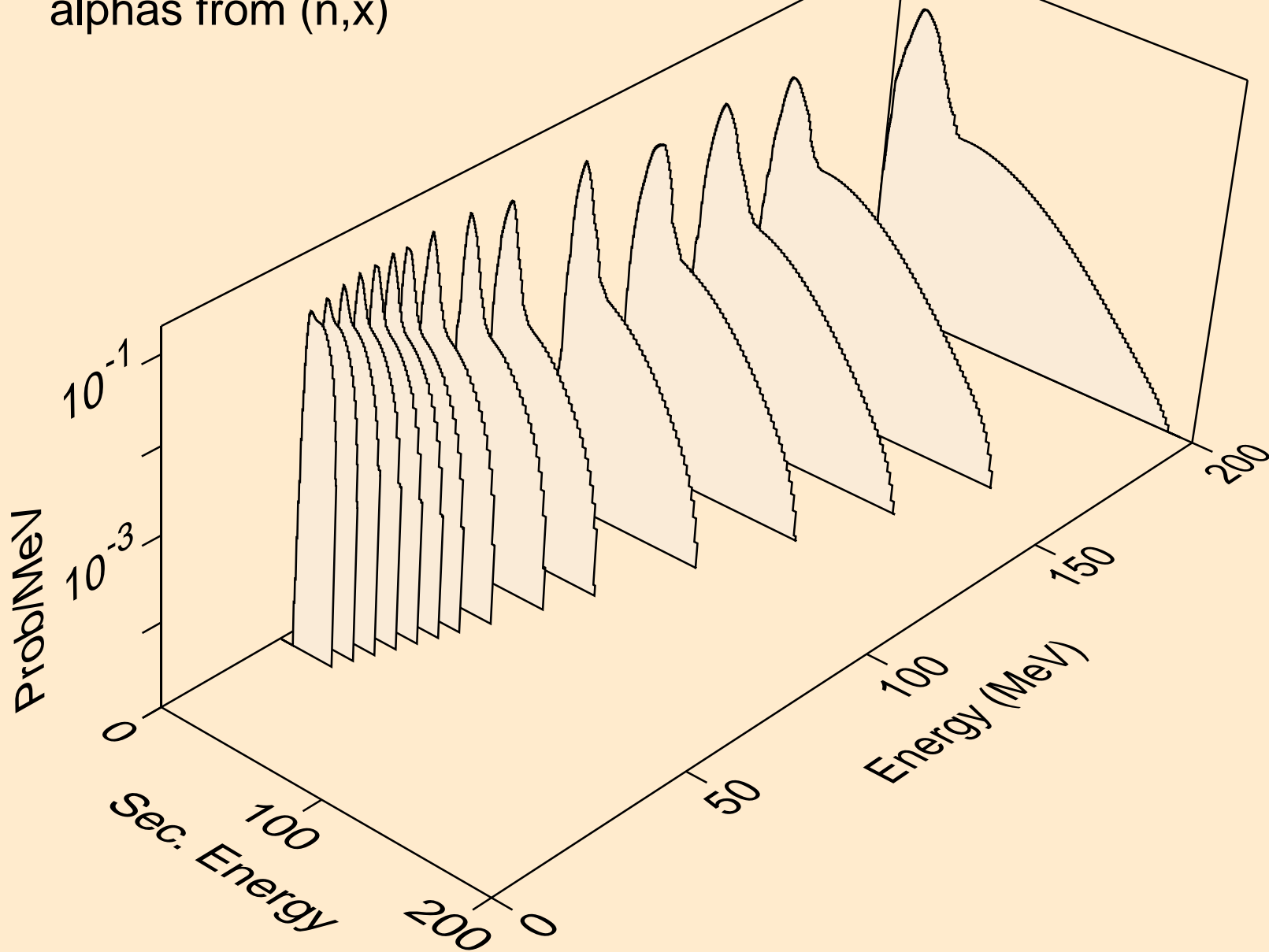

BA136 NEUTRON ACER TENDL-2019 LIBRARY; T=293.16K  
alphas from (n,n\*)a

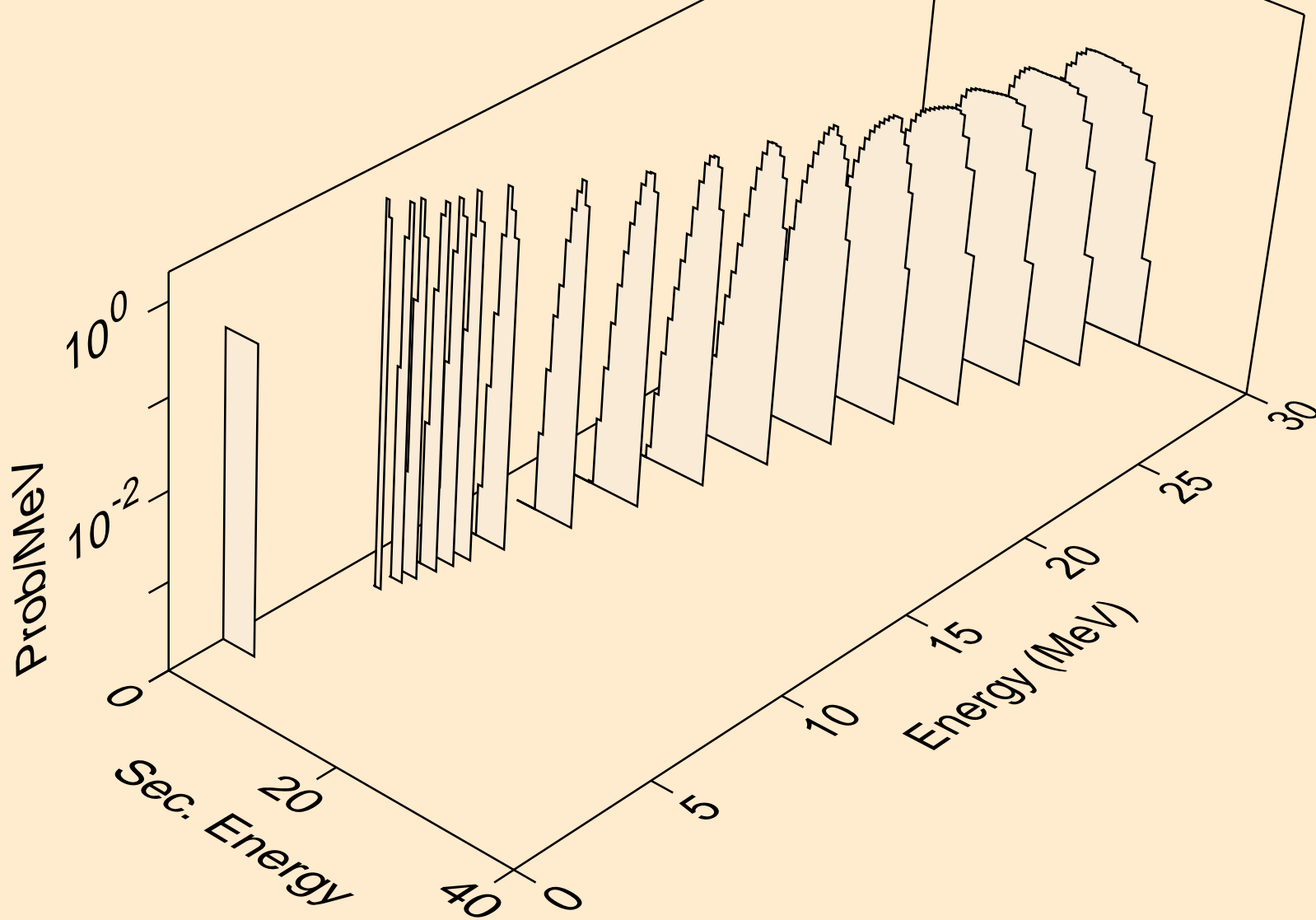

BA136 NEUTRON ACER TENDL-2019 LIBRARY; T=293.16K  
alphas from (n,2n)a

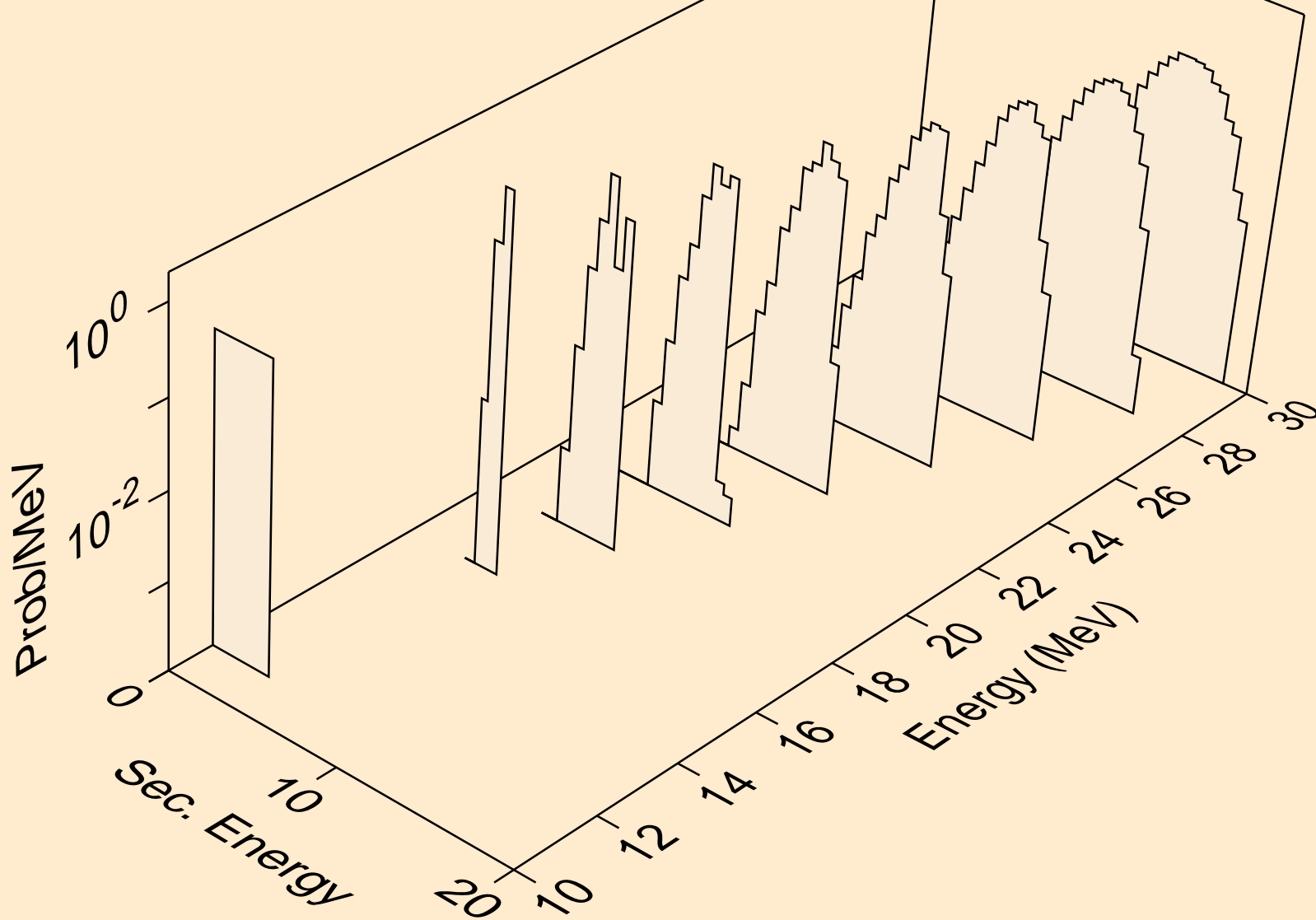

BA136 NEUTRON ACER TENDL-2019 LIBRARY; T=293.16K  
alphas from (n,3n)a

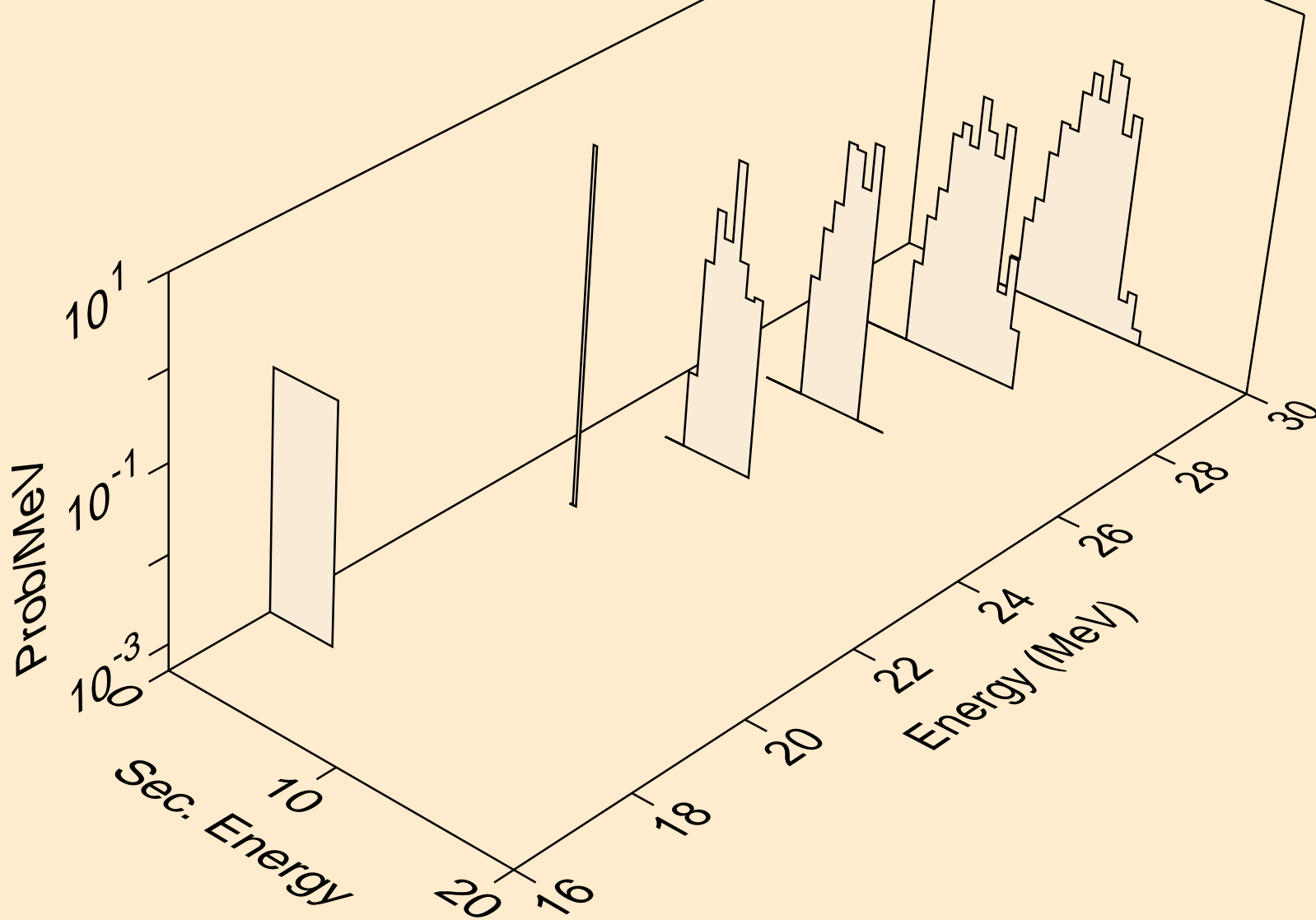

BA136 NEUTRON ACER TENDL-2019 LIBRARY; T=293.16K  
alphas from (n,n\*)2a

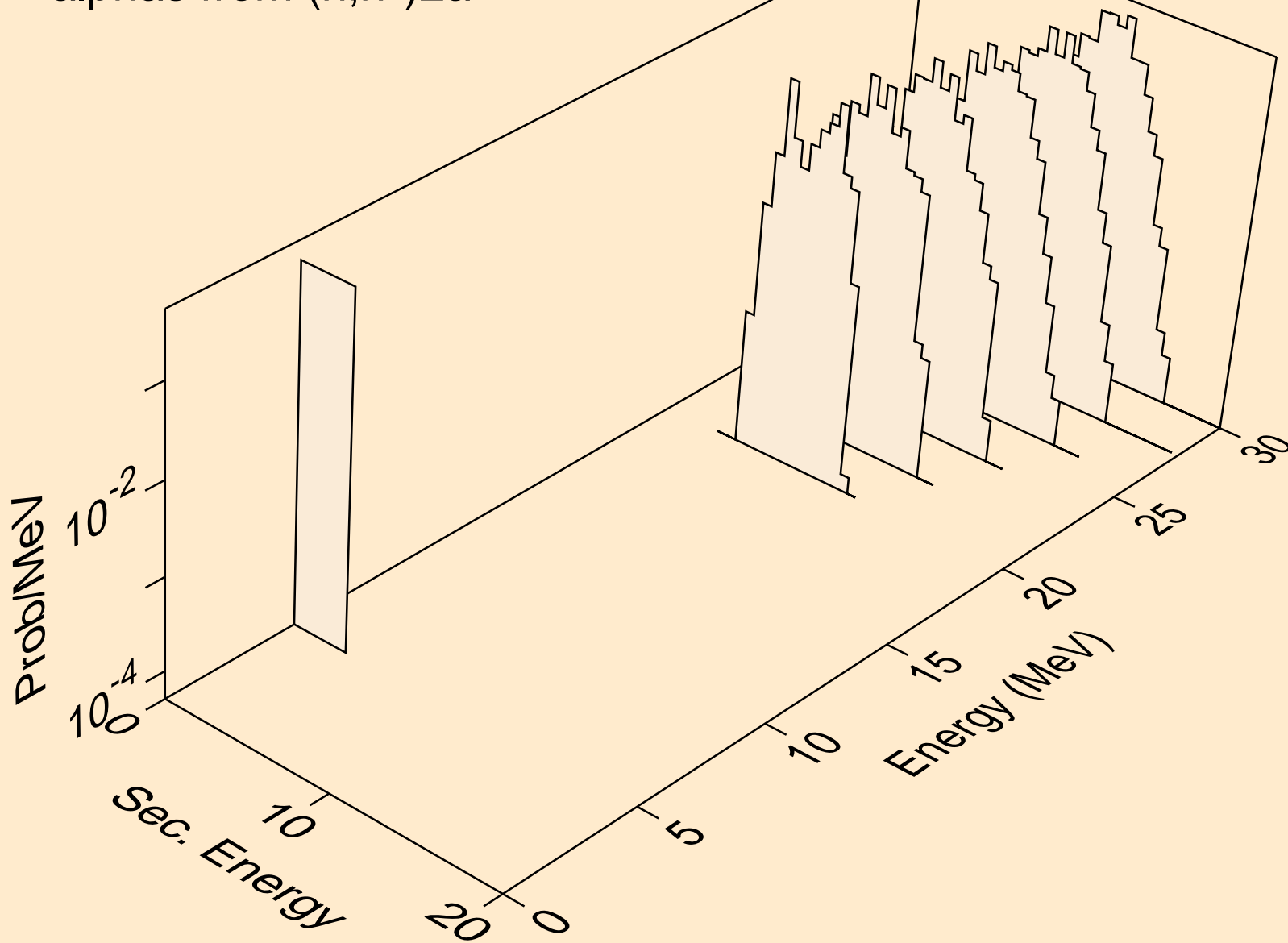

BA136 NEUTRON ACER TENDL-2019 LIBRARY; T=293.16K  
alphas from (n,npa)

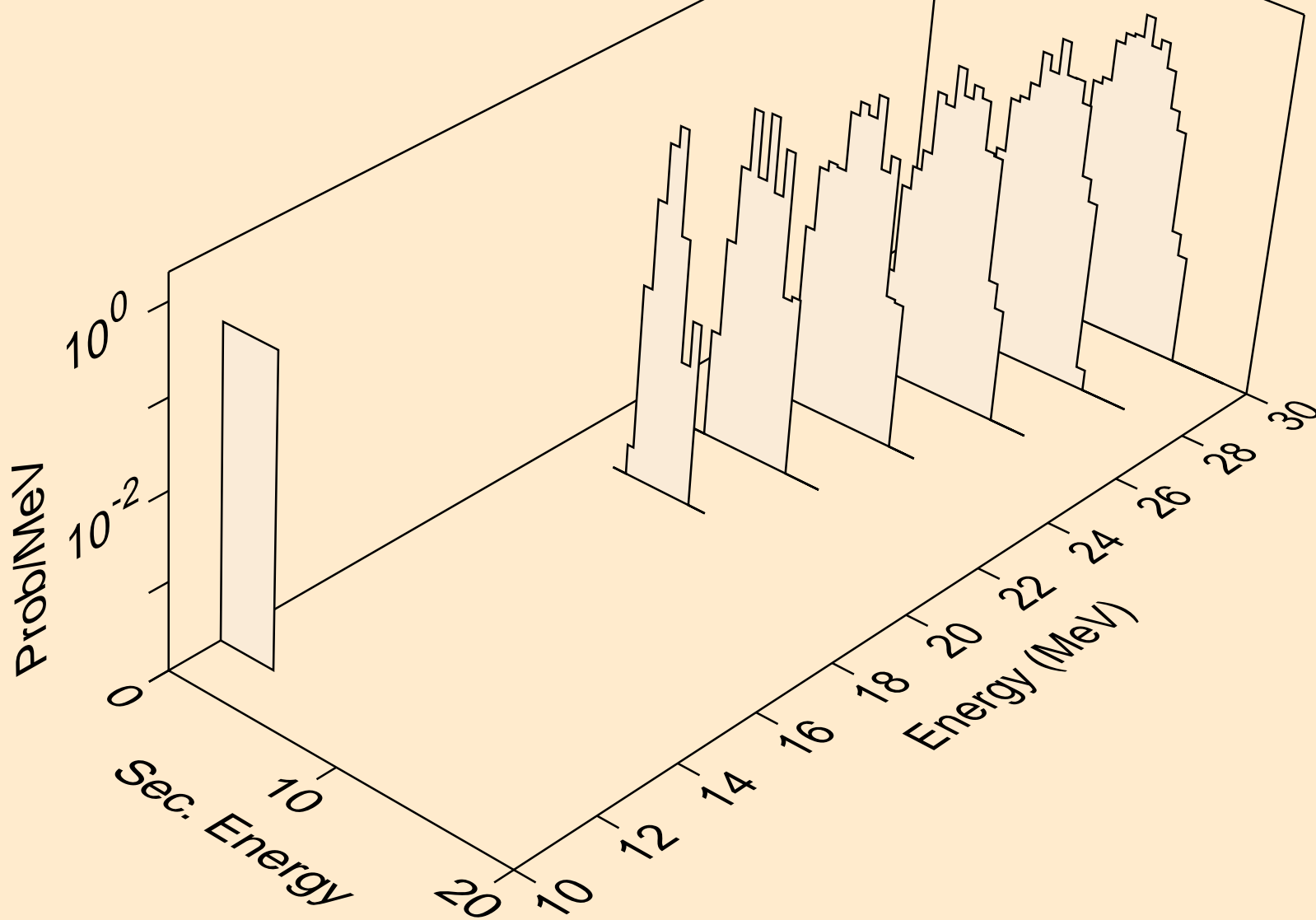

BA136 NEUTRON ACER TENDL-2019 LIBRARY; T=293.16K  
alphas from (n,a)

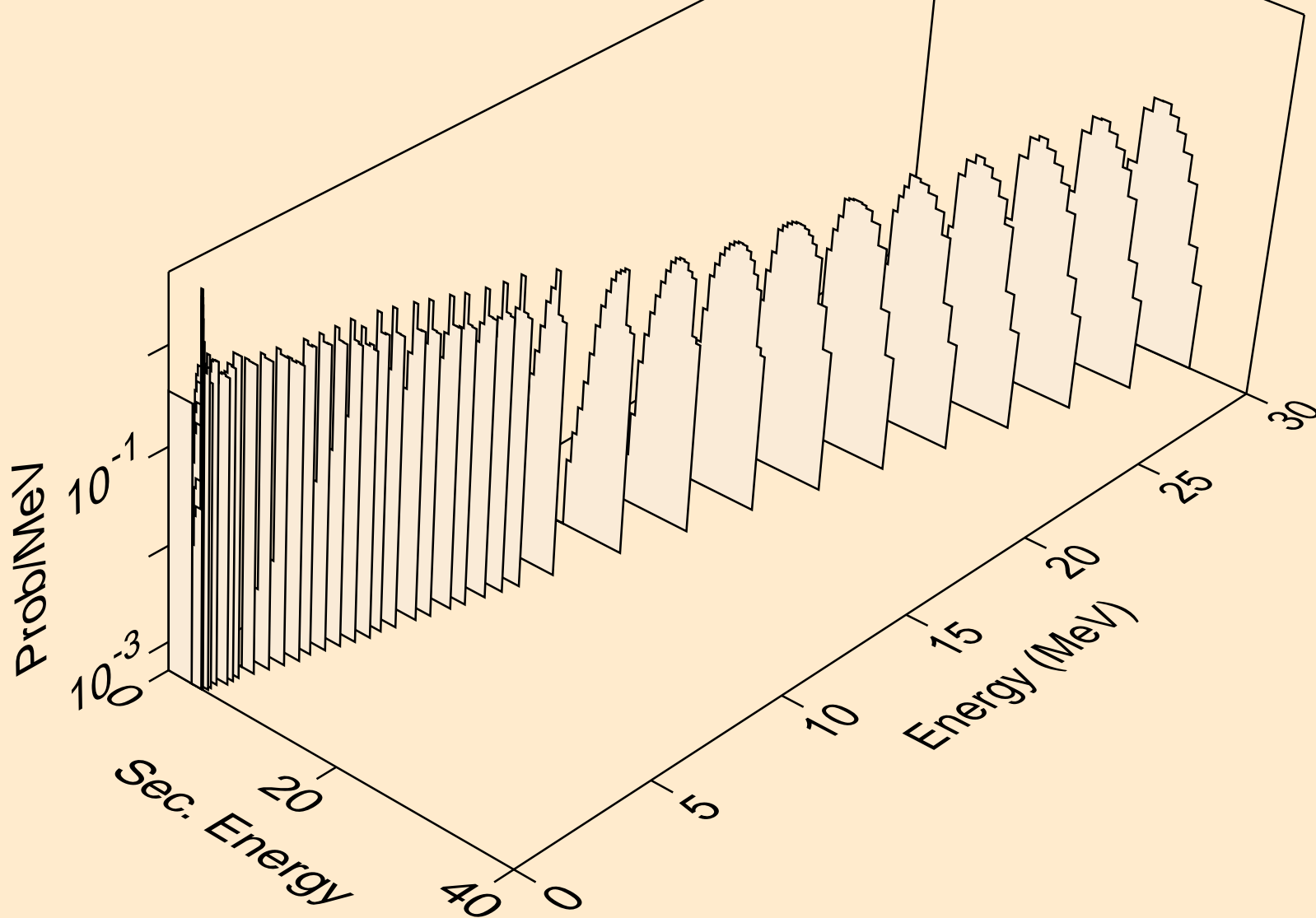

BA136 NEUTRON ACER TENDL-2019 LIBRARY; T=293.16K  
alphas from (n,2a)

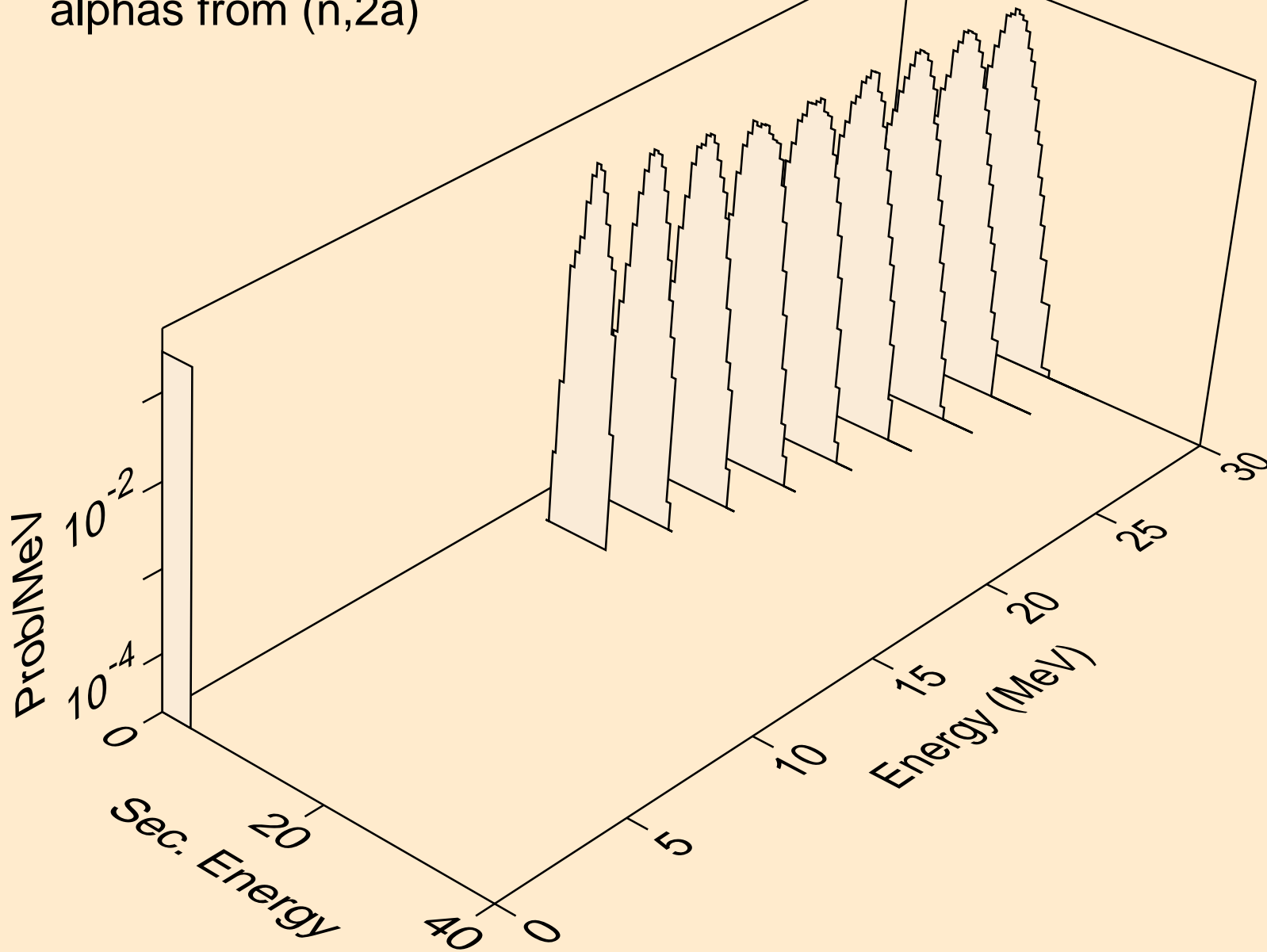



BA136 NEUTRON ACER TENDL-2019 LIBRARY; T=293.16K  
alphas from (n,pa)

