

BH269 NEUTRON ACER TENDL-2019 LIBRARY; T=293.16K
Principal cross sections

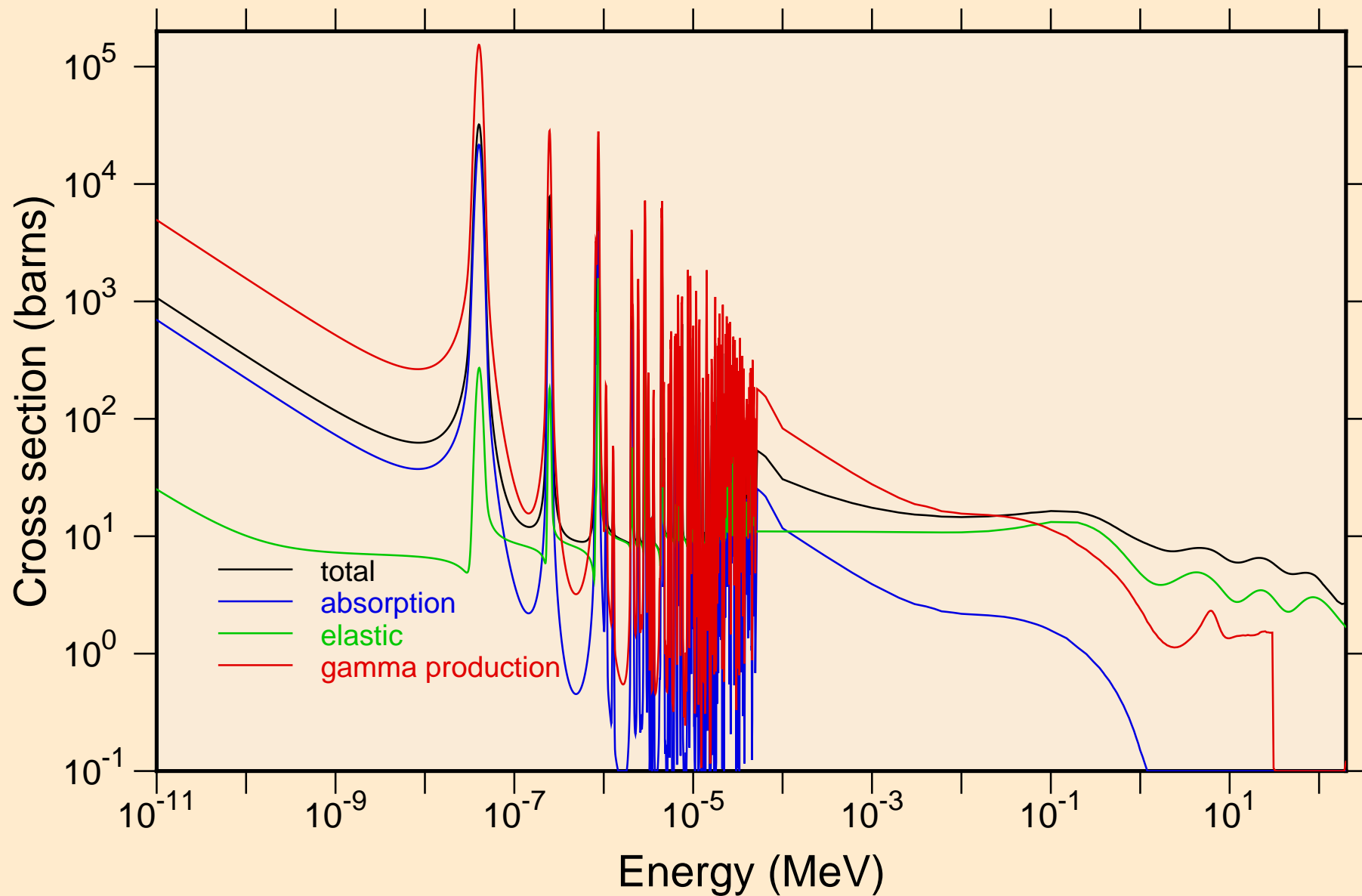

BH269 NEUTRON ACER TENDL-2019 LIBRARY; T=293.16K
resonance total cross section

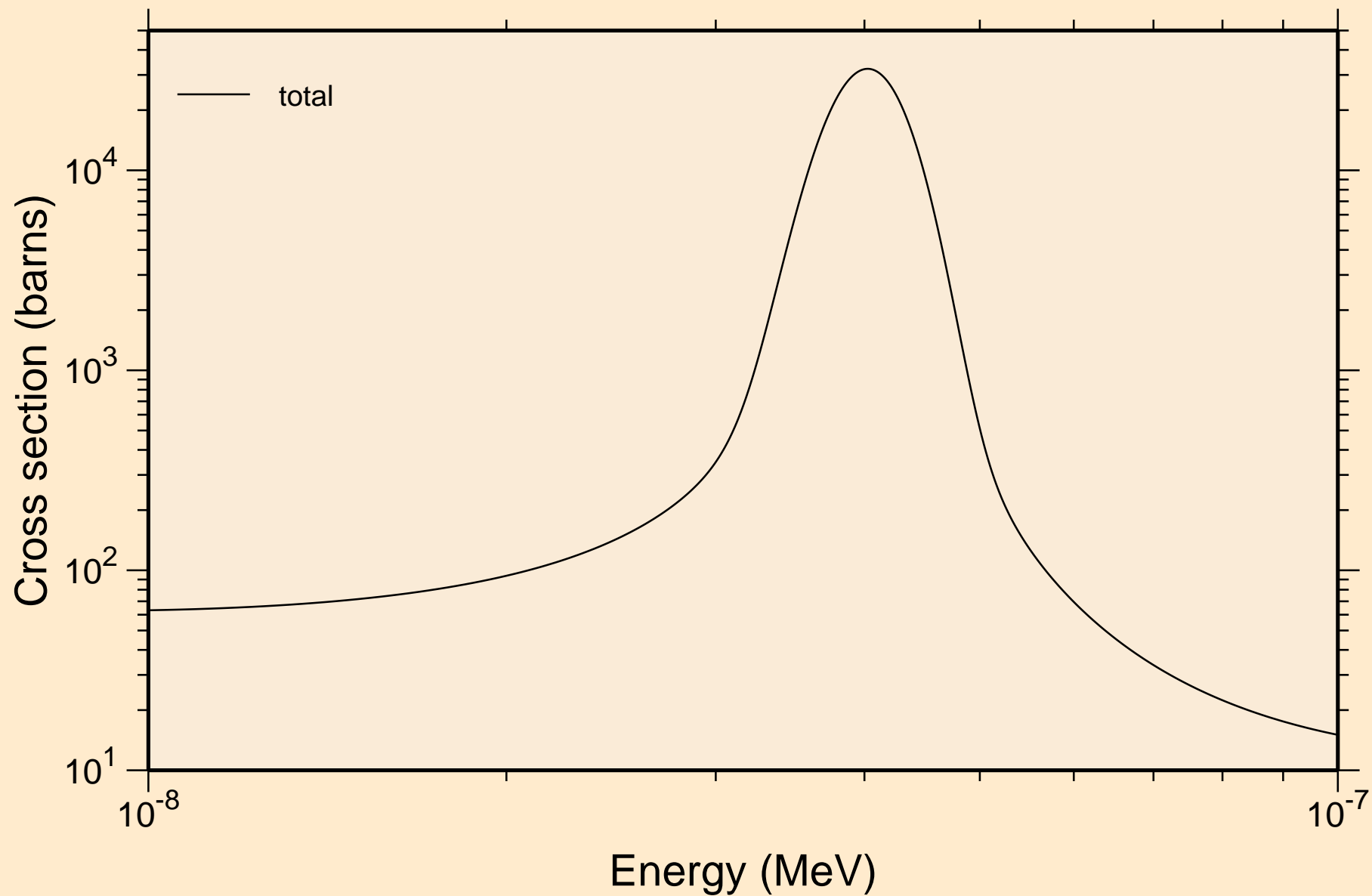

BH269 NEUTRON ACER TENDL-2019 LIBRARY; T=293.16K
resonance total cross section

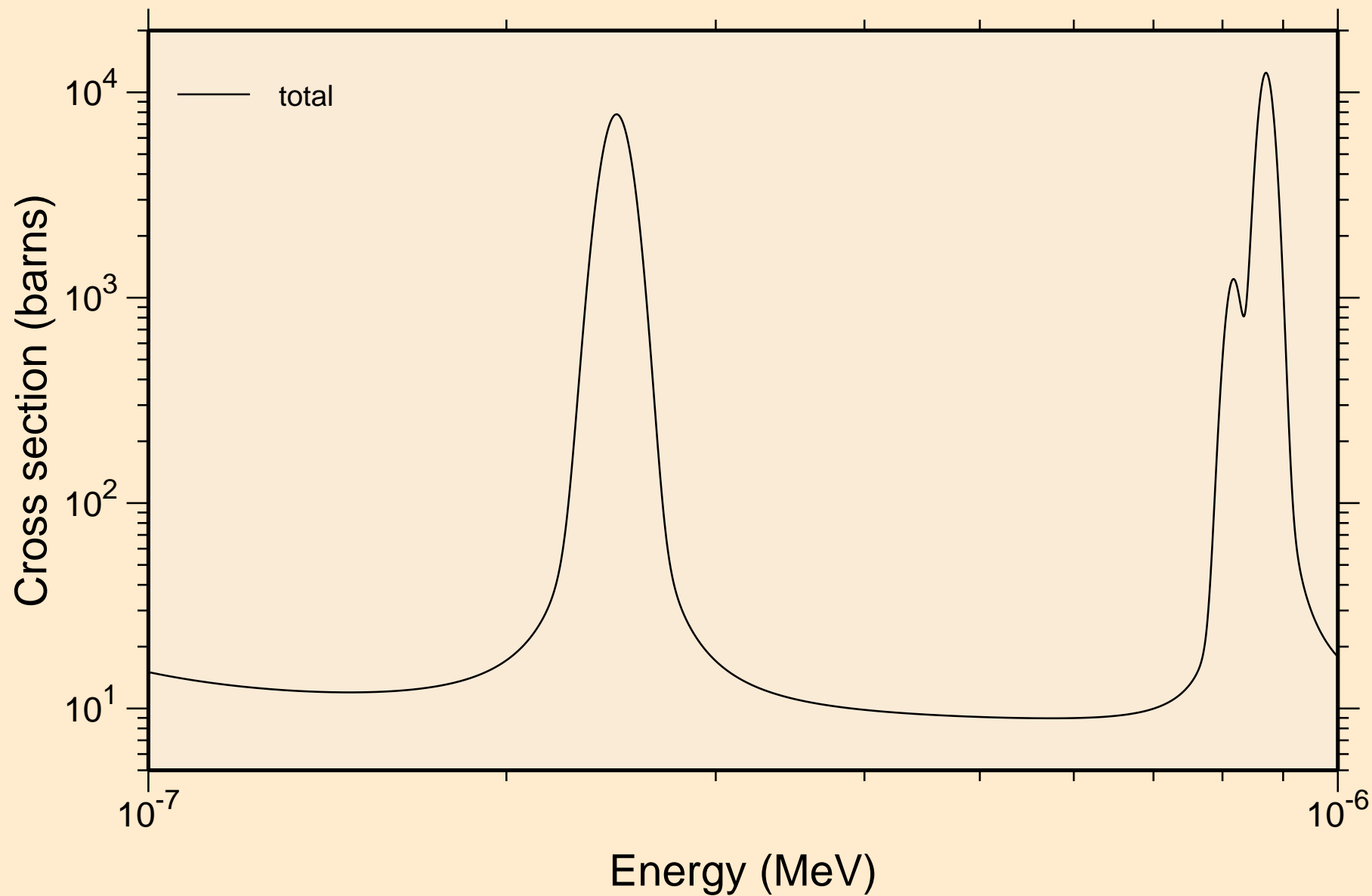

BH269 NEUTRON ACER TENDL-2019 LIBRARY; T=293.16K
resonance total cross section

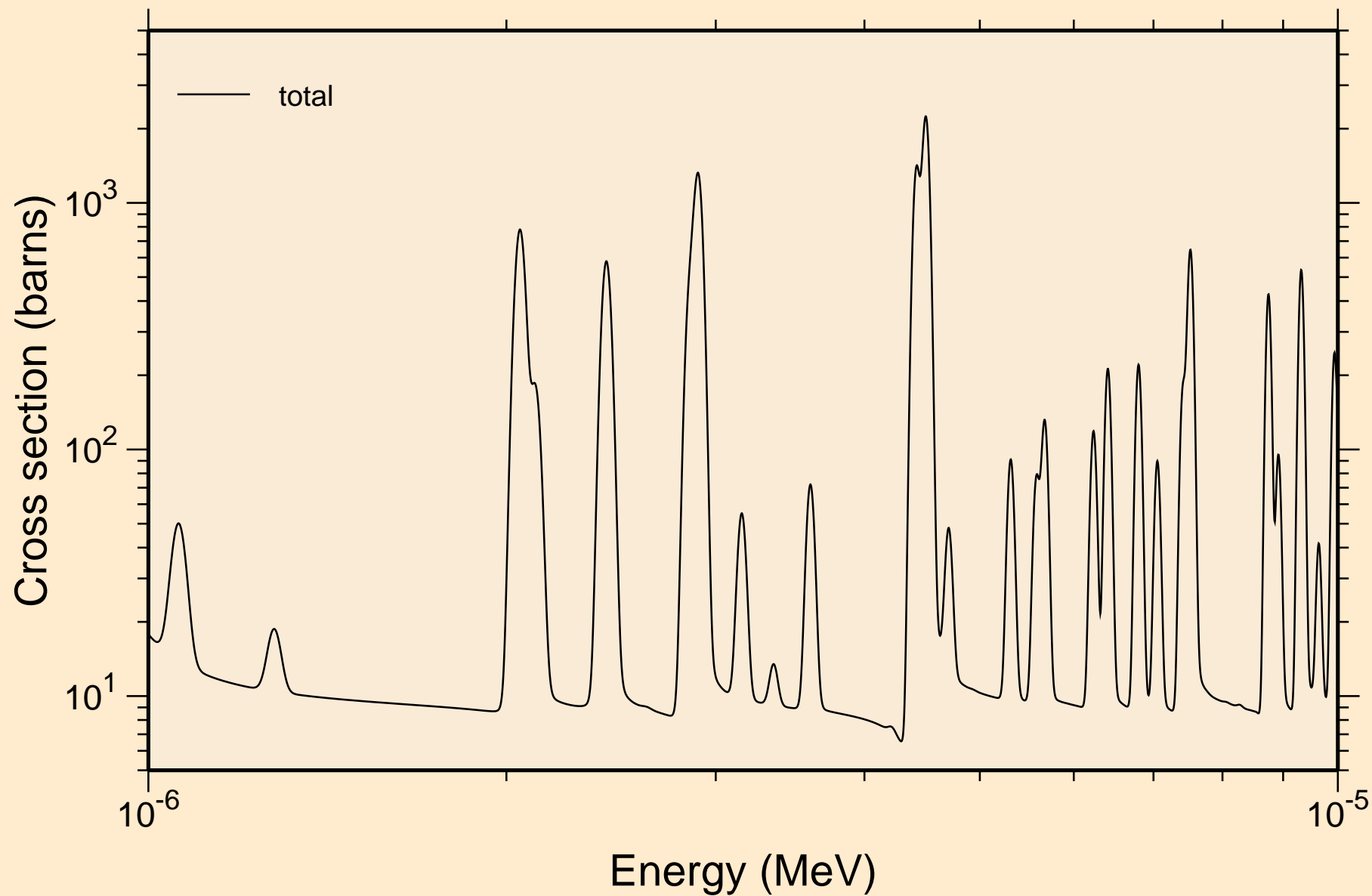

BH269 NEUTRON ACER TENDL-2019 LIBRARY; T=293.16K
resonance total cross section

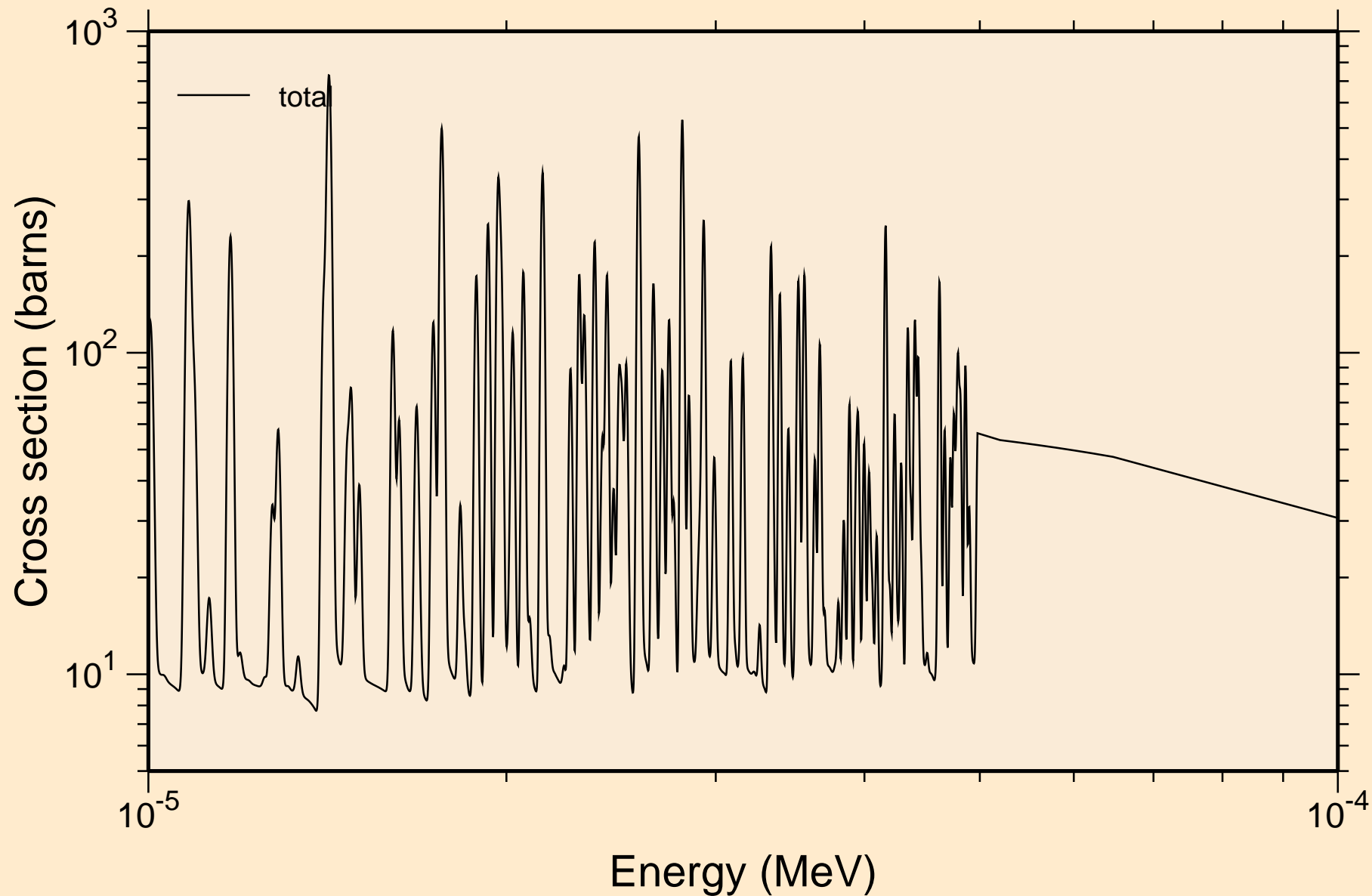

BH269 NEUTRON ACER TENDL-2019 LIBRARY; T=293.16K
resonance total cross section

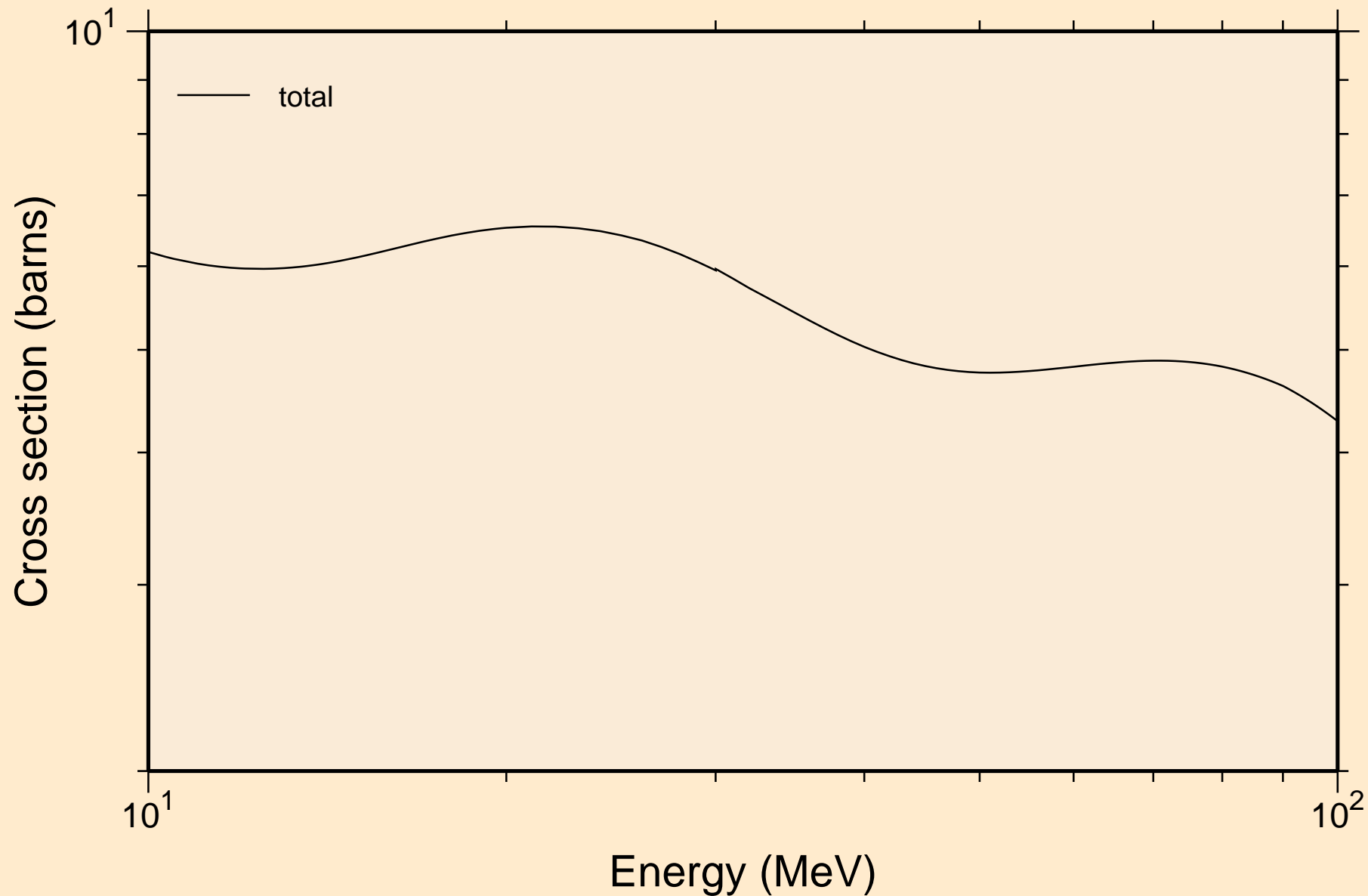

BH269 NEUTRON ACER TENDL-2019 LIBRARY; T=293.16K
resonance absorption cross sections

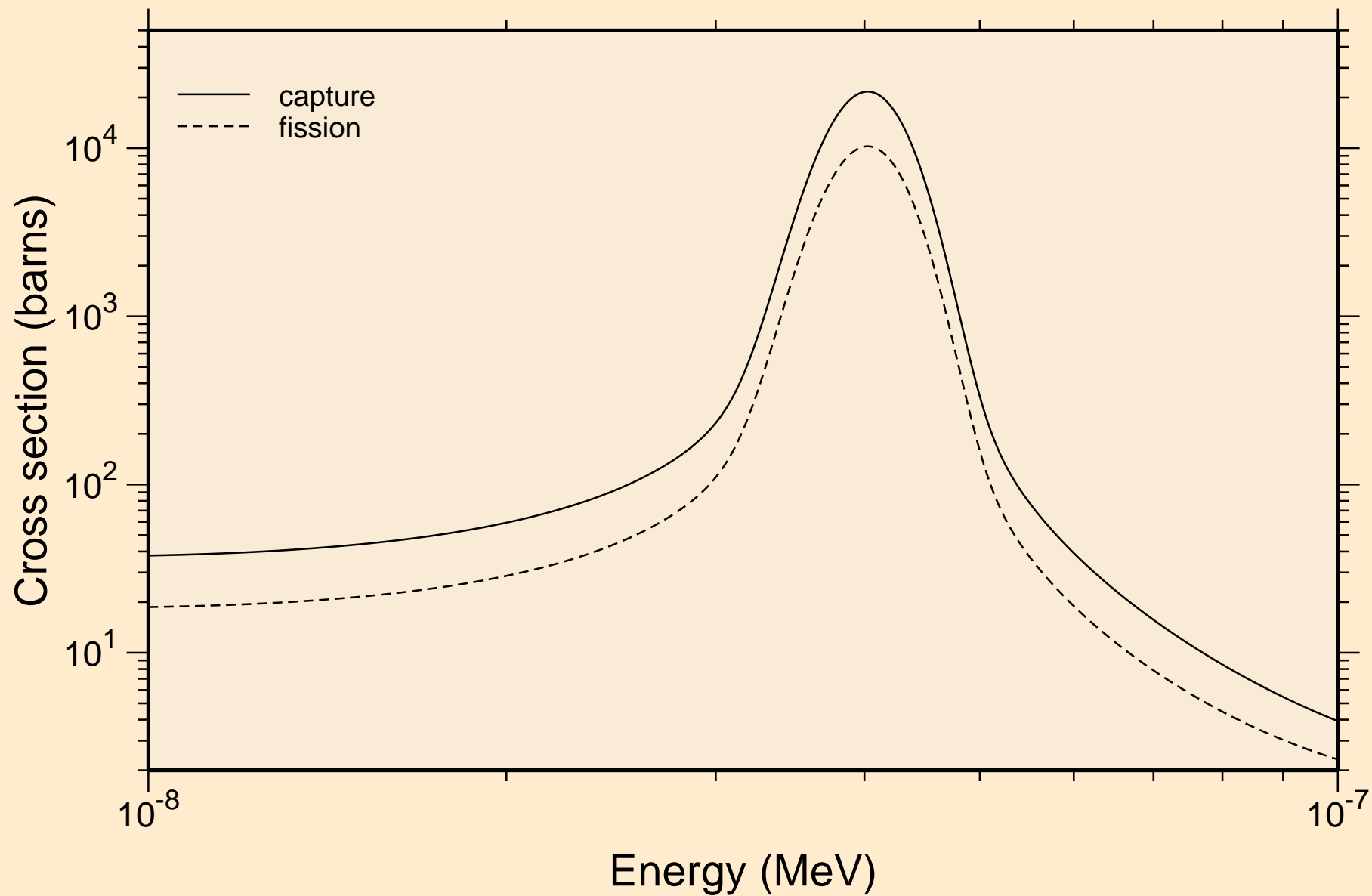

BH269 NEUTRON ACER TENDL-2019 LIBRARY; T=293.16K
resonance absorption cross sections

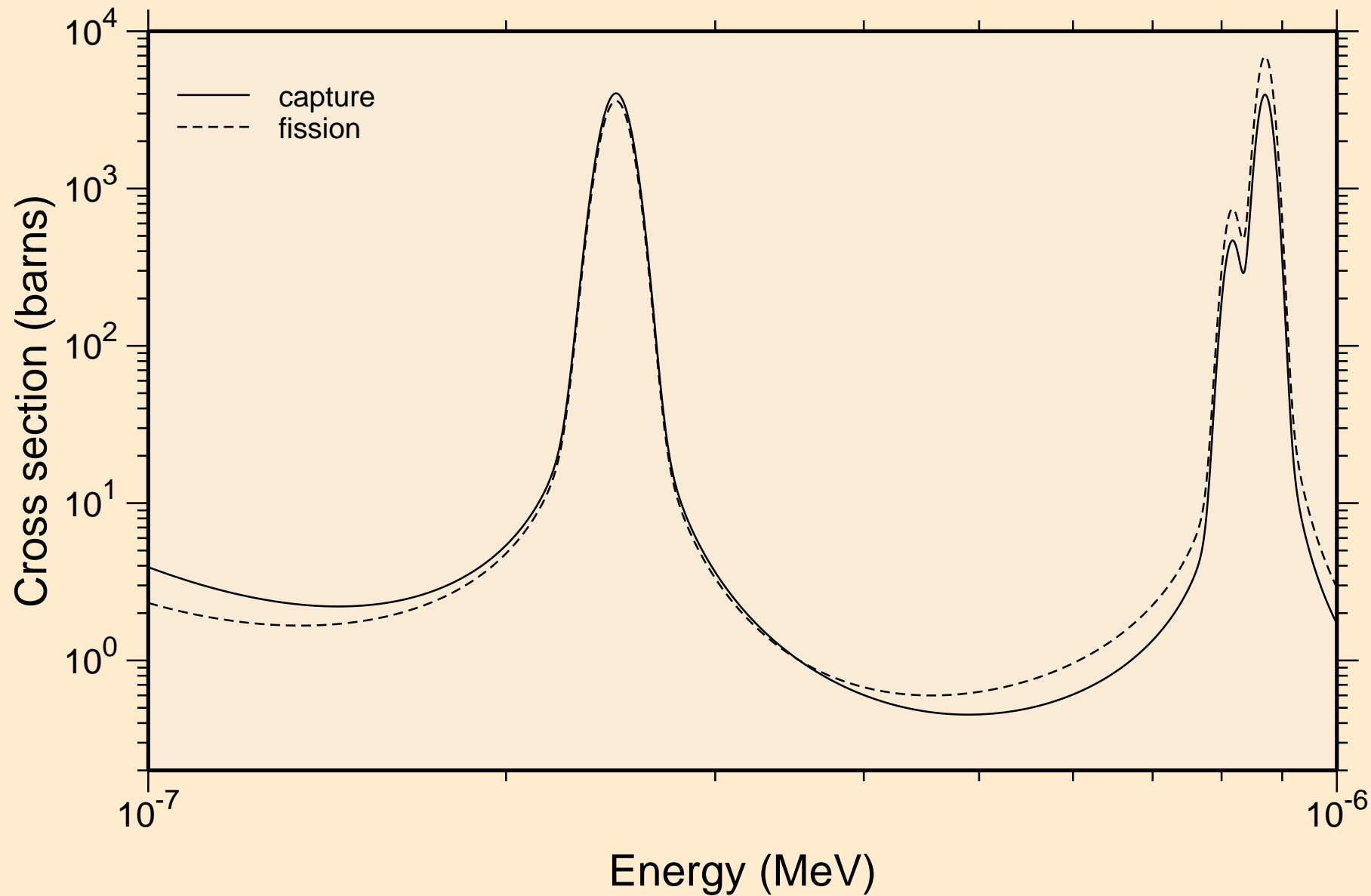

BH269 NEUTRON ACER TENDL-2019 LIBRARY; T=293.16K
resonance absorption cross sections

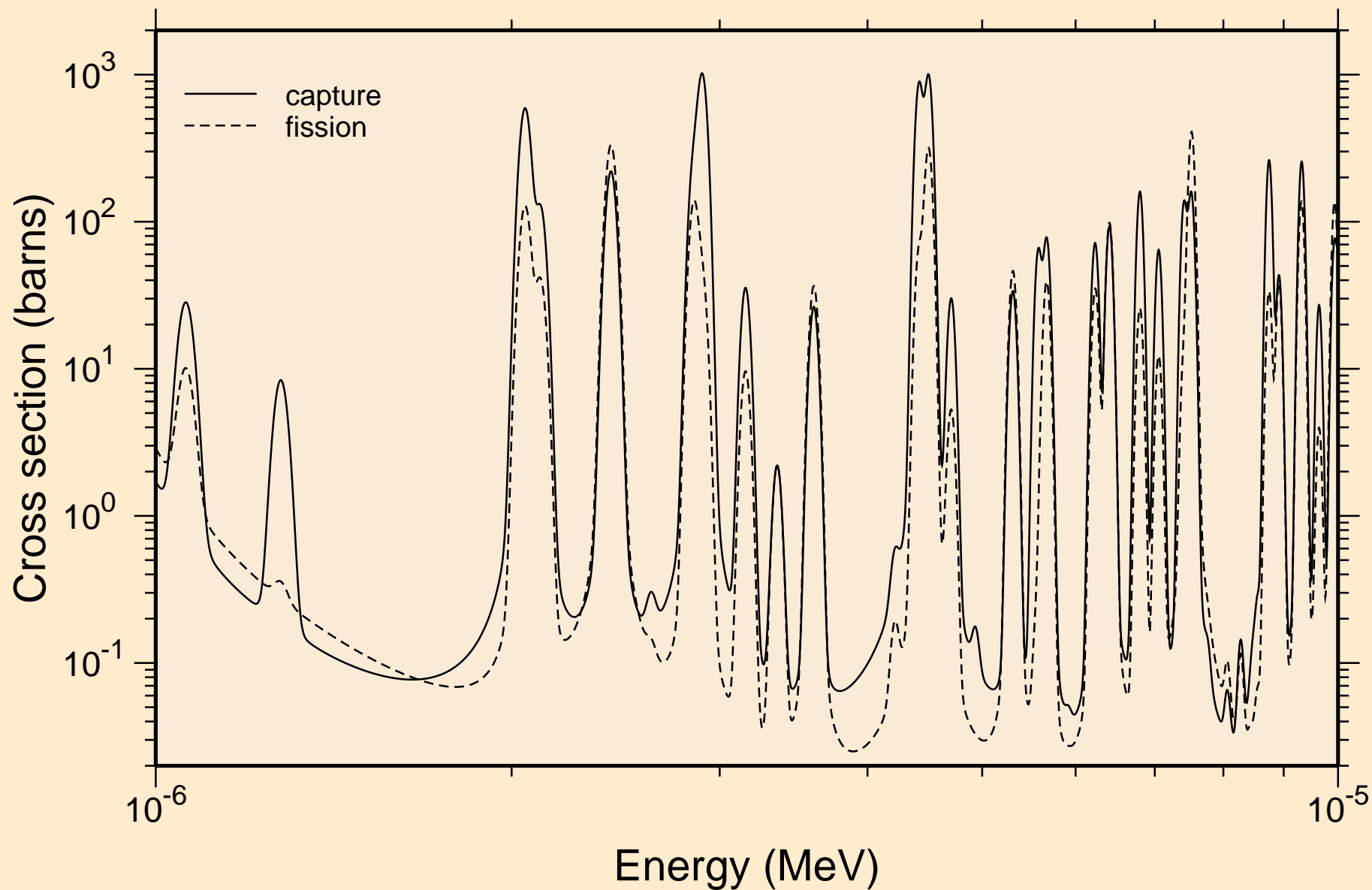

BH269 NEUTRON ACER TENDL-2019 LIBRARY; T=293.16K
resonance absorption cross sections

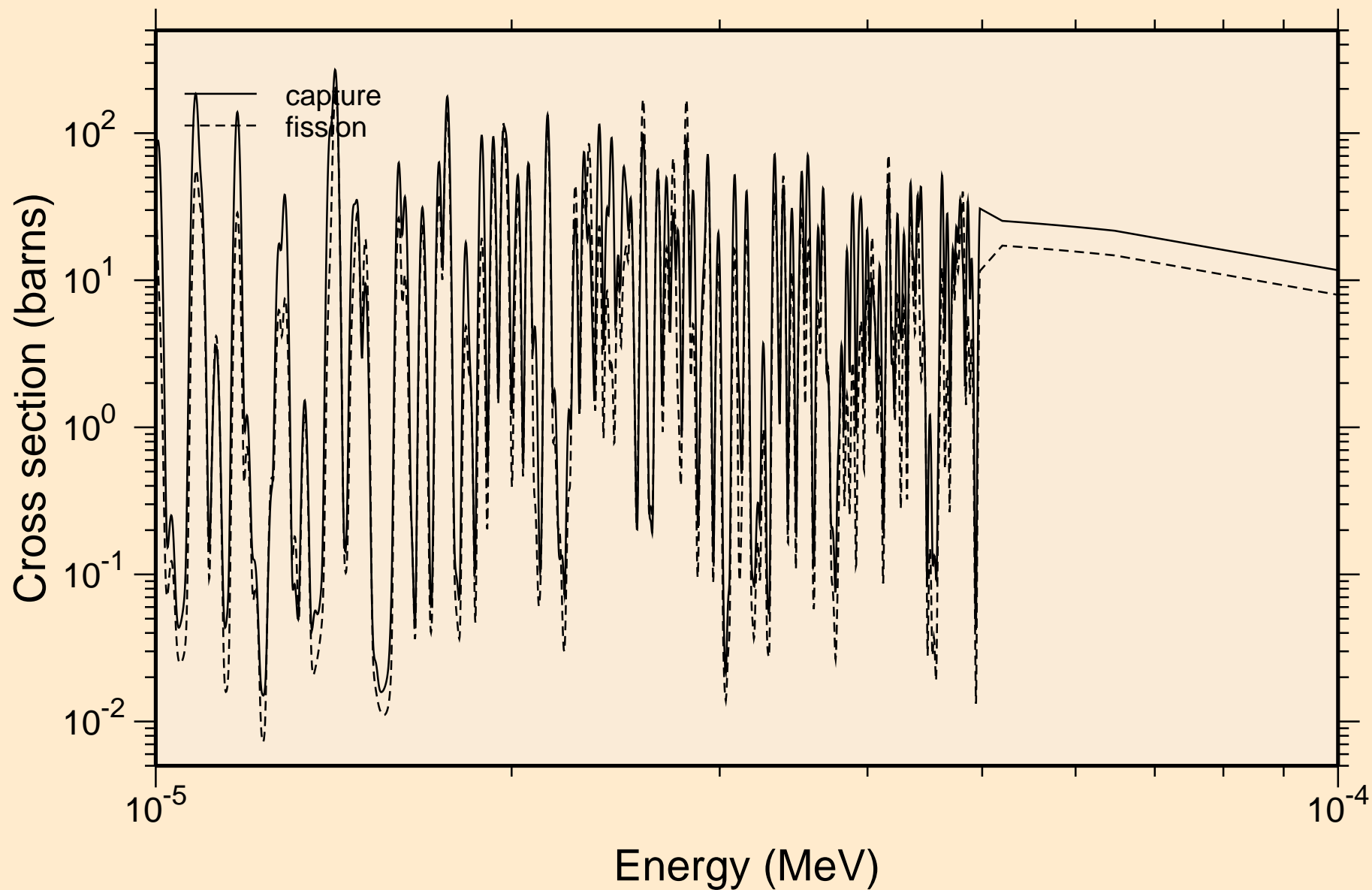

BH269 NEUTRON ACER TENDL-2019 LIBRARY; T=293.16K
resonance absorption cross sections

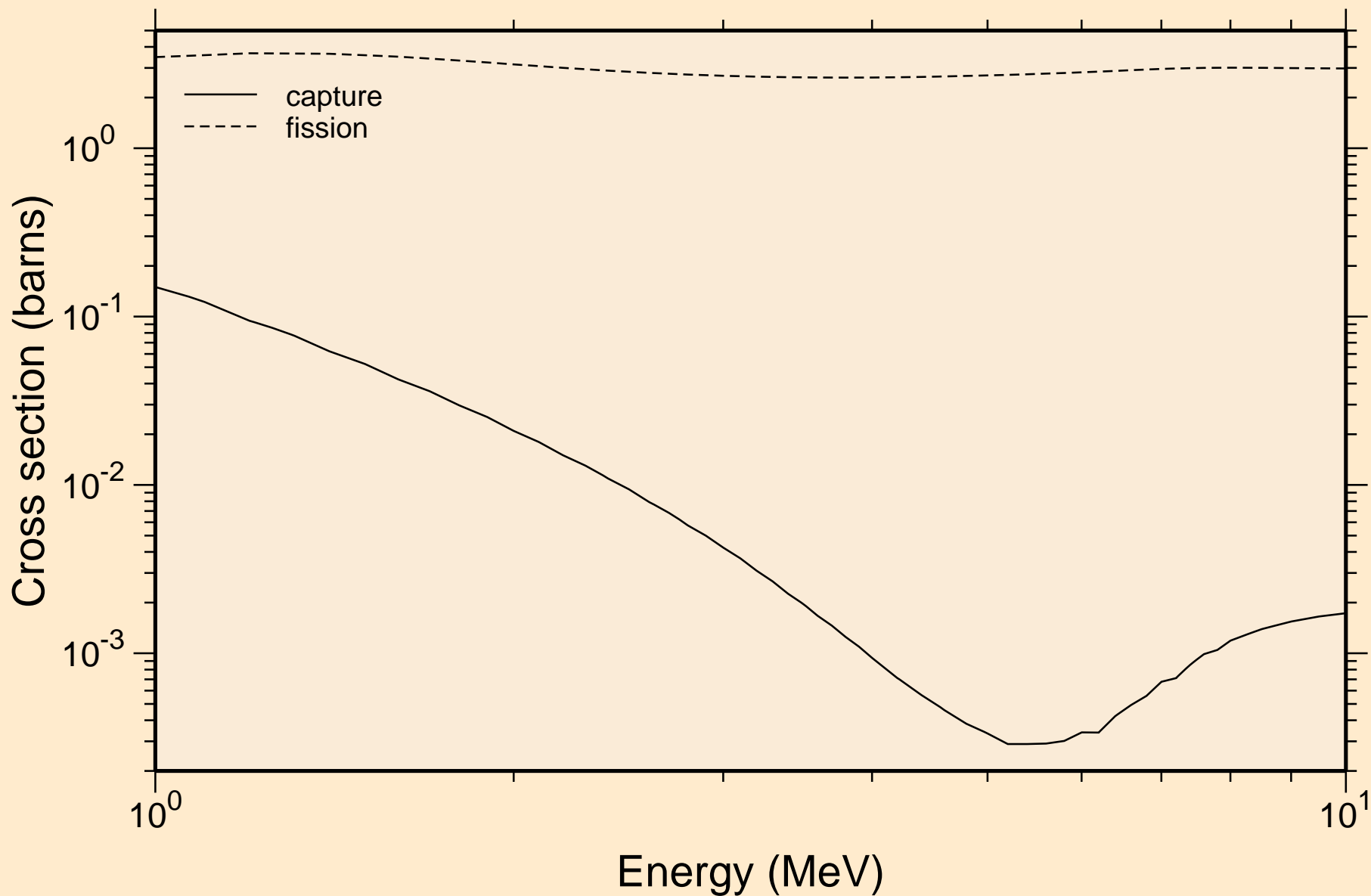

BH269 NEUTRON ACER TENDL-2019 LIBRARY; T=293.16K
Heating

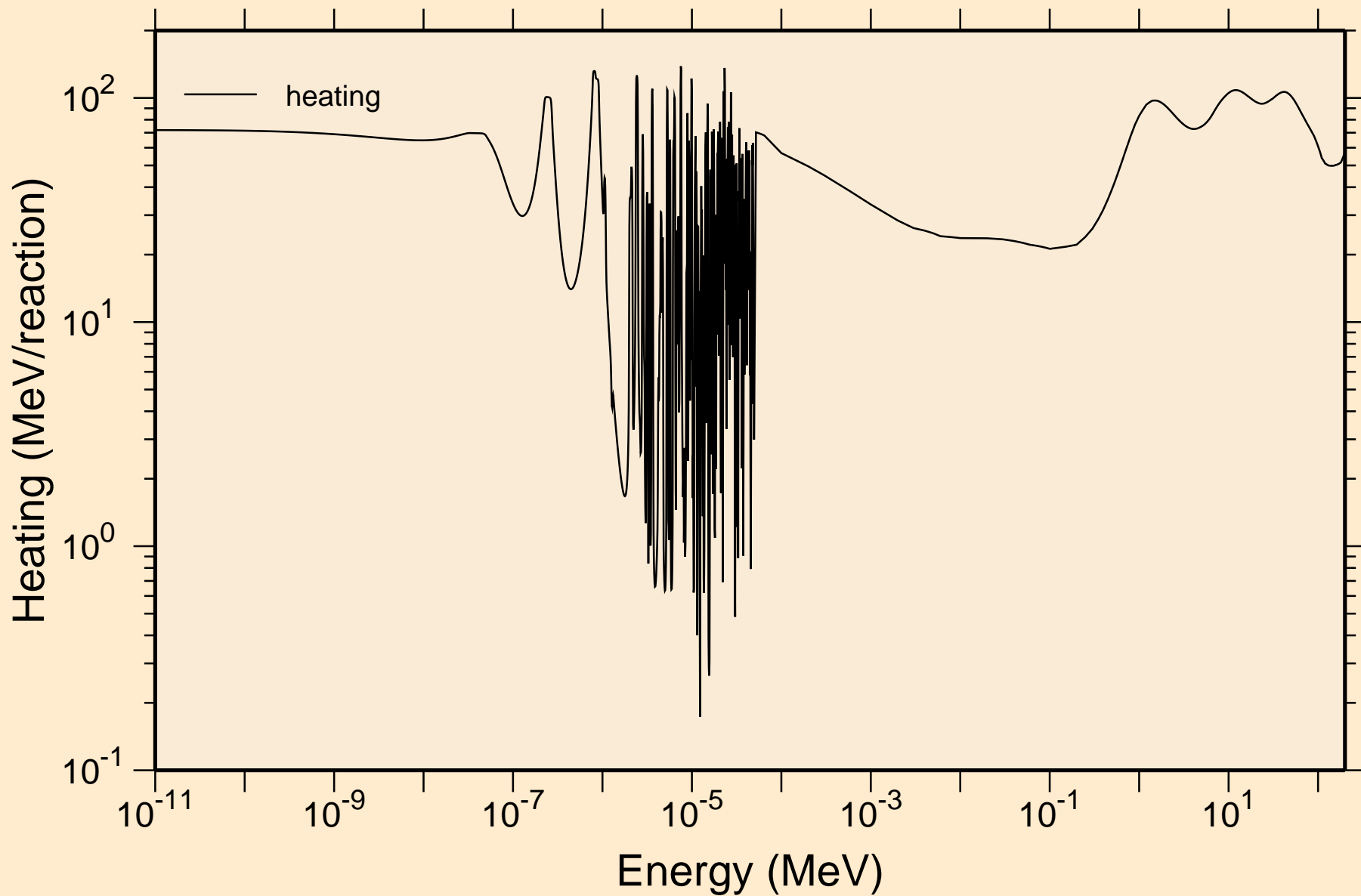

BH269 NEUTRON ACER TENDL-2019 LIBRARY; T=293.16K
Damage

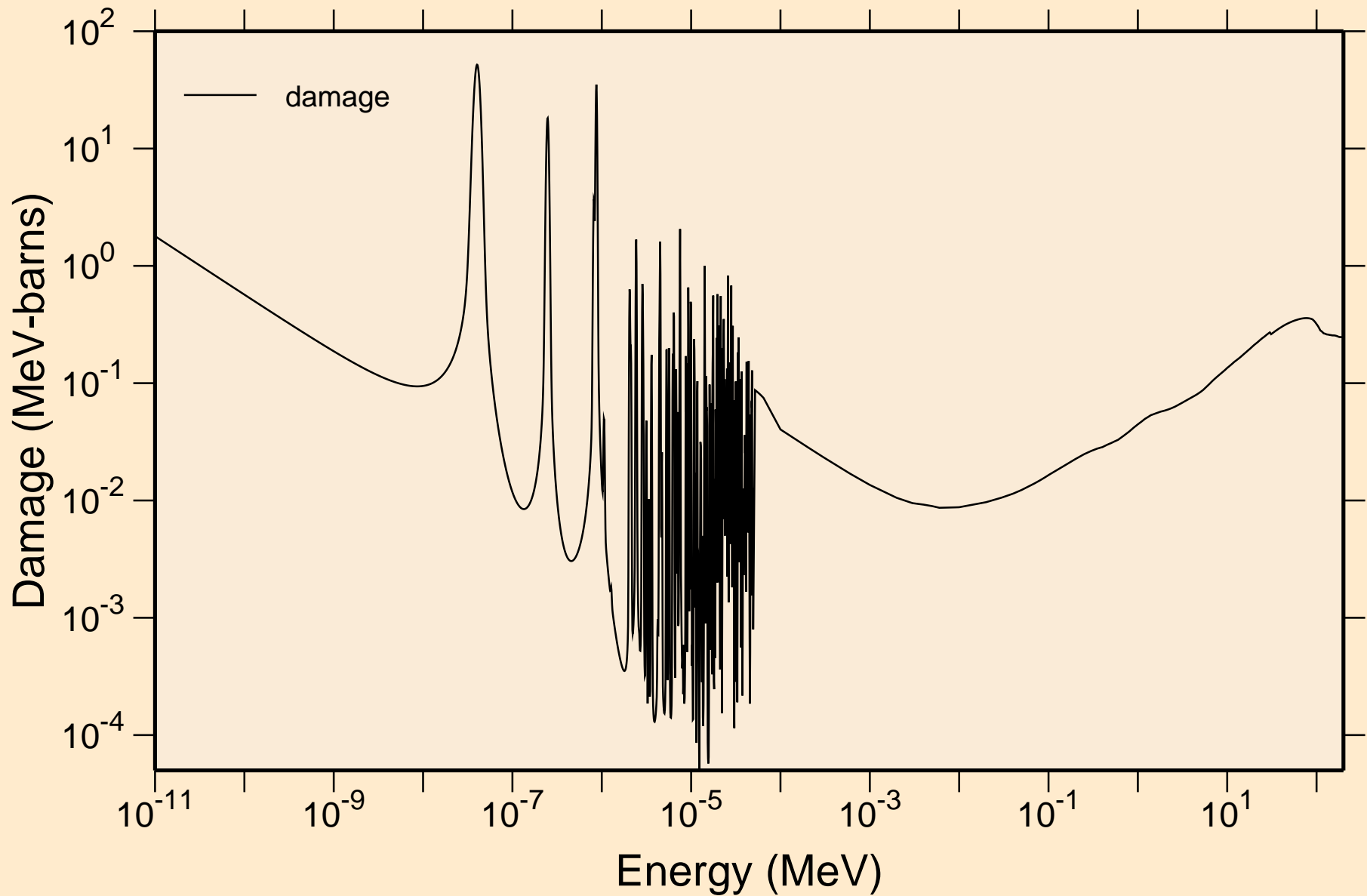

BH269 NEUTRON ACER TENDL-2019 LIBRARY; T=293.16K
Non-threshold reactions

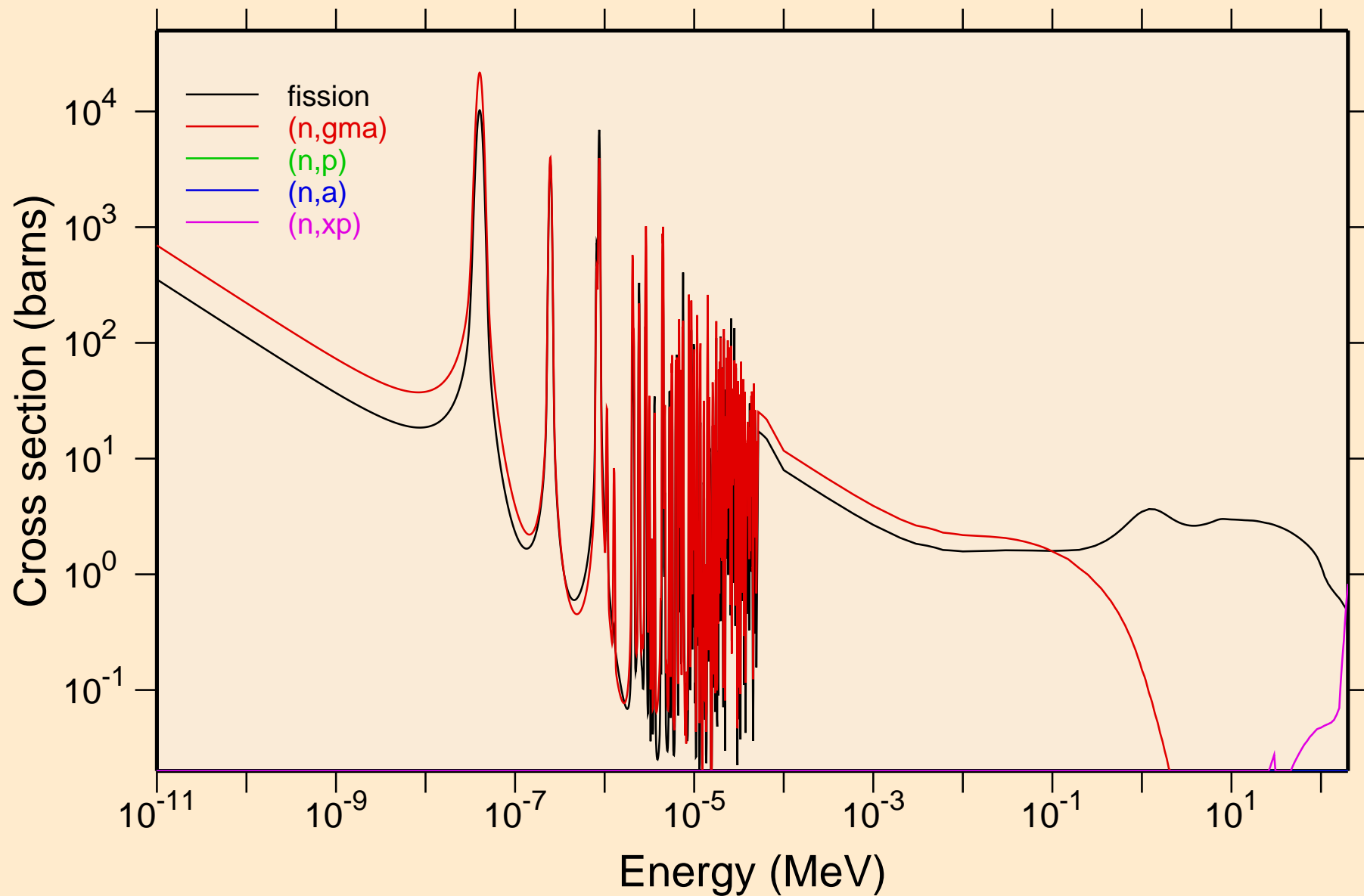

BH269 NEUTRON ACER TENDL-2019 LIBRARY; T=293.16K
Non-threshold reactions

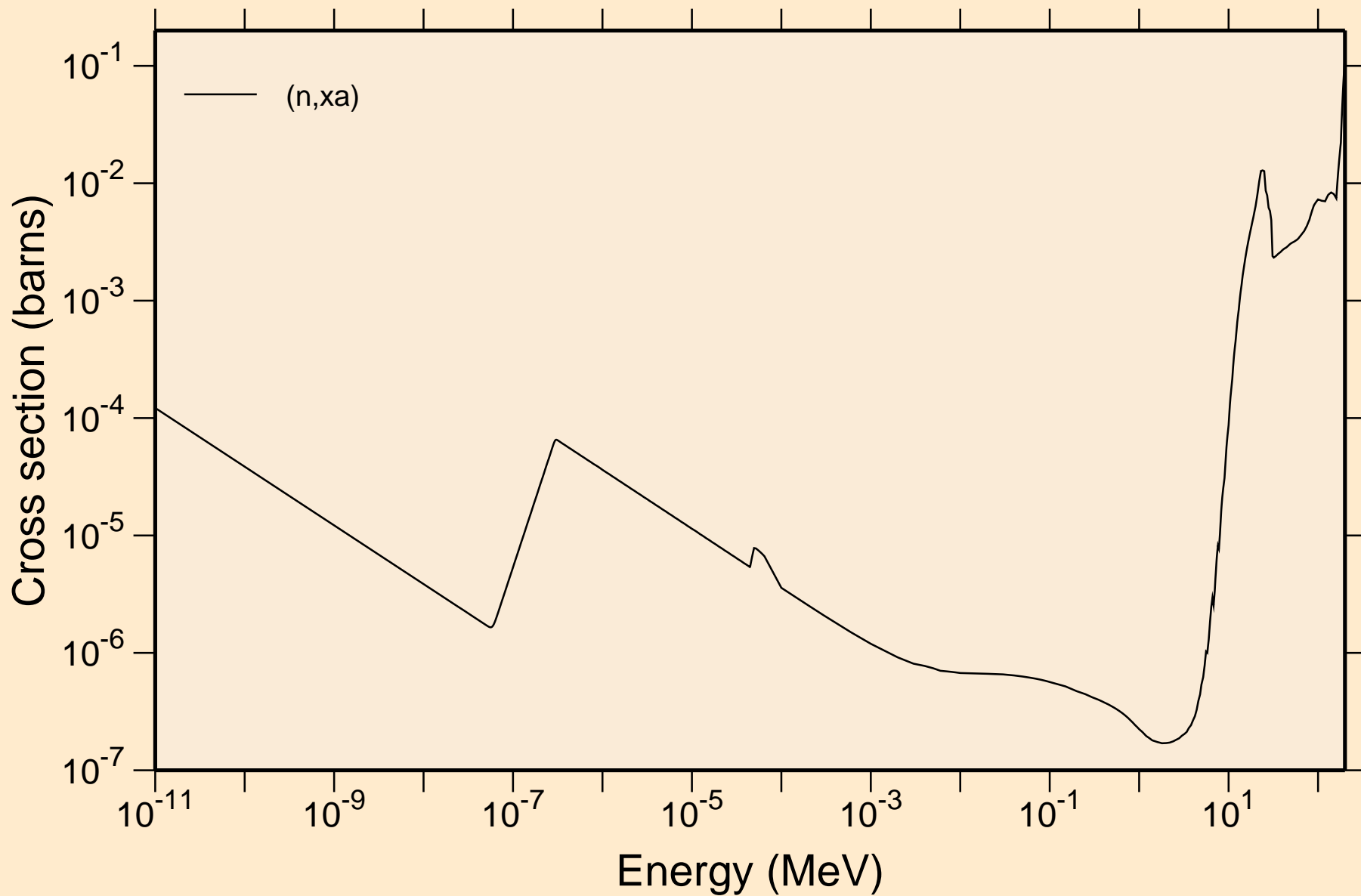

BH269 NEUTRON ACER TENDL-2019 LIBRARY; T=293.16K
Principal cross sections

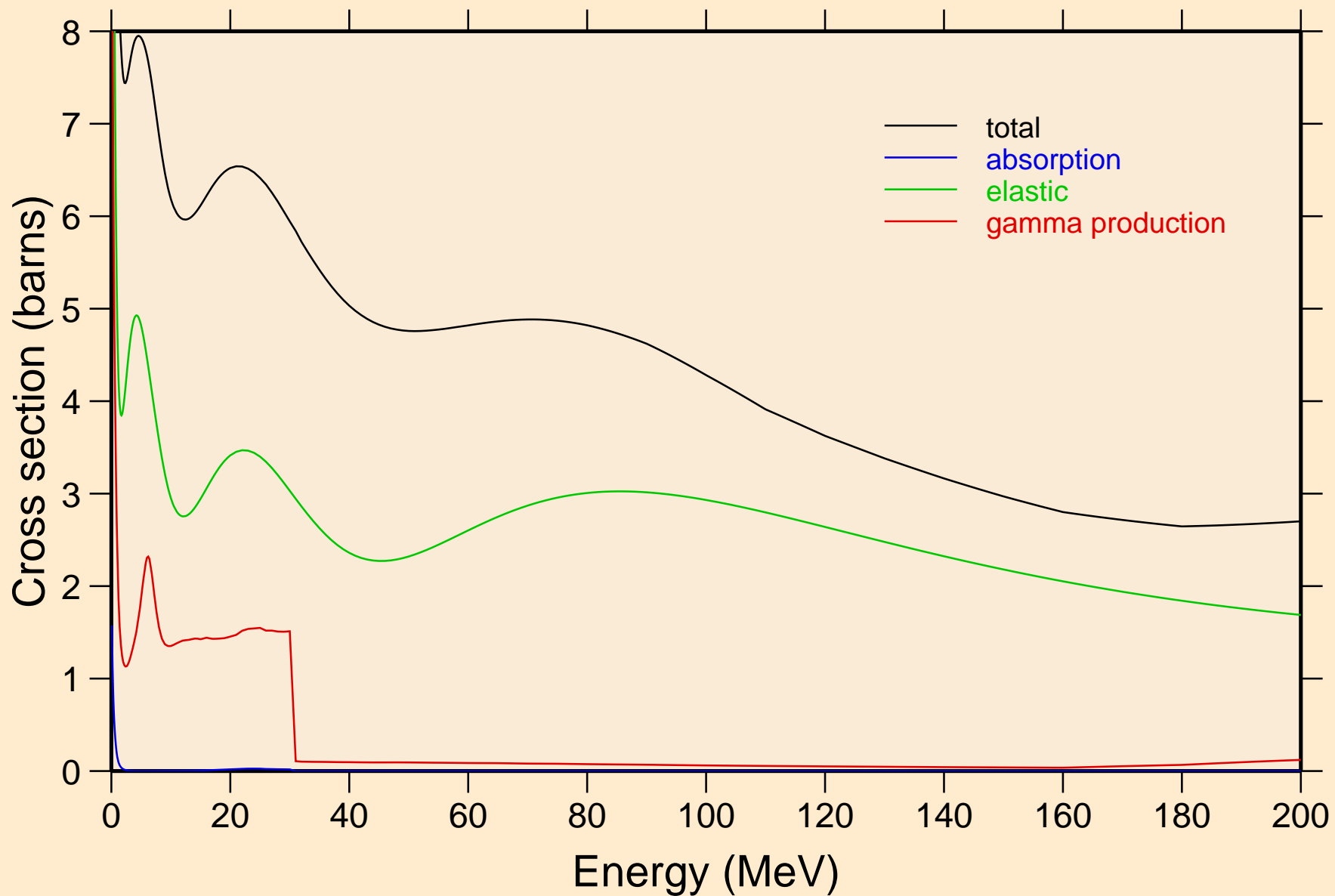

BH269 NEUTRON ACER TENDL-2019 LIBRARY; T=293.16K
Heating

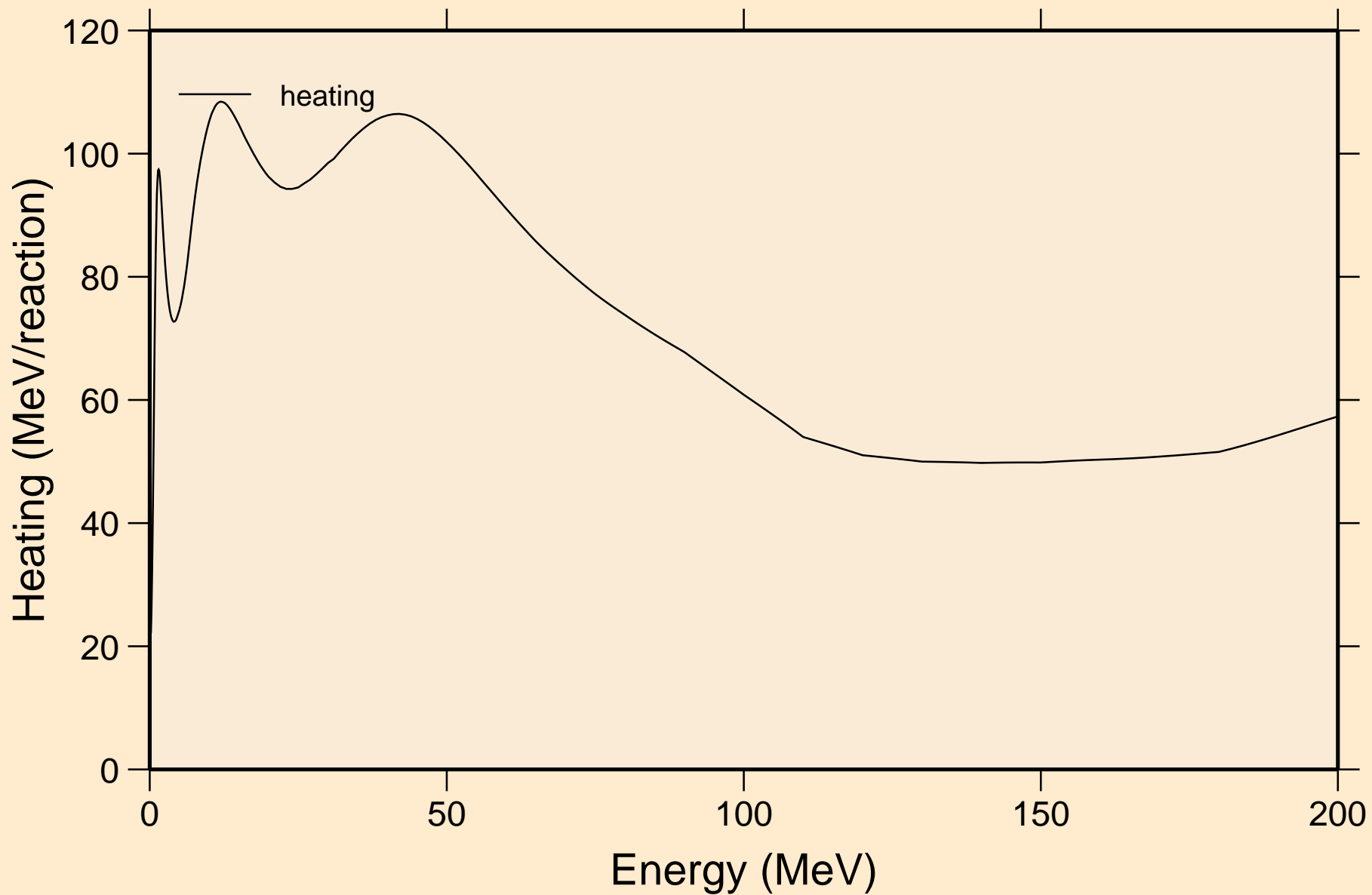

BH269 NEUTRON ACER TENDL-2019 LIBRARY; T=293.16K
Damage

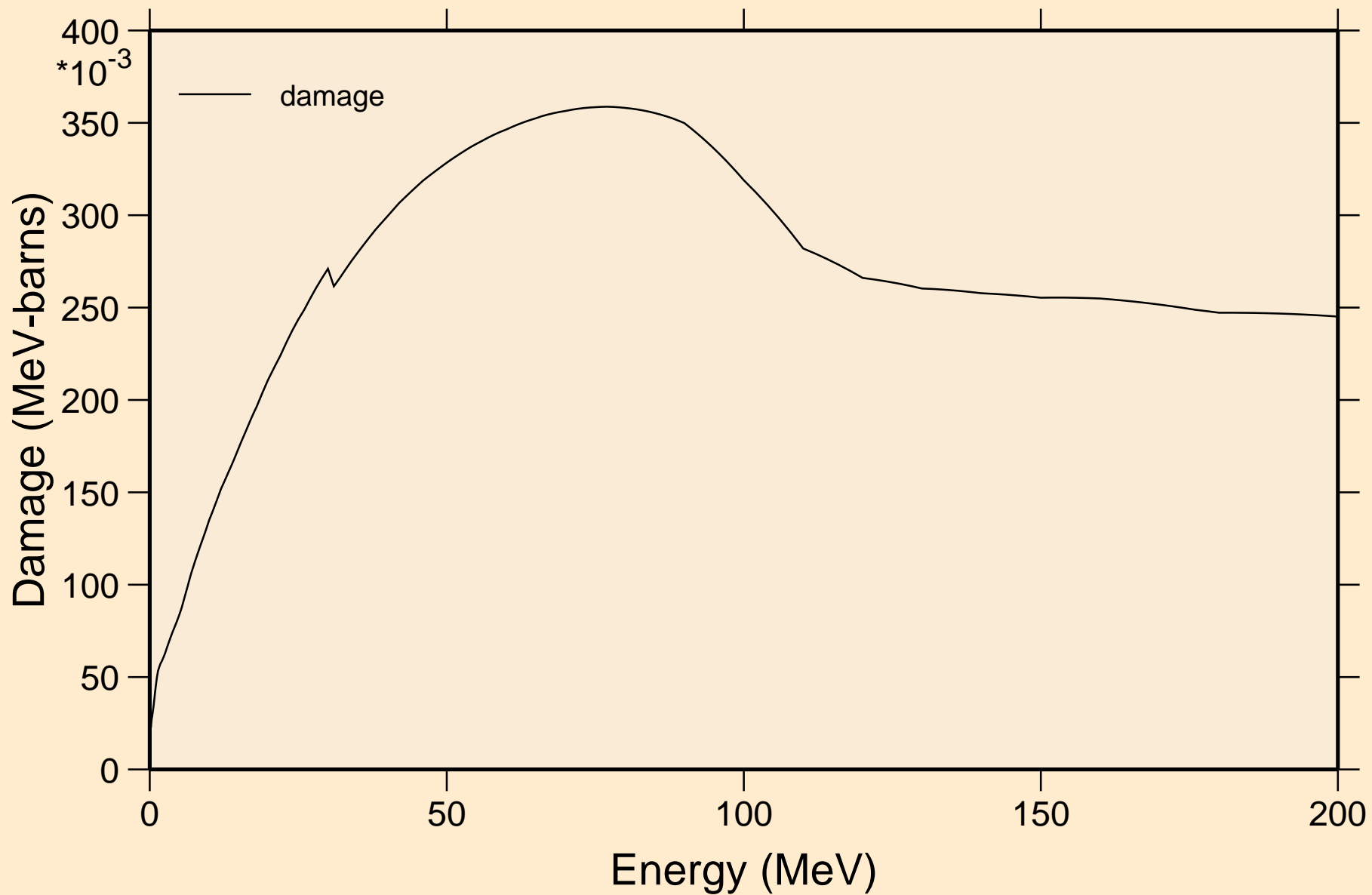

BH269 NEUTRON ACER TENDL-2019 LIBRARY; T=293.16K
Non-threshold reactions

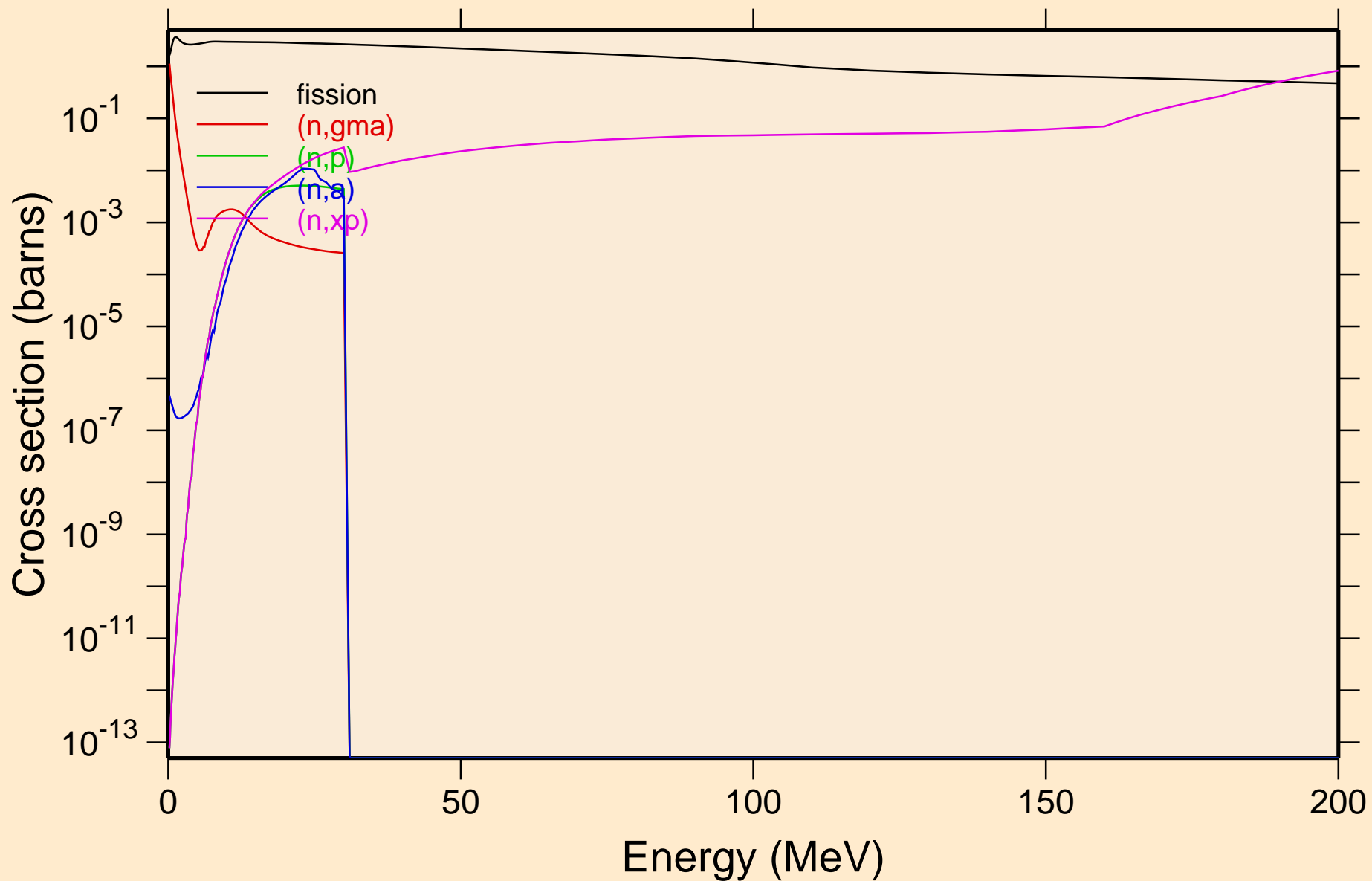

BH269 NEUTRON ACER TENDL-2019 LIBRARY; T=293.16K
Non-threshold reactions

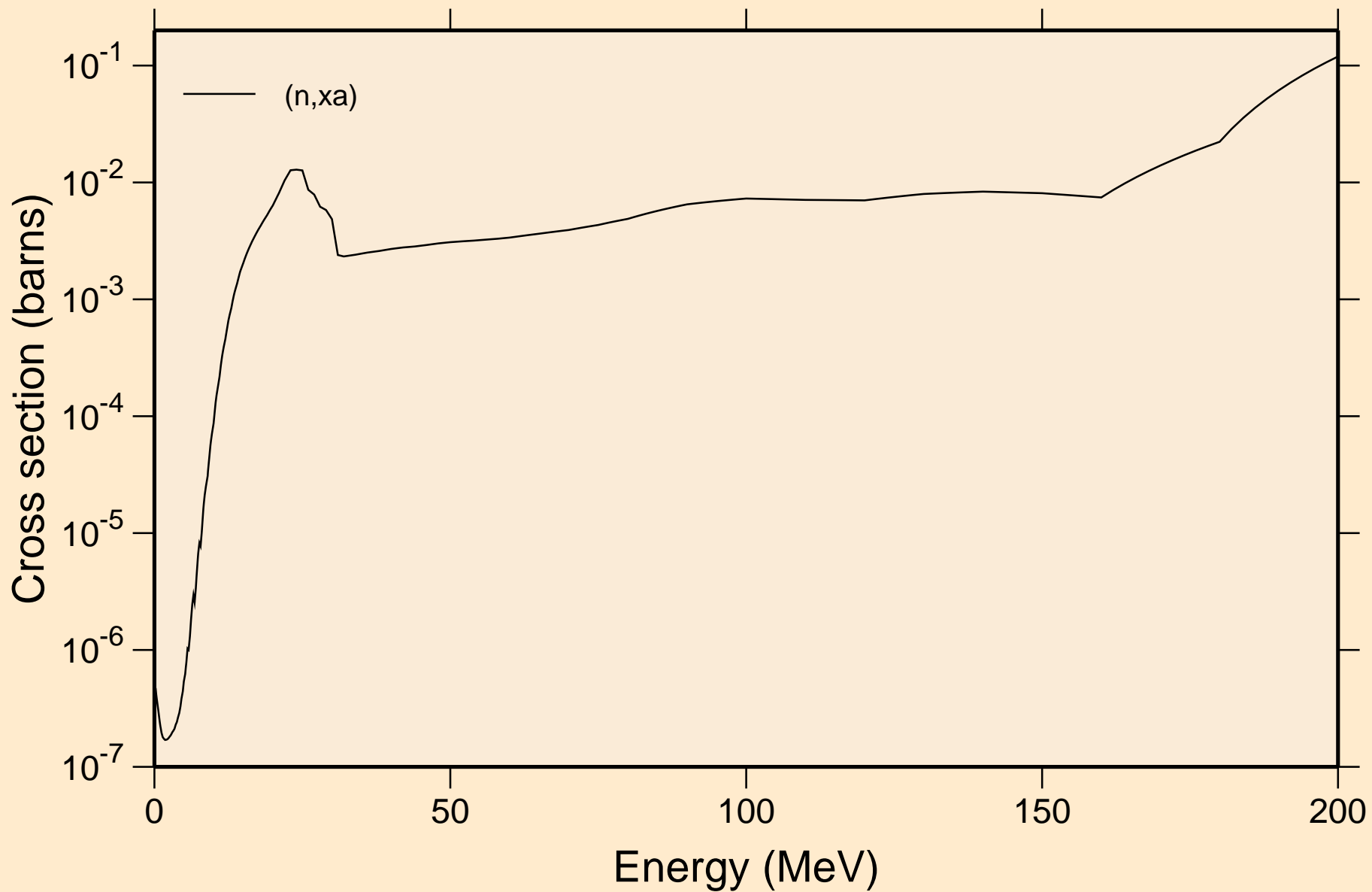

BH269 NEUTRON ACER TENDL-2019 LIBRARY; T=293.16K
Inelastic levels

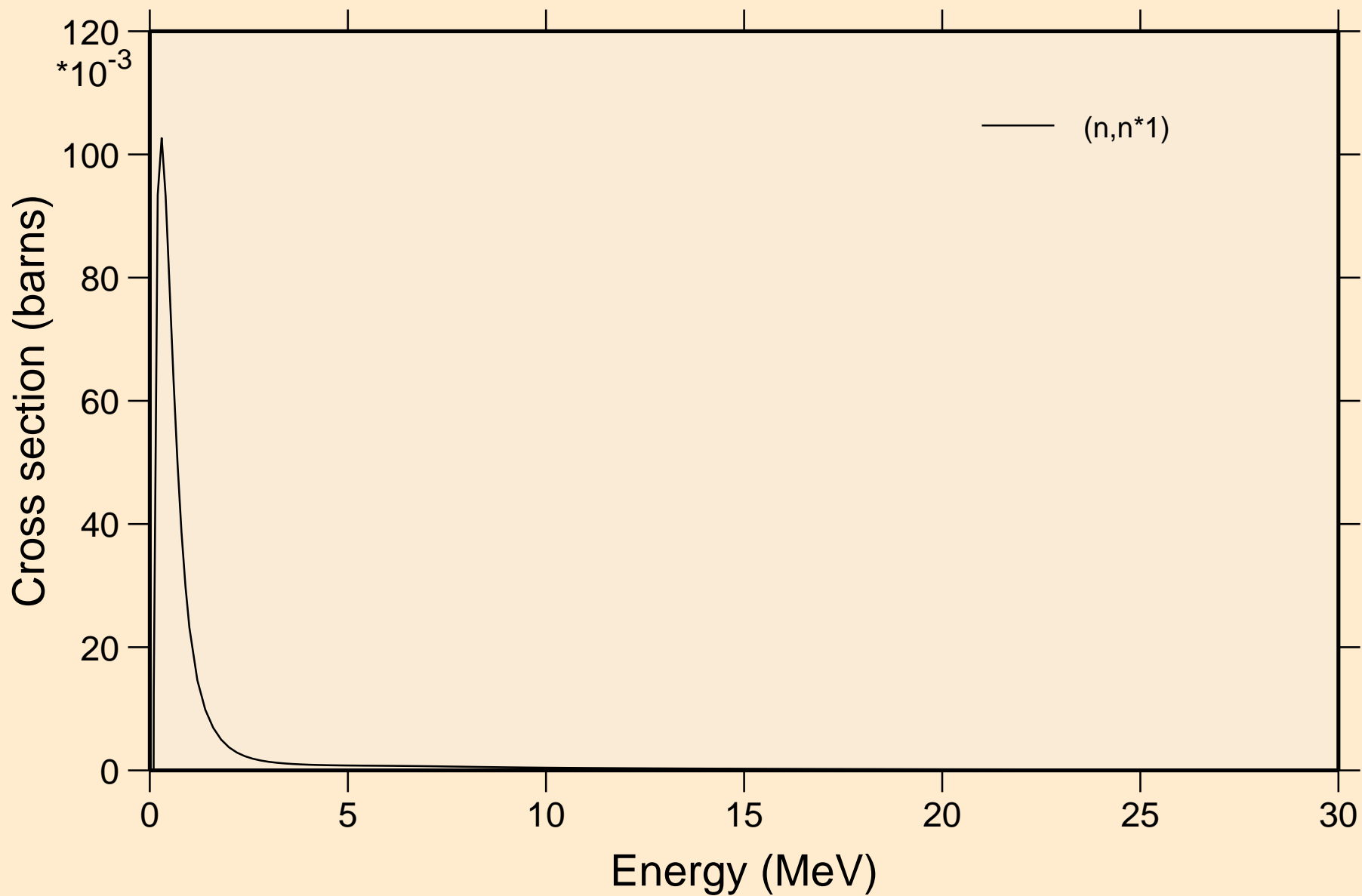

BH269 NEUTRON ACER TENDL-2019 LIBRARY; T=293.16K
Threshold reactions

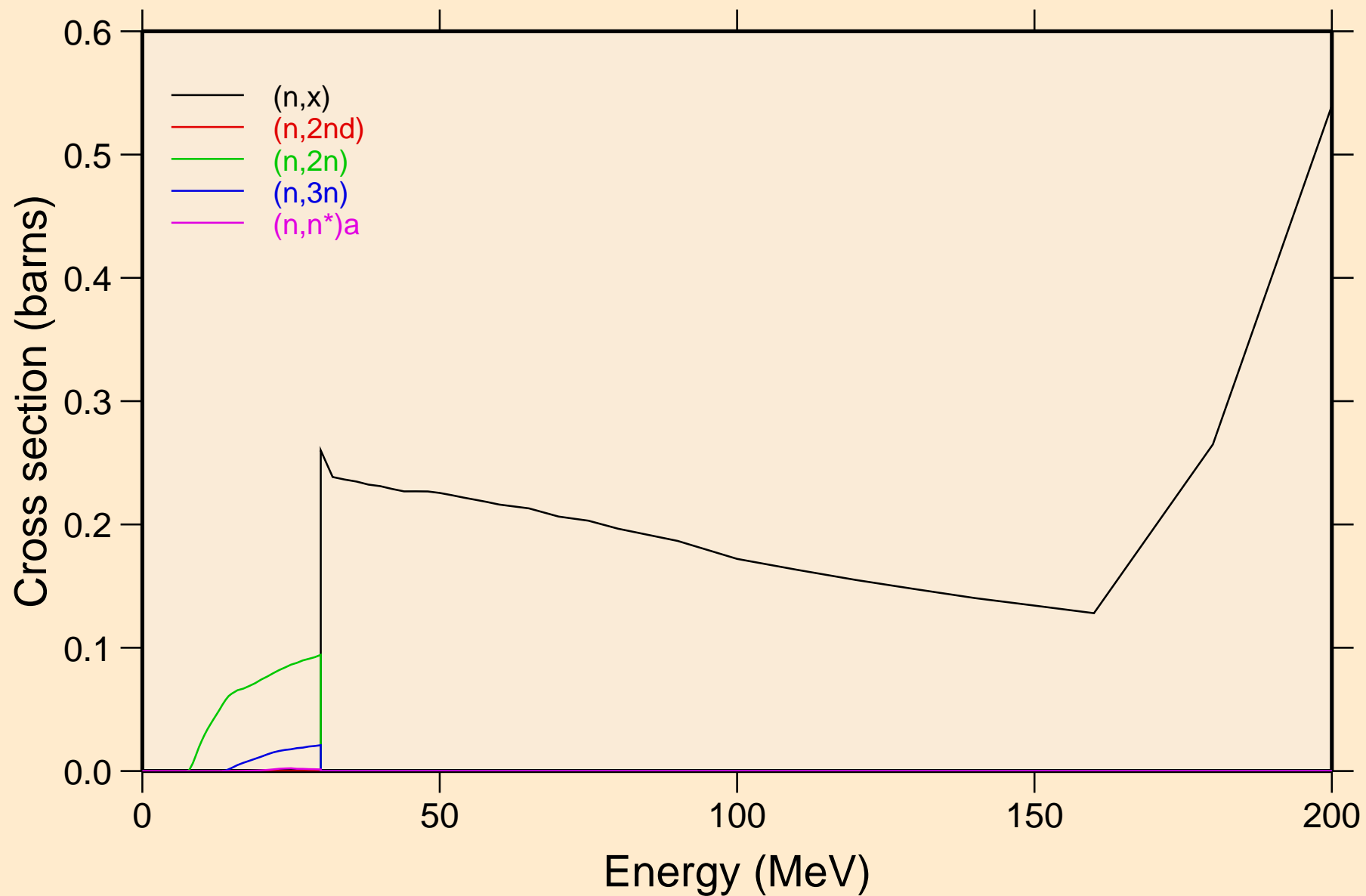

BH269 NEUTRON ACER TENDL-2019 LIBRARY; T=293.16K
Threshold reactions

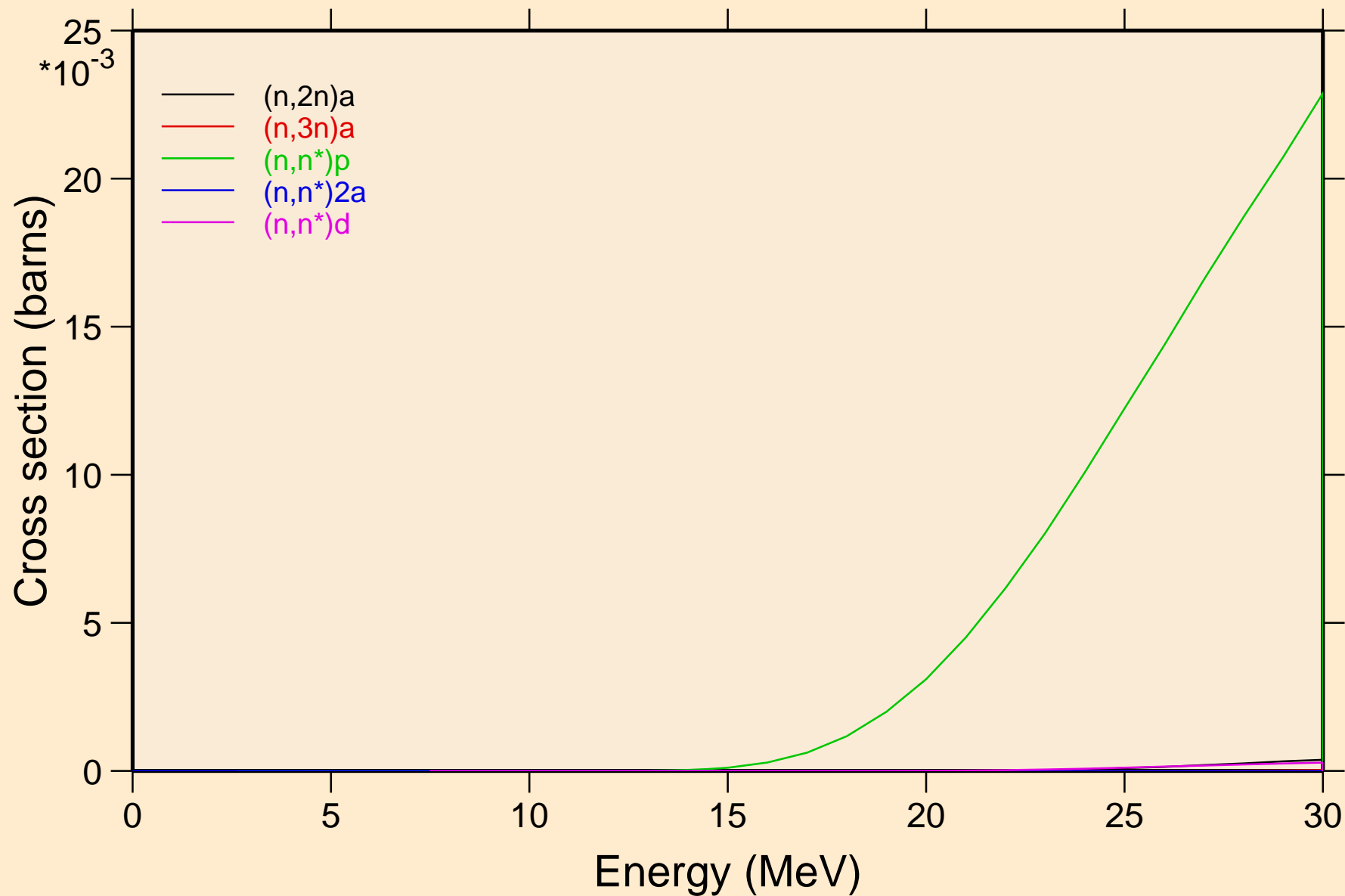

BH269 NEUTRON ACER TENDL-2019 LIBRARY; T=293.16K
Threshold reactions

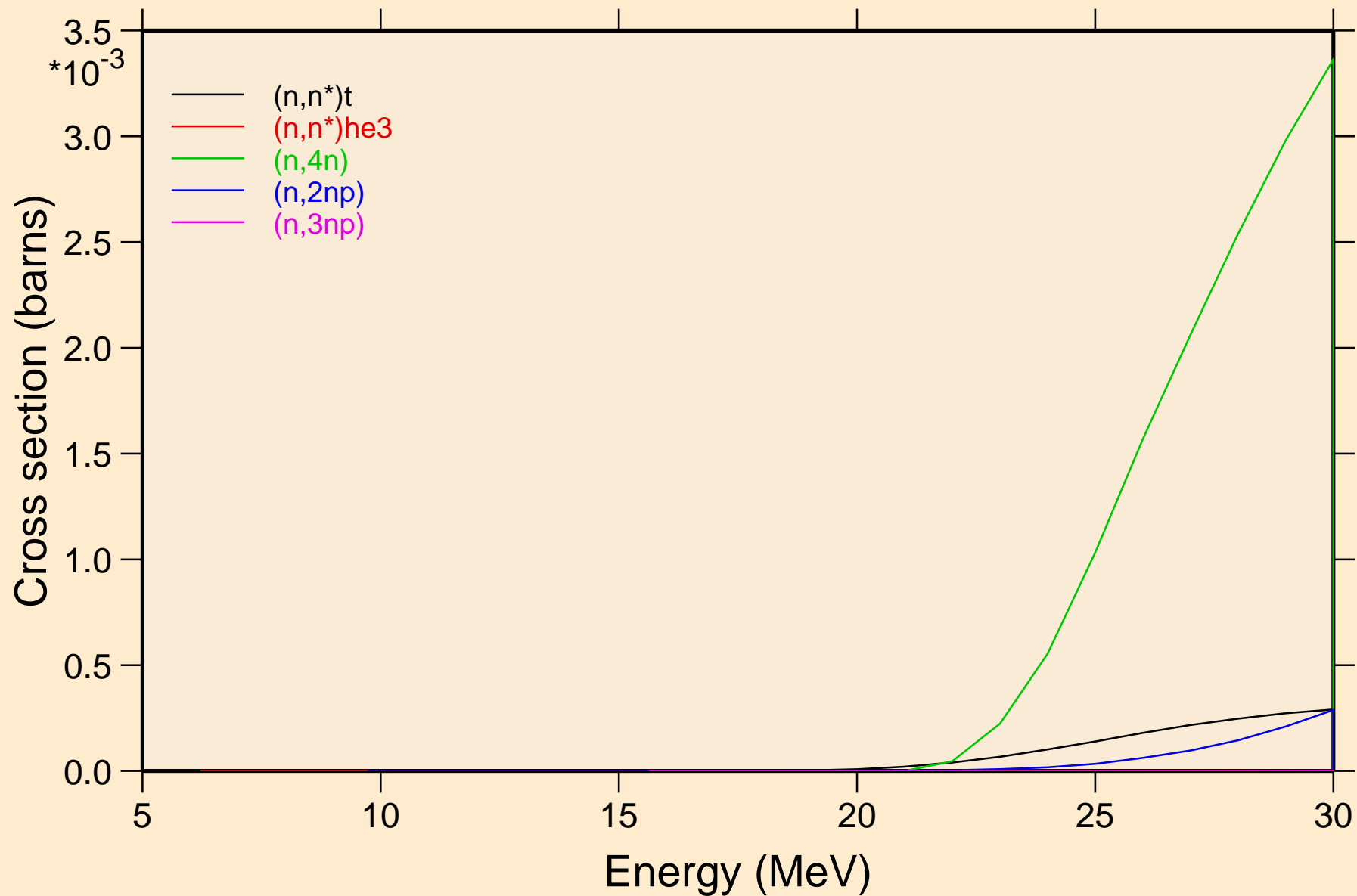

BH269 NEUTRON ACER TENDL-2019 LIBRARY; T=293.16K
Threshold reactions

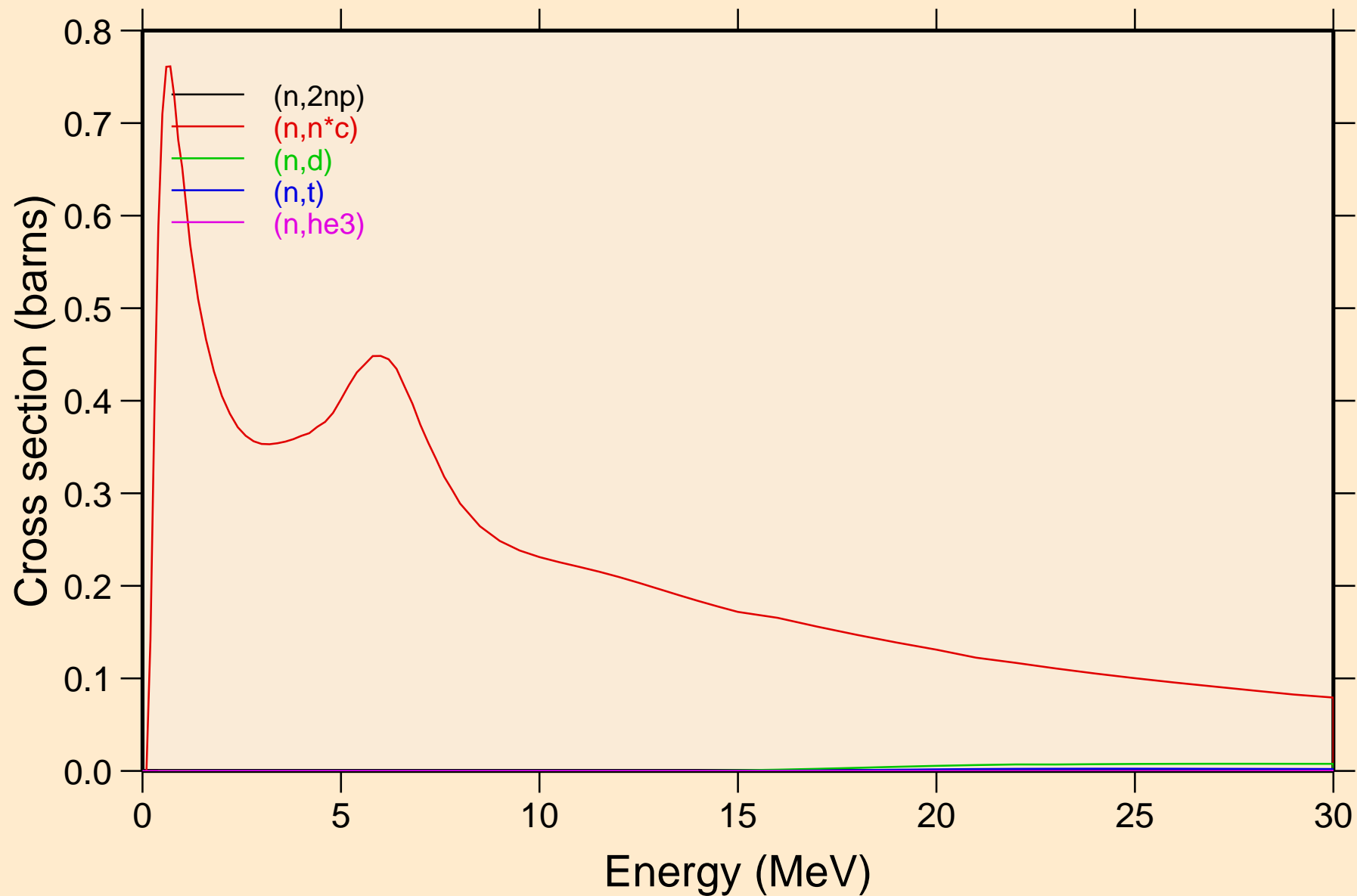

BH269 NEUTRON ACER TENDL-2019 LIBRARY; T=293.16K
Threshold reactions

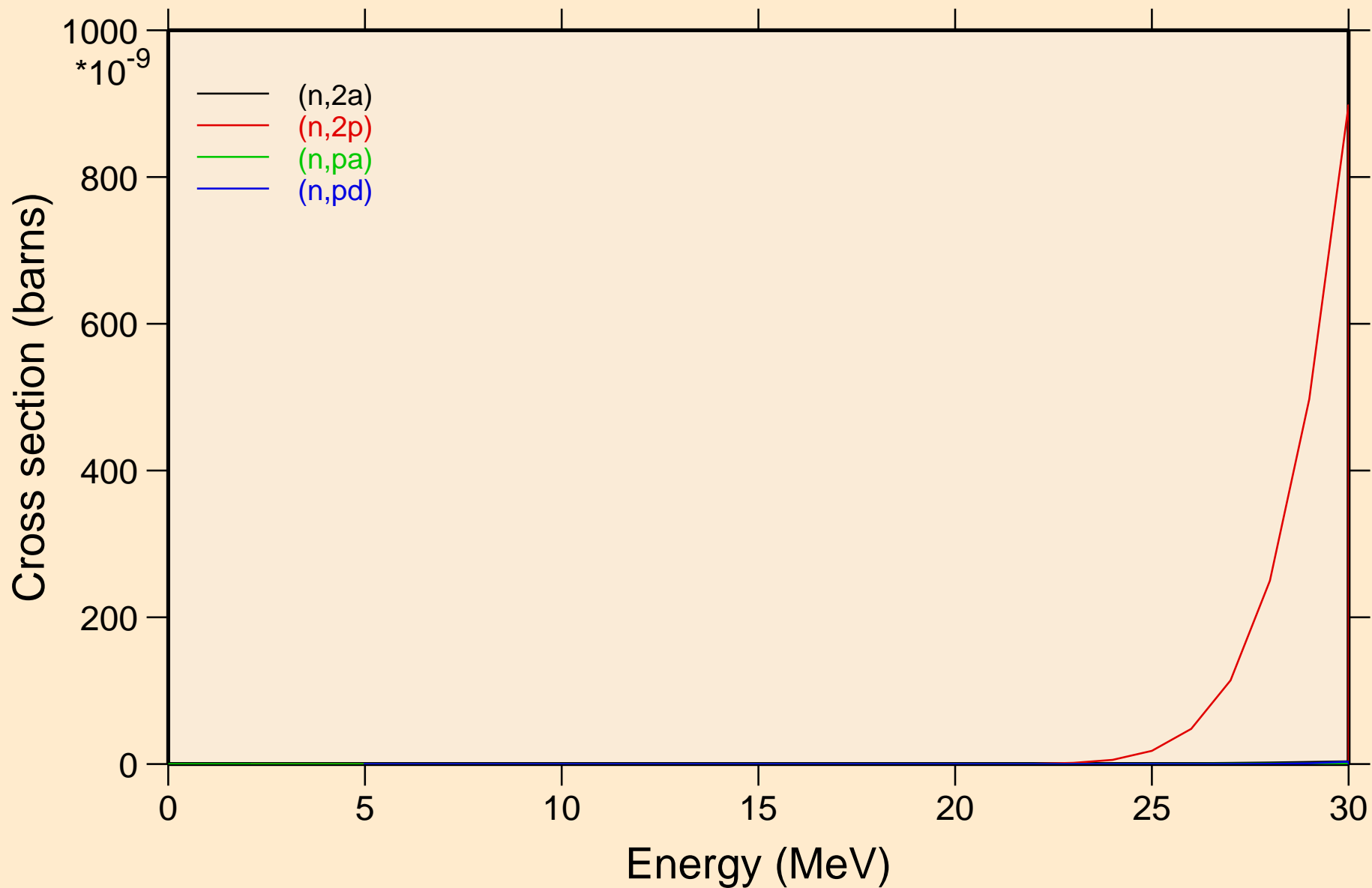

BH269 NEUTRON ACER TENDL-2019 LIBRARY; T=293.16K
Threshold reactions

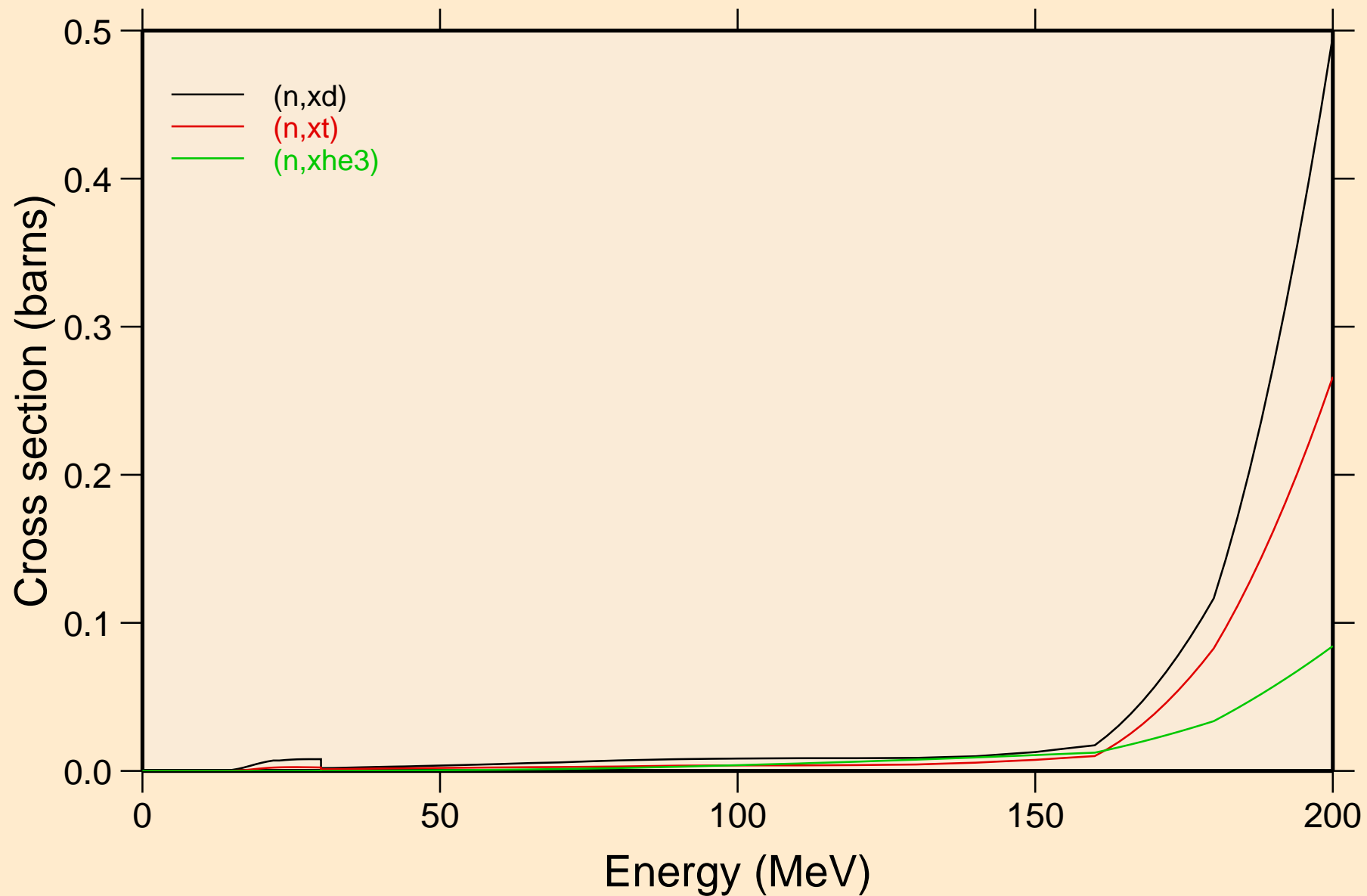

BH269 NEUTRON ACER TENDL-2019 LIBRARY; T=293.16K
angular distribution for elastic

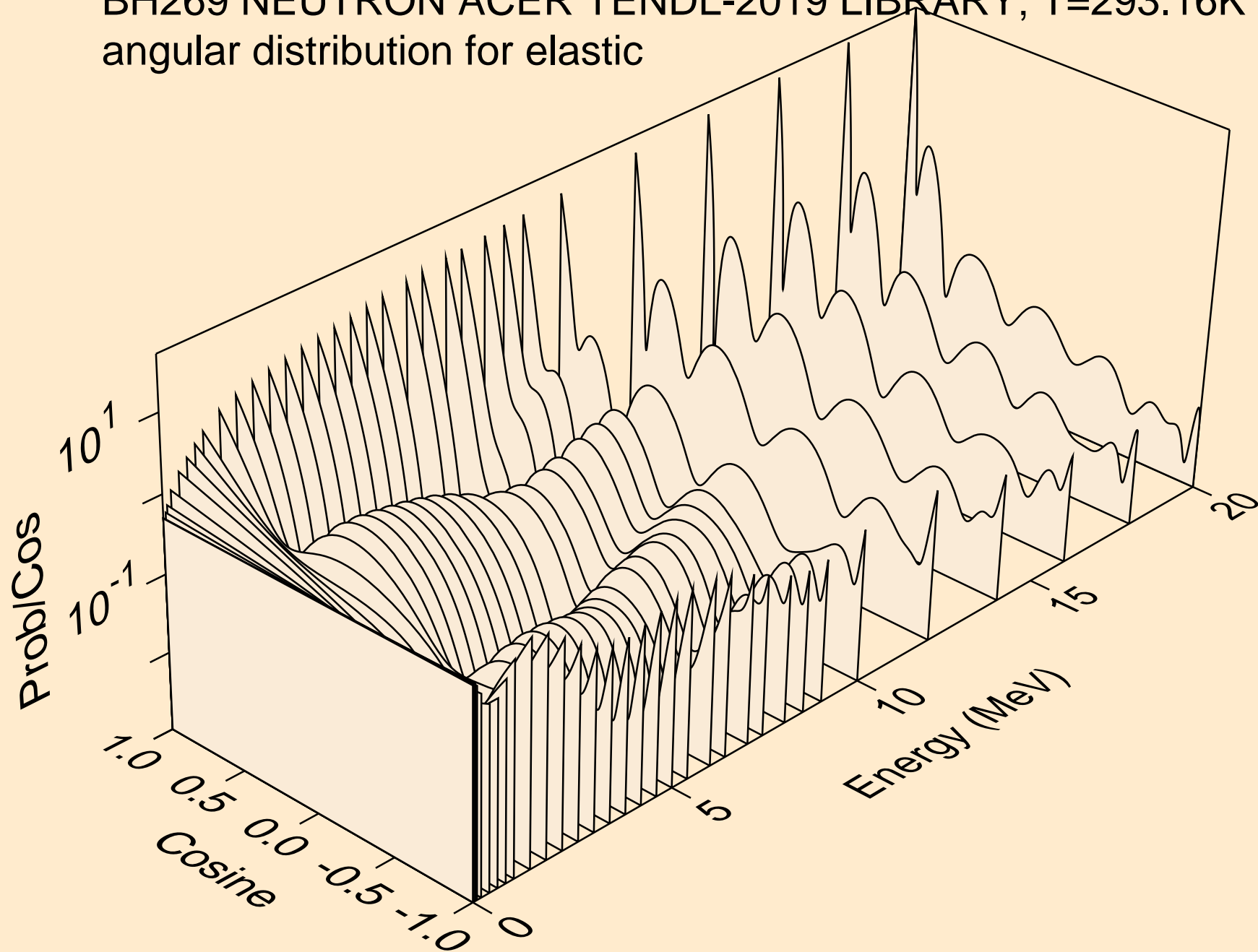

BH269 NEUTRON ACER TENDL-2019 LIBRARY; T=293.16K
angular distribution for elastic

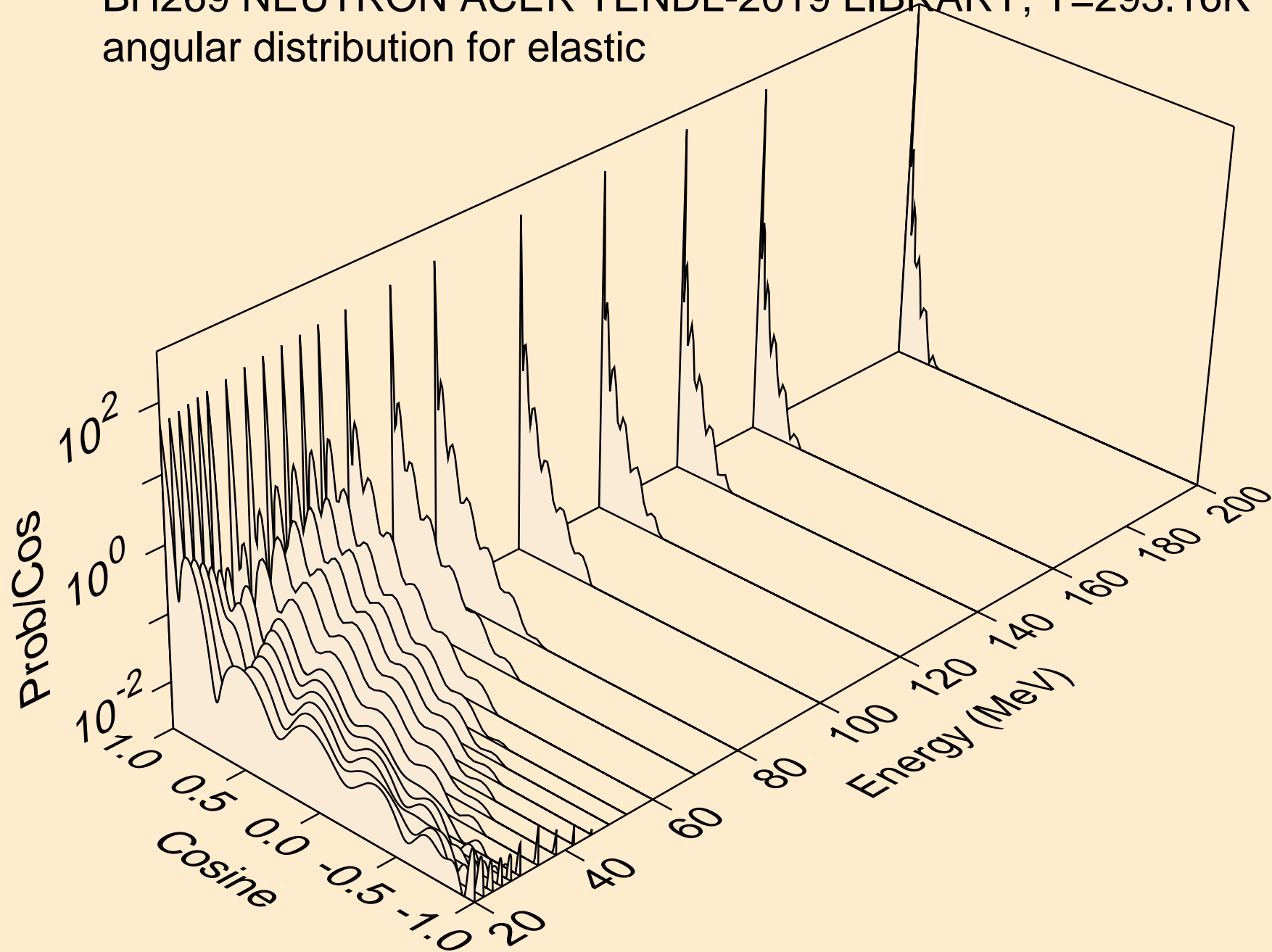

BH269 NEUTRON ACER TENDL-2019 LIBRARY; T=293.16K
angular distribution for (n,n*1)

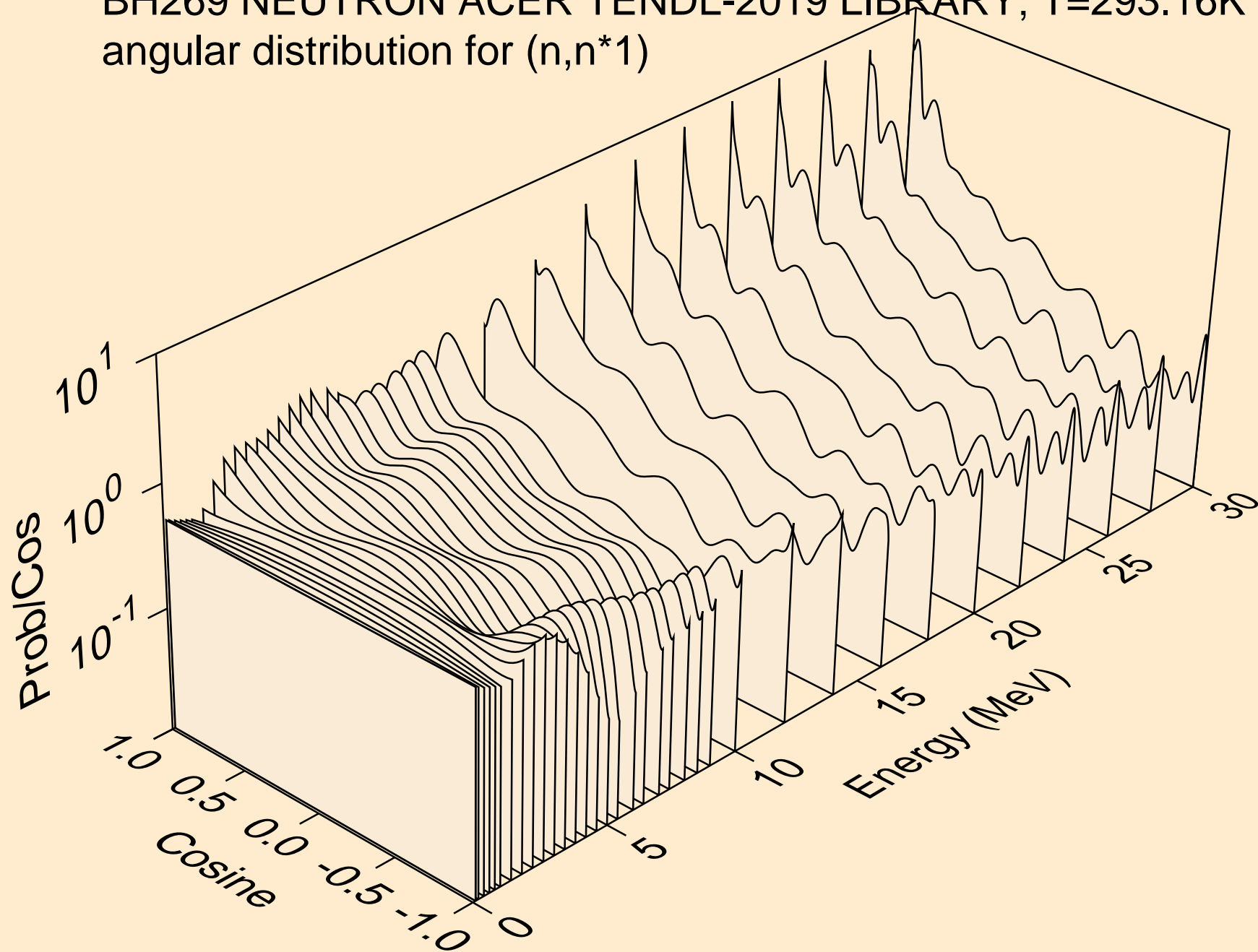

BH269 NEUTRON ACER TENDL-2019 LIBRARY; T=293.16K
Total fission nubar

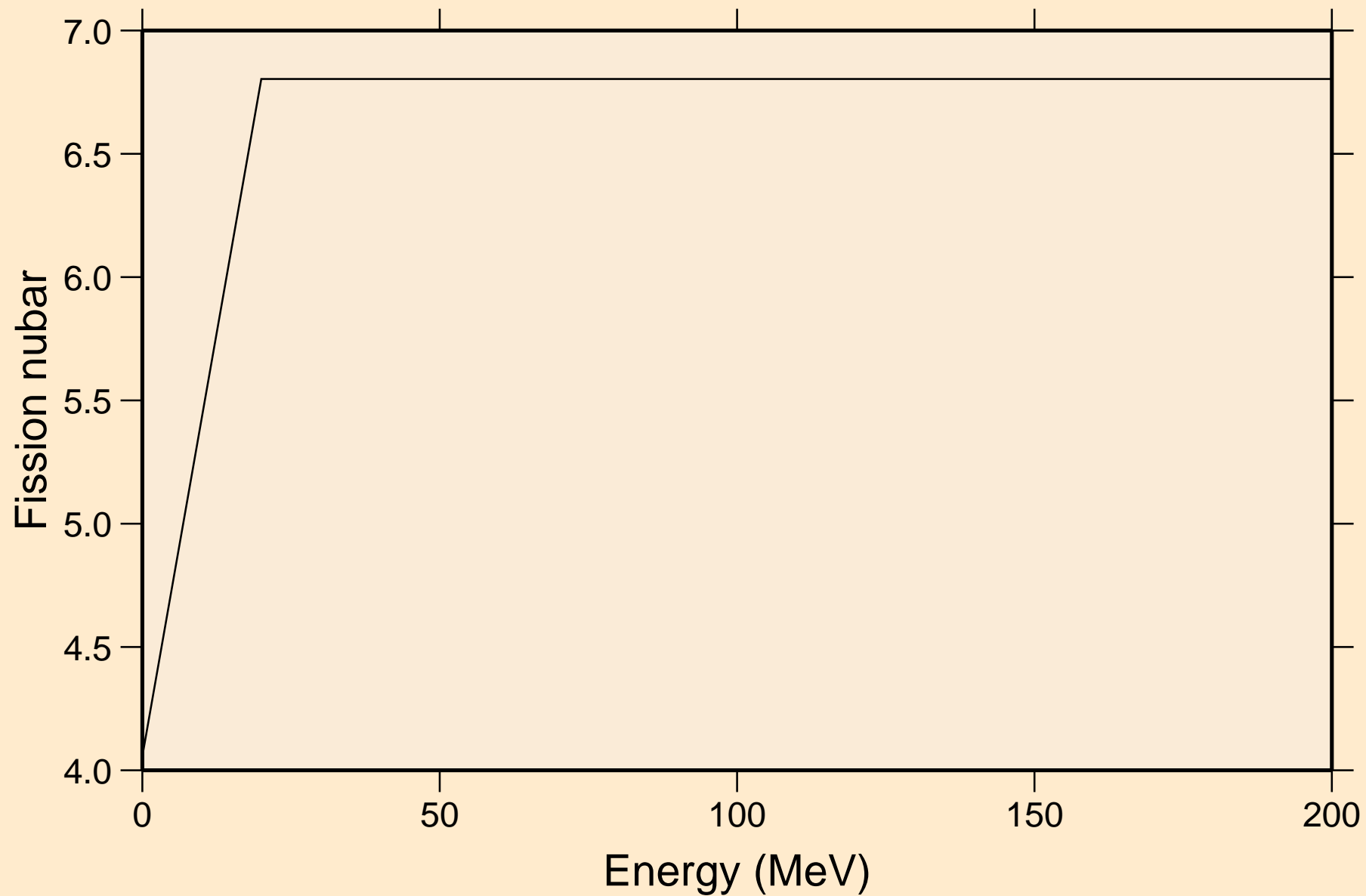

BH269 NEUTRON ACER TENDL-2019 LIBRARY; T=293.16K
Neutron emission for (n,x)

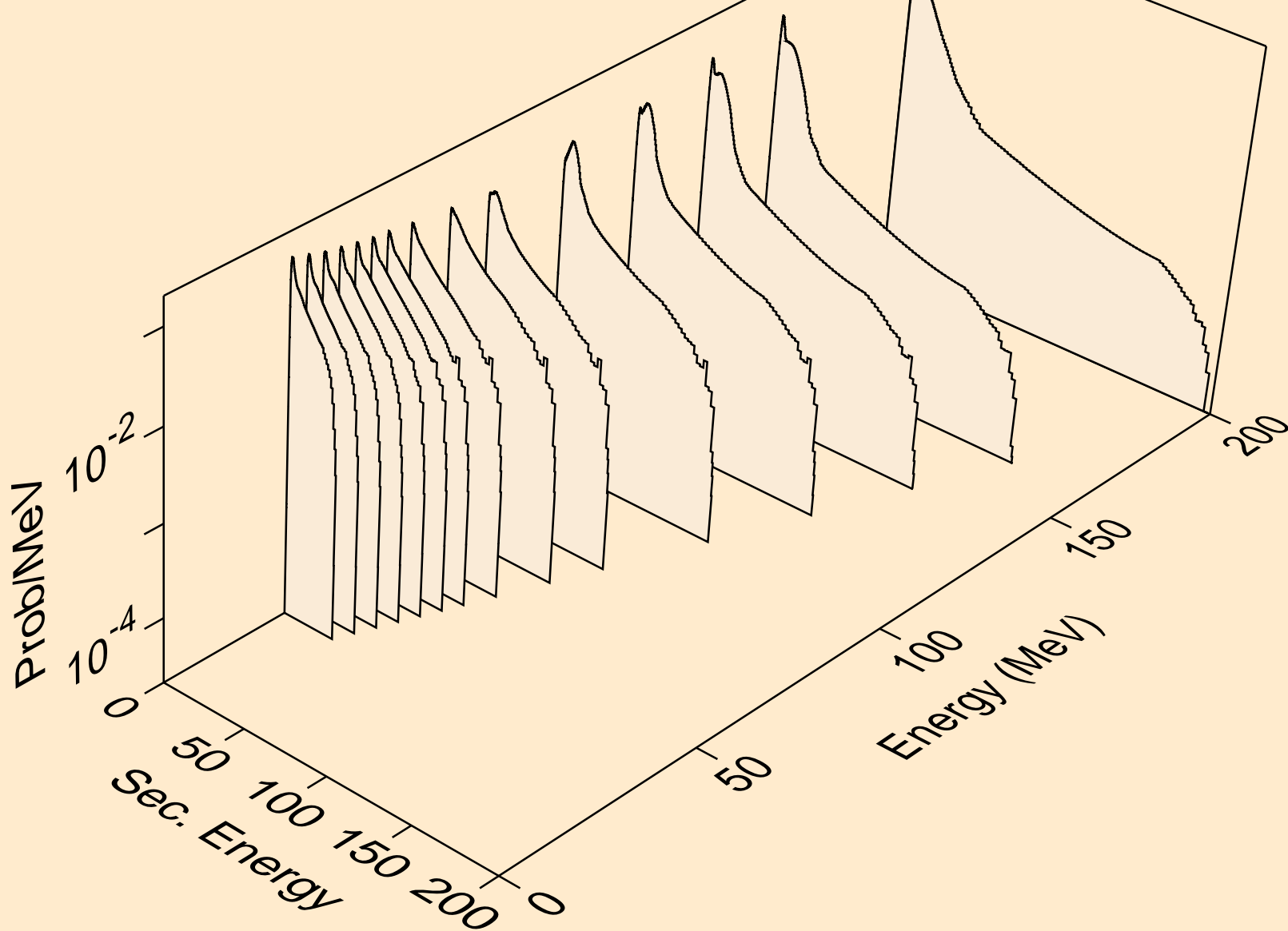

BH269 NEUTRON ACER TENDL-2019 LIBRARY; T=293.16K
Neutron emission for (n,2nd)

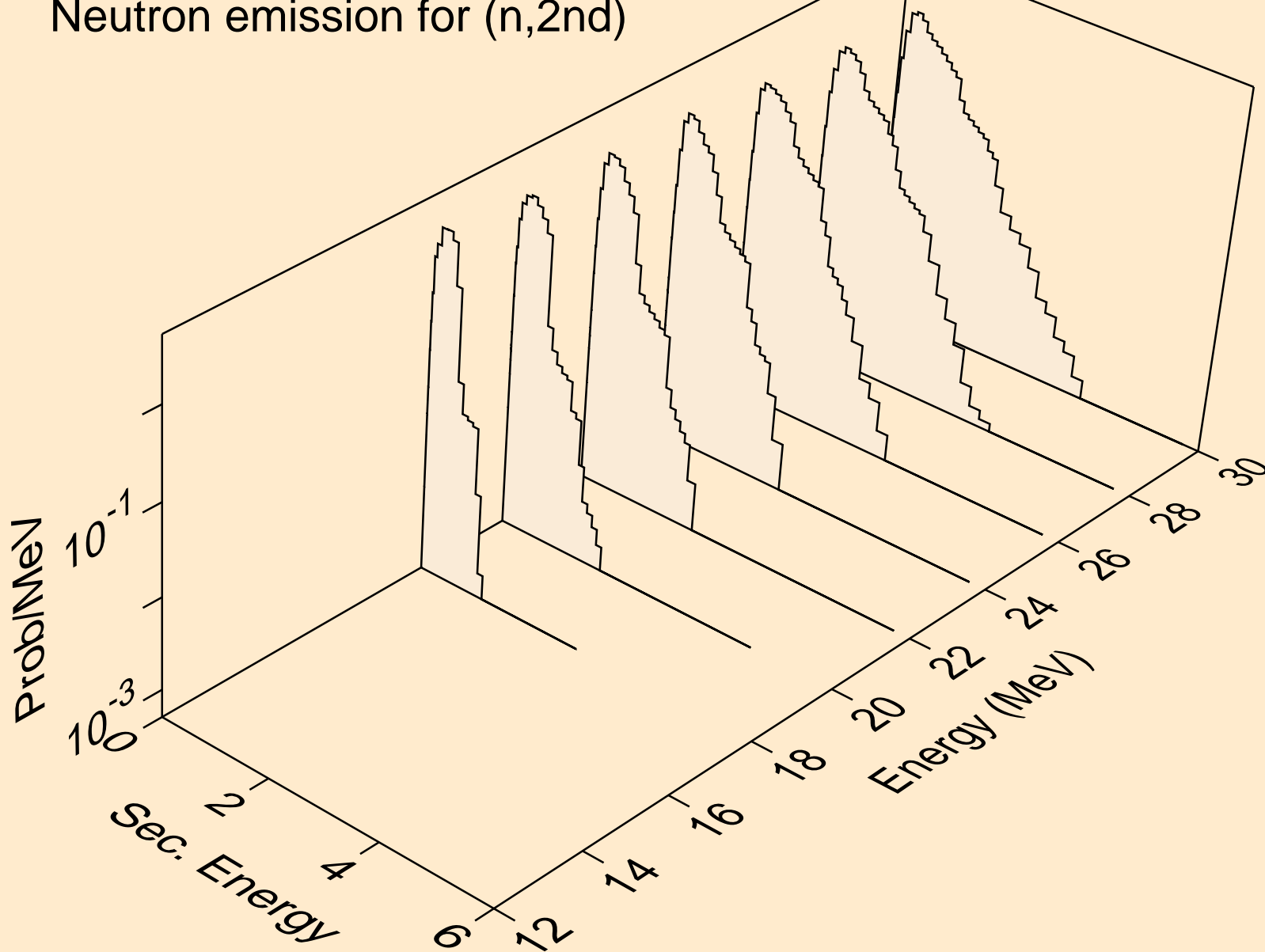

BH269 NEUTRON ACER TENDL-2019 LIBRARY; T=293.16K
Neutron emission for (n,2n)

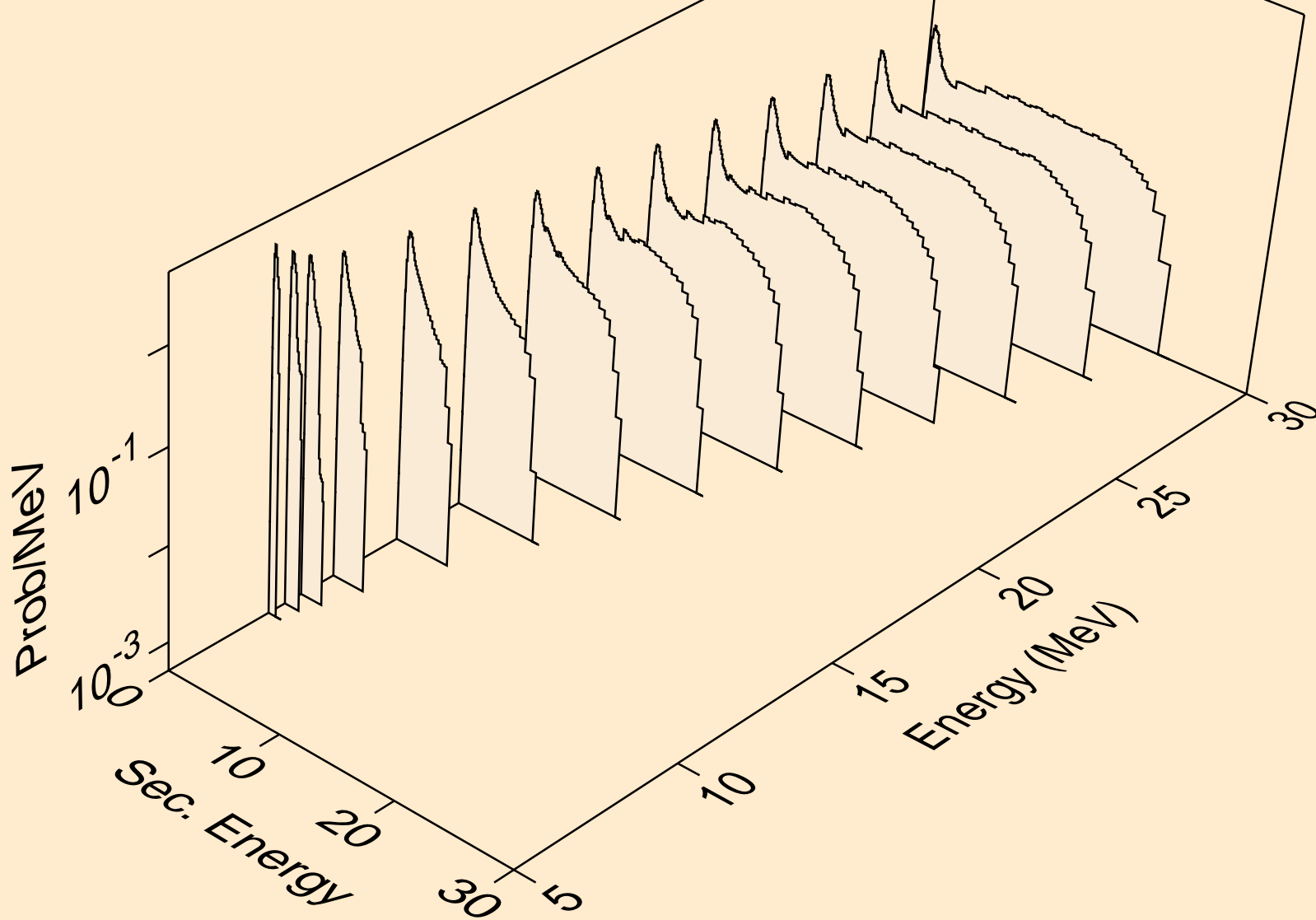

BH269 NEUTRON ACER TENDL-2019 LIBRARY; T=293.16K
Neutron emission for (n,3n)

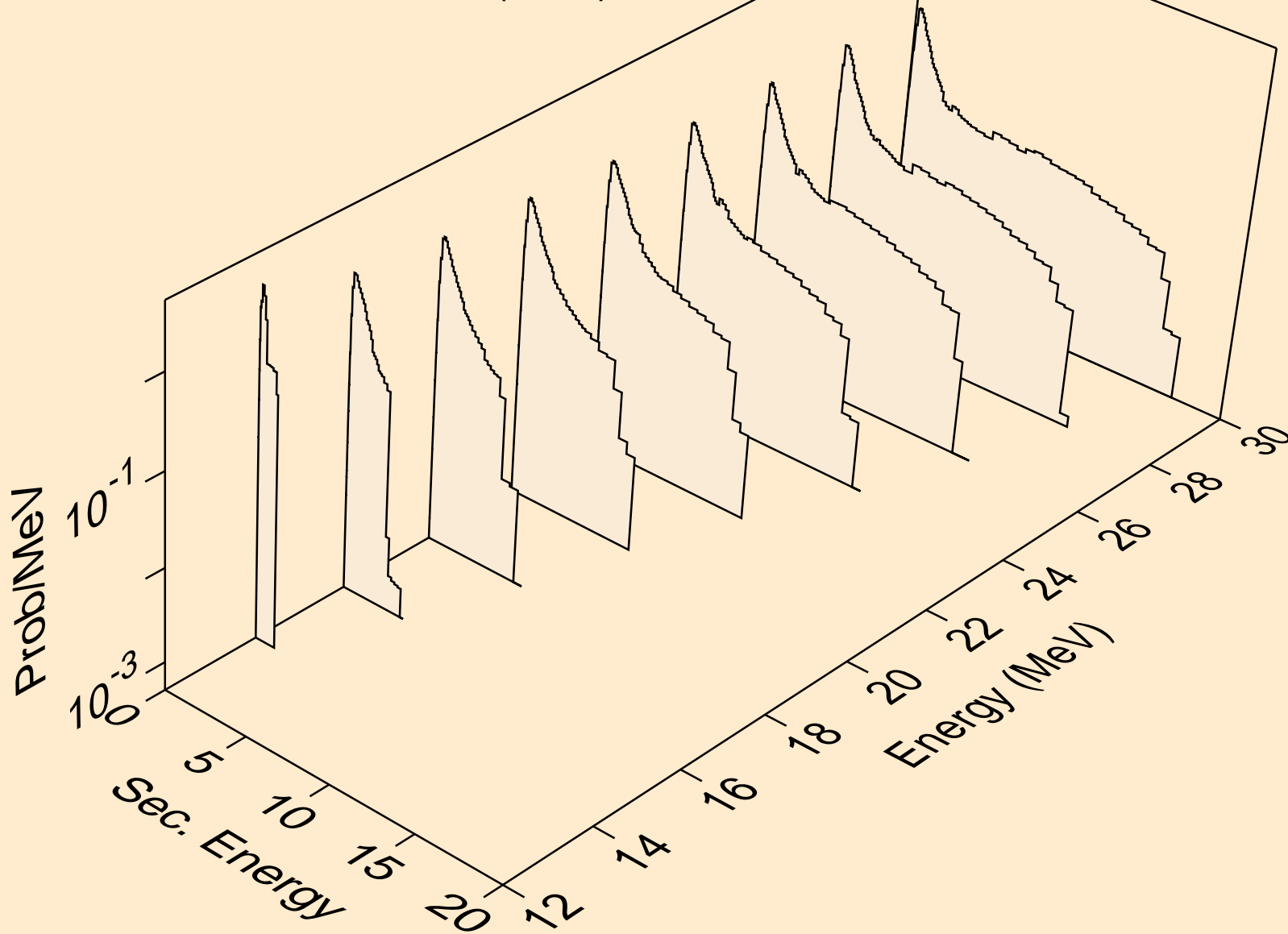

BH269 NEUTRON ACER TENDL-2019 LIBRARY; T=293.16K
Neutron emission for fission

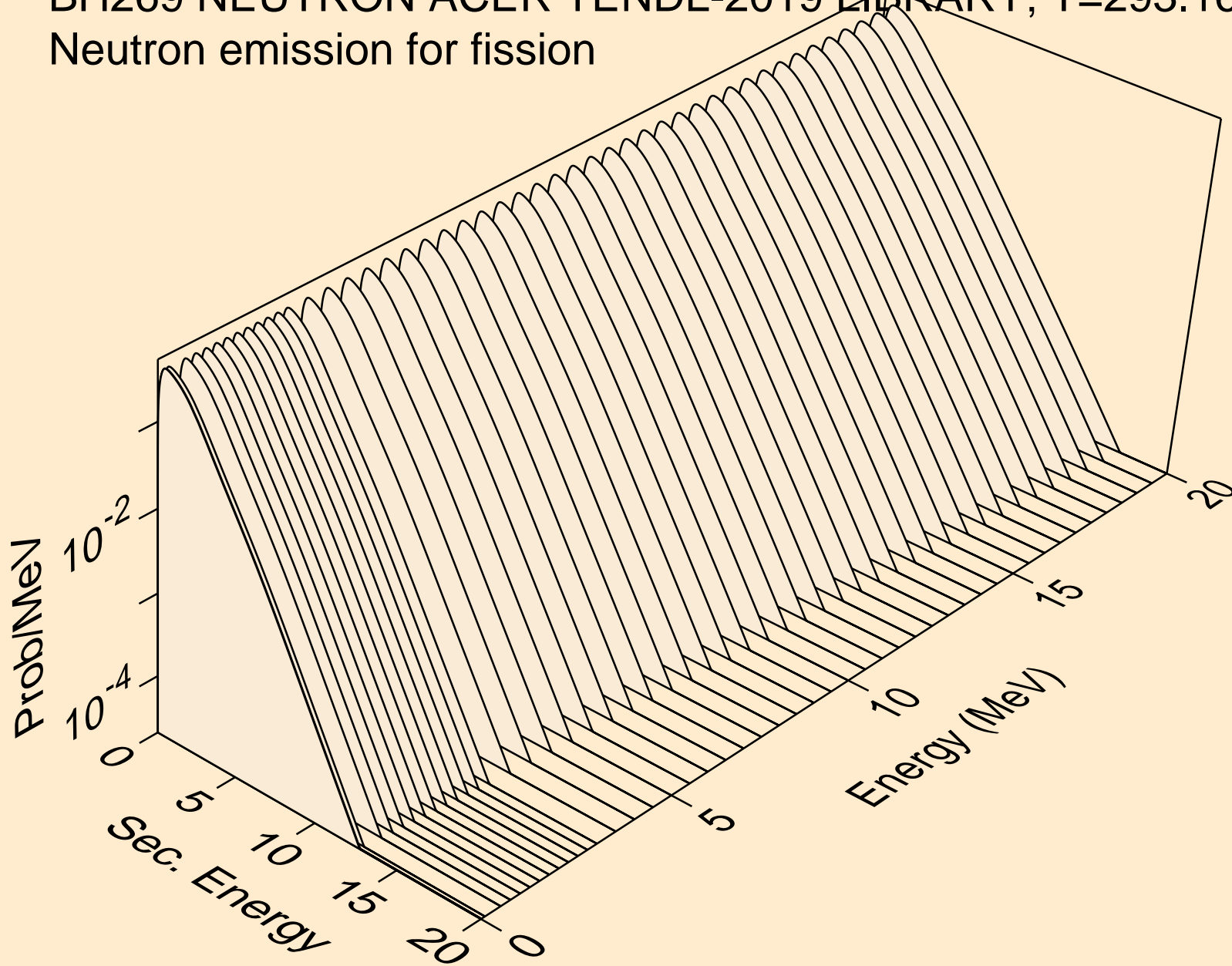

BH269 NEUTRON ACER TENDL-2019 LIBRARY; T=293.16K
Neutron emission for (n,n*)a

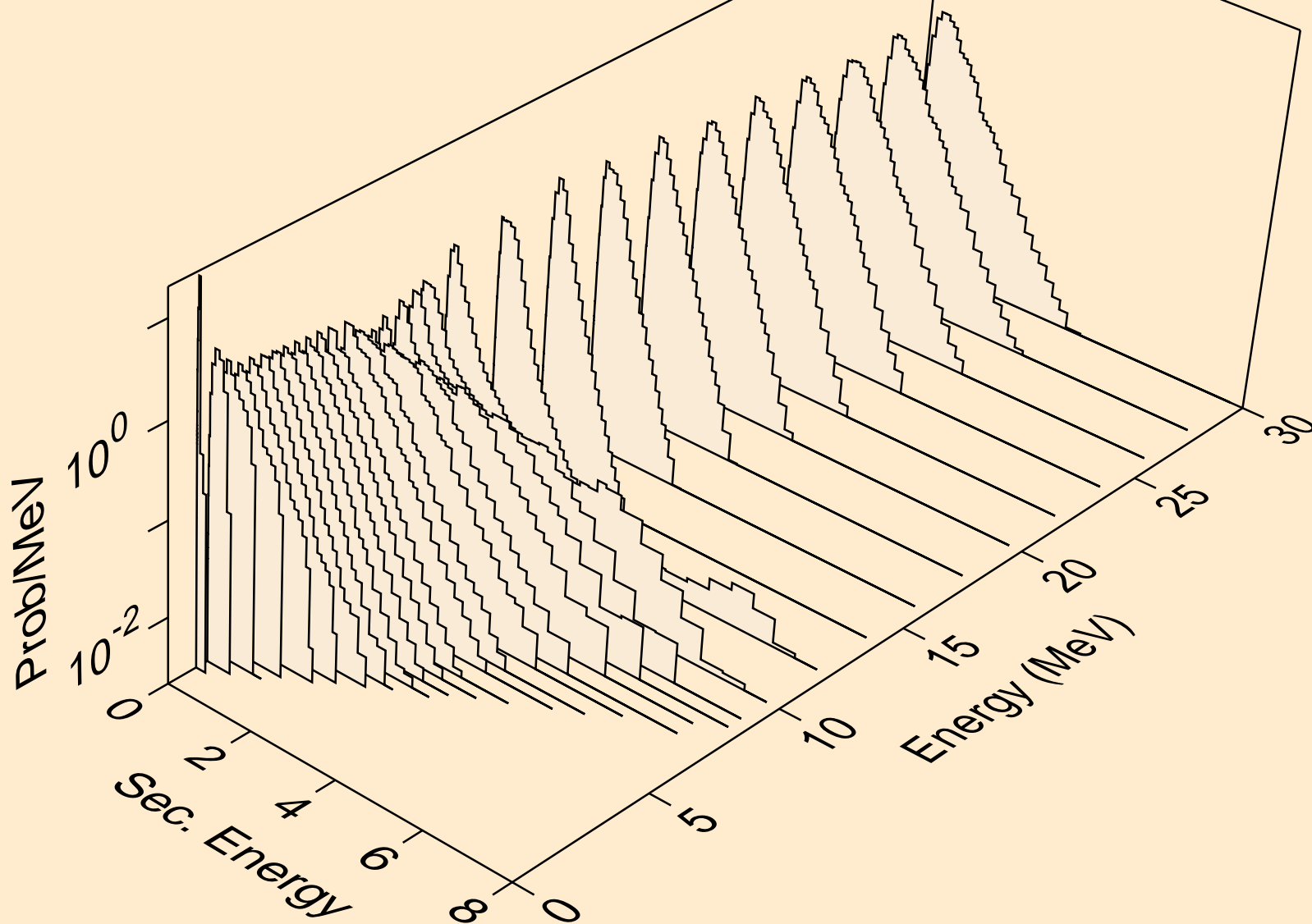

BH269 NEUTRON ACER TENDL-2019 LIBRARY; T=293.16K
Neutron emission for (n,2n)a

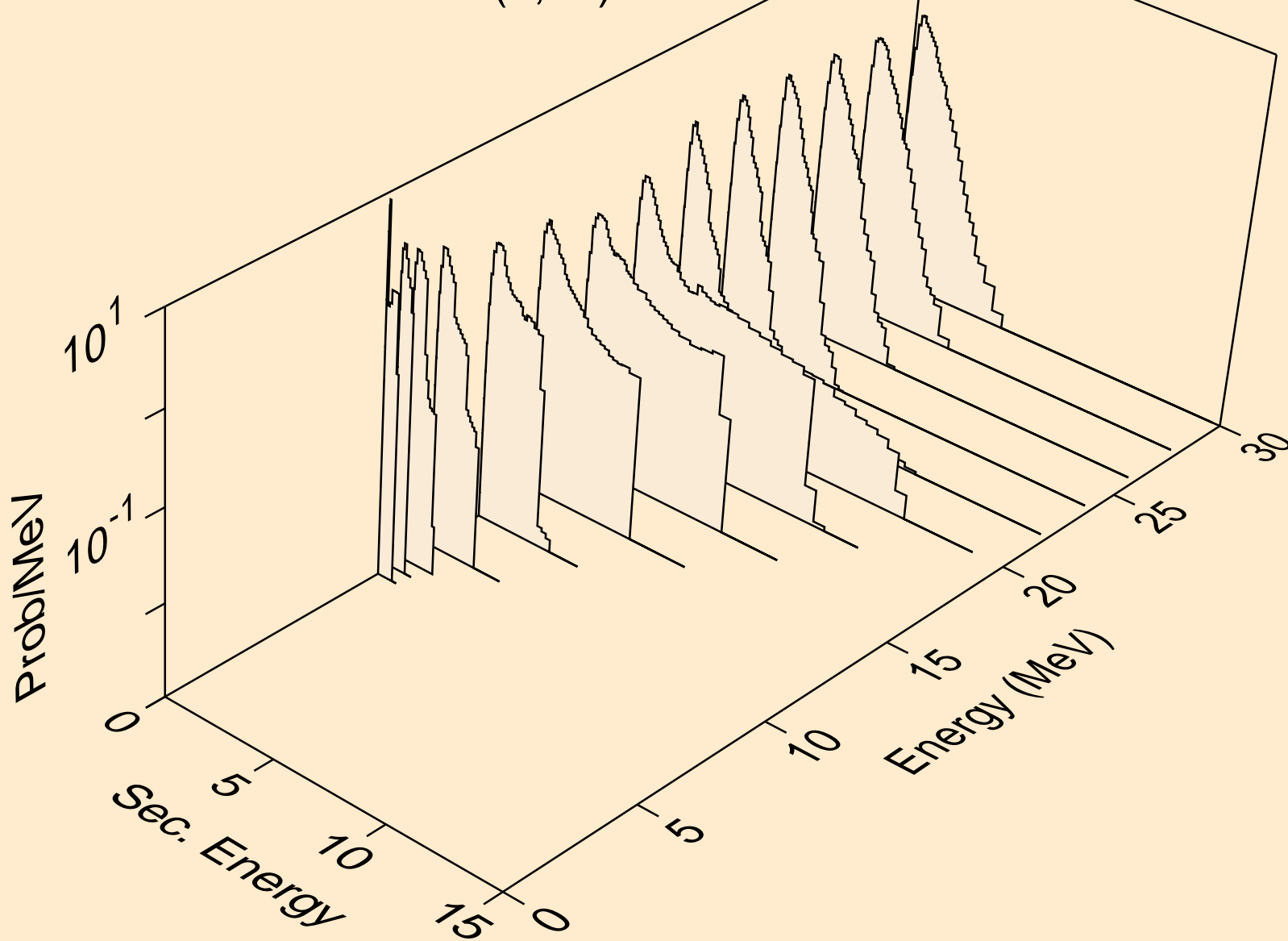

BH269 NEUTRON ACER TENDL-2019 LIBRARY; T=293.16K
Neutron emission for (n,3n)a

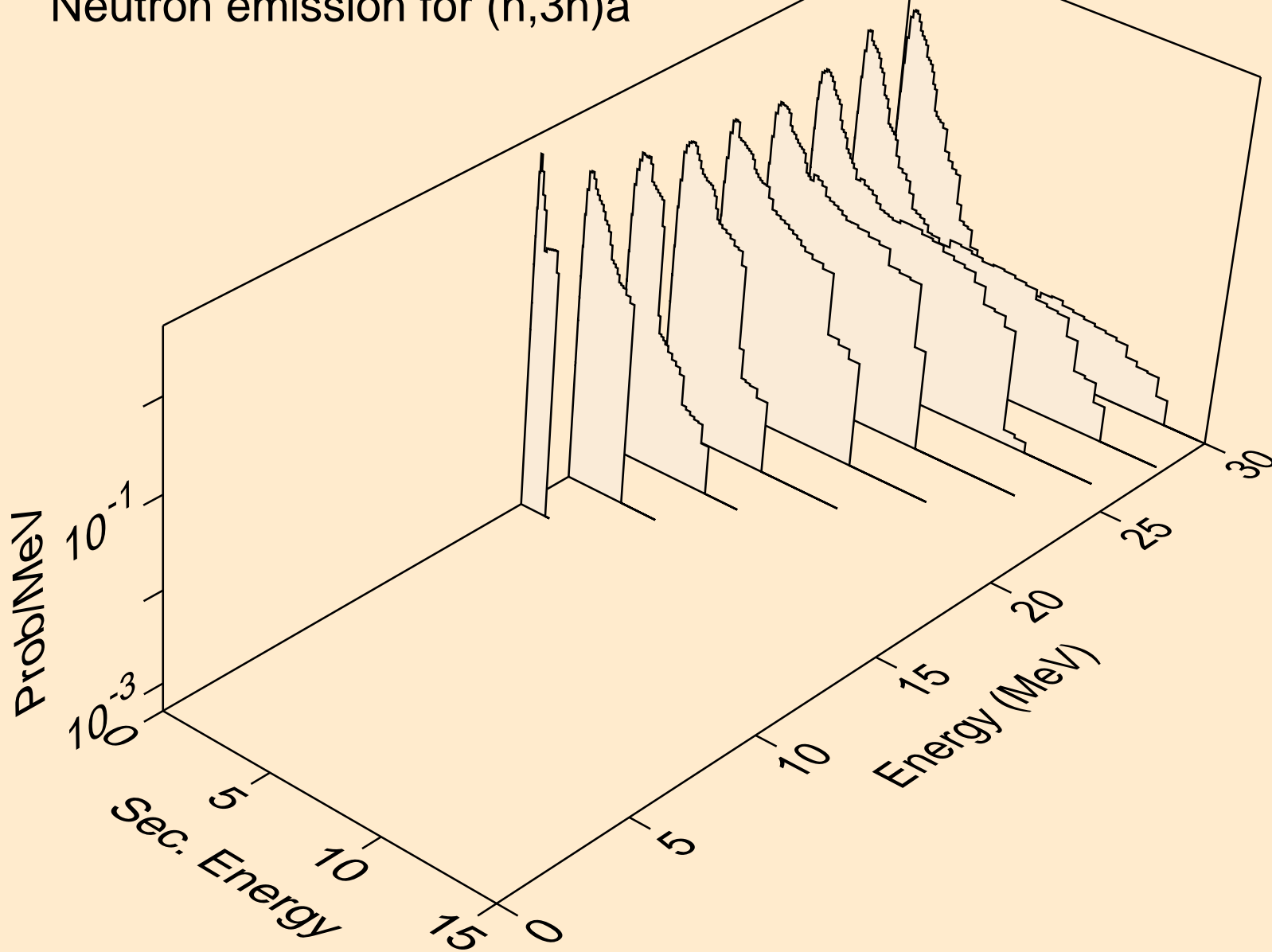

BH269 NEUTRON ACER TENDL-2019 LIBRARY; T=293.16K
Neutron emission for (n,n*)p

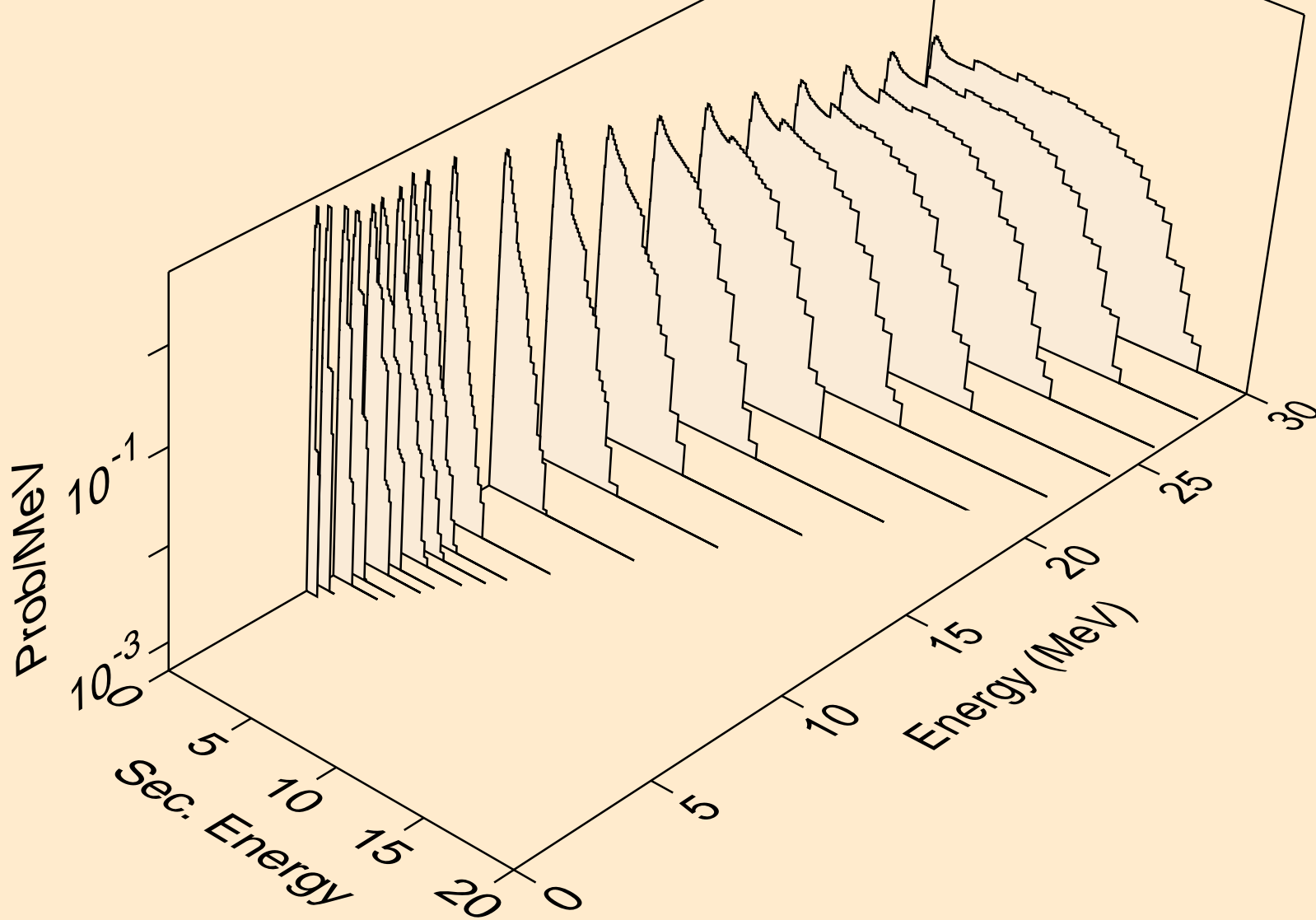

BH269 NEUTRON ACER TENDL-2019 LIBRARY; T=293.16K
Neutron emission for (n,n*)2a

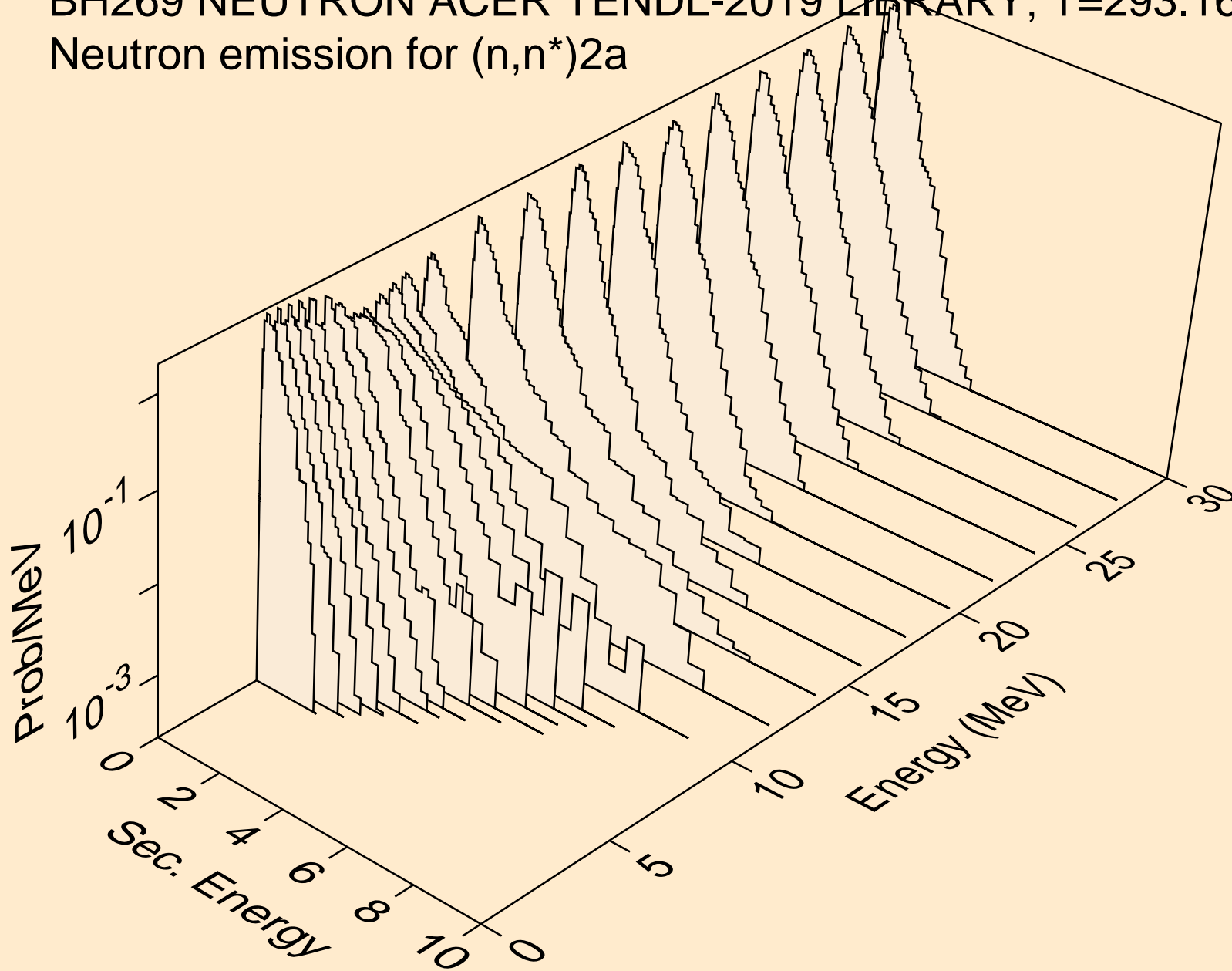

BH269 NEUTRON ACER TENDL-2019 LIBRARY; T=293.16K
Neutron emission for (n,n*)d

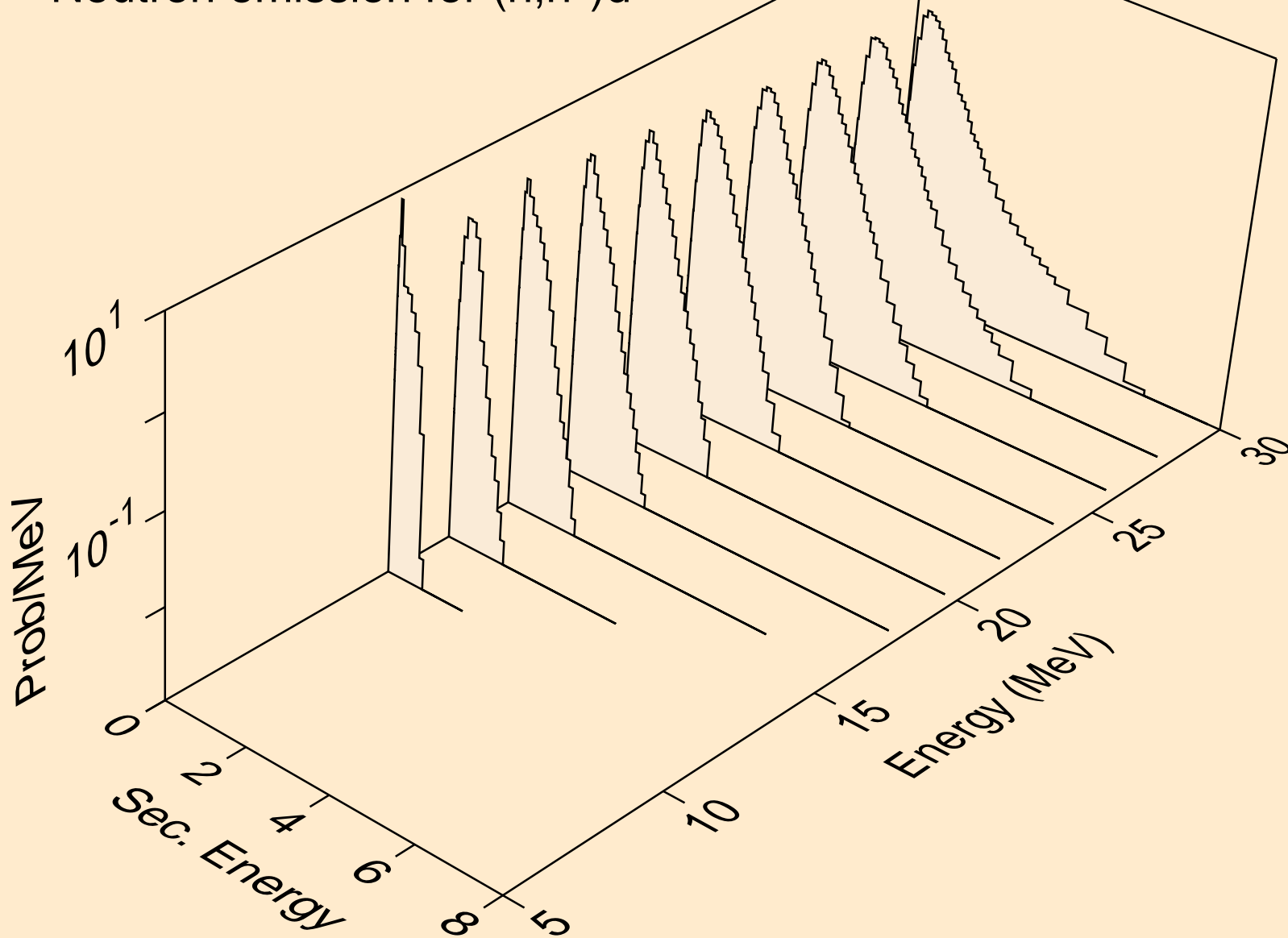

BH269 NEUTRON ACER TENDL-2019 LIBRARY; T=293.16K
Neutron emission for (n,n*)t

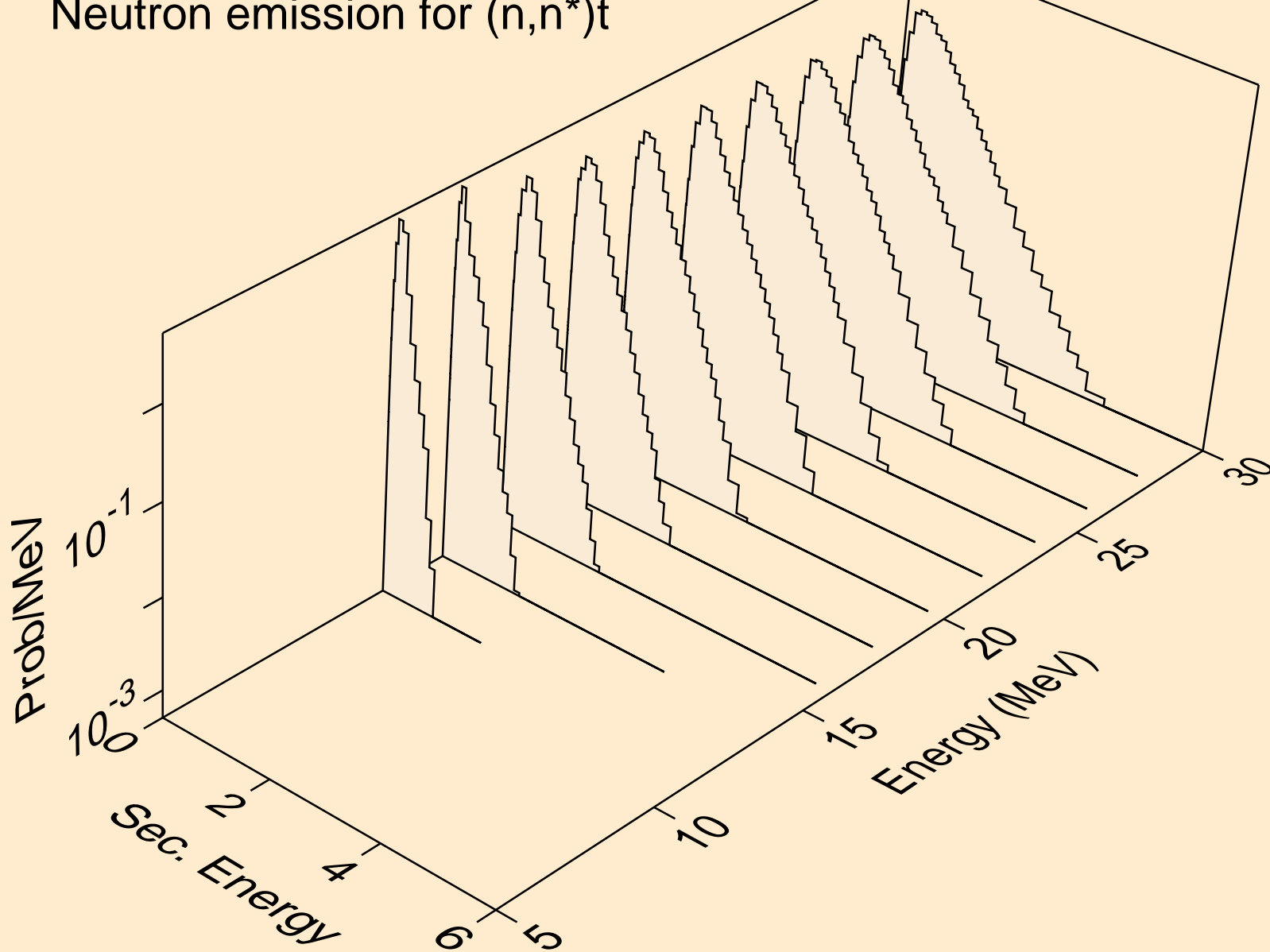

BH269 NEUTRON ACER TENDL-2019 LIBRARY; T=293.16K
Neutron emission for (n,n*)he3

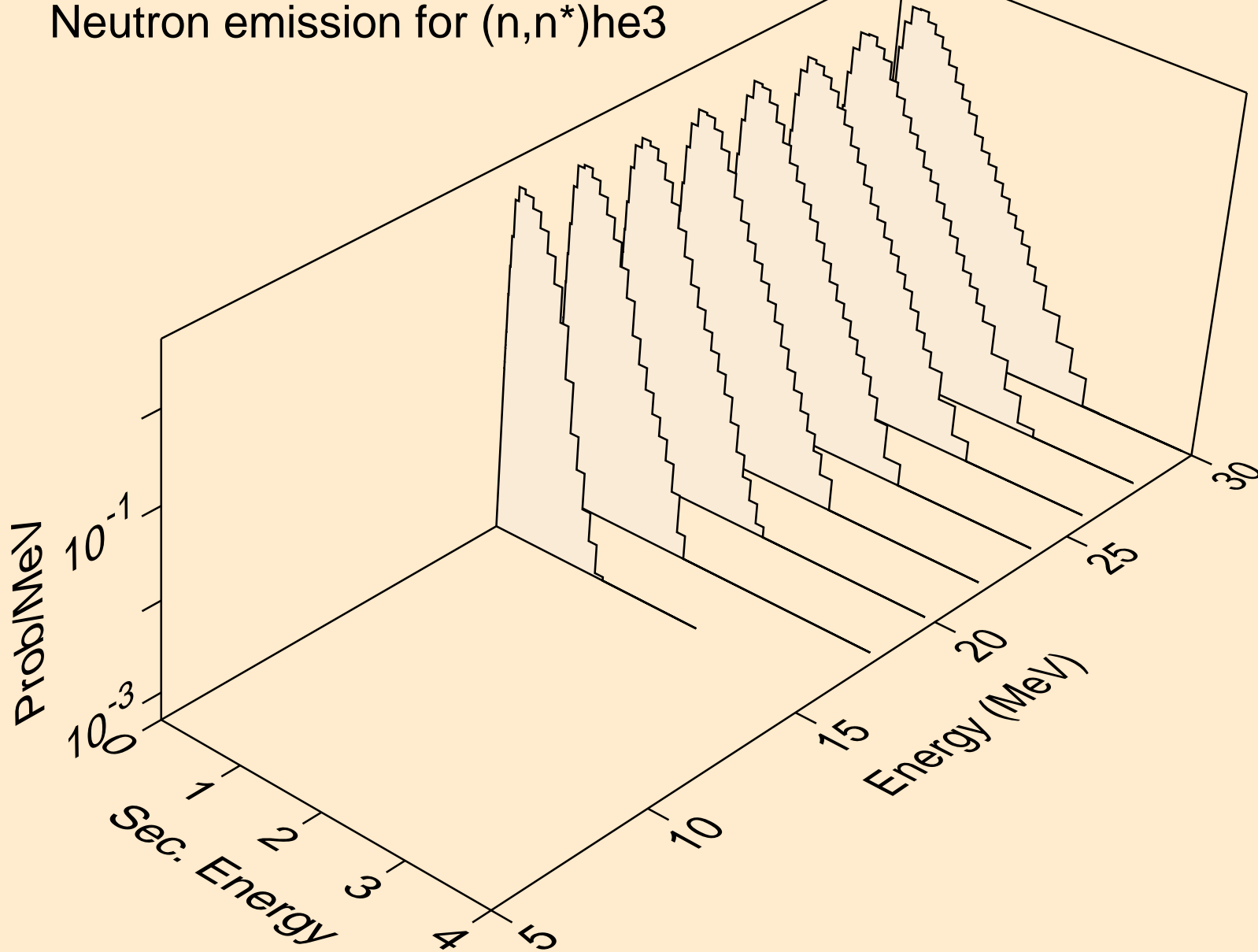

BH269 NEUTRON ACER TENDL-2019 LIBRARY; T=293.16K
Neutron emission for (n,4n)

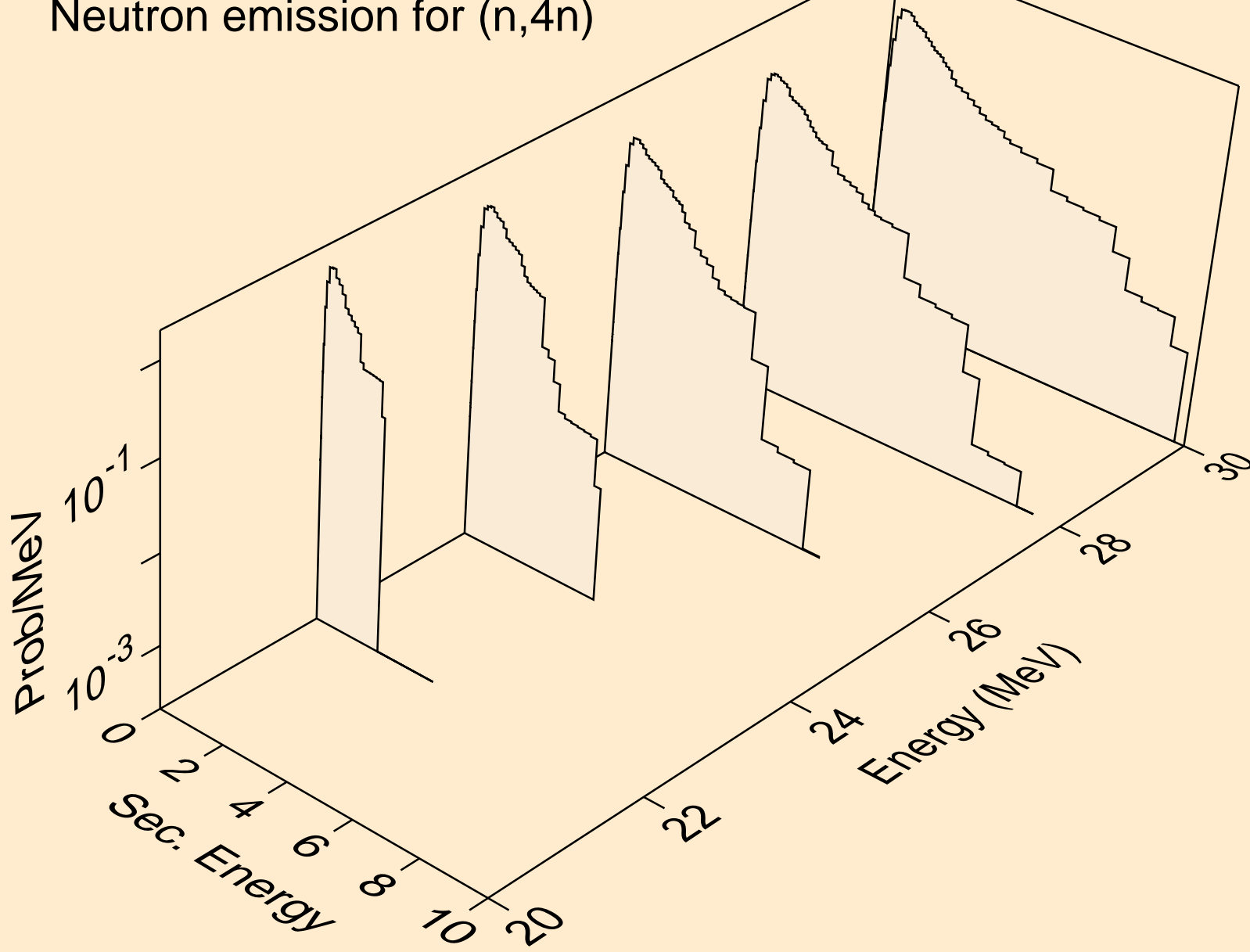

BH269 NEUTRON ACER TENDL-2019 LIBRARY; T=293.16K
Neutron emission for (n,2np)

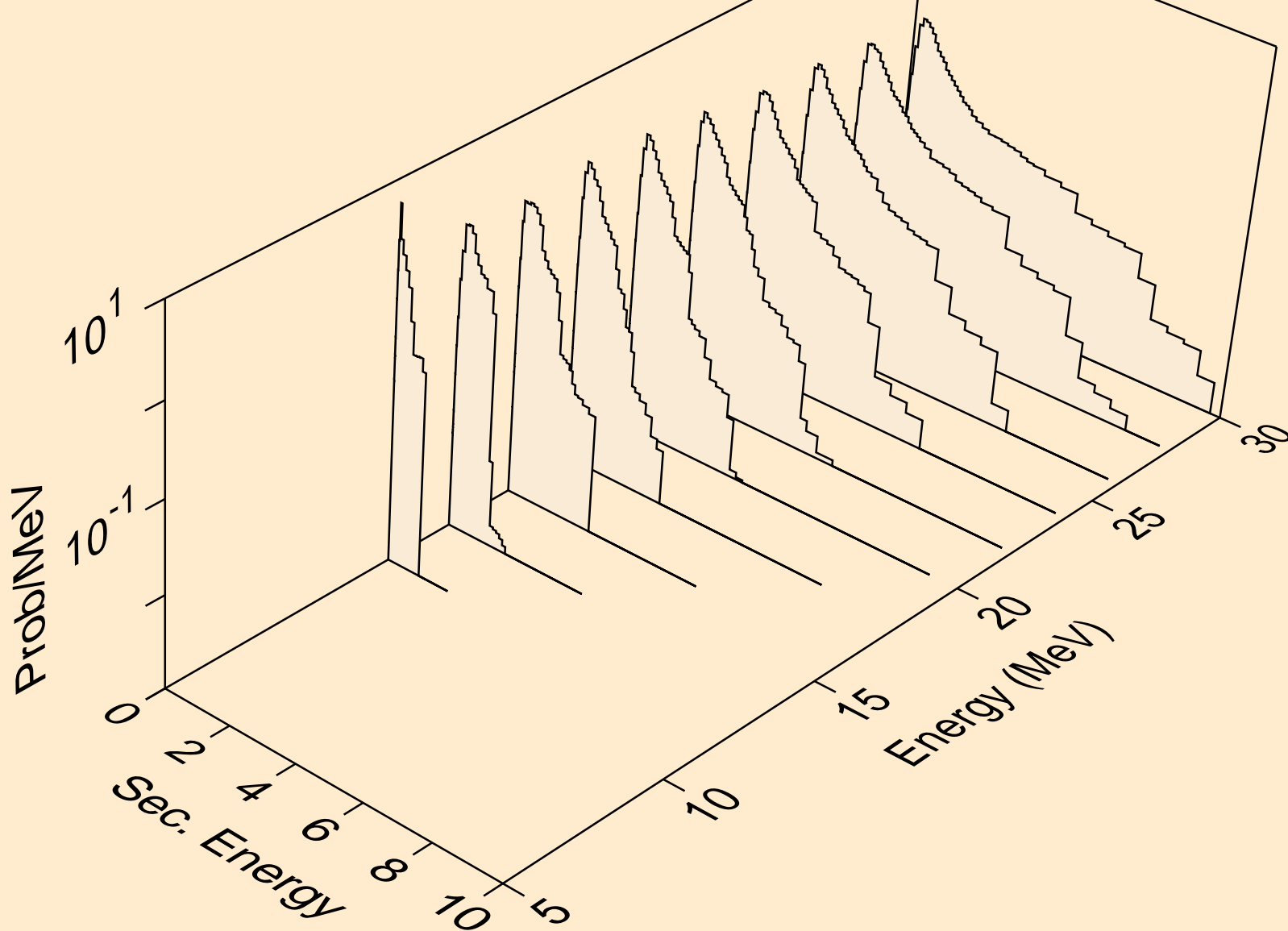

BH269 NEUTRON ACER TENDL-2019 LIBRARY; T=293.16K
Neutron emission for (n,3np)

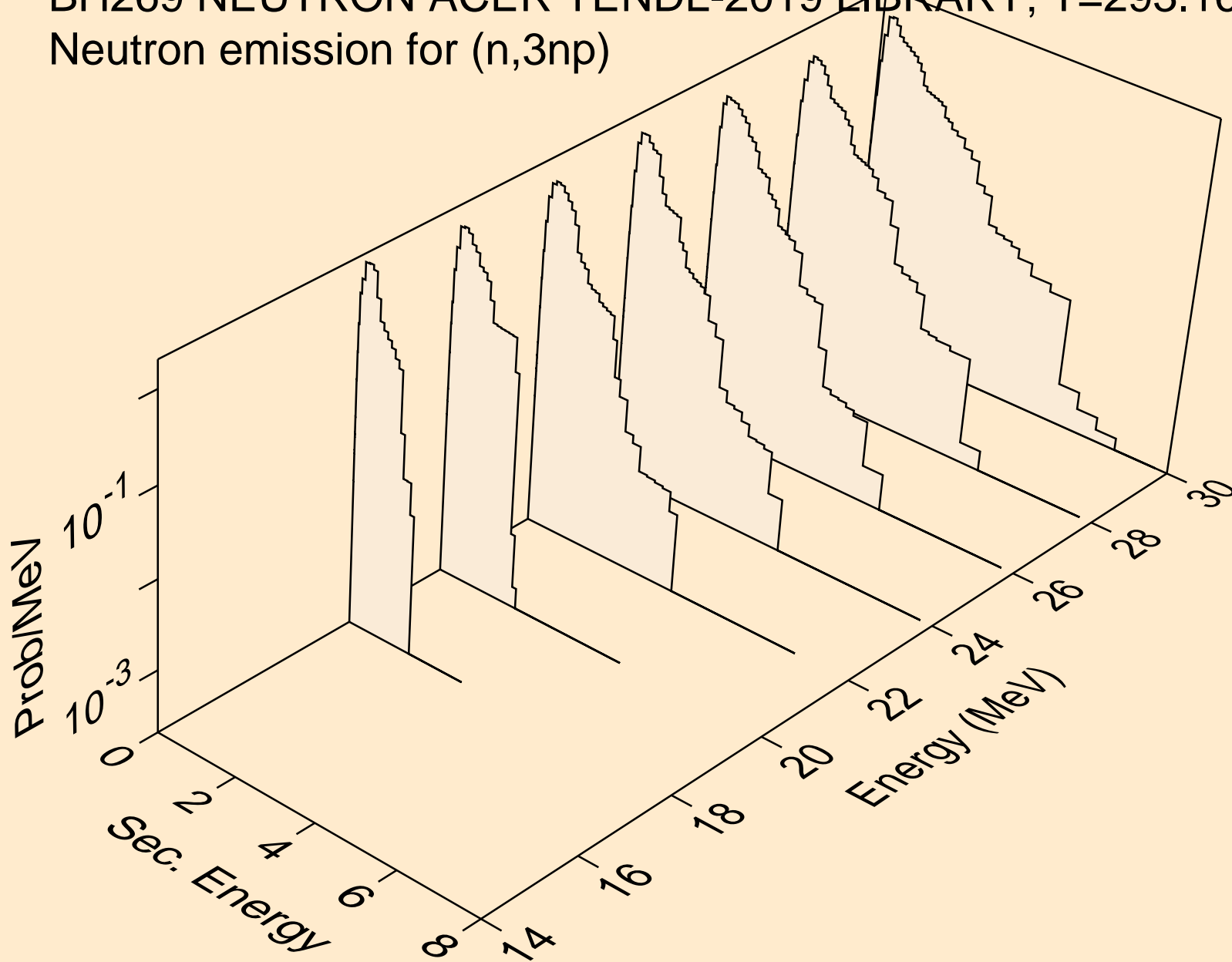

BH269 NEUTRON ACER TENDL-2019 LIBRARY; T=293.16K
Neutron emission for (n,2np)

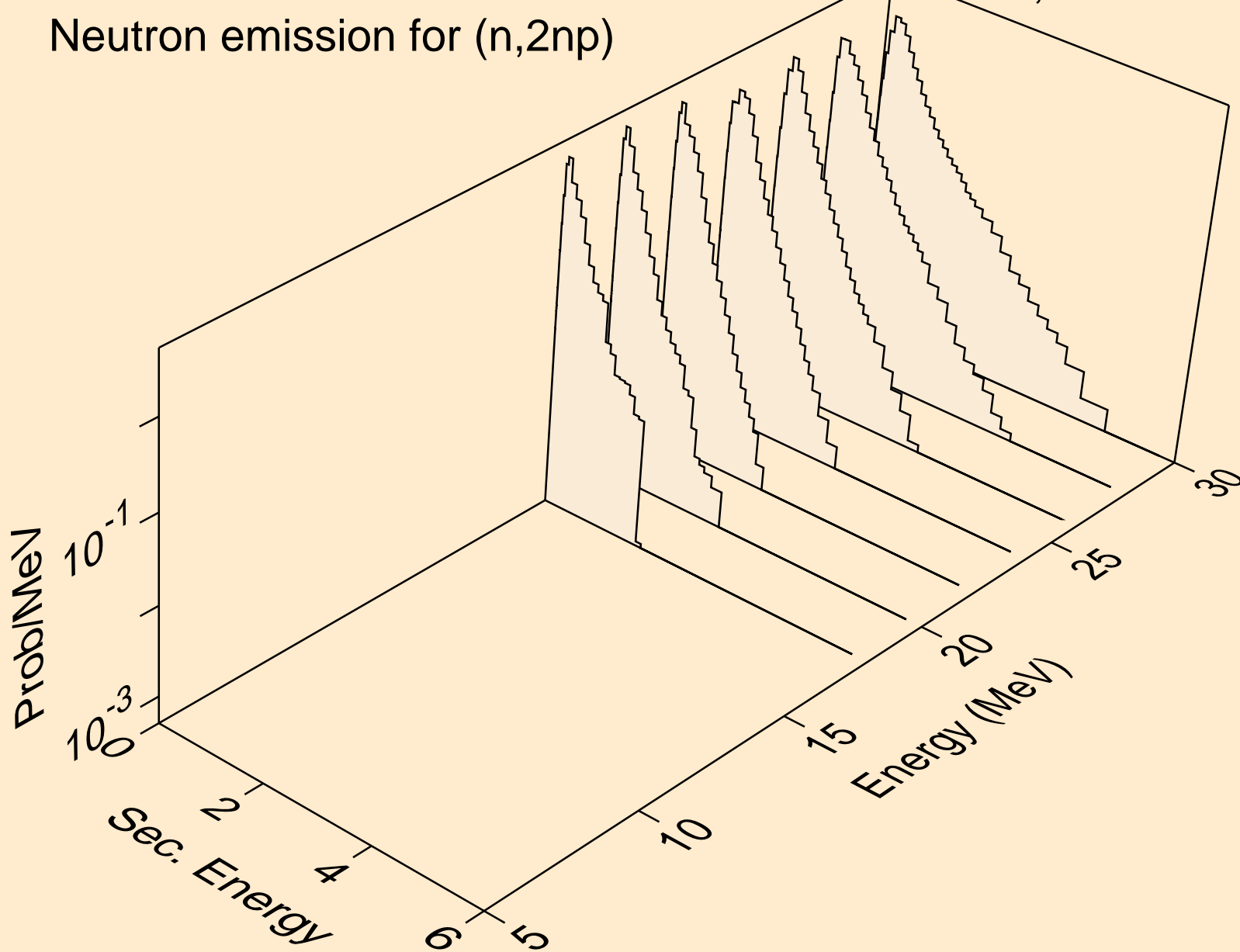

BH269 NEUTRON ACER TENDL-2019 LIBRARY; T=293.16K
Neutron emission for (n,n*c)

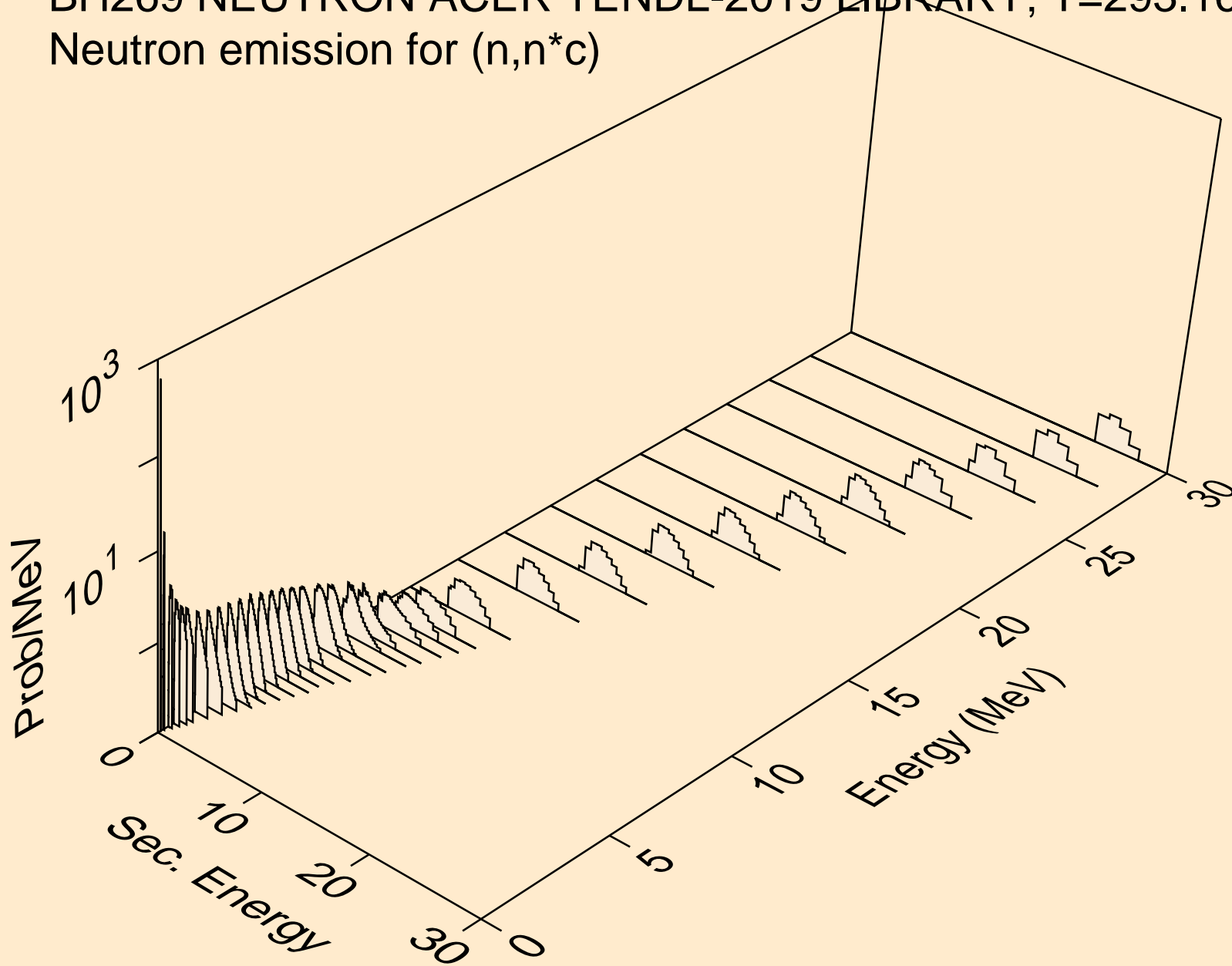

BH269 NEUTRON ACER TENDL-2019 LIBRARY; T=293.16K

Delayed nubar

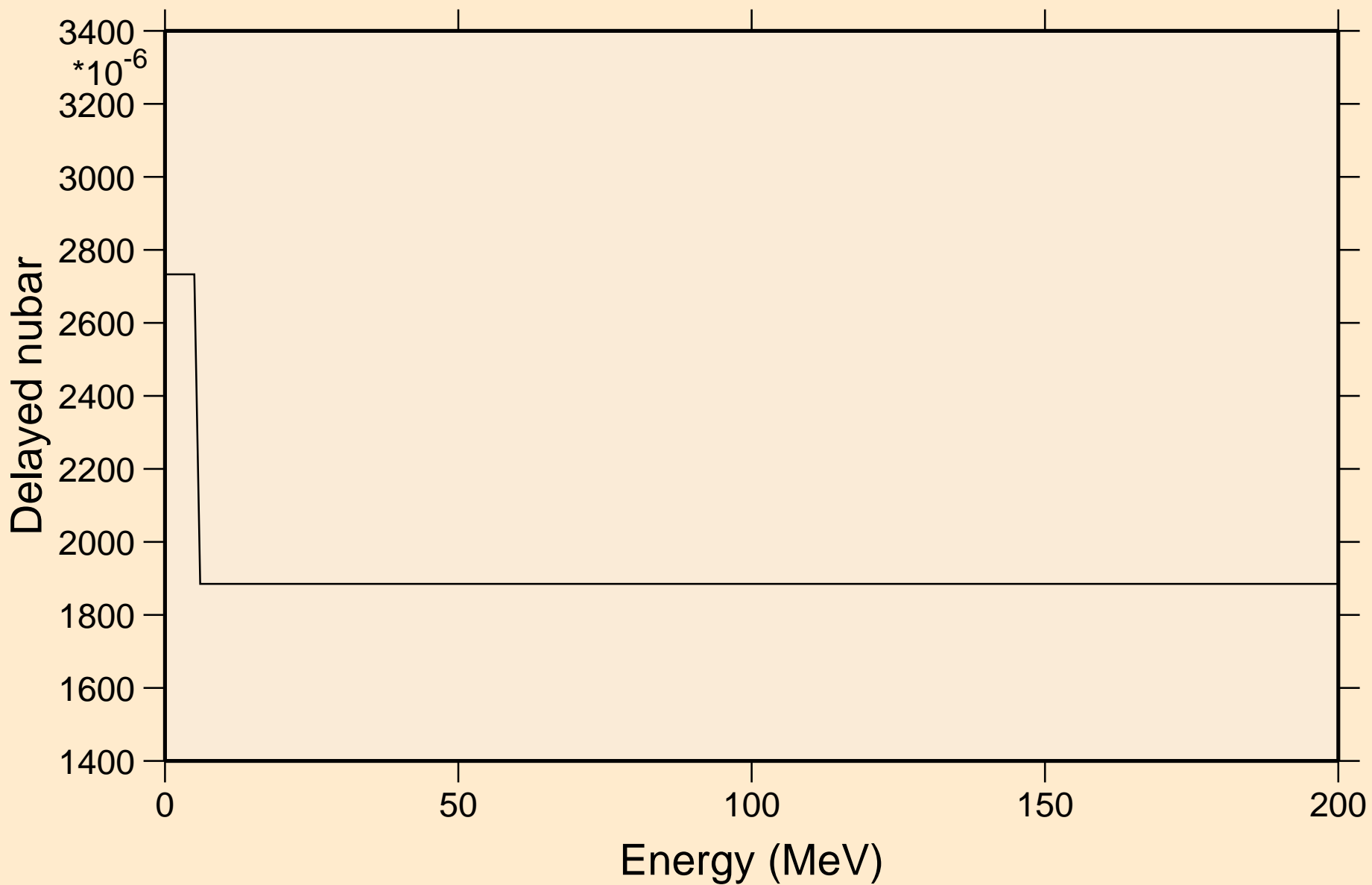

BH269 NEUTRON ACER TENDL-2019 LIBRARY; T=293.16K

Delayed neutron spectra

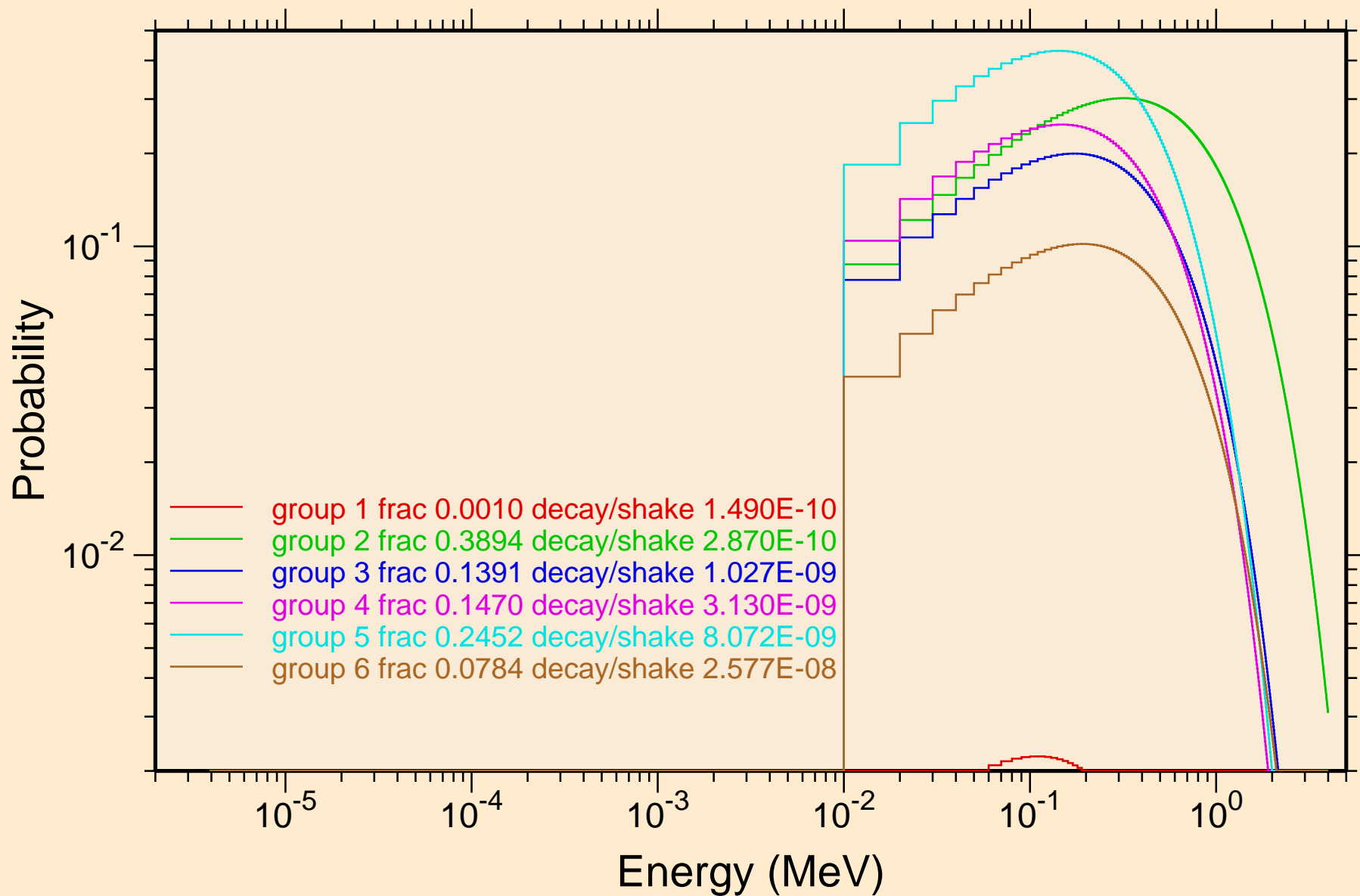

BH269 NEUTRON ACER TENDL-2019 LIBRARY; T=293.16K
Photon emission for (n,x)

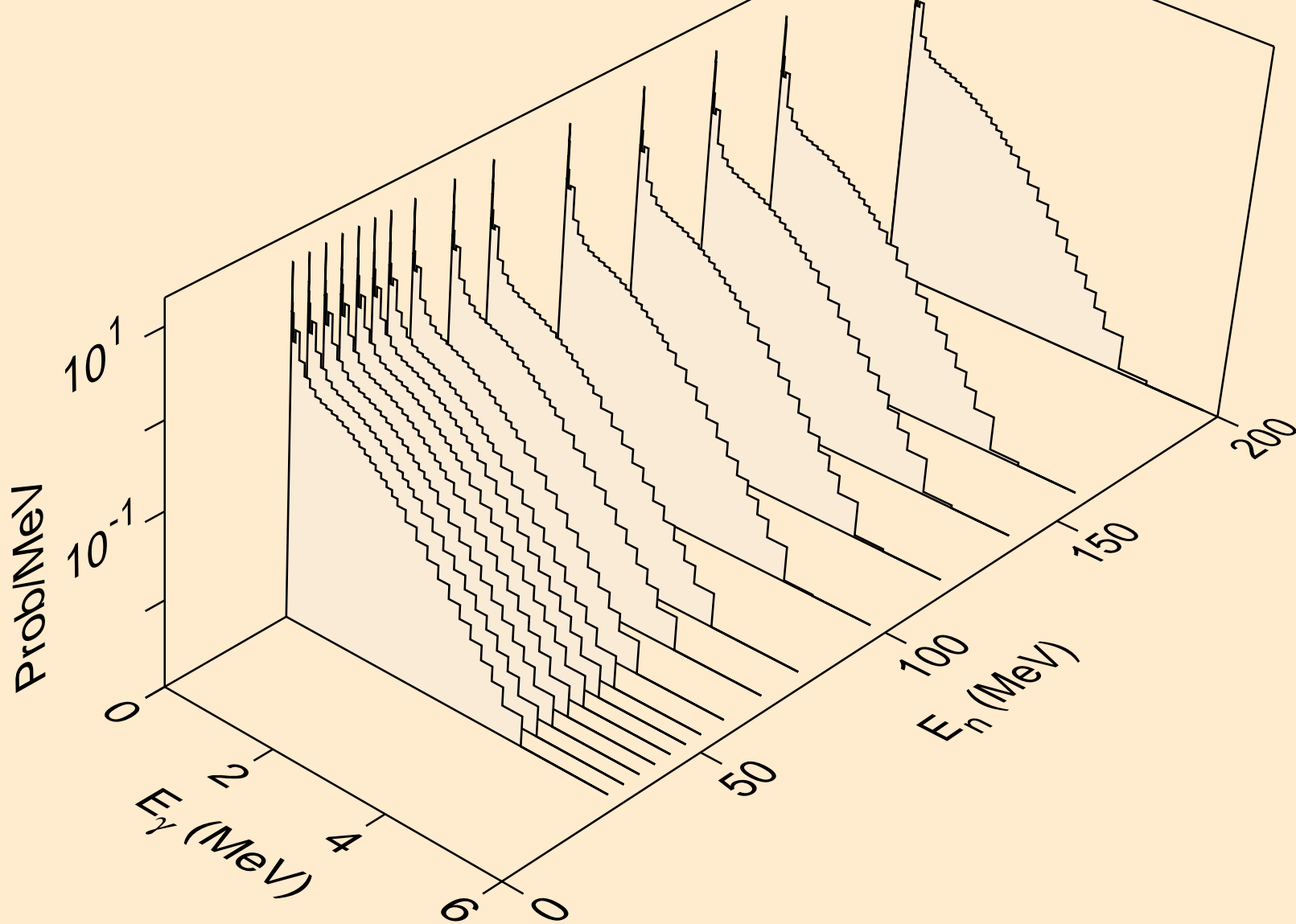

BH269 NEUTRON ACER TENDL-2019 LIBRARY; T=293.16K
Photon emission for (n,2nd)

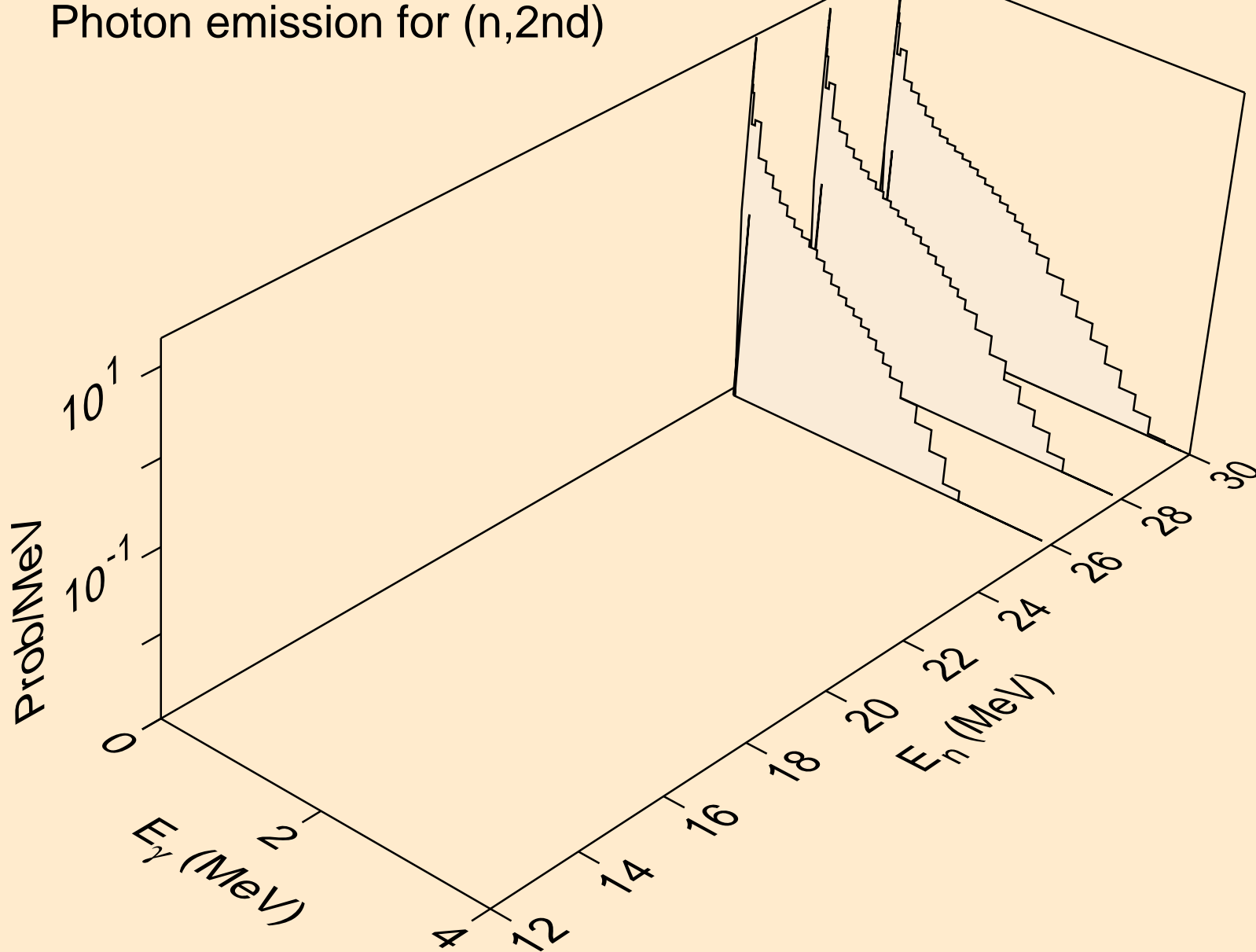

BH269 NEUTRON ACER TENDL-2019 LIBRARY; T=293.16K
Photon emission for (n,2n)

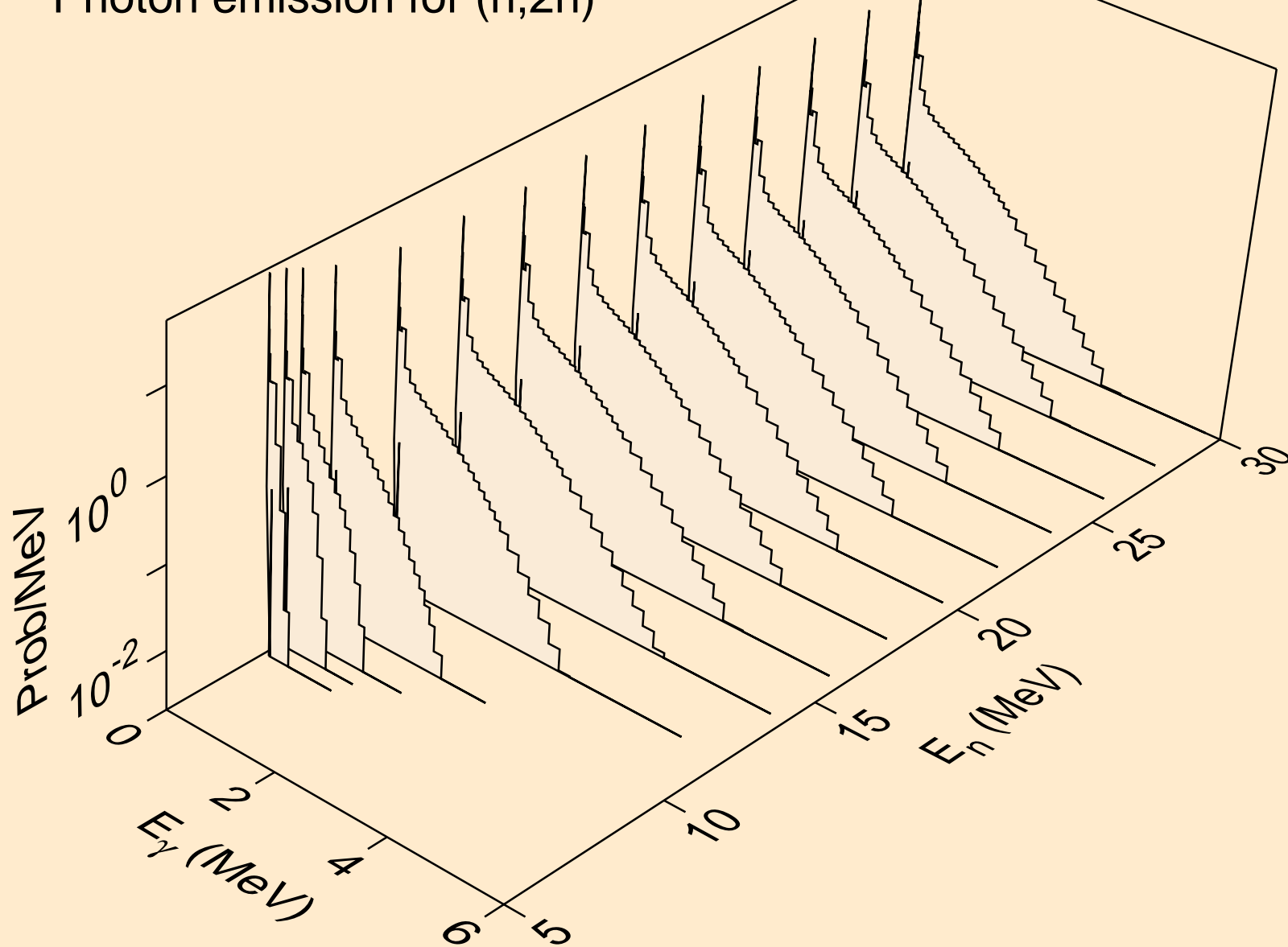

BH269 NEUTRON ACER TENDL-2019 LIBRARY; T=293.16K
Photon emission for (n,3n)

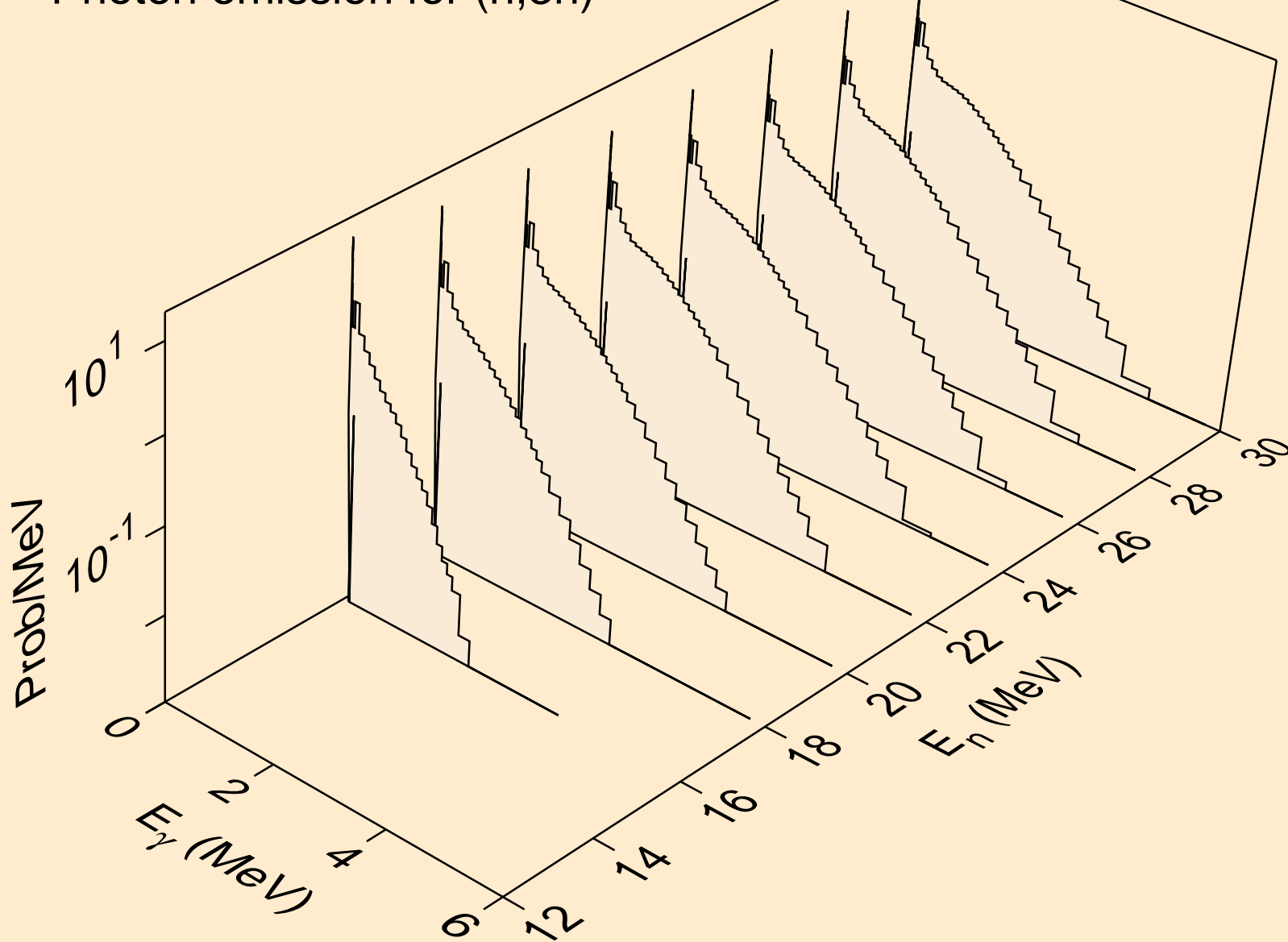

BH269 NEUTRON ACER TENDL-2019 LIBRARY; T=293.16K
Photon emission for (n,n*)a

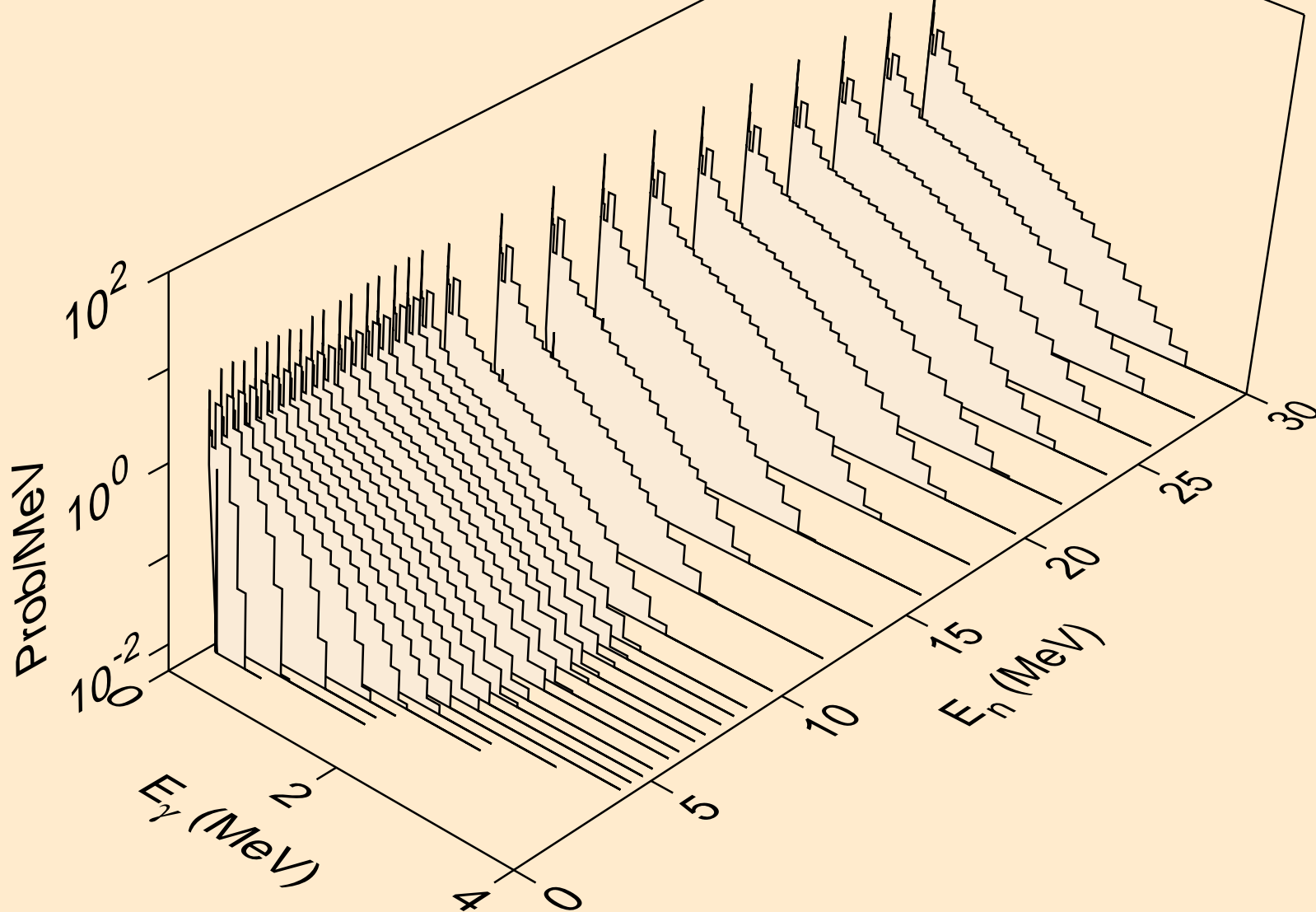

BH269 NEUTRON ACER TENDL-2019 LIBRARY; T=293.16K
Photon emission for (n,2n) α

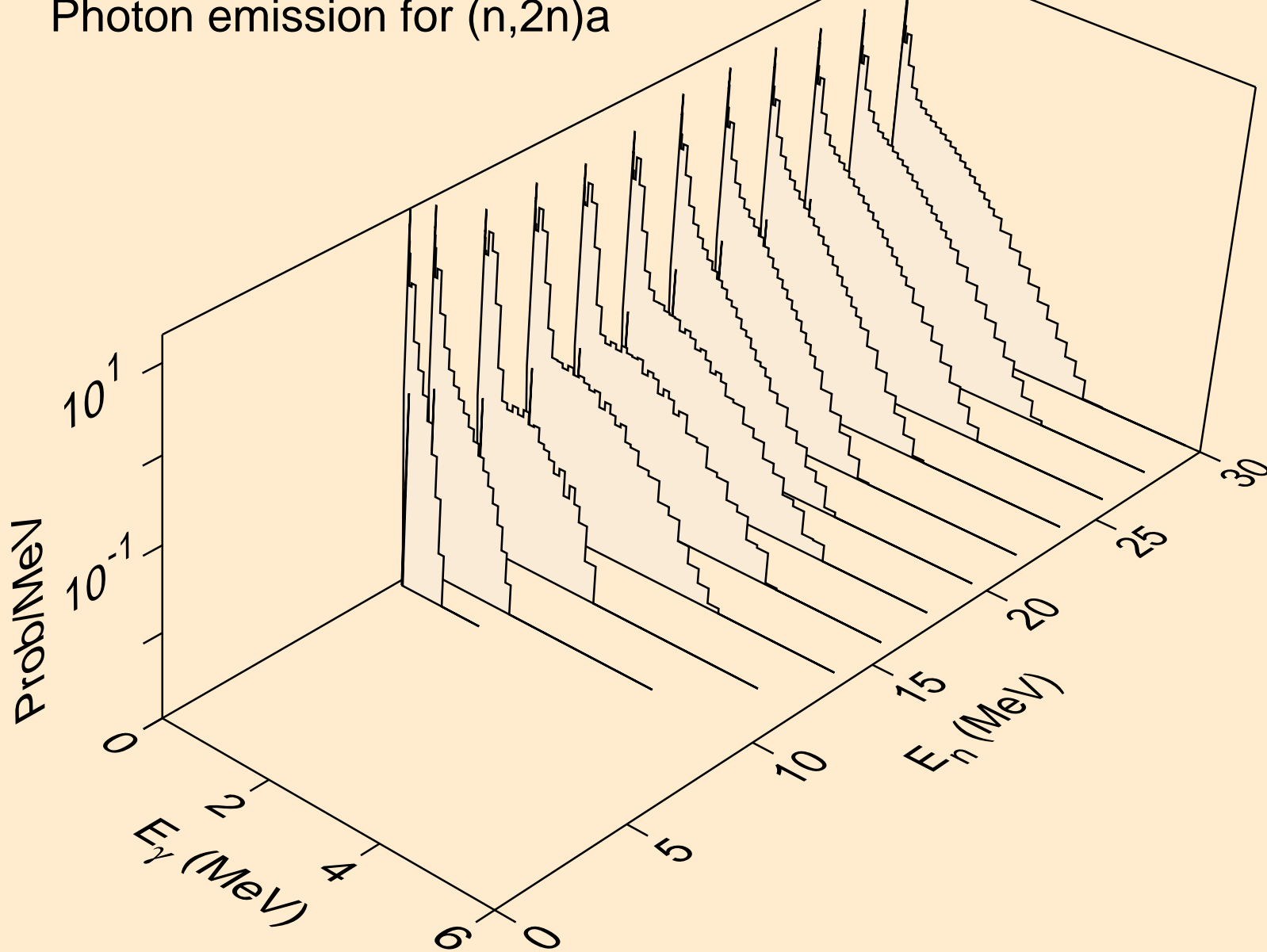

BH269 NEUTRON ACER TENDL-2019 LIBRARY; T=293.16K
Photon emission for (n,3n)a

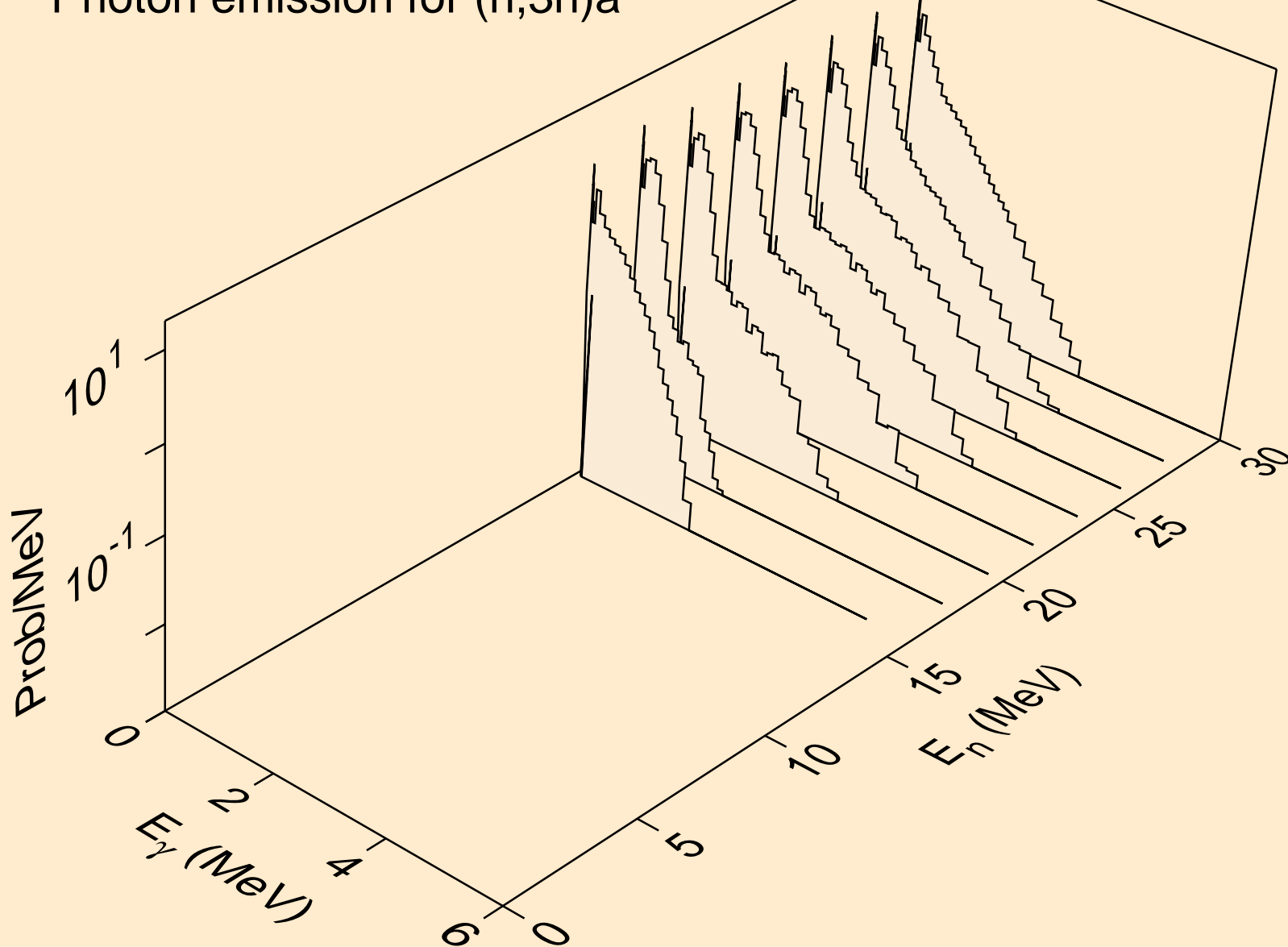

BH269 NEUTRON ACER TENDL-2019 LIBRARY; T=293.16K
Photon emission for (n,n*)p

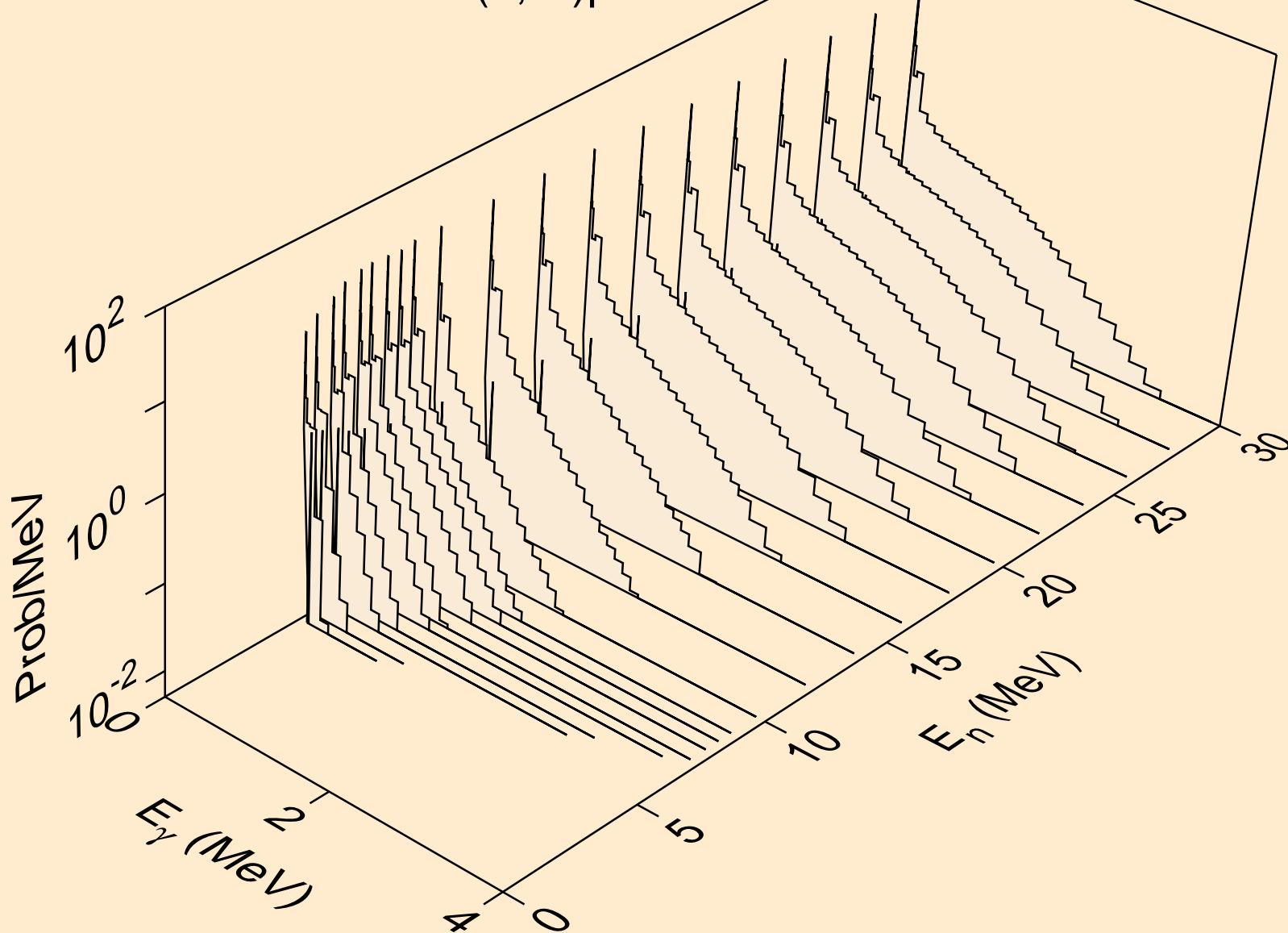

BH269 NEUTRON ACER TENDL-2019 LIBRARY; T=293.16K
Photon emission for (n,n*)2a

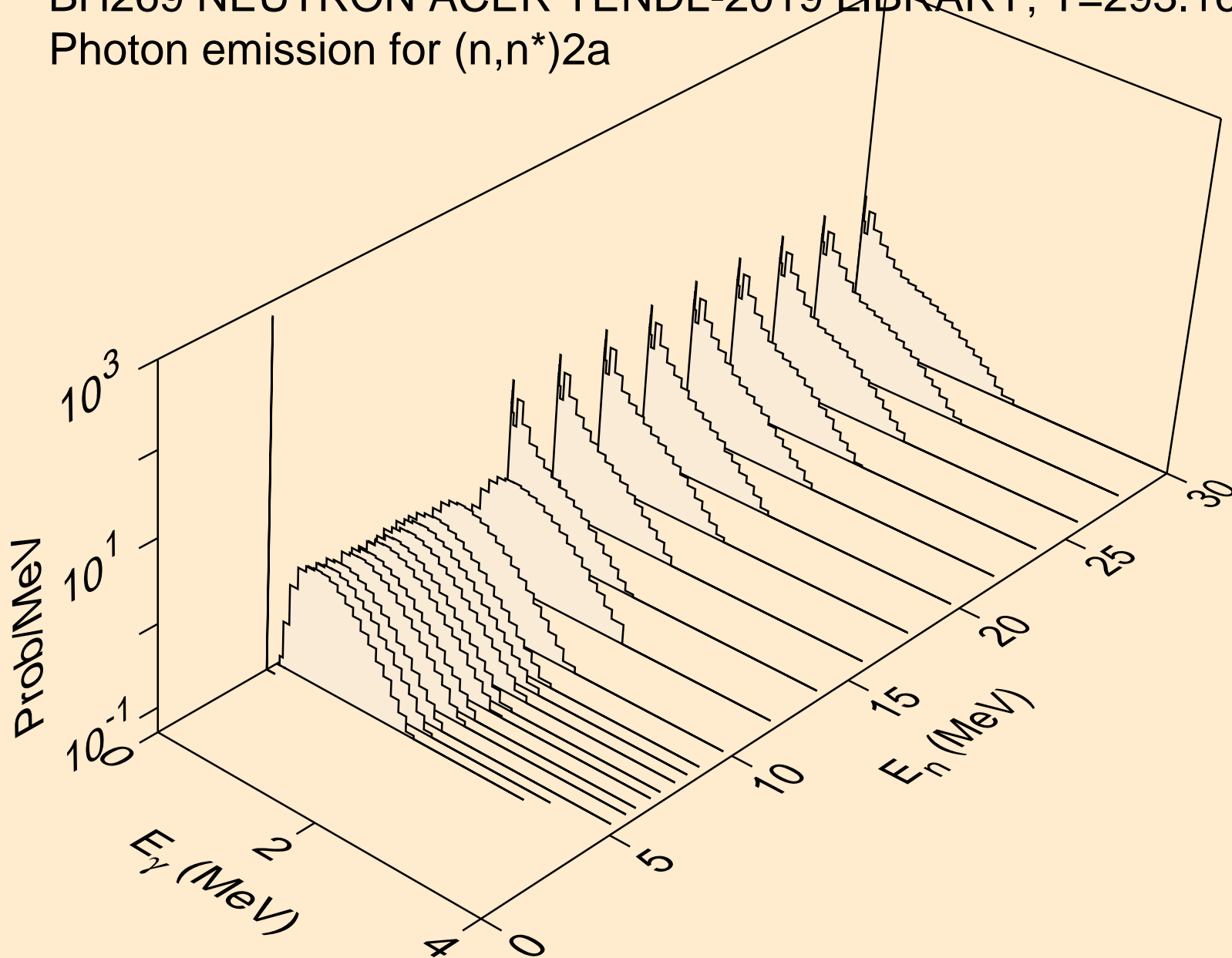

BH269 NEUTRON ACER TENDL-2019 LIBRARY; T=293.16K
Photon emission for (n,n*)d

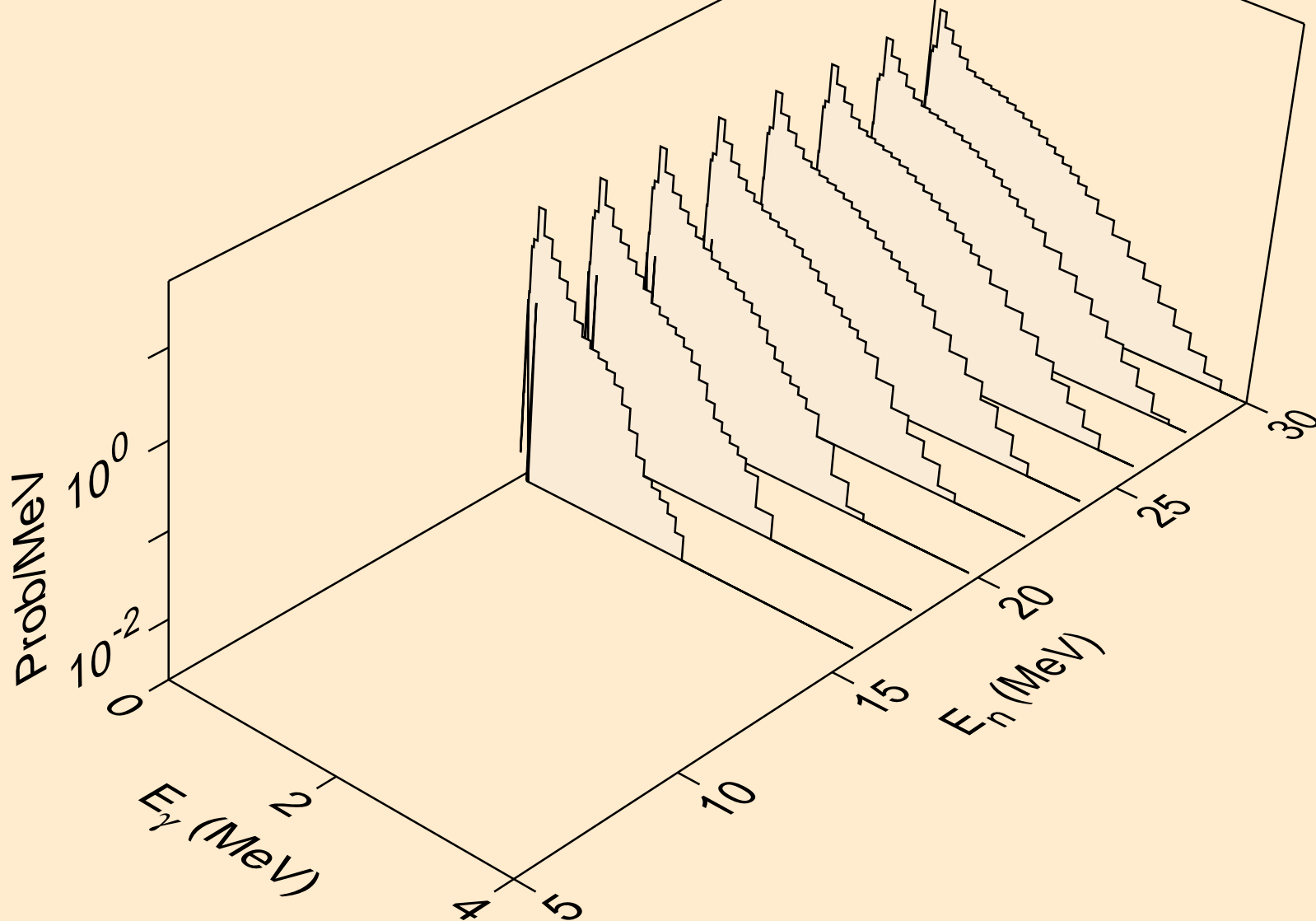

BH269 NEUTRON ACER TENDL-2019 LIBRARY; T=293.16K
Photon emission for (n,n*)t

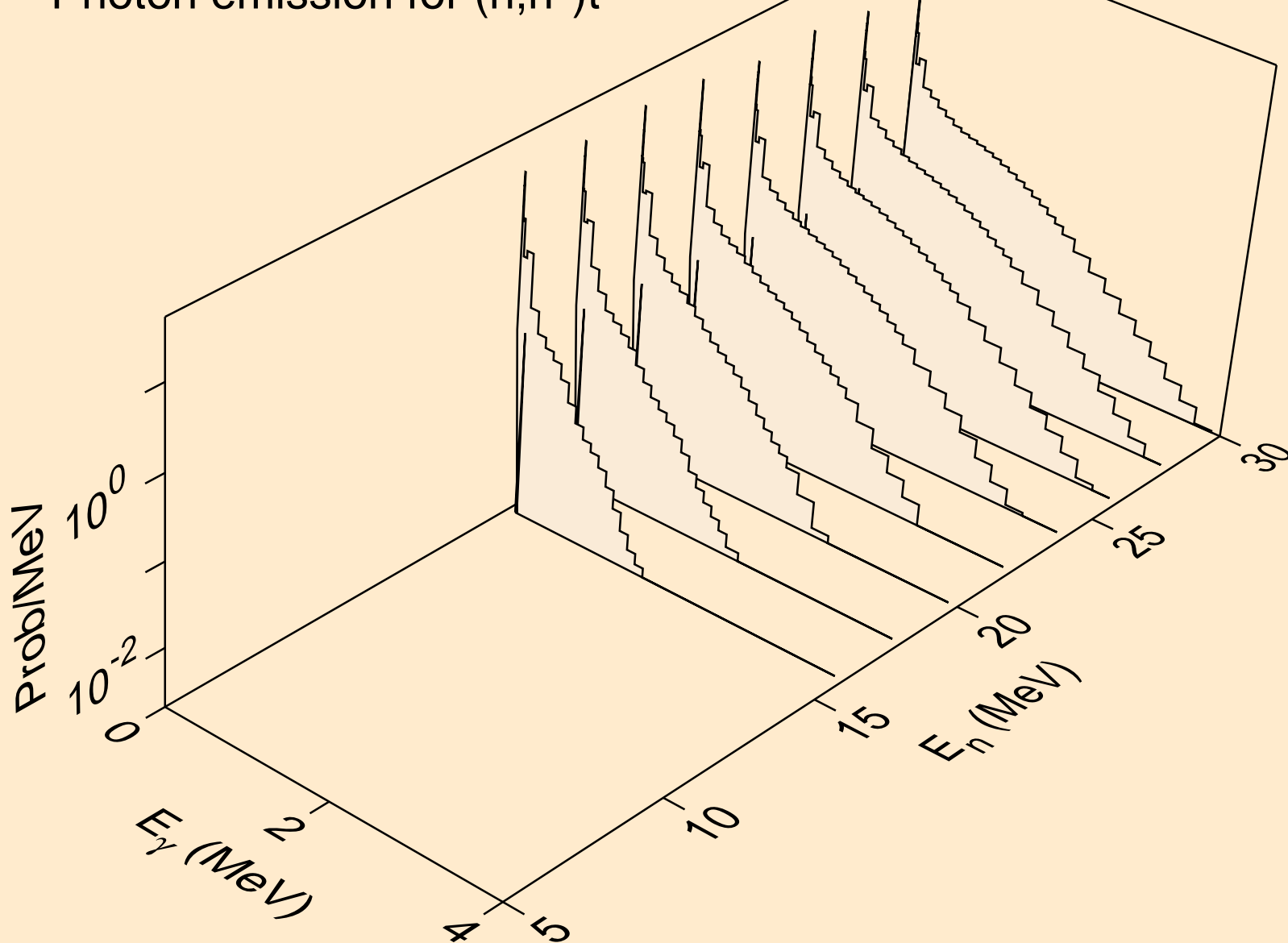

BH269 NEUTRON ACER TENDL-2019 LIBRARY; T=293.16K
Photon emission for (n,n*)he3

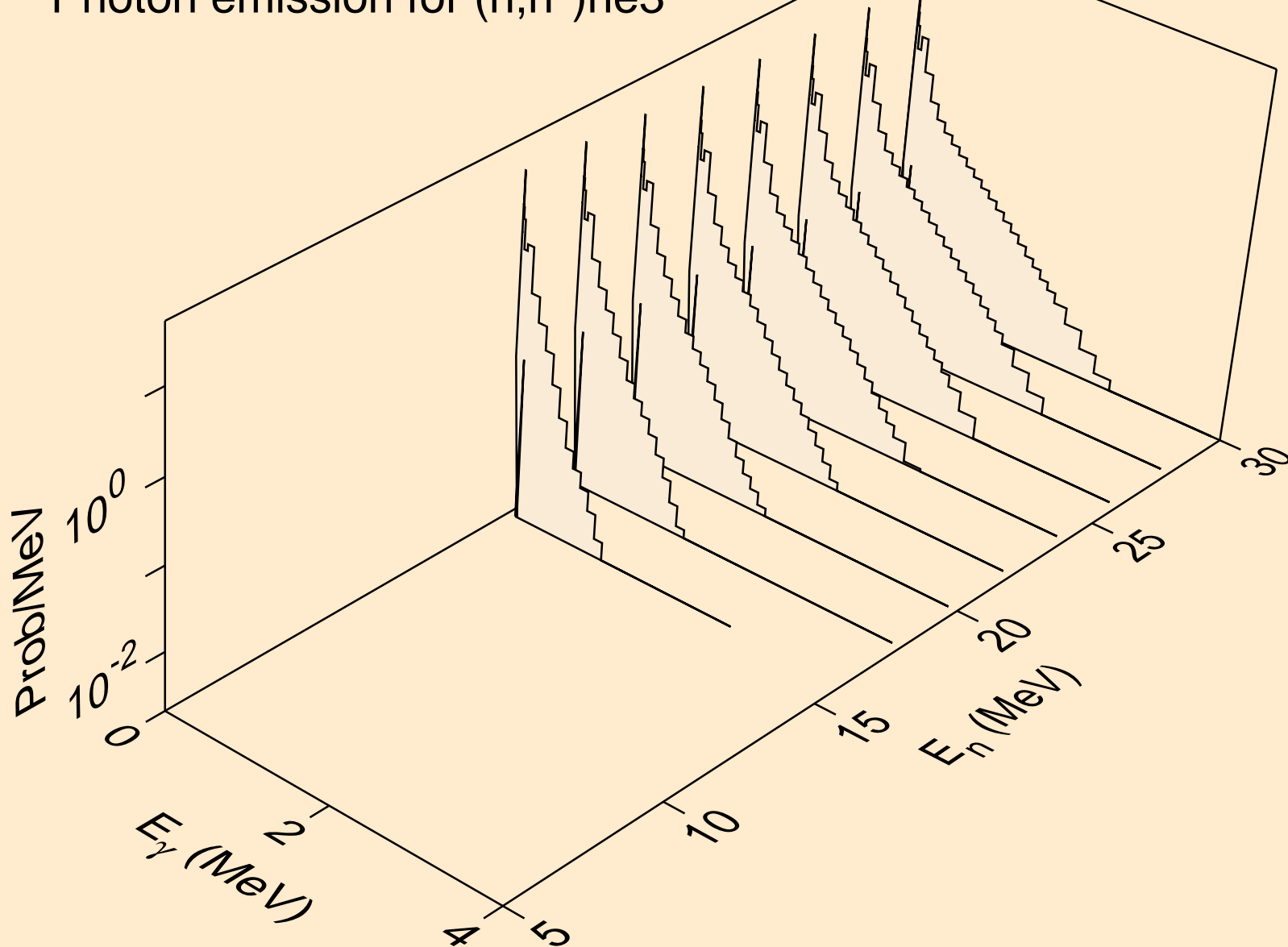

BH269 NEUTRON ACER TENDL-2019 LIBRARY; T=293.16K
Photon emission for (n,4n)

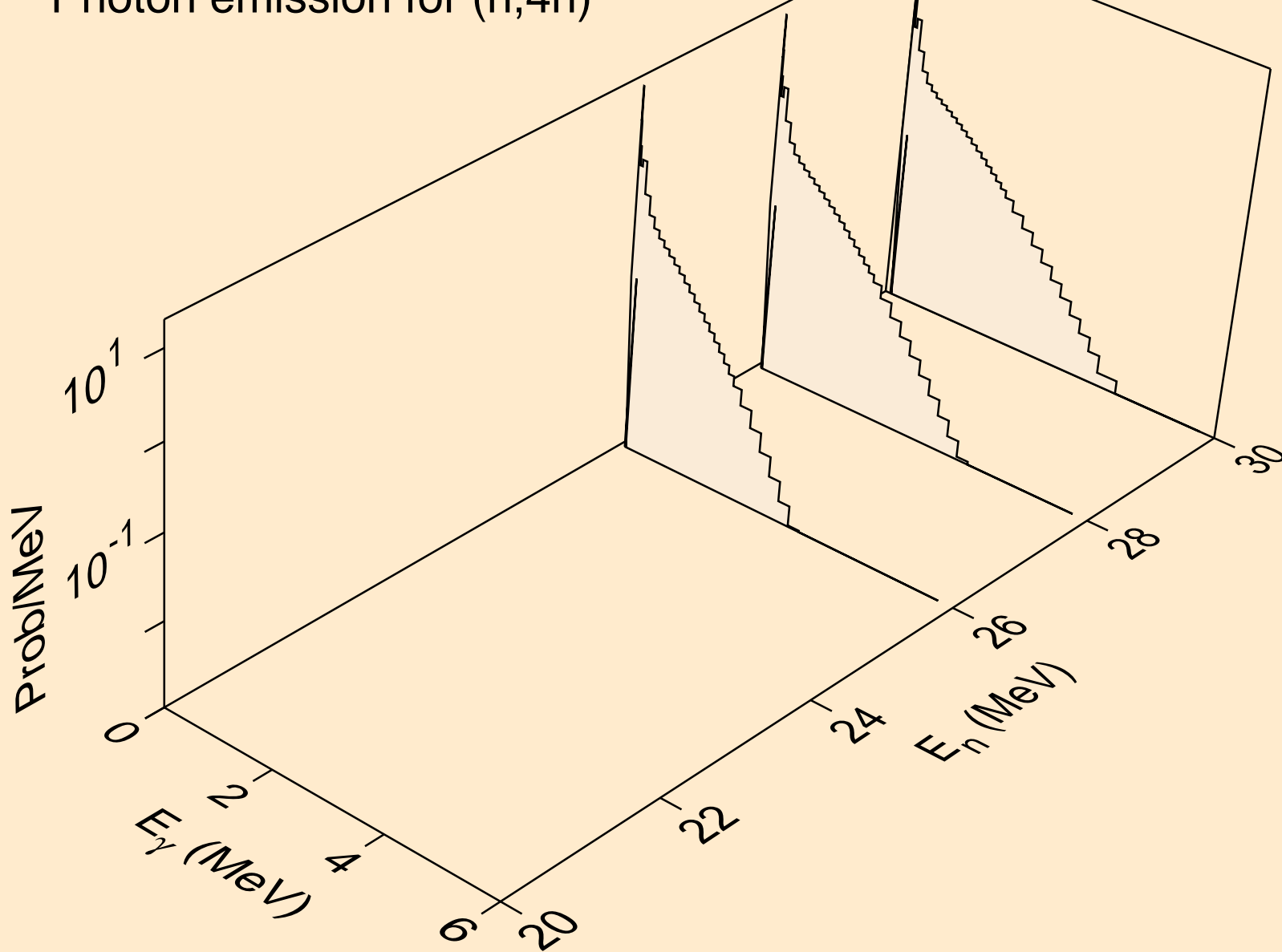

BH269 NEUTRON ACER TENDL-2019 LIBRARY; T=293.16K
Photon emission for (n,2np)

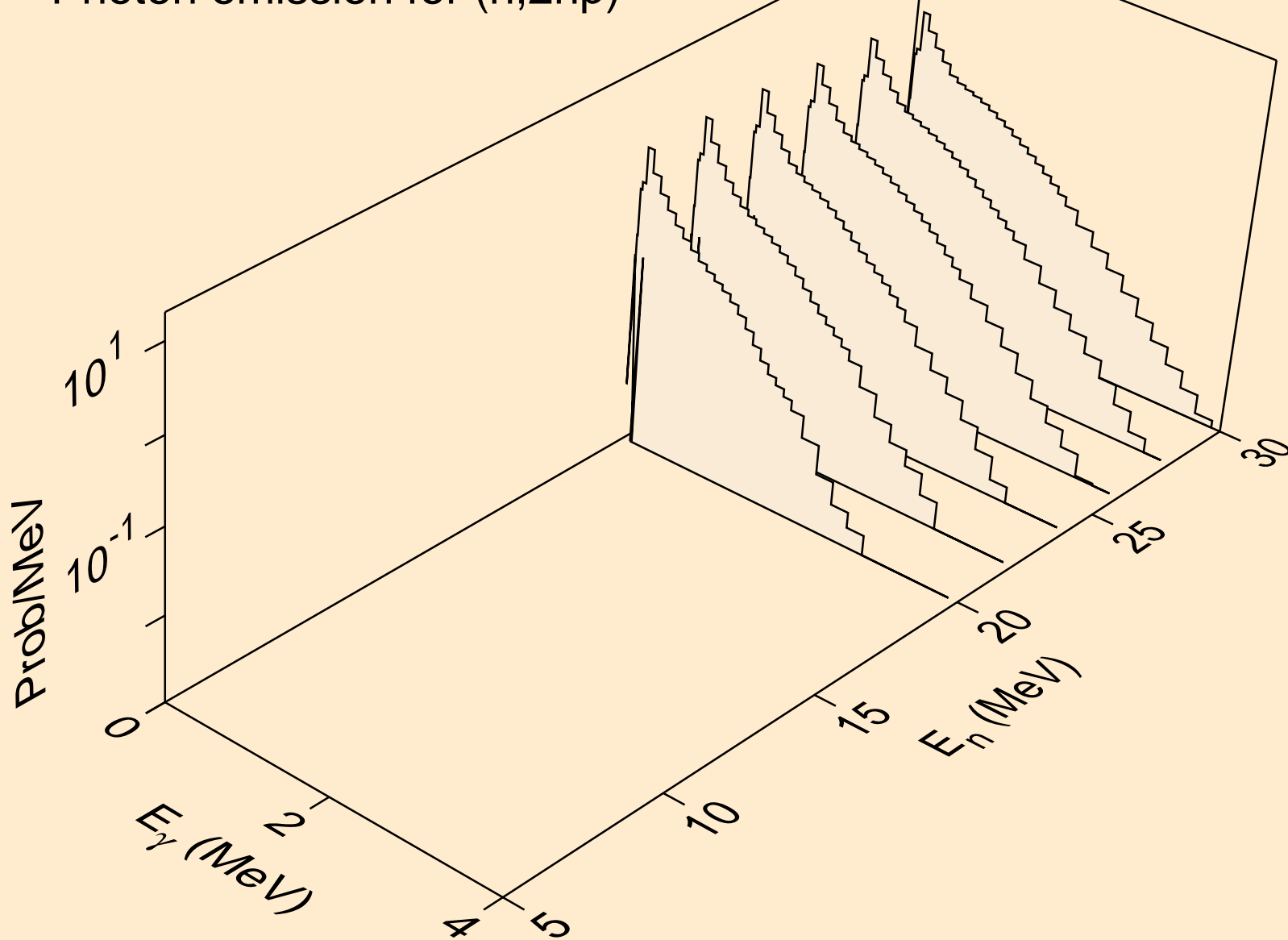

BH269 NEUTRON ACER TENDL-2019 LIBRARY; T=293.16K
Photon emission for (n,3np)

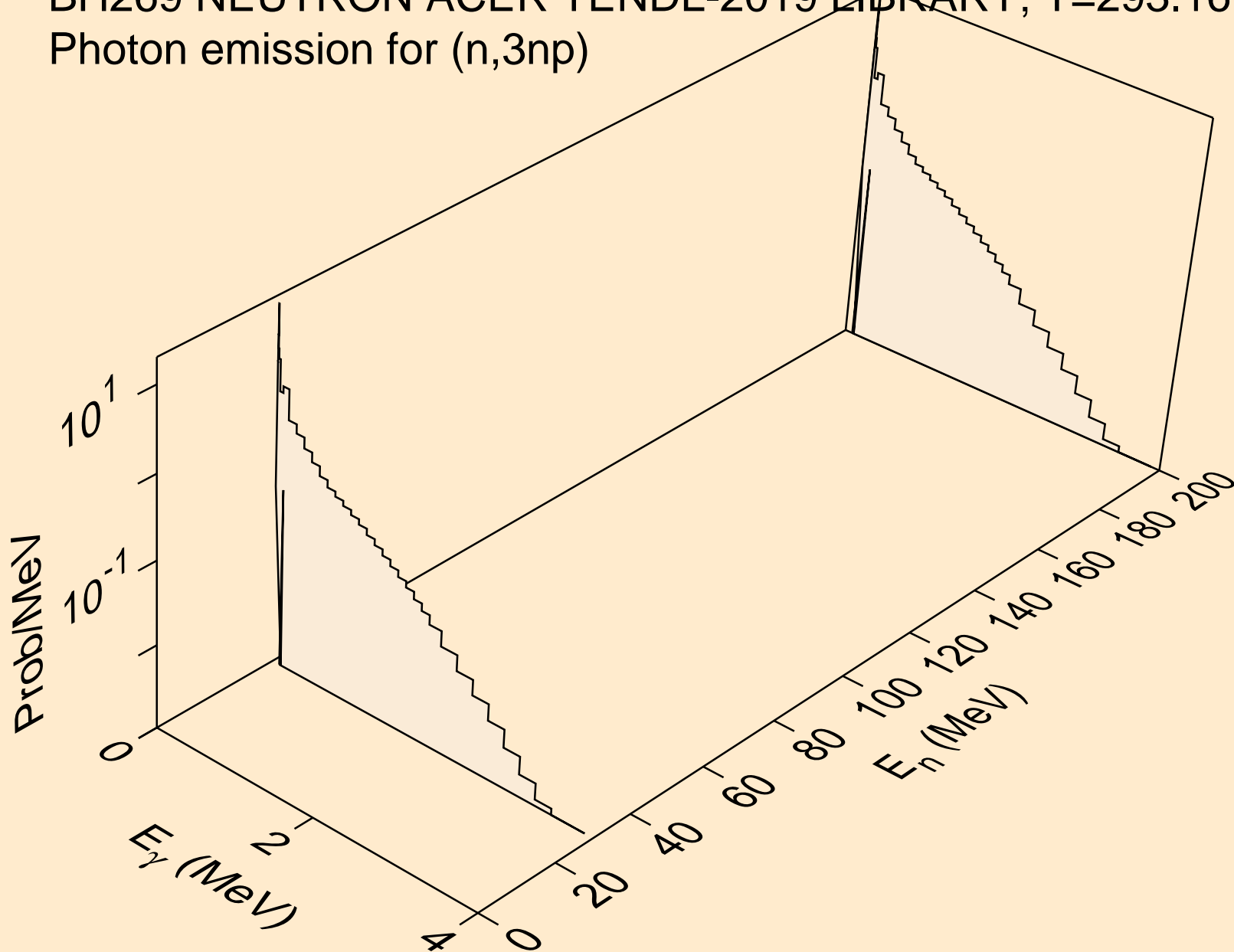

BH269 NEUTRON ACER TENDL-2019 LIBRARY; T=293.16K
Photon emission for (n,2np)

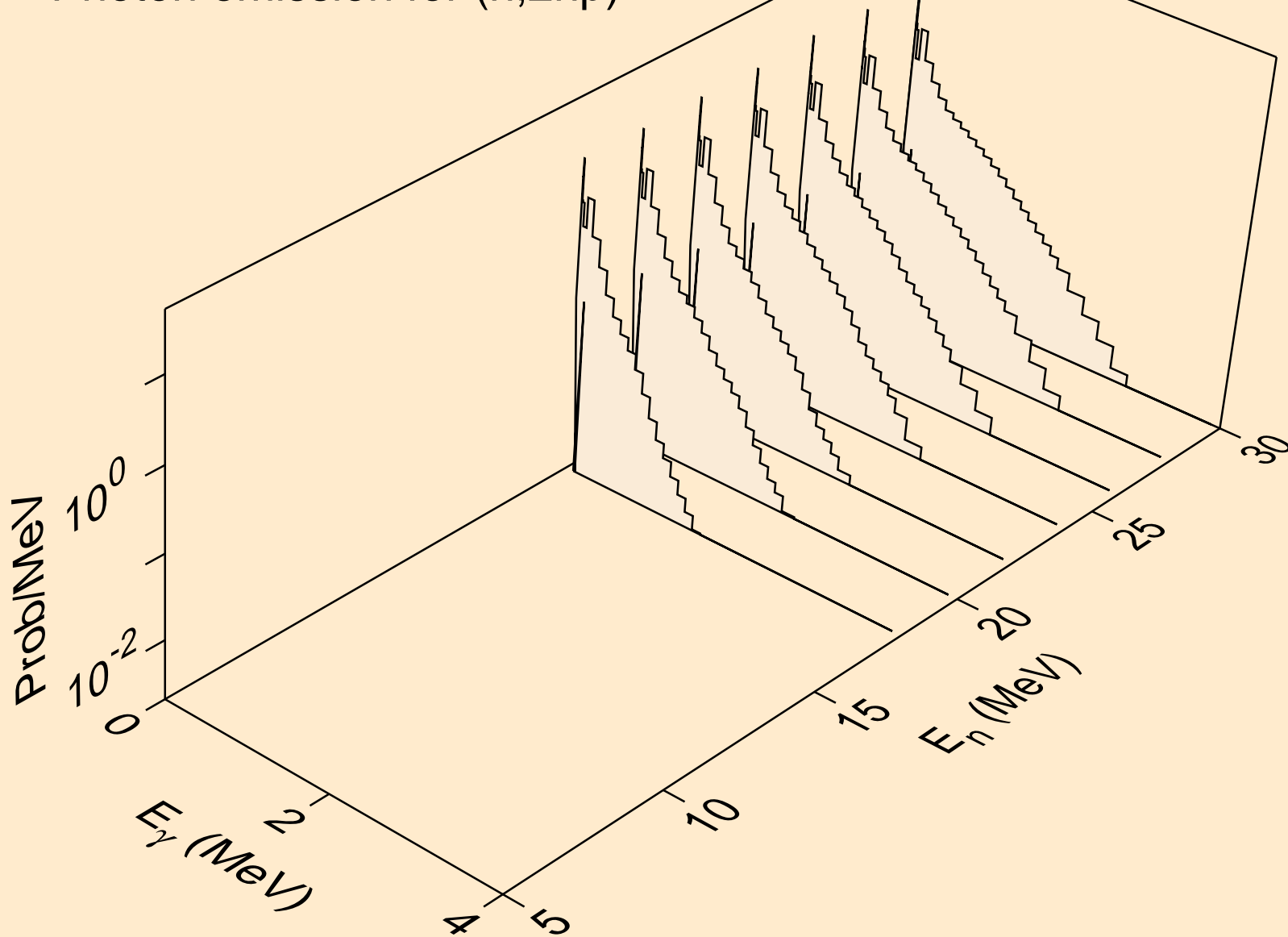

BH269 NEUTRON ACER TENDL-2019 LIBRARY; T=293.16K
Photon emission for (n,n*c)

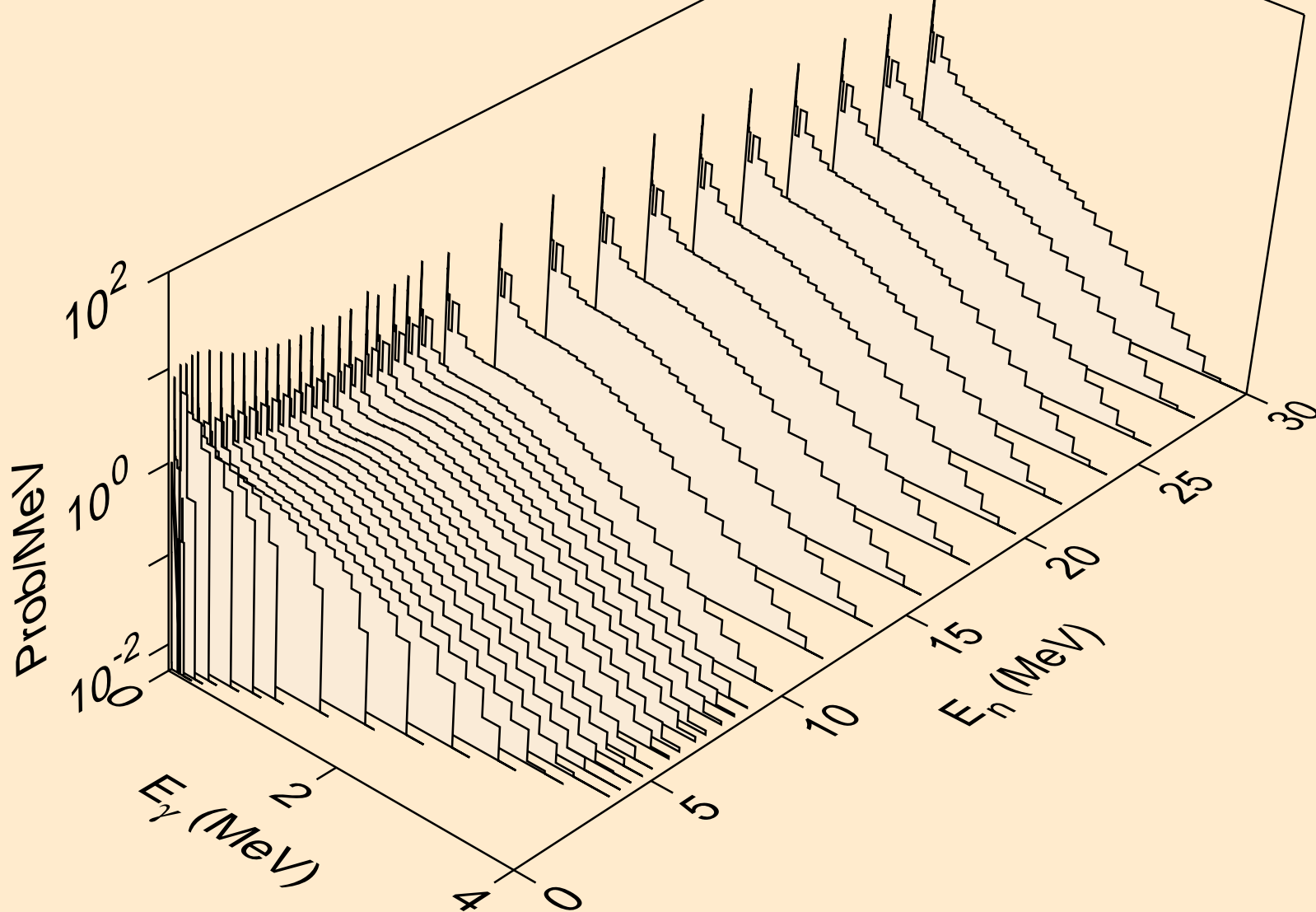

BH269 NEUTRON ACER TENDL-2019 LIBRARY; T=293.16K
Photon emission for (n,gma)

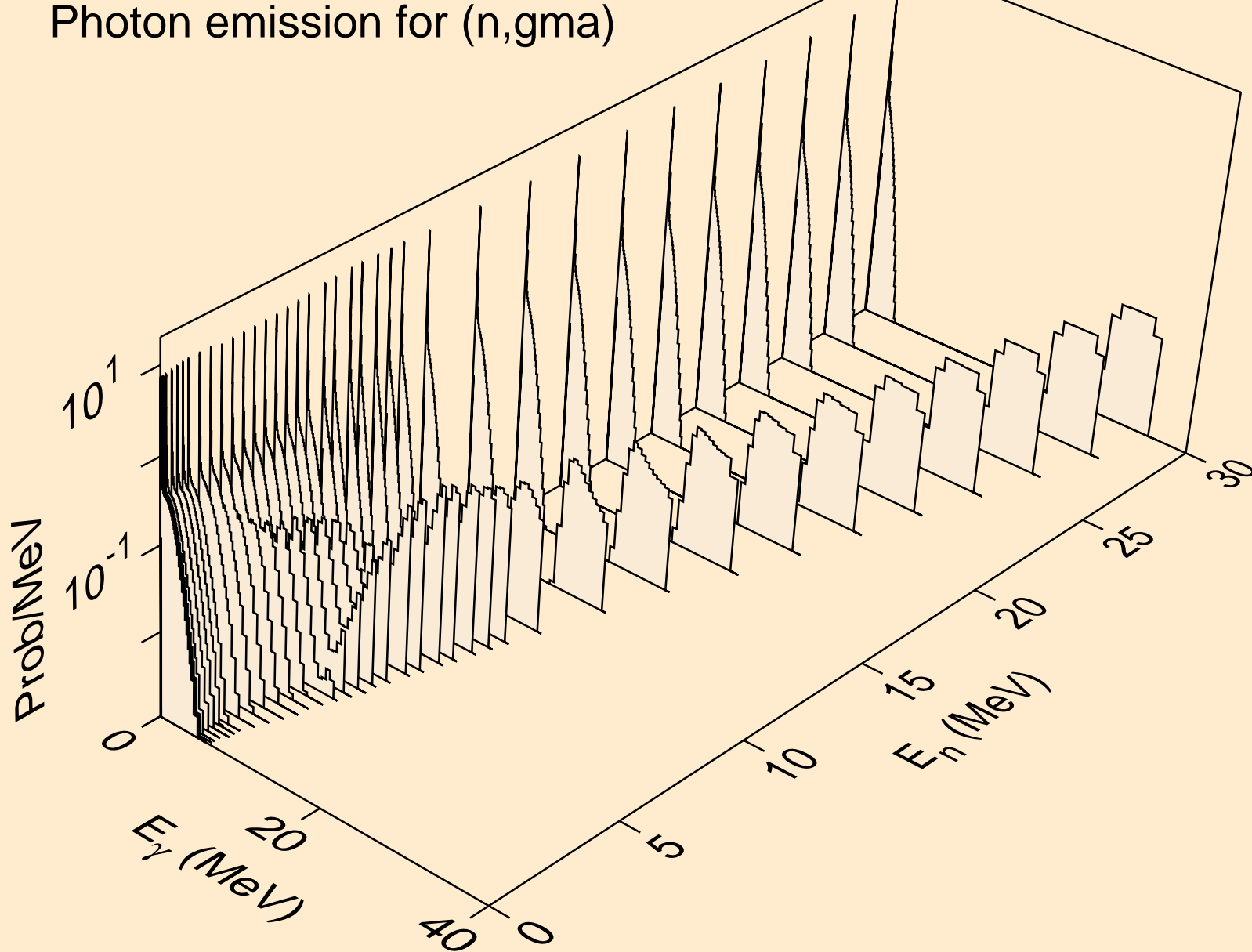

BH269 NEUTRON ACER TENDL-2019 LIBRARY; T=293.16K
Photon emission for (n,p)

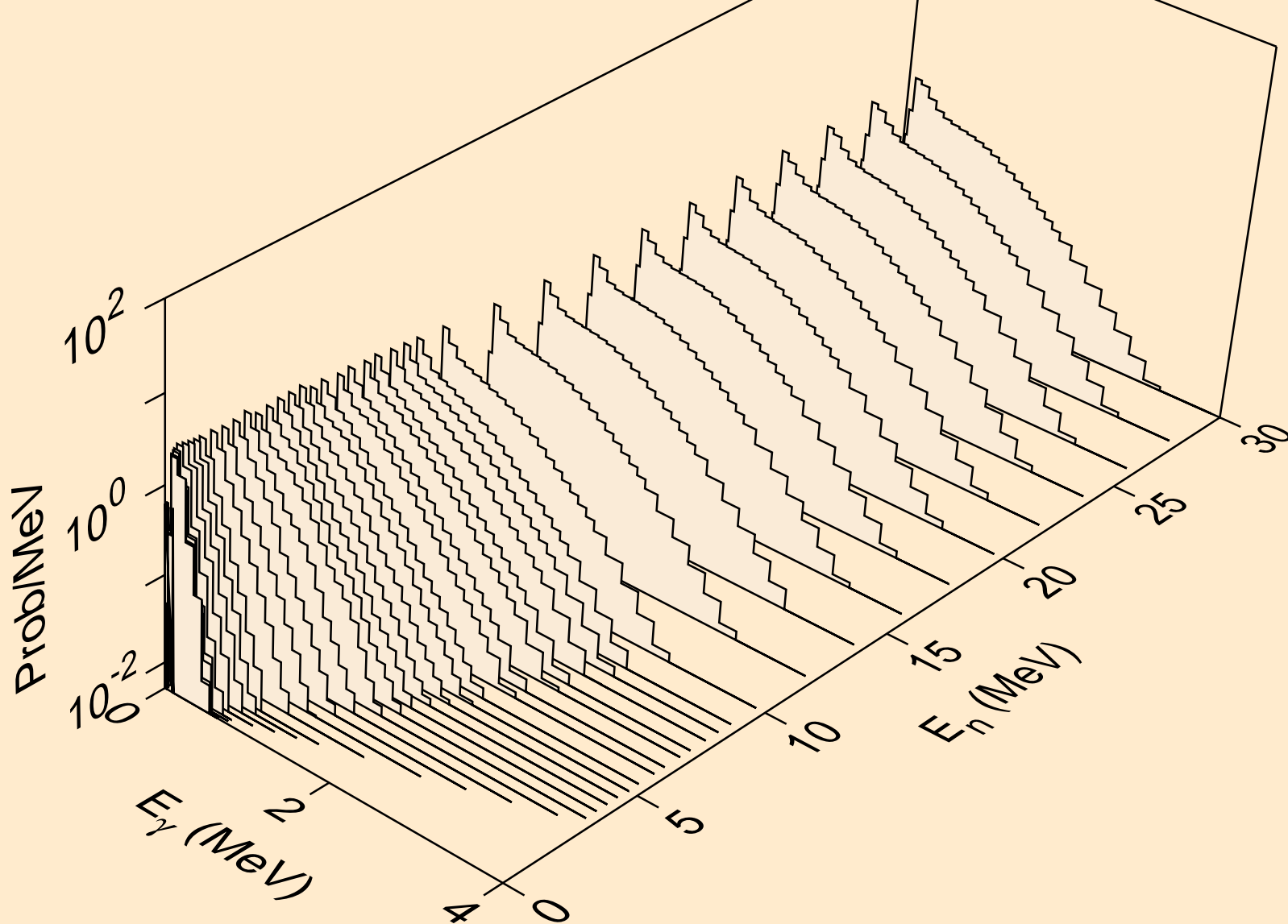

BH269 NEUTRON ACER TENDL-2019 LIBRARY; T=293.16K
Photon emission for (n,d)

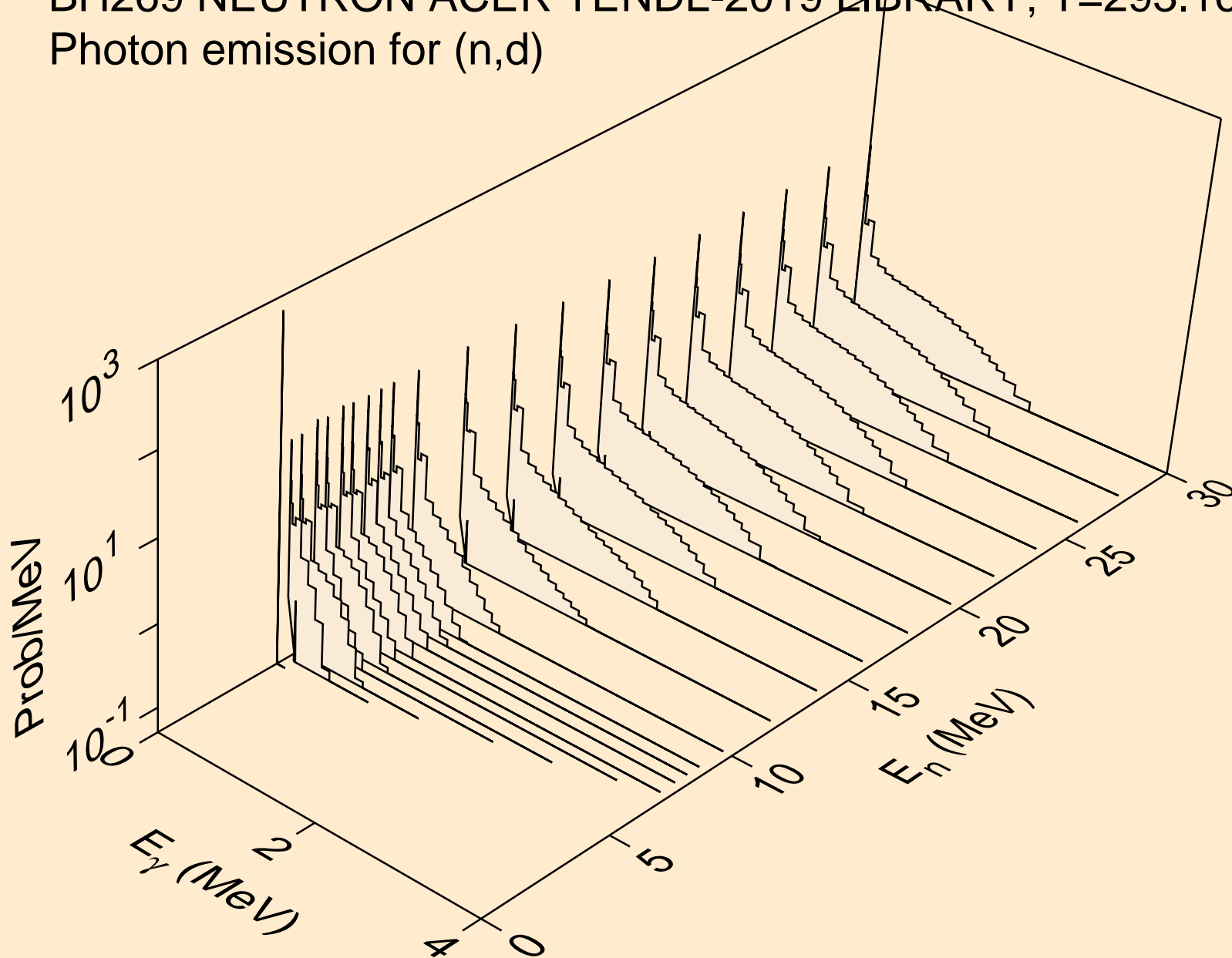

BH269 NEUTRON ACER TENDL-2019 LIBRARY; T=293.16K
Photon emission for (n,t)

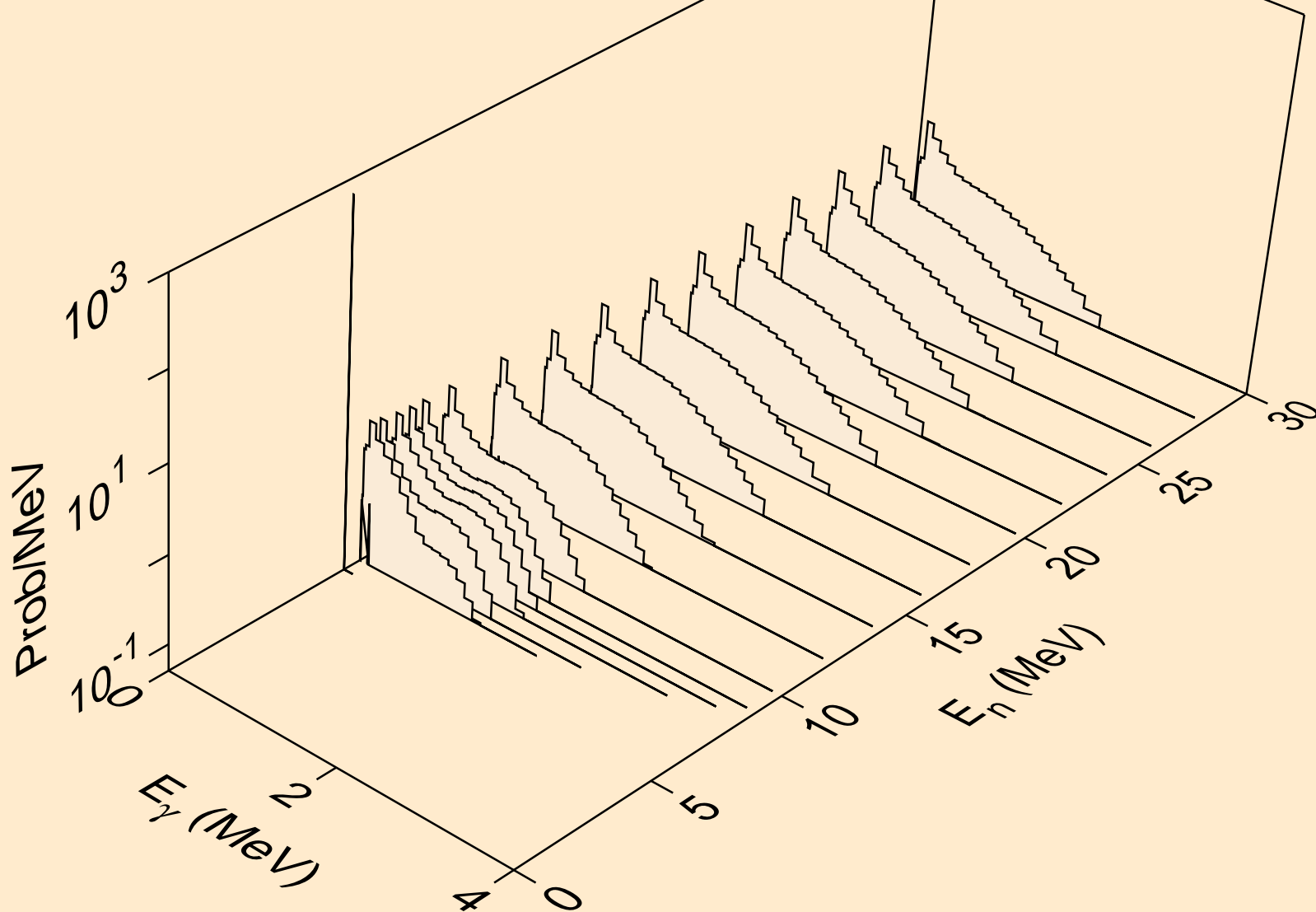

BH269 NEUTRON ACER TENDL-2019 LIBRARY; T=293.16K
Photon emission for (n,he3)

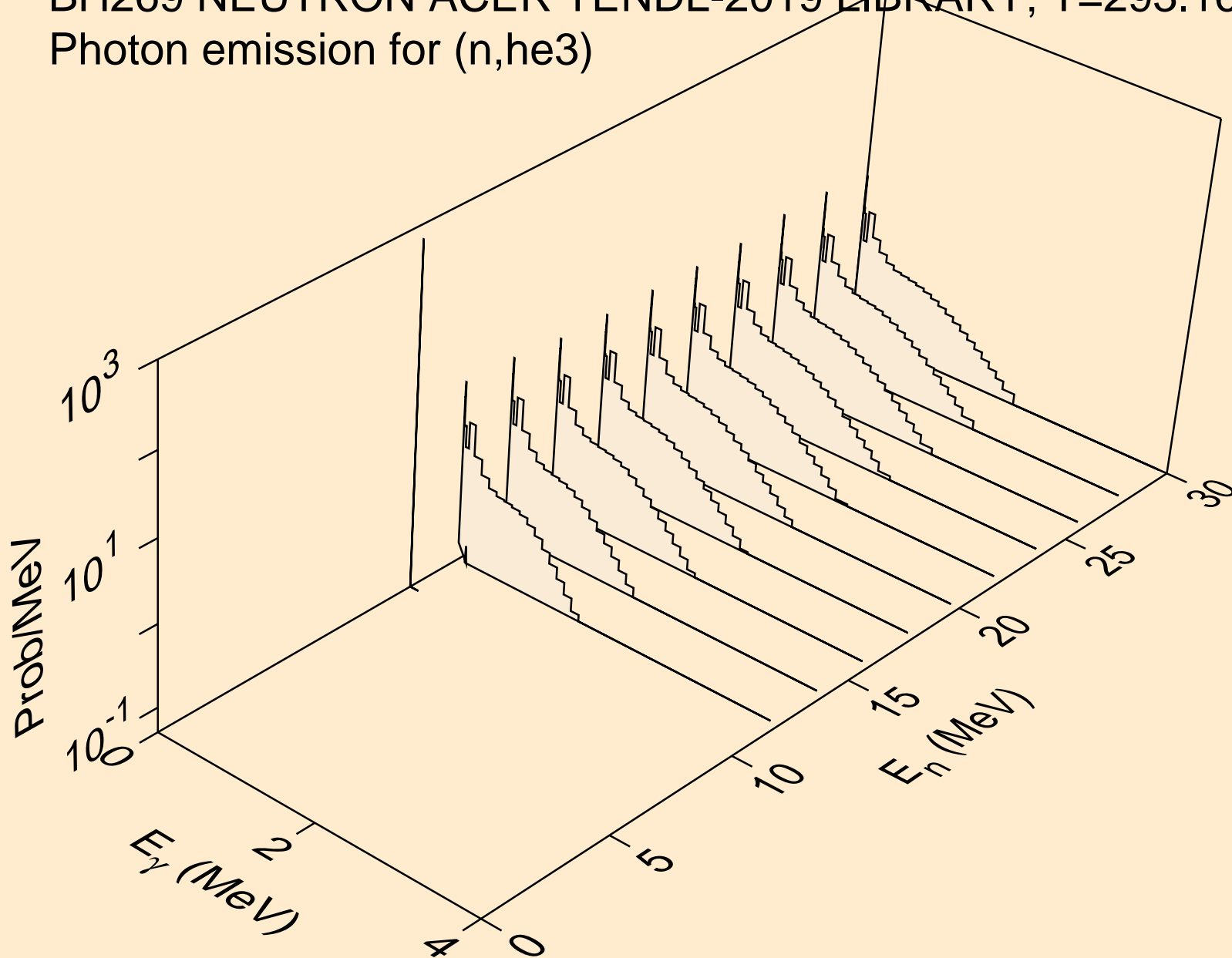

BH269 NEUTRON ACER TENDL-2019 LIBRARY; T=293.16K
Photon emission for (n,a)

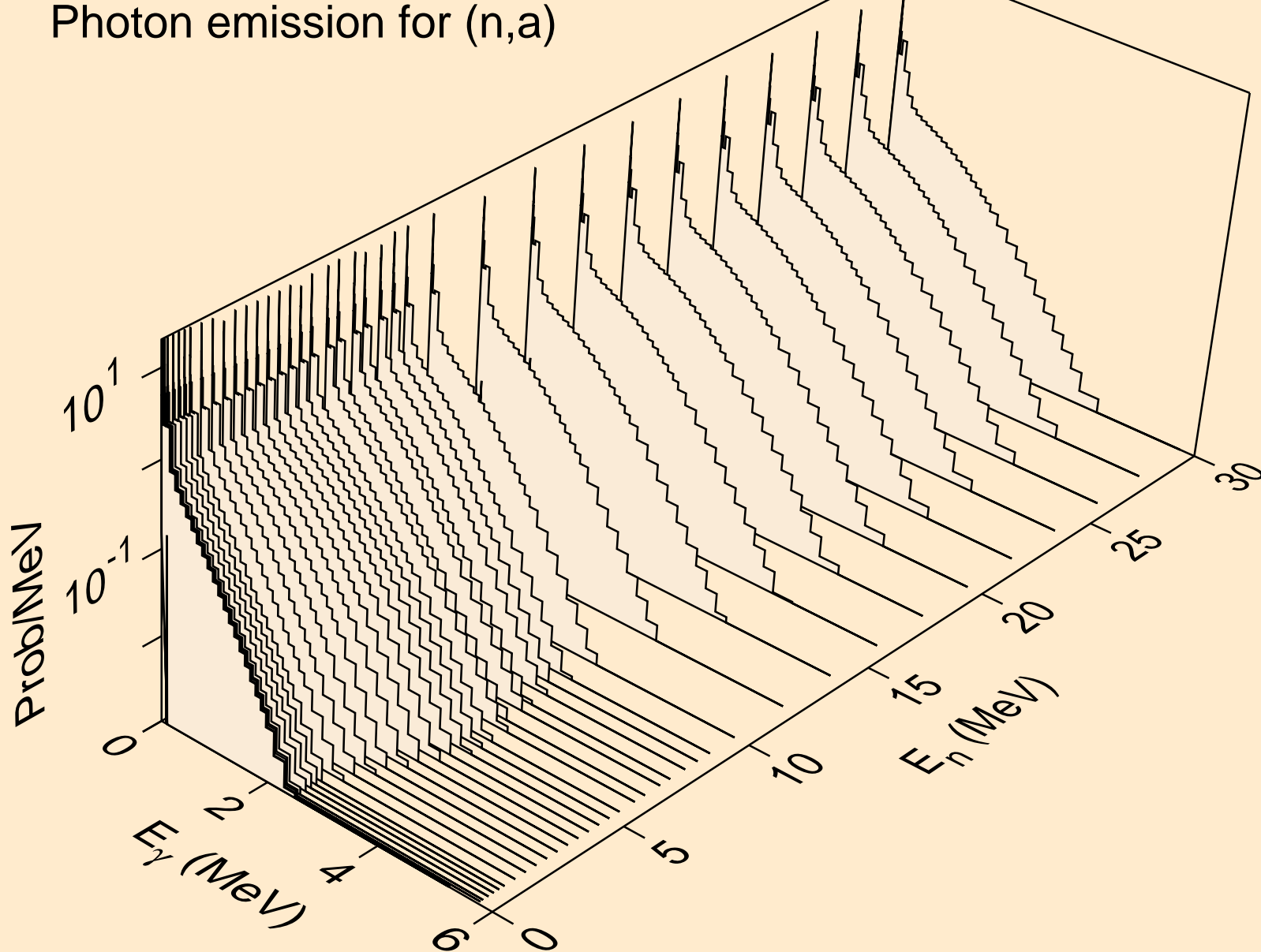

BH269 NEUTRON ACER TENDL-2019 LIBRARY; T=293.16K
Photon emission for (n,2a)

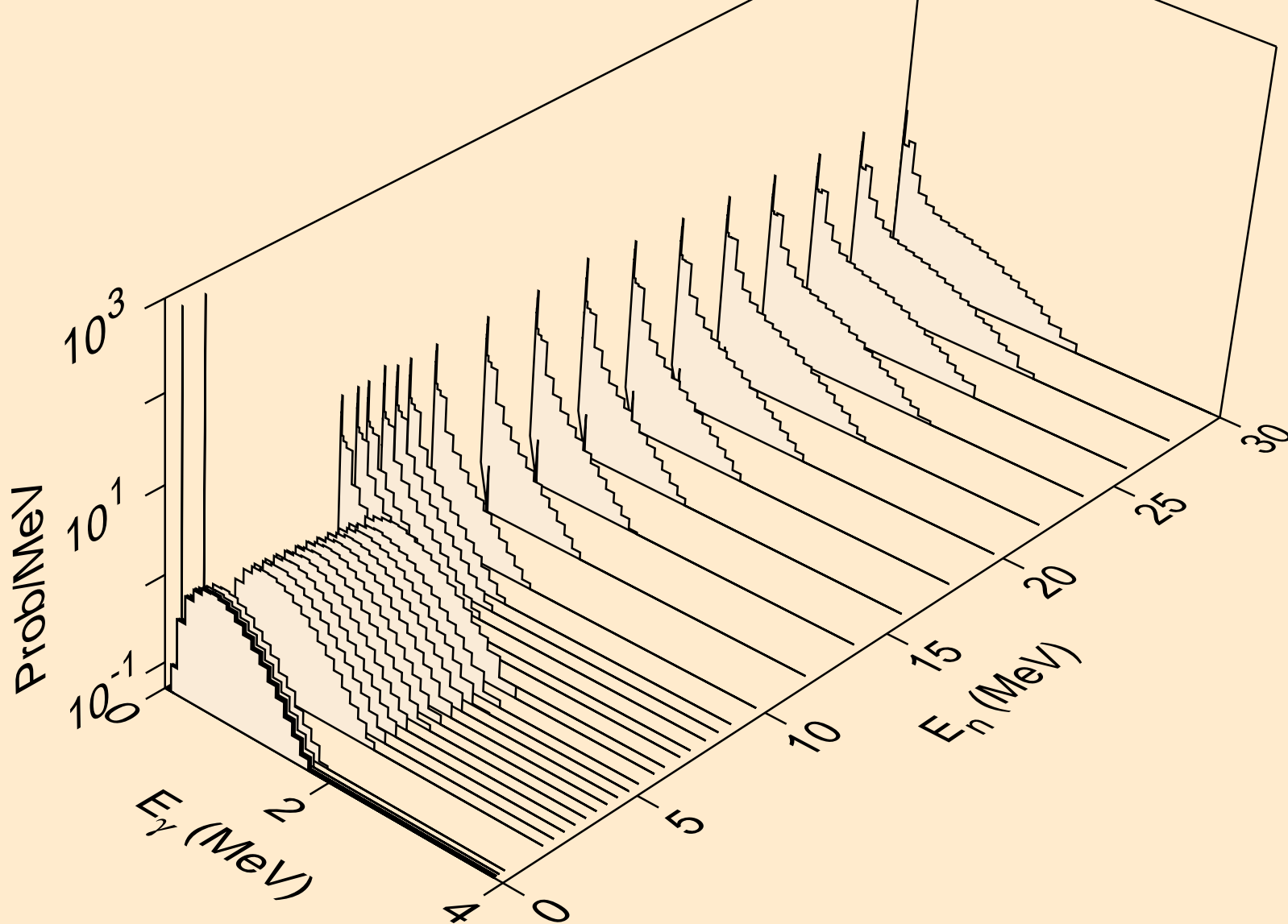

BH269 NEUTRON ACER TENDL-2019 LIBRARY; T=293.16K
Photon emission for (n,2p)

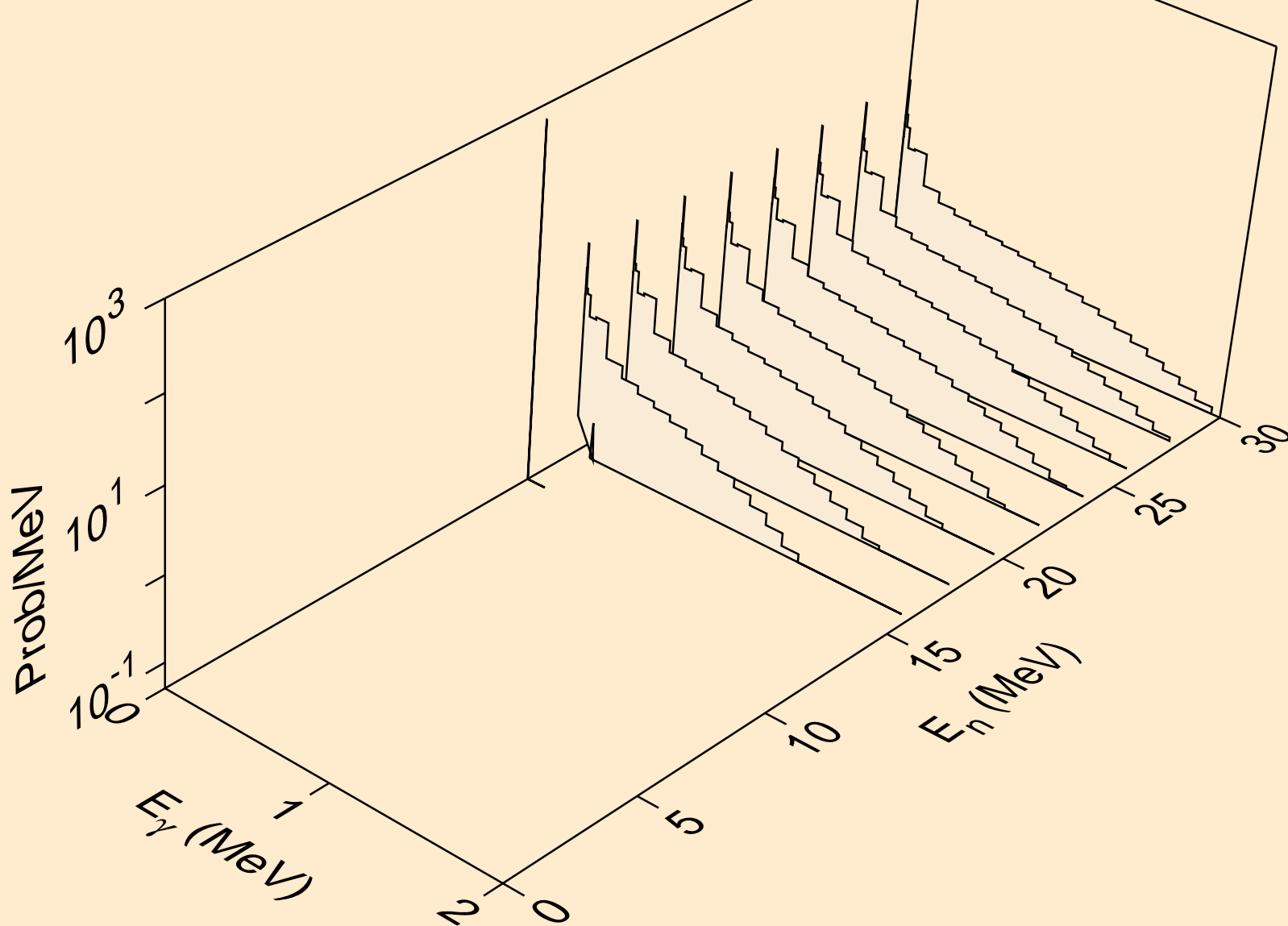

BH269 NEUTRON ACER TENDL-2019 LIBRARY; T=293.16K
Photon emission for (n,p)

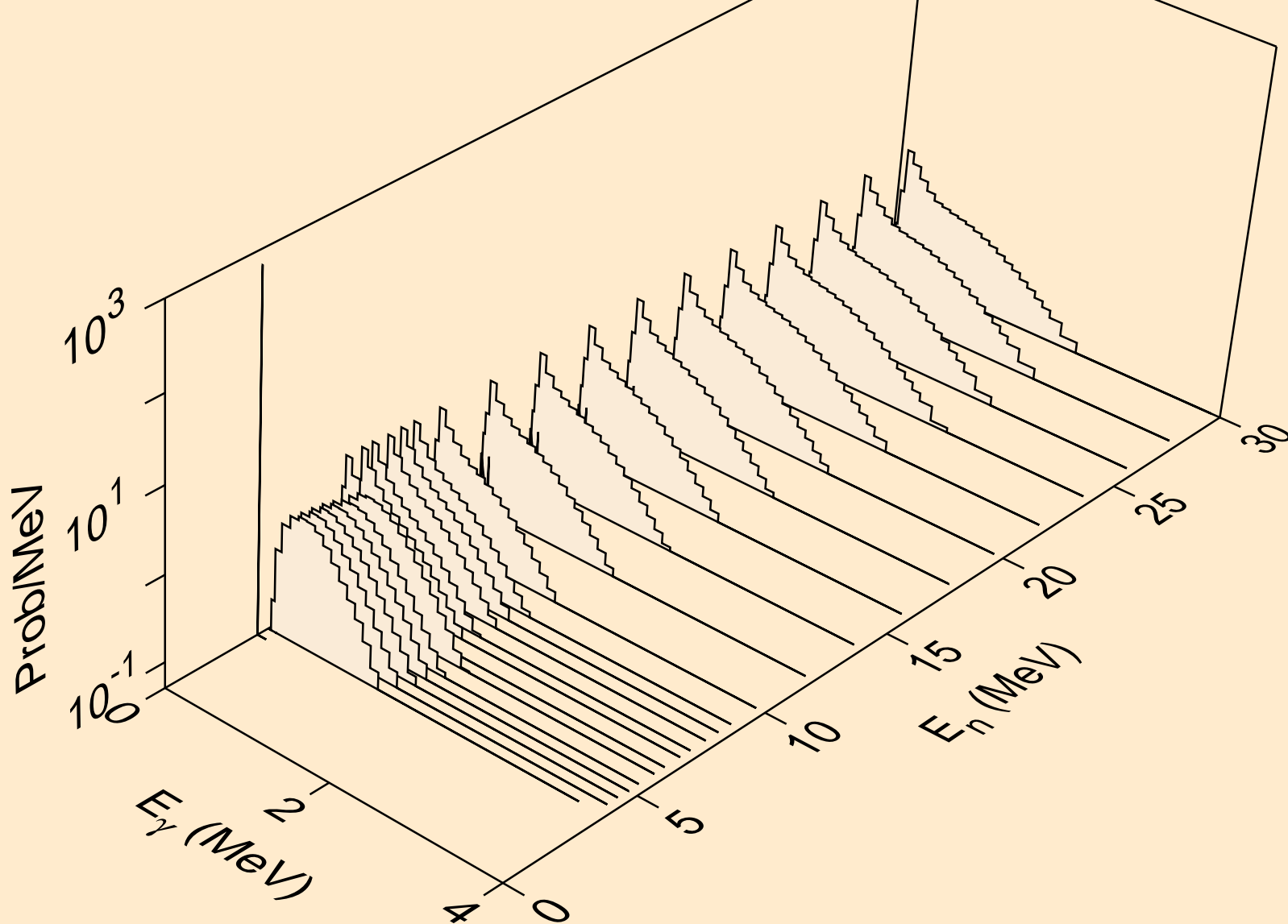

BH269 NEUTRON ACER TENDL-2019 LIBRARY; T=293.16K
Photon emission for (n,pd)

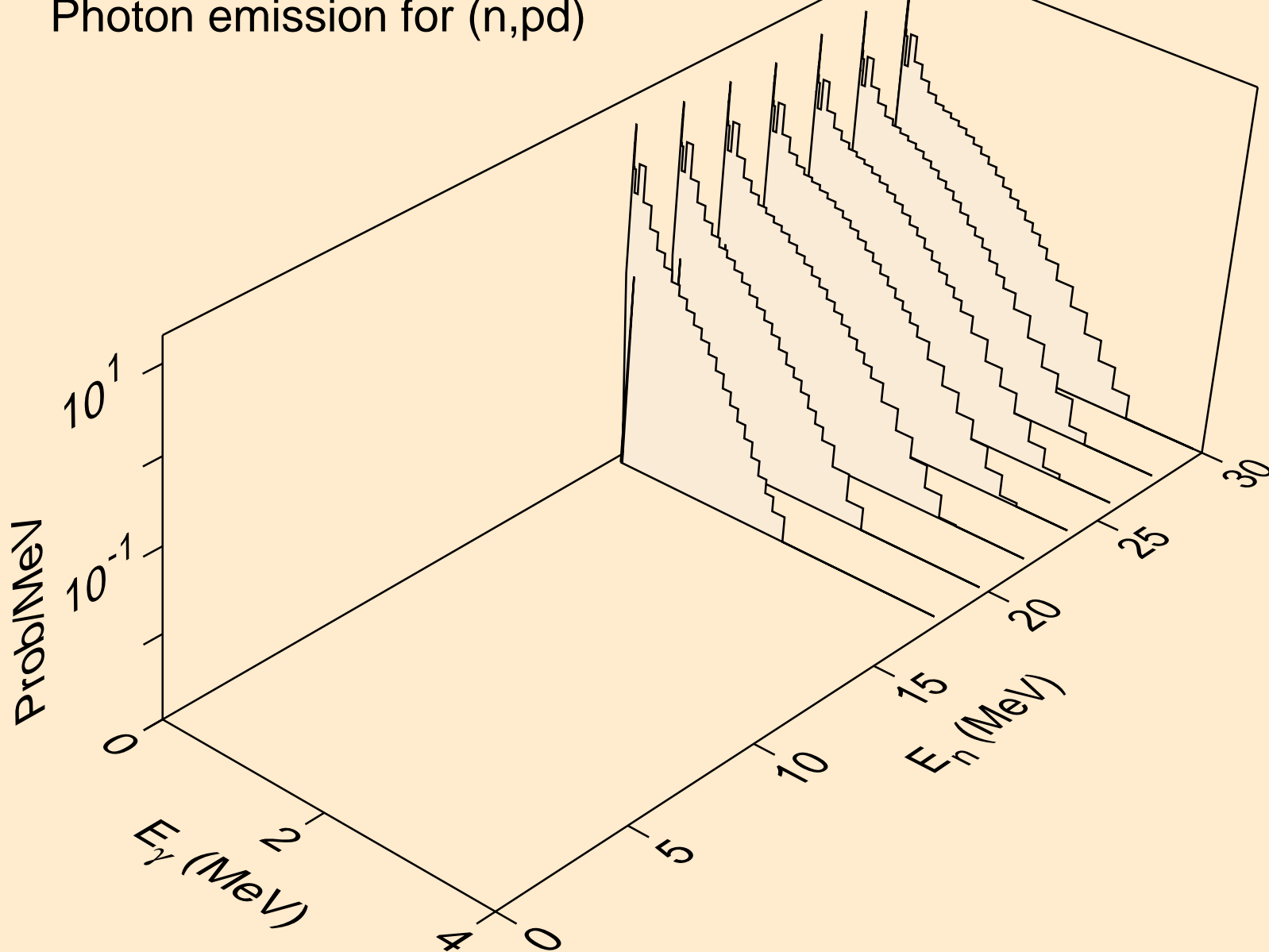

BH269 NEUTRON ACER TENDL-2019 LIBRARY; T=293.16K
thermal capture photon spectrum

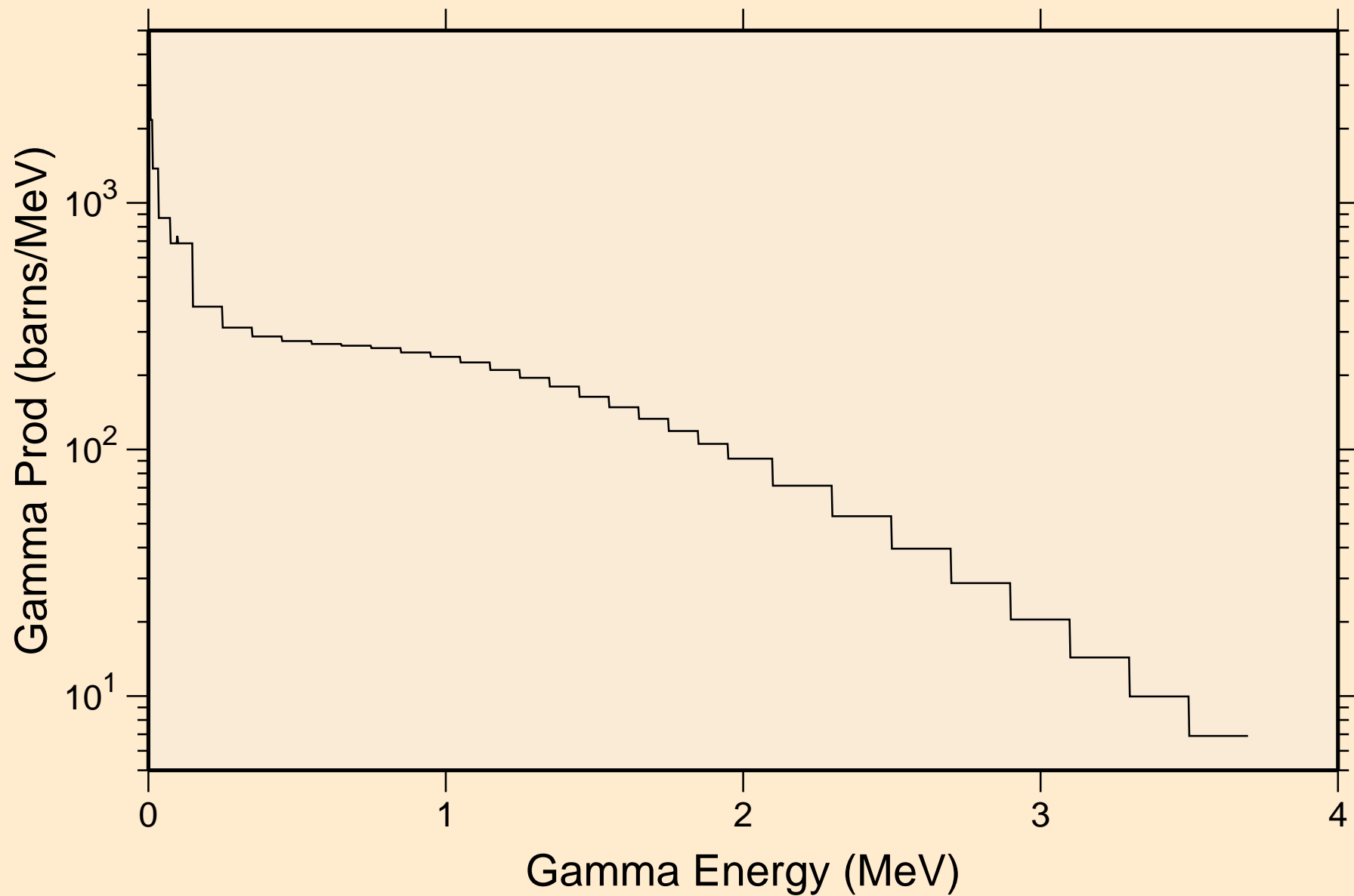

BH269 NEUTRON ACER TENDL-2019 LIBRARY; T=293.16K
14 MeV photon spectrum

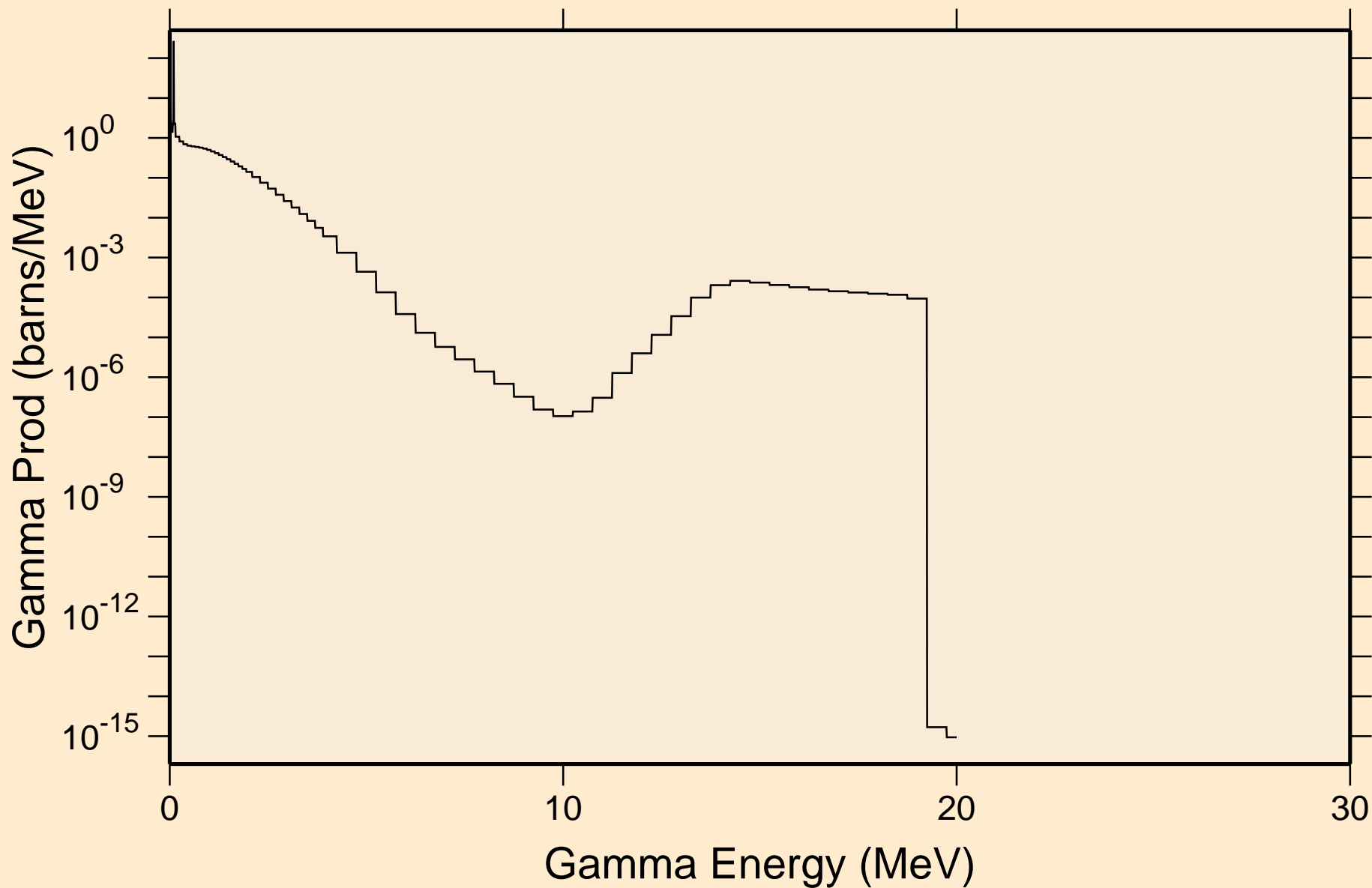

BH269 NEUTRON ACER TENDL-2019 LIBRARY; T=293.16K
Particle heating contributions

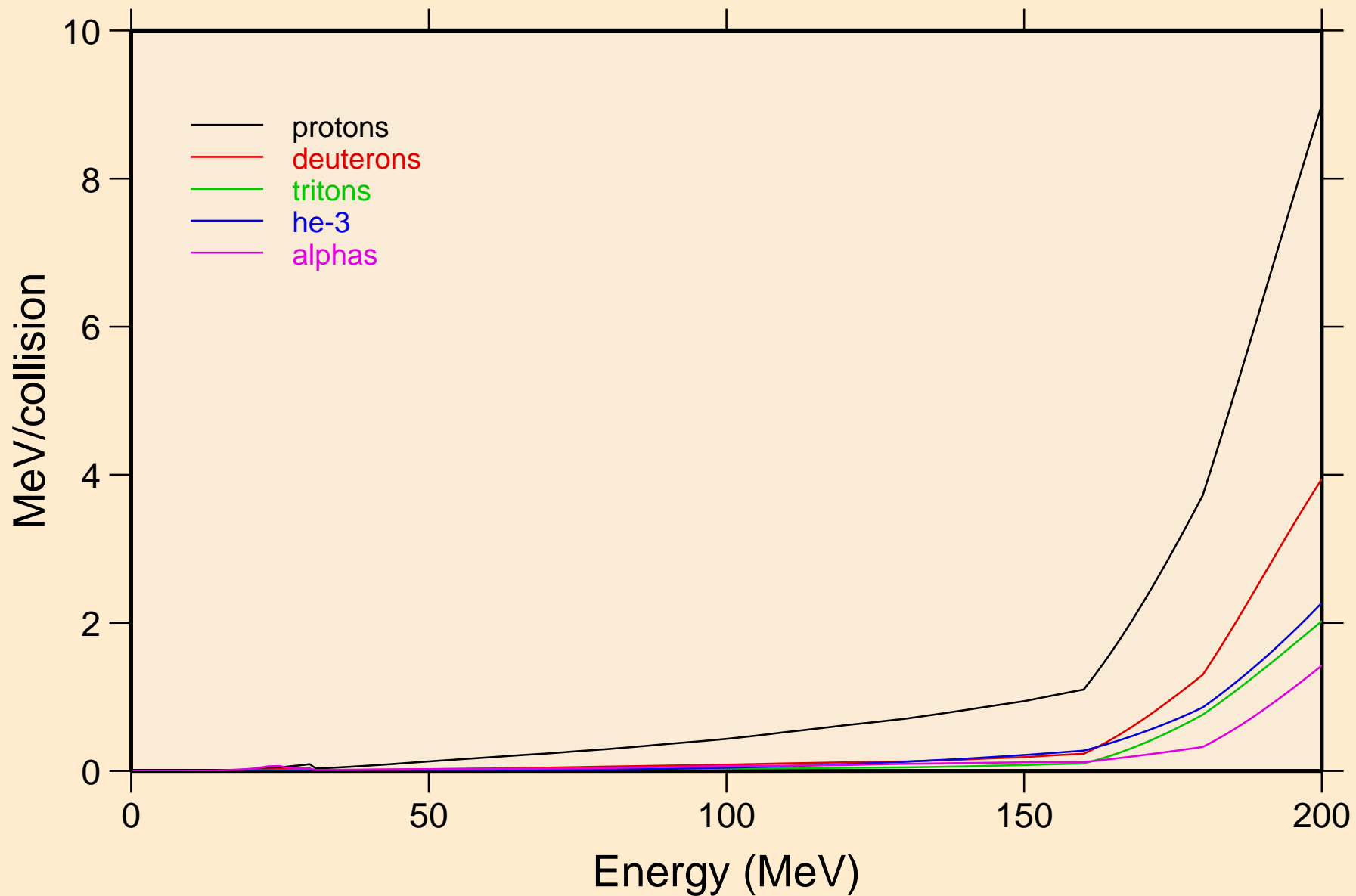

BH269 NEUTRON ACER TENDL-2019 LIBRARY; T=293.16K
Recoil Heating

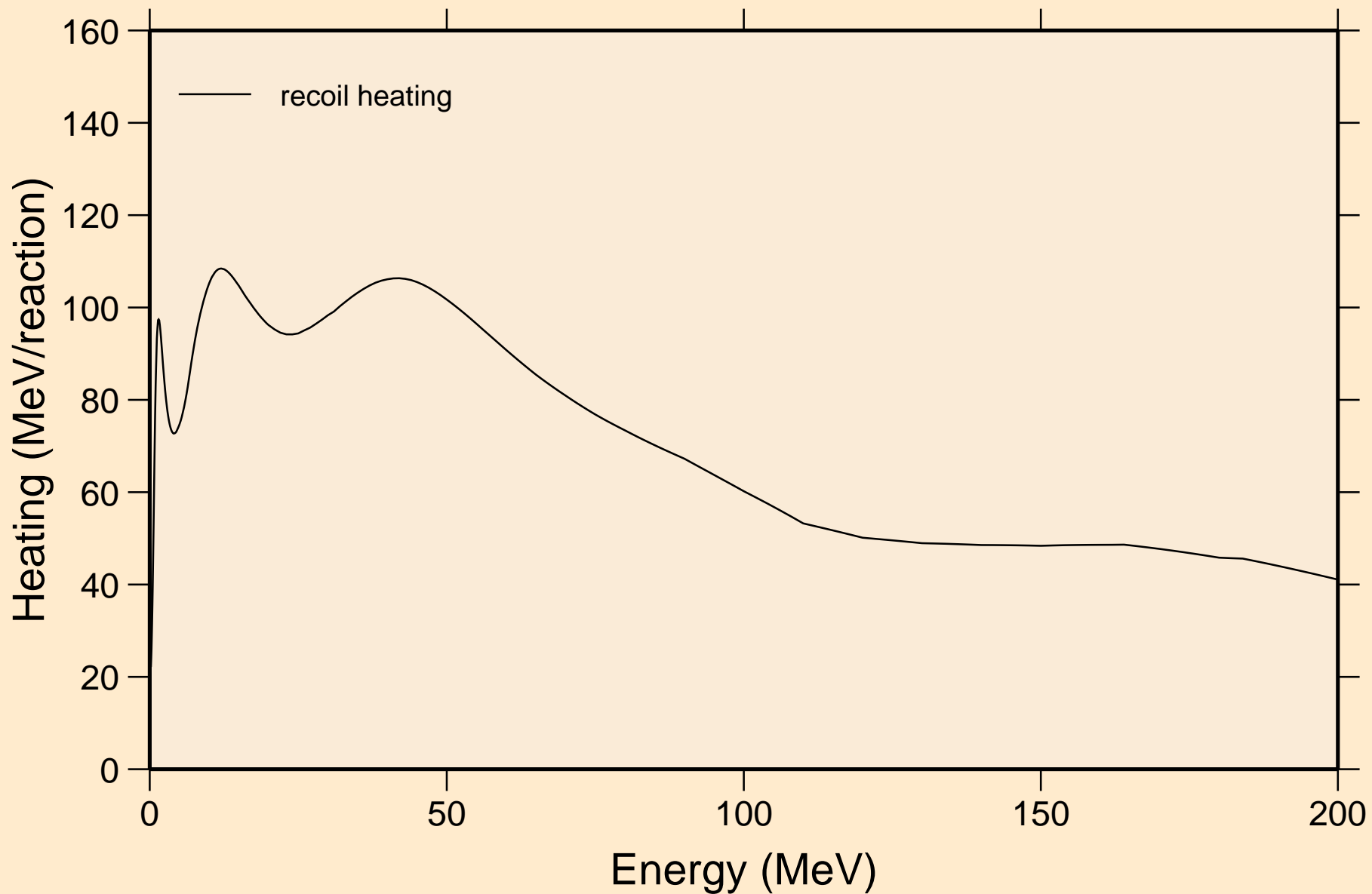

BH269 NEUTRON ACER TENDL-2019 LIBRARY; T=293.16K
Particle production cross sections

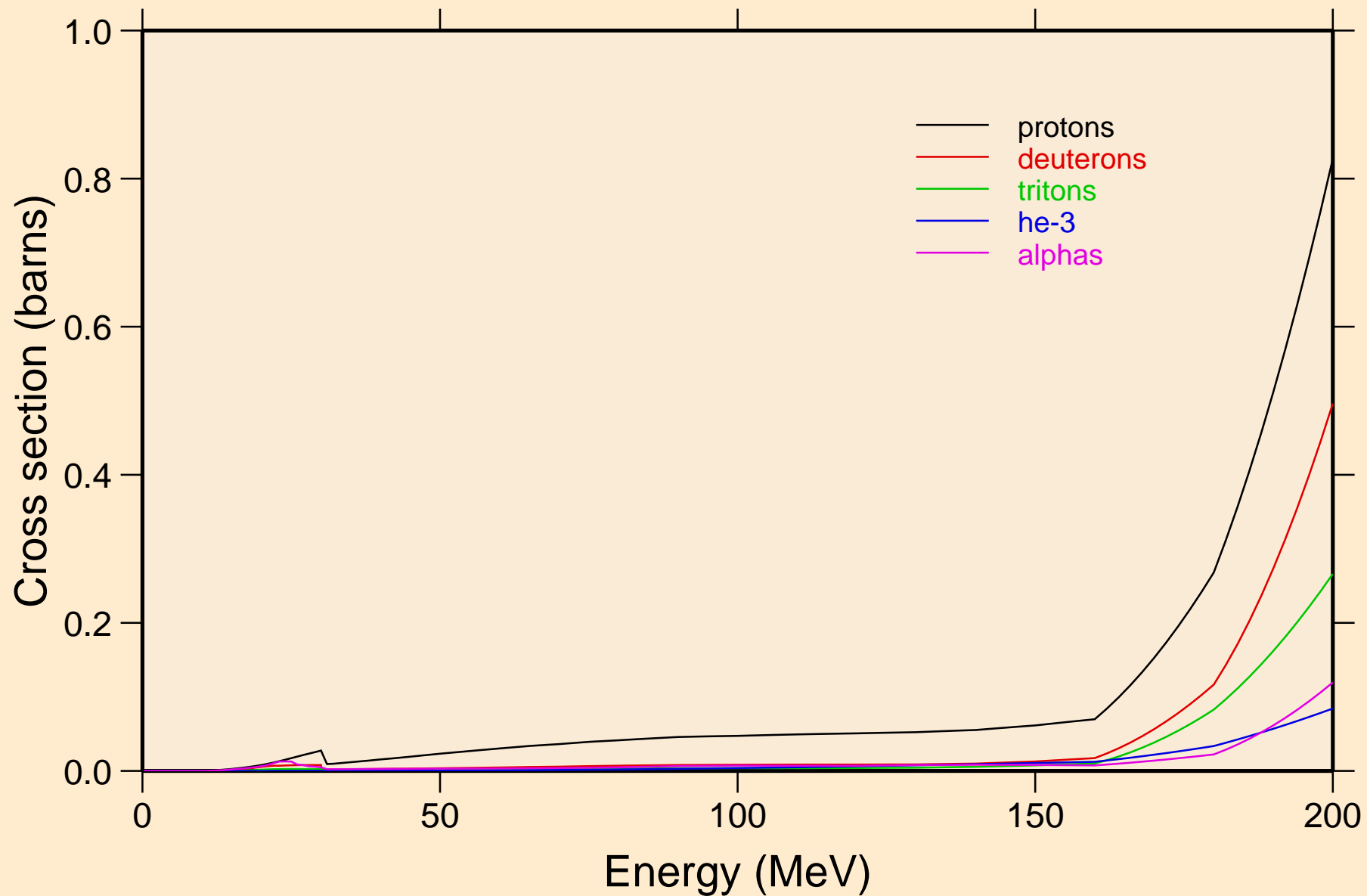

BH269 NEUTRON ACER TENDL-2019 LIBRARY; T=293.16K
protons from (n,x)

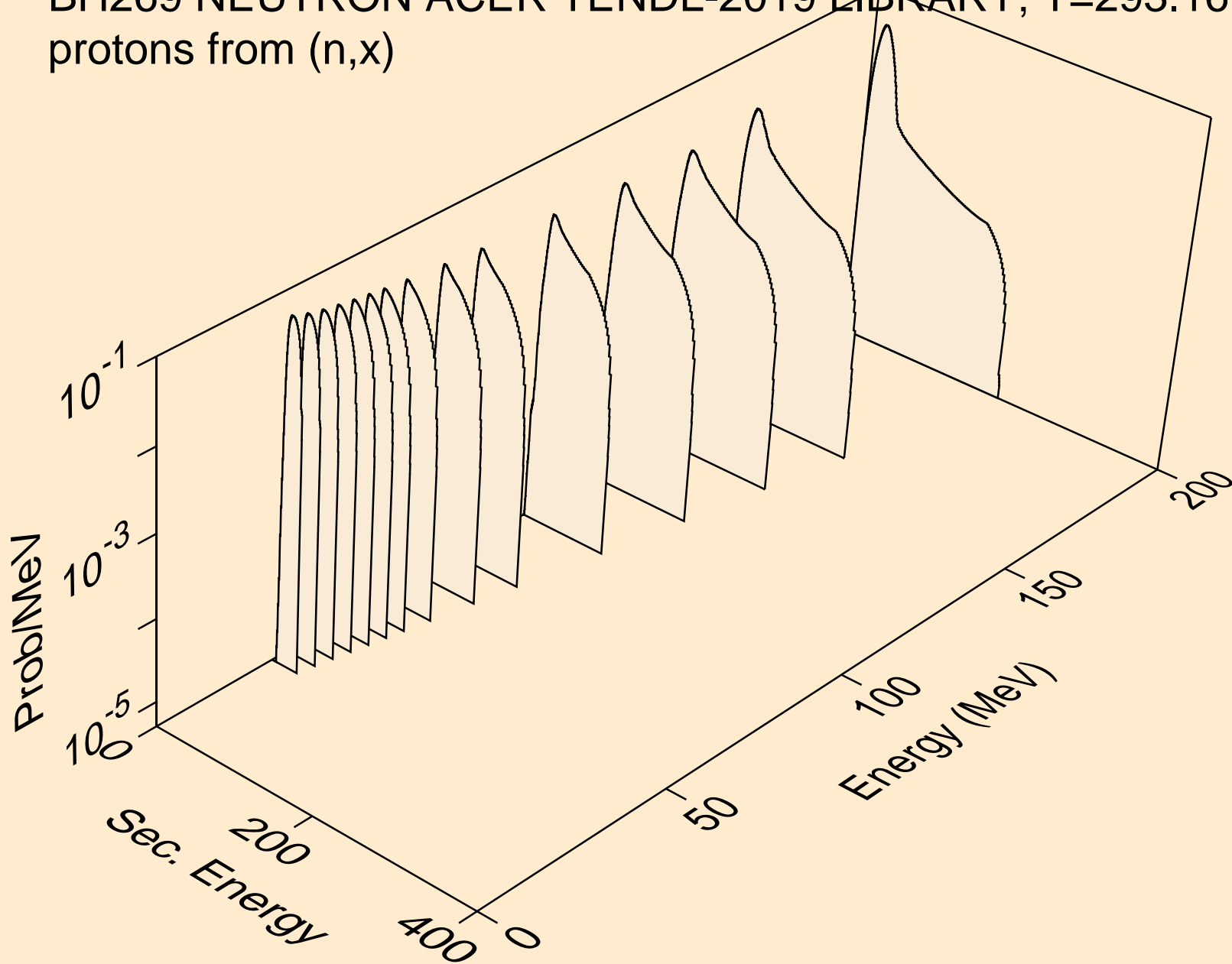

BH269 NEUTRON ACER TENDL-2019 LIBRARY; T=293.16K
protons from (n,n*)p

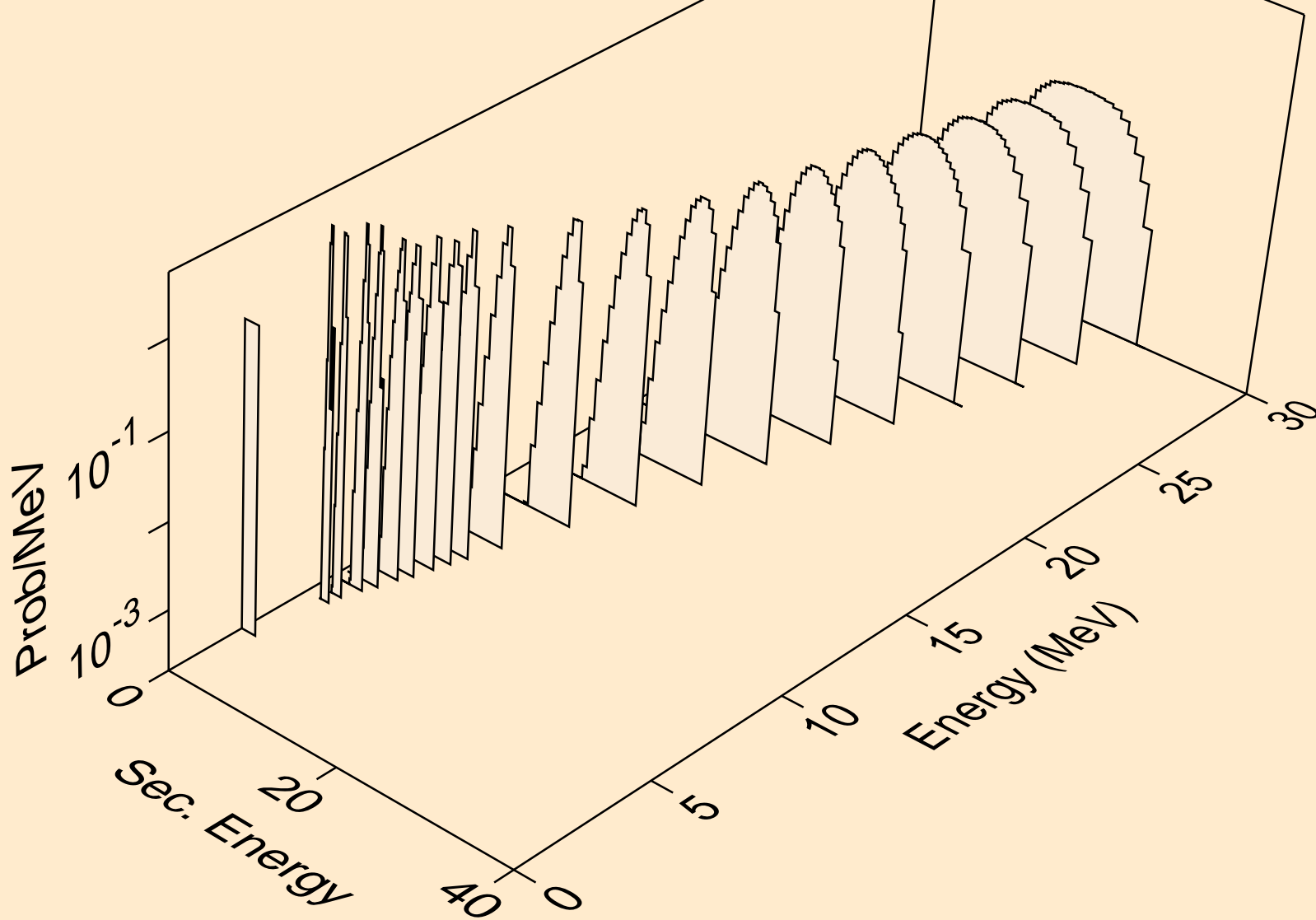

BH269 NEUTRON ACER TENDL-2019 LIBRARY; T=293.16K
protons from (n,2np)

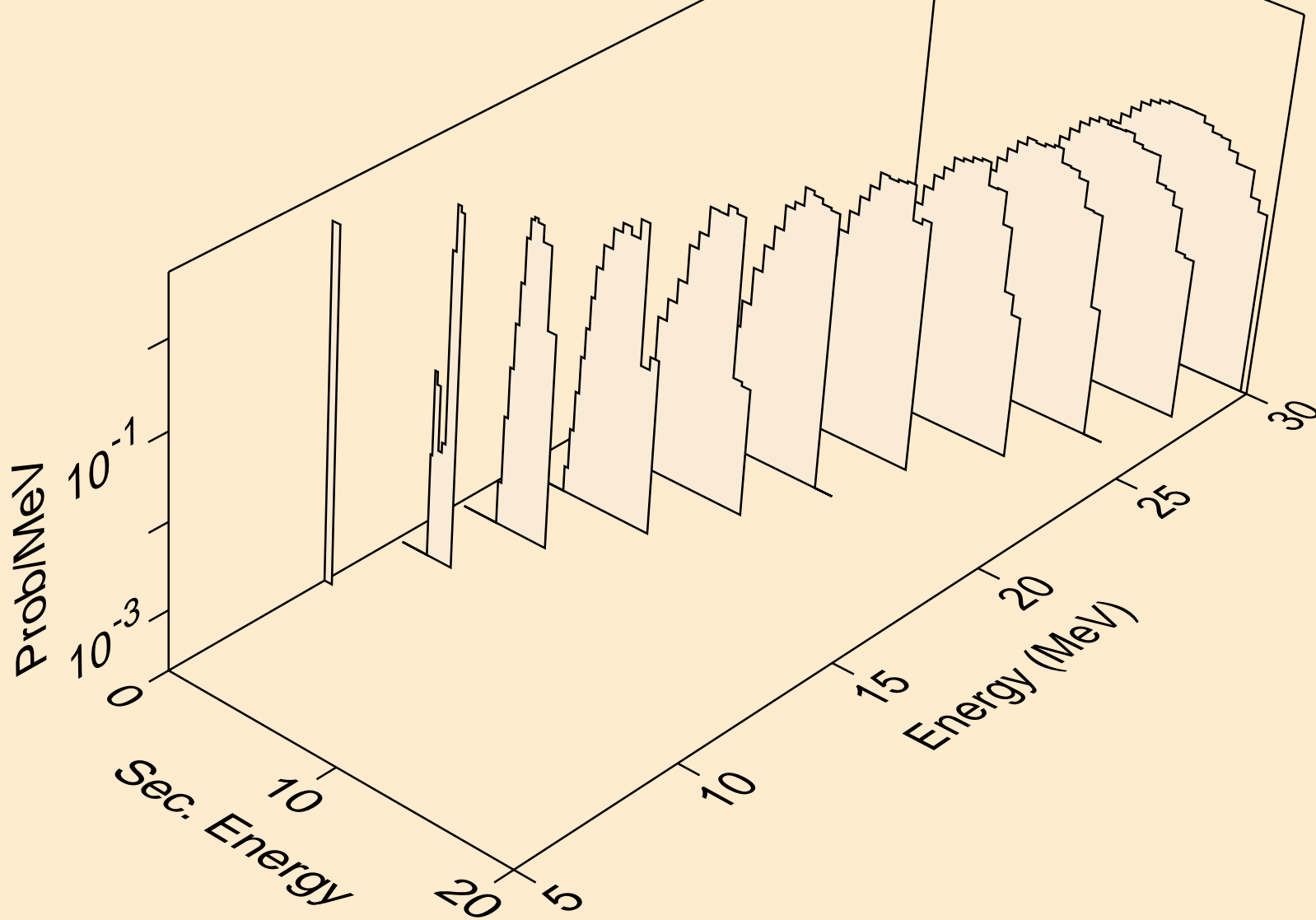

BH269 NEUTRON ACER TENDL-2019 LIBRARY; T=293.16K
protons from (n,3np)

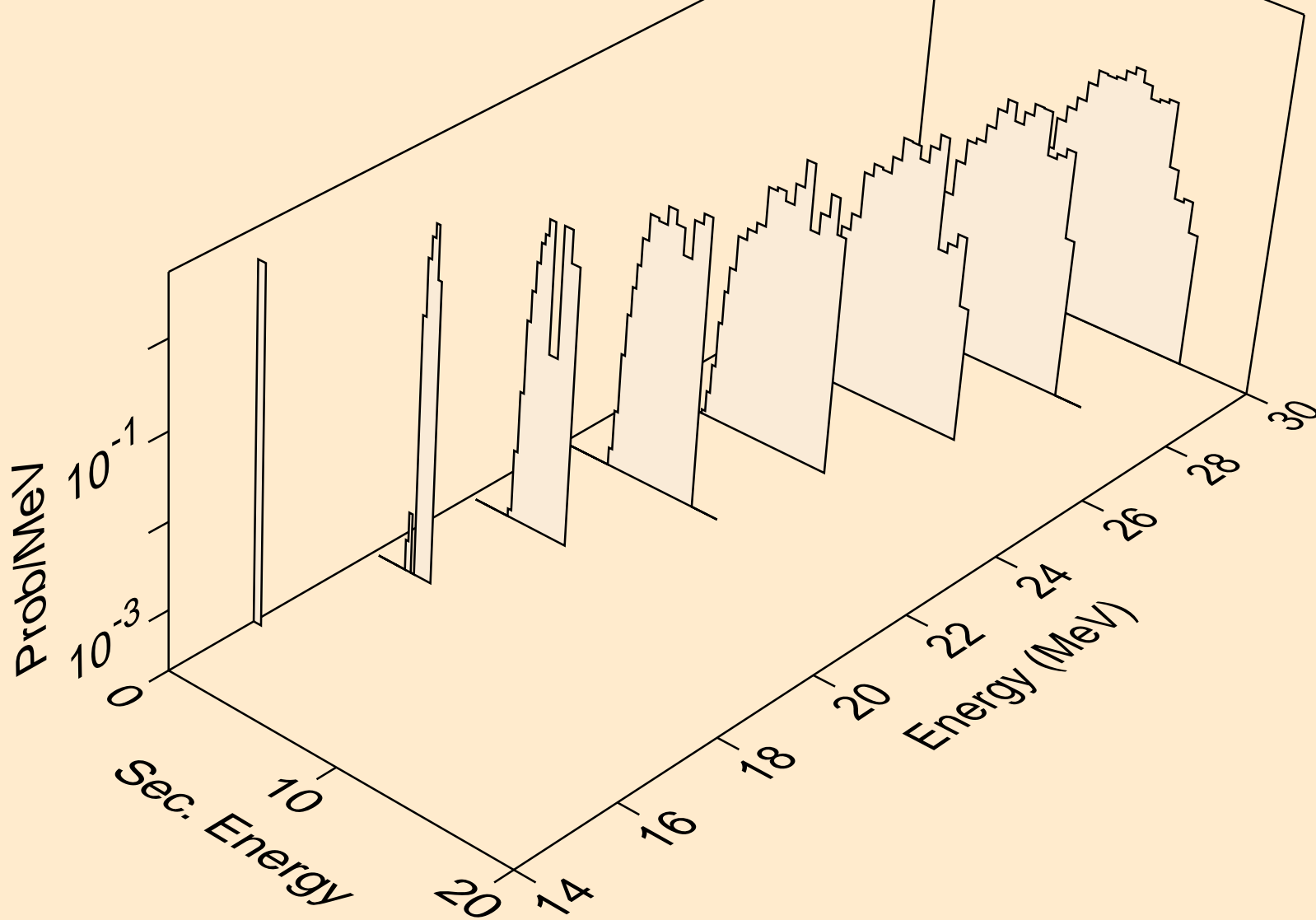

BH269 NEUTRON ACER TENDL-2019 LIBRARY; T=293.16K
protons from (n,2np)

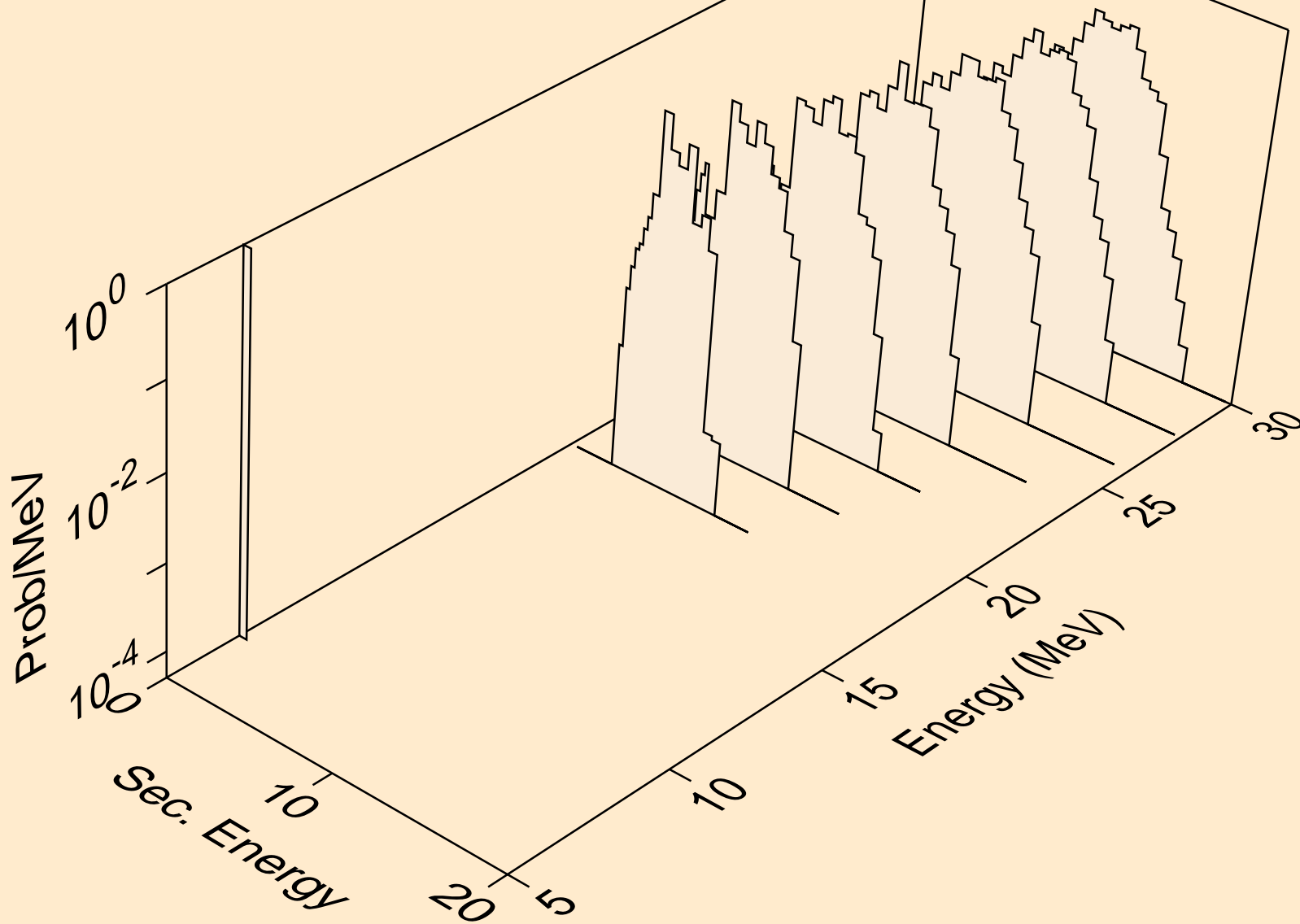

BH269 NEUTRON ACER TENDL-2019 LIBRARY; T=293.16K
protons from (n,p)

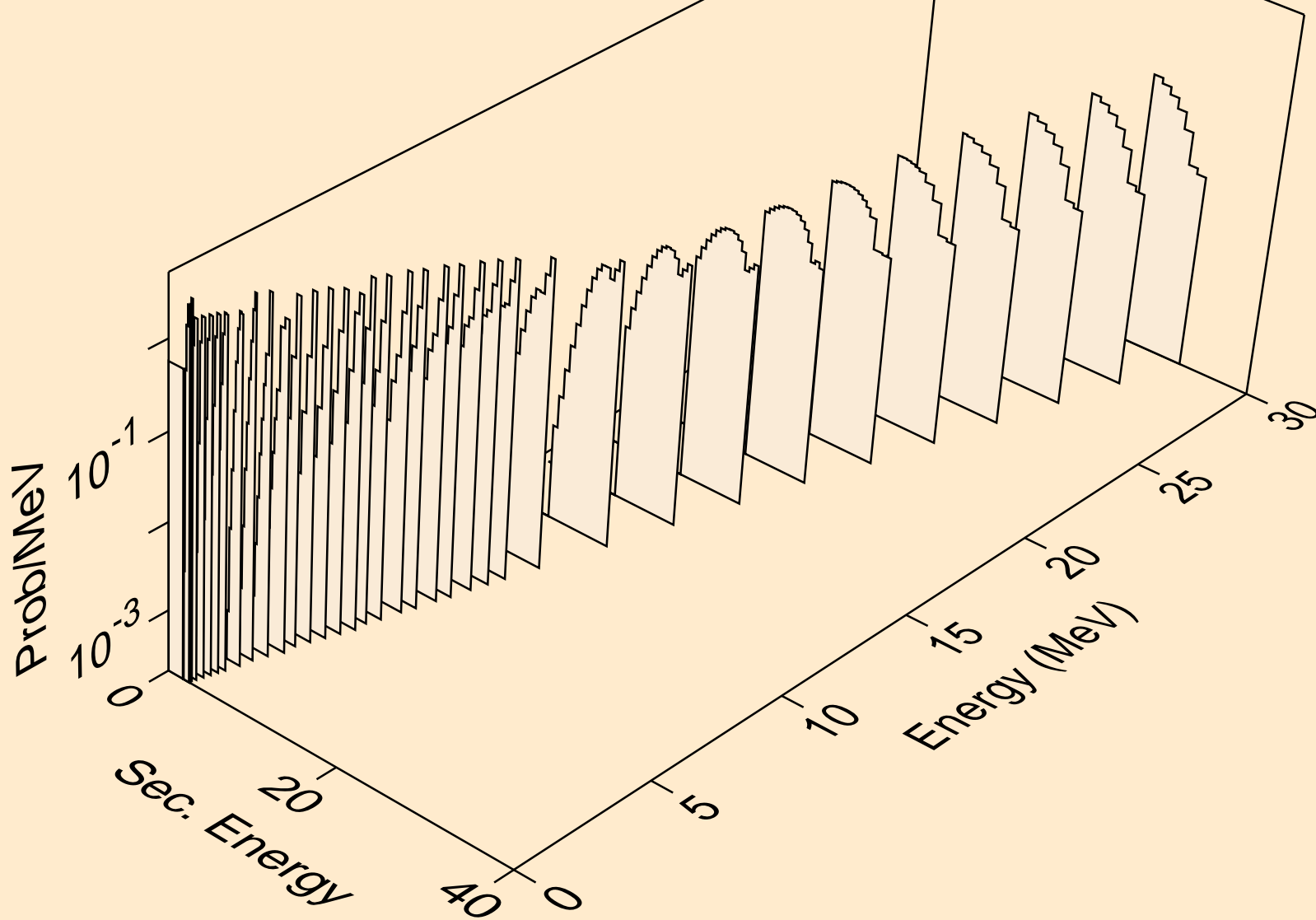

BH269 NEUTRON ACER TENDL-2019 LIBRARY; T=293.16K
protons from (n,2p)

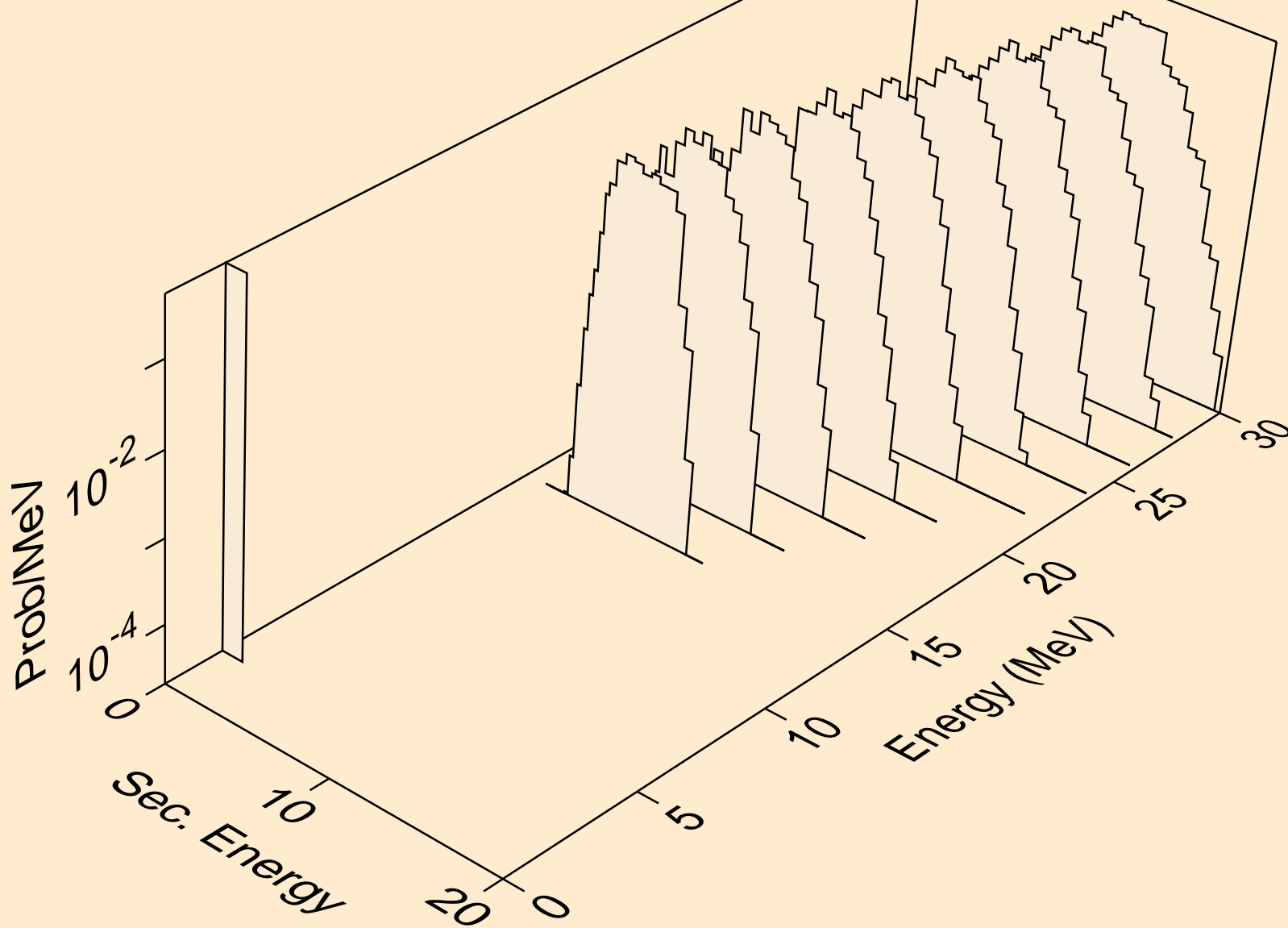

BH269 NEUTRON ACER TENDL-2019 LIBRARY; T=293.16K
protons from (n,p)

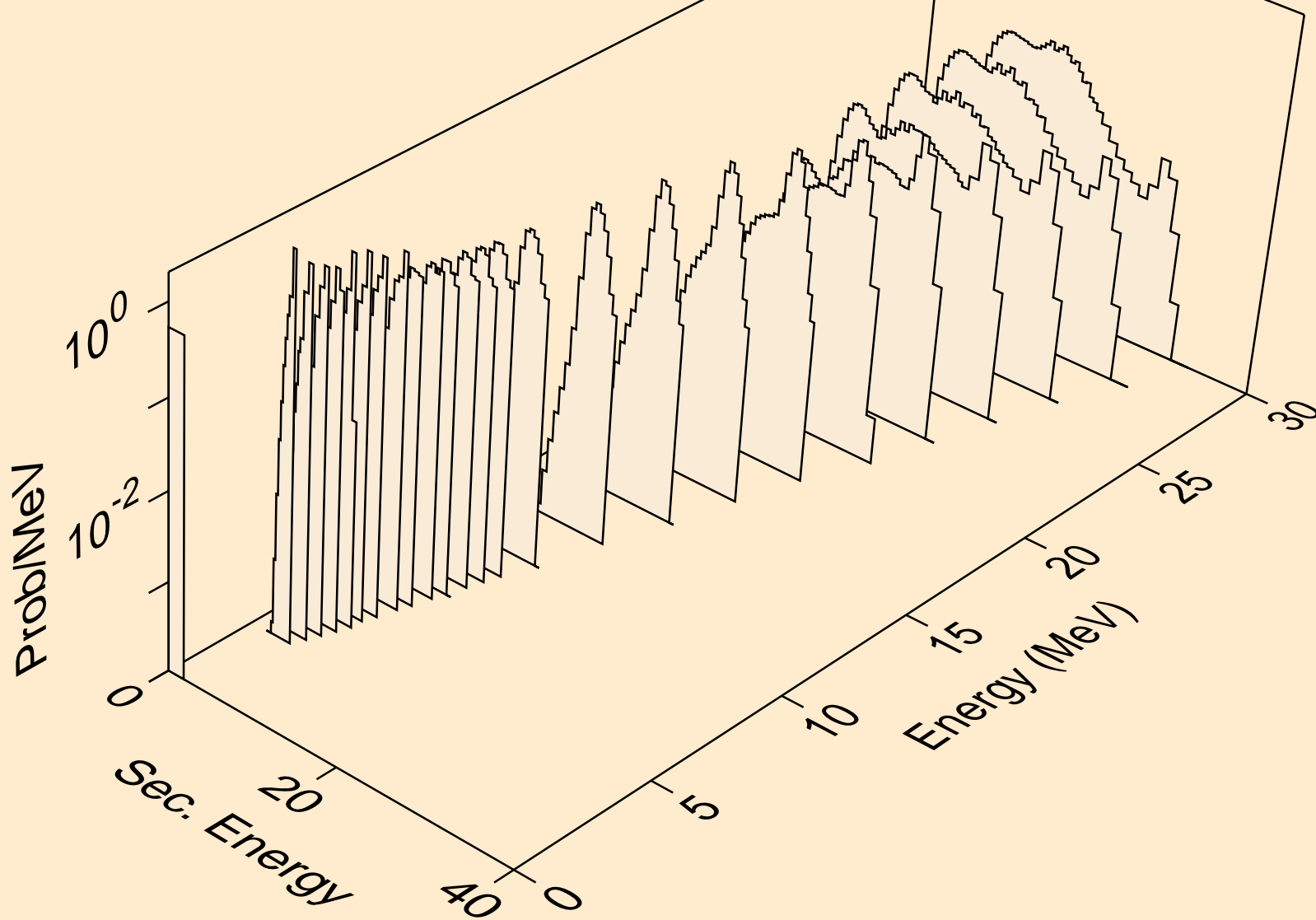

BH269 NEUTRON ACER TENDL-2019 LIBRARY; T=293.16K
protons from (n,pd)

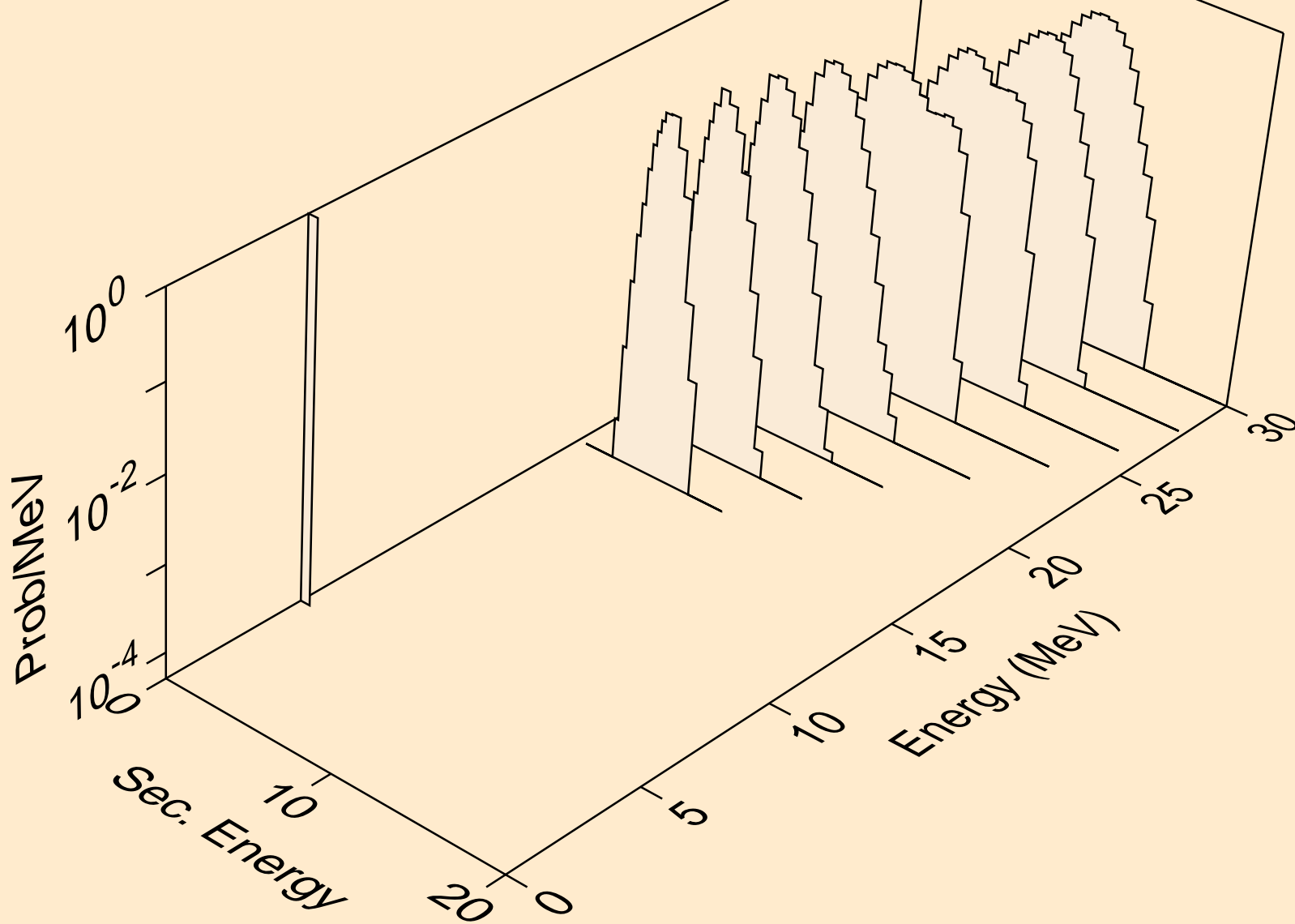

BH269 NEUTRON ACER TENDL-2019 LIBRARY; T=293.16K
deuterons from (n,x)

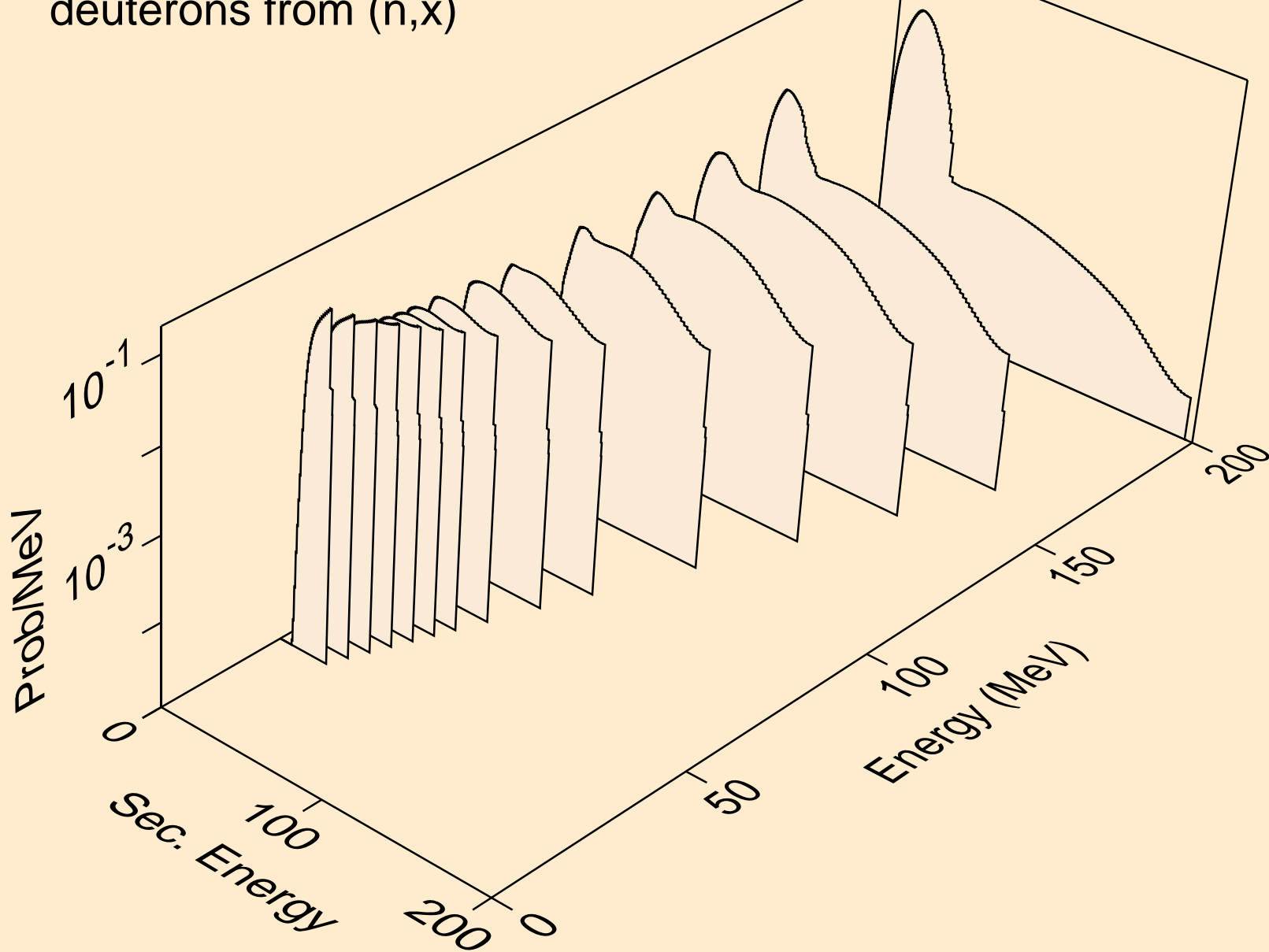

BH269 NEUTRON ACER TENDL-2019 LIBRARY; T=293.16K
deuterons from (n,2nd)

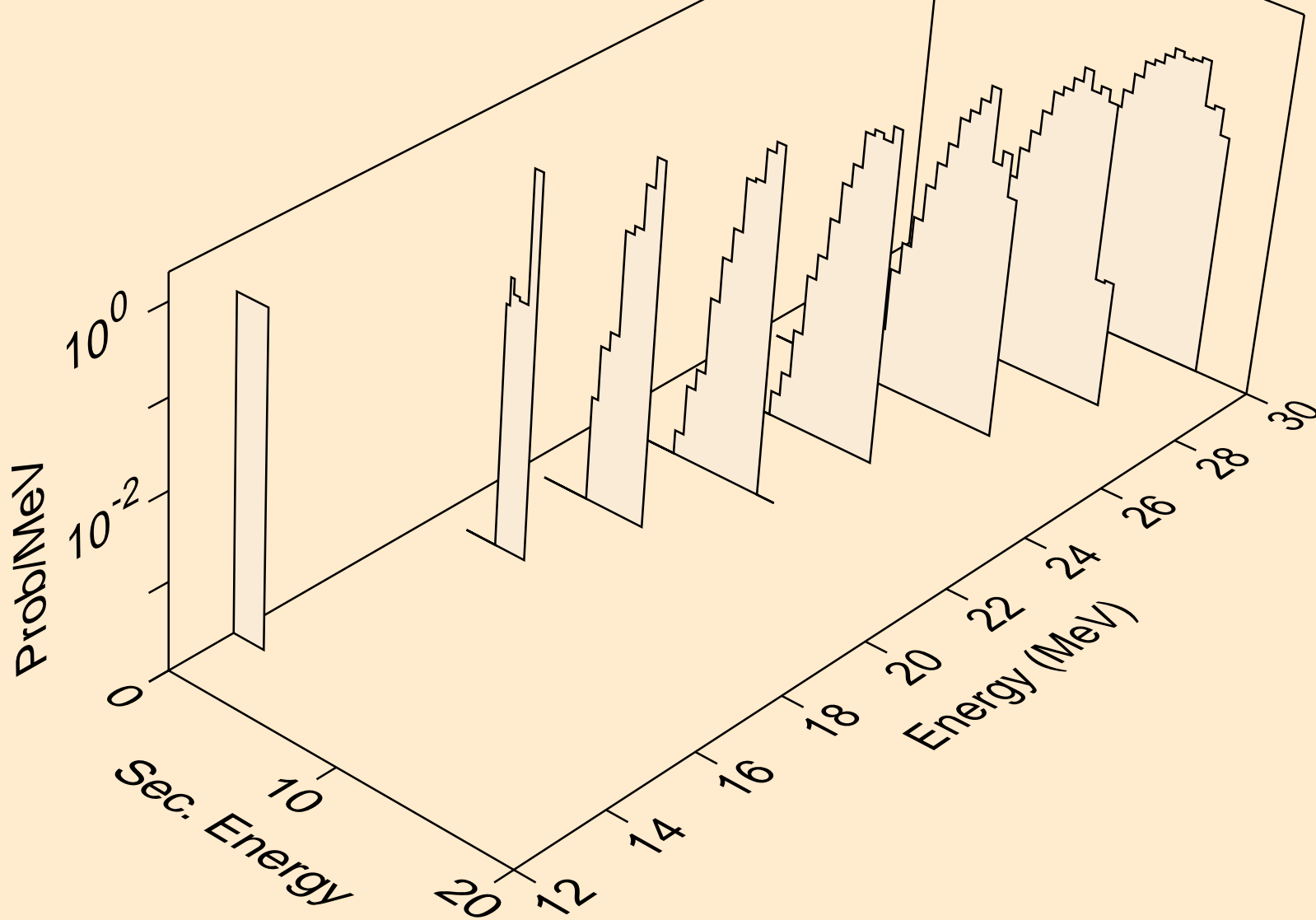

BH269 NEUTRON ACER TENDL-2019 LIBRARY; T=293.16K
deuterons from (n,n*)d

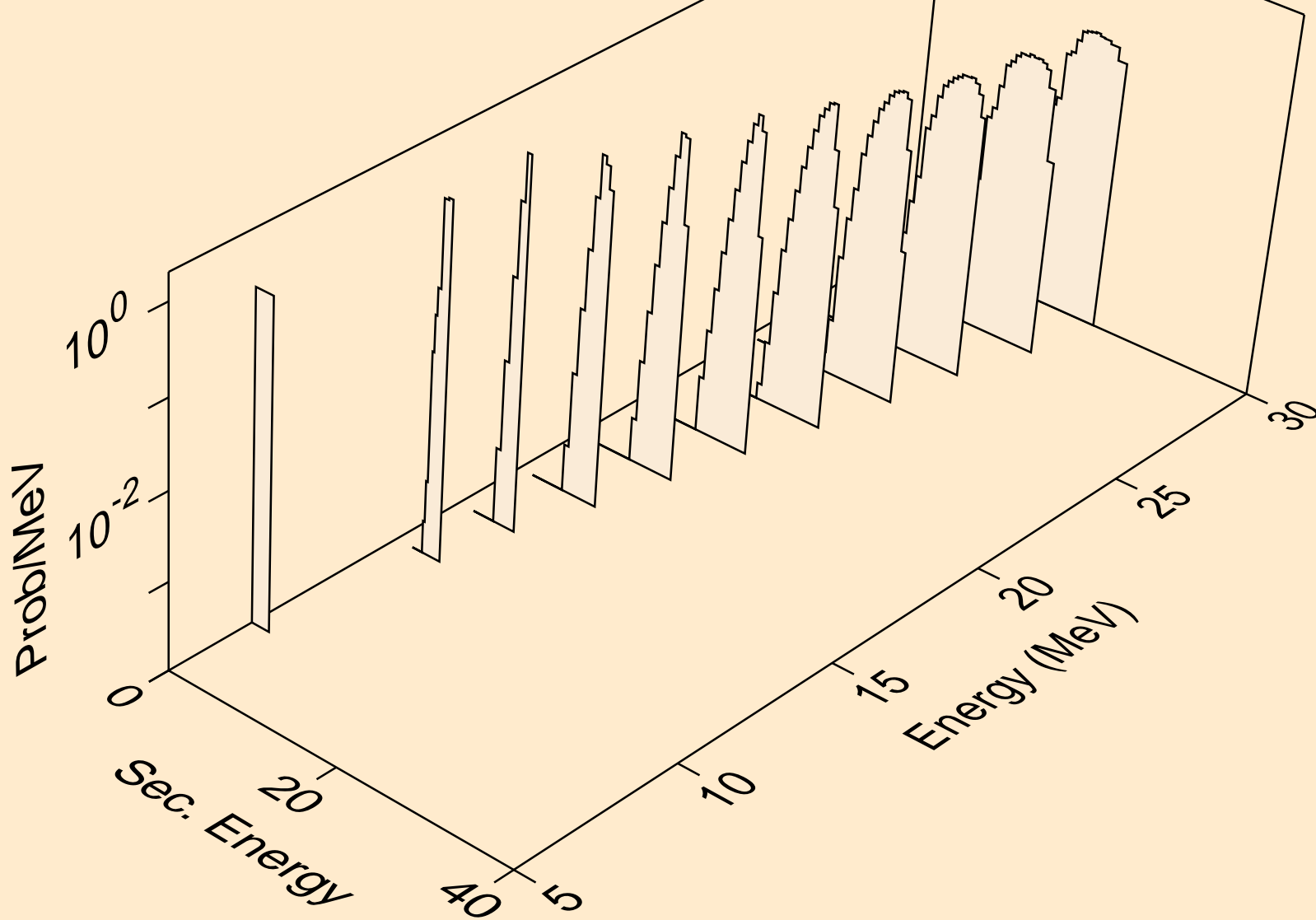

BH269 NEUTRON ACER TENDL-2019 LIBRARY; T=293.16K
deuterons from (n,d)

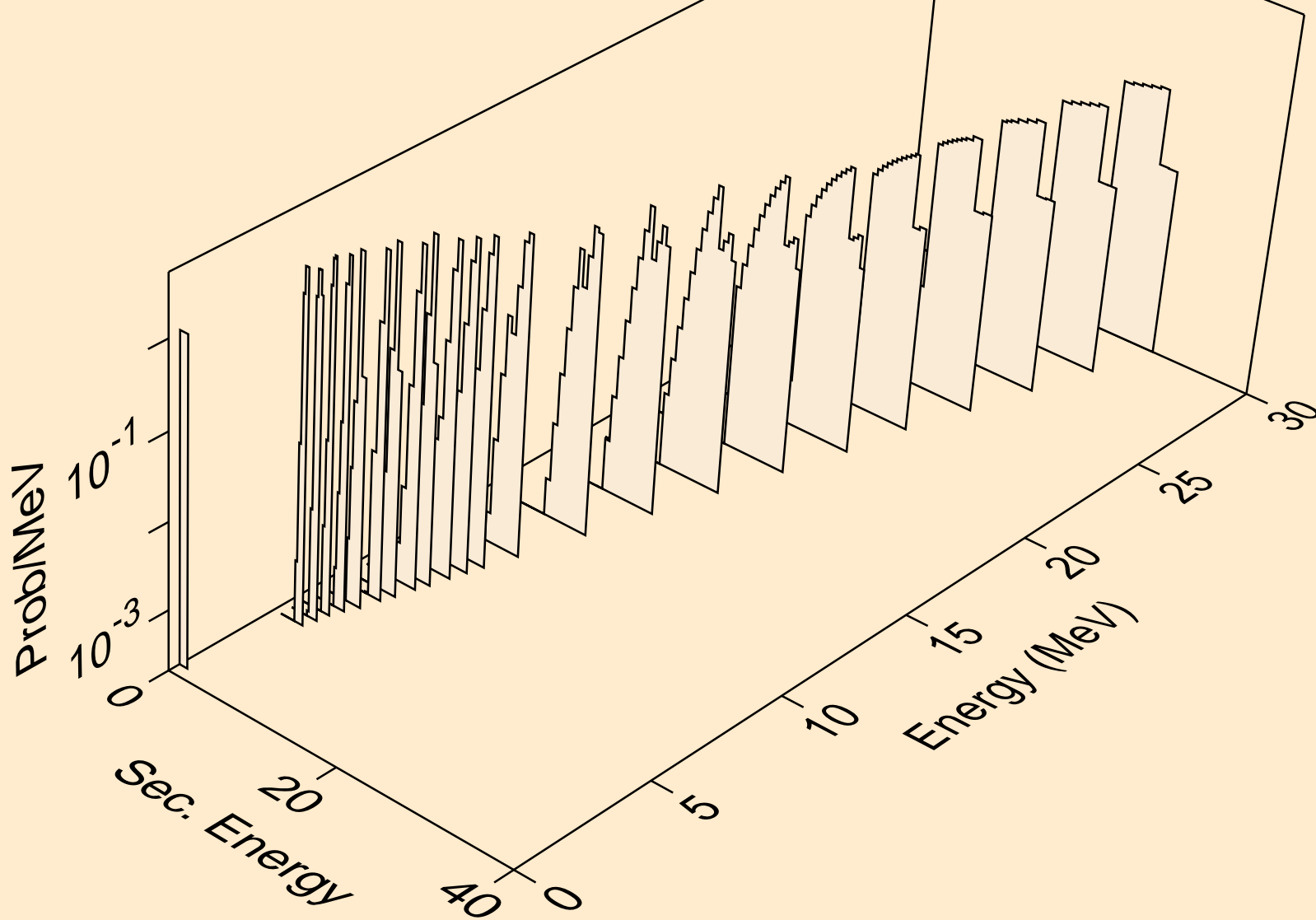

BH269 NEUTRON ACER TENDL-2019 LIBRARY; T=293.16K
deuterons from (n,pd)

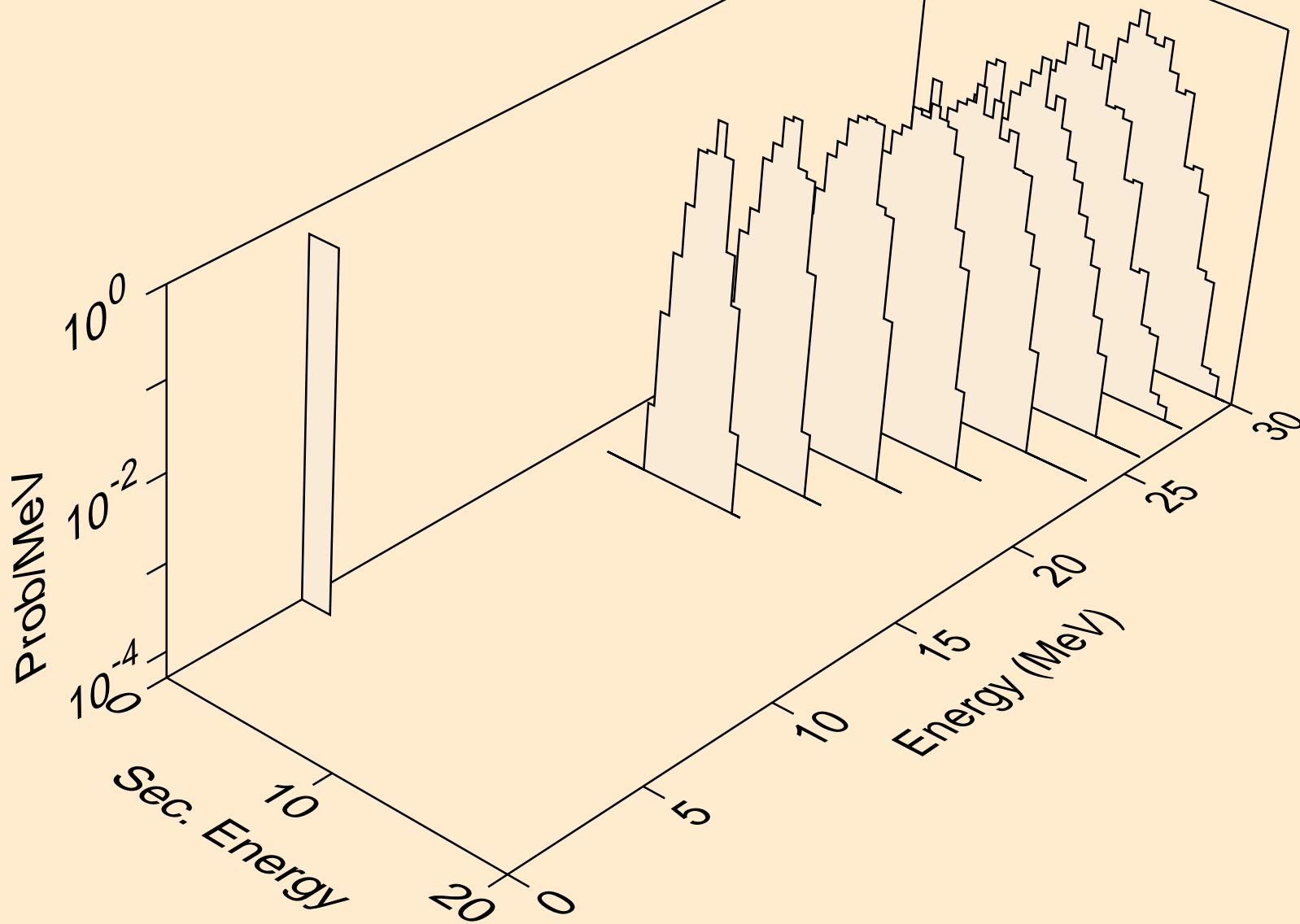

BH269 NEUTRON ACER TENDL-2019 LIBRARY; T=293.16K
tritons from (n,x)

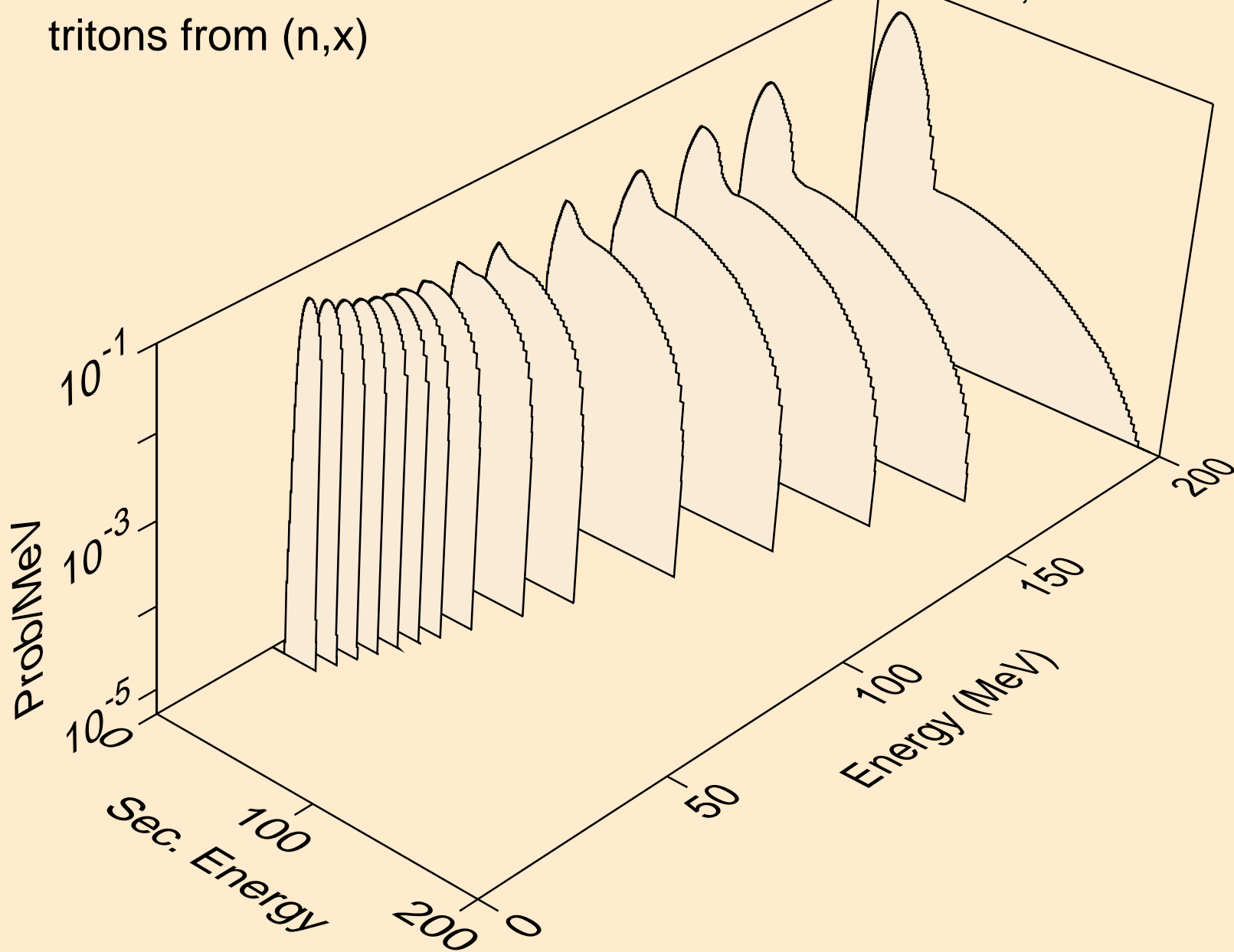

BH269 NEUTRON ACER TENDL-2019 LIBRARY; T=293.16K
tritons from (n,n*)t

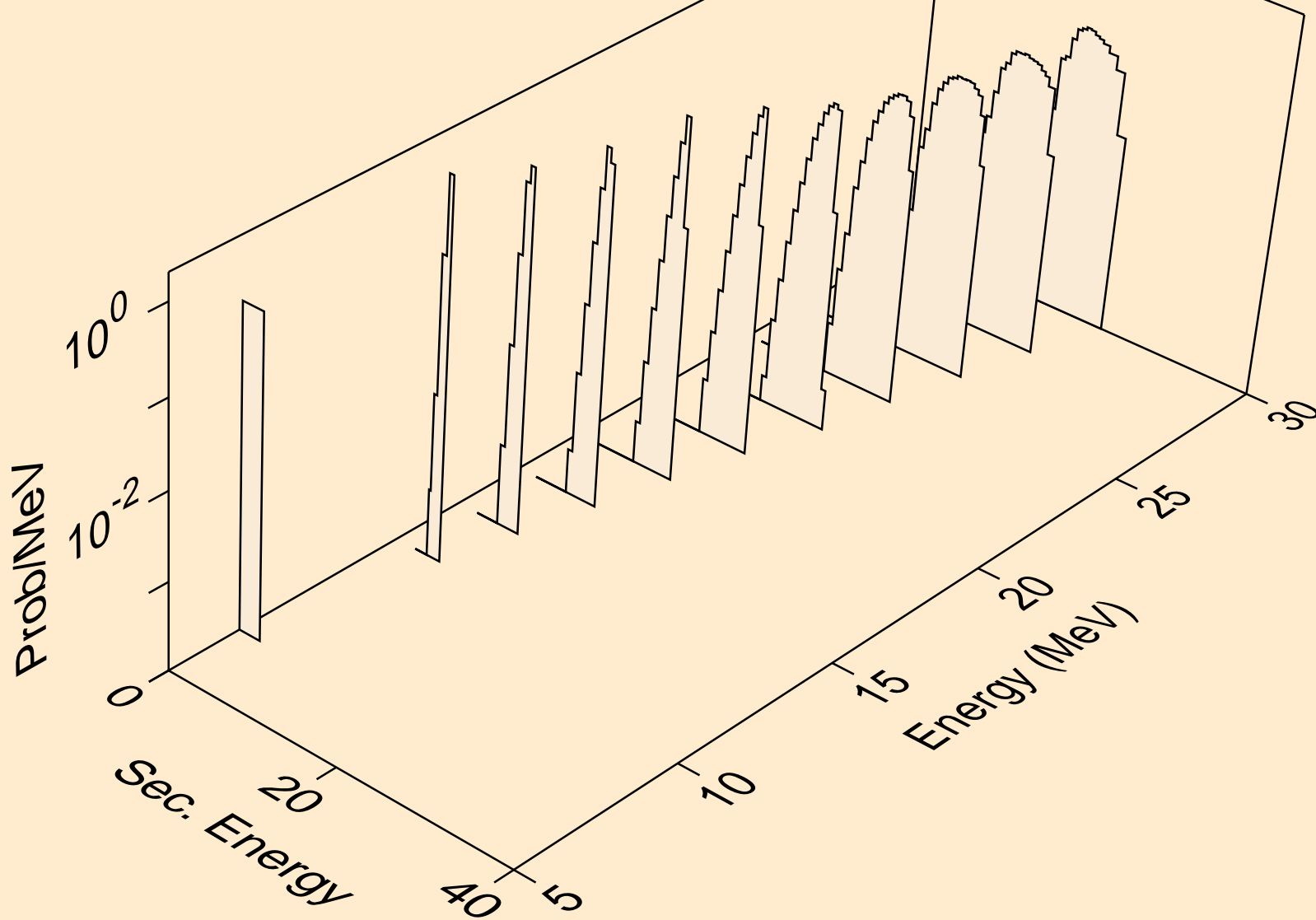

BH269 NEUTRON ACER TENDL-2019 LIBRARY; T=293.16K
tritons from (n,t)

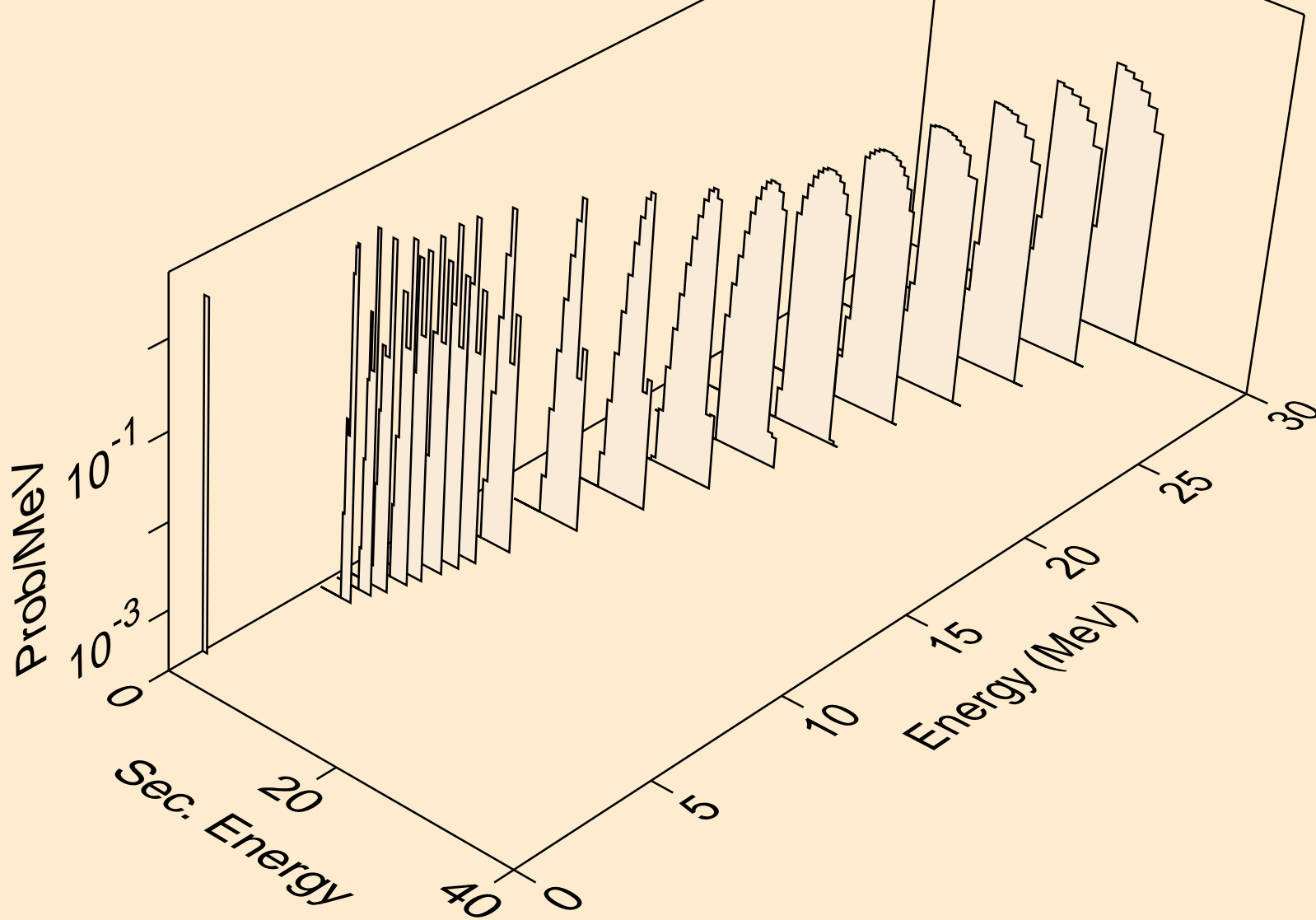

BH269 NEUTRON ACER TENDL-2019 LIBRARY; T=293.16K
he3s from (n,x)

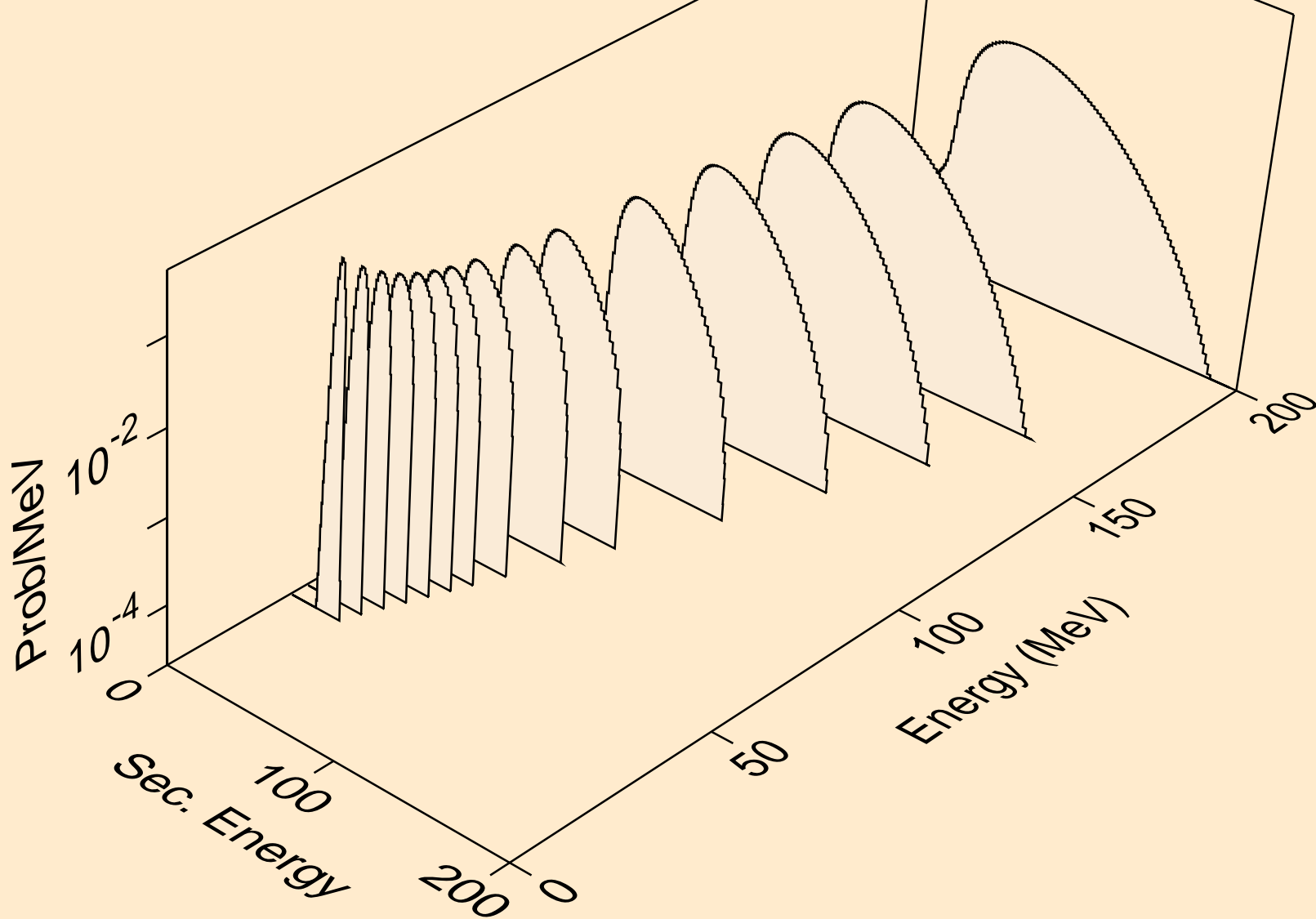

BH269 NEUTRON ACER TENDL-2019 LIBRARY; T=293.16K
he3s from (n,n*)he3

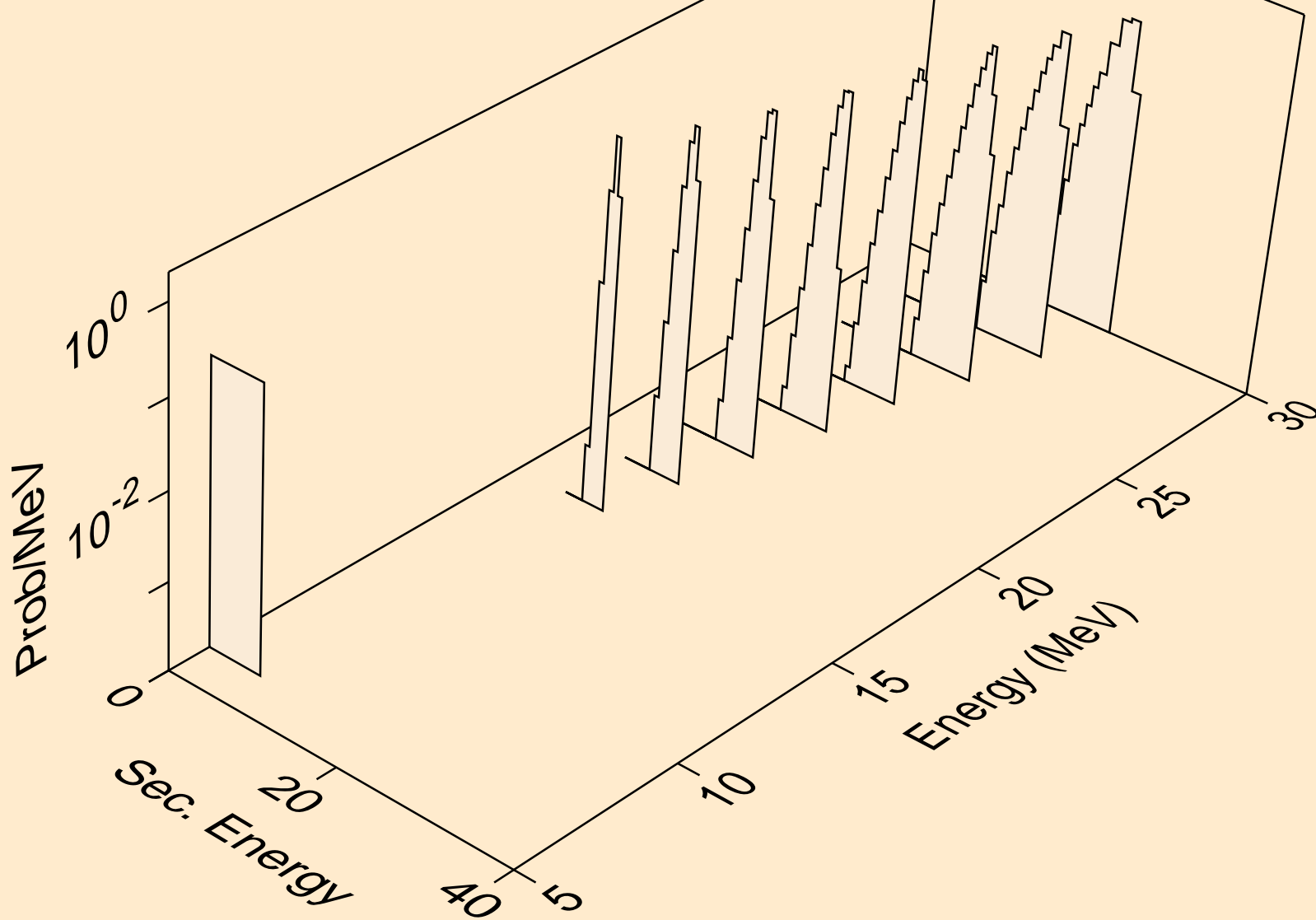

BH269 NEUTRON ACER TENDL-2019 LIBRARY; T=293.16K
he3s from (n,he3)

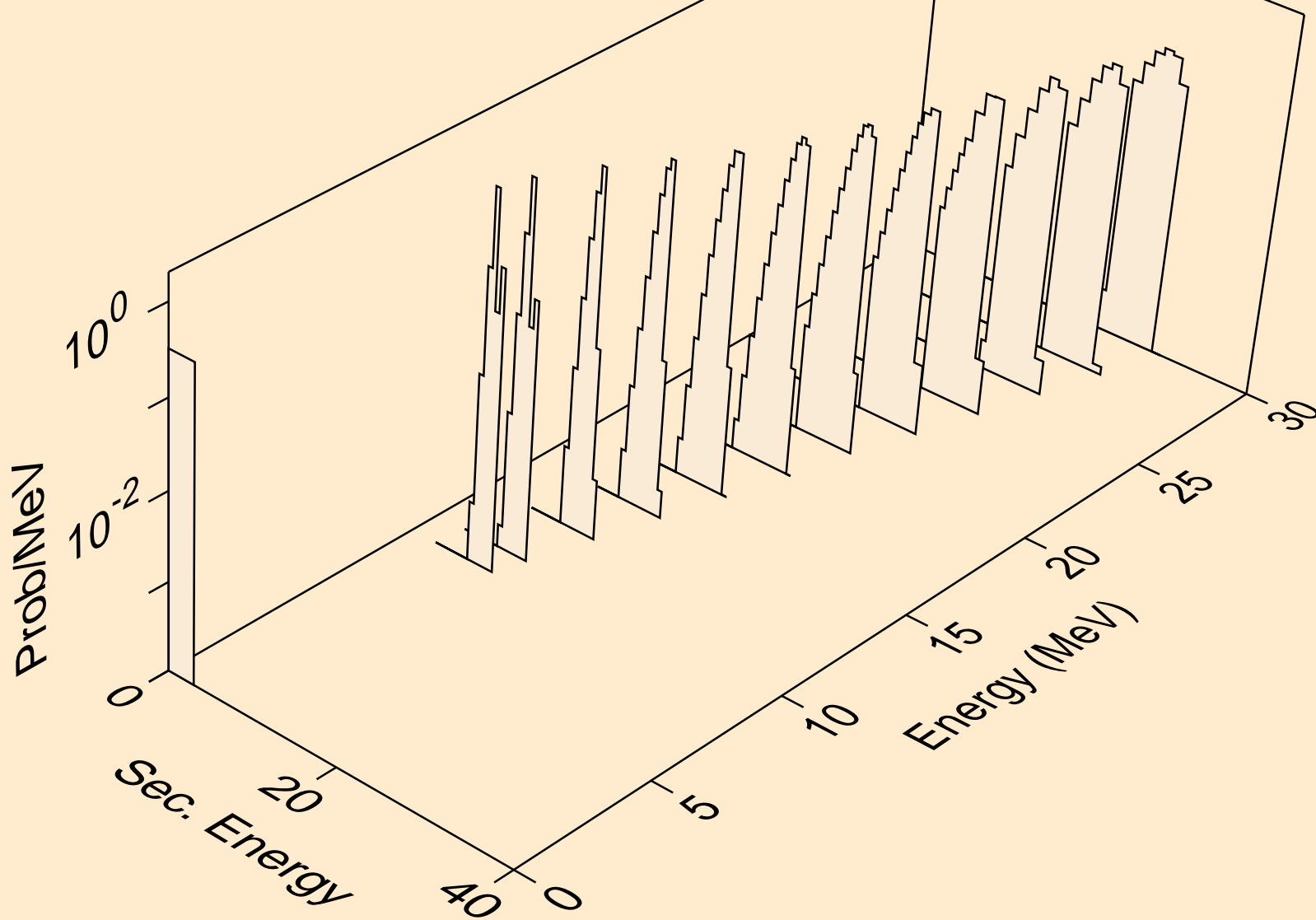

BH269 NEUTRON ACER TENDL-2019 LIBRARY; T=293.16K
alphas from (n,x)

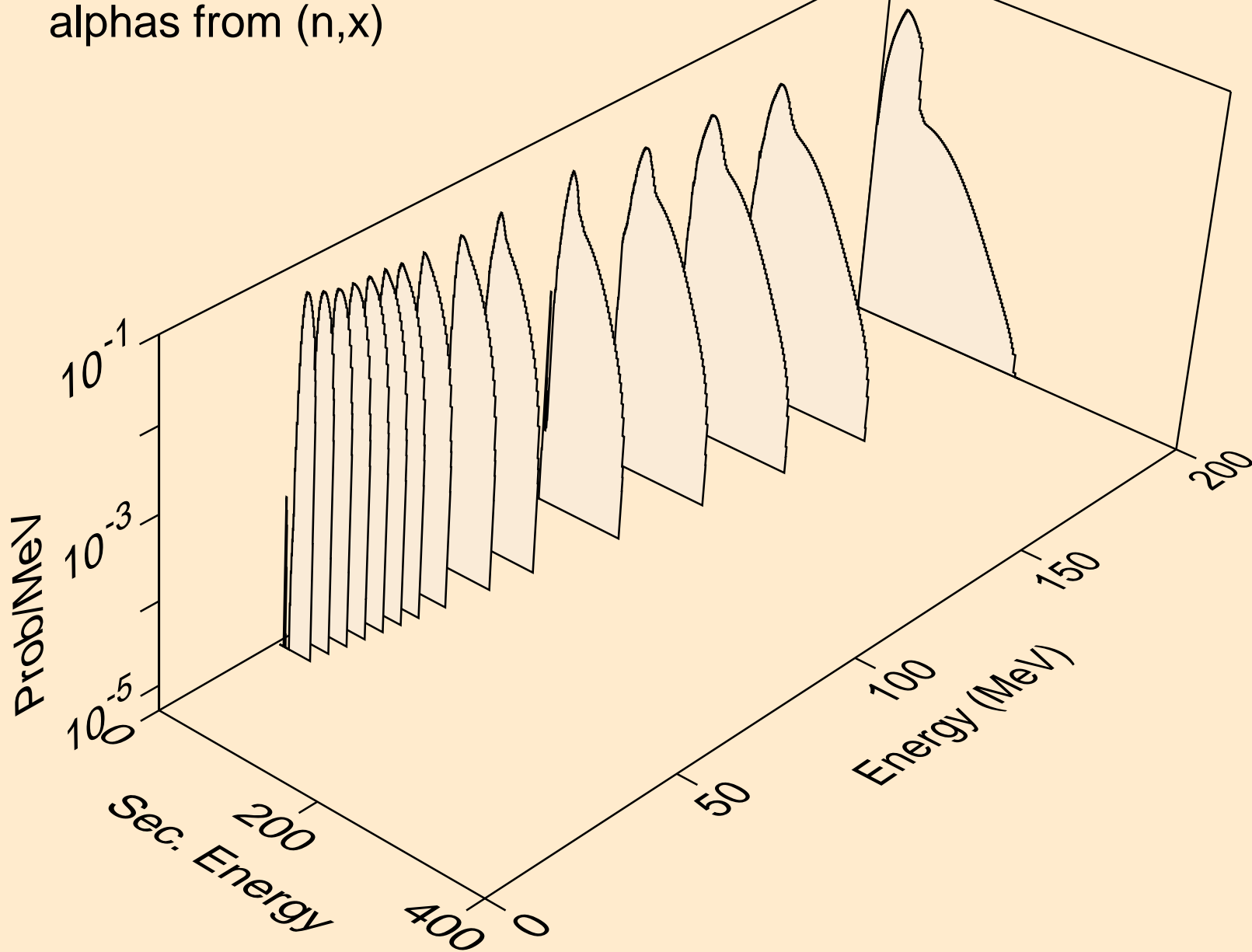

BH269 NEUTRON ACER TENDL-2019 LIBRARY; T=293.16K
alphas from (n,n*)a

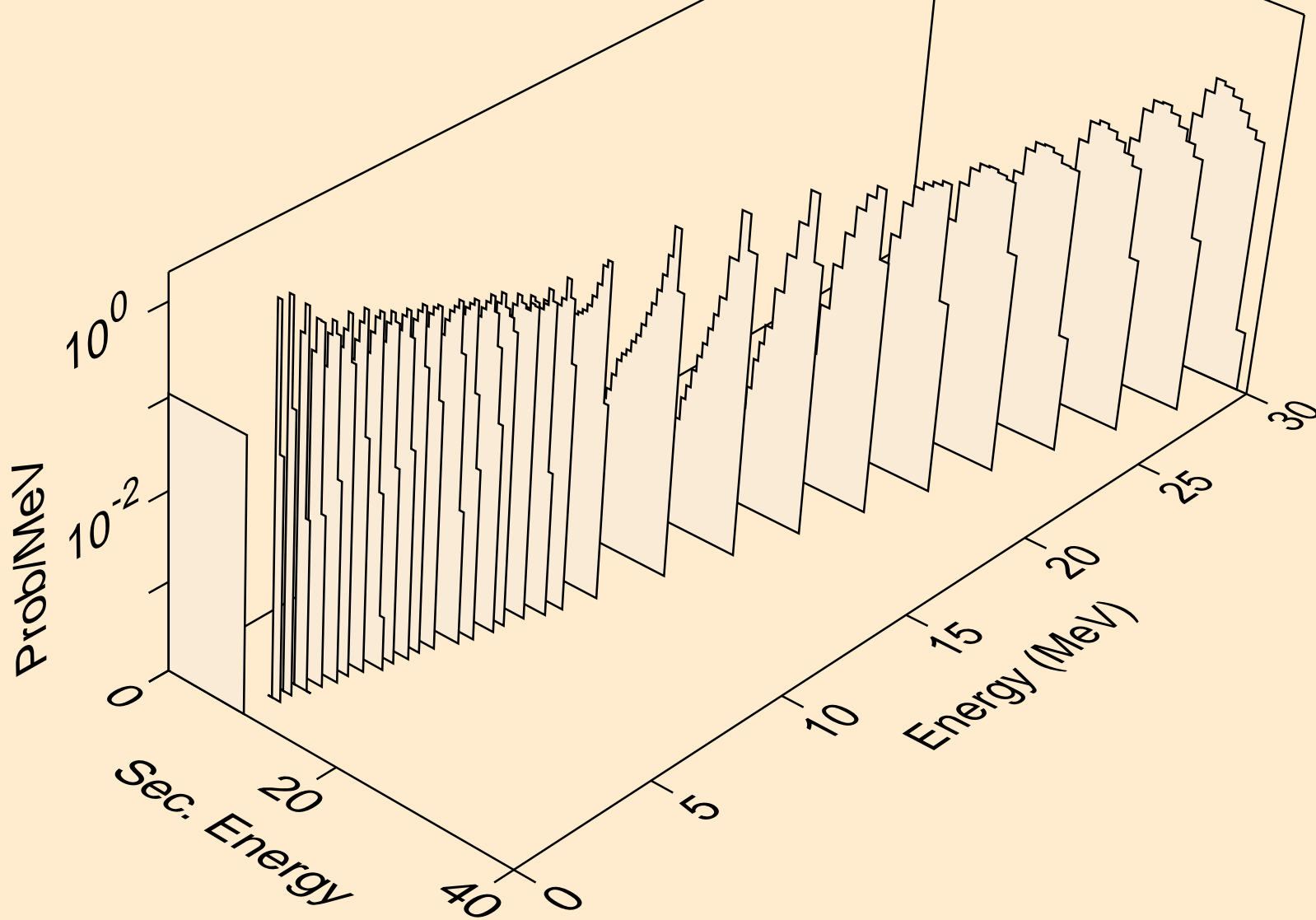

BH269 NEUTRON ACER TENDL-2019 LIBRARY; T=293.16K
alphas from (n,2n)a

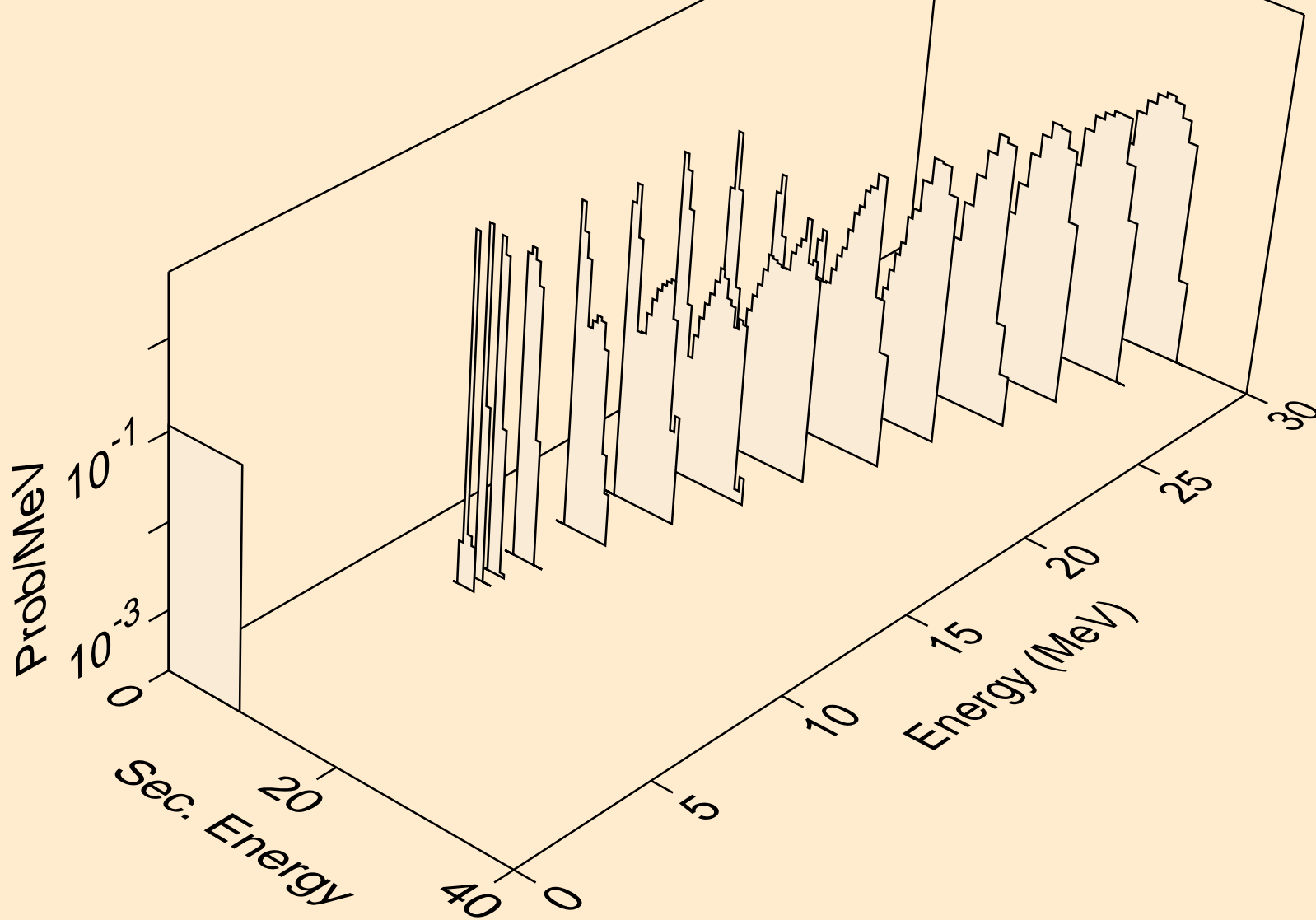

BH269 NEUTRON ACER TENDL-2019 LIBRARY; T=293.16K
alphas from (n,3n)a

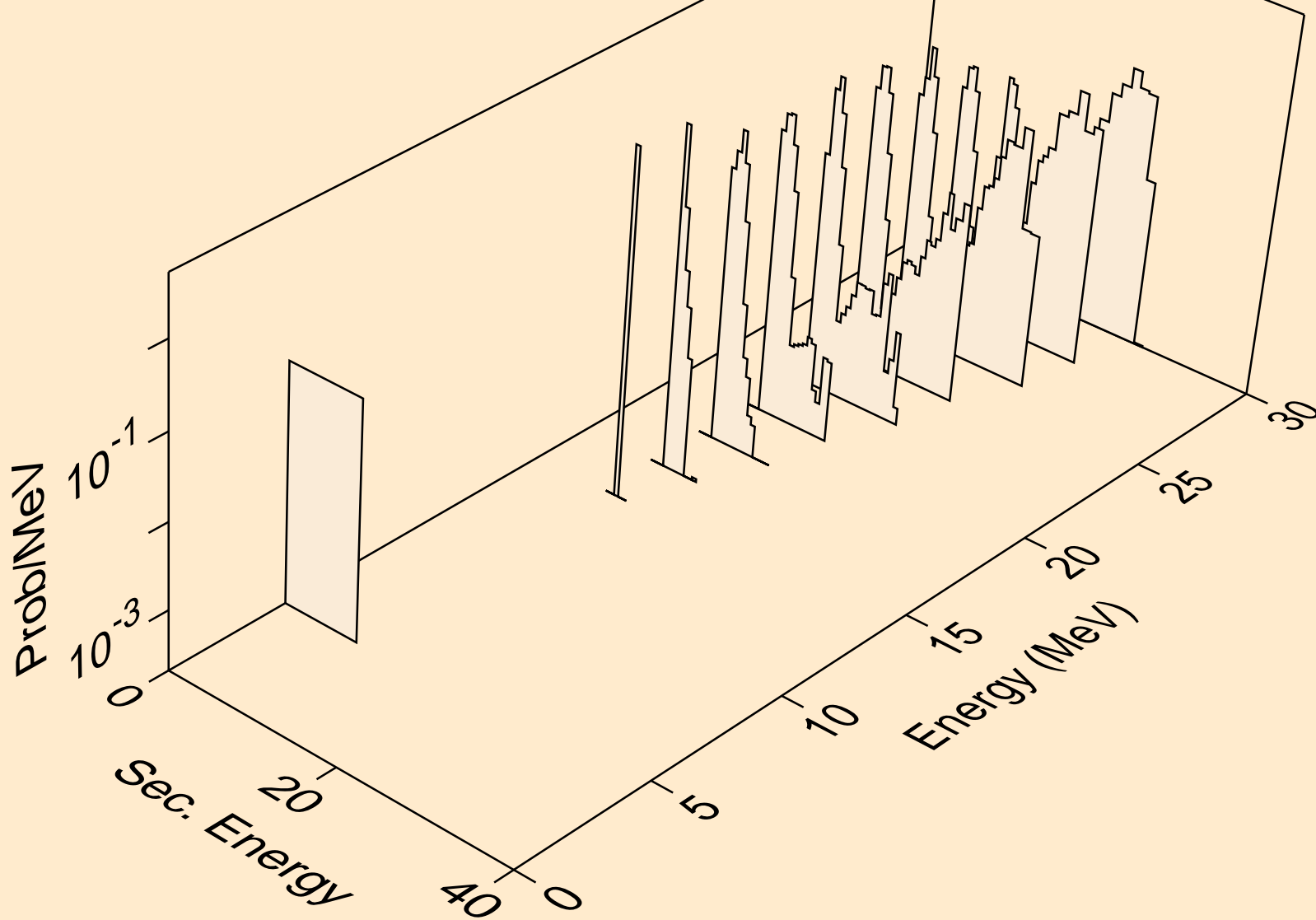

BH269 NEUTRON ACER TENDL-2019 LIBRARY; T=293.16K
alphas from (n,n*)2a

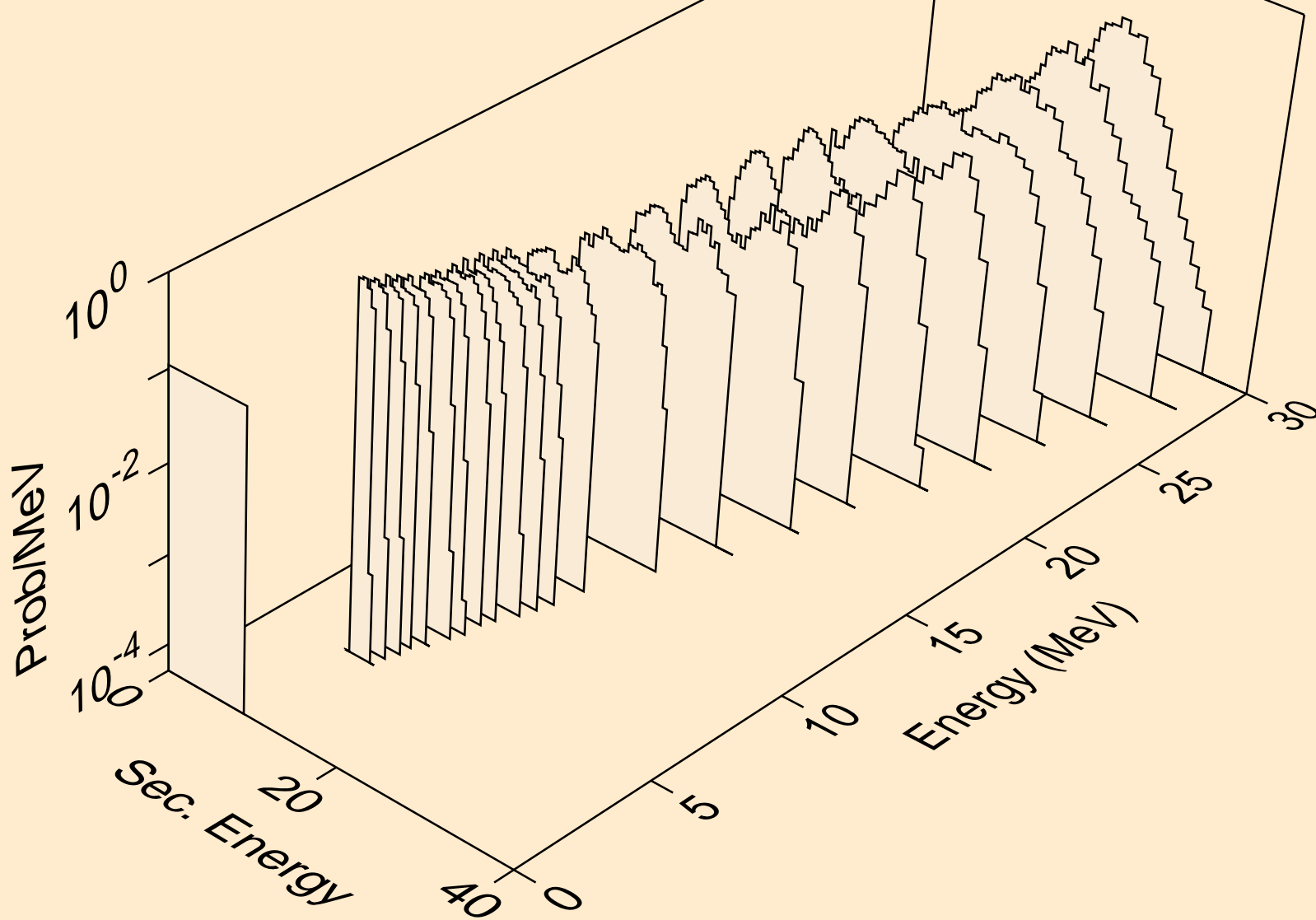

BH269 NEUTRON ACER TENDL-2019 LIBRARY; T=293.16K
alphas from (n,a)

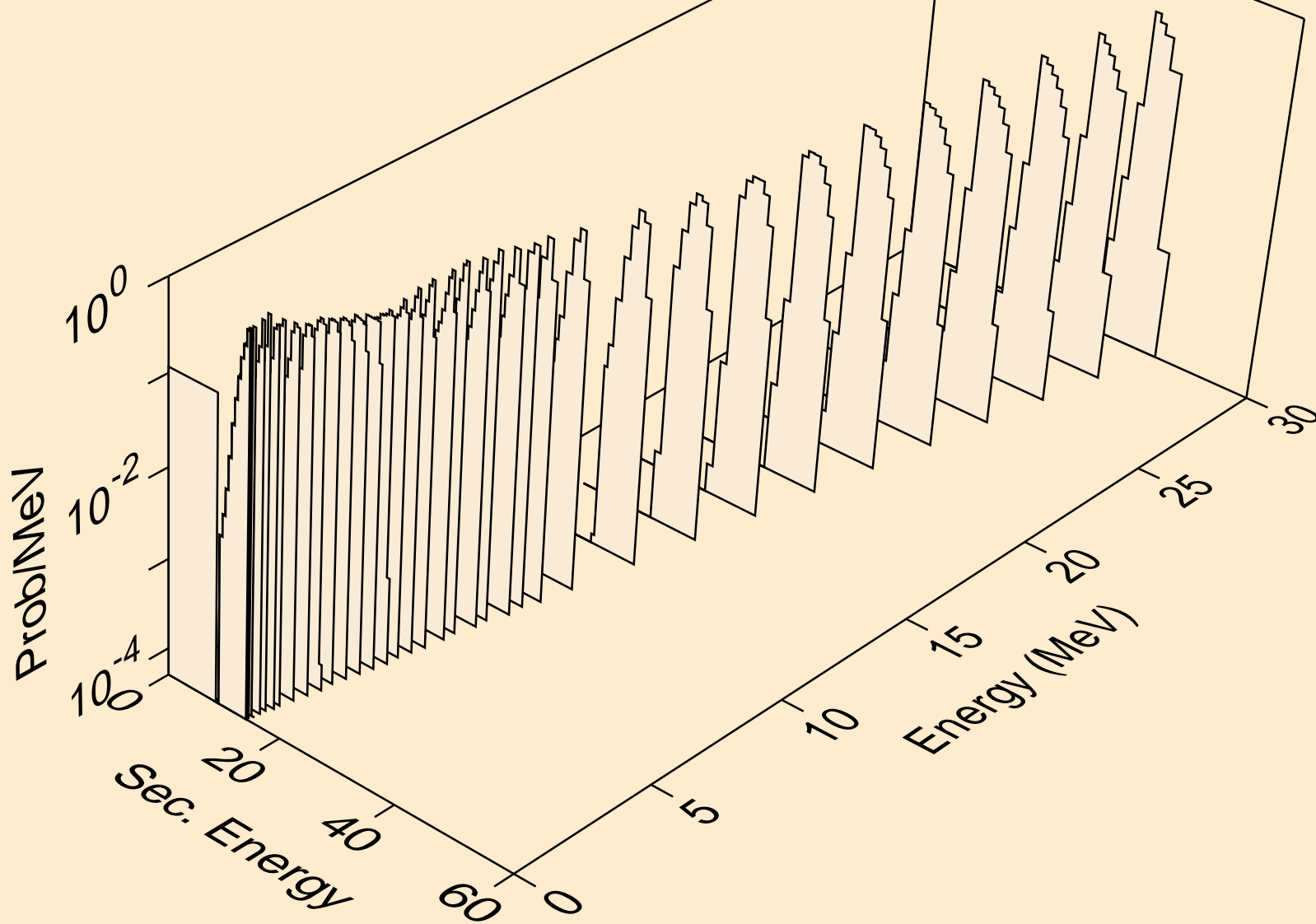

BH269 NEUTRON ACER TENDL-2019 LIBRARY; T=293.16K
alphas from (n,2a)

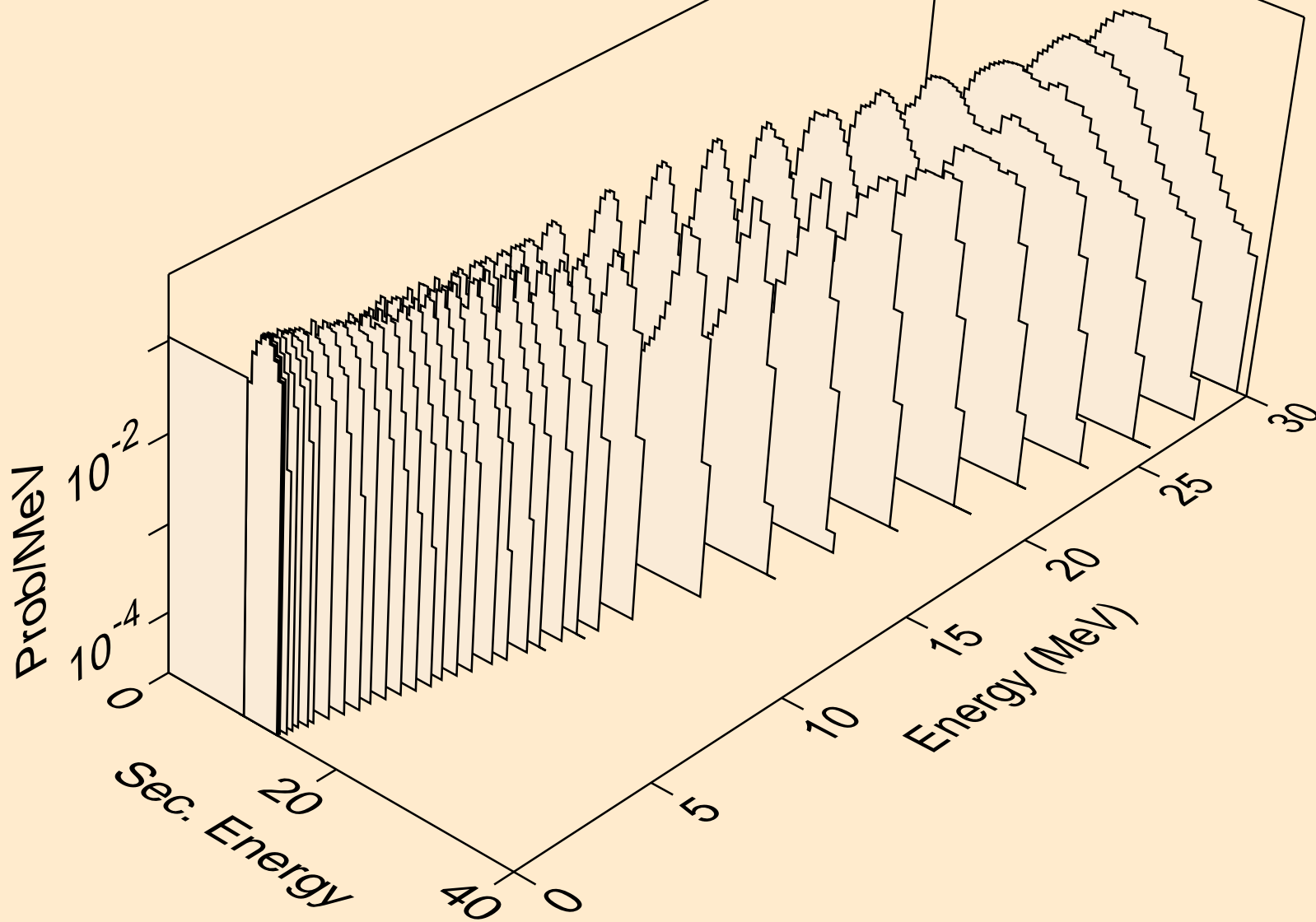

BH269 NEUTRON ACER TENDL-2019 LIBRARY; T=293.16K
alphas from (n,pa)

