

BI190 NEUTRON ACER TENDL-2019 LIBRARY; T=293.16K
Principal cross sections

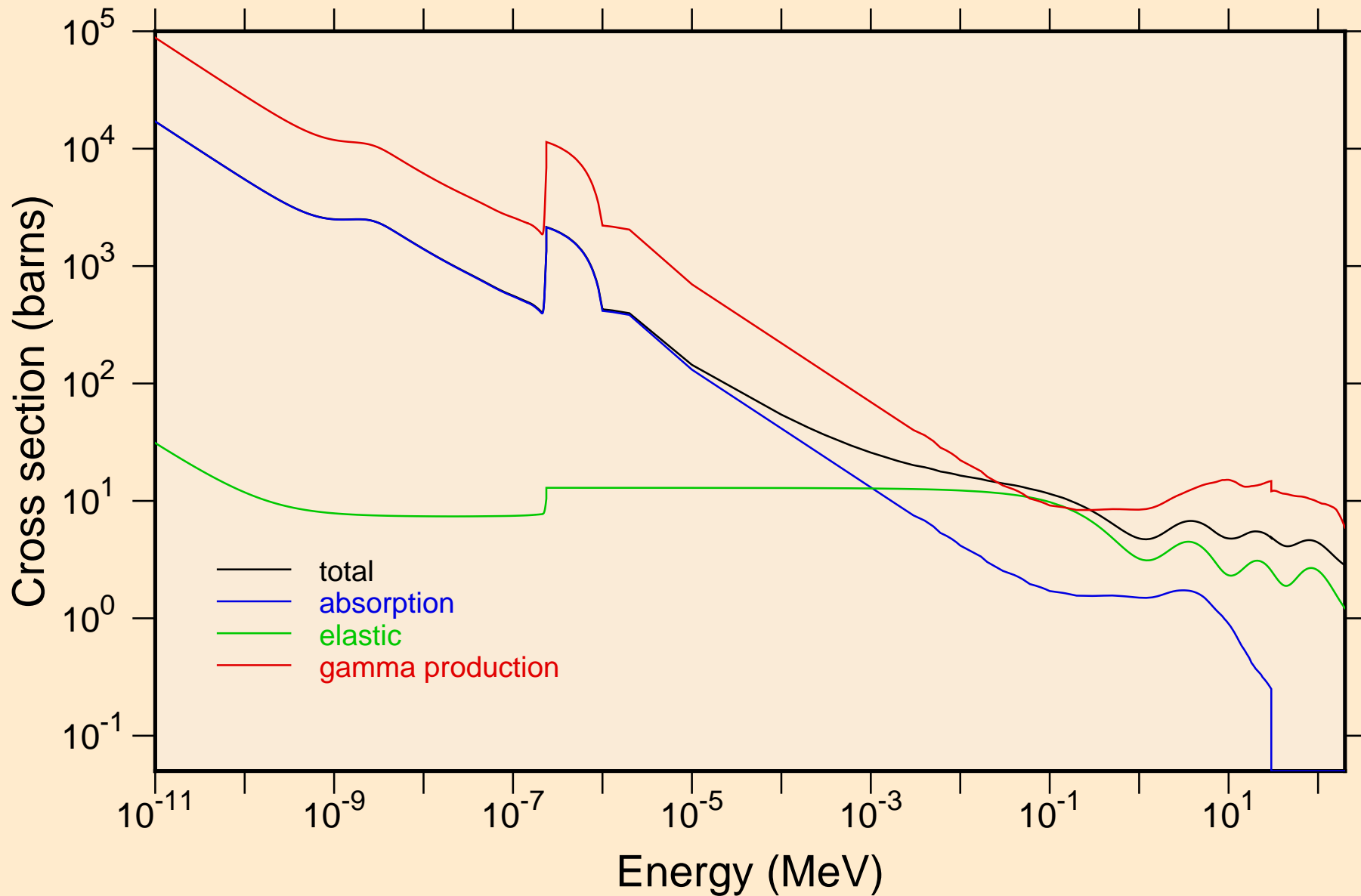

BI190 NEUTRON ACER TENDL-2019 LIBRARY; T=293.16K
Heating

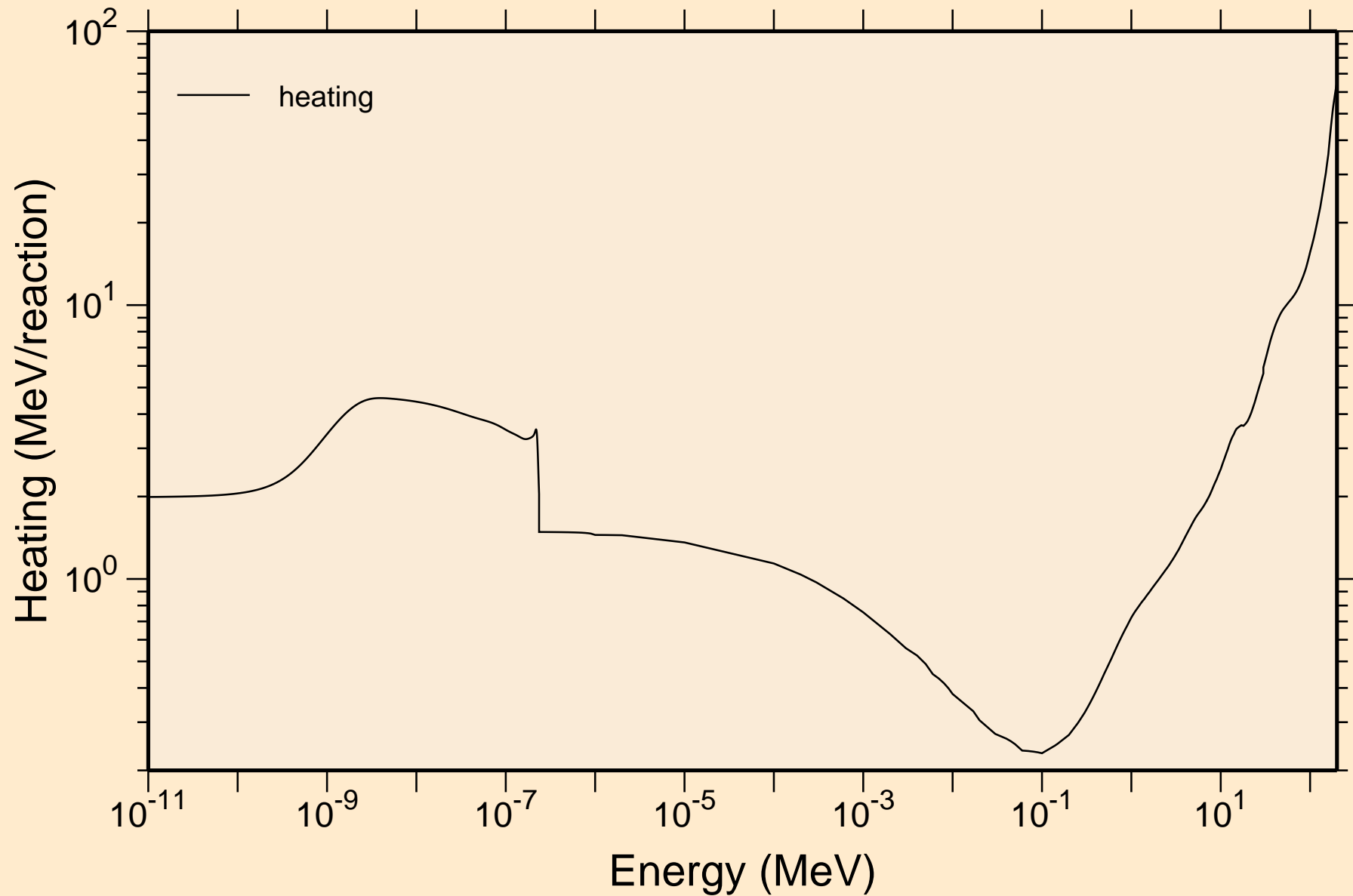

BI190 NEUTRON ACER TENDL-2019 LIBRARY; T=293.16K
Damage

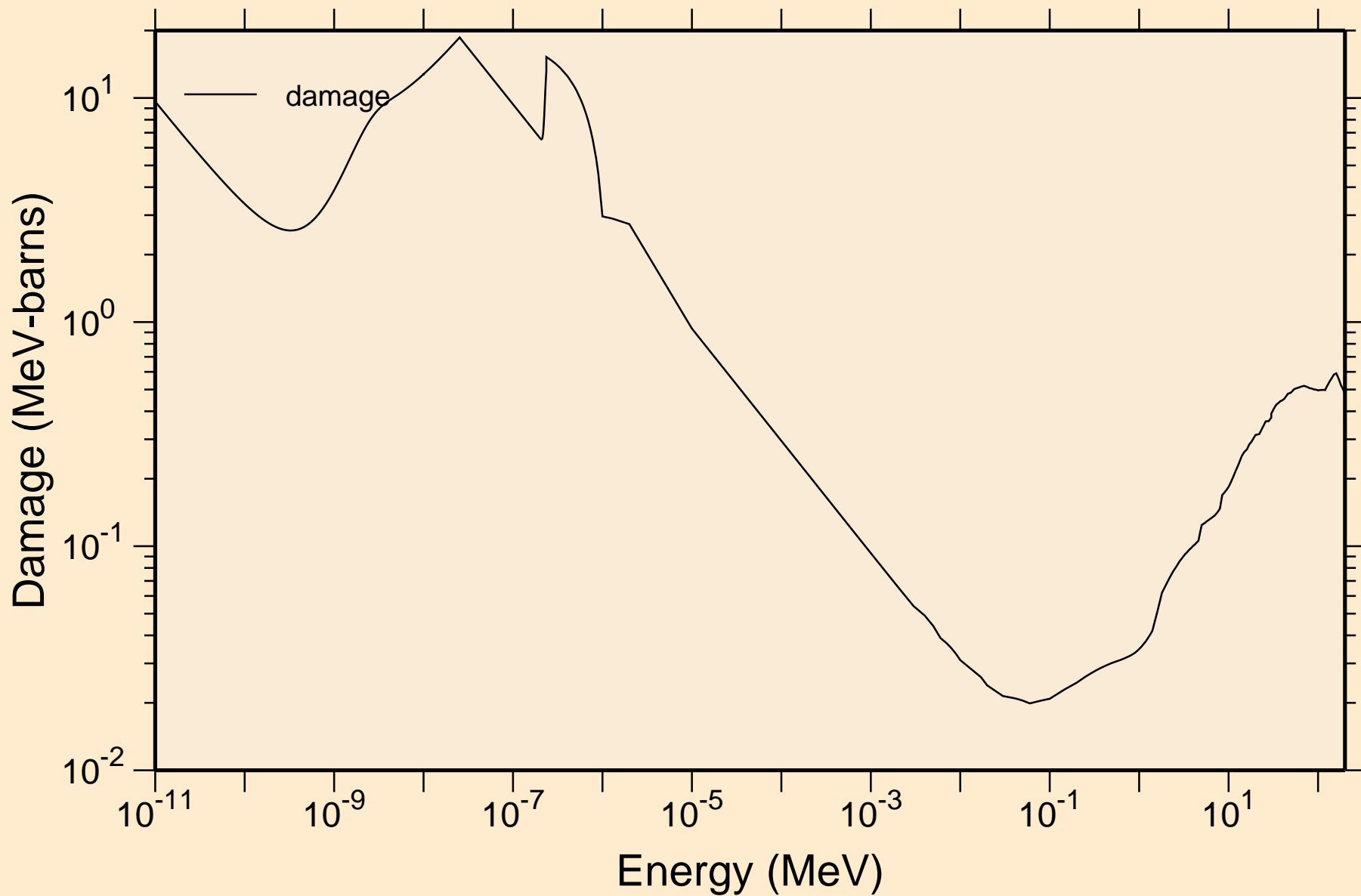

BI190 NEUTRON ACER TENDL-2019 LIBRARY; T=293.16K
Non-threshold reactions

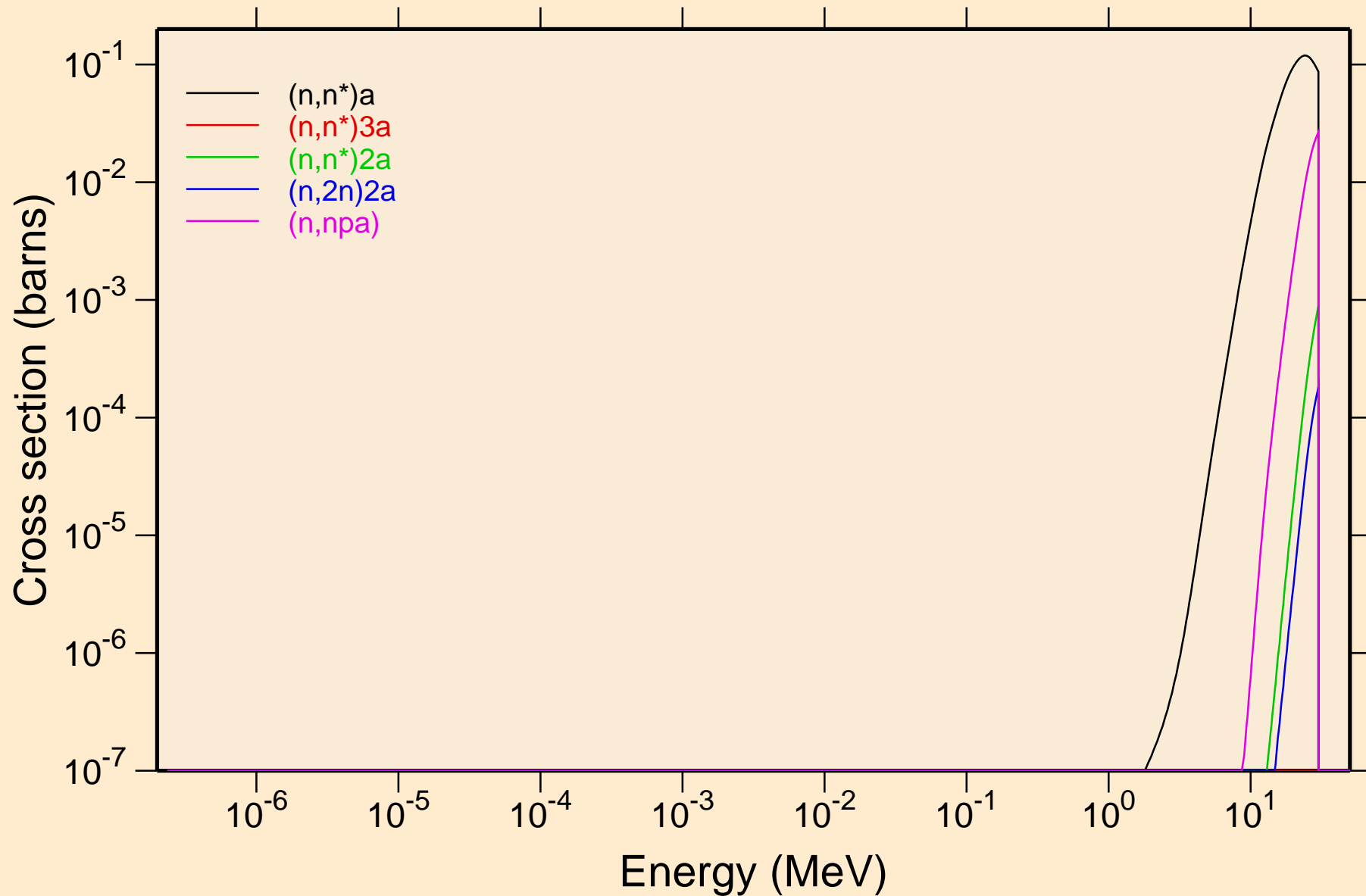

BI190 NEUTRON ACER TENDL-2019 LIBRARY; T=293.16K
Non-threshold reactions

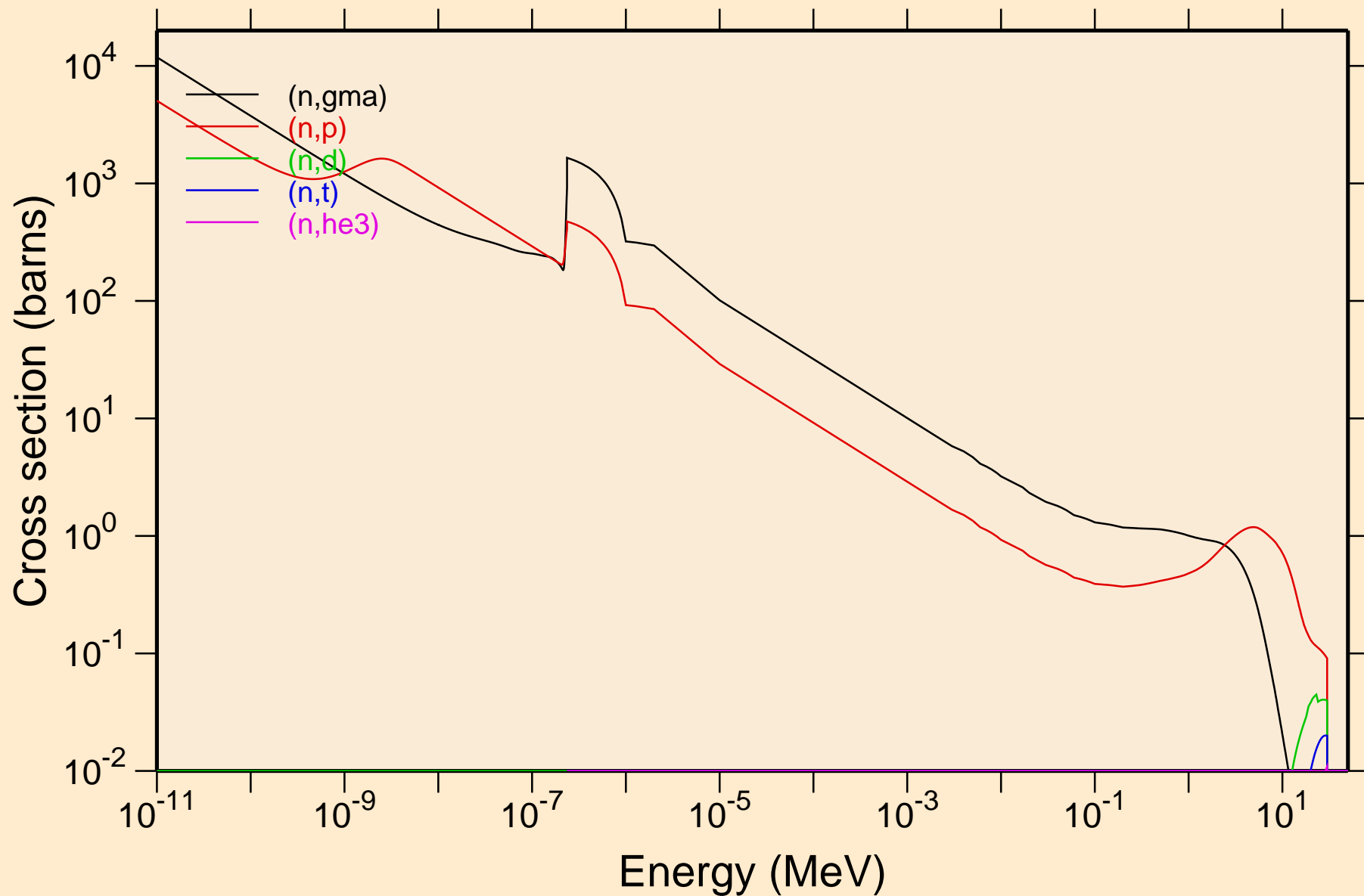

BI190 NEUTRON ACER TENDL-2019 LIBRARY; T=293.16K
Non-threshold reactions

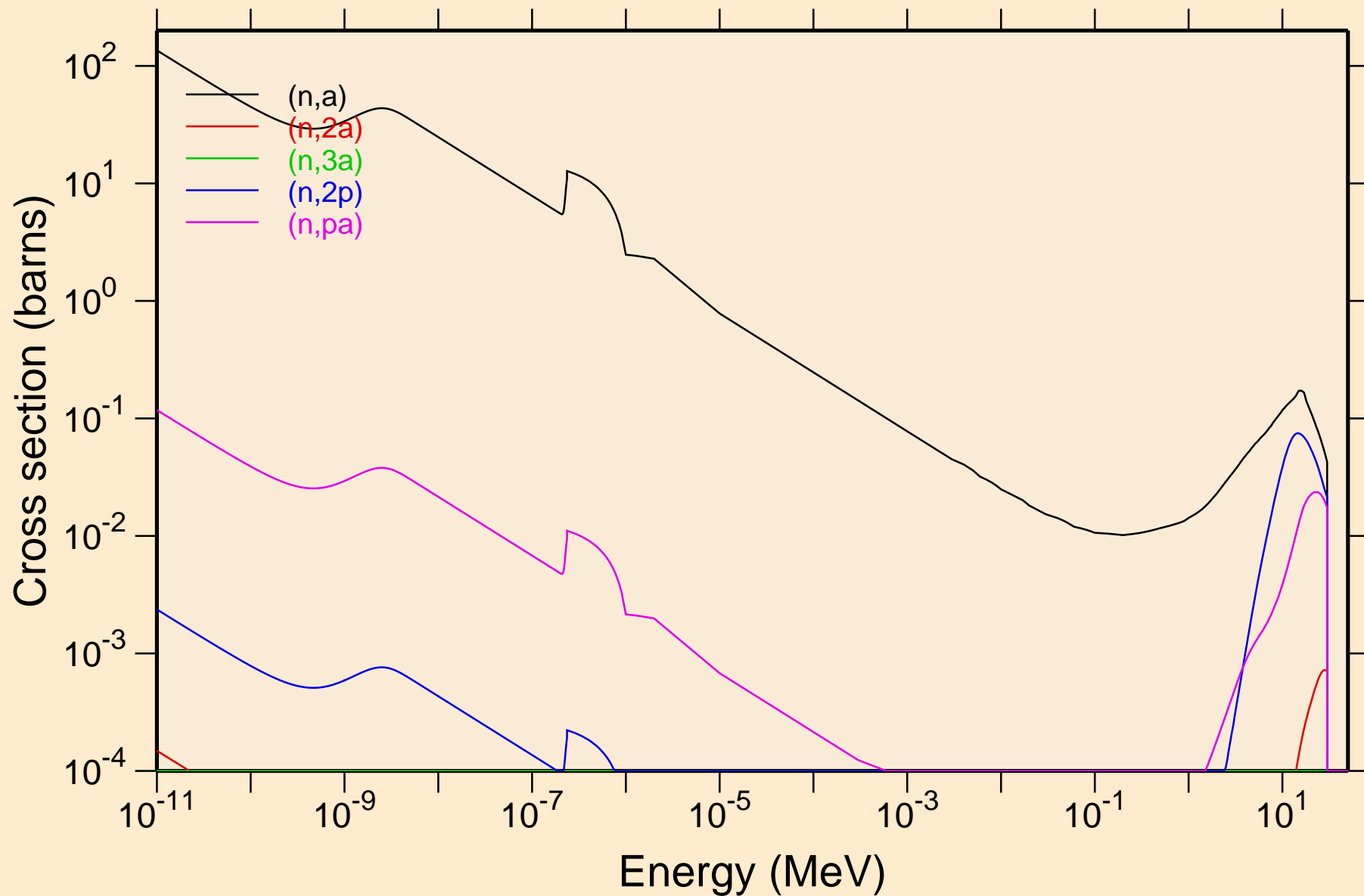

BI190 NEUTRON ACER TENDL-2019 LIBRARY; T=293.16K
Non-threshold reactions

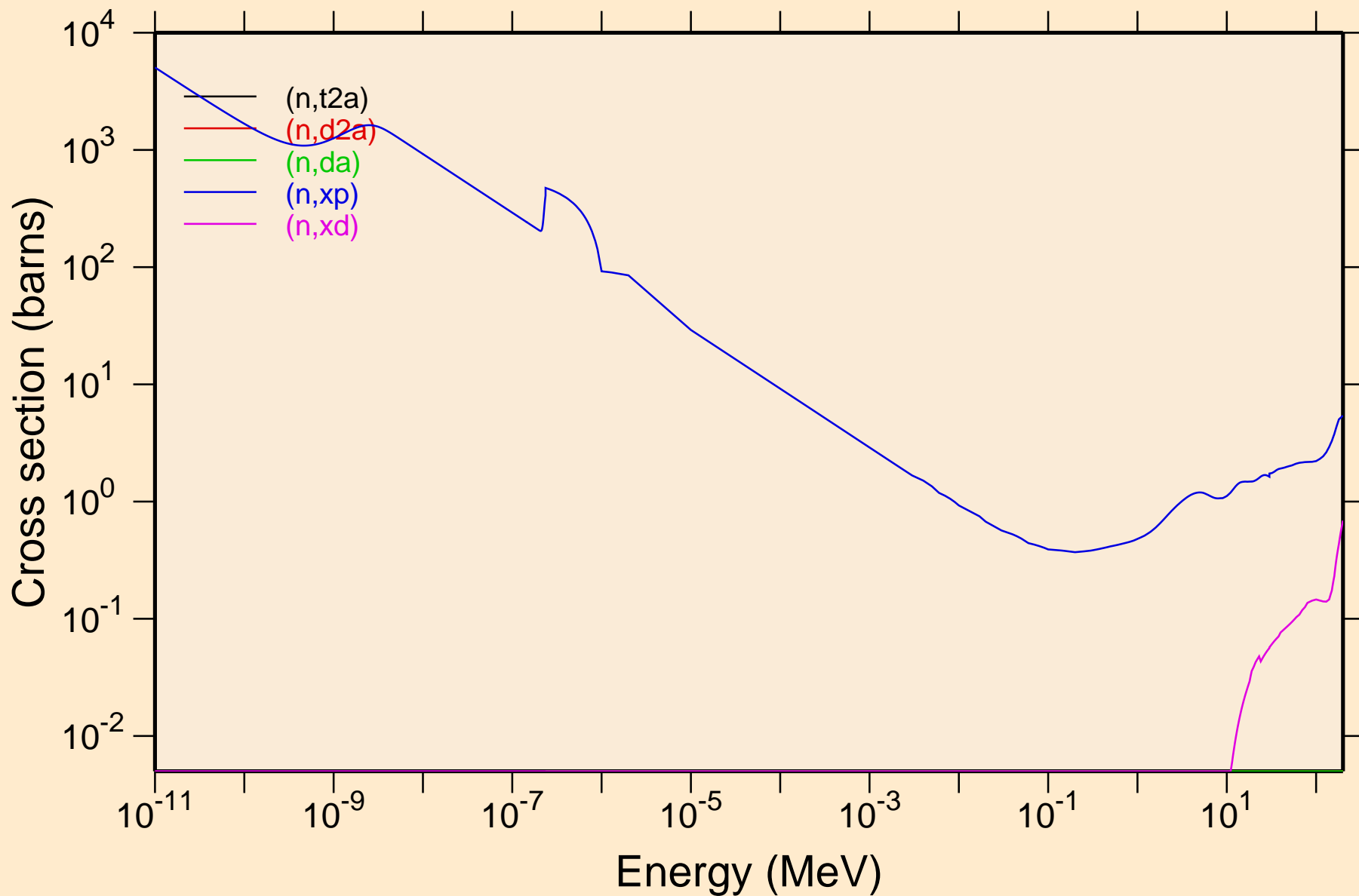

BI190 NEUTRON ACER TENDL-2019 LIBRARY; T=293.16K
Non-threshold reactions

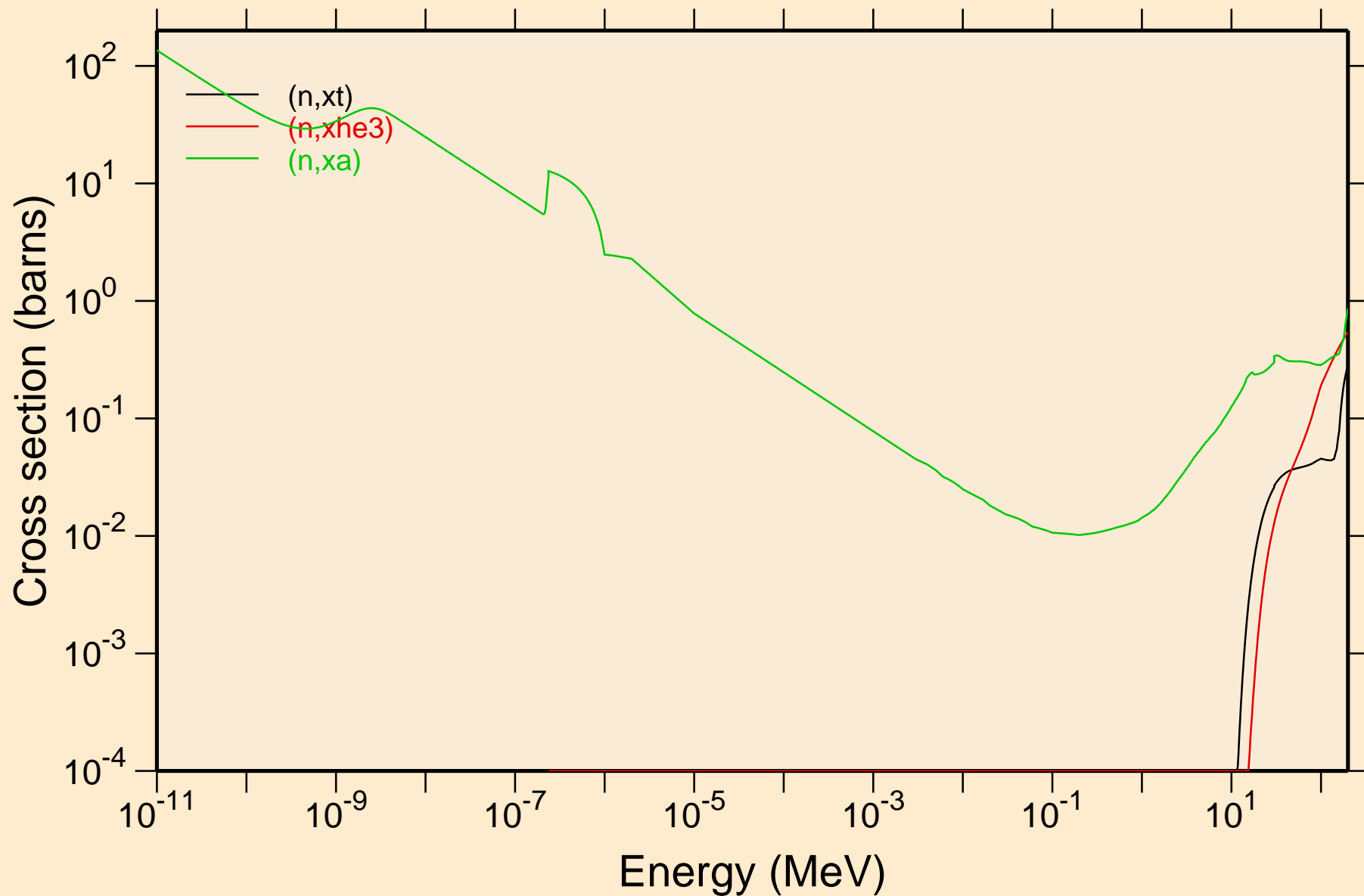

BI190 NEUTRON ACER TENDL-2019 LIBRARY; T=293.16K

Principal cross sections

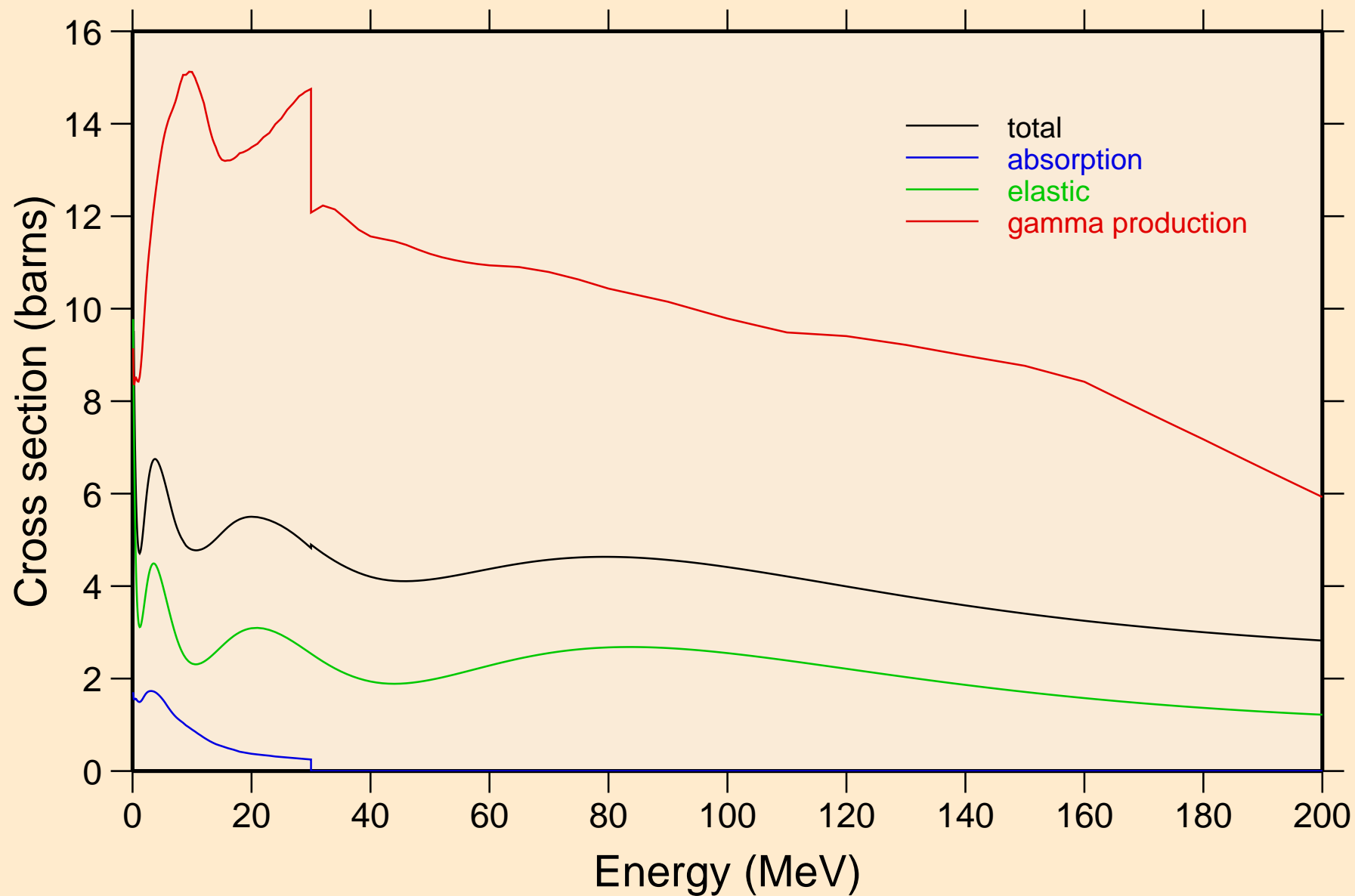

BI190 NEUTRON ACER TENDL-2019 LIBRARY; T=293.16K
Heating

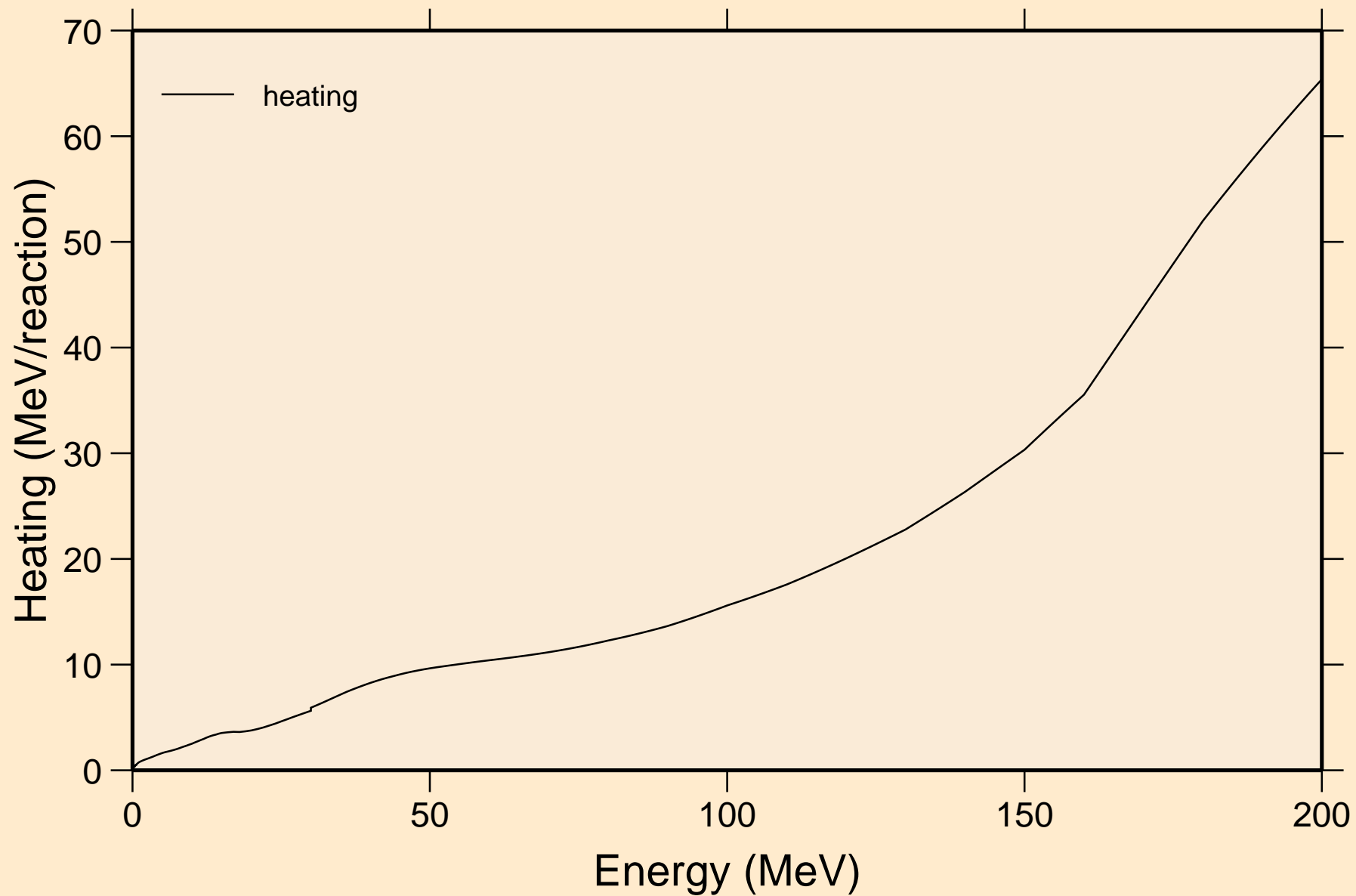

BI190 NEUTRON ACER TENDL-2019 LIBRARY; T=293.16K
Damage

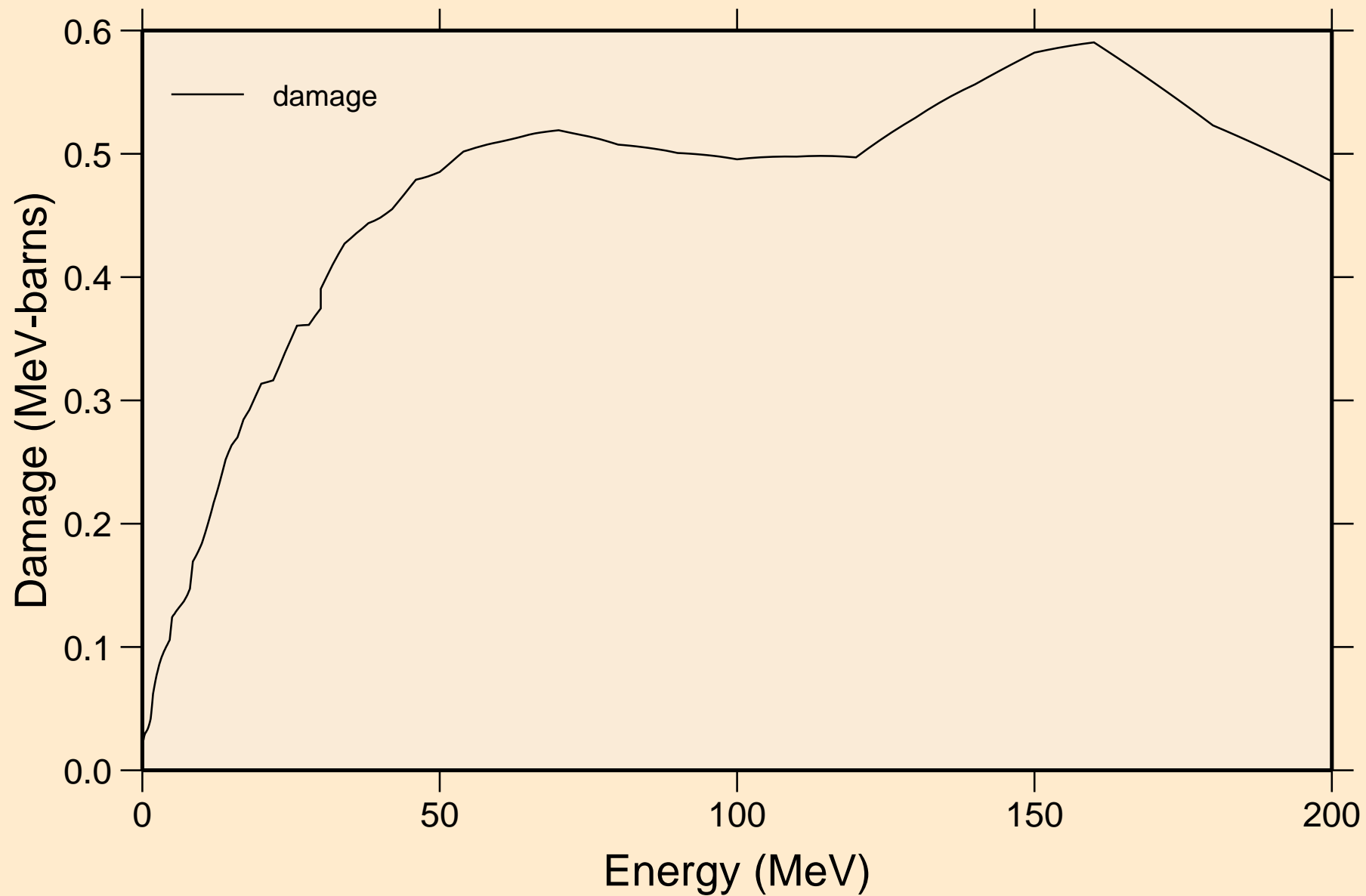

BI190 NEUTRON ACER TENDL-2019 LIBRARY; T=293.16K
Non-threshold reactions

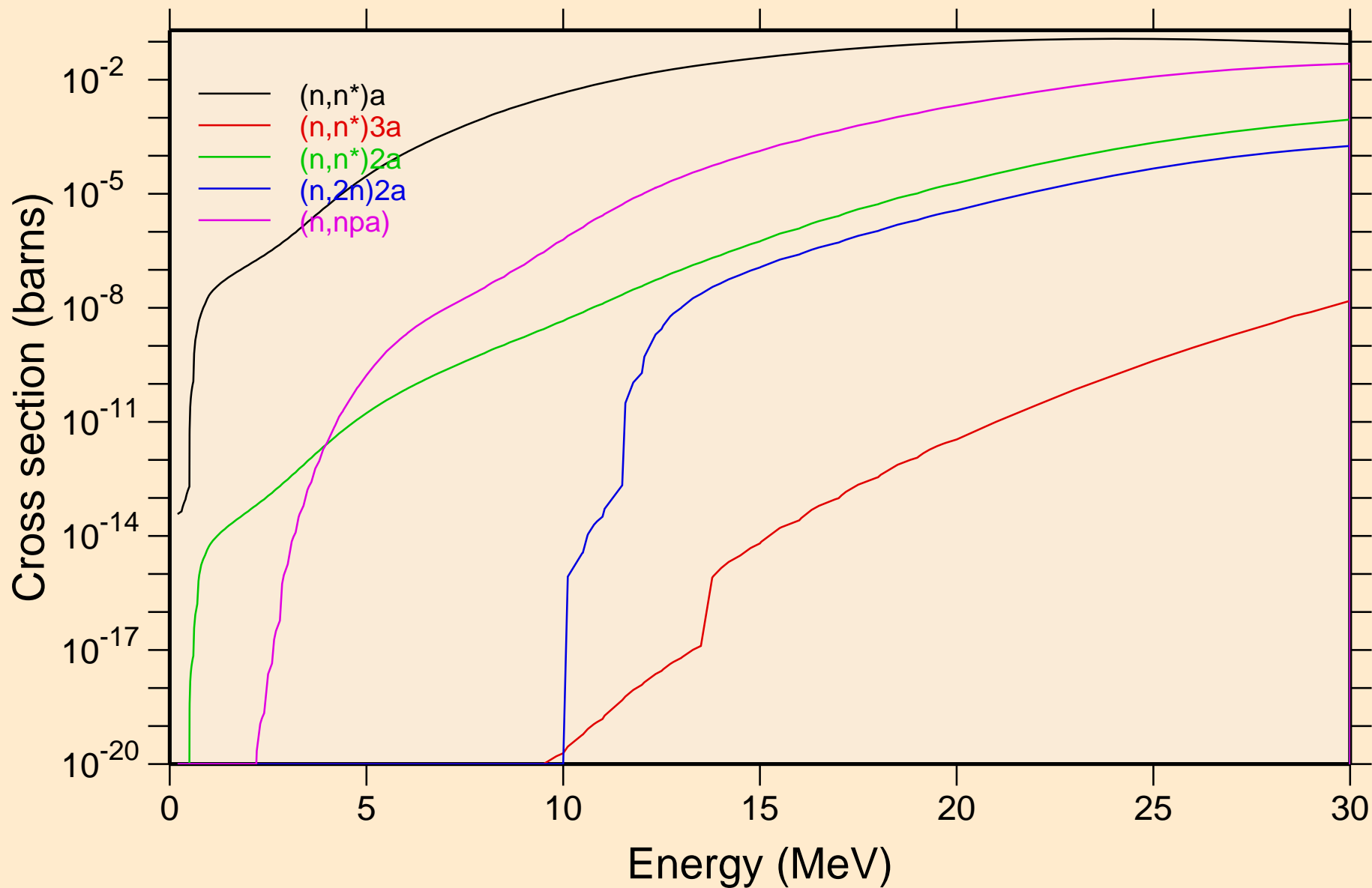

BI190 NEUTRON ACER TENDL-2019 LIBRARY; T=293.16K
Non-threshold reactions

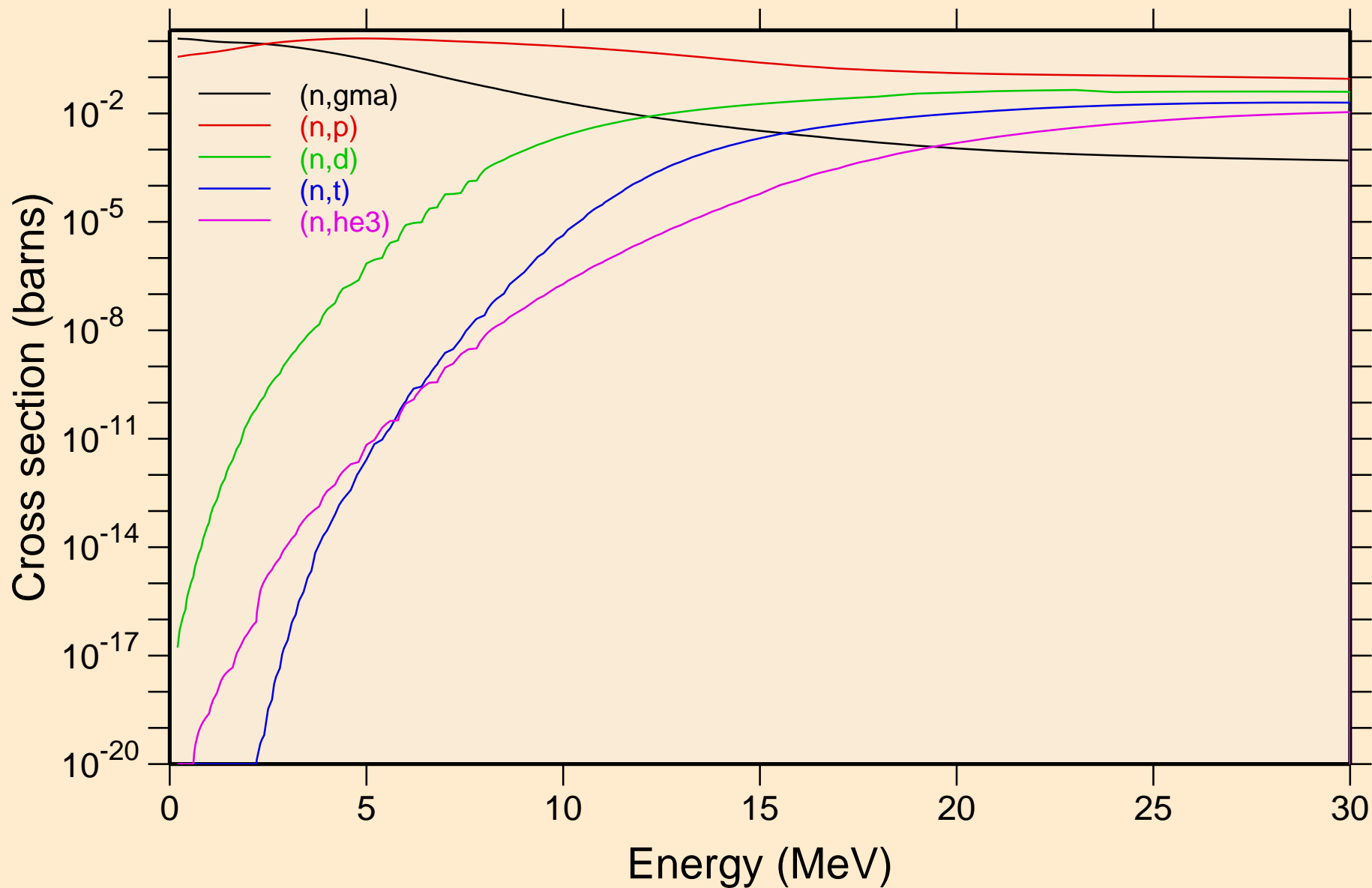

BI190 NEUTRON ACER TENDL-2019 LIBRARY; T=293.16K
Non-threshold reactions

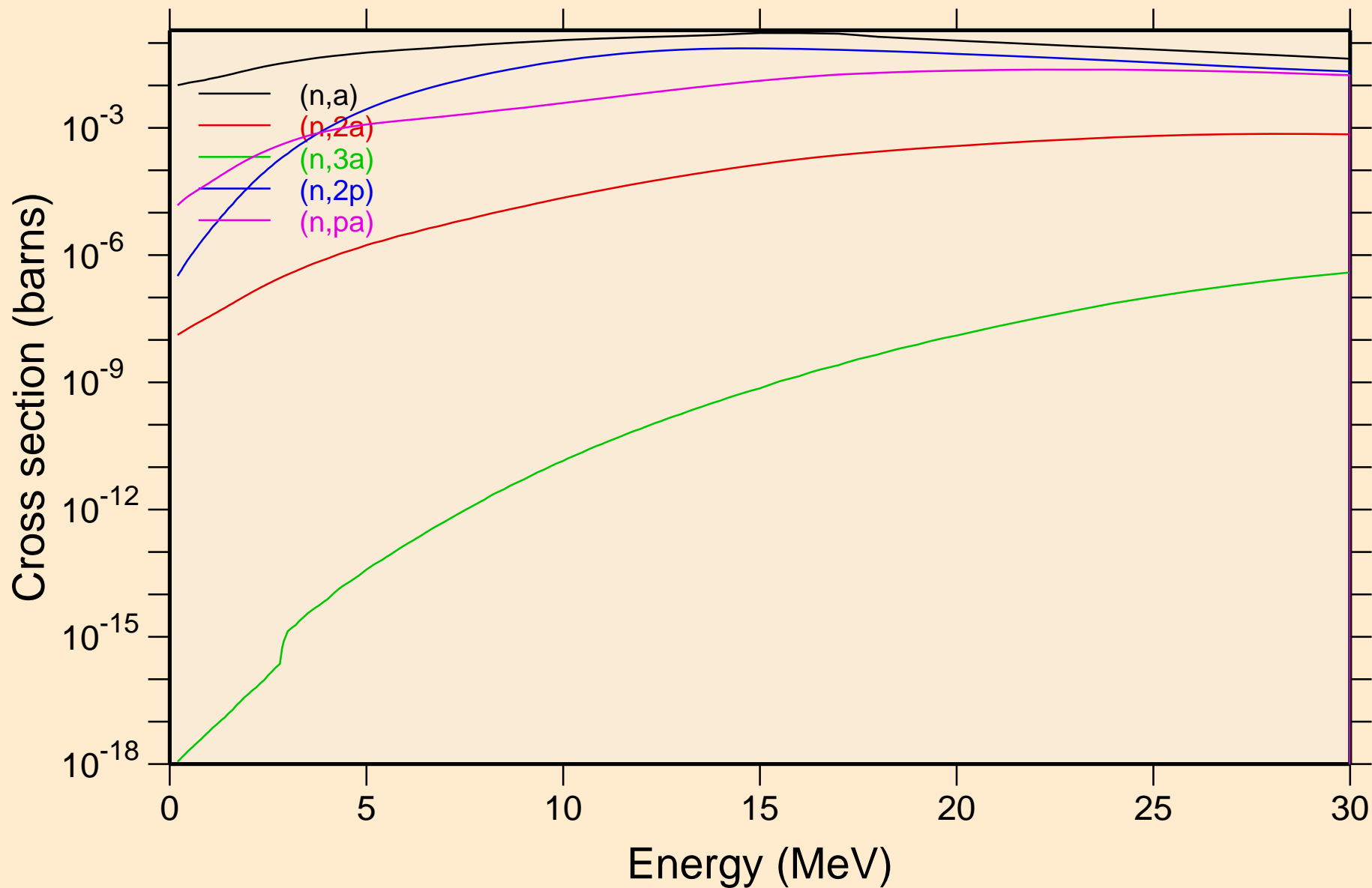

BI190 NEUTRON ACER TENDL-2019 LIBRARY; T=293.16K
Non-threshold reactions

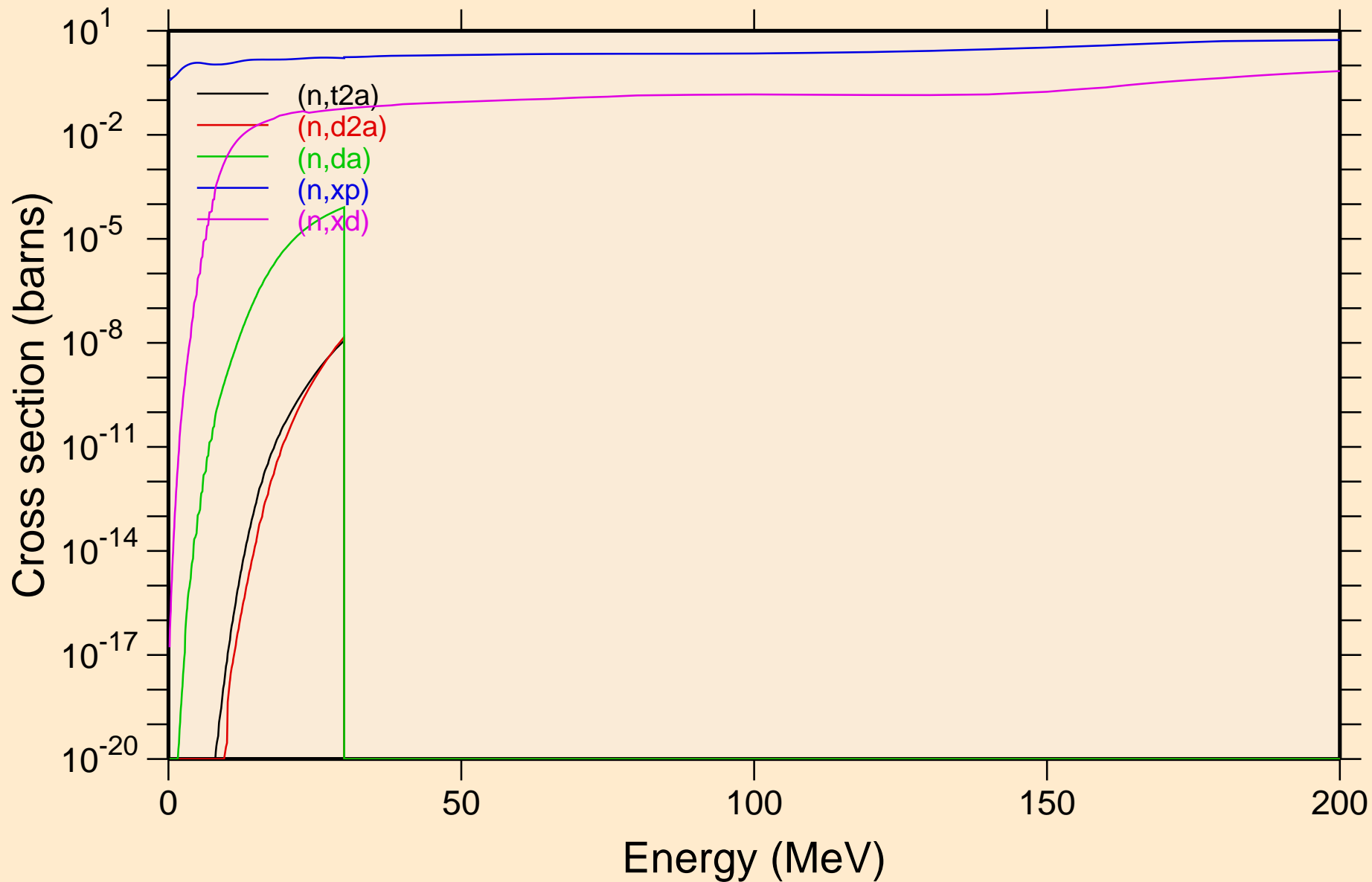

BI190 NEUTRON ACER TENDL-2019 LIBRARY; T=293.16K
Non-threshold reactions

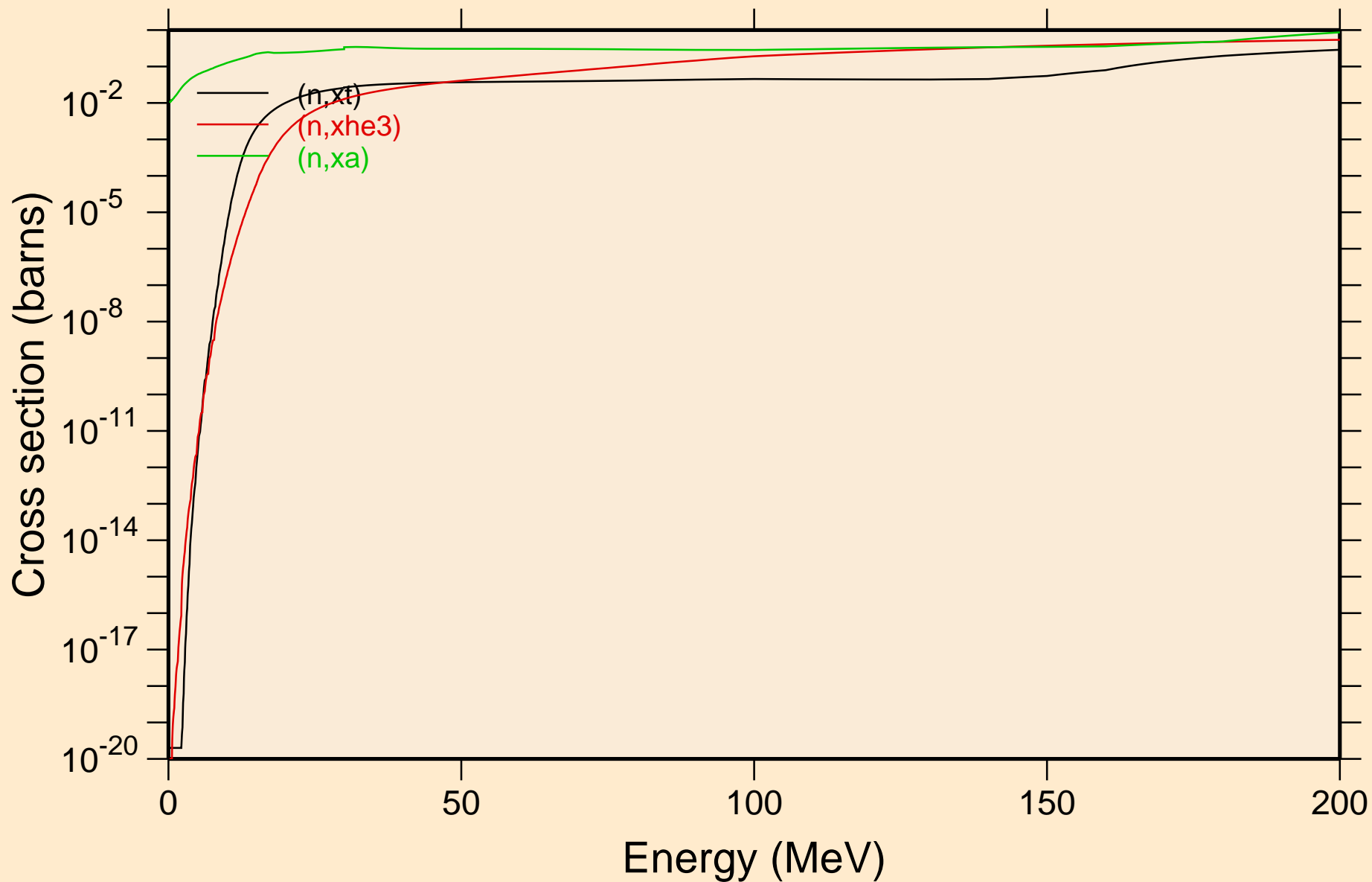

BI190 NEUTRON ACER TENDL-2019 LIBRARY; T=293.16K
Inelastic levels

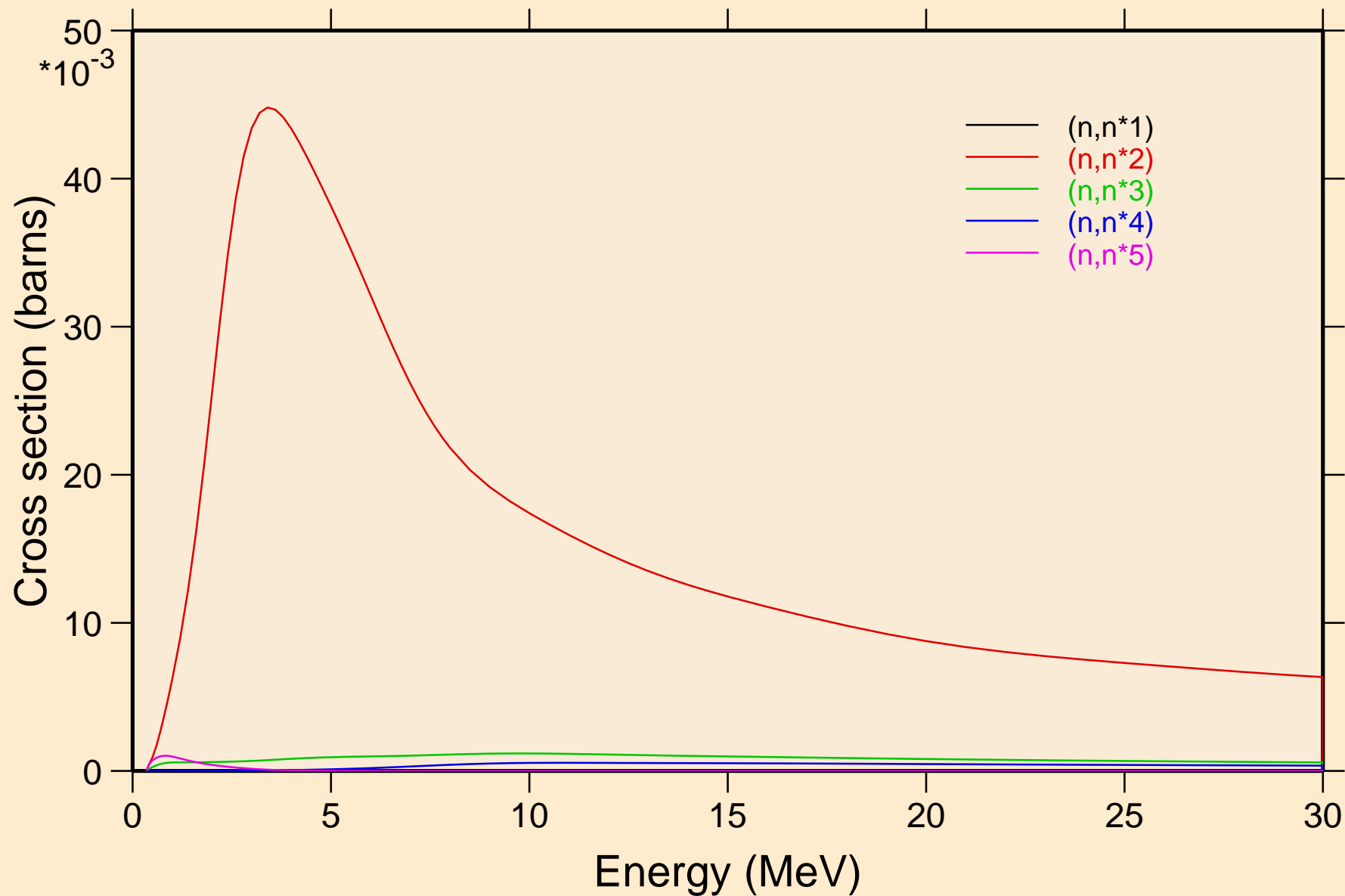

BI190 NEUTRON ACER TENDL-2019 LIBRARY; T=293.16K
Inelastic levels

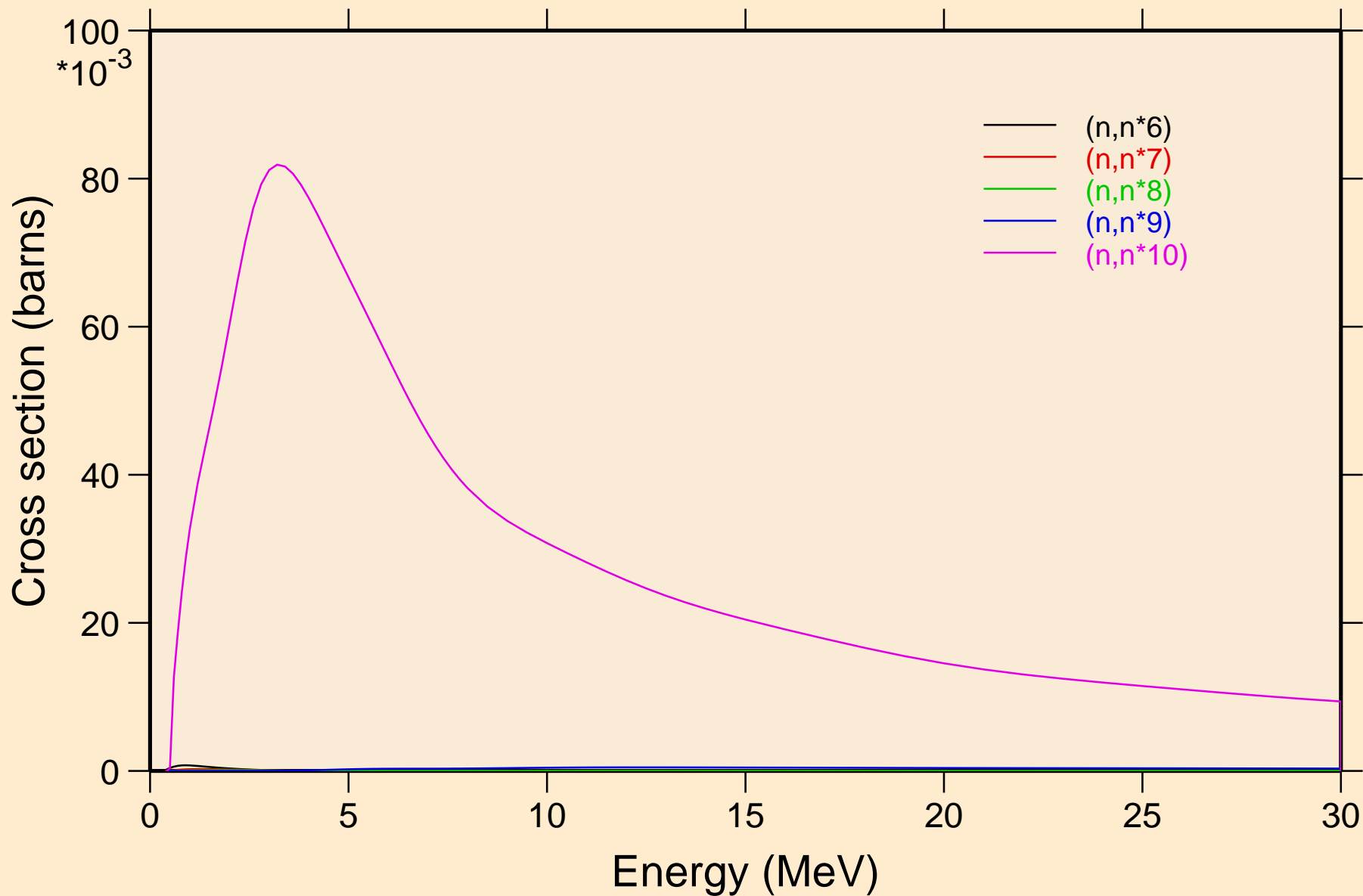

BI190 NEUTRON ACER TENDL-2019 LIBRARY; T=293.16K
Inelastic levels

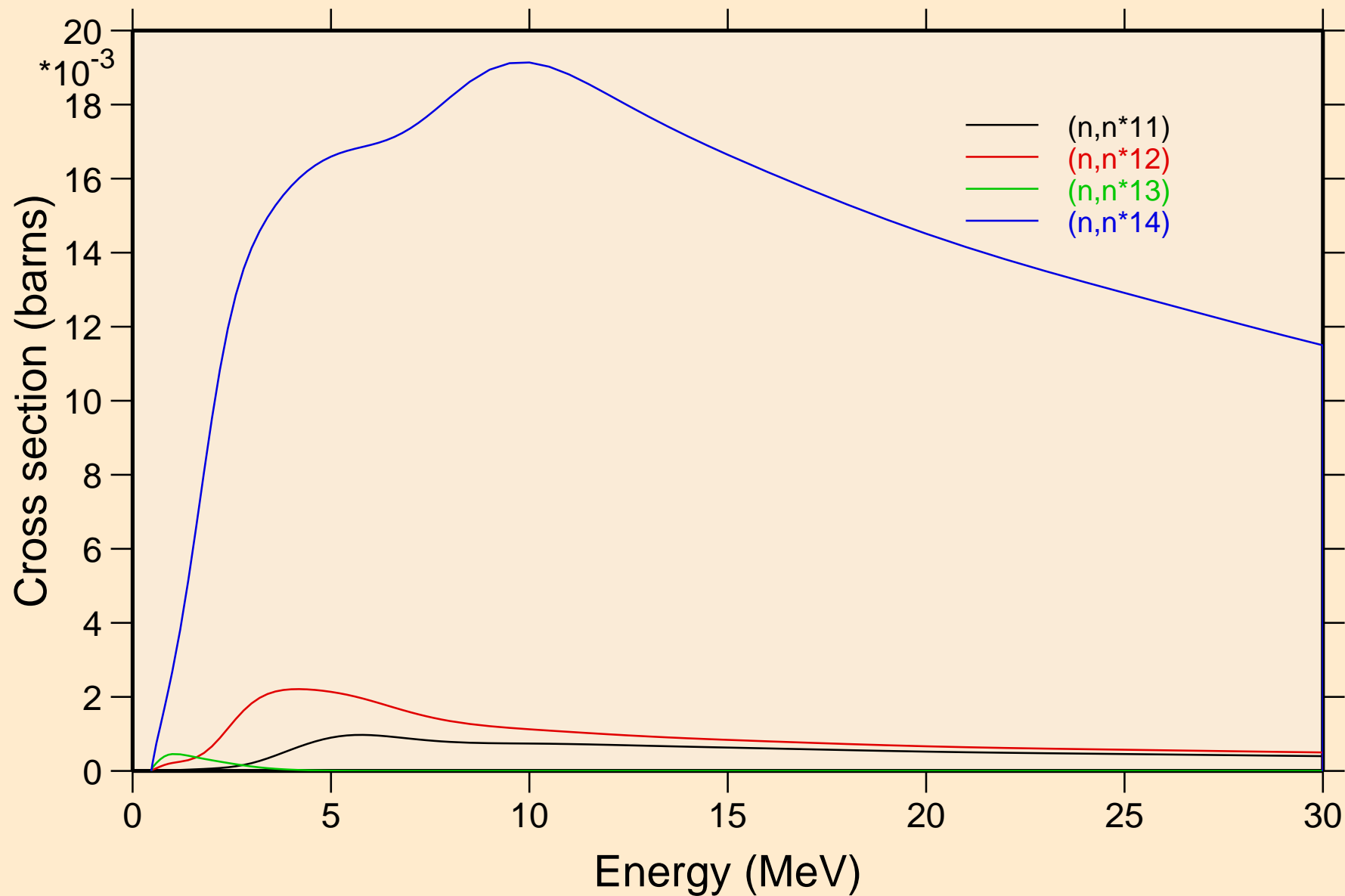

BI190 NEUTRON ACER TENDL-2019 LIBRARY; T=293.16K
Threshold reactions

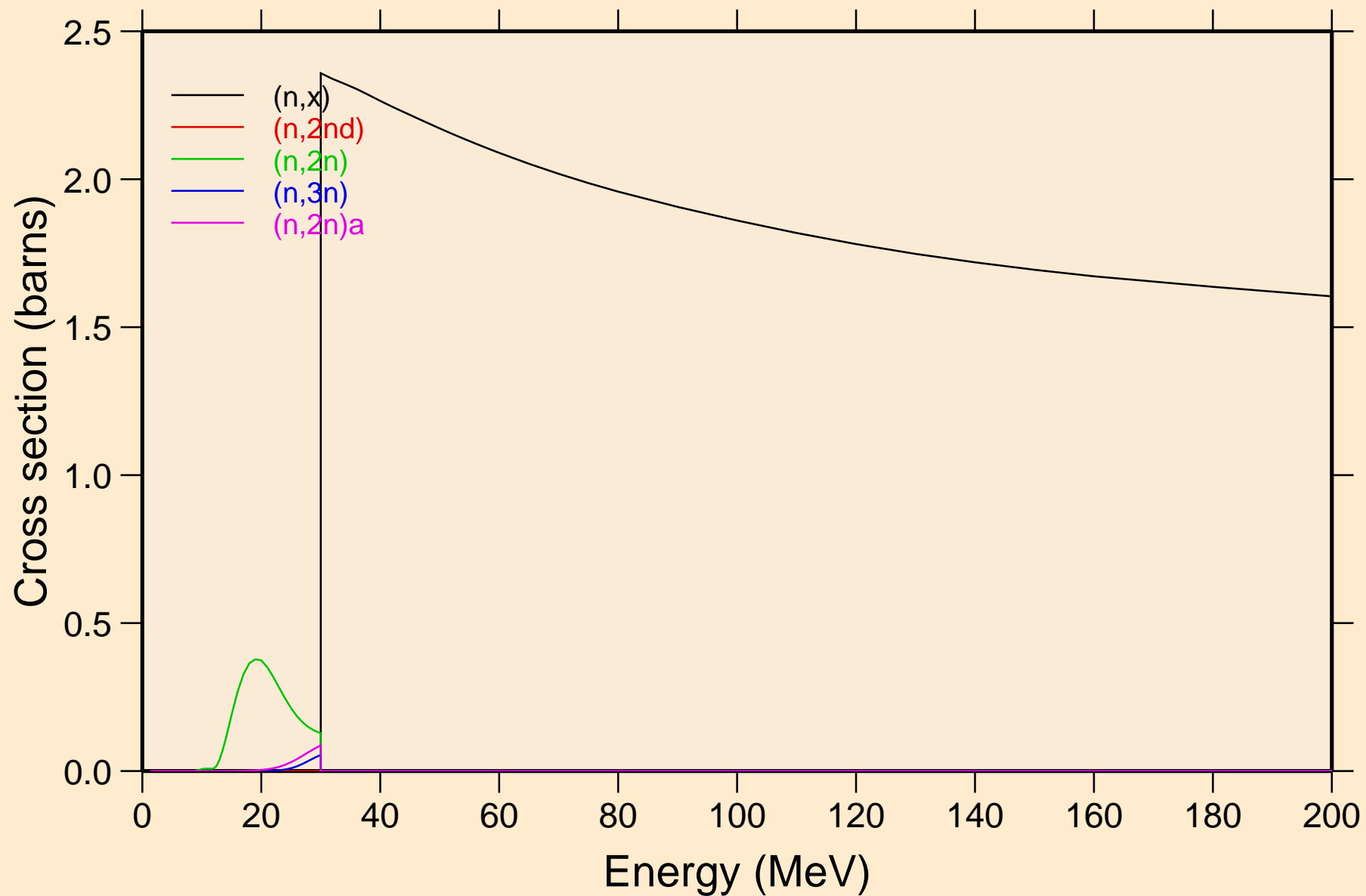

BI190 NEUTRON ACER TENDL-2019 LIBRARY; T=293.16K
Threshold reactions

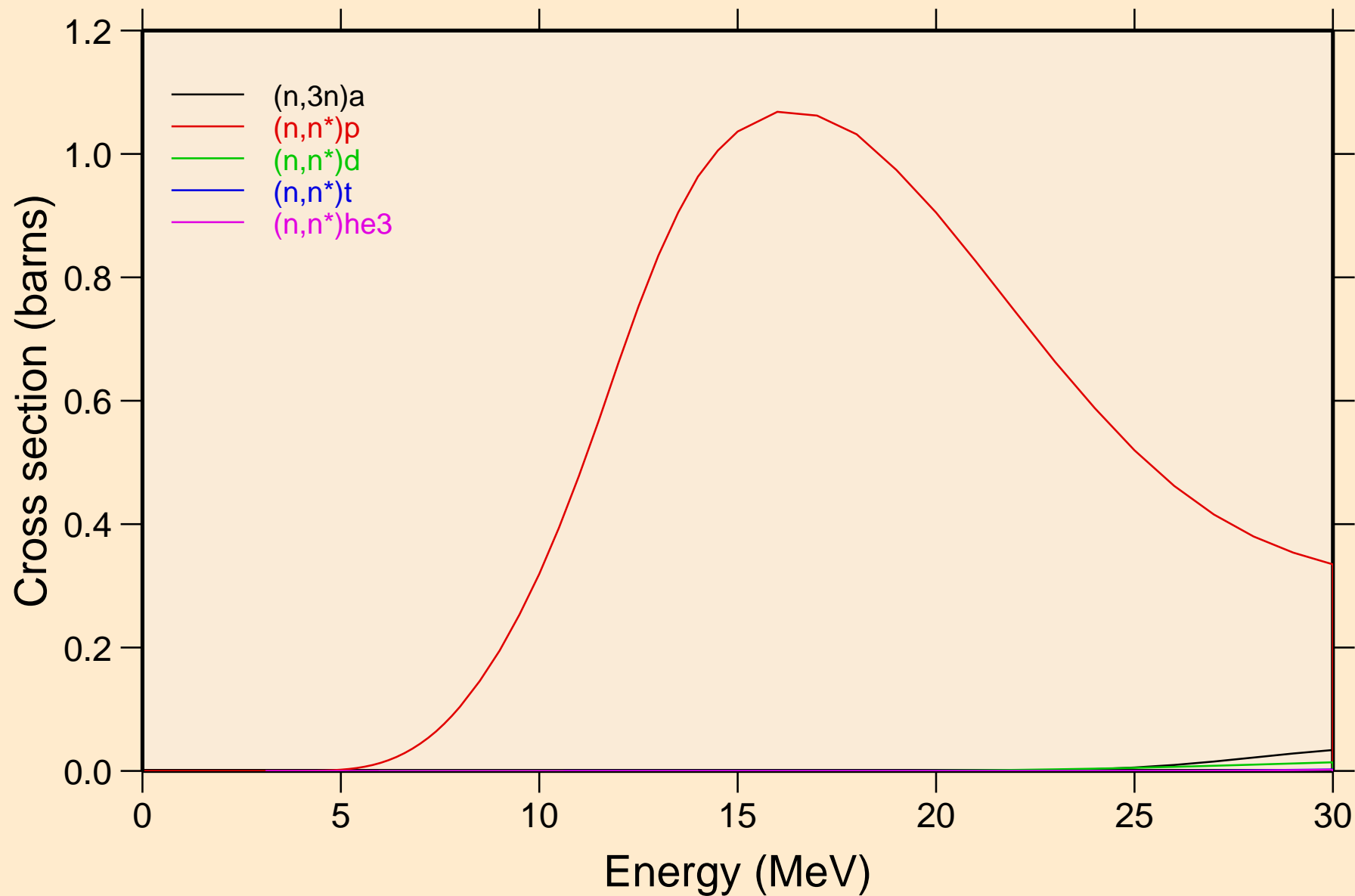

BI190 NEUTRON ACER TENDL-2019 LIBRARY; T=293.16K
Threshold reactions

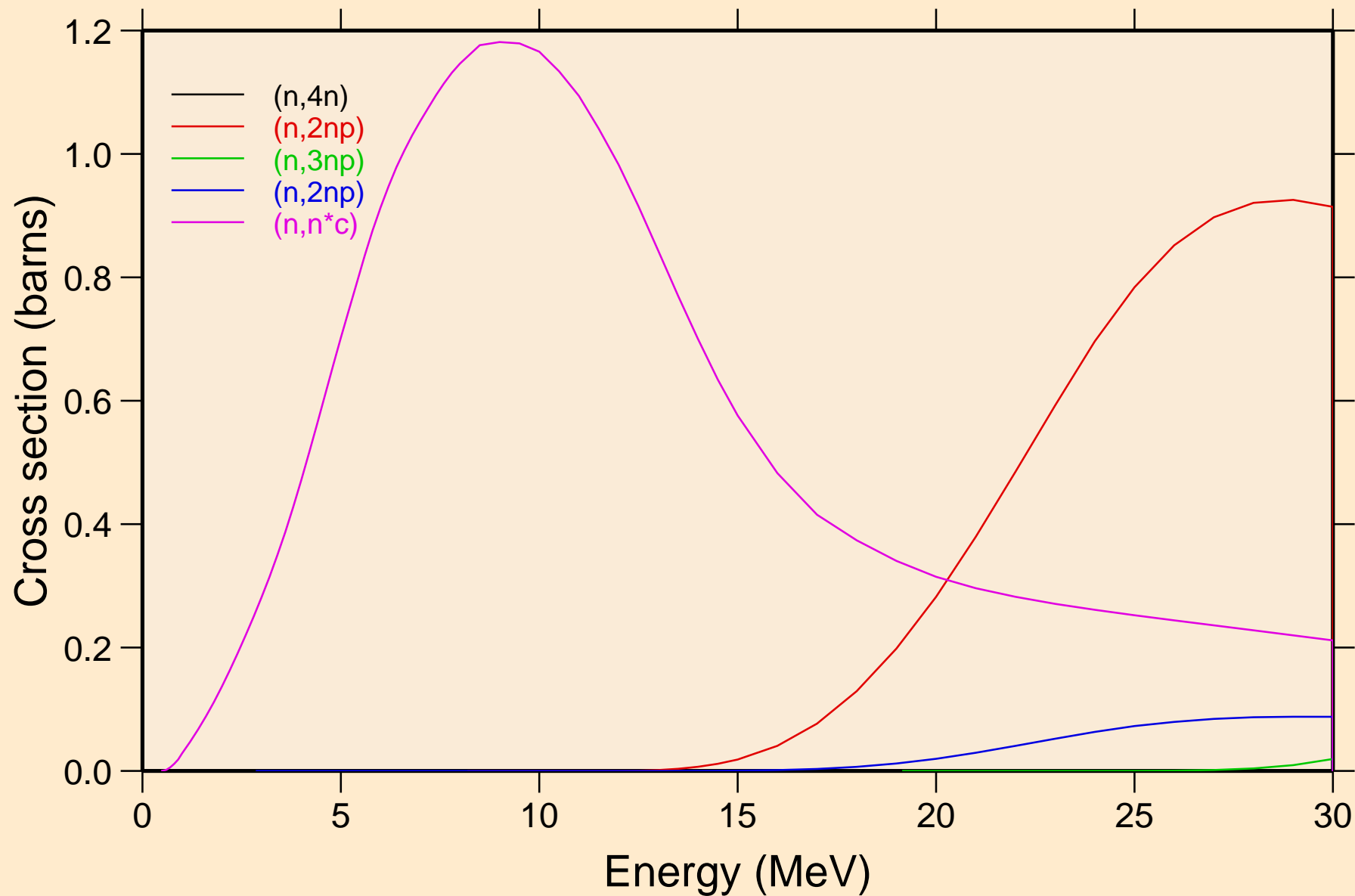

BI190 NEUTRON ACER TENDL-2019 LIBRARY; T=293.16K
Threshold reactions

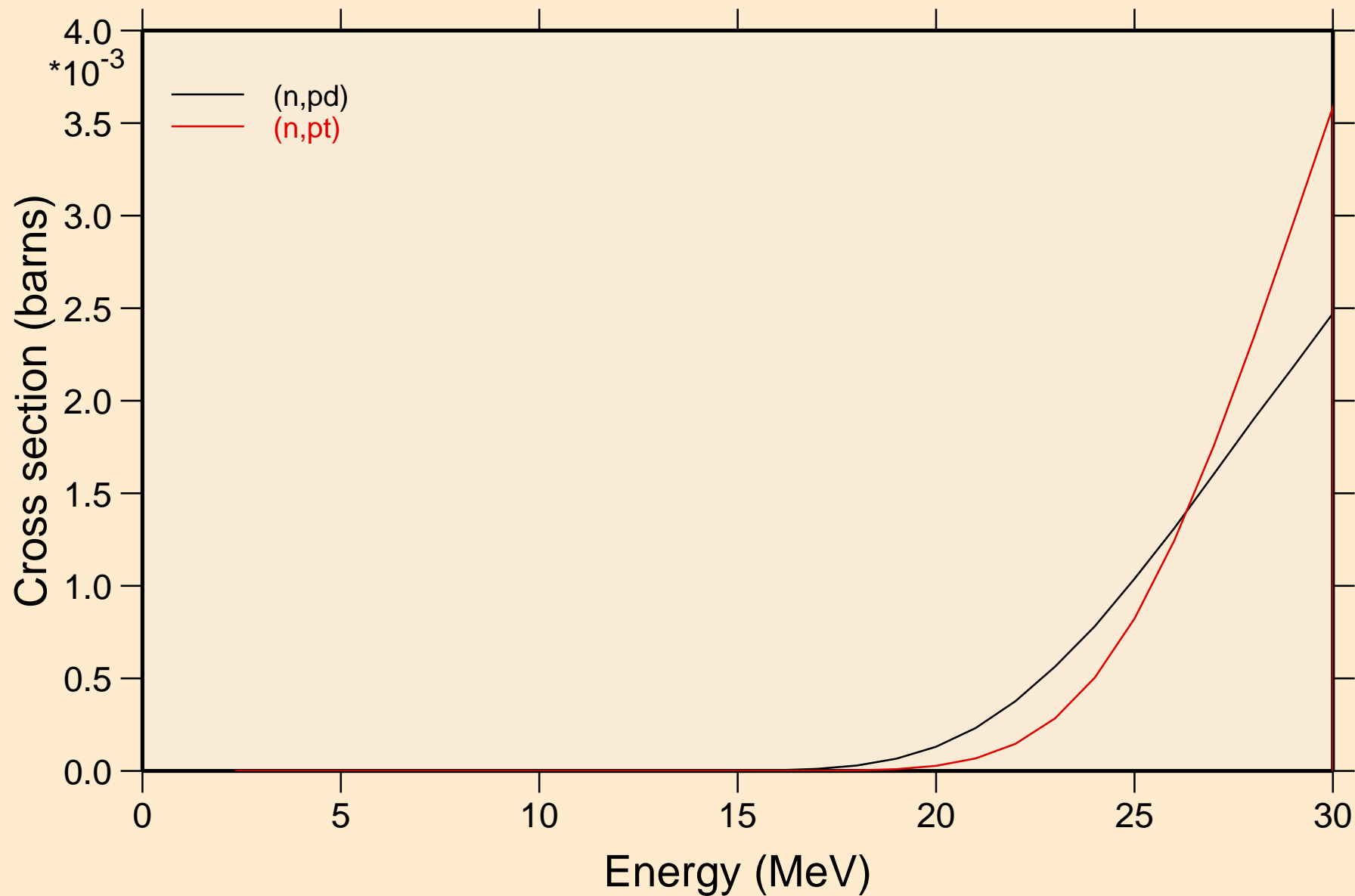

BI190 NEUTRON ACER TENDL-2019 LIBRARY; T=293.16K
angular distribution for elastic

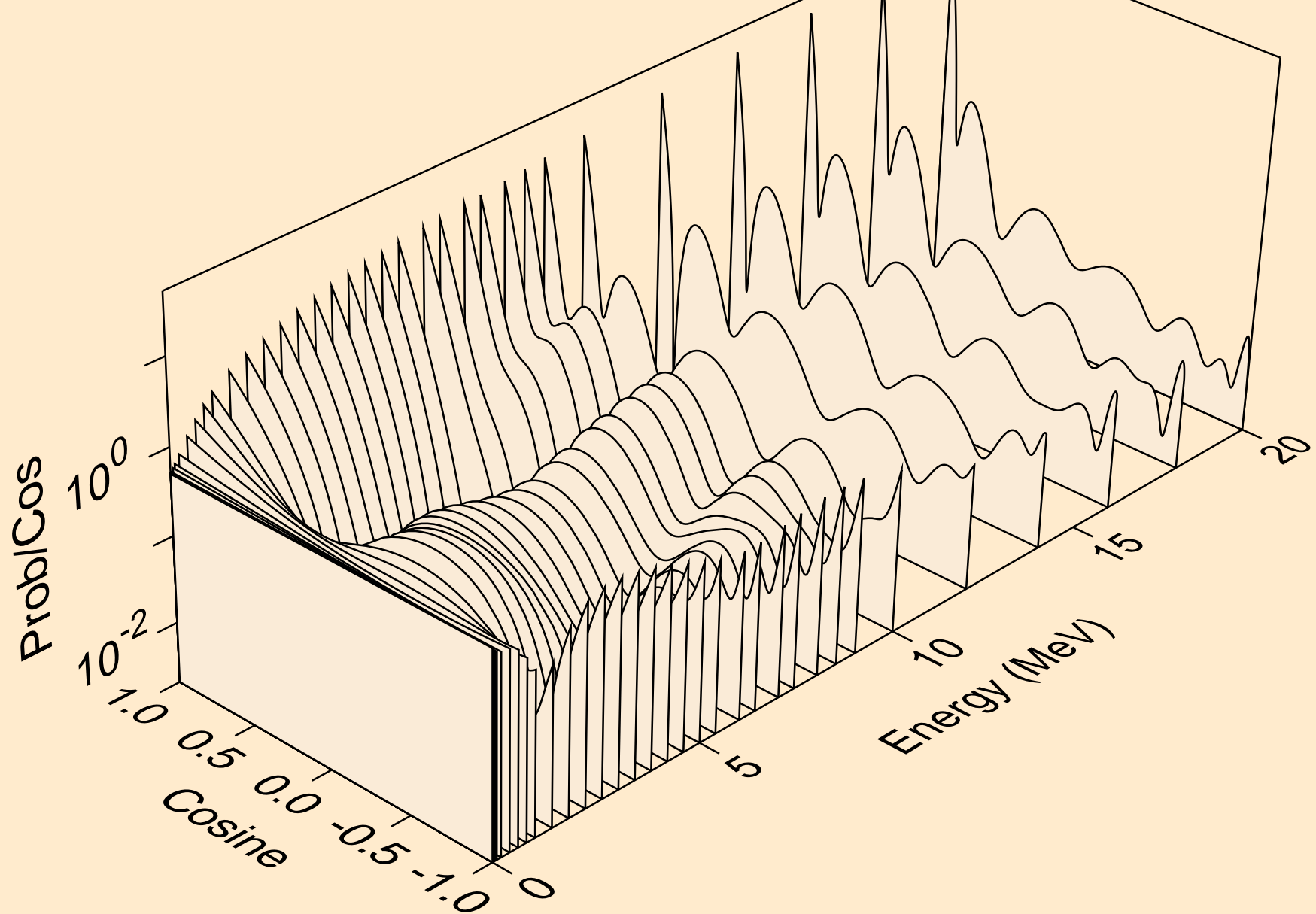

BI190 NEUTRON ACER TENDL-2019 LIBRARY; T=293.16K
angular distribution for elastic

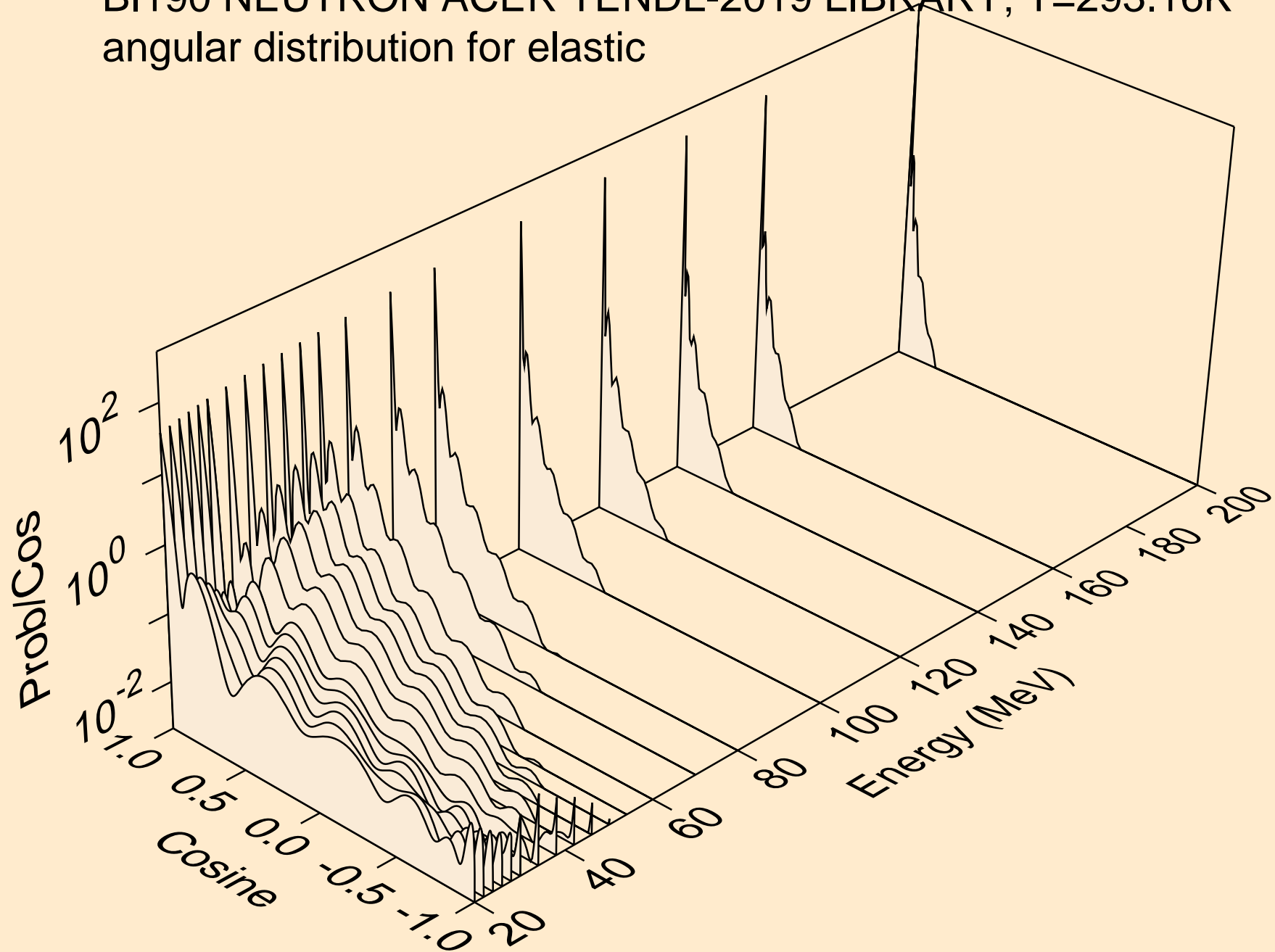

BI190 NEUTRON ACER TENDL-2019 LIBRARY; T=293.16K
angular distribution for (n,n*1)

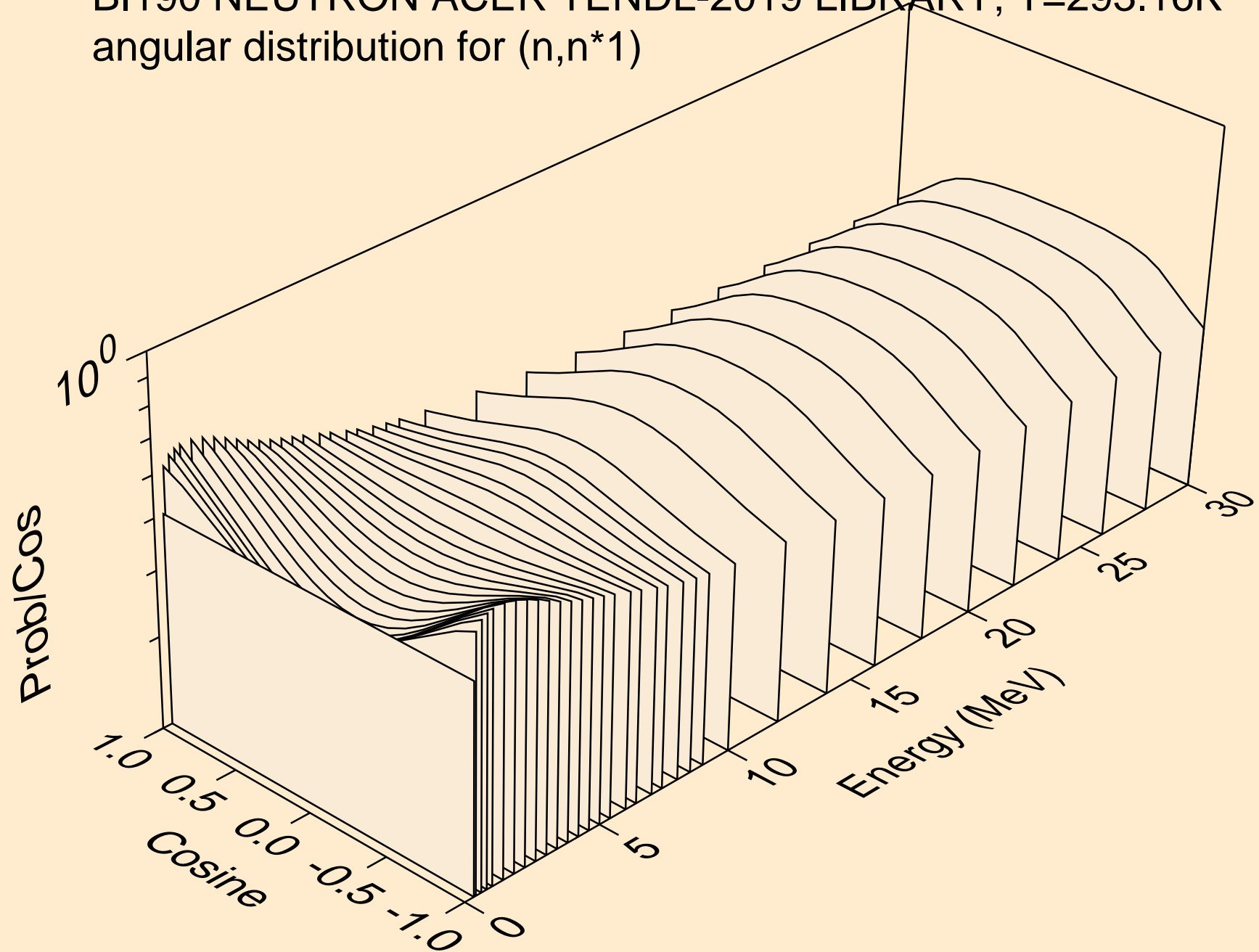

BI190 NEUTRON ACER TENDL-2019 LIBRARY; T=293.16K
angular distribution for (n,n*2)

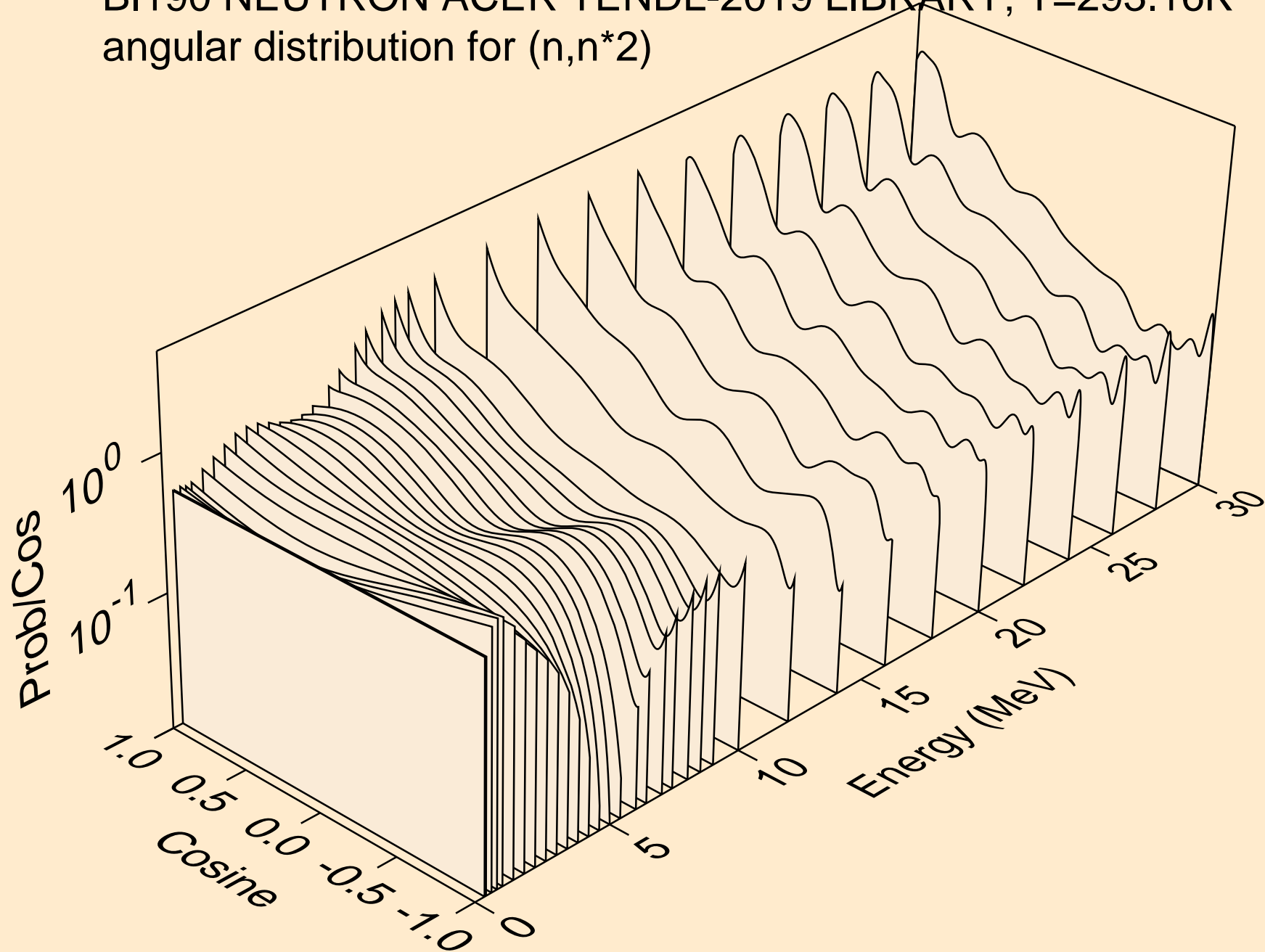

BI190 NEUTRON ACER TENDL-2019 LIBRARY; T=293.16K
angular distribution for (n,n*3)

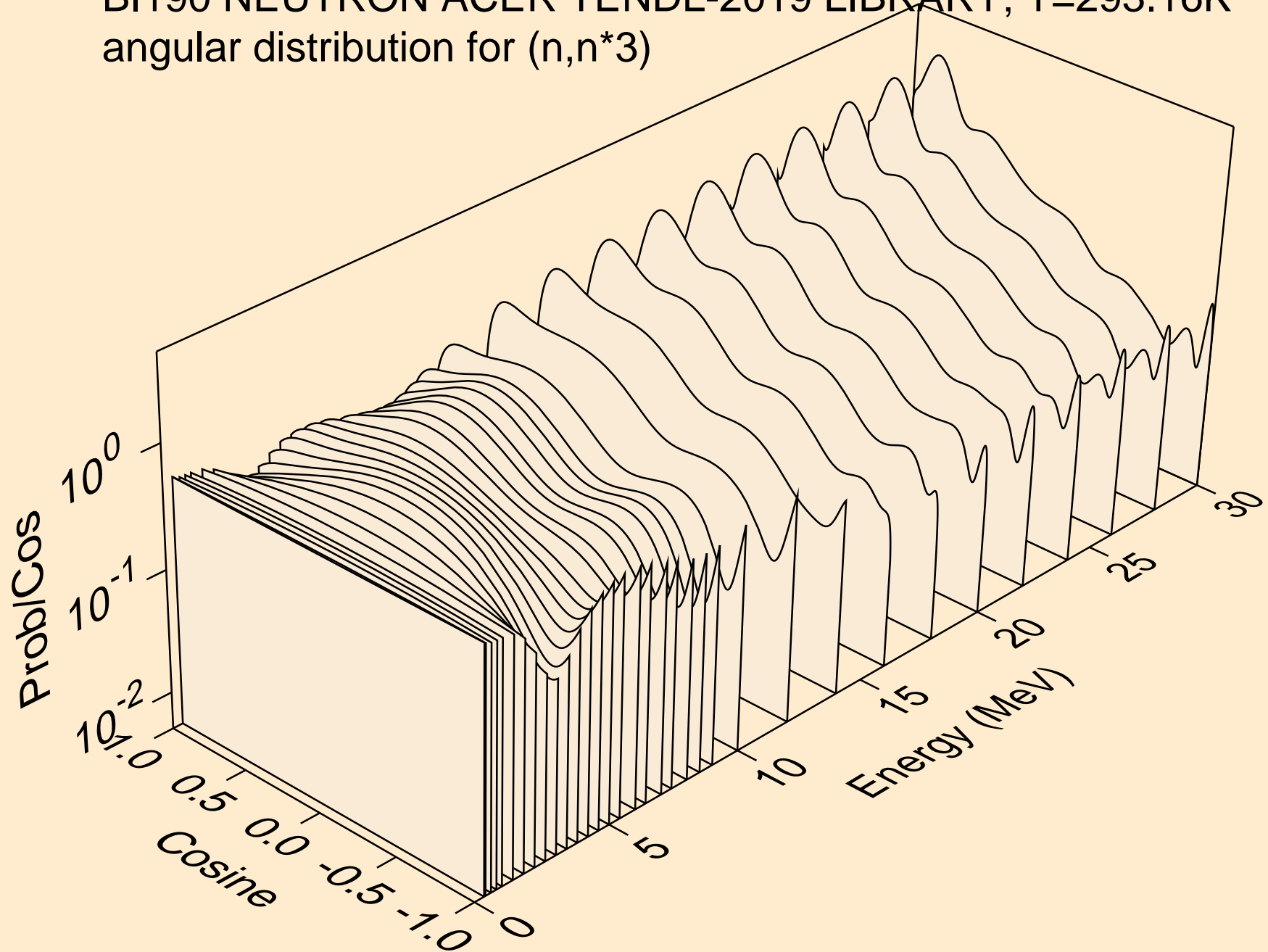

BI190 NEUTRON ACER TENDL-2019 LIBRARY; T=293.16K
angular distribution for (n,n*4)

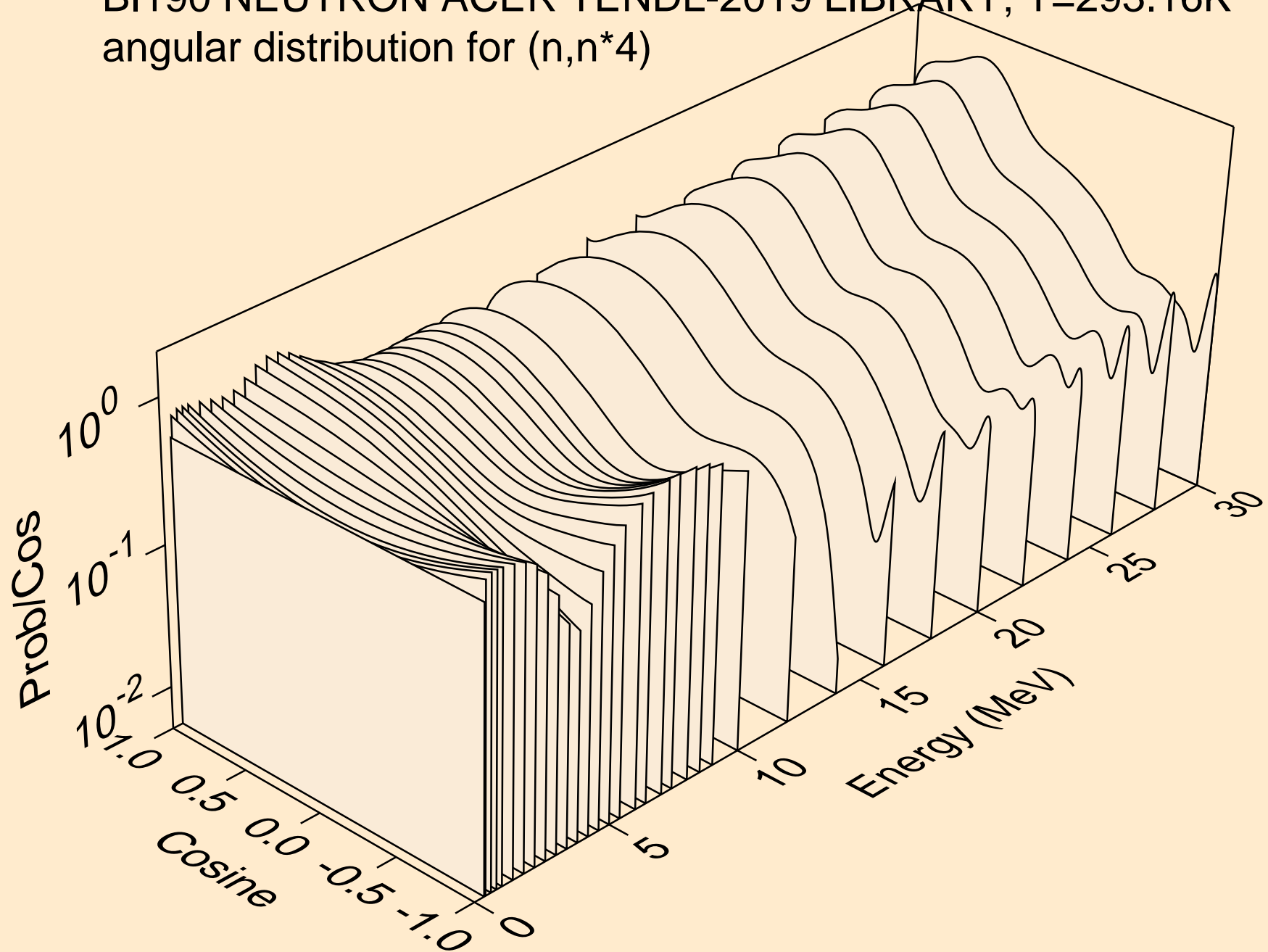

BI190 NEUTRON ACER TENDL-2019 LIBRARY; T=293.16K
angular distribution for (n,n*5)

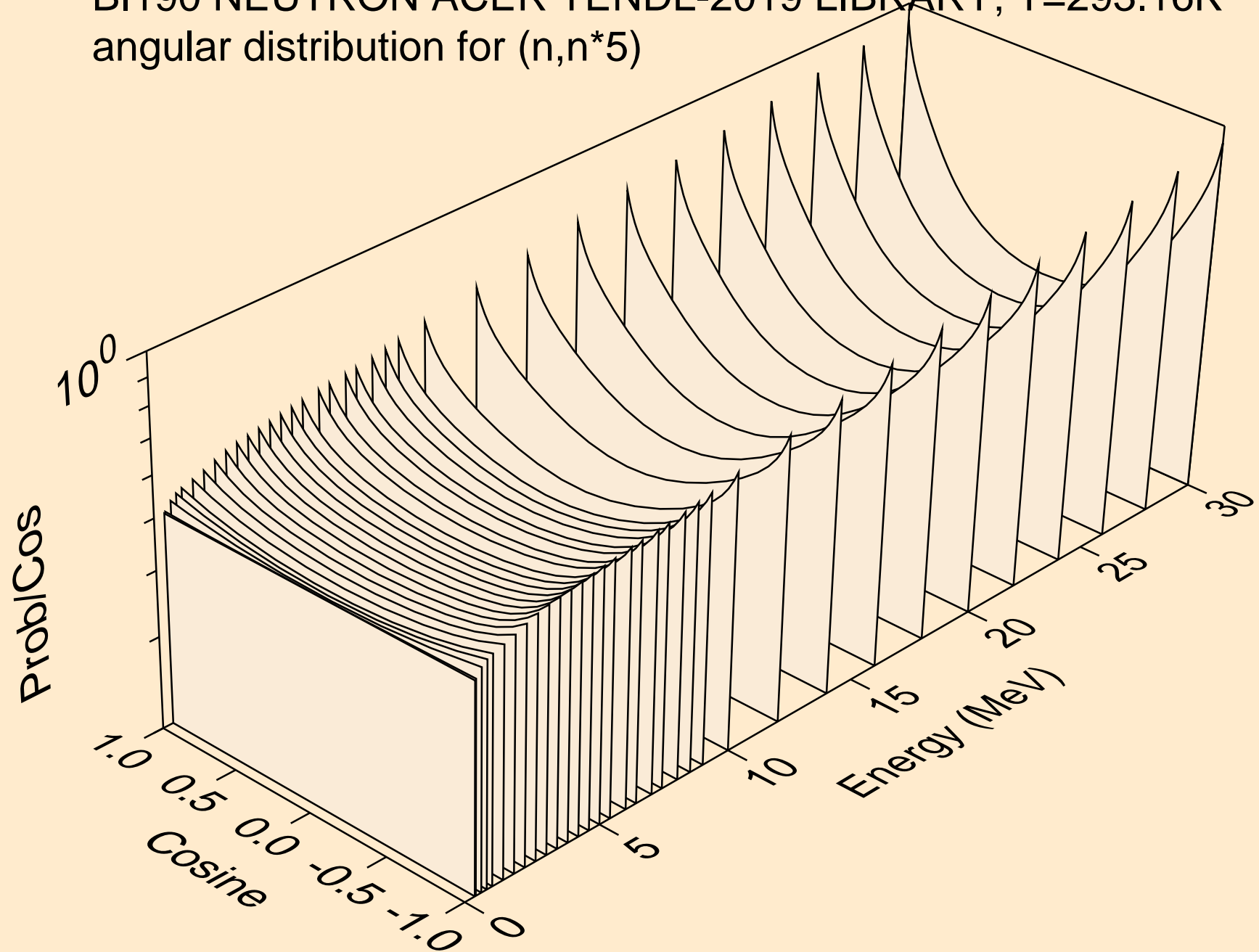

BI190 NEUTRON ACER TENDL-2019 LIBRARY; T=293.16K
angular distribution for (n,n*6)

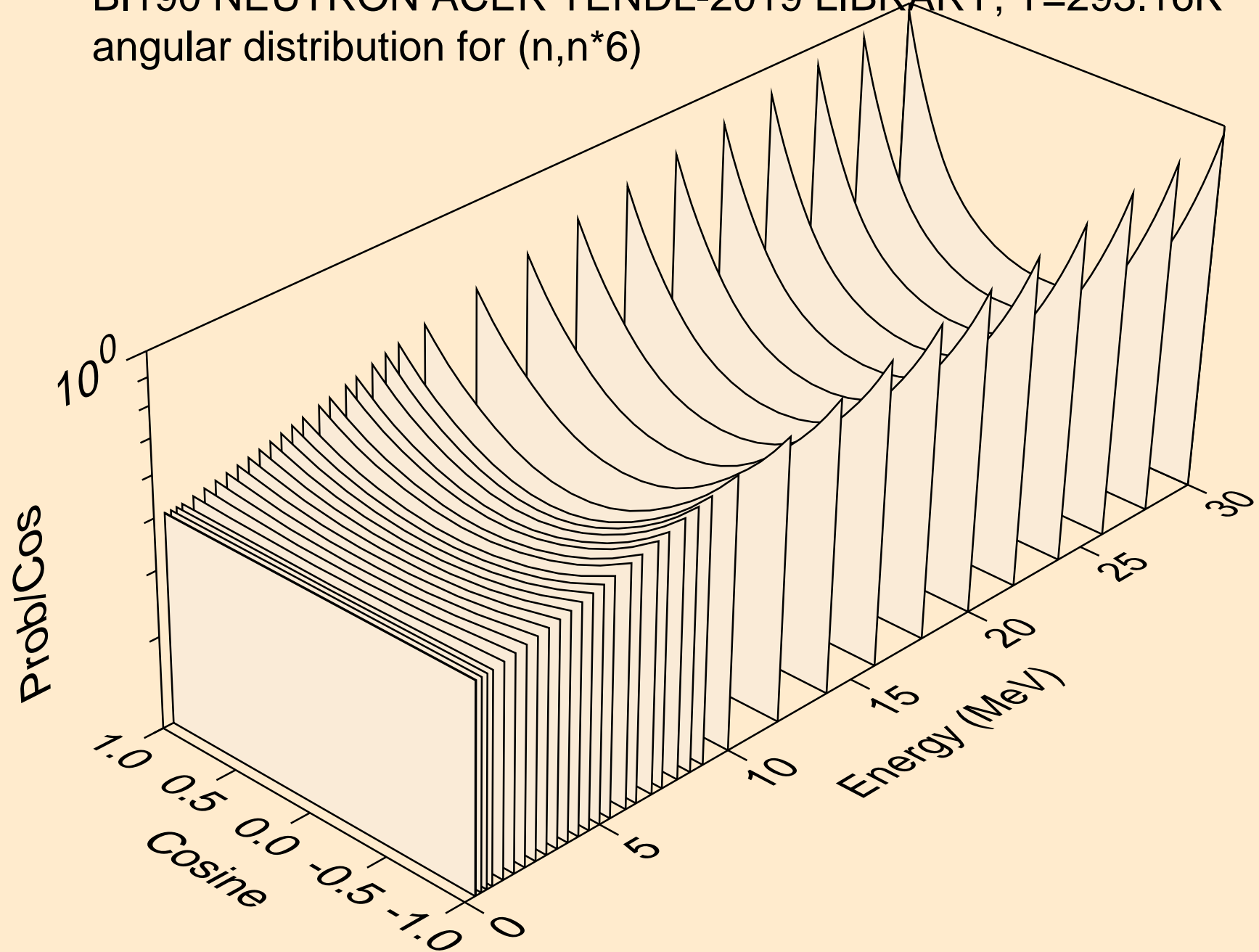

BI190 NEUTRON ACER TENDL-2019 LIBRARY; T=293.16K
angular distribution for (n,n*7)

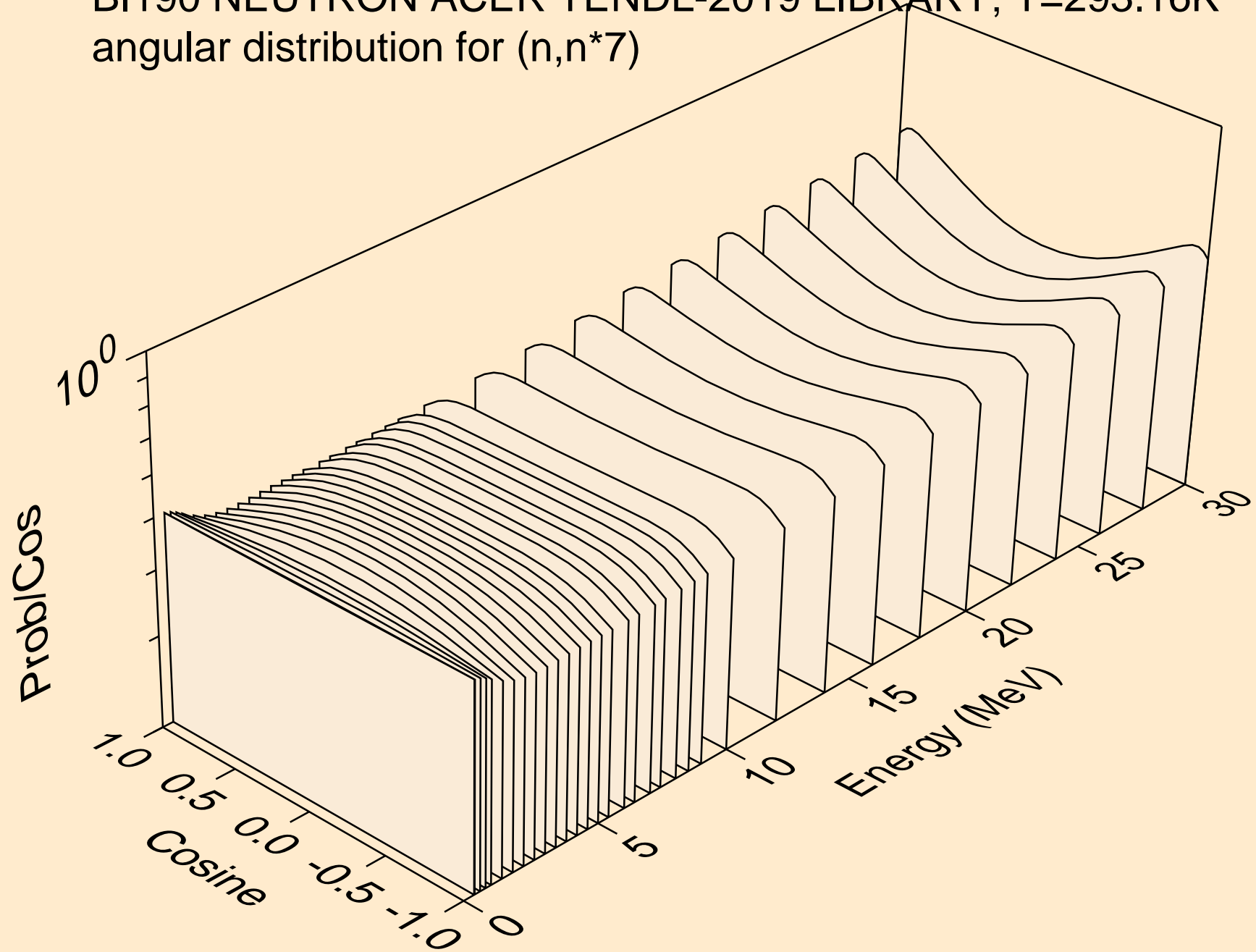

BI190 NEUTRON ACER TENDL-2019 LIBRARY; T=293.16K
angular distribution for (n,n*8)

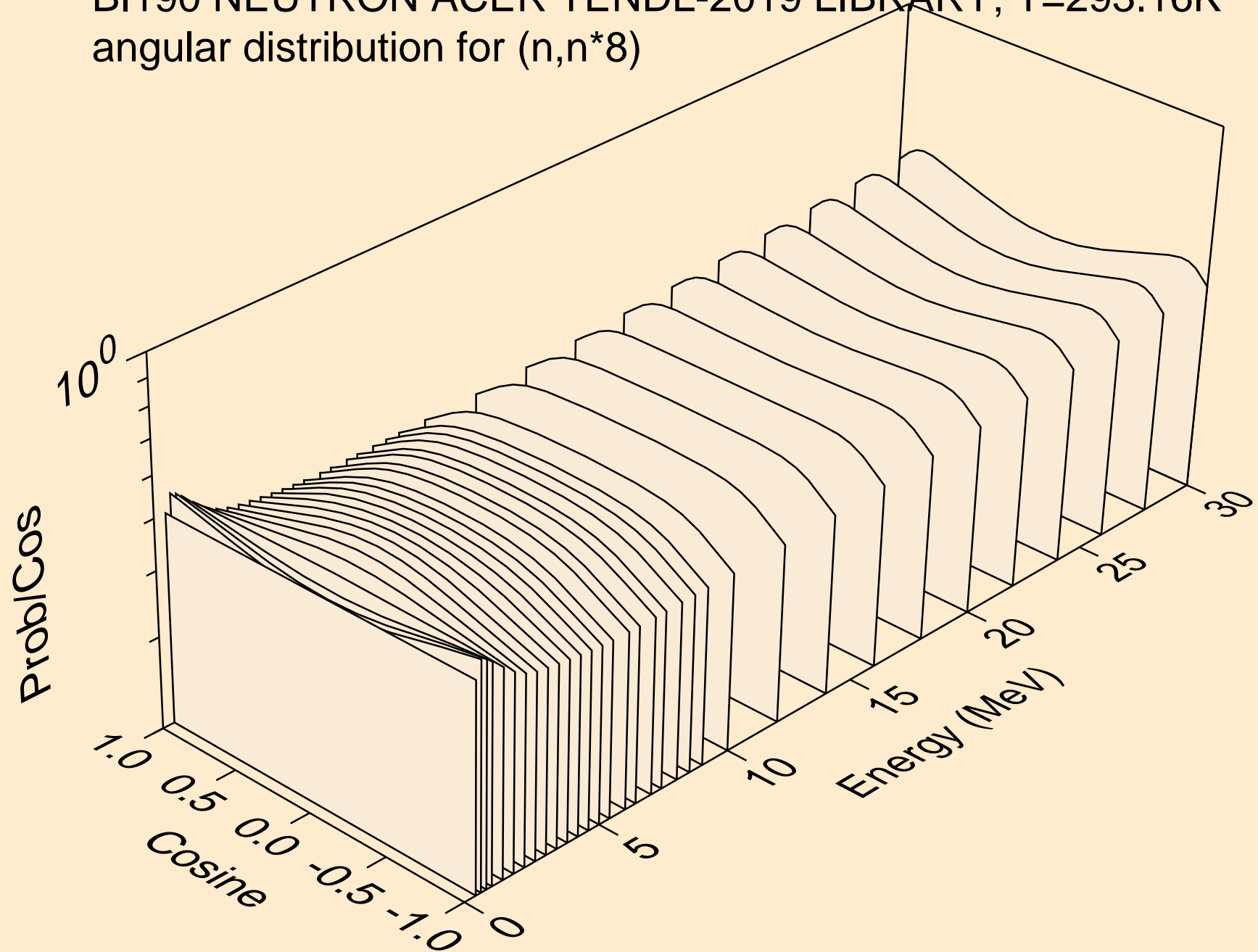

BI190 NEUTRON ACER TENDL-2019 LIBRARY; T=293.16K
angular distribution for (n,n*9)

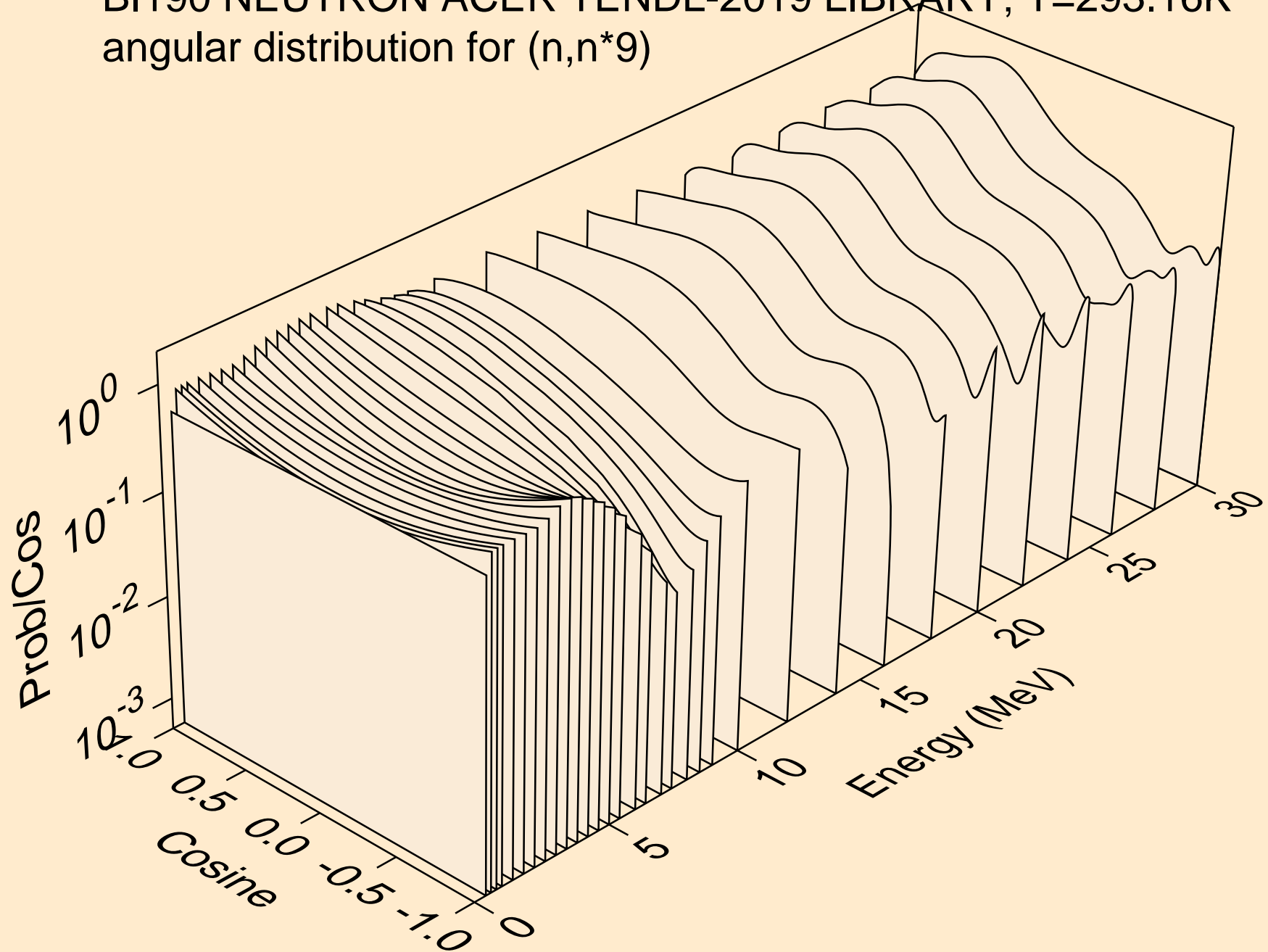

BI190 NEUTRON ACER TENDL-2019 LIBRARY; T=293.16K
angular distribution for (n,n*10)

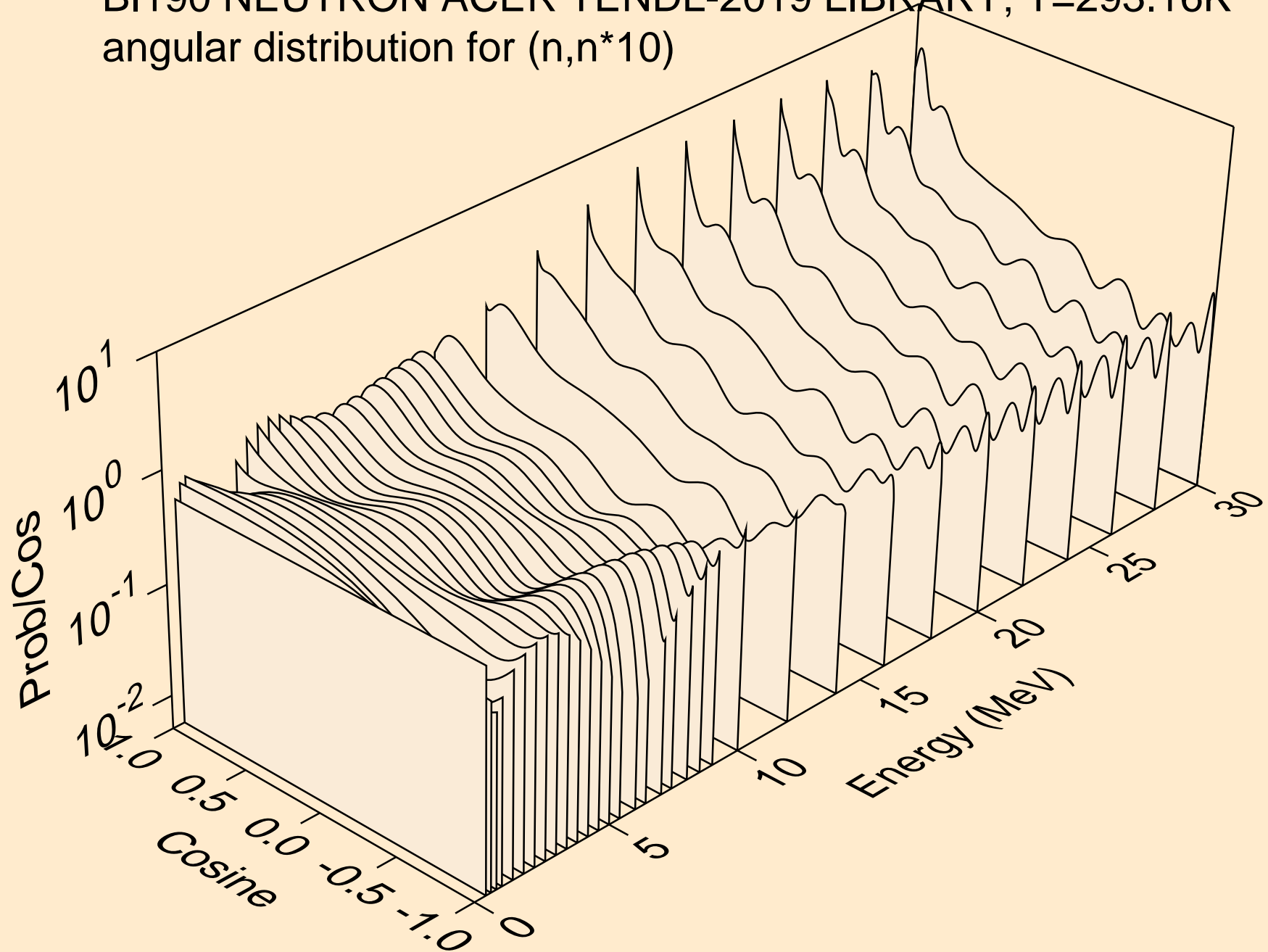

BI190 NEUTRON ACER TENDL-2019 LIBRARY; T=293.16K
angular distribution for (n,n*11)

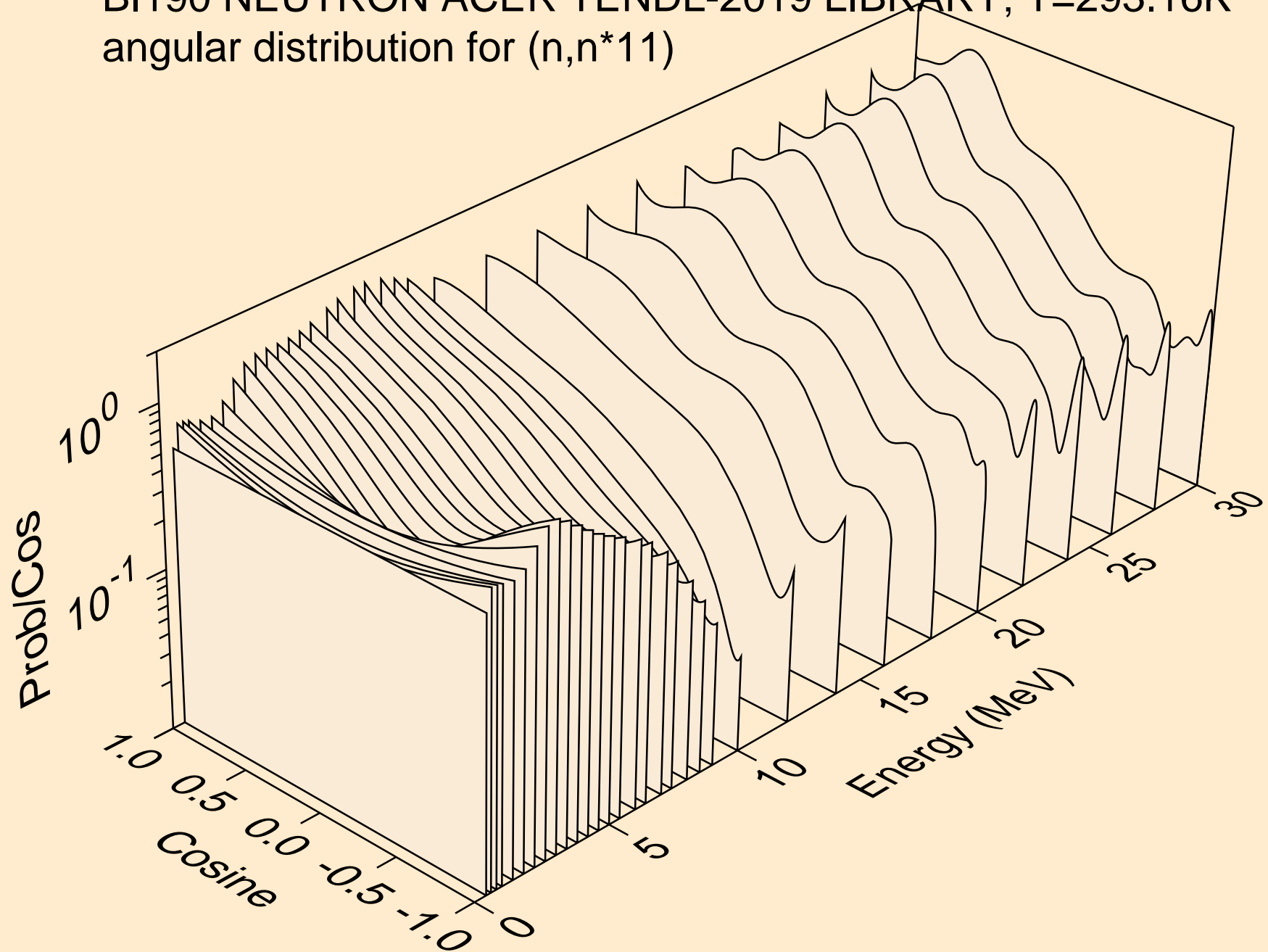

BI190 NEUTRON ACER TENDL-2019 LIBRARY; T=293.16K
angular distribution for (n,n*12)

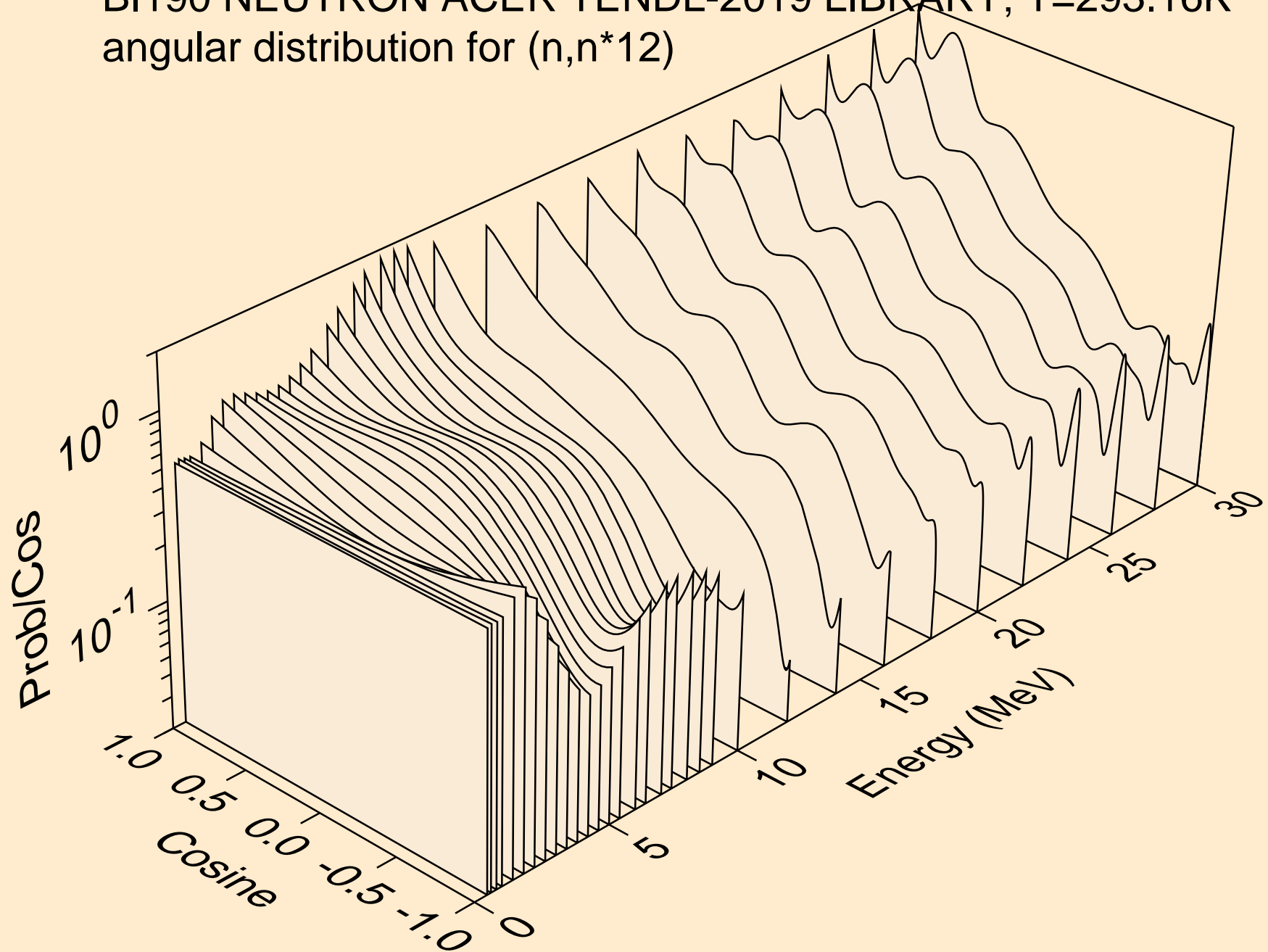

BI190 NEUTRON ACER TENDL-2019 LIBRARY; T=293.16K
angular distribution for (n,n*13)

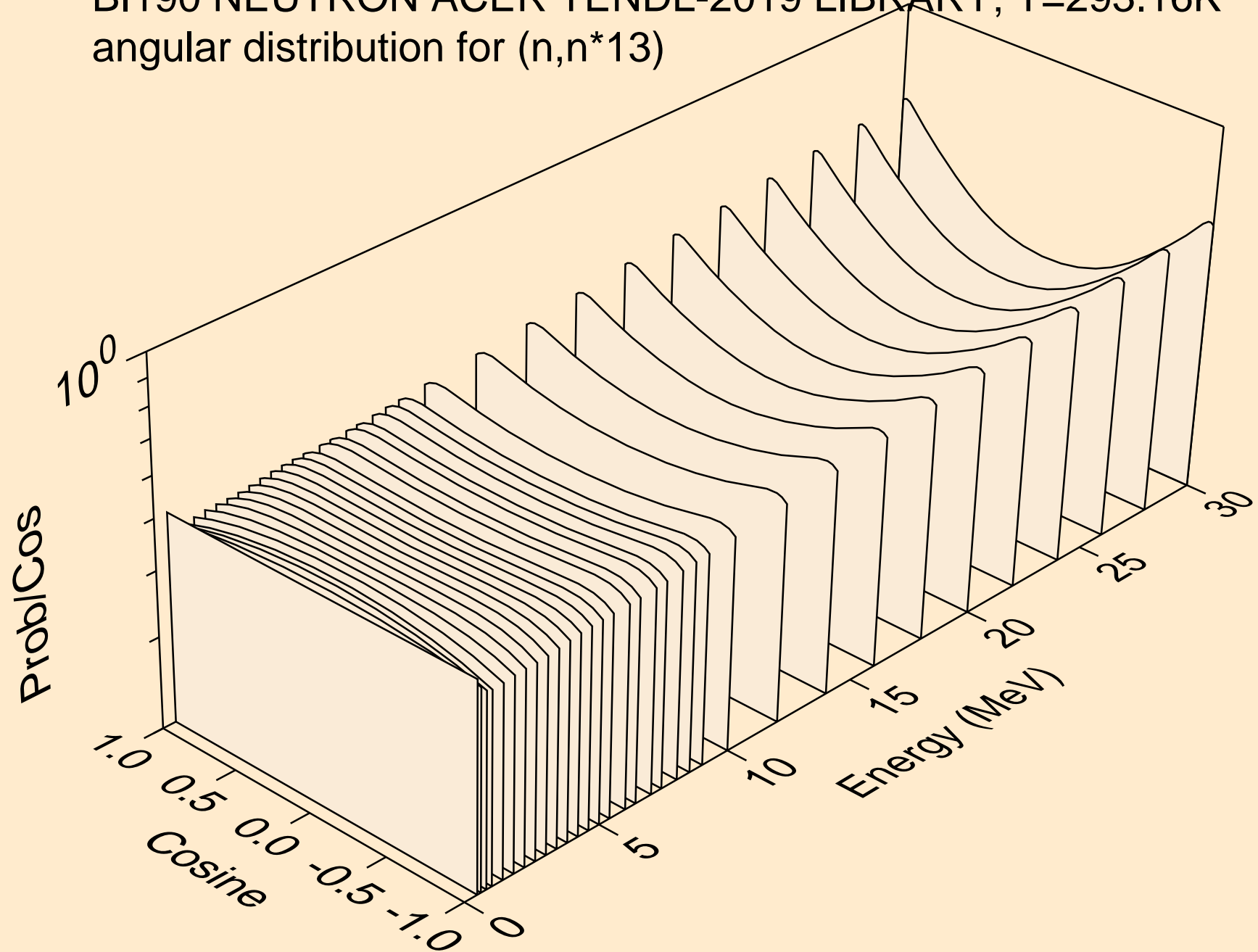

BI190 NEUTRON ACER TENDL-2019 LIBRARY; T=293.16K
angular distribution for (n,n*14)

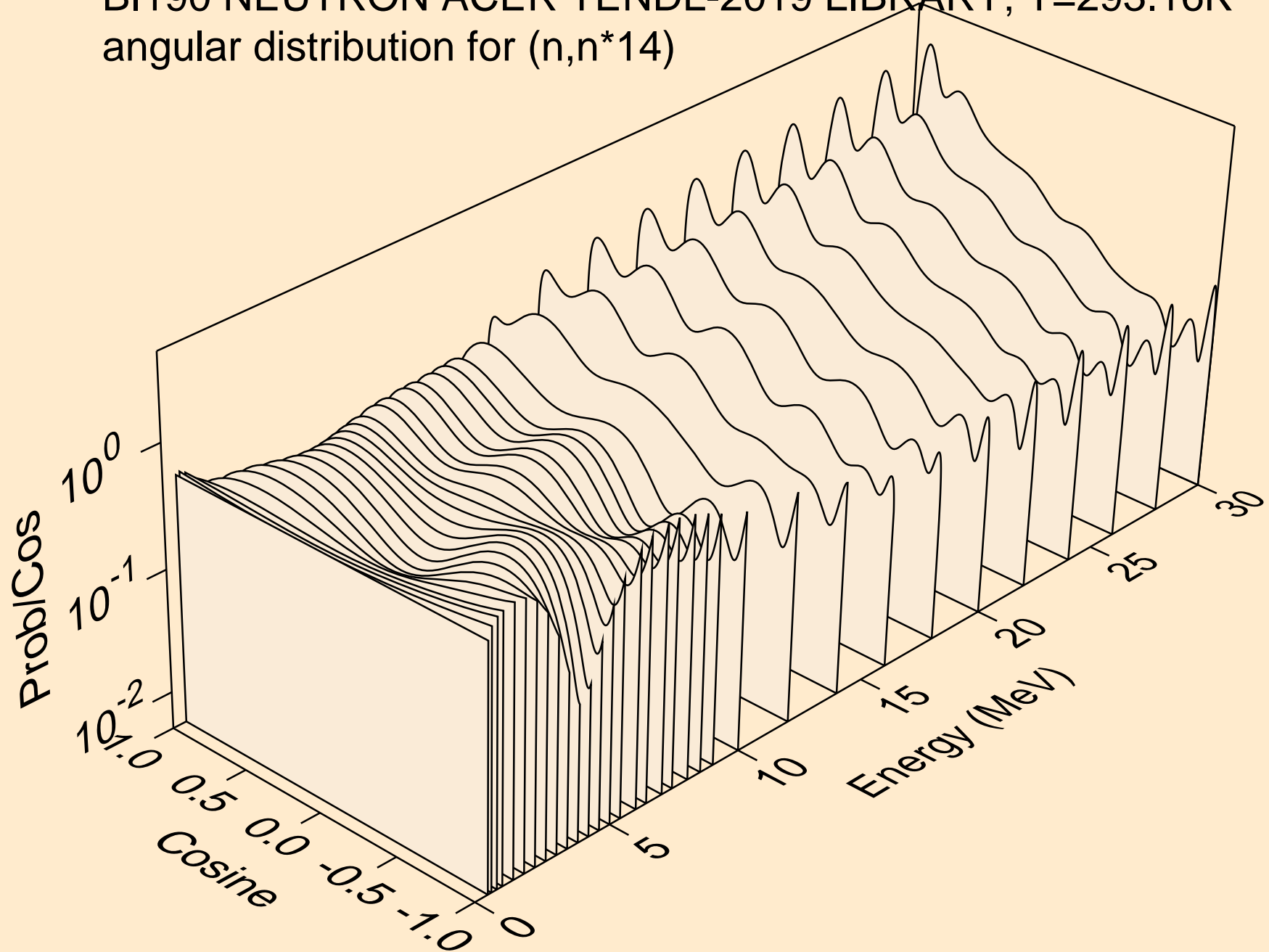

BI190 NEUTRON ACER TENDL-2019 LIBRARY; T=293.16K
Neutron emission for (n,x)

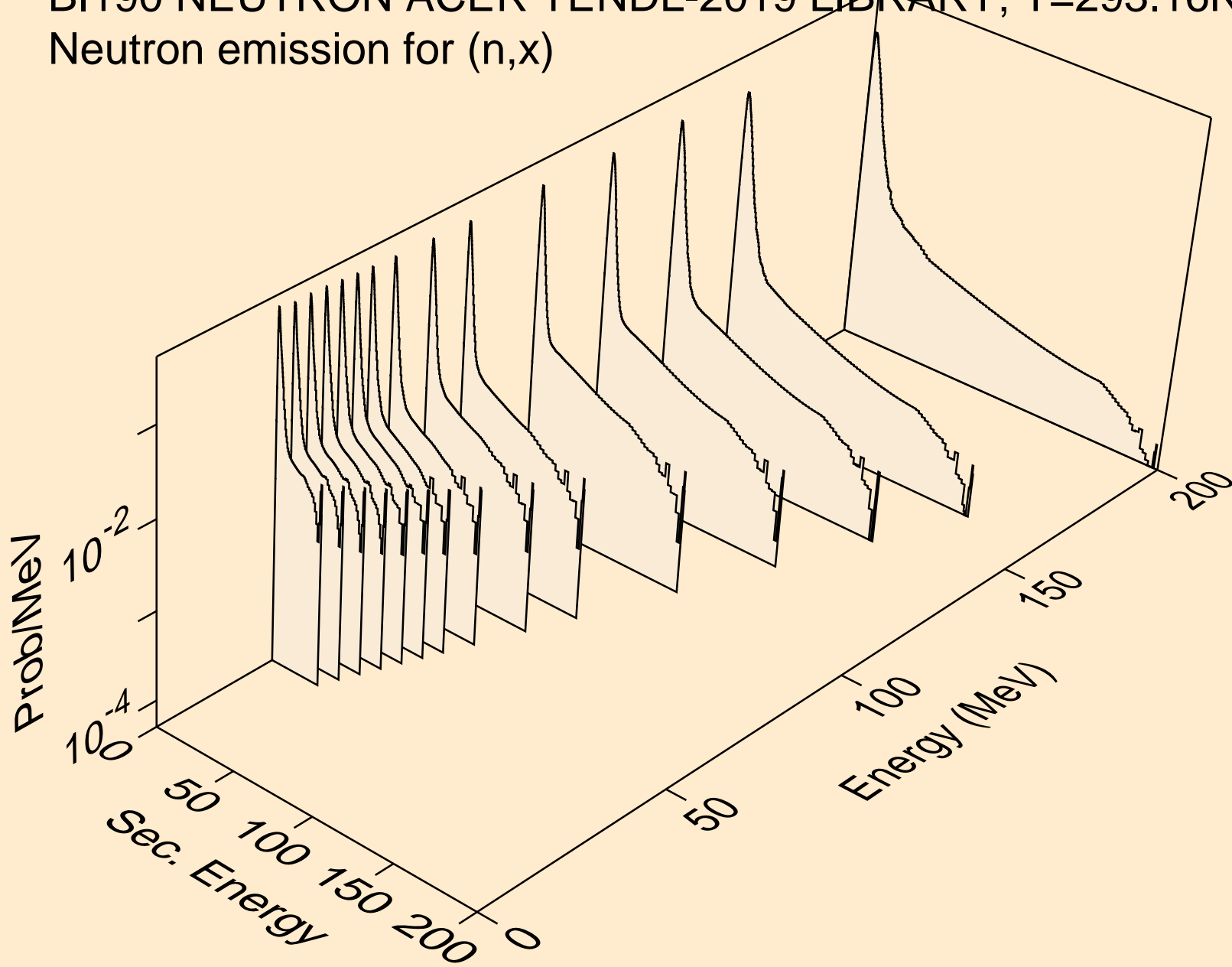

BI190 NEUTRON ACER TENDL-2019 LIBRARY; T=293.16K
Neutron emission for (n,2nd)

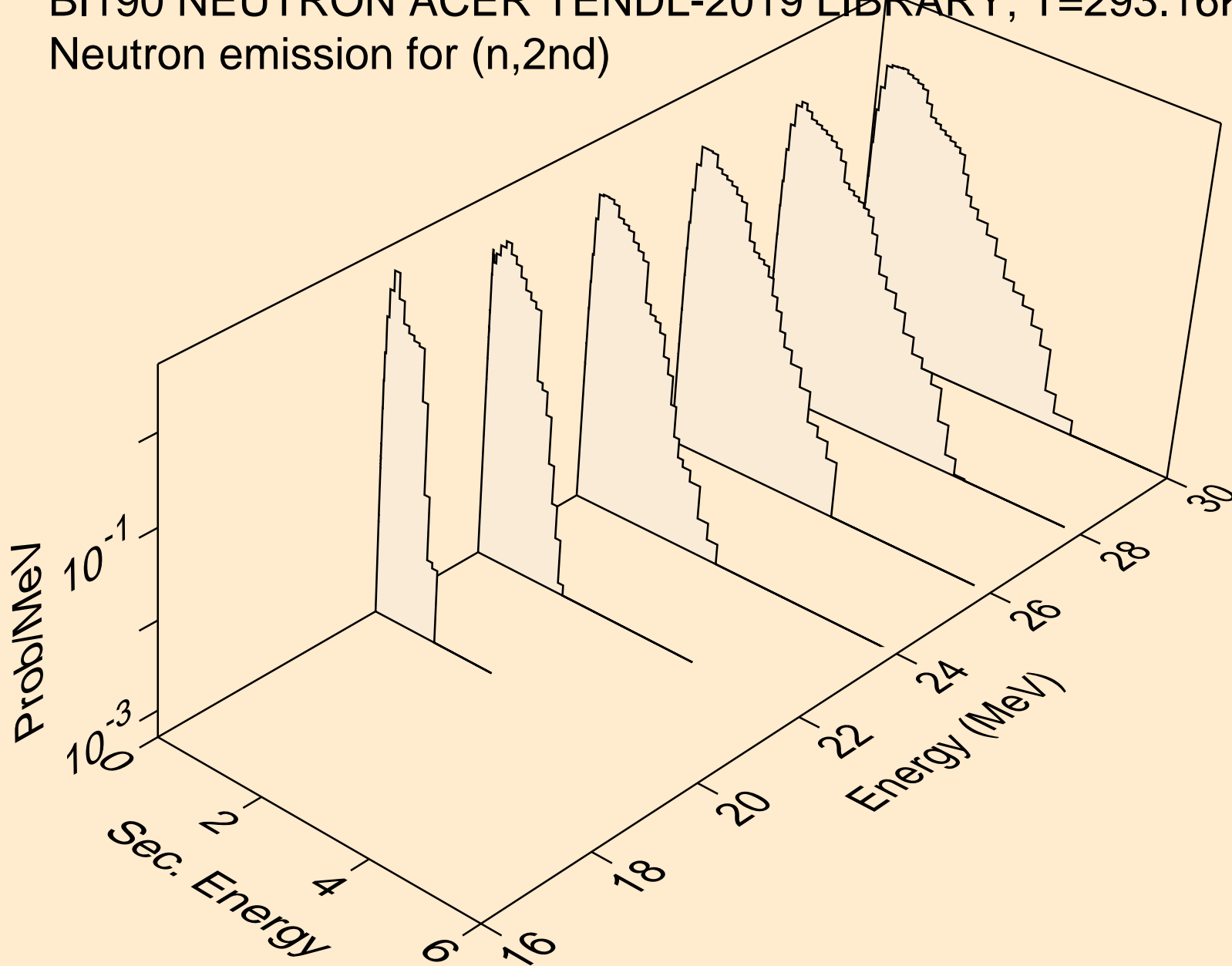

BI190 NEUTRON ACER TENDL-2019 LIBRARY; T=293.16K
Neutron emission for (n,2n)

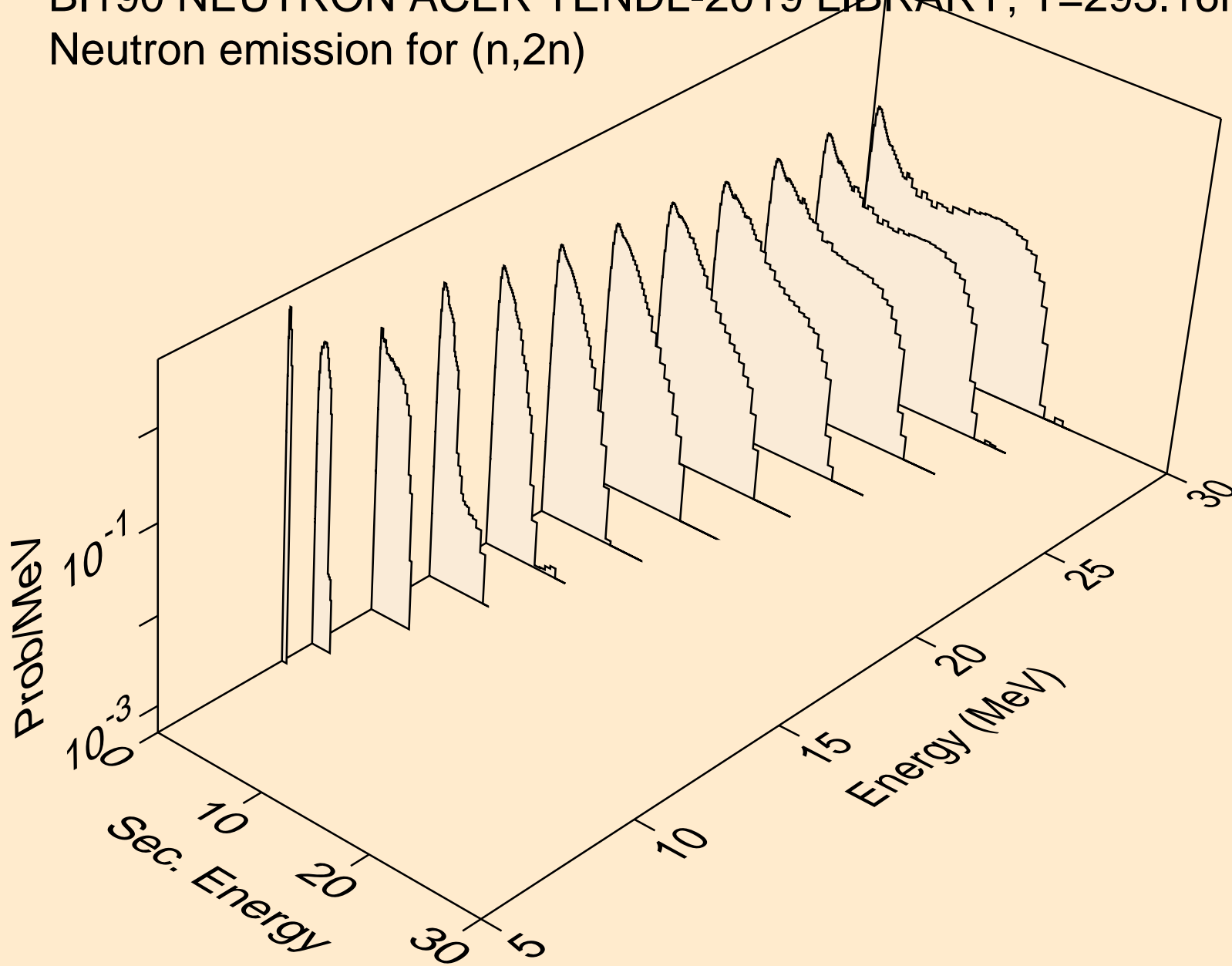

BI190 NEUTRON ACER TENDL-2019 LIBRARY; T=293.16K
Neutron emission for (n,3n)

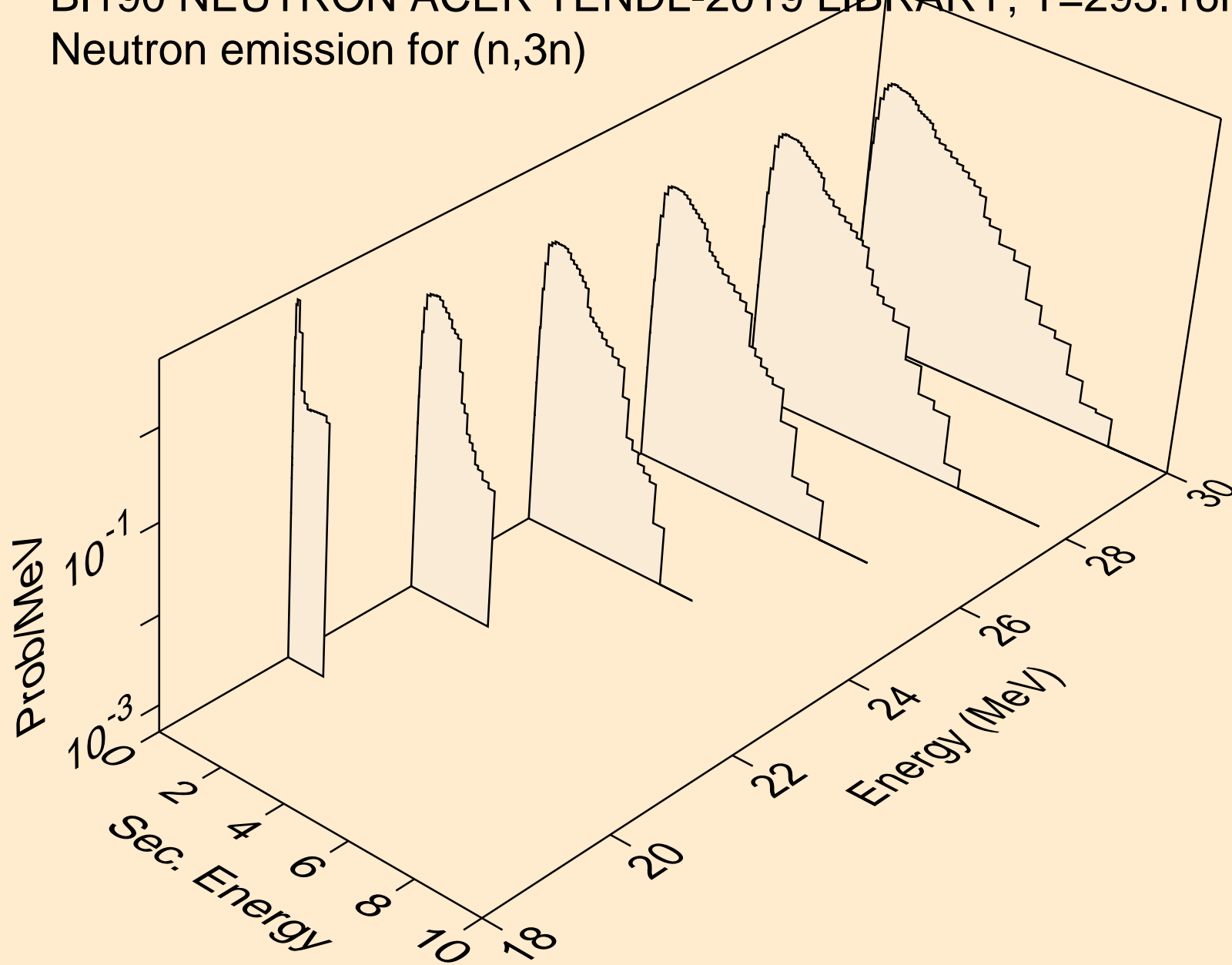

BI190 NEUTRON ACER TENDL-2019 LIBRARY; T=293.16K
Neutron emission for (n,n*)a

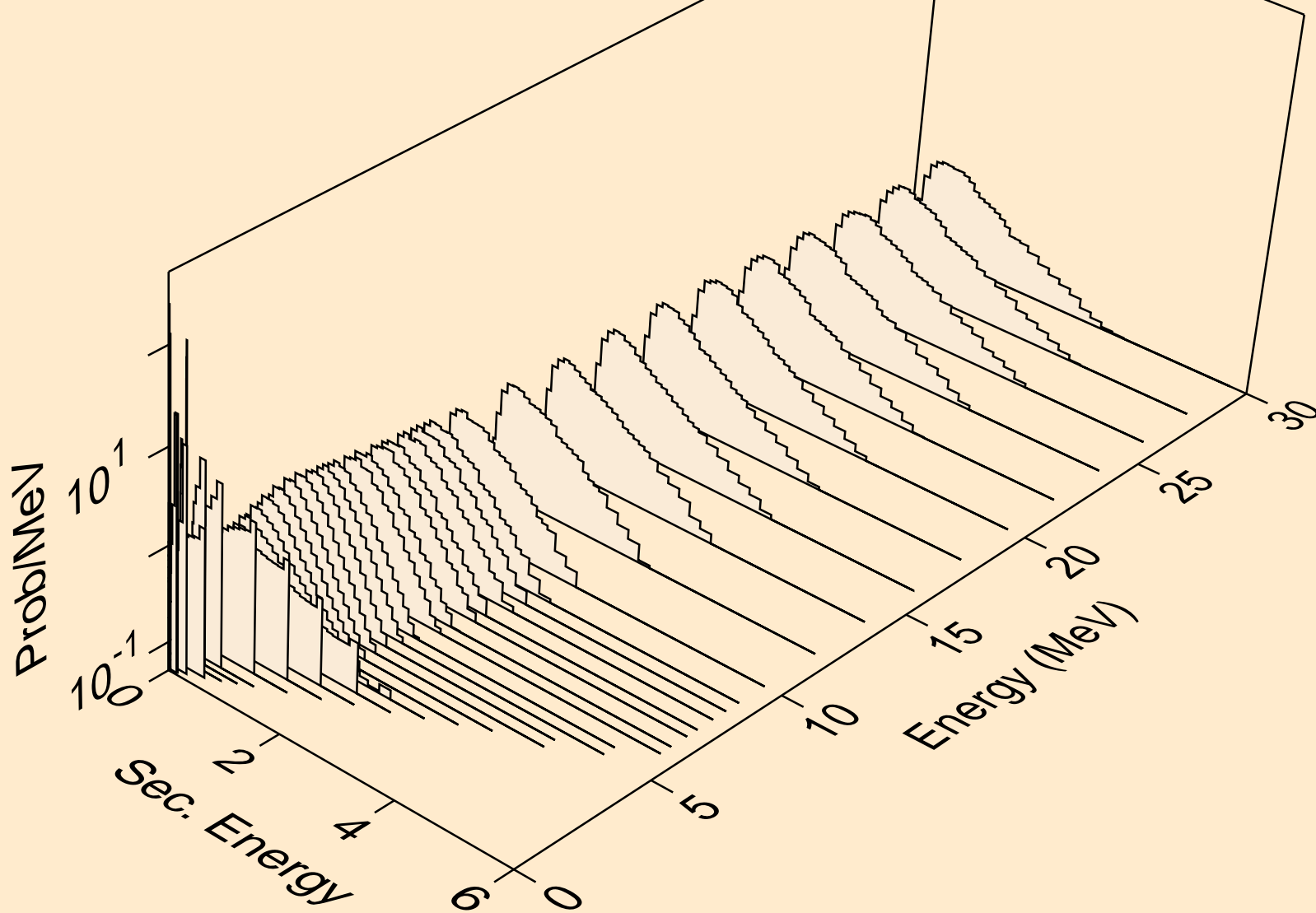

BI190 NEUTRON ACER TENDL-2019 LIBRARY; T=293.16K
Neutron emission for (n,n*)3a

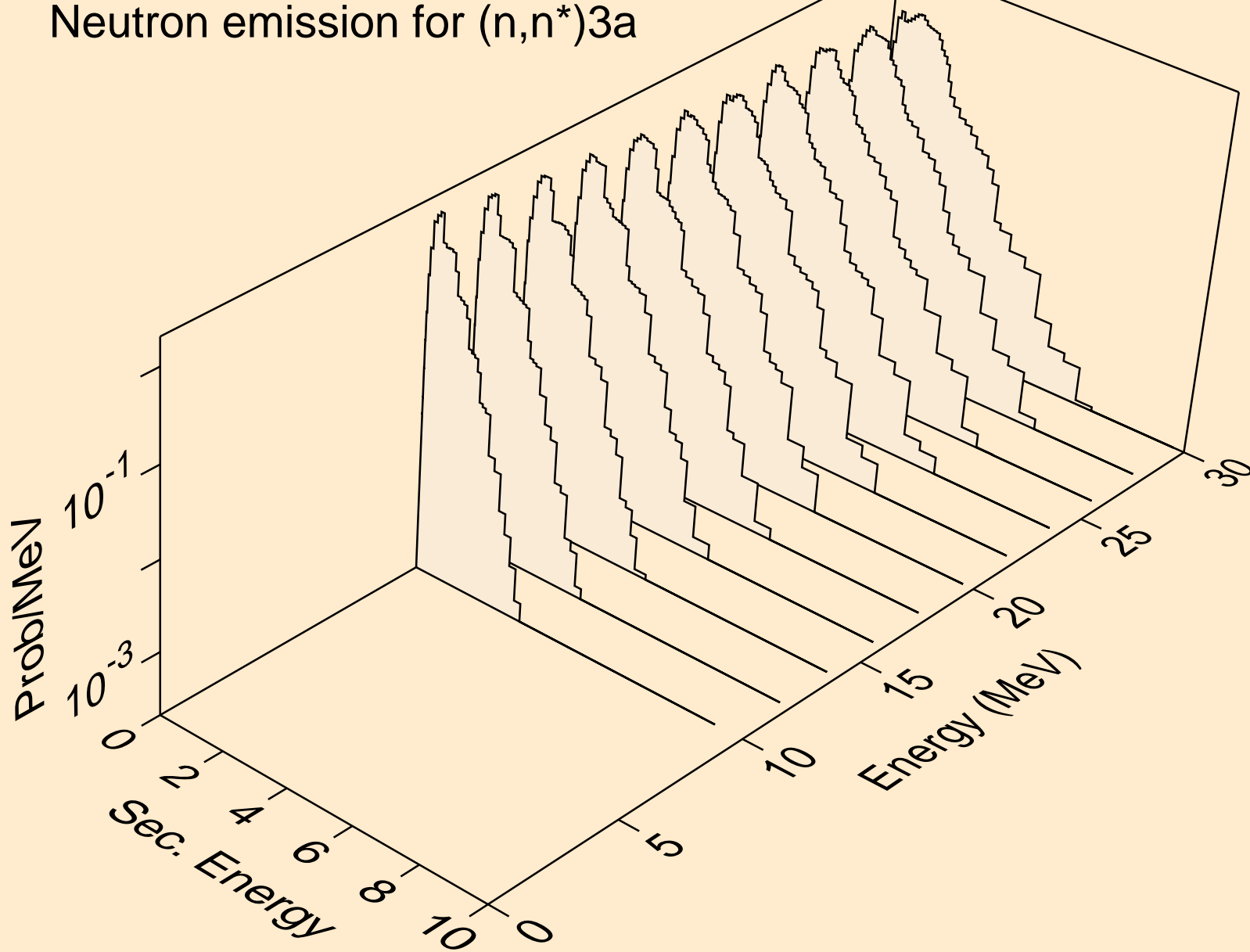

BI190 NEUTRON ACER TENDL-2019 LIBRARY; T=293.16K
Neutron emission for (n,2n)a

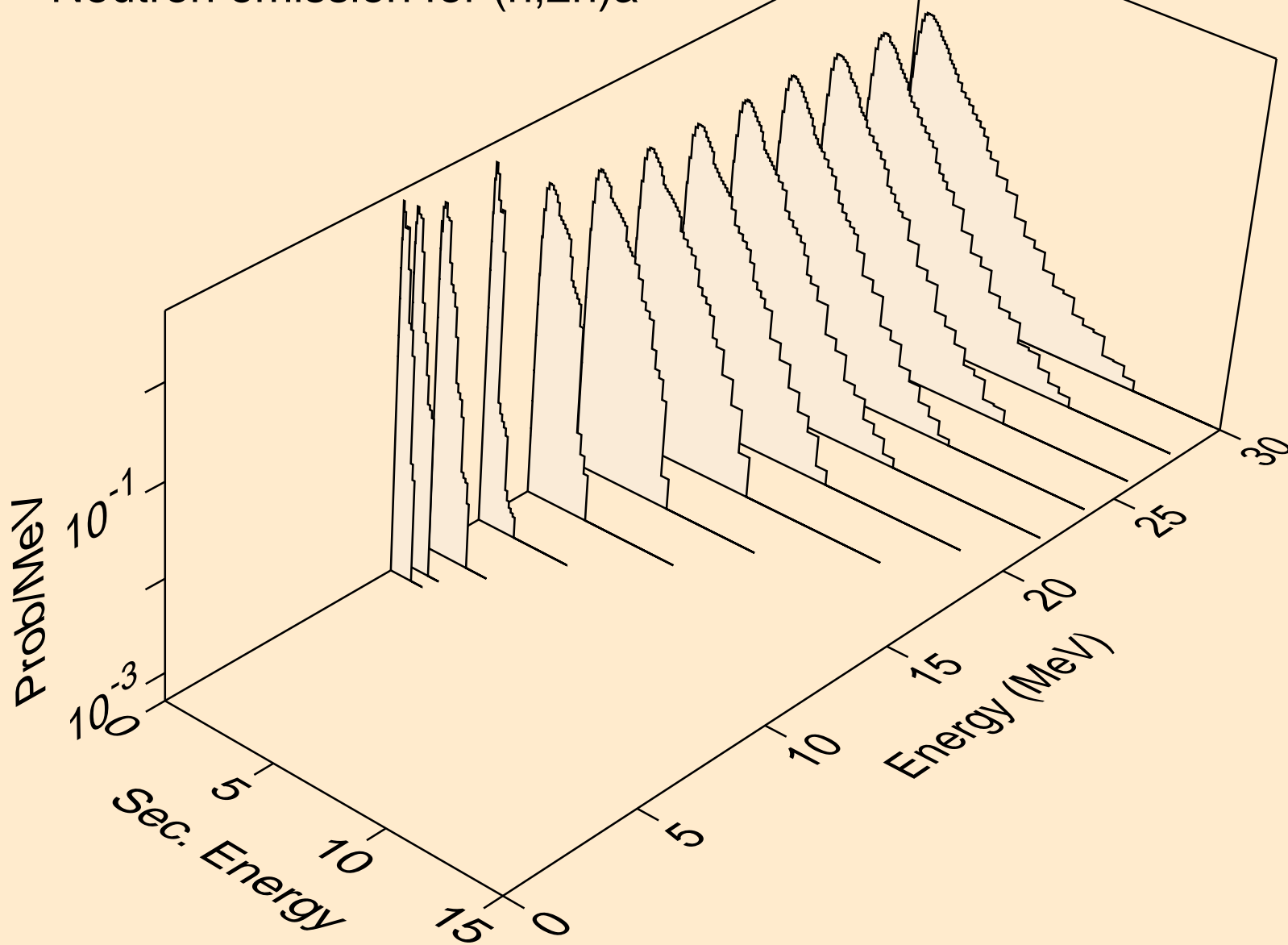

BI190 NEUTRON ACER TENDL-2019 LIBRARY; T=293.16K
Neutron emission for (n,3n)a

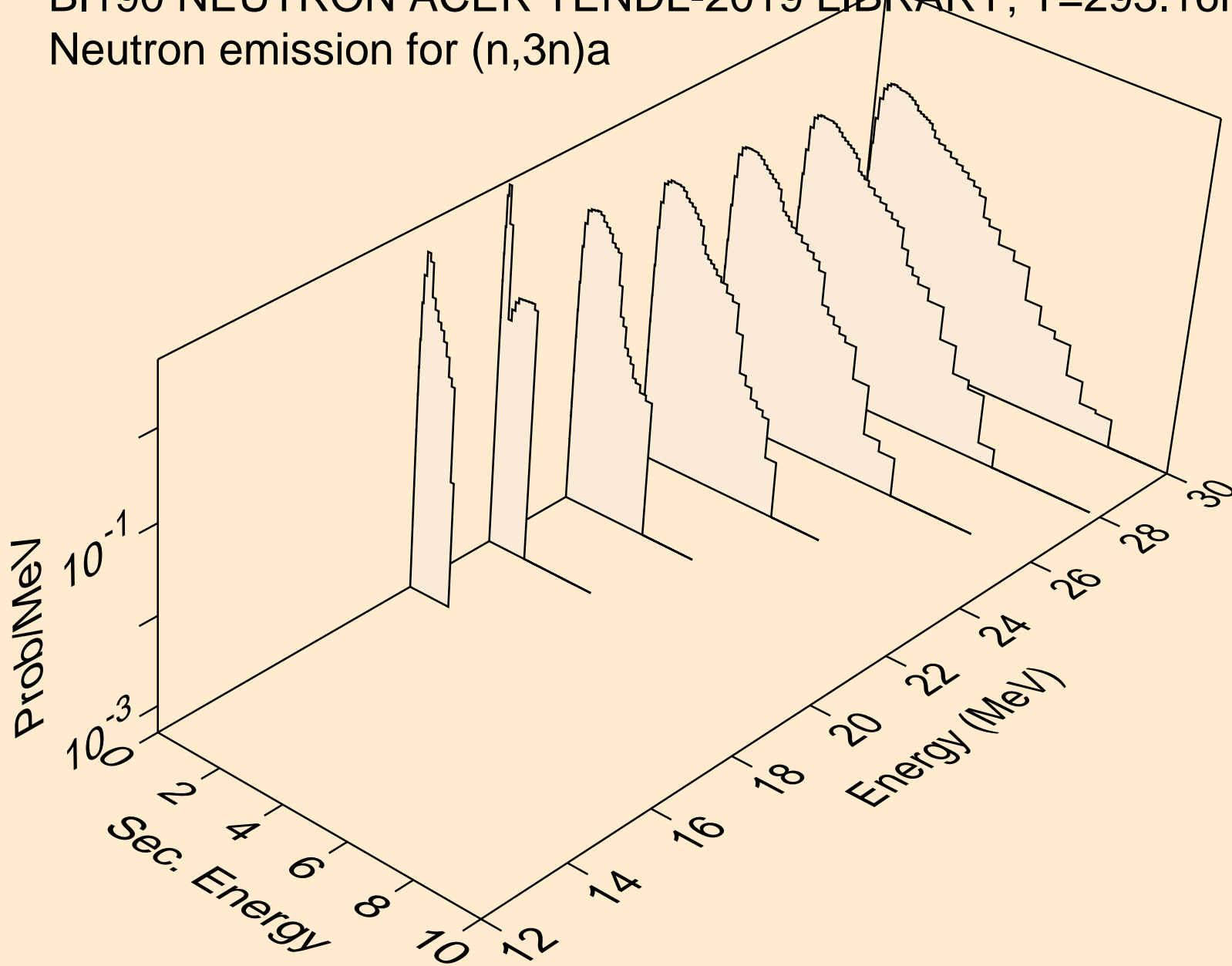

BI190 NEUTRON ACER TENDL-2019 LIBRARY; T=293.16K
Neutron emission for (n,n*)p

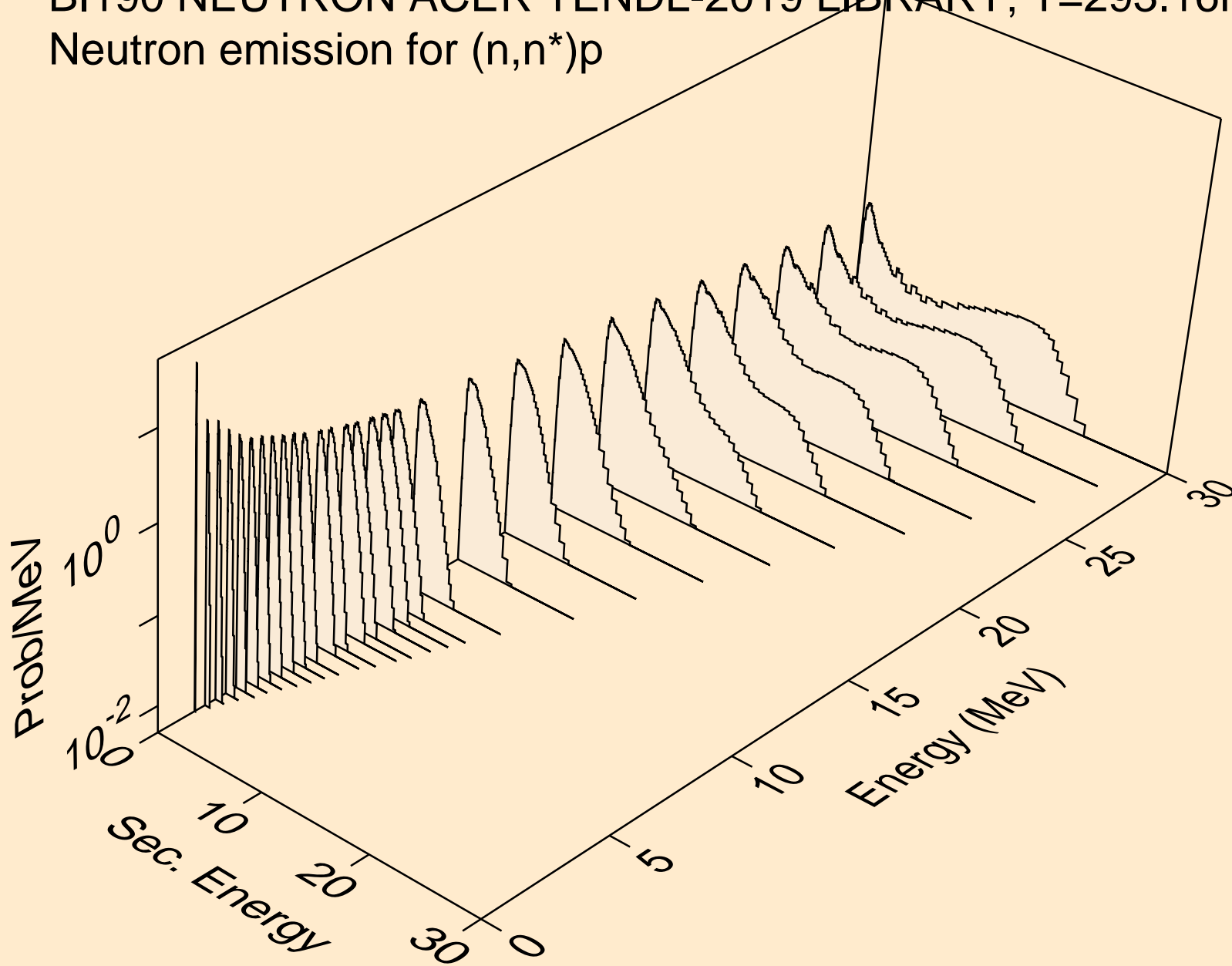

BI190 NEUTRON ACER TENDL-2019 LIBRARY; T=293.16K
Neutron emission for (n,n*)2a

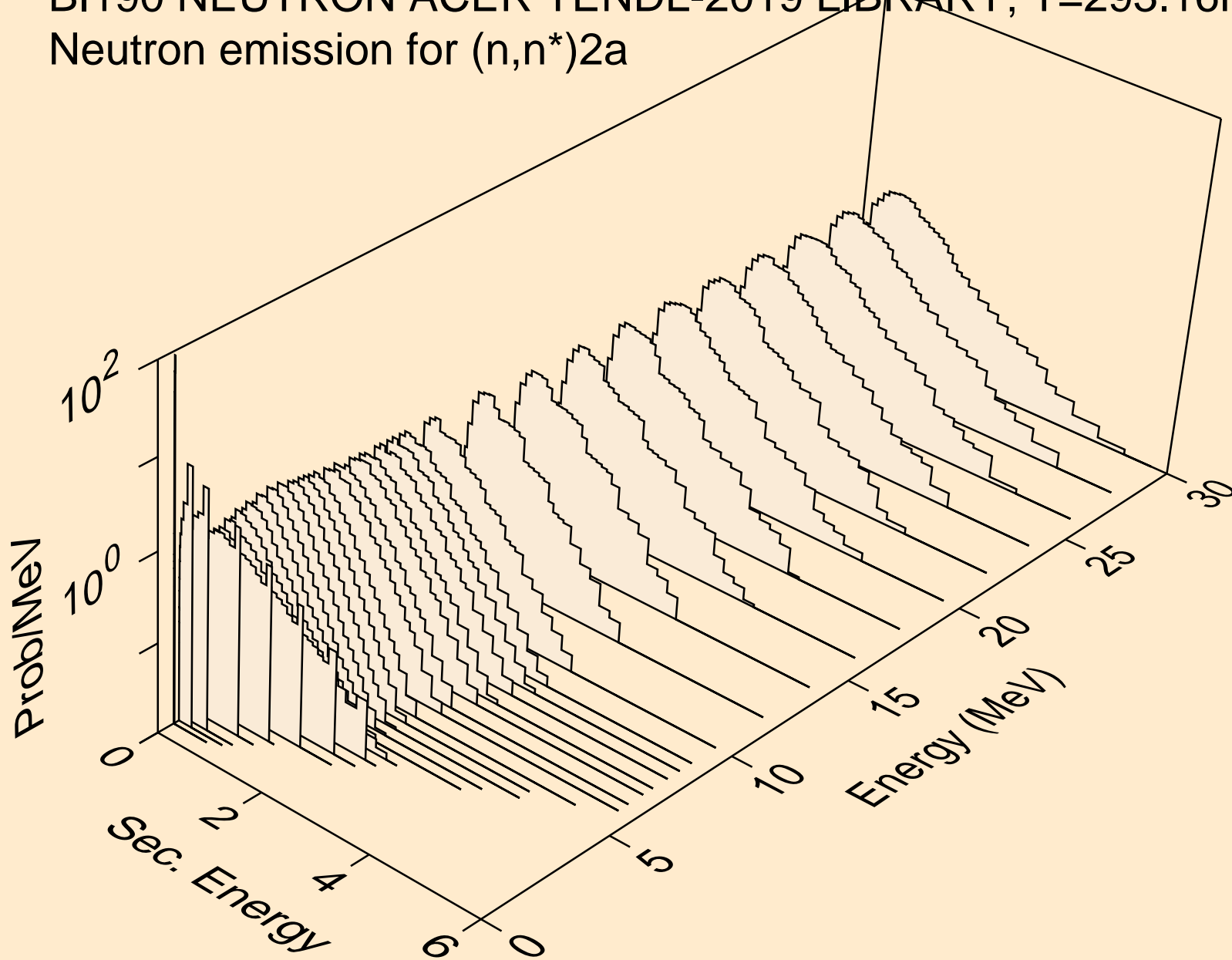

BI190 NEUTRON ACER TENDL-2019 LIBRARY; T=293.16K
Neutron emission for (n,2n)2a

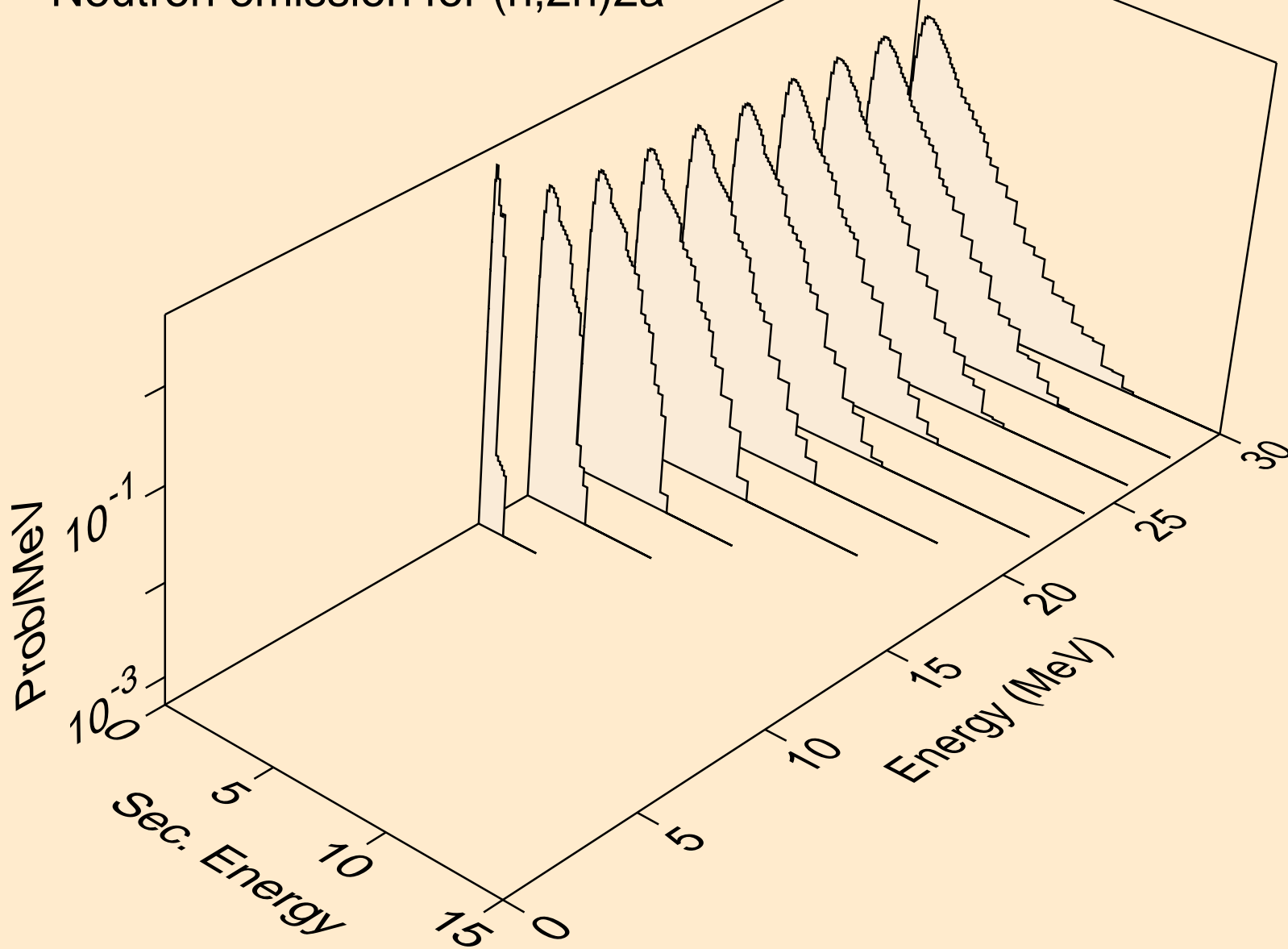

BI190 NEUTRON ACER TENDL-2019 LIBRARY; T=293.16K
Neutron emission for (n,n*)d

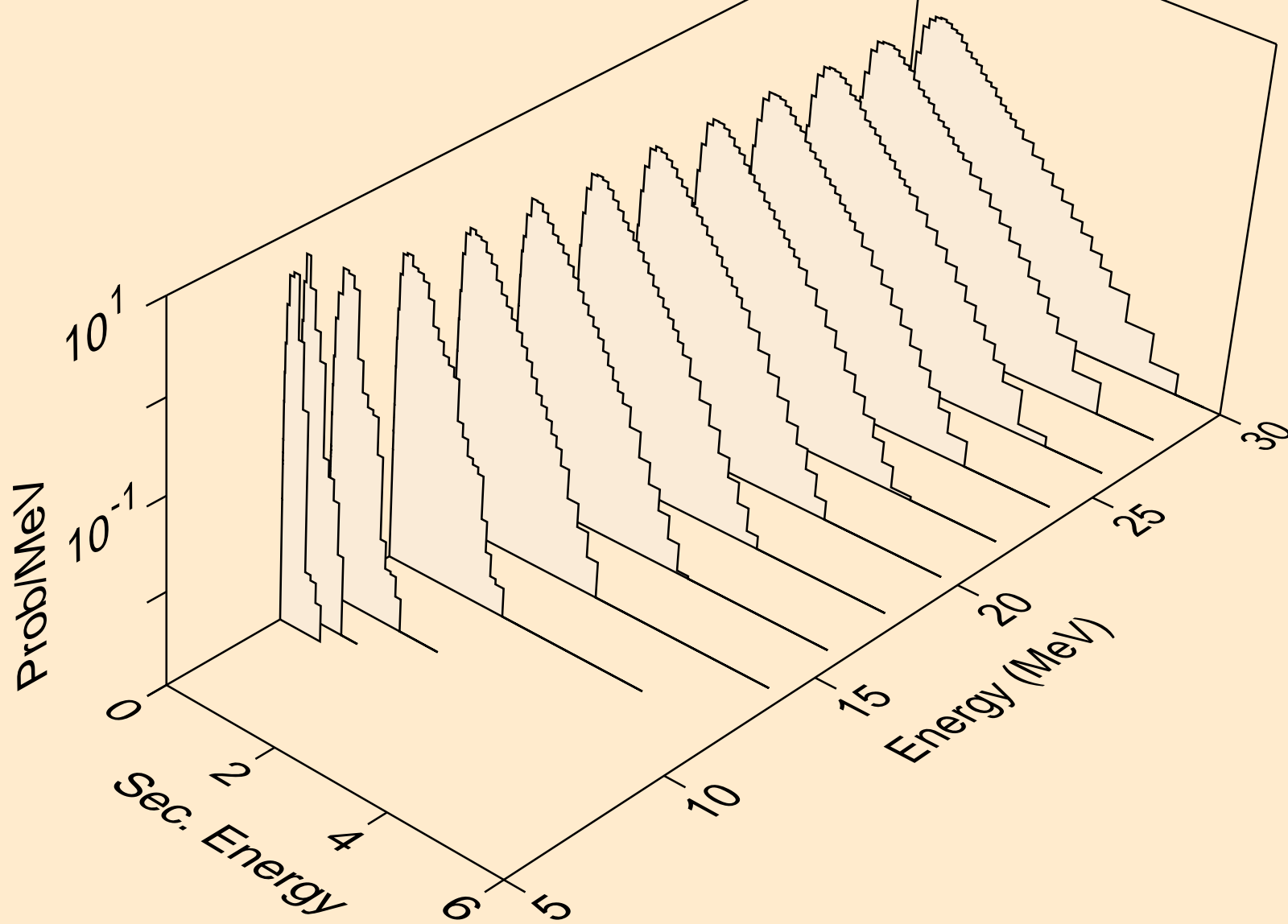

BI190 NEUTRON ACER TENDL-2019 LIBRARY; T=293.16K
Neutron emission for (n,n*)t

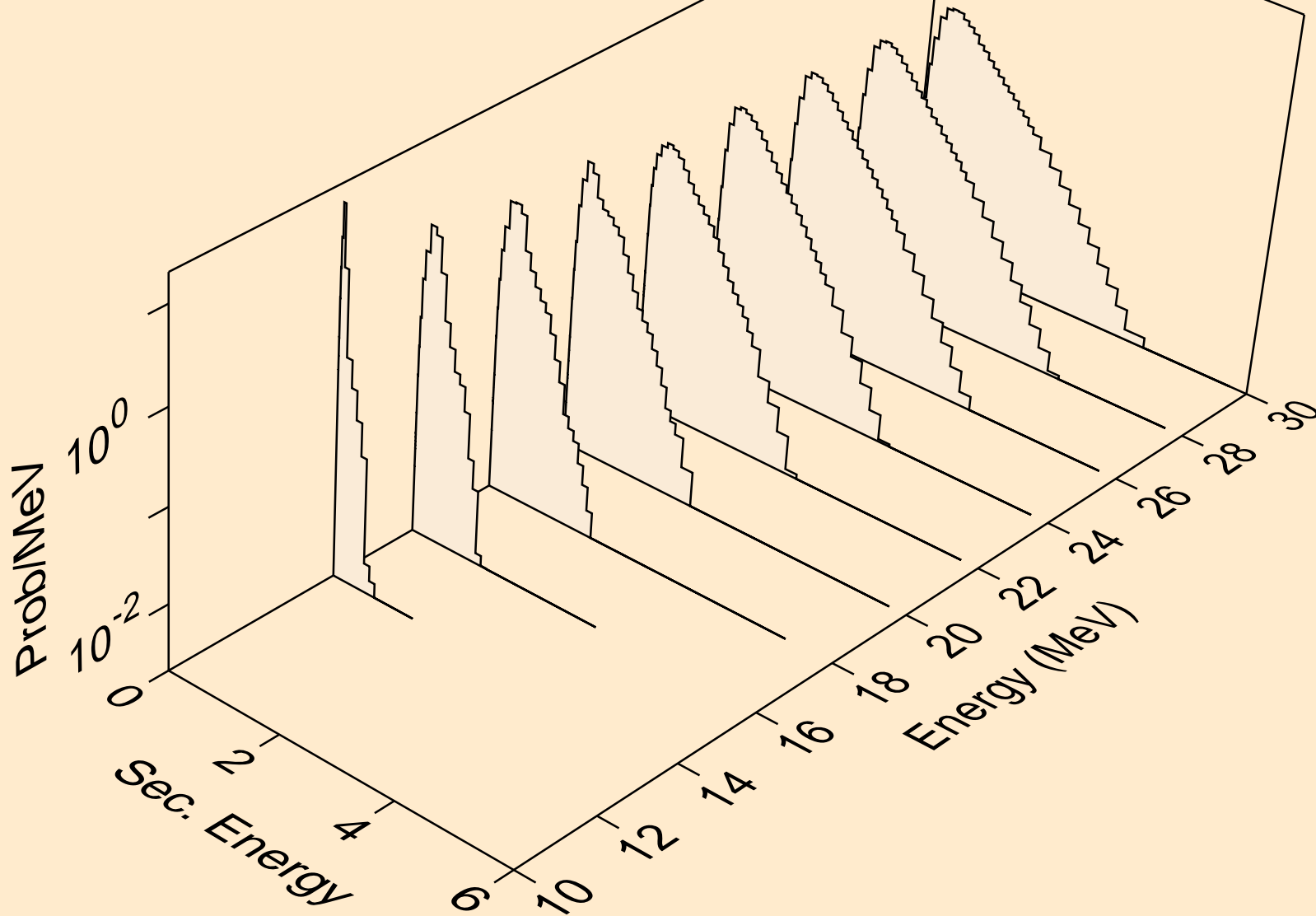

BI190 NEUTRON ACER TENDL-2019 LIBRARY; T=293.16K
Neutron emission for (n,n*)he3

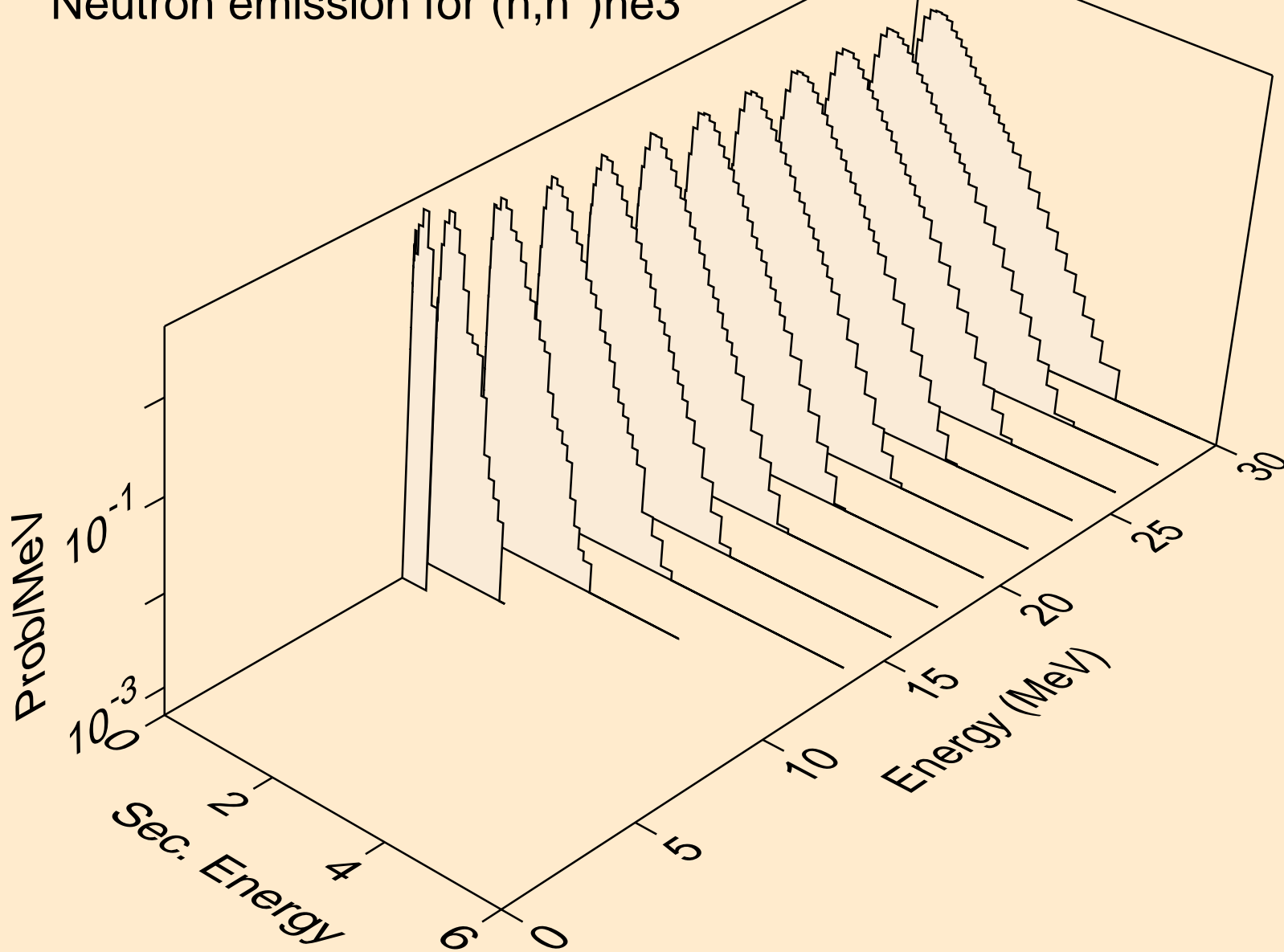

BI190 NEUTRON ACER TENDL-2019 LIBRARY; T=293.16K
Neutron emission for (n,4n)

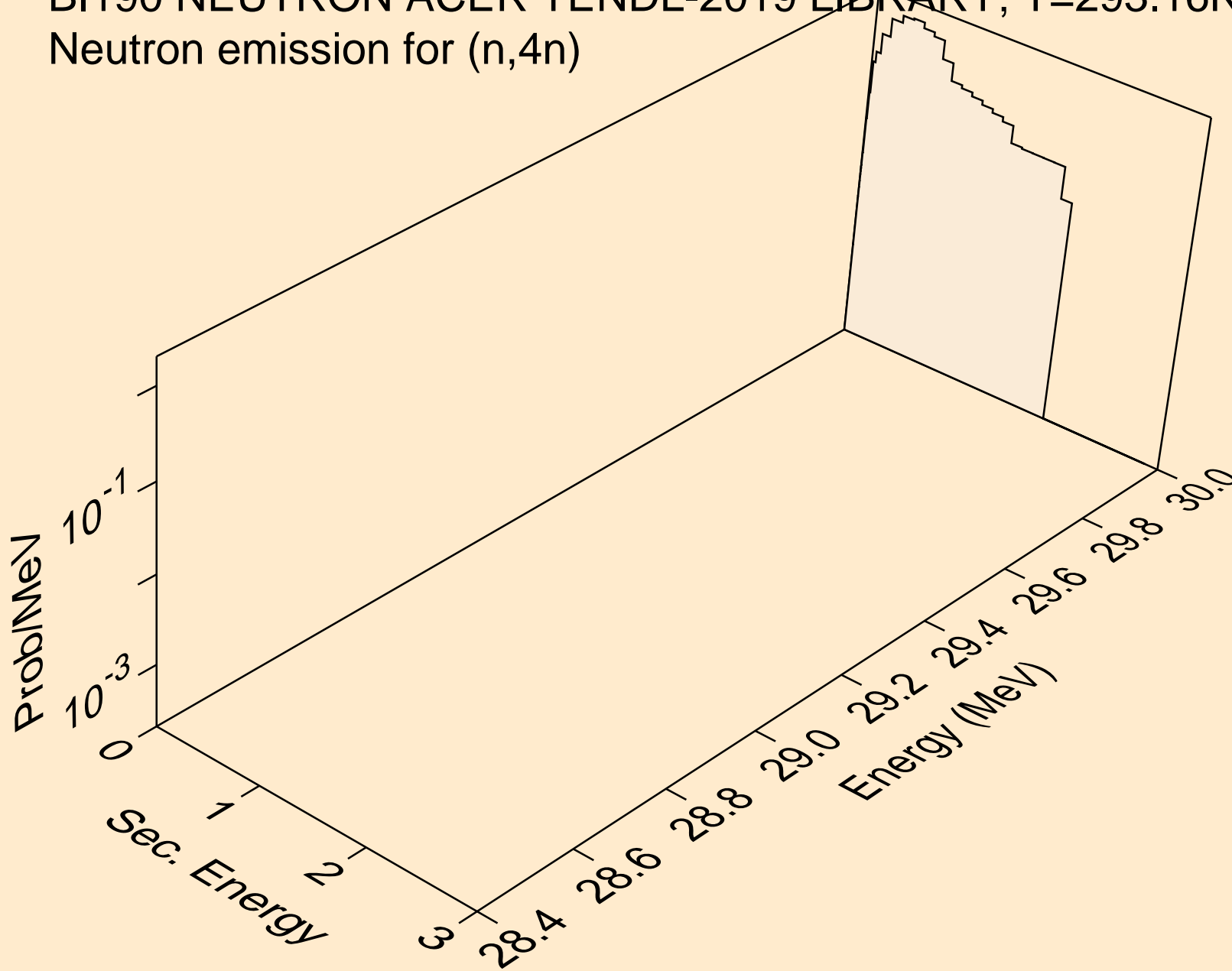

BI190 NEUTRON ACER TENDL-2019 LIBRARY; T=293.16K
Neutron emission for (n,2np)

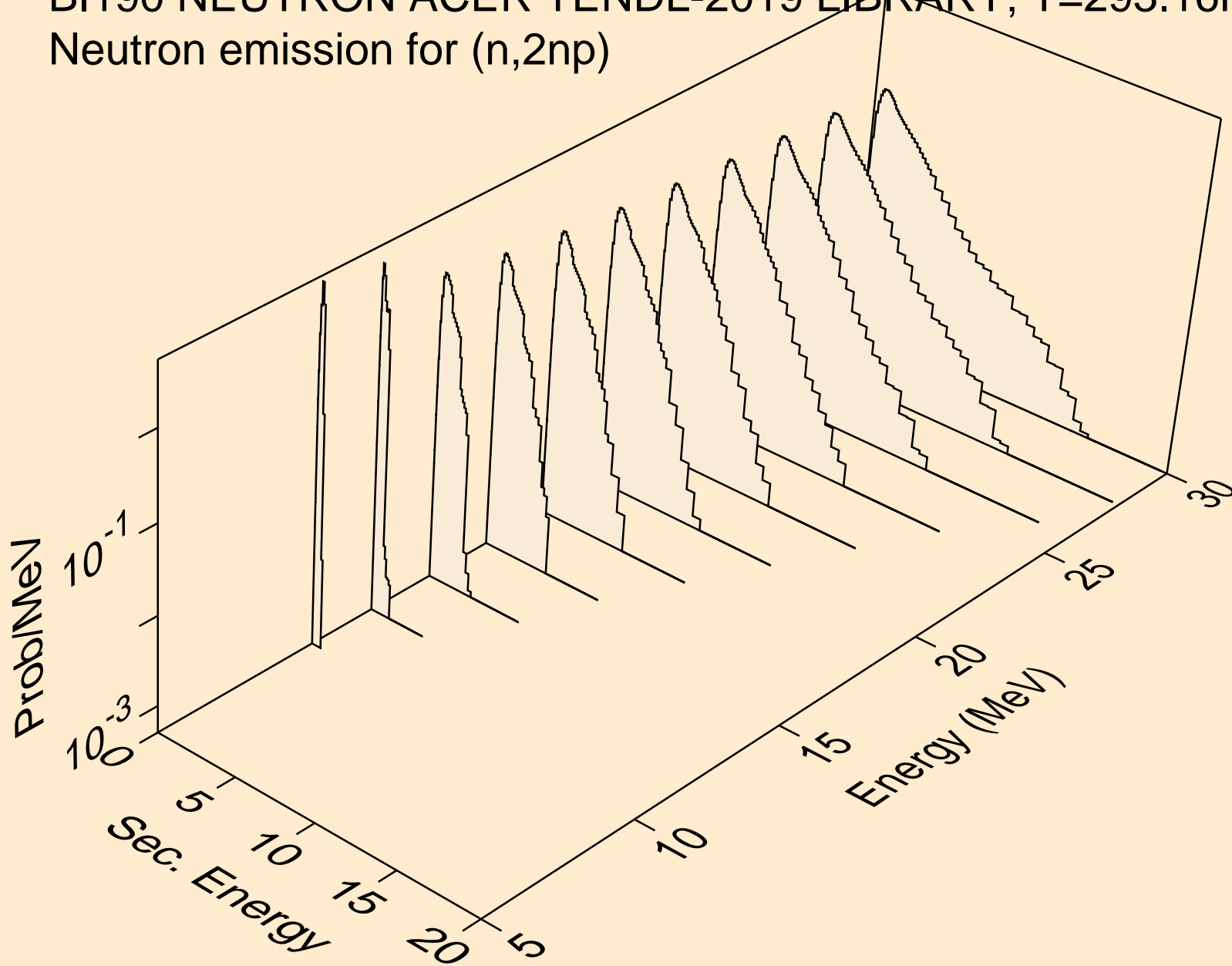

BI190 NEUTRON ACER TENDL-2019 LIBRARY; T=293.16K
Neutron emission for (n,3np)

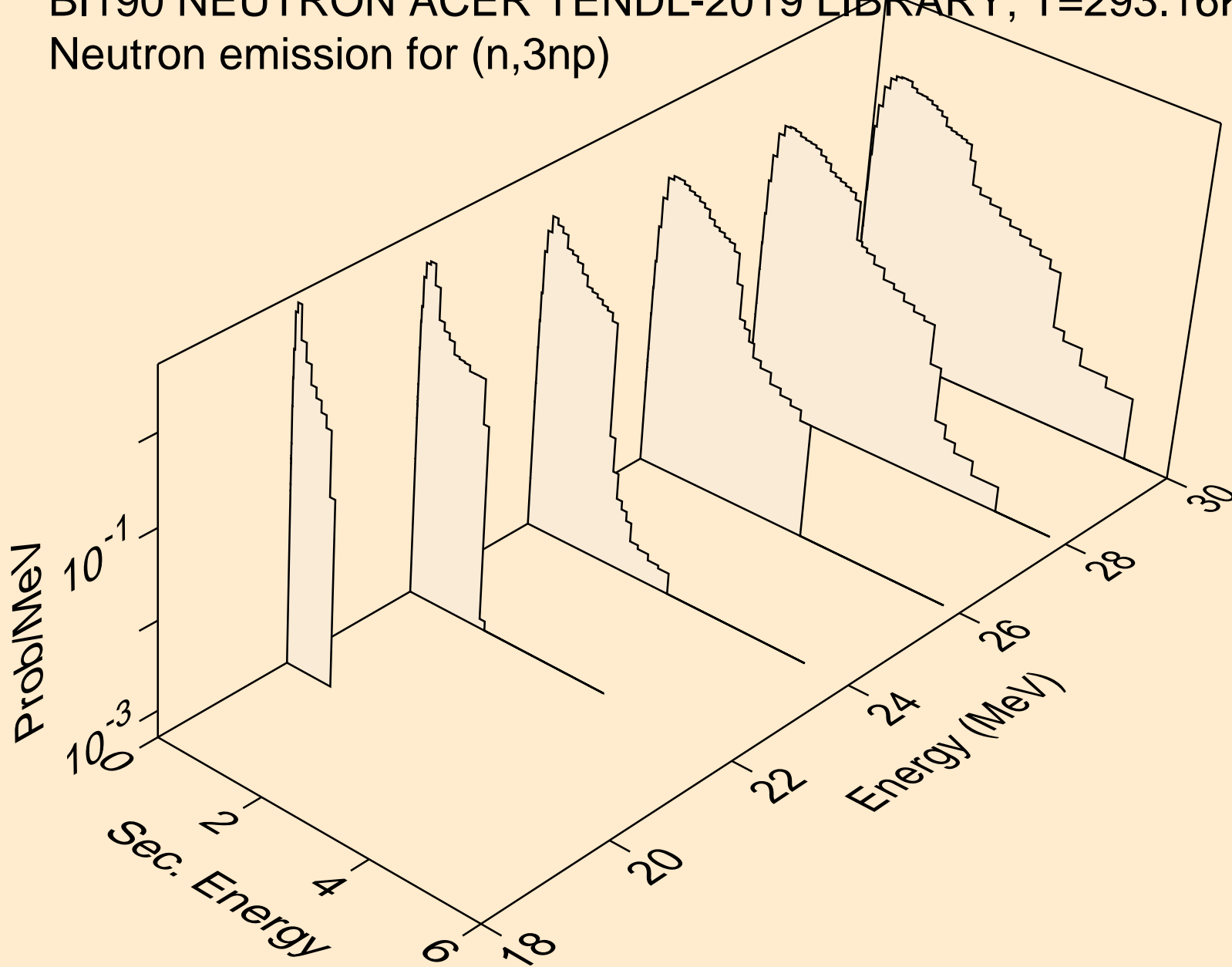

BI190 NEUTRON ACER TENDL-2019 LIBRARY; T=293.16K
Neutron emission for (n,2np)

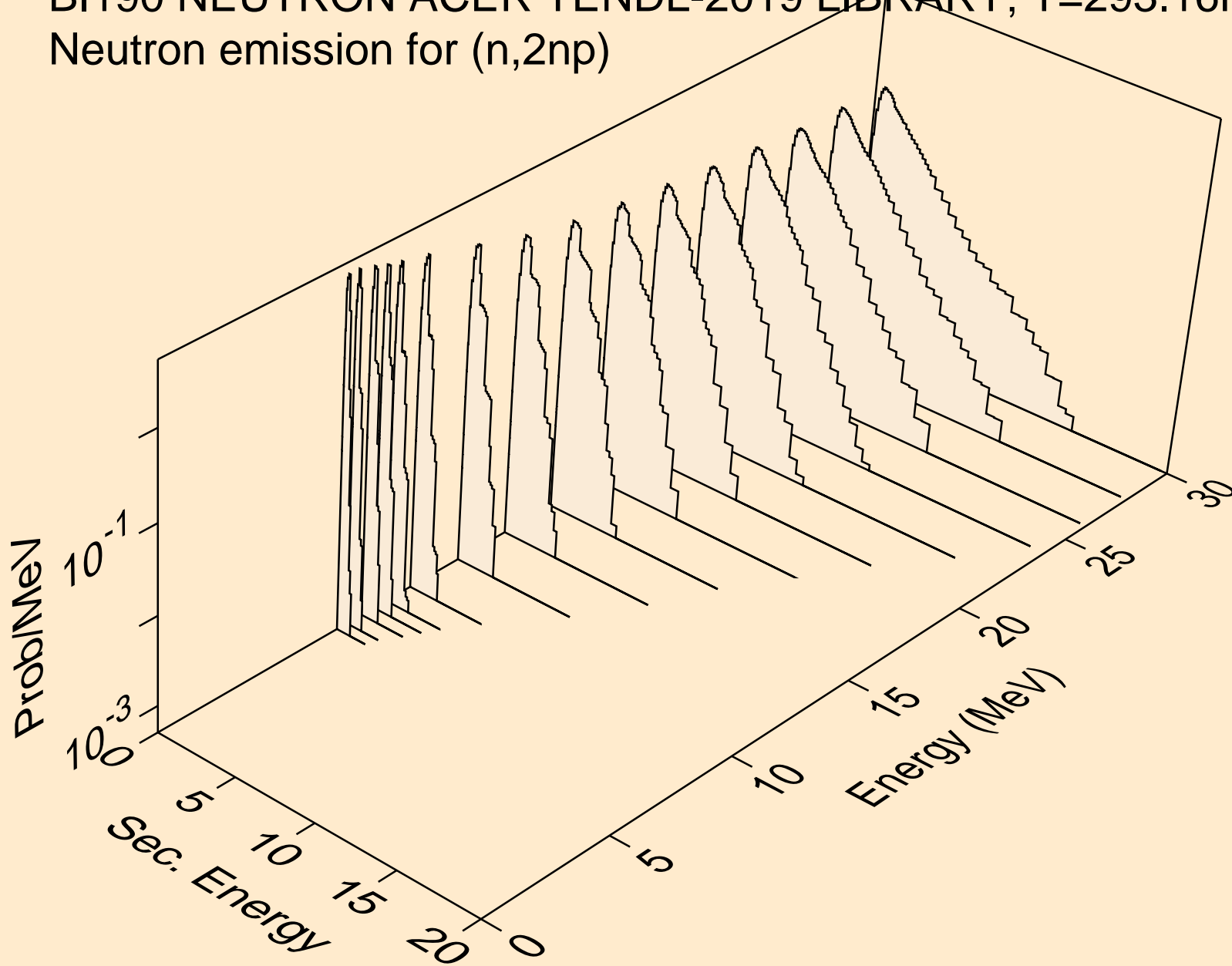

BI190 NEUTRON ACER TENDL-2019 LIBRARY; T=293.16K
Neutron emission for (n,npa)

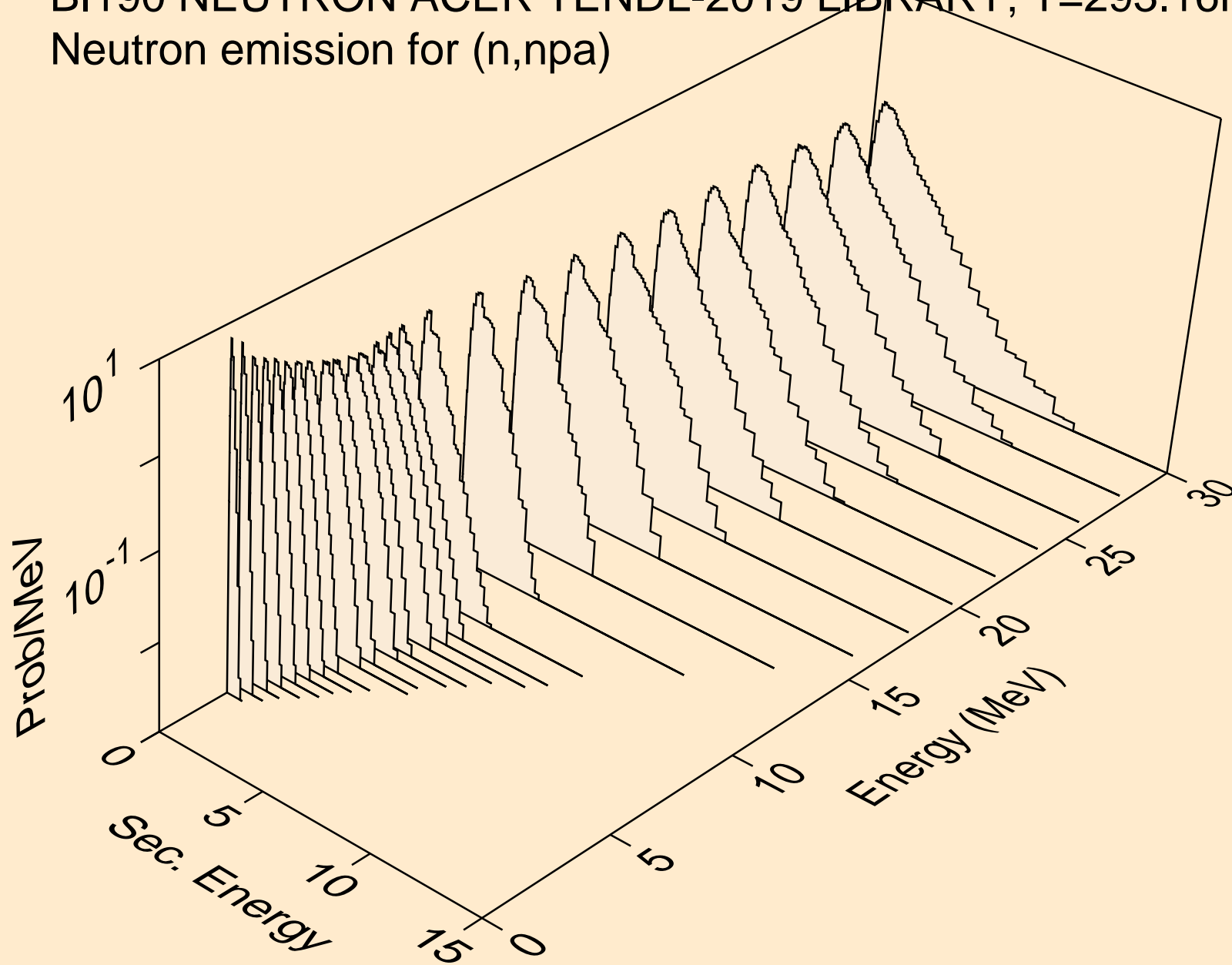

BI190 NEUTRON ACER TENDL-2019 LIBRARY; T=293.16K
Neutron emission for (n,n*c)

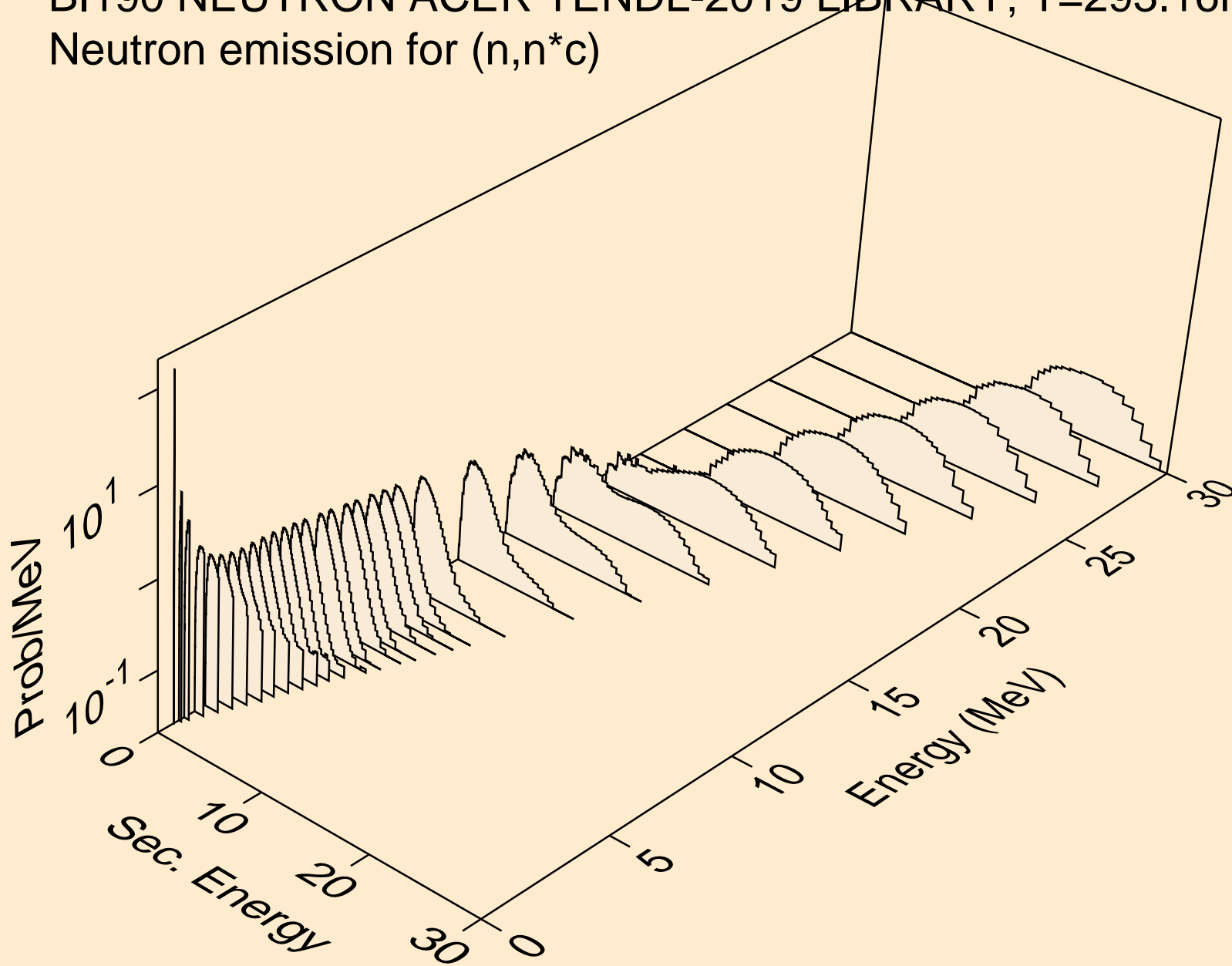

BI190 NEUTRON ACER TENDL-2019 LIBRARY; T=293.16K
Photon emission for (n,x)

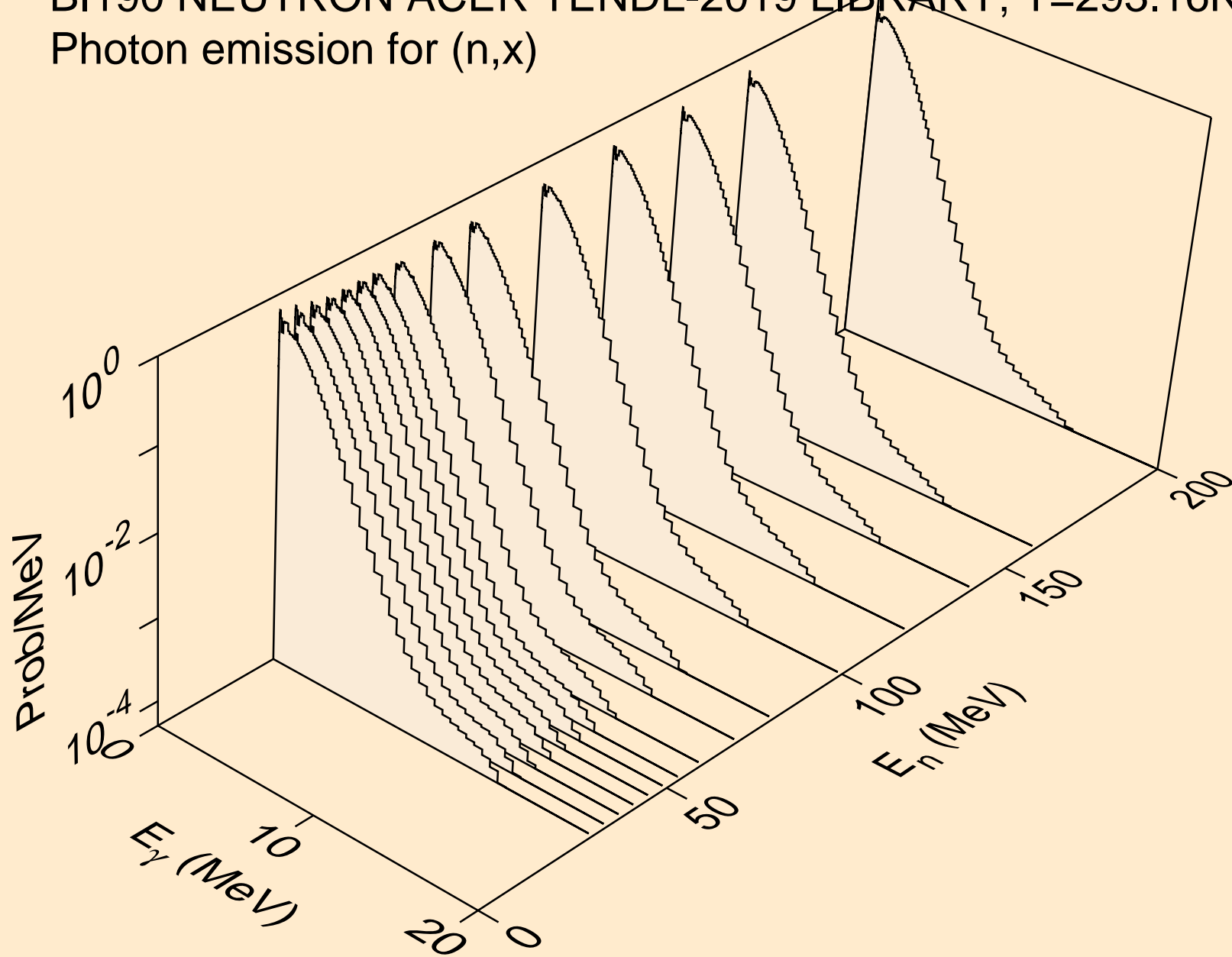

BI190 NEUTRON ACER TENDL-2019 LIBRARY; T=293.16K
Photon emission for (n,2nd)

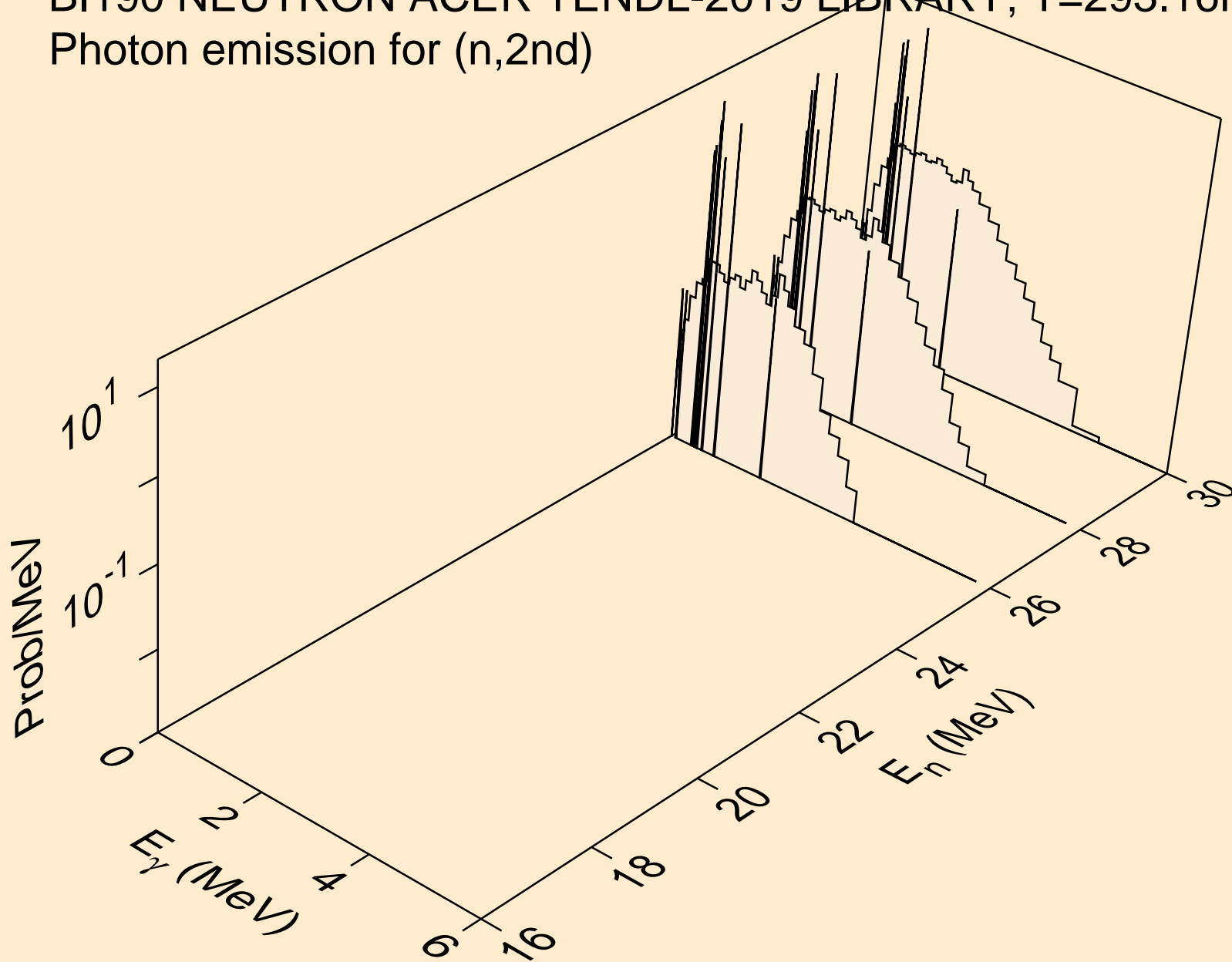

BI190 NEUTRON ACER TENDL-2019 LIBRARY; T=293.16K
Photon emission for (n,2n)

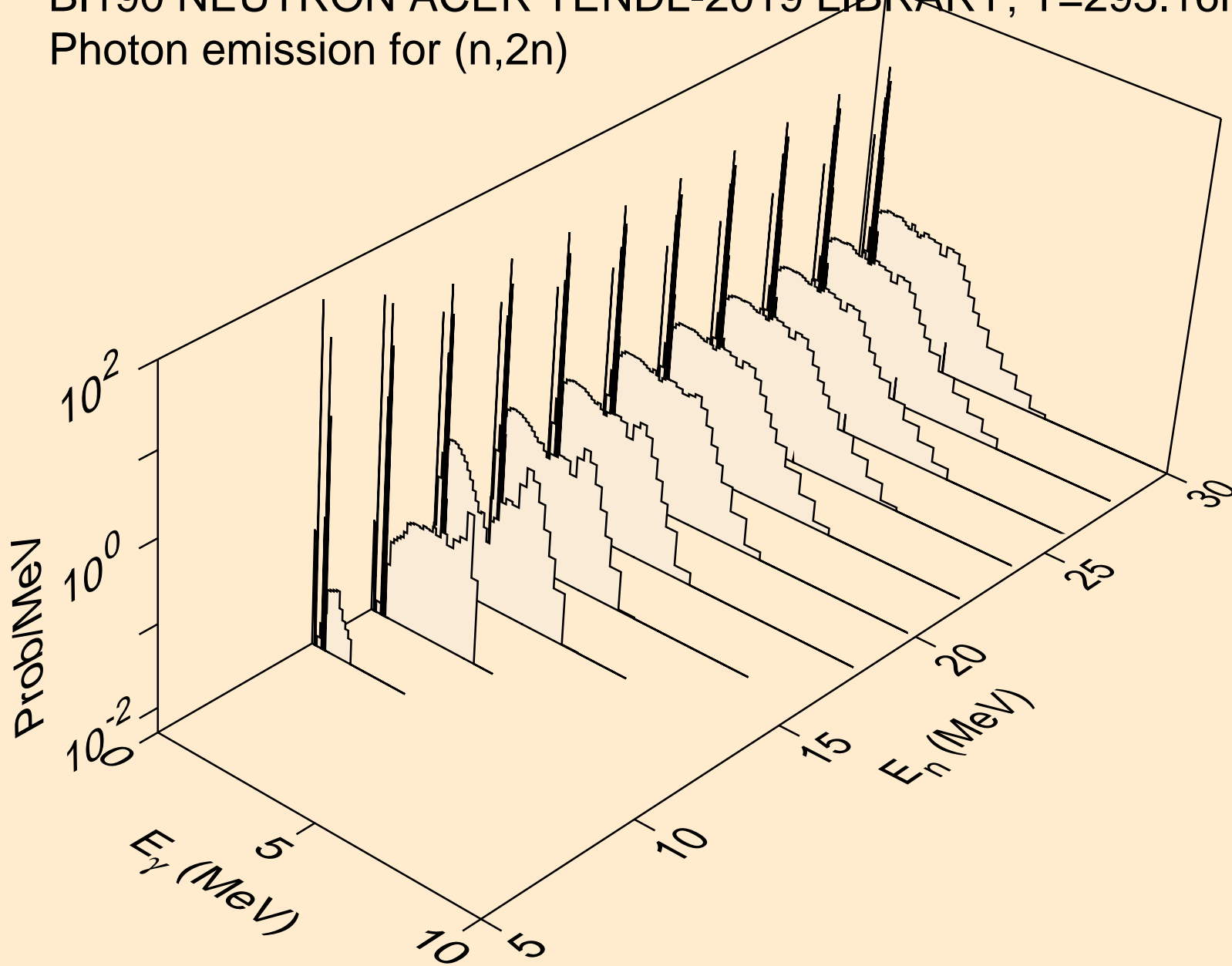

BI190 NEUTRON ACER TENDL-2019 LIBRARY; T=293.16K
Photon emission for (n,3n)

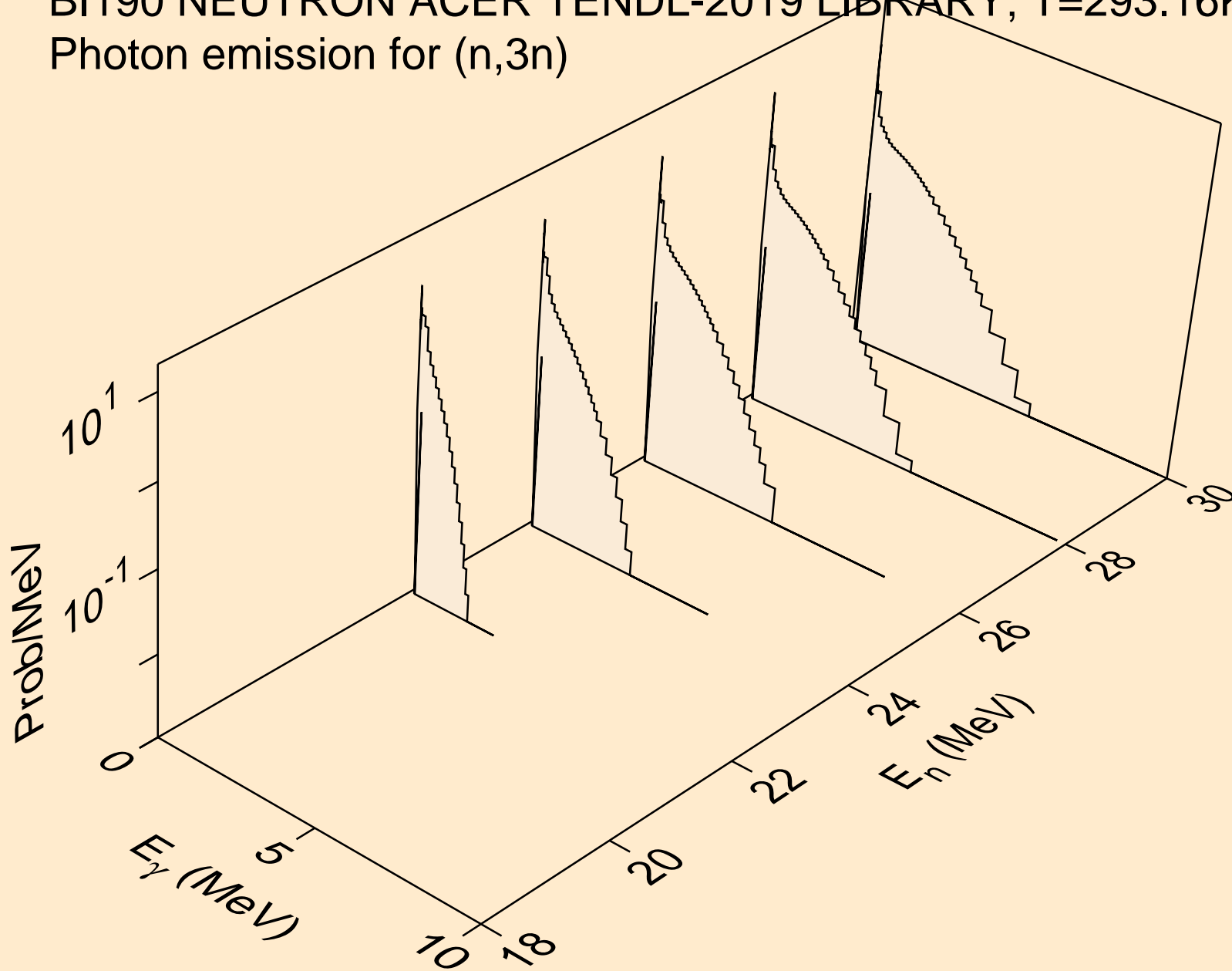

BI190 NEUTRON ACER TENDL-2019 LIBRARY; T=293.16K
Photon emission for (n,n*)a

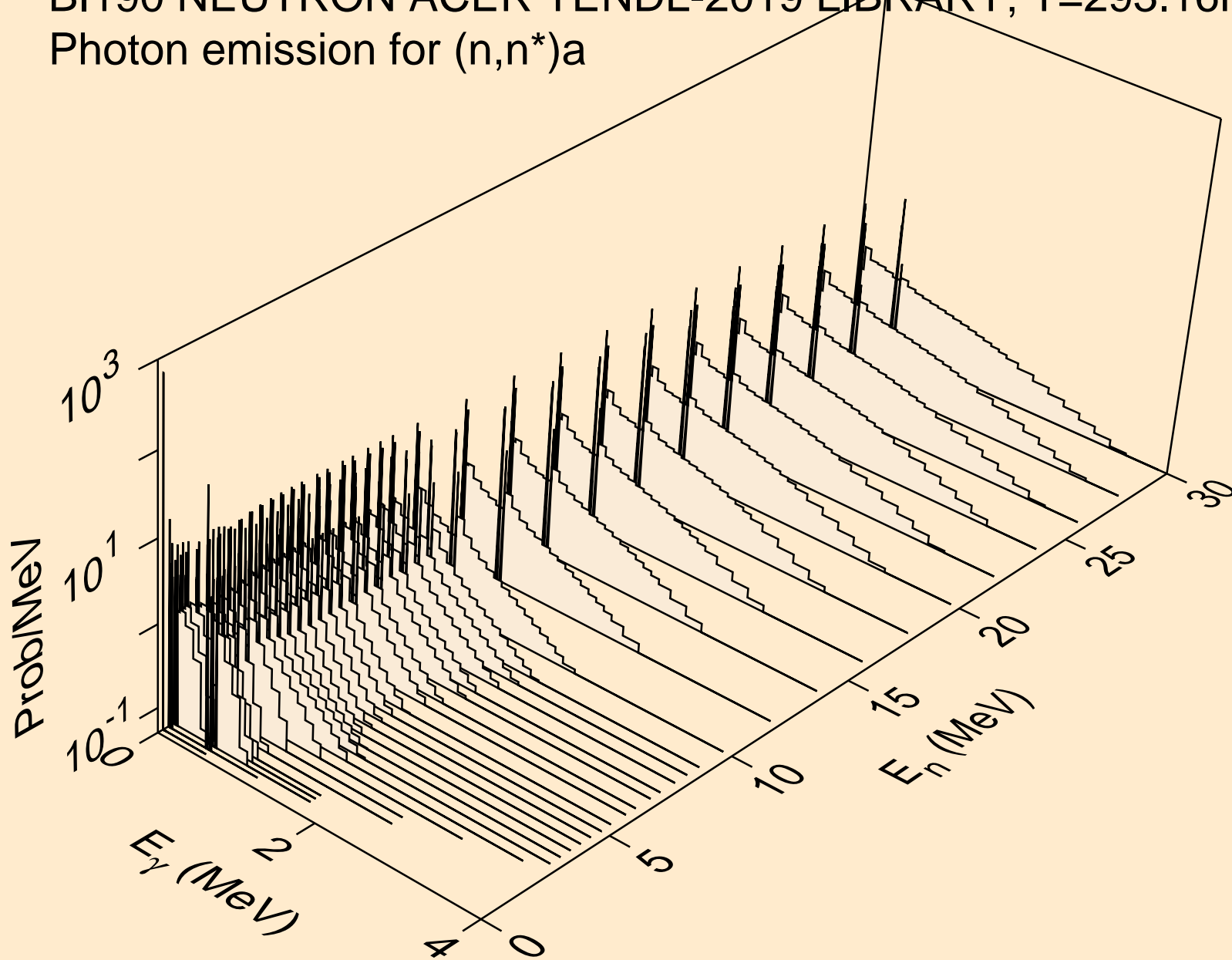

BI190 NEUTRON ACER TENDL-2019 LIBRARY; T=293.16K
Photon emission for (n,n*)3a

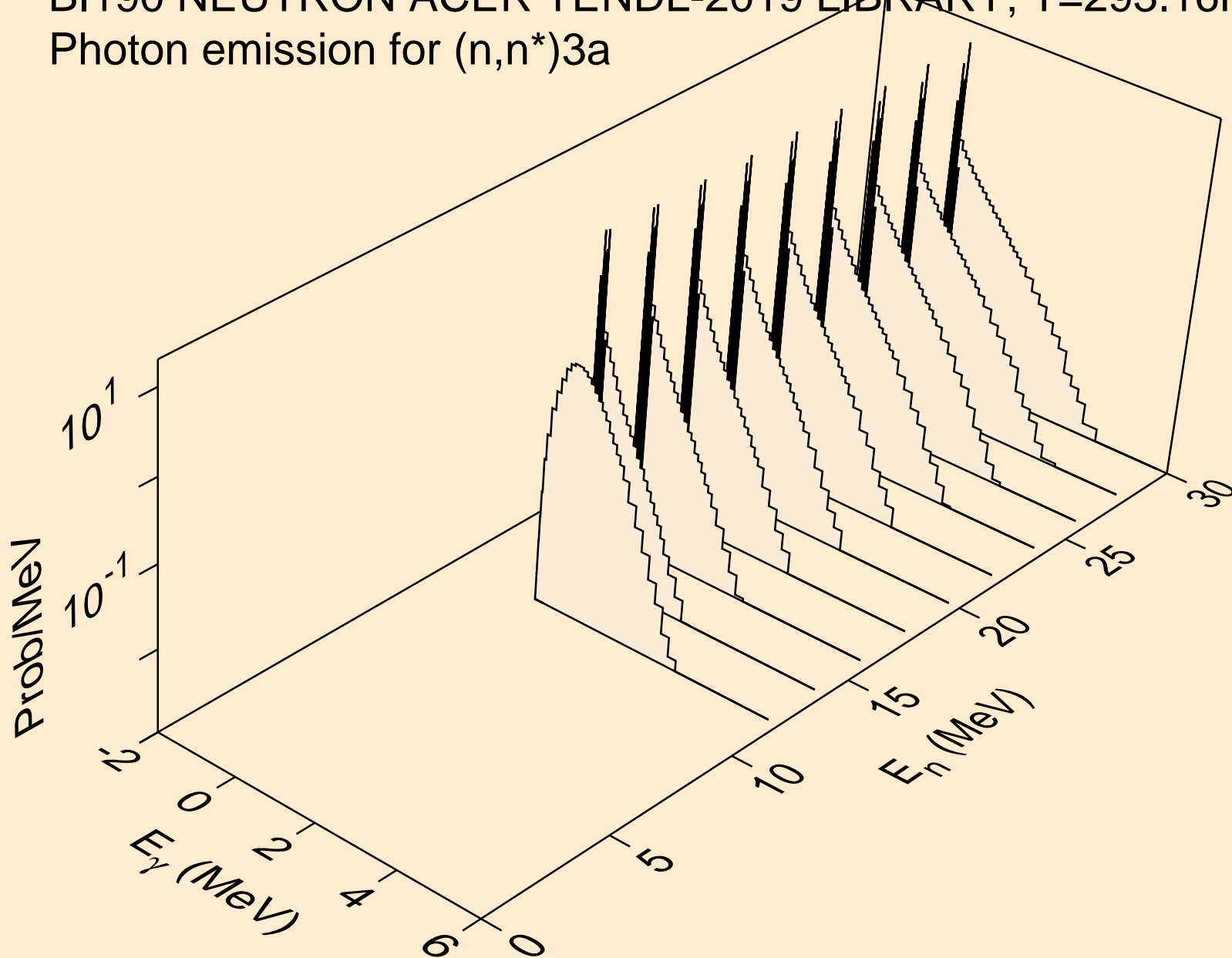

BI190 NEUTRON ACER TENDL-2019 LIBRARY; T=293.16K
Photon emission for (n,2n) α

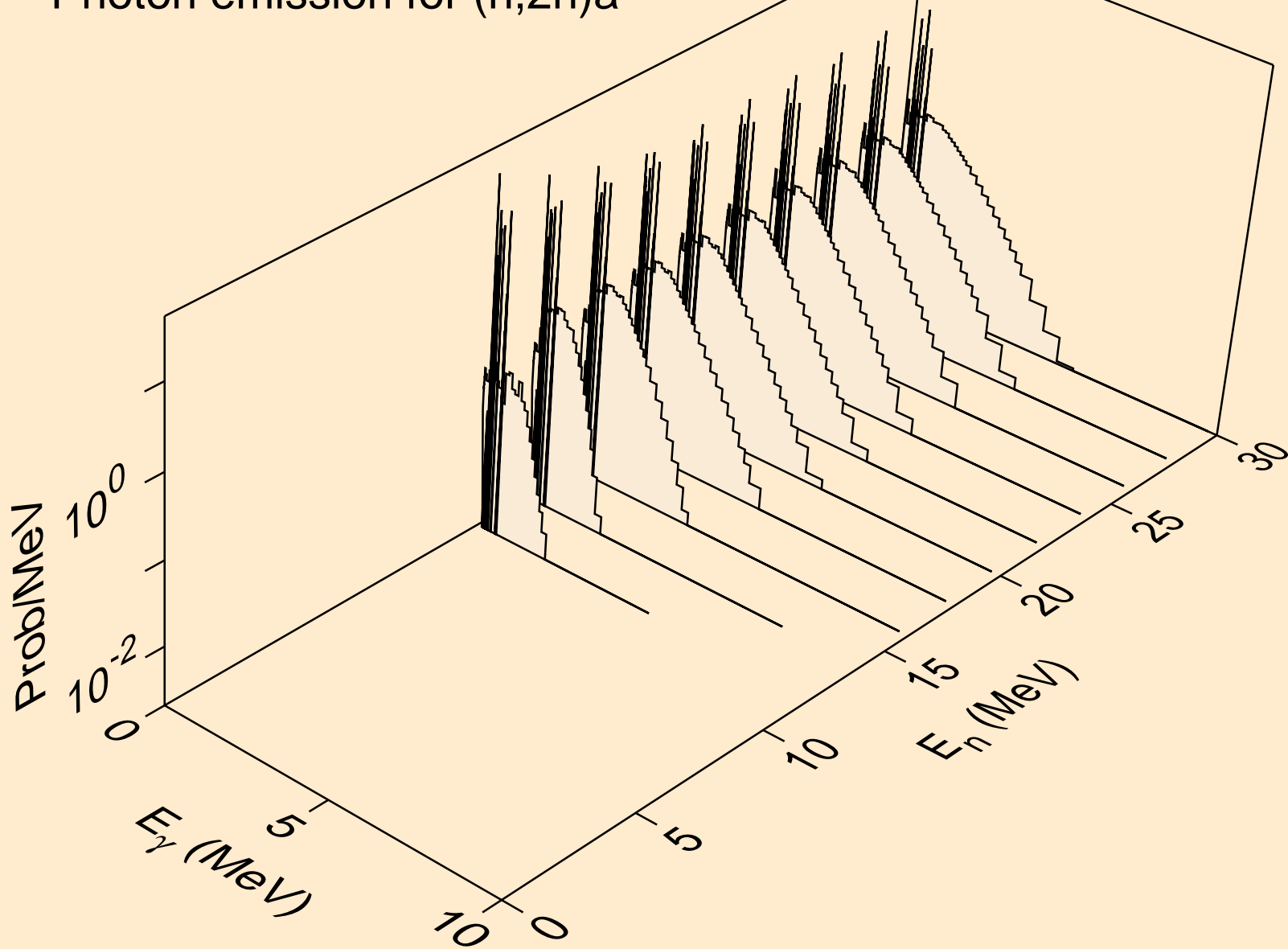

BI190 NEUTRON ACER TENDL-2019 LIBRARY; T=293.16K
Photon emission for (n,3n)a

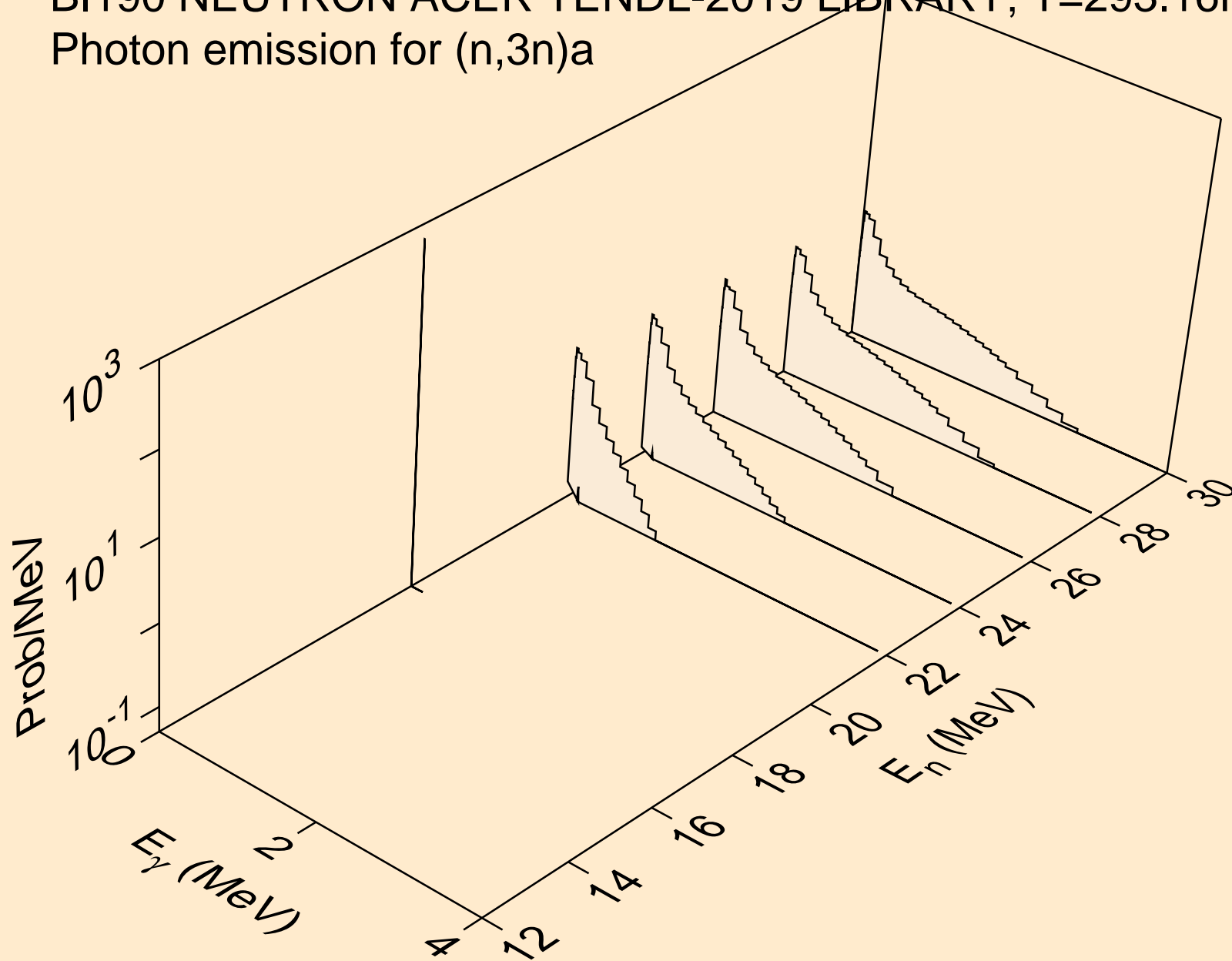

BI190 NEUTRON ACER TENDL-2019 LIBRARY; T=293.16K
Photon emission for (n,n*)p

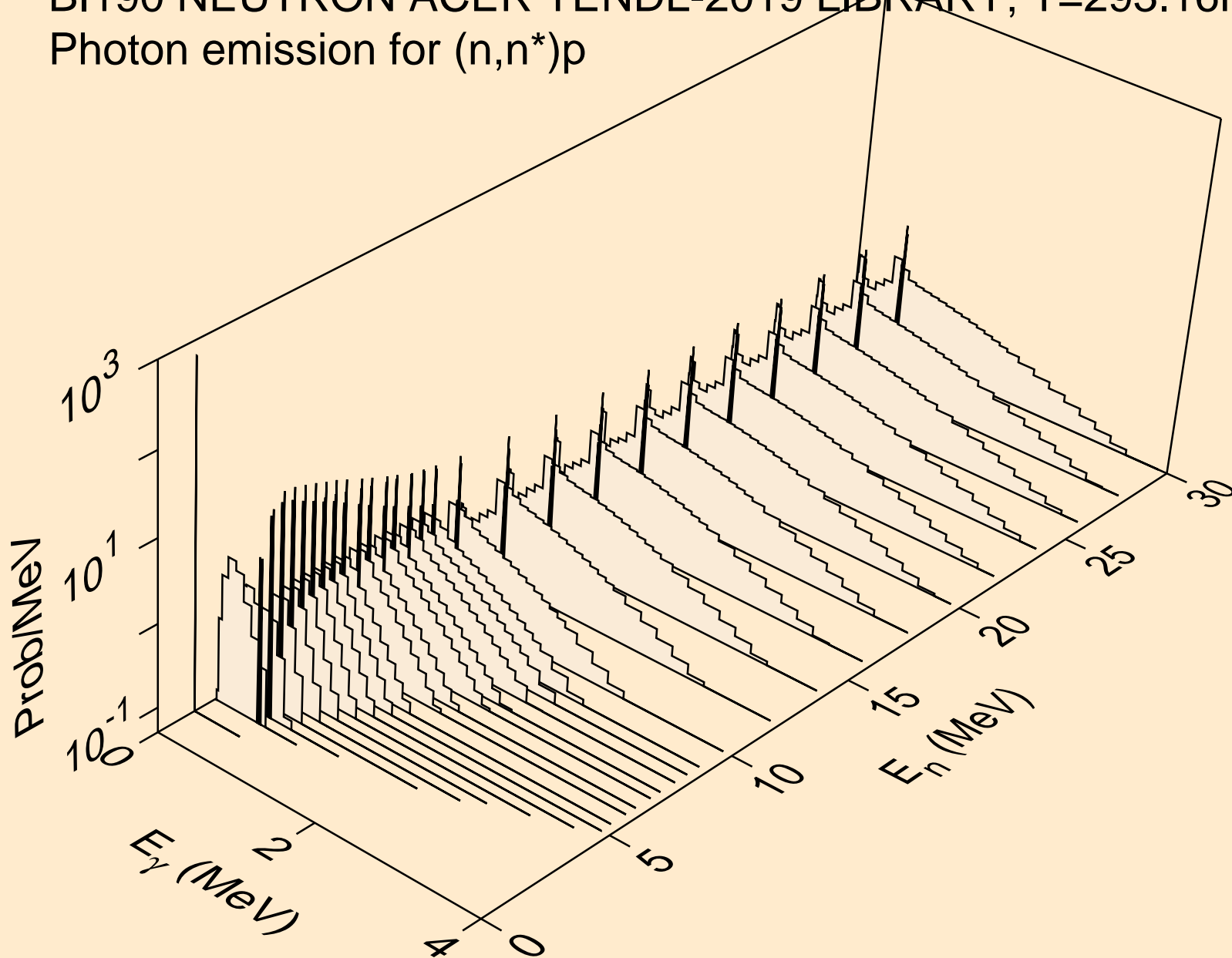

BI190 NEUTRON ACER TENDL-2019 LIBRARY; T=293.16K
Photon emission for (n,n*)2a

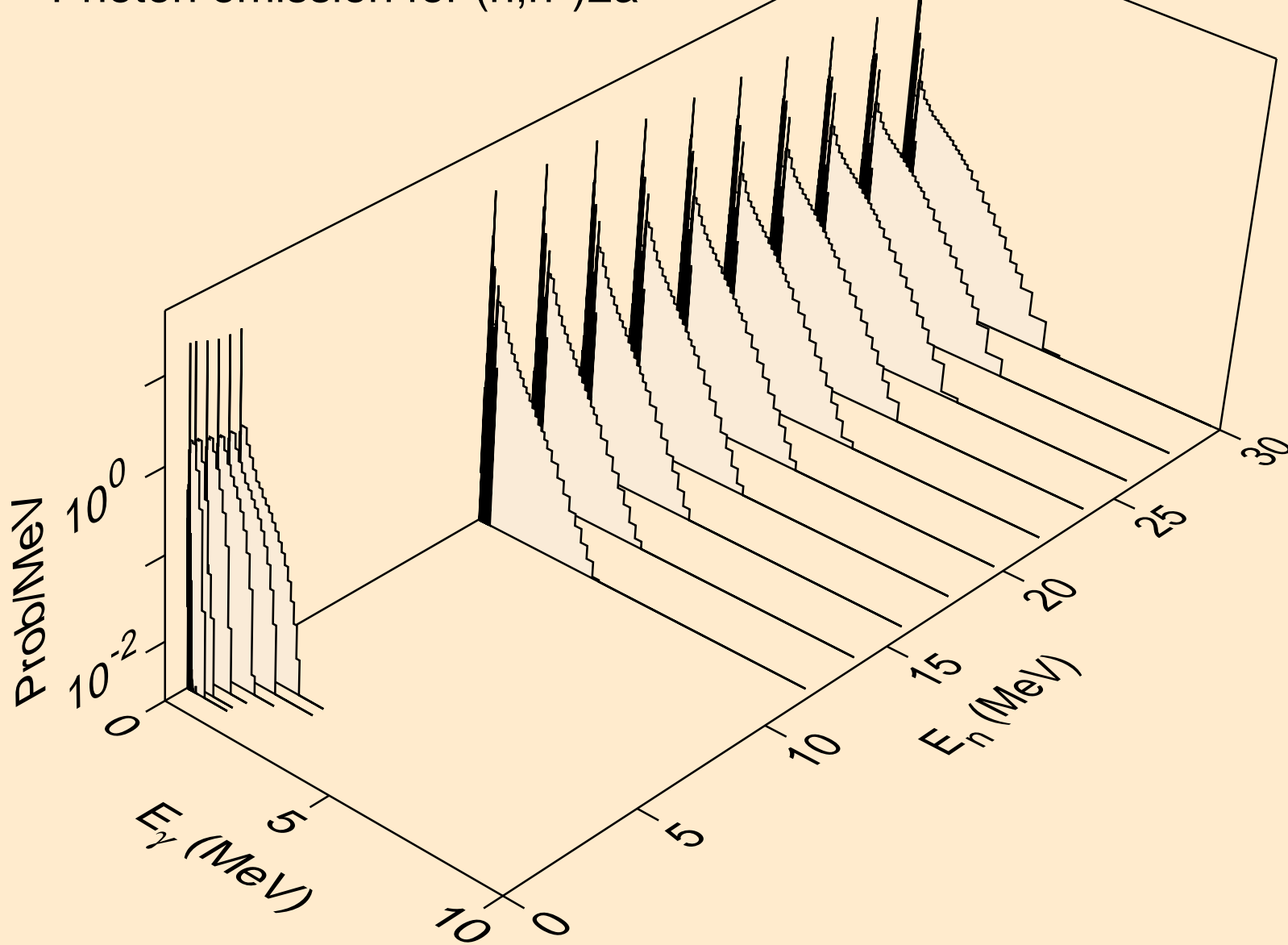

BI190 NEUTRON ACER TENDL-2019 LIBRARY; T=293.16K
Photon emission for (n,2n)2a

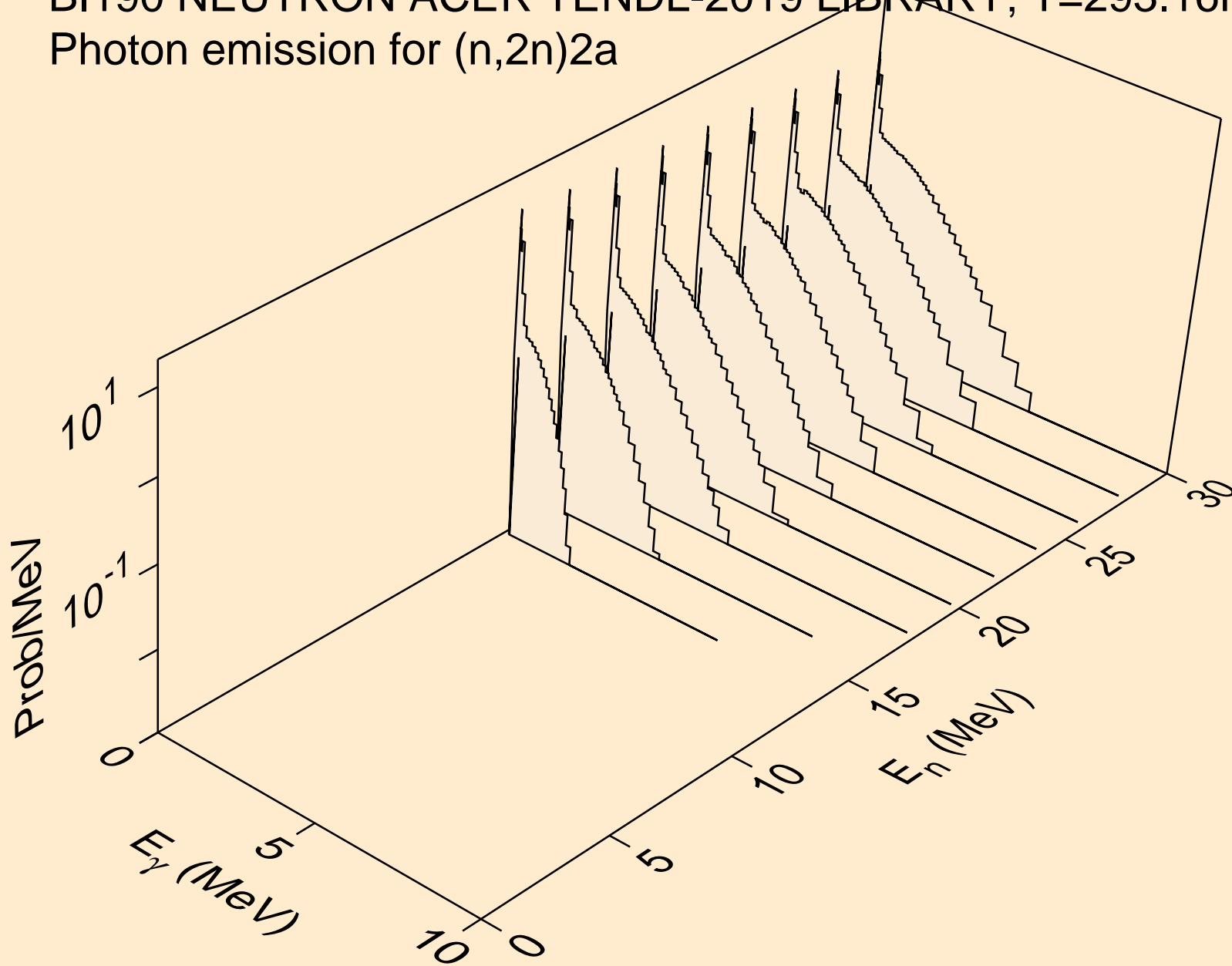

BI190 NEUTRON ACER TENDL-2019 LIBRARY; T=293.16K
Photon emission for (n,n*)d

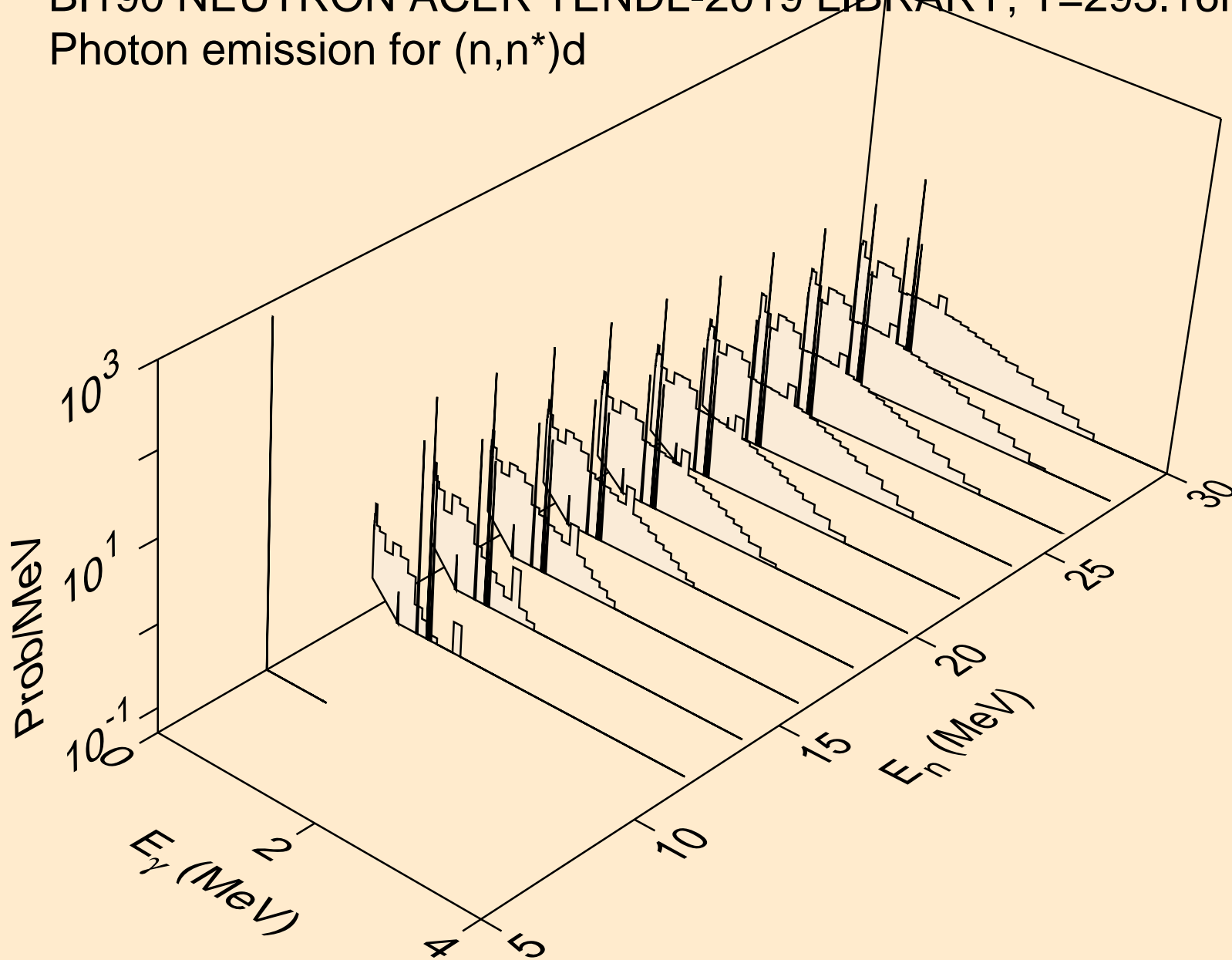

BI190 NEUTRON ACER TENDL-2019 LIBRARY; T=293.16K
Photon emission for (n,n*)t

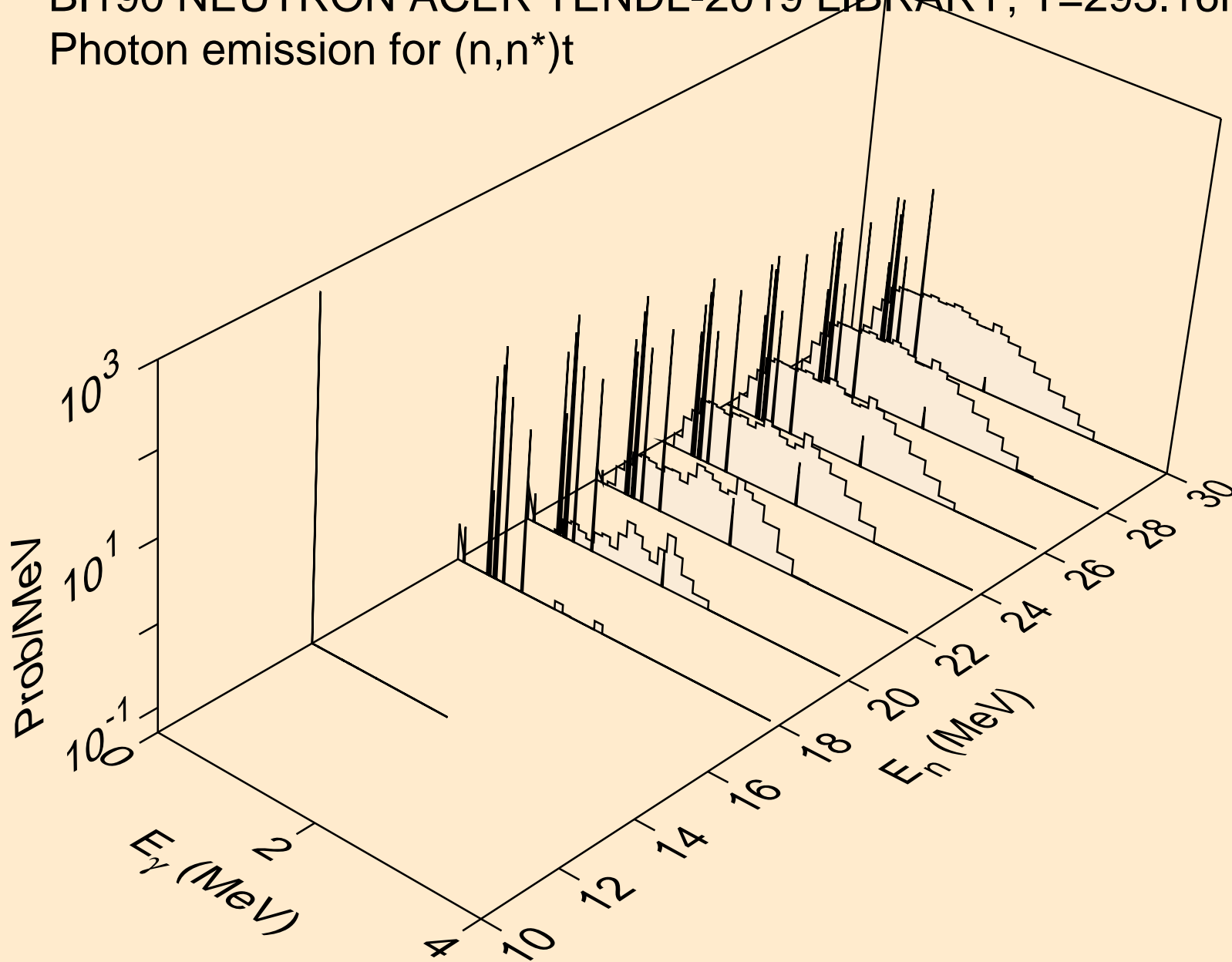

BI190 NEUTRON ACER TENDL-2019 LIBRARY; T=293.16K
Photon emission for (n,n*)he3

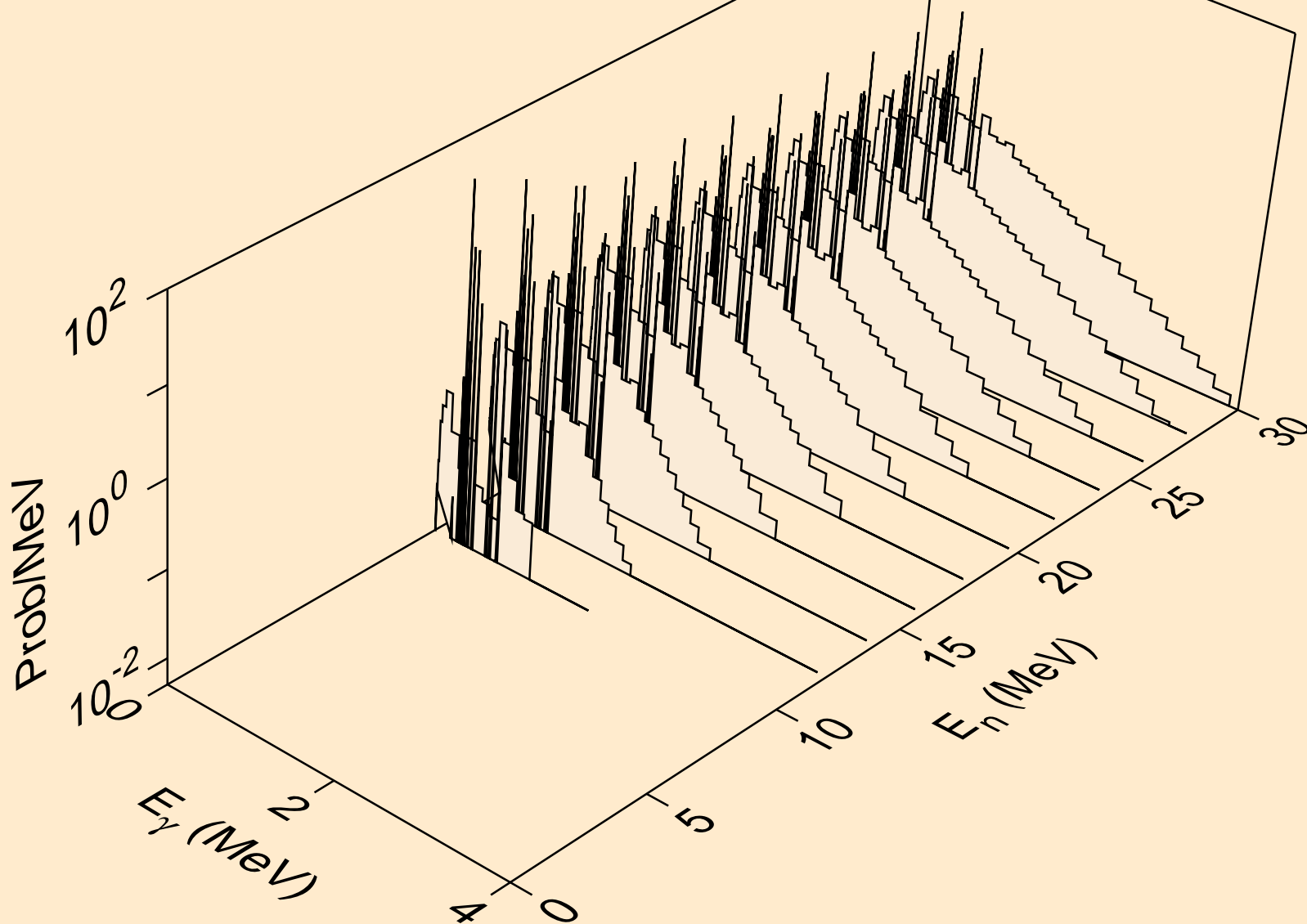

BI190 NEUTRON ACER TENDL-2019 LIBRARY; T=293.16K
Photon emission for (n,4n)

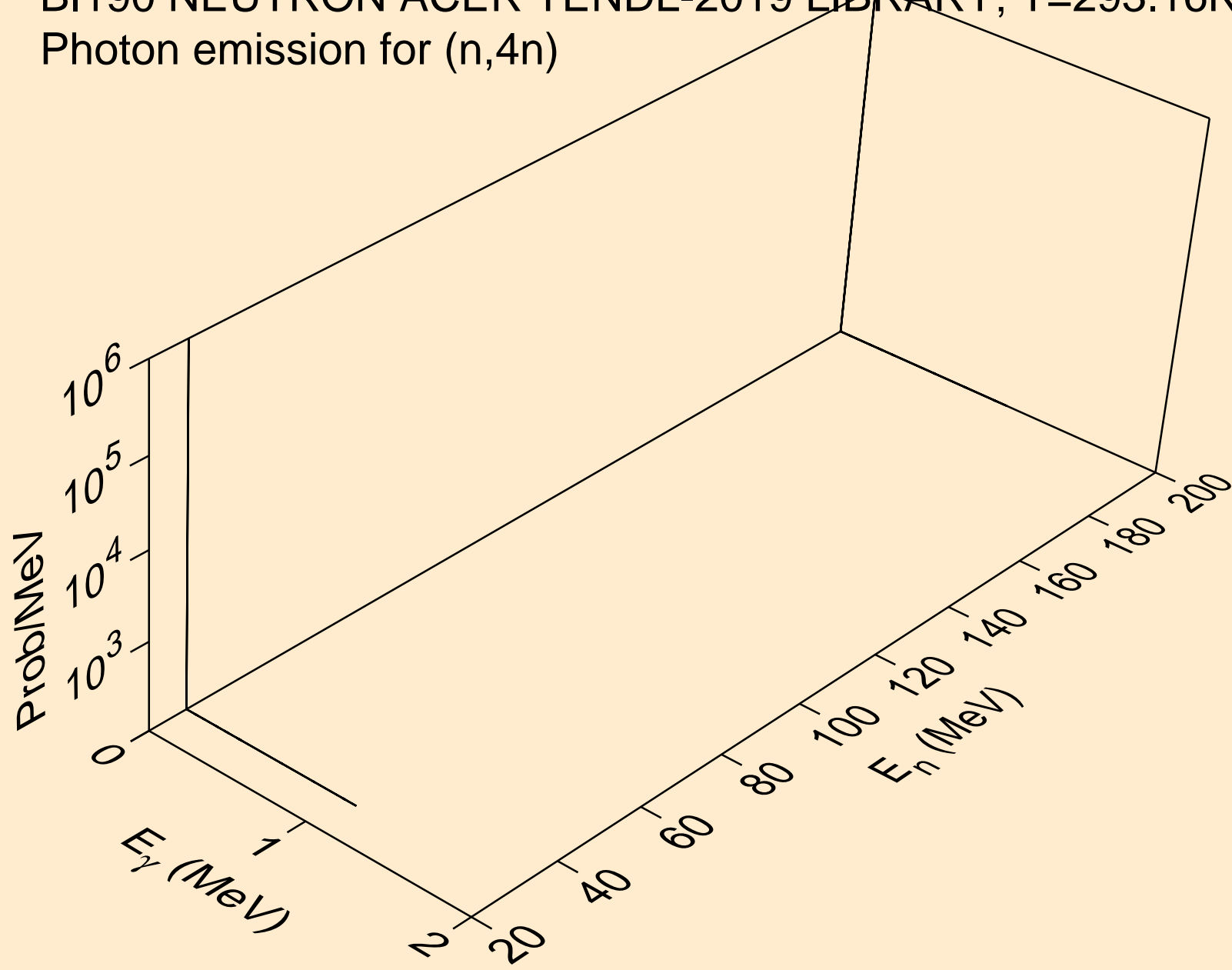

BI190 NEUTRON ACER TENDL-2019 LIBRARY; T=293.16K
Photon emission for (n,2np)

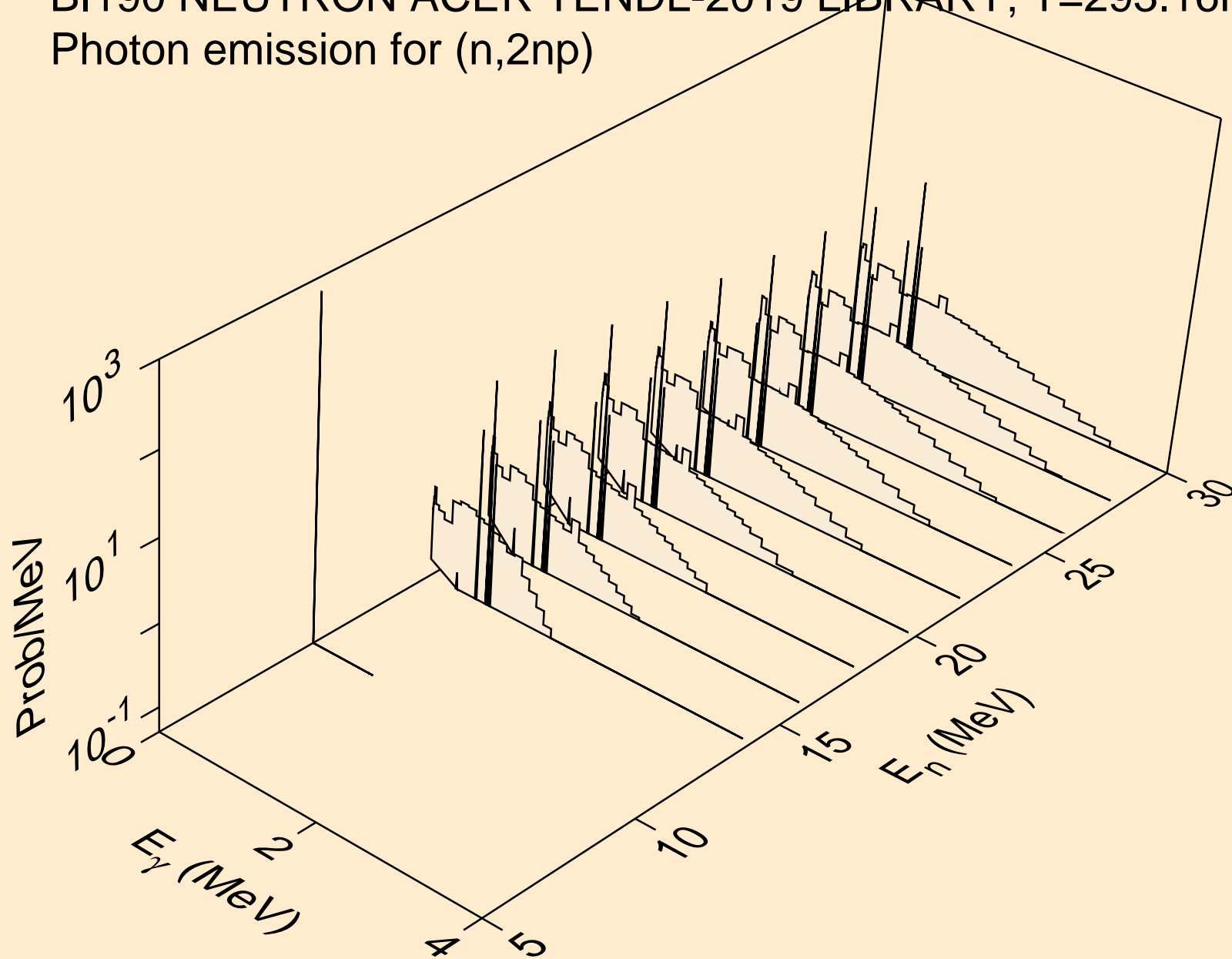

BI190 NEUTRON ACER TENDL-2019 LIBRARY; T=293.16K
Photon emission for (n,3np)

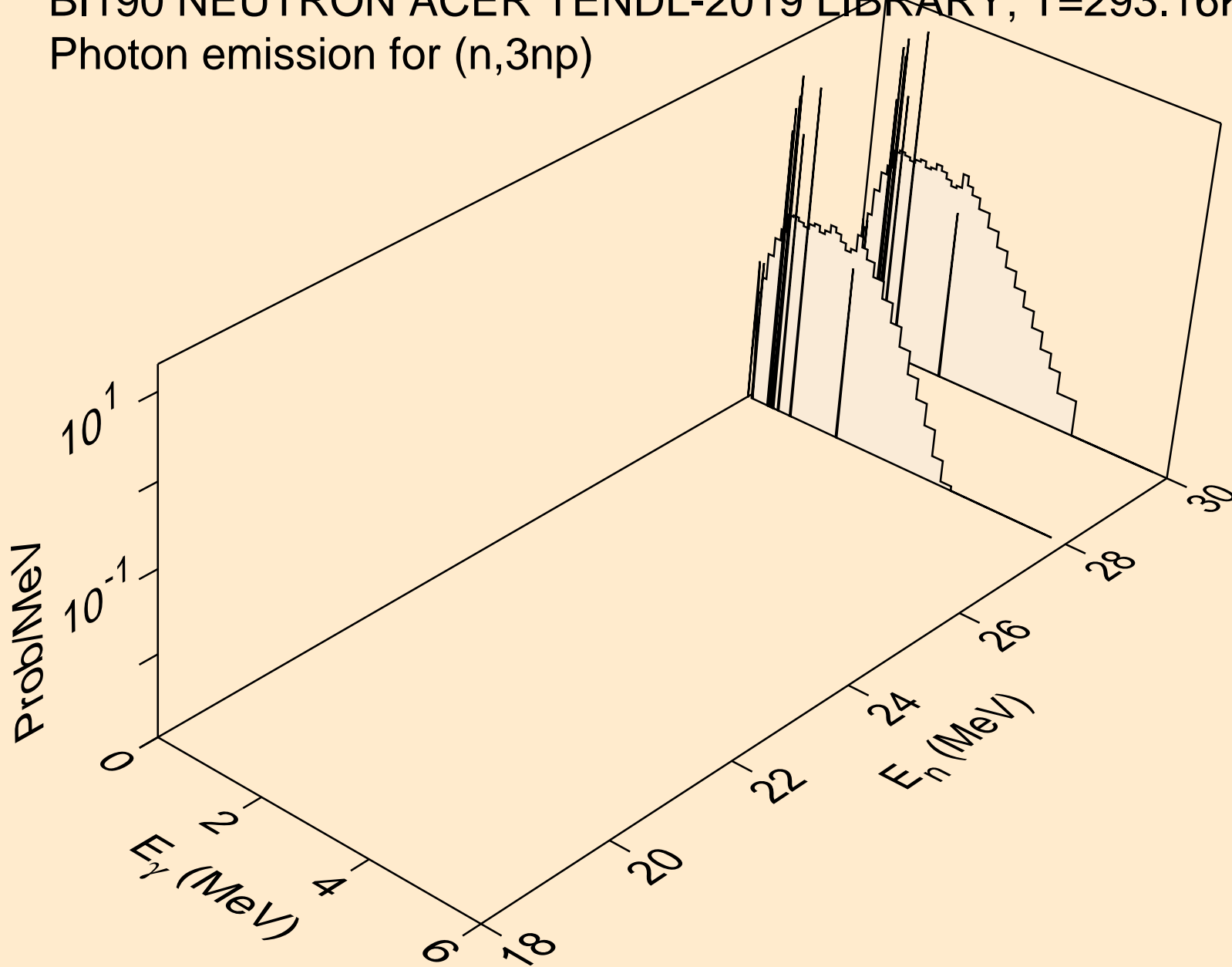

BI190 NEUTRON ACER TENDL-2019 LIBRARY; T=293.16K
Photon emission for (n,2np)

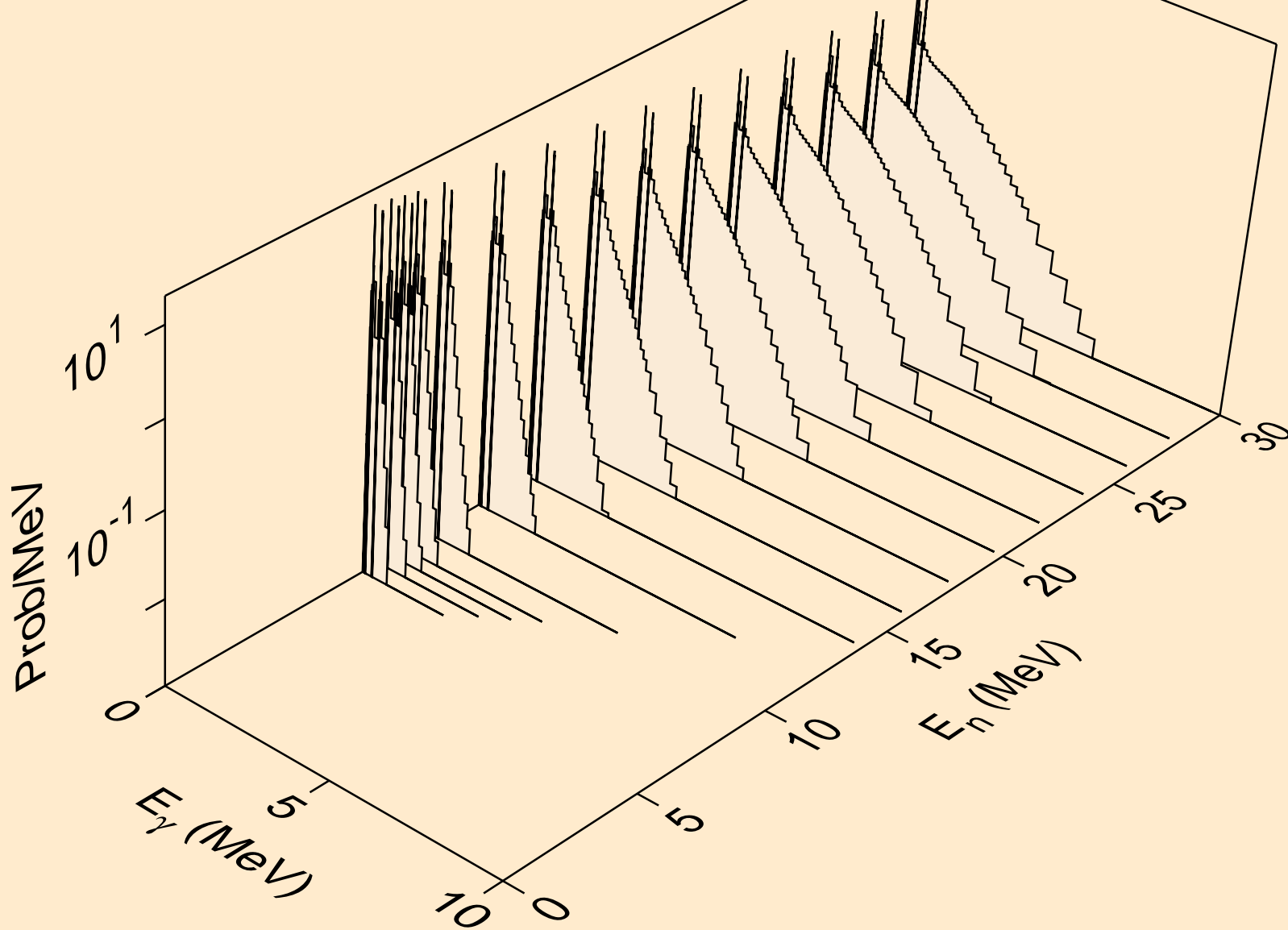

BI190 NEUTRON ACER TENDL-2019 LIBRARY; T=293.16K
Photon emission for (n,npa)

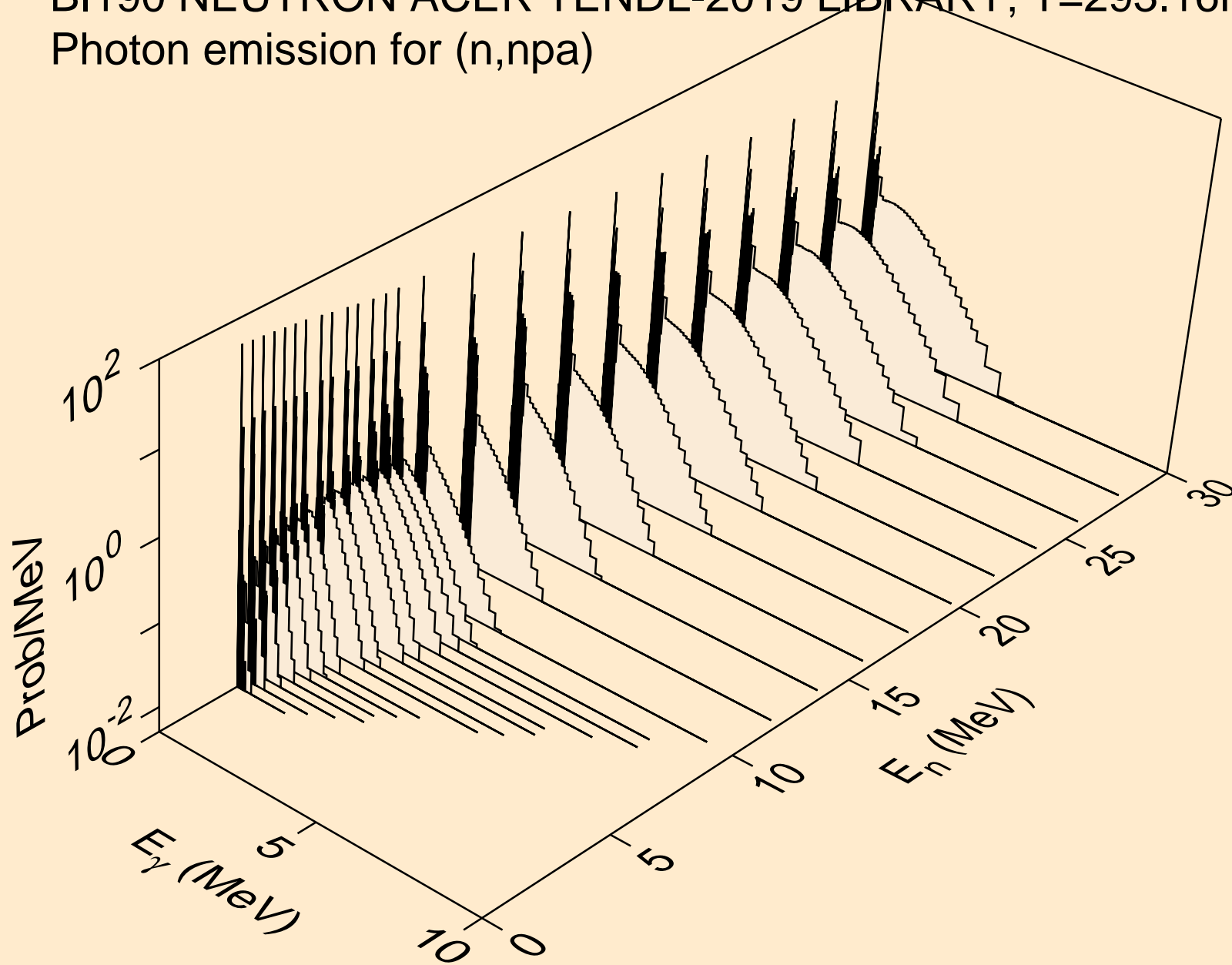

BI190 NEUTRON ACER TENDL-2019 LIBRARY; T=293.16K
Photon emission for (n,n*c)

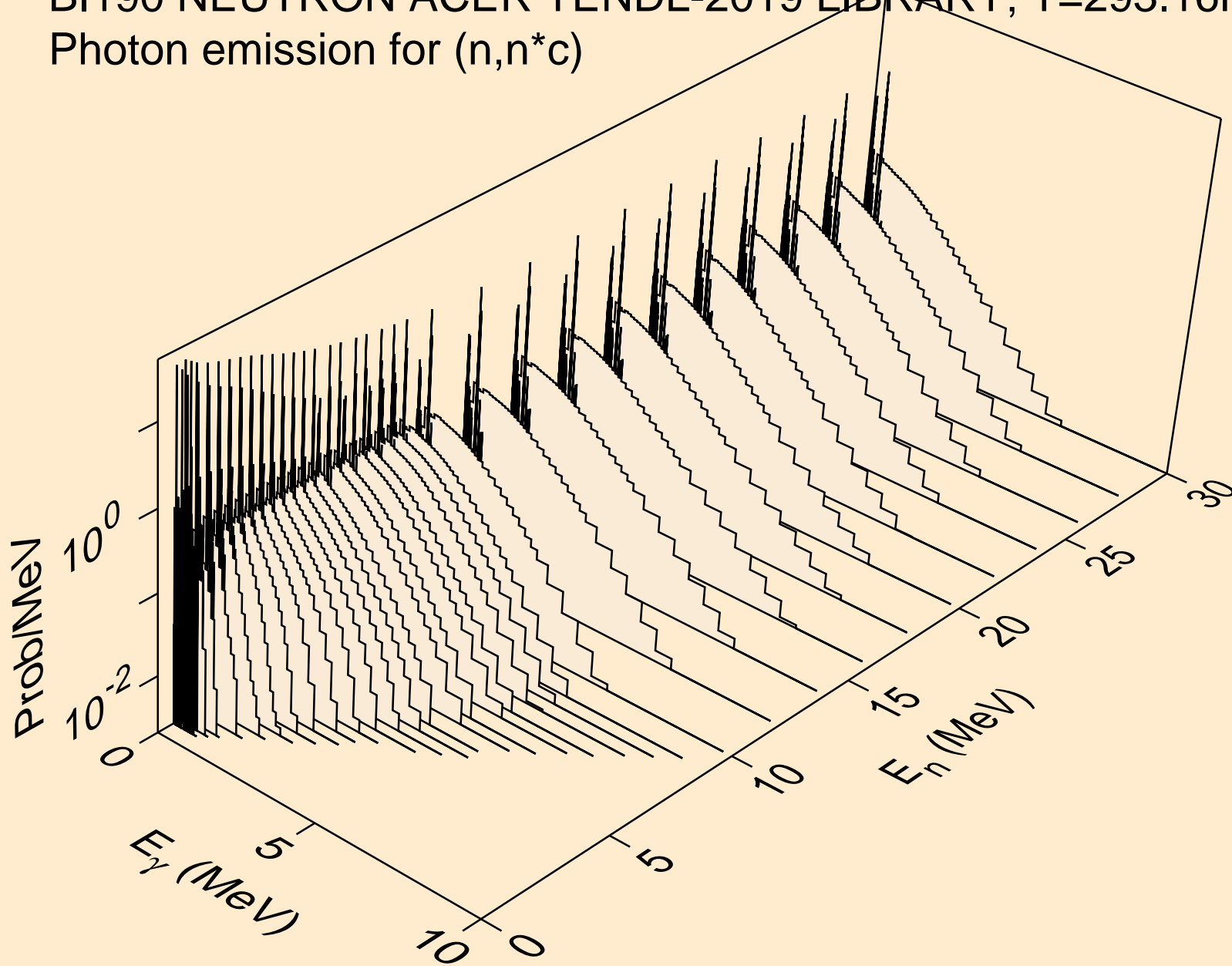

BI190 NEUTRON ACER TENDL-2019 LIBRARY; T=293.16K
Photon emission for (n,gma)

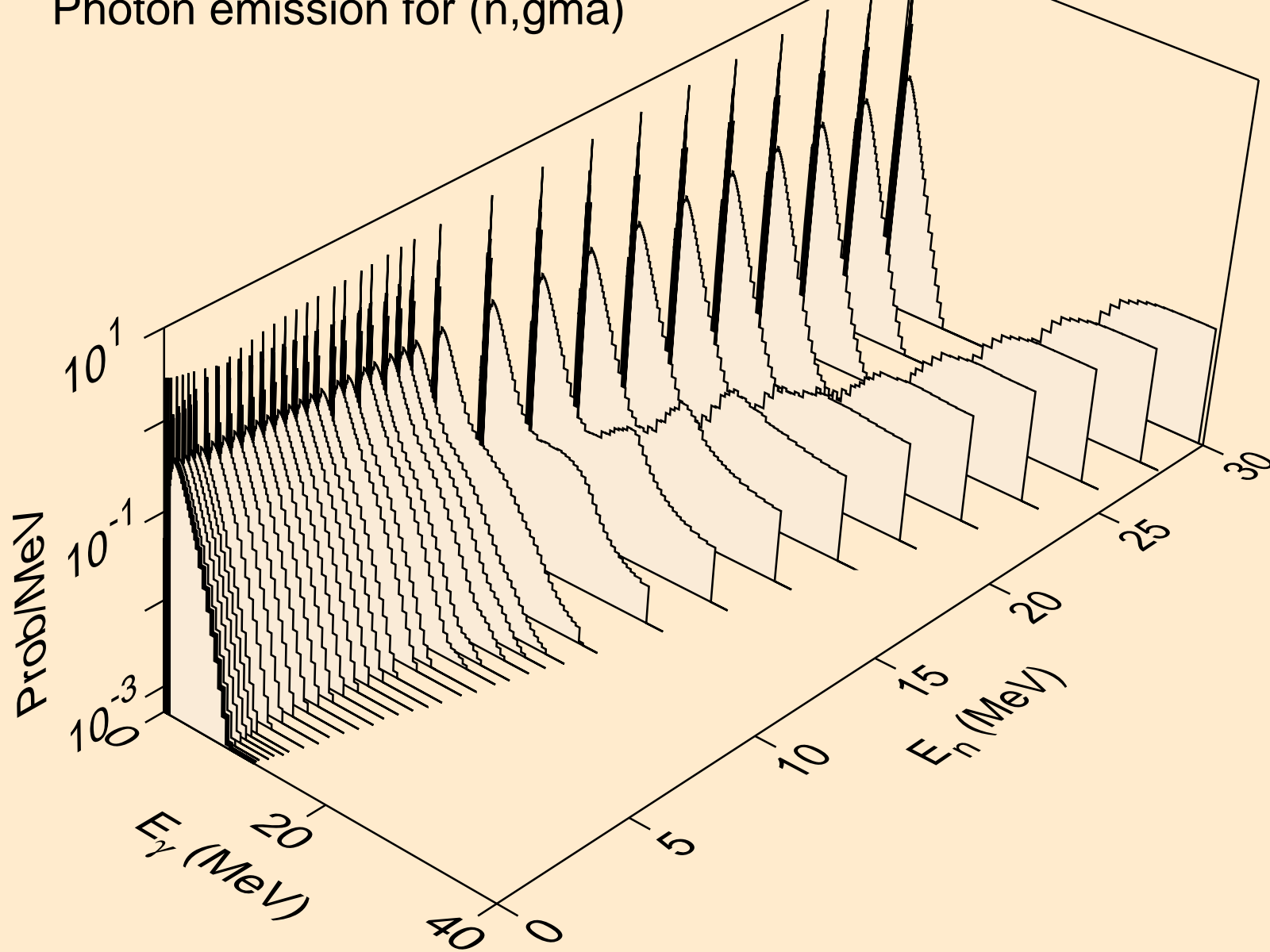

BI190 NEUTRON ACER TENDL-2019 LIBRARY; T=293.16K
Photon emission for (n,p)

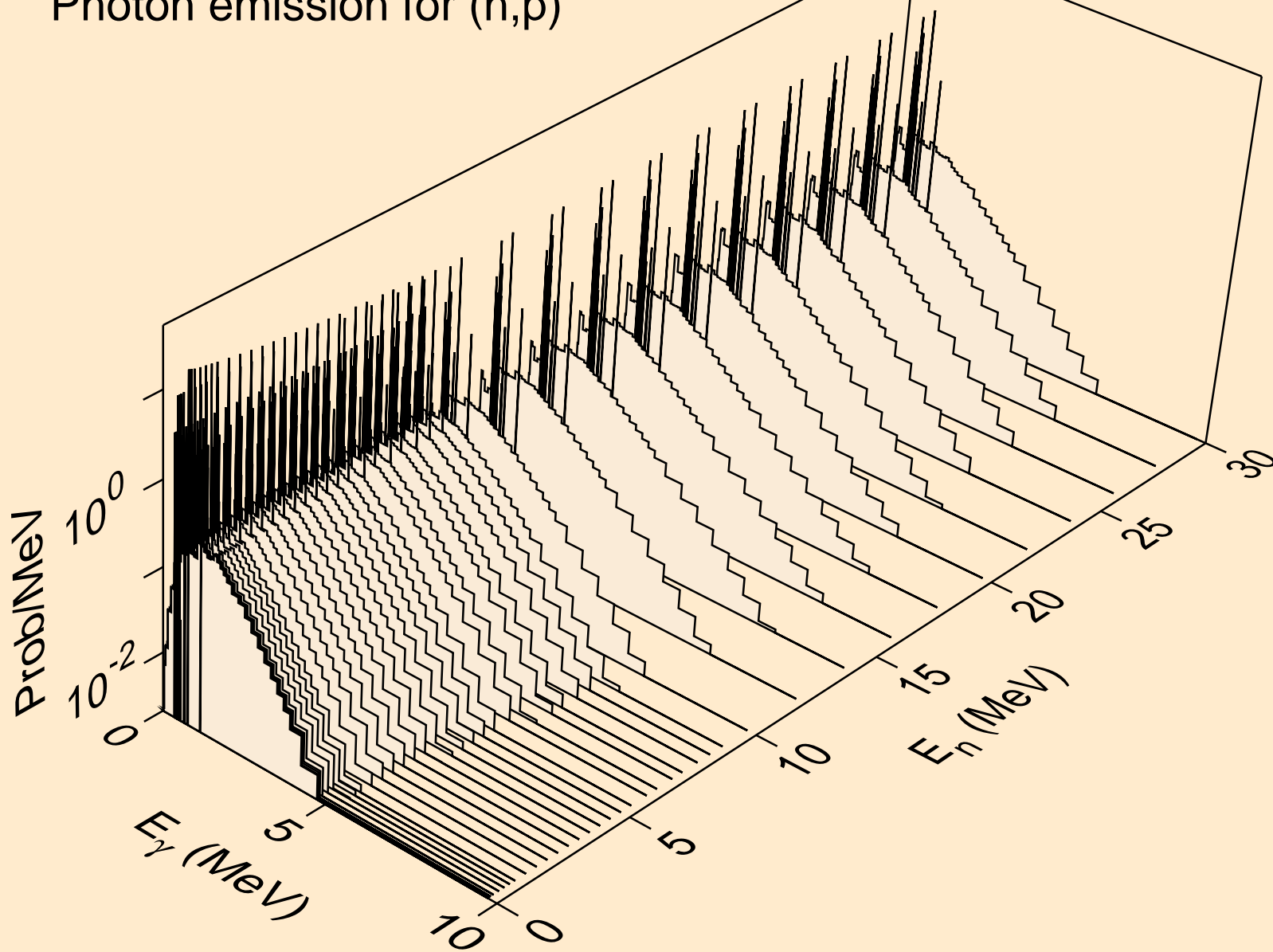

BI190 NEUTRON ACER TENDL-2019 LIBRARY; T=293.16K
Photon emission for (n,d)

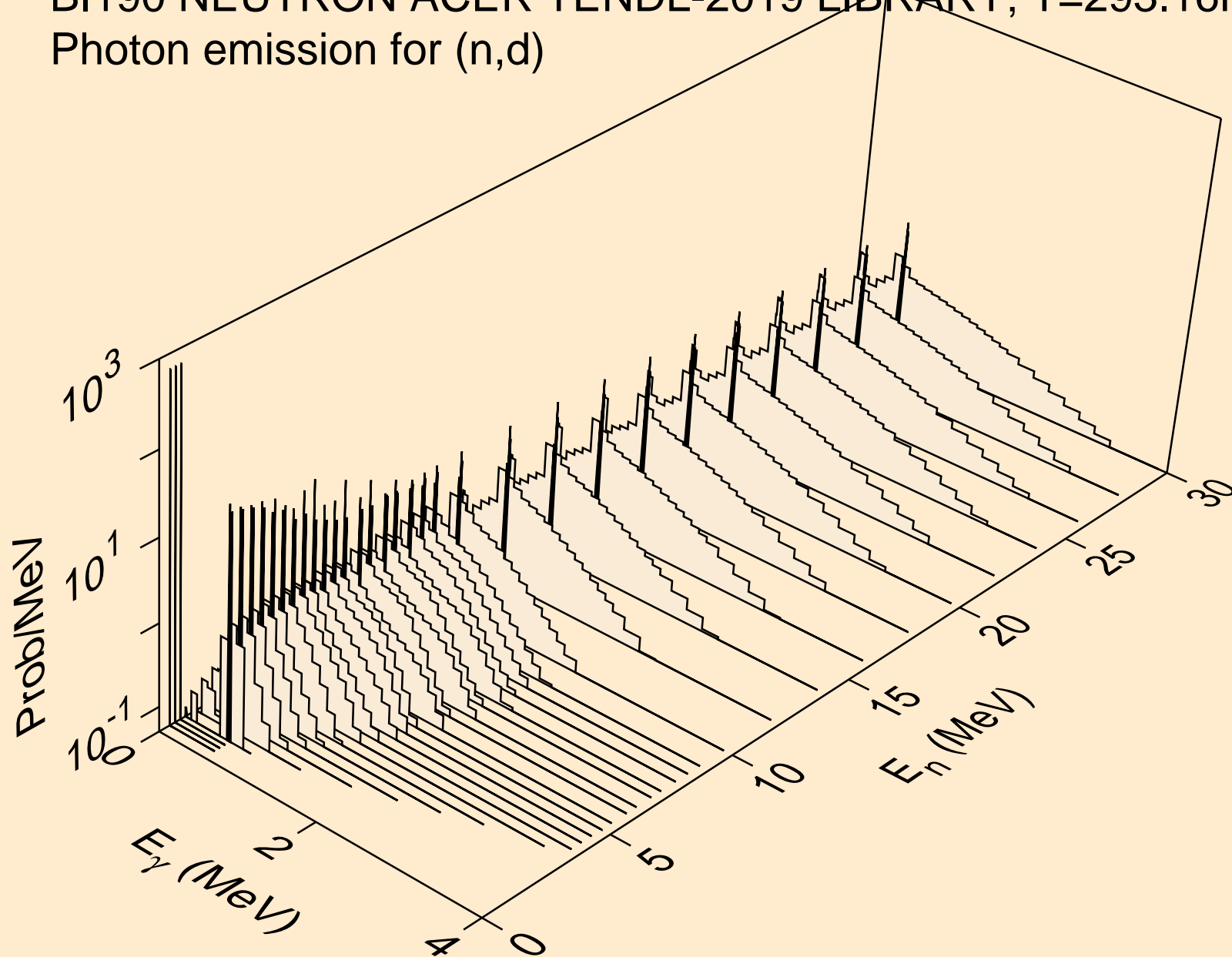

BI190 NEUTRON ACER TENDL-2019 LIBRARY; T=293.16K
Photon emission for (n,t)

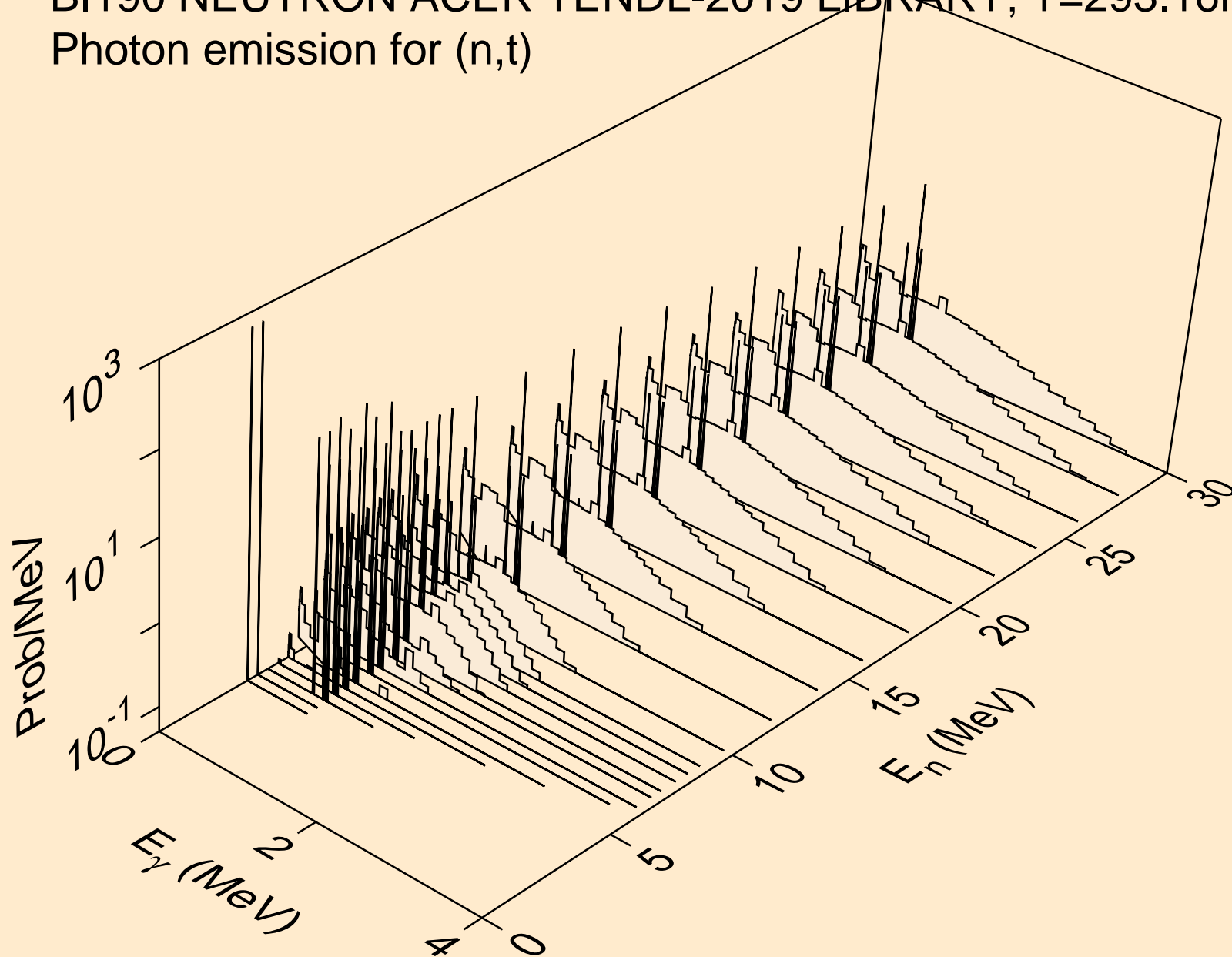

BI190 NEUTRON ACER TENDL-2019 LIBRARY; T=293.16K
Photon emission for (n,he3)

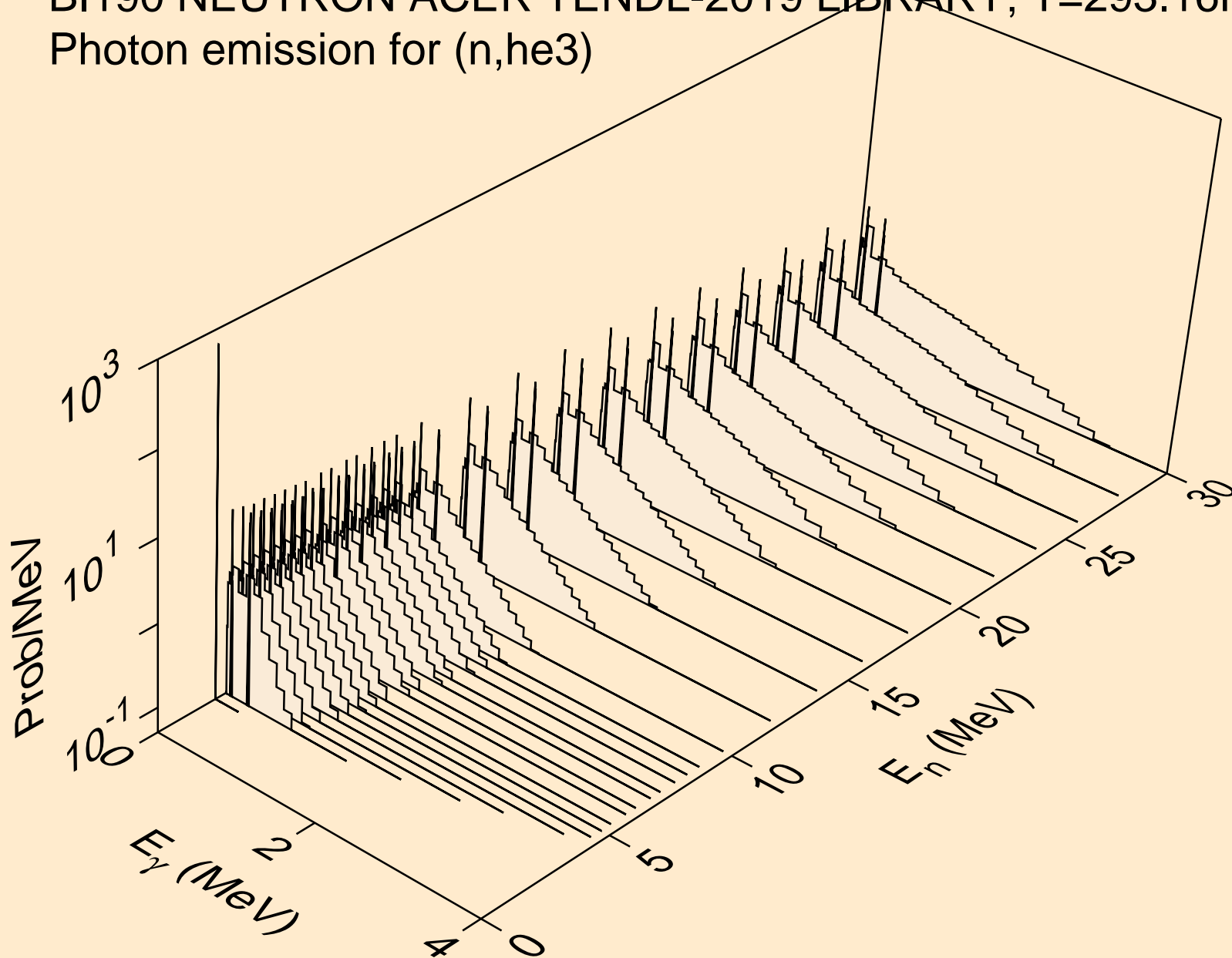

BI190 NEUTRON ACER TENDL-2019 LIBRARY; T=293.16K
Photon emission for (n,a)

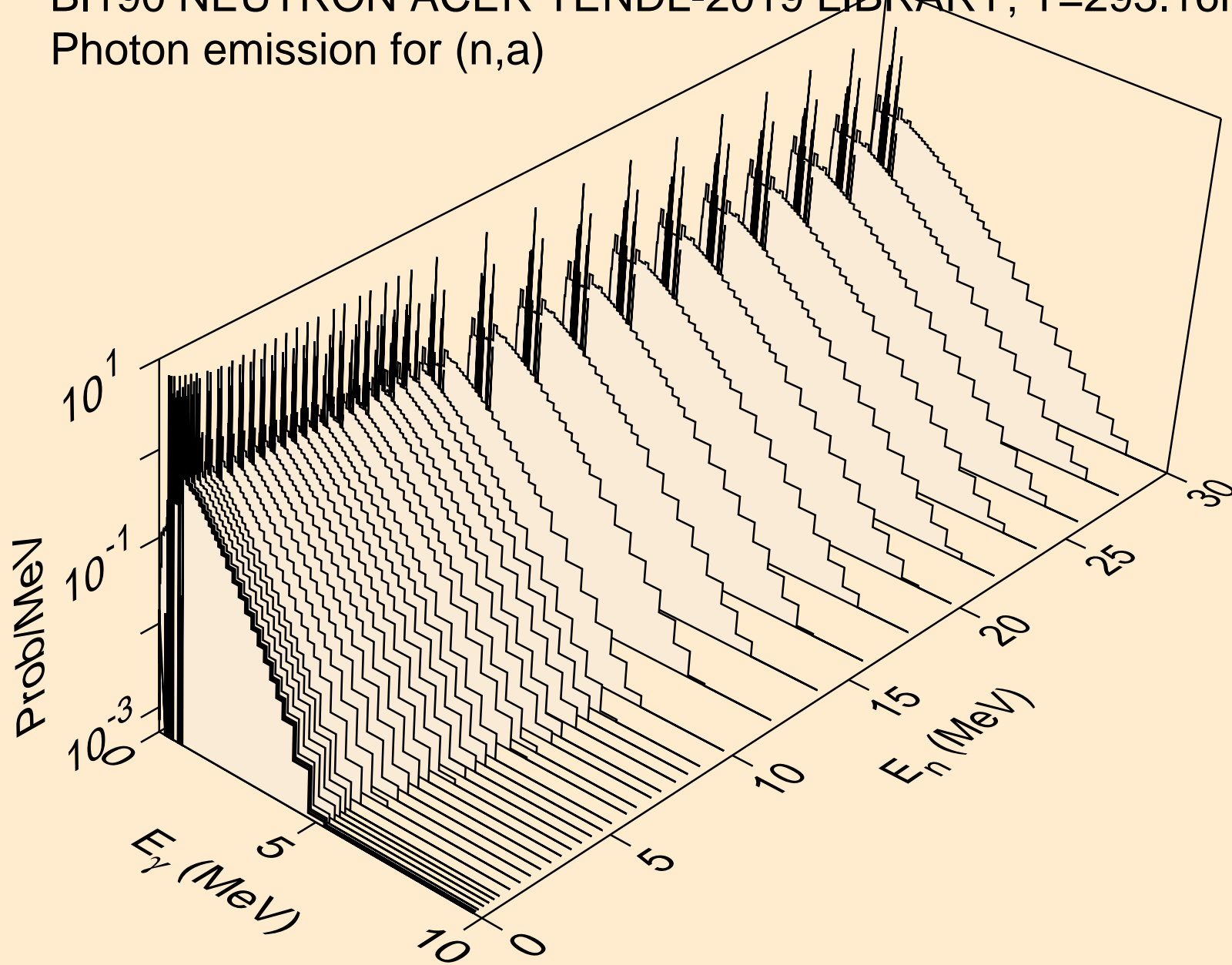

BI190 NEUTRON ACER TENDL-2019 LIBRARY; T=293.16K
Photon emission for (n,2a)

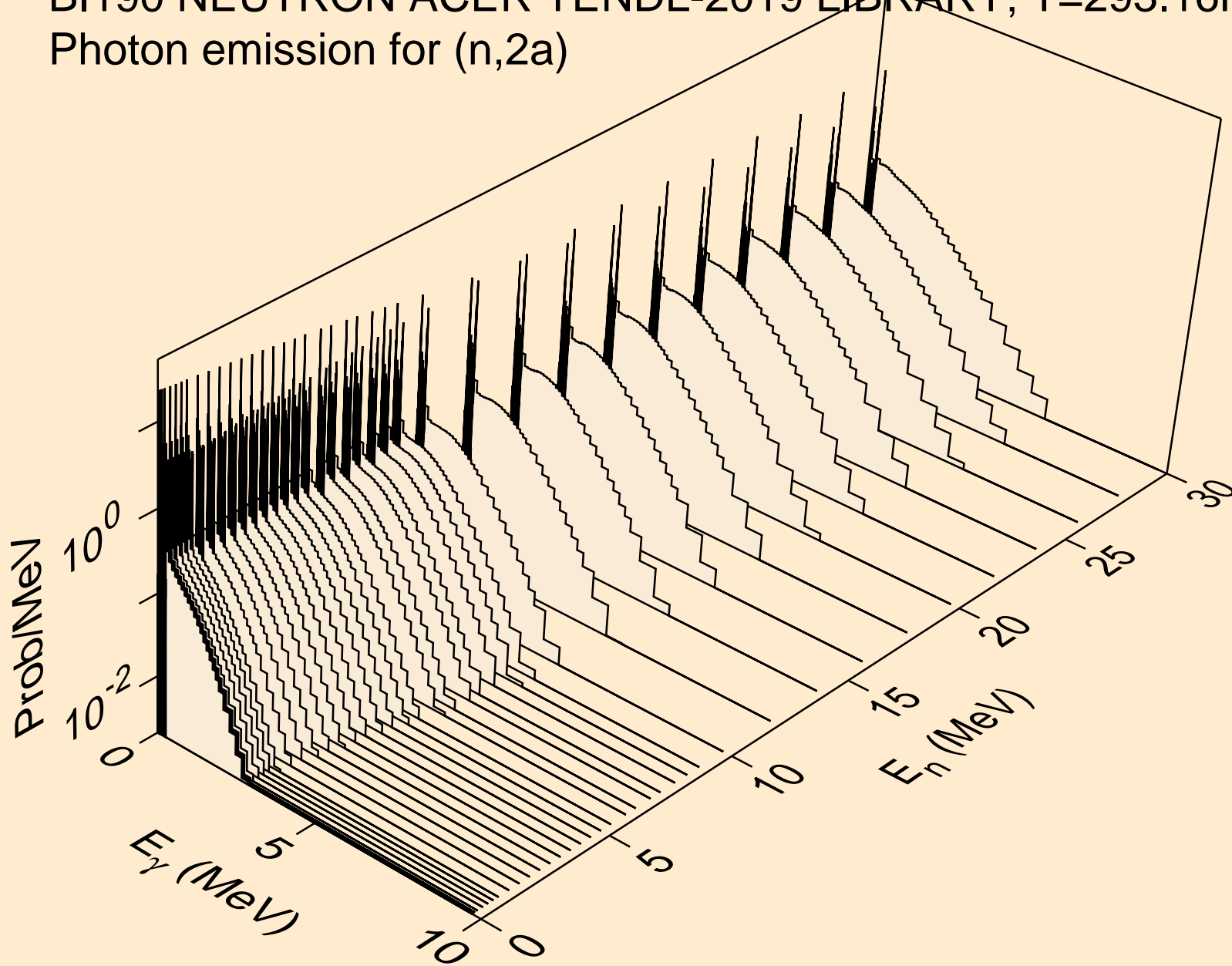

BI190 NEUTRON ACER TENDL-2019 LIBRARY; T=293.16K
Photon emission for (n,3a)

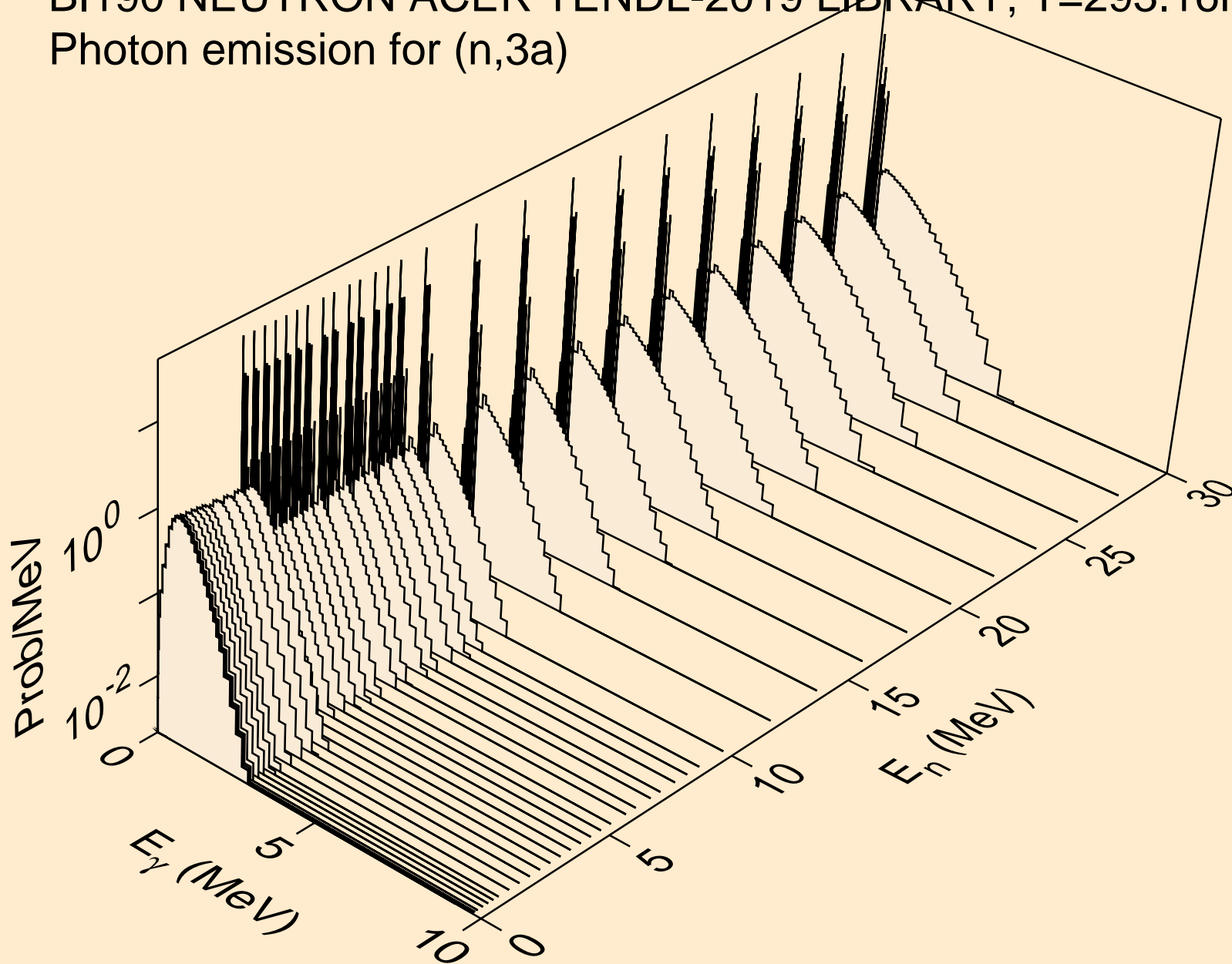

BI190 NEUTRON ACER TENDL-2019 LIBRARY; T=293.16K
Photon emission for (n,2p)

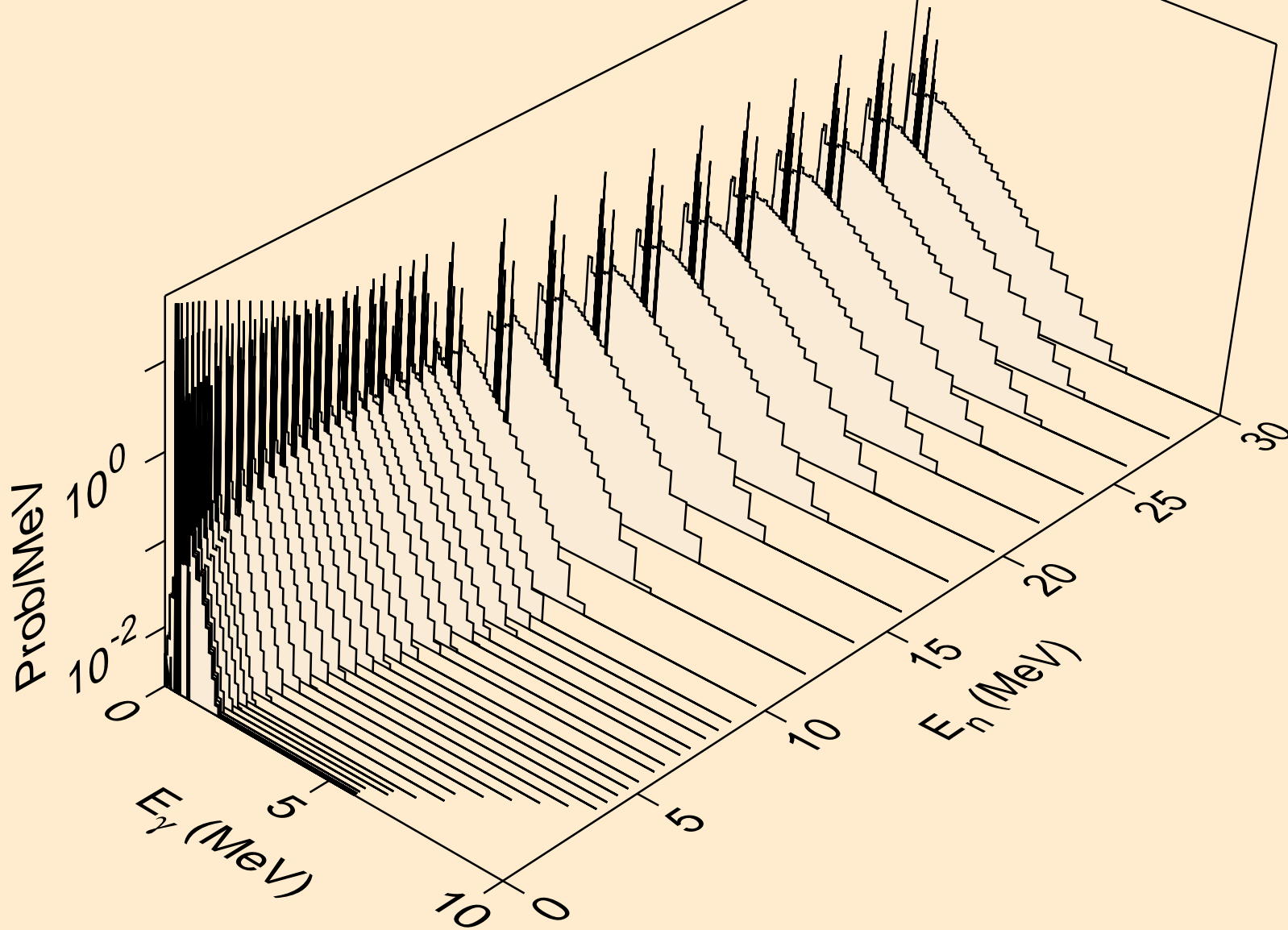

BI190 NEUTRON ACER TENDL-2019 LIBRARY; T=293.16K
Photon emission for (n,p α)

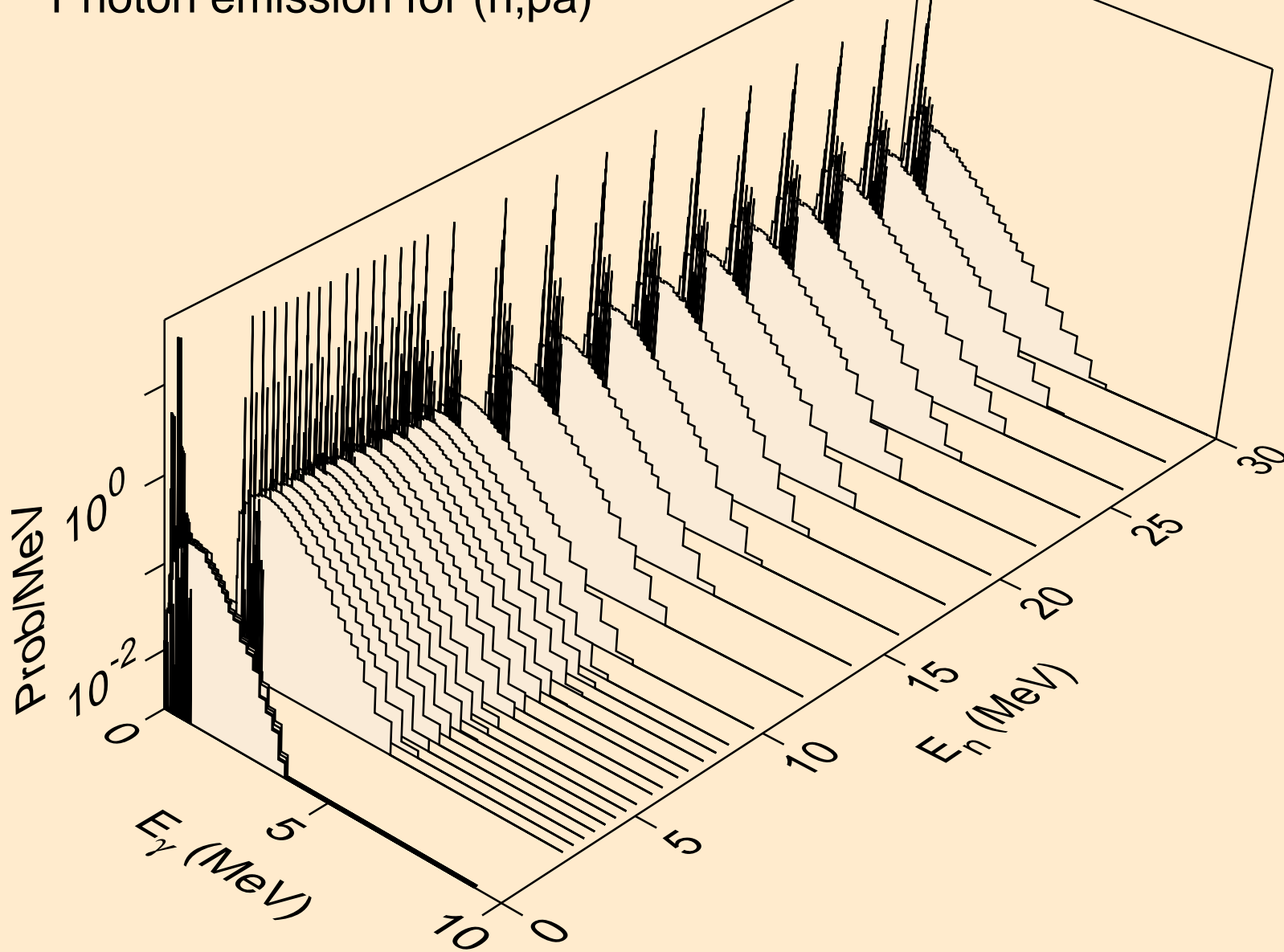

BI190 NEUTRON ACER TENDL-2019 LIBRARY; T=293.16K
Photon emission for (n,t2a)

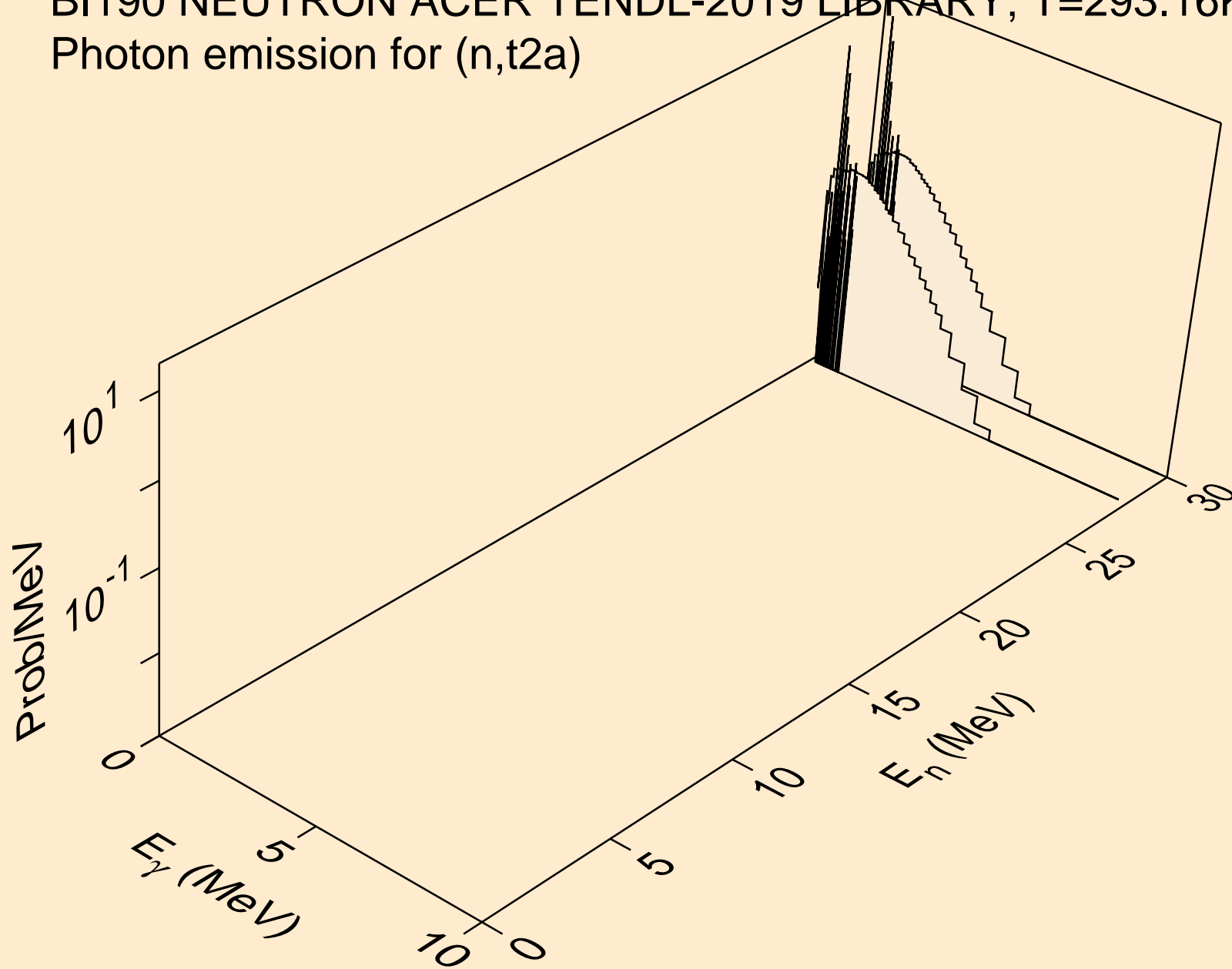

BI190 NEUTRON ACER TENDL-2019 LIBRARY; T=293.16K
Photon emission for (n,d2a)

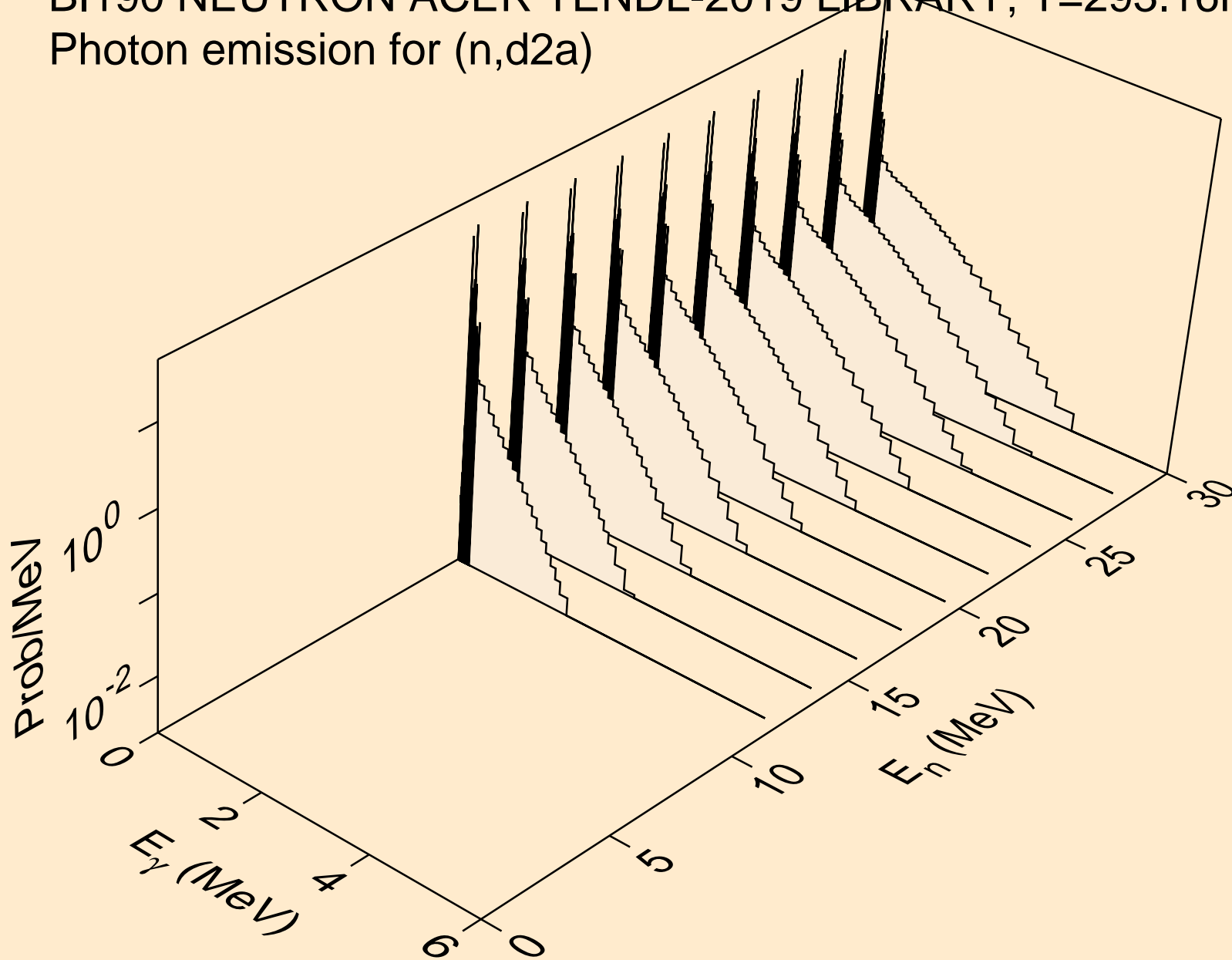

BI190 NEUTRON ACER TENDL-2019 LIBRARY; T=293.16K
Photon emission for (n,pd)

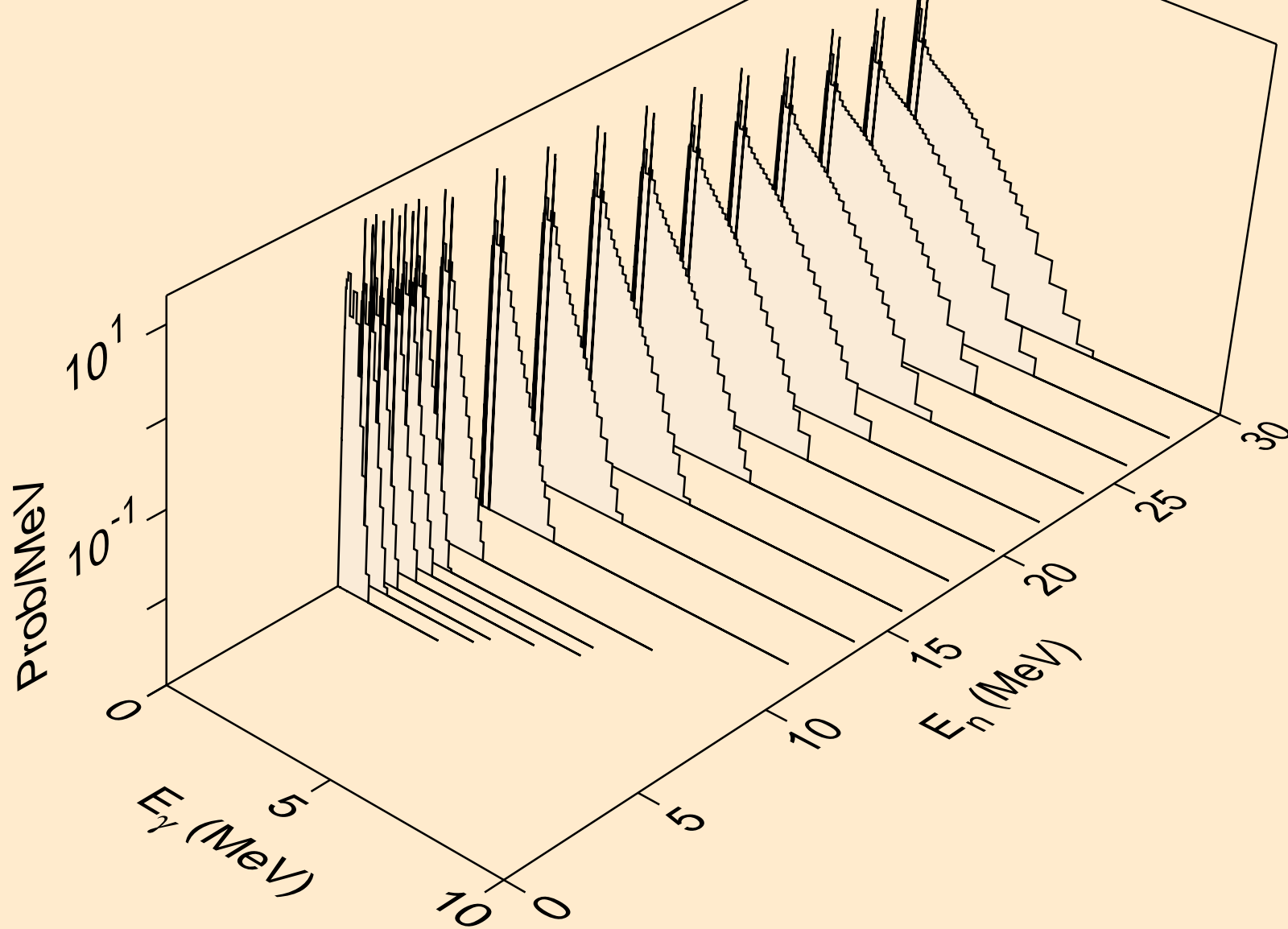

BI190 NEUTRON ACER TENDL-2019 LIBRARY; T=293.16K
Photon emission for (n,pt)

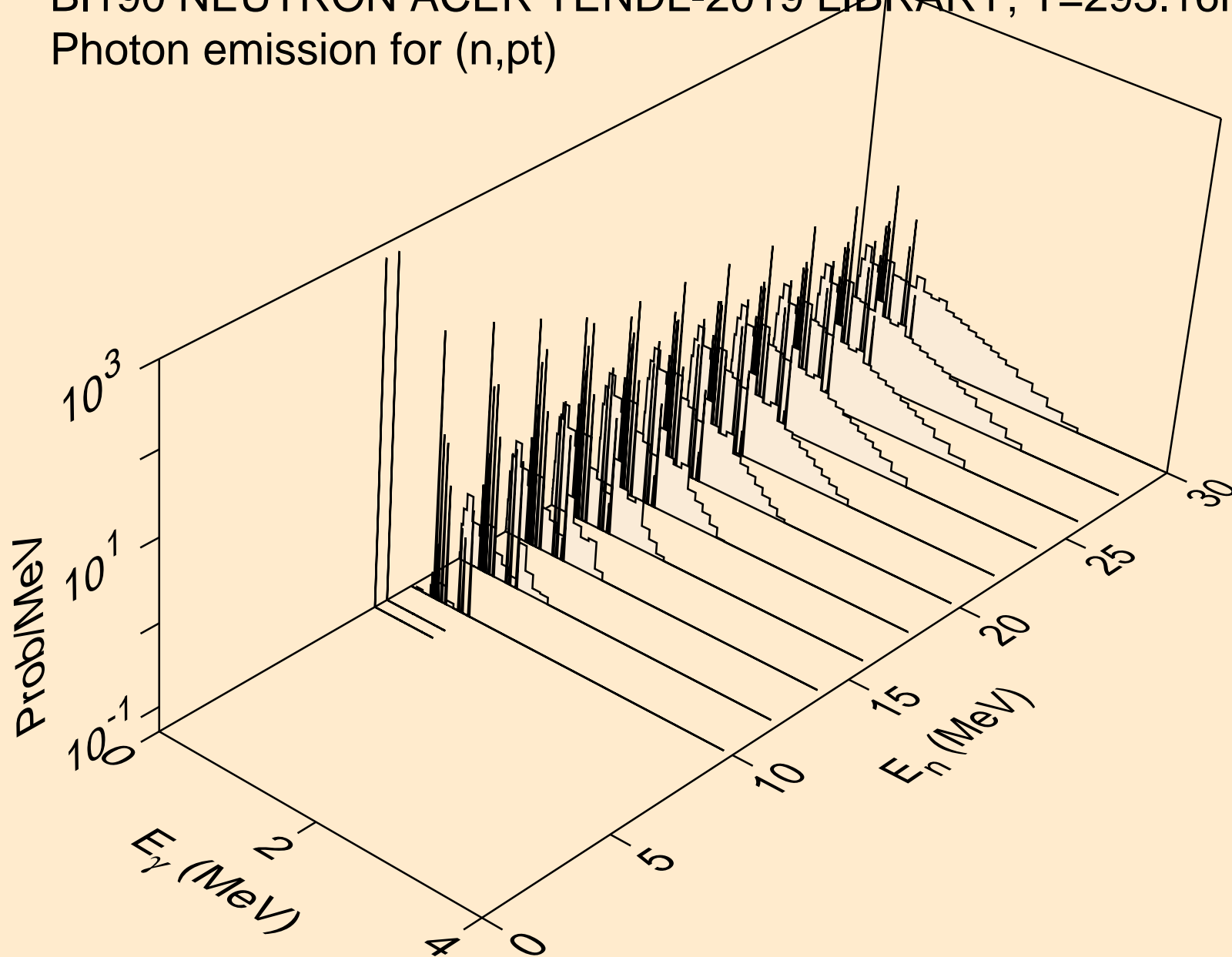

BI190 NEUTRON ACER TENDL-2019 LIBRARY; T=293.16K
Photon emission for (n,da)

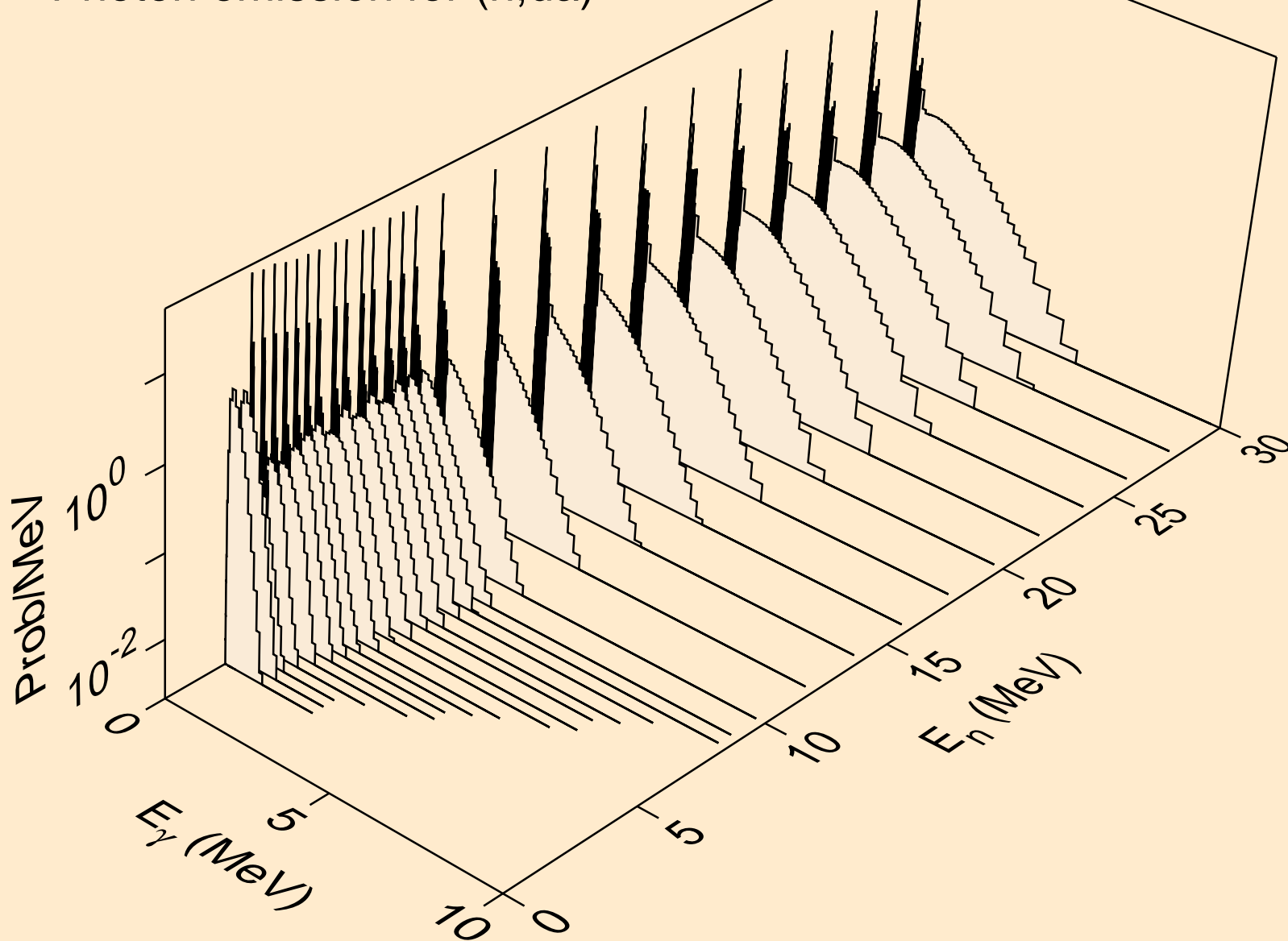

BI190 NEUTRON ACER TENDL-2019 LIBRARY; T=293.16K
thermal capture photon spectrum

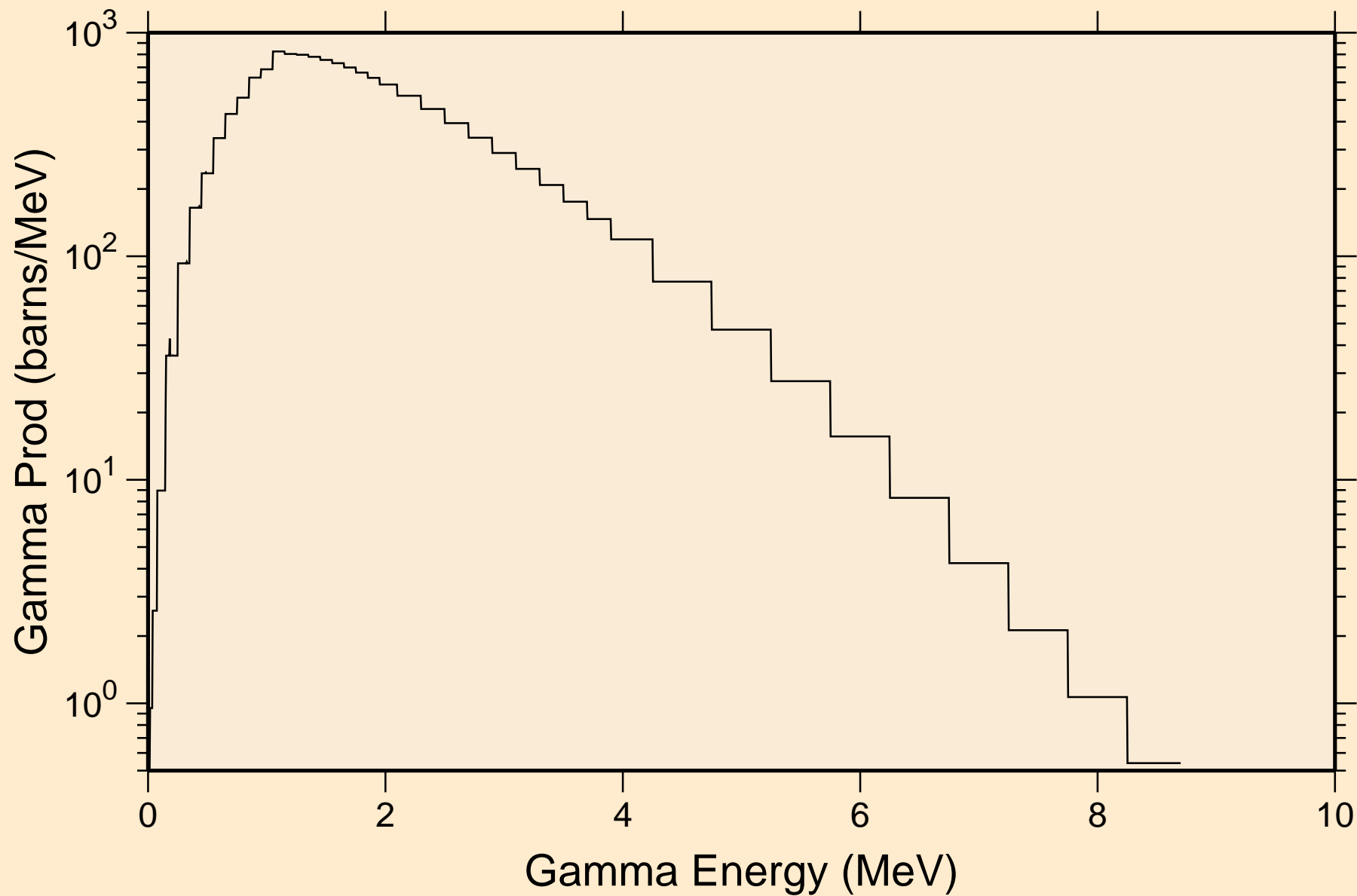

BI190 NEUTRON ACER TENDL-2019 LIBRARY; T=293.16K
14 MeV photon spectrum

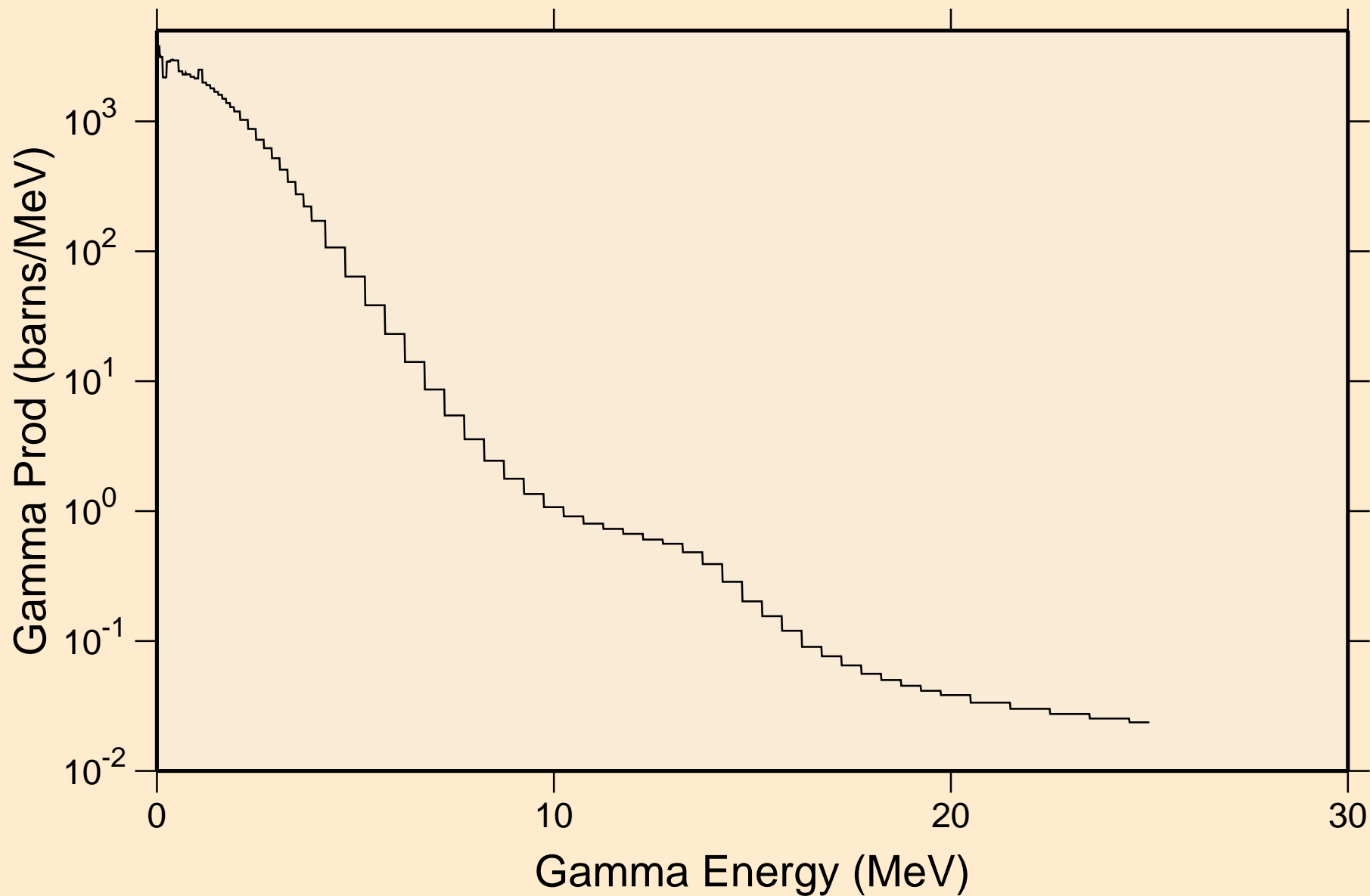

BI190 NEUTRON ACER TENDL-2019 LIBRARY; T=293.16K

Particle heating contributions

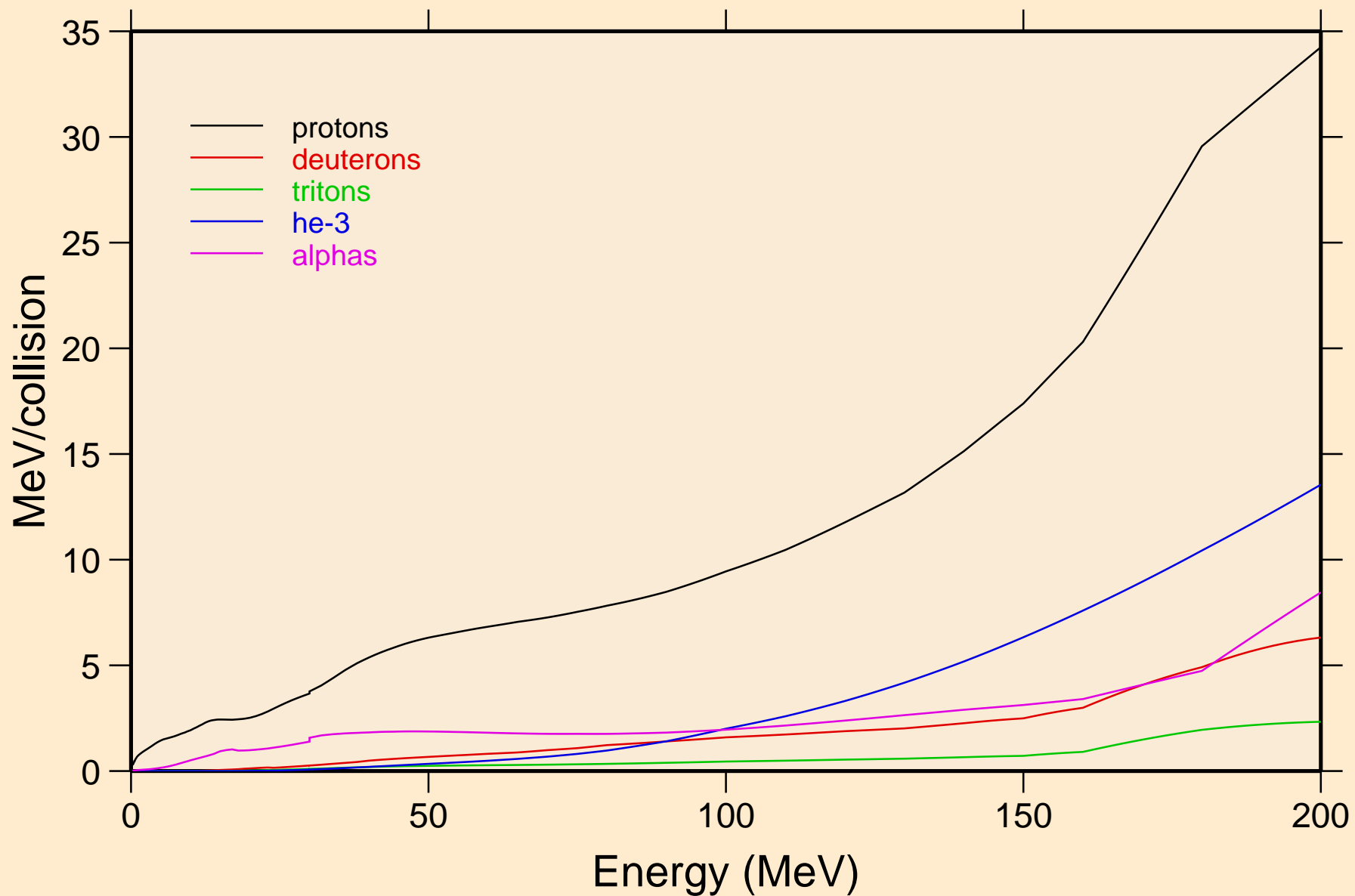

BI190 NEUTRON ACER TENDL-2019 LIBRARY; T=293.16K
Recoil Heating

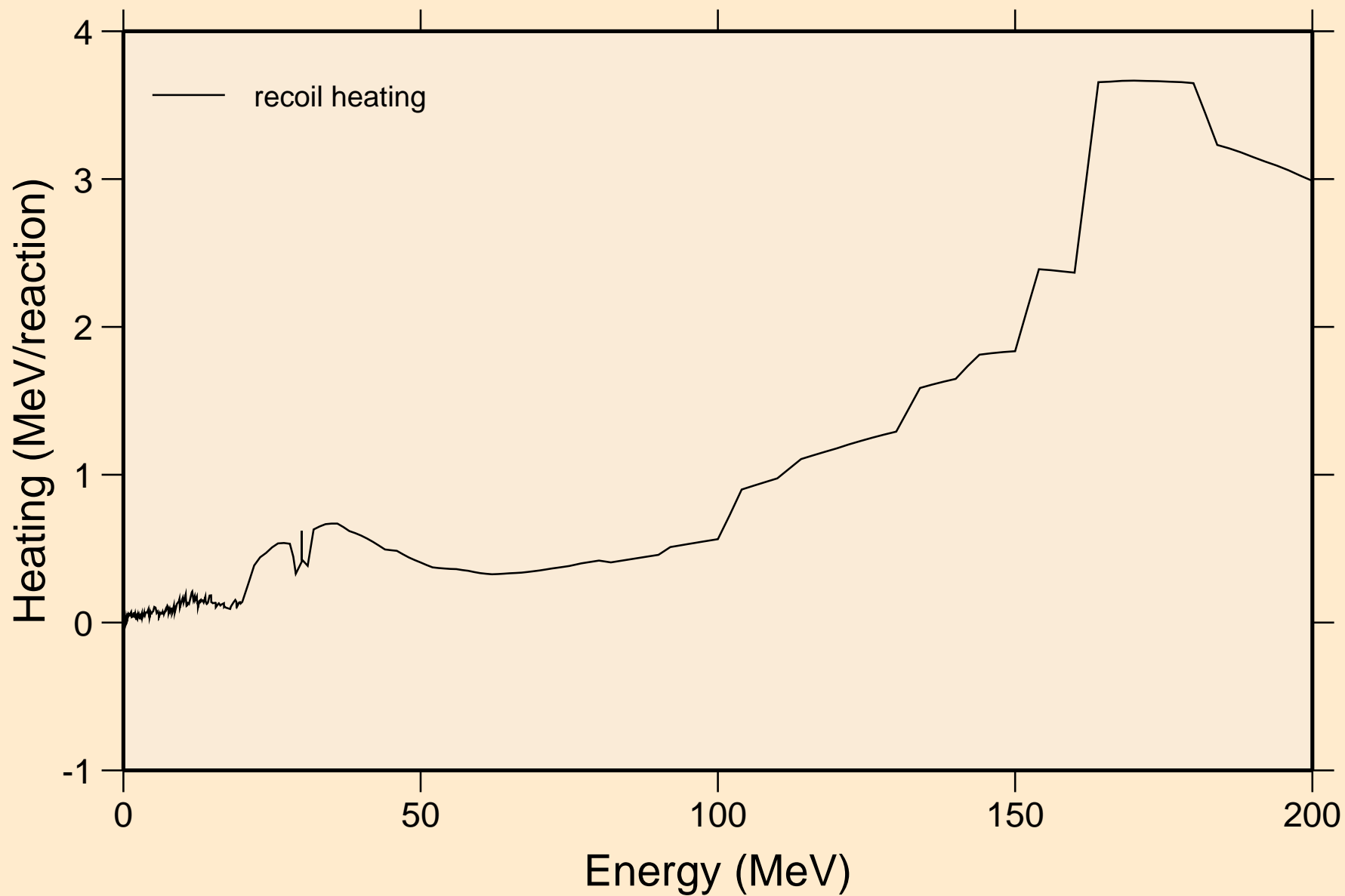

BI190 NEUTRON ACER TENDL-2019 LIBRARY; T=293.16K
Particle production cross sections

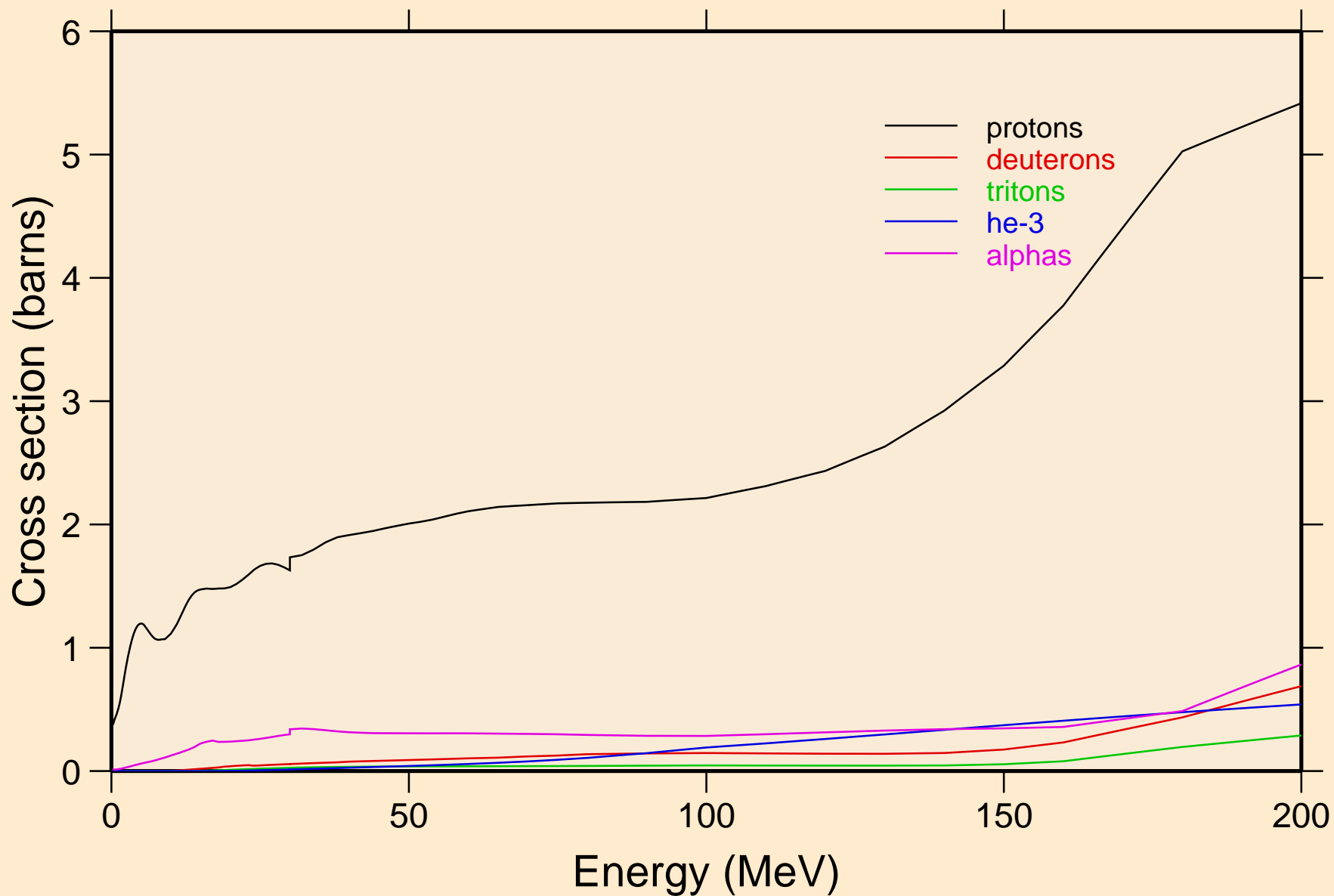

BI190 NEUTRON ACER TENDL-2019 LIBRARY; T=293.16K
protons from (n,x)

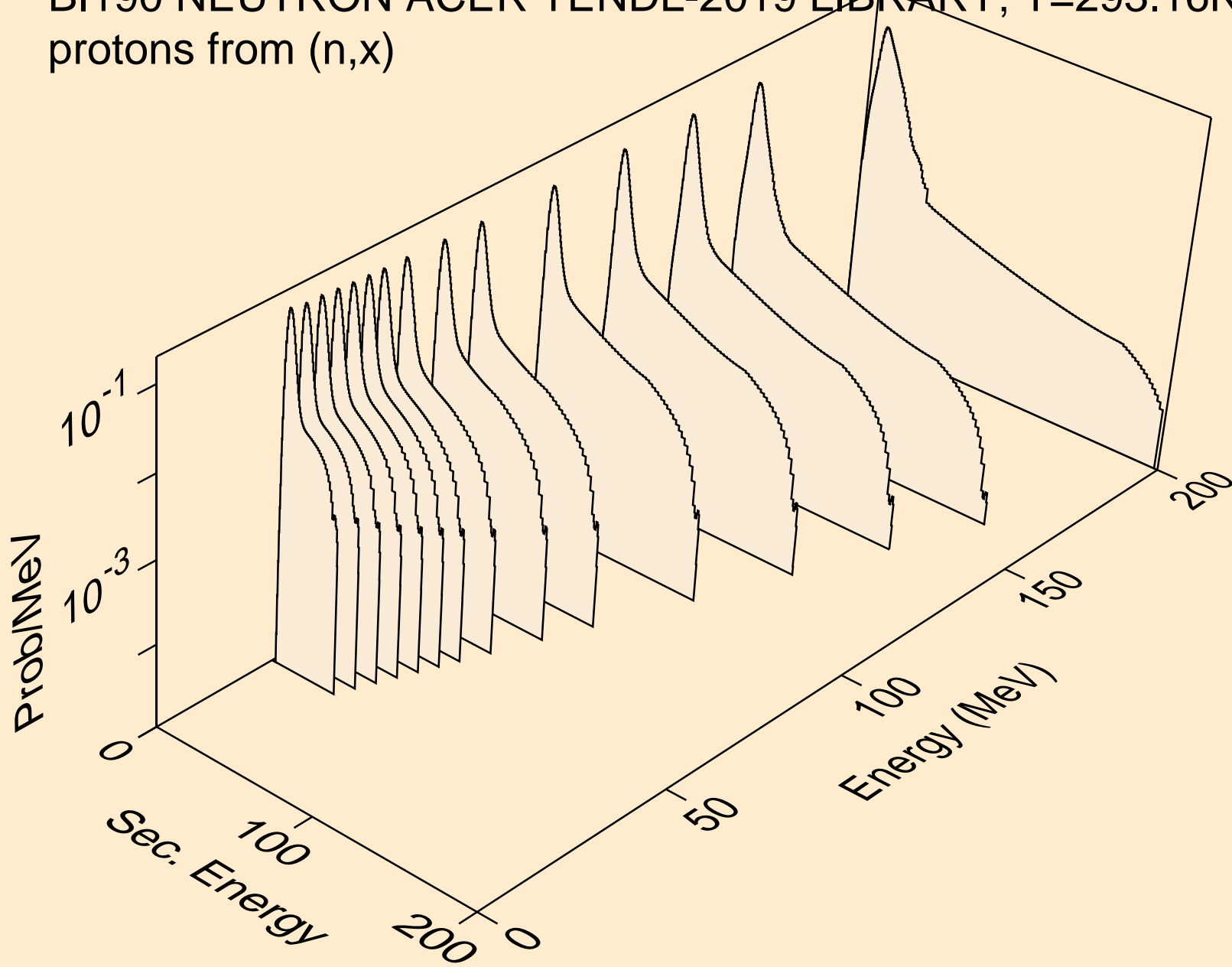

BI190 NEUTRON ACER TENDL-2019 LIBRARY; T=293.16K
protons from (n,n*)p

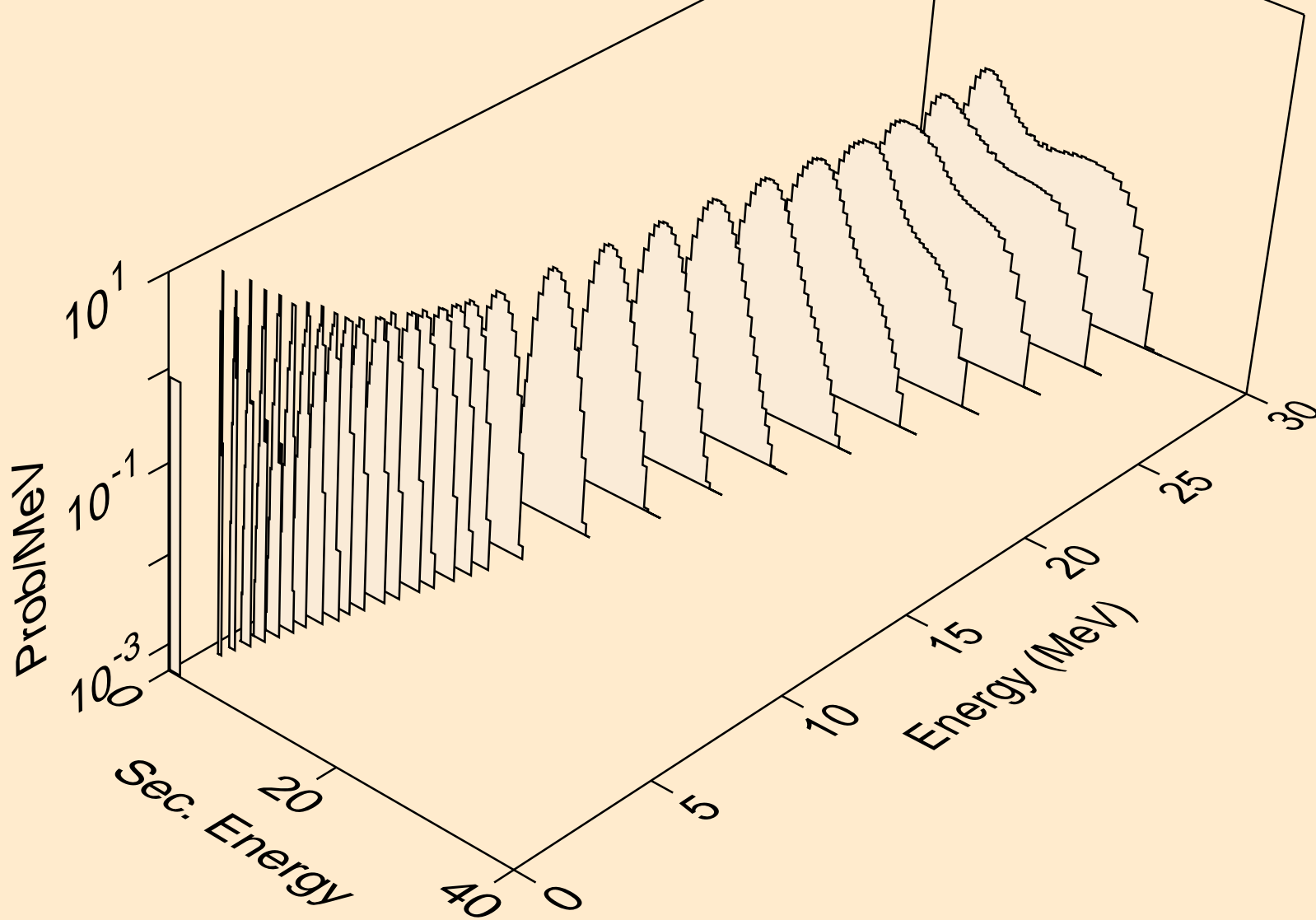

BI190 NEUTRON ACER TENDL-2019 LIBRARY; T=293.16K
protons from (n,2np)

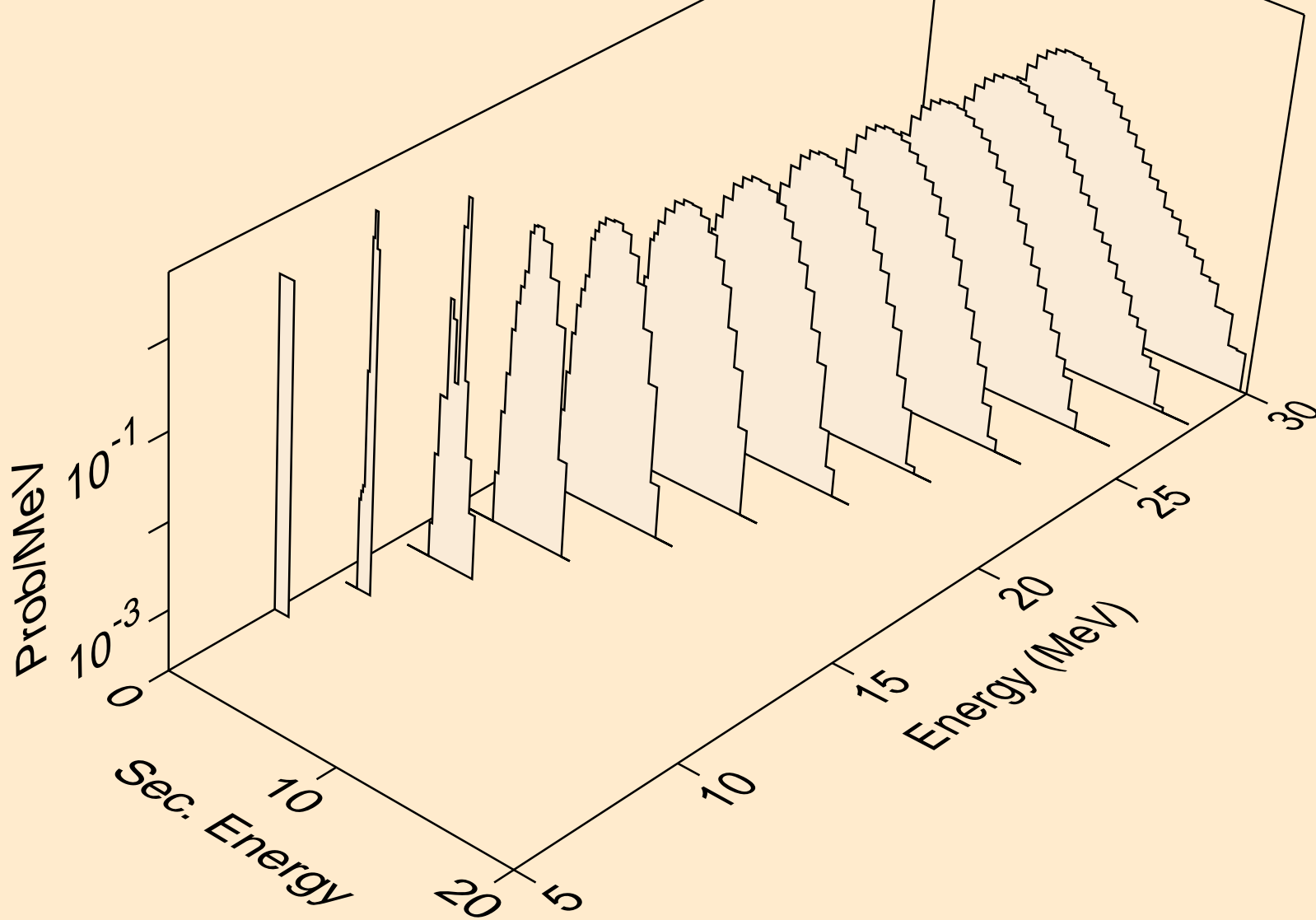

BI190 NEUTRON ACER TENDL-2019 LIBRARY; T=293.16K
protons from (n,3np)

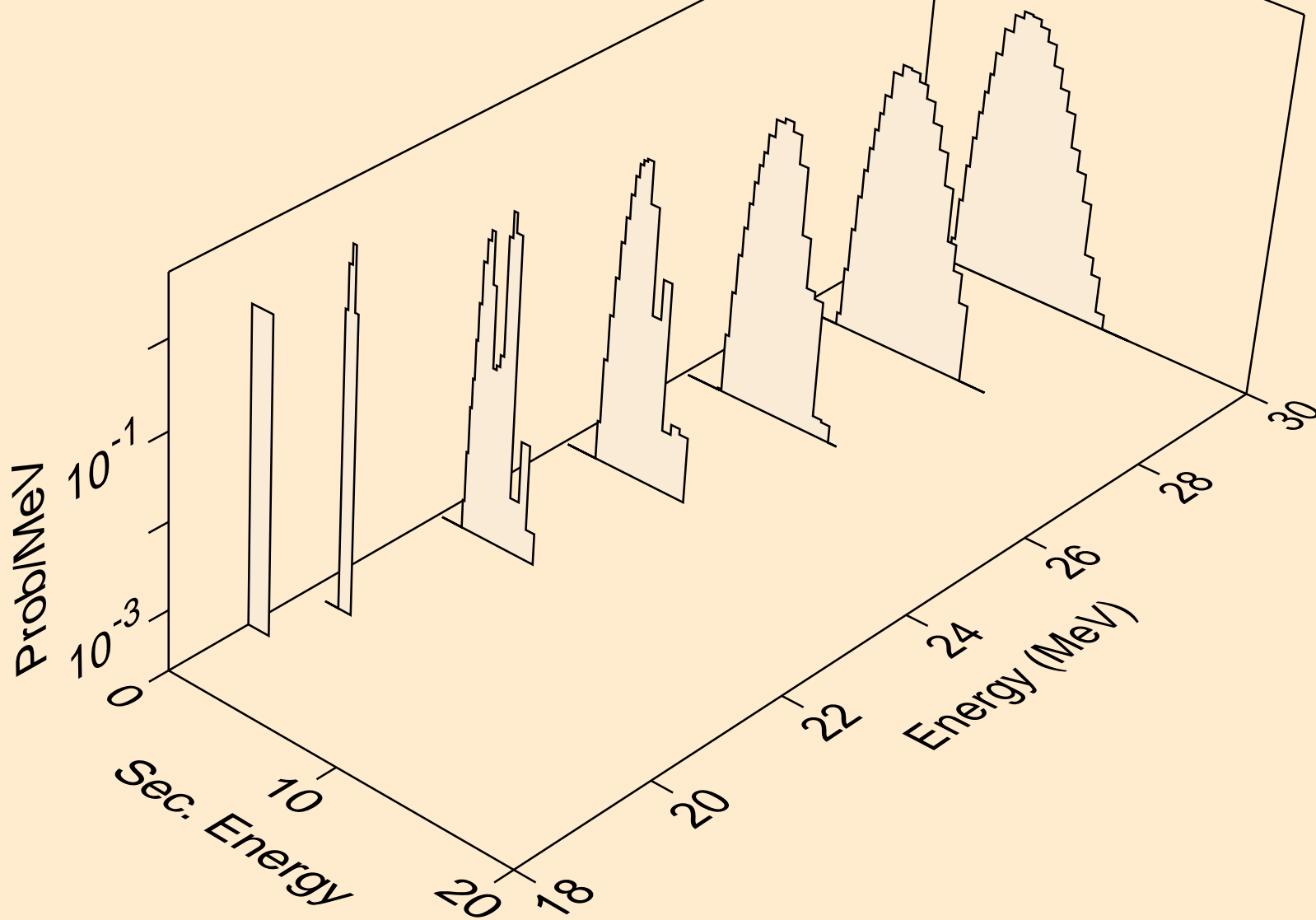

BI190 NEUTRON ACER TENDL-2019 LIBRARY; T=293.16K
protons from (n,2np)

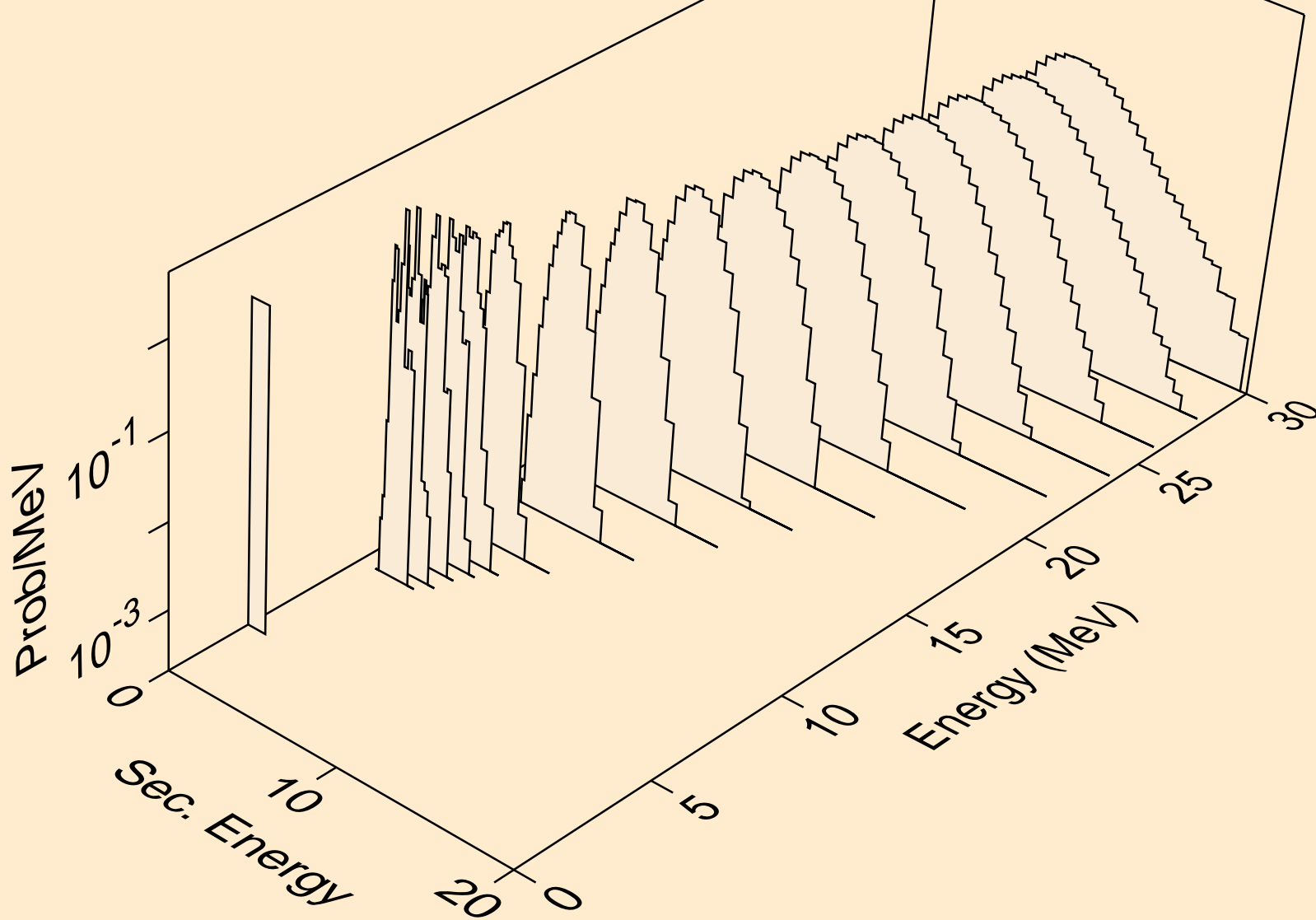

BI190 NEUTRON ACER TENDL-2019 LIBRARY; T=293.16K
protons from (n,npa)

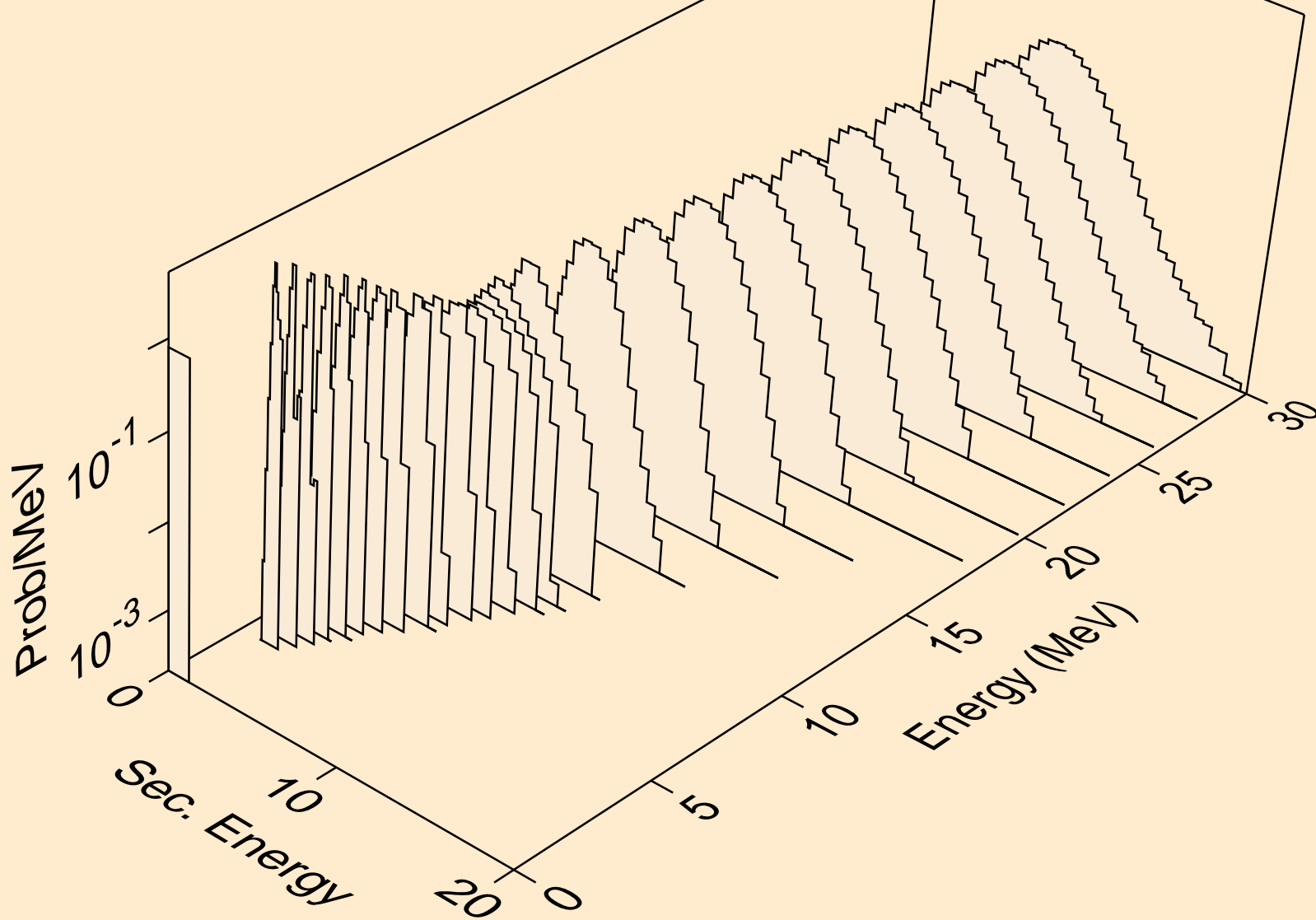

BI190 NEUTRON ACER TENDL-2019 LIBRARY; T=293.16K
protons from (n,p)

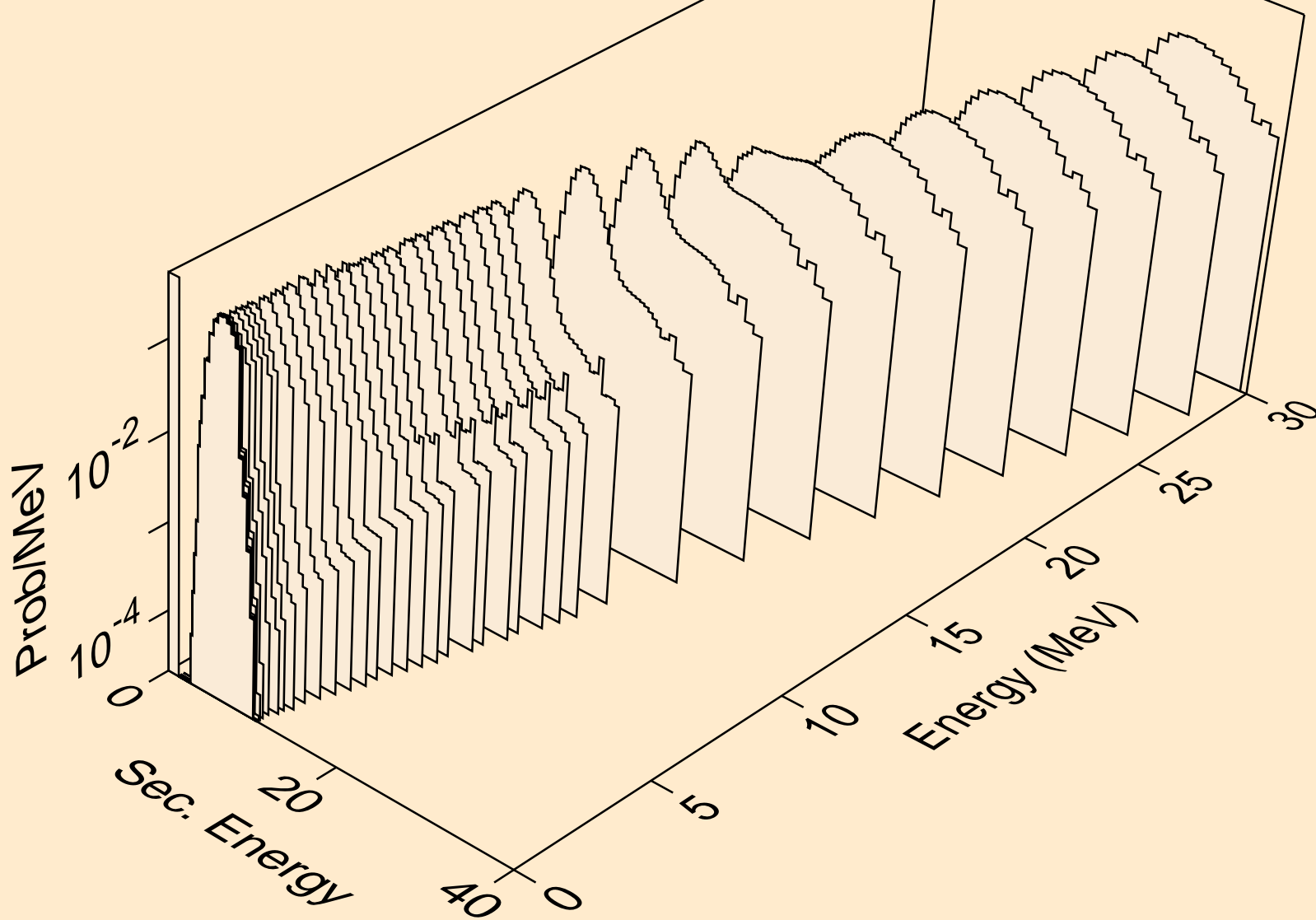

BI190 NEUTRON ACER TENDL-2019 LIBRARY; T=293.16K
protons from (n,2p)

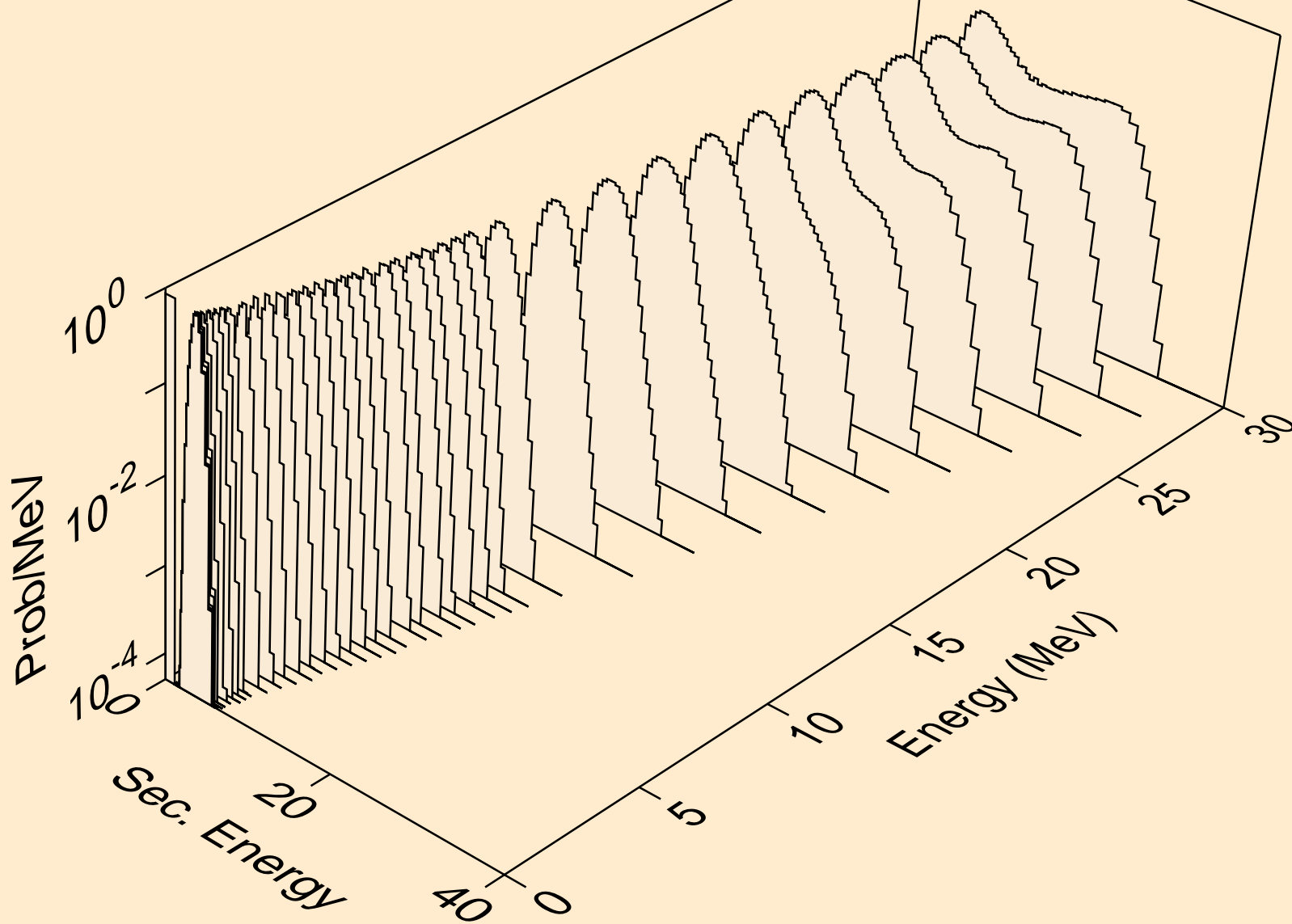

BI190 NEUTRON ACER TENDL-2019 LIBRARY; T=293.16K
protons from (n,p)

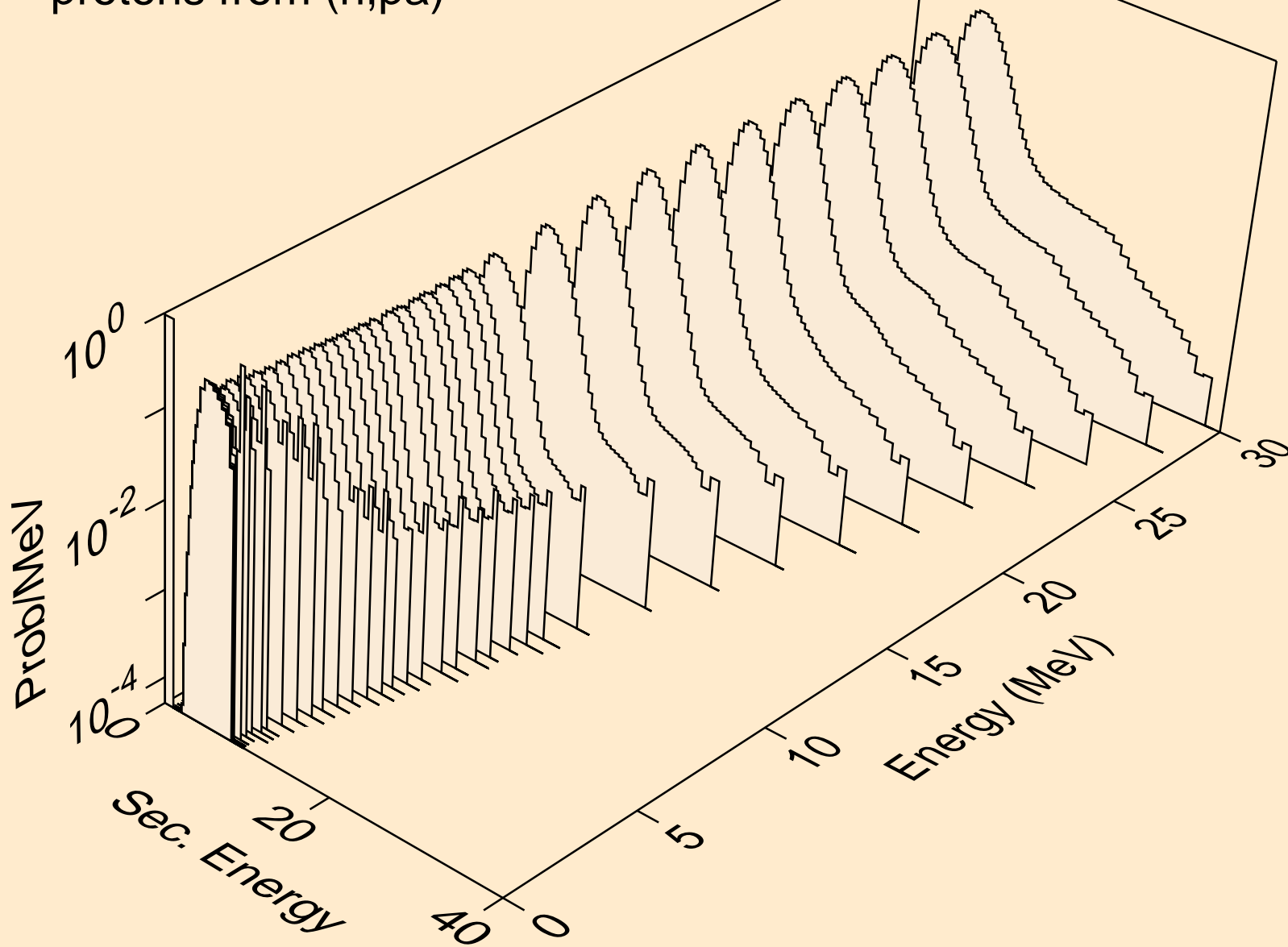

BI190 NEUTRON ACER TENDL-2019 LIBRARY; T=293.16K
protons from (n,pd)

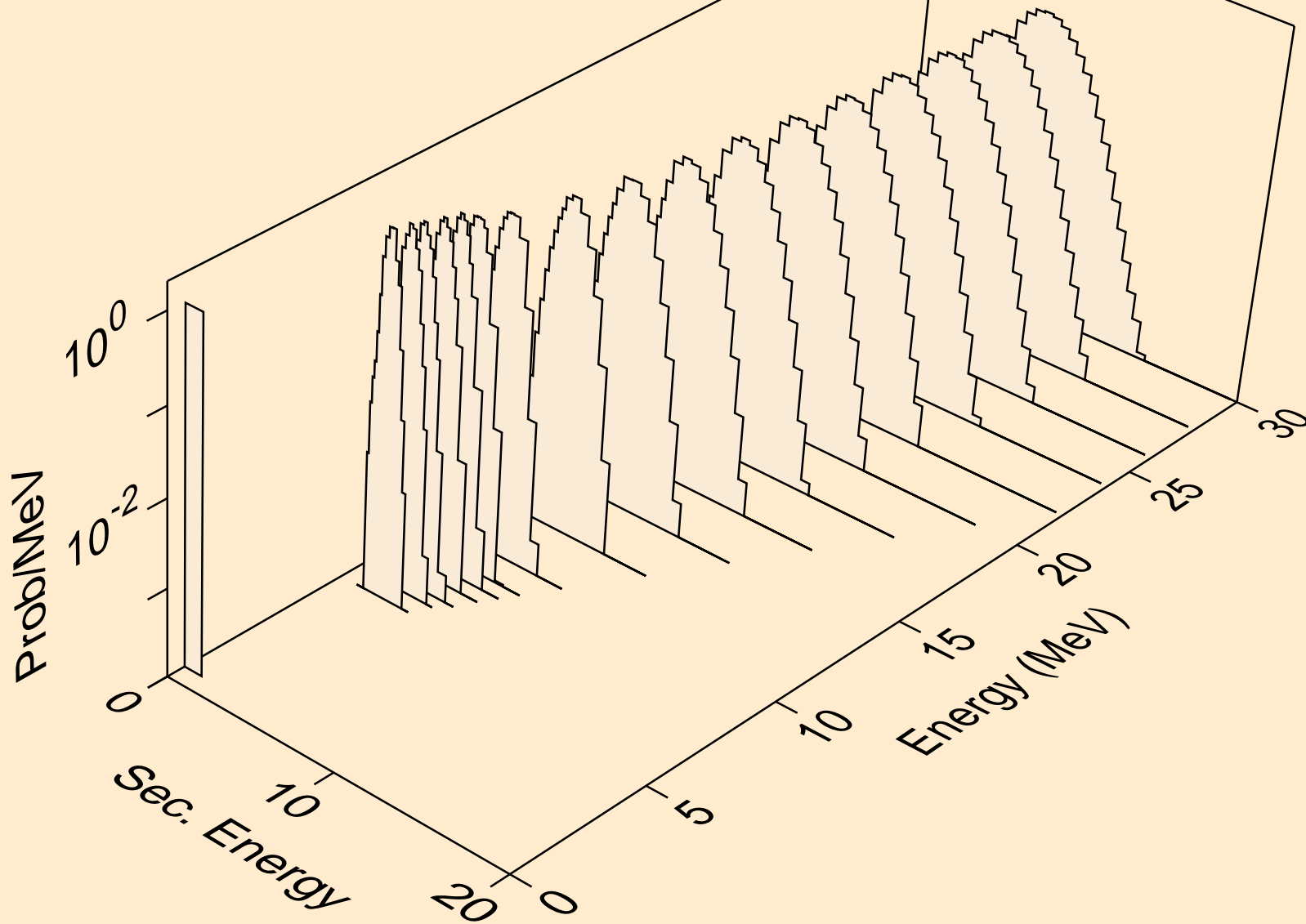

BI190 NEUTRON ACER TENDL-2019 LIBRARY; T=293.16K
protons from (n,pt)

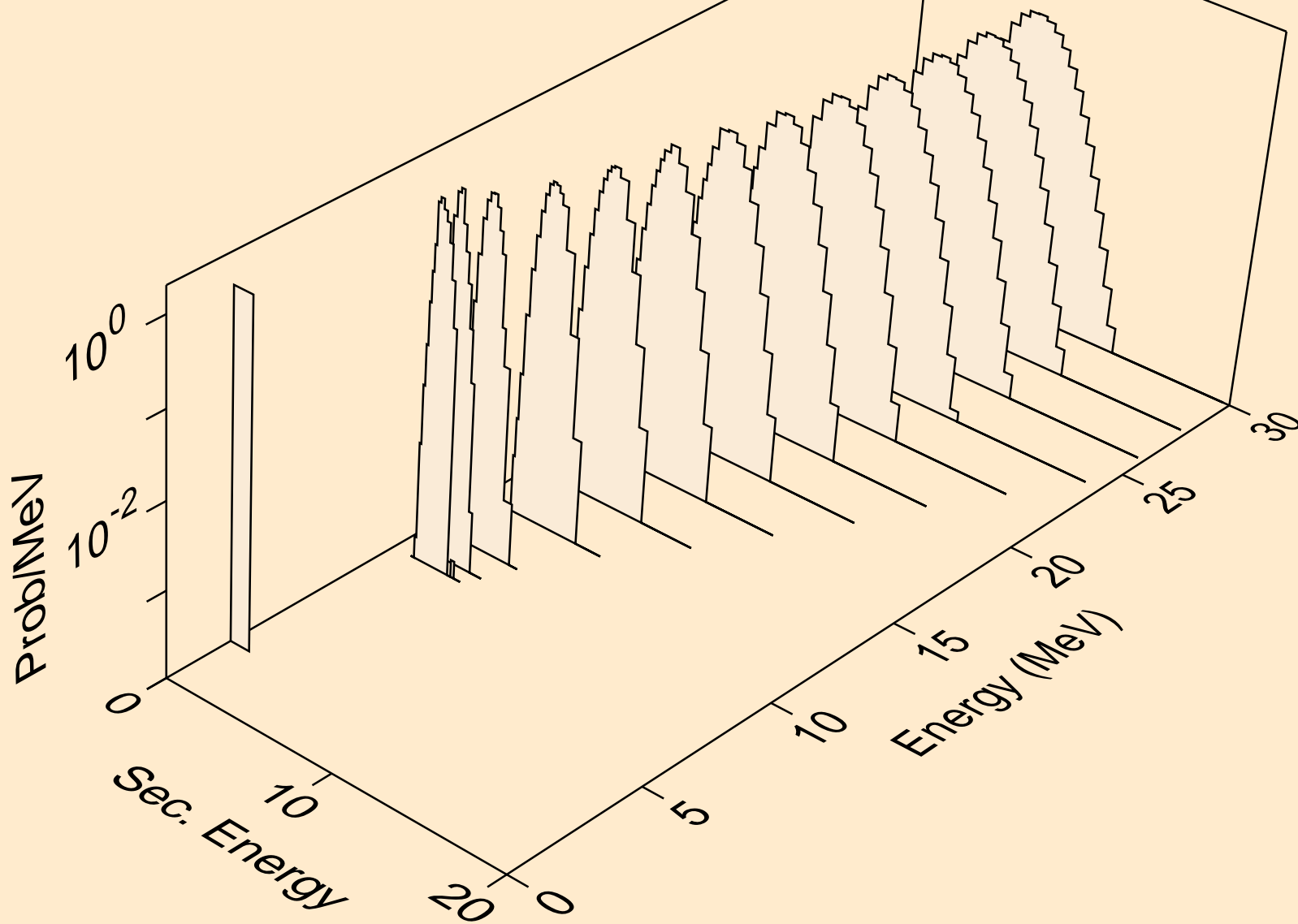

BI190 NEUTRON ACER TENDL-2019 LIBRARY; T=293.16K
deuterons from (n,x)

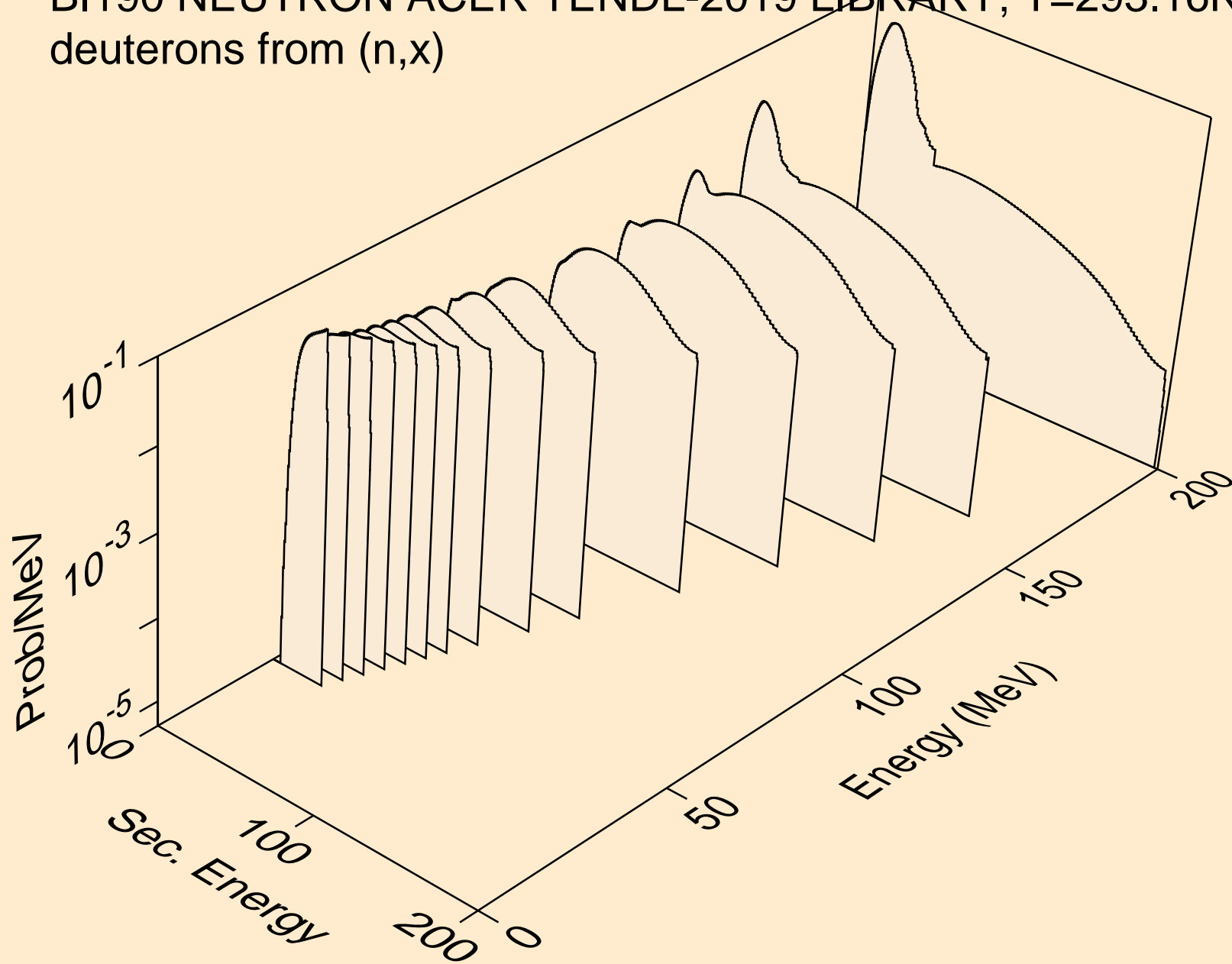

BI190 NEUTRON ACER TENDL-2019 LIBRARY; T=293.16K
deuterons from (n,2nd)

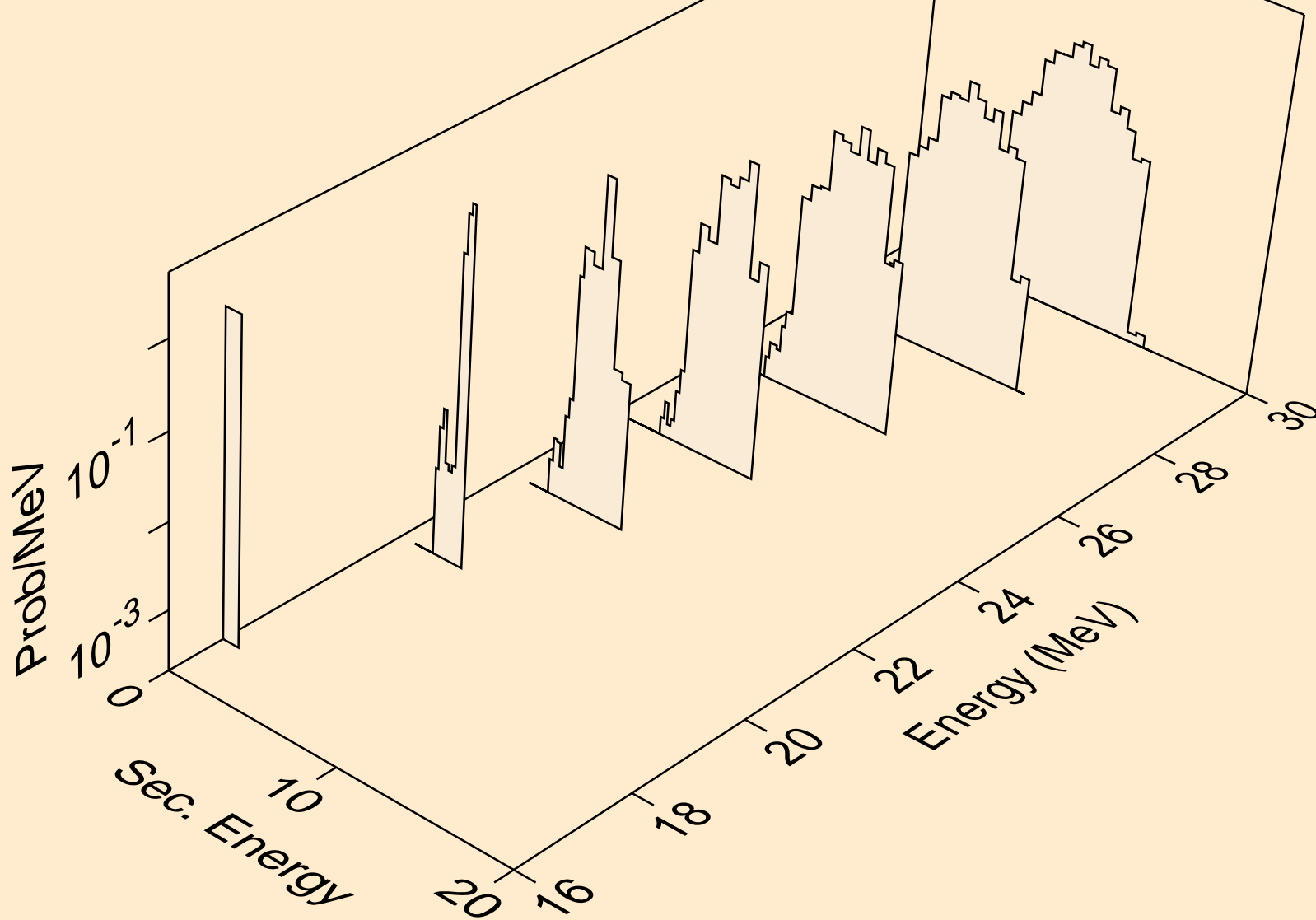

BI190 NEUTRON ACER TENDL-2019 LIBRARY; T=293.16K
deuterons from (n,n*)d

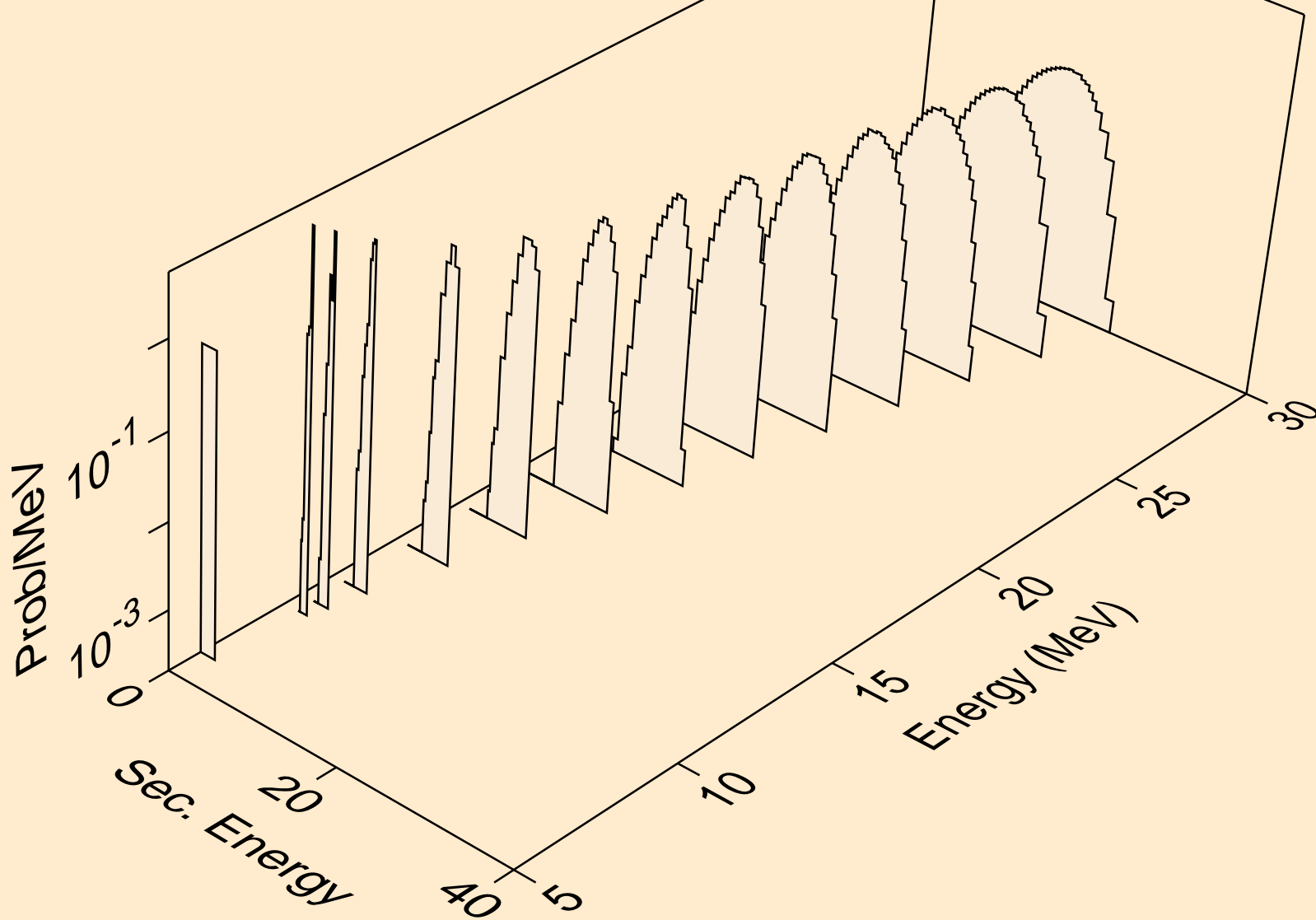

BI190 NEUTRON ACER TENDL-2019 LIBRARY; T=293.16K
deuterons from (n,d)

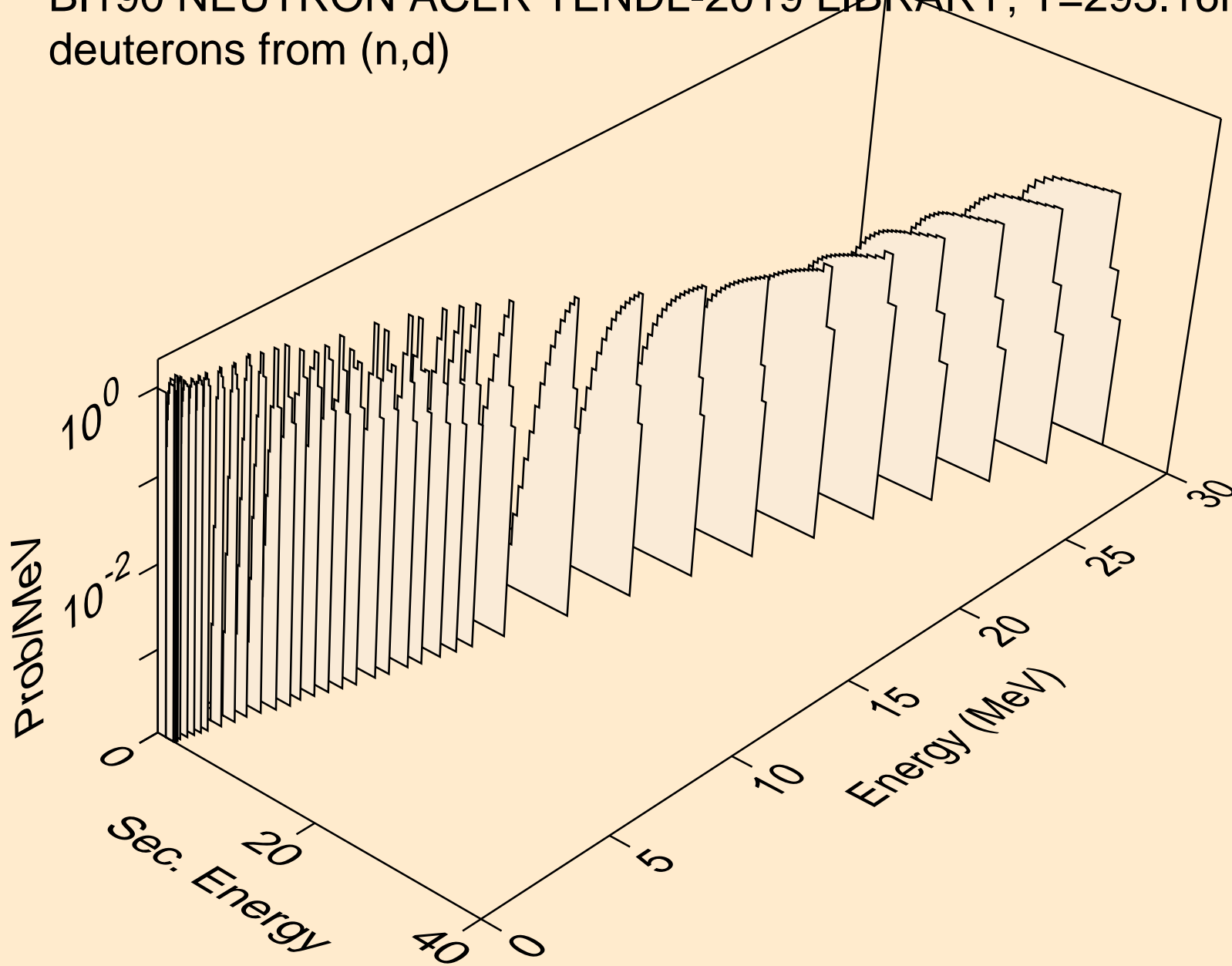

BI190 NEUTRON ACER TENDL-2019 LIBRARY; T=293.16K
deuterons from (n,d2a)

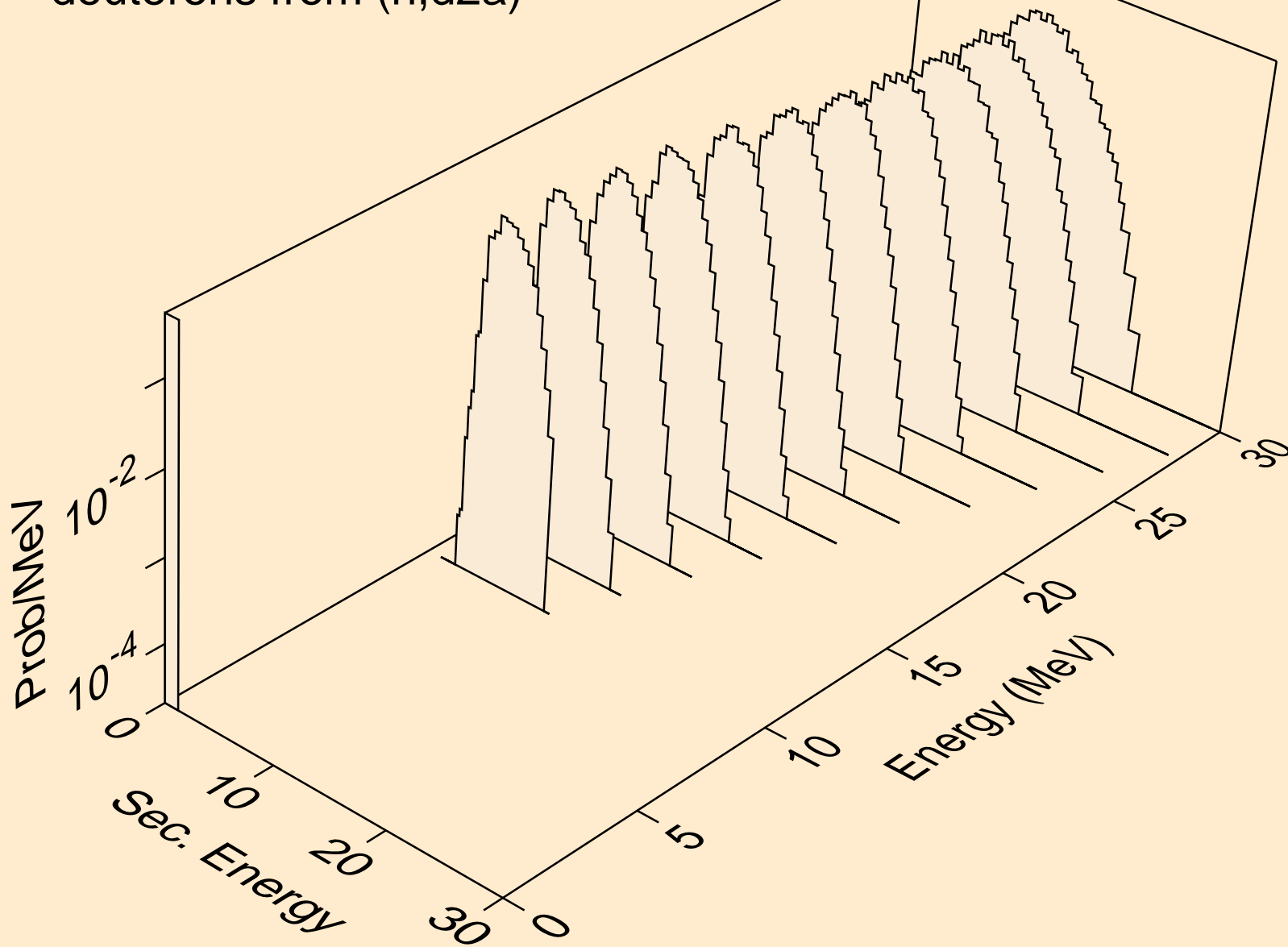

BI190 NEUTRON ACER TENDL-2019 LIBRARY; T=293.16K
deuterons from (n,pd)

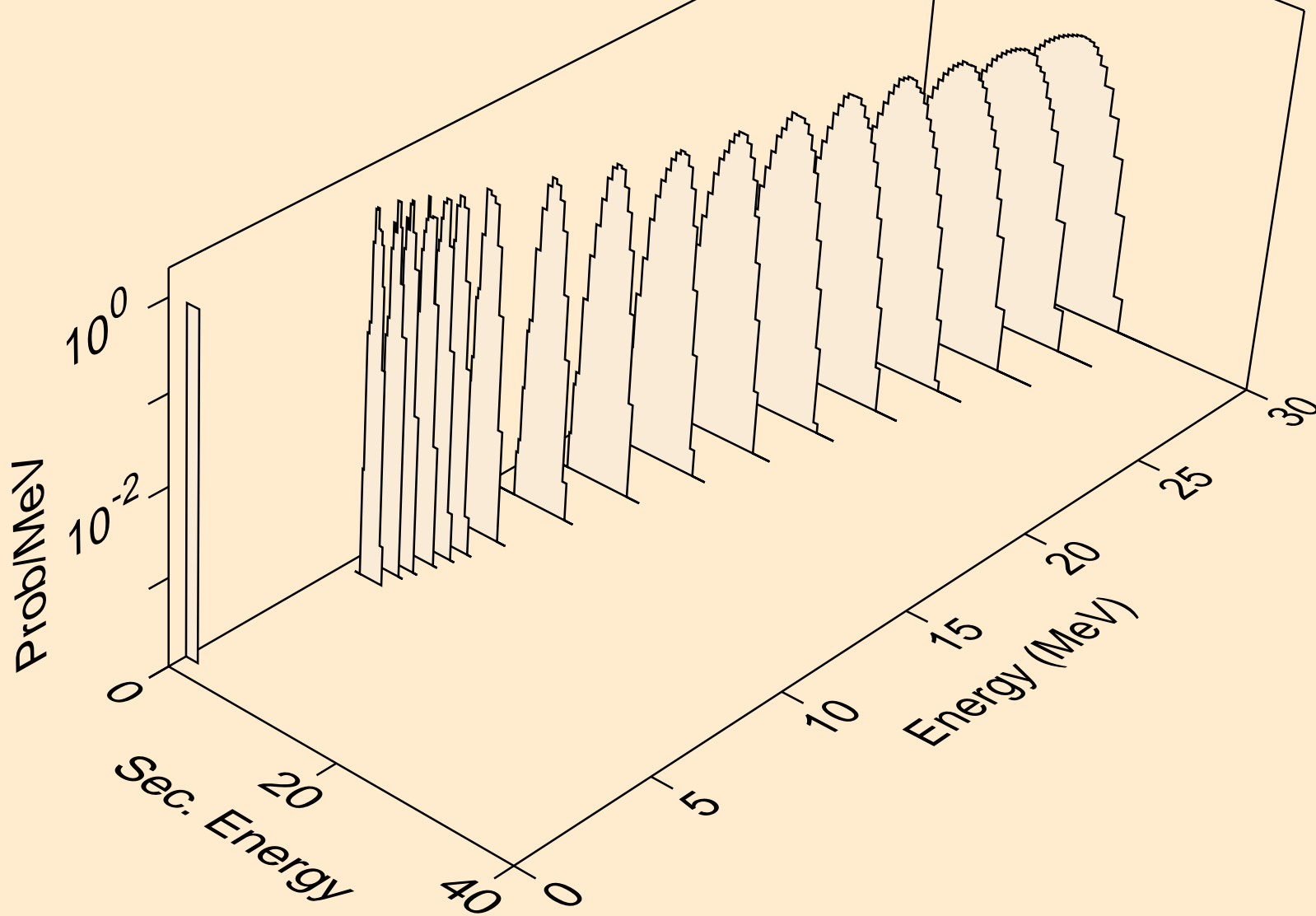

BI190 NEUTRON ACER TENDL-2019 LIBRARY; T=293.16K
deuterons from (n,da)

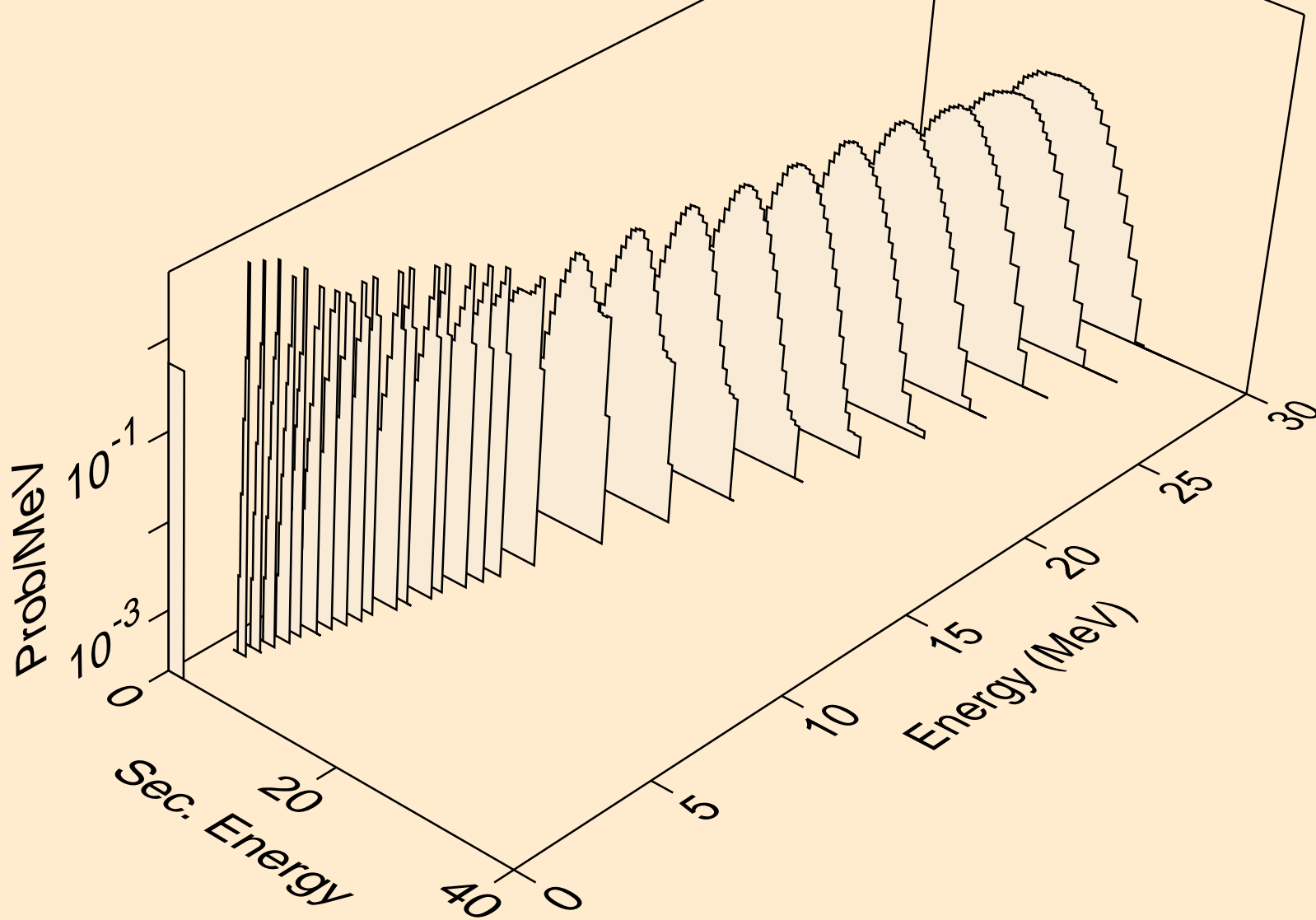

BI190 NEUTRON ACER TENDL-2019 LIBRARY; T=293.16K
tritons from (n,x)

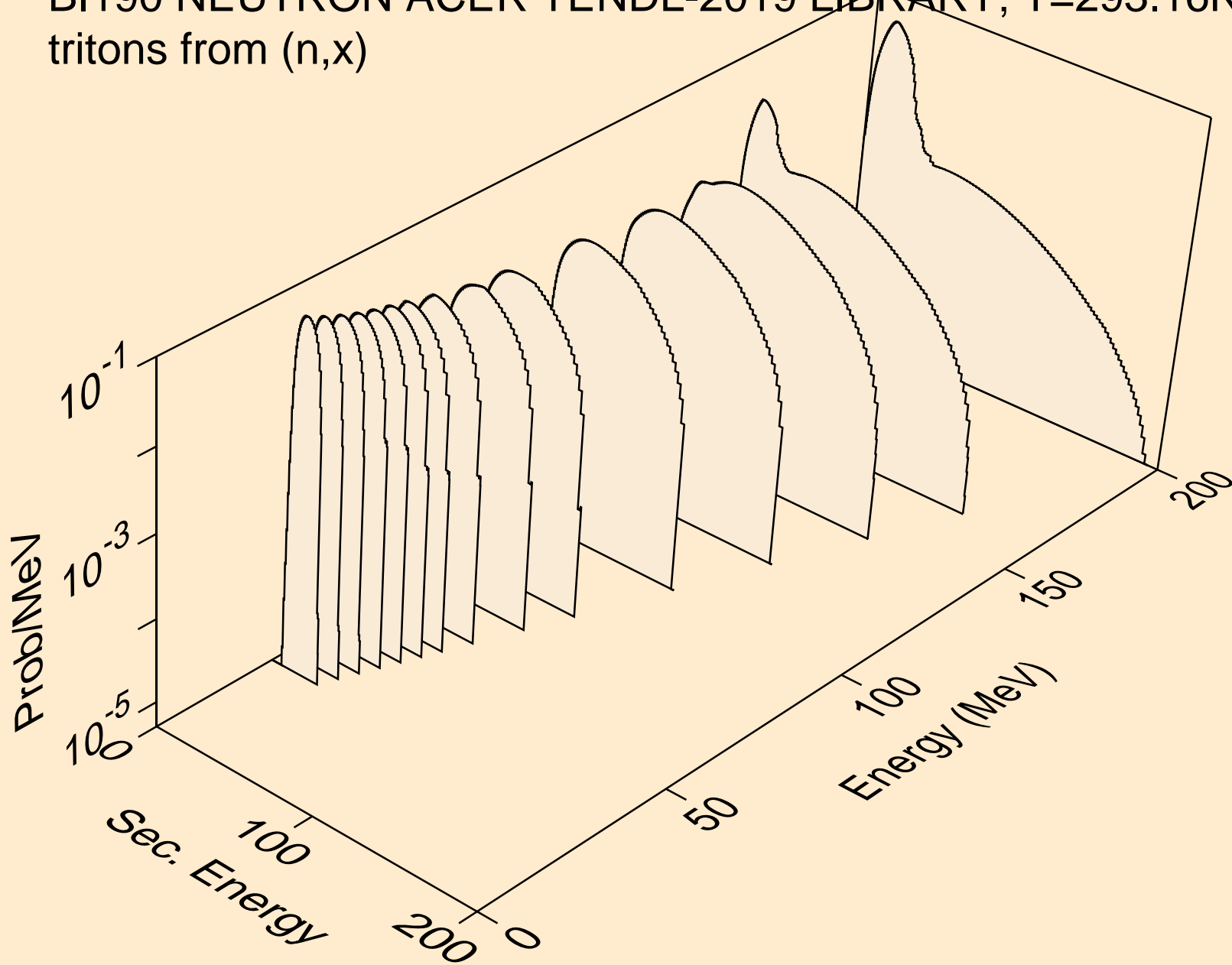

BI190 NEUTRON ACER TENDL-2019 LIBRARY; T=293.16K
tritons from (n,n*)t

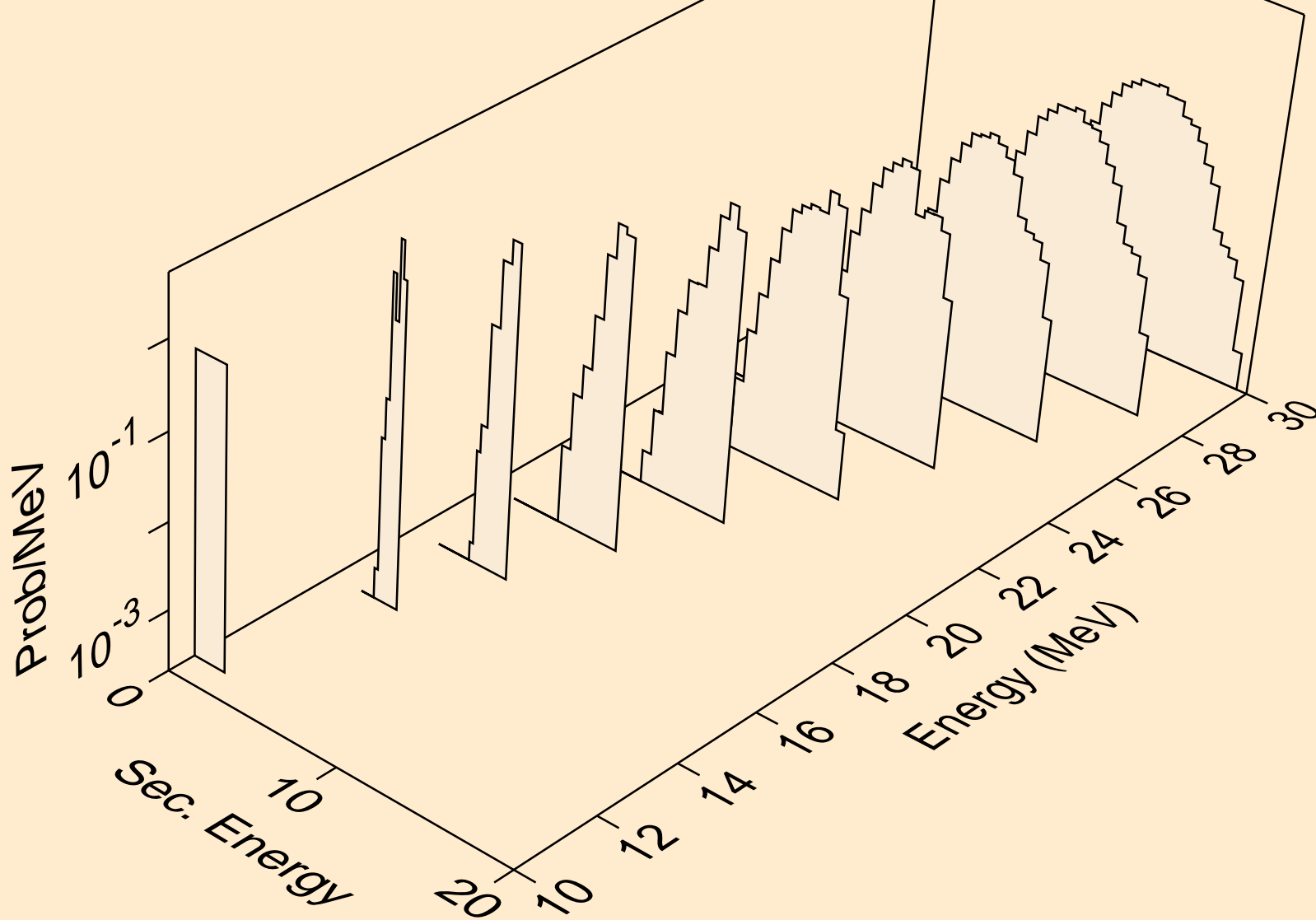

BI190 NEUTRON ACER TENDL-2019 LIBRARY; T=293.16K
tritons from (n,t)

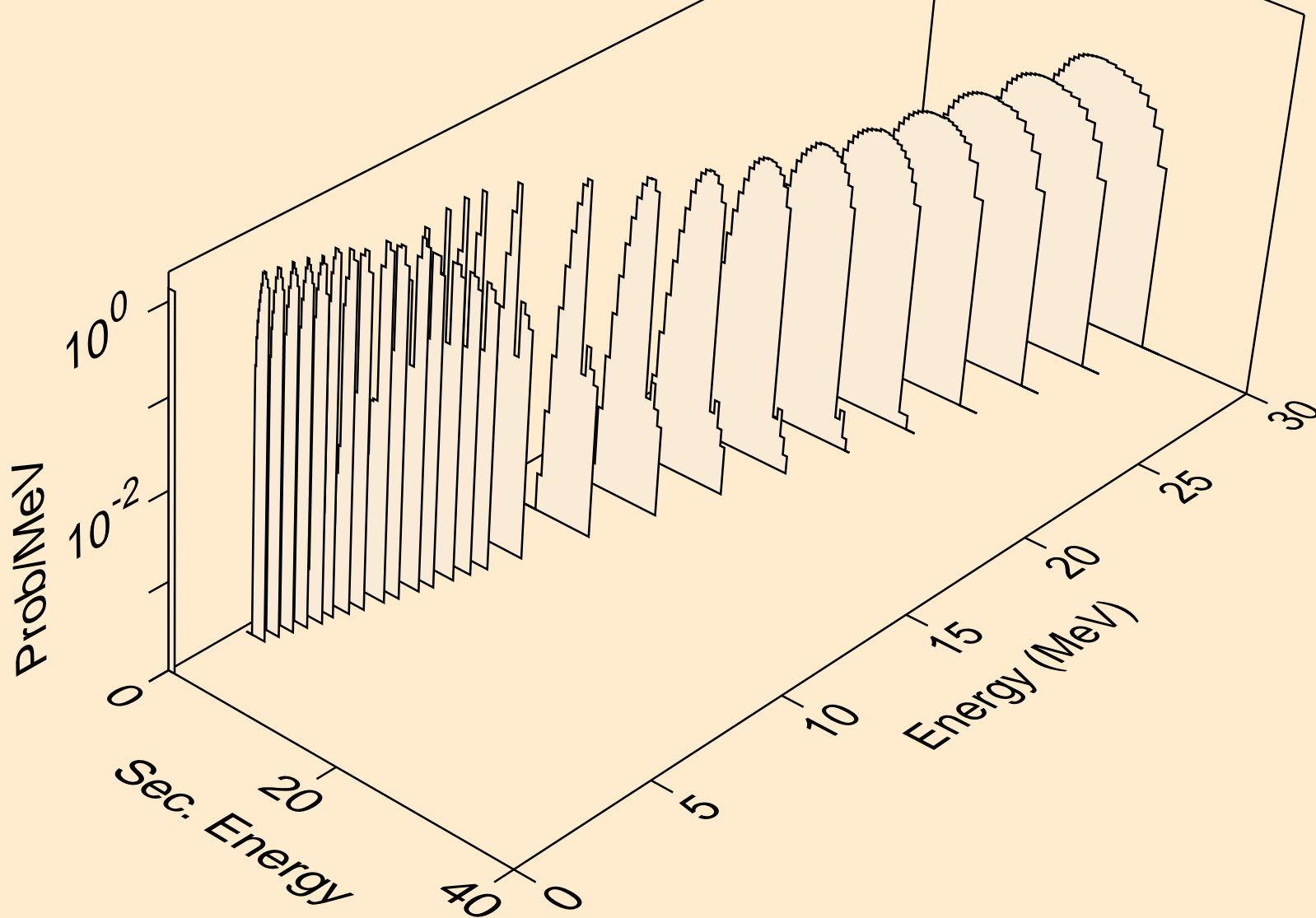

BI190 NEUTRON ACER TENDL-2019 LIBRARY; T=293.16K
tritons from (n,t2a)

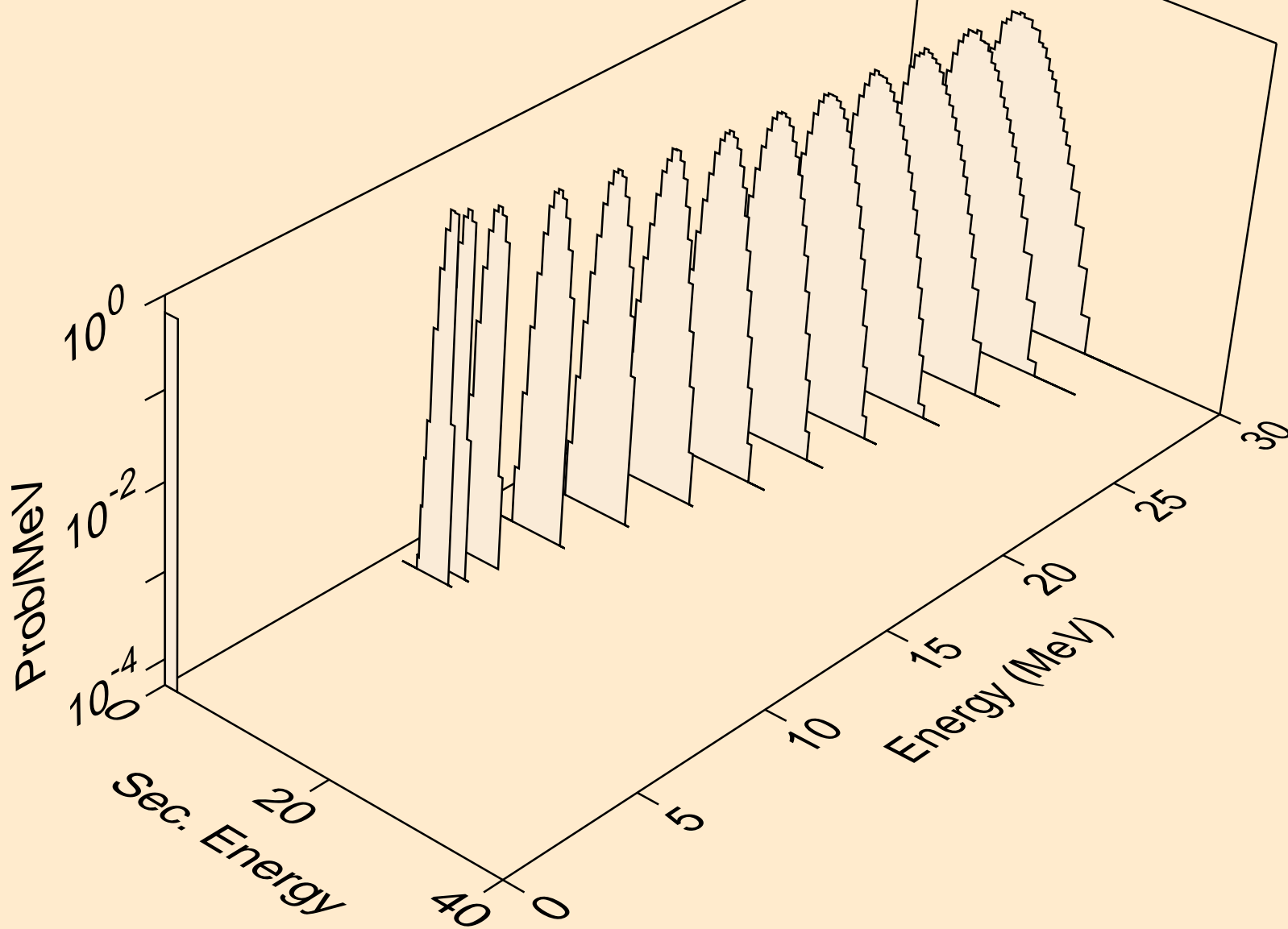

BI190 NEUTRON ACER TENDL-2019 LIBRARY; T=293.16K
tritons from (n,pt)

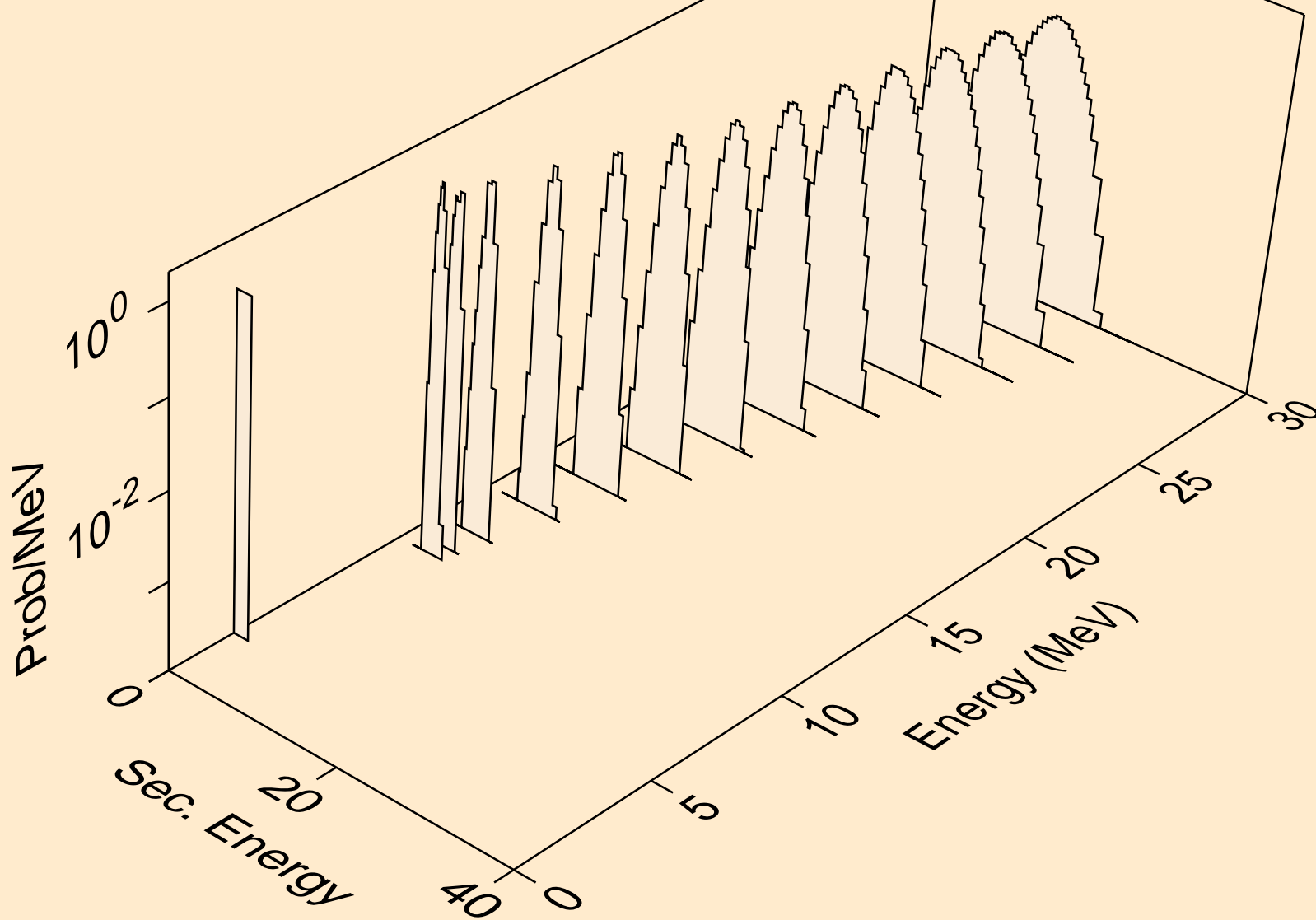

BI190 NEUTRON ACER TENDL-2019 LIBRARY; T=293.16K
he3s from (n,x)

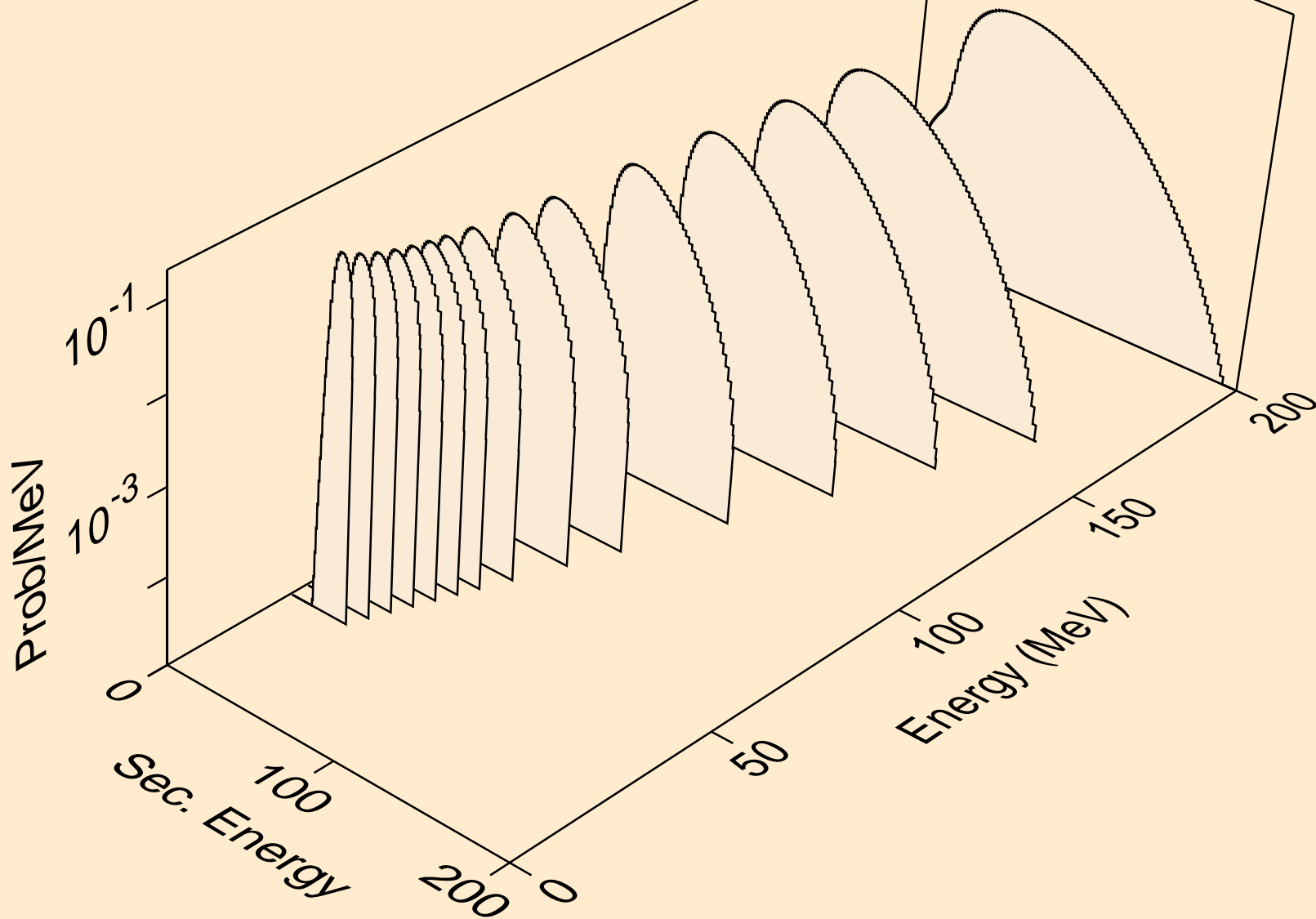

BI190 NEUTRON ACER TENDL-2019 LIBRARY; T=293.16K
he3s from (n,n*)he3

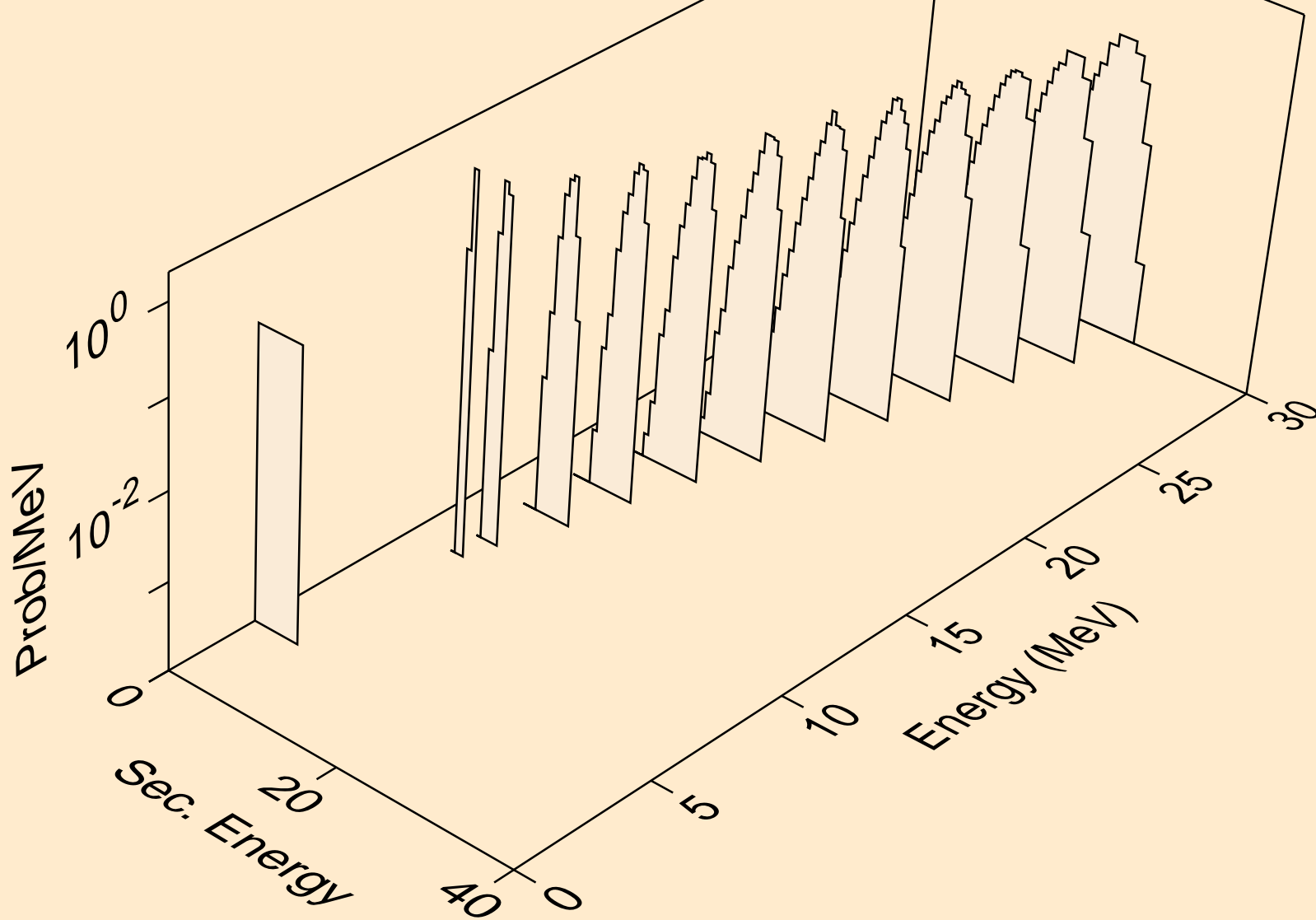

BI190 NEUTRON ACER TENDL-2019 LIBRARY; T=293.16K
he3s from (n,he3)

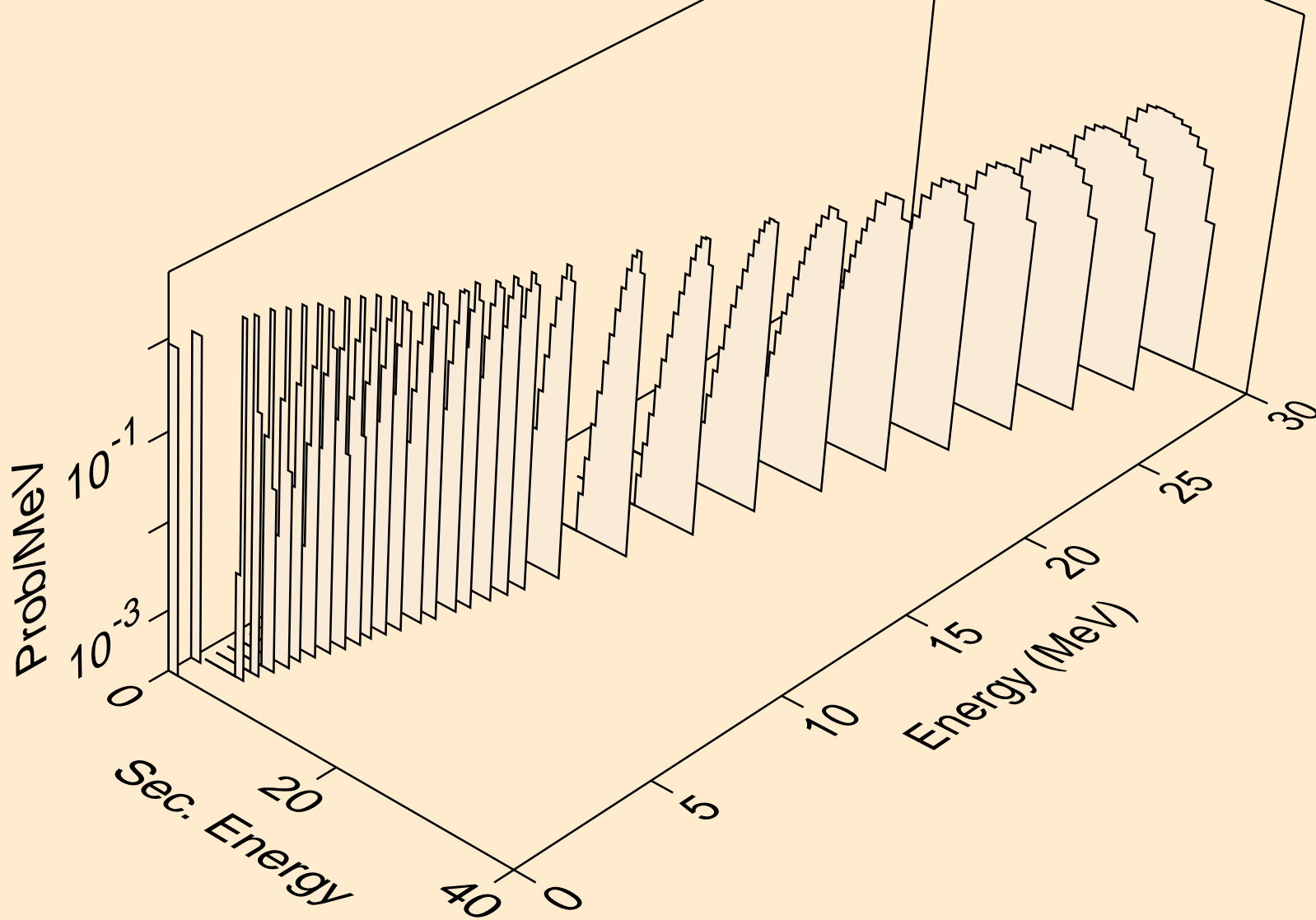

BI190 NEUTRON ACER TENDL-2019 LIBRARY; T=293.16K
alphas from (n,x)

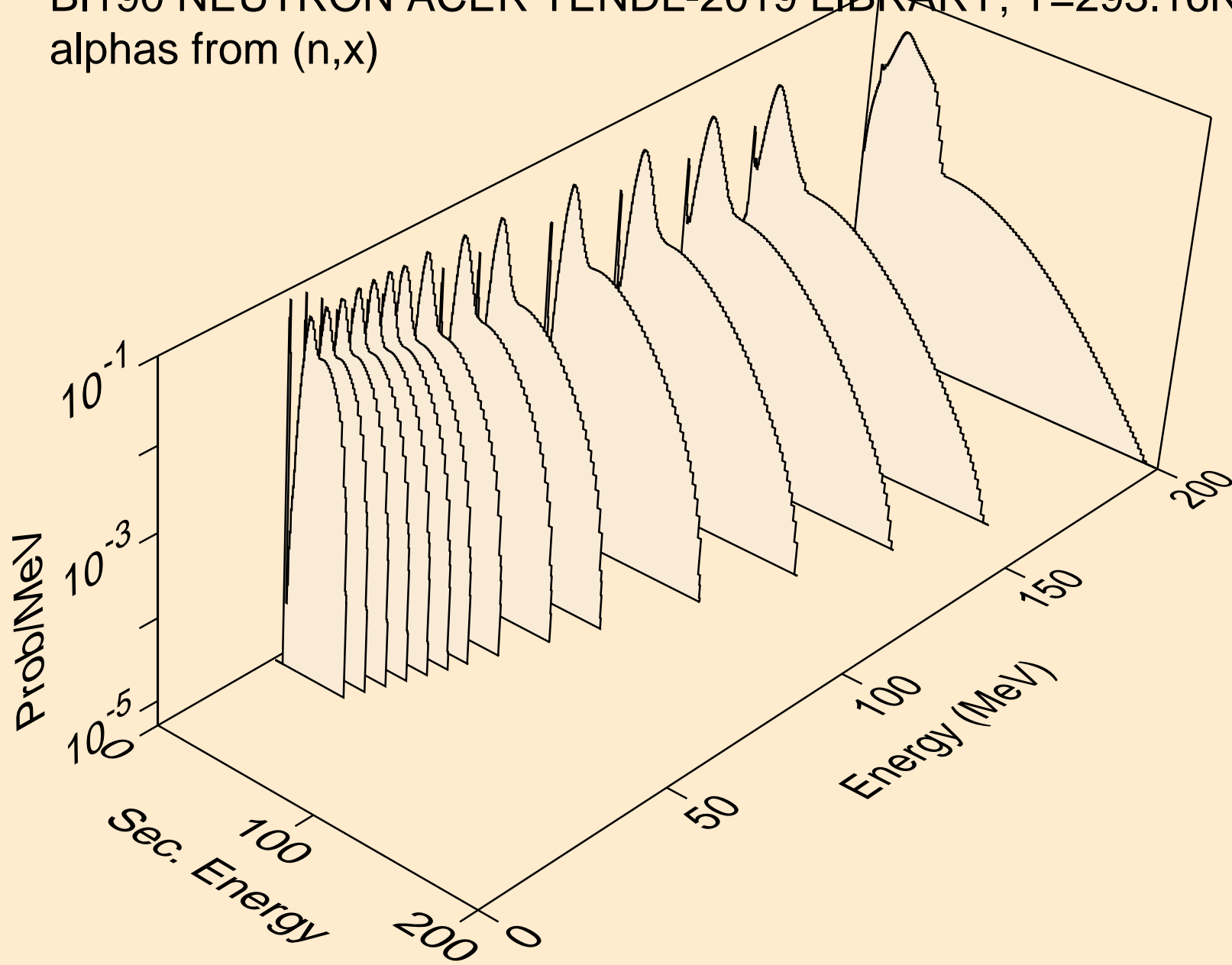

BI190 NEUTRON ACER TENDL-2019 LIBRARY; T=293.16K
alphas from (n,n*)a

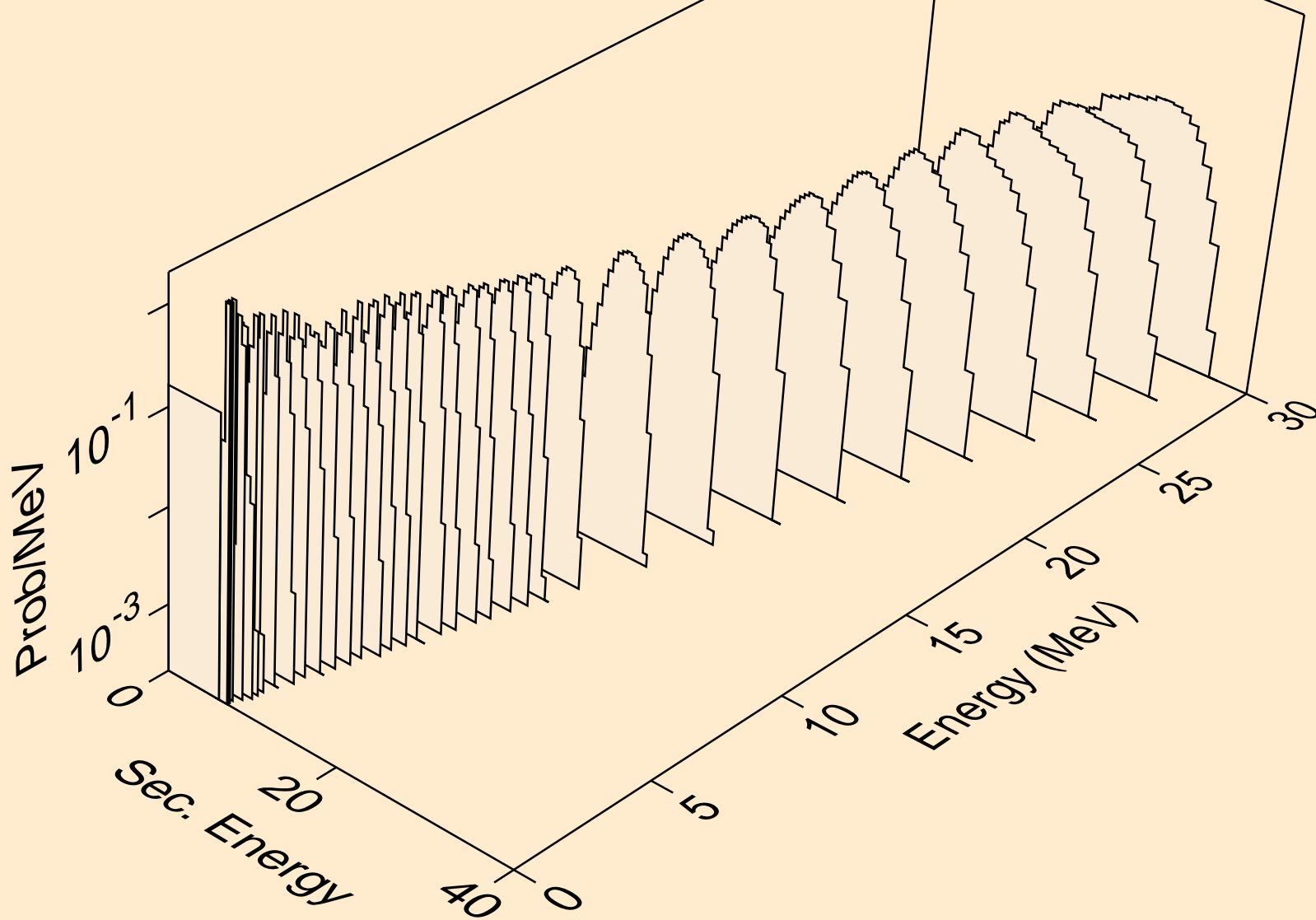

BI190 NEUTRON ACER TENDL-2019 LIBRARY; T=293.16K
alphas from (n,n*)3a

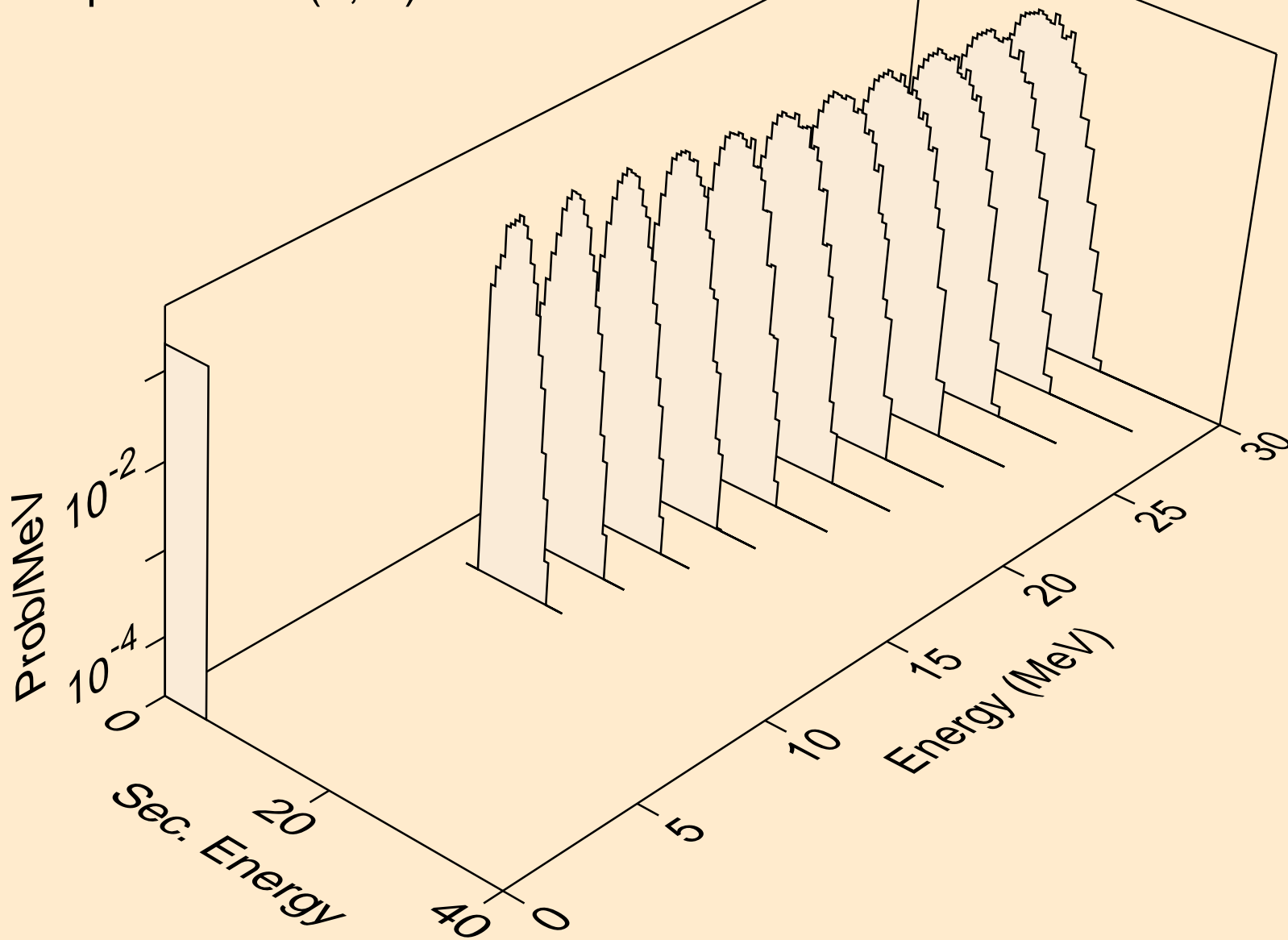

BI190 NEUTRON ACER TENDL-2019 LIBRARY; T=293.16K
alphas from (n,2n)a

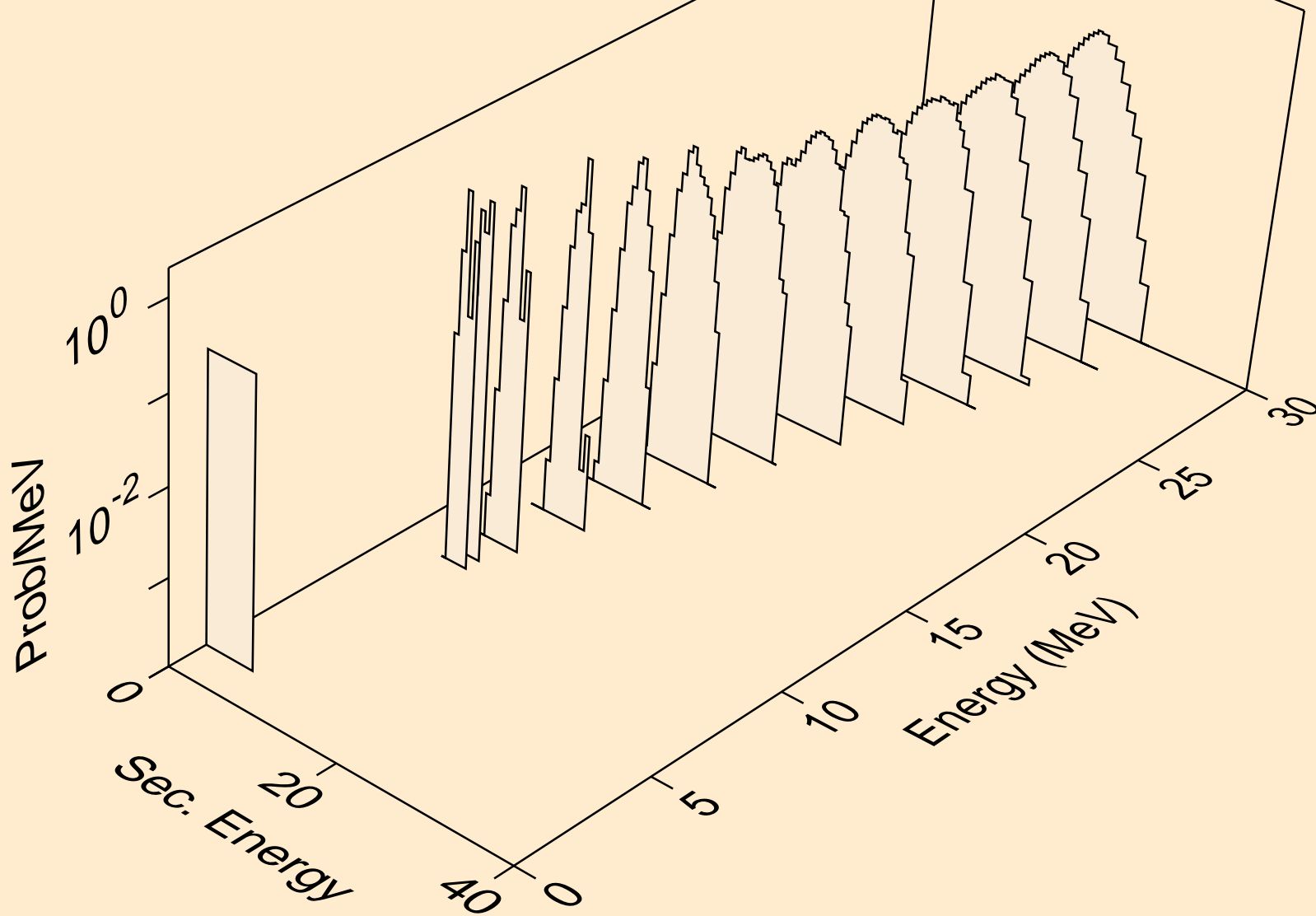

BI190 NEUTRON ACER TENDL-2019 LIBRARY; T=293.16K
alphas from (n,3n)a

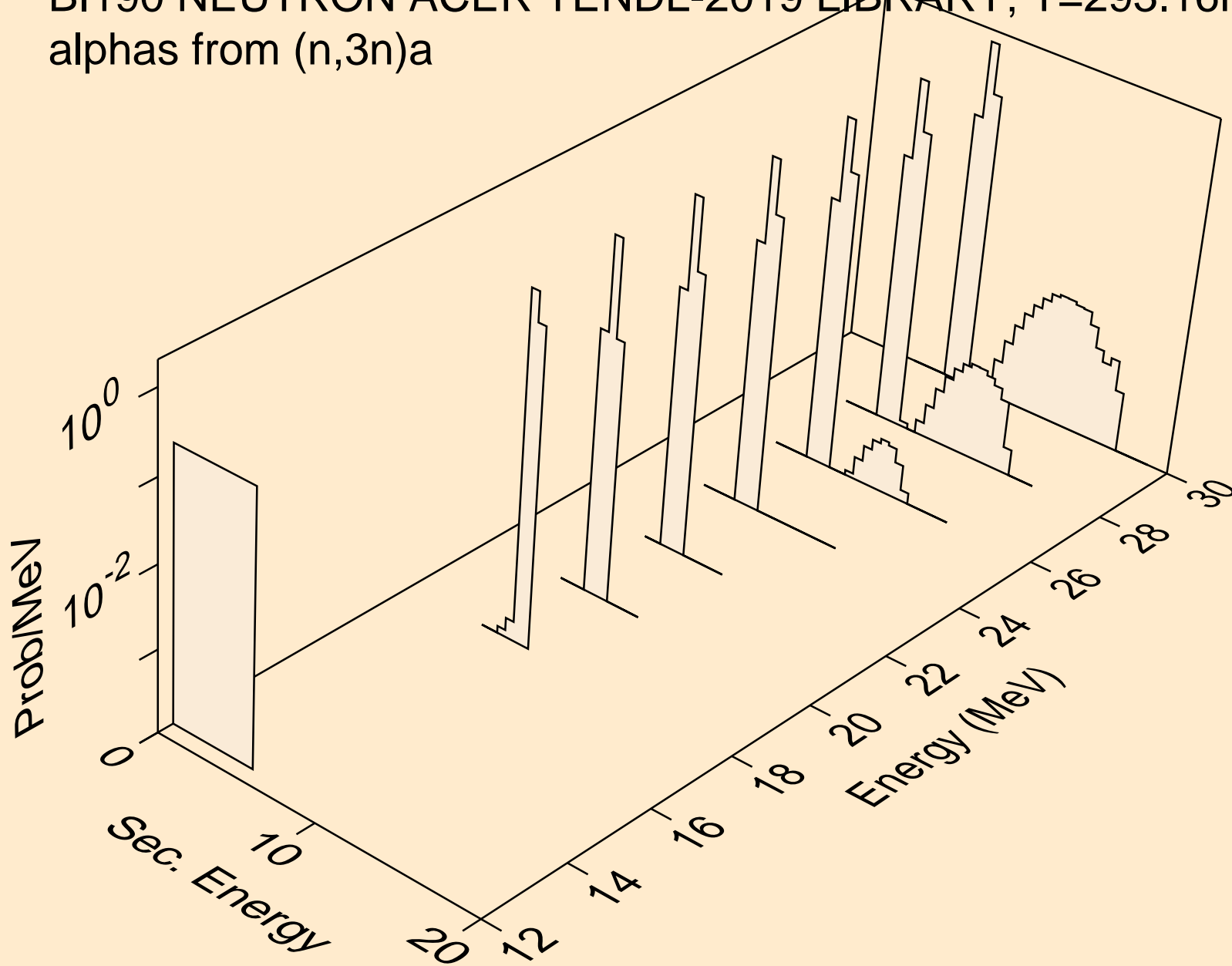

BI190 NEUTRON ACER TENDL-2019 LIBRARY; T=293.16K
alphas from (n,n*)2a

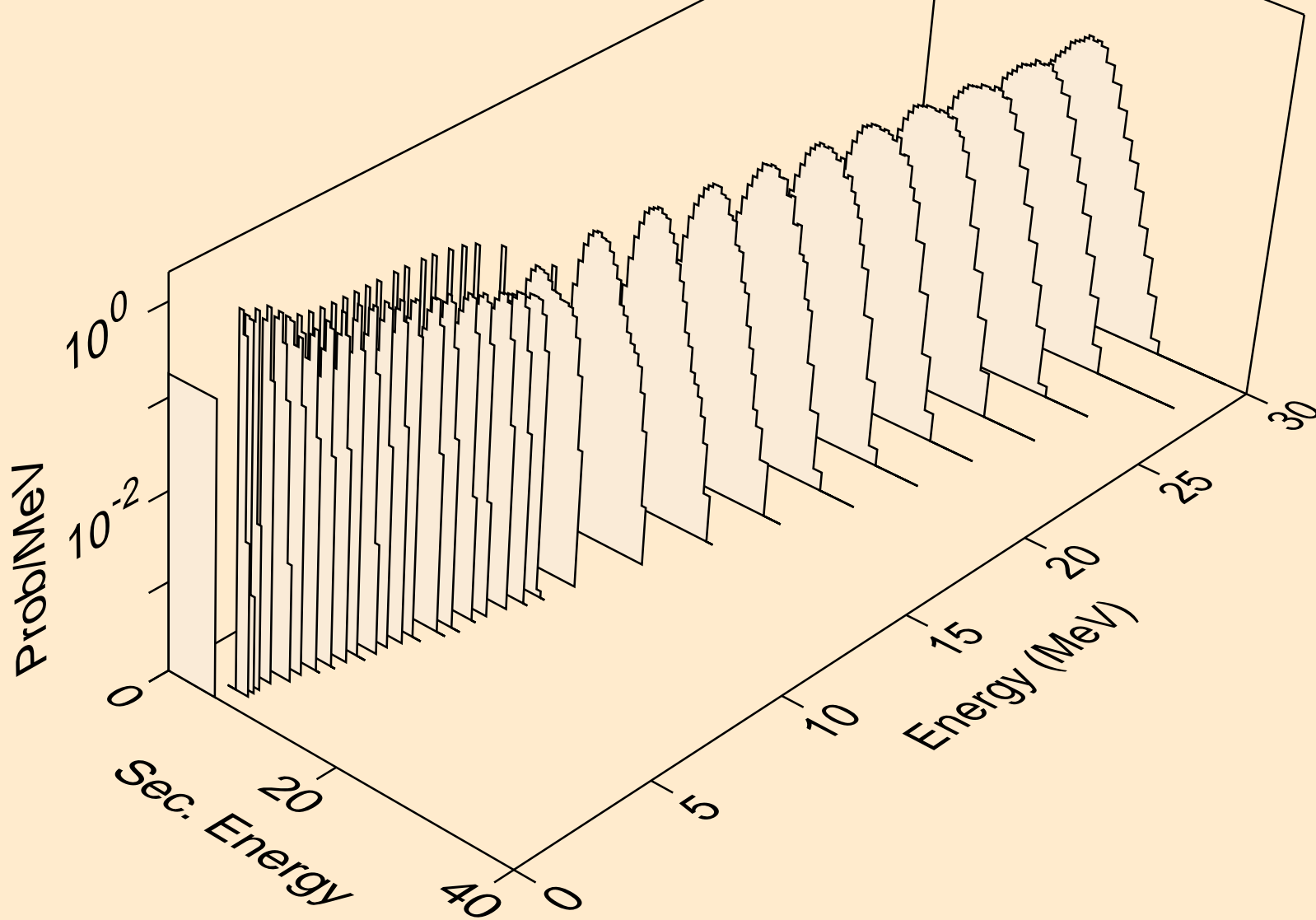

BI190 NEUTRON ACER TENDL-2019 LIBRARY; T=293.16K
alphas from (n,2n)2a

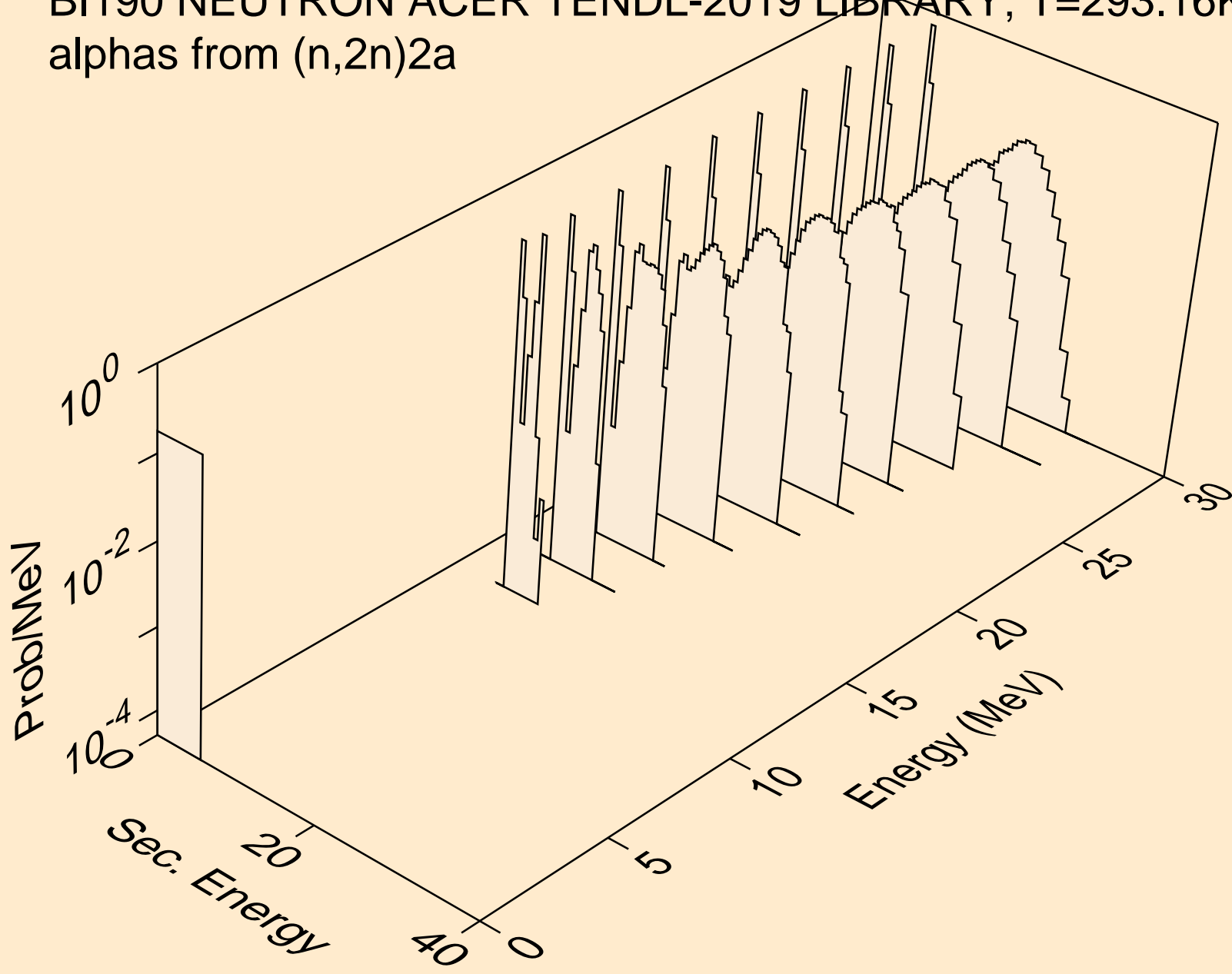

BI190 NEUTRON ACER TENDL-2019 LIBRARY; T=293.16K
alphas from (n,npa)

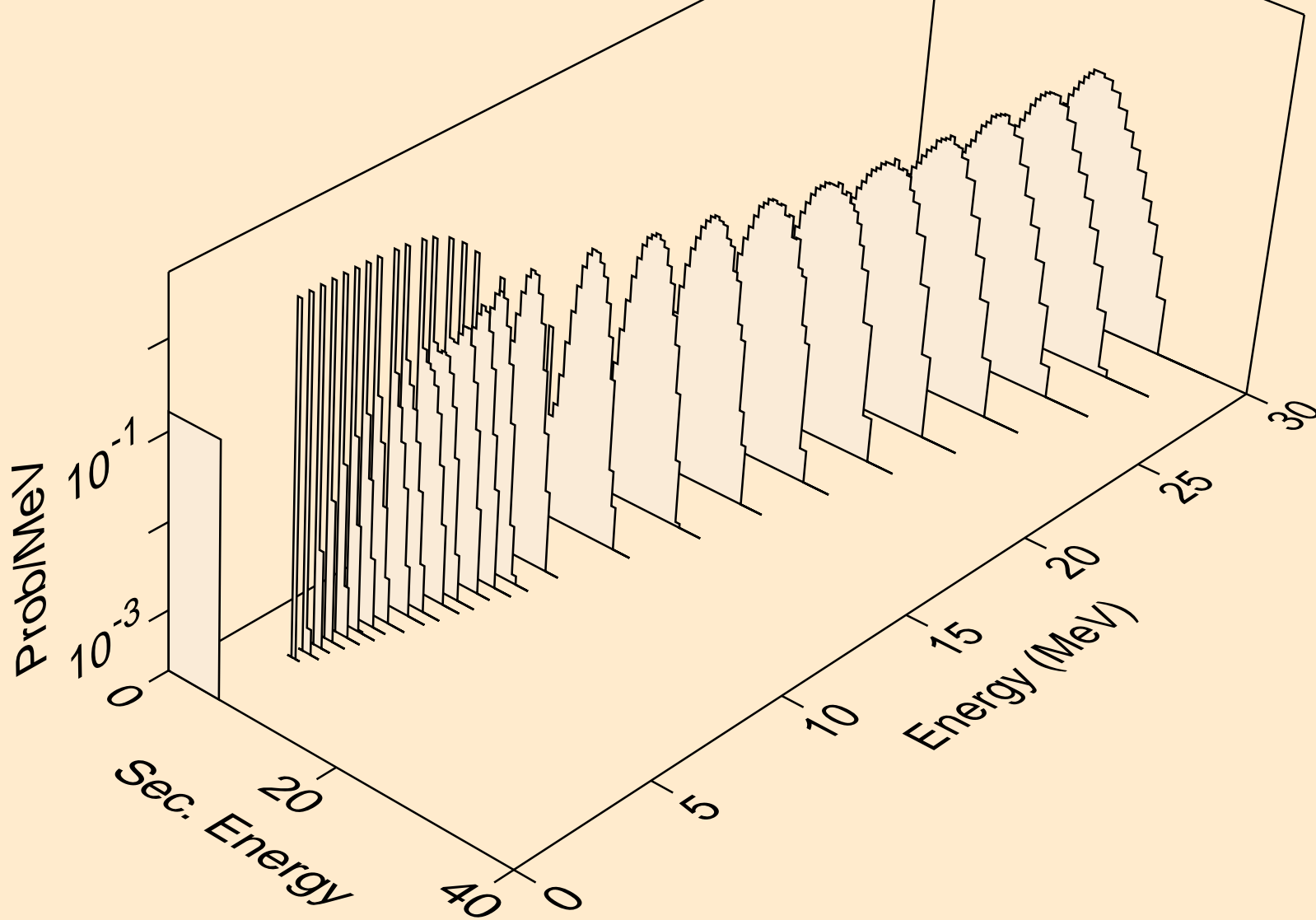

BI190 NEUTRON ACER TENDL-2019 LIBRARY; T=293.16K
alphas from (n,a)

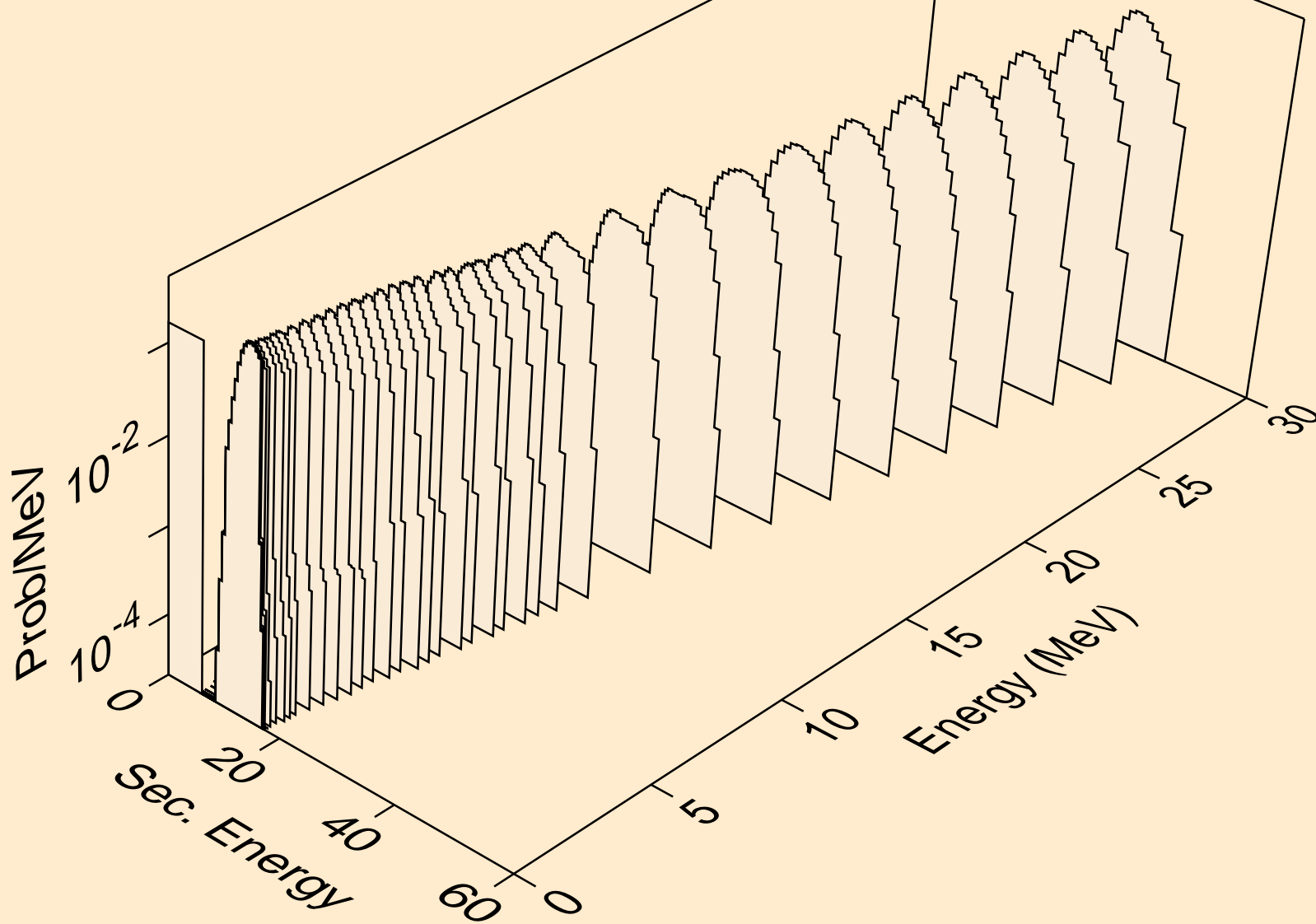

BI190 NEUTRON ACER TENDL-2019 LIBRARY; T=293.16K
alphas from (n,2a)

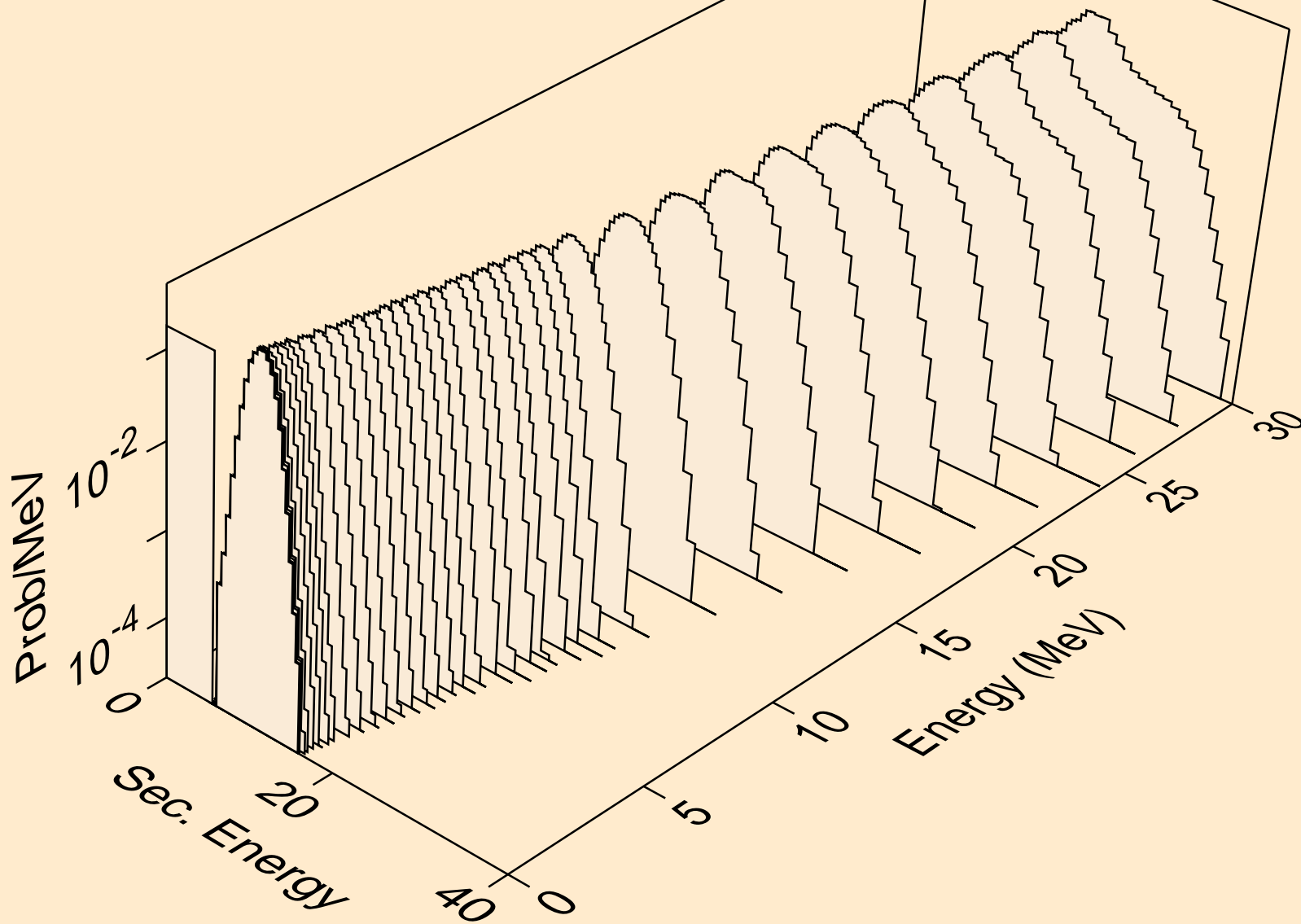

BI190 NEUTRON ACER TENDL-2019 LIBRARY; T=293.16K
alphas from (n,3a)

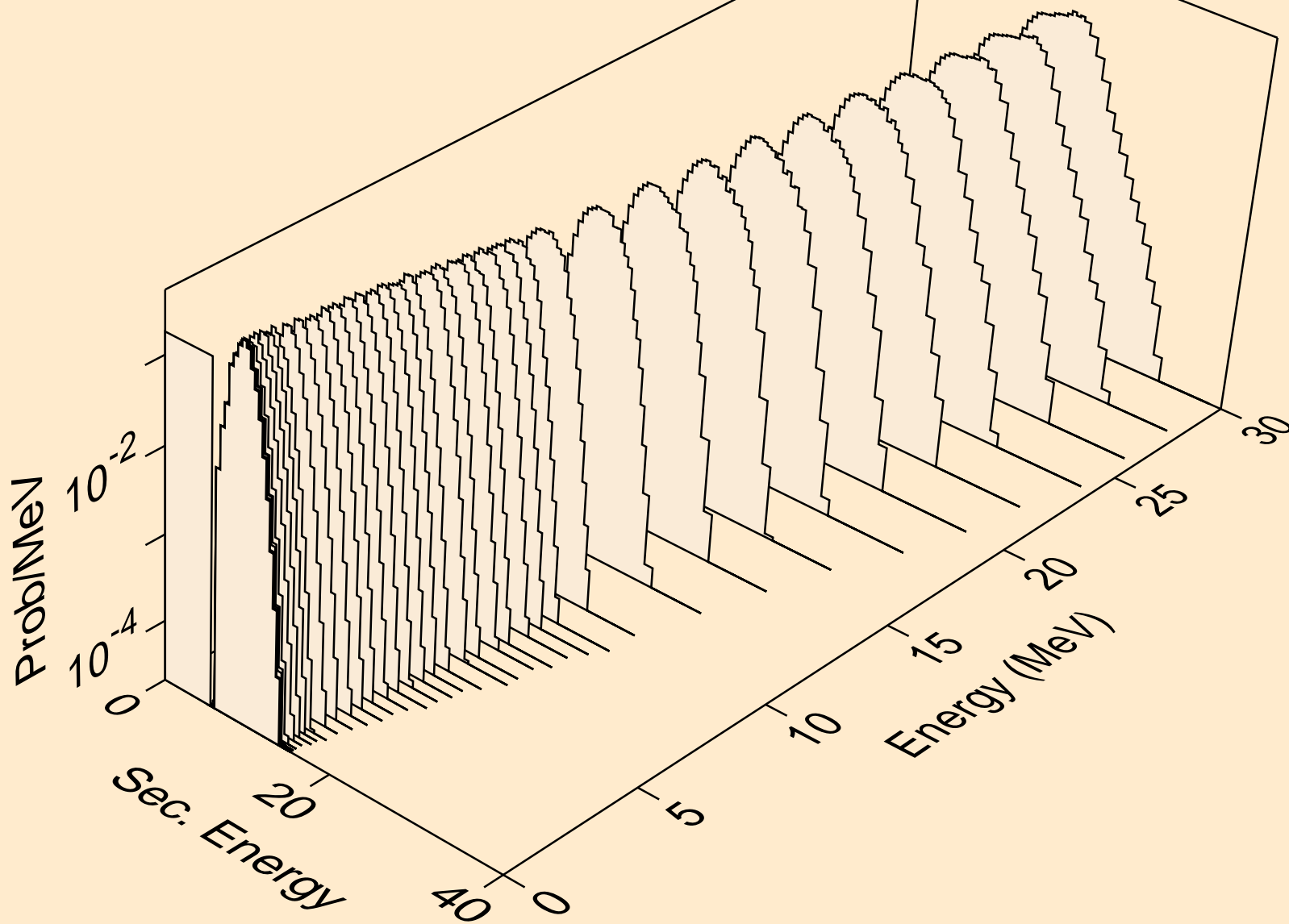

BI190 NEUTRON ACER TENDL-2019 LIBRARY; T=293.16K
alphas from (n,pa)

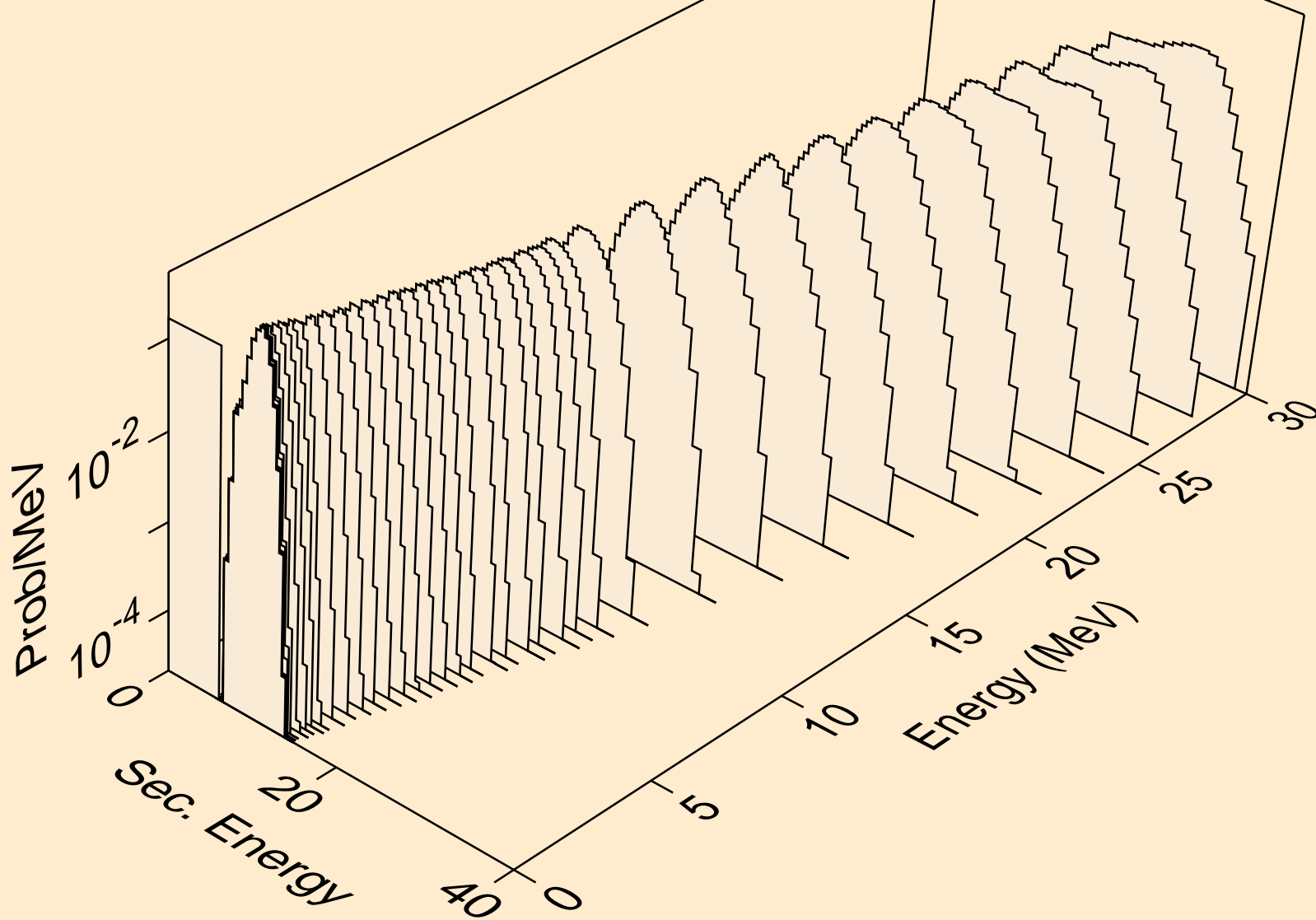

BI190 NEUTRON ACER TENDL-2019 LIBRARY; T=293.16K
alphas from (n,t2a)

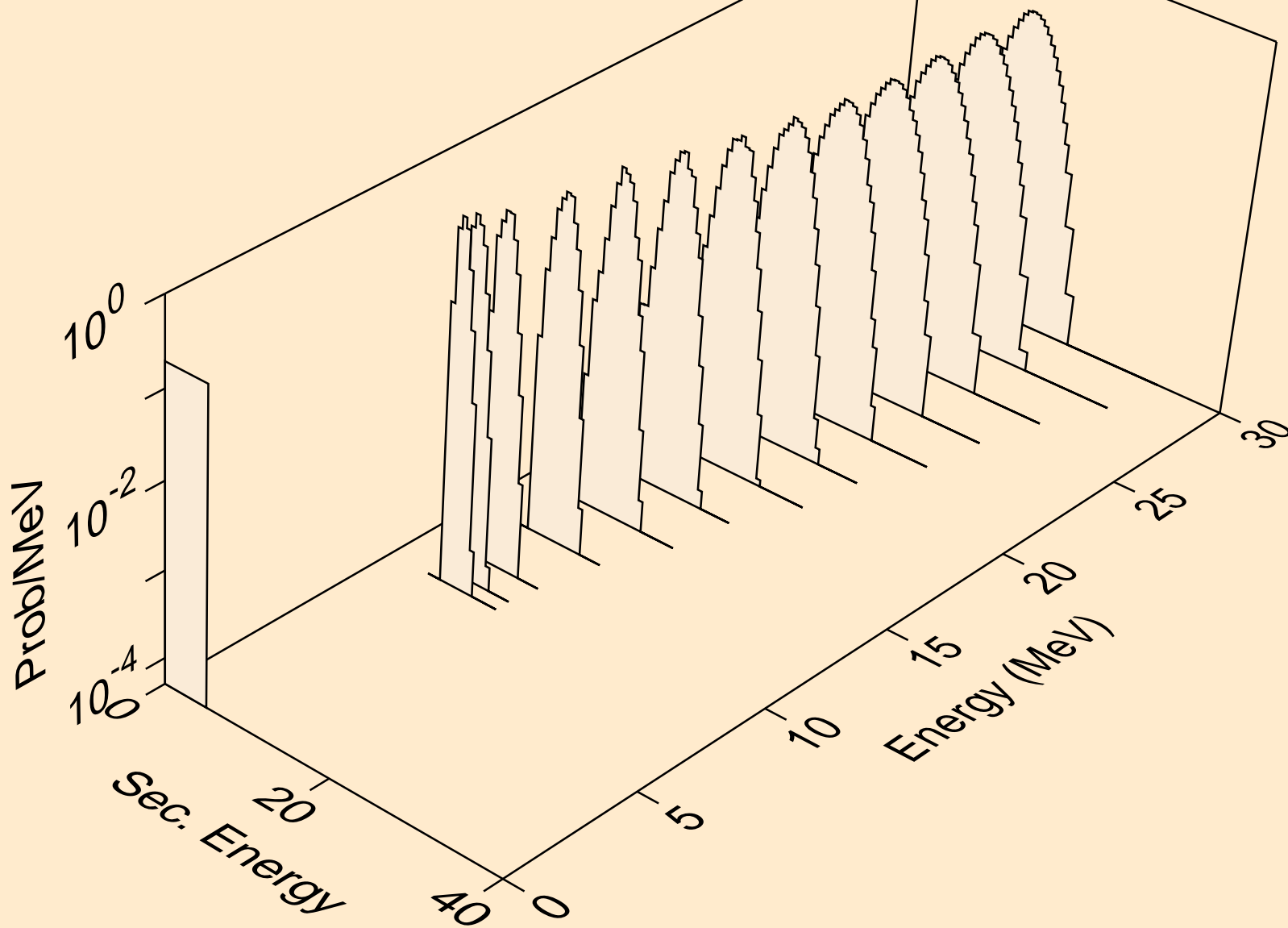

BI190 NEUTRON ACER TENDL-2019 LIBRARY; T=293.16K
alphas from (n,d2a)

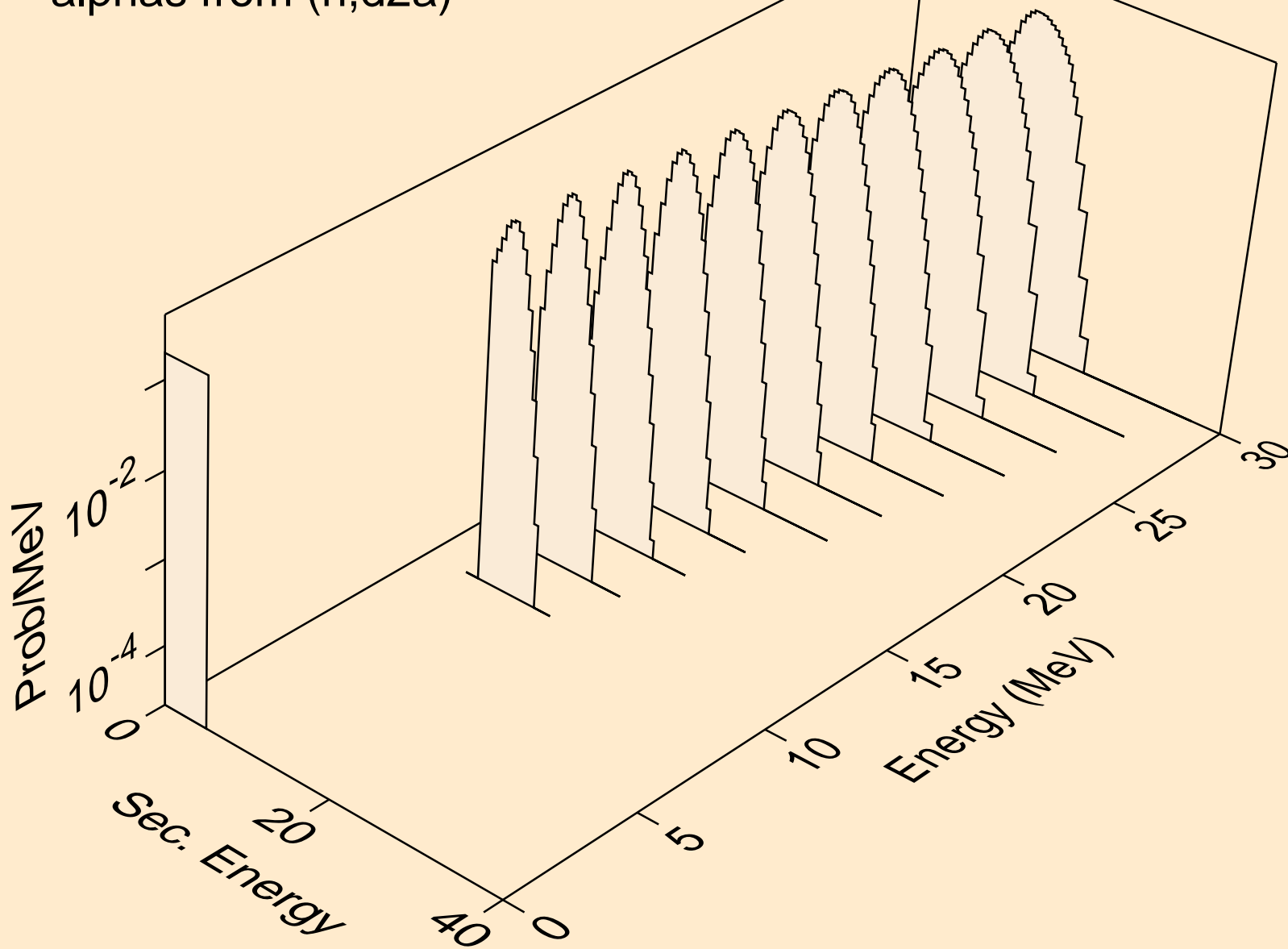

BI190 NEUTRON ACER TENDL-2019 LIBRARY; T=293.16K
alphas from (n,da)

