

BI212M NEUTRON ACER TENDL-2019 LIBRARY; T=293.16K
Principal cross sections

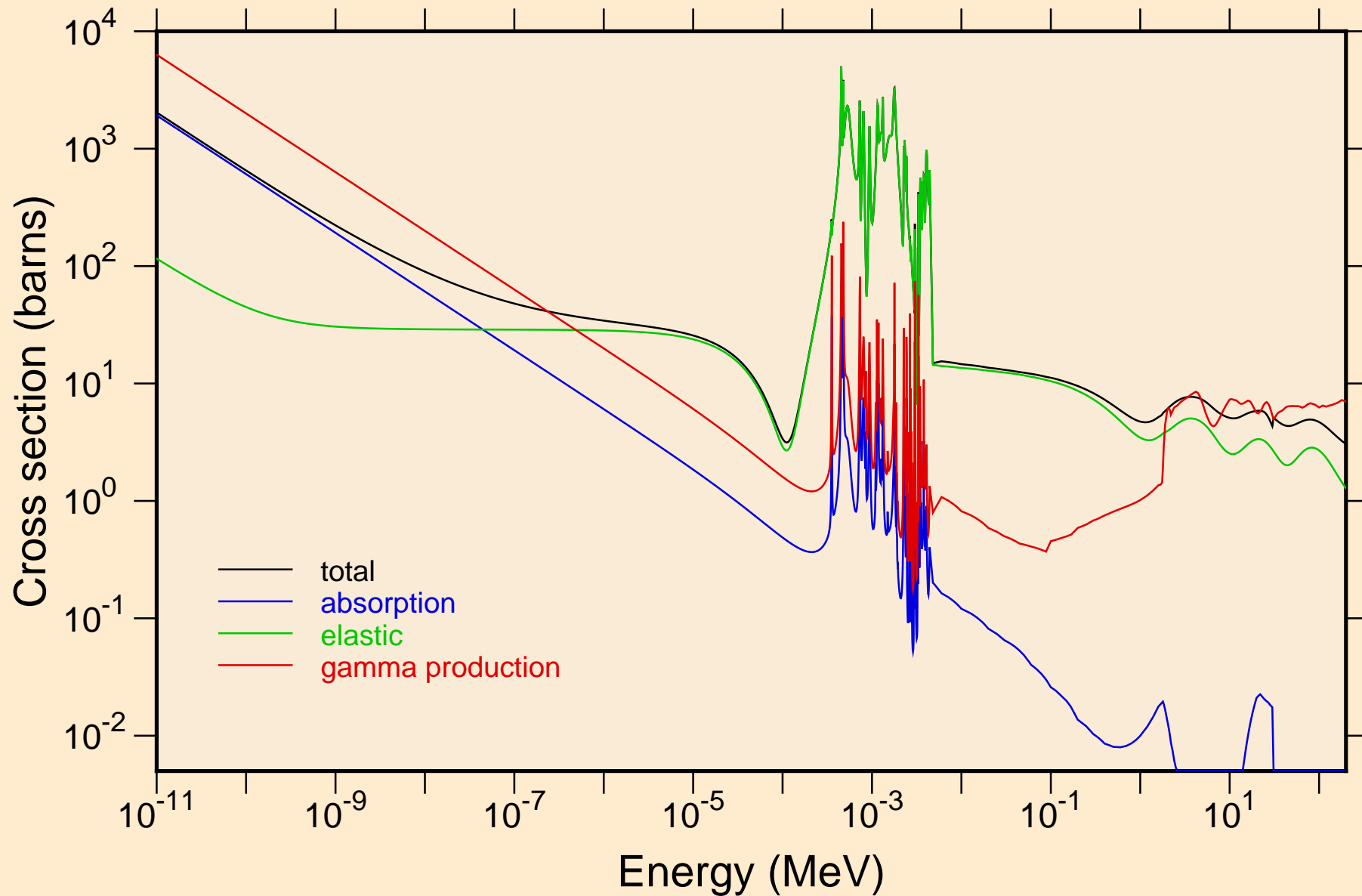

BI212M NEUTRON ACER TENDL-2019 LIBRARY; T=293.16K
resonance total cross section

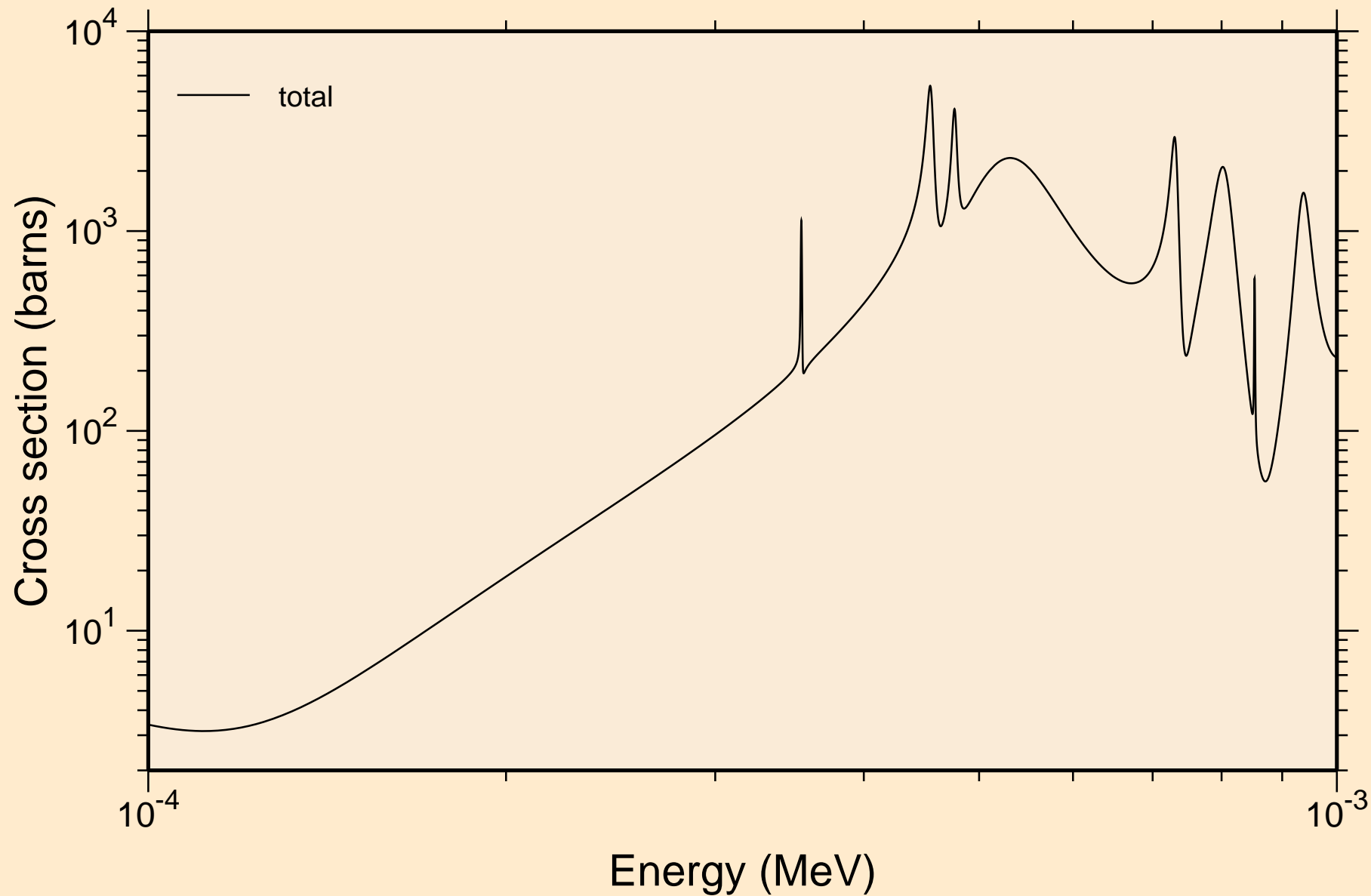

BI212M NEUTRON ACER TENDL-2019 LIBRARY; T=293.16K
resonance total cross section

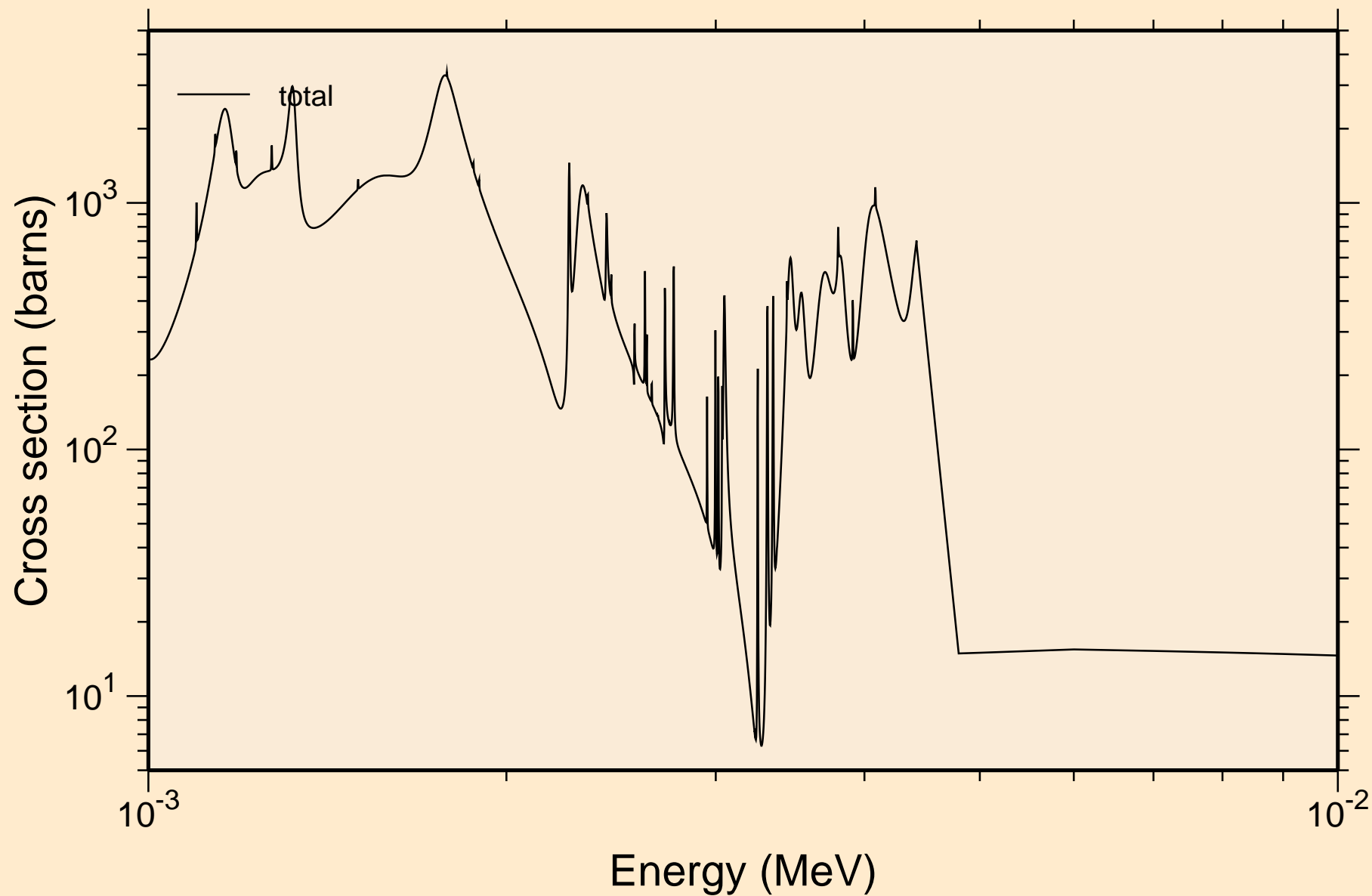

BI212M NEUTRON ACER TENDL-2019 LIBRARY; T=293.16K
resonance total cross section

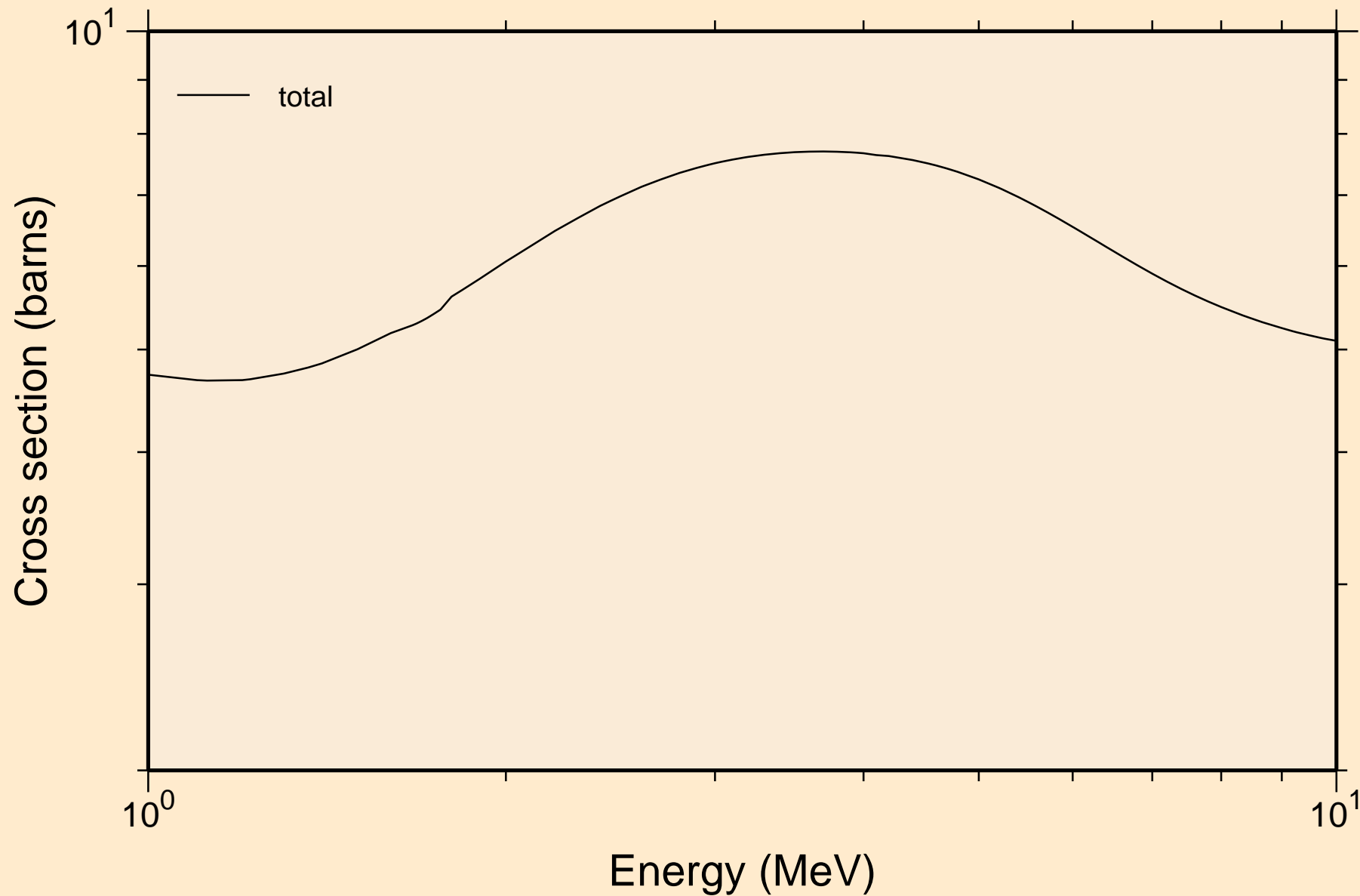

BI212M NEUTRON ACER TENDL-2019 LIBRARY; T=293.16K
resonance absorption cross sections

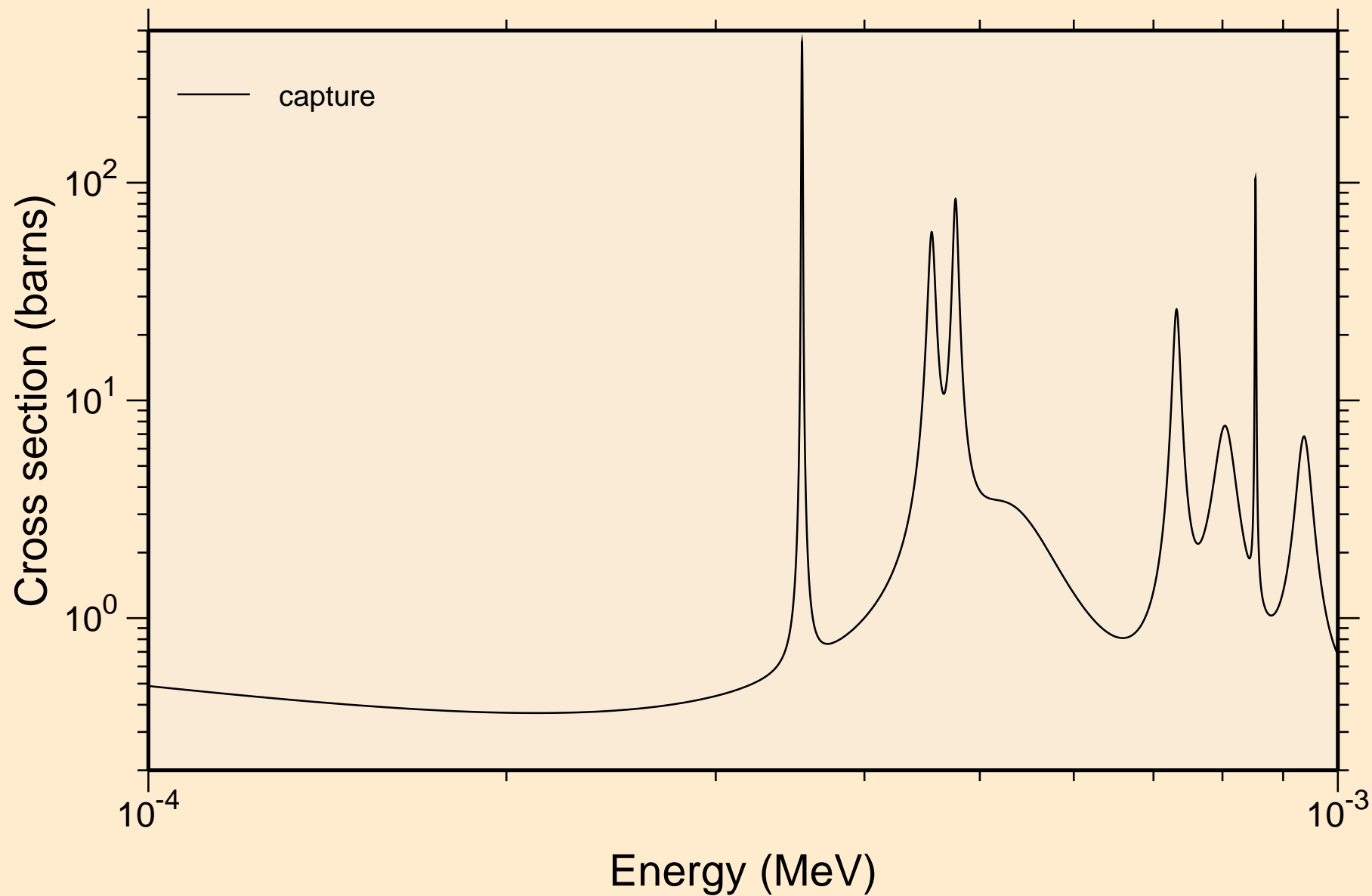

BI212M NEUTRON ACER TENDL-2019 LIBRARY; T=293.16K
resonance absorption cross sections

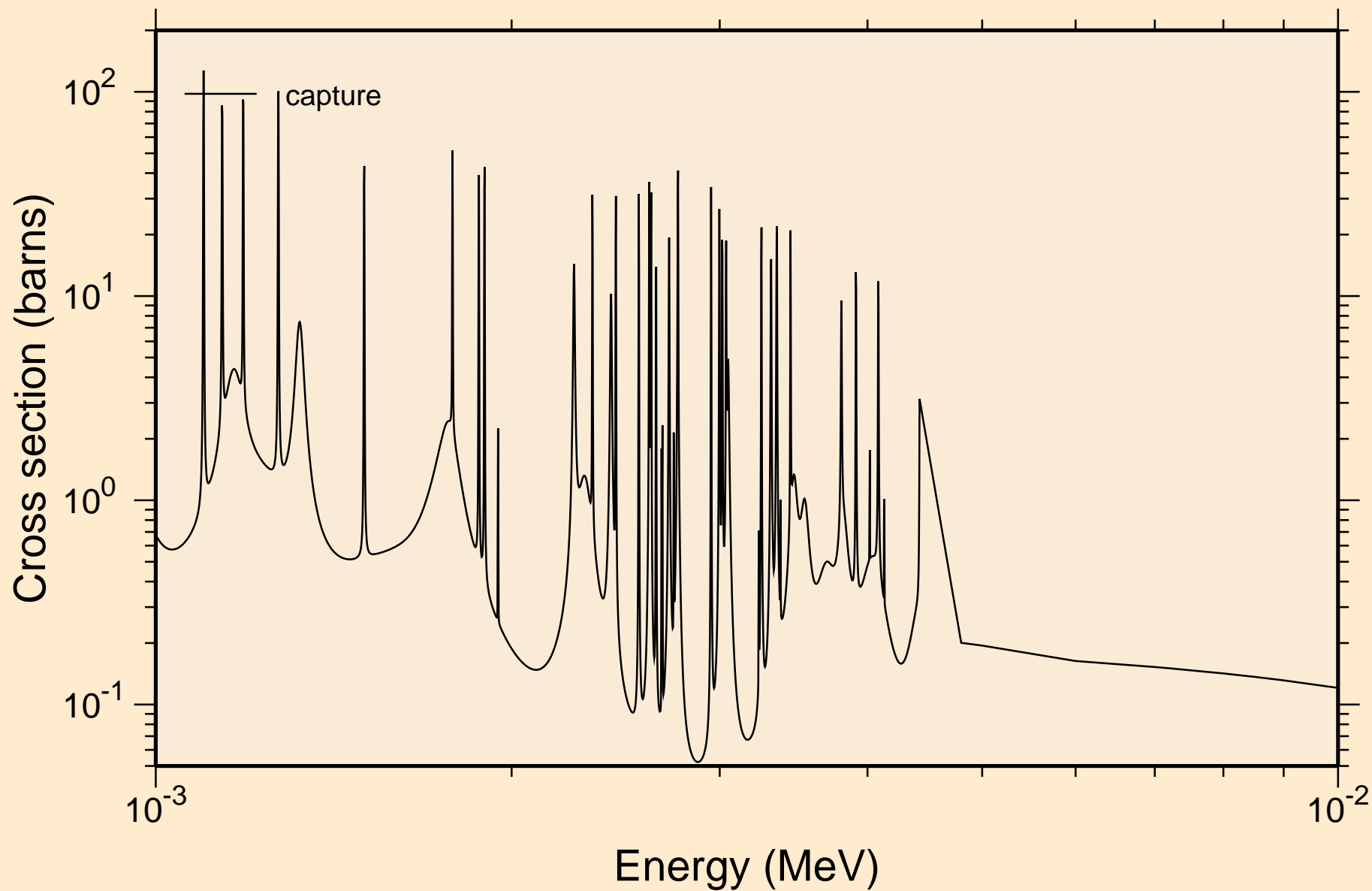

BI212M NEUTRON ACER TENDL-2019 LIBRARY; T=293.16K
resonance absorption cross sections

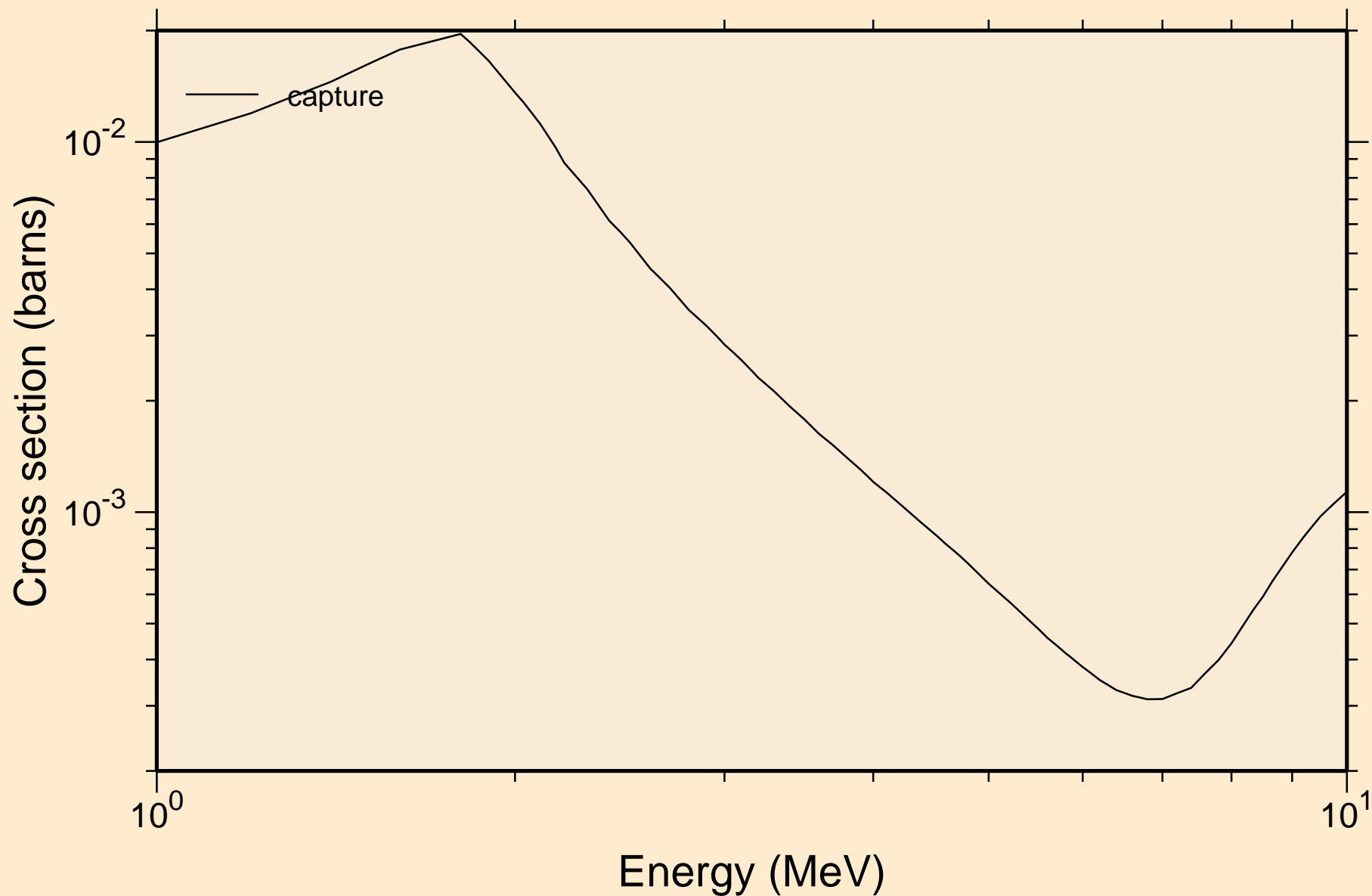

BI212M NEUTRON ACER TENDL-2019 LIBRARY; T=293.16K
Heating

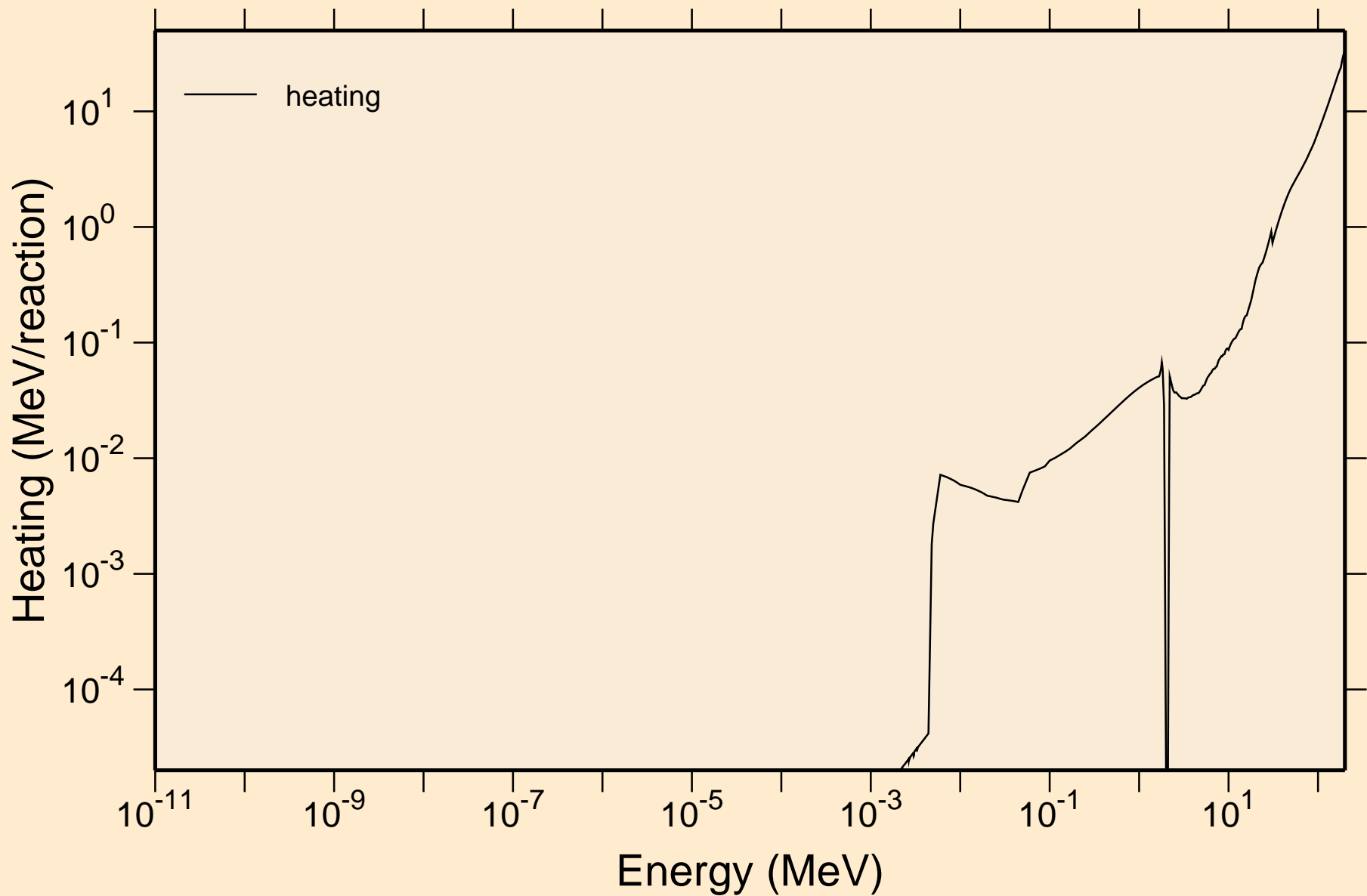

BI212M NEUTRON ACER TENDL-2019 LIBRARY; T=293.16K
Damage

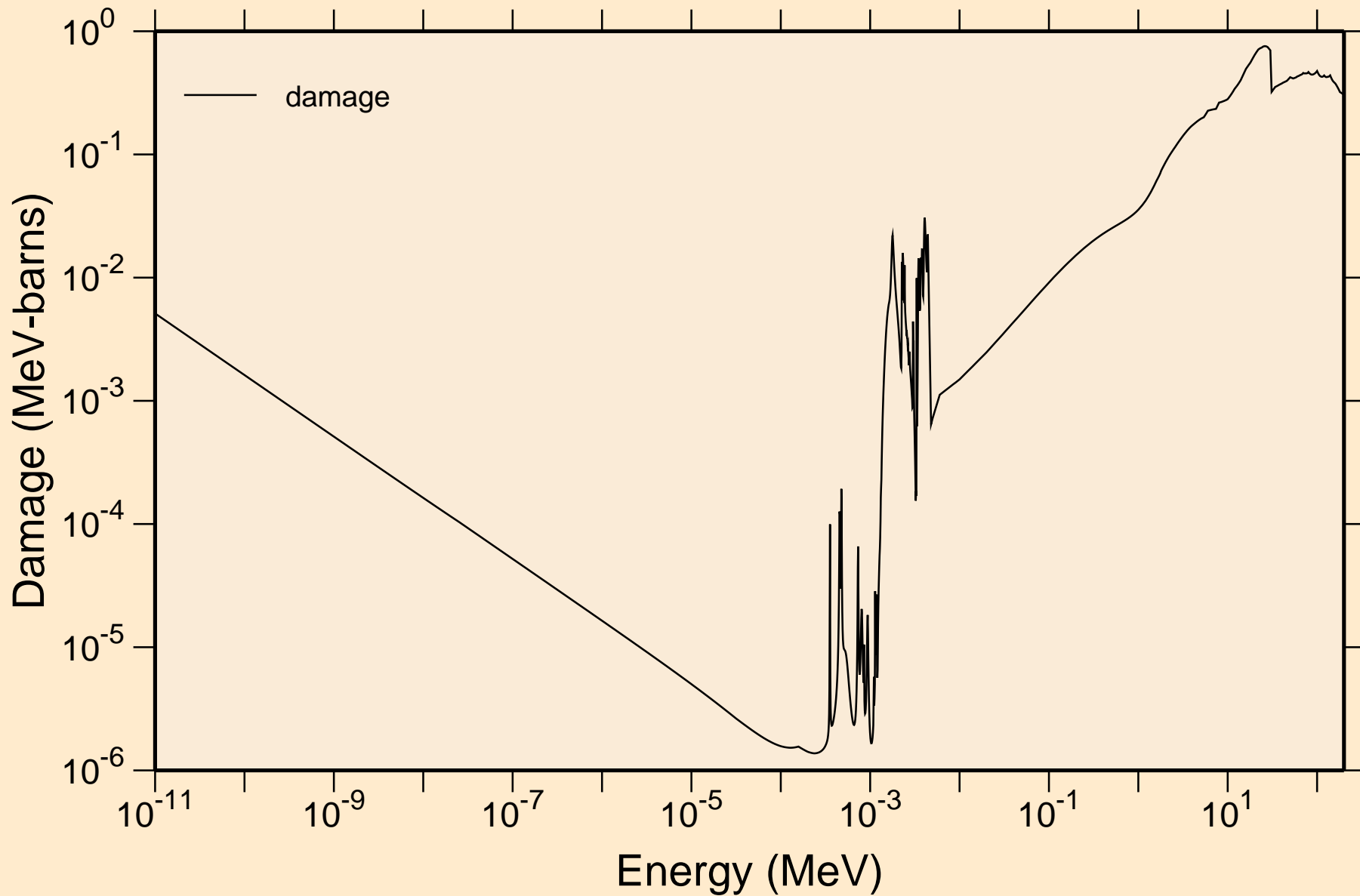

BI212M NEUTRON ACER TENDL-2019 LIBRARY; T=293.16K
Non-threshold reactions

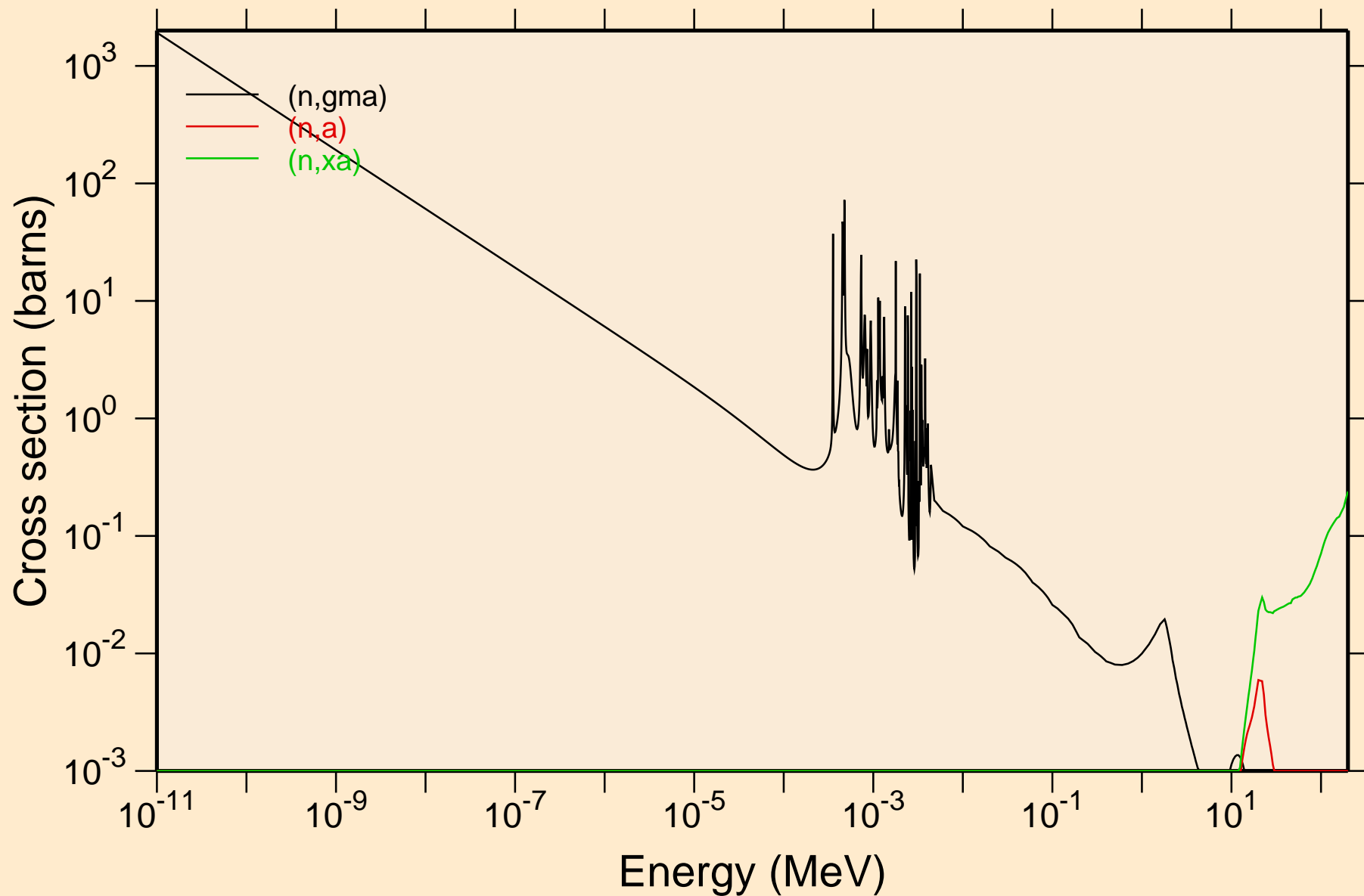

BI212M NEUTRON ACER TENDL-2019 LIBRARY; T=293.16K
Principal cross sections

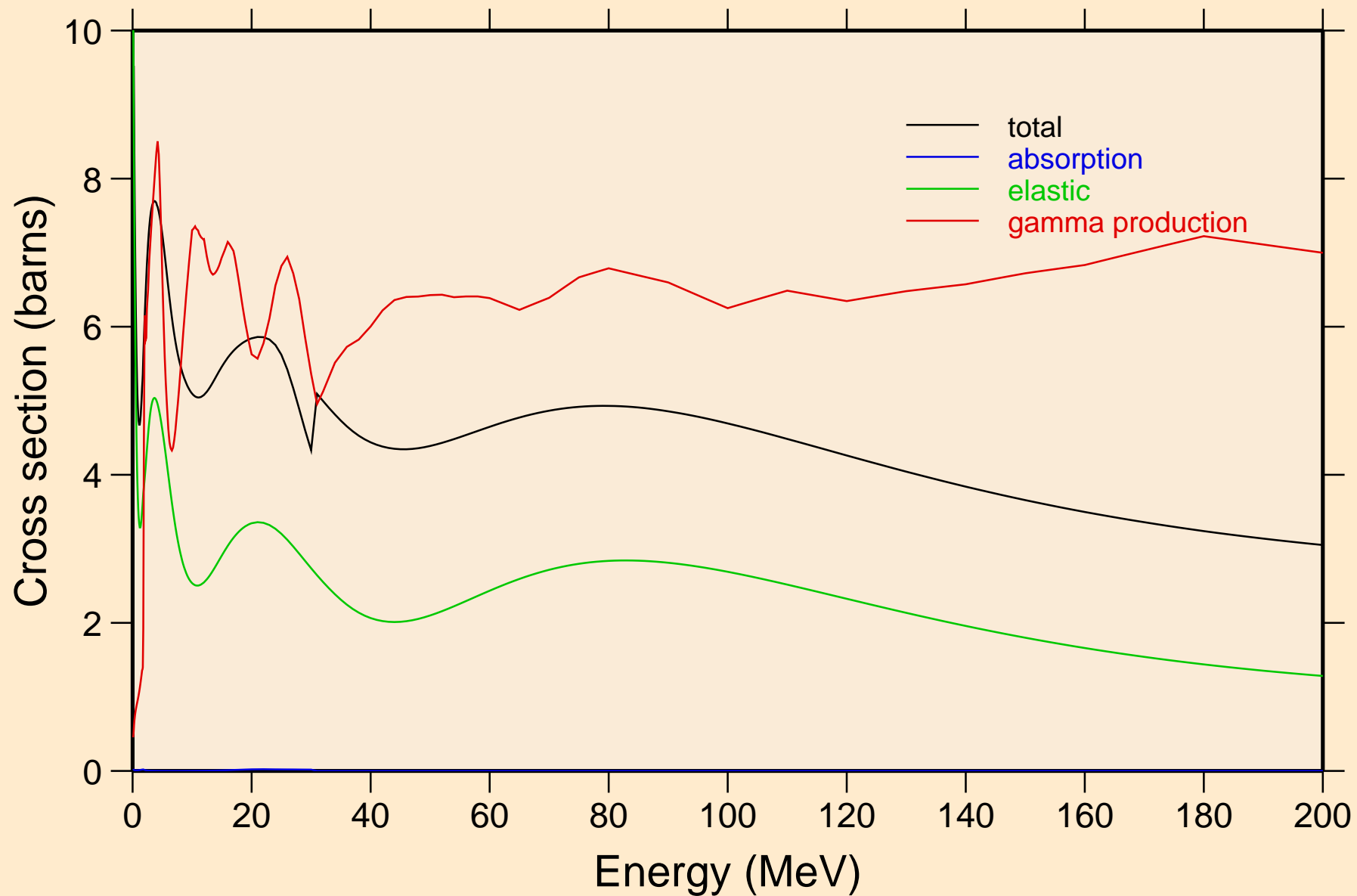

BI212M NEUTRON ACER TENDL-2019 LIBRARY; T=293.16K
Heating

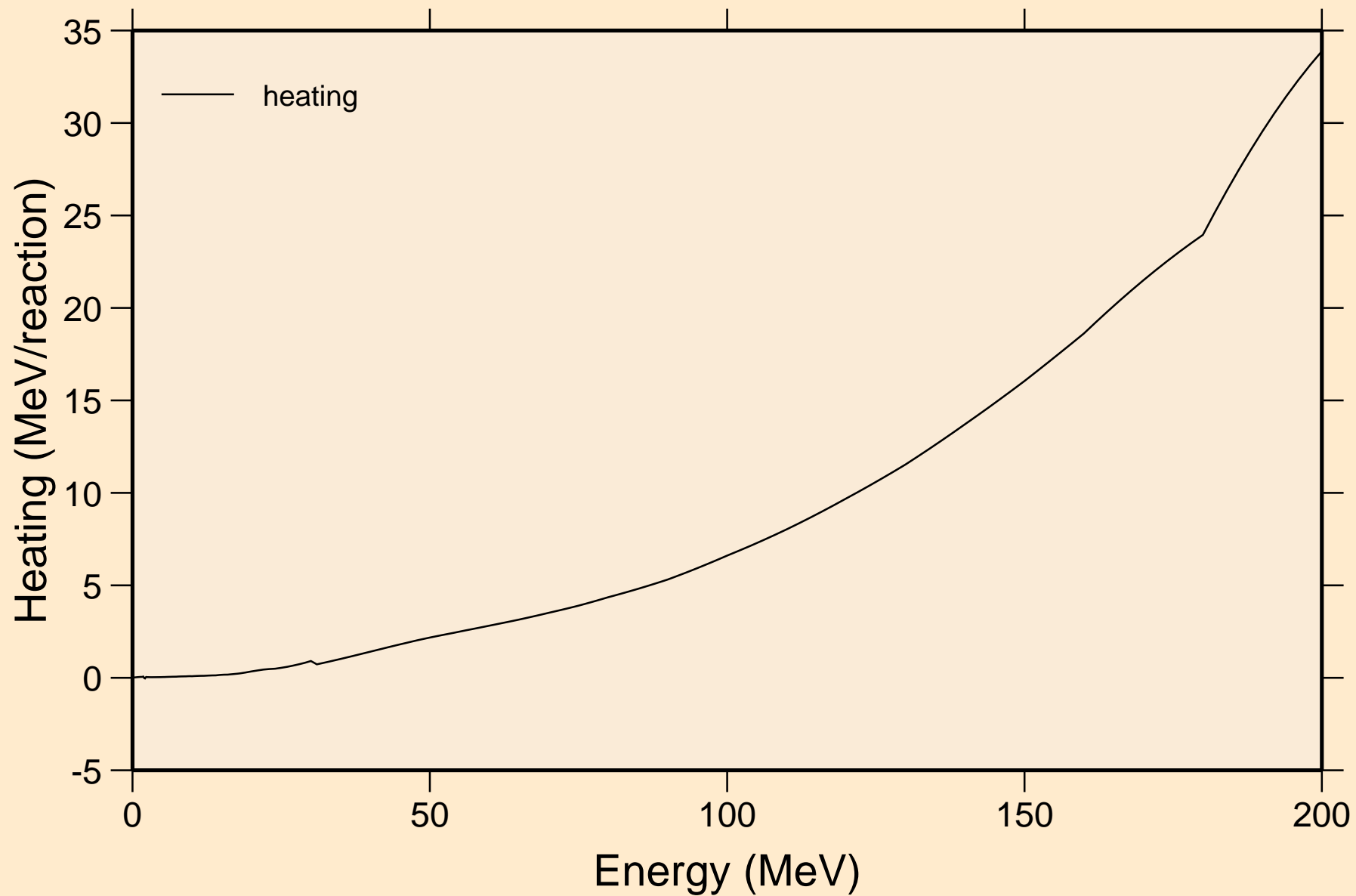

BI212M NEUTRON ACER TENDL-2019 LIBRARY; T=293.16K
Damage

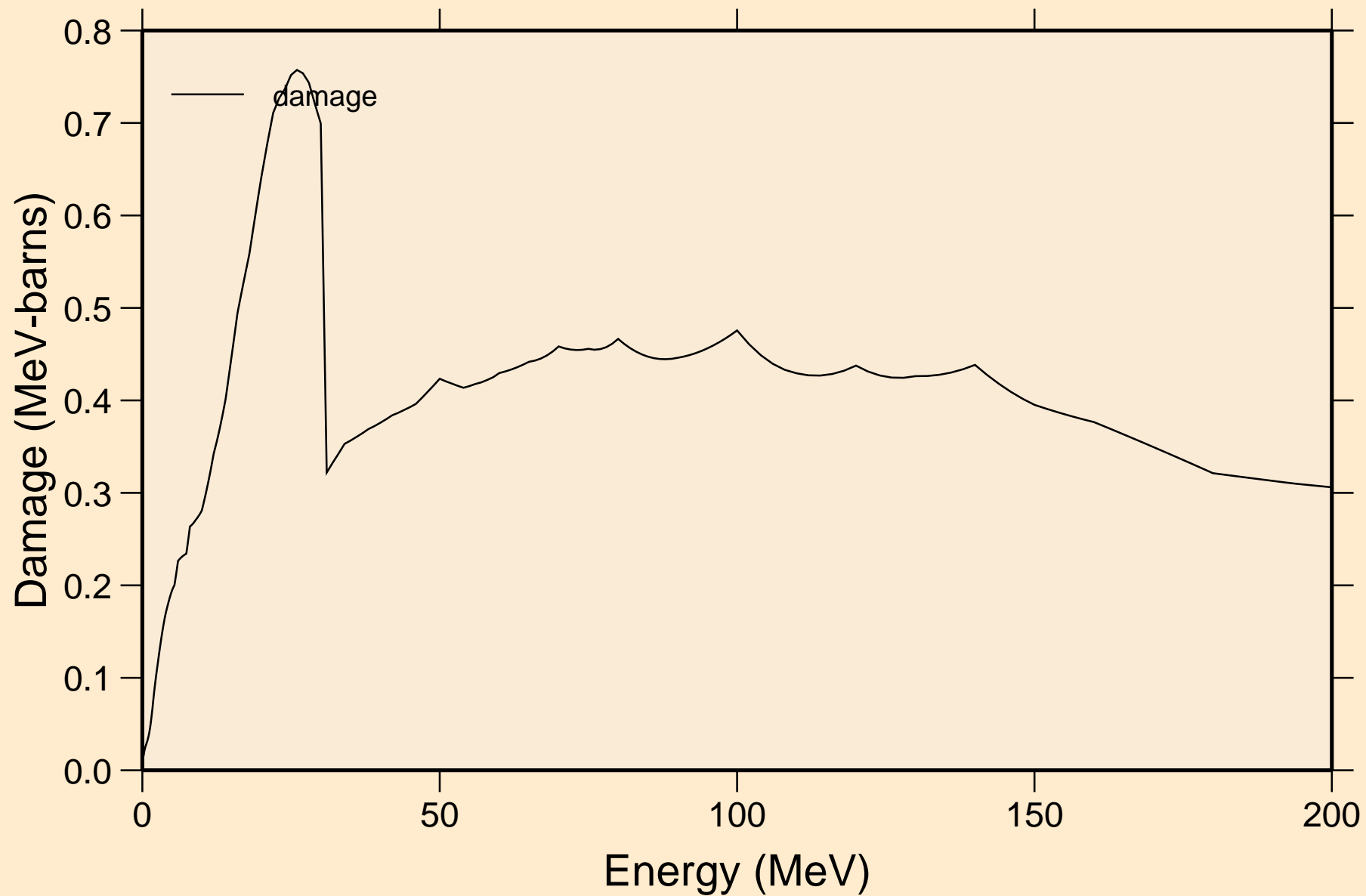

BI212M NEUTRON ACER TENDL-2019 LIBRARY; T=293.16K
Non-threshold reactions

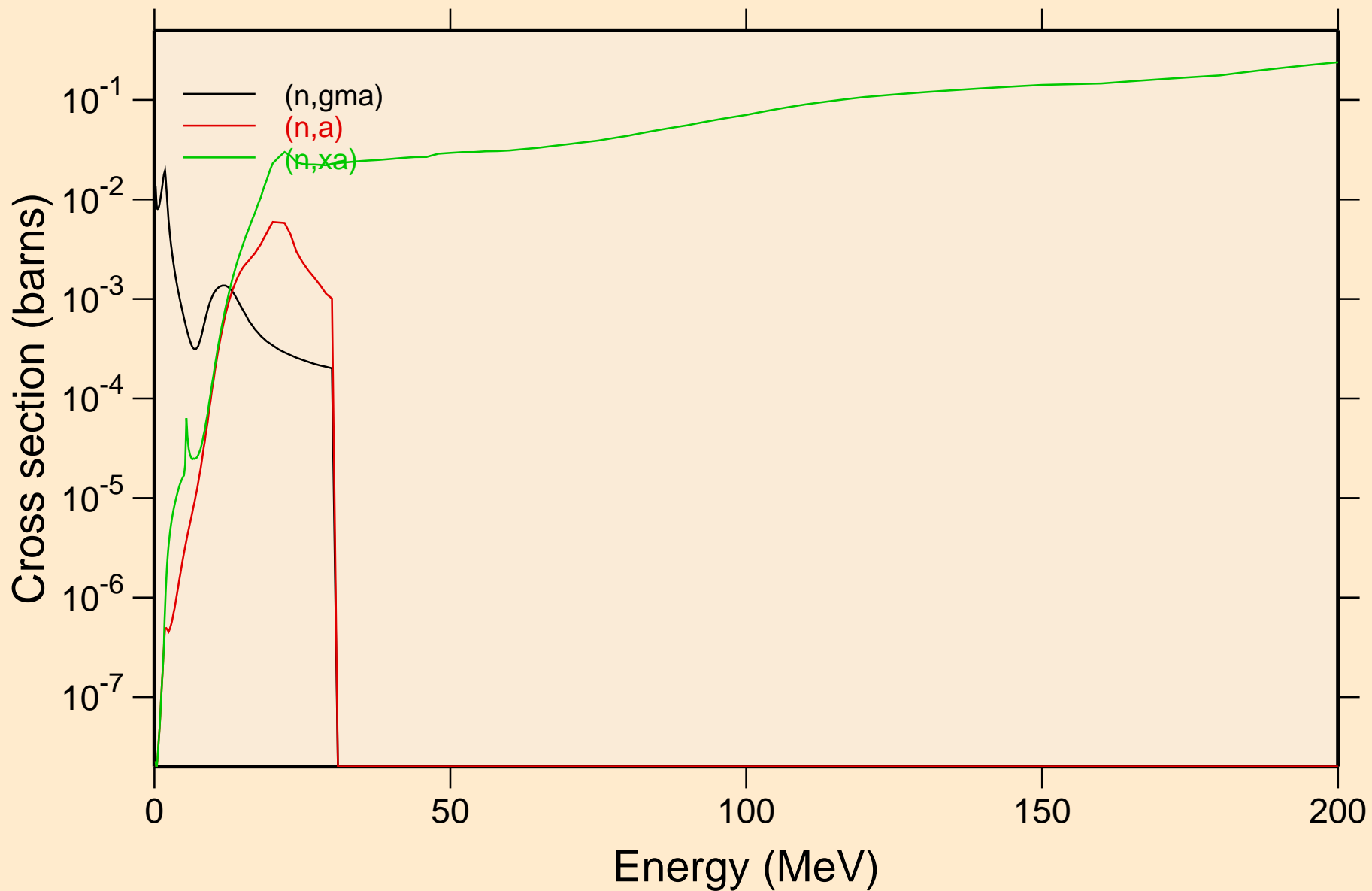

BI212M NEUTRON ACER TENDL-2019 LIBRARY; T=293.16K
Inelastic levels

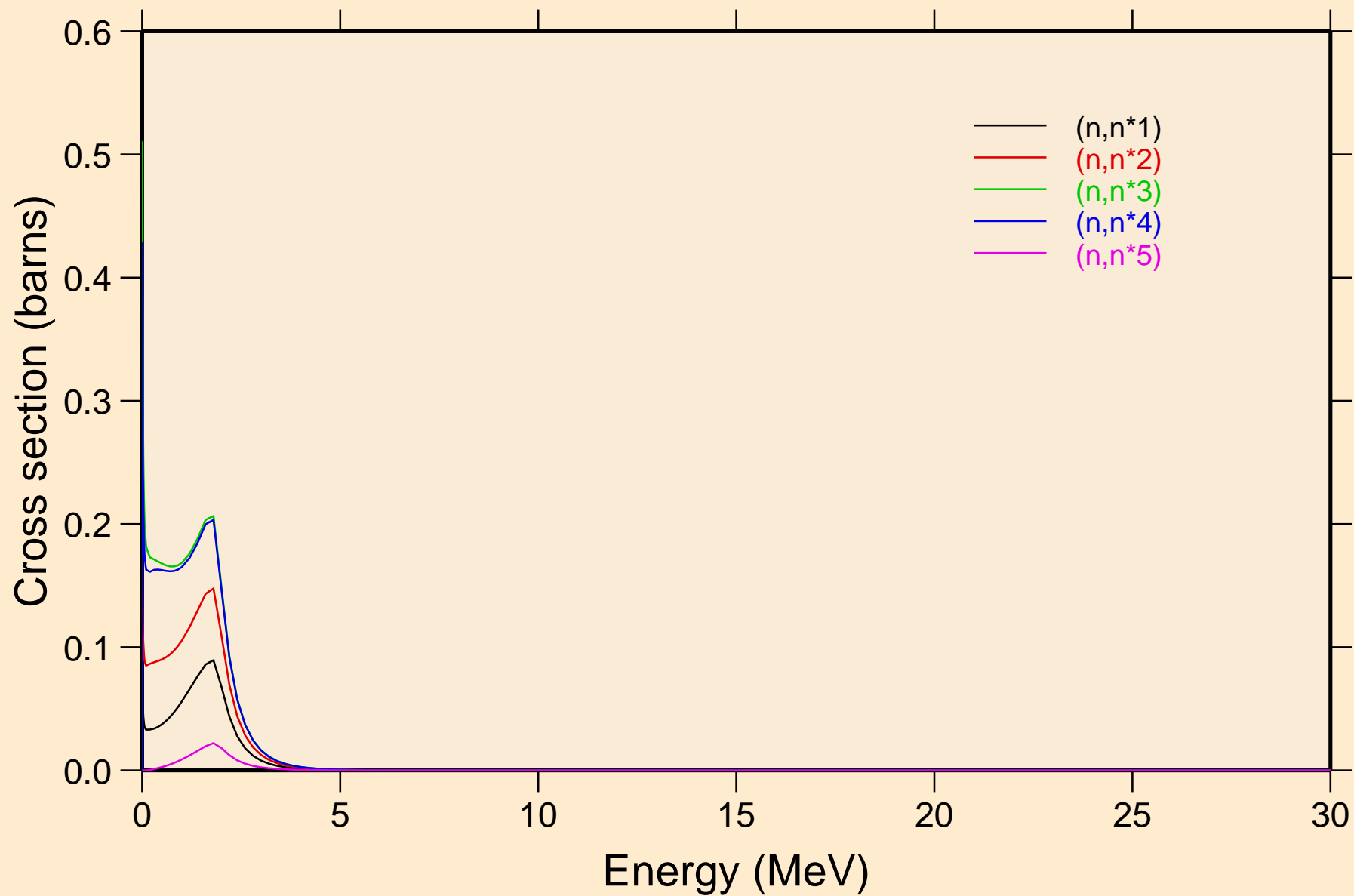

BI212M NEUTRON ACER TENDL-2019 LIBRARY; T=293.16K
Inelastic levels

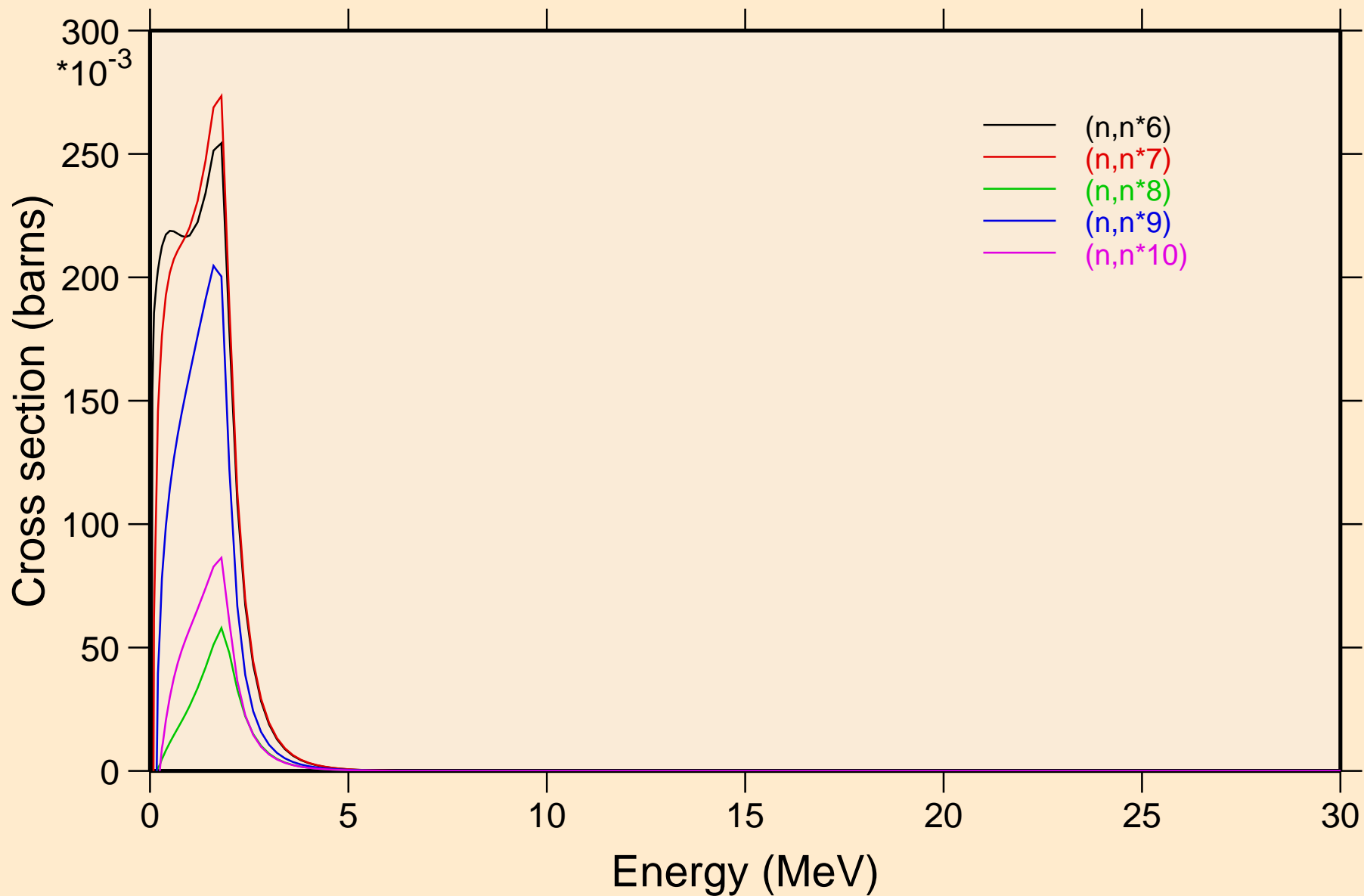

BI212M NEUTRON ACER TENDL-2019 LIBRARY; T=293.16K
Inelastic levels

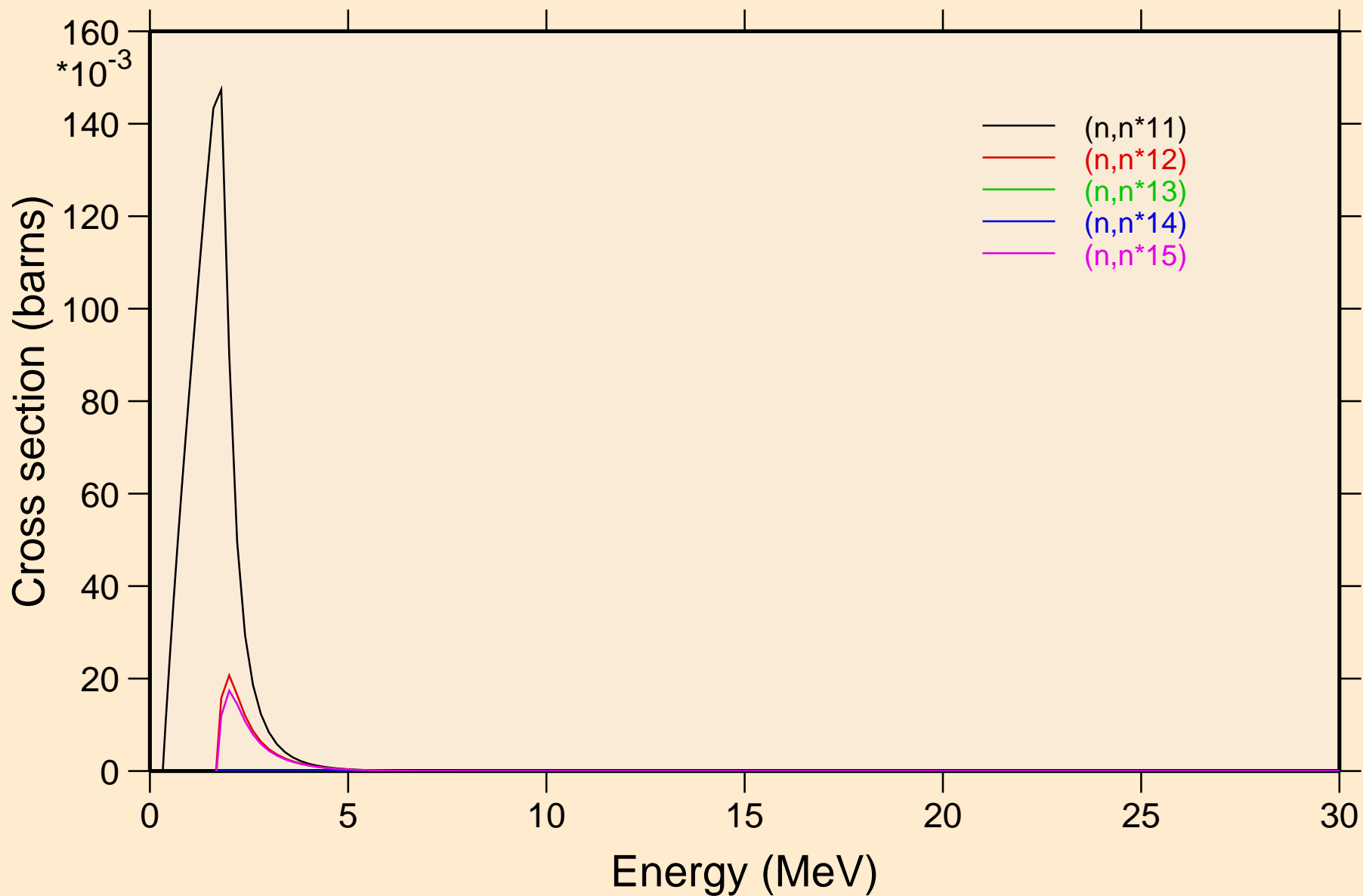

BI212M NEUTRON ACER TENDL-2019 LIBRARY; T=293.16K
Inelastic levels

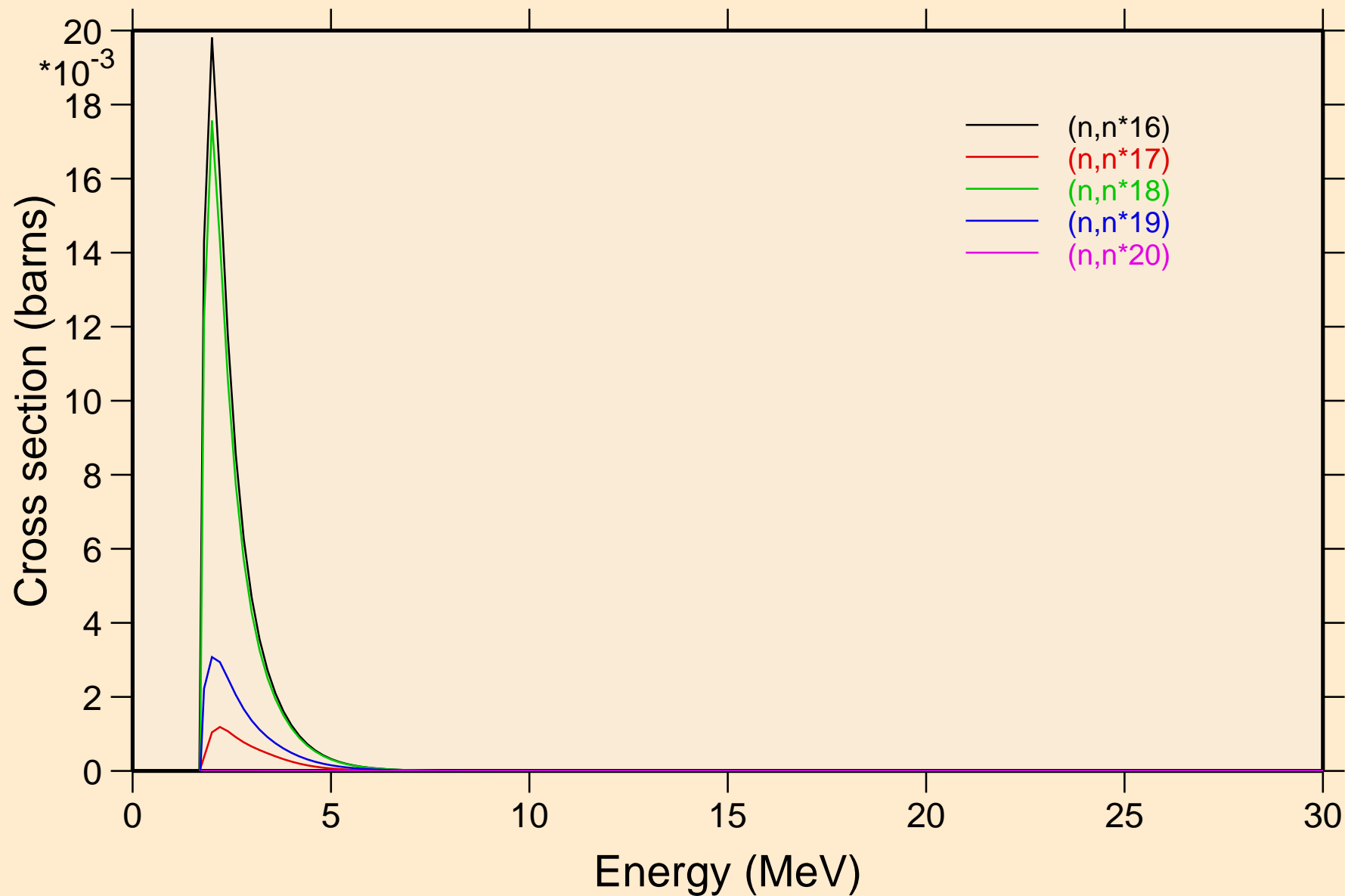

BI212M NEUTRON ACER TENDL-2019 LIBRARY; T=293.16K
Inelastic levels

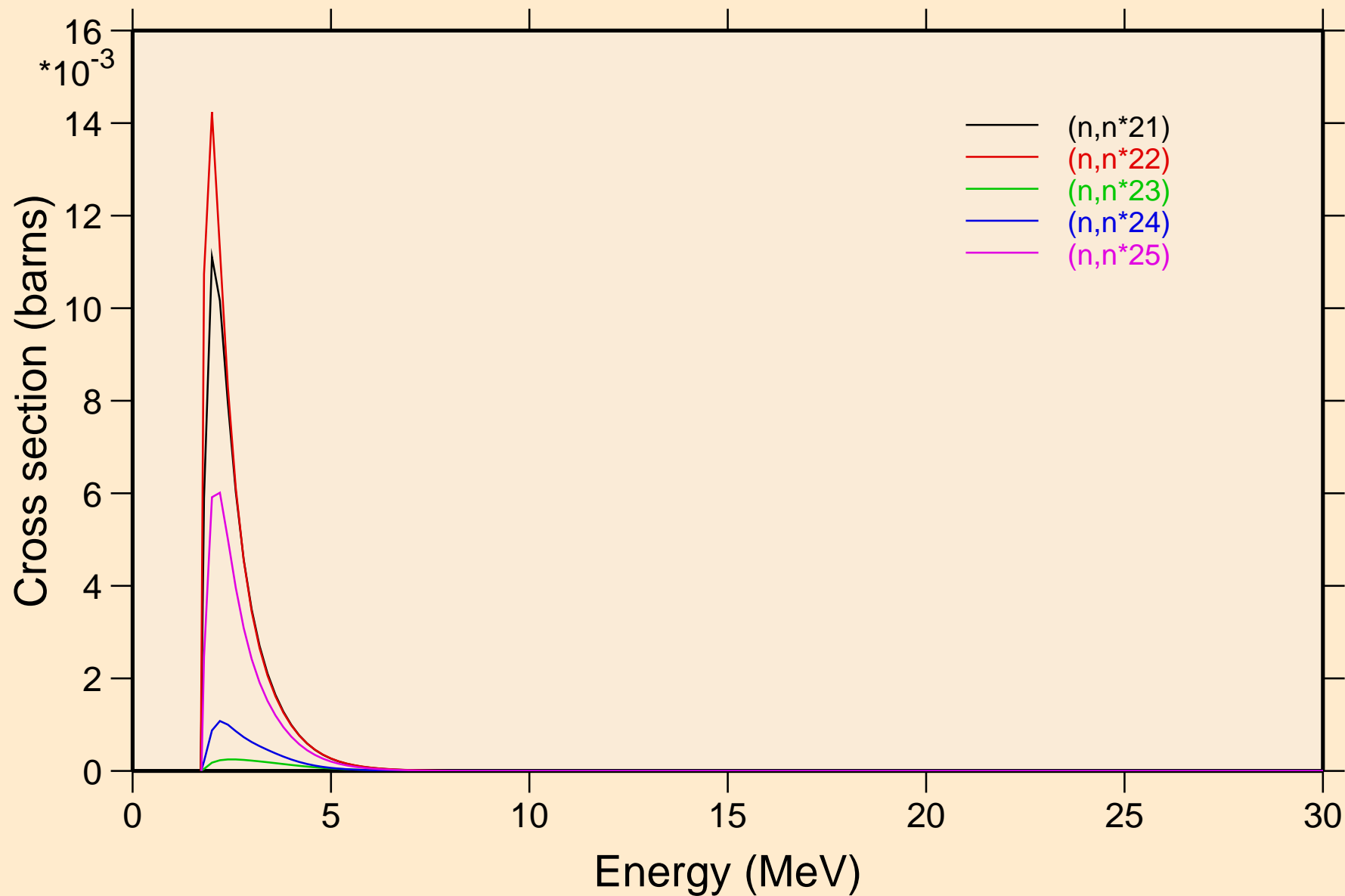

BI212M NEUTRON ACER TENDL-2019 LIBRARY; T=293.16K
Inelastic levels

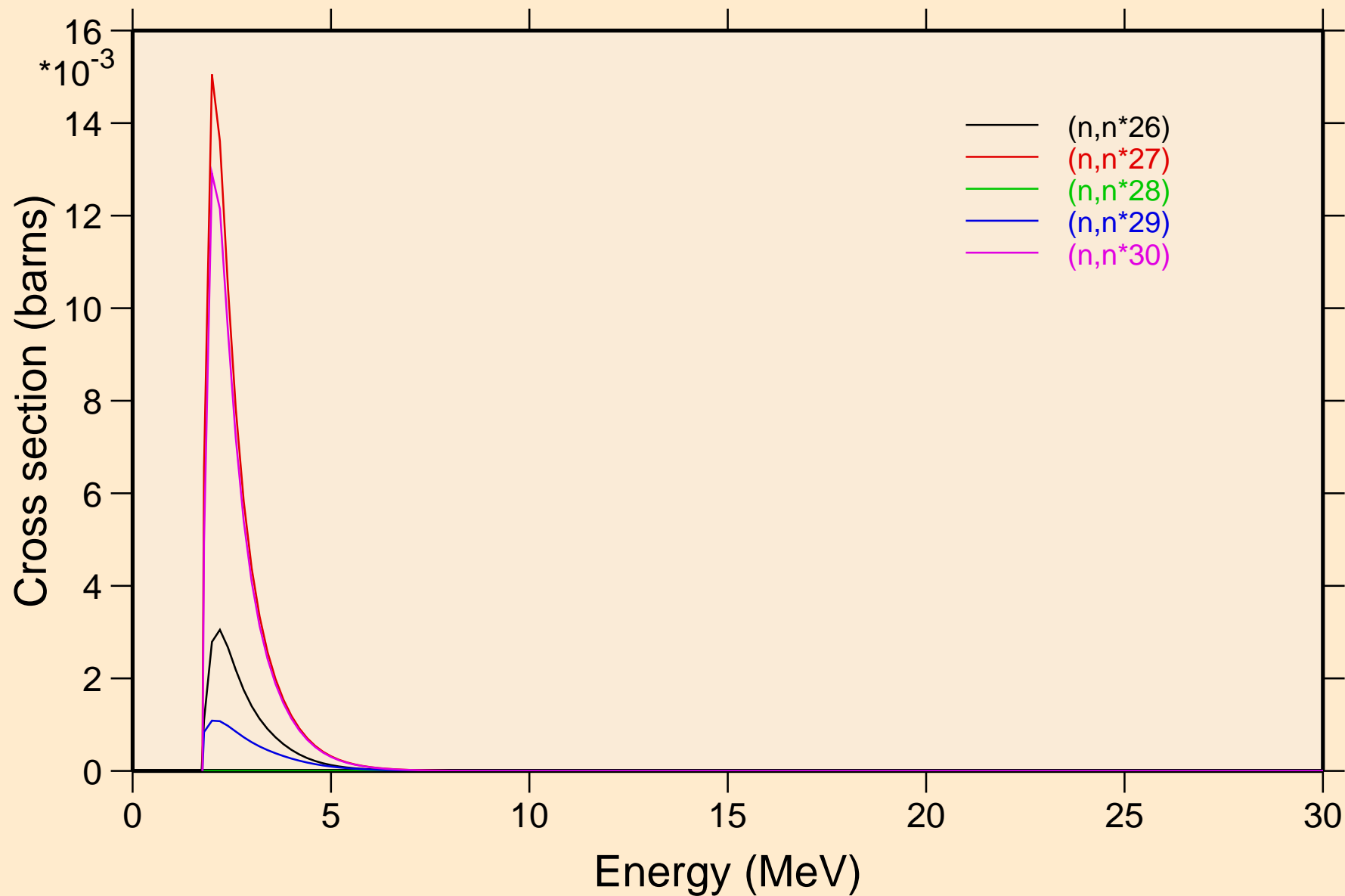

BI212M NEUTRON ACER TENDL-2019 LIBRARY; T=293.16K
Threshold reactions

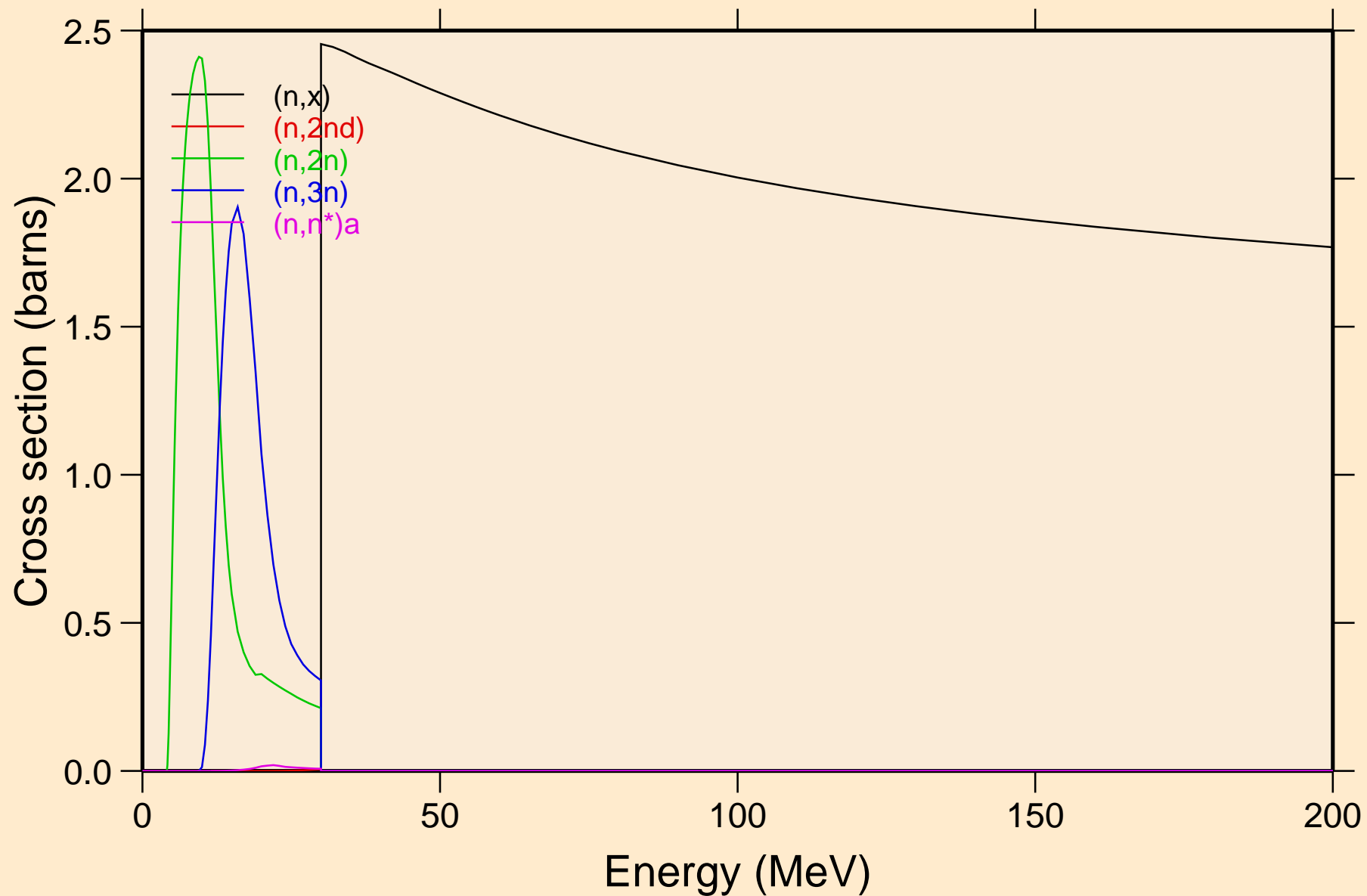

BI212M NEUTRON ACER TENDL-2019 LIBRARY; T=293.16K
Threshold reactions

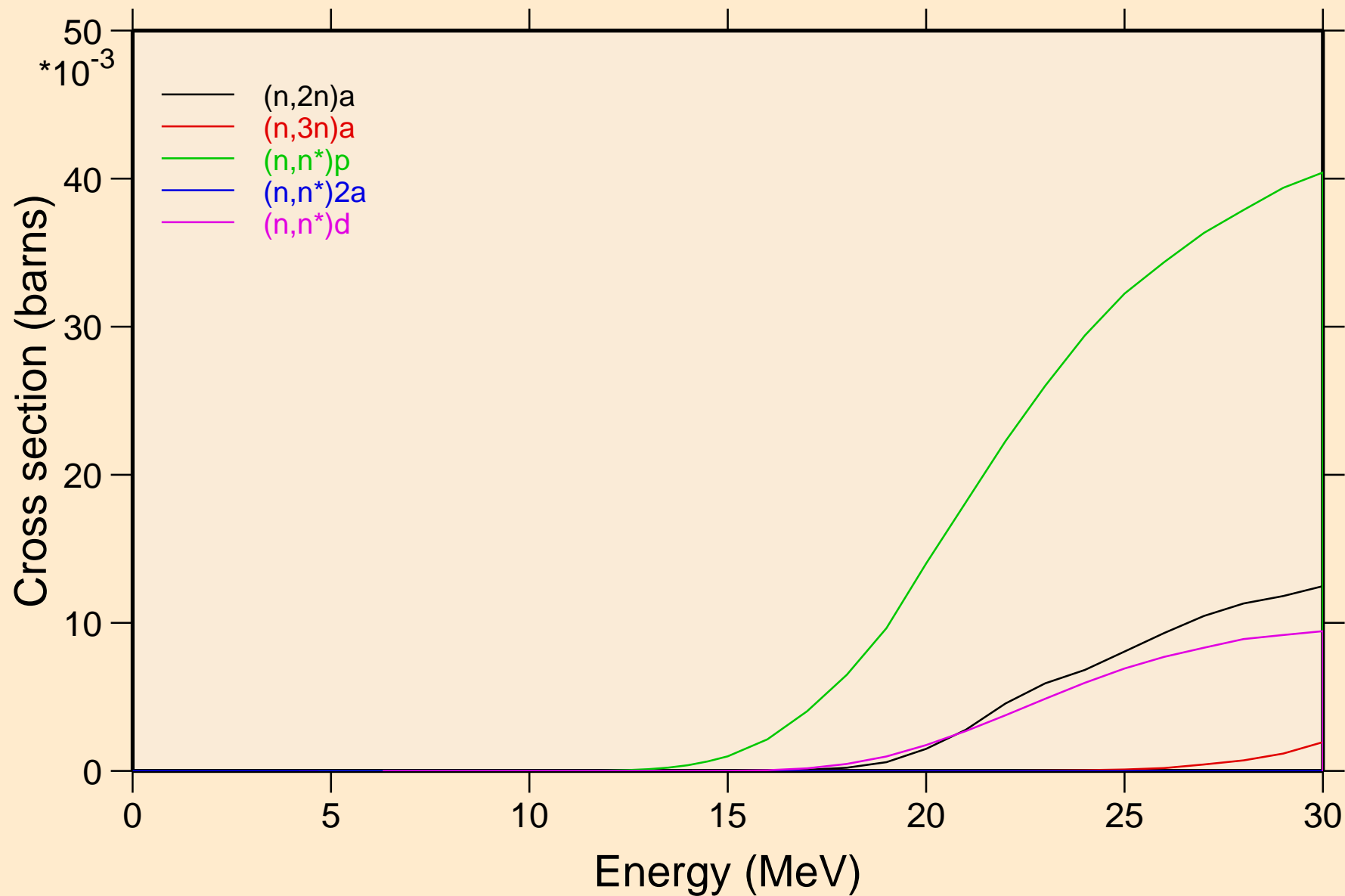

BI212M NEUTRON ACER TENDL-2019 LIBRARY; T=293.16K
Threshold reactions

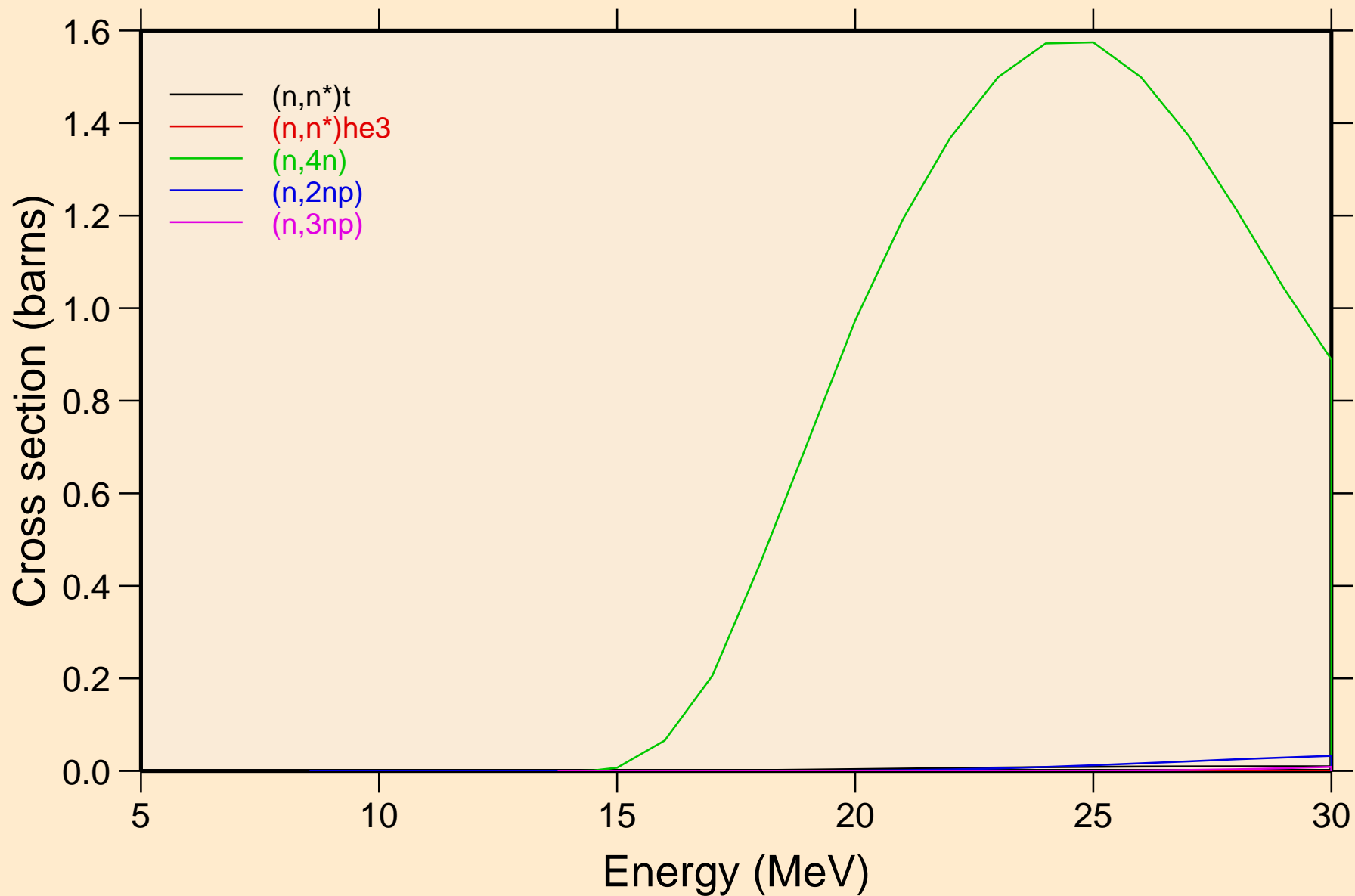

BI212M NEUTRON ACER TENDL-2019 LIBRARY; T=293.16K
Threshold reactions

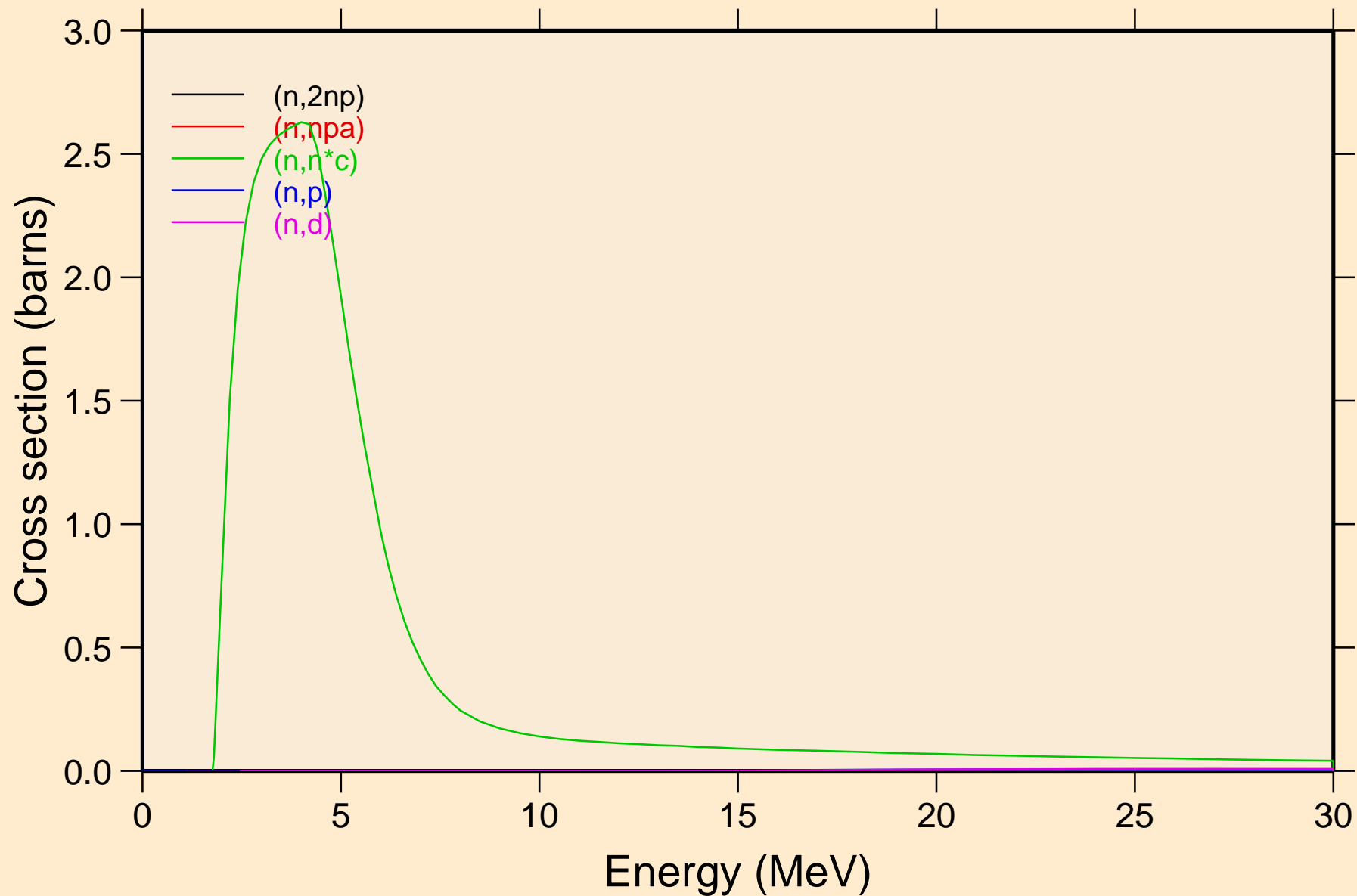

BI212M NEUTRON ACER TENDL-2019 LIBRARY; T=293.16K
Threshold reactions

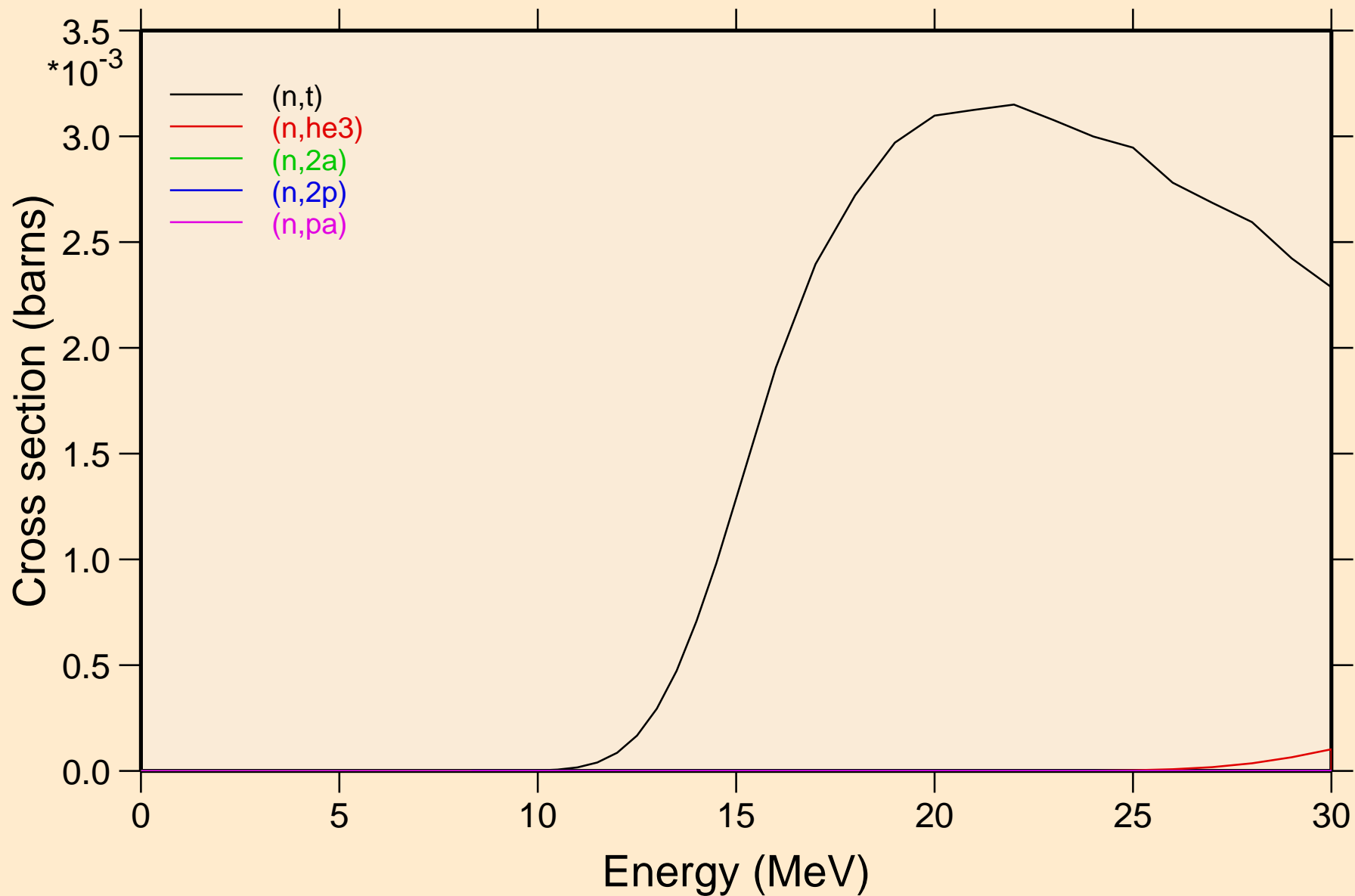

BI212M NEUTRON ACER TENDL-2019 LIBRARY; T=293.16K
Threshold reactions

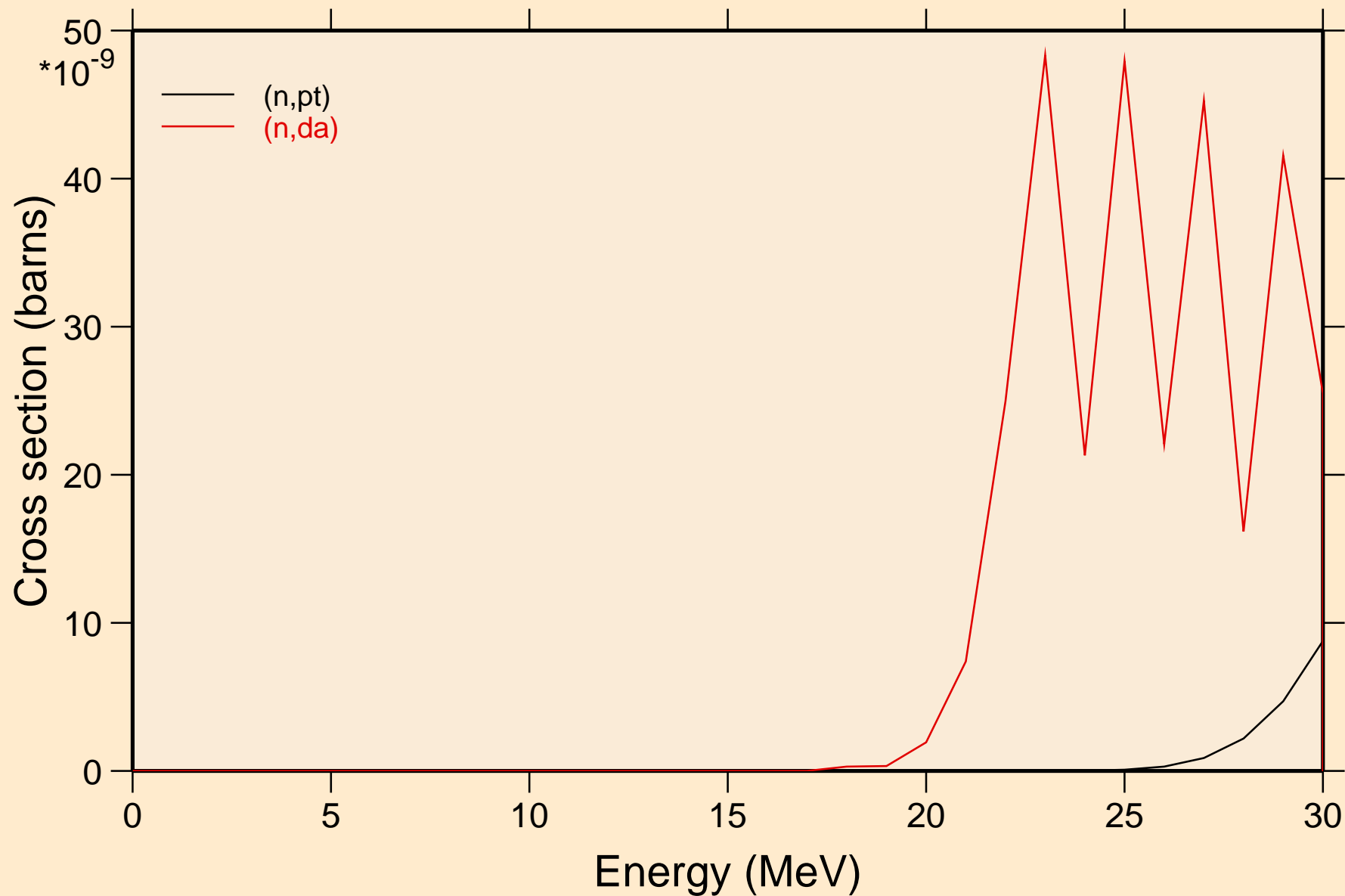

BI212M NEUTRON ACER TENDL-2019 LIBRARY; T=293.16K
Threshold reactions

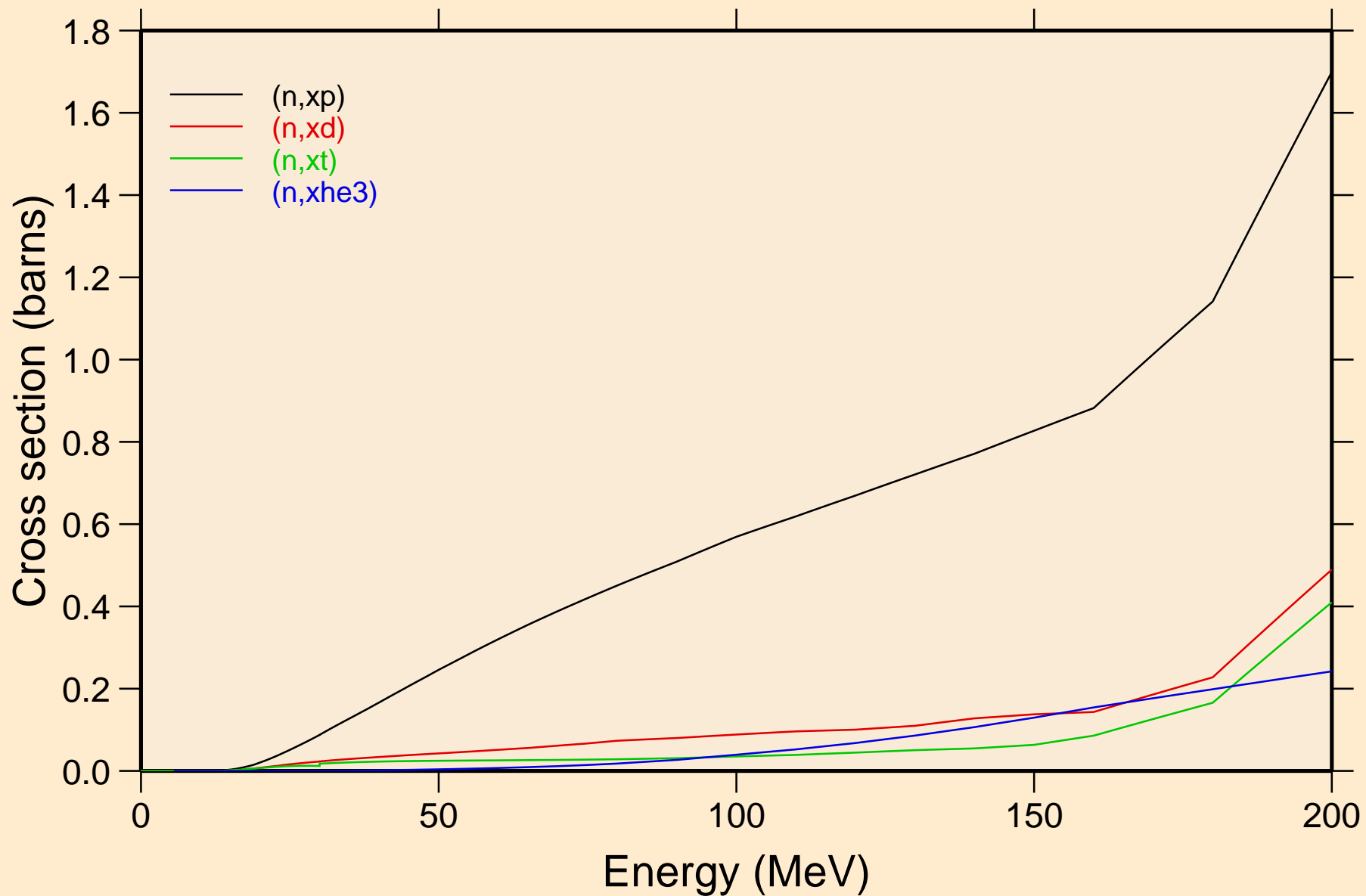

BI212M NEUTRON ACER TENDL-2019 LIBRARY; T=293.16K
angular distribution for elastic

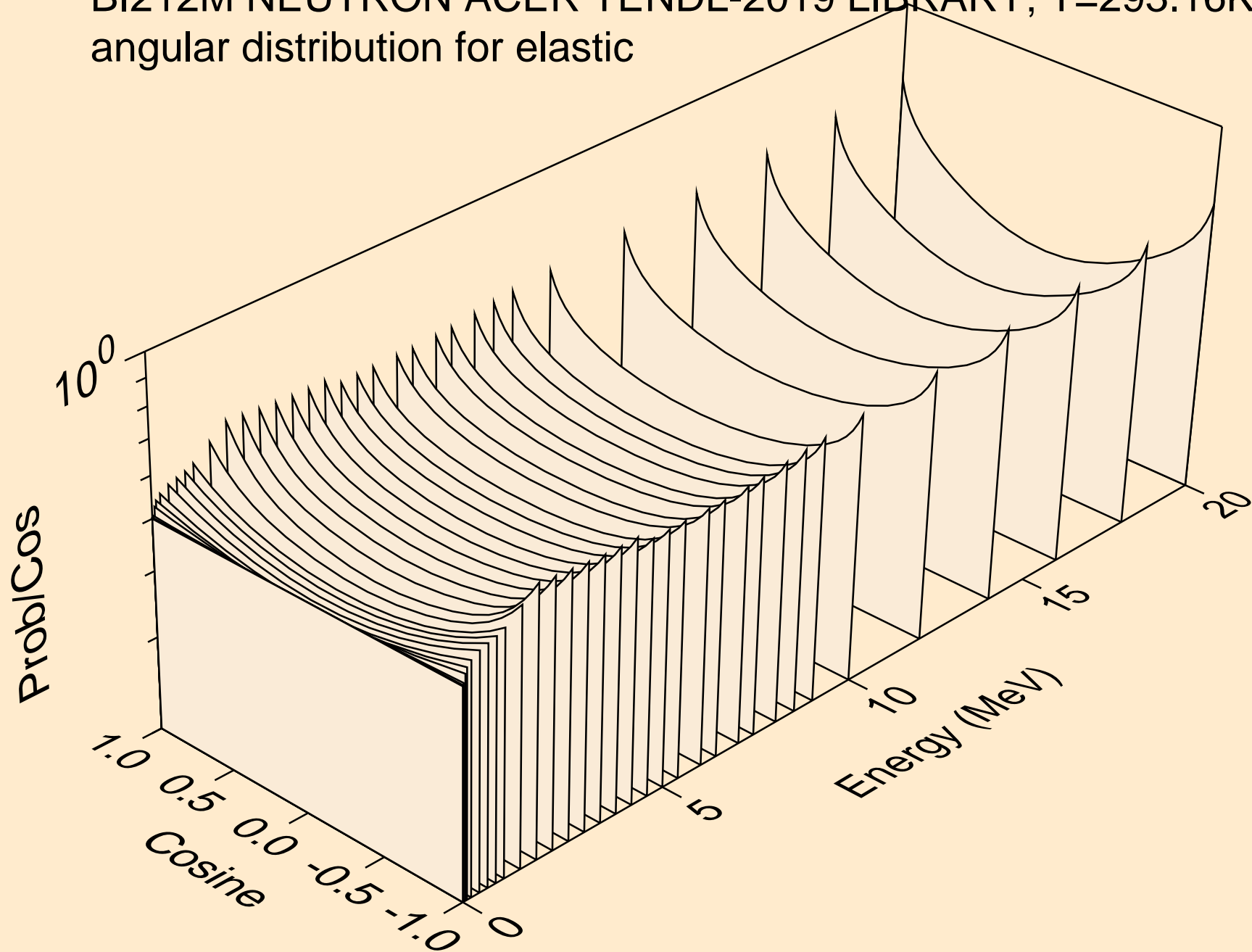

BI212M NEUTRON ACER TENDL-2019 LIBRARY; T=293.16K
angular distribution for elastic

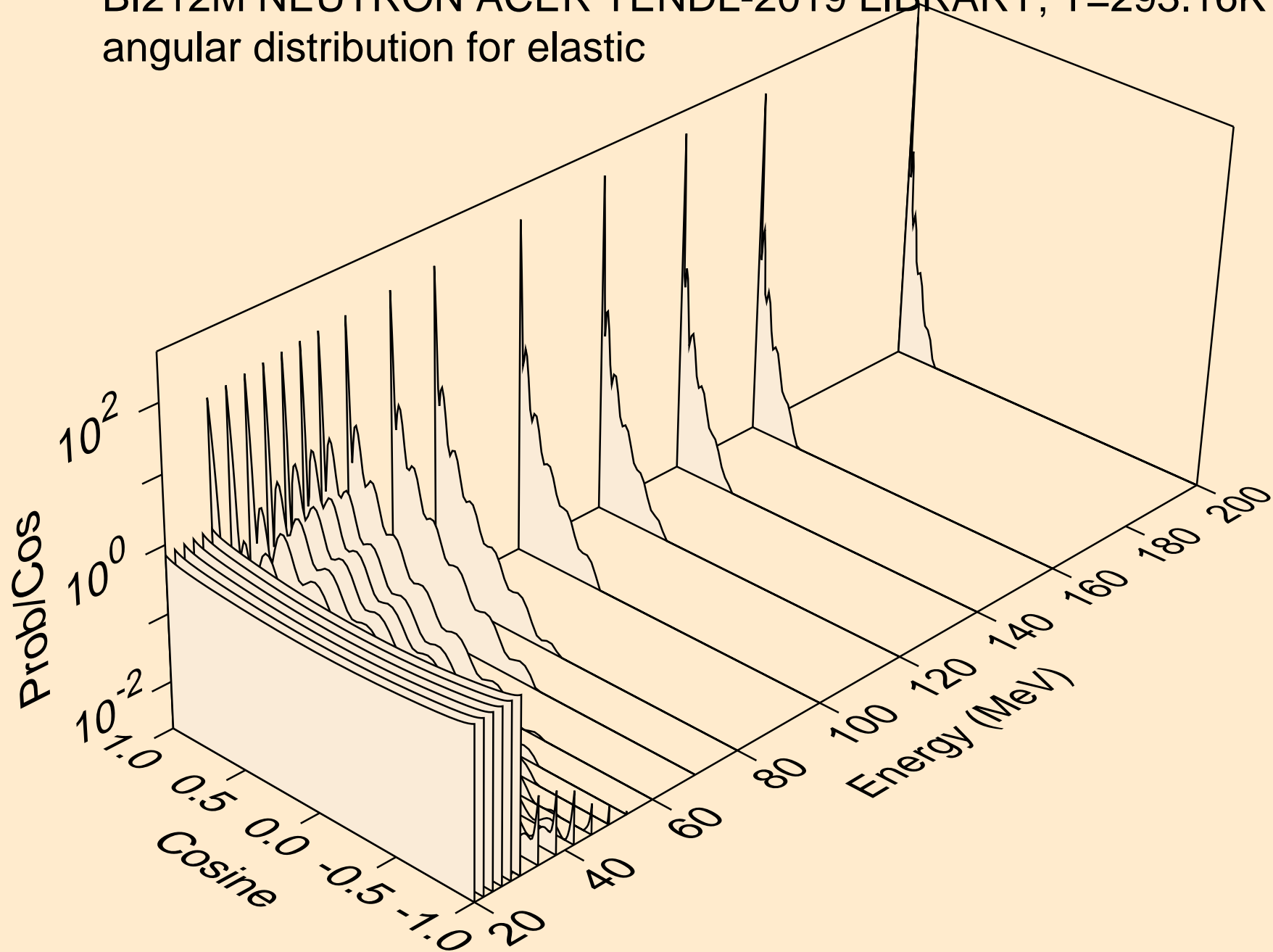

BI212M NEUTRON ACER TENDL-2019 LIBRARY; T=293.16K
angular distribution for (n,n*1)

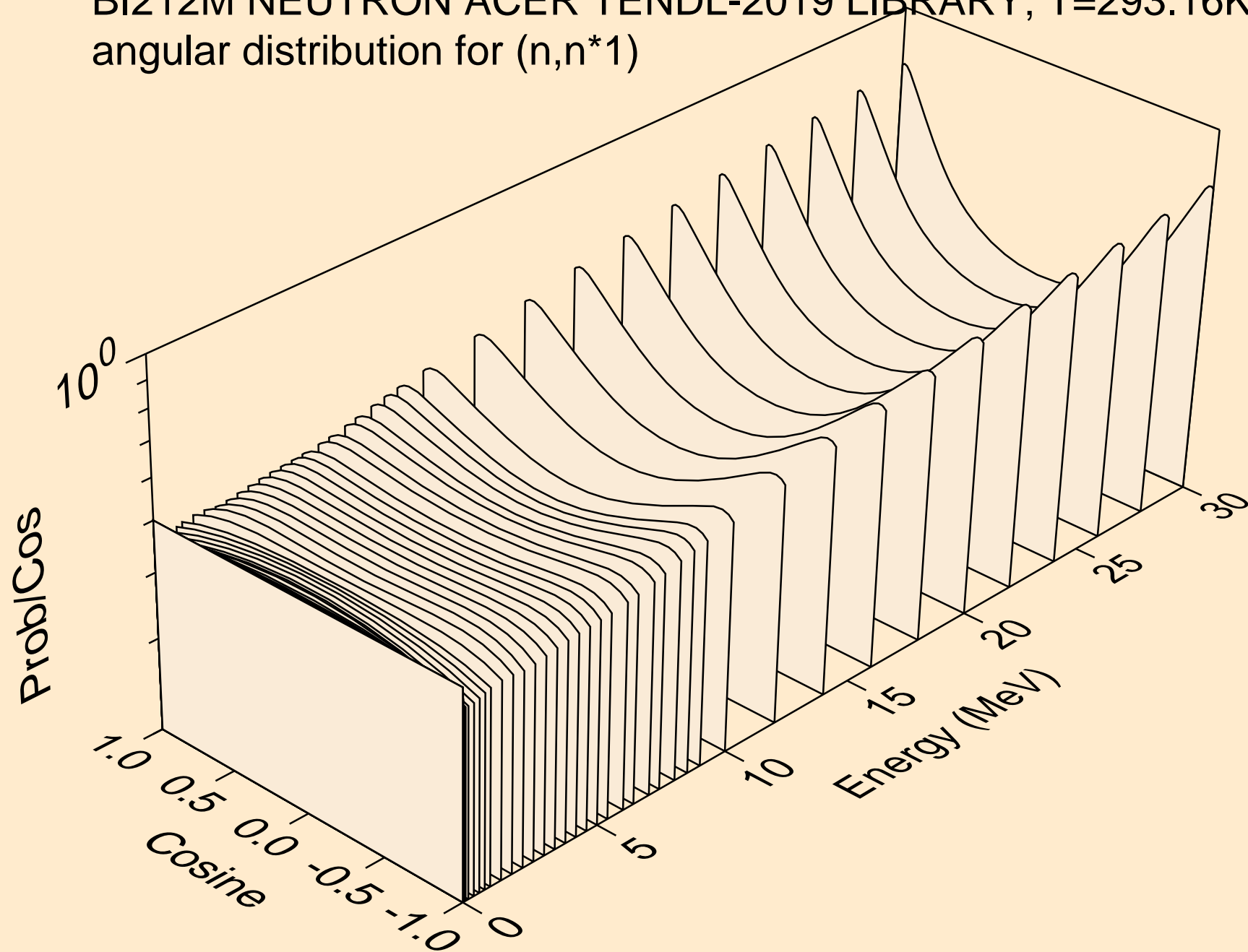

BI212M NEUTRON ACER TENDL-2019 LIBRARY; T=293.16K
angular distribution for (n,n*2)

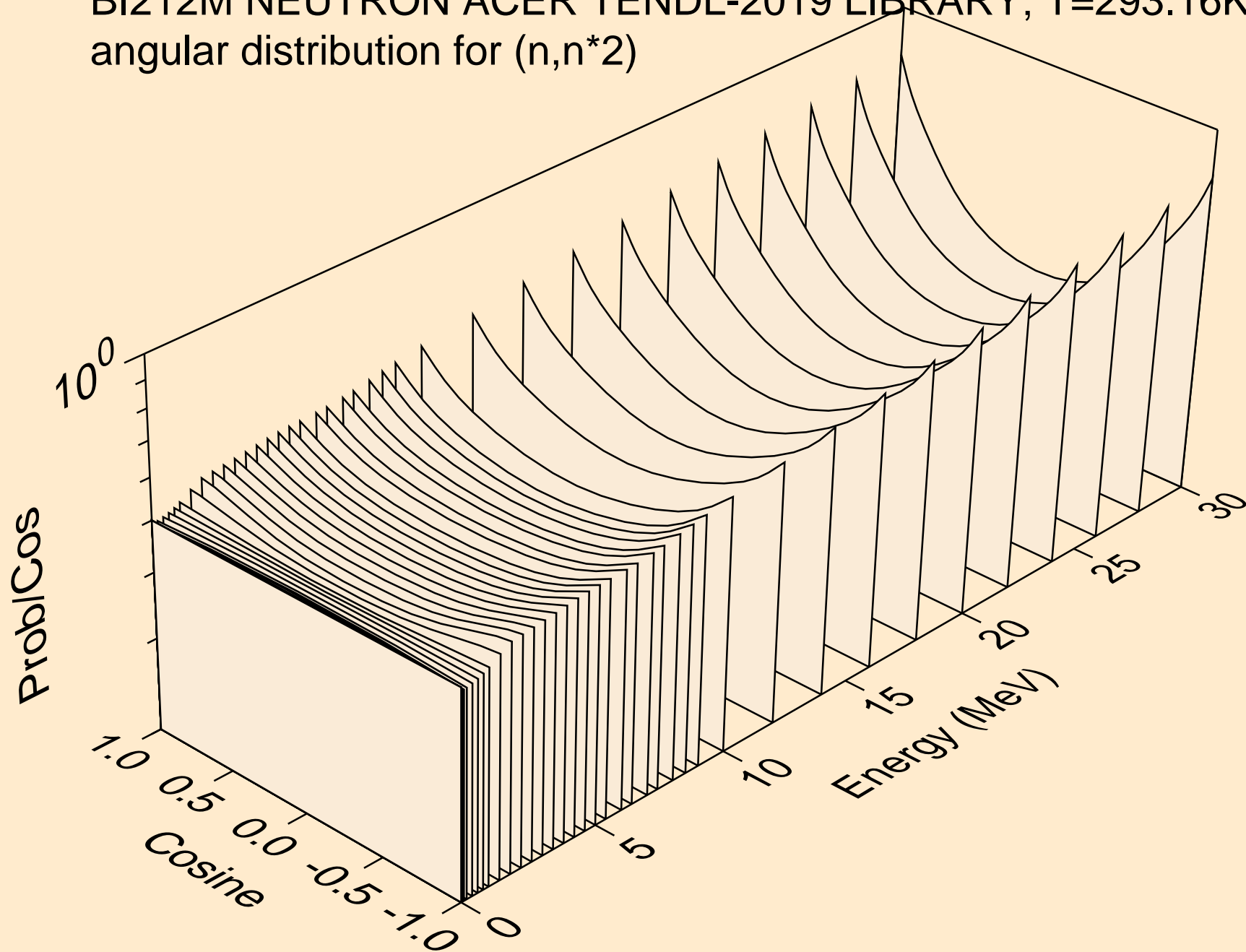

BI212M NEUTRON ACER TENDL-2019 LIBRARY; T=293.16K
angular distribution for (n,n*3)

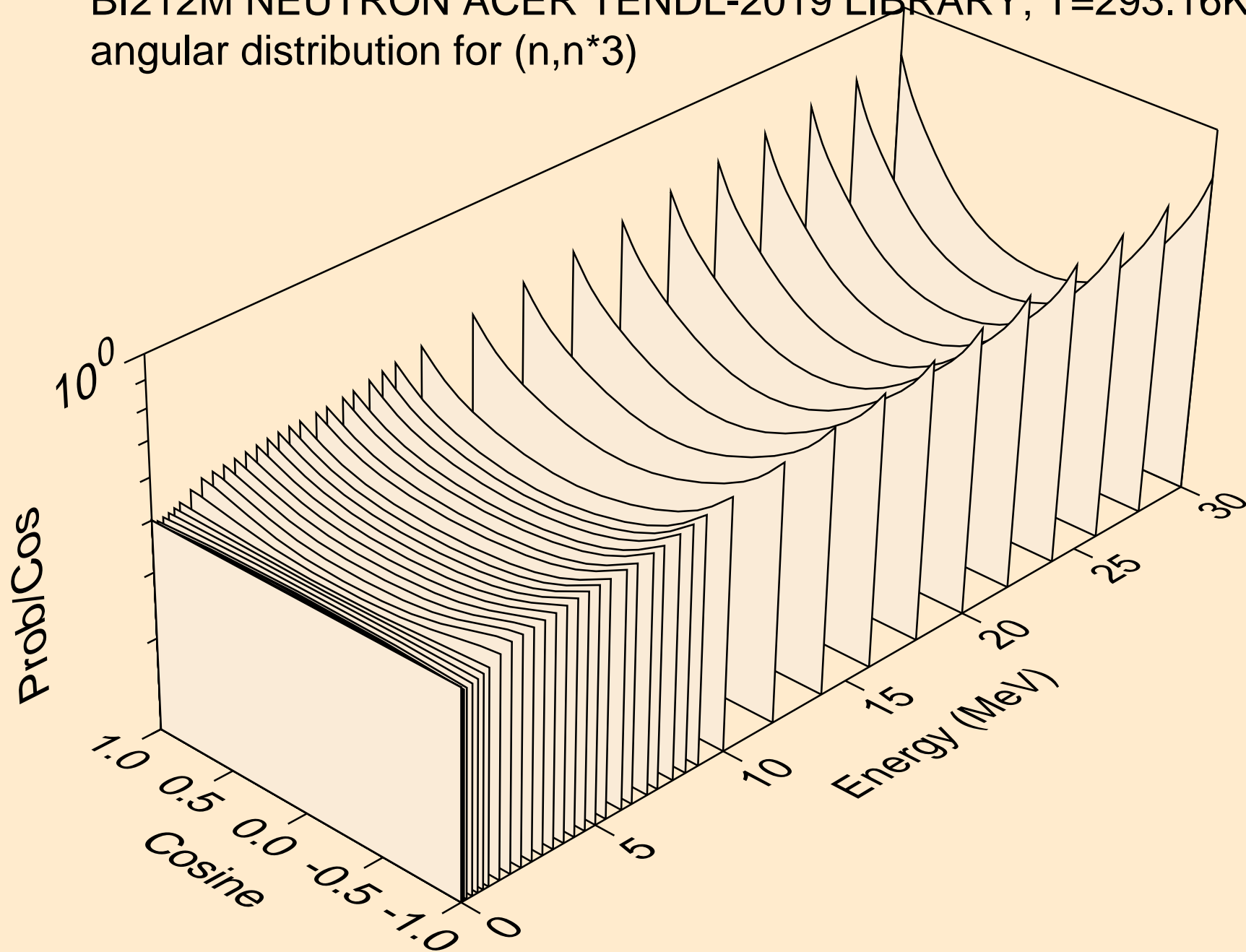

BI212M NEUTRON ACER TENDL-2019 LIBRARY; T=293.16K
angular distribution for (n,n*4)

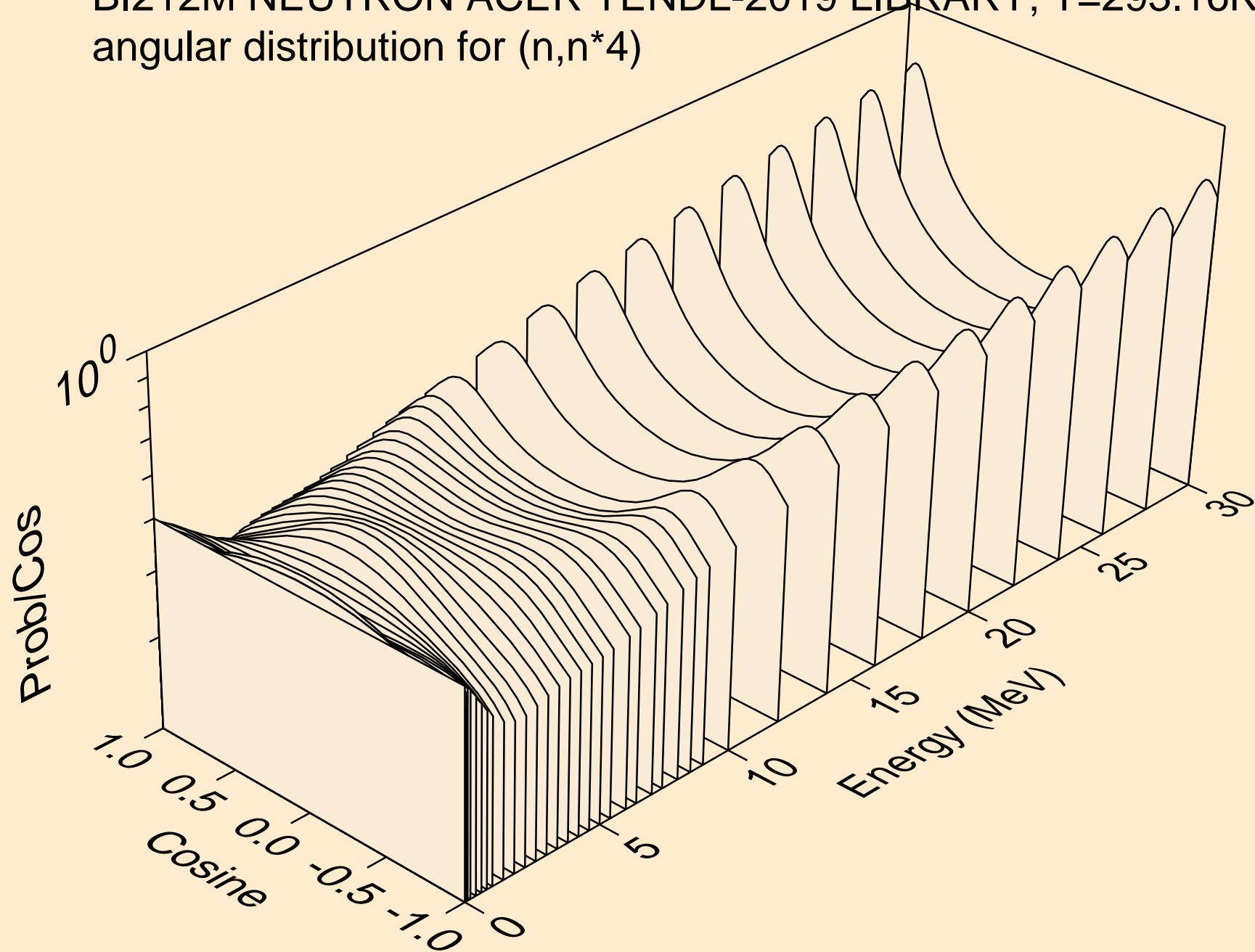

BI212M NEUTRON ACER TENDL-2019 LIBRARY; T=293.16K
angular distribution for (n,n*5)

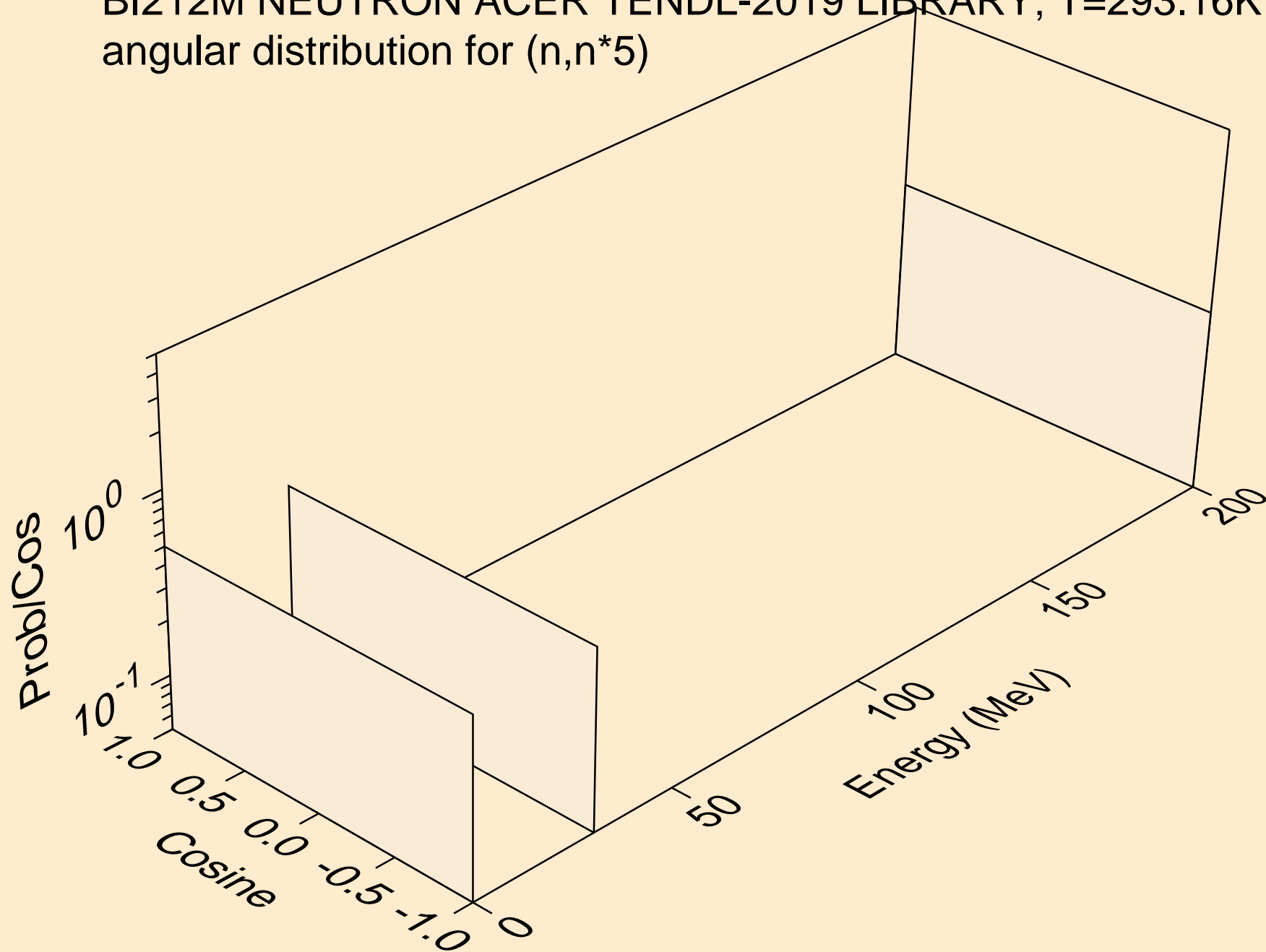

BI212M NEUTRON ACER TENDL-2019 LIBRARY; T=293.16K
angular distribution for (n,n*6)

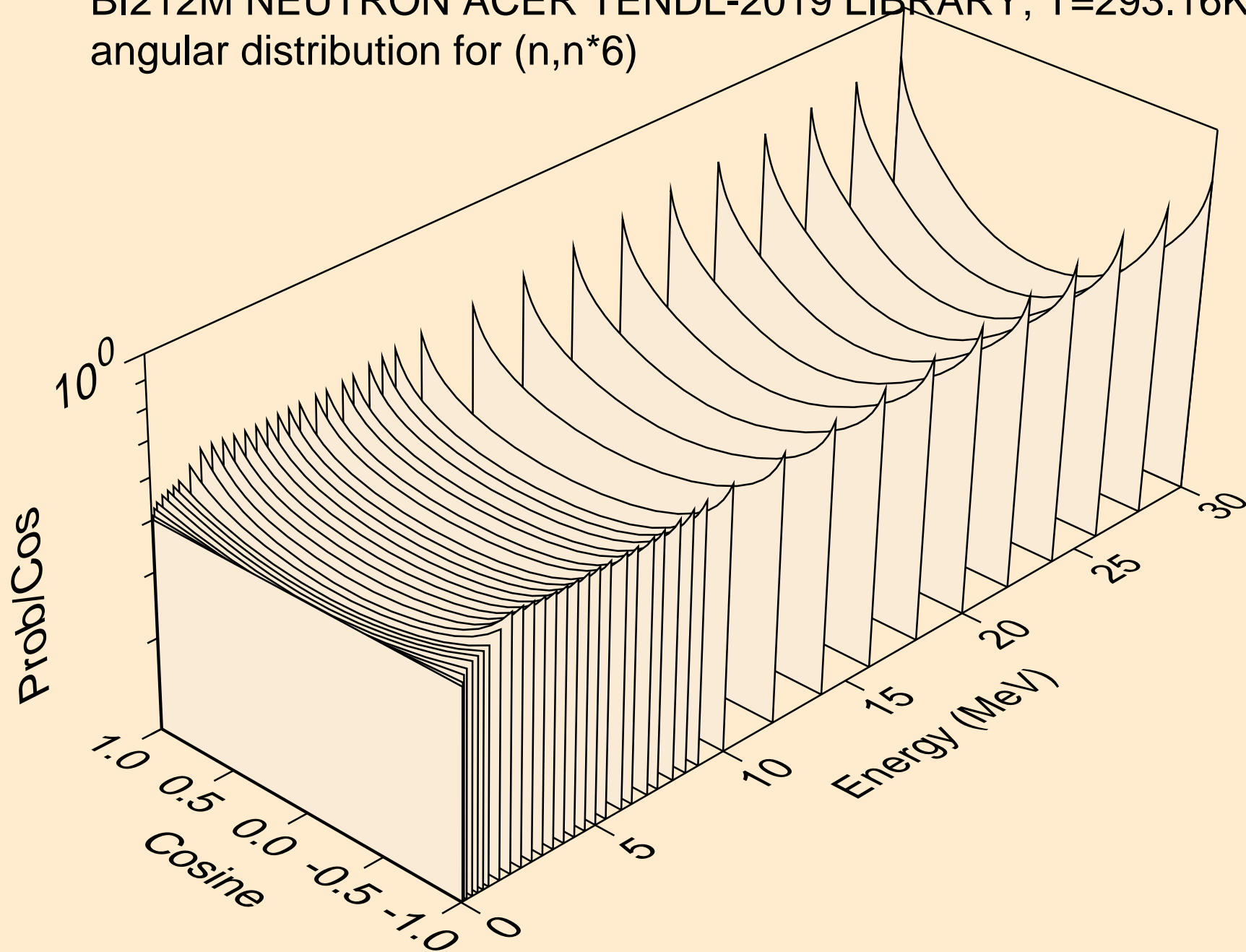

BI212M NEUTRON ACER TENDL-2019 LIBRARY; T=293.16K
angular distribution for (n,n*7)

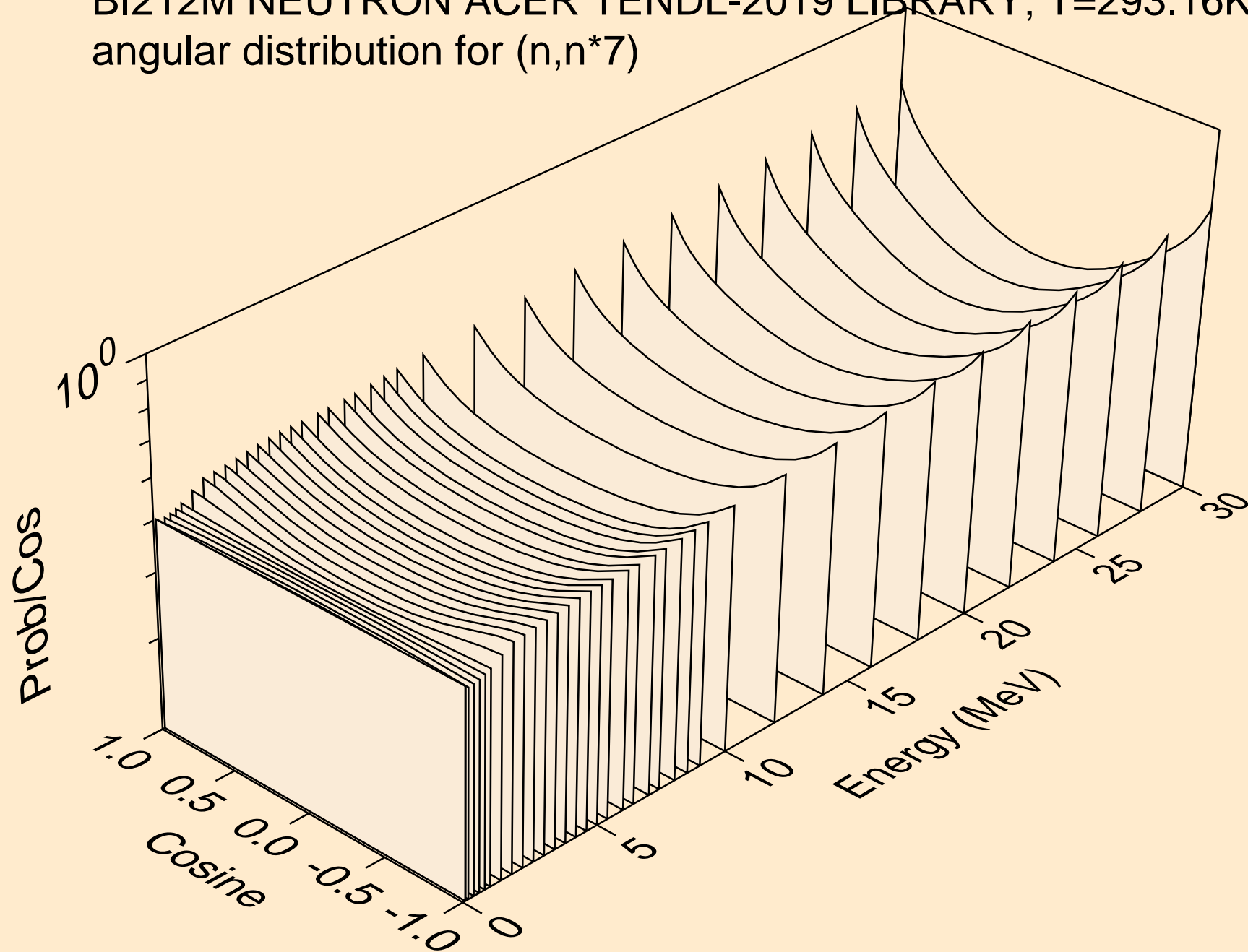

BI212M NEUTRON ACER TENDL-2019 LIBRARY; T=293.16K
angular distribution for (n,n*8)

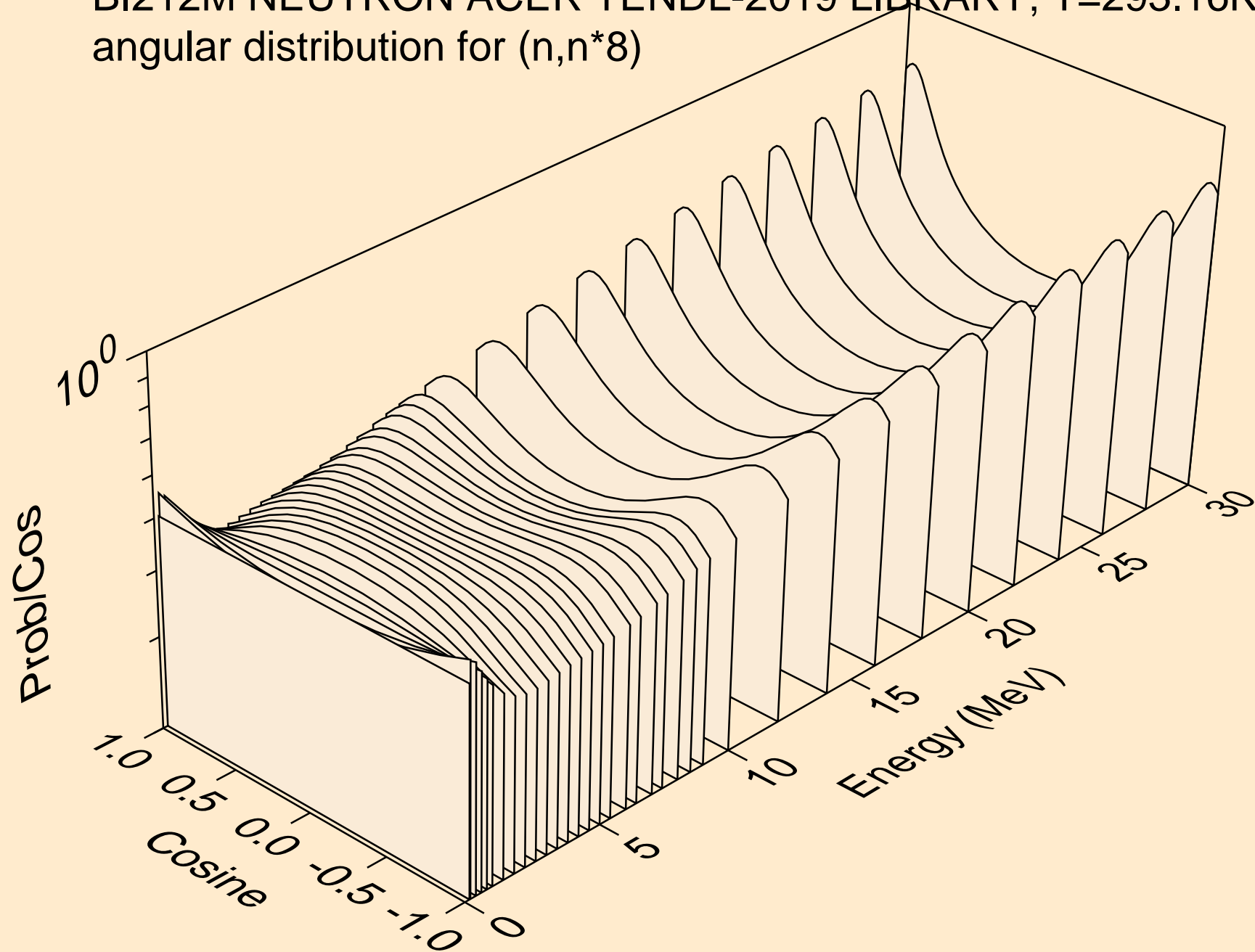

BI212M NEUTRON ACER TENDL-2019 LIBRARY; T=293.16K
angular distribution for (n,n*9)

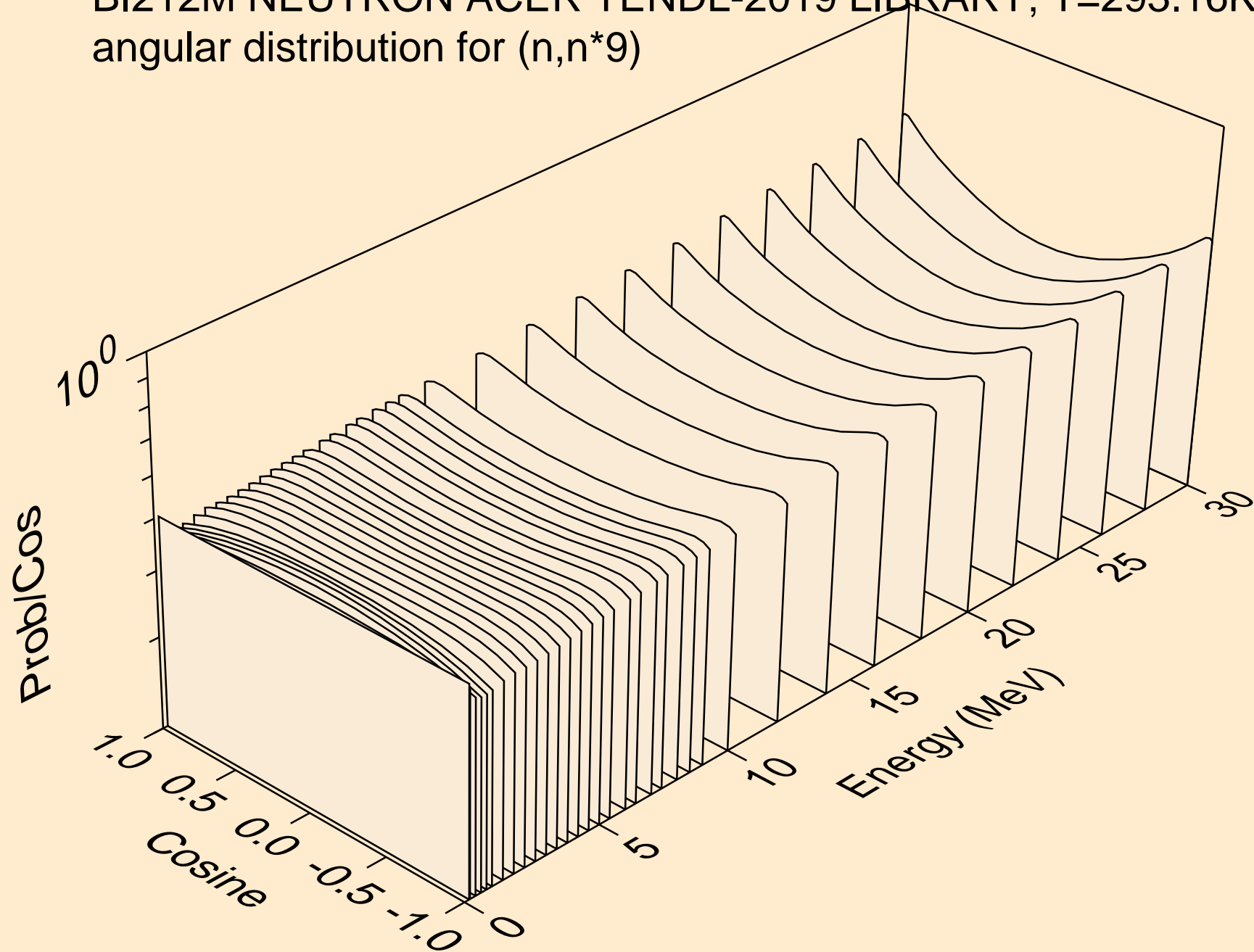

BI212M NEUTRON ACER TENDL-2019 LIBRARY; T=293.16K
angular distribution for (n,n*10)

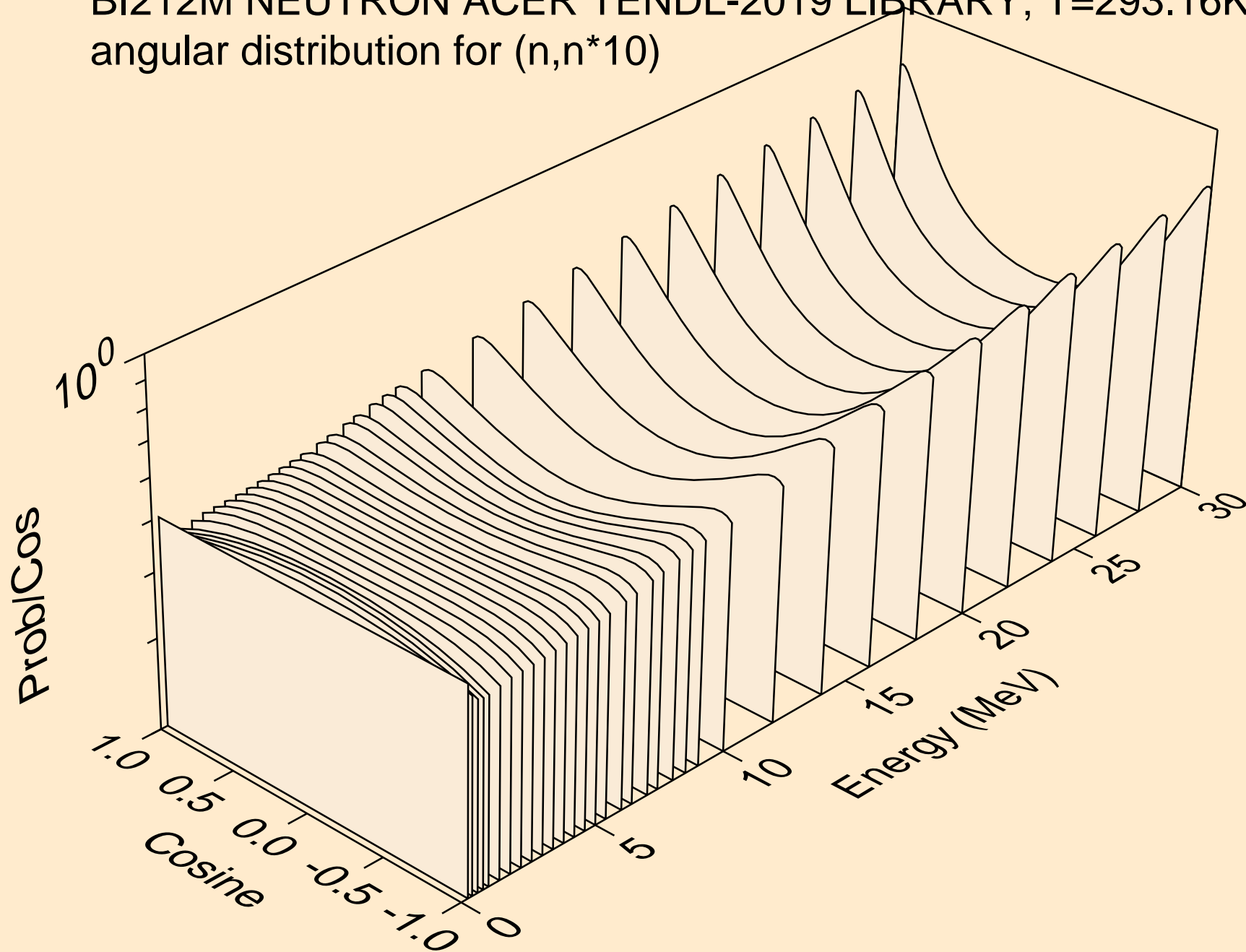

BI212M NEUTRON ACER TENDL-2019 LIBRARY; T=293.16K
angular distribution for (n,n*11)

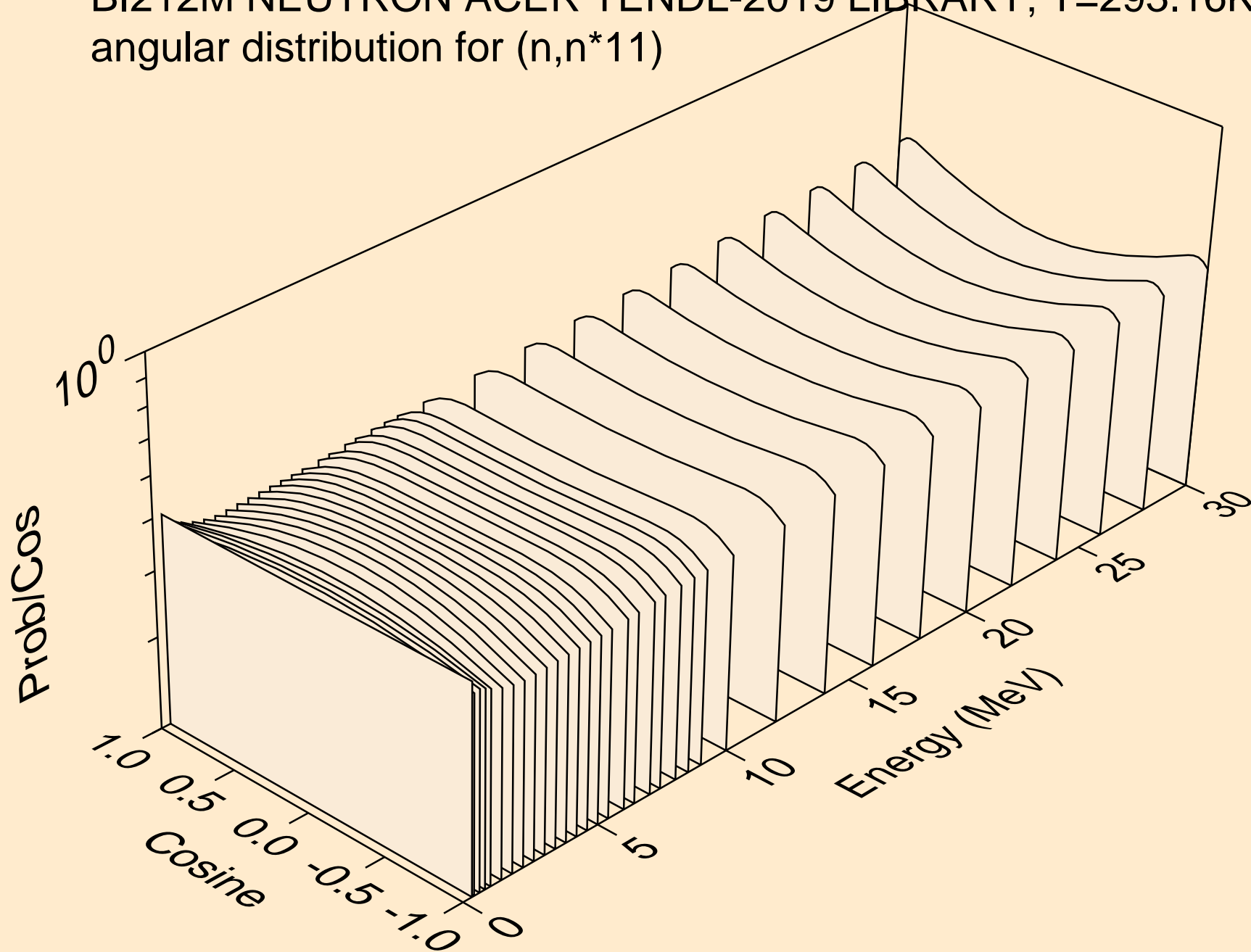

BI212M NEUTRON ACER TENDL-2019 LIBRARY; T=293.16K
angular distribution for (n,n*12)

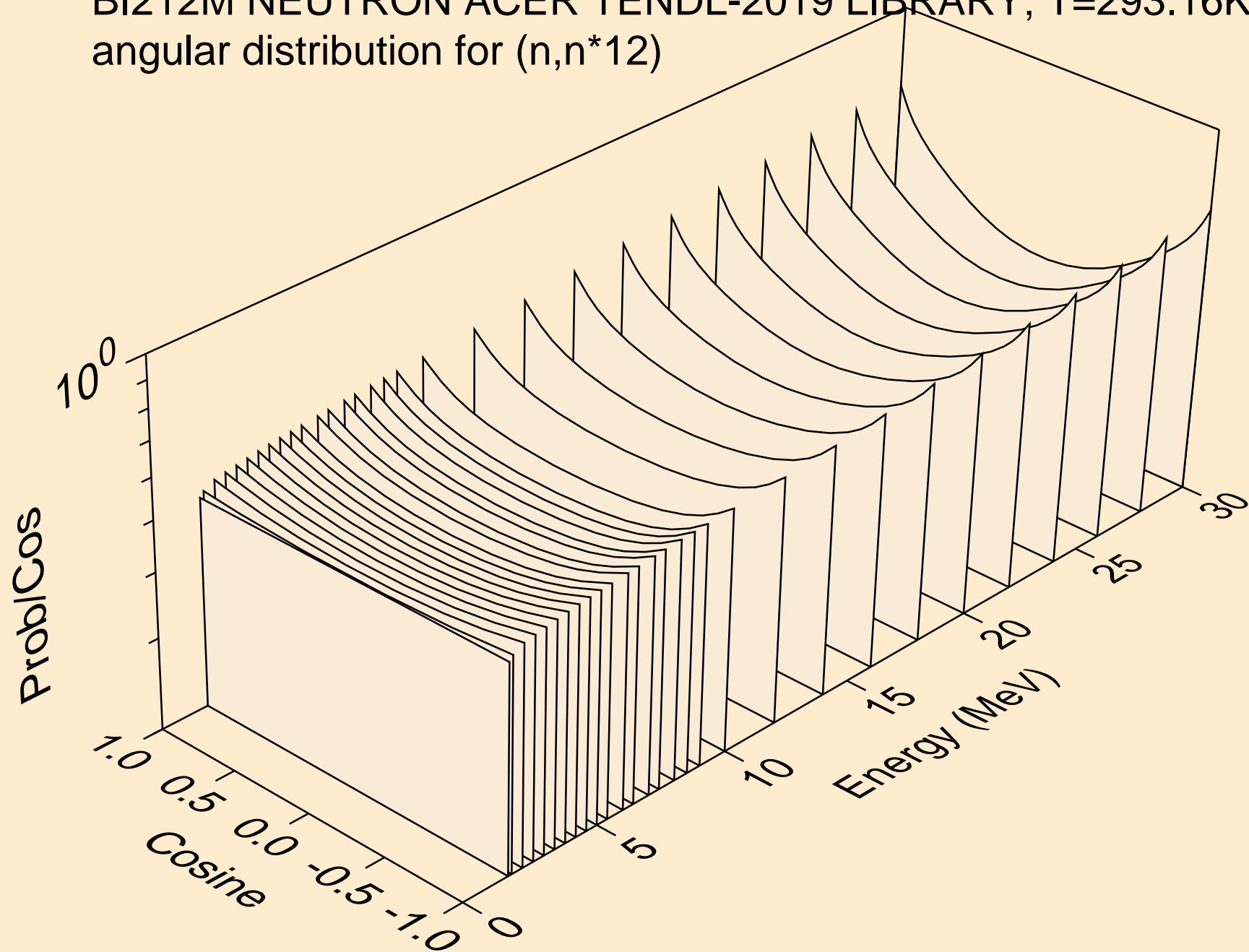

BI212M NEUTRON ACER TENDL-2019 LIBRARY; T=293.16K
angular distribution for (n,n*13)

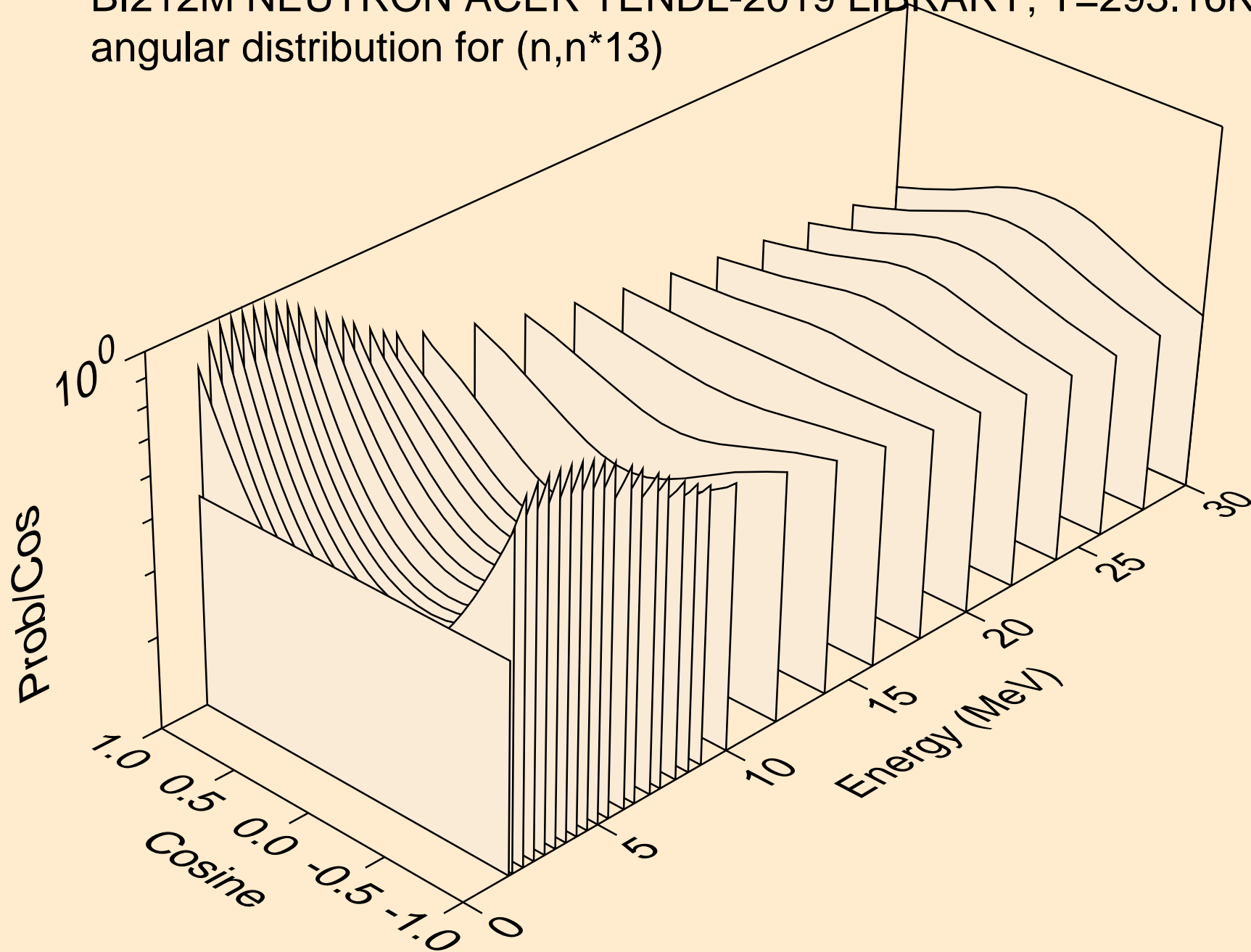

BI212M NEUTRON ACER TENDL-2019 LIBRARY; T=293.16K
angular distribution for (n,n*14)

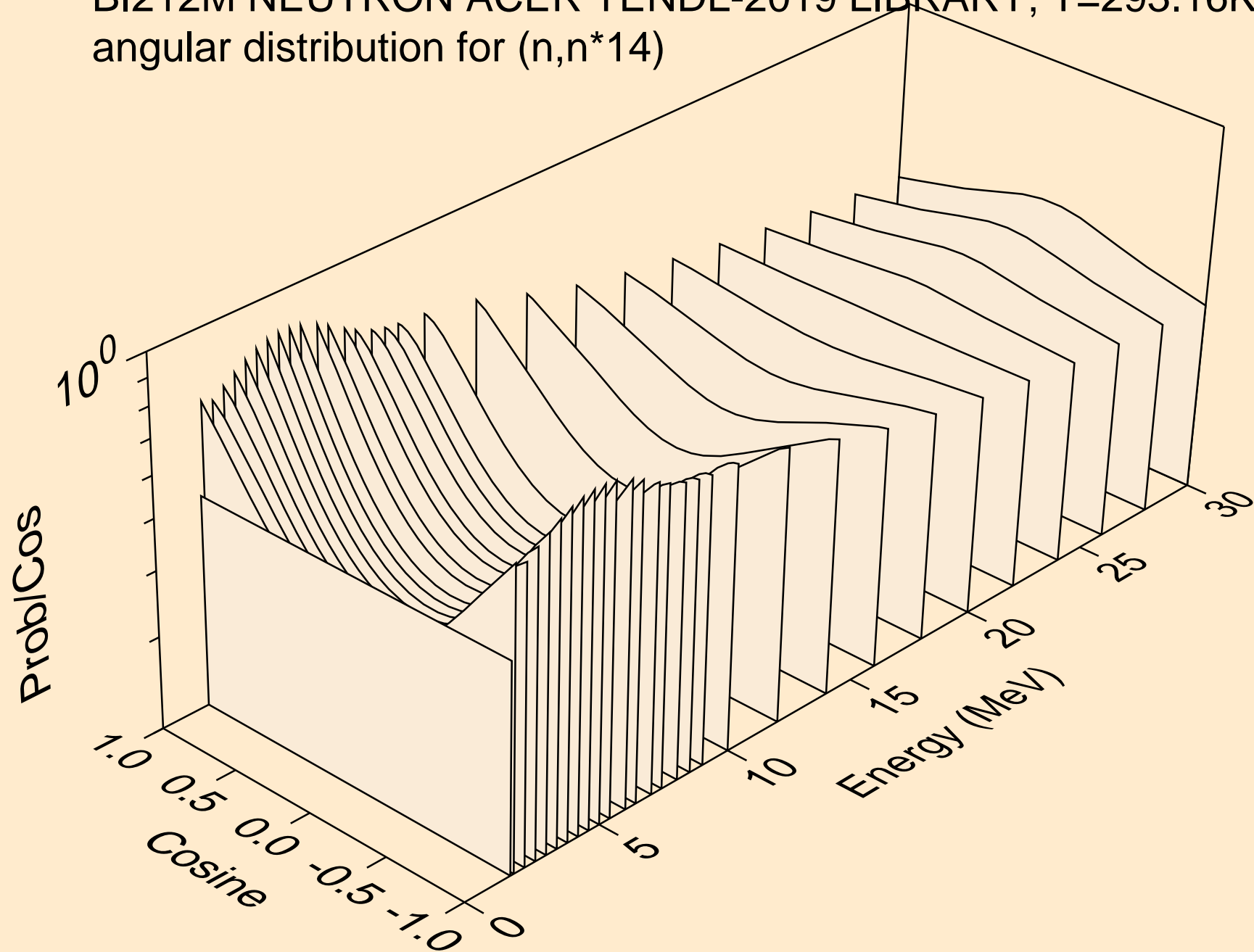

BI212M NEUTRON ACER TENDL-2019 LIBRARY; T=293.16K
angular distribution for (n,n*15)

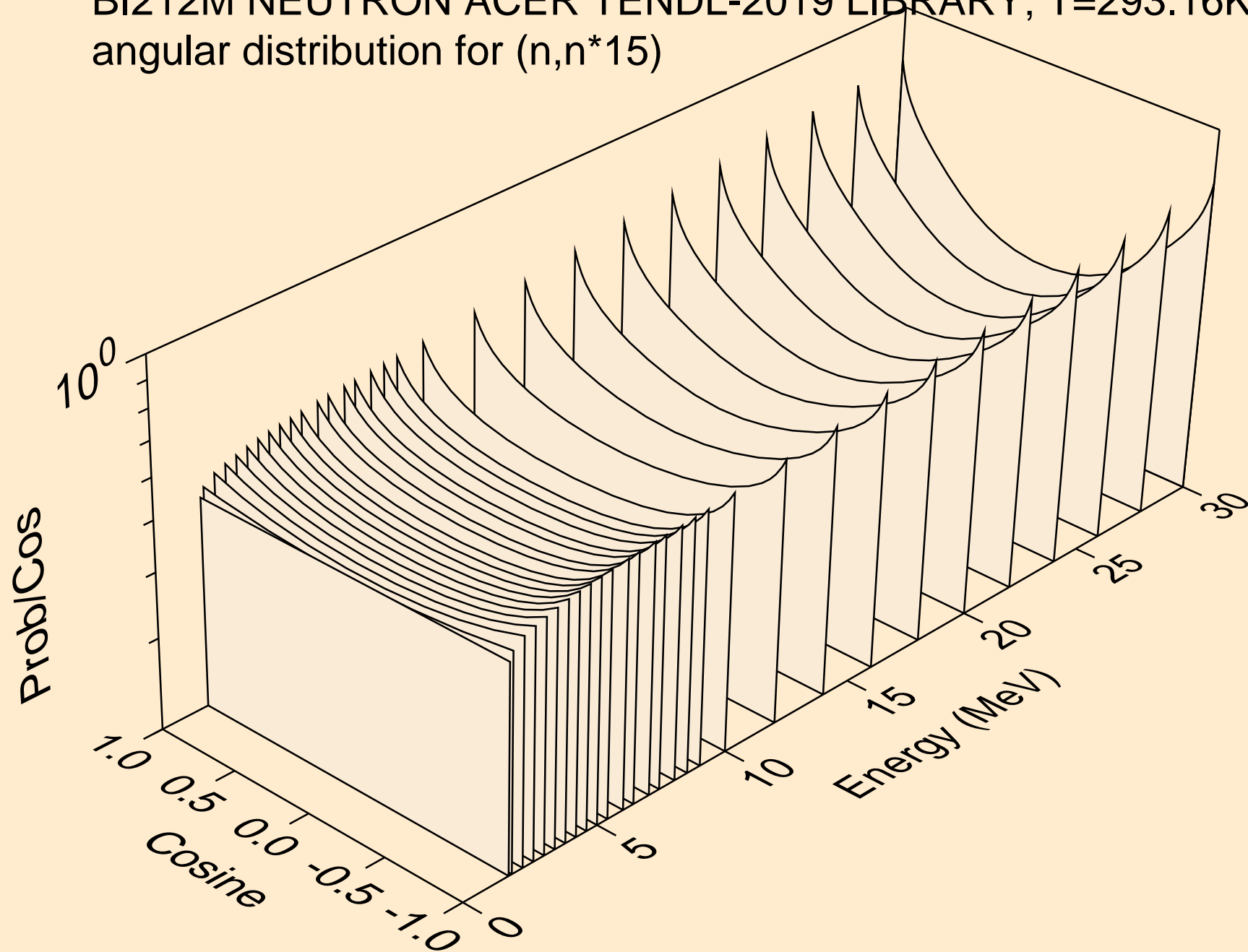

BI212M NEUTRON ACER TENDL-2019 LIBRARY; T=293.16K
angular distribution for (n,n*16)

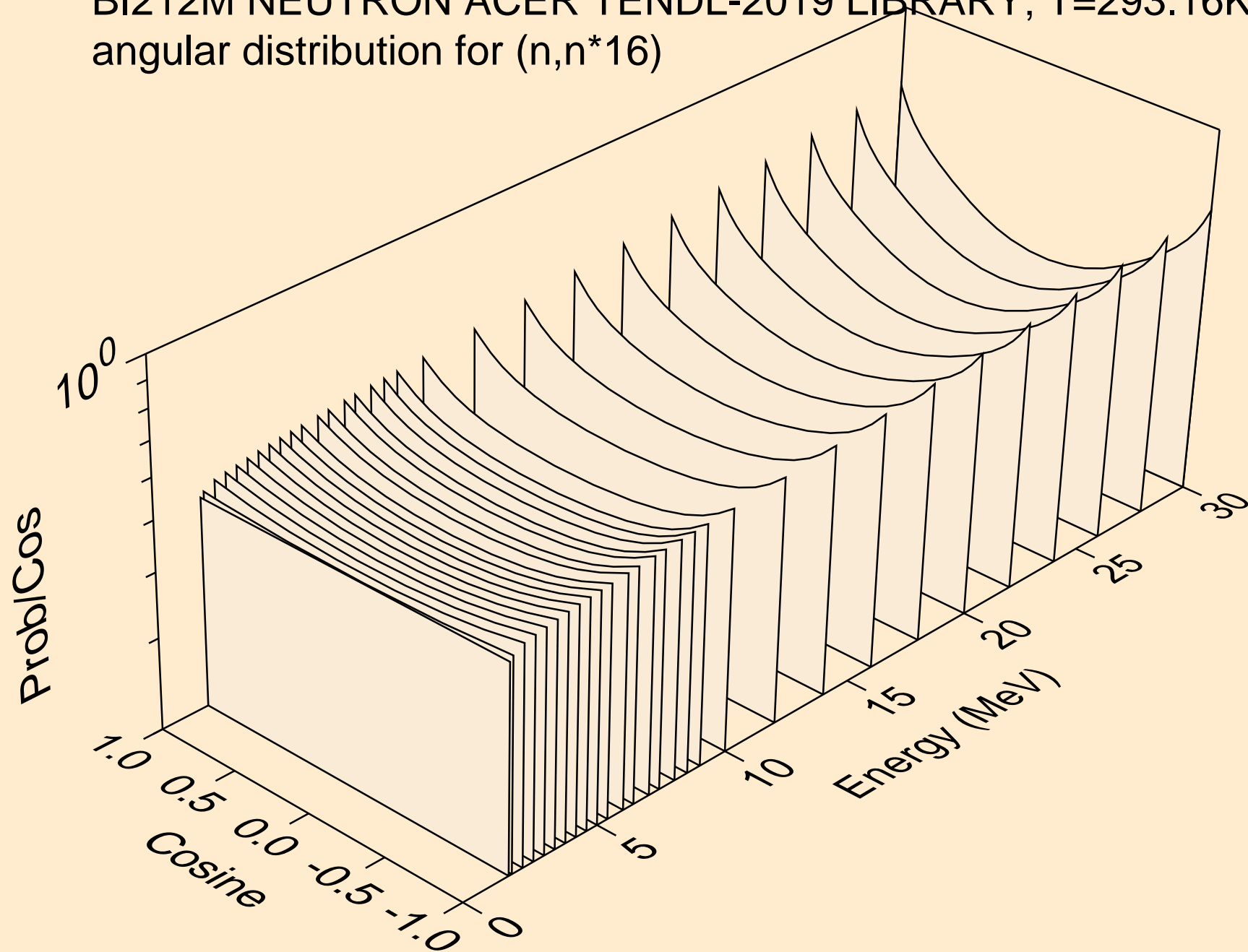

BI212M NEUTRON ACER TENDL-2019 LIBRARY; T=293.16K
angular distribution for (n,n*17)

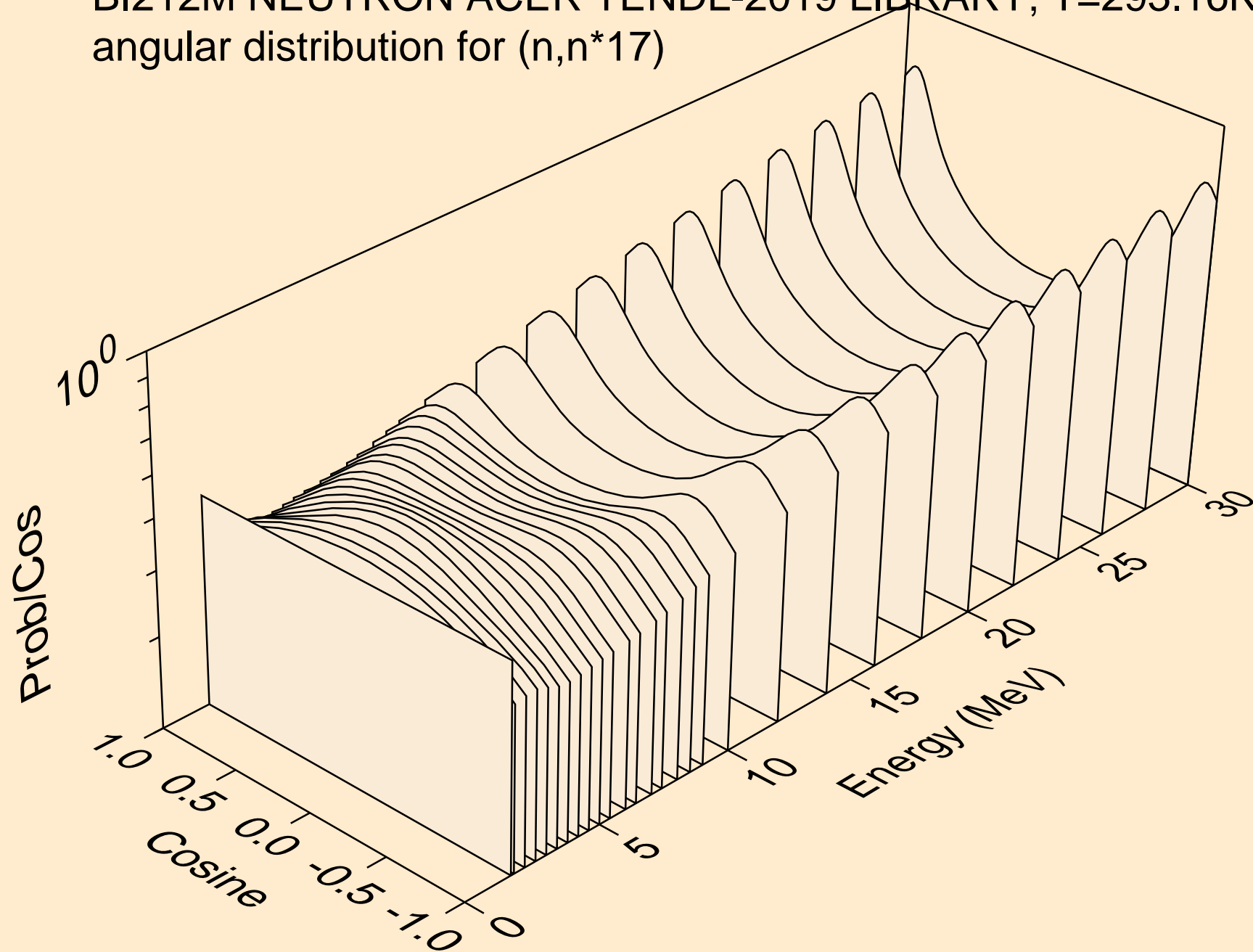

BI212M NEUTRON ACER TENDL-2019 LIBRARY; T=293.16K
angular distribution for (n,n*18)

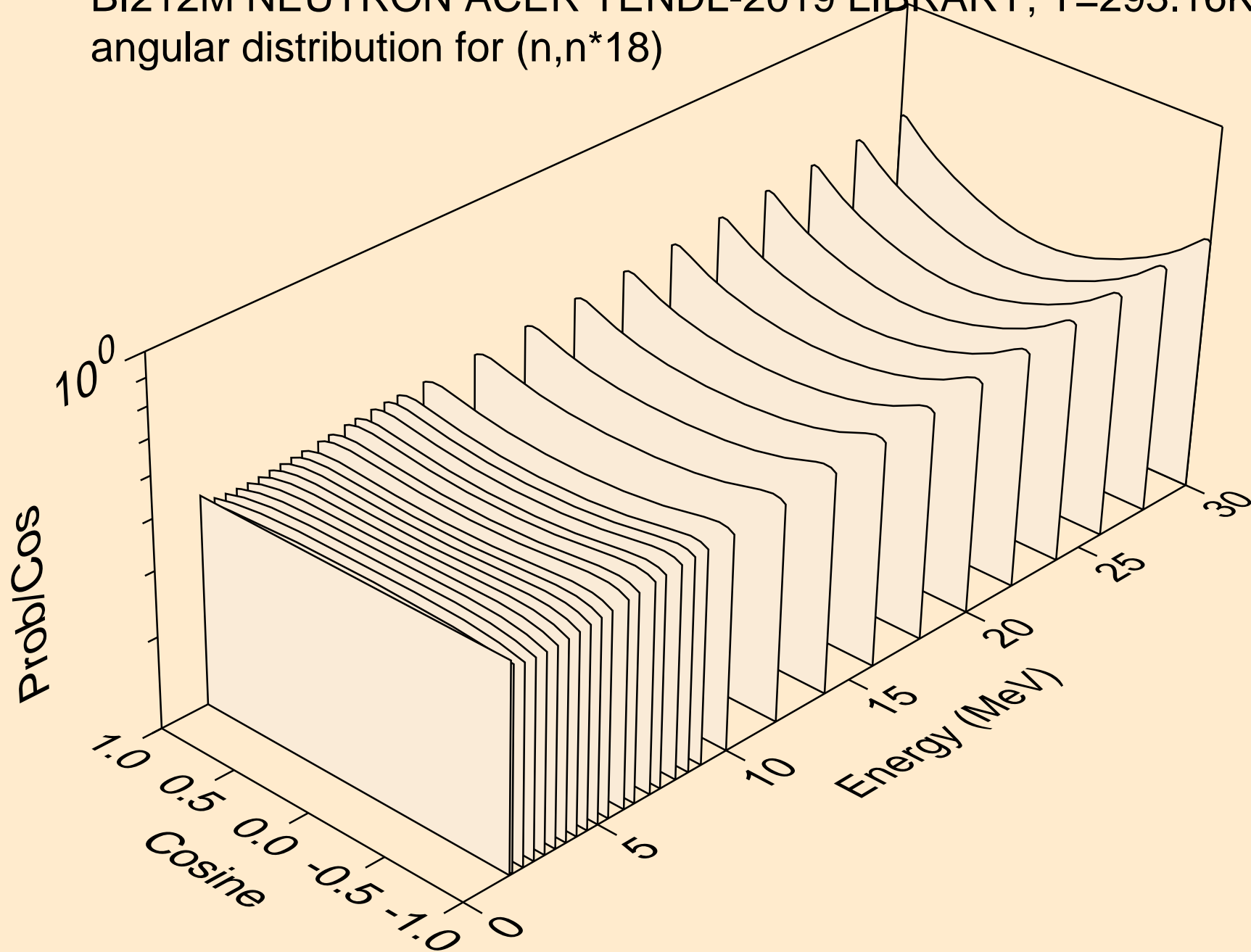

BI212M NEUTRON ACER TENDL-2019 LIBRARY; T=293.16K
angular distribution for (n,n*19)

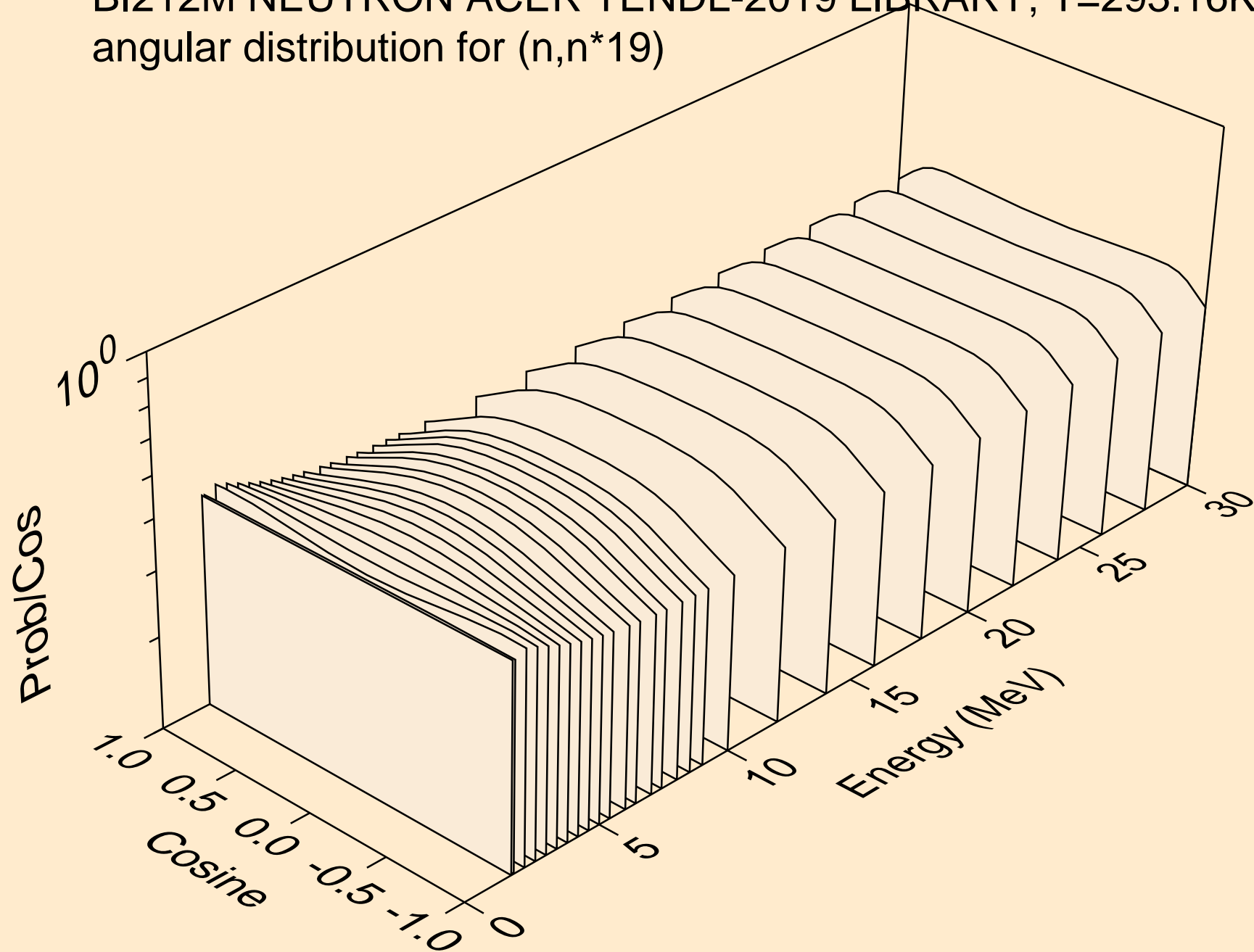

BI212M NEUTRON ACER TENDL-2019 LIBRARY; T=293.16K
angular distribution for (n,n*20)

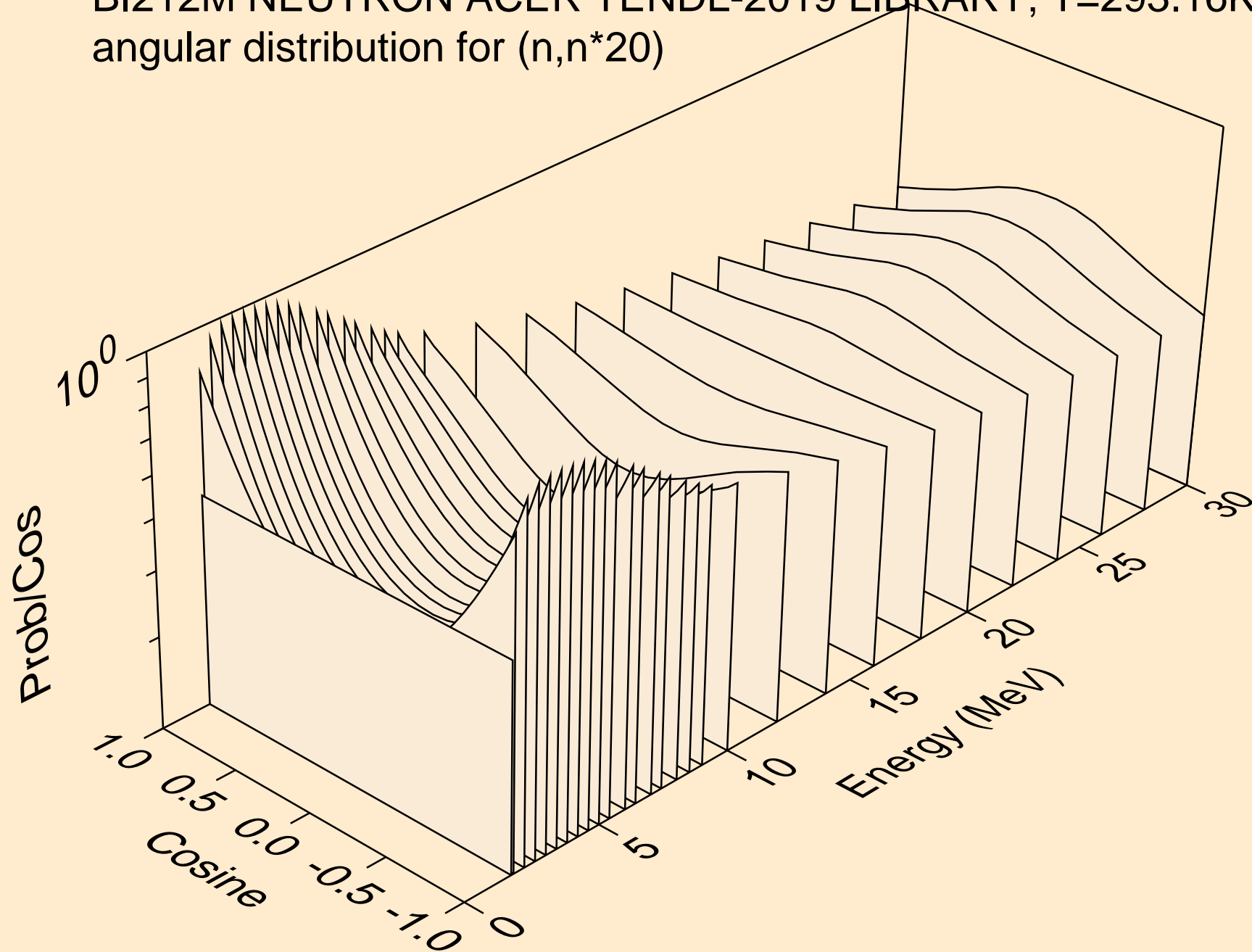

BI212M NEUTRON ACER TENDL-2019 LIBRARY; T=293.16K
angular distribution for (n,n*21)

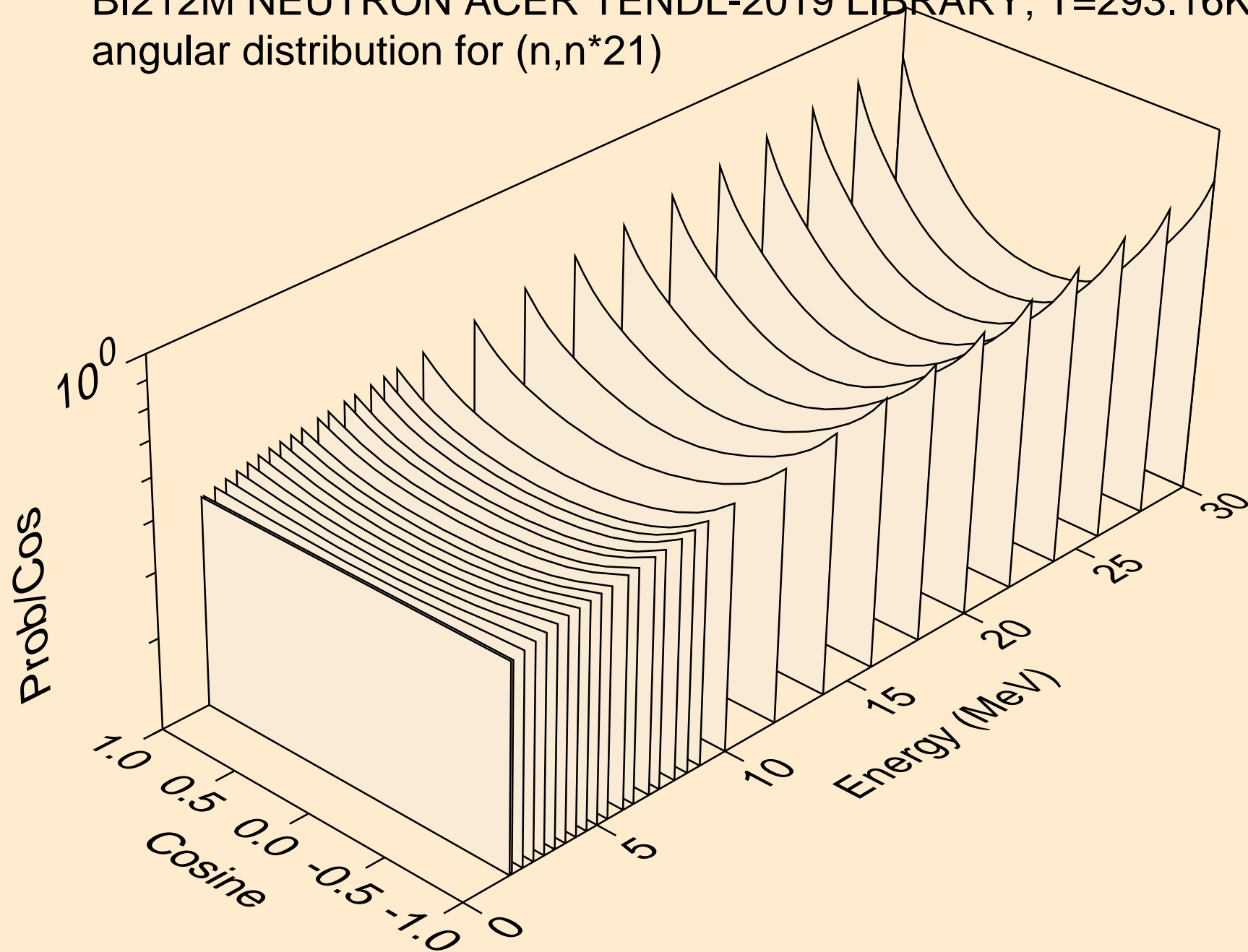

BI212M NEUTRON ACER TENDL-2019 LIBRARY; T=293.16K
angular distribution for (n,n*22)

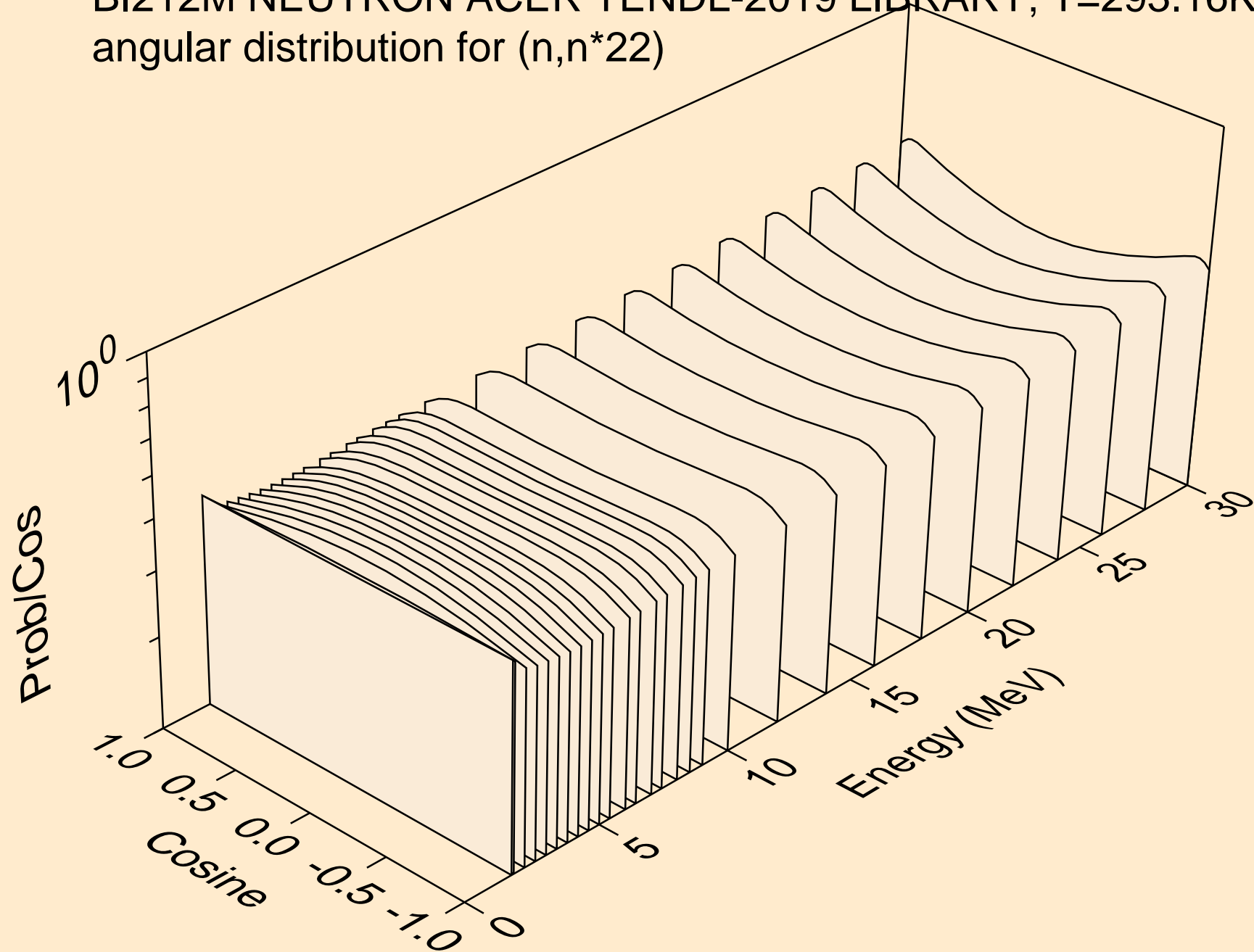

BI212M NEUTRON ACER TENDL-2019 LIBRARY; T=293.16K
angular distribution for (n,n*23)

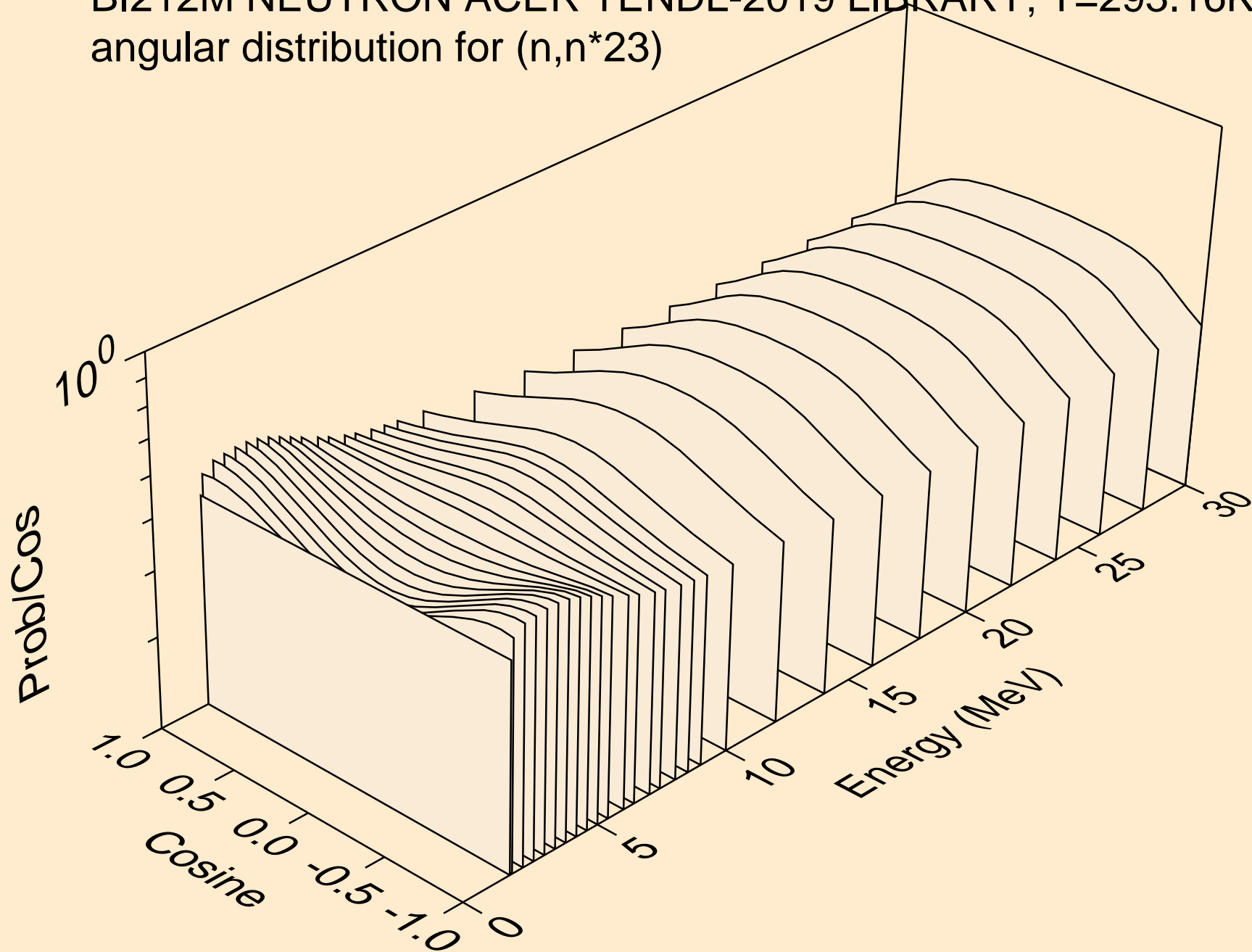

BI212M NEUTRON ACER TENDL-2019 LIBRARY; T=293.16K
angular distribution for (n,n*24)

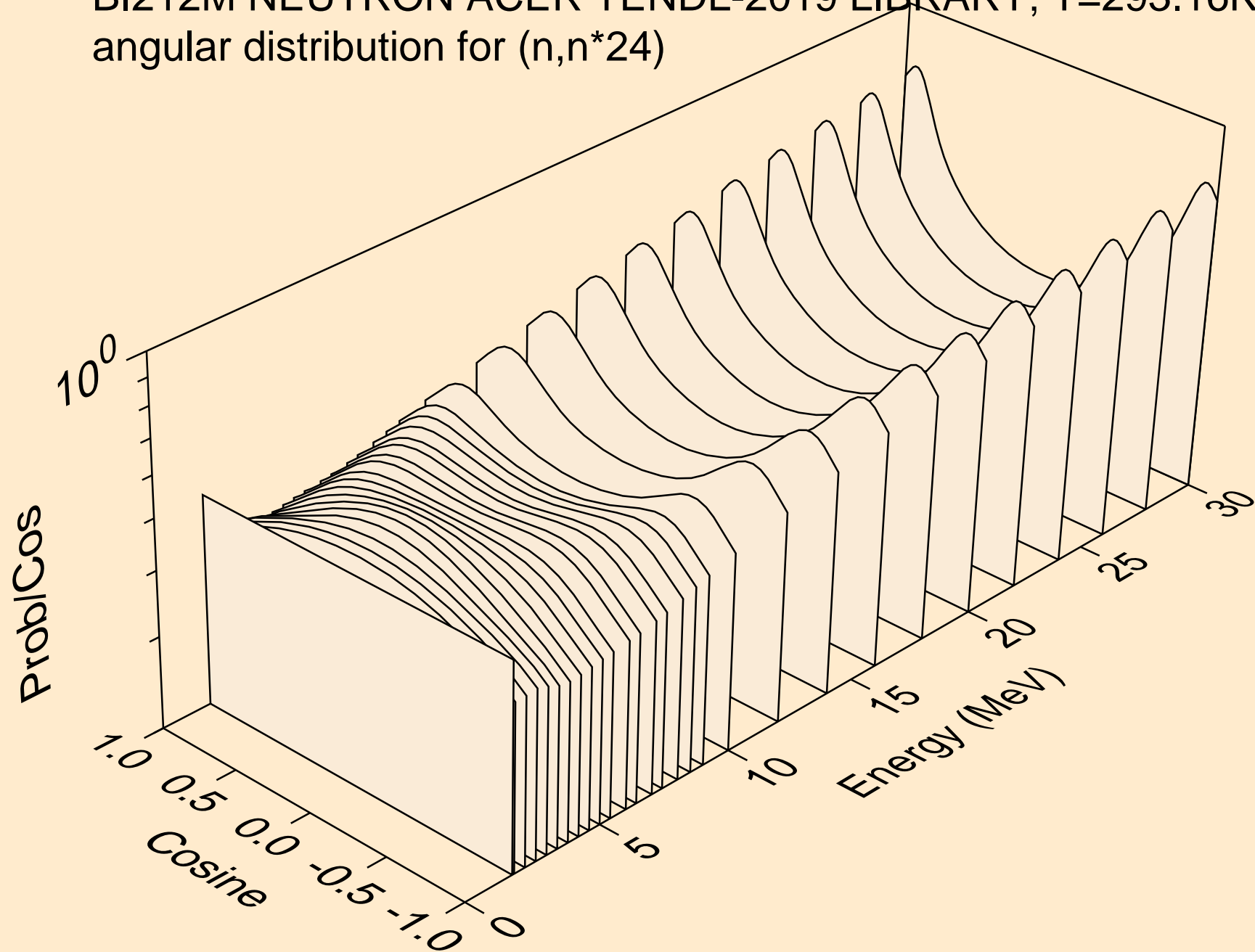

BI212M NEUTRON ACER TENDL-2019 LIBRARY; T=293.16K
angular distribution for (n,n*25)

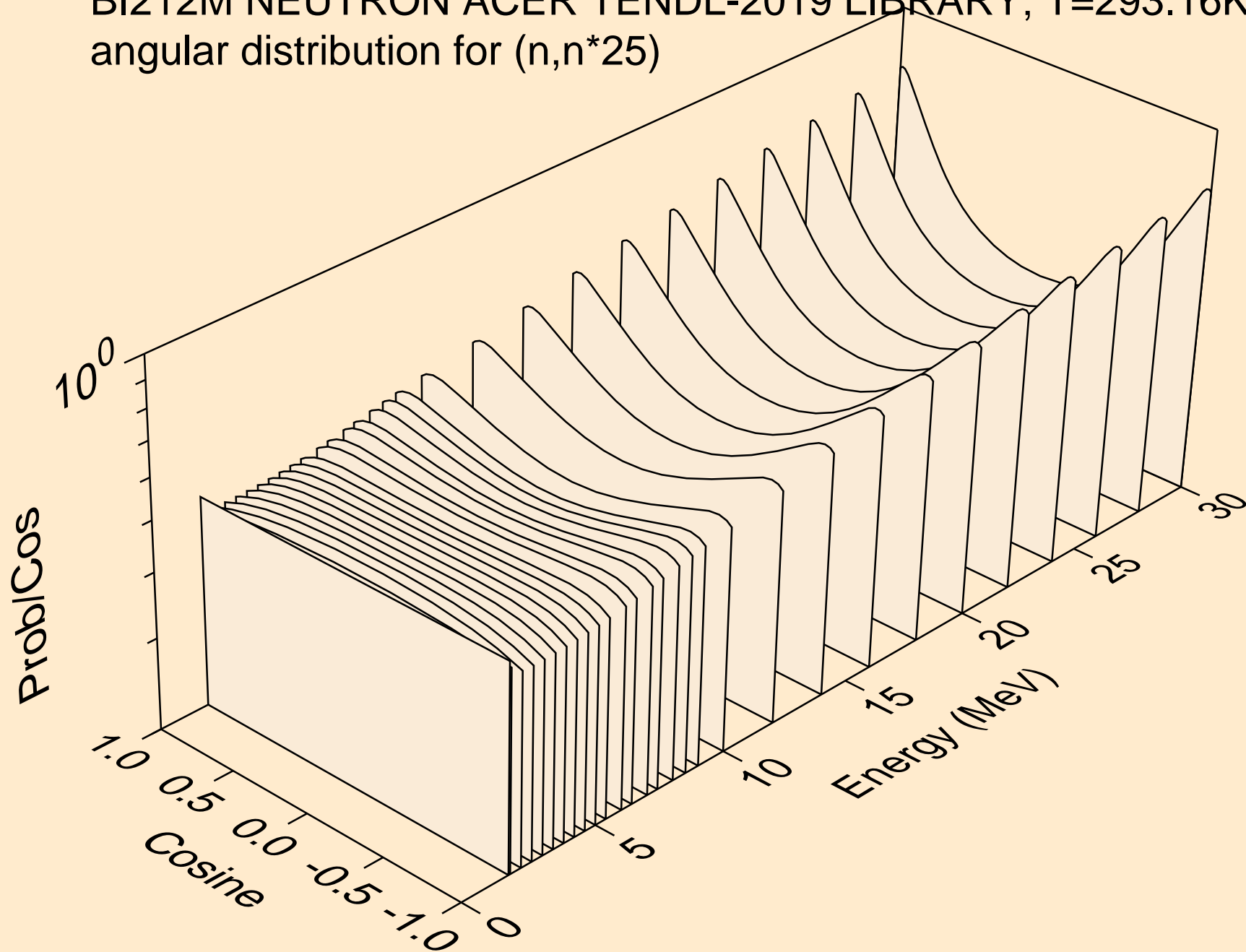

BI212M NEUTRON ACER TENDL-2019 LIBRARY; T=293.16K
angular distribution for (n,n*26)

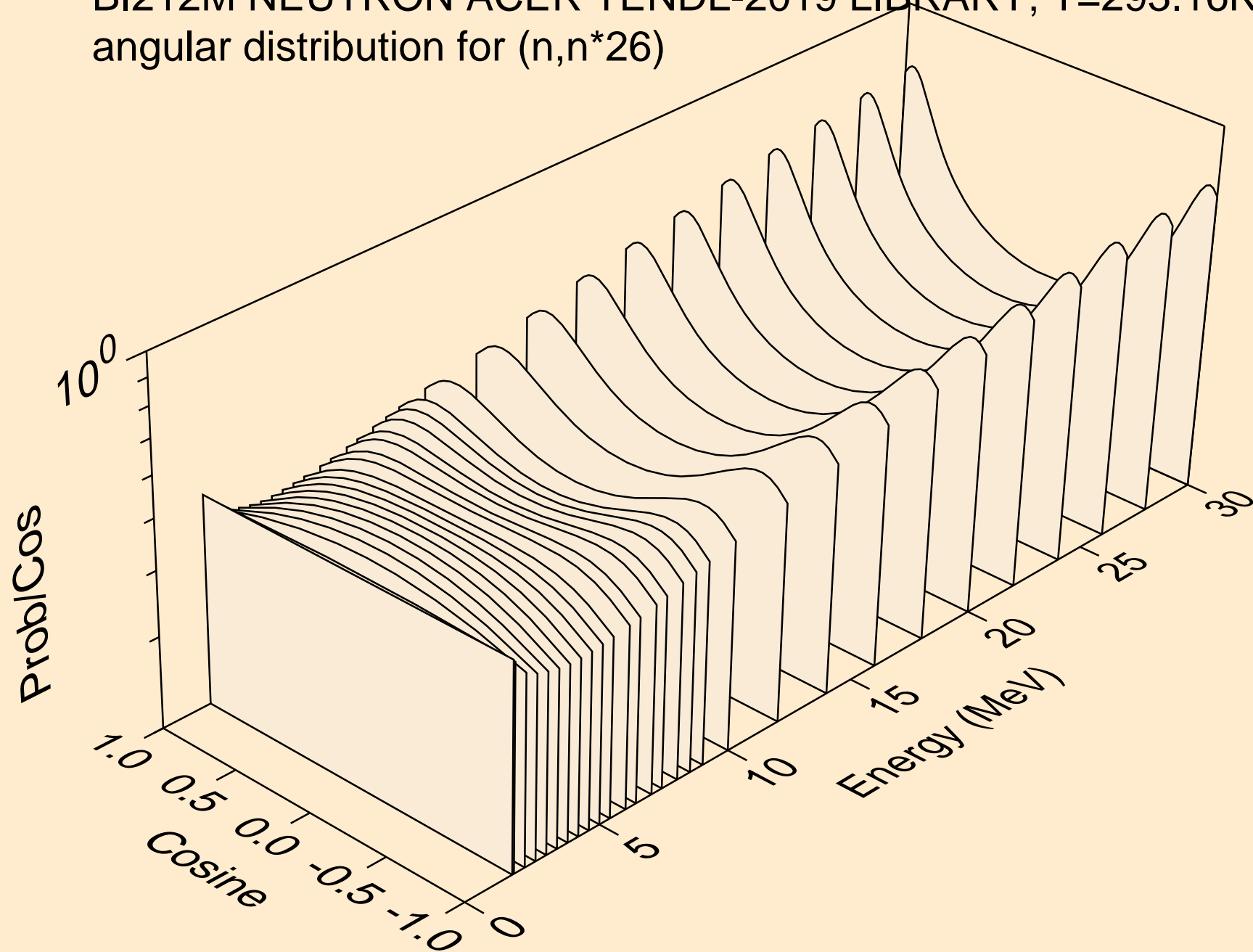

BI212M NEUTRON ACER TENDL-2019 LIBRARY; T=293.16K
angular distribution for (n,n*27)

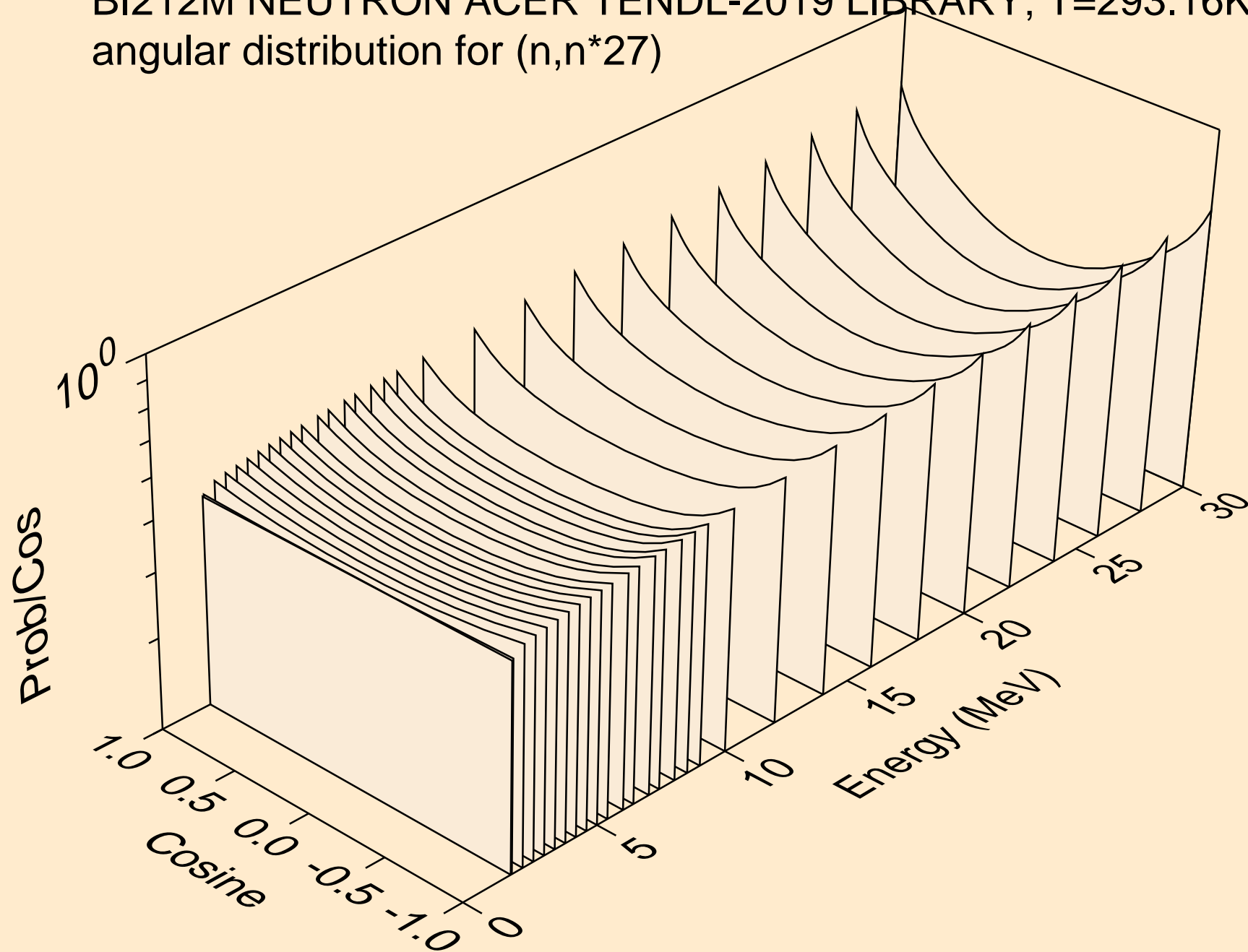

BI212M NEUTRON ACER TENDL-2019 LIBRARY; T=293.16K
angular distribution for (n,n*28)

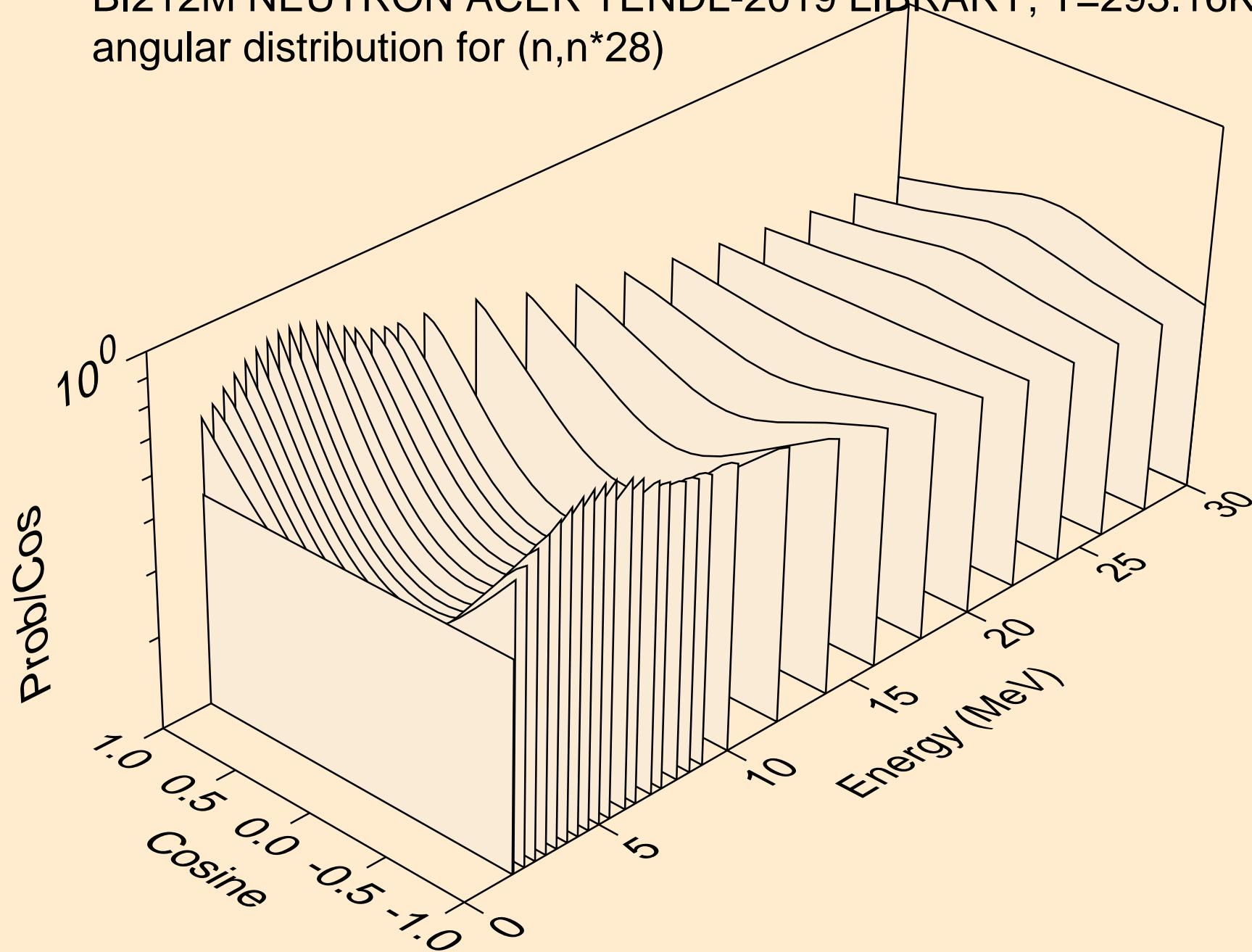

BI212M NEUTRON ACER TENDL-2019 LIBRARY; T=293.16K
angular distribution for (n,n*29)

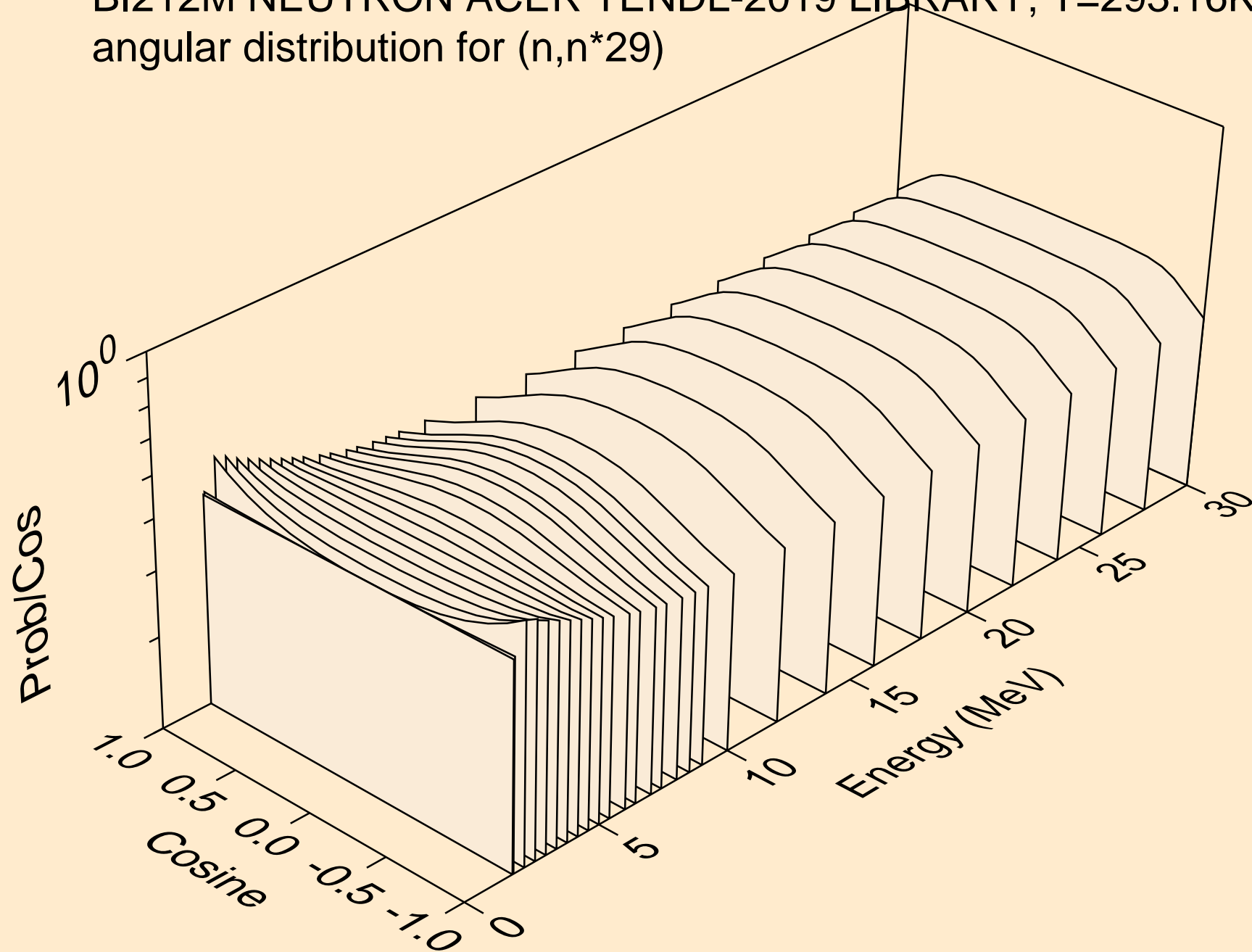

BI212M NEUTRON ACER TENDL-2019 LIBRARY; T=293.16K
angular distribution for (n,n*30)

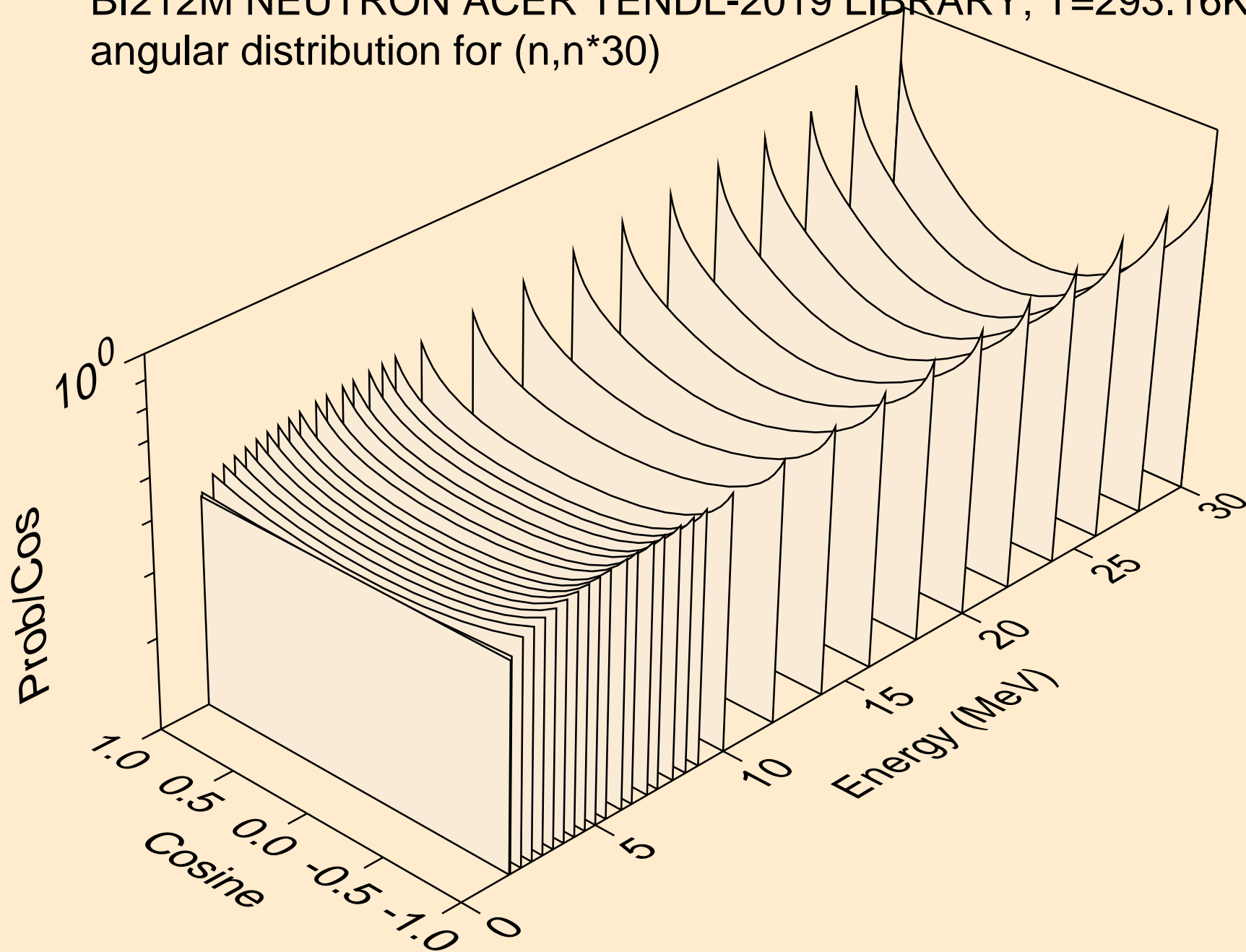

BI212M NEUTRON ACER TENDL-2019 LIBRARY; T=293.16K
Neutron emission for (n,x)

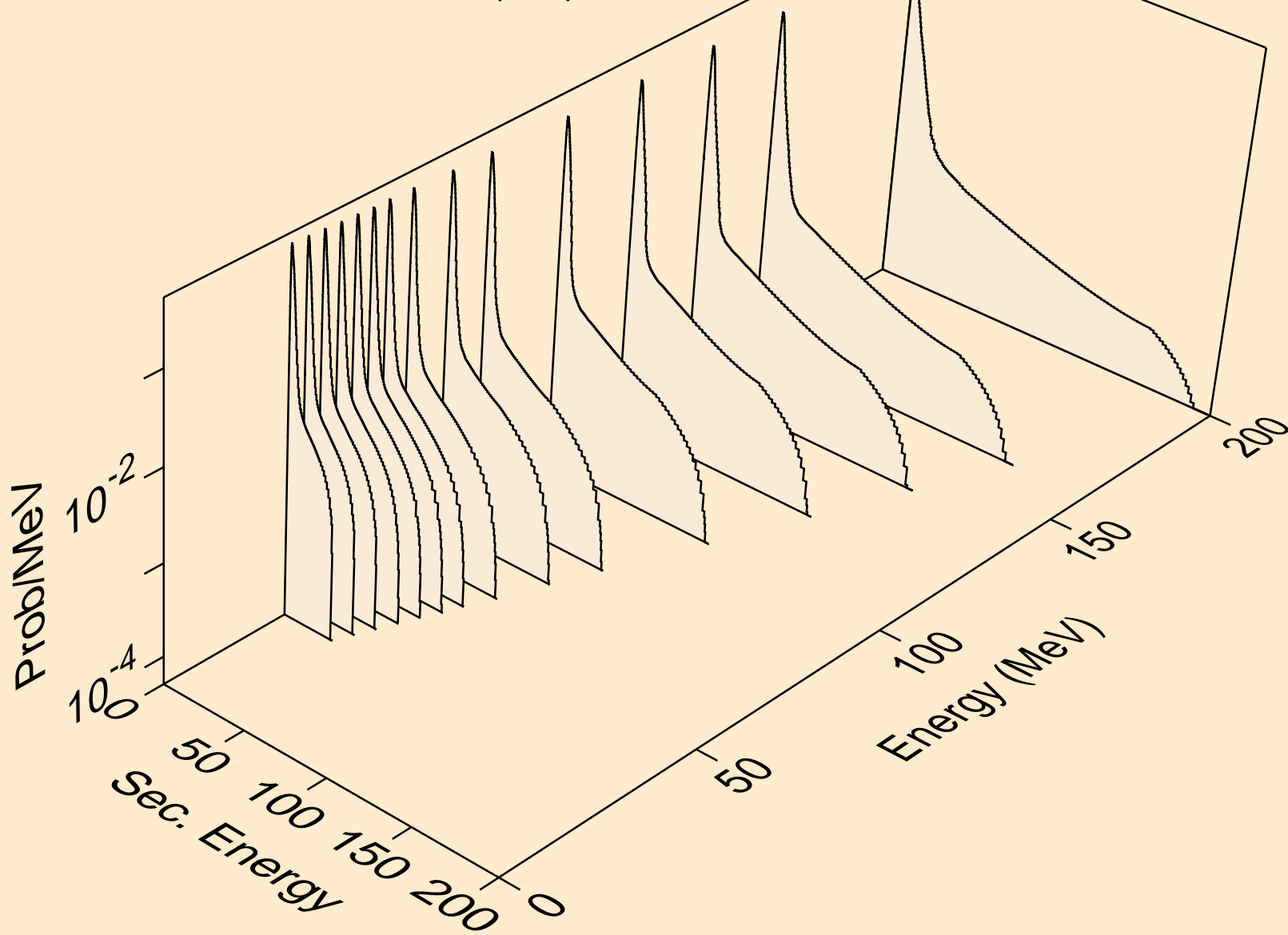

BI212M NEUTRON ACER TENDL-2019 LIBRARY; T=293.16K
Neutron emission for (n,2nd)

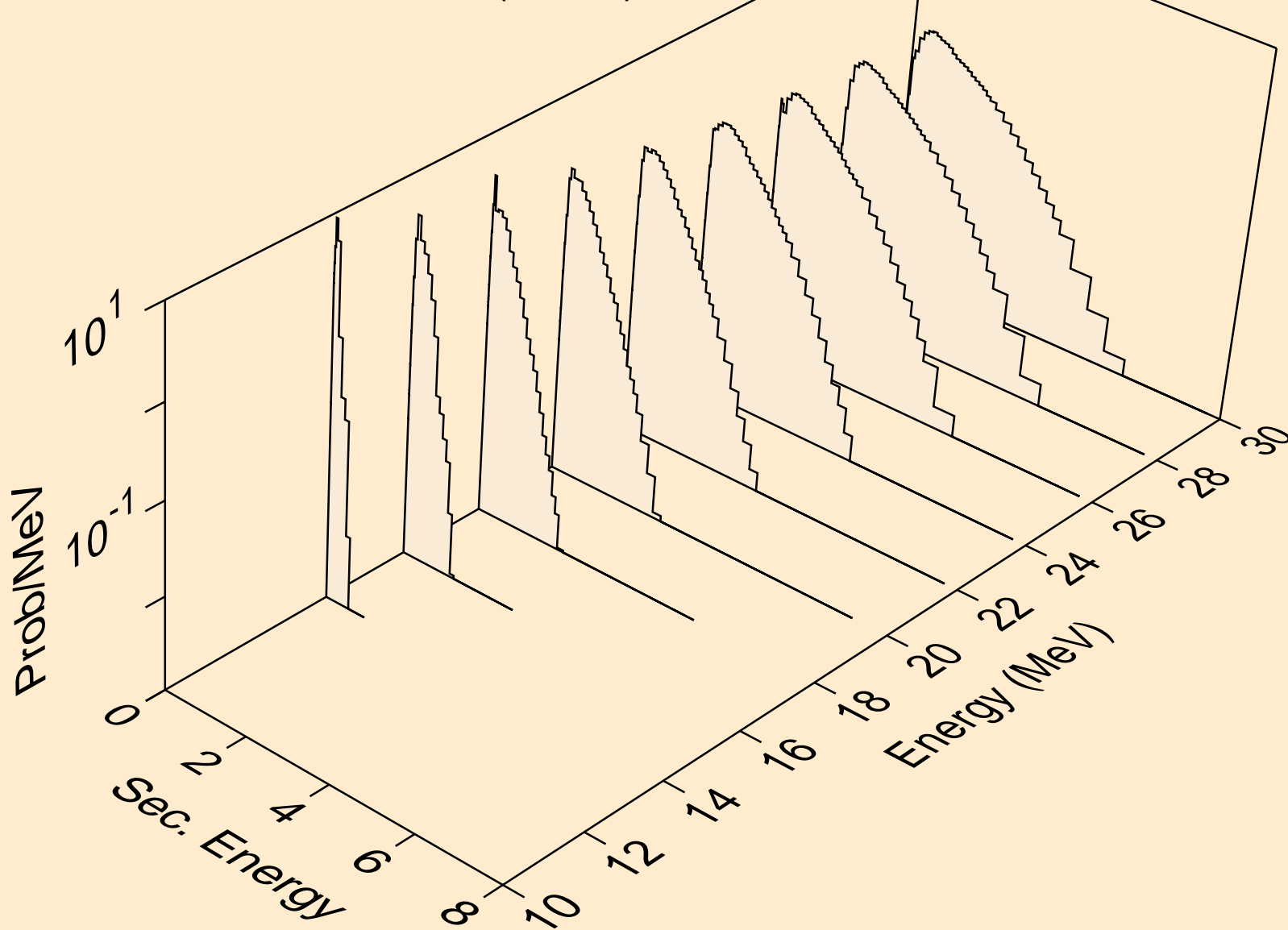

BI212M NEUTRON ACER TENDL-2019 LIBRARY; T=293.16K
Neutron emission for (n,2n)

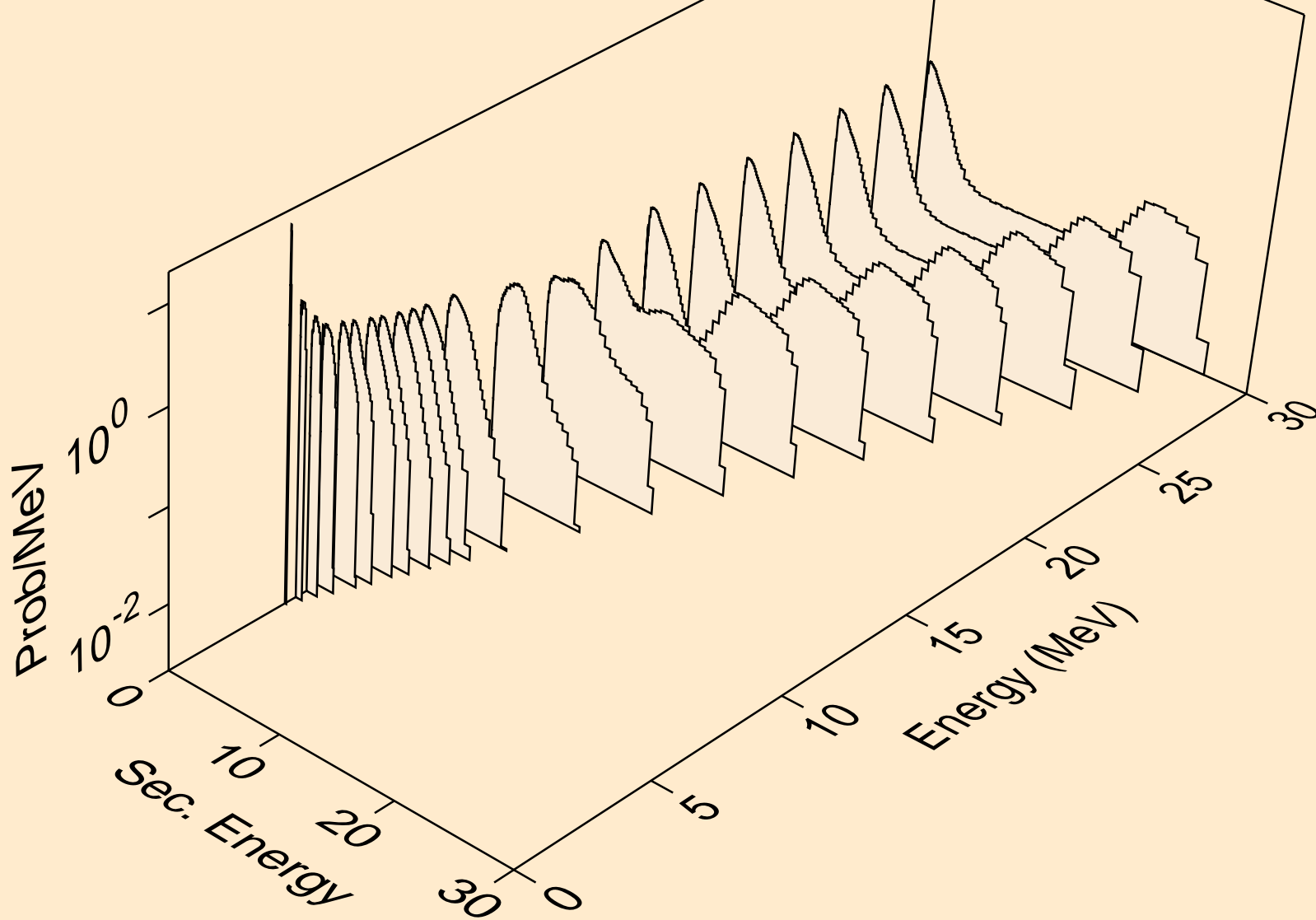

BI212M NEUTRON ACER TENDL-2019 LIBRARY; T=293.16K
Neutron emission for (n,3n)

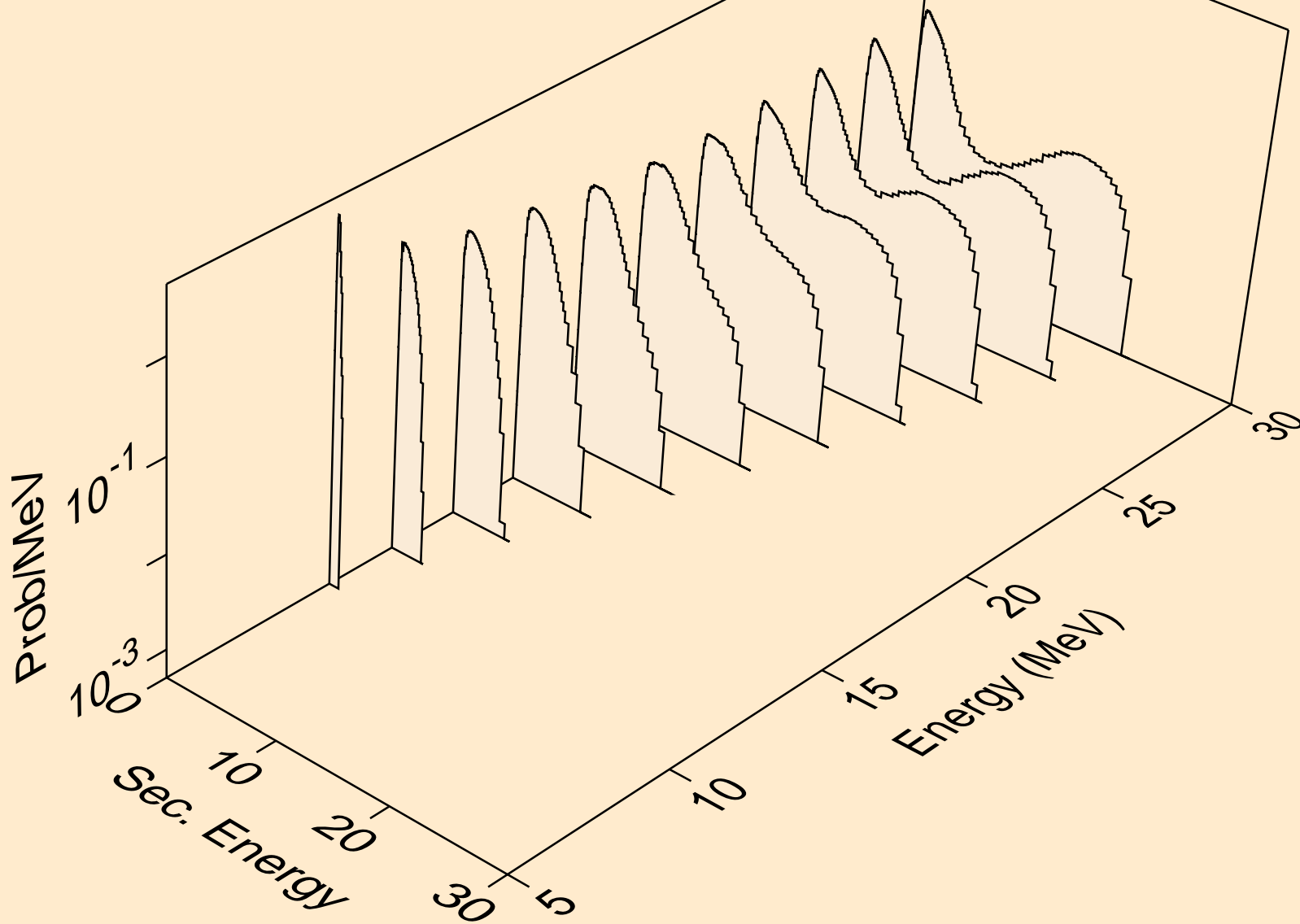

BI212M NEUTRON ACER TENDL-2019 LIBRARY; T=293.16K
Neutron emission for (n,n*)a

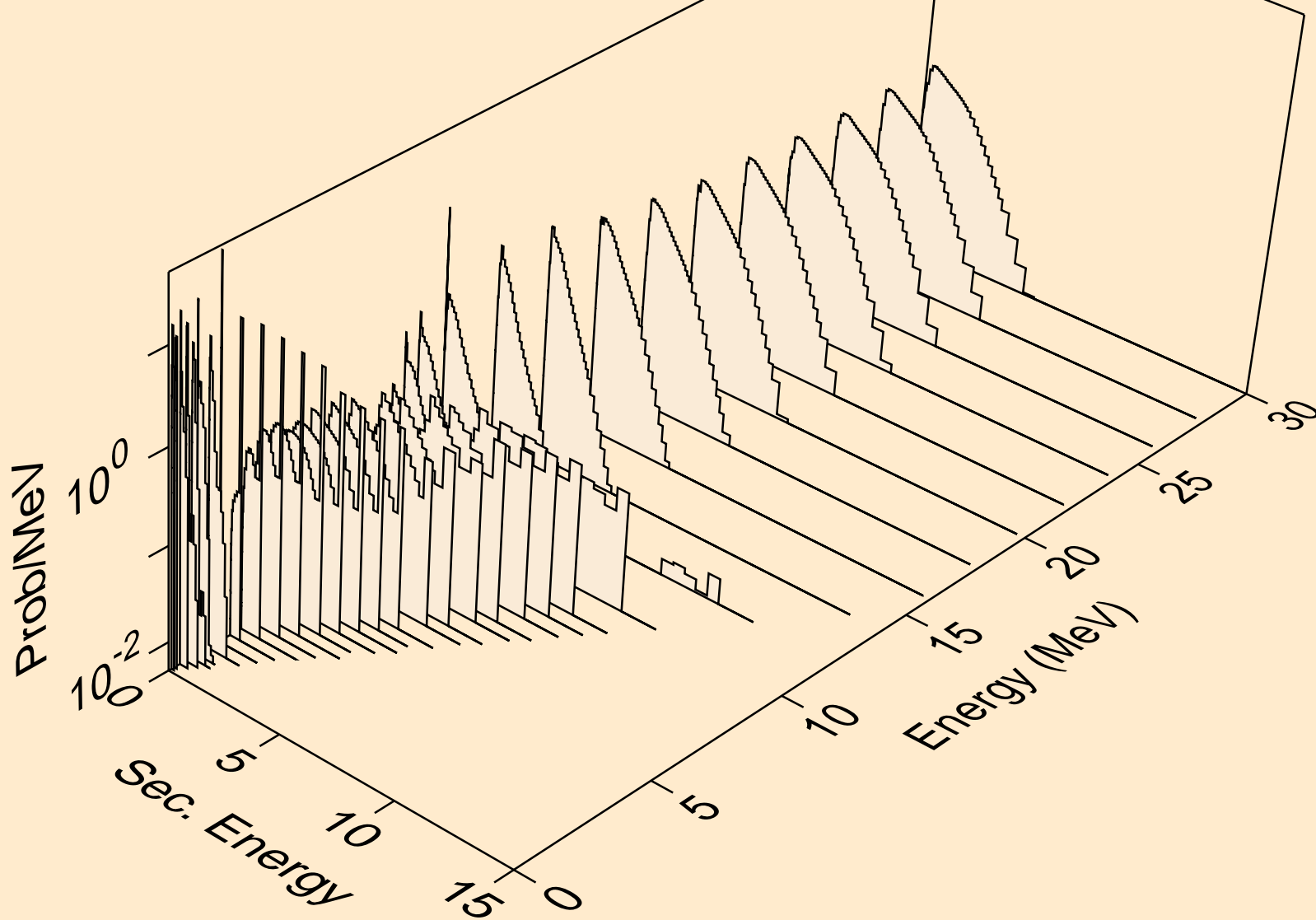

BI212M NEUTRON ACER TENDL-2019 LIBRARY; T=293.16K
Neutron emission for (n,2n)a

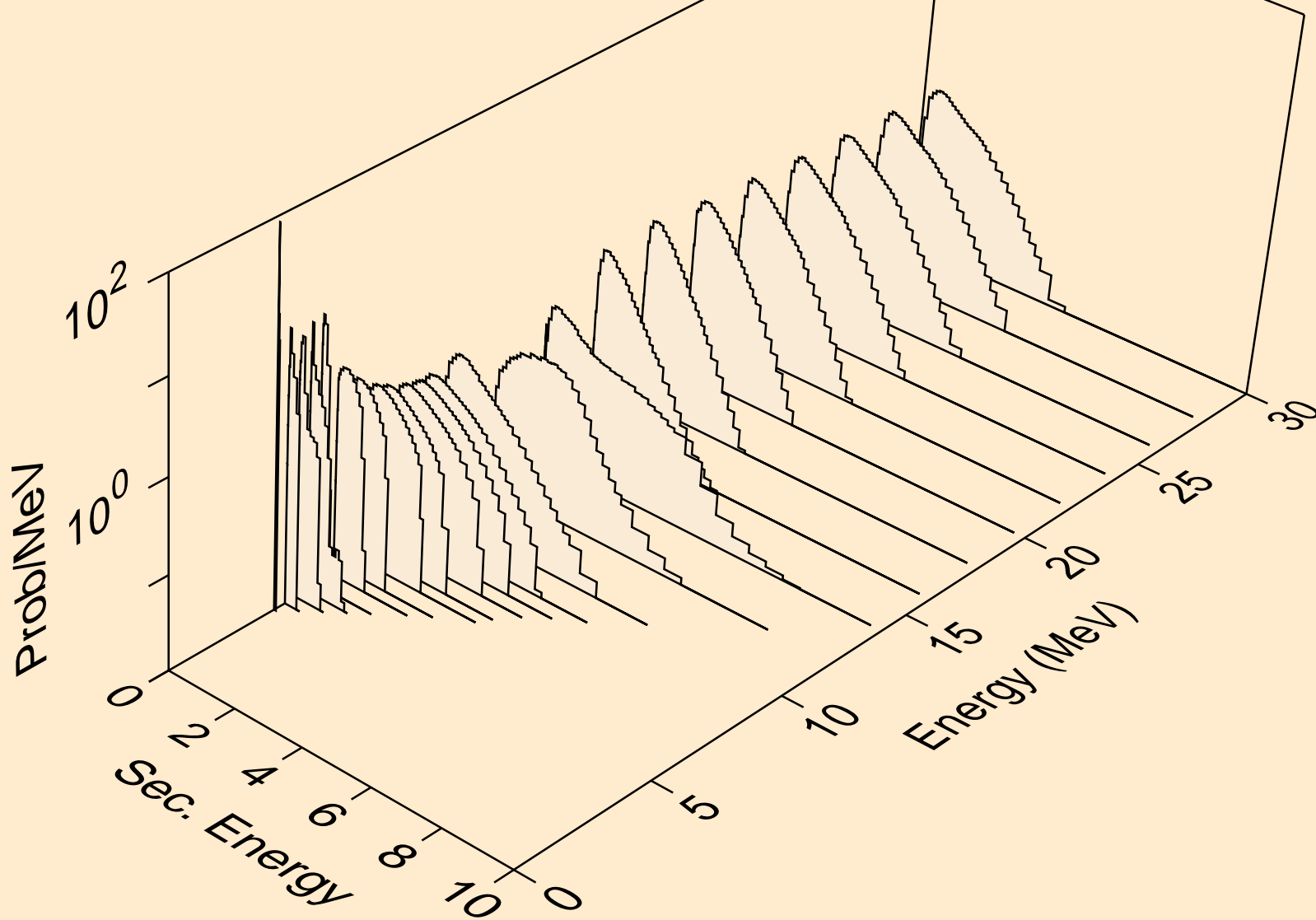

BI212M NEUTRON ACER TENDL-2019 LIBRARY; T=293.16K
Neutron emission for (n,3n)a

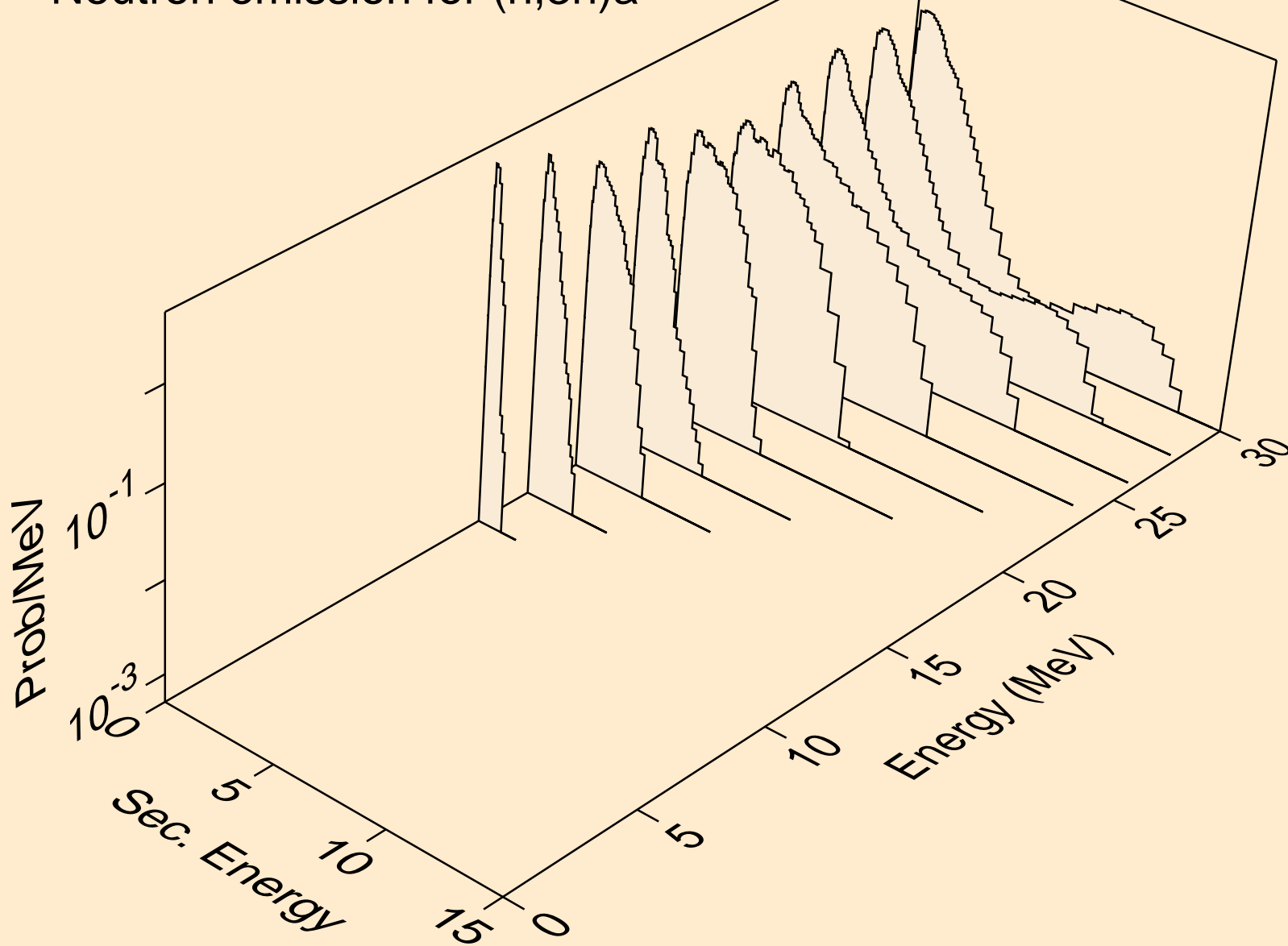

BI212M NEUTRON ACER TENDL-2019 LIBRARY; T=293.16K
Neutron emission for (n,n*)p

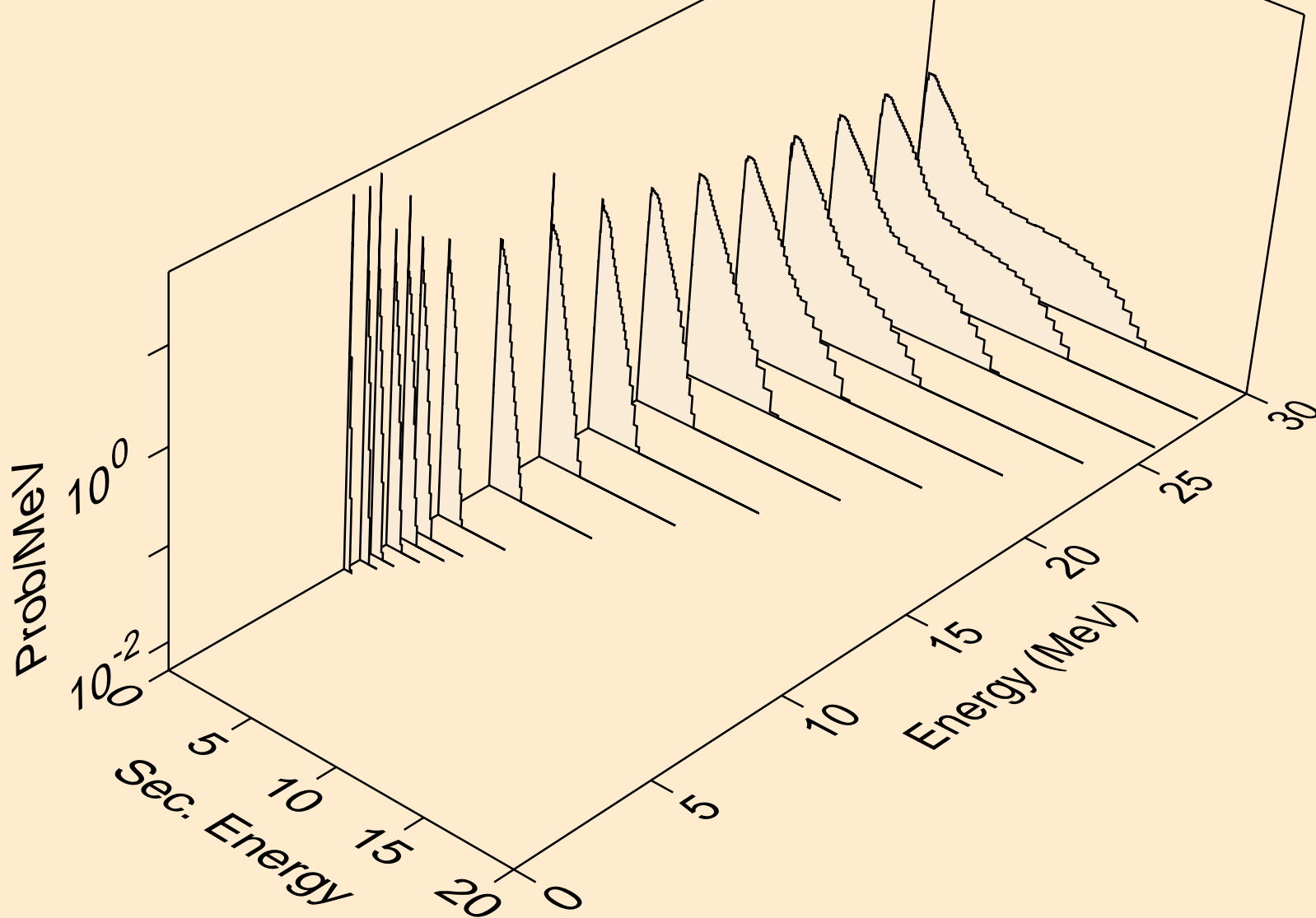

BI212M NEUTRON ACER TENDL-2019 LIBRARY; T=293.16K
Neutron emission for (n,n*)2a

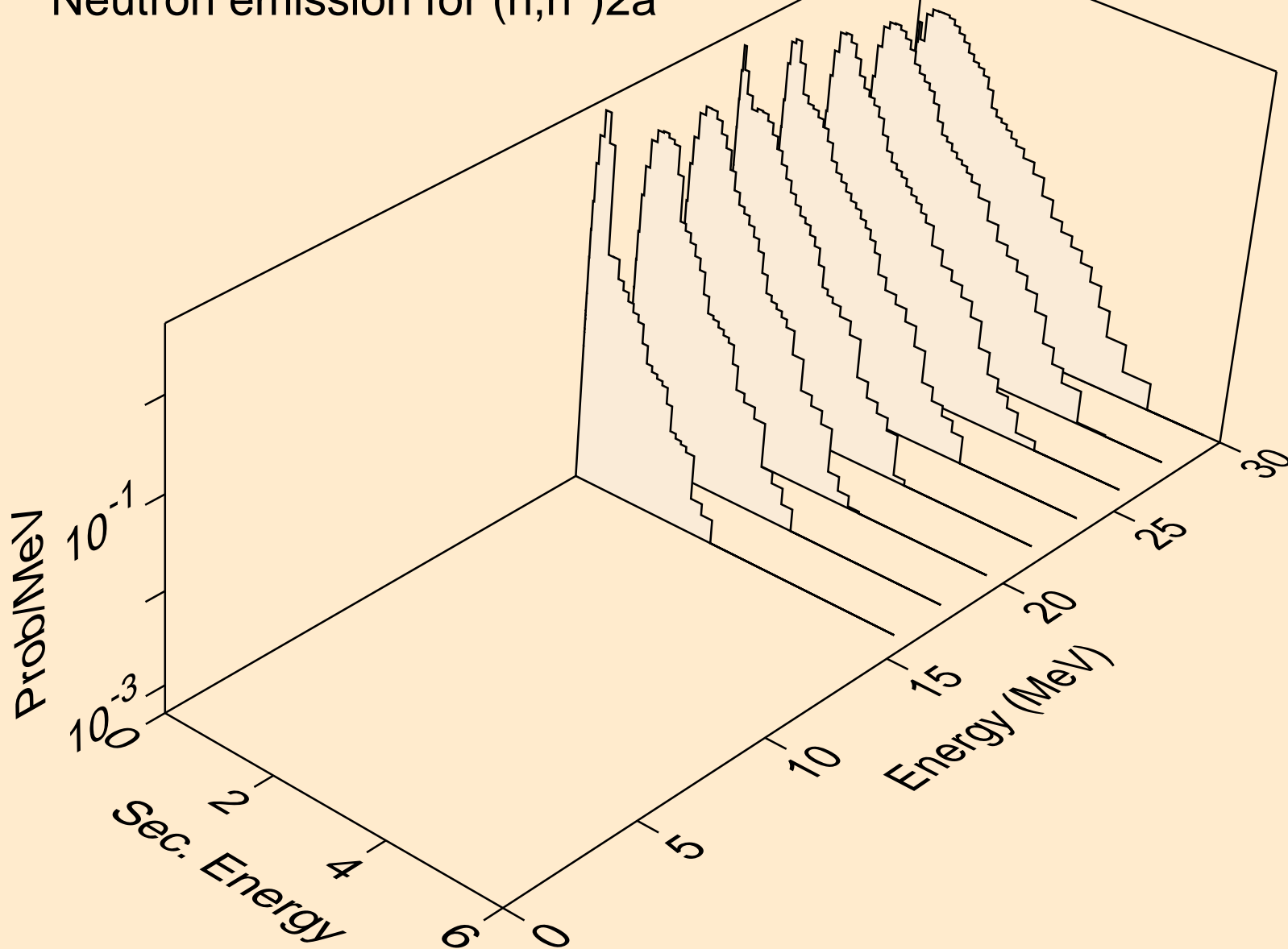

BI212M NEUTRON ACER TENDL-2019 LIBRARY; T=293.16K
Neutron emission for (n,n*)d

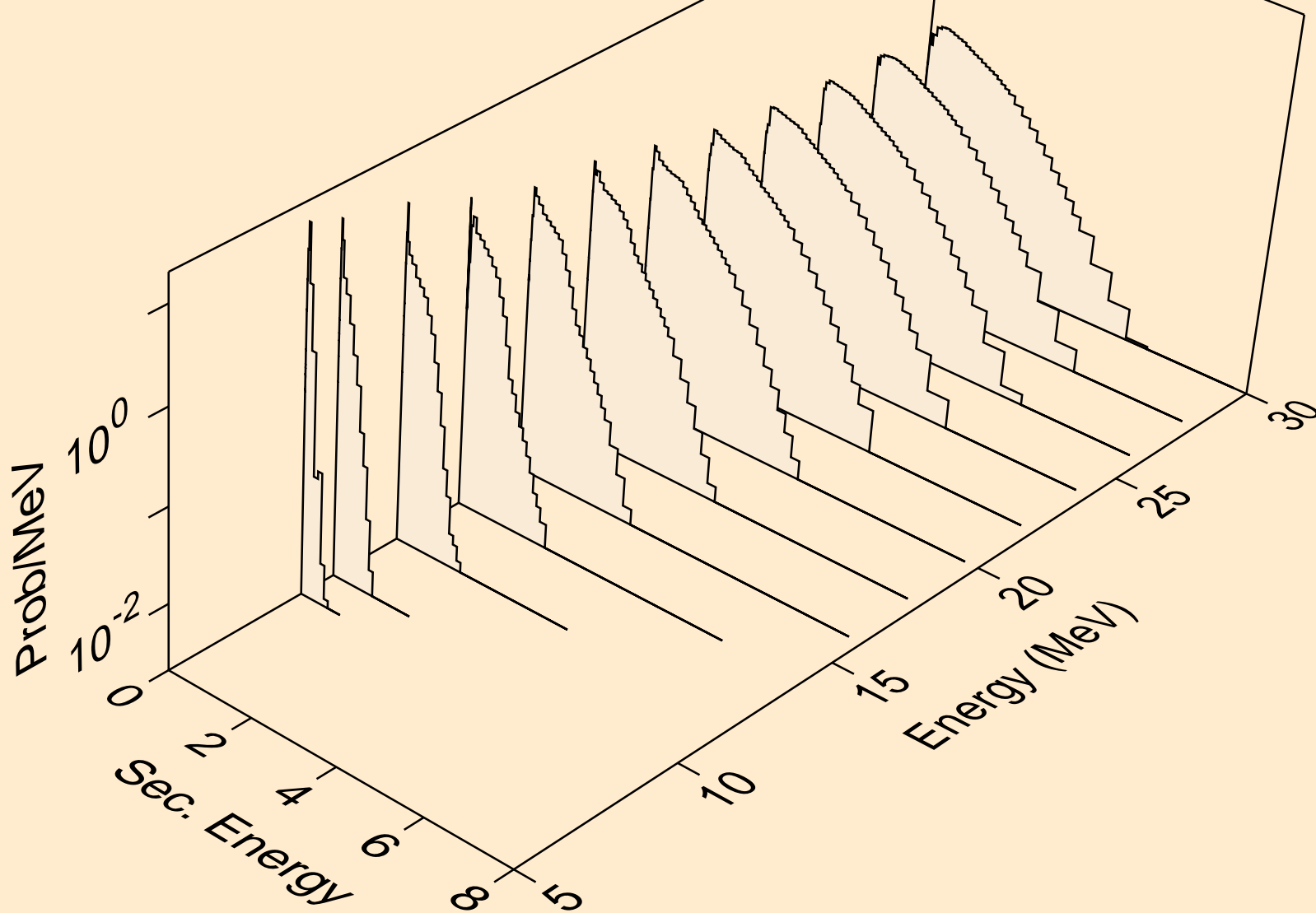

BI212M NEUTRON ACER TENDL-2019 LIBRARY; T=293.16K
Neutron emission for (n,n*)t

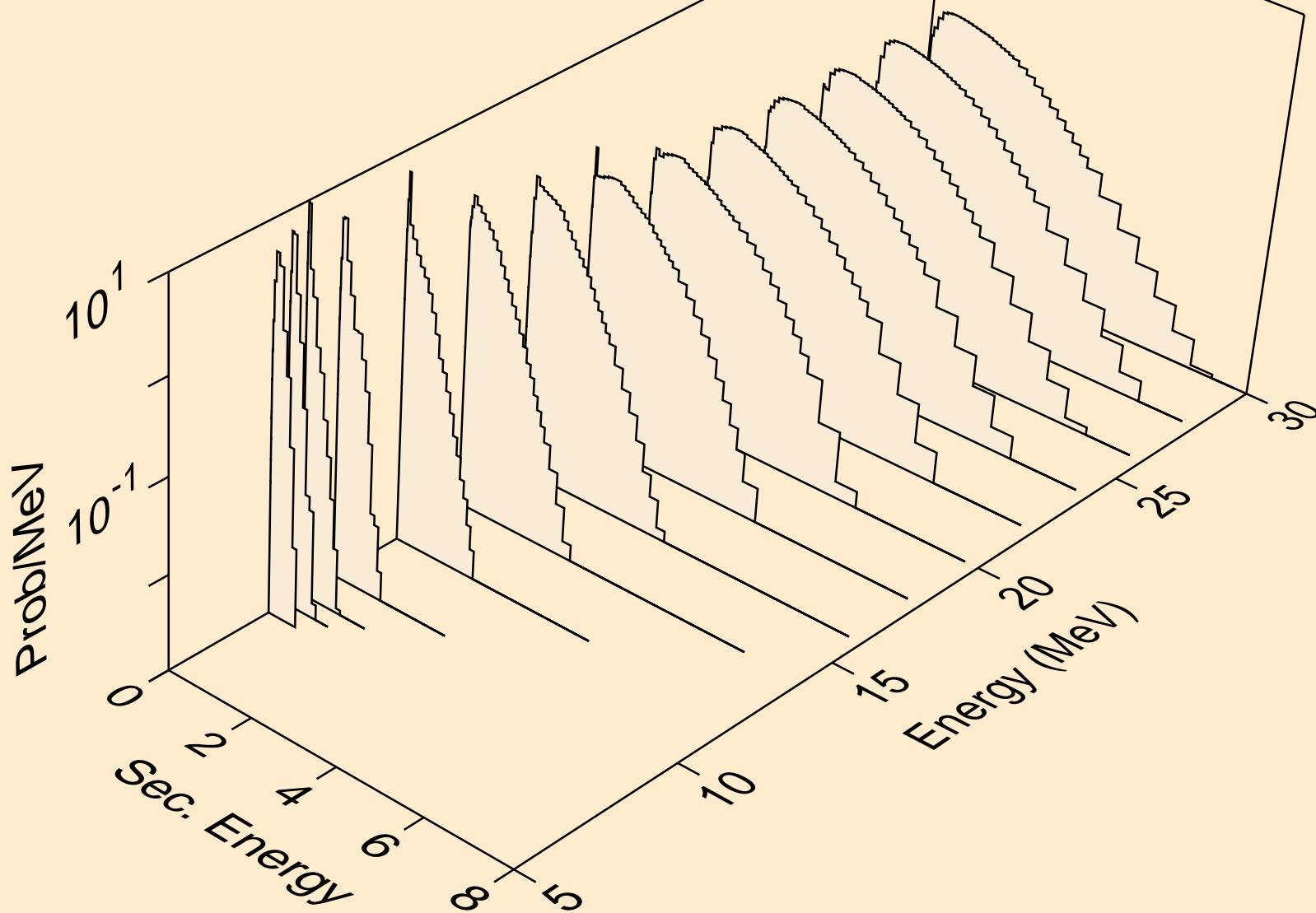

BI212M NEUTRON ACER TENDL-2019 LIBRARY; T=293.16K
Neutron emission for (n,n*)he3

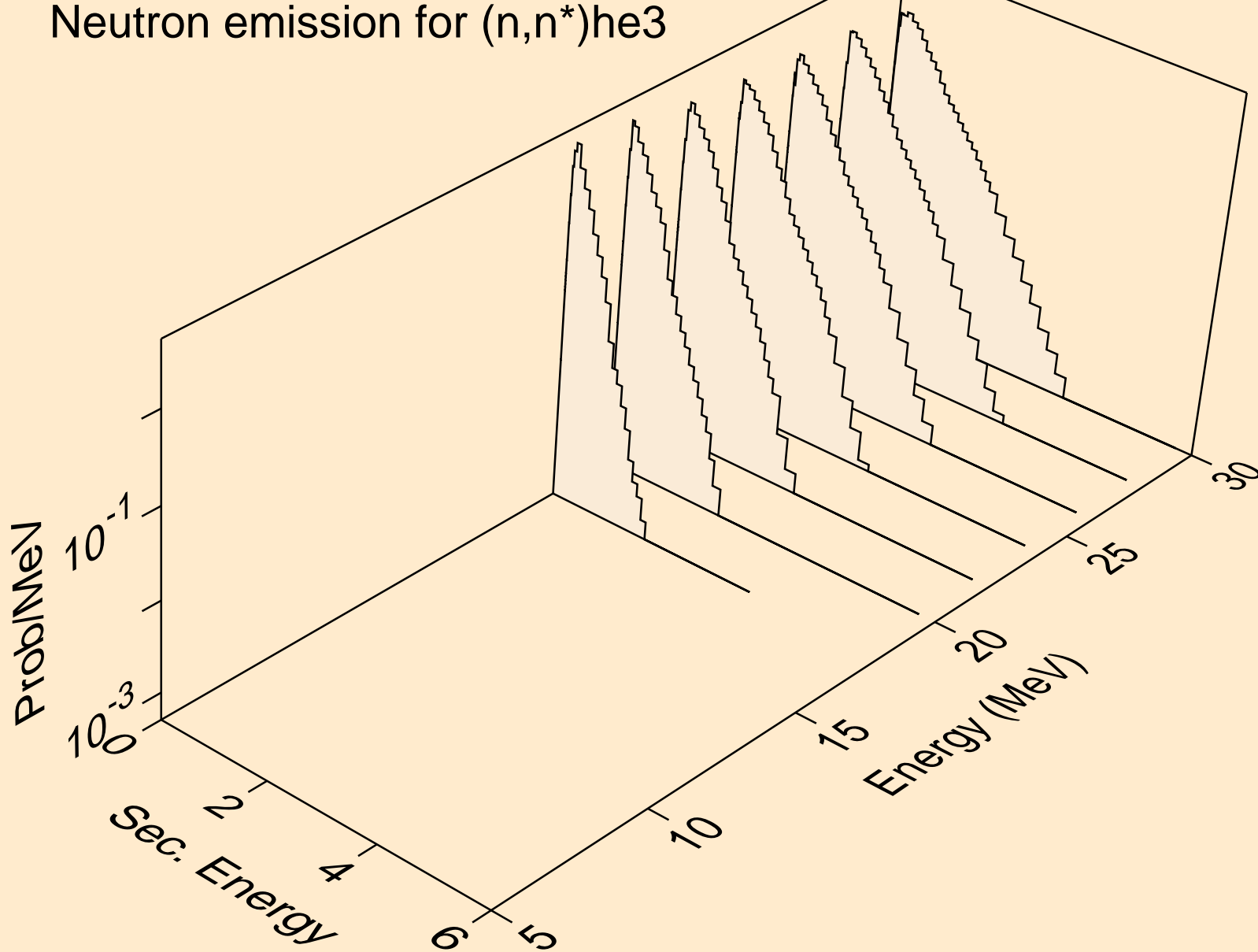

BI212M NEUTRON ACER TENDL-2019 LIBRARY; T=293.16K
Neutron emission for (n,4n)

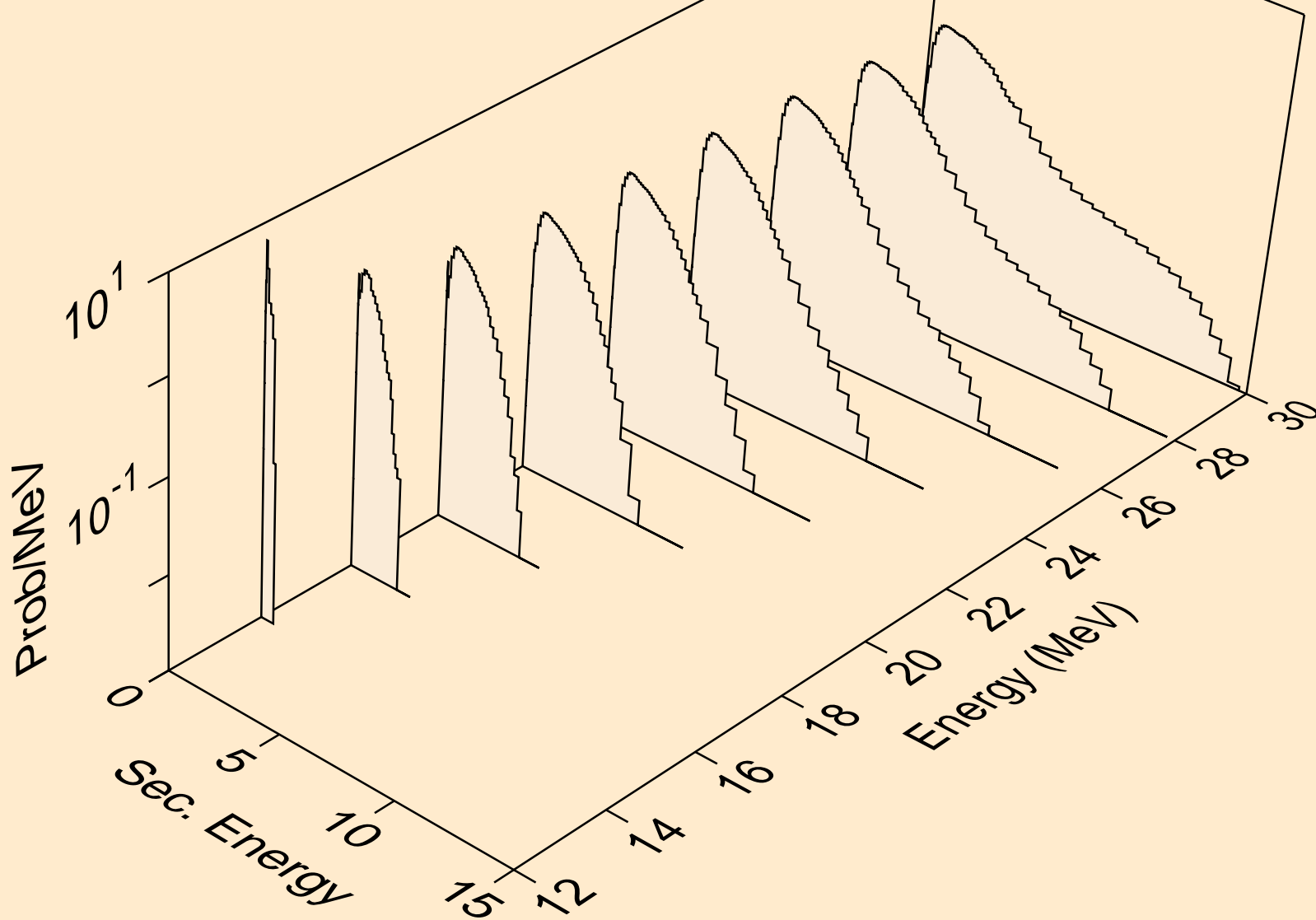

BI212M NEUTRON ACER TENDL-2019 LIBRARY; T=293.16K
Neutron emission for (n,2np)

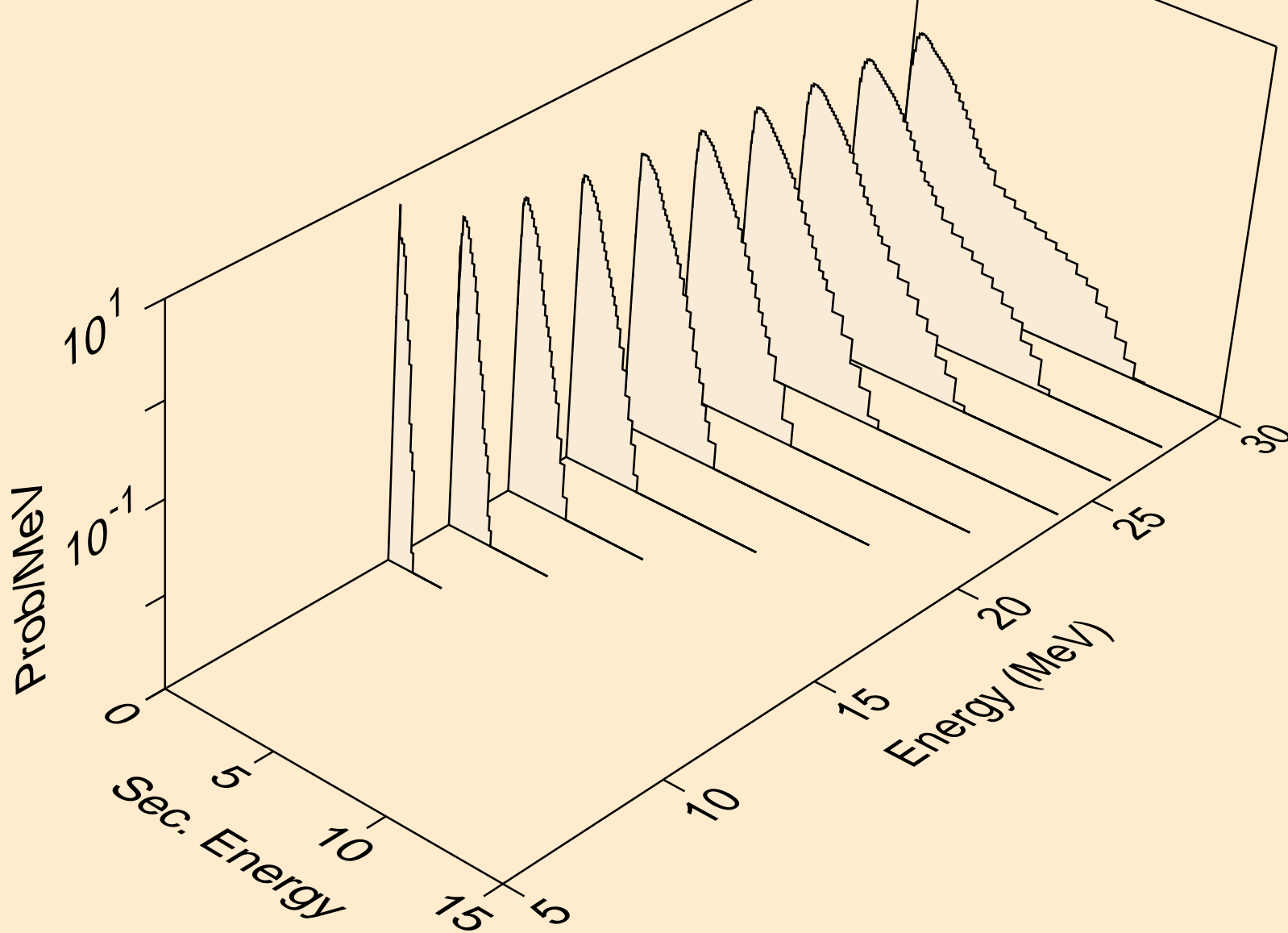

BI212M NEUTRON ACER TENDL-2019 LIBRARY; T=293.16K
Neutron emission for (n,3np)

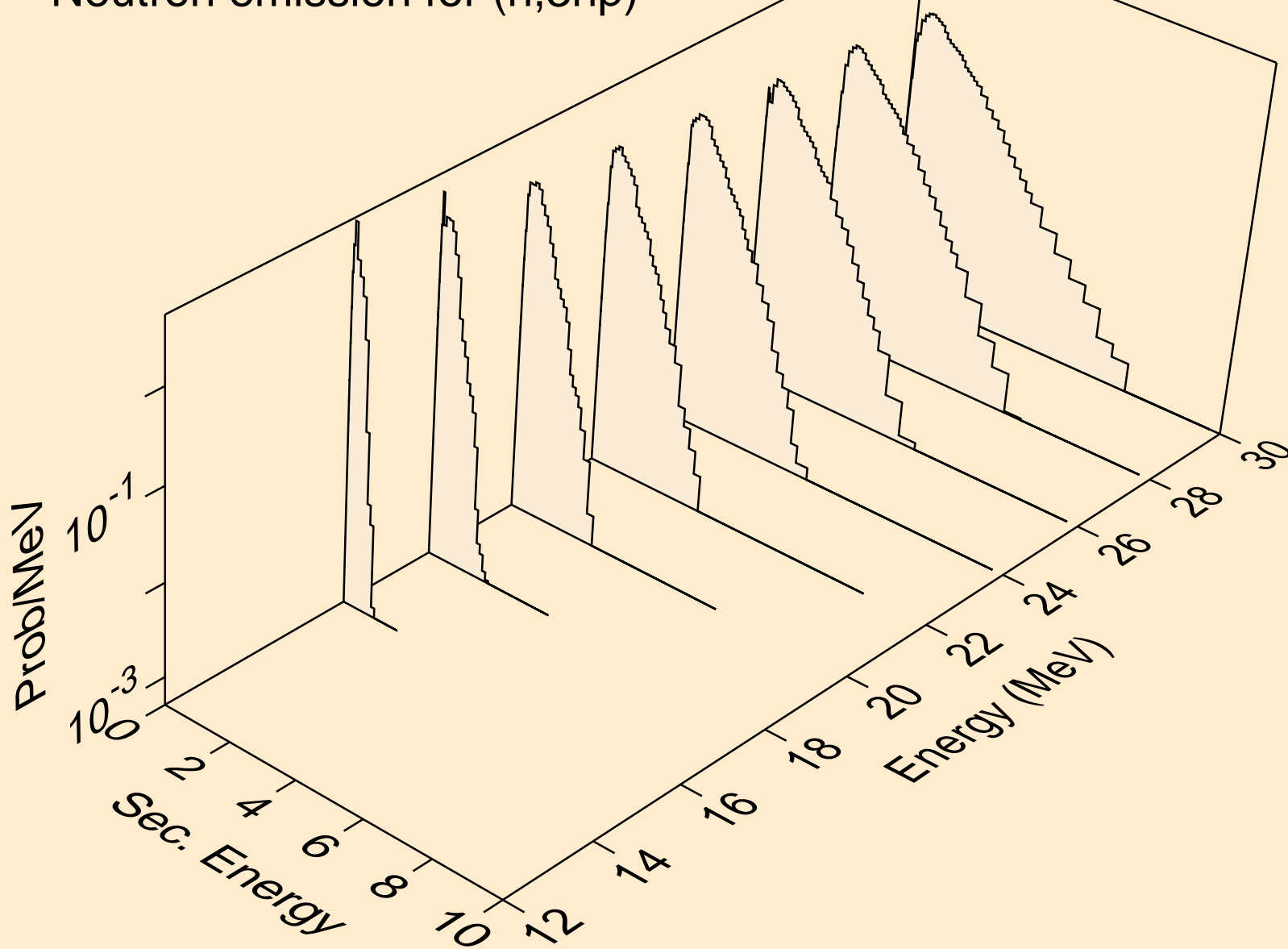

BI212M NEUTRON ACER TENDL-2019 LIBRARY; T=293.16K
Neutron emission for (n,2np)

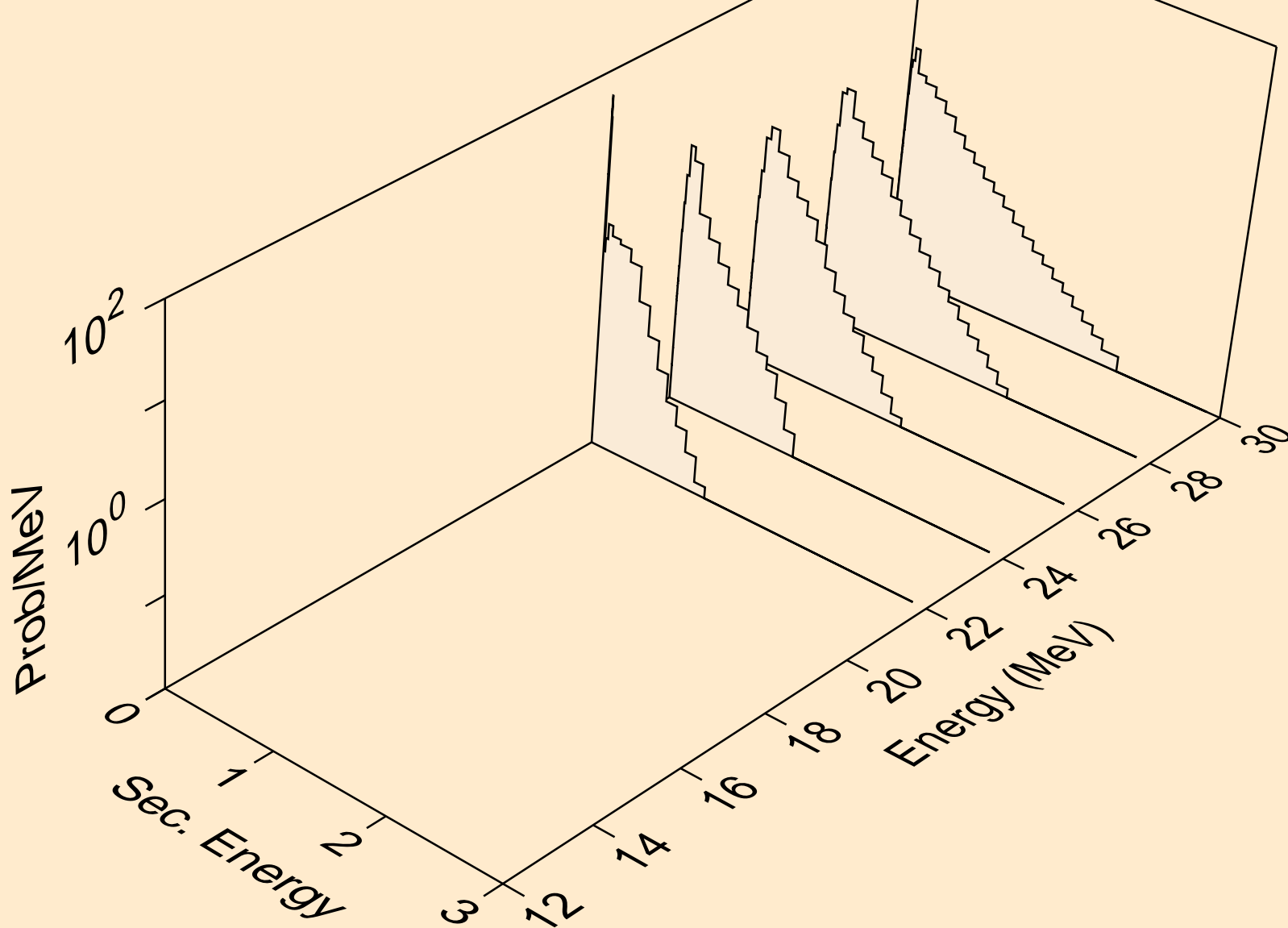

BI212M NEUTRON ACER TENDL-2019 LIBRARY; T=293.16K
Neutron emission for (n,npa)

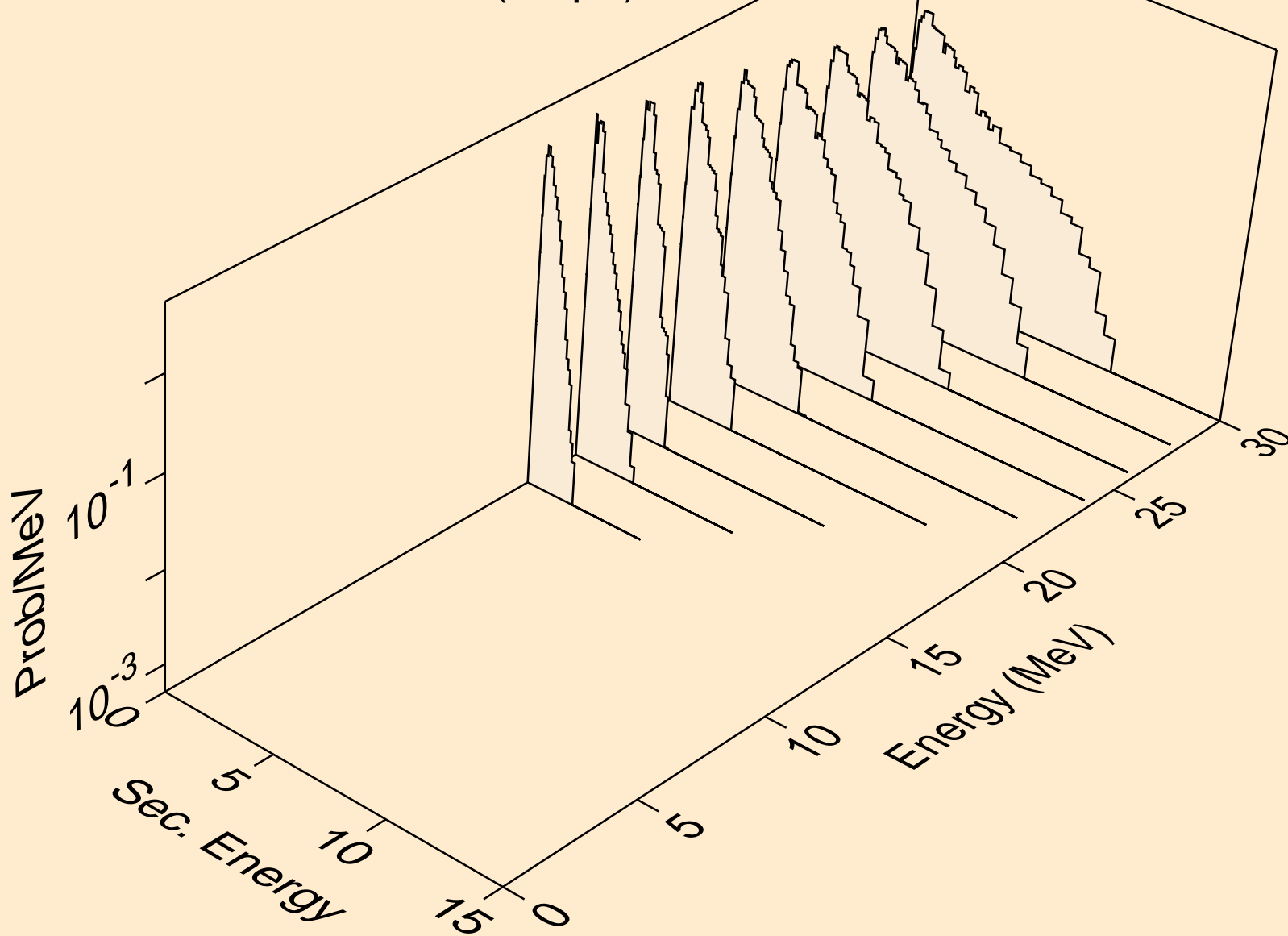

BI212M NEUTRON ACER TENDL-2019 LIBRARY; T=293.16K
Neutron emission for (n,n*c)

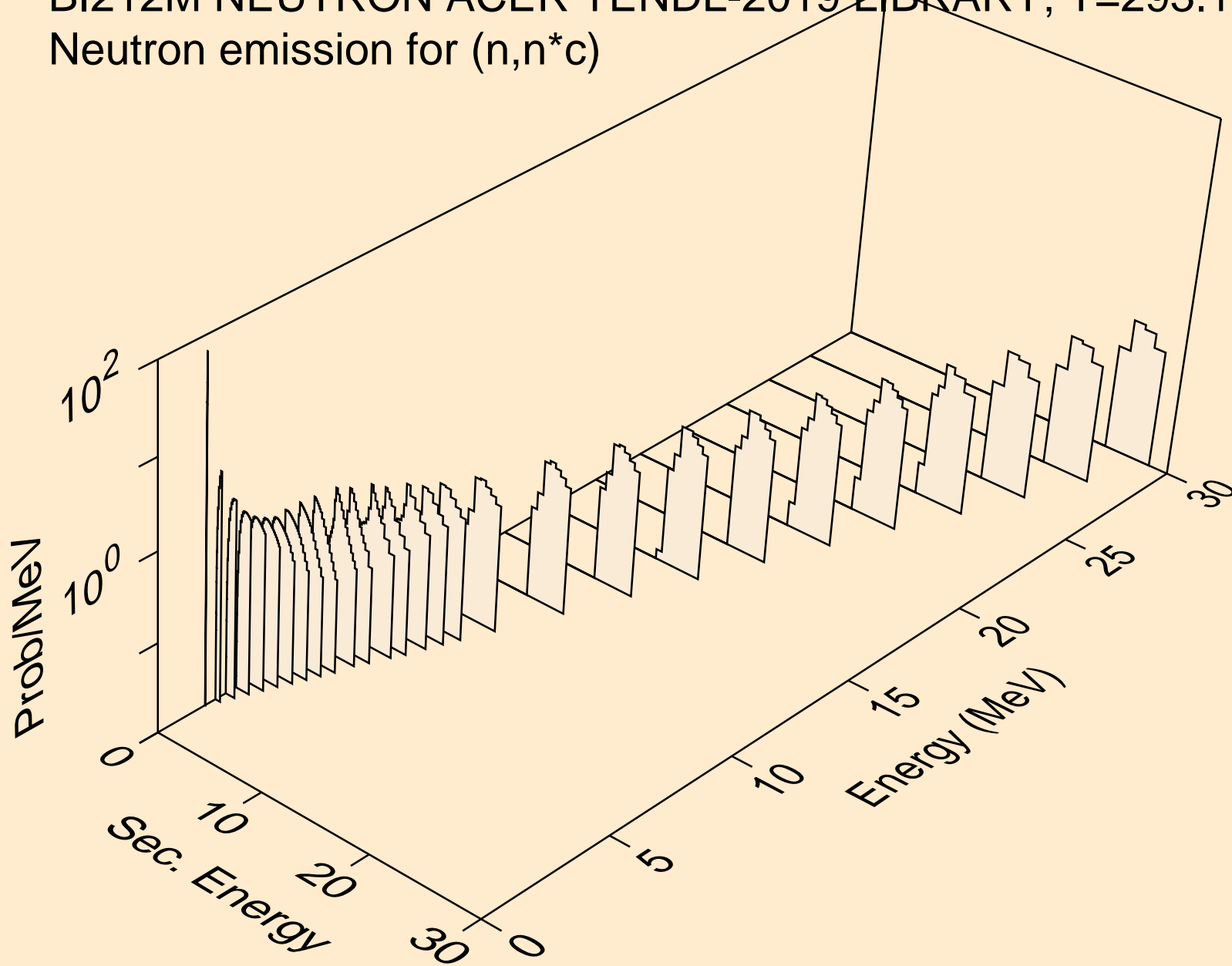

BI212M NEUTRON ACER TENDL-2019 LIBRARY; T=293.16K
Photon emission for (n,x)

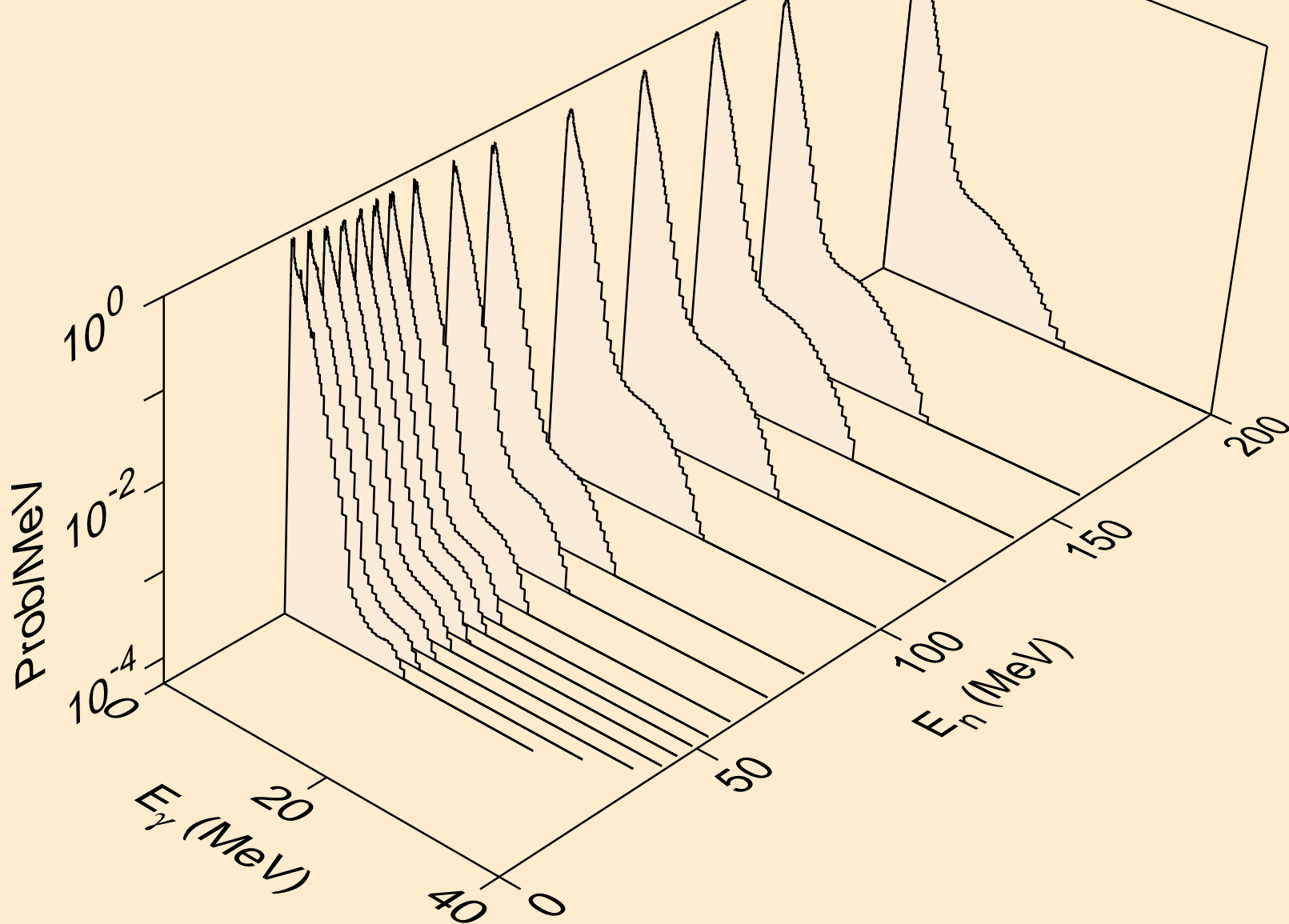

BI212M NEUTRON ACER TENDL-2019 LIBRARY; T=293.16K
Photon emission for (n,2nd)

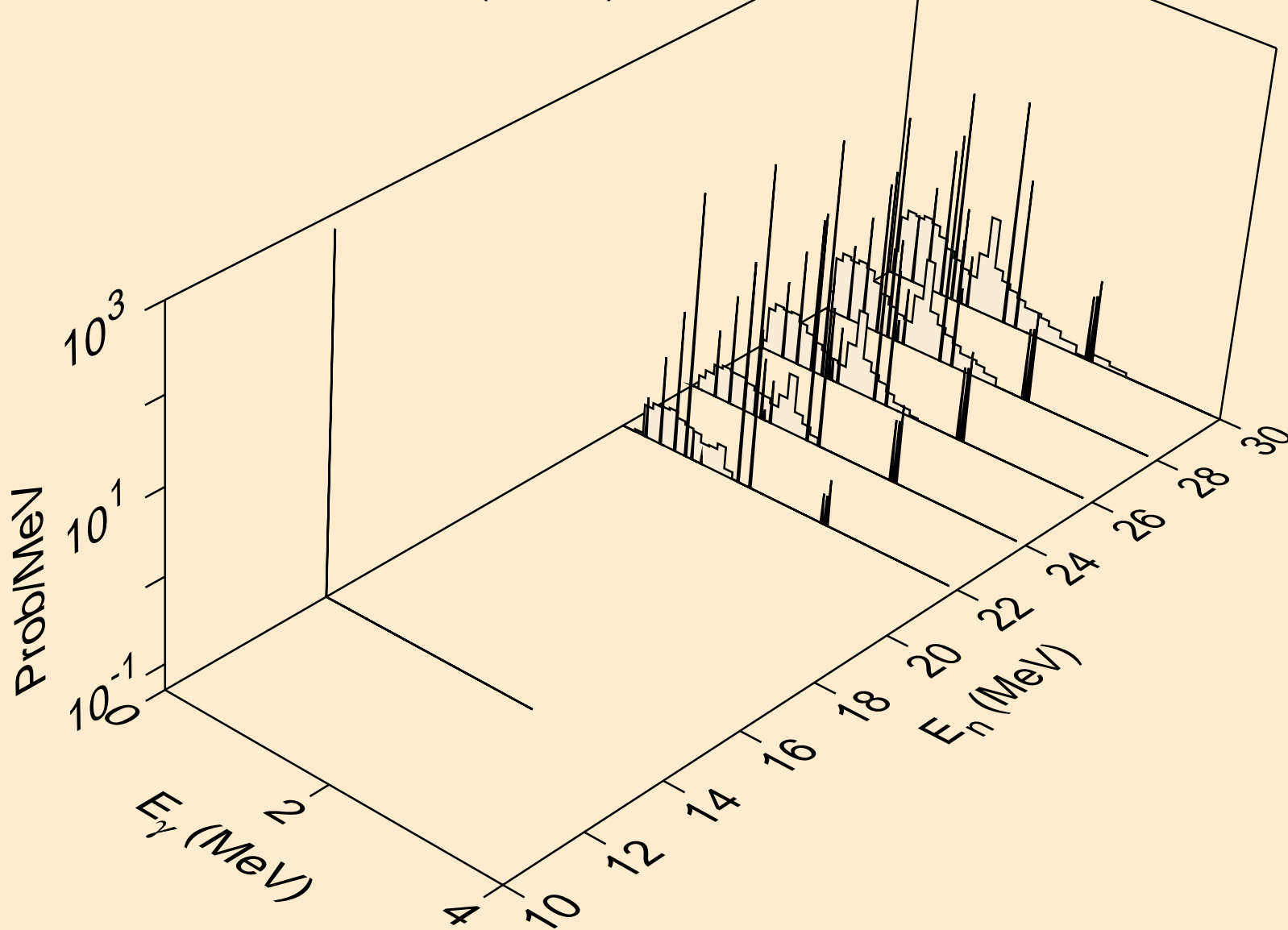

BI212M NEUTRON ACER TENDL-2019 LIBRARY; T=293.16K
Photon emission for (n,2n)

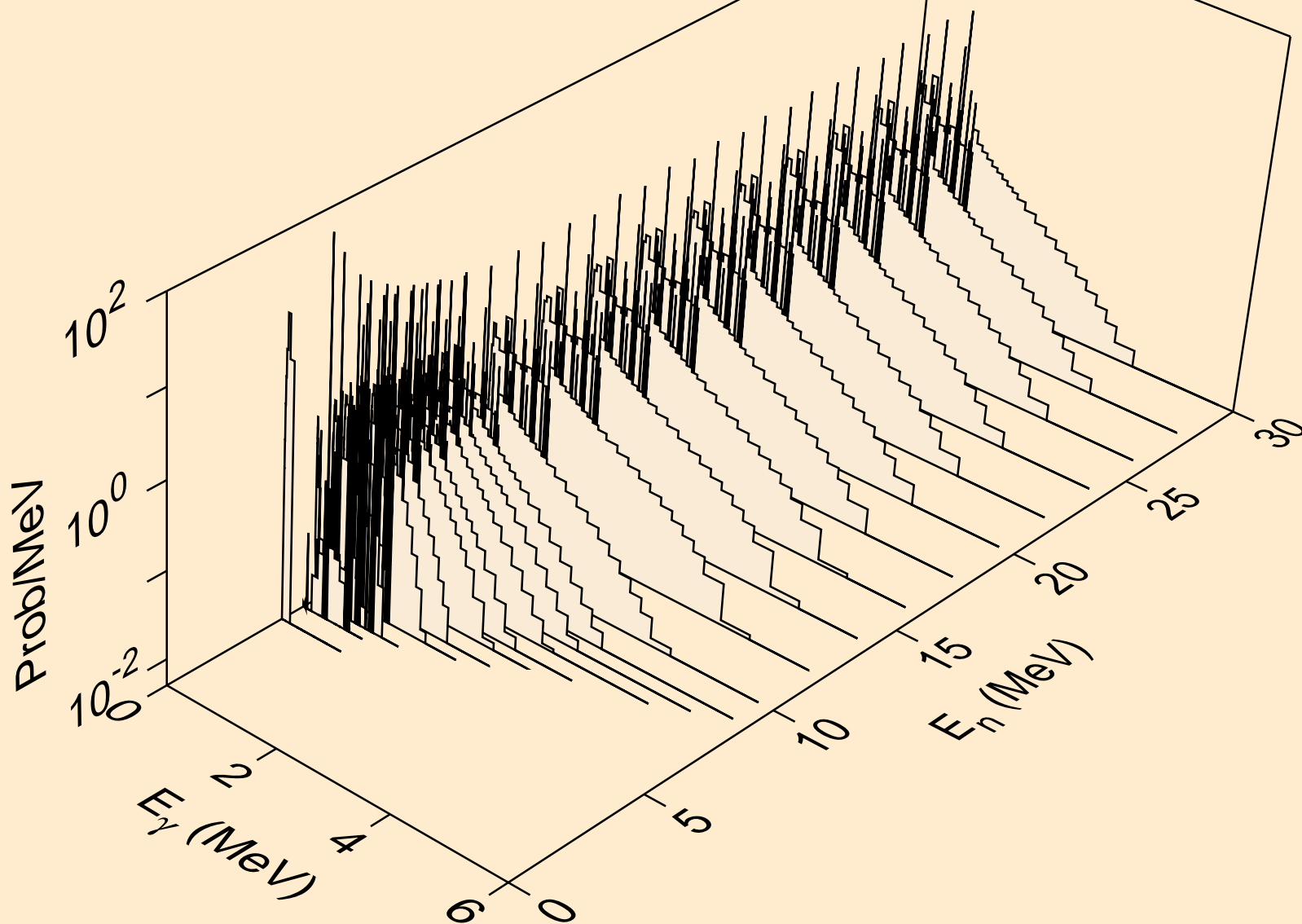

BI212M NEUTRON ACER TENDL-2019 LIBRARY; T=293.16K
Photon emission for (n,3n)

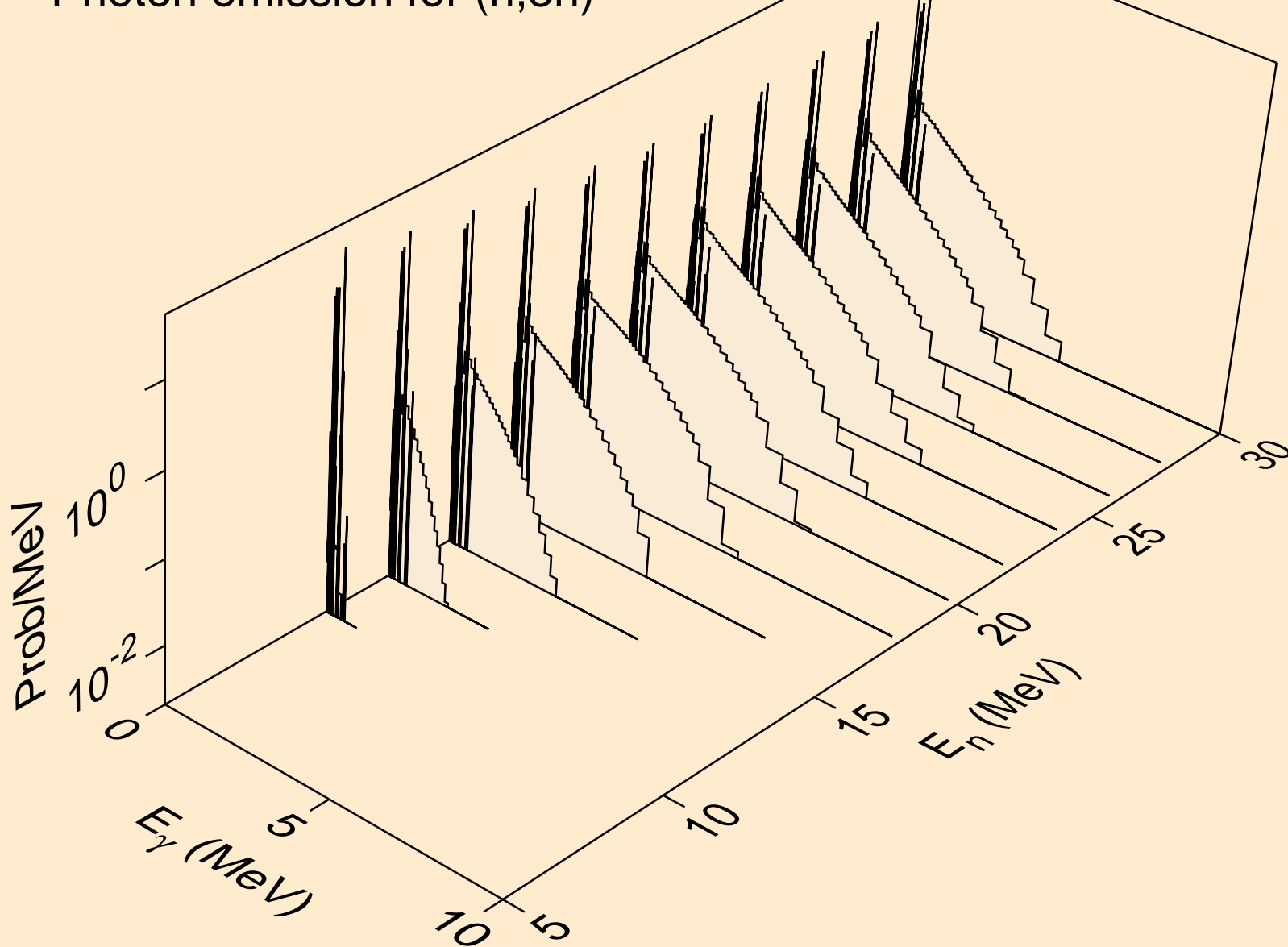

BI212M NEUTRON ACER TENDL-2019 LIBRARY; T=293.16K
Photon emission for (n,n*)a

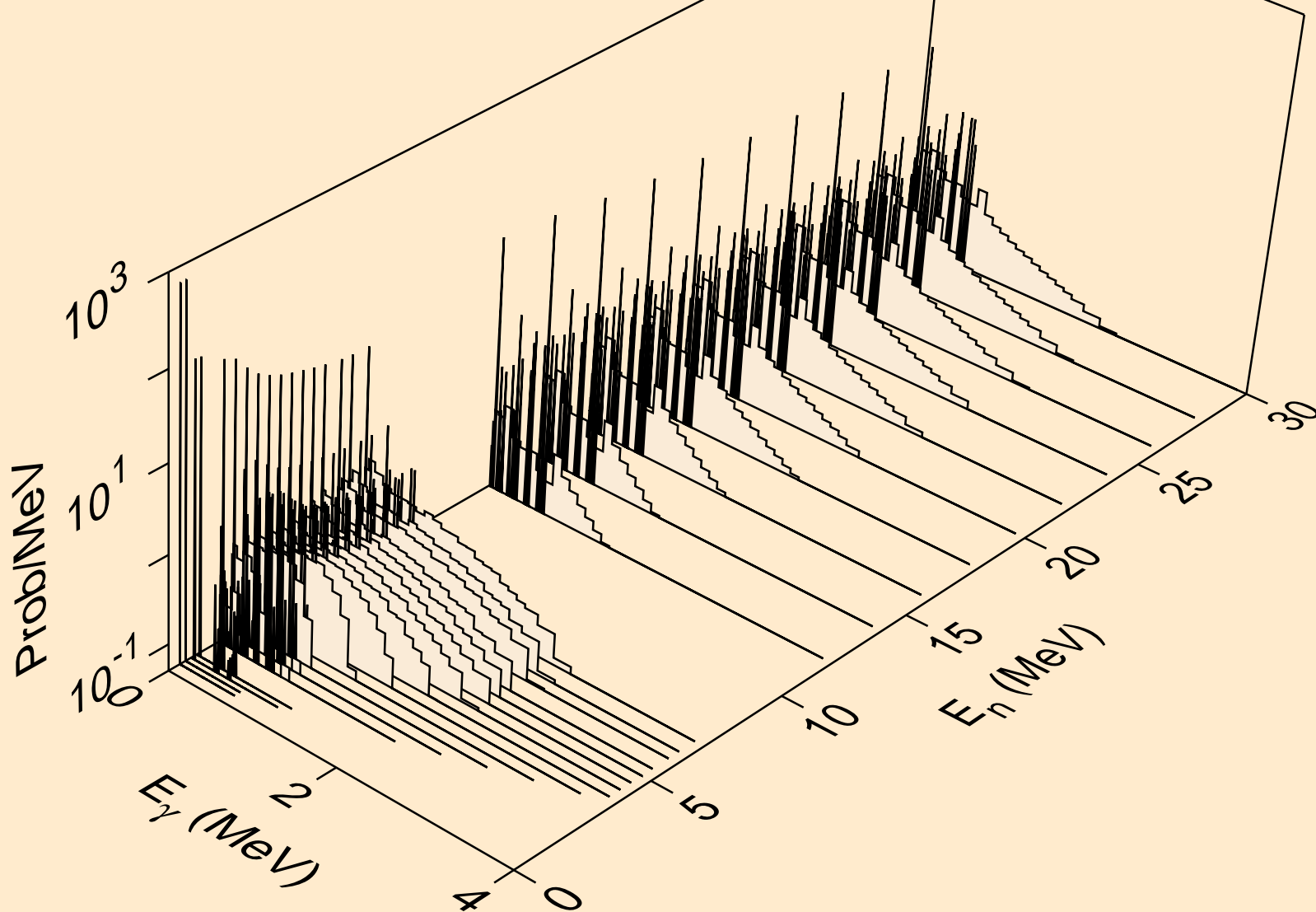

BI212M NEUTRON ACER TENDL-2019 LIBRARY; T=293.16K
Photon emission for (n,2n)a

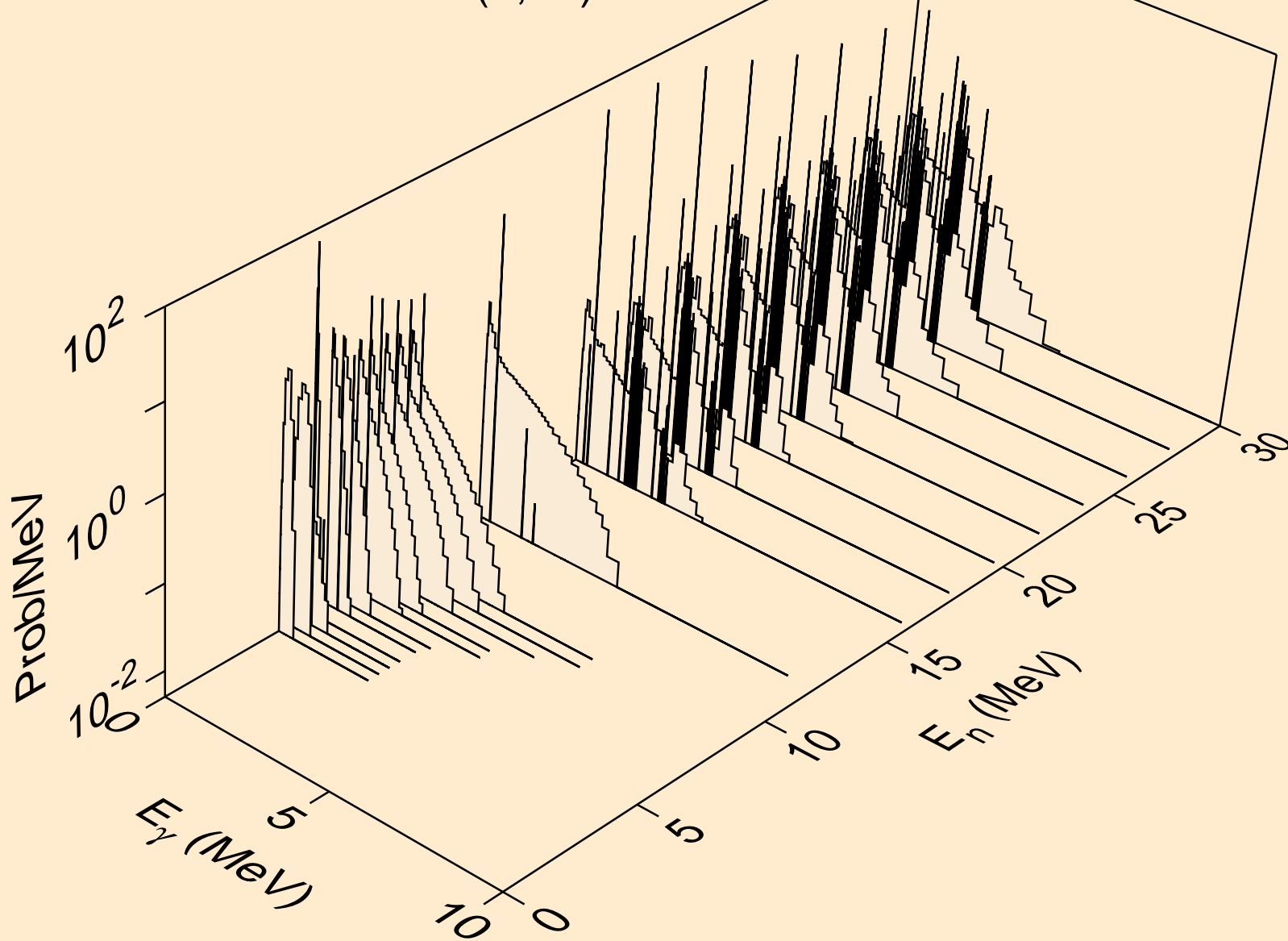

BI212M NEUTRON ACER TENDL-2019 LIBRARY; T=293.16K
Photon emission for (n,3n)a

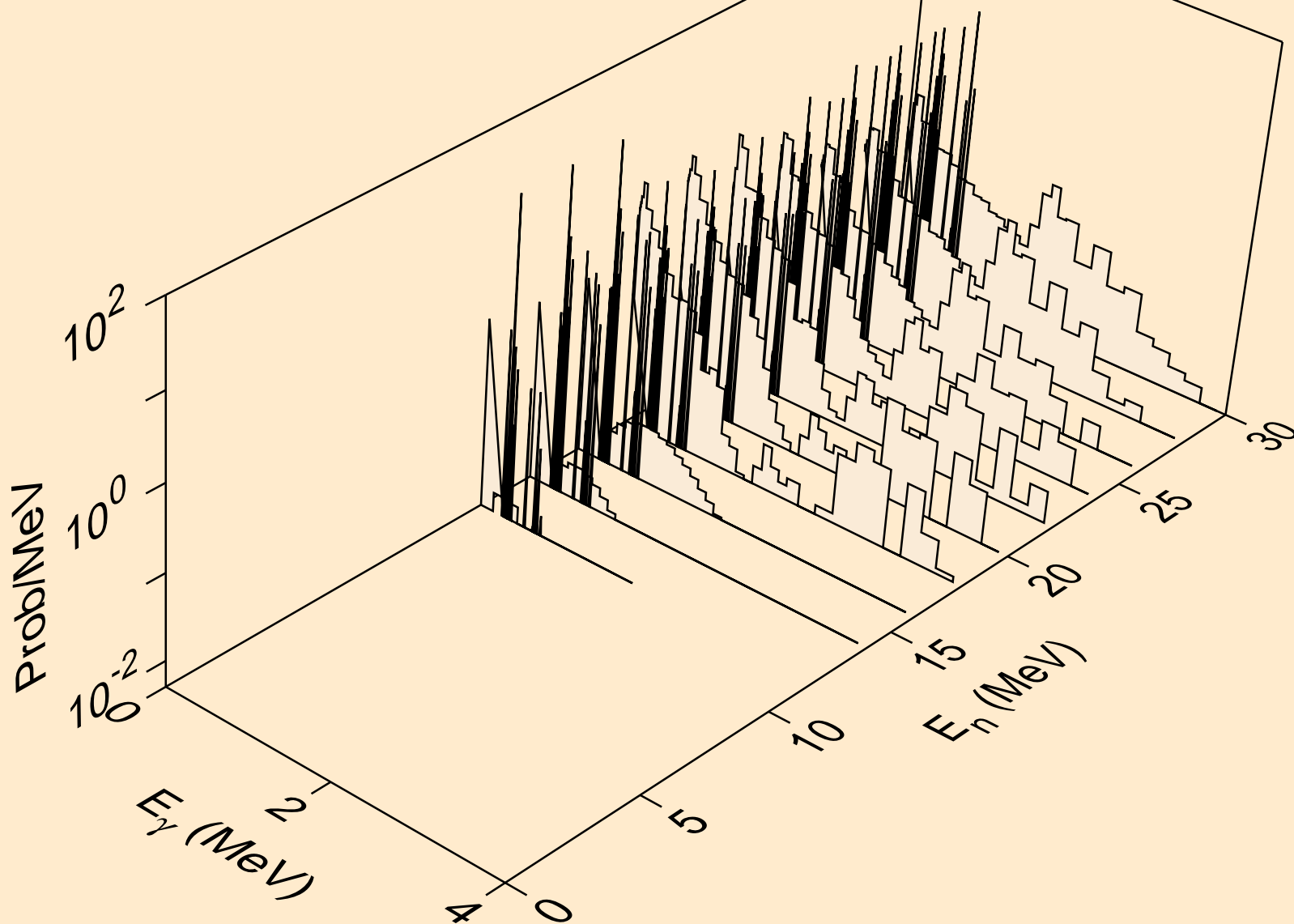

BI212M NEUTRON ACER TENDL-2019 LIBRARY; T=293.16K
Photon emission for (n,n*)p

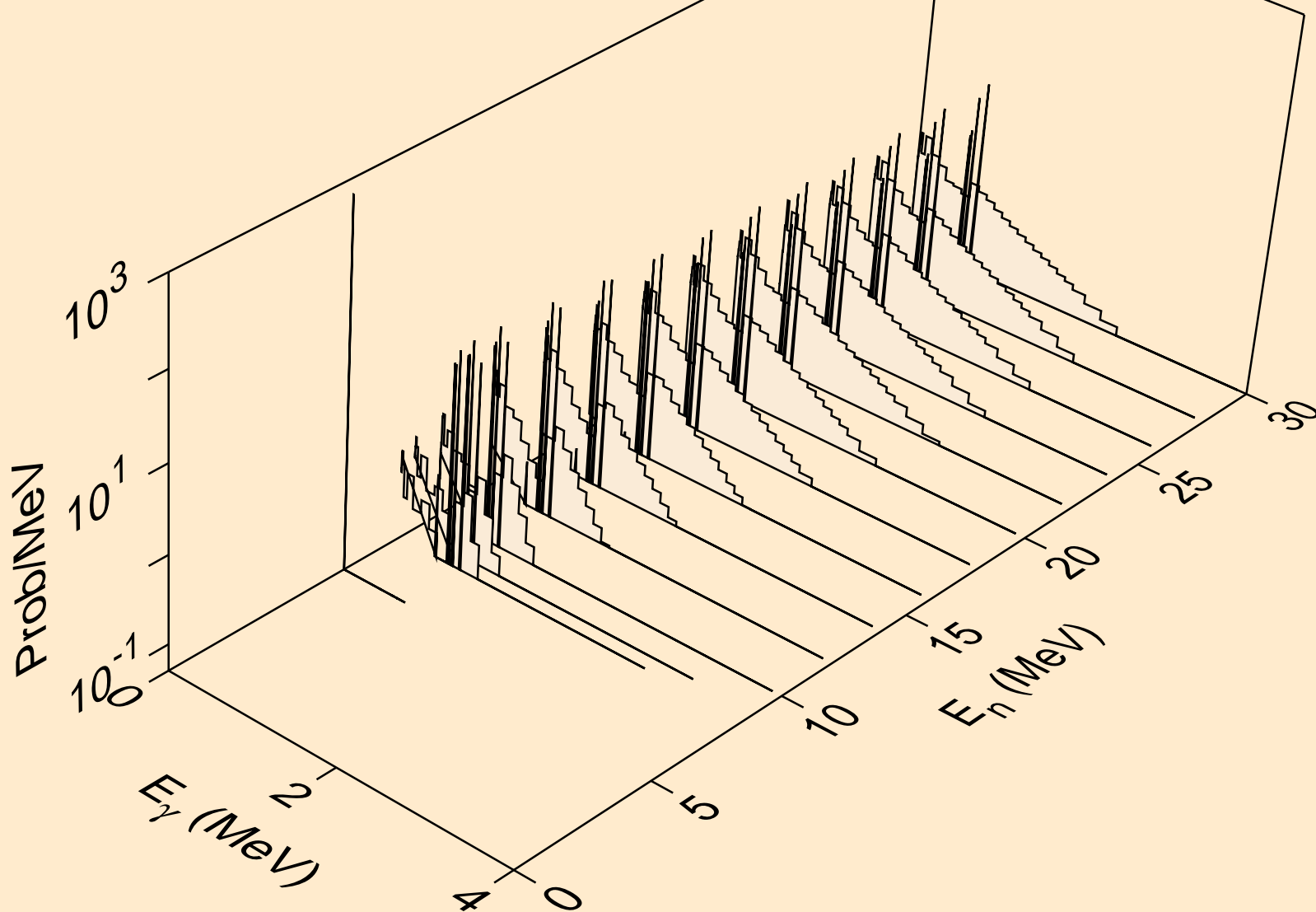

BI212M NEUTRON ACER TENDL-2019 LIBRARY; T=293.16K
Photon emission for (n,n*)2a

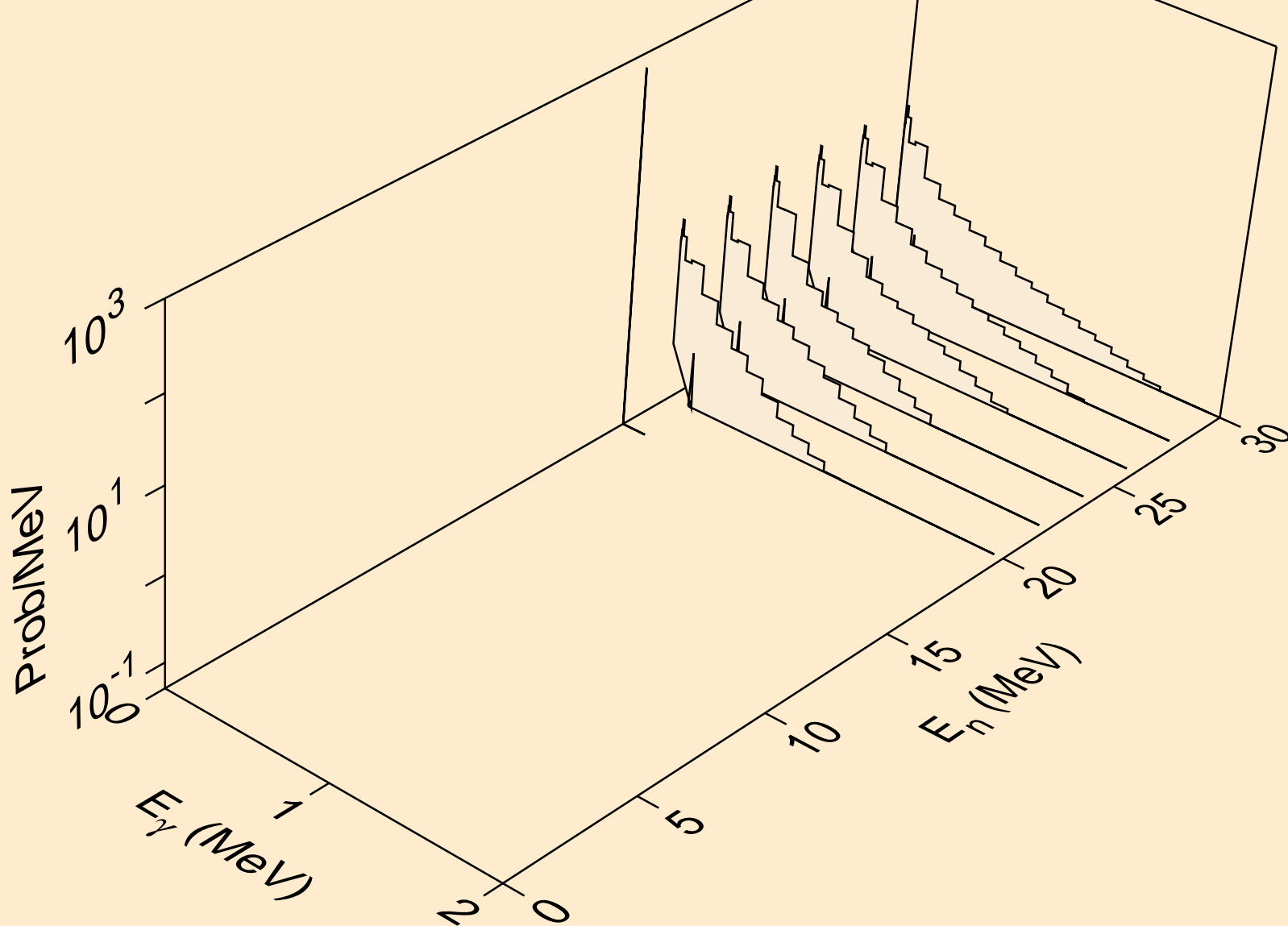

BI212M NEUTRON ACER TENDL-2019 LIBRARY; T=293.16K
Photon emission for (n,n*)d

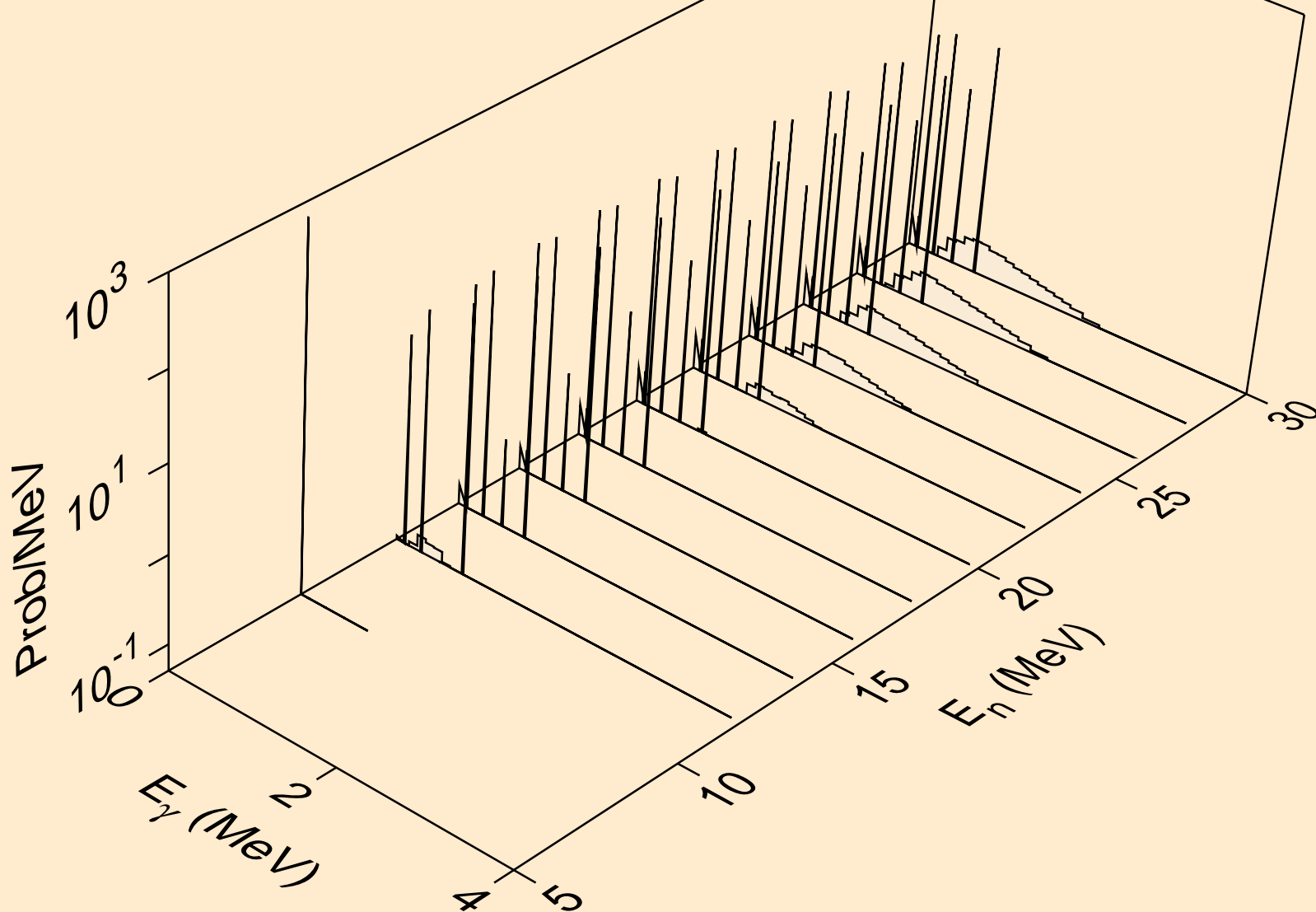

BI212M NEUTRON ACER TENDL-2019 LIBRARY; T=293.16K
Photon emission for (n,n*)t

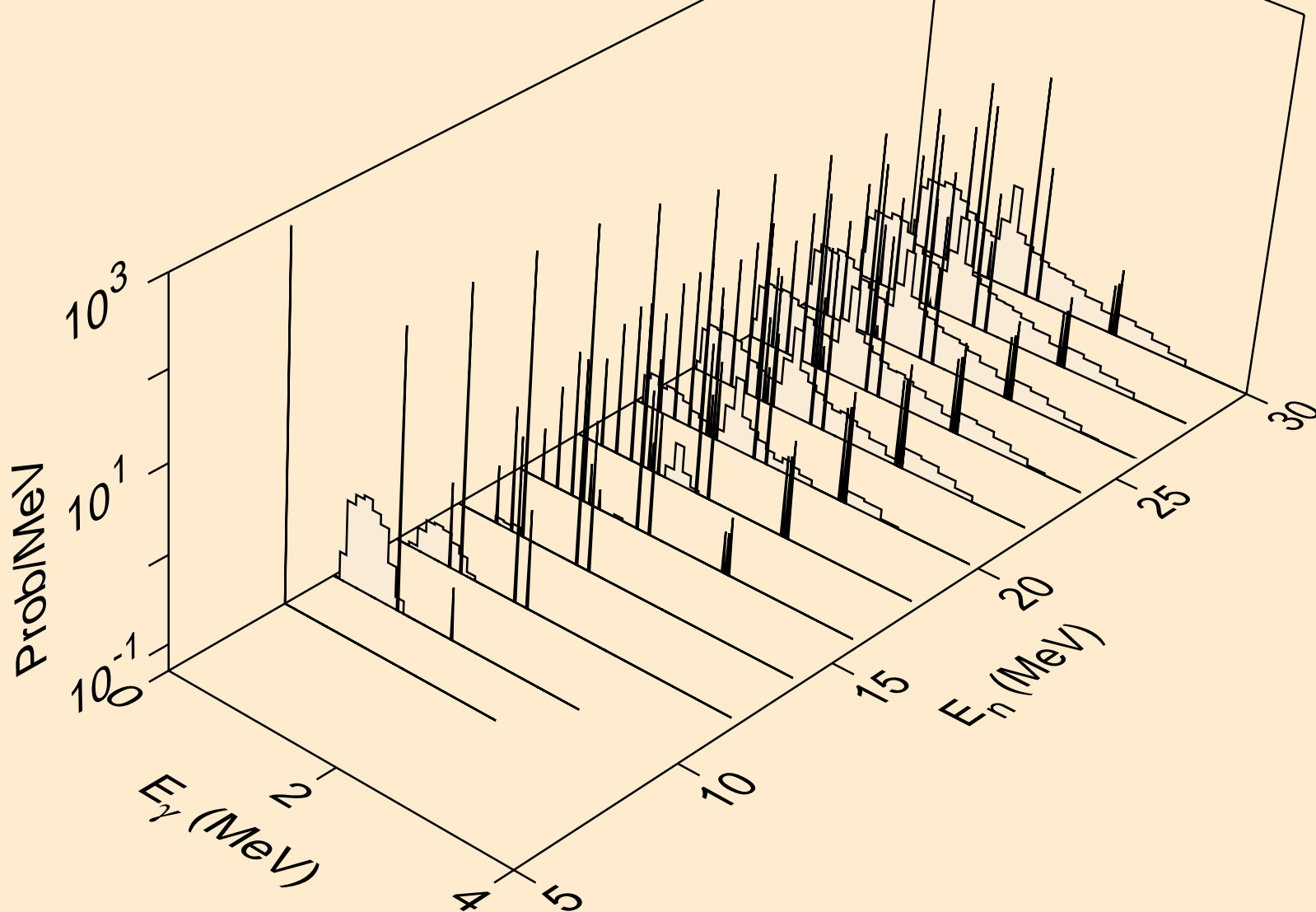

BI212M NEUTRON ACER TENDL-2019 LIBRARY; T=293.16K
Photon emission for (n,n*)he3

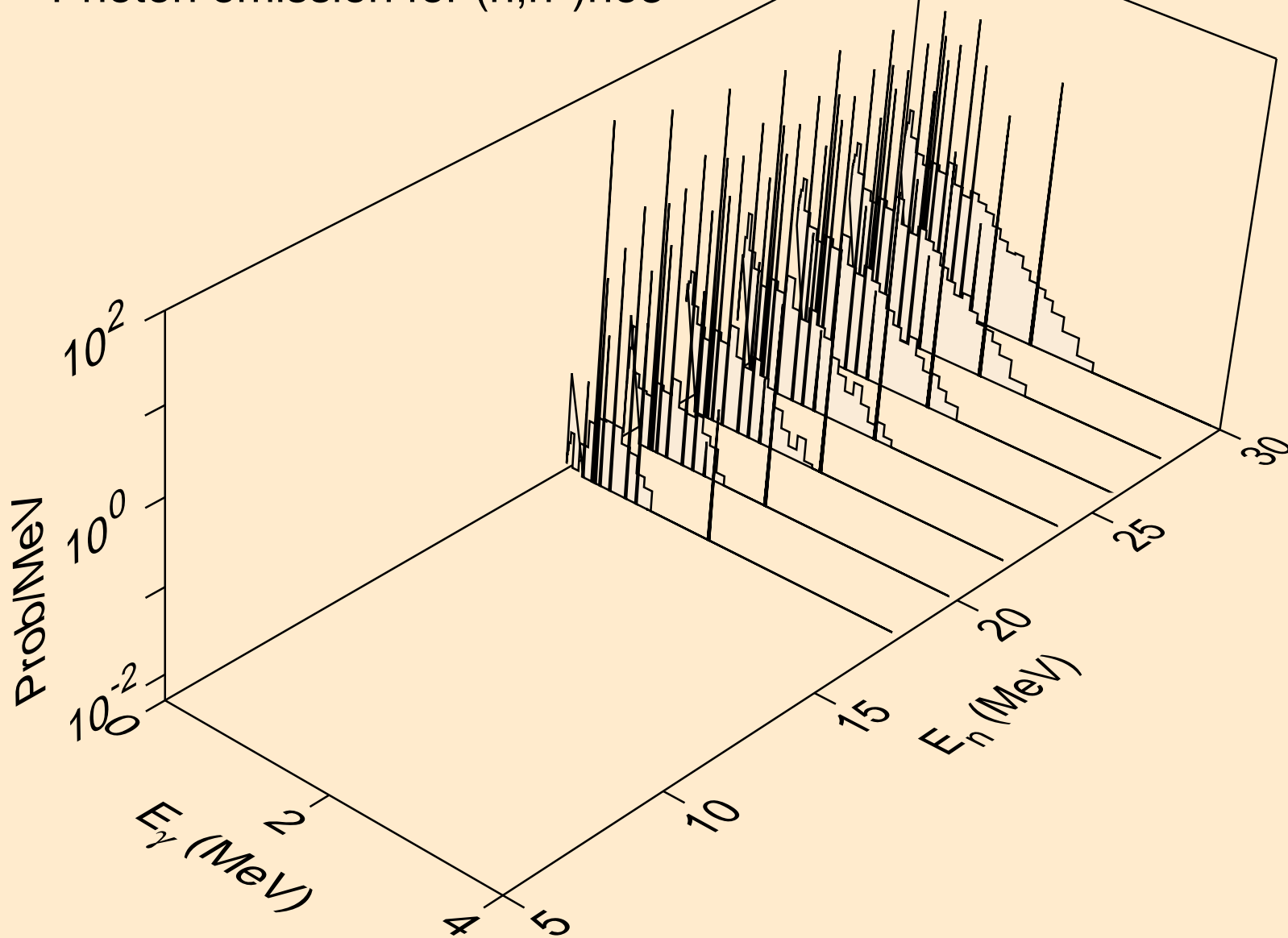

BI212M NEUTRON ACER TENDL-2019 LIBRARY; T=293.16K
Photon emission for (n,4n)

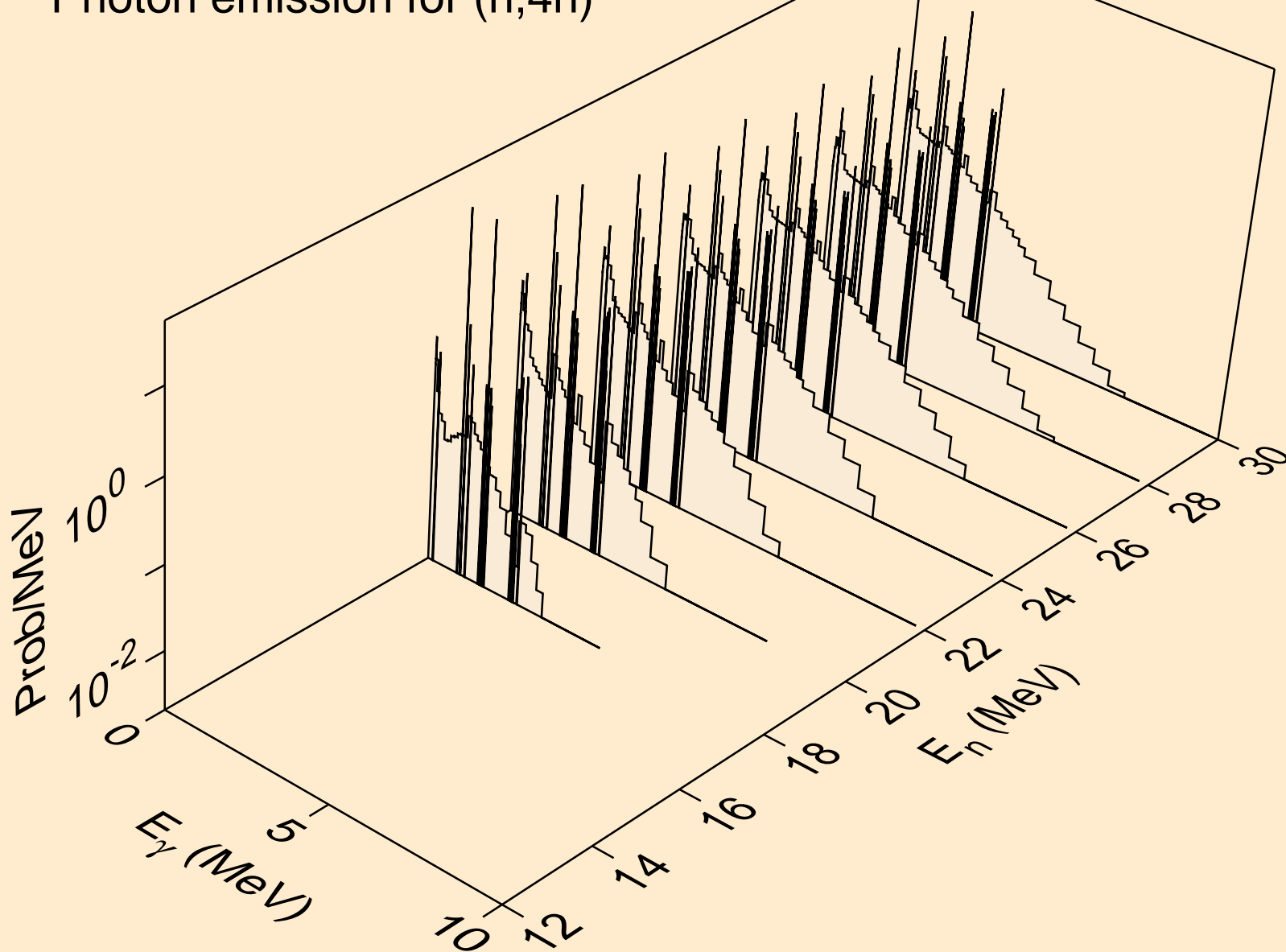

BI212M NEUTRON ACER TENDL-2019 LIBRARY; T=293.16K
Photon emission for (n,2np)

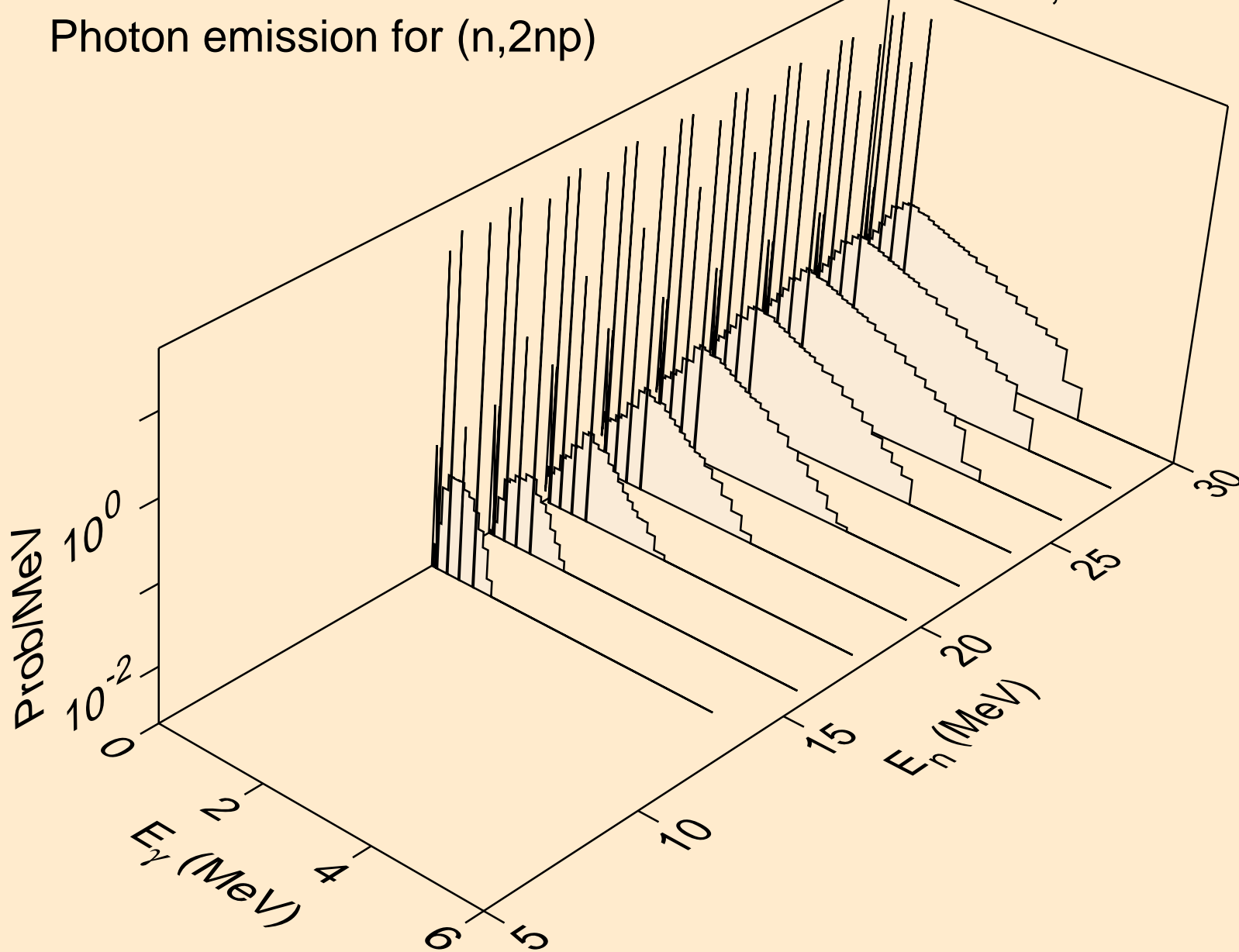

BI212M NEUTRON ACER TENDL-2019 LIBRARY; T=293.16K
Photon emission for (n,3np)

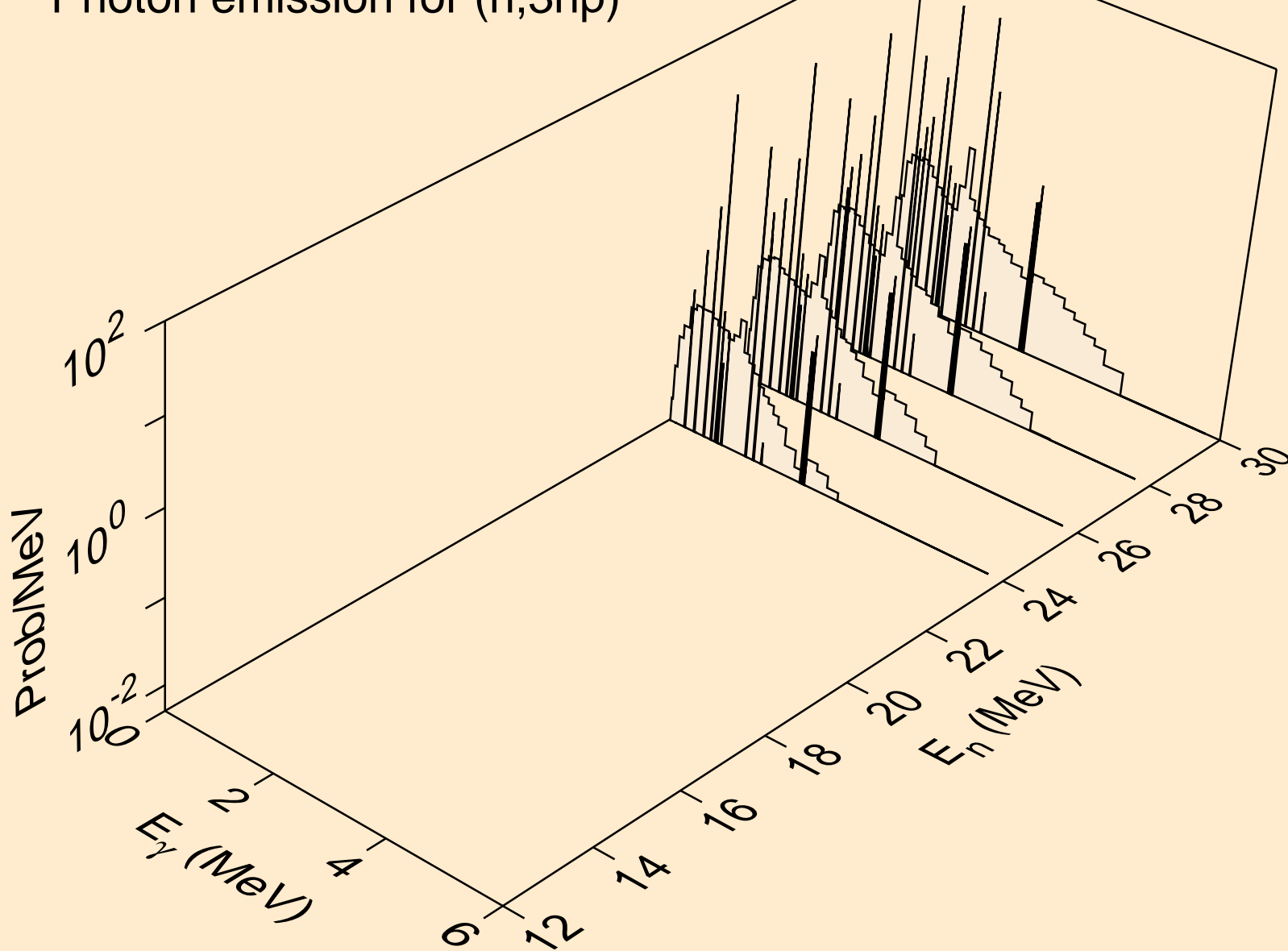

BI212M NEUTRON ACER TENDL-2019 LIBRARY; T=293.16K
Photon emission for (n,2np)

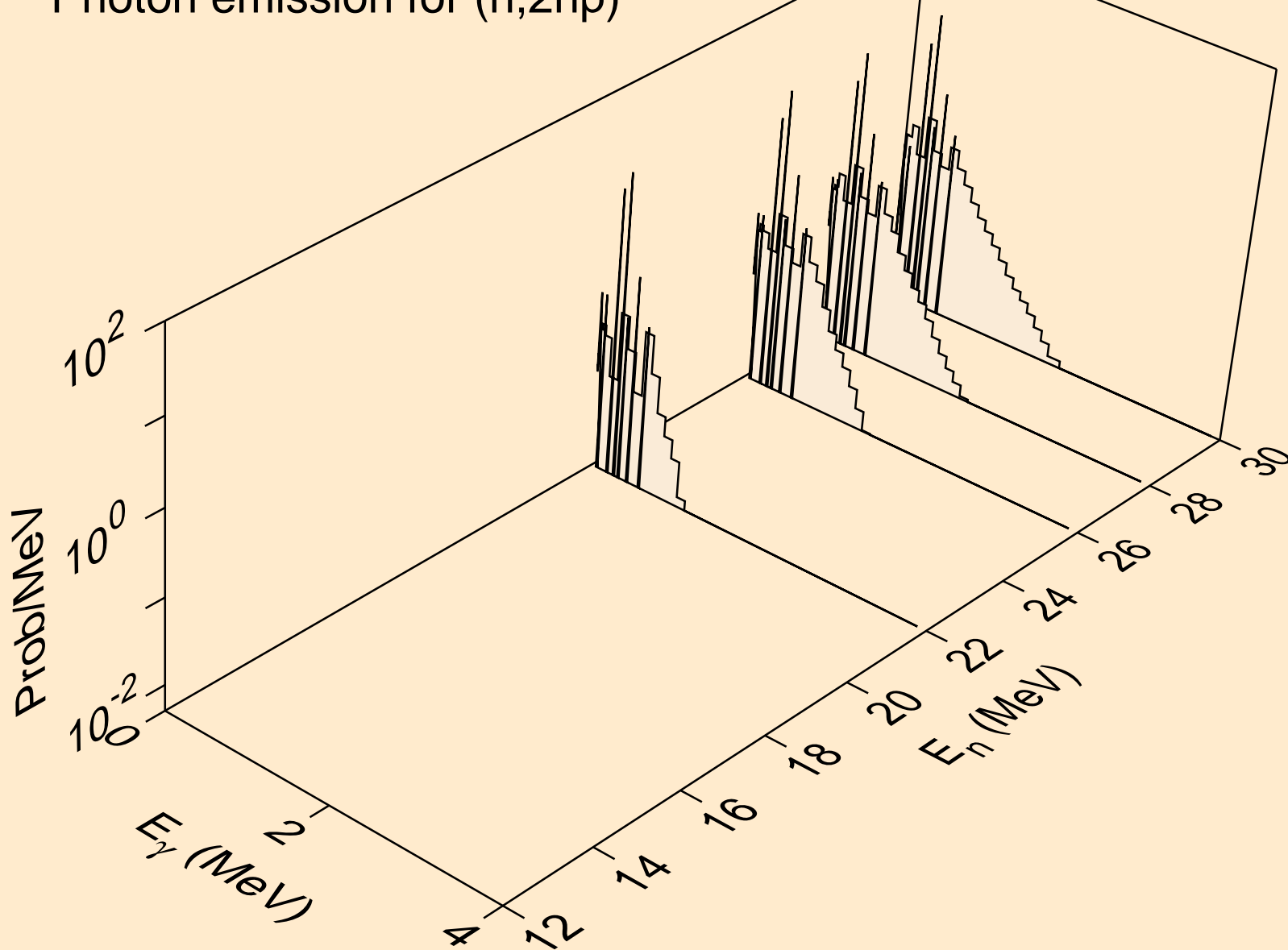

BI212M NEUTRON ACER TENDL-2019 LIBRARY; T=293.16K
Photon emission for (n,npa)

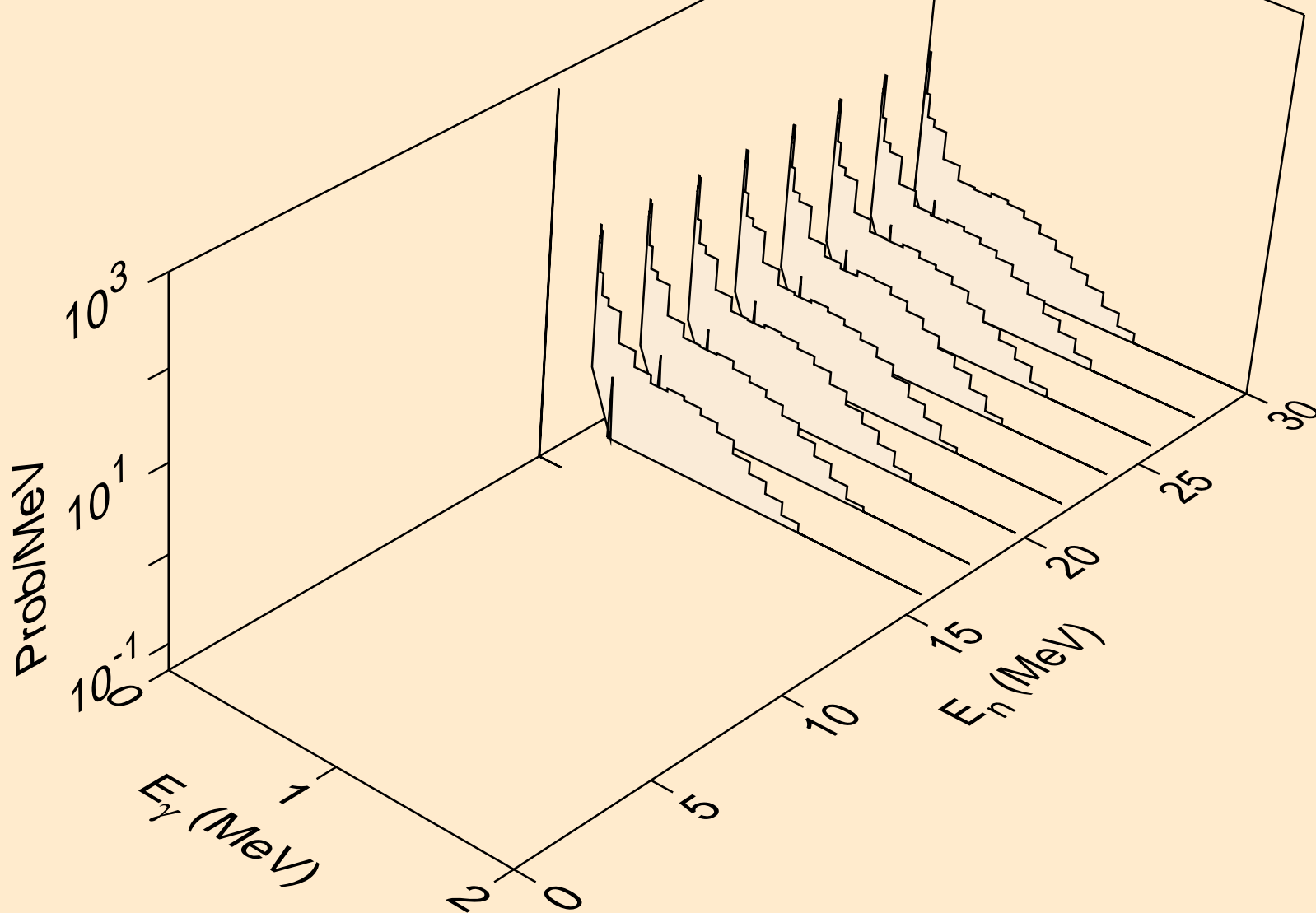

BI212M NEUTRON ACER TENDL-2019 LIBRARY; T=293.16K
Photon emission for (n,n*1)

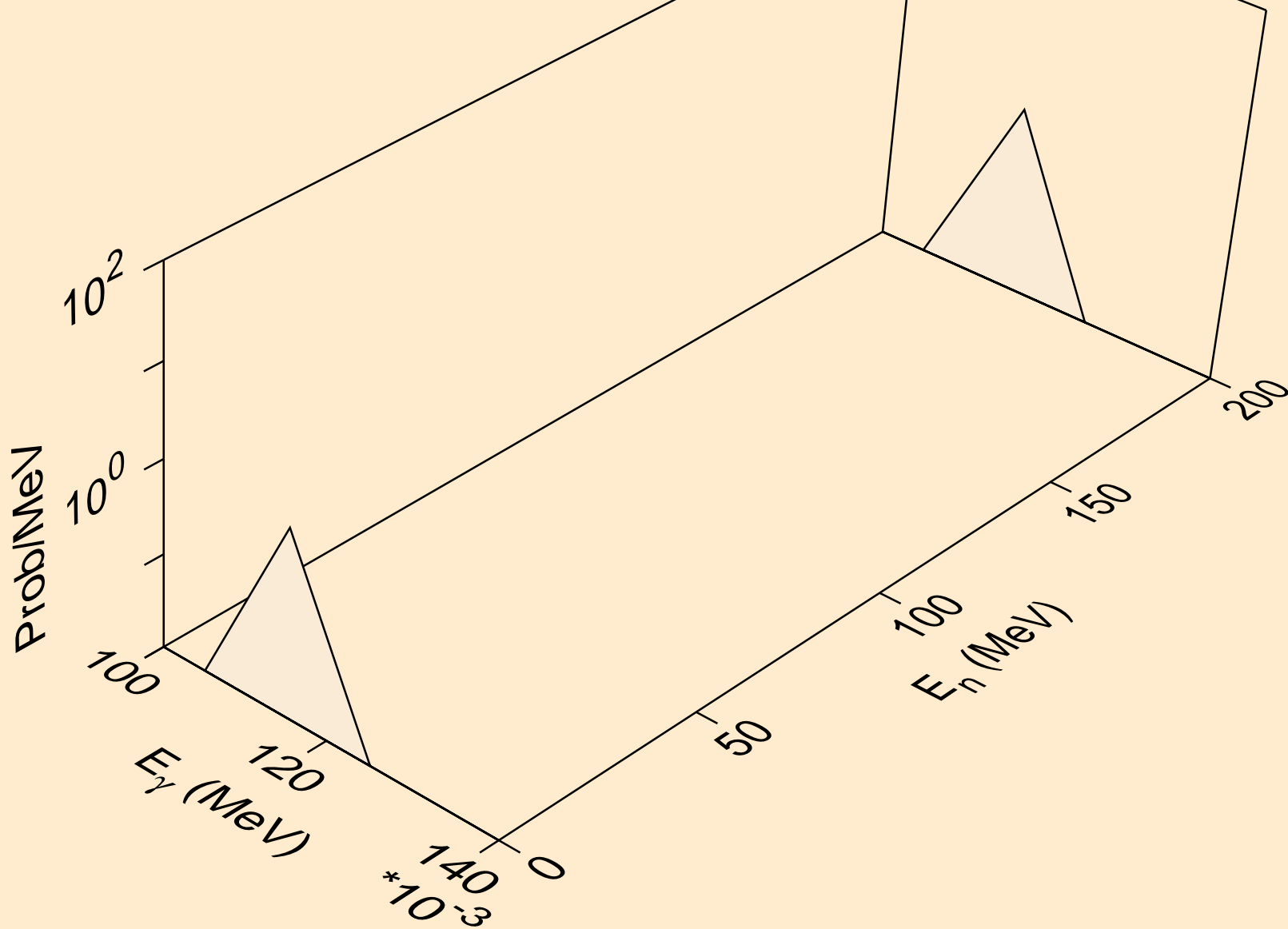

BI212M NEUTRON ACER TENDL-2019 LIBRARY; T=293.16K
Photon emission for (n,n*2)

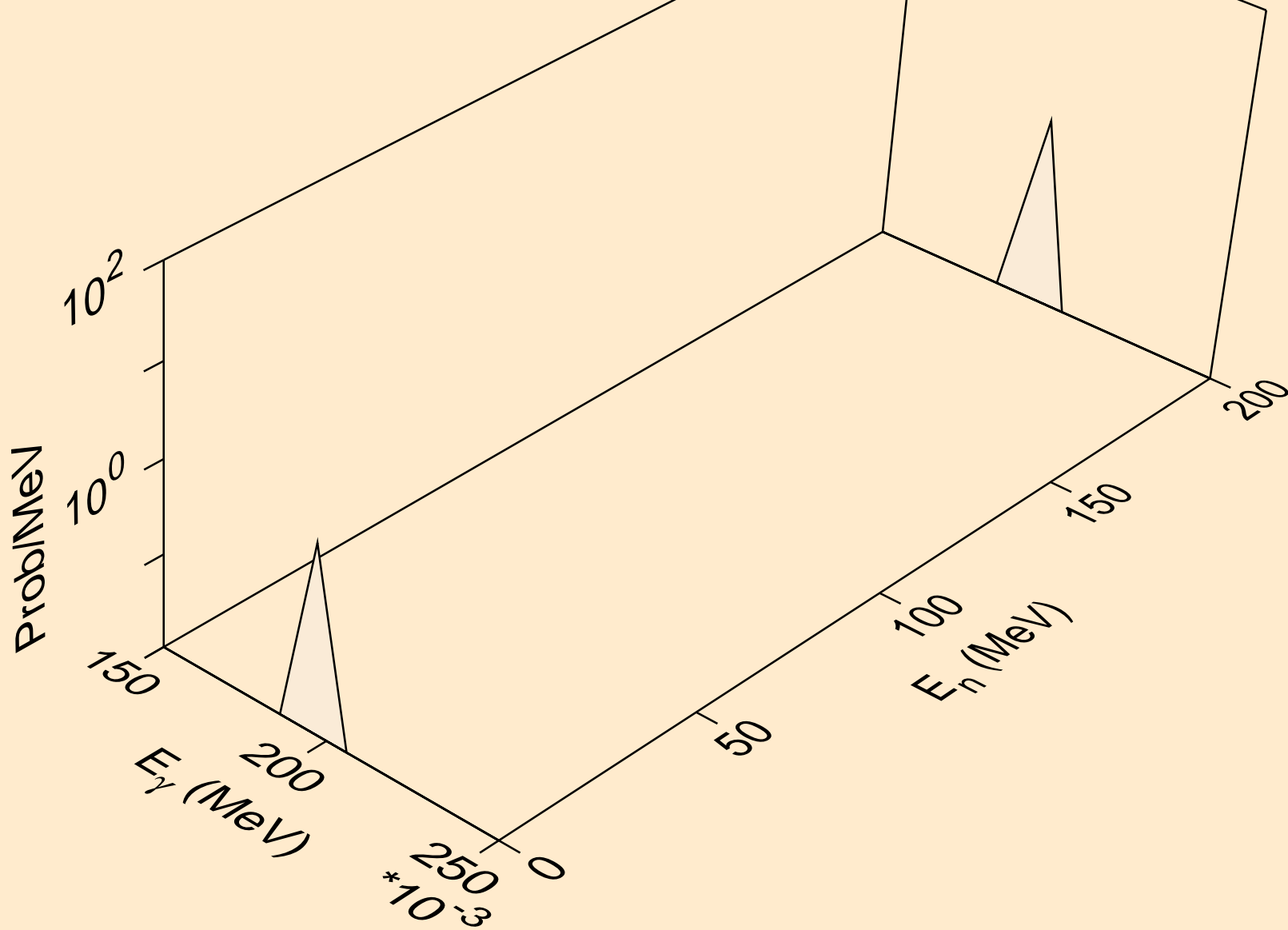

BI212M NEUTRON ACER TENDL-2019 LIBRARY; T=293.16K
Photon emission for (n,n*3)

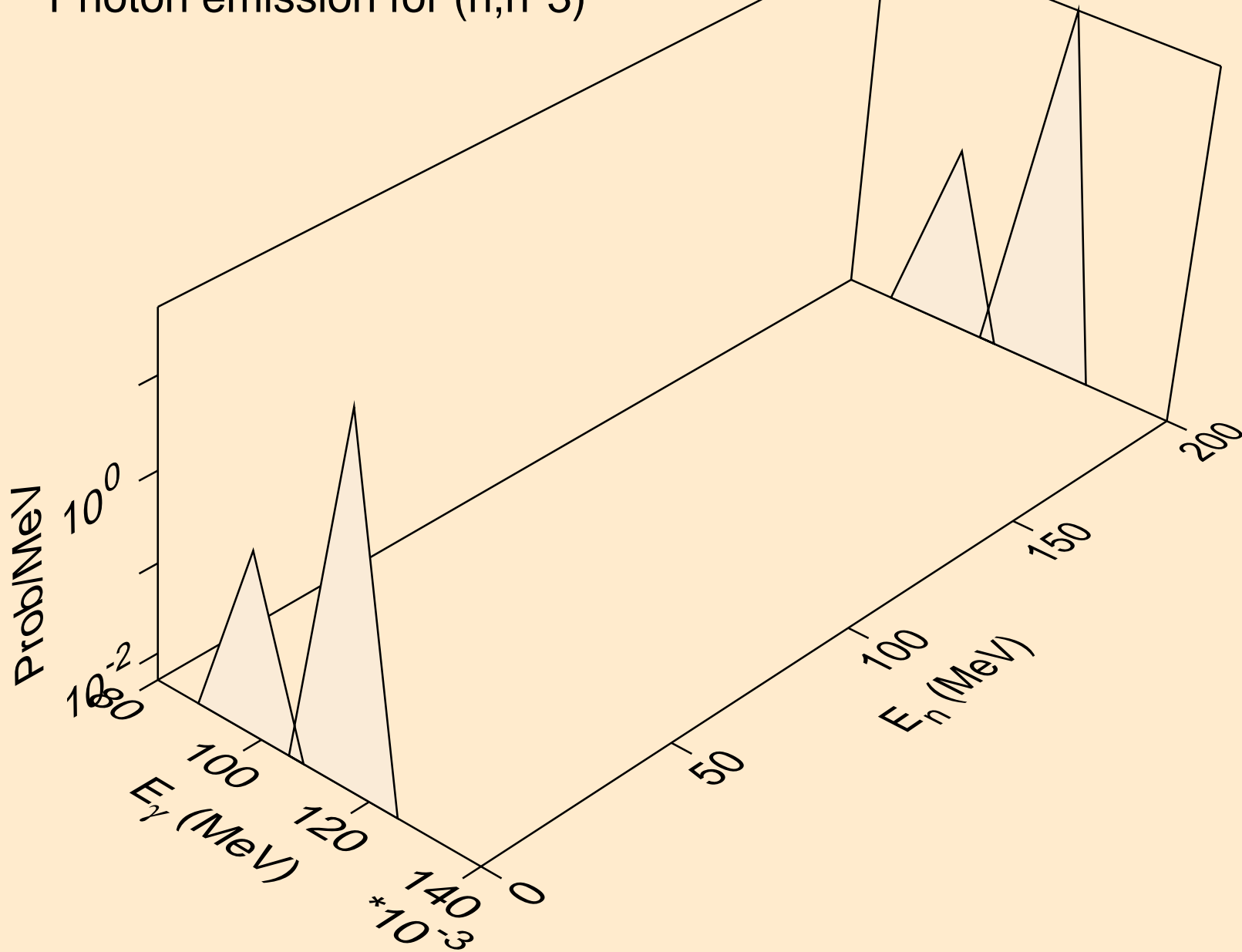

BI212M NEUTRON ACER TENDL-2019 LIBRARY; T=293.16K
Photon emission for (n,n*4)

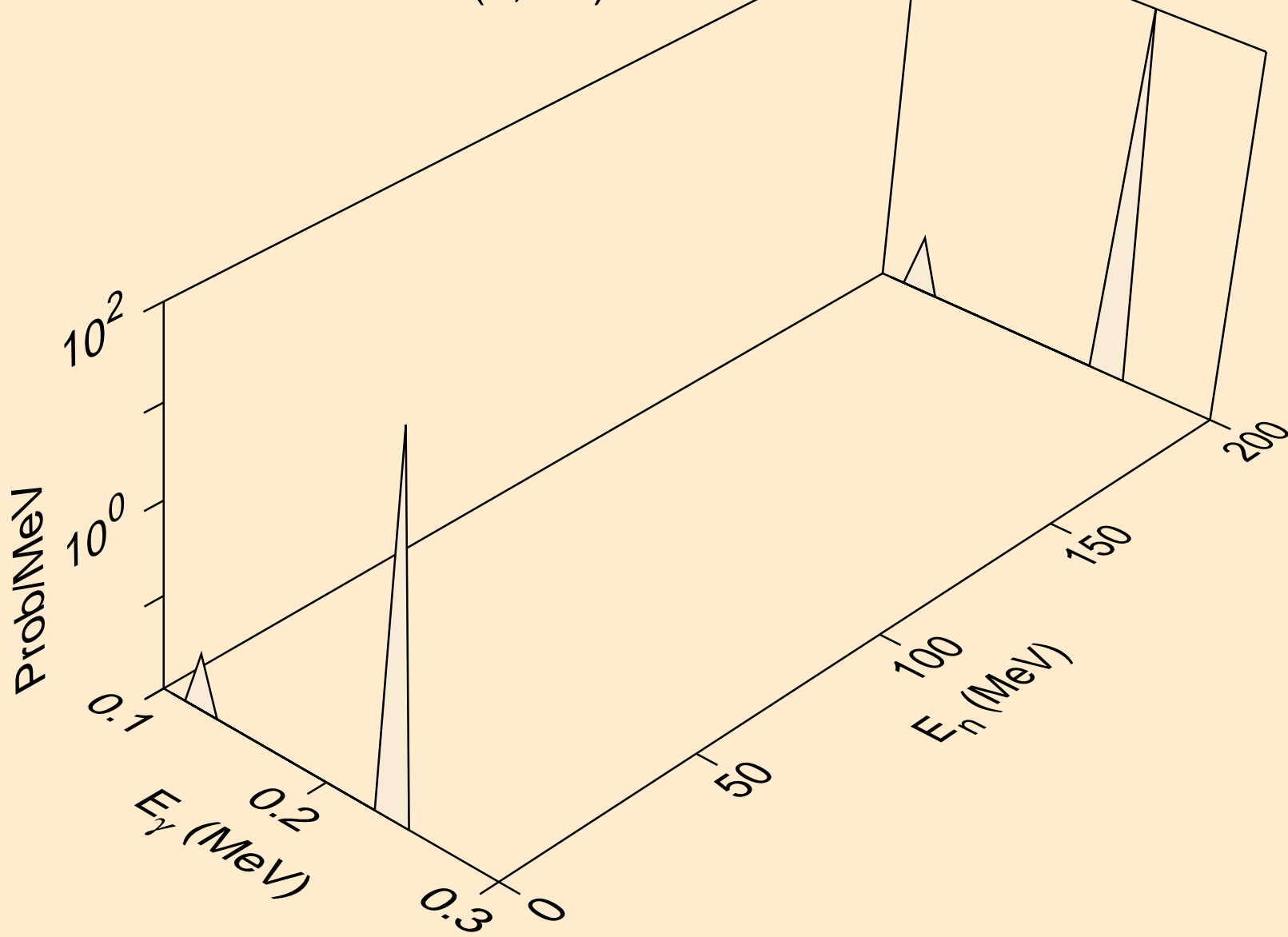

BI212M NEUTRON ACER TENDL-2019 LIBRARY; T=293.16K
Photon emission for (n,n*6)

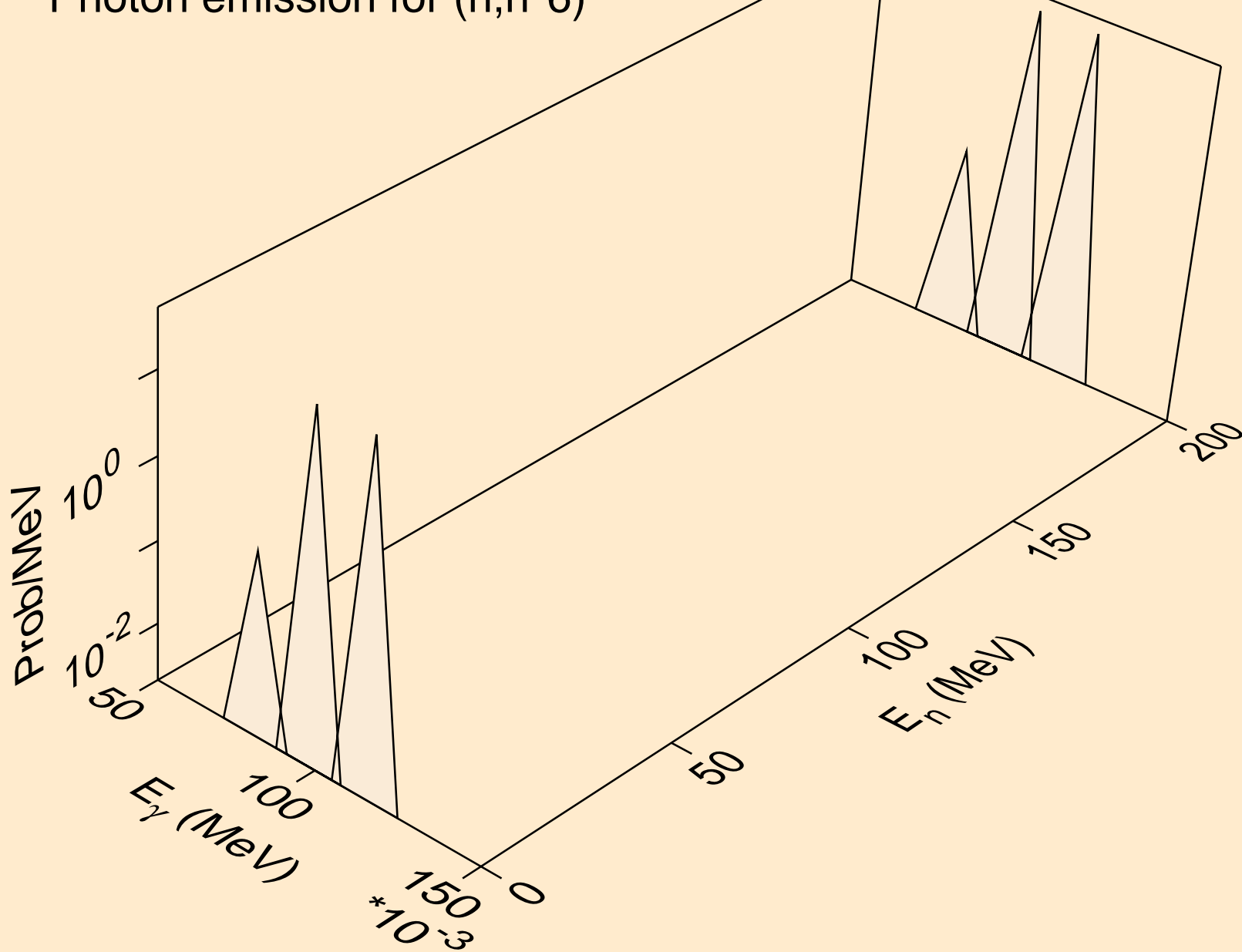

BI212M NEUTRON ACER TENDL-2019 LIBRARY; T=293.16K
Photon emission for (n,n*7)

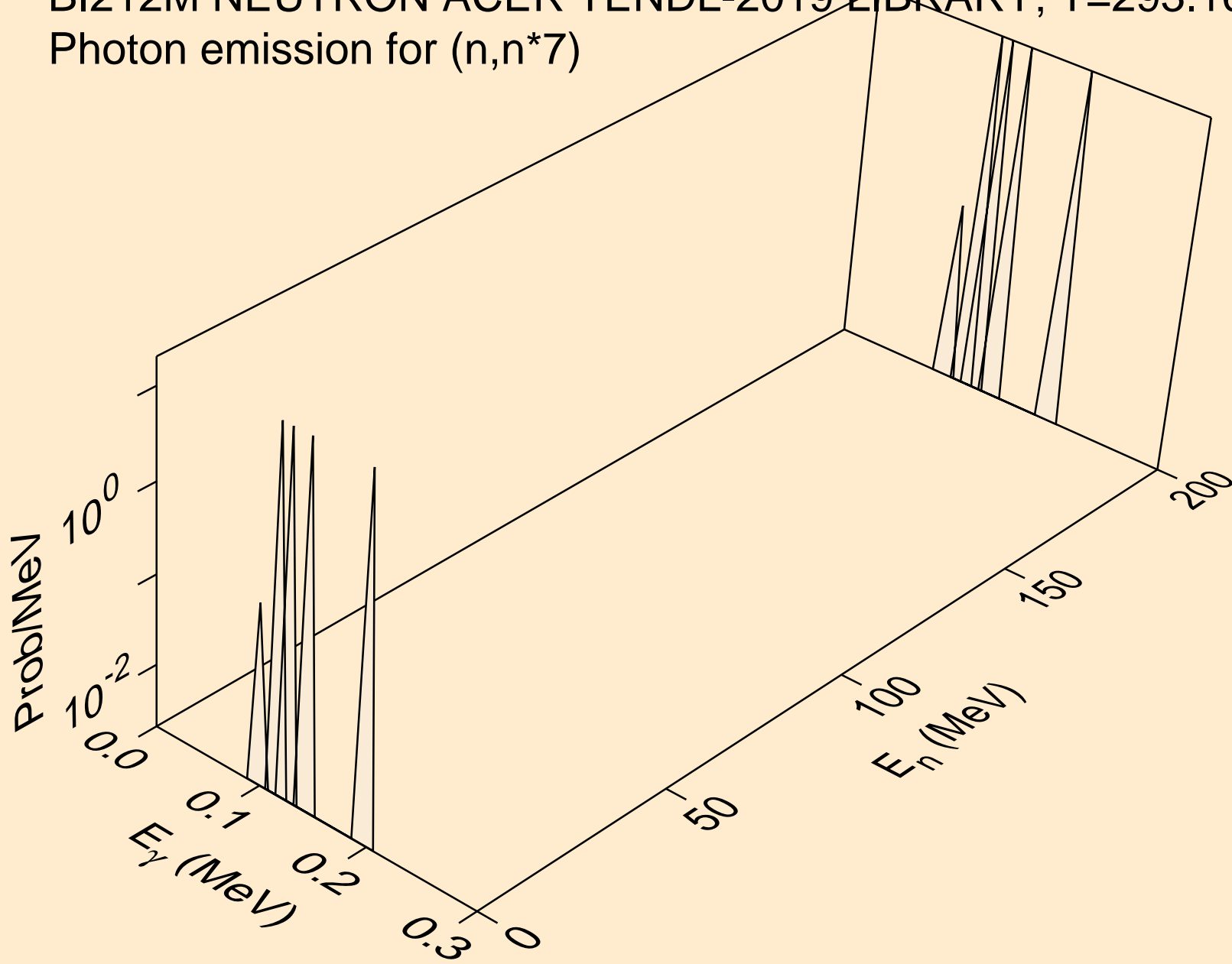

BI212M NEUTRON ACER TENDL-2019 LIBRARY; T=293.16K
Photon emission for (n,n*8)

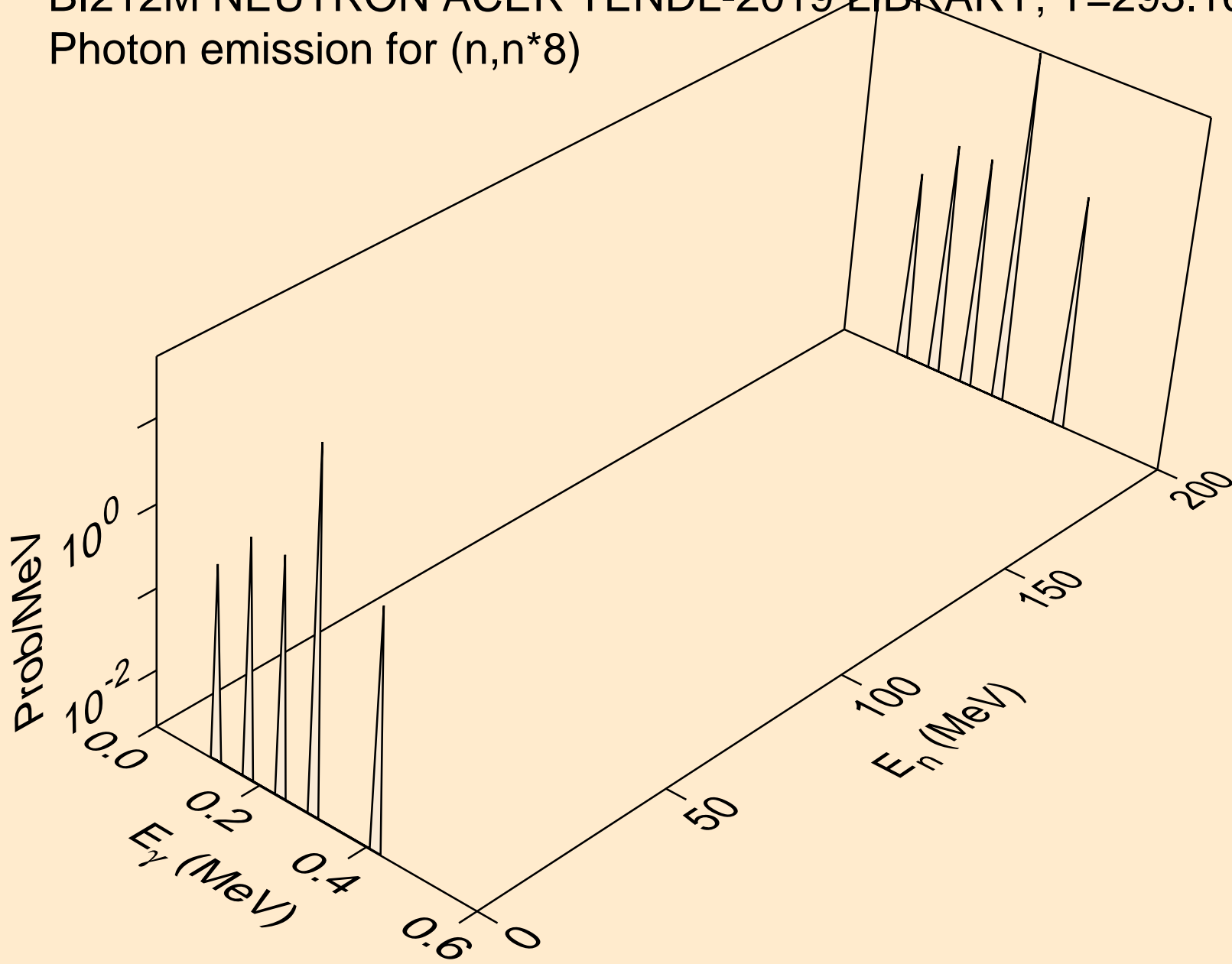

BI212M NEUTRON ACER TENDL-2019 LIBRARY; T=293.16K
Photon emission for (n,n*9)

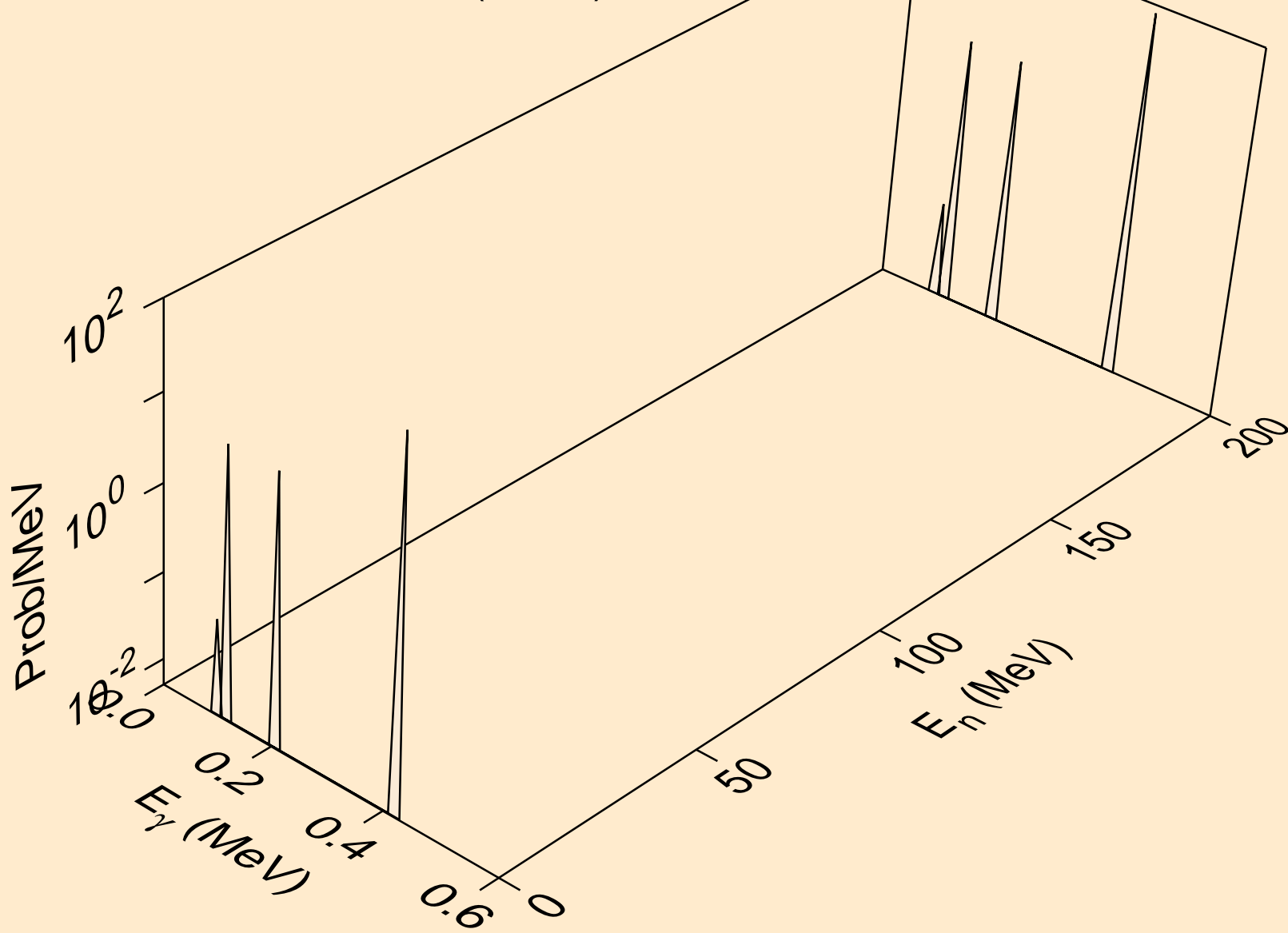

BI212M NEUTRON ACER TENDL-2019 LIBRARY; T=293.16K
Photon emission for (n,n*10)

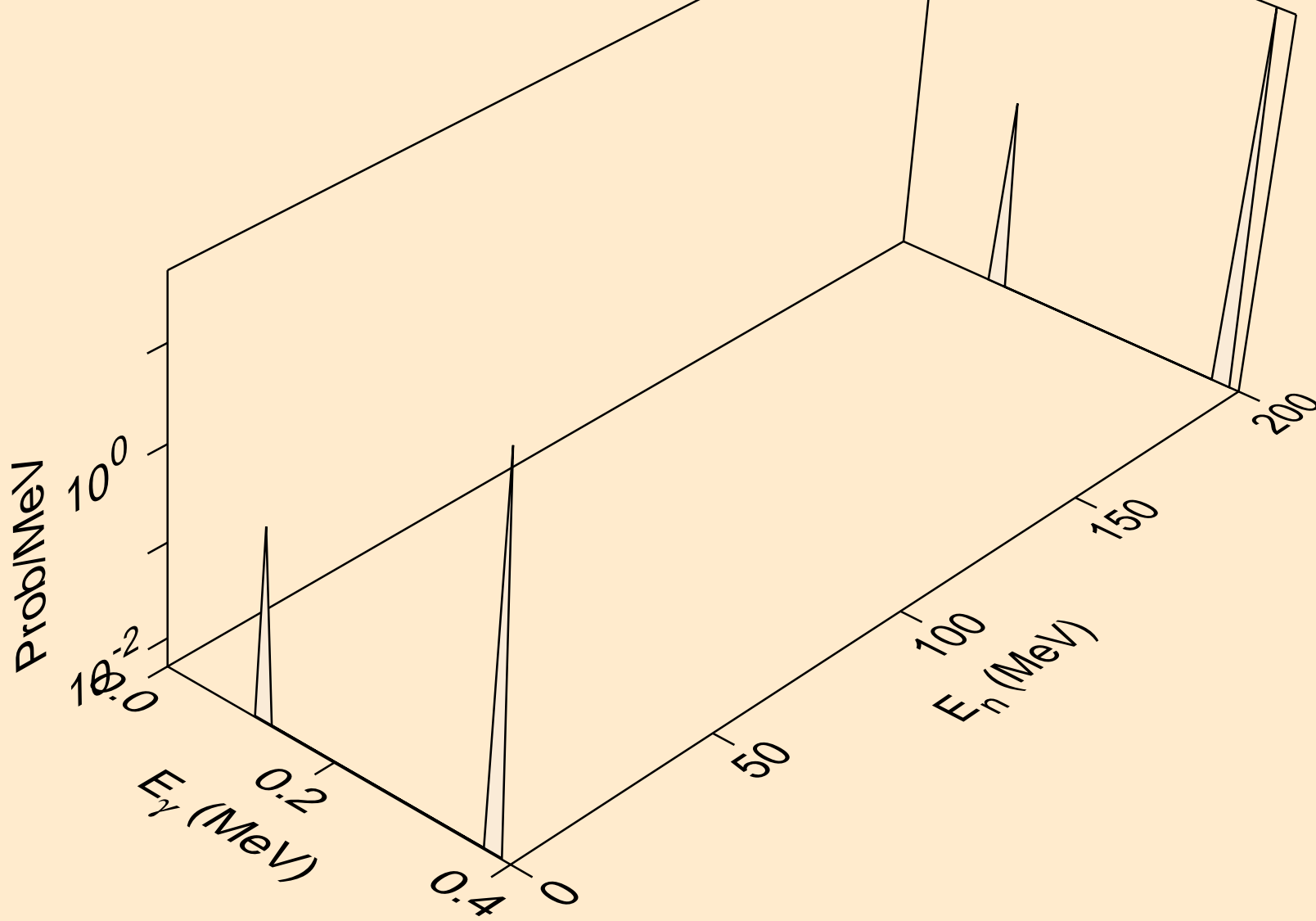

BI212M NEUTRON ACER TENDL-2019 LIBRARY; T=293.16K
Photon emission for (n,n*11)

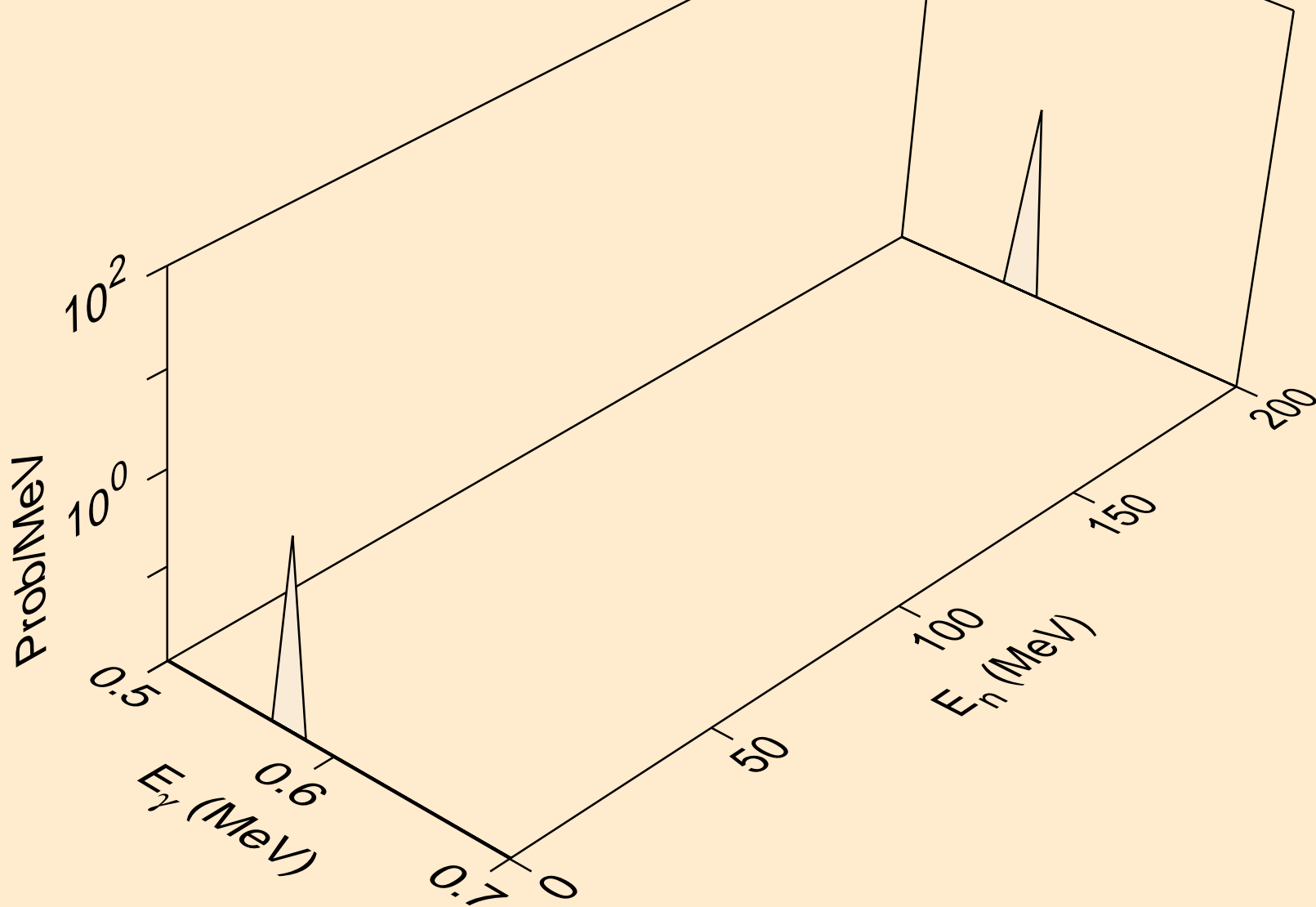

BI212M NEUTRON ACER TENDL-2019 LIBRARY; T=293.16K
Photon emission for (n,n*13)

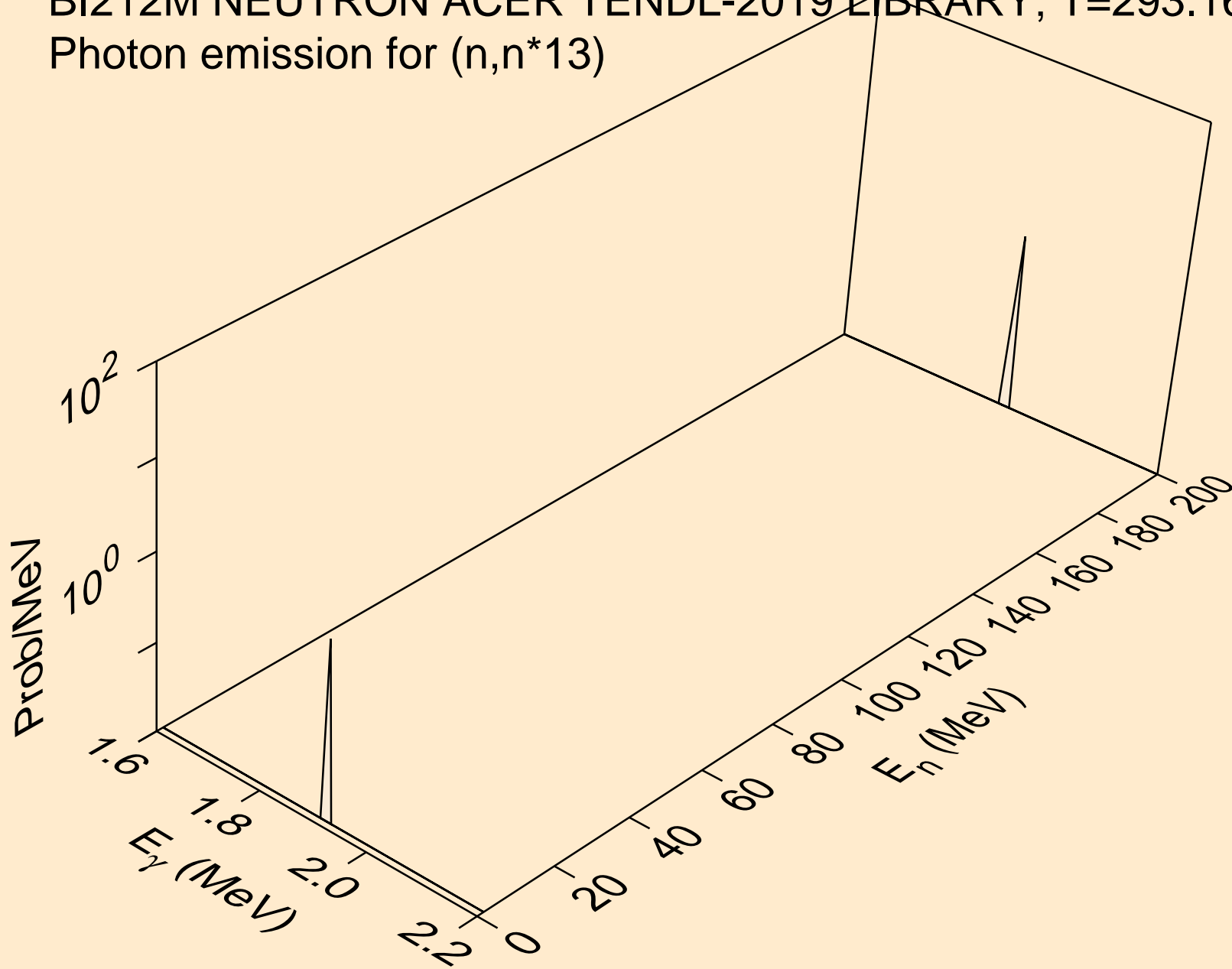

BI212M NEUTRON ACER TENDL-2019 LIBRARY; T=293.16K
Photon emission for (n,n*14)

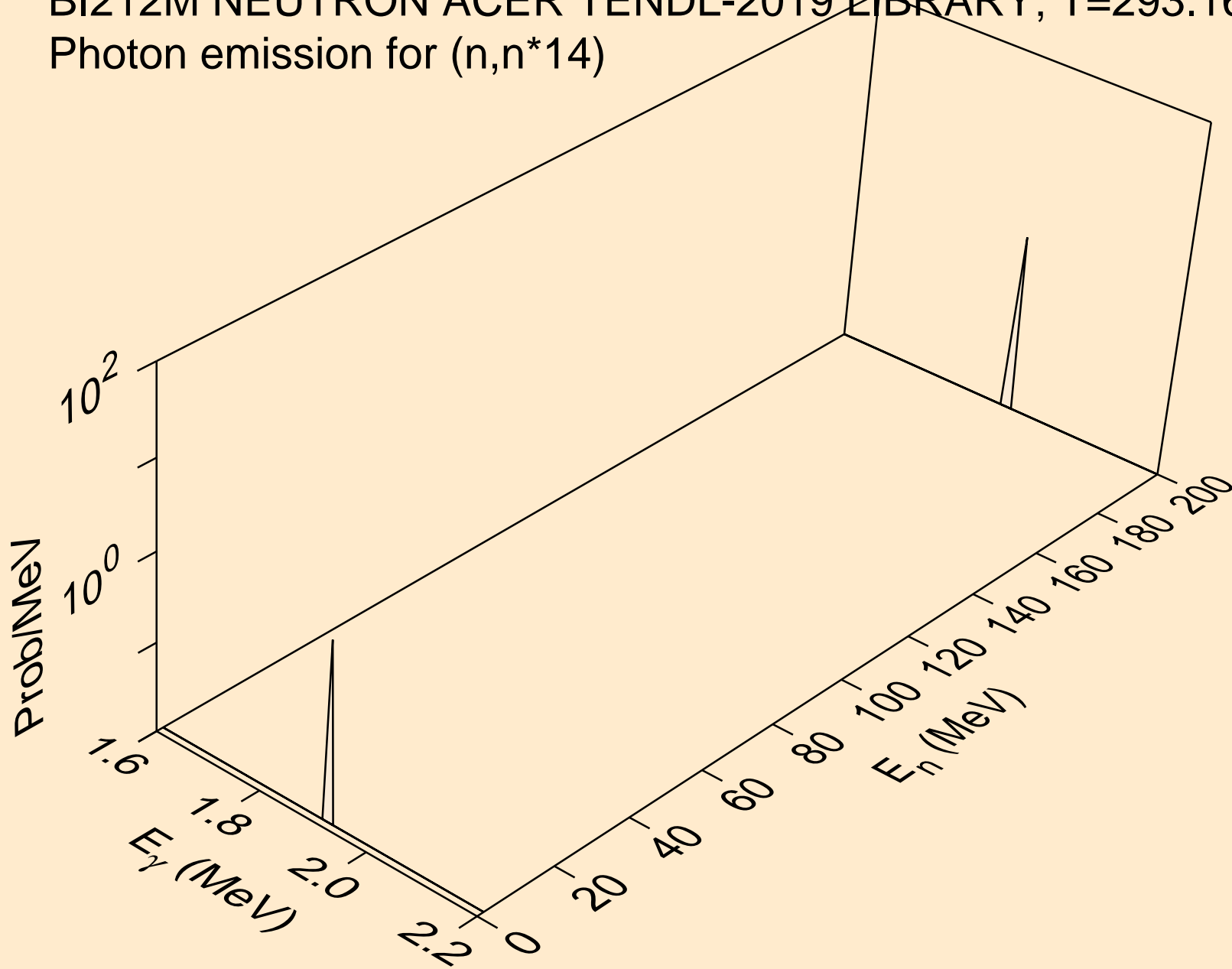

BI212M NEUTRON ACER TENDL-2019 LIBRARY; T=293.16K
Photon emission for (n,n*15)

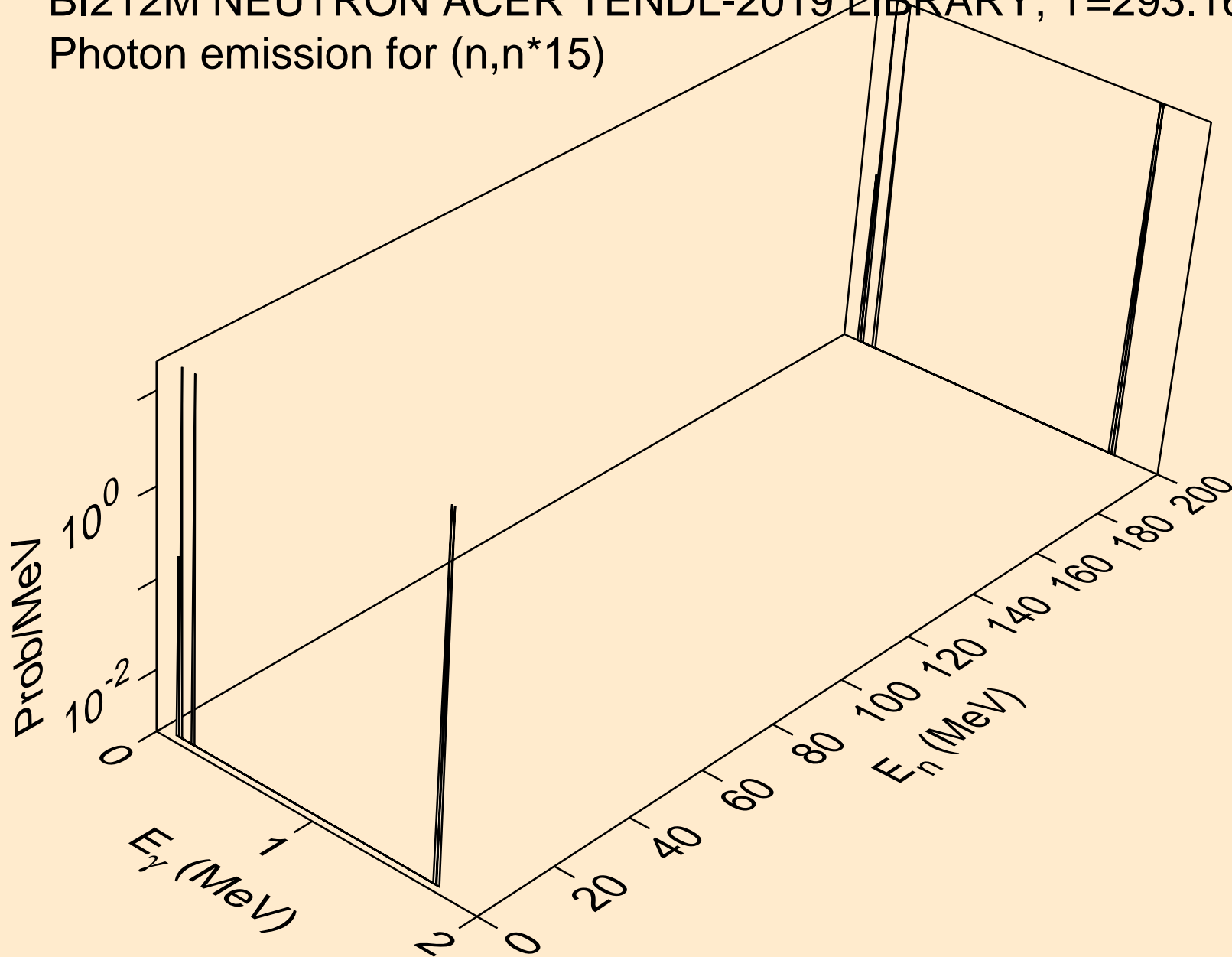

BI212M NEUTRON ACER TENDL-2019 LIBRARY; T=293.16K
Photon emission for (n,n*16)

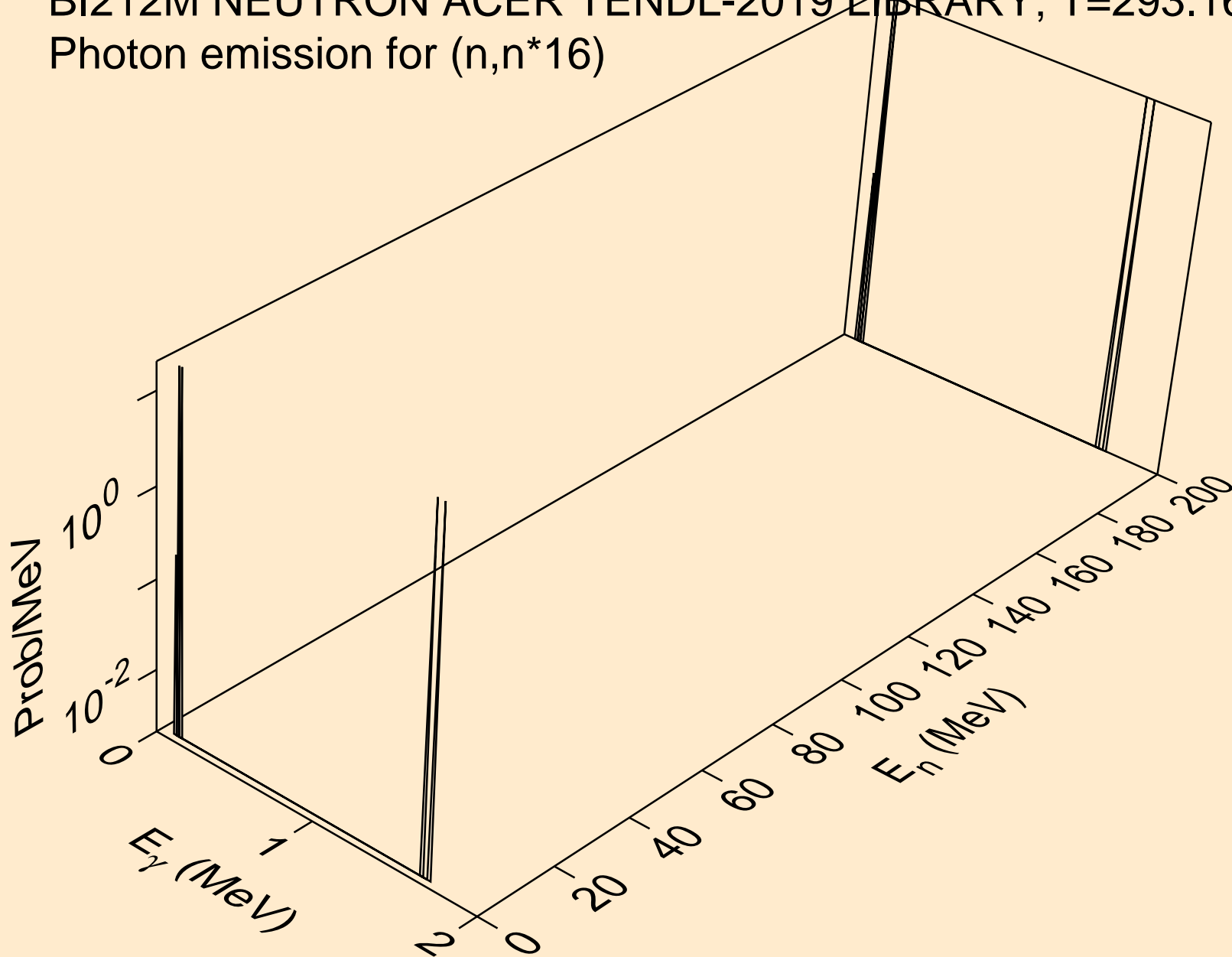

BI212M NEUTRON ACER TENDL-2019 LIBRARY; T=293.16K
Photon emission for (n,n*17)

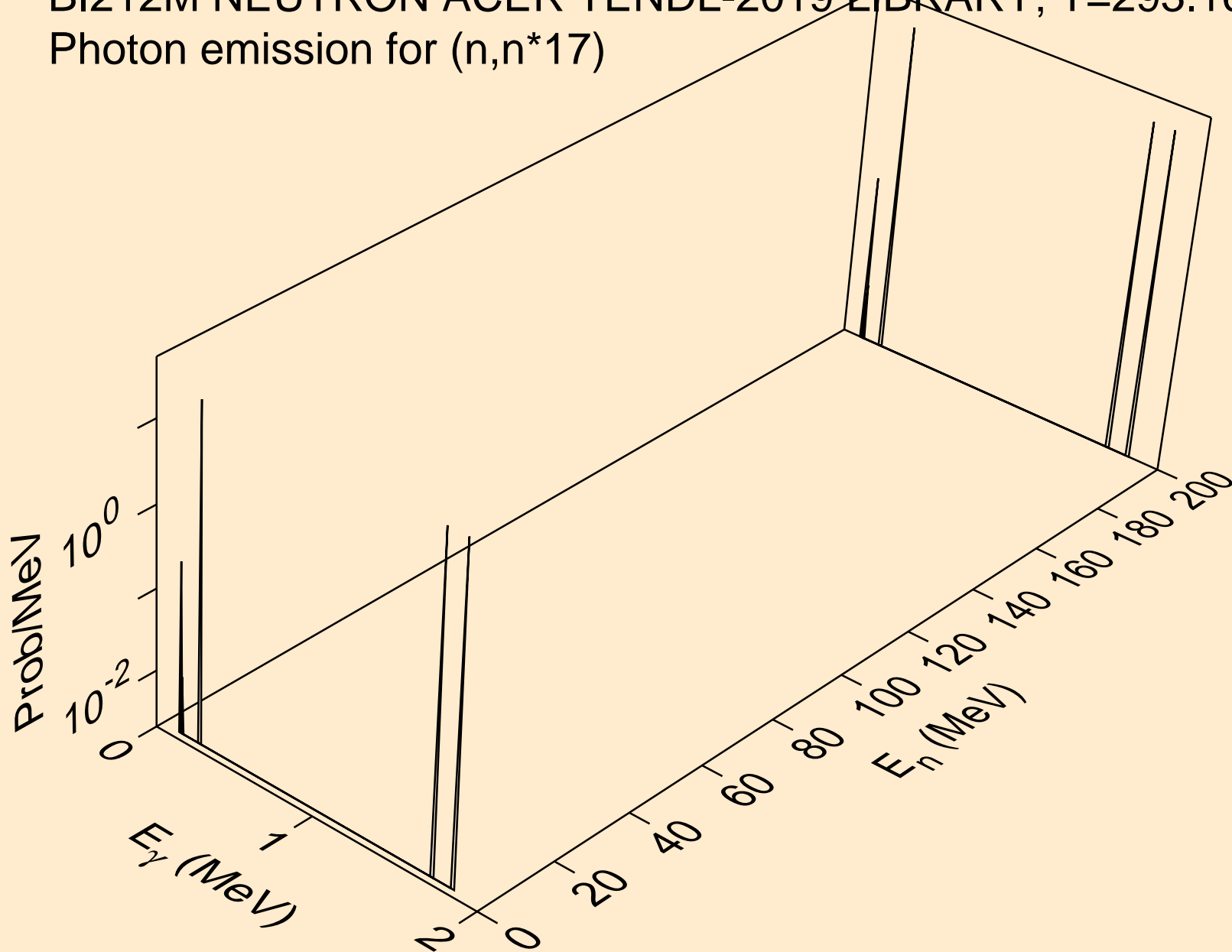

BI212M NEUTRON ACER TENDL-2019 LIBRARY; T=293.16K
Photon emission for (n,n*18)

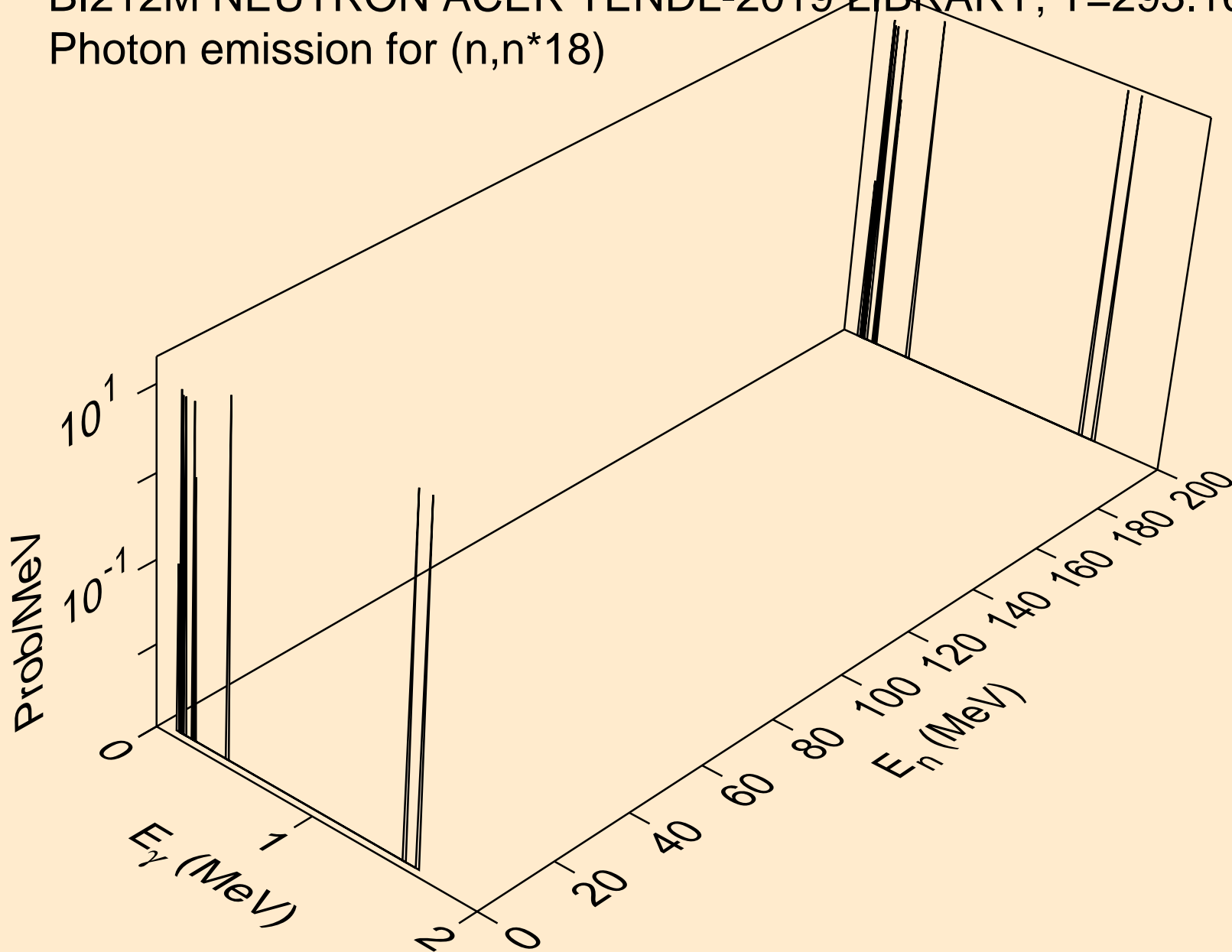

BI212M NEUTRON ACER TENDL-2019 LIBRARY; T=293.16K
Photon emission for (n,n*19)

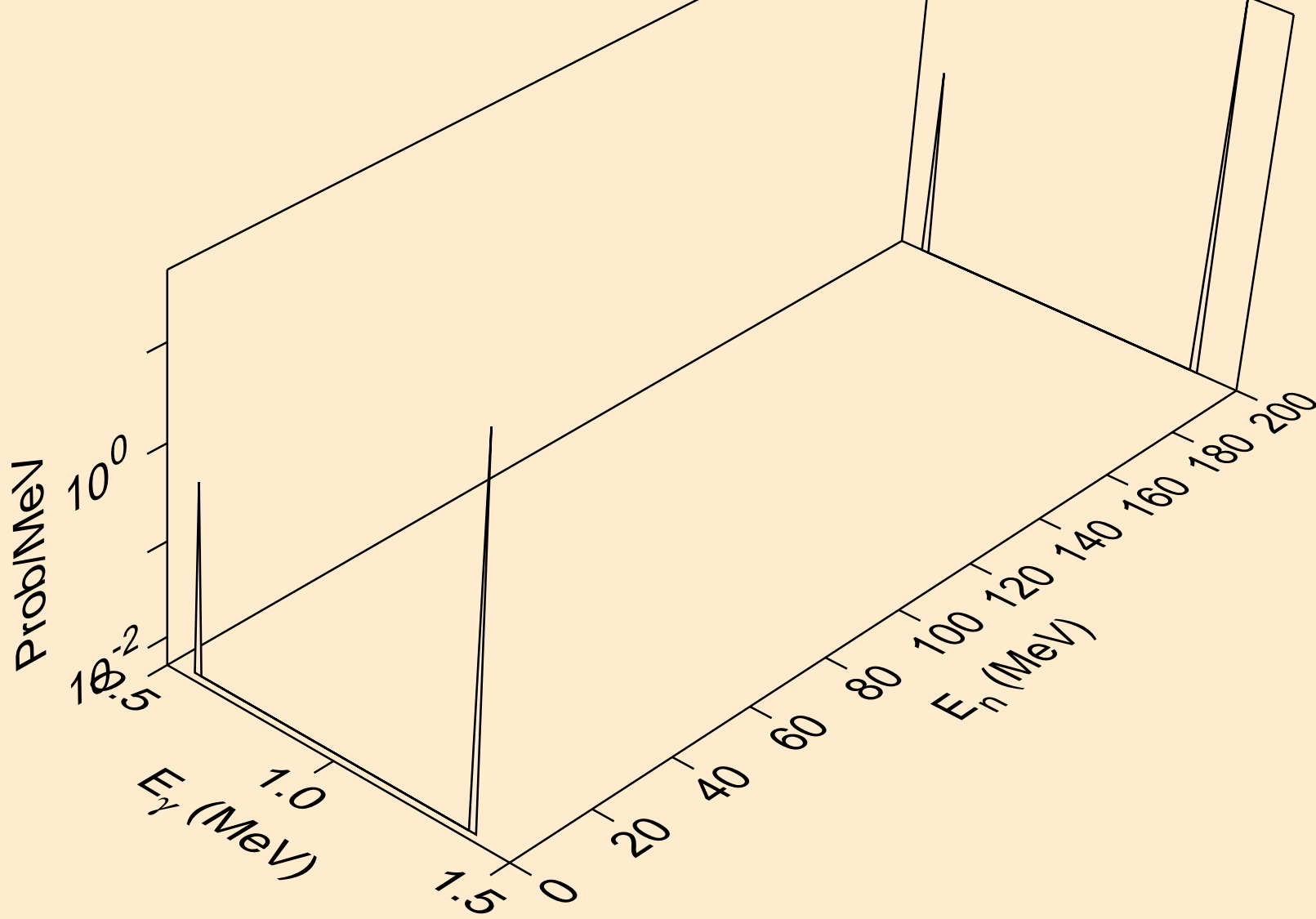

BI212M NEUTRON ACER TENDL-2019 LIBRARY; T=293.16K
Photon emission for (n,n*20)

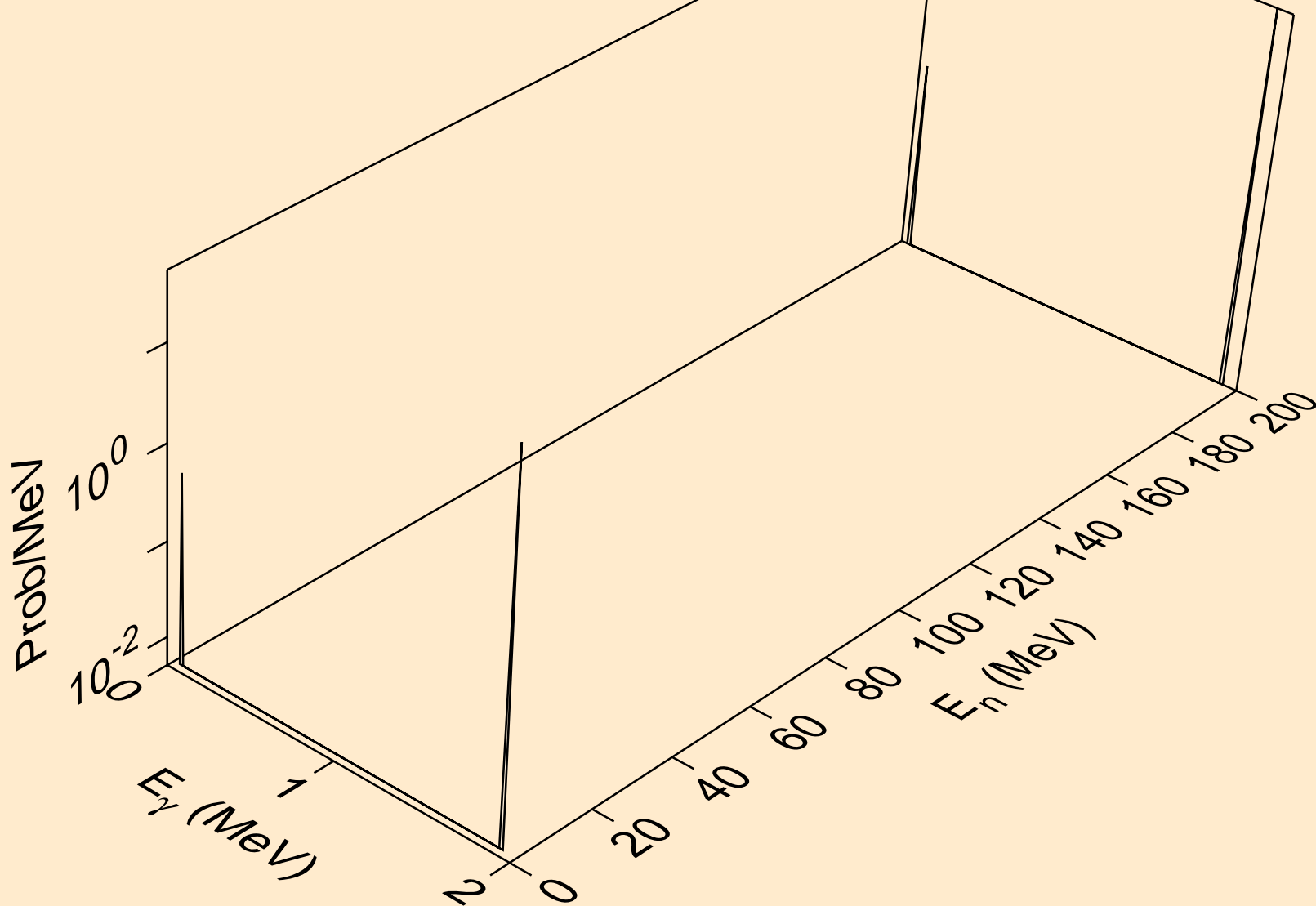

BI212M NEUTRON ACER TENDL-2019 LIBRARY; T=293.16K
Photon emission for (n,n*21)

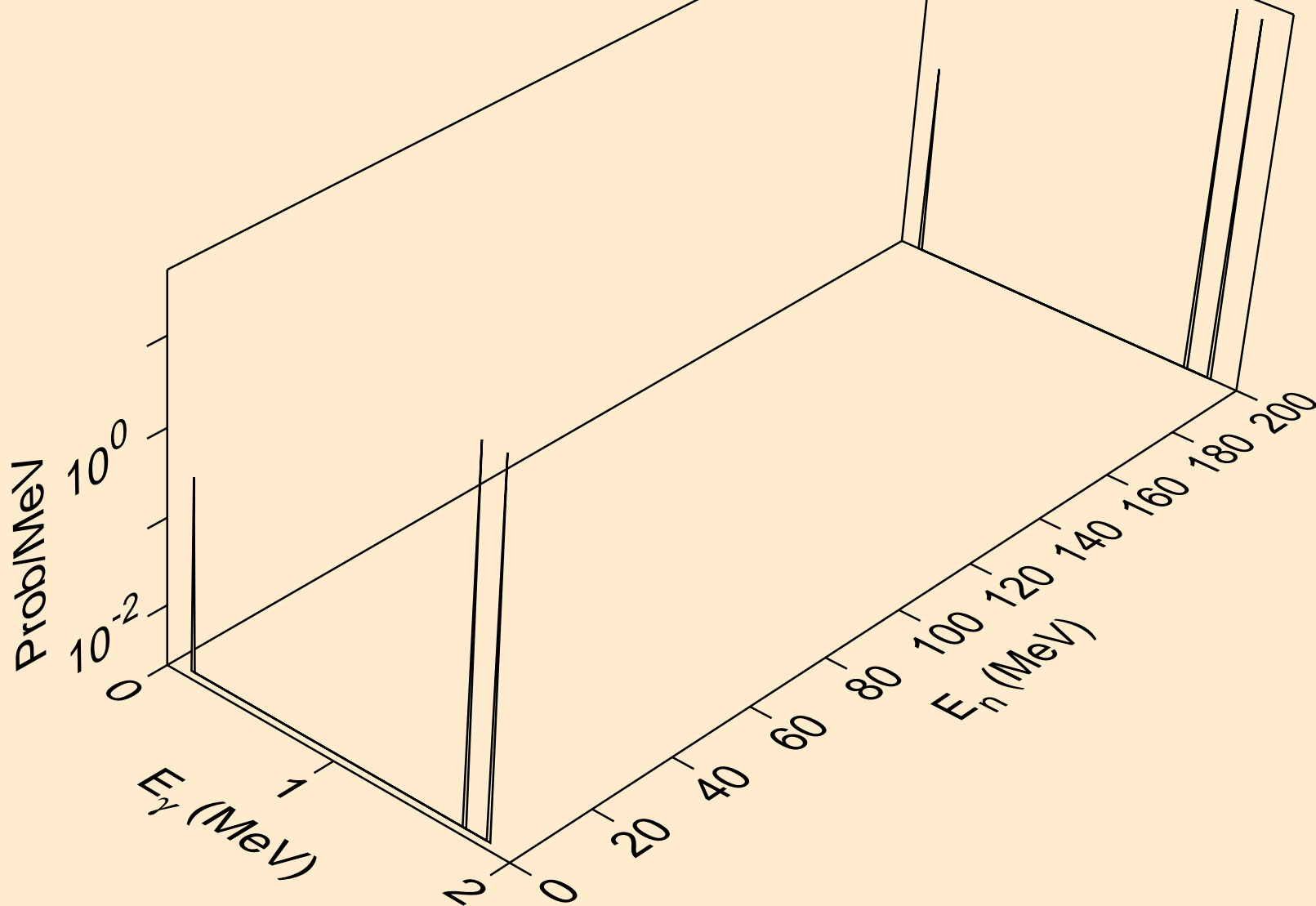

BI212M NEUTRON ACER TENDL-2019 LIBRARY; T=293.16K
Photon emission for (n,n*22)

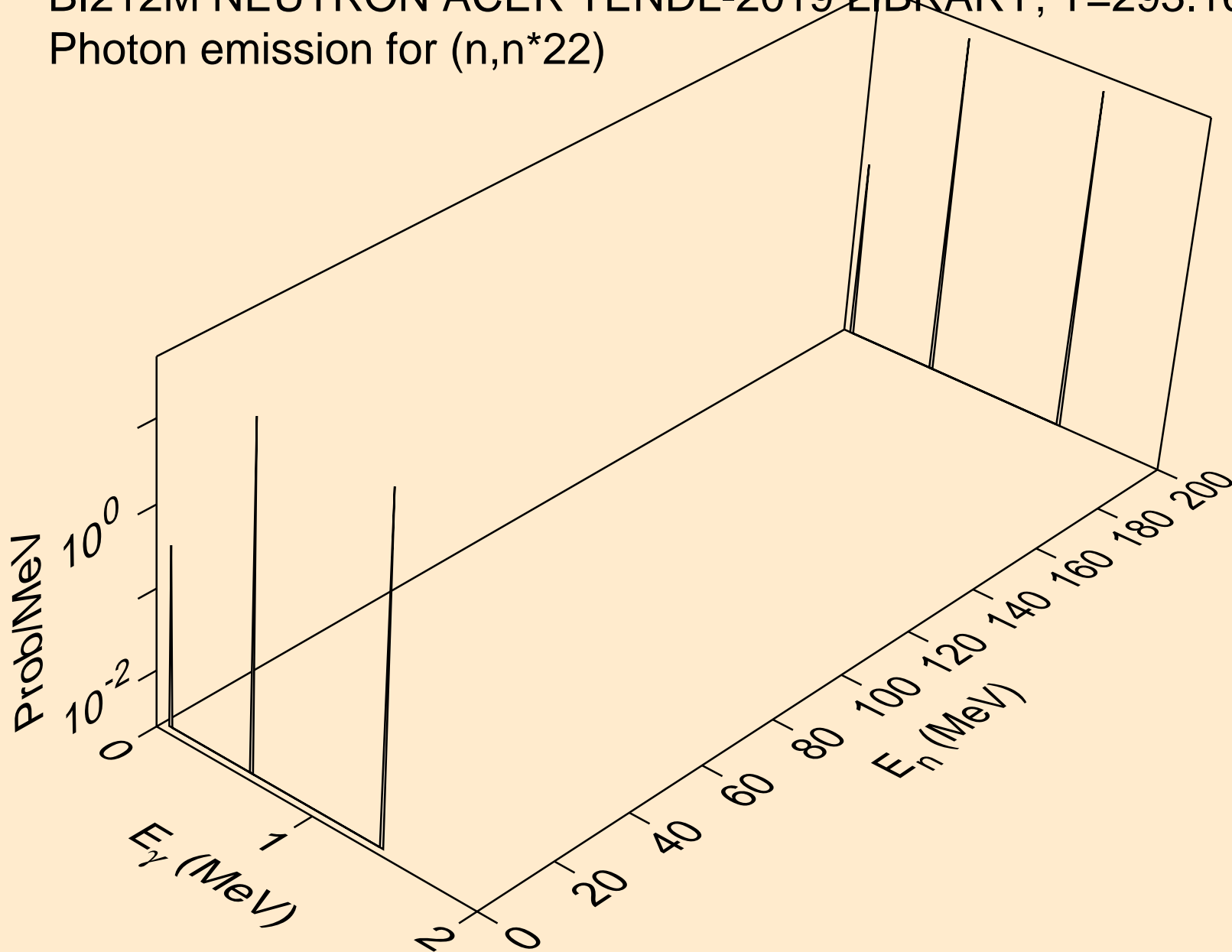

BI212M NEUTRON ACER TENDL-2019 LIBRARY; T=293.16K
Photon emission for (n,n*23)

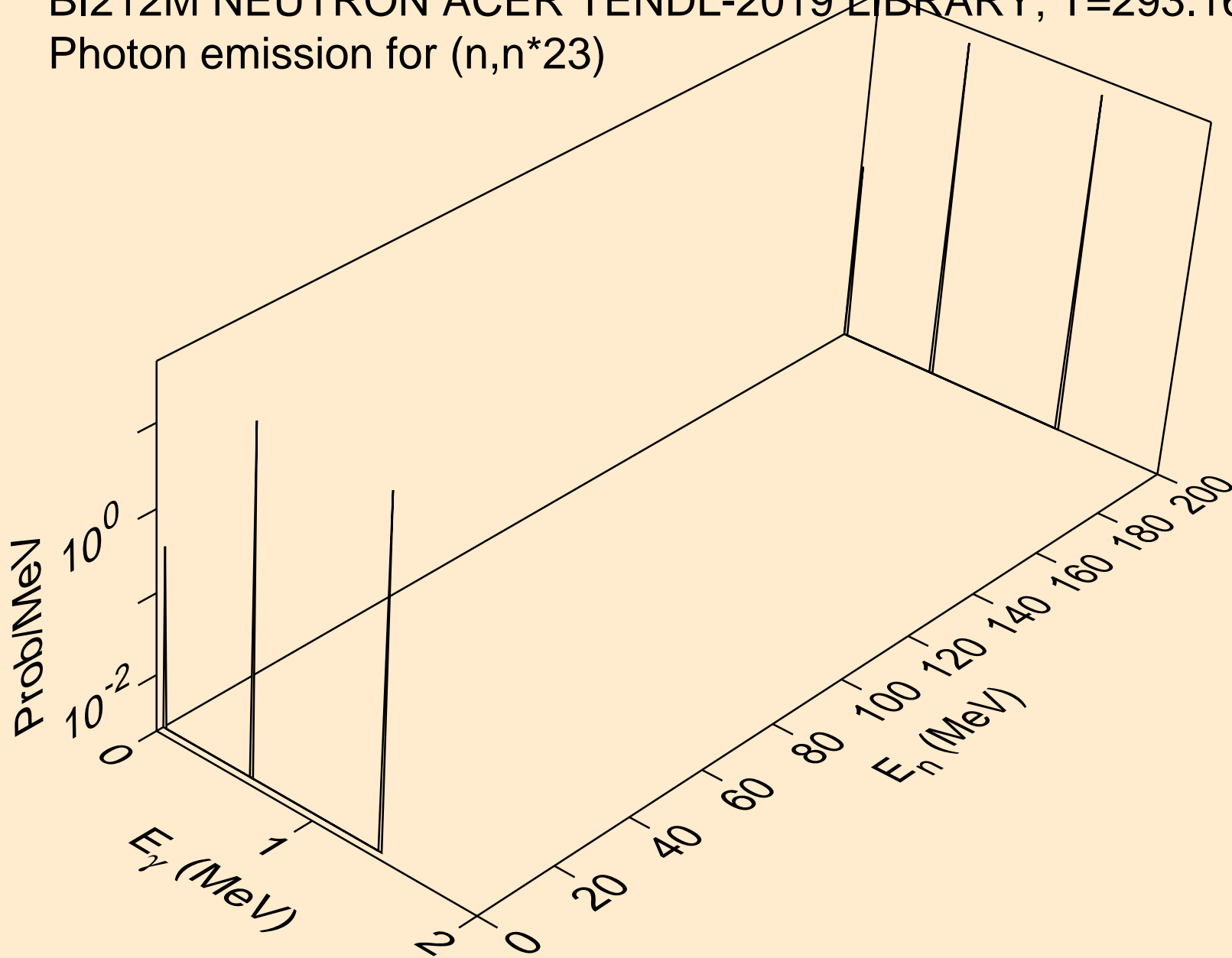

BI212M NEUTRON ACER TENDL-2019 LIBRARY; T=293.16K
Photon emission for (n,n*24)

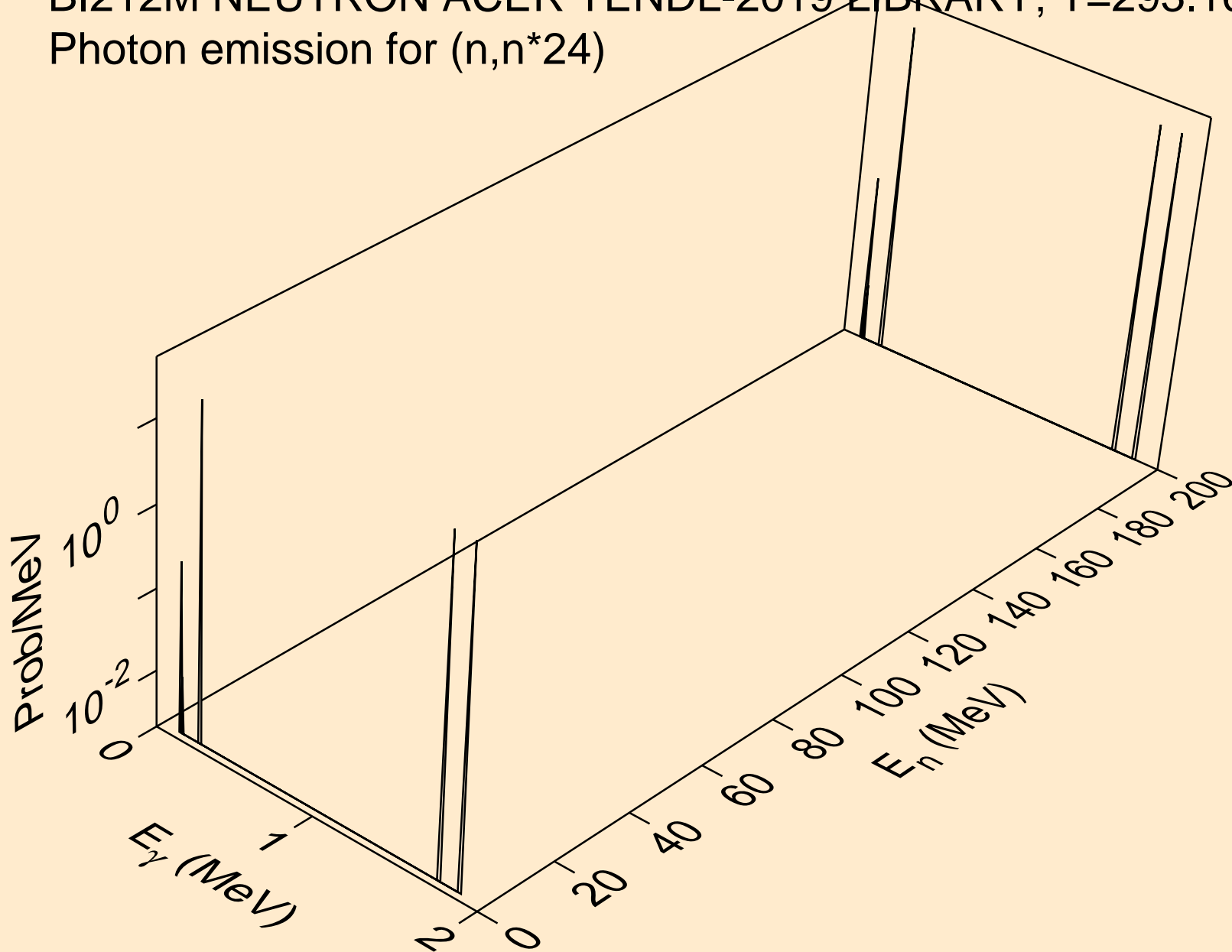

BI212M NEUTRON ACER TENDL-2019 LIBRARY; T=293.16K
Photon emission for (n,n*25)

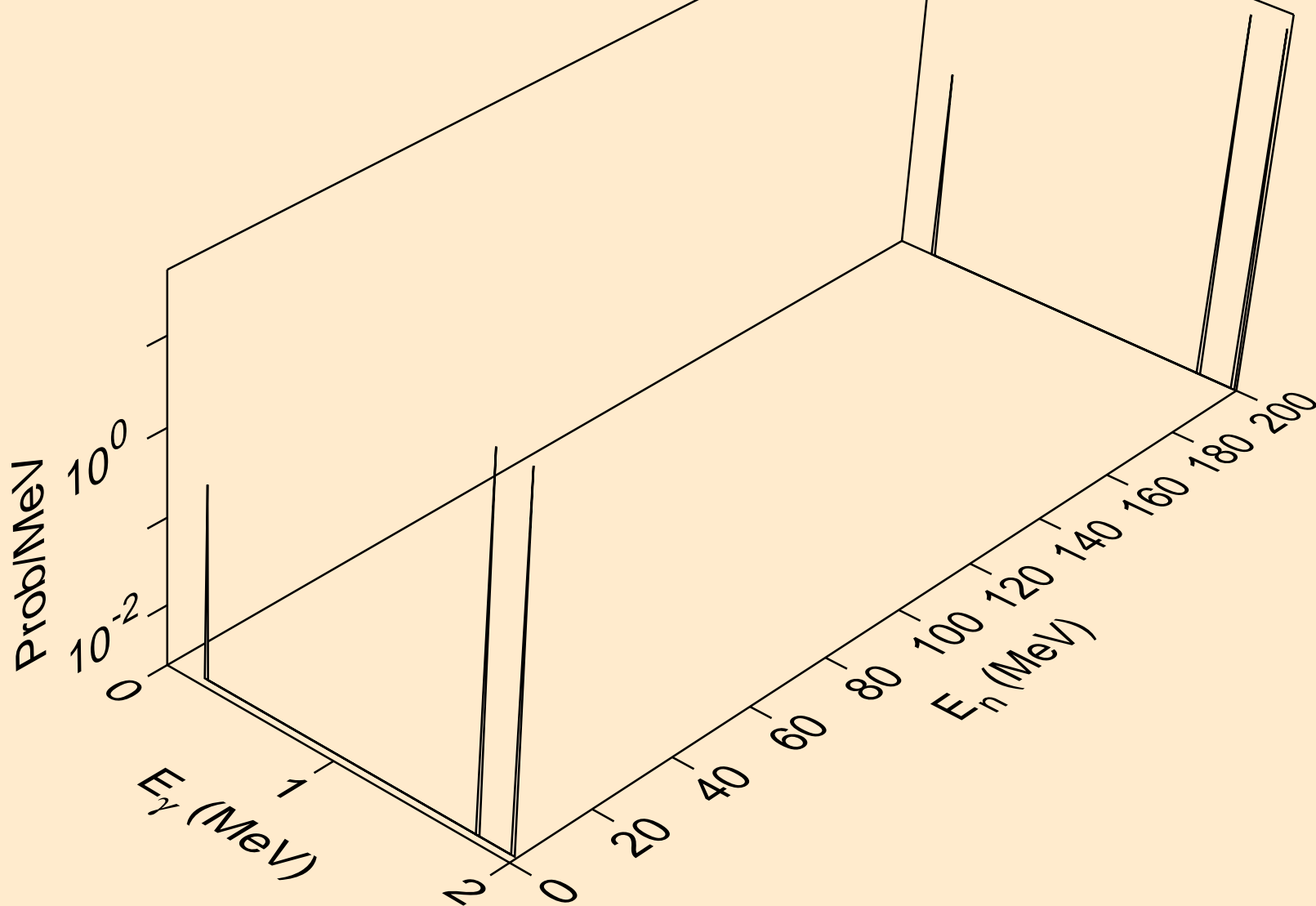

BI212M NEUTRON ACER TENDL-2019 LIBRARY; T=293.16K
Photon emission for (n,n*26)

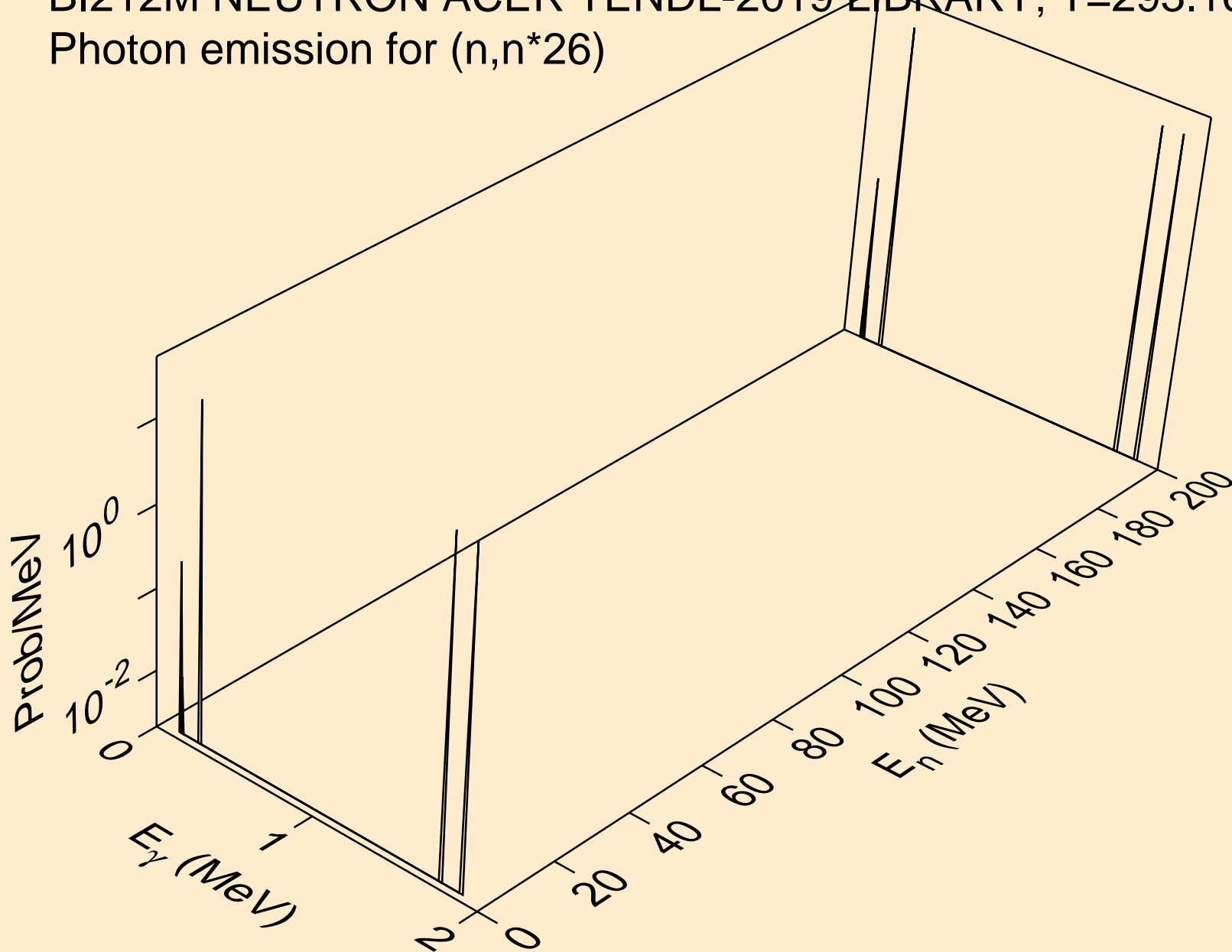

BI212M NEUTRON ACER TENDL-2019 LIBRARY; T=293.16K
Photon emission for (n,n*27)

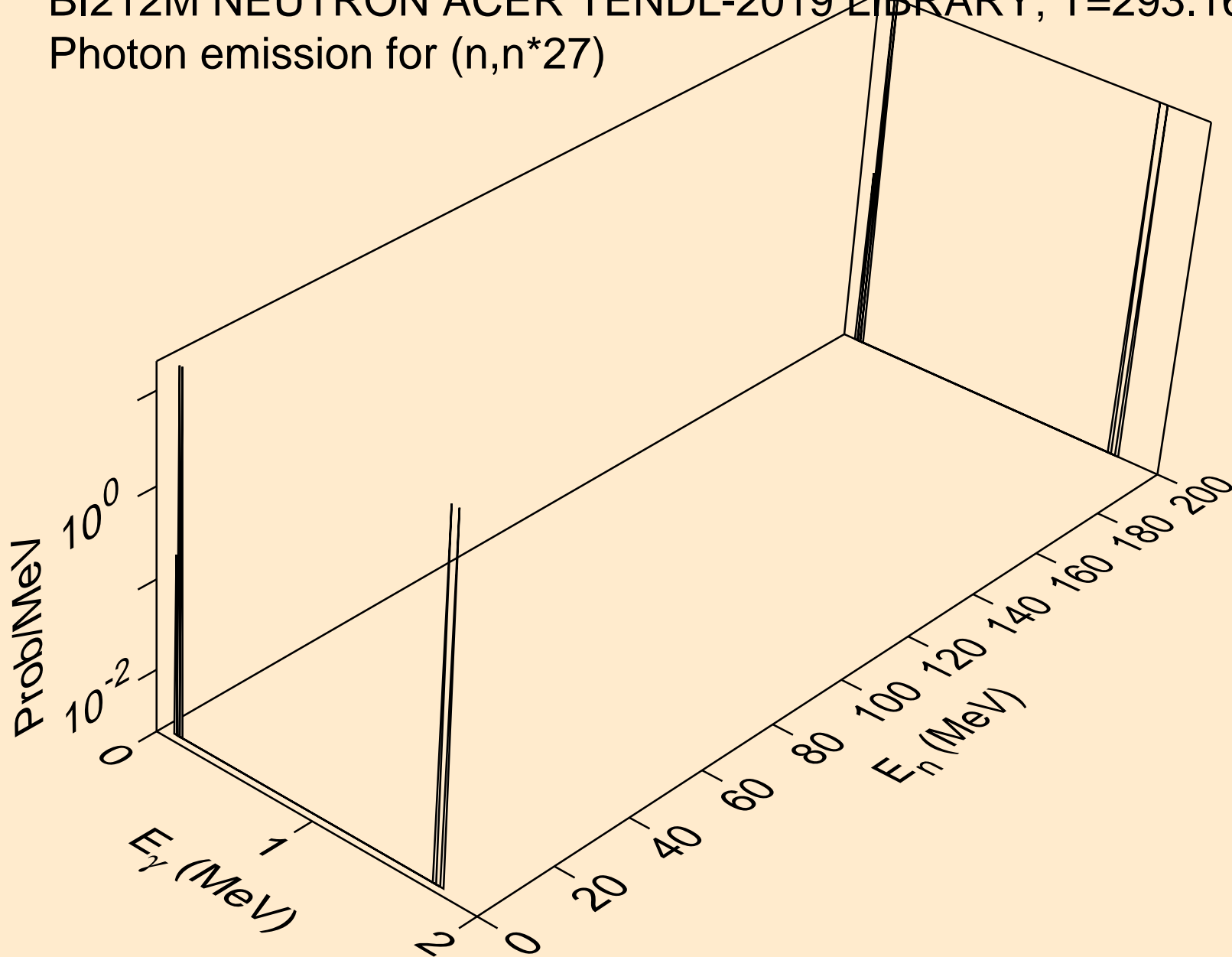

BI212M NEUTRON ACER TENDL-2019 LIBRARY; T=293.16K
Photon emission for (n,n*28)

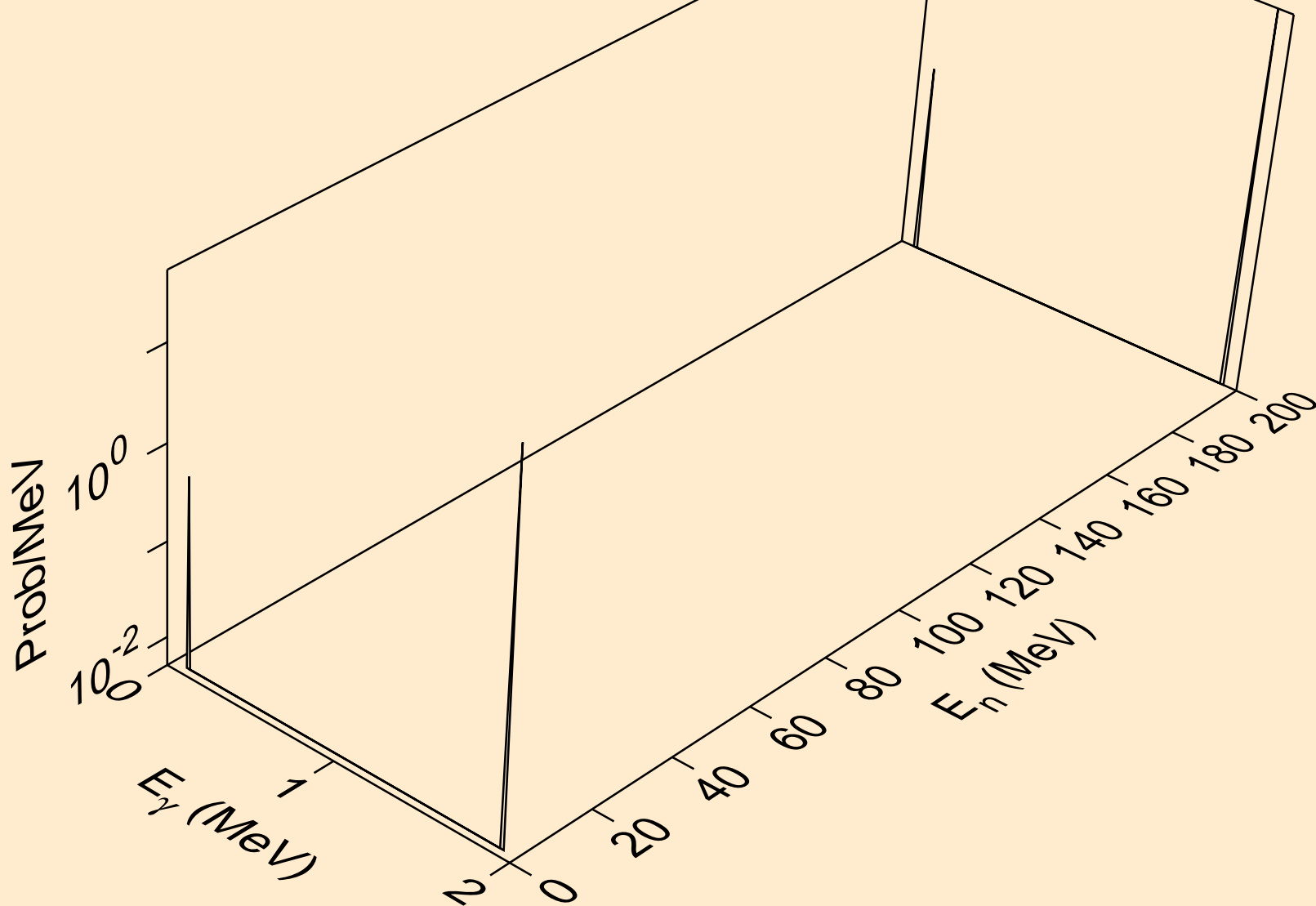

BI212M NEUTRON ACER TENDL-2019 LIBRARY; T=293.16K
Photon emission for (n,n*29)

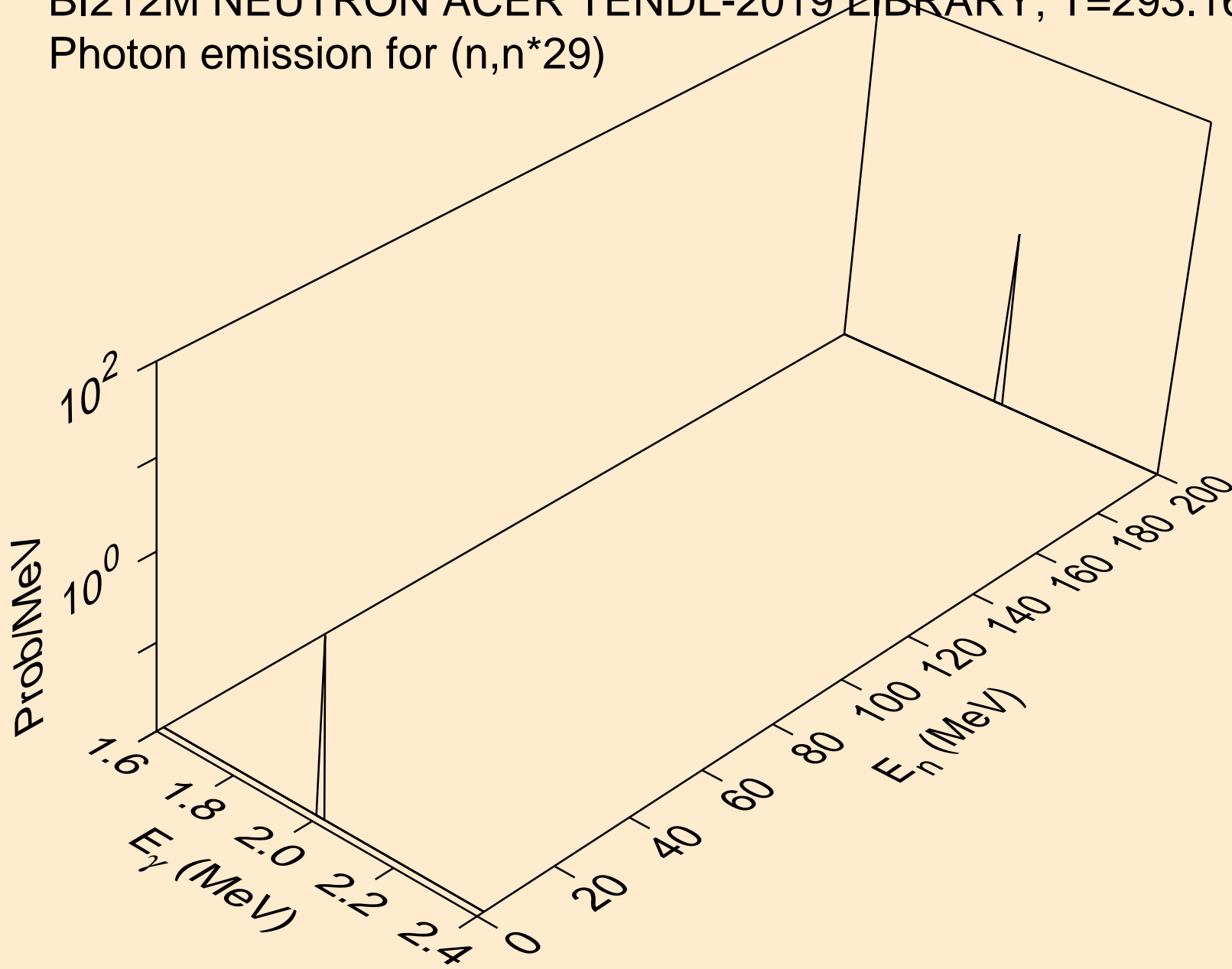

BI212M NEUTRON ACER TENDL-2019 LIBRARY; T=293.16K
Photon emission for (n,n*30)

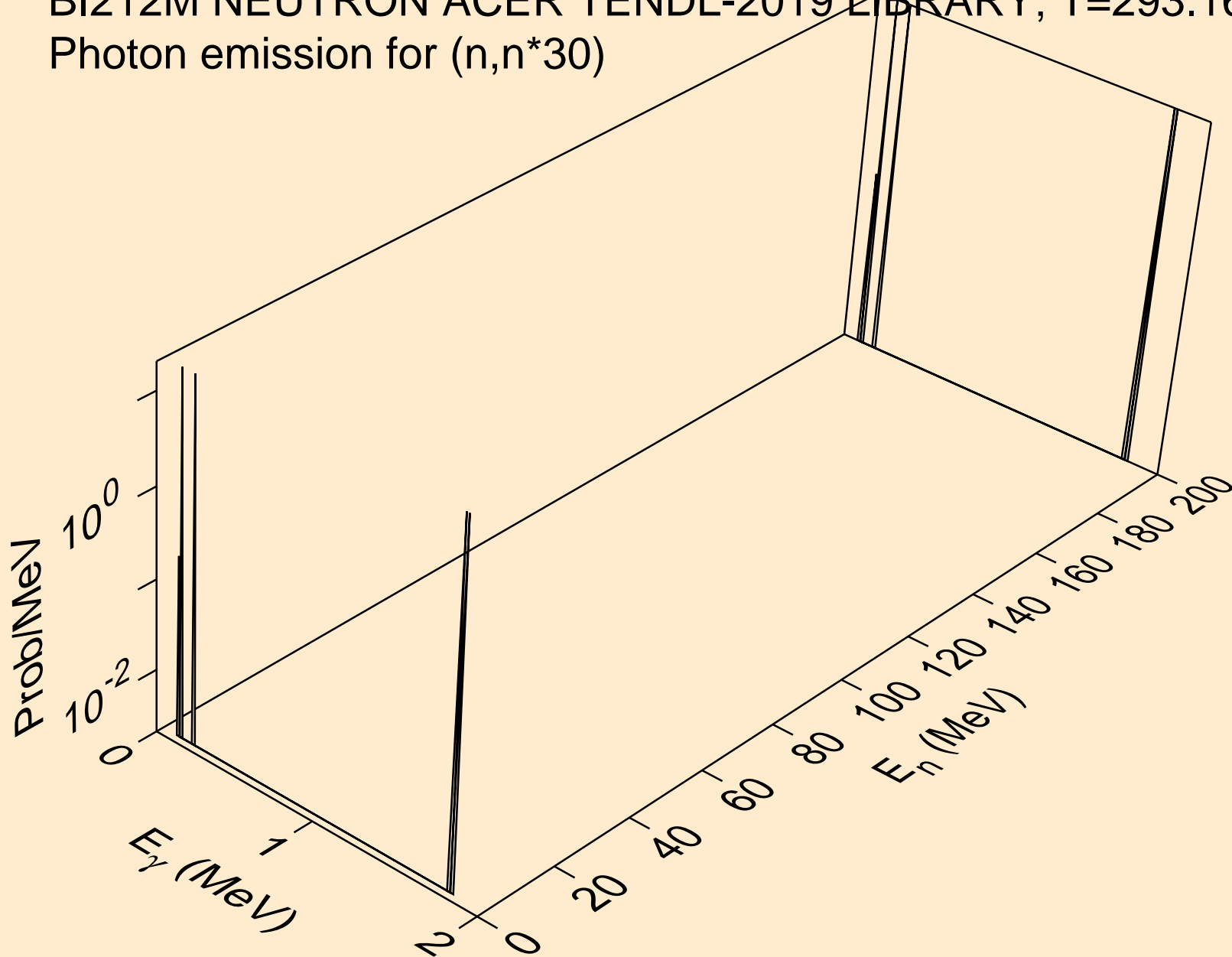

BI212M NEUTRON ACER TENDL-2019 LIBRARY; T=293.16K
Photon emission for (n,n*c)

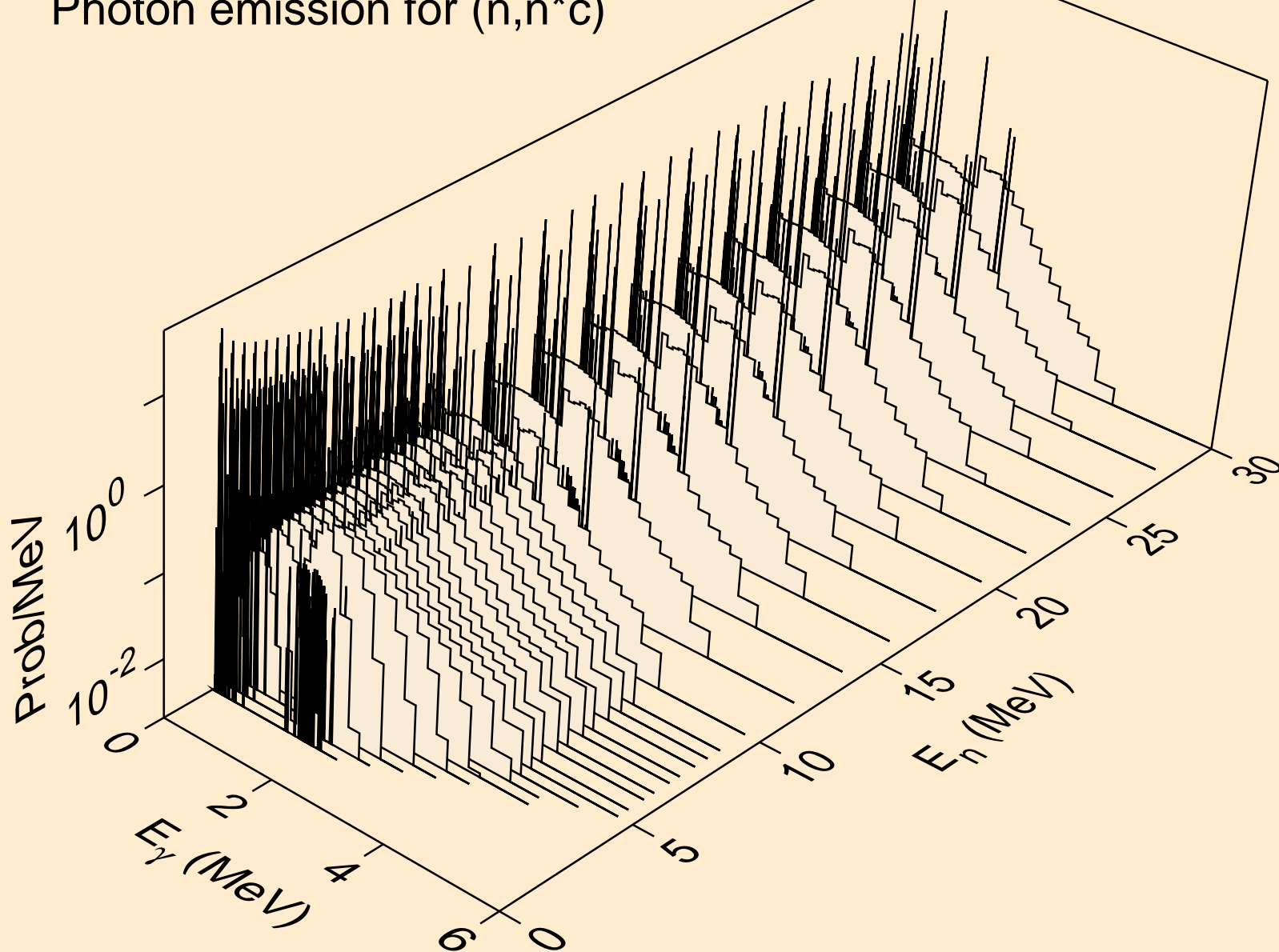

BI212M NEUTRON ACER TENDL-2019 LIBRARY; T=293.16K
Photon emission for (n,gma)

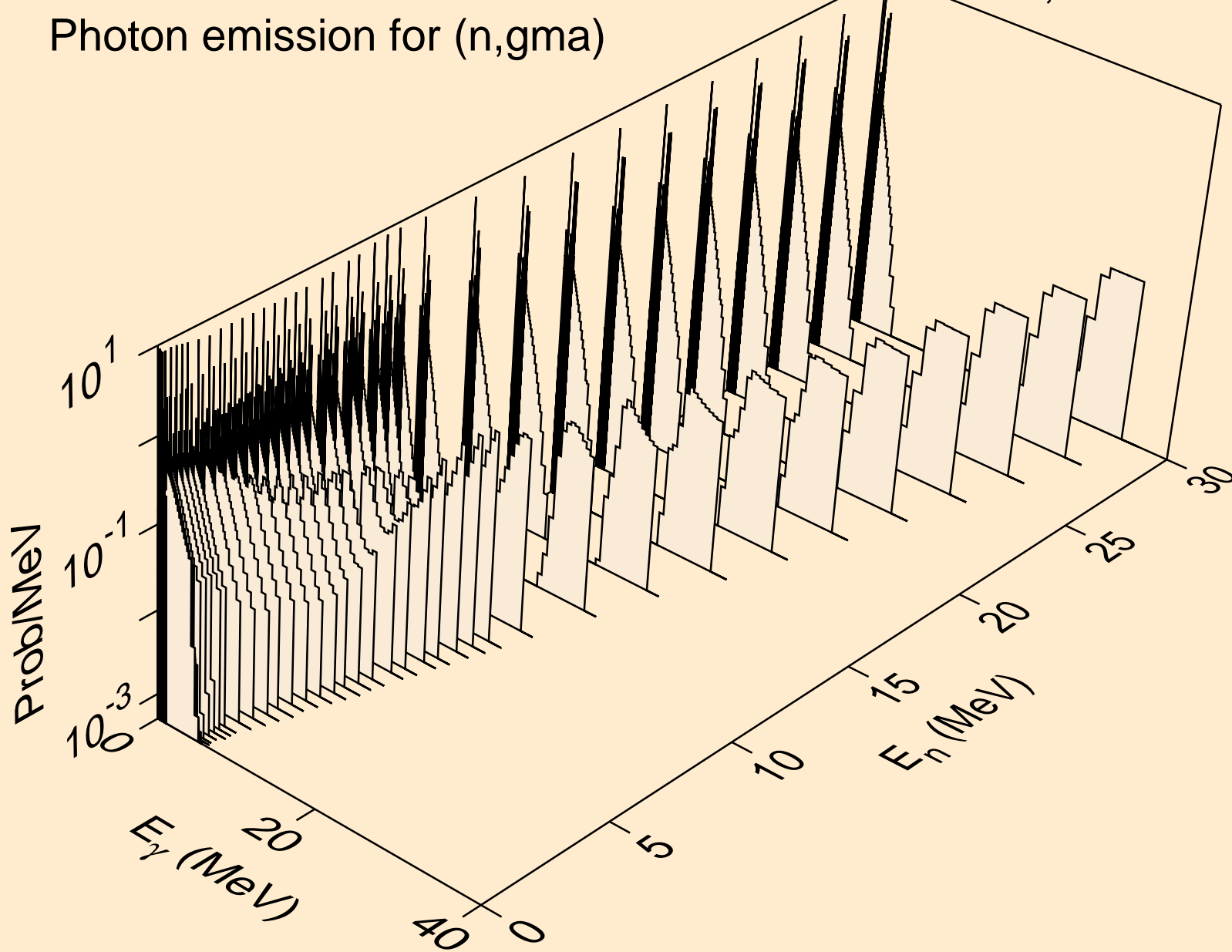

BI212M NEUTRON ACER TENDL-2019 LIBRARY; T=293.16K
Photon emission for (n,p)

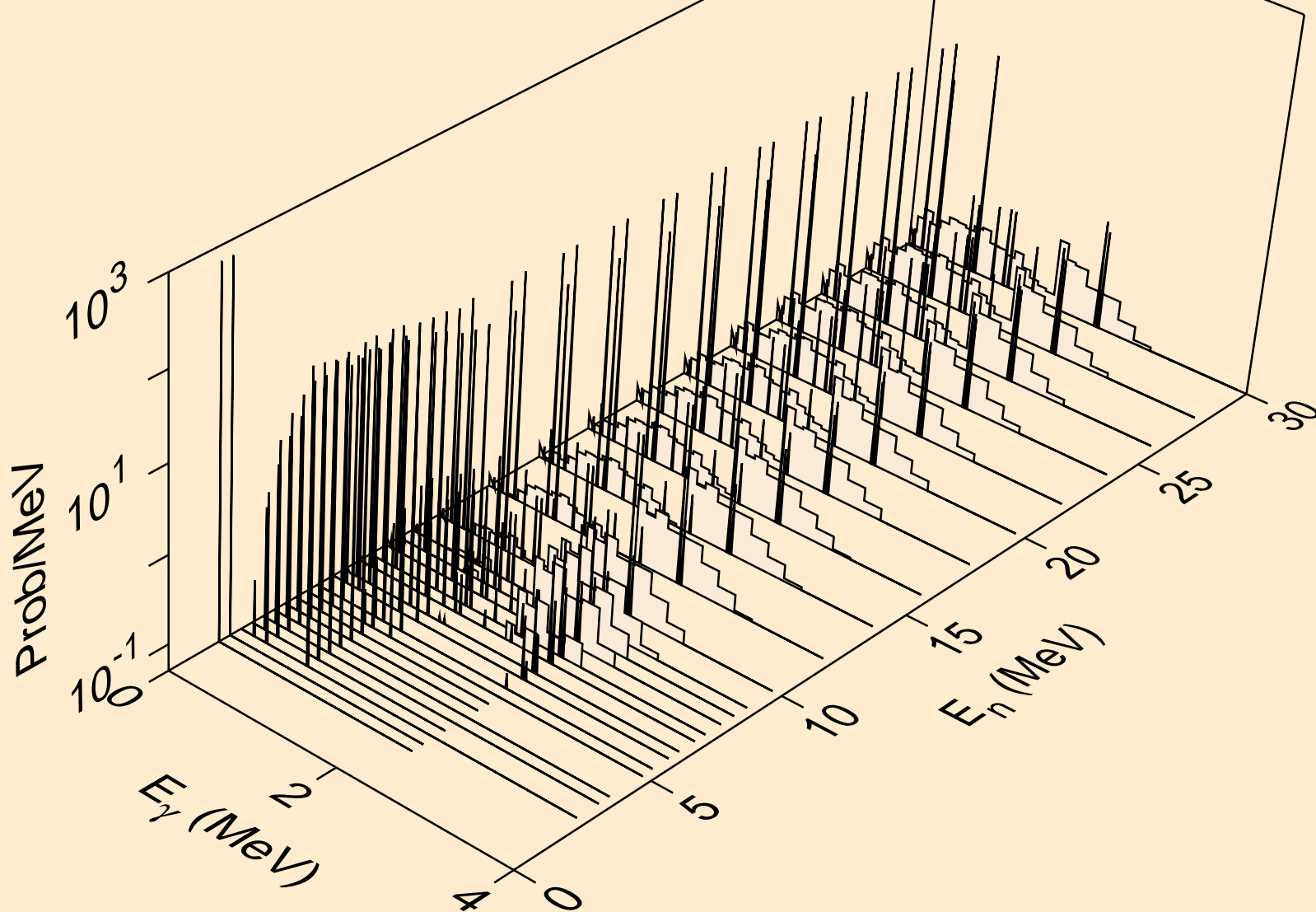

BI212M NEUTRON ACER TENDL-2019 LIBRARY; T=293.16K
Photon emission for (n,d)

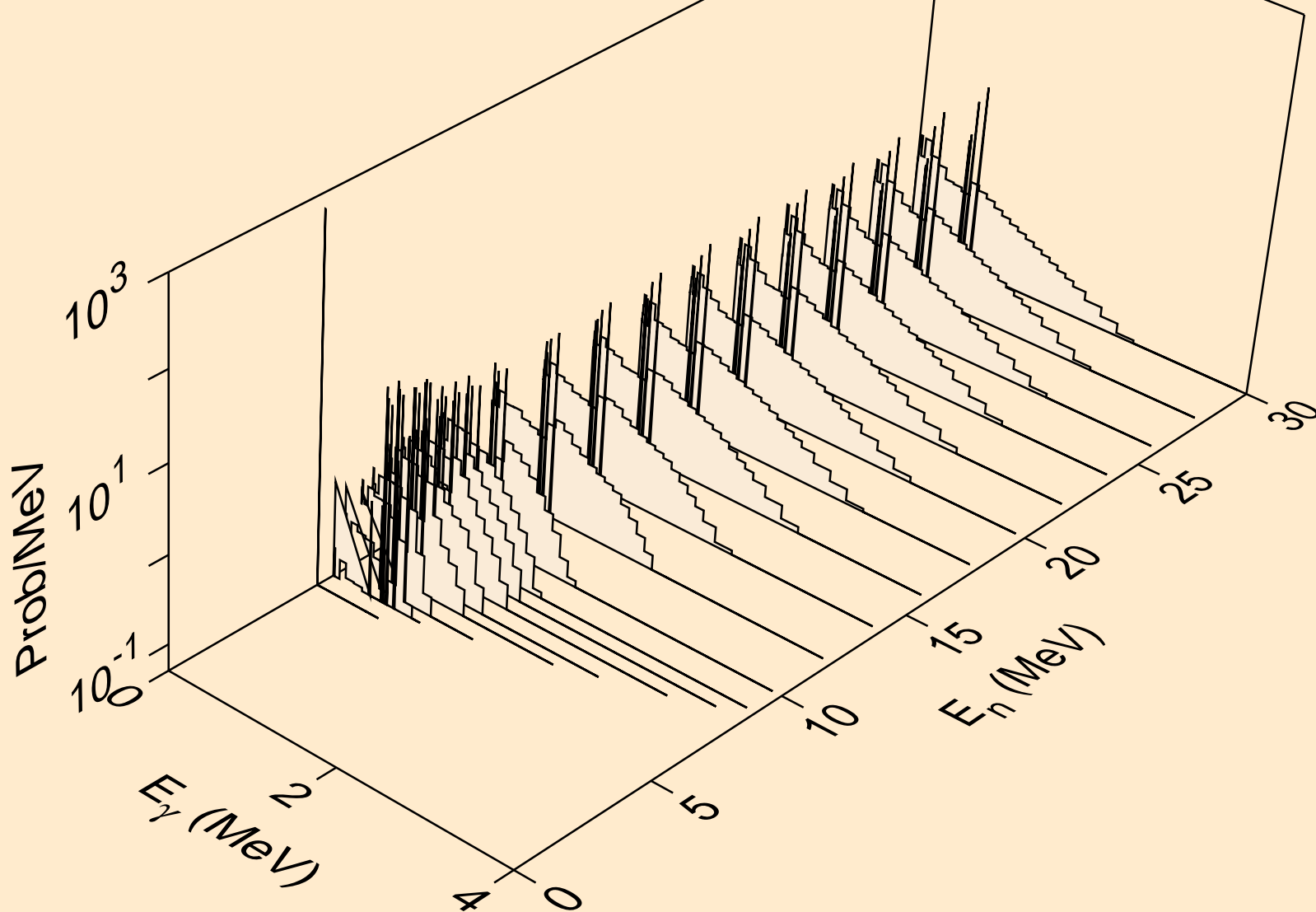

BI212M NEUTRON ACER TENDL-2019 LIBRARY; T=293.16K
Photon emission for (n,t)

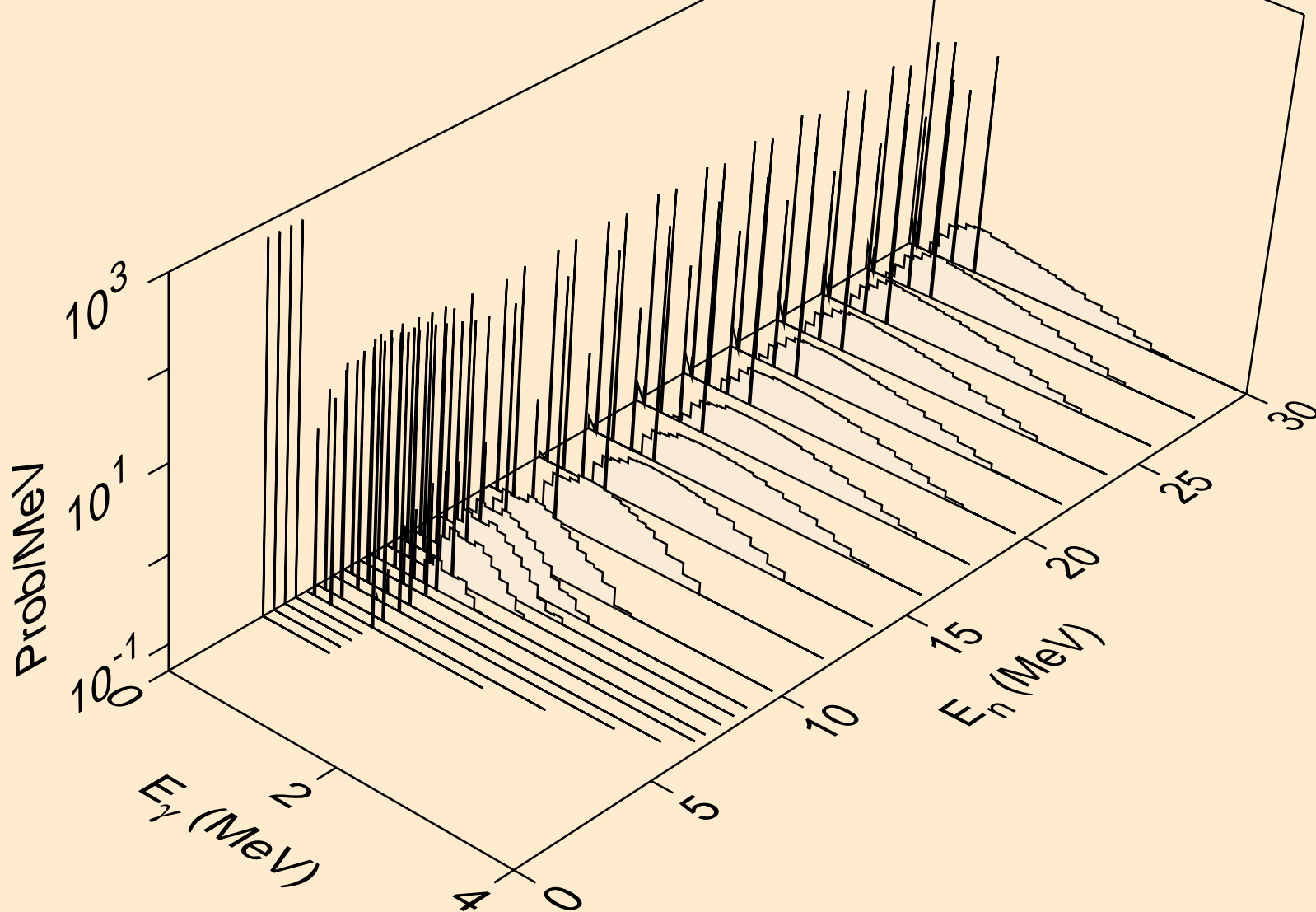

BI212M NEUTRON ACER TENDL-2019 LIBRARY; T=293.16K
Photon emission for (n,he3)

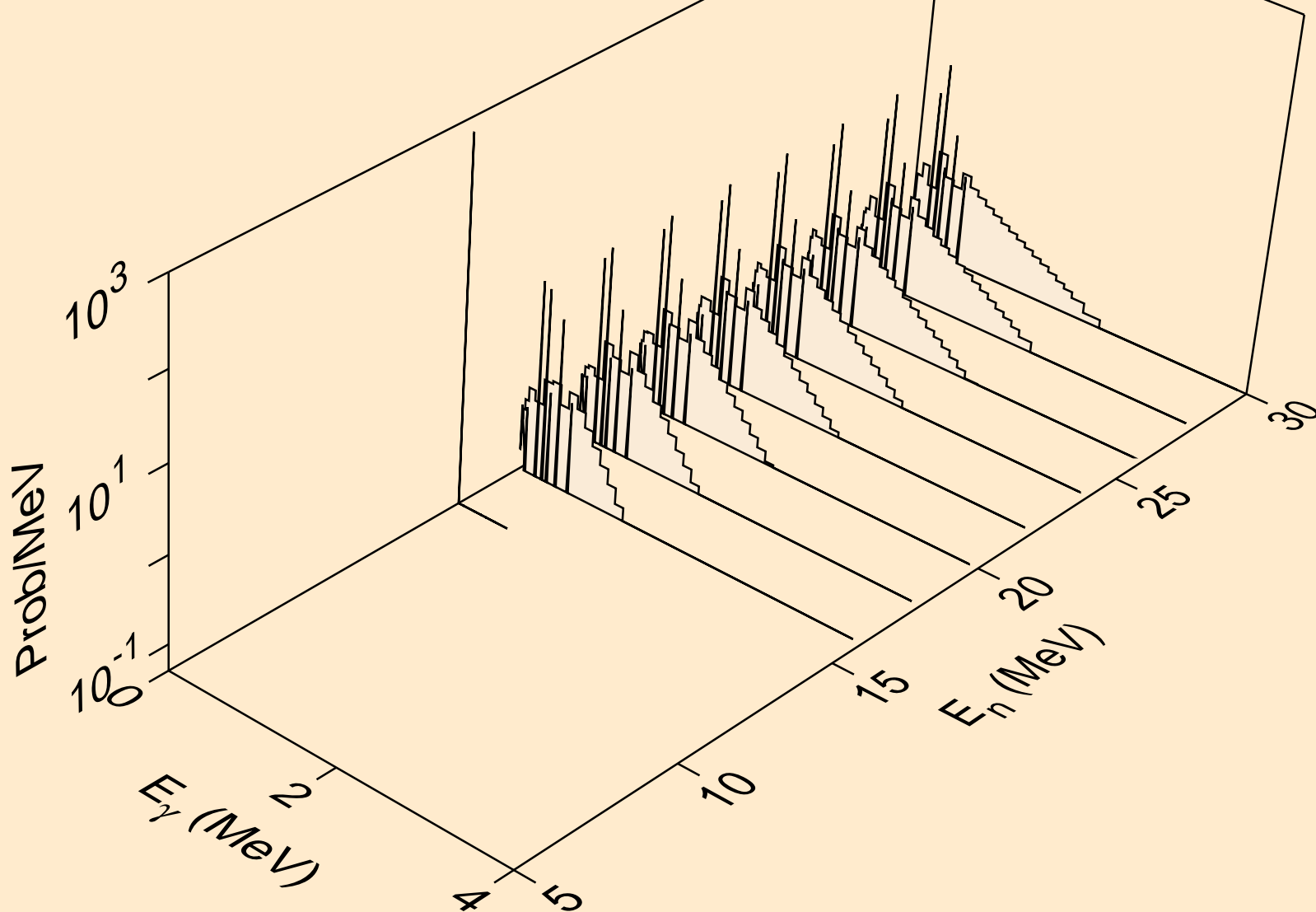

BI212M NEUTRON ACER TENDL-2019 LIBRARY; T=293.16K
Photon emission for (n,a)

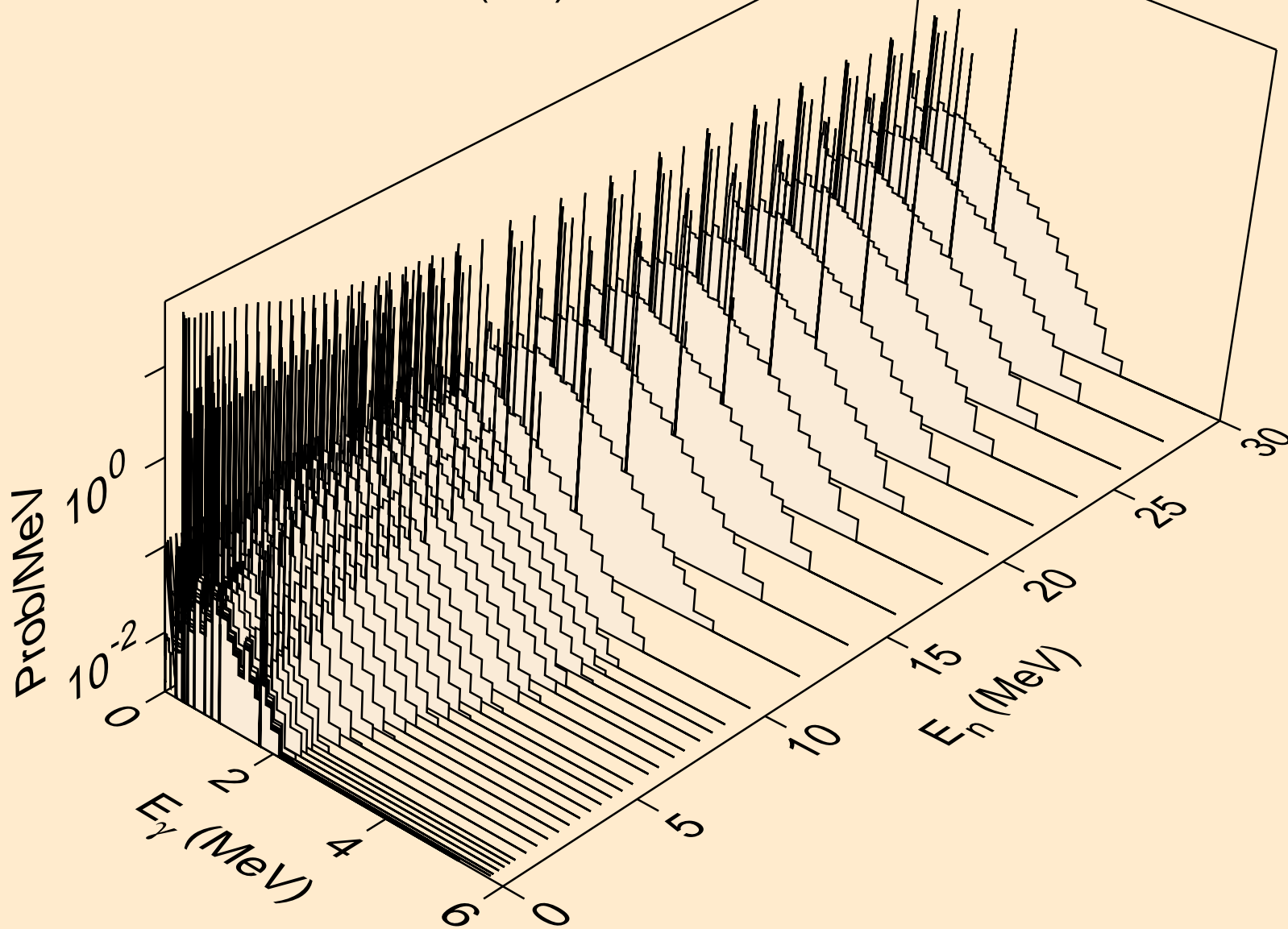

BI212M NEUTRON ACER TENDL-2019 LIBRARY; T=293.16K
Photon emission for (n,2a)

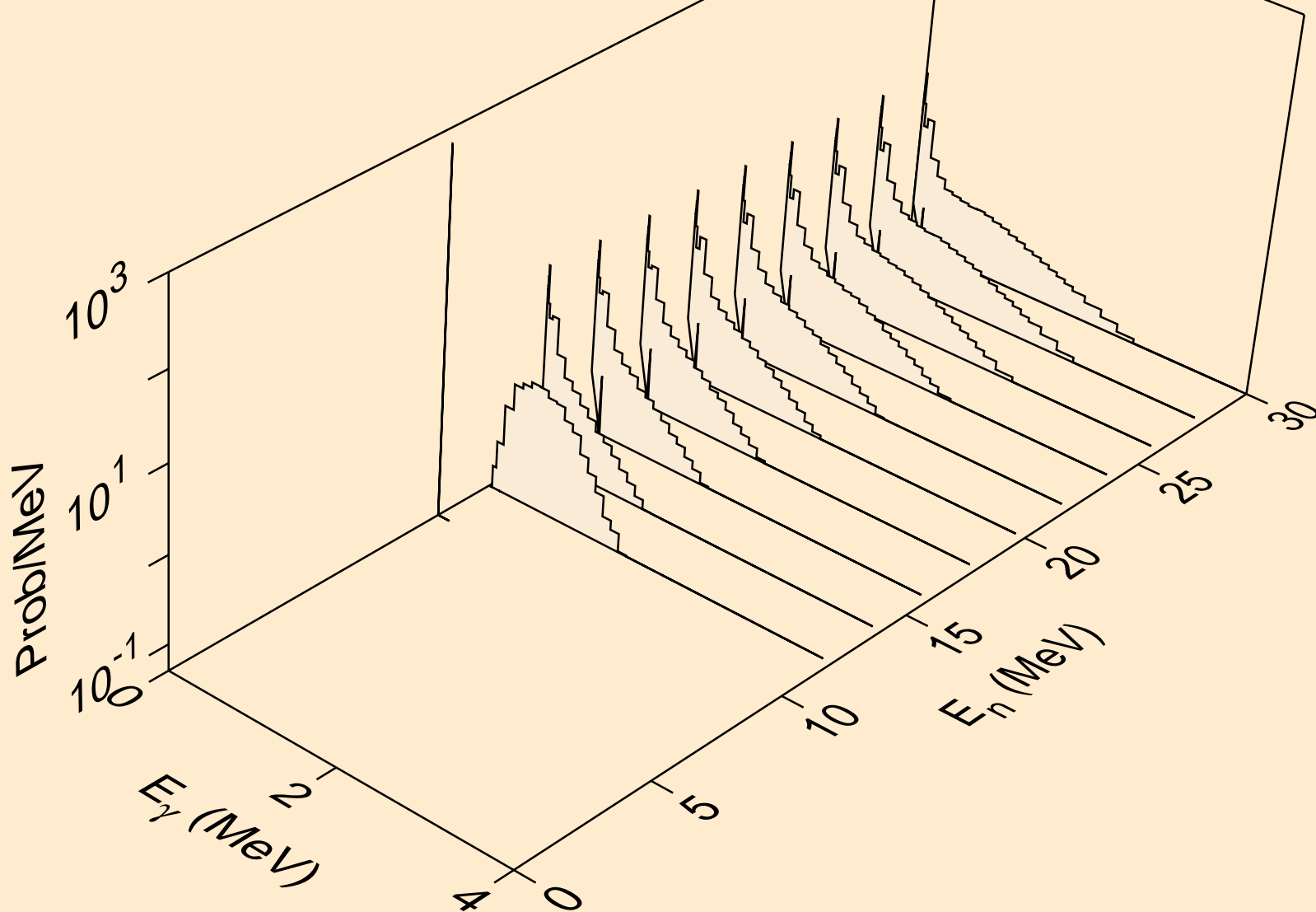

BI212M NEUTRON ACER TENDL-2019 LIBRARY; T=293.16K
Photon emission for (n,2p)

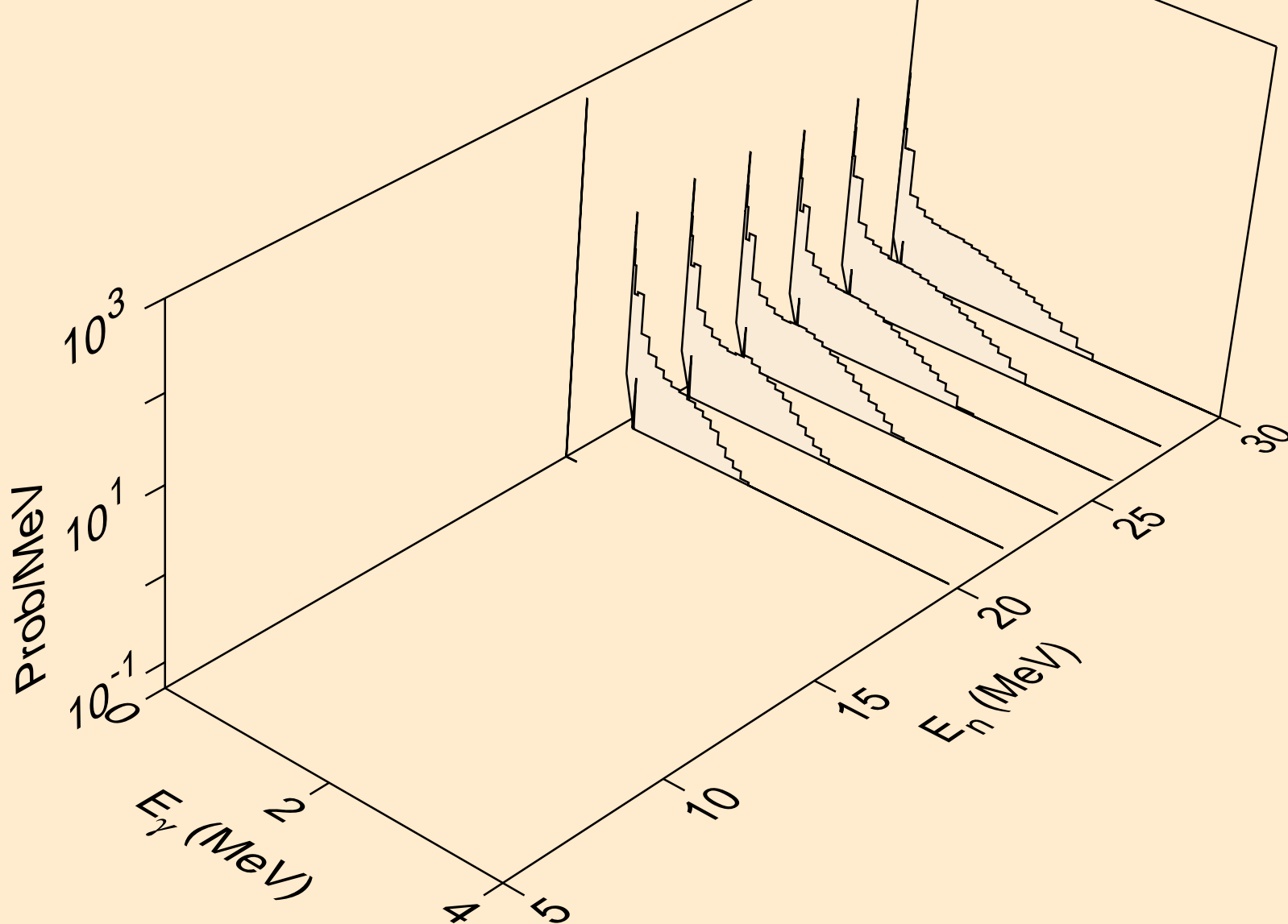

BI212M NEUTRON ACER TENDL-2019 LIBRARY; T=293.16K
Photon emission for (n,p α)

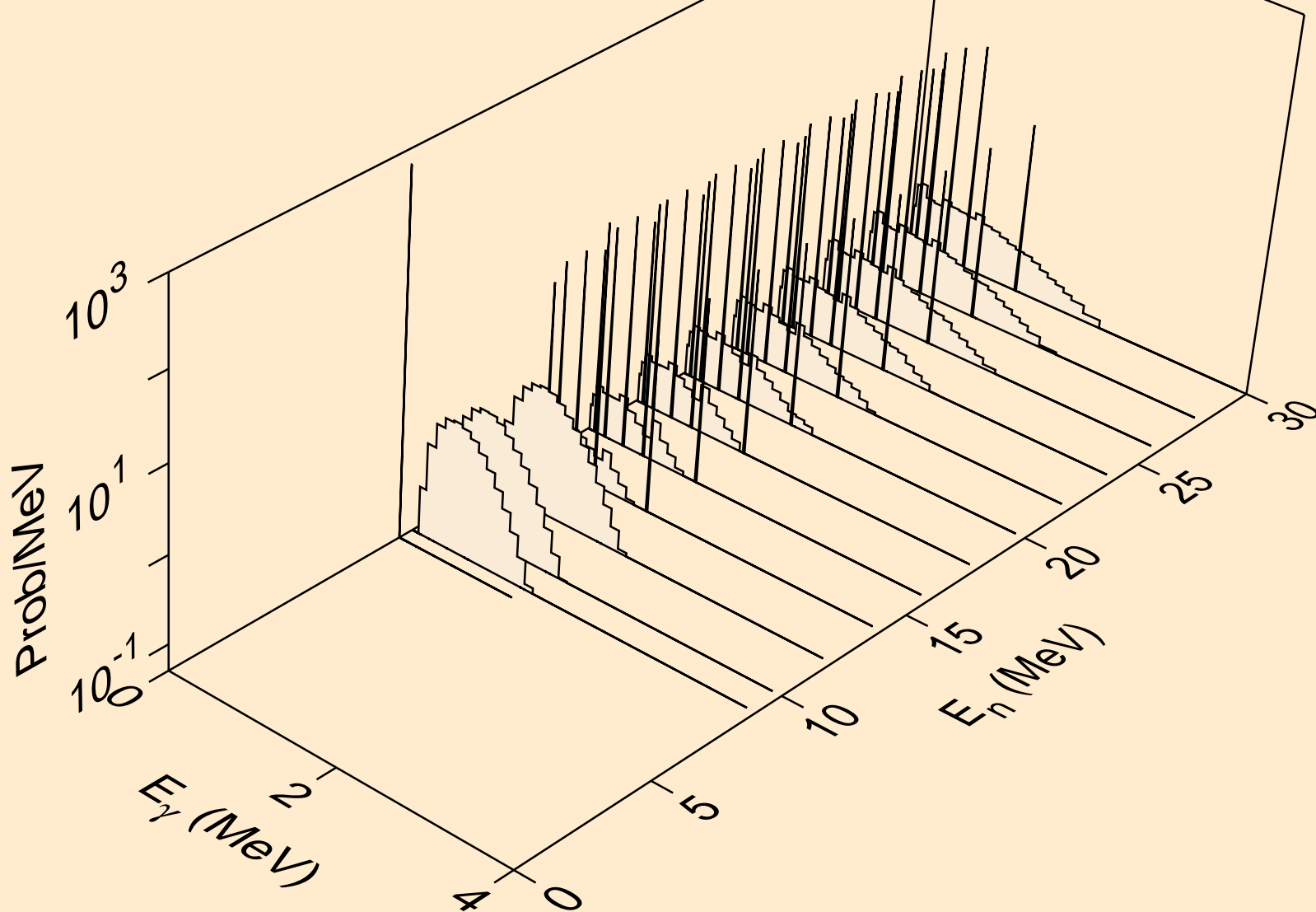

BI212M NEUTRON ACER TENDL-2019 LIBRARY; T=293.16K
Photon emission for (n,pt)

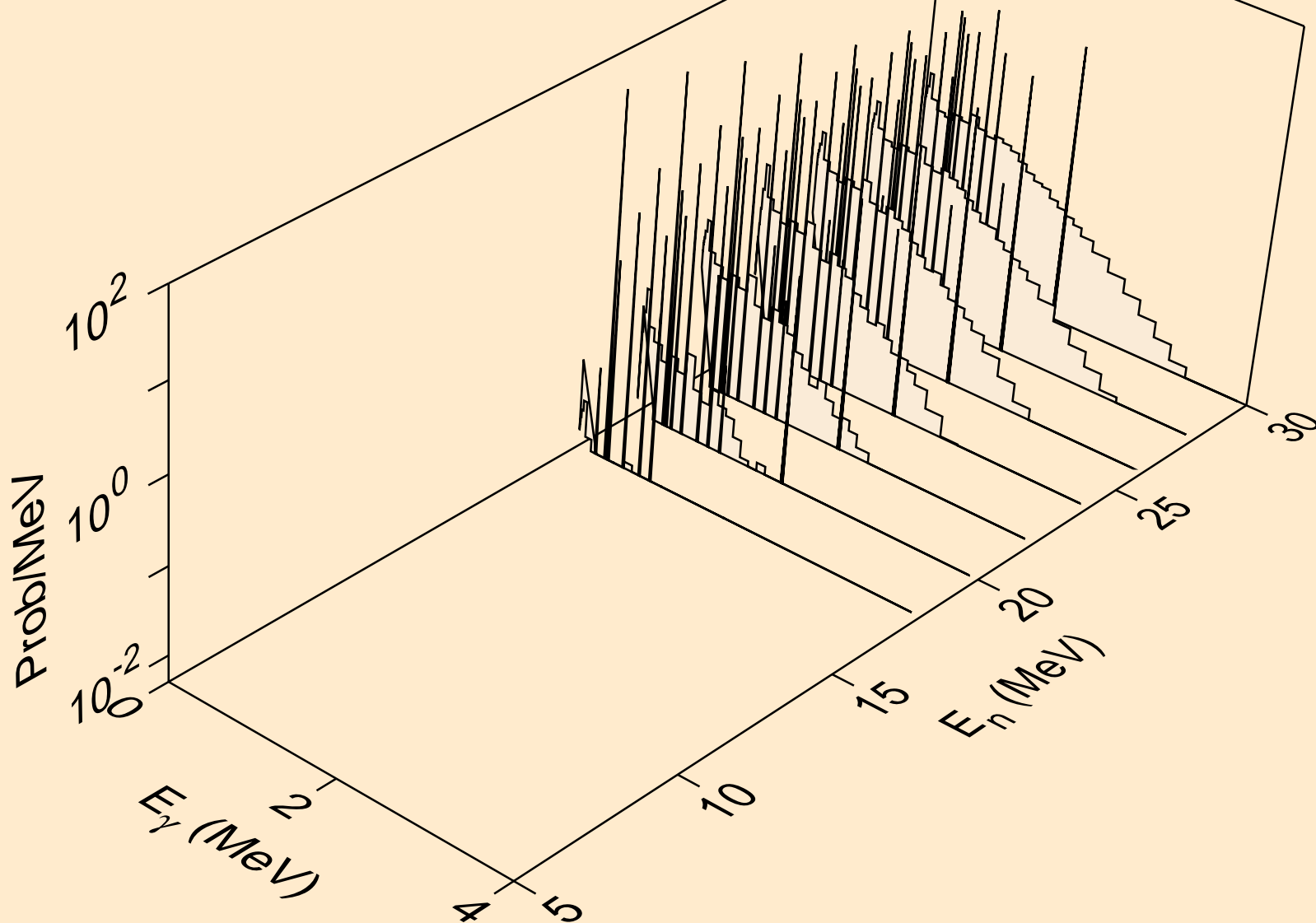

BI212M NEUTRON ACER TENDL-2019 LIBRARY; T=293.16K
Photon emission for (n,da)

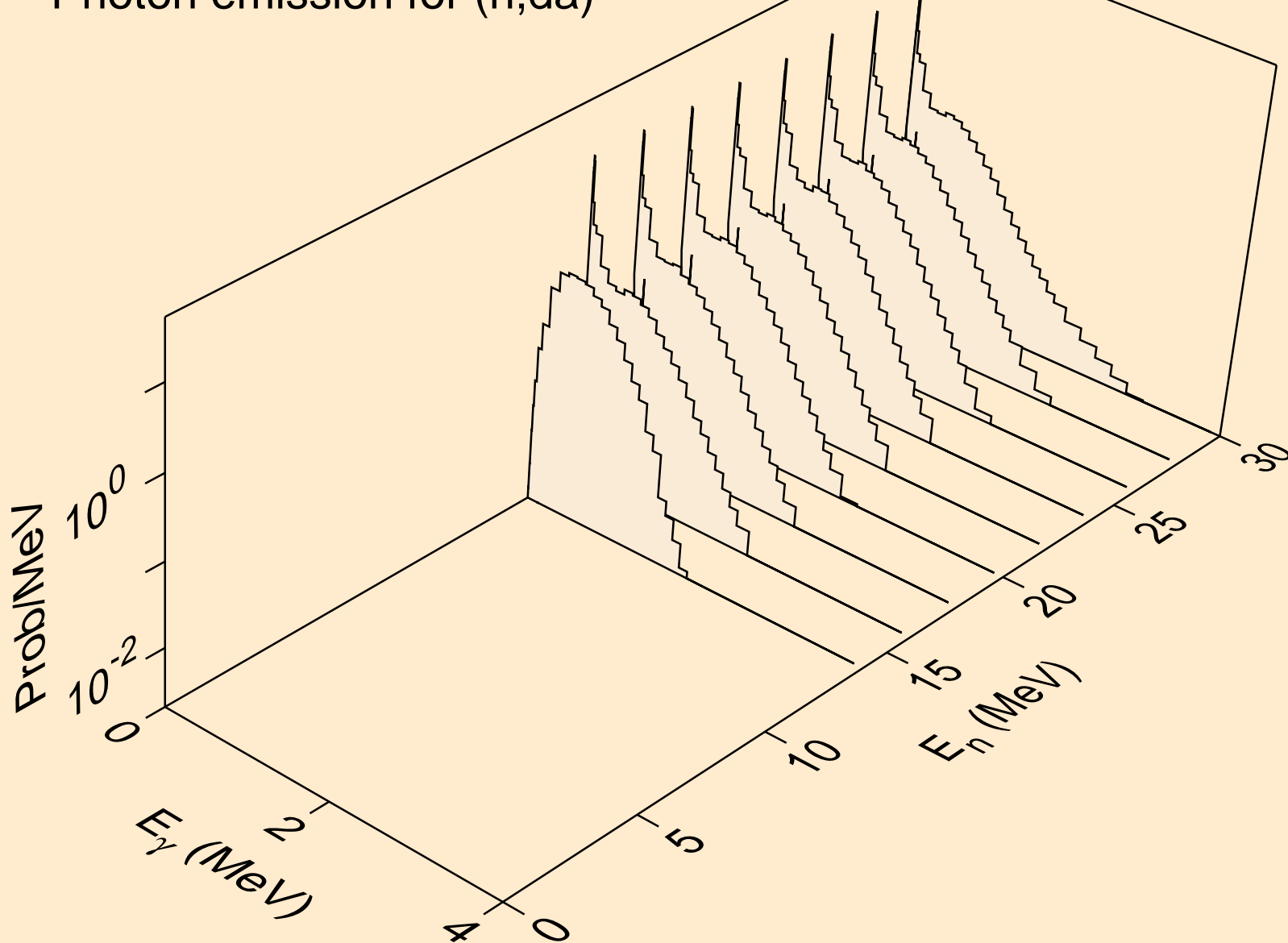

BI212M NEUTRON ACER TENDL-2019 LIBRARY; T=293.16K
thermal capture photon spectrum

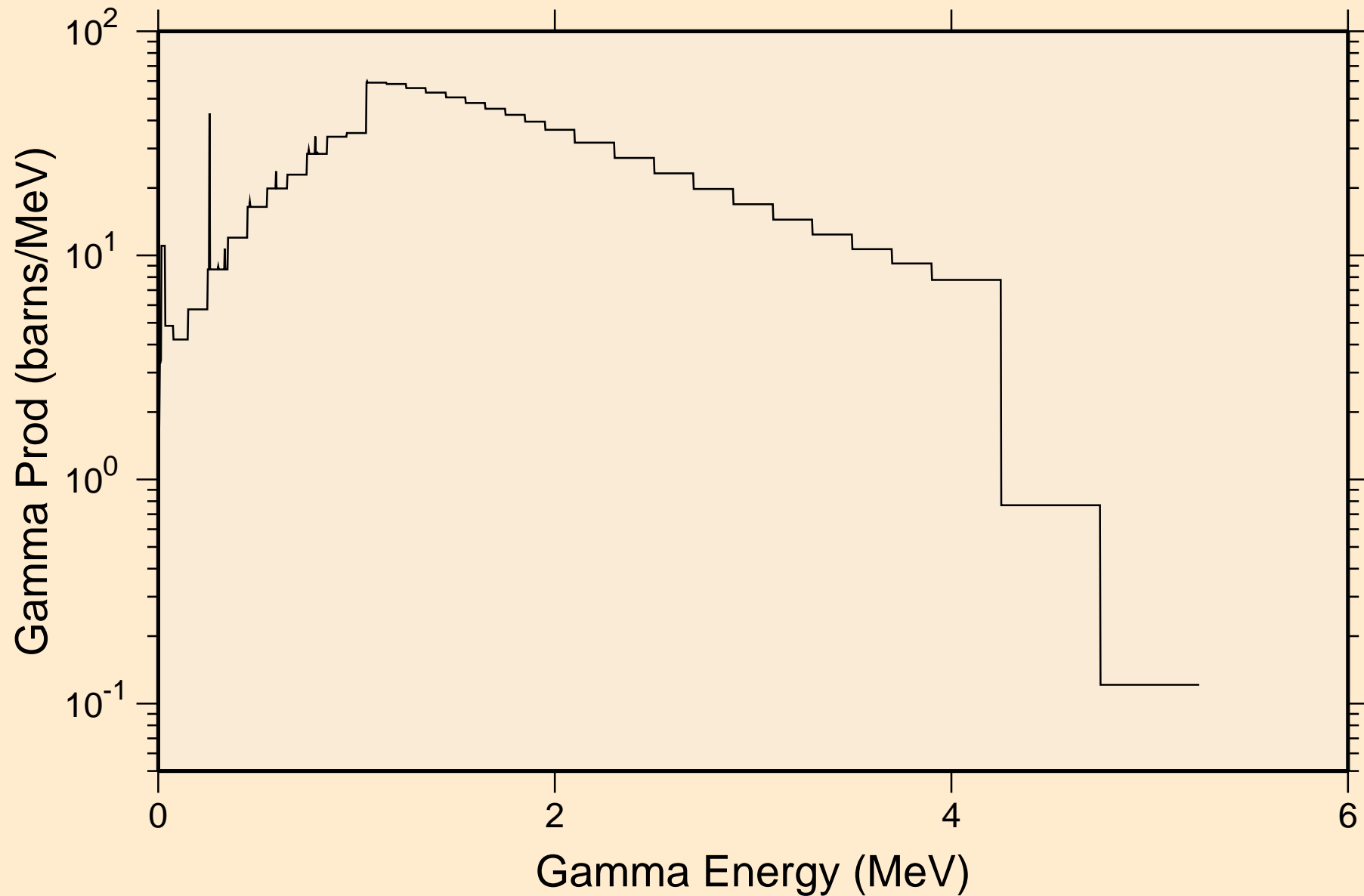

BI212M NEUTRON ACER TENDL-2019 LIBRARY; T=293.16K
14 MeV photon spectrum

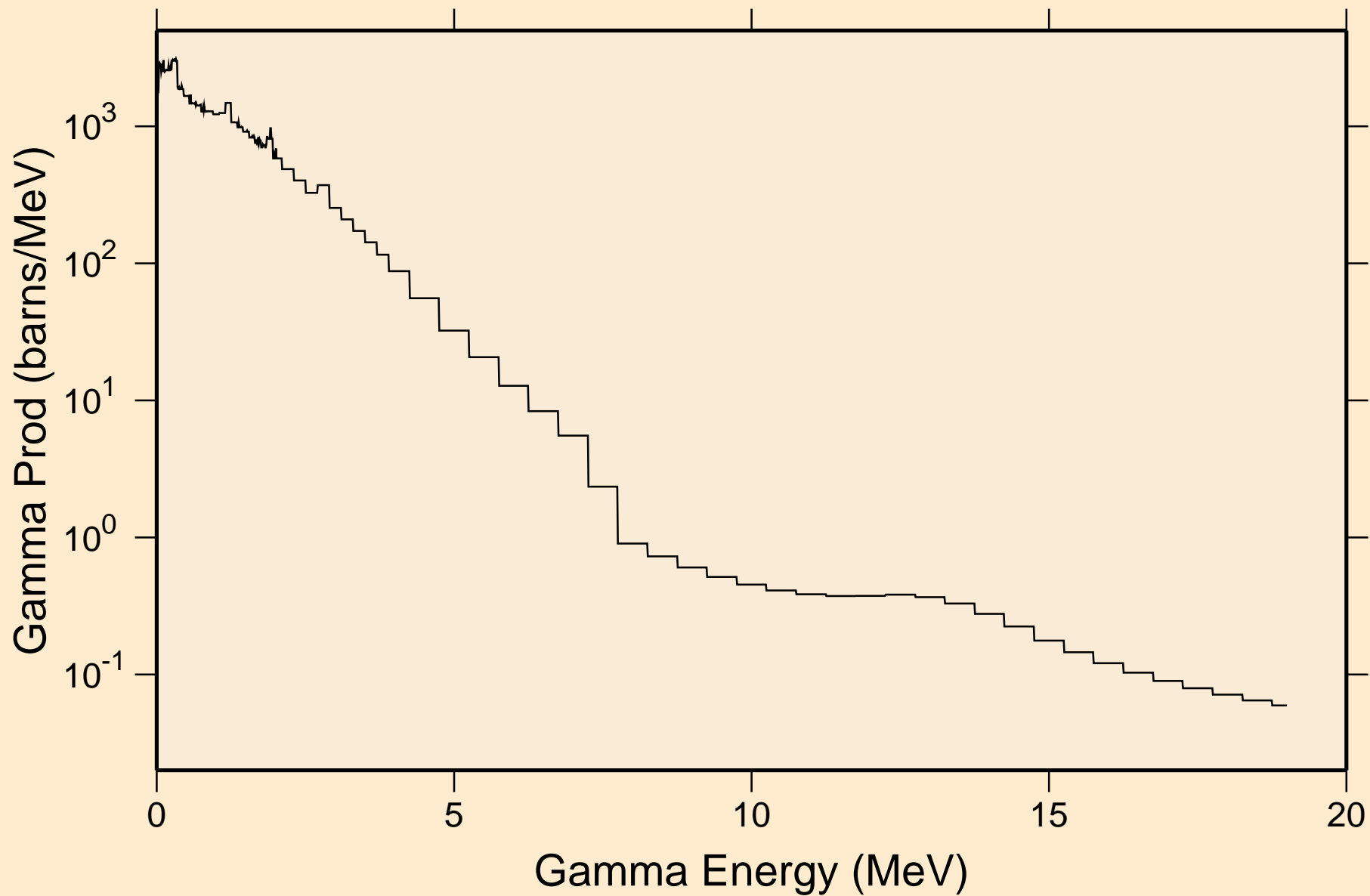

BI212M NEUTRON ACER TENDL-2019 LIBRARY; T=293.16K
Particle heating contributions

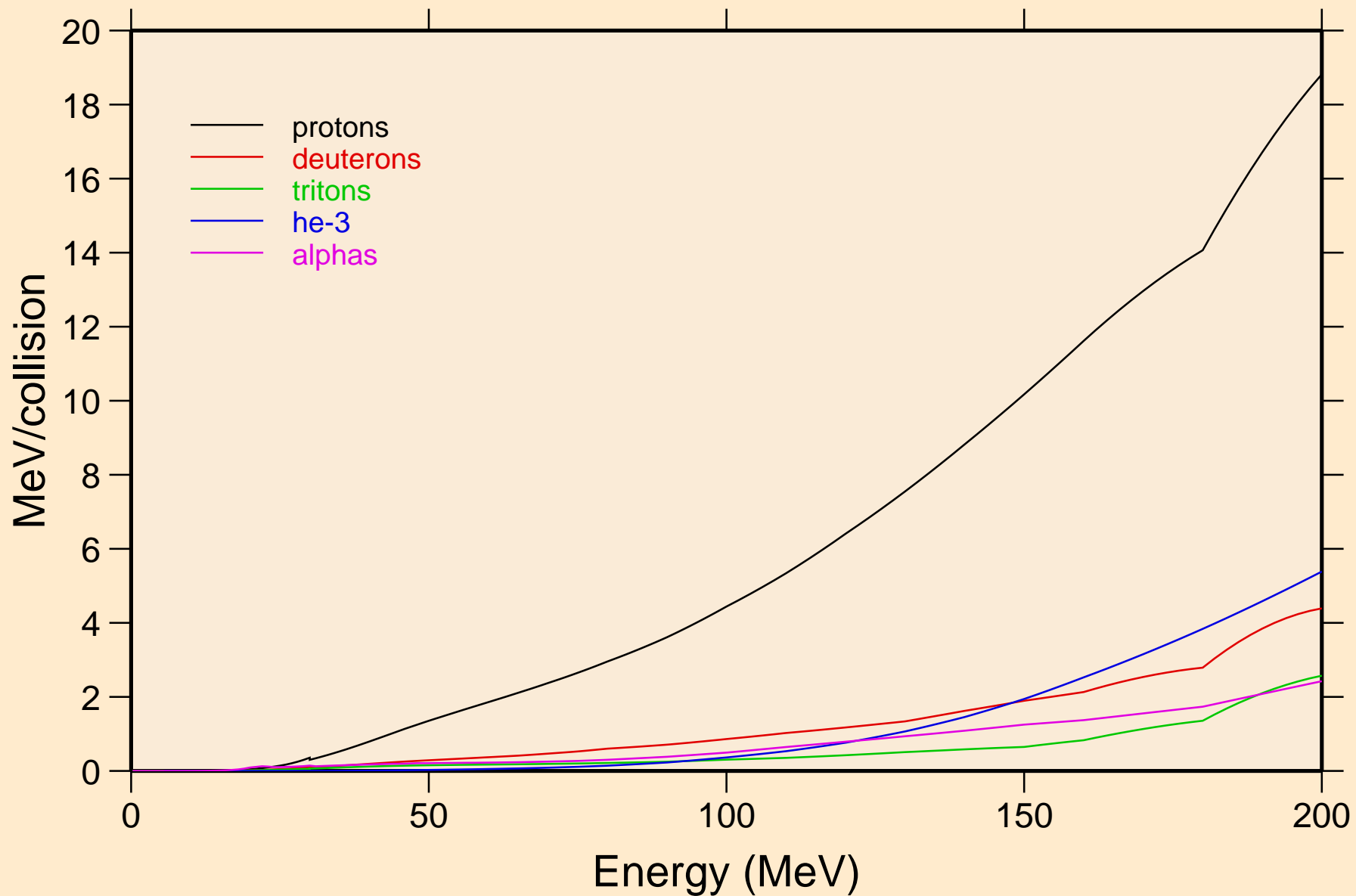

BI212M NEUTRON ACER TENDL-2019 LIBRARY; T=293.16K
Recoil Heating

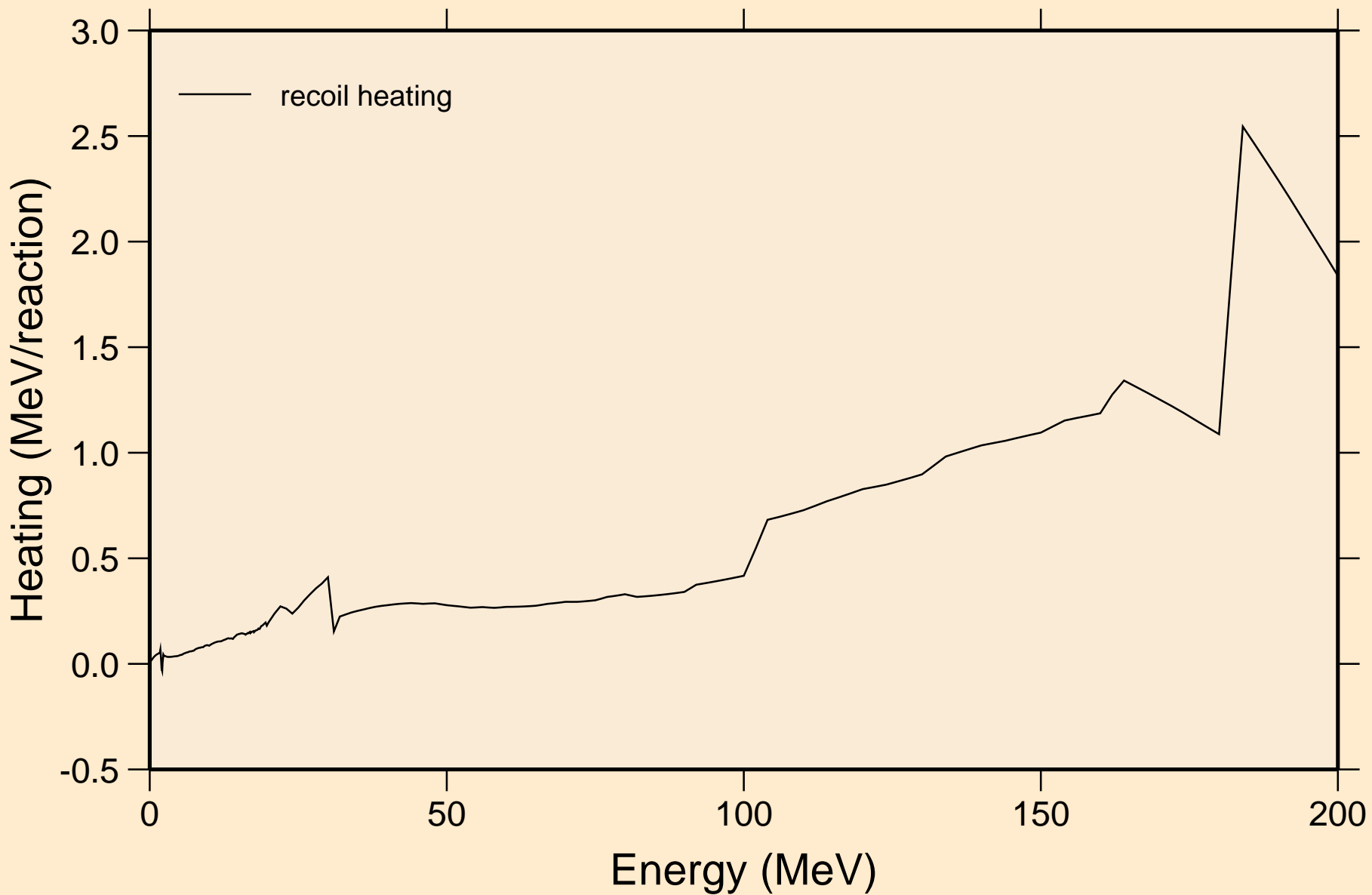

BI212M NEUTRON ACER TENDL-2019 LIBRARY; T=293.16K
Particle production cross sections

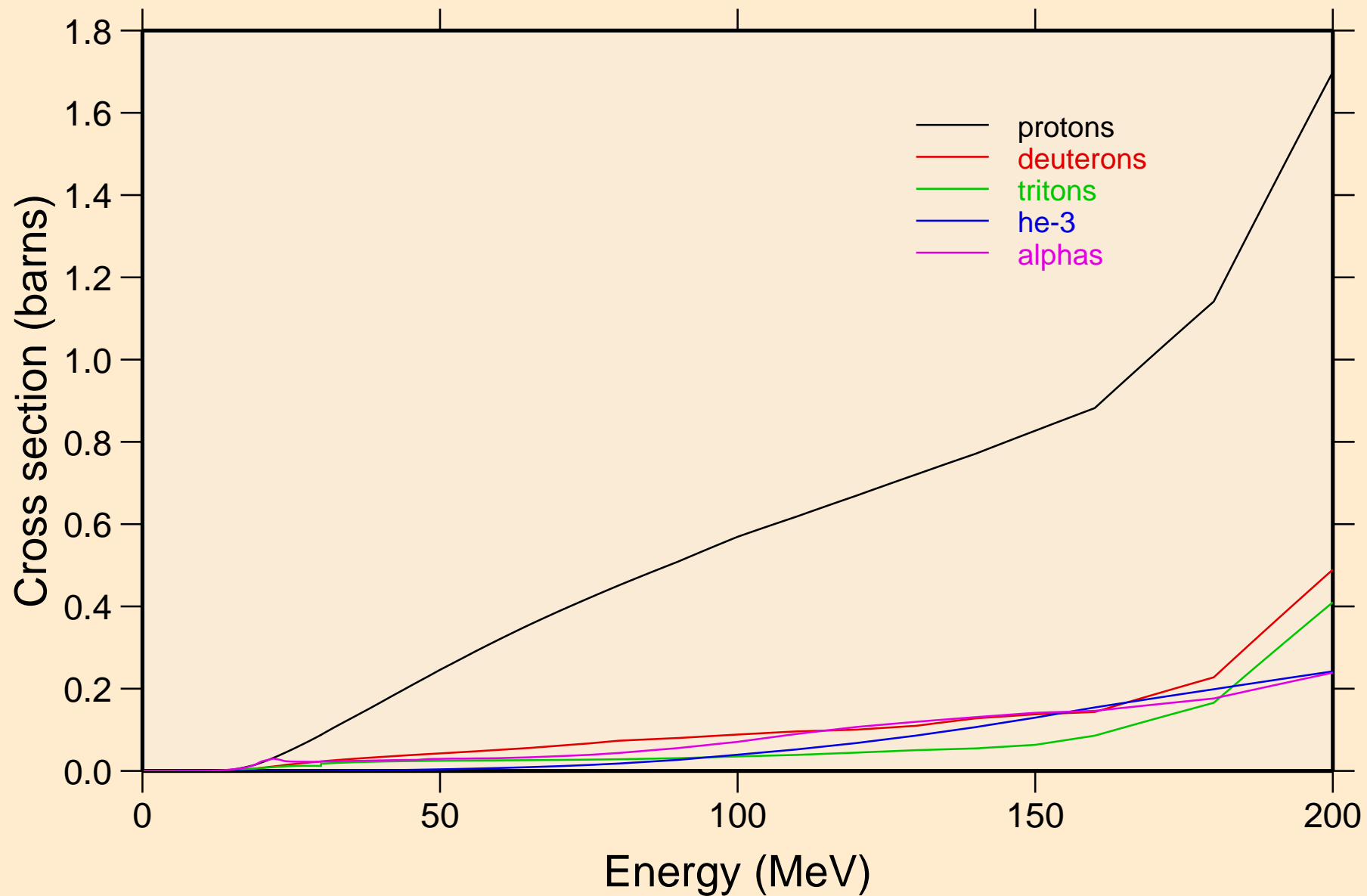

BI212M NEUTRON ACER TENDL-2019 LIBRARY; T=293.16K
protons from (n,x)

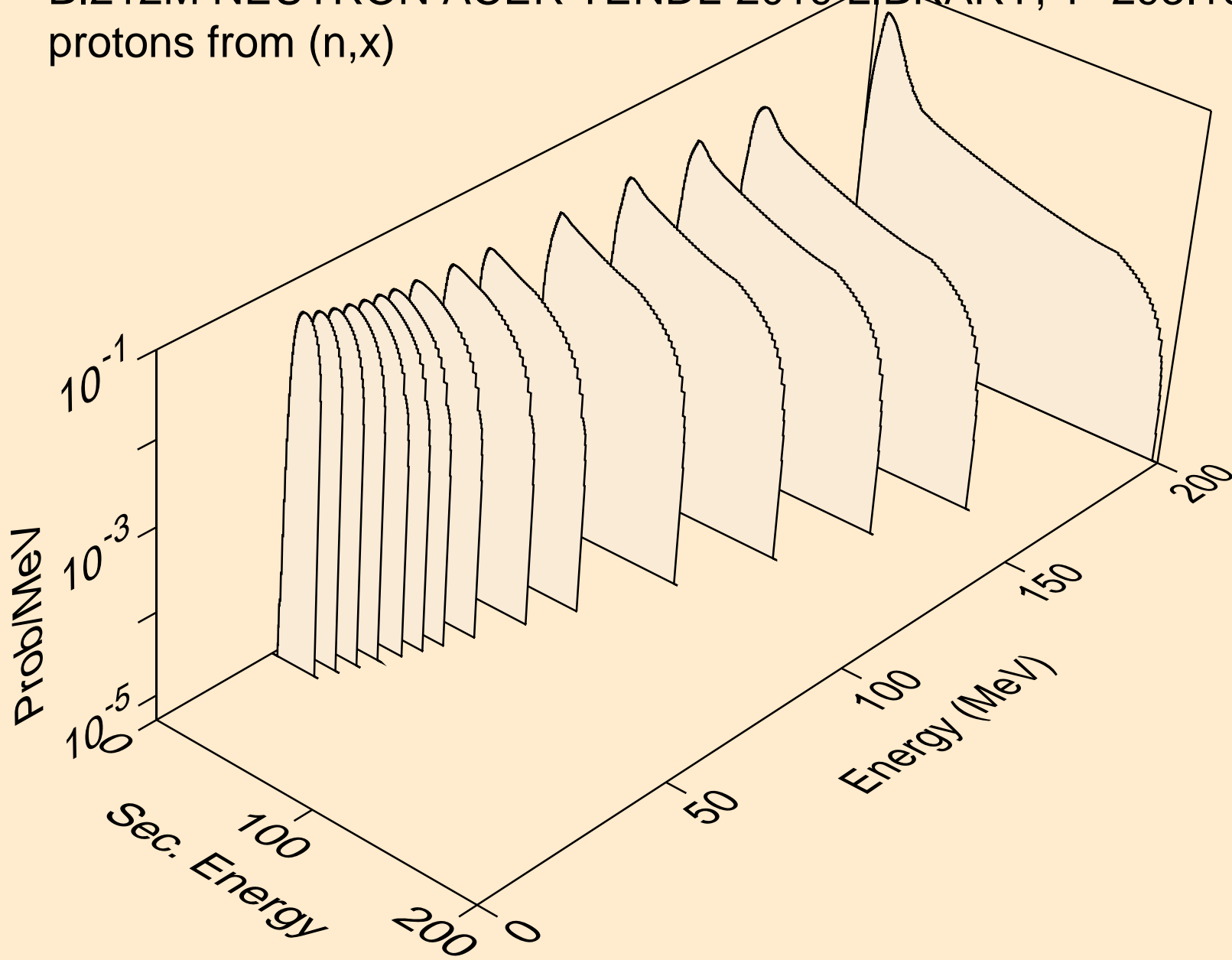

BI212M NEUTRON ACER TENDL-2019 LIBRARY; T=293.16K
protons from (n,n*)p

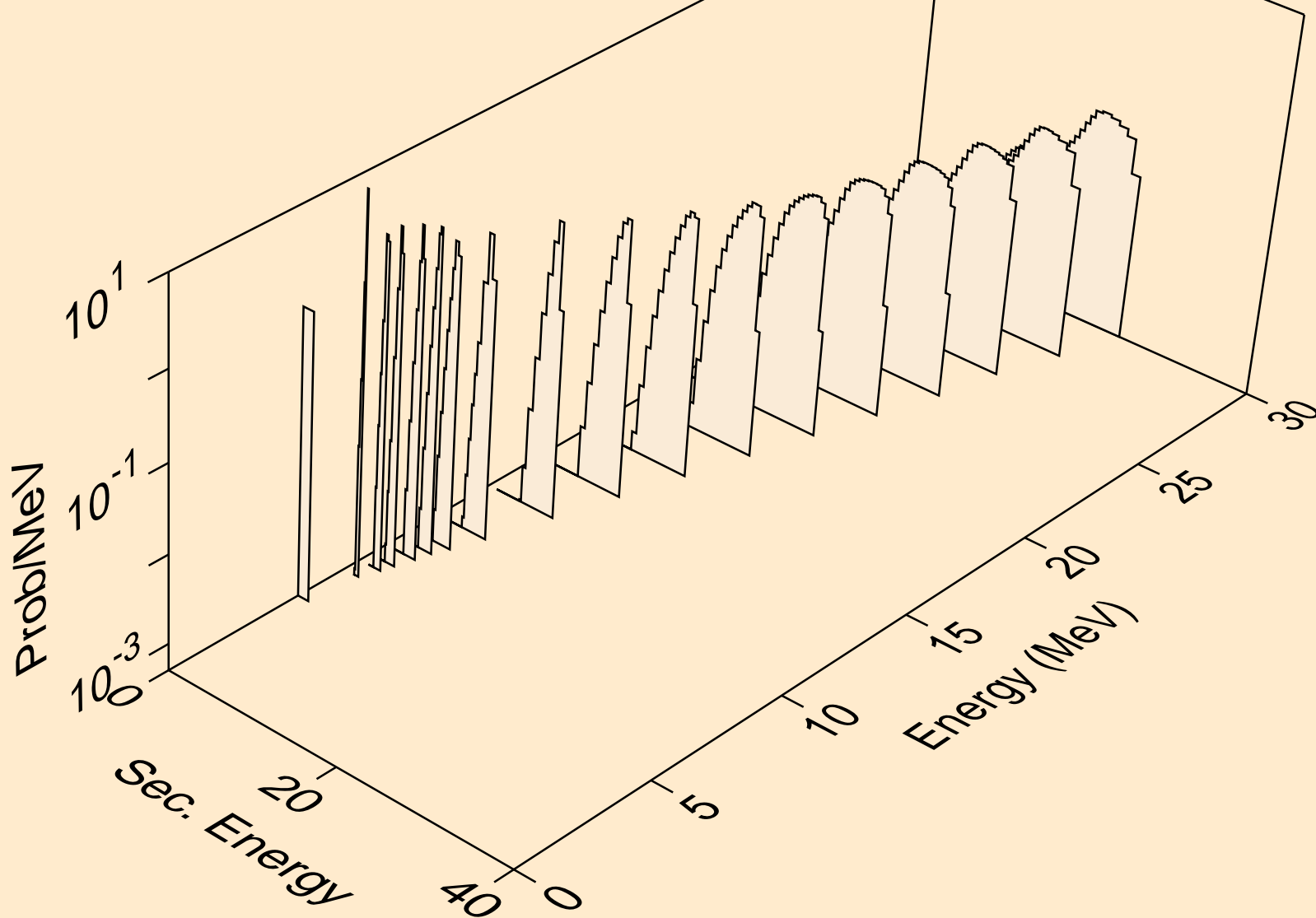

BI212M NEUTRON ACER TENDL-2019 LIBRARY; T=293.16K
protons from (n,2np)

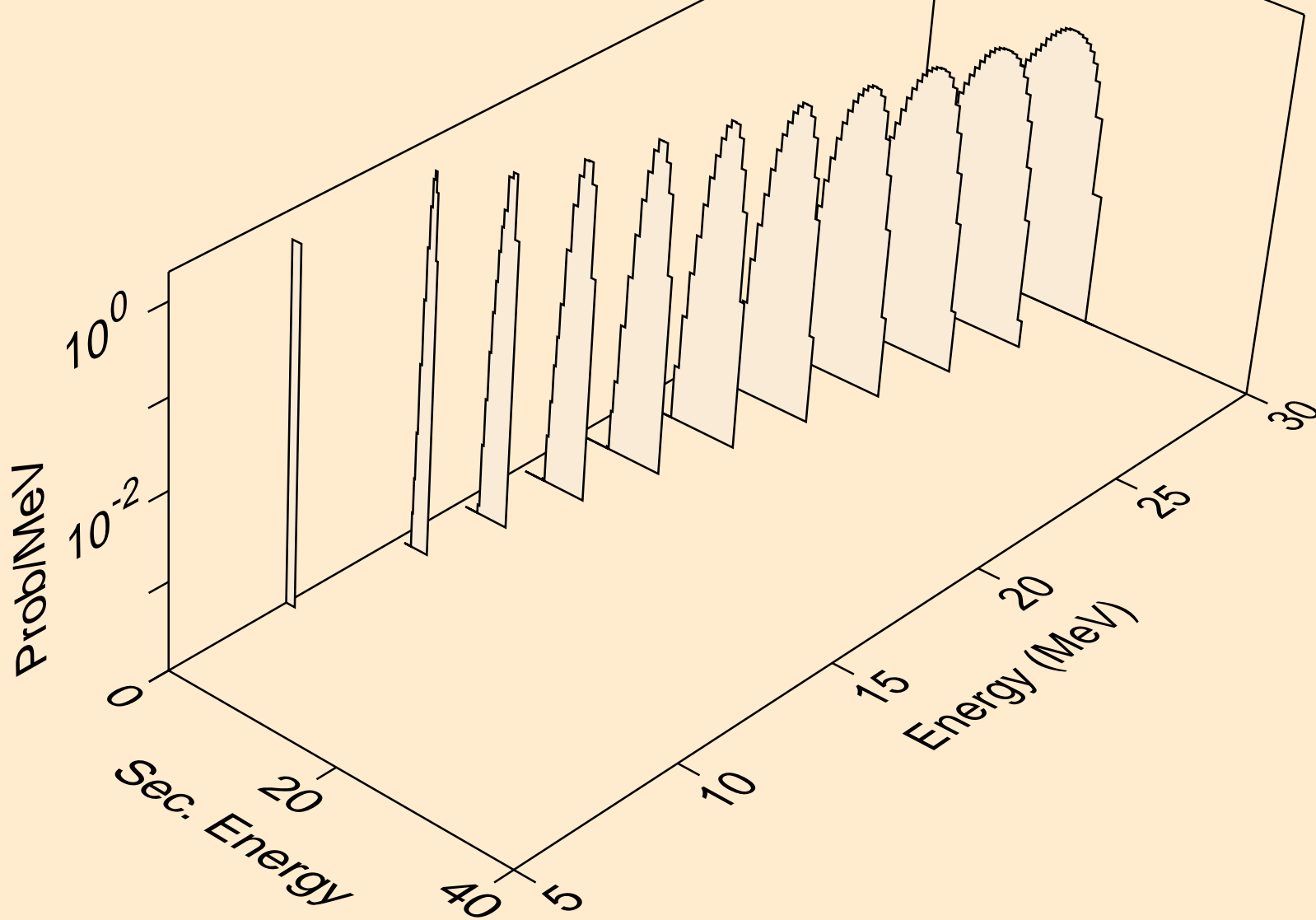

BI212M NEUTRON ACER TENDL-2019 LIBRARY; T=293.16K
protons from (n,3np)

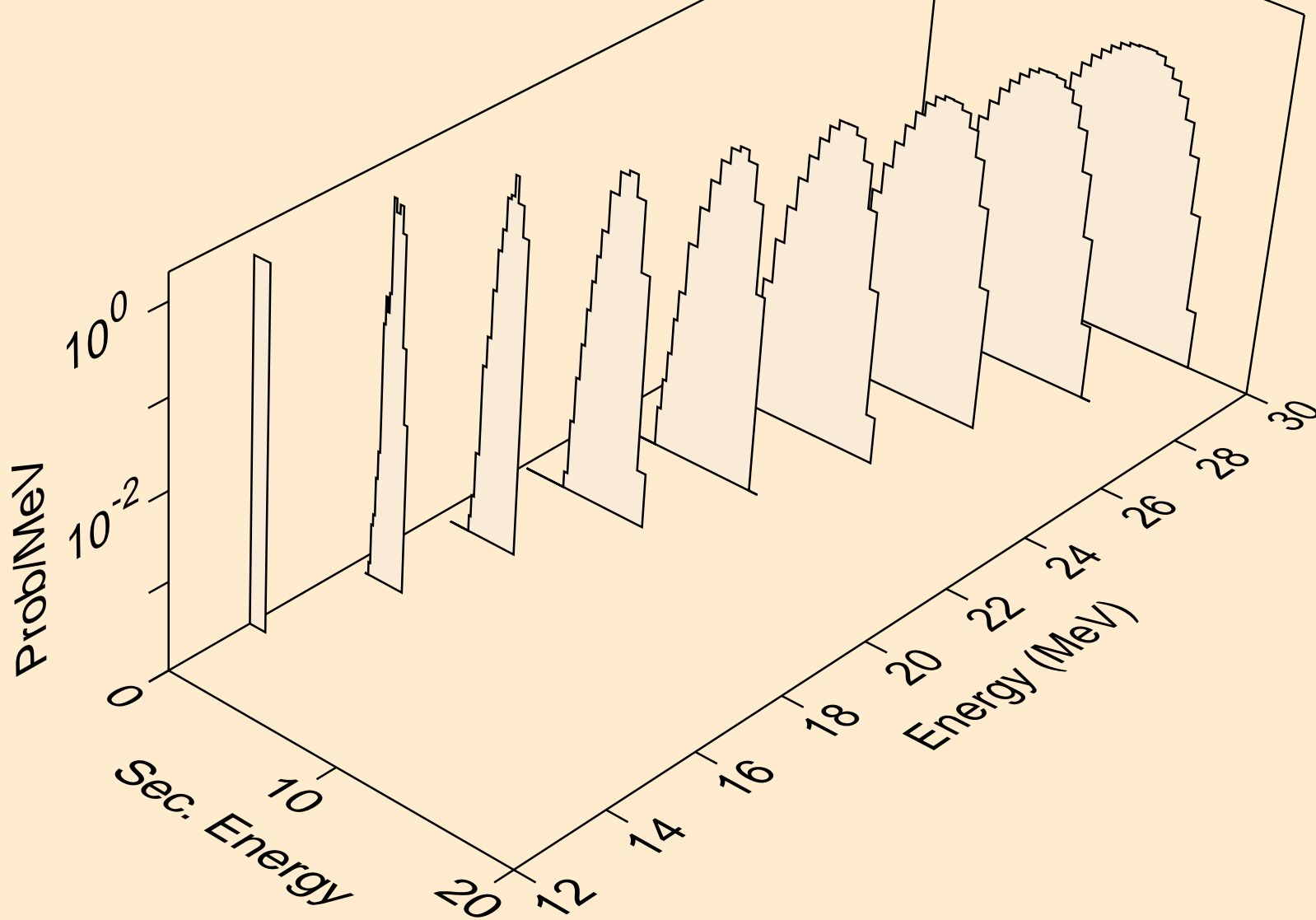

BI212M NEUTRON ACER TENDL-2019 LIBRARY; T=293.16K
protons from (n,2np)

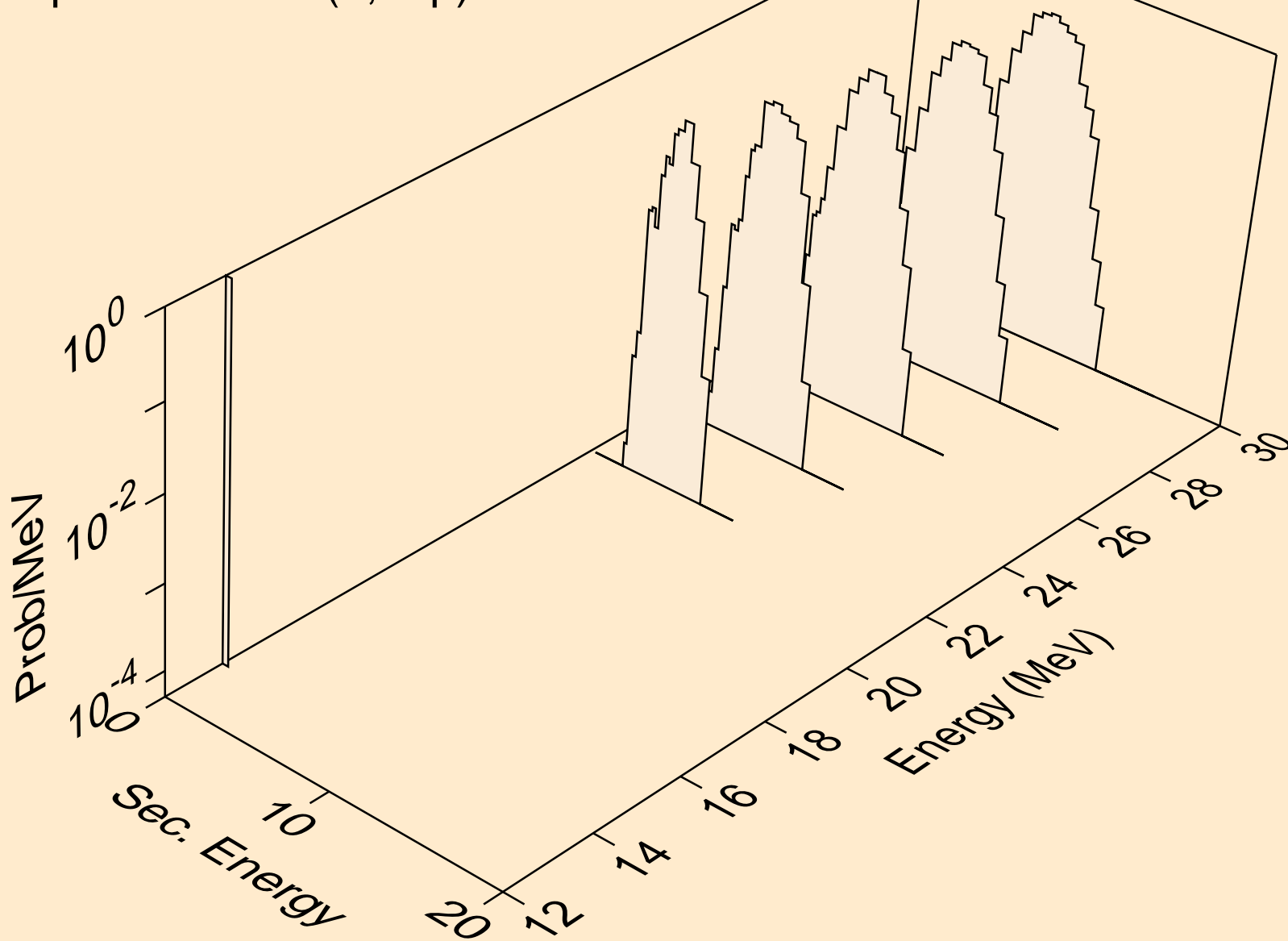

BI212M NEUTRON ACER TENDL-2019 LIBRARY; T=293.16K
protons from (n,npa)

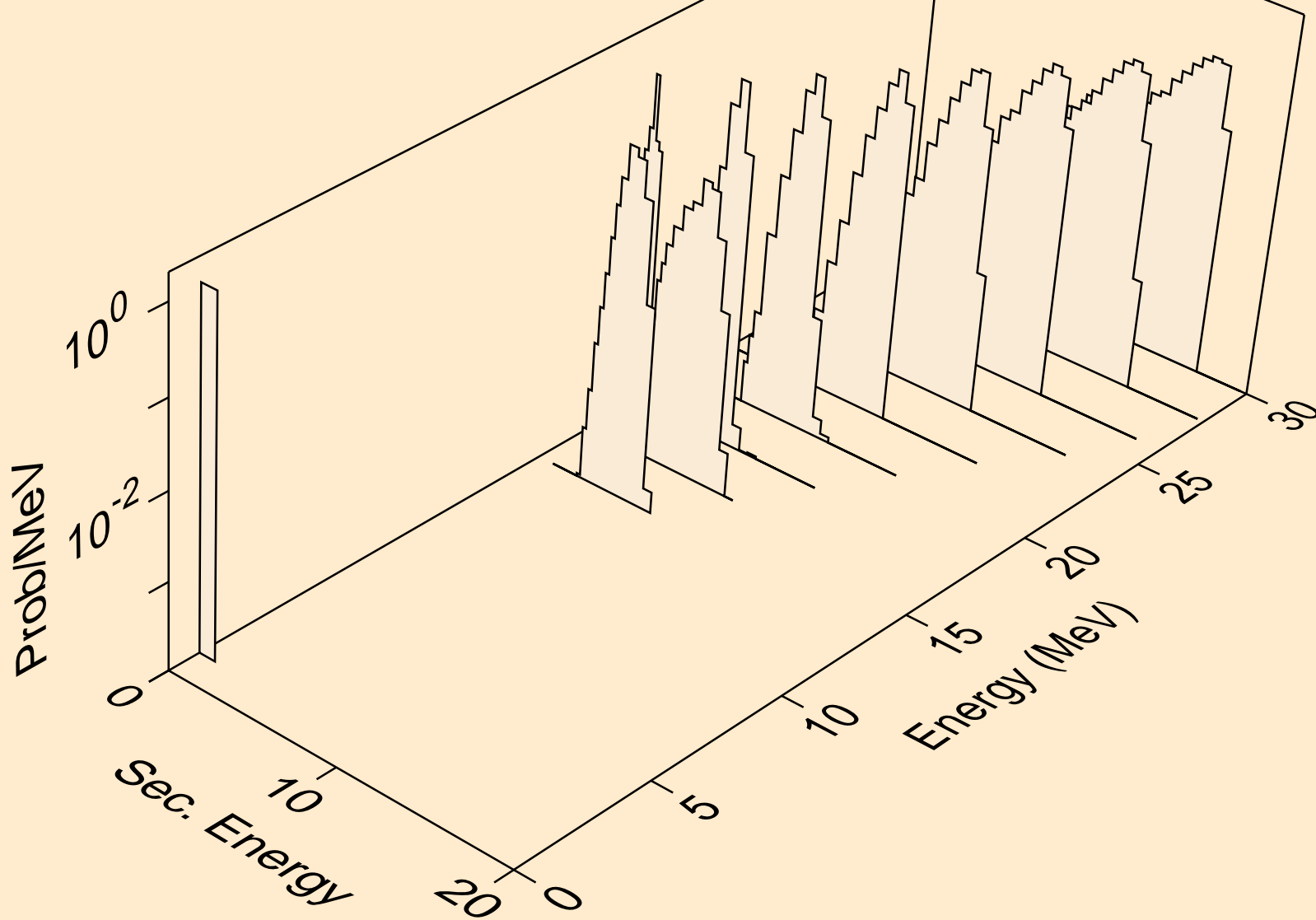

BI212M NEUTRON ACER TENDL-2019 LIBRARY; T=293.16K
protons from (n,p)

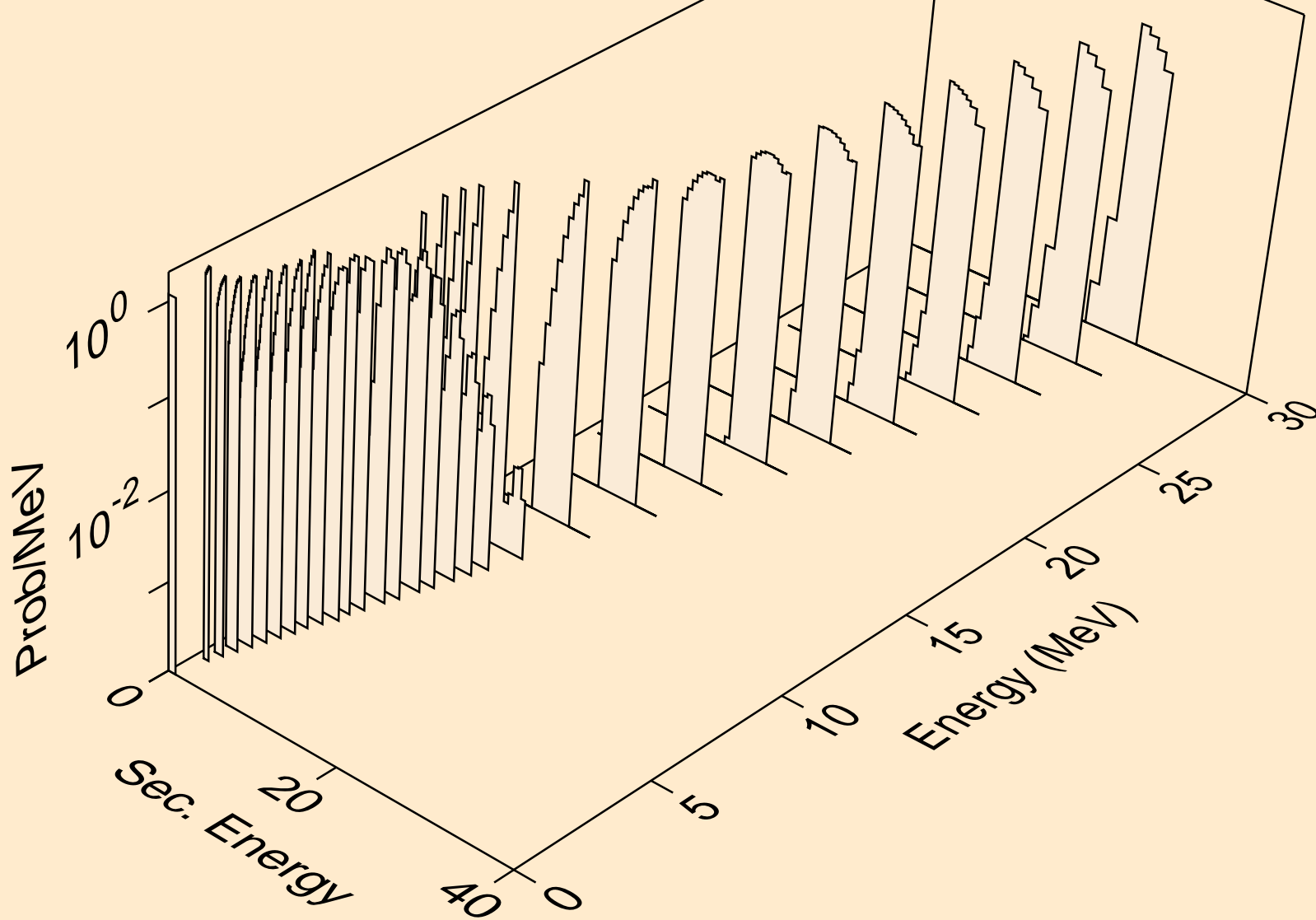

BI212M NEUTRON ACER TENDL-2019 LIBRARY; T=293.16K
protons from (n,2p)

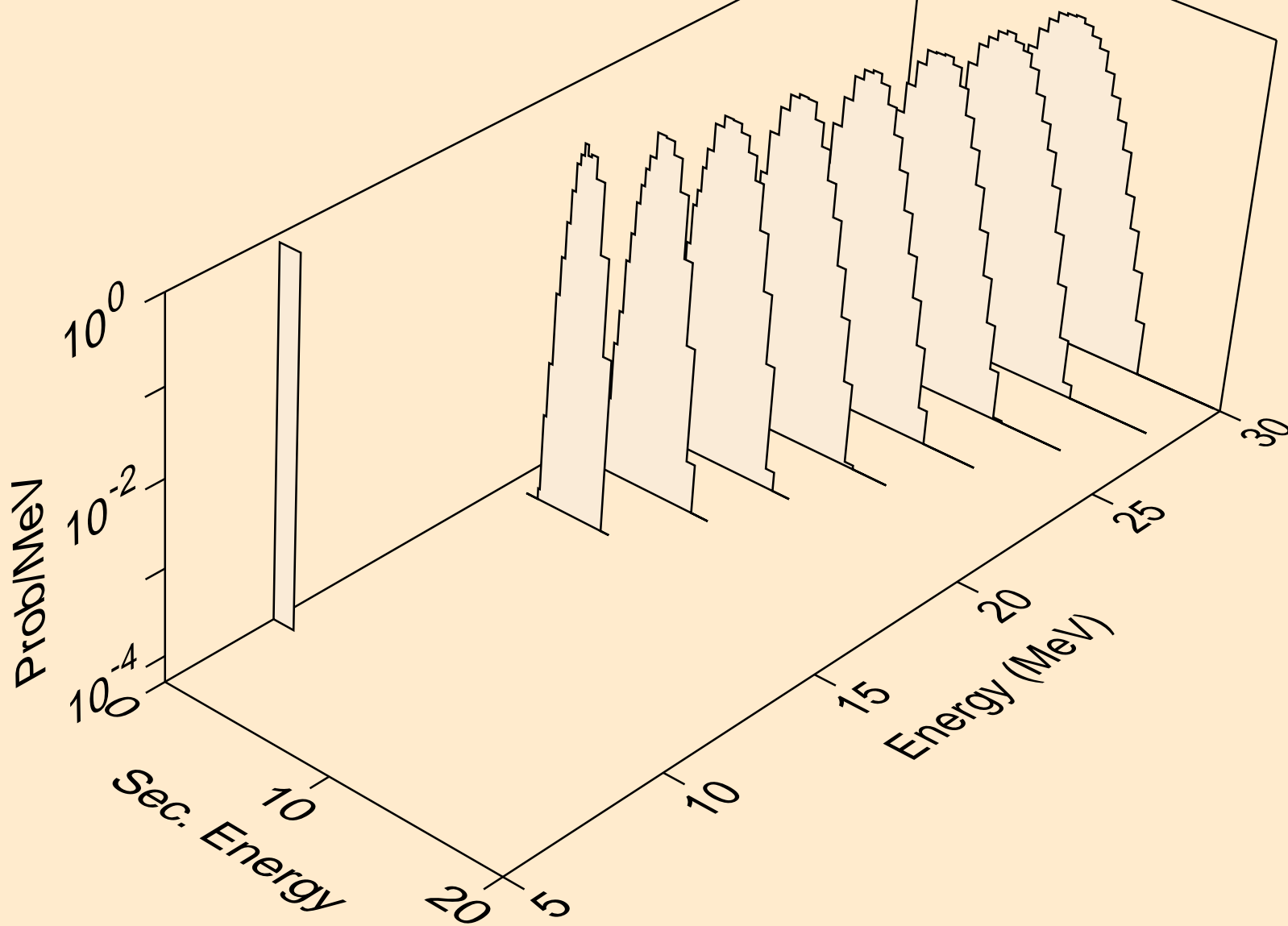

BI212M NEUTRON ACER TENDL-2019 LIBRARY; T=293.16K
protons from (n,p)

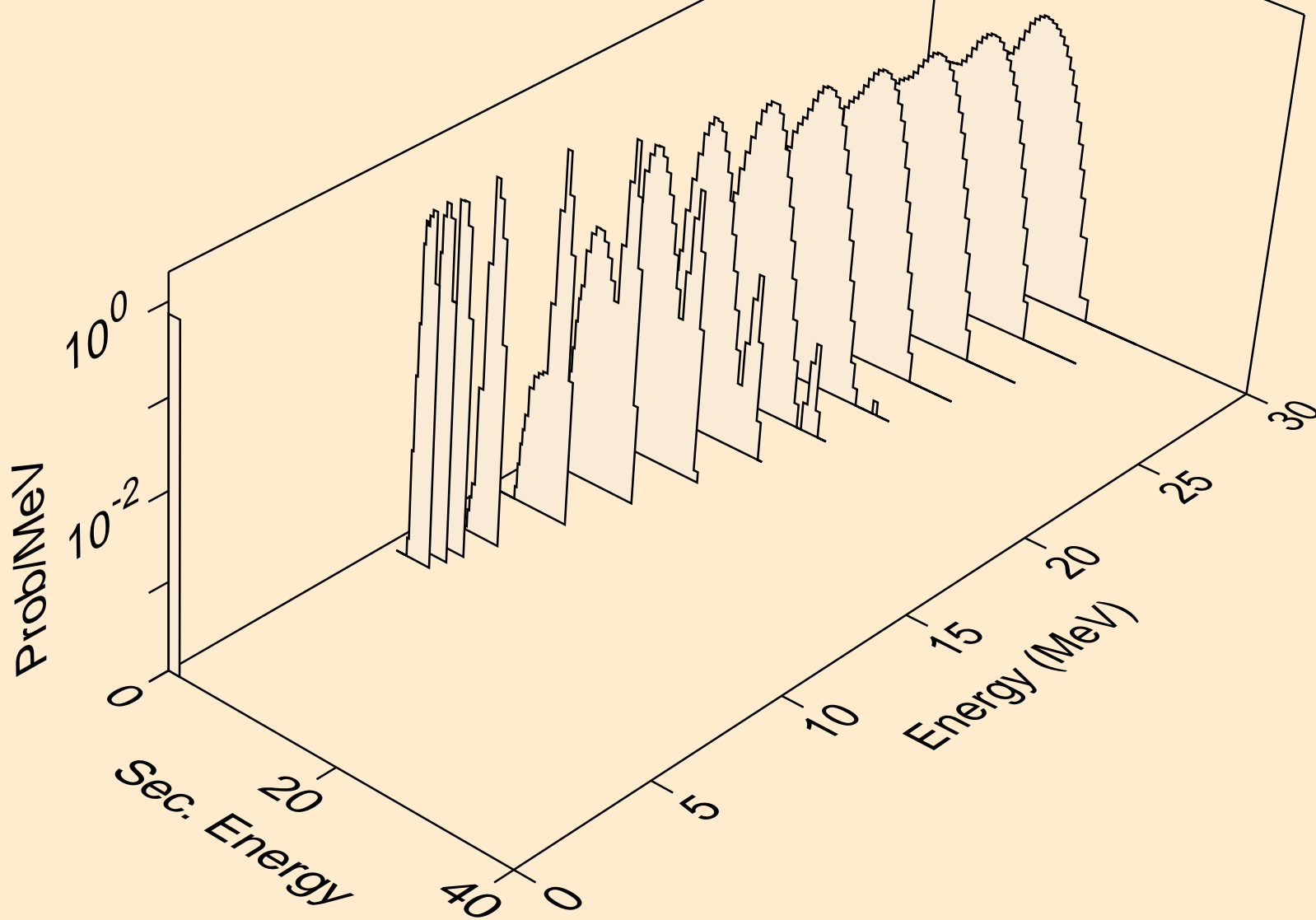

BI212M NEUTRON ACER TENDL-2019 LIBRARY; T=293.16K
protons from (n,pt)

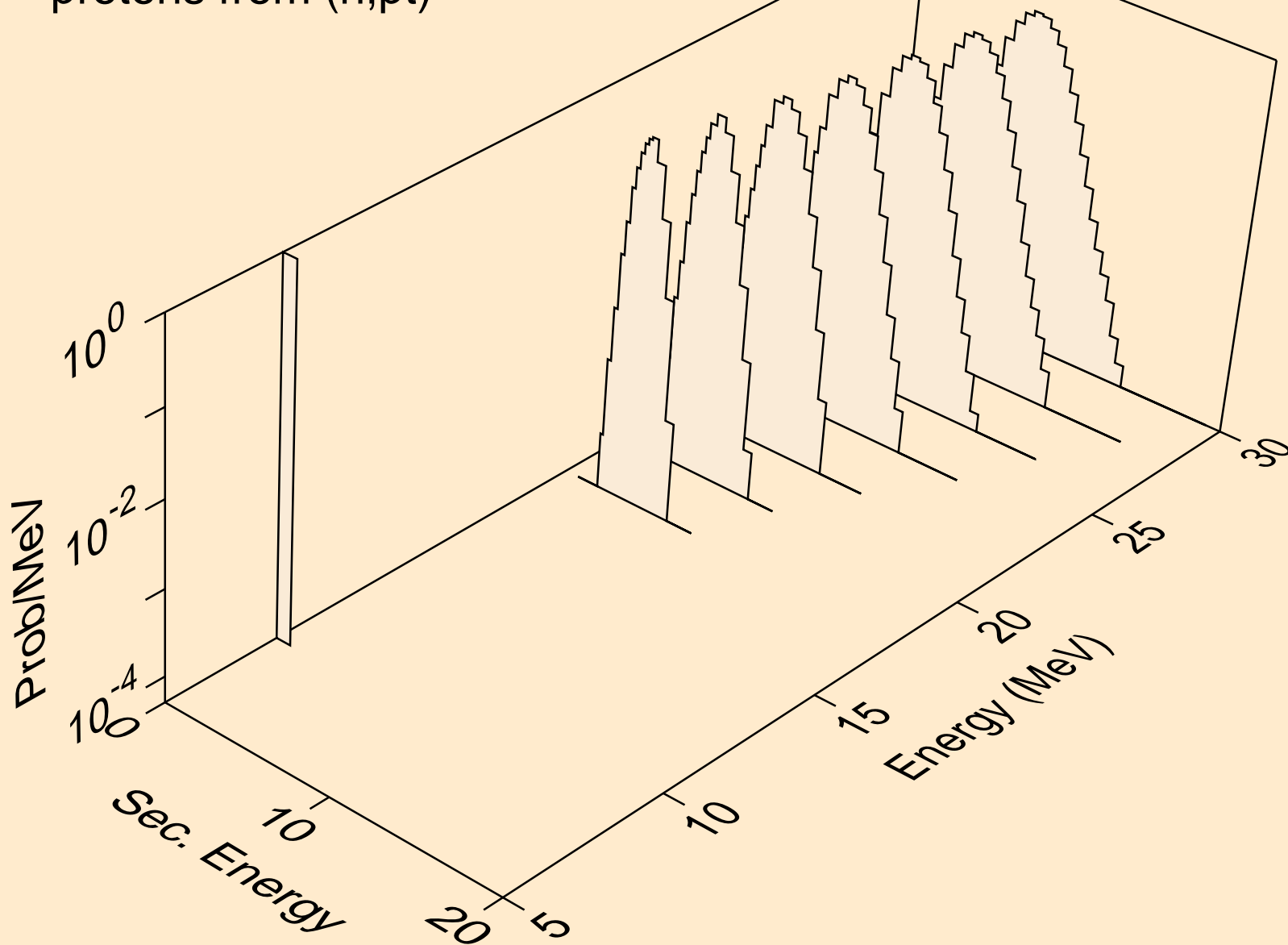

BI212M NEUTRON ACER TENDL-2019 LIBRARY; T=293.16K
deuterons from (n,x)

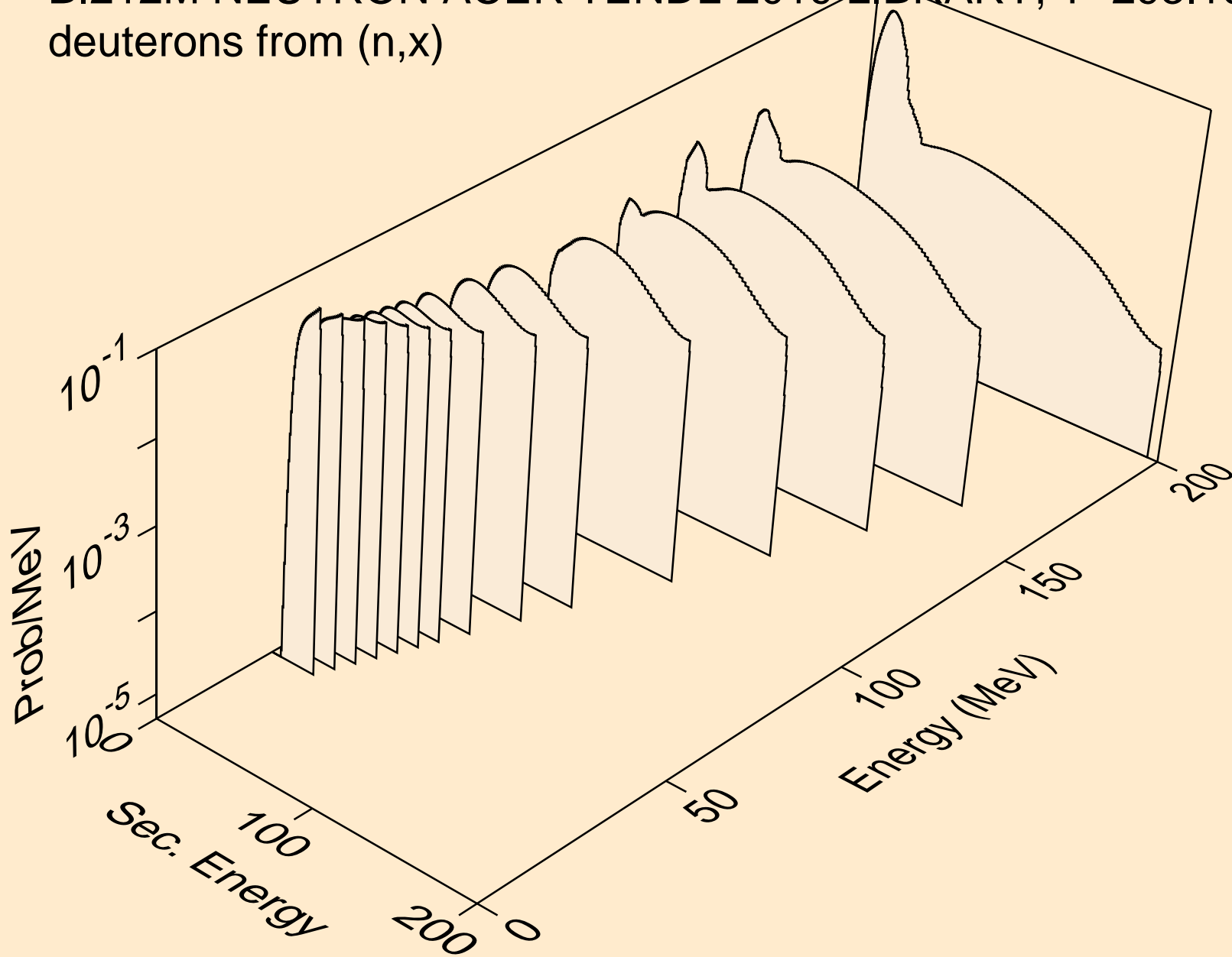

BI212M NEUTRON ACER TENDL-2019 LIBRARY; T=293.16K
deuterons from (n,2nd)

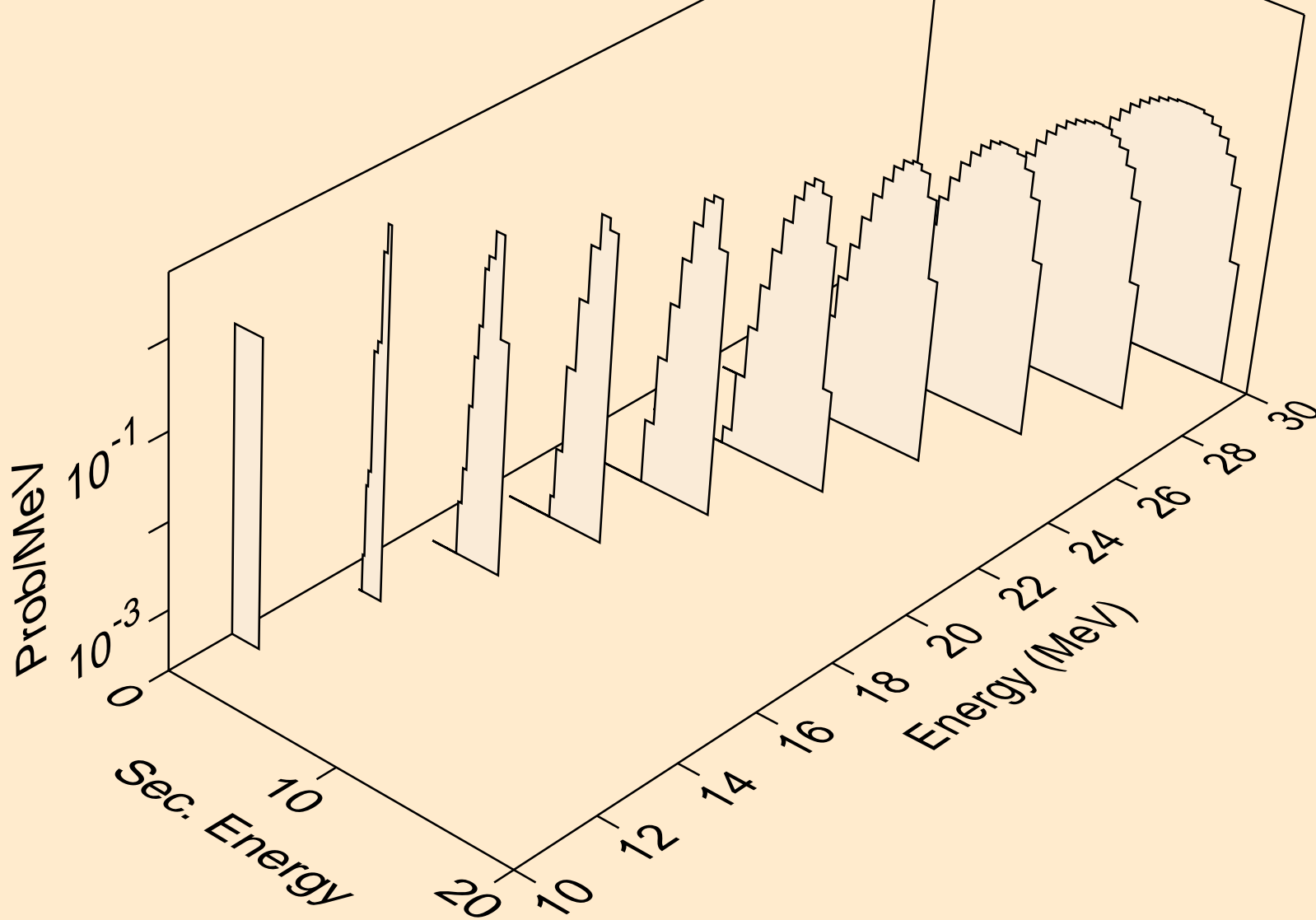

BI212M NEUTRON ACER TENDL-2019 LIBRARY; T=293.16K
deuterons from (n,n*)d

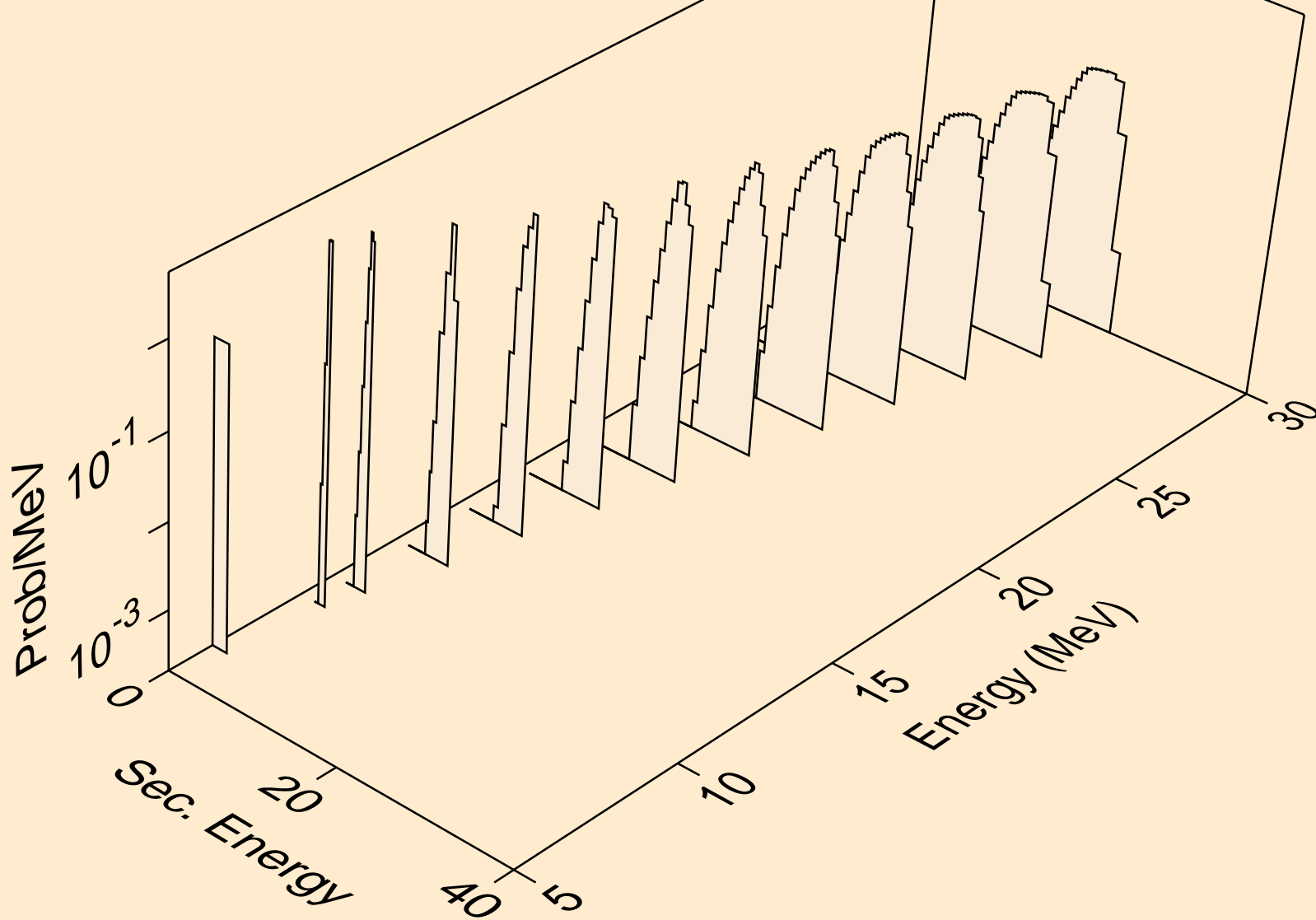

BI212M NEUTRON ACER TENDL-2019 LIBRARY; T=293.16K
deuterons from (n,d)

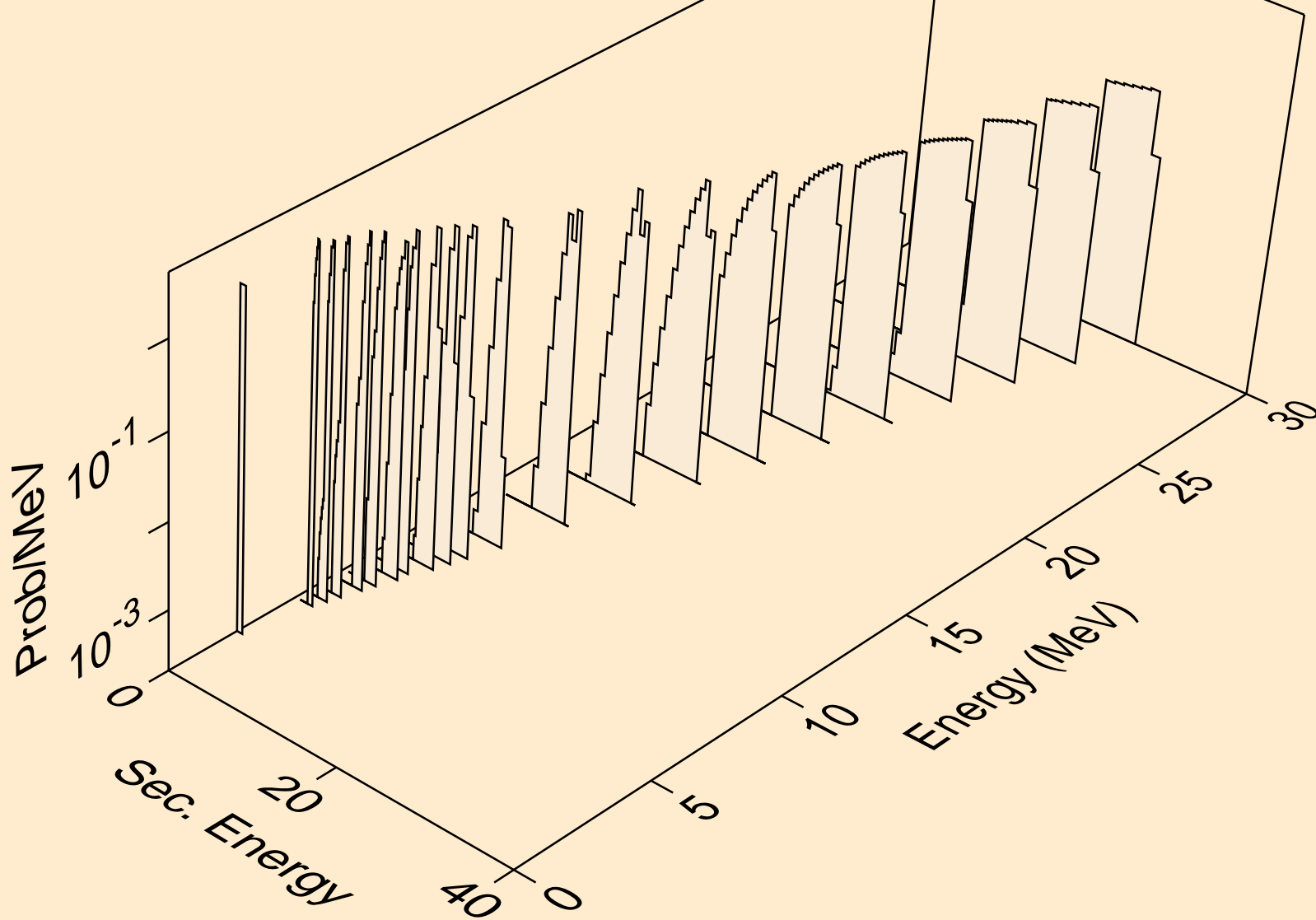

BI212M NEUTRON ACER TENDL-2019 LIBRARY; T=293.16K
deuterons from (n,da)

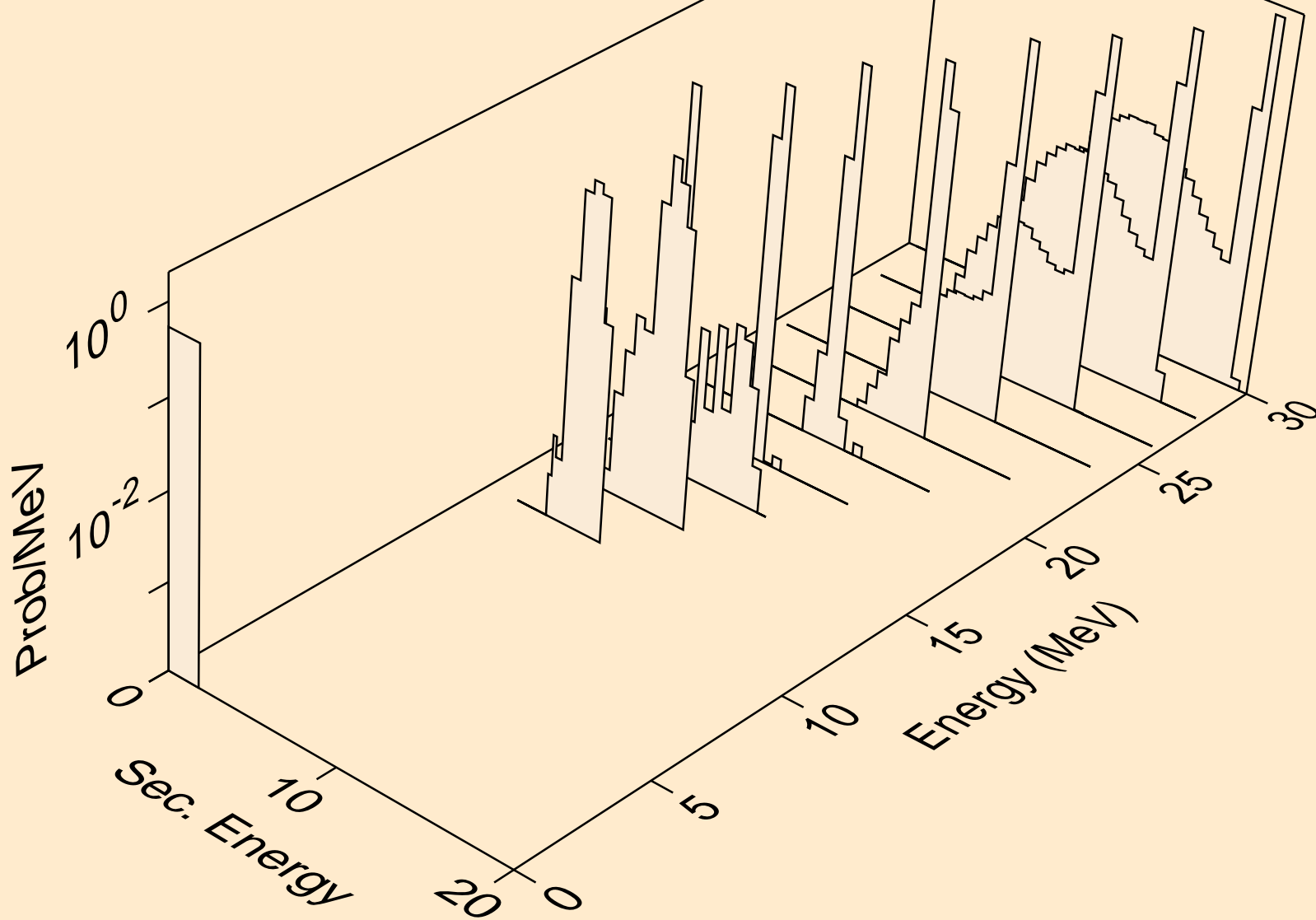

BI212M NEUTRON ACER TENDL-2019 LIBRARY; T=293.16K
tritons from (n,x)

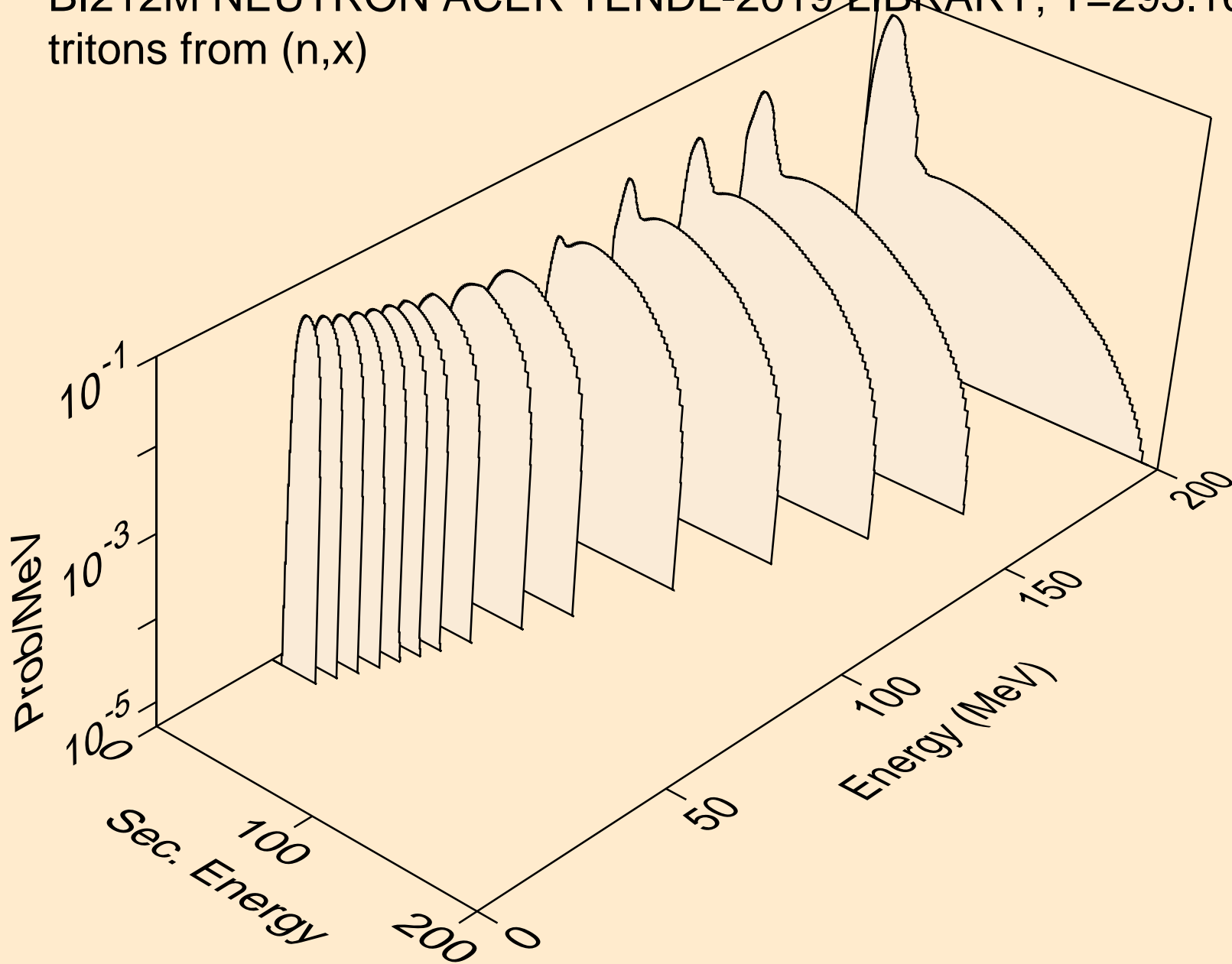

BI212M NEUTRON ACER TENDL-2019 LIBRARY; T=293.16K
tritons from (n,n*)t

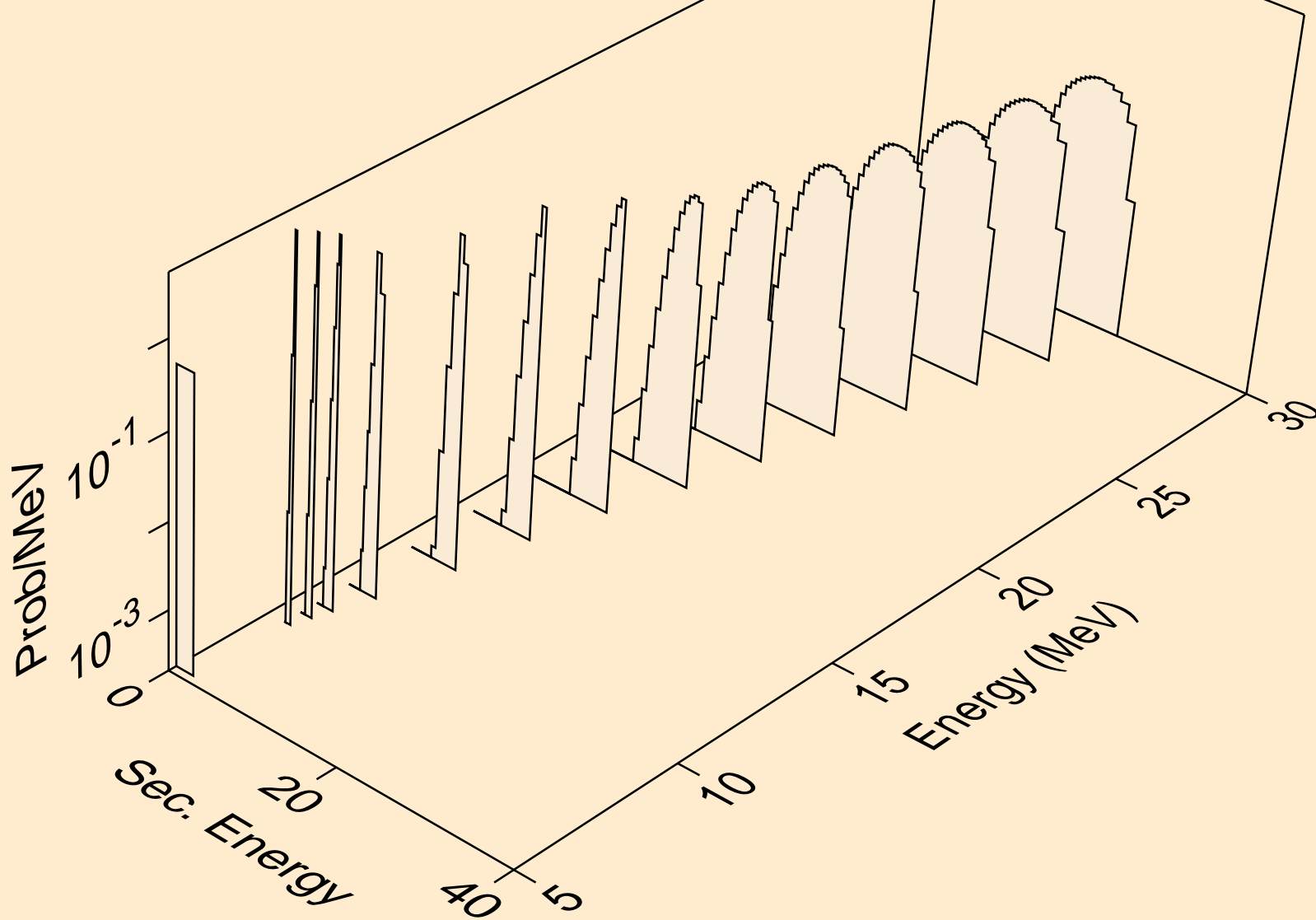

BI212M NEUTRON ACER TENDL-2019 LIBRARY; T=293.16K
tritons from (n,t)

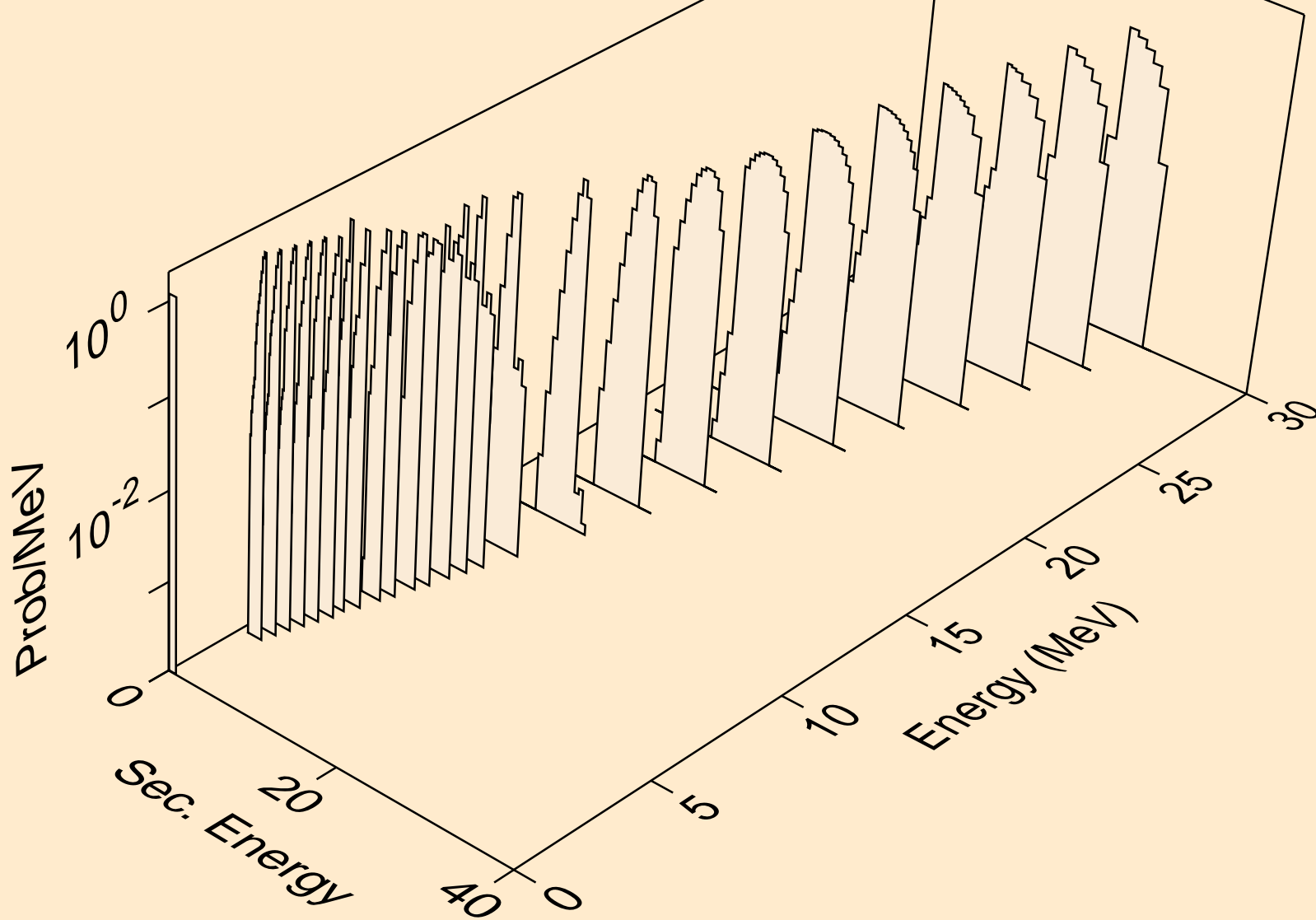

BI212M NEUTRON ACER TENDL-2019 LIBRARY; T=293.16K
tritons from (n,pt)

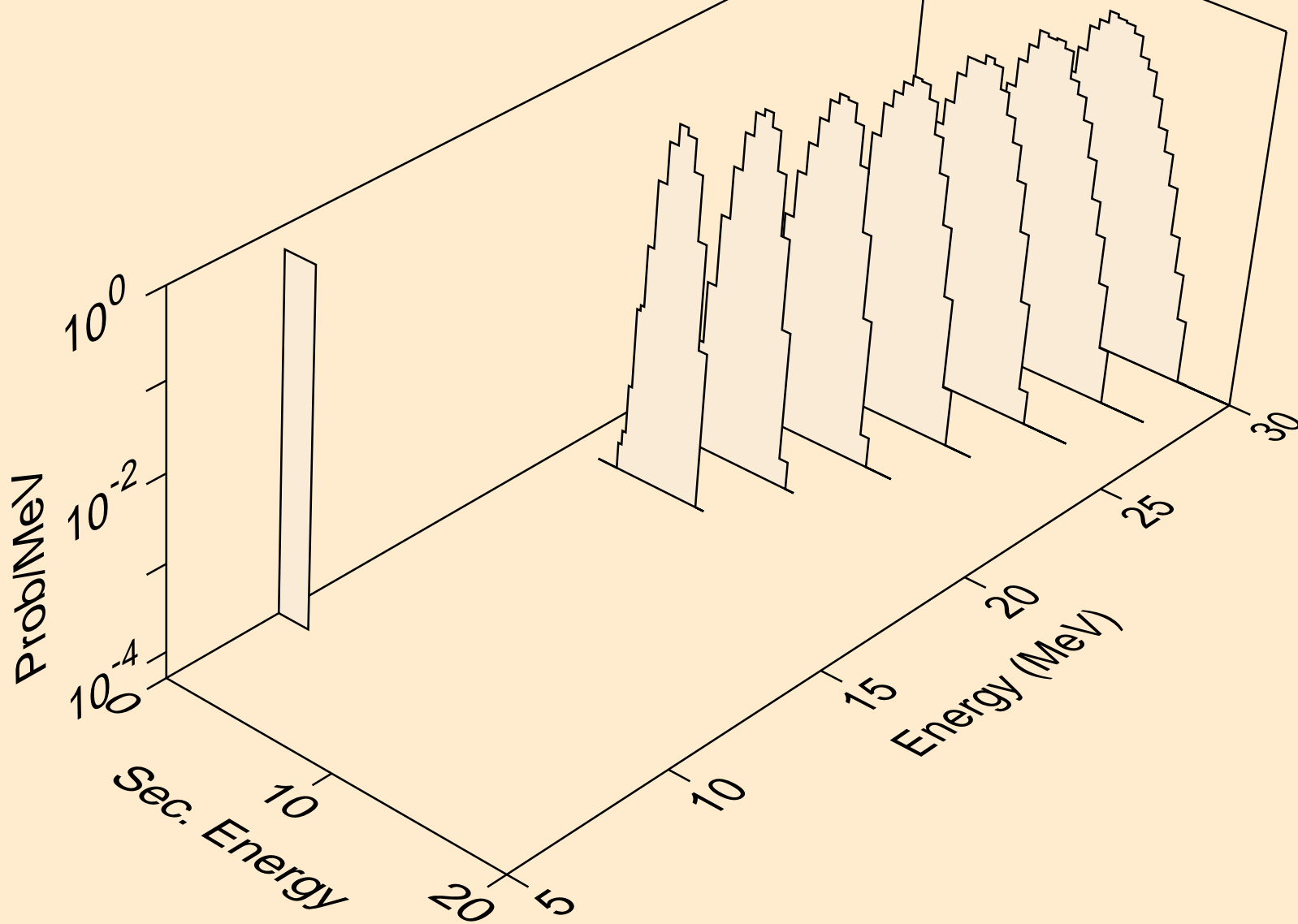

BI212M NEUTRON ACER TENDL-2019 LIBRARY; T=293.16K
he3s from (n,x)

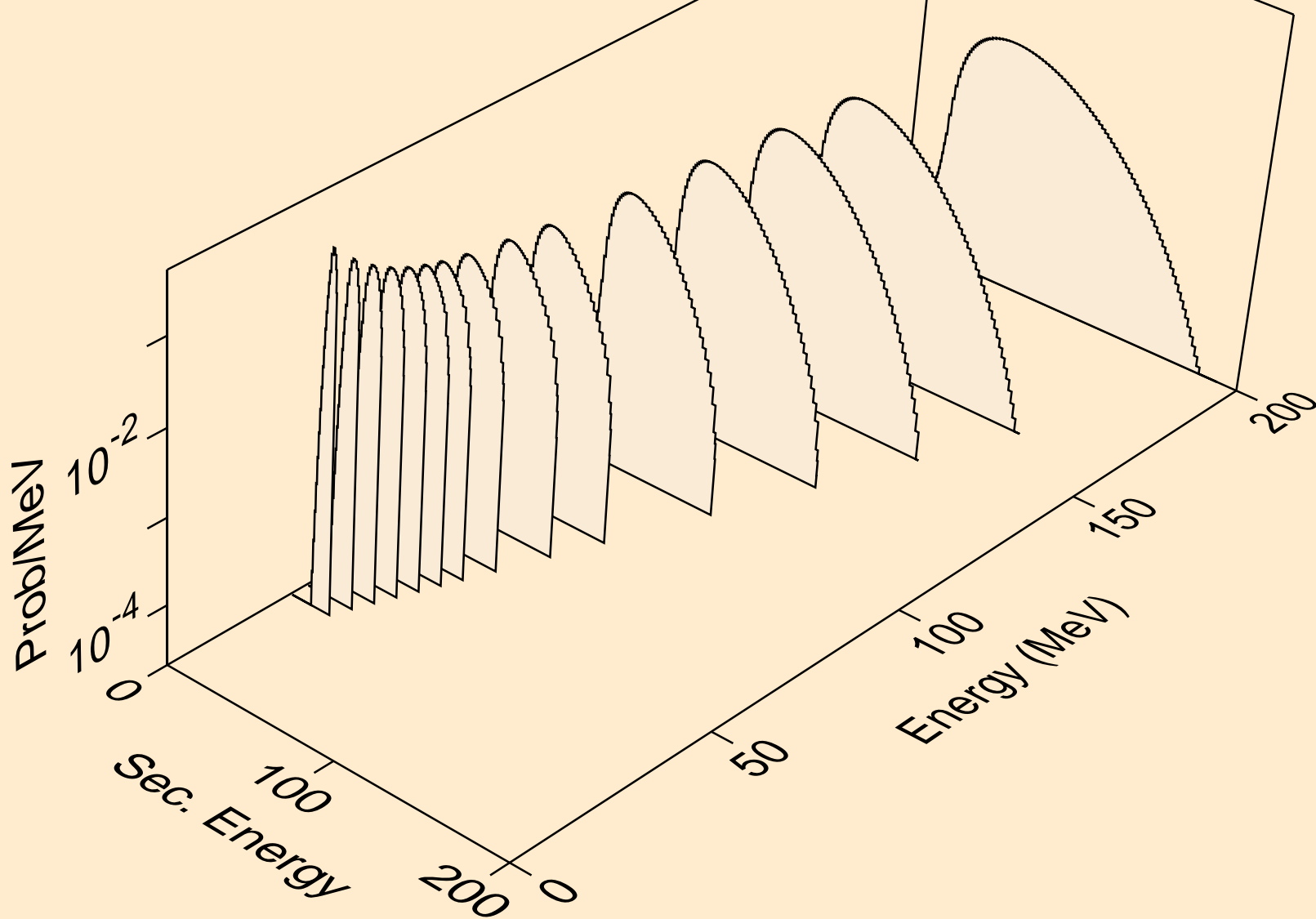

BI212M NEUTRON ACER TENDL-2019 LIBRARY; T=293.16K
he3s from (n,n*)he3

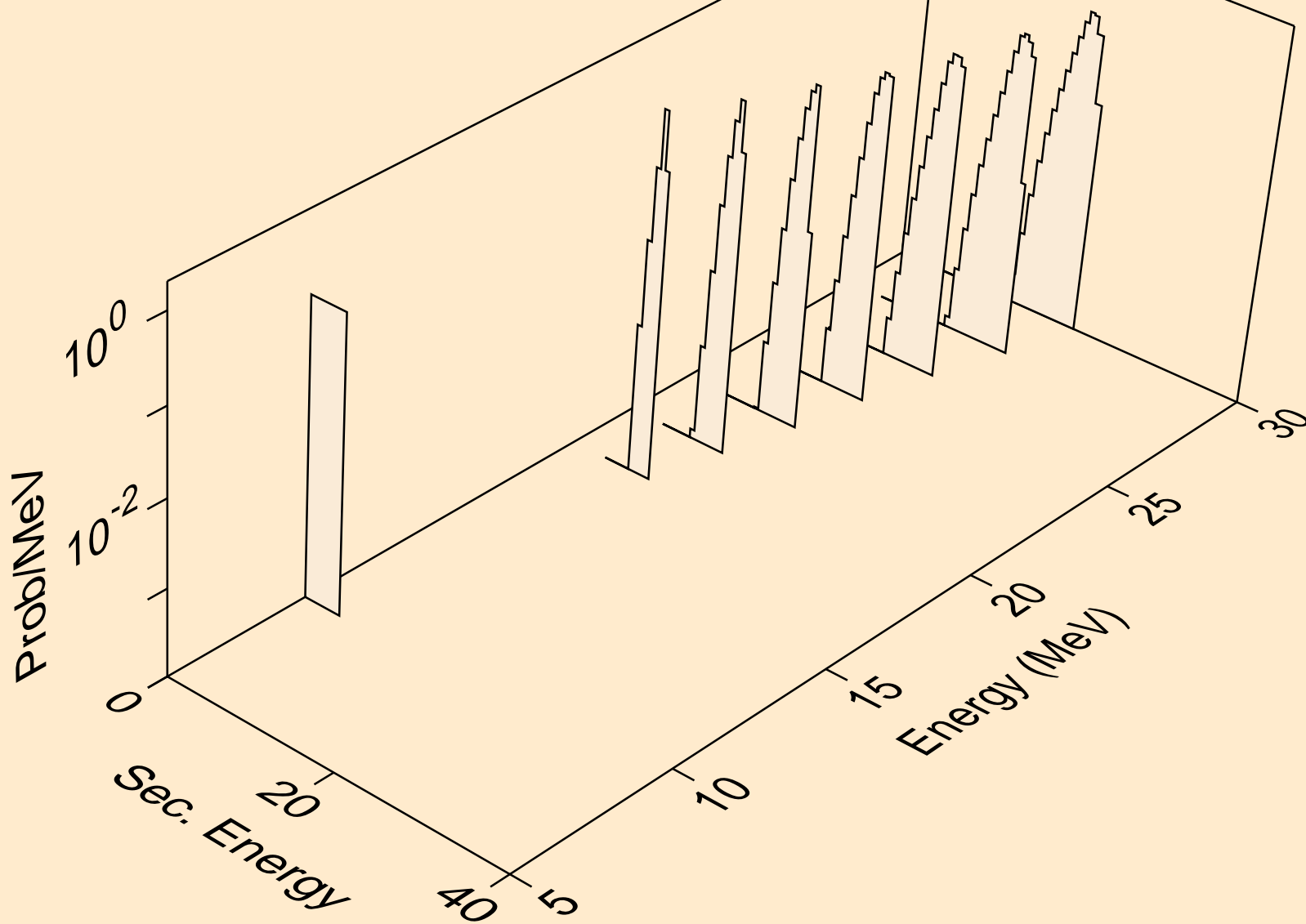

BI212M NEUTRON ACER TENDL-2019 LIBRARY; T=293.16K
he3s from (n,he3)

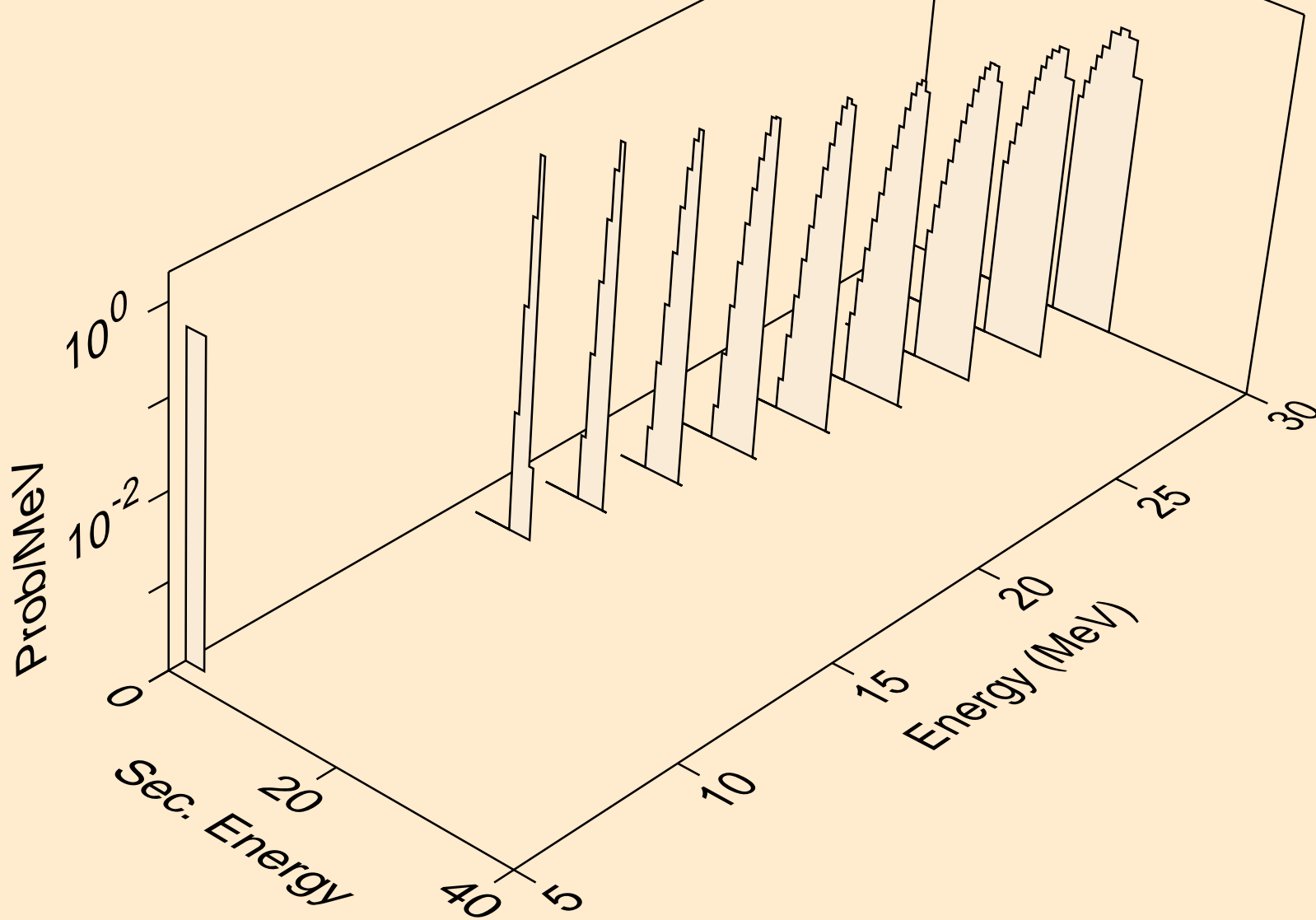

BI212M NEUTRON ACER TENDL-2019 LIBRARY; T=293.16K
alphas from (n,x)

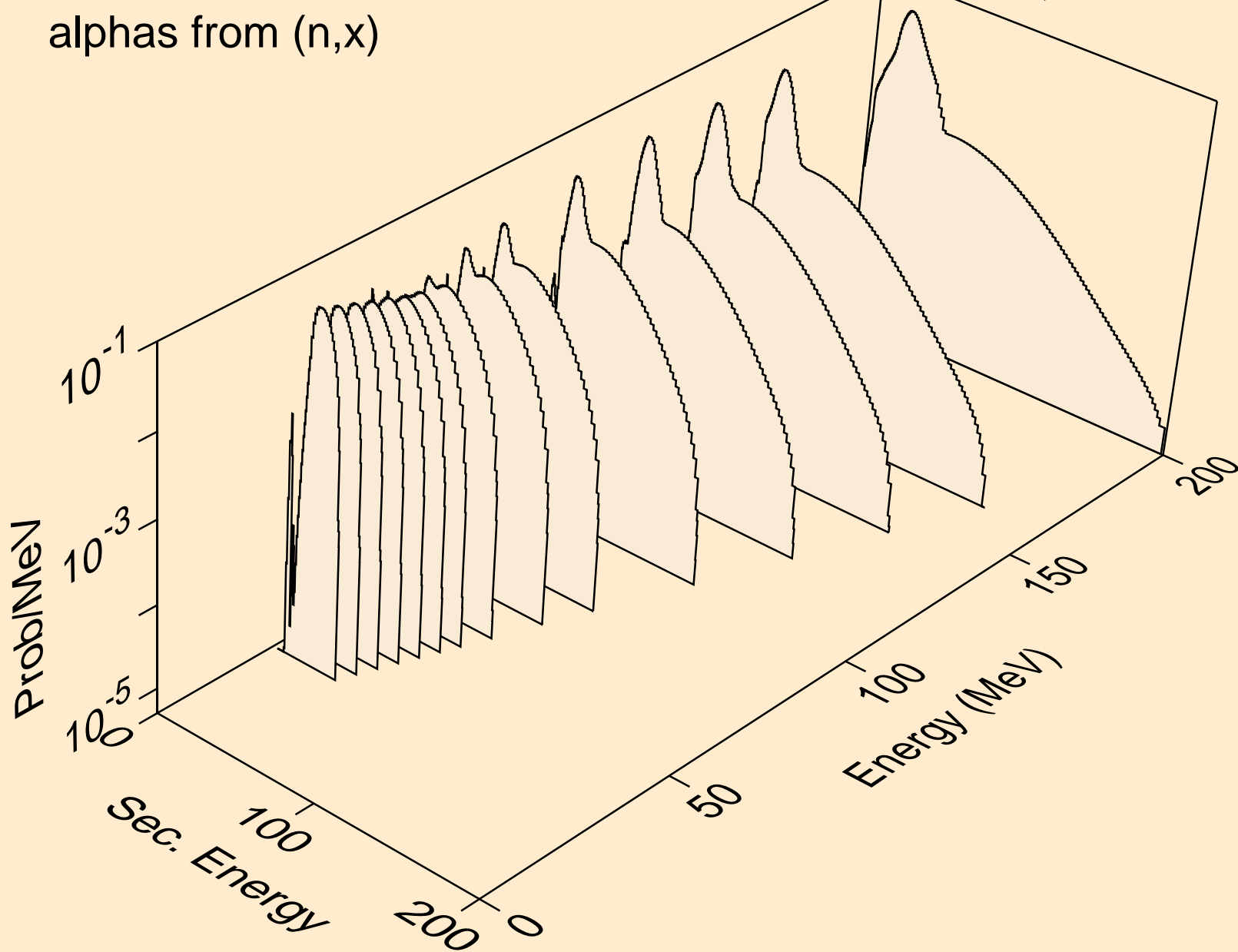

BI212M NEUTRON ACER TENDL-2019 LIBRARY; T=293.16K
alphas from (n,n*)a

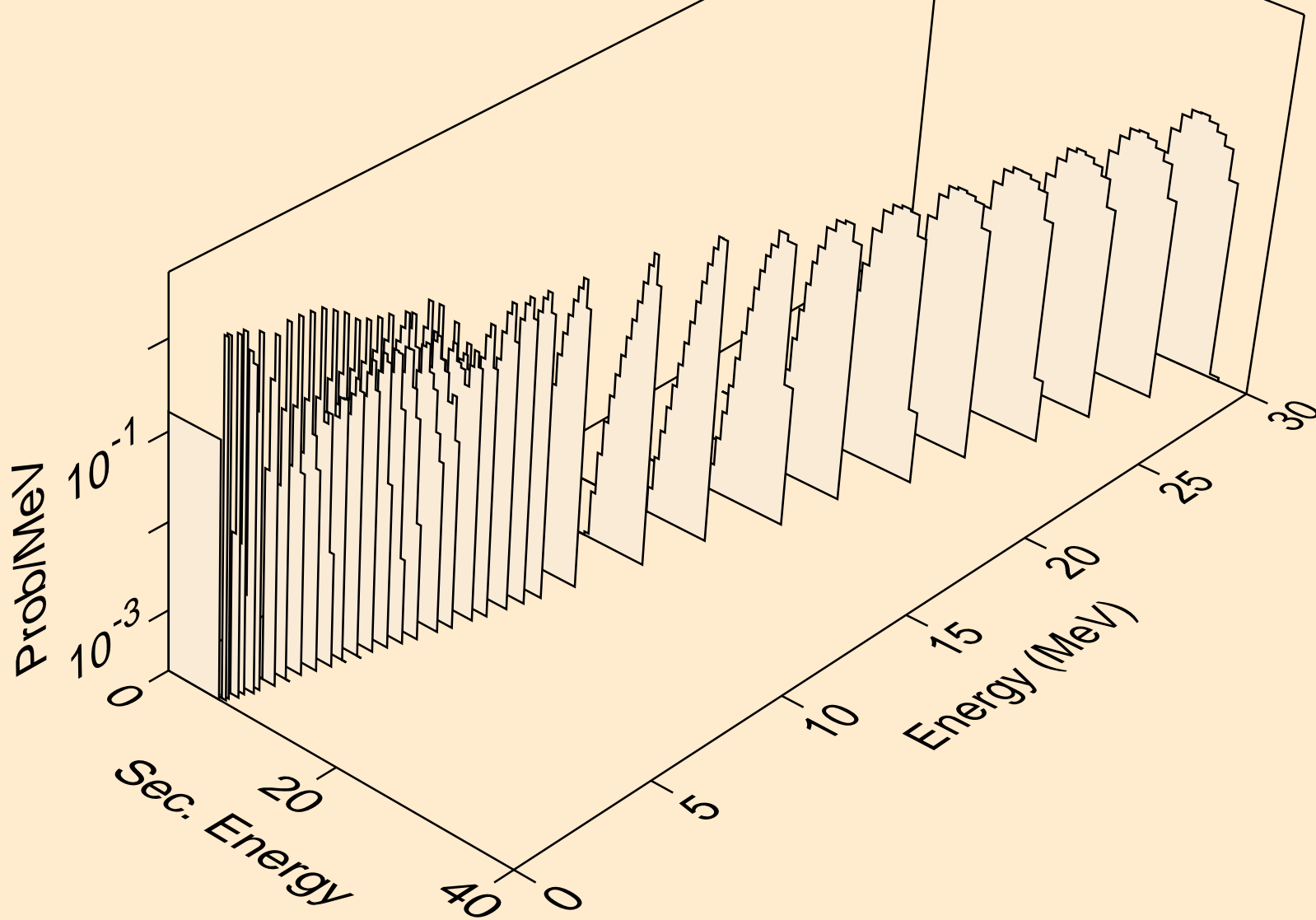

BI212M NEUTRON ACER TENDL-2019 LIBRARY; T=293.16K
alphas from (n,2n)a

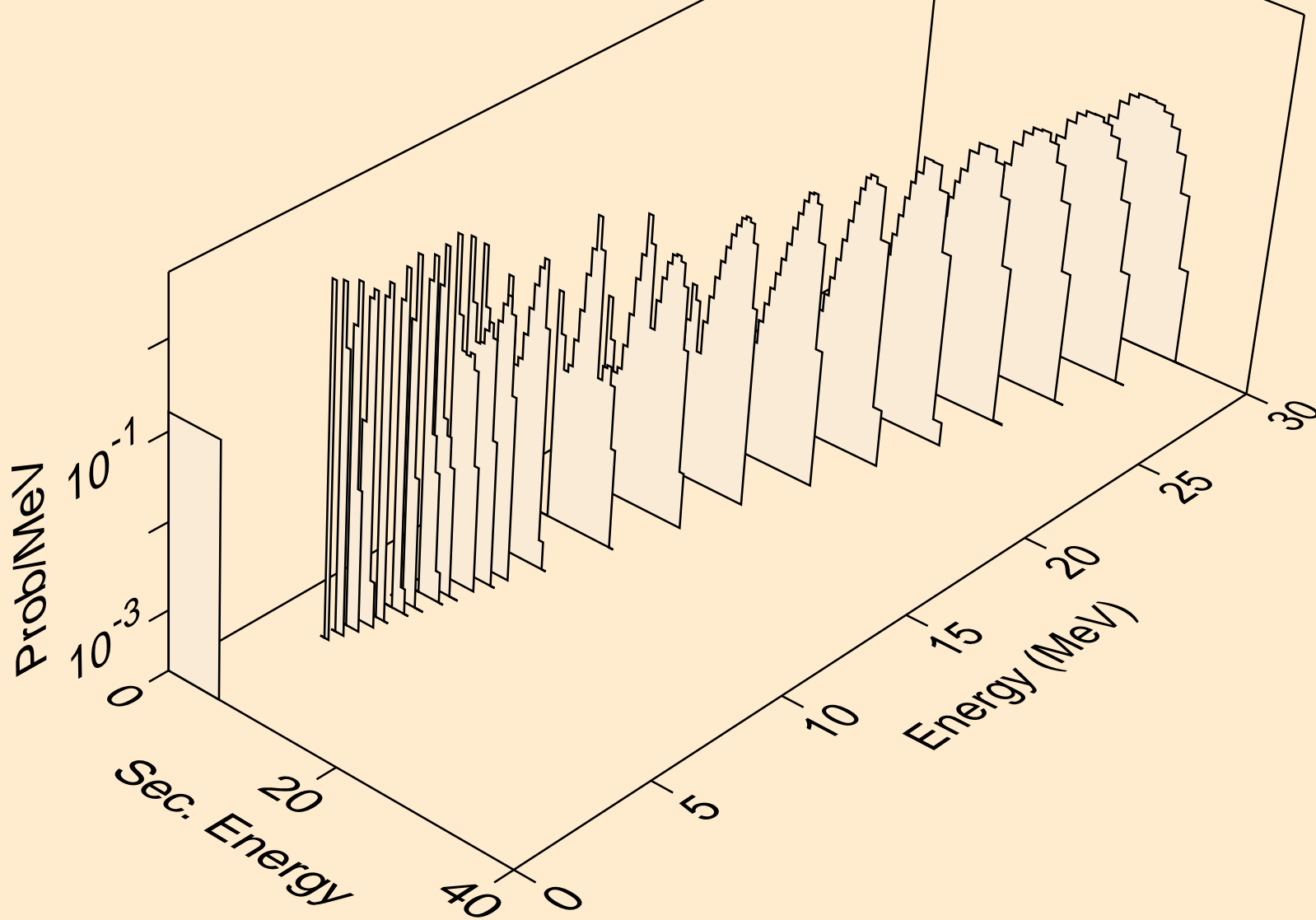

BI212M NEUTRON ACER TENDL-2019 LIBRARY; T=293.16K
alphas from (n,3n)a

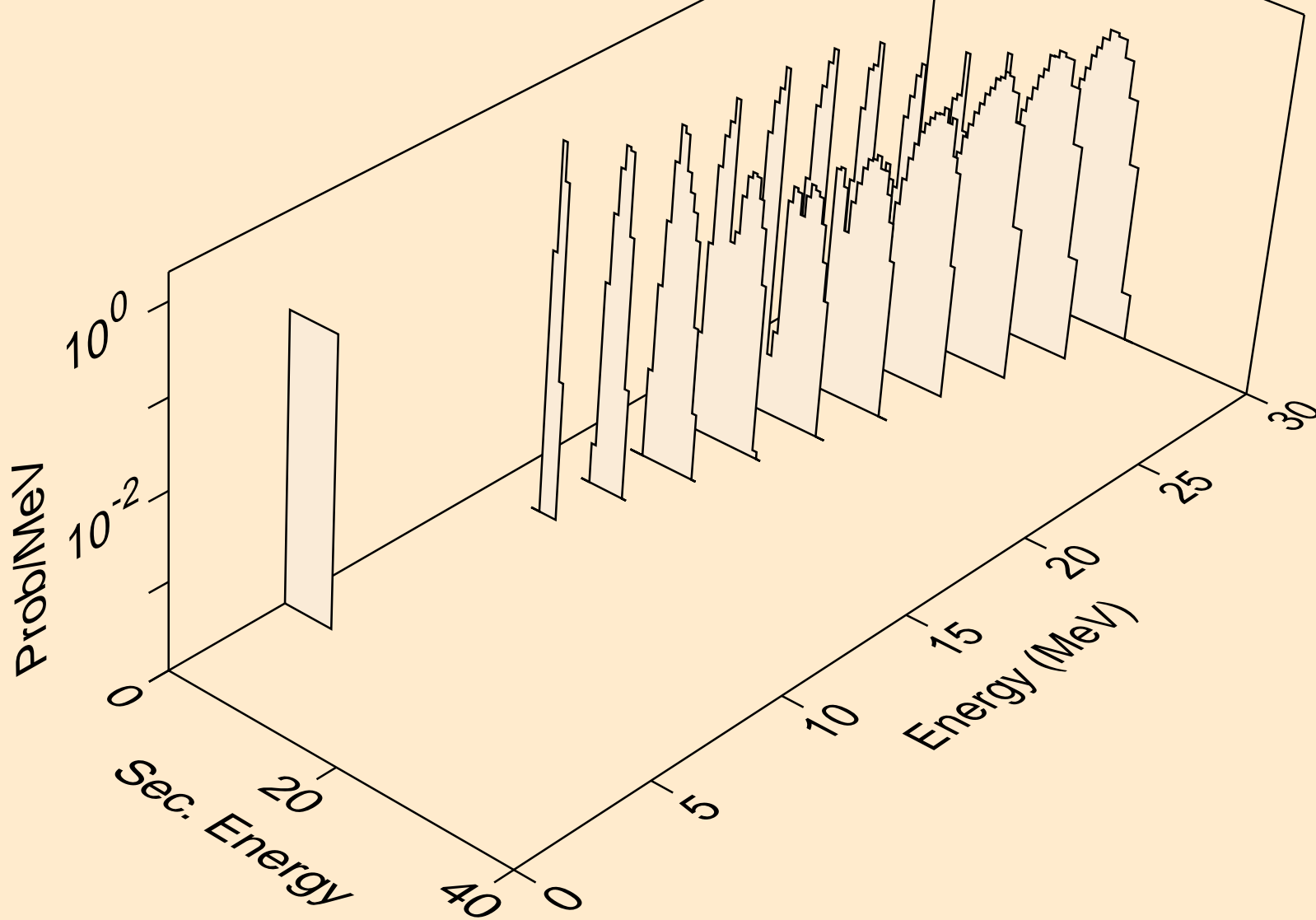

BI212M NEUTRON ACER TENDL-2019 LIBRARY; T=293.16K
alphas from (n,n*)2a

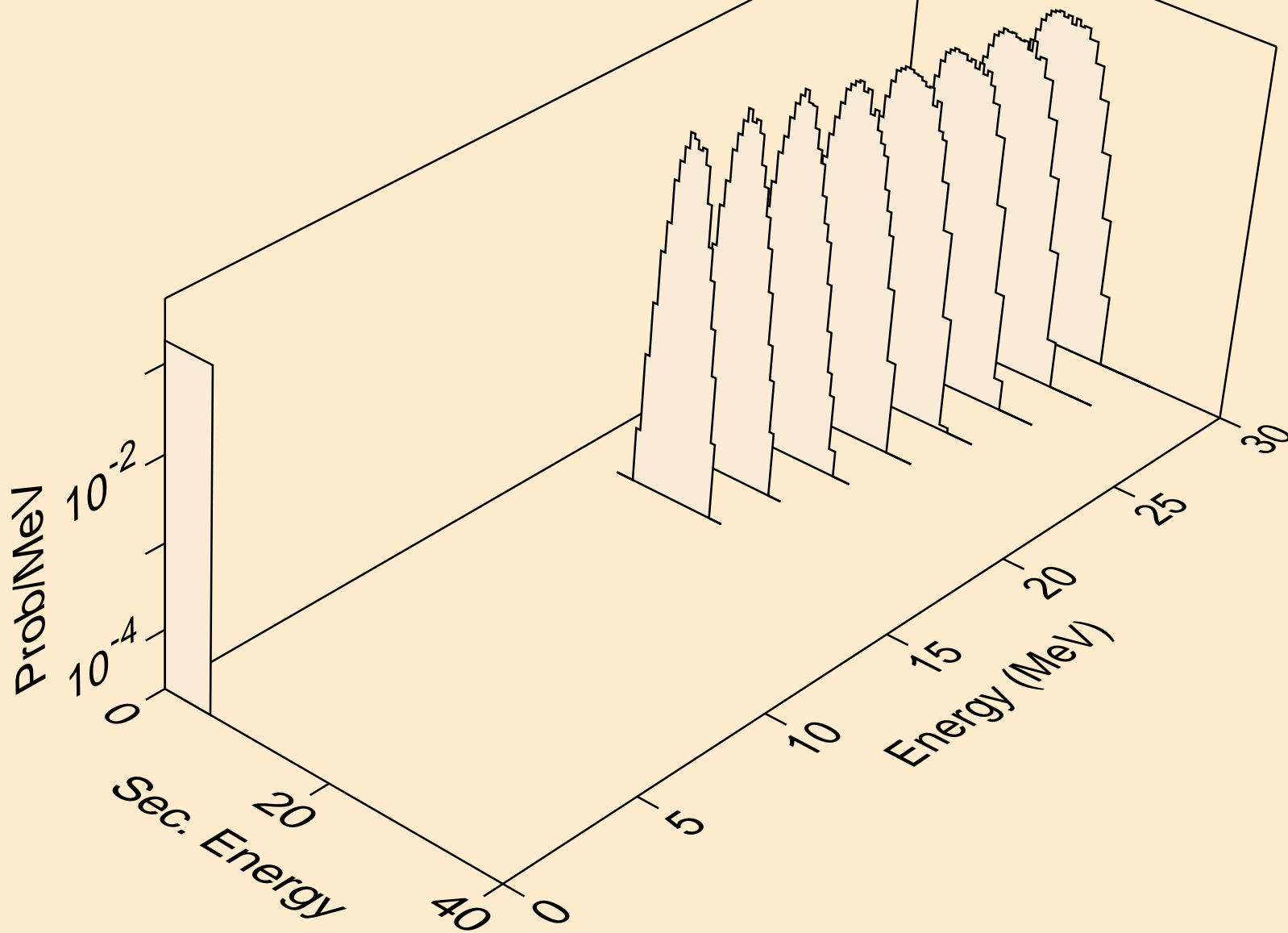

BI212M NEUTRON ACER TENDL-2019 LIBRARY; T=293.16K
alphas from (n,npa)

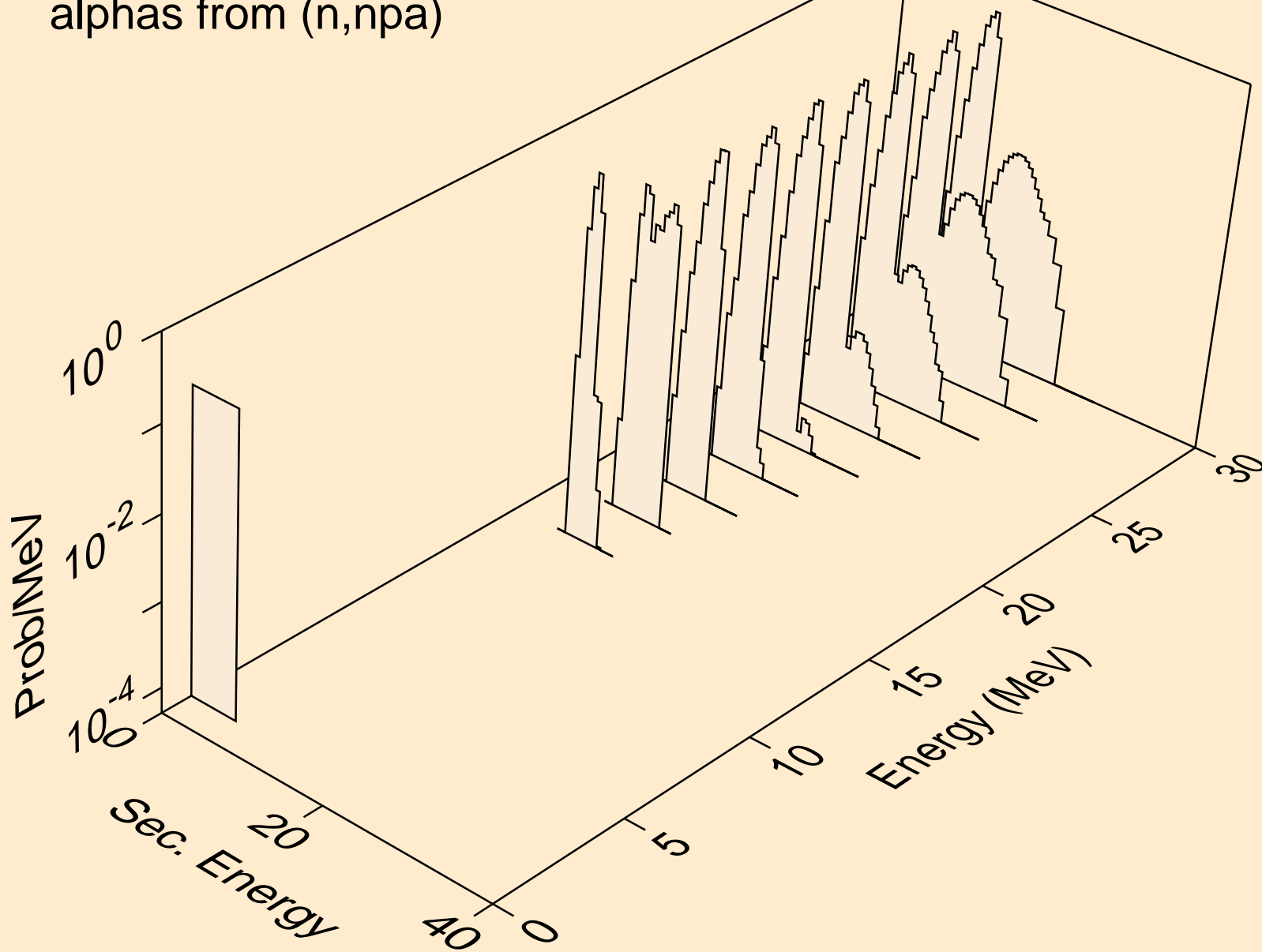

BI212M NEUTRON ACER TENDL-2019 LIBRARY; T=293.16K
alphas from (n,a)

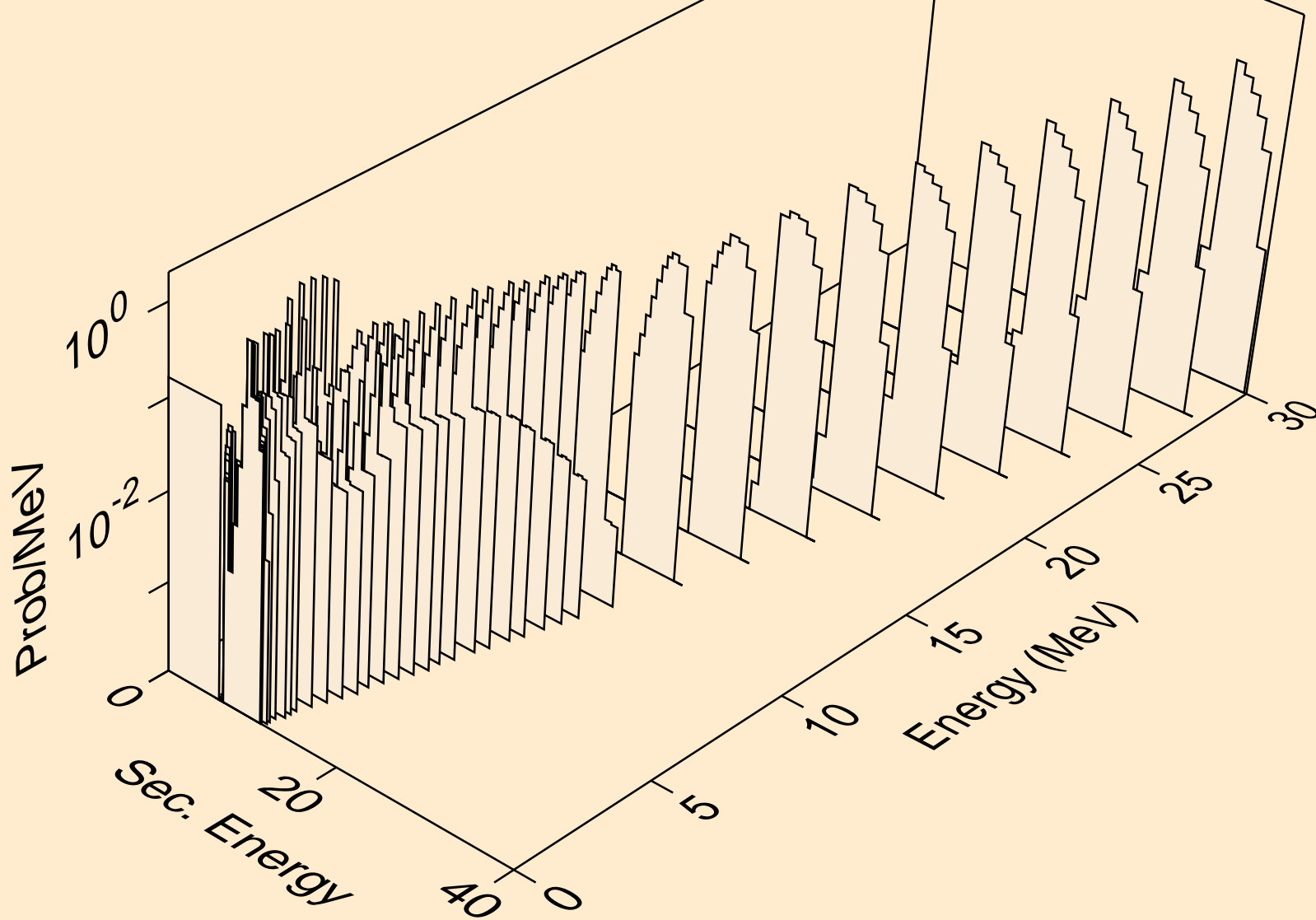

BI212M NEUTRON ACER TENDL-2019 LIBRARY; T=293.16K
alphas from (n,2a)

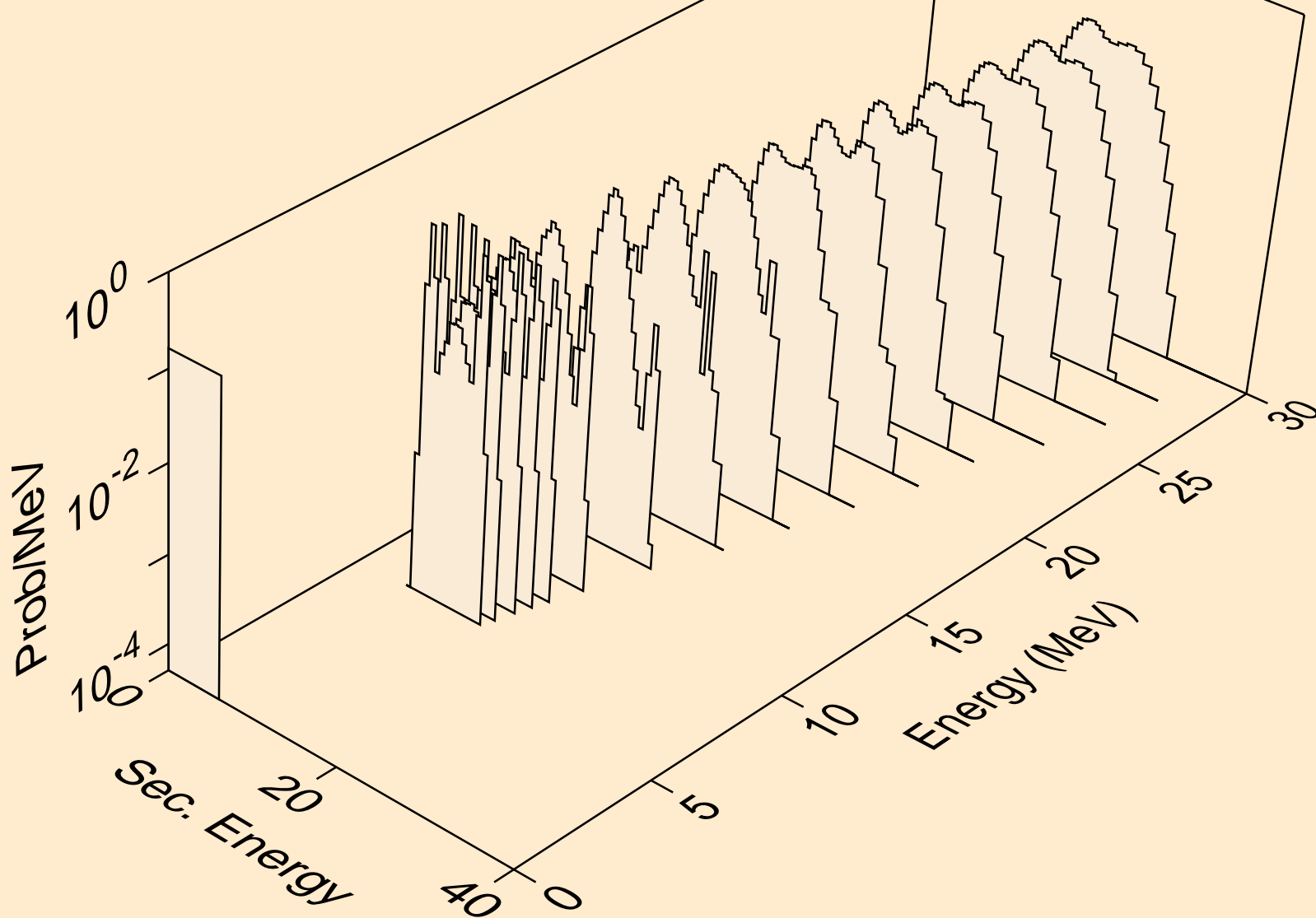

BI212M NEUTRON ACER TENDL-2019 LIBRARY; T=293.16K
alphas from (n,pa)

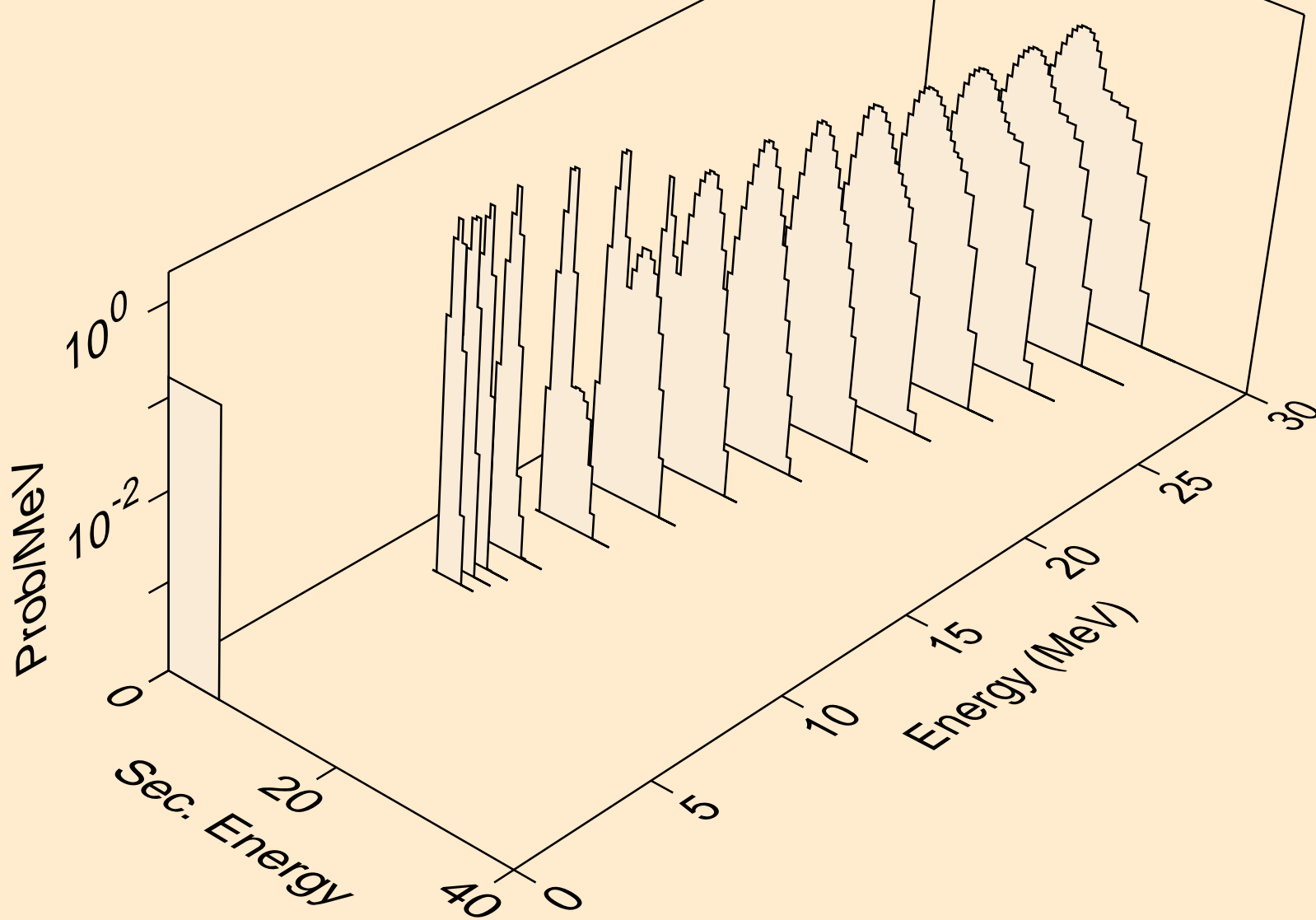

BI212M NEUTRON ACER TENDL-2019 LIBRARY; T=293.16K
alphas from (n,da)

