

BI219 NEUTRON ACER TENDL-2019 LIBRARY; T=293.16K
Principal cross sections

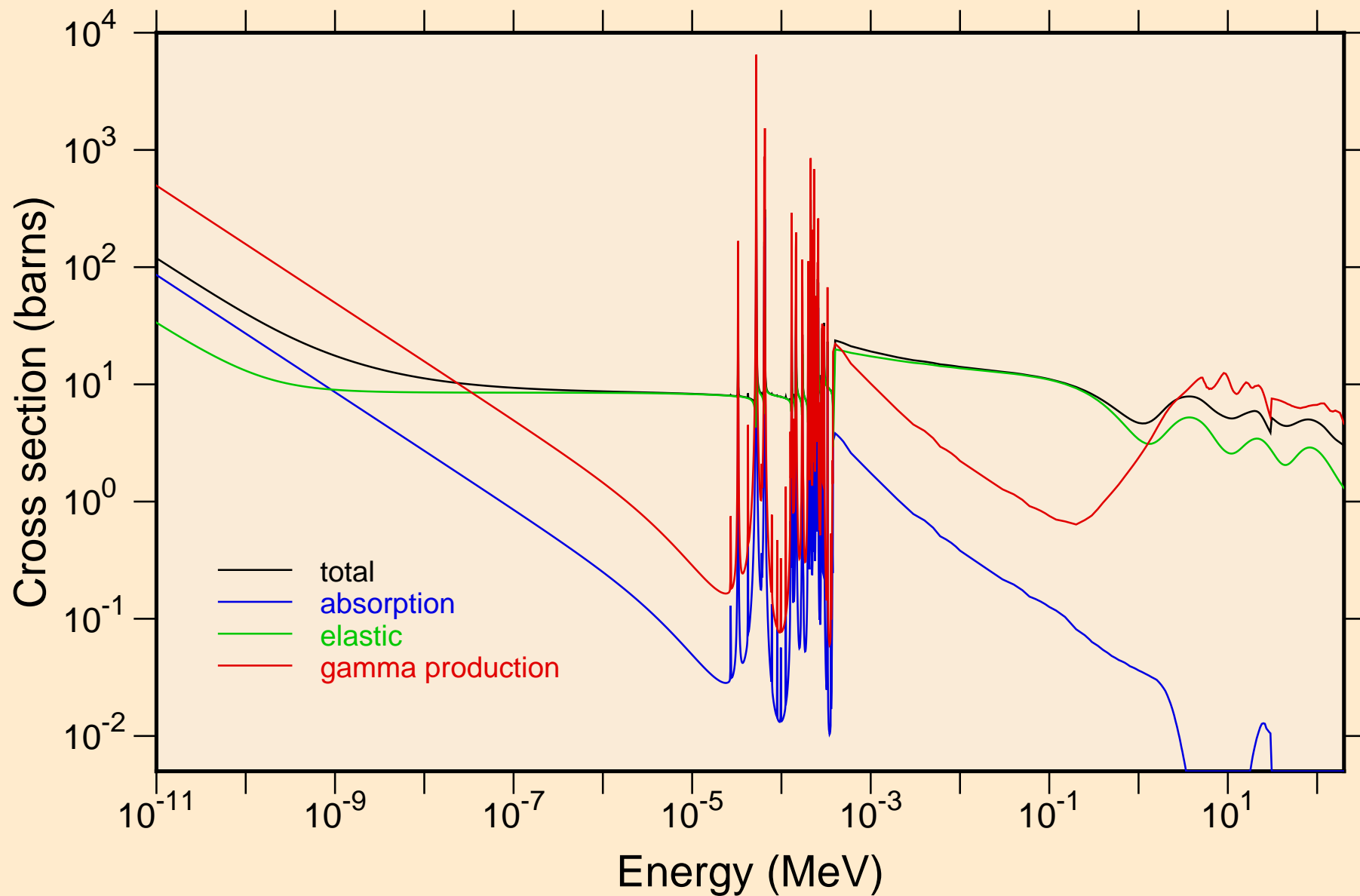

BI219 NEUTRON ACER TENDL-2019 LIBRARY; T=293.16K
resonance total cross section

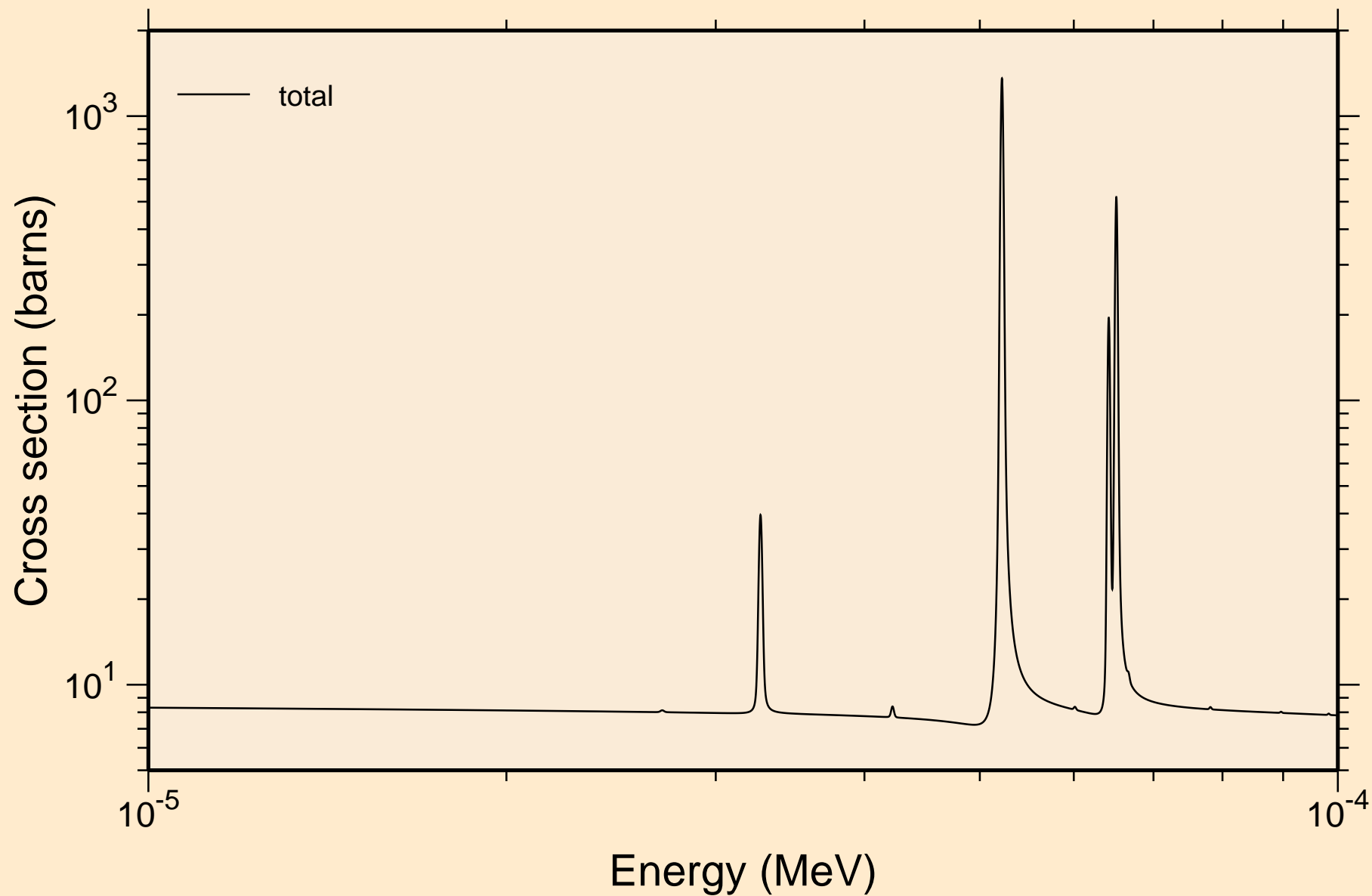

BI219 NEUTRON ACER TENDL-2019 LIBRARY; T=293.16K
resonance total cross section

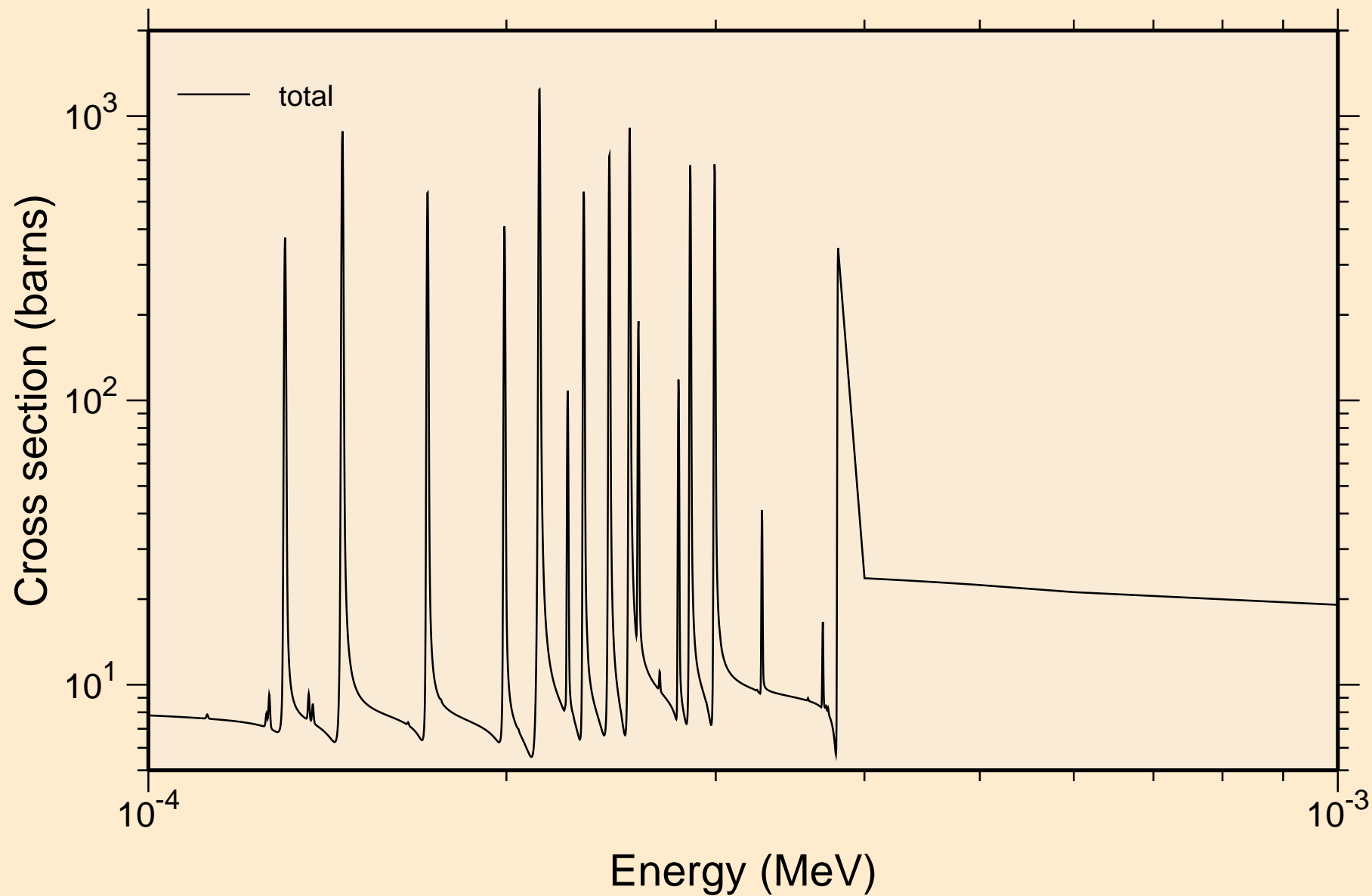

BI219 NEUTRON ACER TENDL-2019 LIBRARY; T=293.16K
resonance total cross section

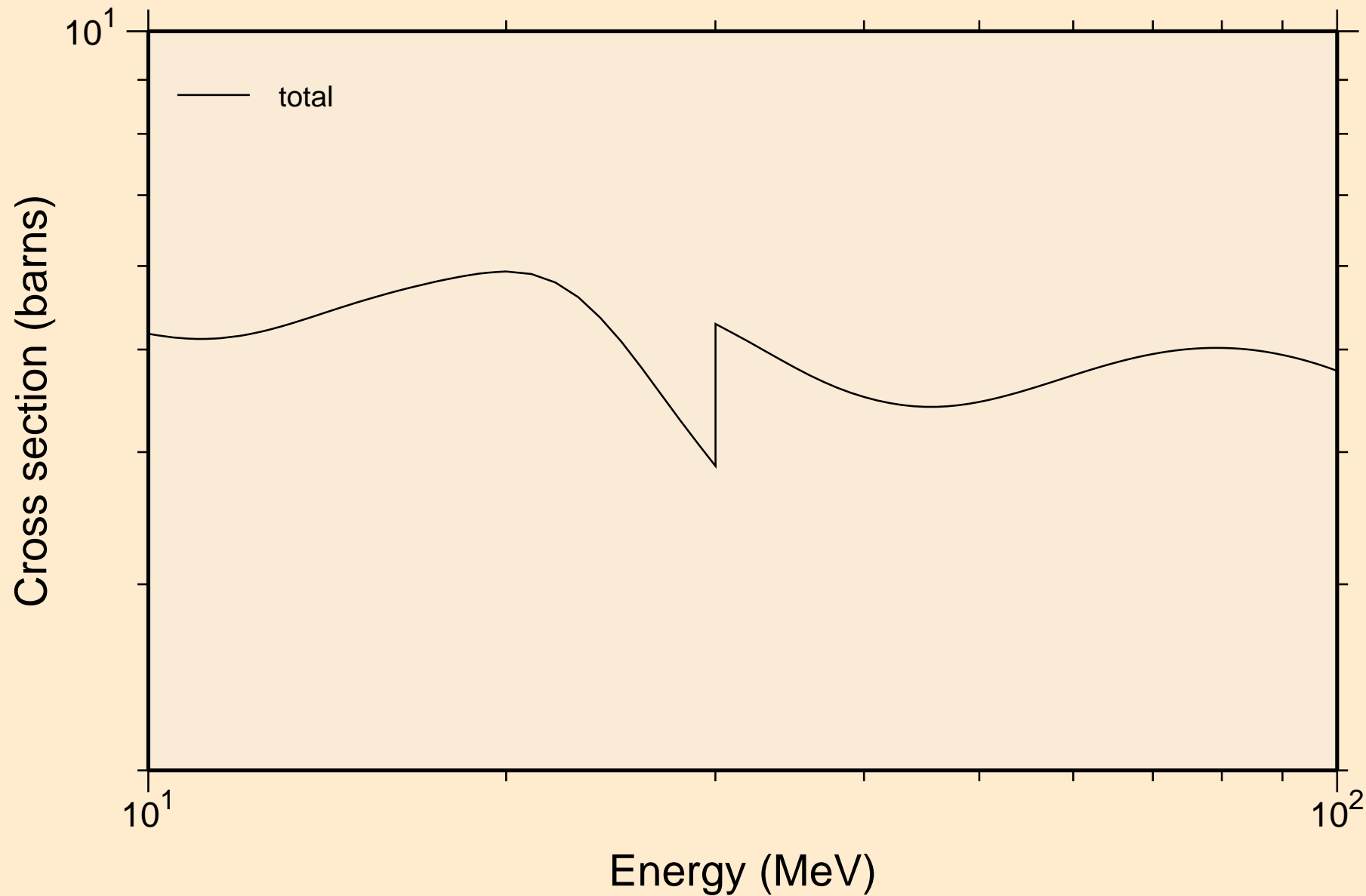

BI219 NEUTRON ACER TENDL-2019 LIBRARY; T=293.16K
resonance absorption cross sections

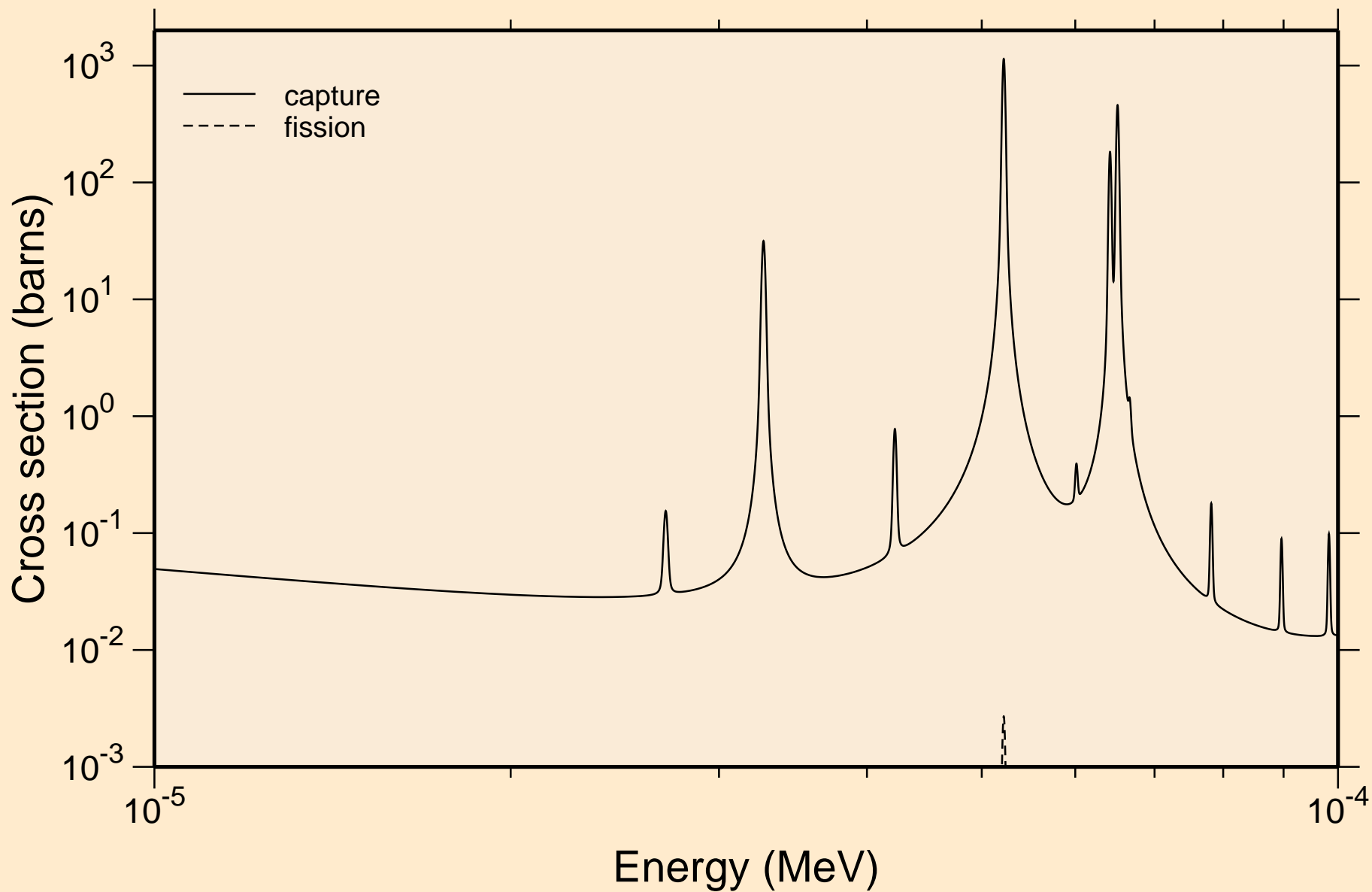

BI219 NEUTRON ACER TENDL-2019 LIBRARY; T=293.16K
resonance absorption cross sections

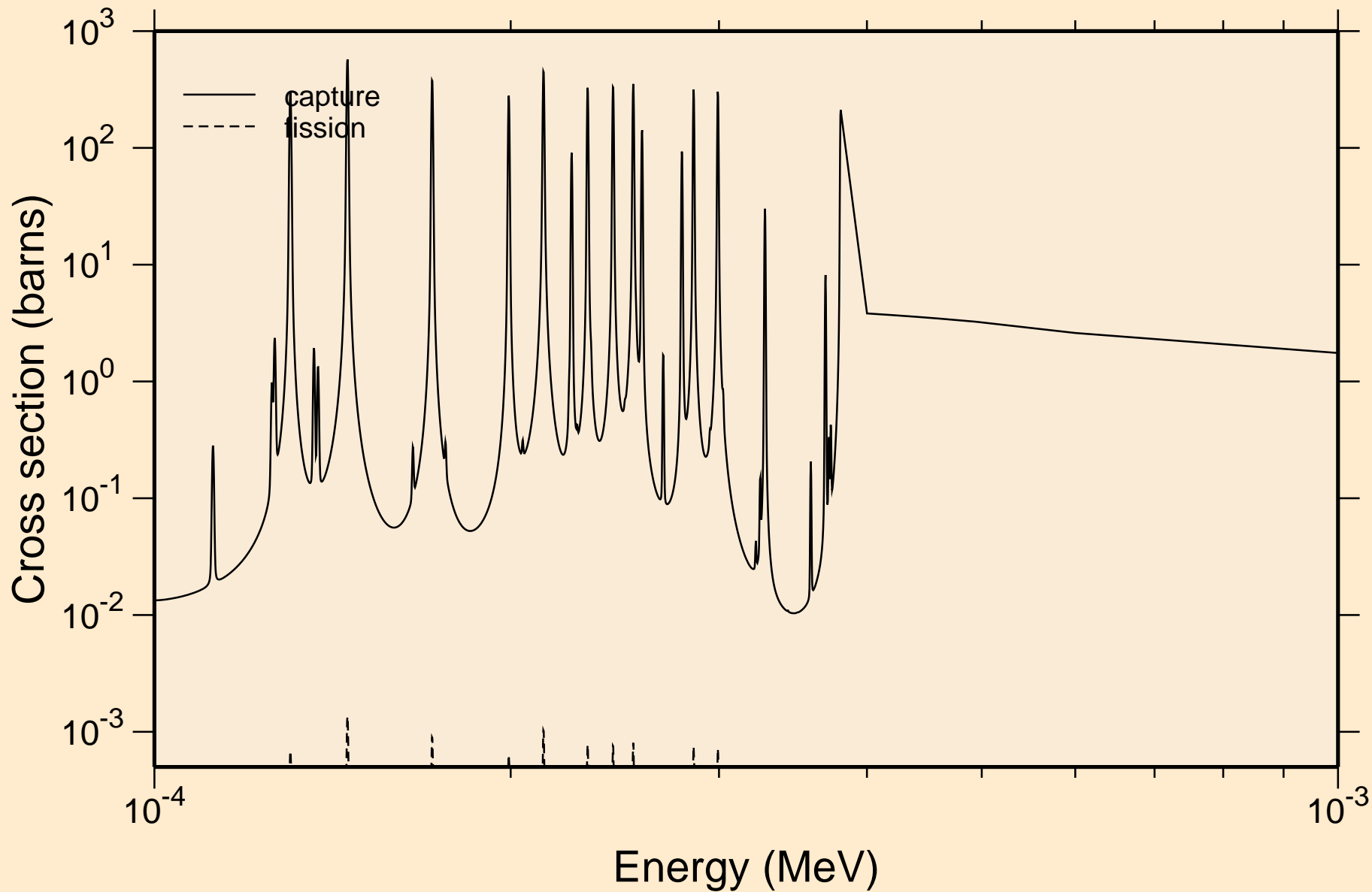

BI219 NEUTRON ACER TENDL-2019 LIBRARY; T=293.16K
resonance absorption cross sections

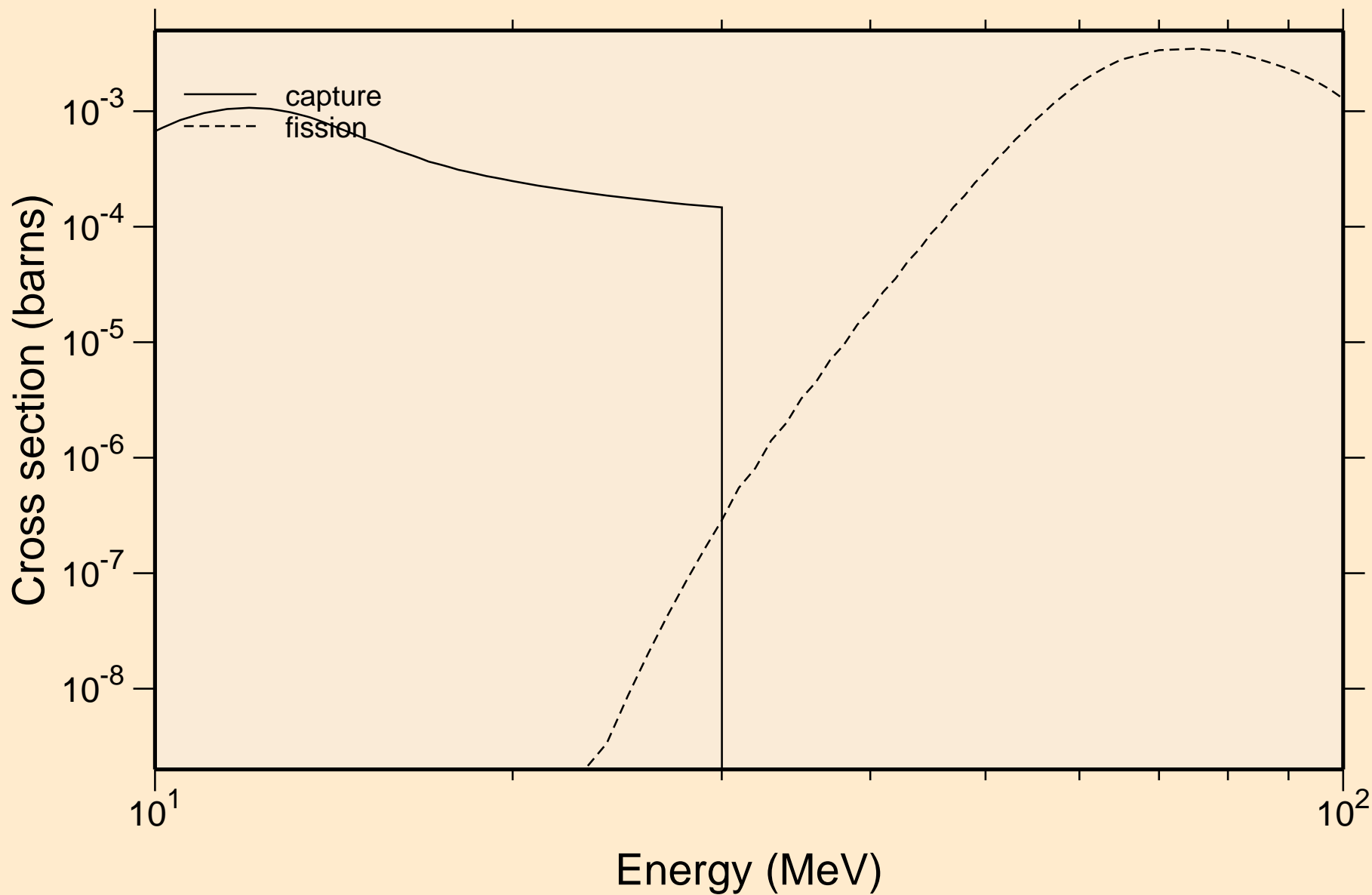

BI219 NEUTRON ACER TENDL-2019 LIBRARY; T=293.16K
Heating

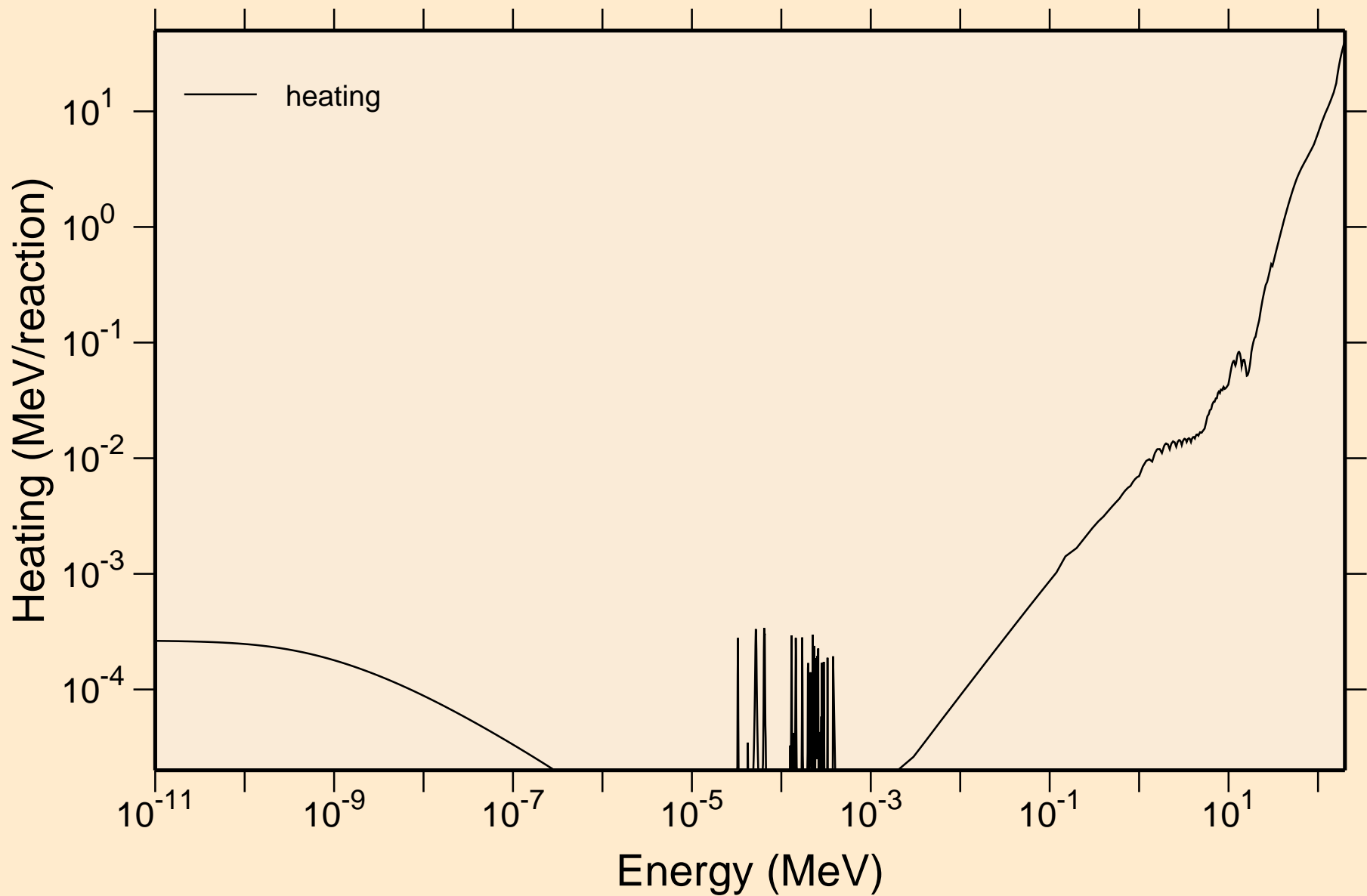

BI219 NEUTRON ACER TENDL-2019 LIBRARY; T=293.16K Damage

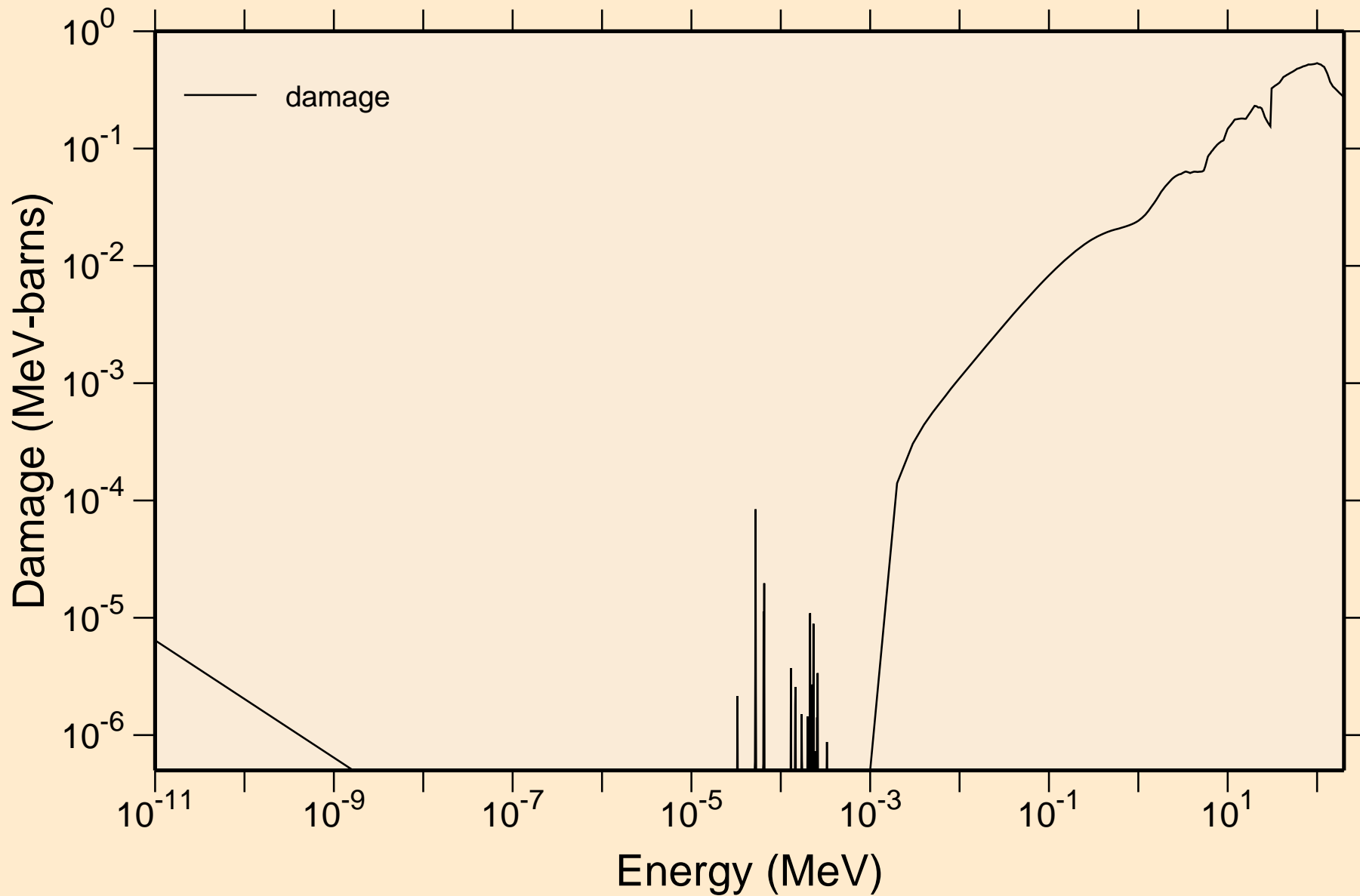

BI219 NEUTRON ACER TENDL-2019 LIBRARY; T=293.16K
Non-threshold reactions

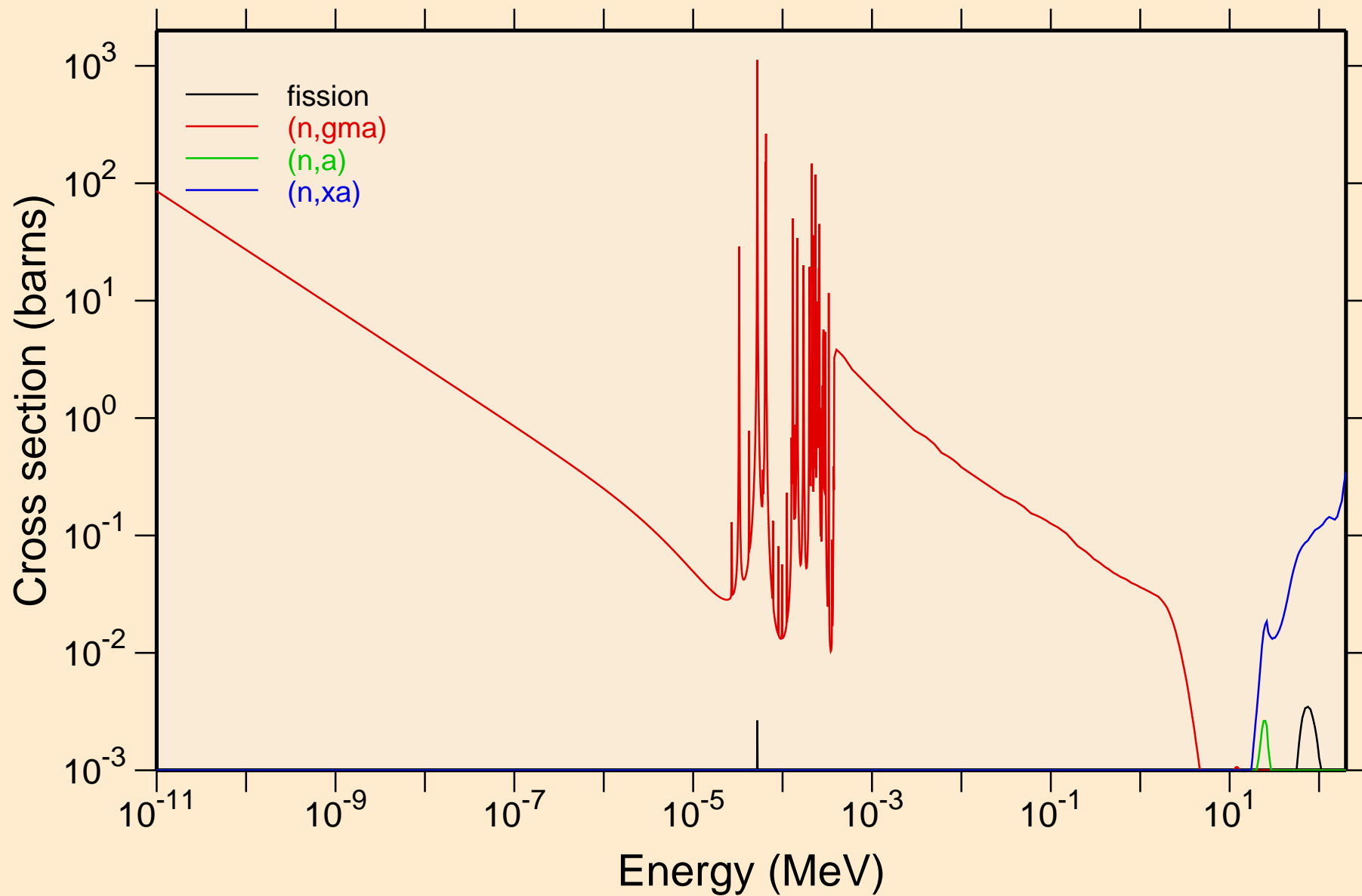

BI219 NEUTRON ACER TENDL-2019 LIBRARY; T=293.16K
Principal cross sections

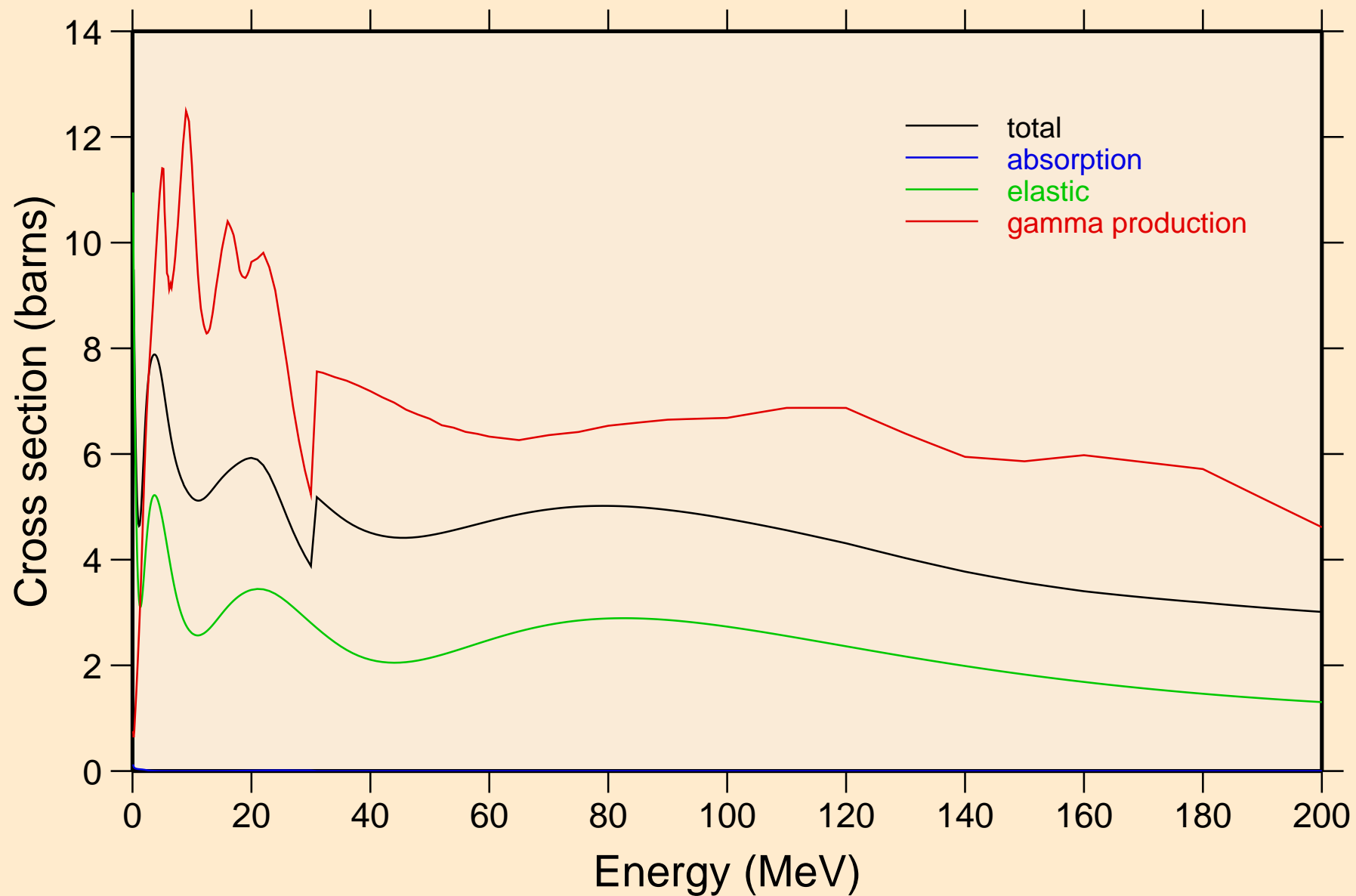

BI219 NEUTRON ACER TENDL-2019 LIBRARY; T=293.16K
Heating

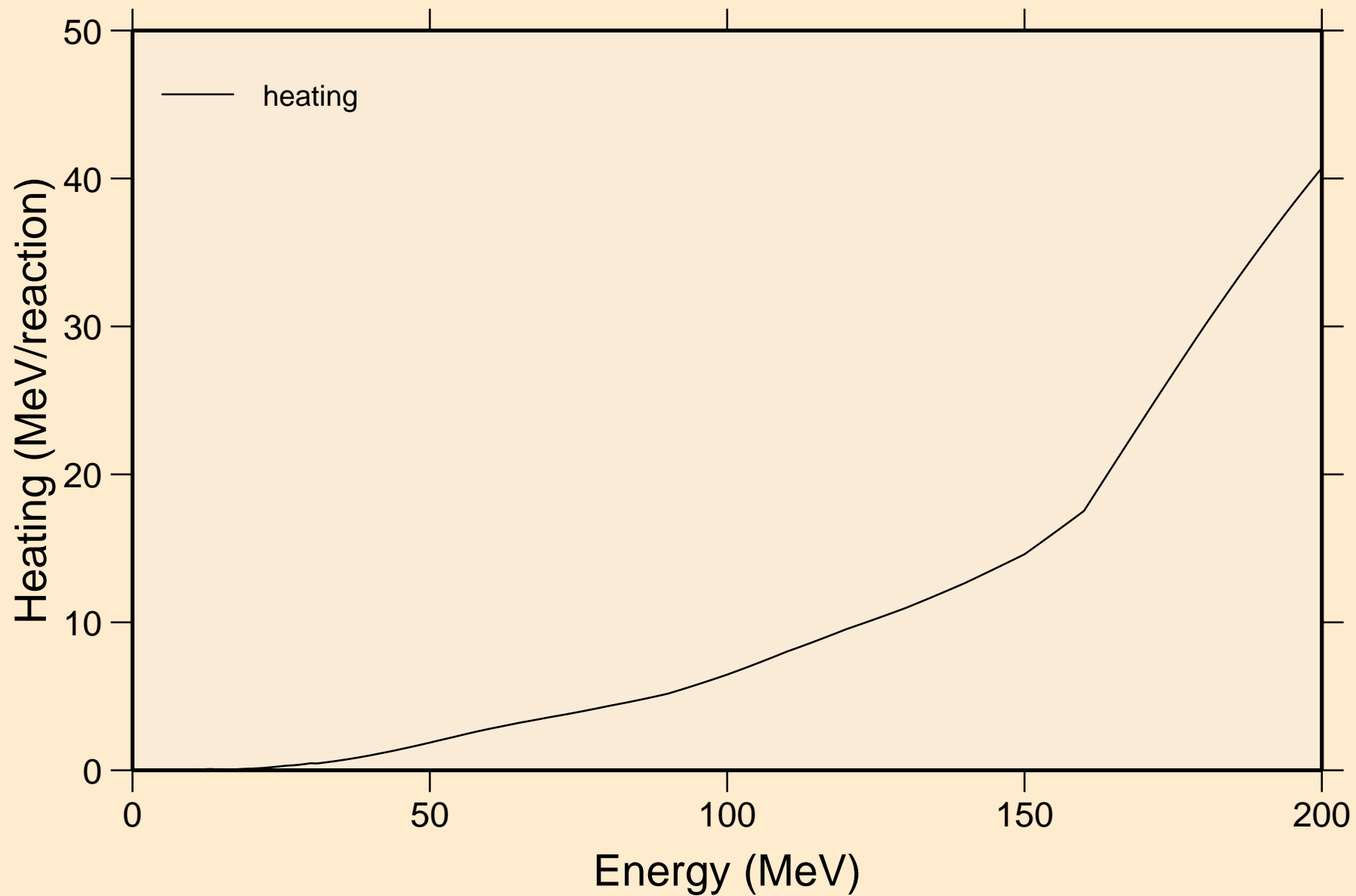

BI219 NEUTRON ACER TENDL-2019 LIBRARY; T=293.16K
Damage

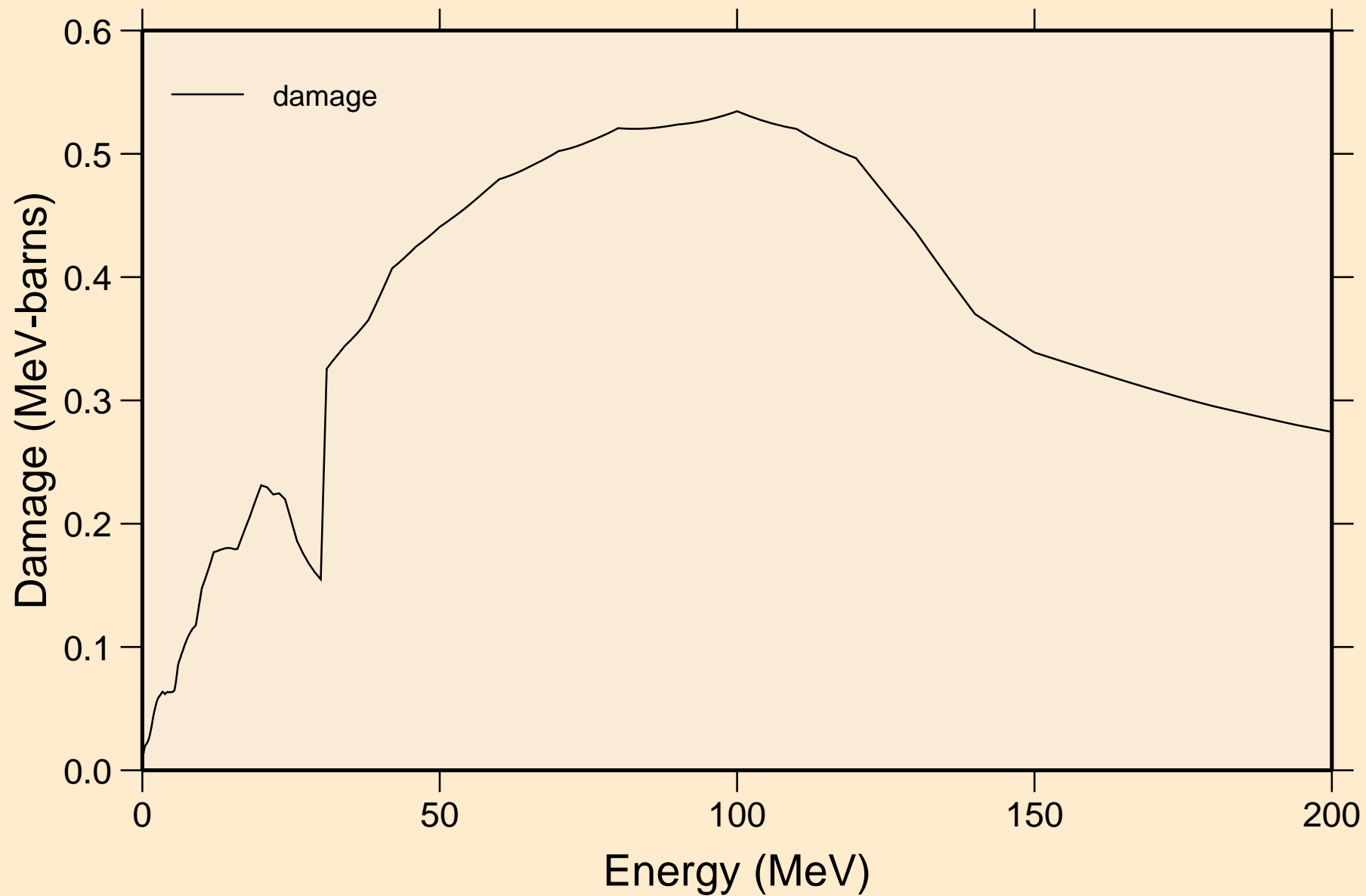

BI219 NEUTRON ACER TENDL-2019 LIBRARY; T=293.16K
Non-threshold reactions

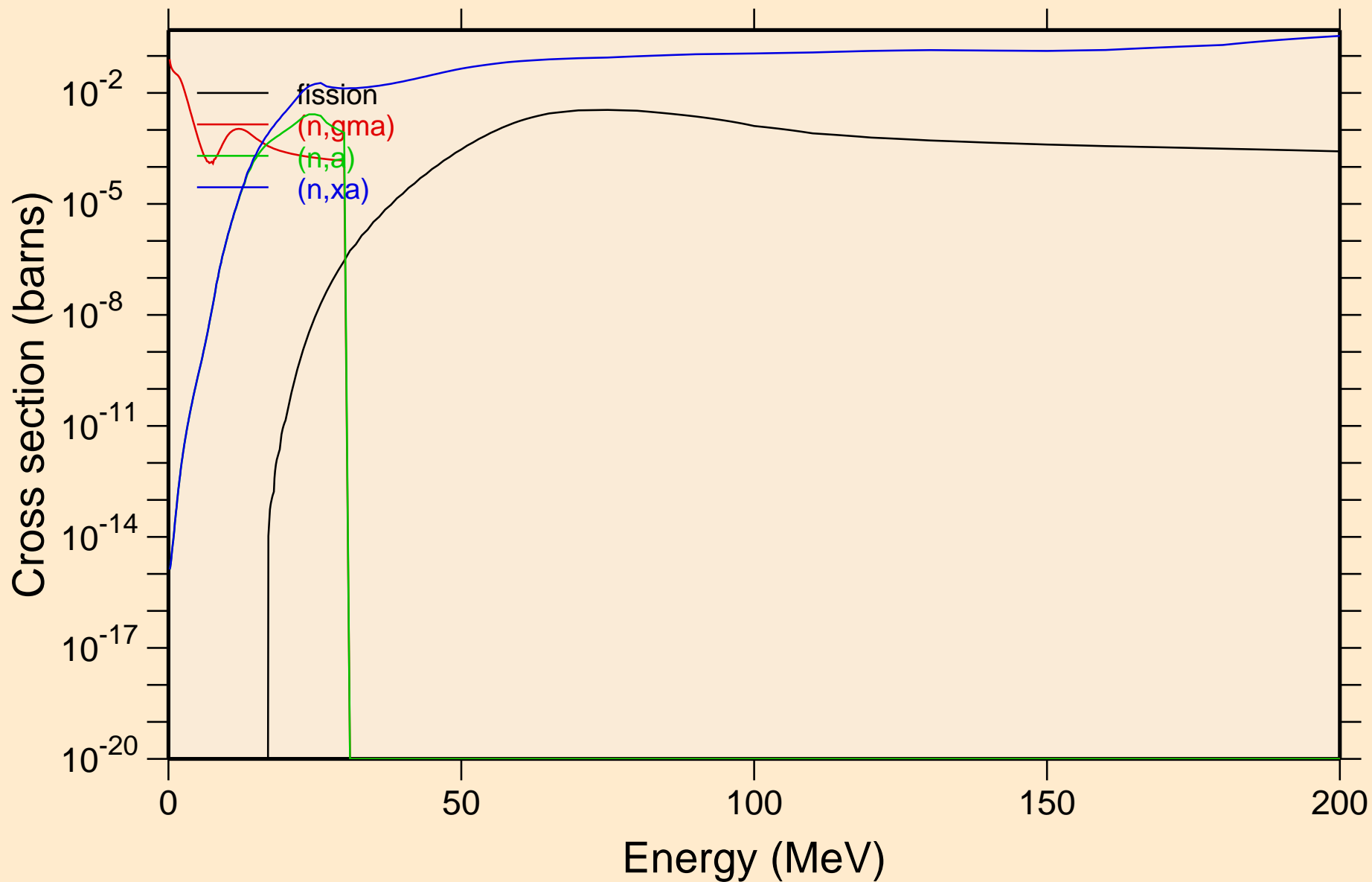

BI219 NEUTRON ACER TENDL-2019 LIBRARY; T=293.16K
Inelastic levels

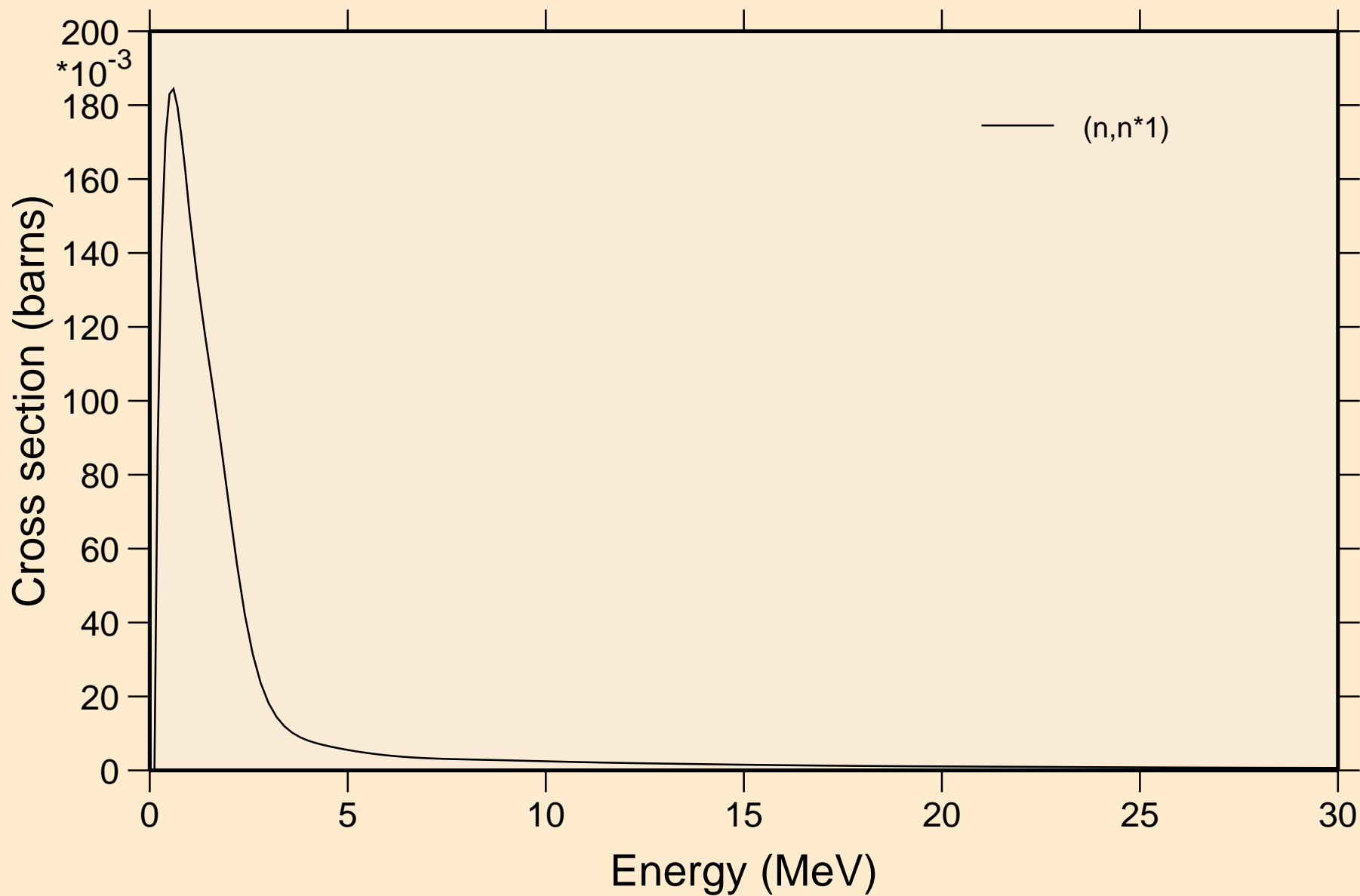

BI219 NEUTRON ACER TENDL-2019 LIBRARY; T=293.16K
Threshold reactions

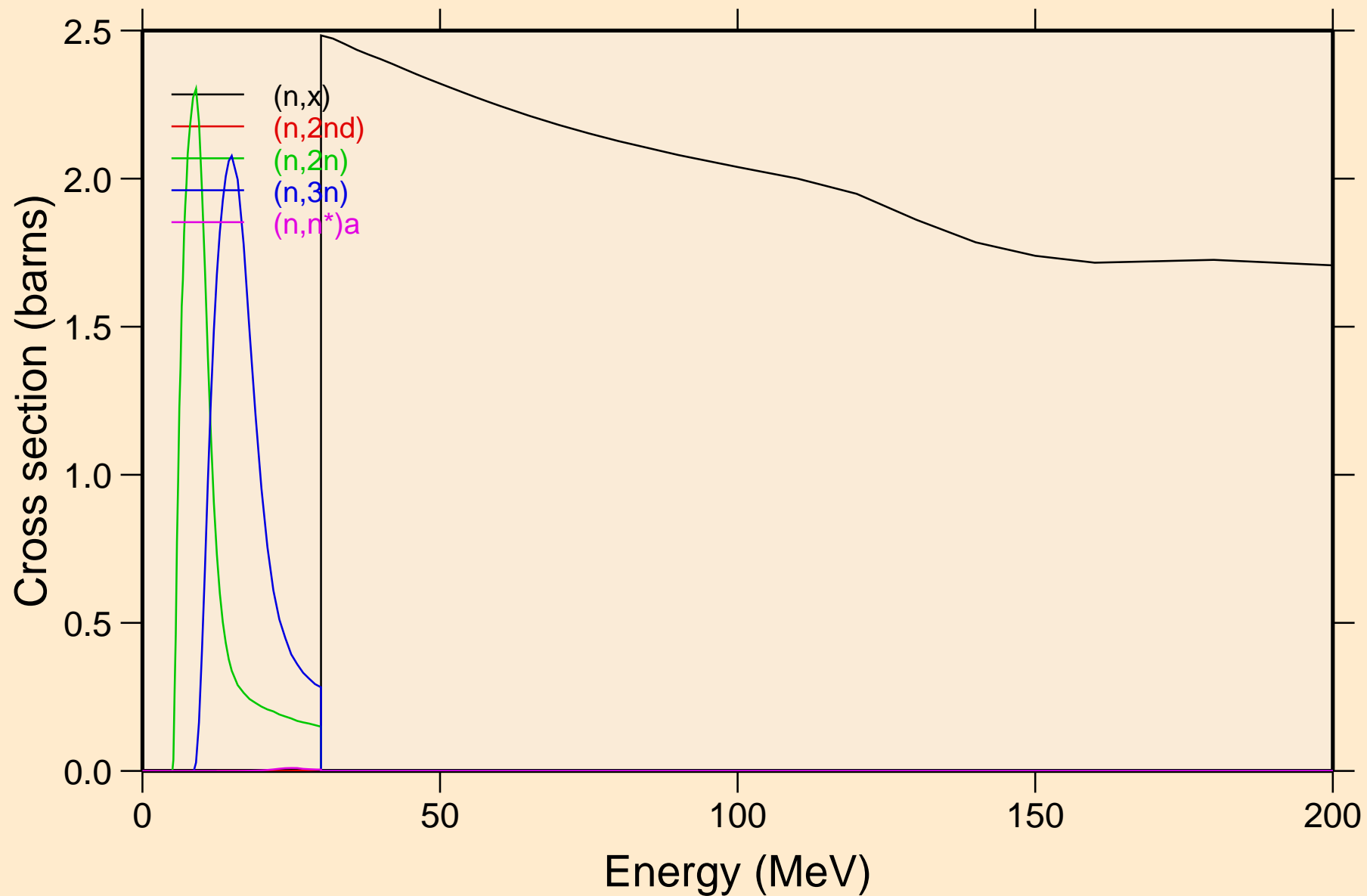

BI219 NEUTRON ACER TENDL-2019 LIBRARY; T=293.16K
Threshold reactions

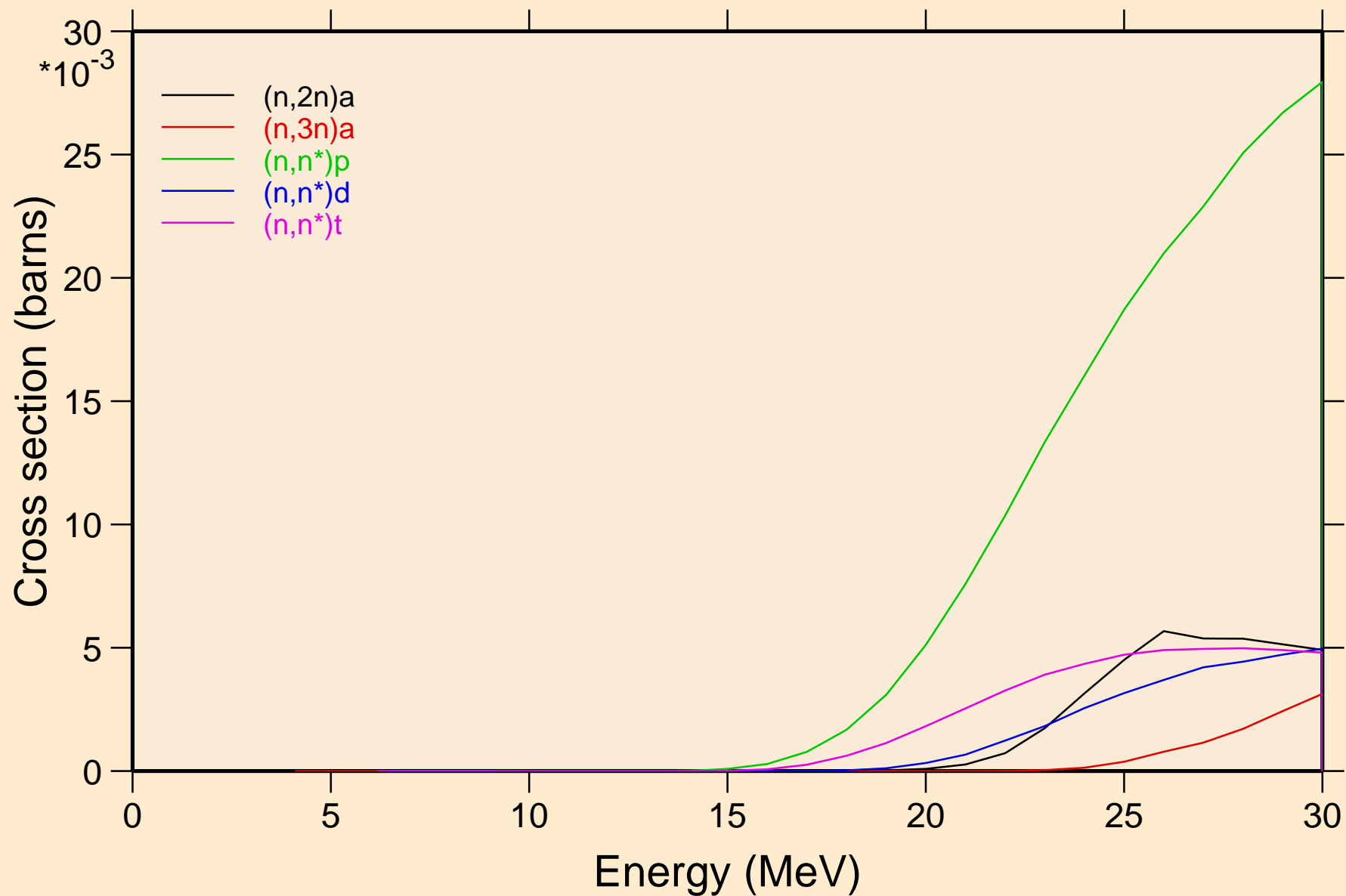

BI219 NEUTRON ACER TENDL-2019 LIBRARY; T=293.16K
Threshold reactions

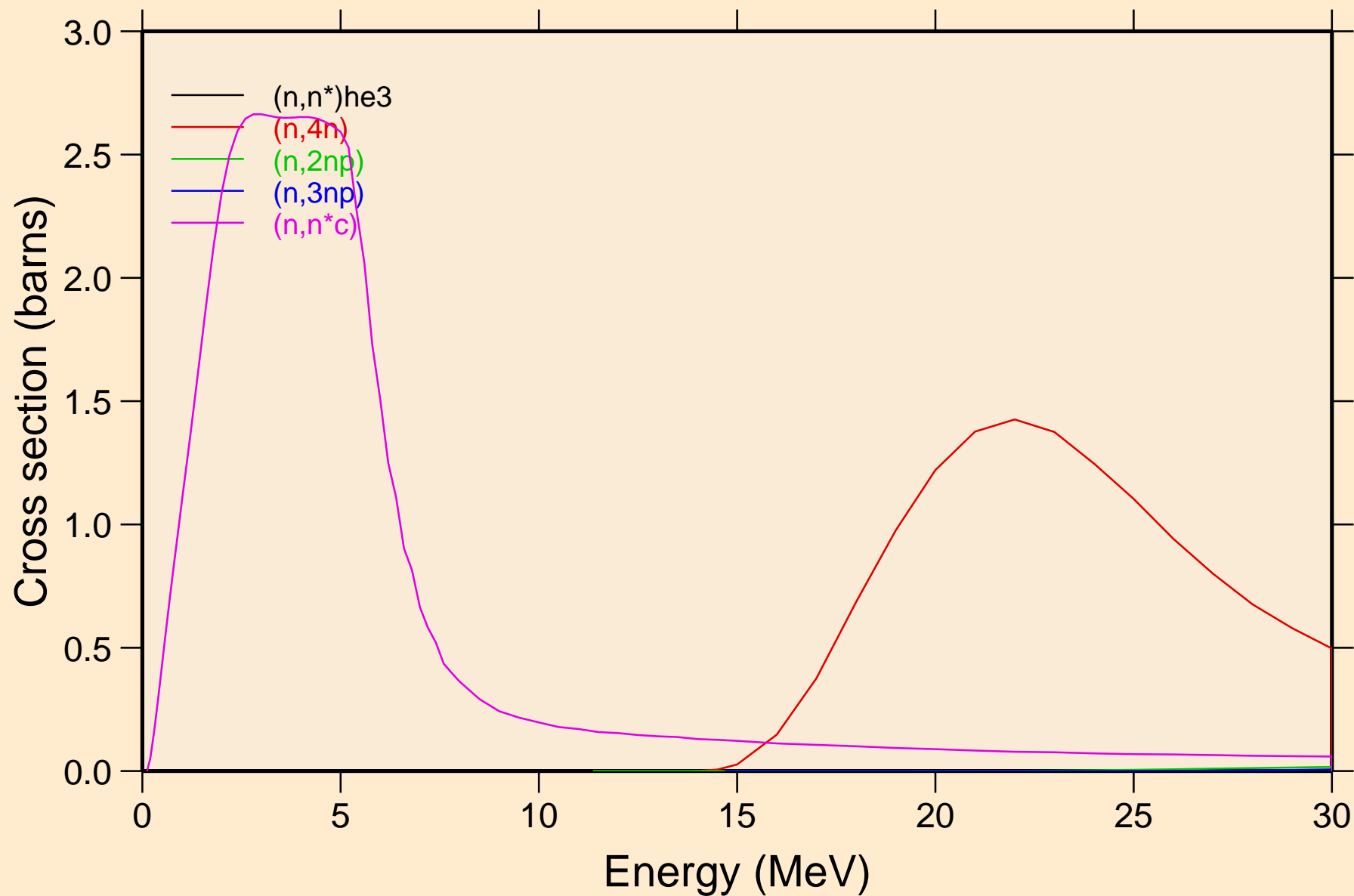

BI219 NEUTRON ACER TENDL-2019 LIBRARY; T=293.16K
Threshold reactions

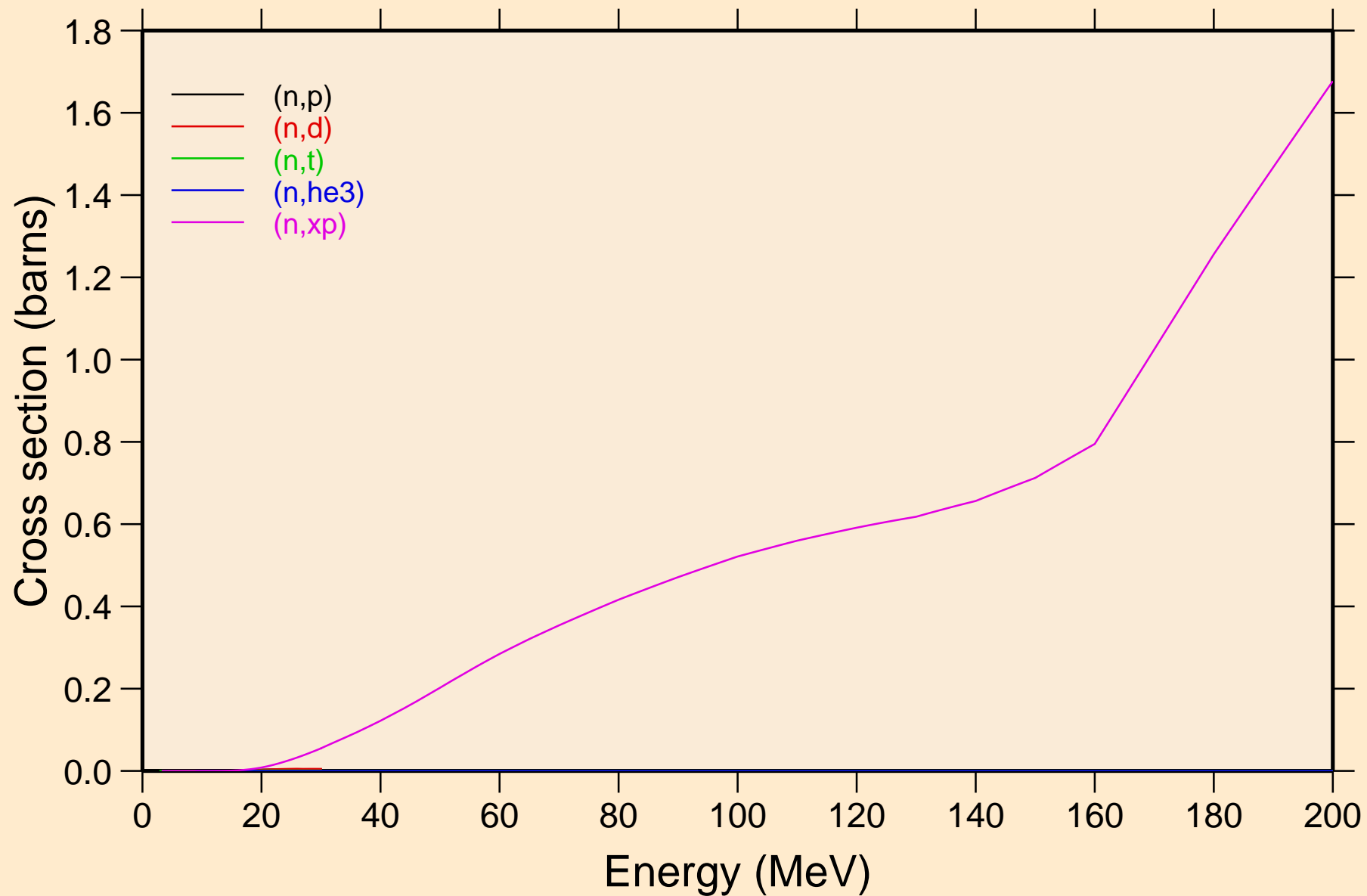

BI219 NEUTRON ACER TENDL-2019 LIBRARY; T=293.16K
Threshold reactions

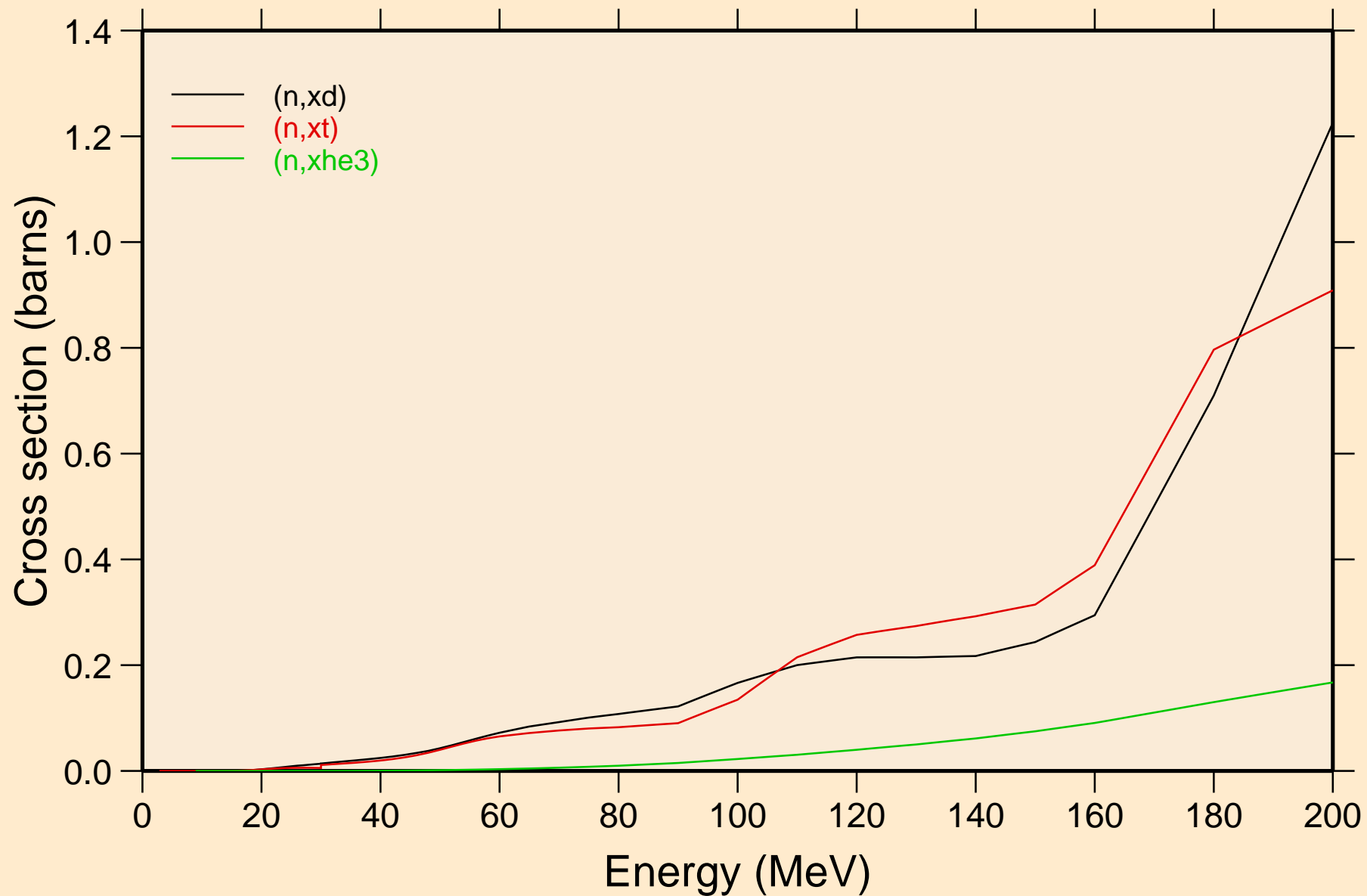

BI219 NEUTRON ACER TENDL-2019 LIBRARY; T=293.16K
angular distribution for elastic

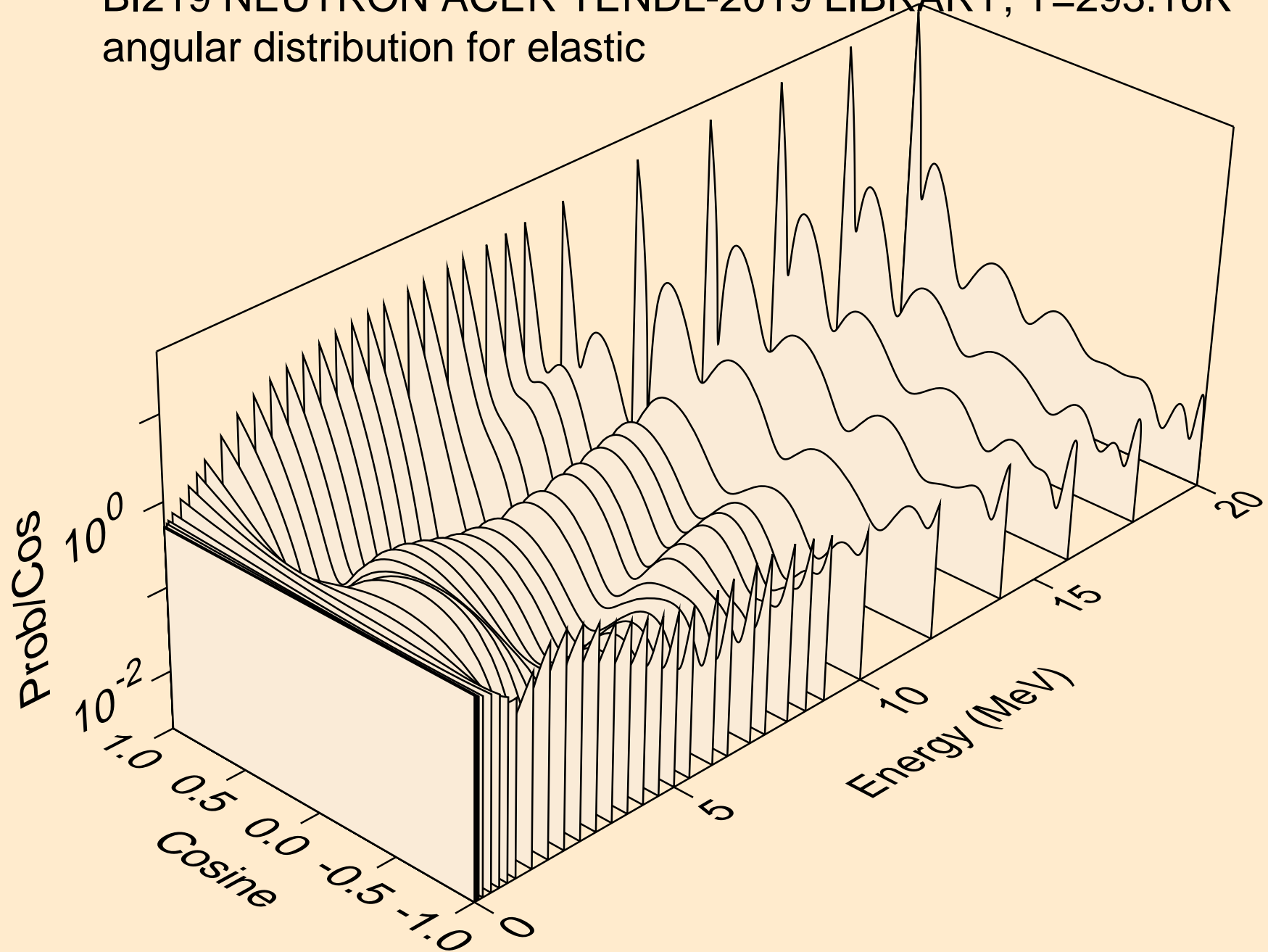

BI219 NEUTRON ACER TENDL-2019 LIBRARY; T=293.16K
angular distribution for elastic

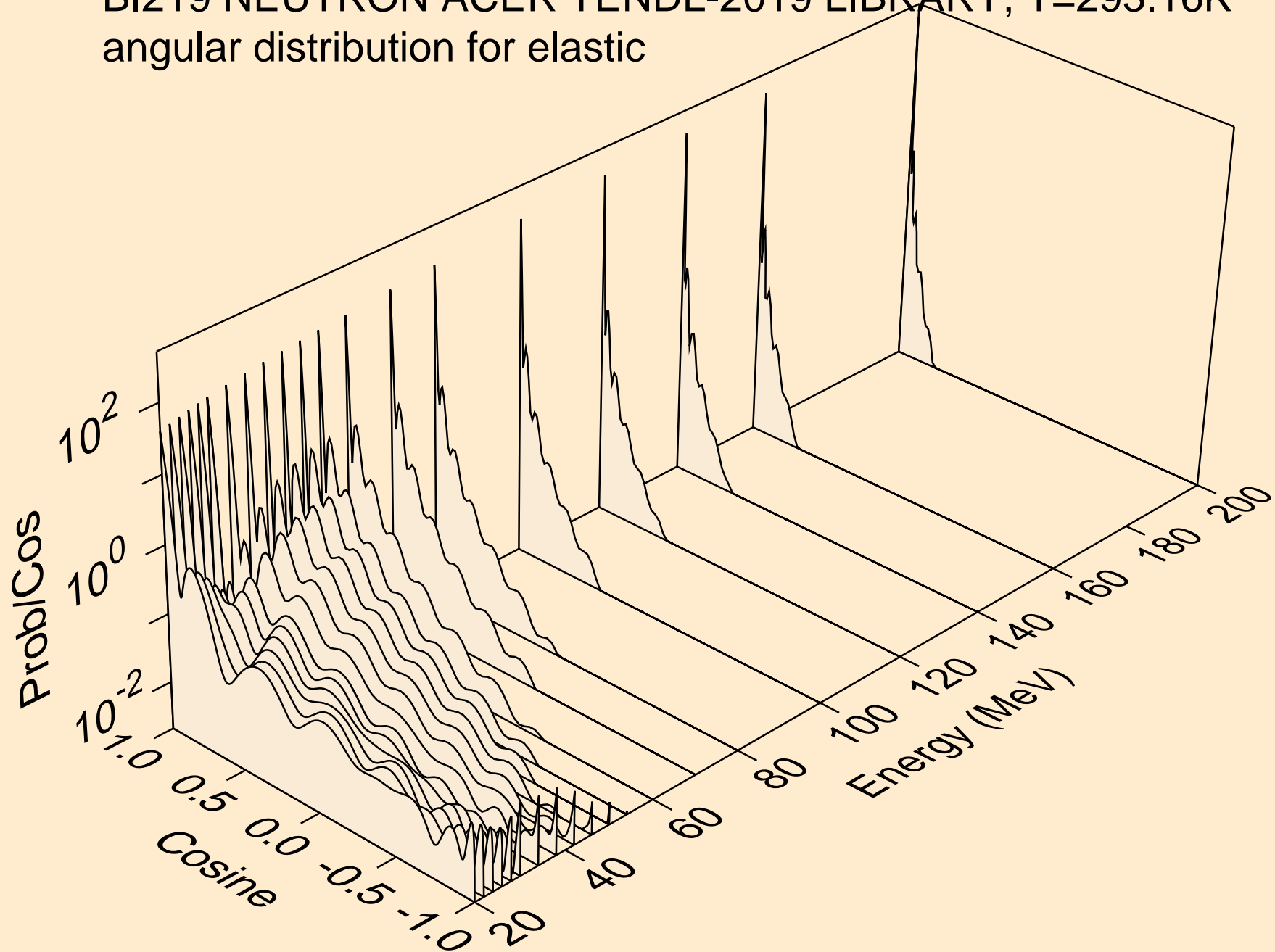

BI219 NEUTRON ACER TENDL-2019 LIBRARY; T=293.16K
angular distribution for (n,n*1)

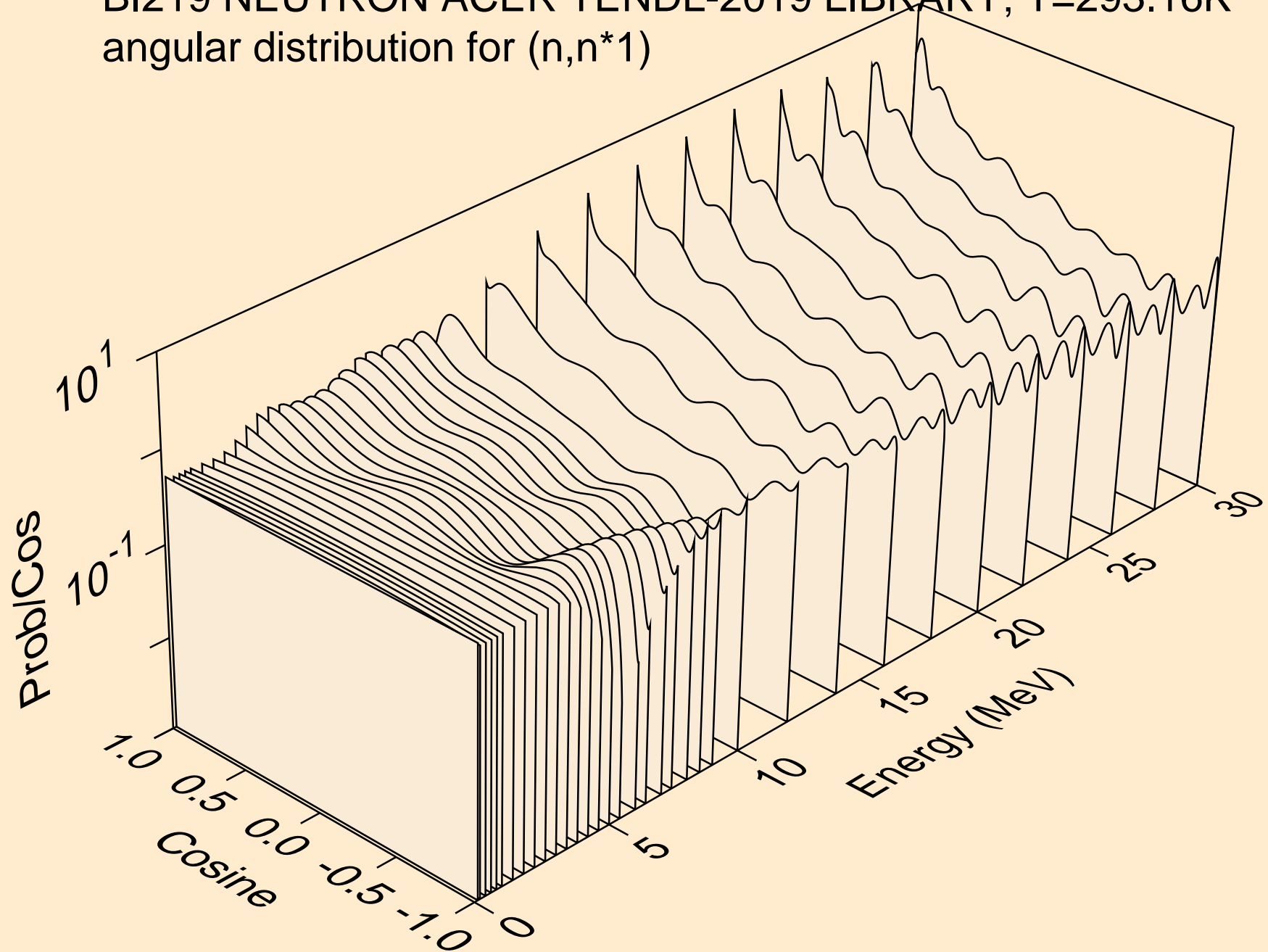

BI219 NEUTRON ACER TENDL-2019 LIBRARY; T=293.16K

Total fission nubar

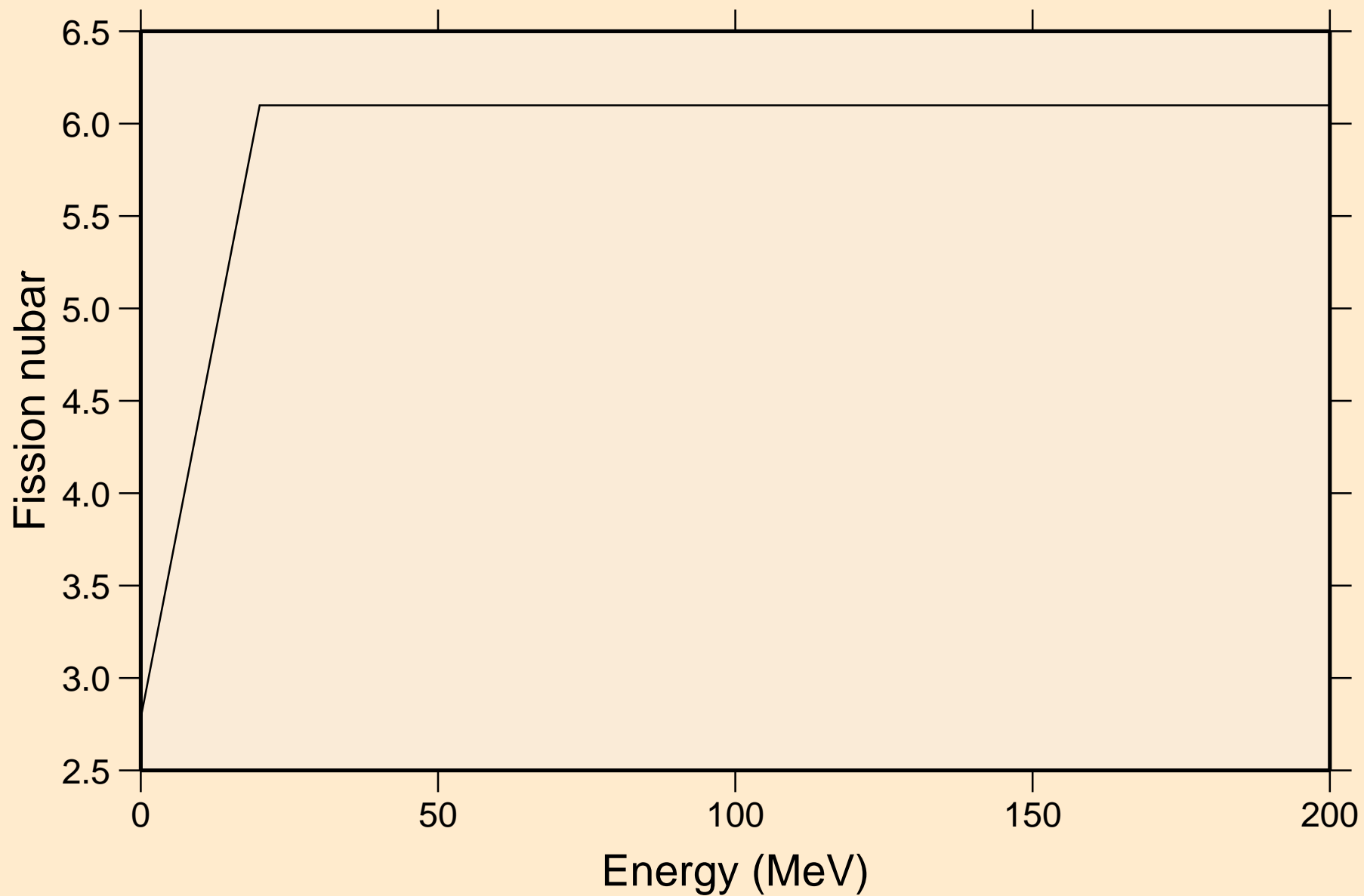

BI219 NEUTRON ACER TENDL-2019 LIBRARY; T=293.16K
Neutron emission for (n,x)

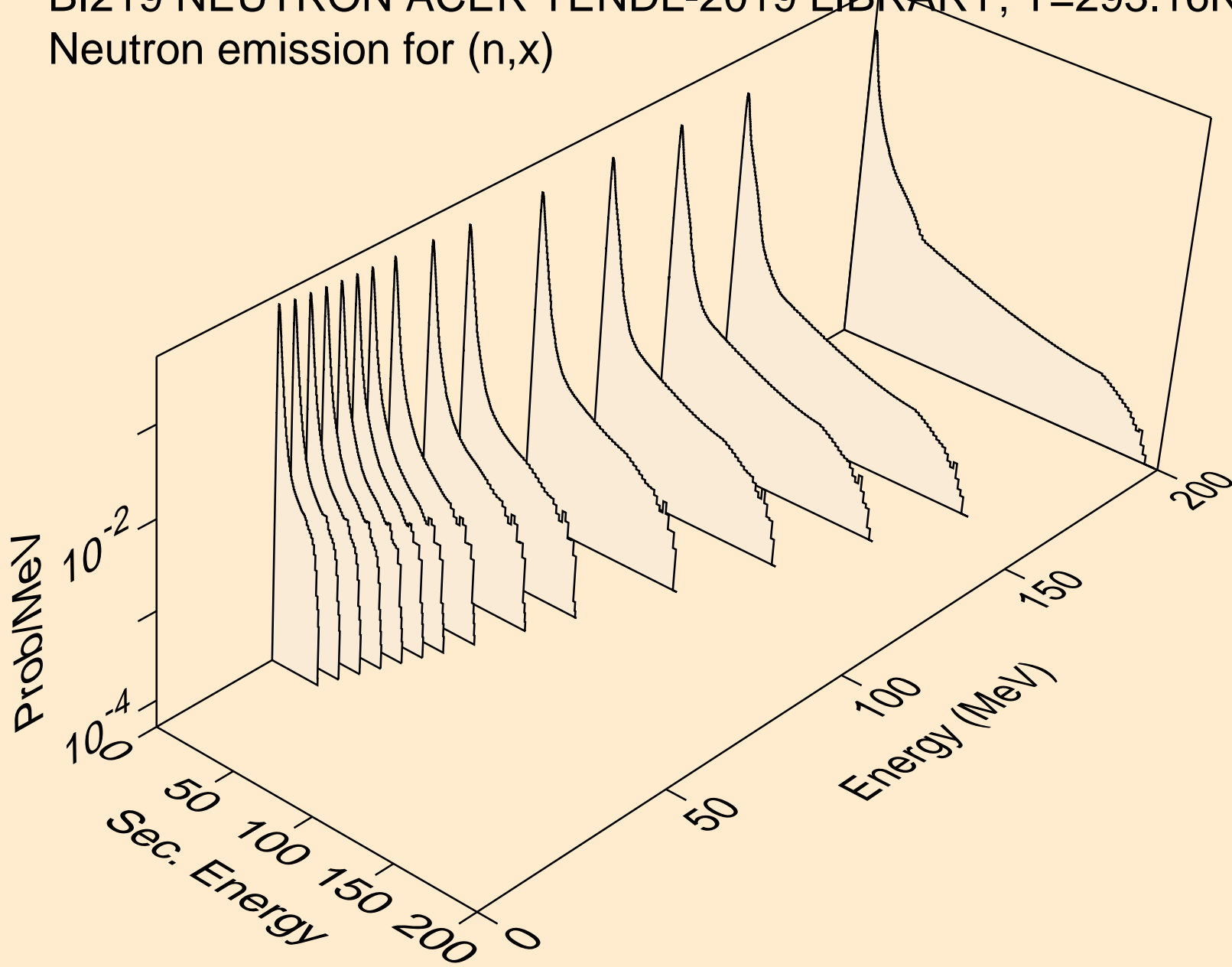

BI219 NEUTRON ACER TENDL-2019 LIBRARY; T=293.16K
Neutron emission for (n,2nd)

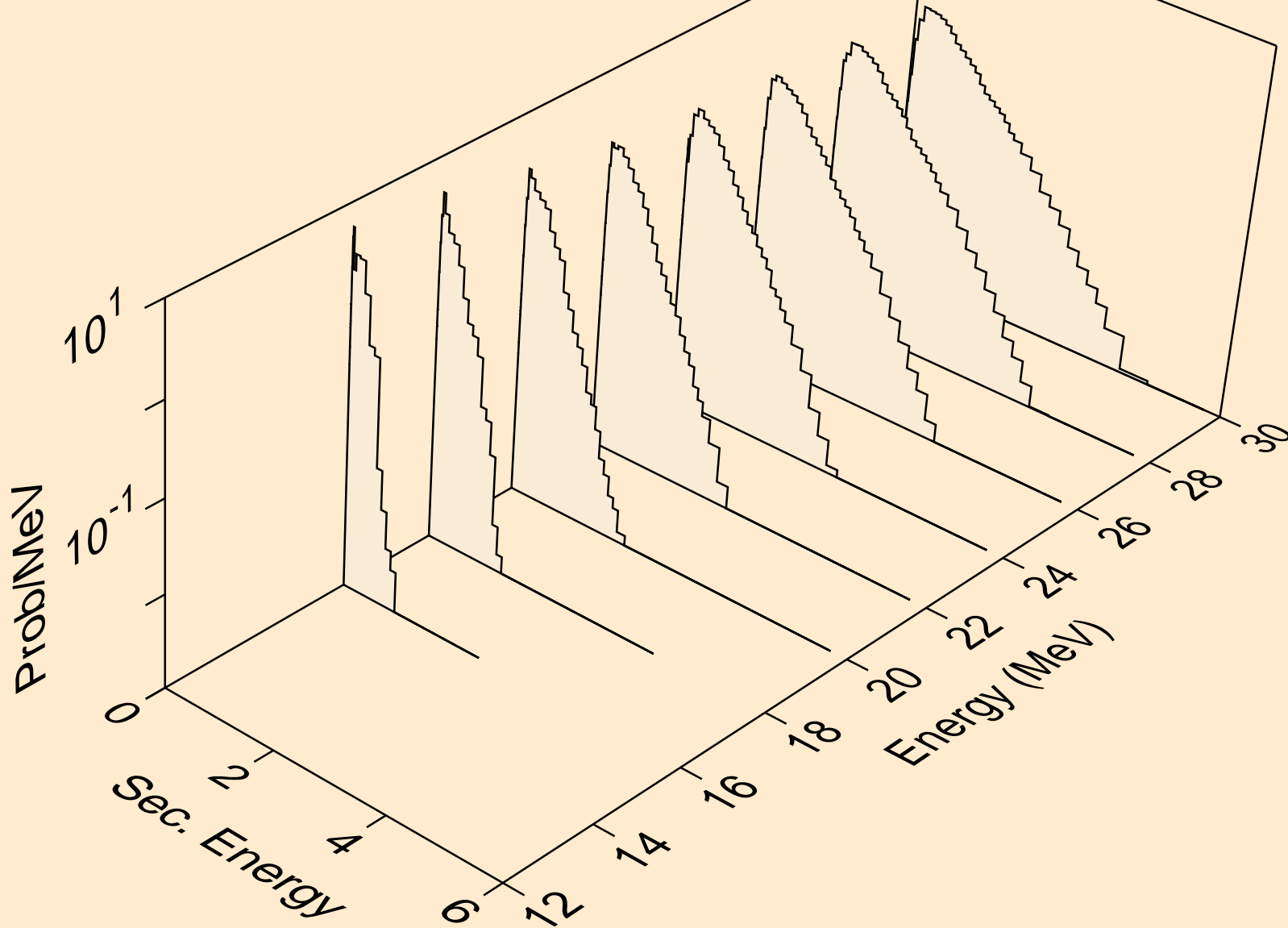

BI219 NEUTRON ACER TENDL-2019 LIBRARY; T=293.16K
Neutron emission for (n,2n)

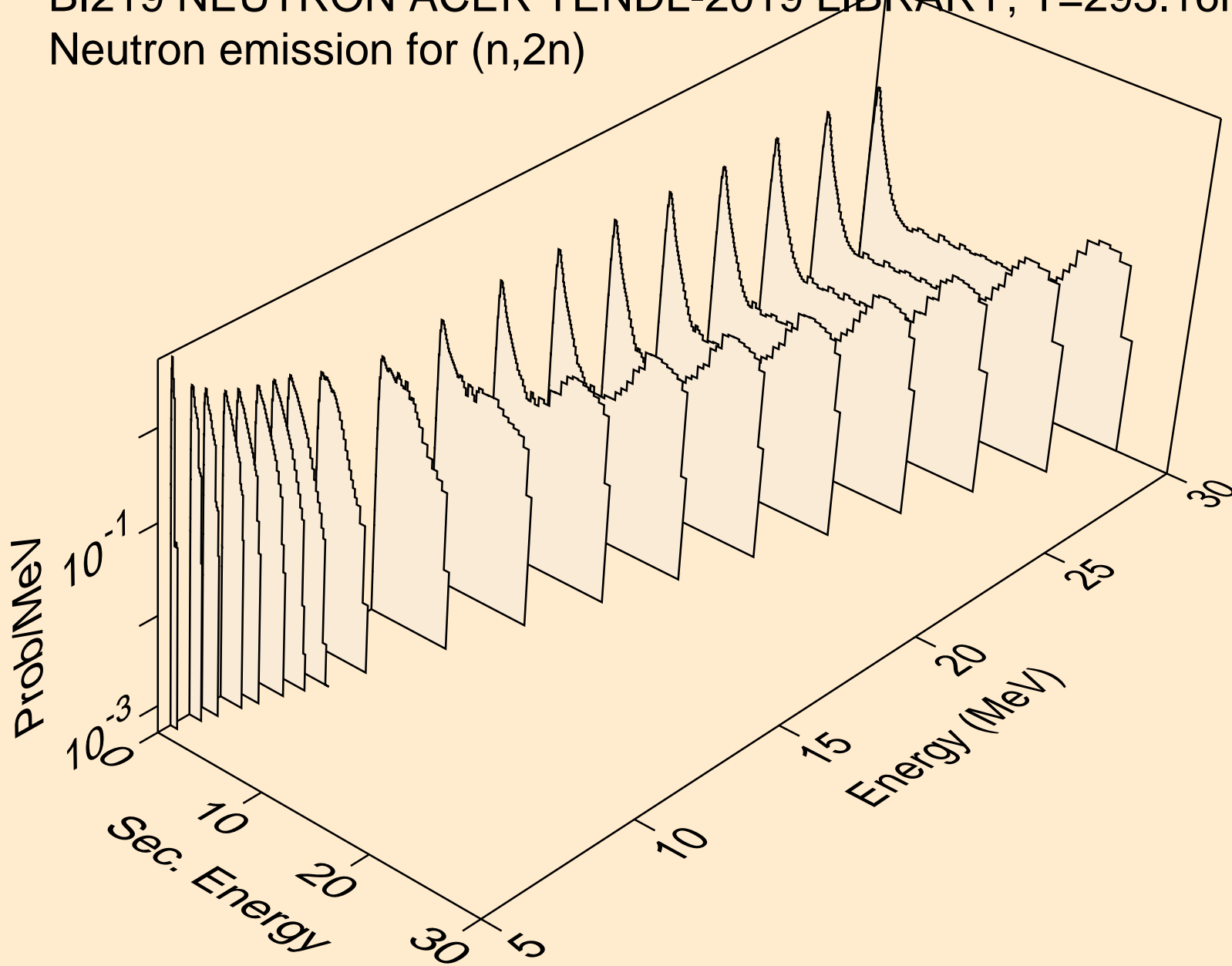

BI219 NEUTRON ACER TENDL-2019 LIBRARY; T=293.16K
Neutron emission for (n,3n)

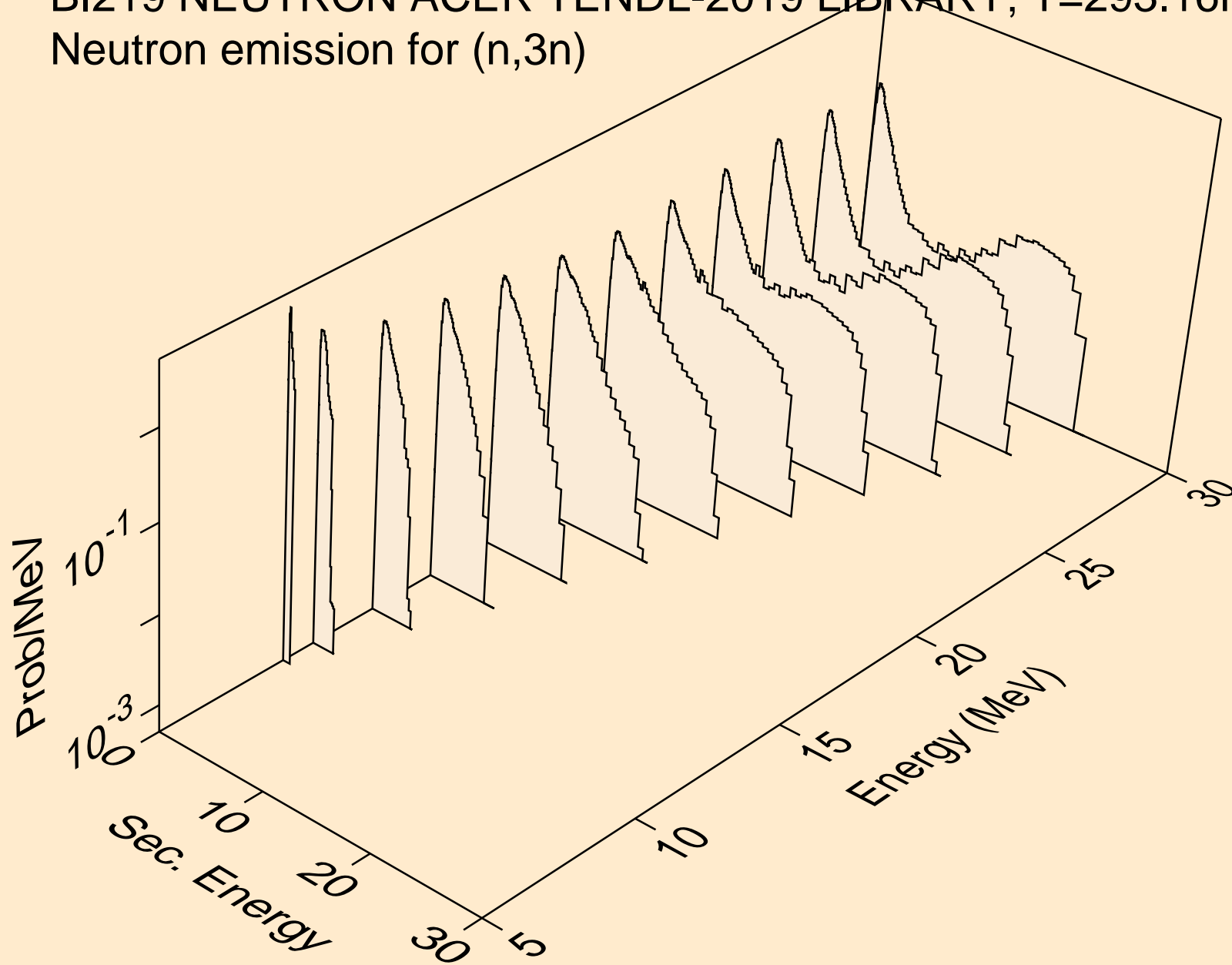

BI219 NEUTRON ACER TENDL-2019 LIBRARY; T=293.16K
Neutron emission for fission

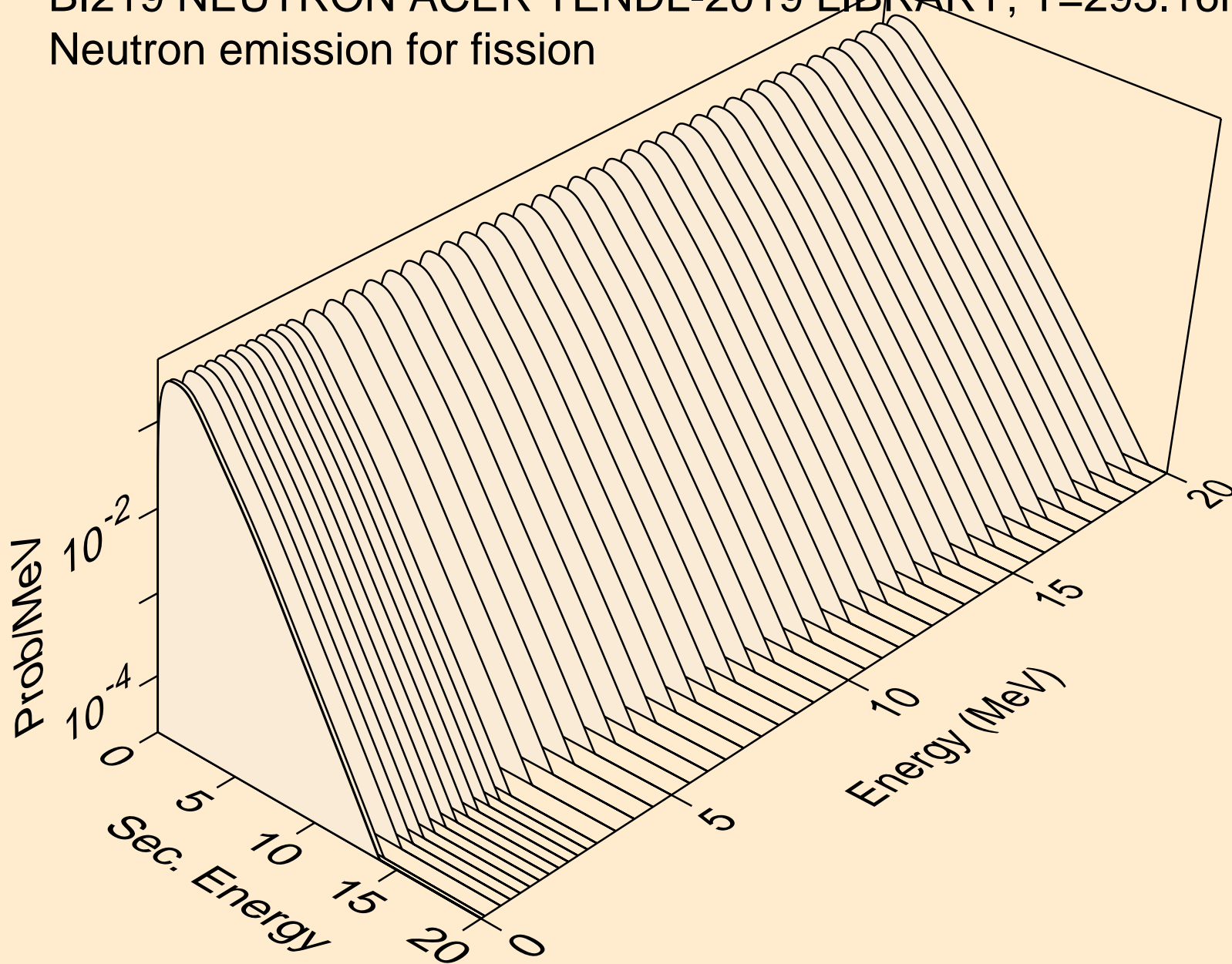

BI219 NEUTRON ACER TENDL-2019 LIBRARY; T=293.16K
Neutron emission for (n,n*)a

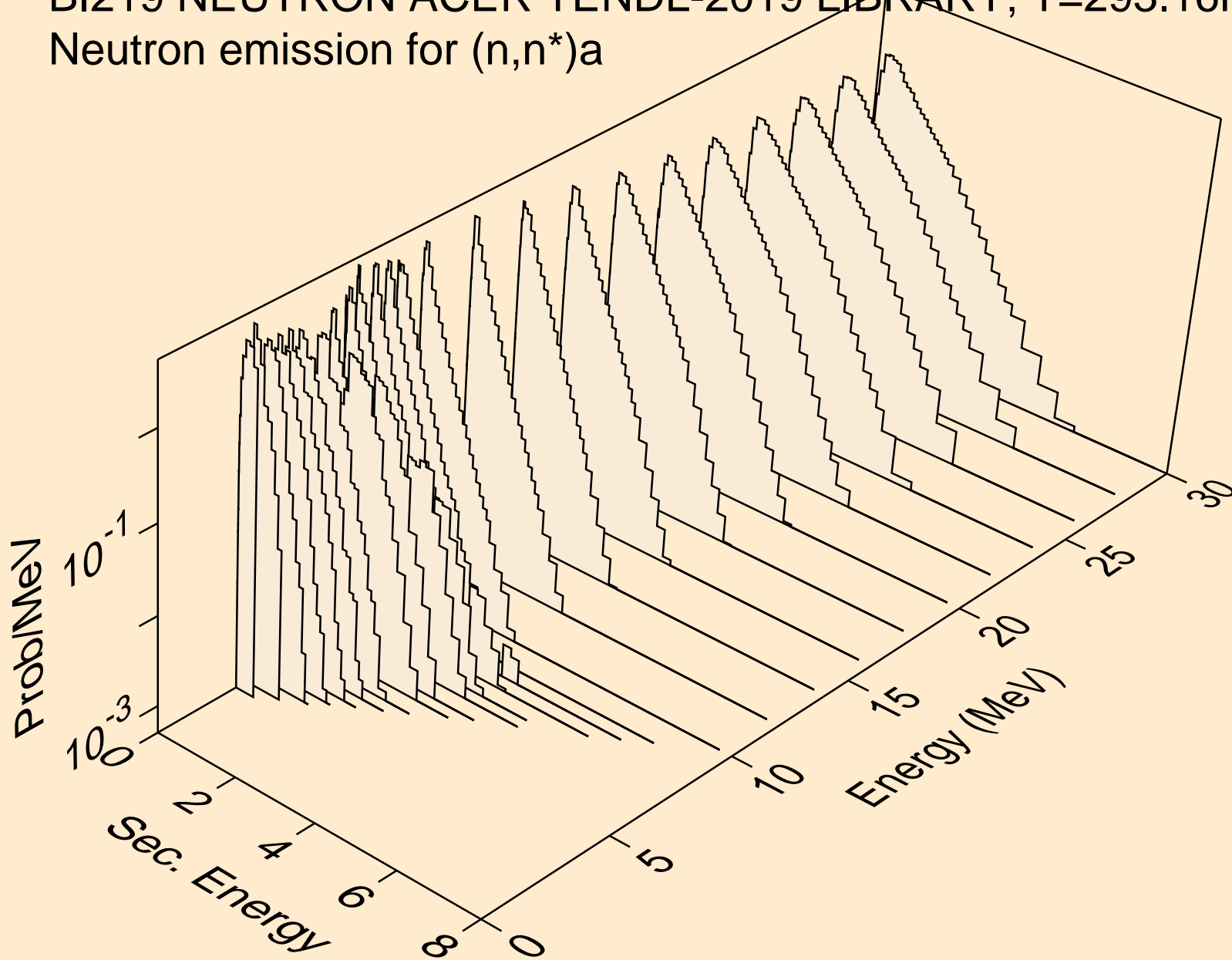

BI219 NEUTRON ACER TENDL-2019 LIBRARY; T=293.16K
Neutron emission for (n,2n)a

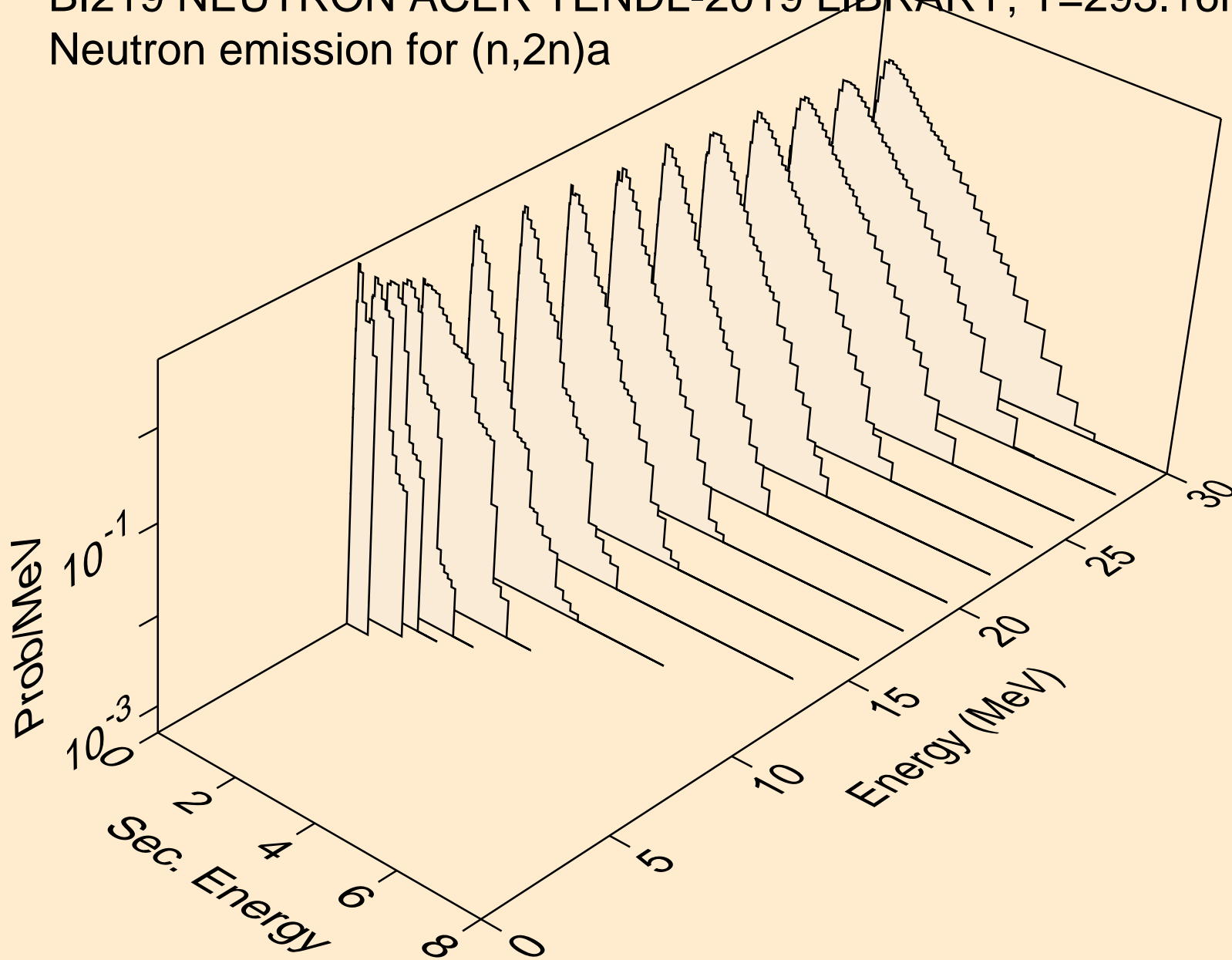

BI219 NEUTRON ACER TENDL-2019 LIBRARY; T=293.16K
Neutron emission for (n,3n)a

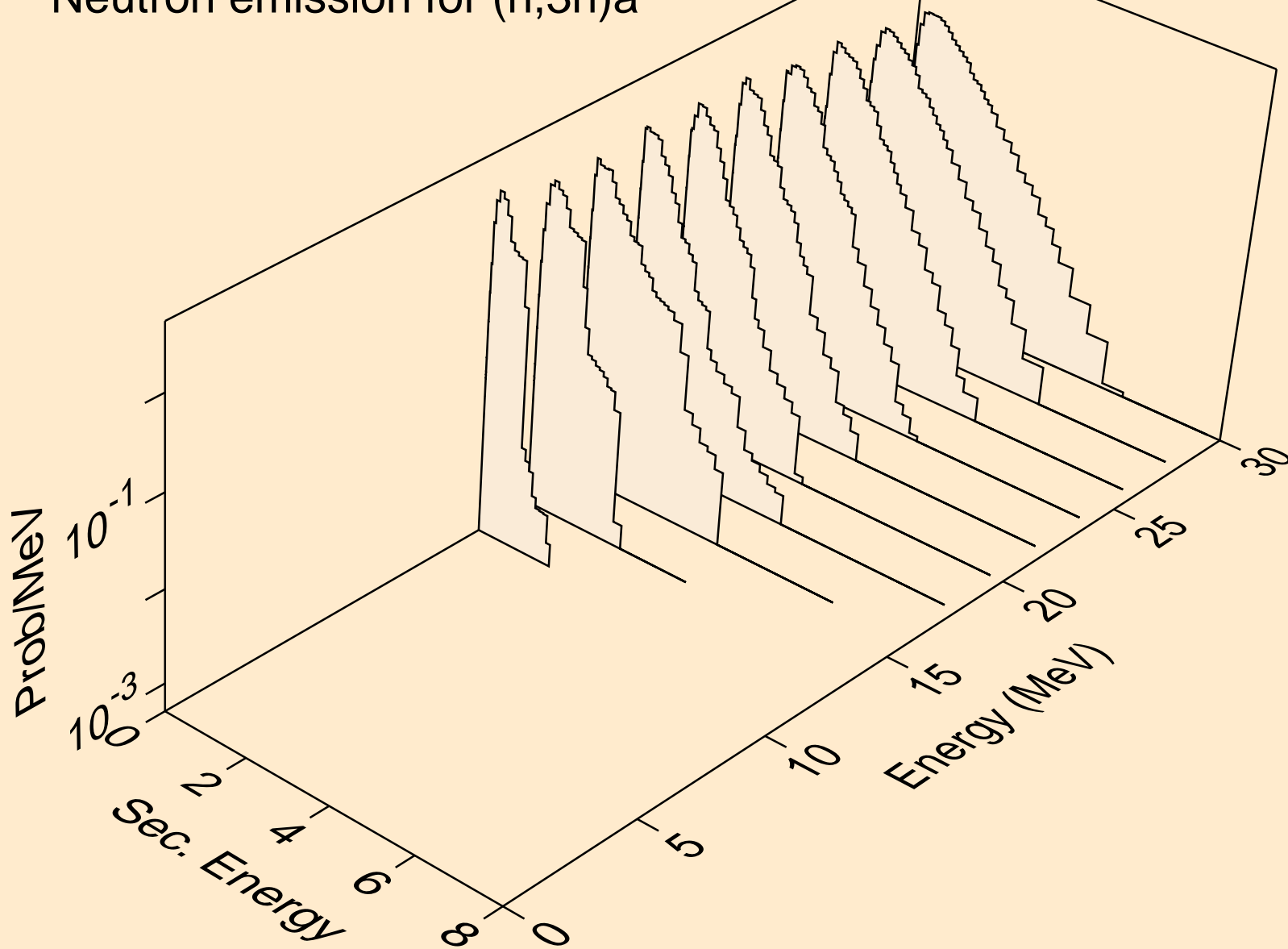

BI219 NEUTRON ACER TENDL-2019 LIBRARY; T=293.16K
Neutron emission for (n,n*)p

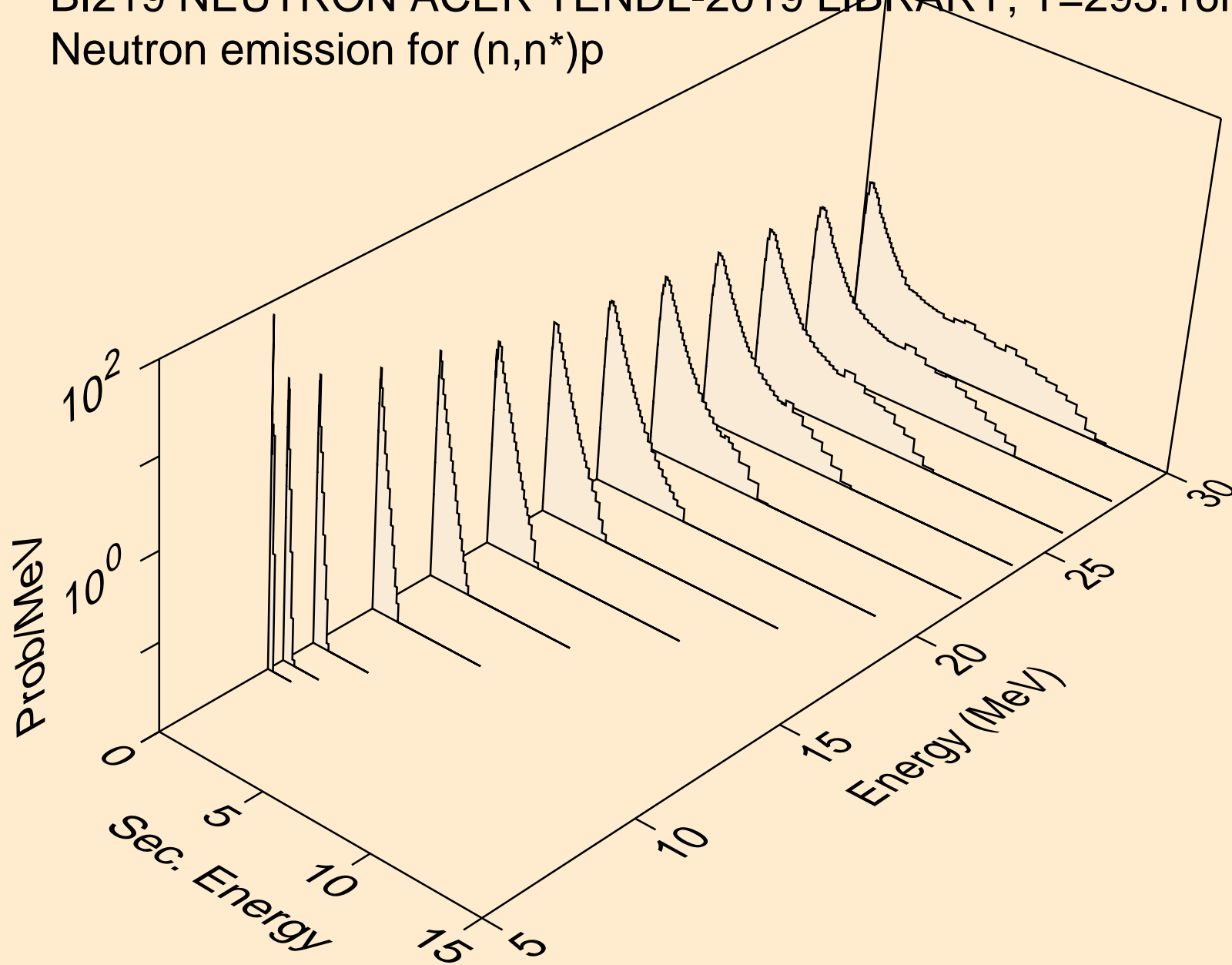

BI219 NEUTRON ACER TENDL-2019 LIBRARY; T=293.16K
Neutron emission for (n,n*)d

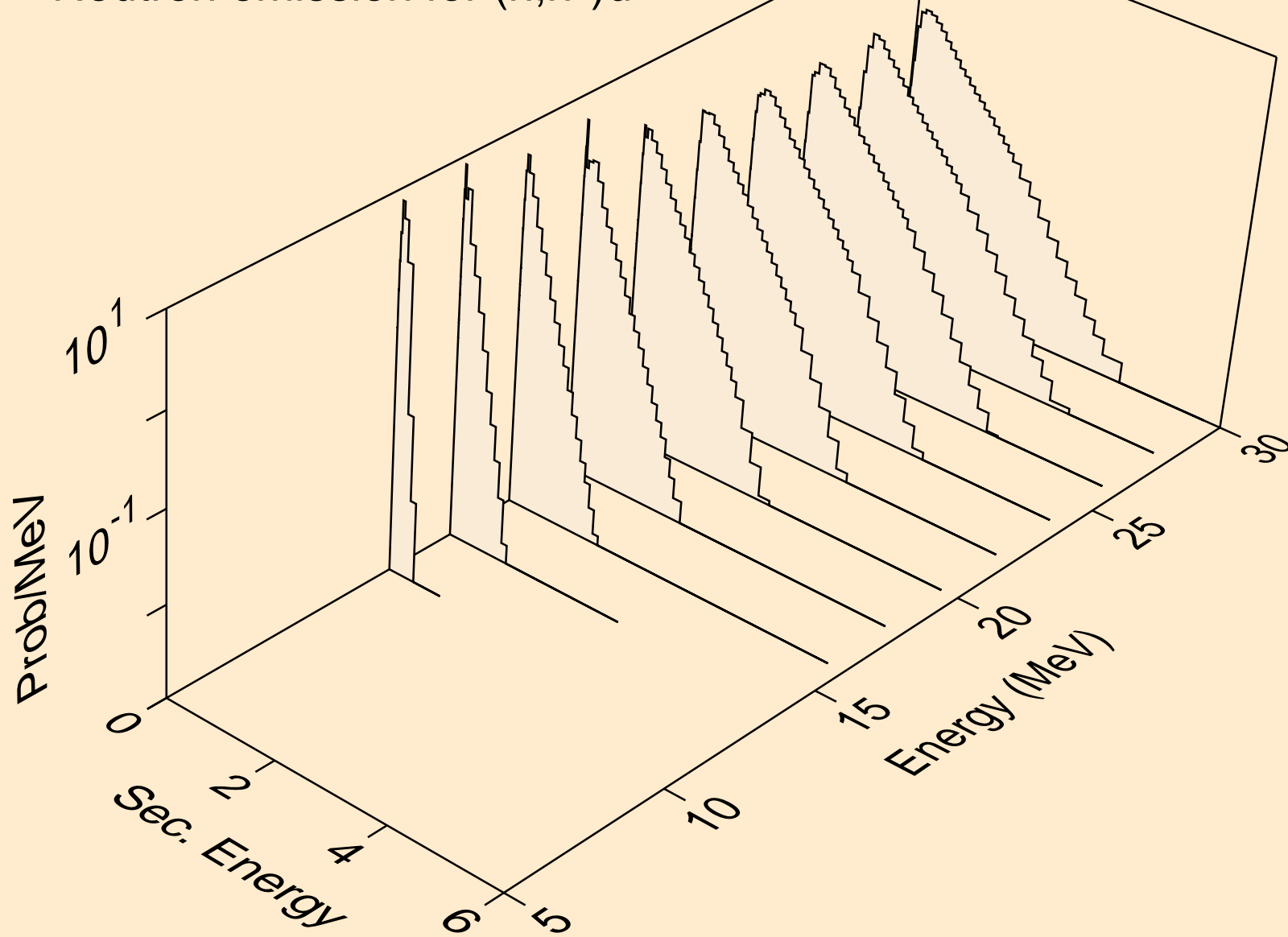

BI219 NEUTRON ACER TENDL-2019 LIBRARY; T=293.16K
Neutron emission for (n,n*)t

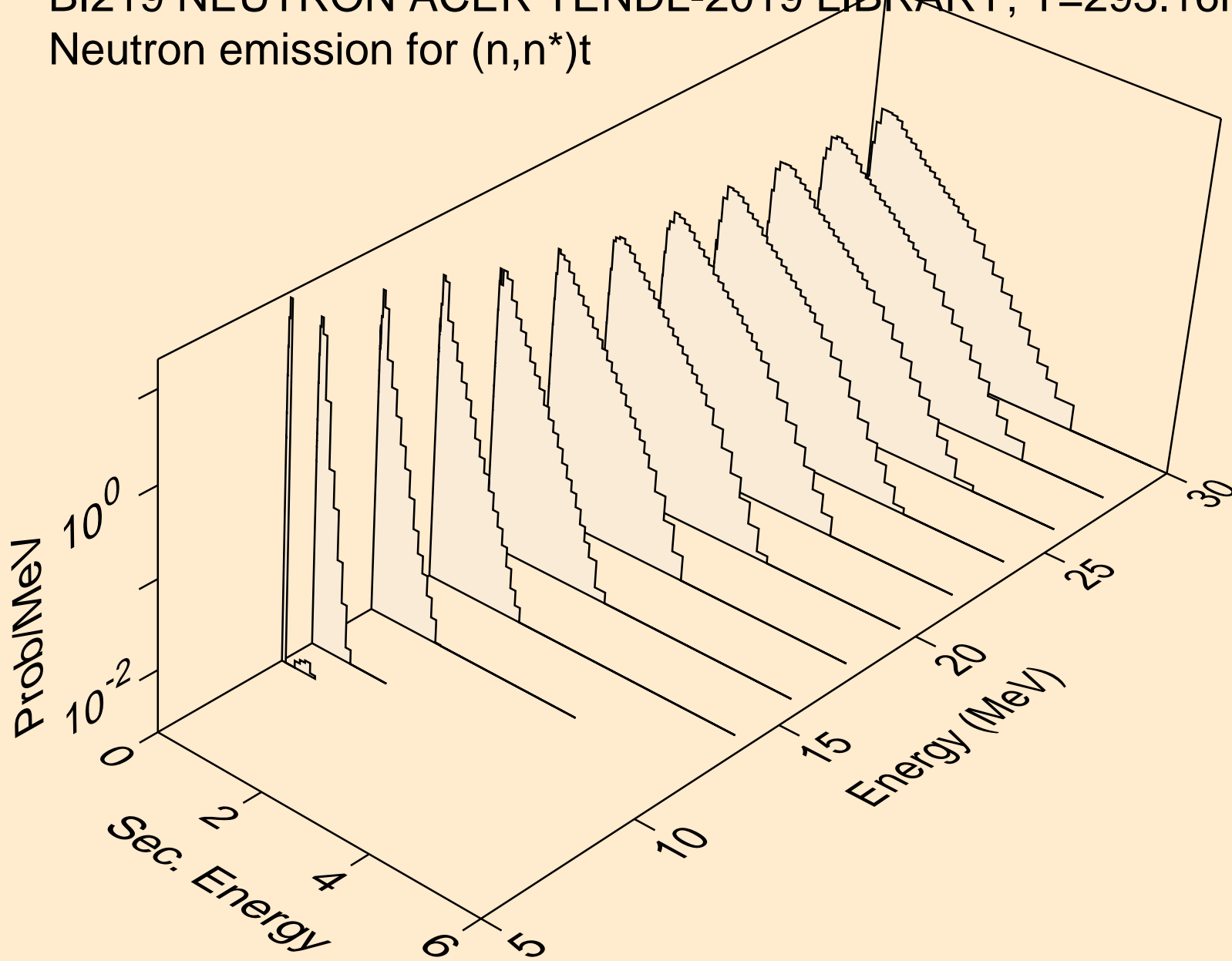

BI219 NEUTRON ACER TENDL-2019 LIBRARY; T=293.16K
Neutron emission for (n,n*)he3

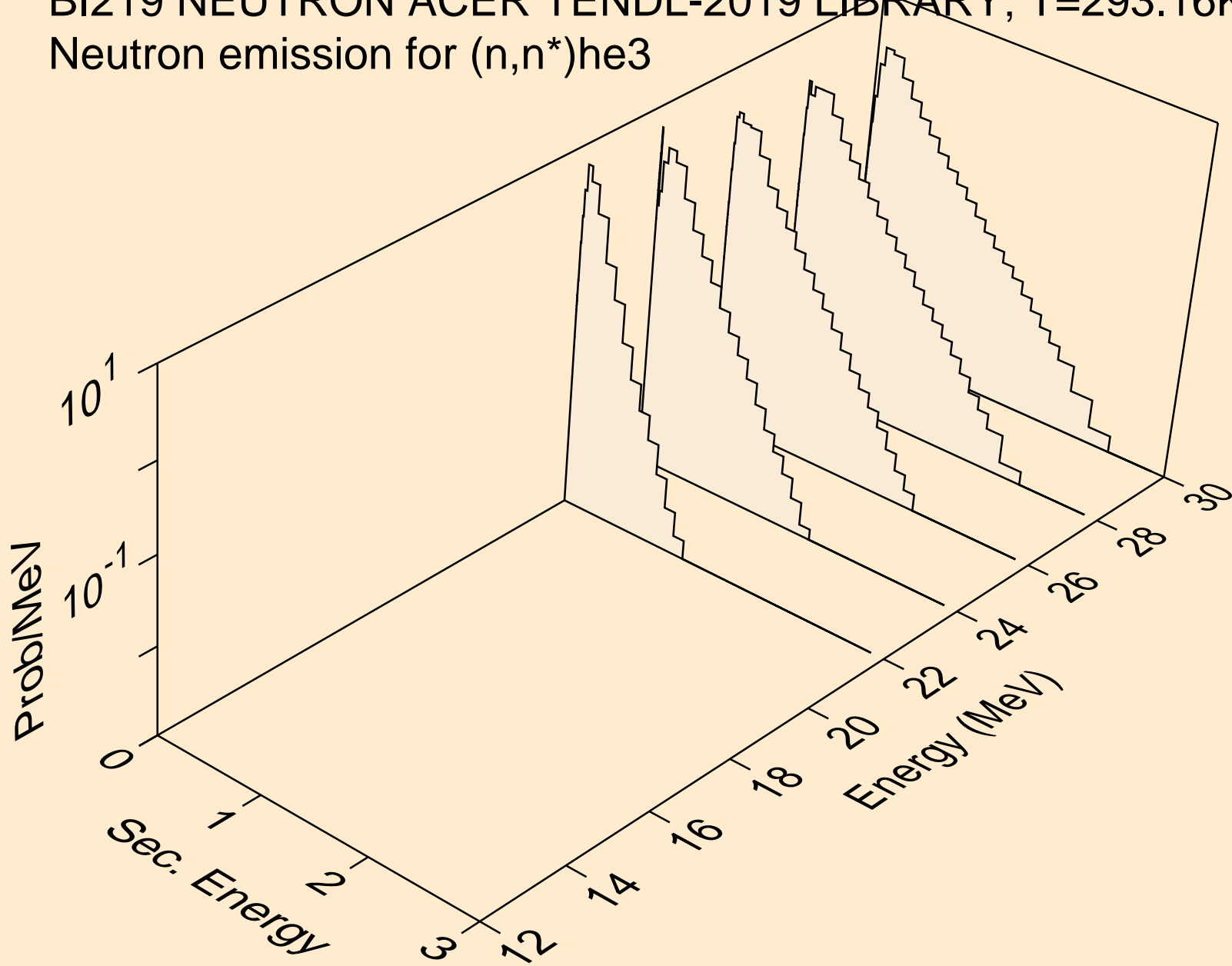

BI219 NEUTRON ACER TENDL-2019 LIBRARY; T=293.16K
Neutron emission for (n,4n)

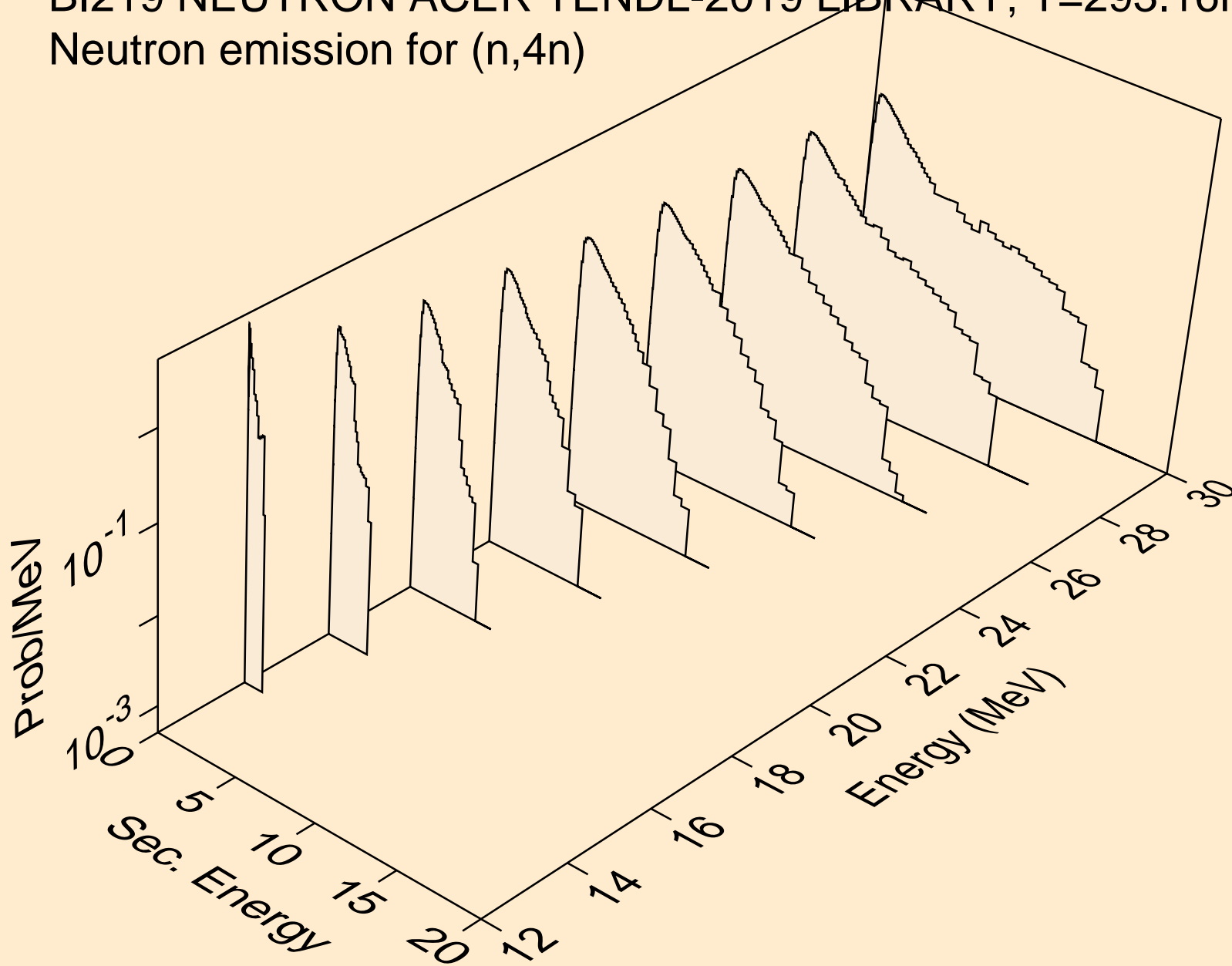

BI219 NEUTRON ACER TENDL-2019 LIBRARY; T=293.16K
Neutron emission for (n,2np)

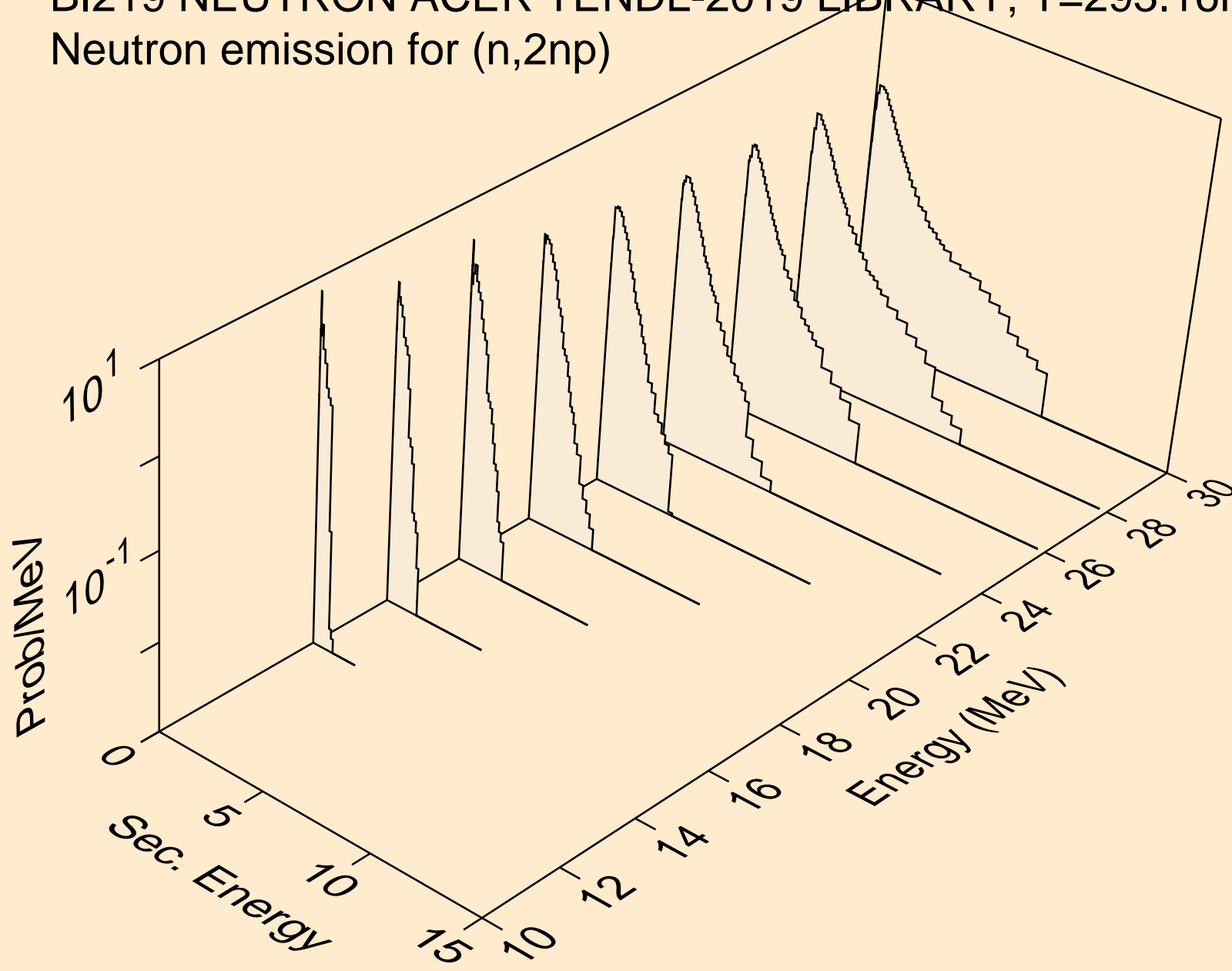

BI219 NEUTRON ACER TENDL-2019 LIBRARY; T=293.16K
Neutron emission for (n,3np)

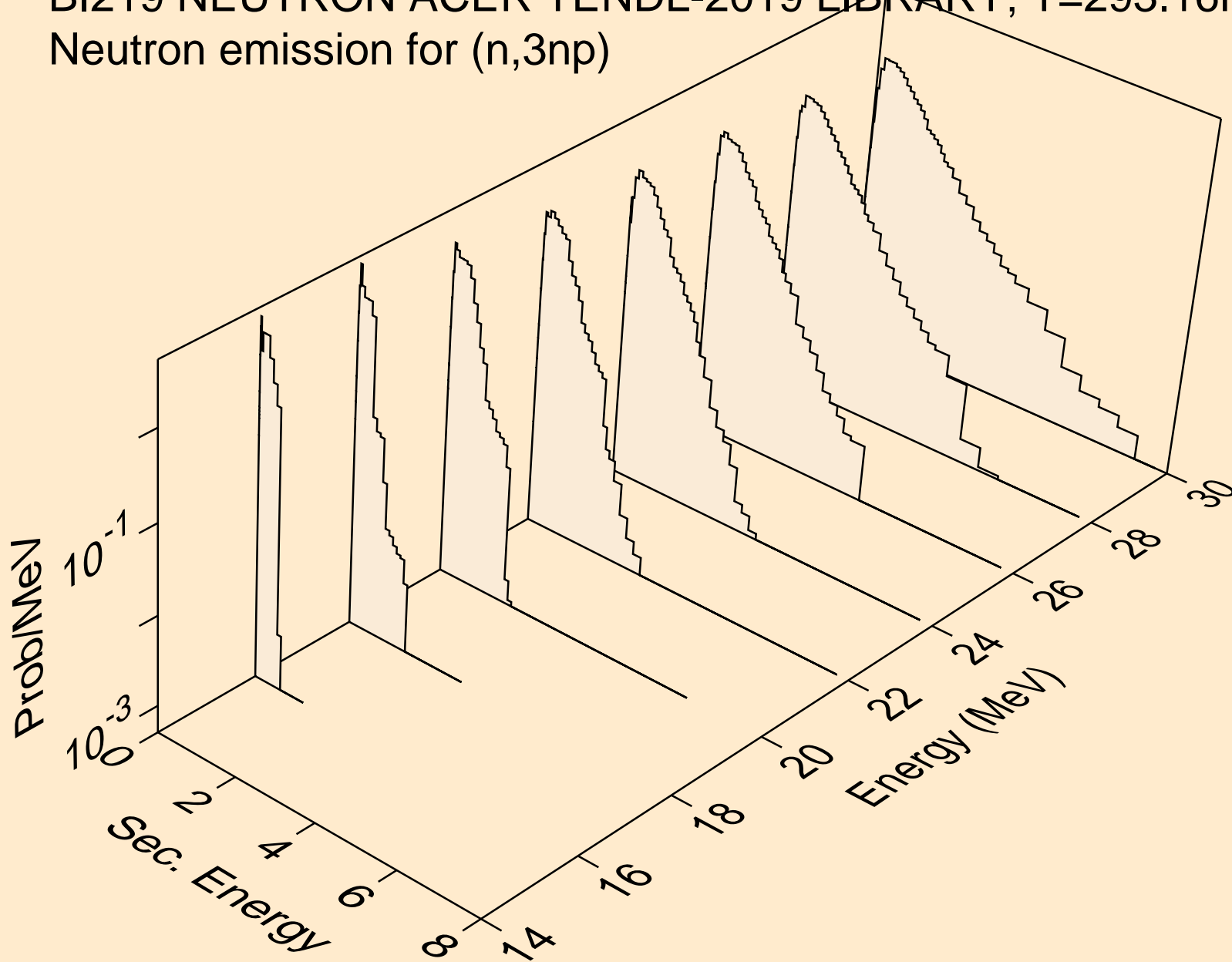

BI219 NEUTRON ACER TENDL-2019 LIBRARY; T=293.16K
Neutron emission for (n,n*c)

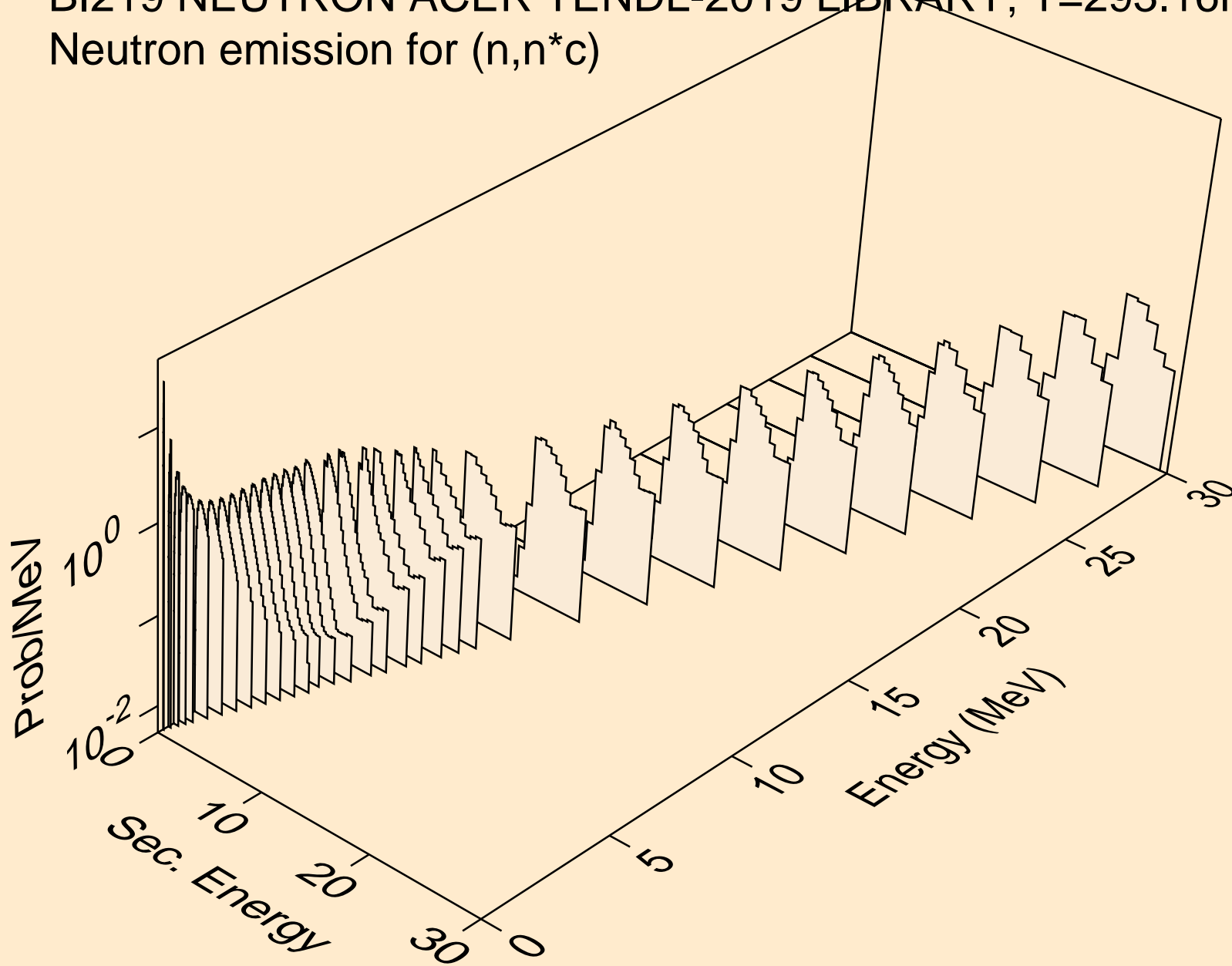

BI219 NEUTRON ACER TENDL-2019 LIBRARY; T=293.16K

Delayed nubar

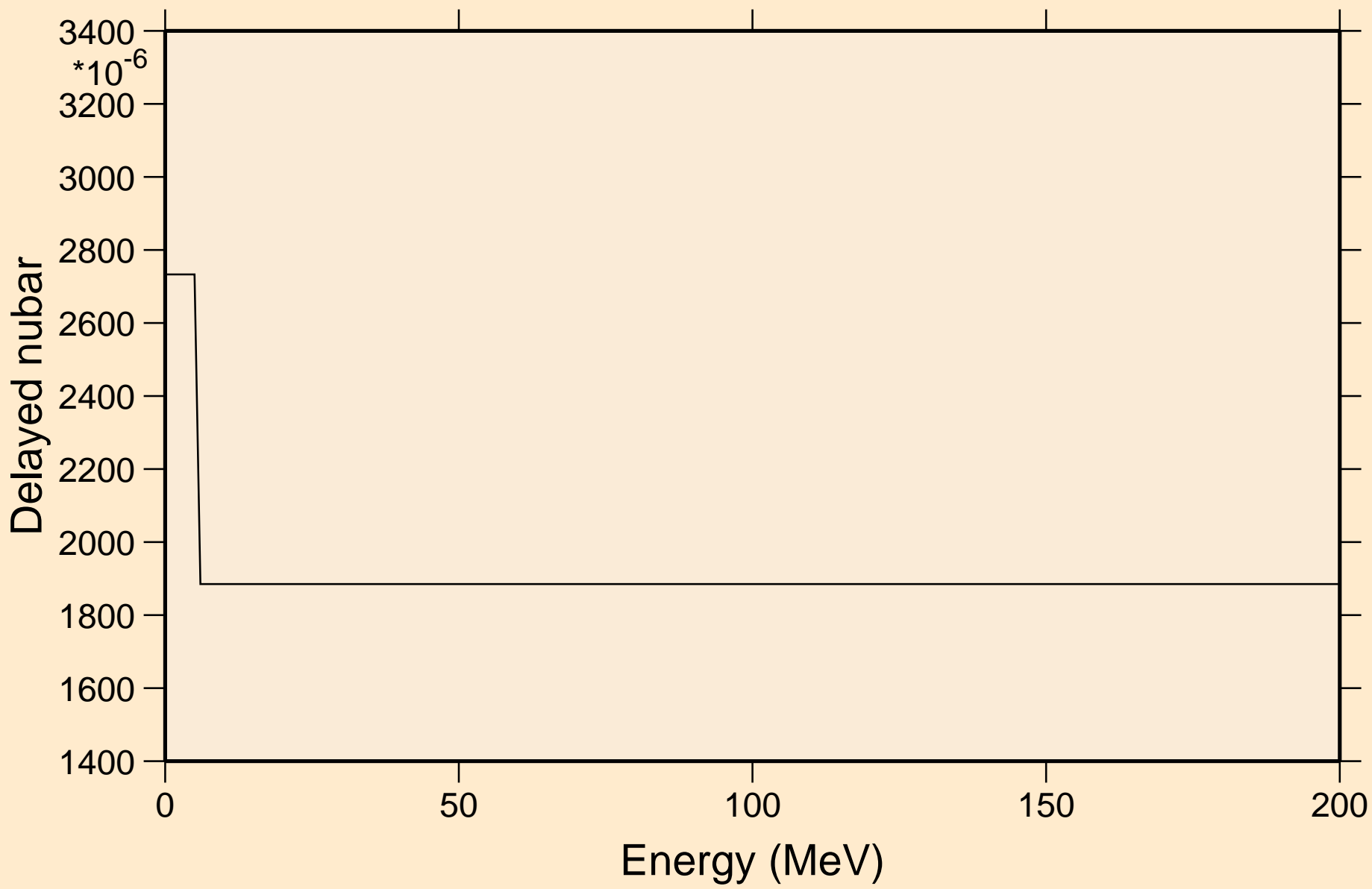

BI219 NEUTRON ACER TENDL-2019 LIBRARY; T=293.16K

Delayed neutron spectra

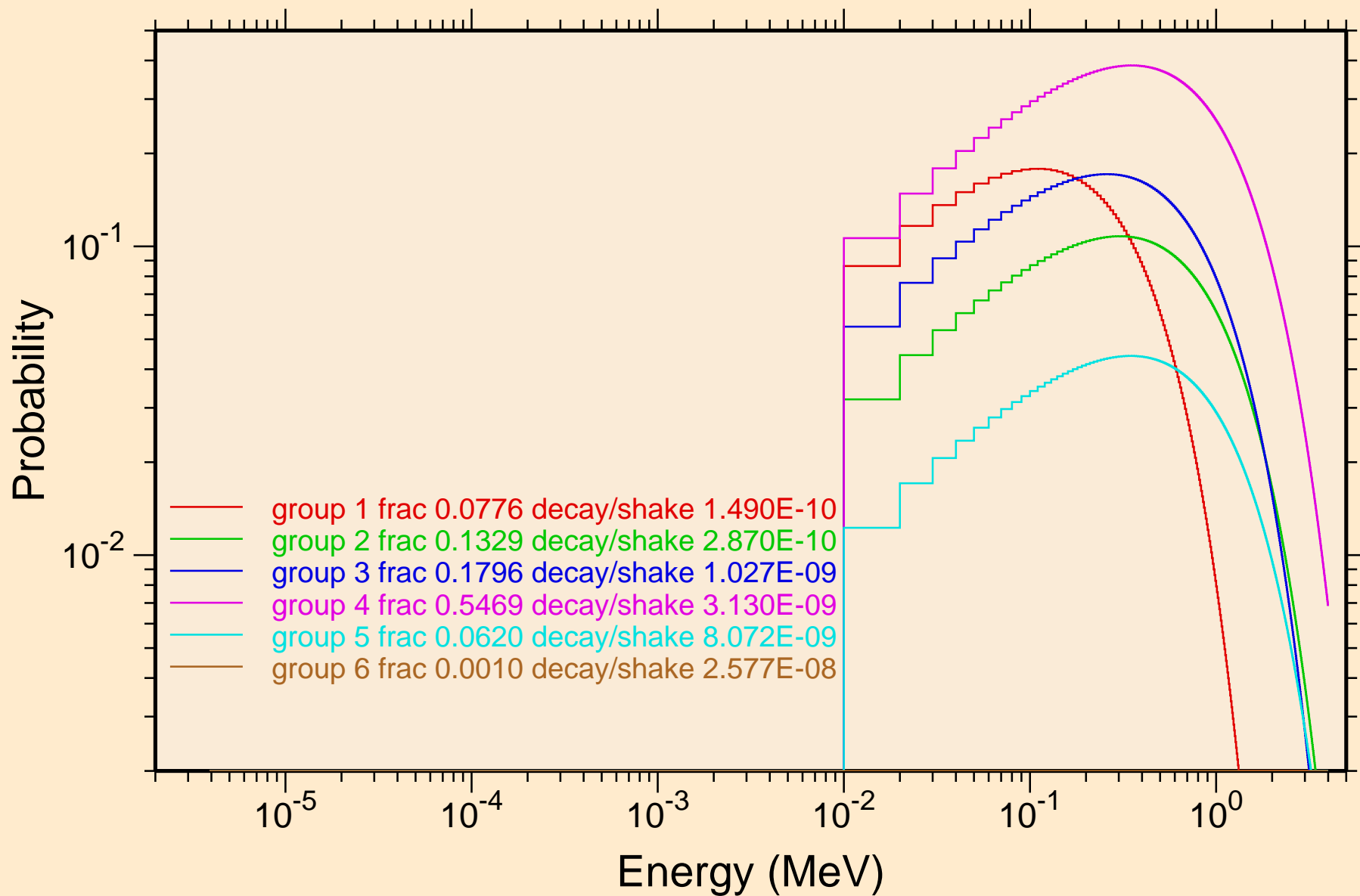

BI219 NEUTRON ACER TENDL-2019 LIBRARY; T=293.16K
Photon emission for (n,x)

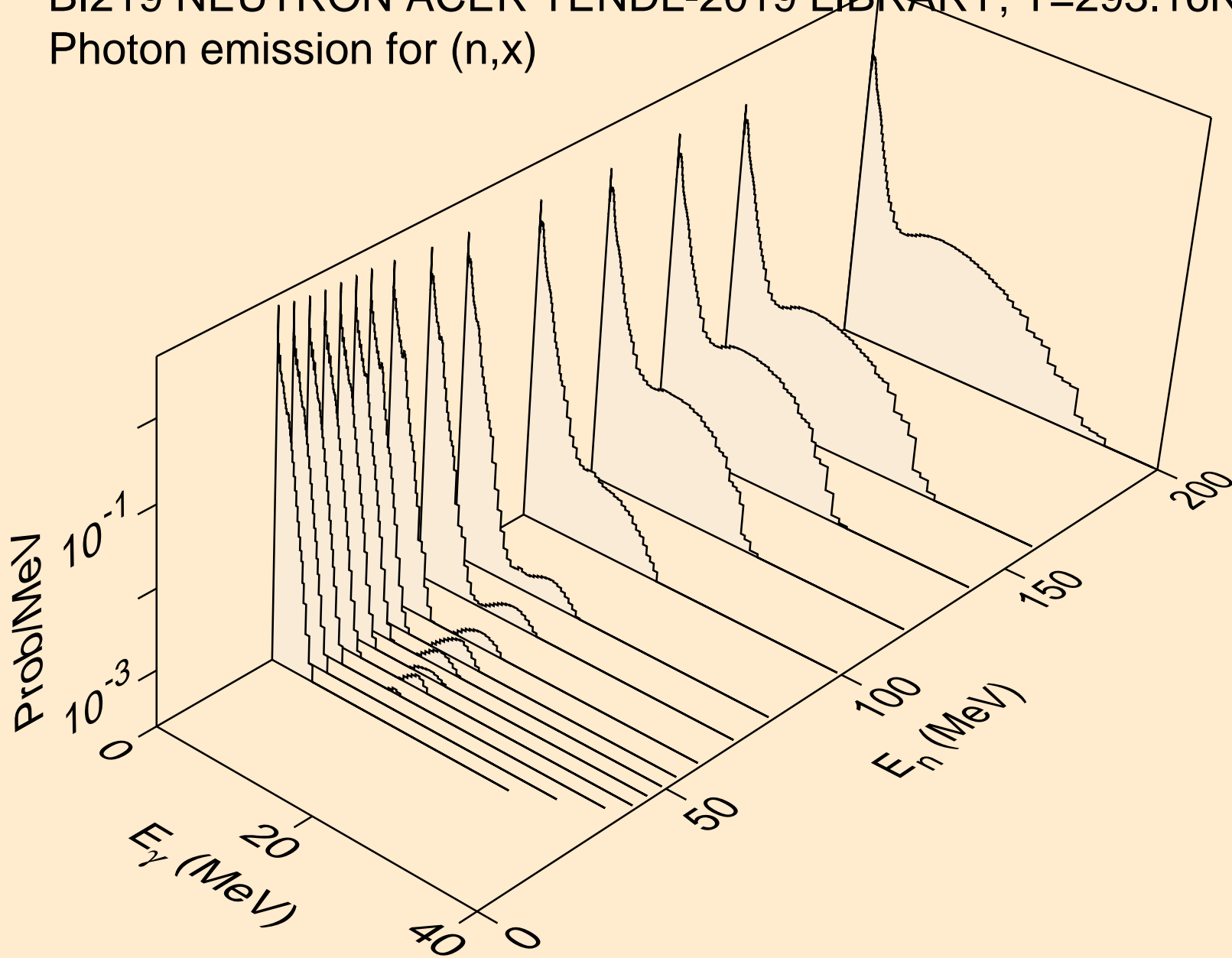

BI219 NEUTRON ACER TENDL-2019 LIBRARY; T=293.16K
Photon emission for (n,2nd)

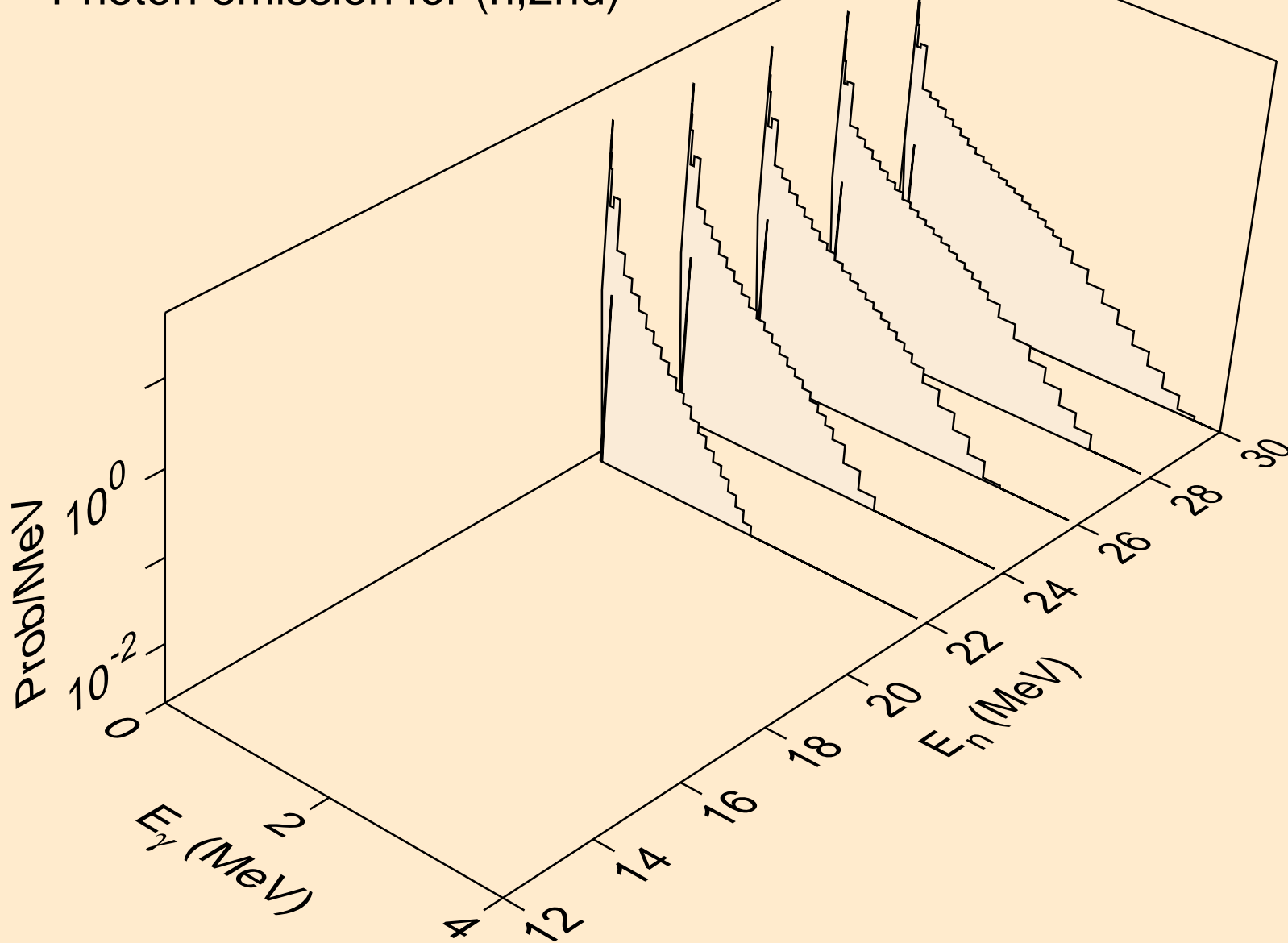

BI219 NEUTRON ACER TENDL-2019 LIBRARY; T=293.16K
Photon emission for (n,2n)

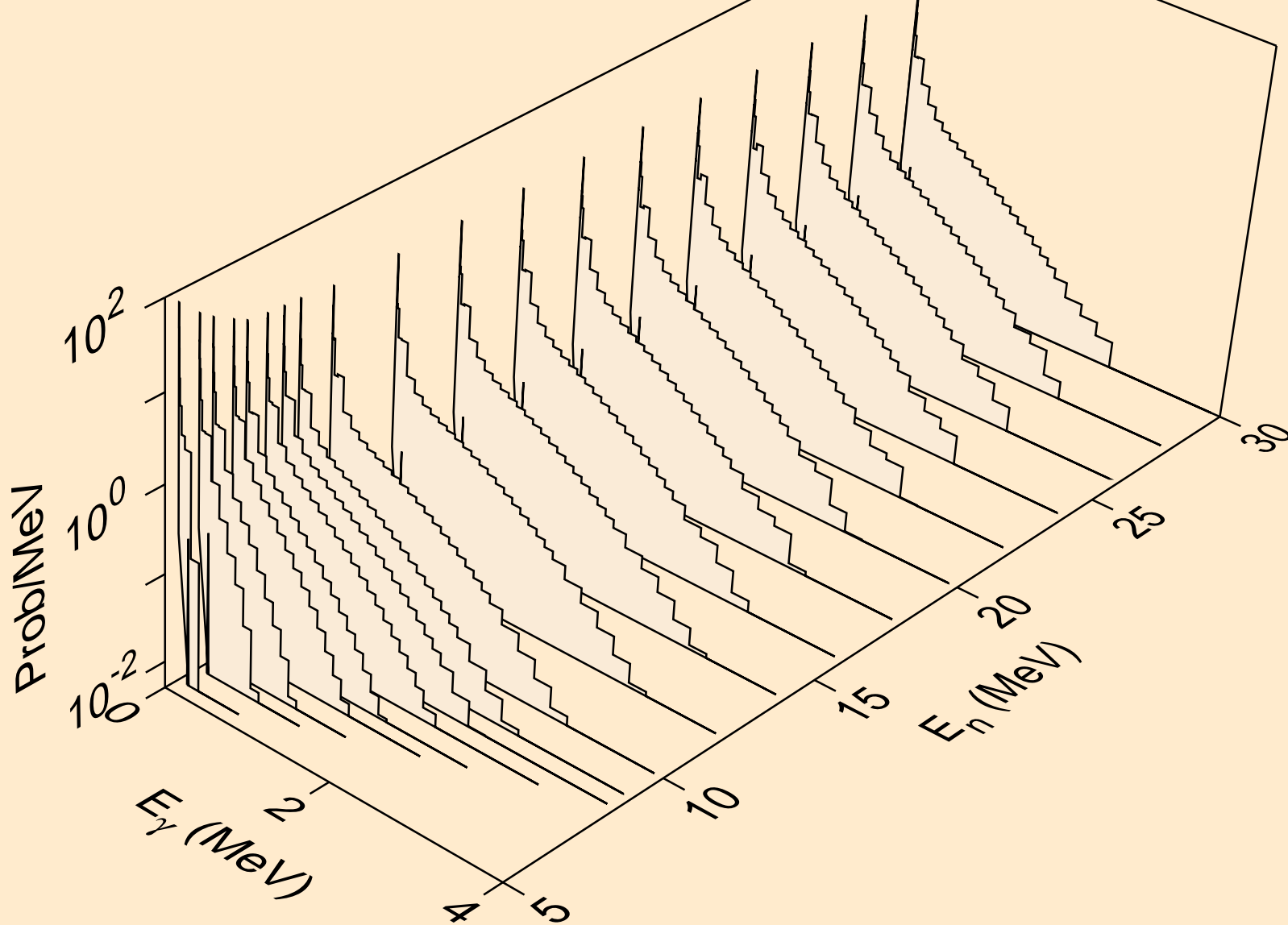

BI219 NEUTRON ACER TENDL-2019 LIBRARY; T=293.16K
Photon emission for (n,3n)

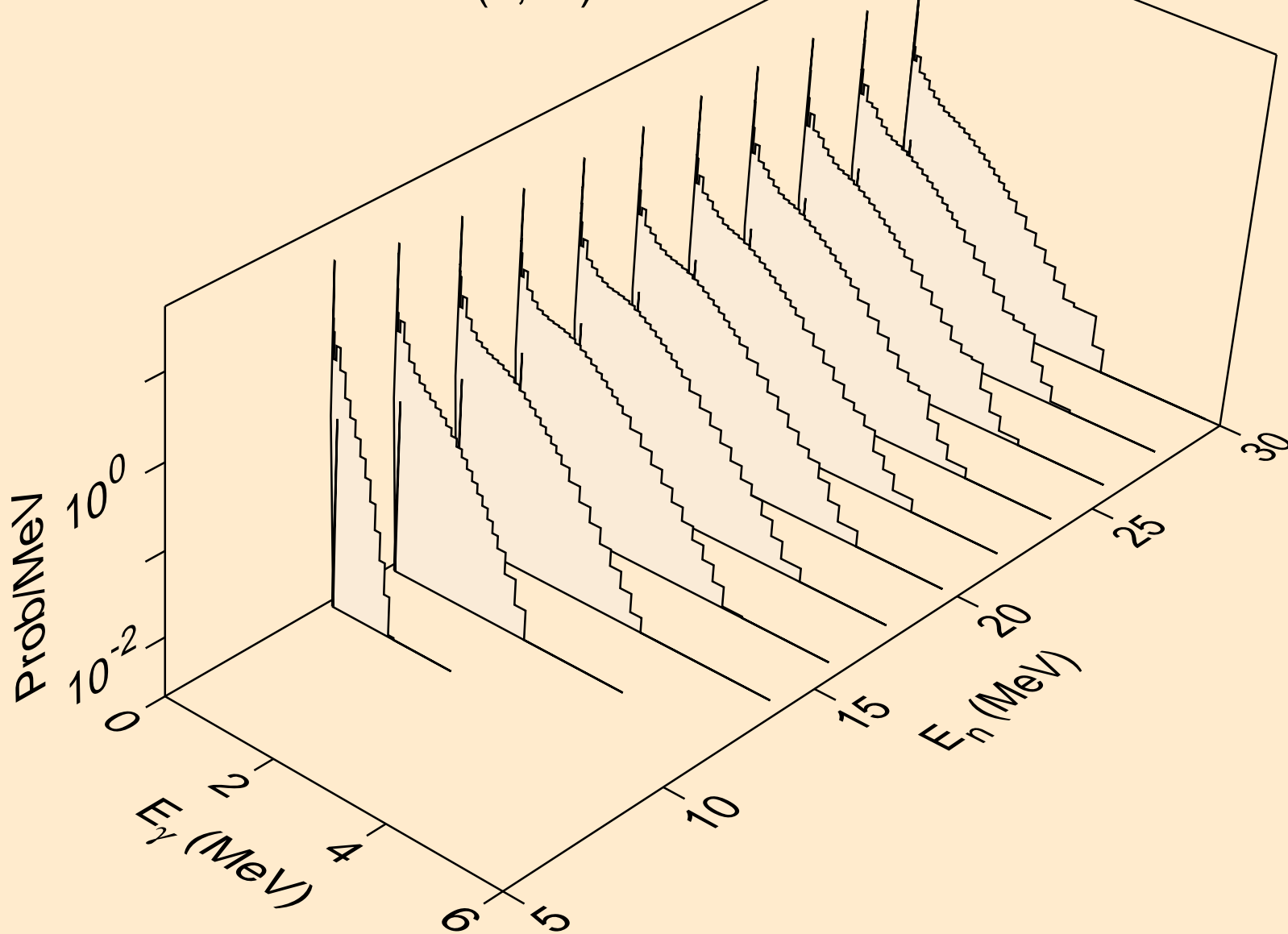

BI219 NEUTRON ACER TENDL-2019 LIBRARY; T=293.16K
Photon emission for (n,n*)a

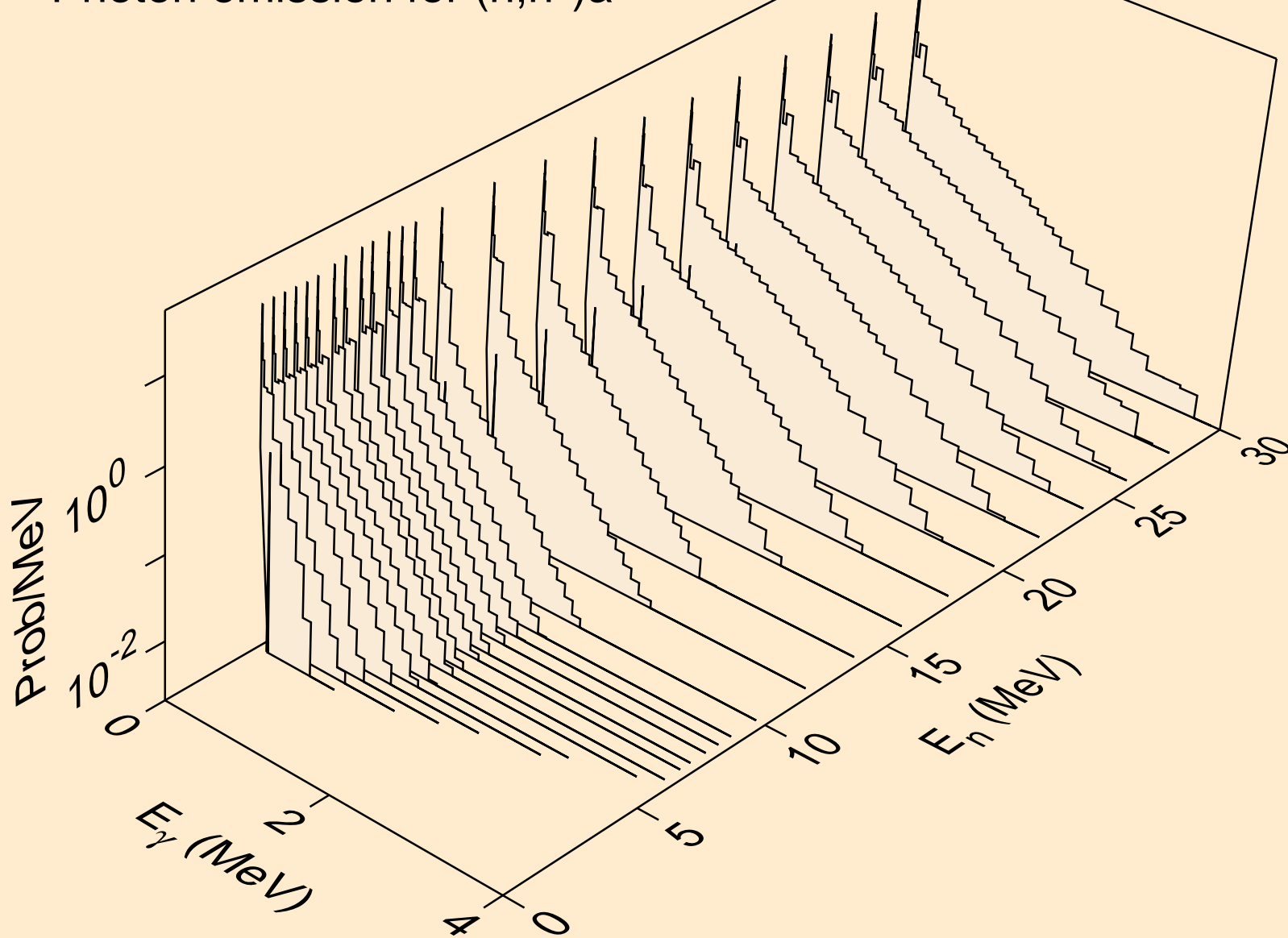

BI219 NEUTRON ACER TENDL-2019 LIBRARY; T=293.16K
Photon emission for (n,2n)a

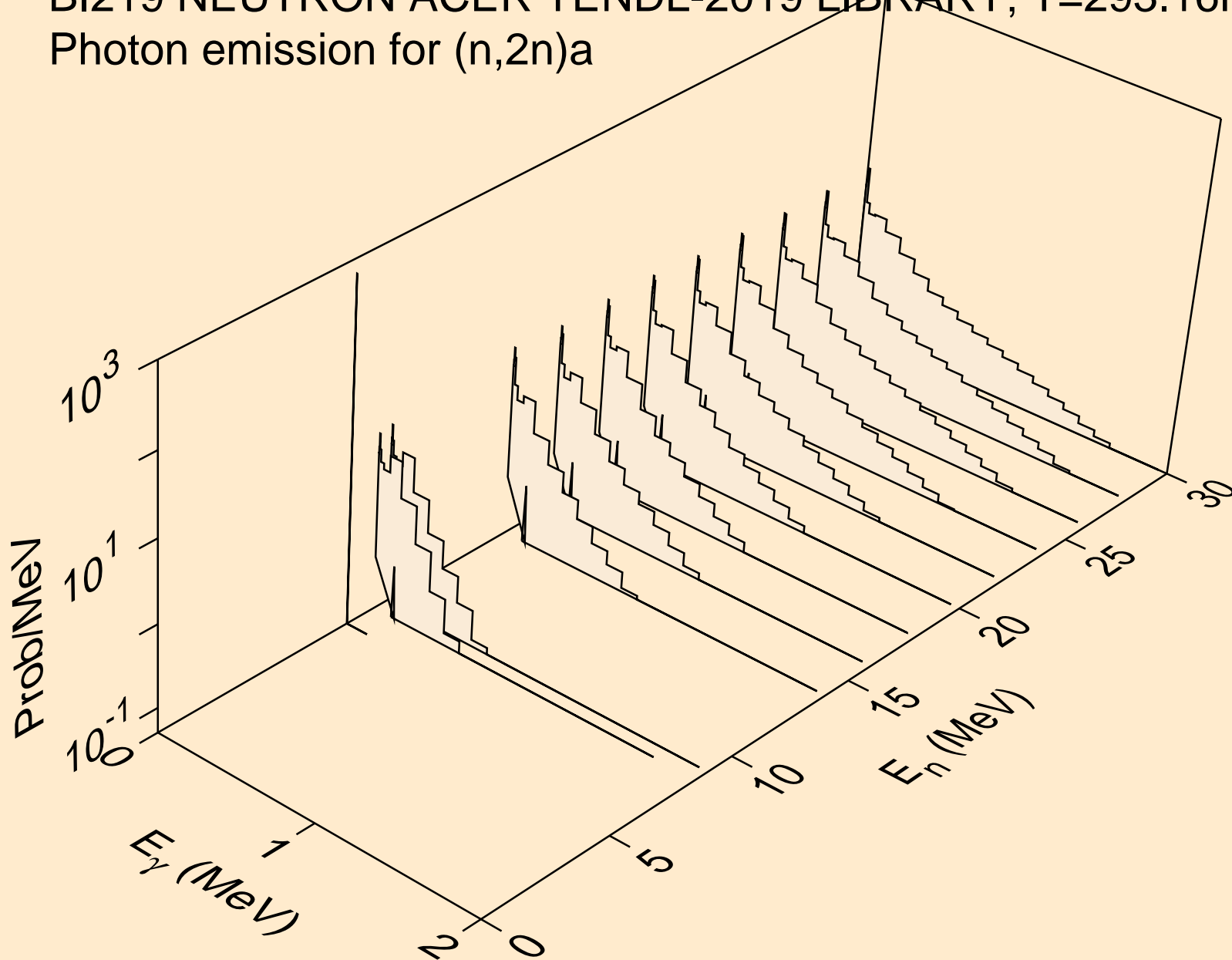

BI219 NEUTRON ACER TENDL-2019 LIBRARY; T=293.16K
Photon emission for (n,3n)a

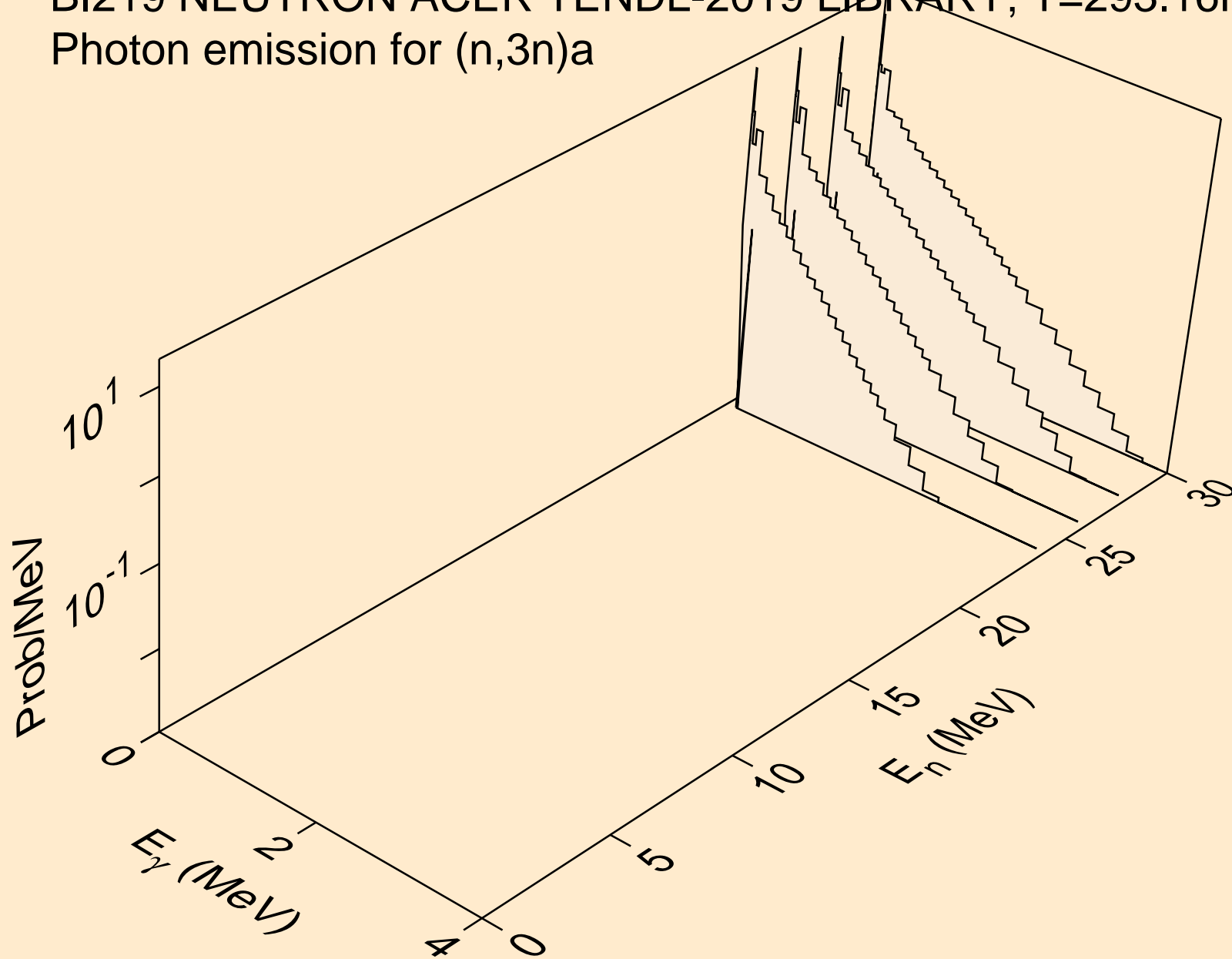

BI219 NEUTRON ACER TENDL-2019 LIBRARY; T=293.16K
Photon emission for (n,n*)p

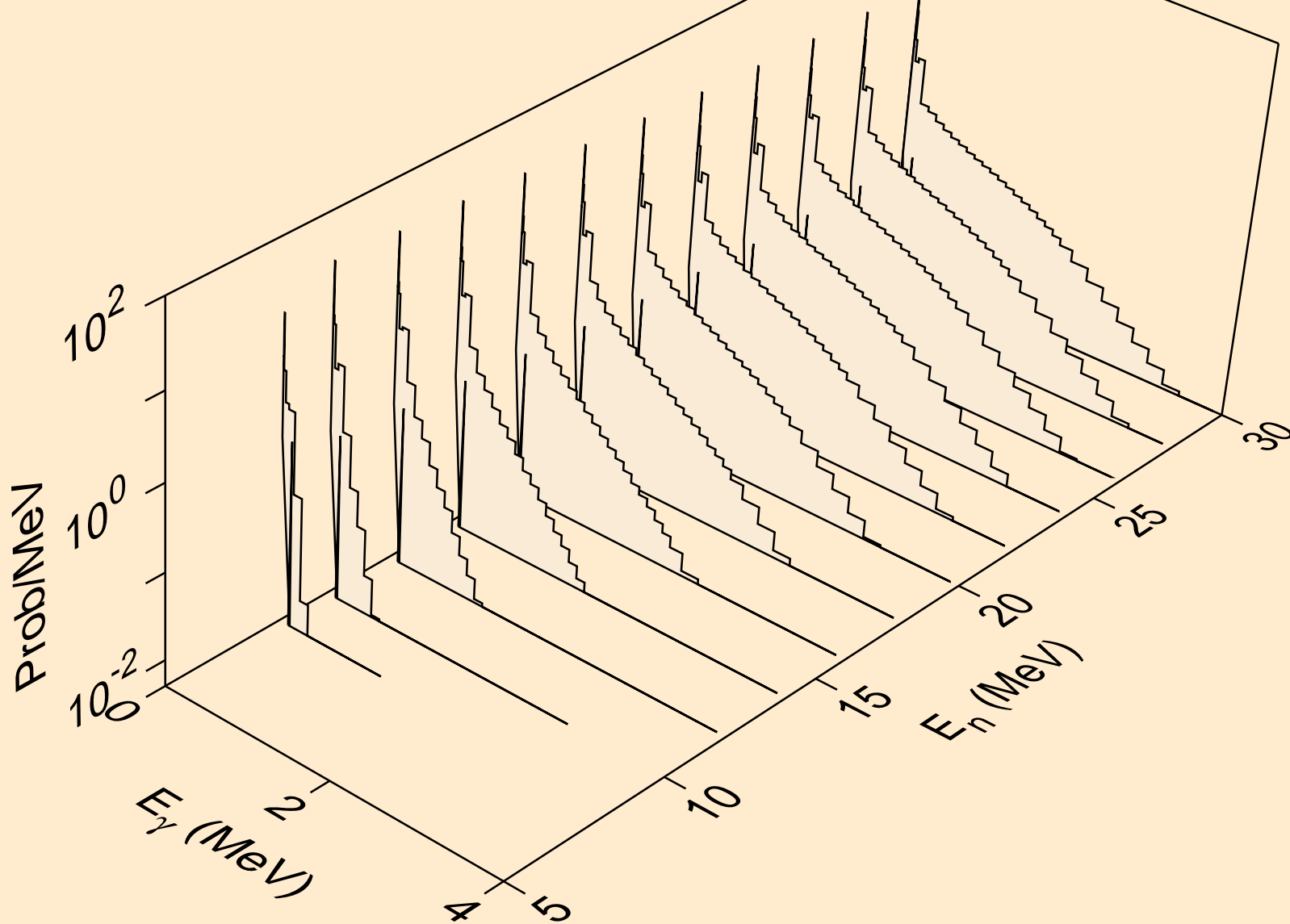

BI219 NEUTRON ACER TENDL-2019 LIBRARY; T=293.16K
Photon emission for (n,n*)d

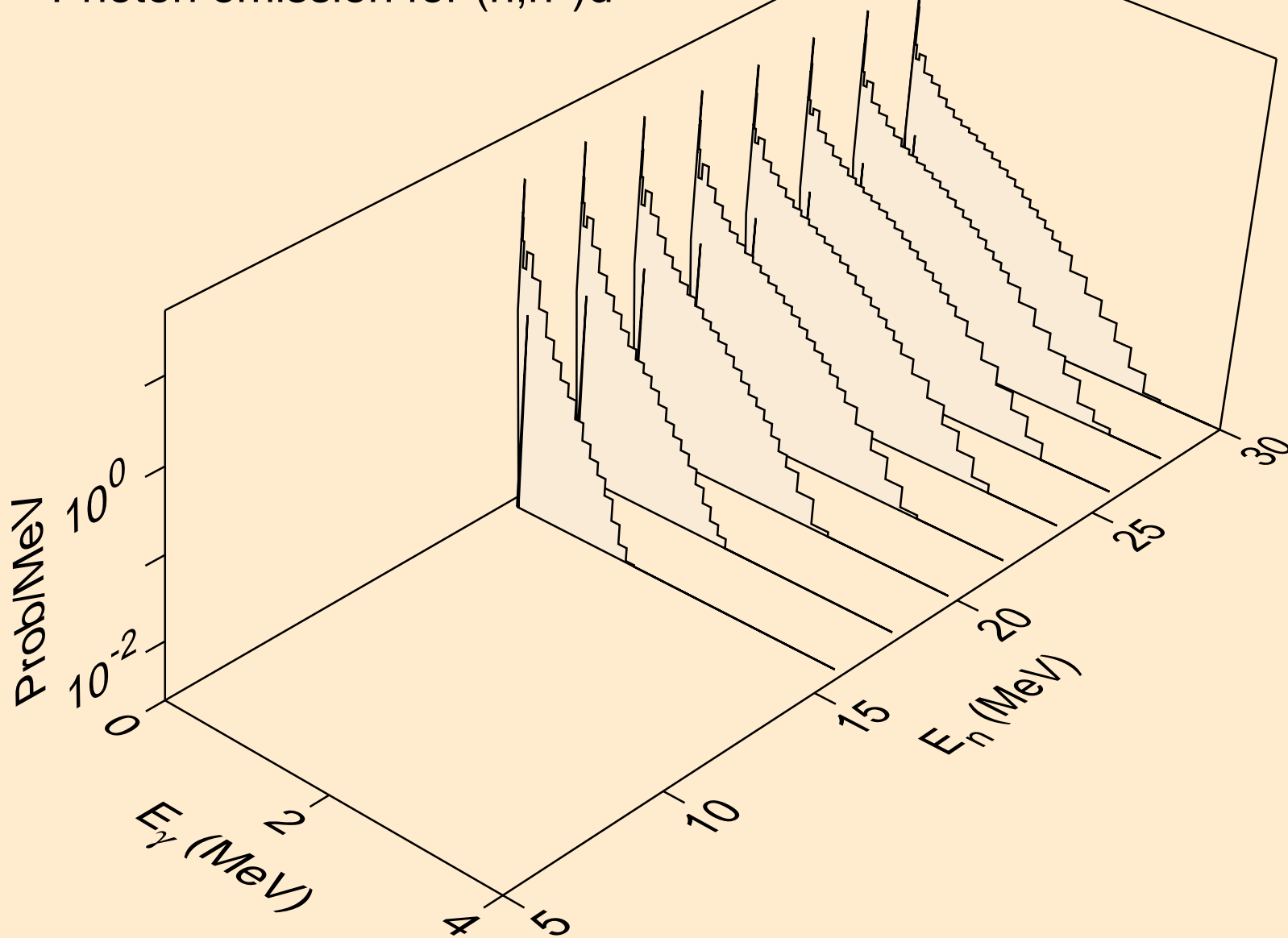

BI219 NEUTRON ACER TENDL-2019 LIBRARY; T=293.16K
Photon emission for (n,n*)t

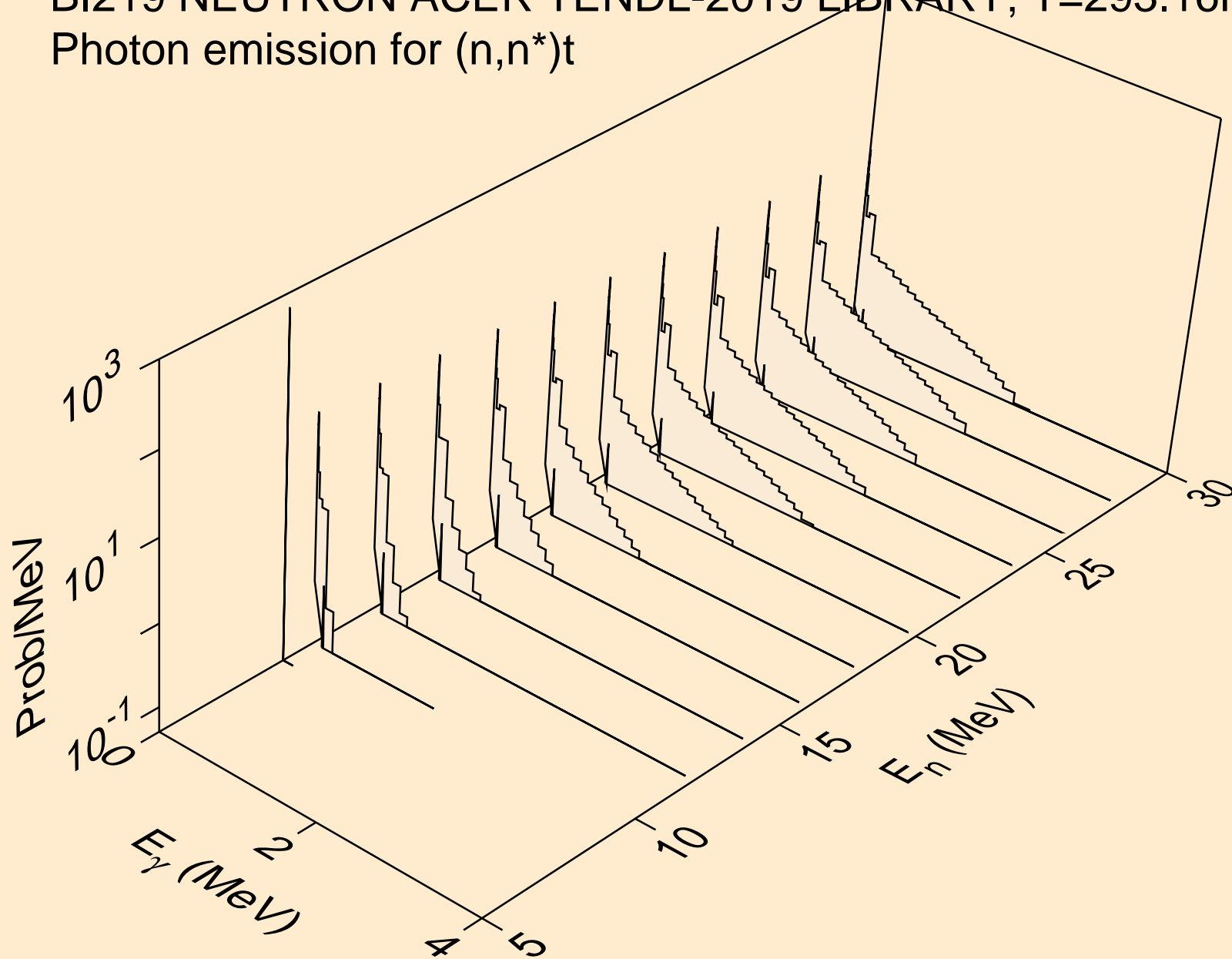

BI219 NEUTRON ACER TENDL-2019 LIBRARY; T=293.16K
Photon emission for (n,n*)he3

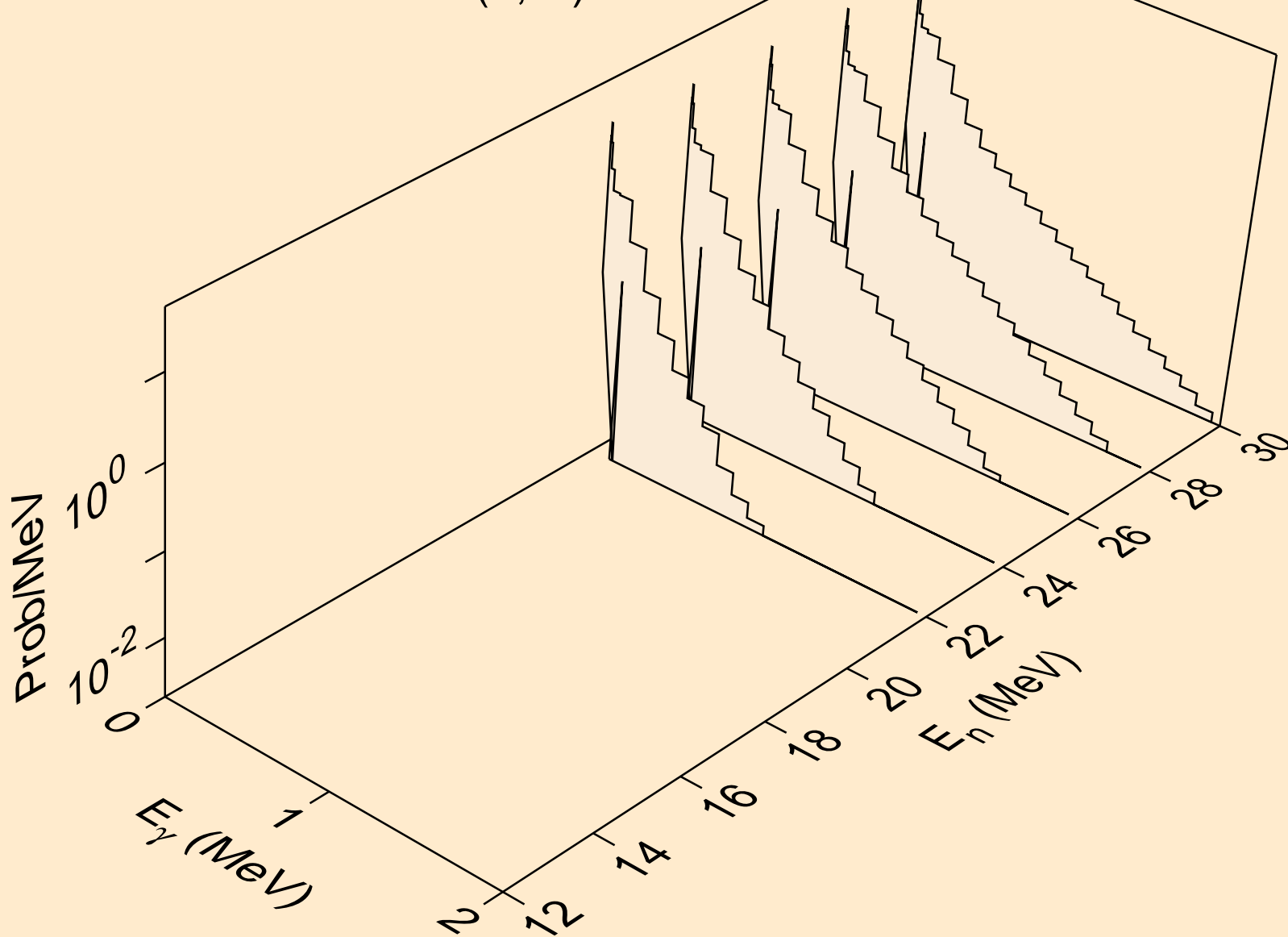

BI219 NEUTRON ACER TENDL-2019 LIBRARY; T=293.16K
Photon emission for (n,4n)

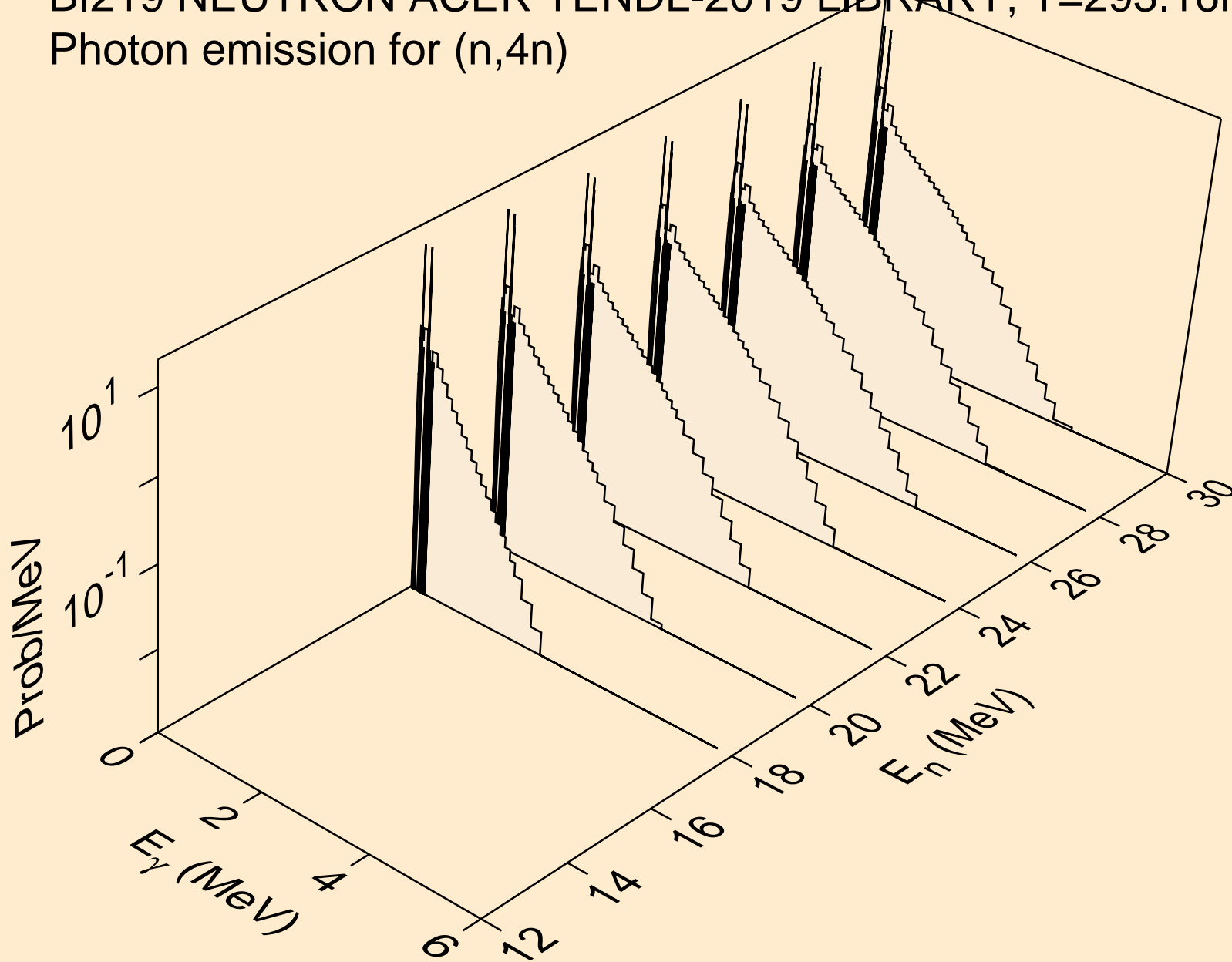

BI219 NEUTRON ACER TENDL-2019 LIBRARY; T=293.16K
Photon emission for (n,2np)

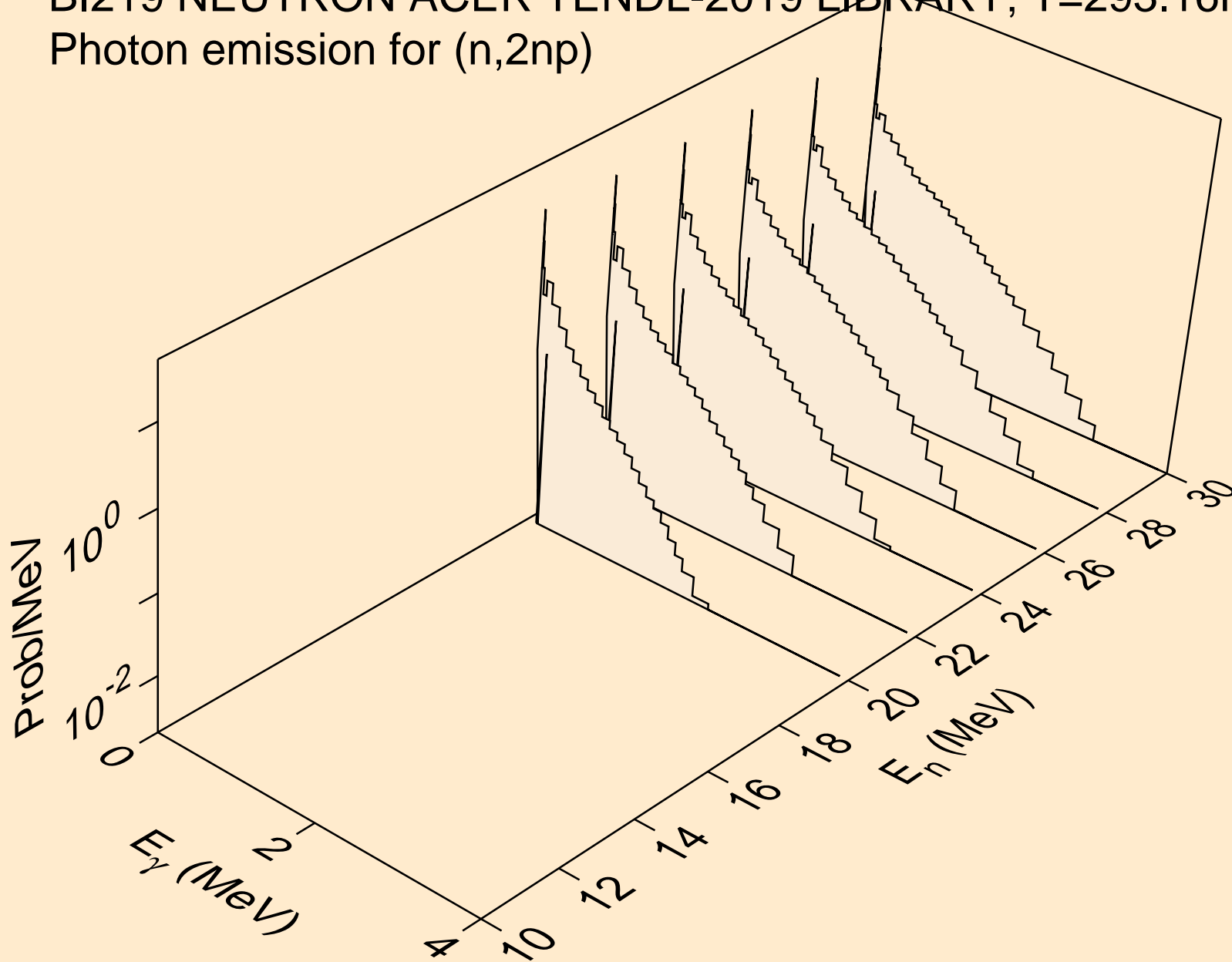

BI219 NEUTRON ACER TENDL-2019 LIBRARY; T=293.16K
Photon emission for (n,3np)

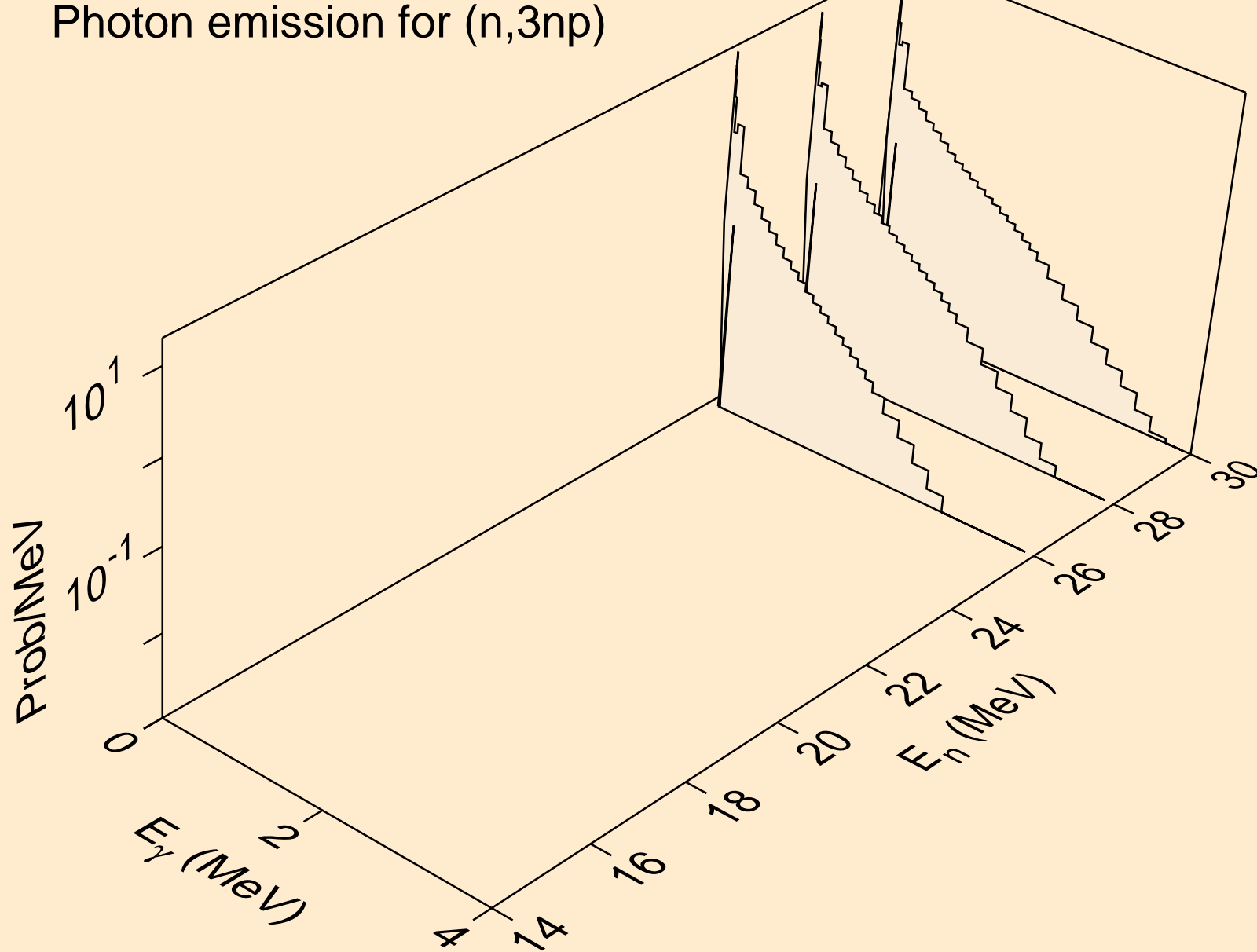

BI219 NEUTRON ACER TENDL-2019 LIBRARY; T=293.16K
Photon emission for (n,n*c)

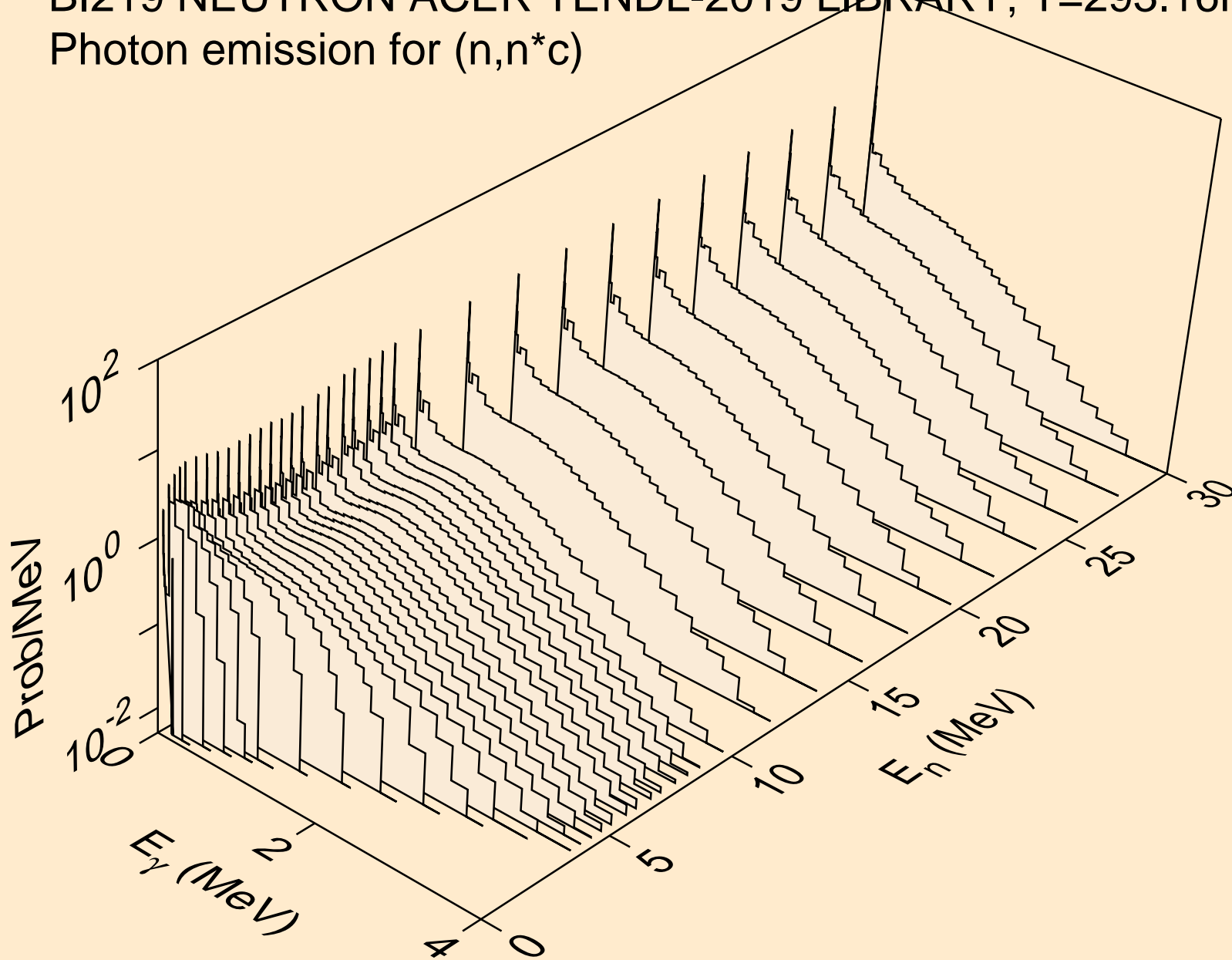

BI219 NEUTRON ACER TENDL-2019 LIBRARY; T=293.16K
Photon emission for (n,gma)

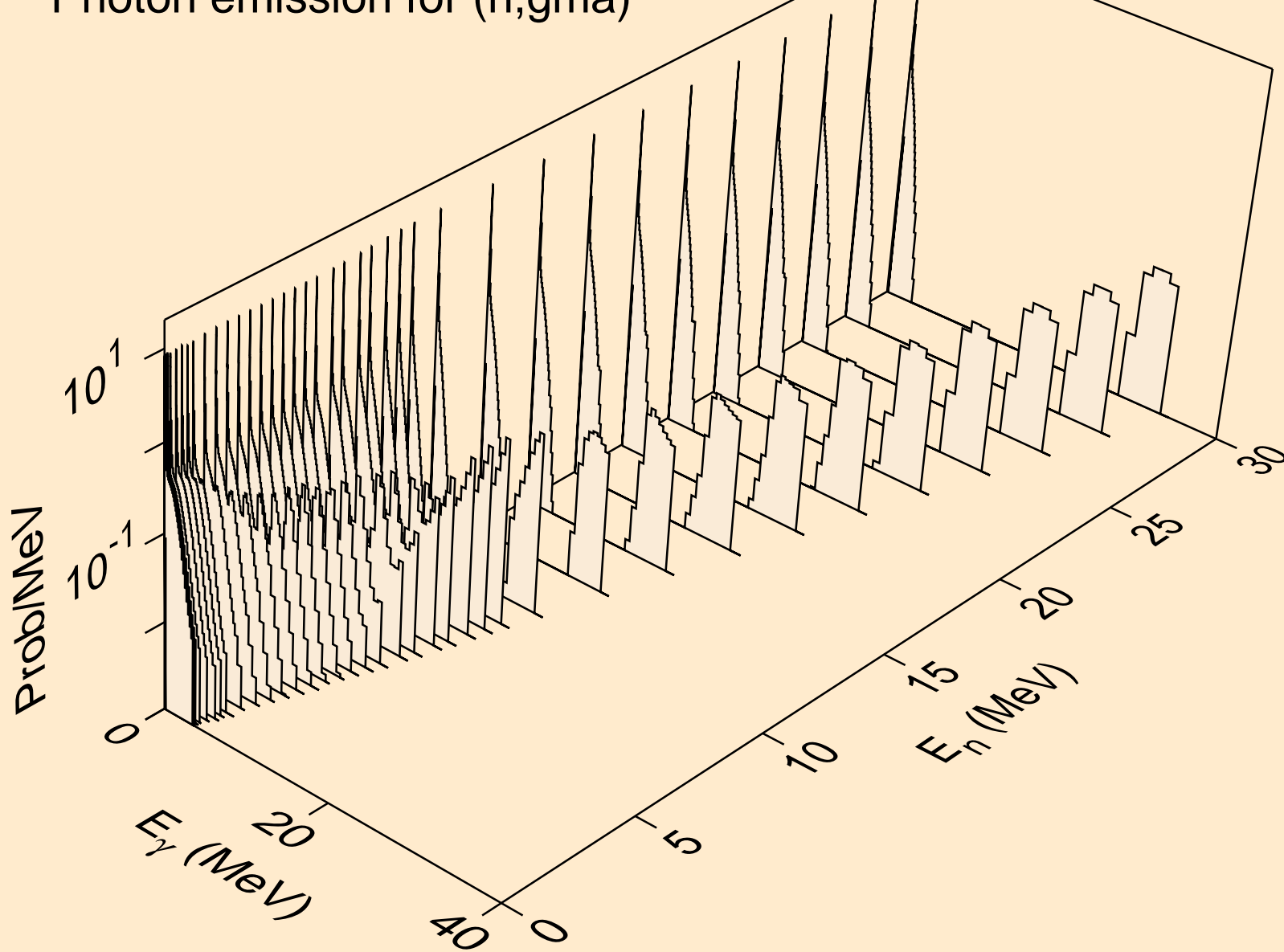

BI219 NEUTRON ACER TENDL-2019 LIBRARY; T=293.16K
Photon emission for (n,p)

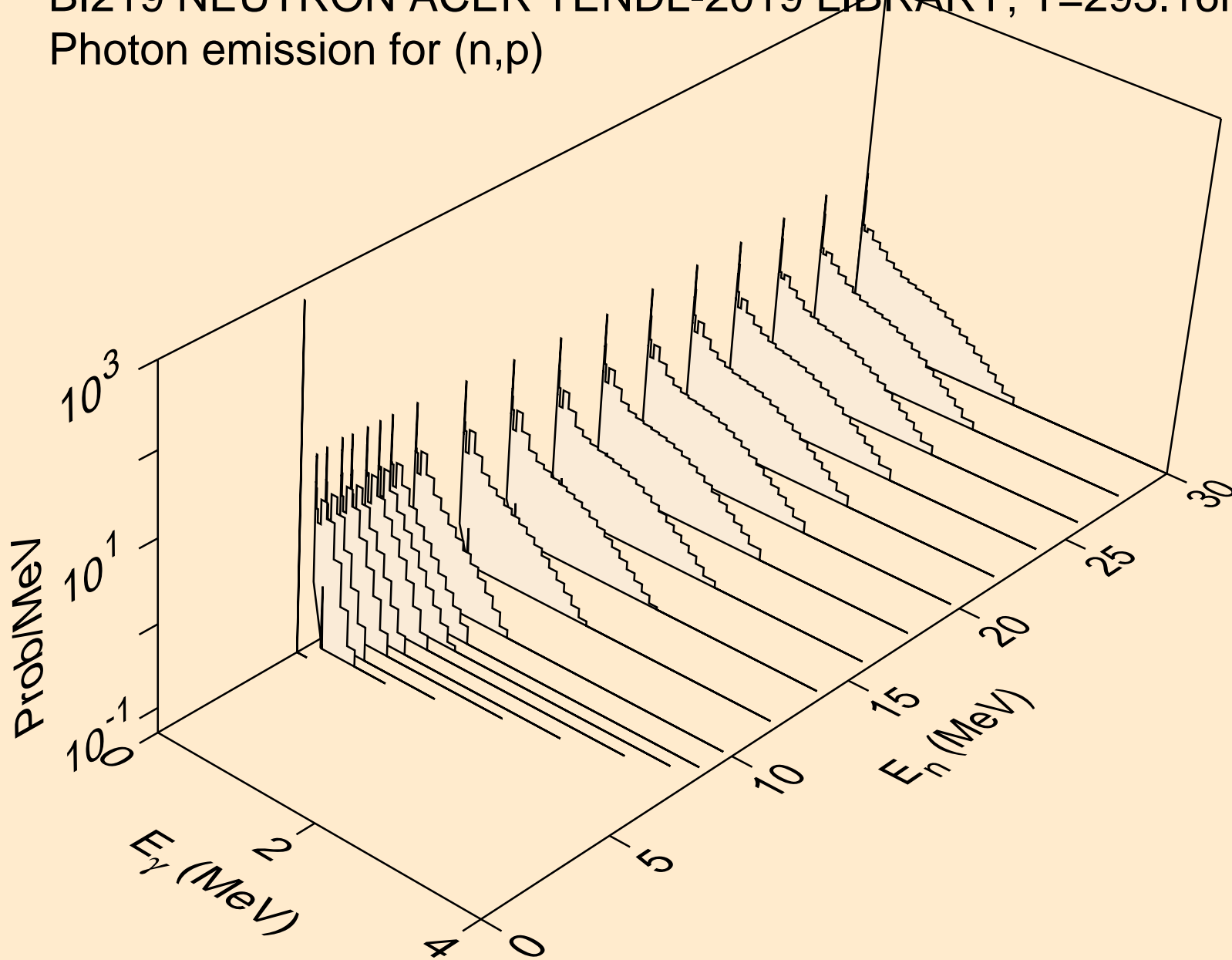

BI219 NEUTRON ACER TENDL-2019 LIBRARY; T=293.16K
Photon emission for (n,d)

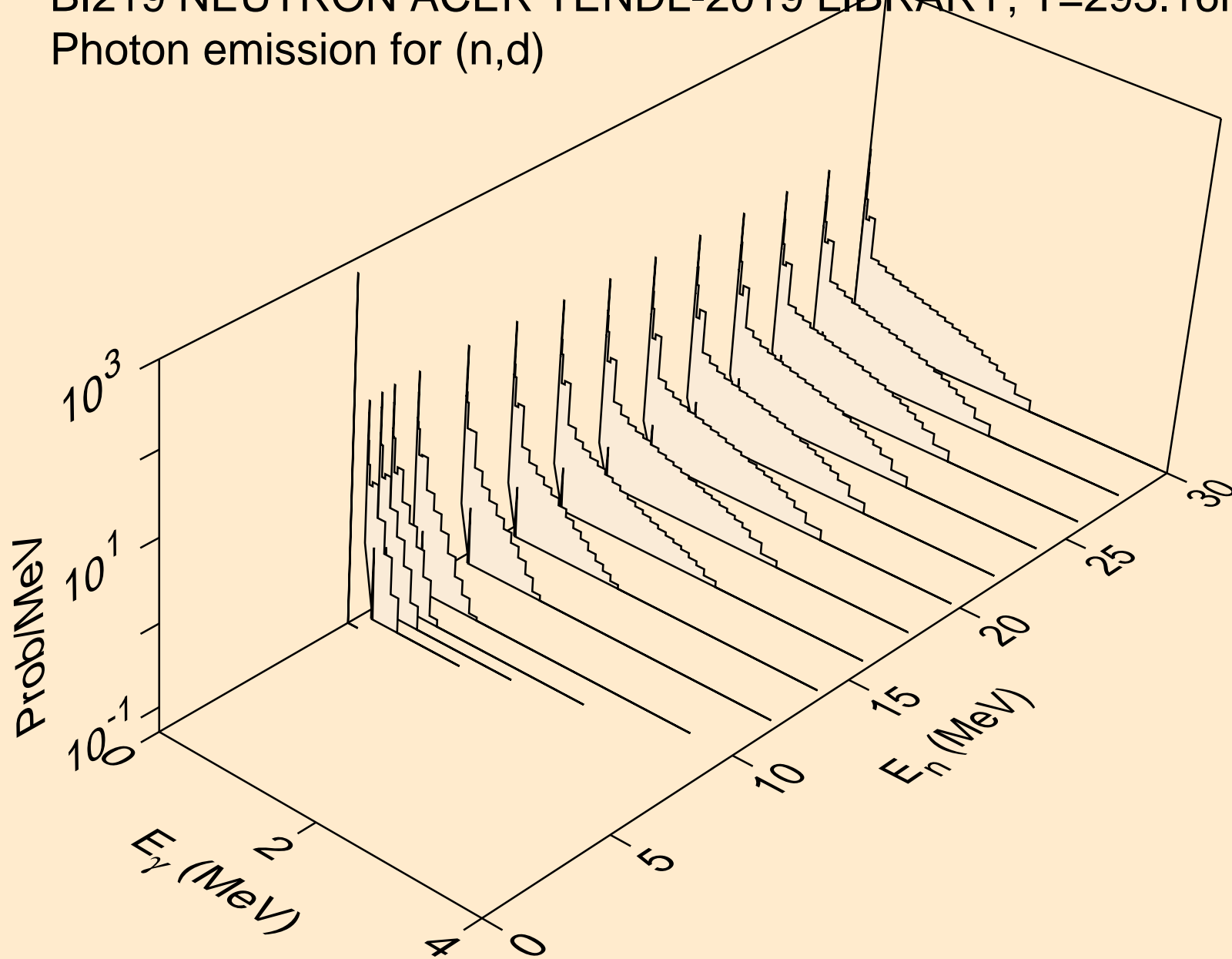

BI219 NEUTRON ACER TENDL-2019 LIBRARY; T=293.16K
Photon emission for (n,t)

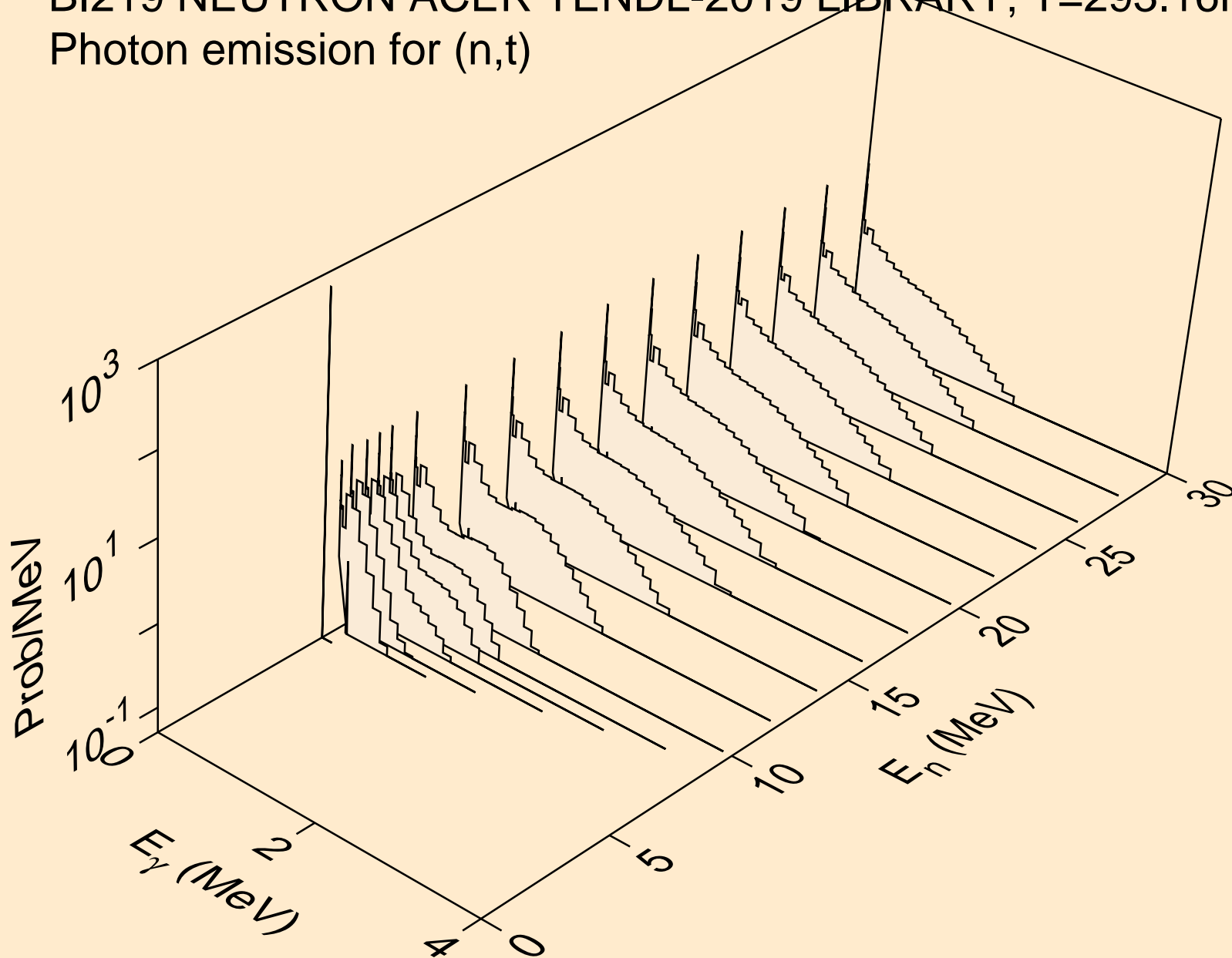

BI219 NEUTRON ACER TENDL-2019 LIBRARY; T=293.16K
Photon emission for (n,he3)

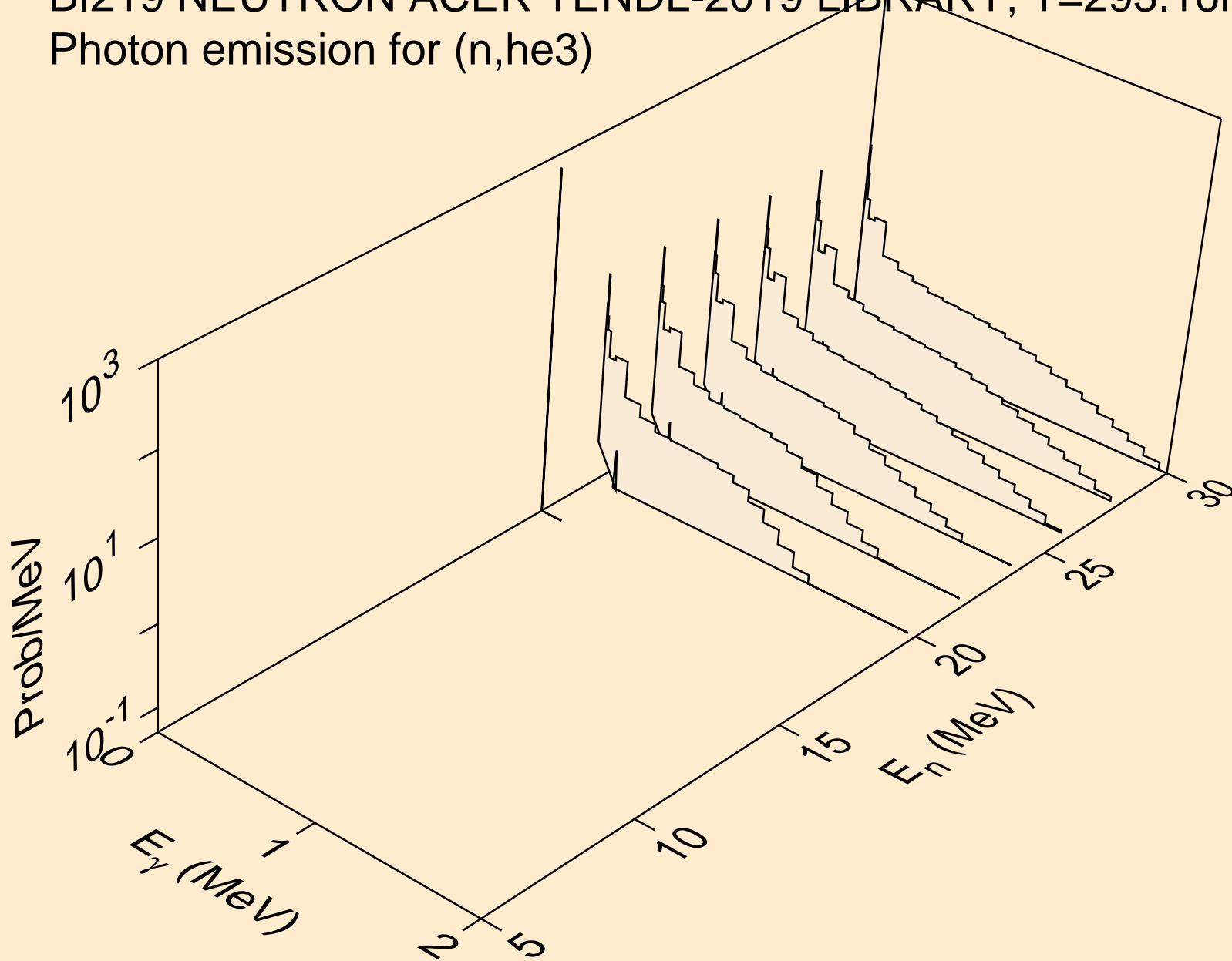

BI219 NEUTRON ACER TENDL-2019 LIBRARY; T=293.16K
Photon emission for (n,a)

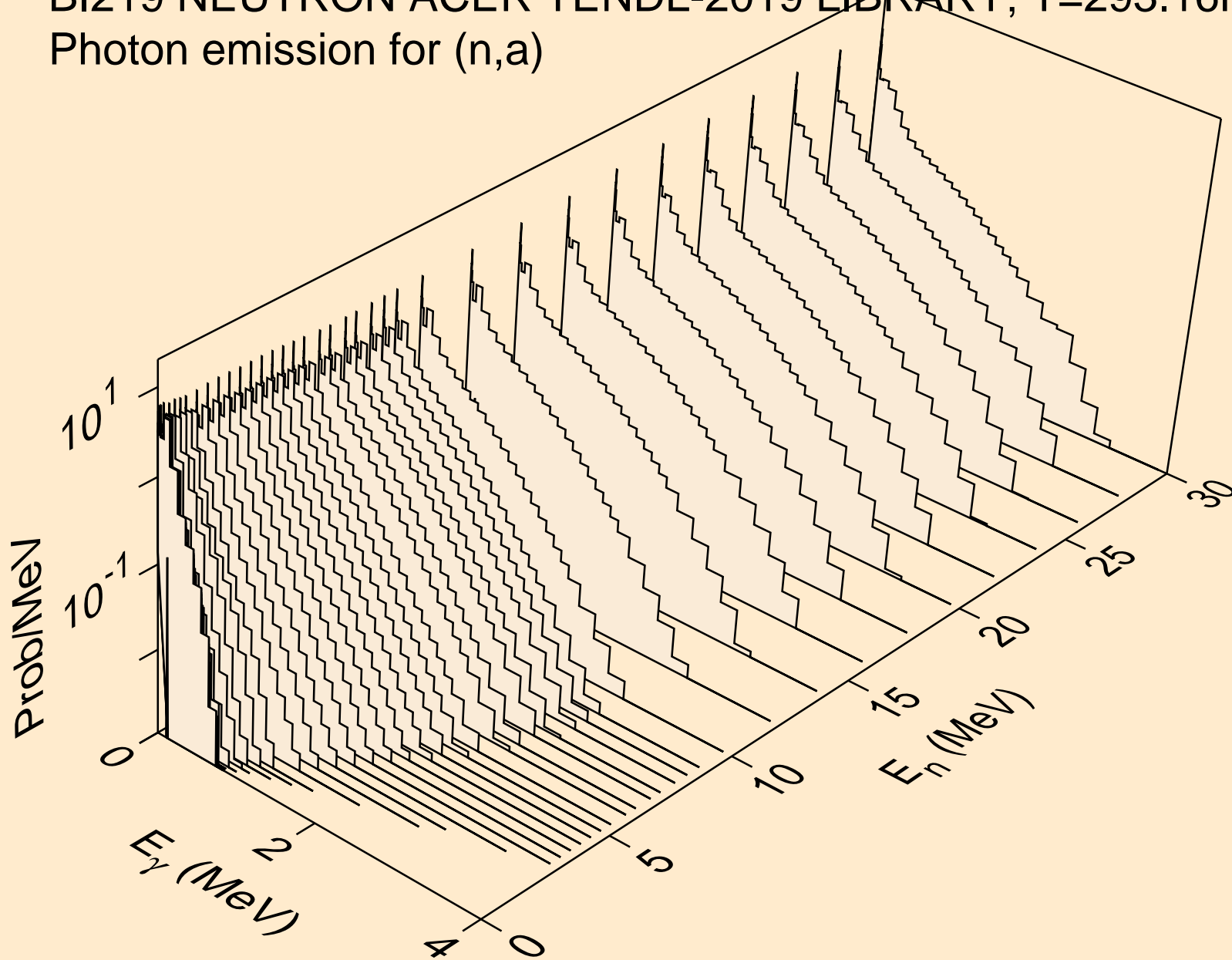

BI219 NEUTRON ACER TENDL-2019 LIBRARY; T=293.16K
thermal capture photon spectrum

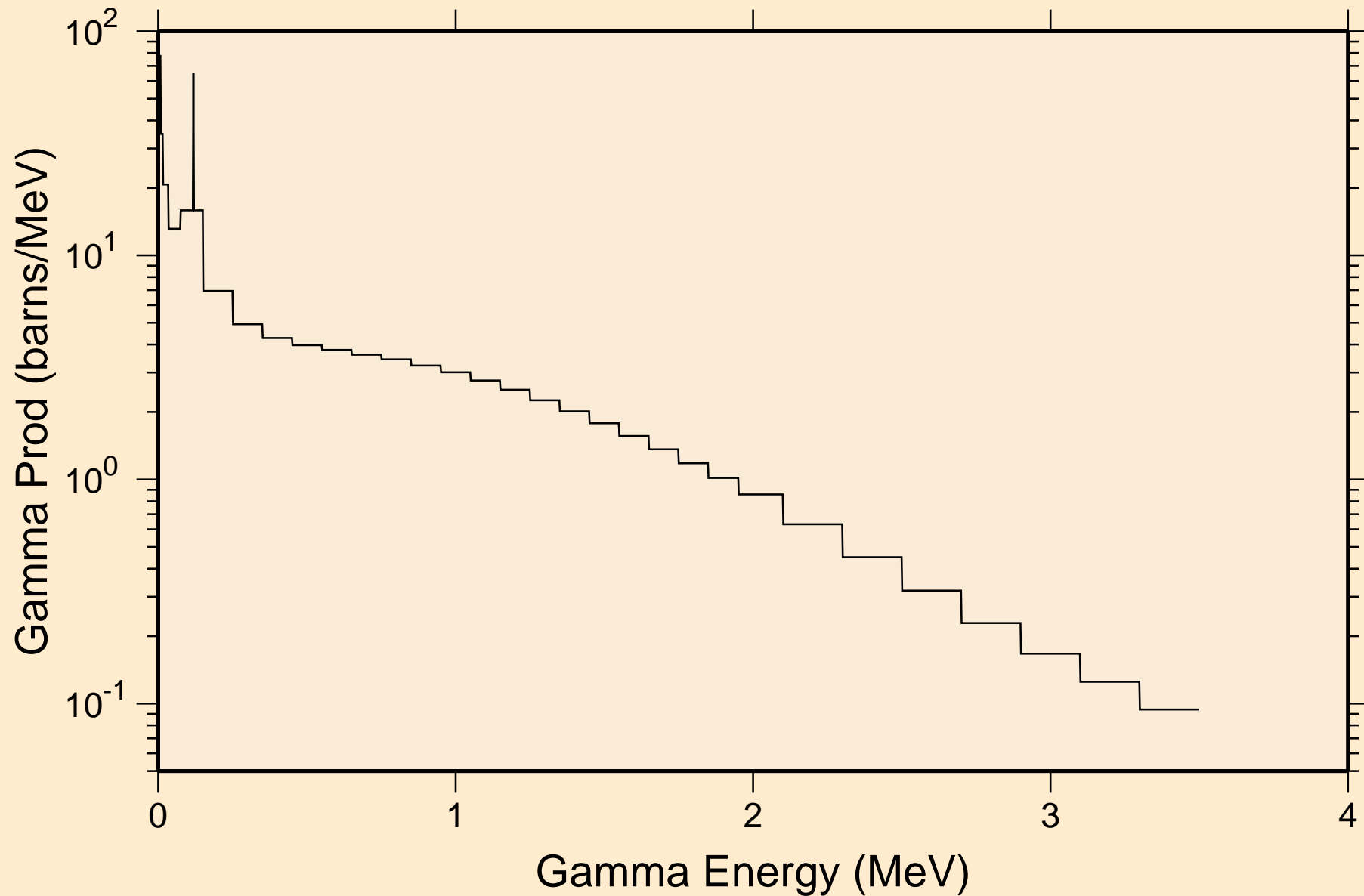

BI219 NEUTRON ACER TENDL-2019 LIBRARY; T=293.16K
14 MeV photon spectrum

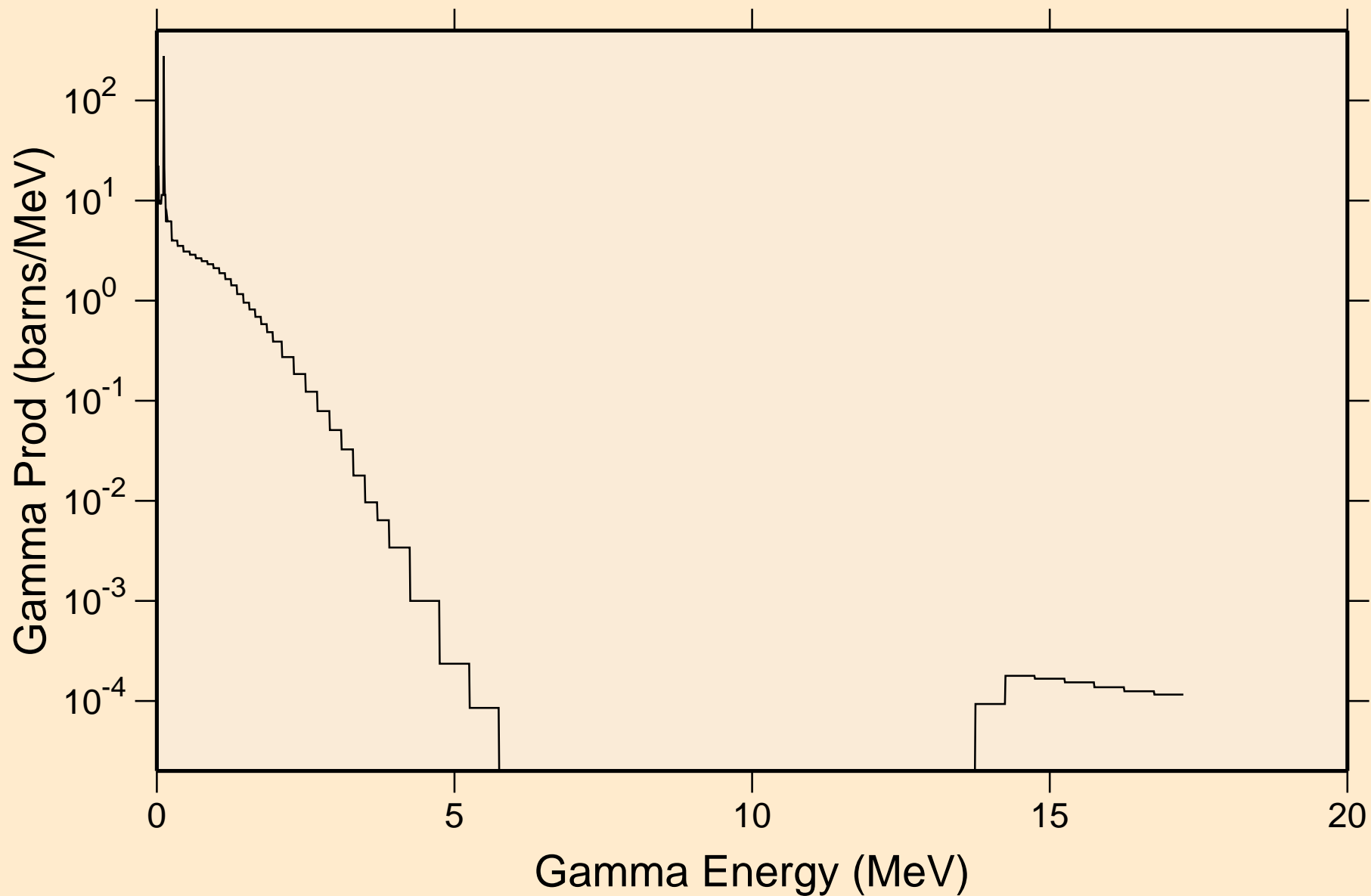

BI219 NEUTRON ACER TENDL-2019 LIBRARY; T=293.16K

Particle heating contributions

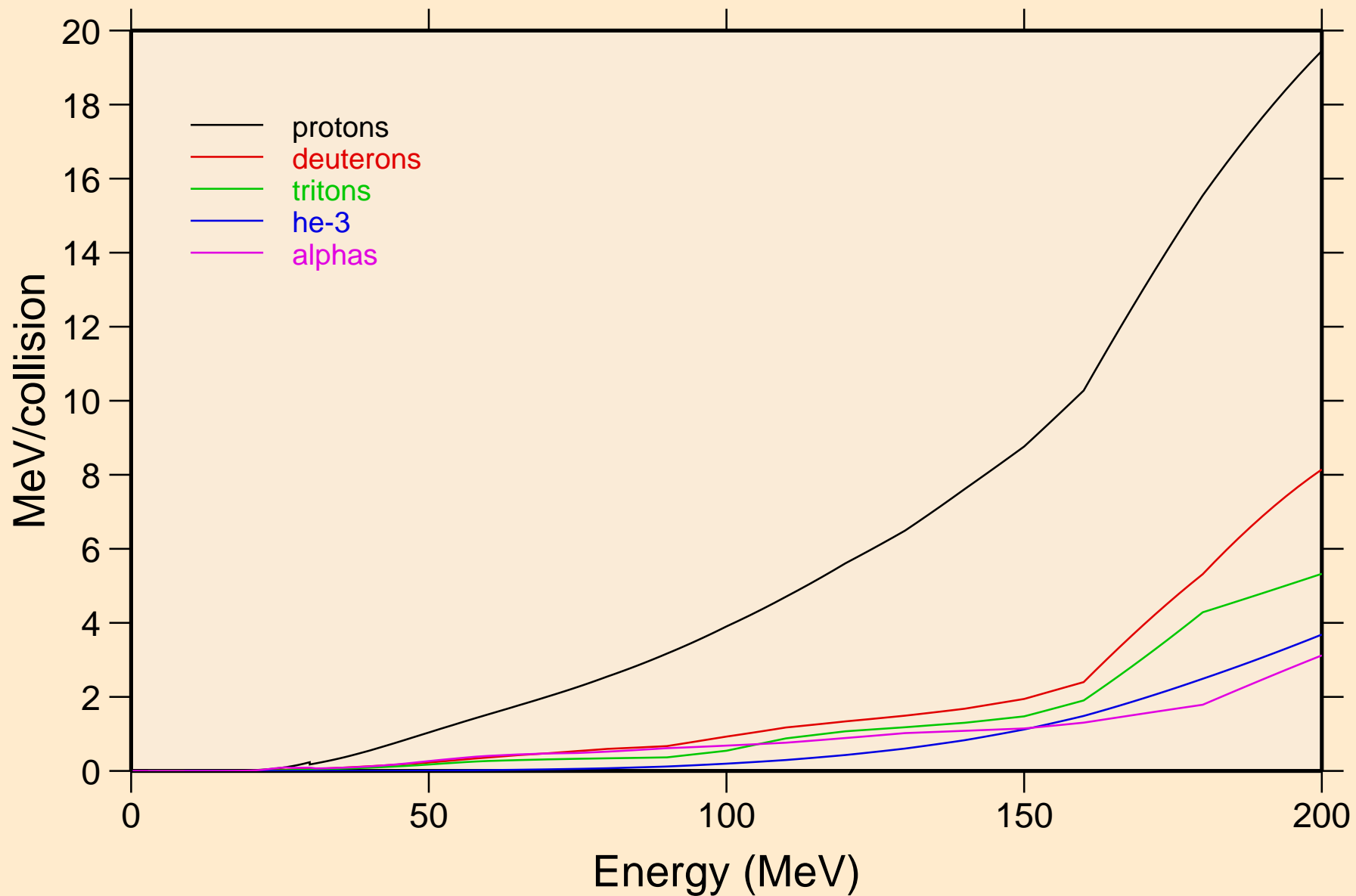

BI219 NEUTRON ACER TENDL-2019 LIBRARY; T=293.16K
Recoil Heating

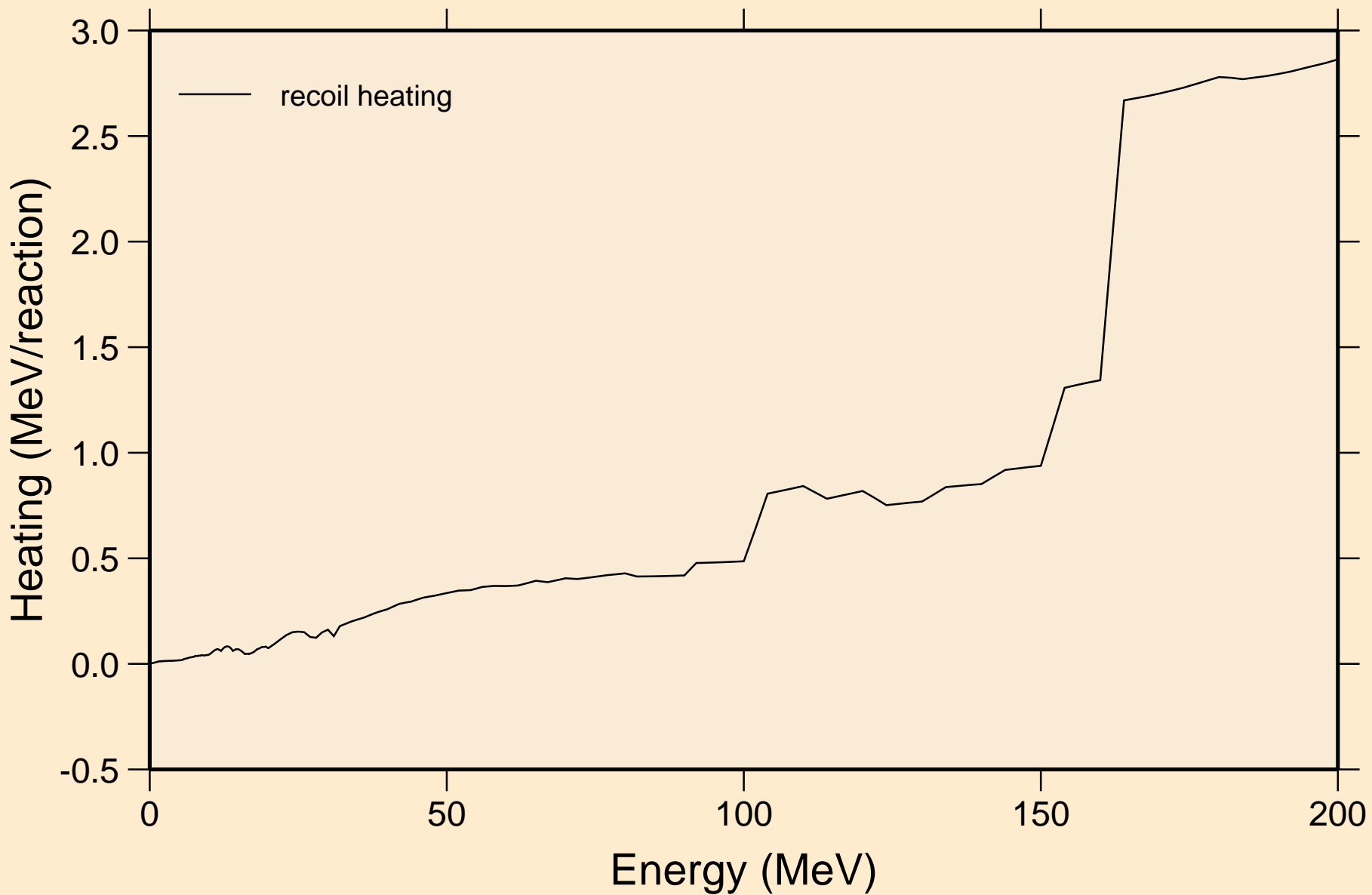

BI219 NEUTRON ACER TENDL-2019 LIBRARY; T=293.16K
Particle production cross sections

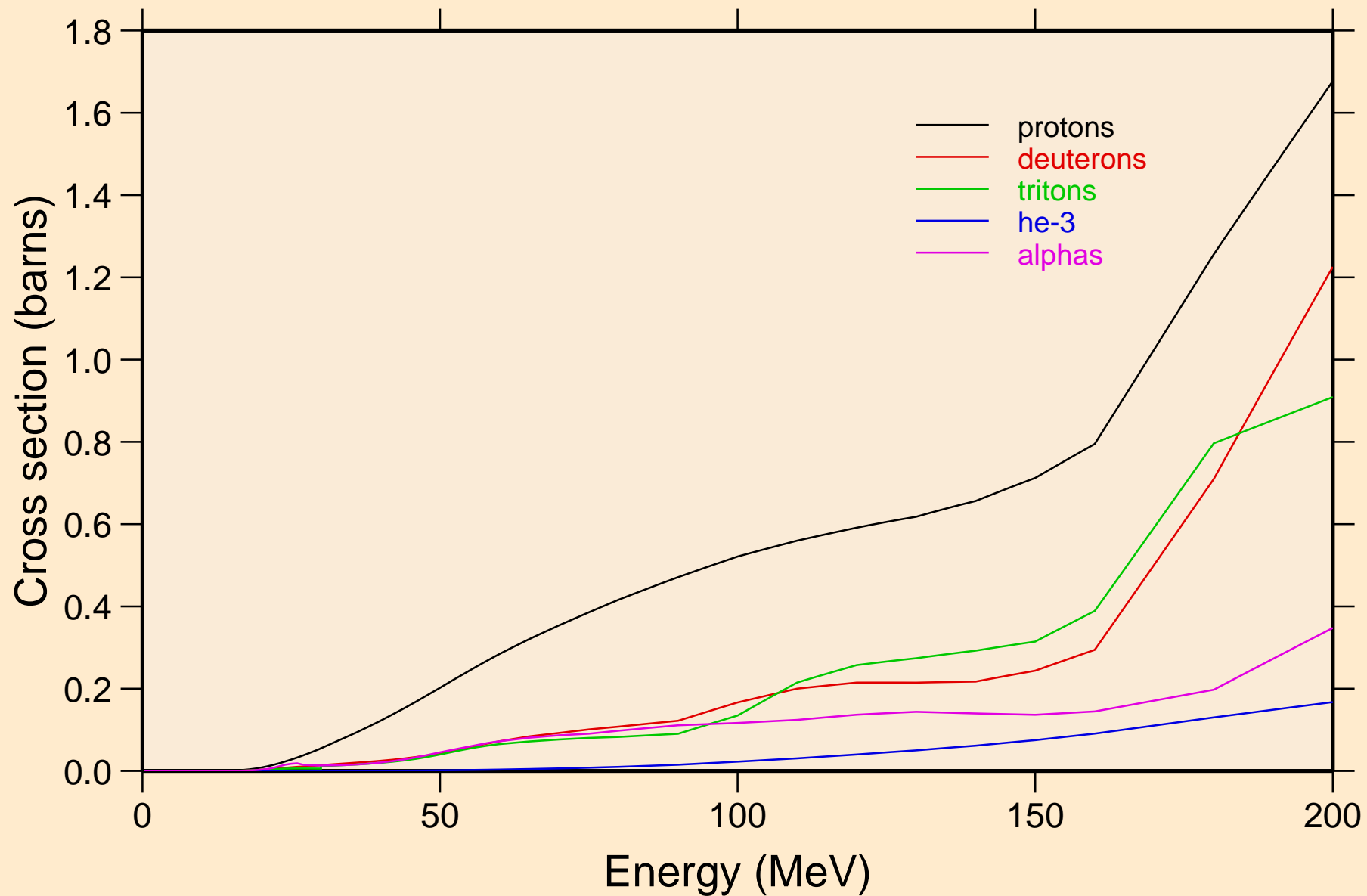

BI219 NEUTRON ACER TENDL-2019 LIBRARY; T=293.16K
protons from (n,x)

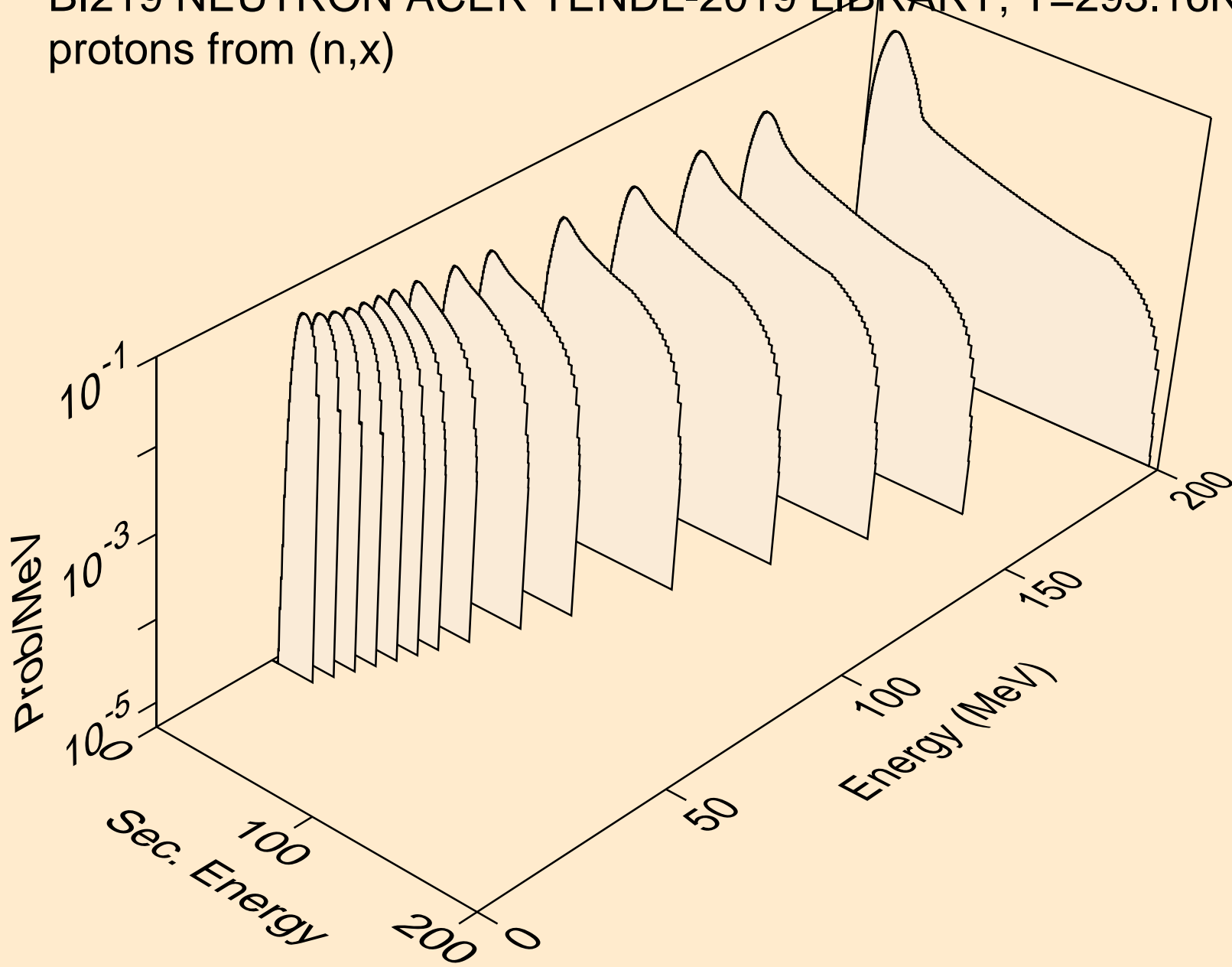

BI219 NEUTRON ACER TENDL-2019 LIBRARY; T=293.16K
protons from (n,n*)p

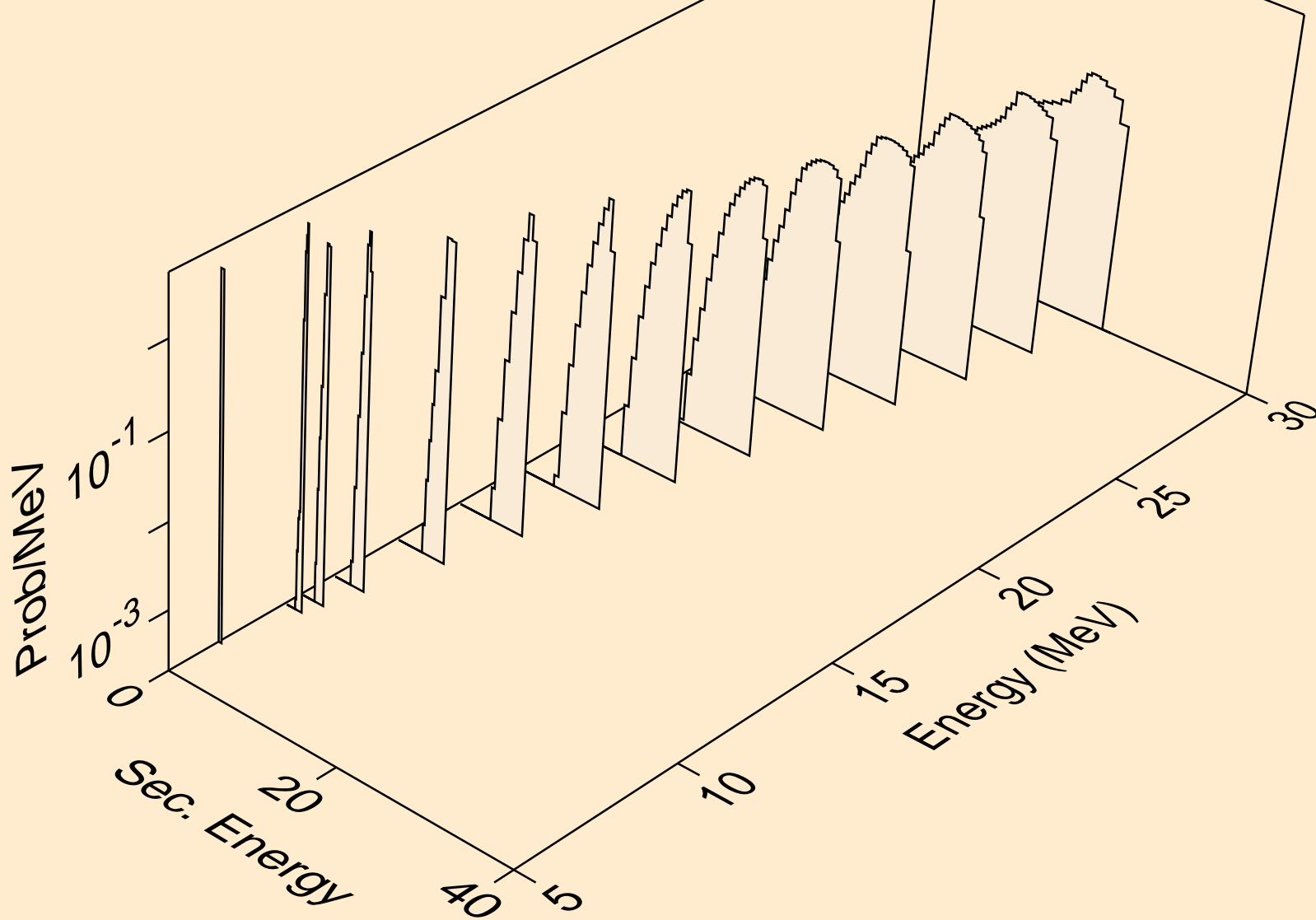

BI219 NEUTRON ACER TENDL-2019 LIBRARY; T=293.16K
protons from (n,2np)

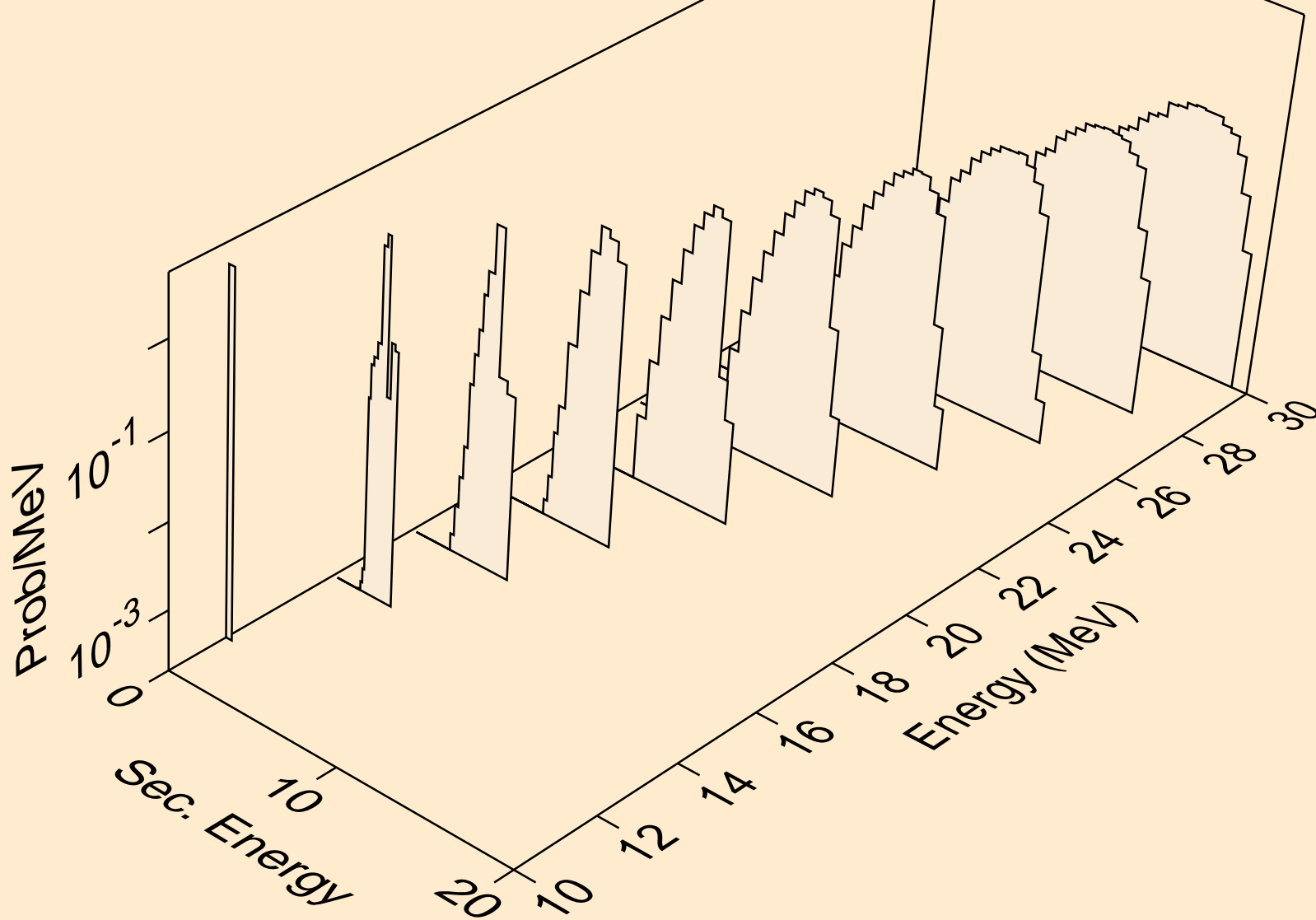

BI219 NEUTRON ACER TENDL-2019 LIBRARY; T=293.16K
protons from (n,3np)

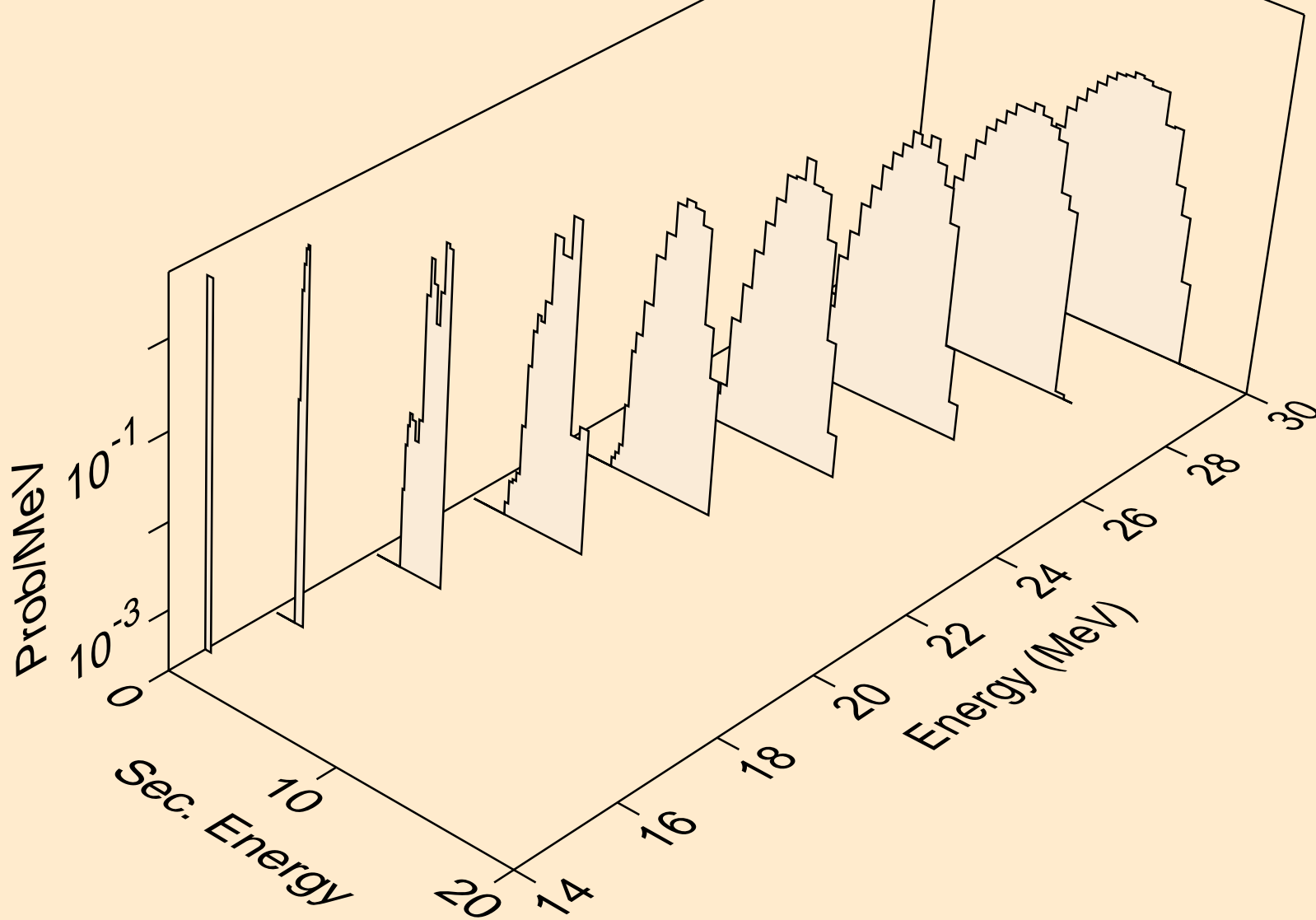

BI219 NEUTRON ACER TENDL-2019 LIBRARY; T=293.16K
protons from (n,p)

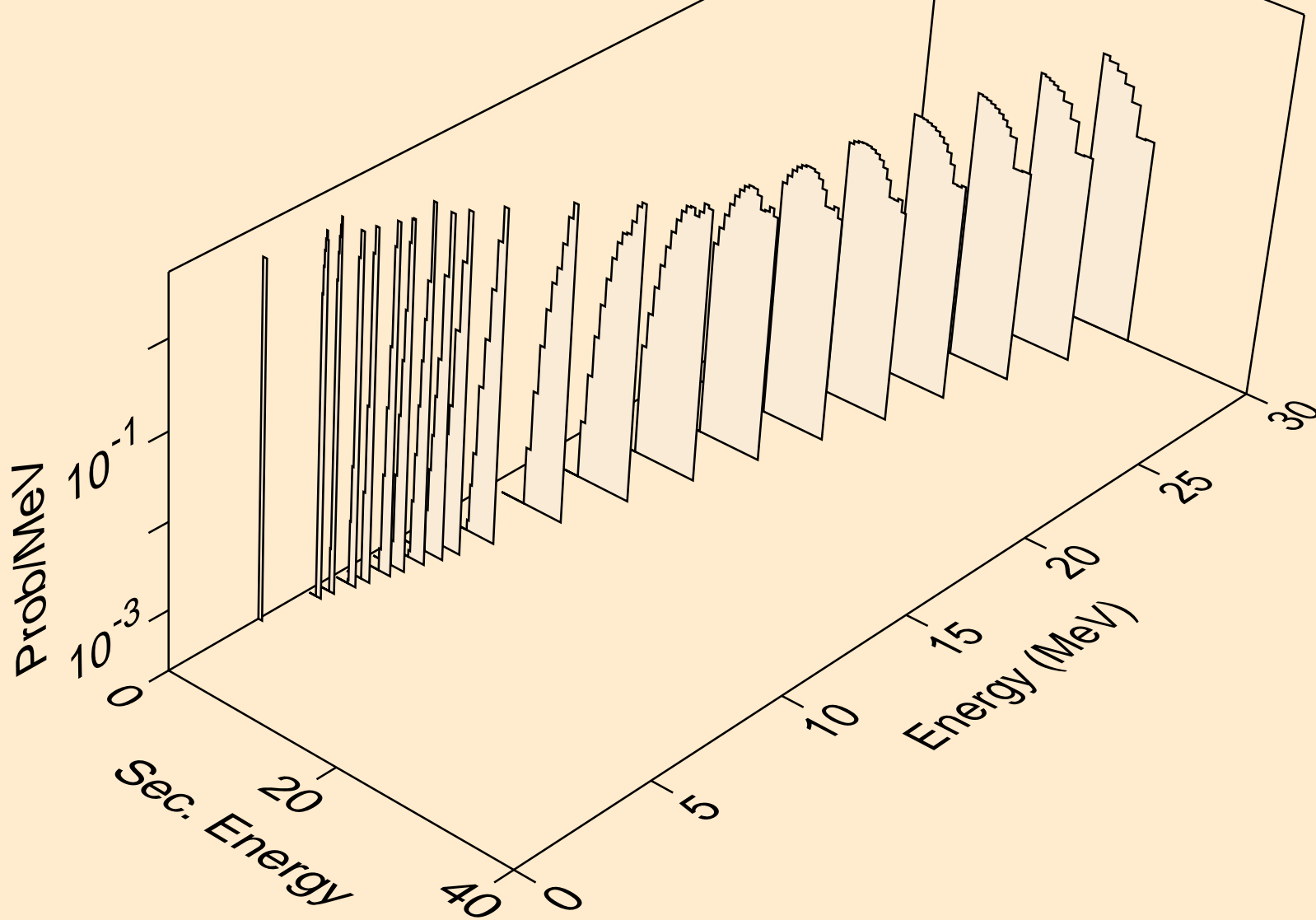

BI219 NEUTRON ACER TENDL-2019 LIBRARY; T=293.16K
deuterons from (n,x)

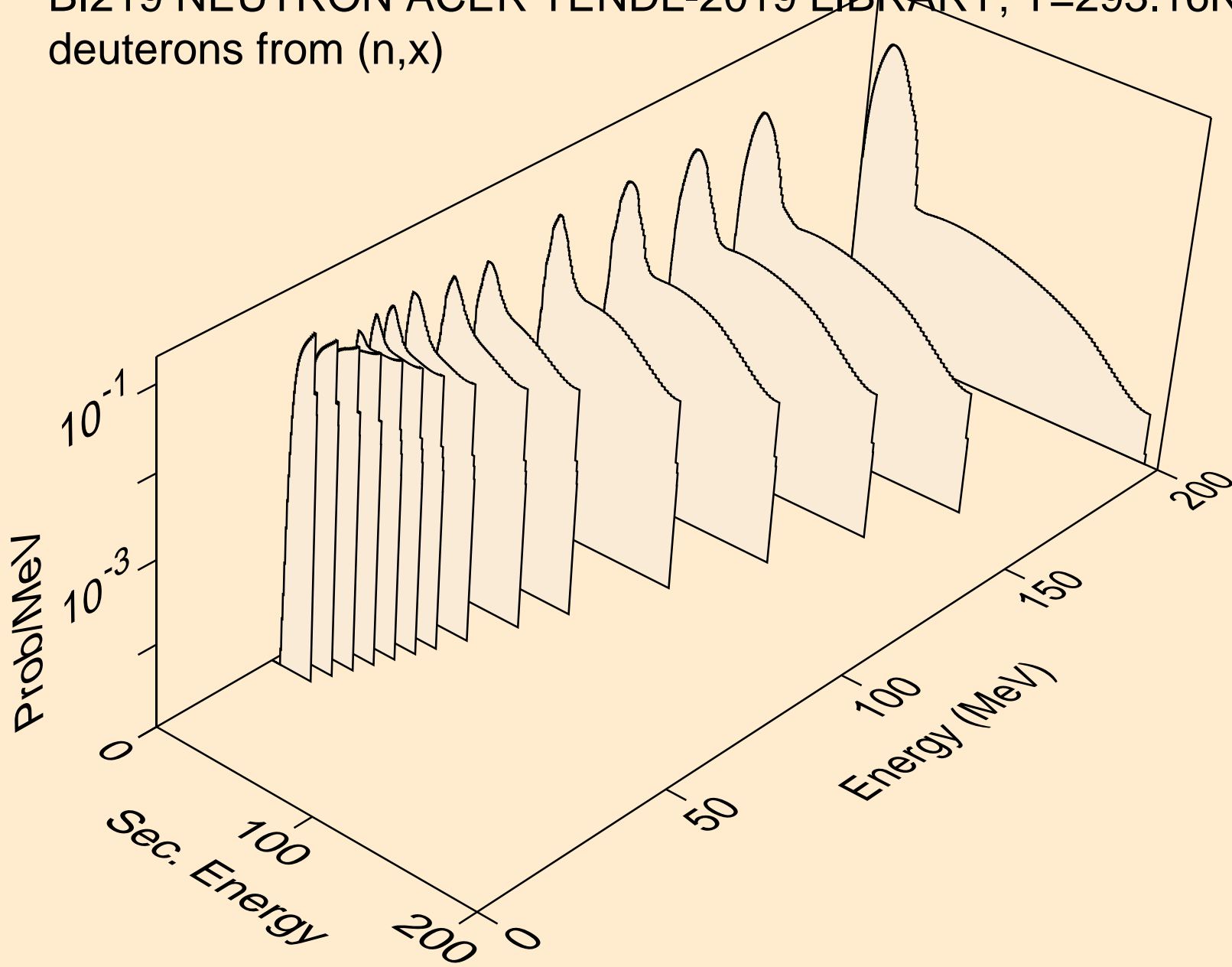

BI219 NEUTRON ACER TENDL-2019 LIBRARY; T=293.16K
deuterons from (n,2nd)

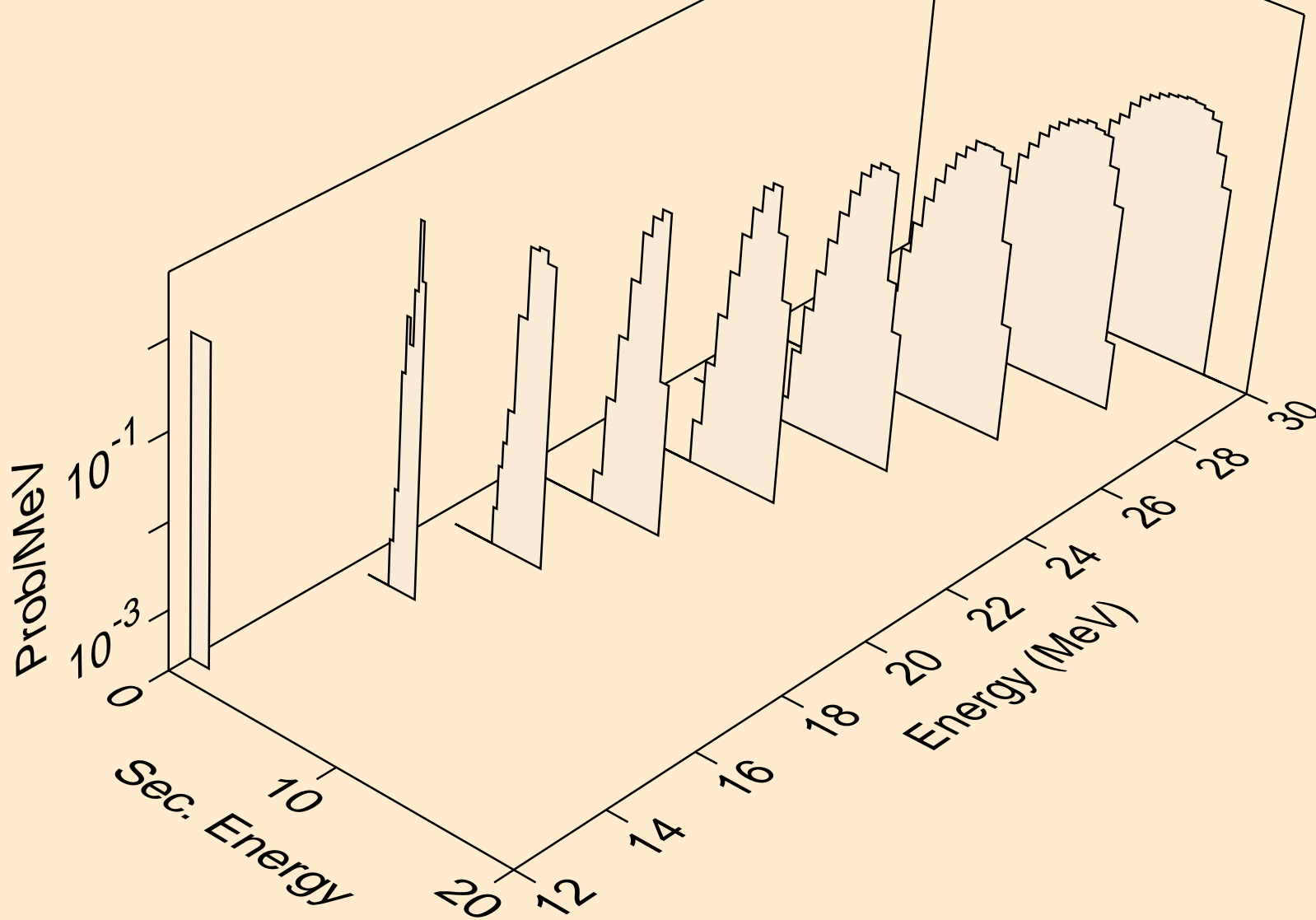

BI219 NEUTRON ACER TENDL-2019 LIBRARY; T=293.16K
deuterons from (n,n*)d

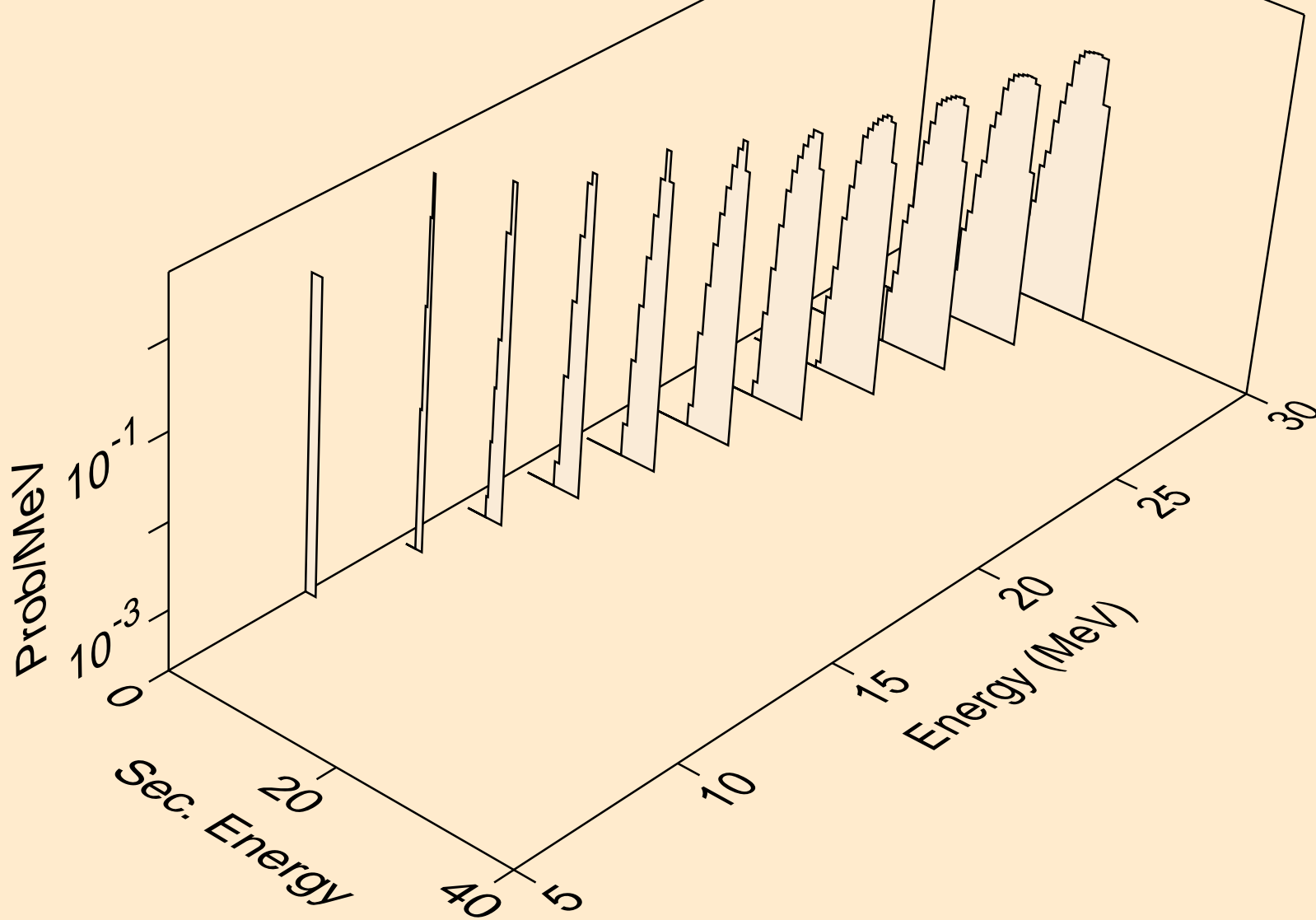

BI219 NEUTRON ACER TENDL-2019 LIBRARY; T=293.16K
deuterons from (n,d)

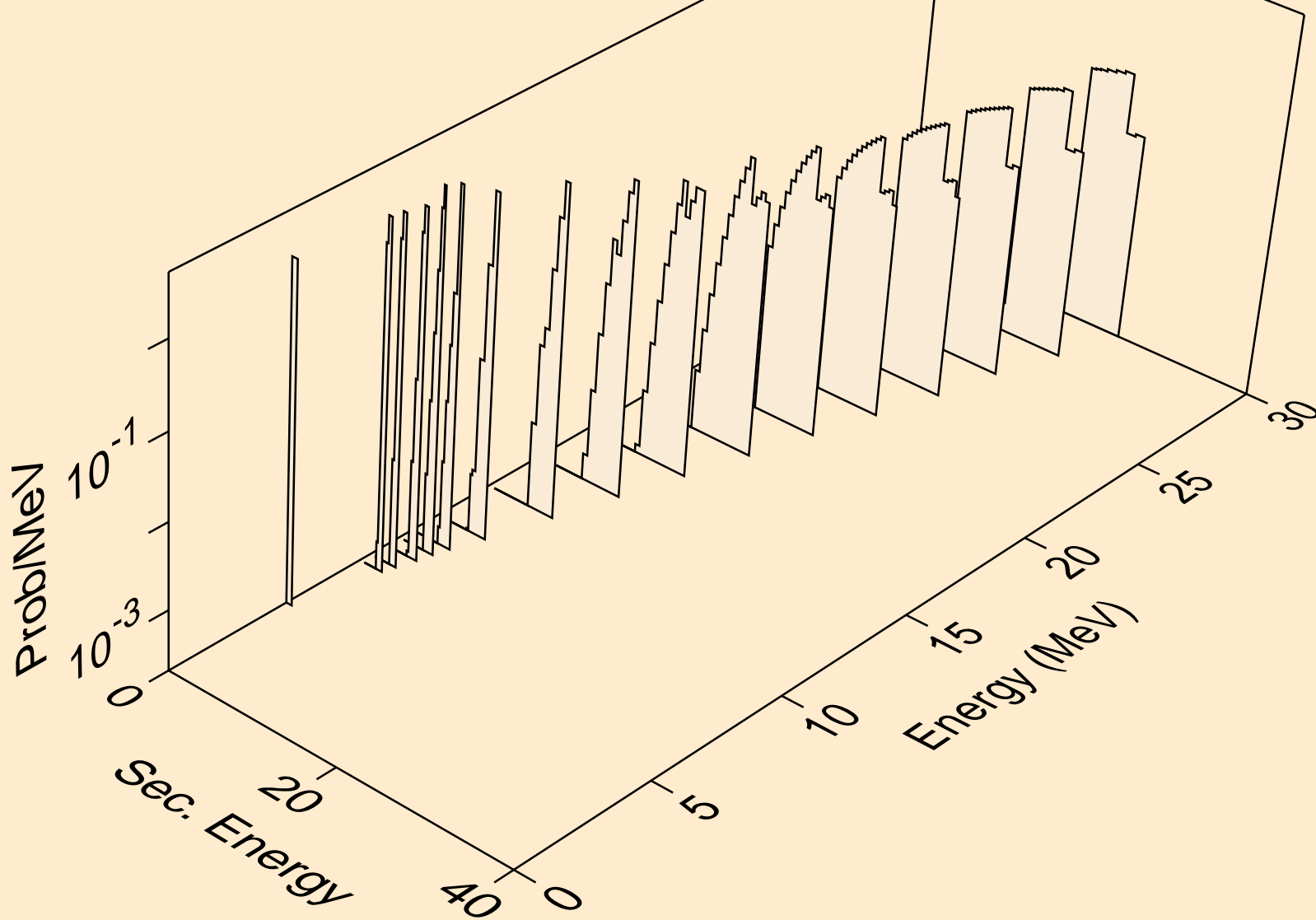

BI219 NEUTRON ACER TENDL-2019 LIBRARY; T=293.16K
tritons from (n,x)

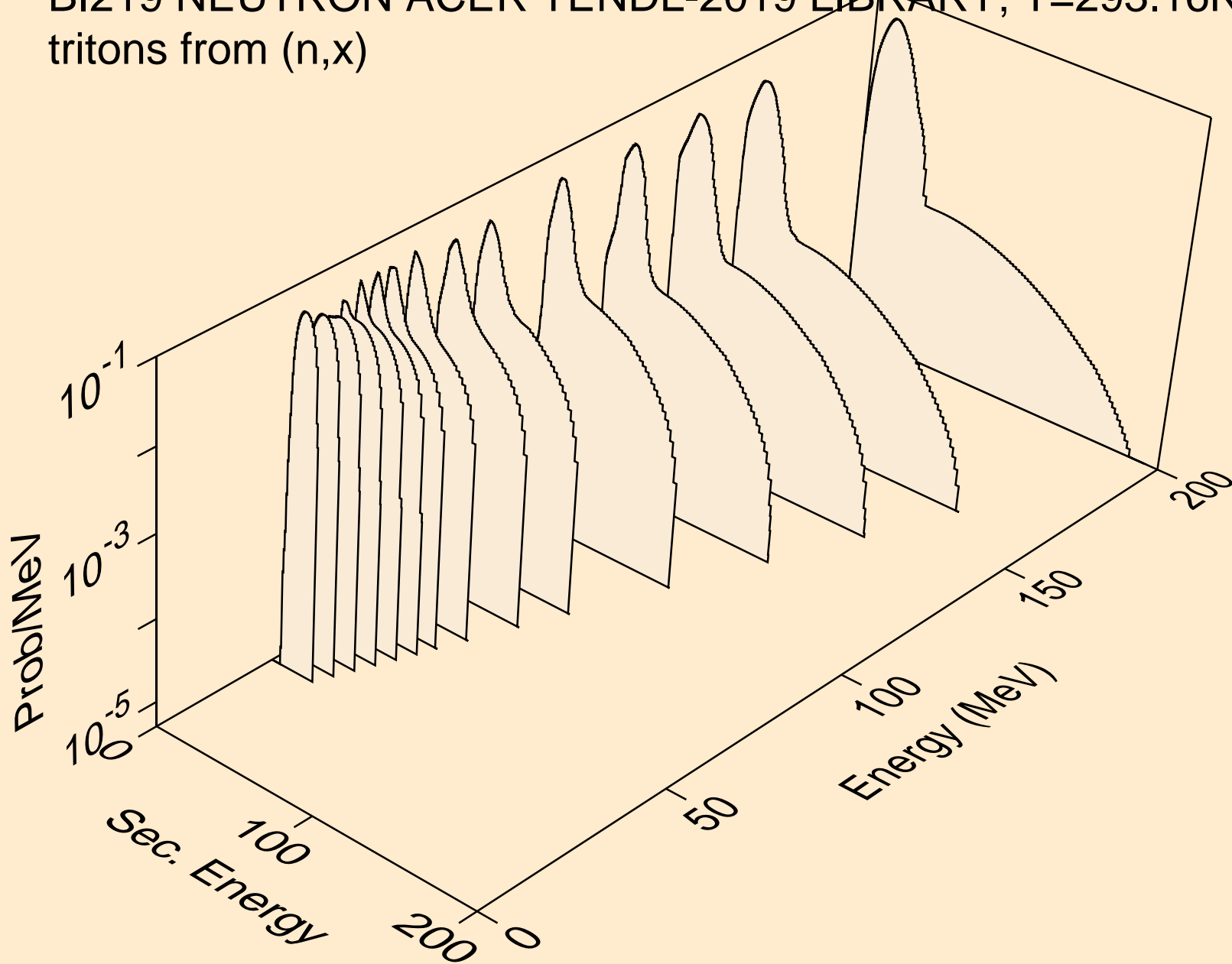

BI219 NEUTRON ACER TENDL-2019 LIBRARY; T=293.16K
tritons from (n,n*)t

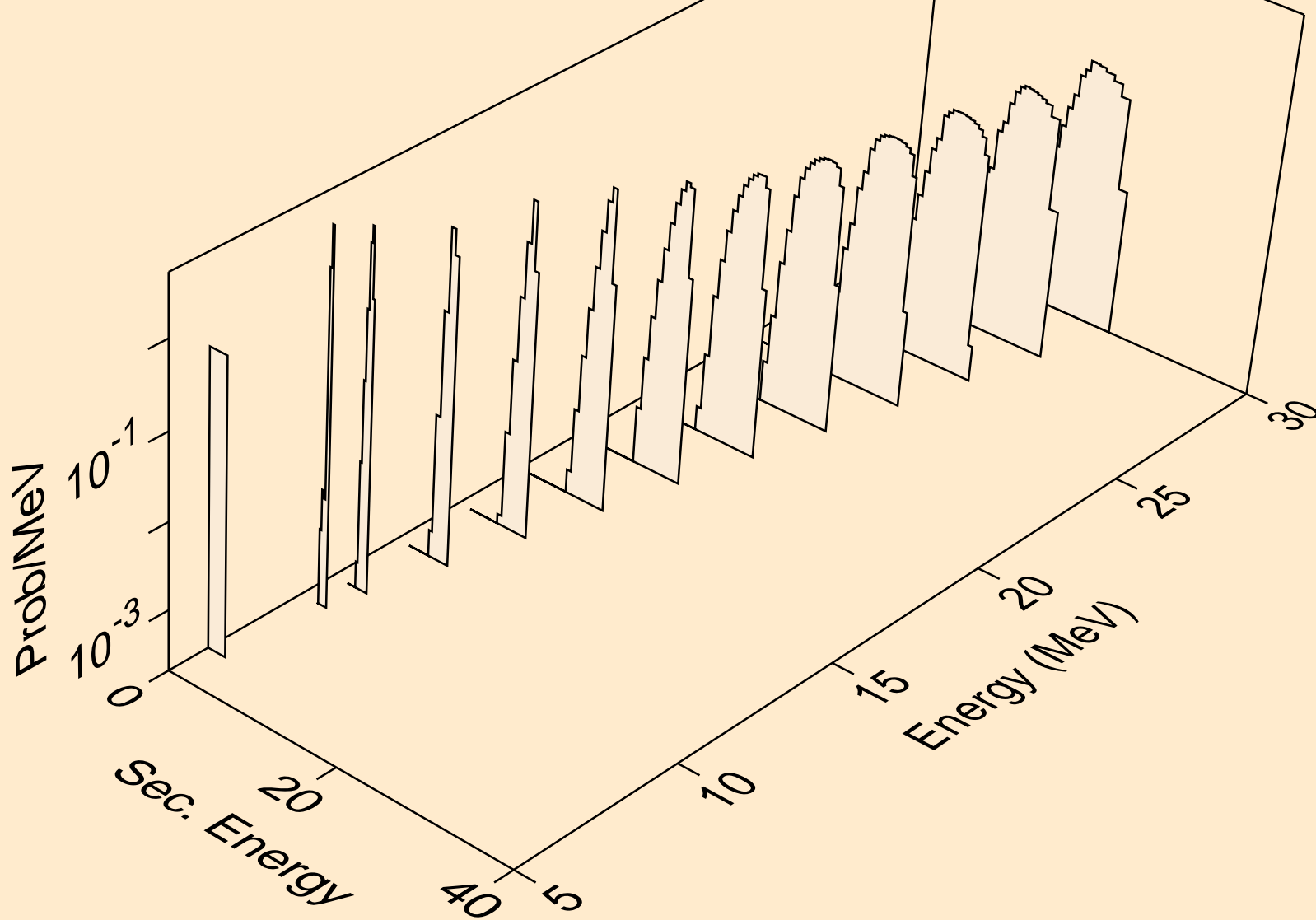

BI219 NEUTRON ACER TENDL-2019 LIBRARY; T=293.16K
tritons from (n,t)

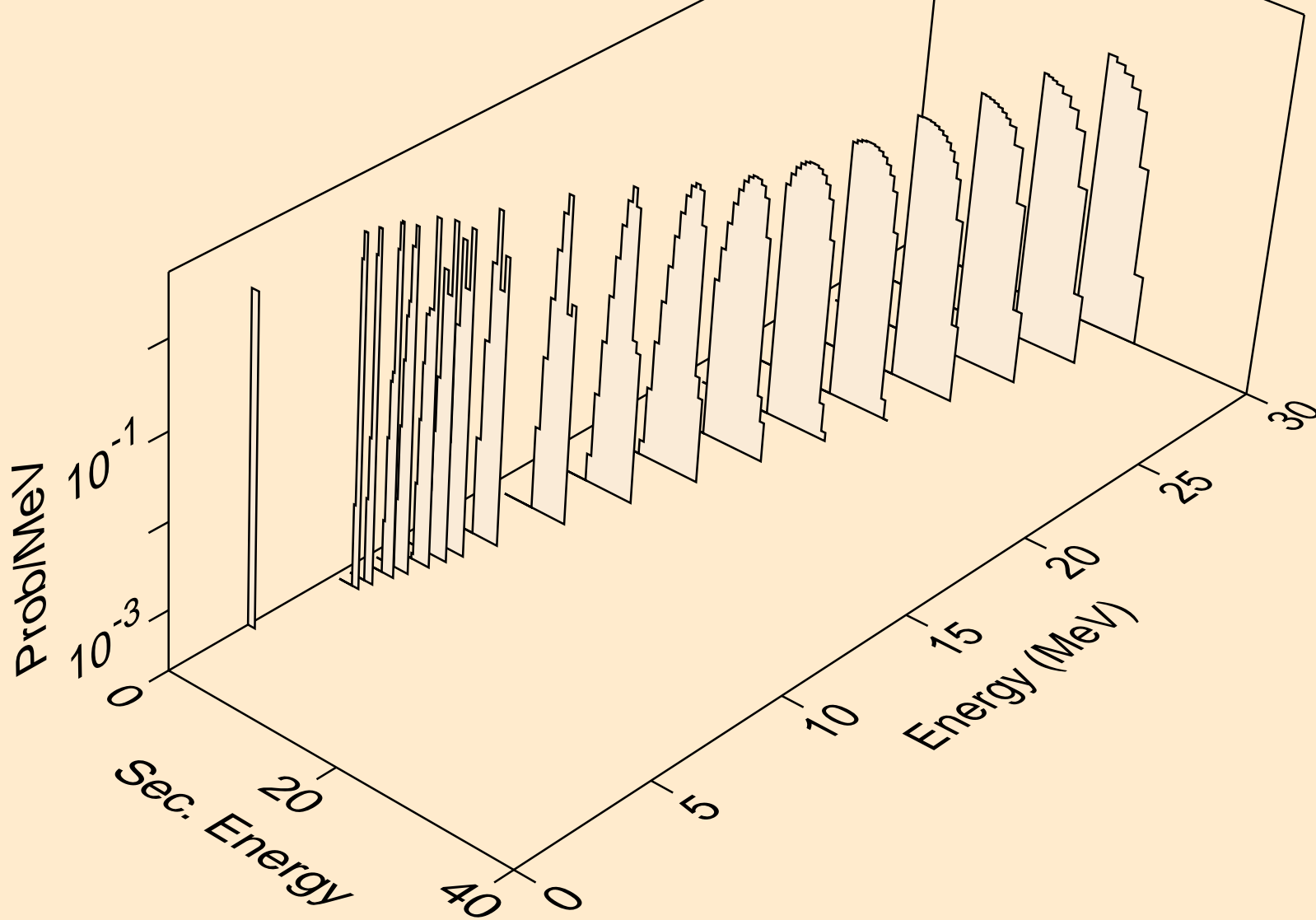

BI219 NEUTRON ACER TENDL-2019 LIBRARY; T=293.16K
he3s from (n,x)

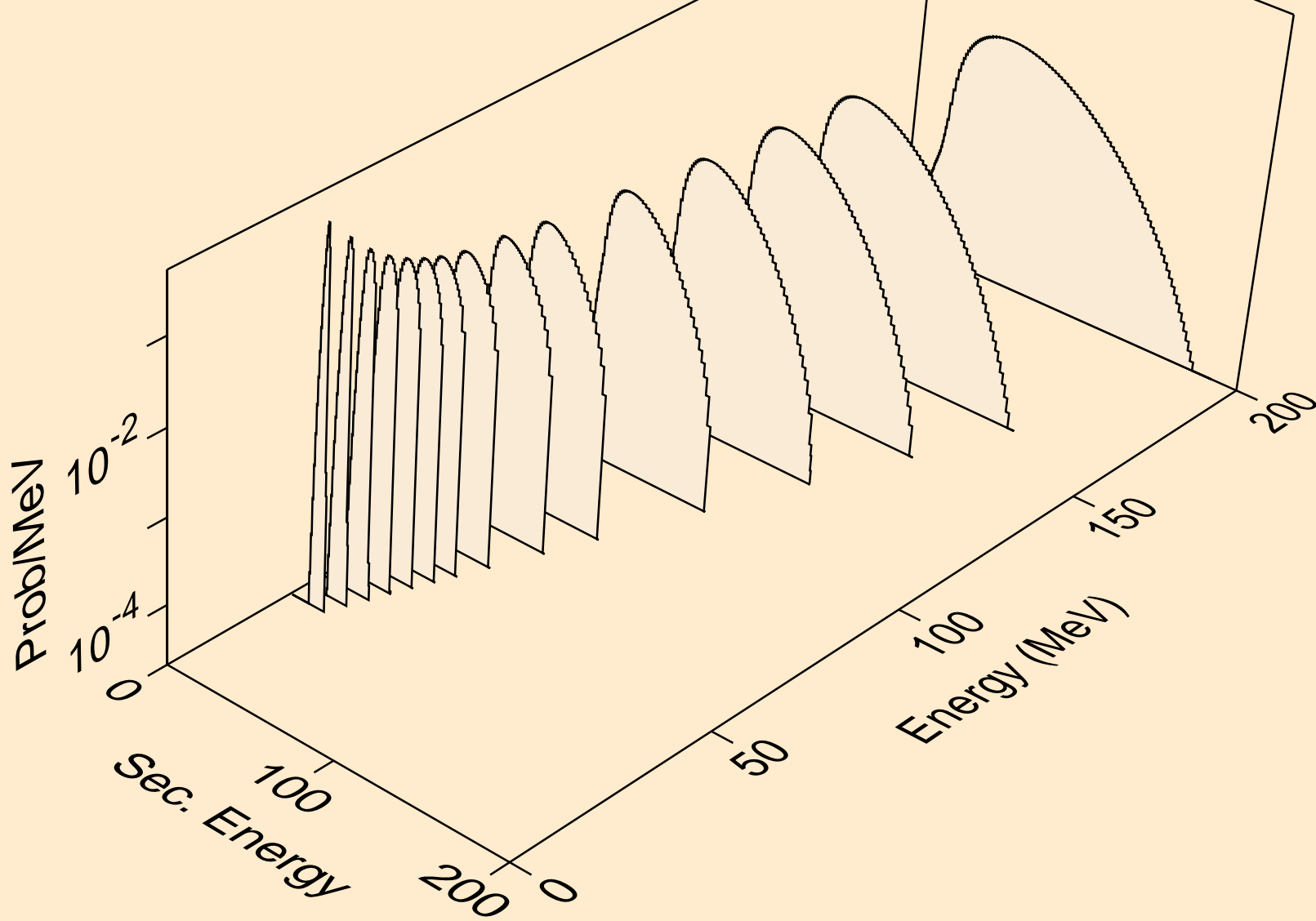

BI219 NEUTRON ACER TENDL-2019 LIBRARY; T=293.16K
he3s from (n,n*)he3

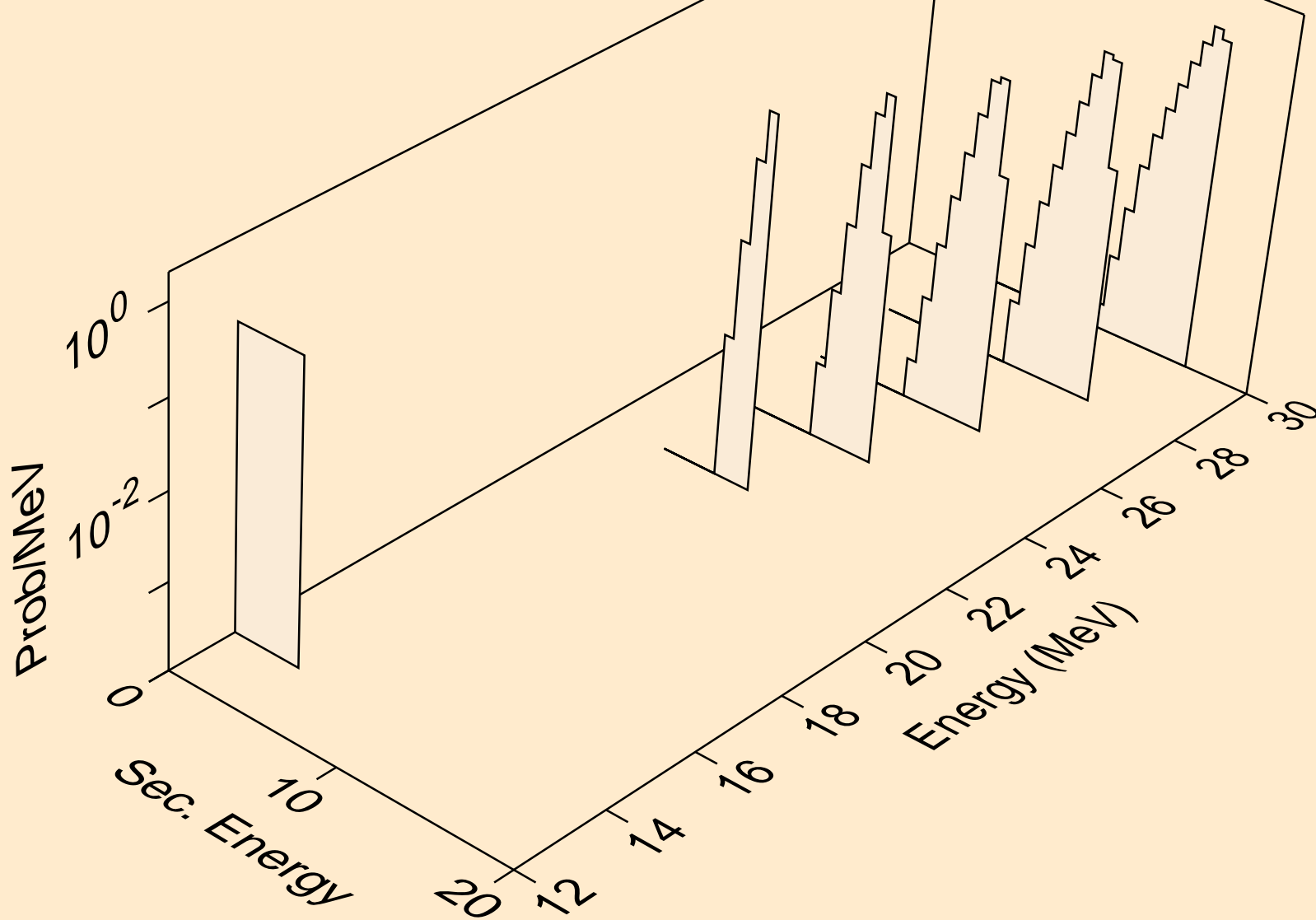

BI219 NEUTRON ACER TENDL-2019 LIBRARY; T=293.16K
he3s from (n,he3)

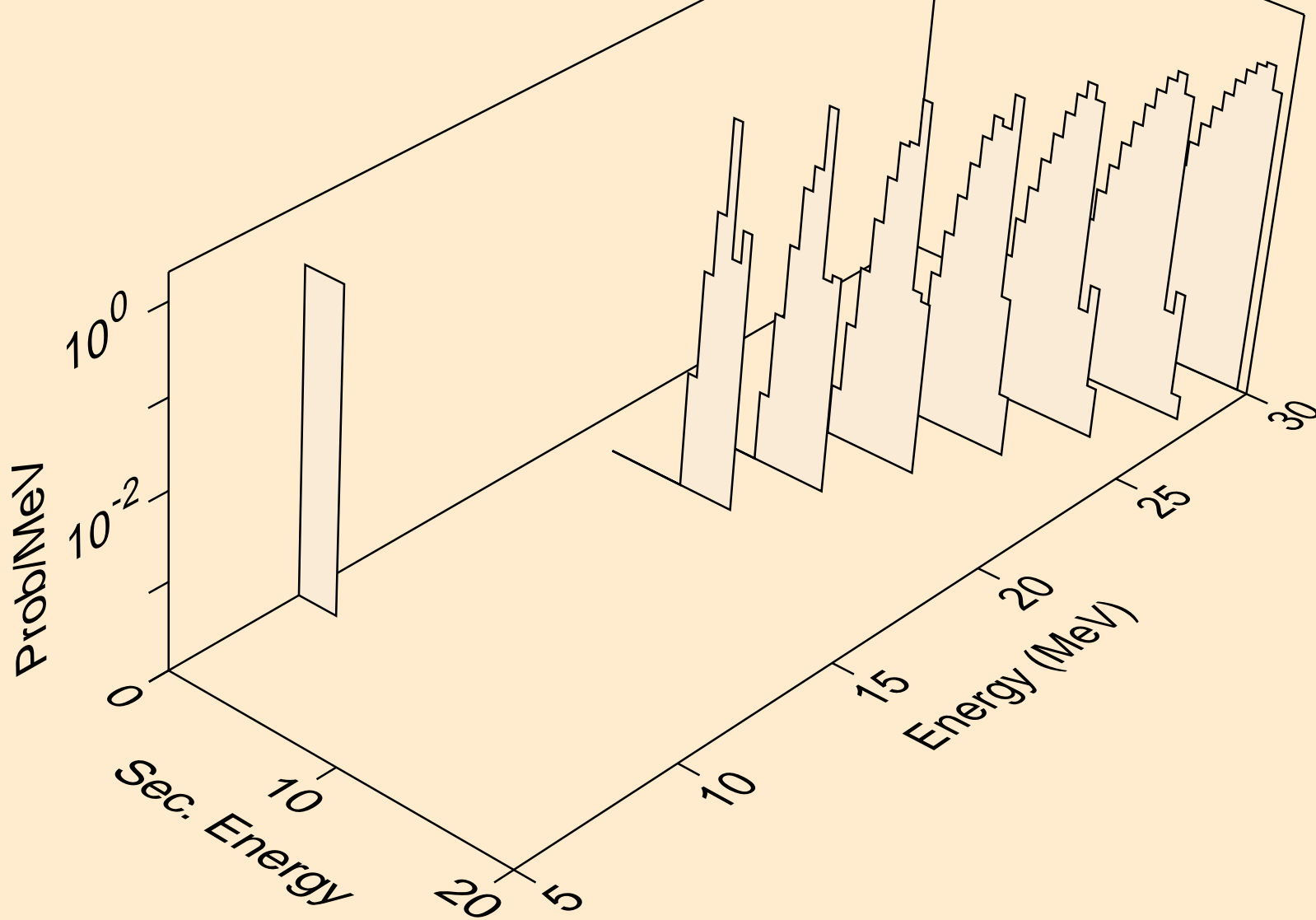

BI219 NEUTRON ACER TENDL-2019 LIBRARY; T=293.16K
alphas from (n,x)

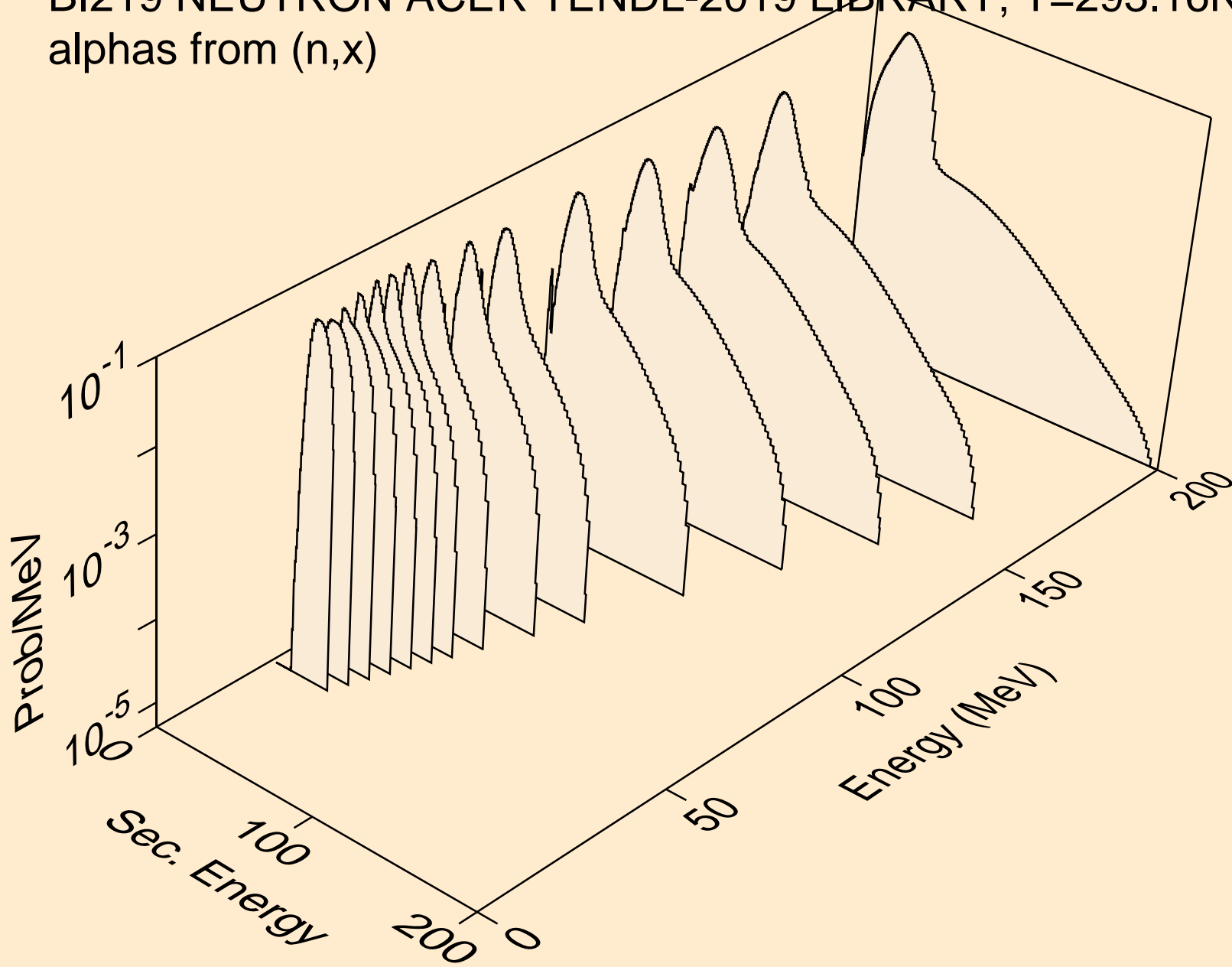

BI219 NEUTRON ACER TENDL-2019 LIBRARY; T=293.16K
alphas from (n,n*)a

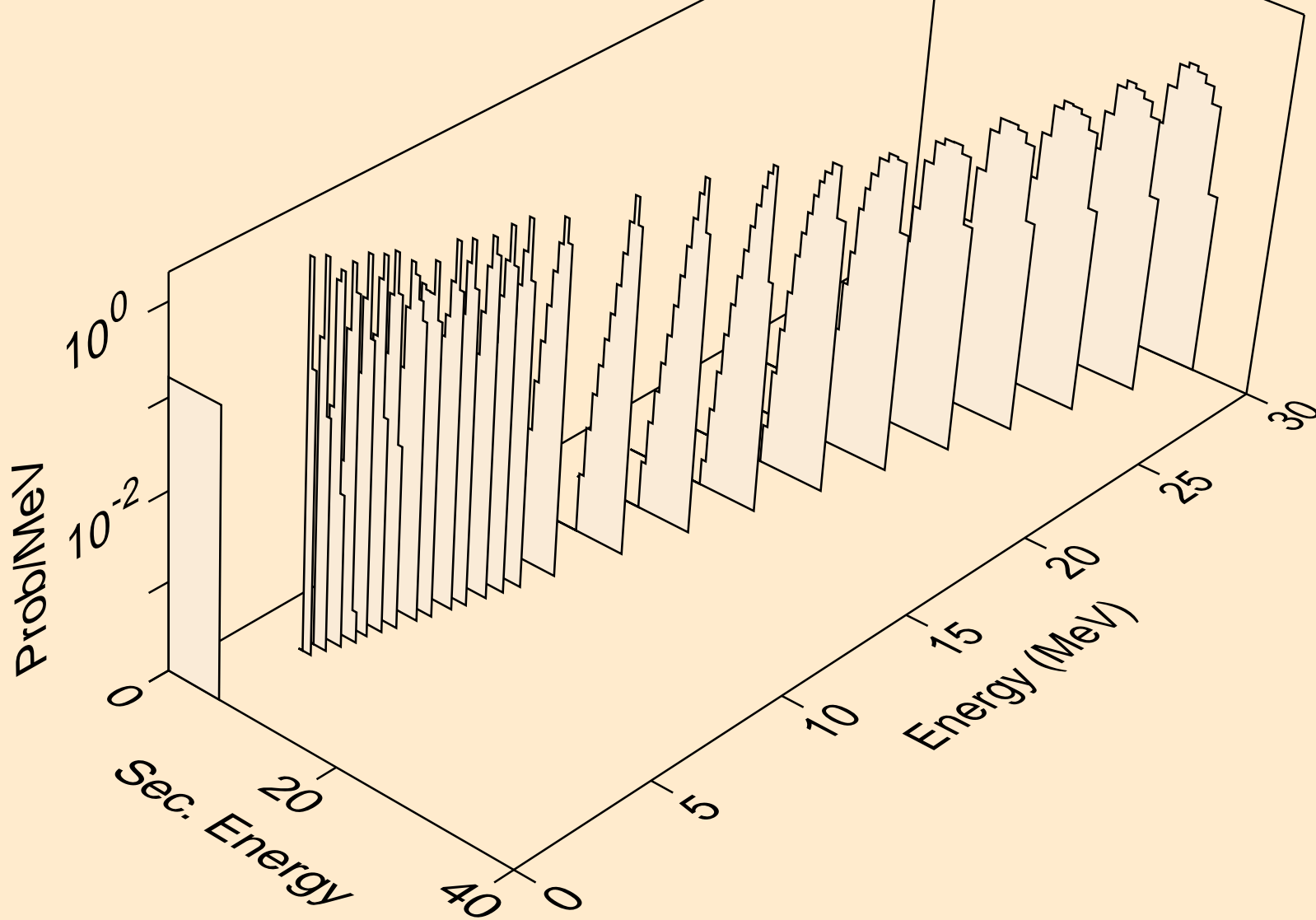

BI219 NEUTRON ACER TENDL-2019 LIBRARY; T=293.16K
alphas from (n,2n)a

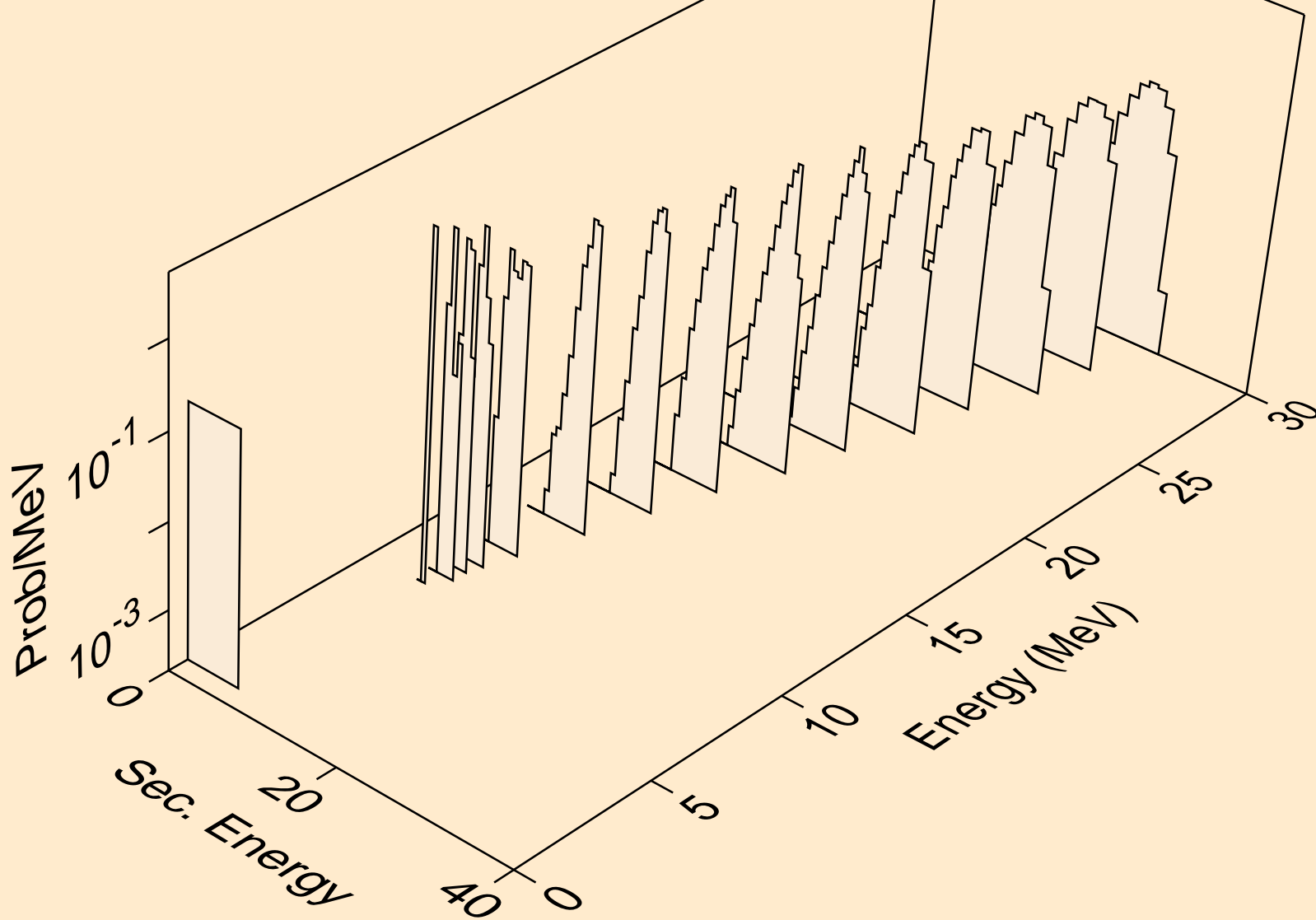

BI219 NEUTRON ACER TENDL-2019 LIBRARY; T=293.16K
alphas from (n,3n)a

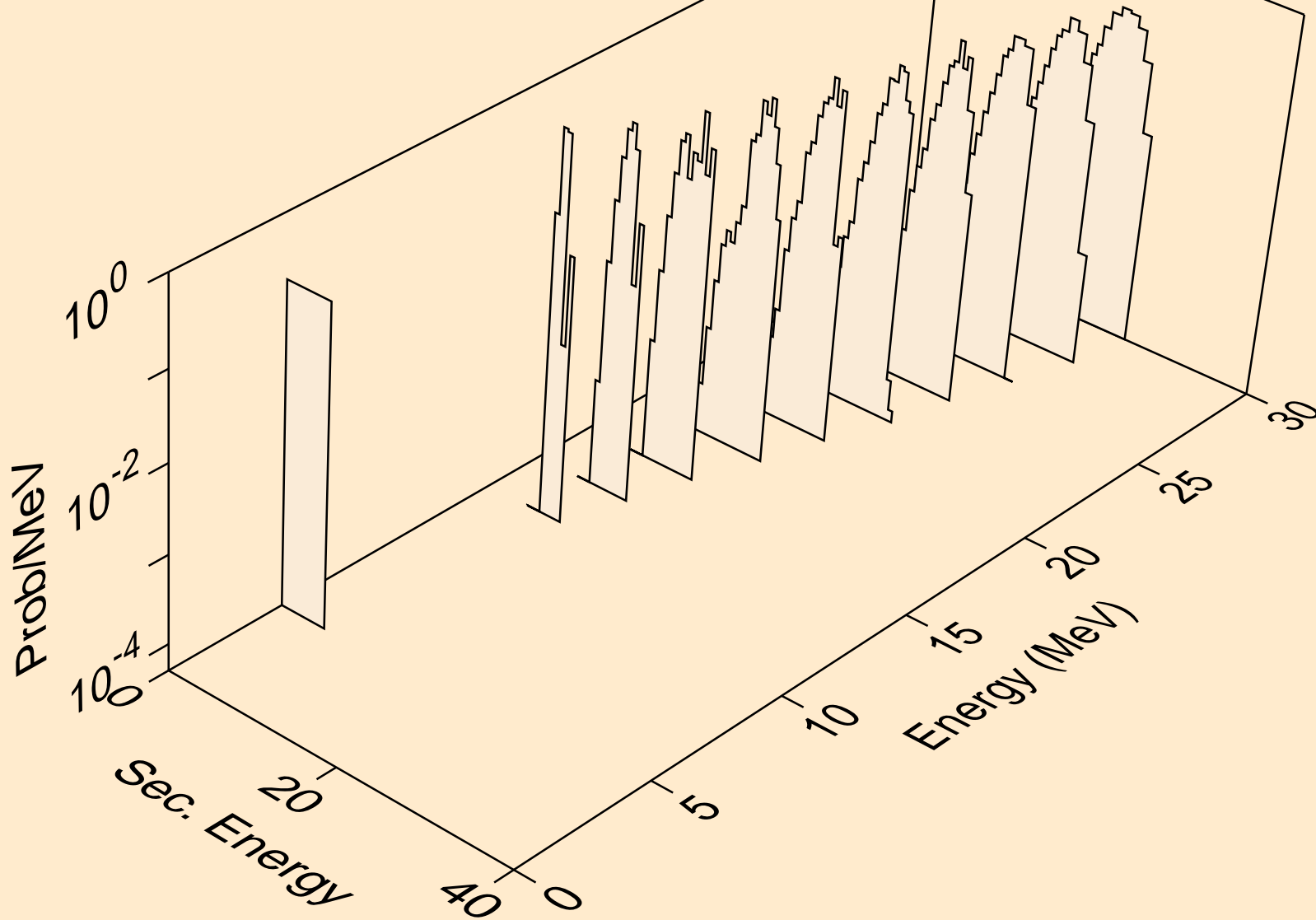

BI219 NEUTRON ACER TENDL-2019 LIBRARY; T=293.16K
alphas from (n,a)

