

BR087 NEUTRON ACER TENDL-2019 LIBRARY; T=293.16K
Principal cross sections

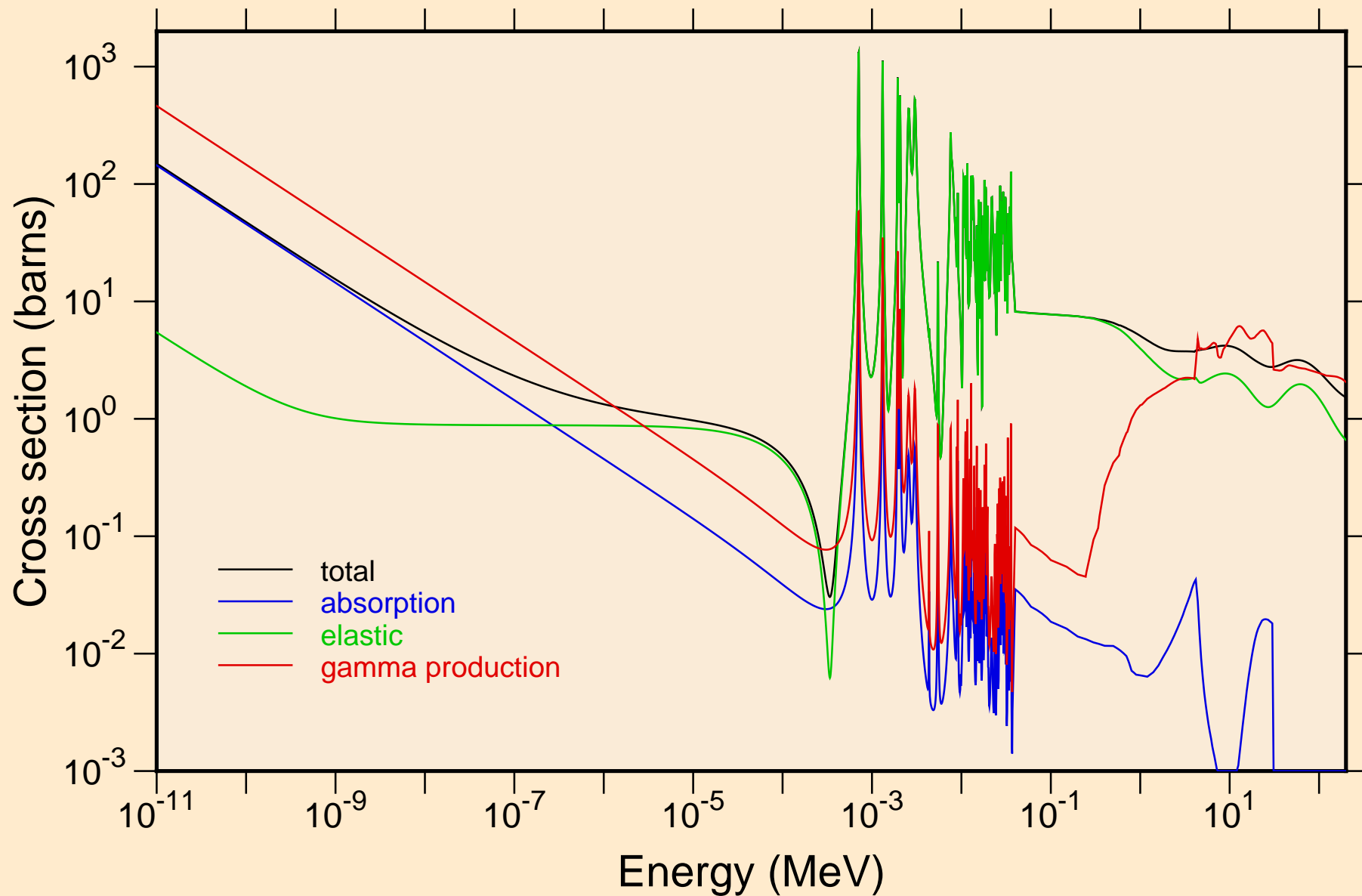

BR087 NEUTRON ACER TENDL-2019 LIBRARY; T=293.16K
resonance total cross section

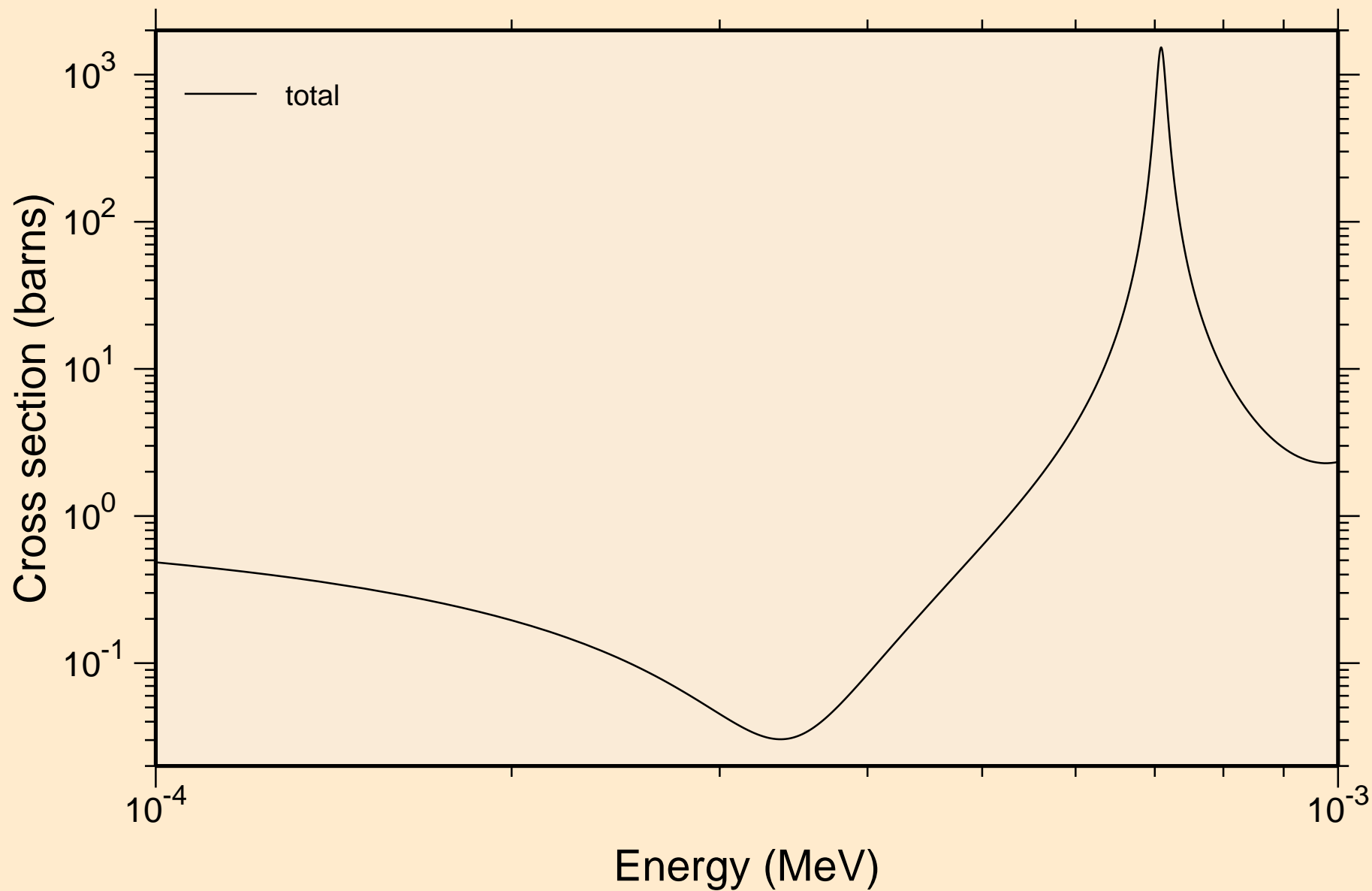

BR087 NEUTRON ACER TENDL-2019 LIBRARY; T=293.16K
resonance total cross section

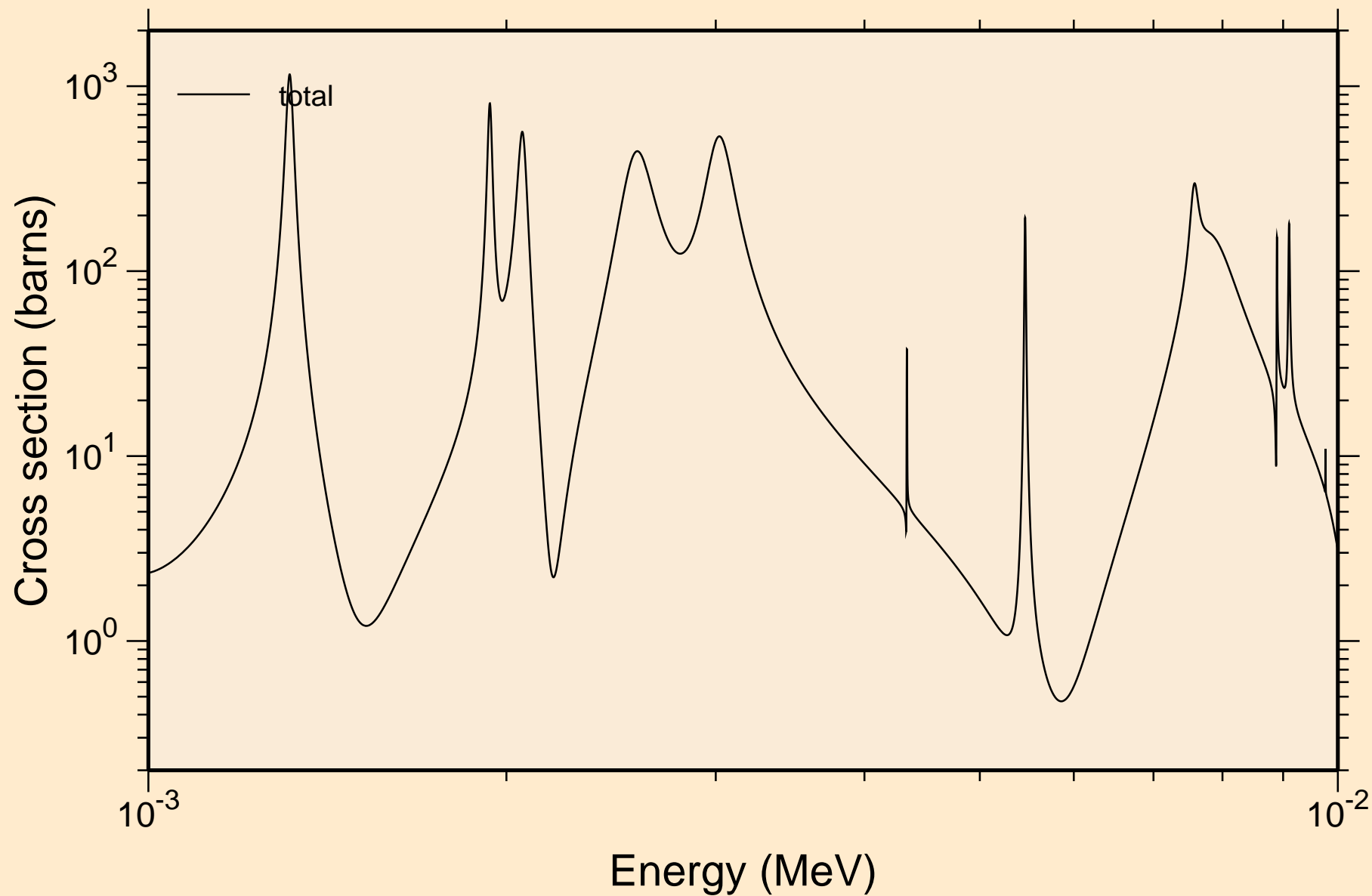

BR087 NEUTRON ACER TENDL-2019 LIBRARY; T=293.16K
resonance total cross section

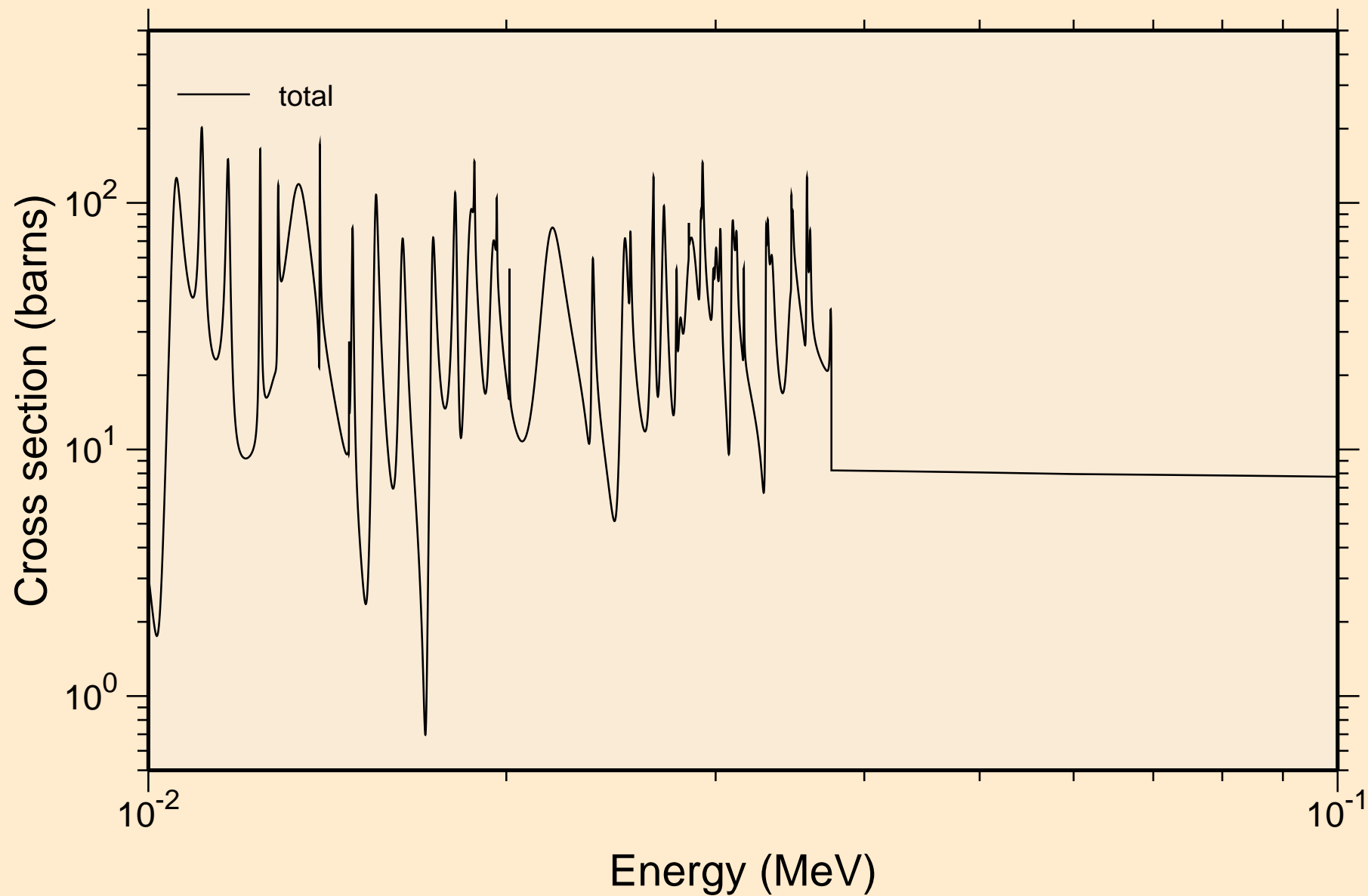

B̄R087 NEUTRON ACER TENDL-2019 LIBRARY; T=293.16K
resonance total cross section

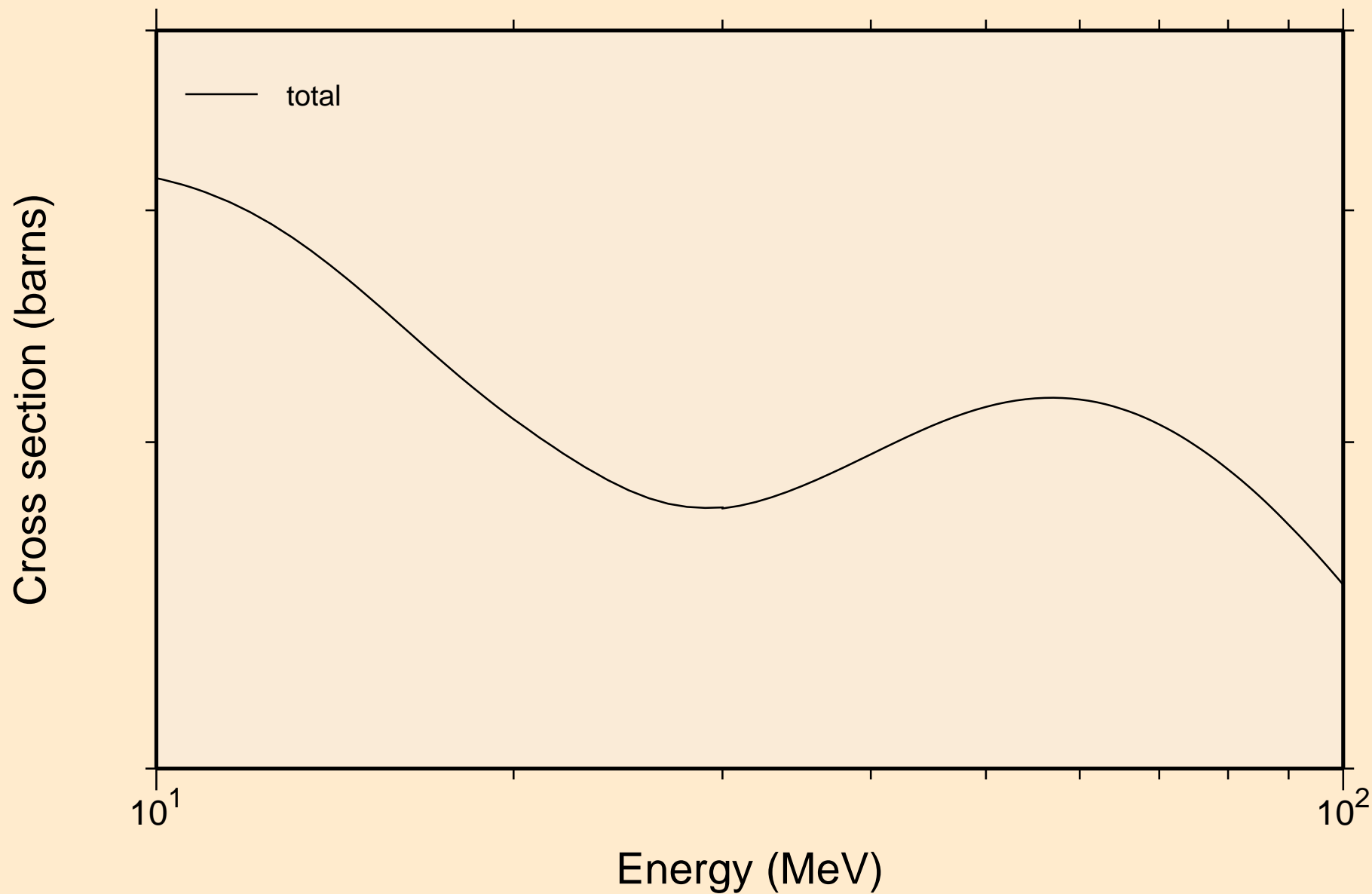

BR087 NEUTRON ACER TENDL-2019 LIBRARY; T=293.16K
resonance absorption cross sections

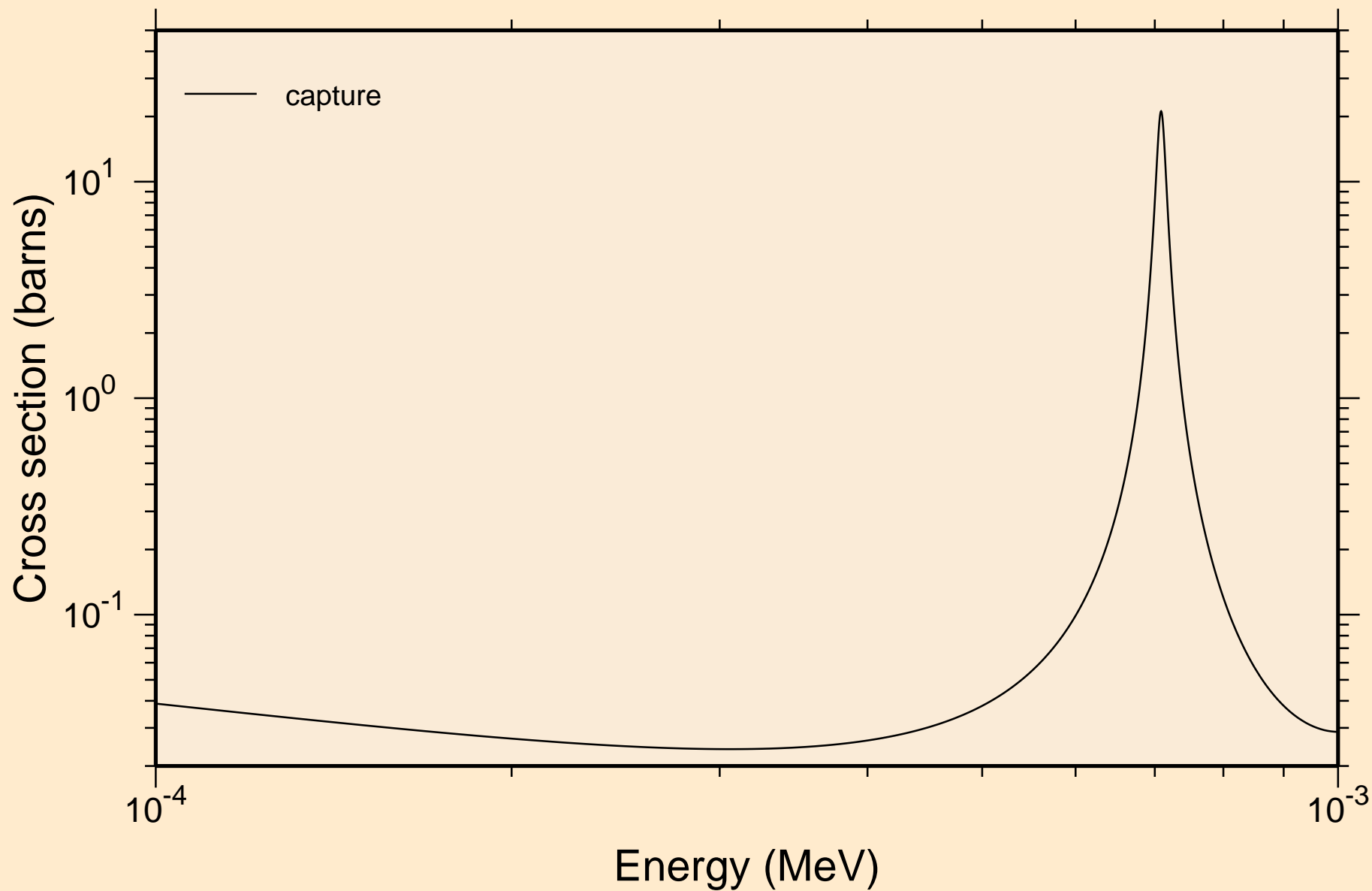

BR087 NEUTRON ACER TENDL-2019 LIBRARY; T=293.16K
resonance absorption cross sections

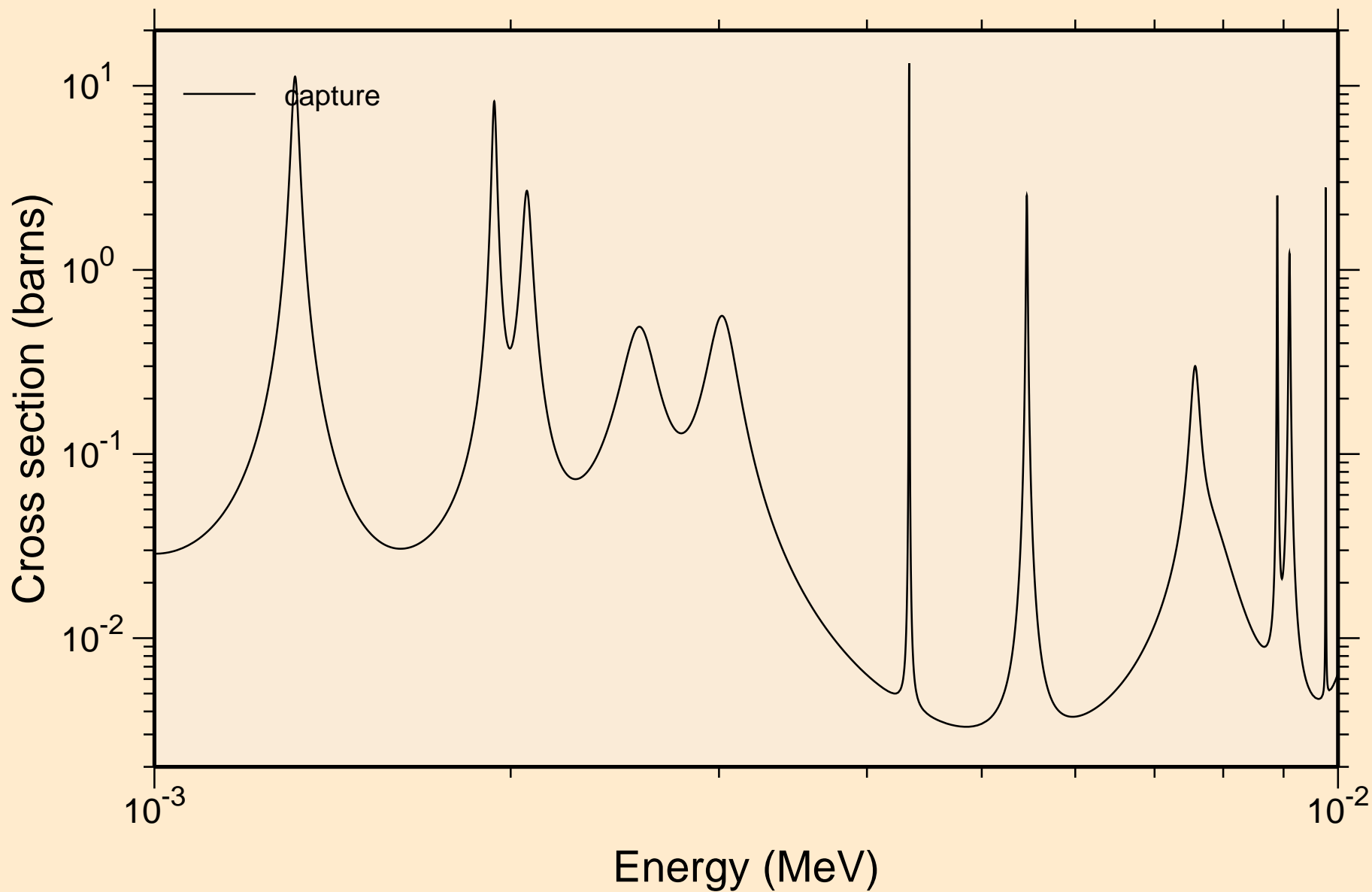

BR087 NEUTRON ACER TENDL-2019 LIBRARY; T=293.16K
resonance absorption cross sections

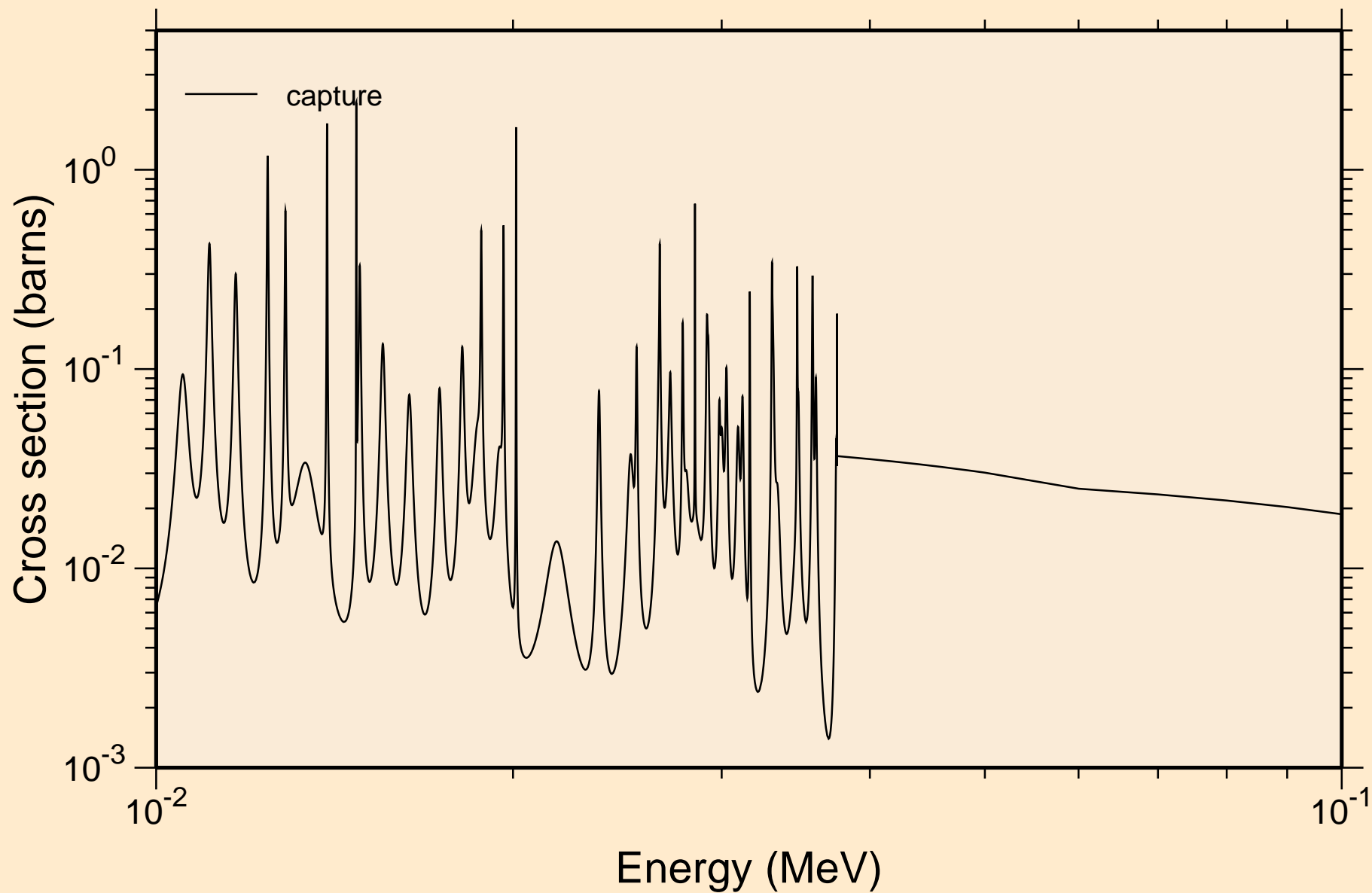

BR087 NEUTRON ACER TENDL-2019 LIBRARY; T=293.16K
resonance absorption cross sections

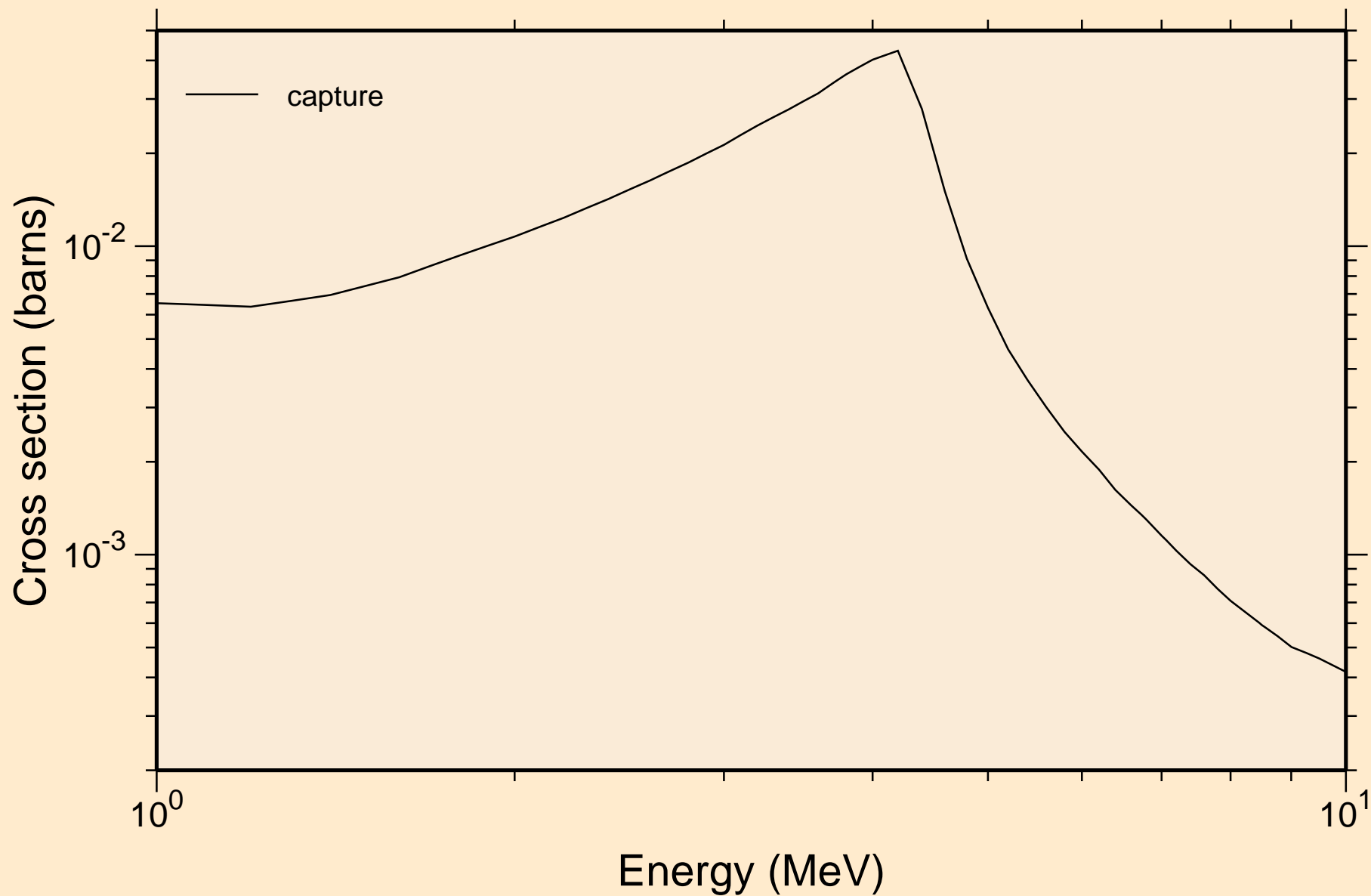

BR087 NEUTRON ACER TENDL-2019 LIBRARY; T=293.16K
Heating

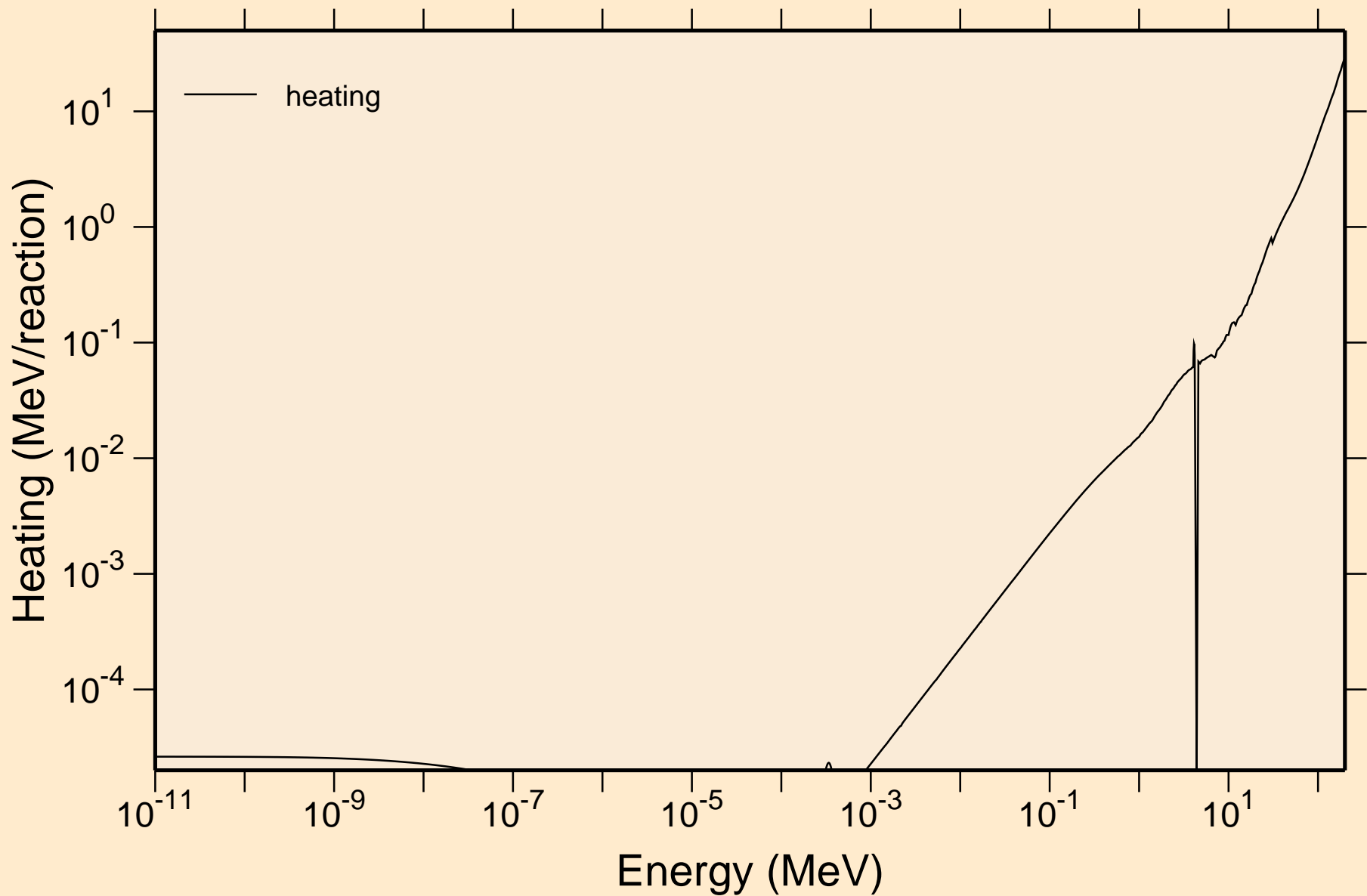

BR087 NEUTRON ACER TENDL-2019 LIBRARY; T=293.16K
Damage

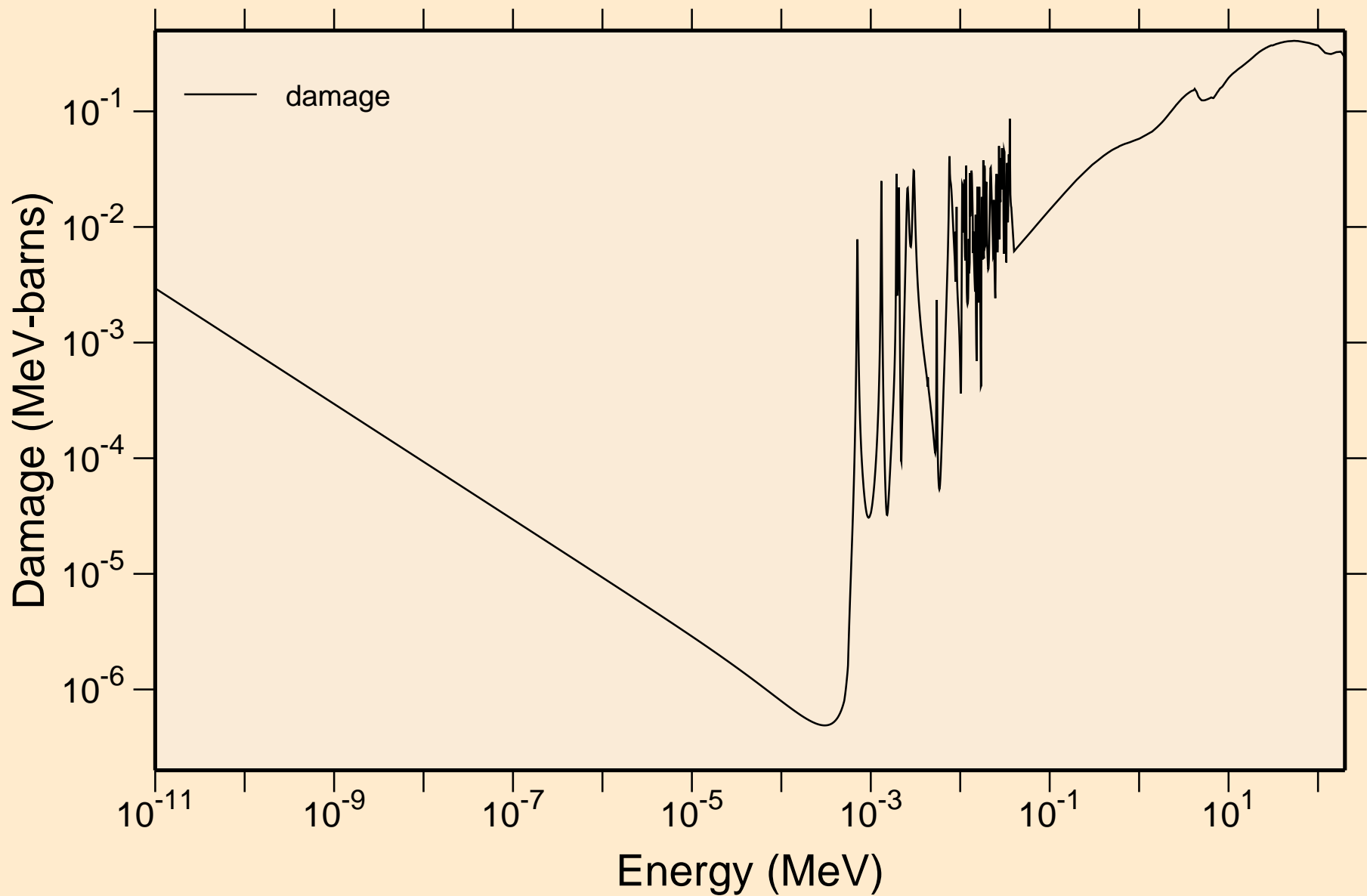

BR087 NEUTRON ACER TENDL-2019 LIBRARY; T=293.16K
Non-threshold reactions

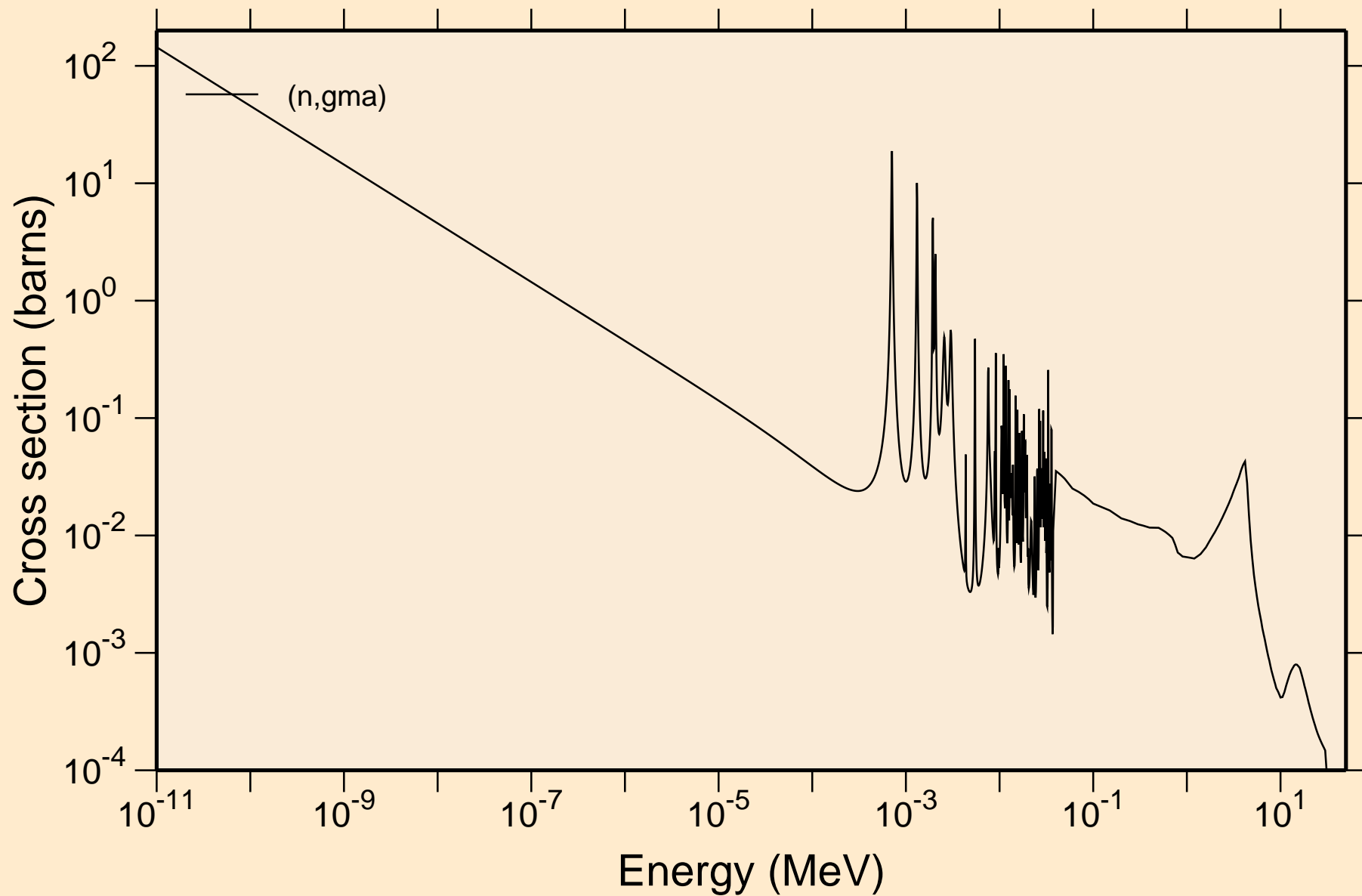

BR087 NEUTRON ACER TENDL-2019 LIBRARY; T=293.16K
Principal cross sections

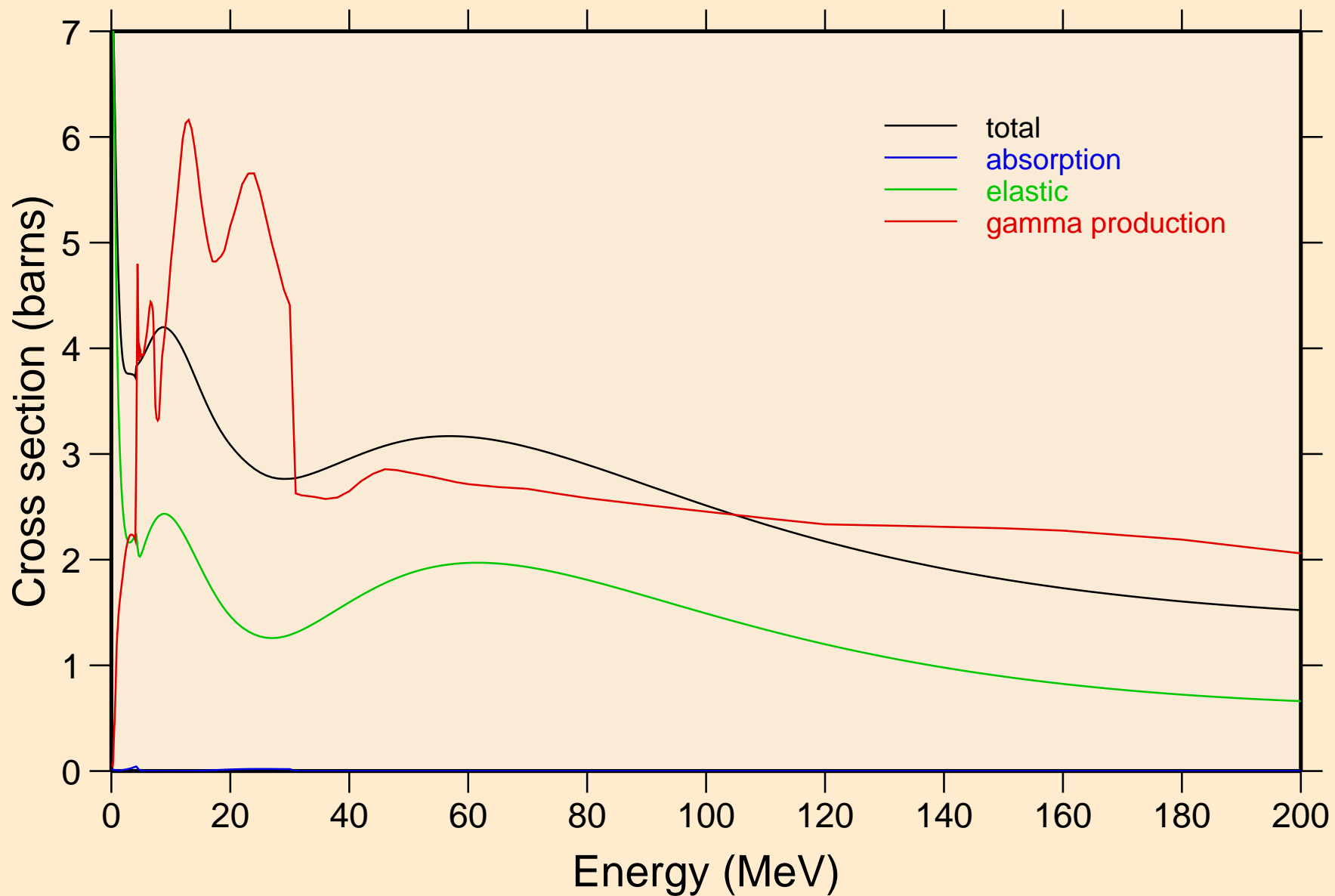

BR087 NEUTRON ACER TENDL-2019 LIBRARY; T=293.16K
Heating

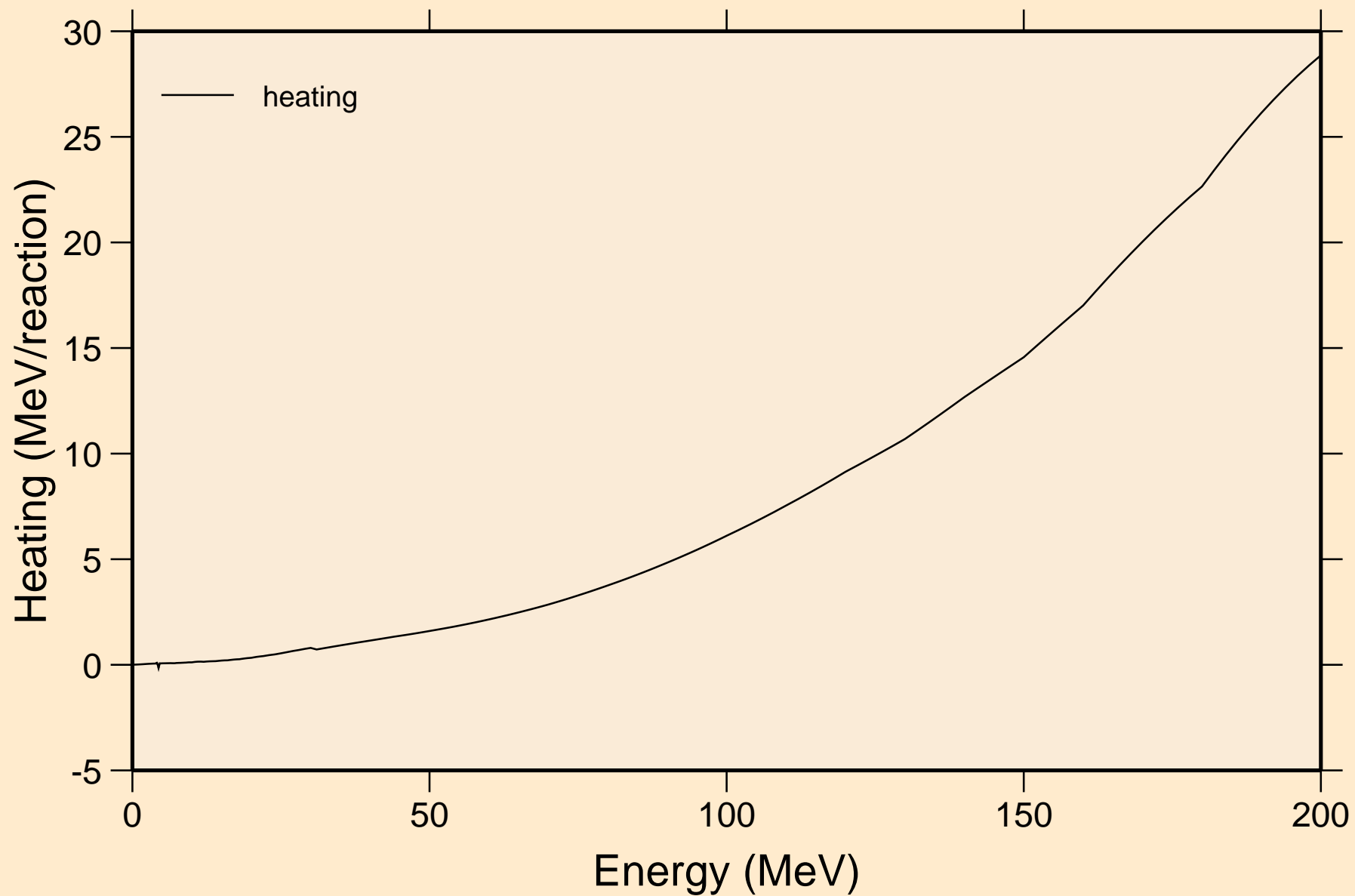

BR087 NEUTRON ACER TENDL-2019 LIBRARY; T=293.16K
Damage

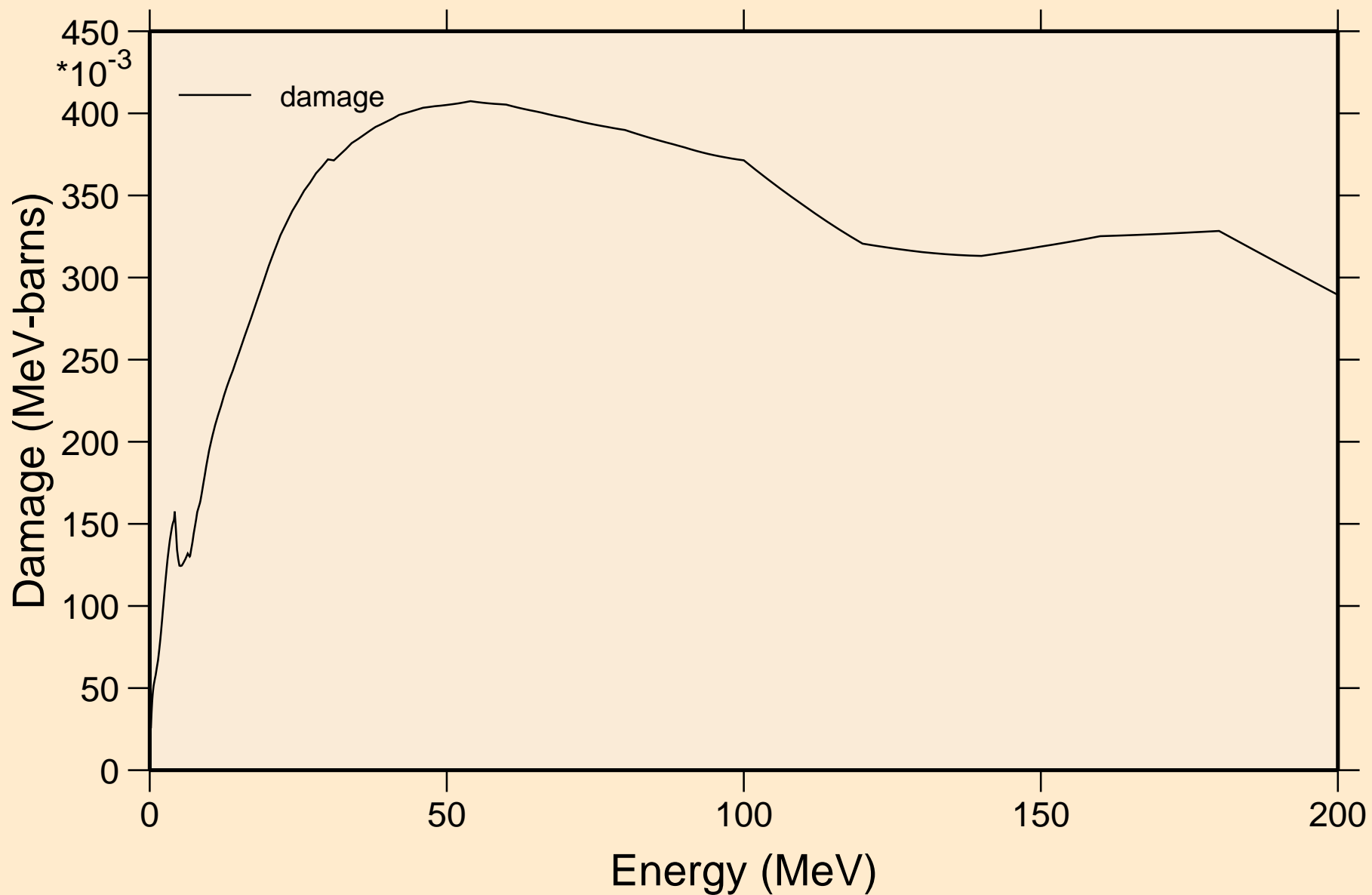

BR087 NEUTRON ACER TENDL-2019 LIBRARY; T=293.16K
Non-threshold reactions

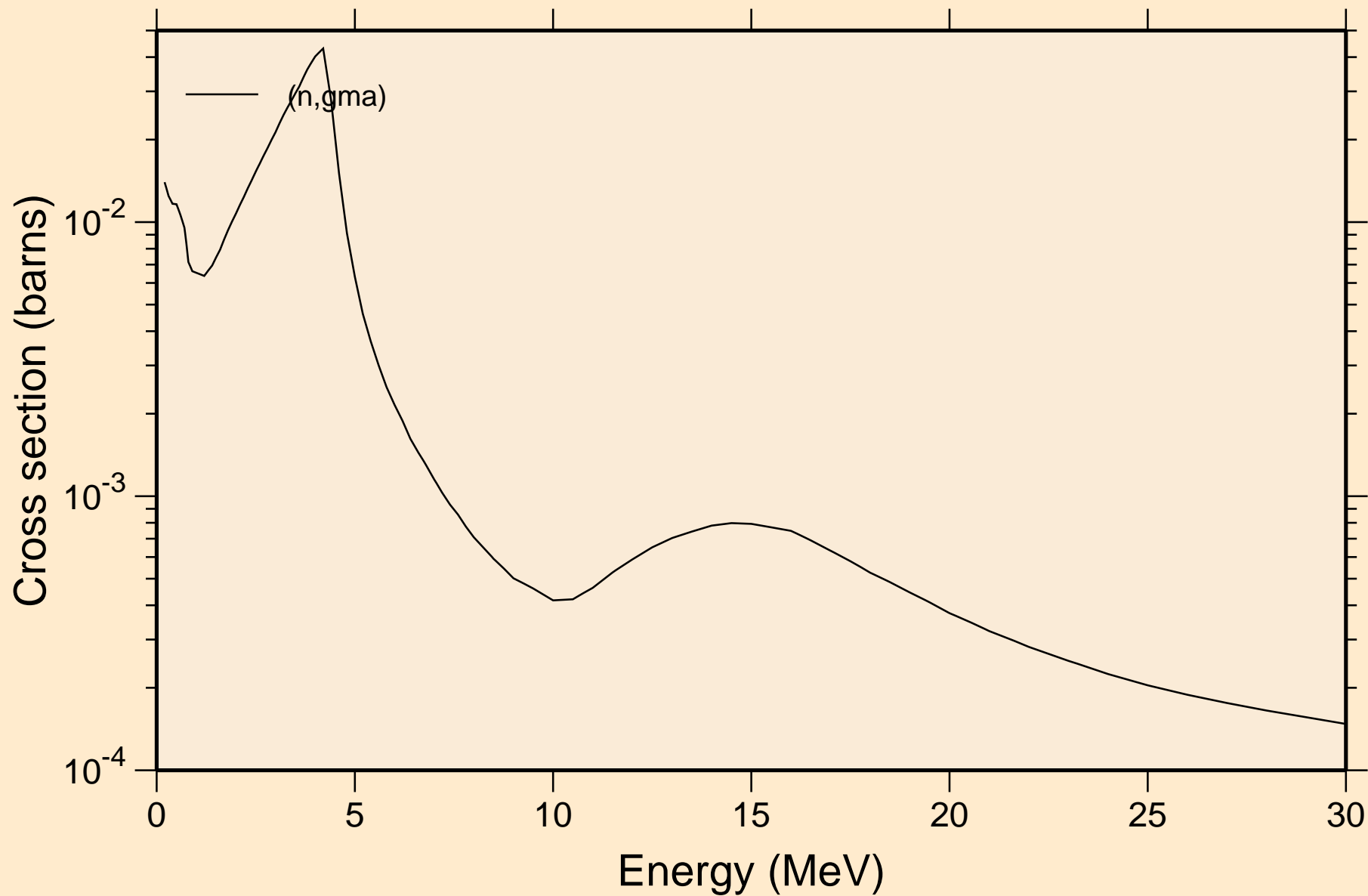

BR087 NEUTRON ACER TENDL-2019 LIBRARY; T=293.16K
Inelastic levels

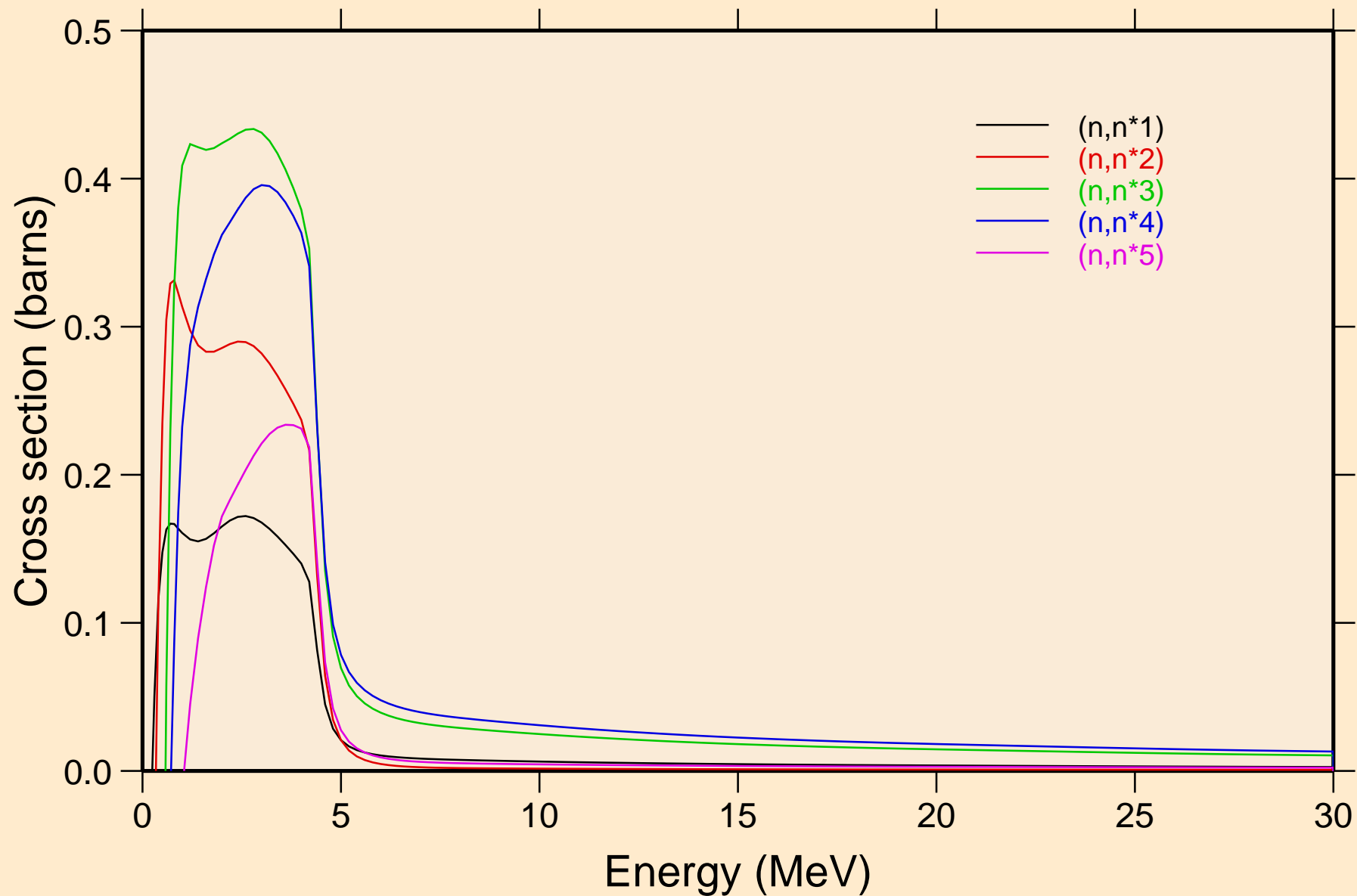

BR087 NEUTRON ACER TENDL-2019 LIBRARY; T=293.16K
Inelastic levels

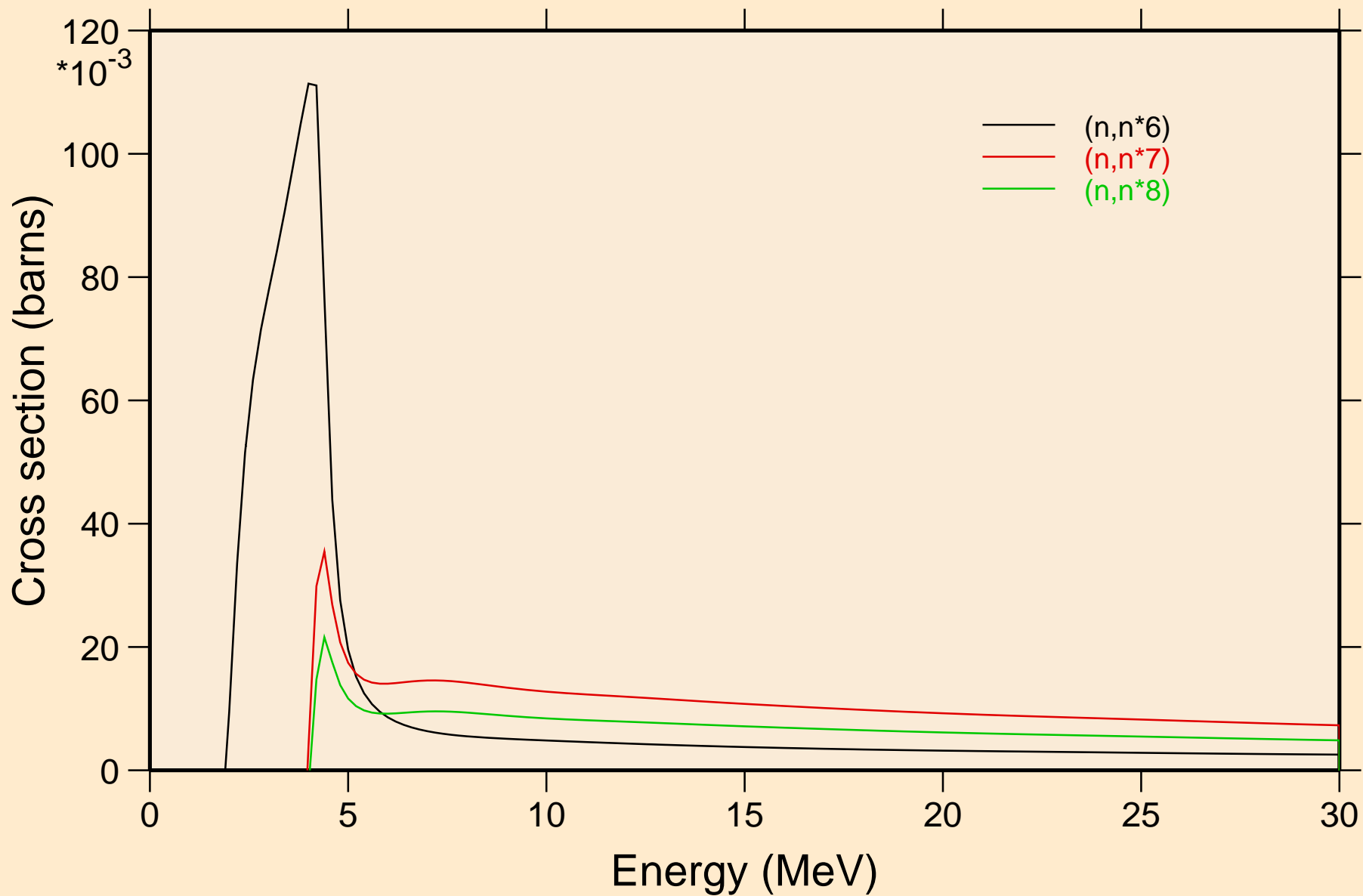

BR087 NEUTRON ACER TENDL-2019 LIBRARY; T=293.16K
Threshold reactions

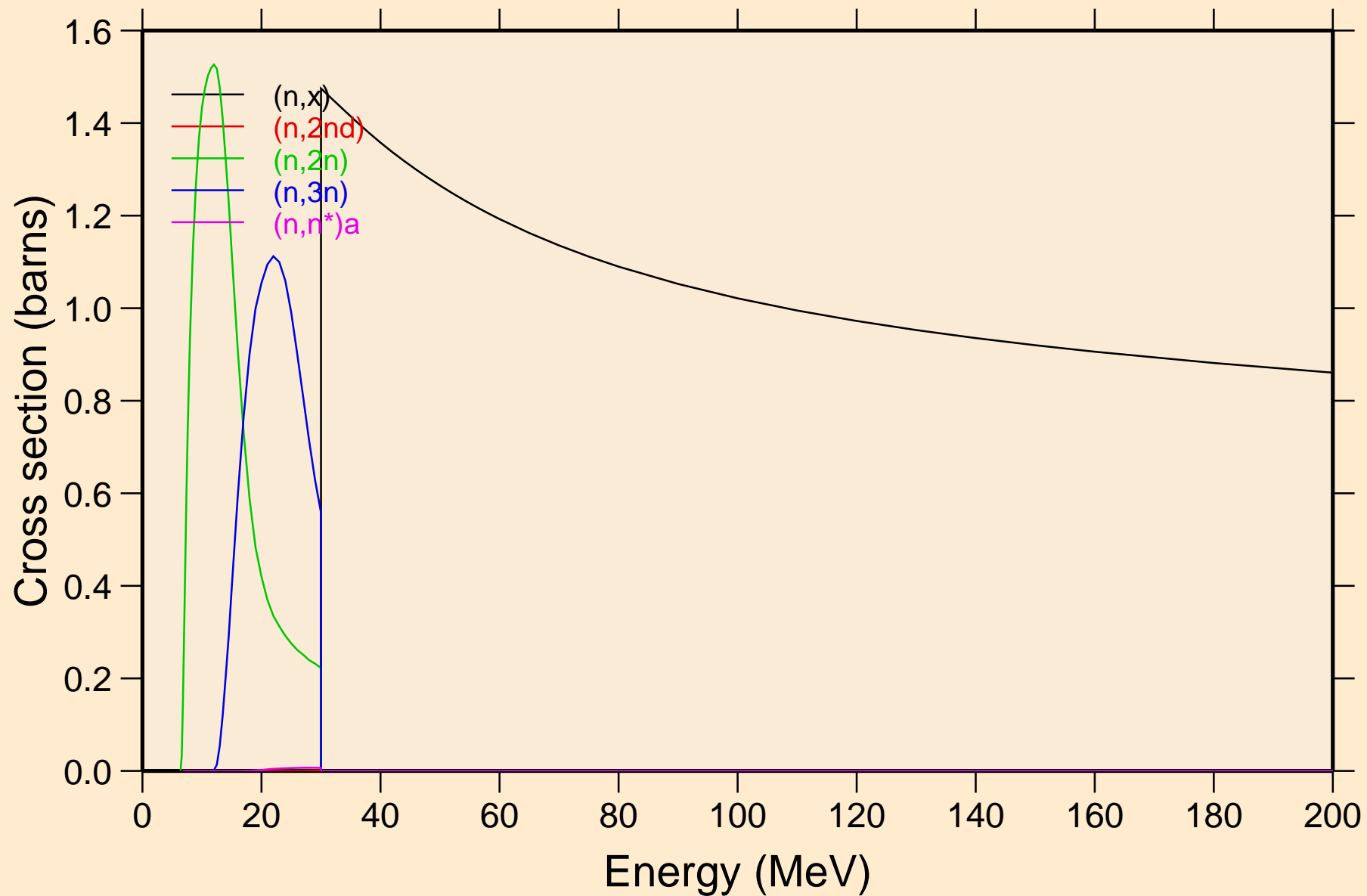

BR087 NEUTRON ACER TENDL-2019 LIBRARY; T=293.16K
Threshold reactions

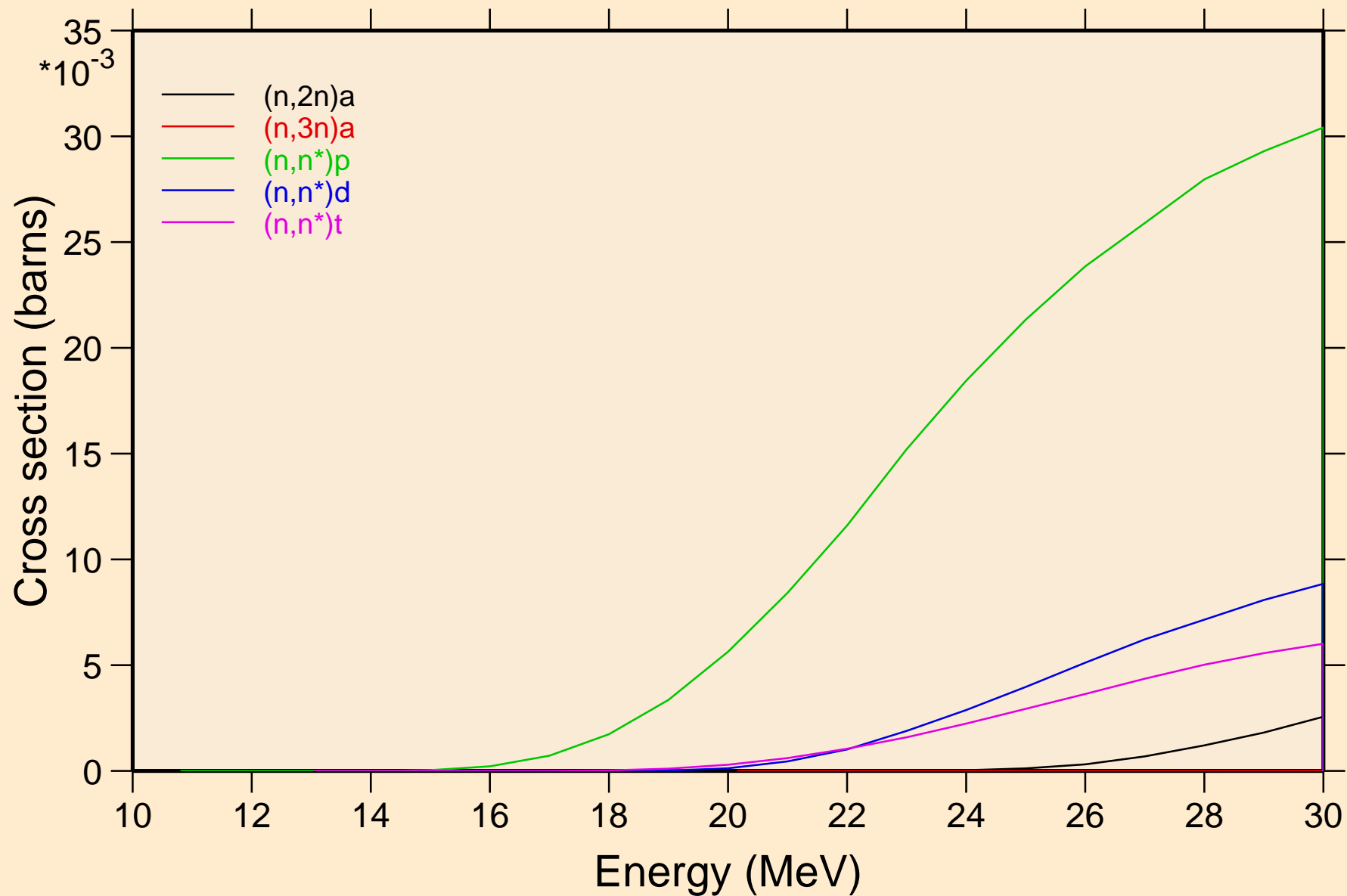

BR087 NEUTRON ACER TENDL-2019 LIBRARY; T=293.16K
Threshold reactions

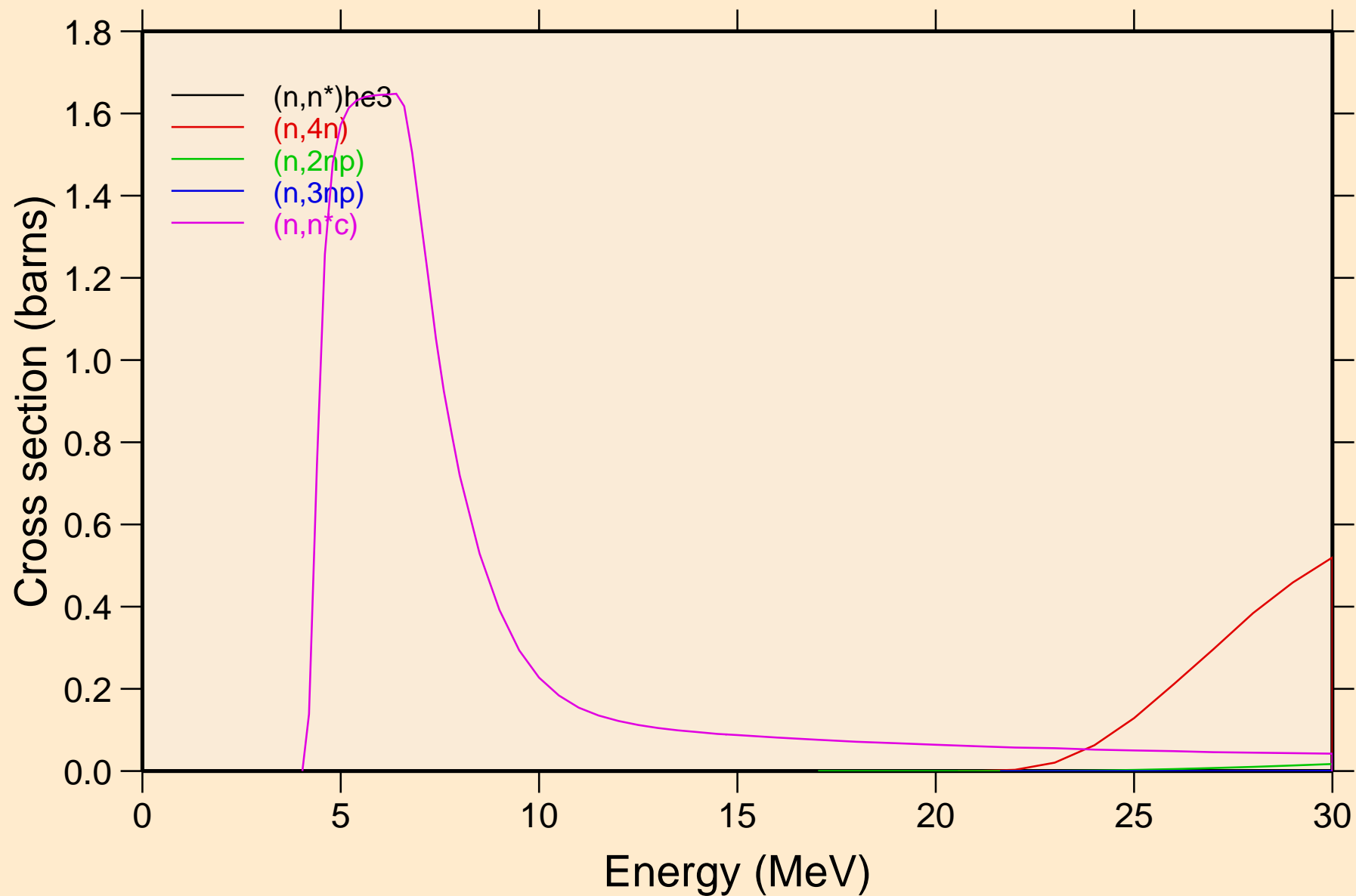

BR087 NEUTRON ACER TENDL-2019 LIBRARY; T=293.16K
Threshold reactions

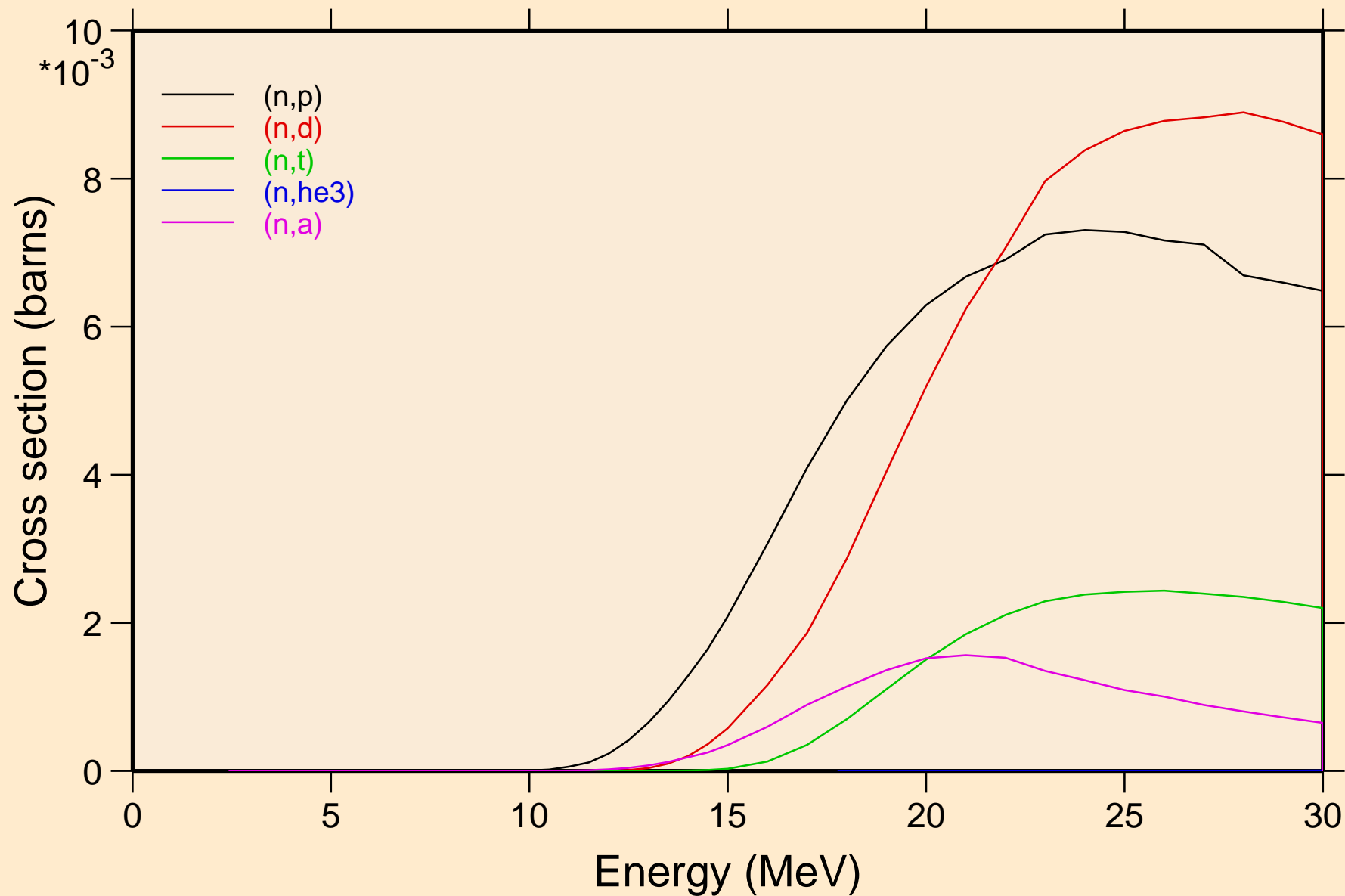

BR087 NEUTRON ACER TENDL-2019 LIBRARY; T=293.16K
Threshold reactions

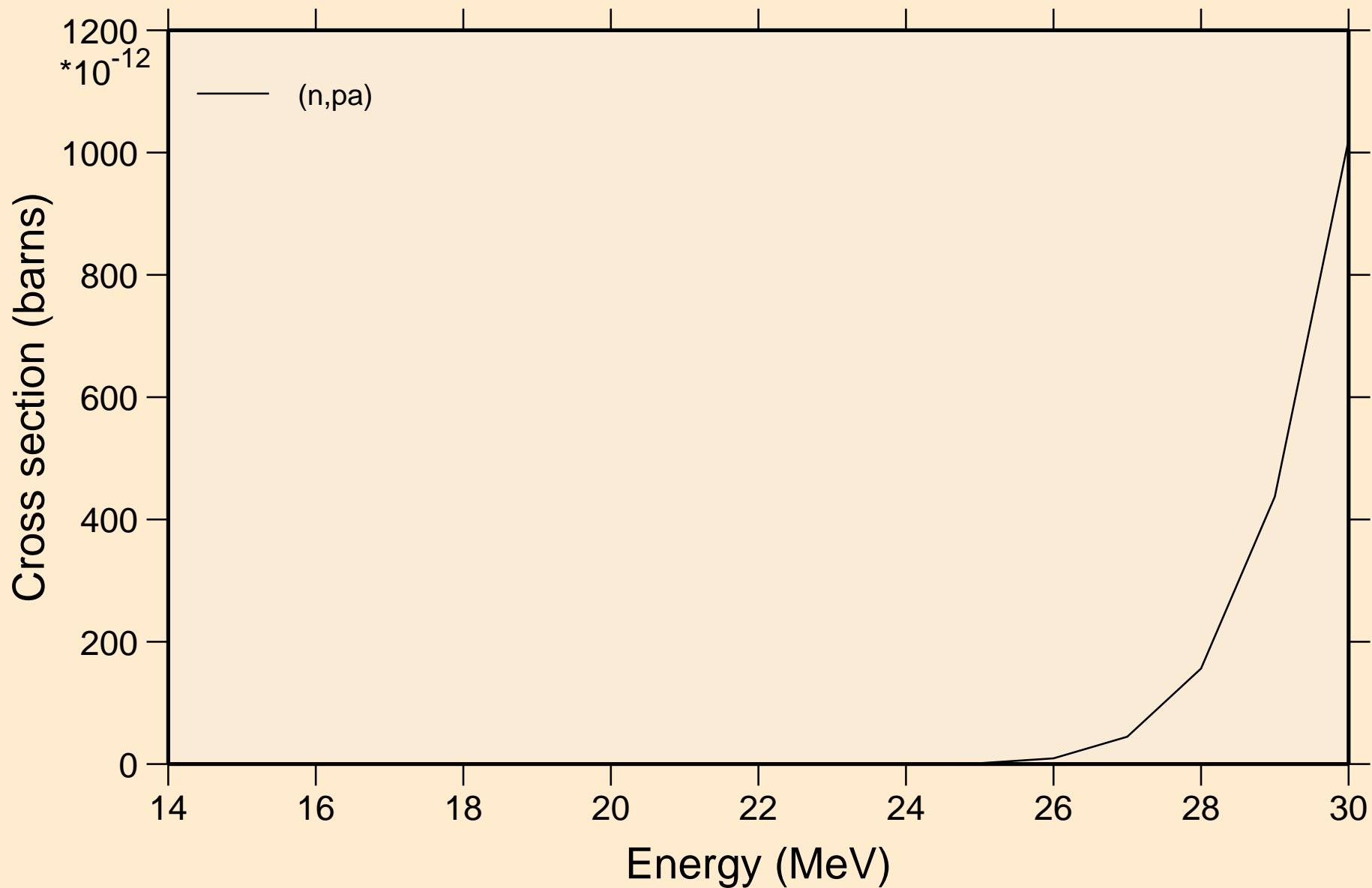

BR087 NEUTRON ACER TENDL-2019 LIBRARY; T=293.16K
Threshold reactions

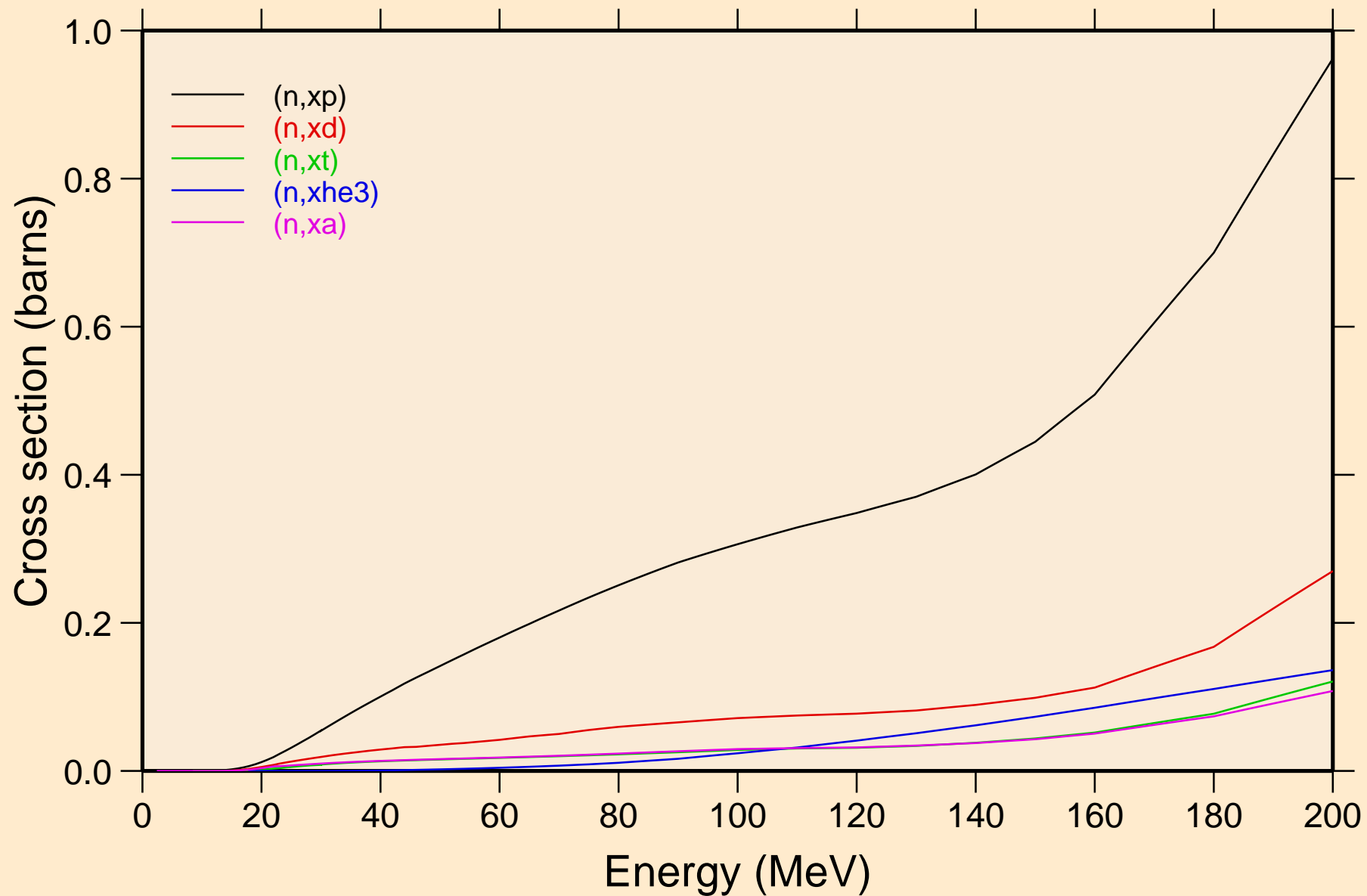

BR087 NEUTRON ACER TENDL-2019 LIBRARY; T=293.16K
angular distribution for elastic

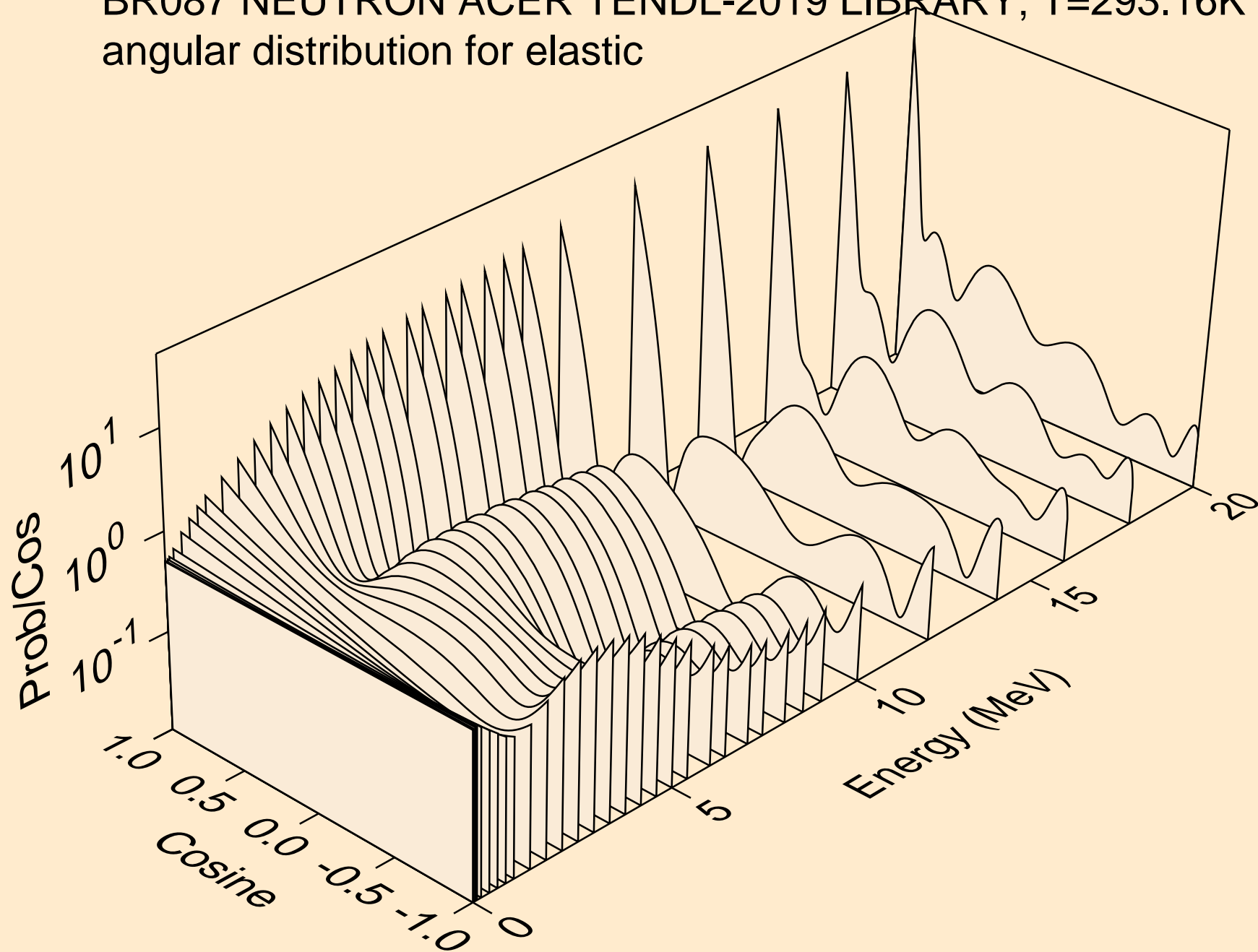

BR087 NEUTRON ACER TENDL-2019 LIBRARY; T=293.16K
angular distribution for elastic

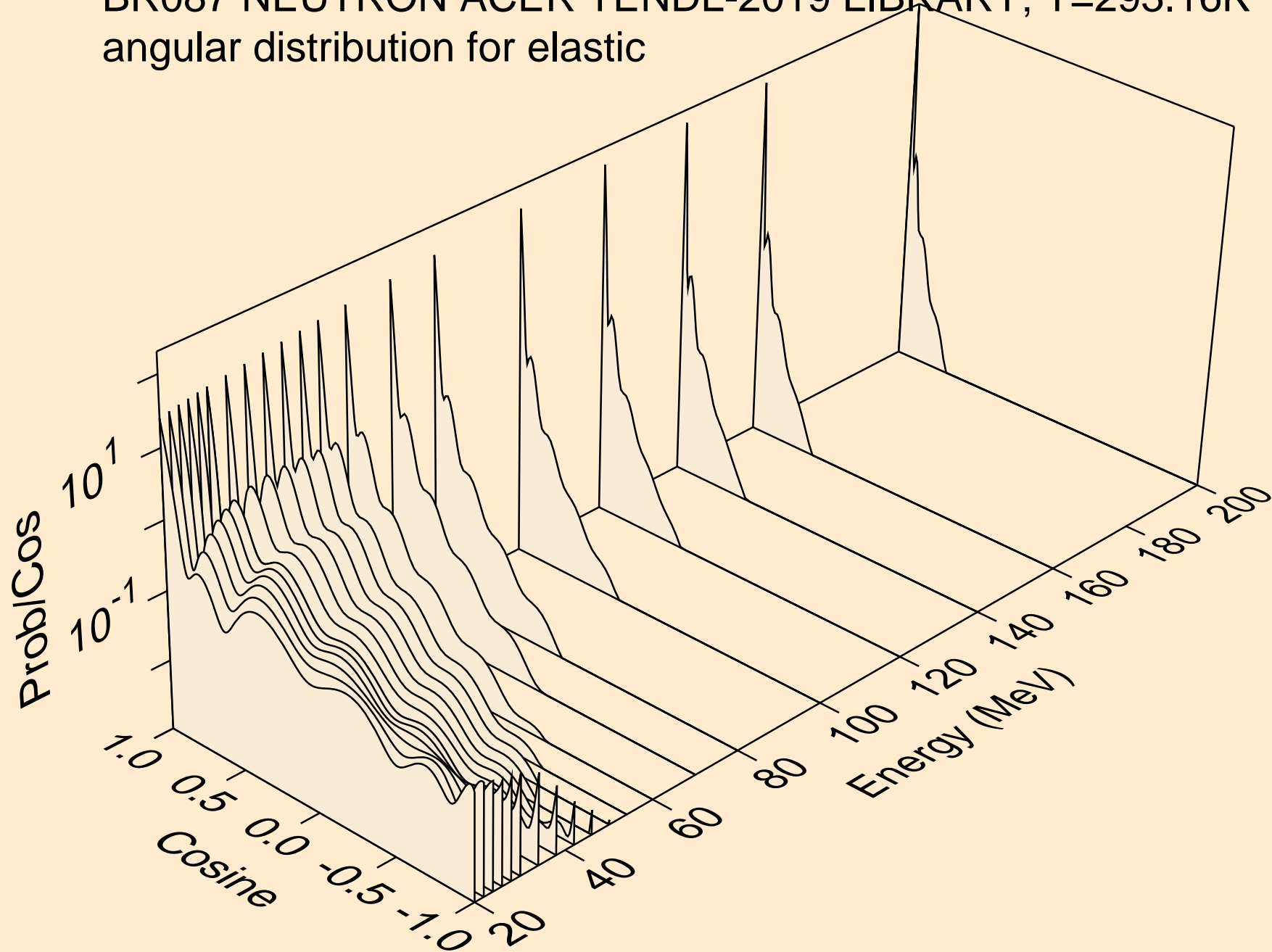

BR087 NEUTRON ACER TENDL-2019 LIBRARY; T=293.16K
angular distribution for (n,n*1)

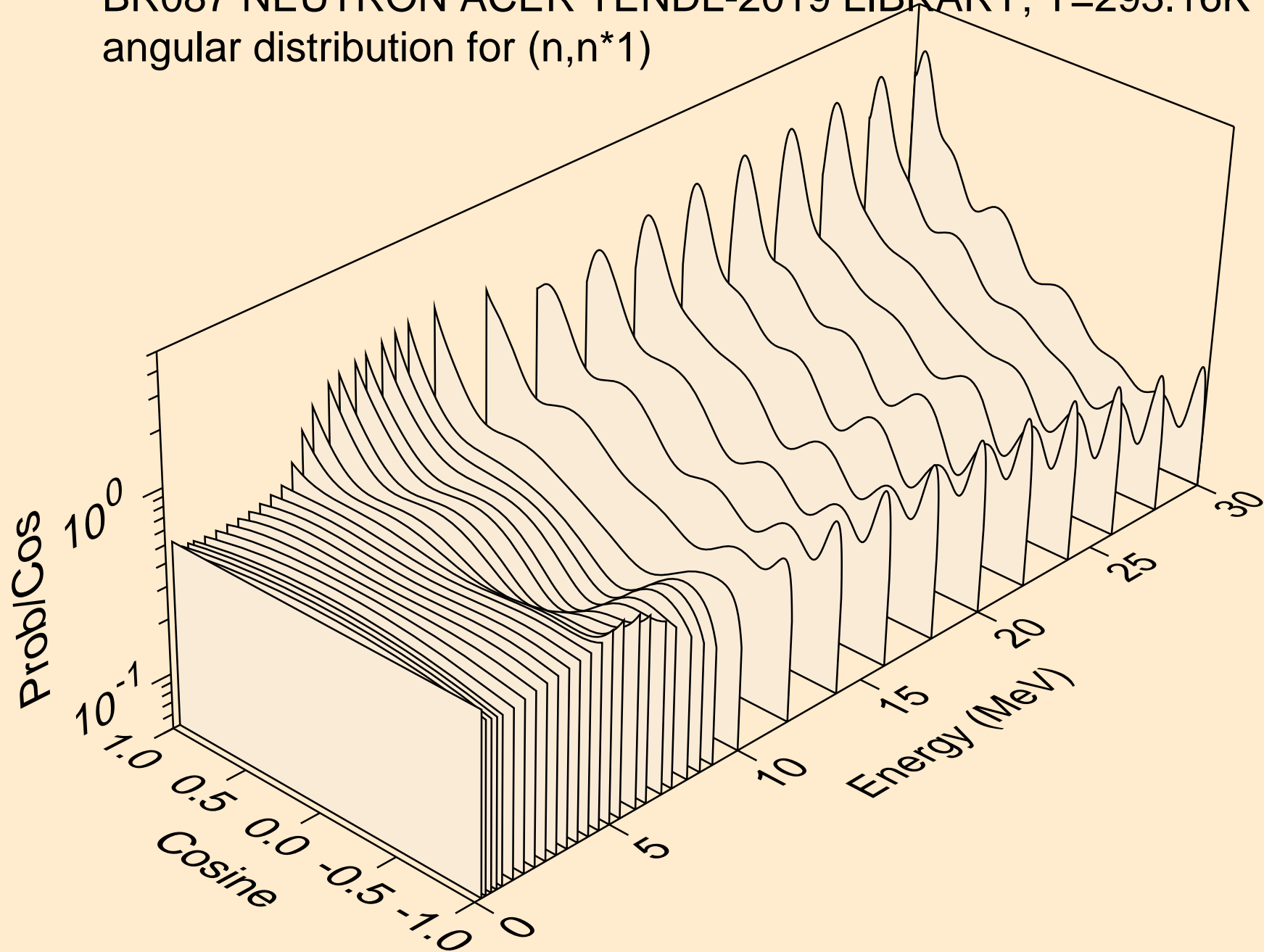

BR087 NEUTRON ACER TENDL-2019 LIBRARY; T=293.16K
angular distribution for (n,n*2)

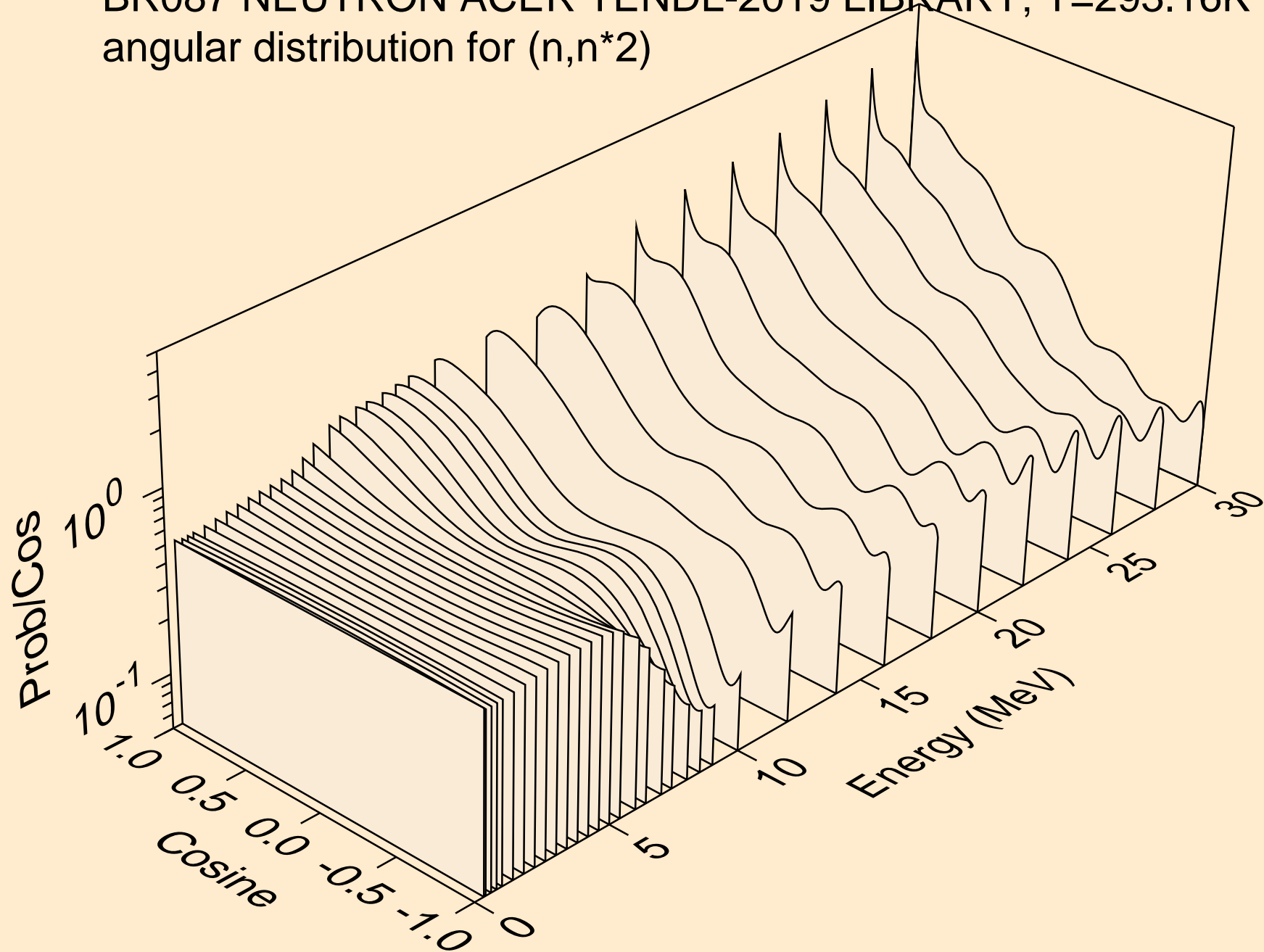

BR087 NEUTRON ACER TENDL-2019 LIBRARY; T=293.16K
angular distribution for (n,n*3)

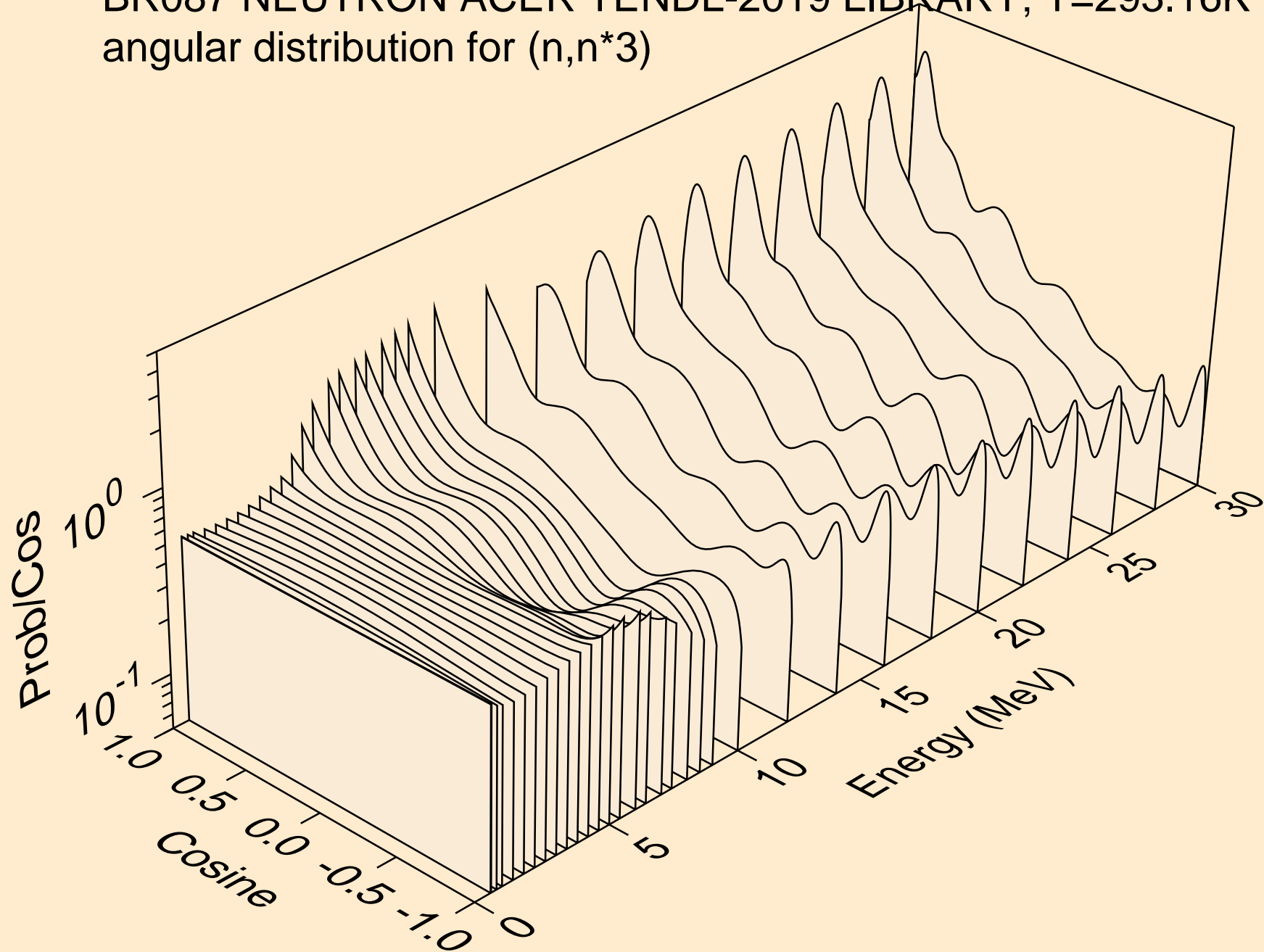

BR087 NEUTRON ACER TENDL-2019 LIBRARY; T=293.16K
angular distribution for (n,n*4)

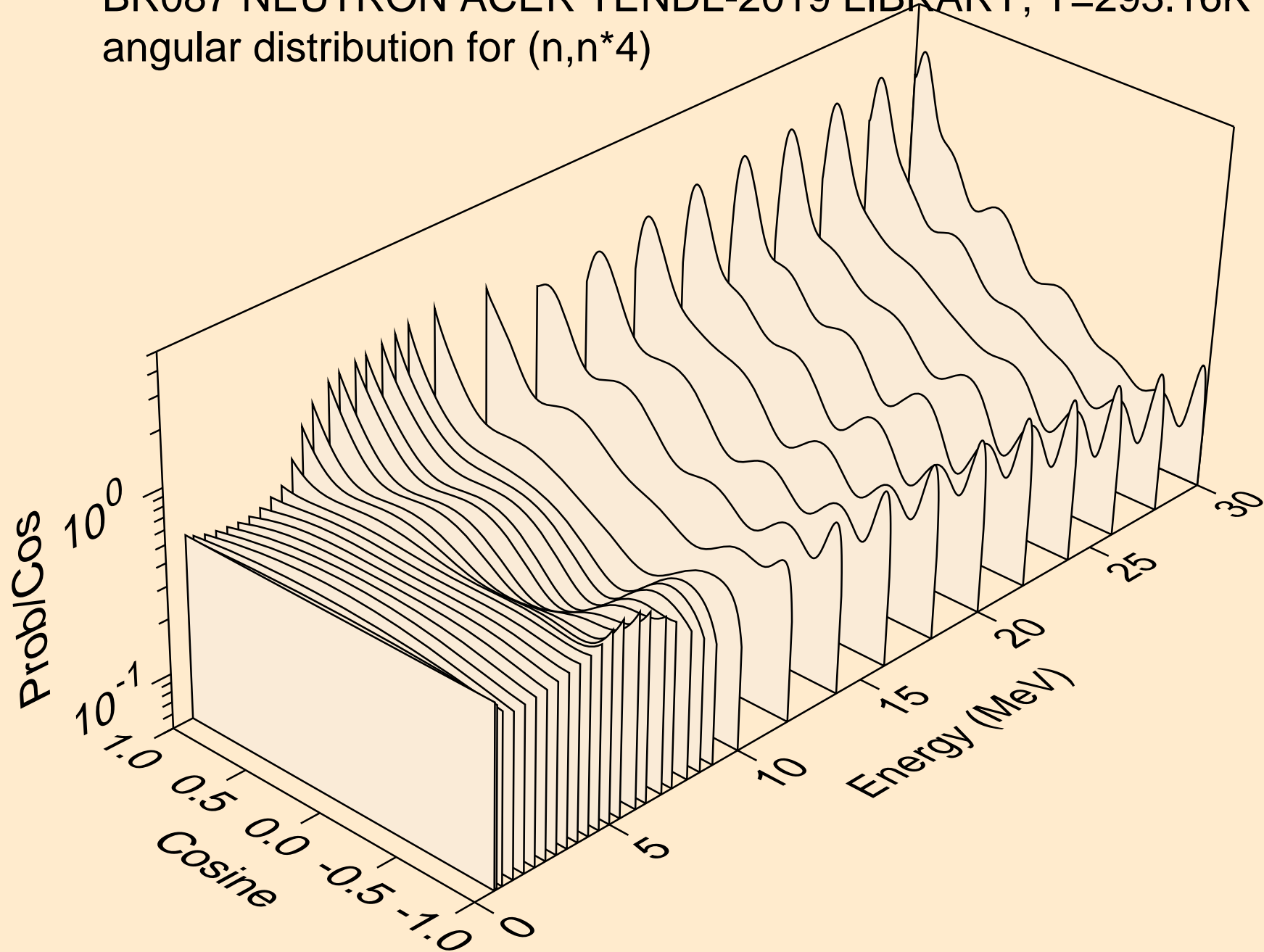

BR087 NEUTRON ACER TENDL-2019 LIBRARY; T=293.16K
angular distribution for (n,n*5)

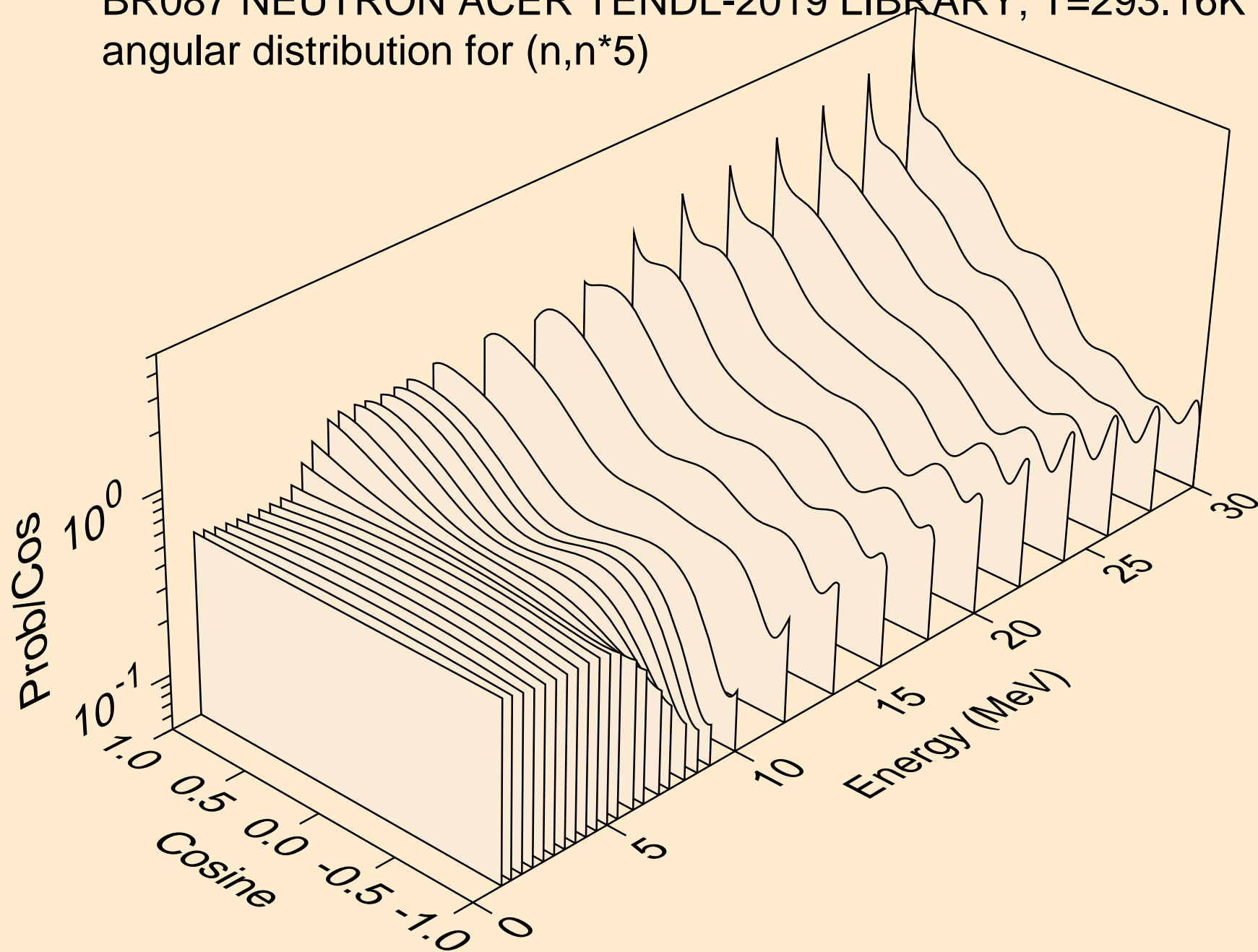

BR087 NEUTRON ACER TENDL-2019 LIBRARY; T=293.16K
angular distribution for (n,n*6)

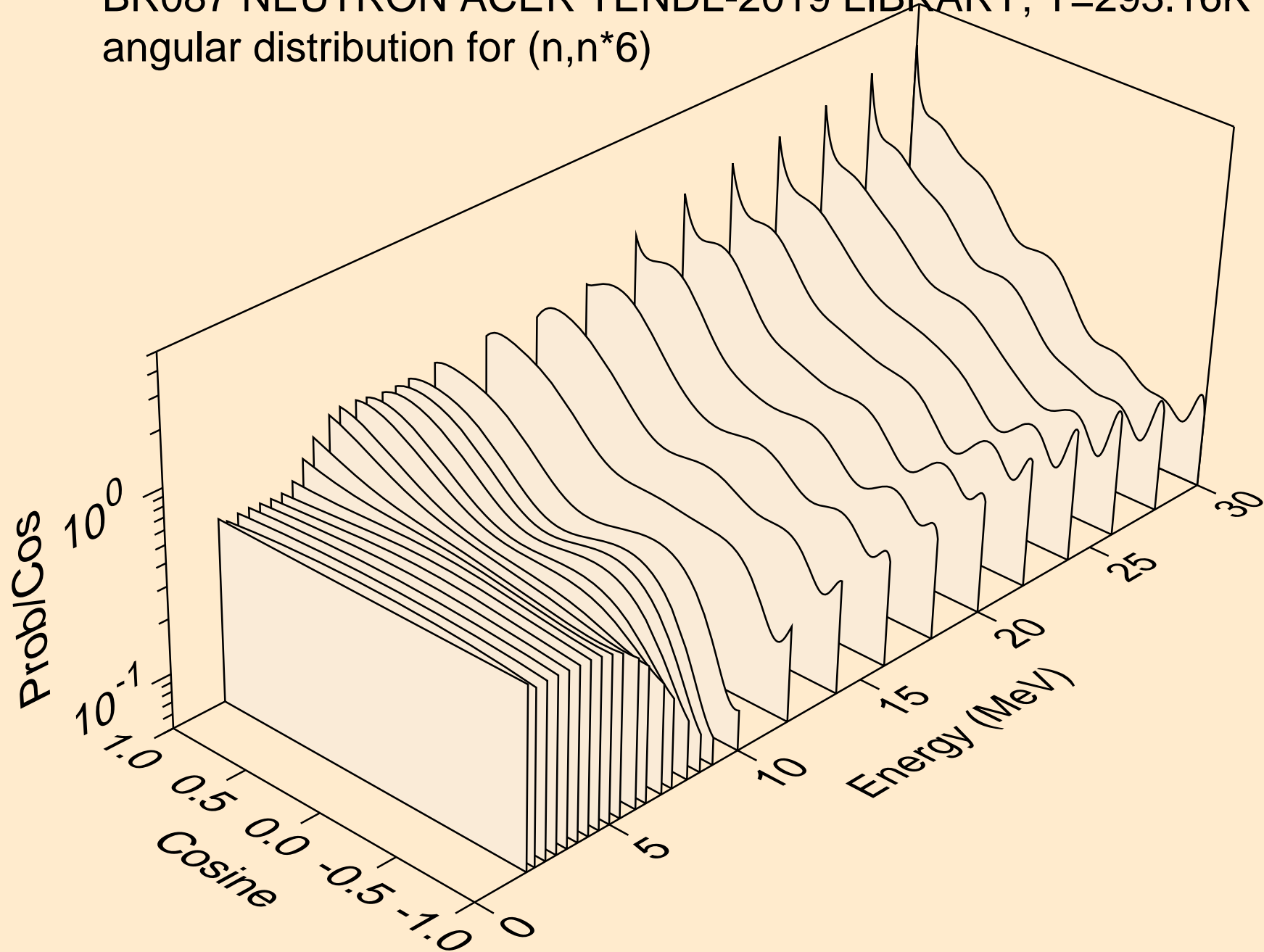

BR087 NEUTRON ACER TENDL-2019 LIBRARY; T=293.16K
angular distribution for (n,n*7)

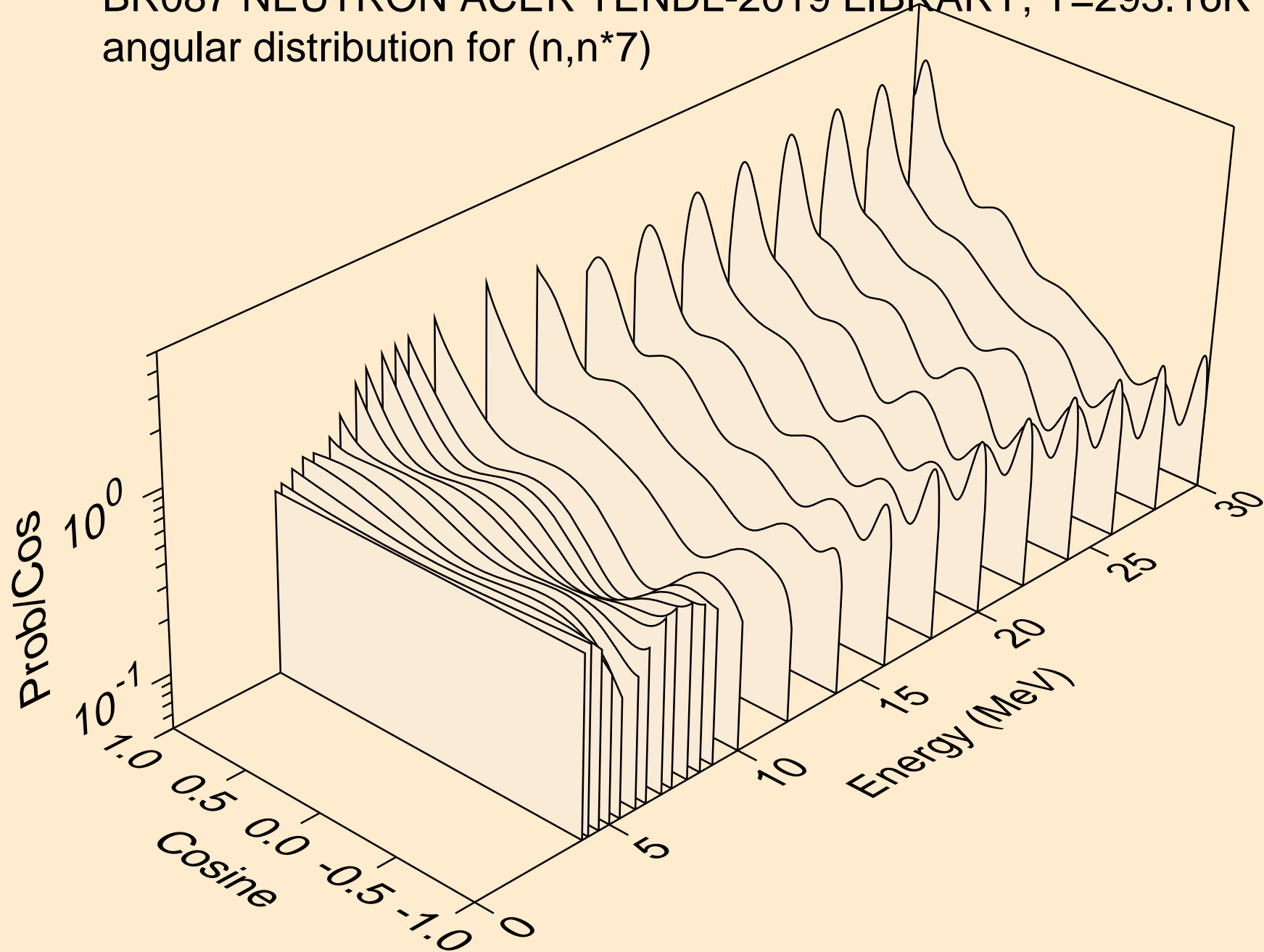

BR087 NEUTRON ACER TENDL-2019 LIBRARY; T=293.16K
angular distribution for (n,n*8)

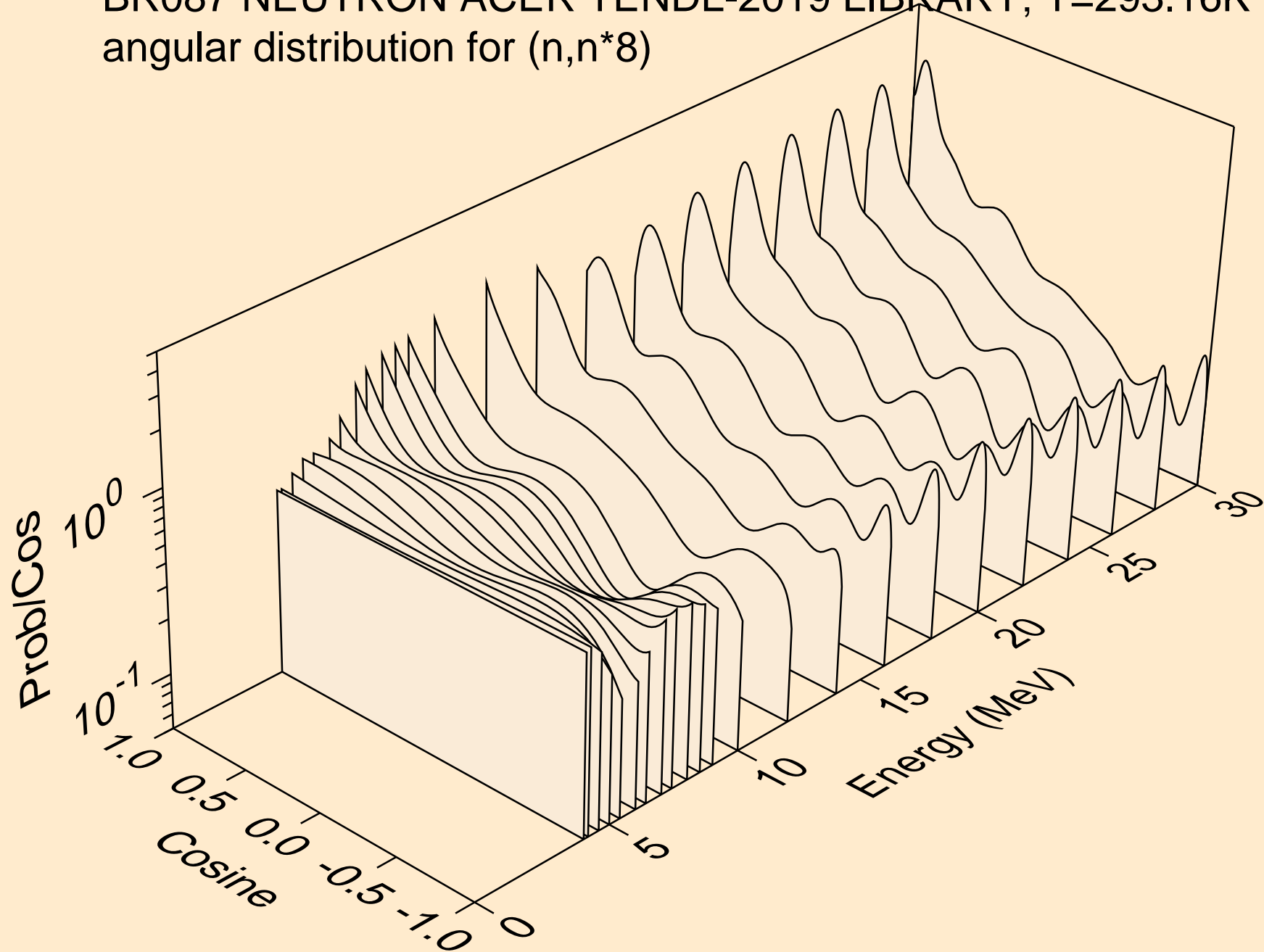

BR087 NEUTRON ACER TENDL-2019 LIBRARY; T=293.16K
Neutron emission for (n,x)

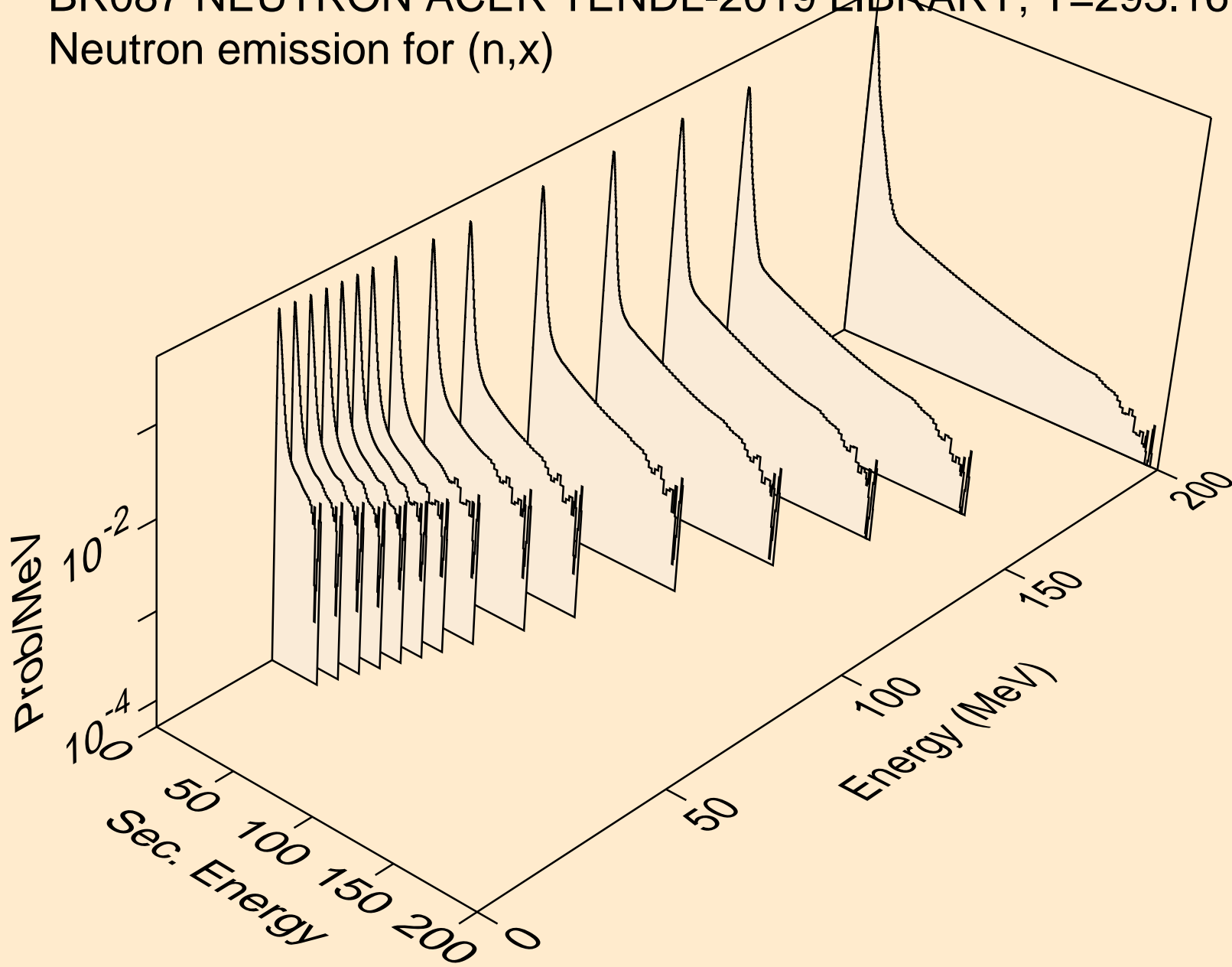

BR087 NEUTRON ACER TENDL-2019 LIBRARY; T=293.16K
Neutron emission for (n,2nd)

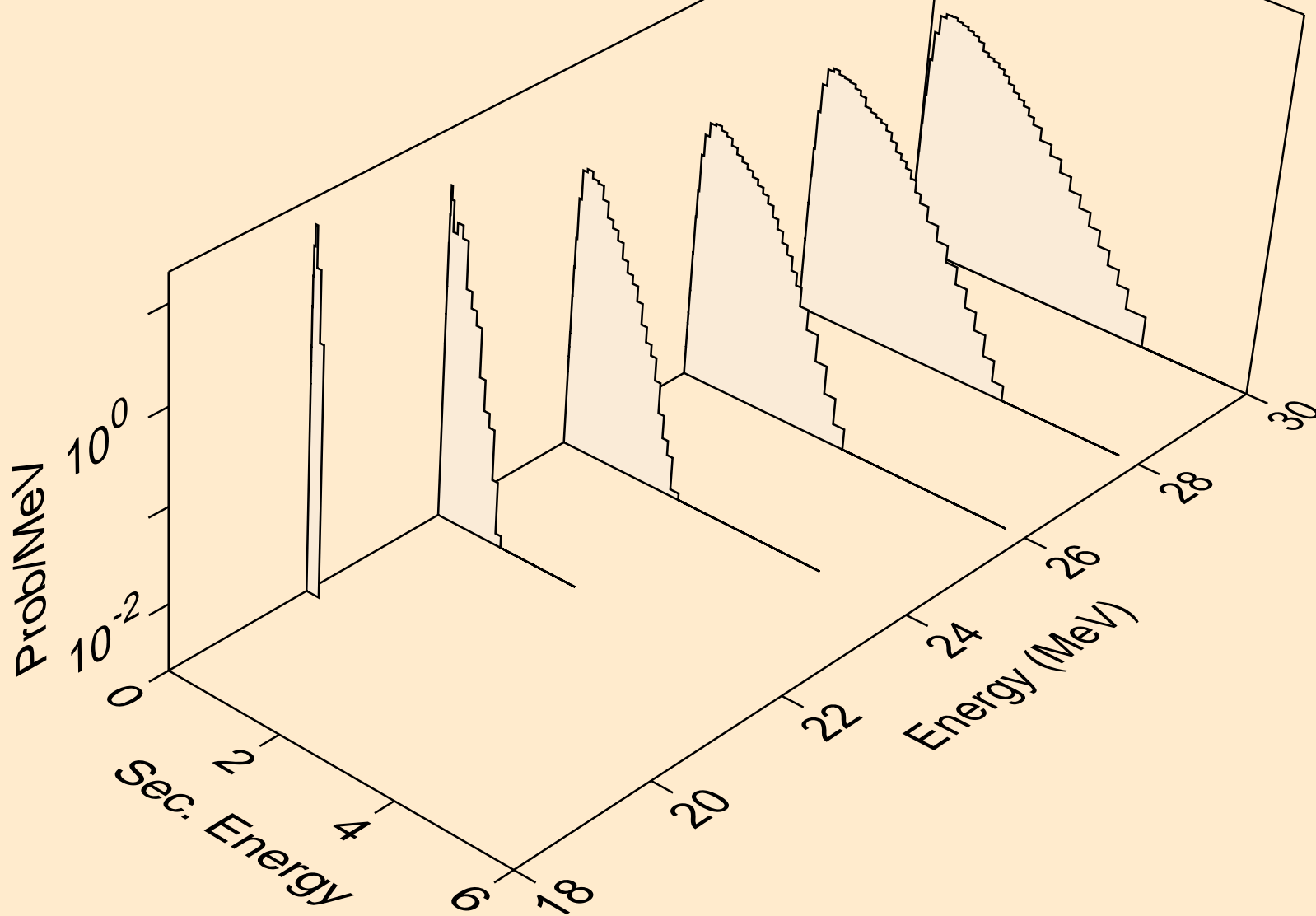

BR087 NEUTRON ACER TENDL-2019 LIBRARY; T=293.16K
Neutron emission for (n,2n)

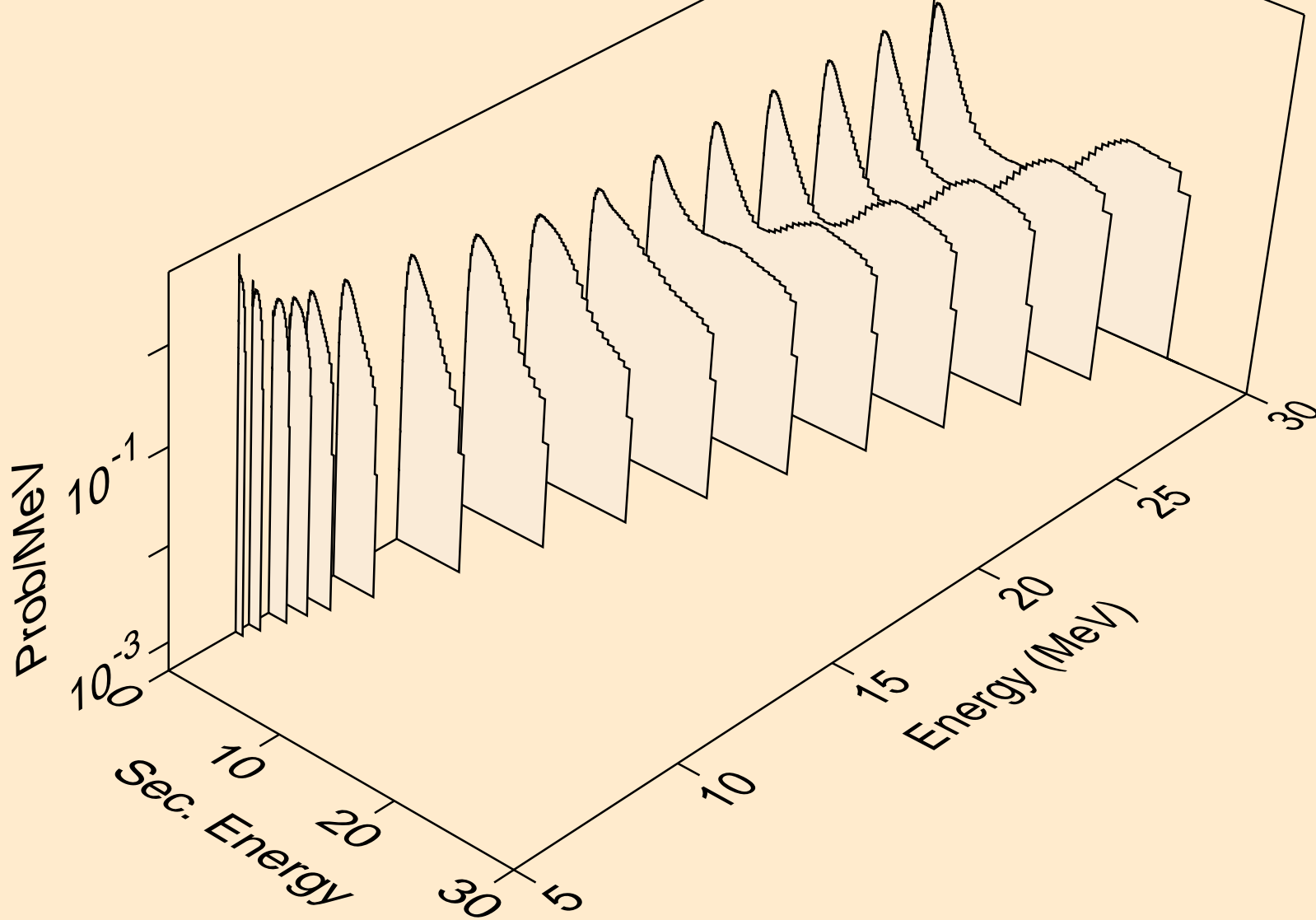

BR087 NEUTRON ACER TENDL-2019 LIBRARY; T=293.16K
Neutron emission for (n,3n)

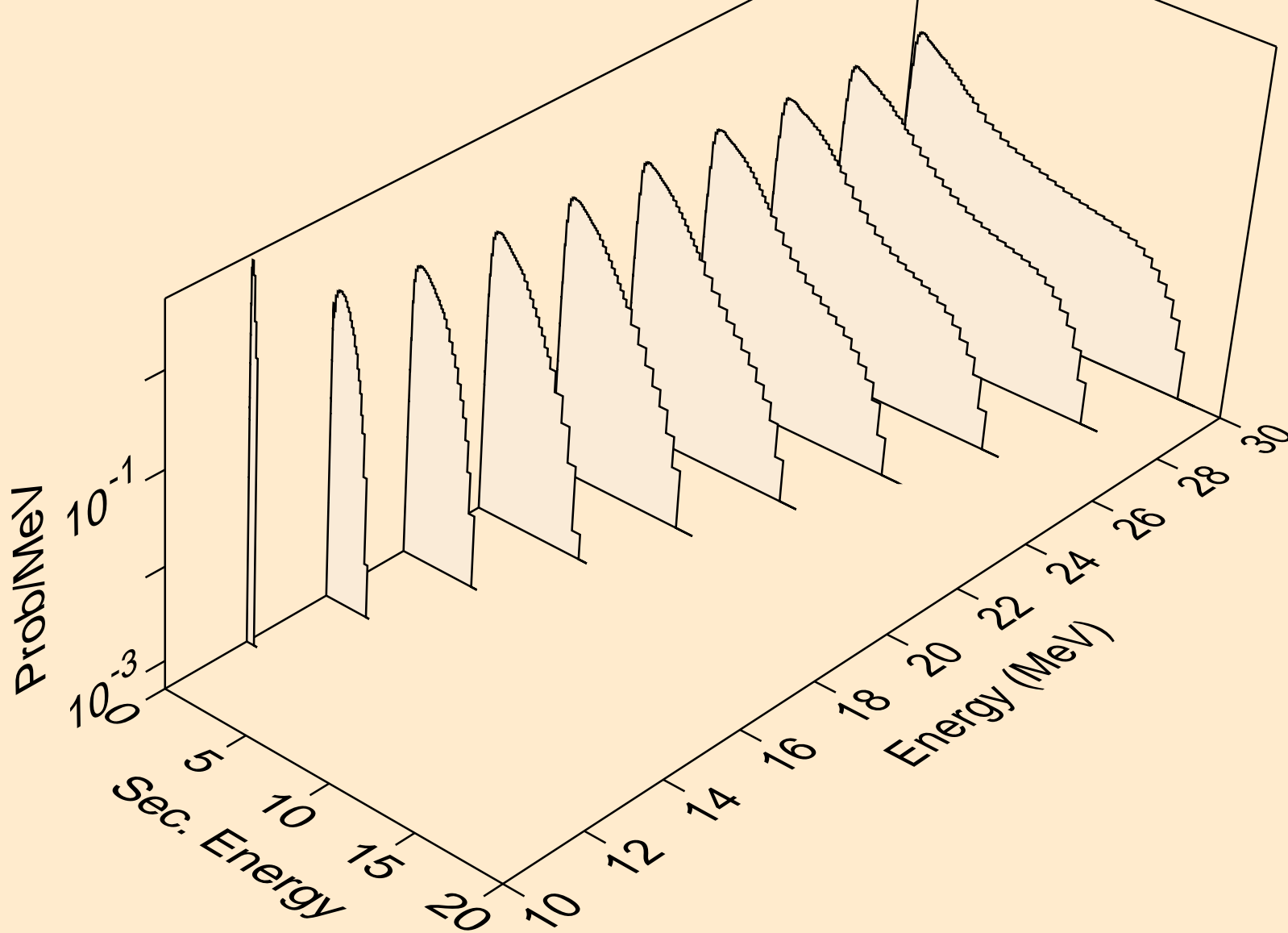

BR087 NEUTRON ACER TENDL-2019 LIBRARY; T=293.16K
Neutron emission for (n,n*)a

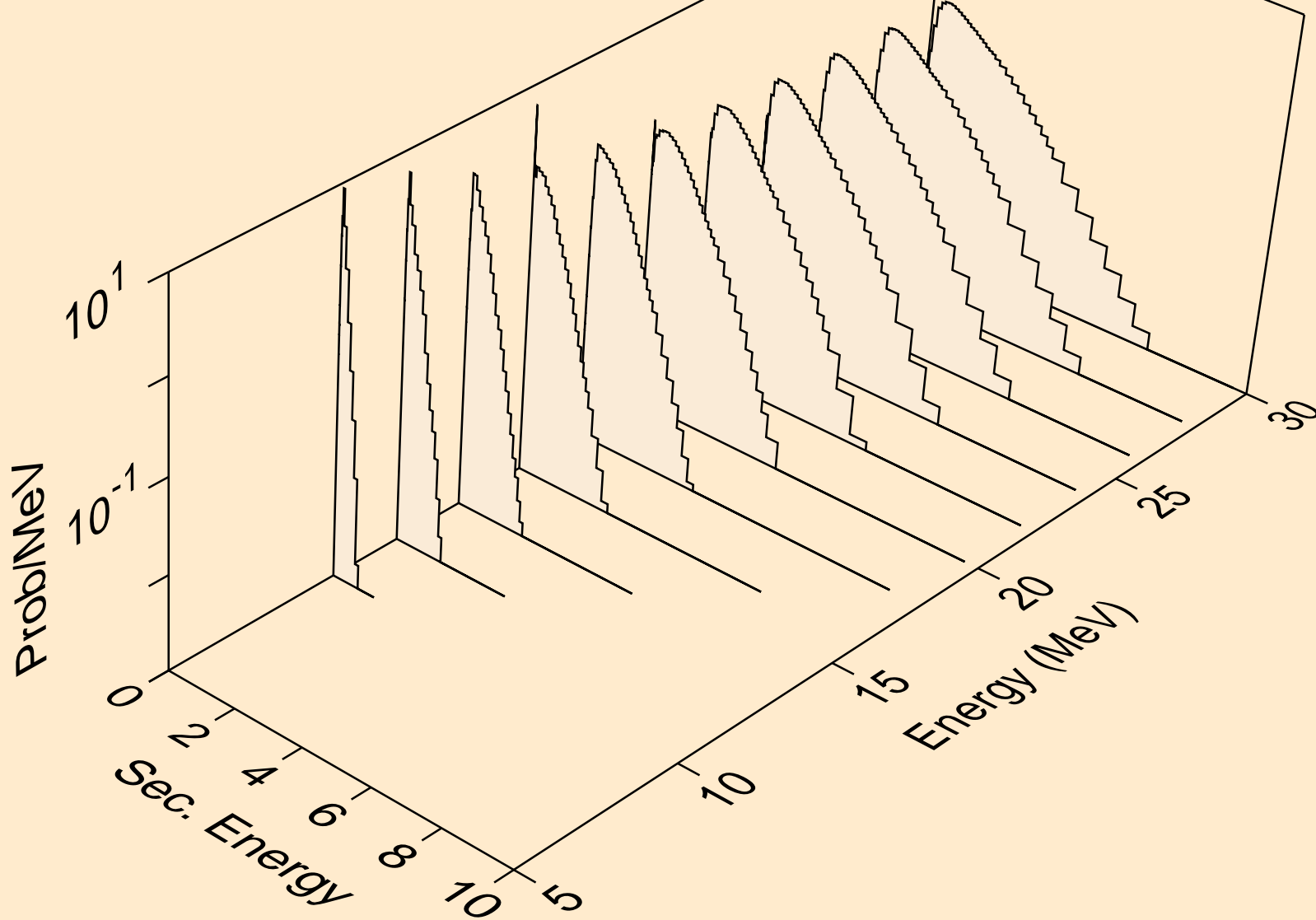

BR087 NEUTRON ACER TENDL-2019 LIBRARY; T=293.16K
Neutron emission for (n,2n)a

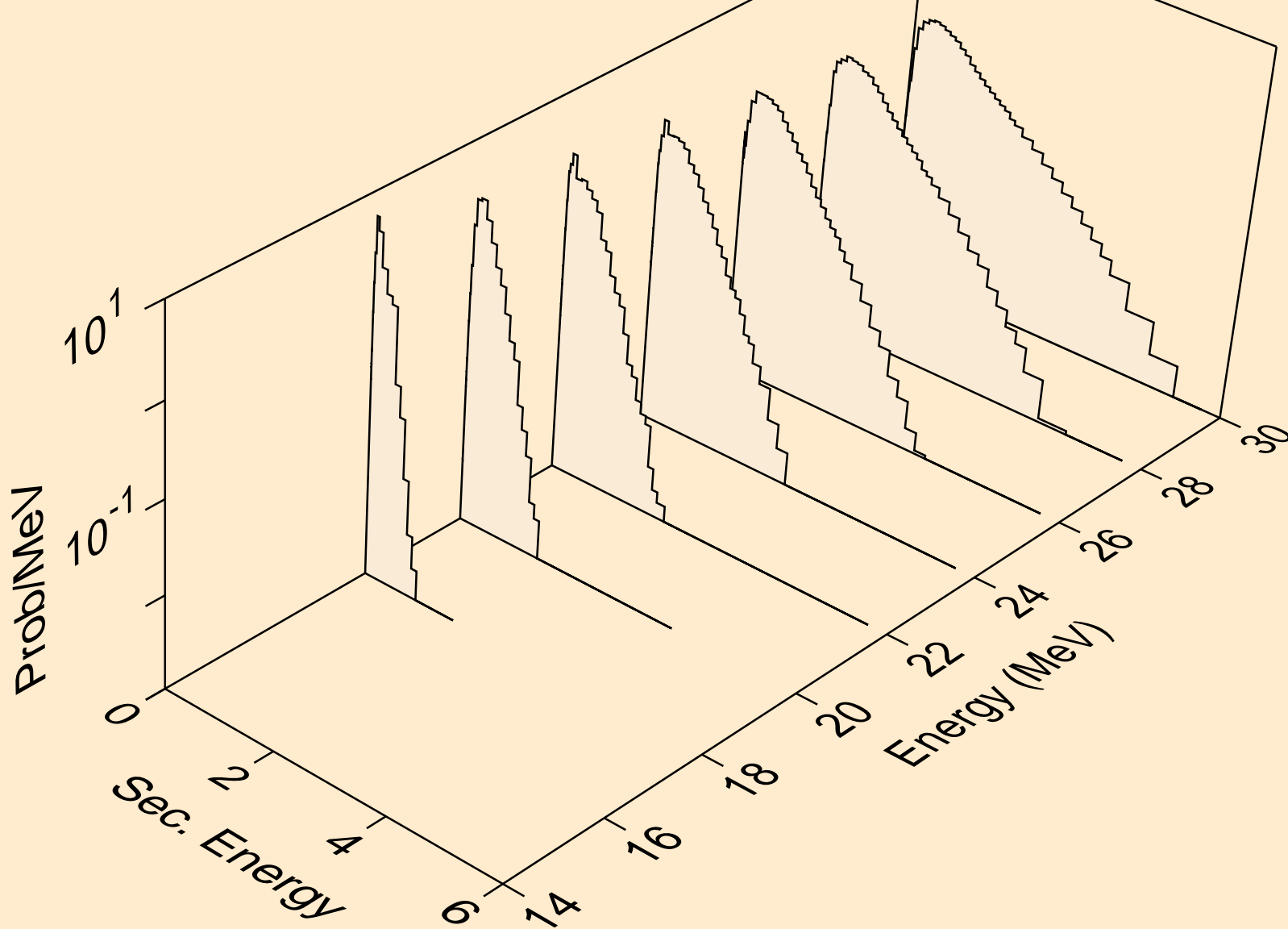

BR087 NEUTRON ACER TENDL-2019 LIBRARY; T=293.16K
Neutron emission for (n,3n)a

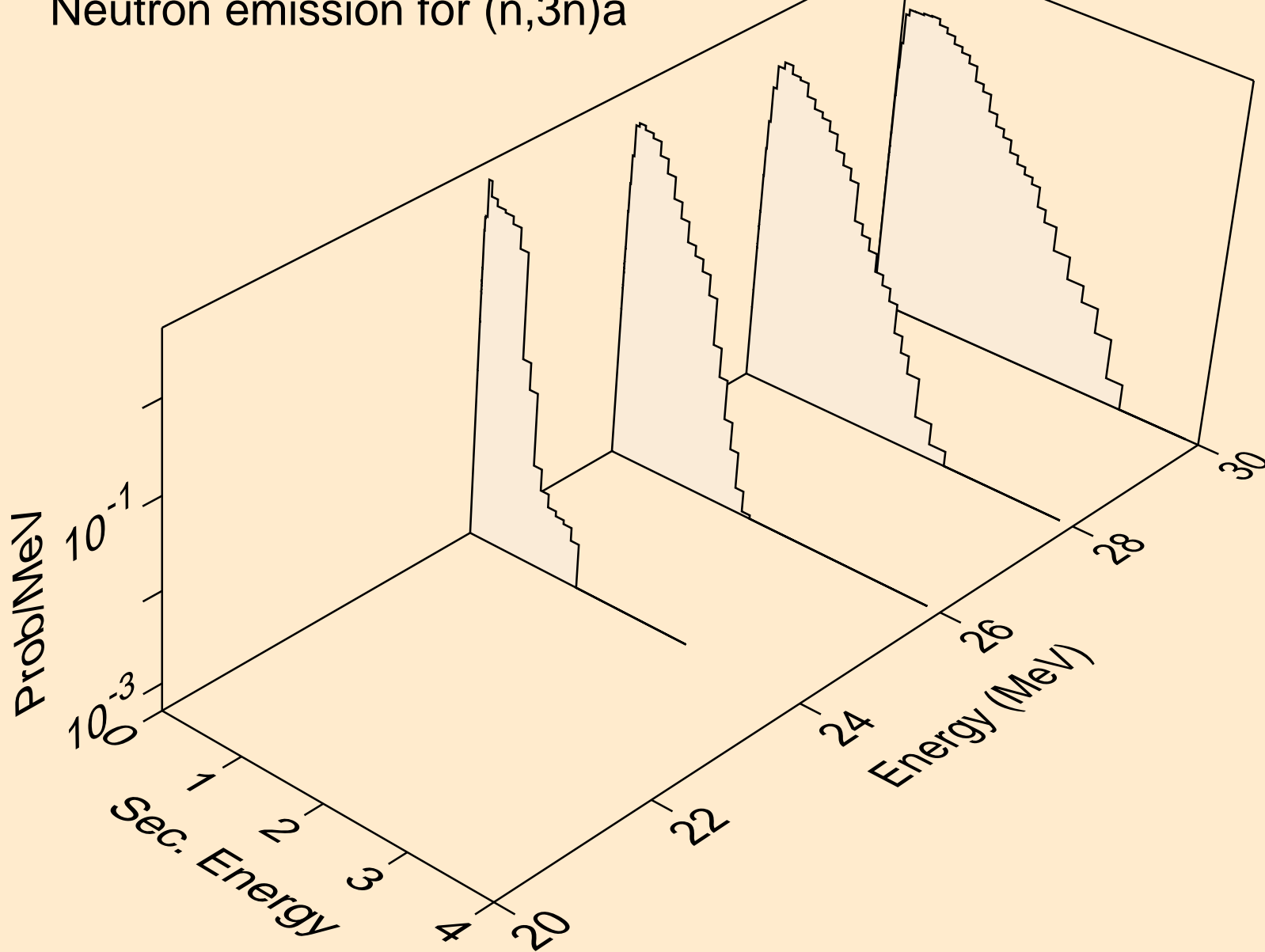

BR087 NEUTRON ACER TENDL-2019 LIBRARY; T=293.16K
Neutron emission for (n,n*)p

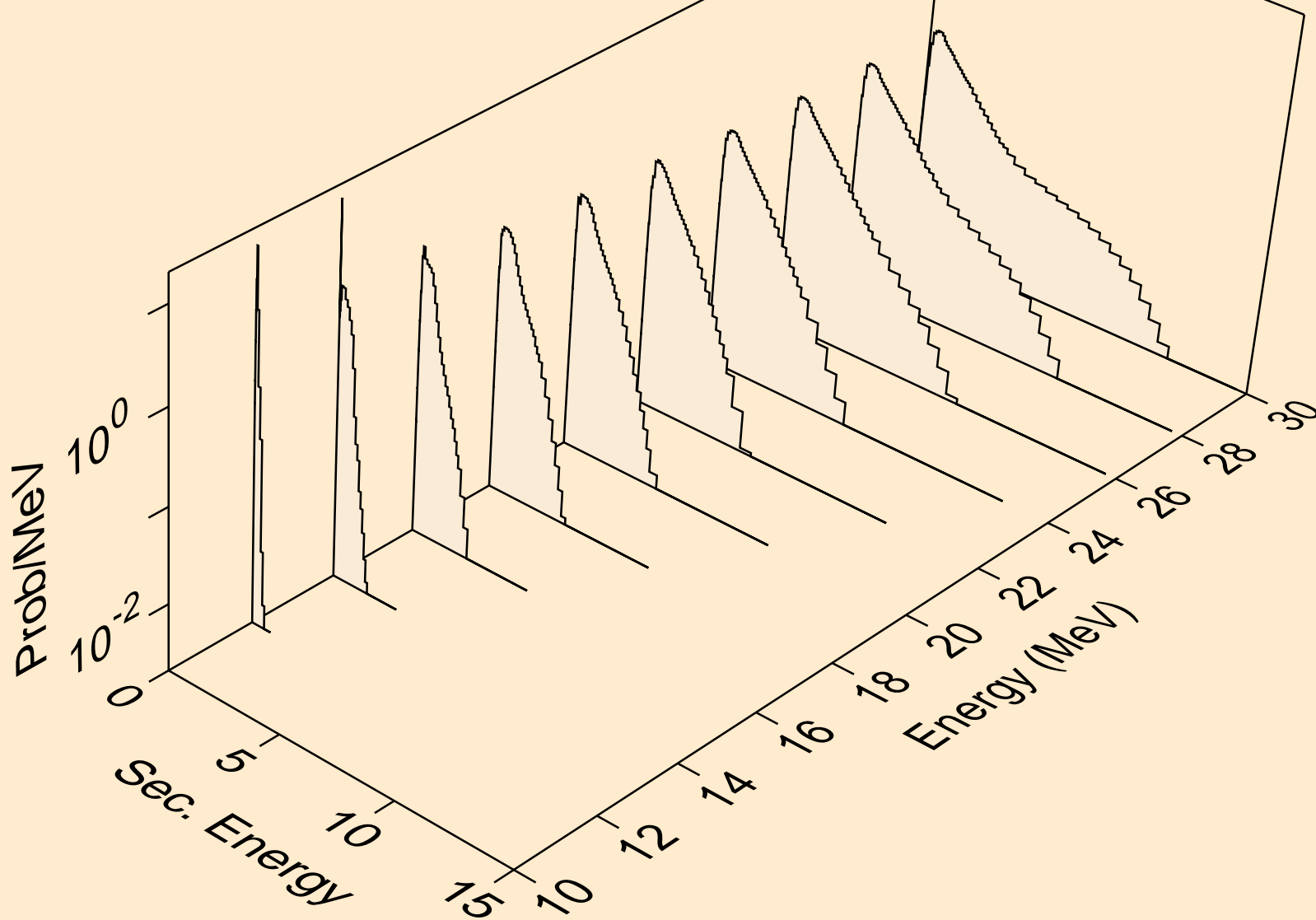

BR087 NEUTRON ACER TENDL-2019 LIBRARY; T=293.16K
Neutron emission for (n,n*)d

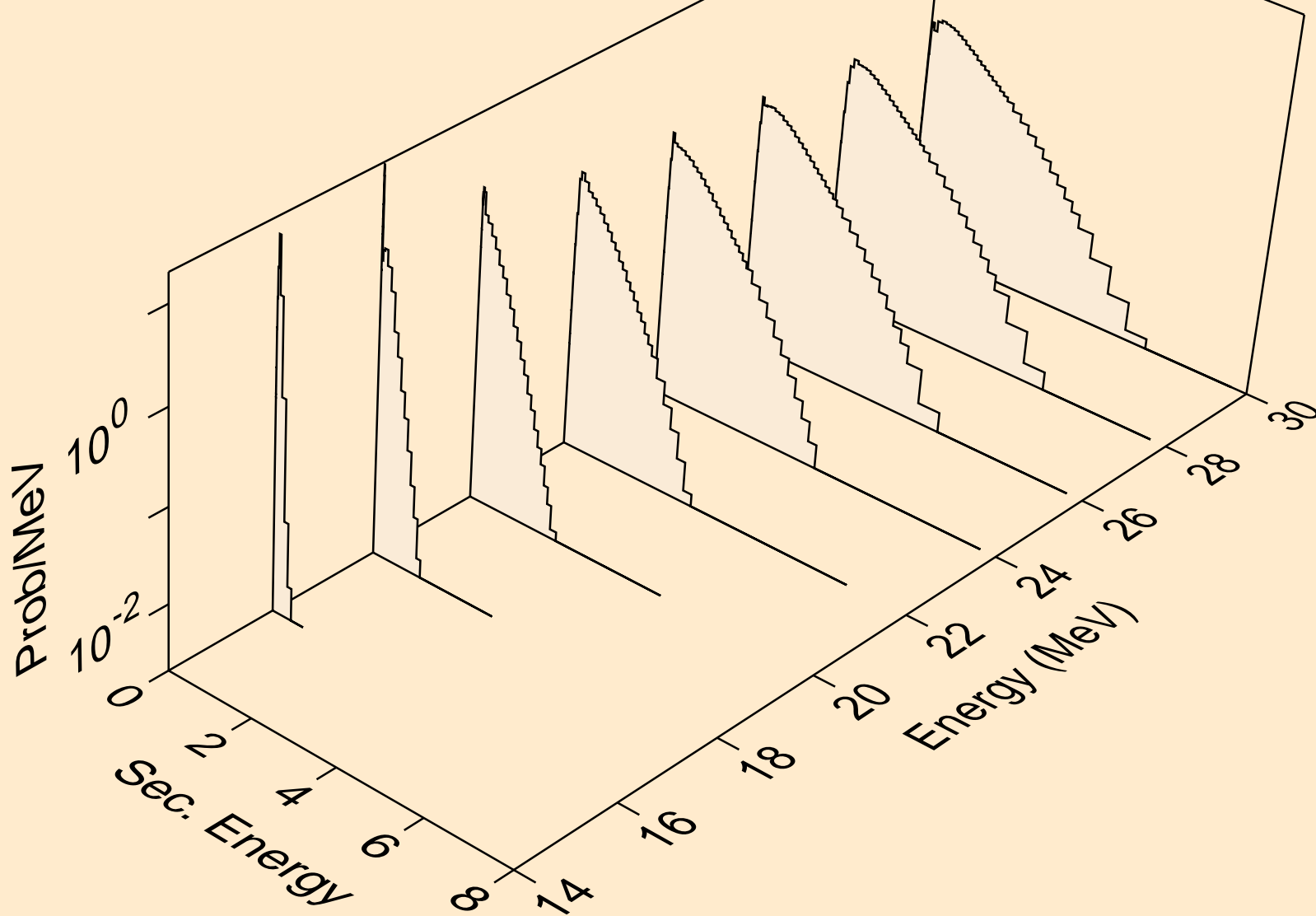

BR087 NEUTRON ACER TENDL-2019 LIBRARY; T=293.16K
Neutron emission for (n,n*)t

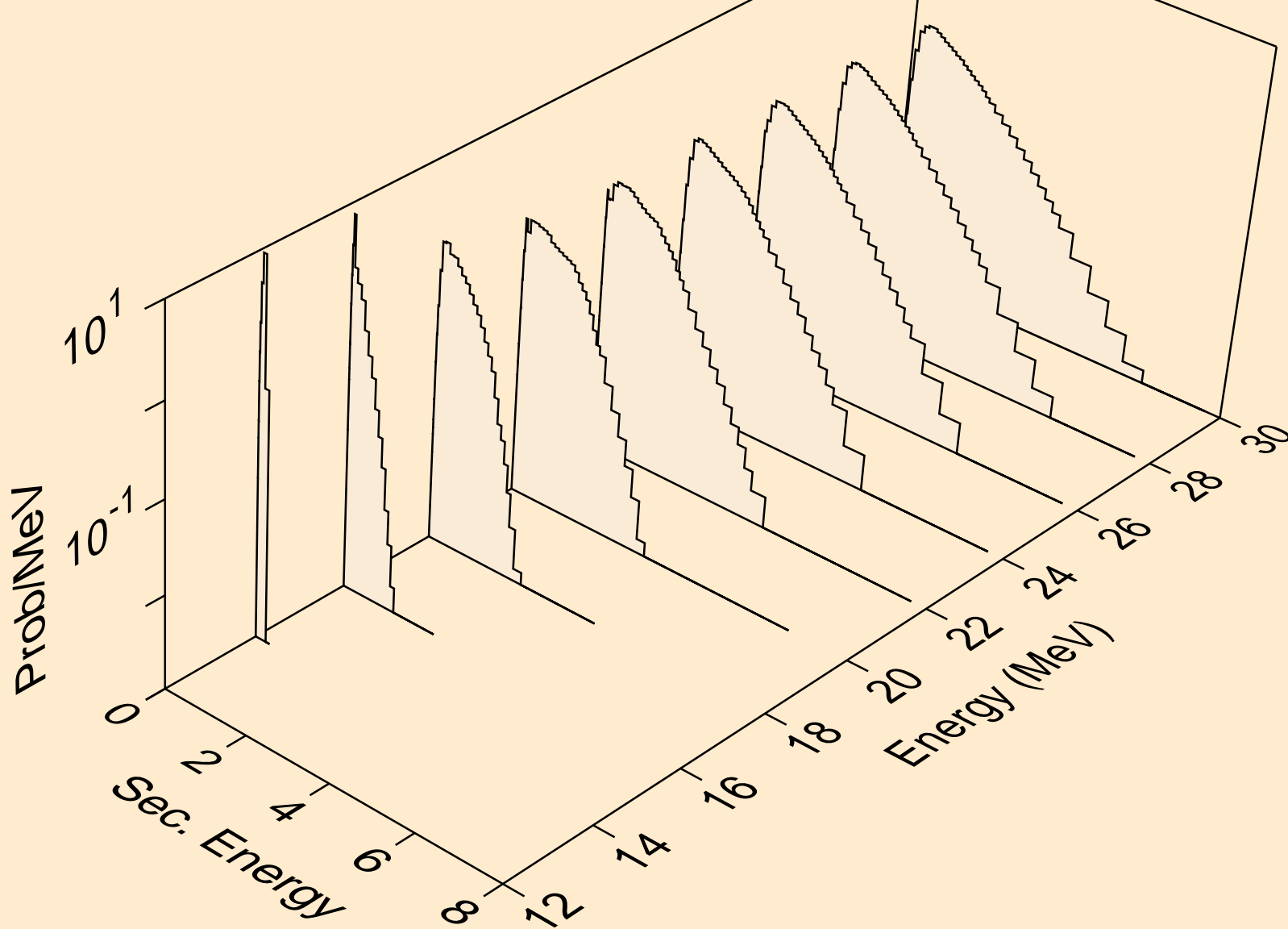

BR087 NEUTRON ACER TENDL-2019 LIBRARY; T=293.16K
Neutron emission for (n,n*)he3

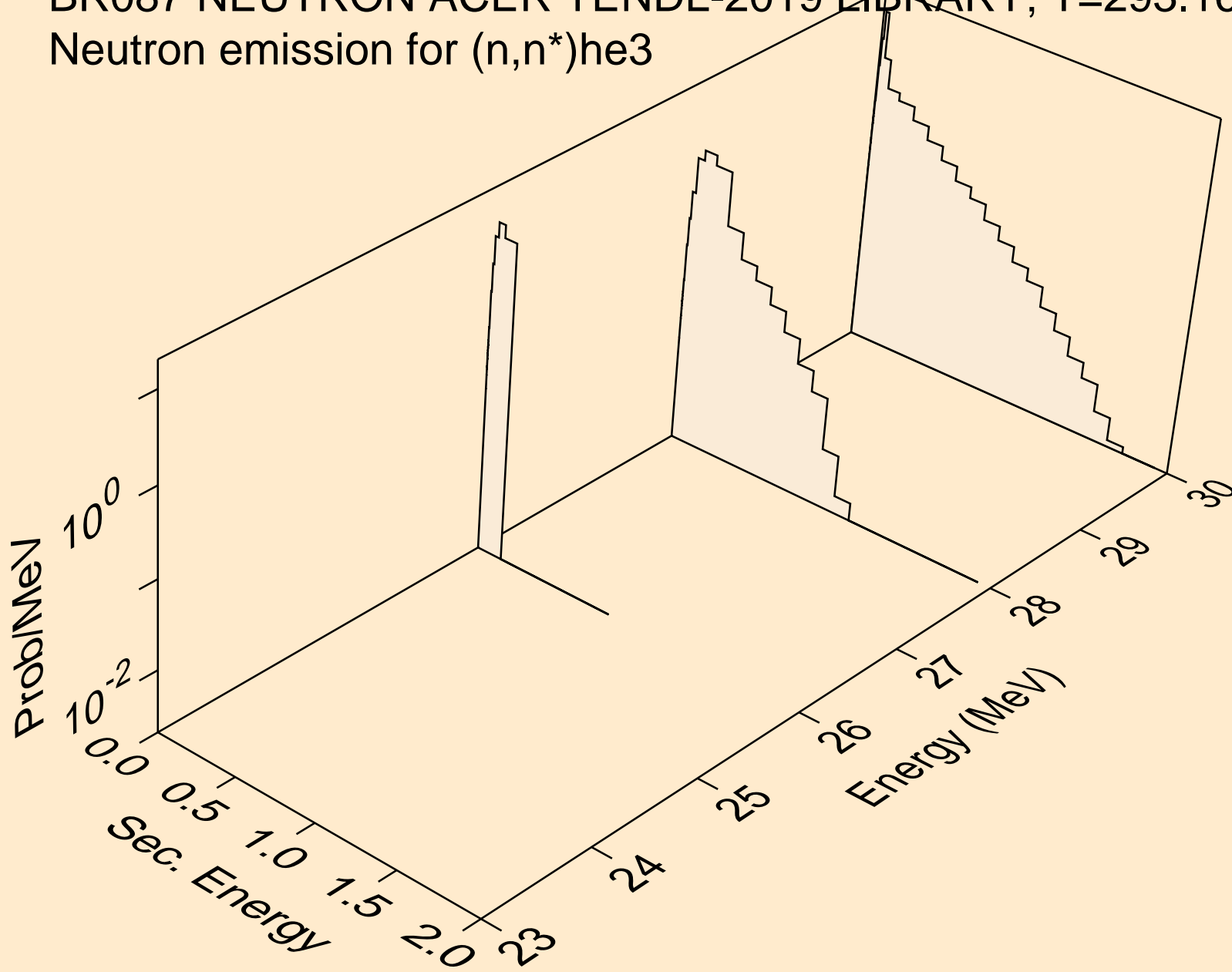

BR087 NEUTRON ACER TENDL-2019 LIBRARY; T=293.16K
Neutron emission for (n,4n)

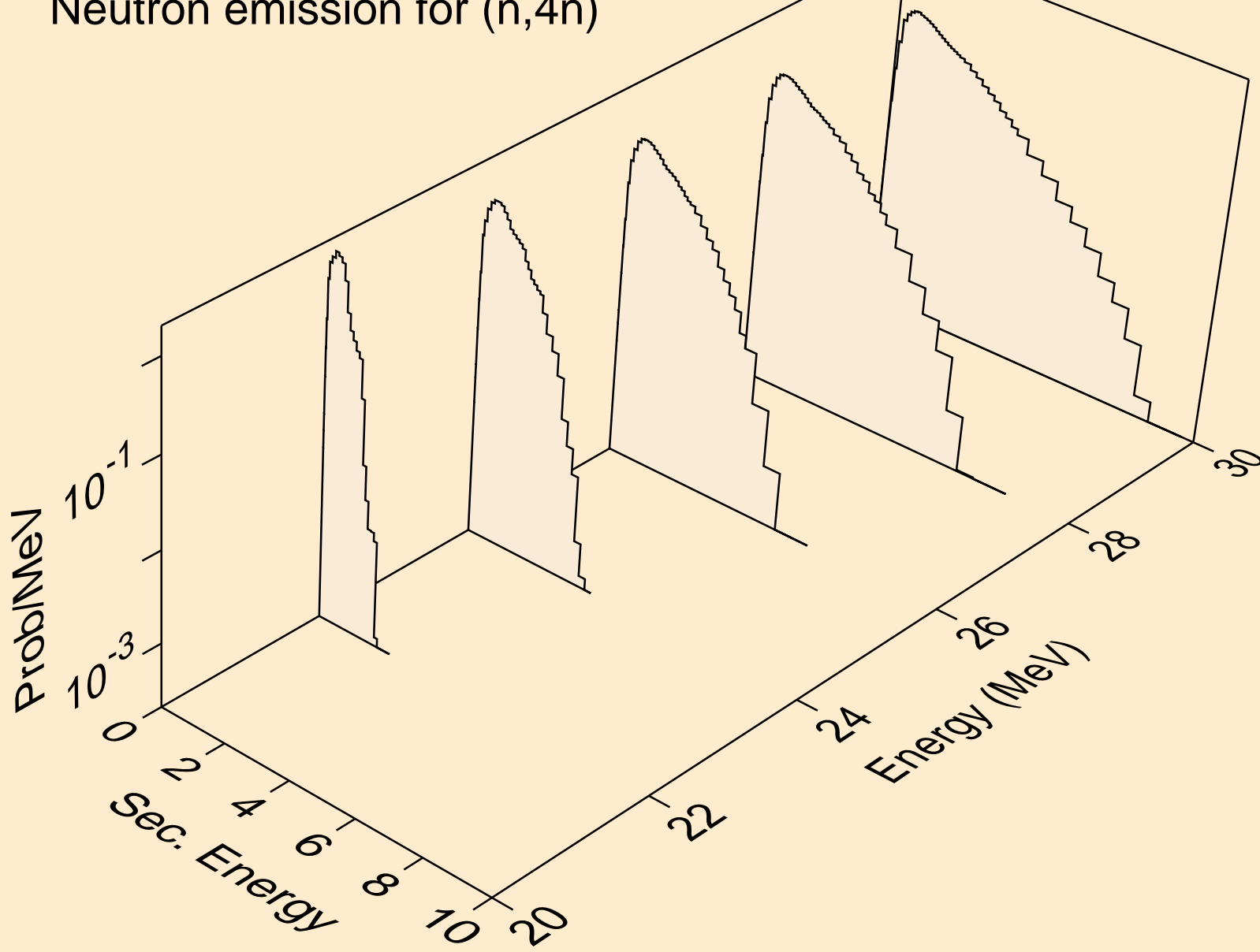

BR087 NEUTRON ACER TENDL-2019 LIBRARY; T=293.16K
Neutron emission for (n,2np)

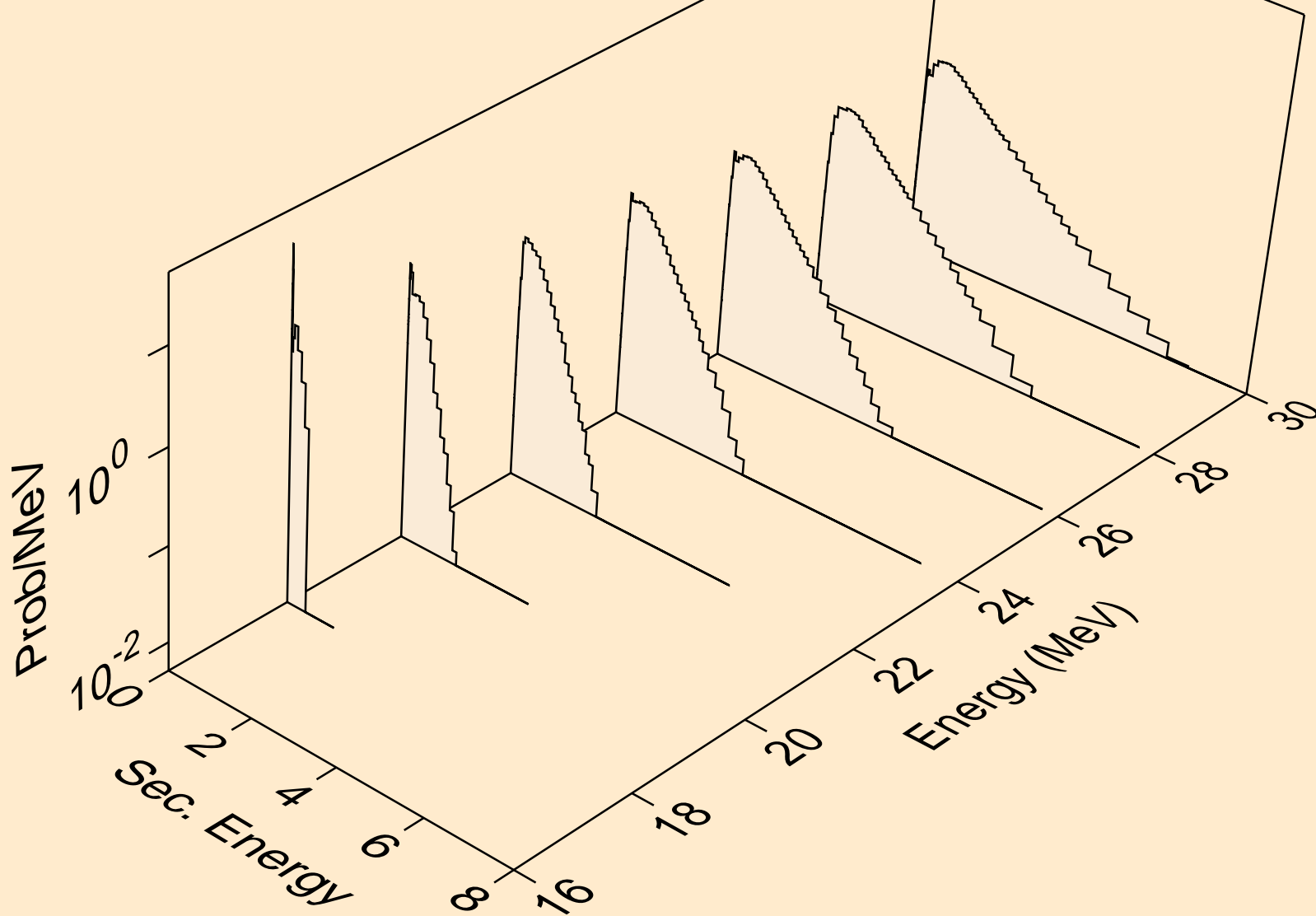

BR087 NEUTRON ACER TENDL-2019 LIBRARY; T=293.16K
Neutron emission for (n,3np)

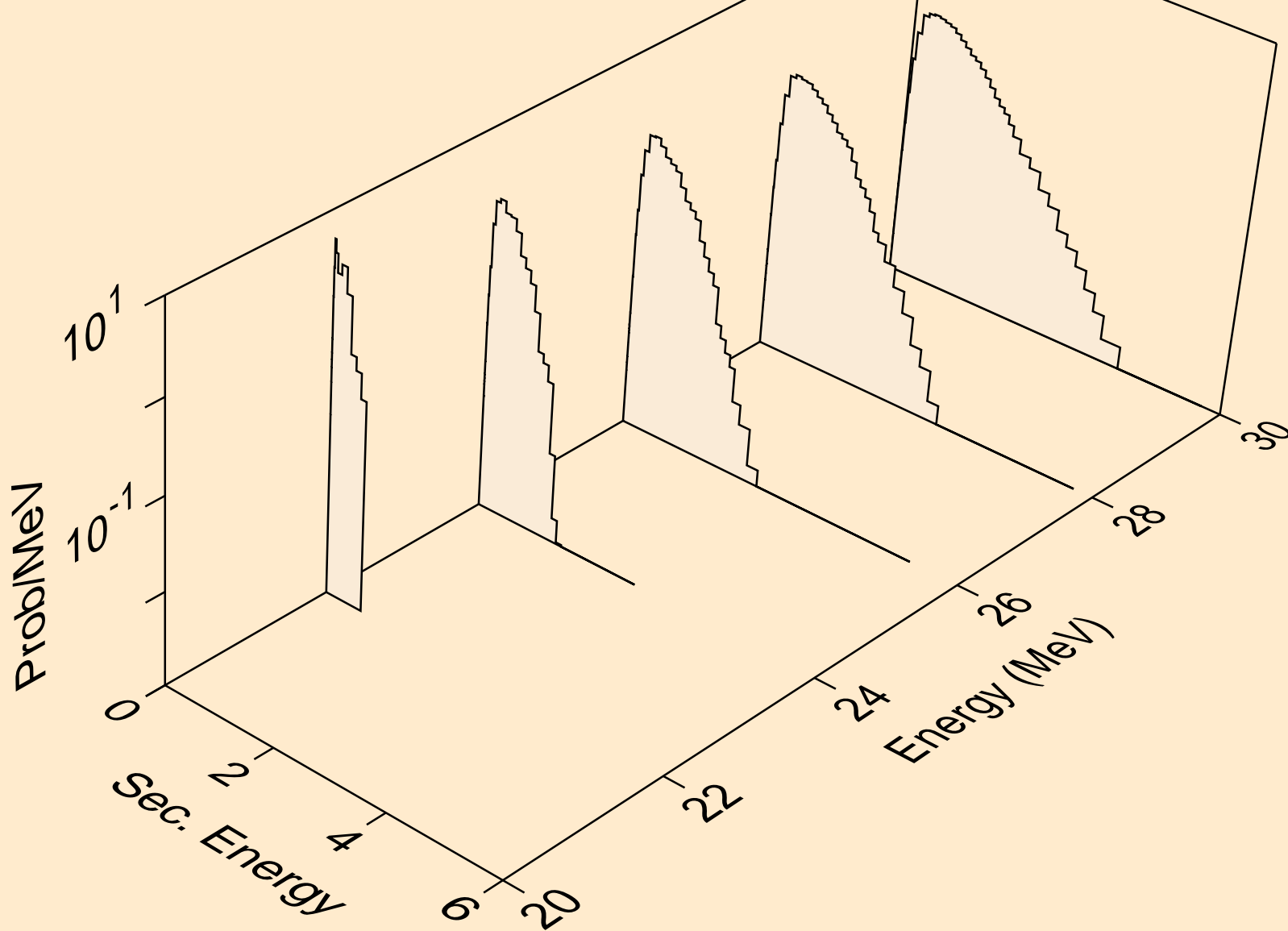

BR087 NEUTRON ACER TENDL-2019 LIBRARY; T=293.16K
Neutron emission for (n,n*c)

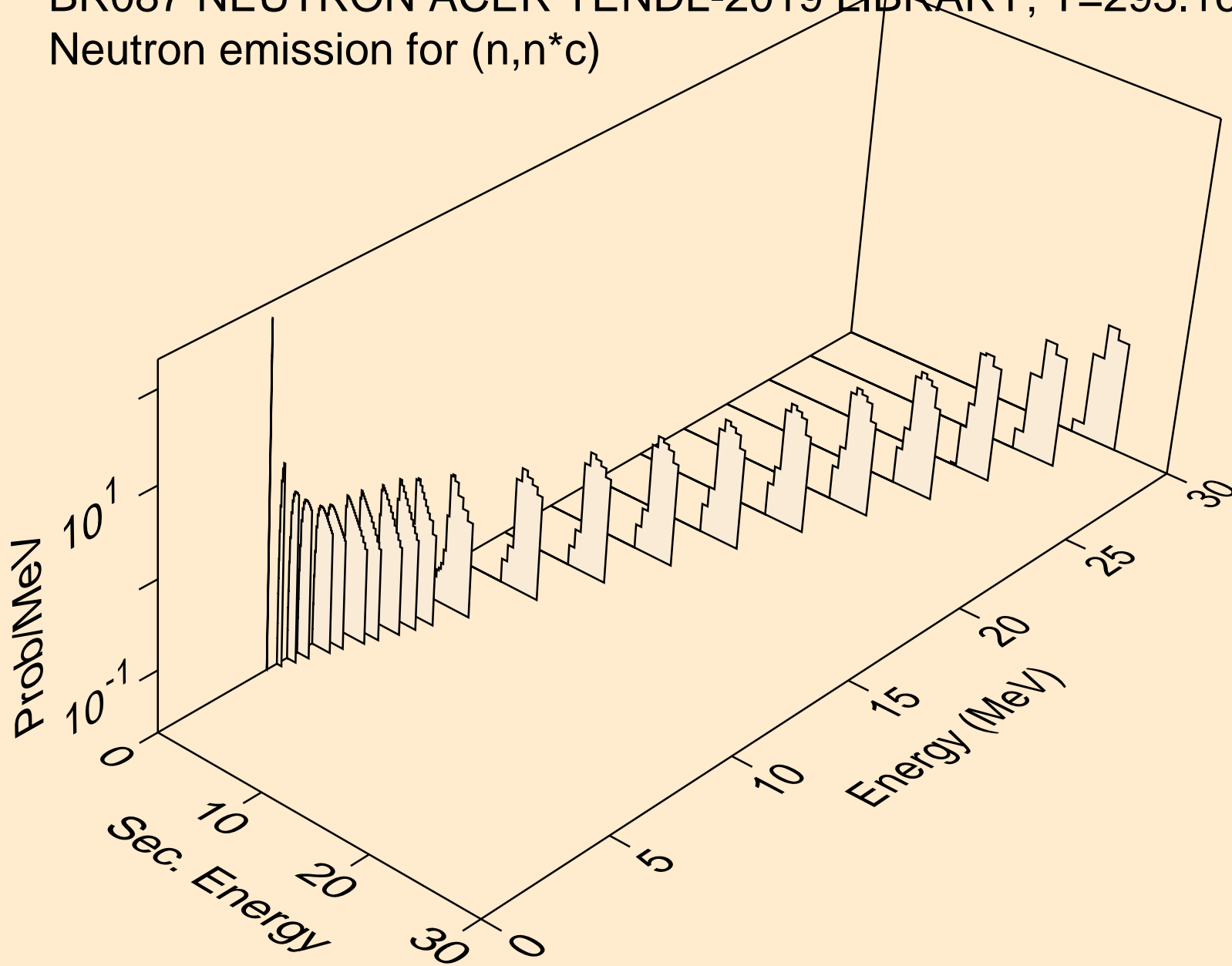

BR087 NEUTRON ACER TENDL-2019 LIBRARY; T=293.16K
Photon emission for (n,x)

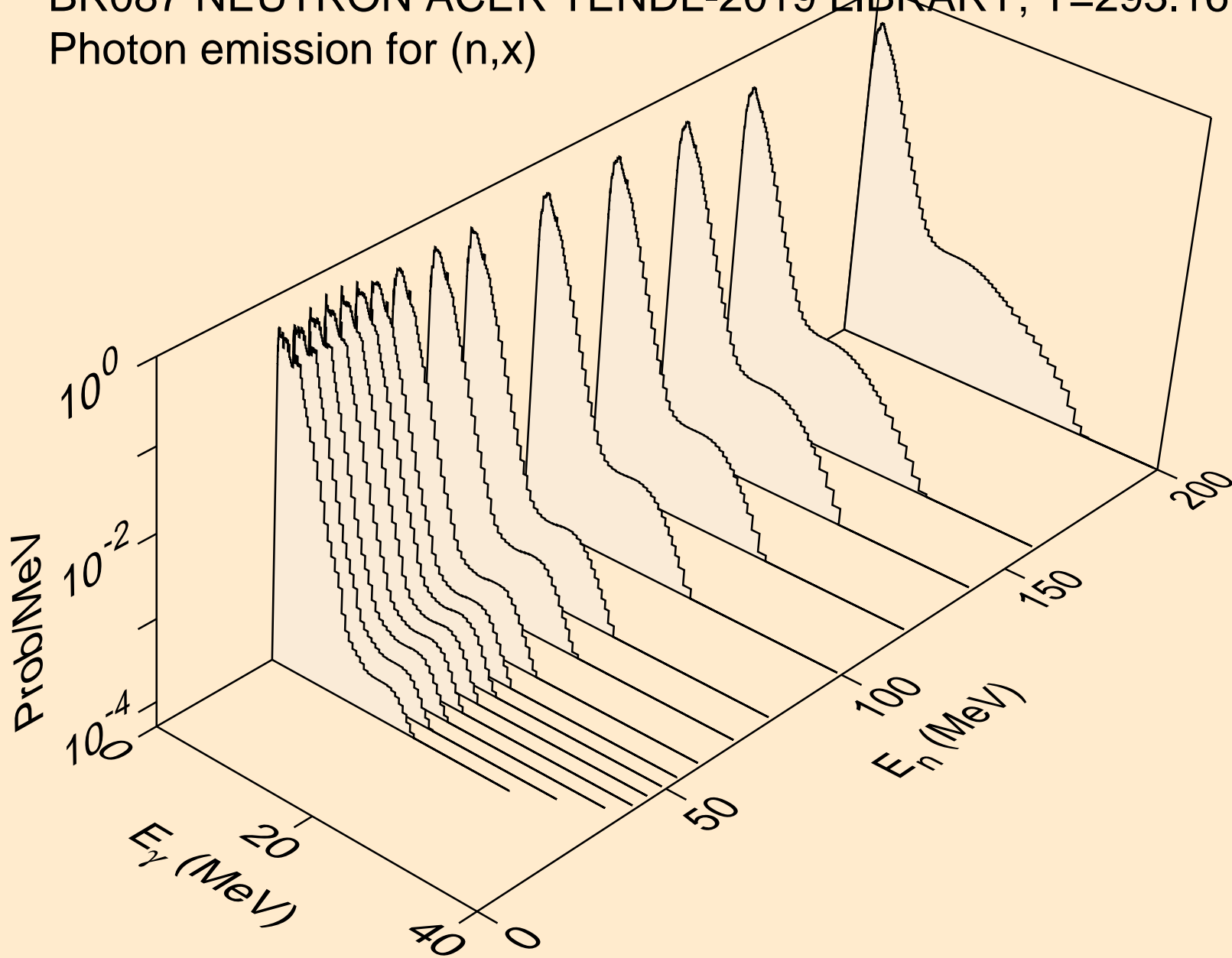

BR087 NEUTRON ACER TENDL-2019 LIBRARY; T=293.16K
Photon emission for (n,2nd)

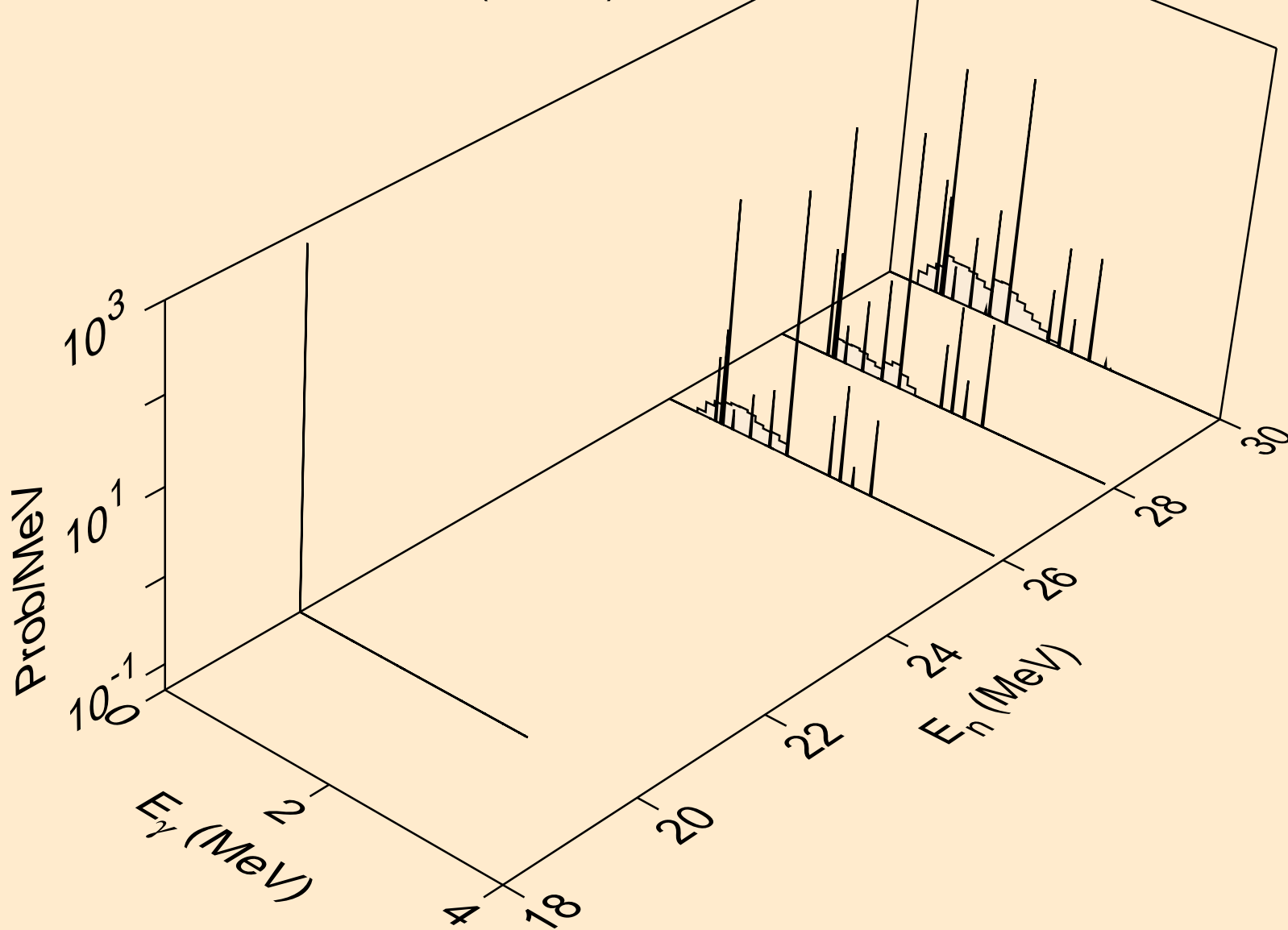

BR087 NEUTRON ACER TENDL-2019 LIBRARY; T=293.16K
Photon emission for (n,2n)

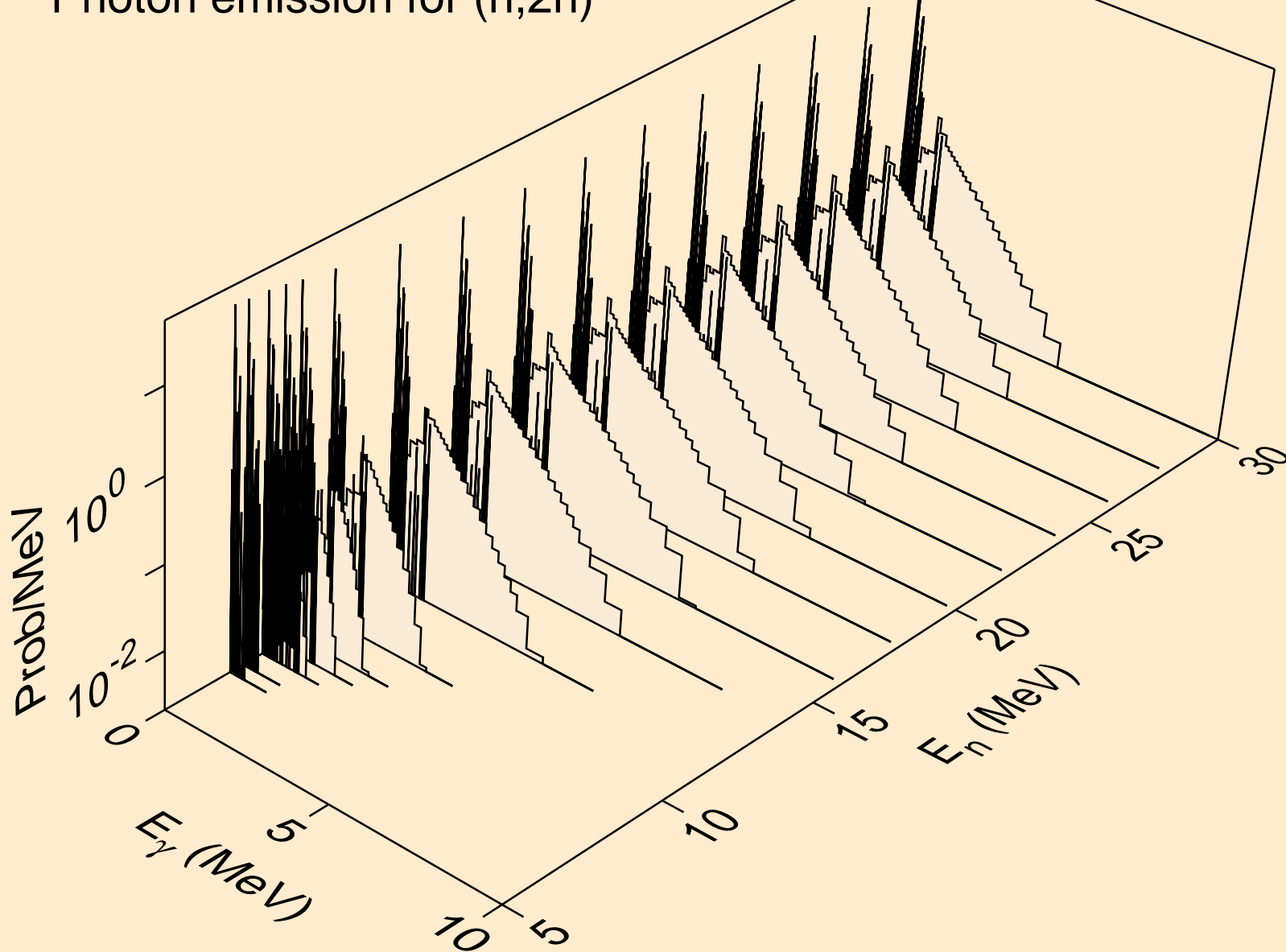

BR087 NEUTRON ACER TENDL-2019 LIBRARY; T=293.16K
Photon emission for (n,3n)

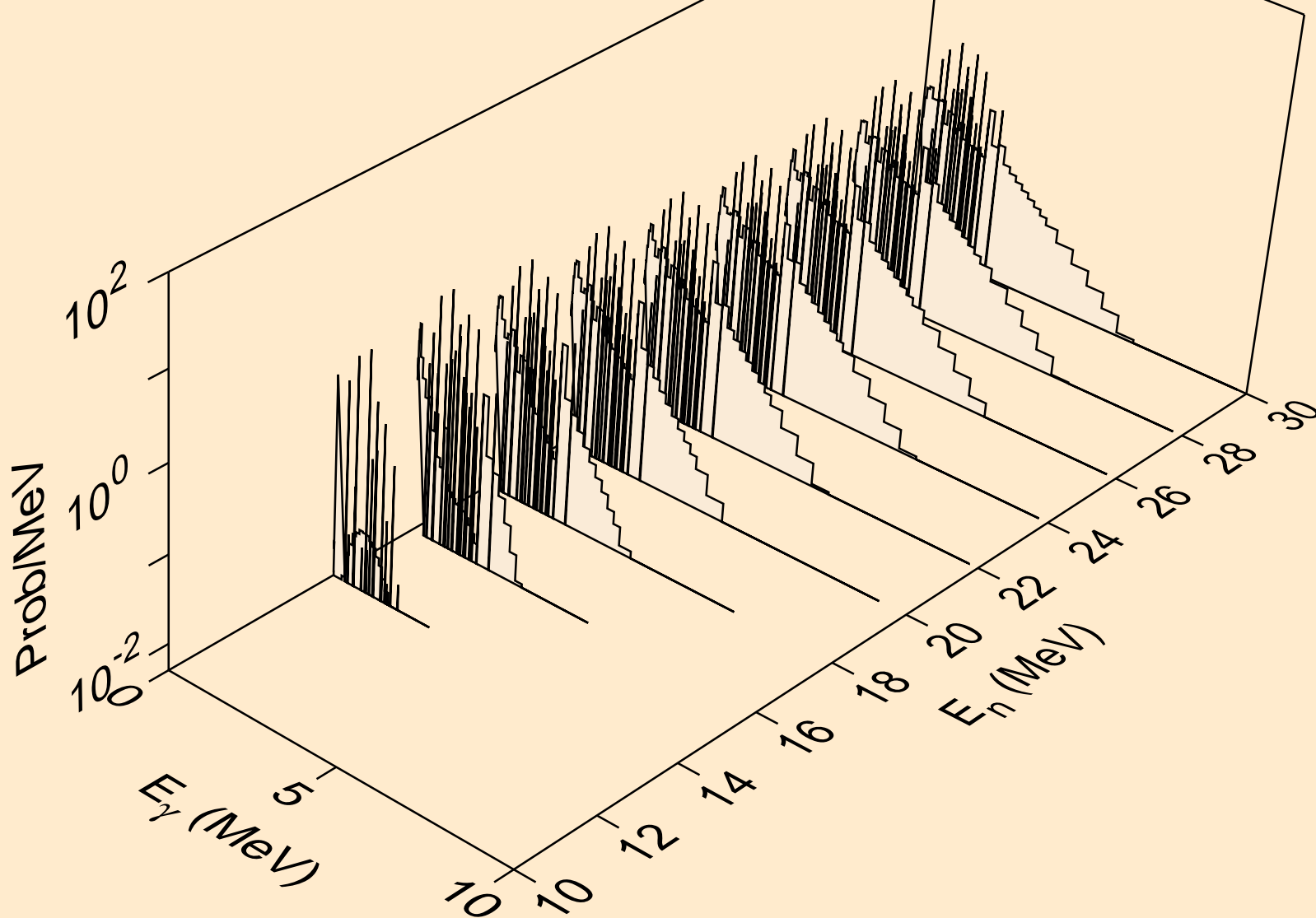

BR087 NEUTRON ACER TENDL-2019 LIBRARY; T=293.16K
Photon emission for (n,n*)a

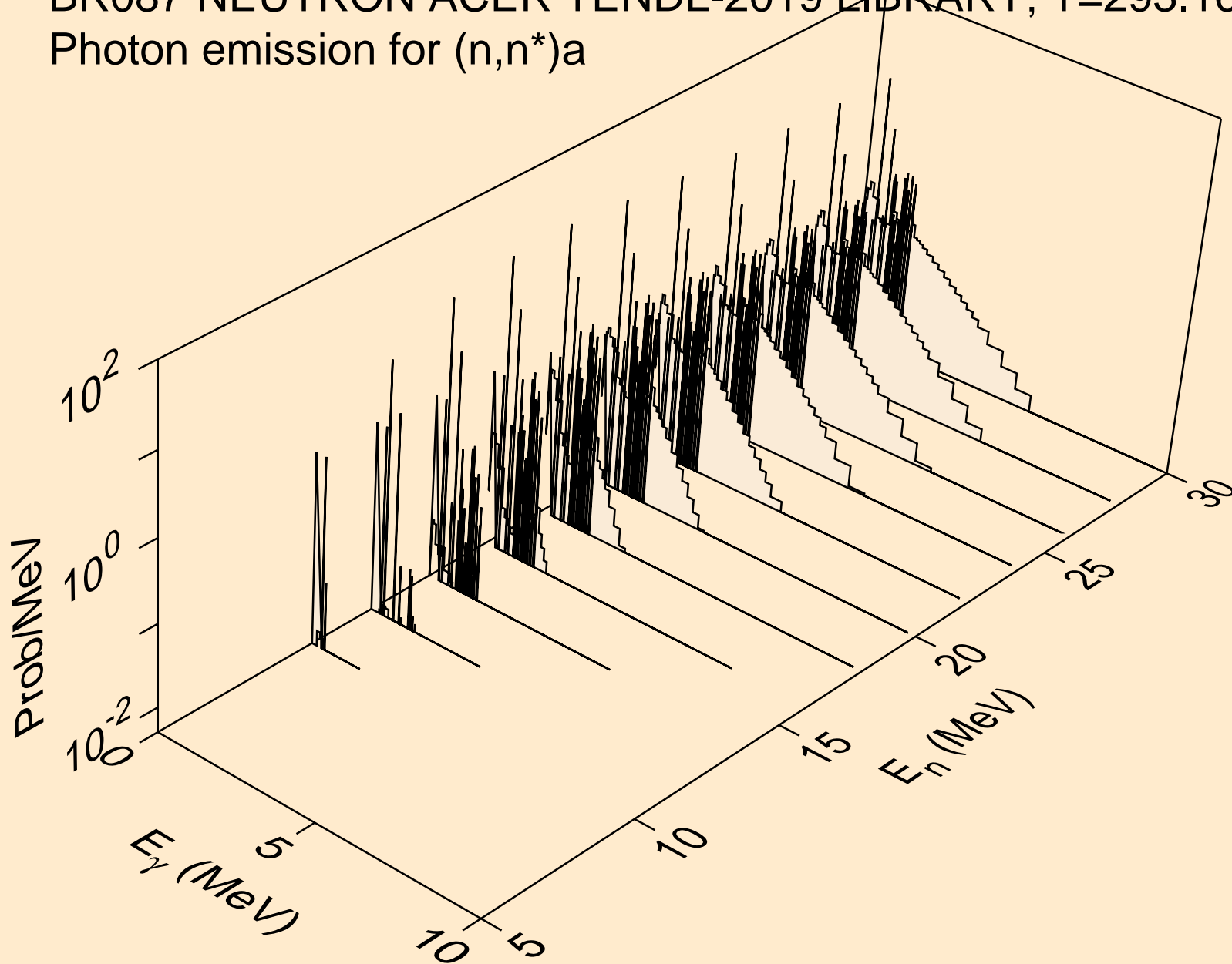

BR087 NEUTRON ACER TENDL-2019 LIBRARY; T=293.16K
Photon emission for (n,2n)a

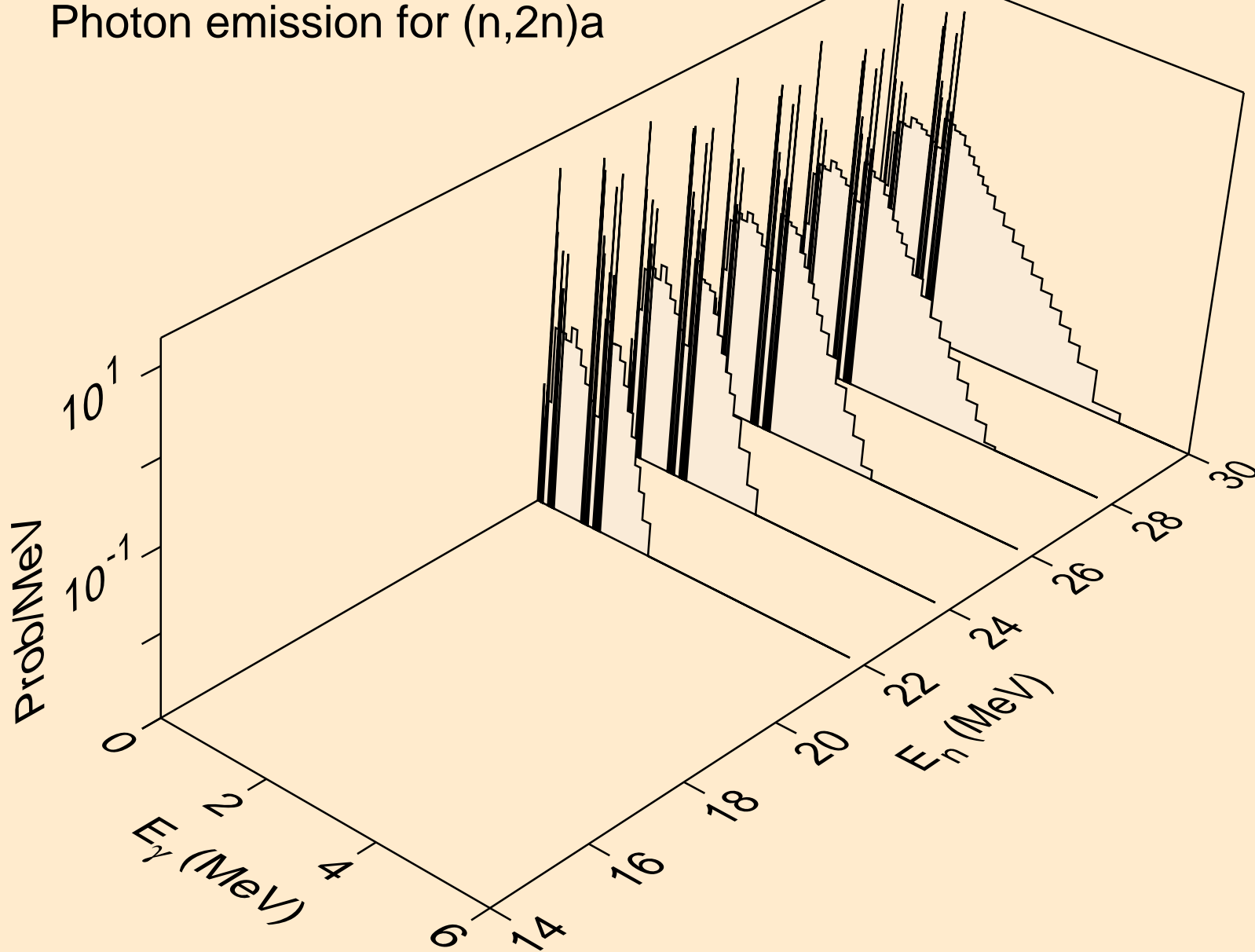

BR087 NEUTRON ACER TENDL-2019 LIBRARY; T=293.16K
Photon emission for (n,3n)a

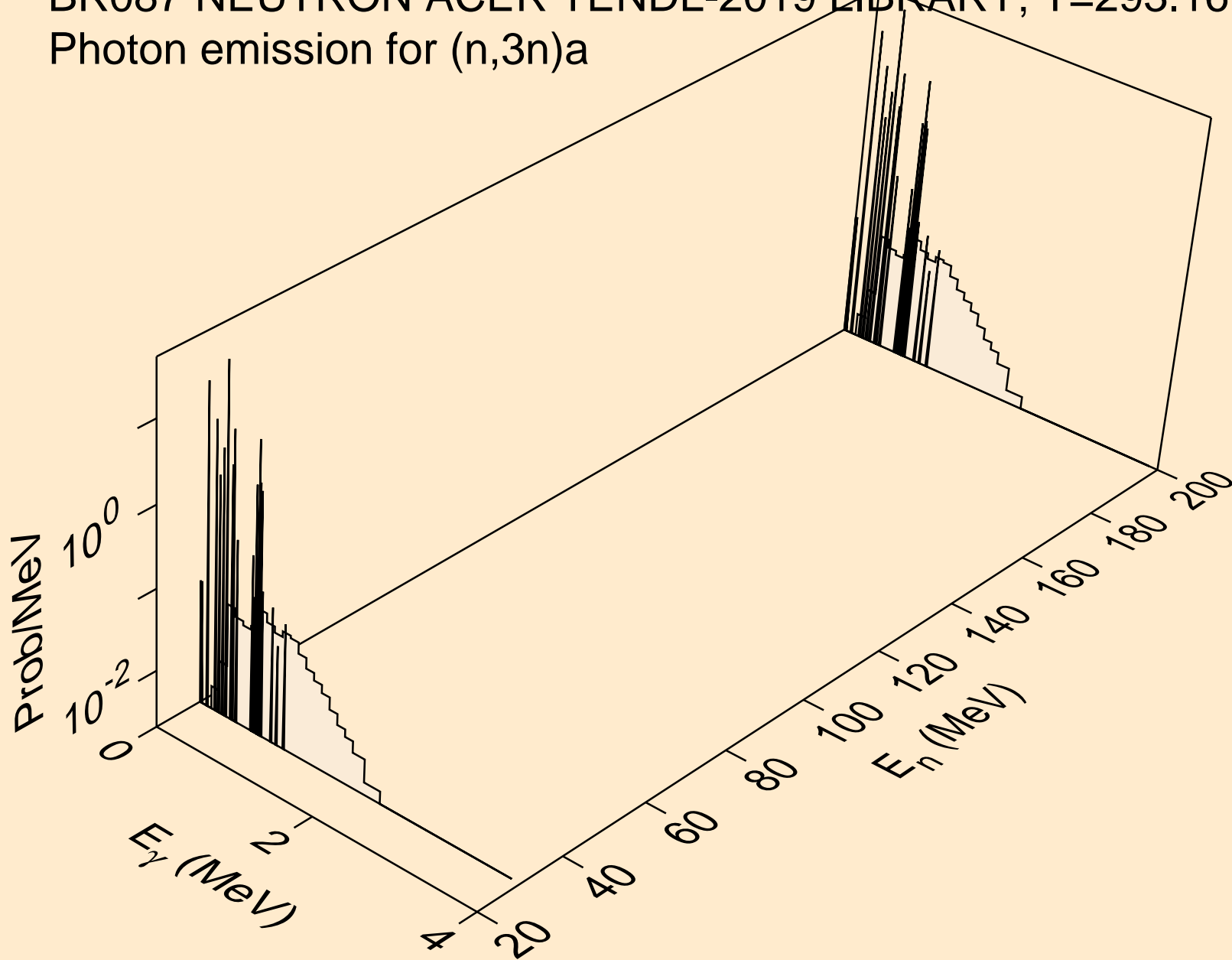

BR087 NEUTRON ACER TENDL-2019 LIBRARY; T=293.16K
Photon emission for (n,n*)p

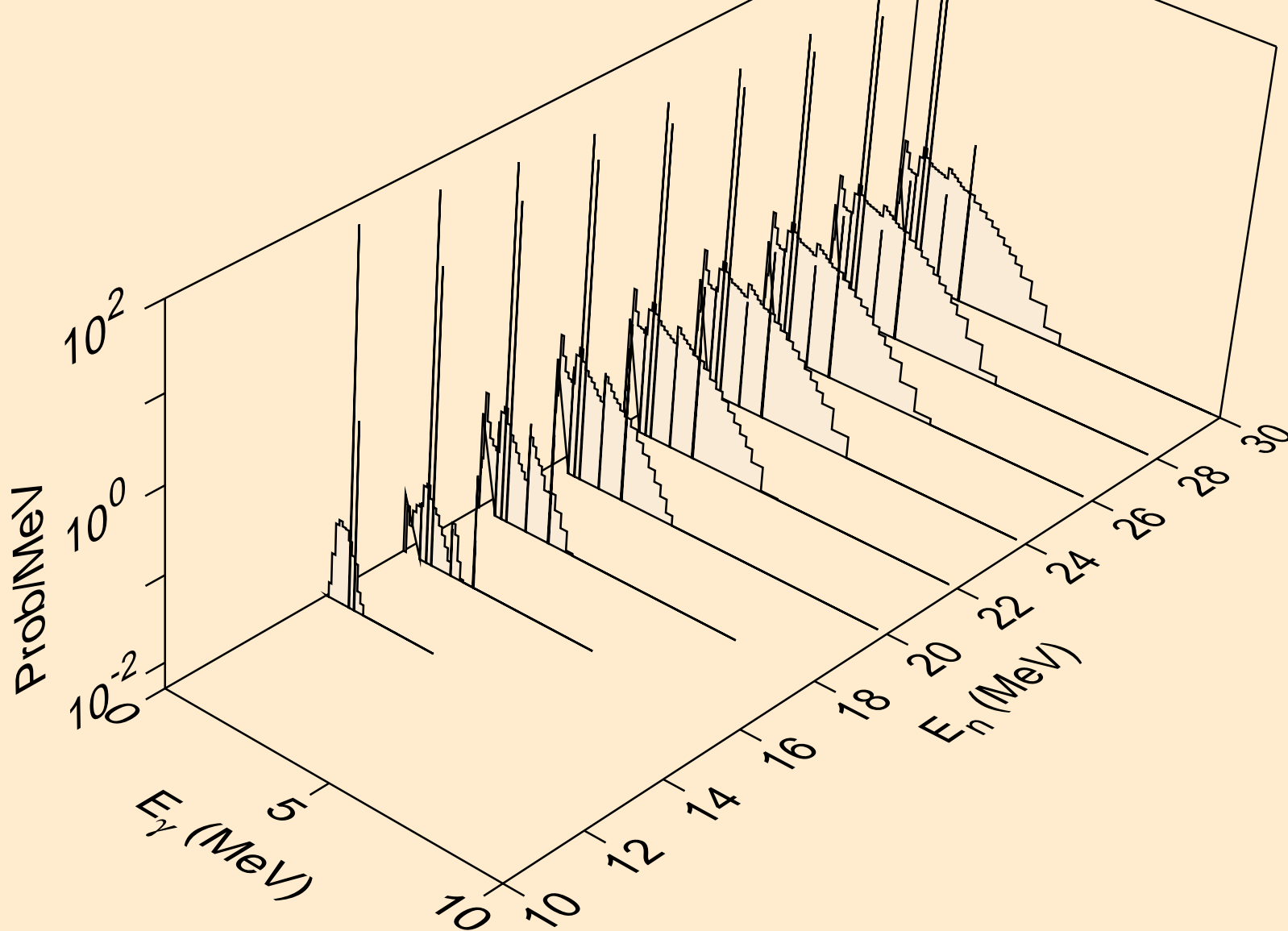

BR087 NEUTRON ACER TENDL-2019 LIBRARY; T=293.16K
Photon emission for (n,n*)d

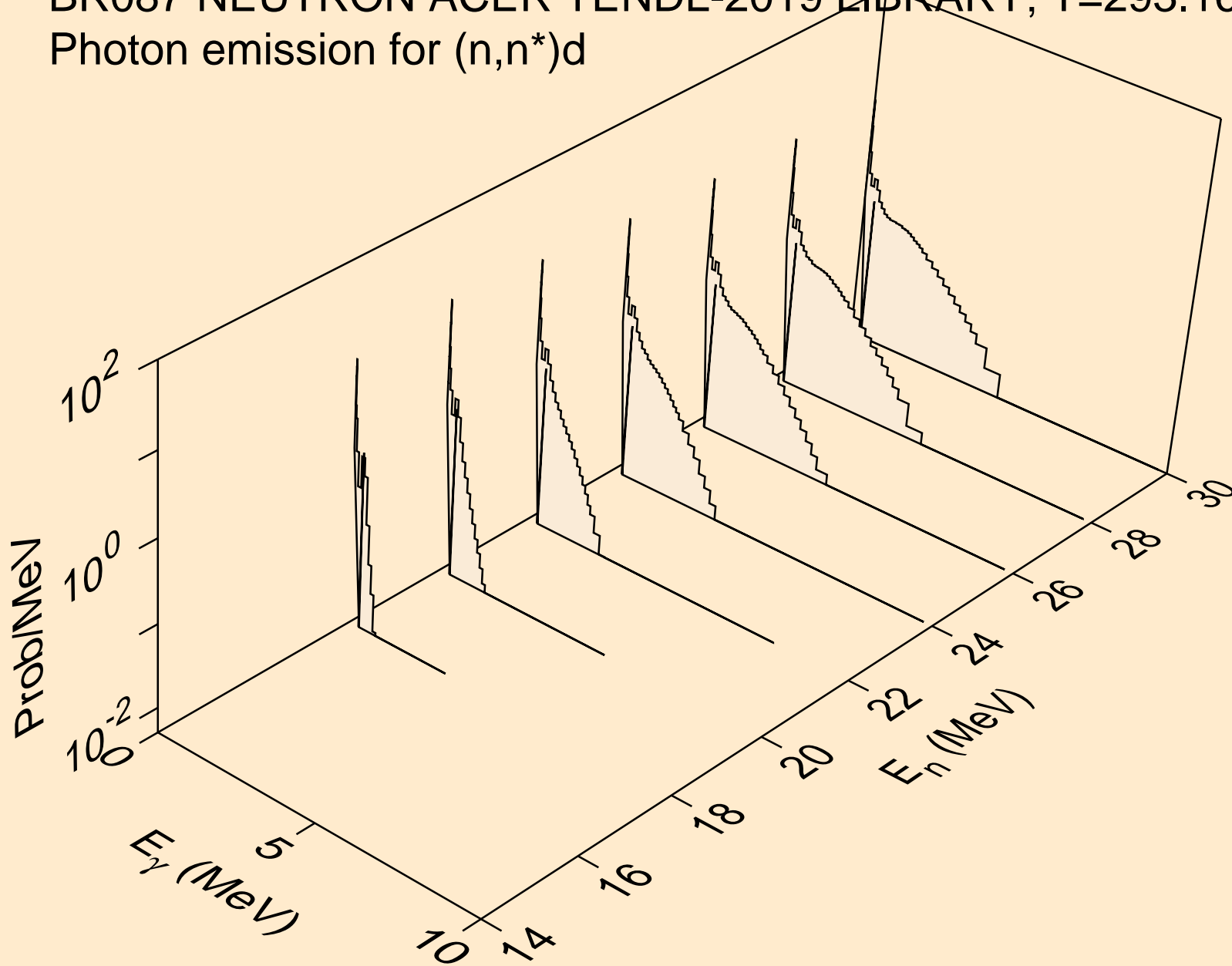

BR087 NEUTRON ACER TENDL-2019 LIBRARY; T=293.16K
Photon emission for (n,n*)t

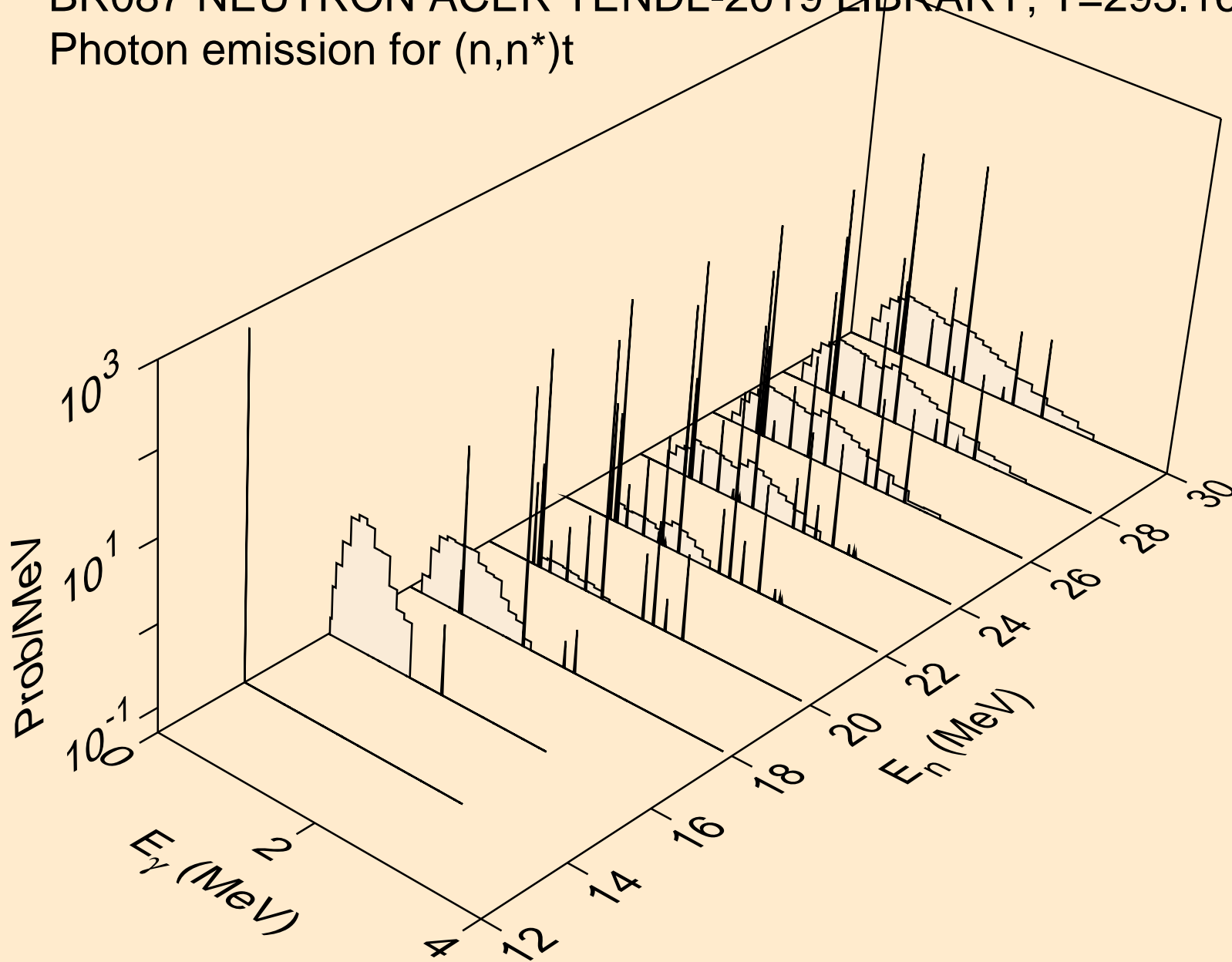

BR087 NEUTRON ACER TENDL-2019 LIBRARY; T=293.16K
Photon emission for (n,n*)he3

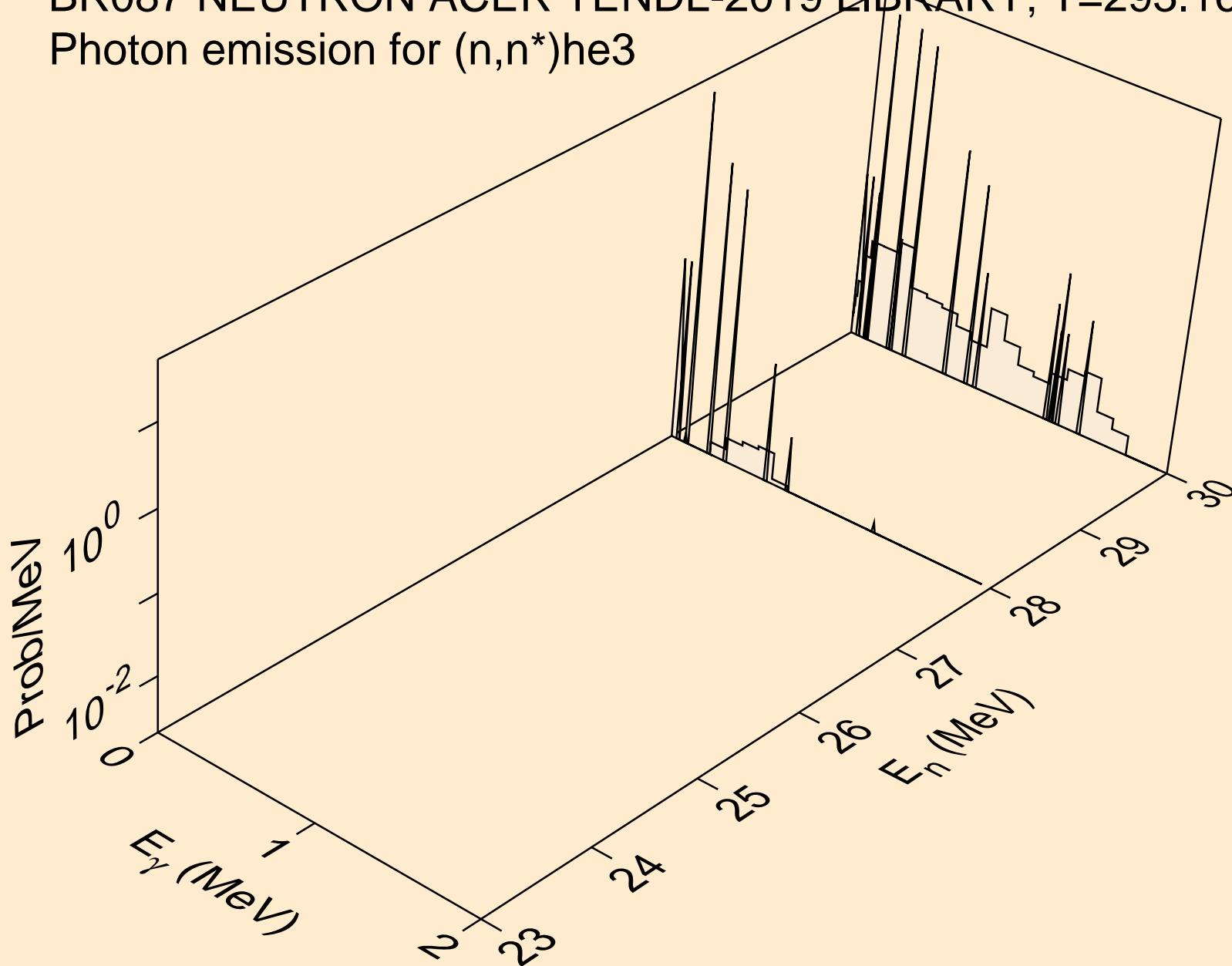

BR087 NEUTRON ACER TENDL-2019 LIBRARY; T=293.16K
Photon emission for (n,4n)

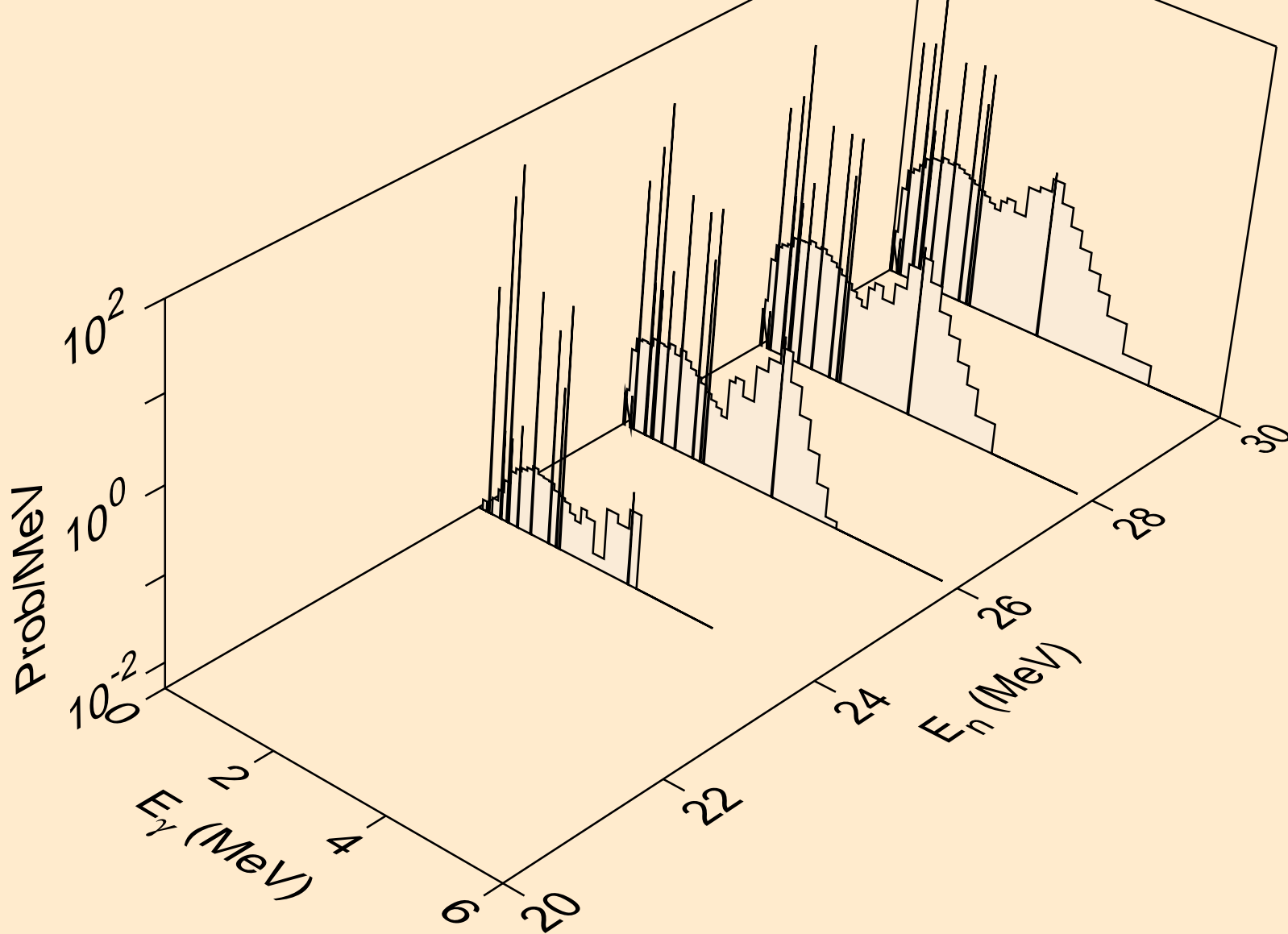

BR087 NEUTRON ACER TENDL-2019 LIBRARY; T=293.16K
Photon emission for (n,2np)

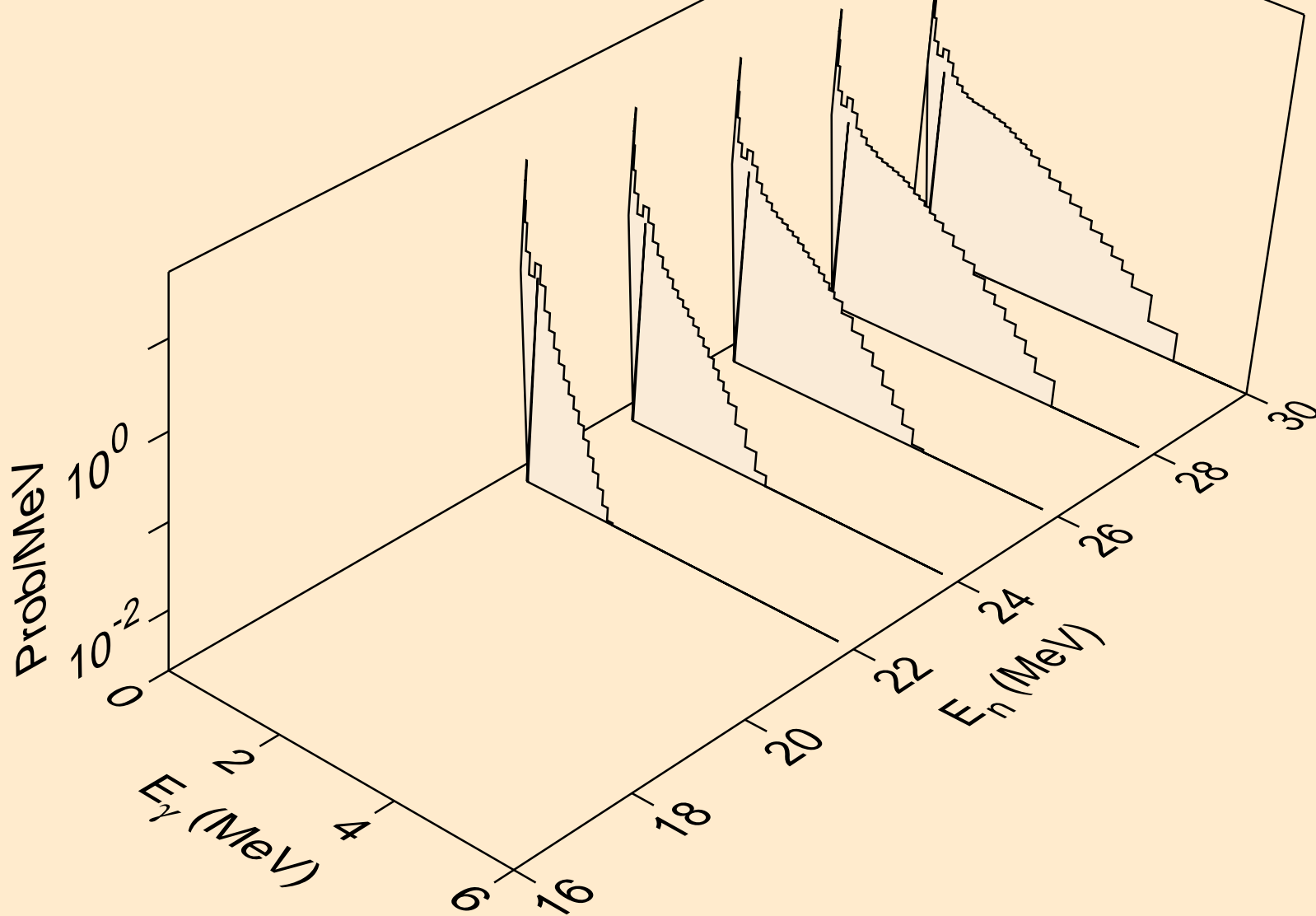

BR087 NEUTRON ACER TENDL-2019 LIBRARY; T=293.16K
Photon emission for (n,3np)

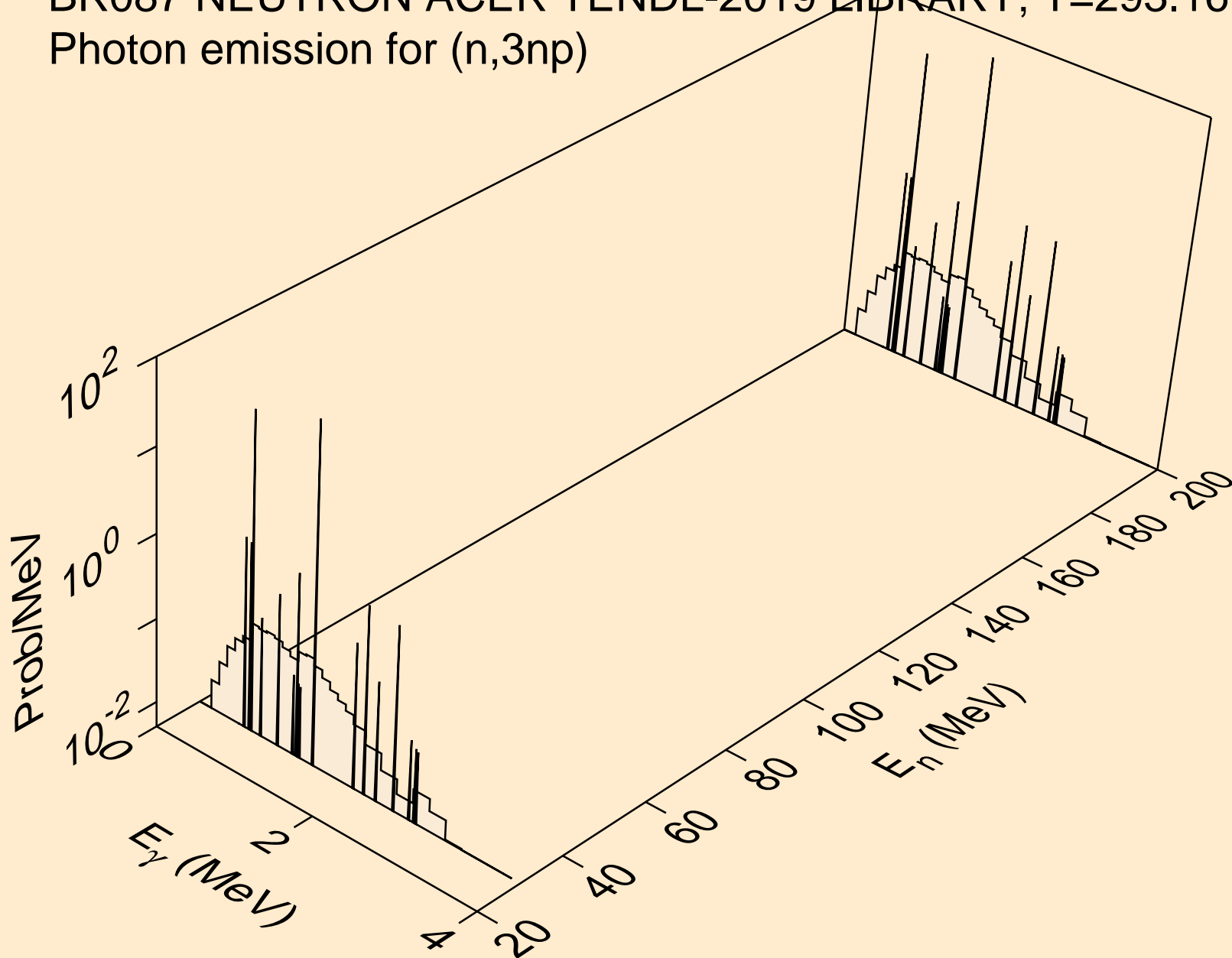

BR087 NEUTRON ACER TENDL-2019 LIBRARY; T=293.16K
Photon emission for (n,n*c)

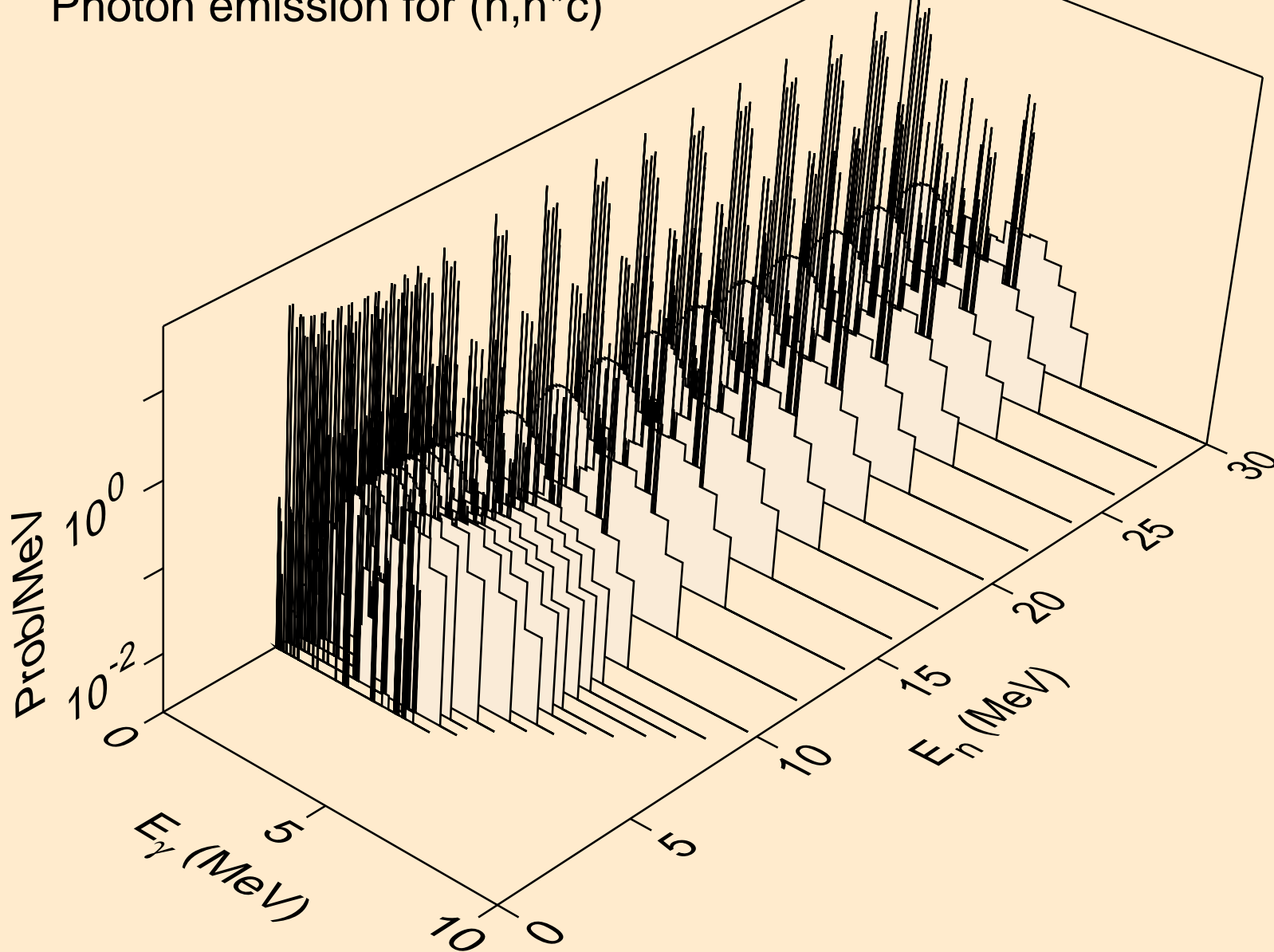

BR087 NEUTRON ACER TENDL-2019 LIBRARY; T=293.16K
Photon emission for (n,gma)

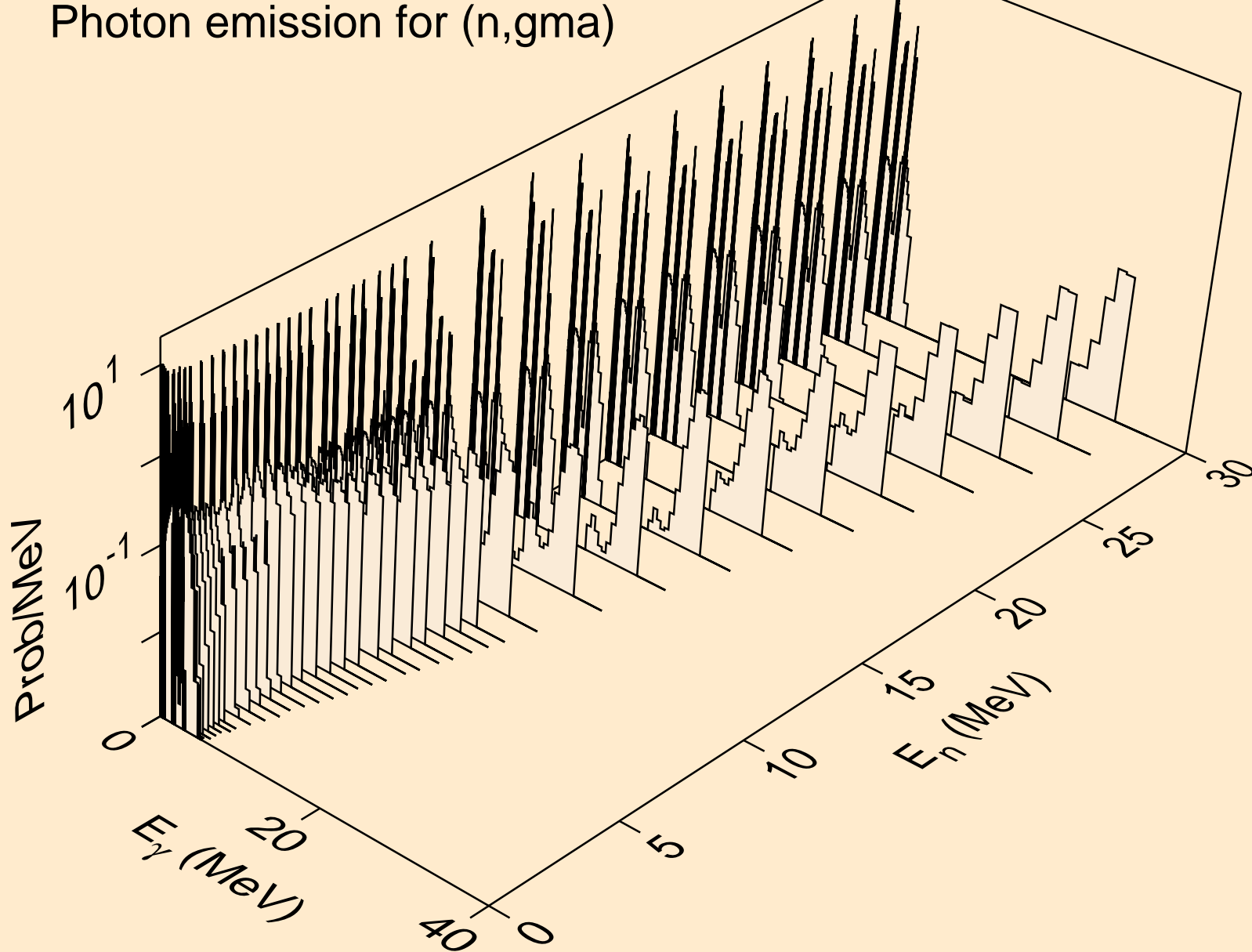

BR087 NEUTRON ACER TENDL-2019 LIBRARY; T=293.16K
Photon emission for (n,p)

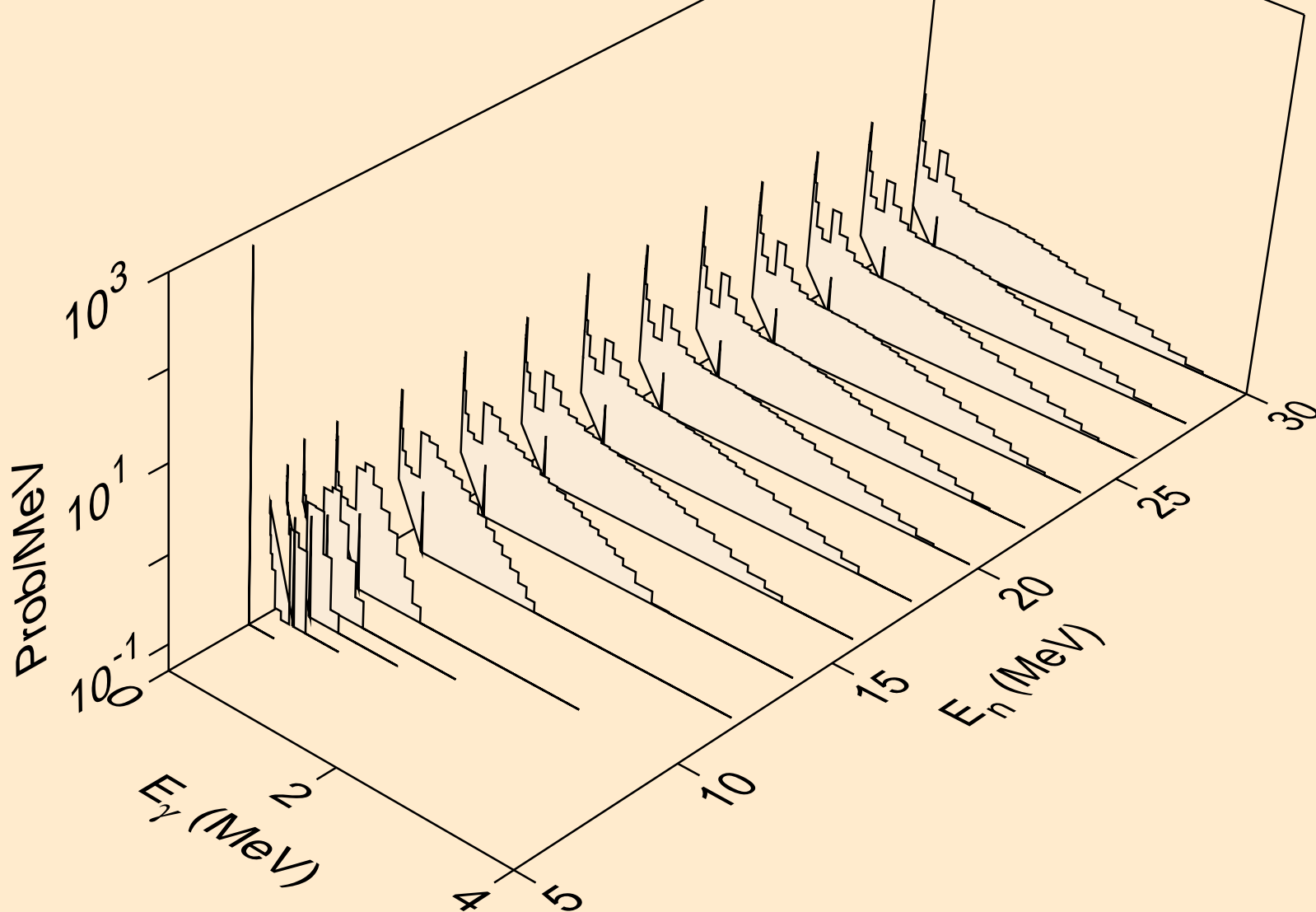

BR087 NEUTRON ACER TENDL-2019 LIBRARY; T=293.16K
Photon emission for (n,d)

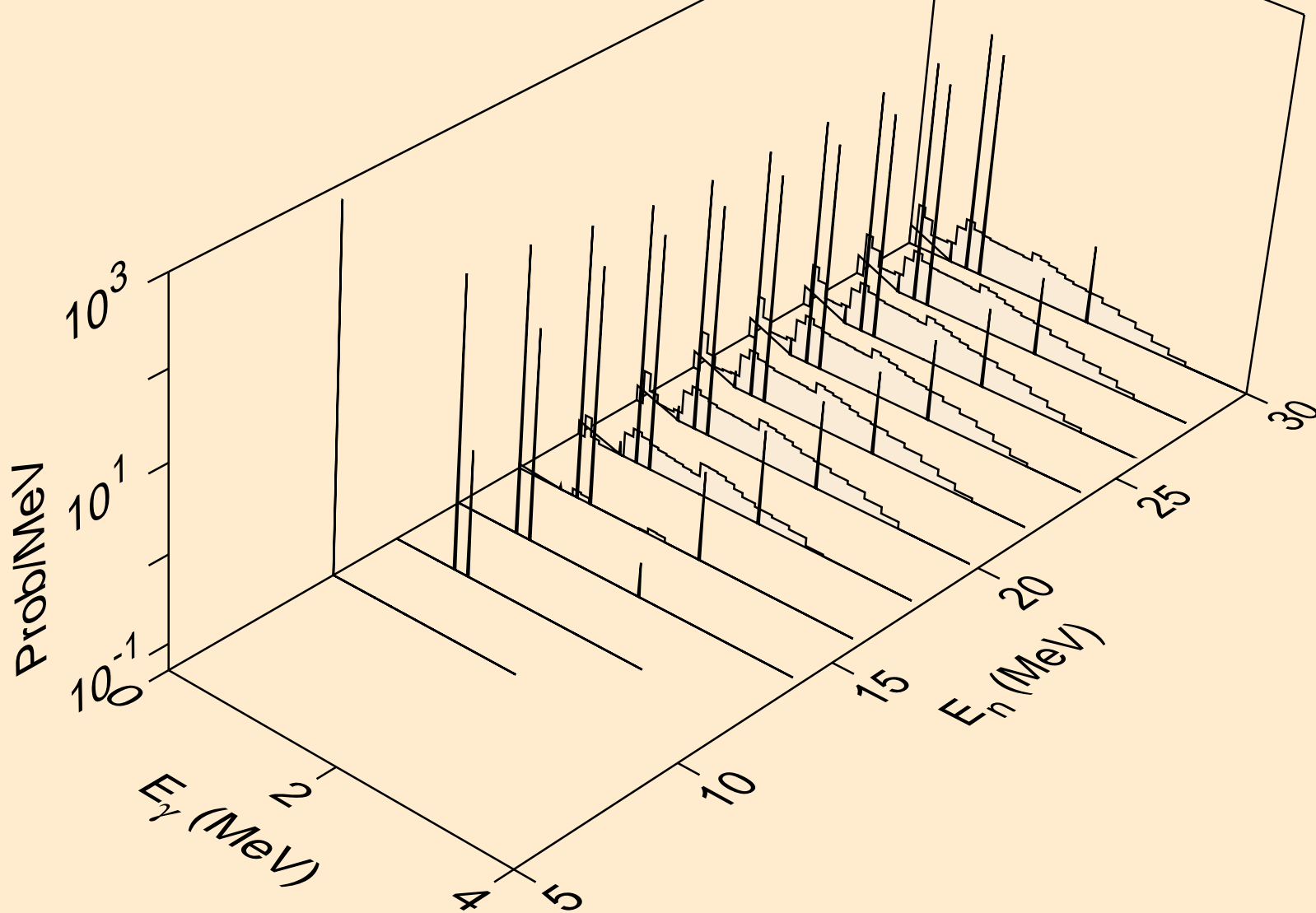

BR087 NEUTRON ACER TENDL-2019 LIBRARY; T=293.16K
Photon emission for (n,t)

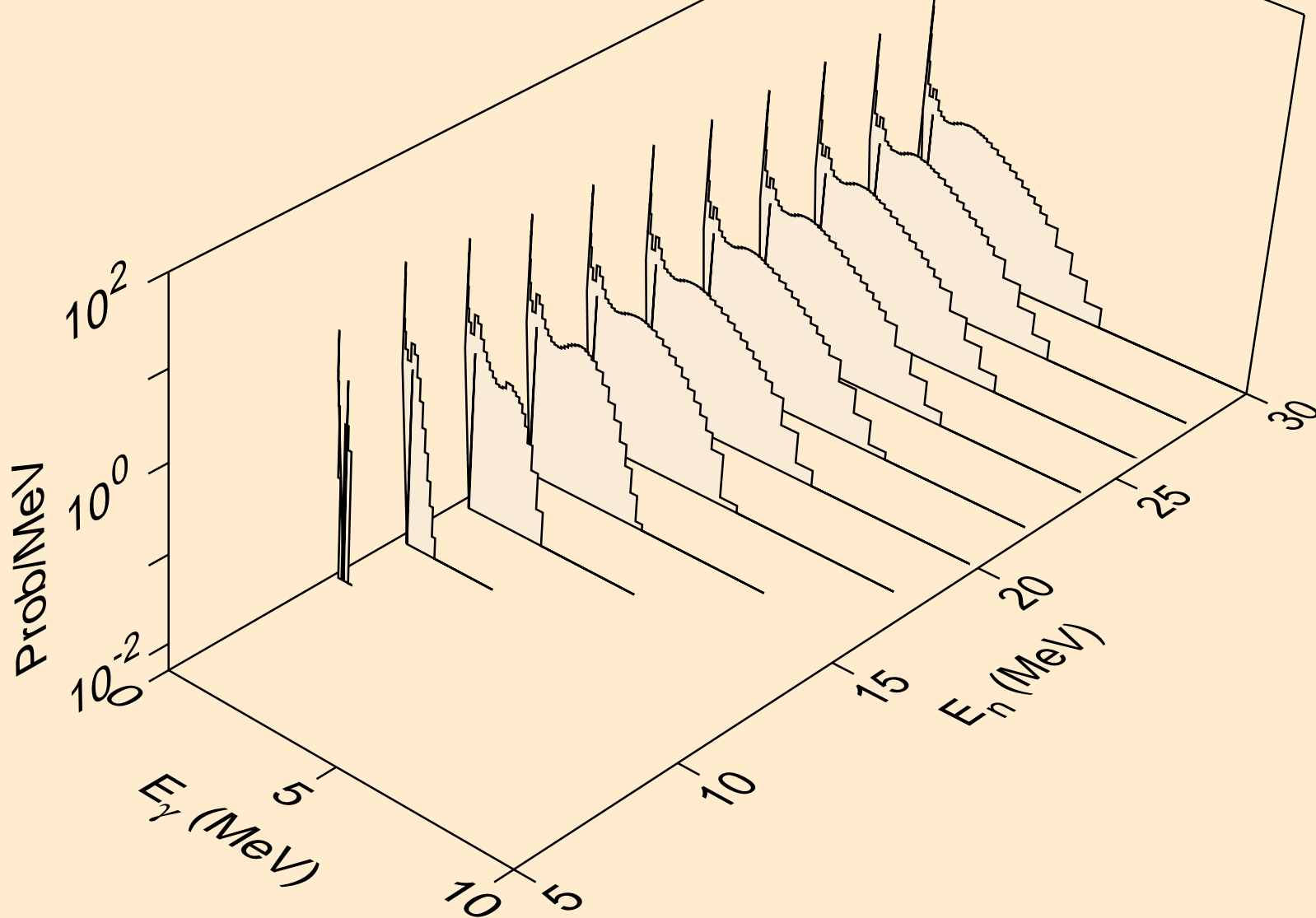

BR087 NEUTRON ACER TENDL-2019 LIBRARY; T=293.16K
Photon emission for (n,he3)

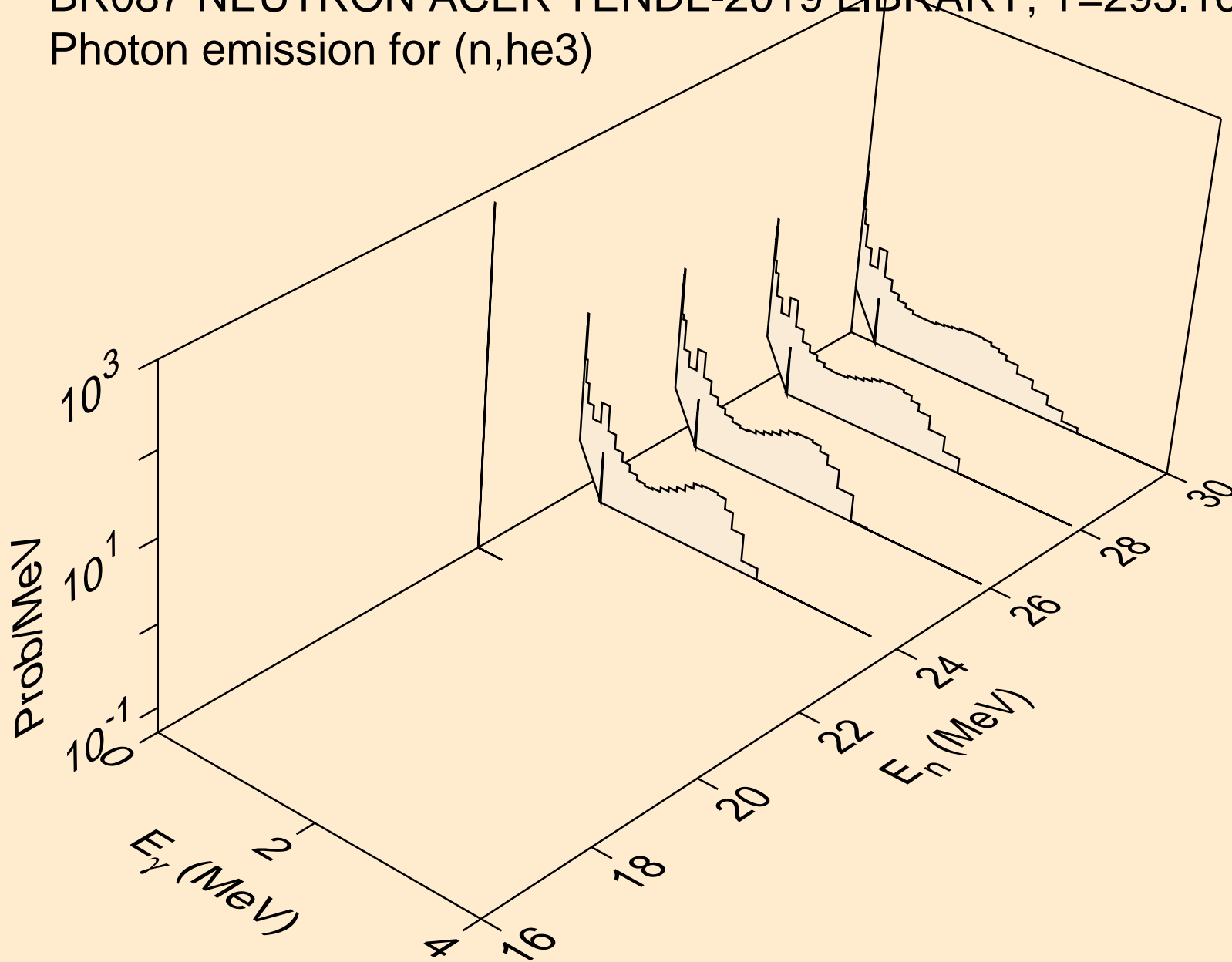

BR087 NEUTRON ACER TENDL-2019 LIBRARY; T=293.16K
Photon emission for (n,a)

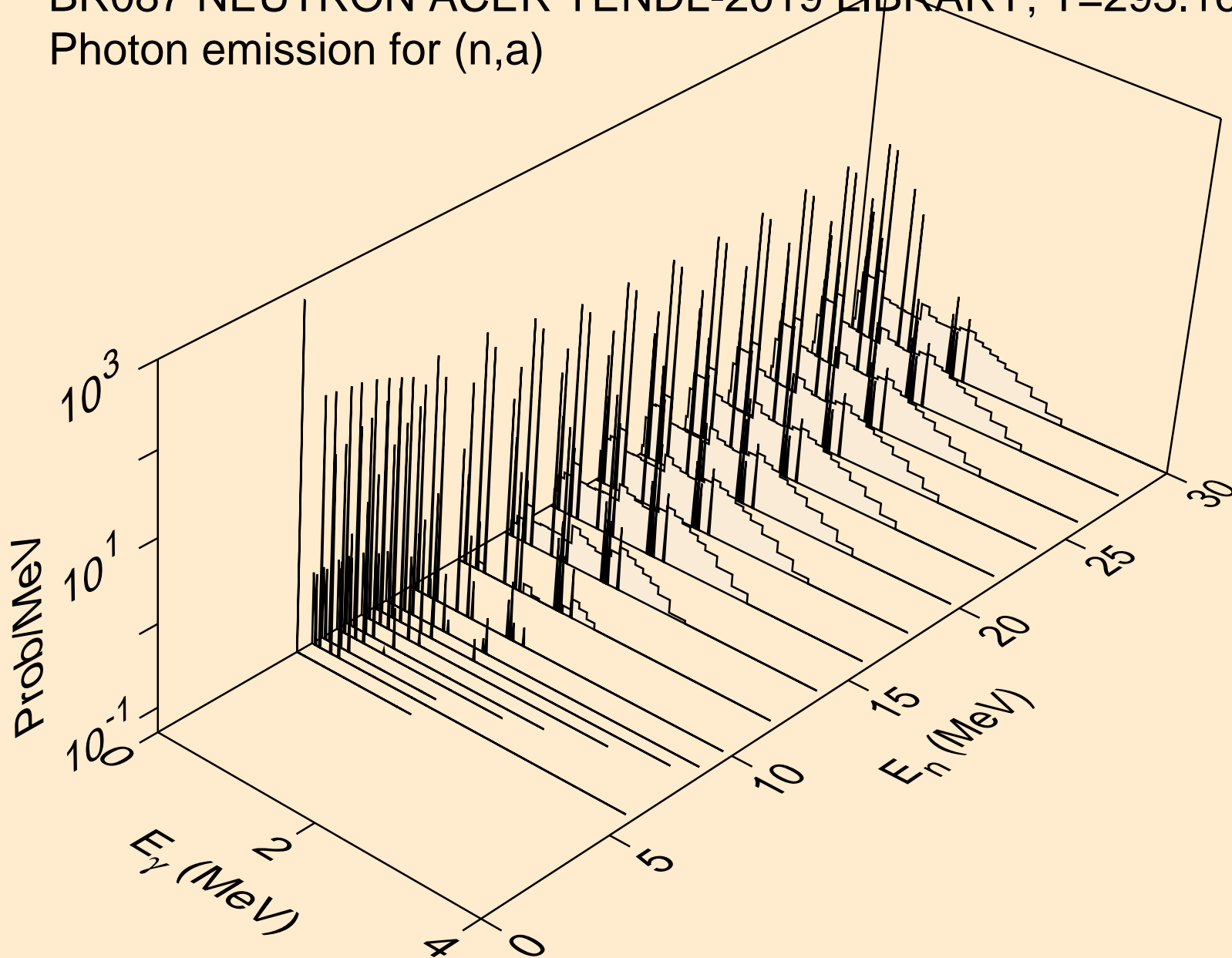

BR087 NEUTRON ACER TENDL-2019 LIBRARY; T=293.16K
Photon emission for (n,p)

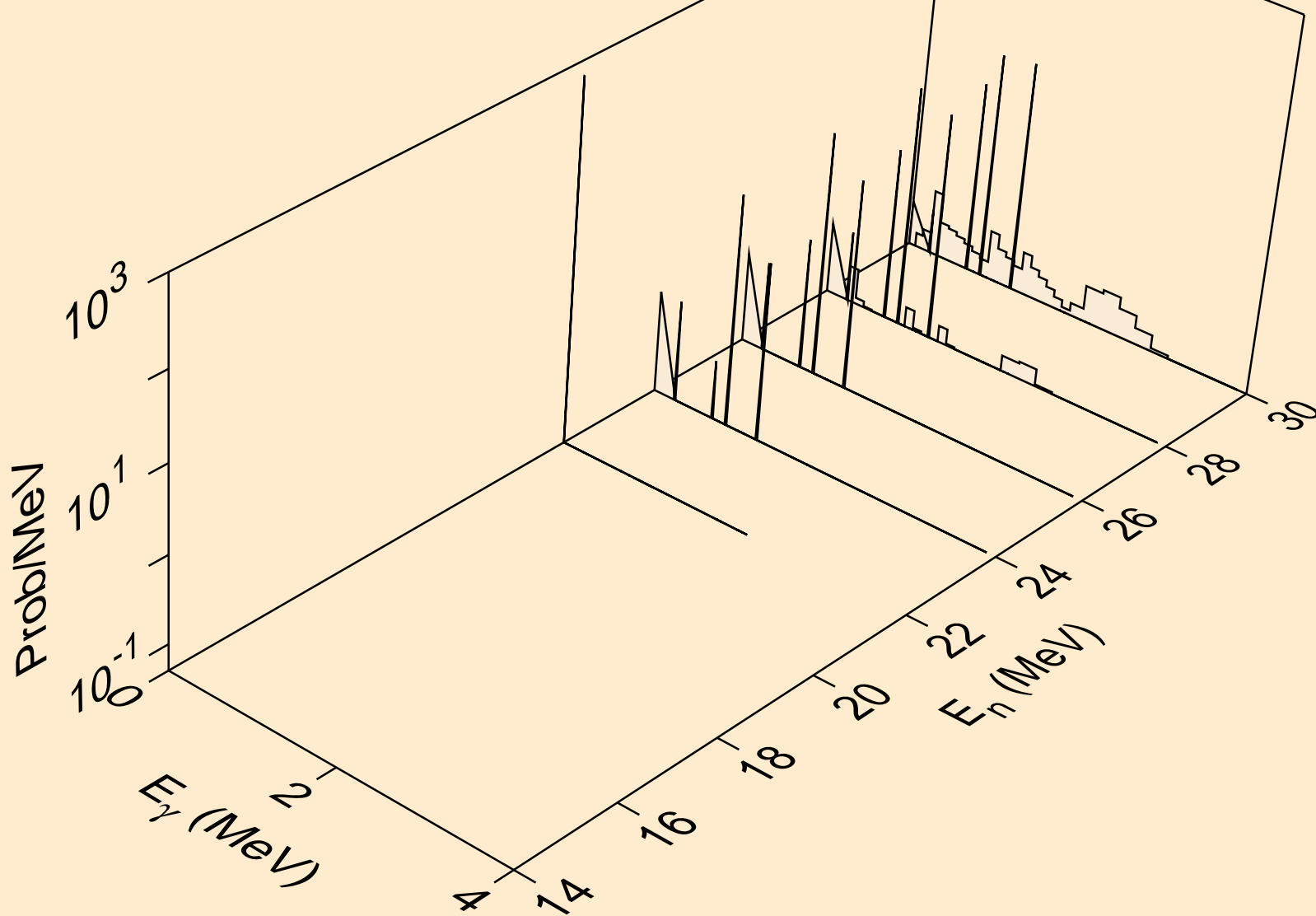

BR087 NEUTRON ACER TENDL-2019 LIBRARY; T=293.16K
thermal capture photon spectrum

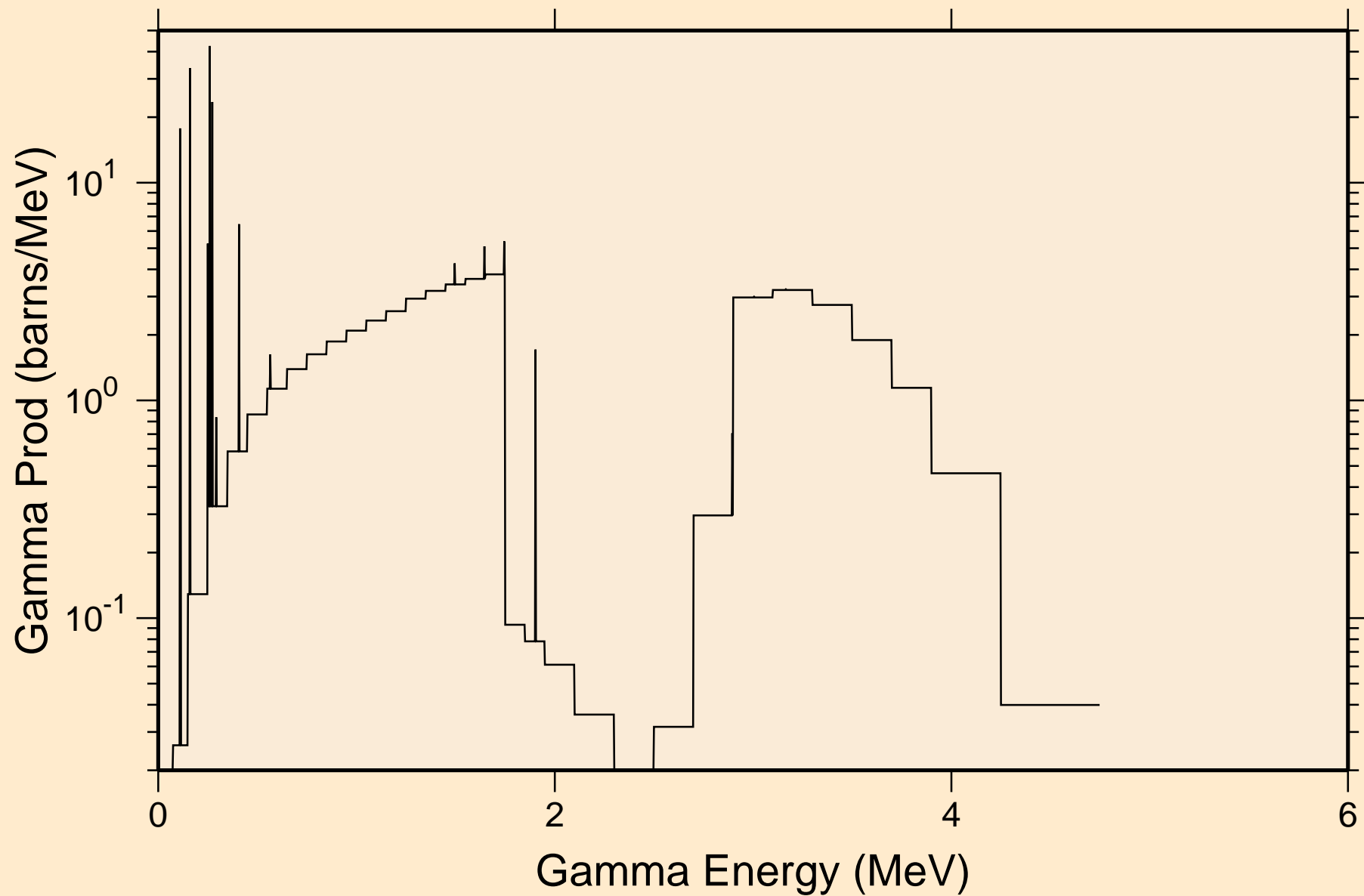

BR087 NEUTRON ACER TENDL-2019 LIBRARY; T=293.16K
14 MeV photon spectrum

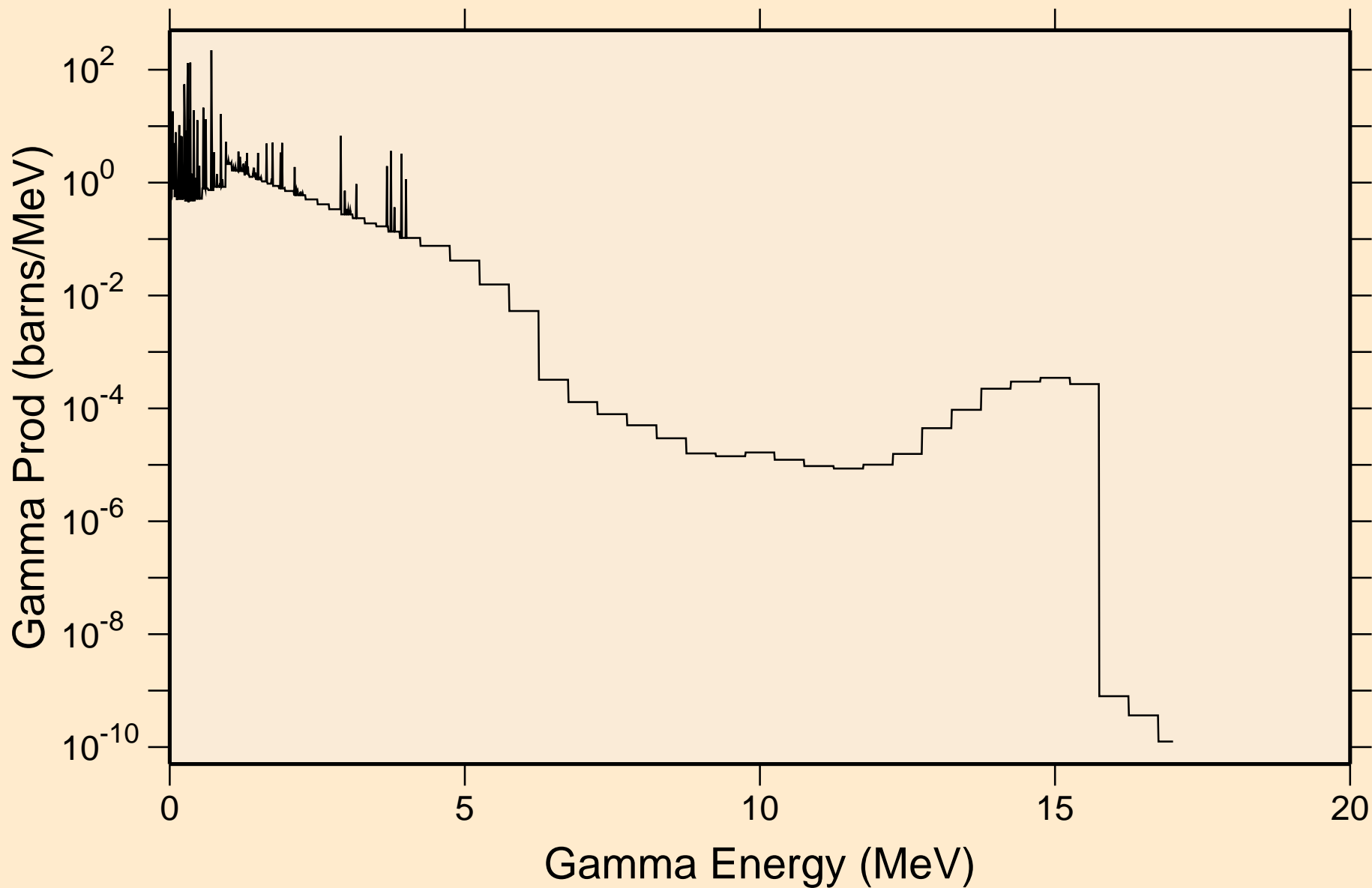

BR087 NEUTRON ACER TENDL-2019 LIBRARY; T=293.16K
Particle heating contributions

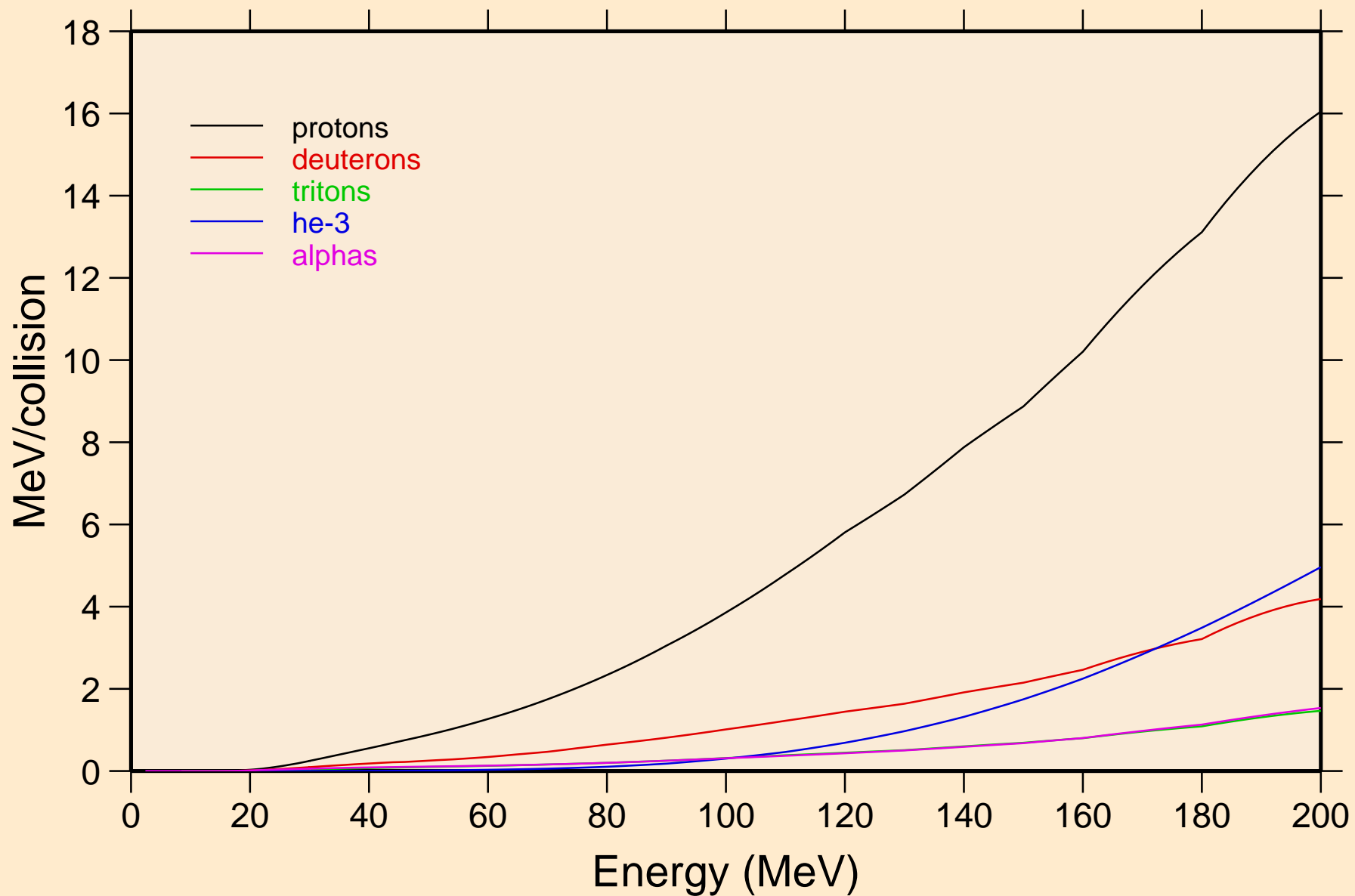

BR087 NEUTRON ACER TENDL-2019 LIBRARY; T=293.16K
Recoil Heating

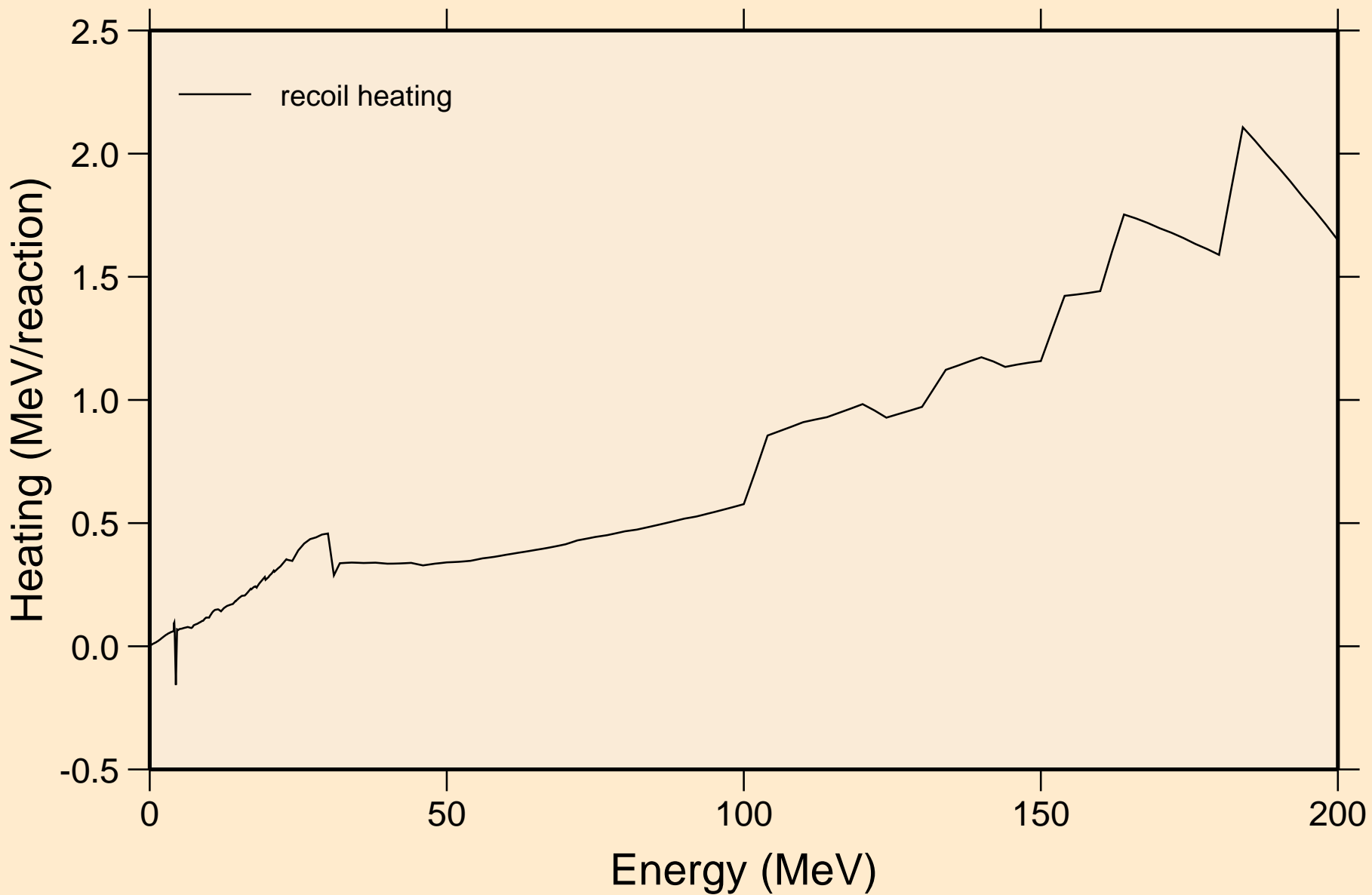

BR087 NEUTRON ACER TENDL-2019 LIBRARY; T=293.16K
Particle production cross sections

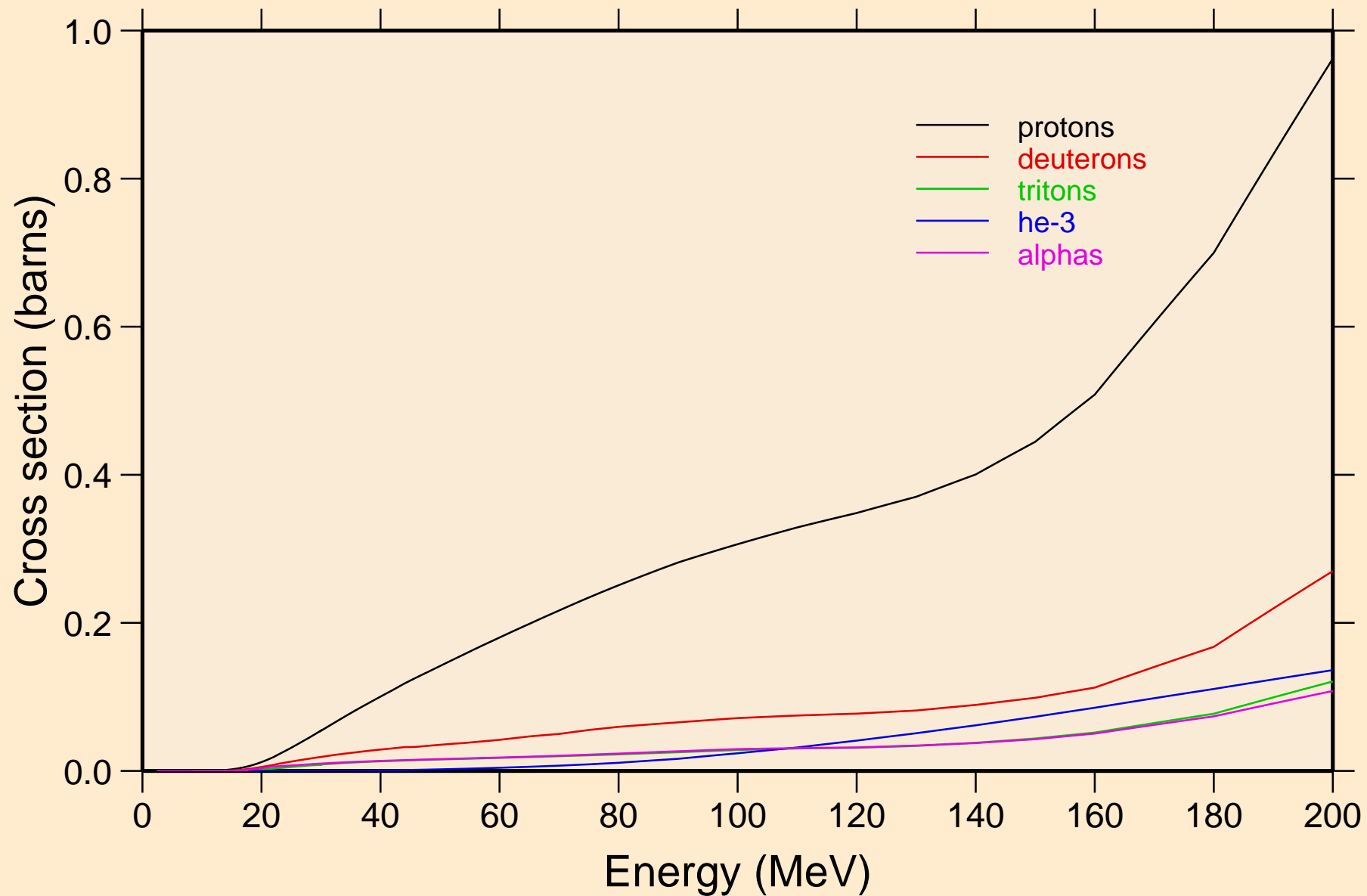

BR087 NEUTRON ACER TENDL-2019 LIBRARY; T=293.16K
protons from (n,x)

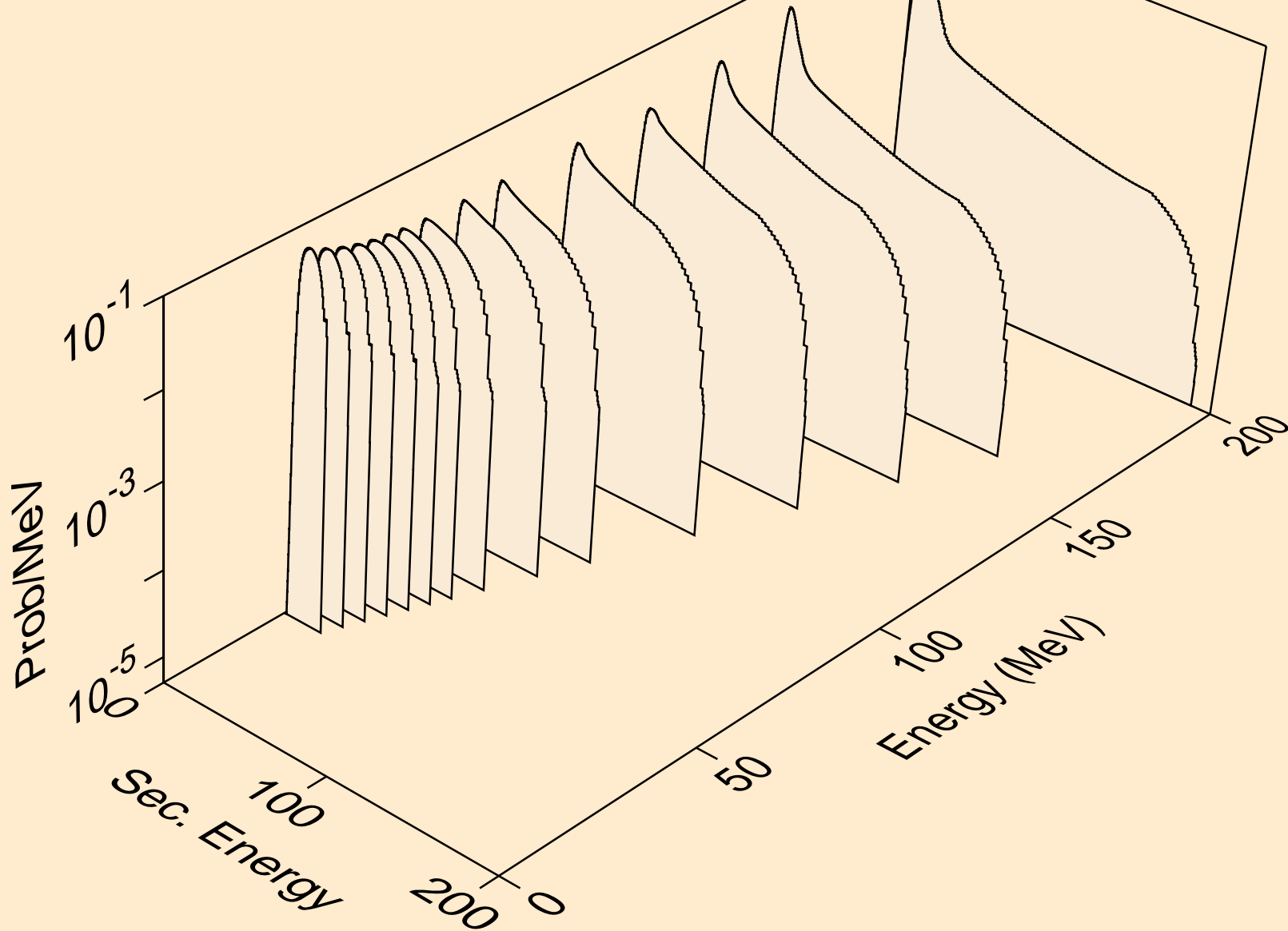

BR087 NEUTRON ACER TENDL-2019 LIBRARY; T=293.16K
protons from (n,n*)p

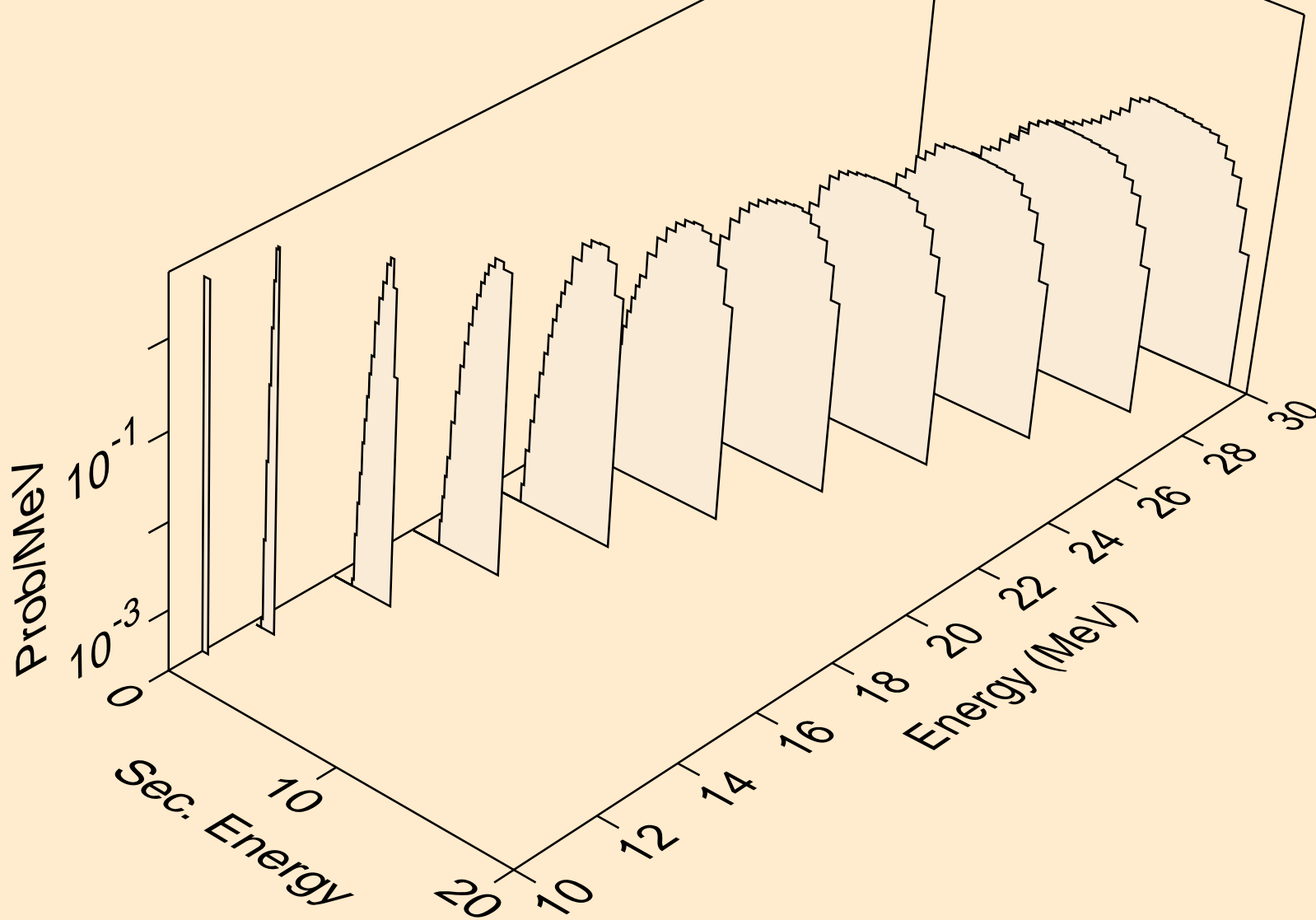

BR087 NEUTRON ACER TENDL-2019 LIBRARY; T=293.16K
protons from (n,2np)

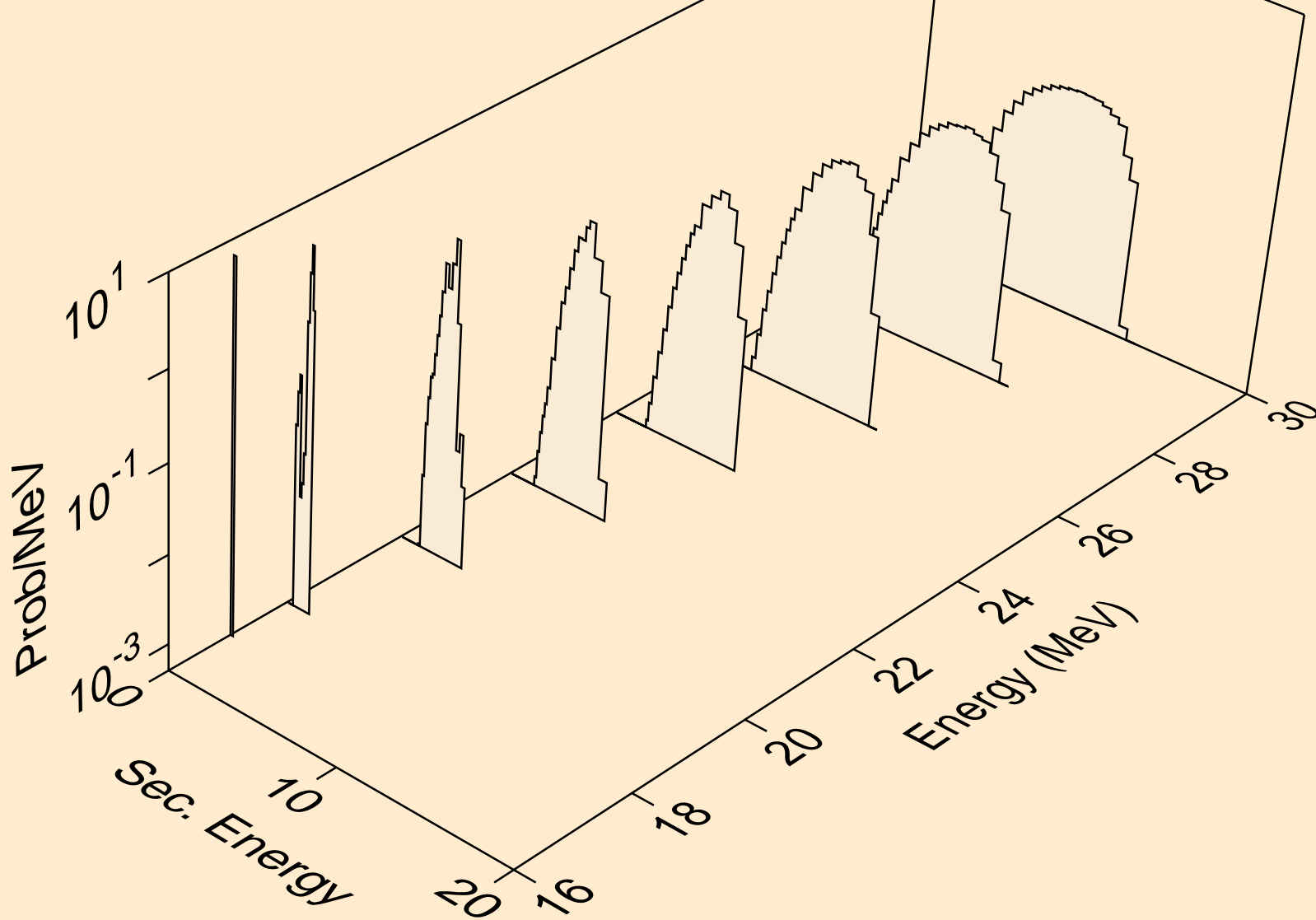

BR087 NEUTRON ACER TENDL-2019 LIBRARY; T=293.16K
protons from (n,3np)

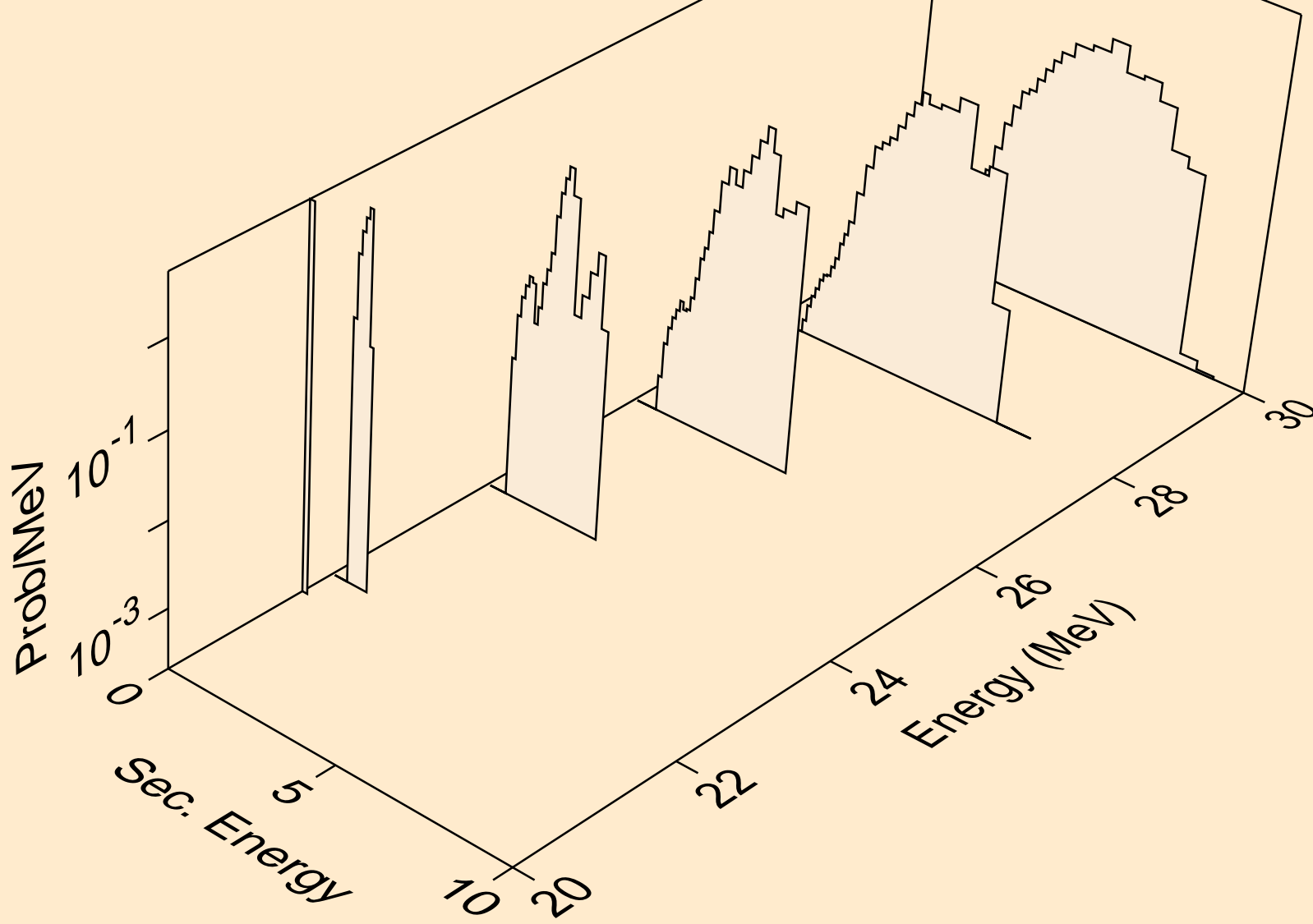

BR087 NEUTRON ACER TENDL-2019 LIBRARY; T=293.16K
protons from (n,p)

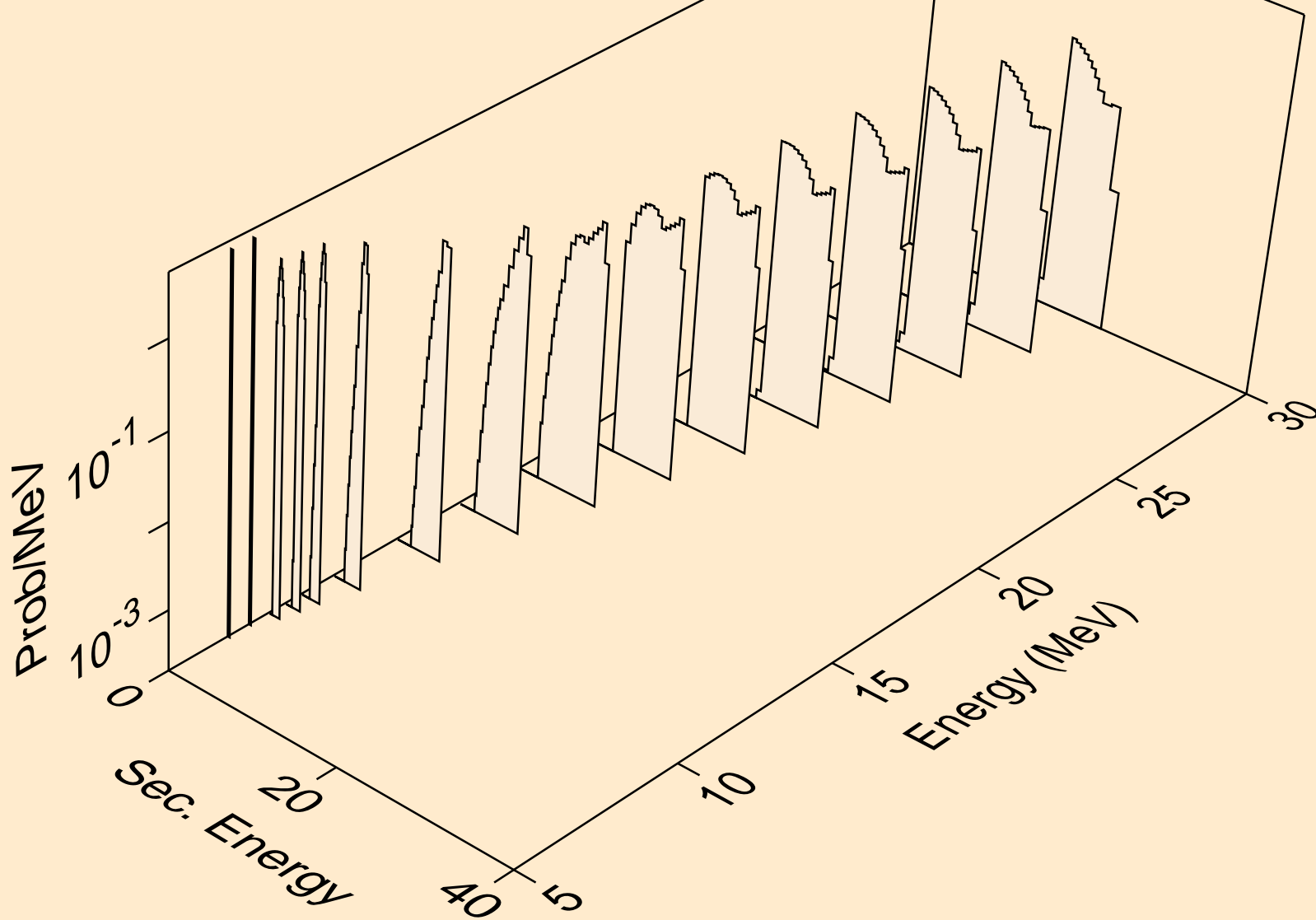

BR087 NEUTRON ACER TENDL-2019 LIBRARY; T=293.16K
protons from (n,p)

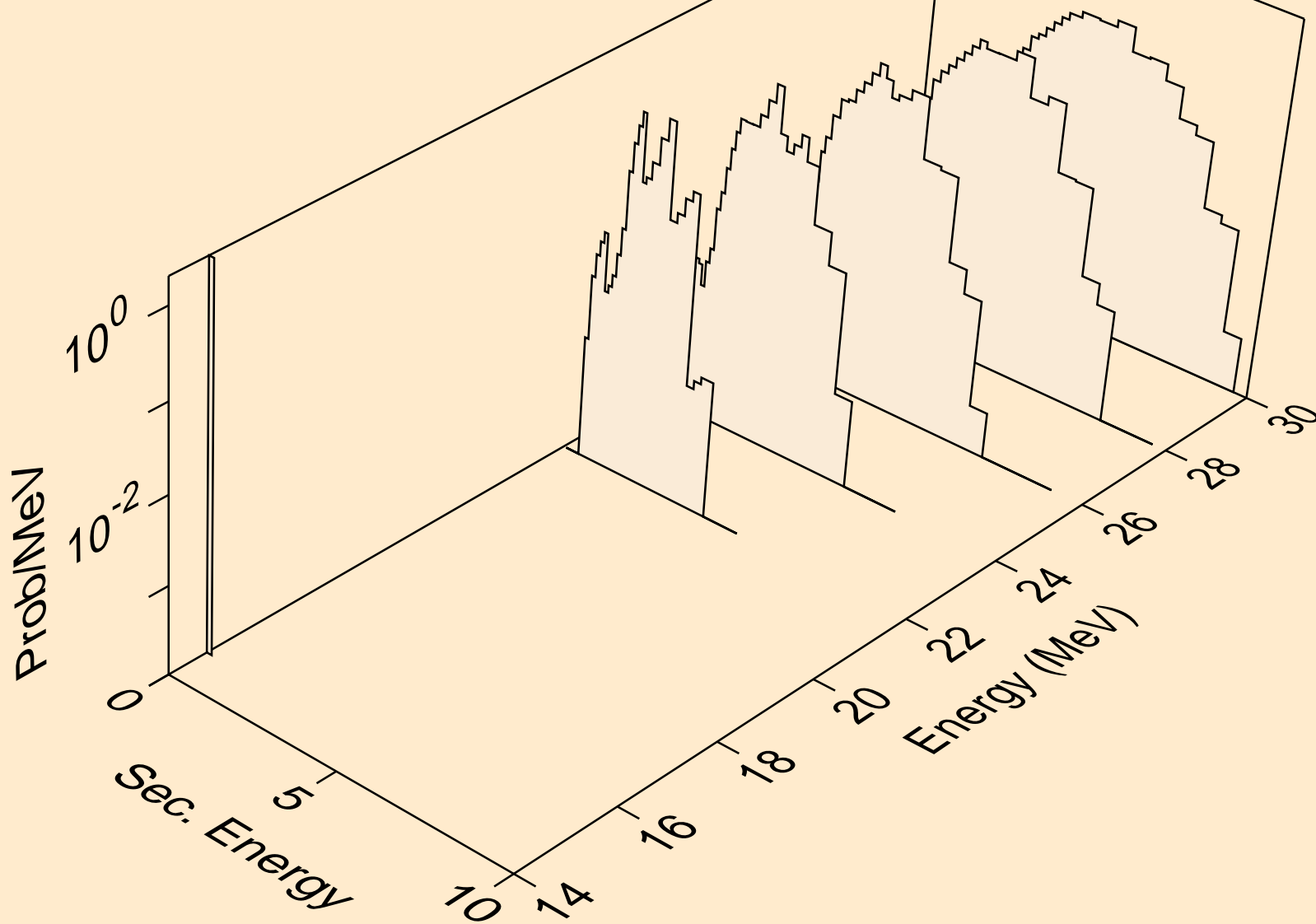

BR087 NEUTRON ACER TENDL-2019 LIBRARY; T=293.16K
deuterons from (n,x)

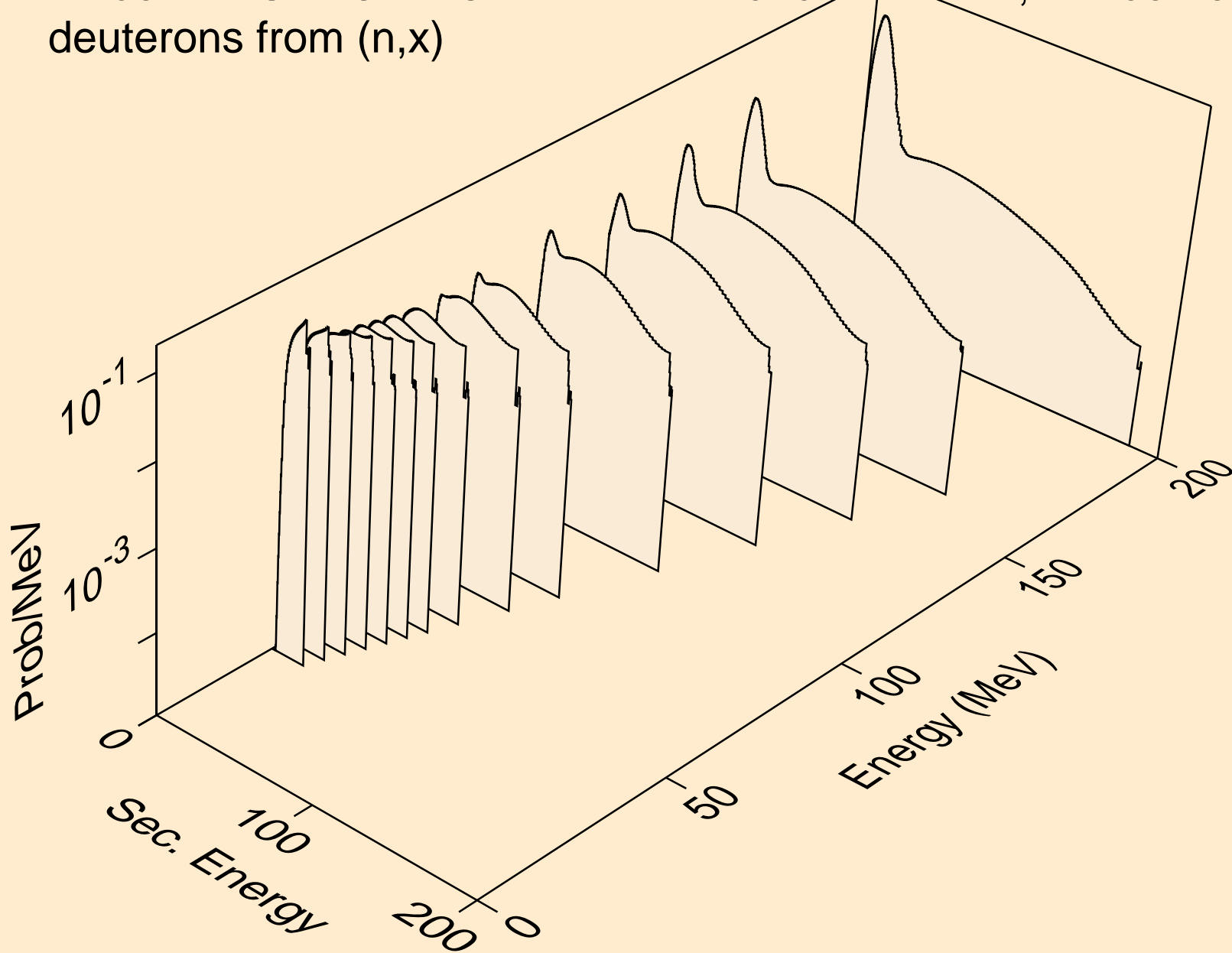

BR087 NEUTRON ACER TENDL-2019 LIBRARY; T=293.16K
deuterons from (n,2nd)

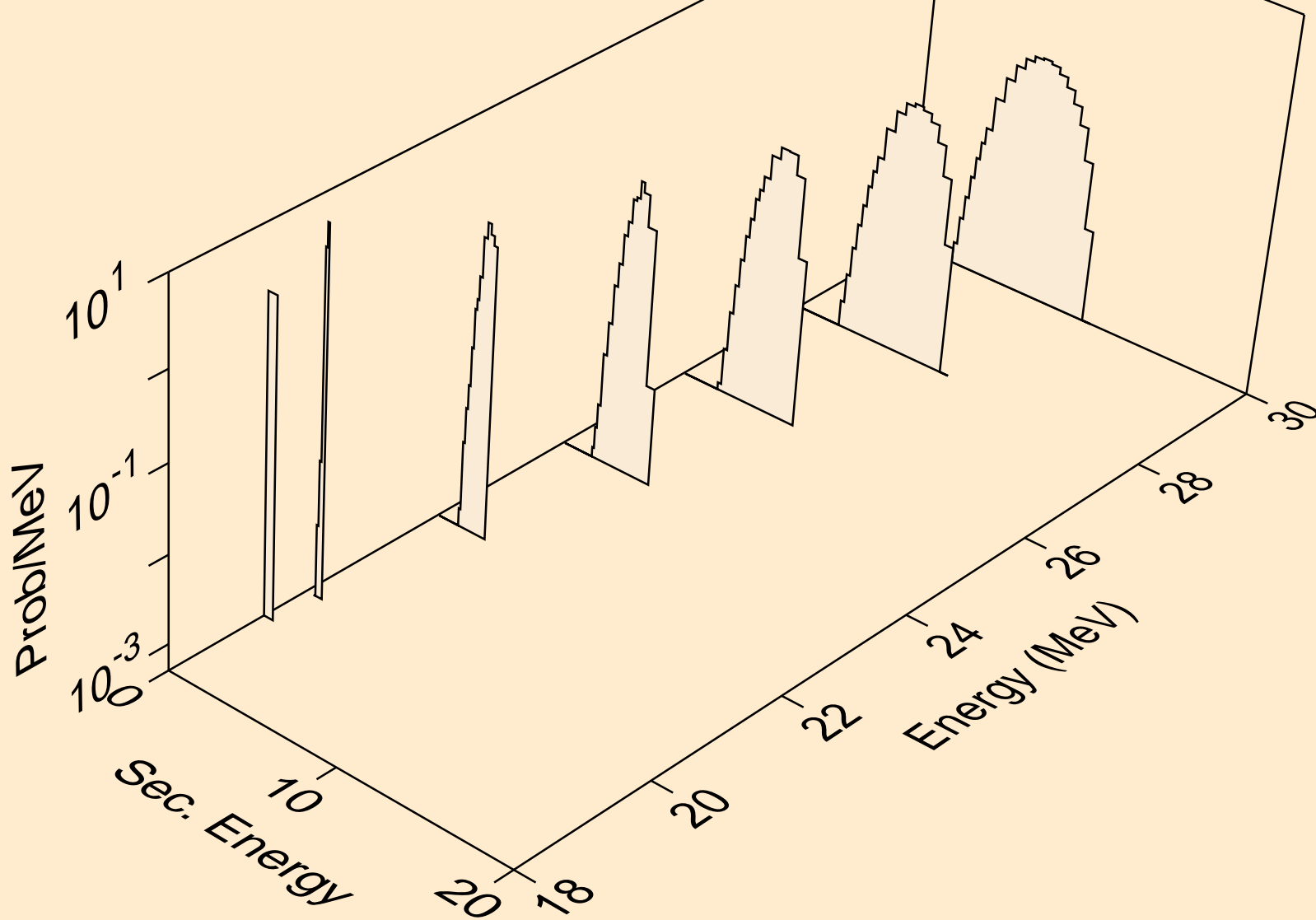

BR087 NEUTRON ACER TENDL-2019 LIBRARY; T=293.16K
deuterons from (n,n*)d

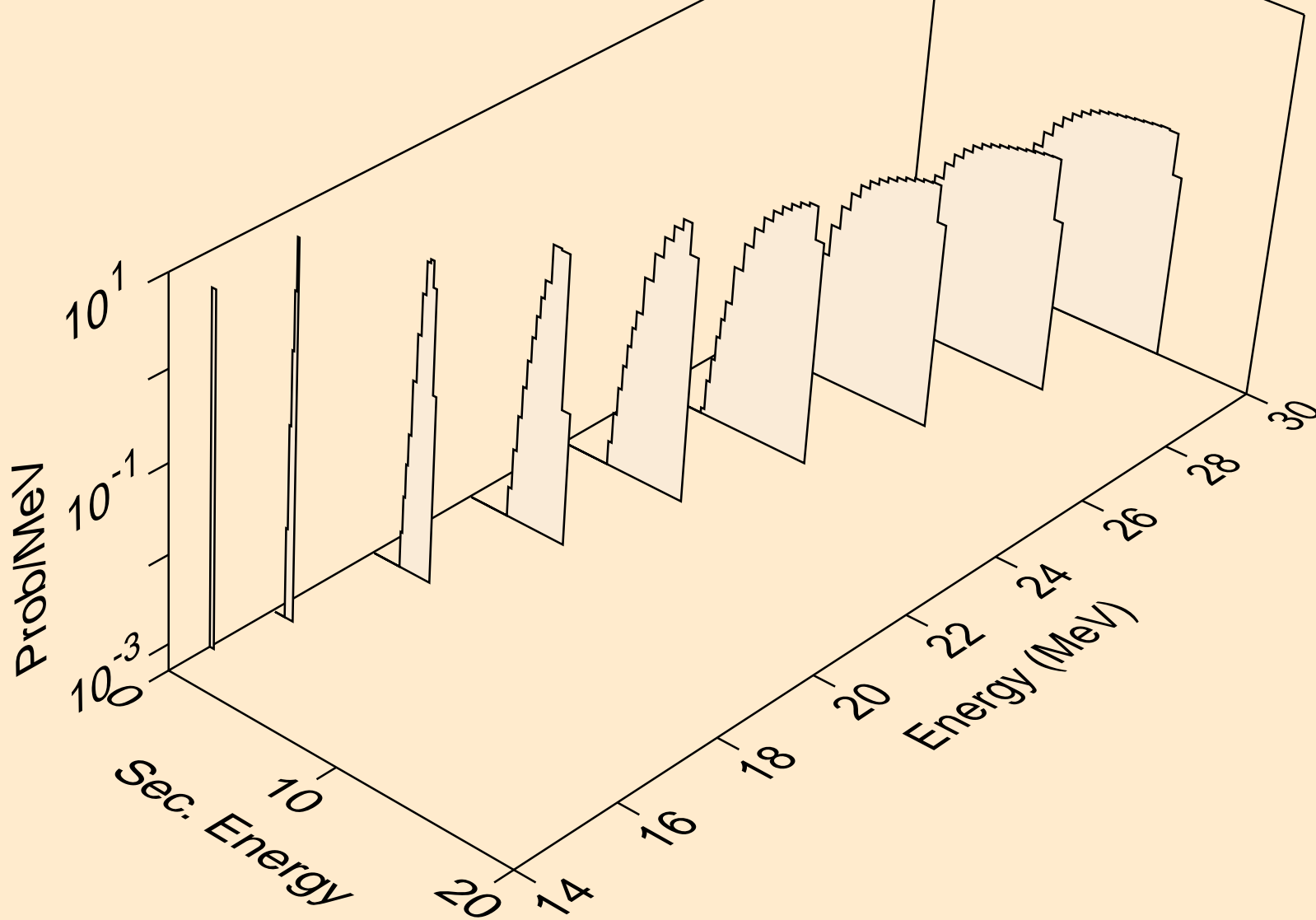

BR087 NEUTRON ACER TENDL-2019 LIBRARY; T=293.16K
deuterons from (n,d)

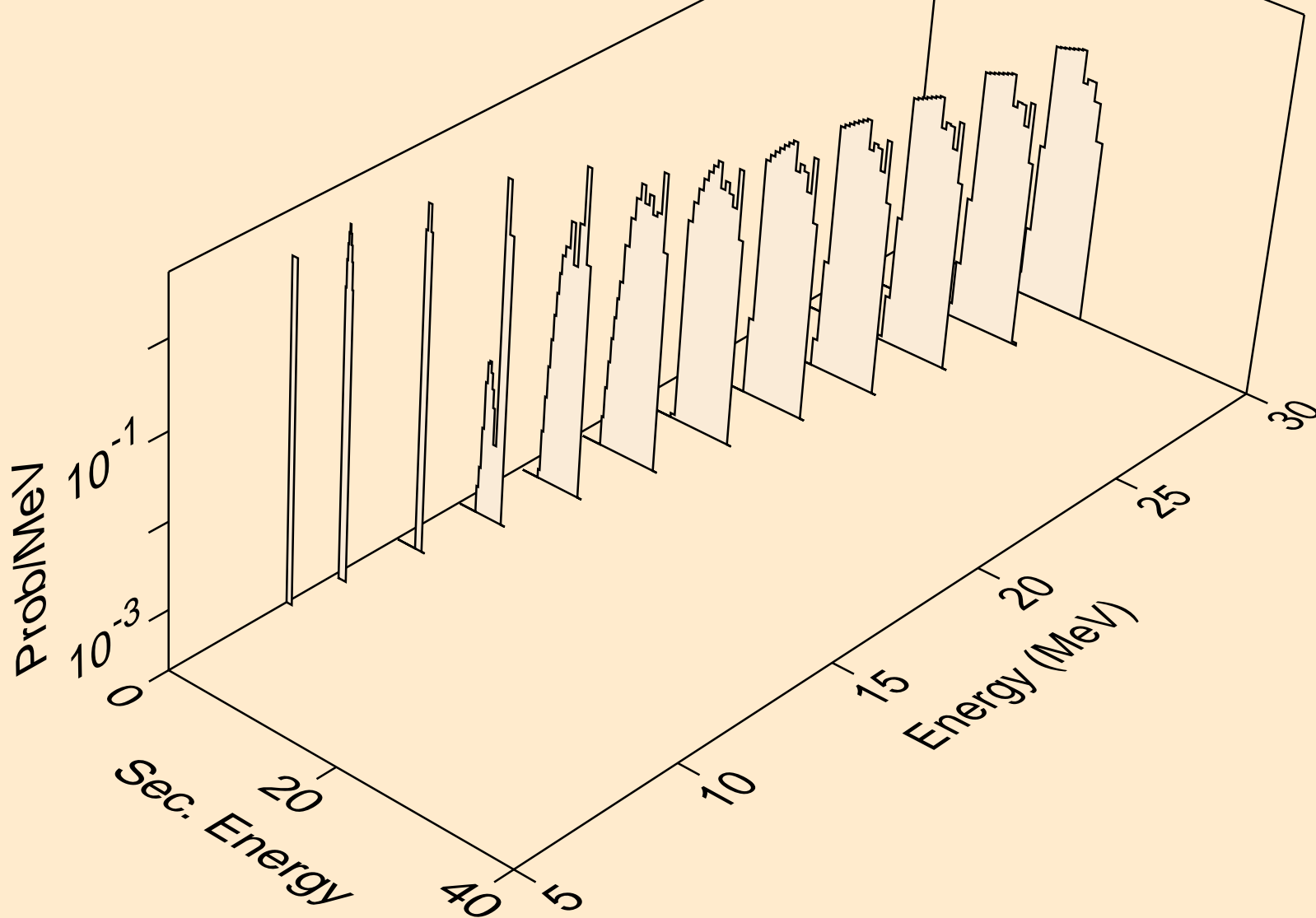

BR087 NEUTRON ACER TENDL-2019 LIBRARY; T=293.16K
tritons from (n,x)

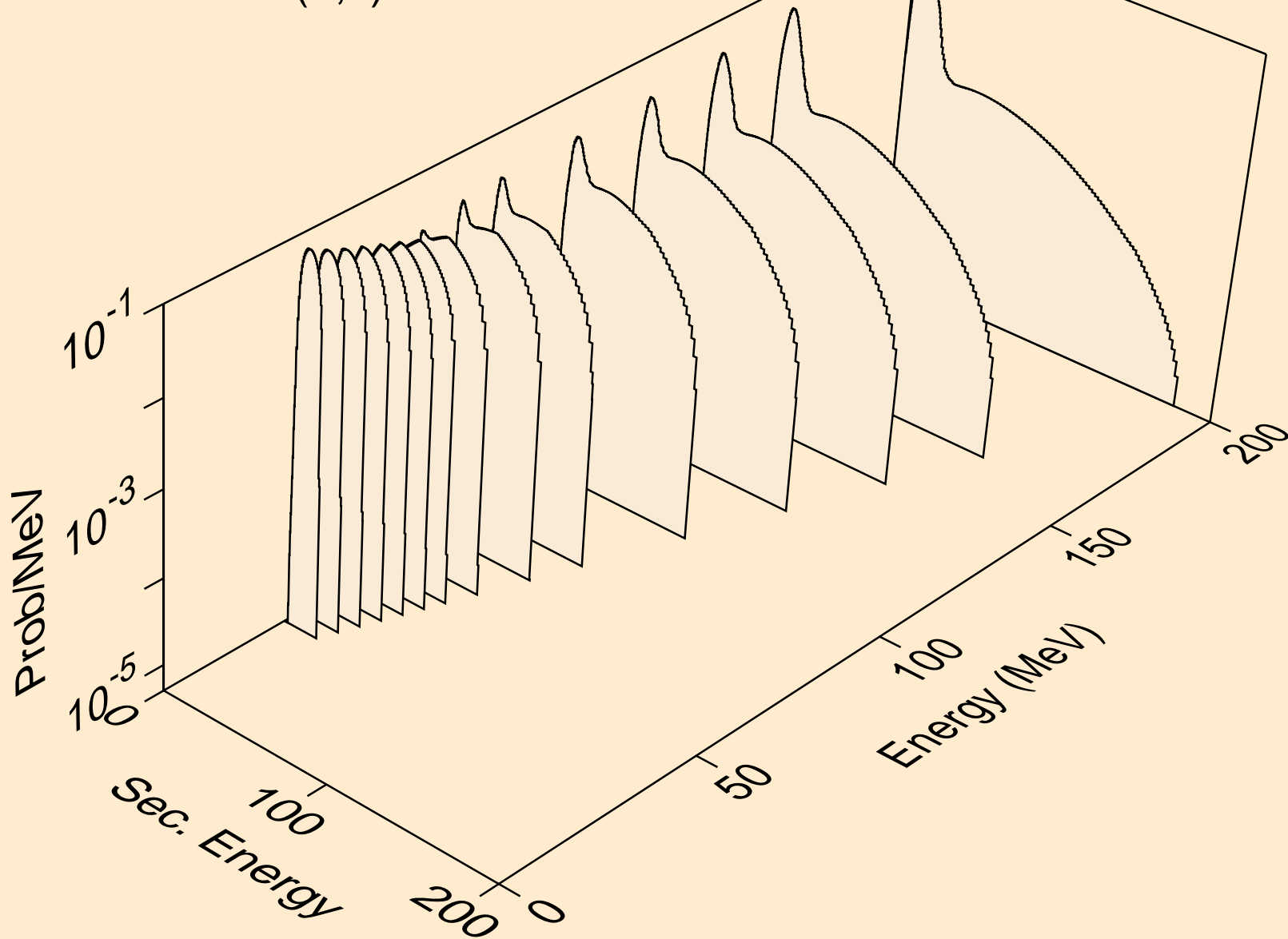

BR087 NEUTRON ACER TENDL-2019 LIBRARY; T=293.16K
tritons from (n,n*)t

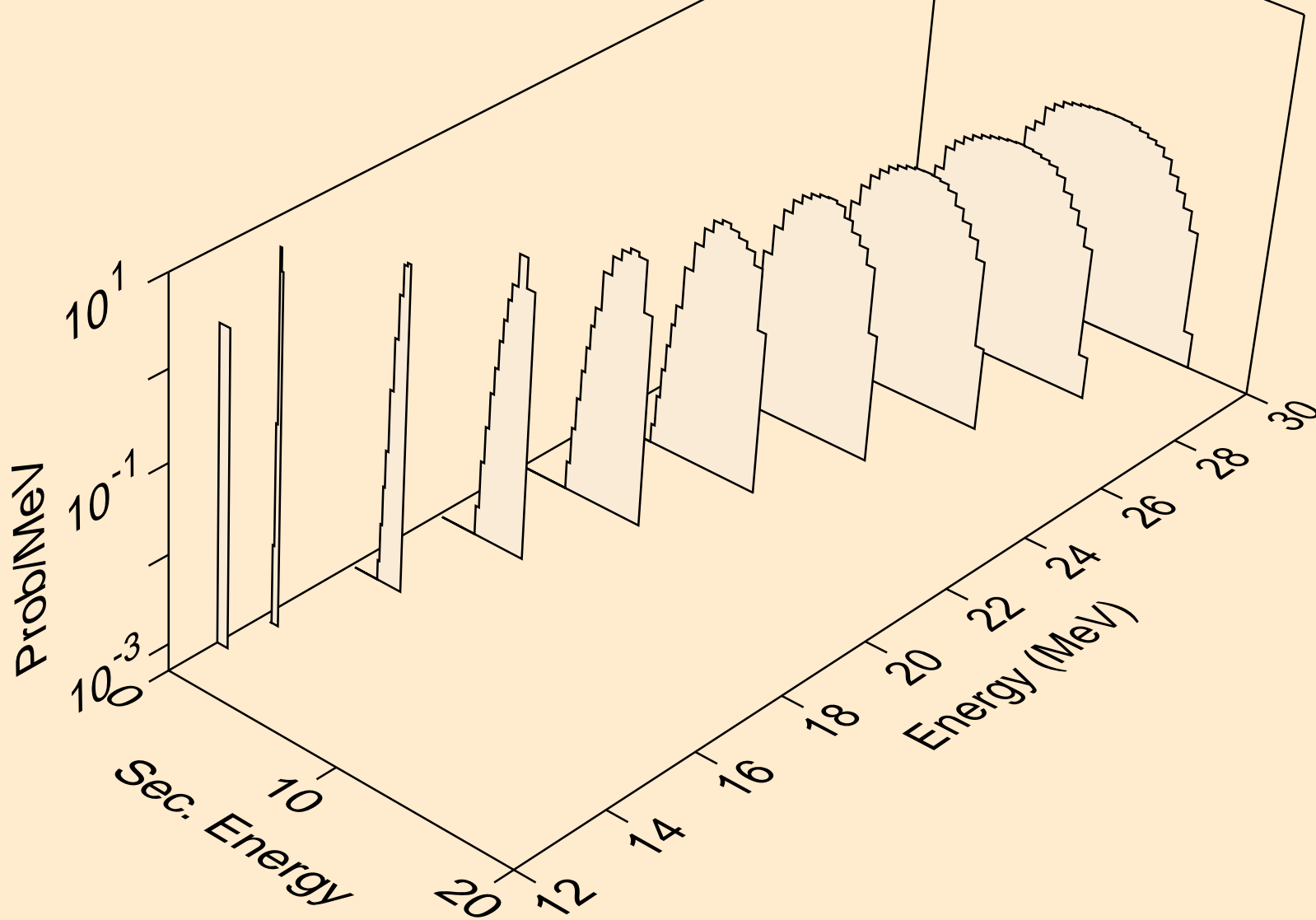

BR087 NEUTRON ACER TENDL-2019 LIBRARY; T=293.16K
tritons from (n,t)

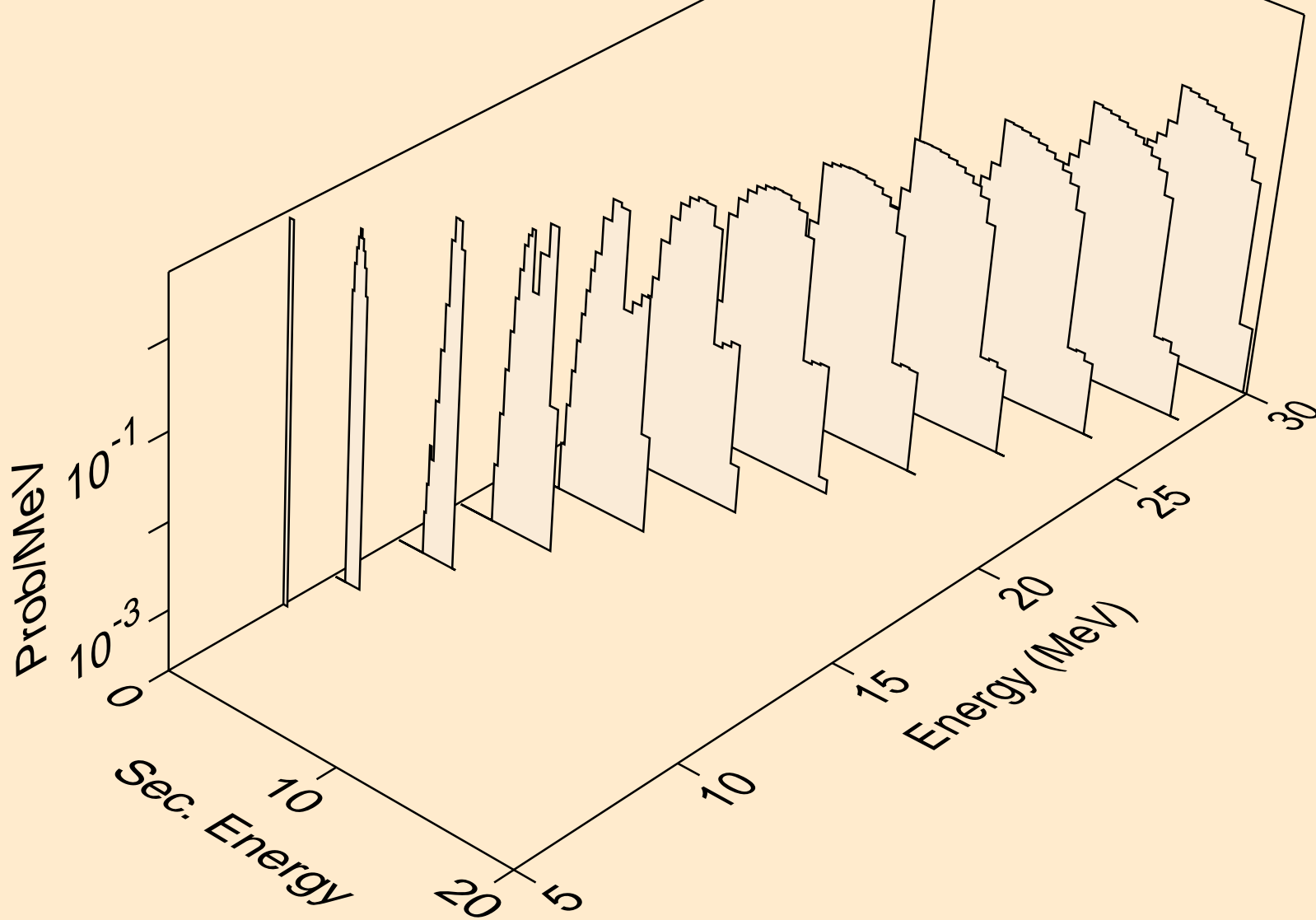

BR087 NEUTRON ACER TENDL-2019 LIBRARY; T=293.16K
he3s from (n,x)

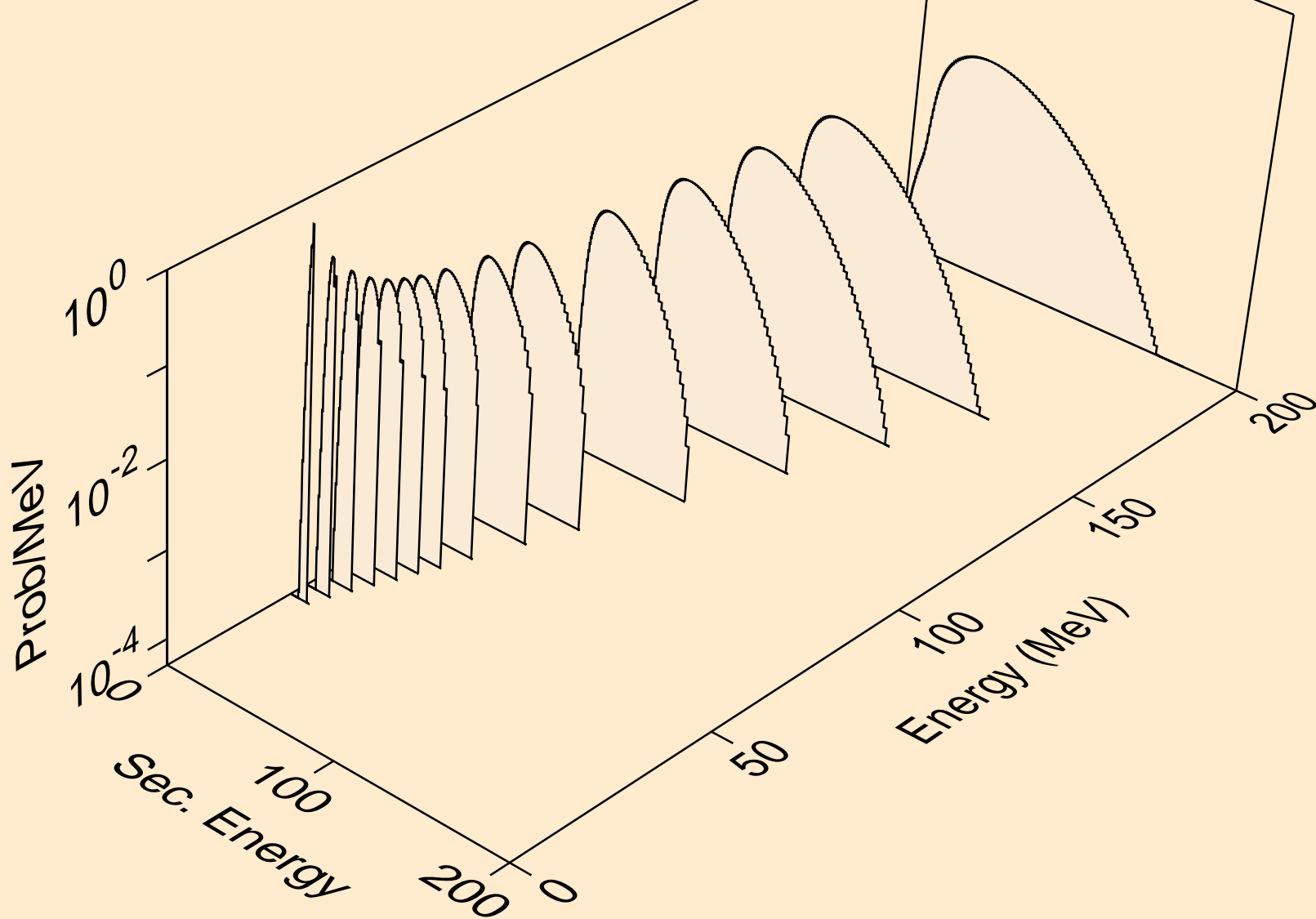

BR087 NEUTRON ACER TENDL-2019 LIBRARY; T=293.16K
he3s from (n,n*)he3

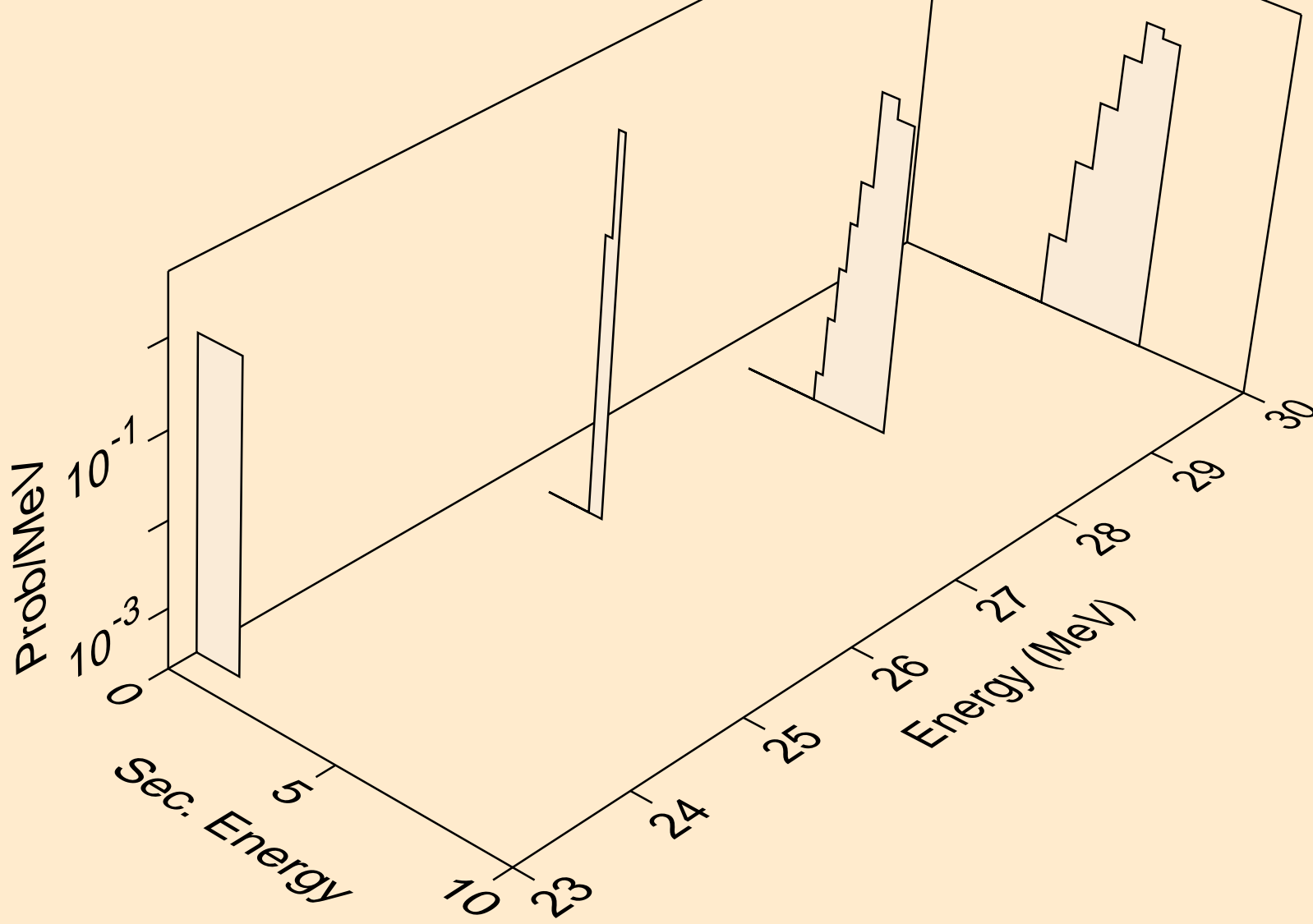

BR087 NEUTRON ACER TENDL-2019 LIBRARY; T=293.16K
he3s from (n,he3)

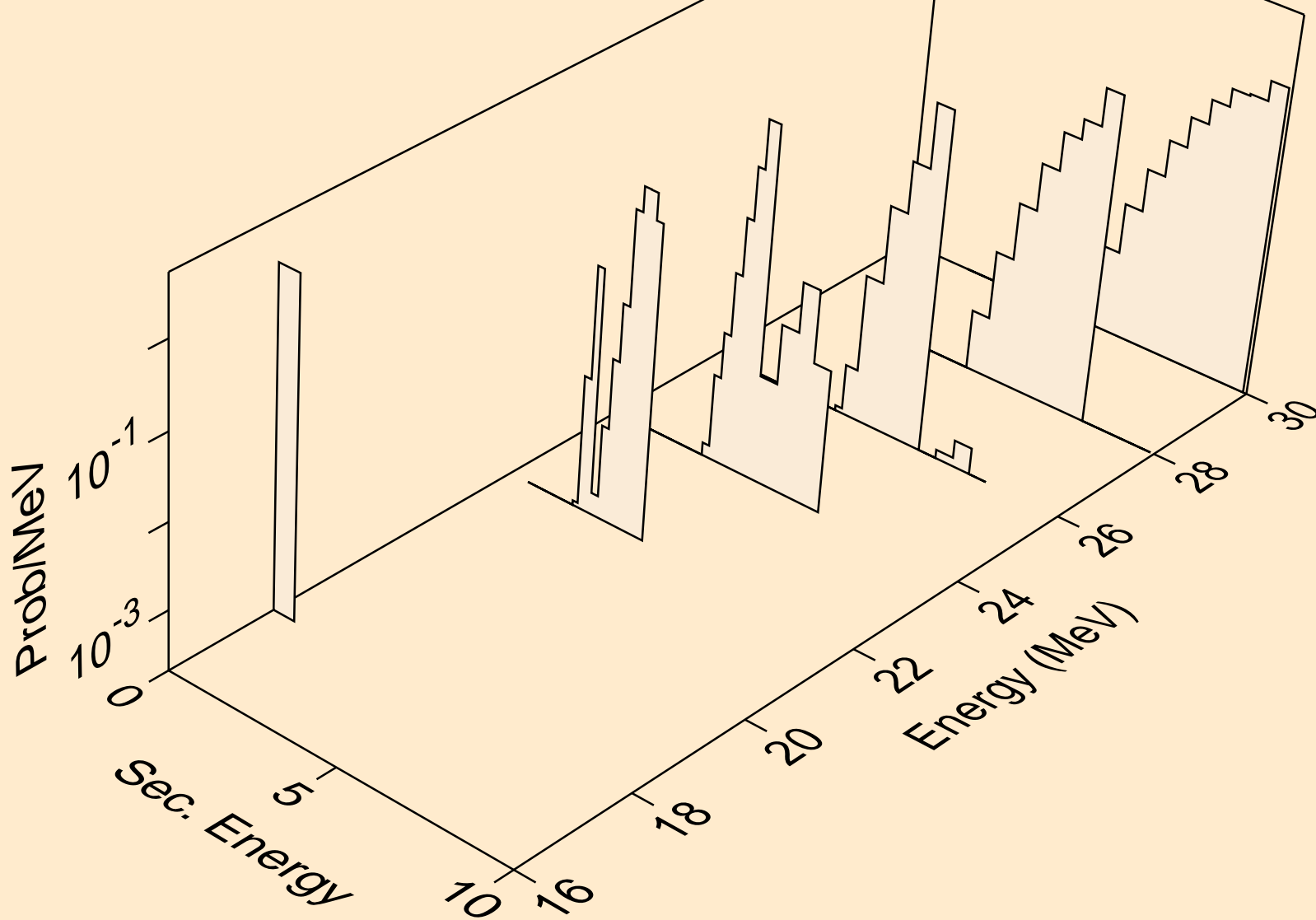

BR087 NEUTRON ACER TENDL-2019 LIBRARY; T=293.16K
alphas from (n,x)

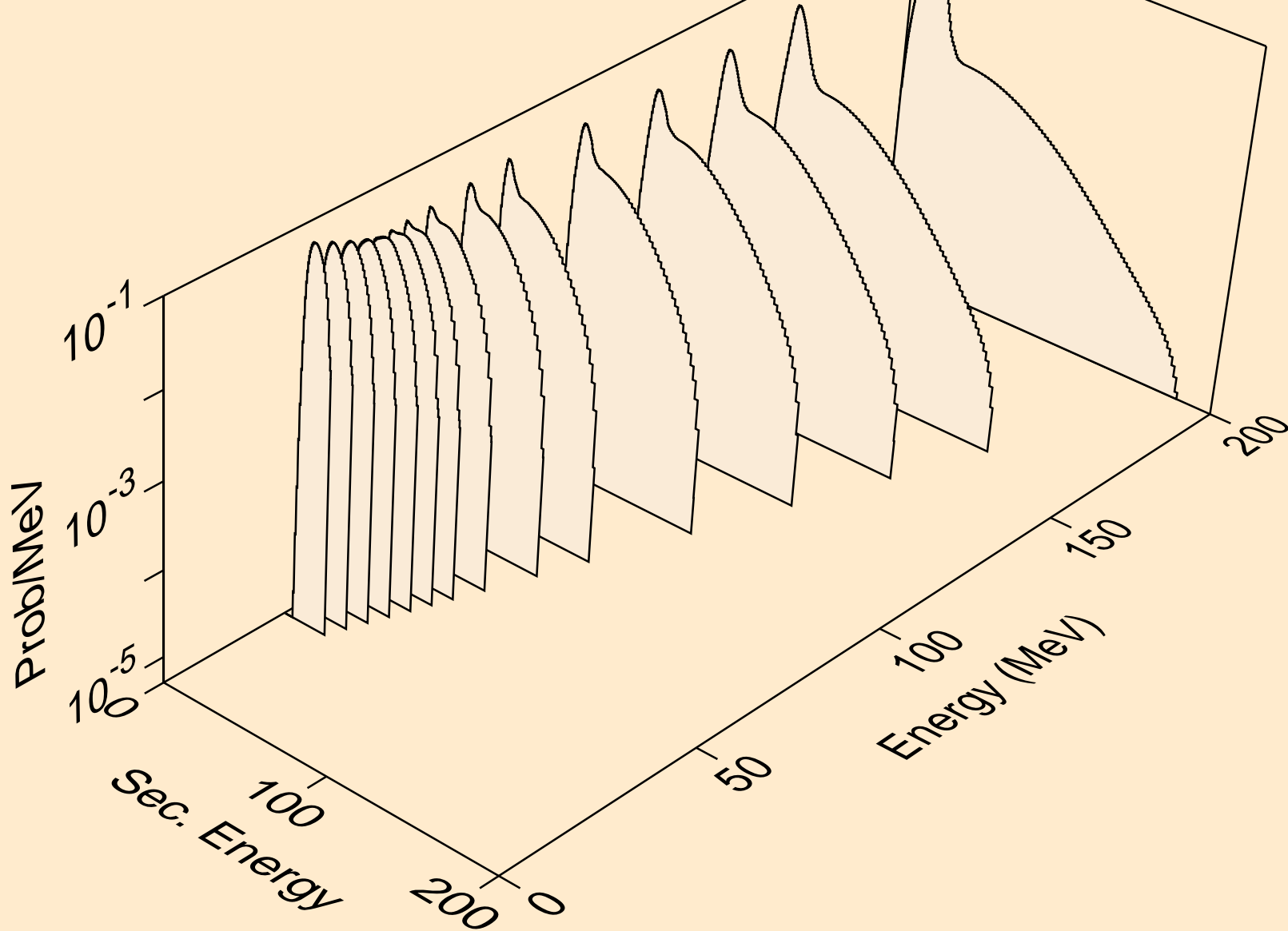

BR087 NEUTRON ACER TENDL-2019 LIBRARY; T=293.16K
alphas from (n,n*)a

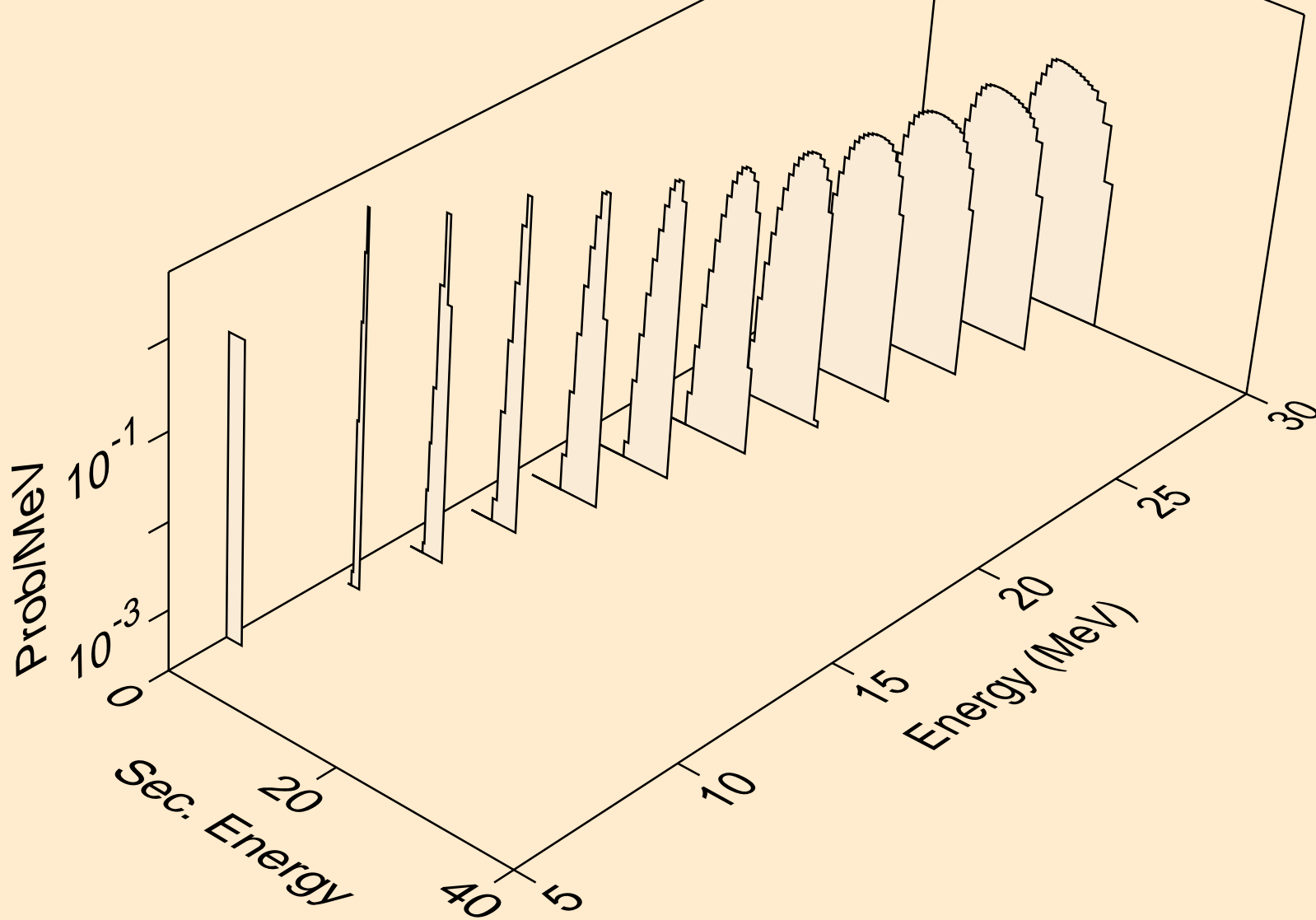

BR087 NEUTRON ACER TENDL-2019 LIBRARY; T=293.16K
alphas from (n,2n)a

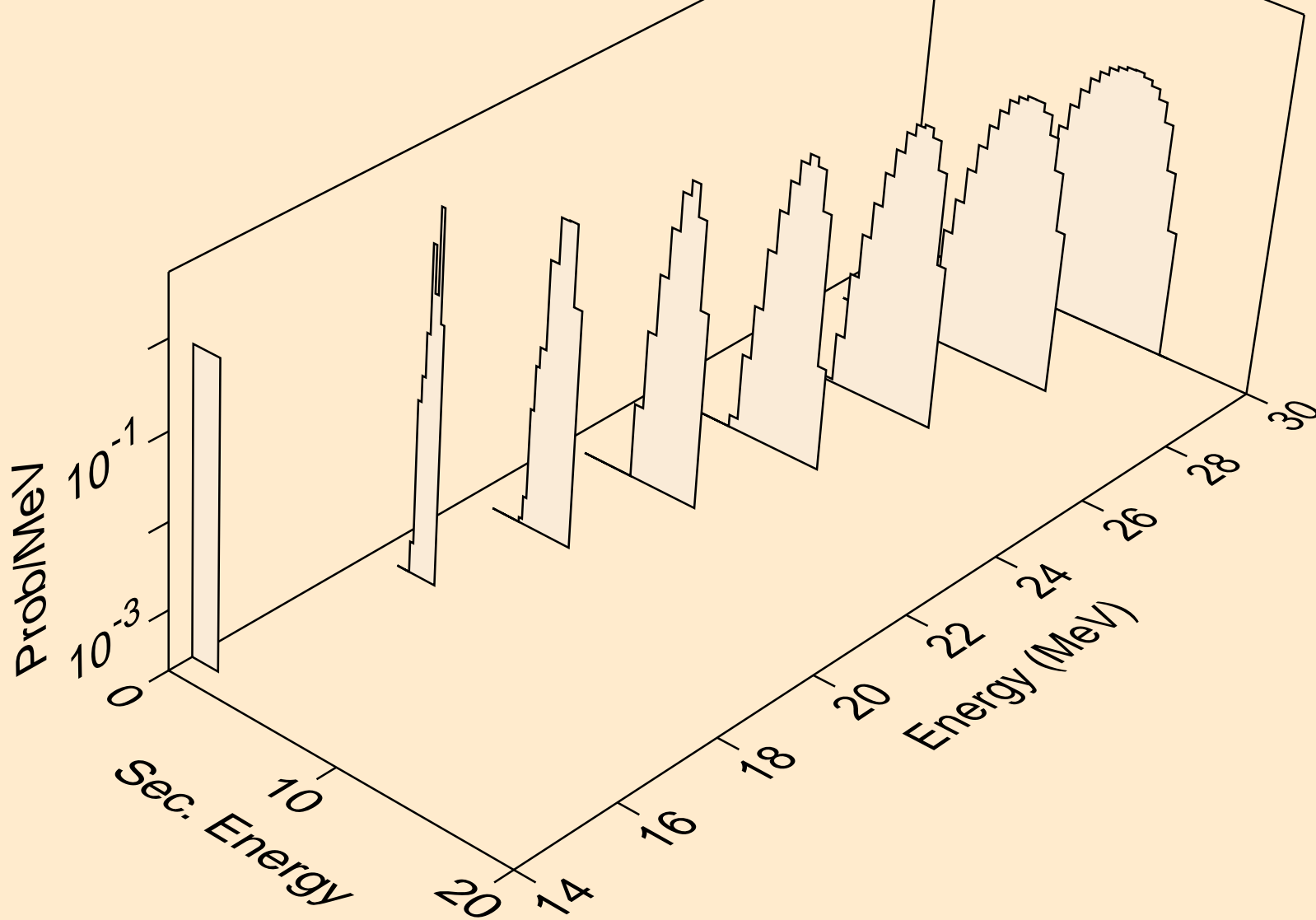

BR087 NEUTRON ACER TENDL-2019 LIBRARY; T=293.16K
alphas from (n,3n)a

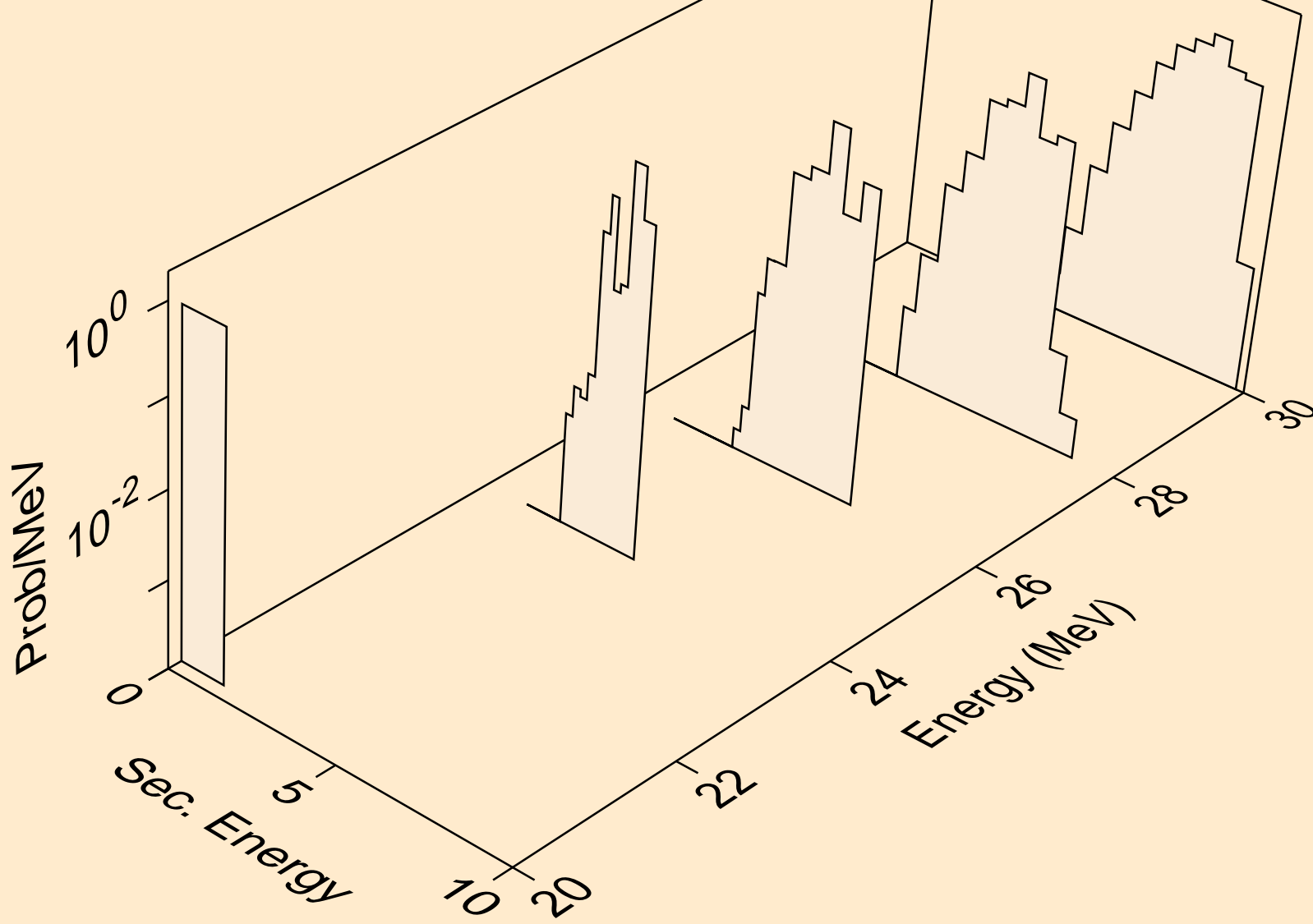

BR087 NEUTRON ACER TENDL-2019 LIBRARY; T=293.16K
alphas from (n,a)

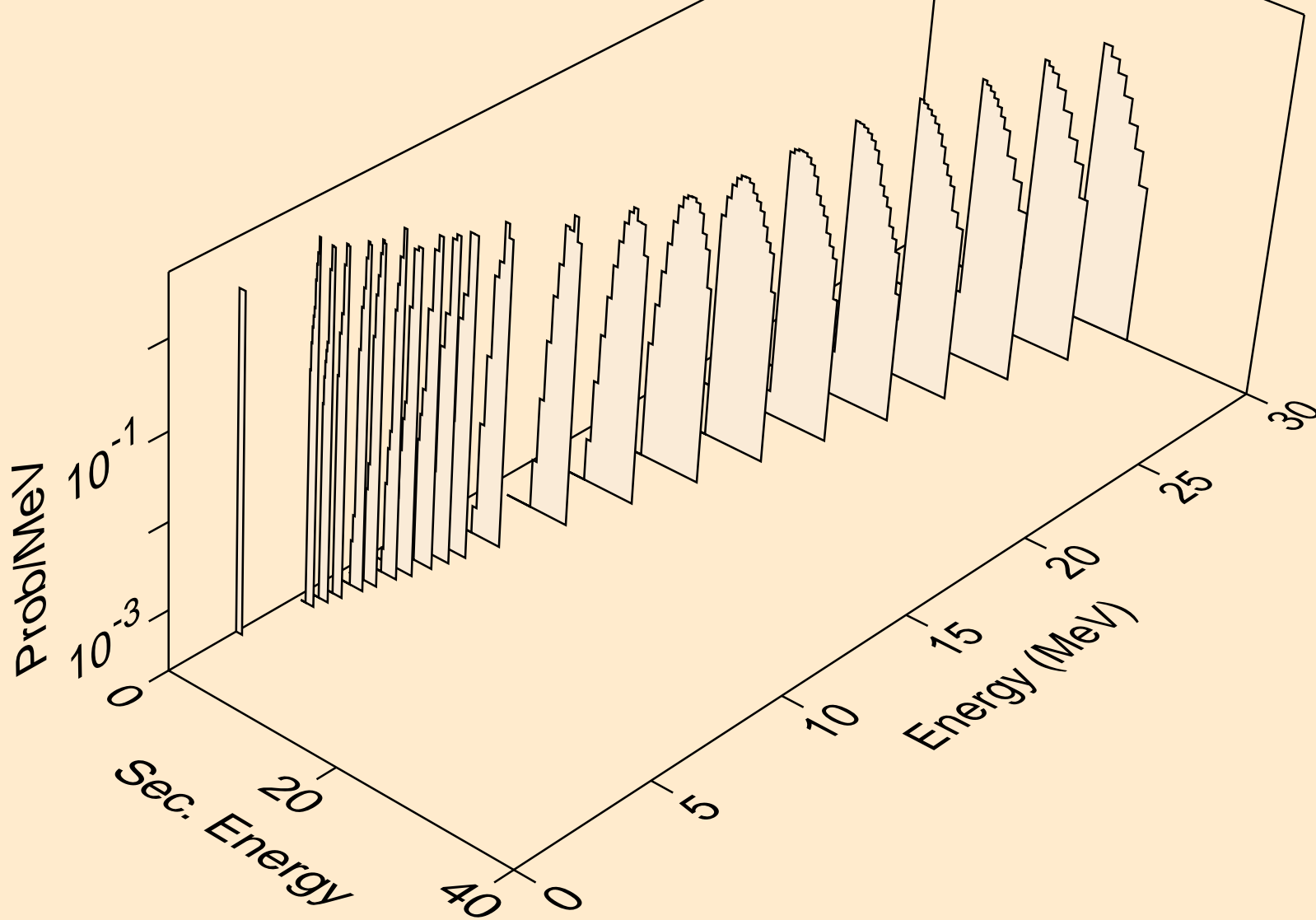

BR087 NEUTRON ACER TENDL-2019 LIBRARY; T=293.16K
alphas from (n,pa)

