

CL043 NEUTRON ACER TENDL-2019 LIBRARY; T=293.16K

Principal cross sections

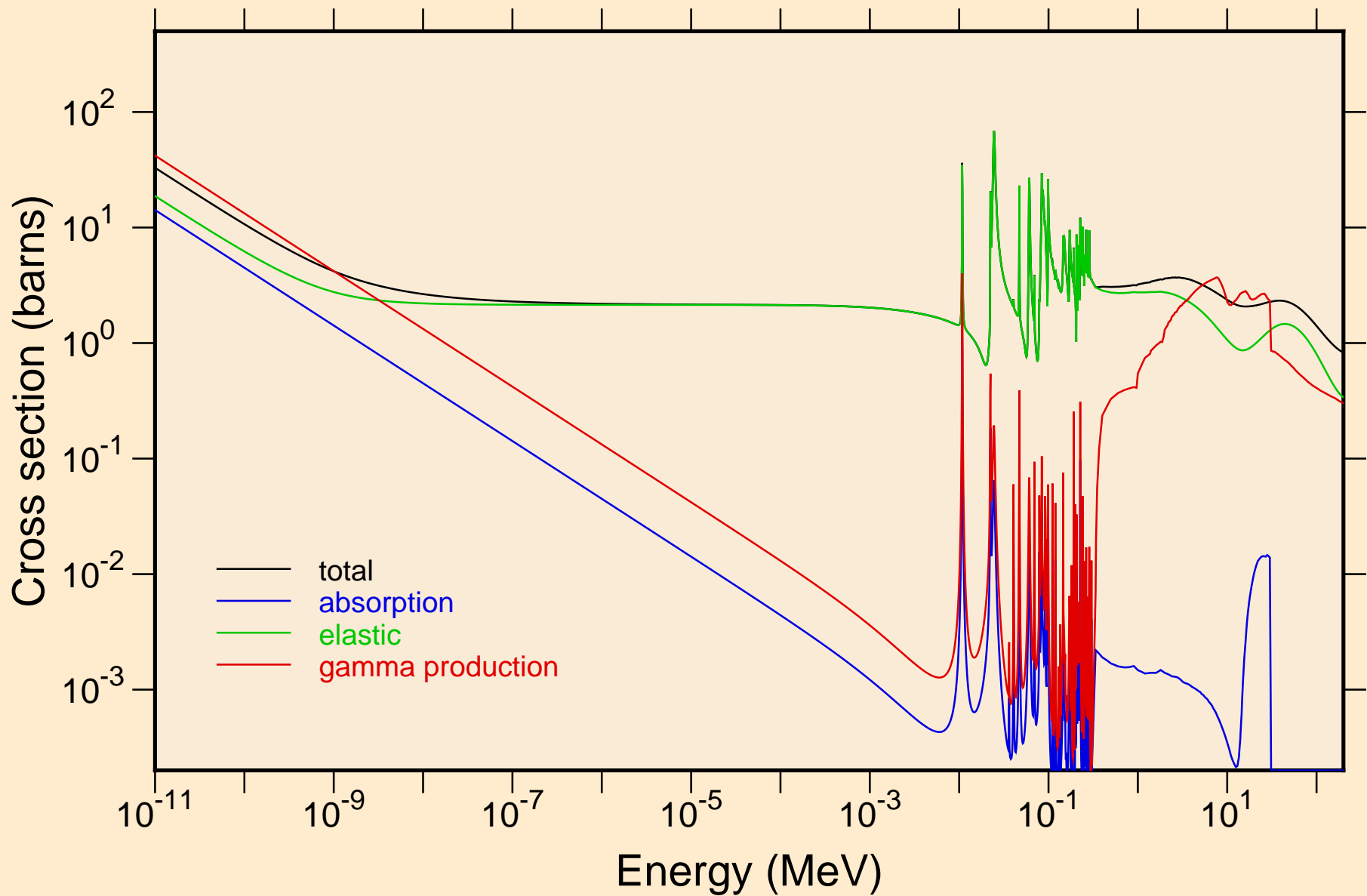

CL043 NEUTRON ACER TENDL-2019 LIBRARY; T=293.16K
resonance total cross section

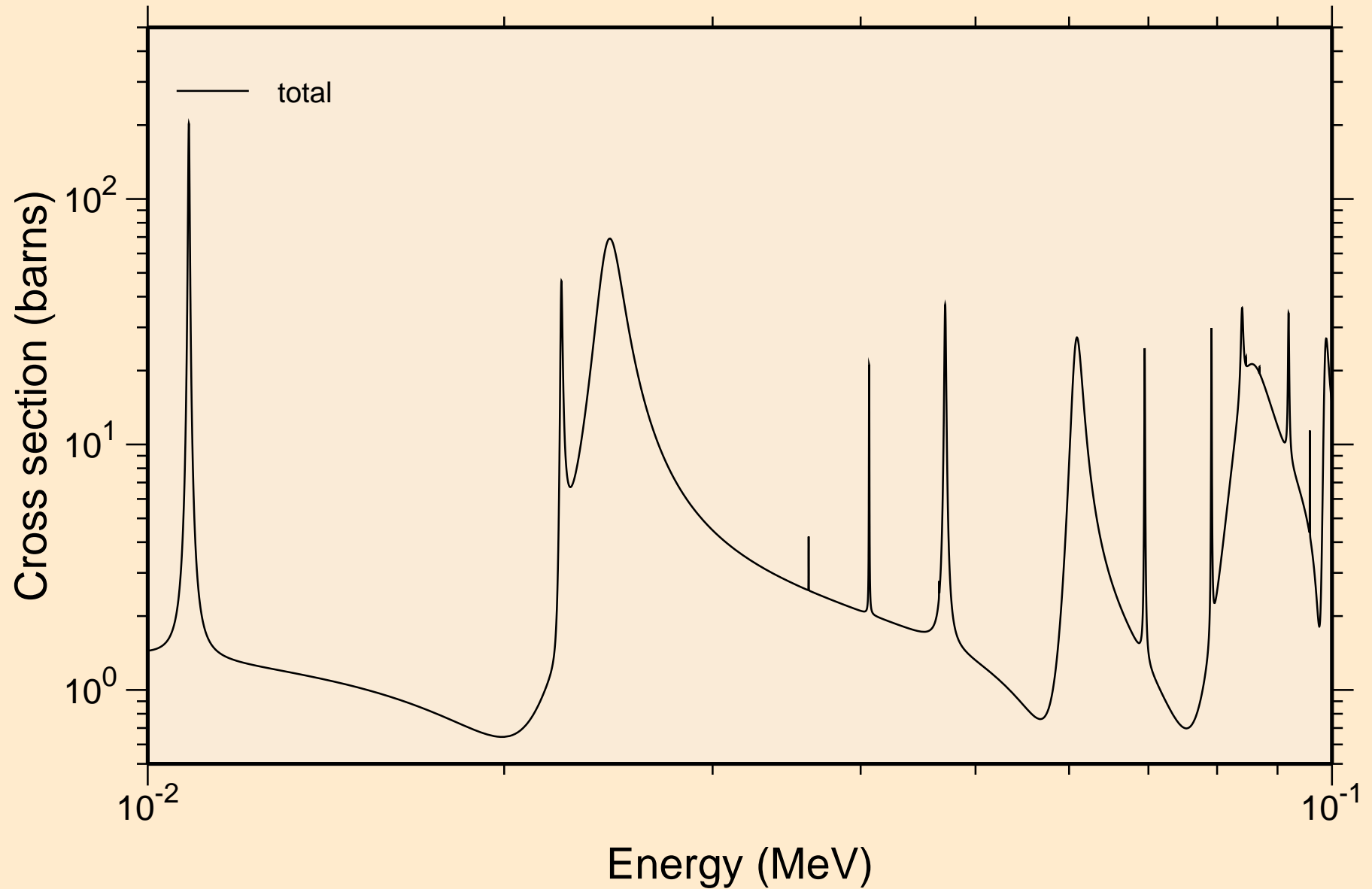

CL043 NEUTRON ACER TENDL-2019 LIBRARY; T=293.16K
resonance total cross section

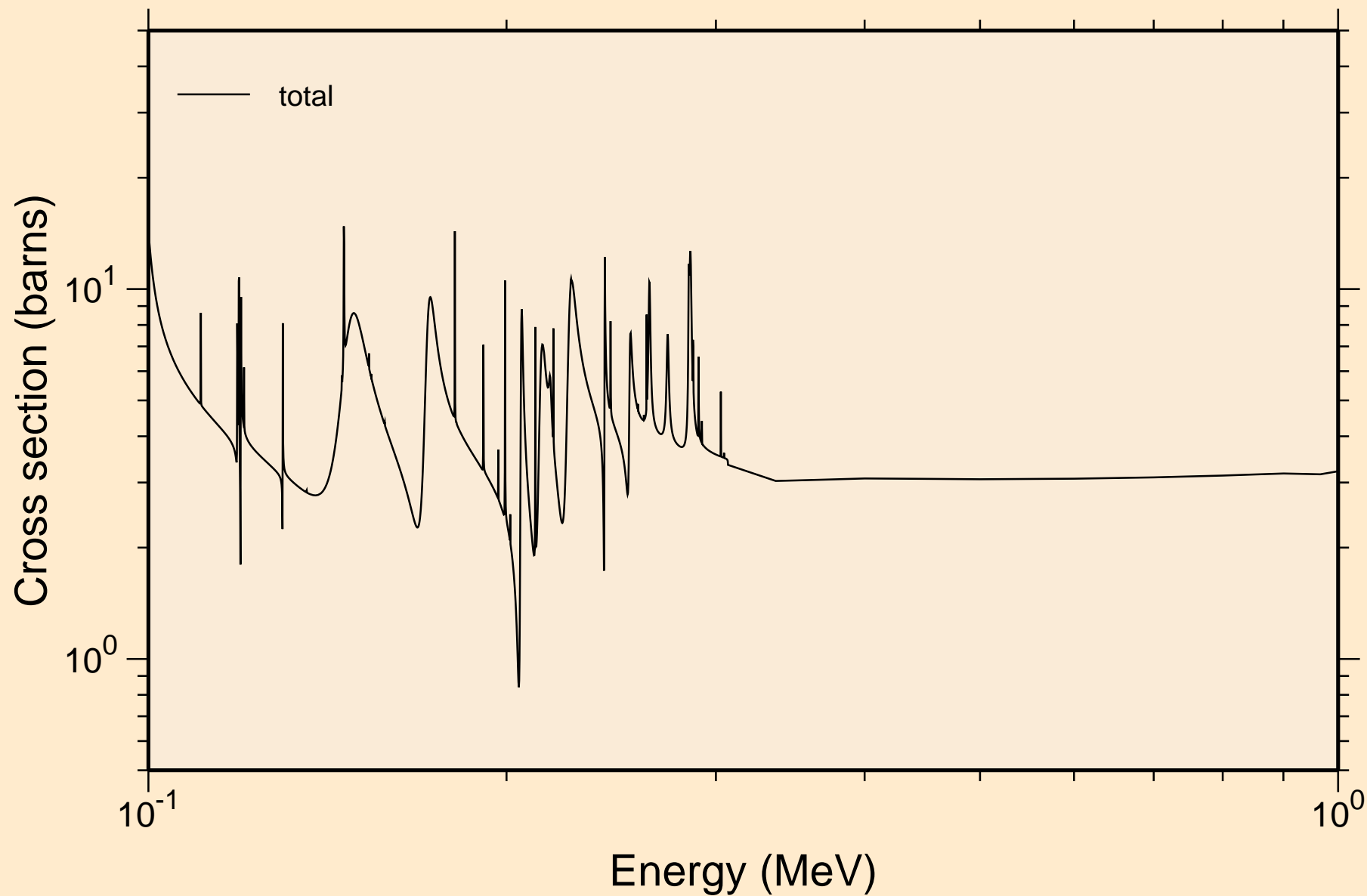

CL043 NEUTRON ACER TENDL-2019 LIBRARY; T=293.16K
resonance total cross section

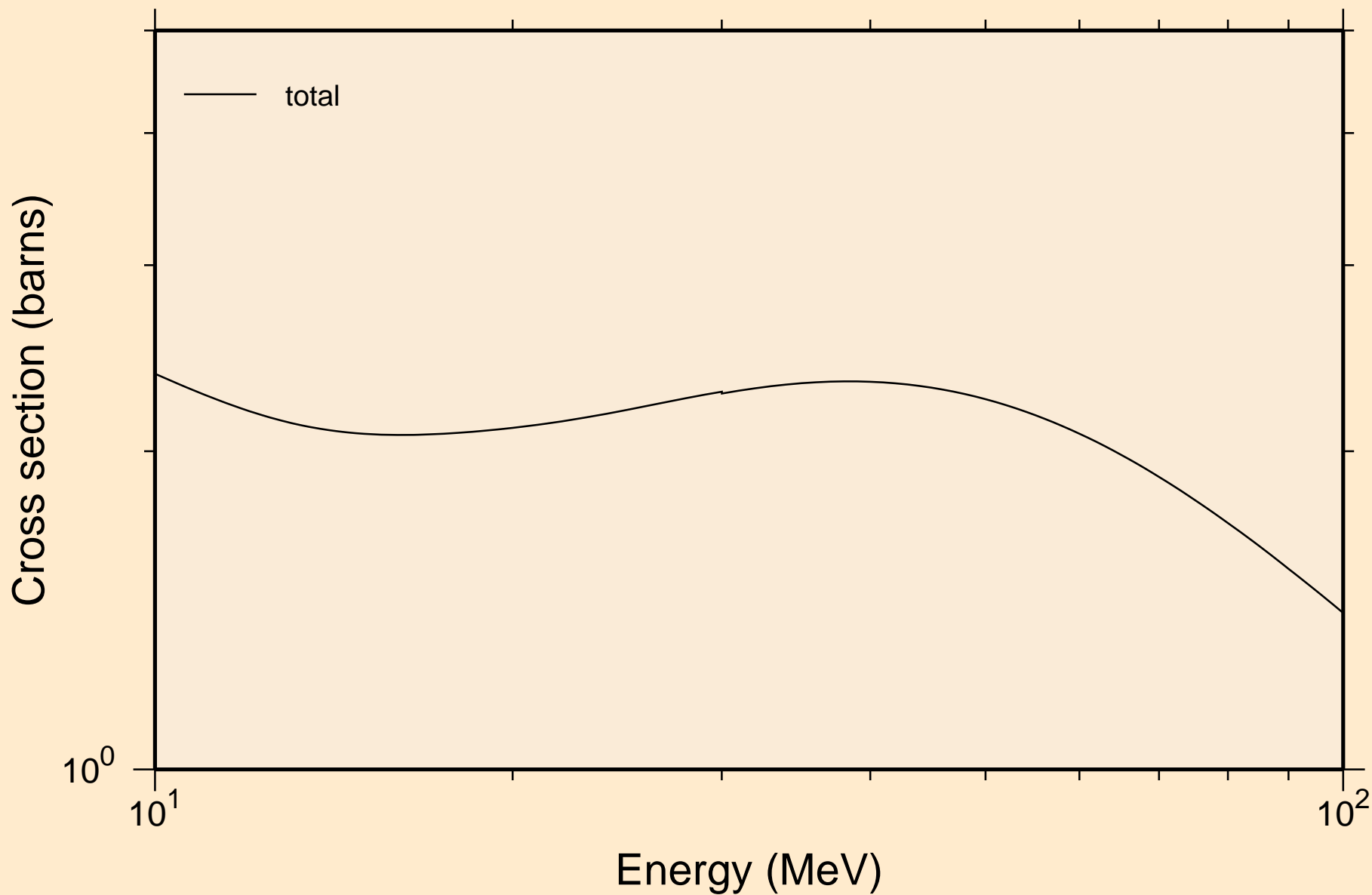

CL043 NEUTRON ACER TENDL-2019 LIBRARY; T=293.16K
resonance absorption cross sections

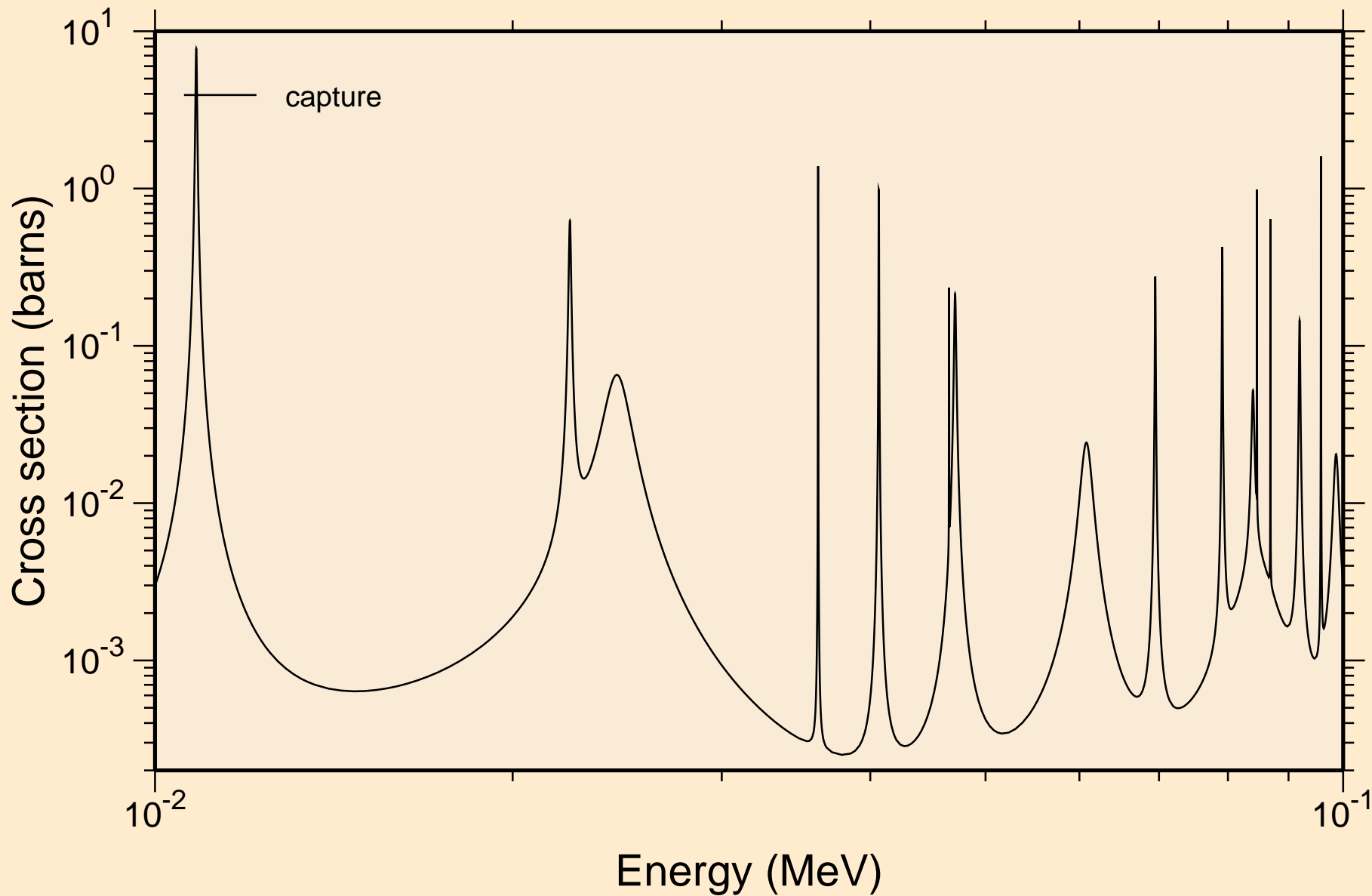

CL043 NEUTRON ACER TENDL-2019 LIBRARY; T=293.16K
resonance absorption cross sections

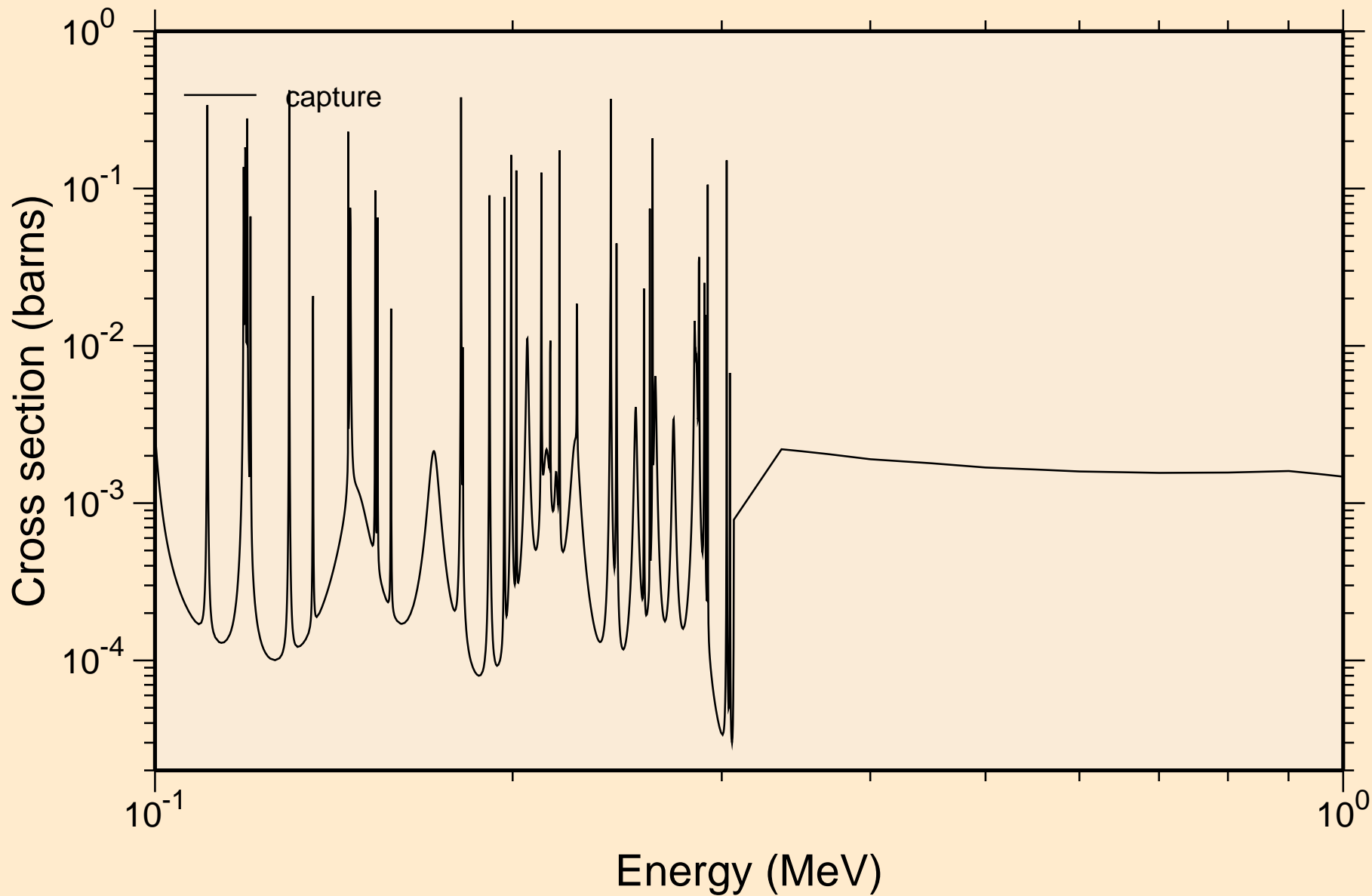

CL043 NEUTRON ACER TENDL-2019 LIBRARY; T=293.16K
resonance absorption cross sections

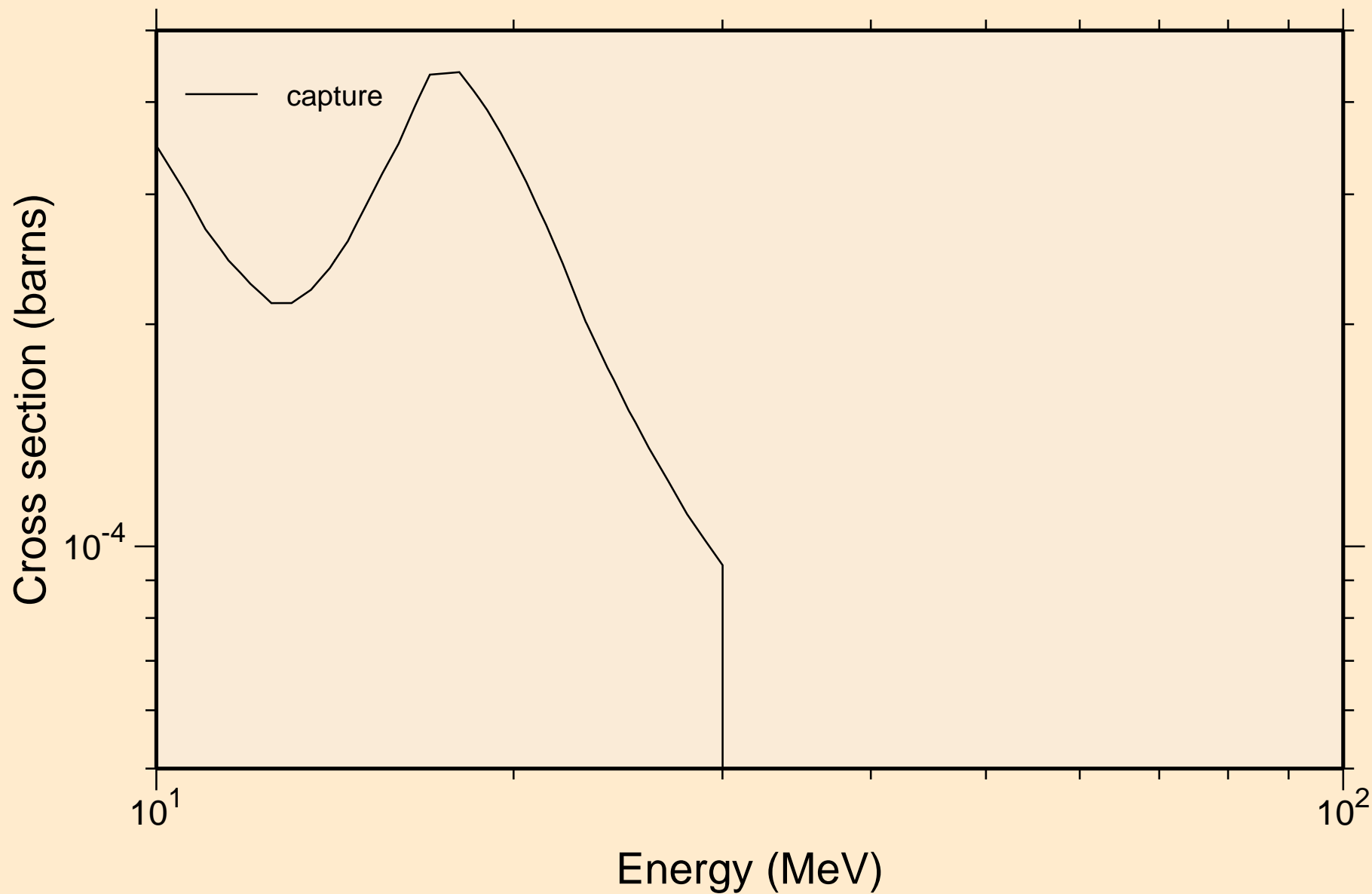

CL043 NEUTRON ACER TENDL-2019 LIBRARY; T=293.16K
Heating

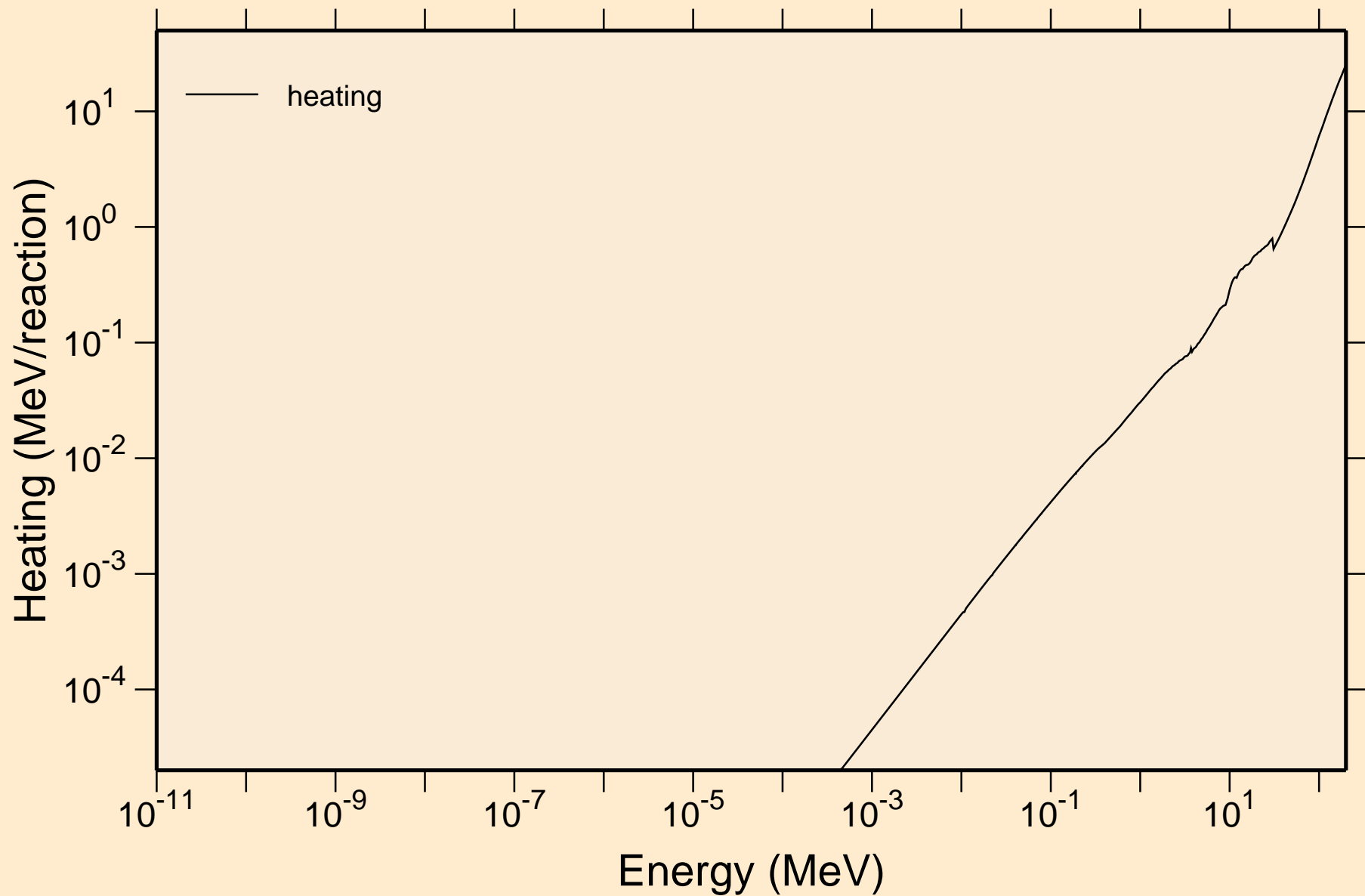

CL043 NEUTRON ACER TENDL-2019 LIBRARY; T=293.16K
Damage

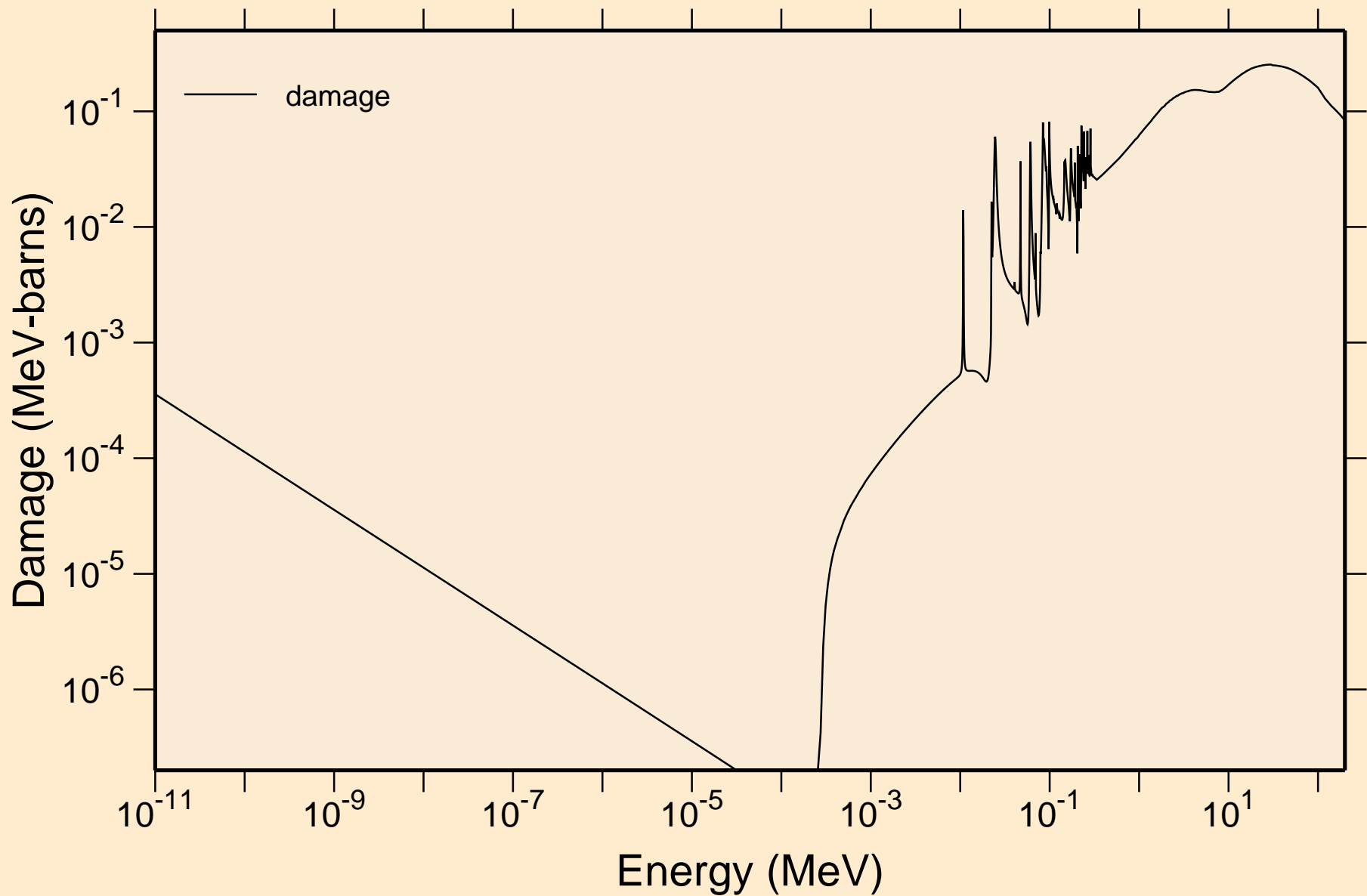

CL043 NEUTRON ACER TENDL-2019 LIBRARY; T=293.16K
Non-threshold reactions

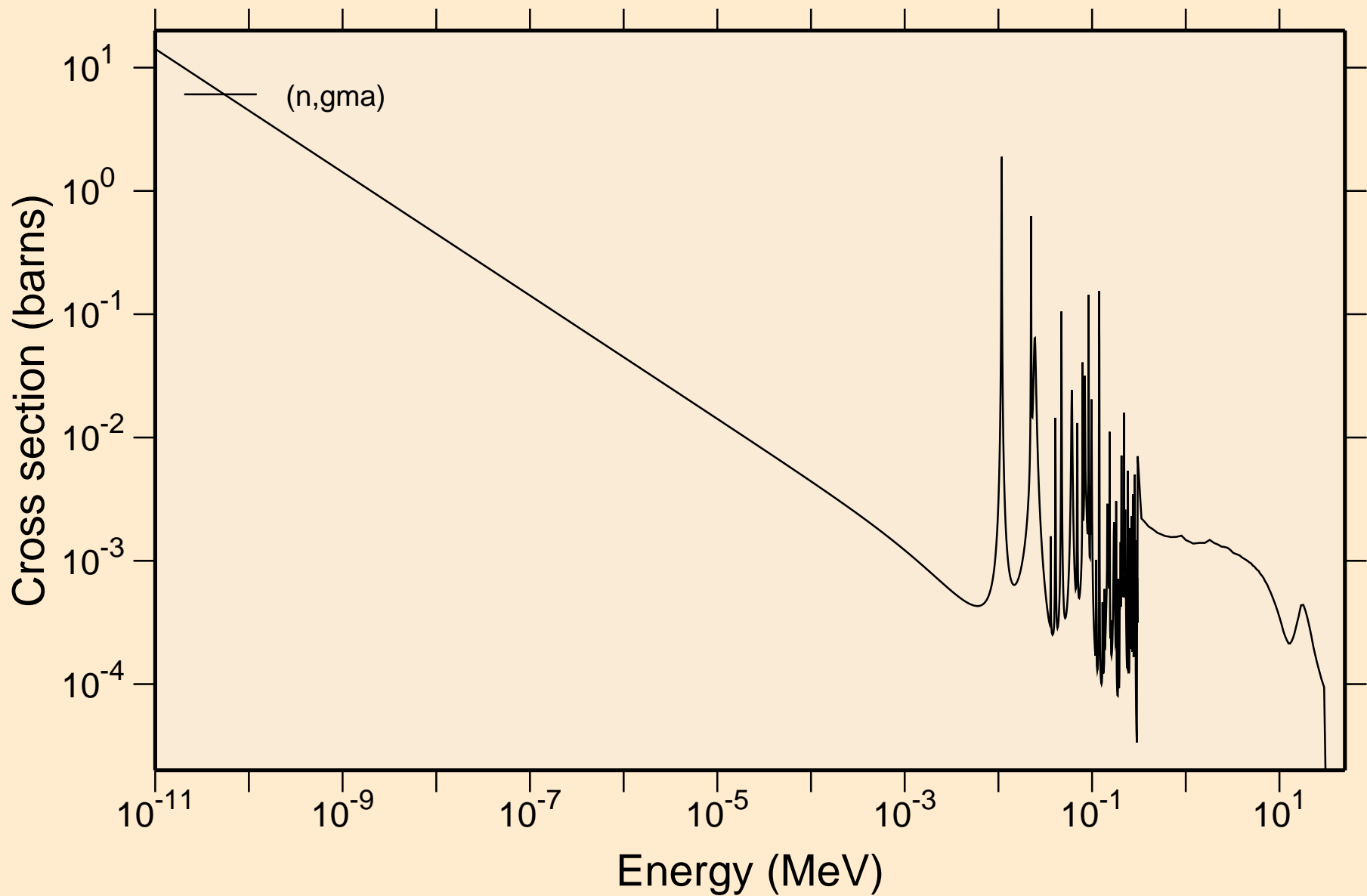

CL043 NEUTRON ACER TENDL-2019 LIBRARY; T=293.16K
Principal cross sections

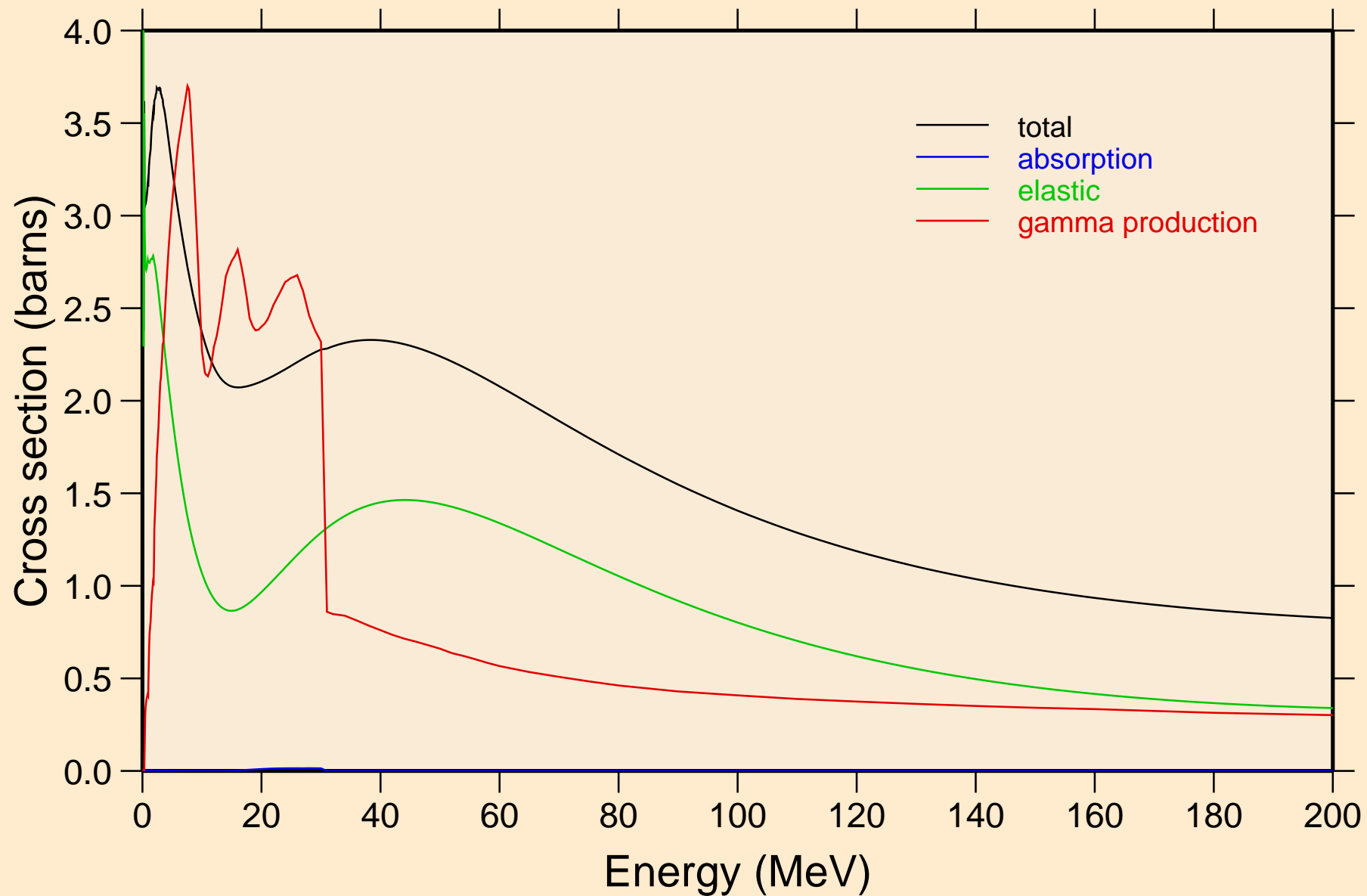

CL043 NEUTRON ACER TENDL-2019 LIBRARY; T=293.16K
Heating

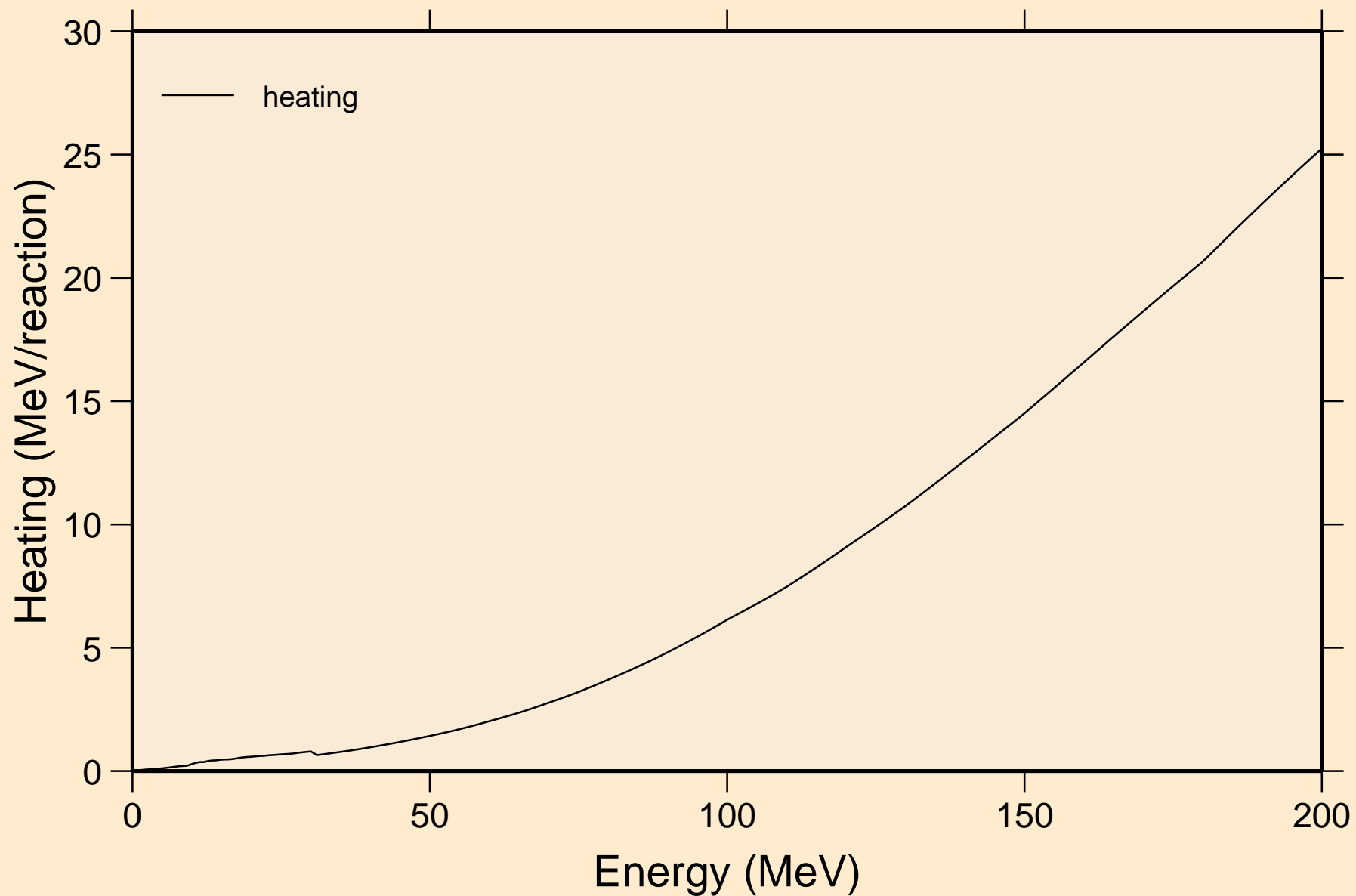

CL043 NEUTRON ACER TENDL-2019 LIBRARY; T=293.16K
Damage

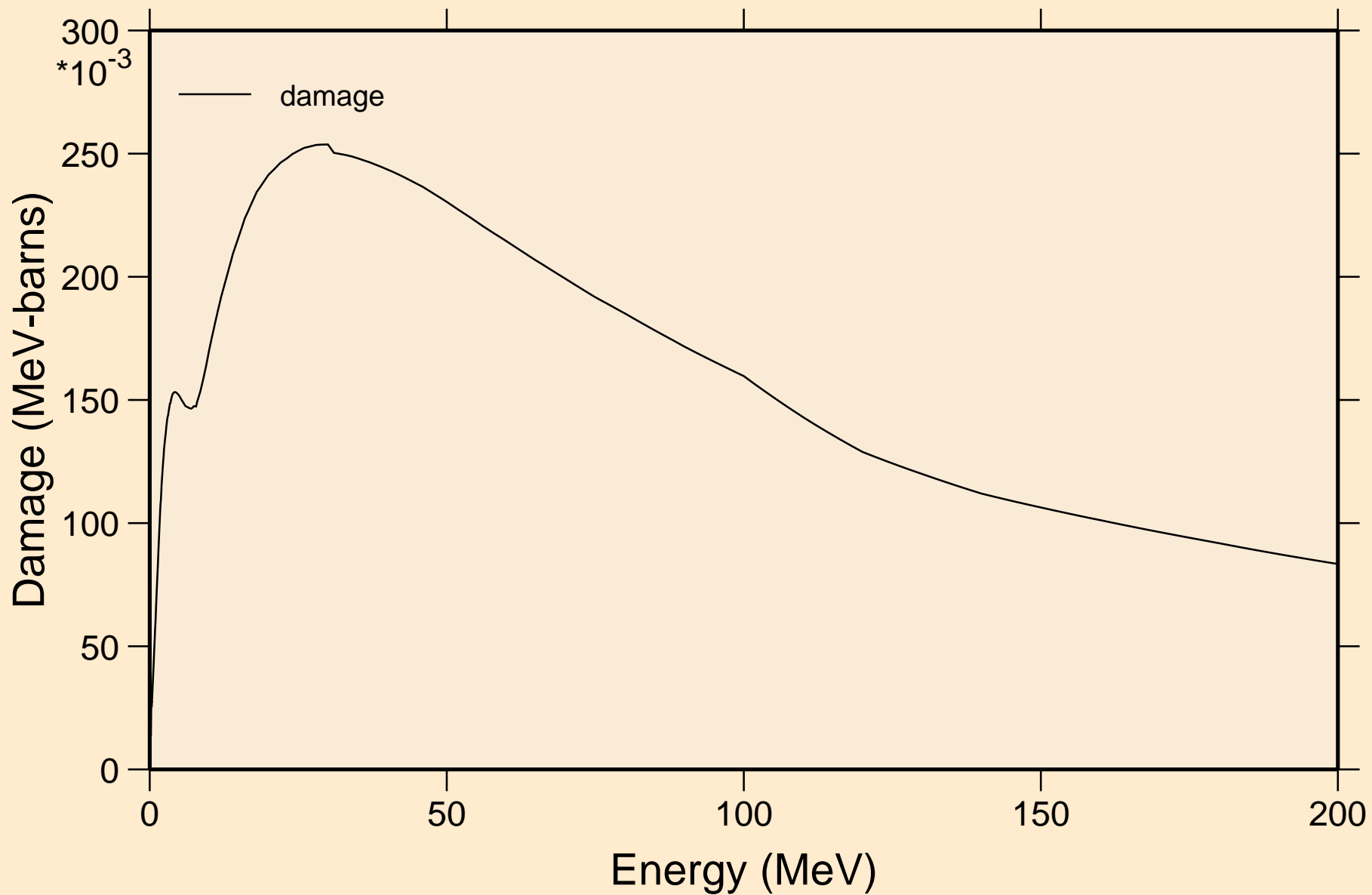

CL043 NEUTRON ACER TENDL-2019 LIBRARY; T=293.16K
Non-threshold reactions

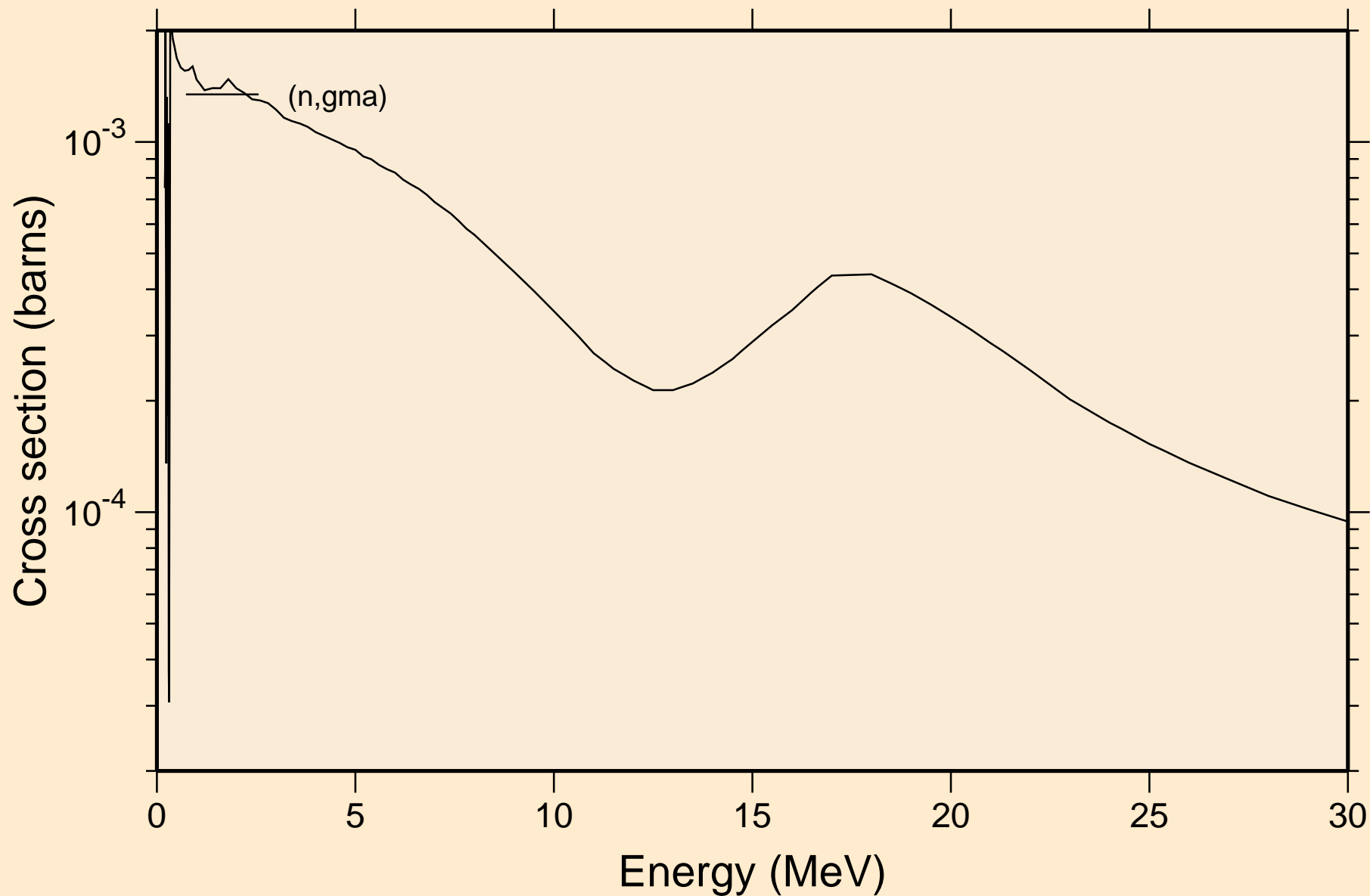

CL043 NEUTRON ACER TENDL-2019 LIBRARY; T=293.16K
Inelastic levels

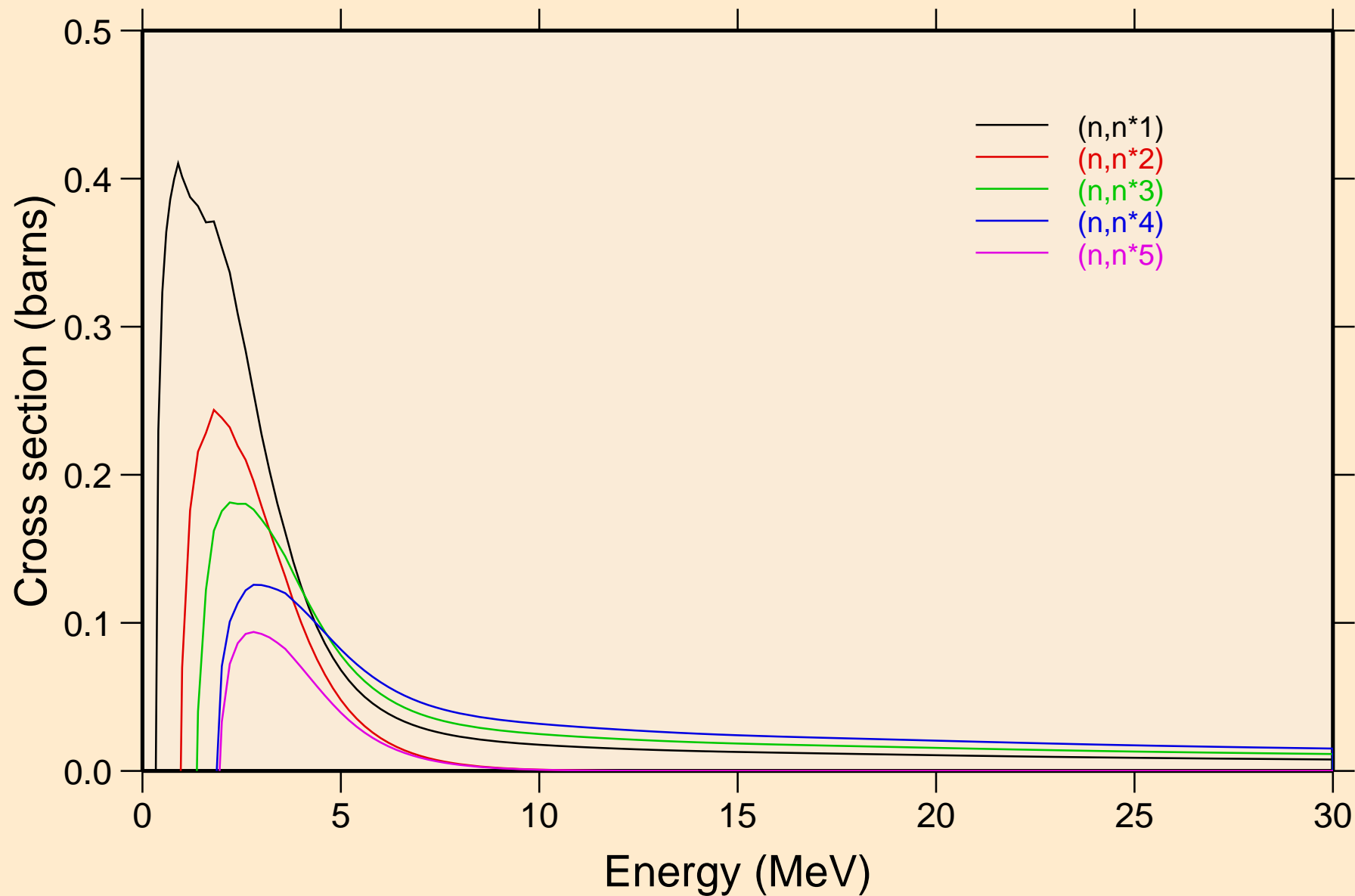

CL043 NEUTRON ACER TENDL-2019 LIBRARY; T=293.16K
Inelastic levels

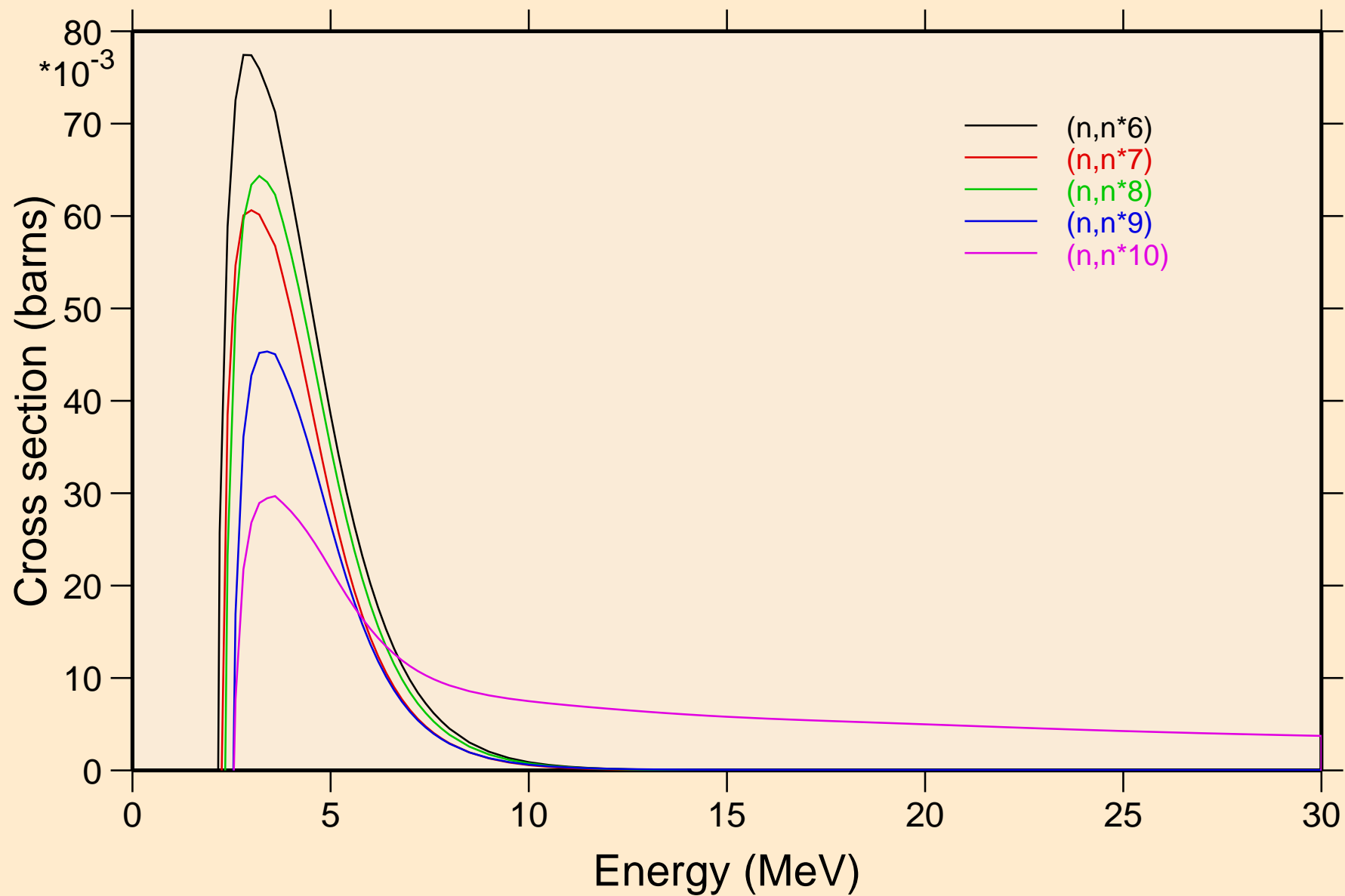

CL043 NEUTRON ACER TENDL-2019 LIBRARY; T=293.16K
Inelastic levels

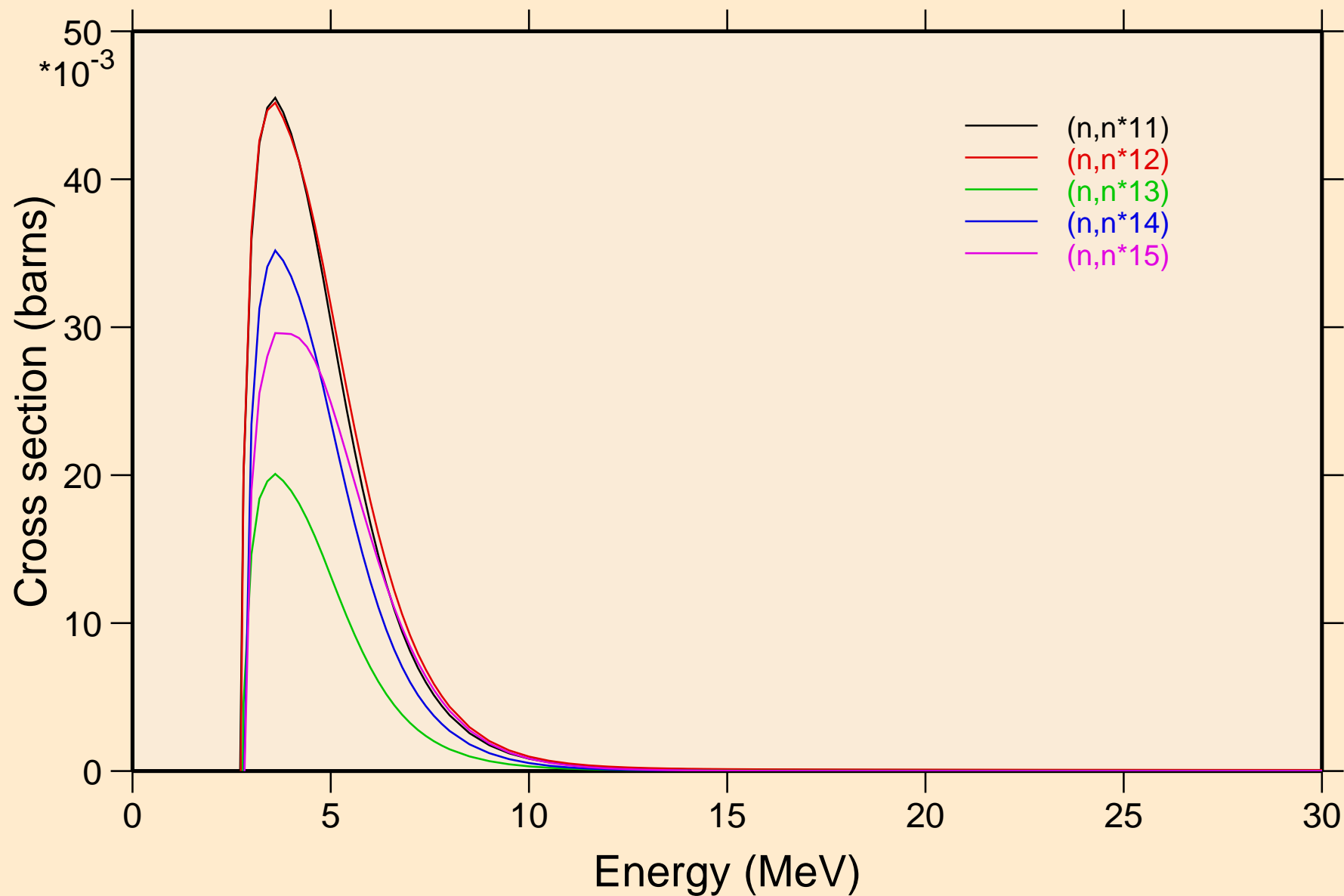

CL043 NEUTRON ACER TENDL-2019 LIBRARY; T=293.16K
Inelastic levels

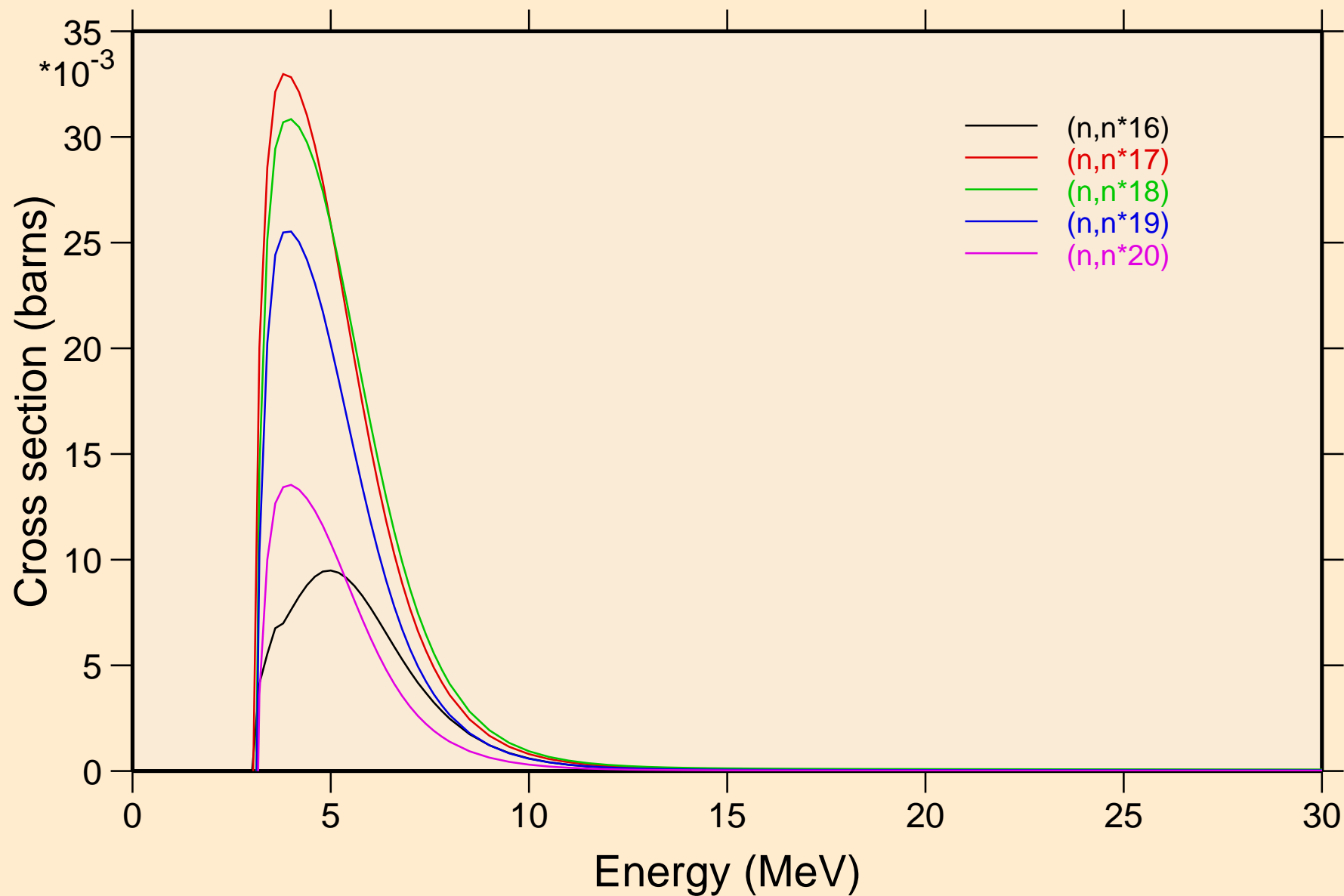

CL043 NEUTRON ACER TENDL-2019 LIBRARY; T=293.16K
Inelastic levels

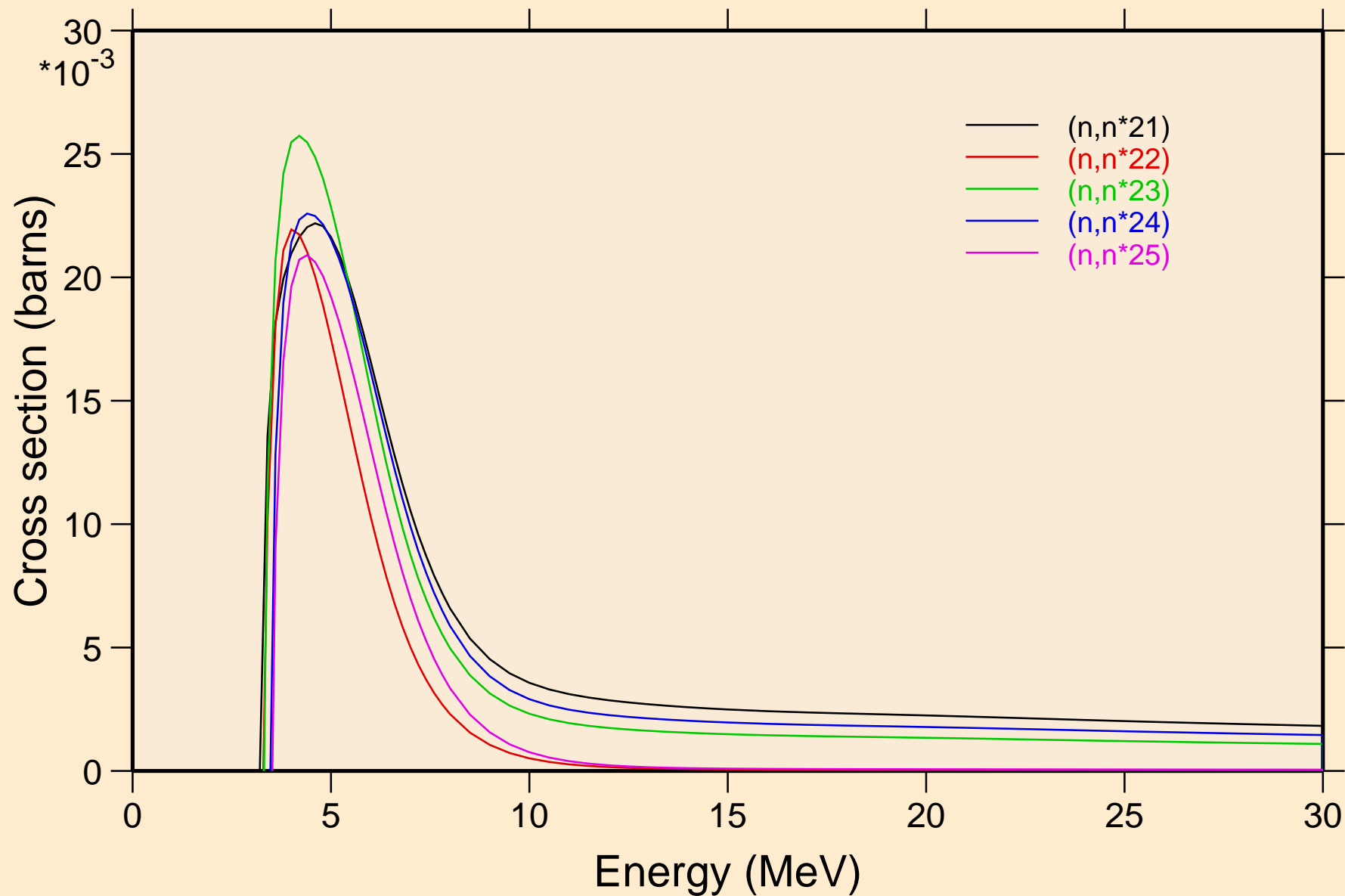

CL043 NEUTRON ACER TENDL-2019 LIBRARY; T=293.16K
Inelastic levels

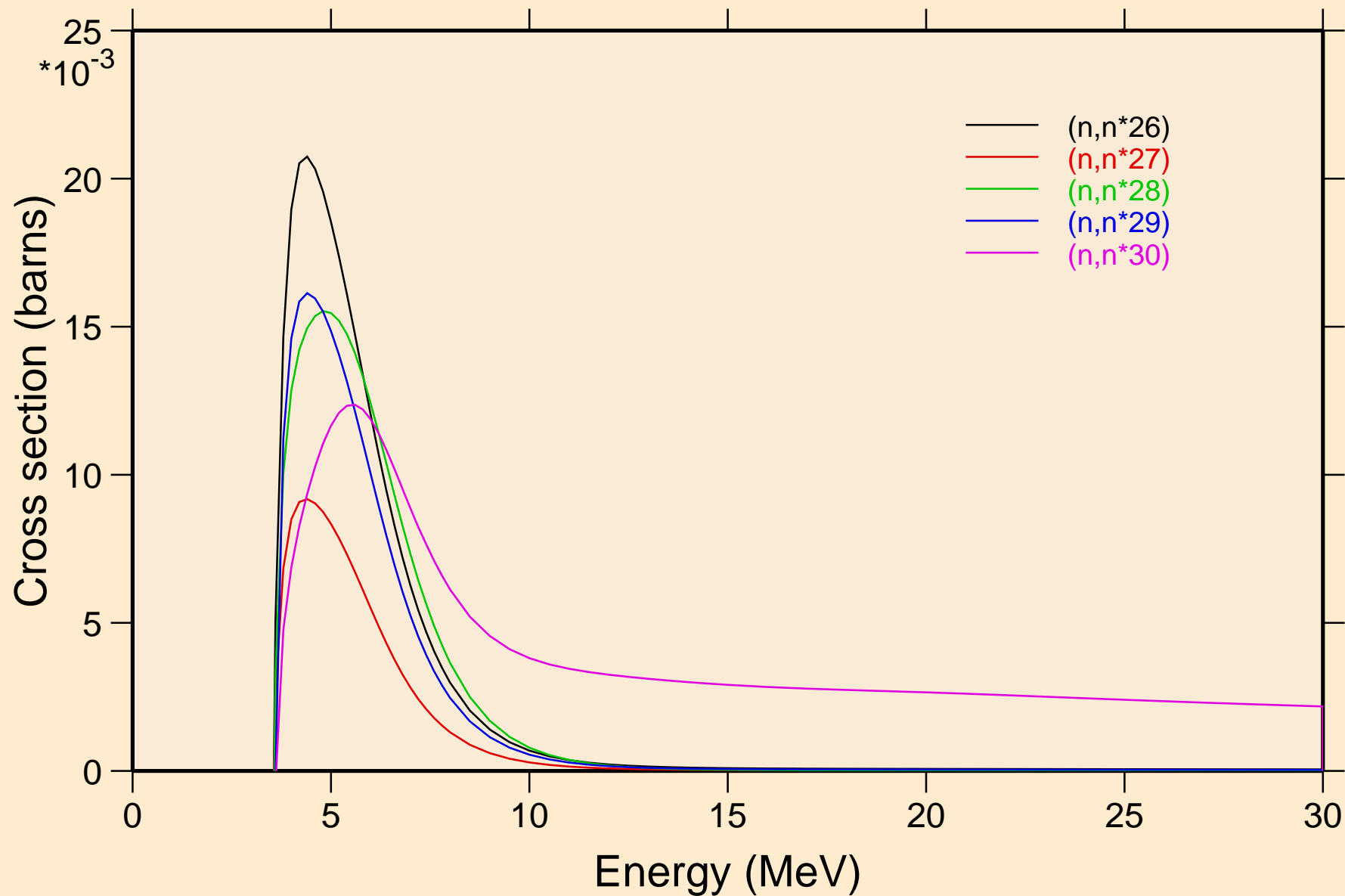

CL043 NEUTRON ACER TENDL-2019 LIBRARY; T=293.16K

Threshold reactions

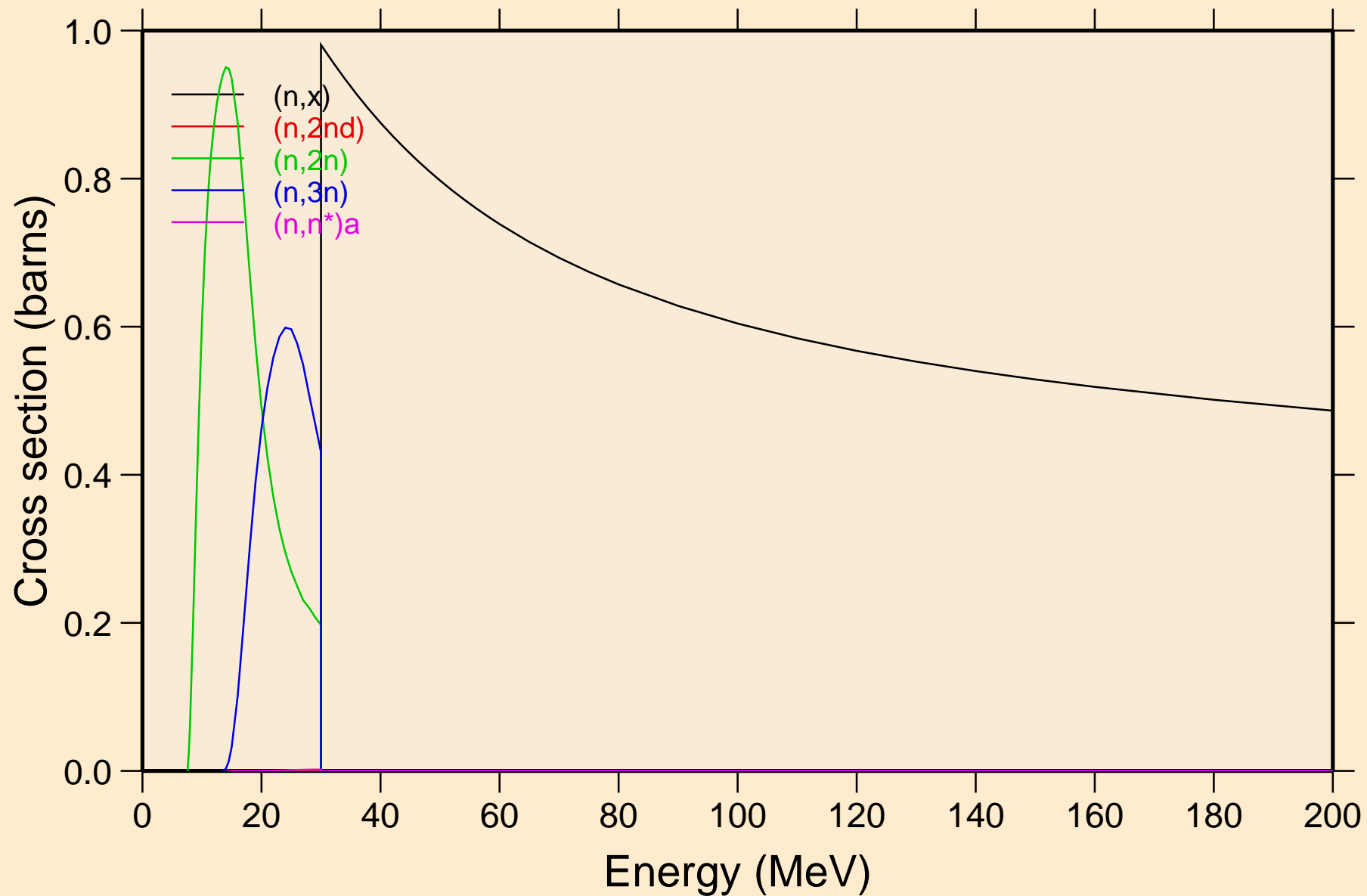

CL043 NEUTRON ACER TENDL-2019 LIBRARY; T=293.16K
Threshold reactions

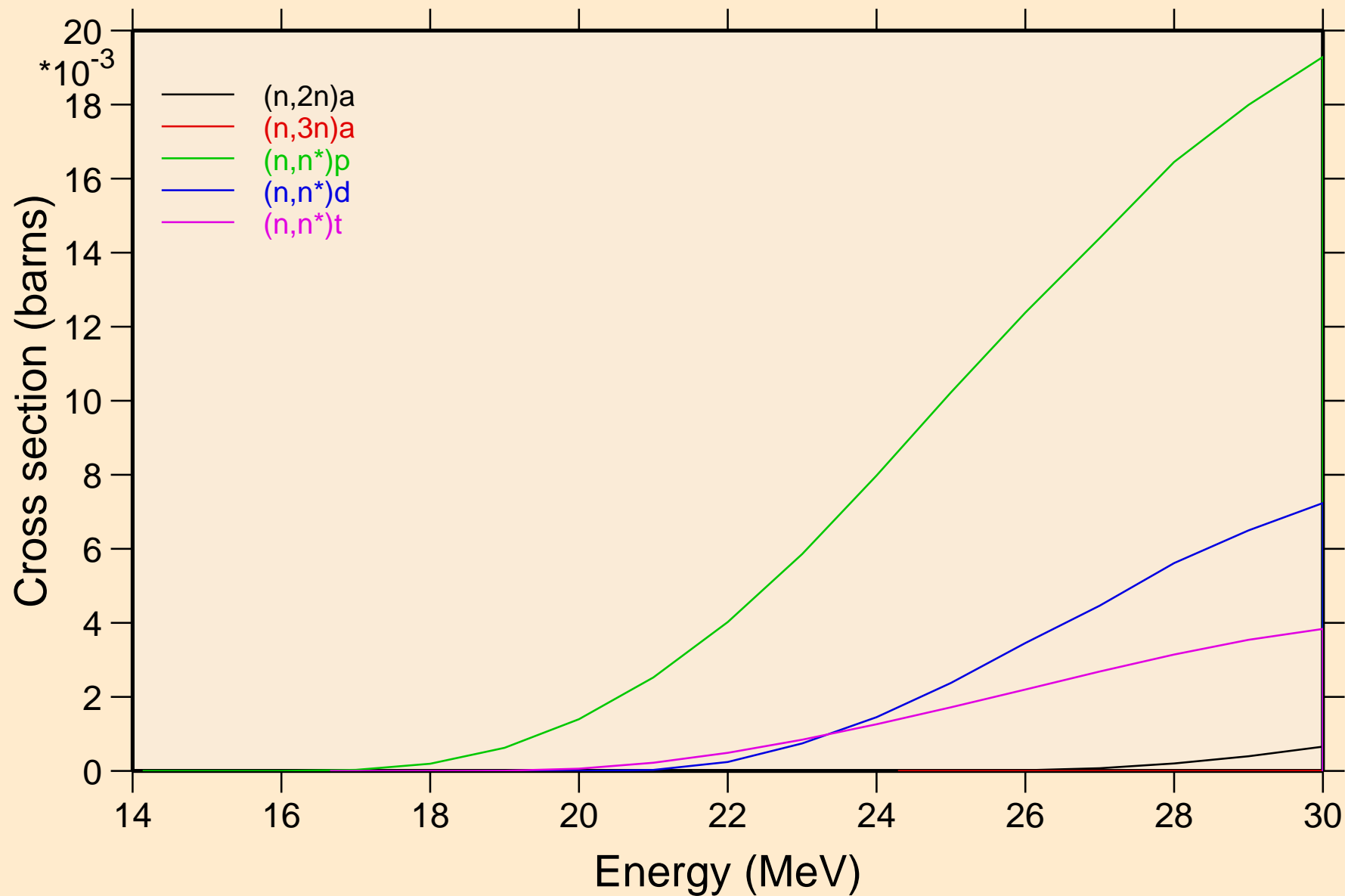

CL043 NEUTRON ACER TENDL-2019 LIBRARY; T=293.16K
Threshold reactions

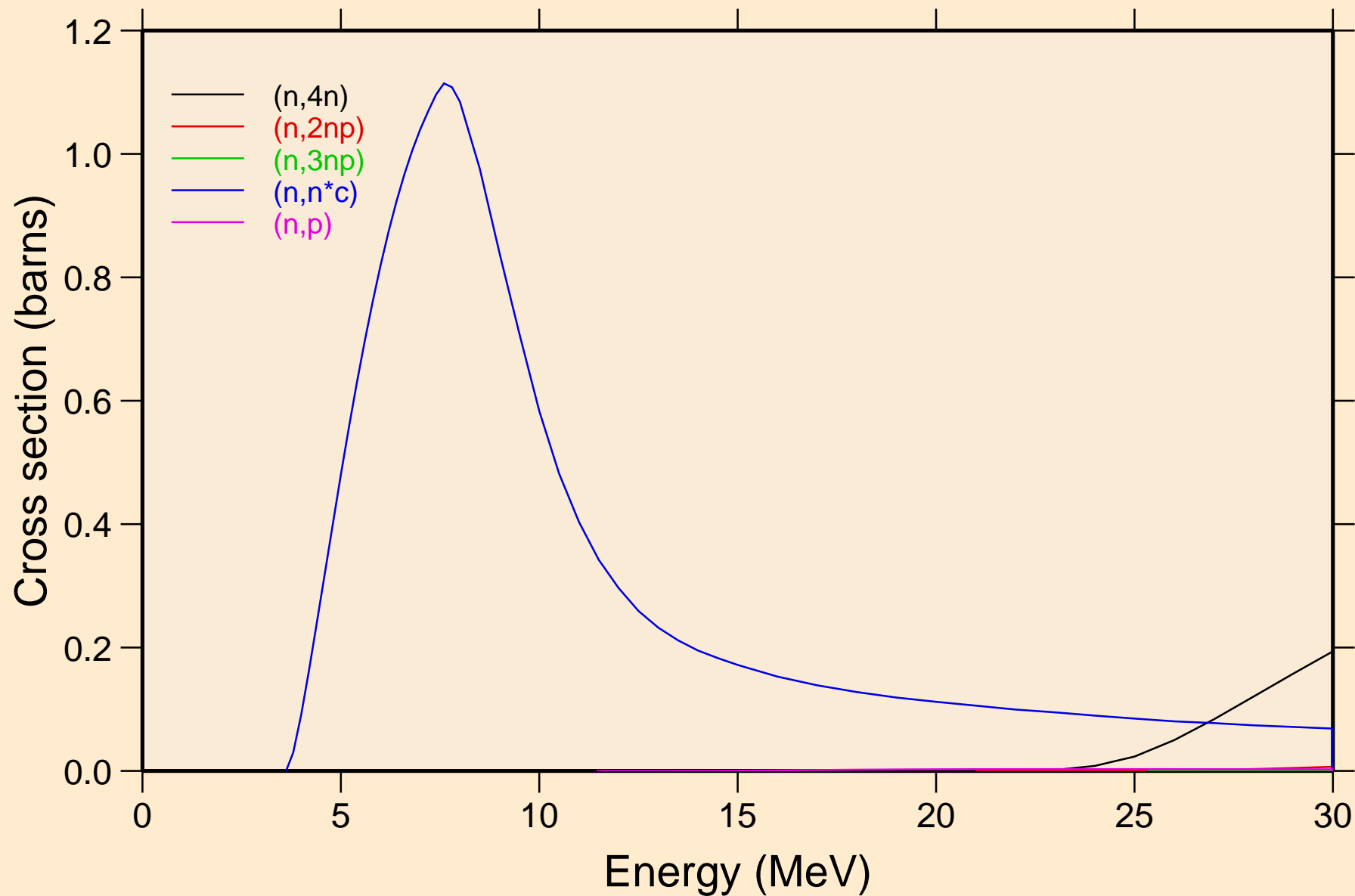

CL043 NEUTRON ACER TENDL-2019 LIBRARY; T=293.16K
Threshold reactions

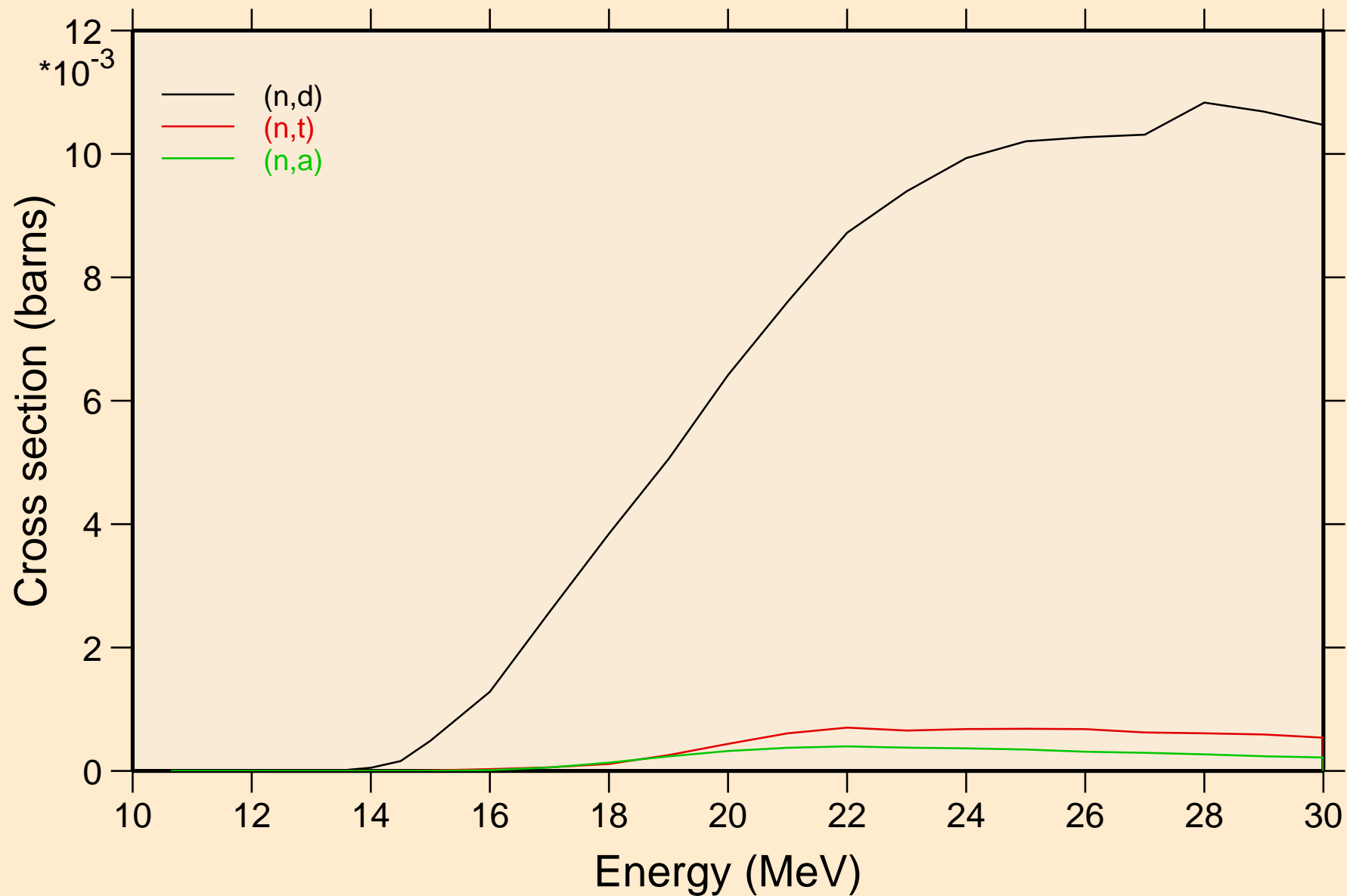

CL043 NEUTRON ACER TENDL-2019 LIBRARY; T=293.16K

Threshold reactions

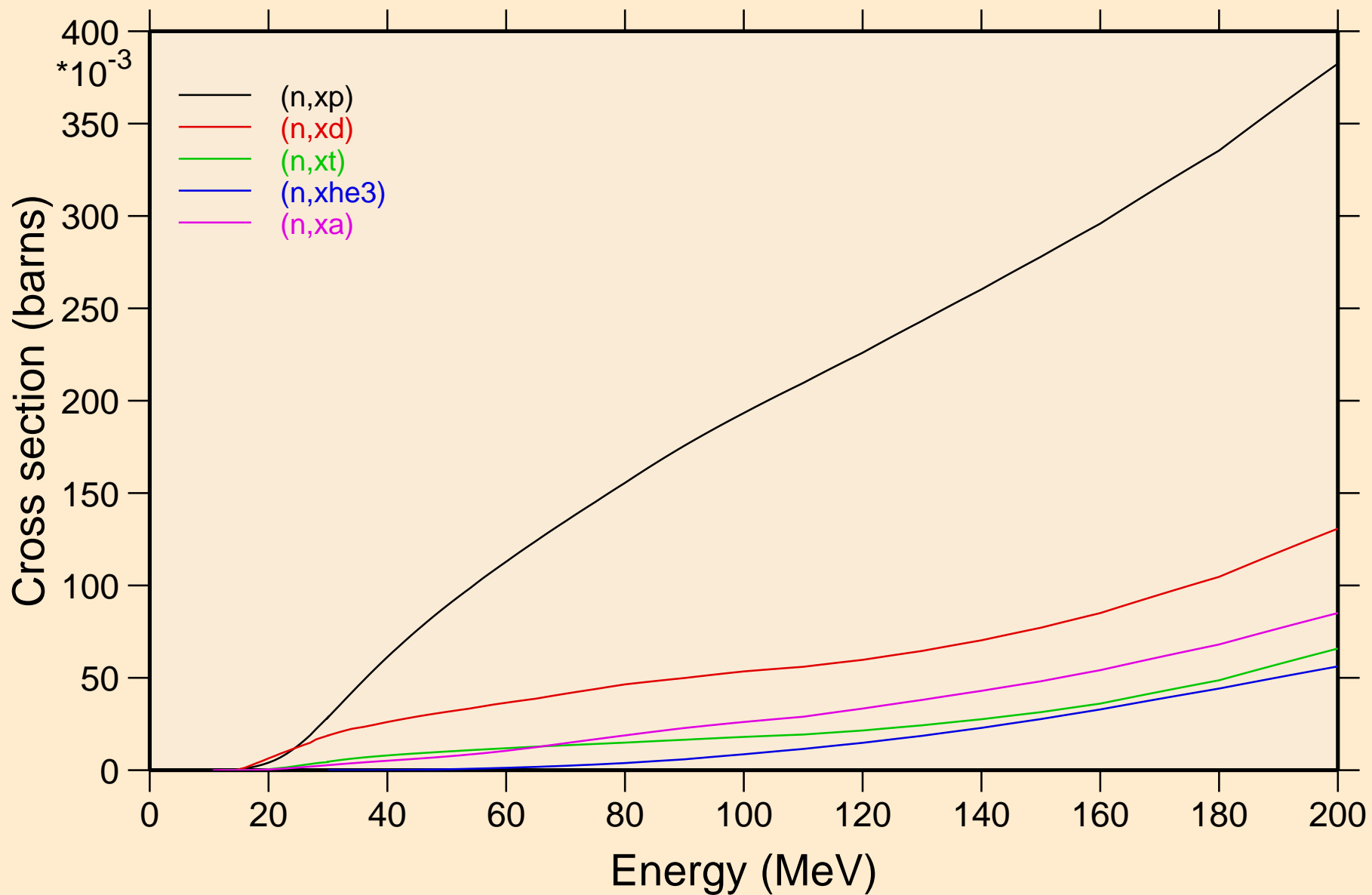

CL043 NEUTRON ACER TENDL-2019 LIBRARY; T=293.16K
angular distribution for elastic

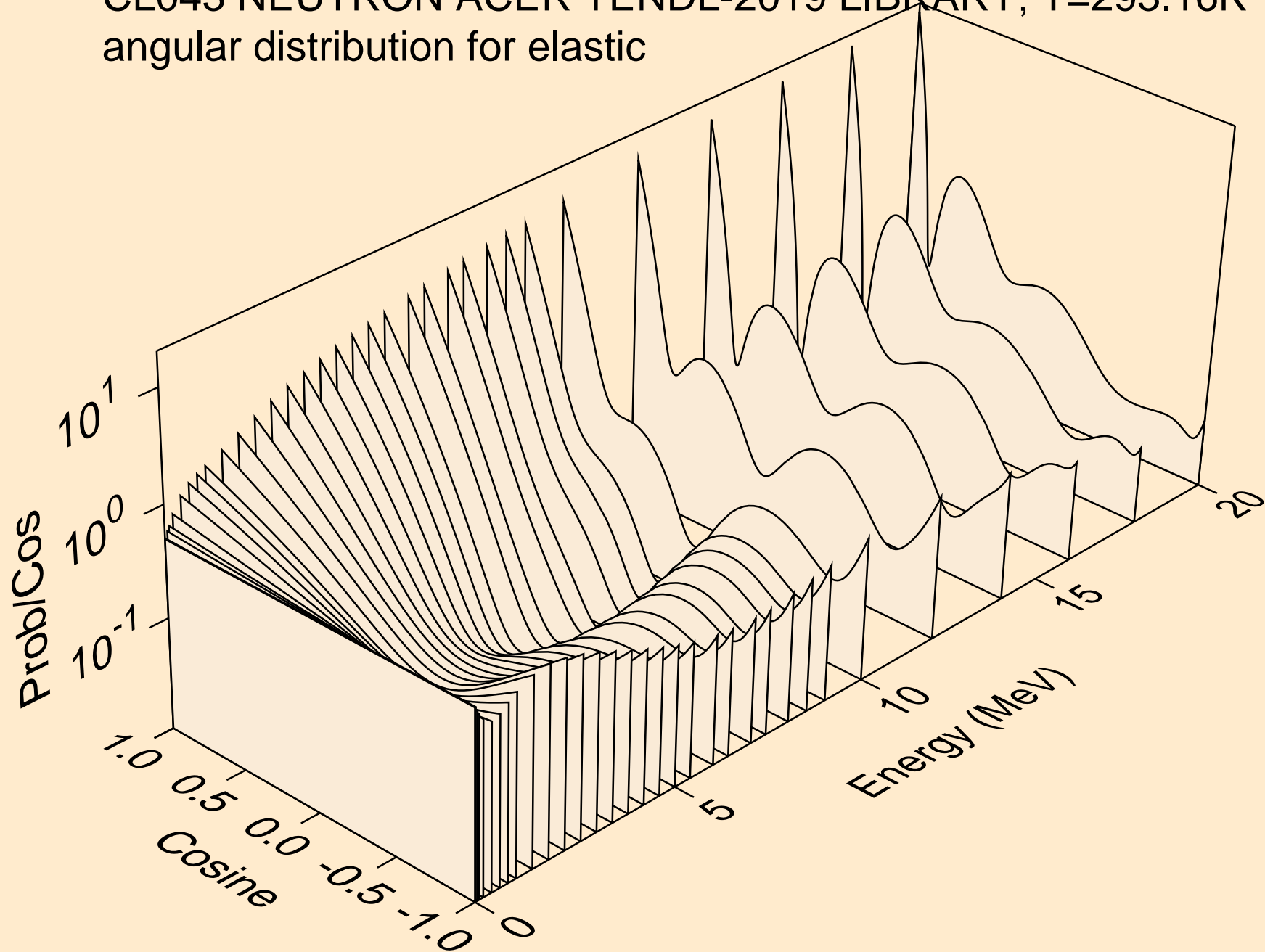

CL043 NEUTRON ACER TENDL-2019 LIBRARY; T=293.16K
angular distribution for elastic

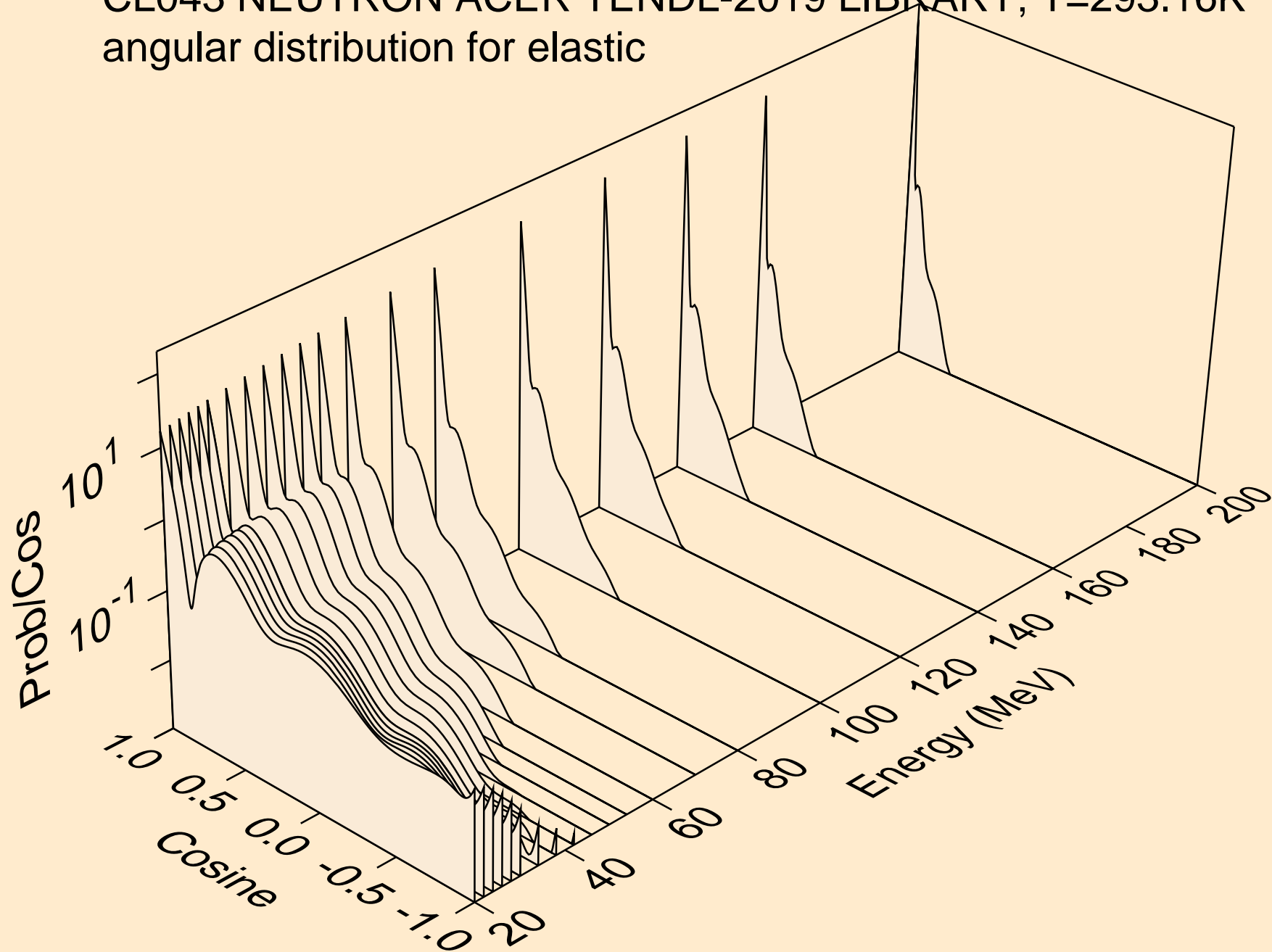

CL043 NEUTRON ACER TENDL-2019 LIBRARY; T=293.16K
angular distribution for (n,n*1)

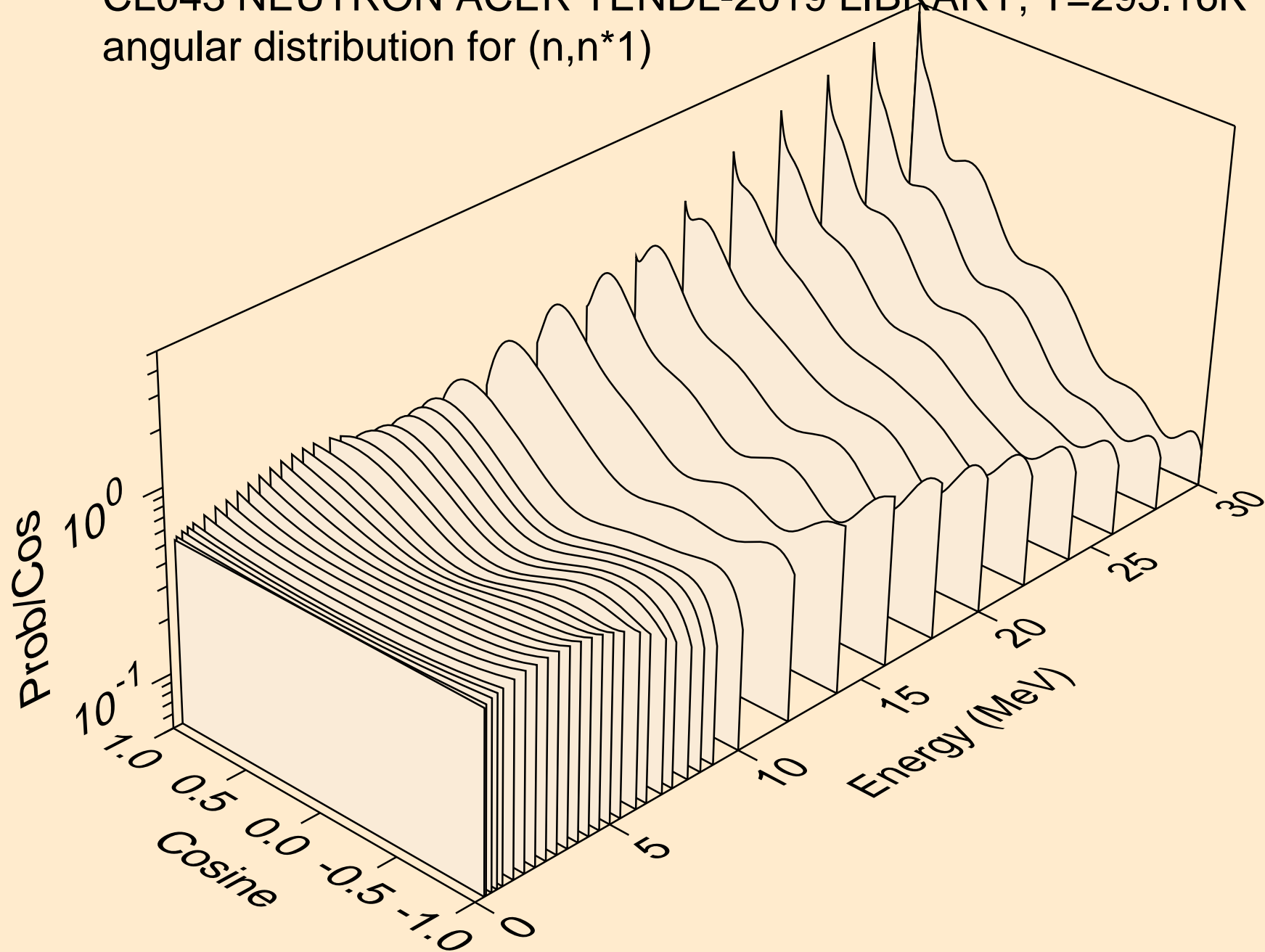

CL043 NEUTRON ACER TENDL-2019 LIBRARY; T=293.16K
angular distribution for (n,n*2)

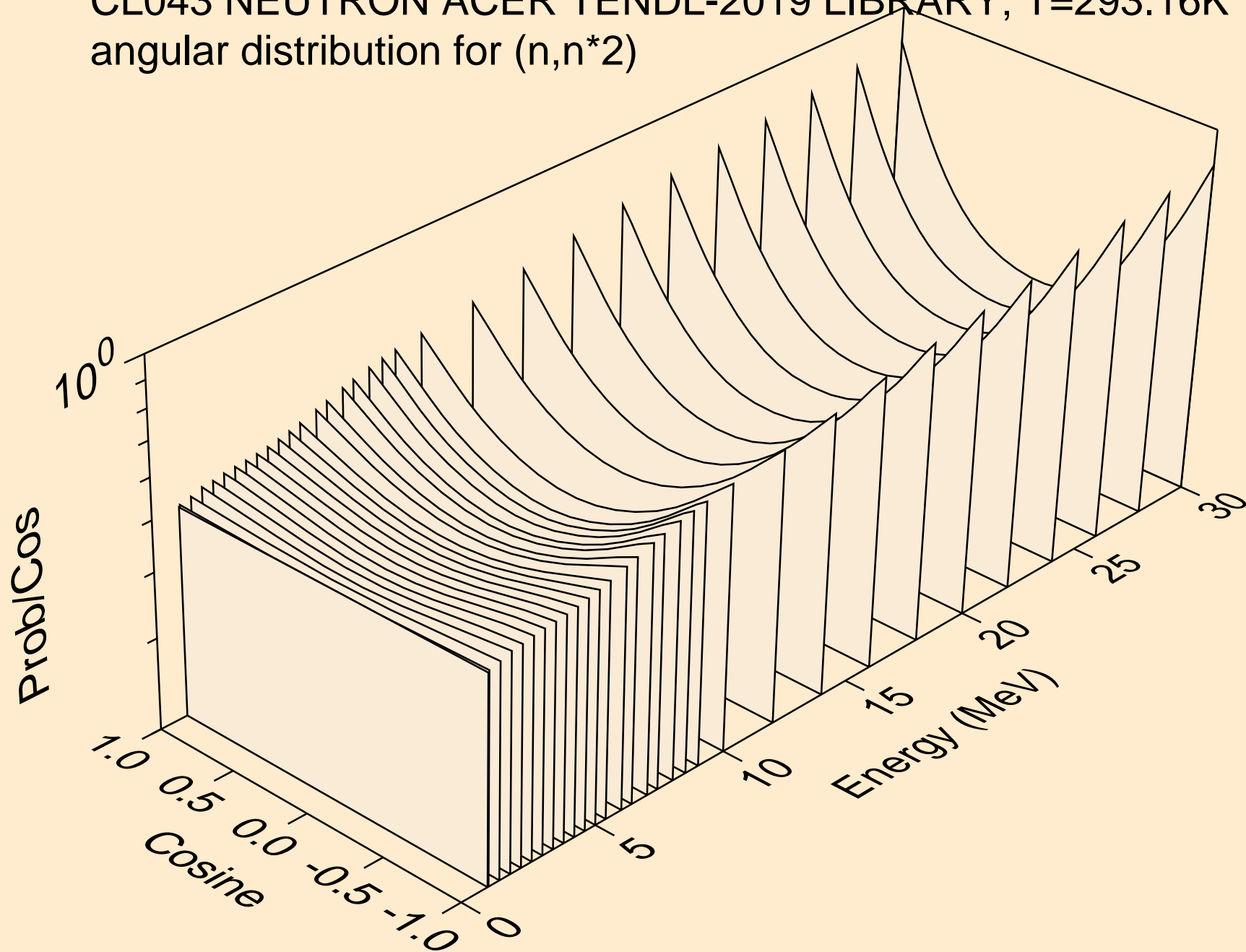

CL043 NEUTRON ACER TENDL-2019 LIBRARY; T=293.16K
angular distribution for (n,n*3)

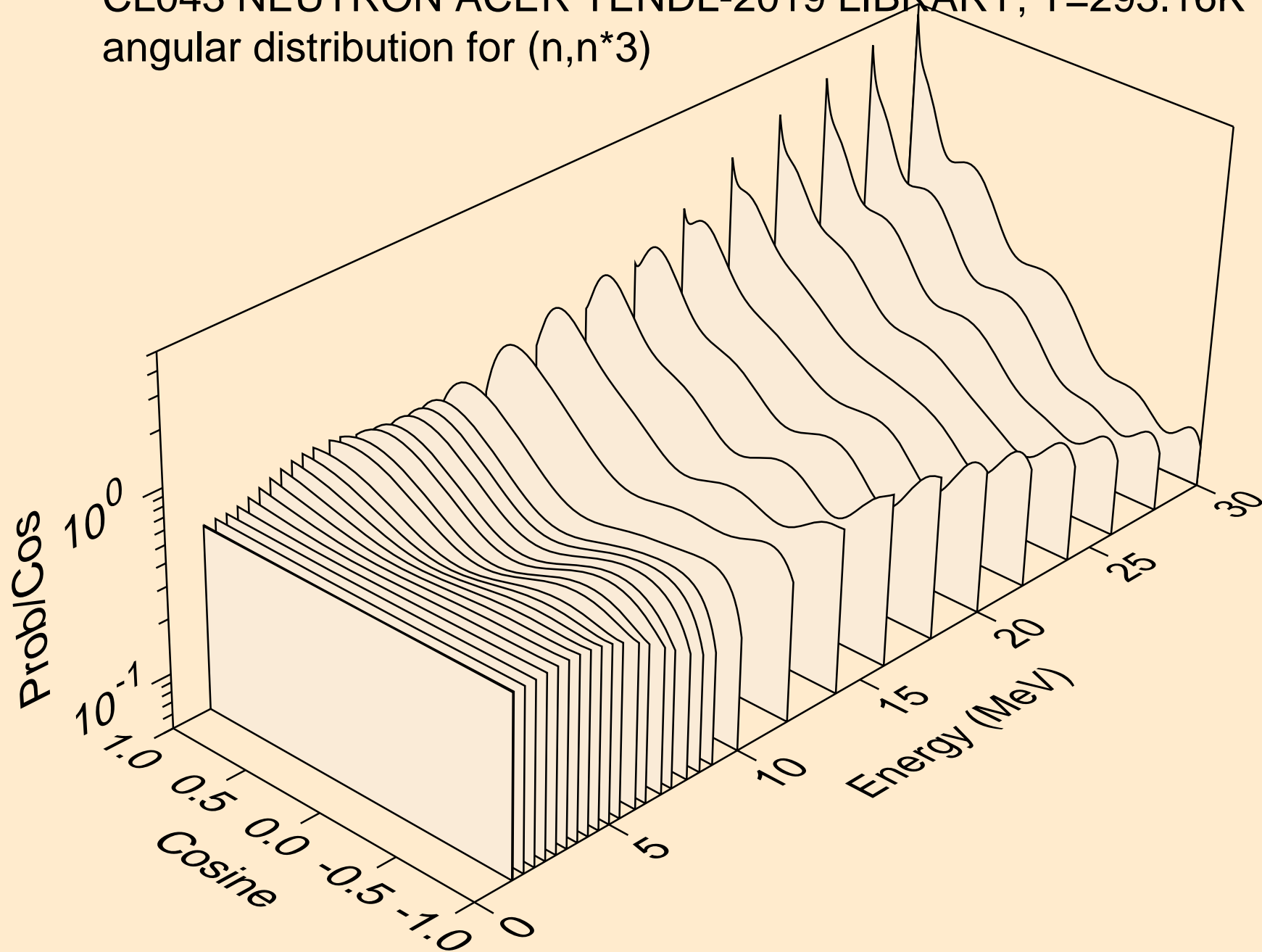

CL043 NEUTRON ACER TENDL-2019 LIBRARY; T=293.16K
angular distribution for (n,n*4)

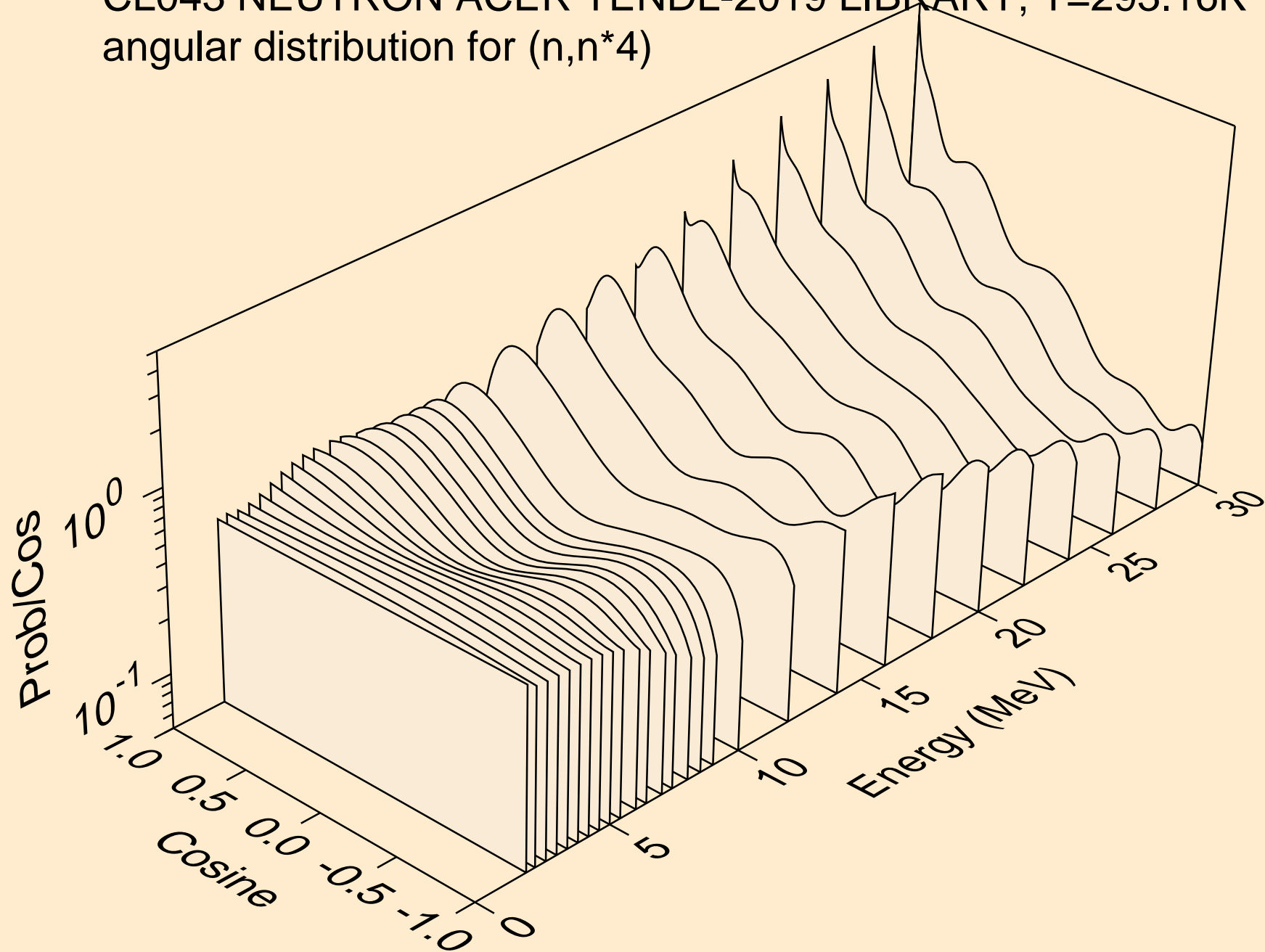

CL043 NEUTRON ACER TENDL-2019 LIBRARY; T=293.16K
angular distribution for (n,n*5)

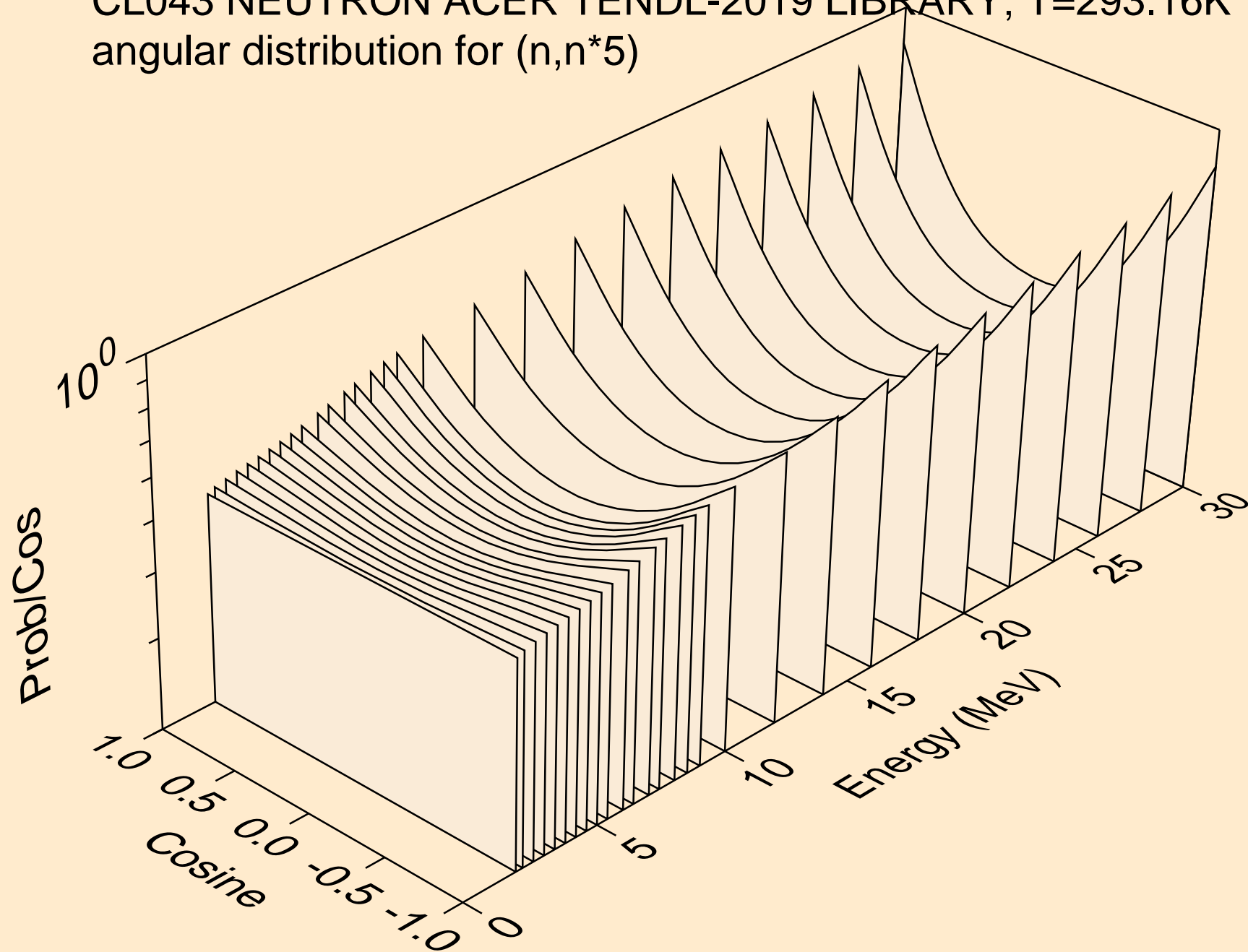

CL043 NEUTRON ACER TENDL-2019 LIBRARY; T=293.16K
angular distribution for (n,n*6)

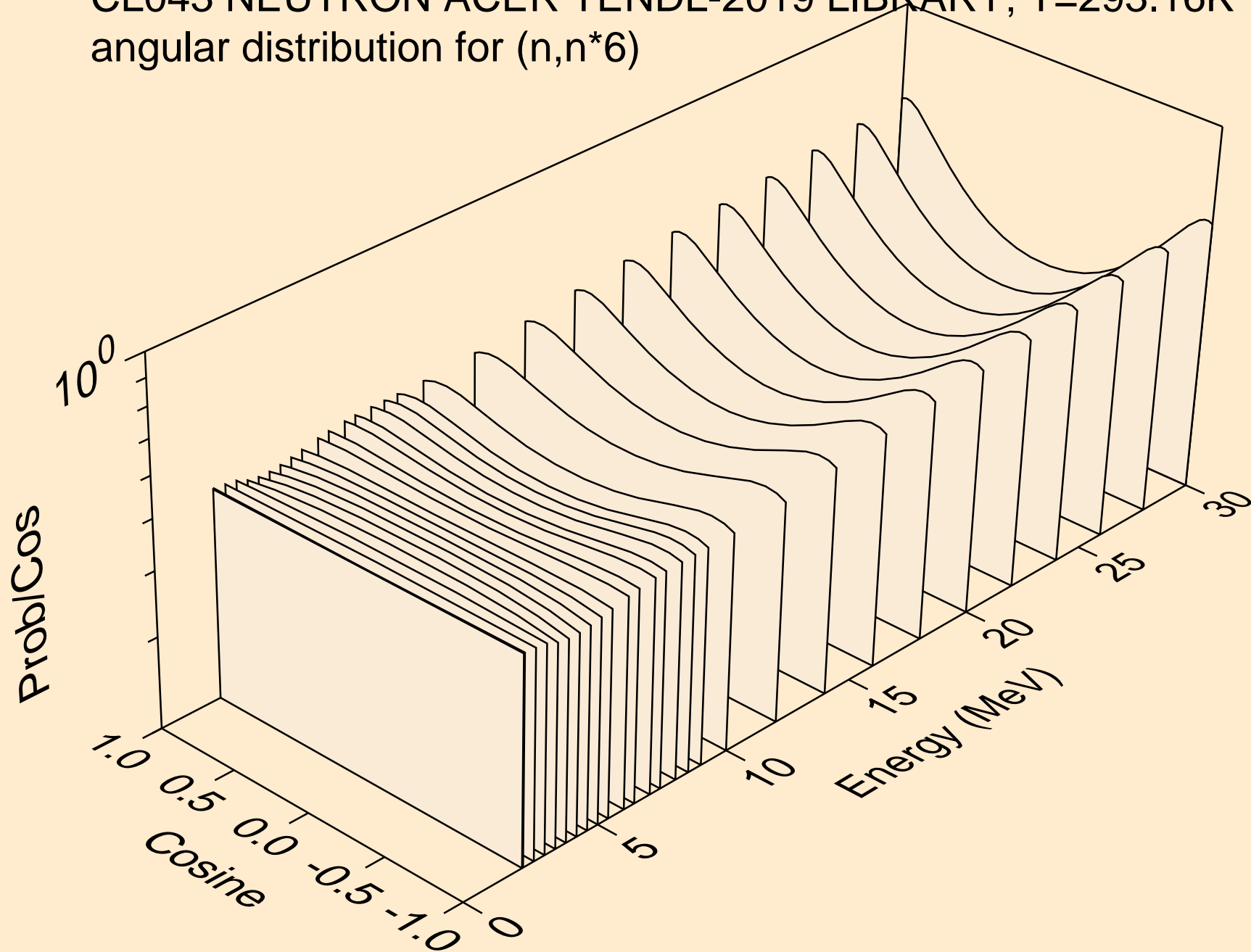

CL043 NEUTRON ACER TENDL-2019 LIBRARY; T=293.16K
angular distribution for (n,n*7)

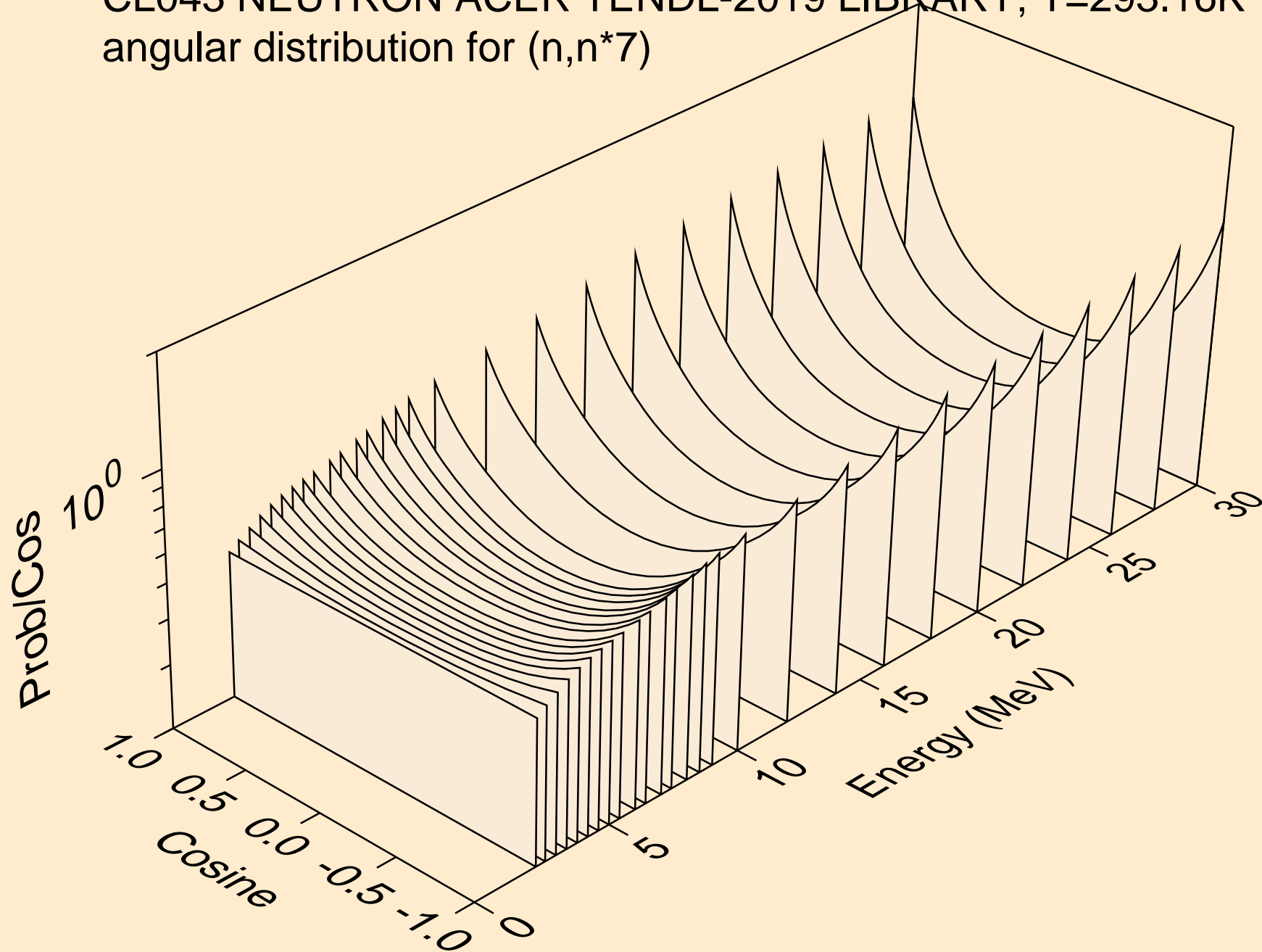

CL043 NEUTRON ACER TENDL-2019 LIBRARY; T=293.16K
angular distribution for (n,n*8)

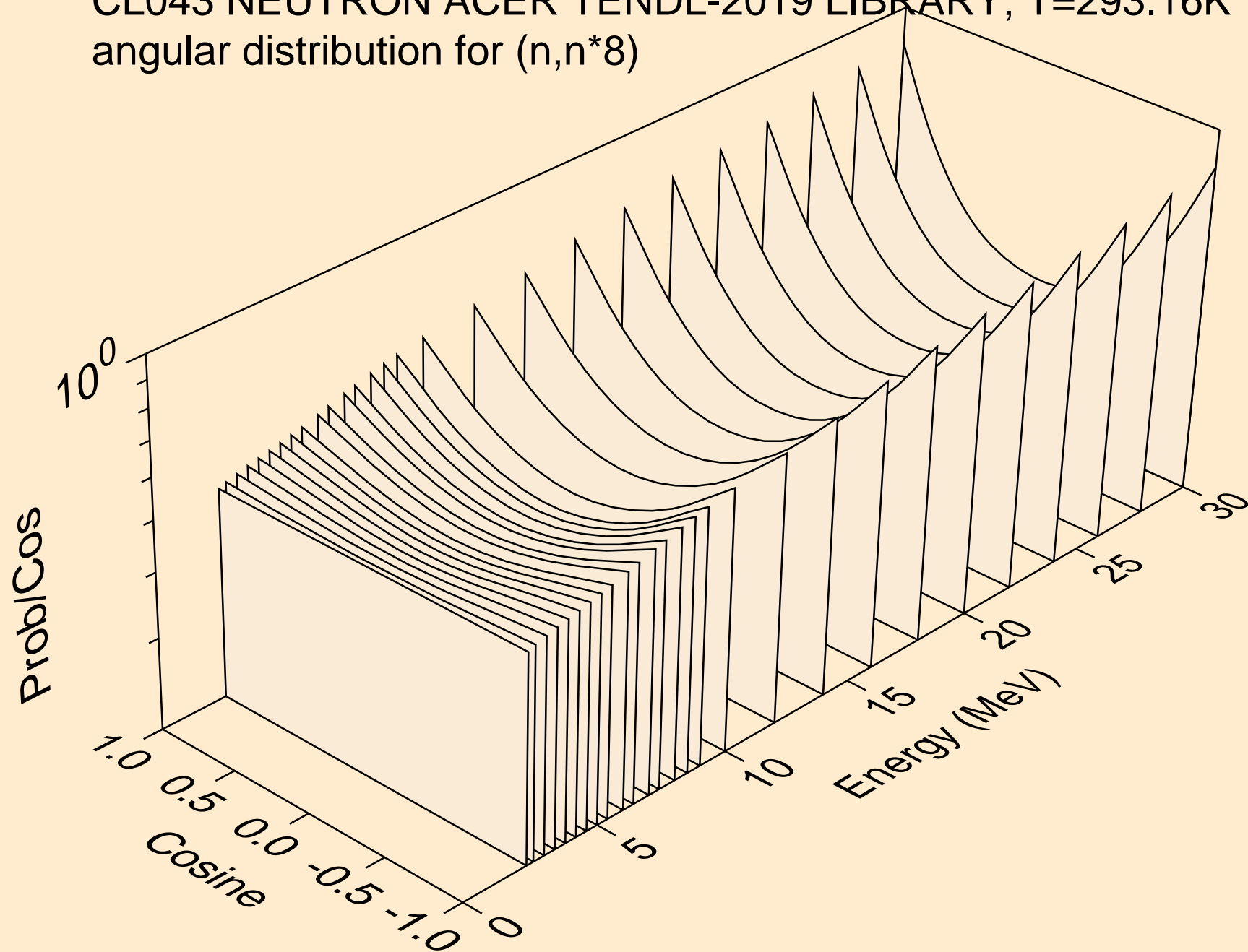

CL043 NEUTRON ACER TENDL-2019 LIBRARY; T=293.16K
angular distribution for (n,n*9)

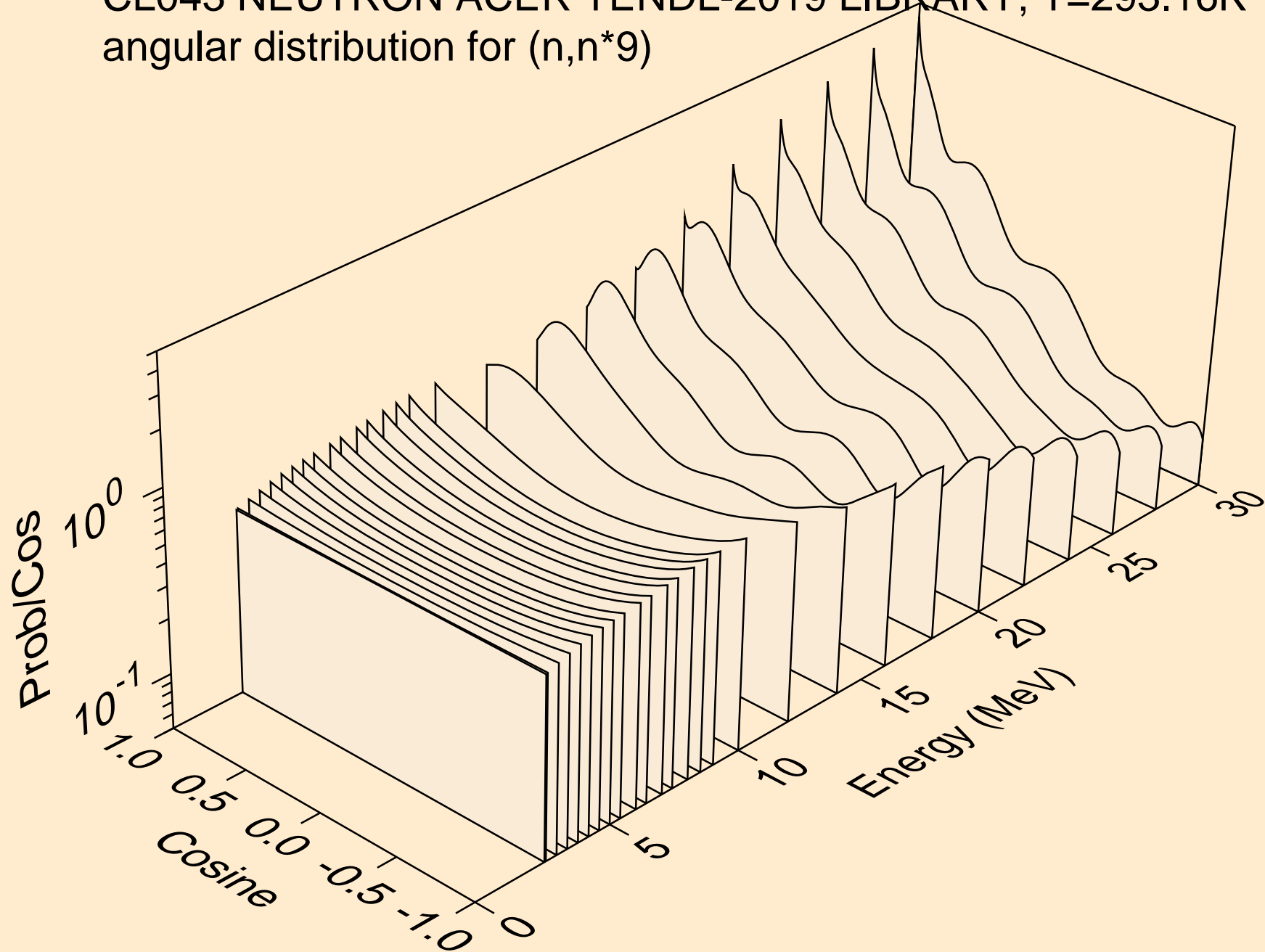

CL043 NEUTRON ACER TENDL-2019 LIBRARY; T=293.16K
angular distribution for (n,n*10)

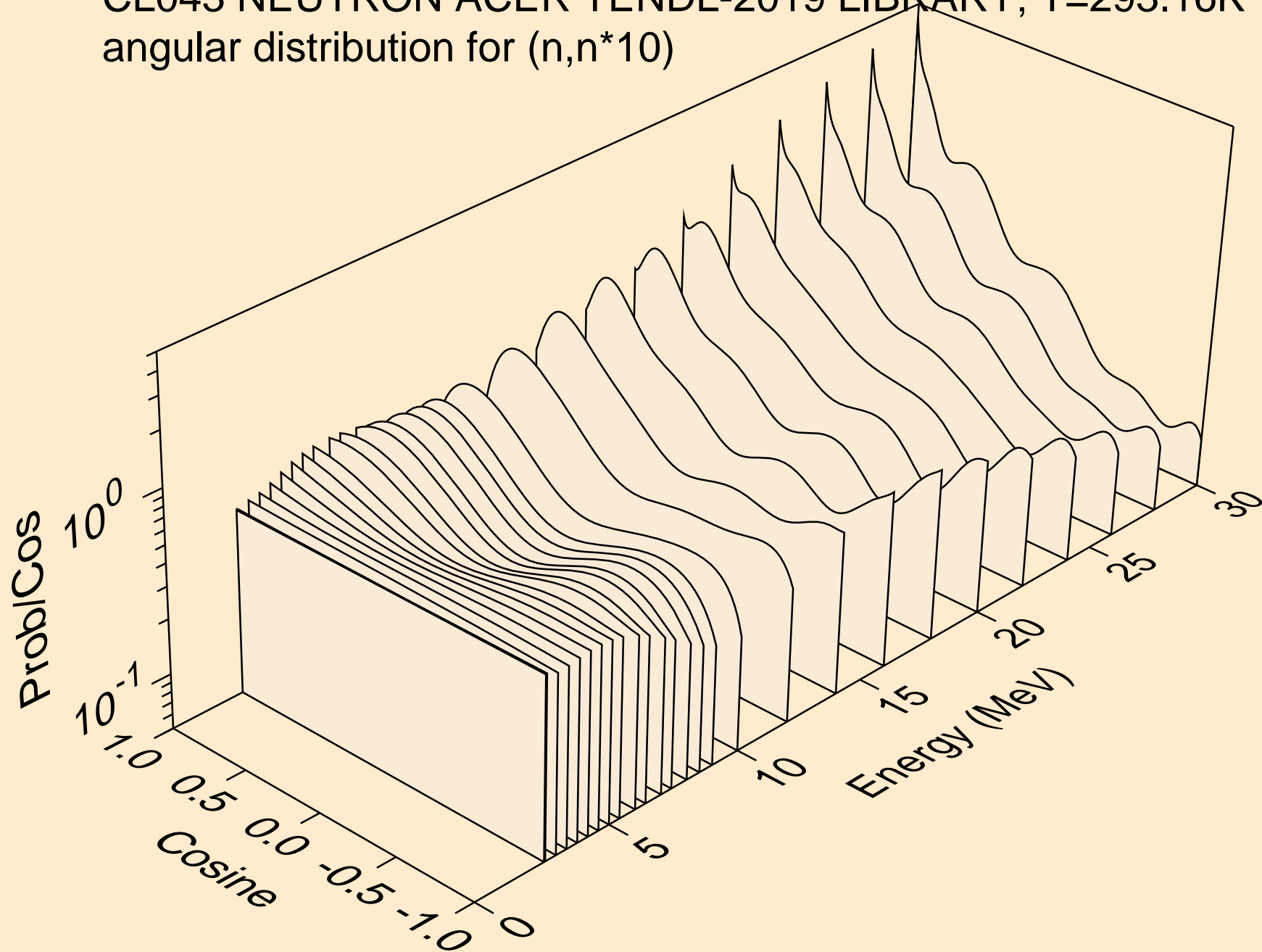

CL043 NEUTRON ACER TENDL-2019 LIBRARY; T=293.16K
angular distribution for (n,n*11)

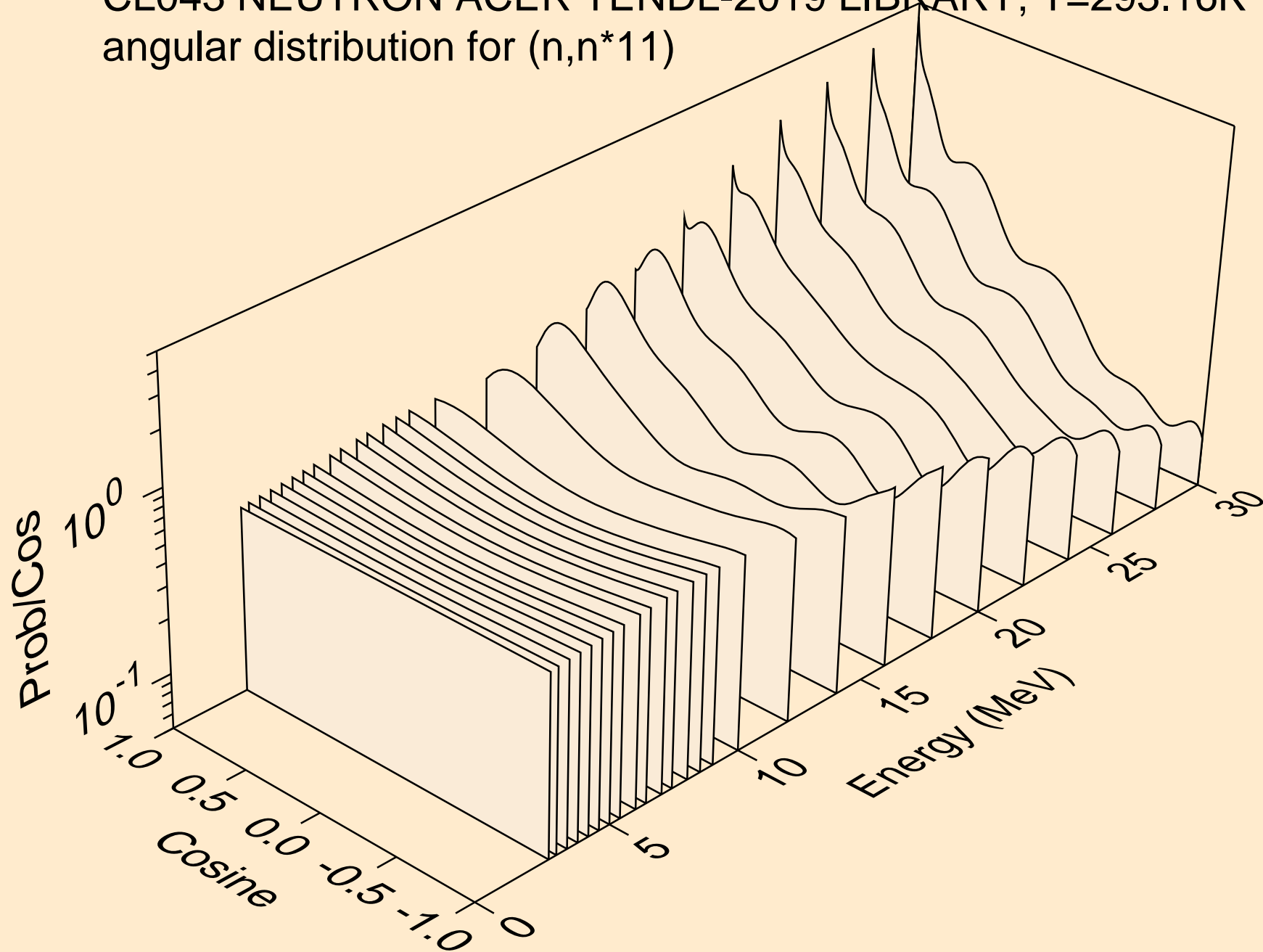

CL043 NEUTRON ACER TENDL-2019 LIBRARY; T=293.16K
angular distribution for (n,n*12)

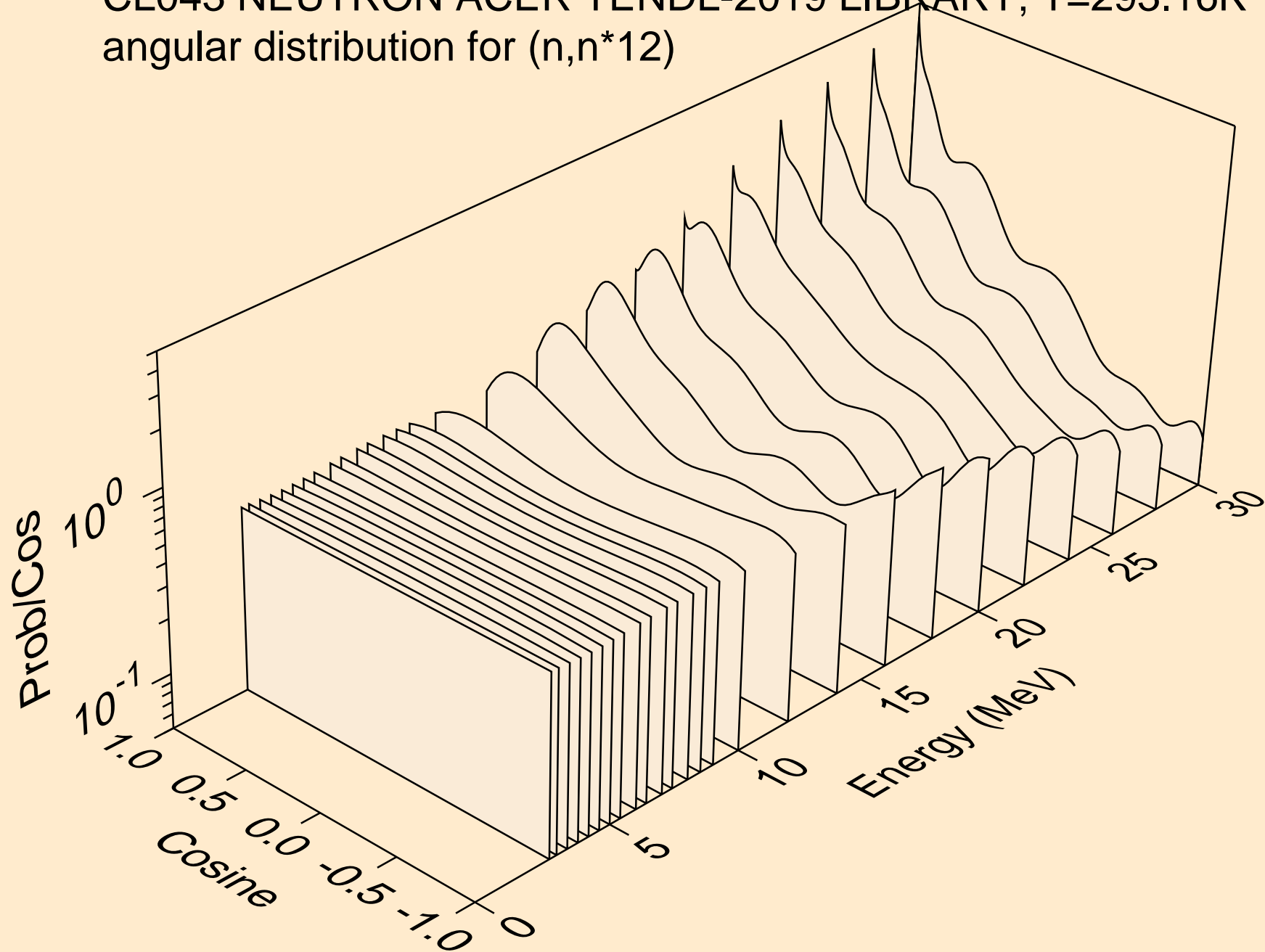

CL043 NEUTRON ACER TENDL-2019 LIBRARY; T=293.16K
angular distribution for (n,n*13)

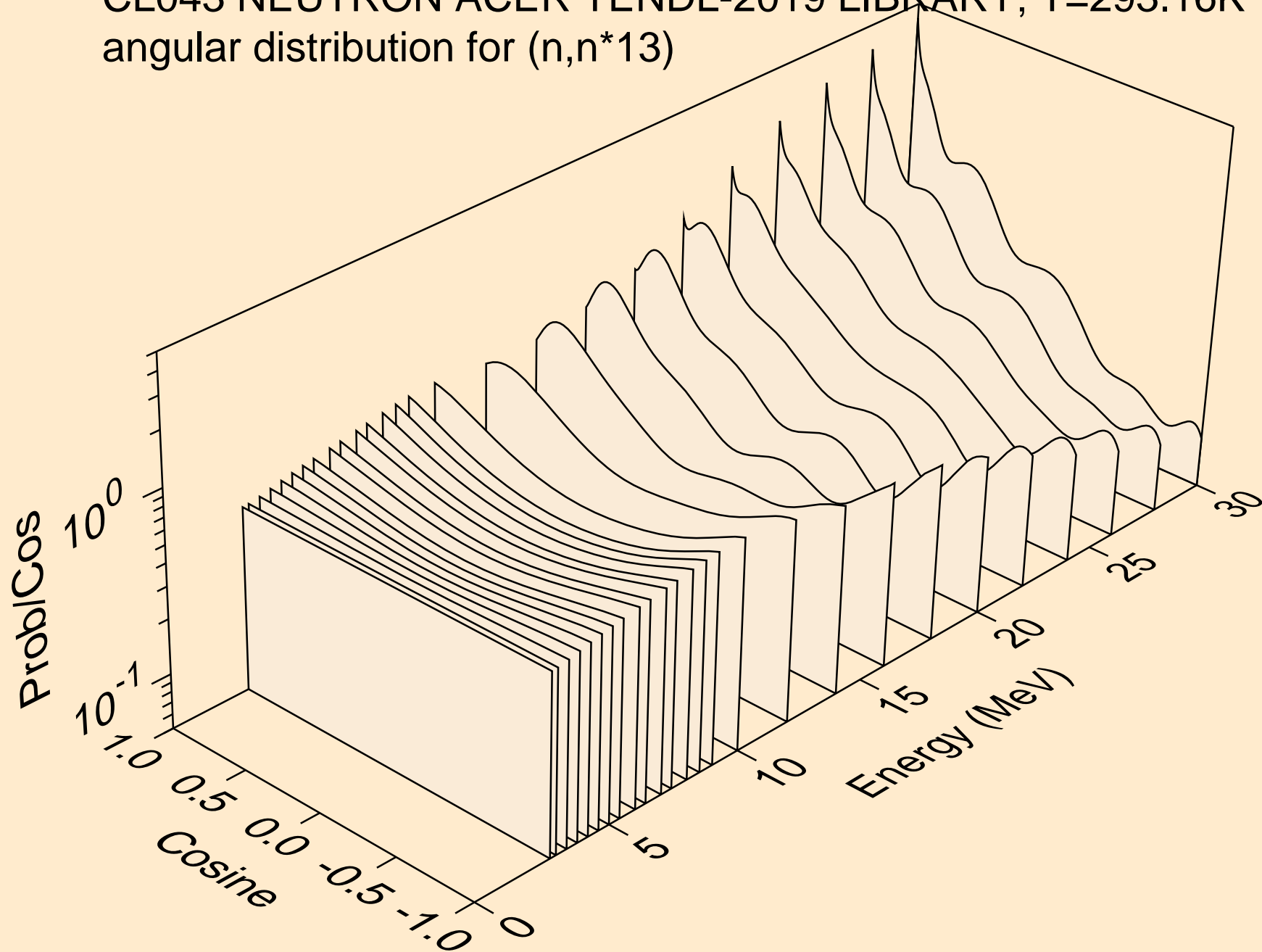

CL043 NEUTRON ACER TENDL-2019 LIBRARY; T=293.16K
angular distribution for (n,n*14)

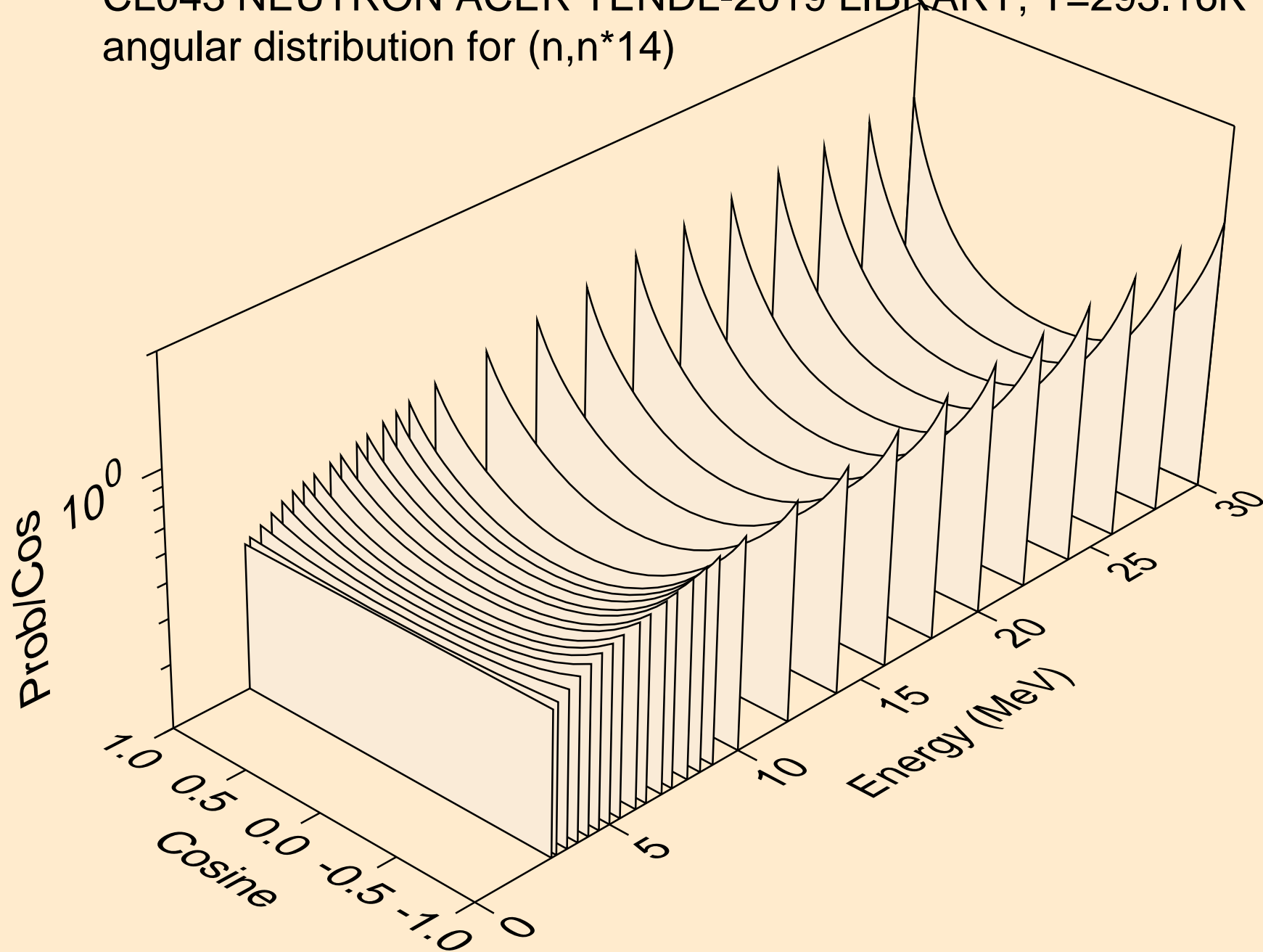

CL043 NEUTRON ACER TENDL-2019 LIBRARY; T=293.16K
angular distribution for (n,n*15)

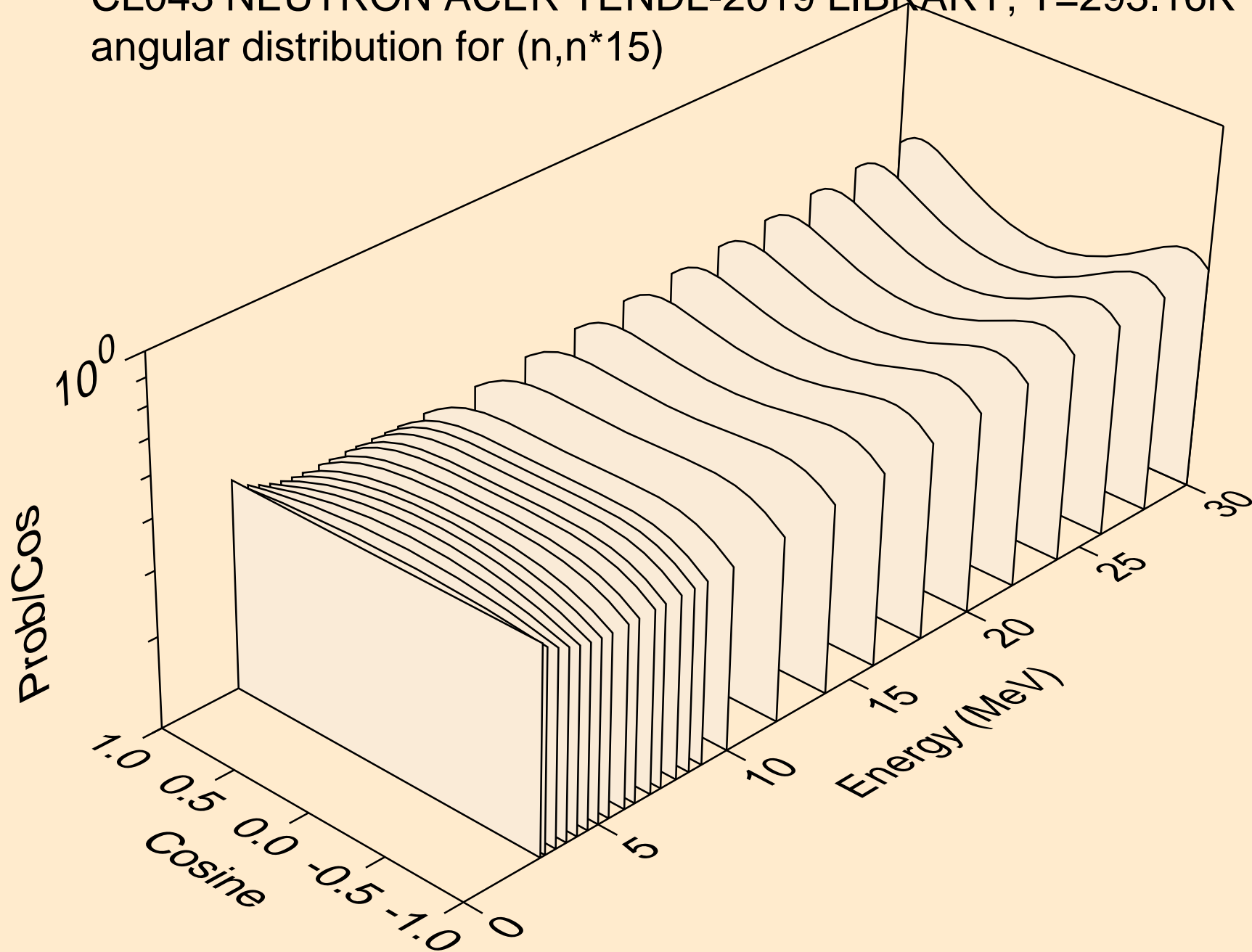

CL043 NEUTRON ACER TENDL-2019 LIBRARY; T=293.16K
angular distribution for (n,n*16)

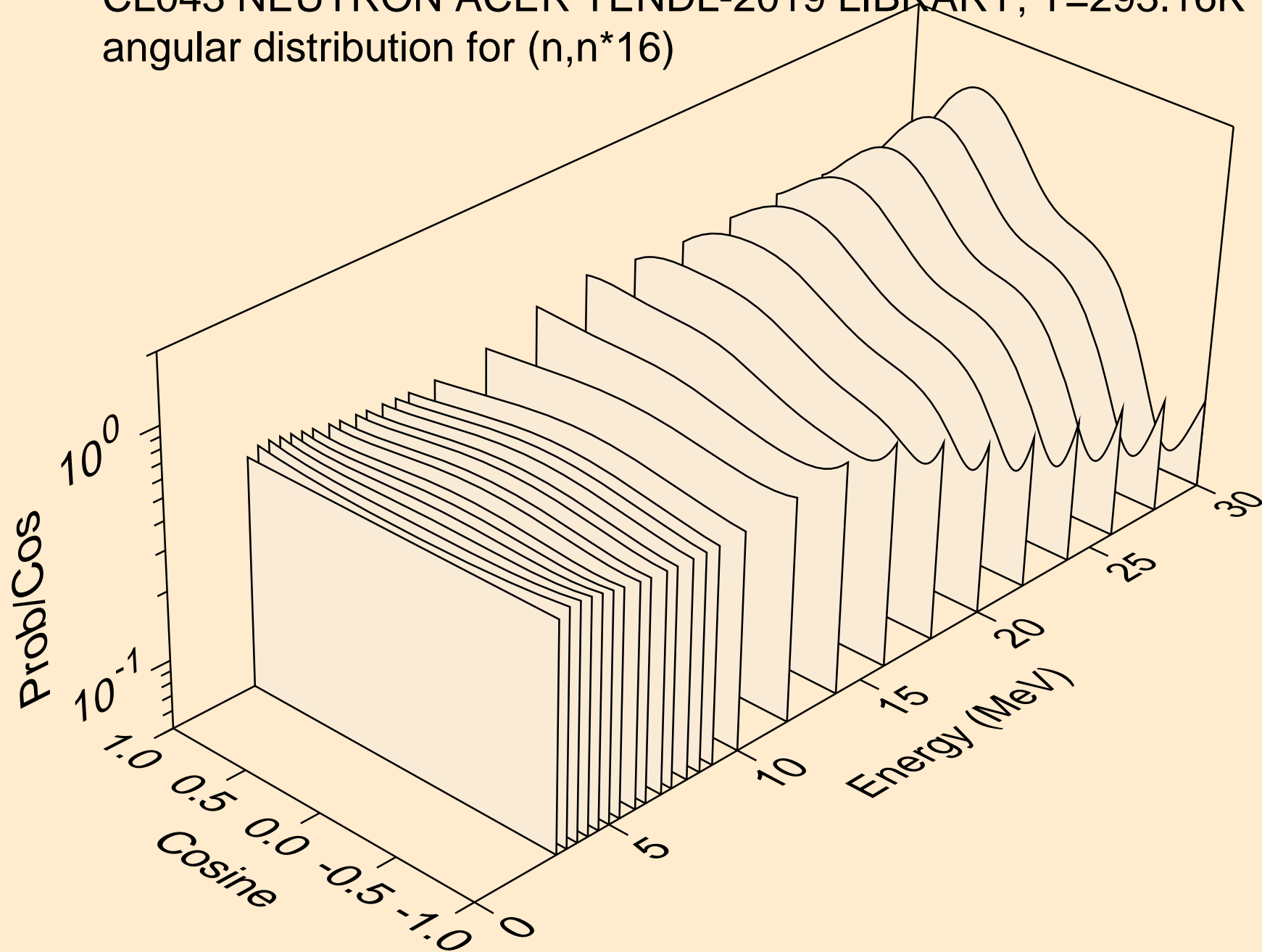

CL043 NEUTRON ACER TENDL-2019 LIBRARY; T=293.16K
angular distribution for (n,n*17)

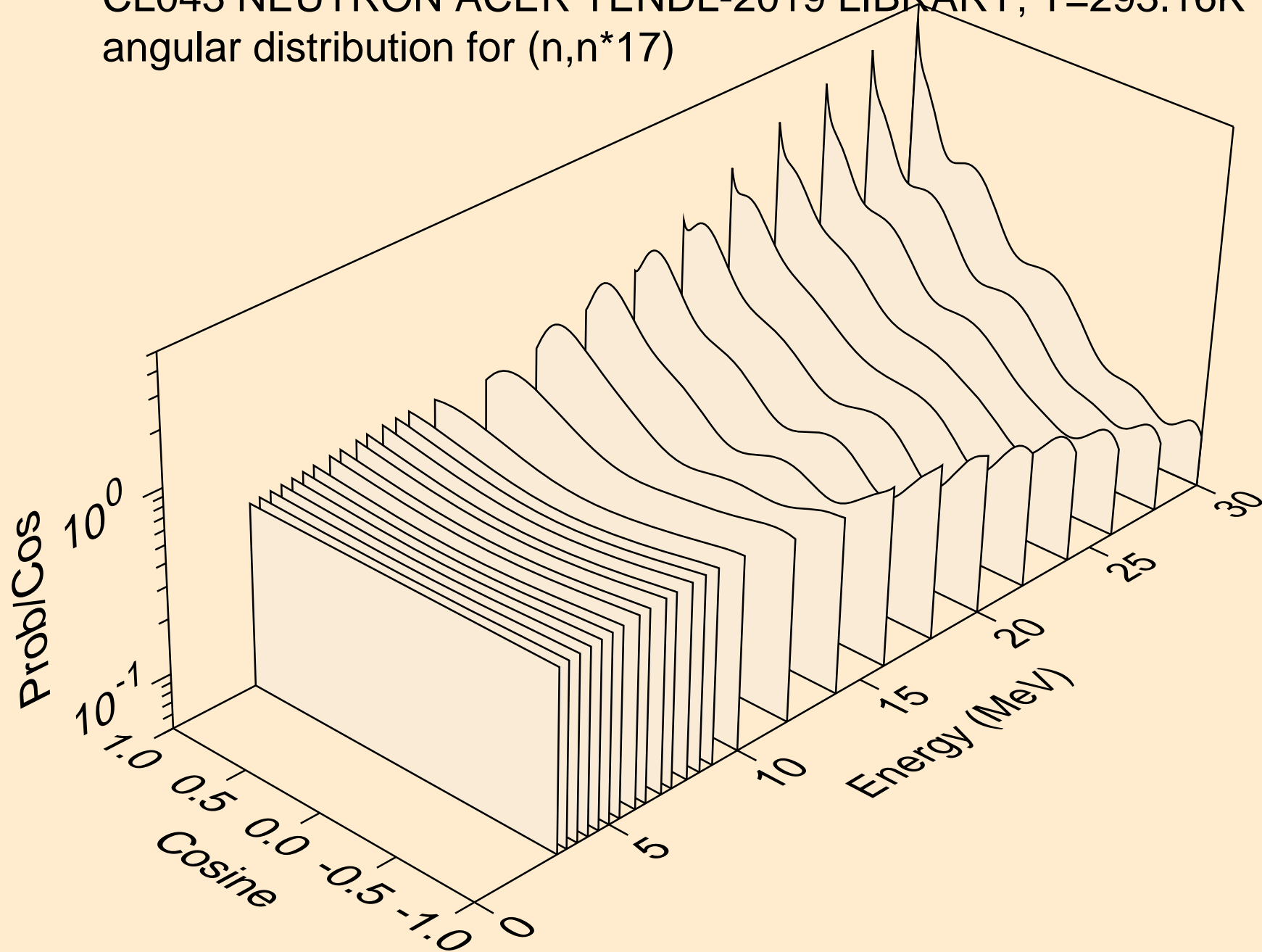

CL043 NEUTRON ACER TENDL-2019 LIBRARY; T=293.16K
angular distribution for (n,n*18)

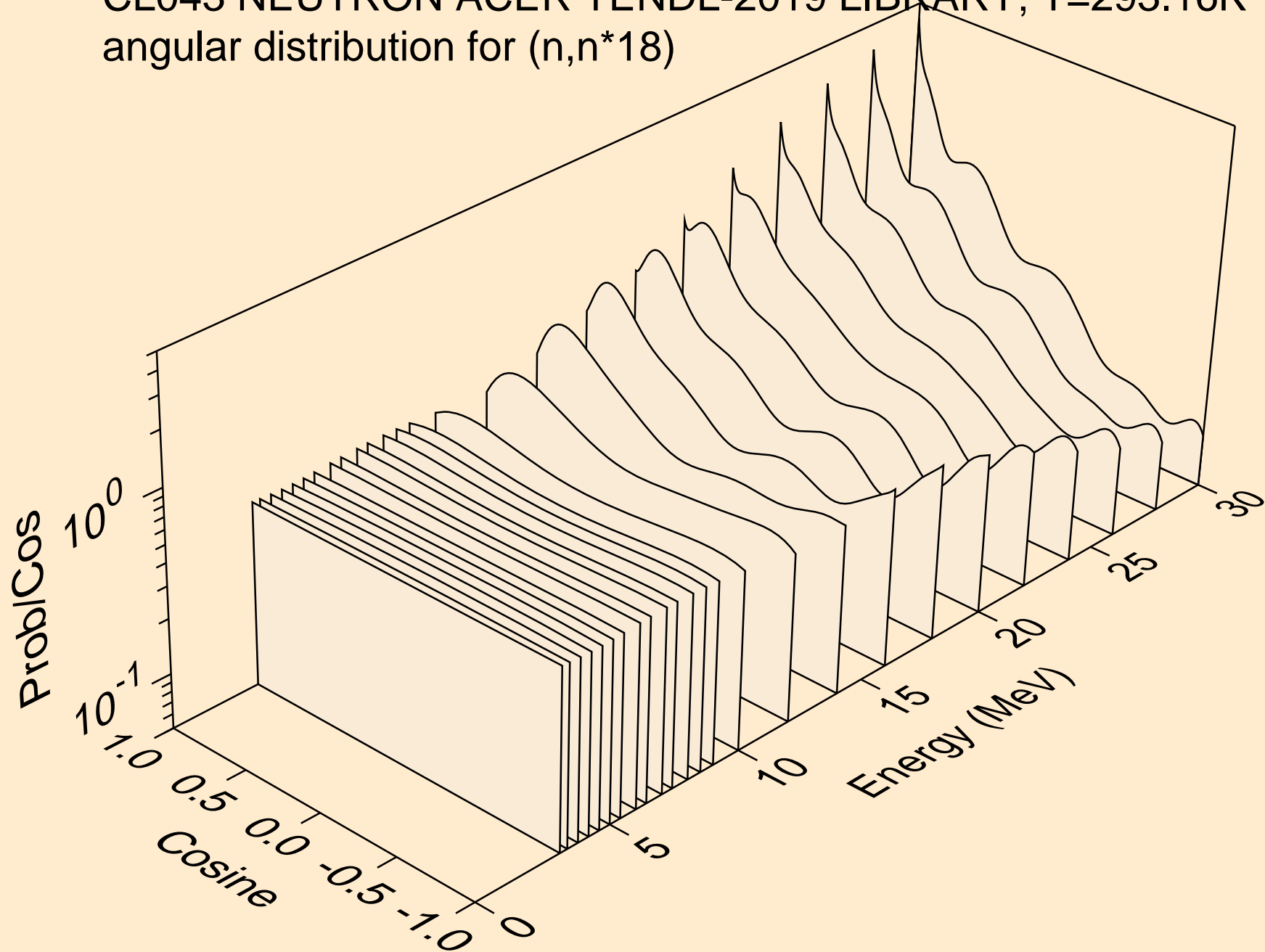

CL043 NEUTRON ACER TENDL-2019 LIBRARY; T=293.16K
angular distribution for (n,n*19)

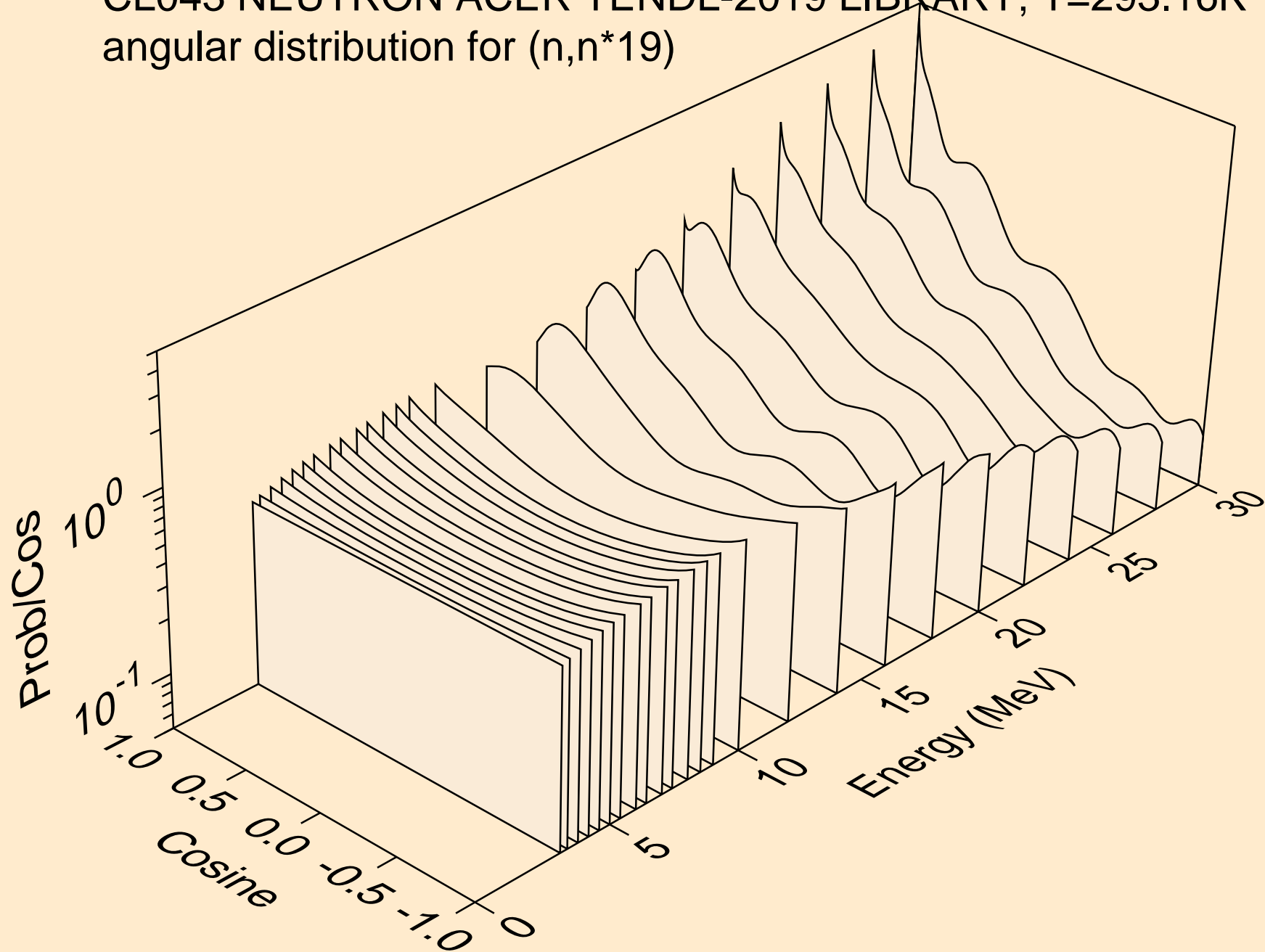

CL043 NEUTRON ACER TENDL-2019 LIBRARY; T=293.16K
angular distribution for (n,n*20)

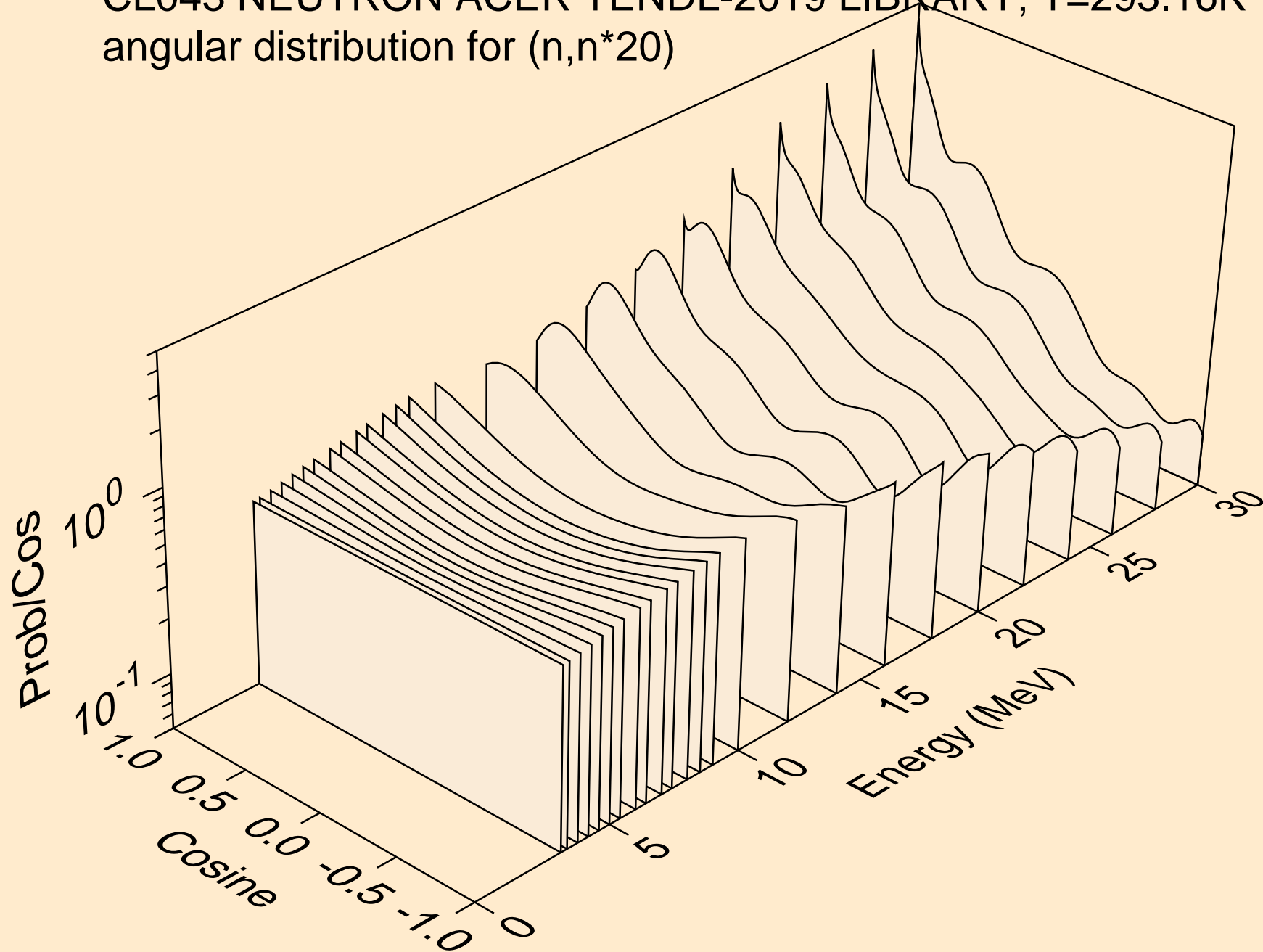

CL043 NEUTRON ACER TENDL-2019 LIBRARY; T=293.16K
angular distribution for (n,n*21)

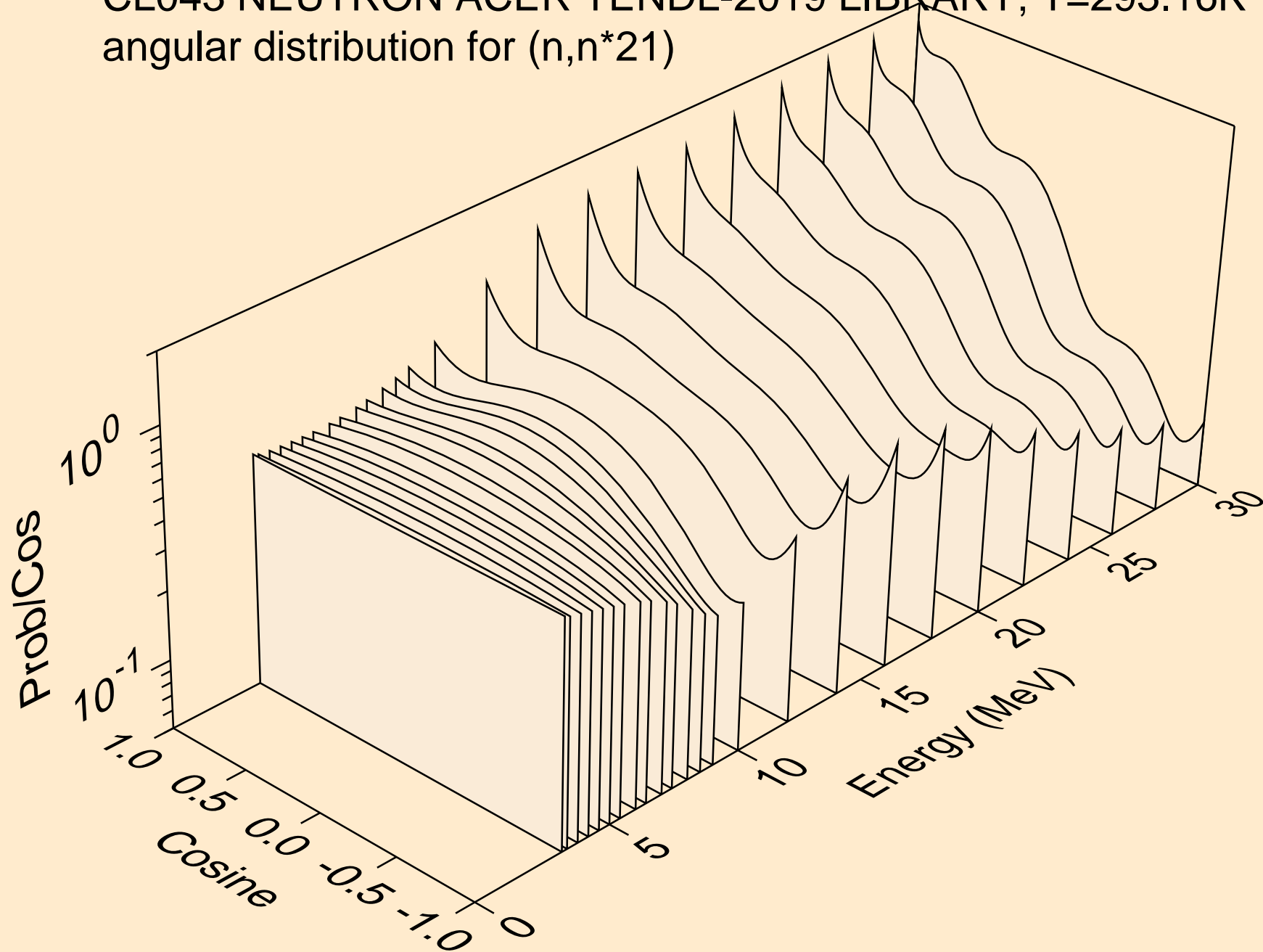

CL043 NEUTRON ACER TENDL-2019 LIBRARY; T=293.16K
angular distribution for (n,n*22)

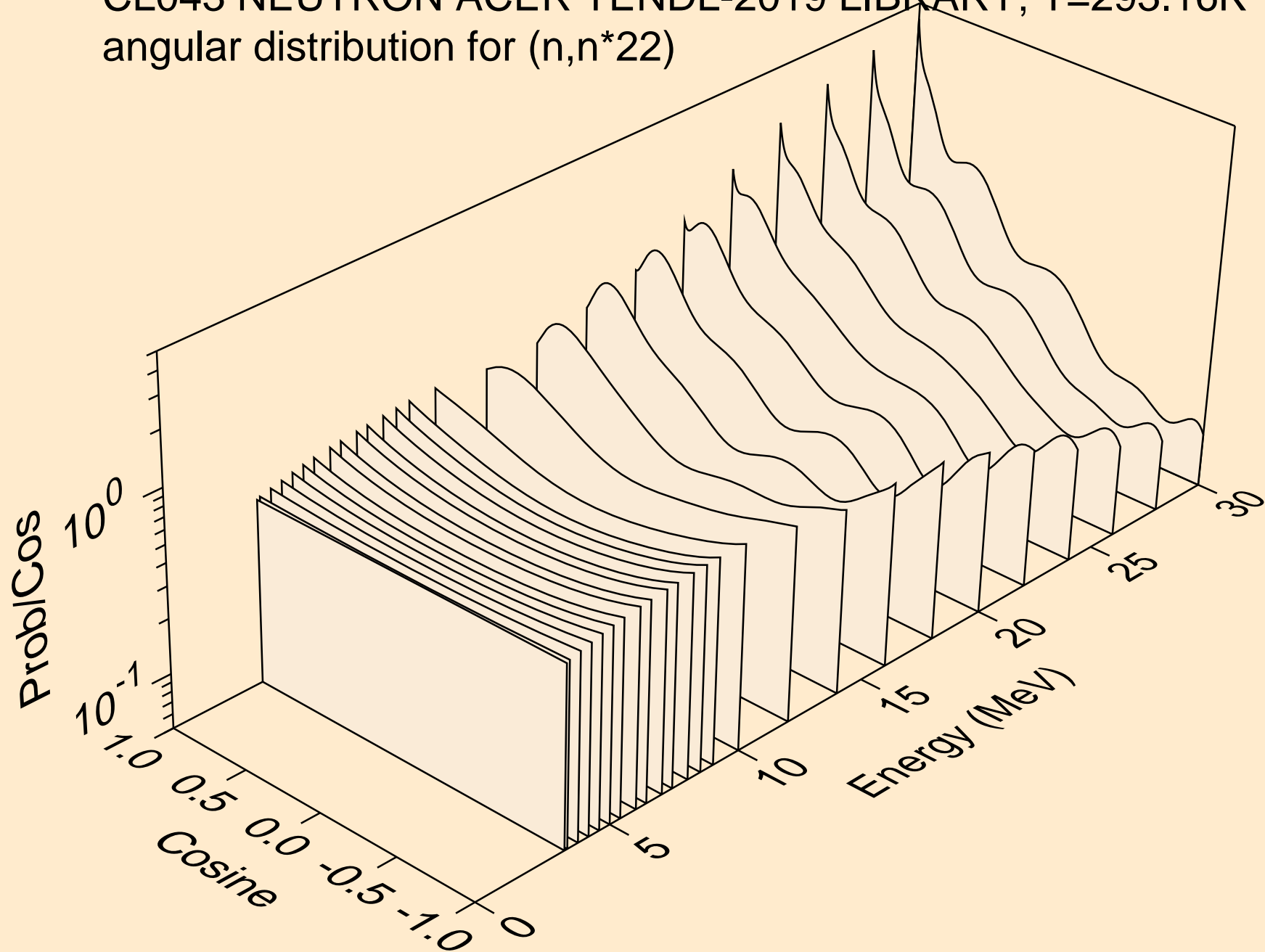

CL043 NEUTRON ACER TENDL-2019 LIBRARY; T=293.16K
angular distribution for (n,n*23)

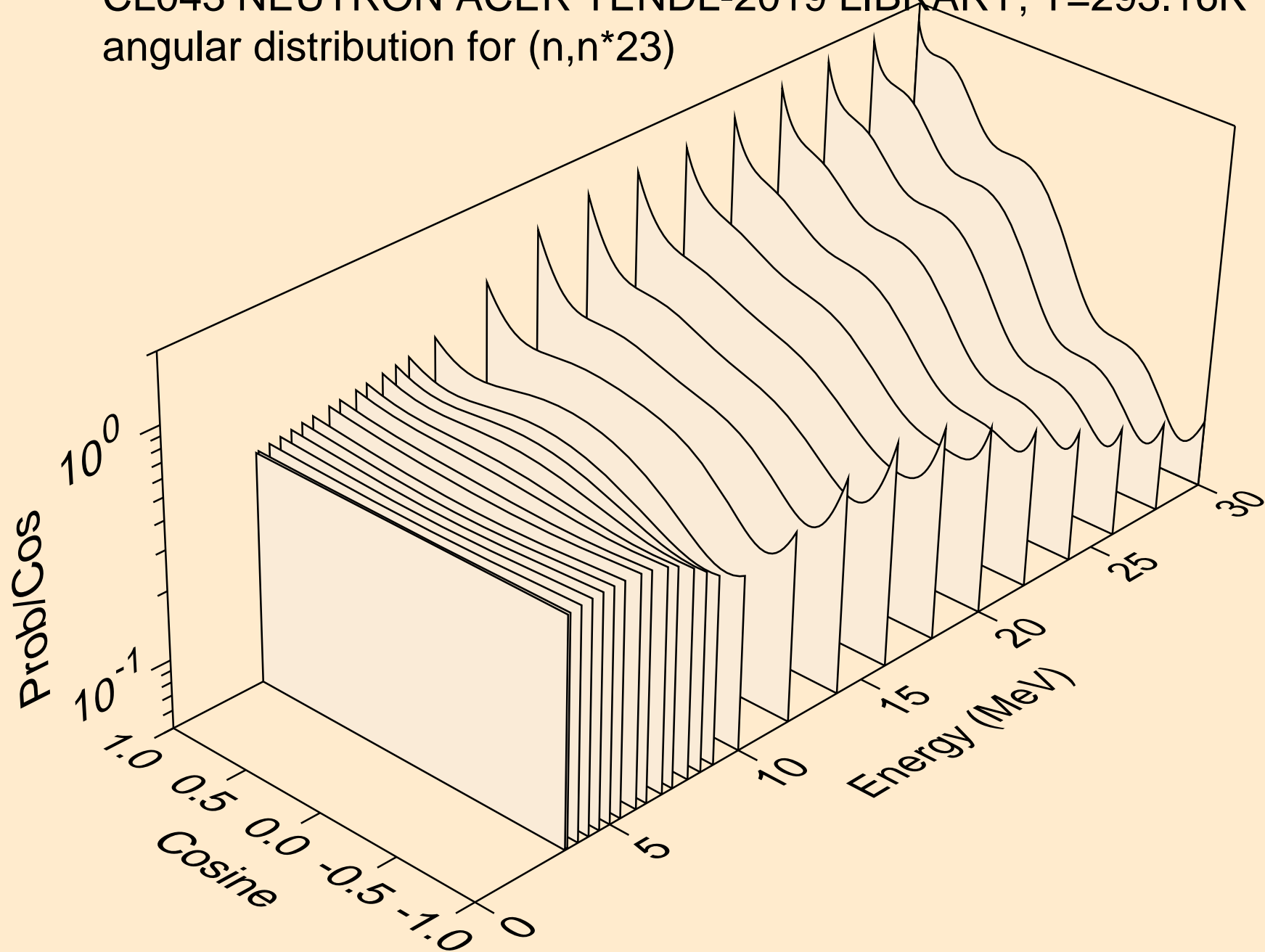

CL043 NEUTRON ACER TENDL-2019 LIBRARY; T=293.16K
angular distribution for (n,n*24)

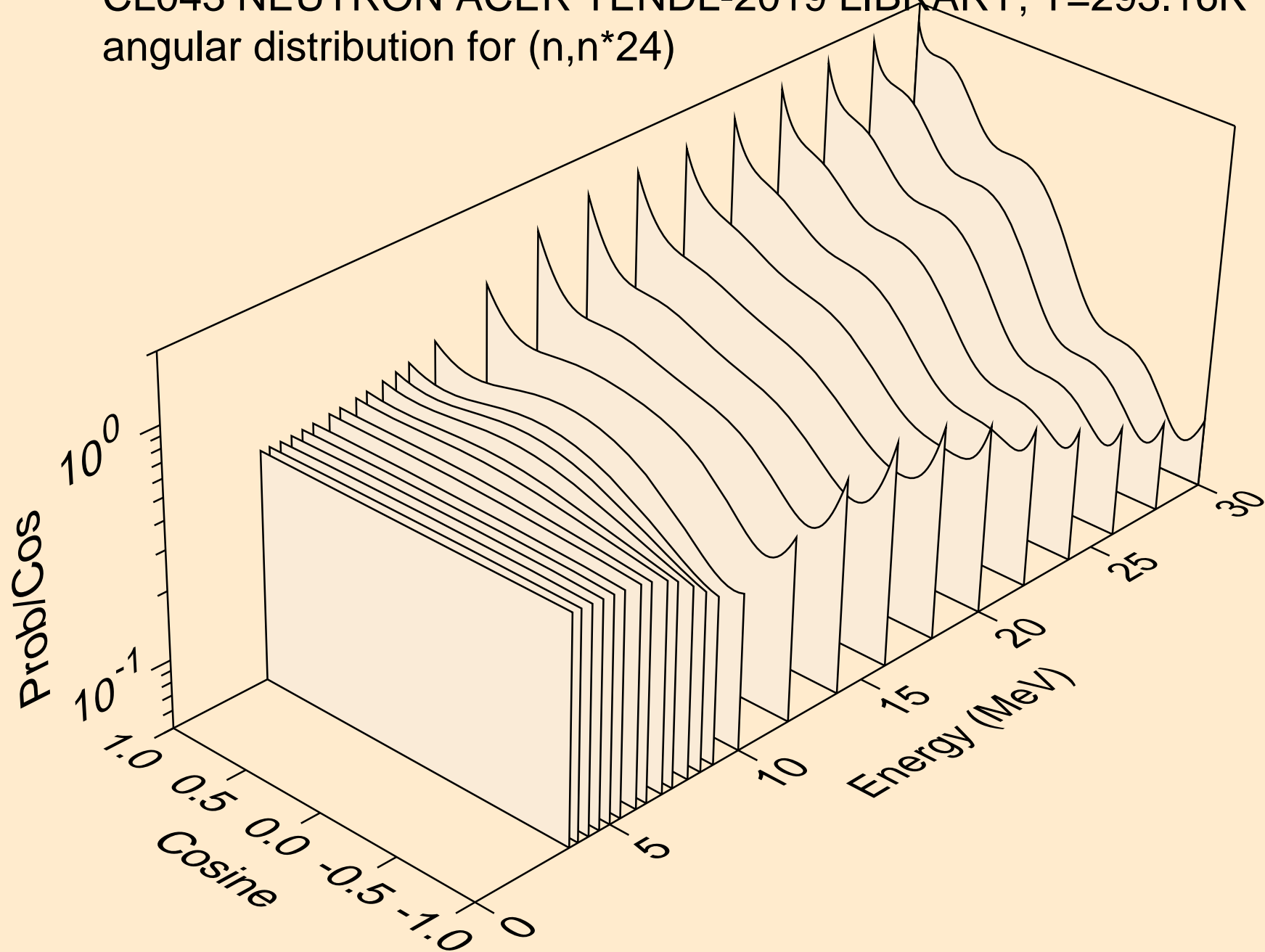

CL043 NEUTRON ACER TENDL-2019 LIBRARY; T=293.16K
angular distribution for (n,n*25)

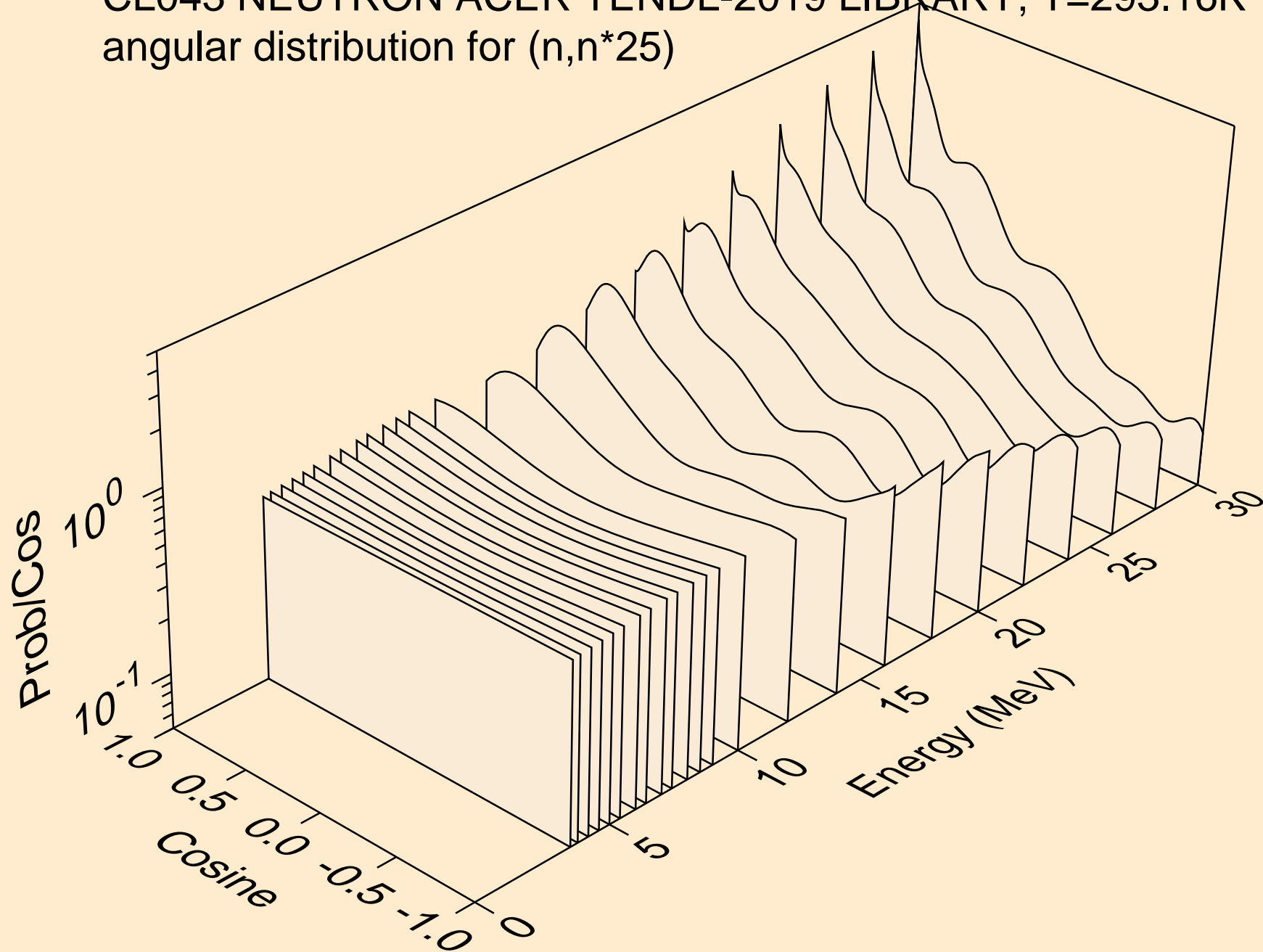

CL043 NEUTRON ACER TENDL-2019 LIBRARY; T=293.16K
angular distribution for (n,n*26)

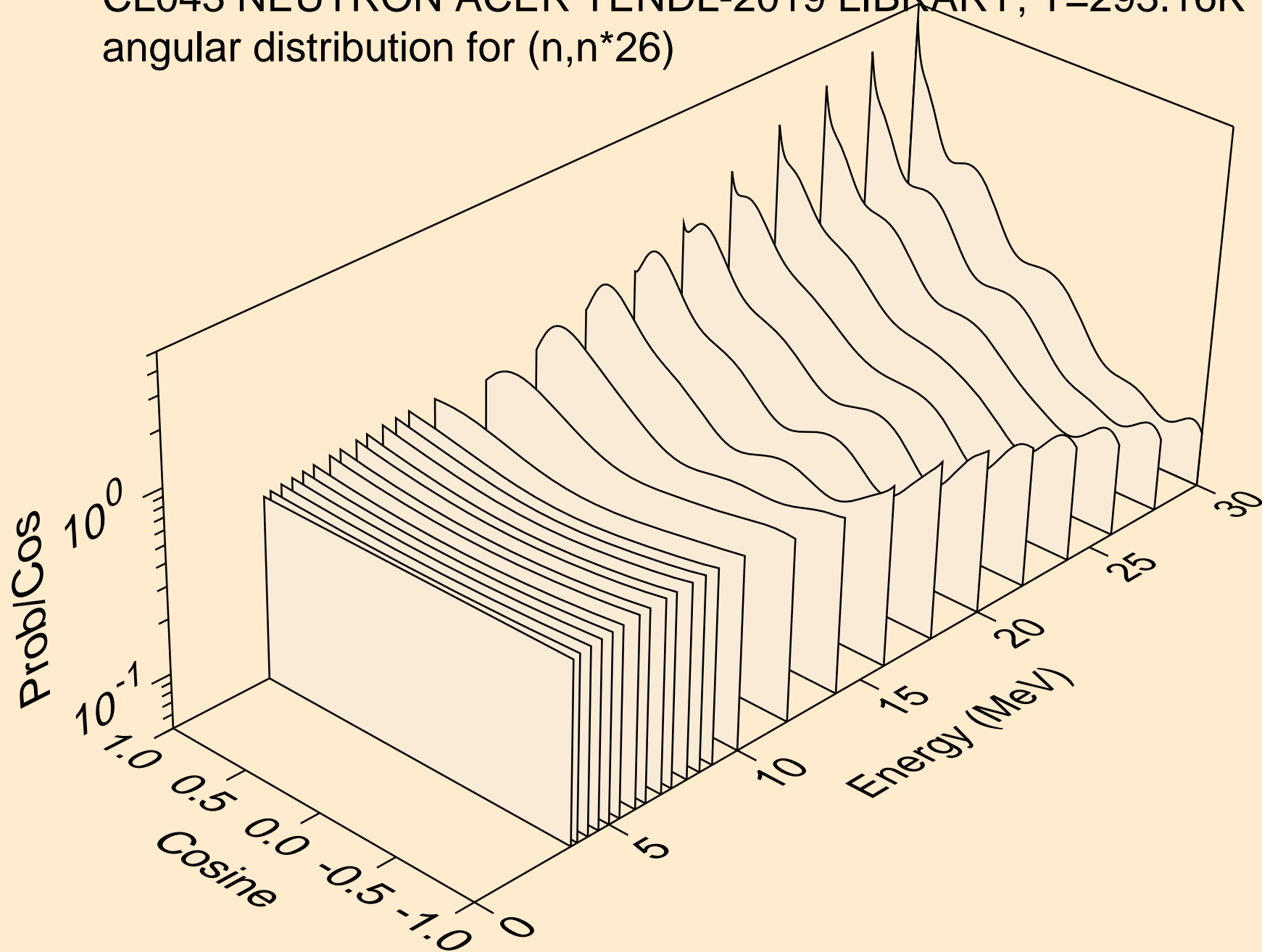

CL043 NEUTRON ACER TENDL-2019 LIBRARY; T=293.16K
angular distribution for (n,n*27)

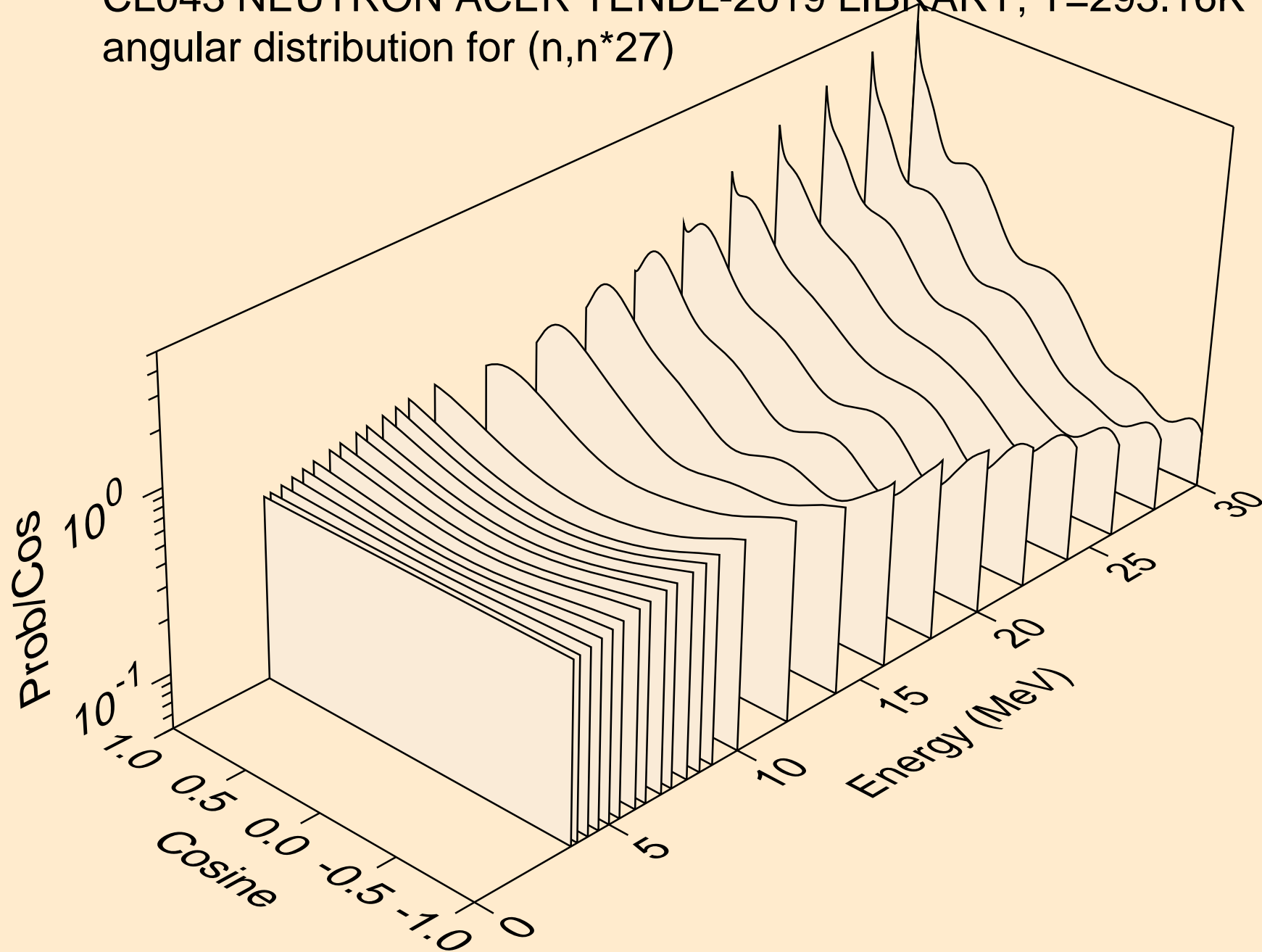

CL043 NEUTRON ACER TENDL-2019 LIBRARY; T=293.16K
angular distribution for (n,n*28)

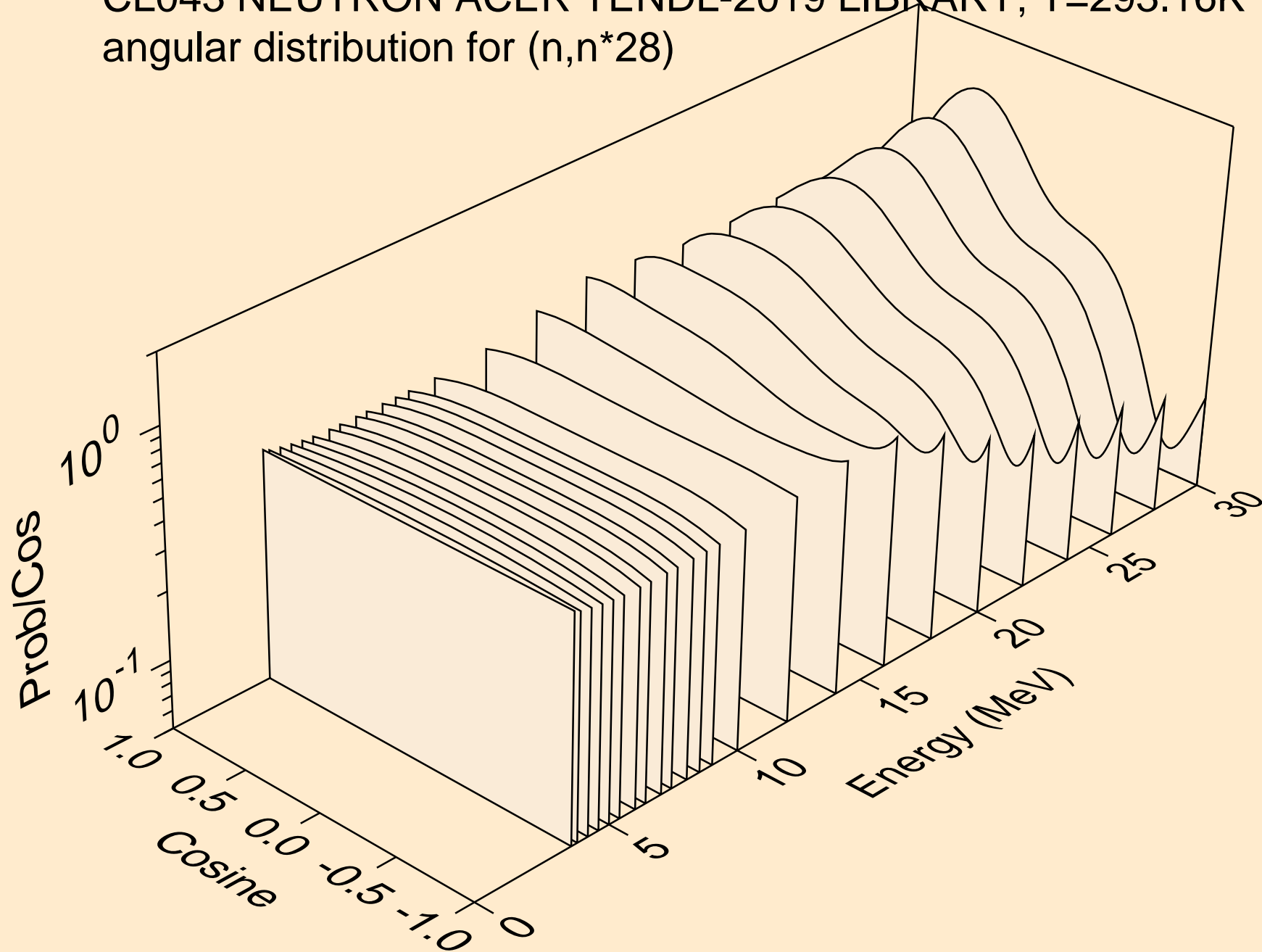

CL043 NEUTRON ACER TENDL-2019 LIBRARY; T=293.16K
angular distribution for (n,n*29)

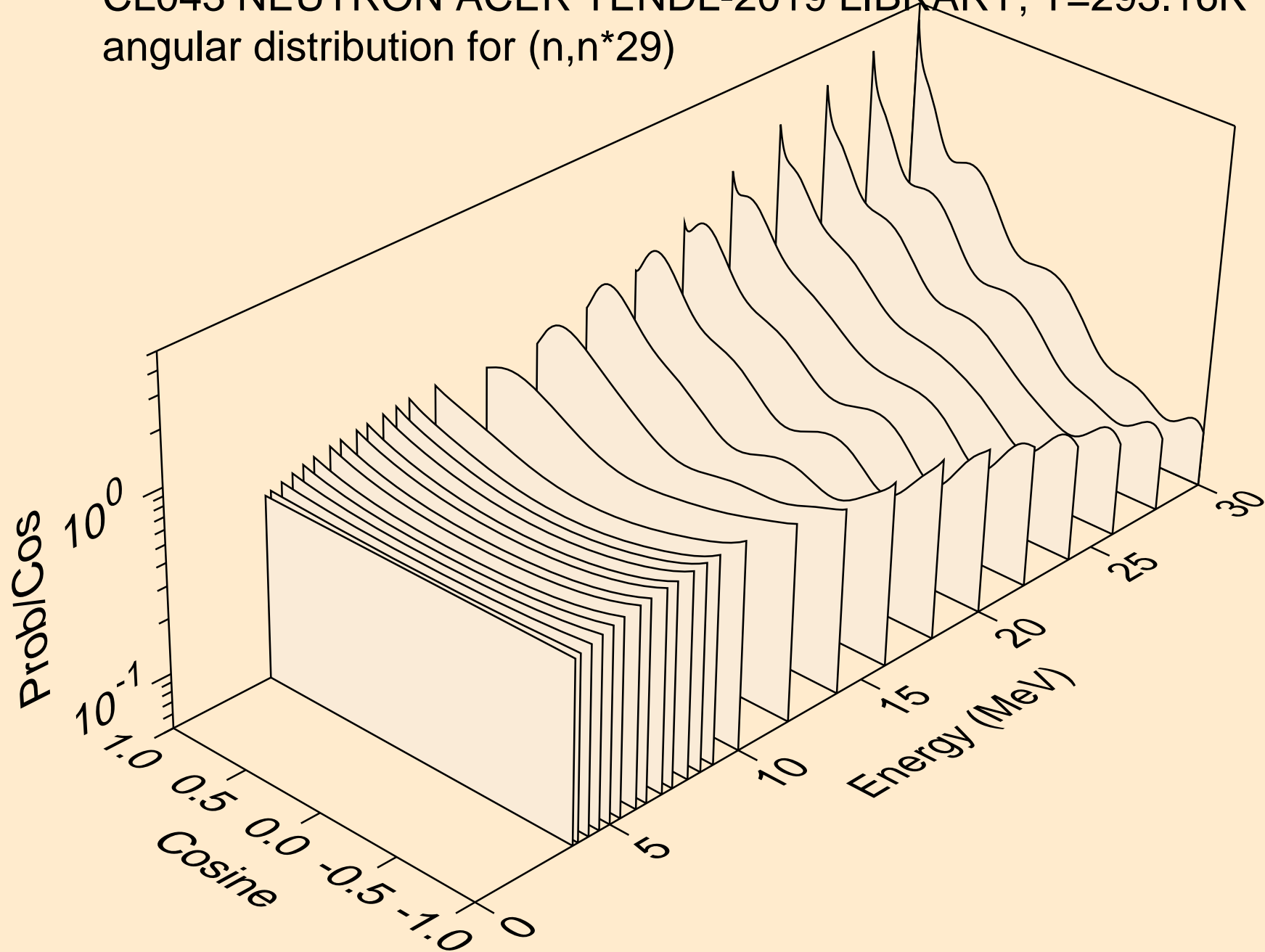

CL043 NEUTRON ACER TENDL-2019 LIBRARY; T=293.16K
angular distribution for (n,n*30)

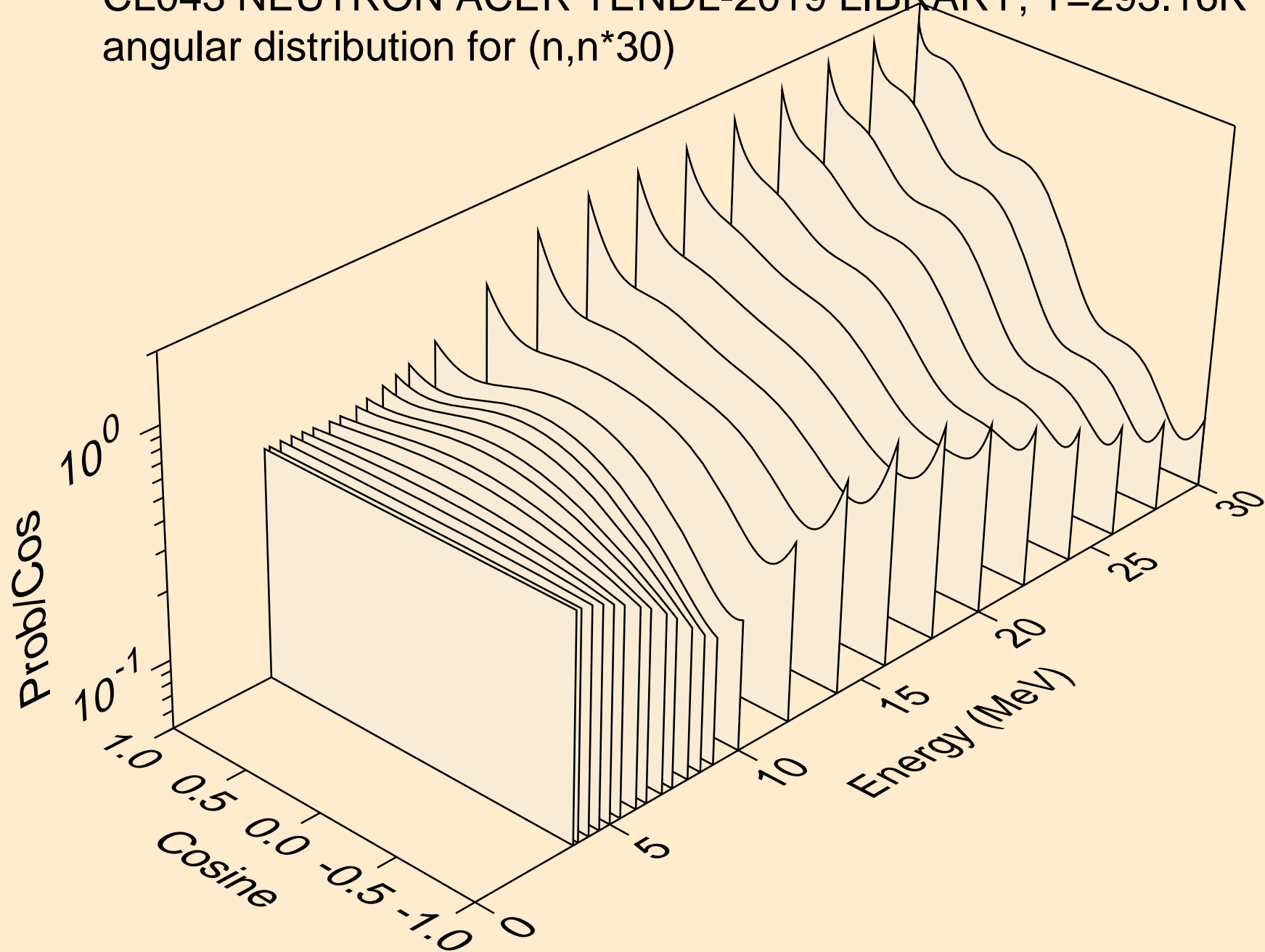

CL043 NEUTRON ACER TENDL-2019 LIBRARY; T=293.16K
Neutron emission for (n,x)

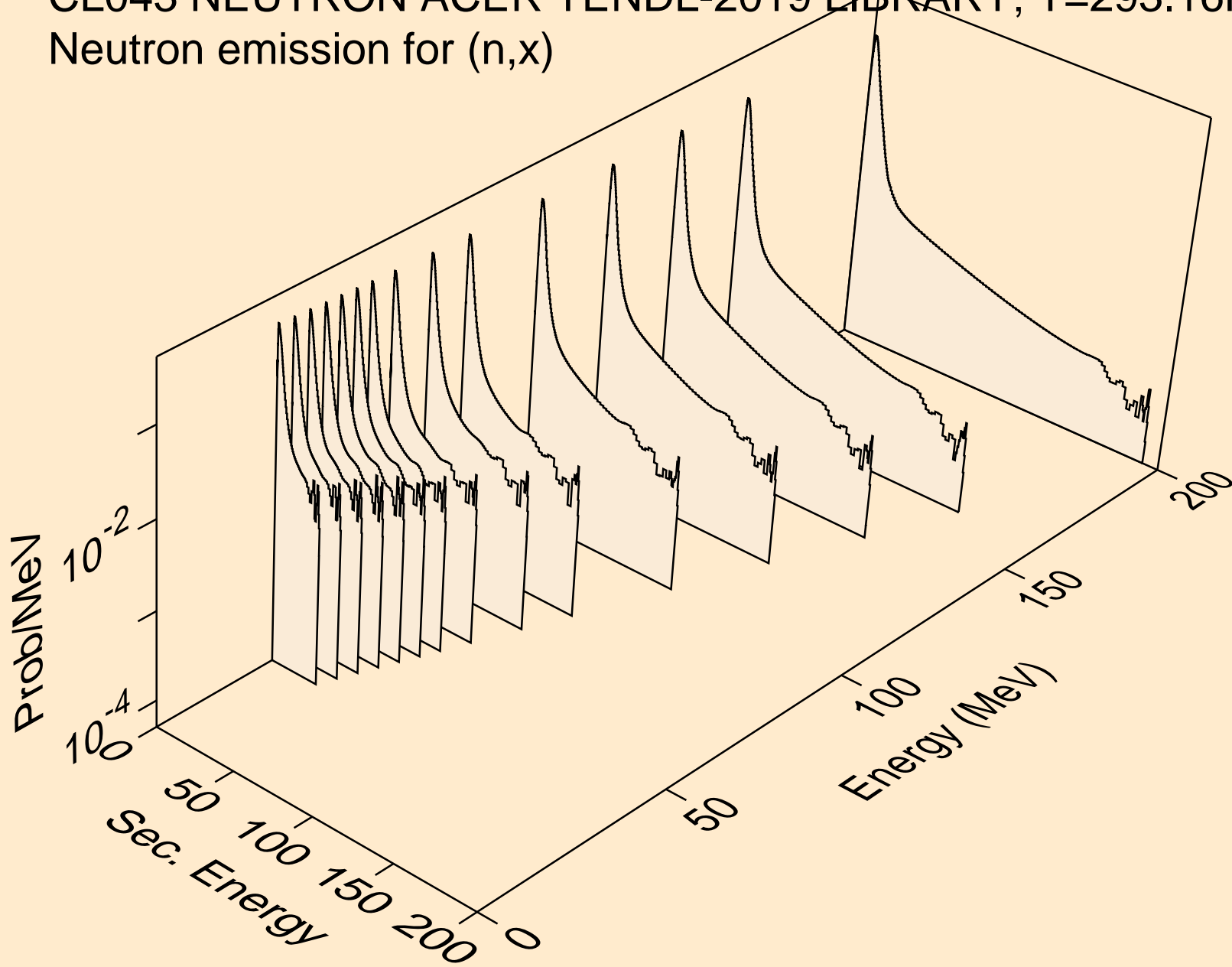

CL043 NEUTRON ACER TENDL-2019 LIBRARY; T=293.16K
Neutron emission for (n,2nd)

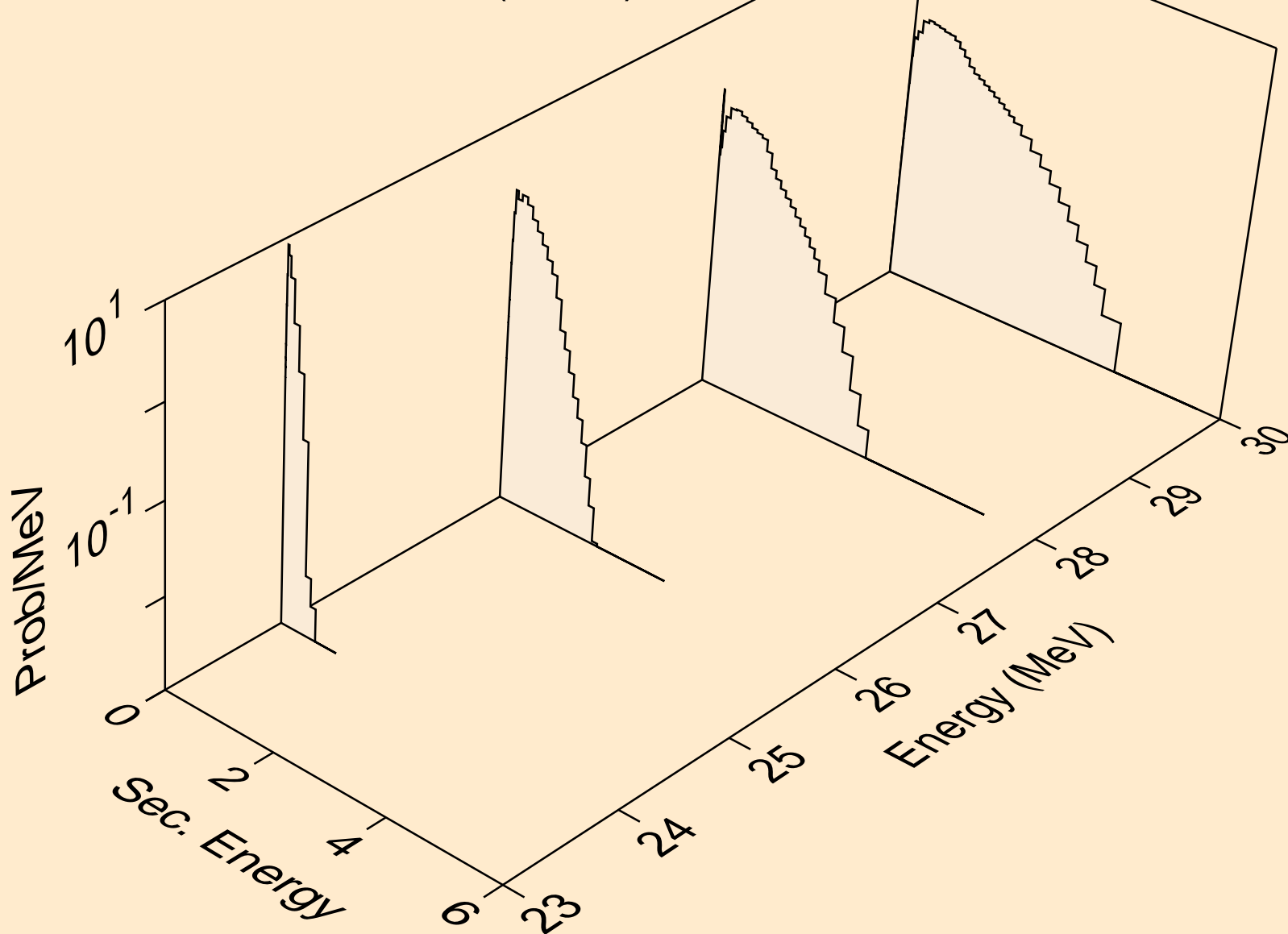

CL043 NEUTRON ACER TENDL-2019 LIBRARY; T=293.16K
Neutron emission for (n,2n)

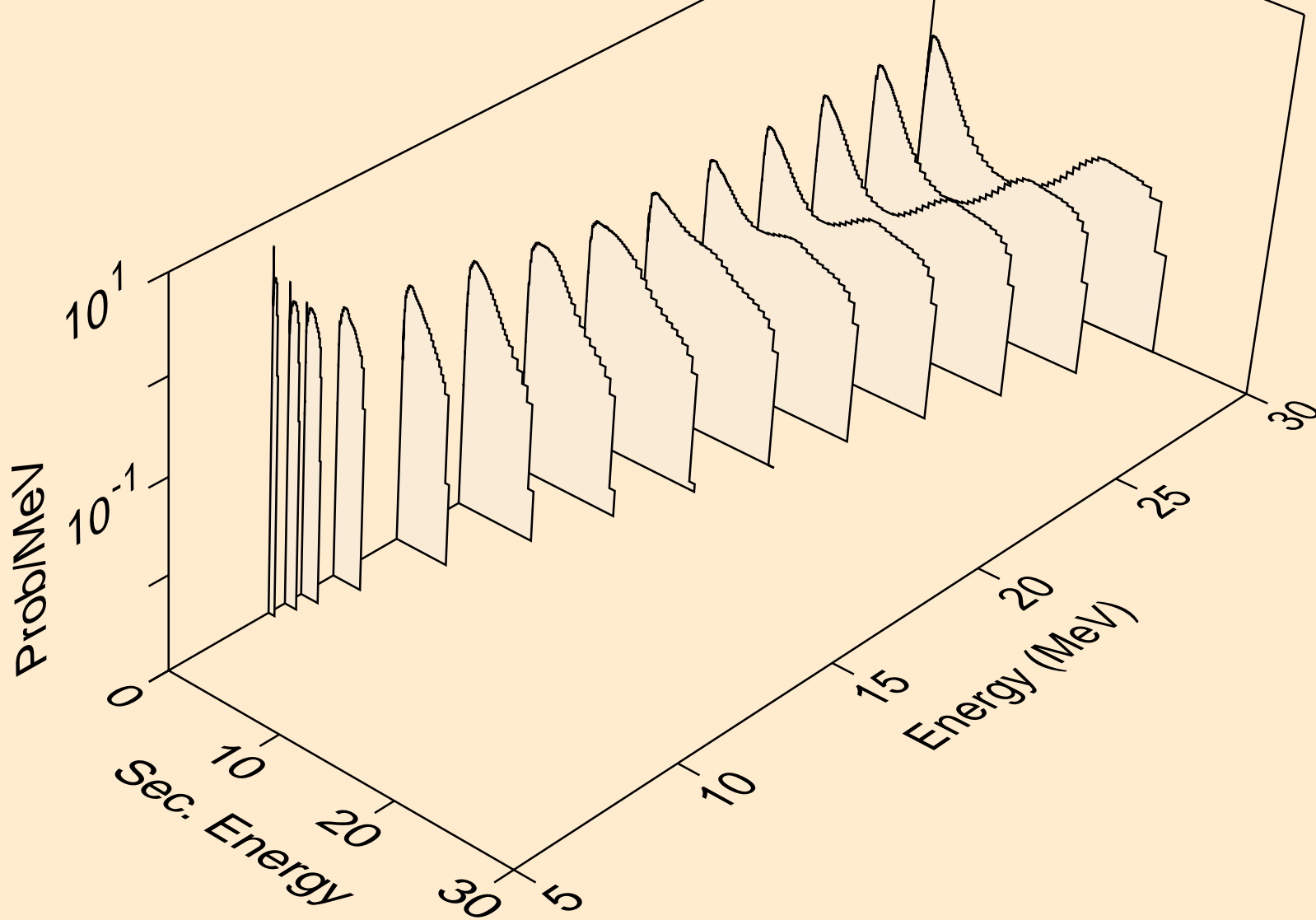

CL043 NEUTRON ACER TENDL-2019 LIBRARY; T=293.16K
Neutron emission for (n,3n)

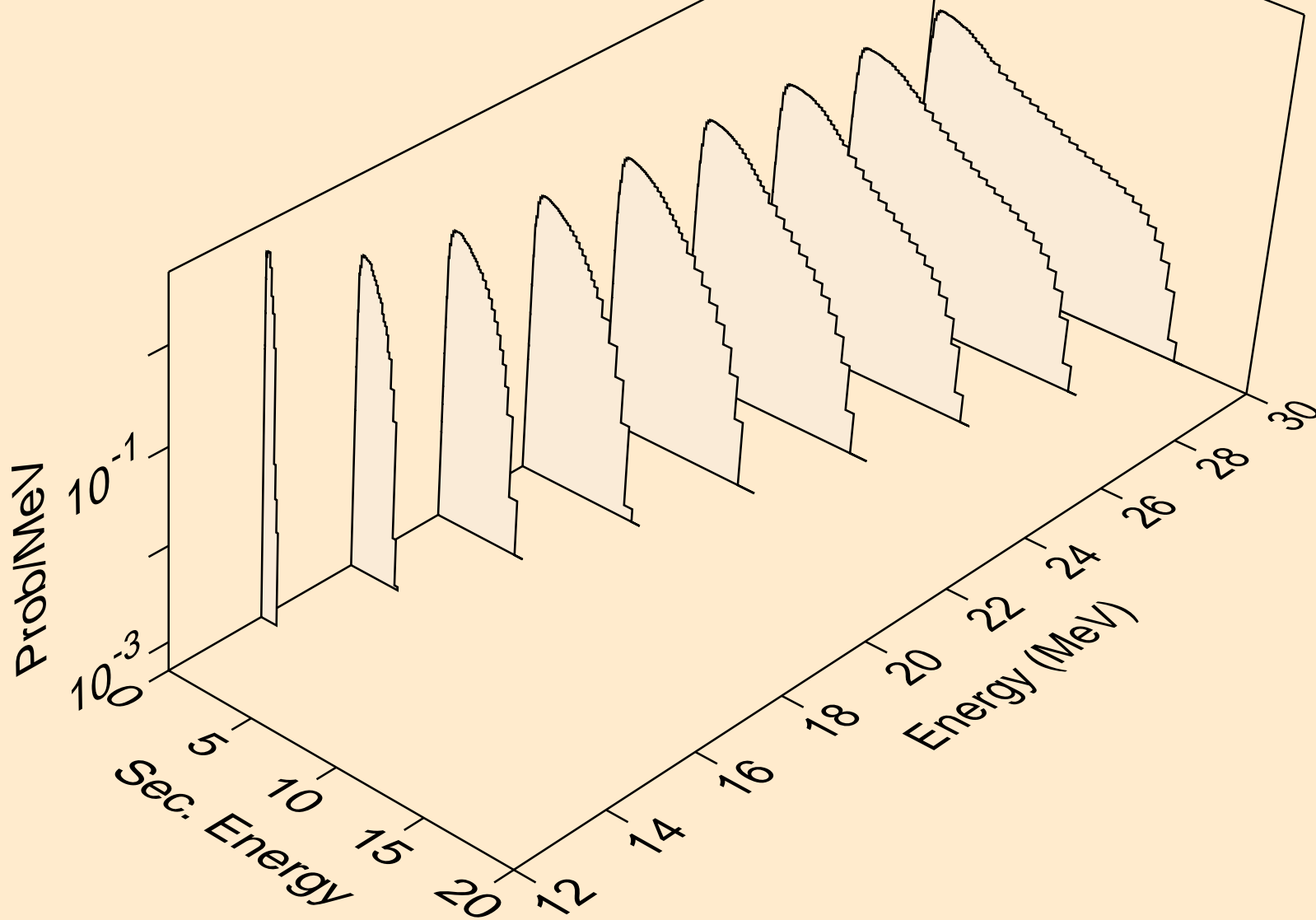

CL043 NEUTRON ACER TENDL-2019 LIBRARY; T=293.16K
Neutron emission for (n,n*)a

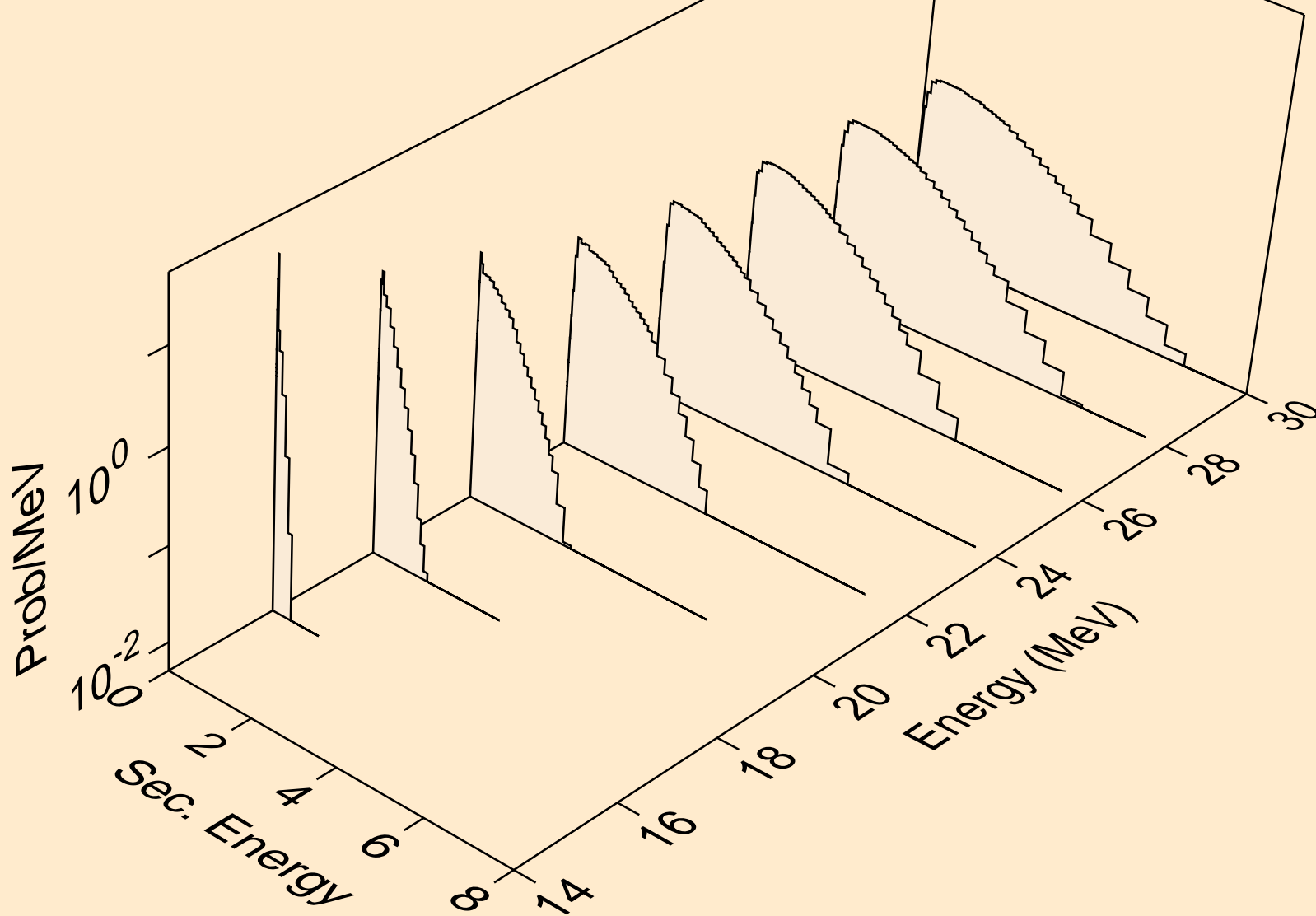

CL043 NEUTRON ACER TENDL-2019 LIBRARY; T=293.16K
Neutron emission for (n,2n)a

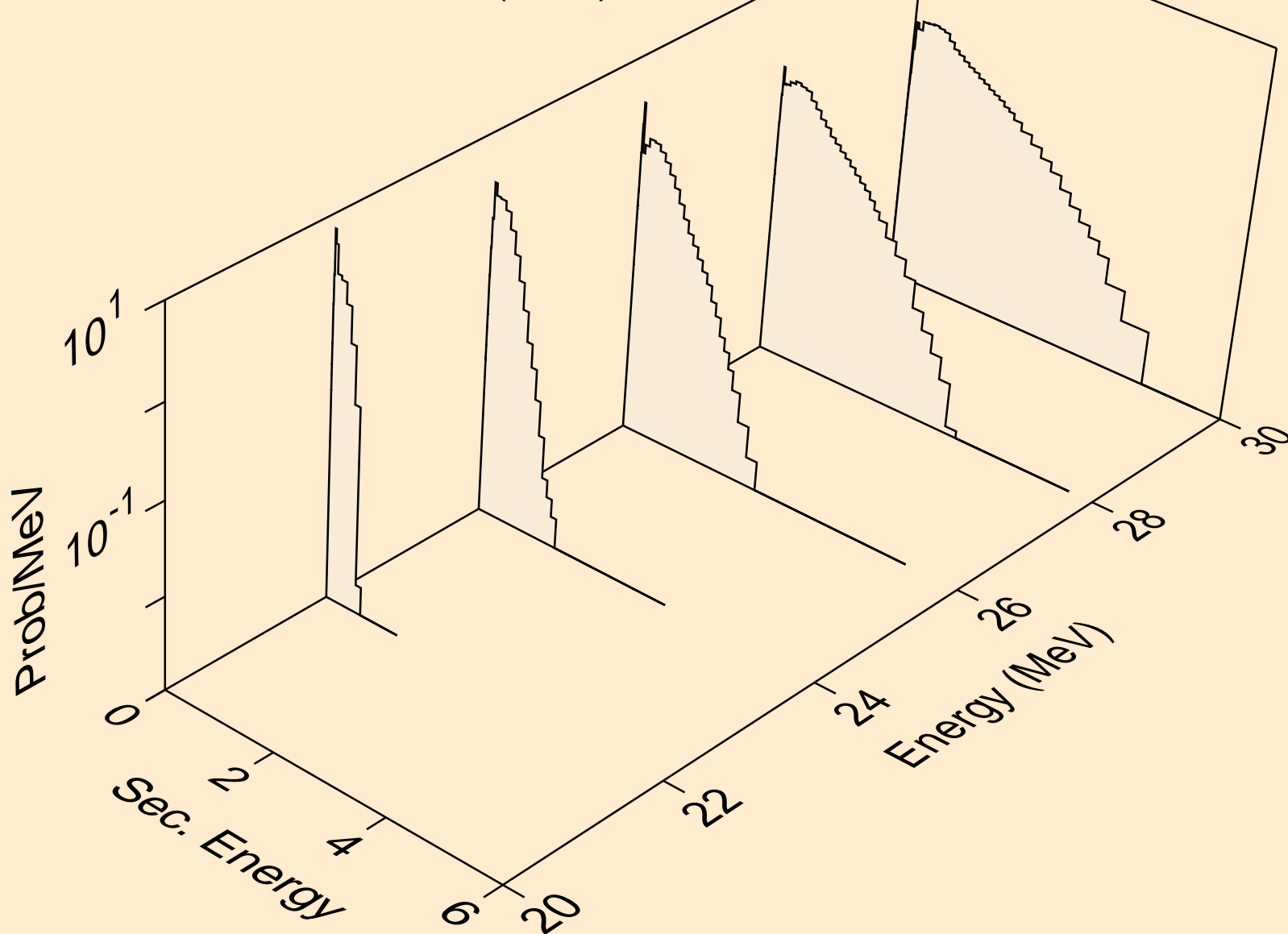

CL043 NEUTRON ACER TENDL-2019 LIBRARY; T=293.16K
Neutron emission for (n,3n)a

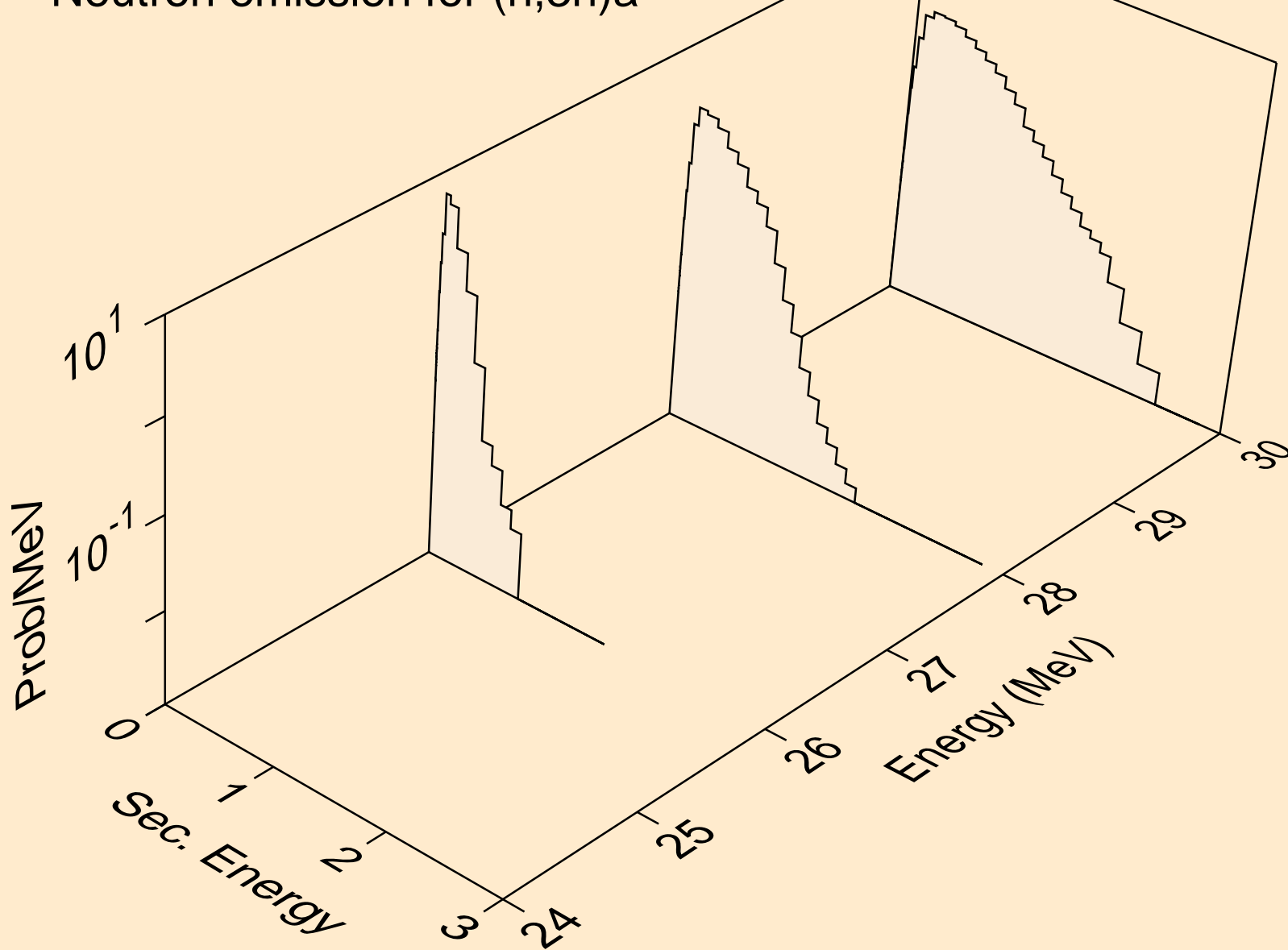

CL043 NEUTRON ACER TENDL-2019 LIBRARY; T=293.16K
Neutron emission for (n,n*)p

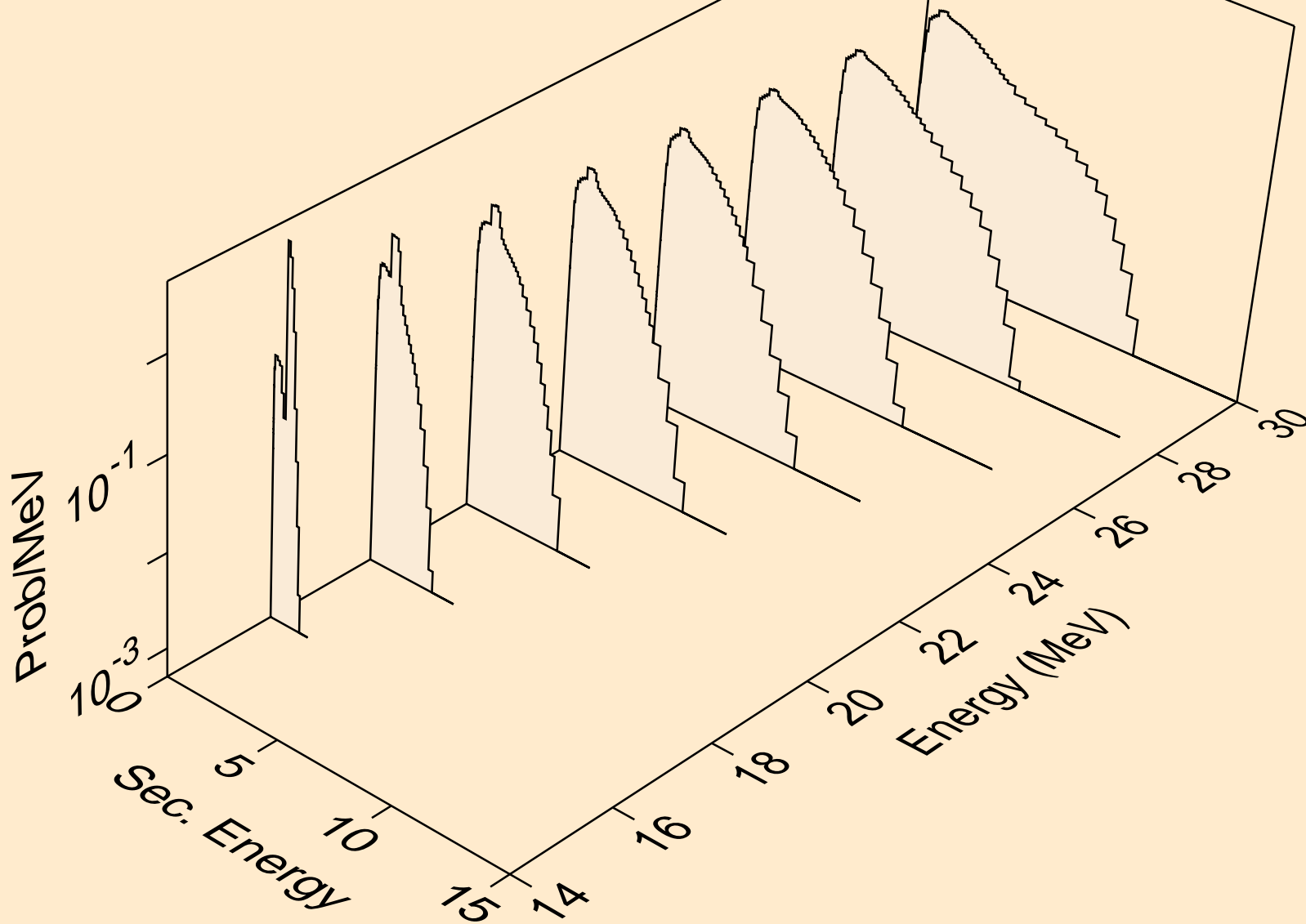

CL043 NEUTRON ACER TENDL-2019 LIBRARY; T=293.16K
Neutron emission for (n,n*)d

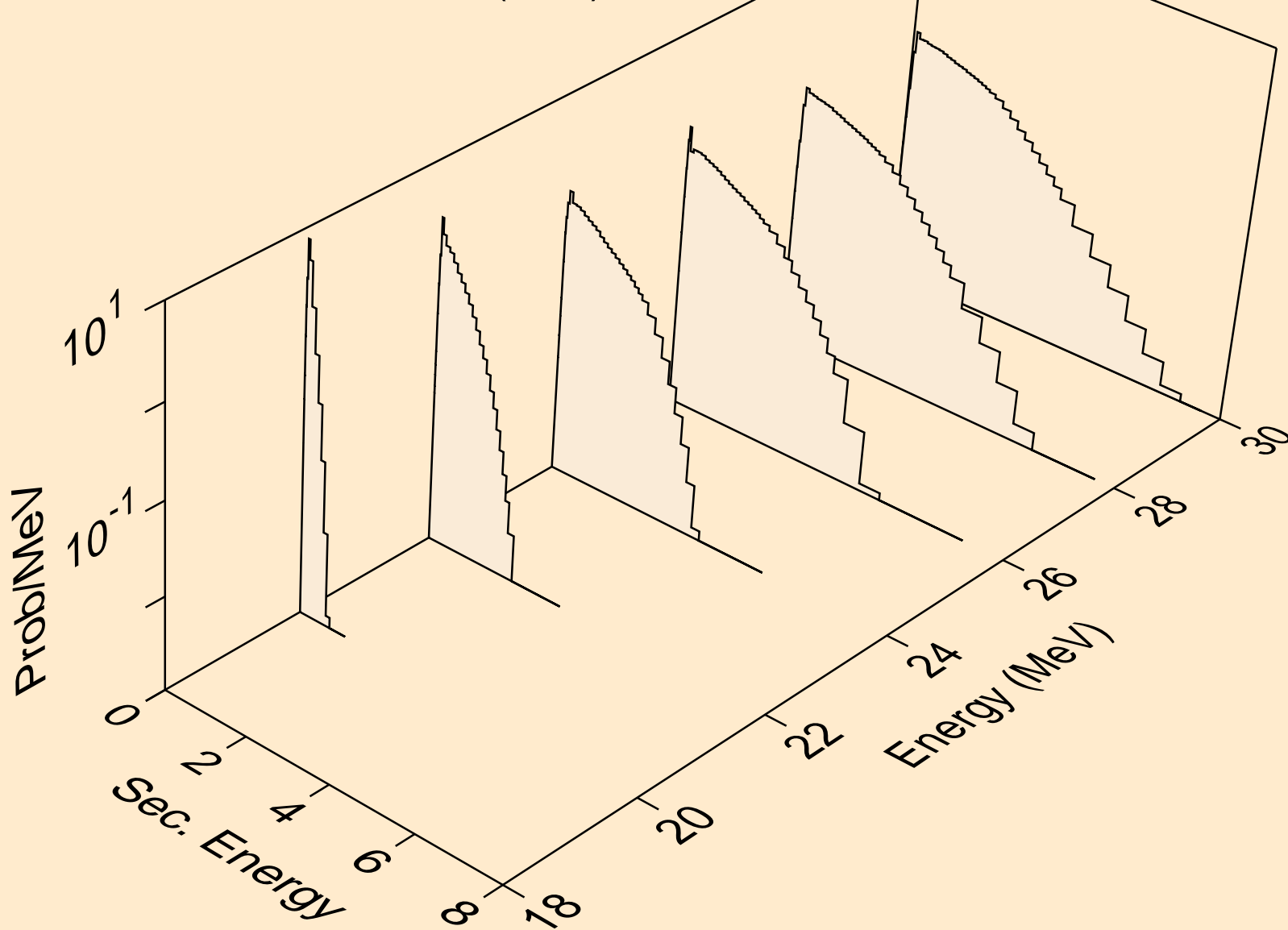

CL043 NEUTRON ACER TENDL-2019 LIBRARY; T=293.16K
Neutron emission for (n,n*)t

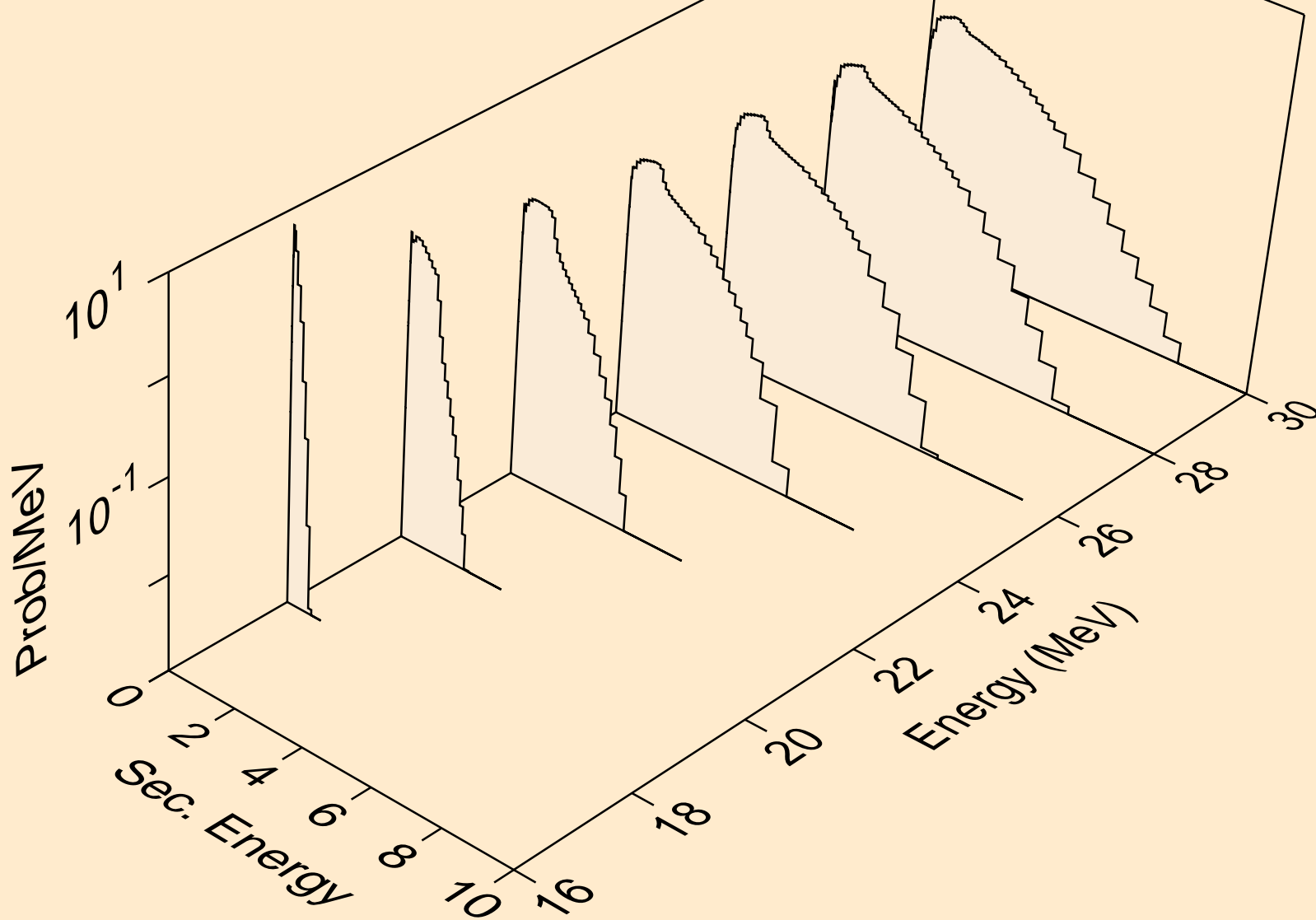

CL043 NEUTRON ACER TENDL-2019 LIBRARY; T=293.16K
Neutron emission for (n,4n)

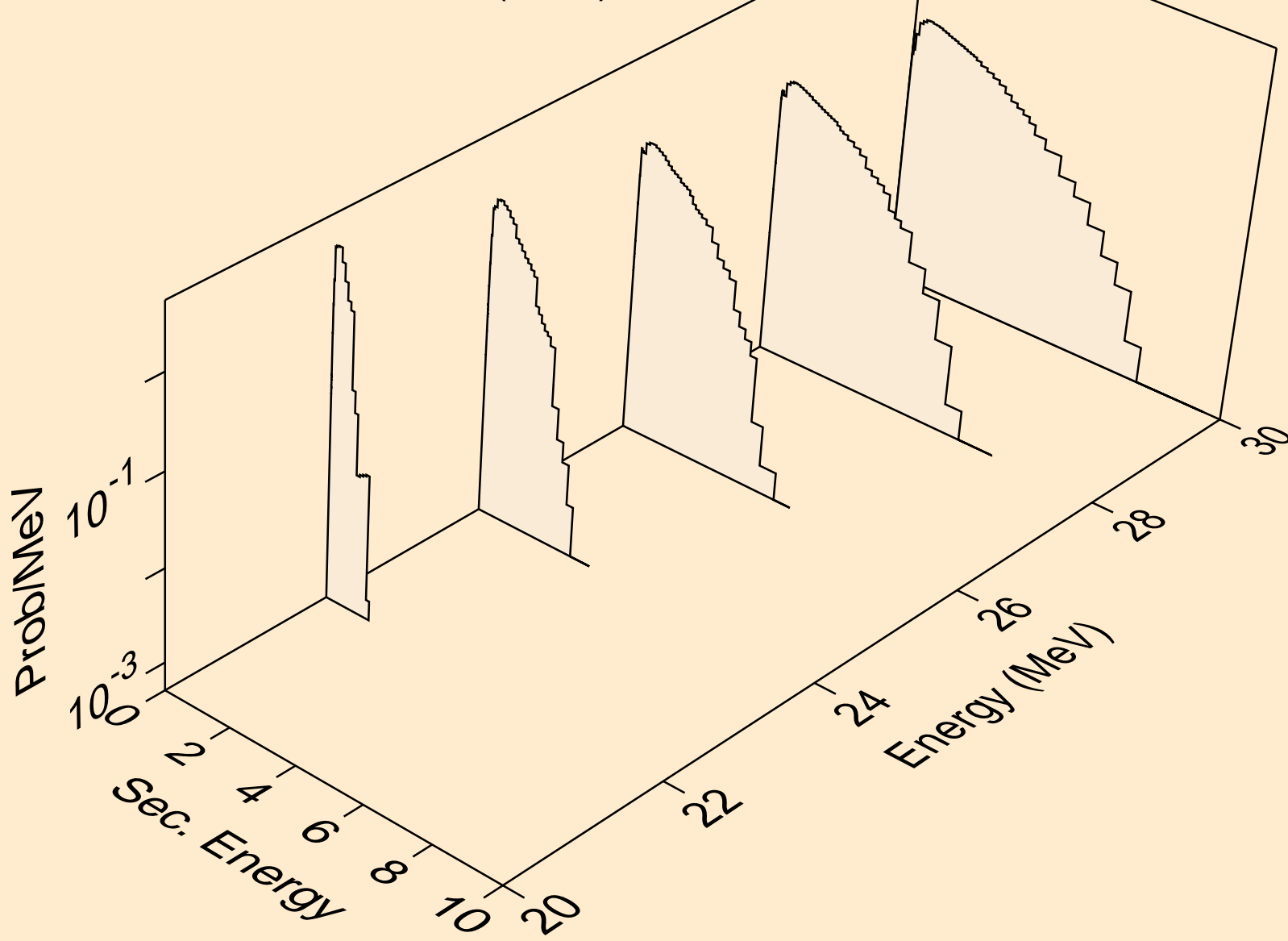

CL043 NEUTRON ACER TENDL-2019 LIBRARY; T=293.16K
Neutron emission for (n,2np)

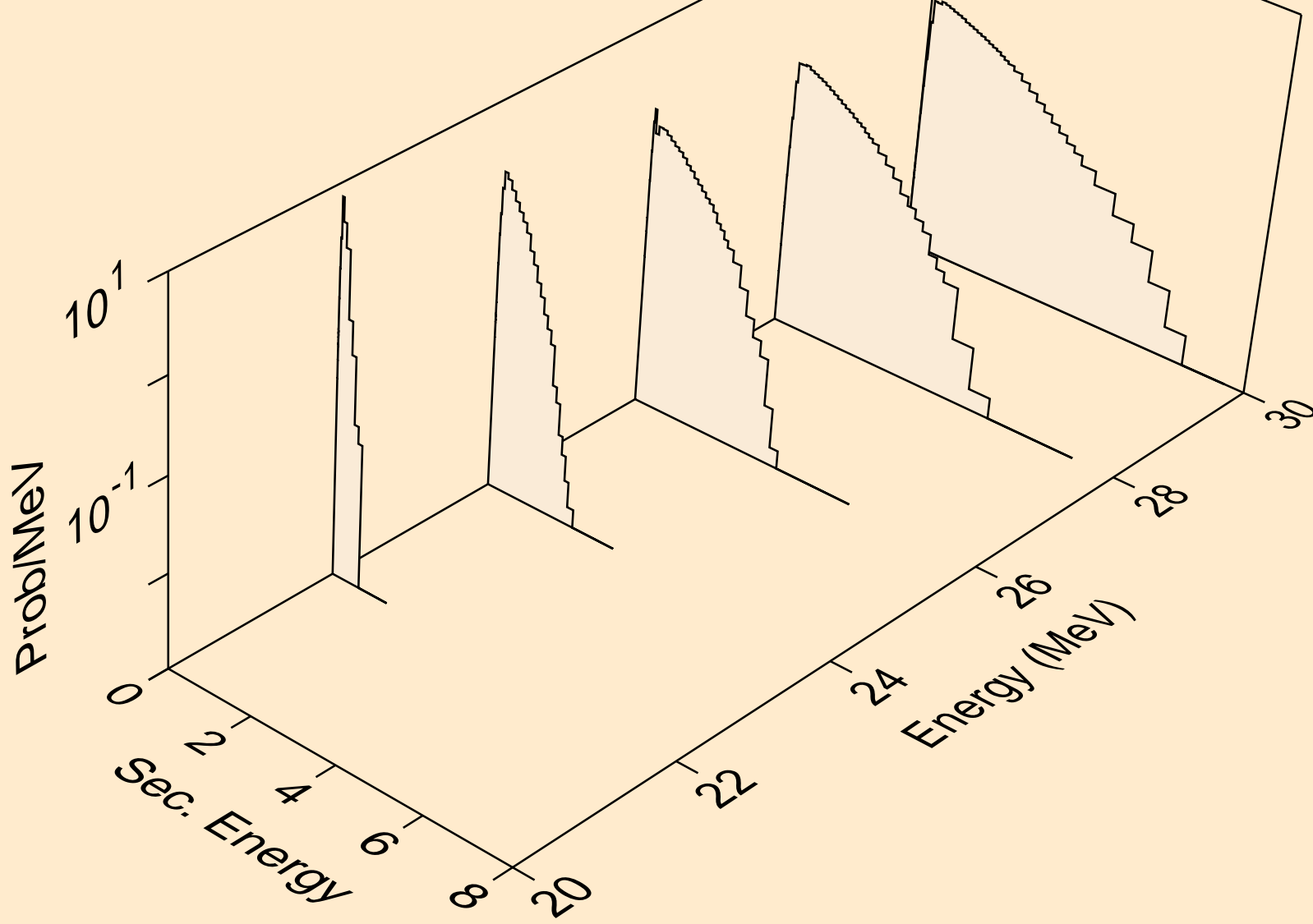

CL043 NEUTRON ACER TENDL-2019 LIBRARY; T=293.16K
Neutron emission for (n,3np)

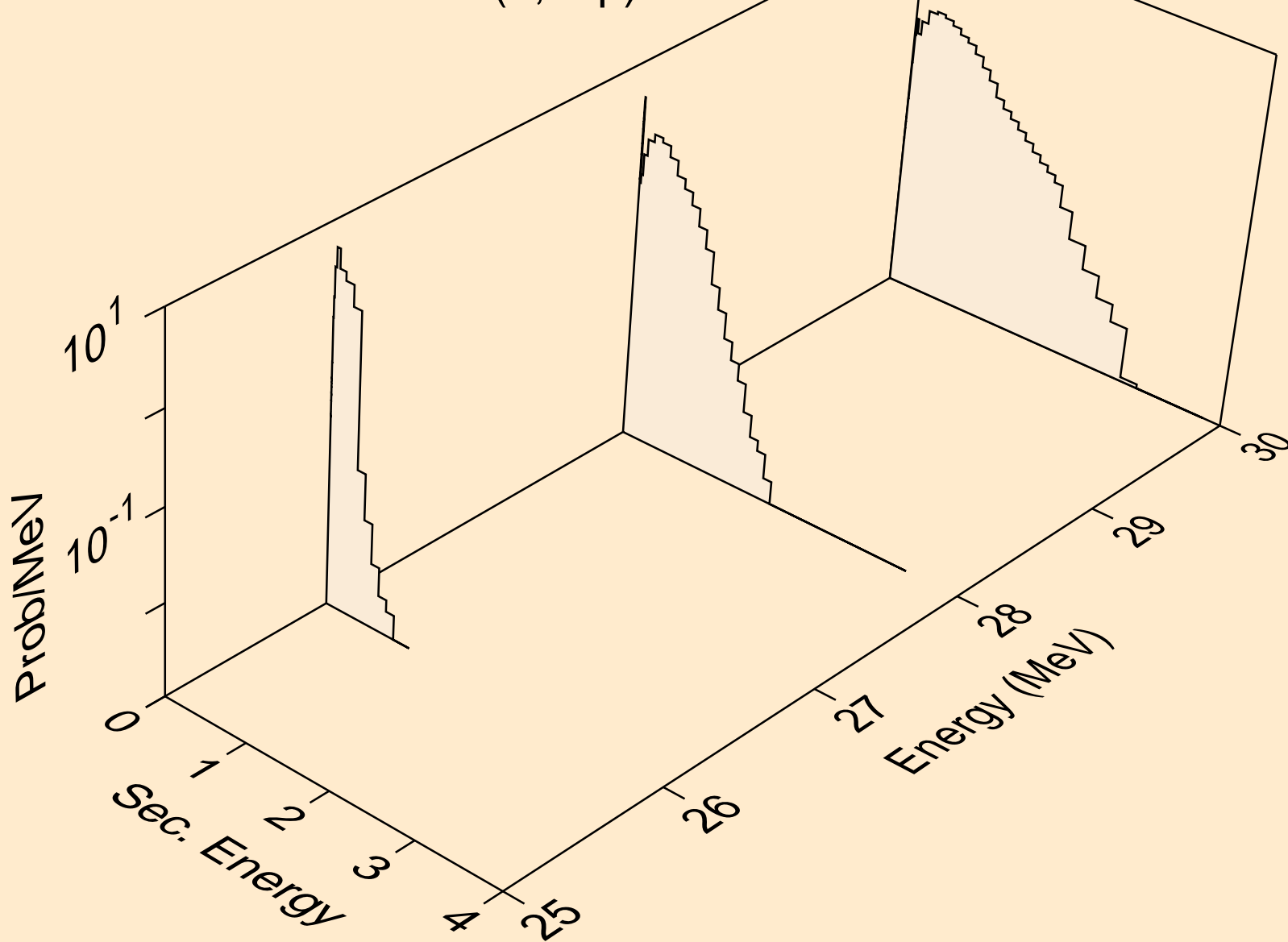

CL043 NEUTRON ACER TENDL-2019 LIBRARY; T=293.16K
Neutron emission for (n,n*c)

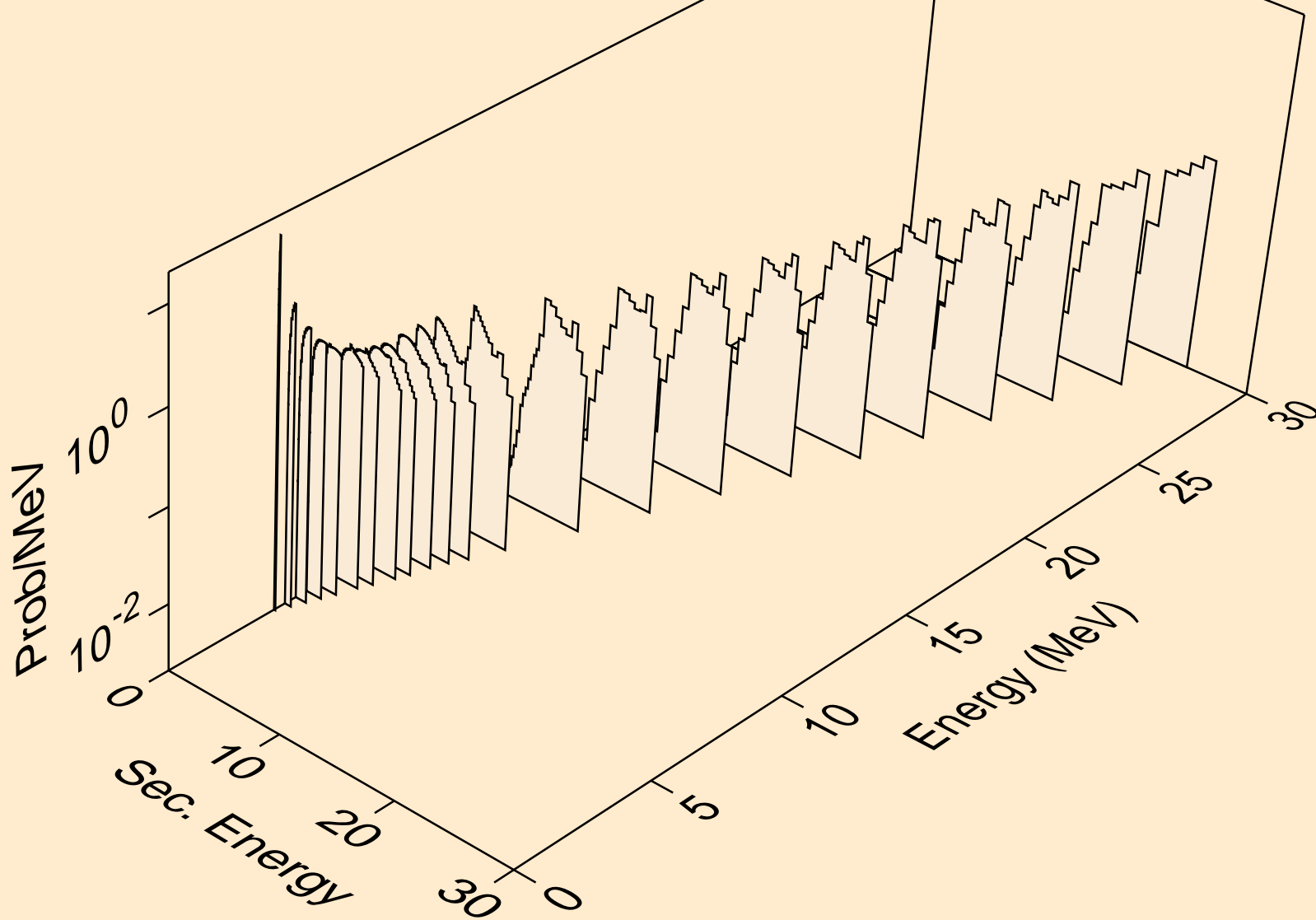

CL043 NEUTRON ACER TENDL-2019 LIBRARY; T=293.16K
Photon emission for (n,x)

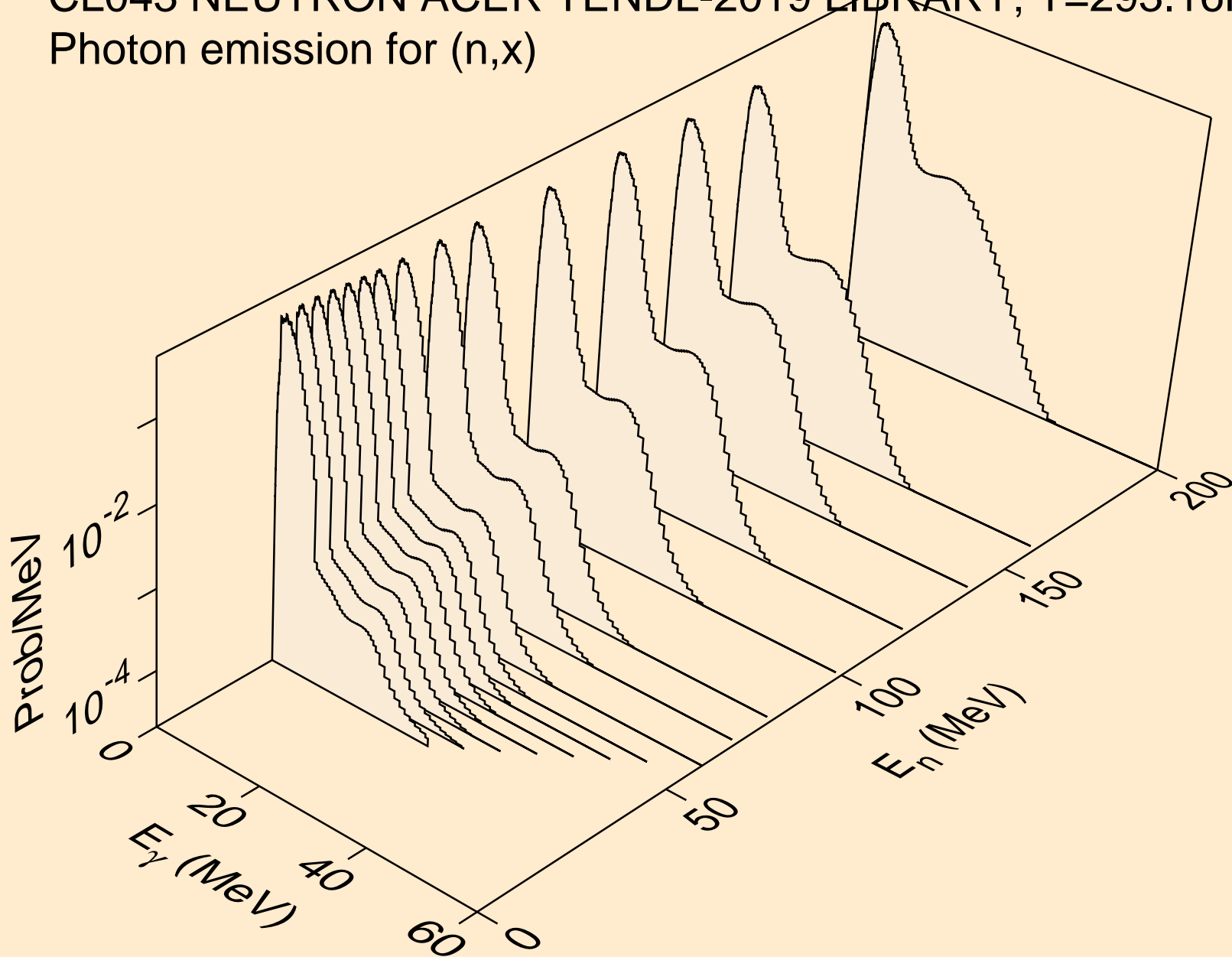

CL043 NEUTRON ACER TENDL-2019 LIBRARY; T=293.16K
Photon emission for (n,2nd)

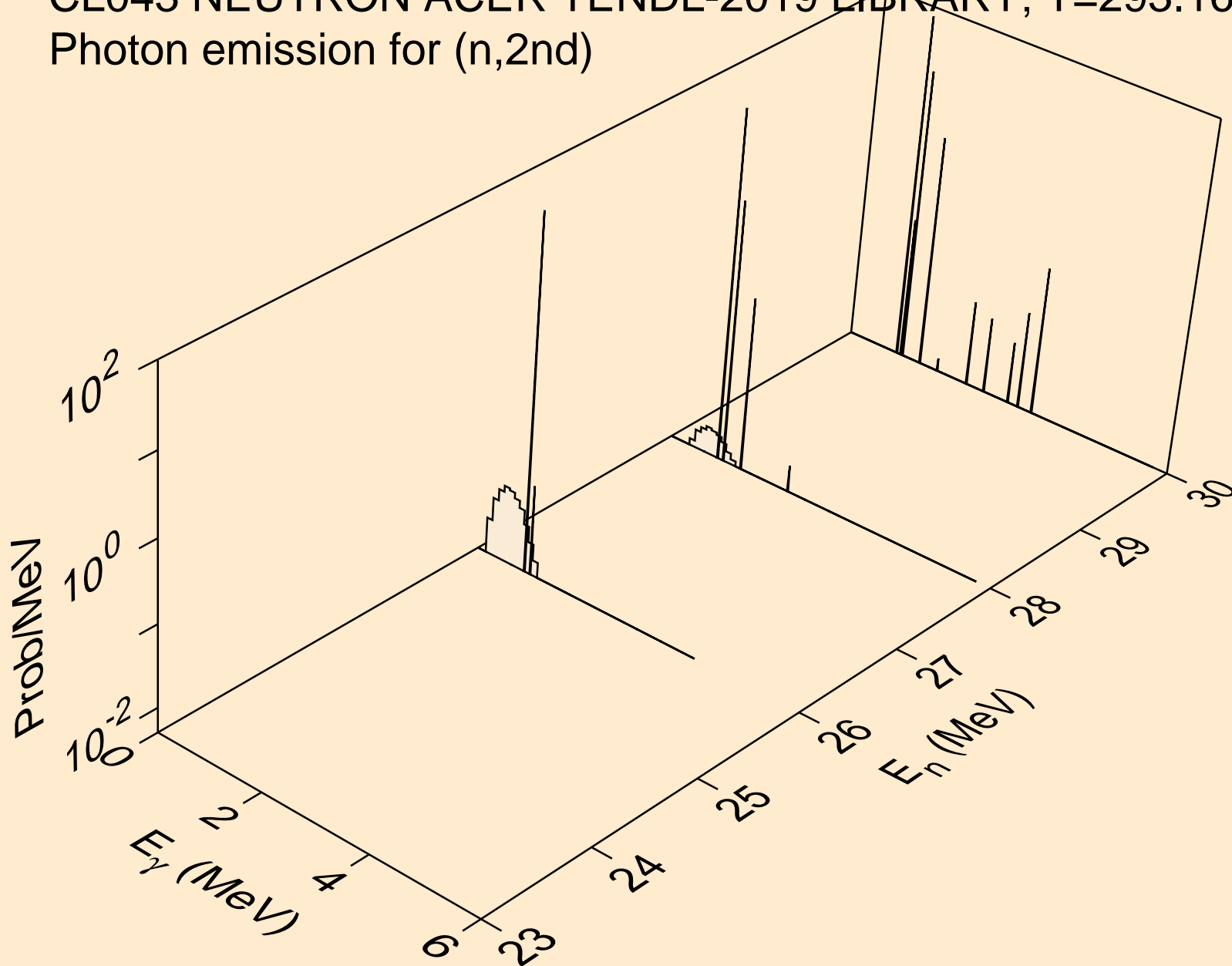

CL043 NEUTRON ACER TENDL-2019 LIBRARY; T=293.16K
Photon emission for (n,2n)

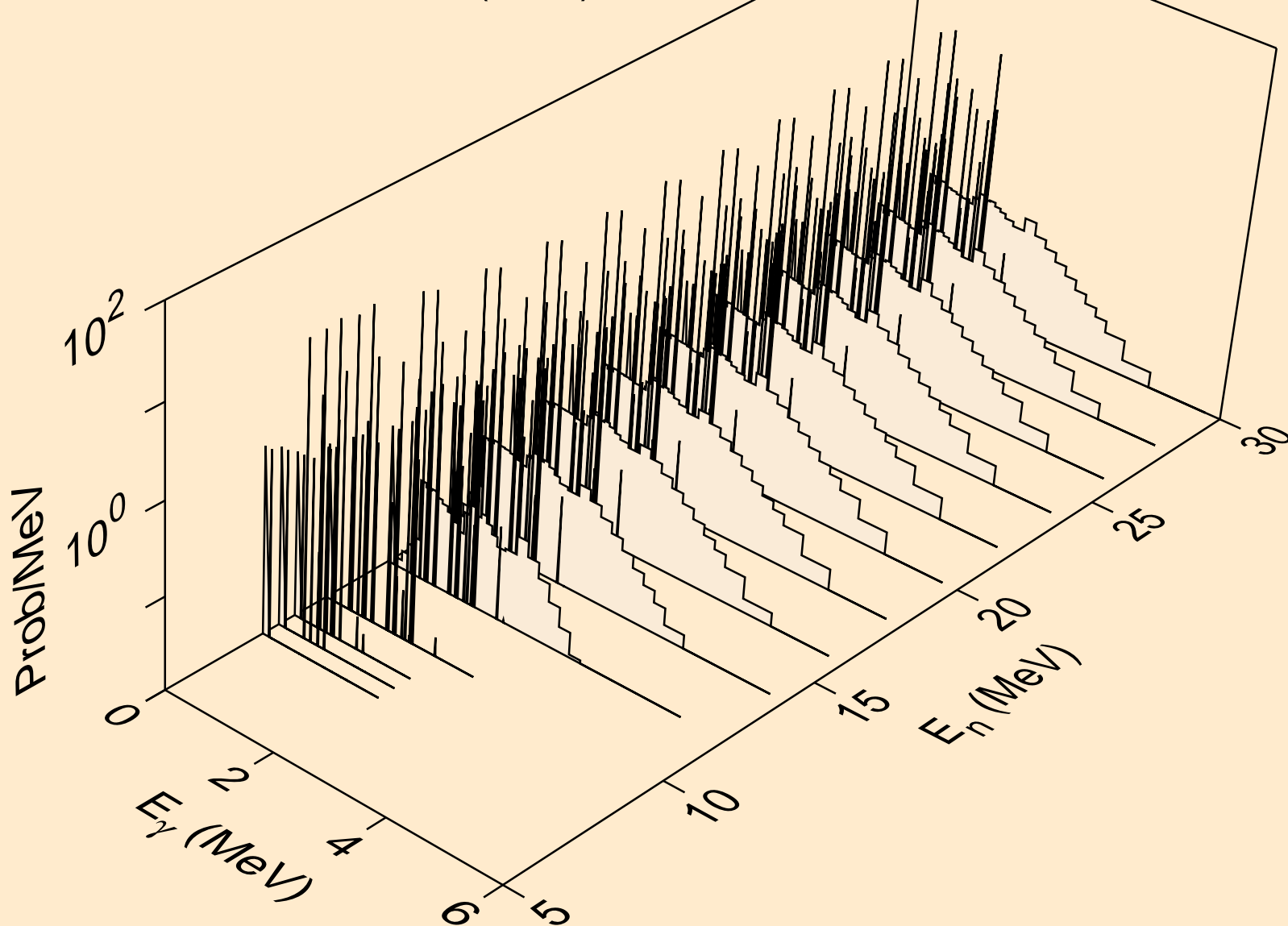

CL043 NEUTRON ACER TENDL-2019 LIBRARY; T=293.16K
Photon emission for (n,3n)

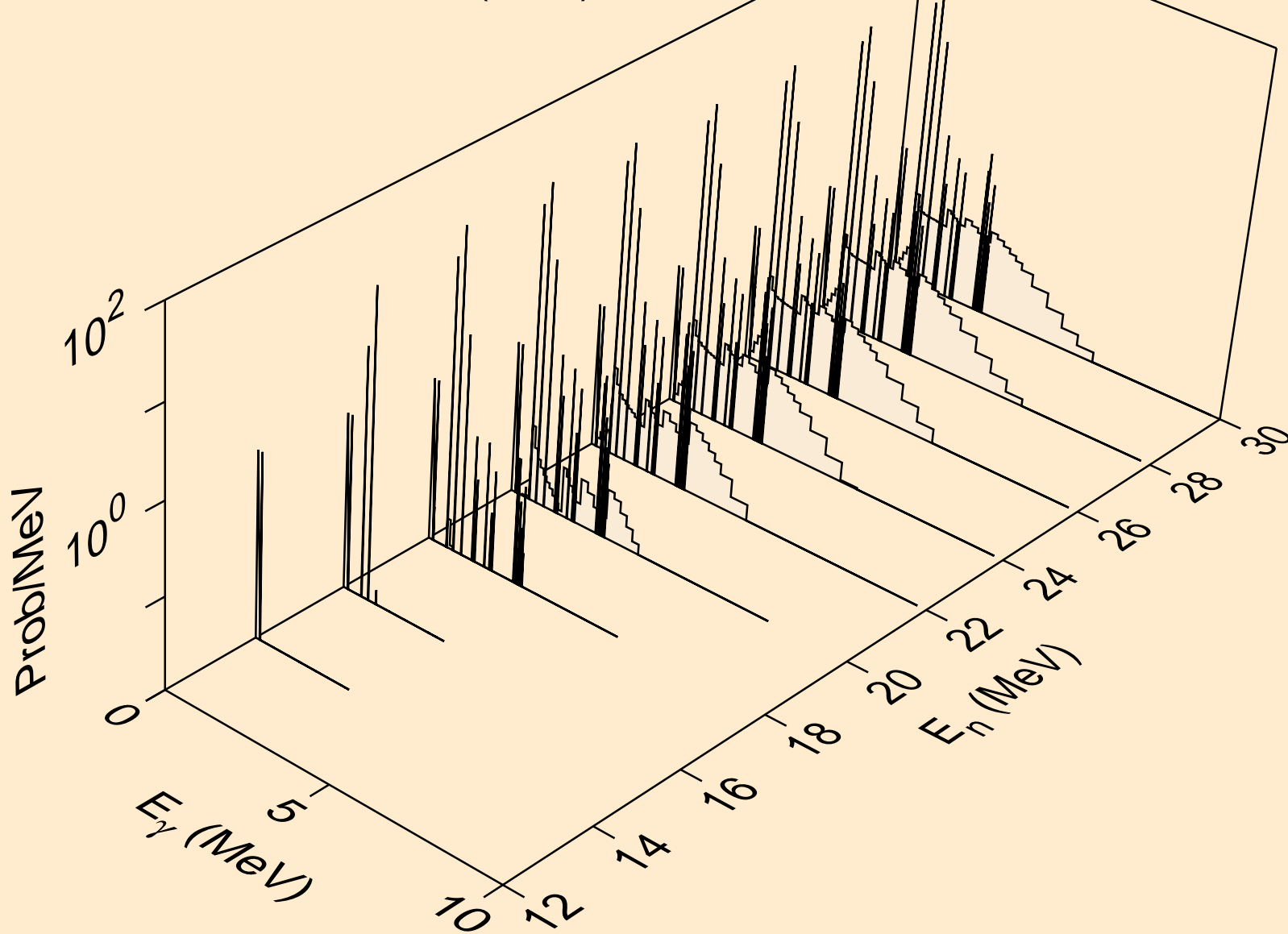

CL043 NEUTRON ACER TENDL-2019 LIBRARY; T=293.16K
Photon emission for (n,n*)a

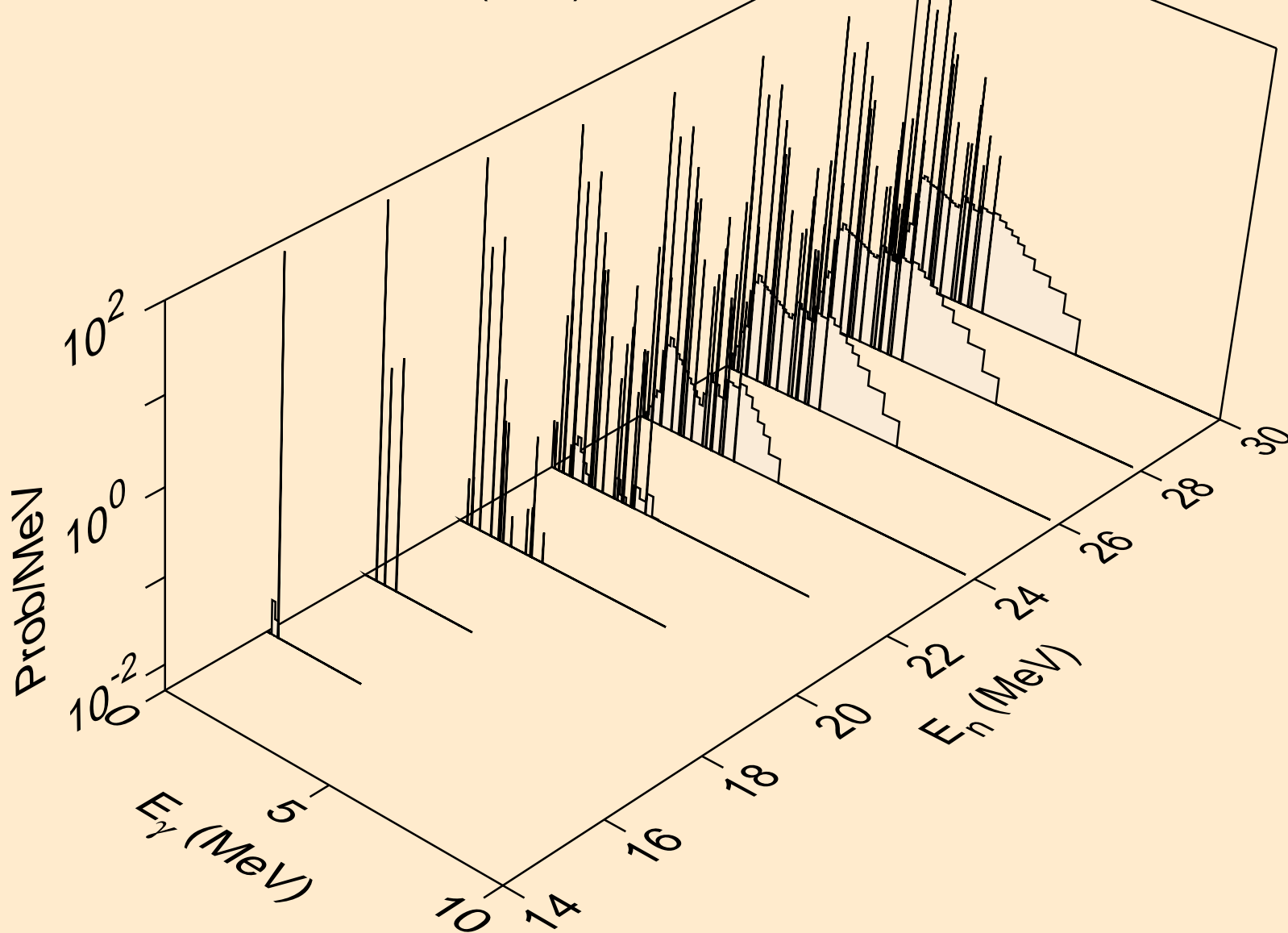

CL043 NEUTRON ACER TENDL-2019 LIBRARY; T=293.16K
Photon emission for (n,2n)a

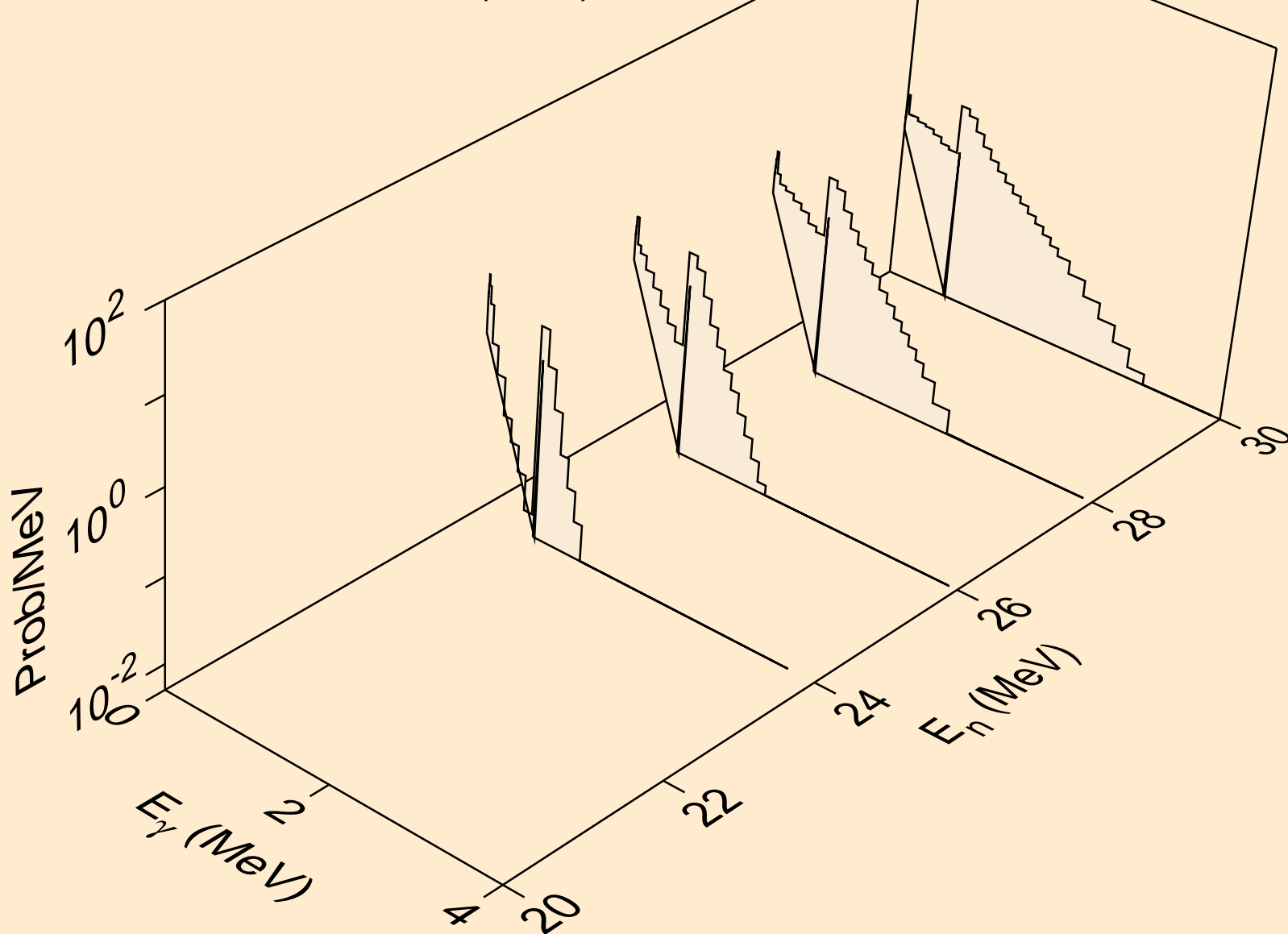

CL043 NEUTRON ACER TENDL-2019 LIBRARY; T=293.16K
Photon emission for (n,3n)a

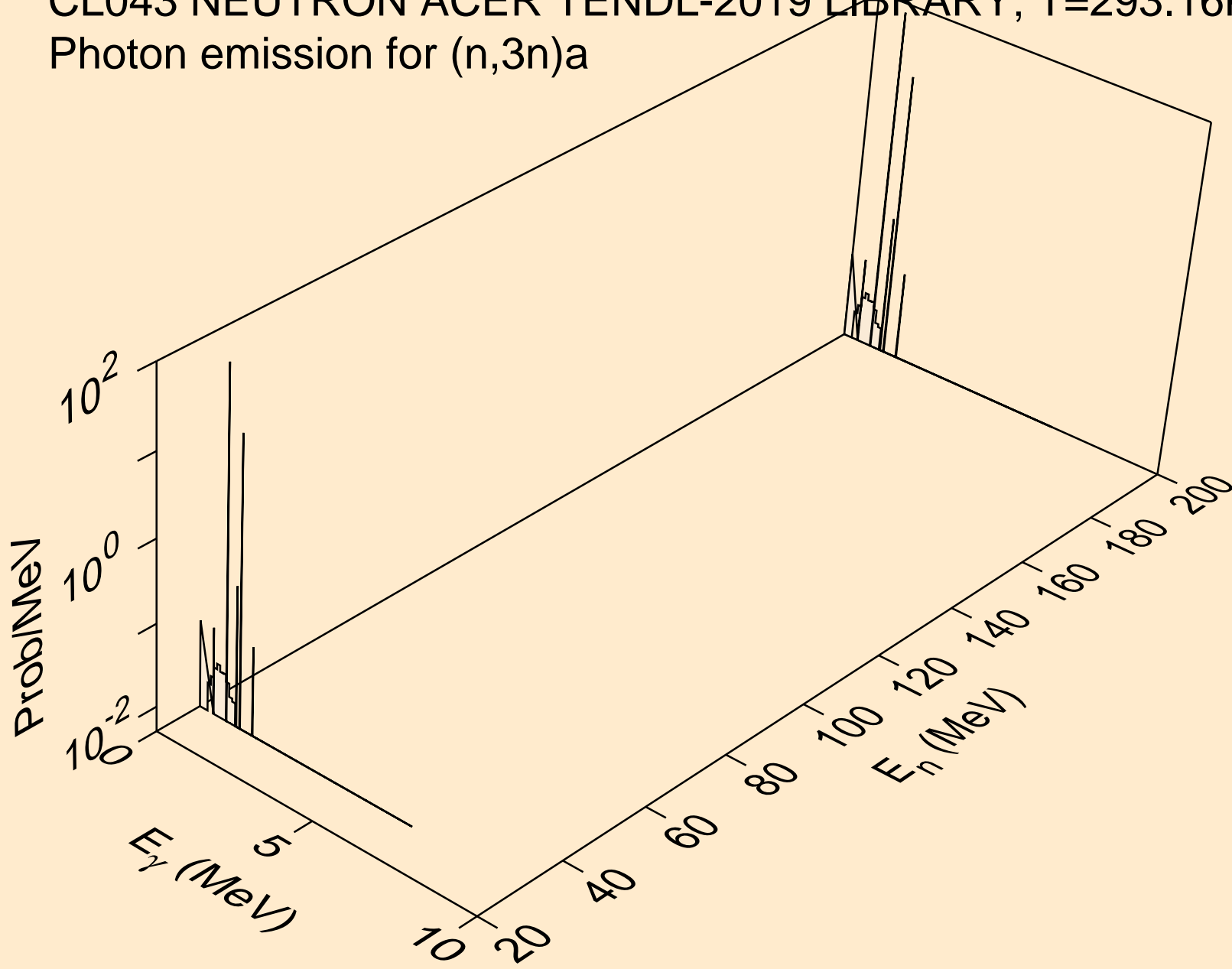

CL043 NEUTRON ACER TENDL-2019 LIBRARY; T=293.16K
Photon emission for (n,n*)p

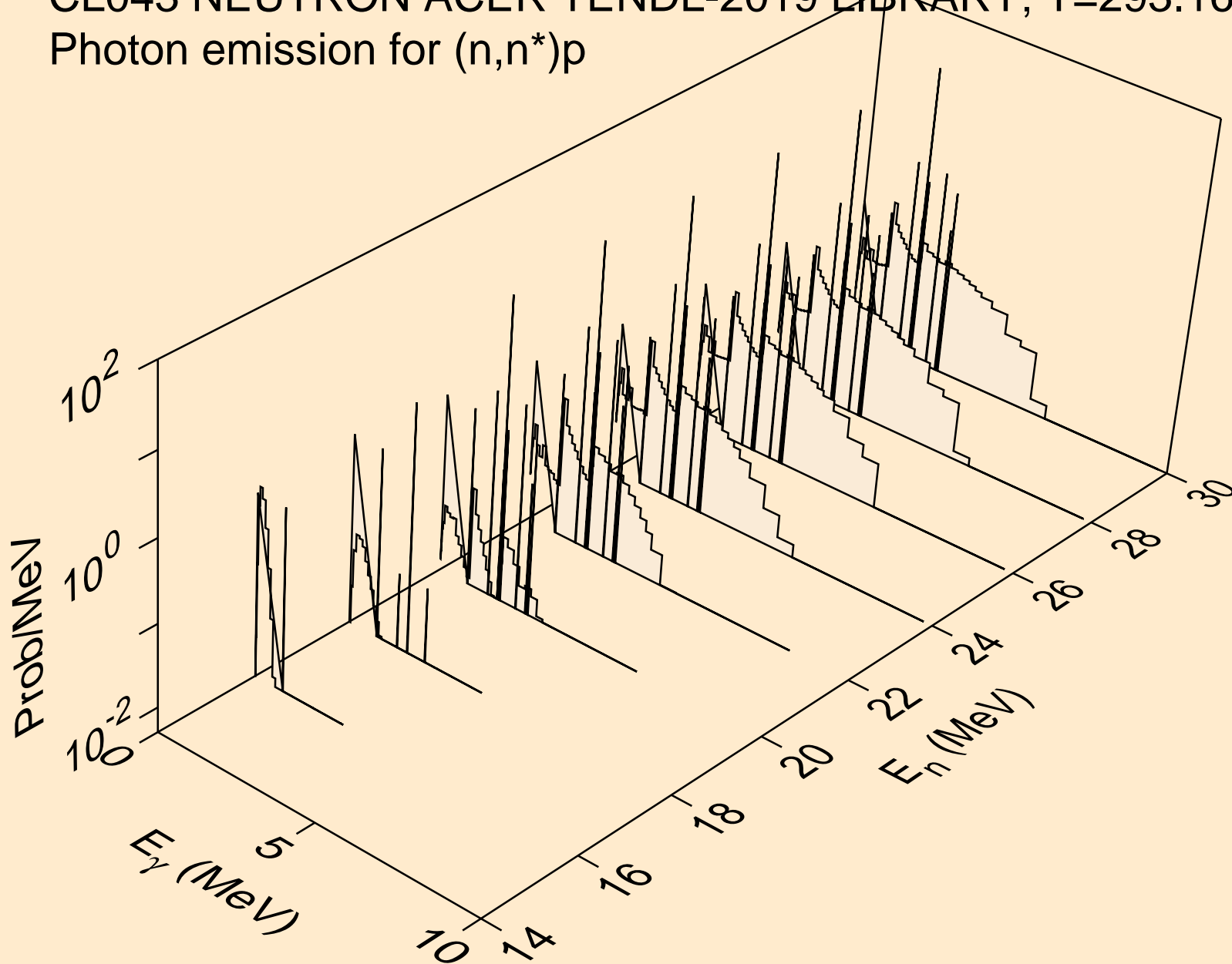

CL043 NEUTRON ACER TENDL-2019 LIBRARY; T=293.16K
Photon emission for (n,n*)d

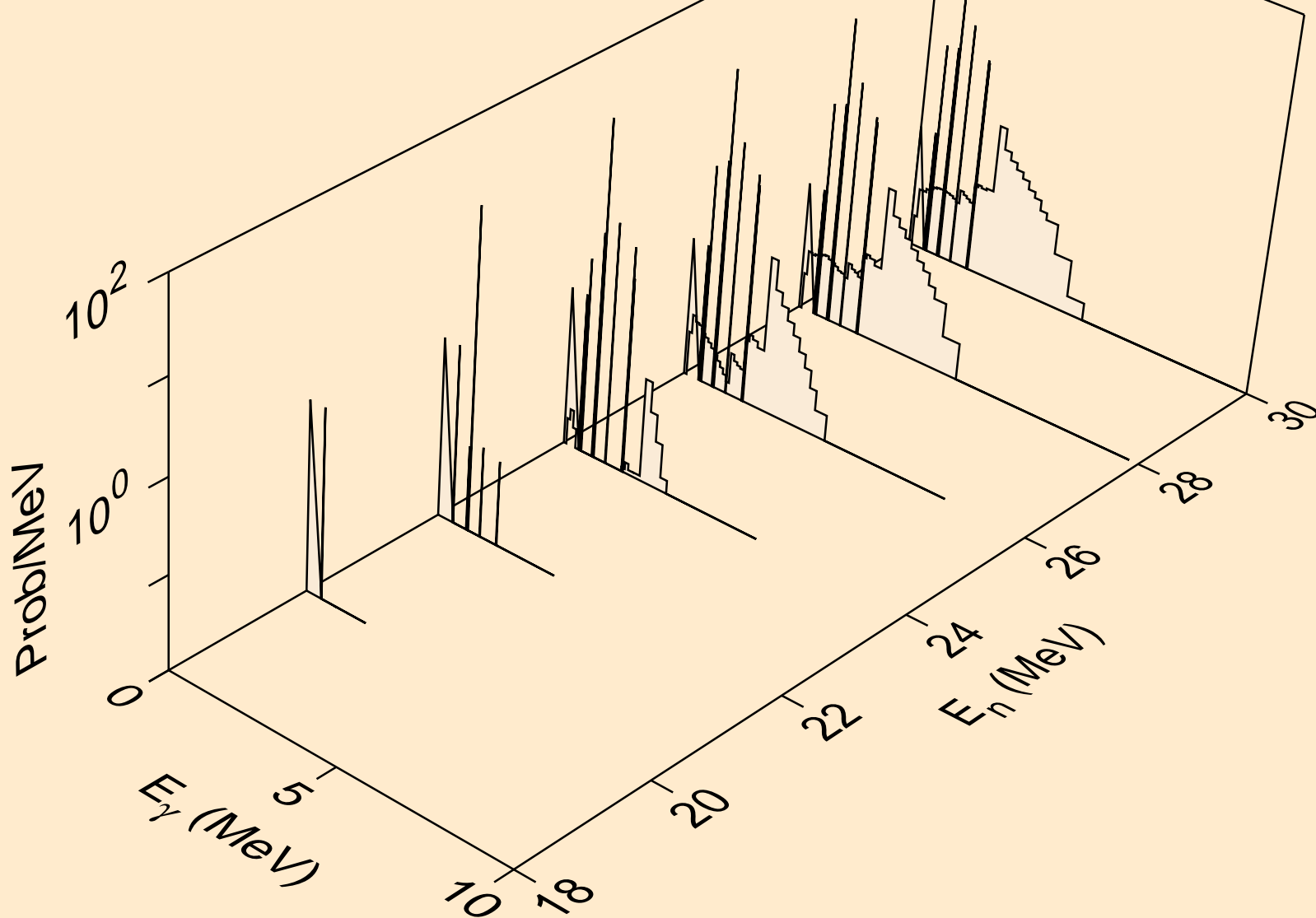

CL043 NEUTRON ACER TENDL-2019 LIBRARY; T=293.16K
Photon emission for (n,n*)t

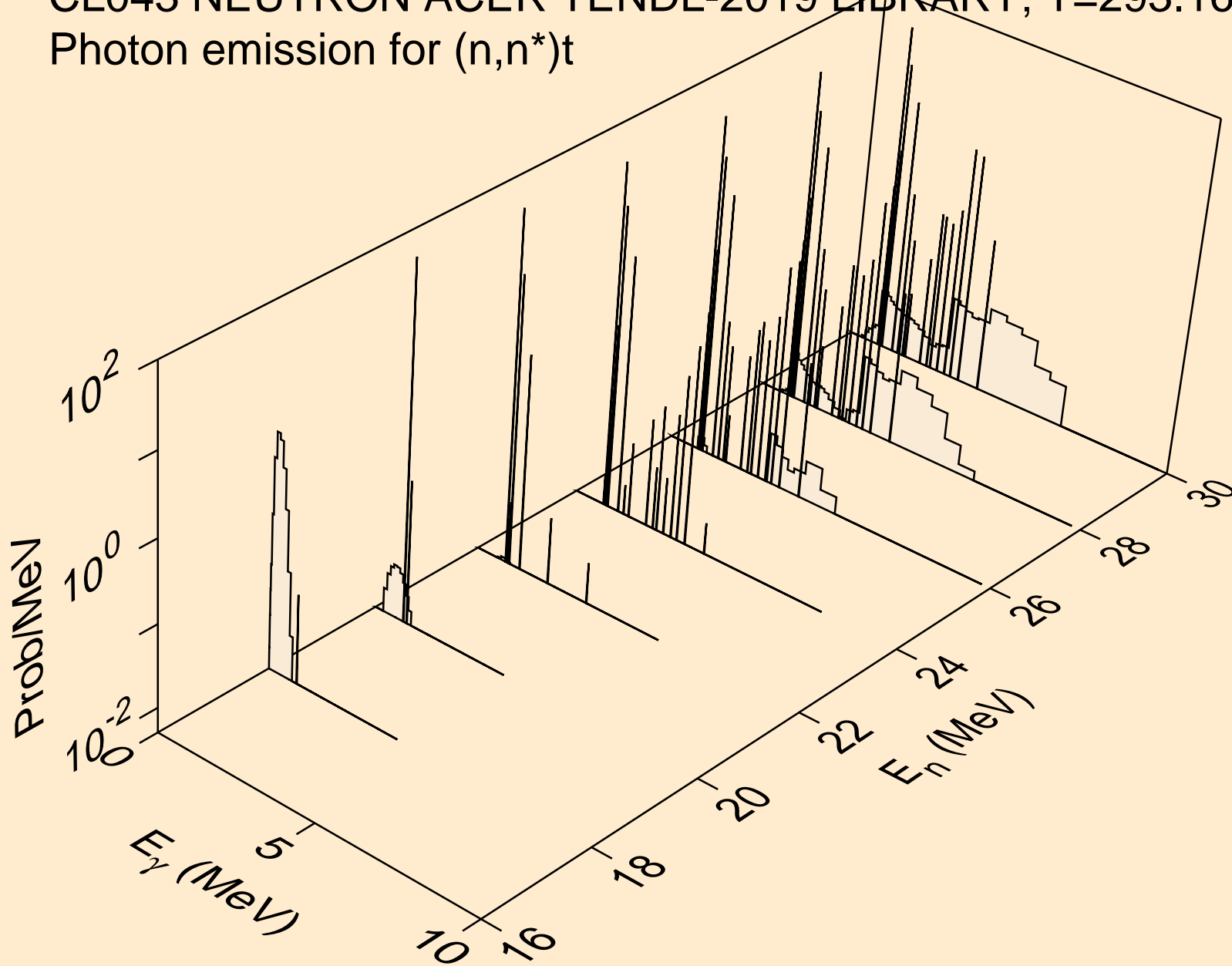

CL043 NEUTRON ACER TENDL-2019 LIBRARY; T=293.16K
Photon emission for (n,4n)

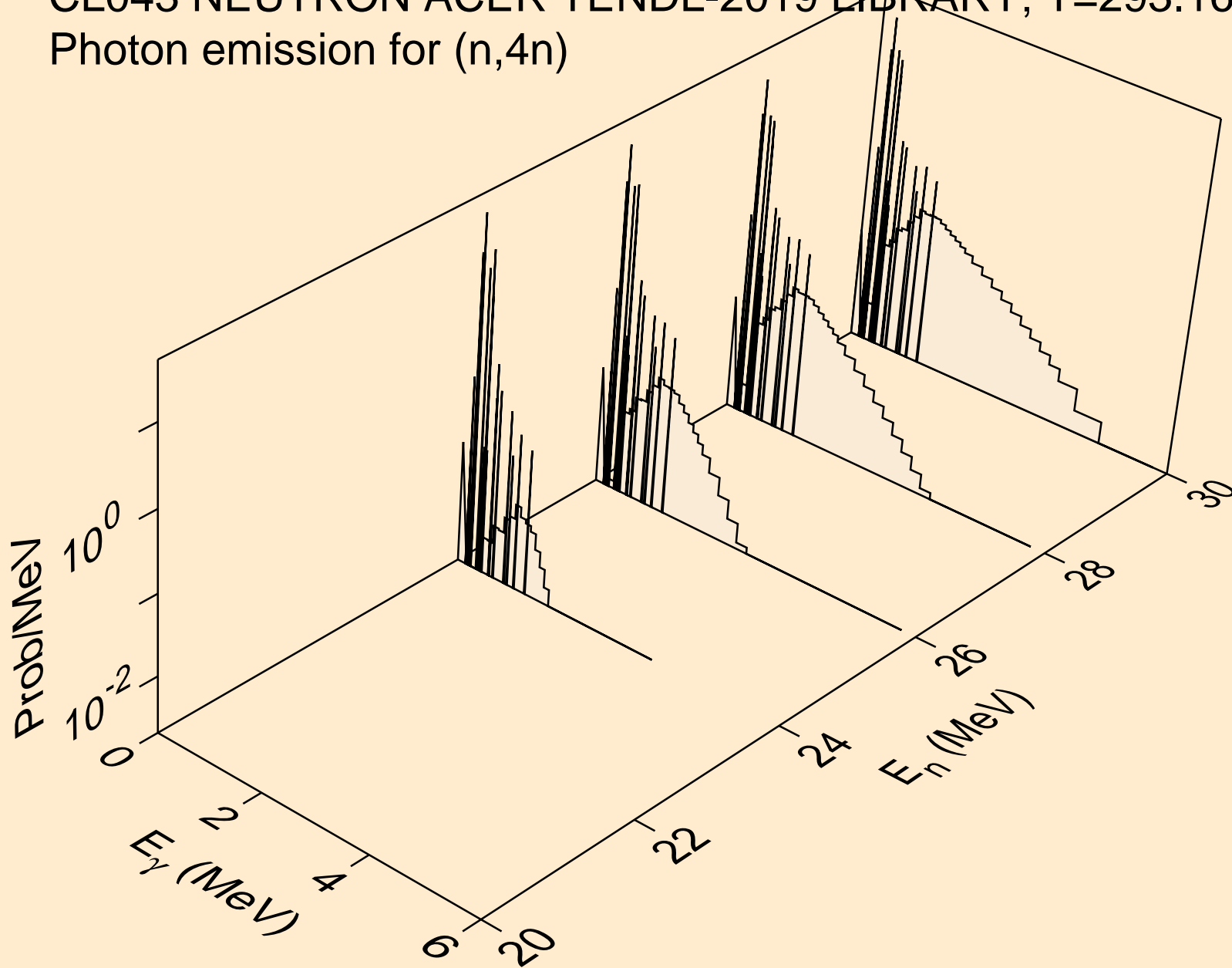

CL043 NEUTRON ACER TENDL-2019 LIBRARY; T=293.16K
Photon emission for (n,2np)

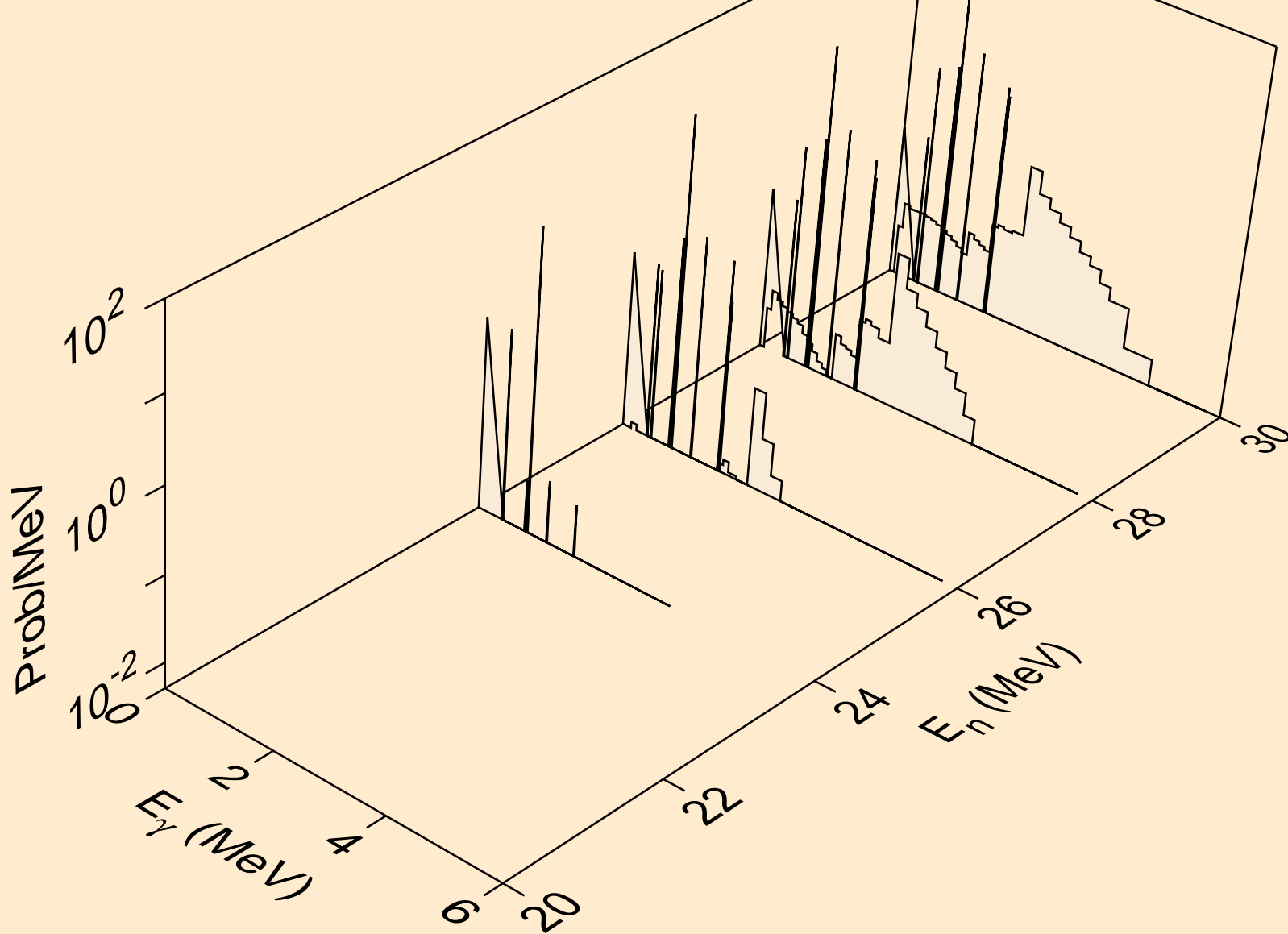

CL043 NEUTRON ACER TENDL-2019 LIBRARY; T=293.16K
Photon emission for (n,3np)

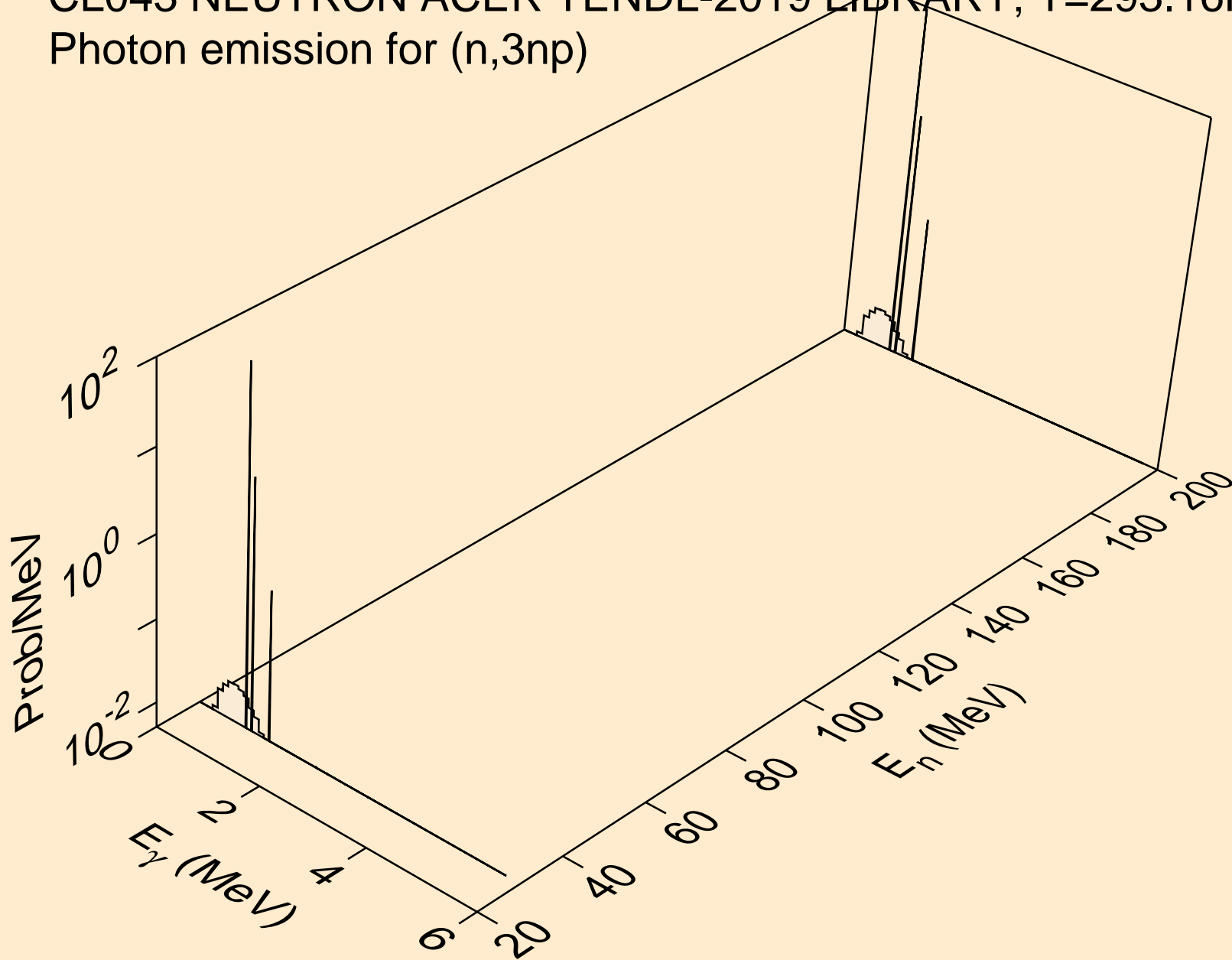

CL043 NEUTRON ACER TENDL-2019 LIBRARY; T=293.16K
Photon emission for (n,n*c)

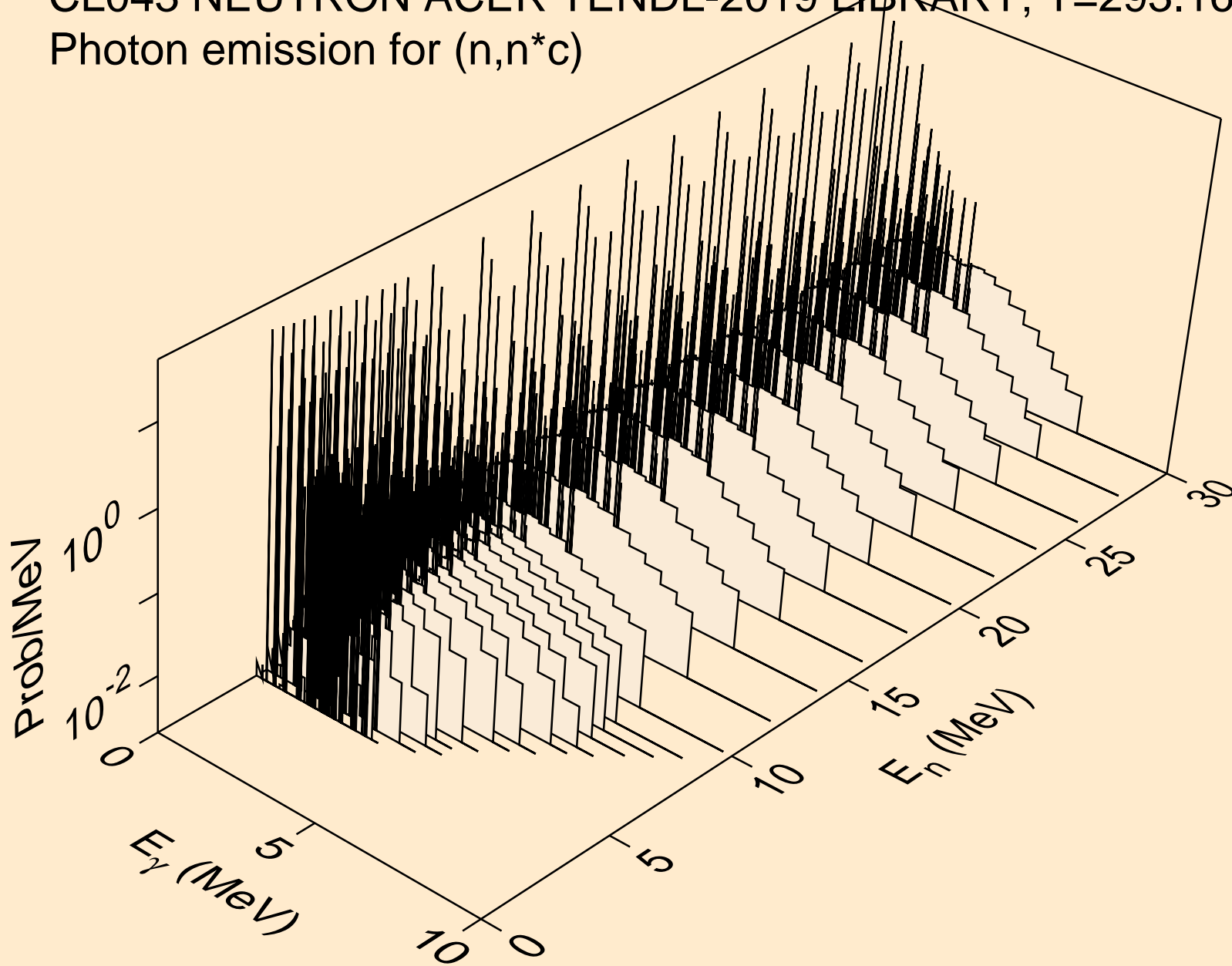

CL043 NEUTRON ACER TENDL-2019 LIBRARY; T=293.16K
Photon emission for (n,gma)

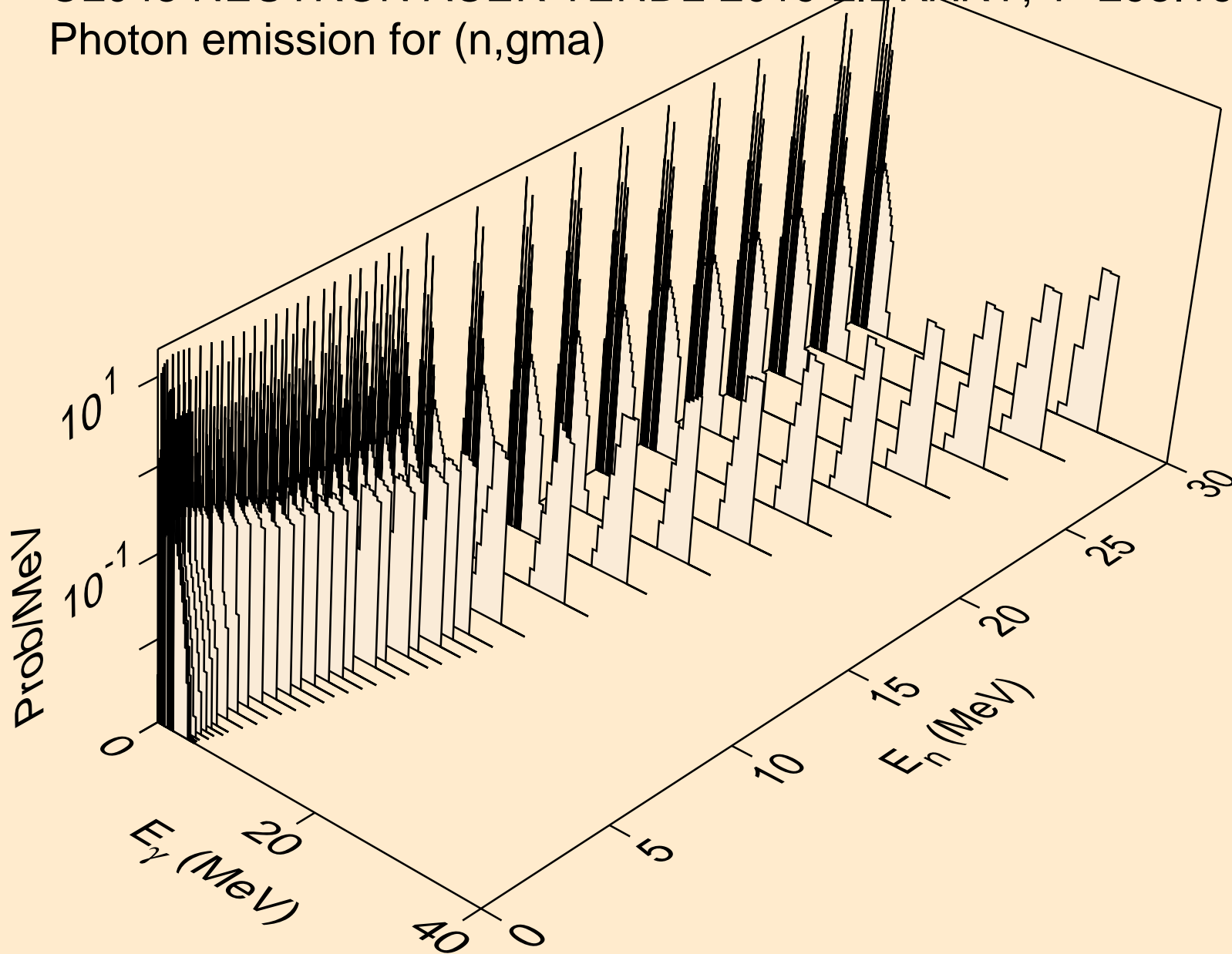

CL043 NEUTRON ACER TENDL-2019 LIBRARY; T=293.16K
Photon emission for (n,p)

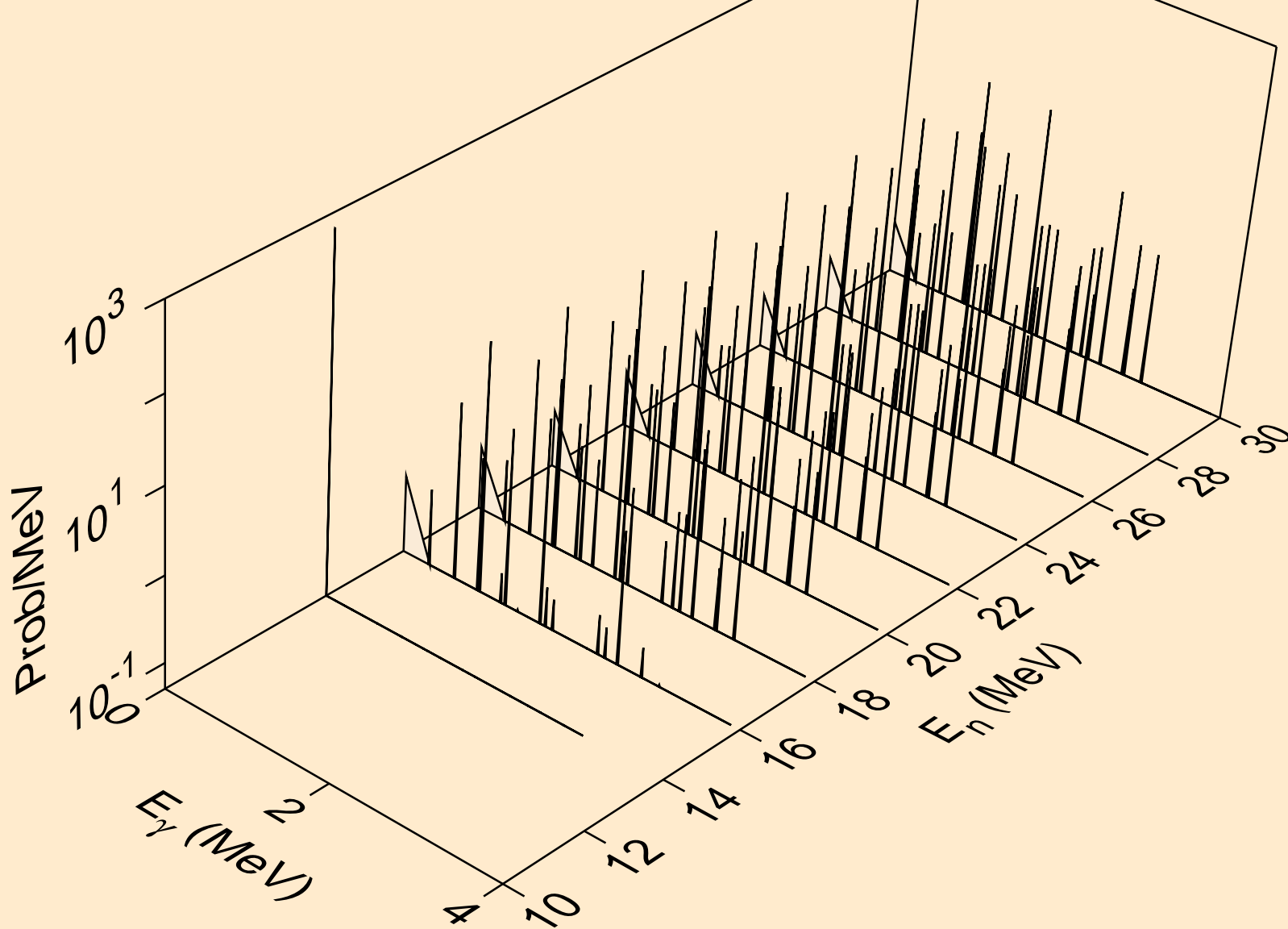

CL043 NEUTRON ACER TENDL-2019 LIBRARY; T=293.16K
Photon emission for (n,d)

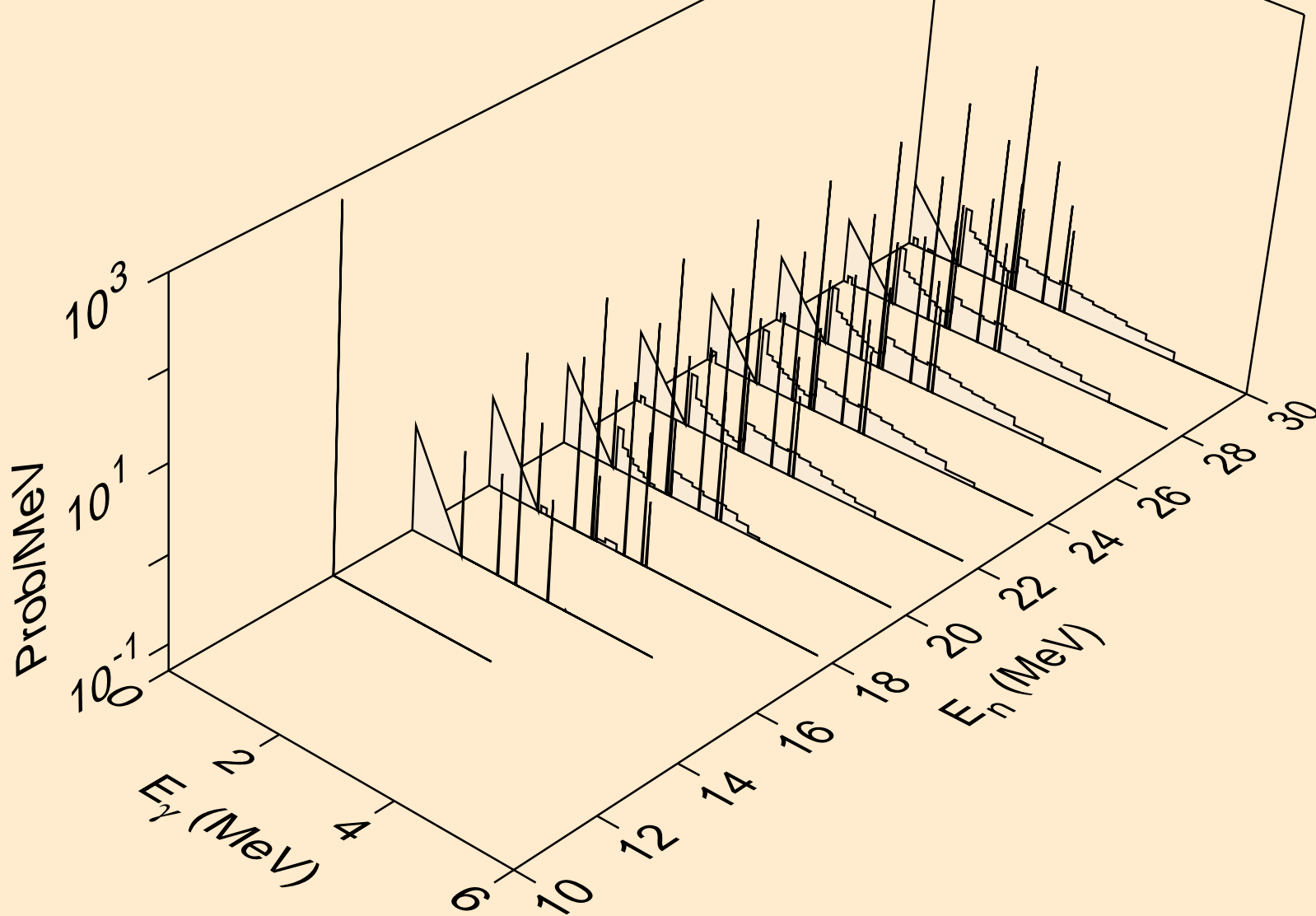

CL043 NEUTRON ACER TENDL-2019 LIBRARY; T=293.16K
Photon emission for (n,t)

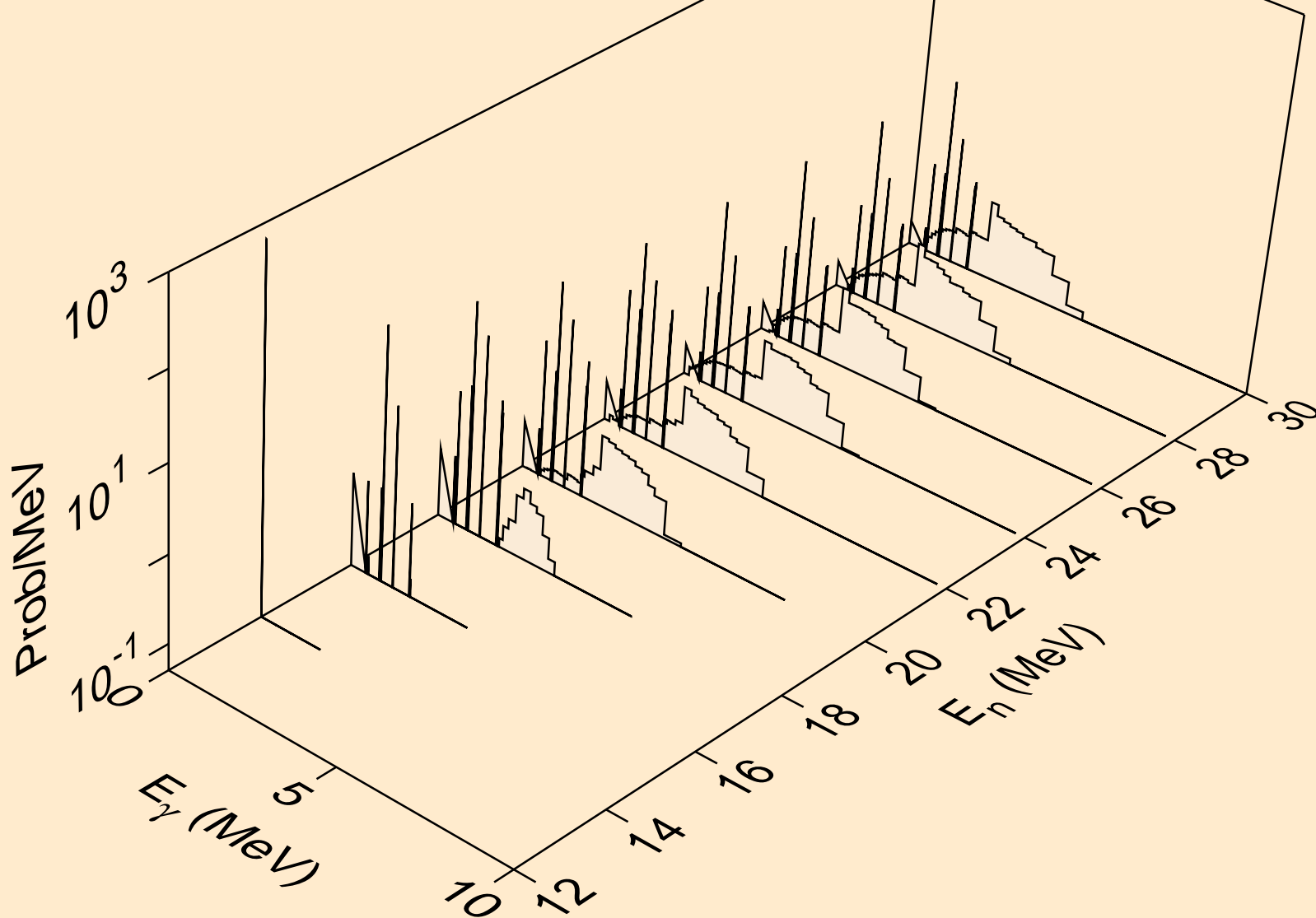

CL043 NEUTRON ACER TENDL-2019 LIBRARY; T=293.16K
Photon emission for (n,a)

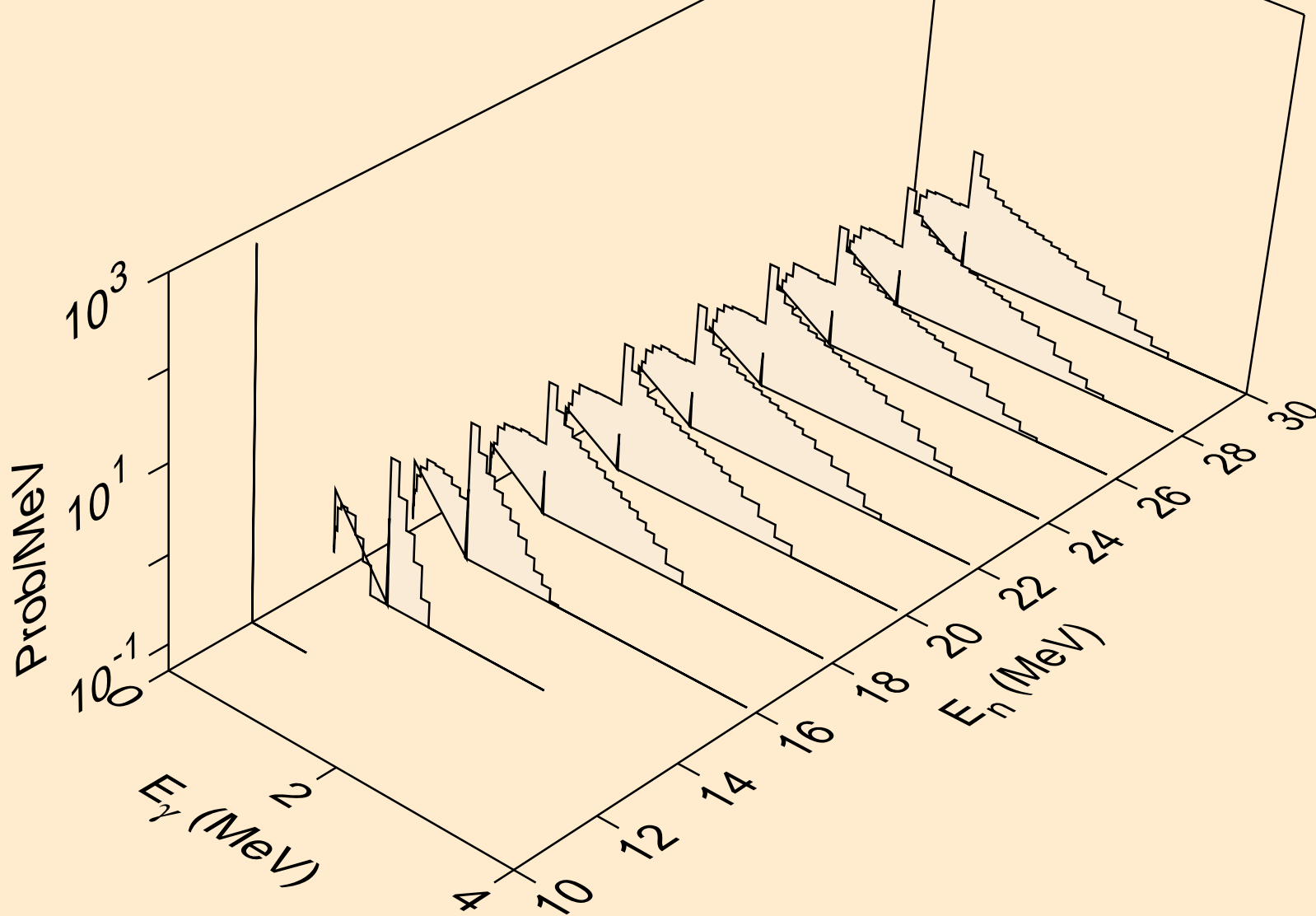

CL043 NEUTRON ACER TENDL-2019 LIBRARY; T=293.16K
thermal capture photon spectrum

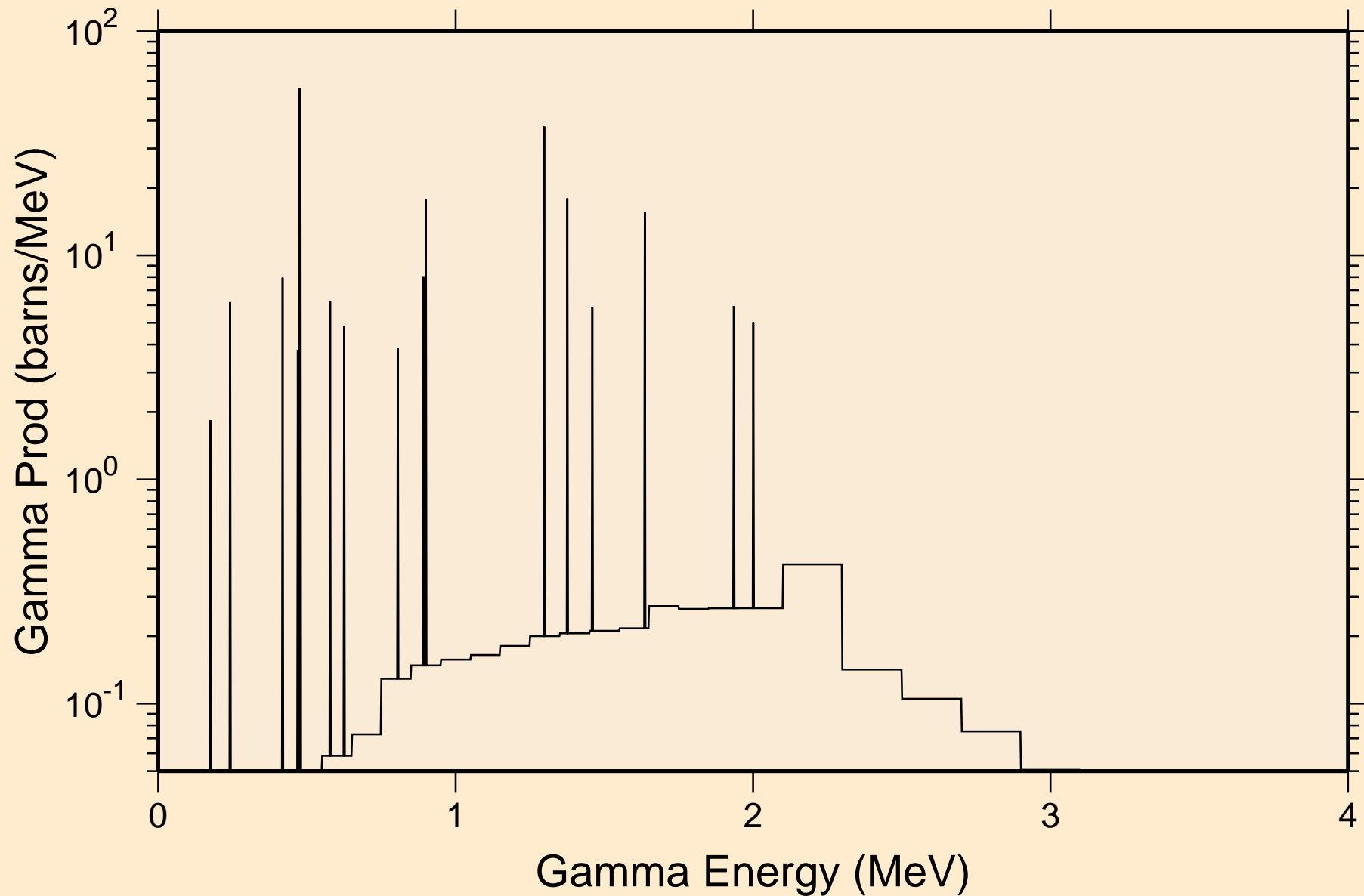

CL043 NEUTRON ACER TENDL-2019 LIBRARY; T=293.16K
14 MeV photon spectrum

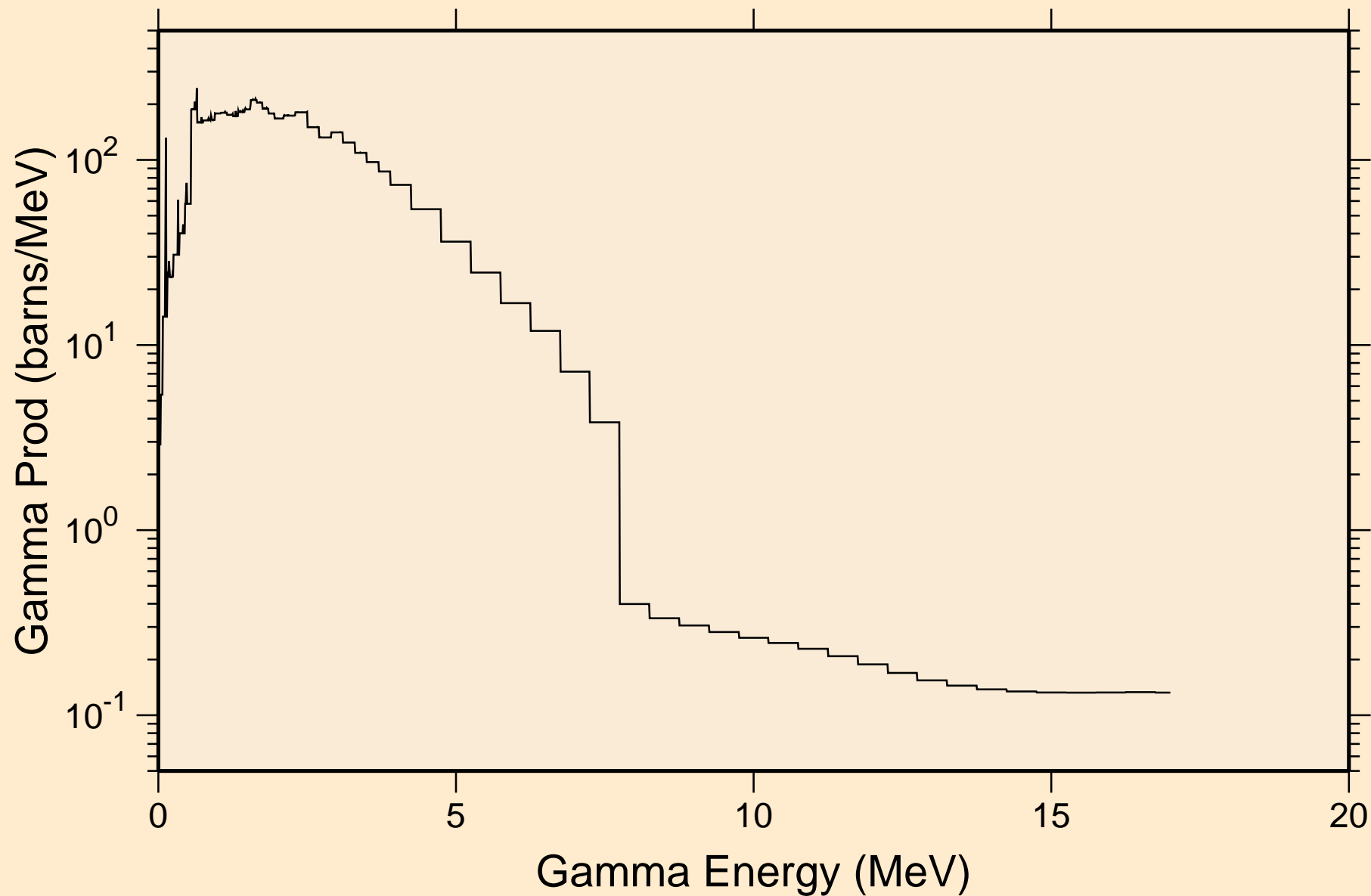

CL043 NEUTRON ACER TENDL-2019 LIBRARY; T=293.16K

Particle heating contributions

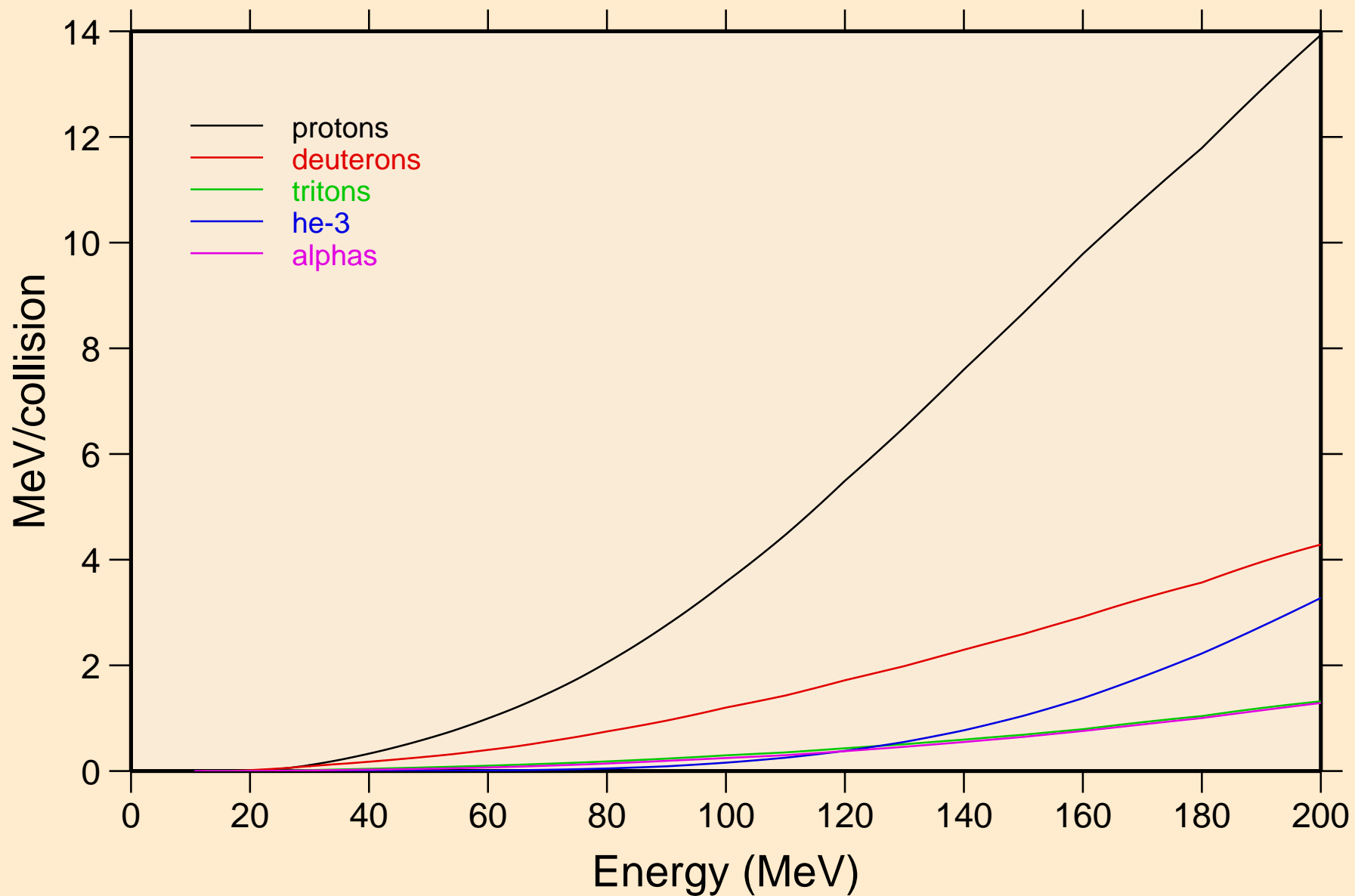

CL043 NEUTRON ACER TENDL-2019 LIBRARY; T=293.16K
Recoil Heating

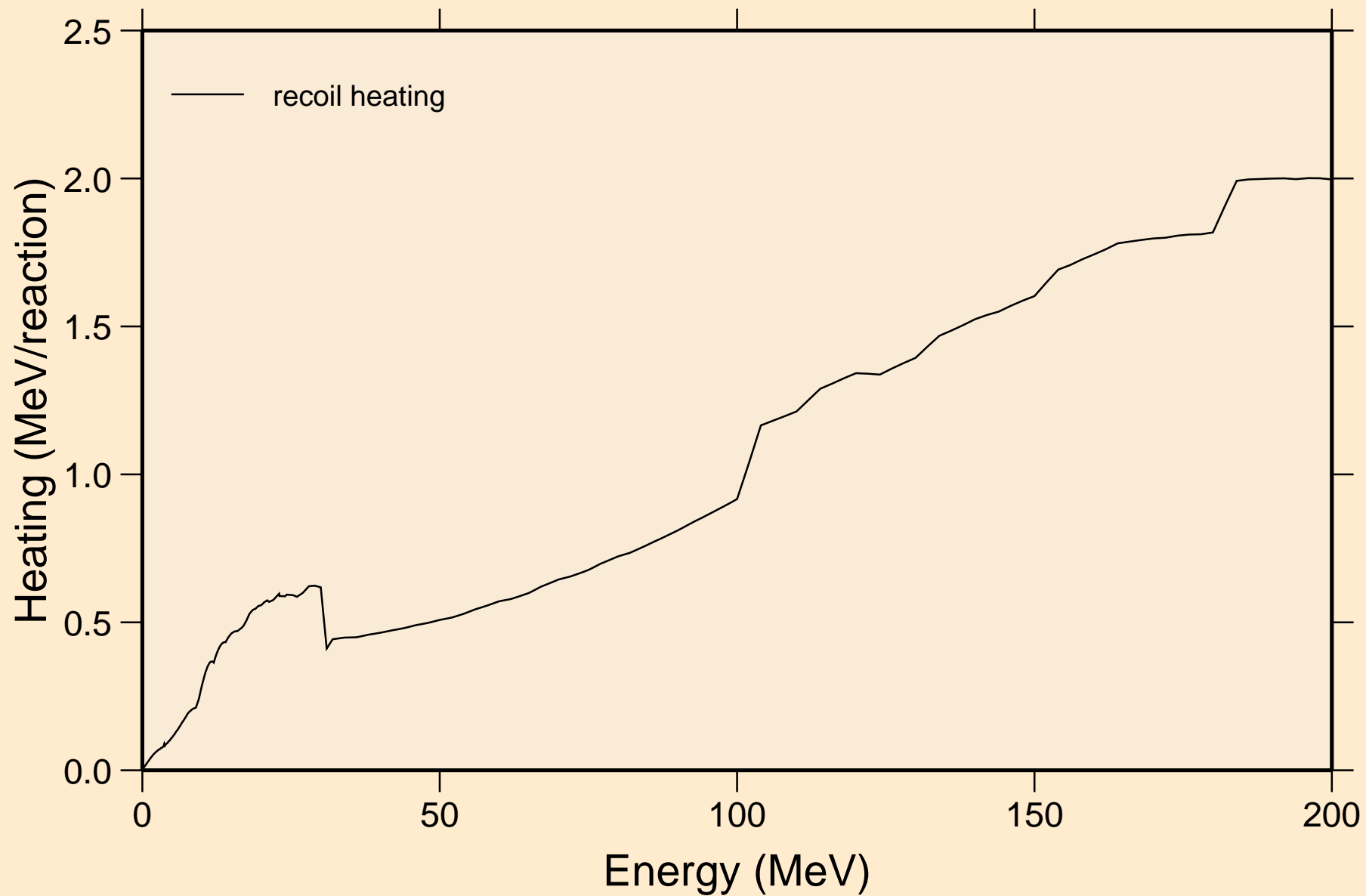

CL043 NEUTRON ACER TENDL-2019 LIBRARY; T=293.16K

Particle production cross sections

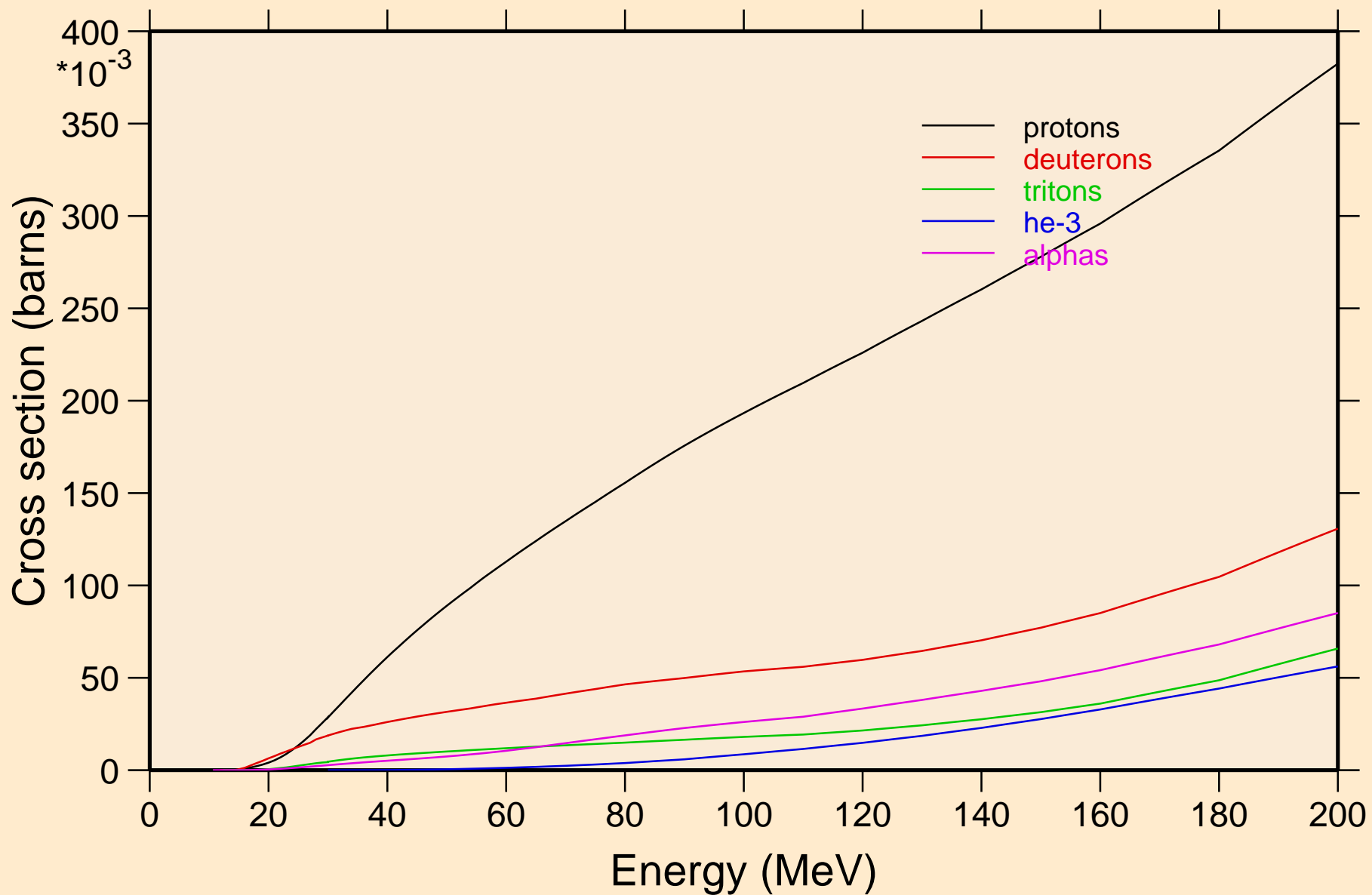

CL043 NEUTRON ACER TENDL-2019 LIBRARY; T=293.16K
protons from (n,x)

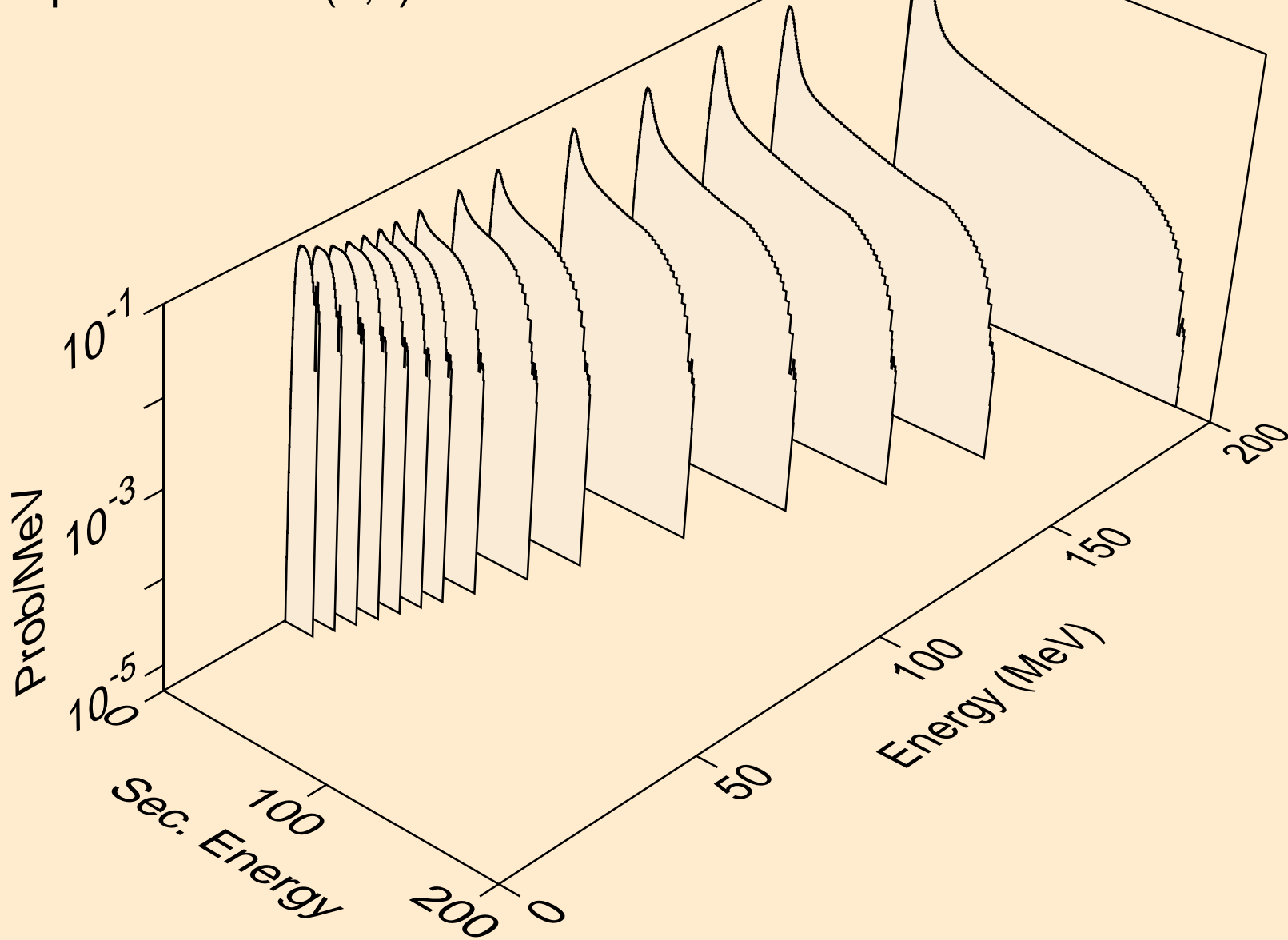

CL043 NEUTRON ACER TENDL-2019 LIBRARY; T=293.16K
protons from (n,n*)p

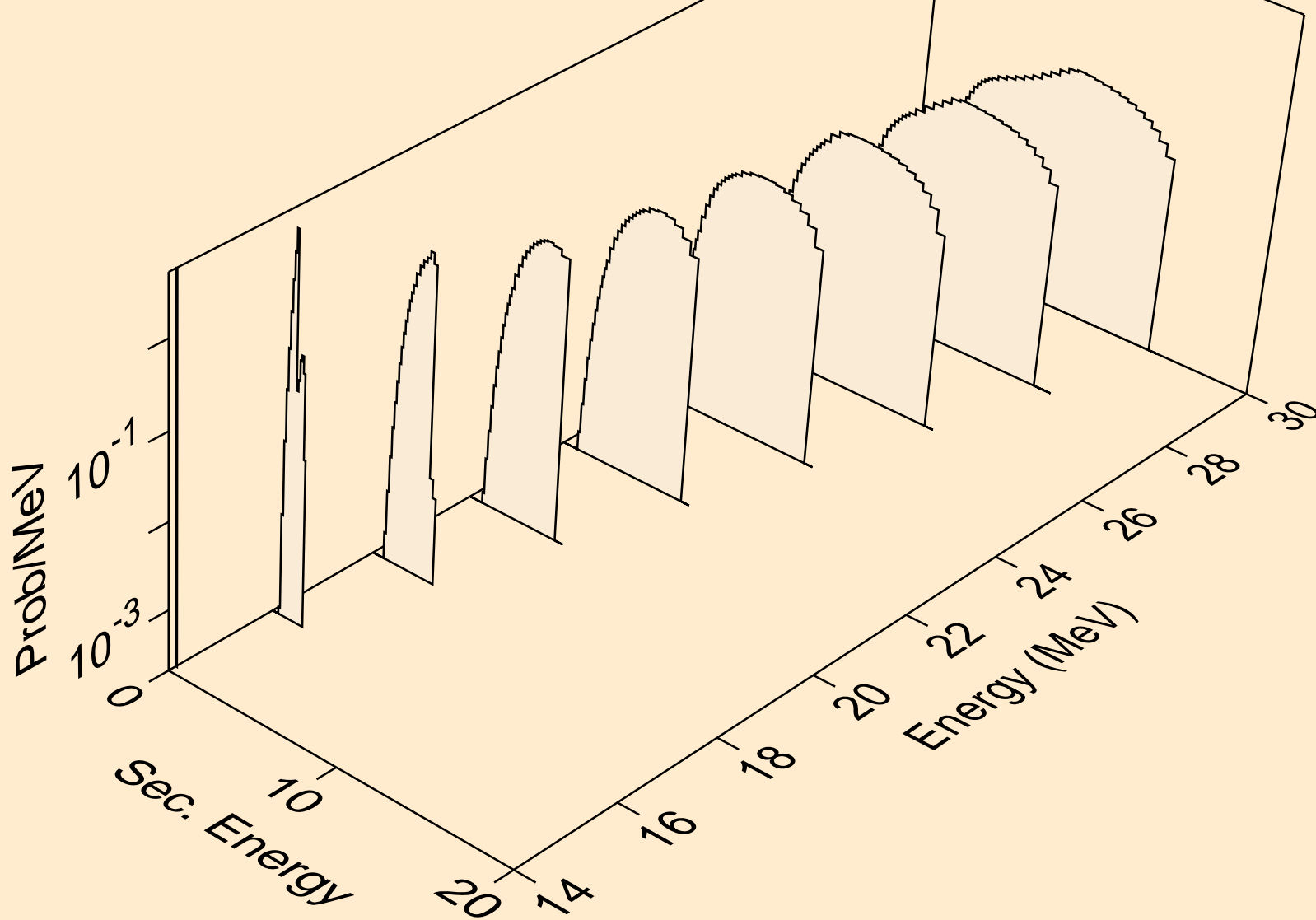

CL043 NEUTRON ACER TENDL-2019 LIBRARY; T=293.16K
protons from (n,2np)

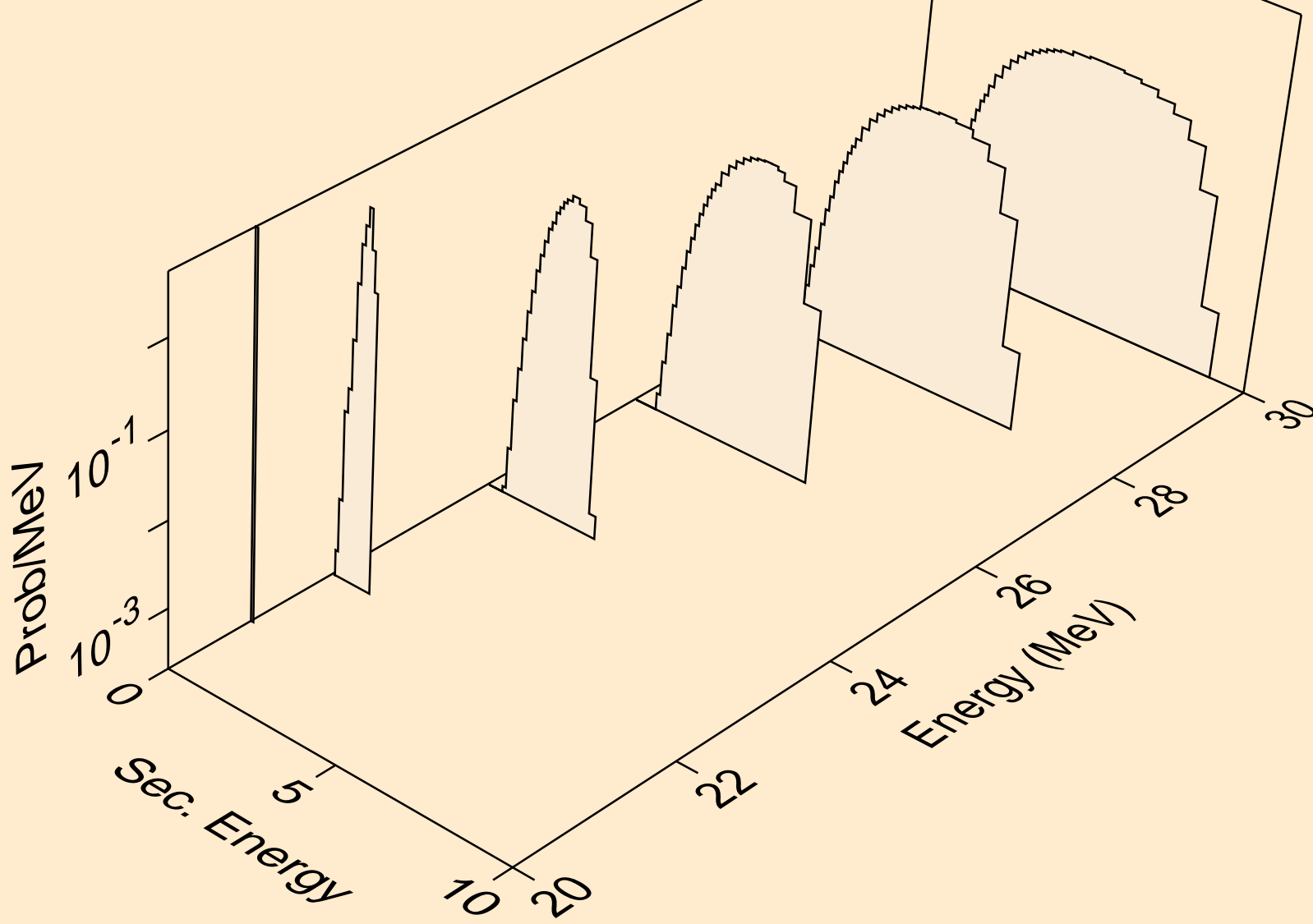

CL043 NEUTRON ACER TENDL-2019 LIBRARY; T=293.16K
protons from (n,3np)

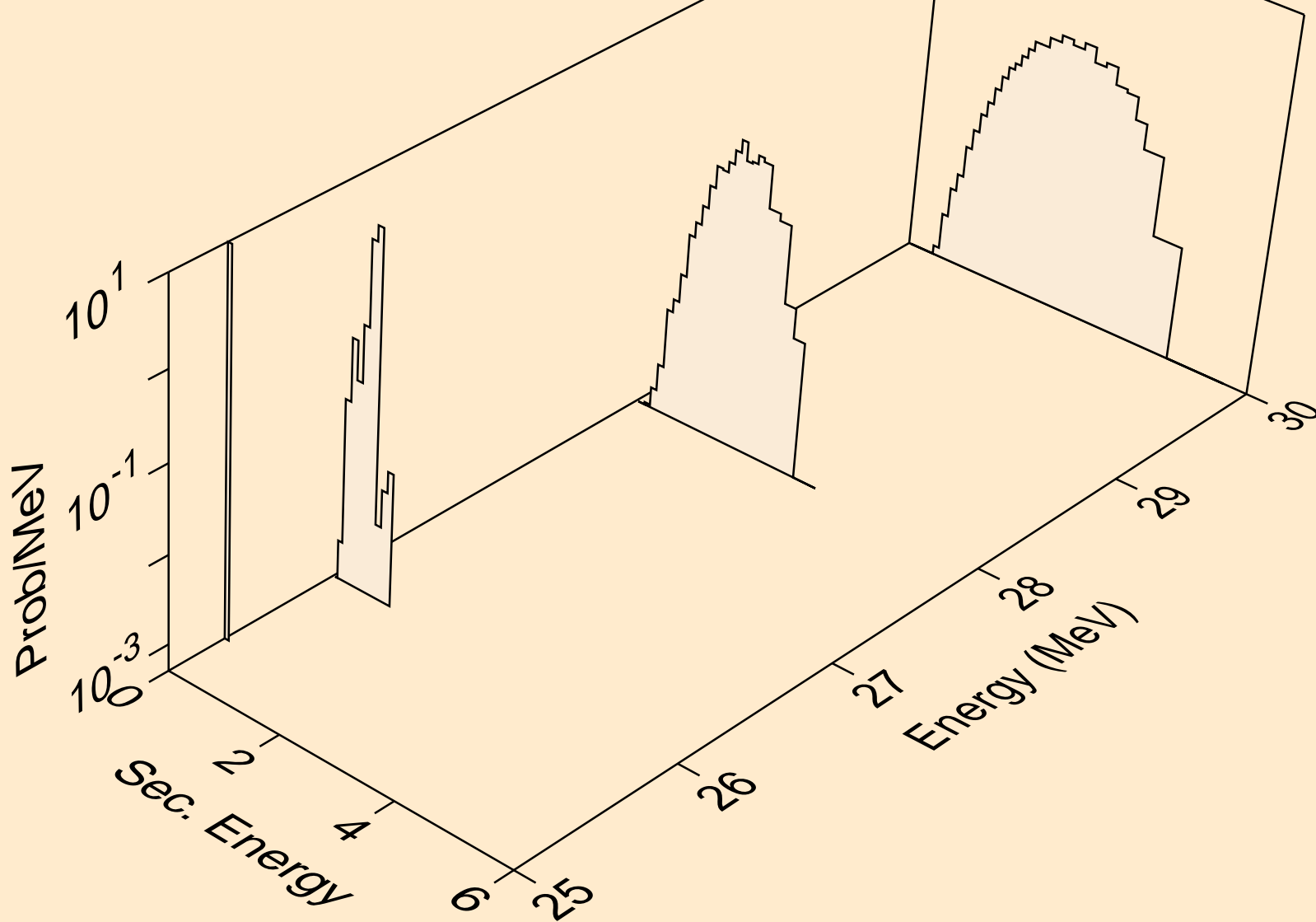

CL043 NEUTRON ACER TENDL-2019 LIBRARY; T=293.16K
protons from (n,p)

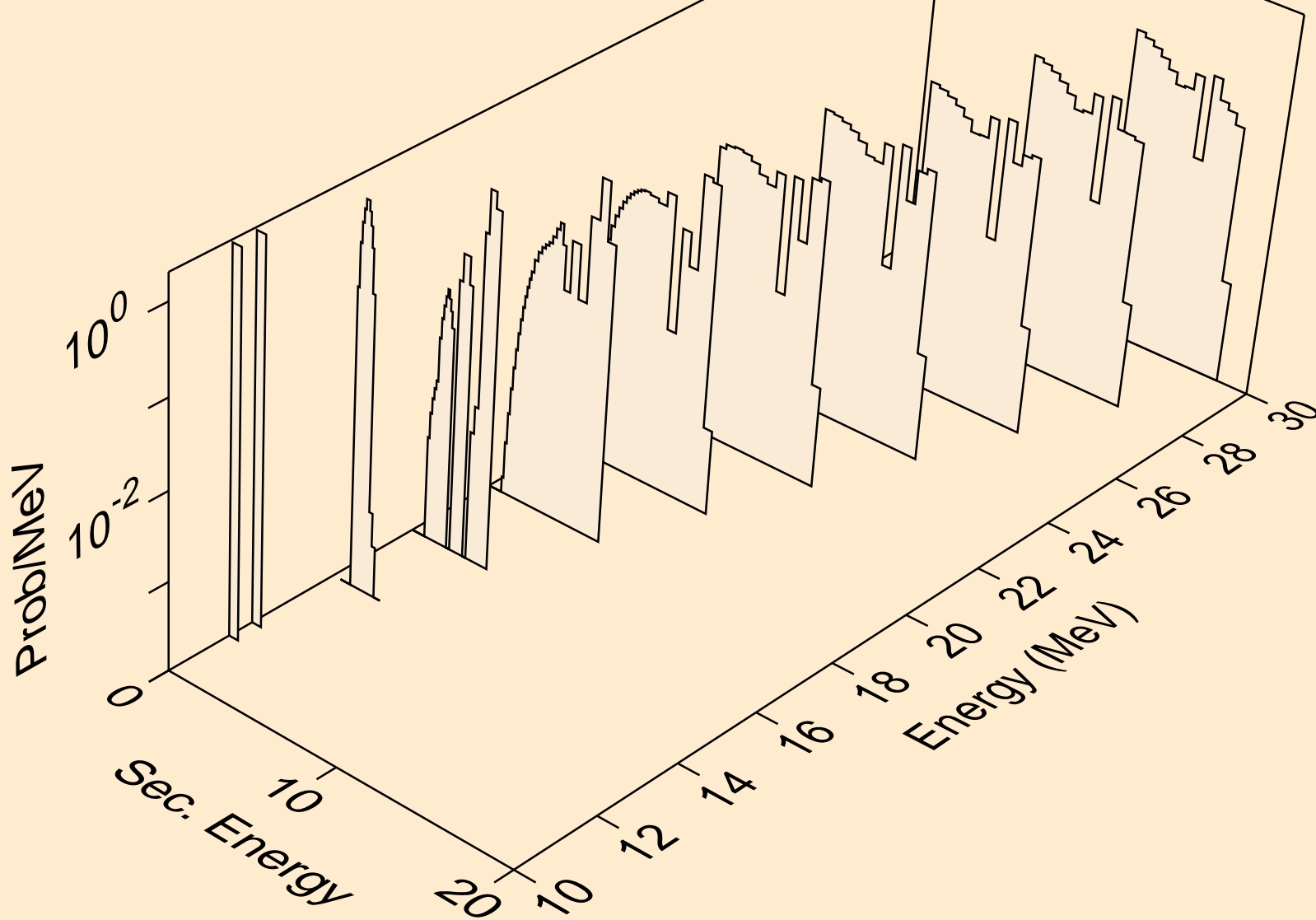

CL043 NEUTRON ACER TENDL-2019 LIBRARY; T=293.16K
deuterons from (n,x)

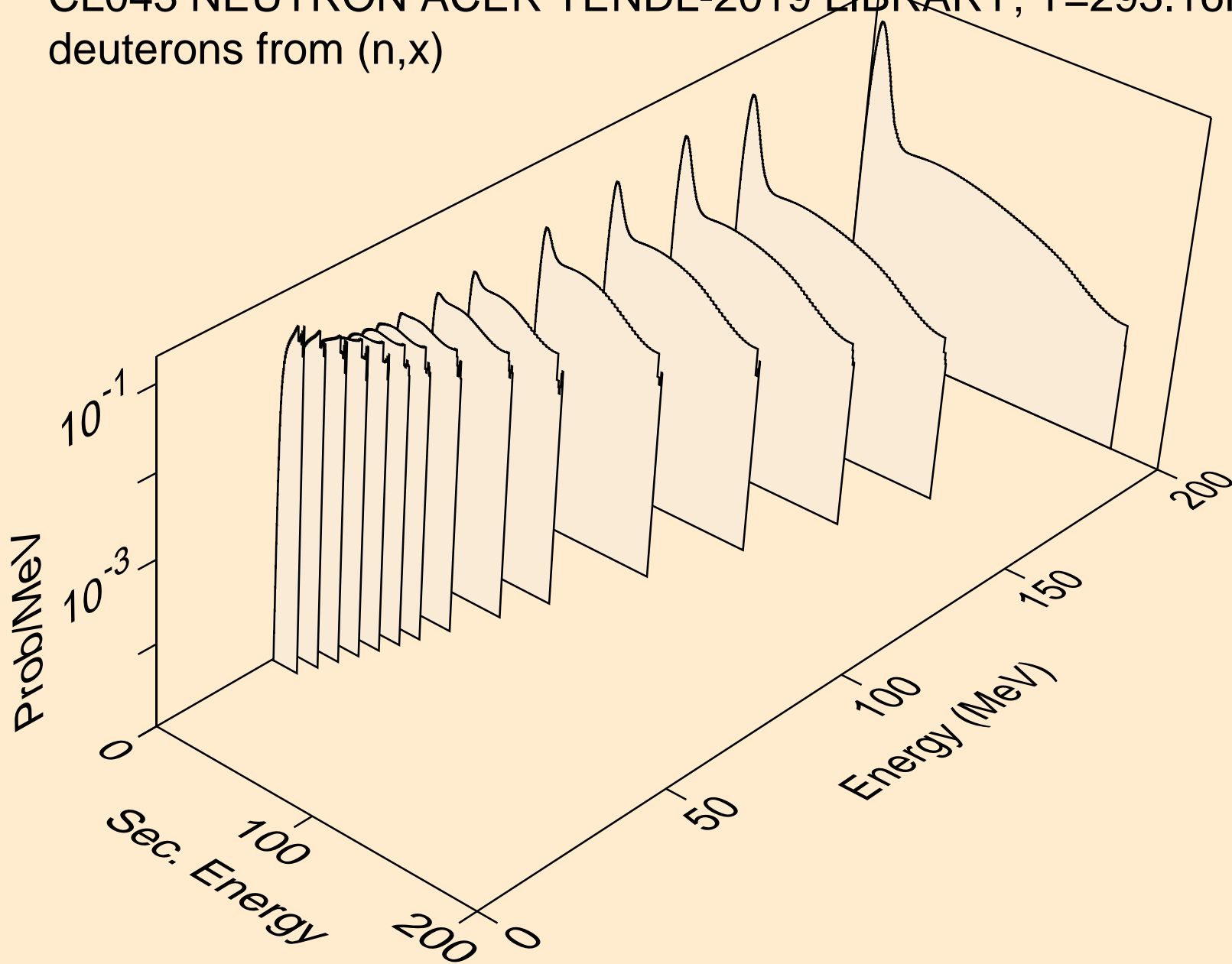

CL043 NEUTRON ACER TENDL-2019 LIBRARY; T=293.16K
deuterons from (n,2nd)

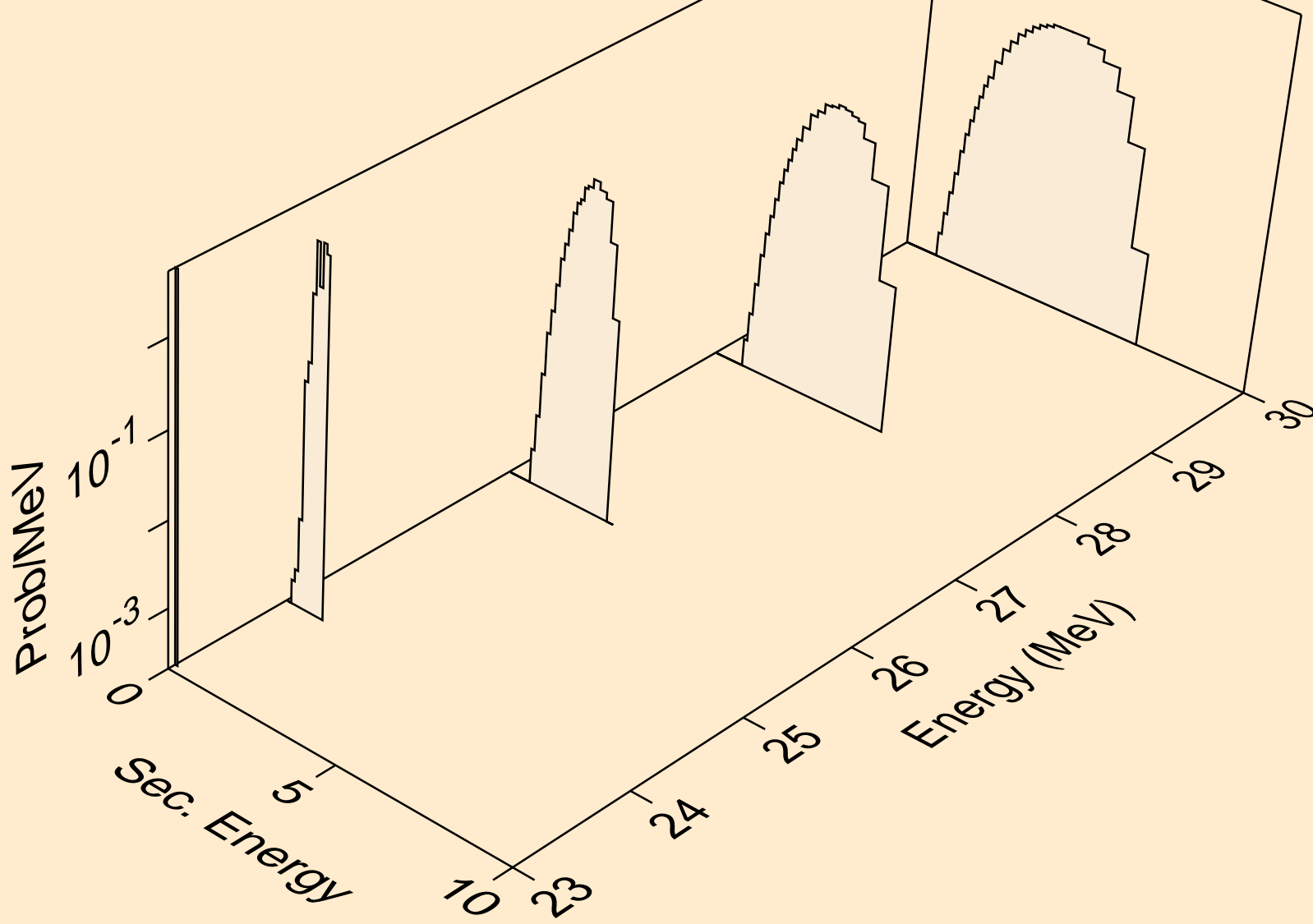

CL043 NEUTRON ACER TENDL-2019 LIBRARY; T=293.16K
deuterons from (n,n*)d

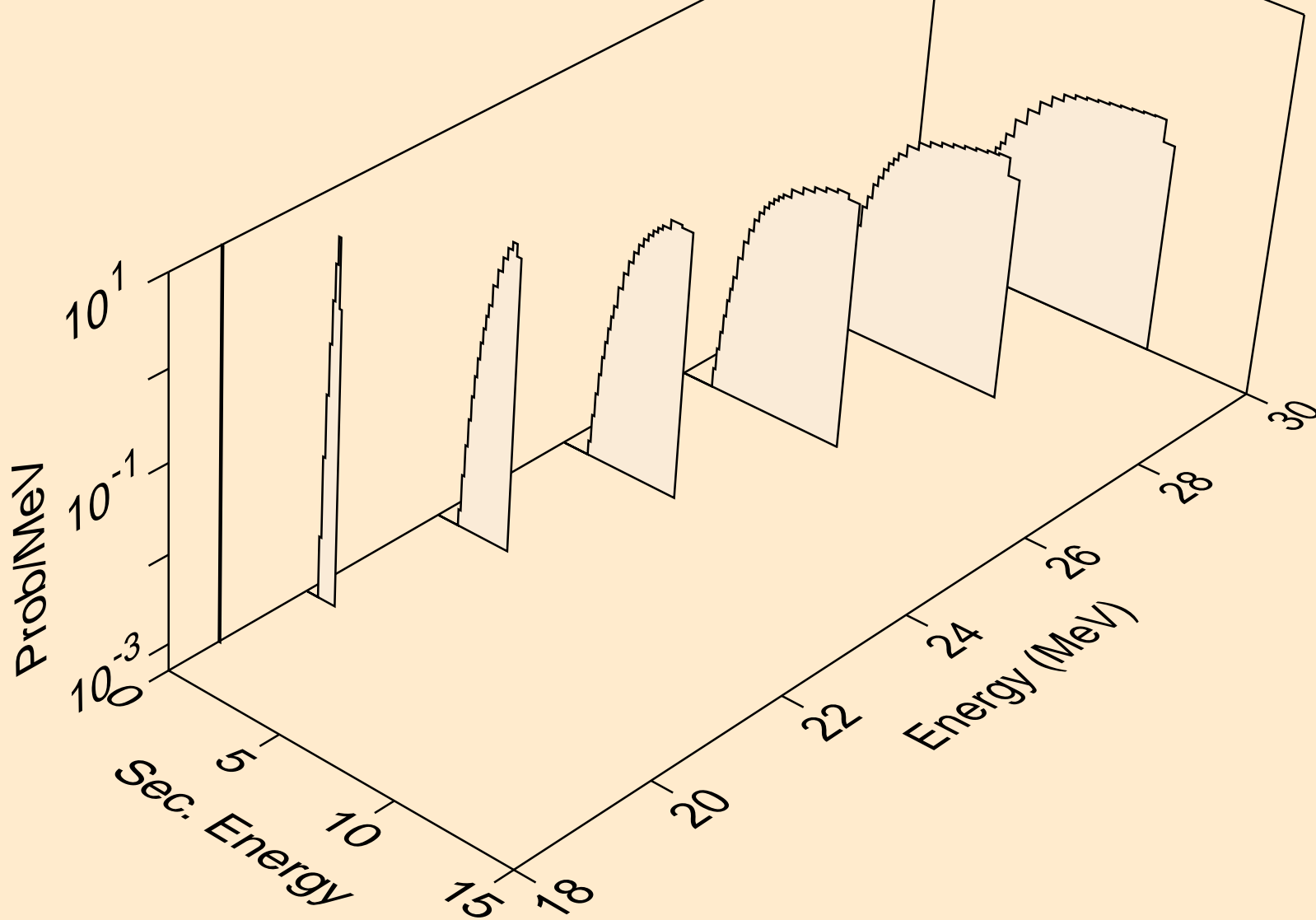

CL043 NEUTRON ACER TENDL-2019 LIBRARY; T=293.16K
deuterons from (n,d)

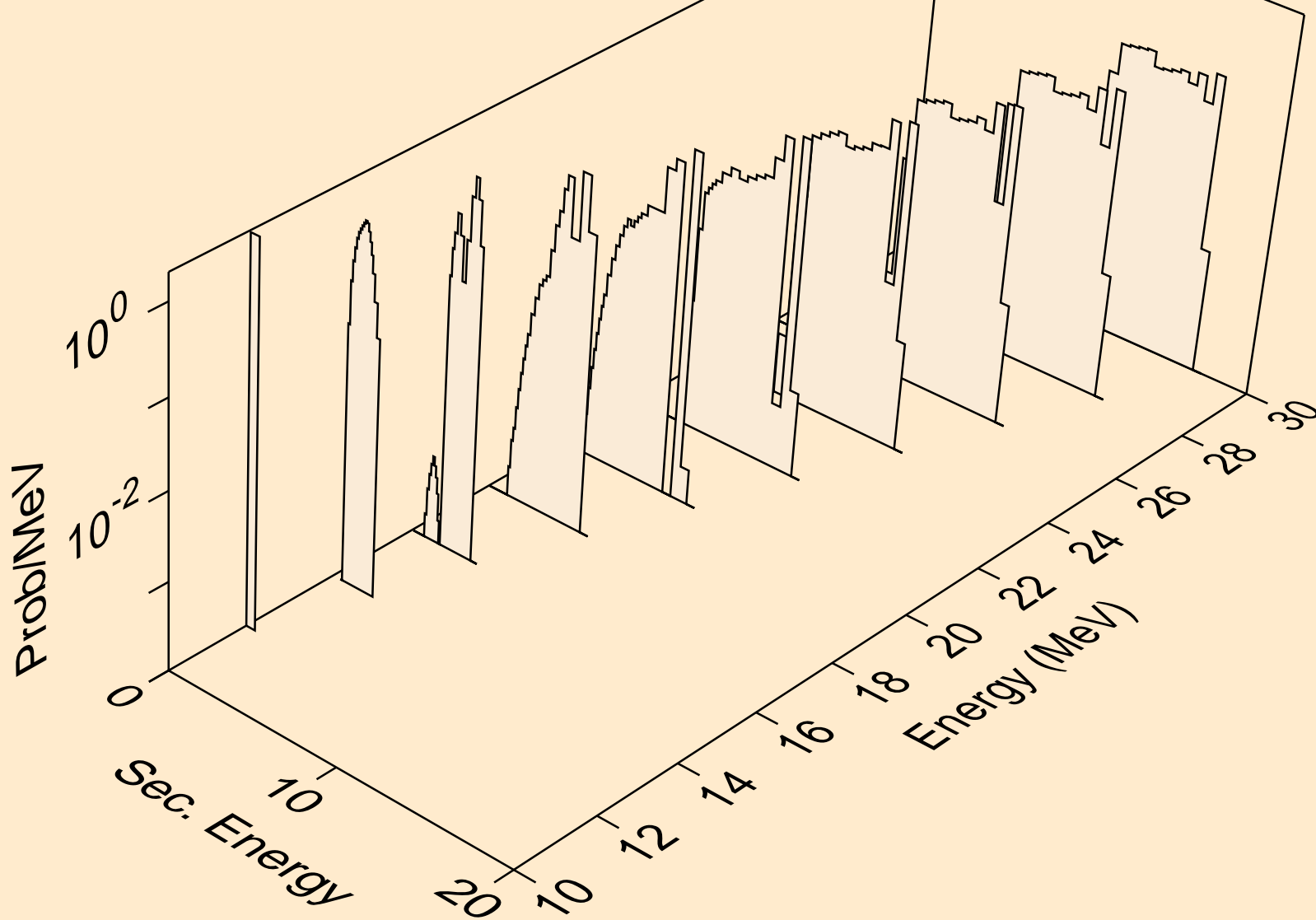

CL043 NEUTRON ACER TENDL-2019 LIBRARY; T=293.16K
tritons from (n,x)

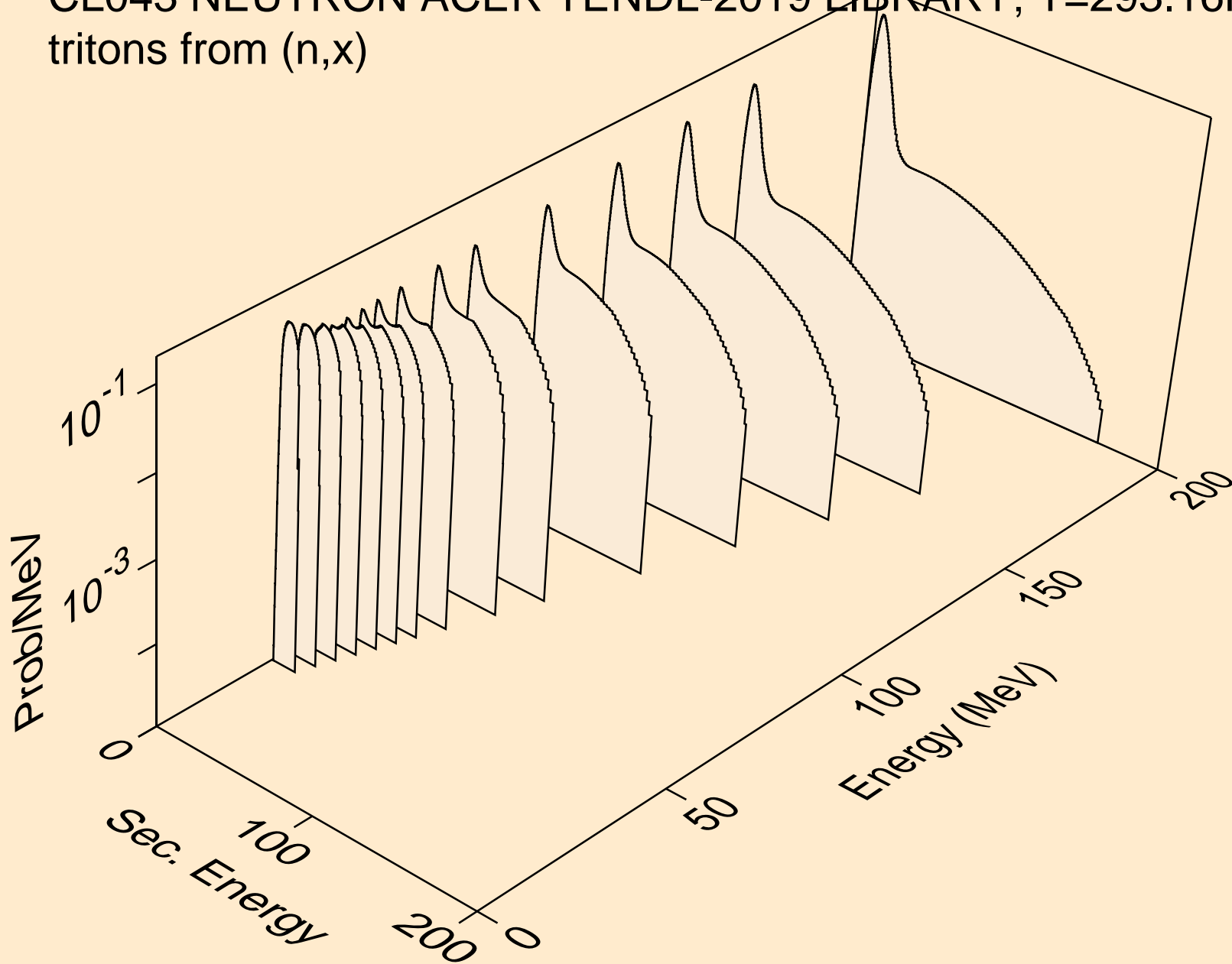

CL043 NEUTRON ACER TENDL-2019 LIBRARY; T=293.16K
tritons from (n,n*)t

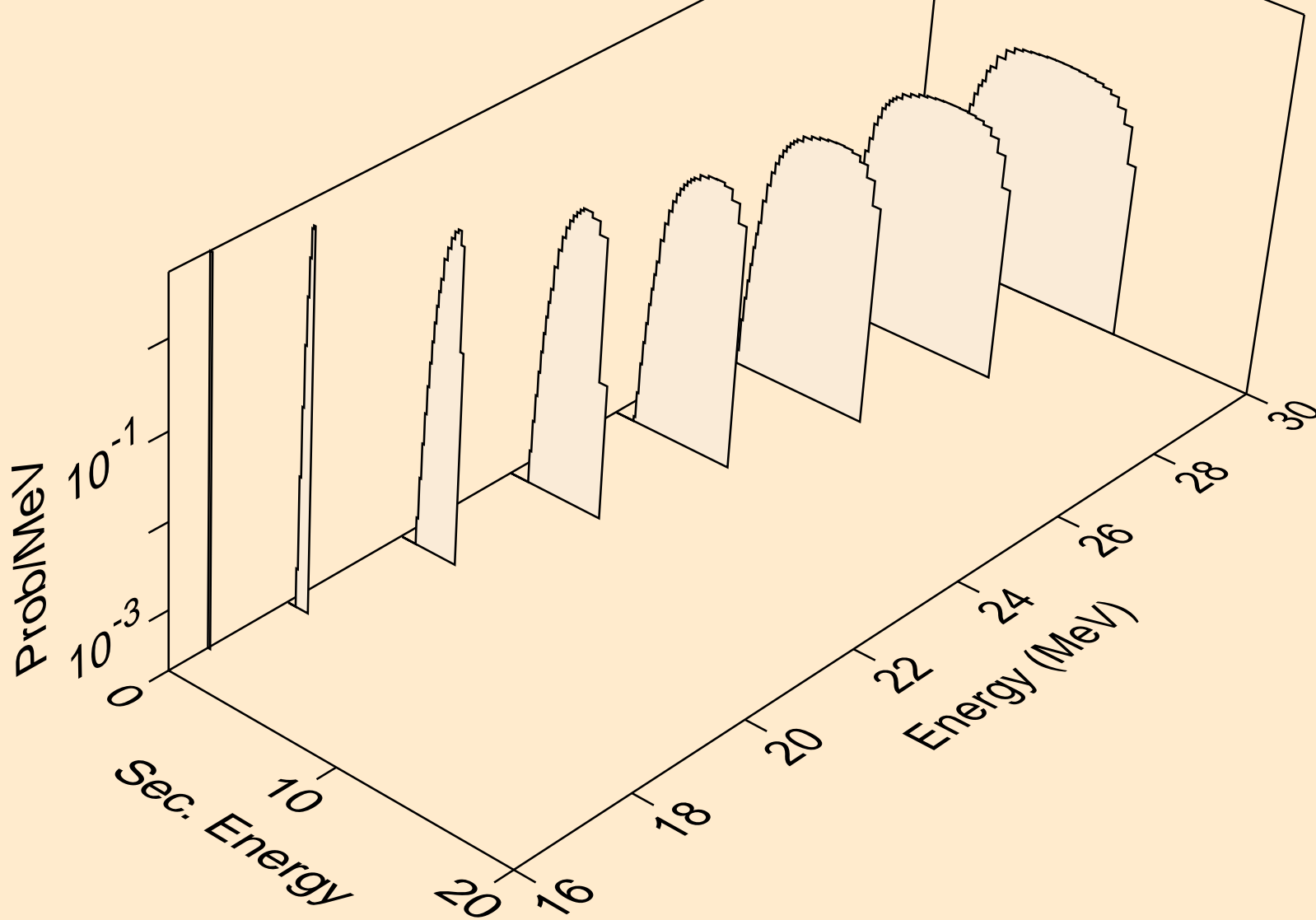

CL043 NEUTRON ACER TENDL-2019 LIBRARY; T=293.16K
tritons from (n,t)

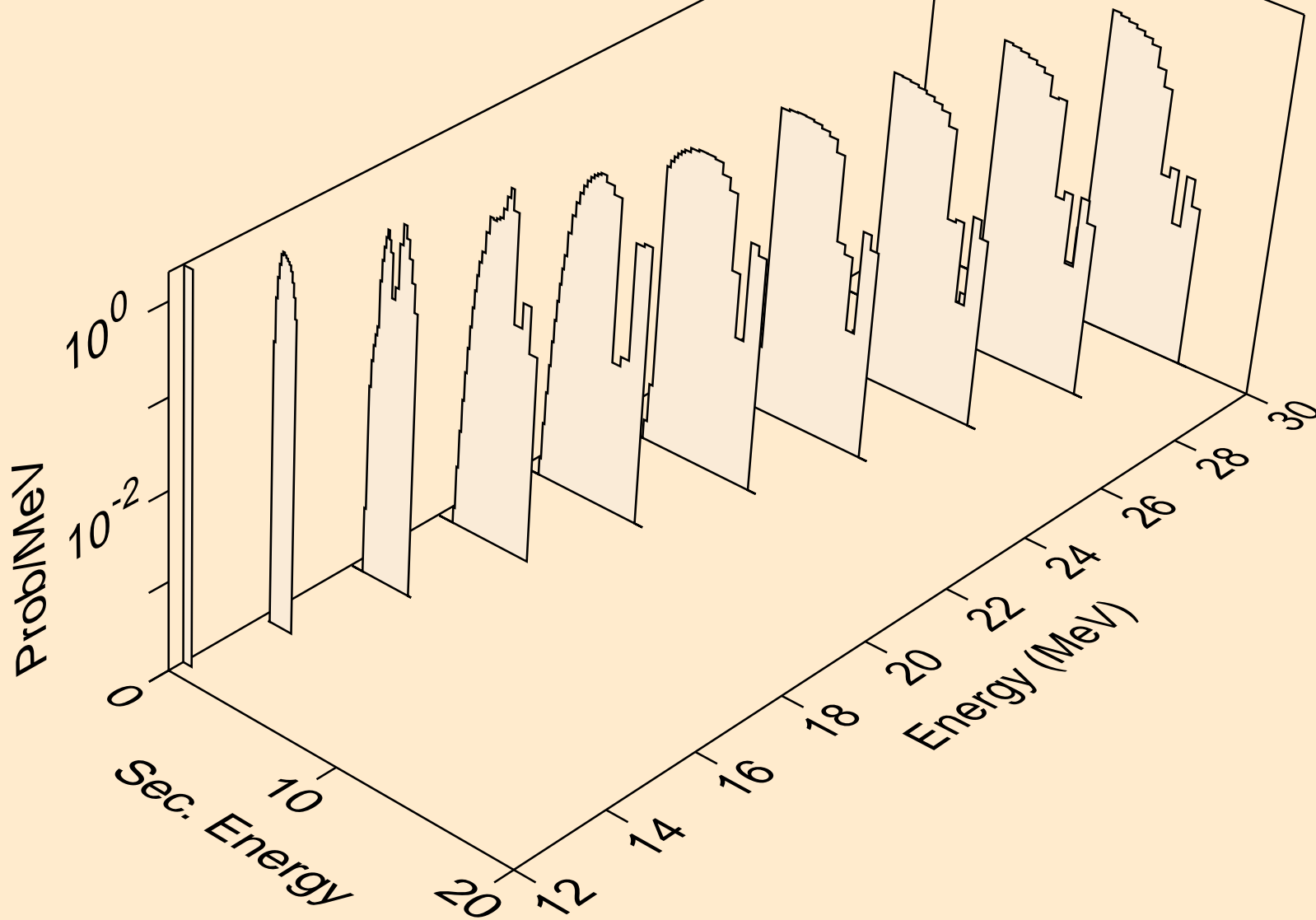

CL043 NEUTRON ACER TENDL-2019 LIBRARY; T=293.16K
he3s from (n,x)

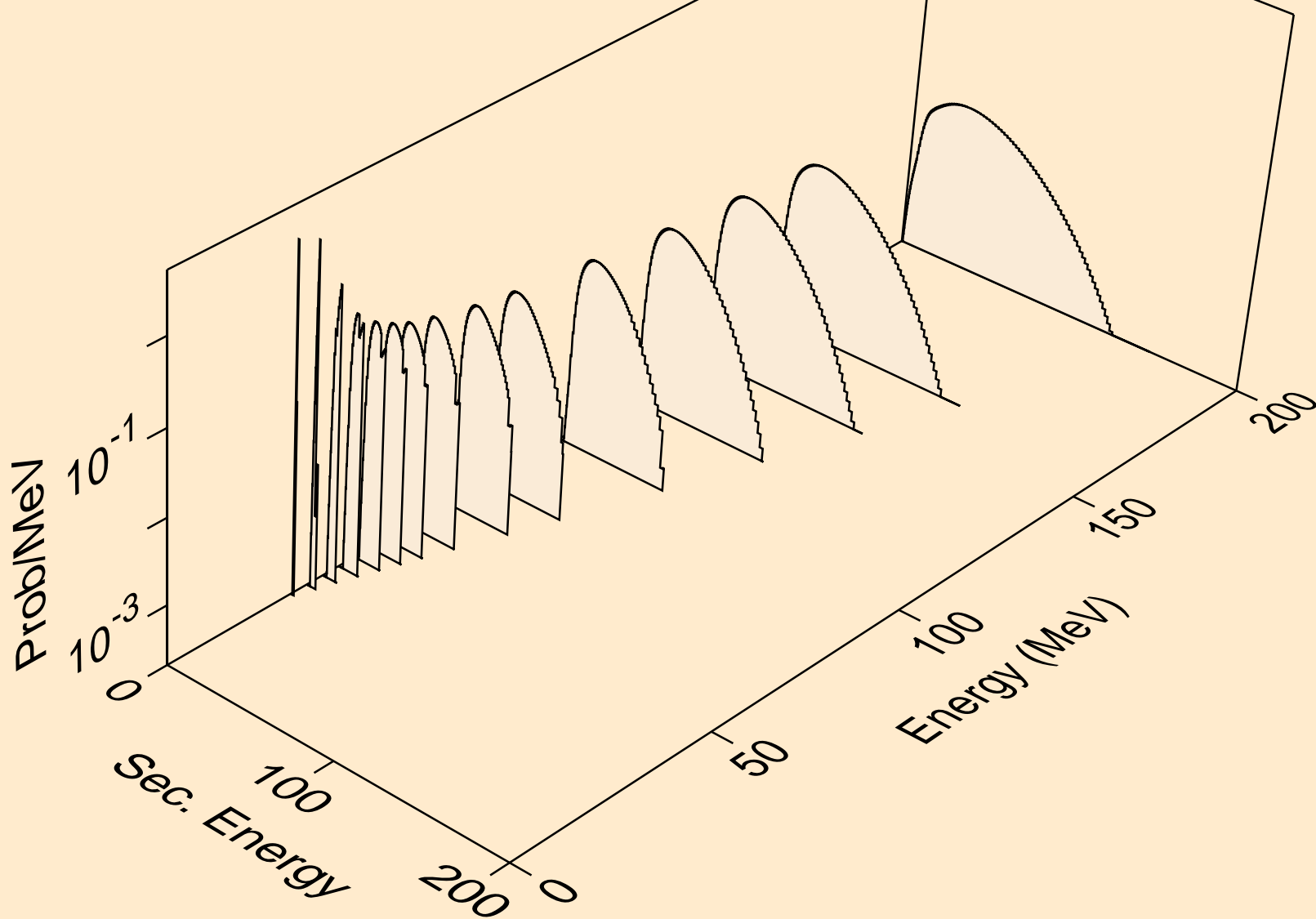

CL043 NEUTRON ACER TENDL-2019 LIBRARY; T=293.16K
alphas from (n,x)

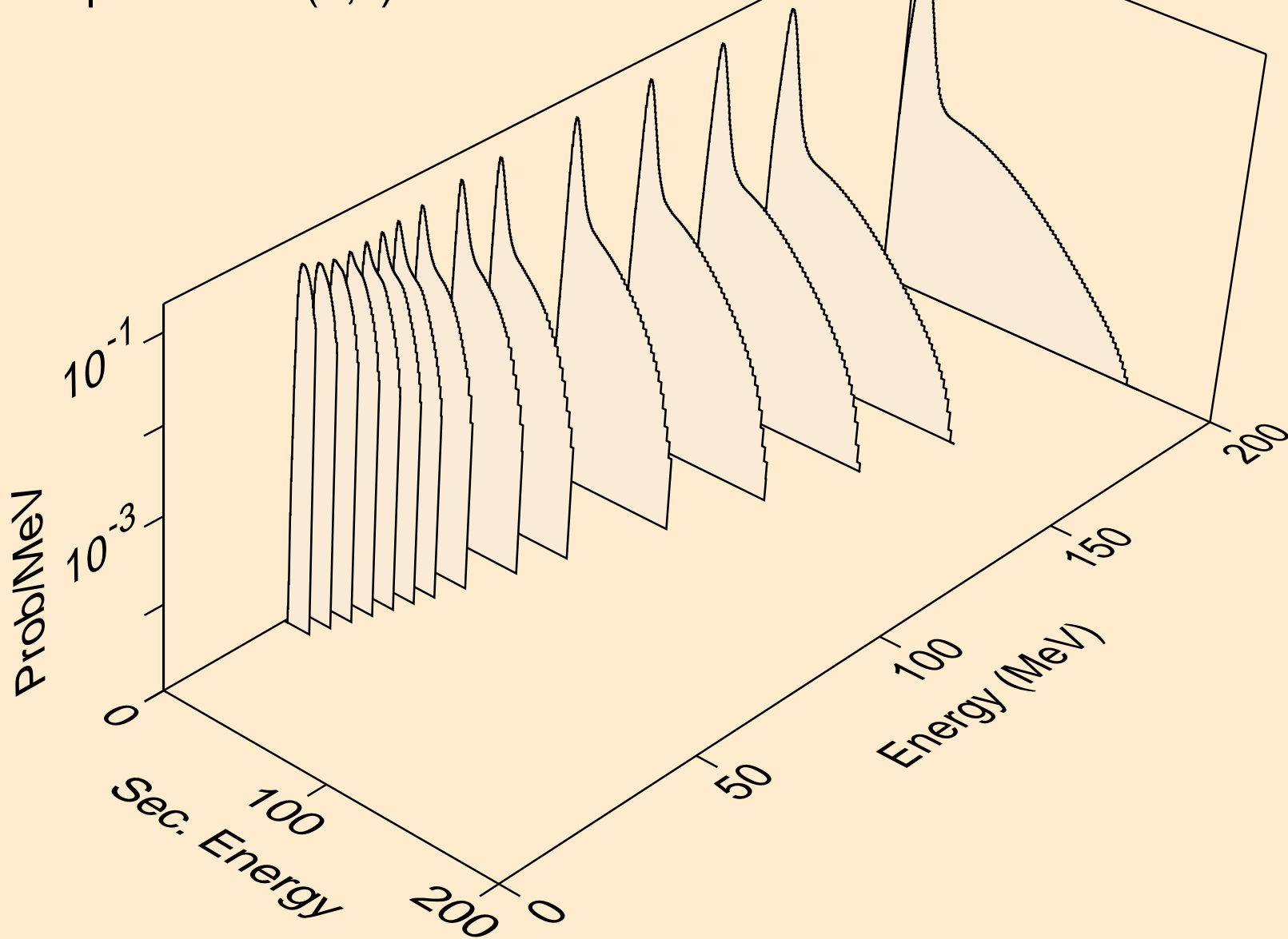

CL043 NEUTRON ACER TENDL-2019 LIBRARY; T=293.16K
alphas from (n,n*)a

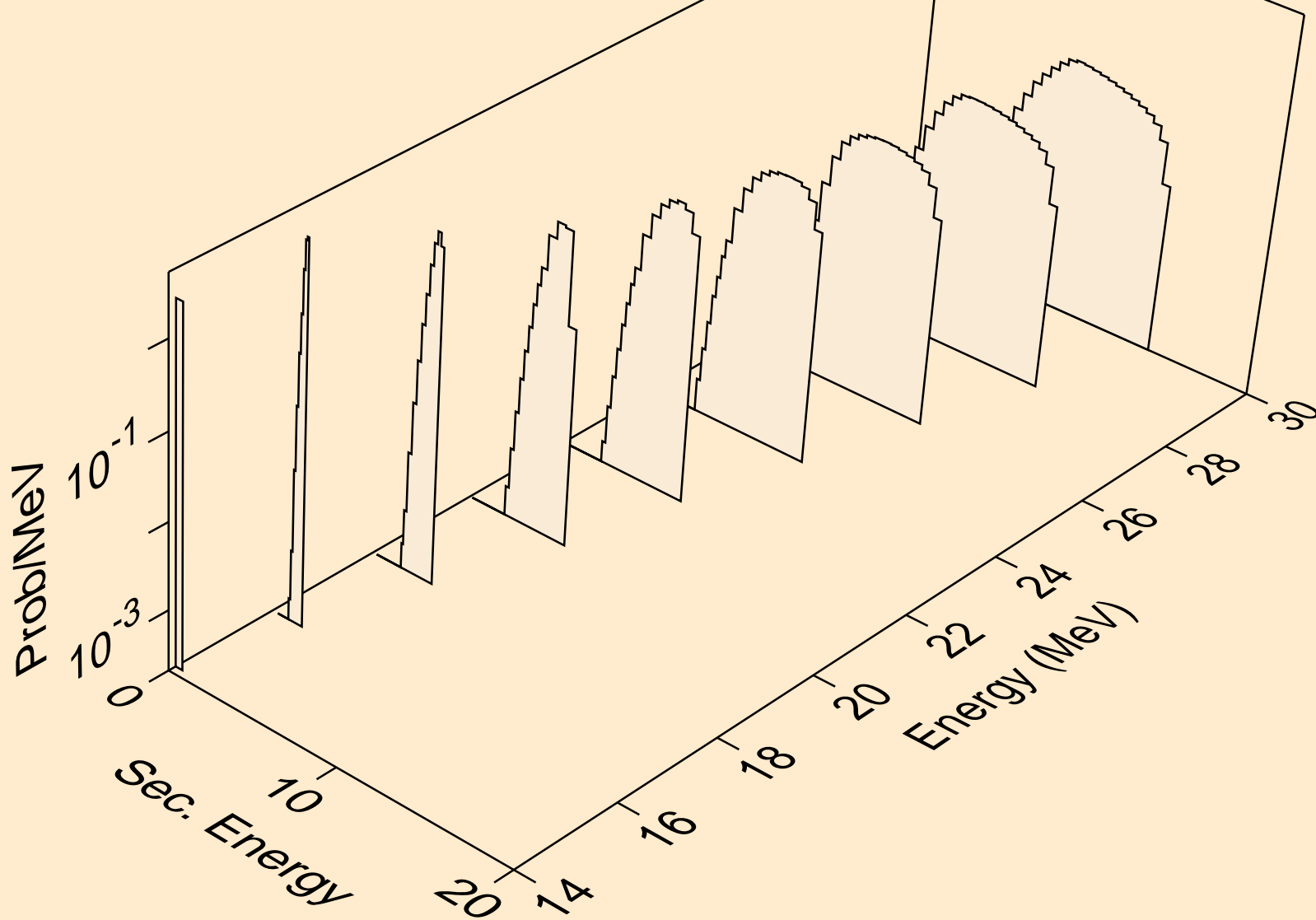

CL043 NEUTRON ACER TENDL-2019 LIBRARY; T=293.16K
alphas from (n,2n)a

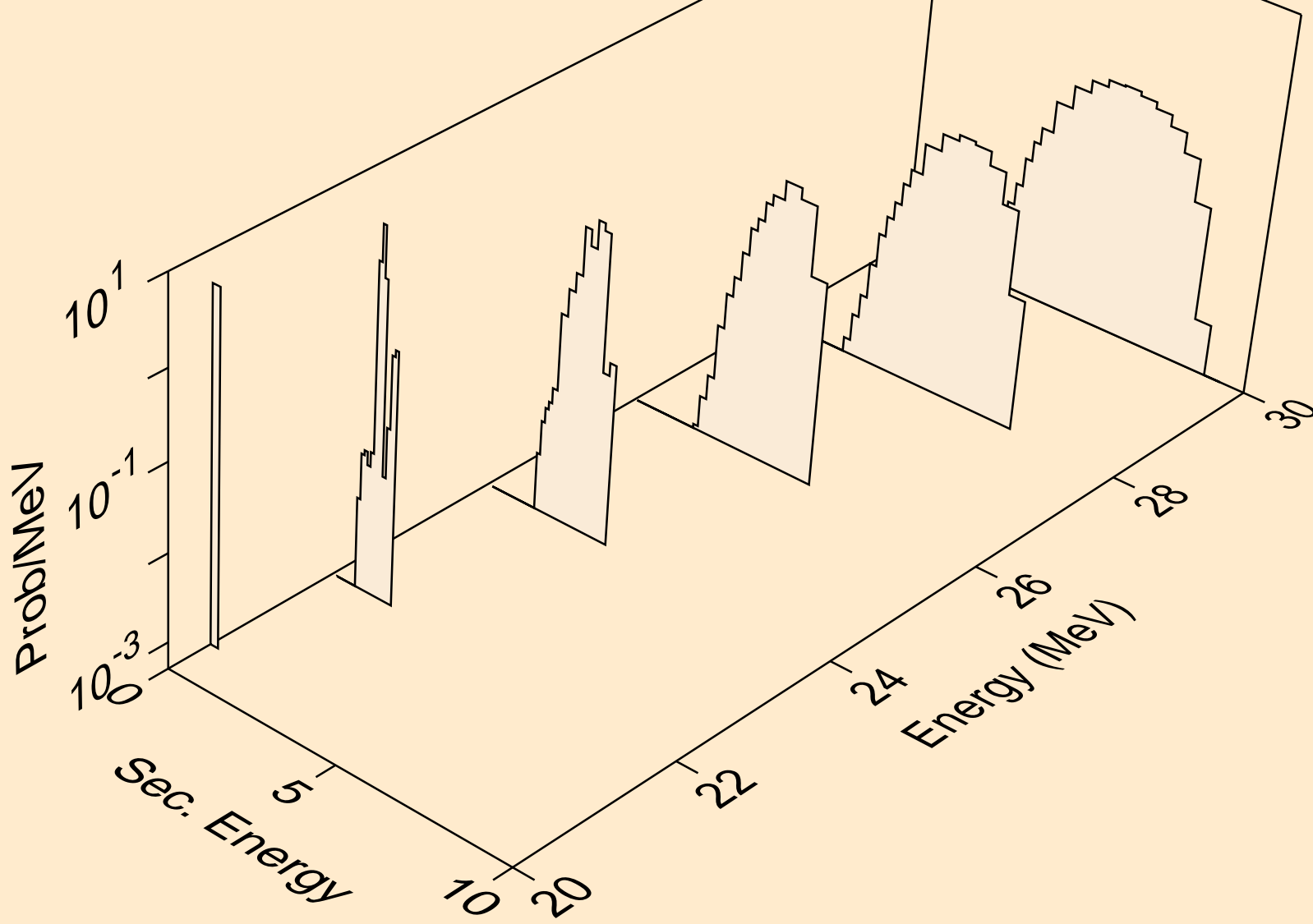

CL043 NEUTRON ACER TENDL-2019 LIBRARY; T=293.16K
alphas from (n,3n)a

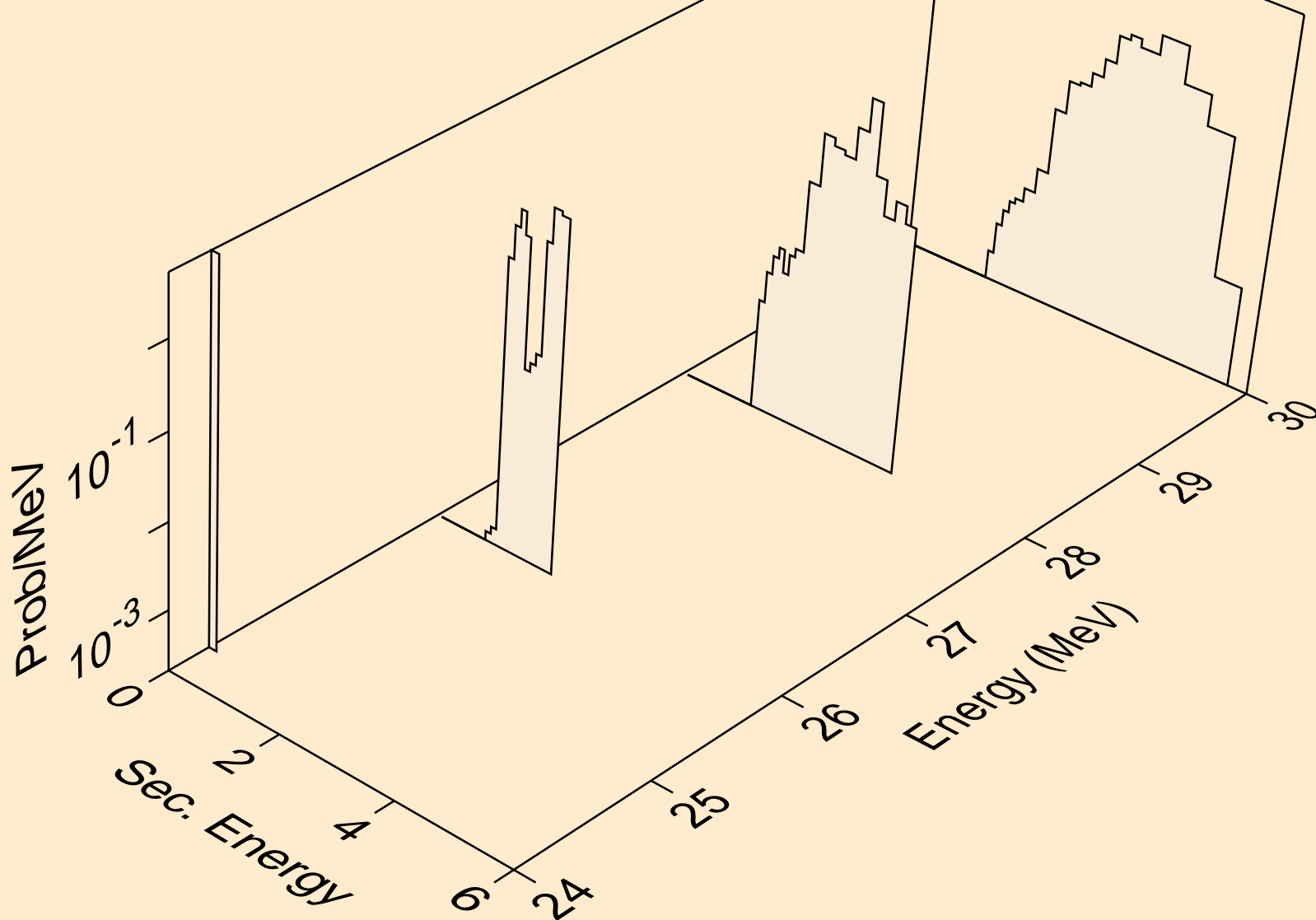

CL043 NEUTRON ACER TENDL-2019 LIBRARY; T=293.16K
alphas from (n,a)

