

CO057 NEUTRON ACER TENDL-2019 LIBRARY; T=293.16K
Principal cross sections

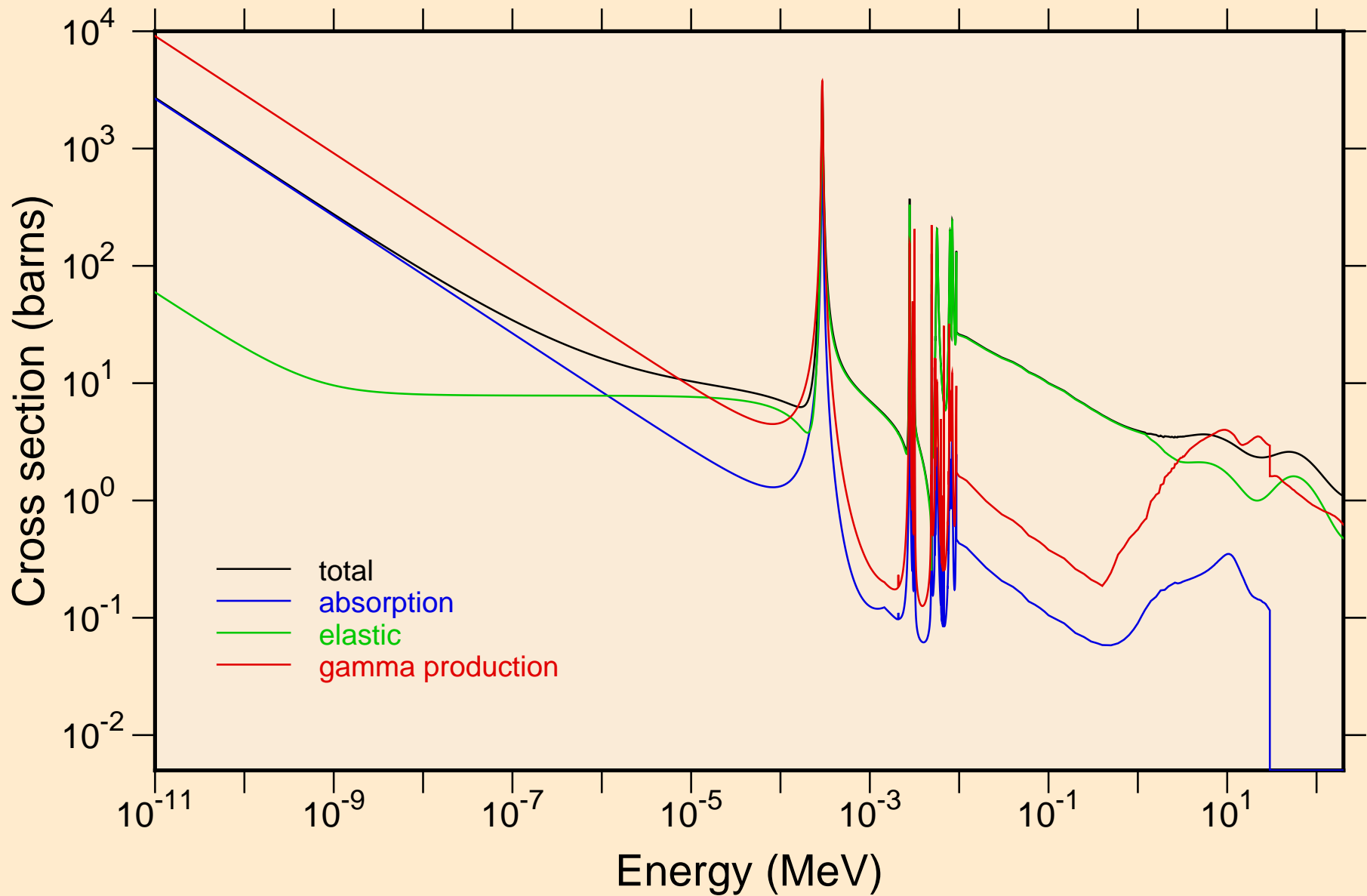

CO057 NEUTRON ACER TENDL-2019 LIBRARY; T=293.16K
resonance total cross section

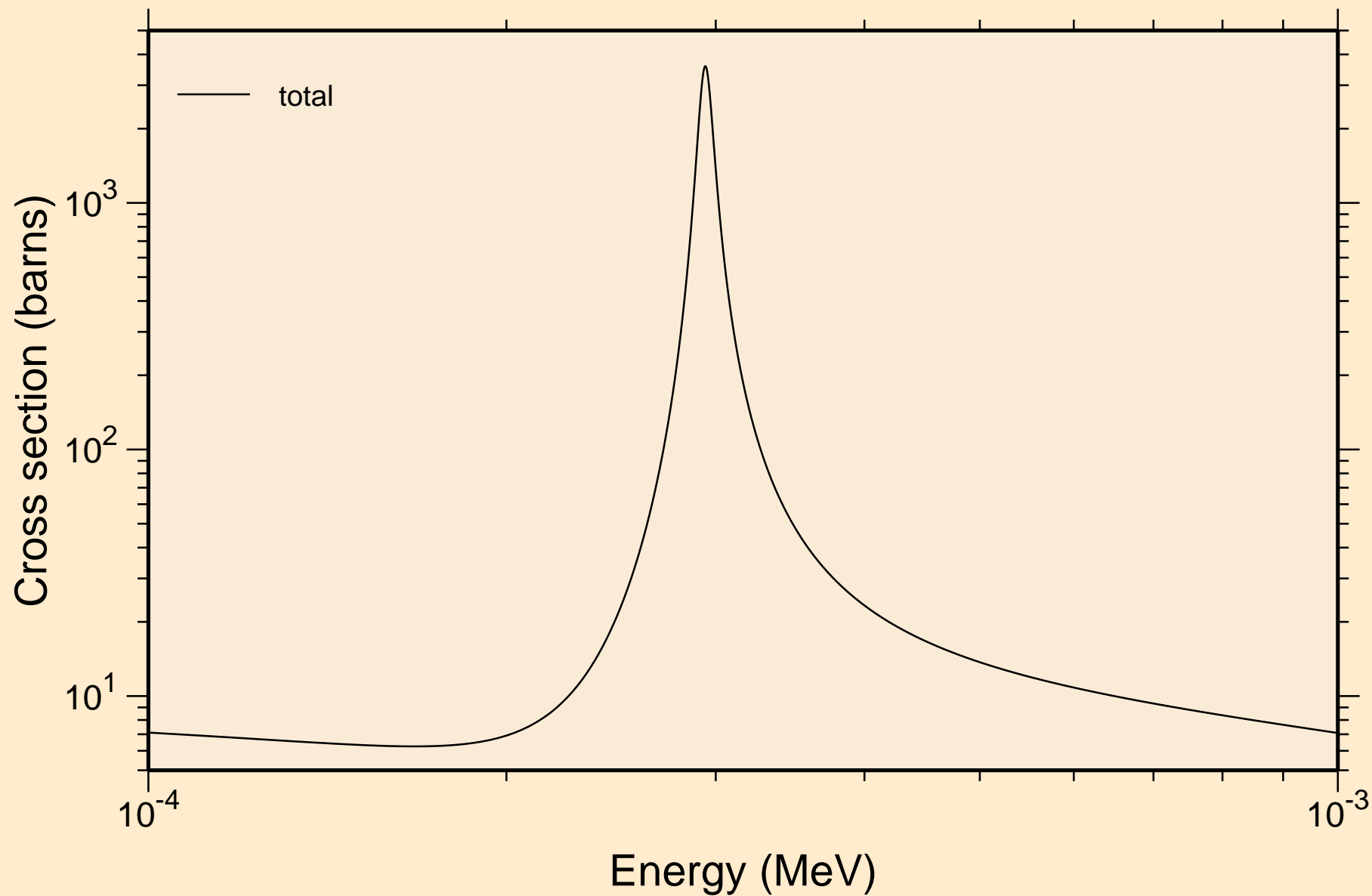

CO057 NEUTRON ACER TENDL-2019 LIBRARY; T=293.16K
resonance total cross section

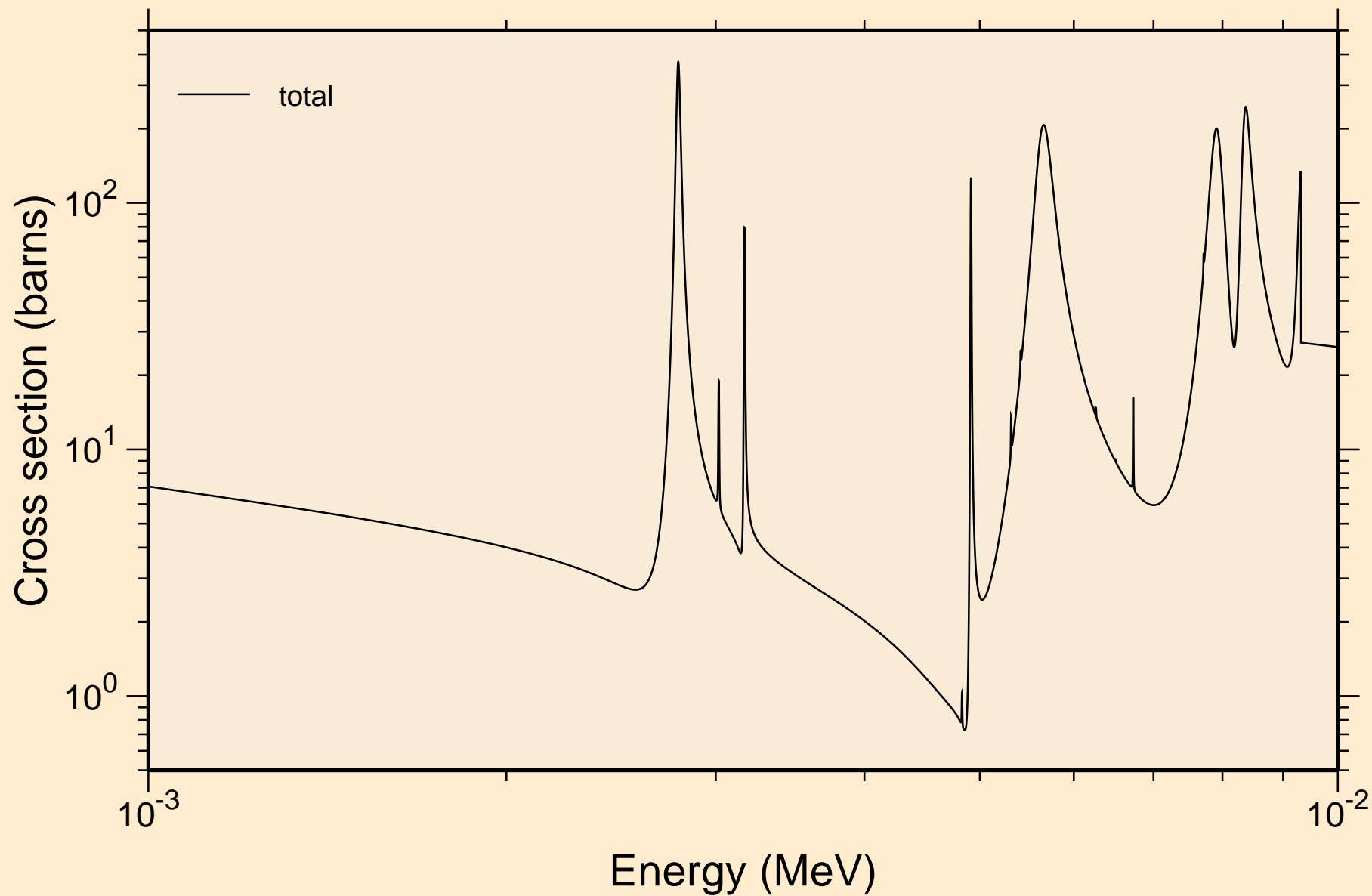

C0057 NEUTRON ACER TENDL-2019 LIBRARY; T=293.16K
resonance total cross section

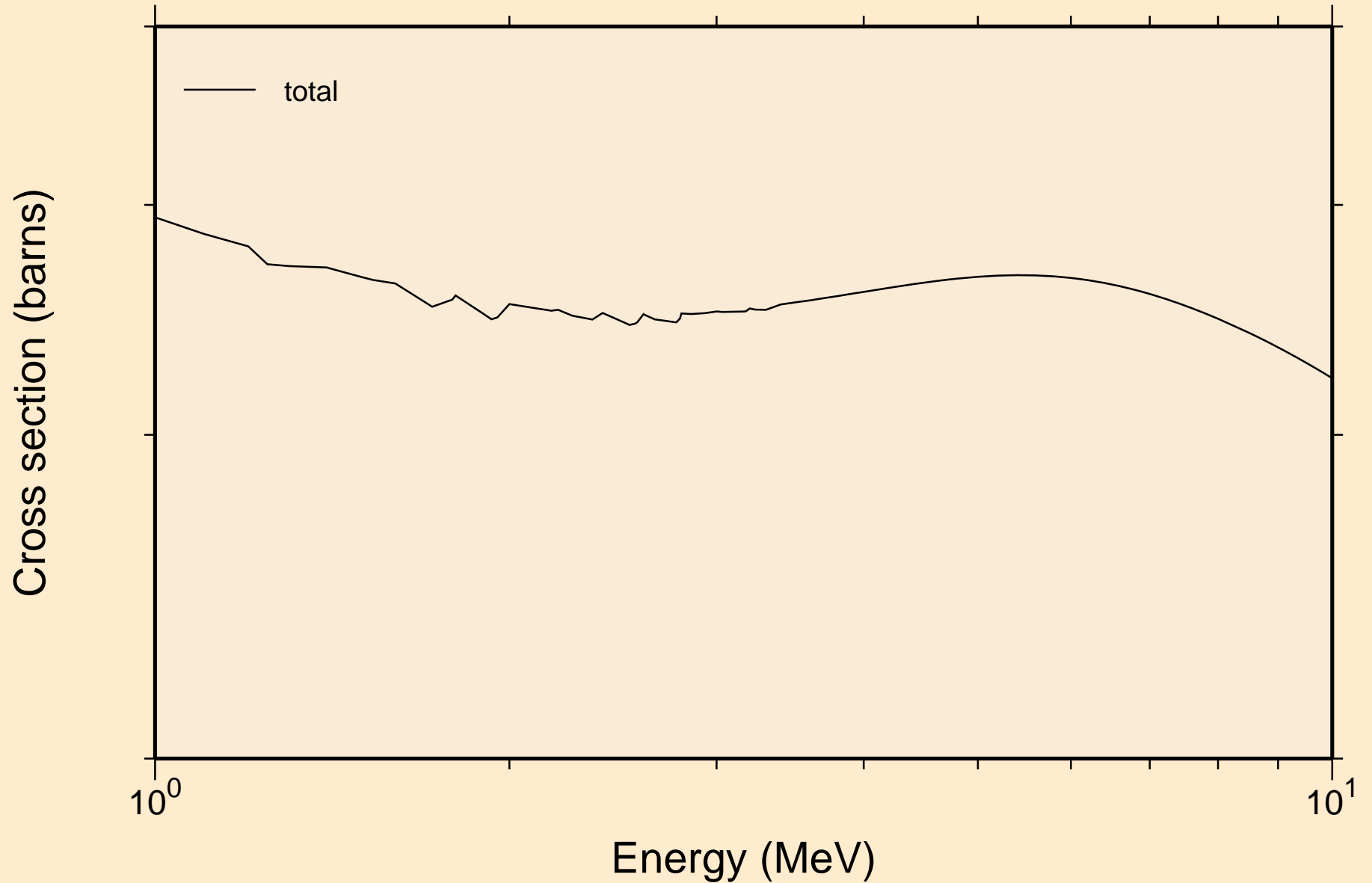

CO057 NEUTRON ACER TENDL-2019 LIBRARY; T=293.16K
resonance absorption cross sections

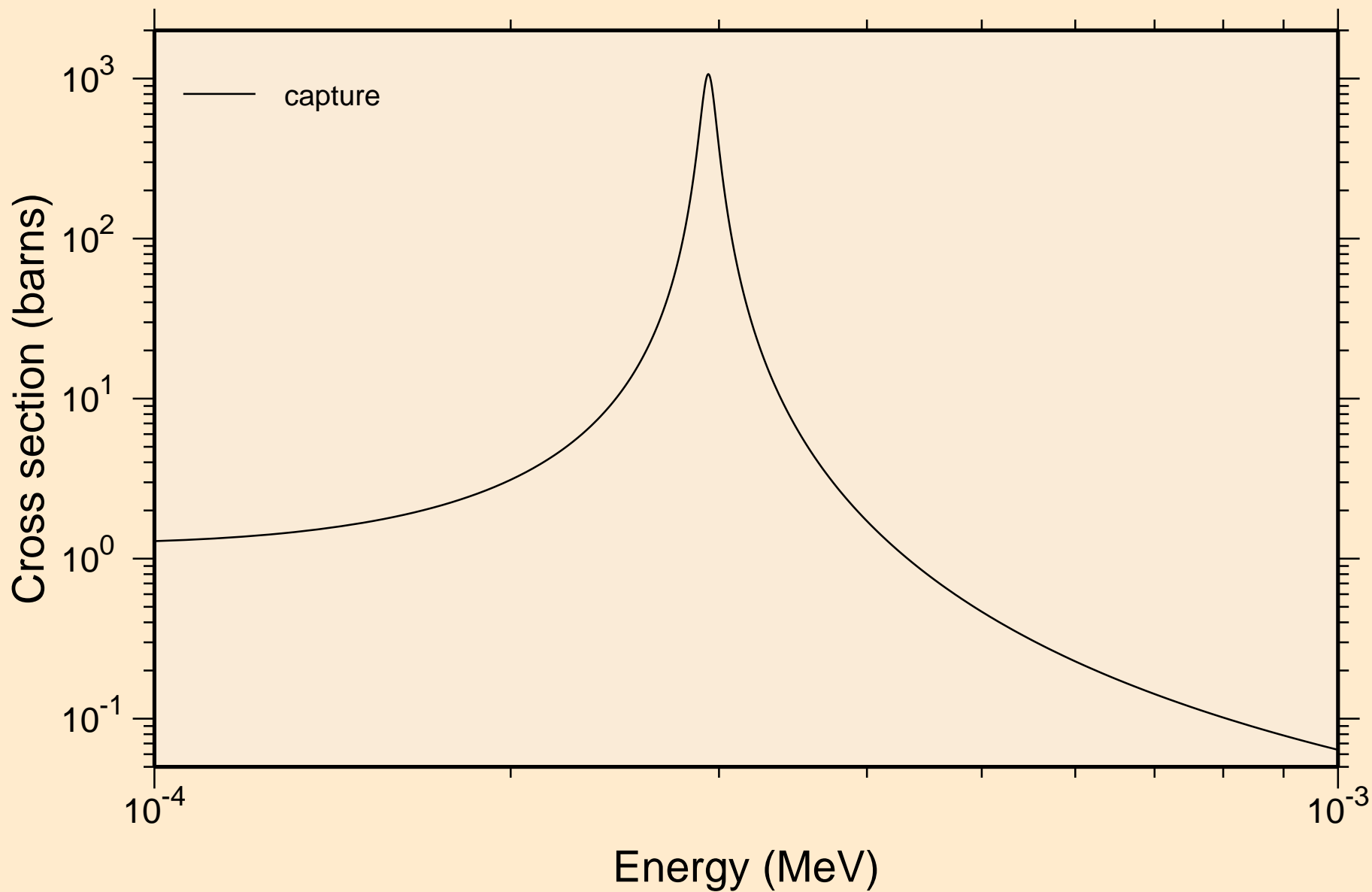

CO057 NEUTRON ACER TENDL-2019 LIBRARY; T=293.16K
resonance absorption cross sections

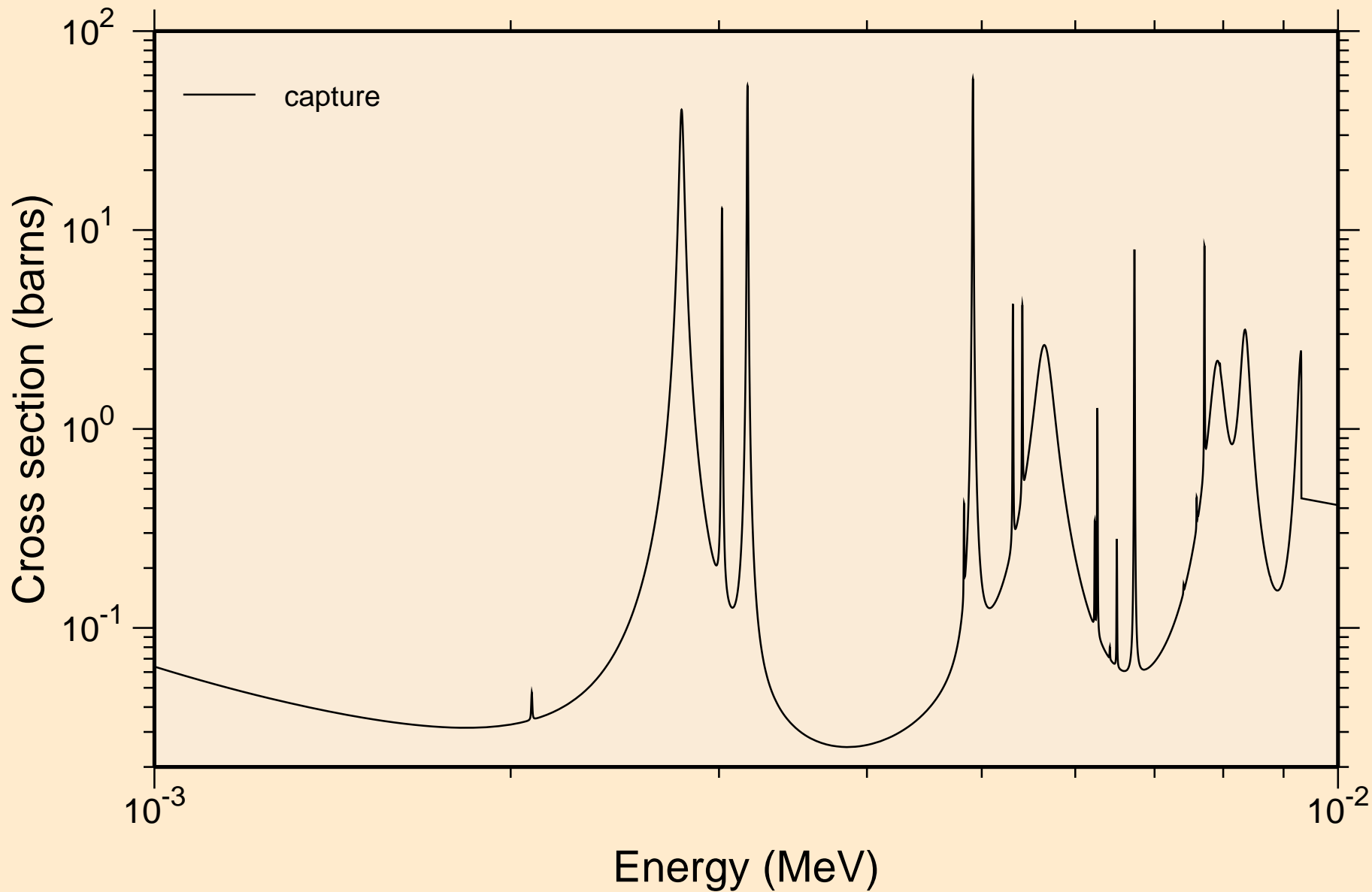

CO057 NEUTRON ACER TENDL-2019 LIBRARY; T=293.16K
resonance absorption cross sections

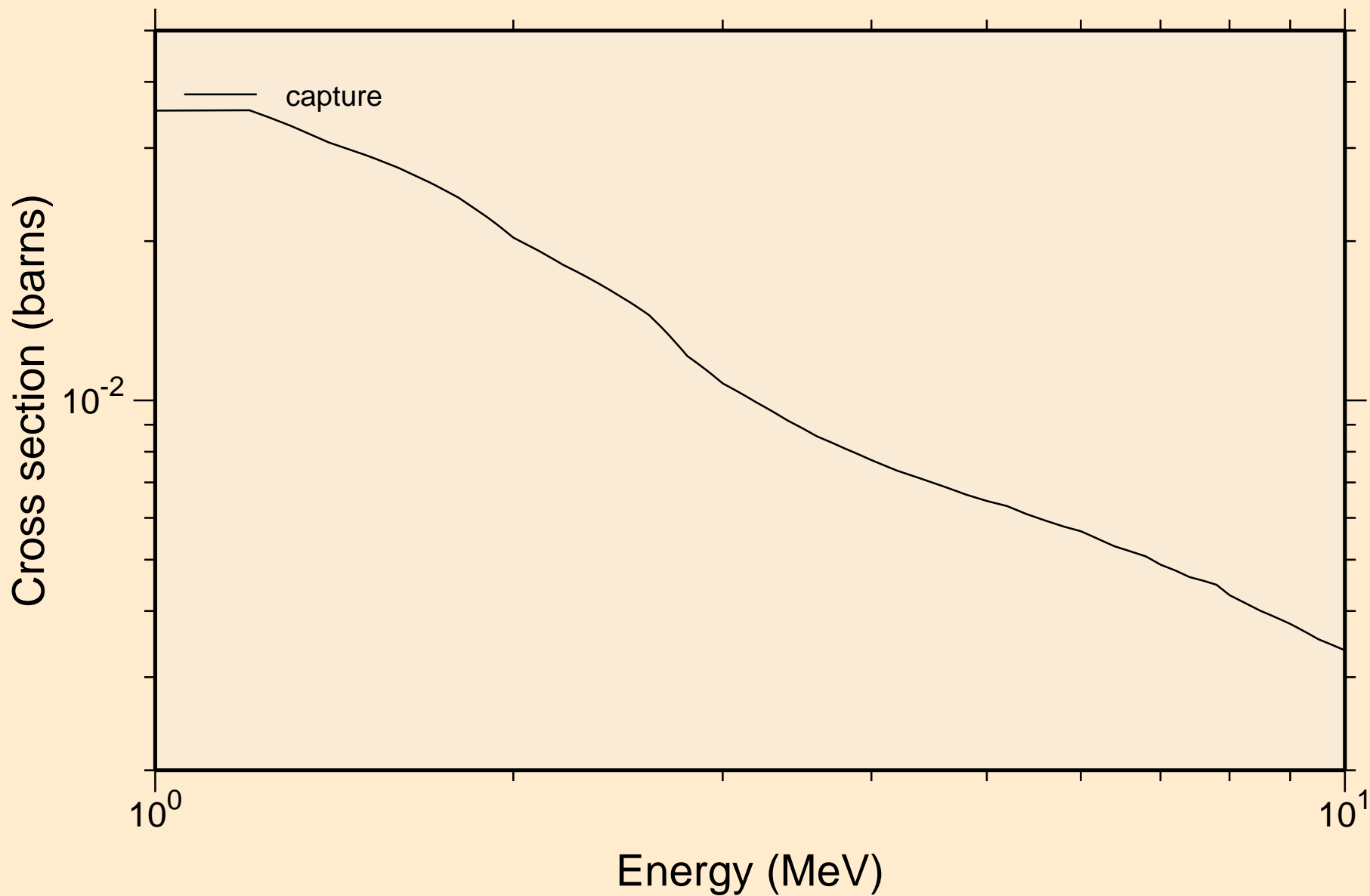

CO057 NEUTRON ACER TENDL-2019 LIBRARY; T=293.16K
Heating

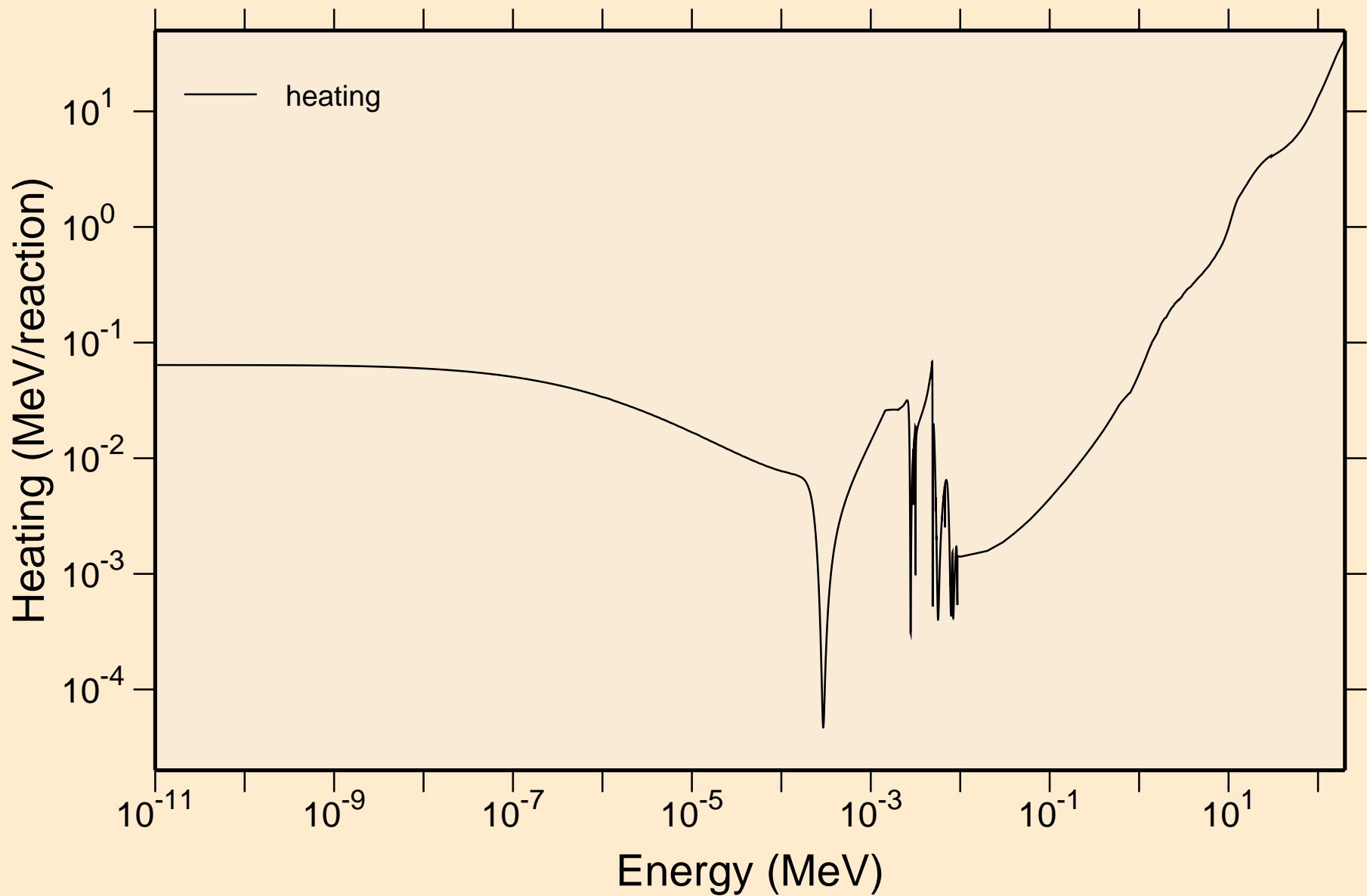

CO057 NEUTRON ACER TENDL-2019 LIBRARY; T=293.16K
Damage

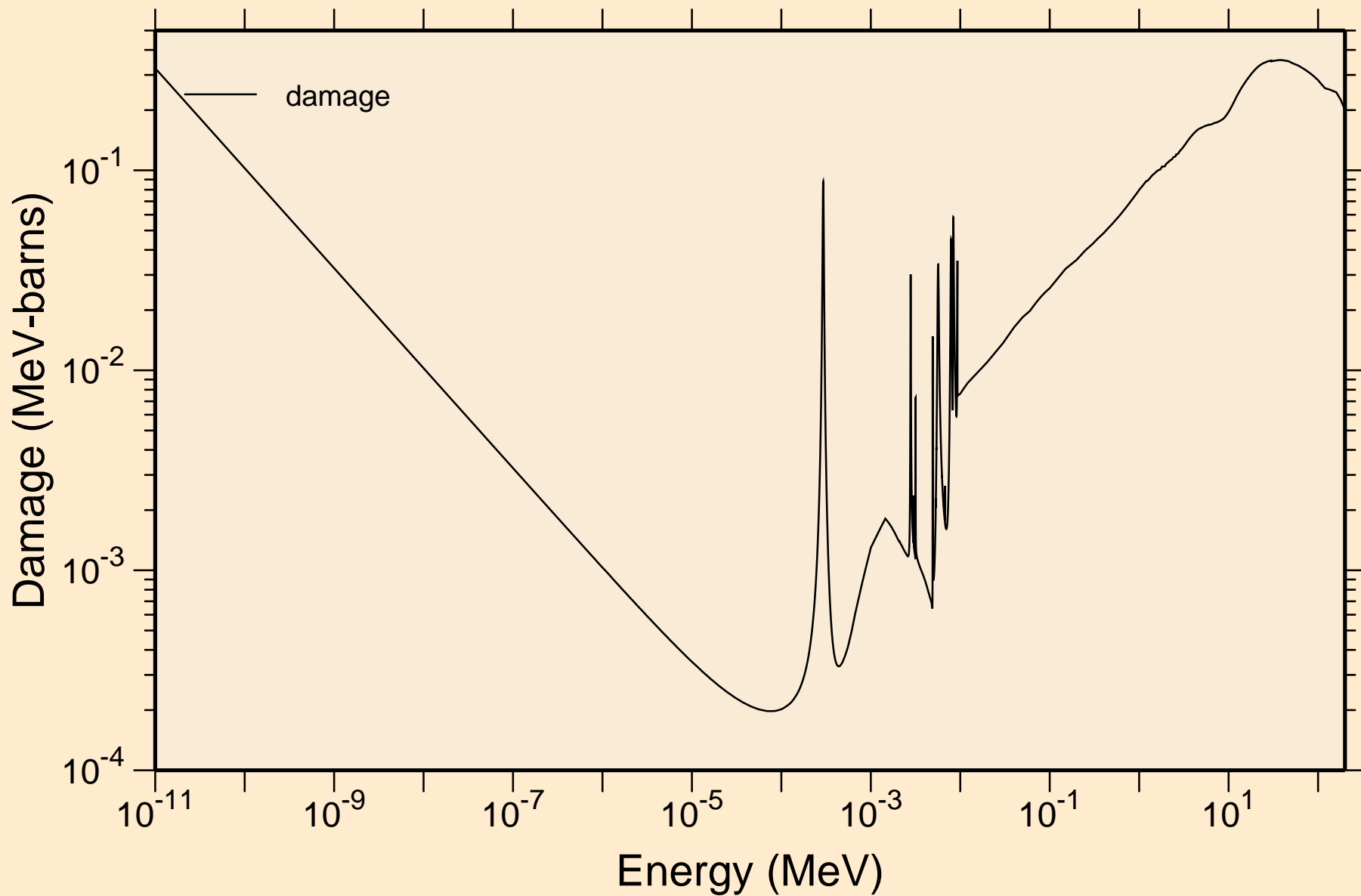

CO057 NEUTRON ACER TENDL-2019 LIBRARY; T=293.16K
Non-threshold reactions

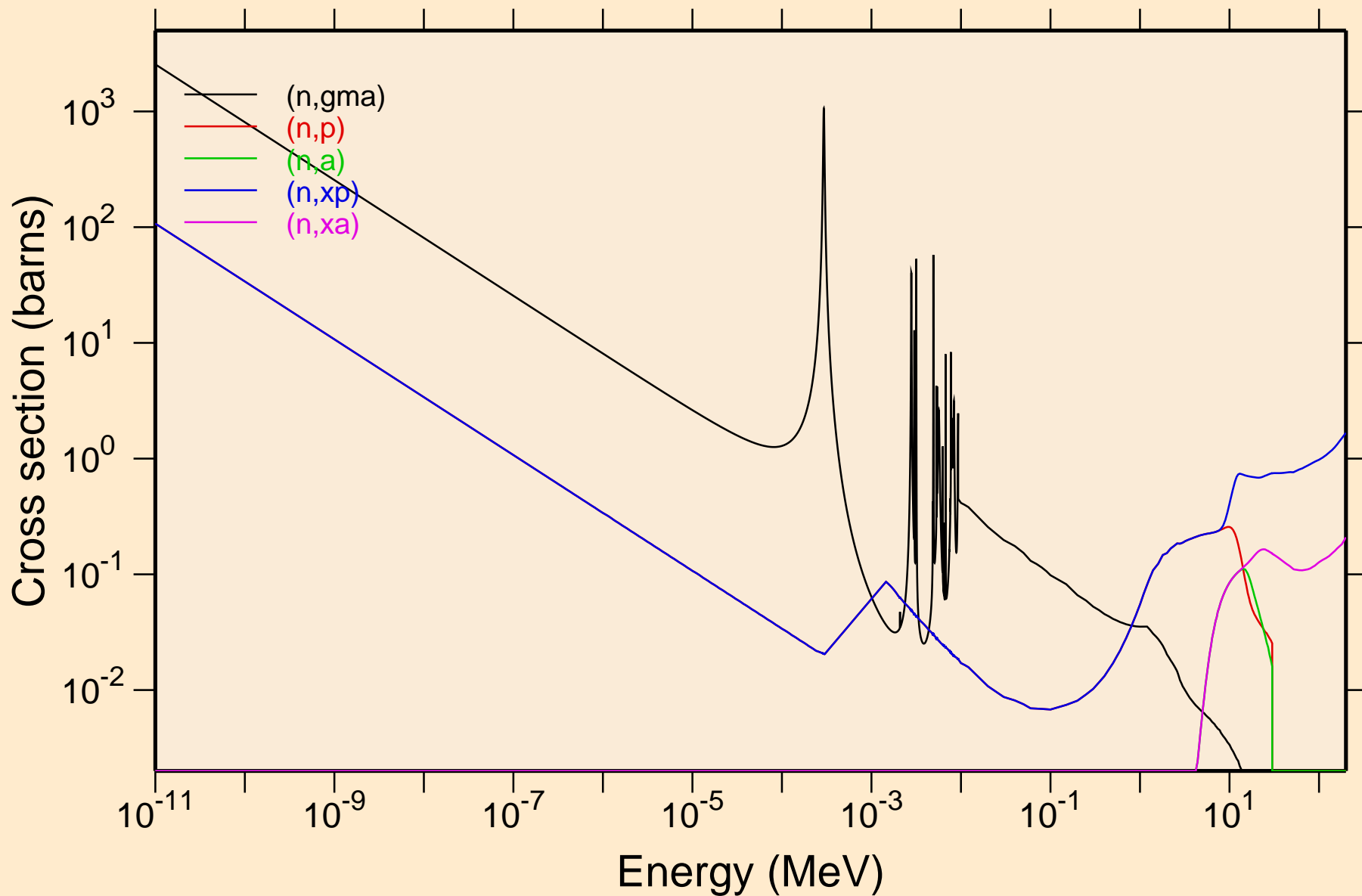

CO057 NEUTRON ACER TENDL-2019 LIBRARY; T=293.16K
Principal cross sections

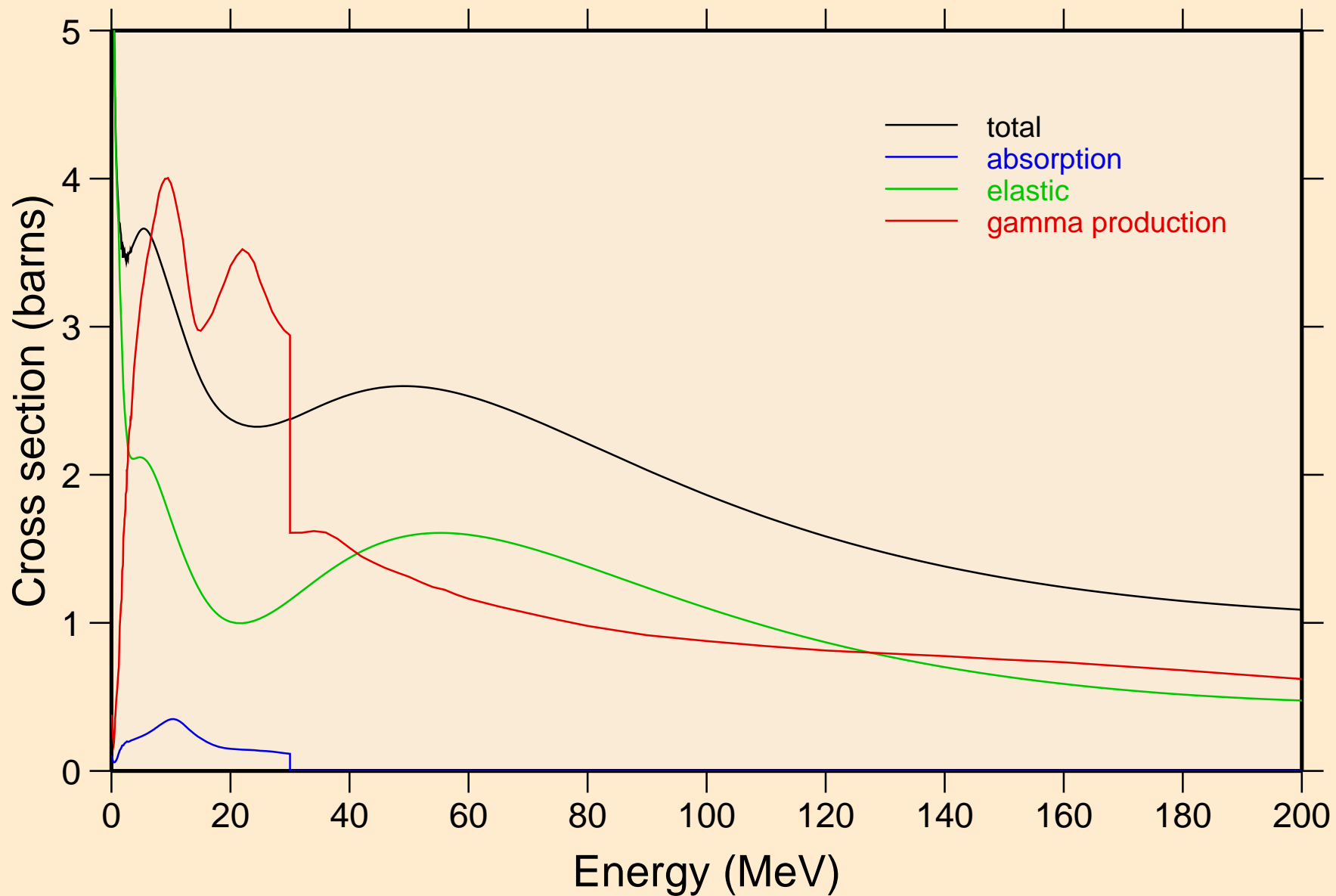

CO057 NEUTRON ACER TENDL-2019 LIBRARY; T=293.16K
Heating

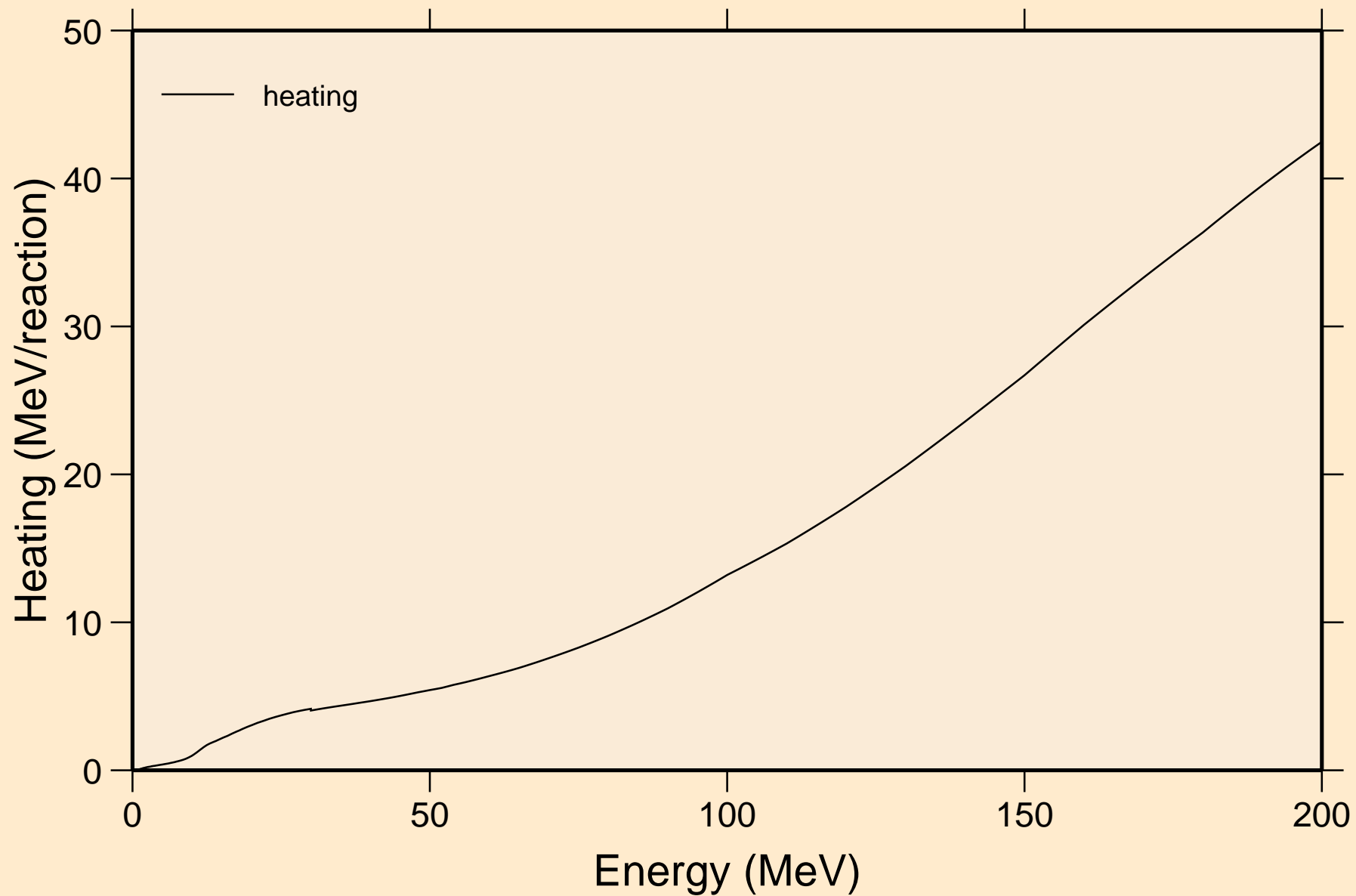

CO057 NEUTRON ACER TENDL-2019 LIBRARY; T=293.16K
Damage

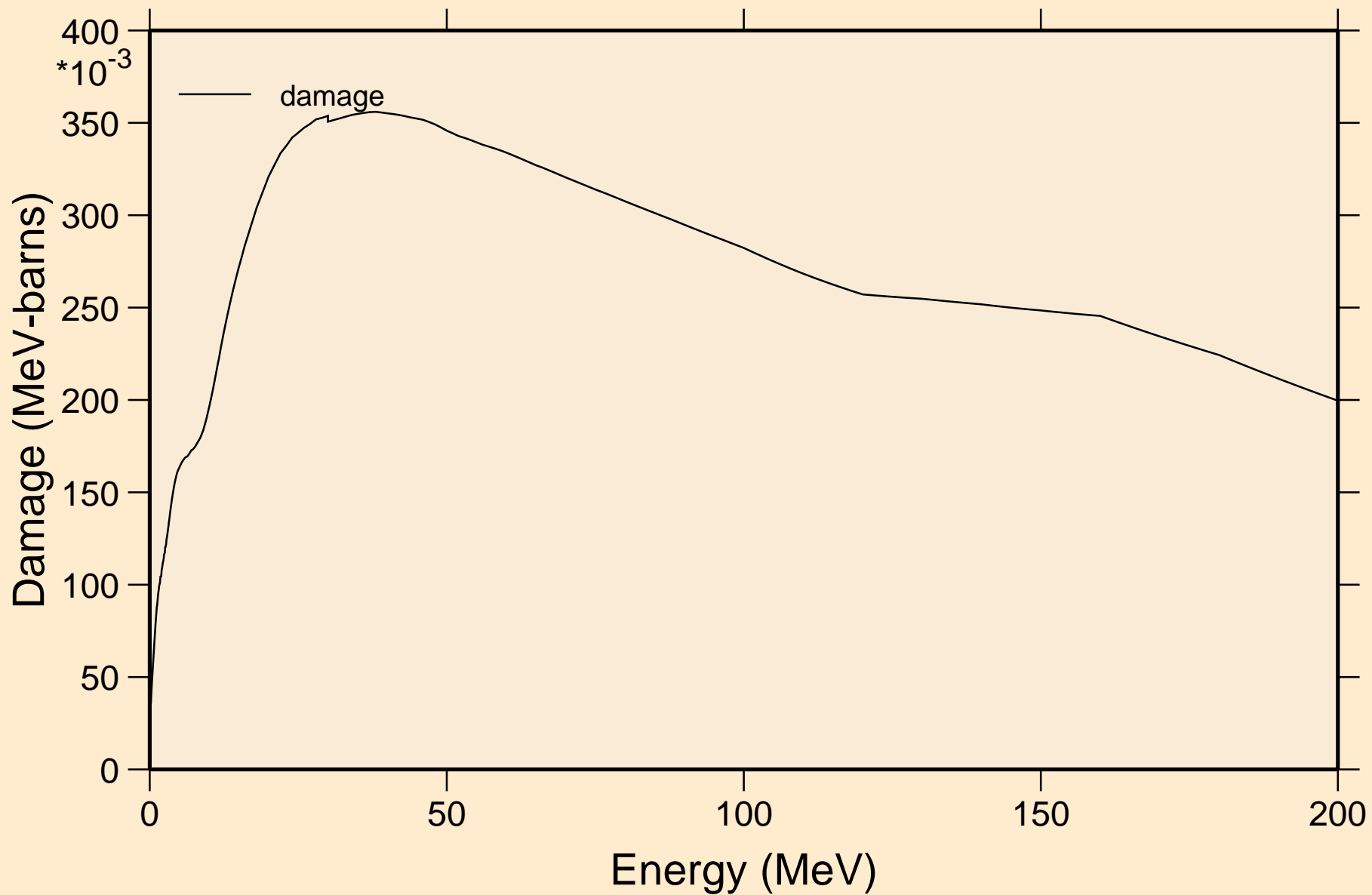

CO057 NEUTRON ACER TENDL-2019 LIBRARY; T=293.16K
Non-threshold reactions

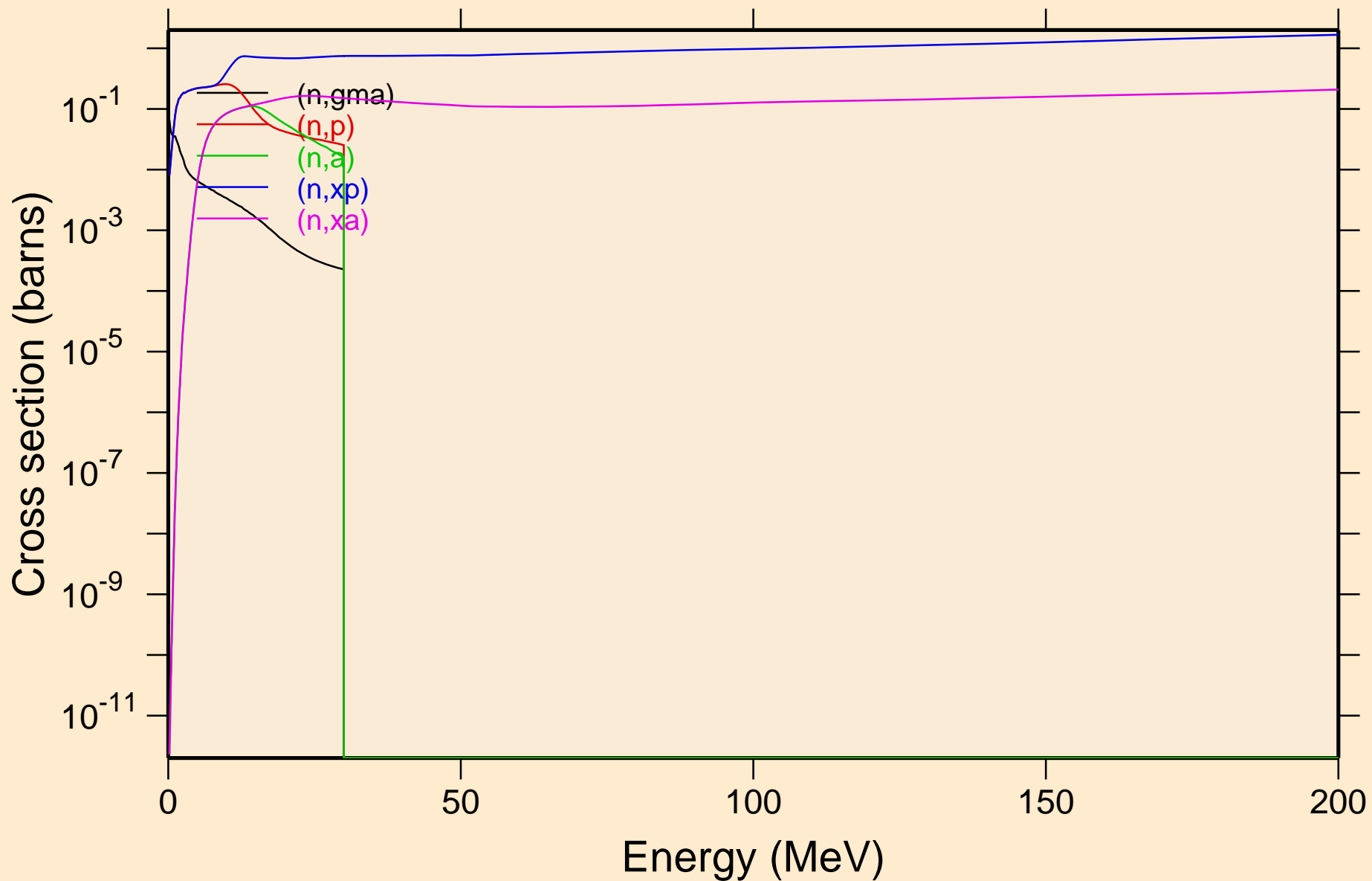

CO057 NEUTRON ACER TENDL-2019 LIBRARY; T=293.16K
Inelastic levels

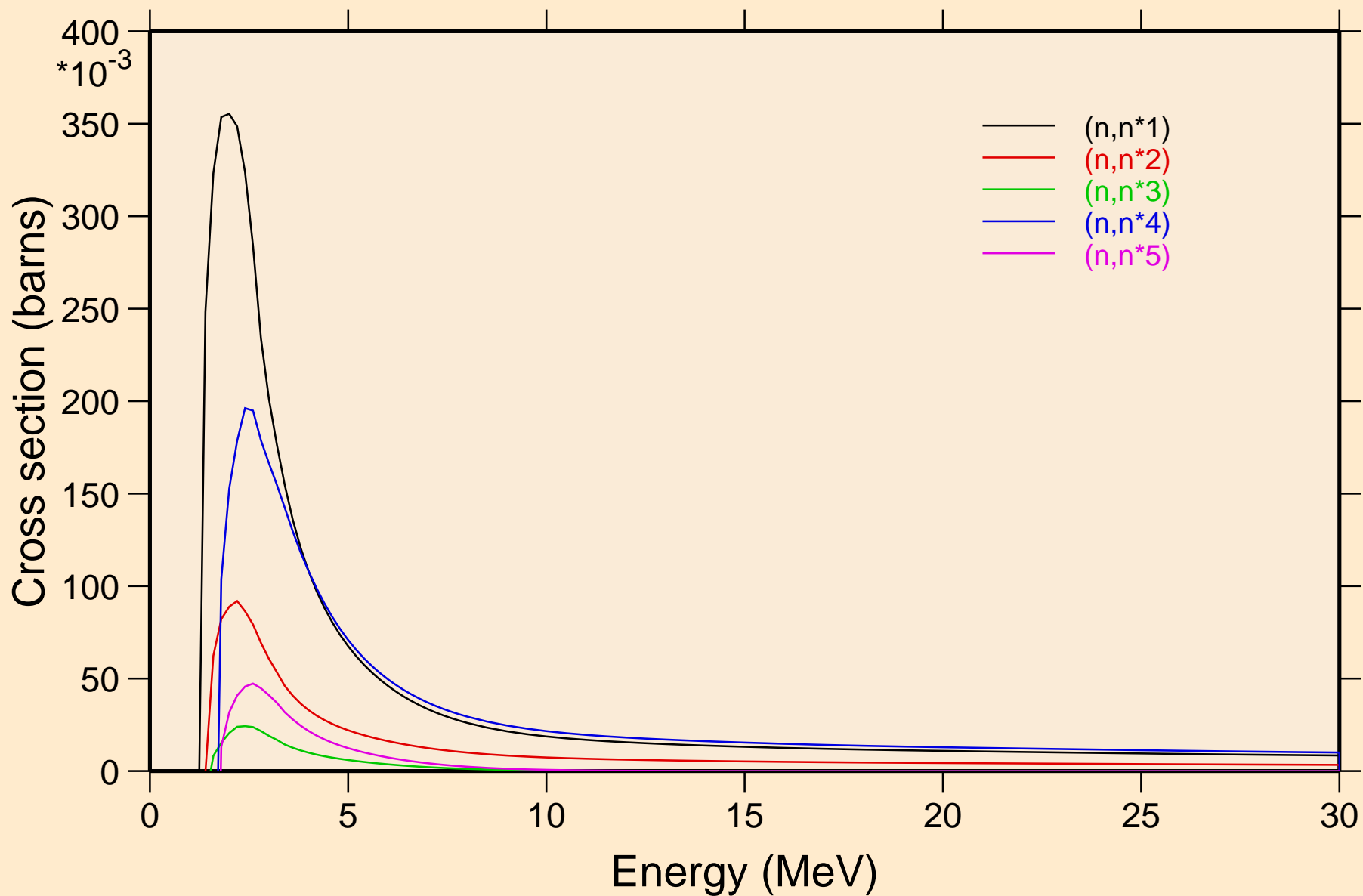

CO057 NEUTRON ACER TENDL-2019 LIBRARY; T=293.16K
Inelastic levels

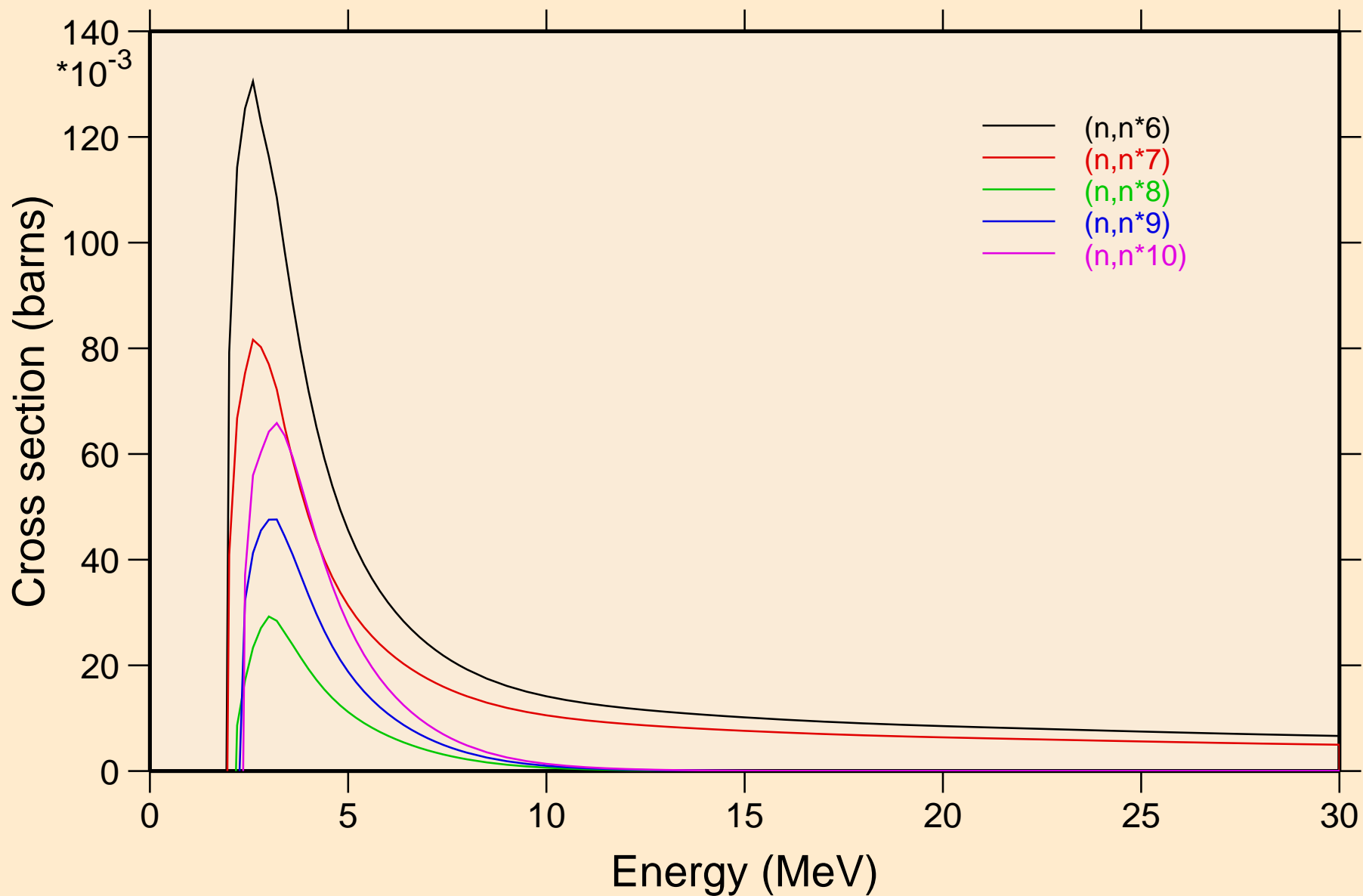

CO057 NEUTRON ACER TENDL-2019 LIBRARY; T=293.16K
Inelastic levels

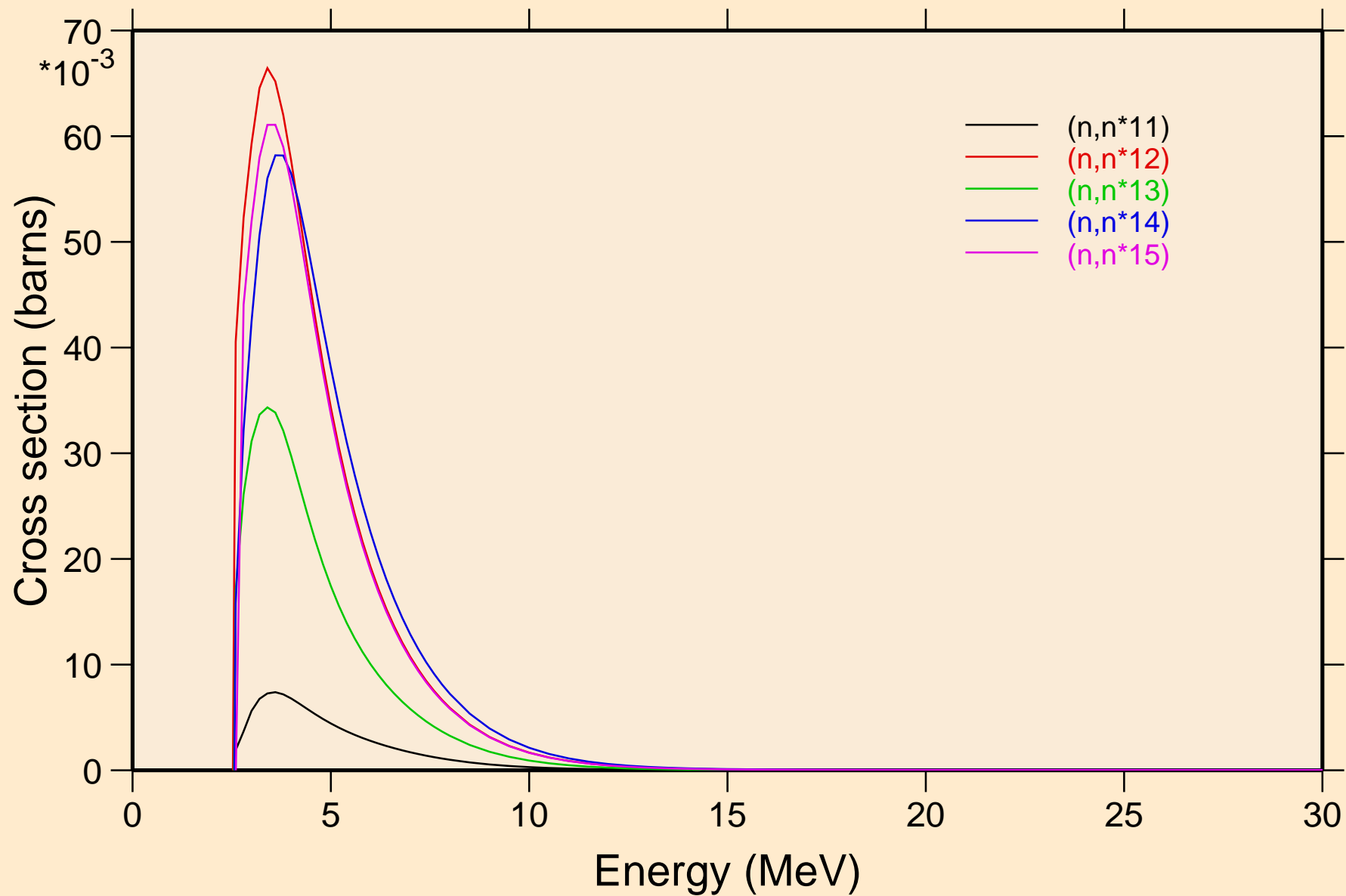

CO057 NEUTRON ACER TENDL-2019 LIBRARY; T=293.16K
Inelastic levels

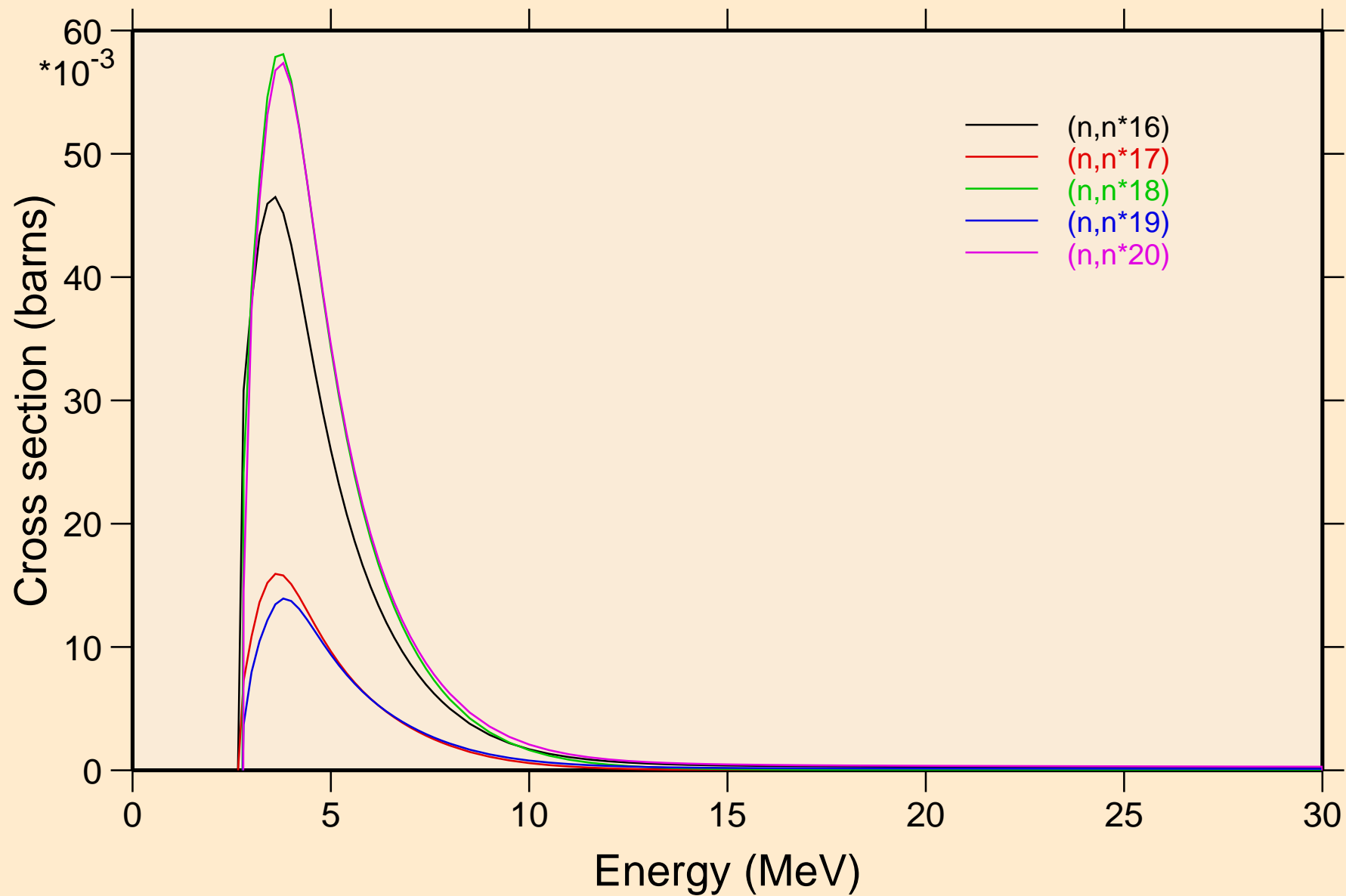

CO057 NEUTRON ACER TENDL-2019 LIBRARY; T=293.16K
Inelastic levels

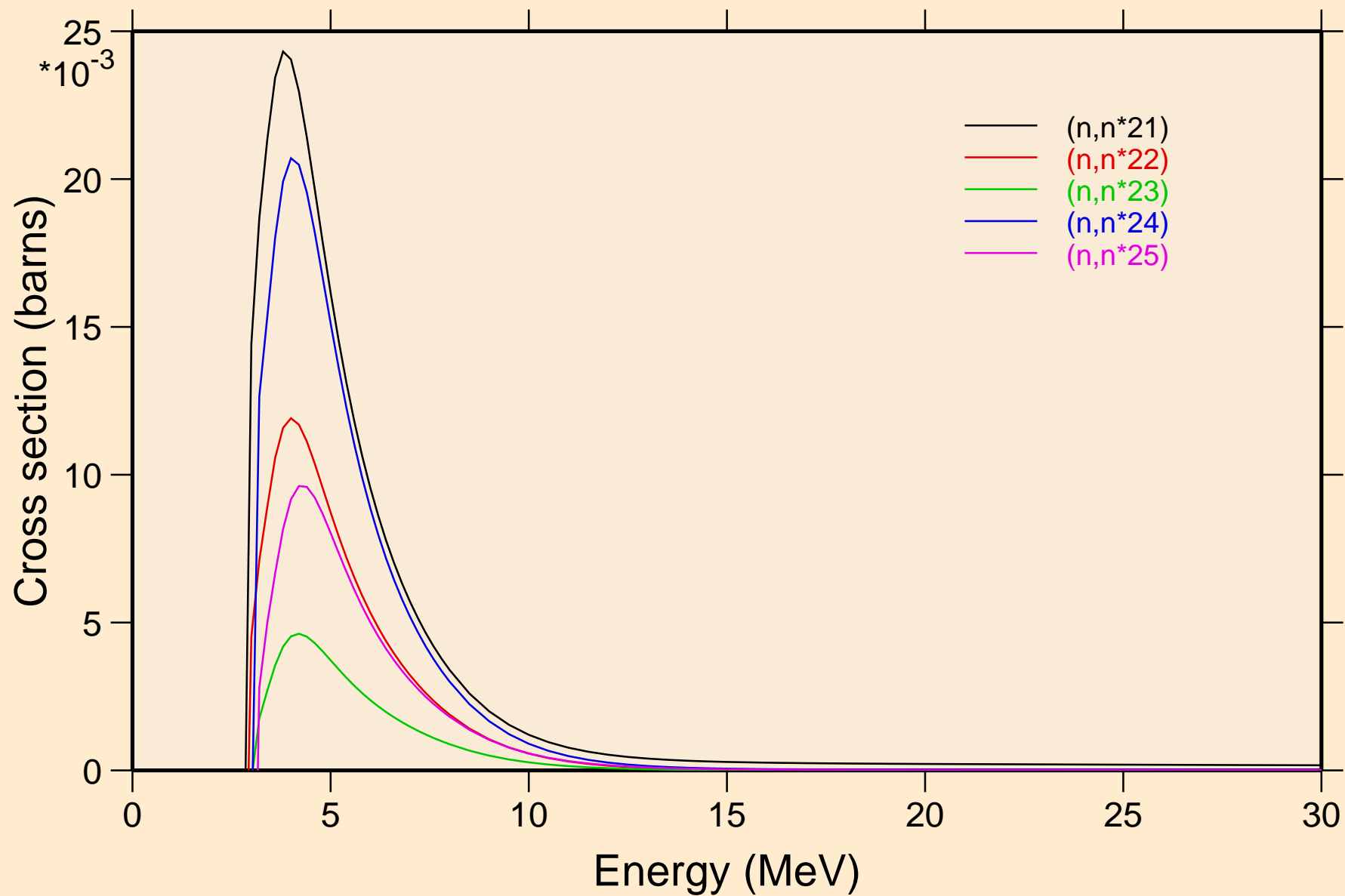

CO057 NEUTRON ACER TENDL-2019 LIBRARY; T=293.16K
Inelastic levels

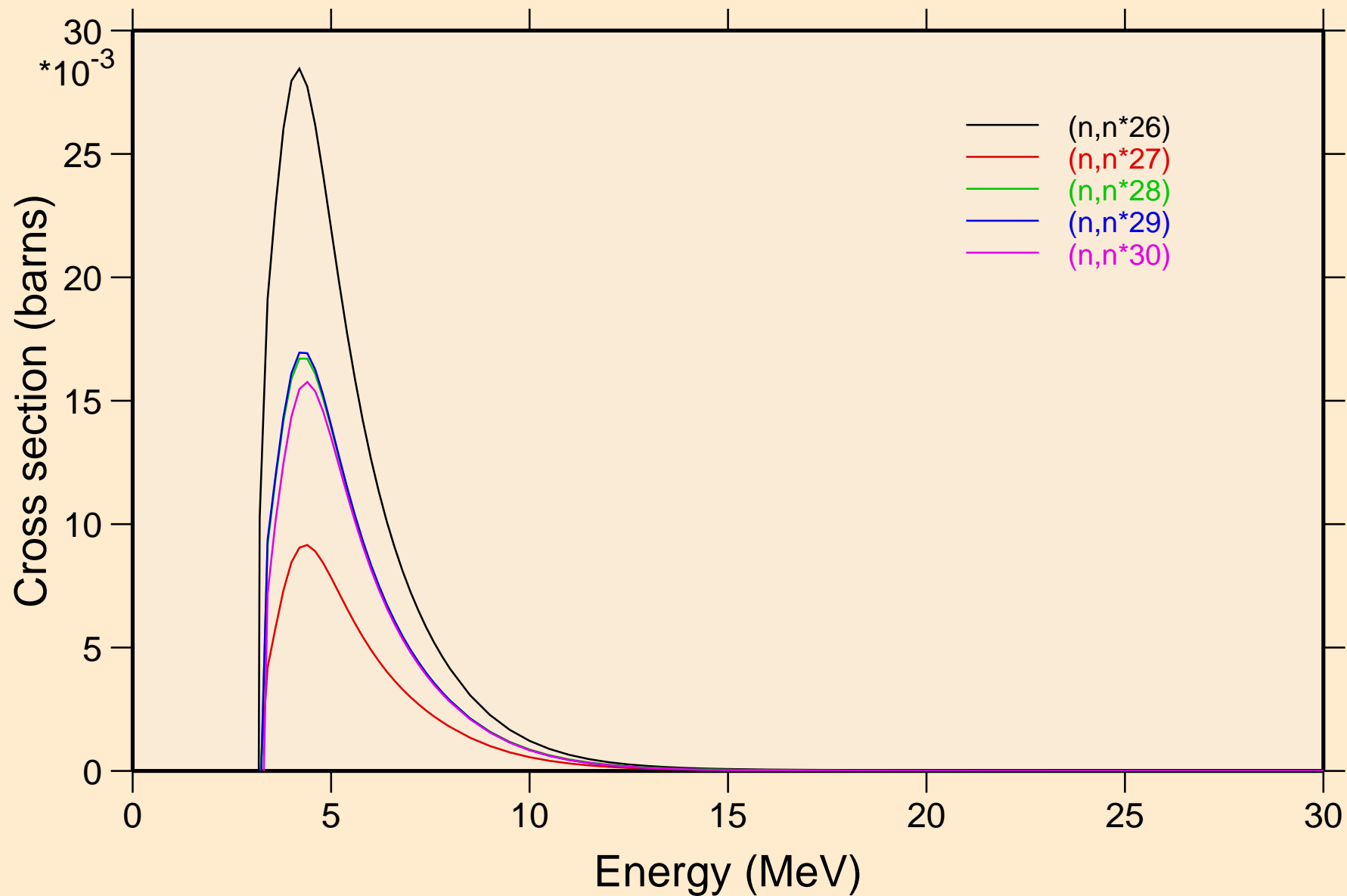

CO057 NEUTRON ACER TENDL-2019 LIBRARY; T=293.16K
Threshold reactions

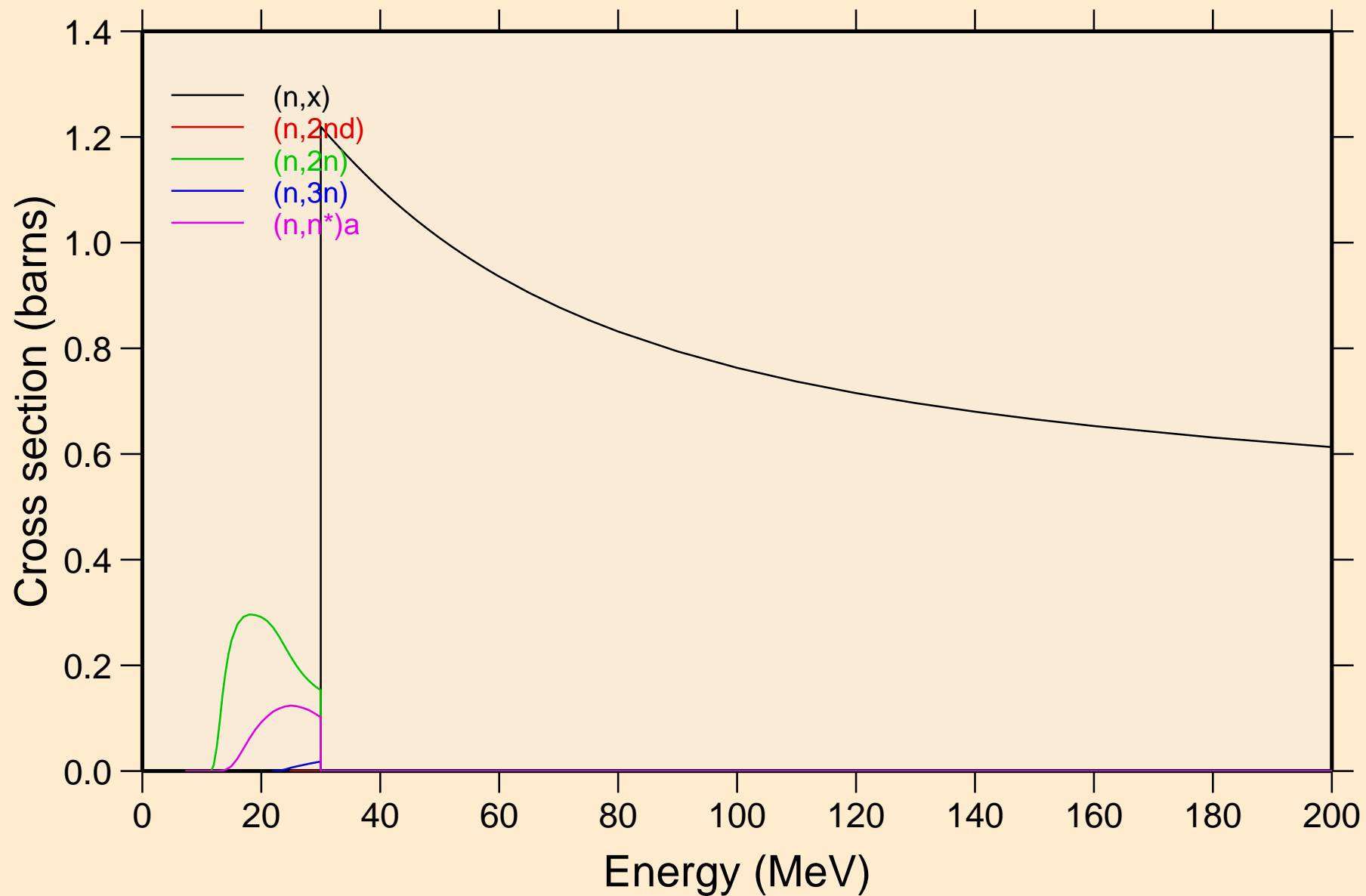

CO057 NEUTRON ACER TENDL-2019 LIBRARY; T=293.16K
Threshold reactions

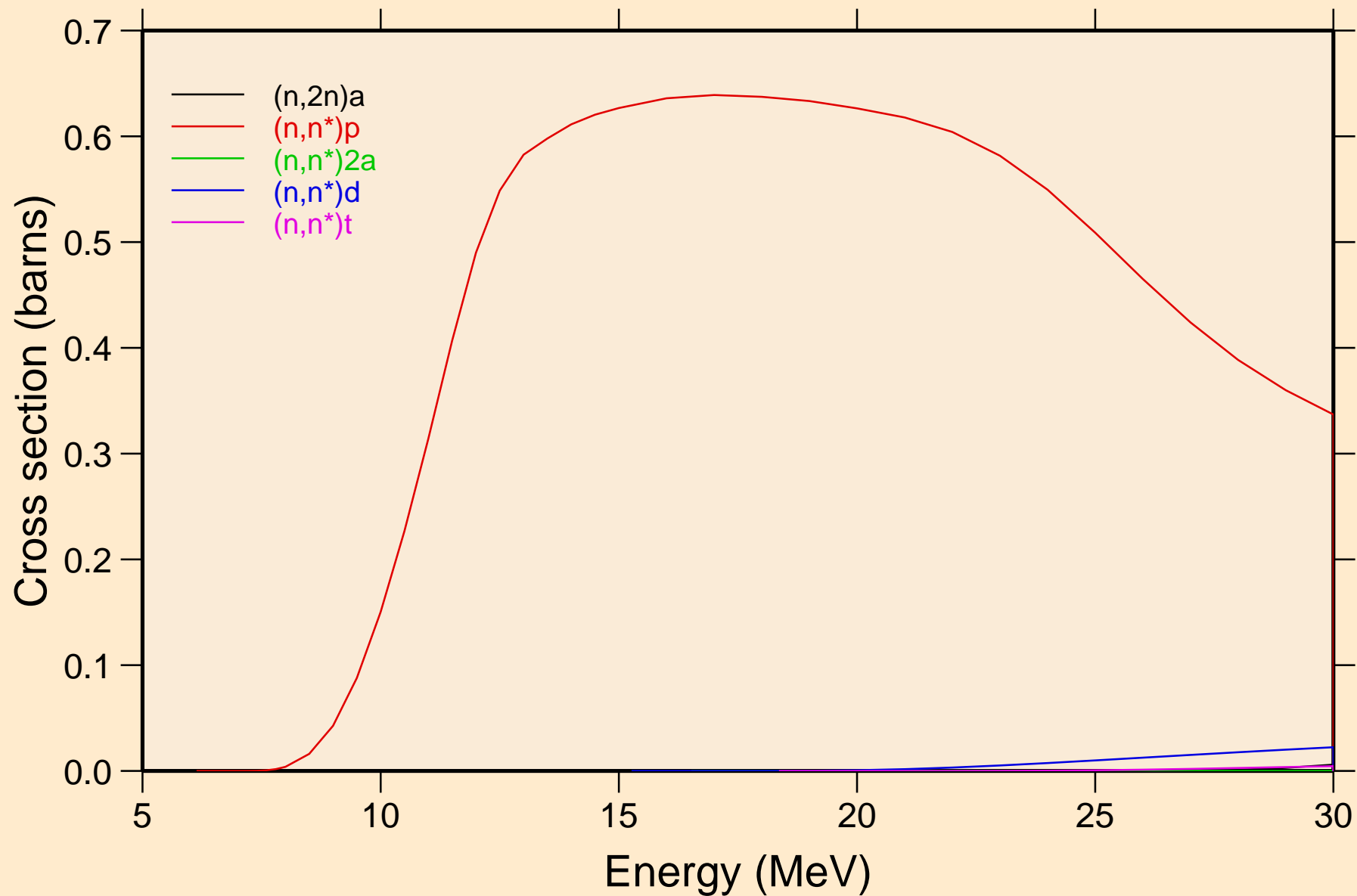

CO057 NEUTRON ACER TENDL-2019 LIBRARY; T=293.16K
Threshold reactions

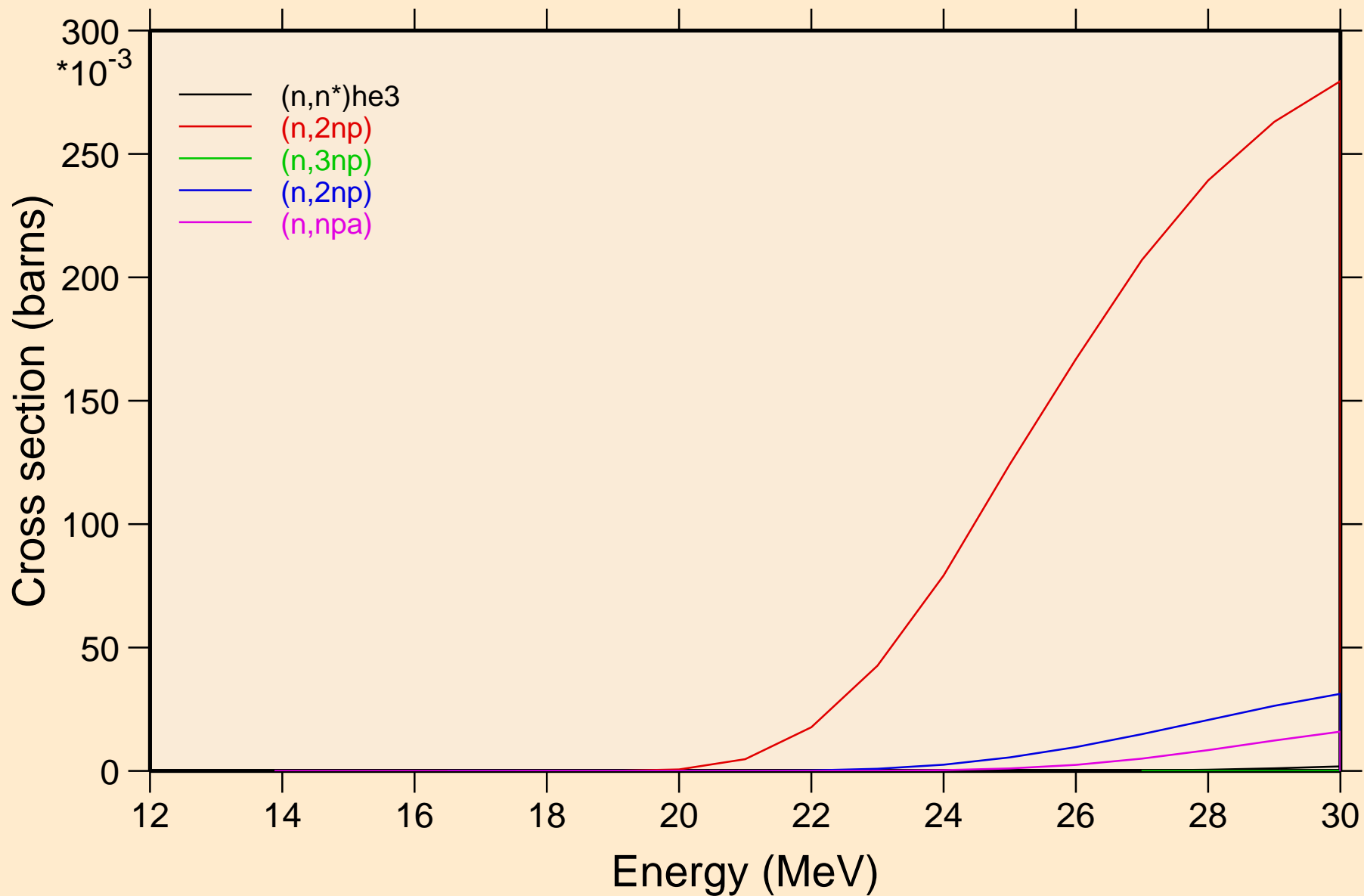

CO057 NEUTRON ACER TENDL-2019 LIBRARY; T=293.16K
Threshold reactions

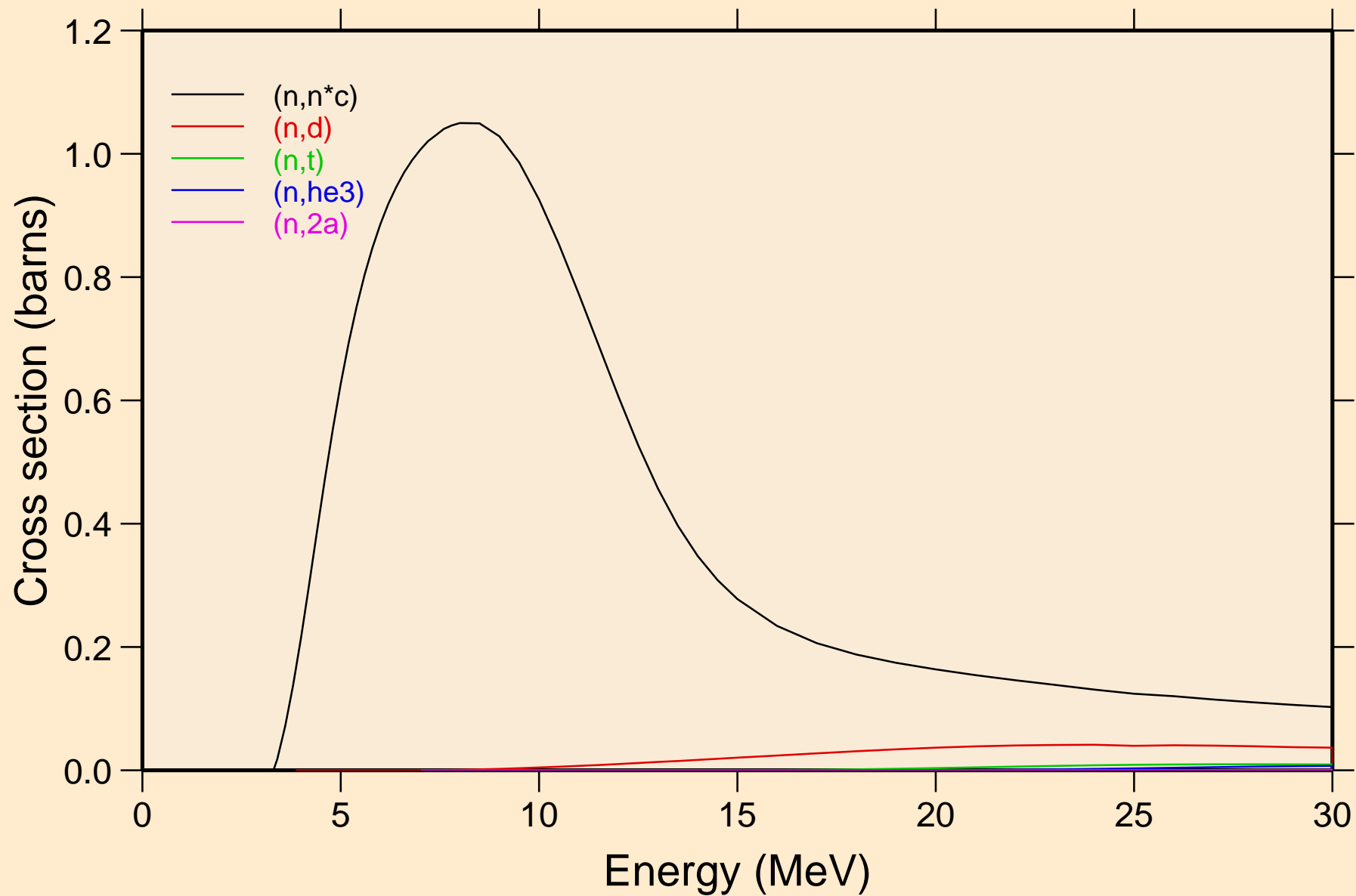

CO057 NEUTRON ACER TENDL-2019 LIBRARY; T=293.16K
Threshold reactions

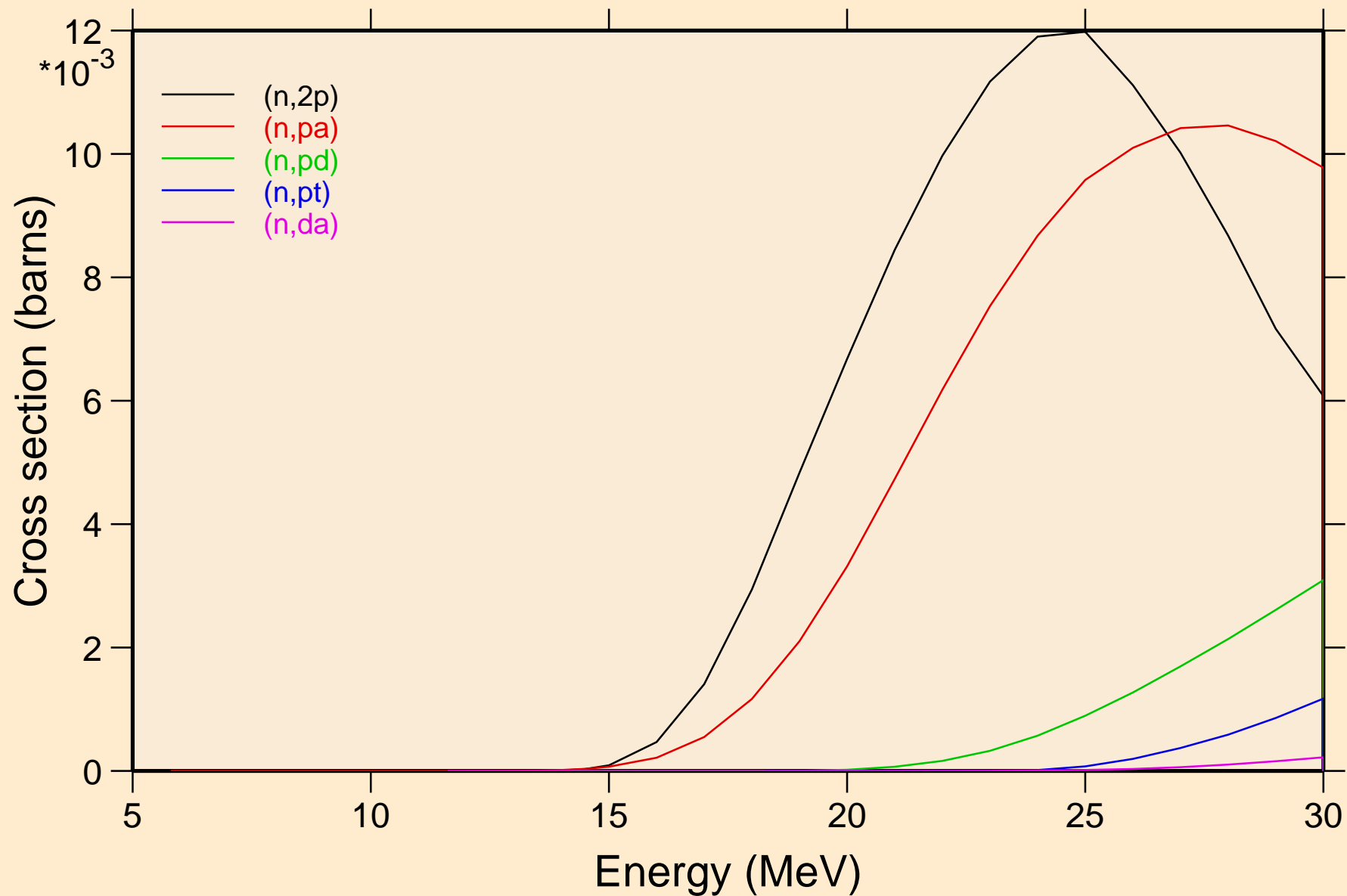

CO057 NEUTRON ACER TENDL-2019 LIBRARY; T=293.16K
Threshold reactions

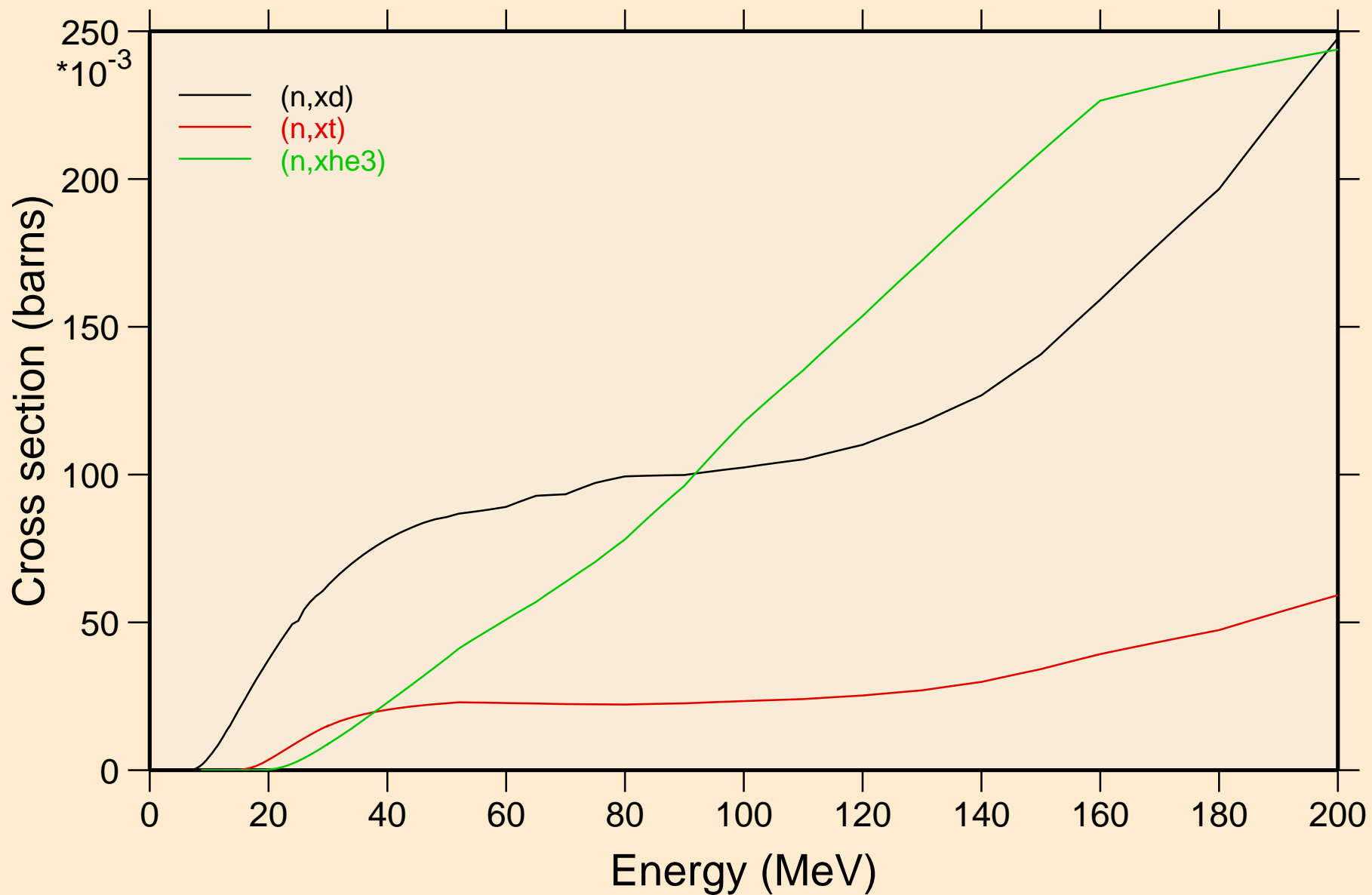

CO057 NEUTRON ACER TENDL-2019 LIBRARY; T=293.16K
angular distribution for elastic

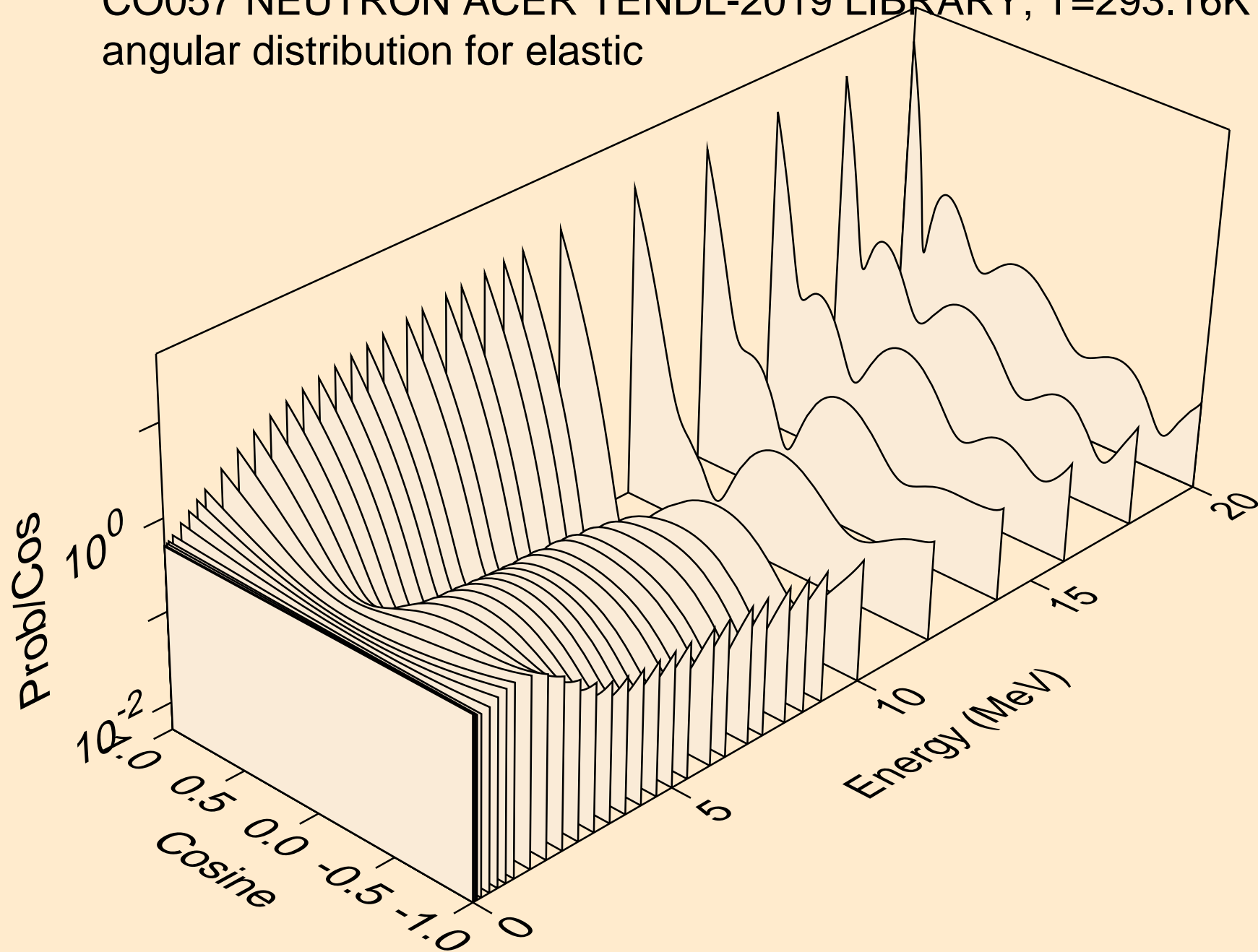

CO057 NEUTRON ACER TENDL-2019 LIBRARY; T=293.16K
angular distribution for elastic

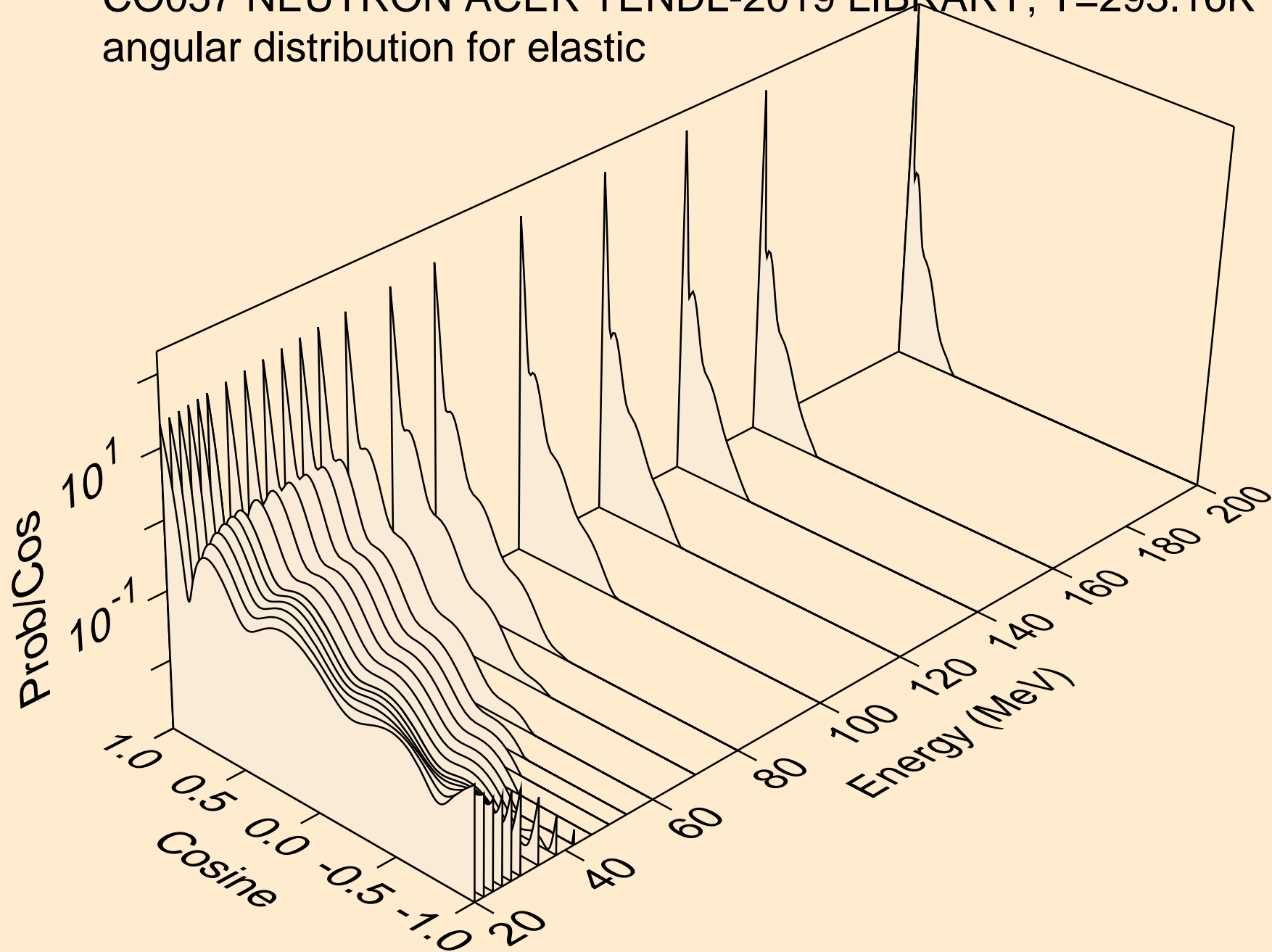

CO057 NEUTRON ACER TENDL-2019 LIBRARY; T=293.16K
angular distribution for (n,n*1)

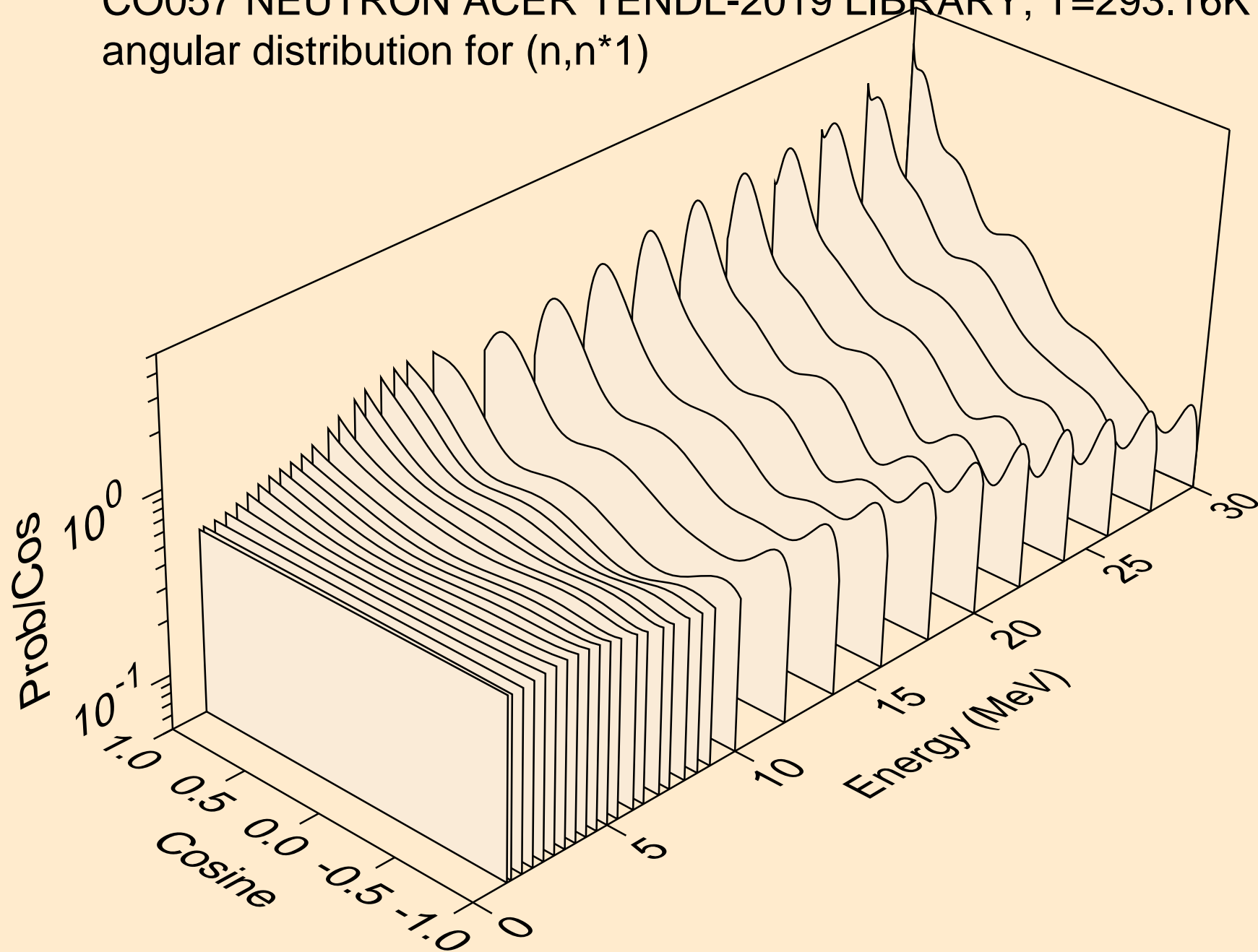

CO057 NEUTRON ACER TENDL-2019 LIBRARY; T=293.16K
angular distribution for (n,n*2)

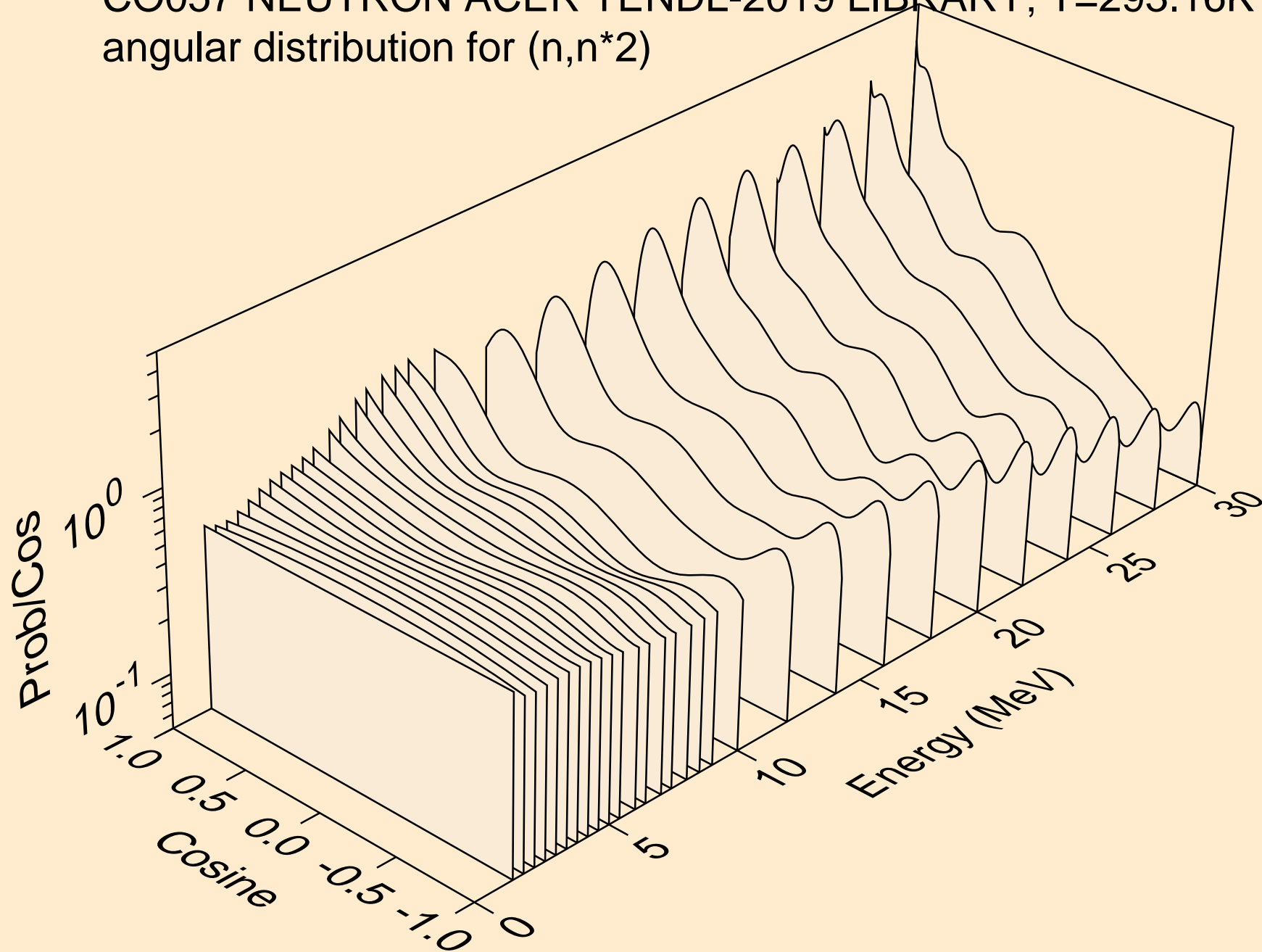

CO057 NEUTRON ACER TENDL-2019 LIBRARY; T=293.16K
angular distribution for (n,n*3)

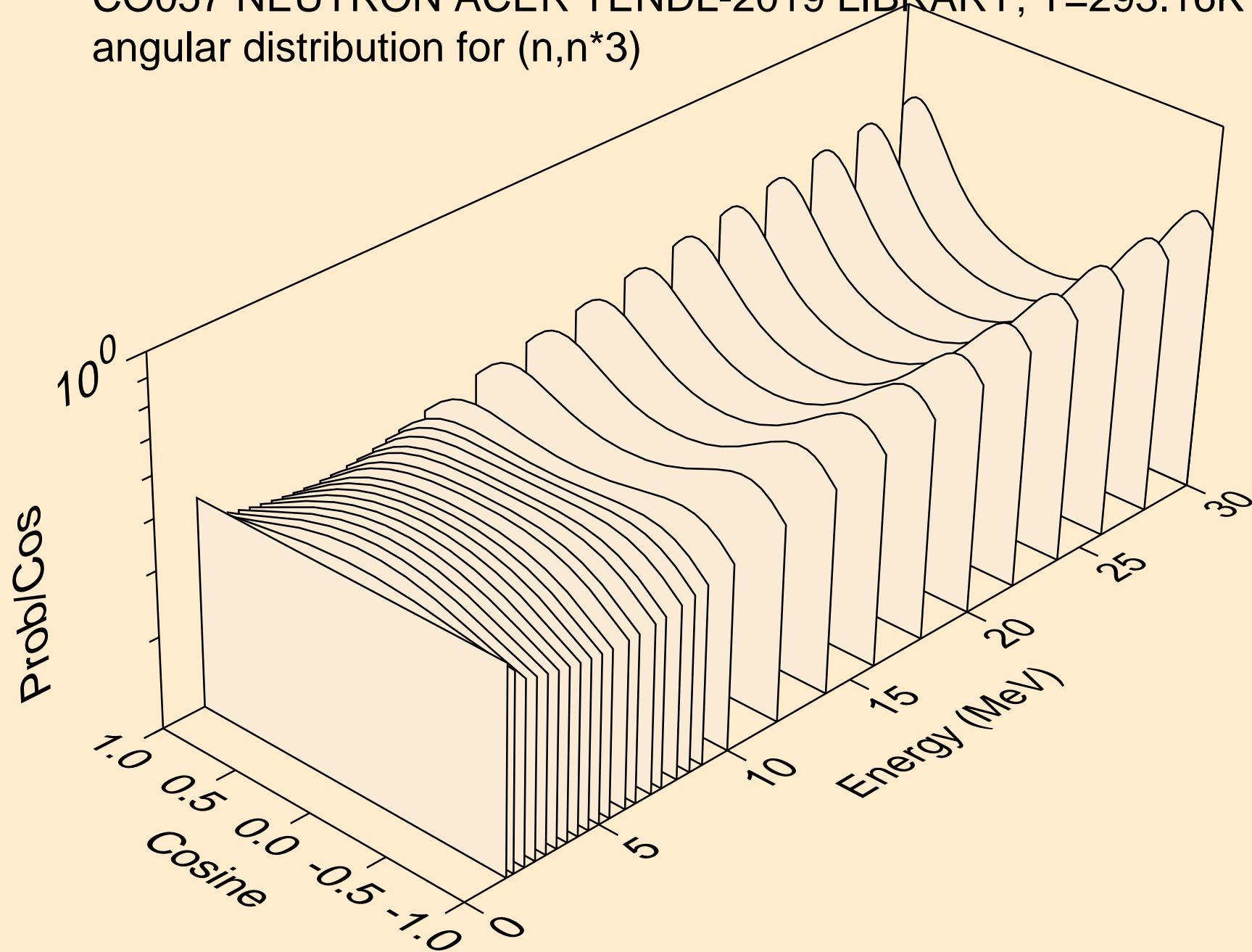

CO057 NEUTRON ACER TENDL-2019 LIBRARY; T=293.16K
angular distribution for (n,n*4)

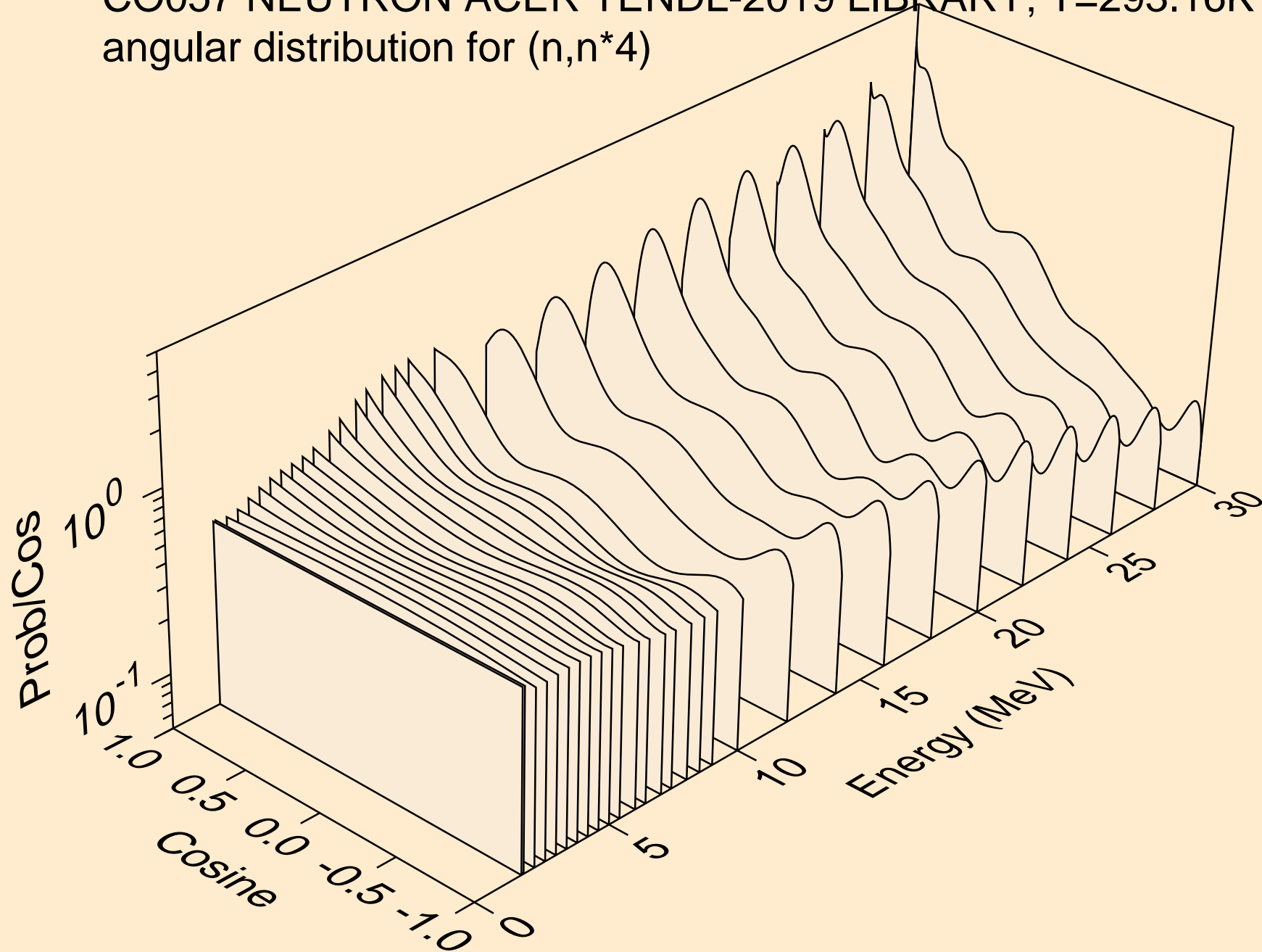

CO057 NEUTRON ACER TENDL-2019 LIBRARY; T=293.16K
angular distribution for (n,n*5)

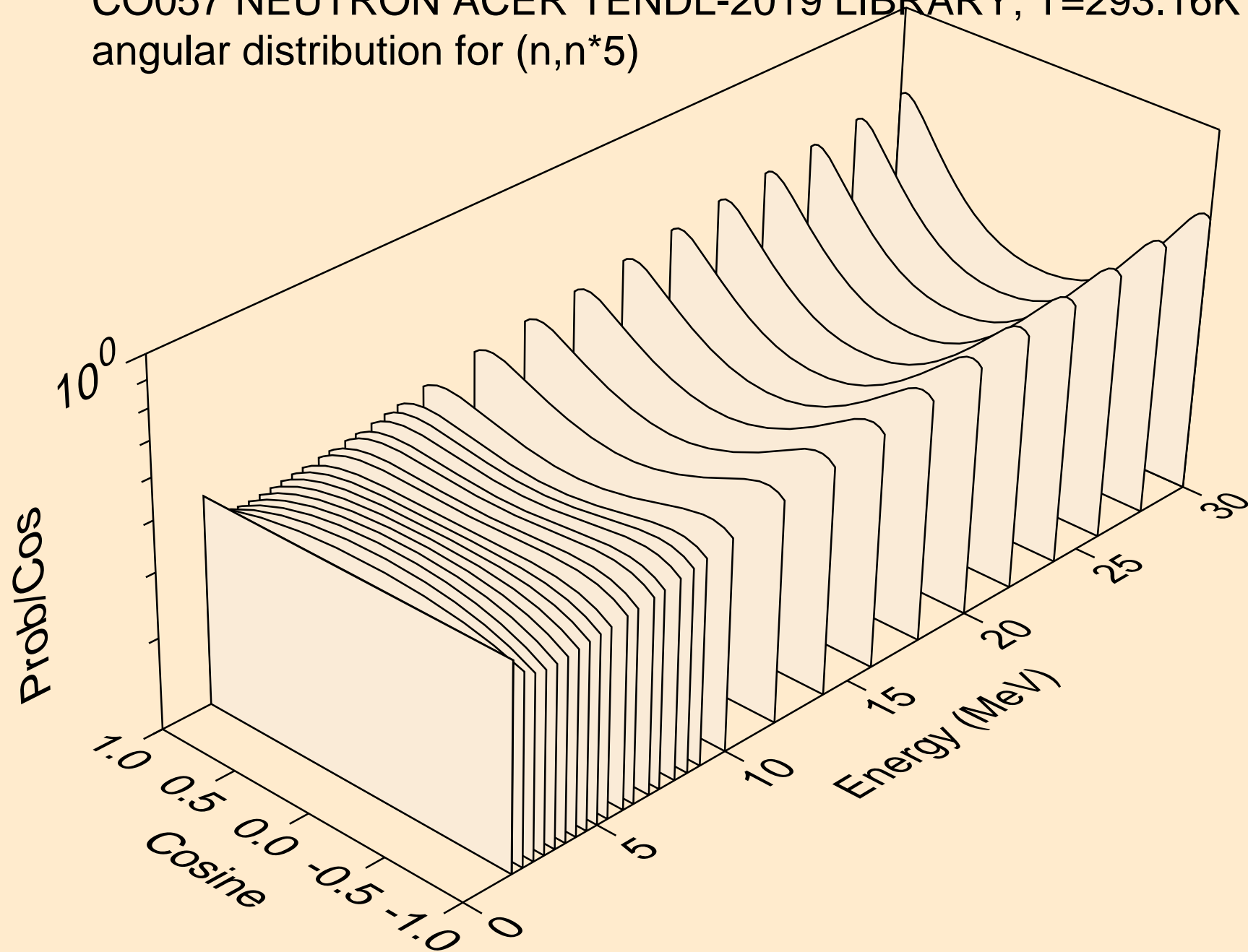

CO057 NEUTRON ACER TENDL-2019 LIBRARY; T=293.16K
angular distribution for (n,n*6)

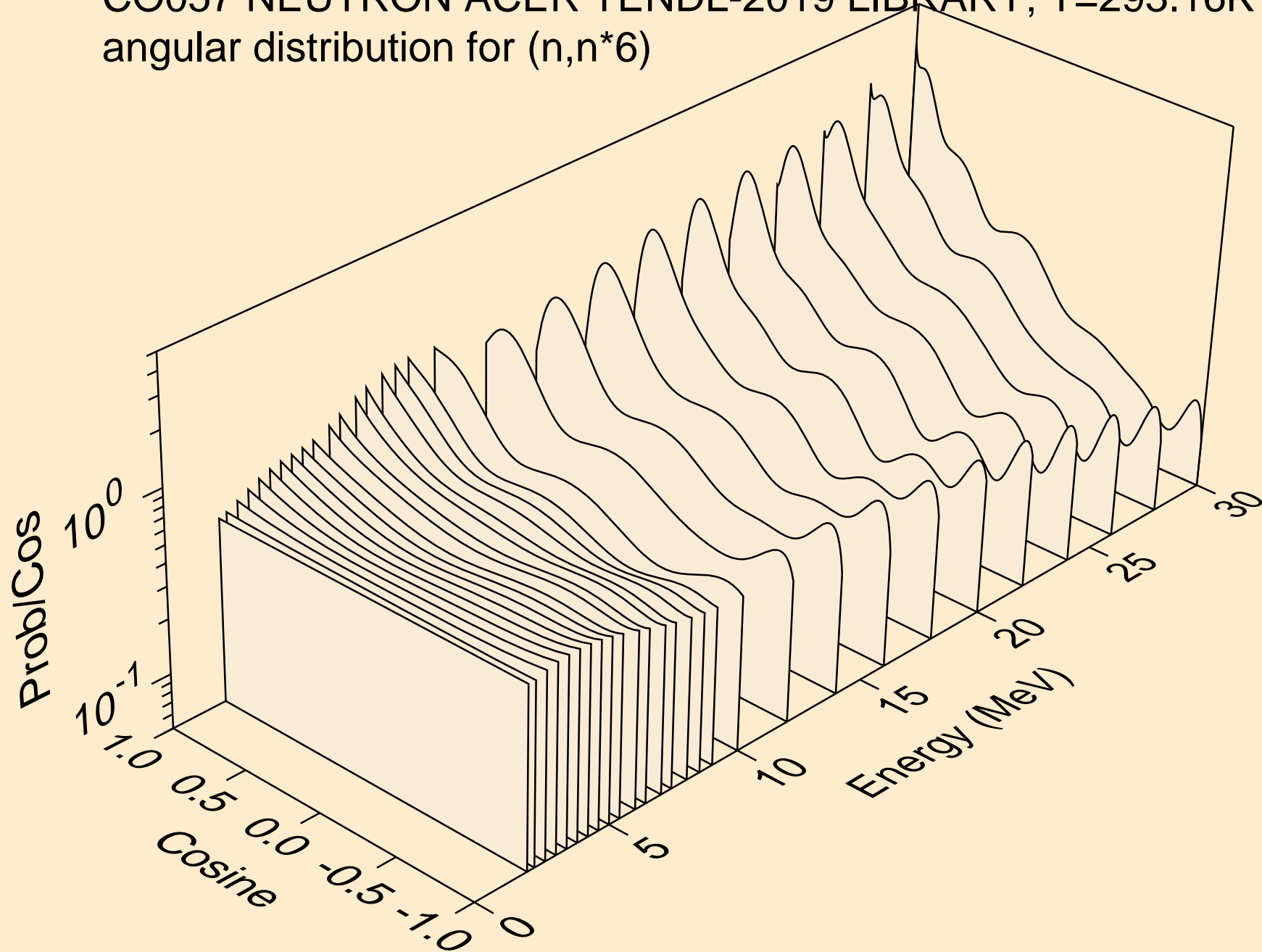

CO057 NEUTRON ACER TENDL-2019 LIBRARY; T=293.16K
angular distribution for (n,n*7)

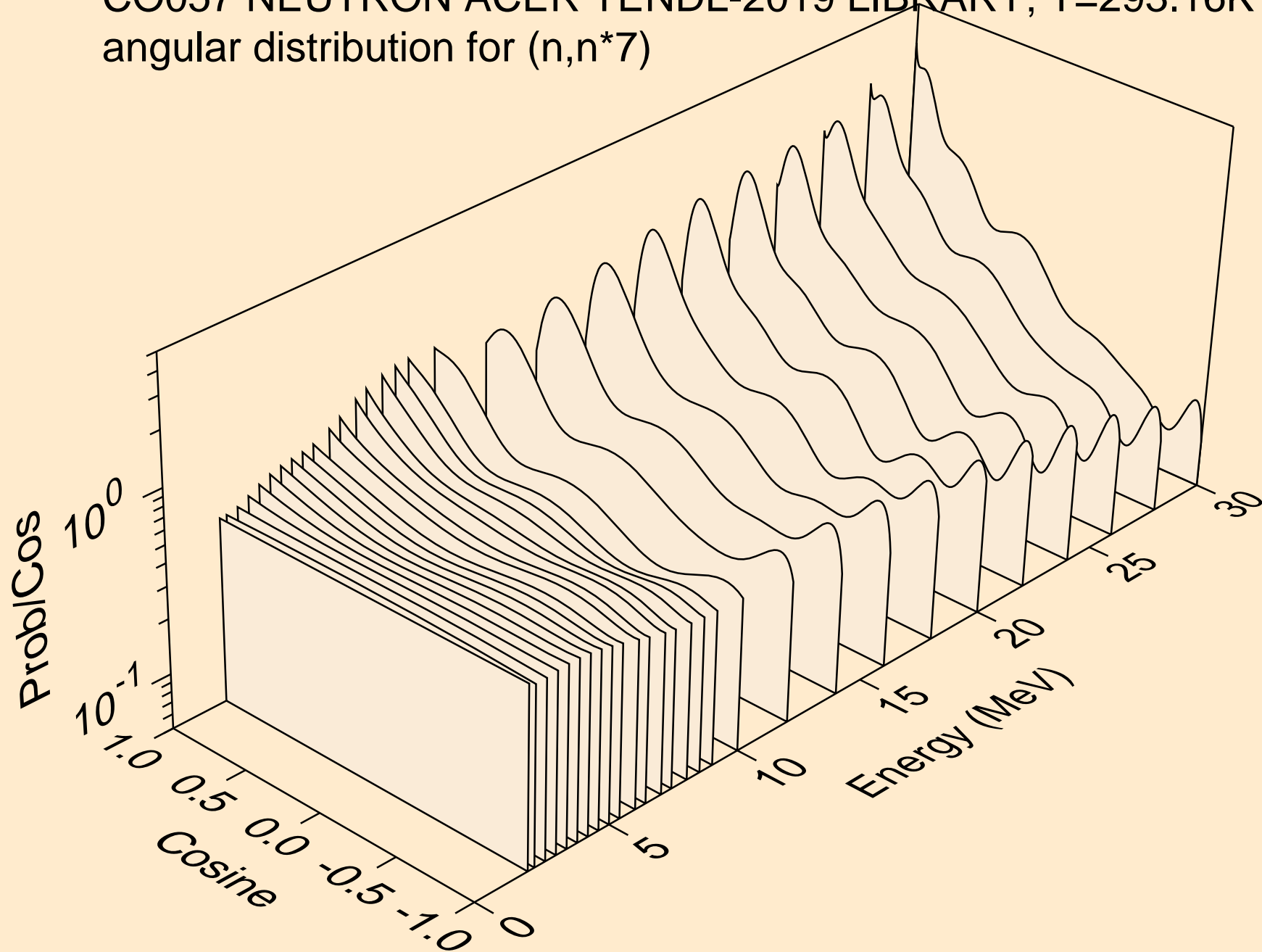

CO057 NEUTRON ACER TENDL-2019 LIBRARY; T=293.16K
angular distribution for (n,n*8)

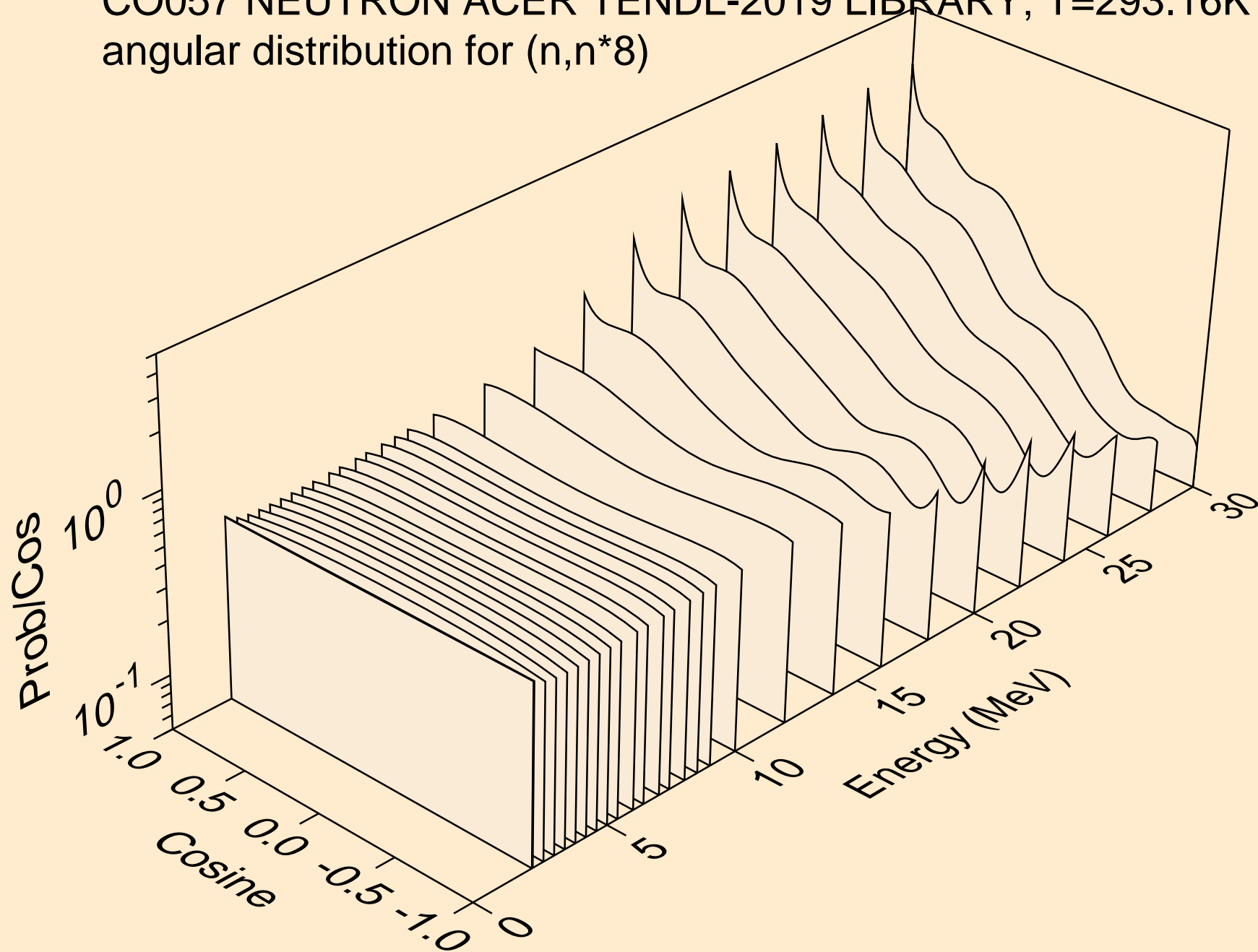

CO057 NEUTRON ACER TENDL-2019 LIBRARY; T=293.16K
angular distribution for (n,n*9)

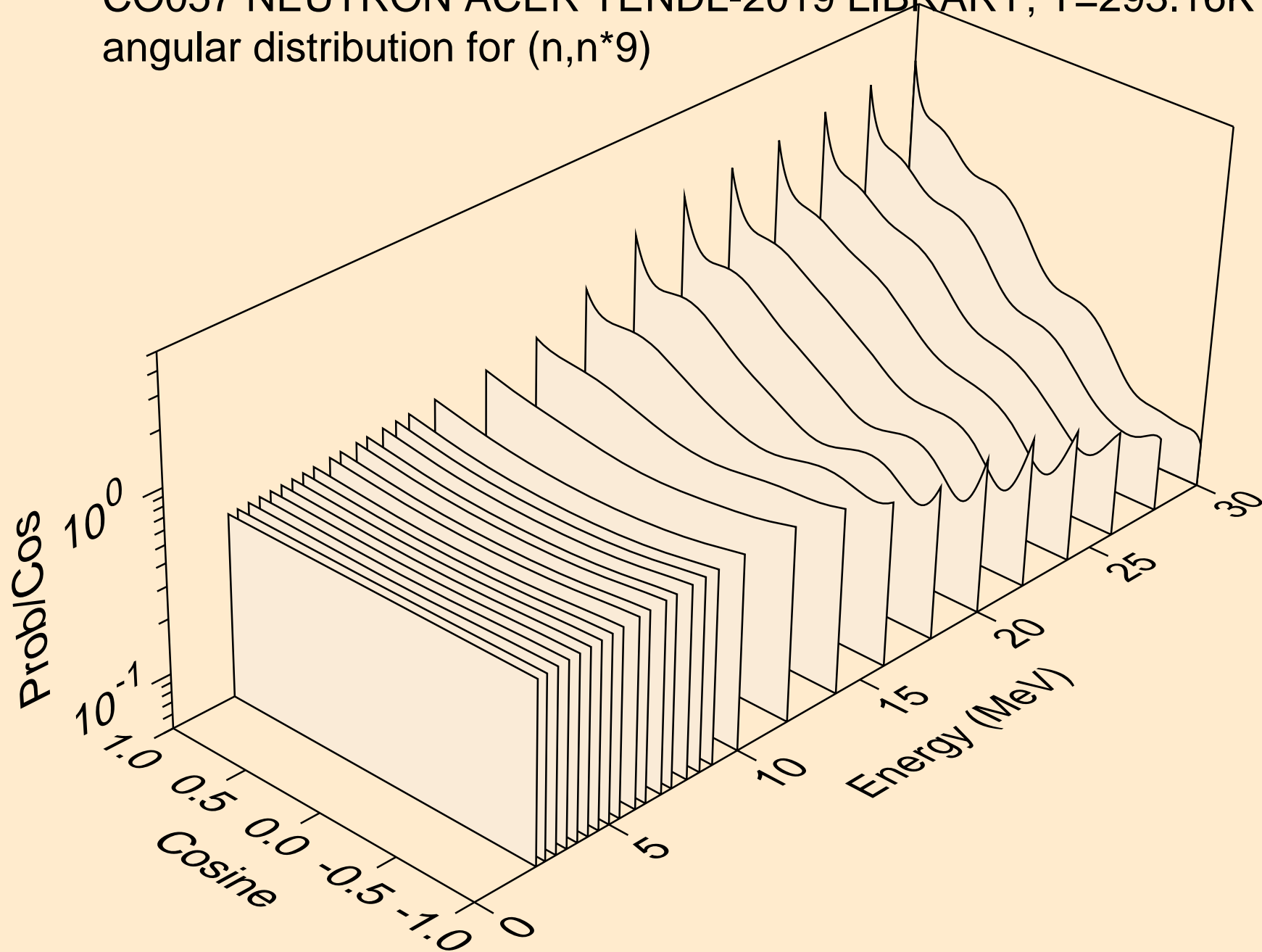

CO057 NEUTRON ACER TENDL-2019 LIBRARY; T=293.16K
angular distribution for (n,n*10)

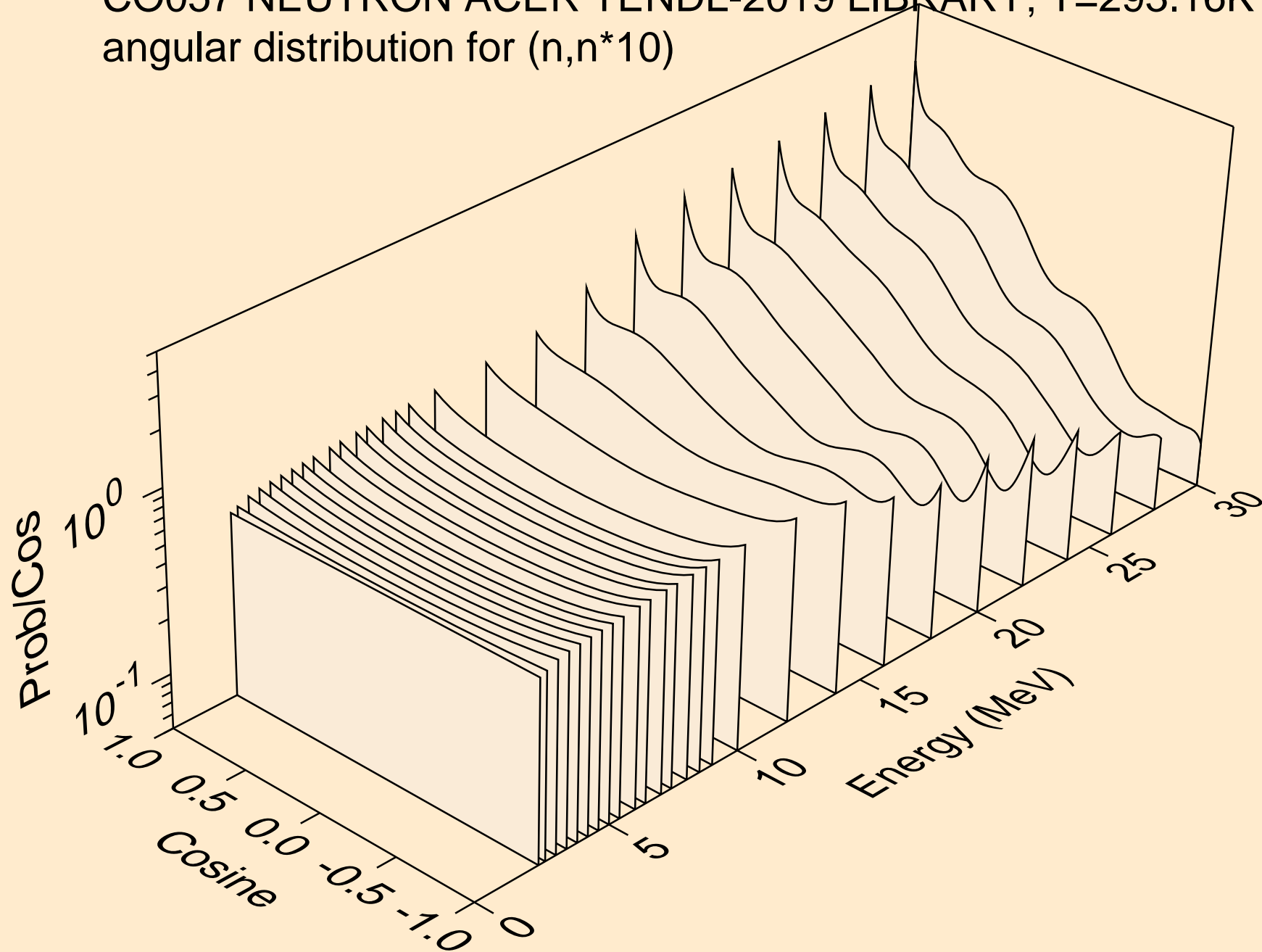

CO057 NEUTRON ACER TENDL-2019 LIBRARY; T=293.16K
angular distribution for (n,n*11)

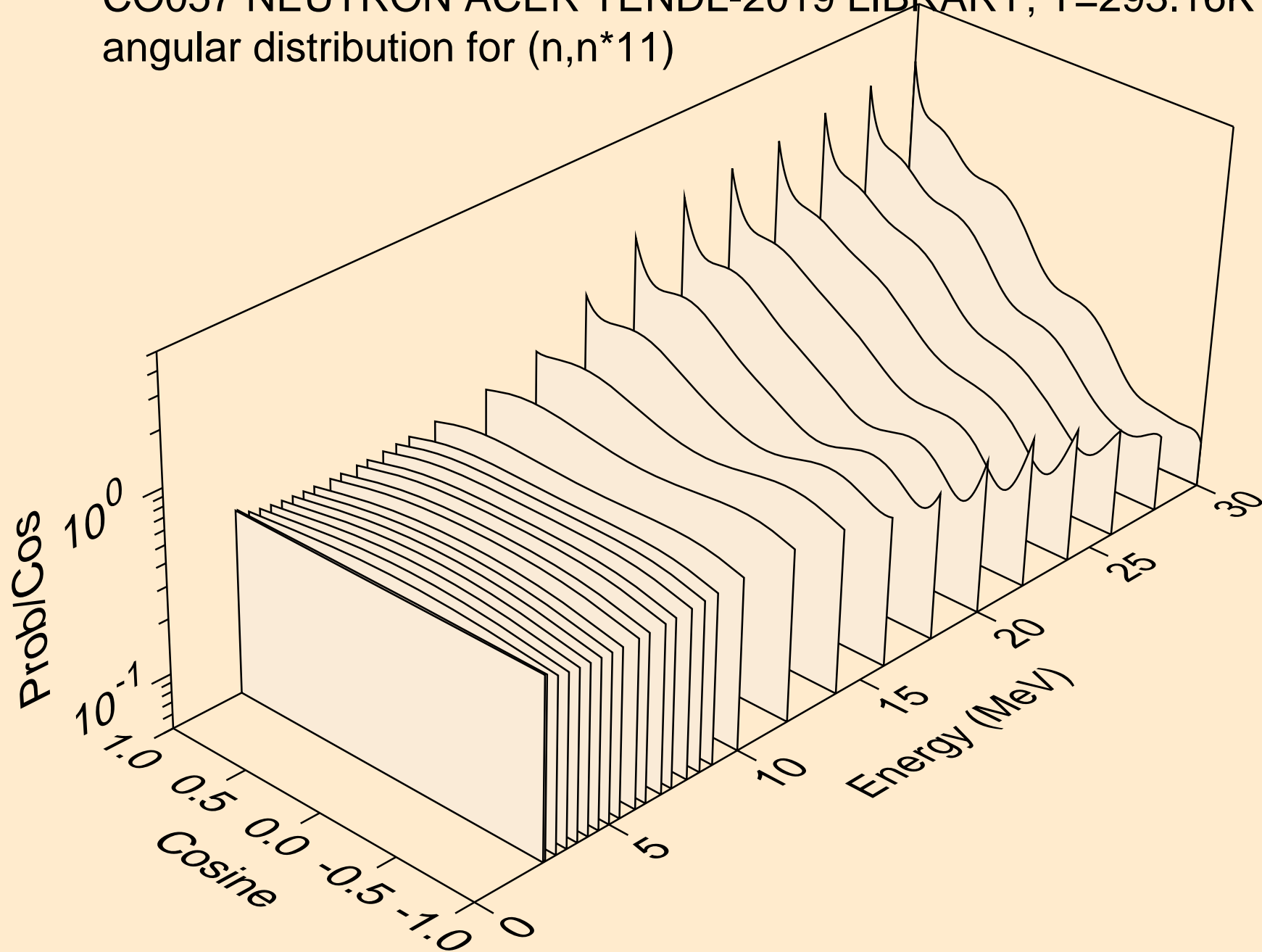

CO057 NEUTRON ACER TENDL-2019 LIBRARY; T=293.16K
angular distribution for (n,n*12)

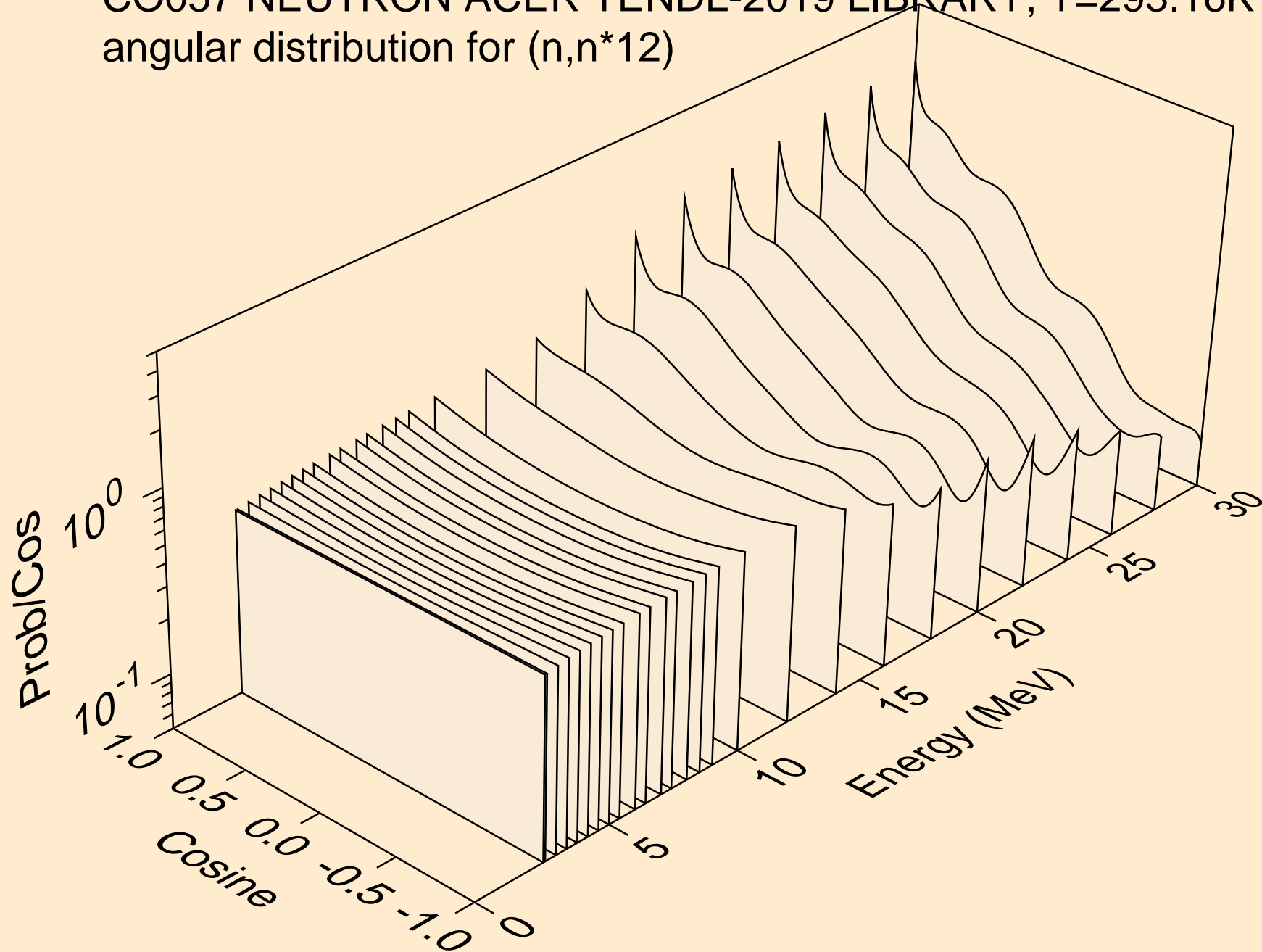

CO057 NEUTRON ACER TENDL-2019 LIBRARY; T=293.16K
angular distribution for (n,n*13)

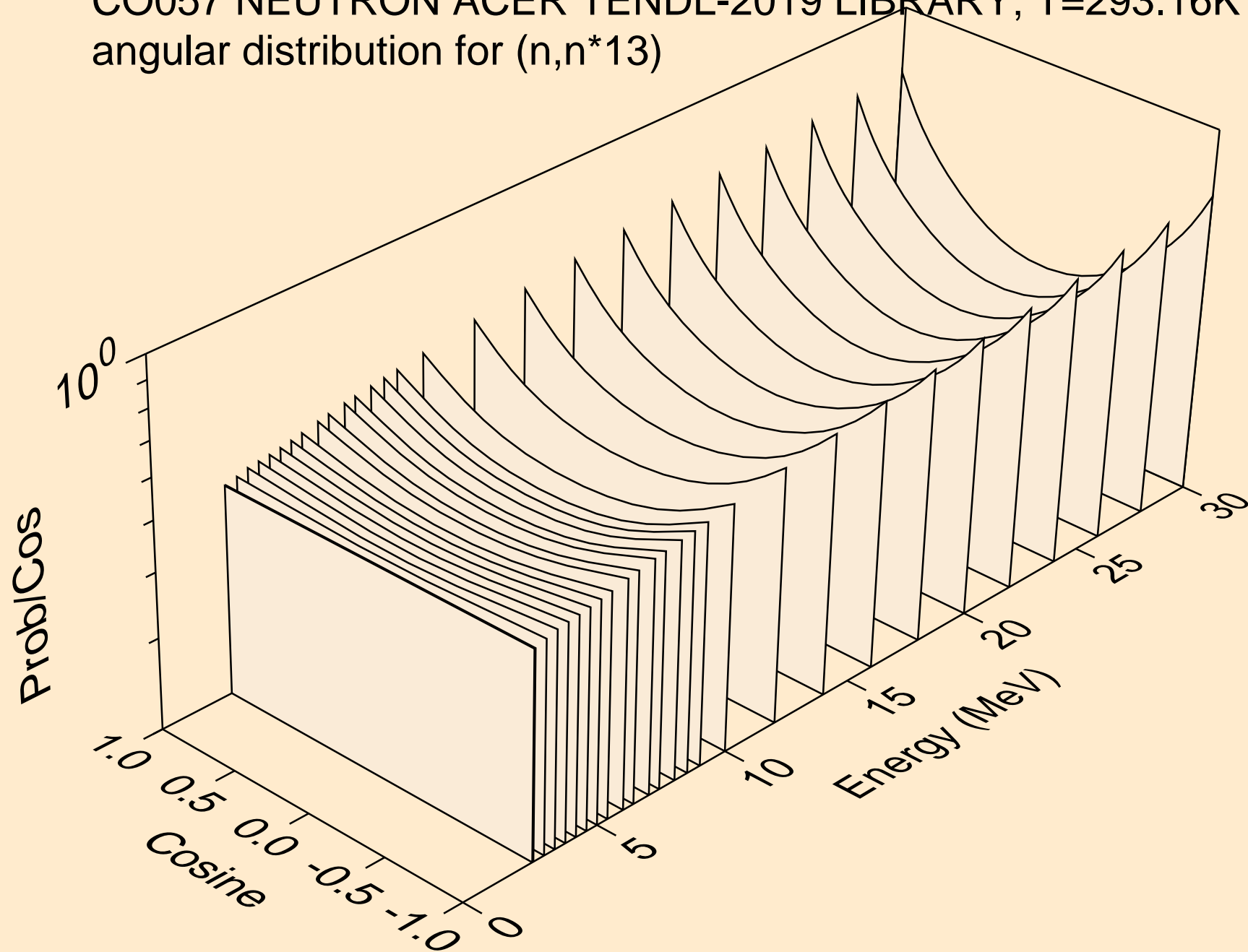

CO057 NEUTRON ACER TENDL-2019 LIBRARY; T=293.16K
angular distribution for (n,n*14)

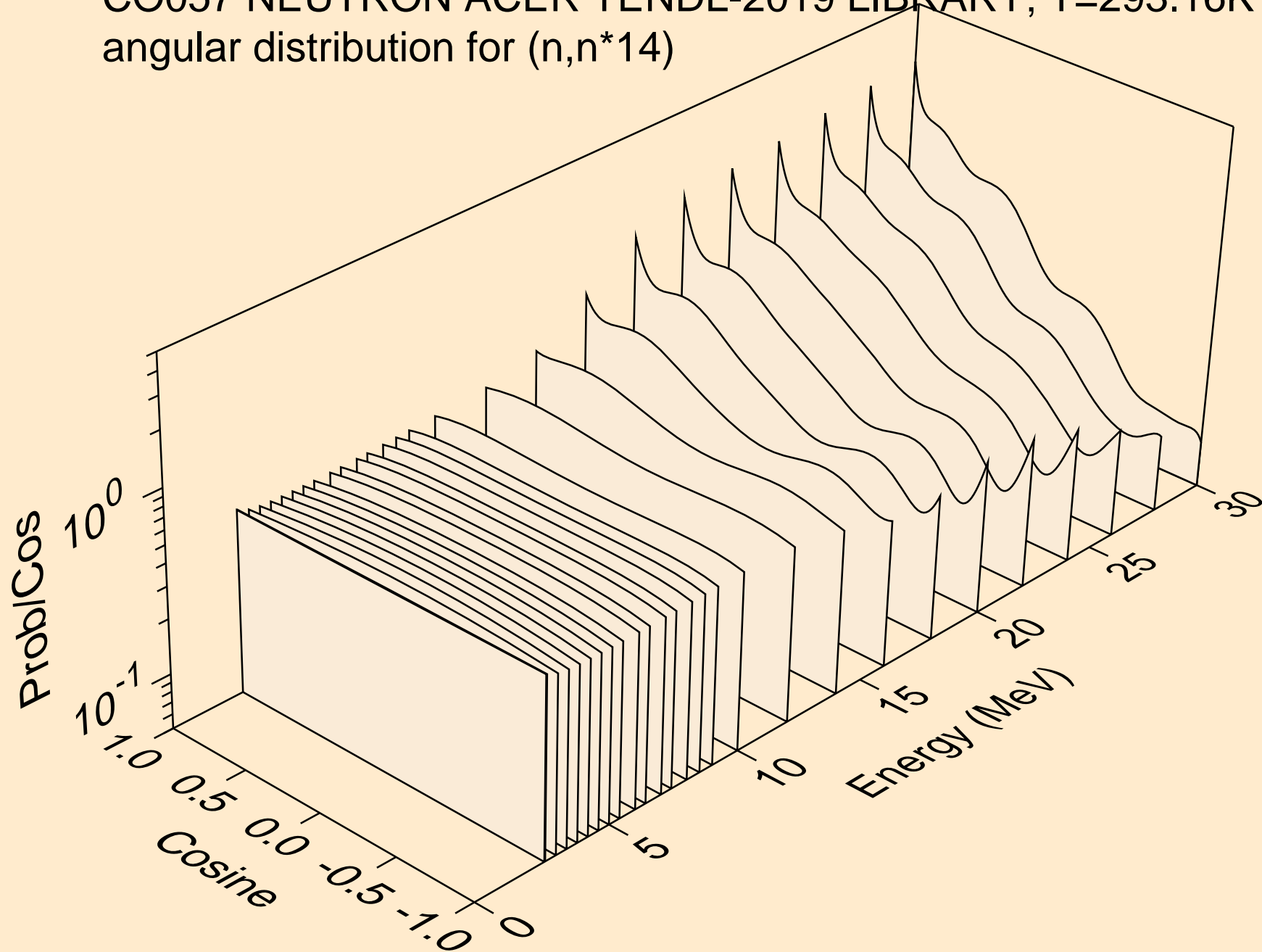

CO057 NEUTRON ACER TENDL-2019 LIBRARY; T=293.16K
angular distribution for (n,n*15)

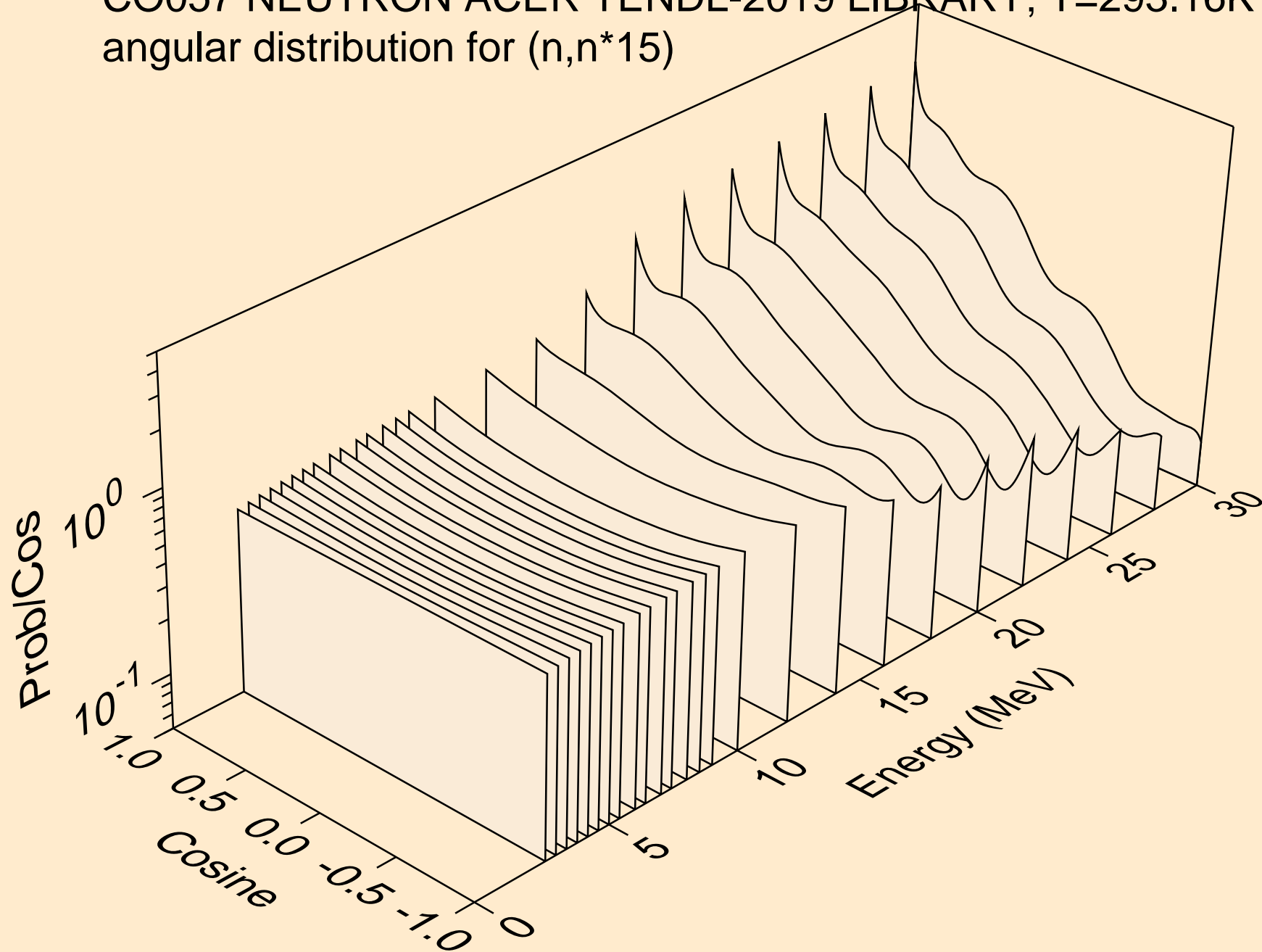

CO057 NEUTRON ACER TENDL-2019 LIBRARY; T=293.16K
angular distribution for (n,n*16)

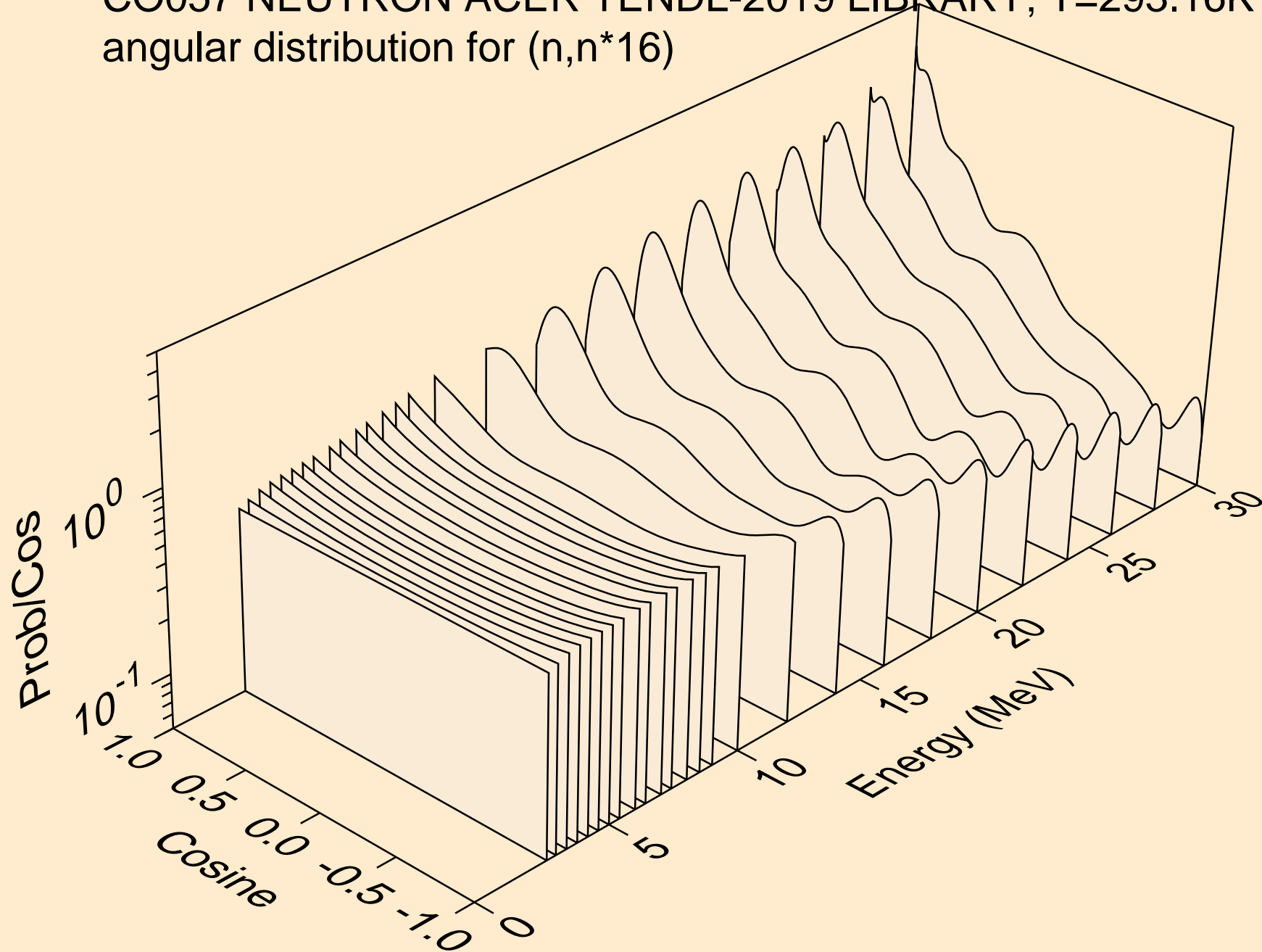

CO057 NEUTRON ACER TENDL-2019 LIBRARY; T=293.16K
angular distribution for (n,n*17)

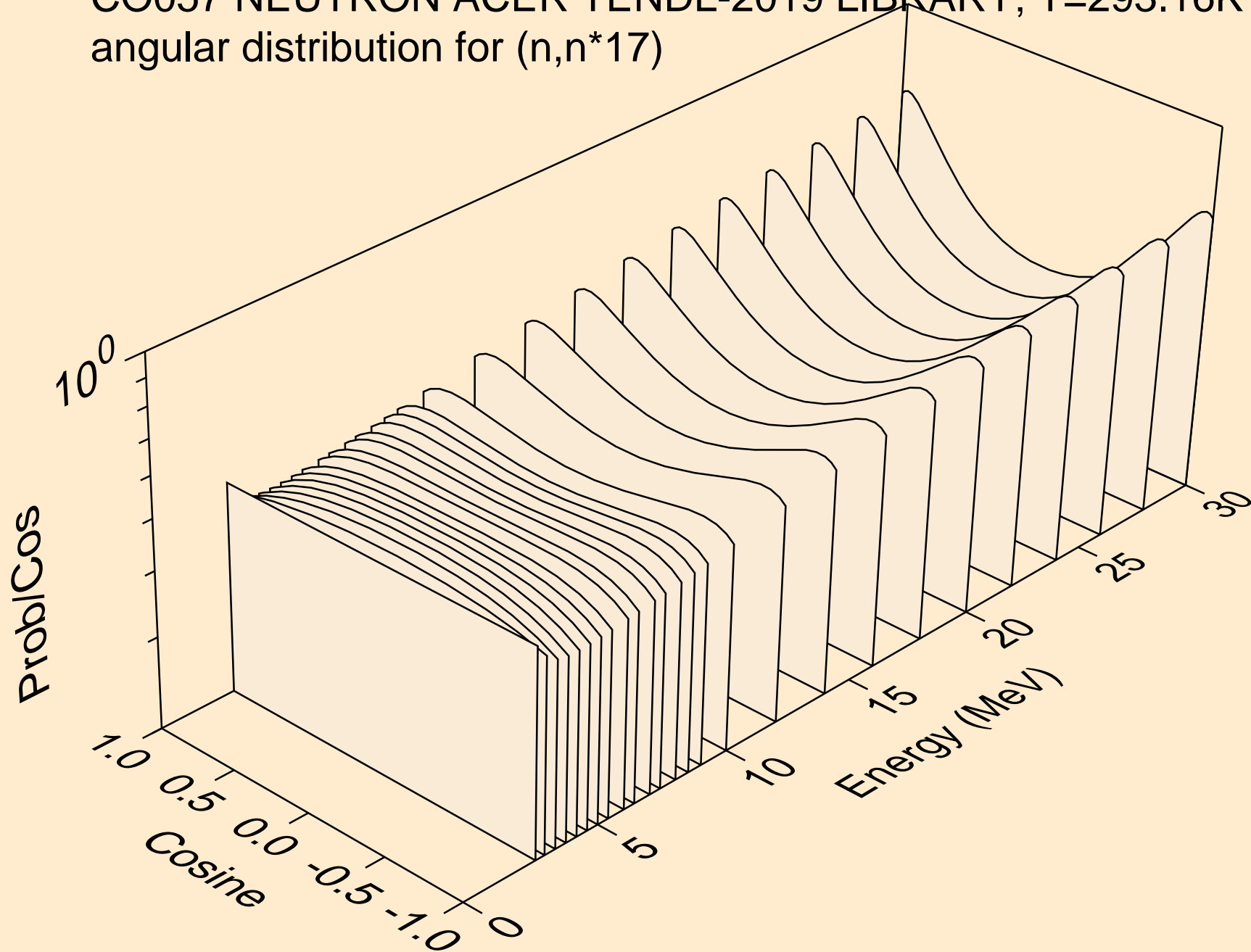

CO057 NEUTRON ACER TENDL-2019 LIBRARY; T=293.16K
angular distribution for (n,n*18)

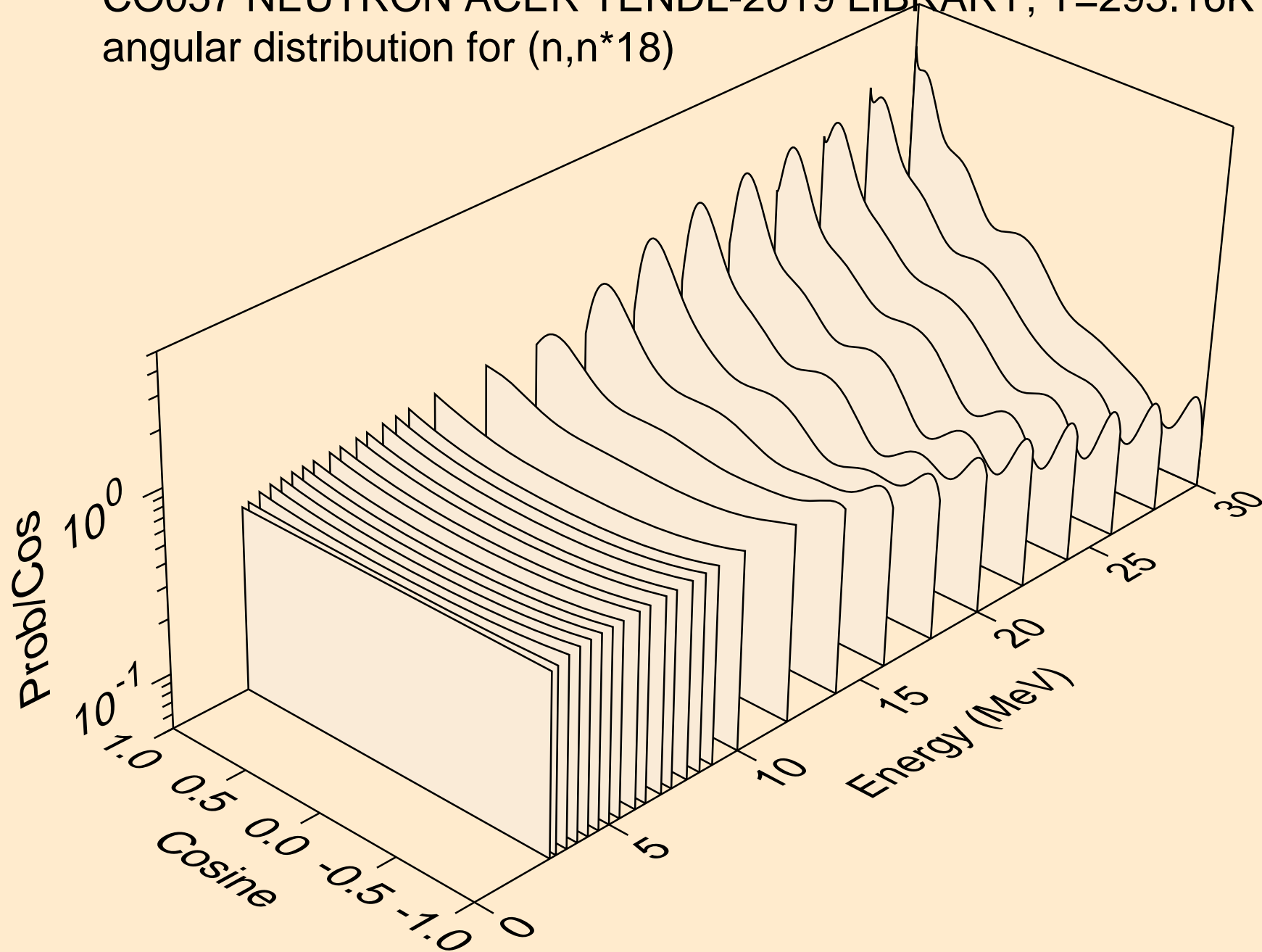

CO057 NEUTRON ACER TENDL-2019 LIBRARY; T=293.16K
angular distribution for (n,n*19)

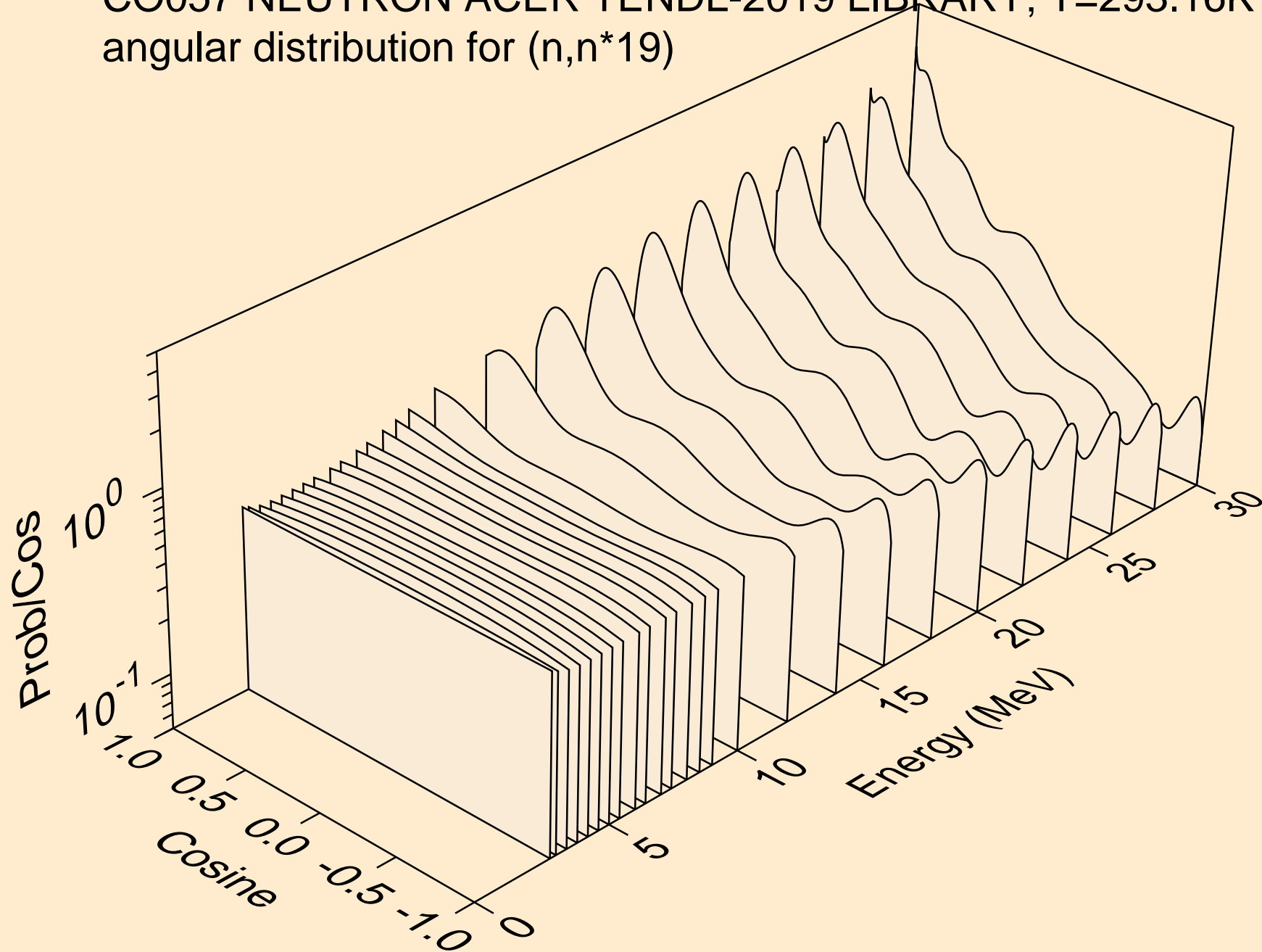

CO057 NEUTRON ACER TENDL-2019 LIBRARY; T=293.16K
angular distribution for (n,n*20)

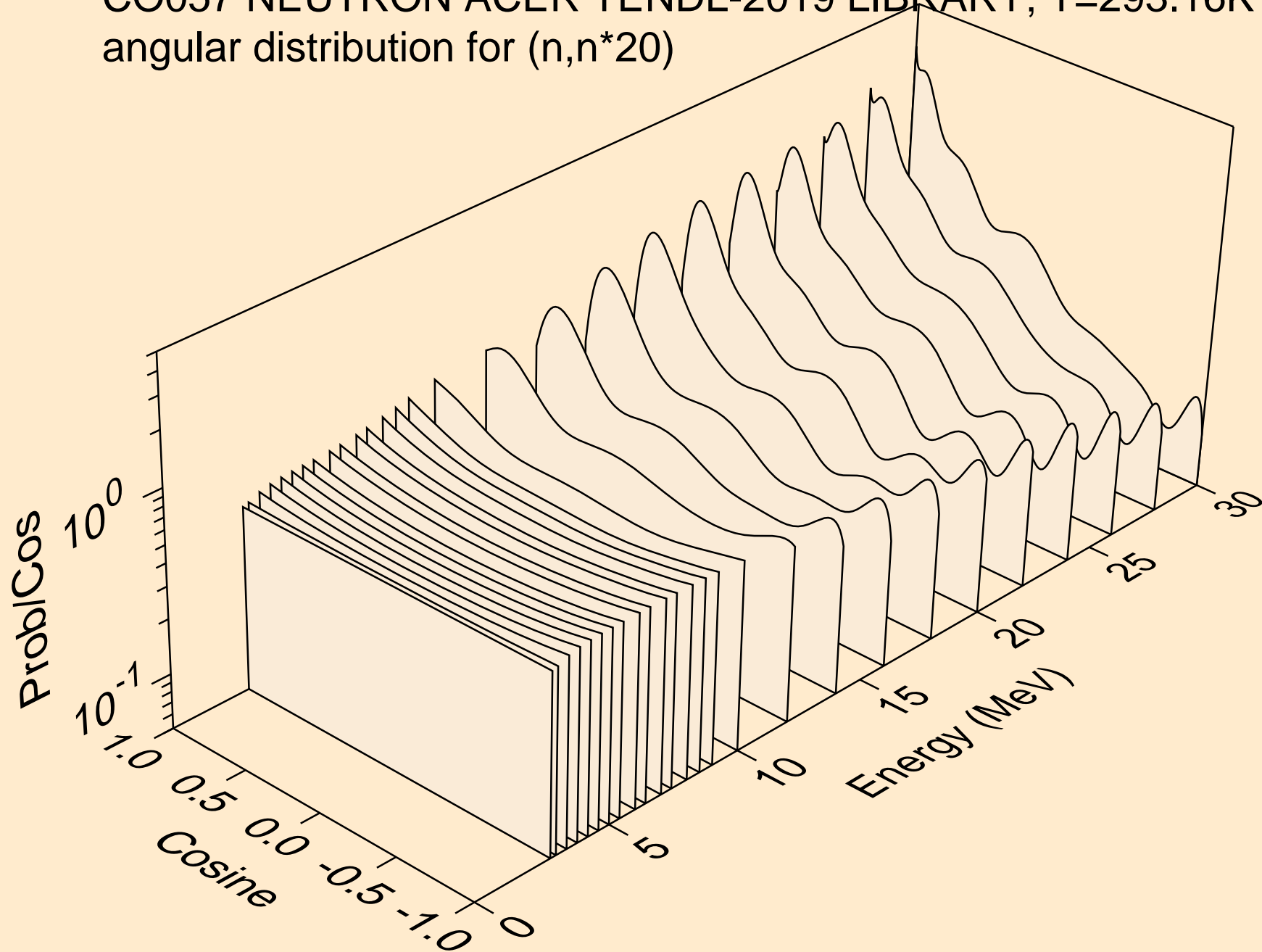

CO057 NEUTRON ACER TENDL-2019 LIBRARY; T=293.16K
angular distribution for (n,n*21)

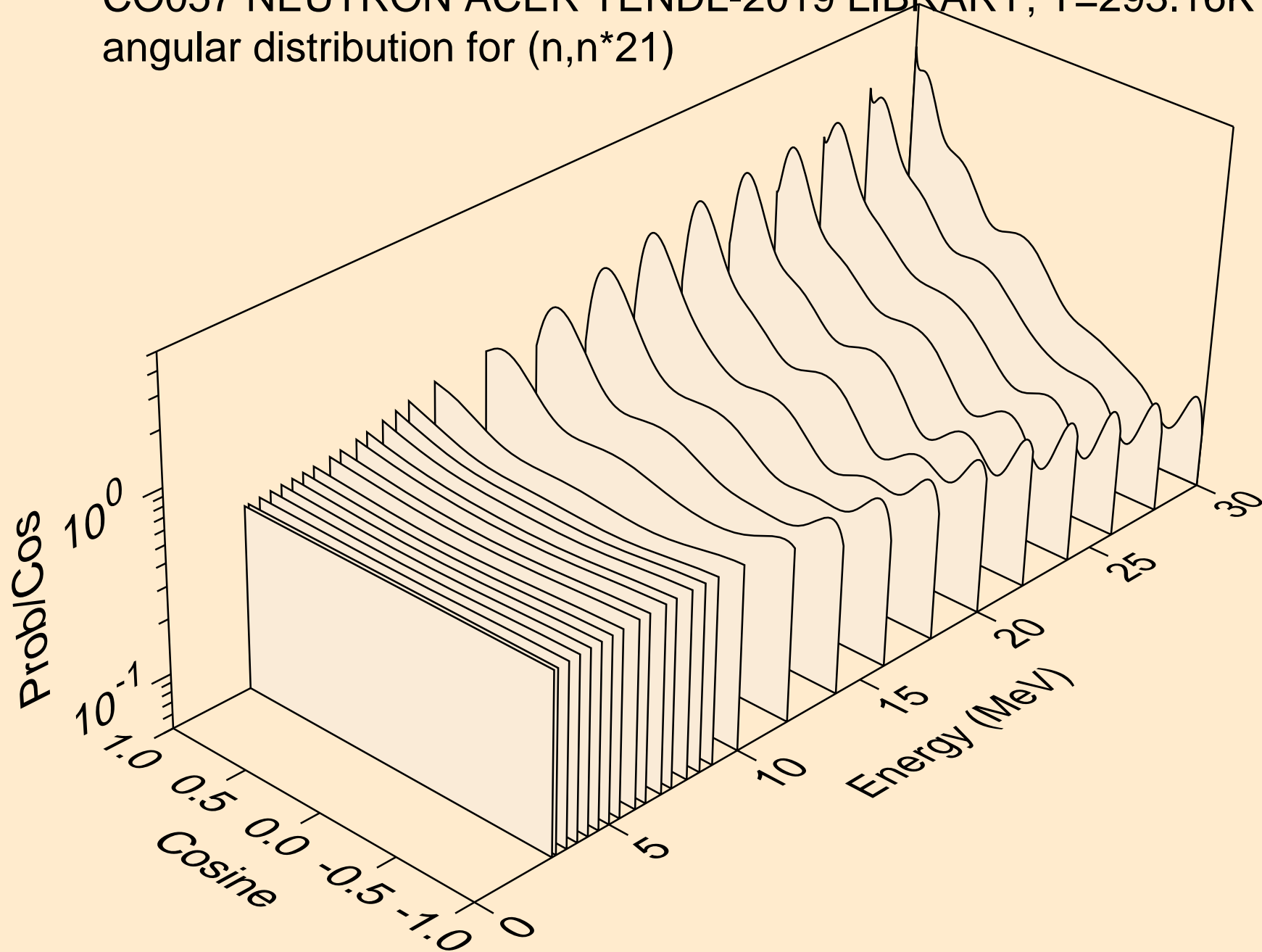

CO057 NEUTRON ACER TENDL-2019 LIBRARY; T=293.16K
angular distribution for (n,n*22)

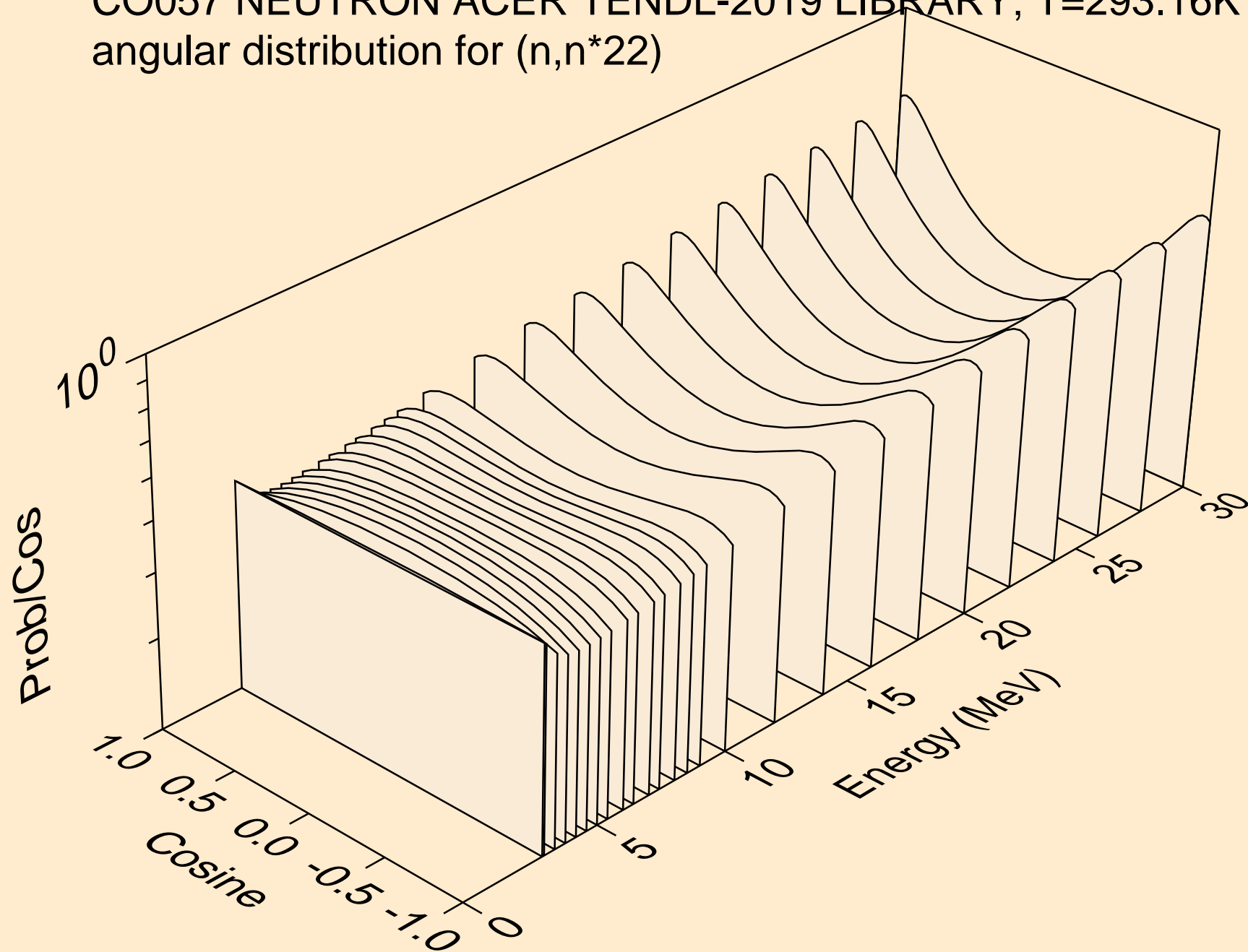

CO057 NEUTRON ACER TENDL-2019 LIBRARY; T=293.16K
angular distribution for (n,n*23)

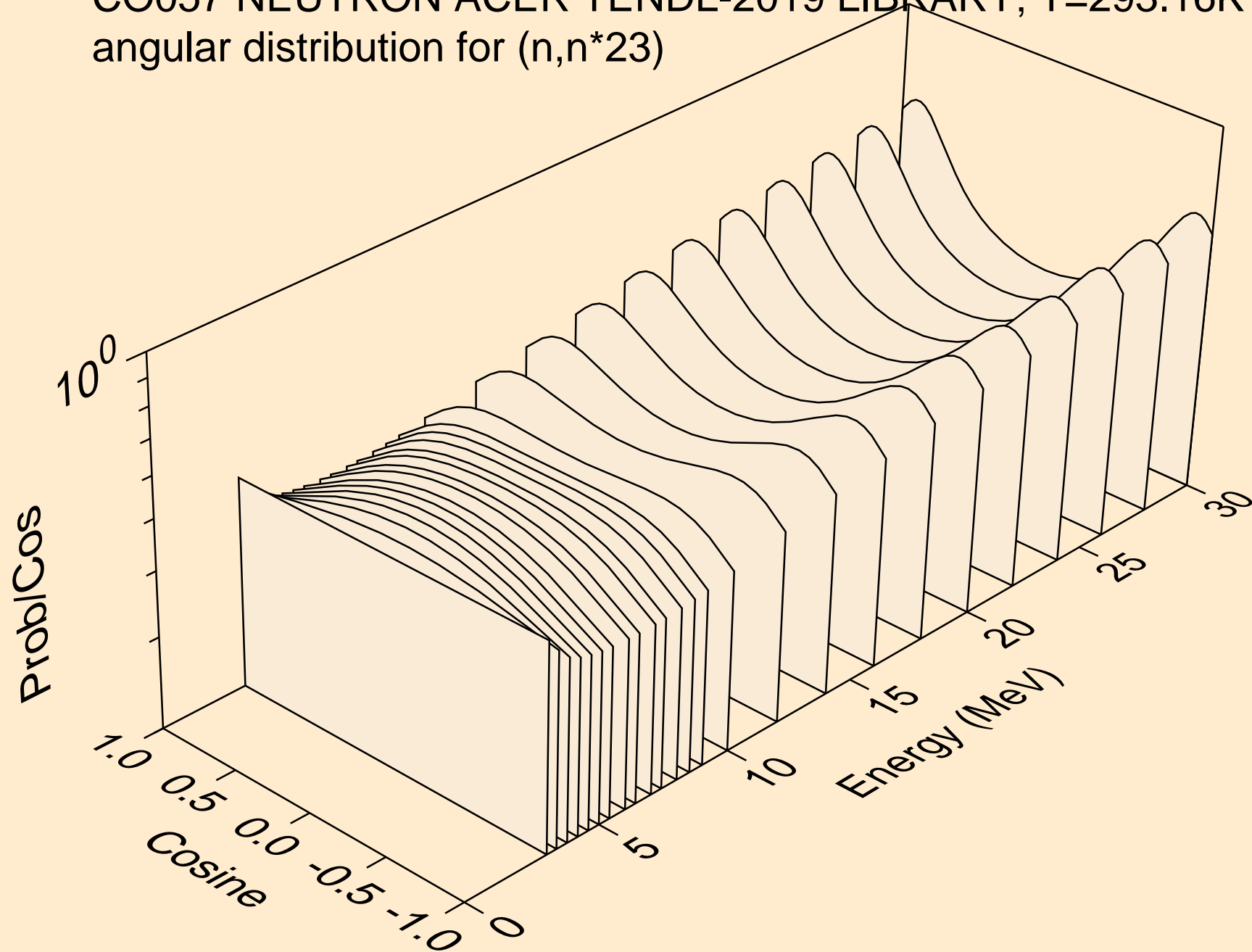

CO057 NEUTRON ACER TENDL-2019 LIBRARY; T=293.16K
angular distribution for (n,n*24)

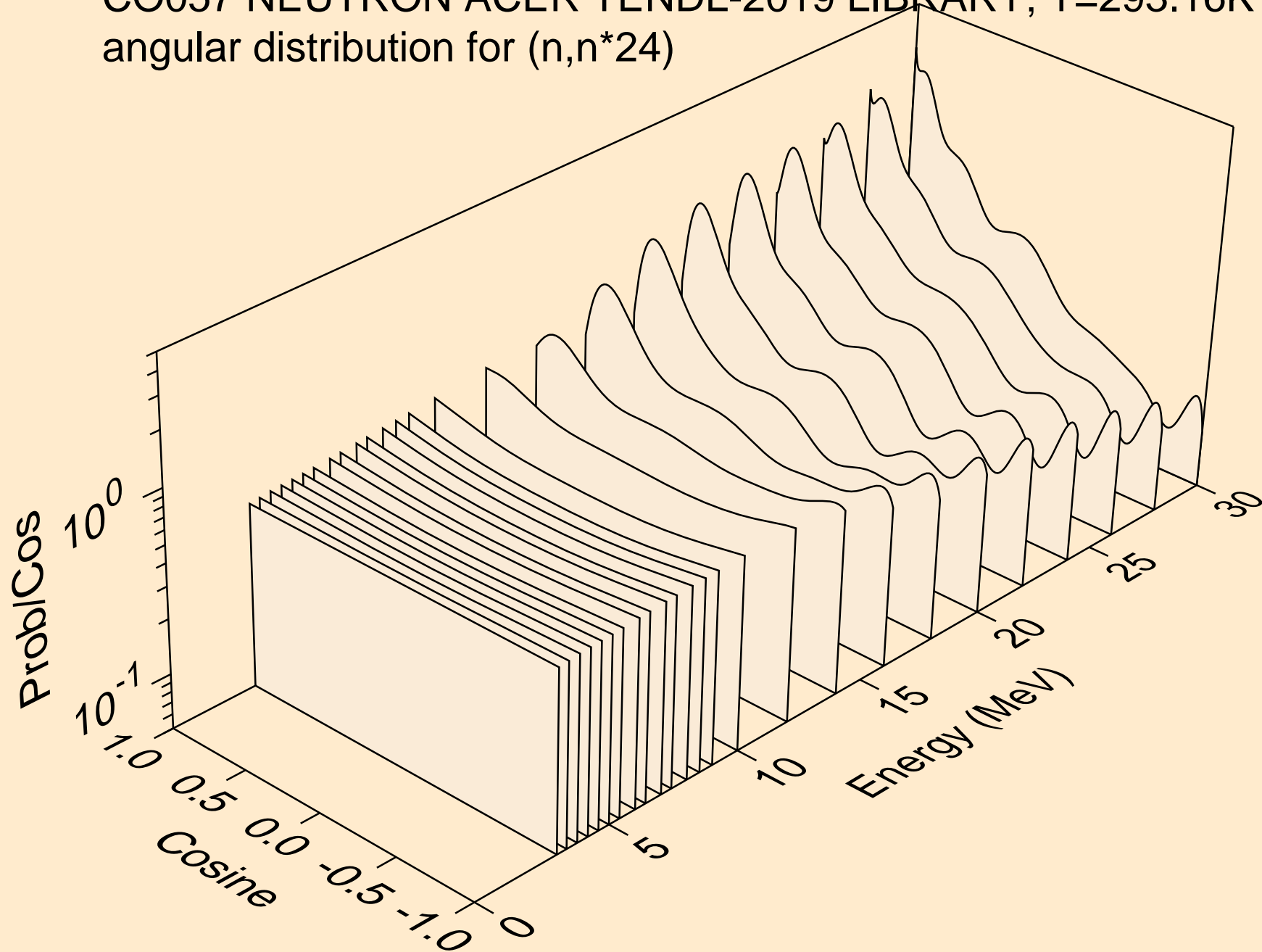

CO057 NEUTRON ACER TENDL-2019 LIBRARY; T=293.16K
angular distribution for (n,n*25)

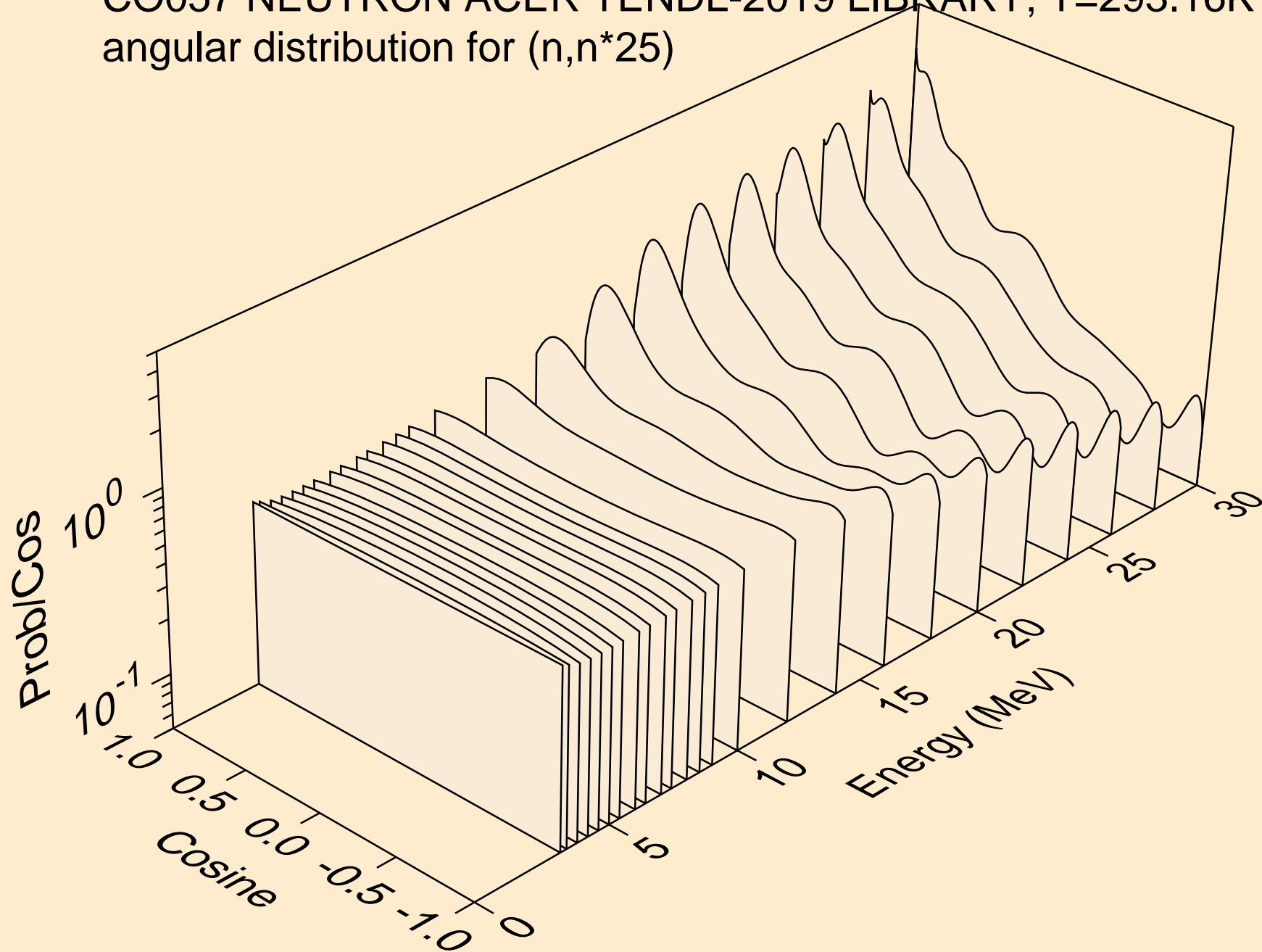

CO057 NEUTRON ACER TENDL-2019 LIBRARY; T=293.16K
angular distribution for (n,n*26)

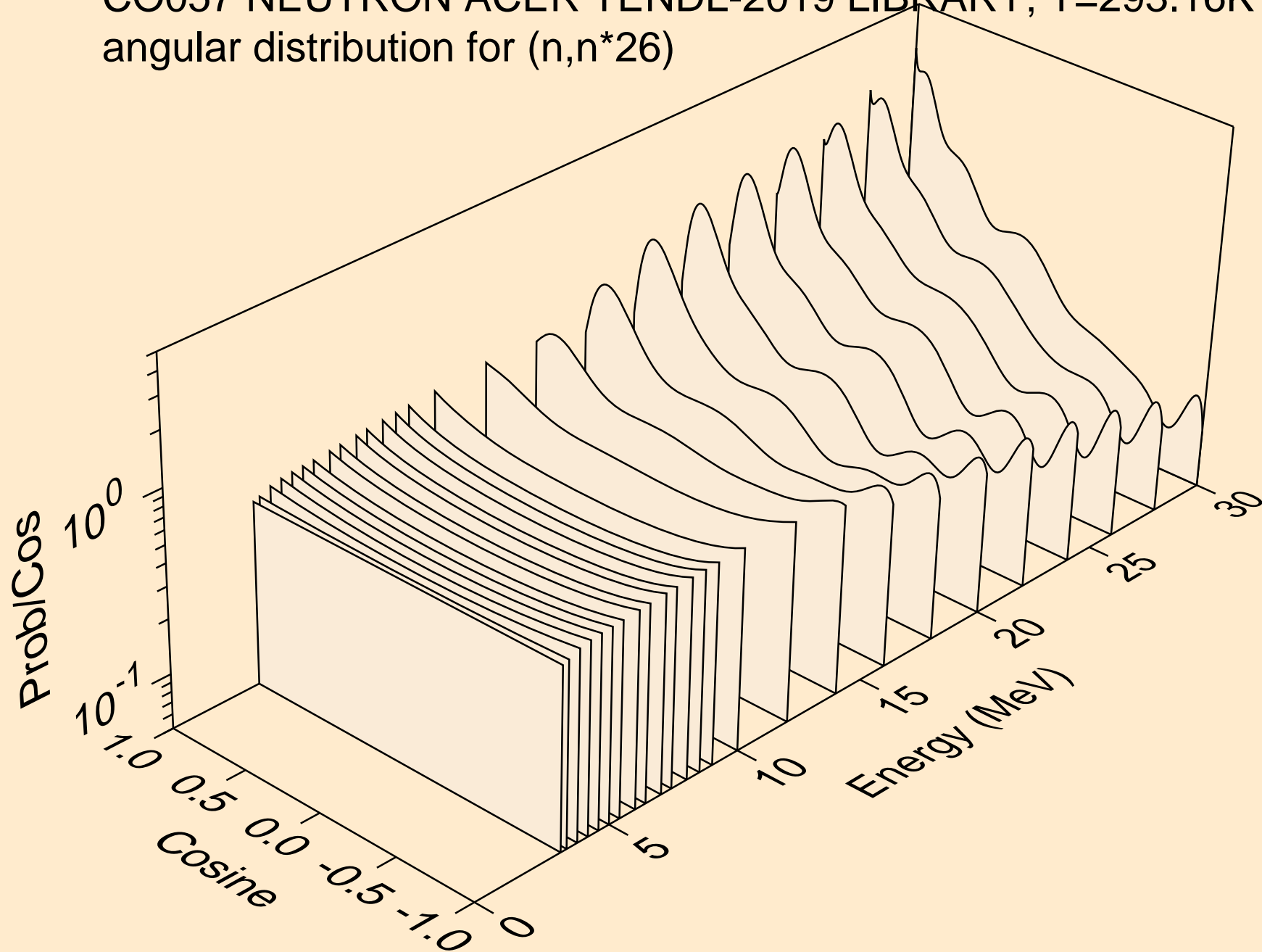

CO057 NEUTRON ACER TENDL-2019 LIBRARY; T=293.16K
angular distribution for (n,n*27)

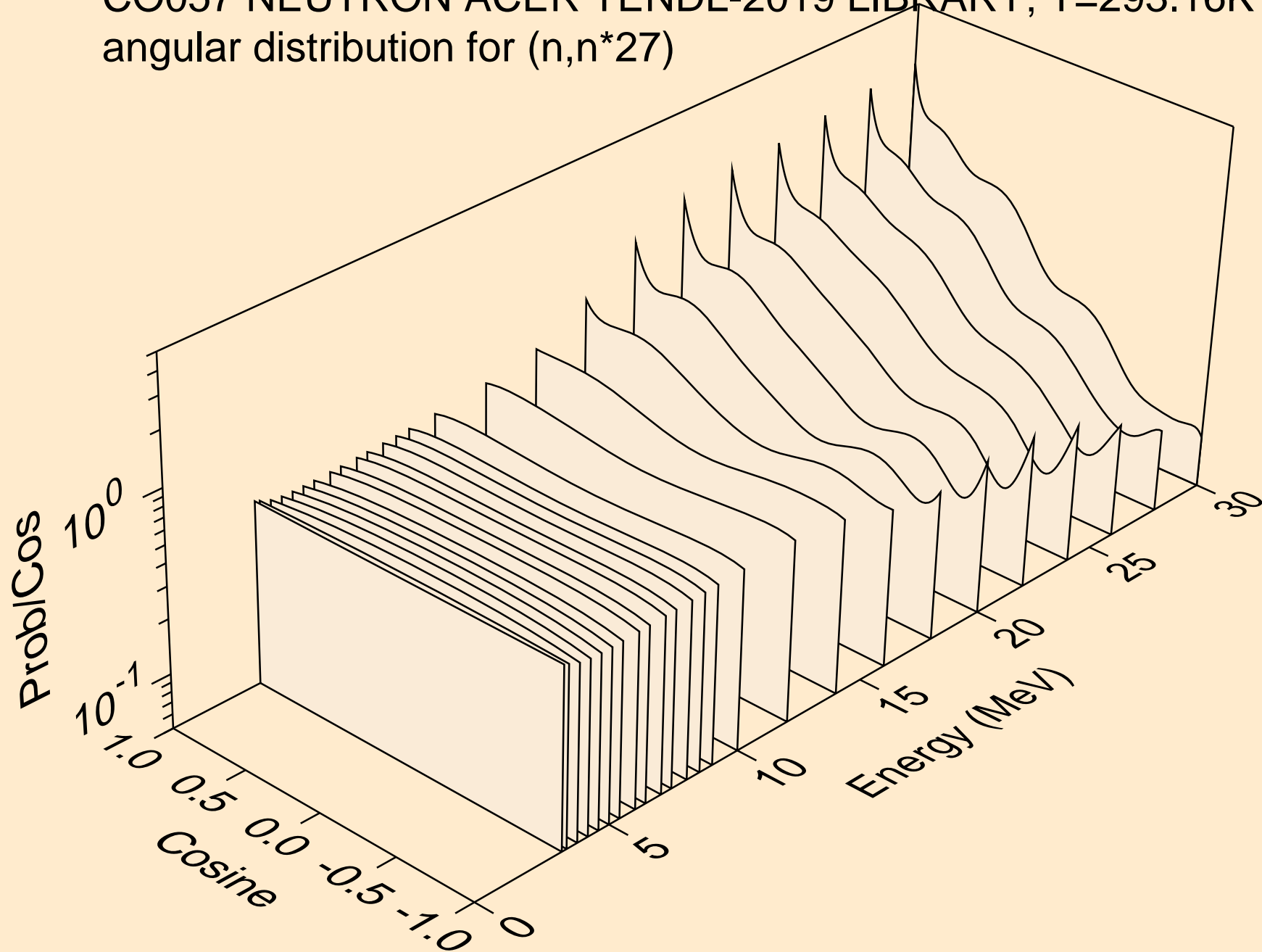

CO057 NEUTRON ACER TENDL-2019 LIBRARY; T=293.16K
angular distribution for (n,n*28)

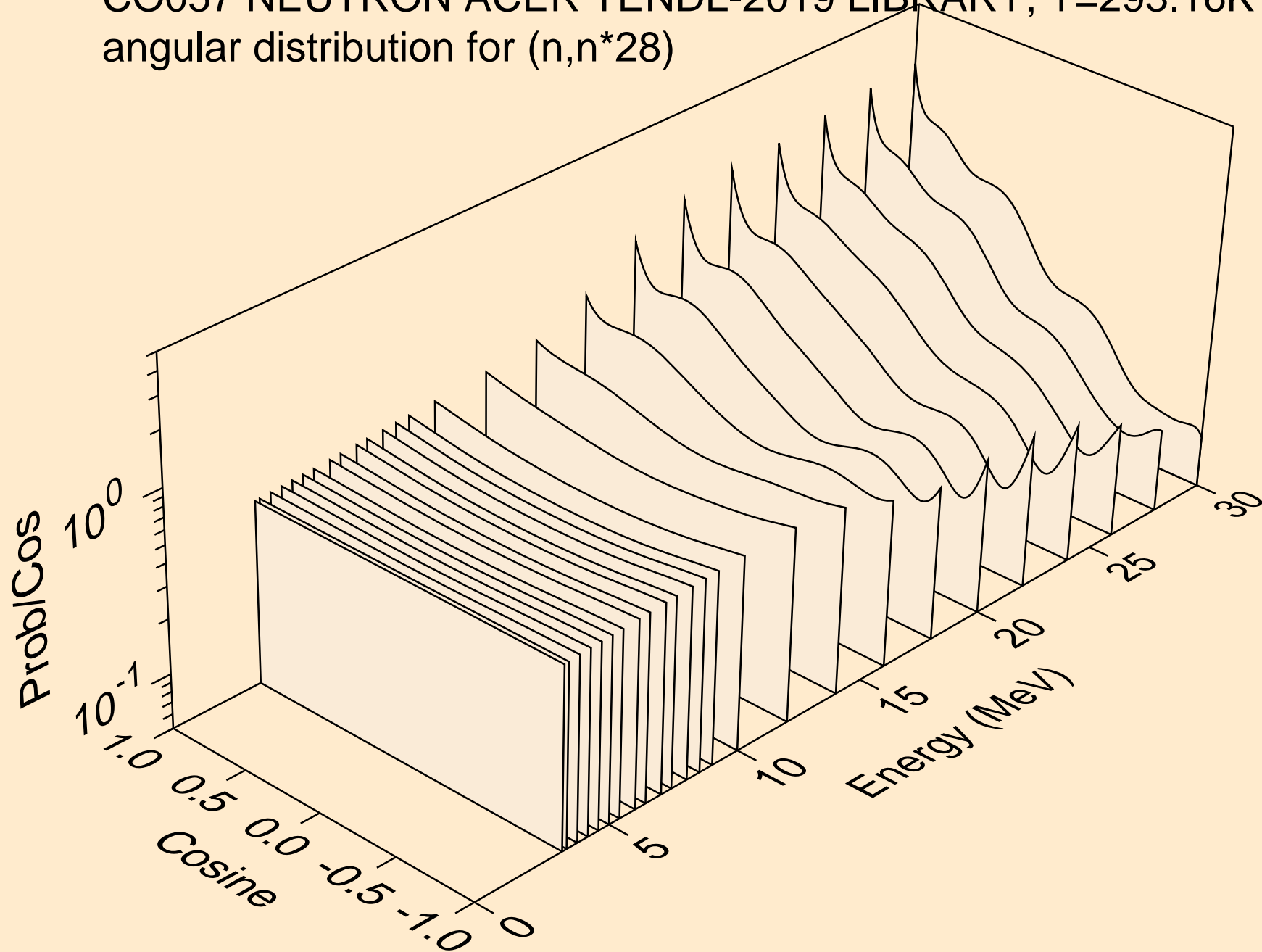

CO057 NEUTRON ACER TENDL-2019 LIBRARY; T=293.16K
angular distribution for (n,n*29)

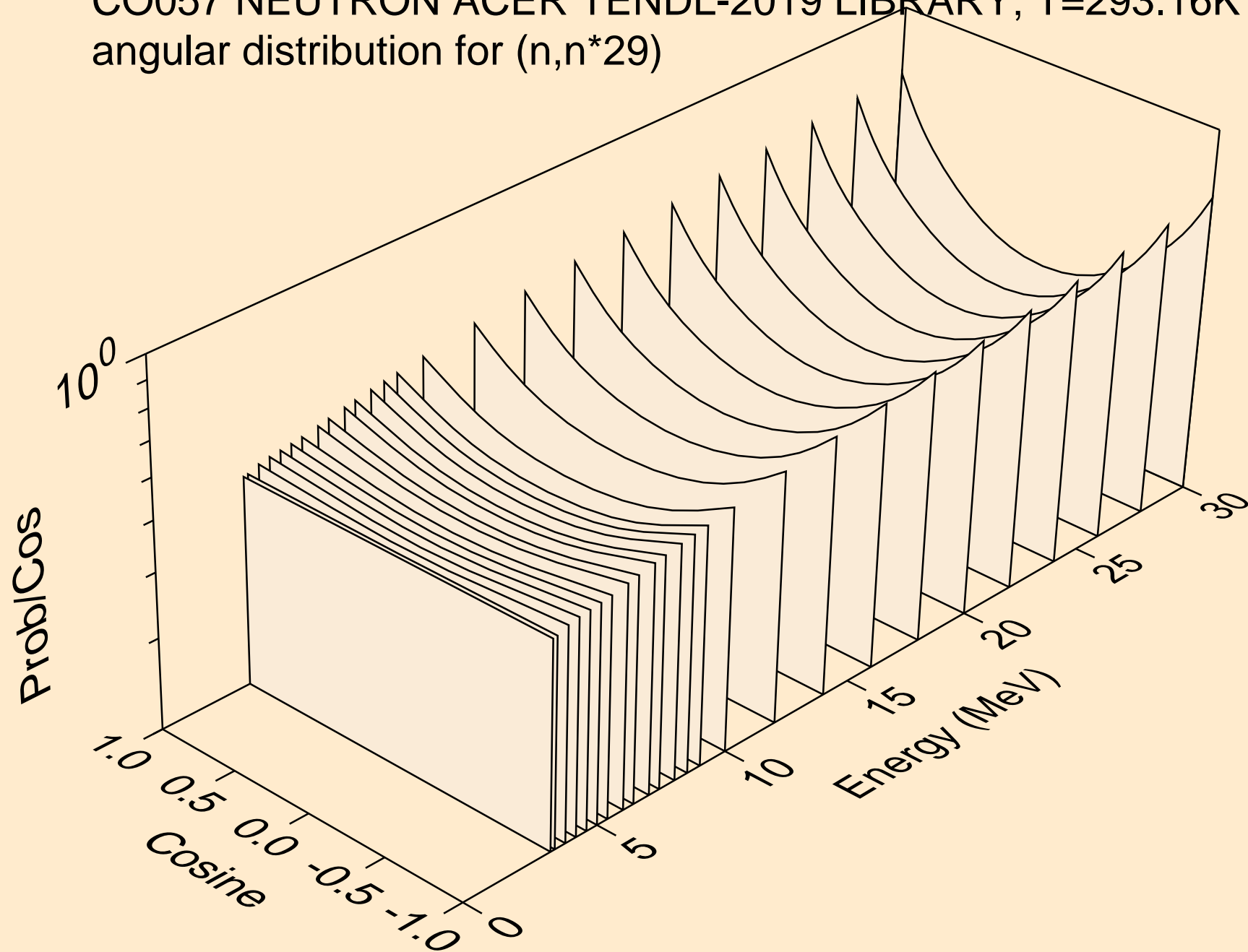

CO057 NEUTRON ACER TENDL-2019 LIBRARY; T=293.16K
angular distribution for (n,n*30)

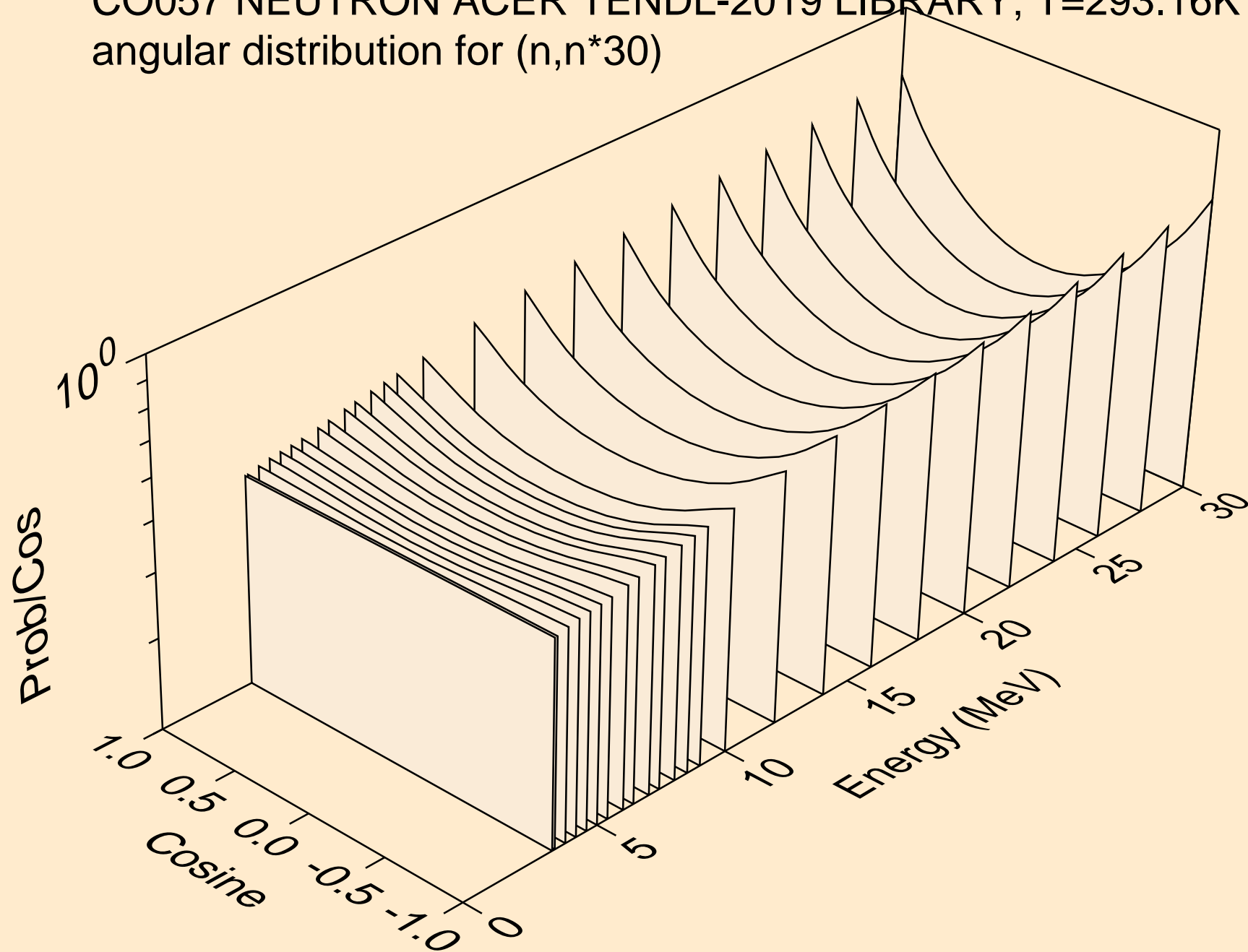

CO057 NEUTRON ACER TENDL-2019 LIBRARY; T=293.16K
Neutron emission for (n,x)

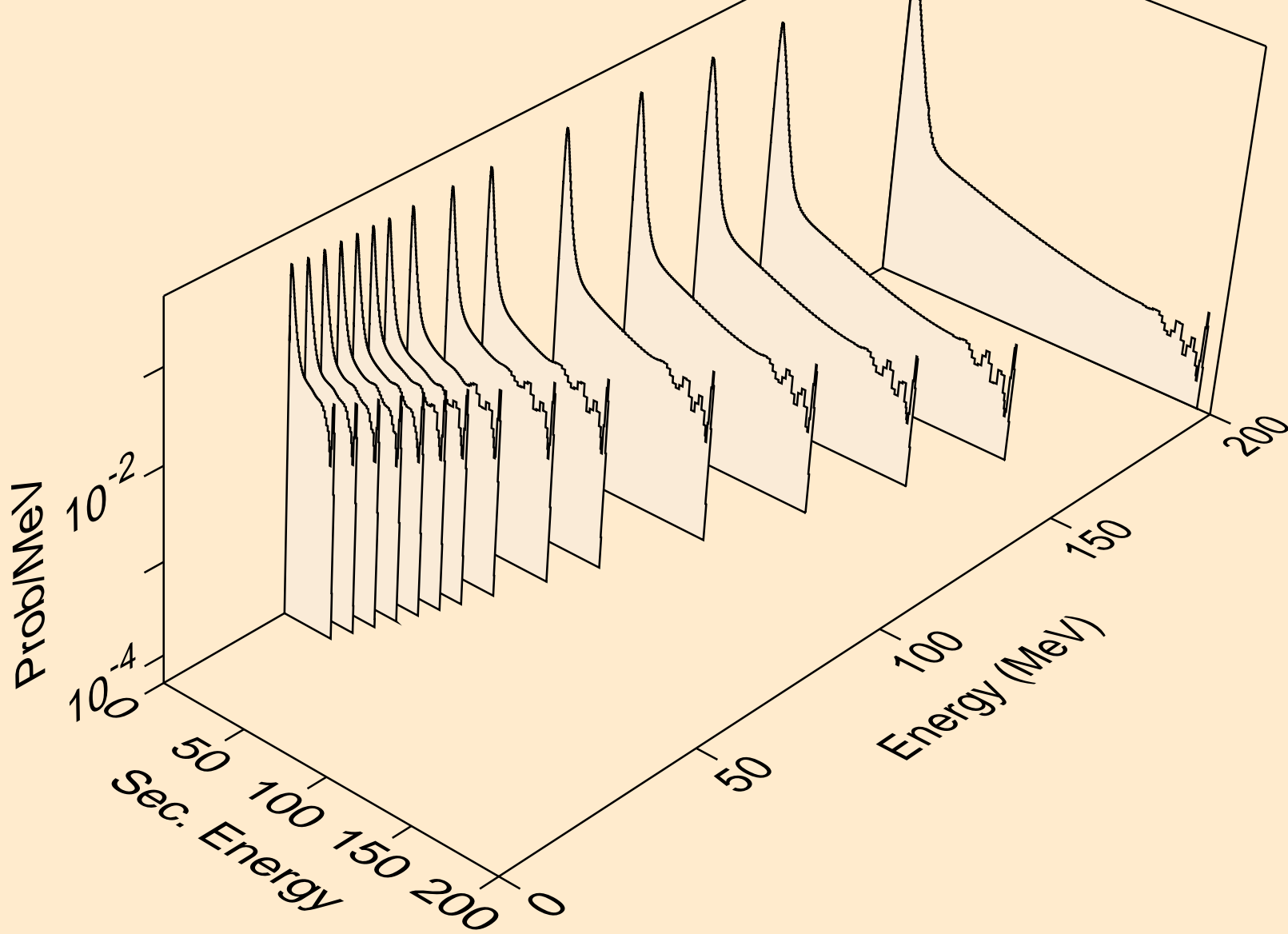

CO057 NEUTRON ACER TENDL-2019 LIBRARY; T=293.16K
Neutron emission for (n,2nd)

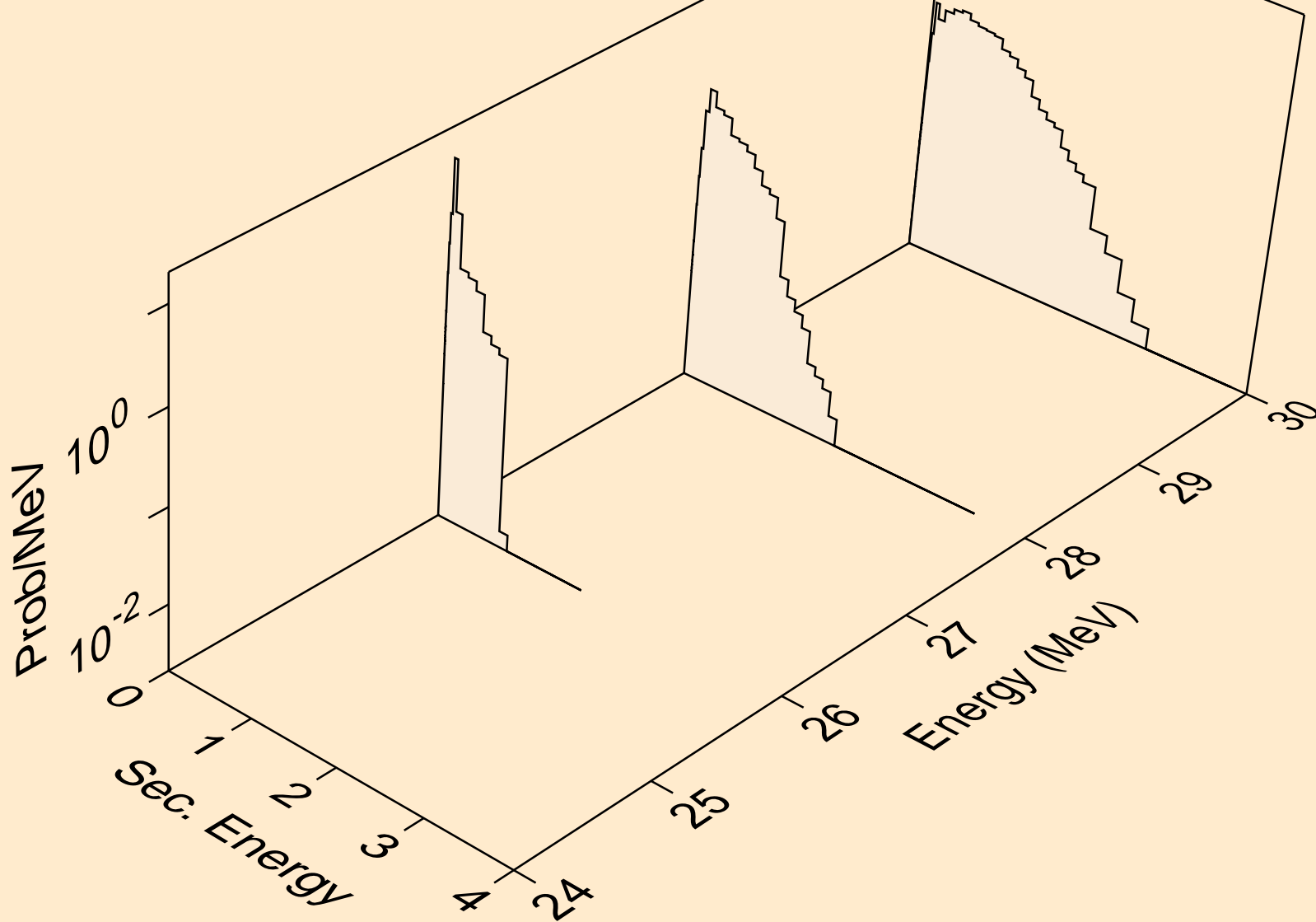

CO057 NEUTRON ACER TENDL-2019 LIBRARY; T=293.16K
Neutron emission for (n,2n)

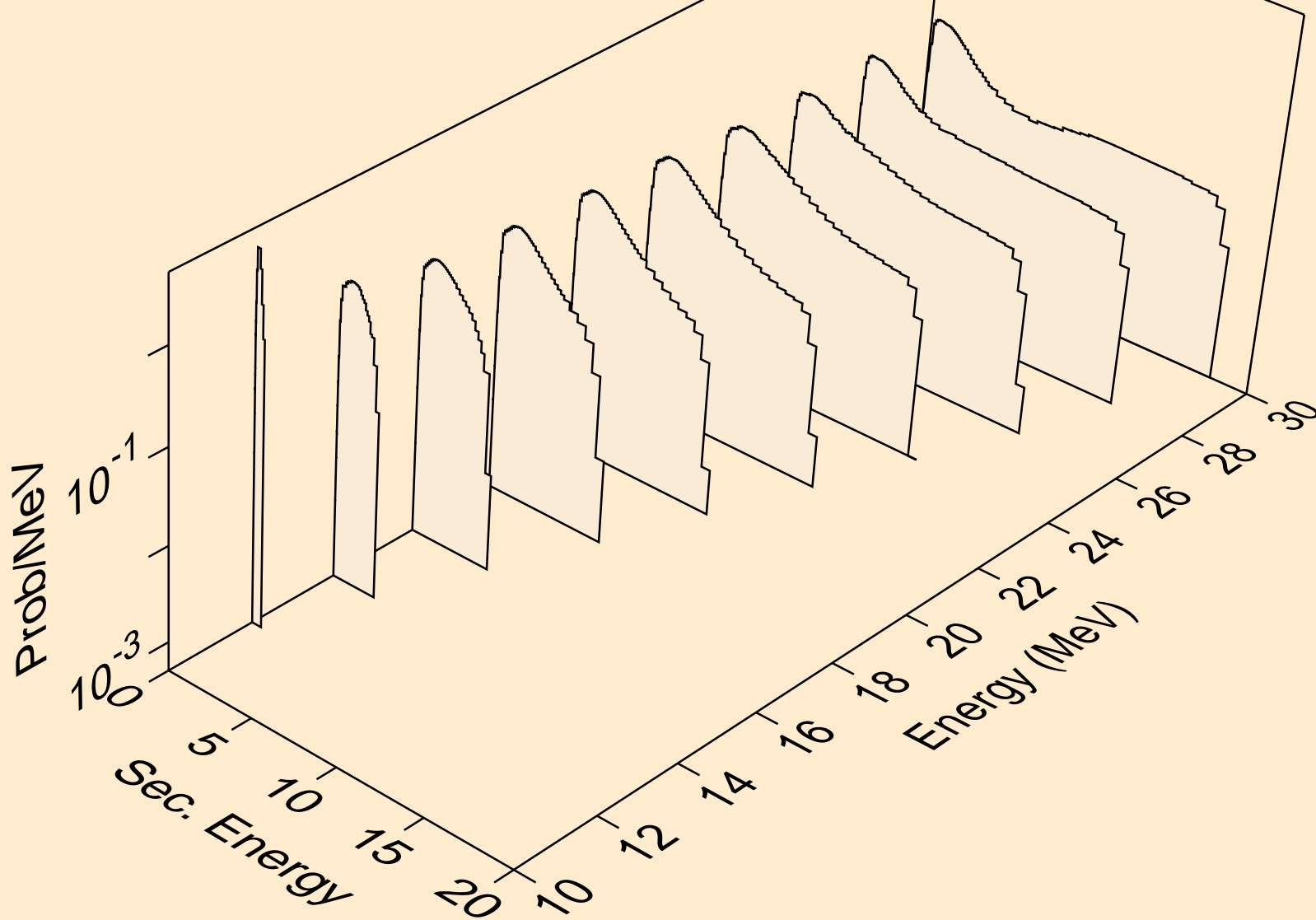

CO057 NEUTRON ACER TENDL-2019 LIBRARY; T=293.16K
Neutron emission for (n,3n)

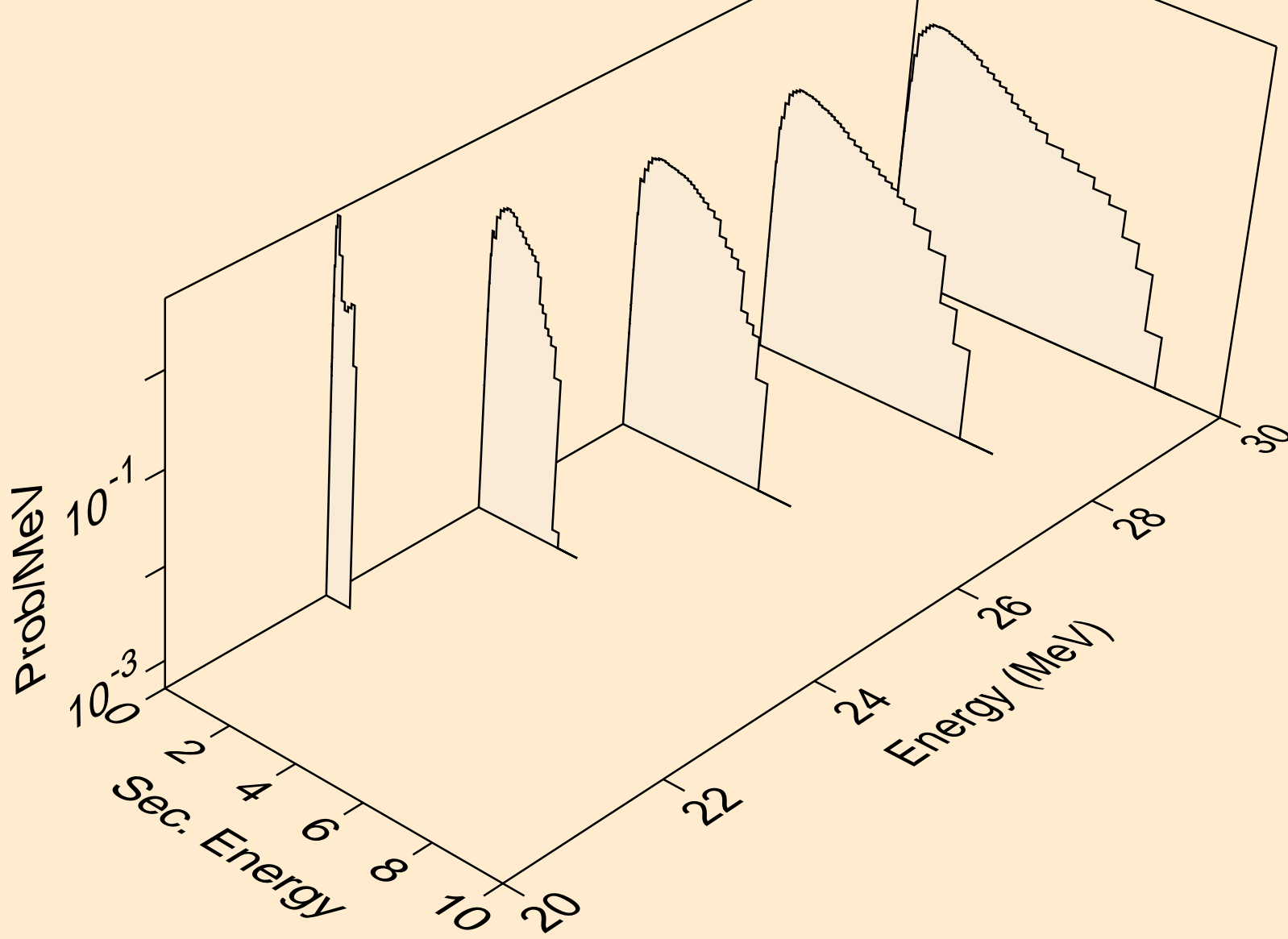

CO057 NEUTRON ACER TENDL-2019 LIBRARY; T=293.16K
Neutron emission for (n,n*)a

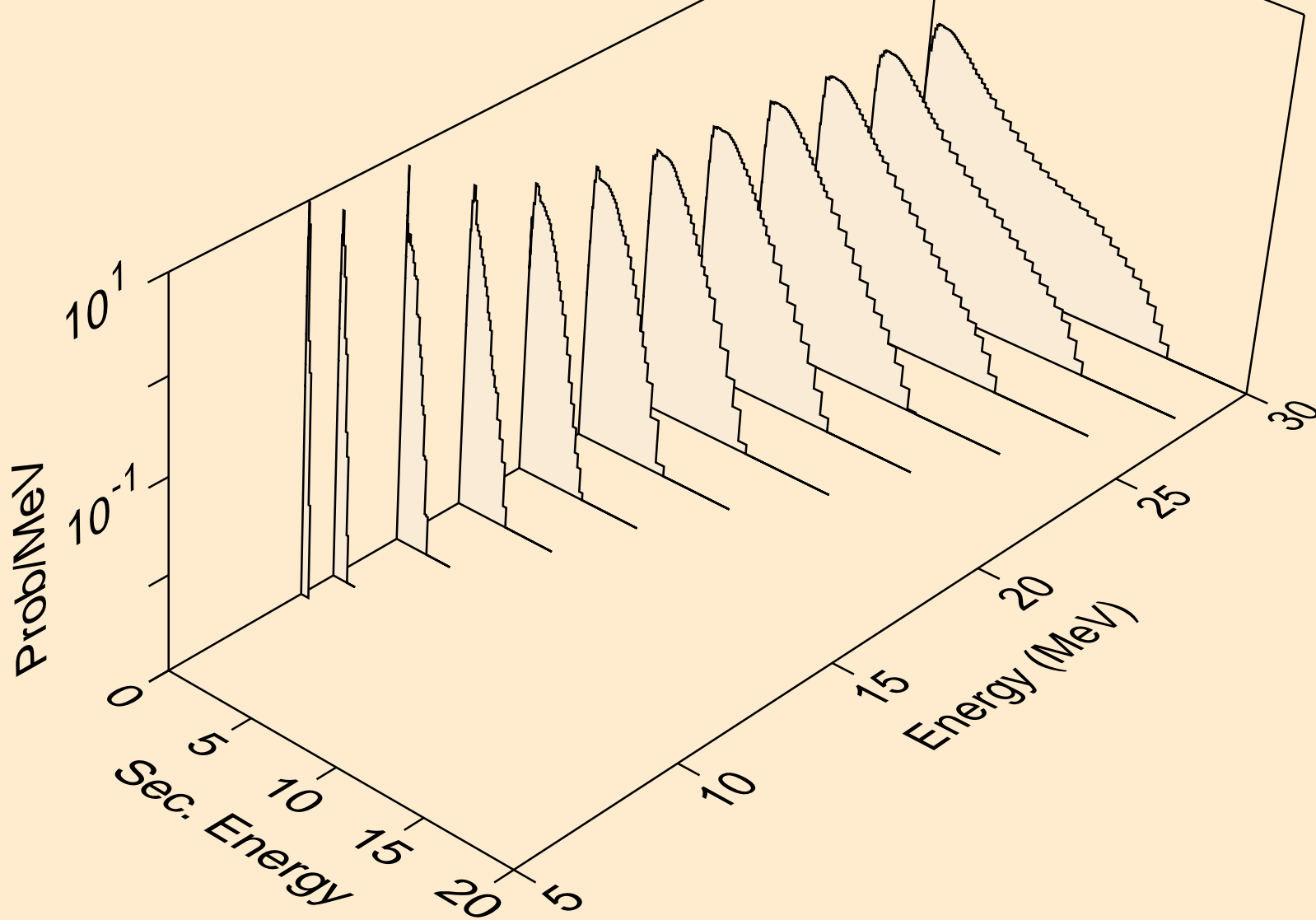

CO057 NEUTRON ACER TENDL-2019 LIBRARY; T=293.16K
Neutron emission for (n,2n)a

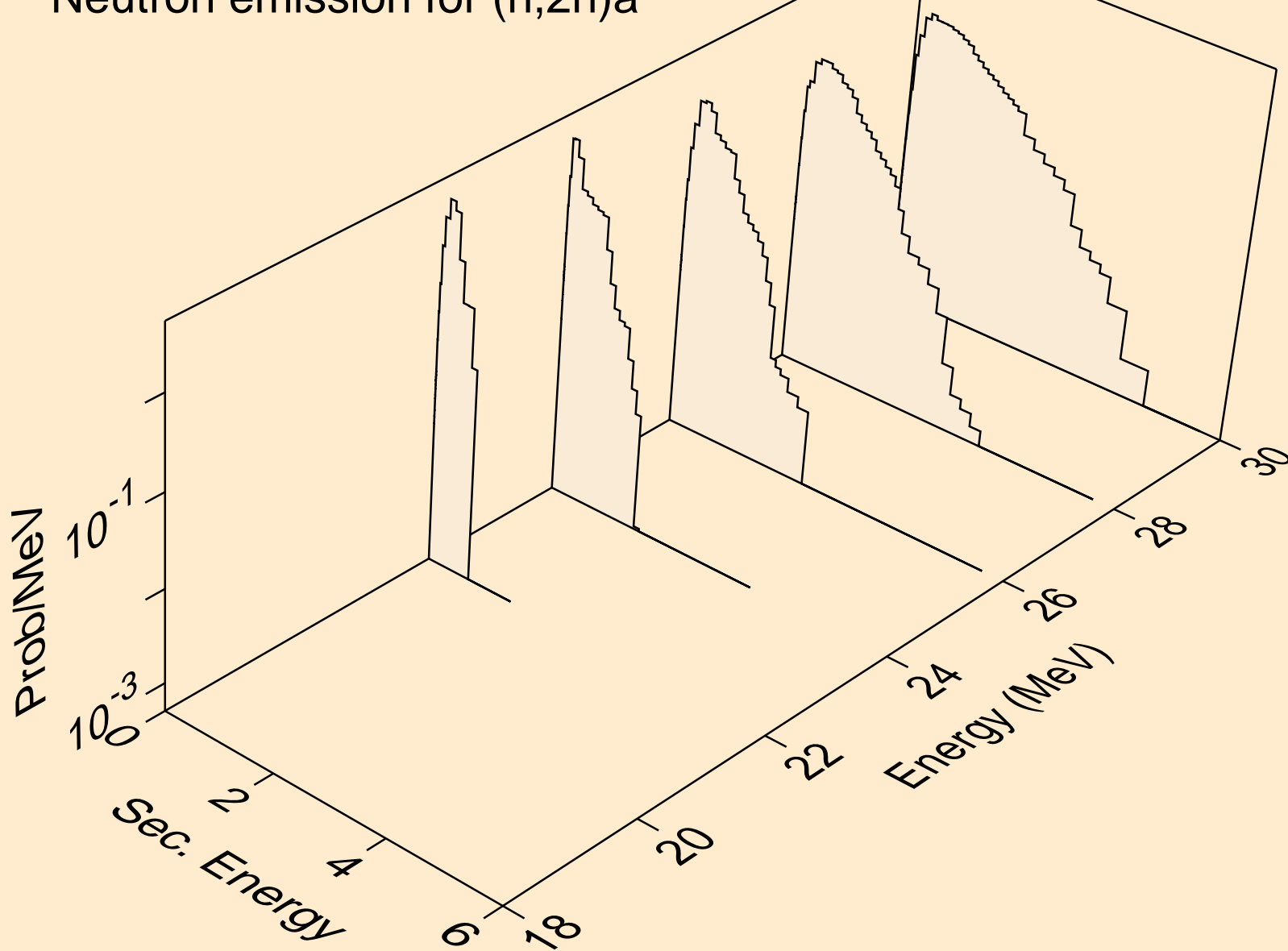

CO057 NEUTRON ACER TENDL-2019 LIBRARY; T=293.16K
Neutron emission for (n,n*)p

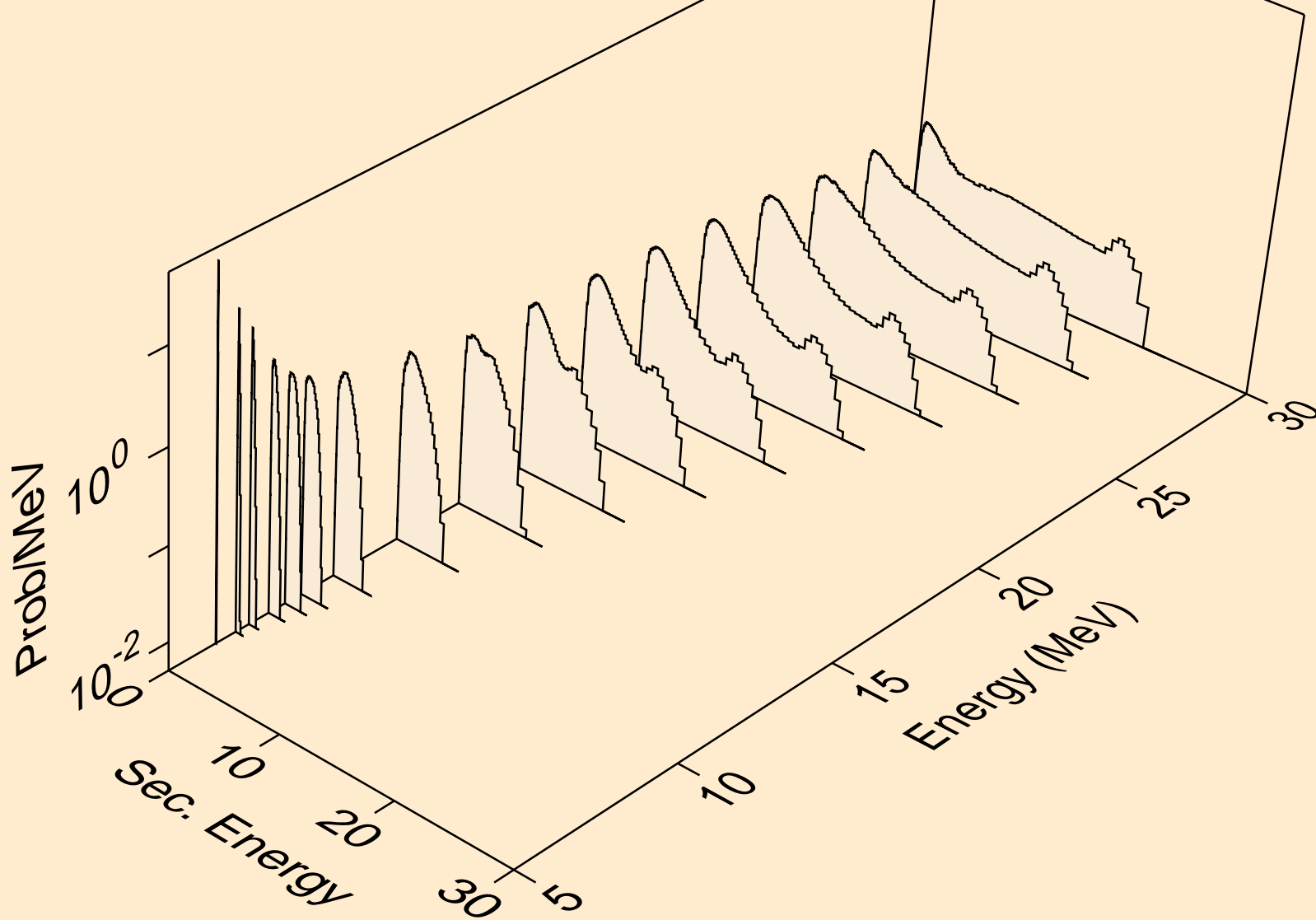

CO057 NEUTRON ACER TENDL-2019 LIBRARY; T=293.16K
Neutron emission for (n,n*)2a

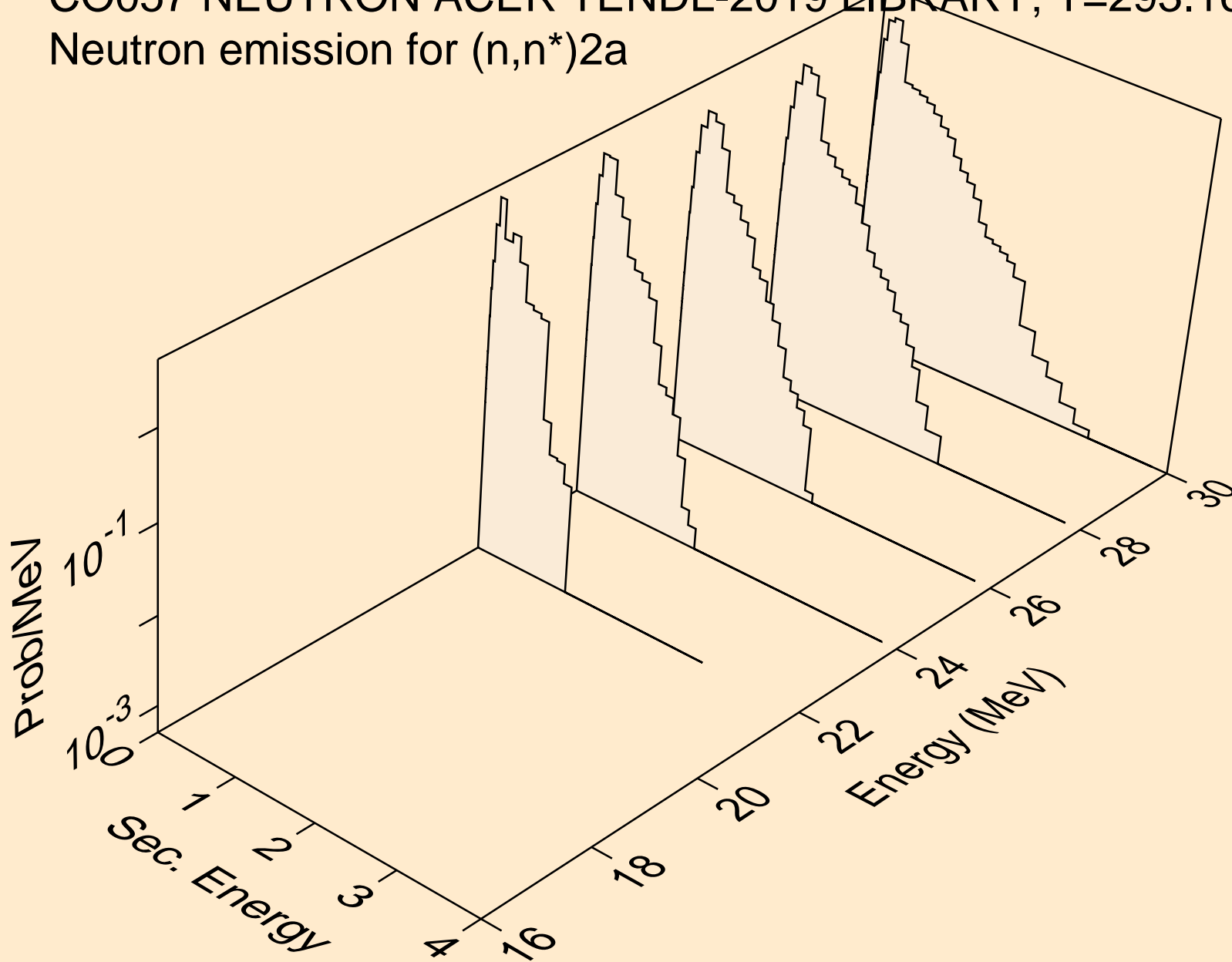

CO057 NEUTRON ACER TENDL-2019 LIBRARY; T=293.16K
Neutron emission for (n,n*)d

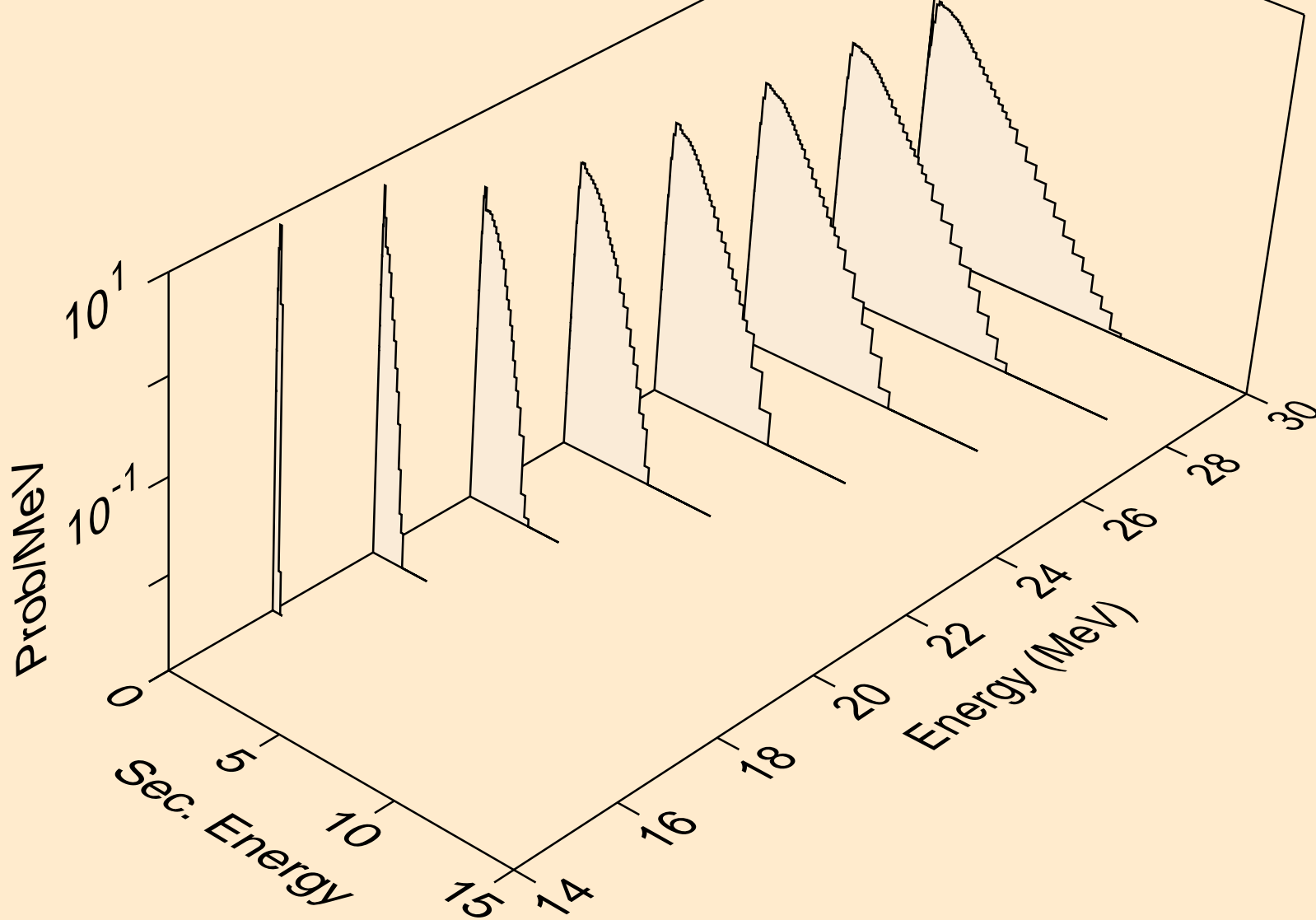

CO057 NEUTRON ACER TENDL-2019 LIBRARY; T=293.16K
Neutron emission for (n,n*)t

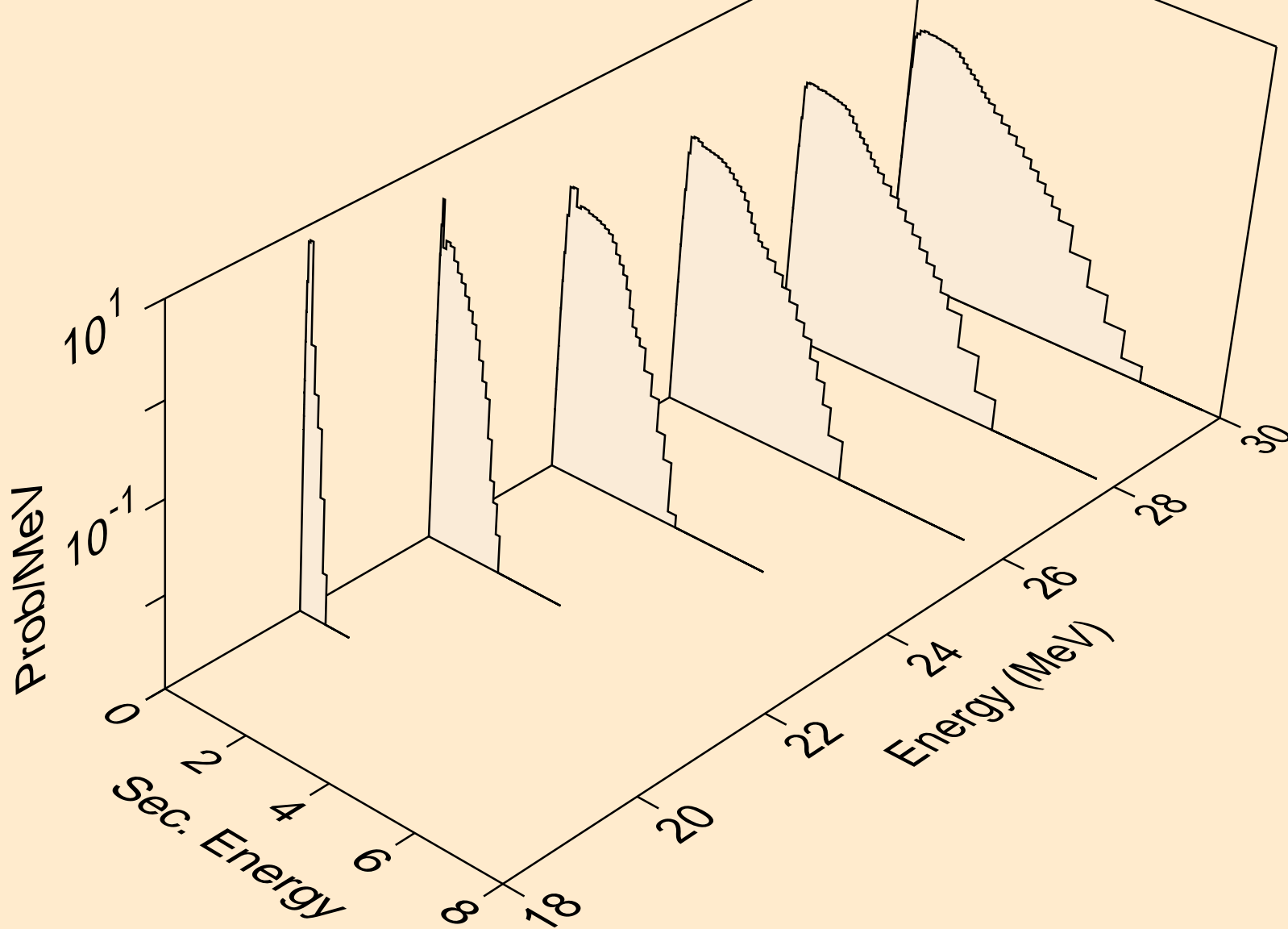

CO057 NEUTRON ACER TENDL-2019 LIBRARY; T=293.16K
Neutron emission for (n,n*)he3

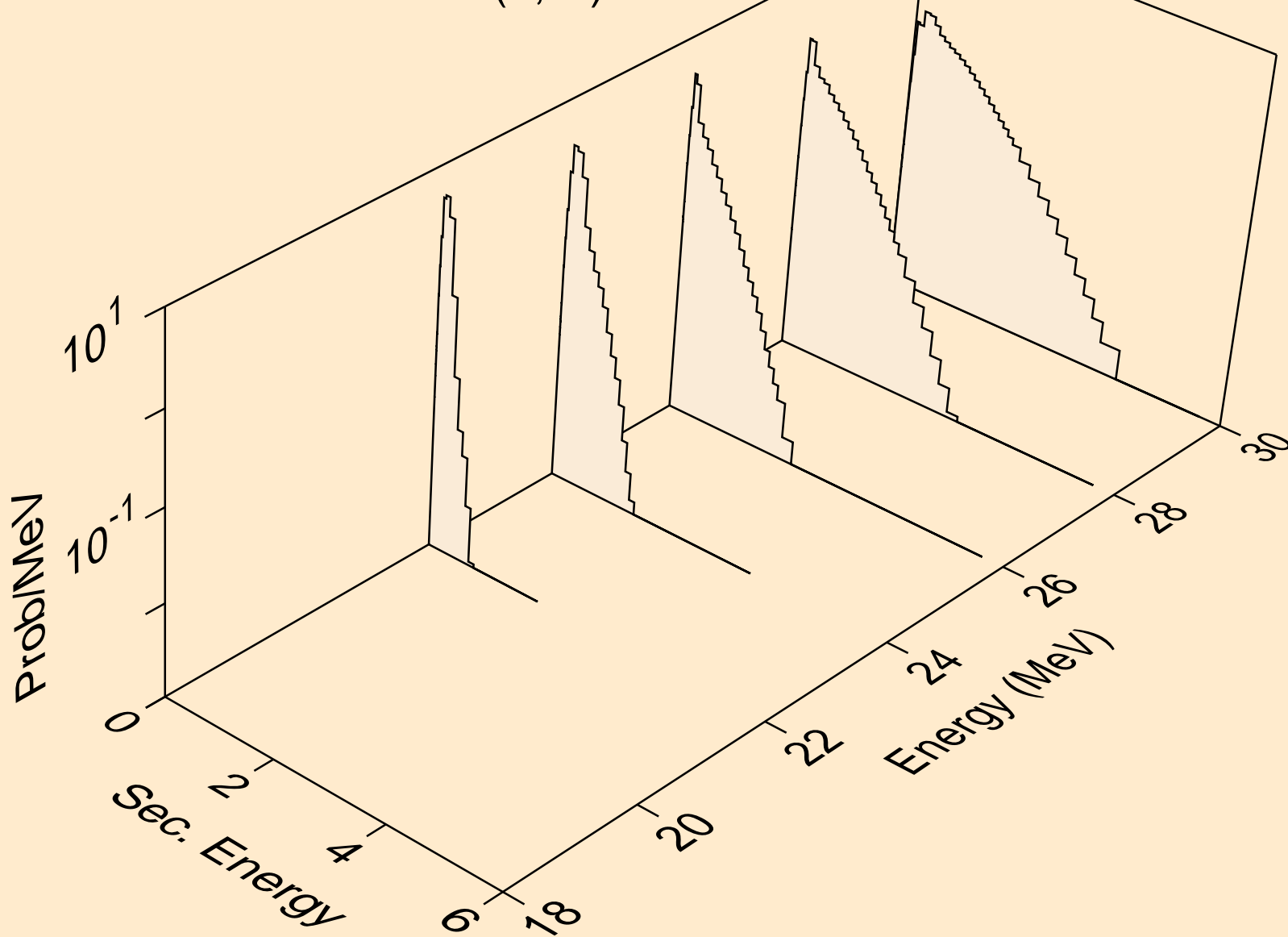

CO057 NEUTRON ACER TENDL-2019 LIBRARY; T=293.16K
Neutron emission for (n,2np)

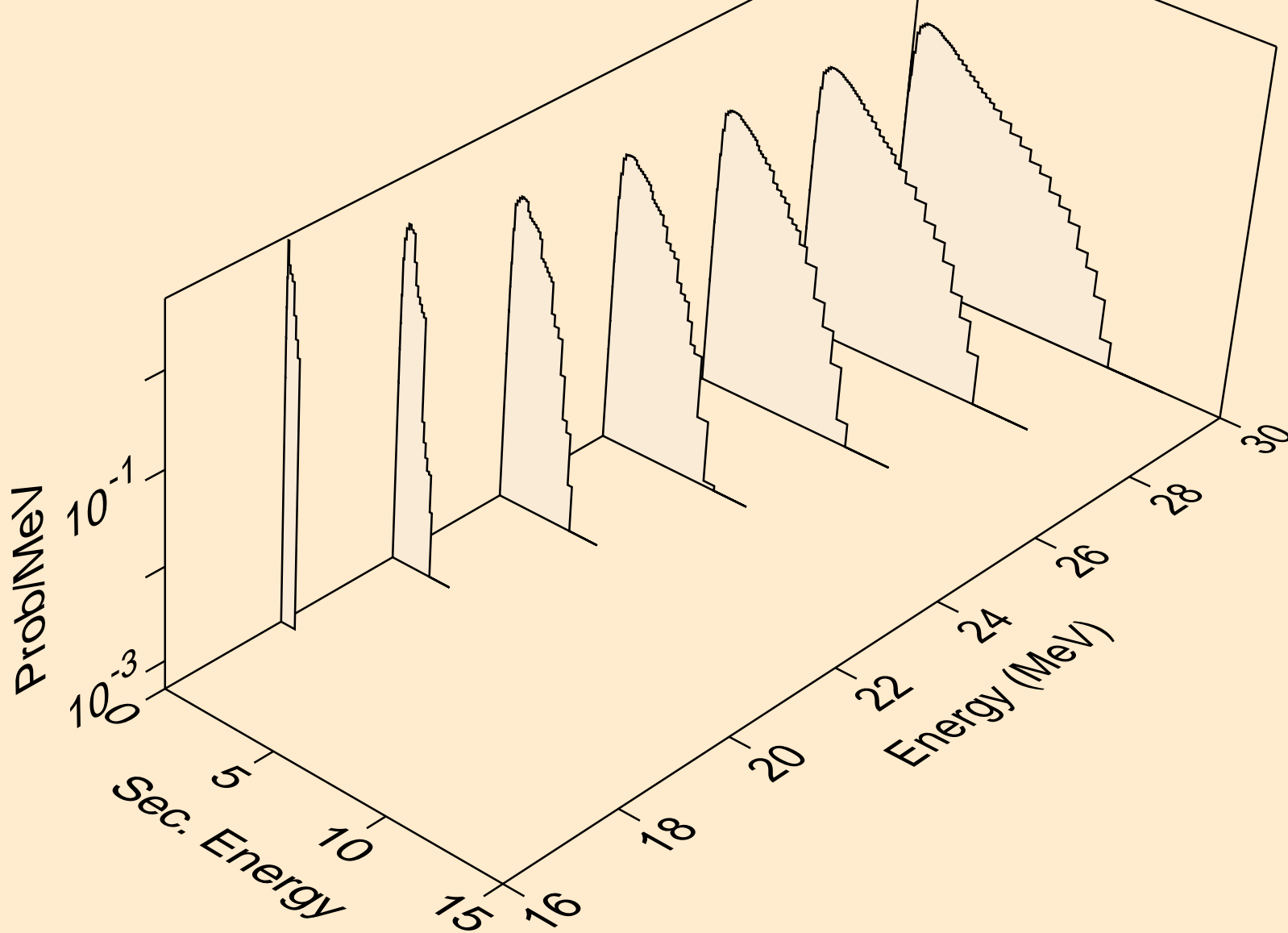

CO057 NEUTRON ACER TENDL-2019 LIBRARY; T=293.16K
Neutron emission for (n,3np)

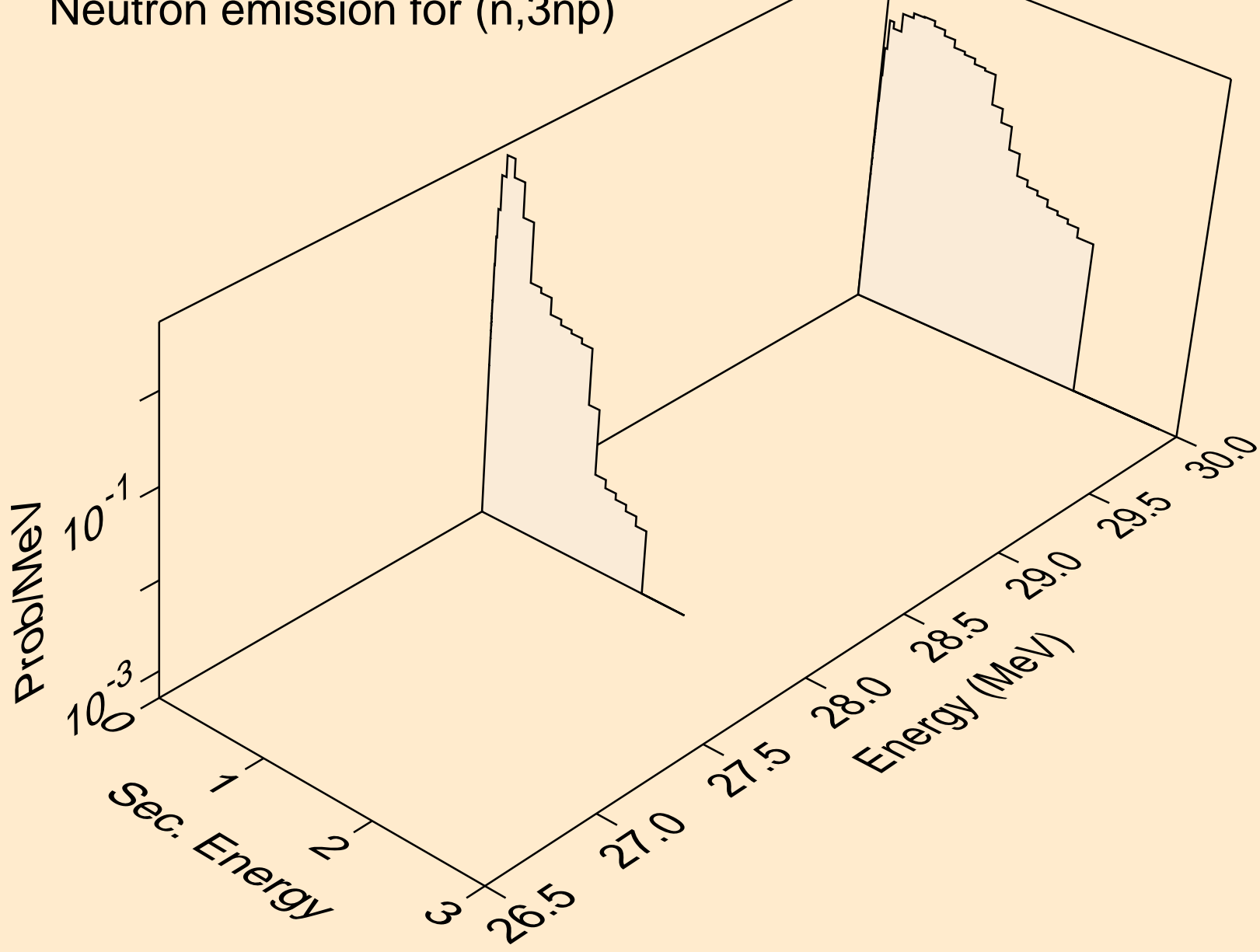

CO057 NEUTRON ACER TENDL-2019 LIBRARY; T=293.16K
Neutron emission for (n,2np)

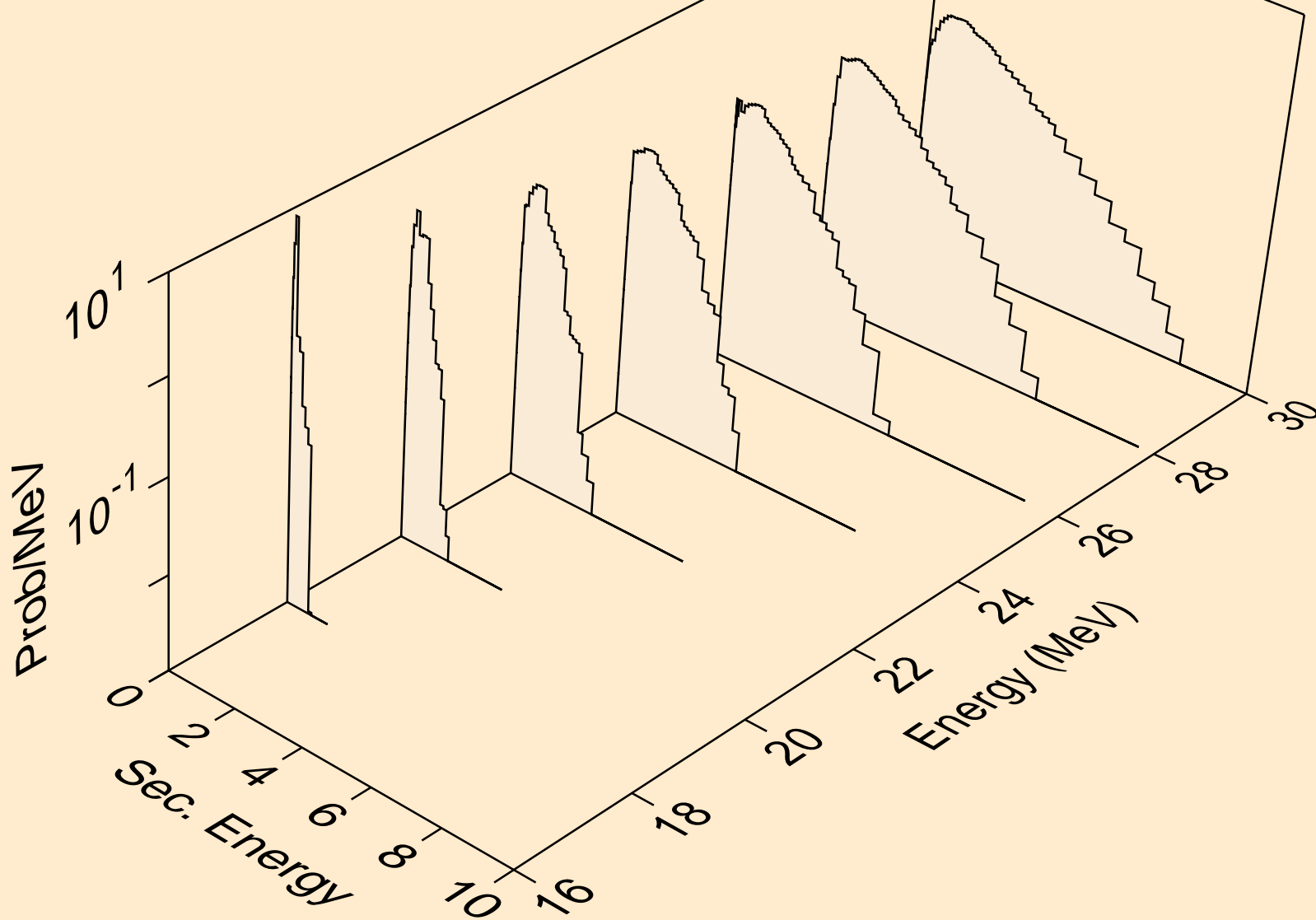

CO057 NEUTRON ACER TENDL-2019 LIBRARY; T=293.16K
Neutron emission for (n,npa)

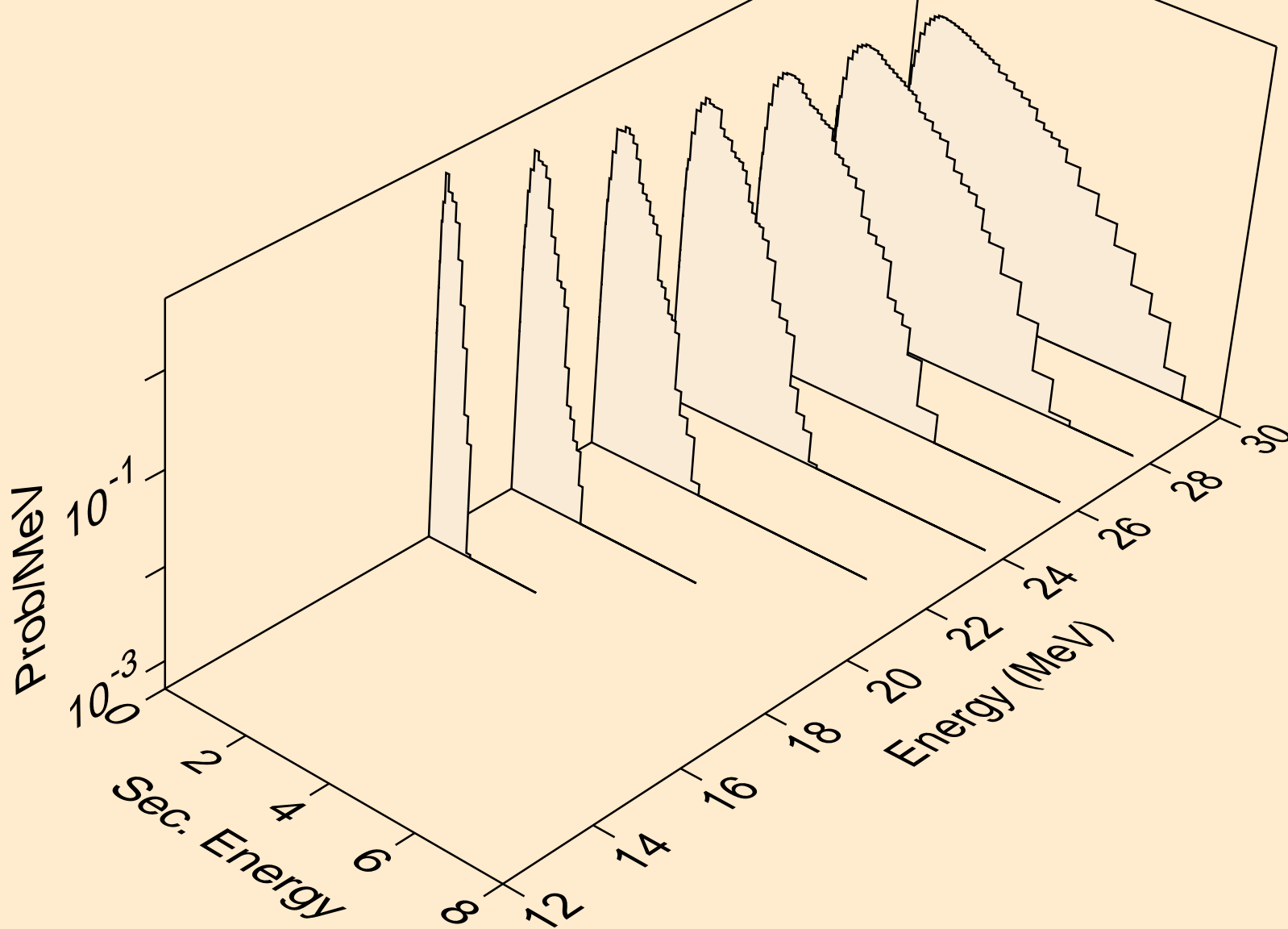

CO057 NEUTRON ACER TENDL-2019 LIBRARY; T=293.16K
Neutron emission for (n,n*c)

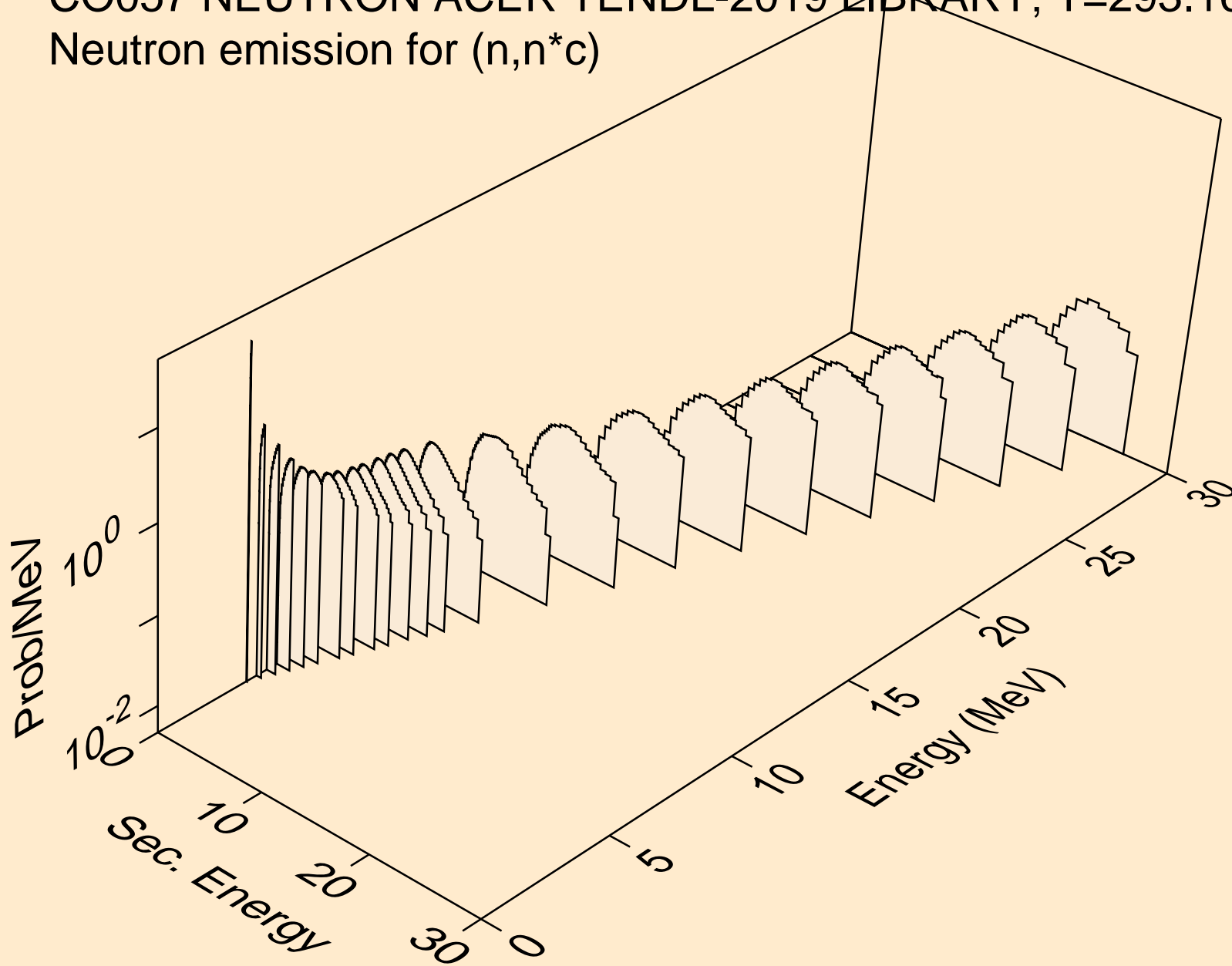

CO057 NEUTRON ACER TENDL-2019 LIBRARY; T=293.16K
Photon emission for (n,x)

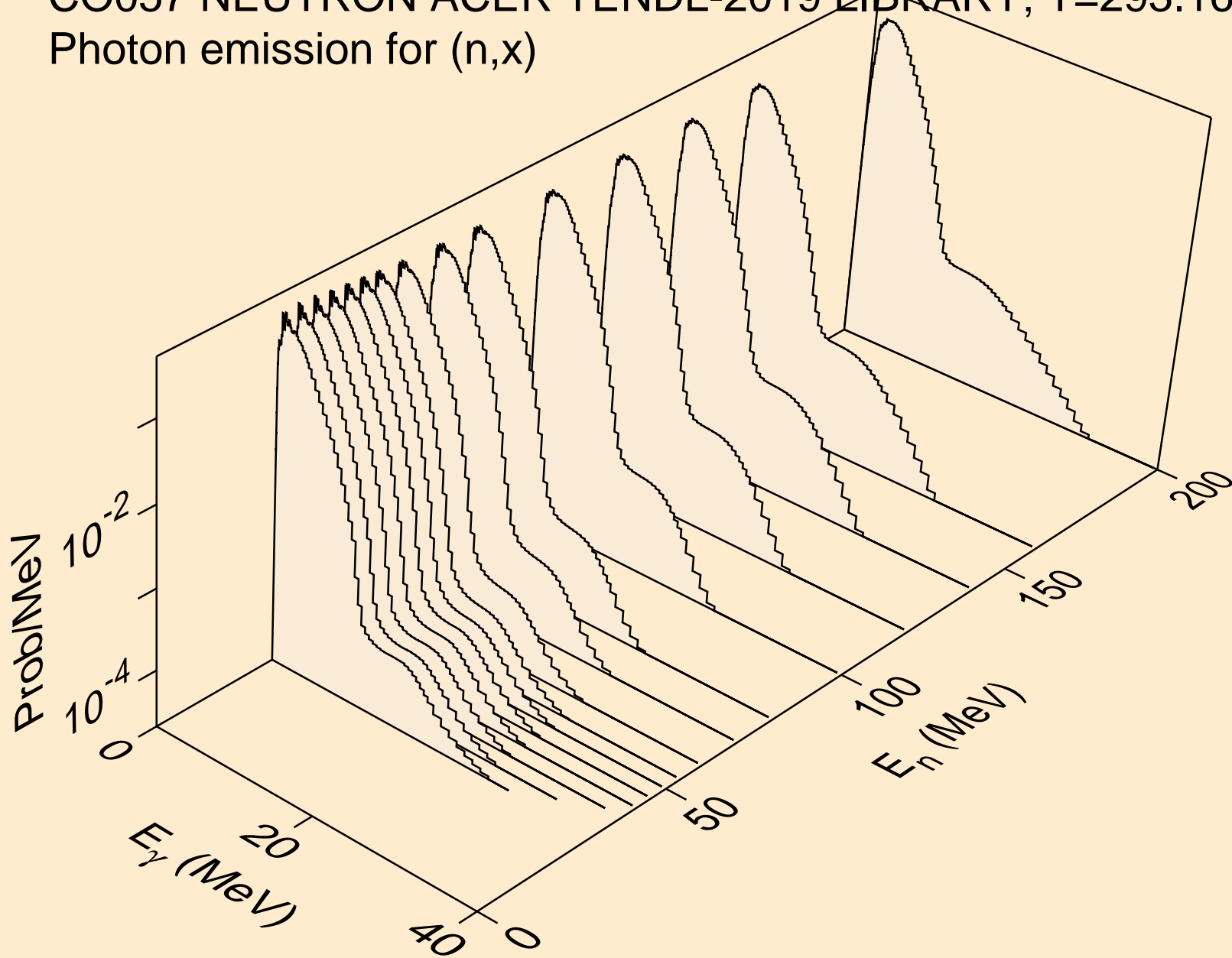

CO057 NEUTRON ACER TENDL-2019 LIBRARY; T=293.16K
Photon emission for (n,2nd)

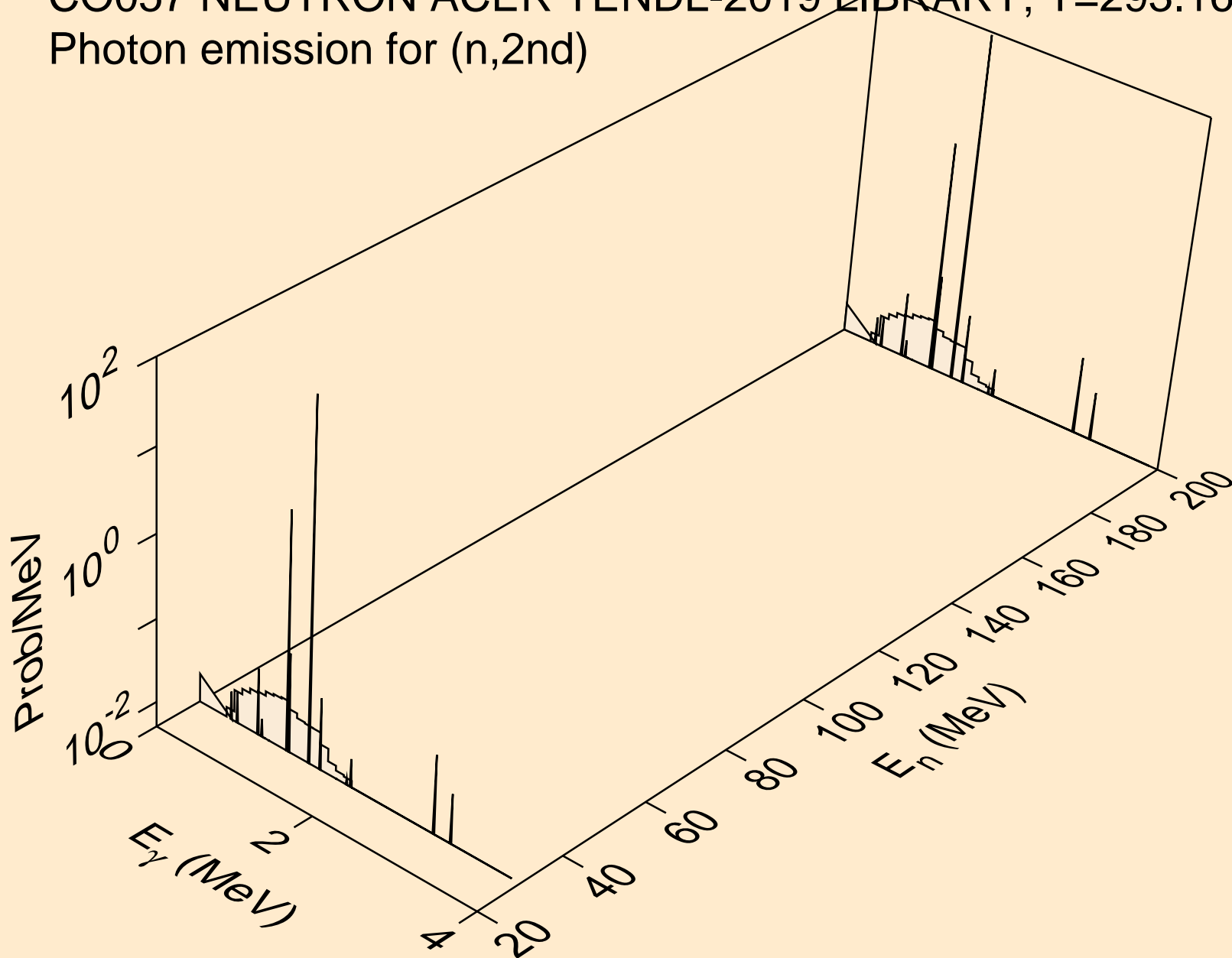

CO057 NEUTRON ACER TENDL-2019 LIBRARY; T=293.16K
Photon emission for (n,2n)

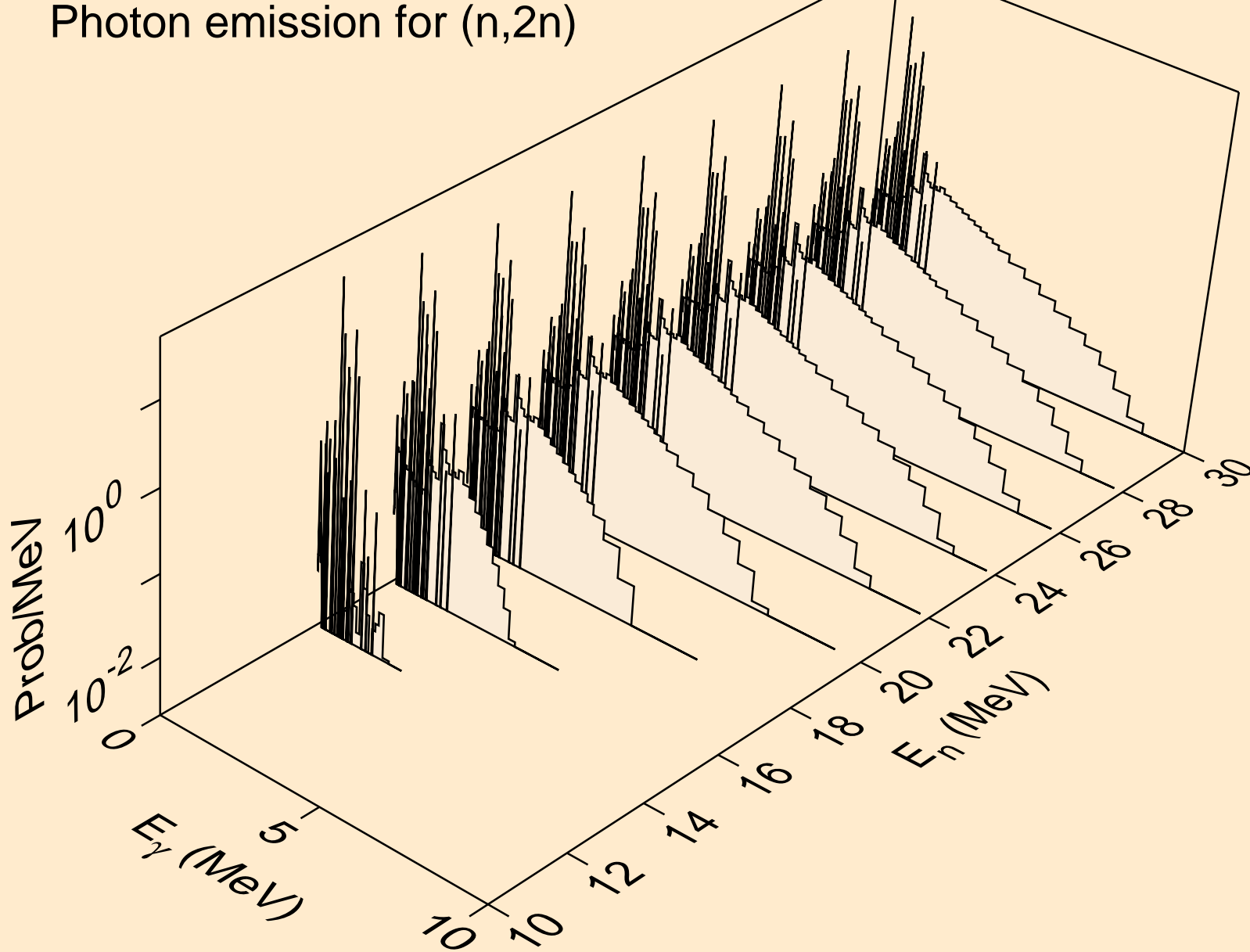

CO057 NEUTRON ACER TENDL-2019 LIBRARY; T=293.16K
Photon emission for (n,3n)

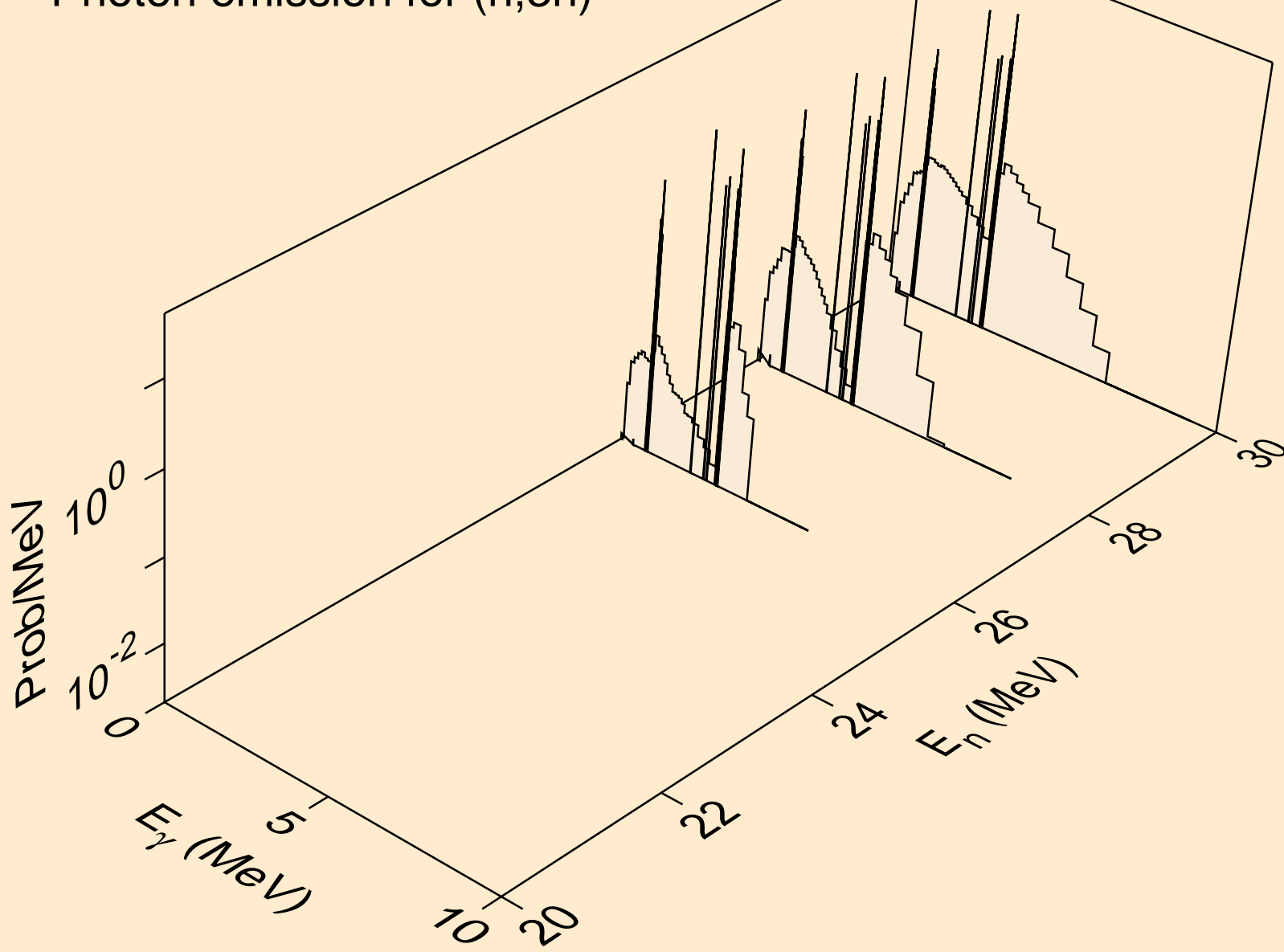

CO057 NEUTRON ACER TENDL-2019 LIBRARY; T=293.16K
Photon emission for (n,n*)a

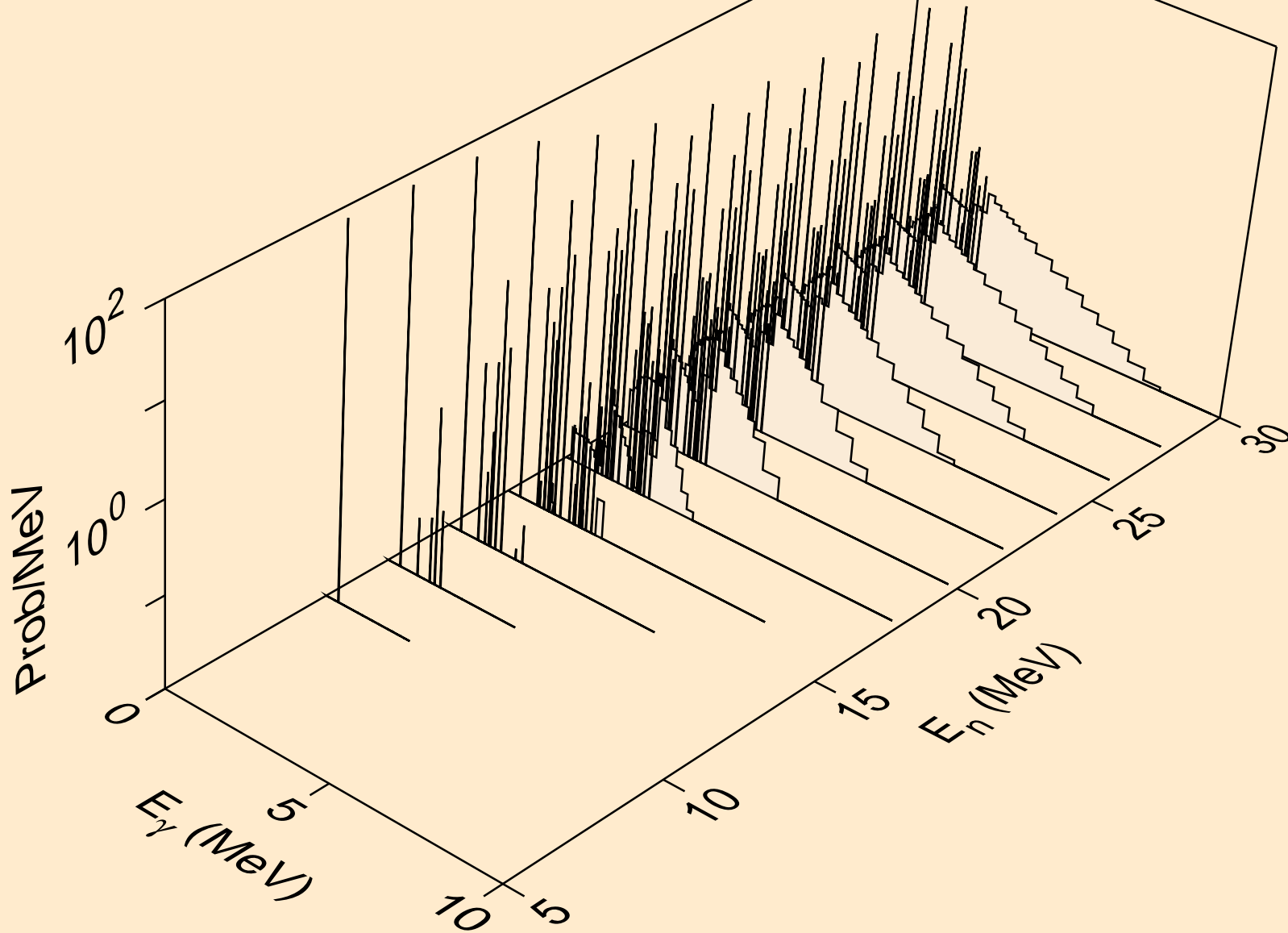

CO057 NEUTRON ACER TENDL-2019 LIBRARY; T=293.16K
Photon emission for (n,2n)a

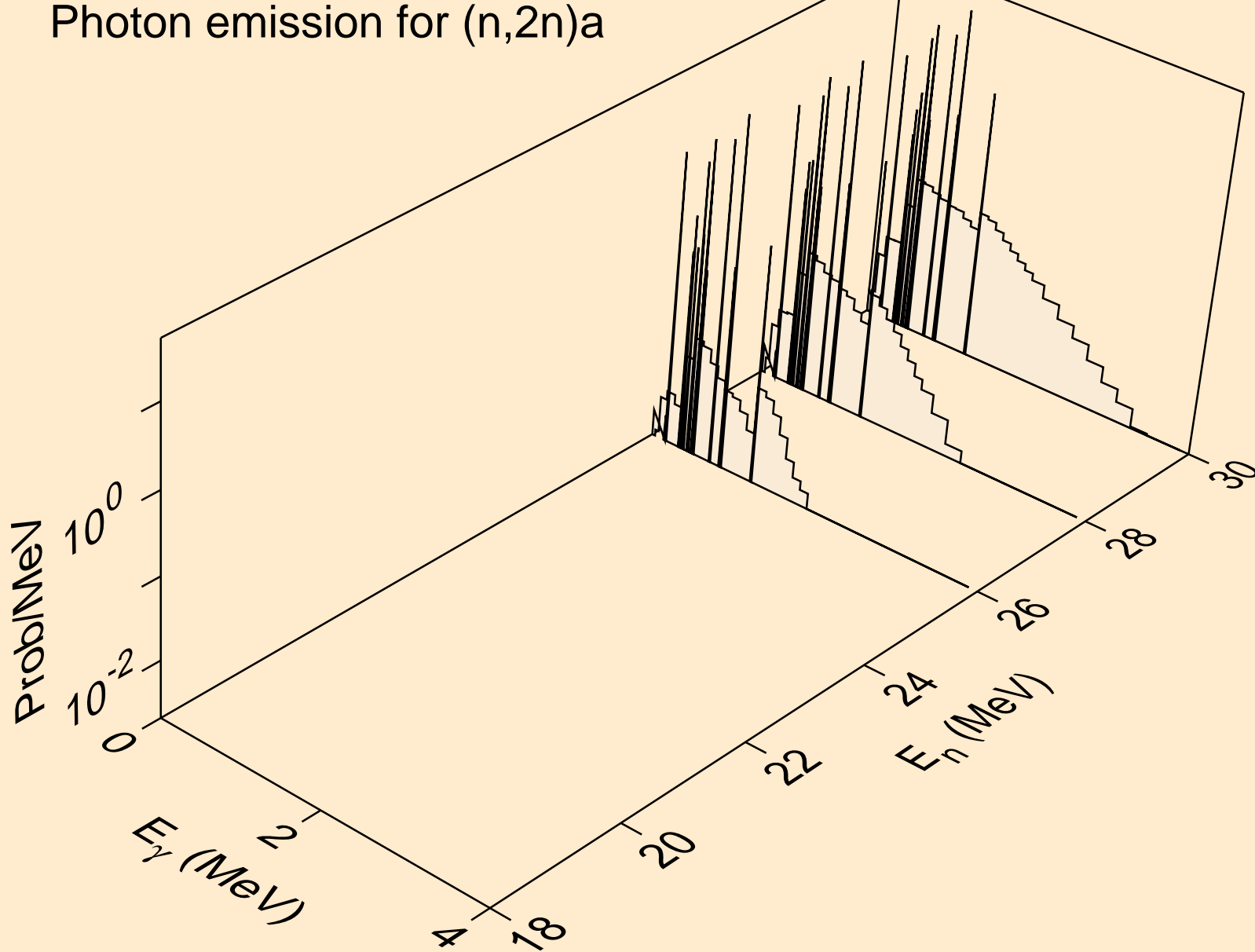

CO057 NEUTRON ACER TENDL-2019 LIBRARY; T=293.16K
Photon emission for (n,n*)p

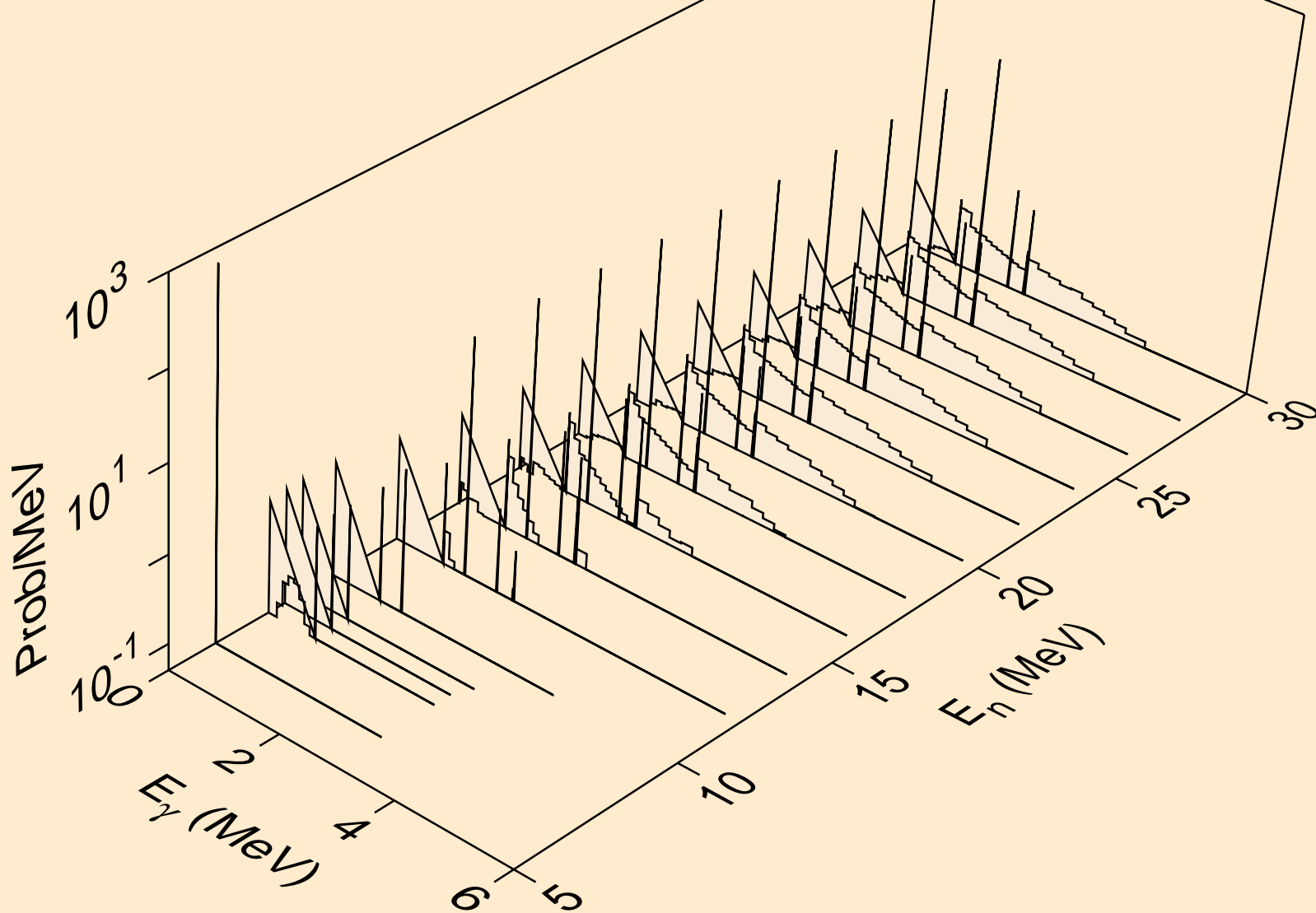

CO057 NEUTRON ACER TENDL-2019 LIBRARY; T=293.16K
Photon emission for (n,n*)2a

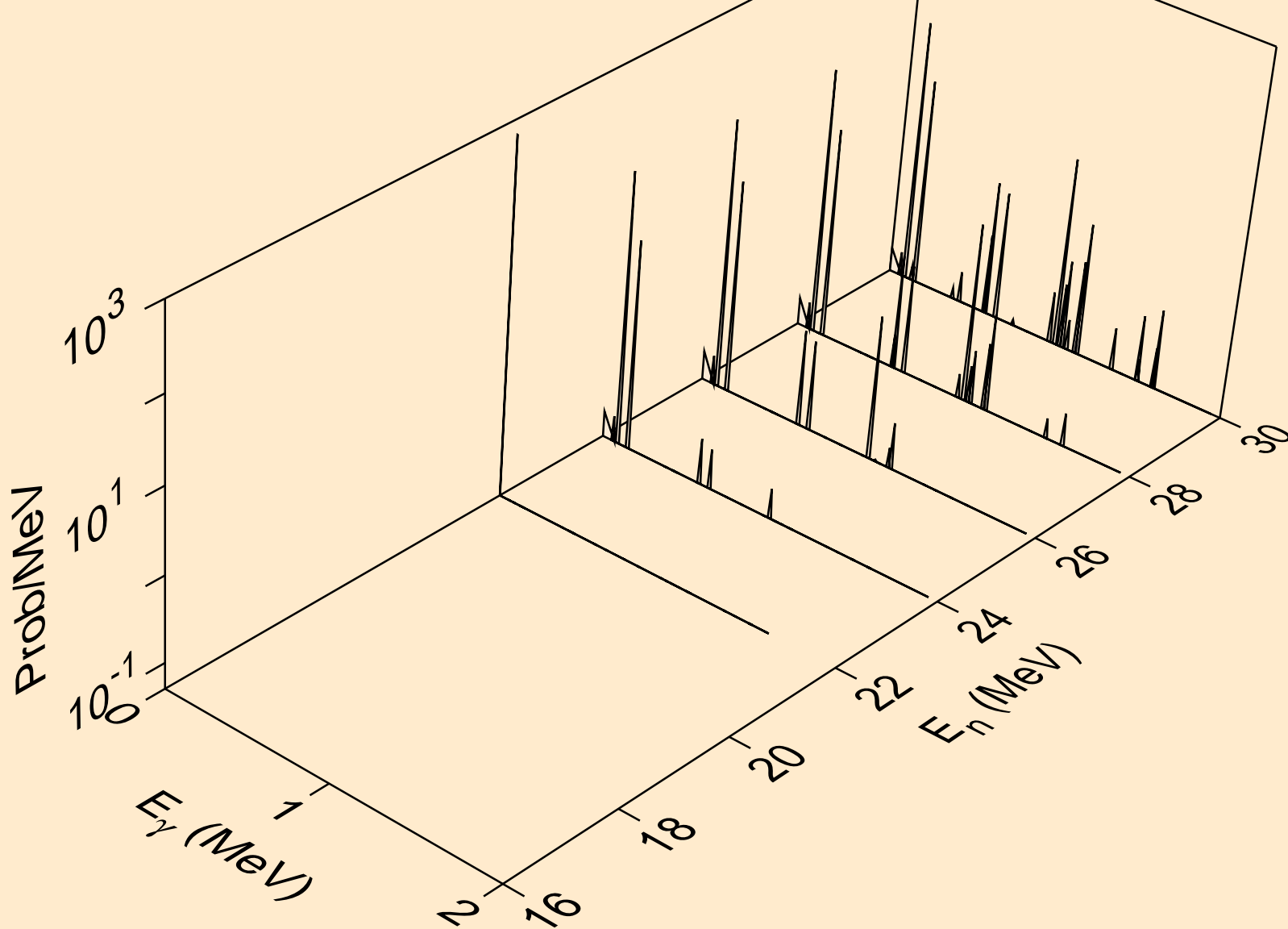

CO057 NEUTRON ACER TENDL-2019 LIBRARY; T=293.16K
Photon emission for (n,n*)d

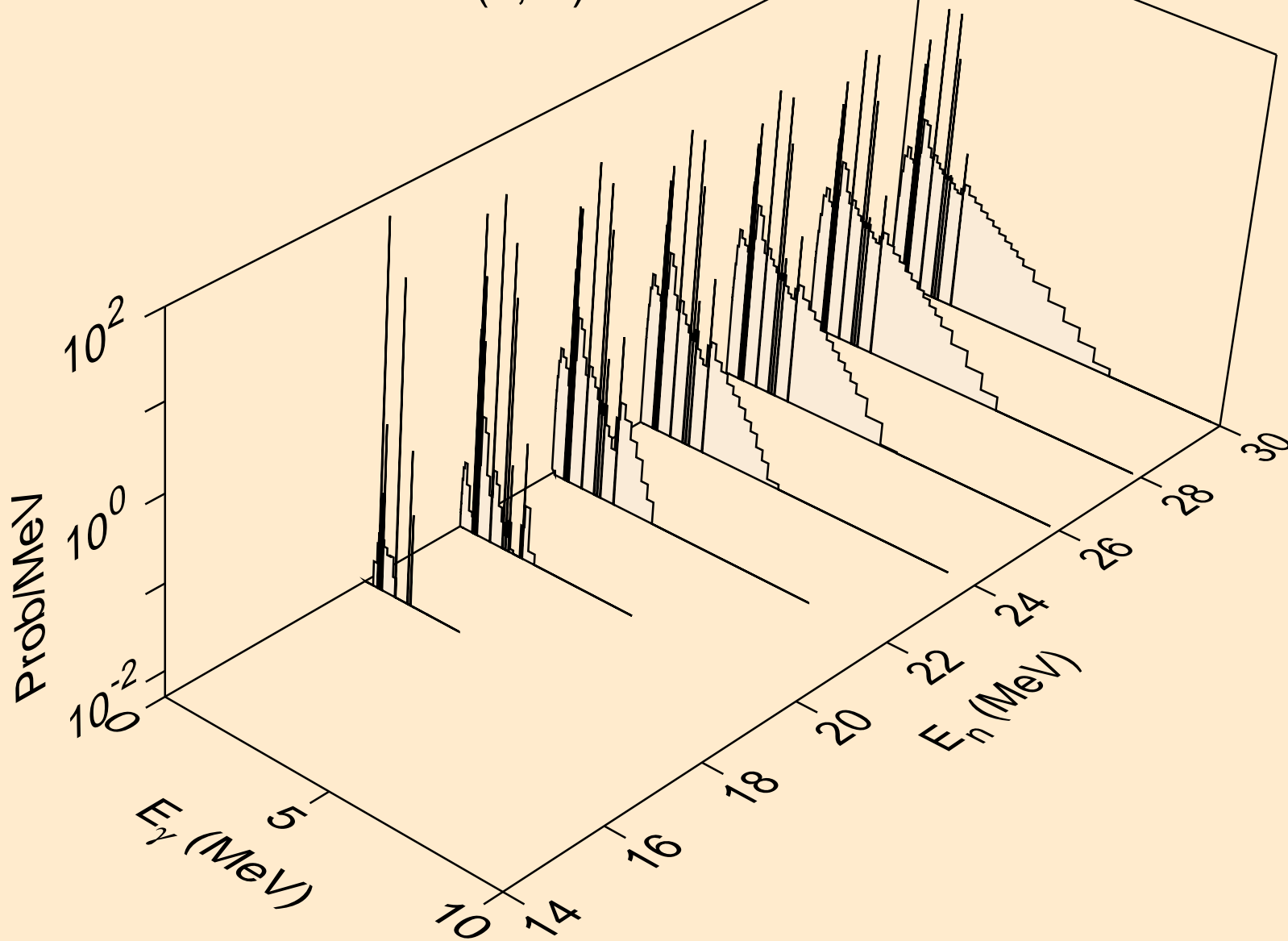

CO057 NEUTRON ACER TENDL-2019 LIBRARY; T=293.16K
Photon emission for (n,n*)t

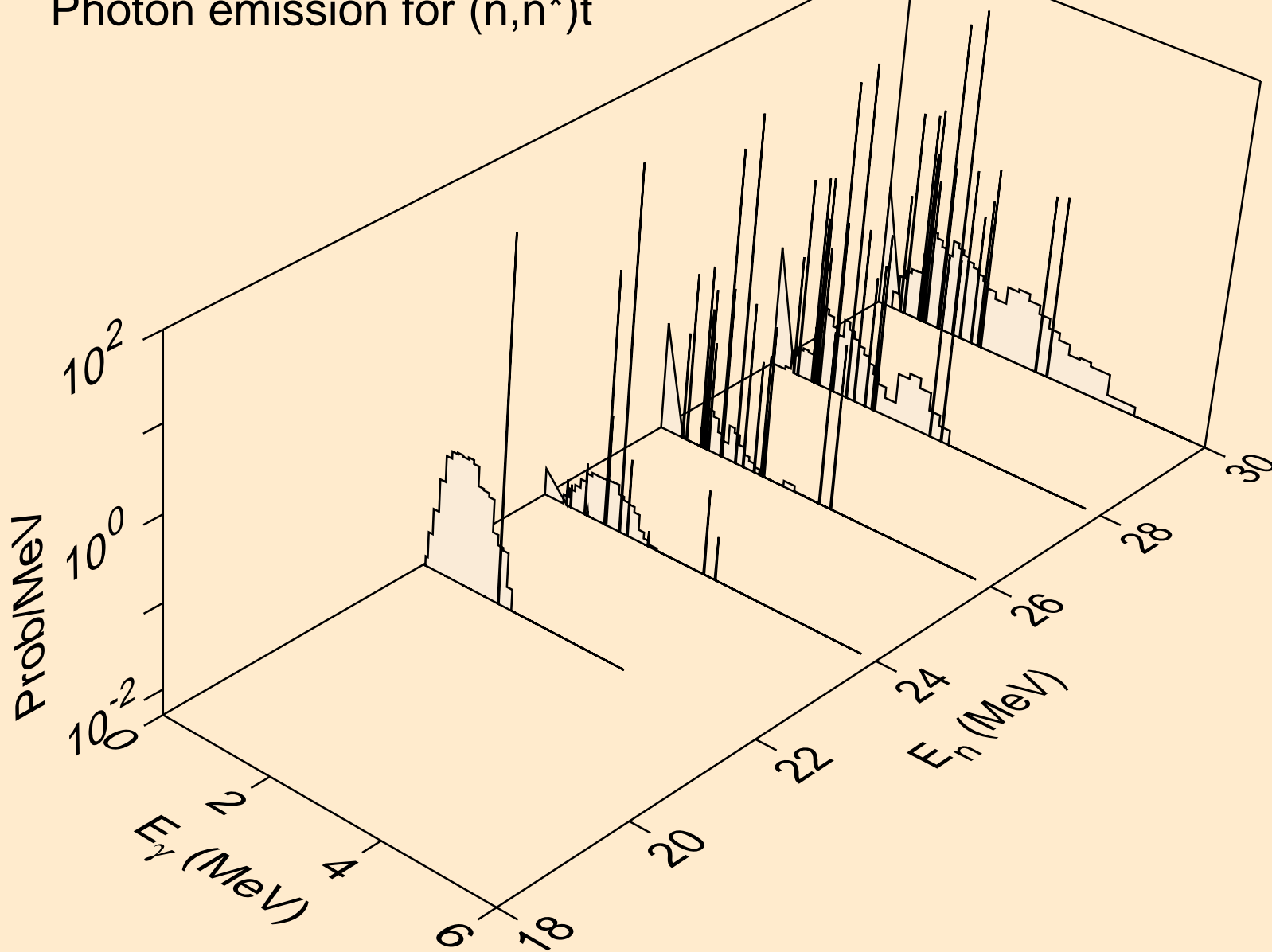

CO057 NEUTRON ACER TENDL-2019 LIBRARY; T=293.16K
Photon emission for (n,n*)he3

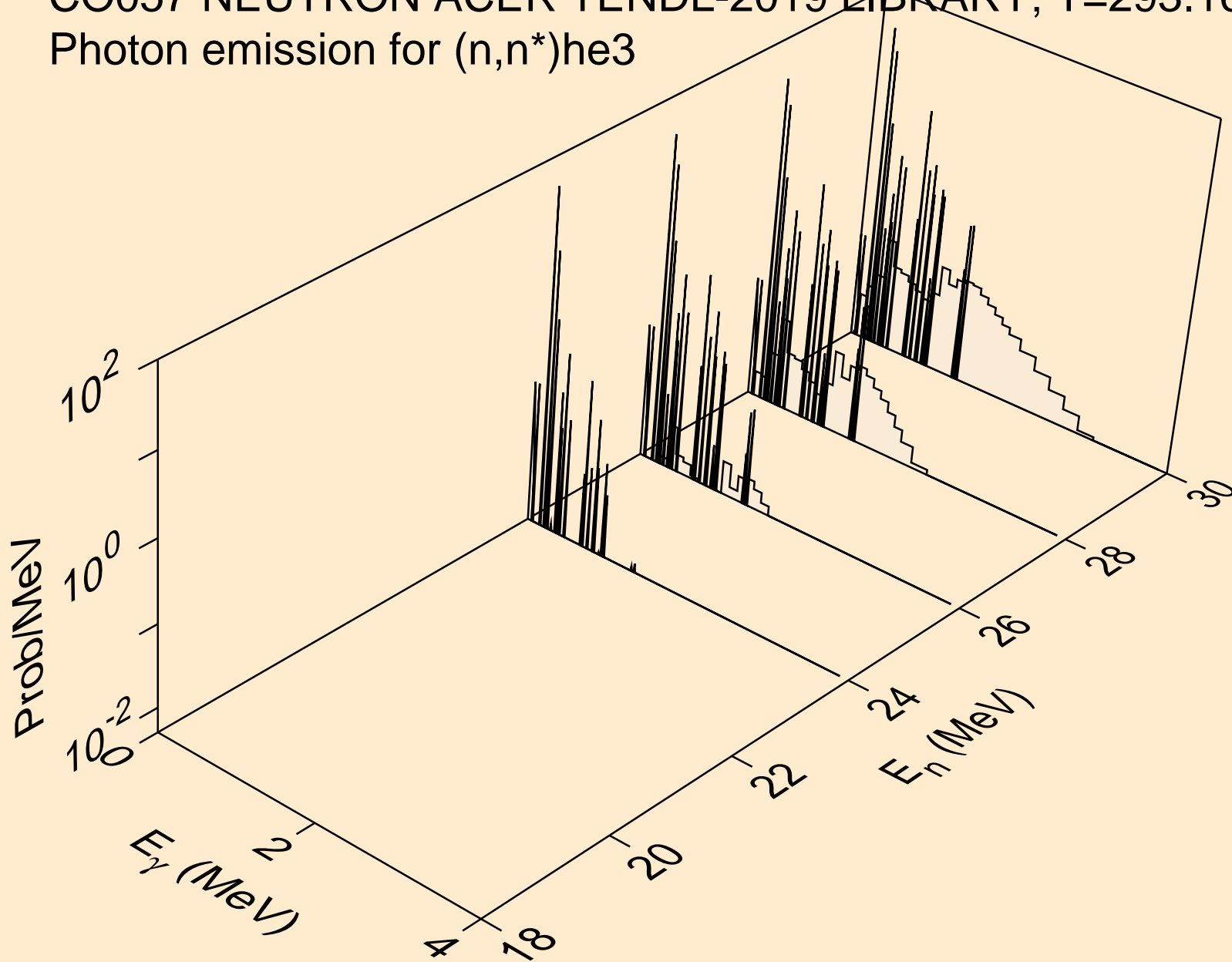

CO057 NEUTRON ACER TENDL-2019 LIBRARY; T=293.16K
Photon emission for (n,2np)

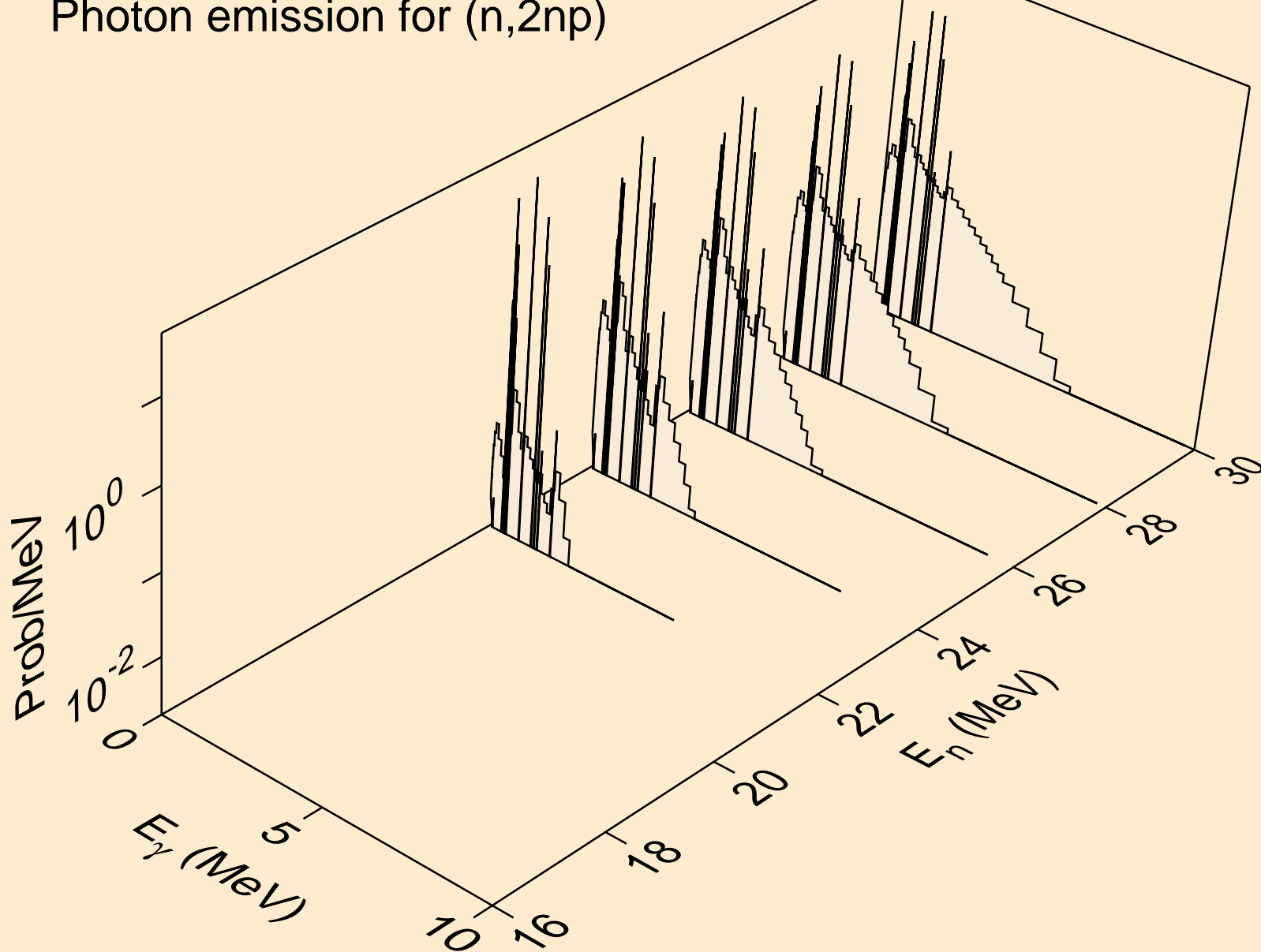

CO057 NEUTRON ACER TENDL-2019 LIBRARY; T=293.16K
Photon emission for (n,3np)

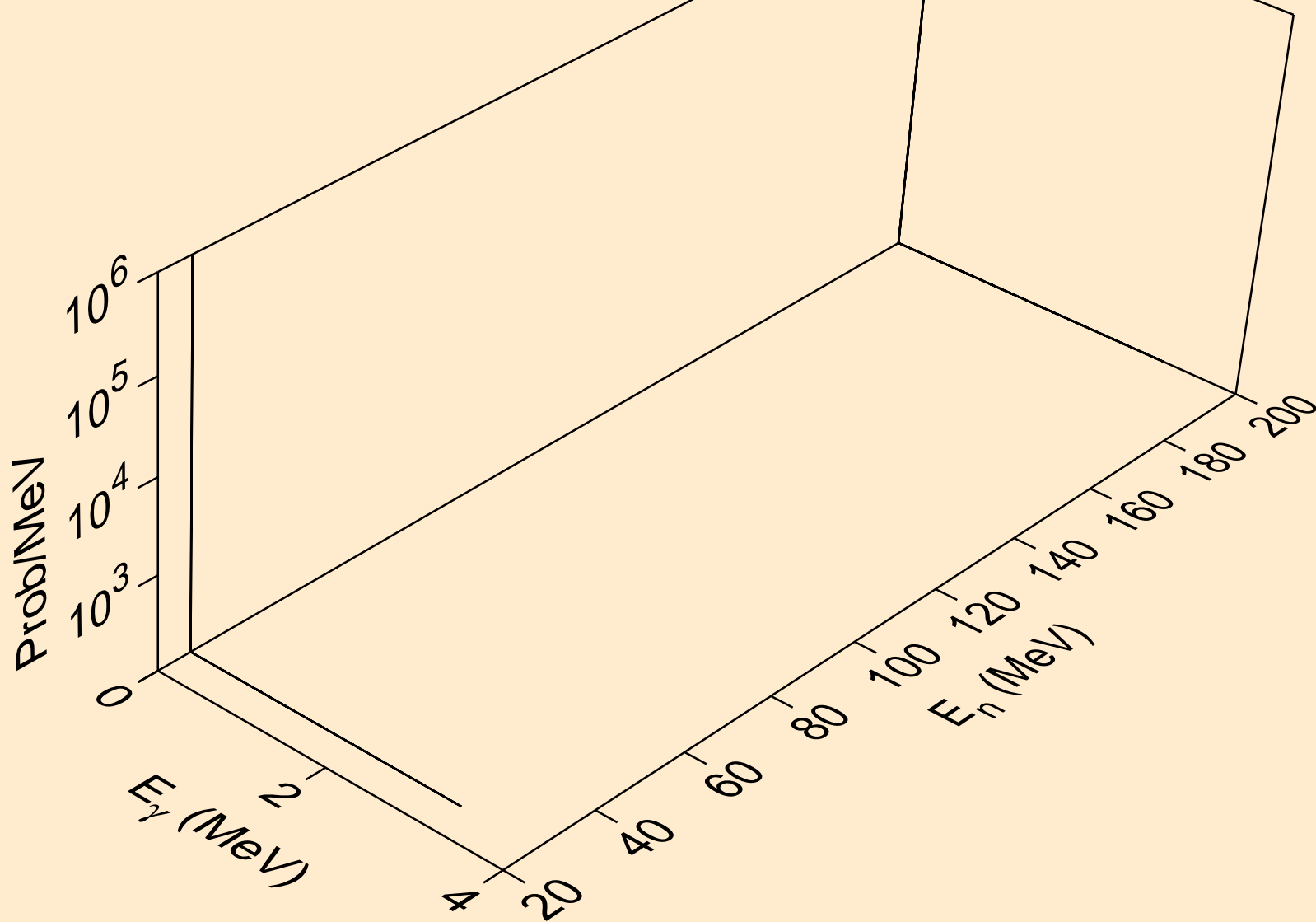

CO057 NEUTRON ACER TENDL-2019 LIBRARY; T=293.16K
Photon emission for (n,2np)

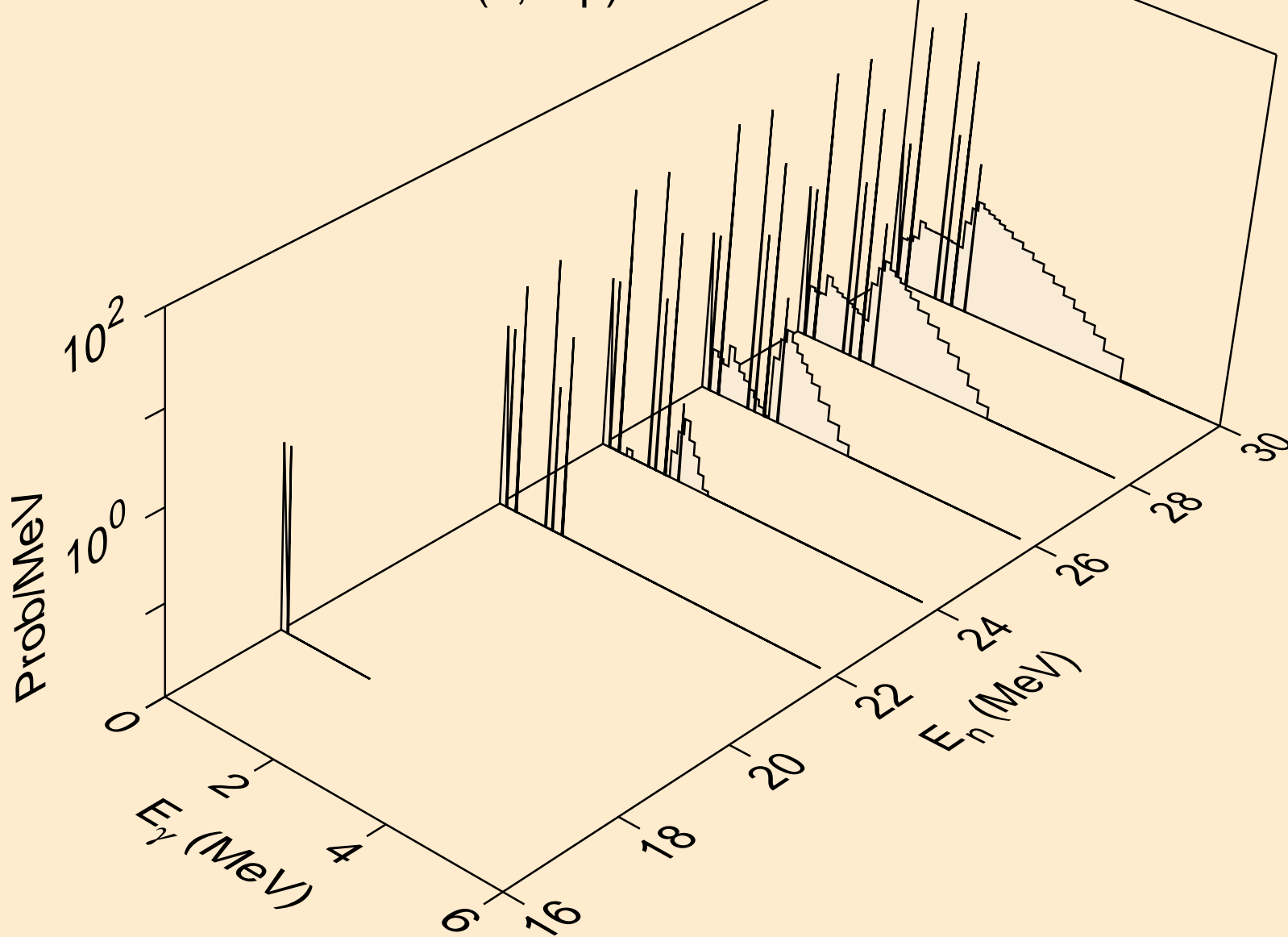

CO057 NEUTRON ACER TENDL-2019 LIBRARY; T=293.16K
Photon emission for (n,npa)

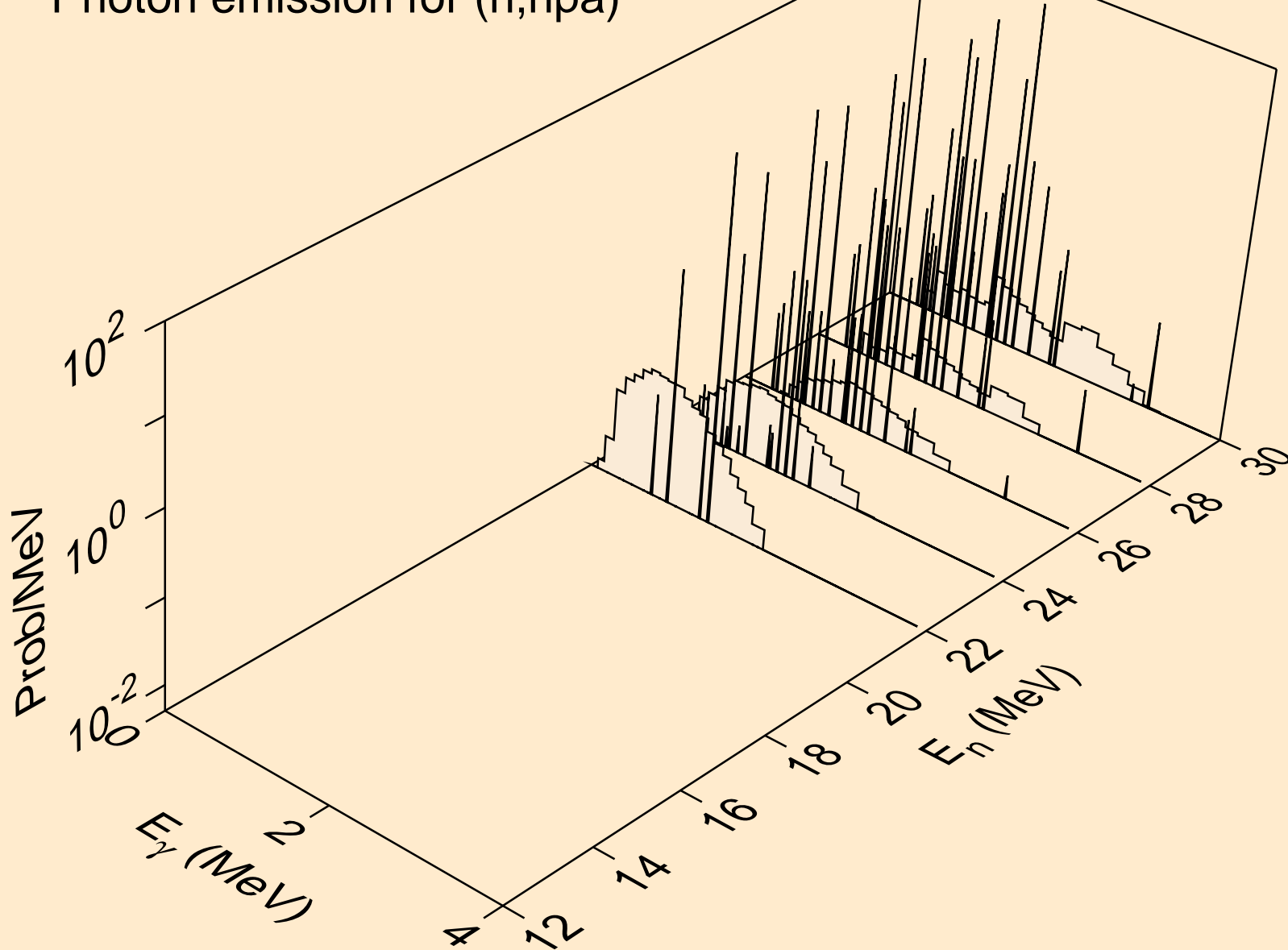

CO057 NEUTRON ACER TENDL-2019 LIBRARY; T=293.16K
Photon emission for (n,n*c)

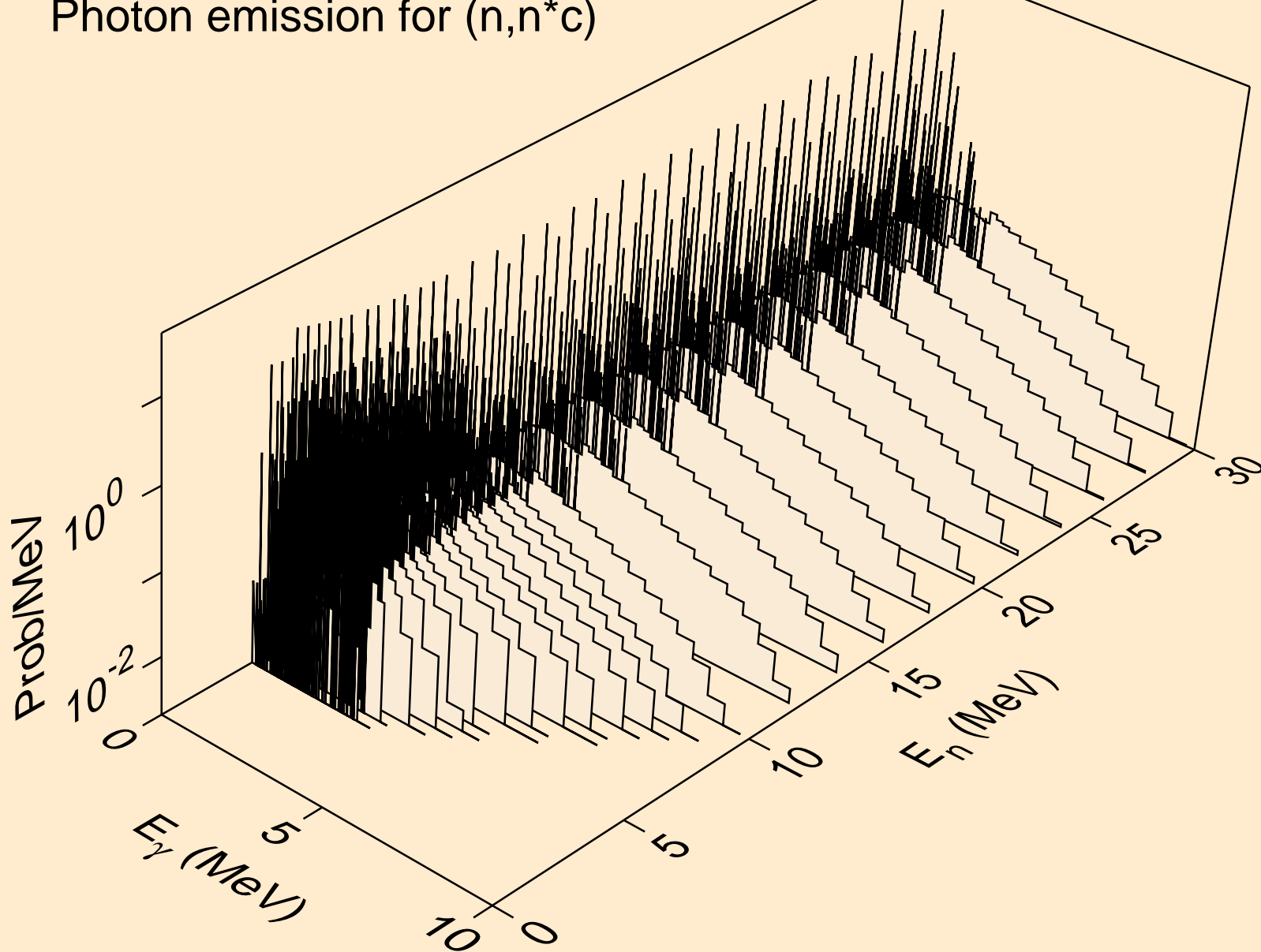

CO057 NEUTRON ACER TENDL-2019 LIBRARY; T=293.16K
Photon emission for (n,gma)

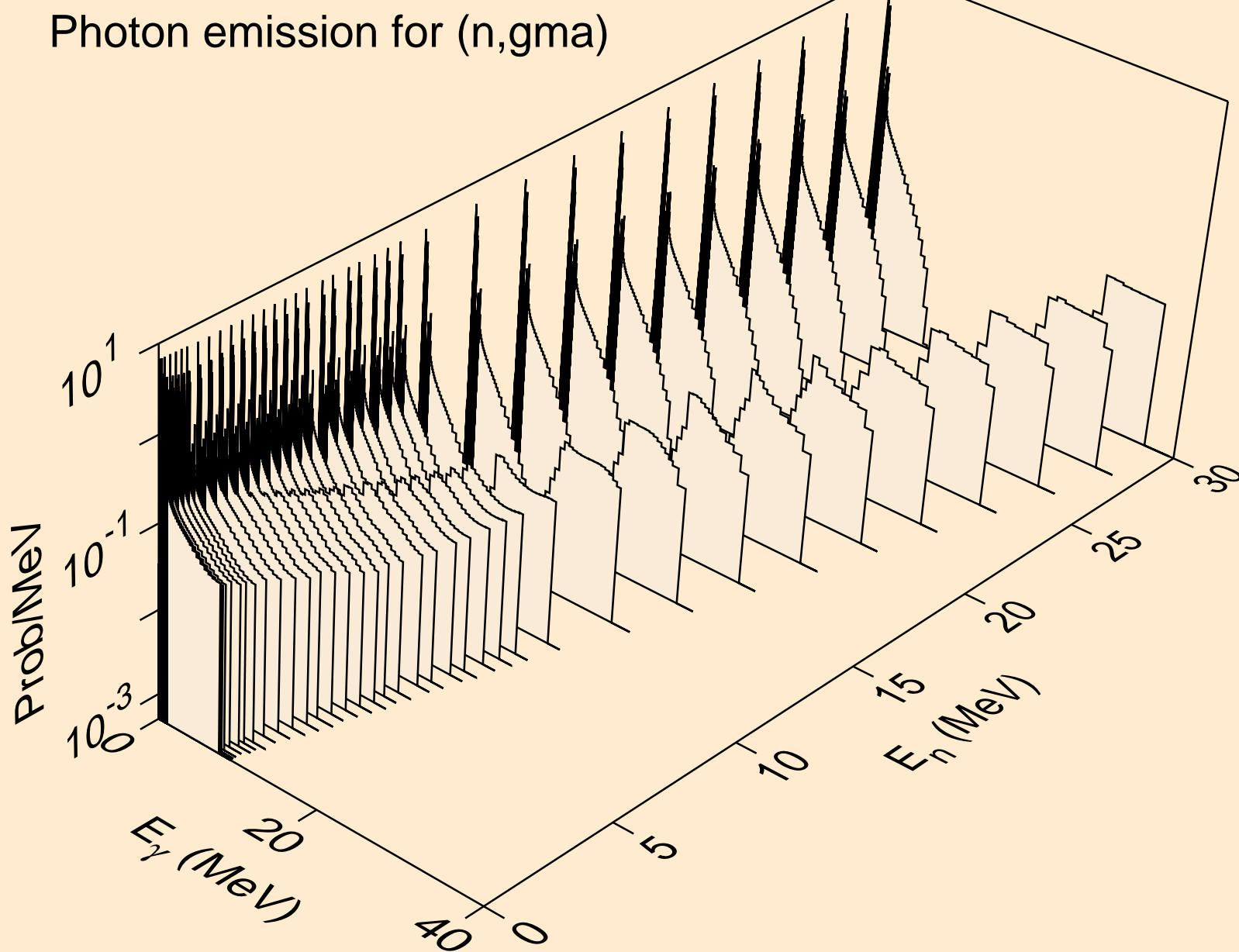

CO057 NEUTRON ACER TENDL-2019 LIBRARY; T=293.16K
Photon emission for (n,p)

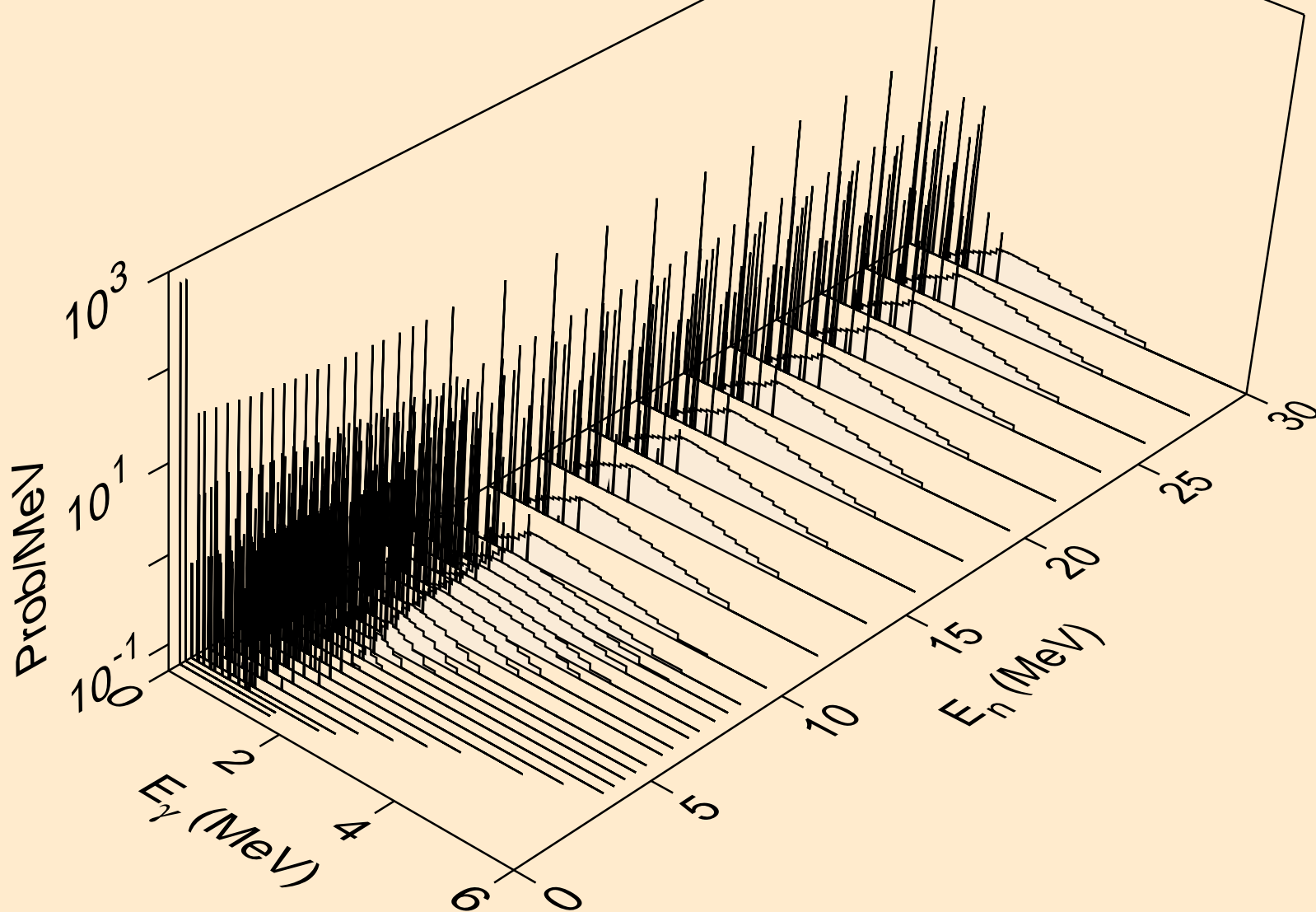

CO057 NEUTRON ACER TENDL-2019 LIBRARY; T=293.16K
Photon emission for (n,d)

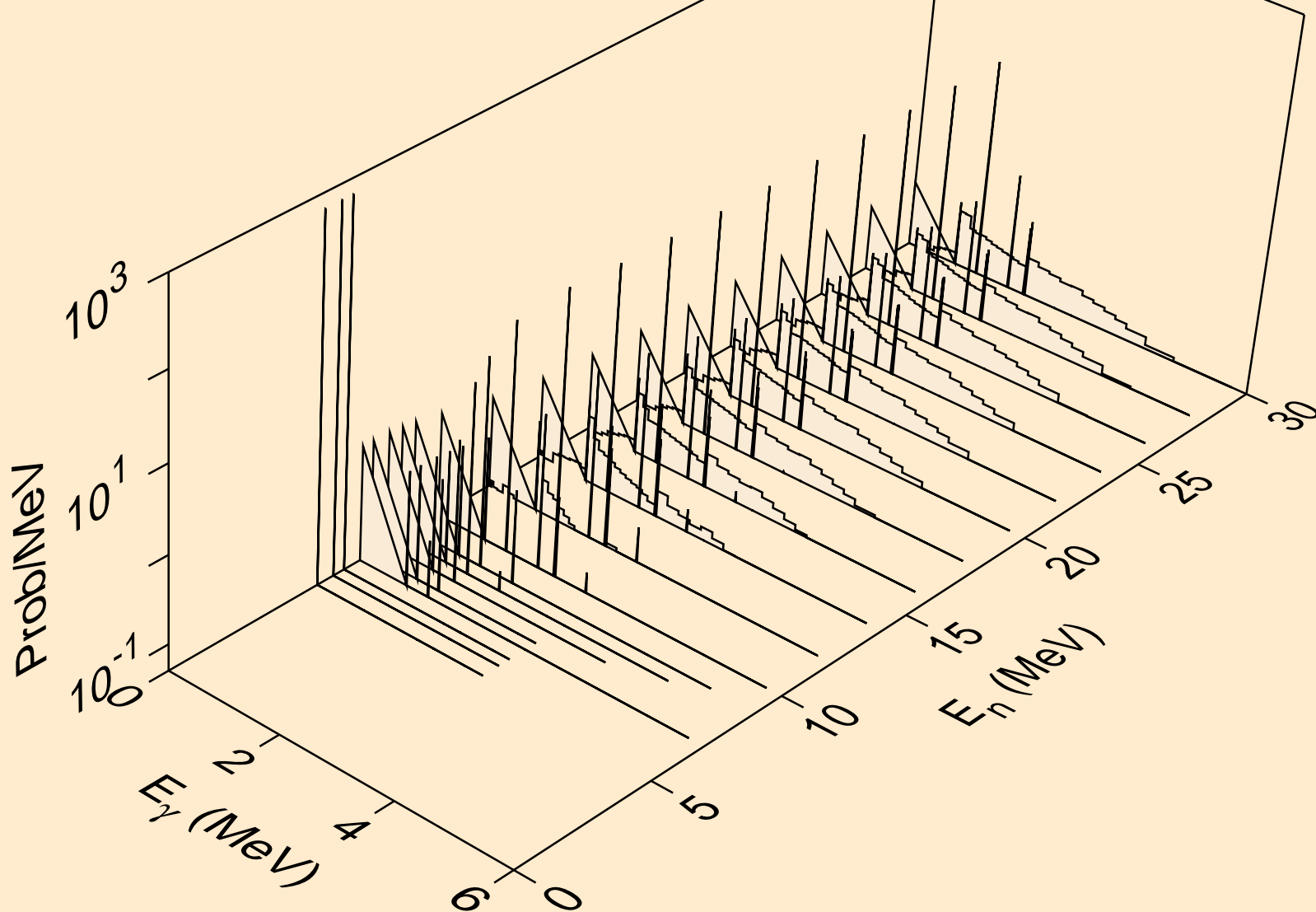

CO057 NEUTRON ACER TENDL-2019 LIBRARY; T=293.16K
Photon emission for (n,t)

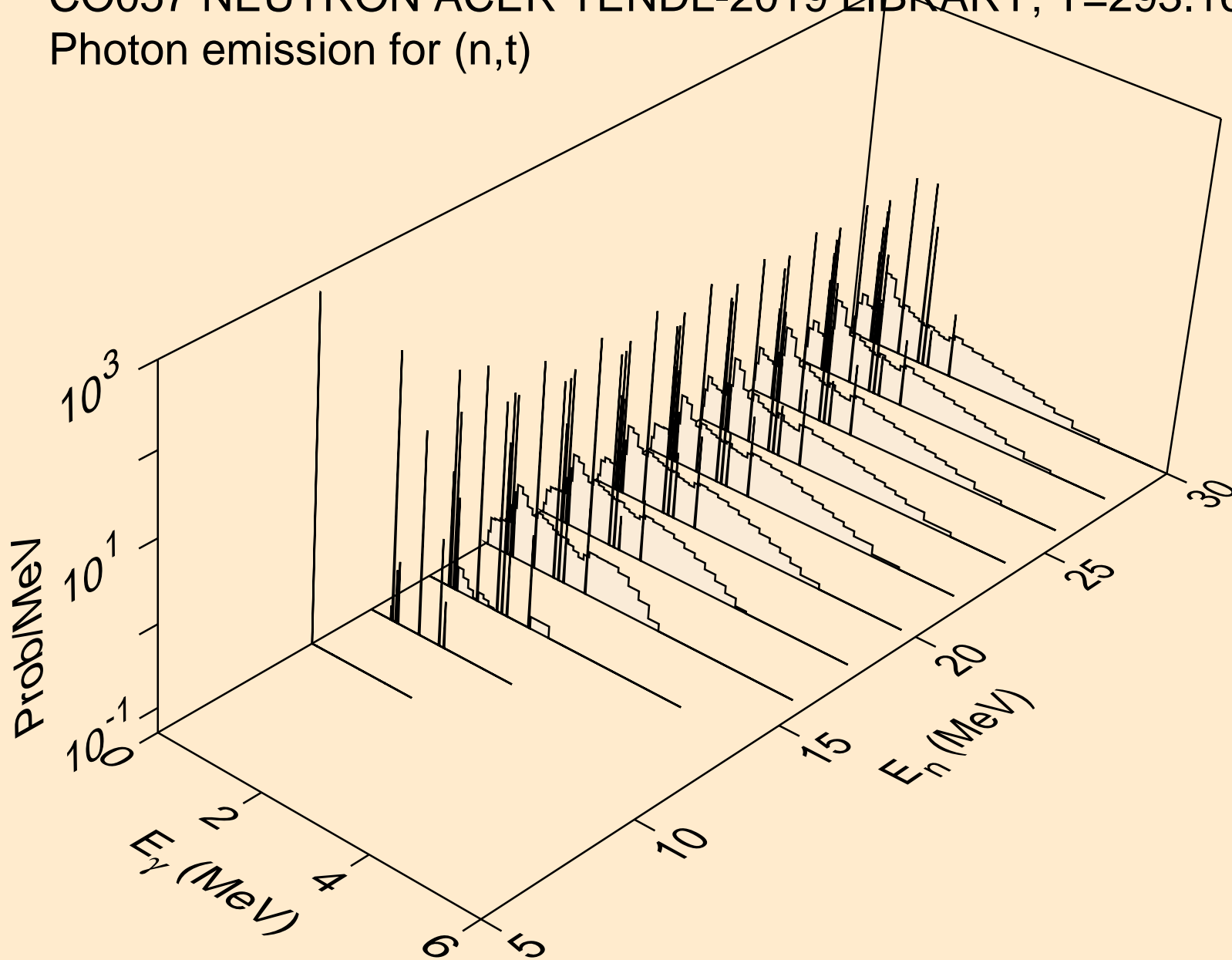

CO057 NEUTRON ACER TENDL-2019 LIBRARY; T=293.16K
Photon emission for (n,he3)

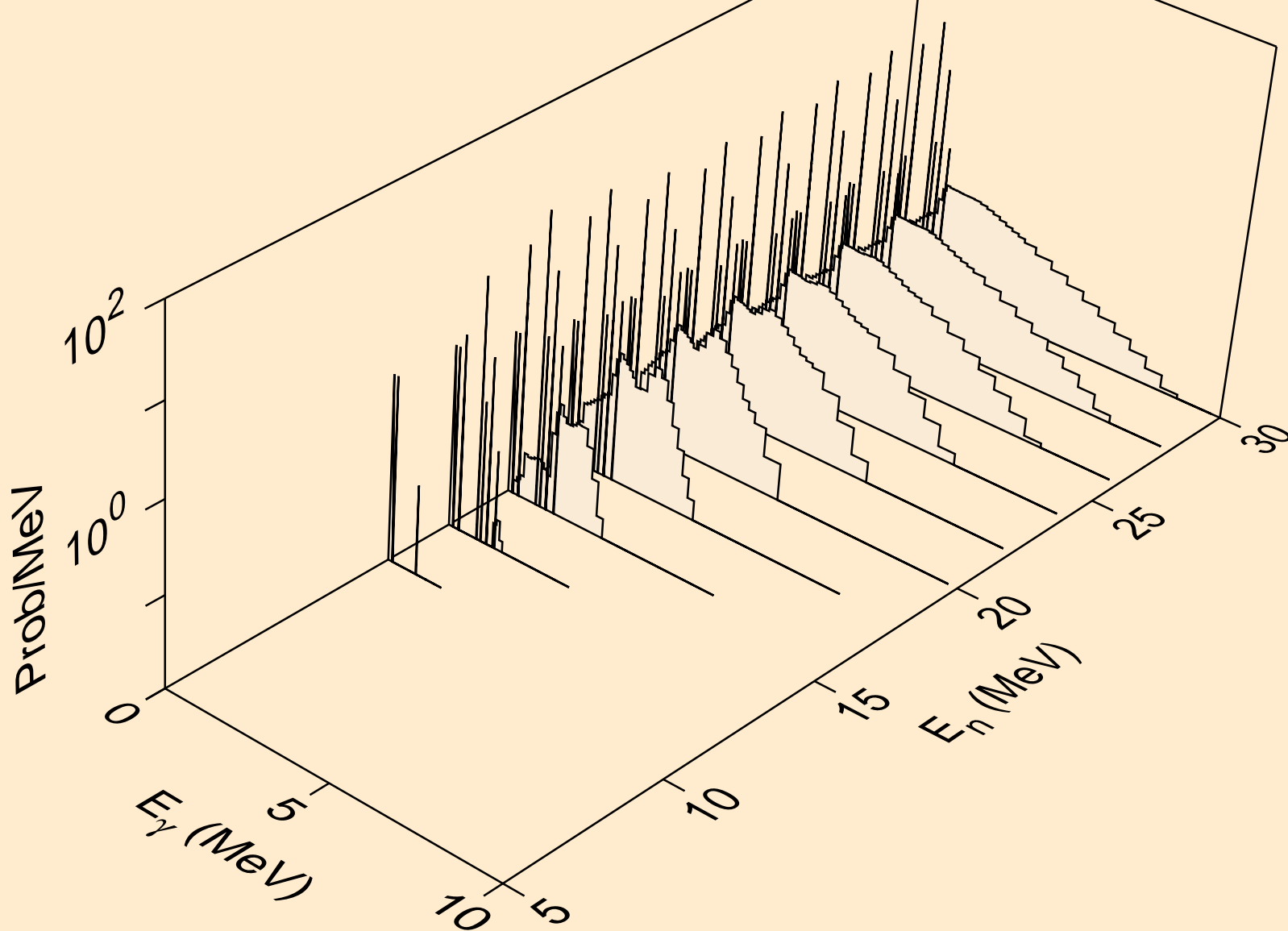

CO057 NEUTRON ACER TENDL-2019 LIBRARY; T=293.16K
Photon emission for (n,a)

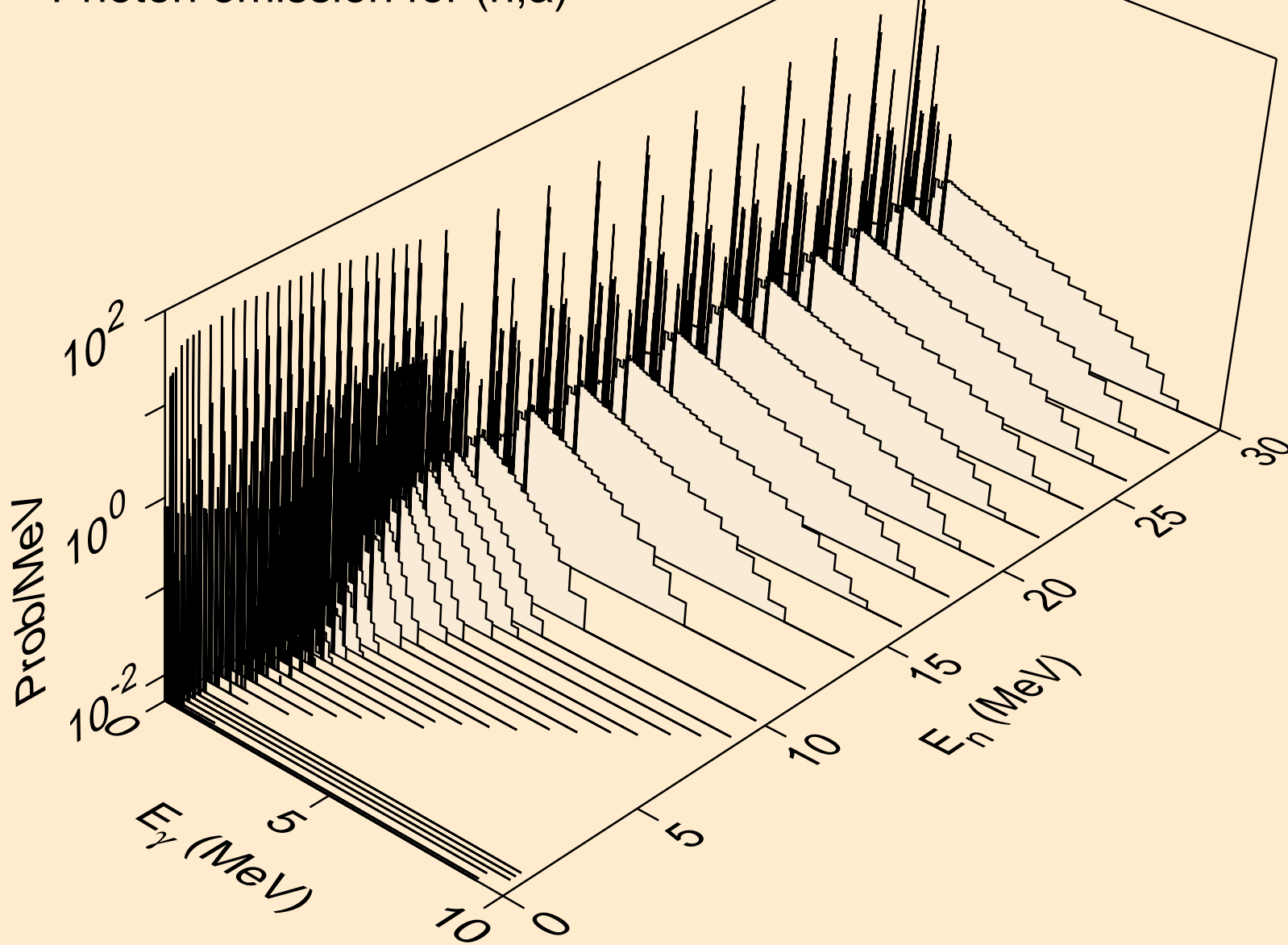

CO057 NEUTRON ACER TENDL-2019 LIBRARY; T=293.16K
Photon emission for (n,2a)

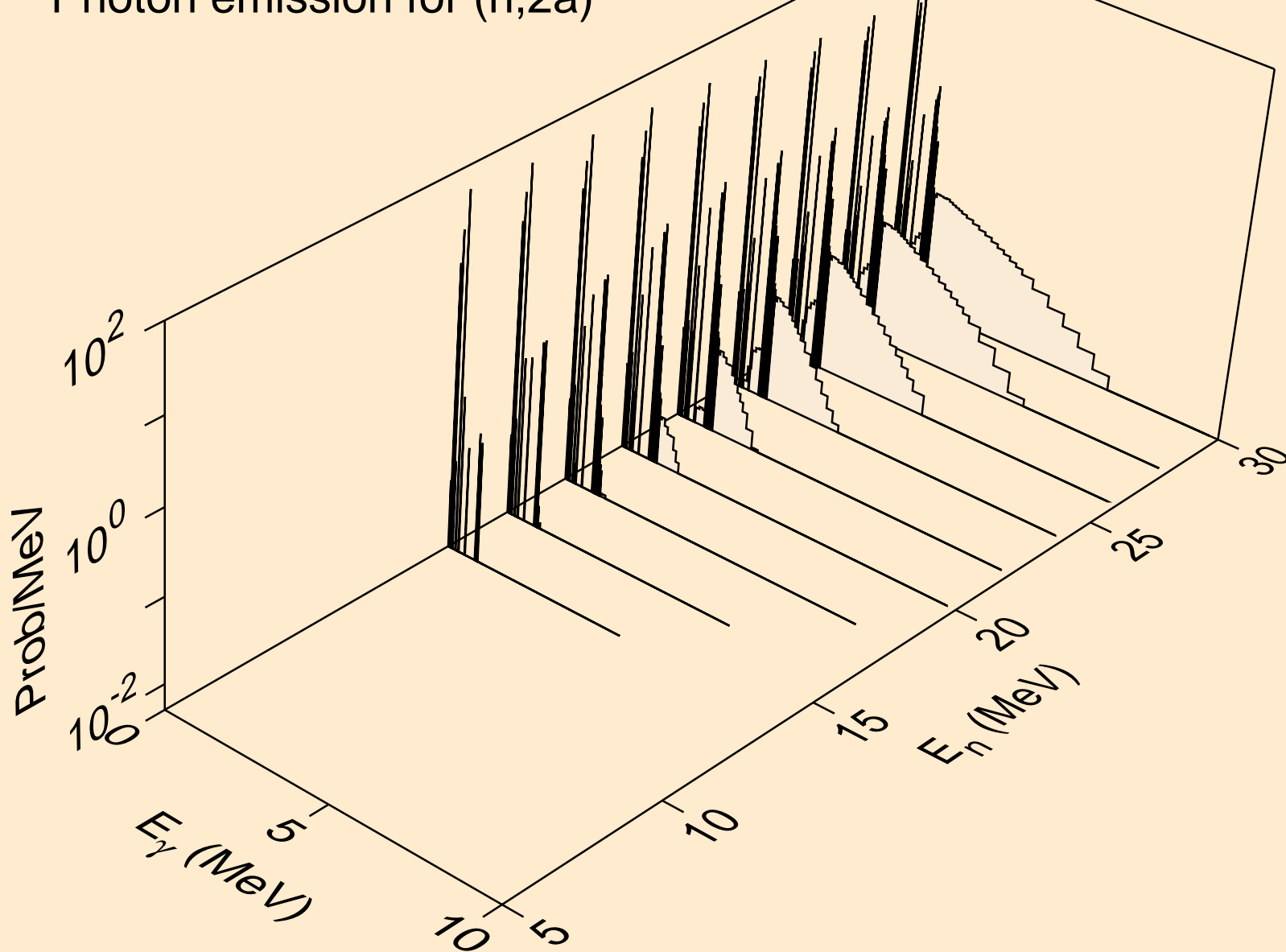

CO057 NEUTRON ACER TENDL-2019 LIBRARY; T=293.16K
Photon emission for (n,2p)

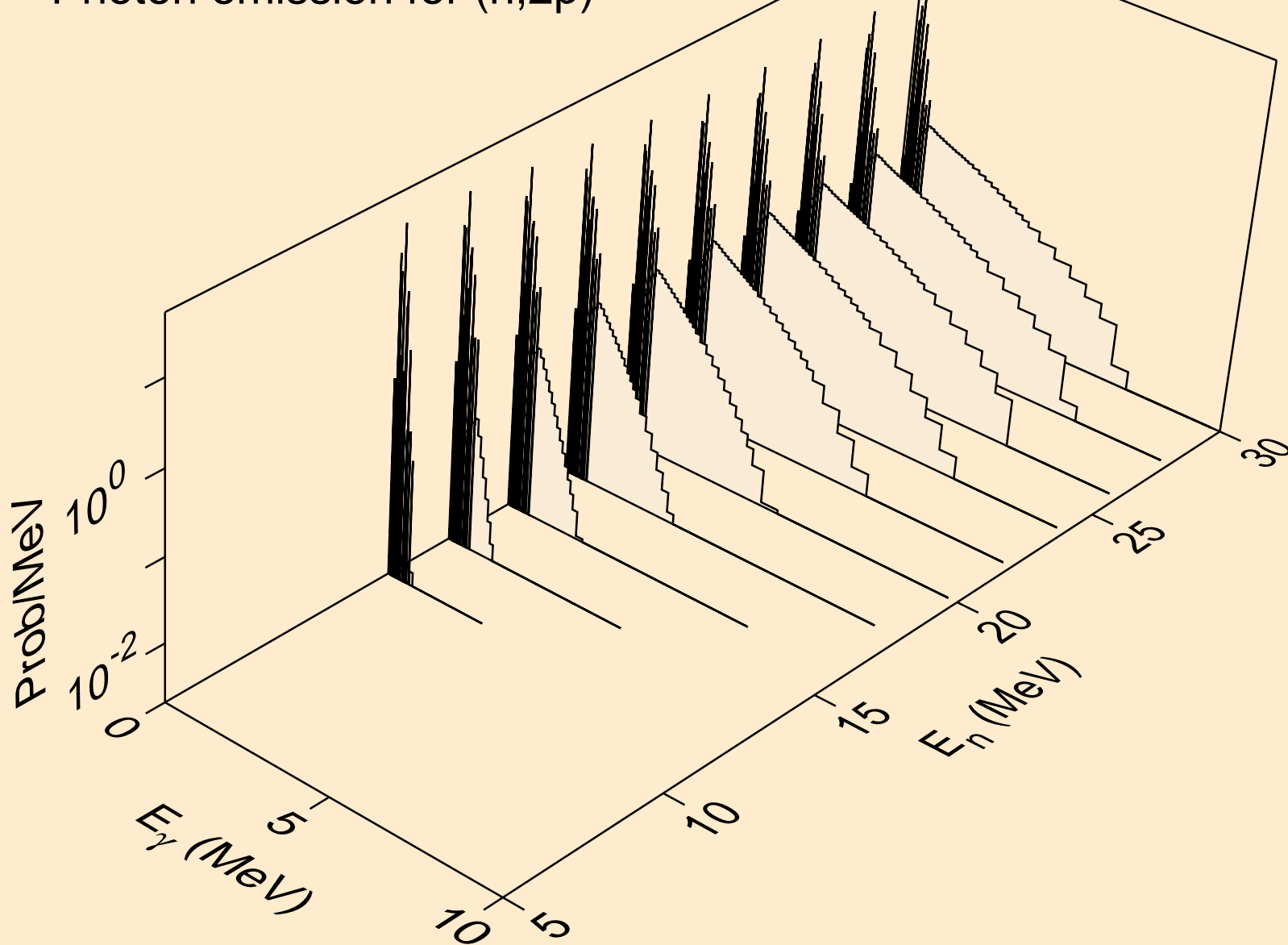

CO057 NEUTRON ACER TENDL-2019 LIBRARY; T=293.16K
Photon emission for (n,p α)

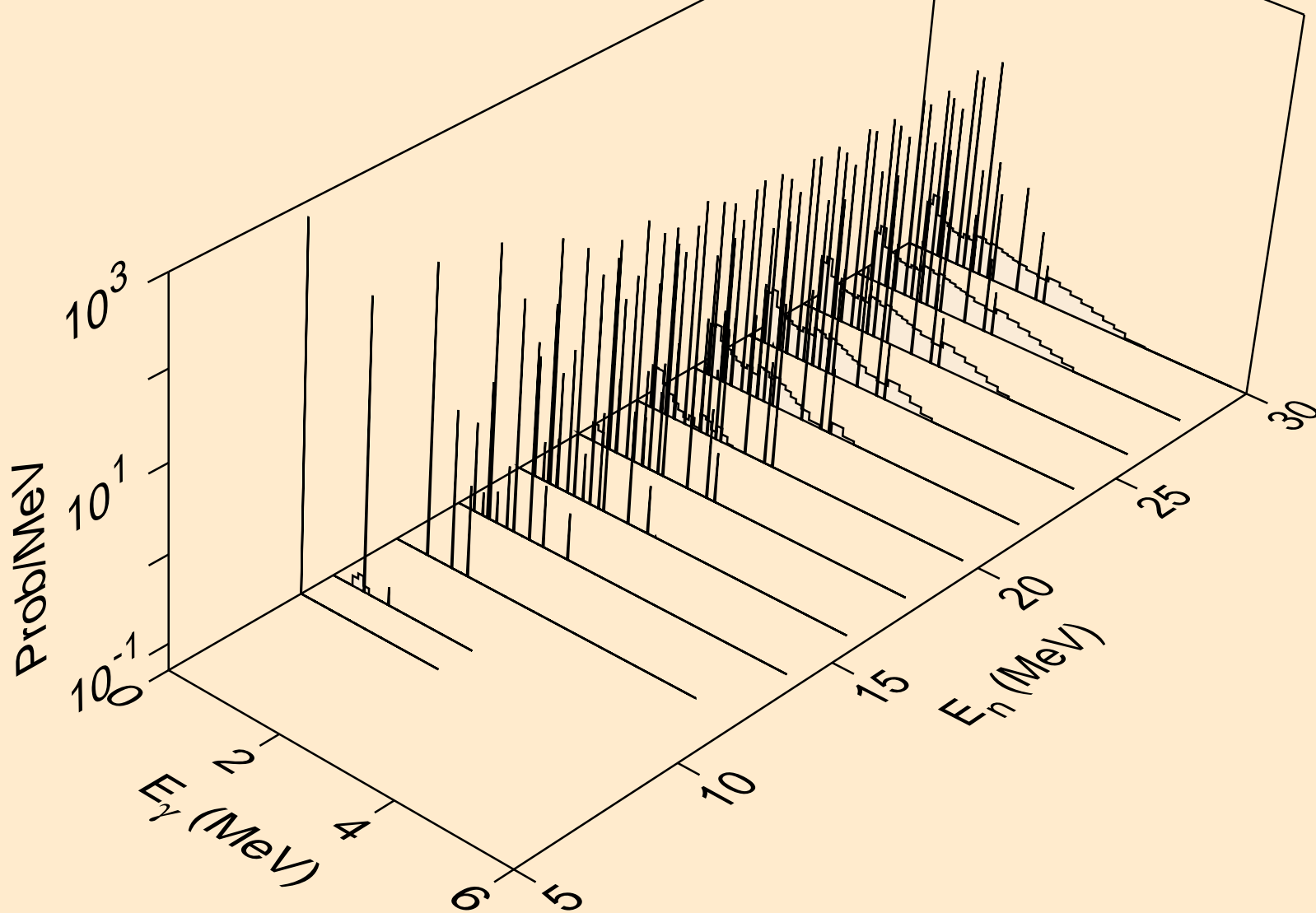

CO057 NEUTRON ACER TENDL-2019 LIBRARY; T=293.16K
Photon emission for (n,pd)

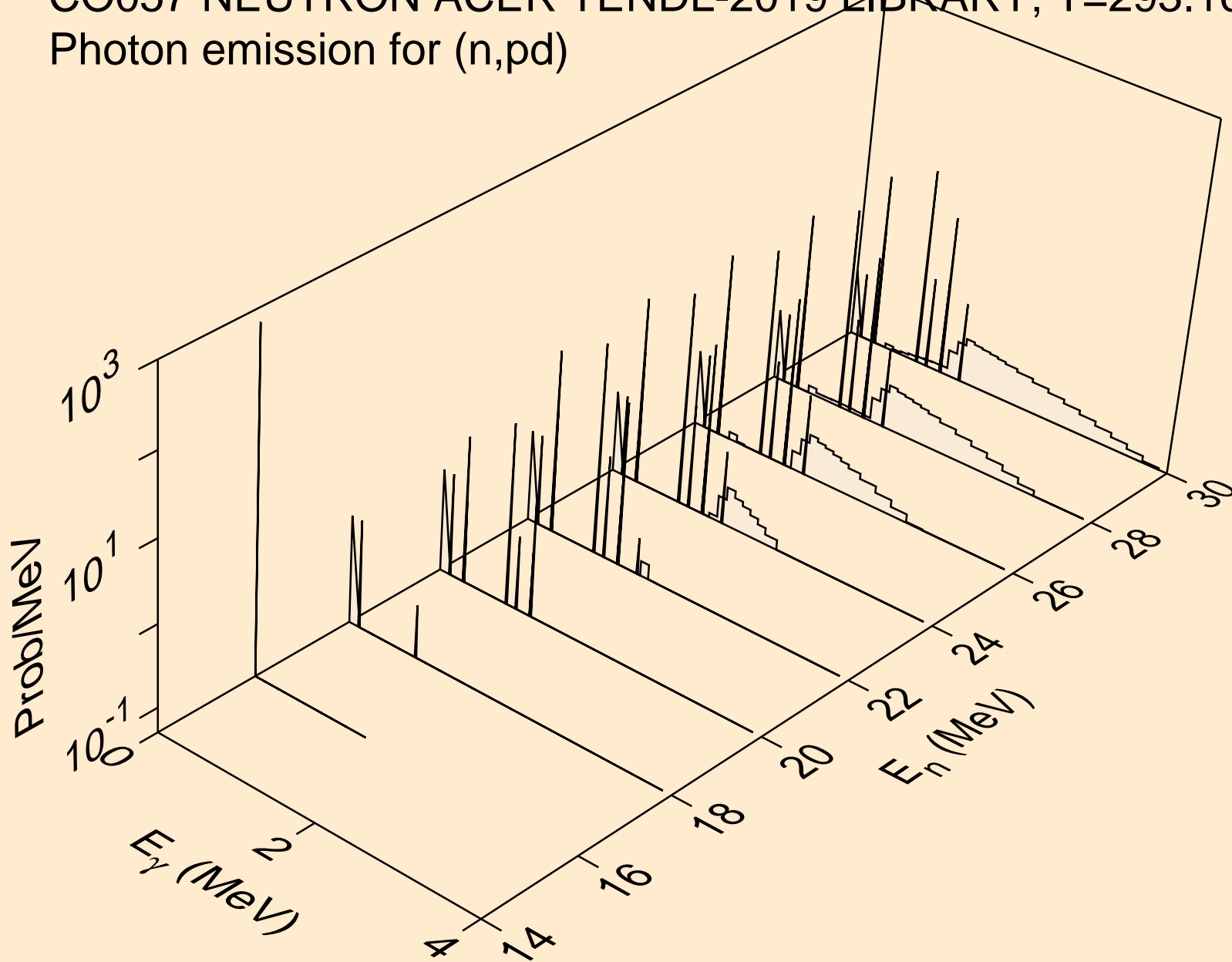

CO057 NEUTRON ACER TENDL-2019 LIBRARY; T=293.16K
Photon emission for (n,pt)

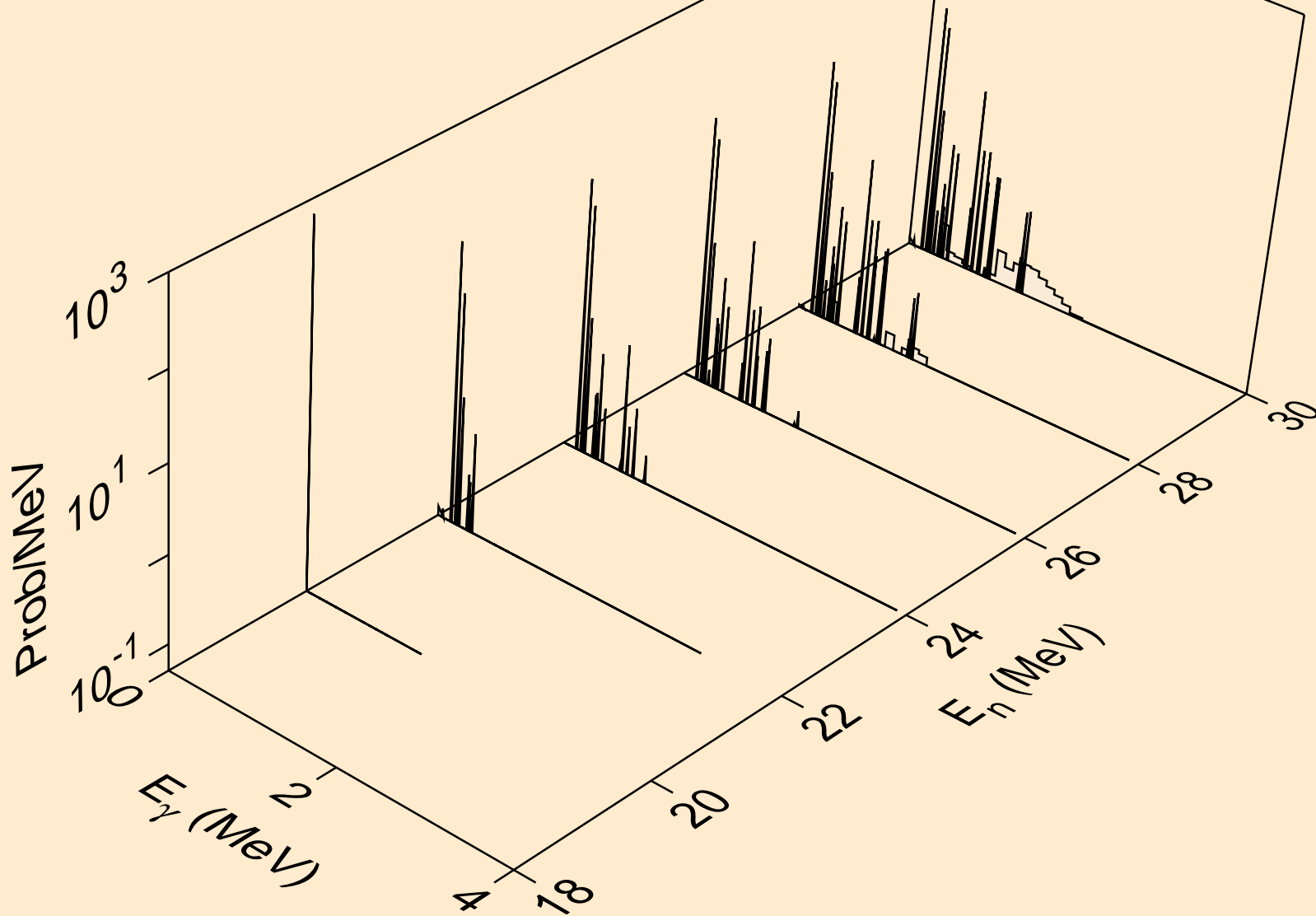

CO057 NEUTRON ACER TENDL-2019 LIBRARY; T=293.16K
Photon emission for (n,da)

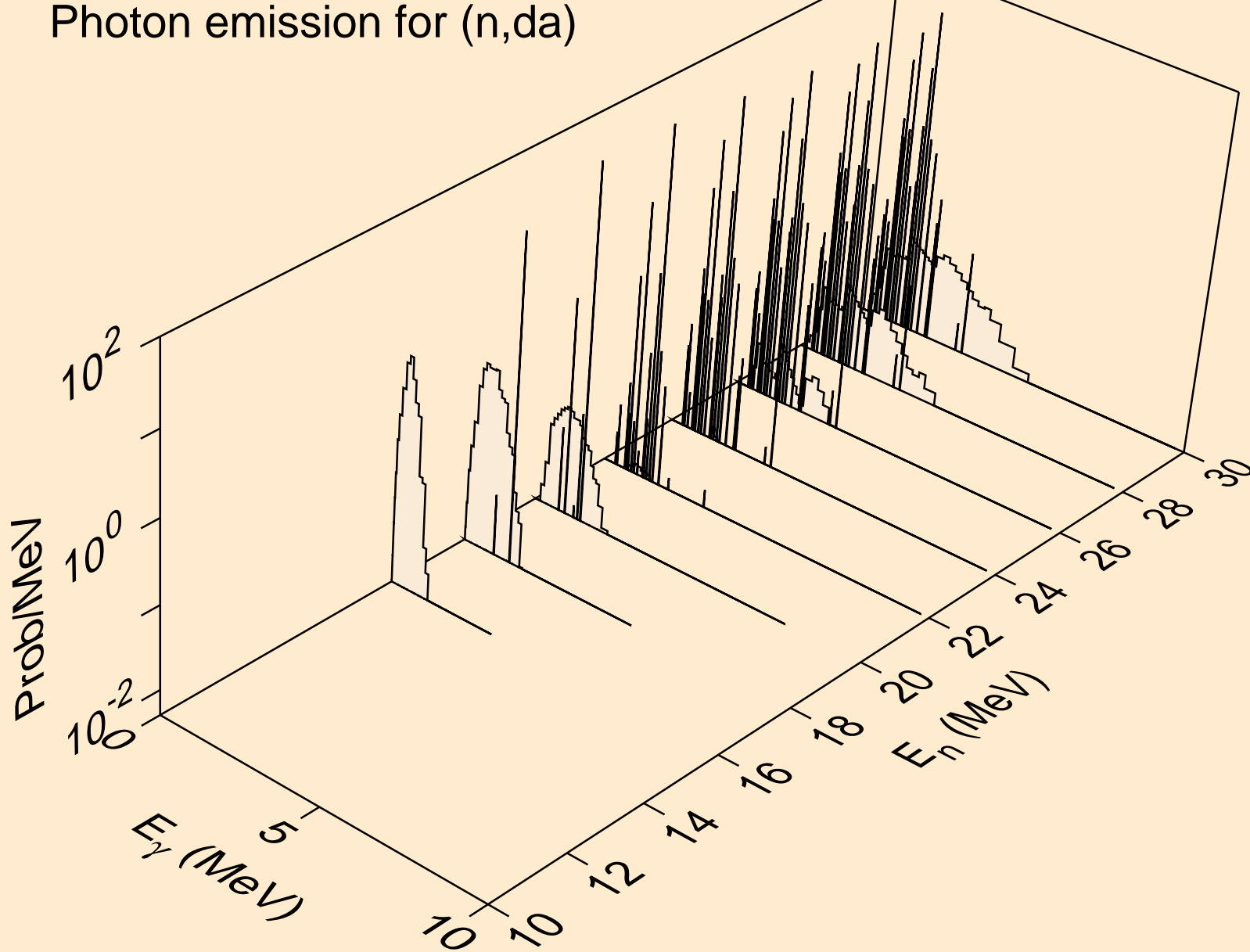

CO057 NEUTRON ACER TENDL-2019 LIBRARY; T=293.16K
thermal capture photon spectrum

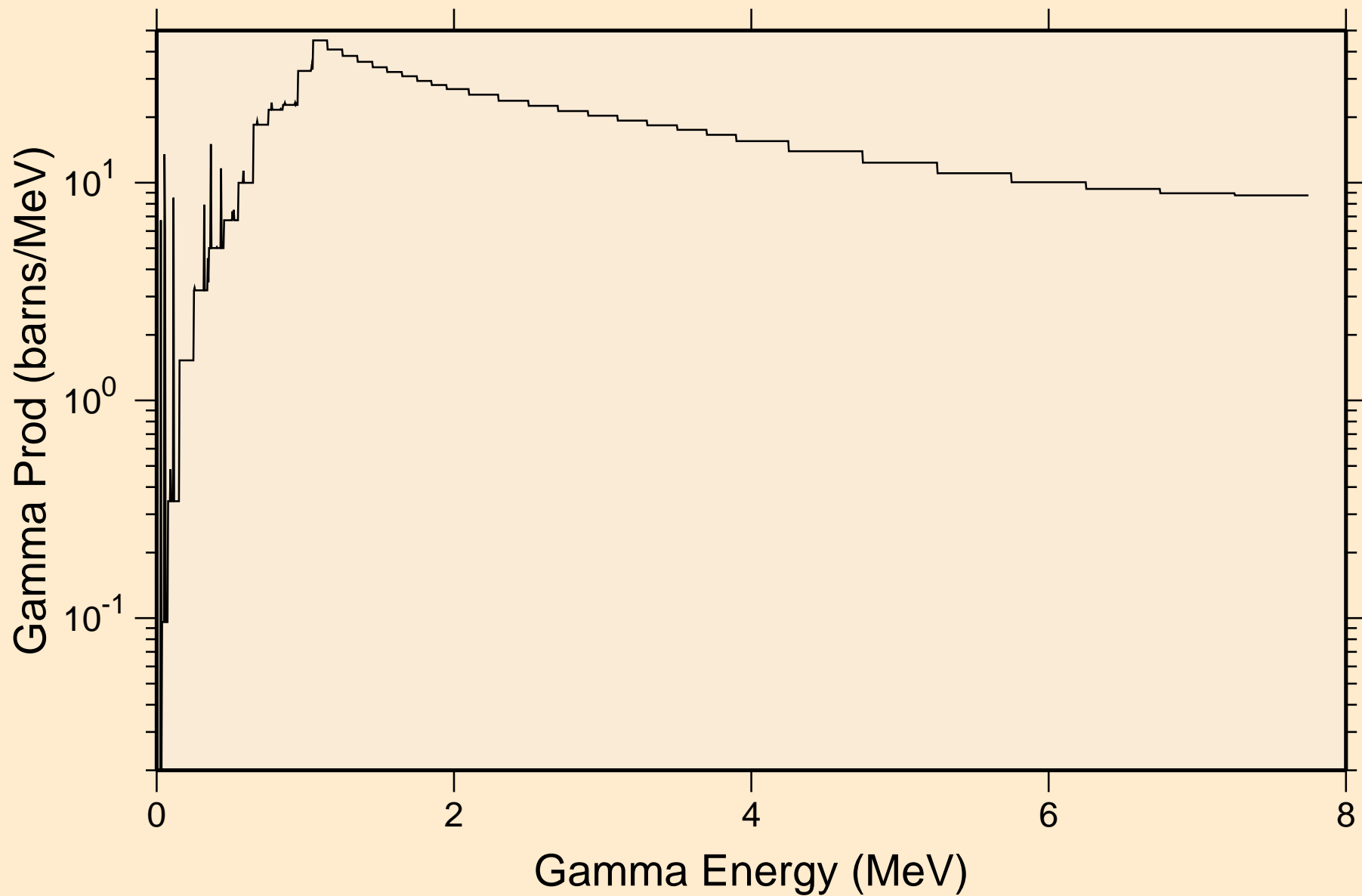

CO057 NEUTRON ACER TENDL-2019 LIBRARY; T=293.16K
14 MeV photon spectrum

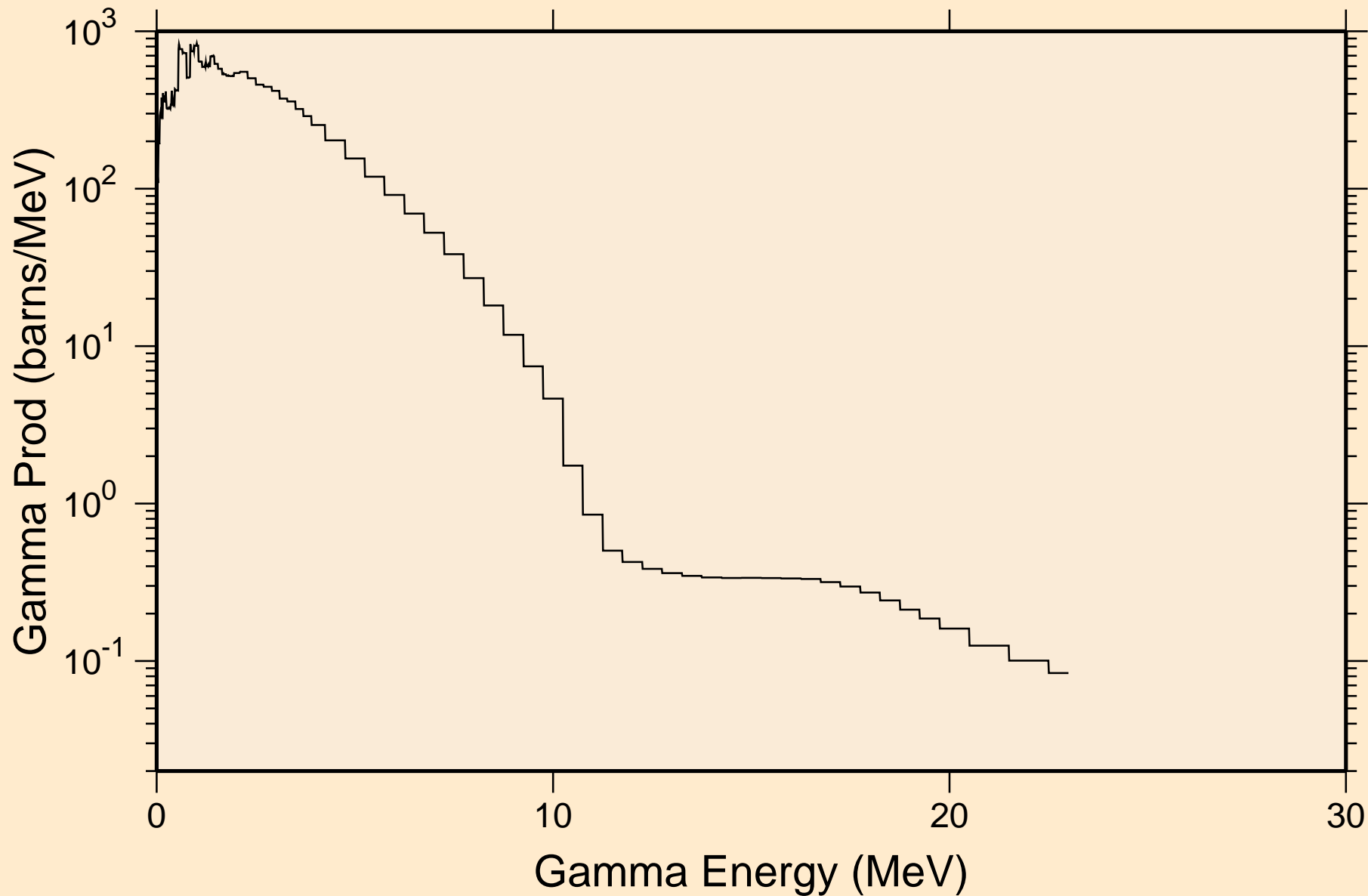

CO057 NEUTRON ACER TENDL-2019 LIBRARY; T=293.16K
Particle heating contributions

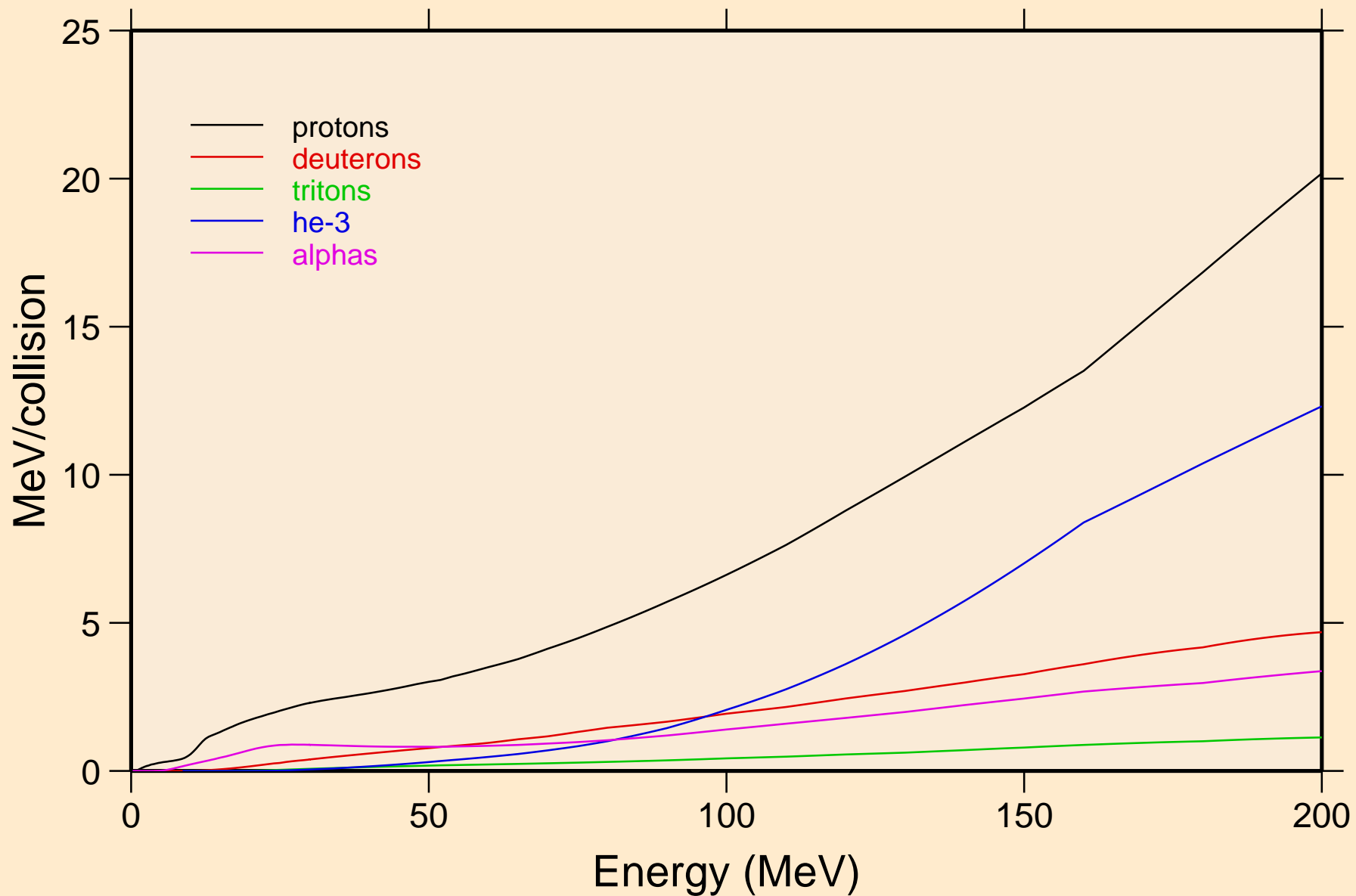

CO057 NEUTRON ACER TENDL-2019 LIBRARY; T=293.16K
Recoil Heating

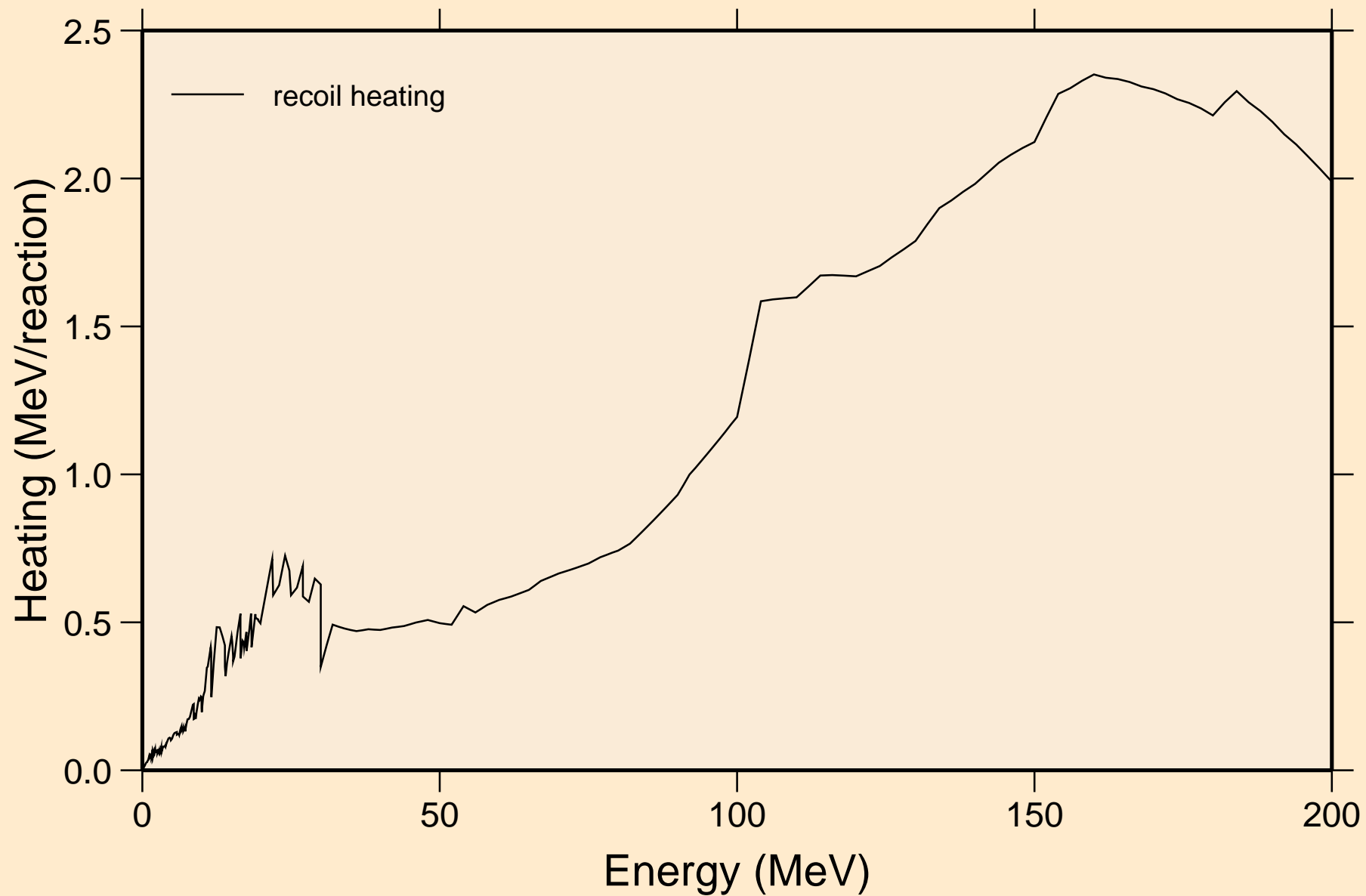

CO057 NEUTRON ACER TENDL-2019 LIBRARY; T=293.16K
Particle production cross sections

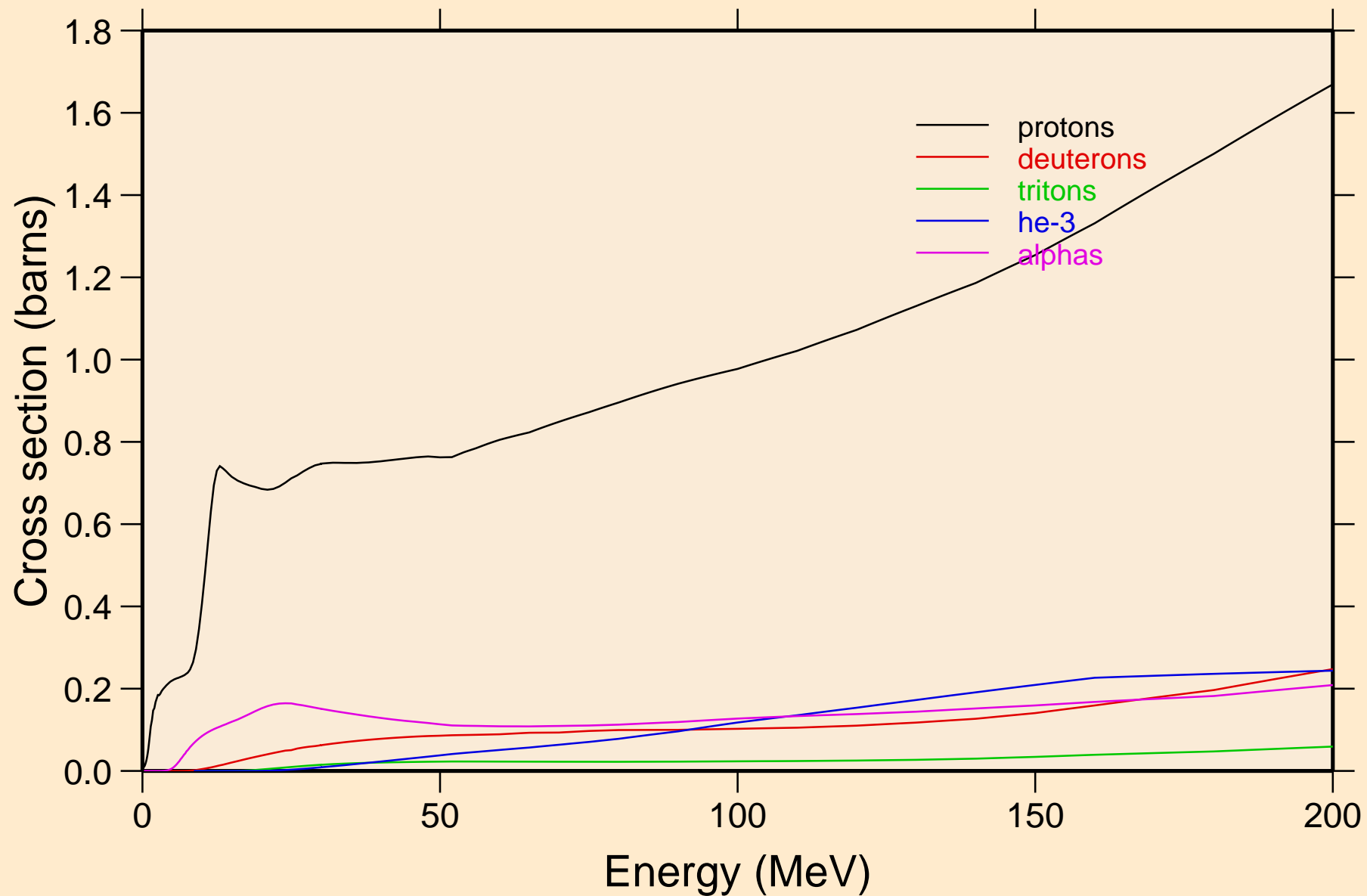

CO057 NEUTRON ACER TENDL-2019 LIBRARY; T=293.16K
protons from (n,x)

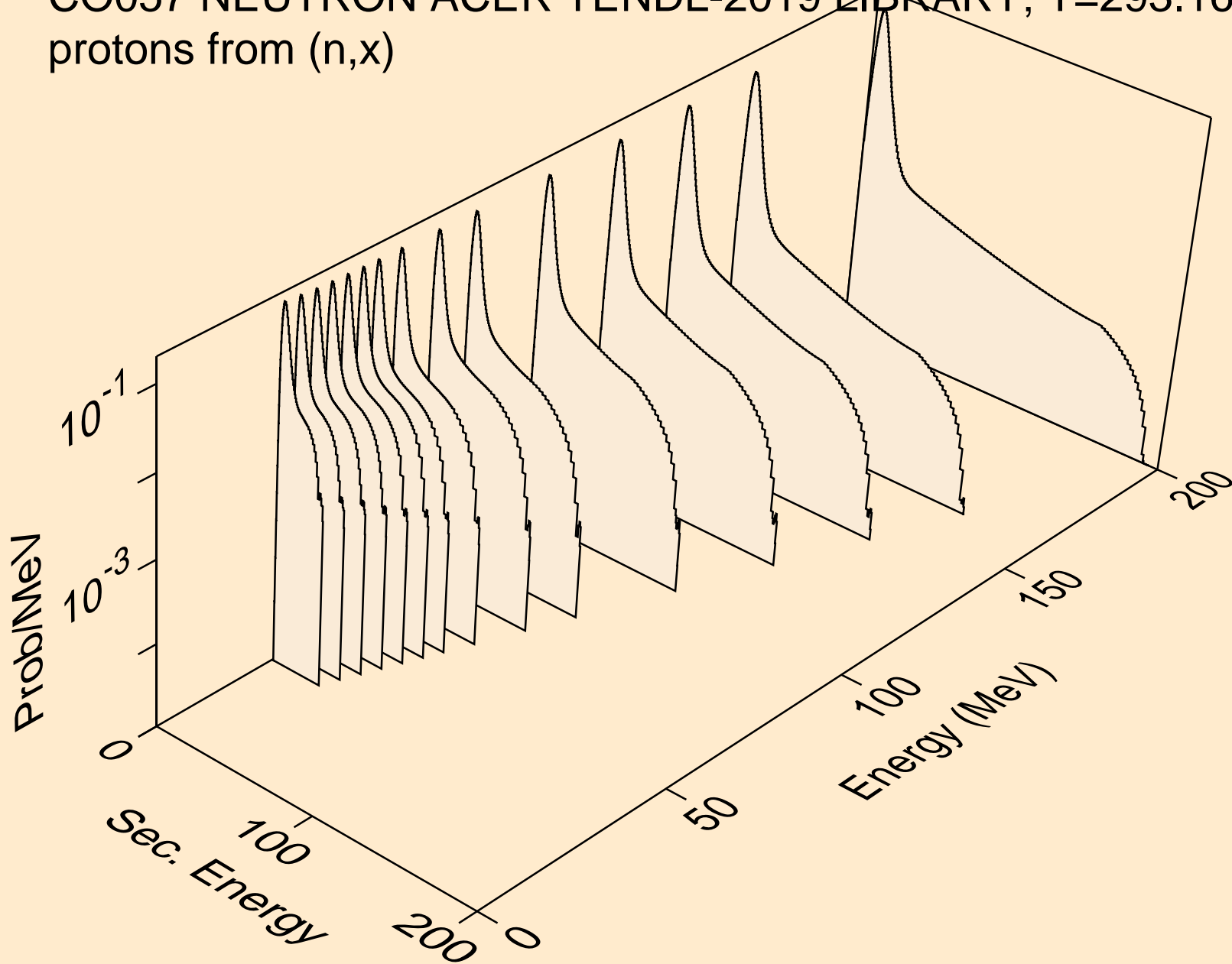

CO057 NEUTRON ACER TENDL-2019 LIBRARY; T=293.16K
protons from (n,n*)p

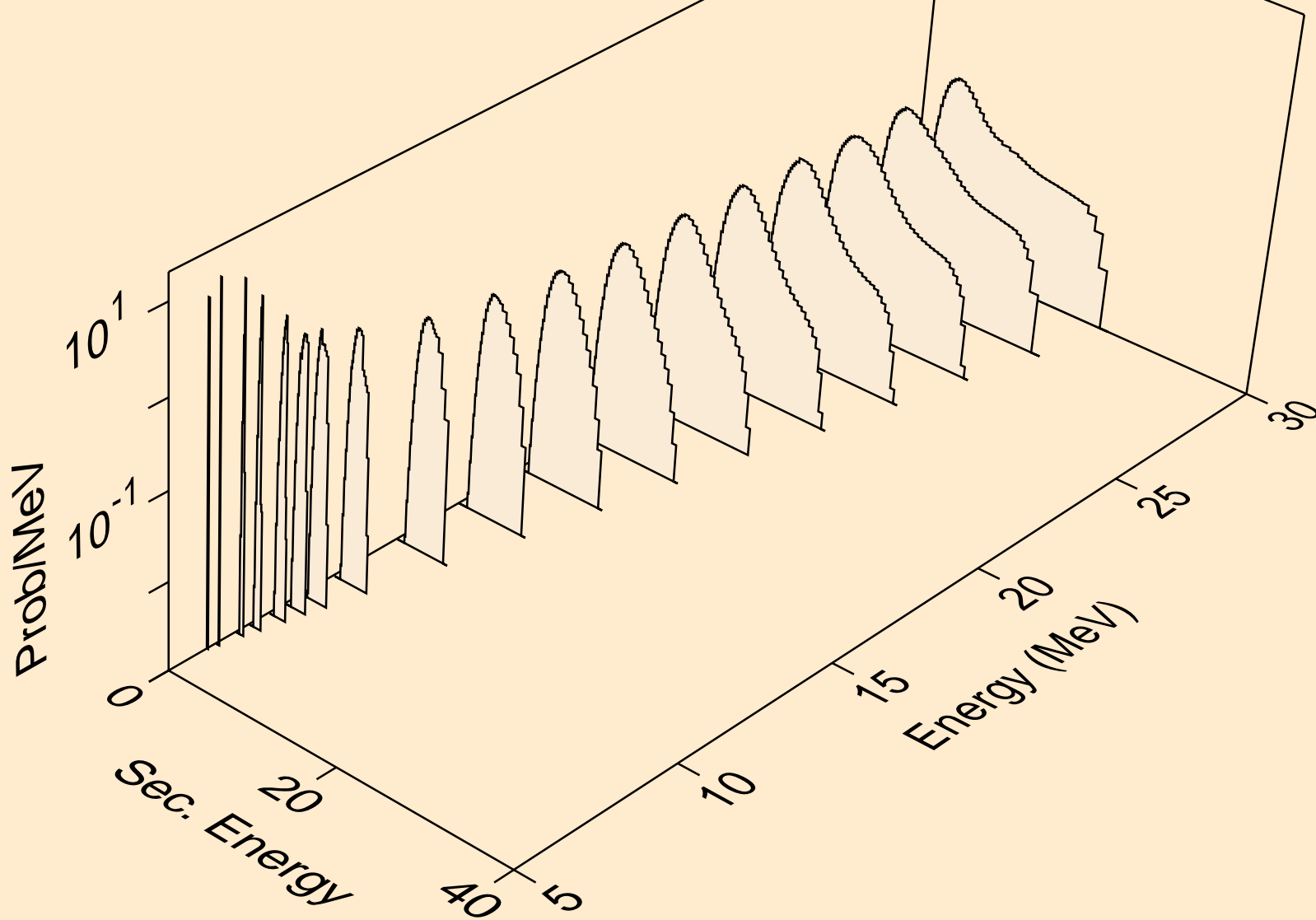

CO057 NEUTRON ACER TENDL-2019 LIBRARY; T=293.16K
protons from (n,2np)

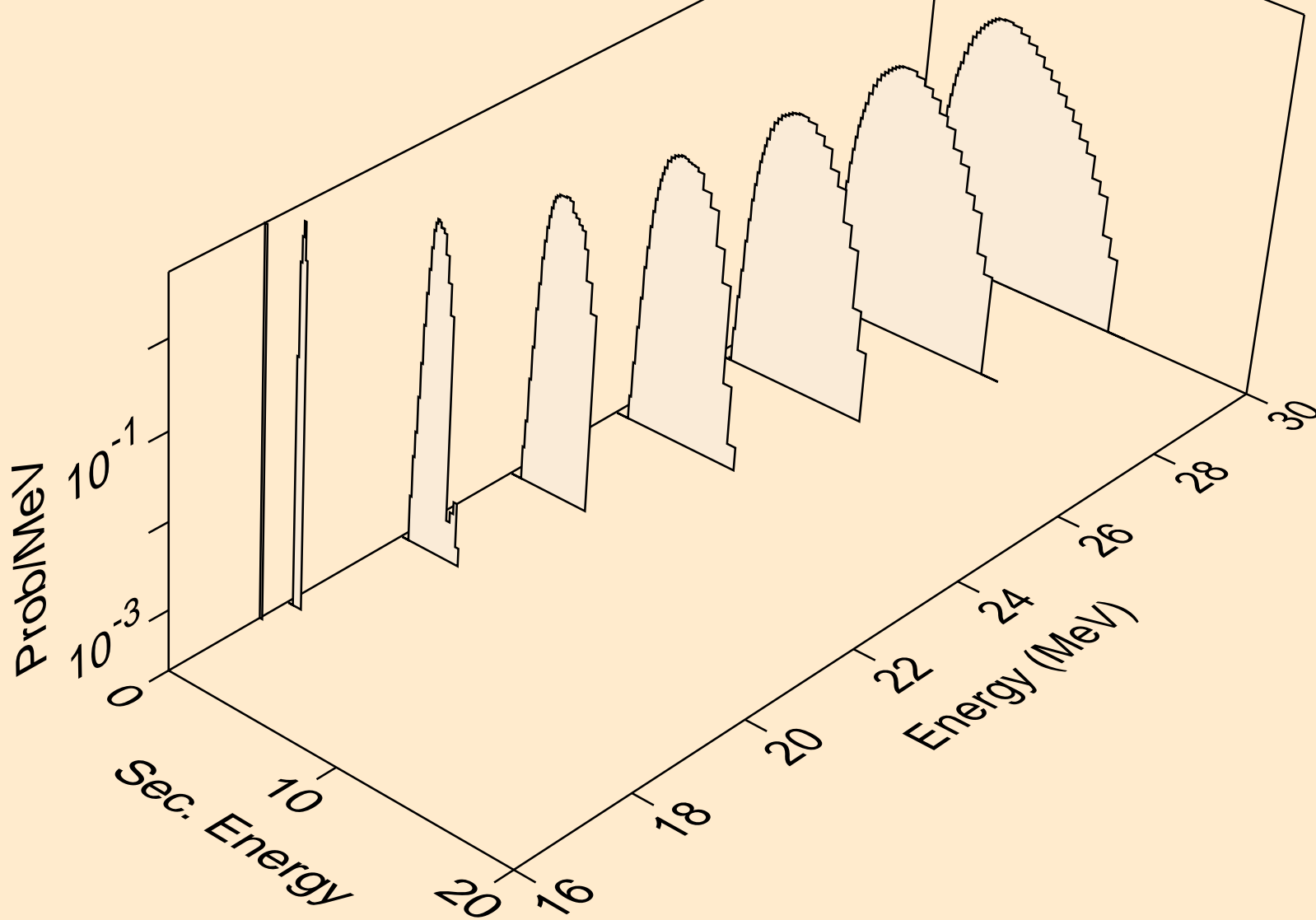

CO057 NEUTRON ACER TENDL-2019 LIBRARY; T=293.16K
protons from (n,3np)

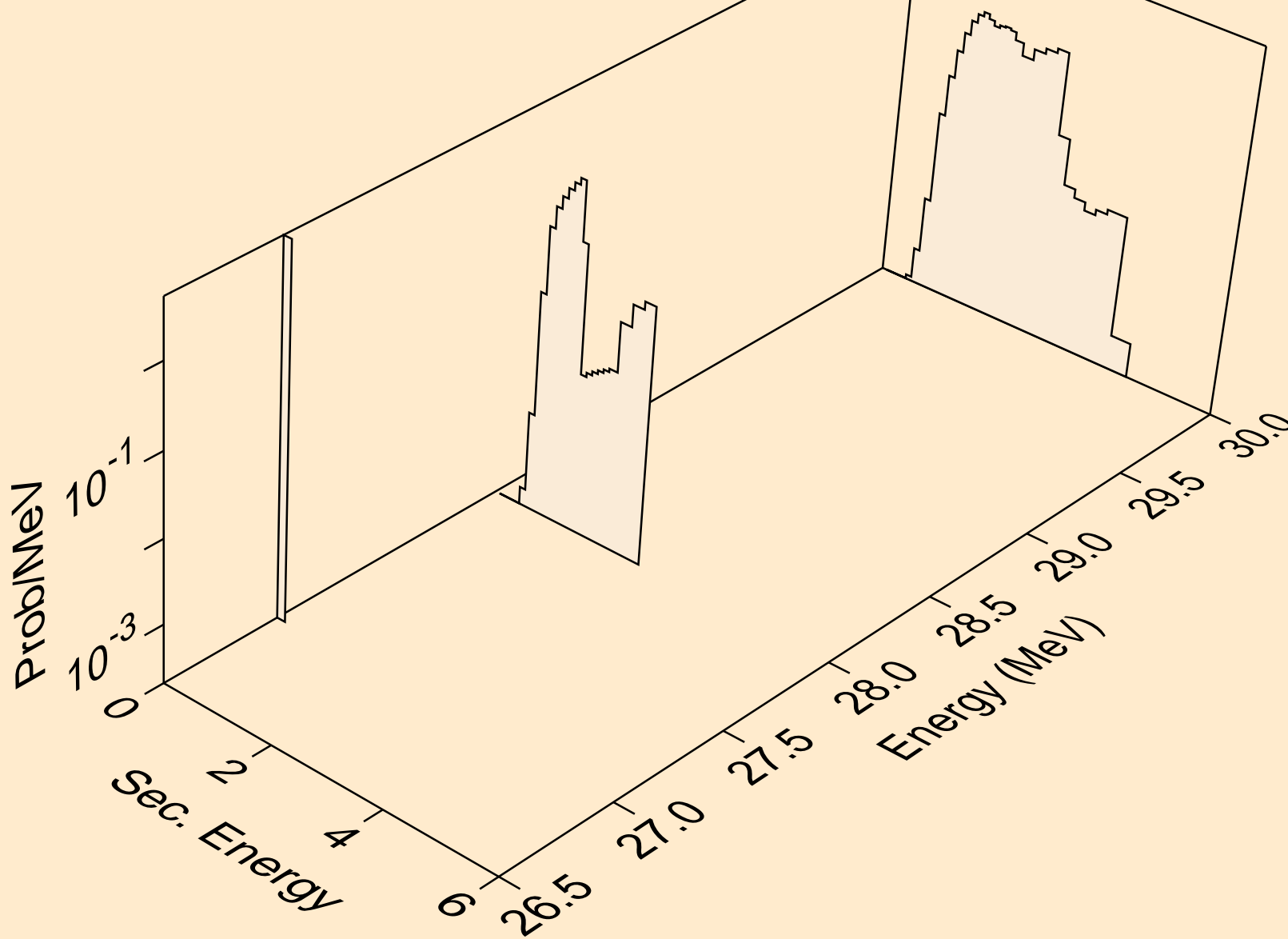

CO057 NEUTRON ACER TENDL-2019 LIBRARY; T=293.16K
protons from (n,2np)

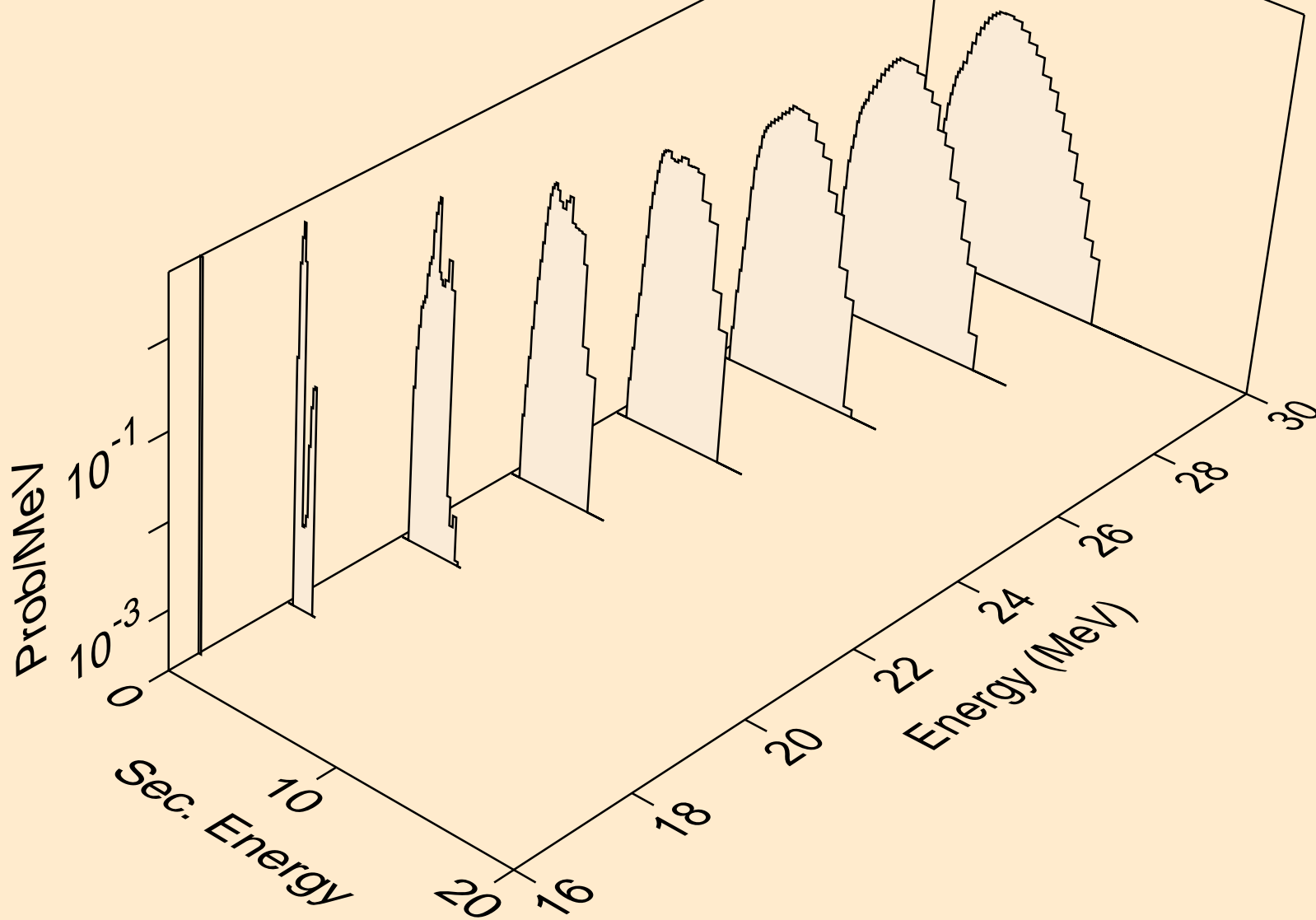

CO057 NEUTRON ACER TENDL-2019 LIBRARY; T=293.16K
protons from (n,npa)

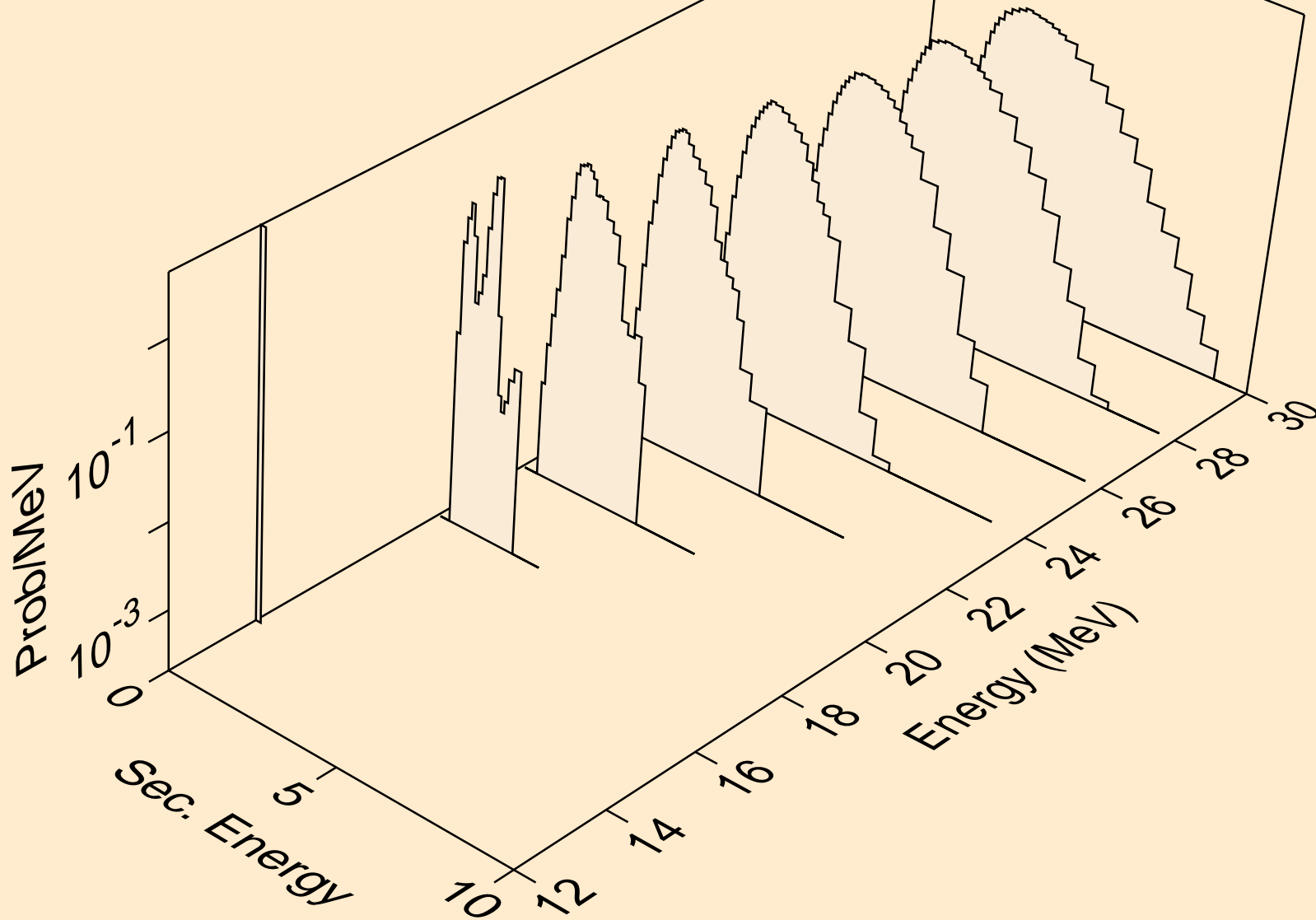

CO057 NEUTRON ACER TENDL-2019 LIBRARY; T=293.16K
protons from (n,p)

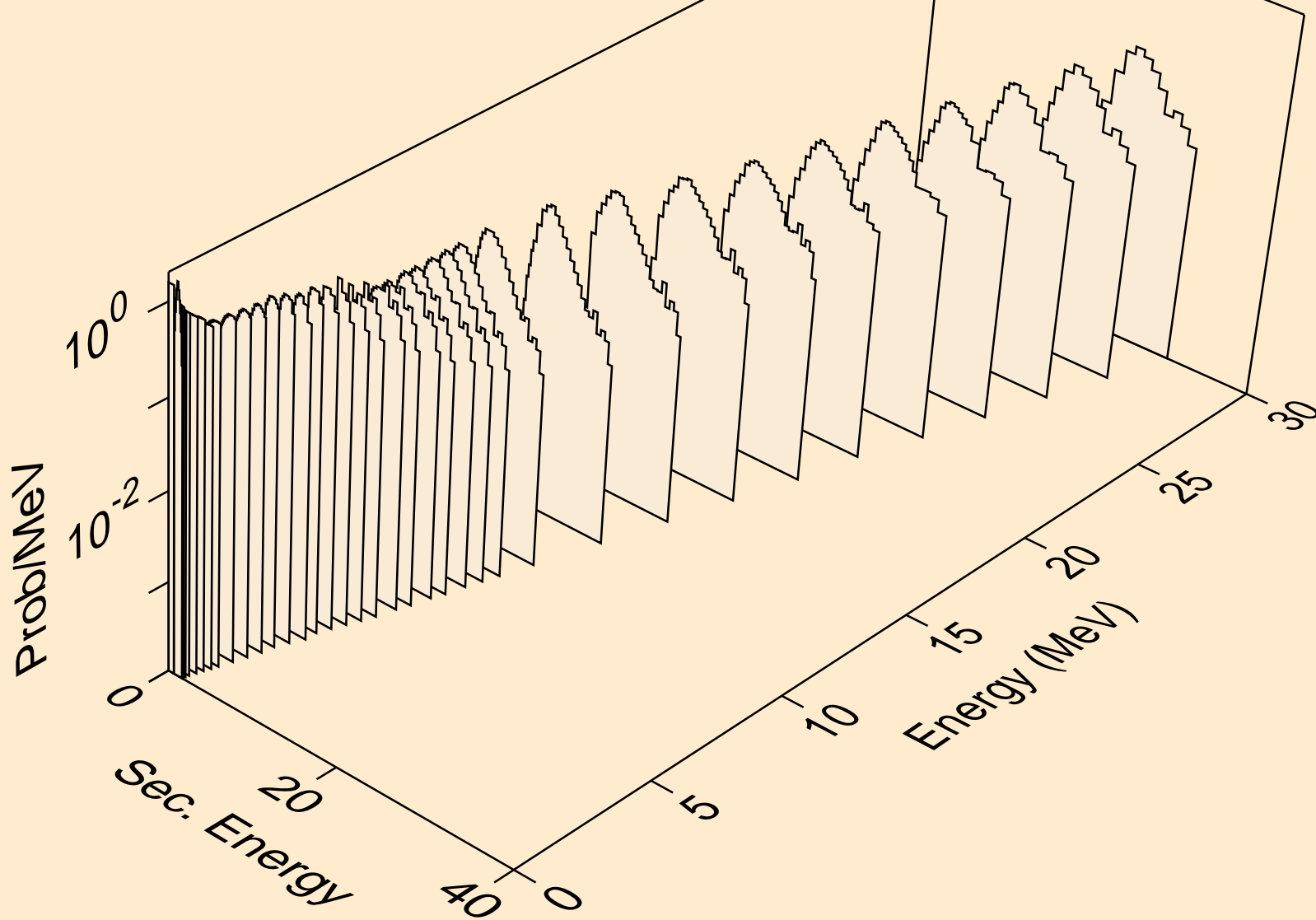

CO057 NEUTRON ACER TENDL-2019 LIBRARY; T=293.16K
protons from (n,2p)

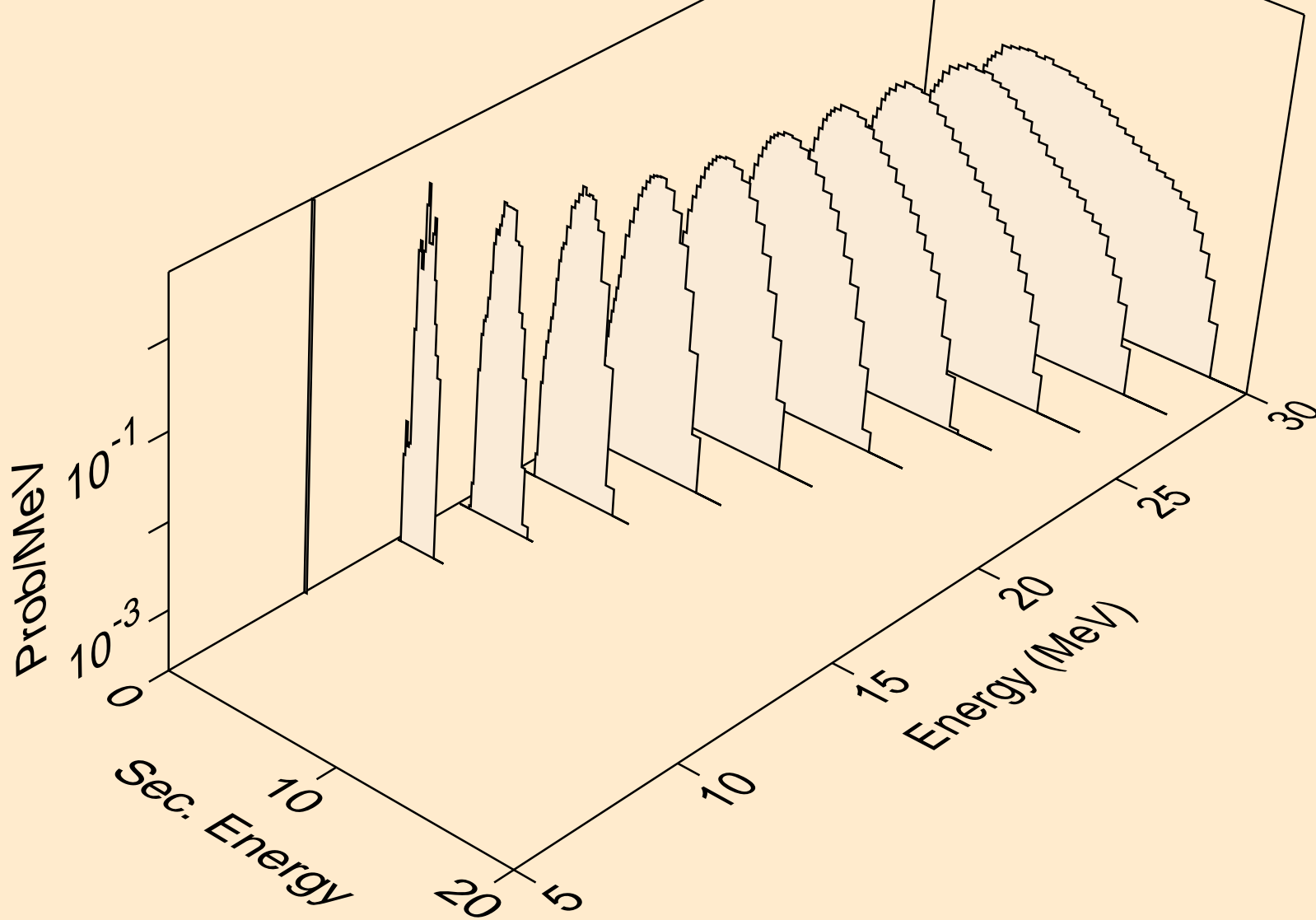

CO057 NEUTRON ACER TENDL-2019 LIBRARY; T=293.16K
protons from (n,p)

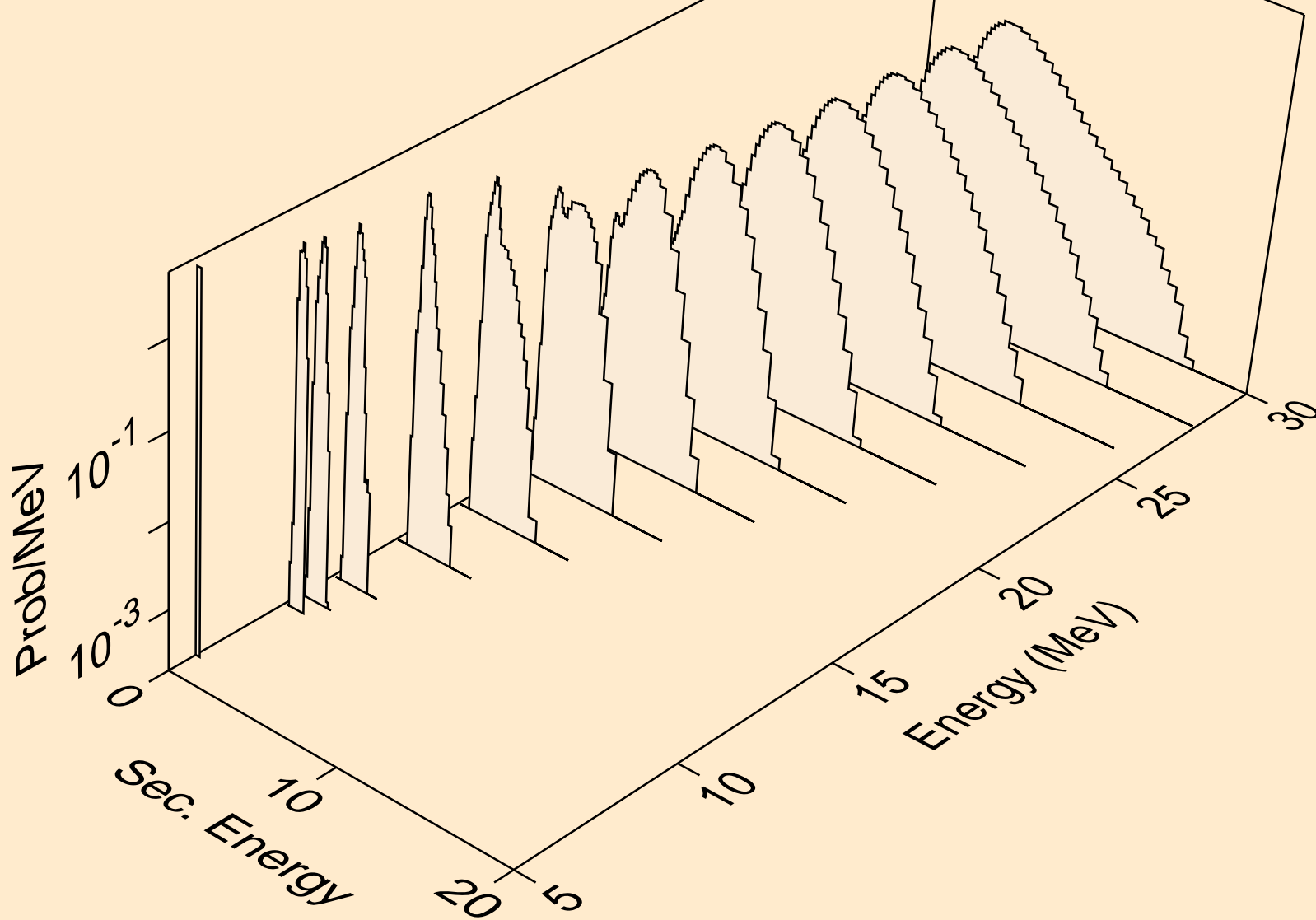

CO057 NEUTRON ACER TENDL-2019 LIBRARY; T=293.16K
protons from (n,pd)

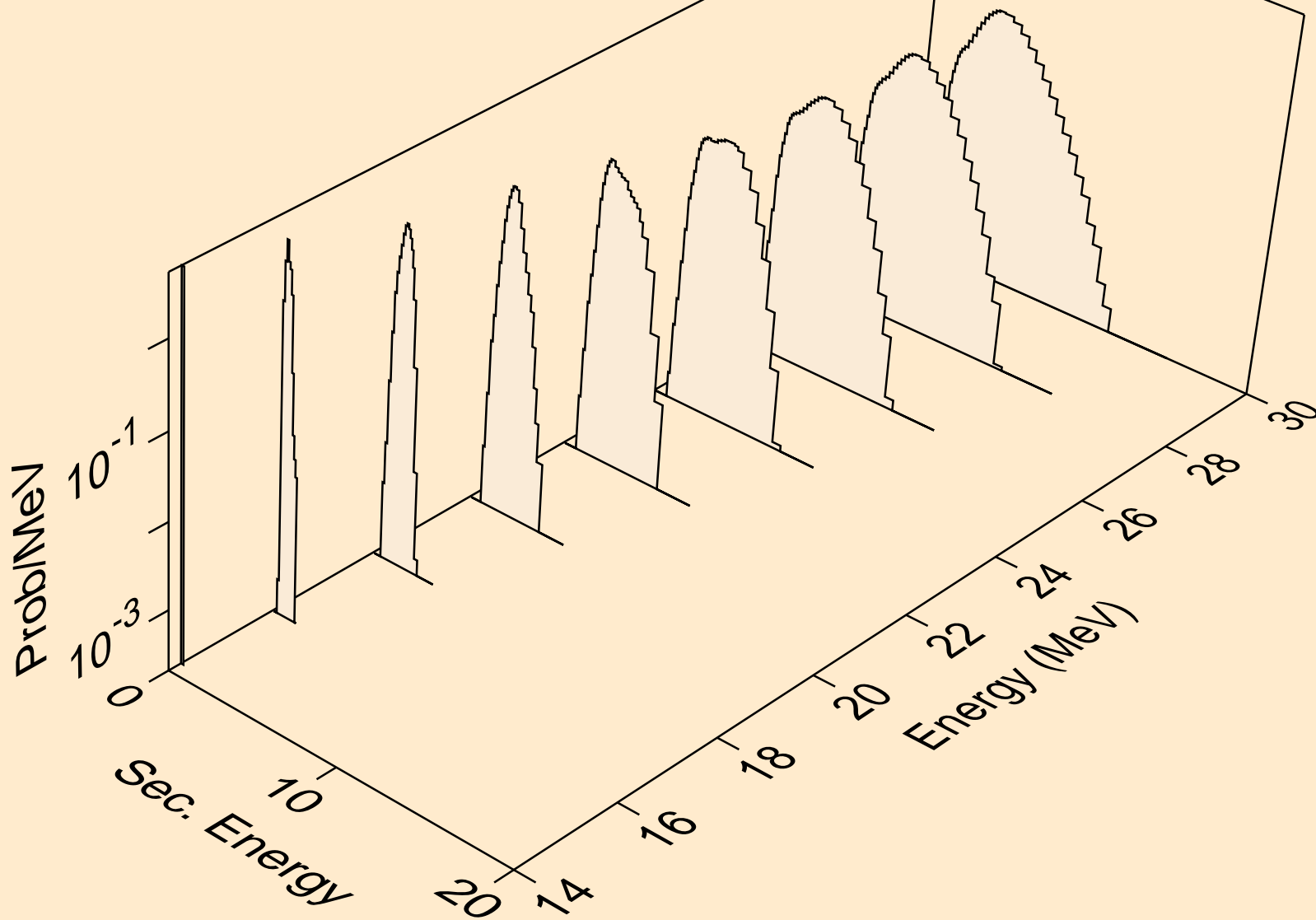

CO057 NEUTRON ACER TENDL-2019 LIBRARY; T=293.16K
protons from (n,pt)

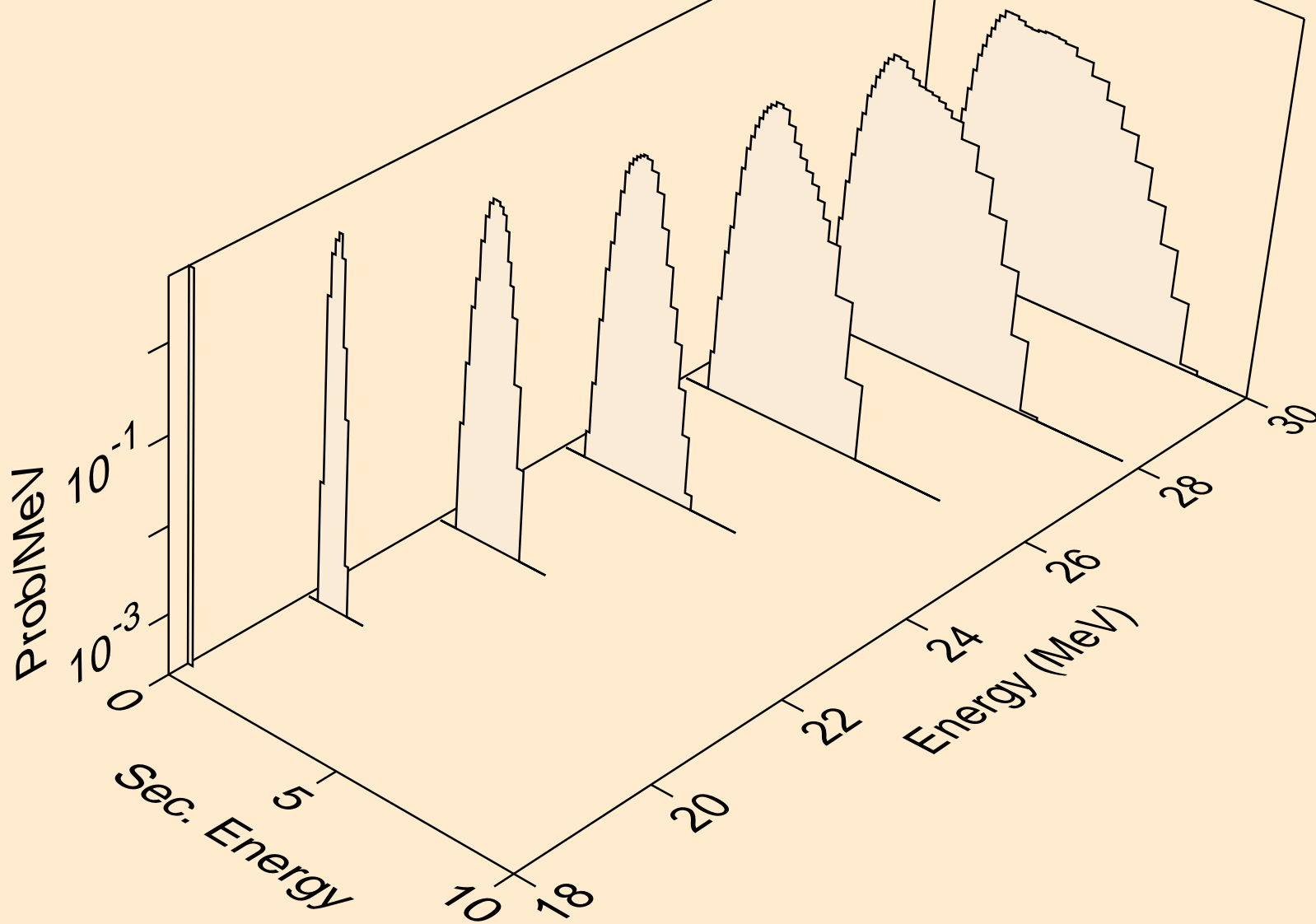

CO057 NEUTRON ACER TENDL-2019 LIBRARY; T=293.16K
deuterons from (n,x)

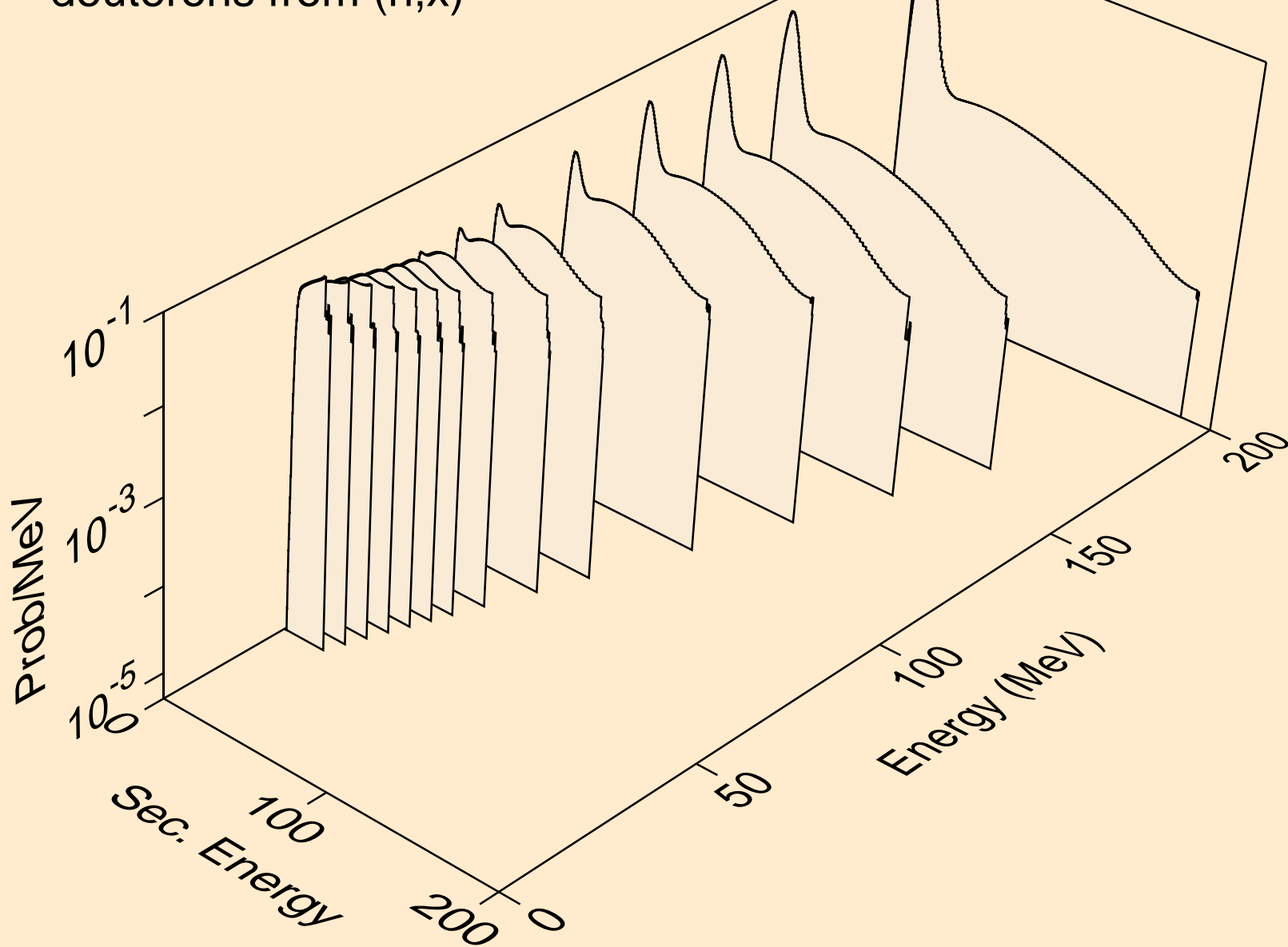

CO057 NEUTRON ACER TENDL-2019 LIBRARY; T=293.16K
deuterons from (n,2nd)

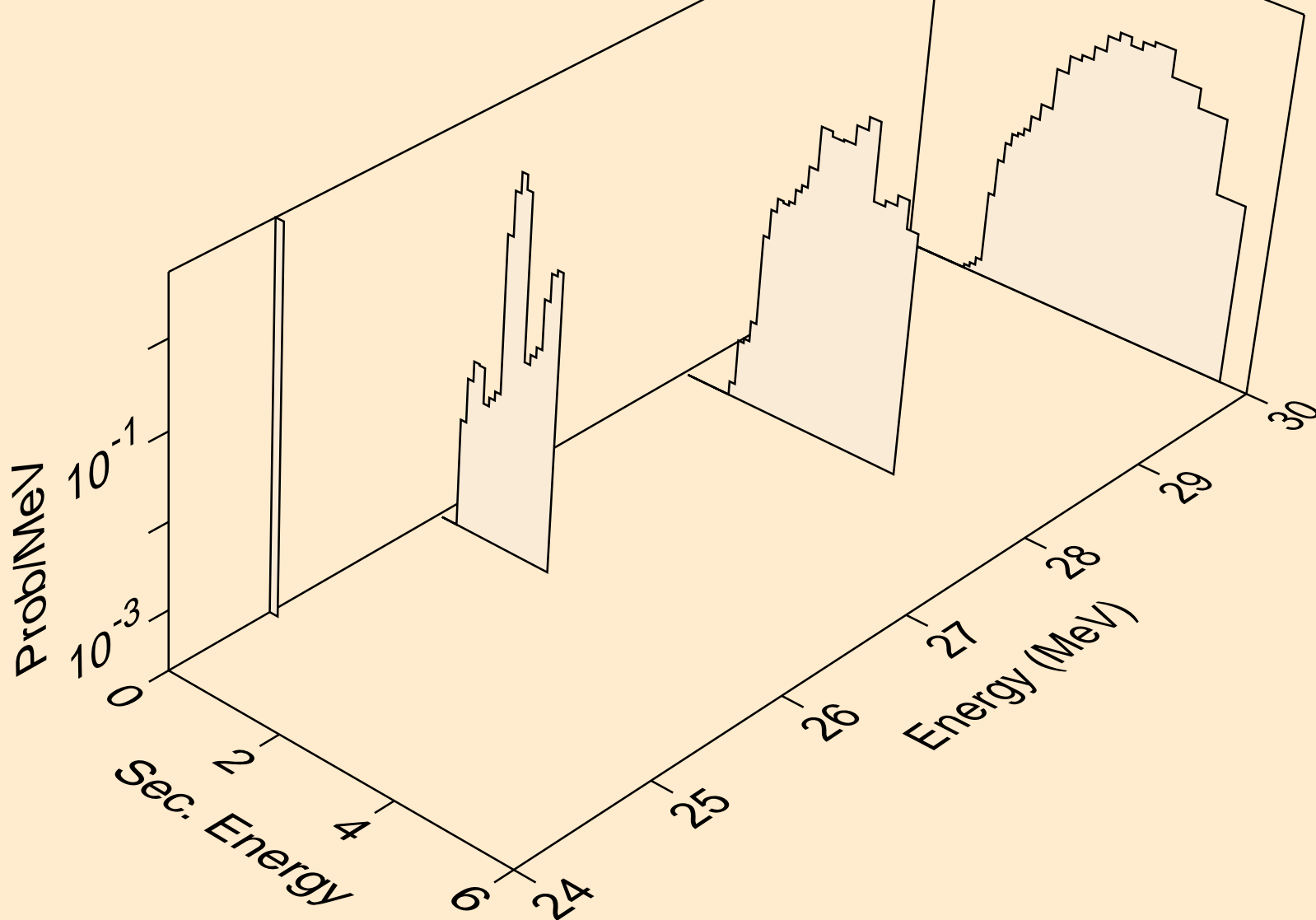

CO057 NEUTRON ACER TENDL-2019 LIBRARY; T=293.16K
deuterons from (n,n*)d

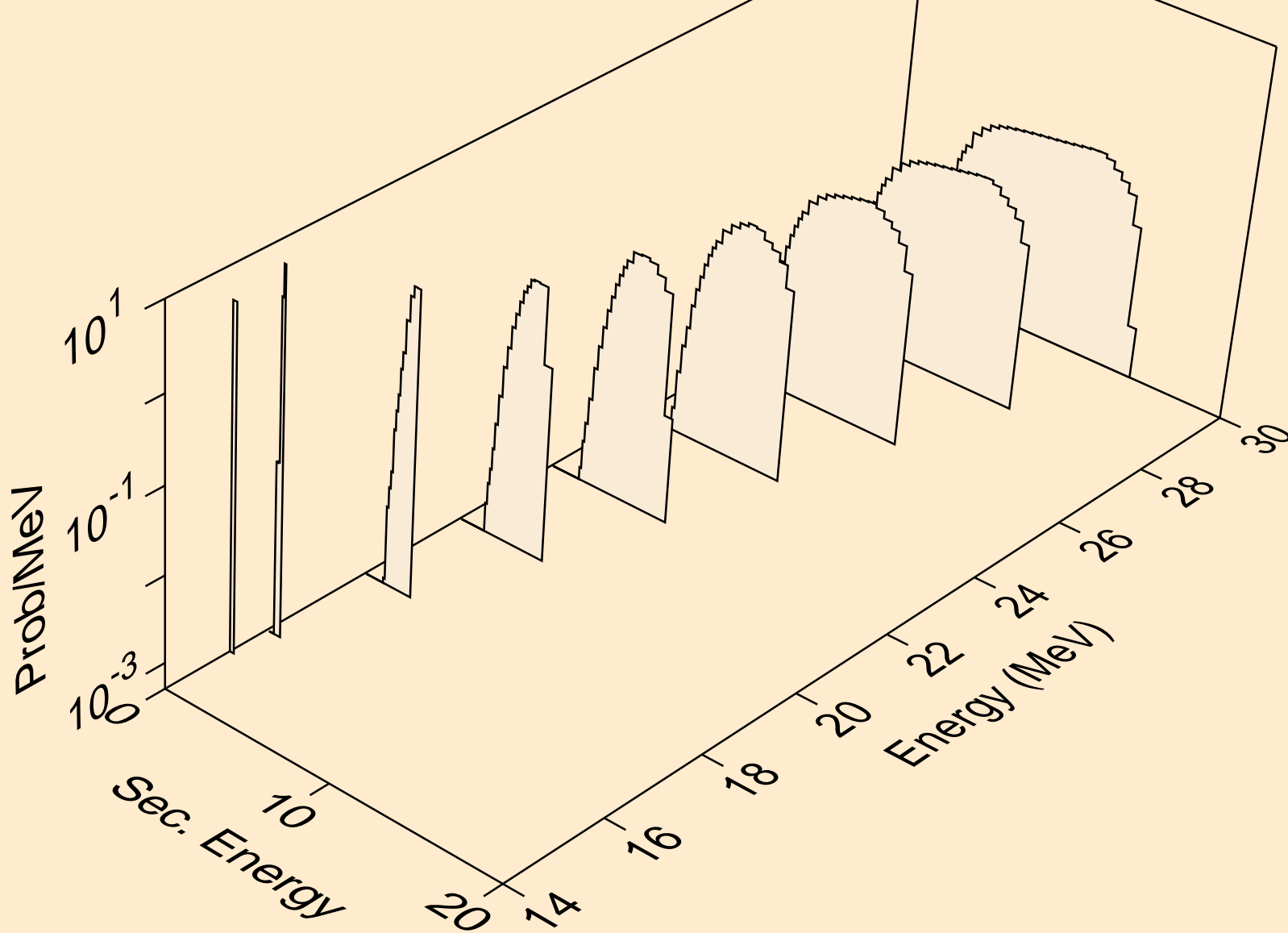

CO057 NEUTRON ACER TENDL-2019 LIBRARY; T=293.16K
deuterons from (n,d)

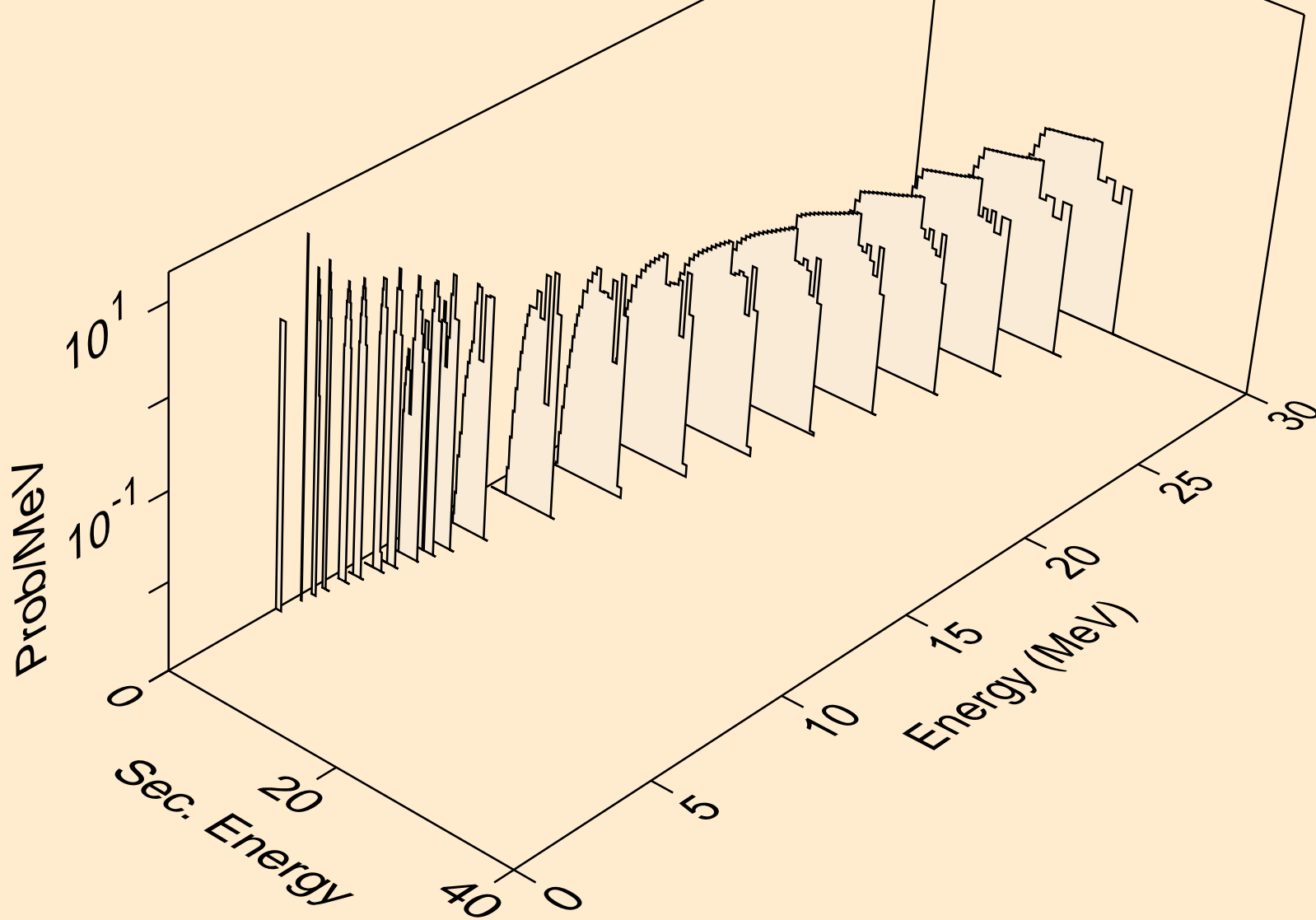

CO057 NEUTRON ACER TENDL-2019 LIBRARY; T=293.16K
deuterons from (n,pd)

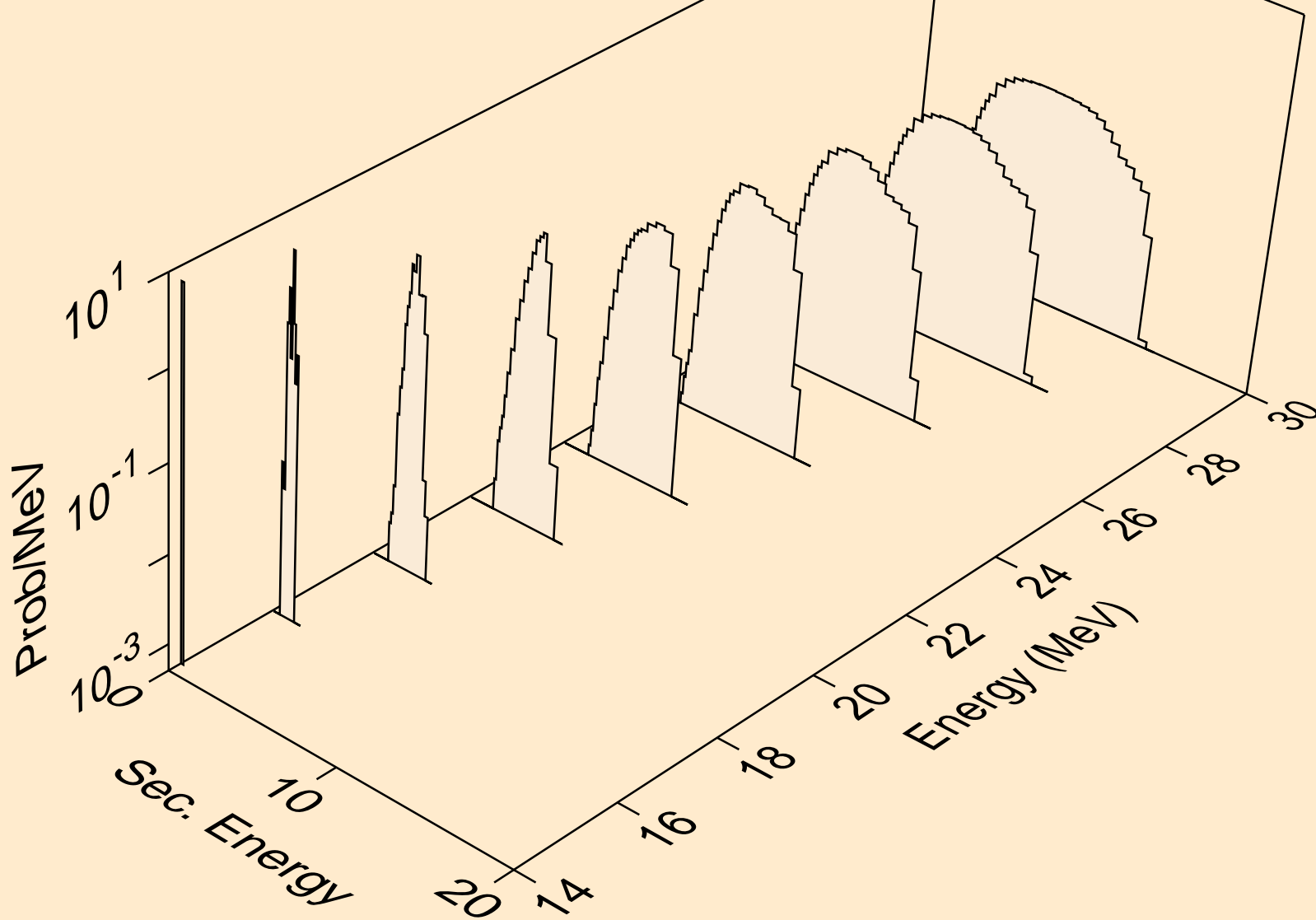

CO057 NEUTRON ACER TENDL-2019 LIBRARY; T=293.16K
deuterons from (n,da)

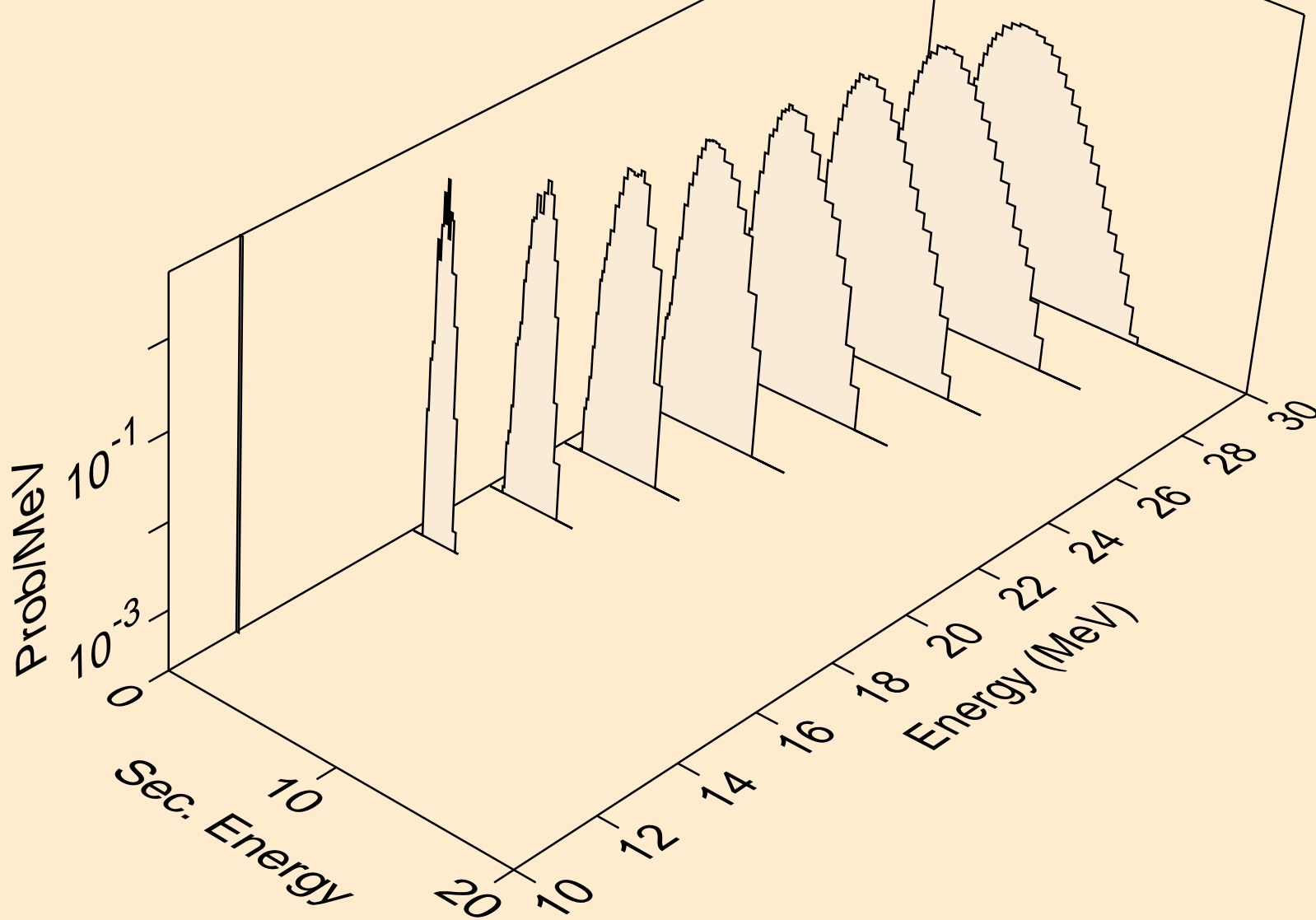

CO057 NEUTRON ACER TENDL-2019 LIBRARY; T=293.16K
tritons from (n,x)

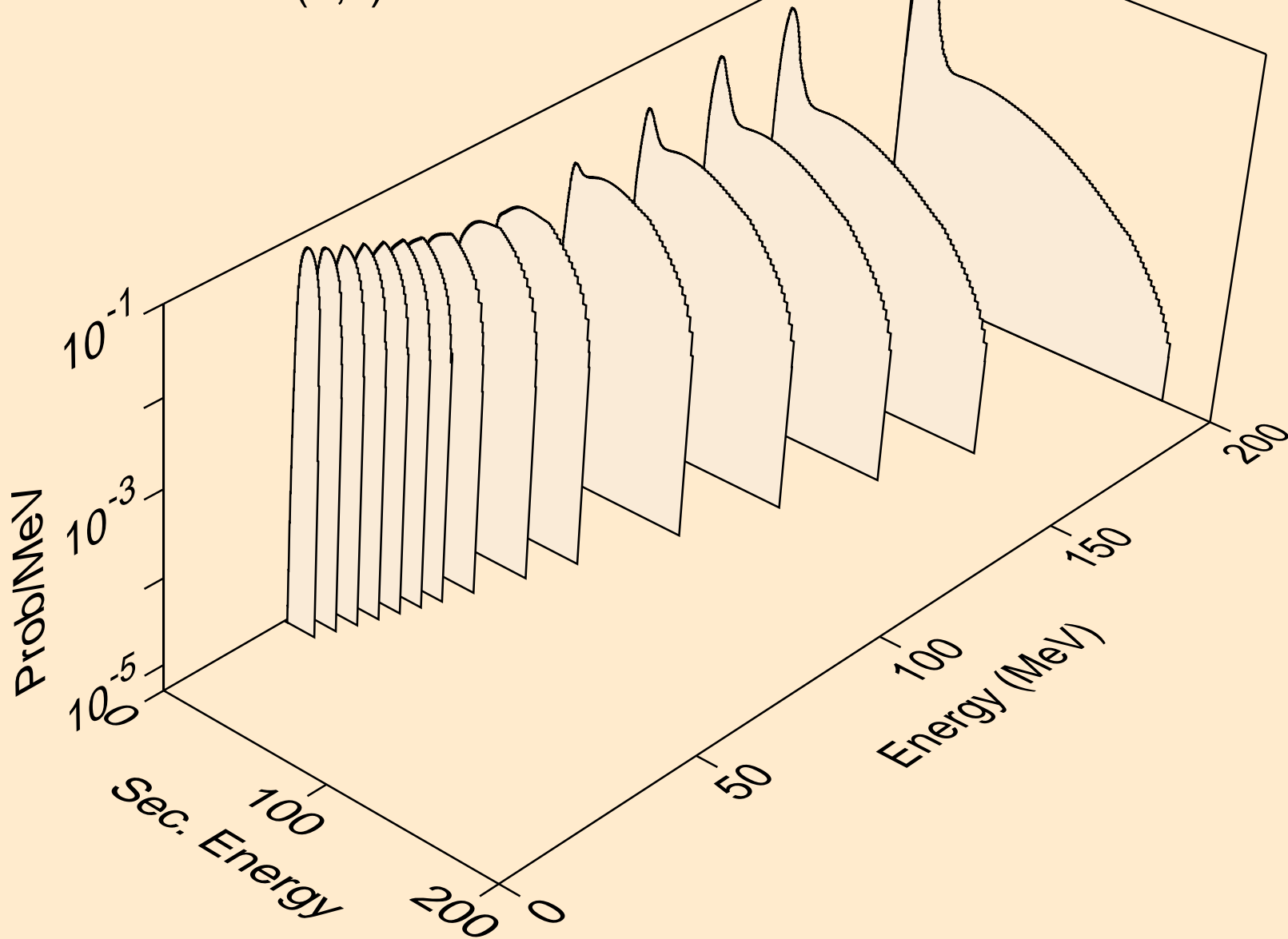

CO057 NEUTRON ACER TENDL-2019 LIBRARY; T=293.16K
tritons from (n,n*)t

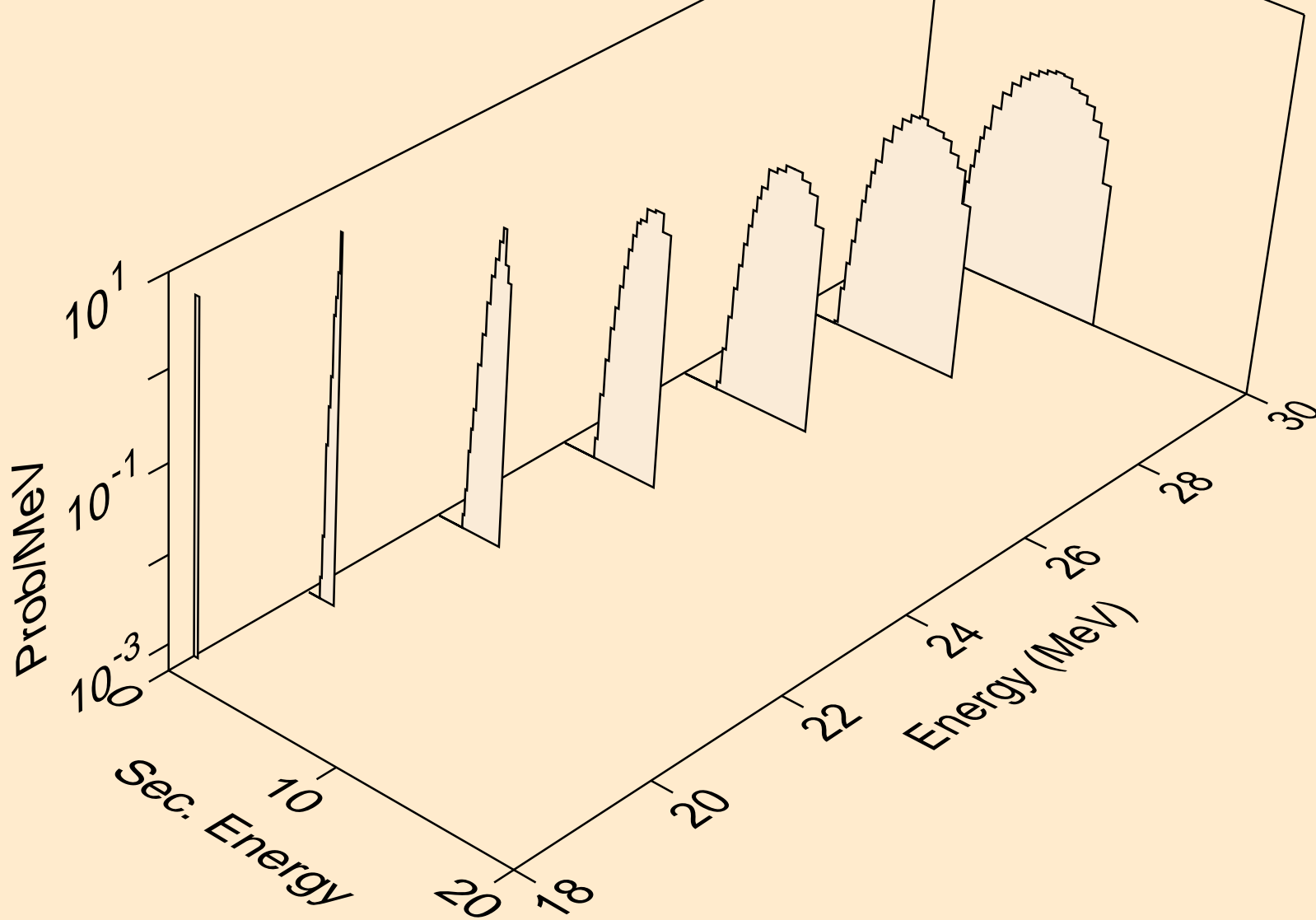

CO057 NEUTRON ACER TENDL-2019 LIBRARY; T=293.16K
tritons from (n,t)

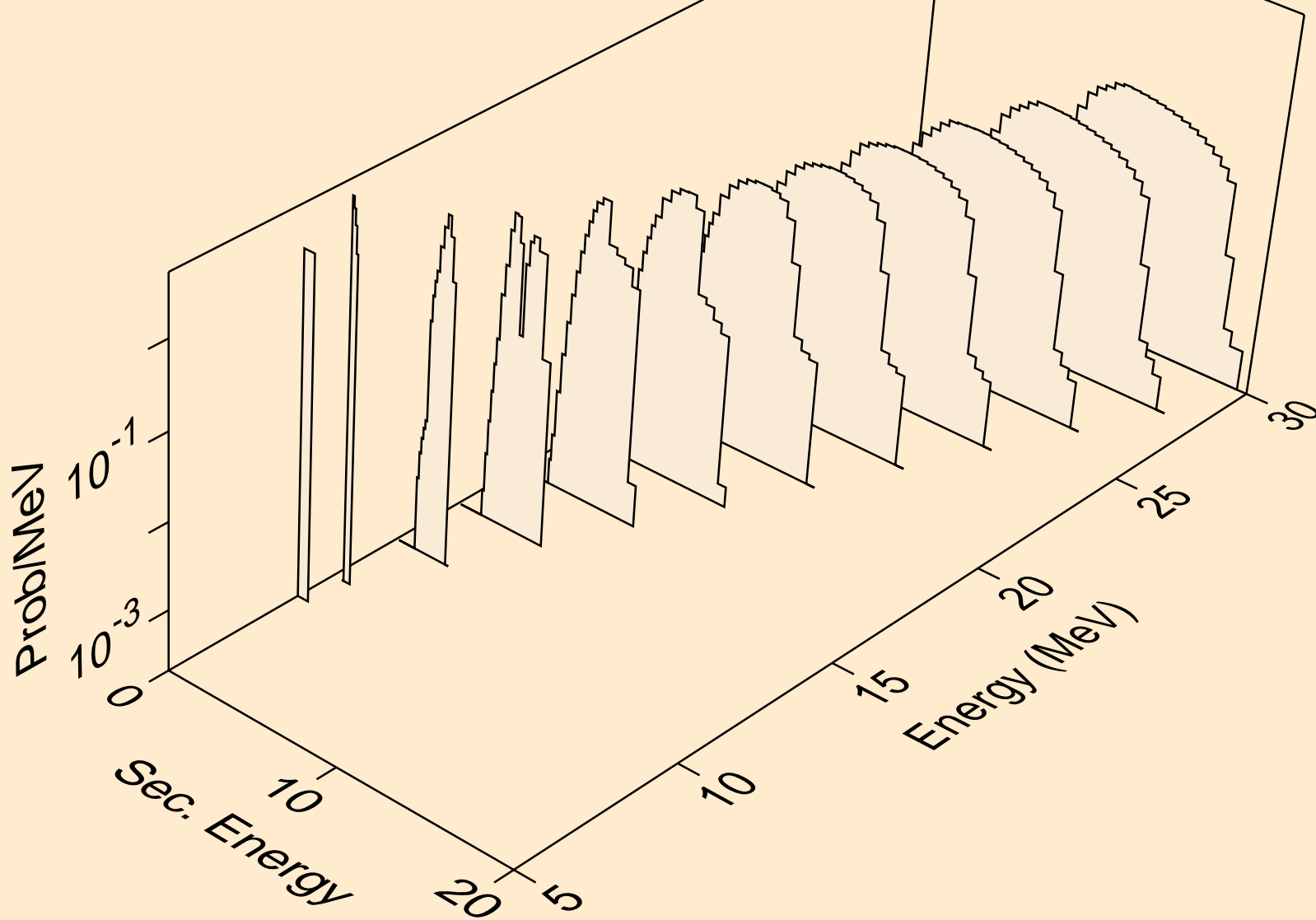

CO057 NEUTRON ACER TENDL-2019 LIBRARY; T=293.16K
tritons from (n,pt)

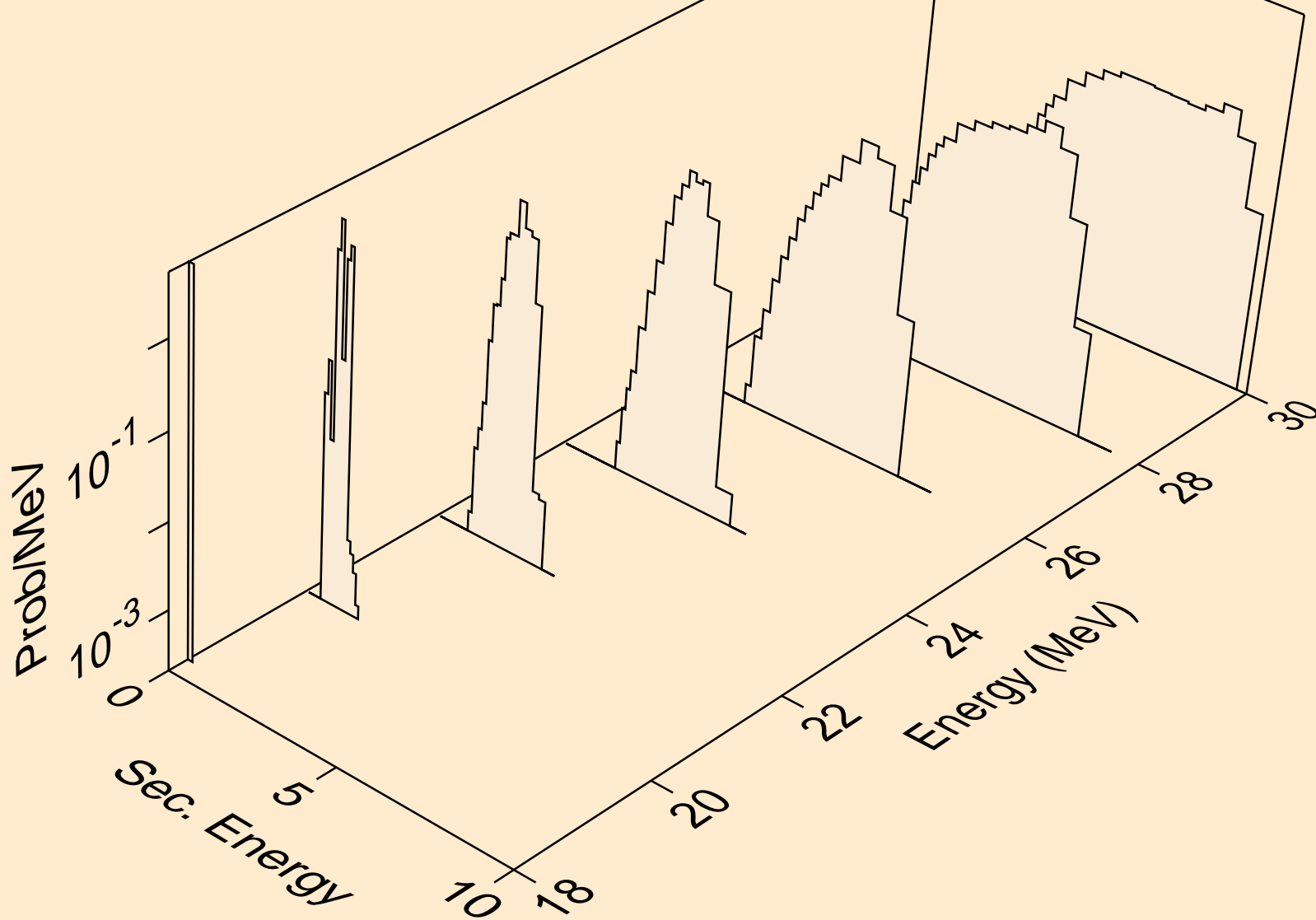

CO057 NEUTRON ACER TENDL-2019 LIBRARY; T=293.16K
he3s from (n,x)

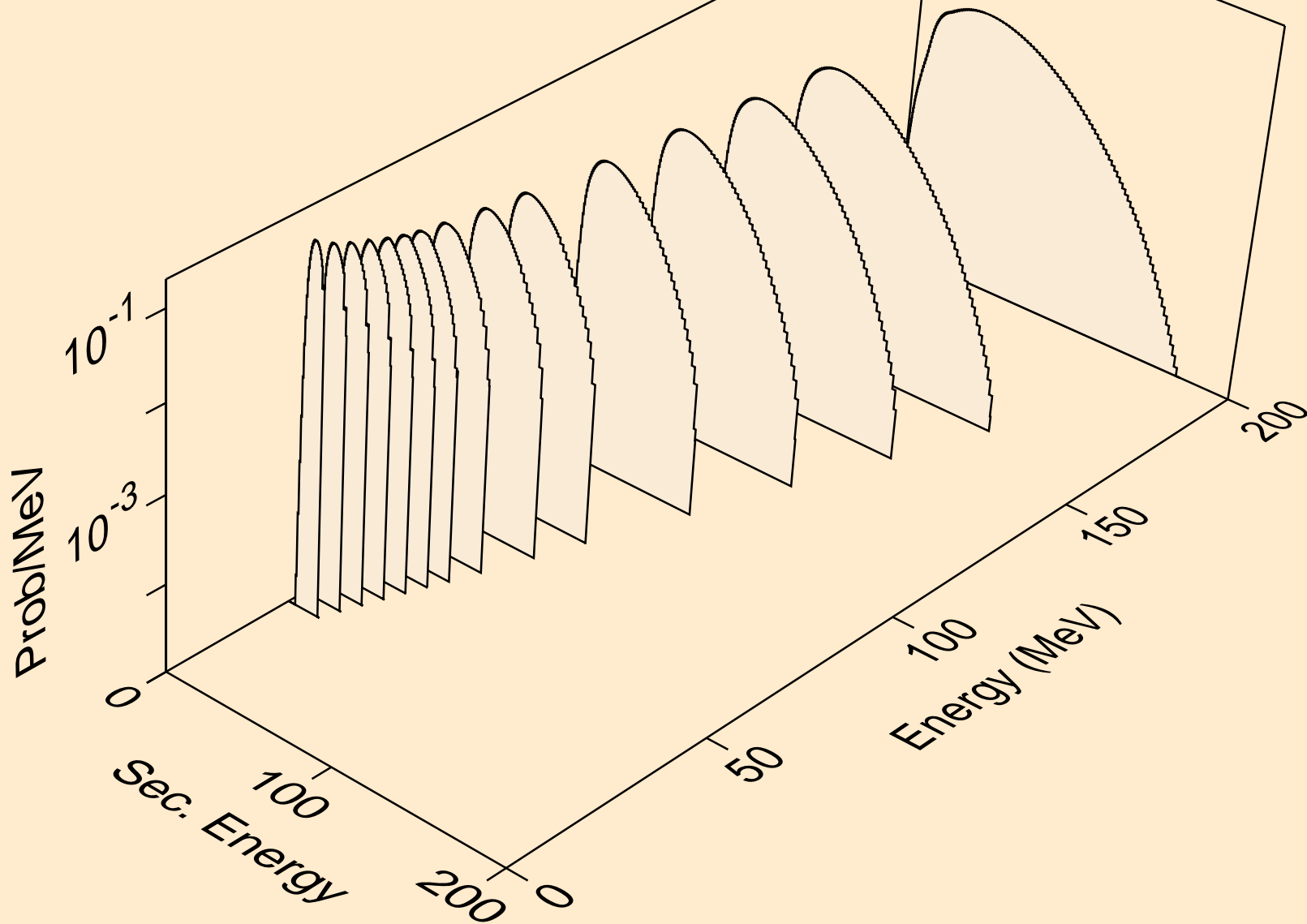

CO057 NEUTRON ACER TENDL-2019 LIBRARY; T=293.16K
he3s from (n,n*)he3

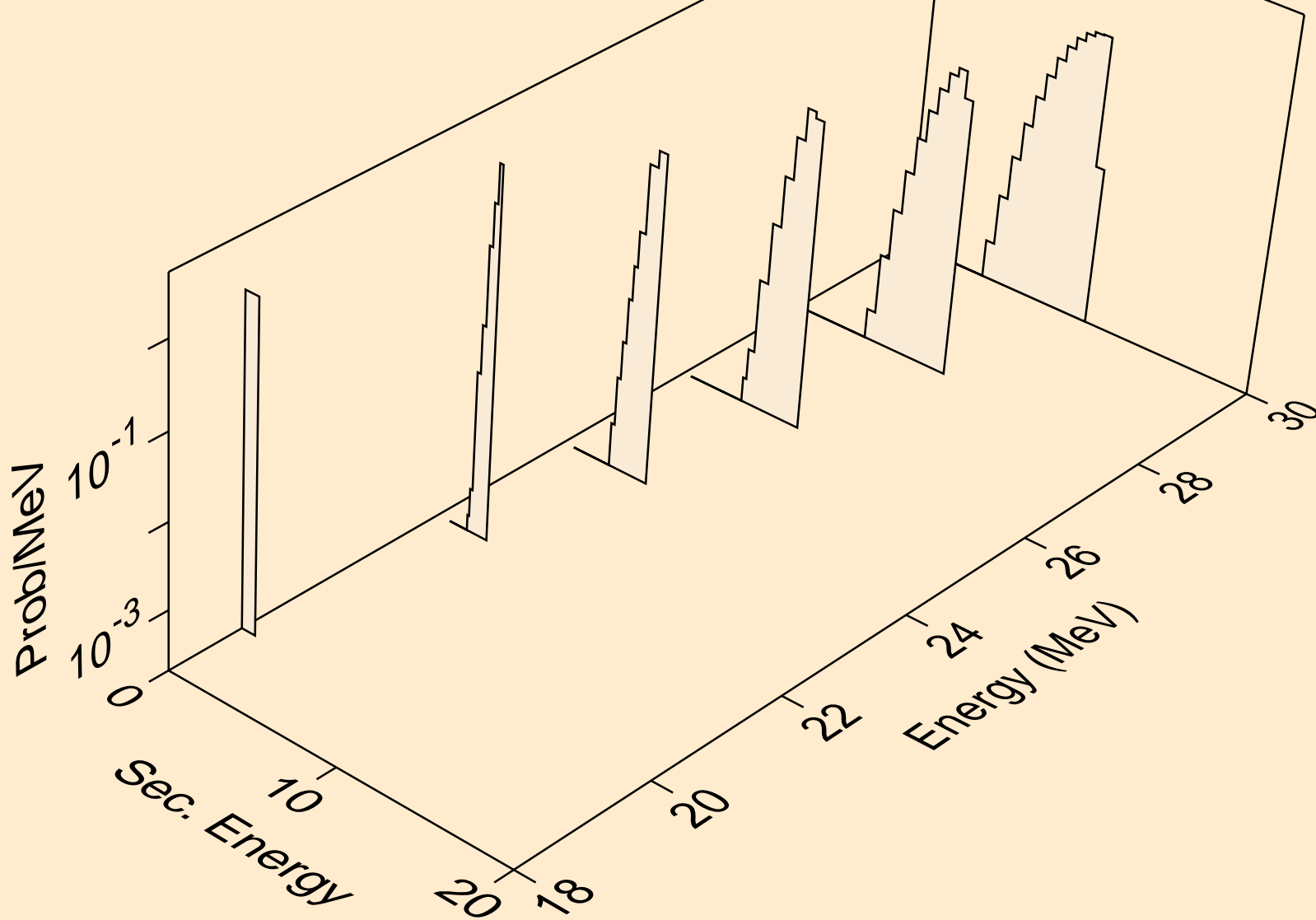

CO057 NEUTRON ACER TENDL-2019 LIBRARY; T=293.16K
he3s from (n,he3)

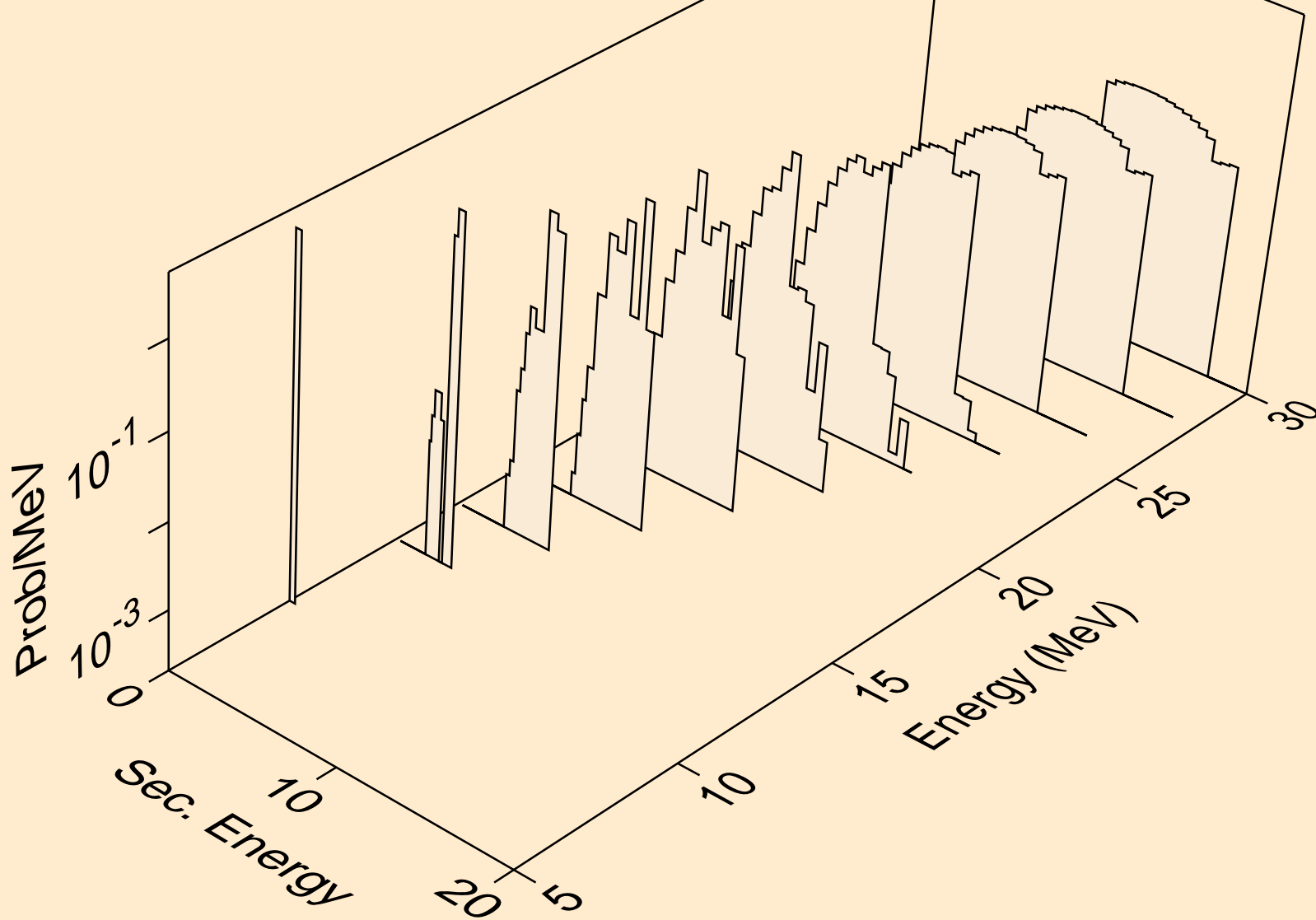

CO057 NEUTRON ACER TENDL-2019 LIBRARY; T=293.16K
alphas from (n,x)

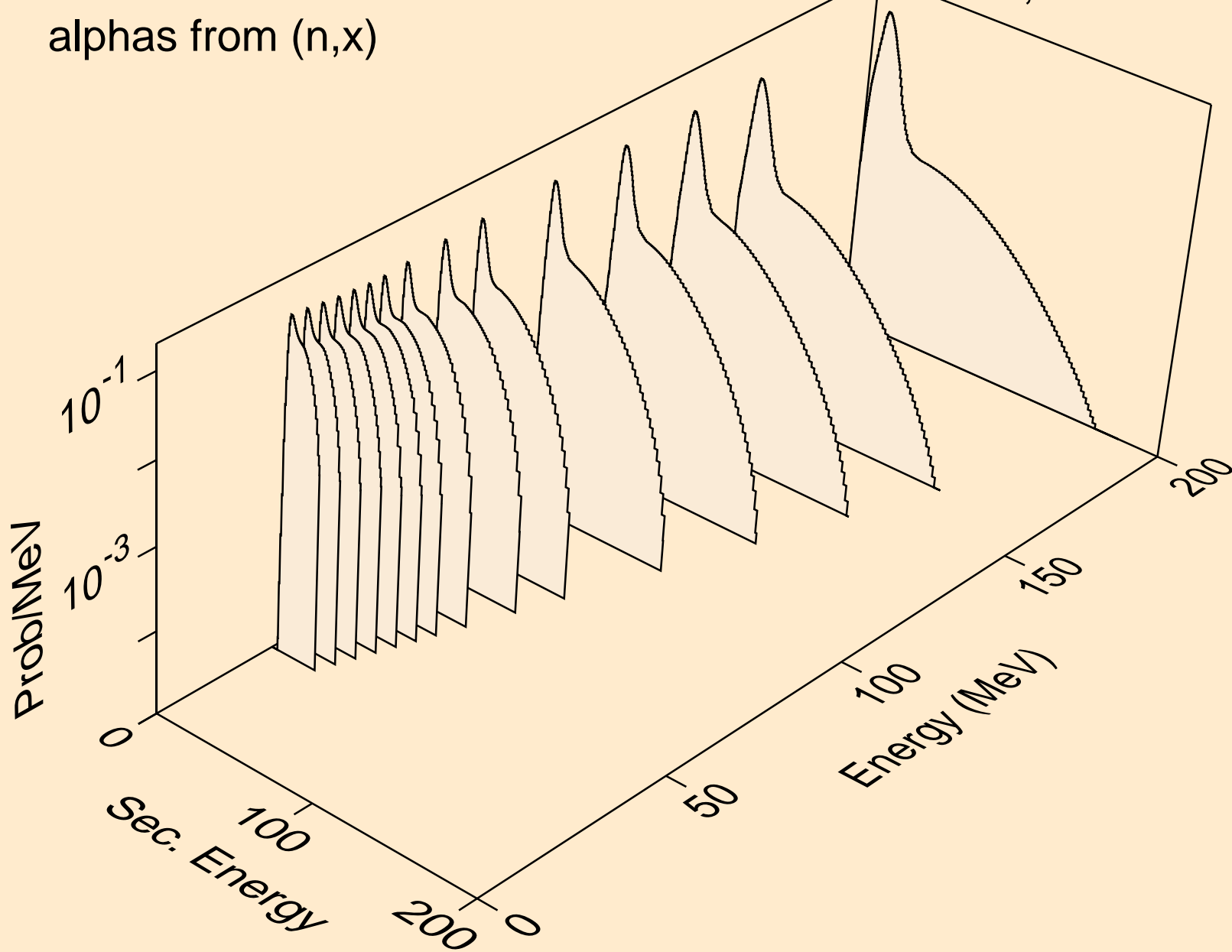

CO057 NEUTRON ACER TENDL-2019 LIBRARY; T=293.16K
alphas from (n,n*)a

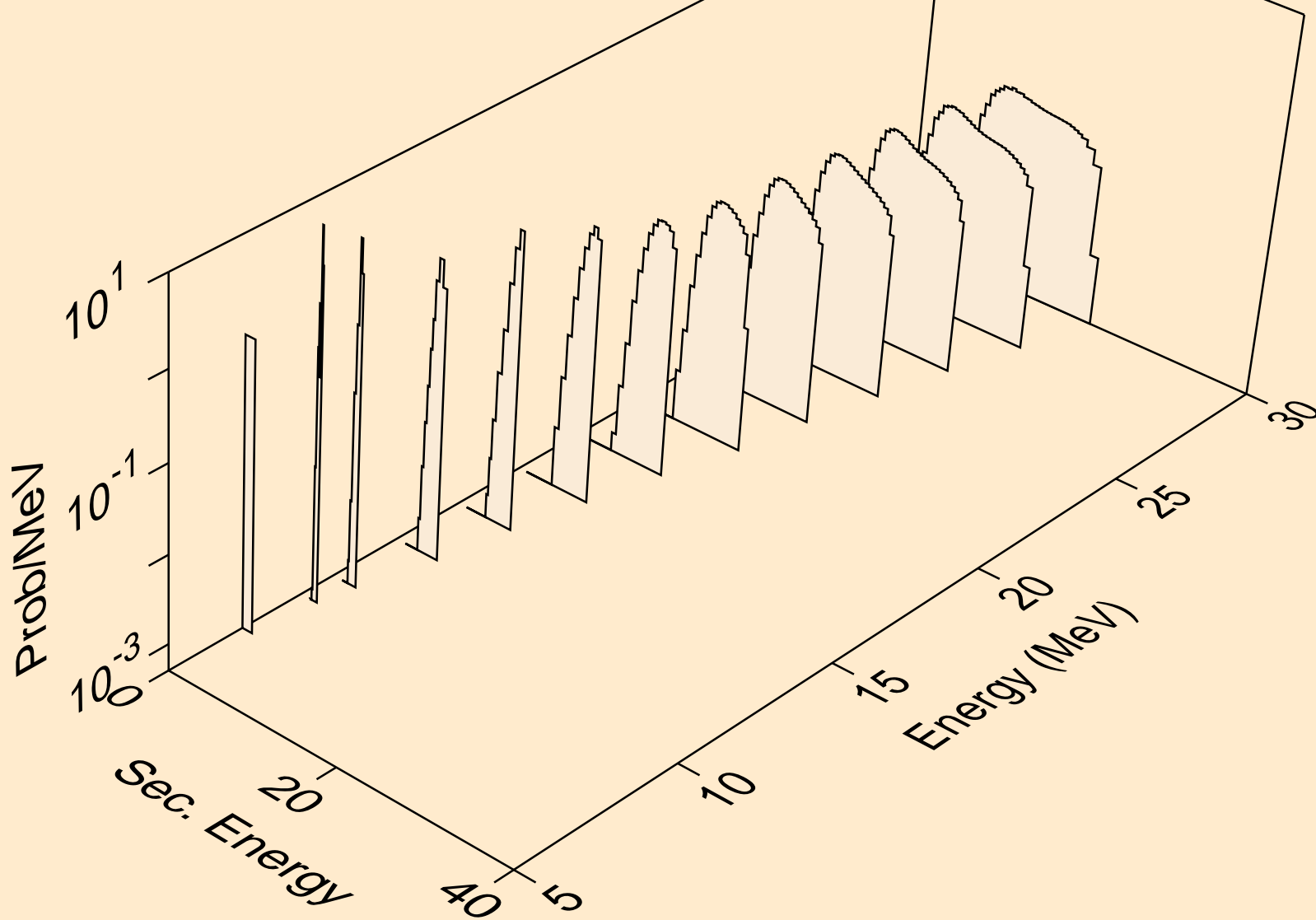

CO057 NEUTRON ACER TENDL-2019 LIBRARY; T=293.16K
alphas from (n,2n)a

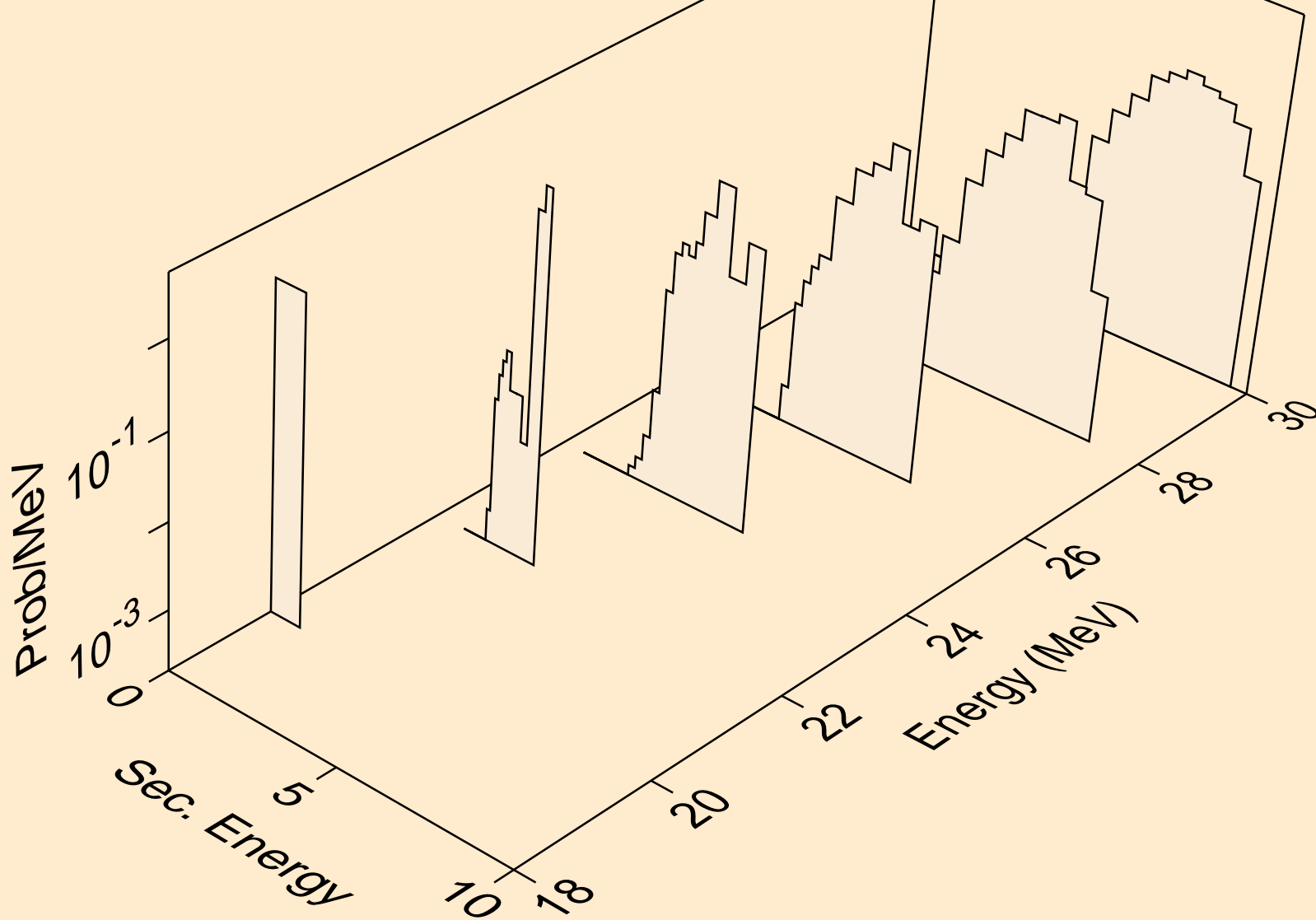

CO057 NEUTRON ACER TENDL-2019 LIBRARY; T=293.16K
alphas from (n,n*)2a

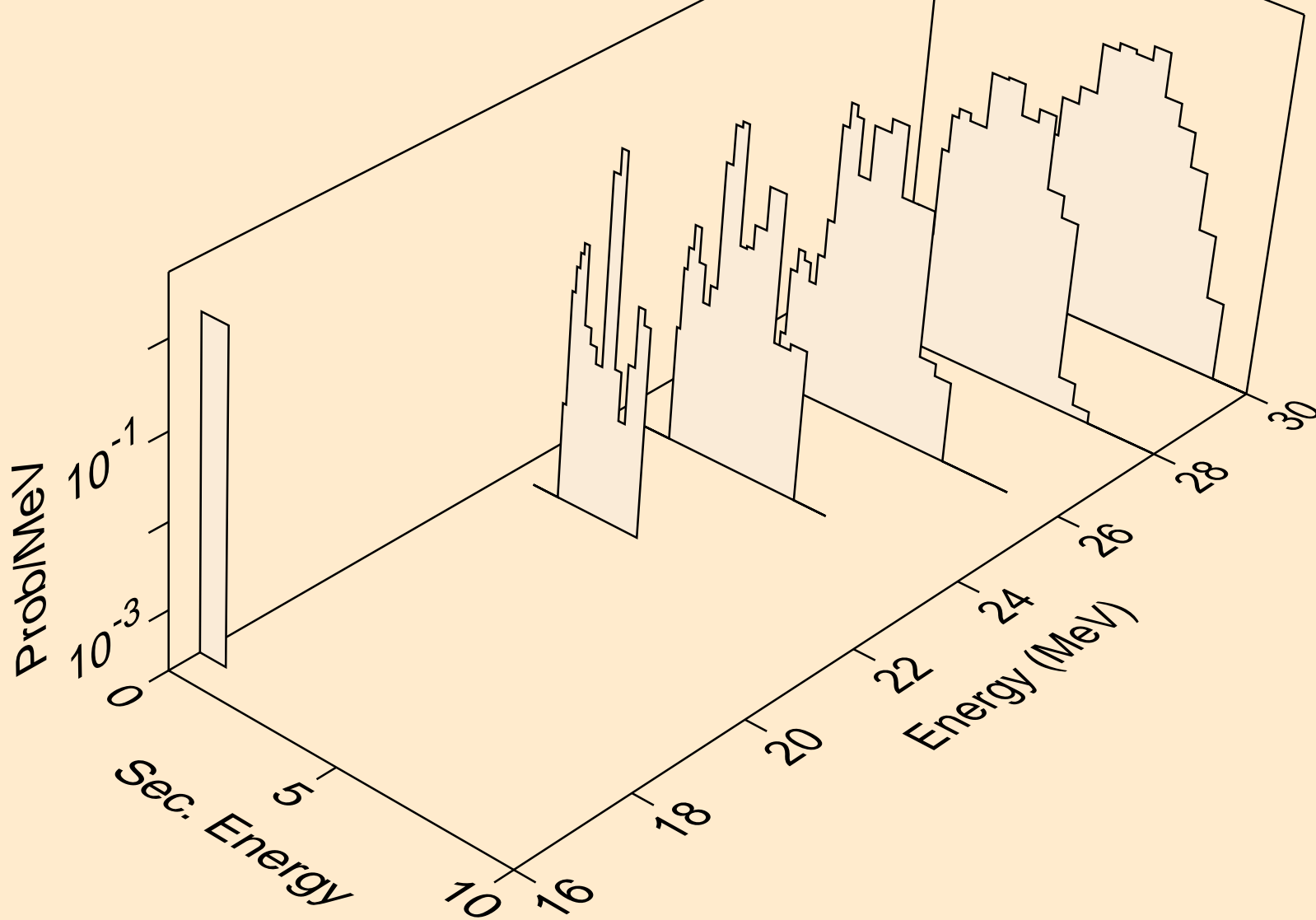

CO057 NEUTRON ACER TENDL-2019 LIBRARY; T=293.16K
alphas from (n,npa)

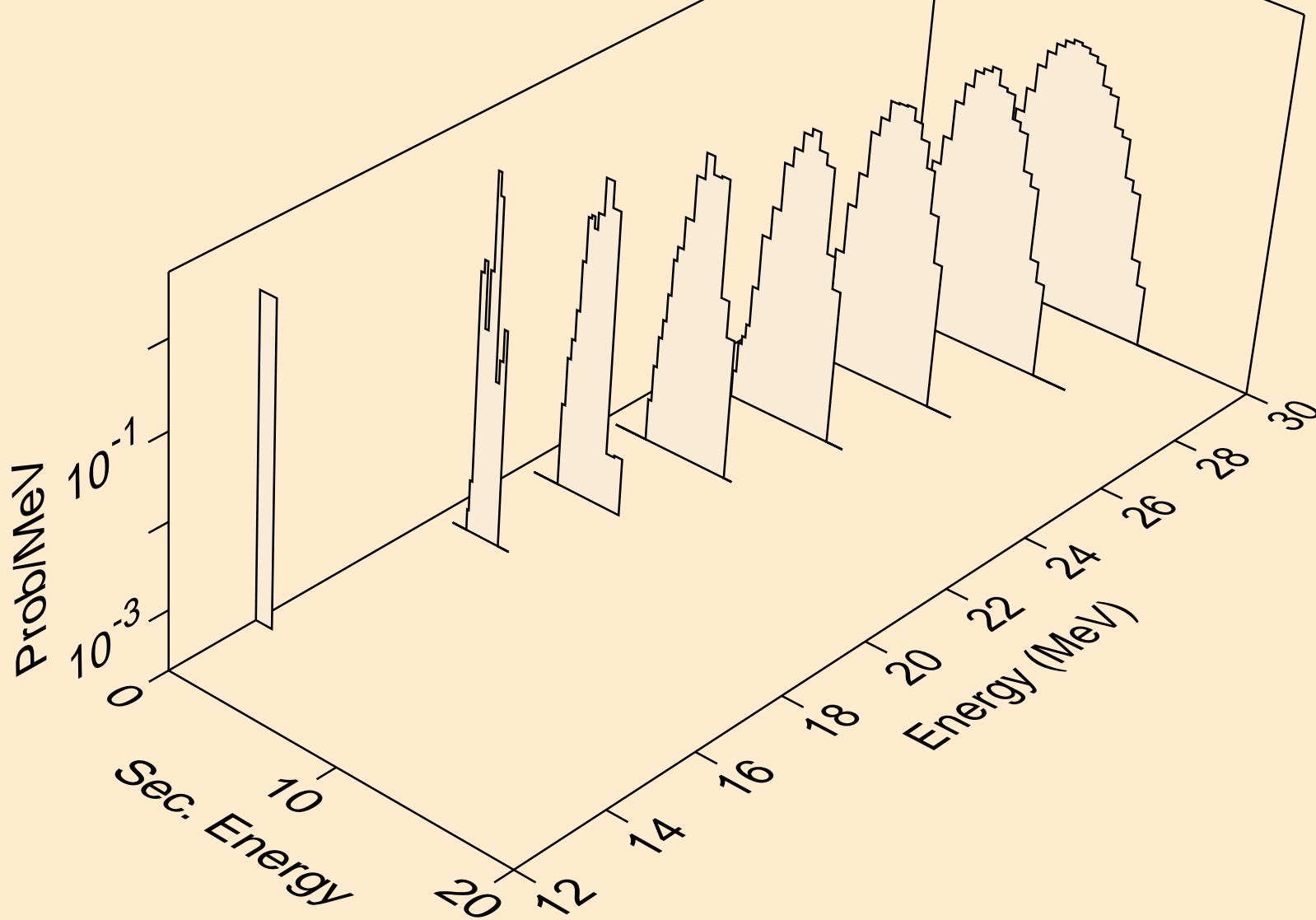

CO057 NEUTRON ACER TENDL-2019 LIBRARY; T=293.16K
alphas from (n,a)

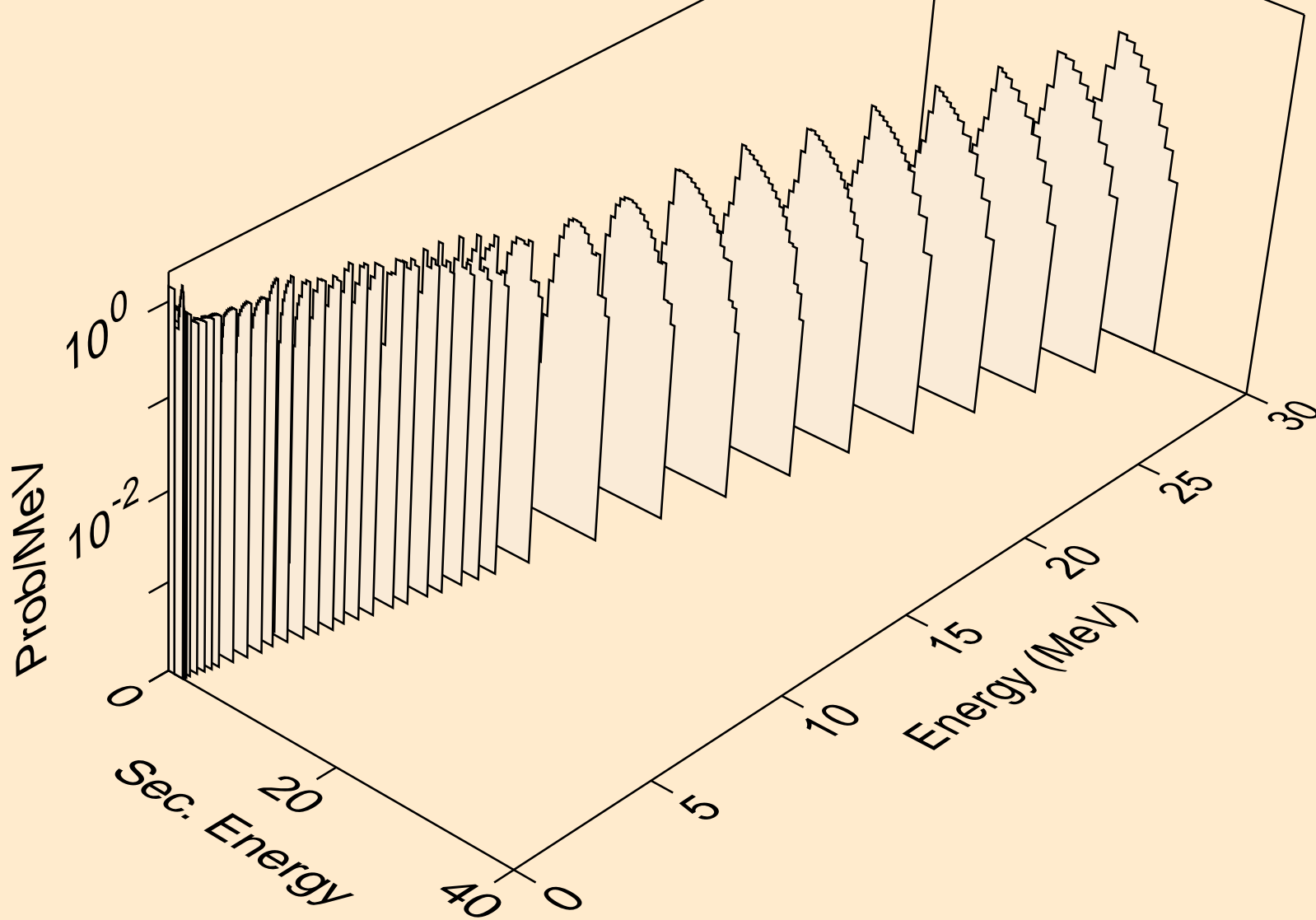

CO057 NEUTRON ACER TENDL-2019 LIBRARY; T=293.16K
alphas from (n,2a)

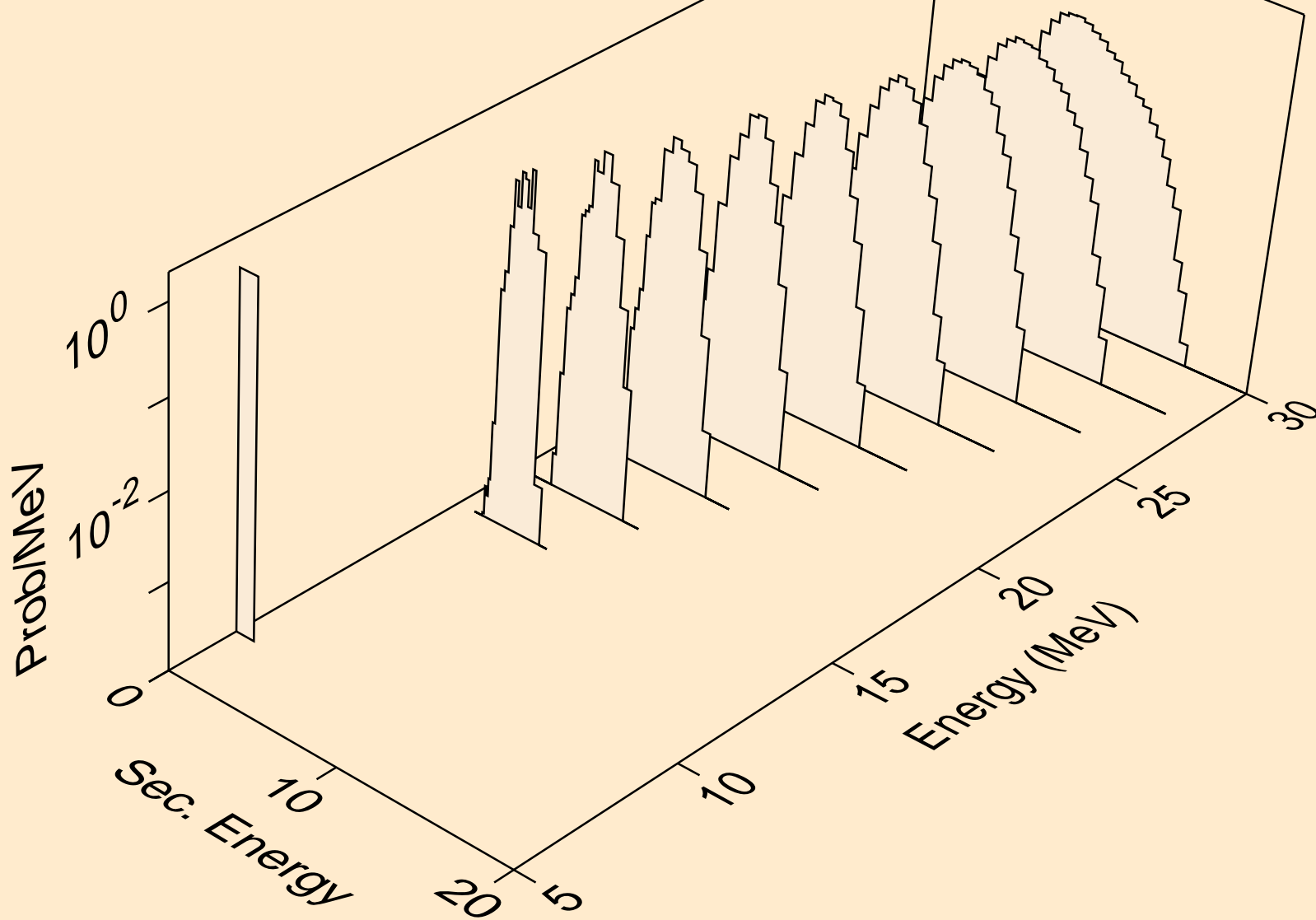

CO057 NEUTRON ACER TENDL-2019 LIBRARY; T=293.16K
alphas from (n,pa)

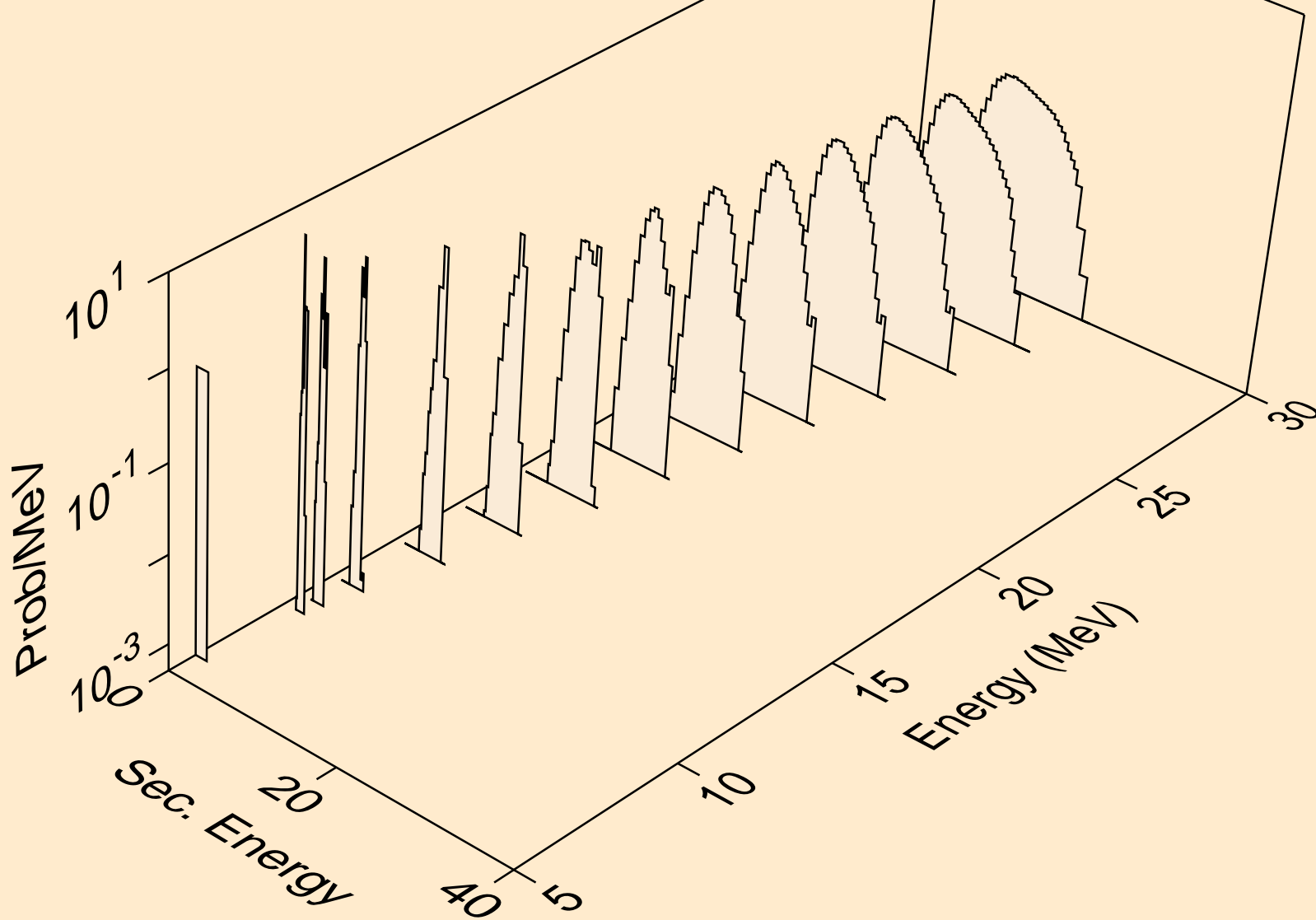

CO057 NEUTRON ACER TENDL-2019 LIBRARY; T=293.16K
alphas from (n,da)

