

CO062M NEUTRON ACER TENDL-2019 LIBRARY; T=293.16K
Principal cross sections

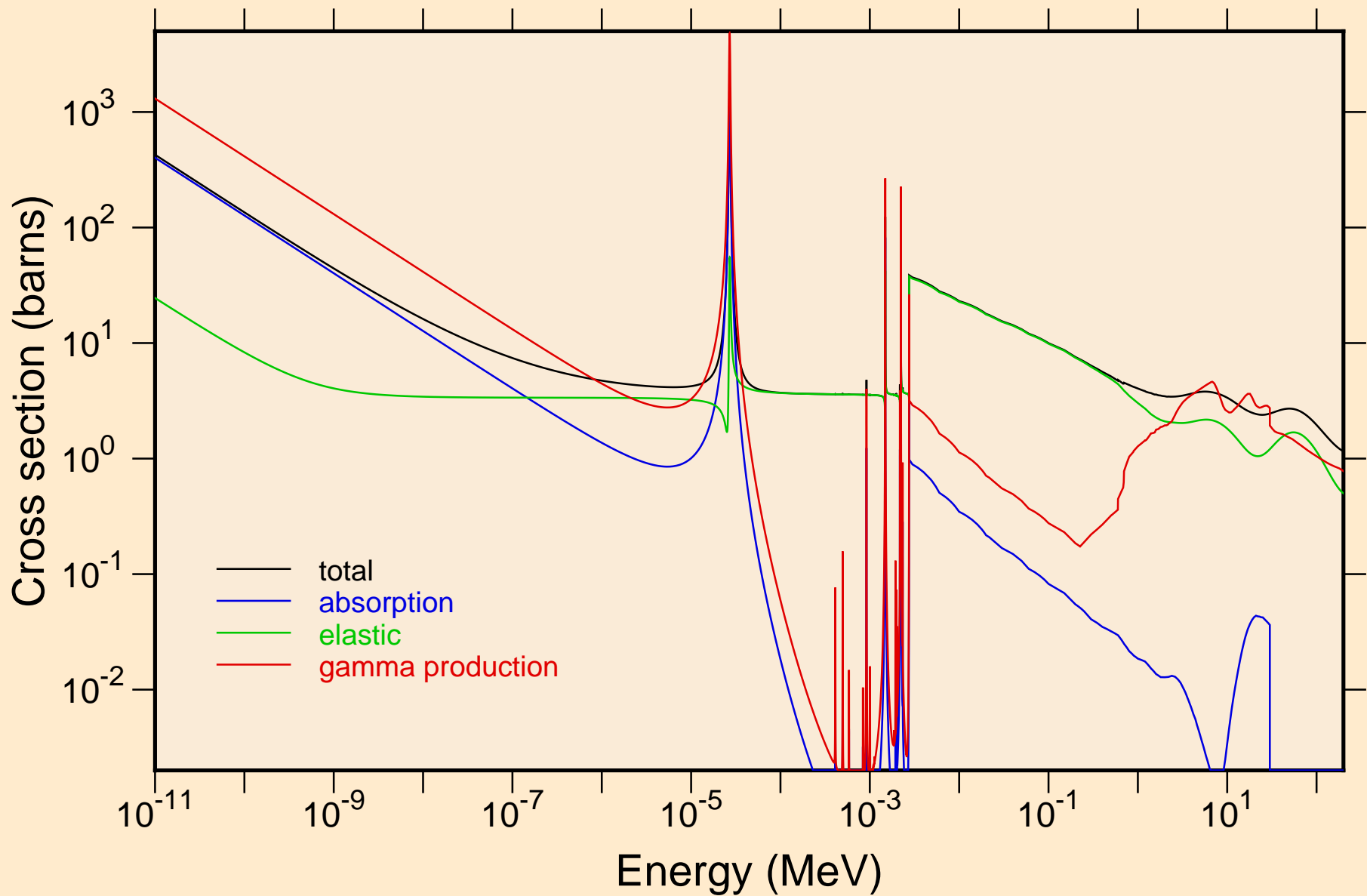

CO062M NEUTRON ACER TENDL-2019 LIBRARY; T=293.16K
resonance total cross section

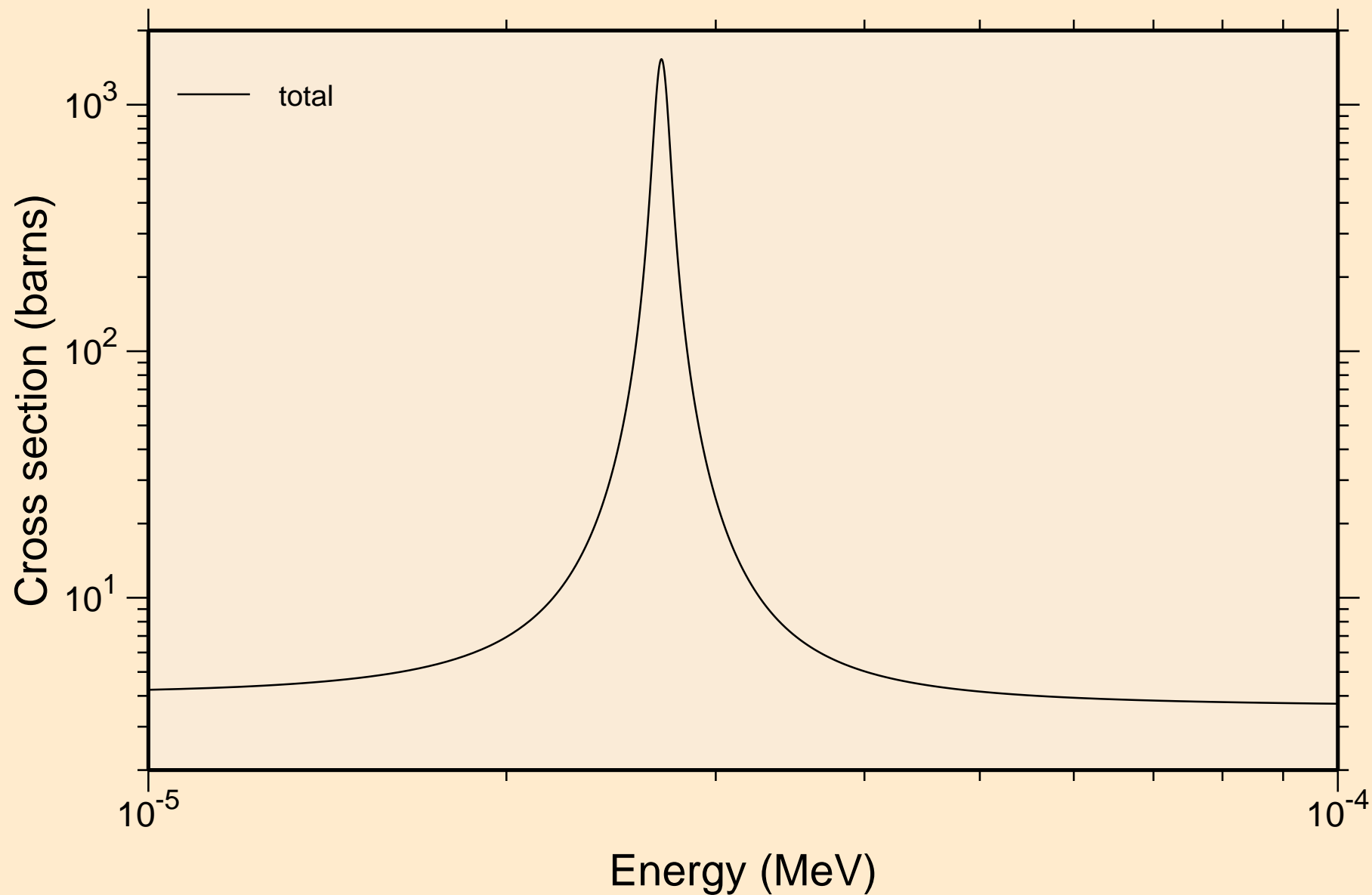

C0062M NEUTRON ACER TENDL-2019 LIBRARY; T=293.16K
resonance total cross section

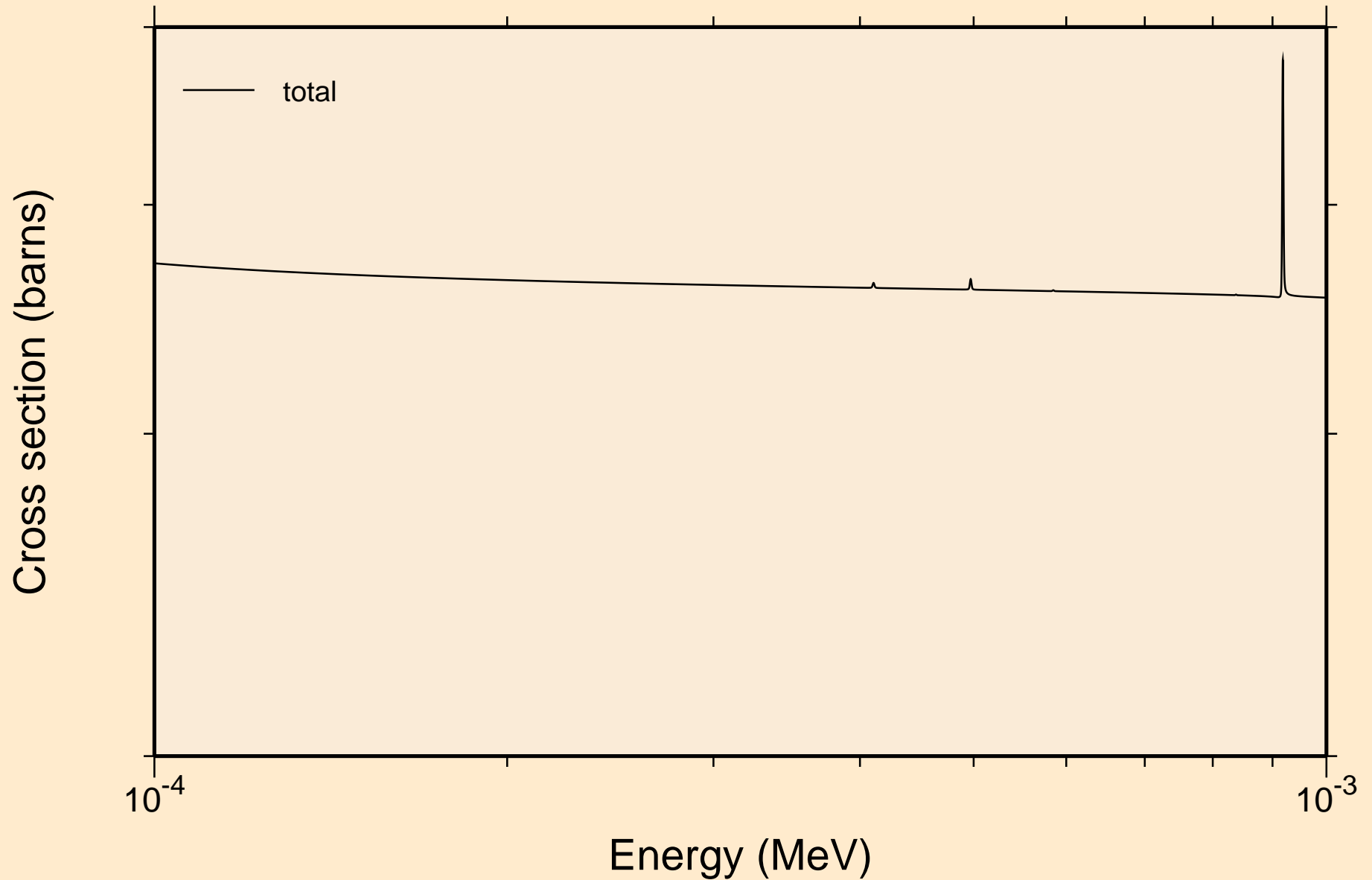

CO062M NEUTRON ACER TENDL-2019 LIBRARY; T=293.16K
resonance total cross section

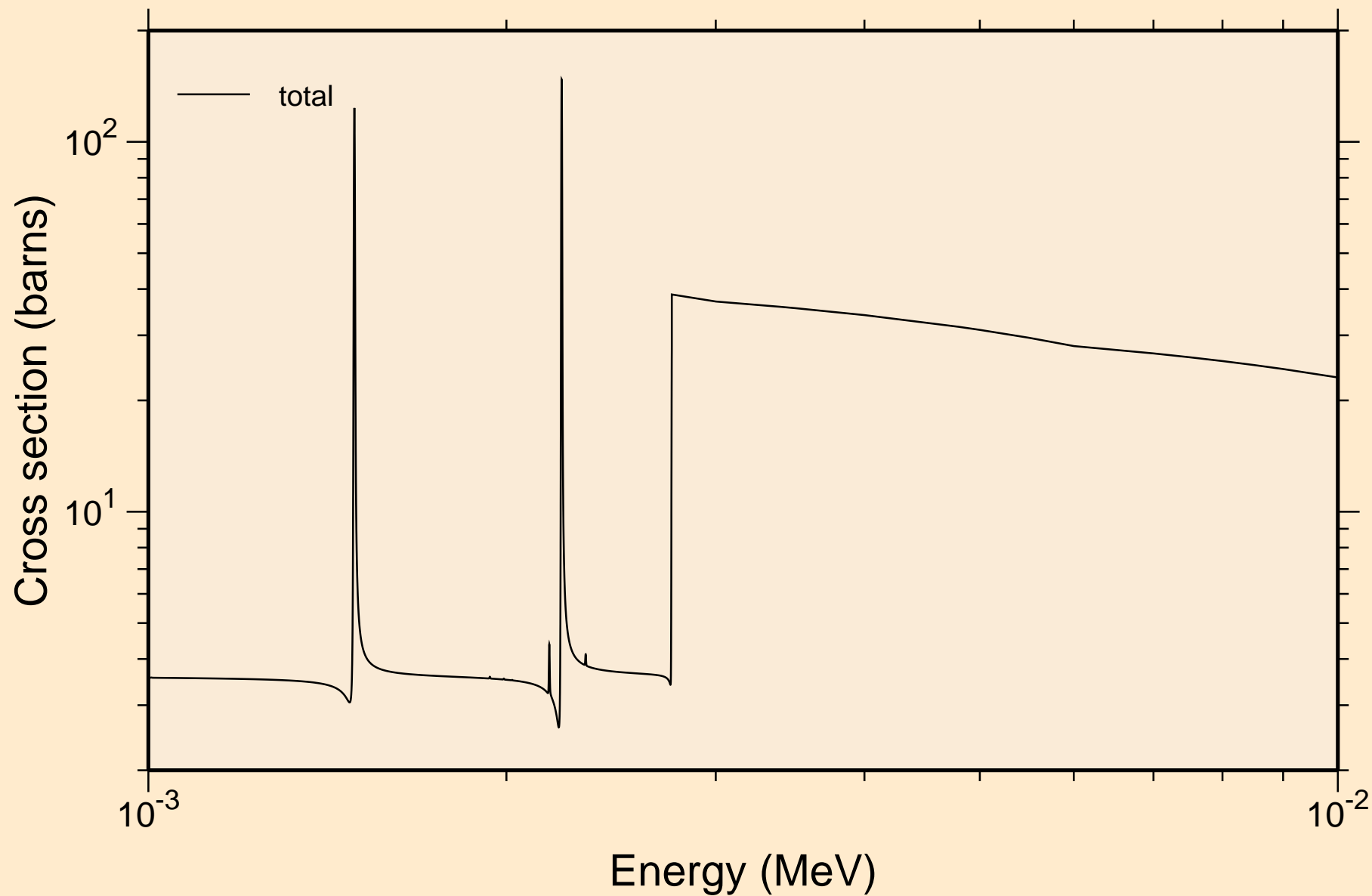

C0062M NEUTRON ACER TENDL-2019 LIBRARY; T=293.16K
resonance total cross section

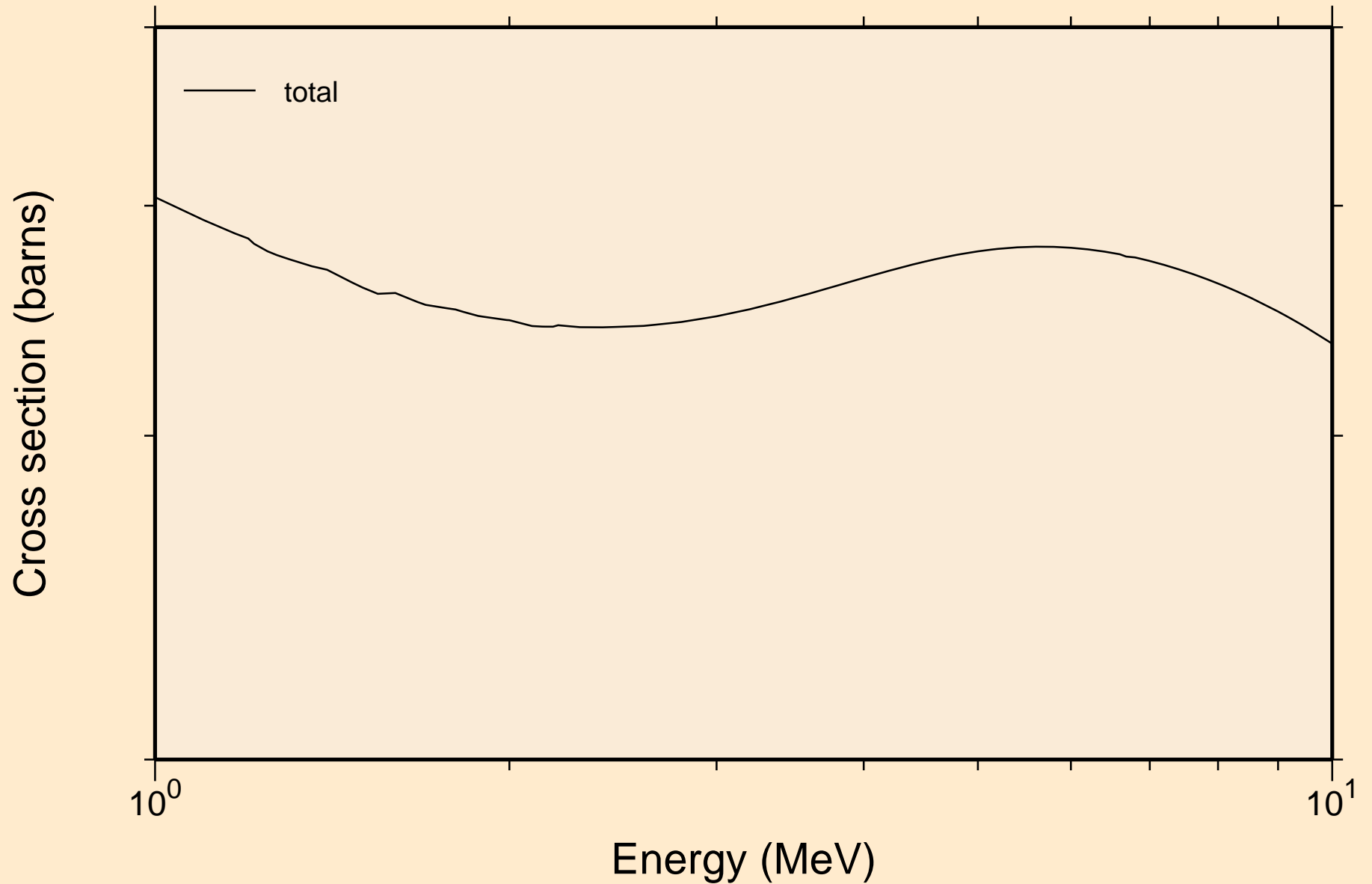

CO062M NEUTRON ACER TENDL-2019 LIBRARY; T=293.16K
resonance absorption cross sections

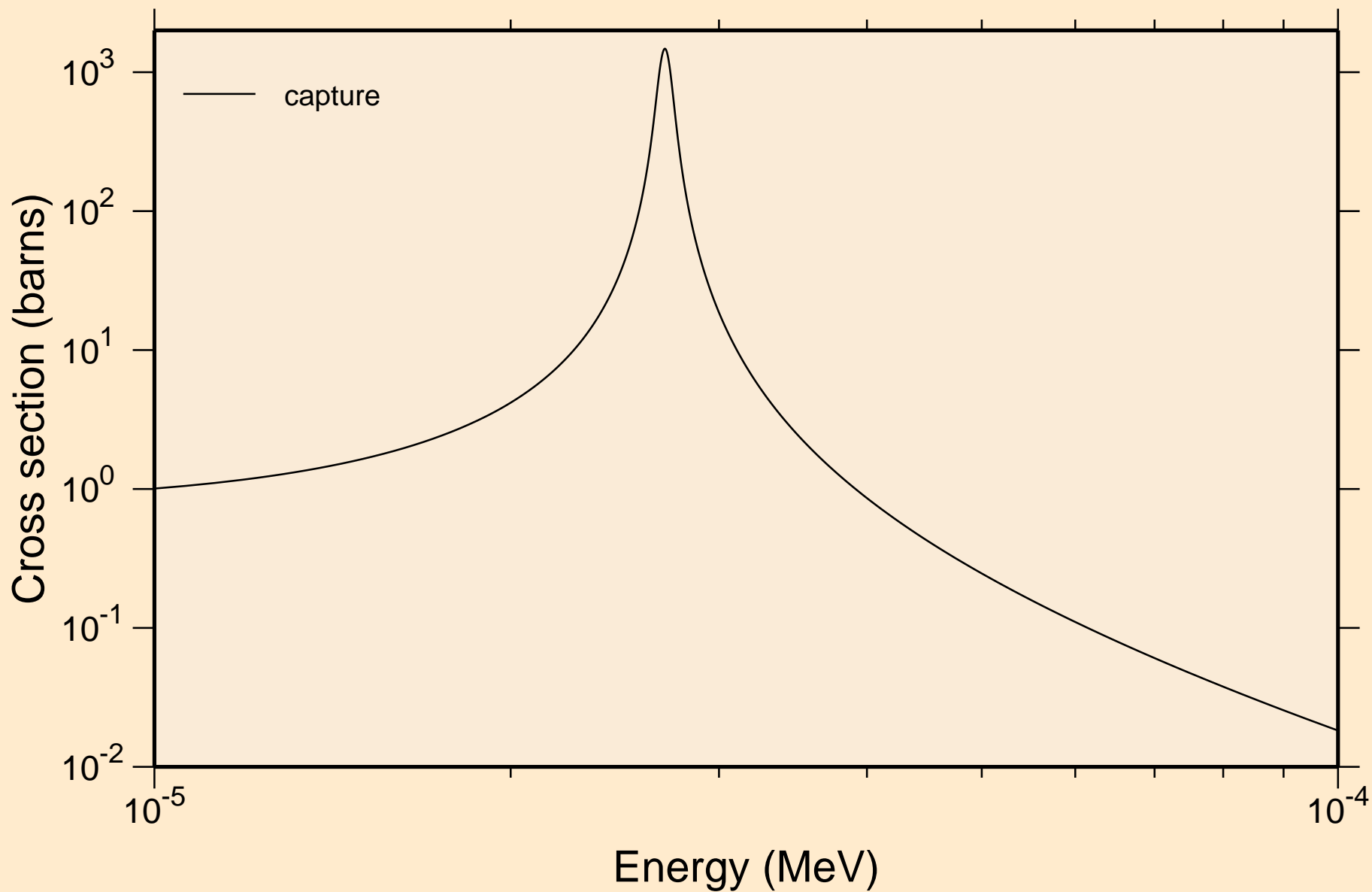

CO062M NEUTRON ACER TENDL-2019 LIBRARY; T=293.16K
resonance absorption cross sections

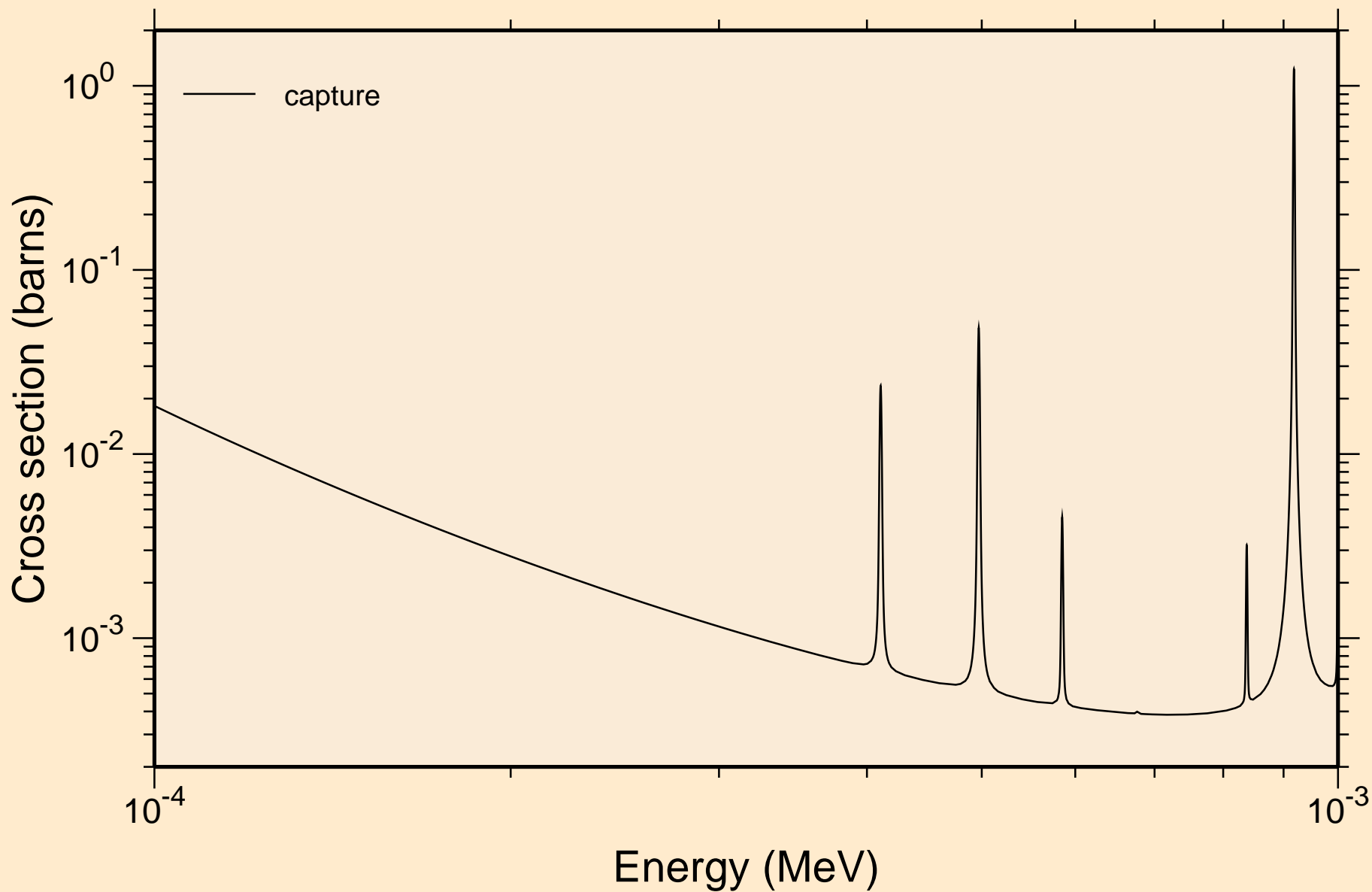

CO062M NEUTRON ACER TENDL-2019 LIBRARY; T=293.16K
resonance absorption cross sections

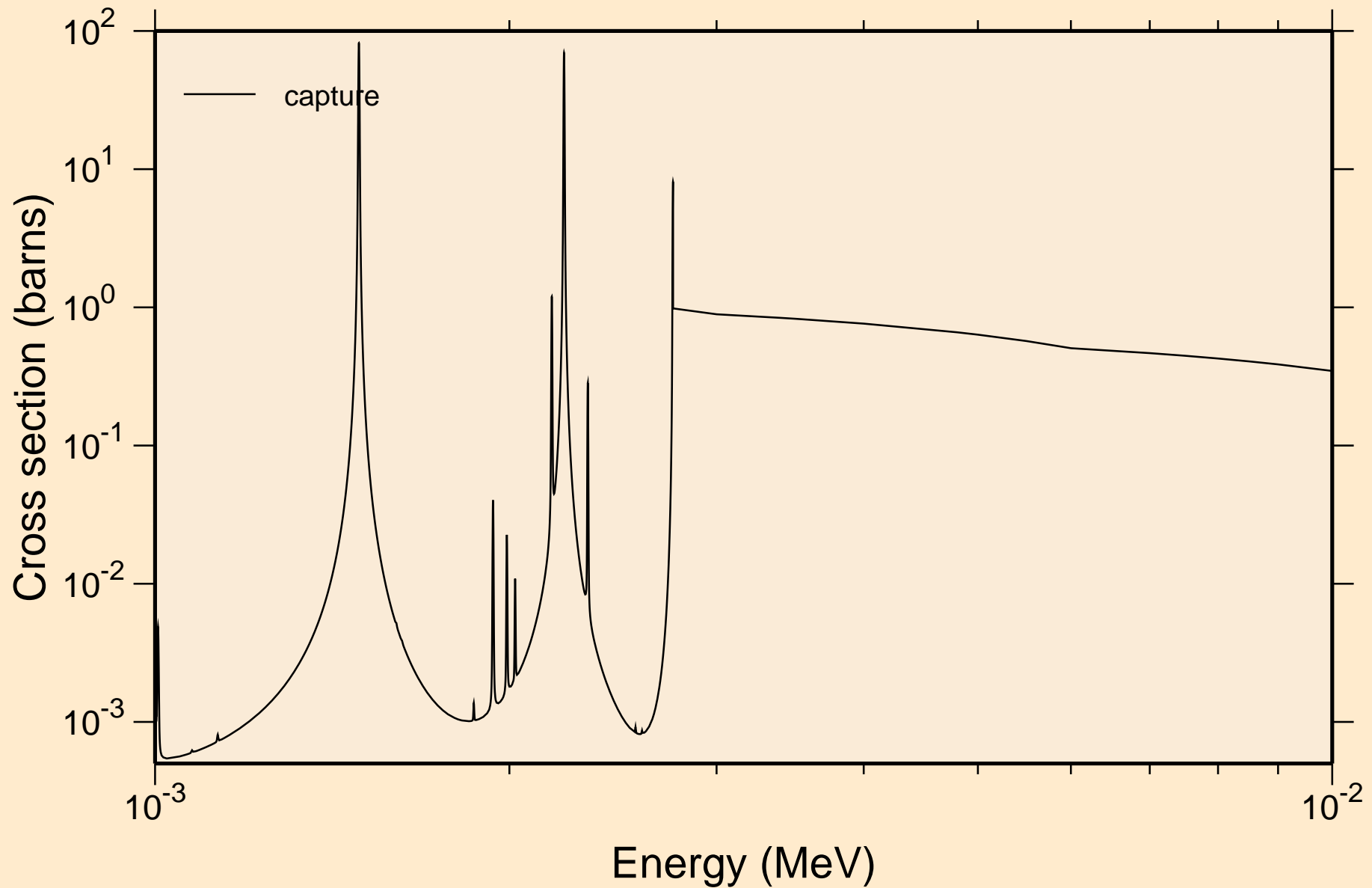

CO062M NEUTRON ACER TENDL-2019 LIBRARY; T=293.16K
resonance absorption cross sections

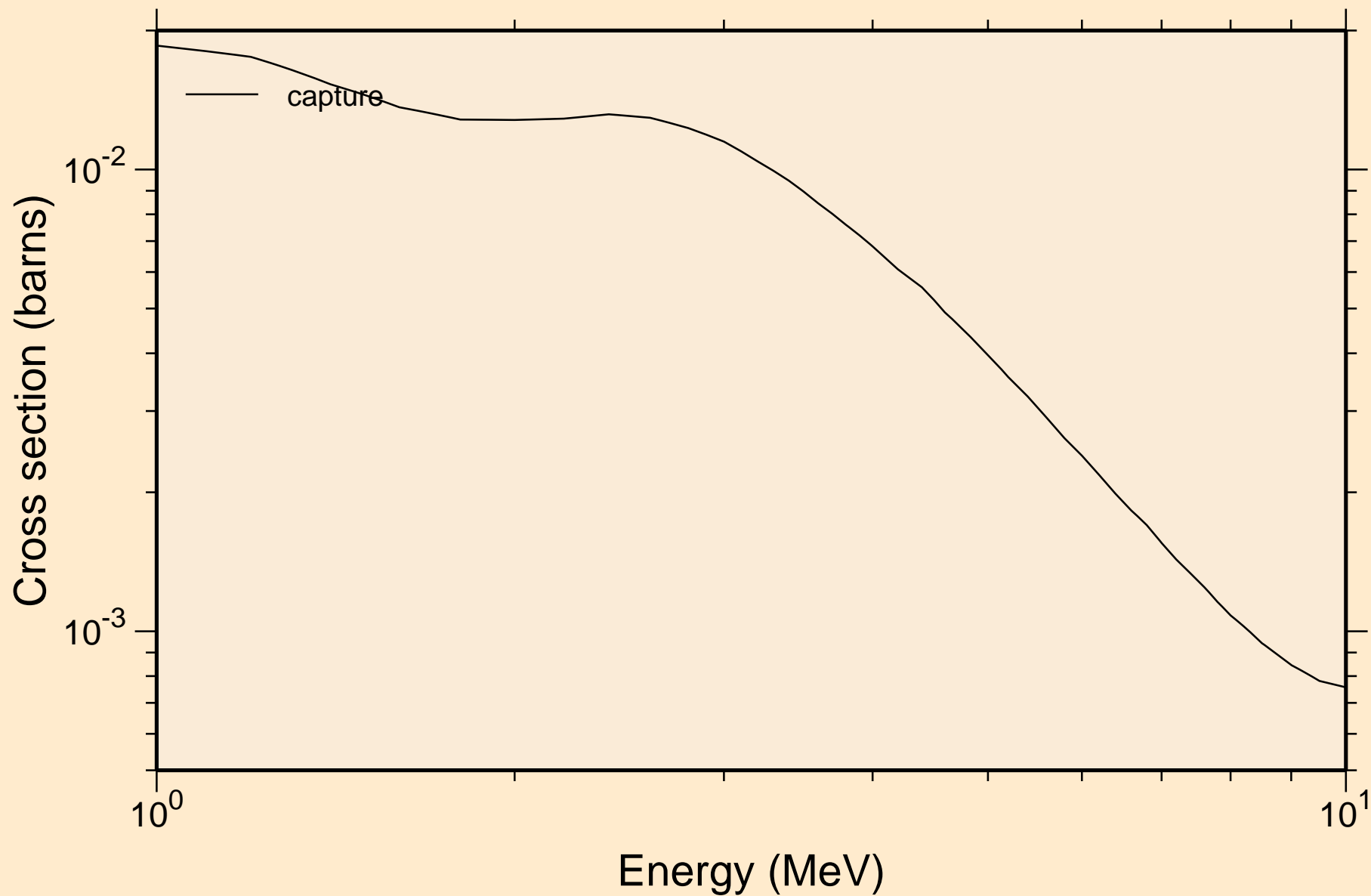

CO062M NEUTRON ACER TENDL-2019 LIBRARY; T=293.16K
Heating

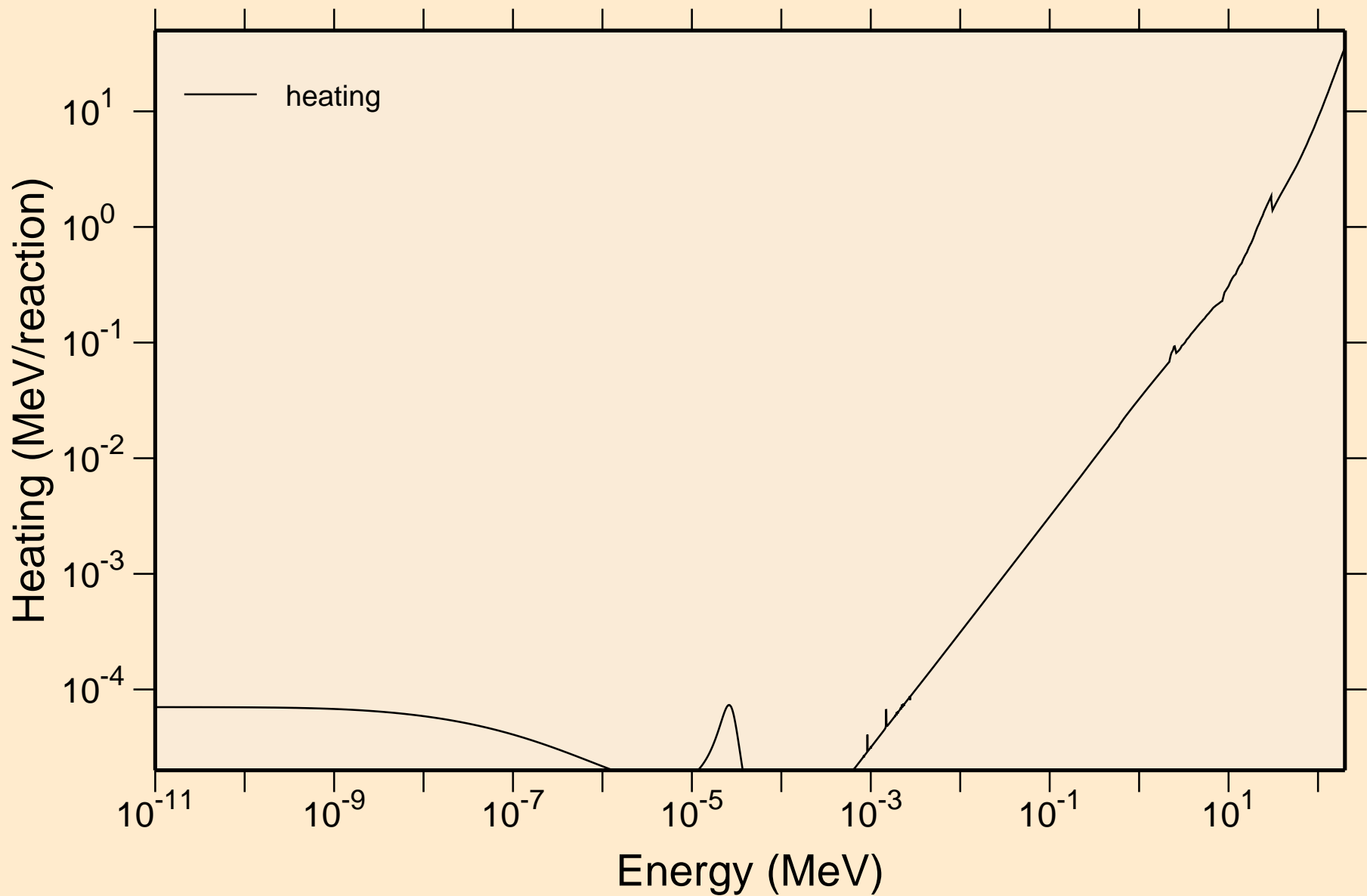

CO062M NEUTRON ACER TENDL-2019 LIBRARY; T=293.16K
Damage

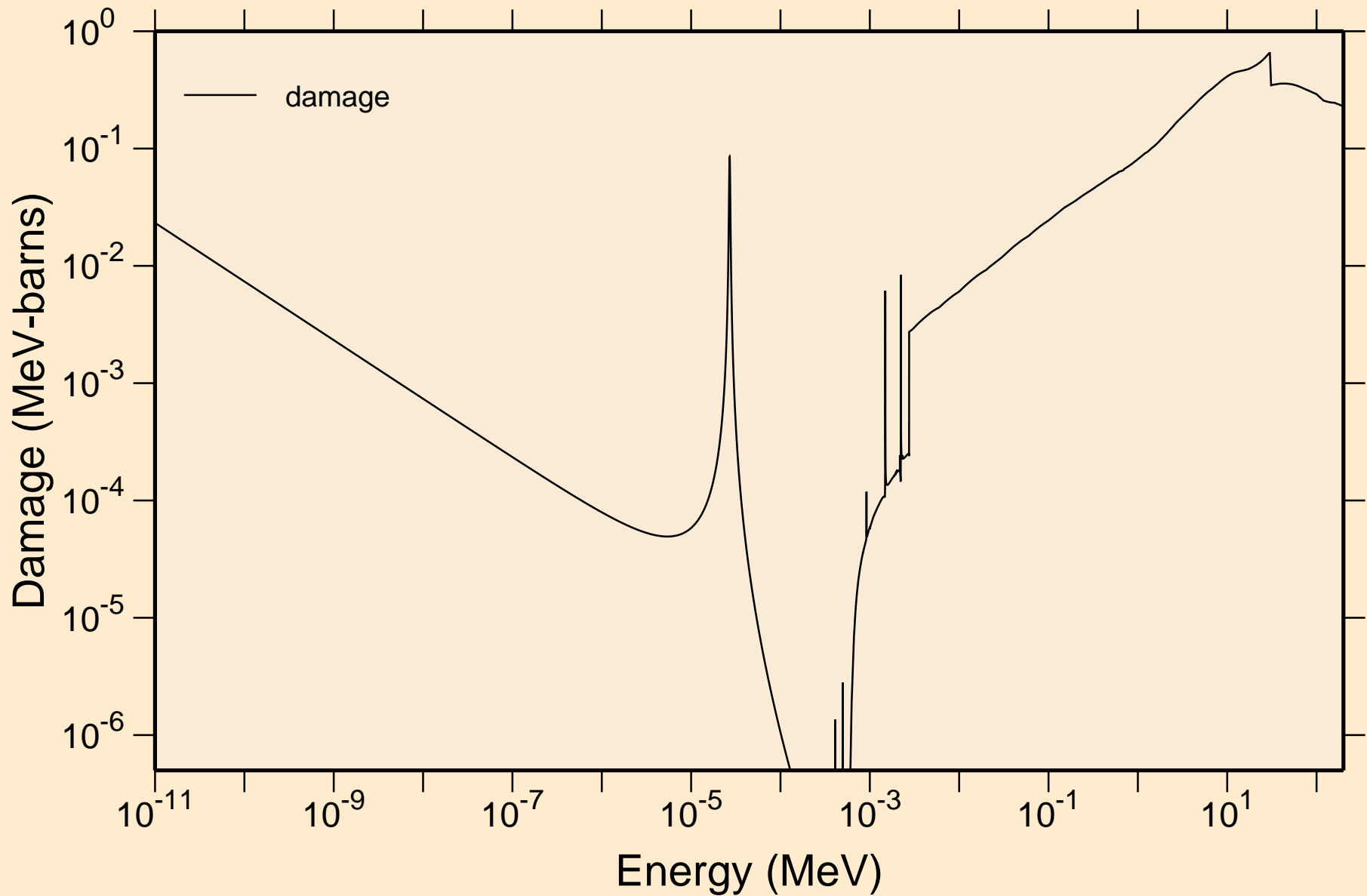

CO062M NEUTRON ACER TENDL-2019 LIBRARY; T=293.16K
Non-threshold reactions

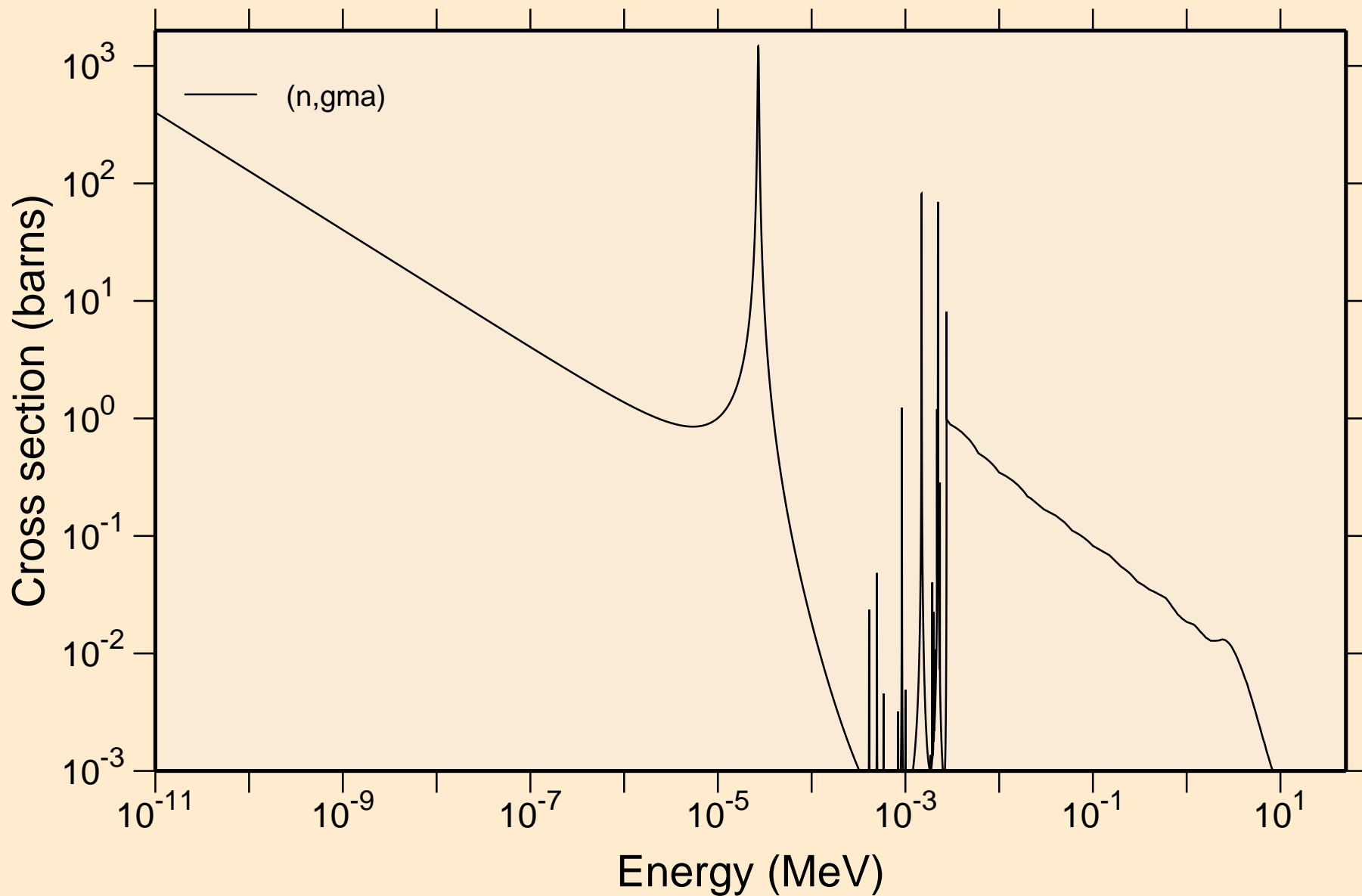

CO062M NEUTRON ACER TENDL-2019 LIBRARY; T=293.16K

Principal cross sections

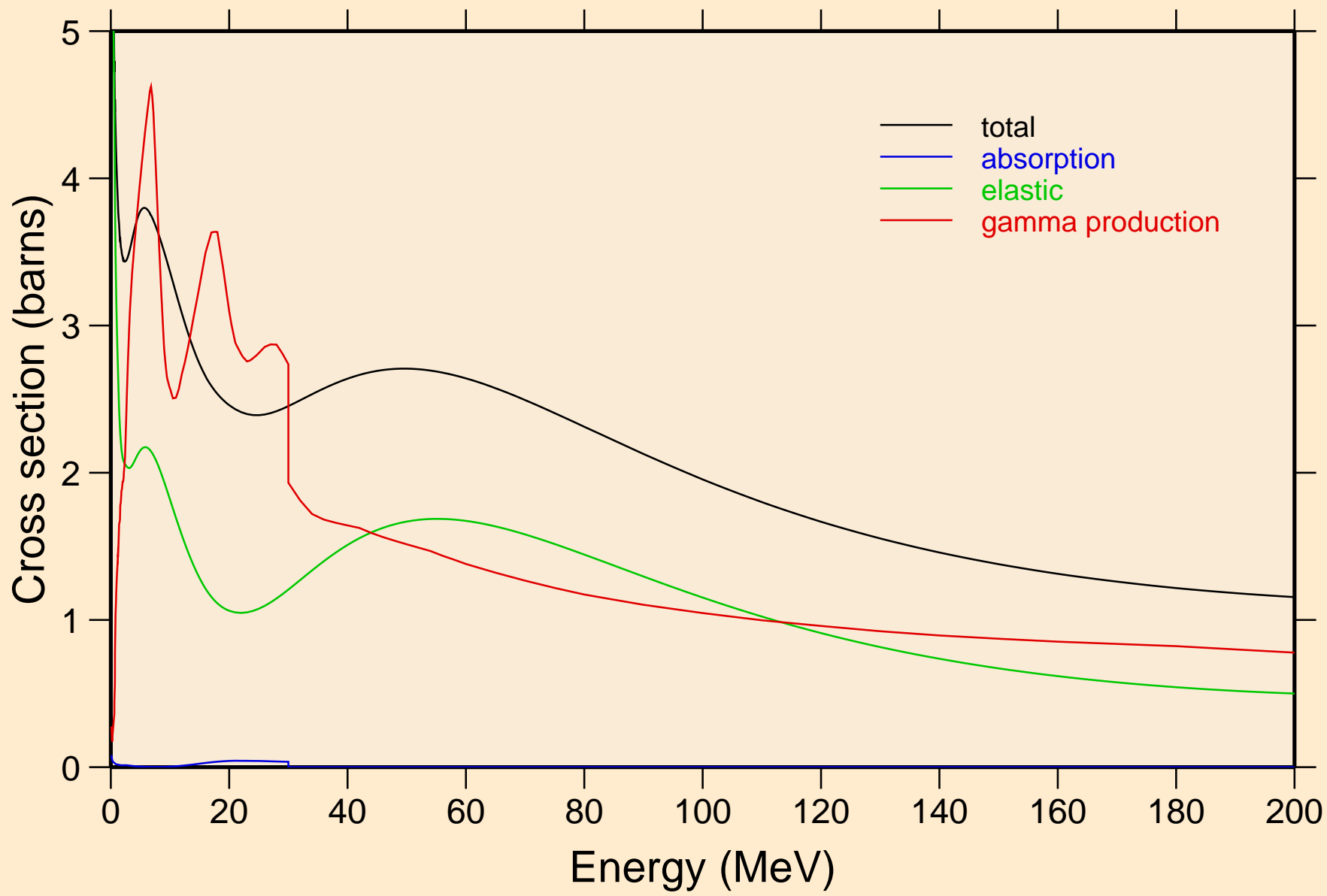

CO062M NEUTRON ACER TENDL-2019 LIBRARY; T=293.16K
Heating

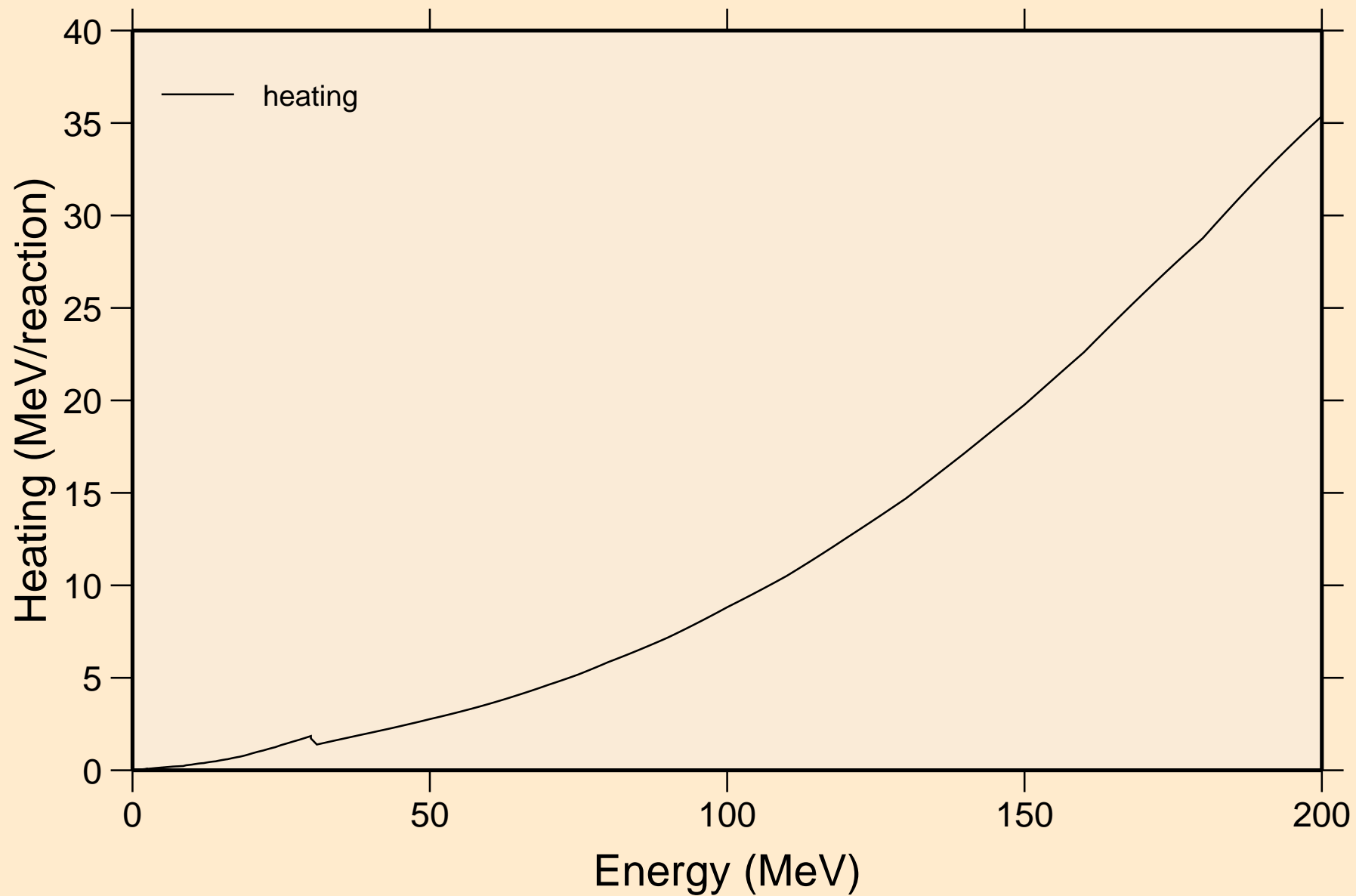

CO062M NEUTRON ACER TENDL-2019 LIBRARY; T=293.16K
Damage

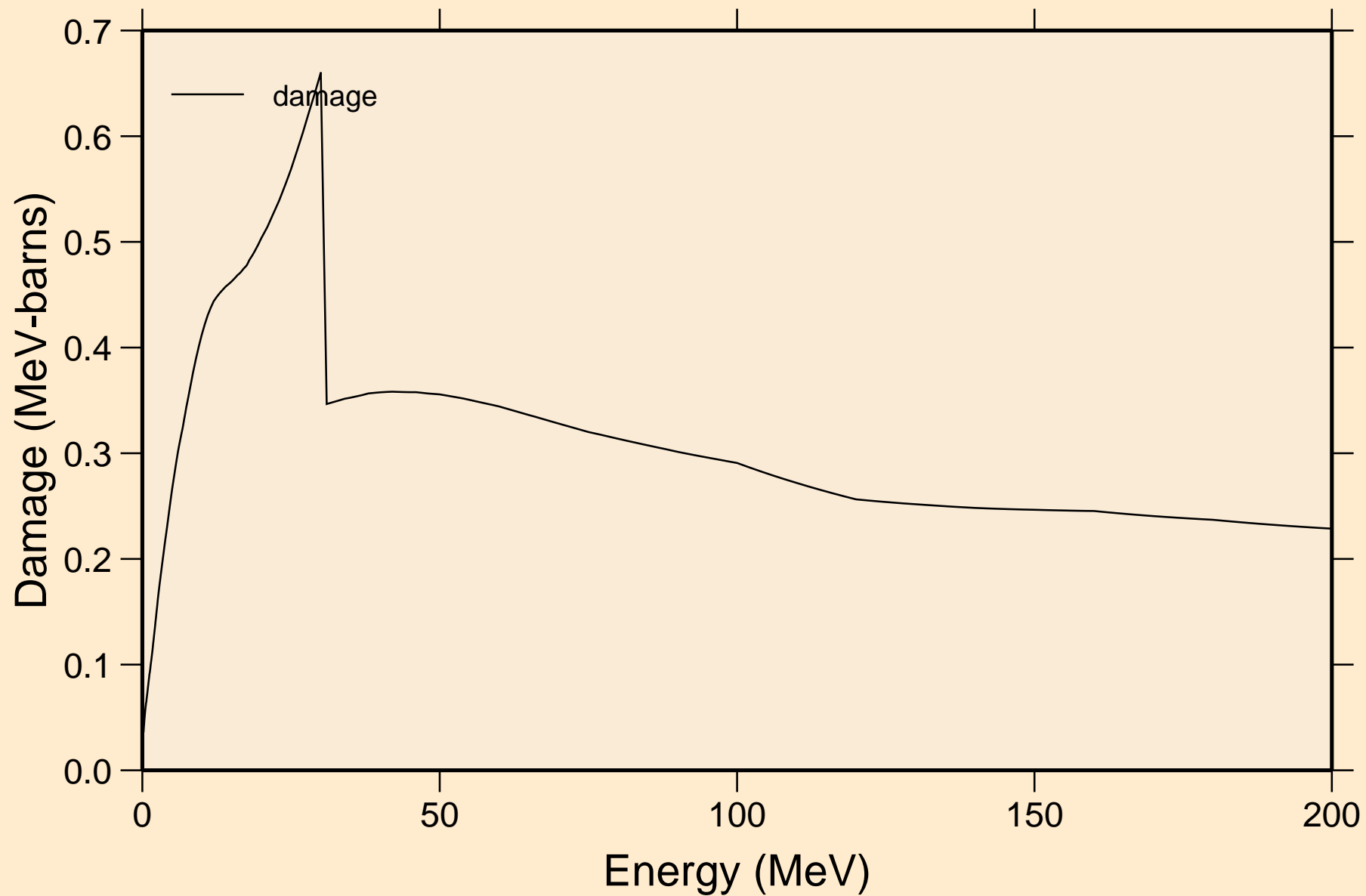

CO062M NEUTRON ACER TENDL-2019 LIBRARY; T=293.16K
Non-threshold reactions

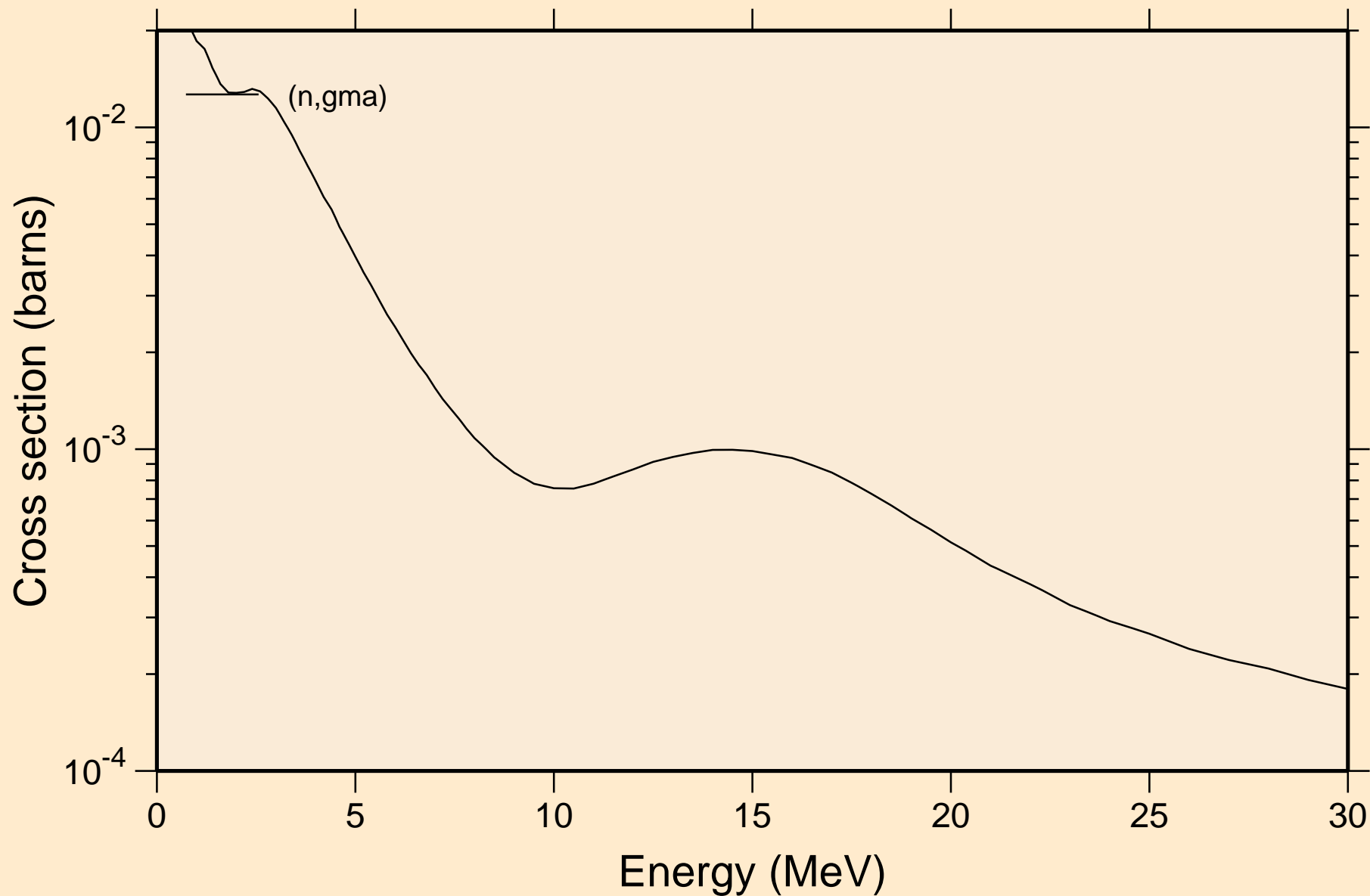

CO062M NEUTRON ACER TENDL-2019 LIBRARY; T=293.16K
Inelastic levels

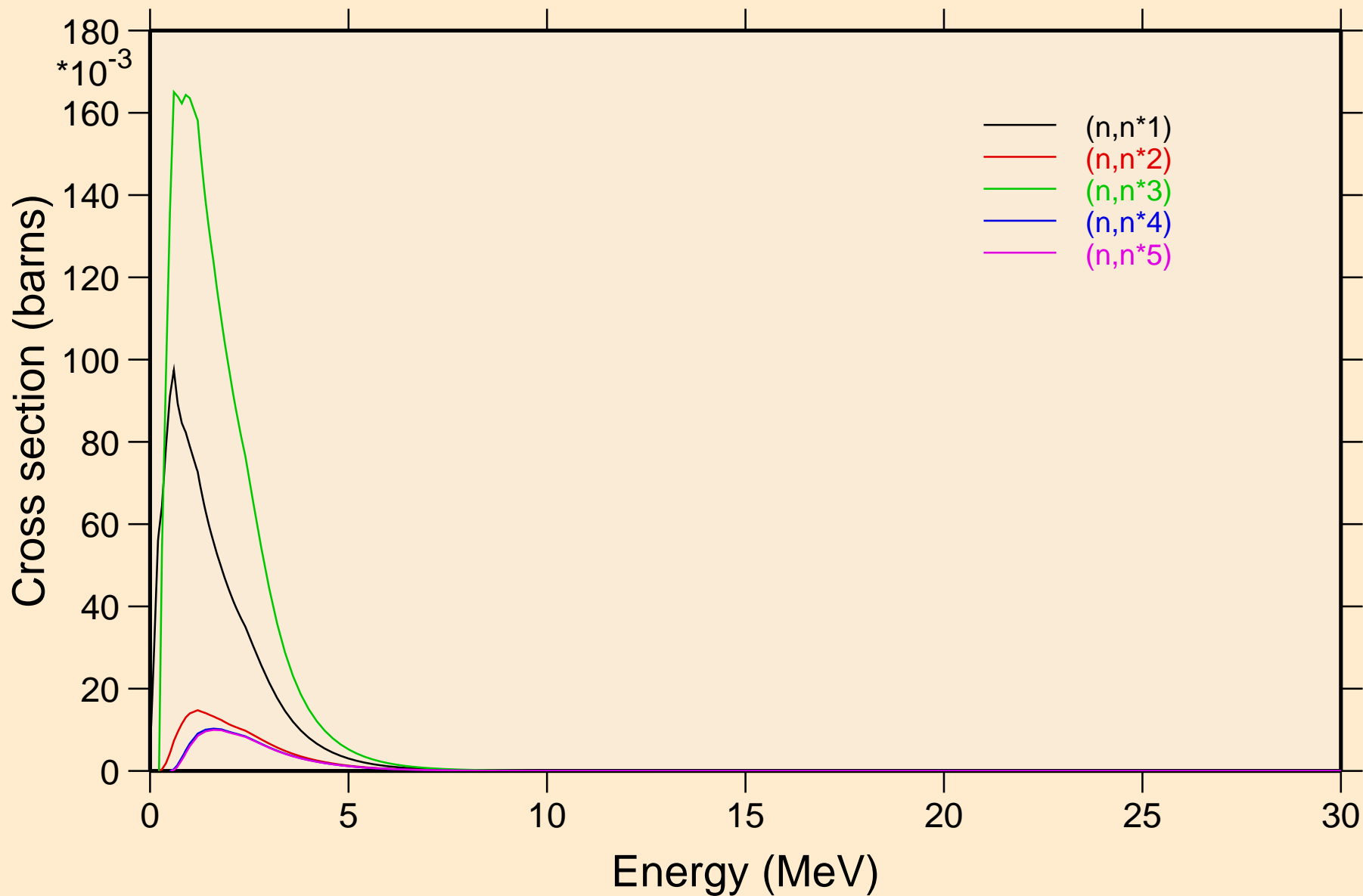

CO062M NEUTRON ACER TENDL-2019 LIBRARY; T=293.16K
Inelastic levels

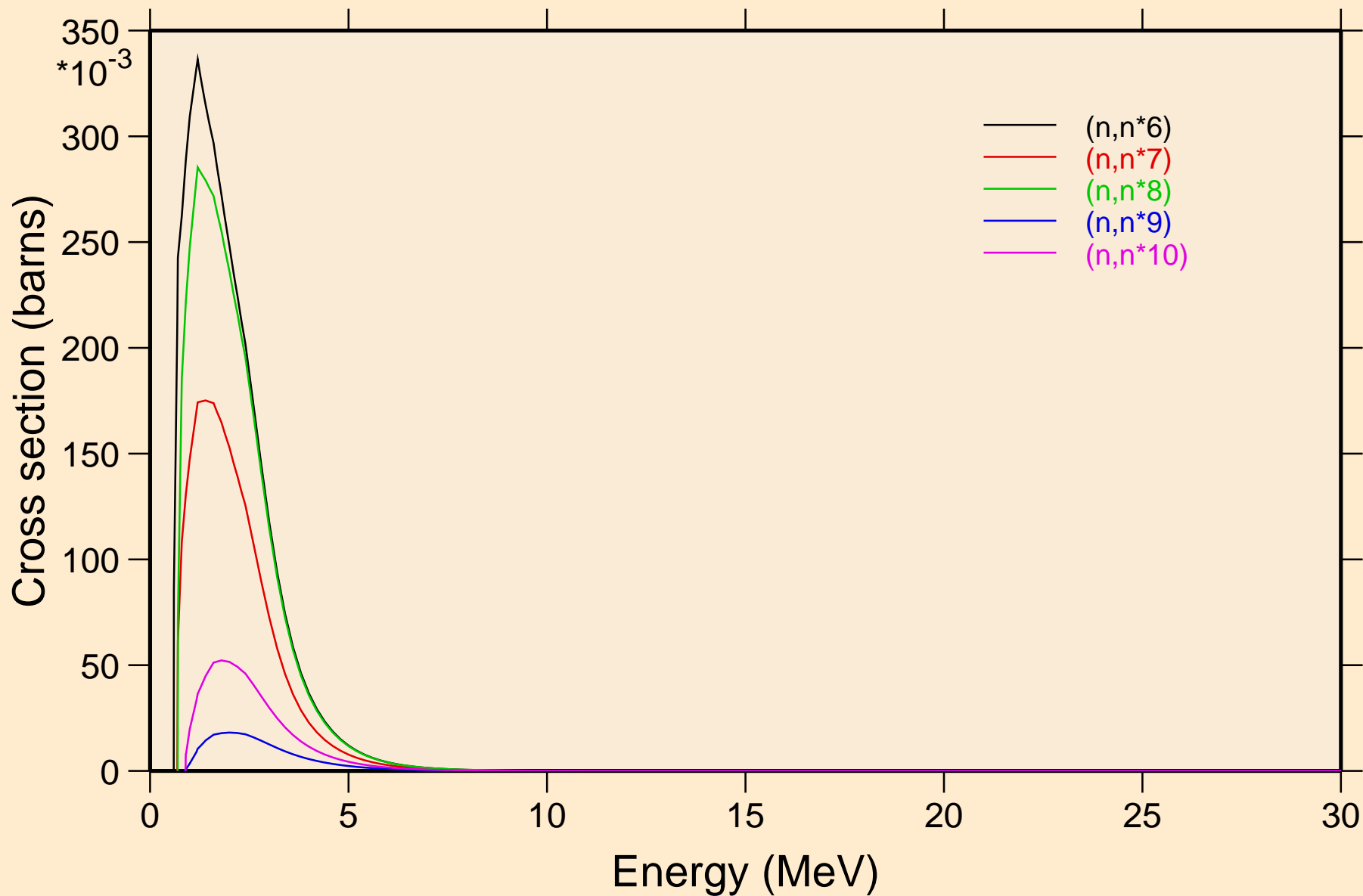

CO062M NEUTRON ACER TENDL-2019 LIBRARY; T=293.16K
Inelastic levels

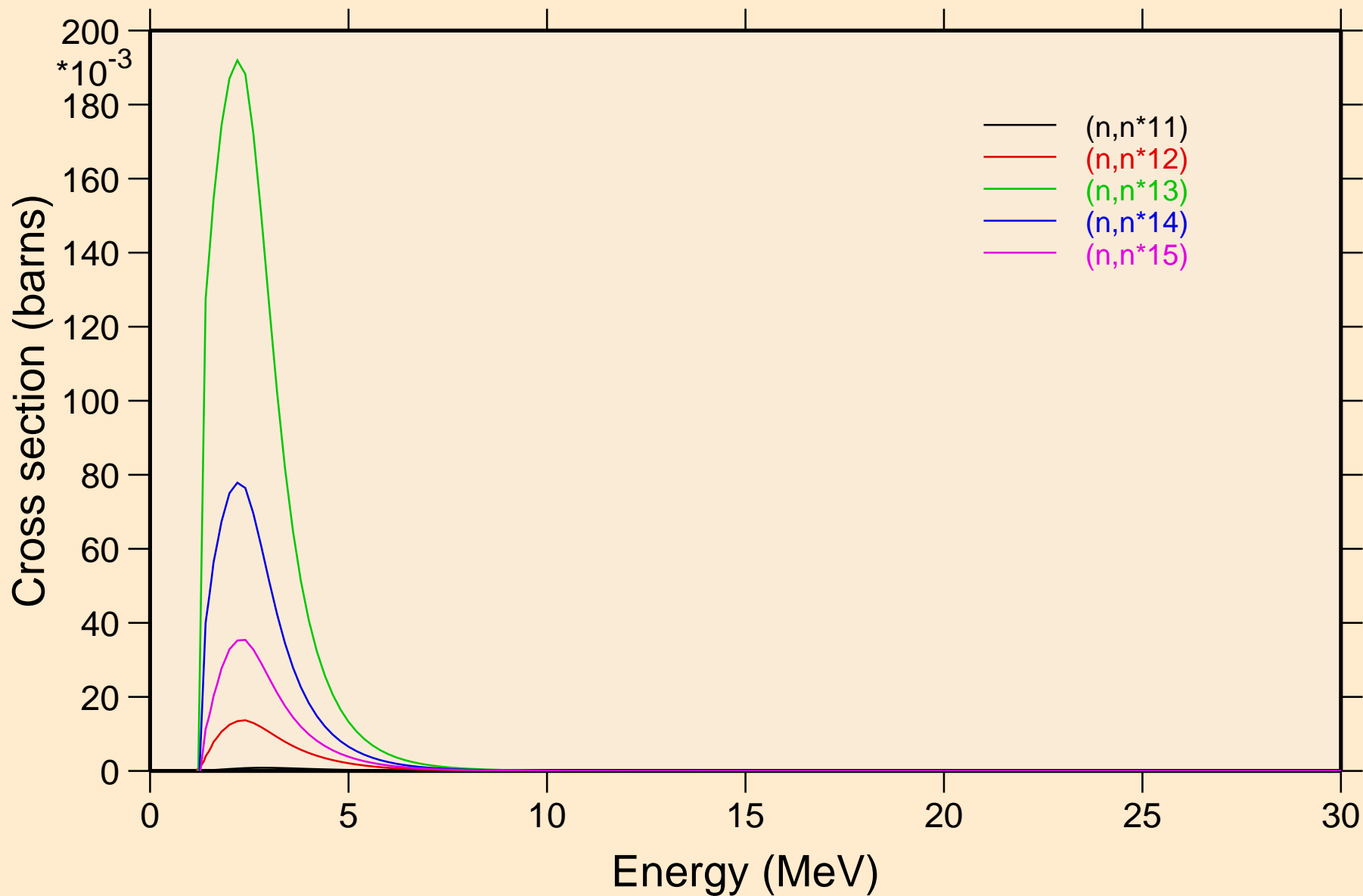

CO062M NEUTRON ACER TENDL-2019 LIBRARY; T=293.16K
Inelastic levels

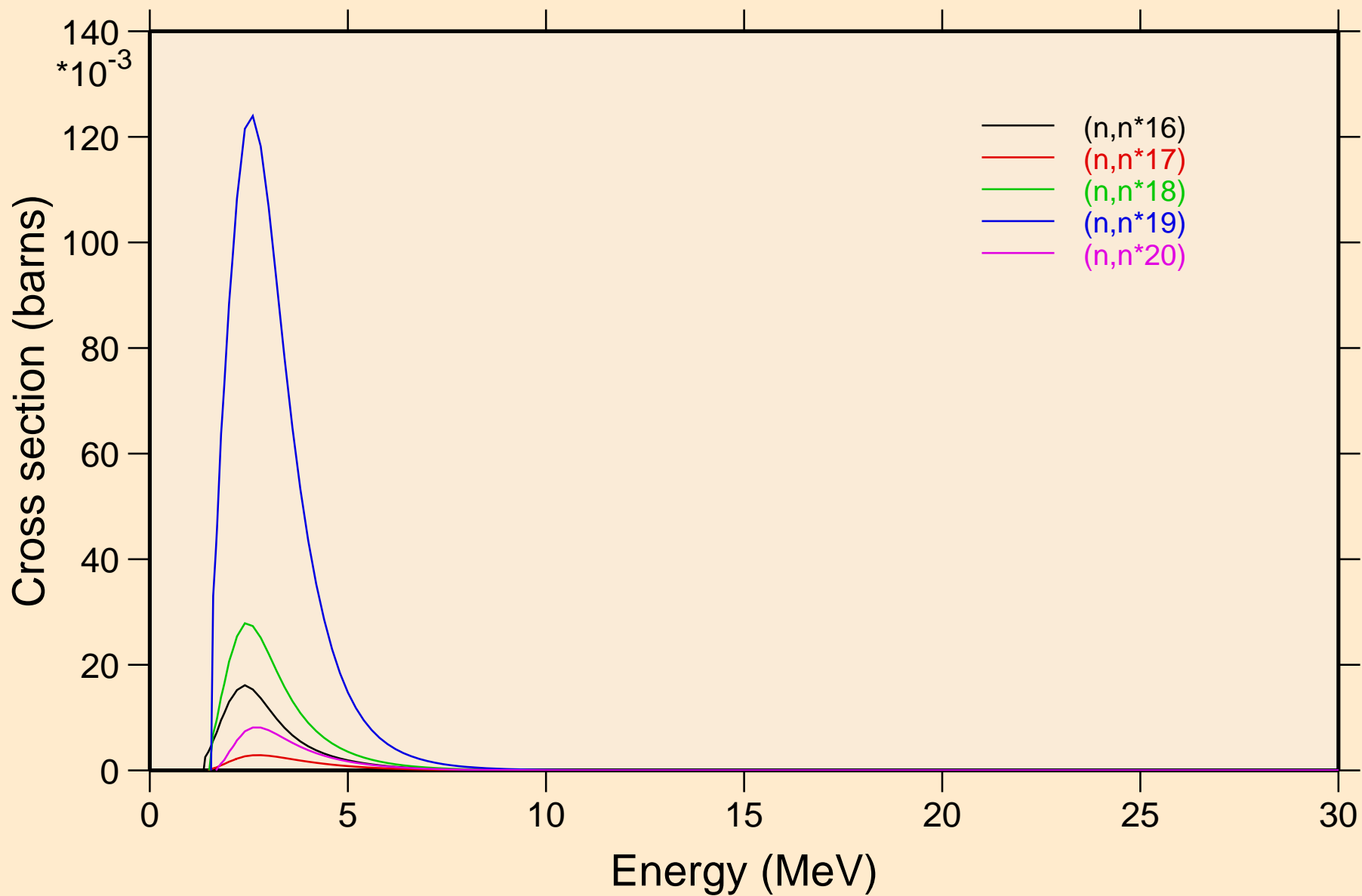

CO062M NEUTRON ACER TENDL-2019 LIBRARY; T=293.16K
Inelastic levels

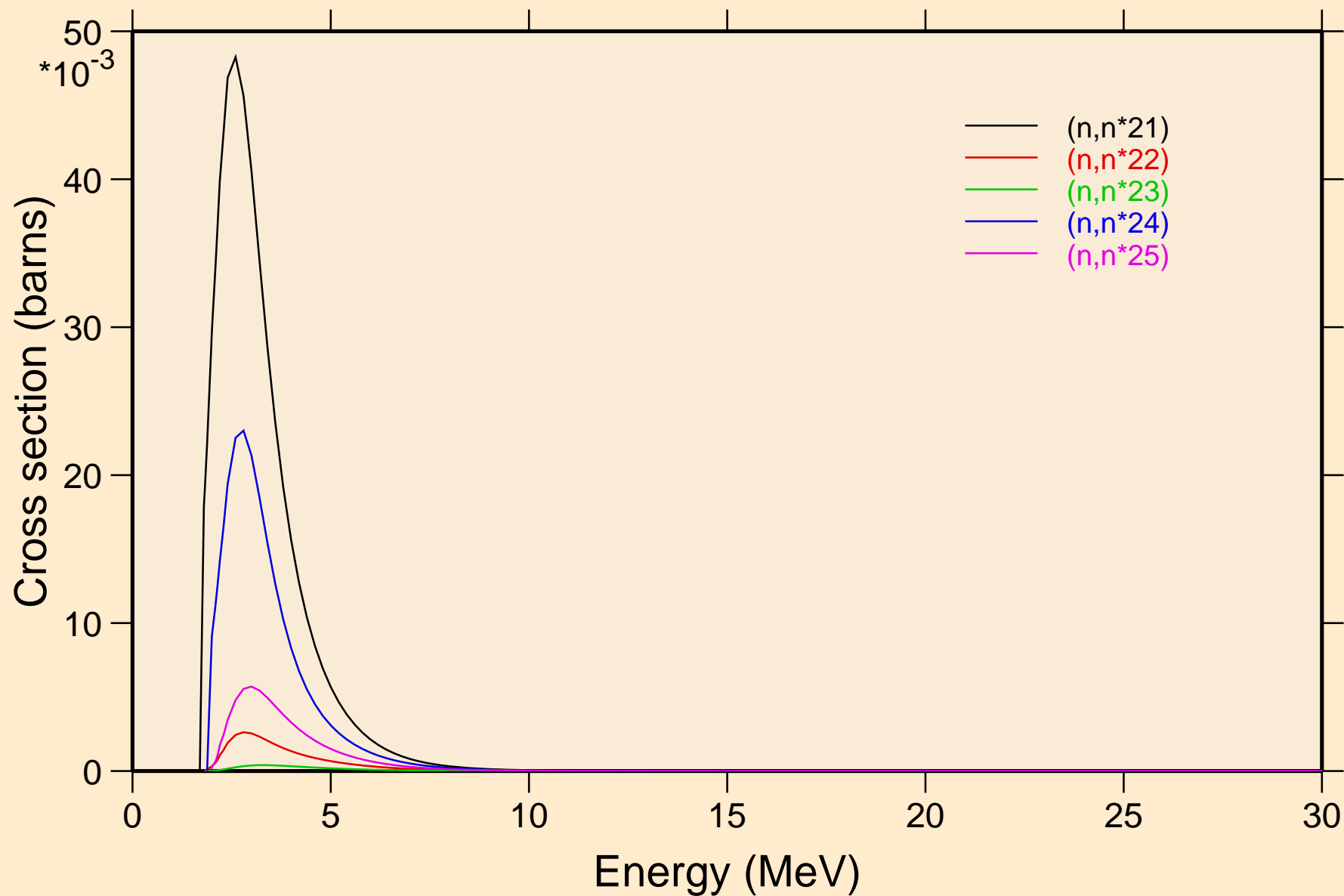

CO062M NEUTRON ACER TENDL-2019 LIBRARY; T=293.16K
Inelastic levels

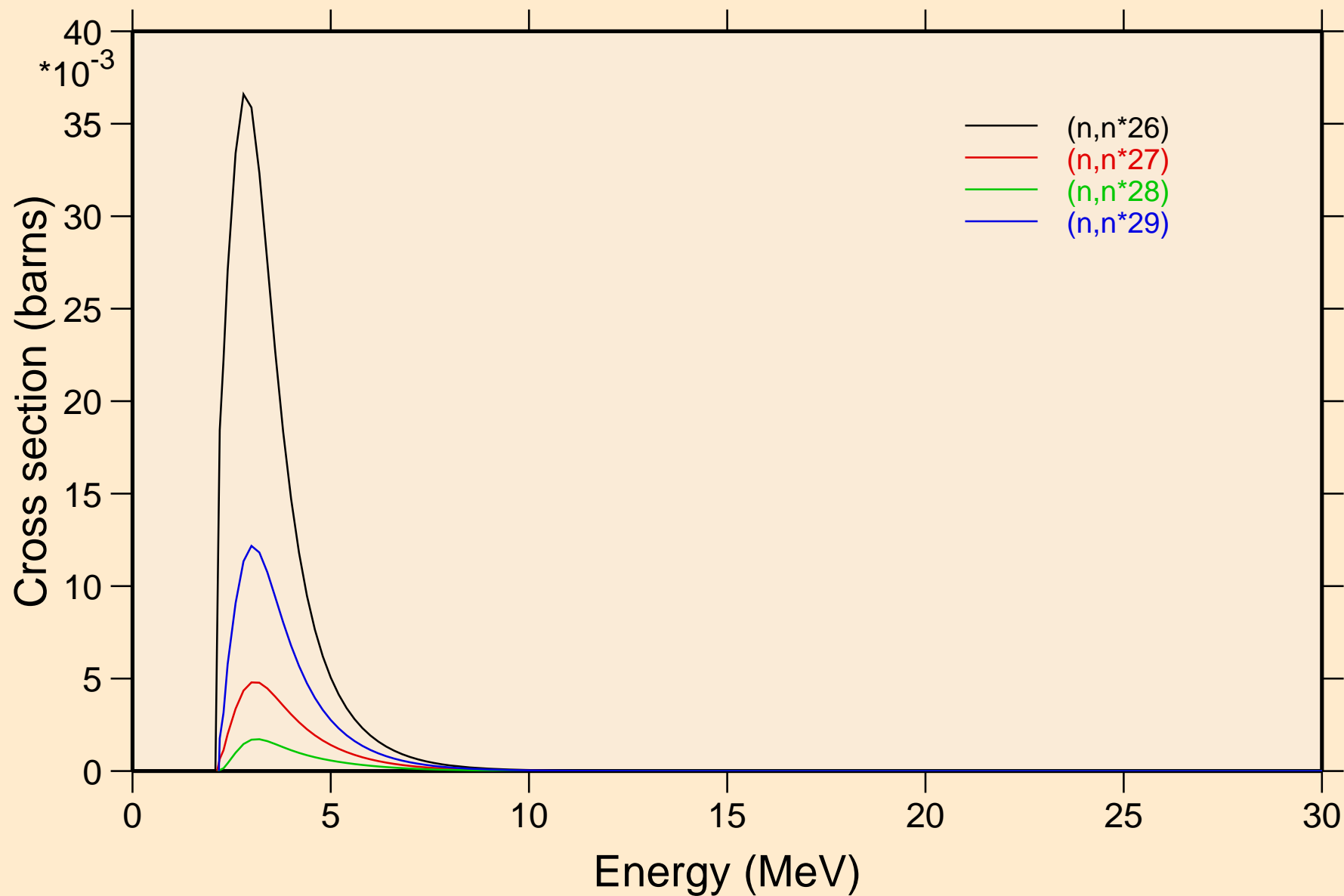

CO062M NEUTRON ACER TENDL-2019 LIBRARY; T=293.16K
Threshold reactions

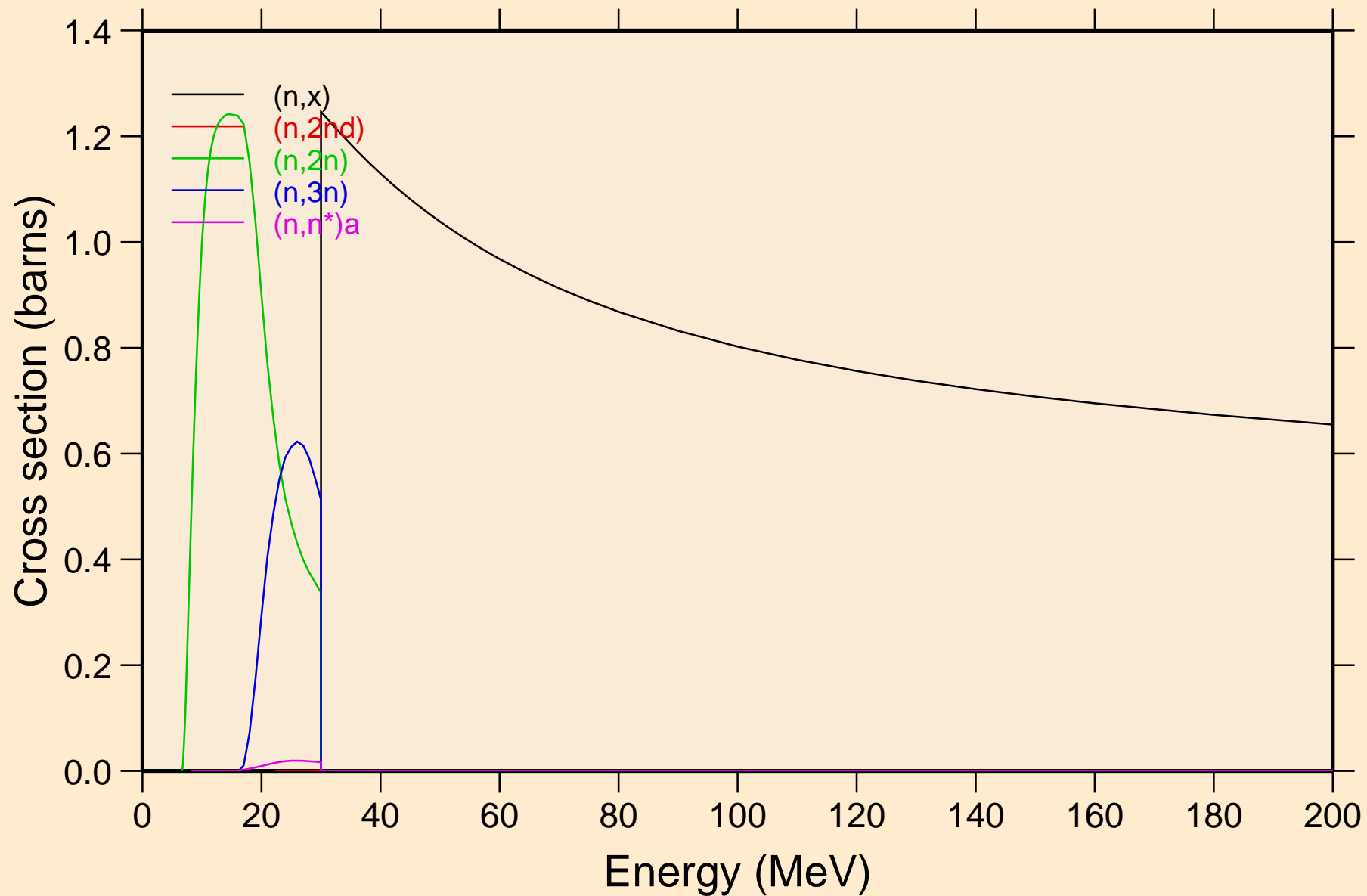

CO062M NEUTRON ACER TENDL-2019 LIBRARY; T=293.16K
Threshold reactions

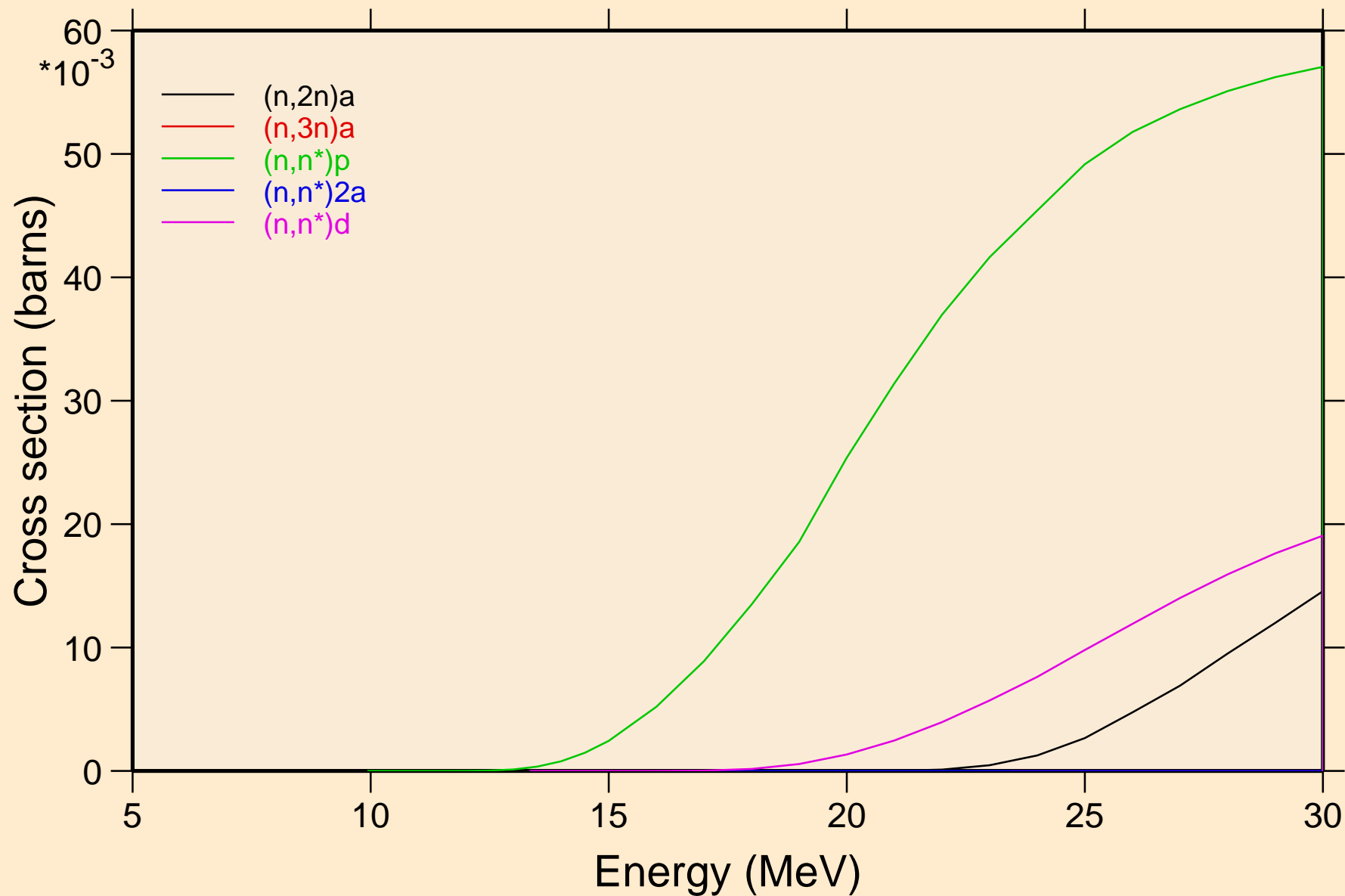

CO062M NEUTRON ACER TENDL-2019 LIBRARY; T=293.16K
Threshold reactions

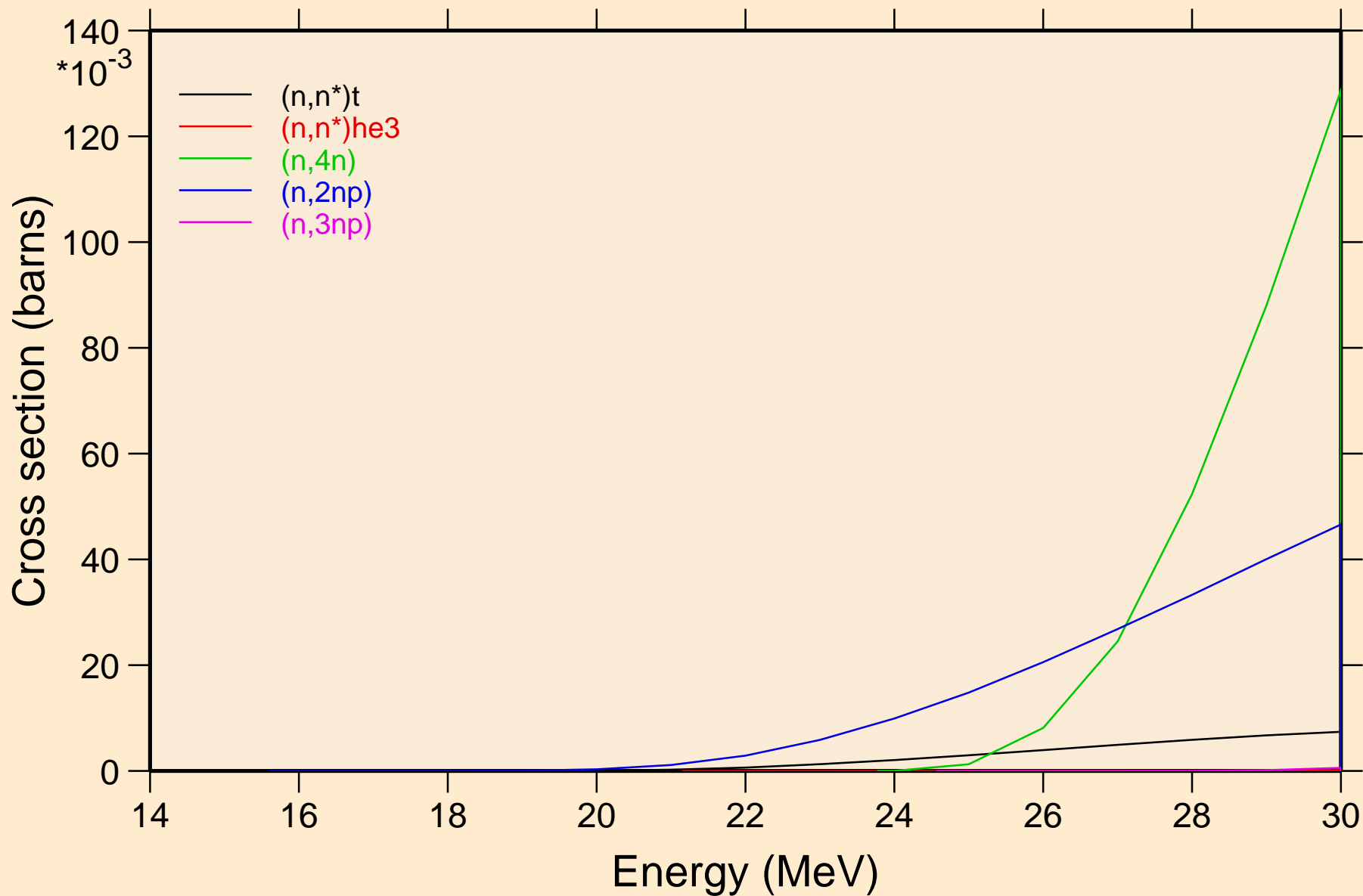

CO062M NEUTRON ACER TENDL-2019 LIBRARY; T=293.16K
Threshold reactions

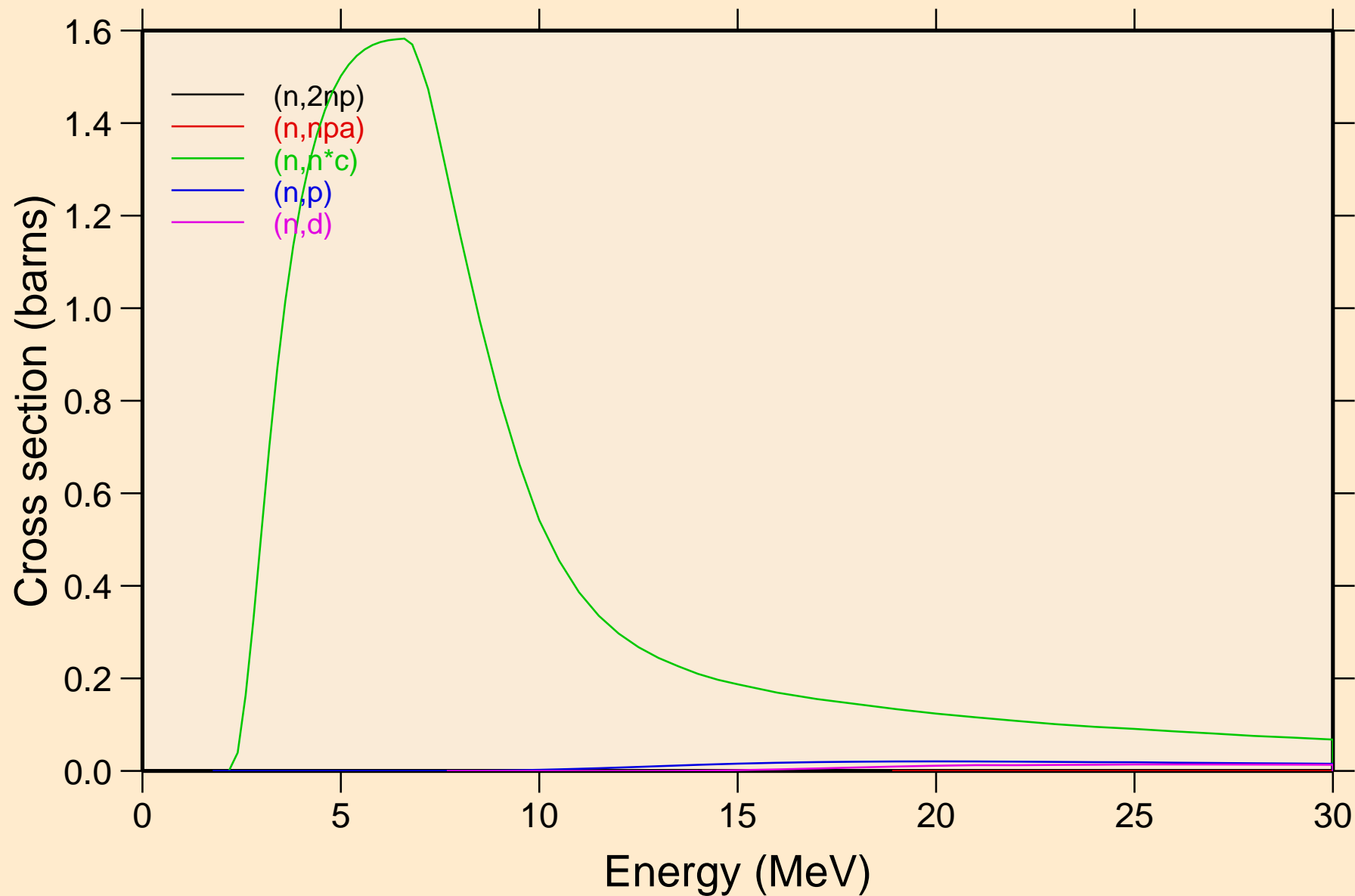

CO062M NEUTRON ACER TENDL-2019 LIBRARY; T=293.16K
Threshold reactions

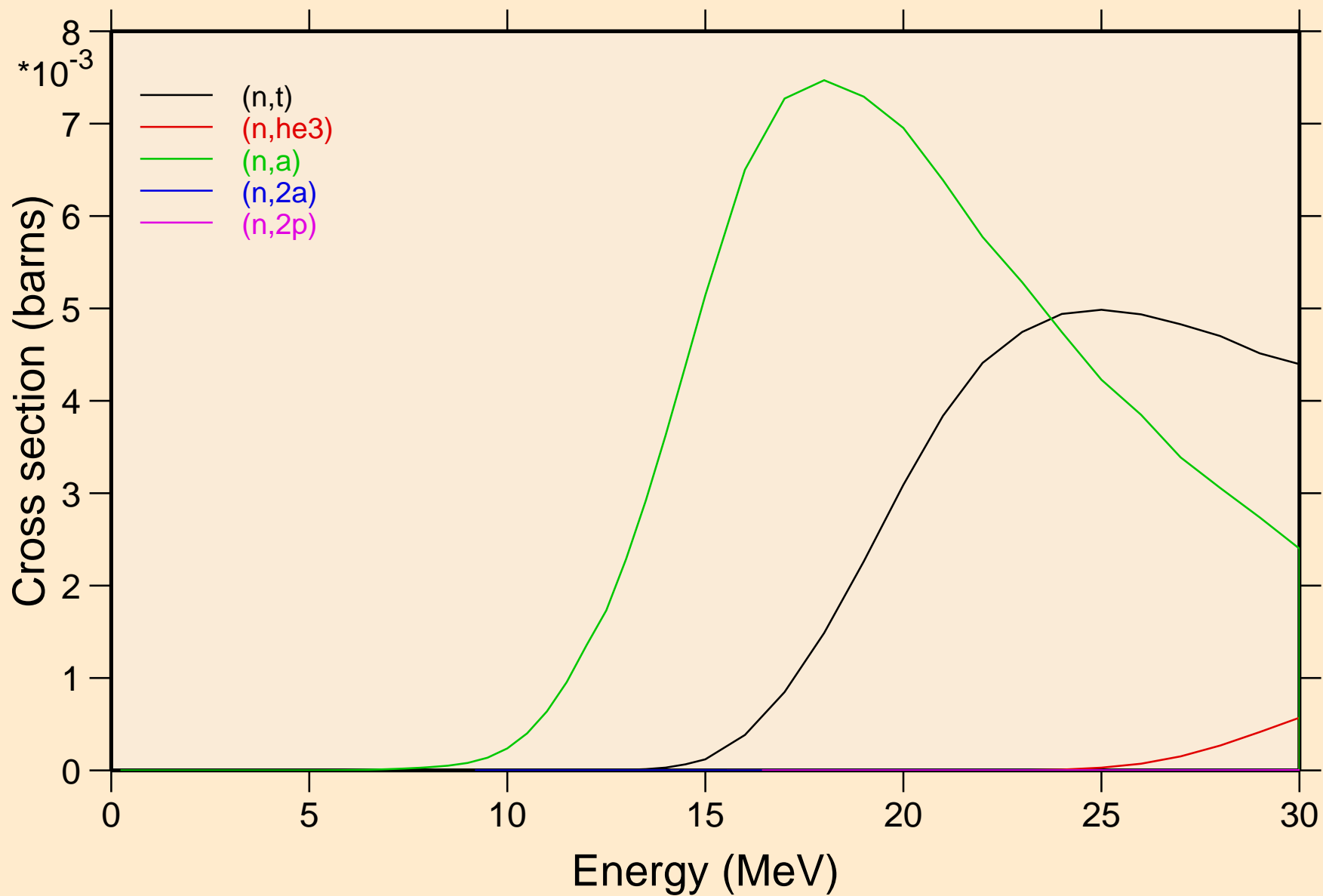

CO062M NEUTRON ACER TENDL-2019 LIBRARY; T=293.16K
Threshold reactions

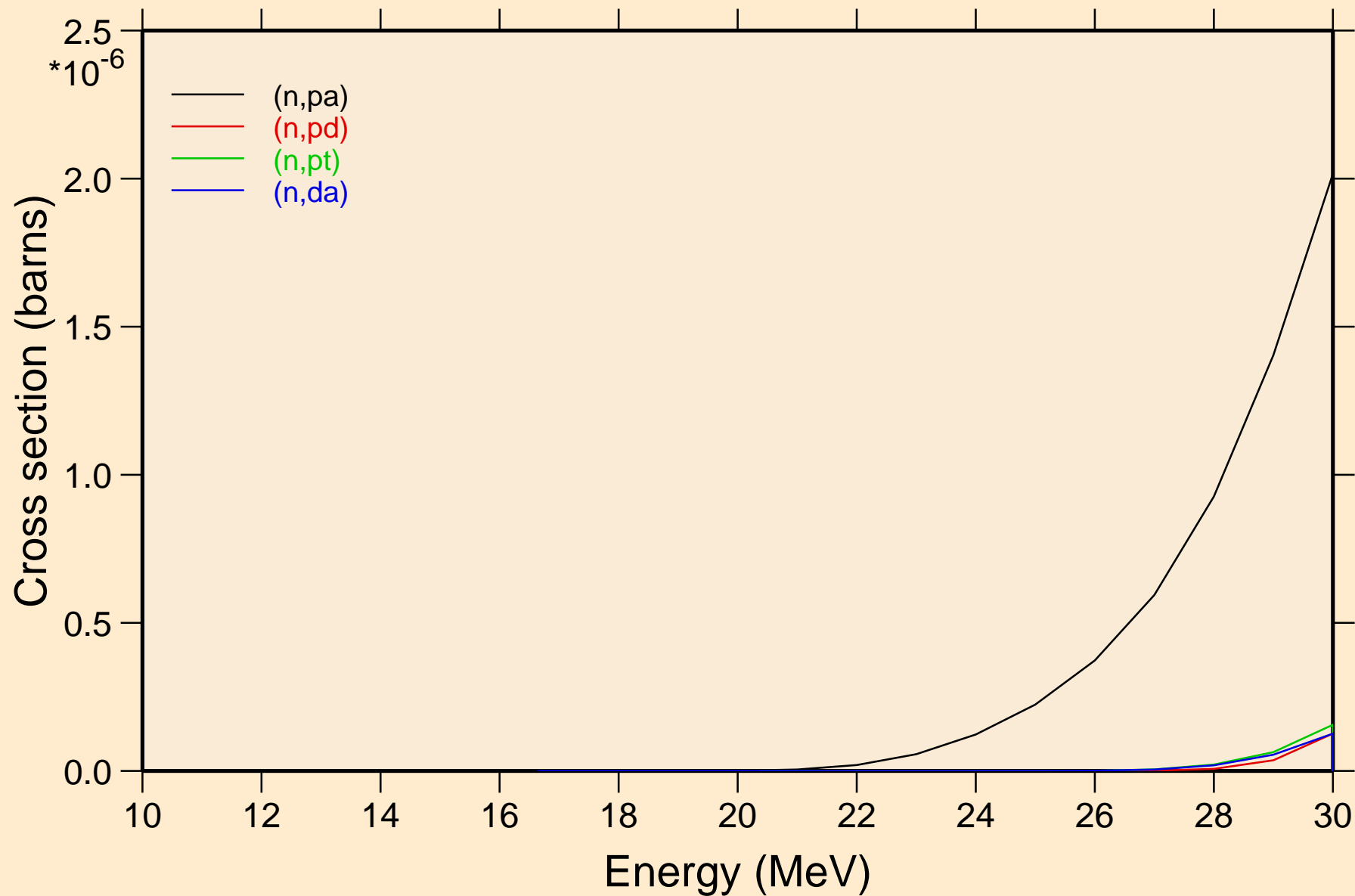

CO062M NEUTRON ACER TENDL-2019 LIBRARY; T=293.16K
Threshold reactions

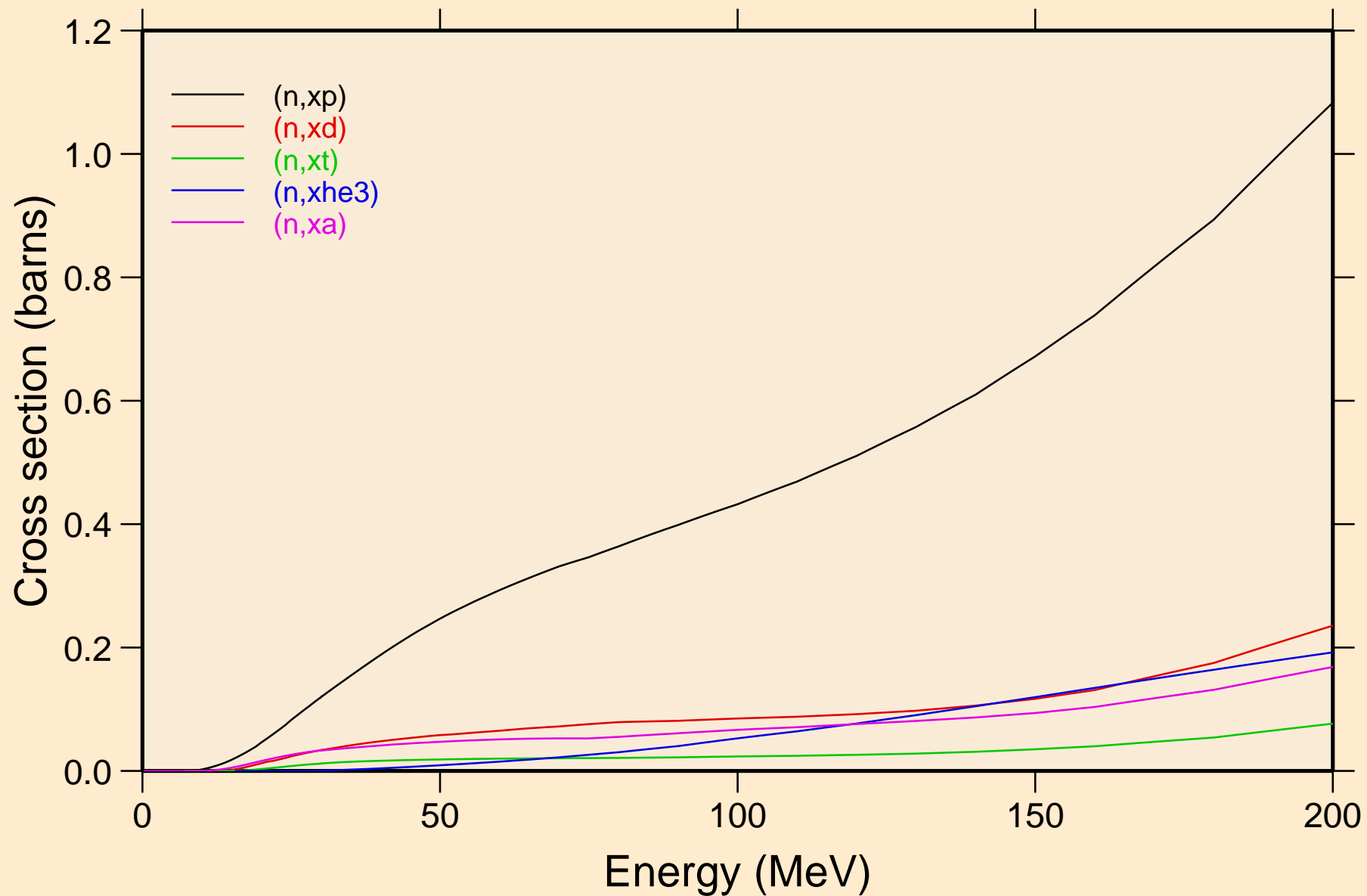

CO062M NEUTRON ACER TENDL-2019 LIBRARY; T=293.16K
angular distribution for elastic

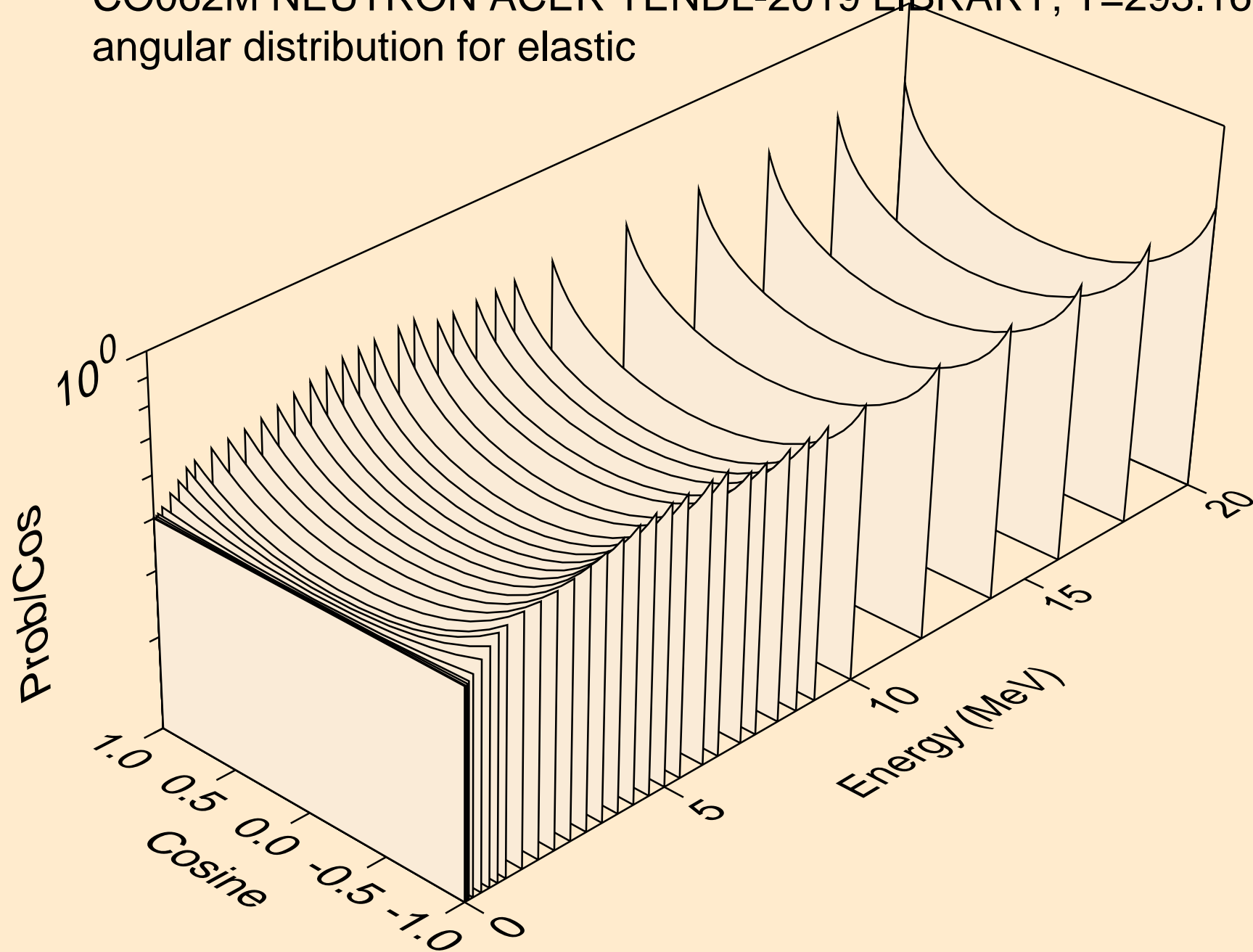

CO062M NEUTRON ACER TENDL-2019 LIBRARY; T=293.16K
angular distribution for elastic

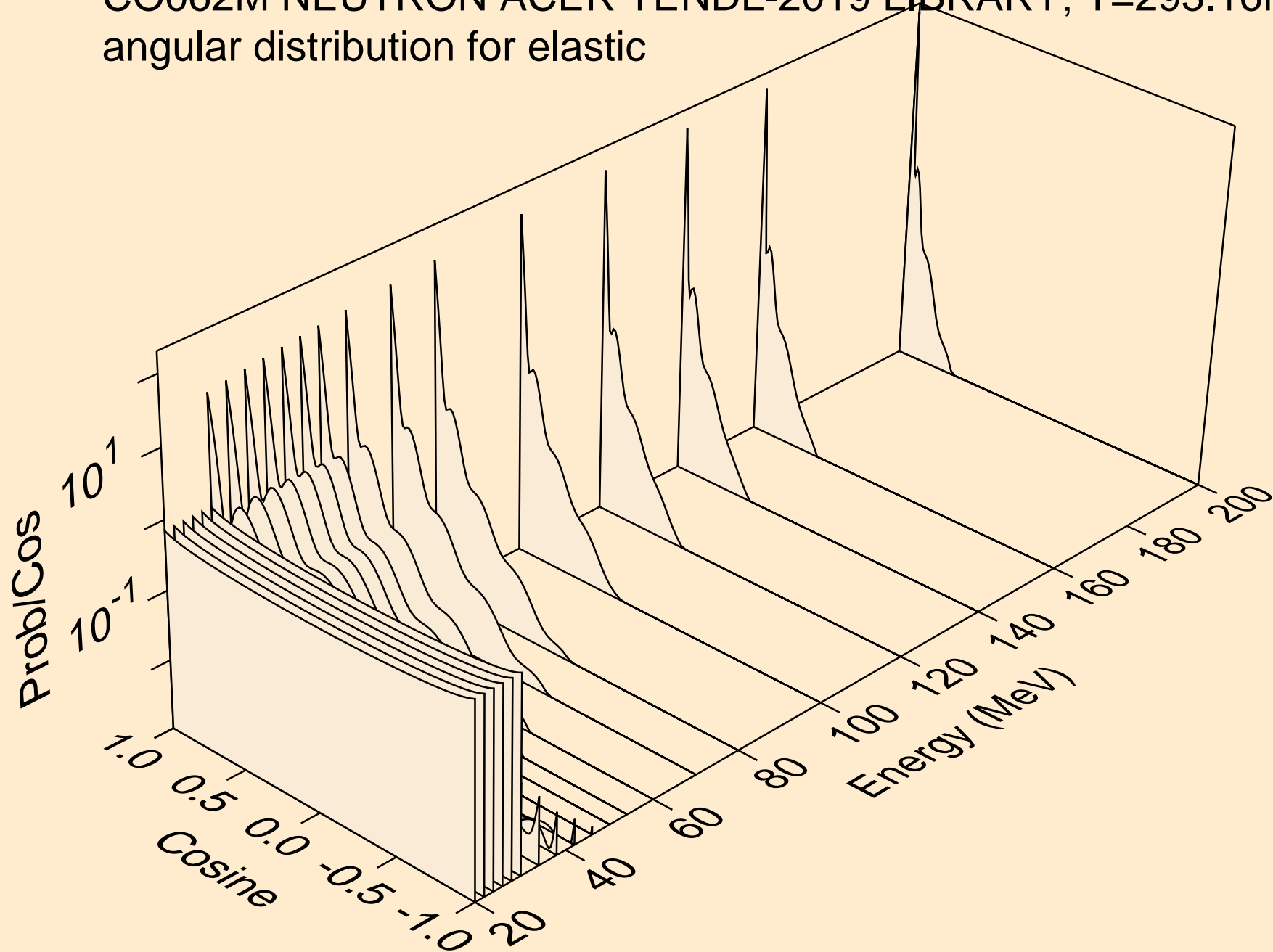

CO062M NEUTRON ACER TENDL-2019 LIBRARY; T=293.16K
angular distribution for (n,n*1)

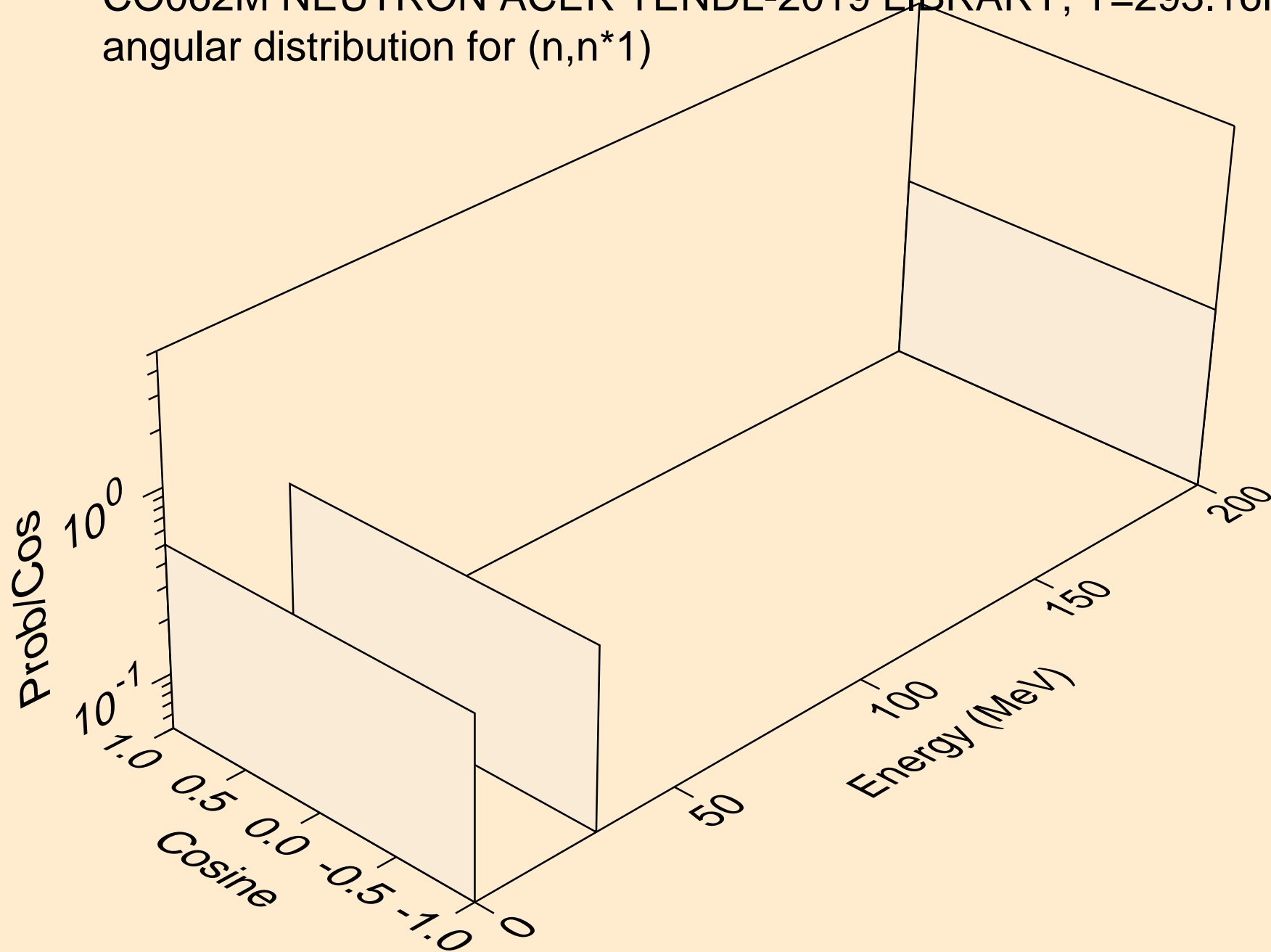

CO062M NEUTRON ACER TENDL-2019 LIBRARY; T=293.16K
angular distribution for (n,n*2)

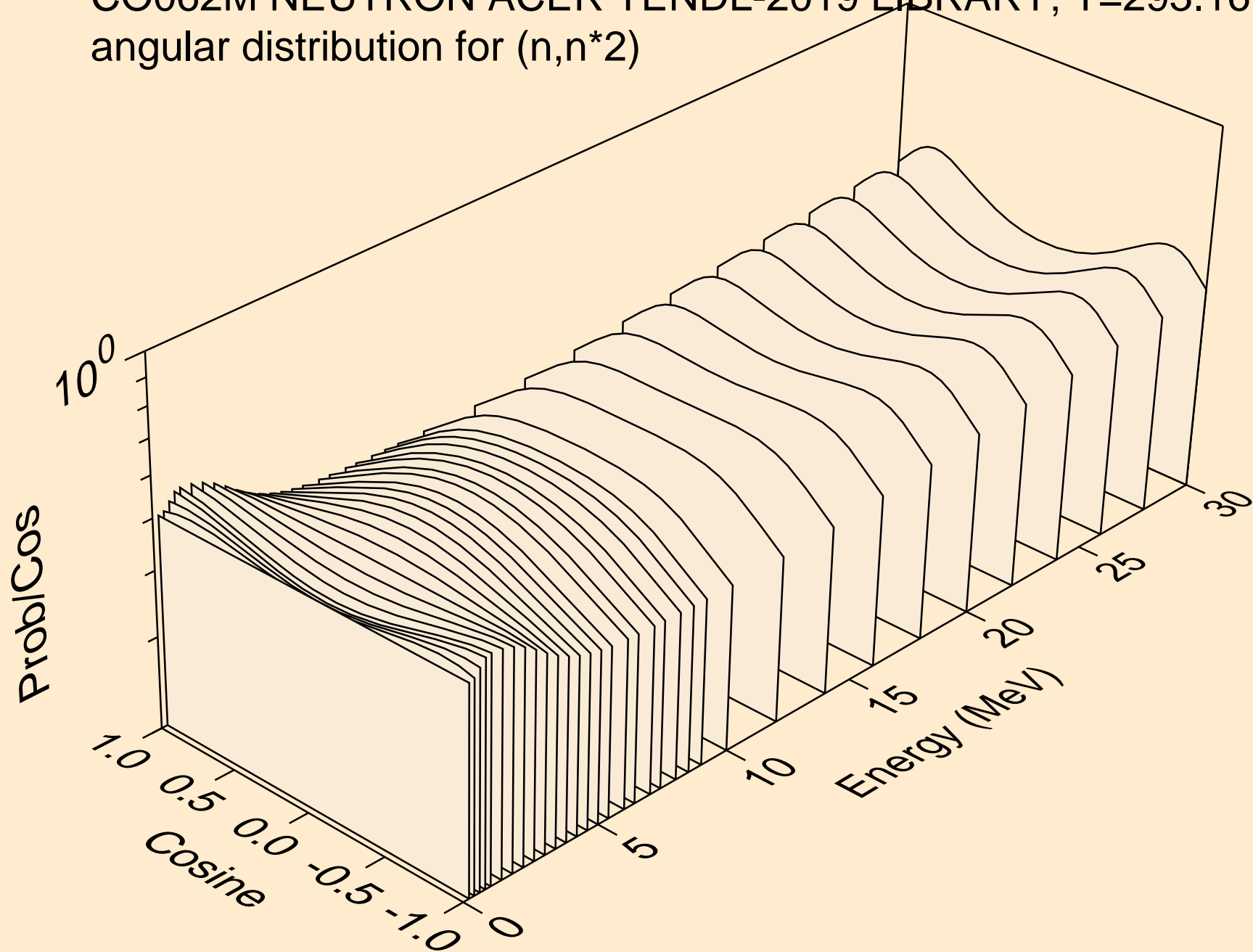

CO062M NEUTRON ACER TENDL-2019 LIBRARY; T=293.16K
angular distribution for (n,n*3)

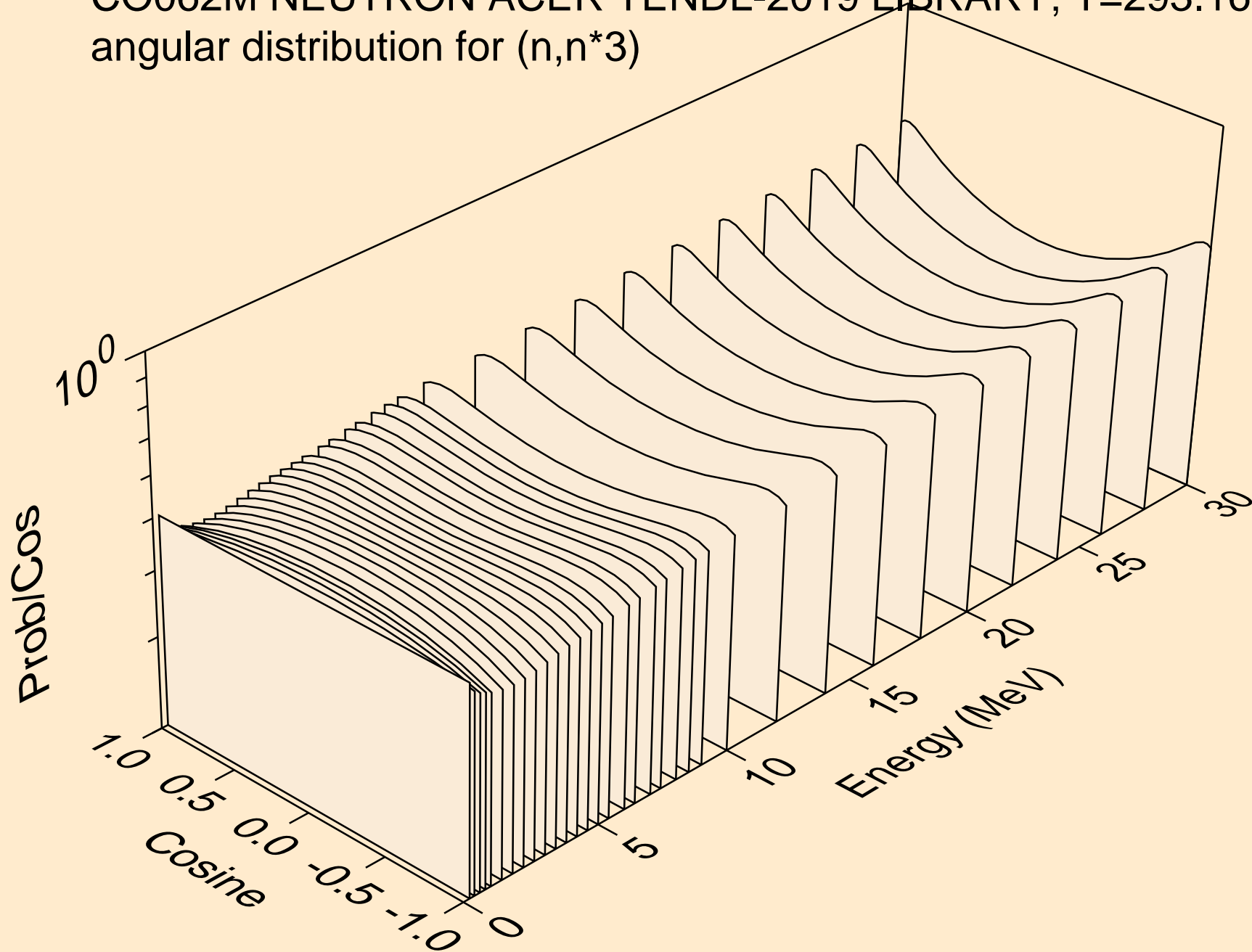

CO062M NEUTRON ACER TENDL-2019 LIBRARY; T=293.16K
angular distribution for (n,n*4)

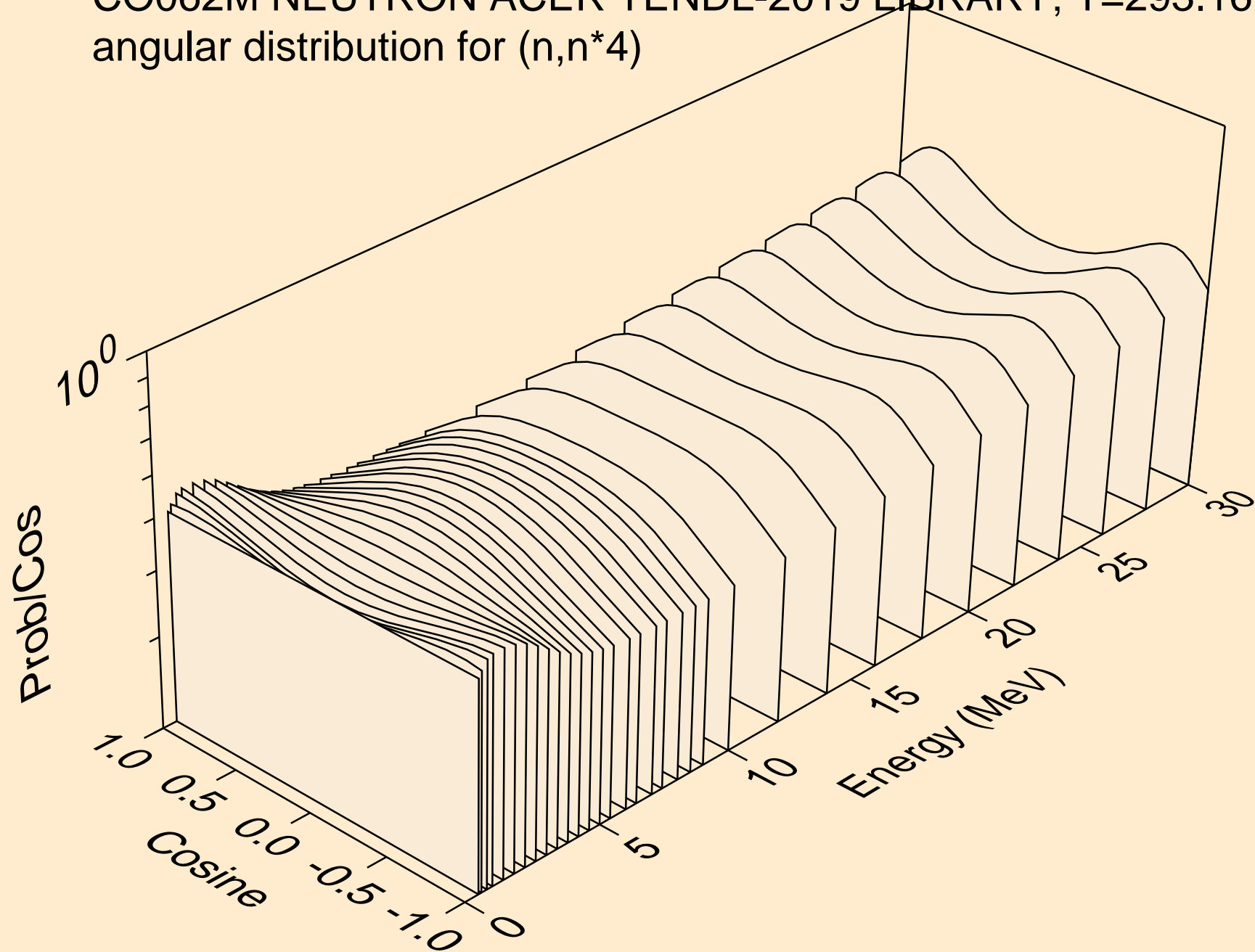

CO062M NEUTRON ACER TENDL-2019 LIBRARY; T=293.16K
angular distribution for (n,n*5)

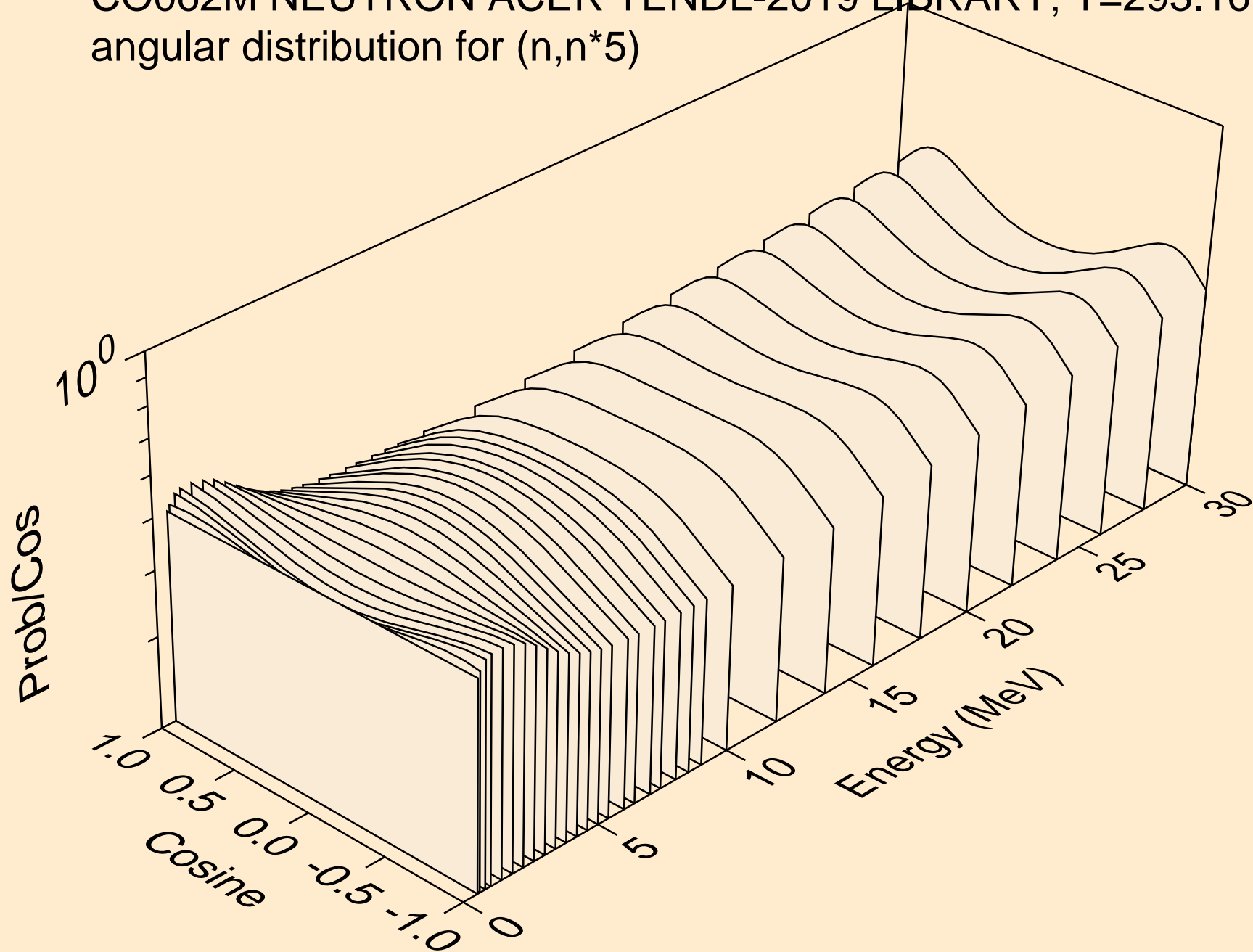

CO062M NEUTRON ACER TENDL-2019 LIBRARY; T=293.16K
angular distribution for (n,n*6)

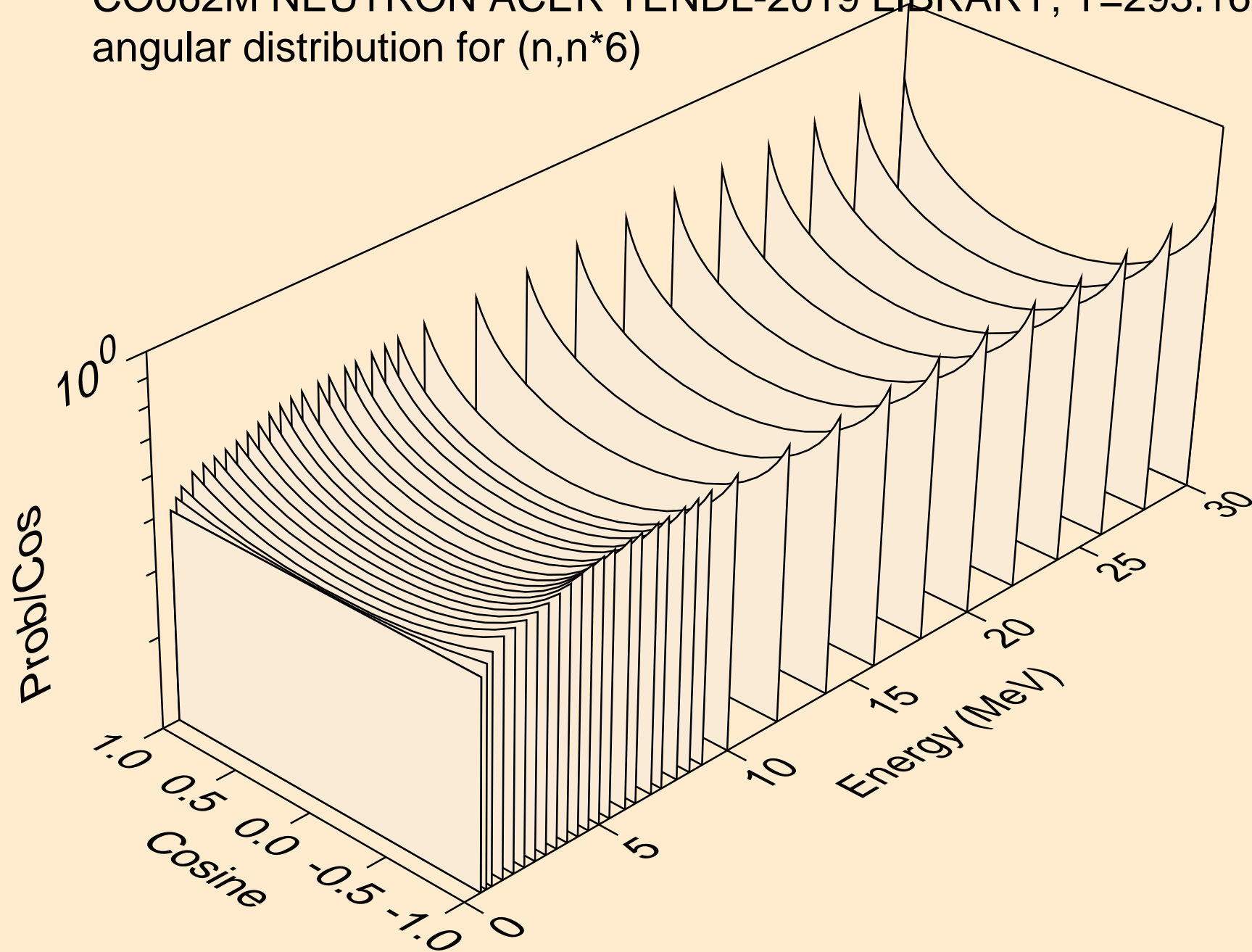

CO062M NEUTRON ACER TENDL-2019 LIBRARY; T=293.16K
angular distribution for (n,n*7)

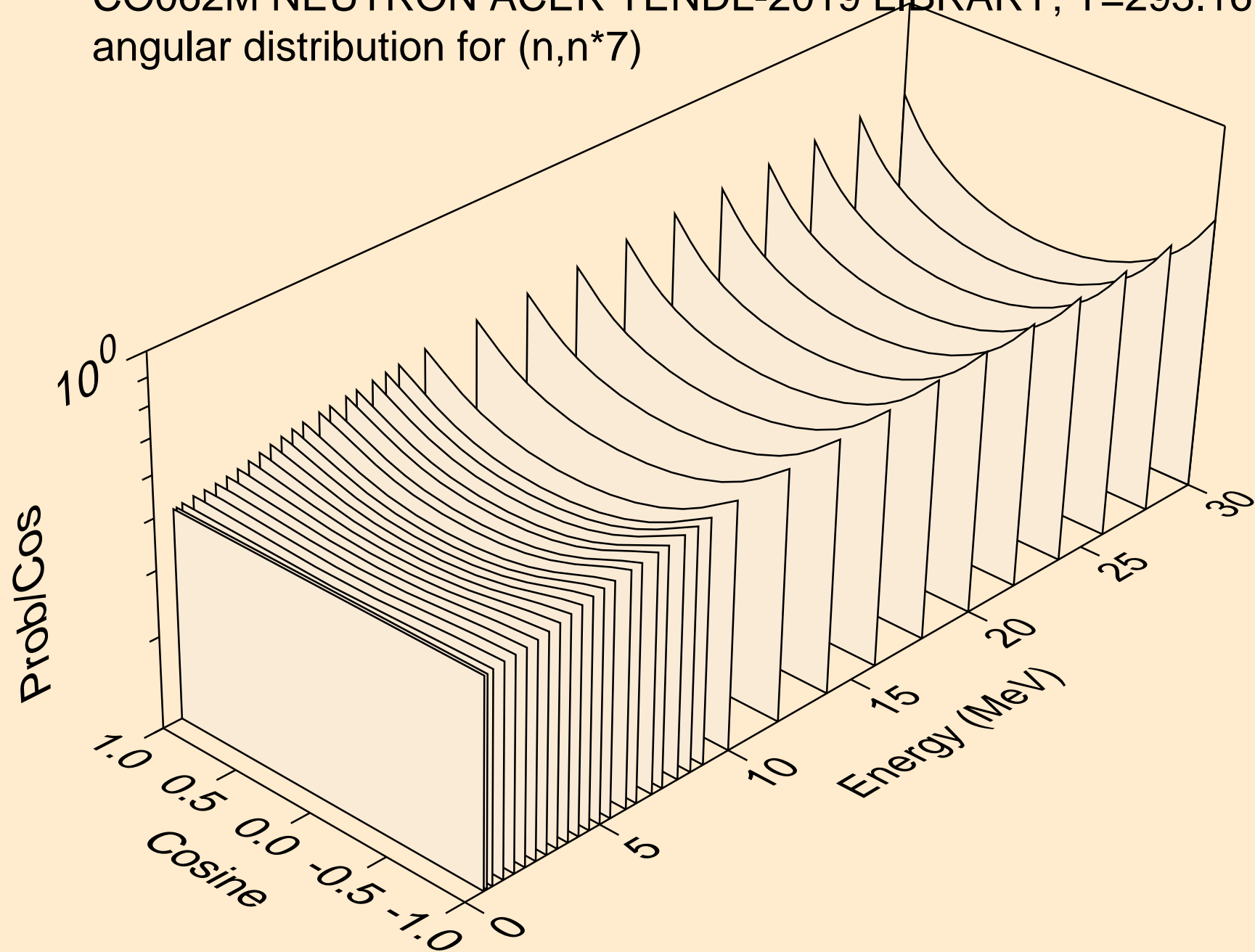

CO062M NEUTRON ACER TENDL-2019 LIBRARY; T=293.16K
angular distribution for (n,n*8)

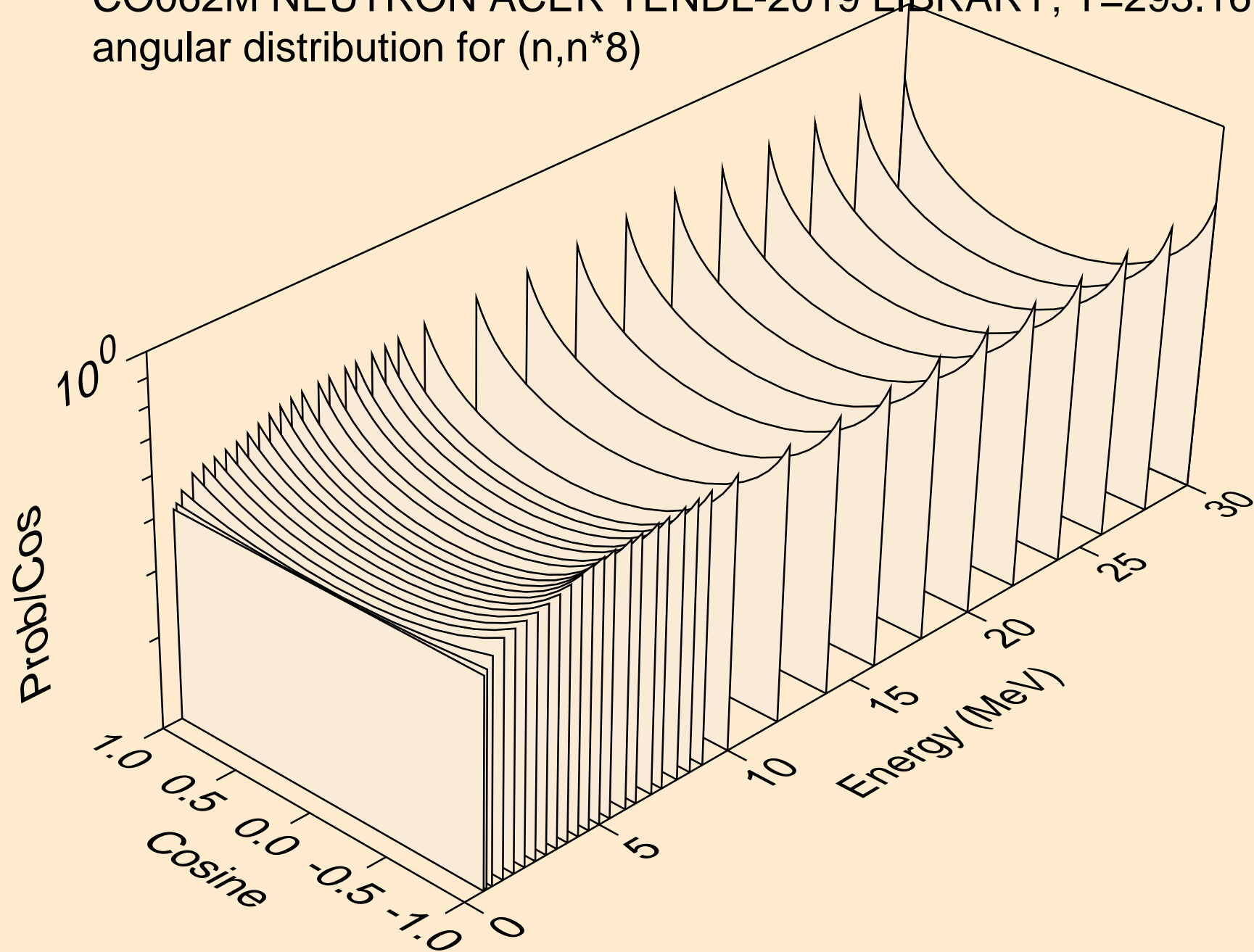

CO062M NEUTRON ACER TENDL-2019 LIBRARY; T=293.16K
angular distribution for (n,n*9)

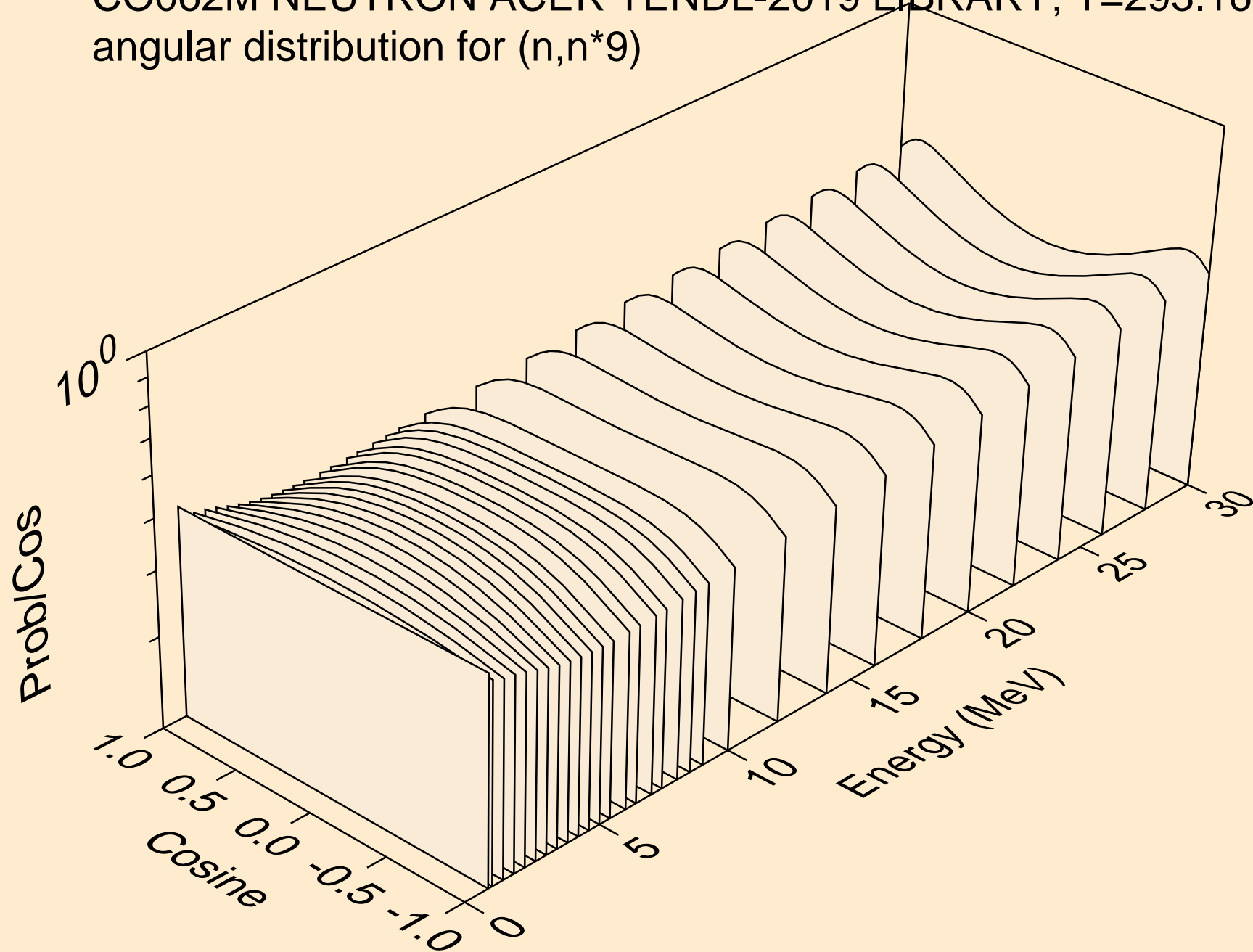

CO062M NEUTRON ACER TENDL-2019 LIBRARY; T=293.16K
angular distribution for (n,n*10)

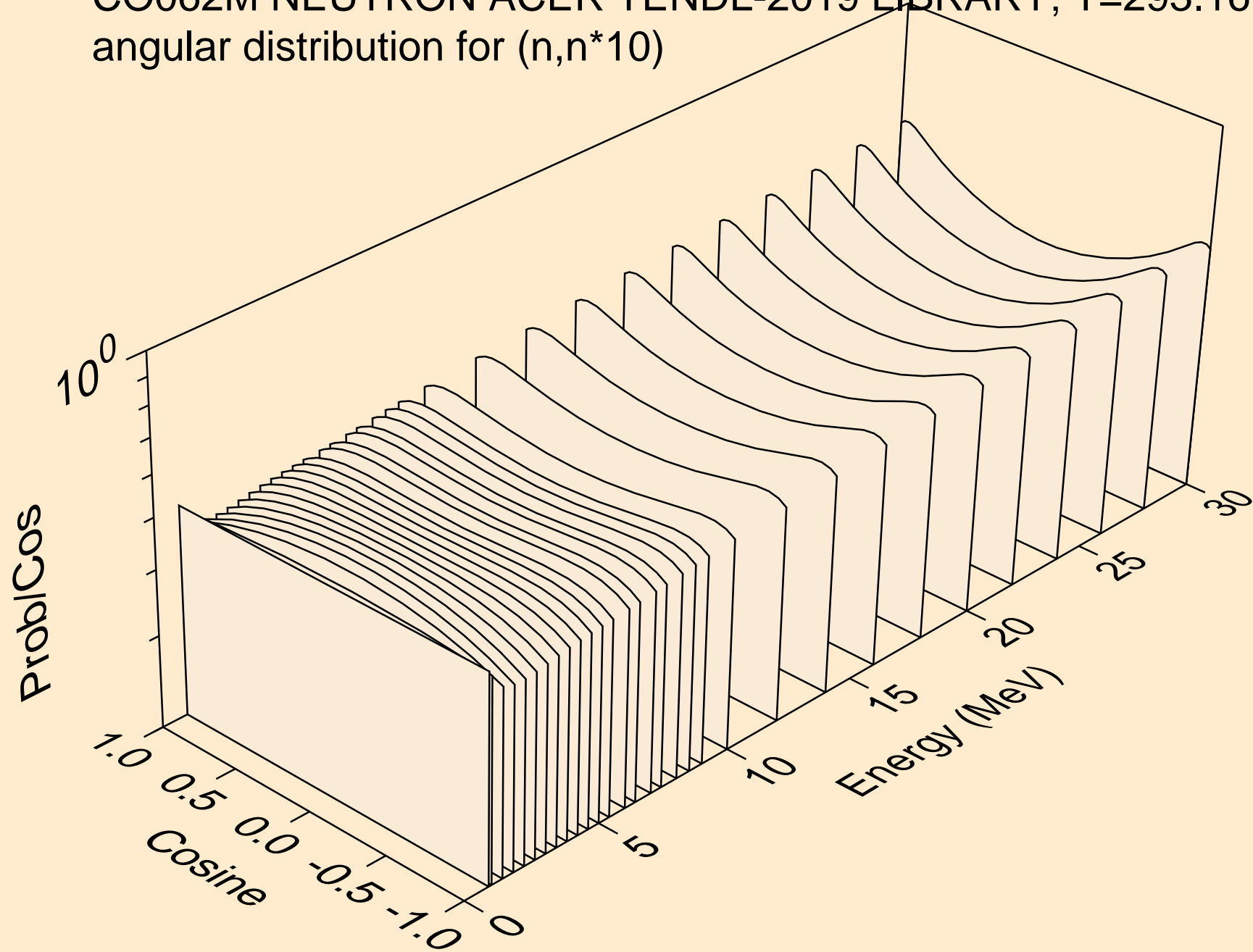

CO062M NEUTRON ACER TENDL-2019 LIBRARY; T=293.16K
angular distribution for (n,n*11)

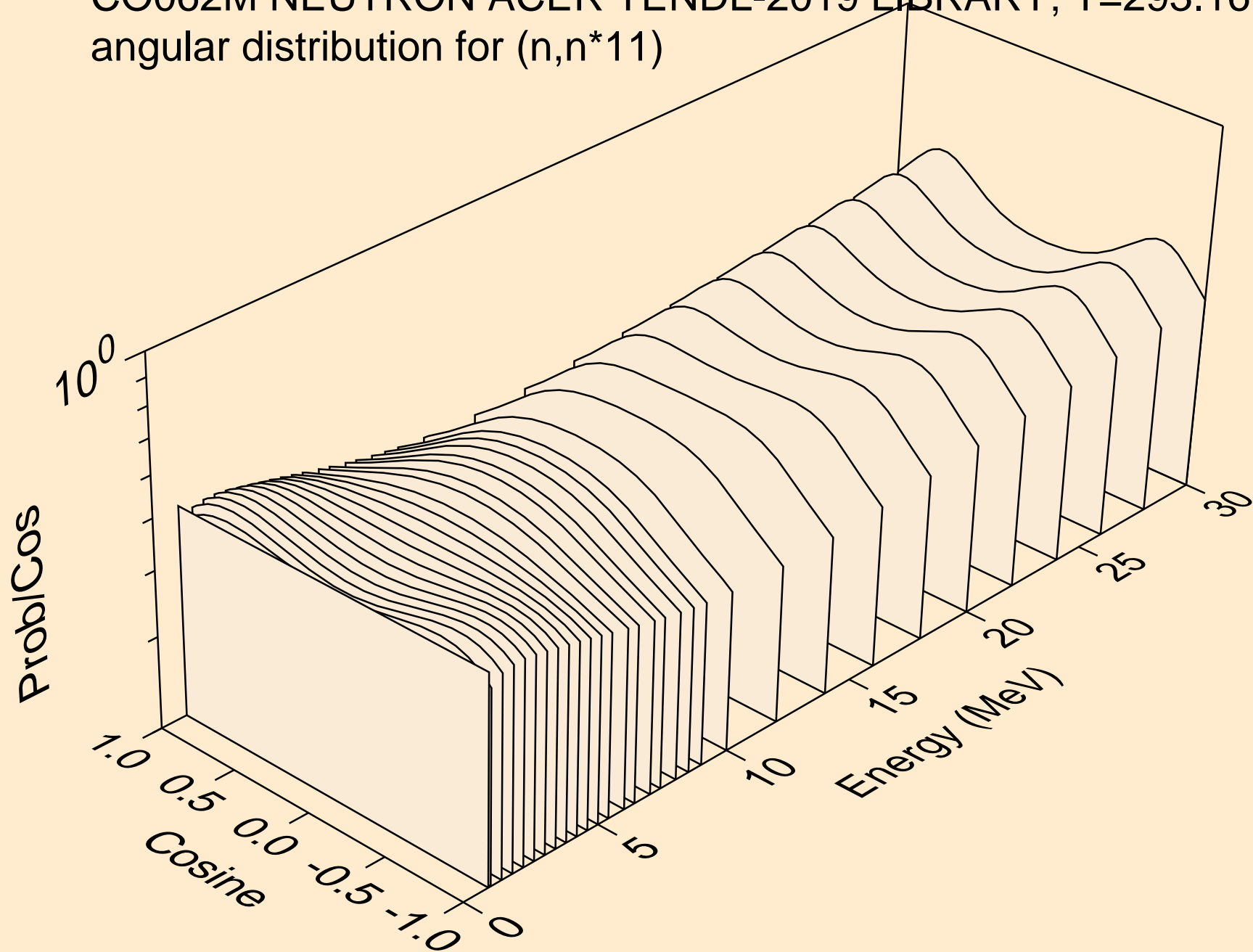

CO062M NEUTRON ACER TENDL-2019 LIBRARY; T=293.16K
angular distribution for (n,n*12)

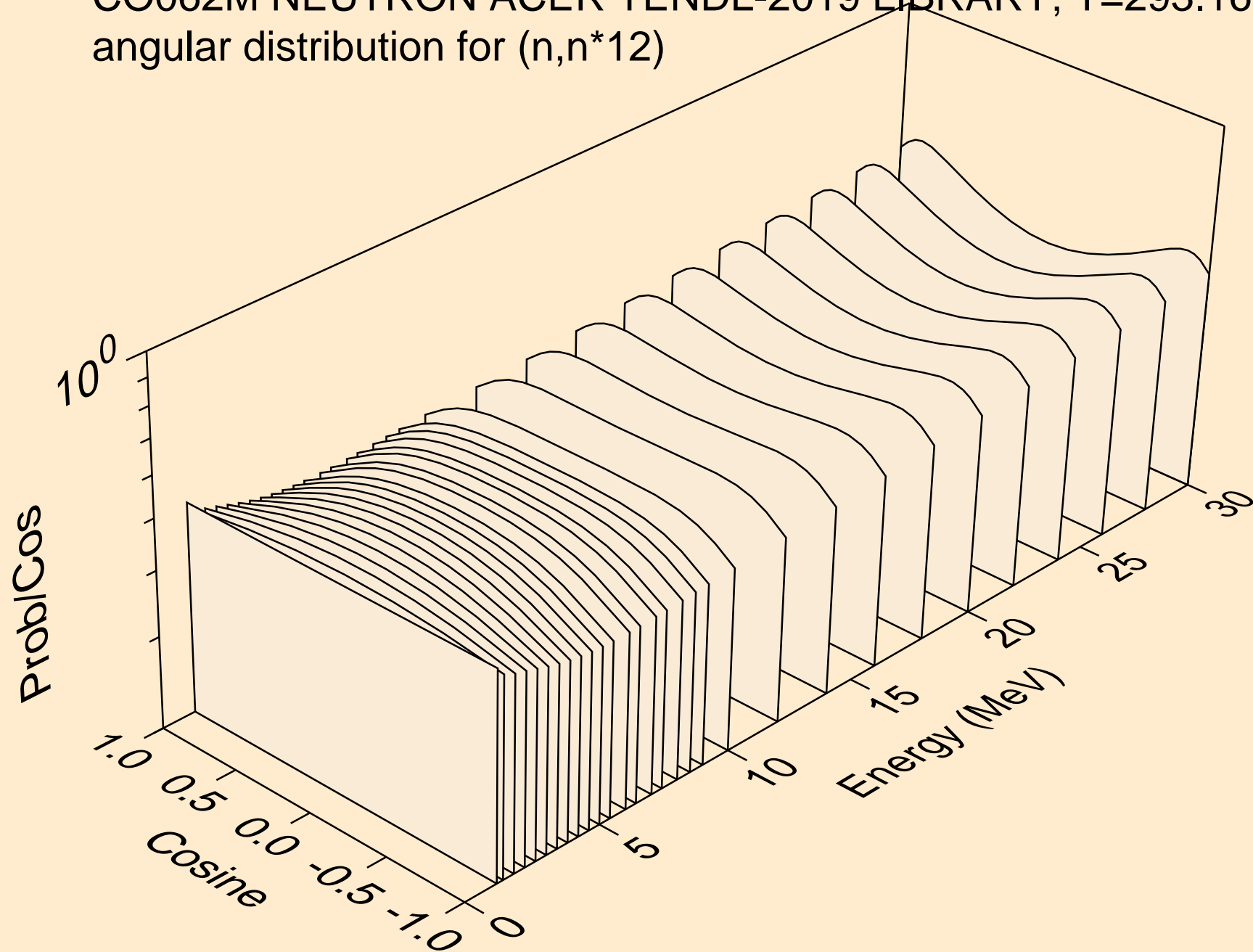

CO062M NEUTRON ACER TENDL-2019 LIBRARY; T=293.16K
angular distribution for (n,n*13)

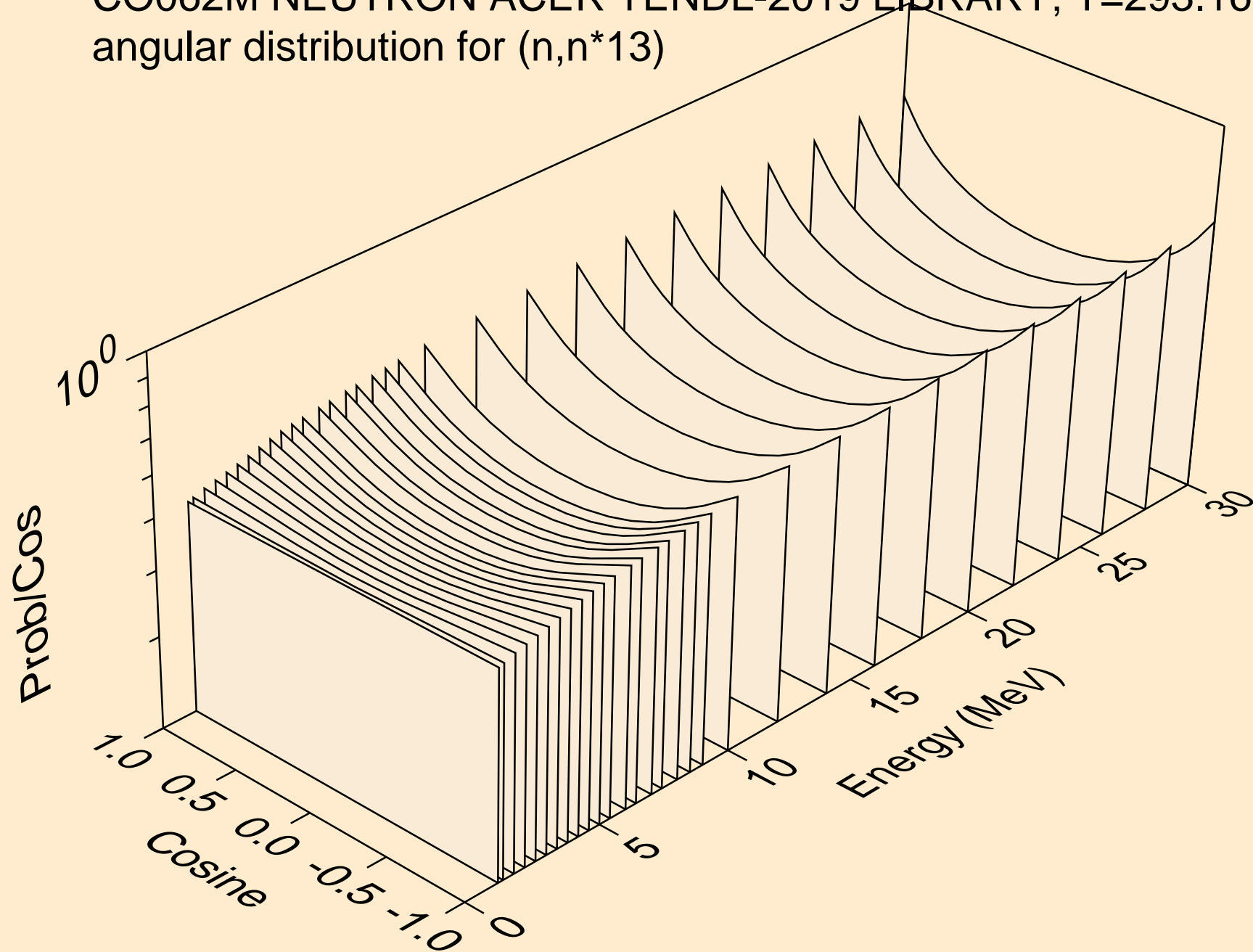

CO062M NEUTRON ACER TENDL-2019 LIBRARY; T=293.16K
angular distribution for (n,n*14)

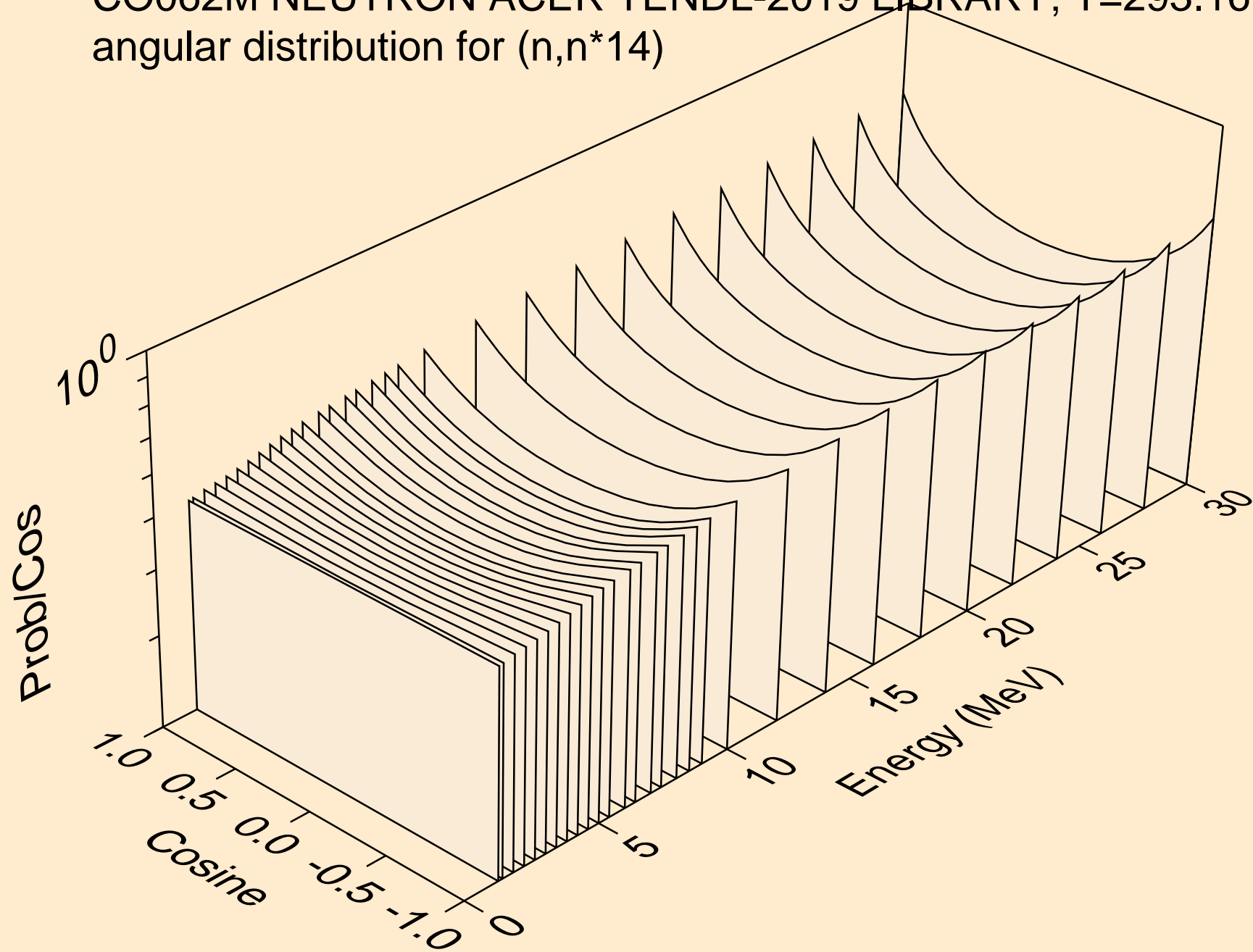

CO062M NEUTRON ACER TENDL-2019 LIBRARY; T=293.16K
angular distribution for (n,n*15)

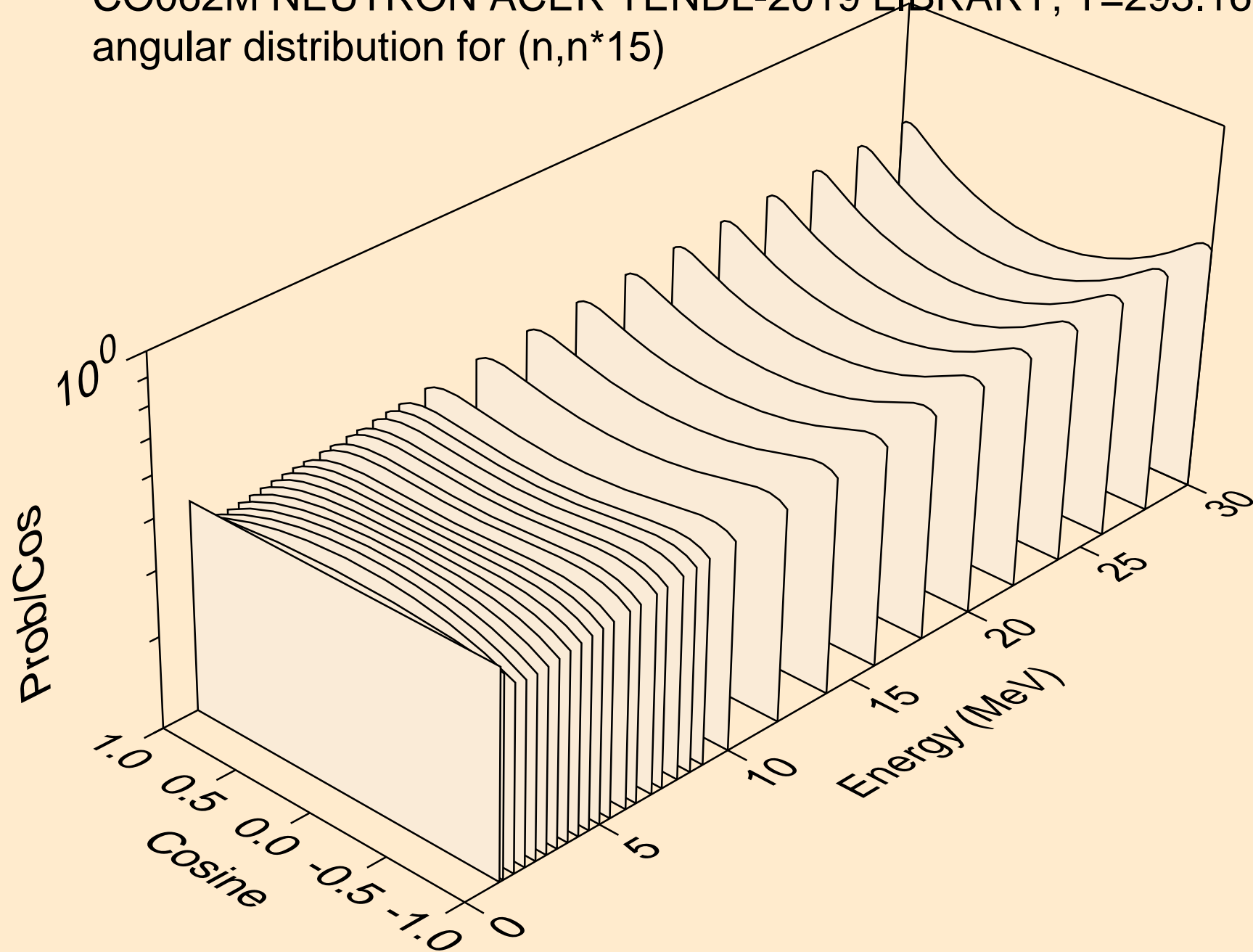

CO062M NEUTRON ACER TENDL-2019 LIBRARY; T=293.16K
angular distribution for (n,n*16)

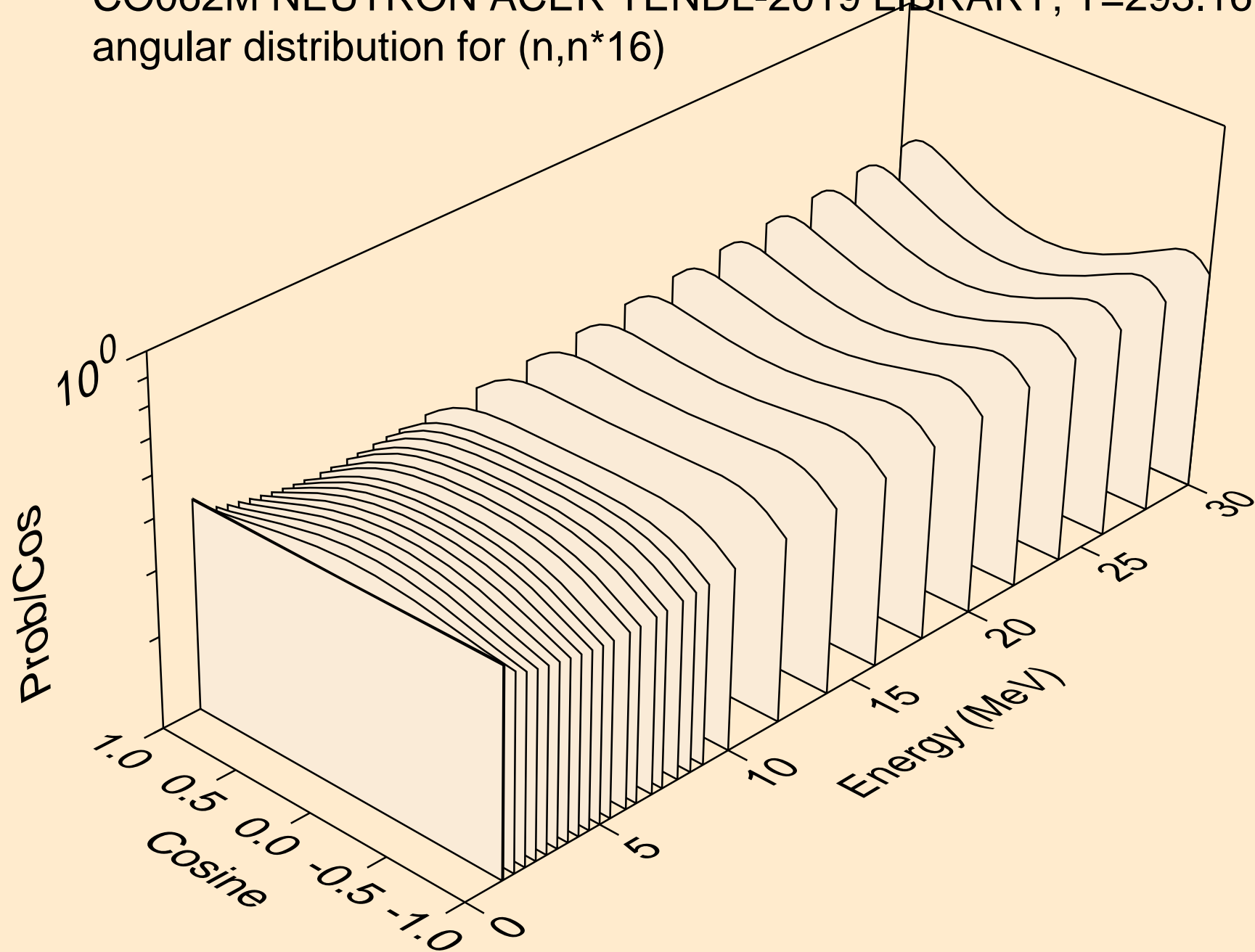

CO062M NEUTRON ACER TENDL-2019 LIBRARY; T=293.16K
angular distribution for (n,n*17)

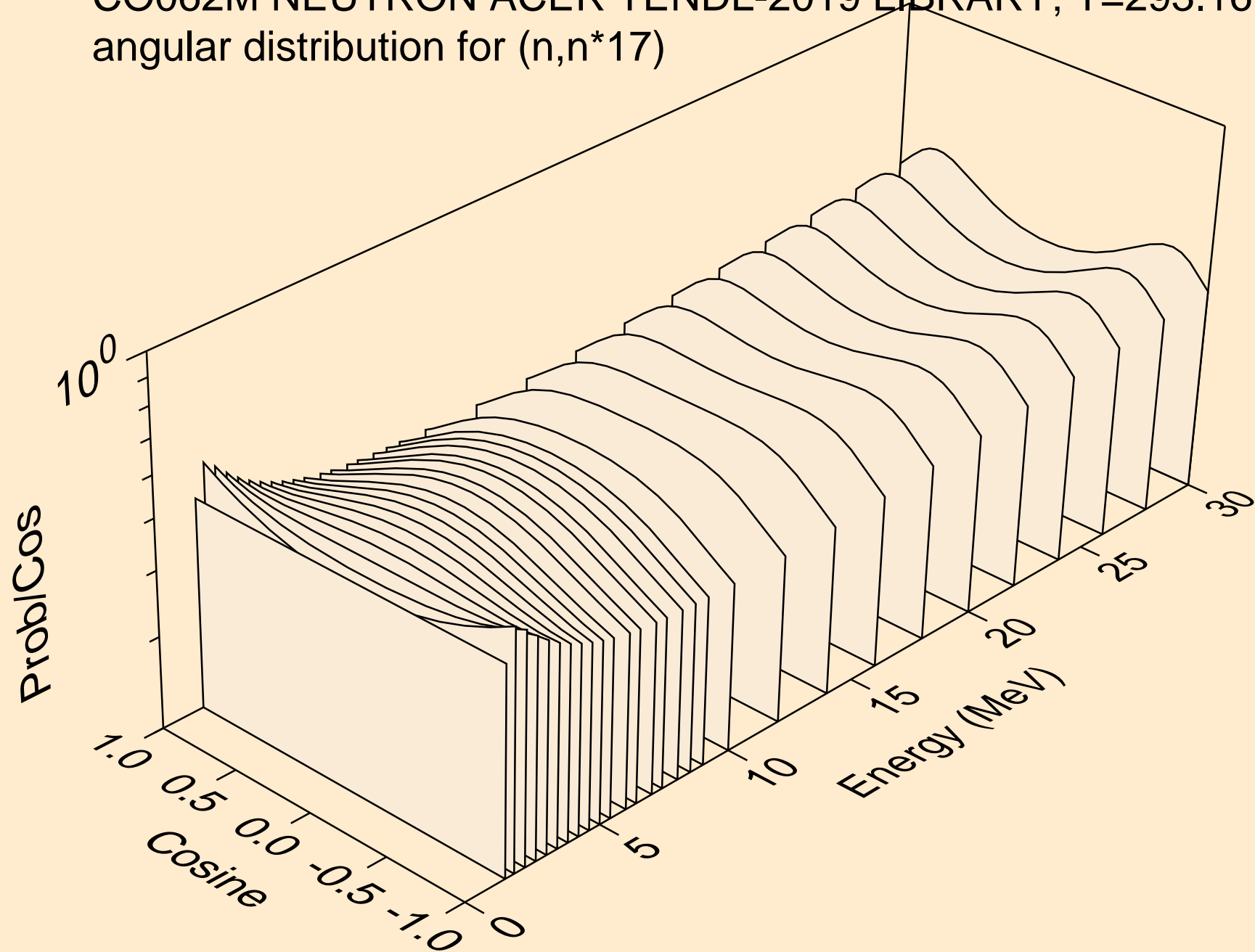

CO062M NEUTRON ACER TENDL-2019 LIBRARY; T=293.16K
angular distribution for (n,n*18)

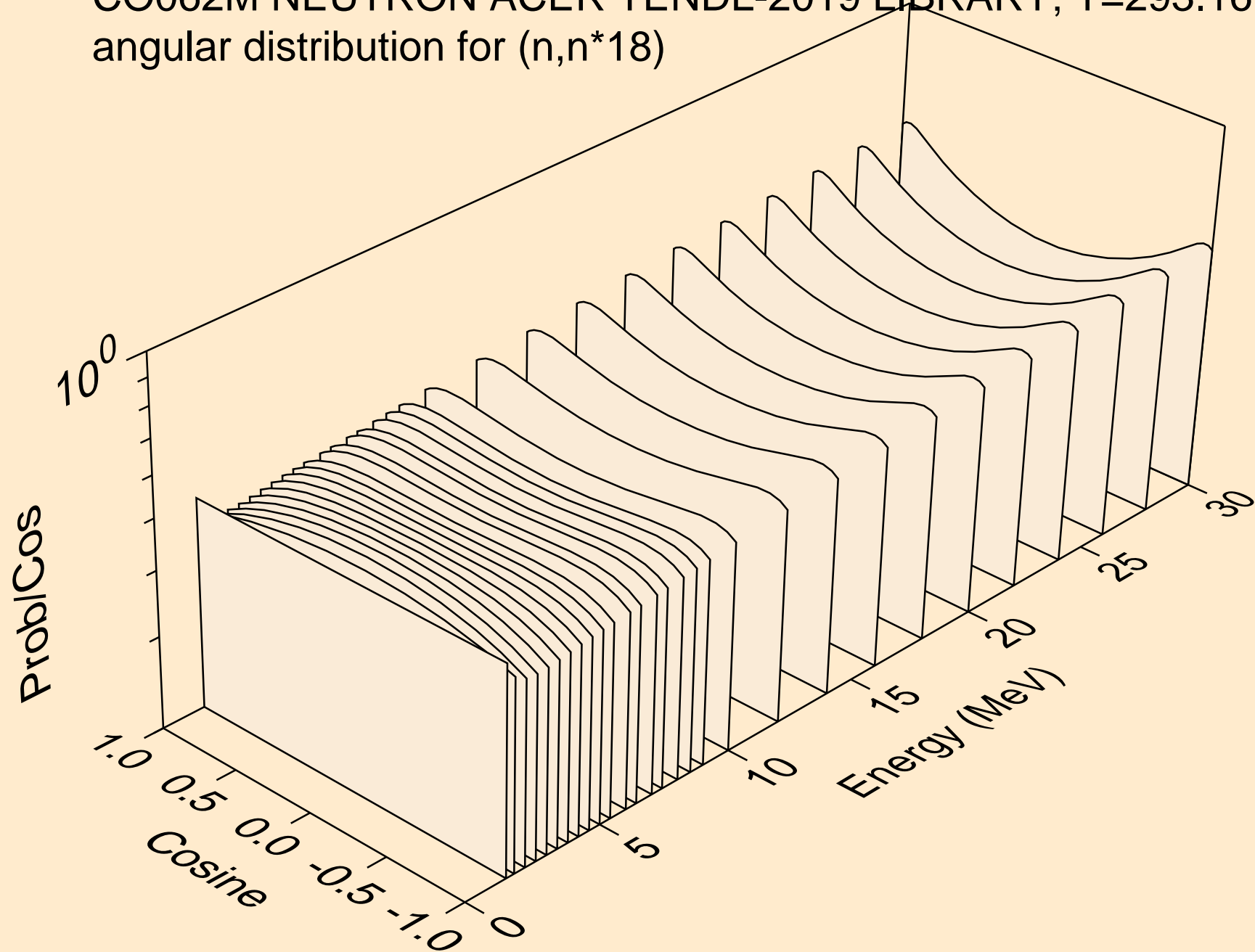

CO062M NEUTRON ACER TENDL-2019 LIBRARY; T=293.16K
angular distribution for (n,n*19)

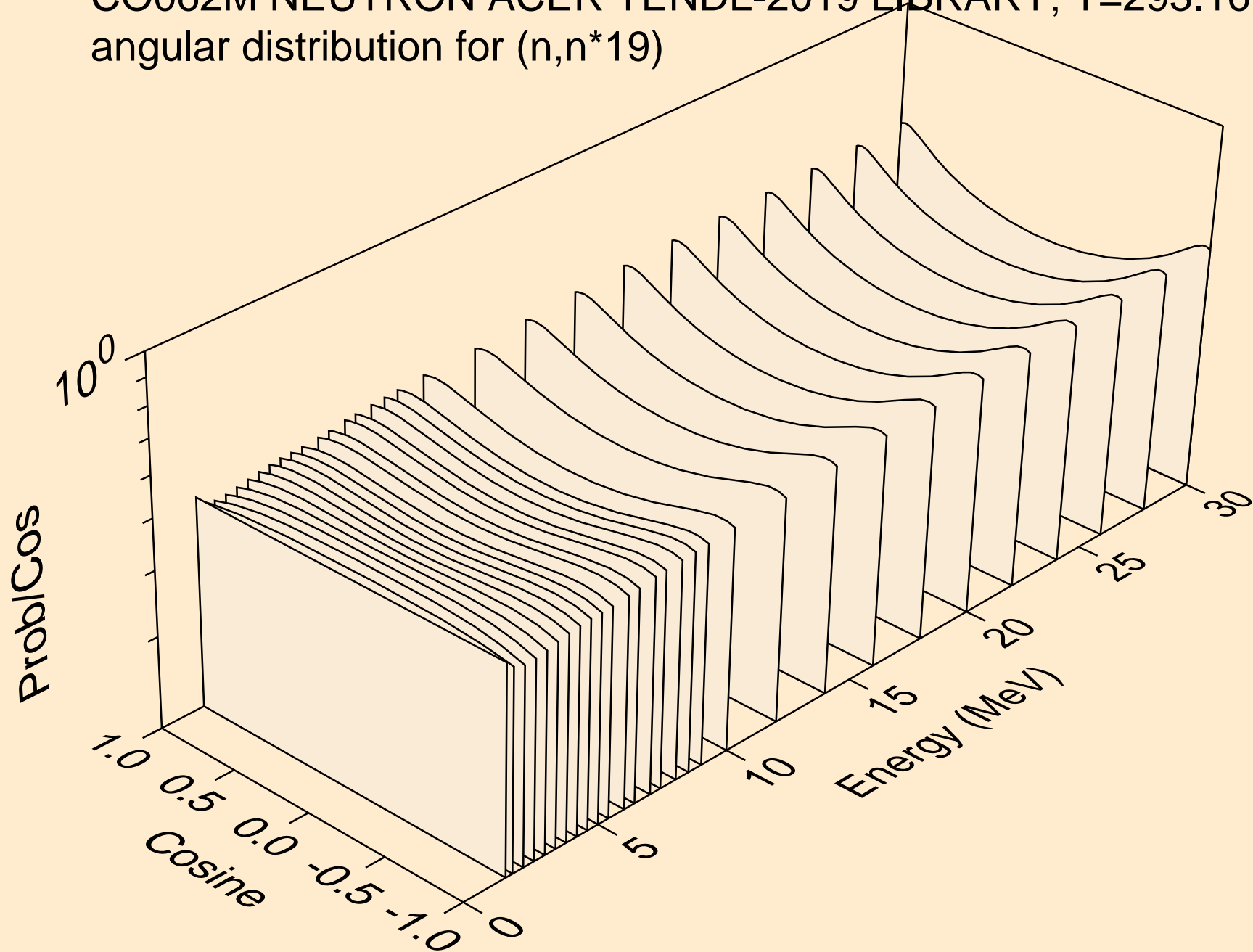

CO062M NEUTRON ACER TENDL-2019 LIBRARY; T=293.16K
angular distribution for (n,n*20)

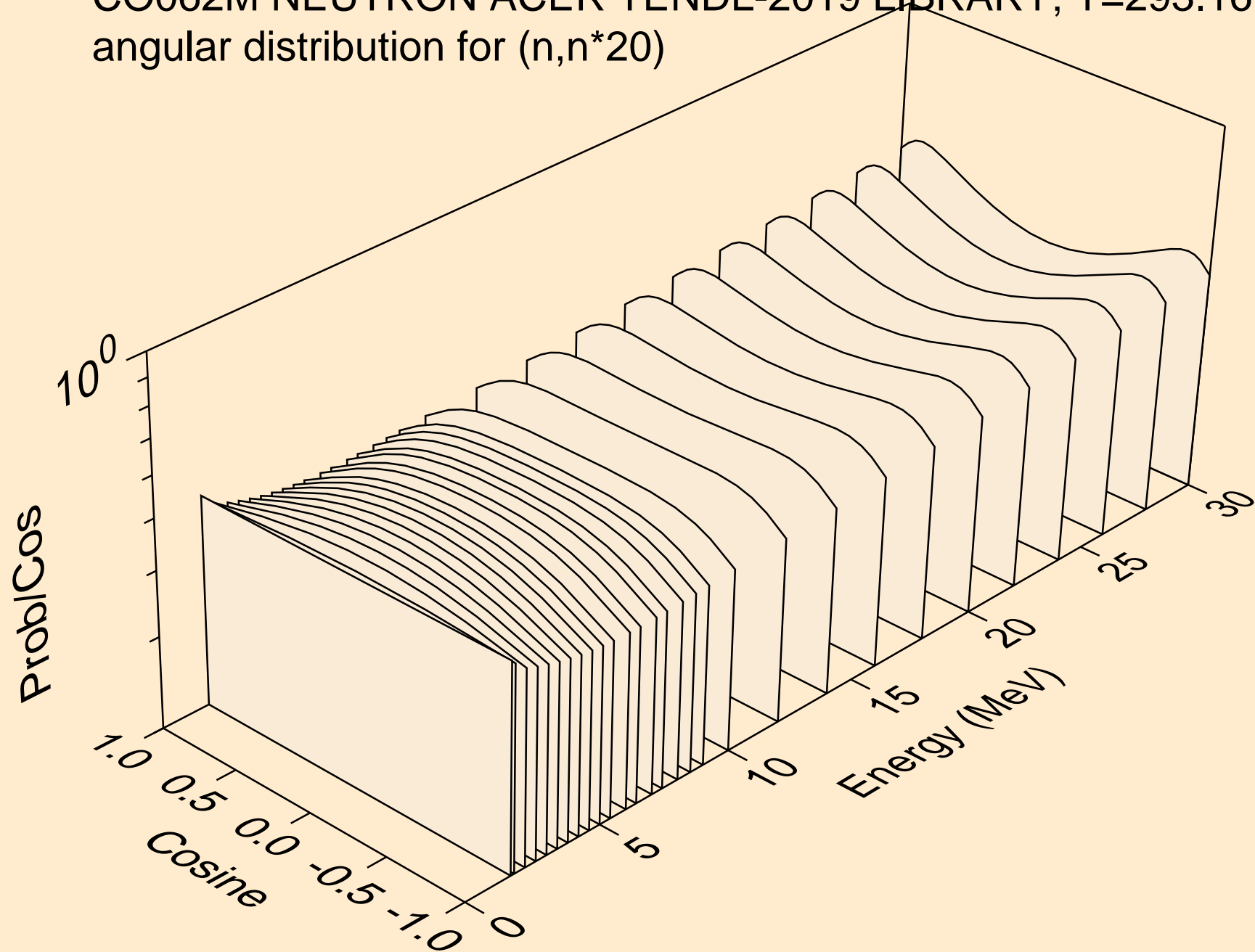

CO062M NEUTRON ACER TENDL-2019 LIBRARY; T=293.16K
angular distribution for (n,n*21)

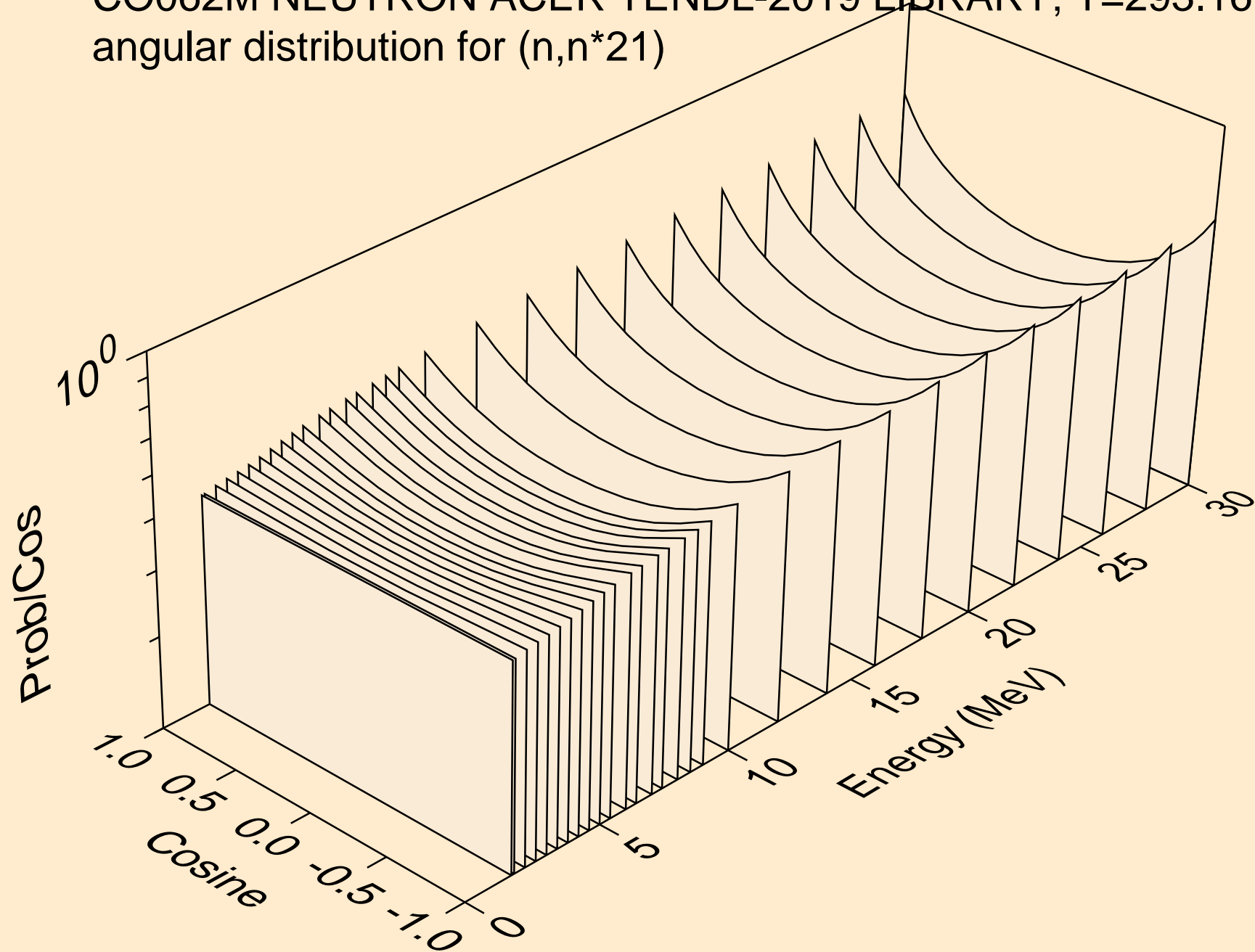

CO062M NEUTRON ACER TENDL-2019 LIBRARY; T=293.16K
angular distribution for (n,n*22)

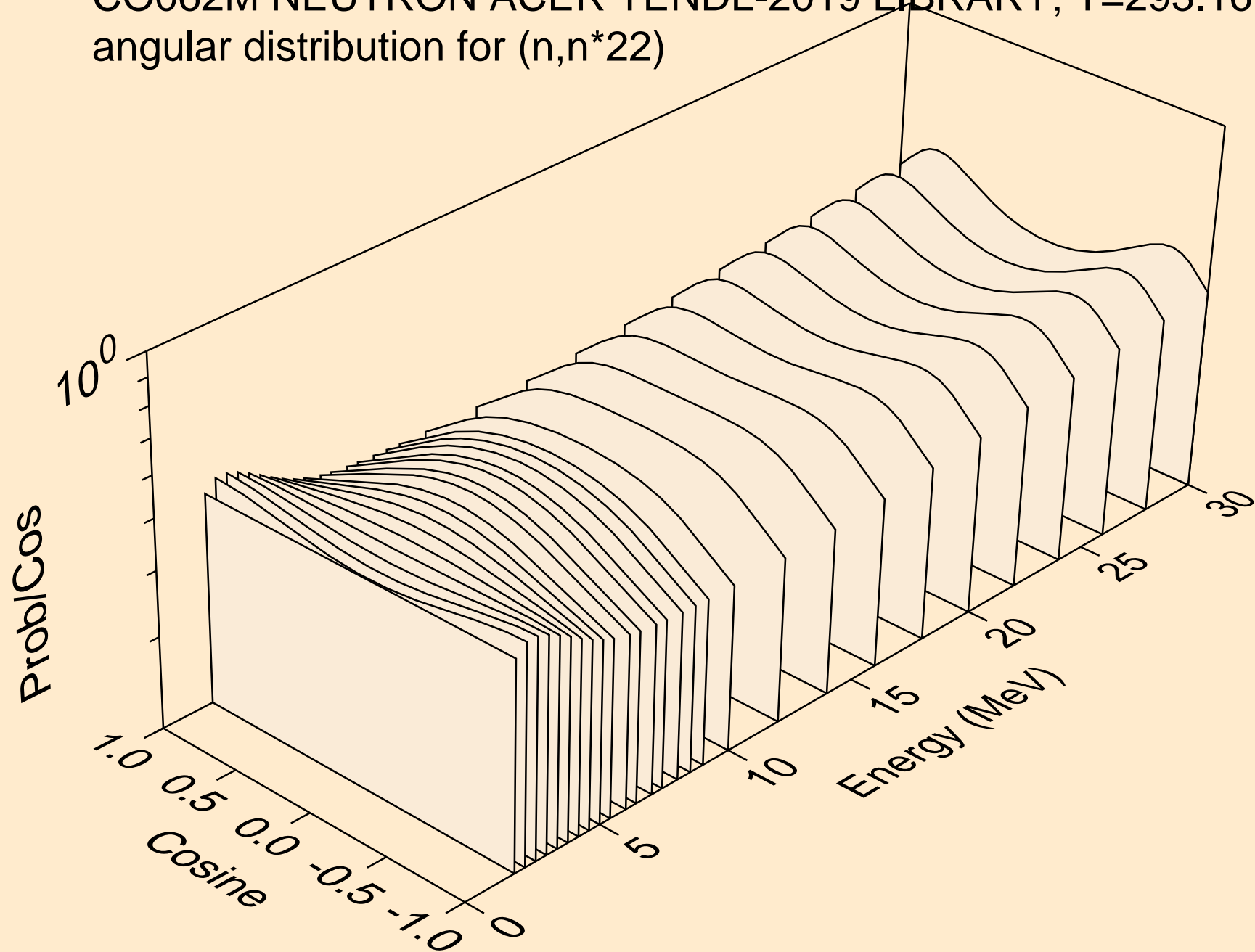

CO062M NEUTRON ACER TENDL-2019 LIBRARY; T=293.16K
angular distribution for (n,n*23)

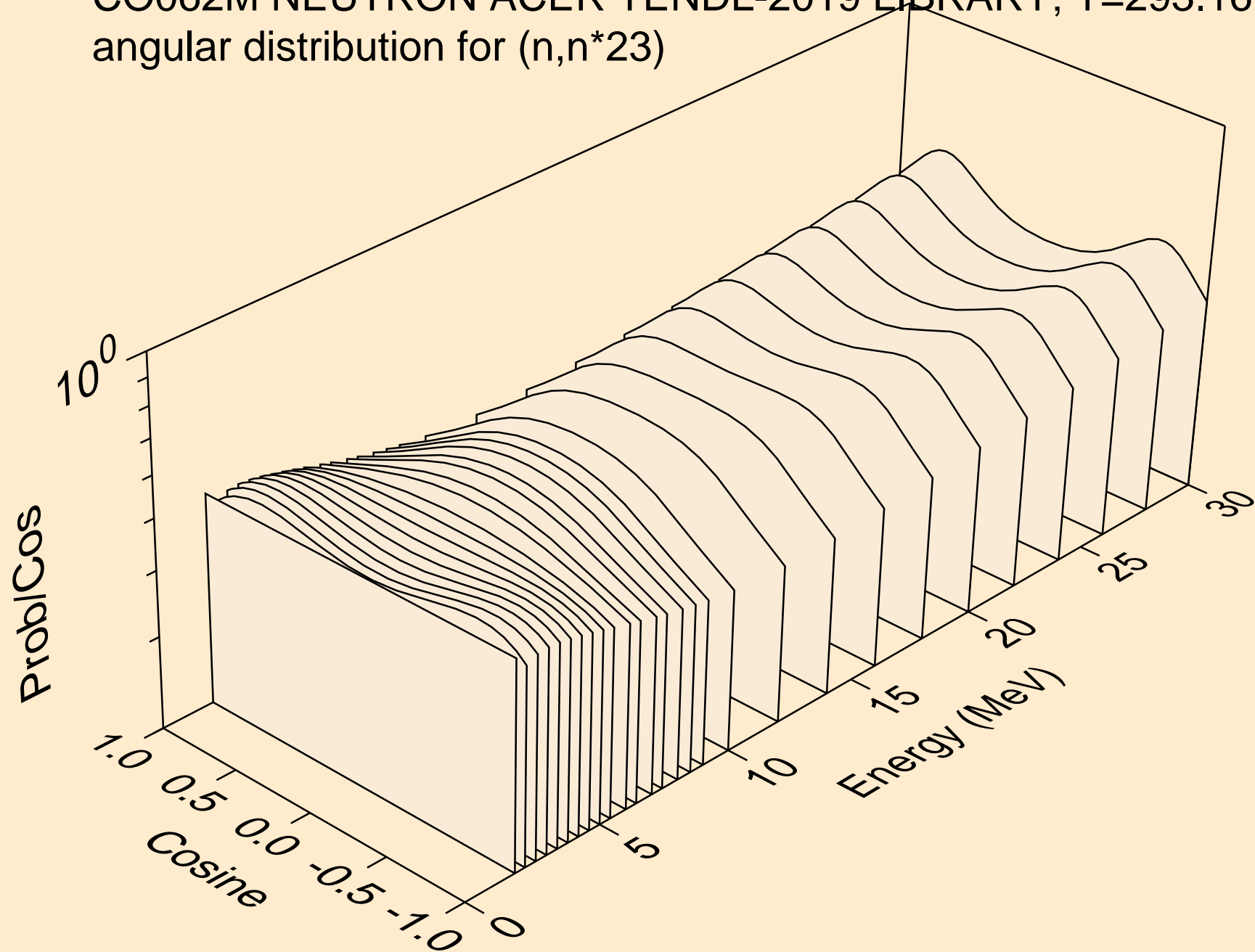

CO062M NEUTRON ACER TENDL-2019 LIBRARY; T=293.16K
angular distribution for (n,n*24)

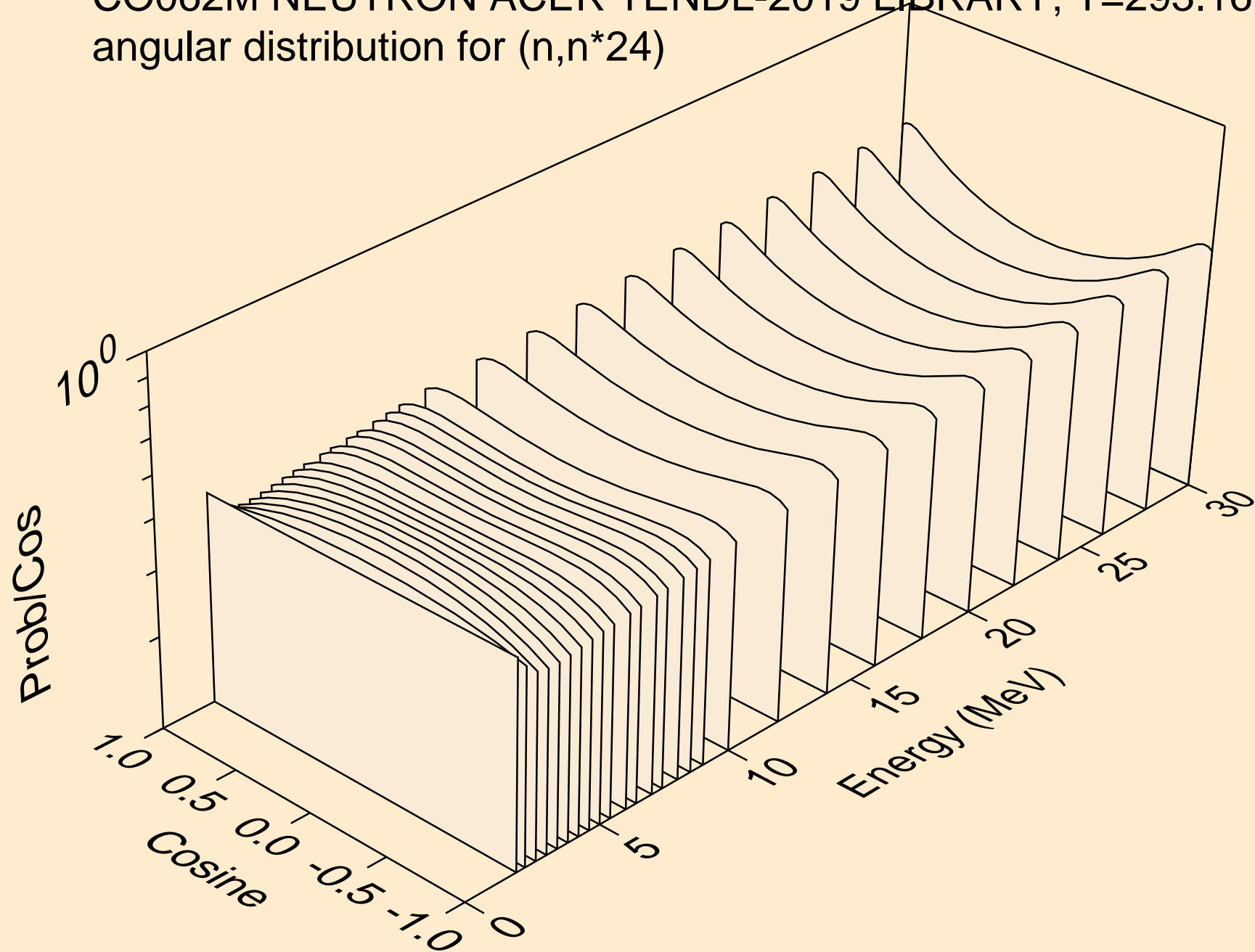

CO062M NEUTRON ACER TENDL-2019 LIBRARY; T=293.16K
angular distribution for (n,n*25)

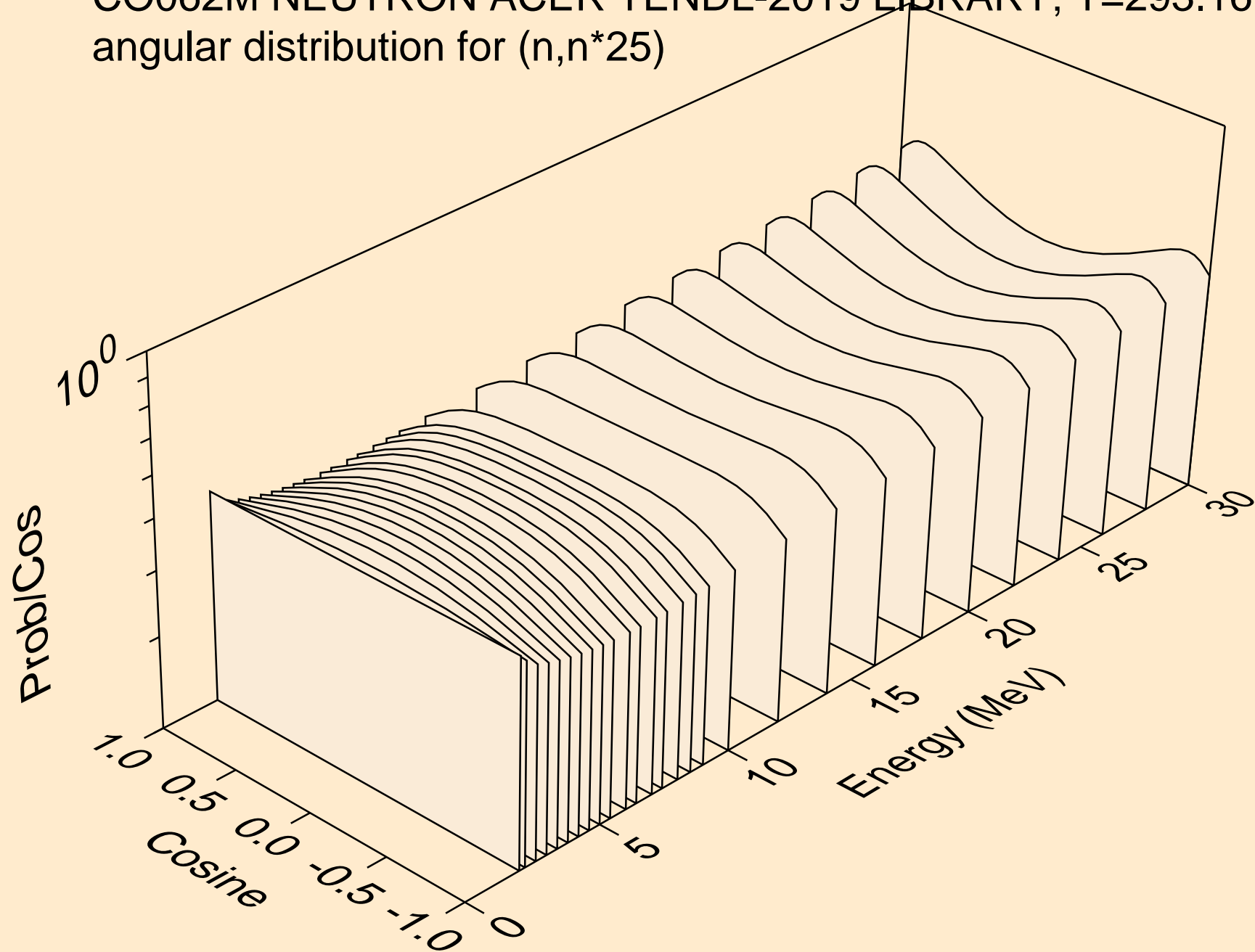

CO062M NEUTRON ACER TENDL-2019 LIBRARY; T=293.16K
angular distribution for (n,n*26)

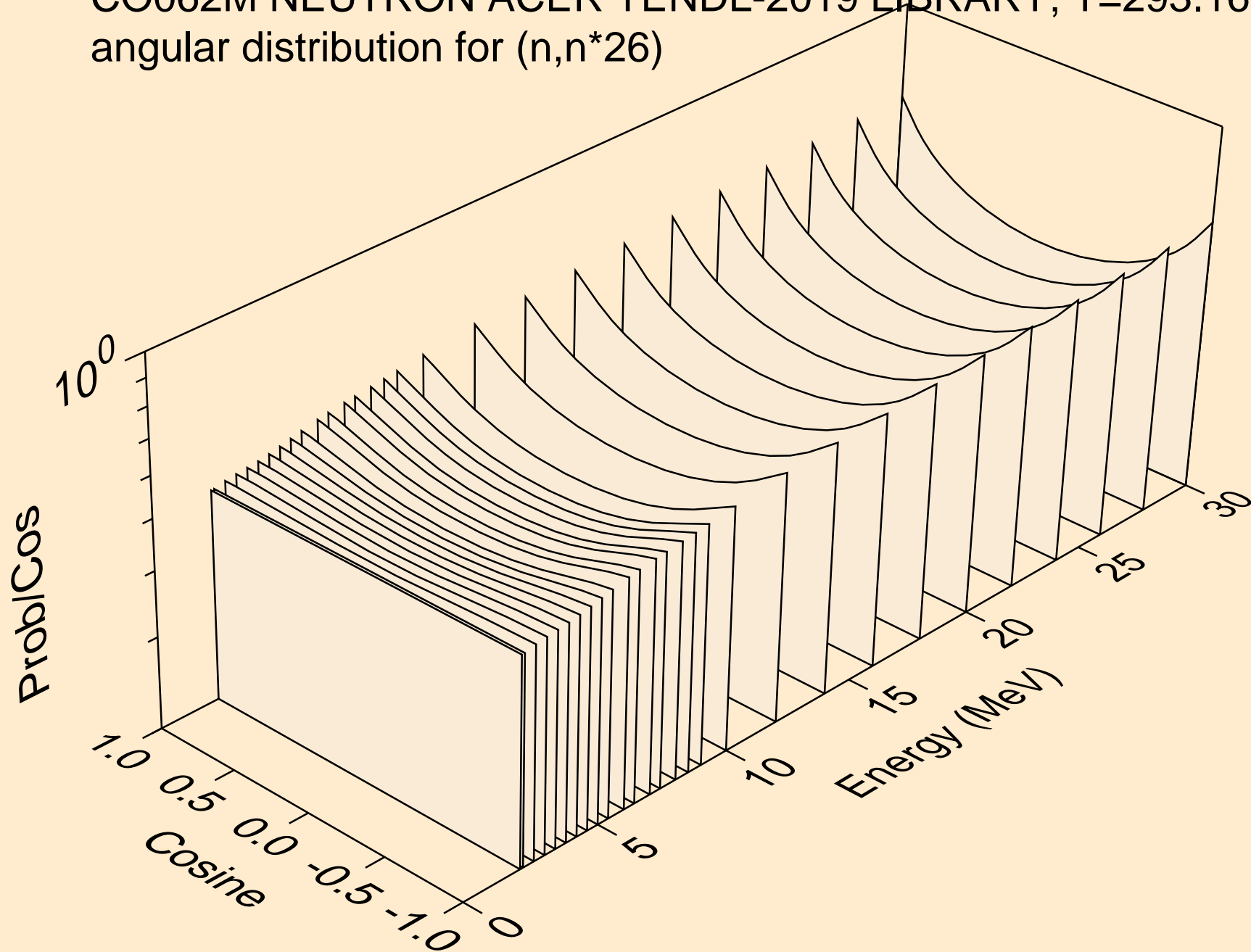

CO062M NEUTRON ACER TENDL-2019 LIBRARY; T=293.16K
angular distribution for (n,n*27)

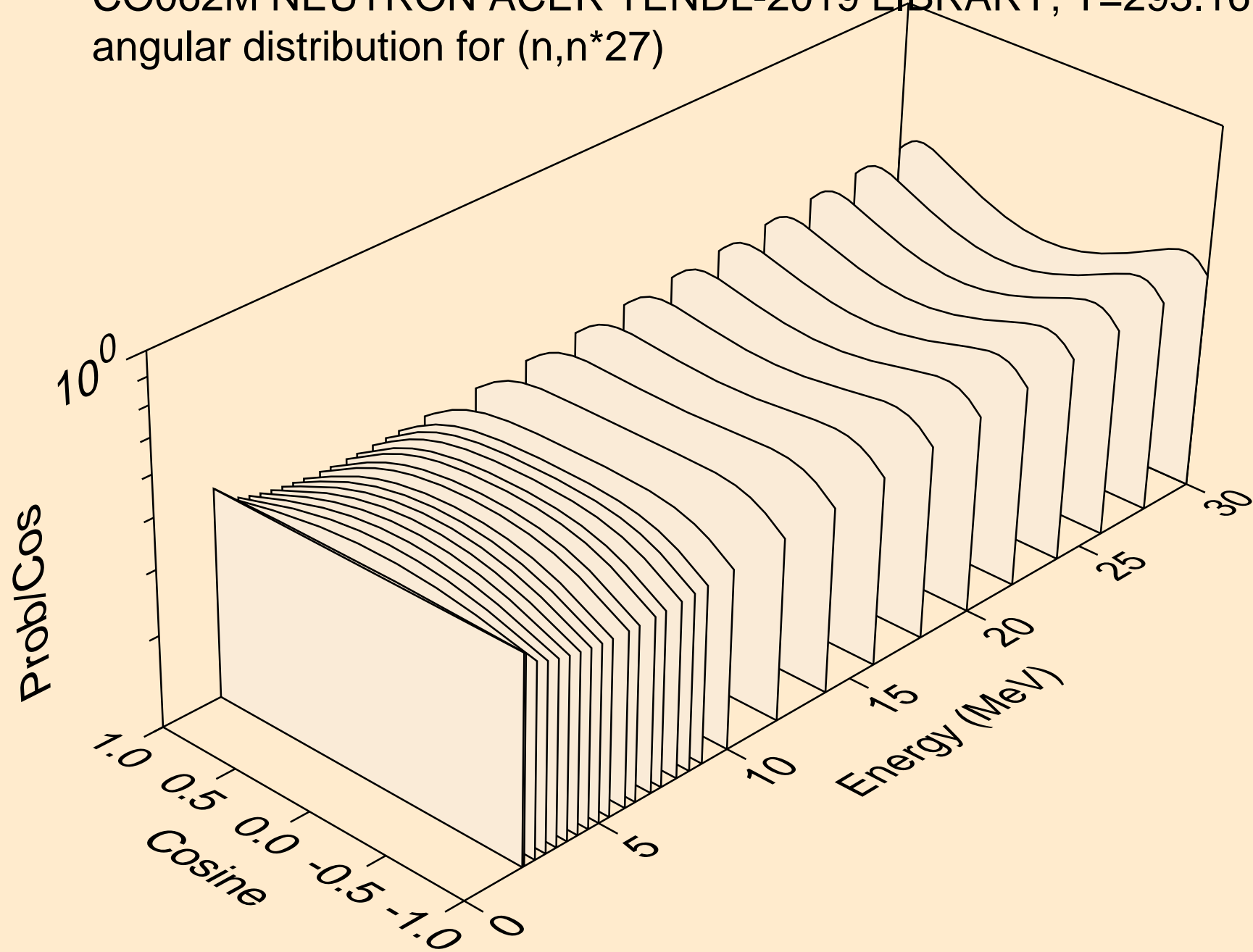

CO062M NEUTRON ACER TENDL-2019 LIBRARY; T=293.16K
angular distribution for (n,n*28)

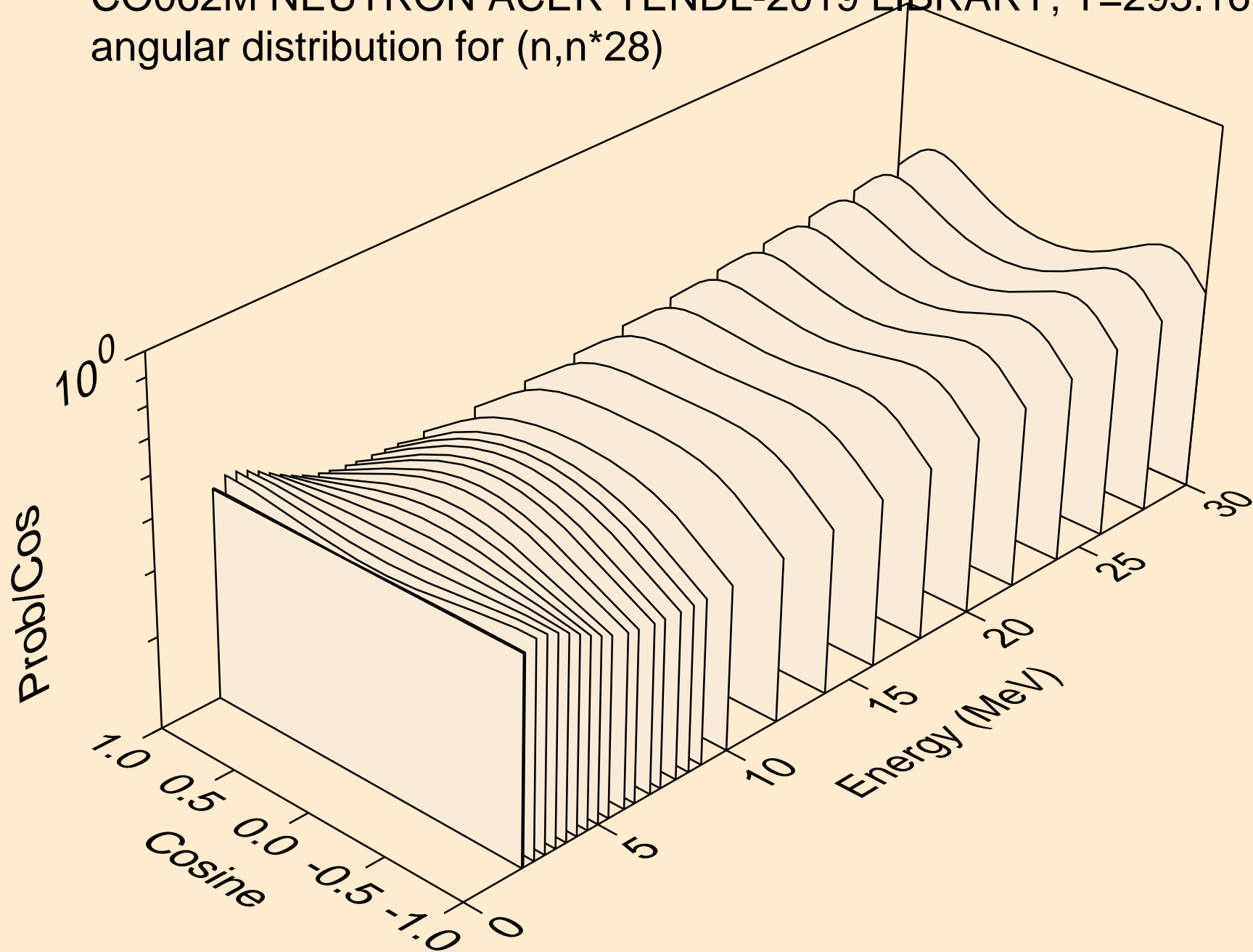

CO062M NEUTRON ACER TENDL-2019 LIBRARY; T=293.16K
angular distribution for (n,n*29)

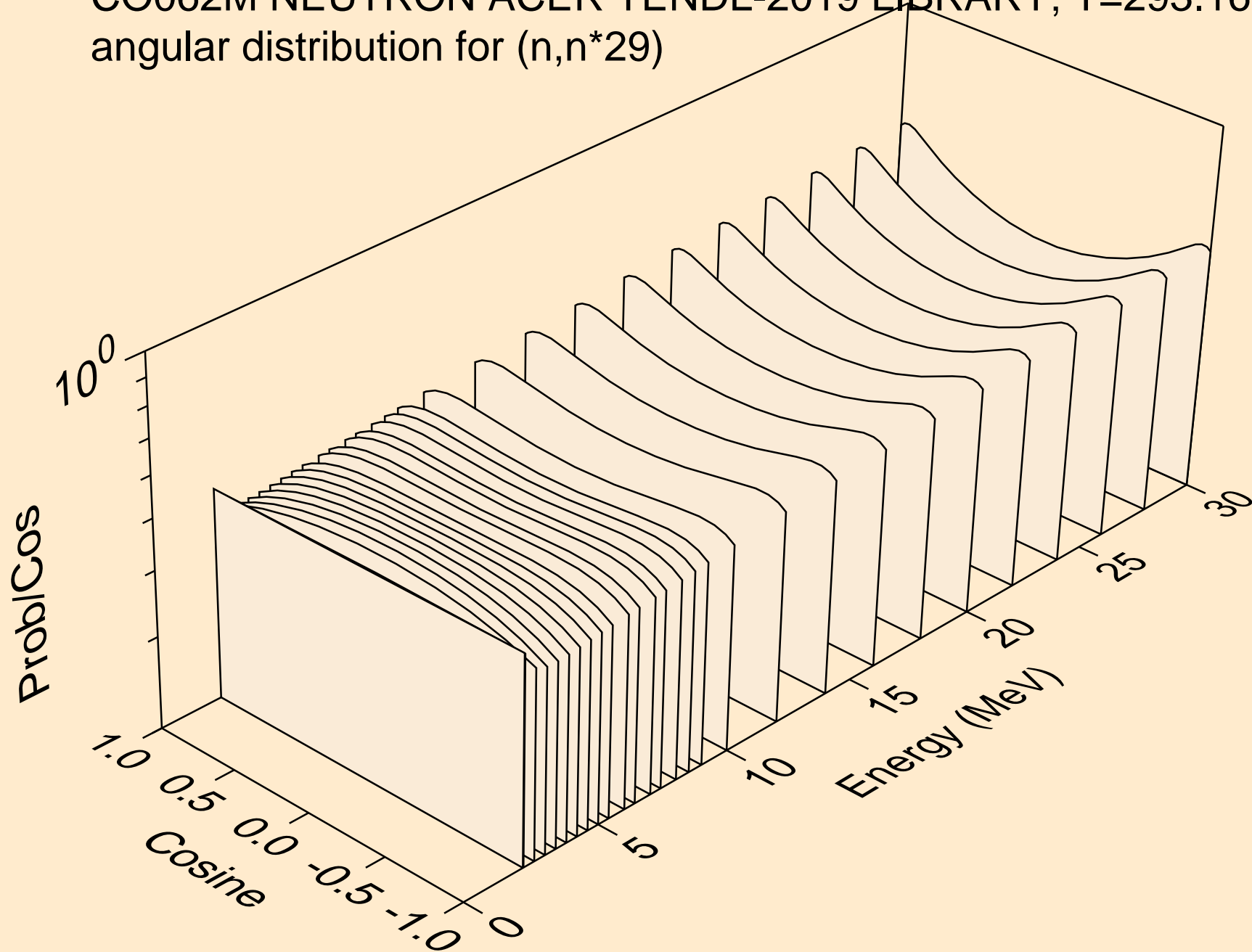

CO062M NEUTRON ACER TENDL-2019 LIBRARY; T=293.16K
Neutron emission for (n,x)

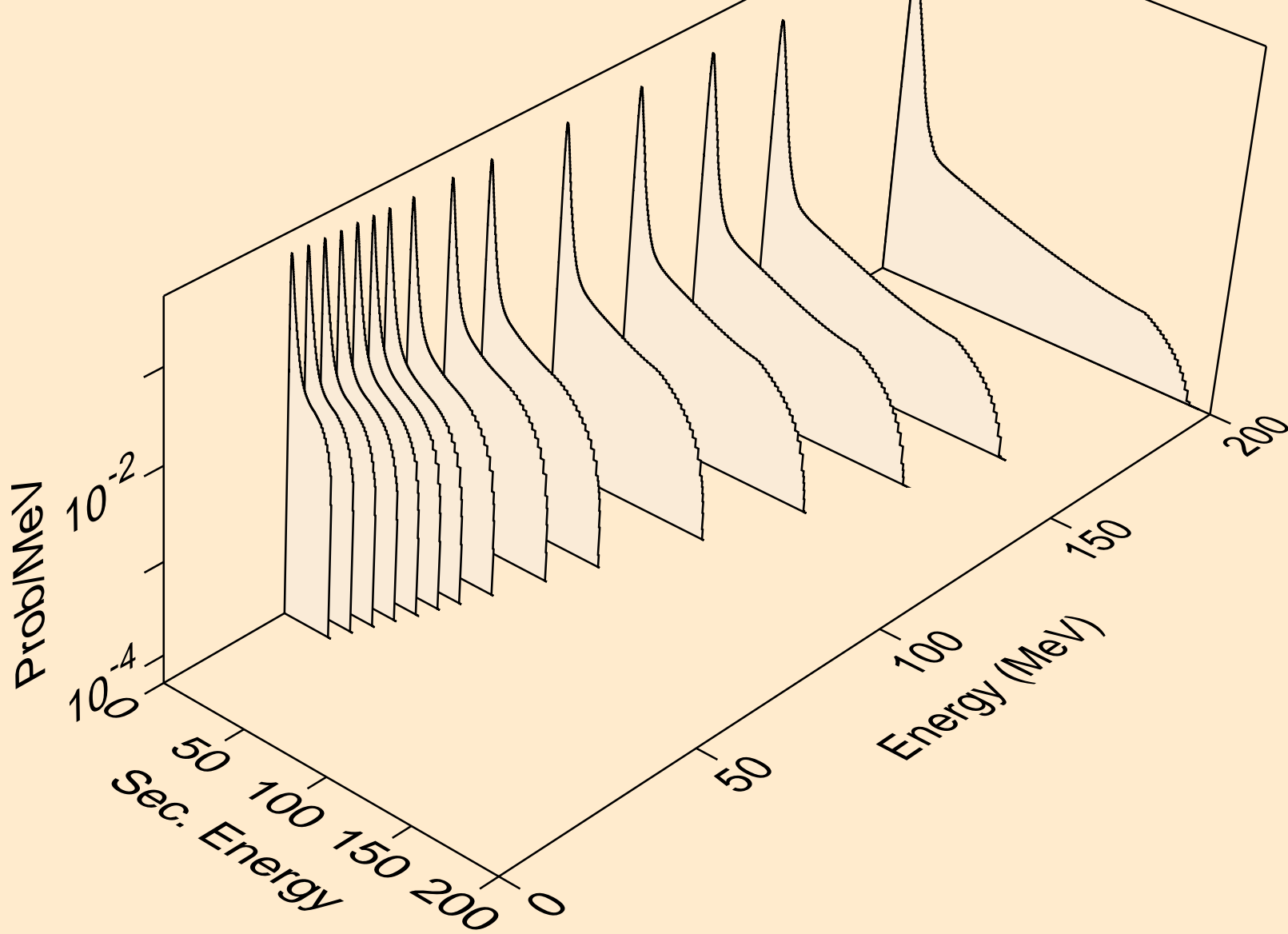

CO062M NEUTRON ACER TENDL-2019 LIBRARY; T=293.16K
Neutron emission for (n,2nd)

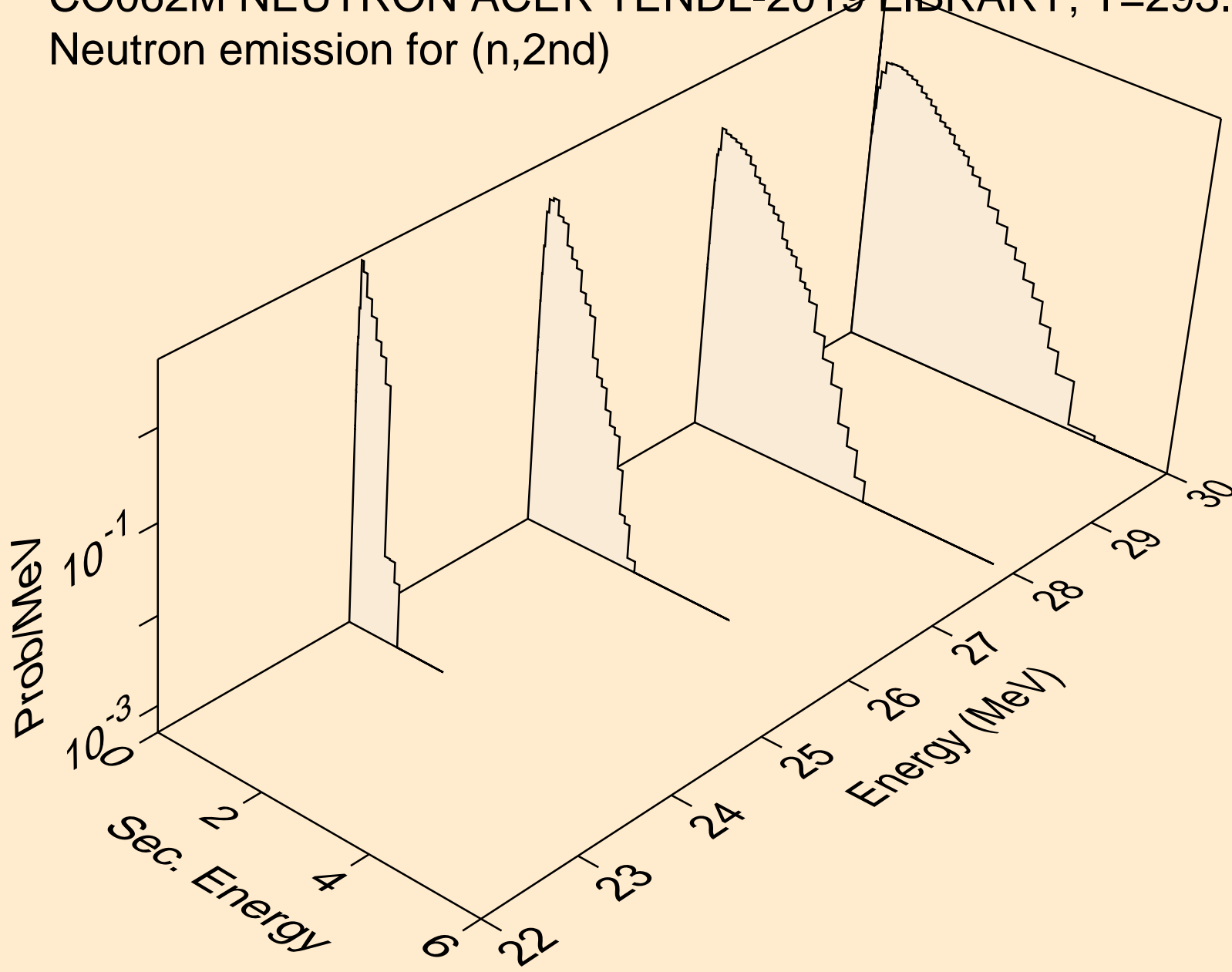

CO062M NEUTRON ACER TENDL-2019 LIBRARY; T=293.16K
Neutron emission for (n,2n)

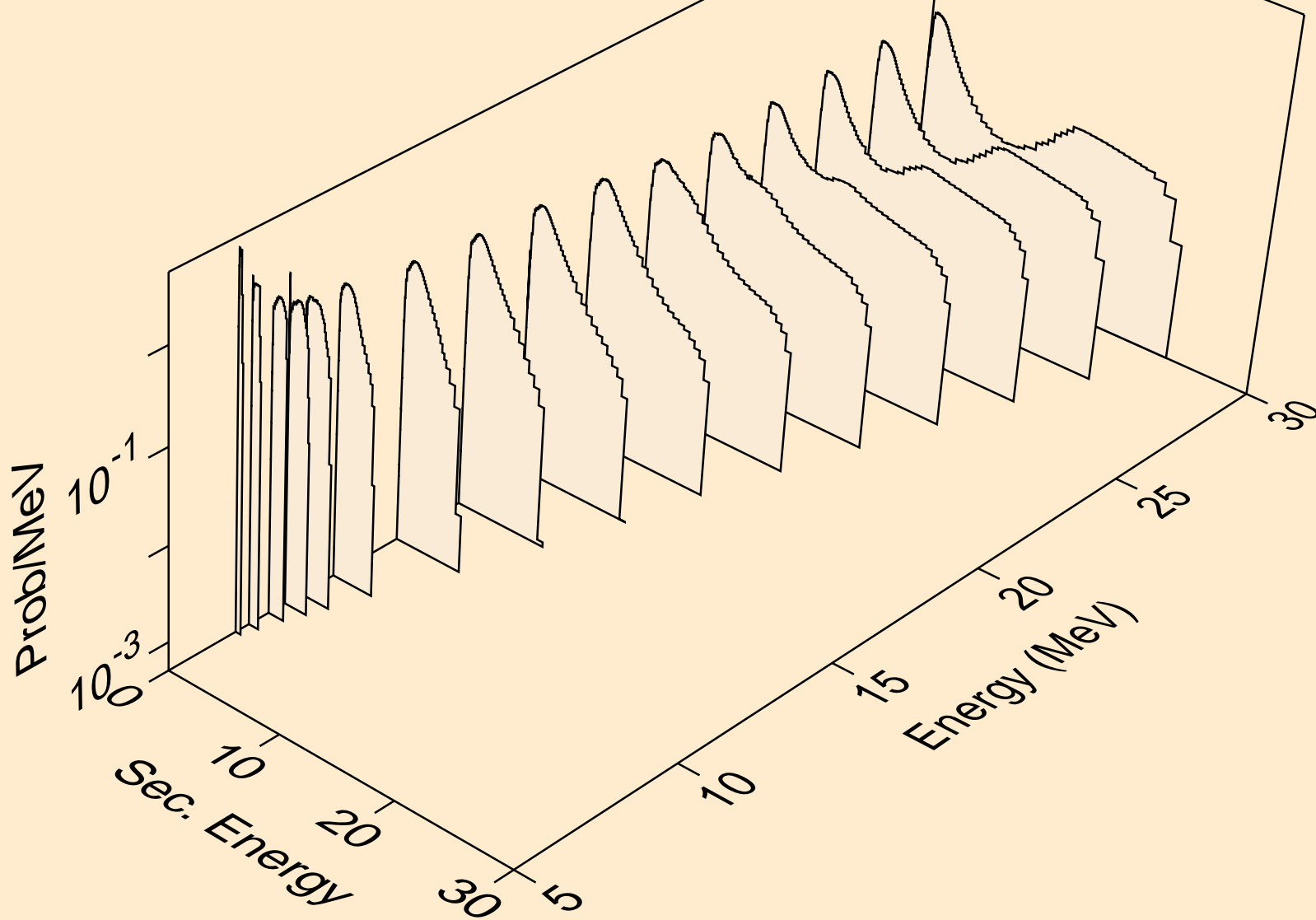

CO062M NEUTRON ACER TENDL-2019 LIBRARY; T=293.16K
Neutron emission for (n,3n)

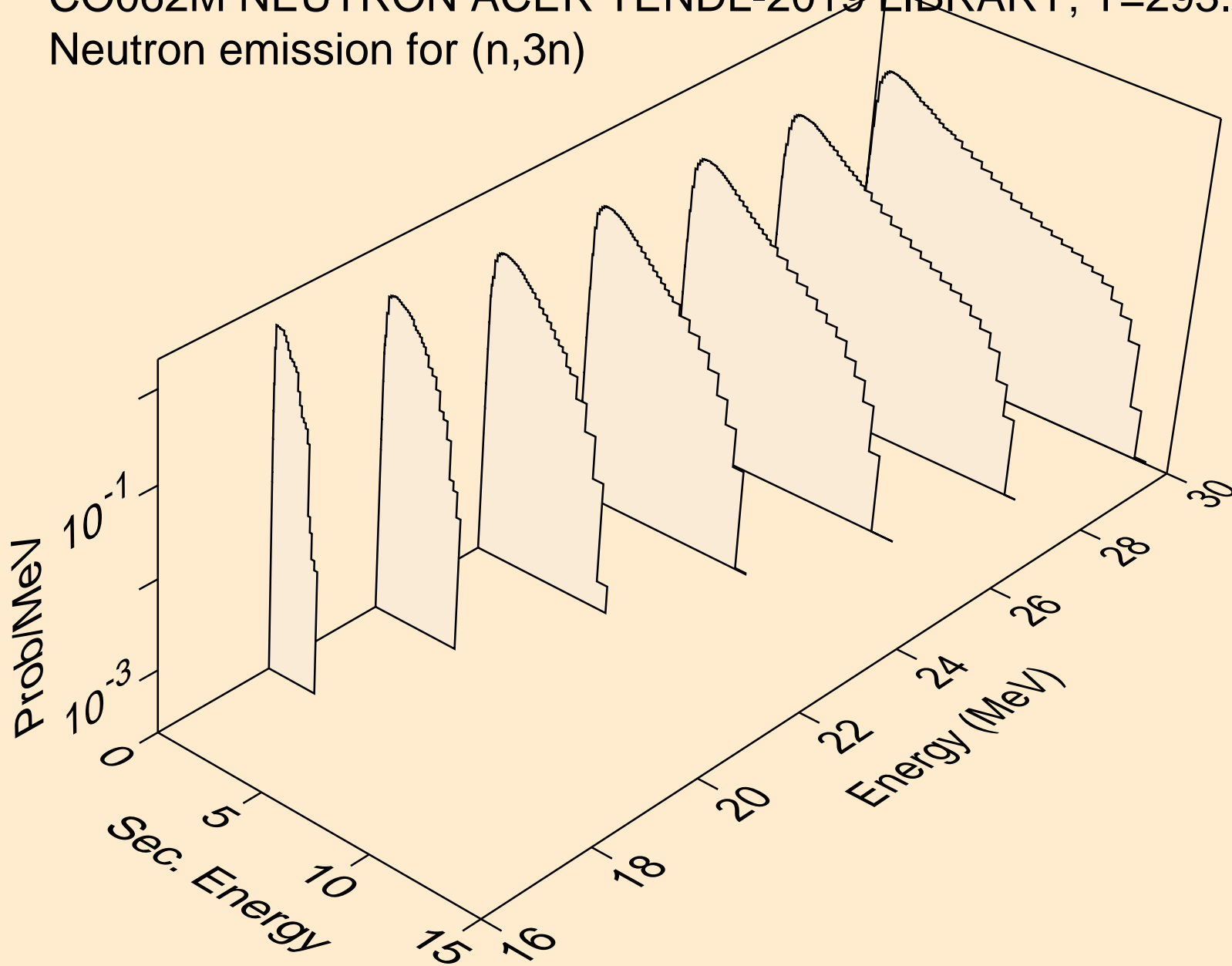

CO062M NEUTRON ACER TENDL-2019 LIBRARY; T=293.16K
Neutron emission for (n,n*)a

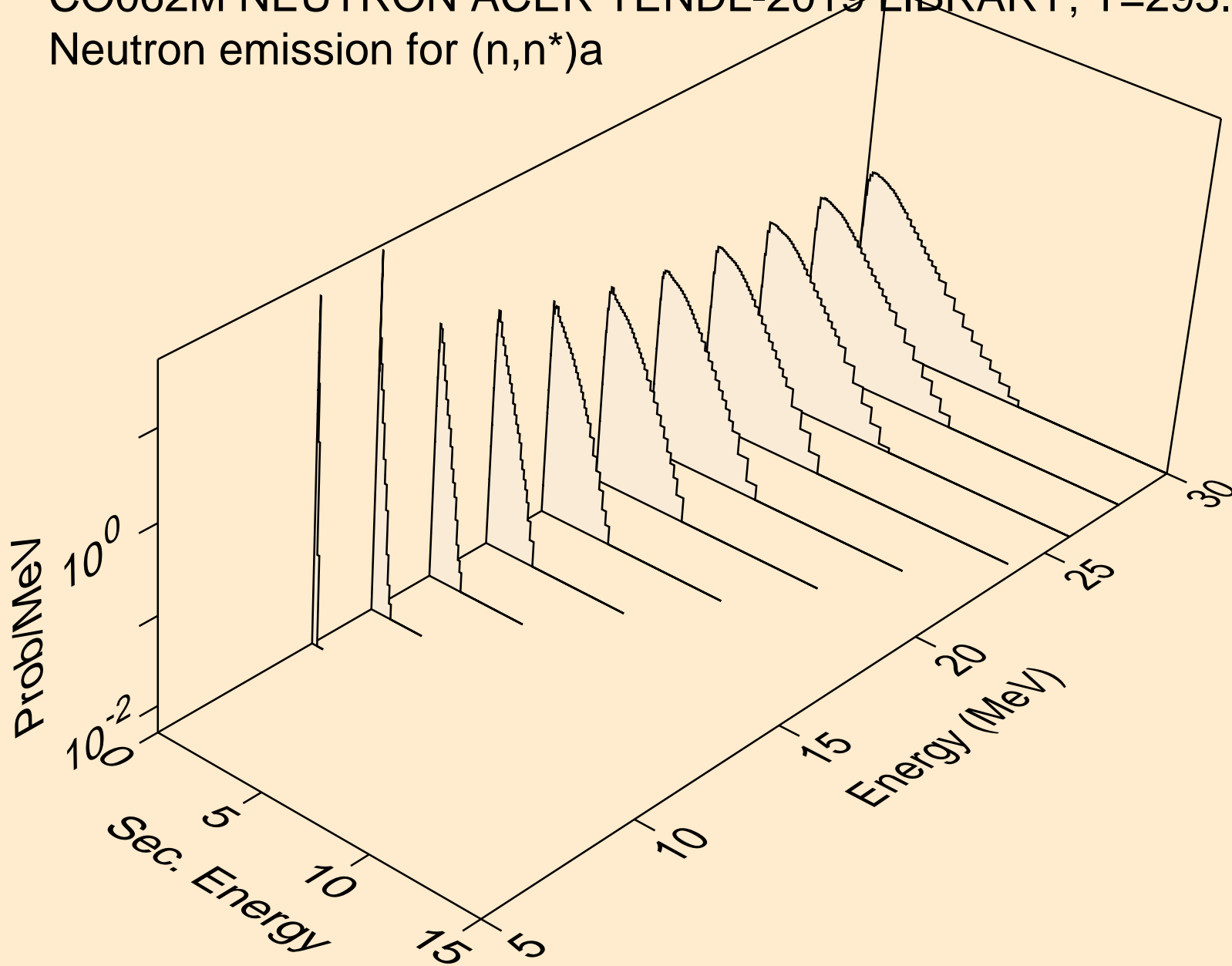

CO062M NEUTRON ACER TENDL-2019 LIBRARY; T=293.16K
Neutron emission for (n,2n)a

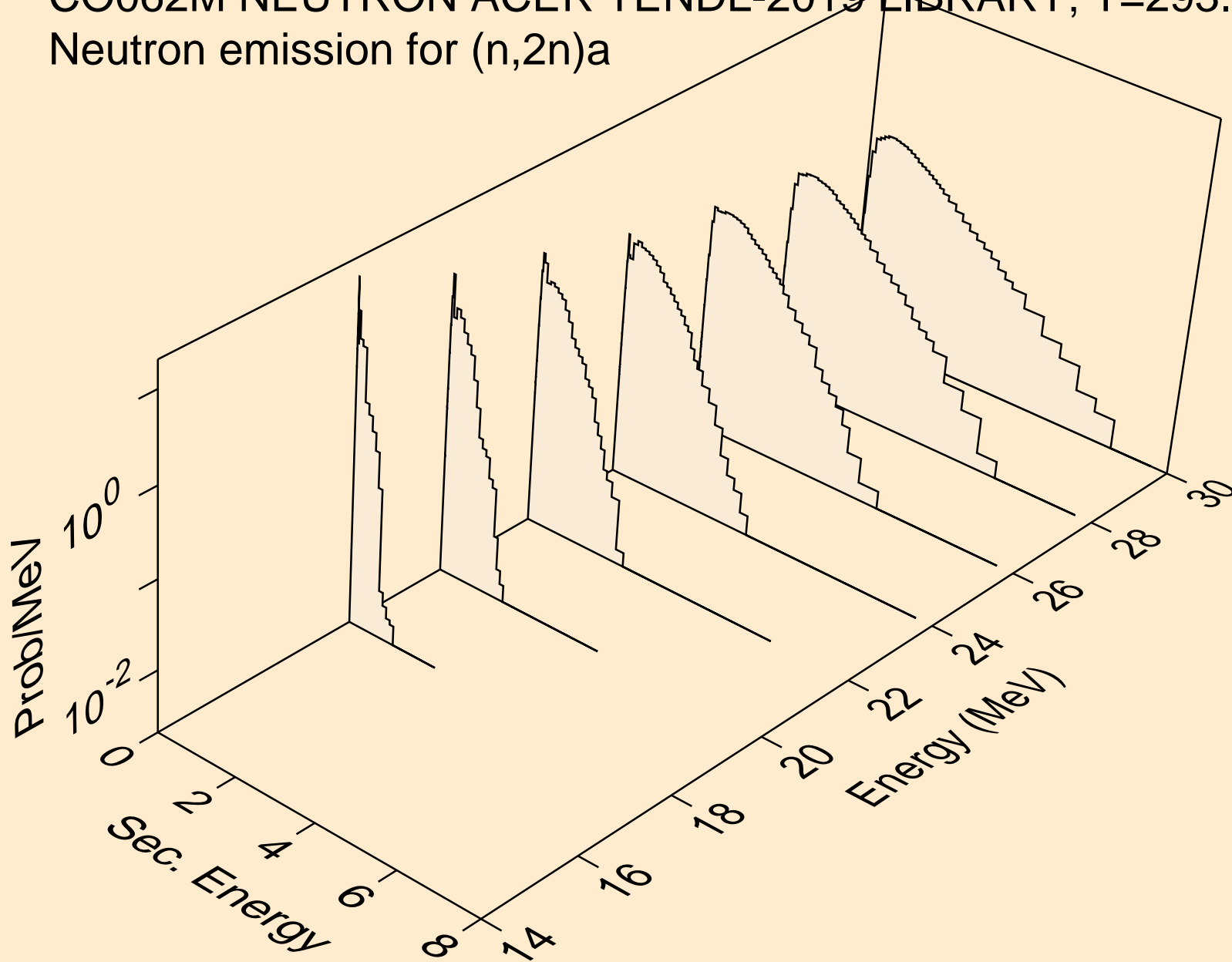

CO062M NEUTRON ACER TENDL-2019 LIBRARY; T=293.16K
Neutron emission for (n,3n)a

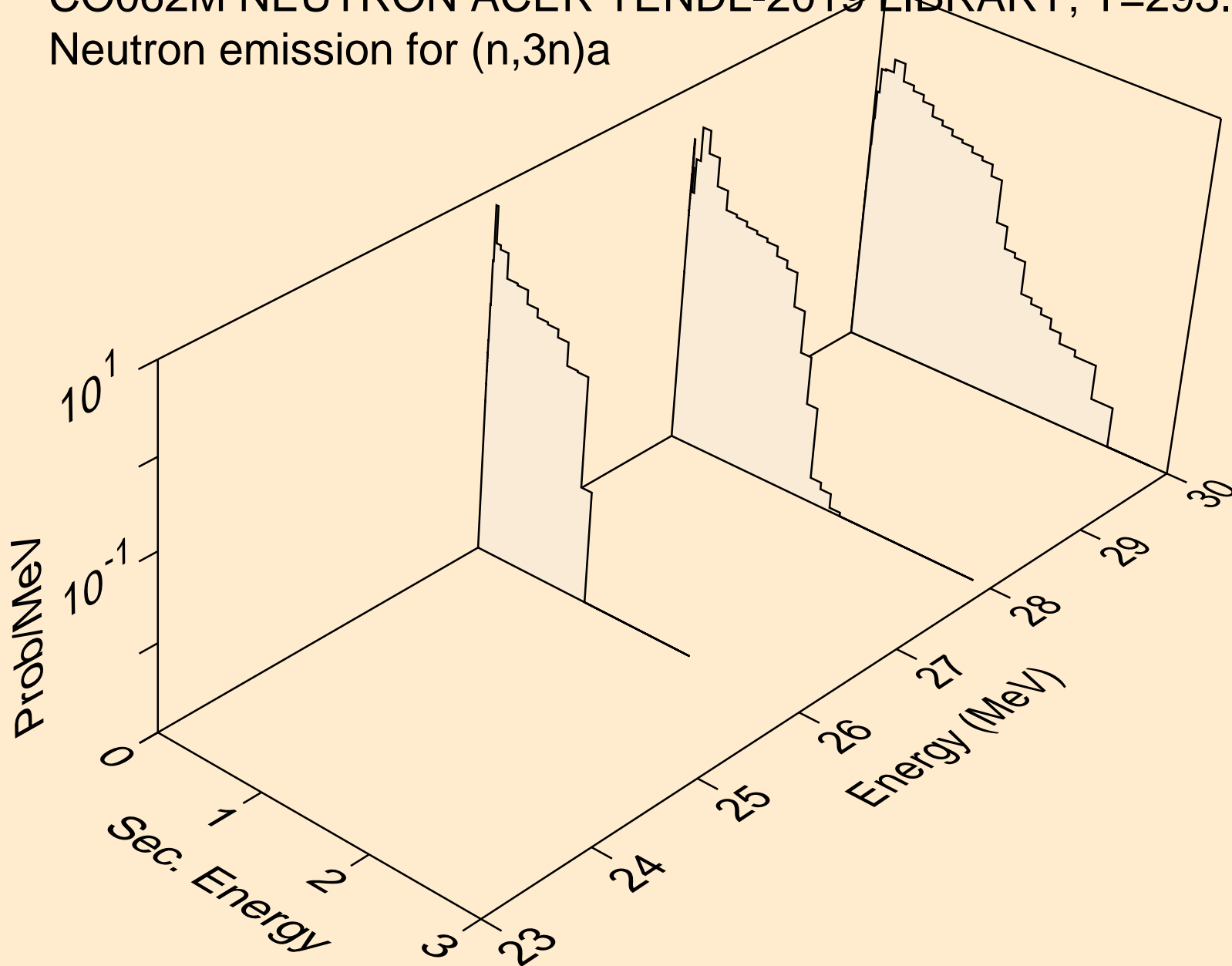

CO062M NEUTRON ACER TENDL-2019 LIBRARY; T=293.16K
Neutron emission for (n,n*)p

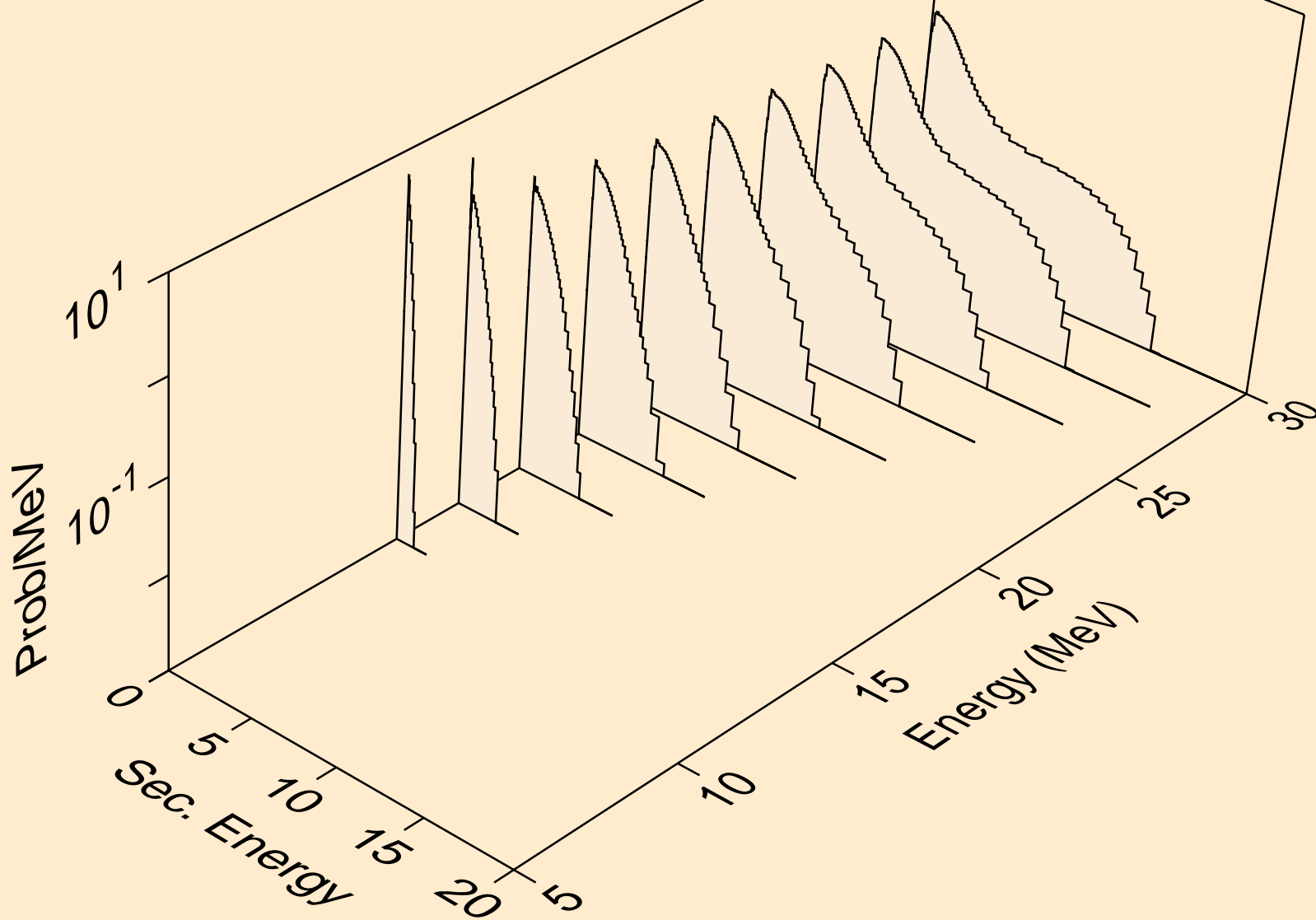

CO062M NEUTRON ACER TENDL-2019 LIBRARY; T=293.16K
Neutron emission for (n,n*)2a

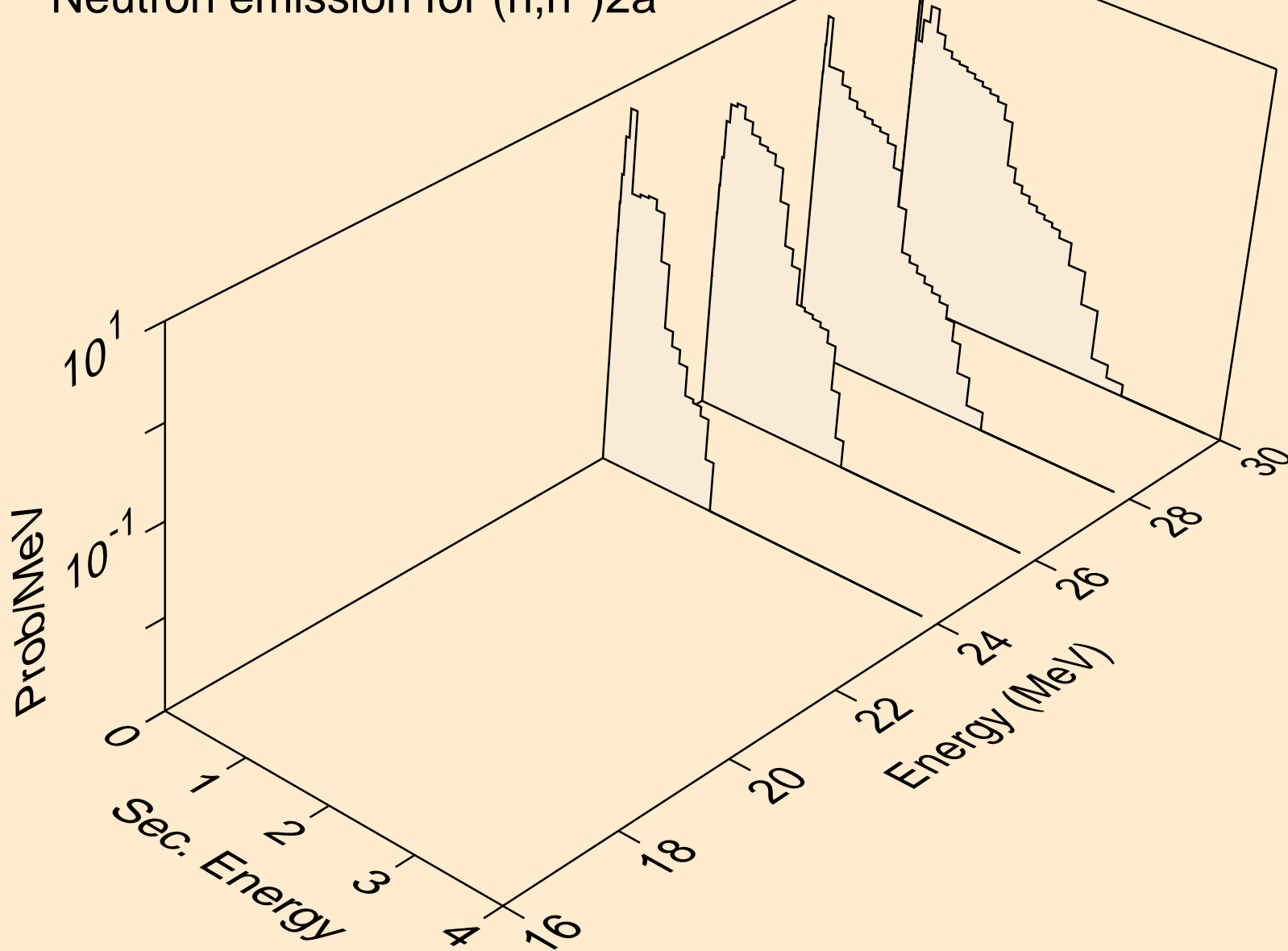

CO062M NEUTRON ACER TENDL-2019 LIBRARY; T=293.16K
Neutron emission for (n,n*)d

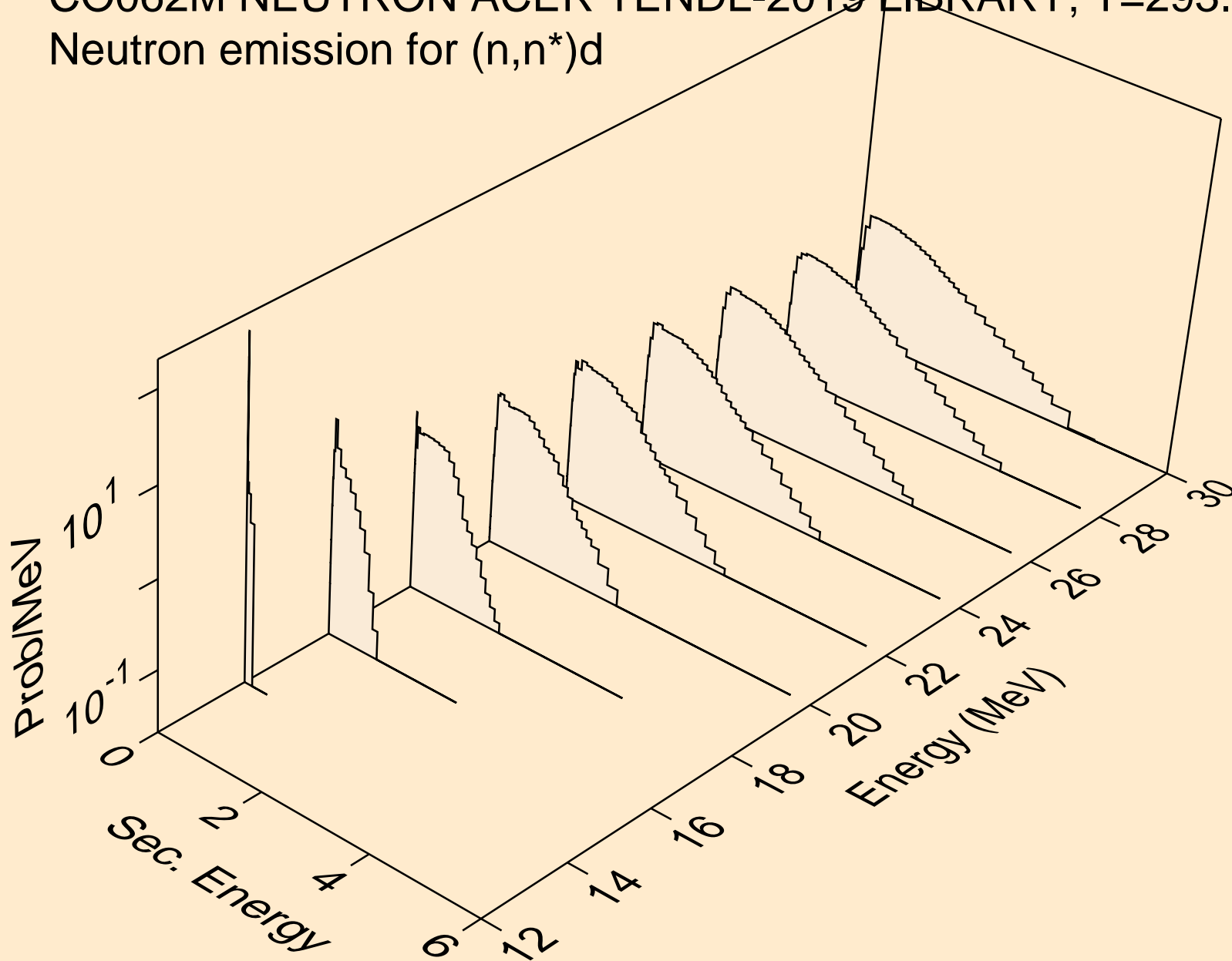

CO062M NEUTRON ACER TENDL-2019 LIBRARY; T=293.16K
Neutron emission for (n,n*)t

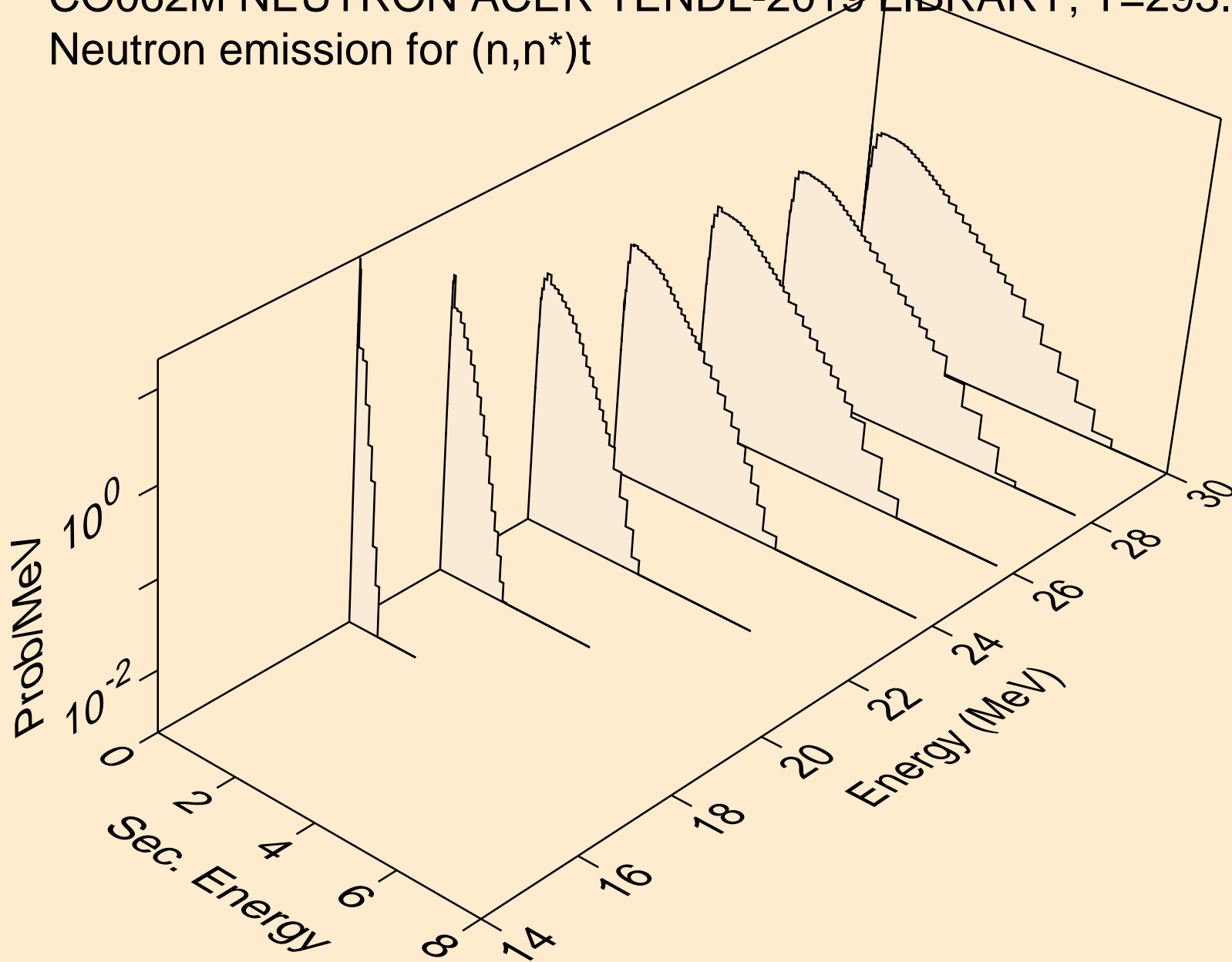

CO062M NEUTRON ACER TENDL-2019 LIBRARY; T=293.16K
Neutron emission for (n,n*)he3

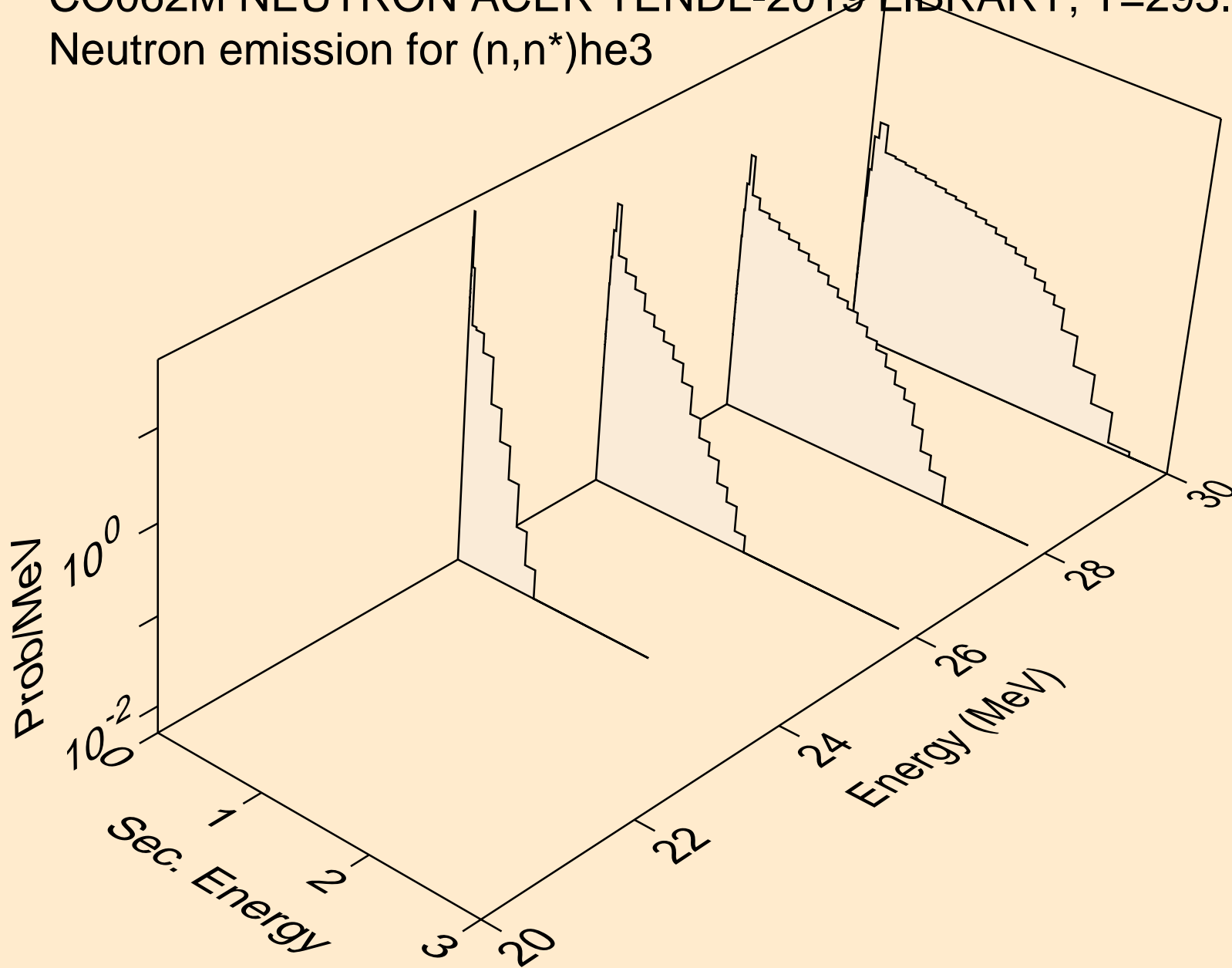

CO062M NEUTRON ACER TENDL-2019 LIBRARY; T=293.16K
Neutron emission for (n,4n)

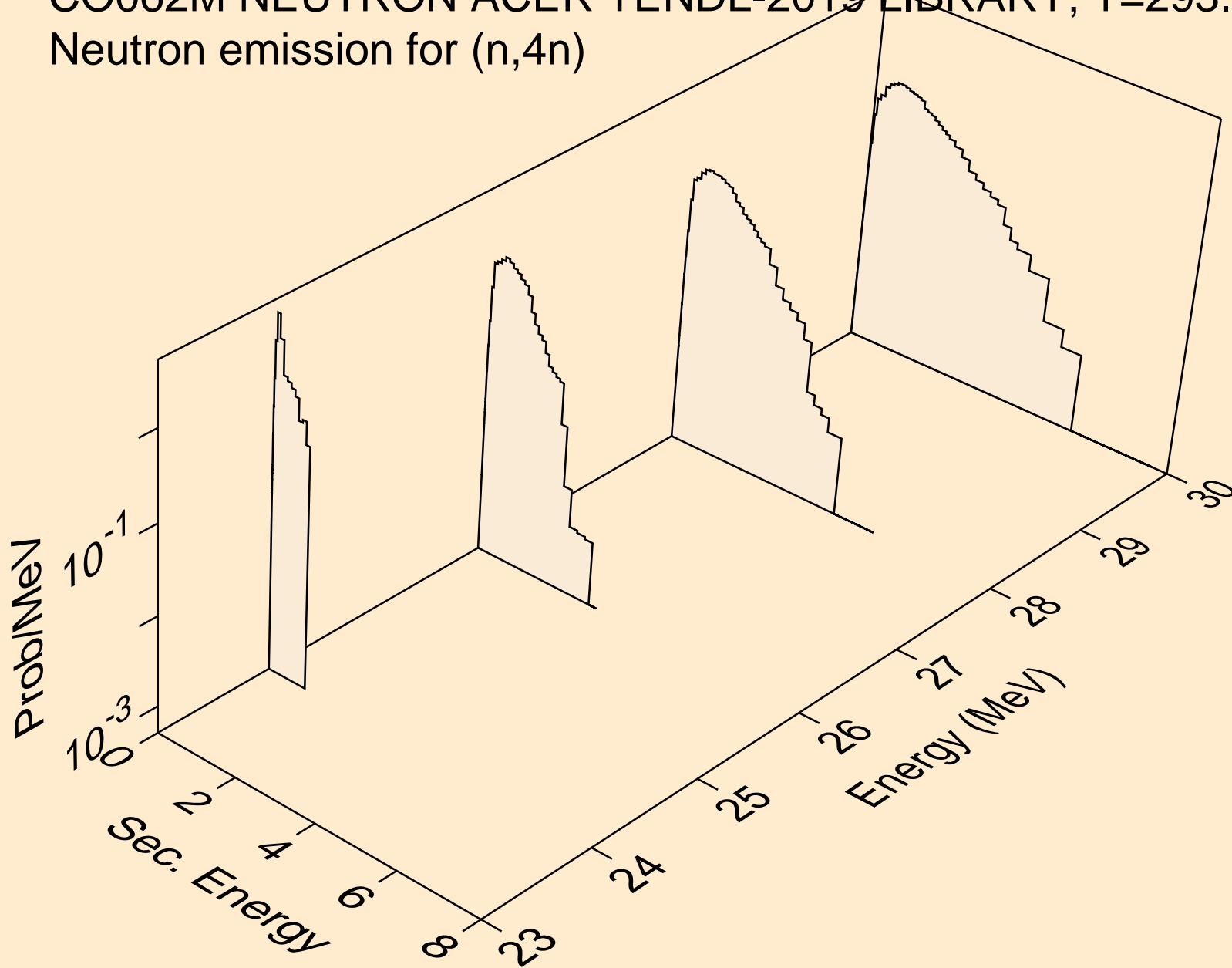

CO062M NEUTRON ACER TENDL-2019 LIBRARY; T=293.16K
Neutron emission for (n,2np)

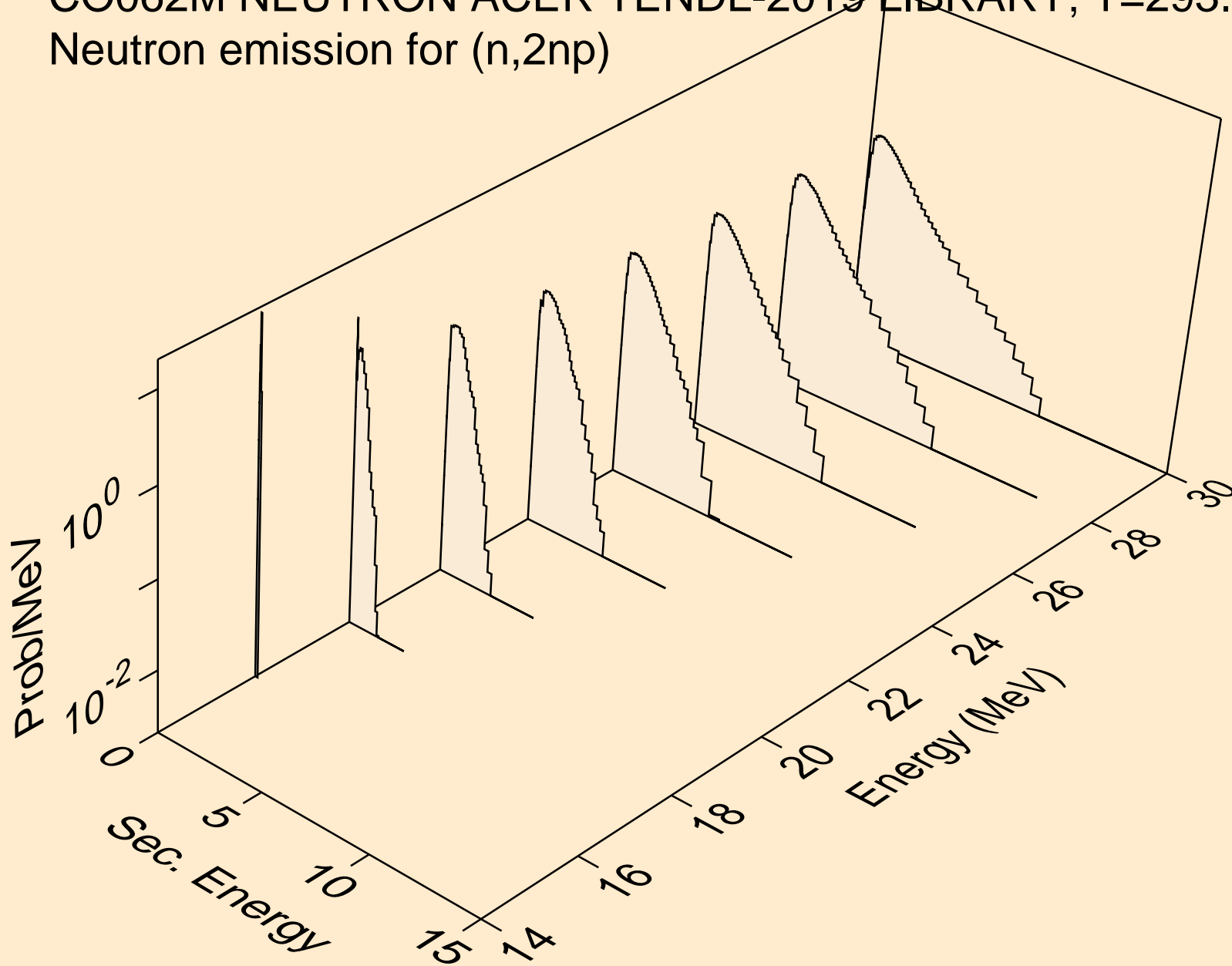

CO062M NEUTRON ACER TENDL-2019 LIBRARY; T=293.16K
Neutron emission for (n,3np)

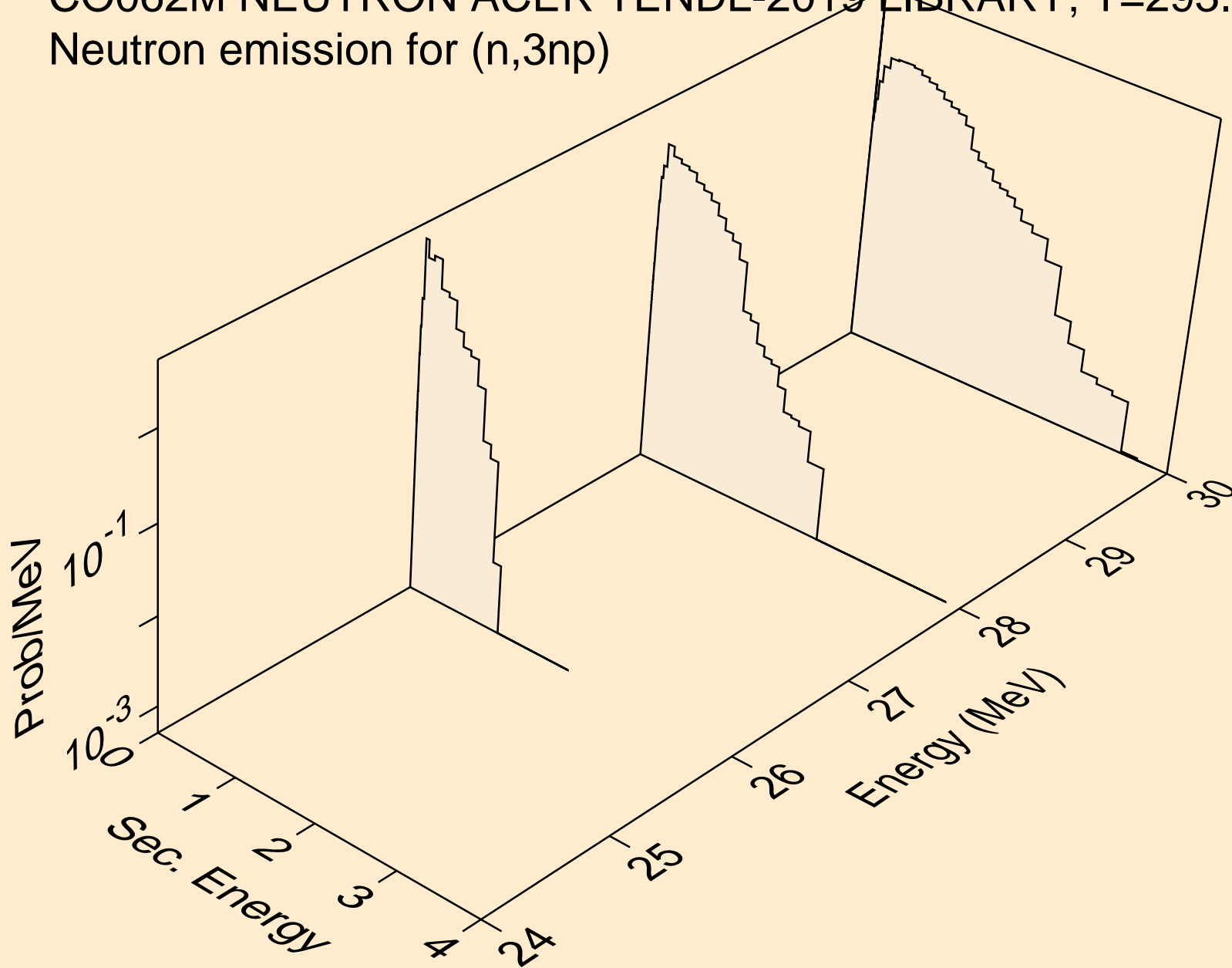

CO062M NEUTRON ACER TENDL-2019 LIBRARY; T=293.16K
Neutron emission for (n,2np)

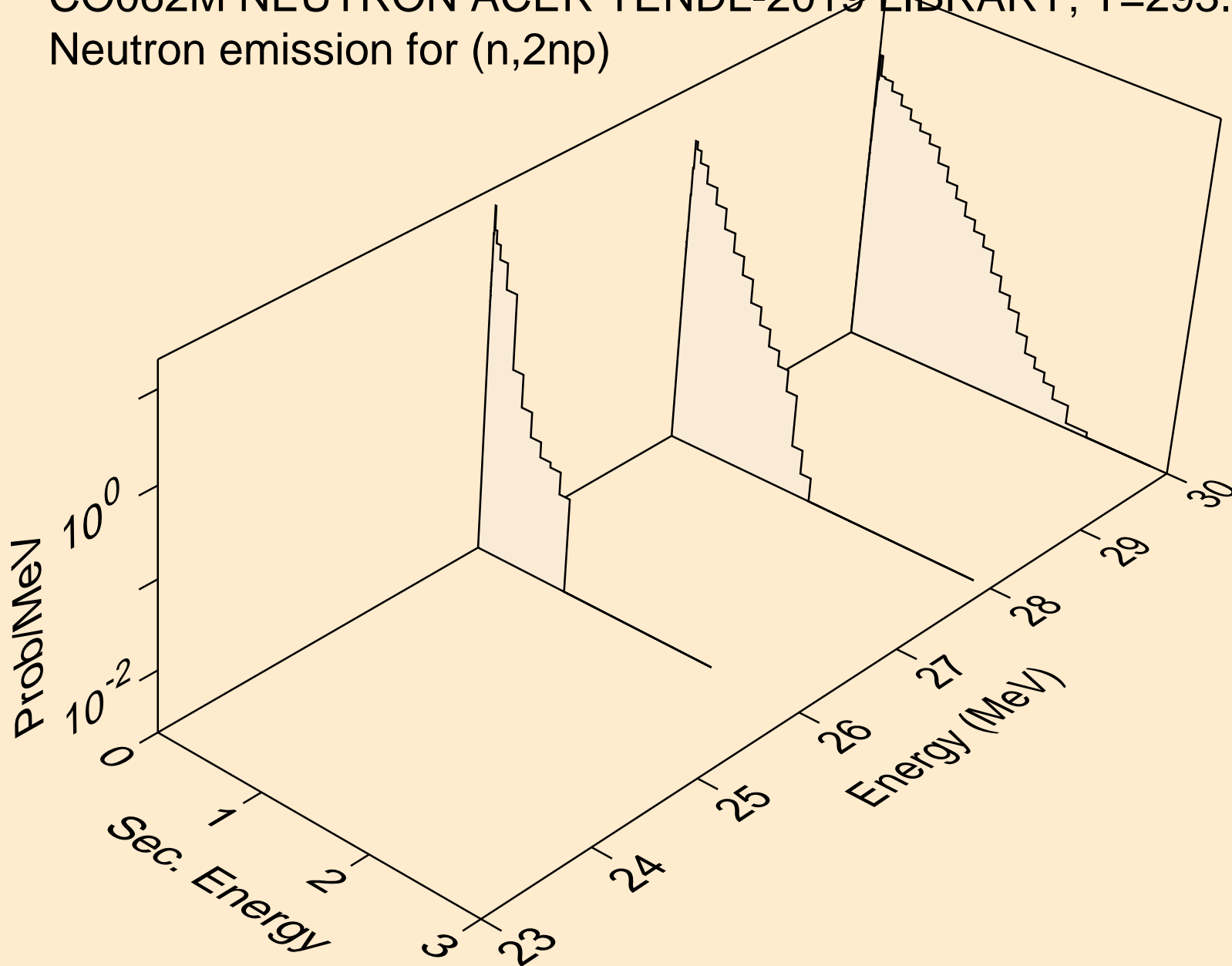

CO062M NEUTRON ACER TENDL-2019 LIBRARY; T=293.16K
Neutron emission for (n,npa)

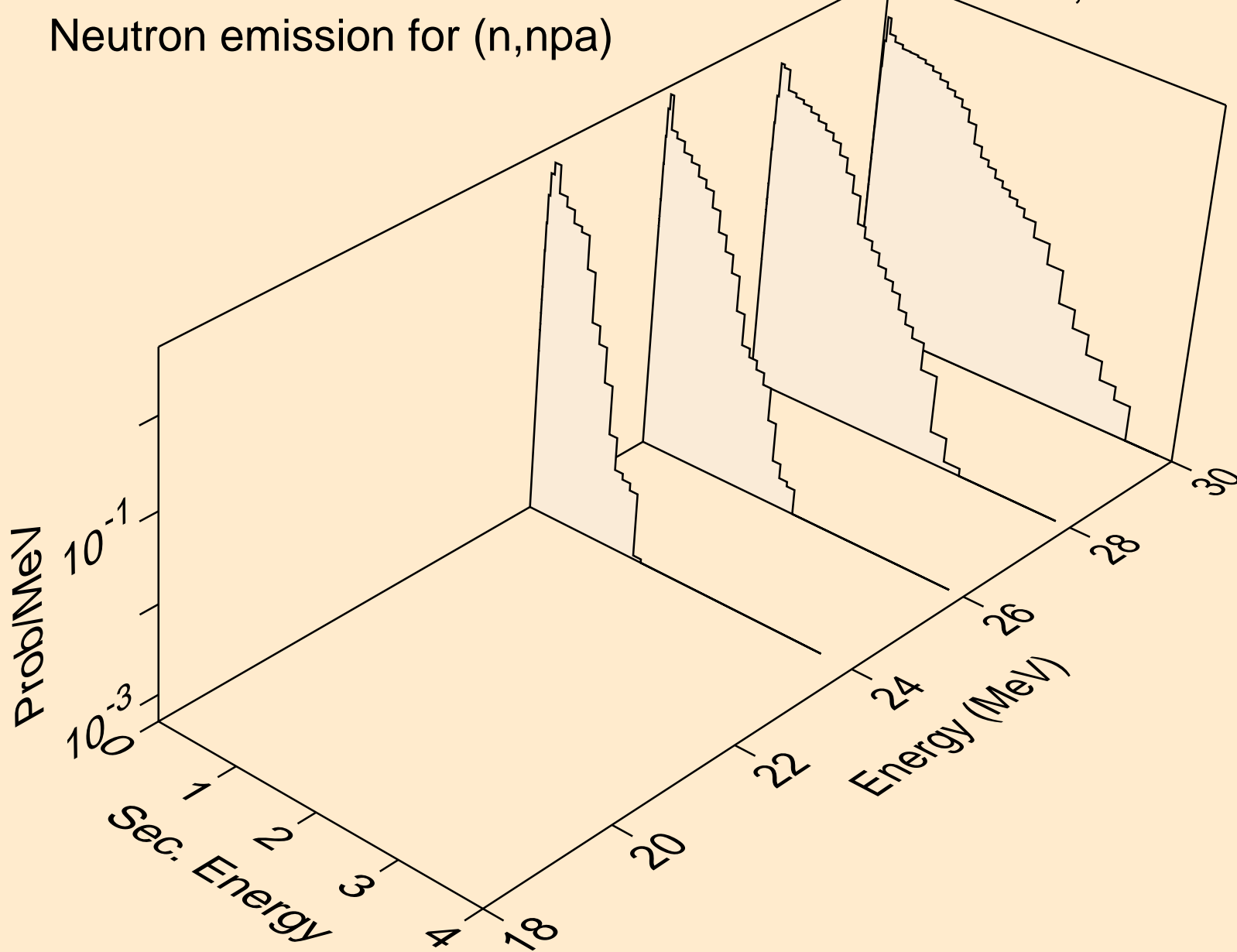

CO062M NEUTRON ACER TENDL-2019 LIBRARY; T=293.16K
Neutron emission for (n,n*c)

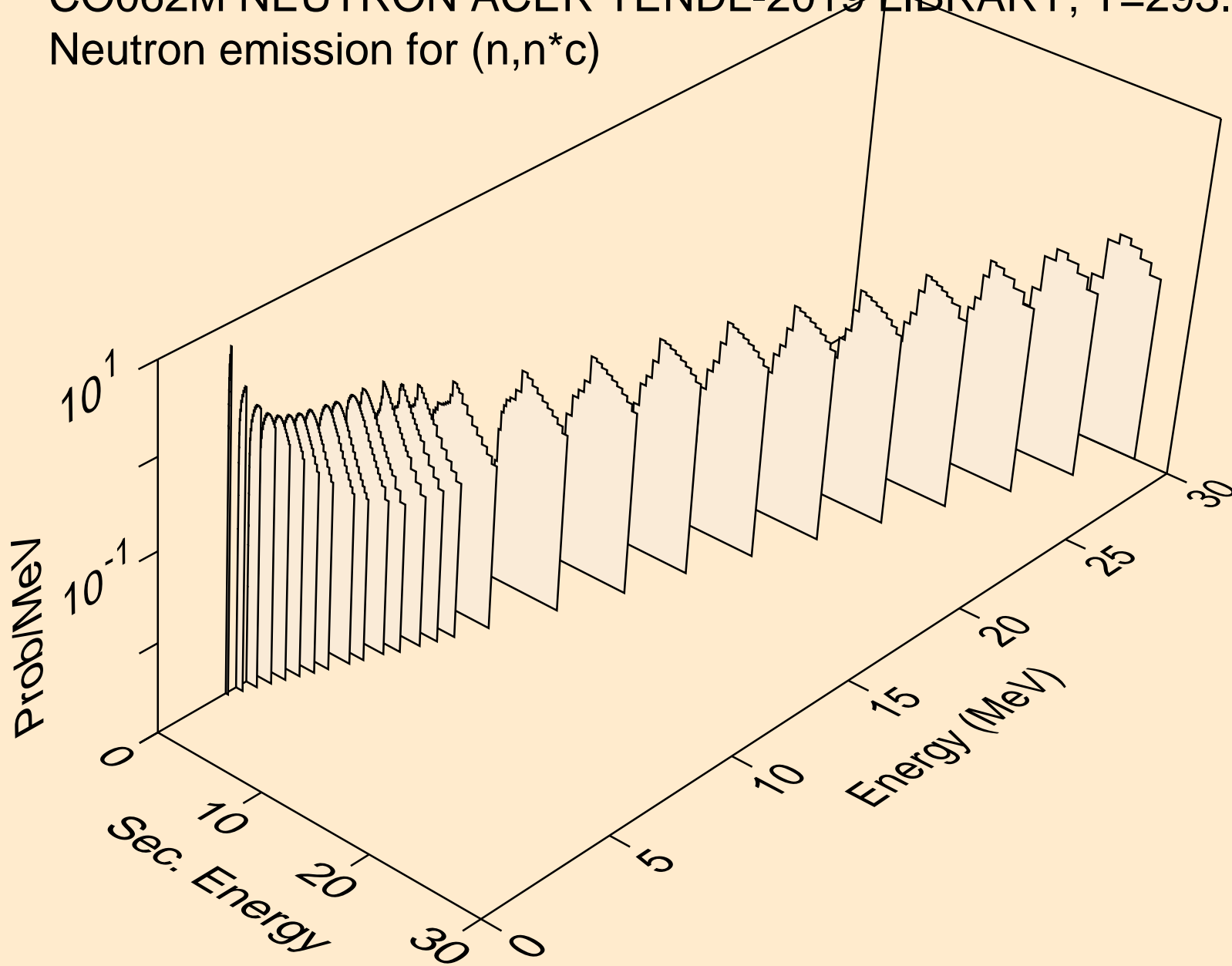

CO062M NEUTRON ACER TENDL-2019 LIBRARY; T=293.16K
Photon emission for (n,x)

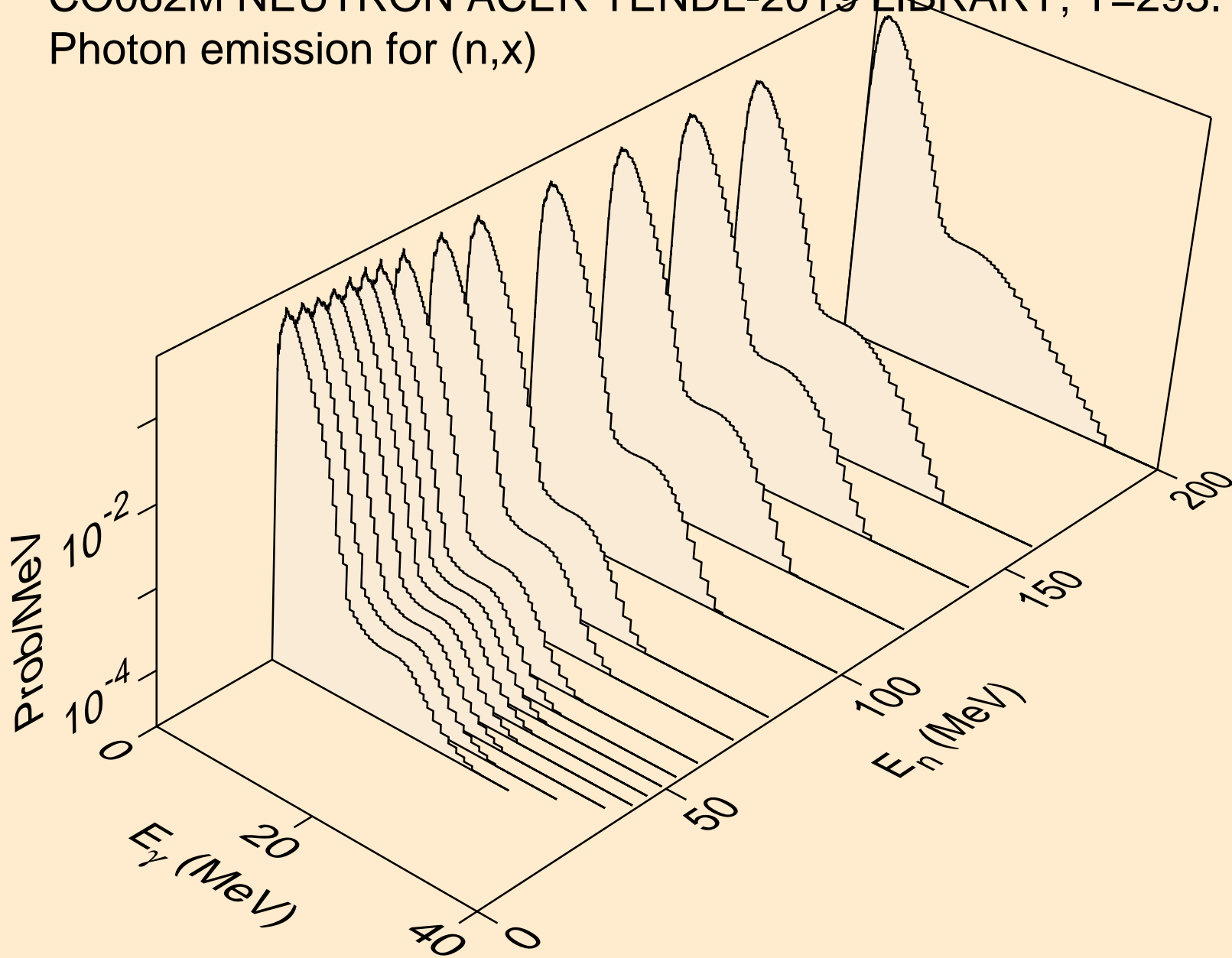

CO062M NEUTRON ACER TENDL-2019 LIBRARY; T=293.16K
Photon emission for (n,2nd)

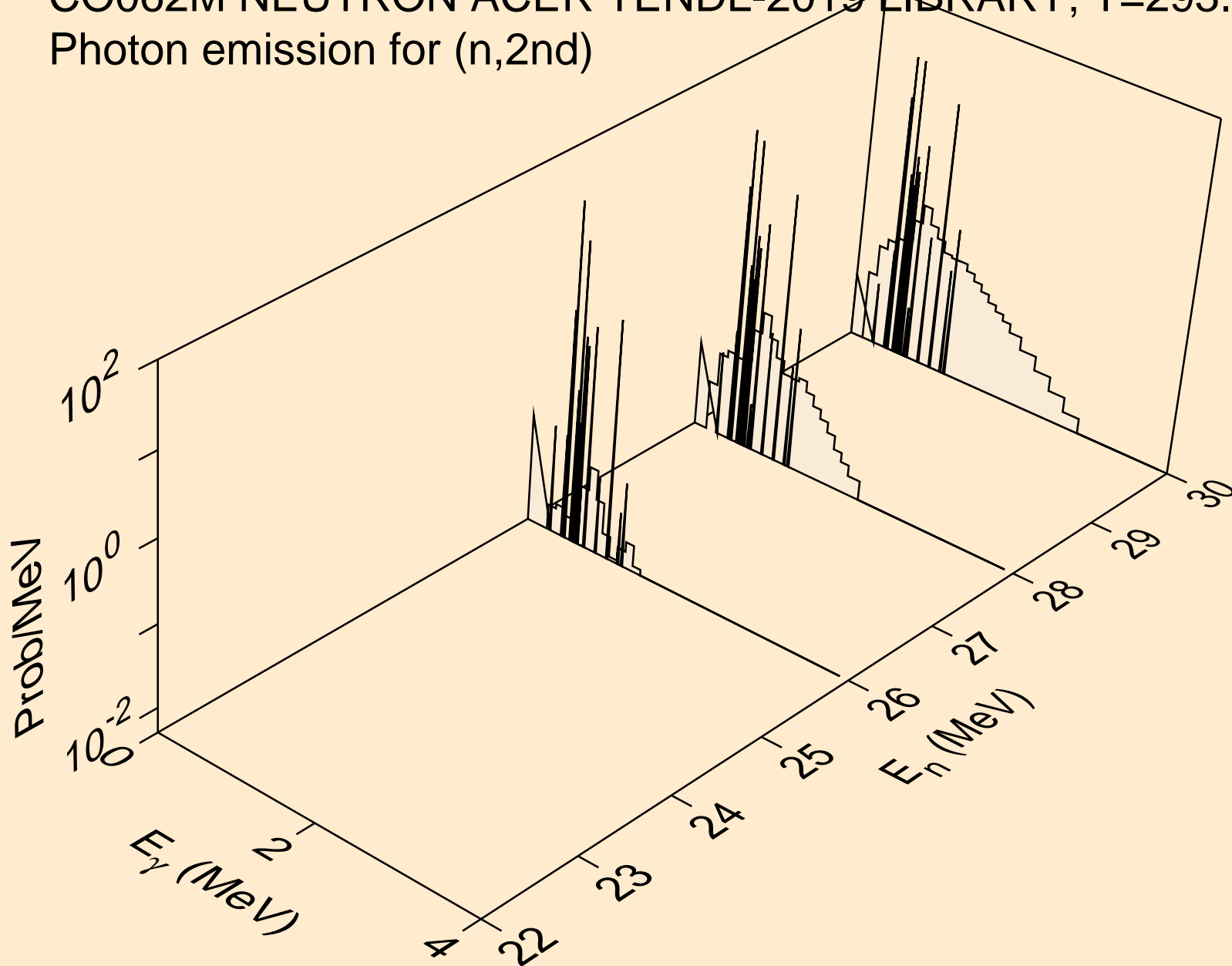

CO062M NEUTRON ACER TENDL-2019 LIBRARY; T=293.16K
Photon emission for (n,2n)

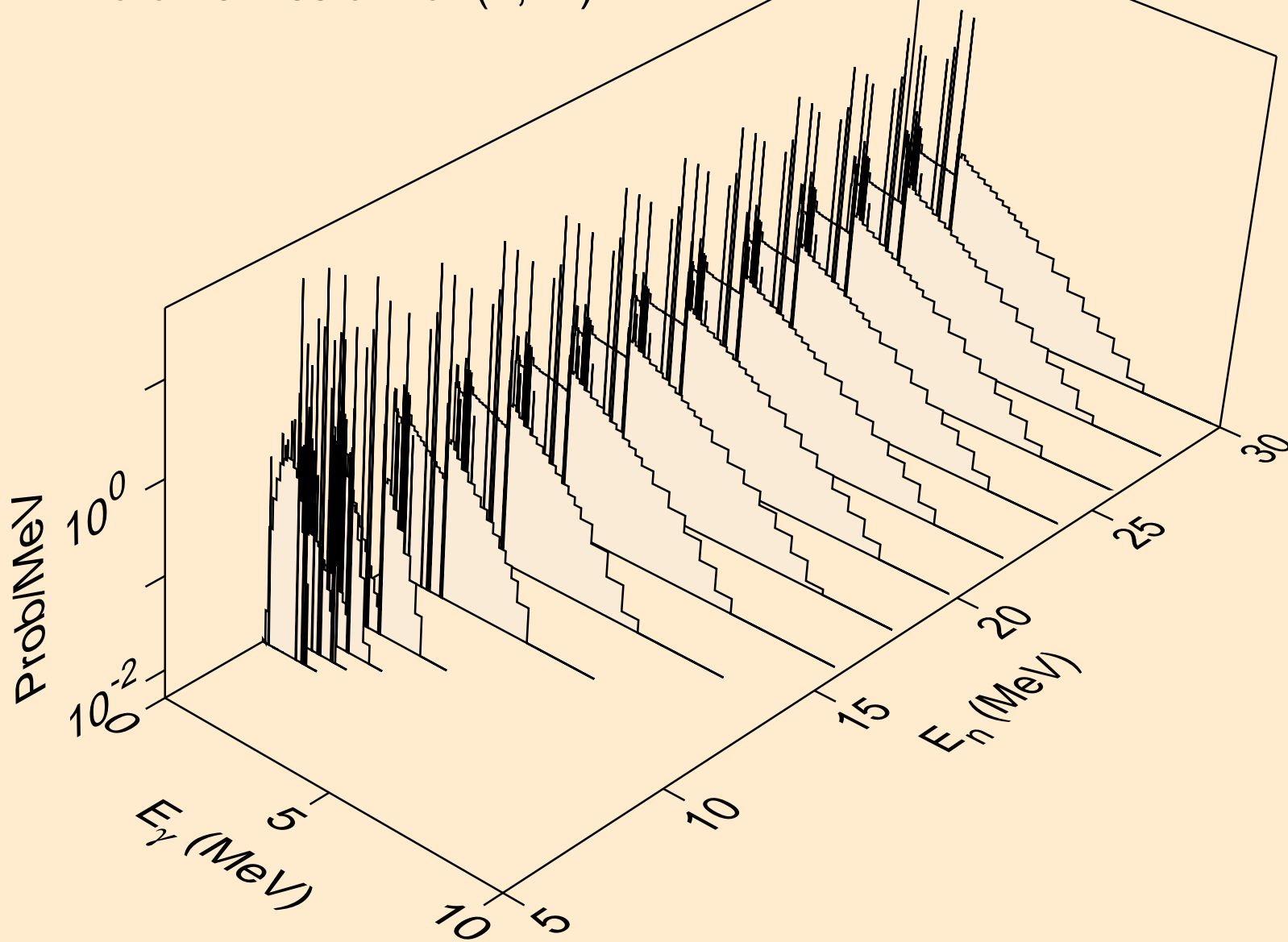

CO062M NEUTRON ACER TENDL-2019 LIBRARY; T=293.16K
Photon emission for (n,3n)

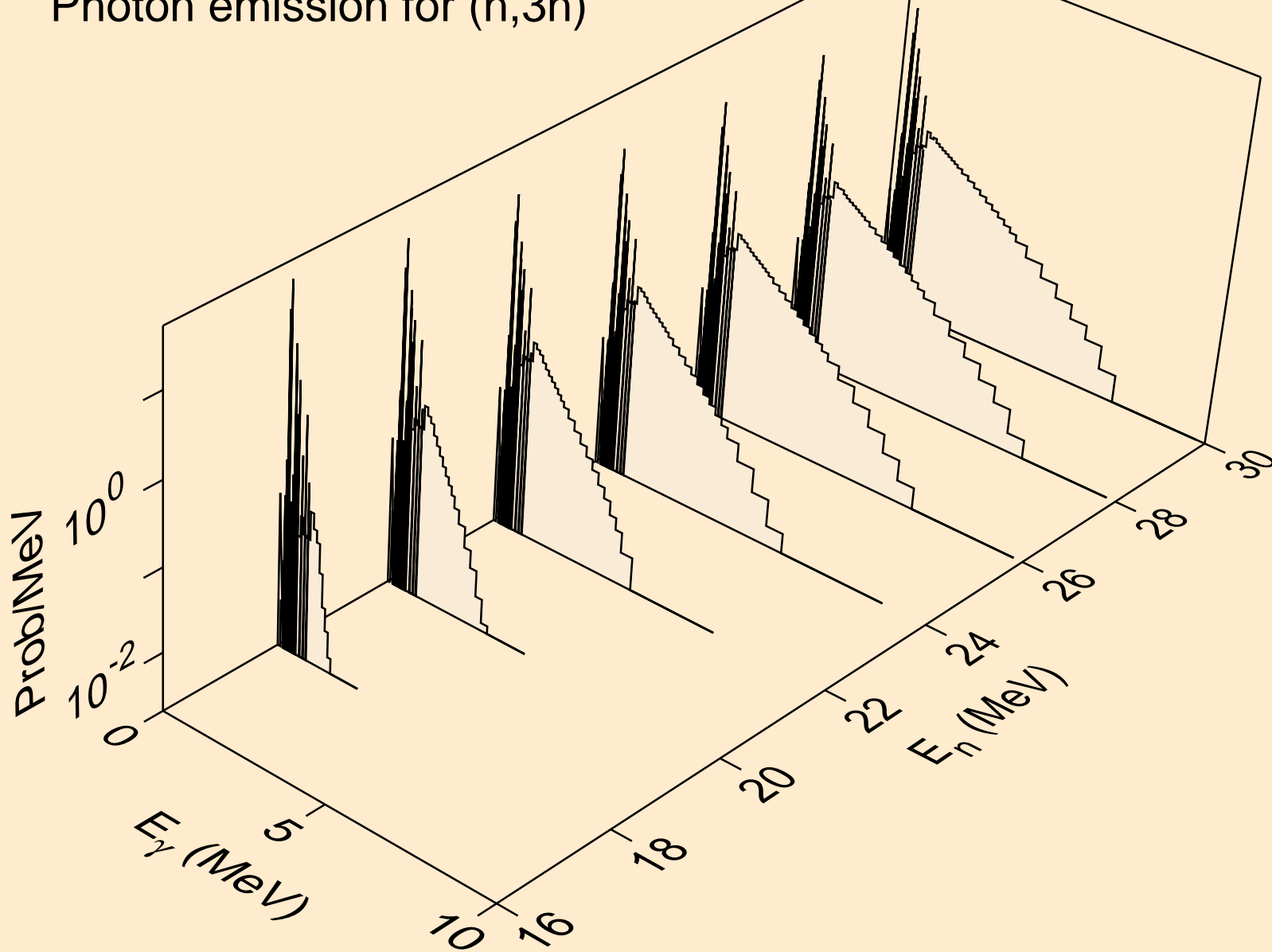

CO062M NEUTRON ACER TENDL-2019 LIBRARY; T=293.16K
Photon emission for (n,n*)a

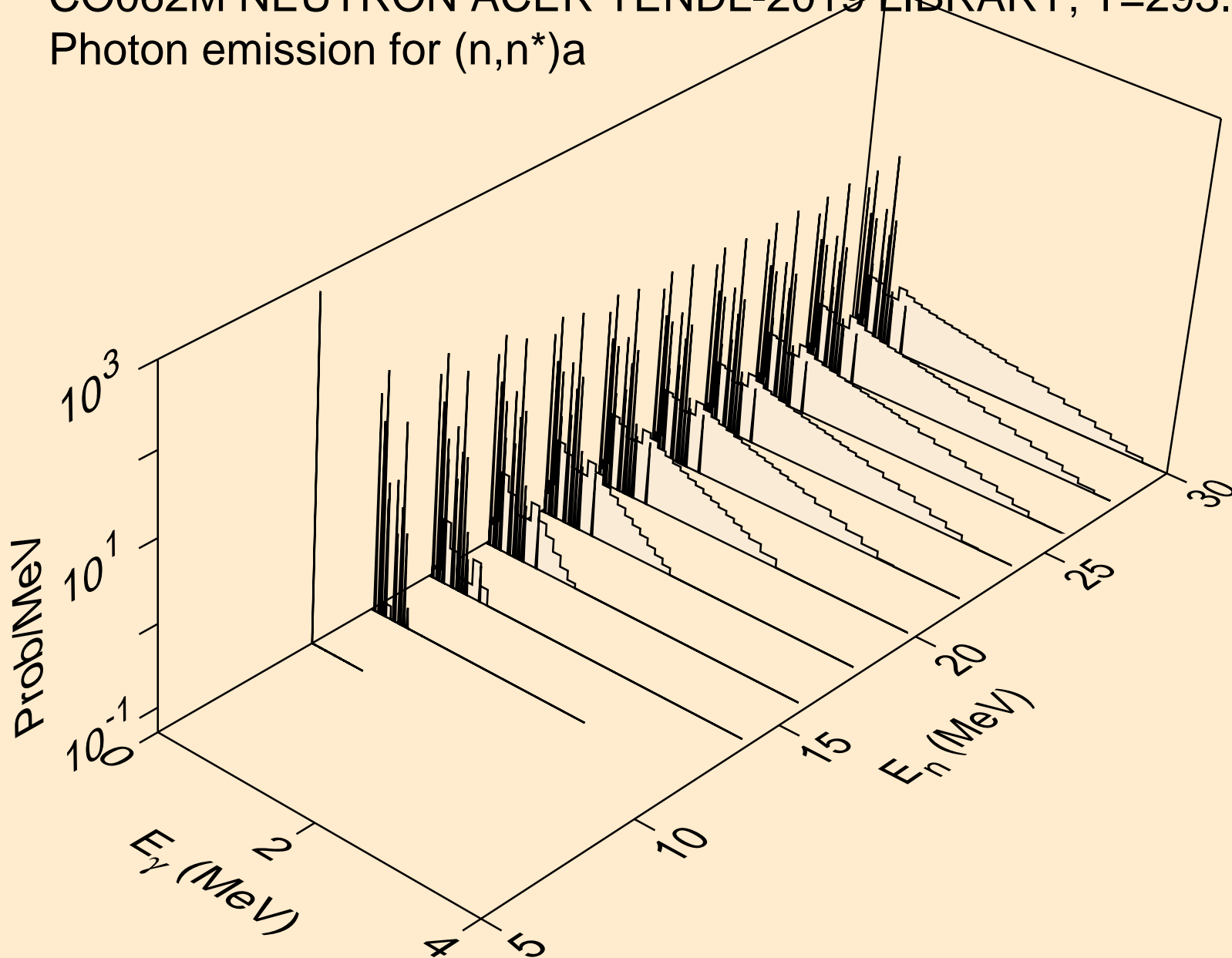

CO062M NEUTRON ACER TENDL-2019 LIBRARY; T=293.16K
Photon emission for (n,2n)a

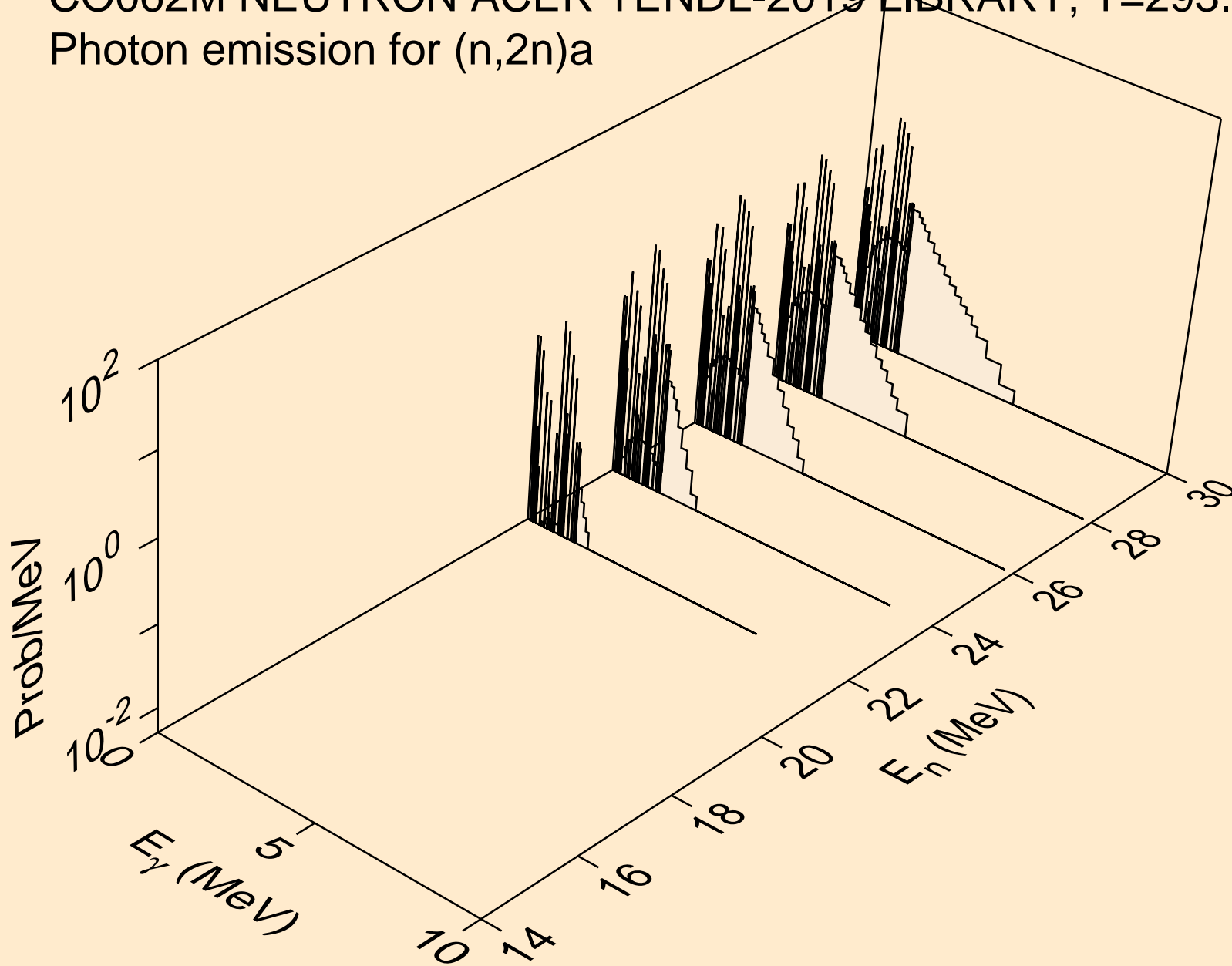

CO062M NEUTRON ACER TENDL-2019 LIBRARY; T=293.16K
Photon emission for (n,3n)a

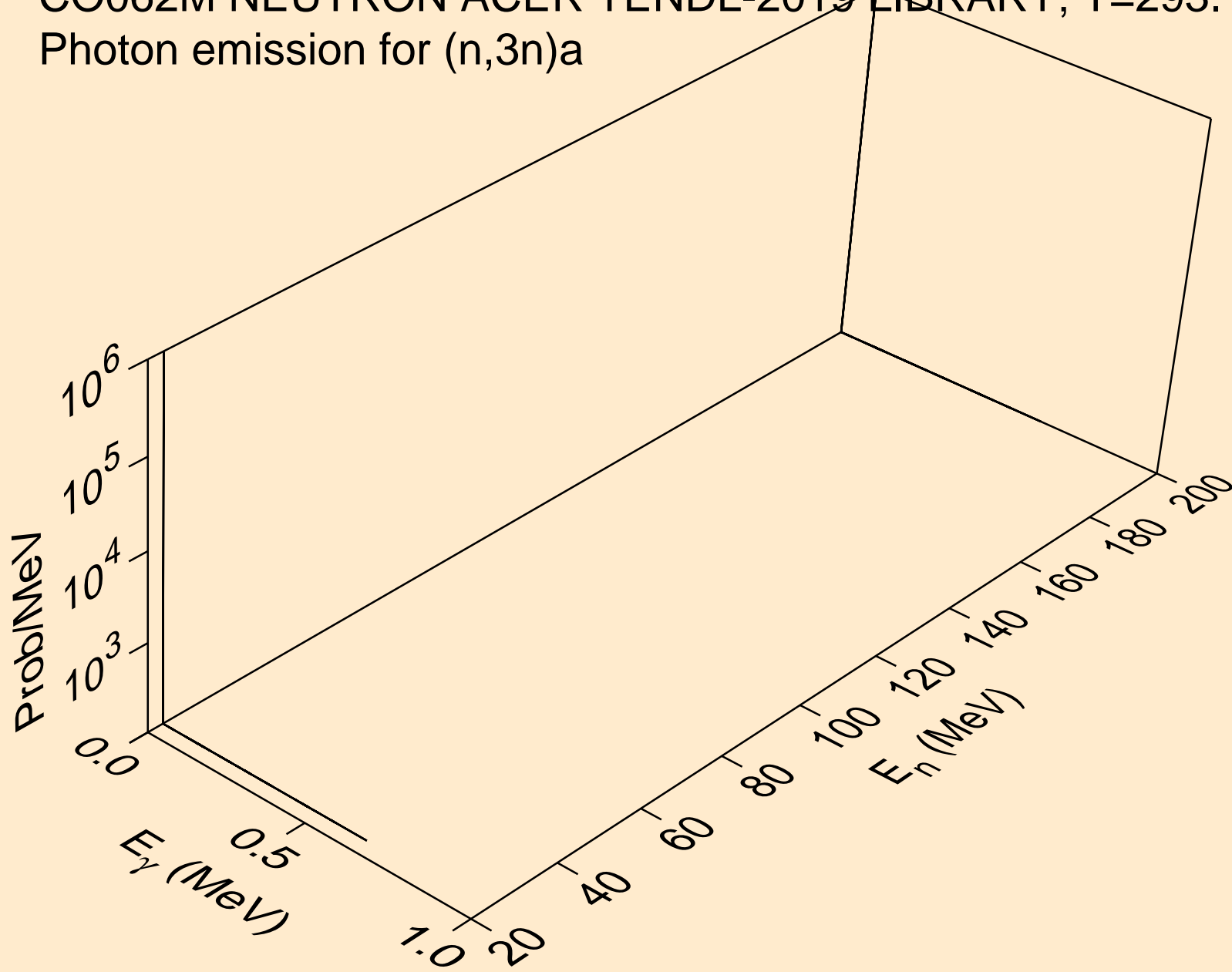

CO062M NEUTRON ACER TENDL-2019 LIBRARY; T=293.16K
Photon emission for (n,n*)p

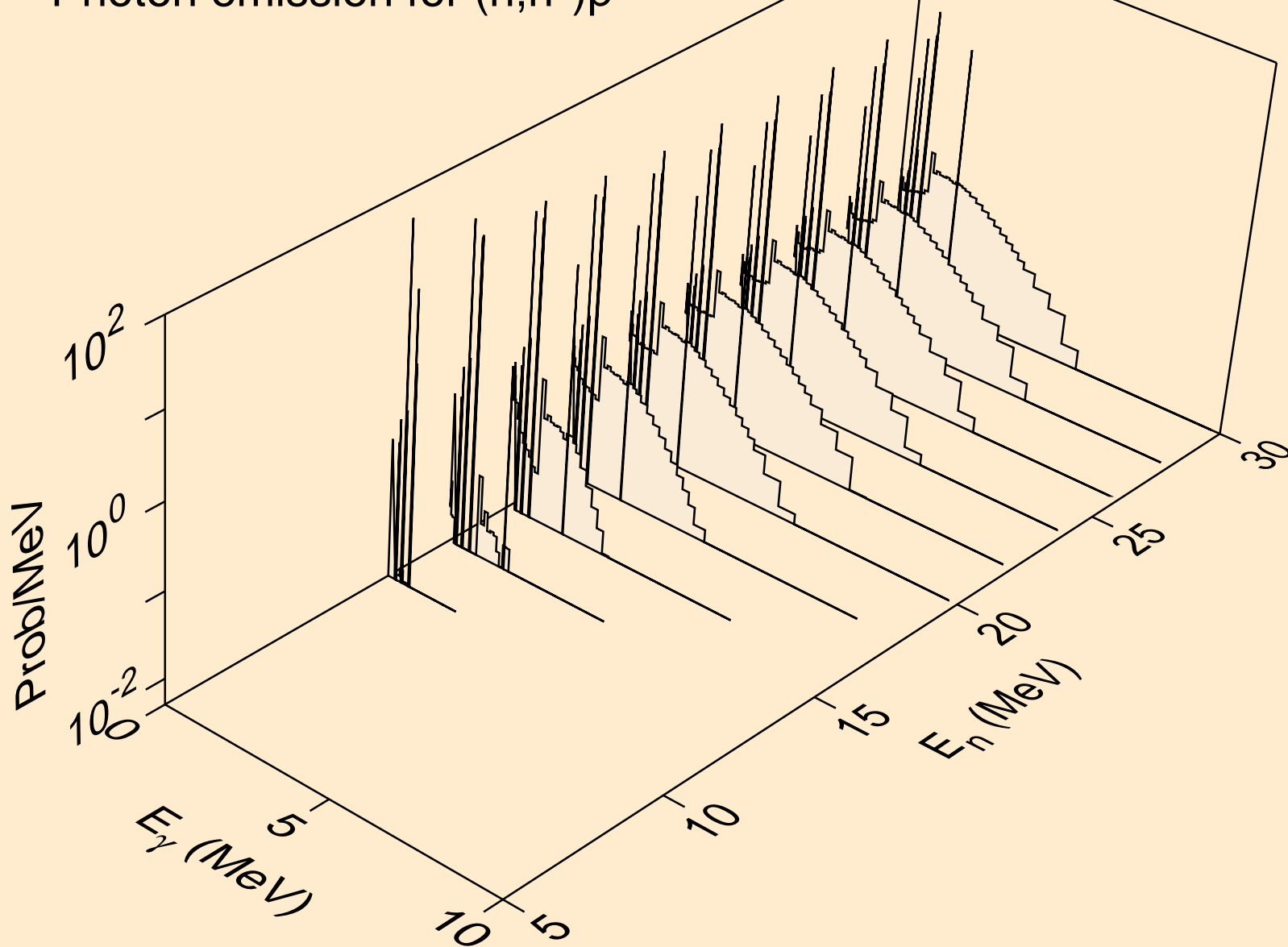

CO062M NEUTRON ACER TENDL-2019 LIBRARY; T=293.16K
Photon emission for (n,n*)2a

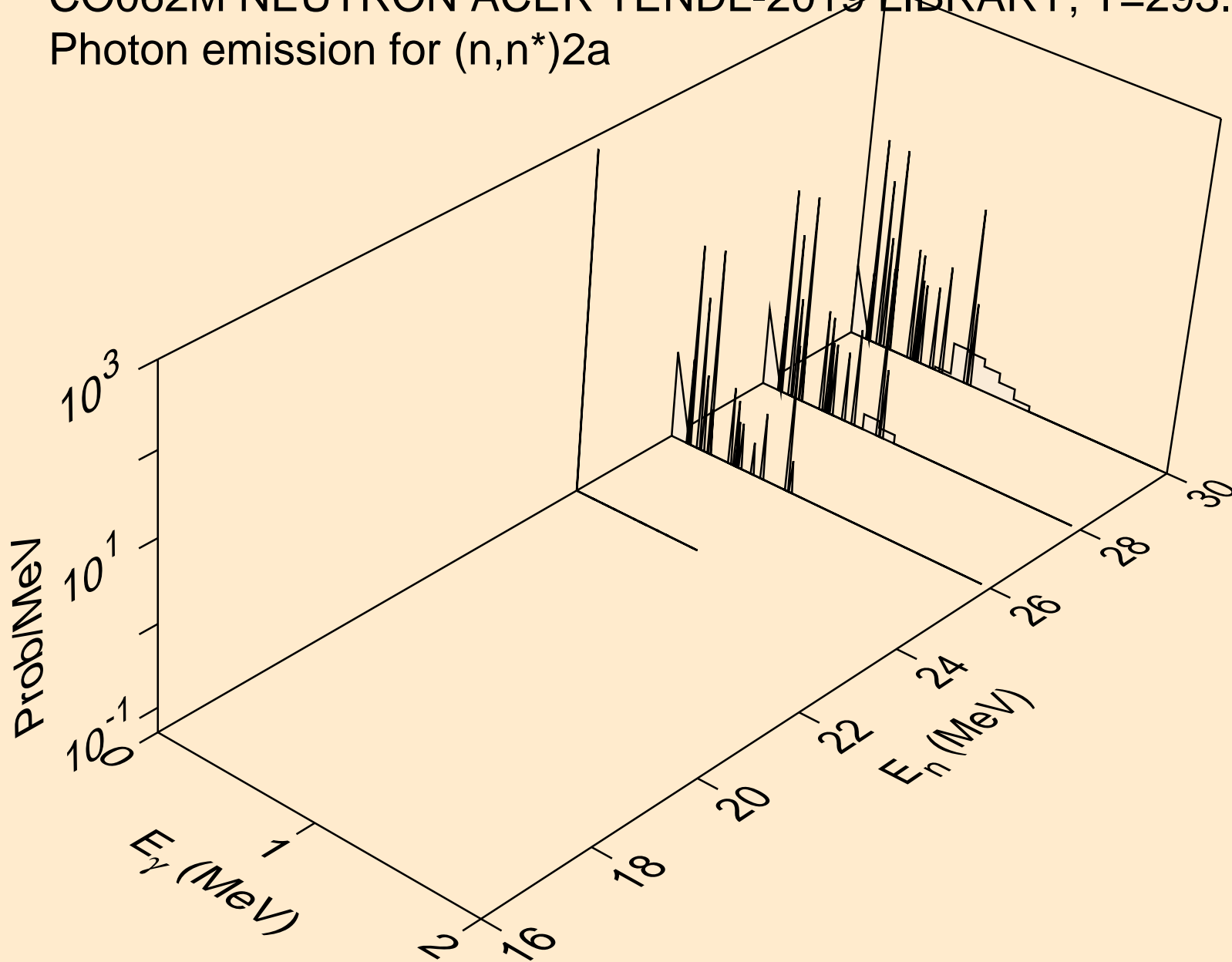

CO062M NEUTRON ACER TENDL-2019 LIBRARY; T=293.16K
Photon emission for (n,n*)d

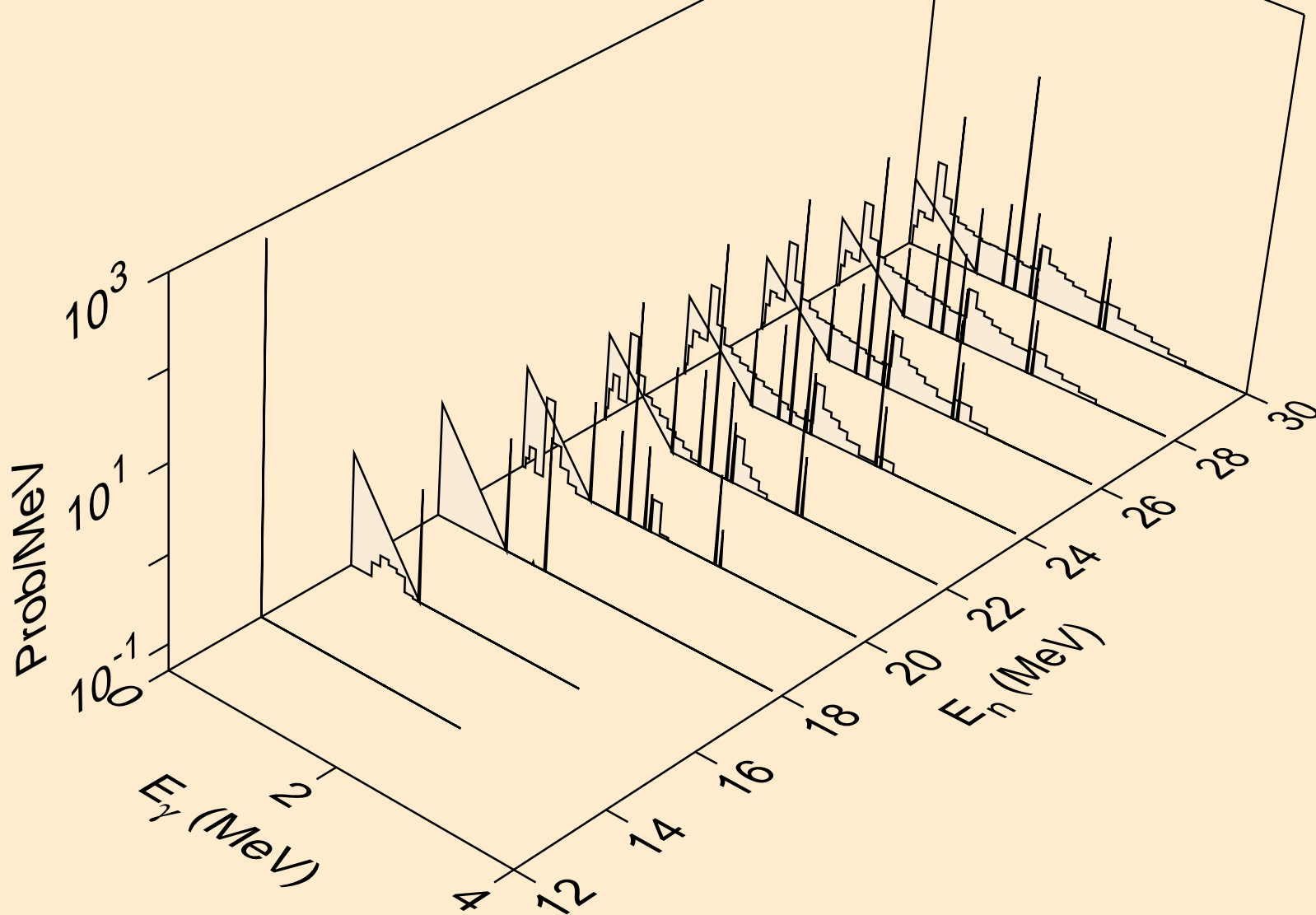

CO062M NEUTRON ACER TENDL-2019 LIBRARY; T=293.16K
Photon emission for (n,n*)t

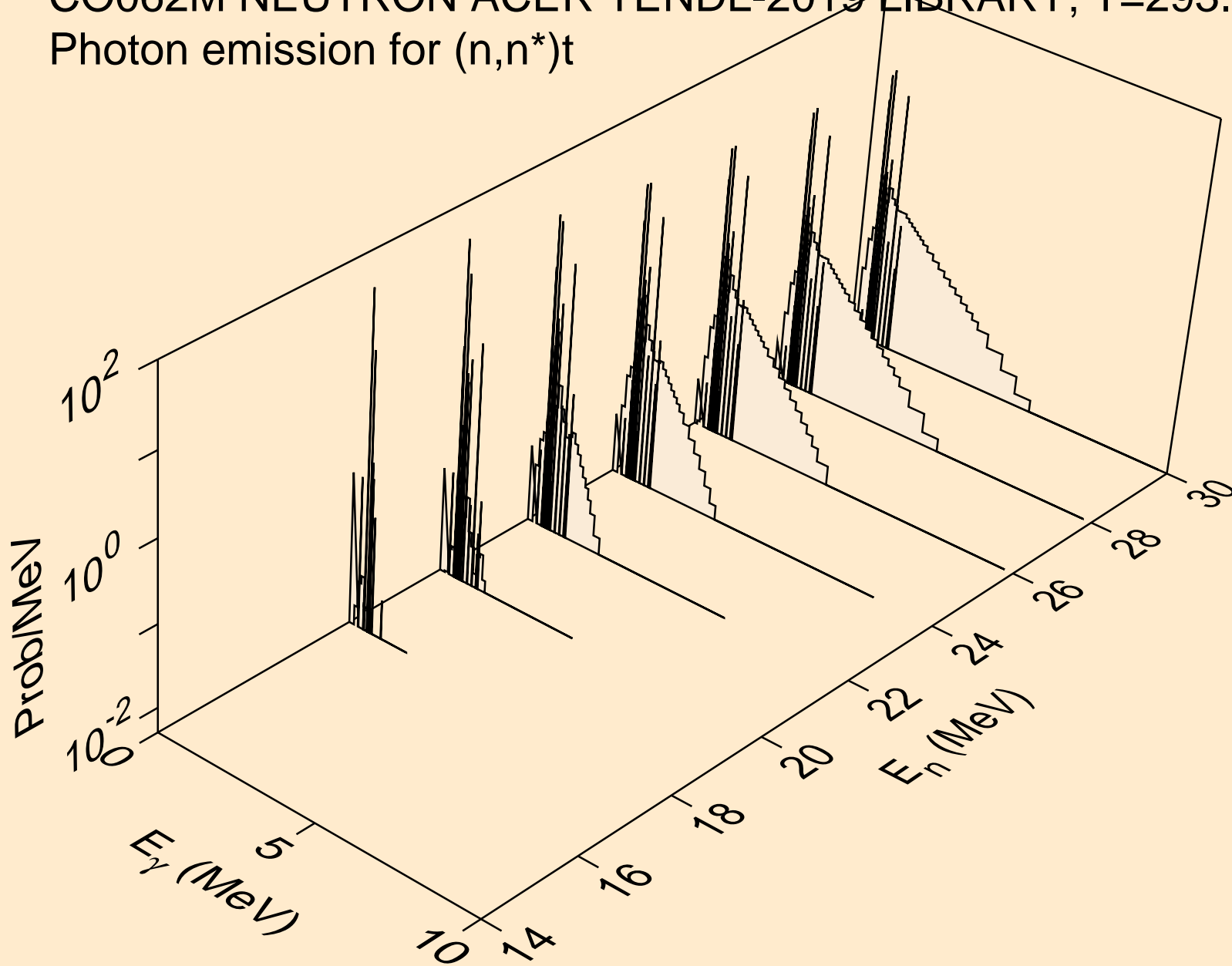

CO062M NEUTRON ACER TENDL-2019 LIBRARY; T=293.16K
Photon emission for (n,n*)he3

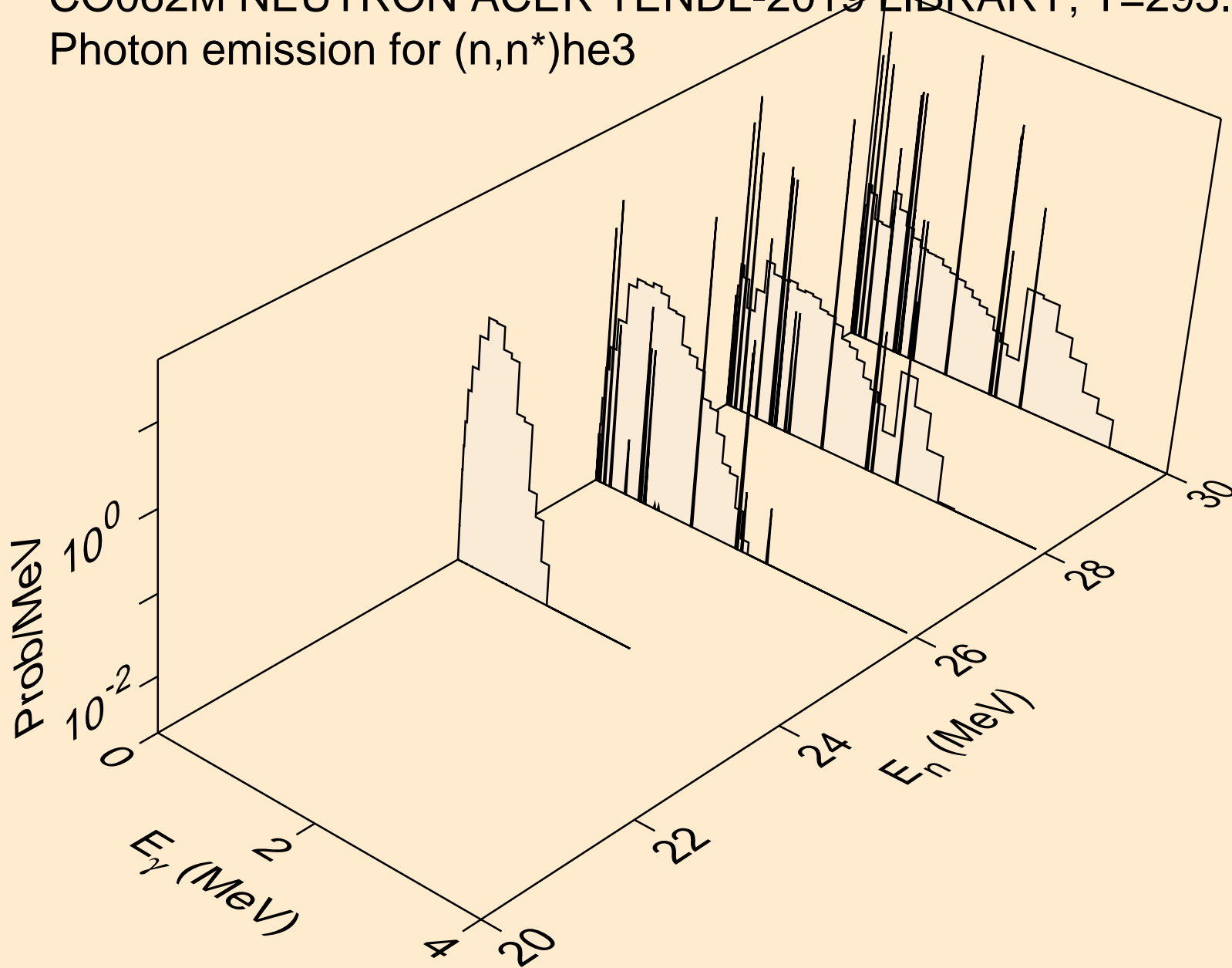

CO062M NEUTRON ACER TENDL-2019 LIBRARY; T=293.16K
Photon emission for (n,4n)

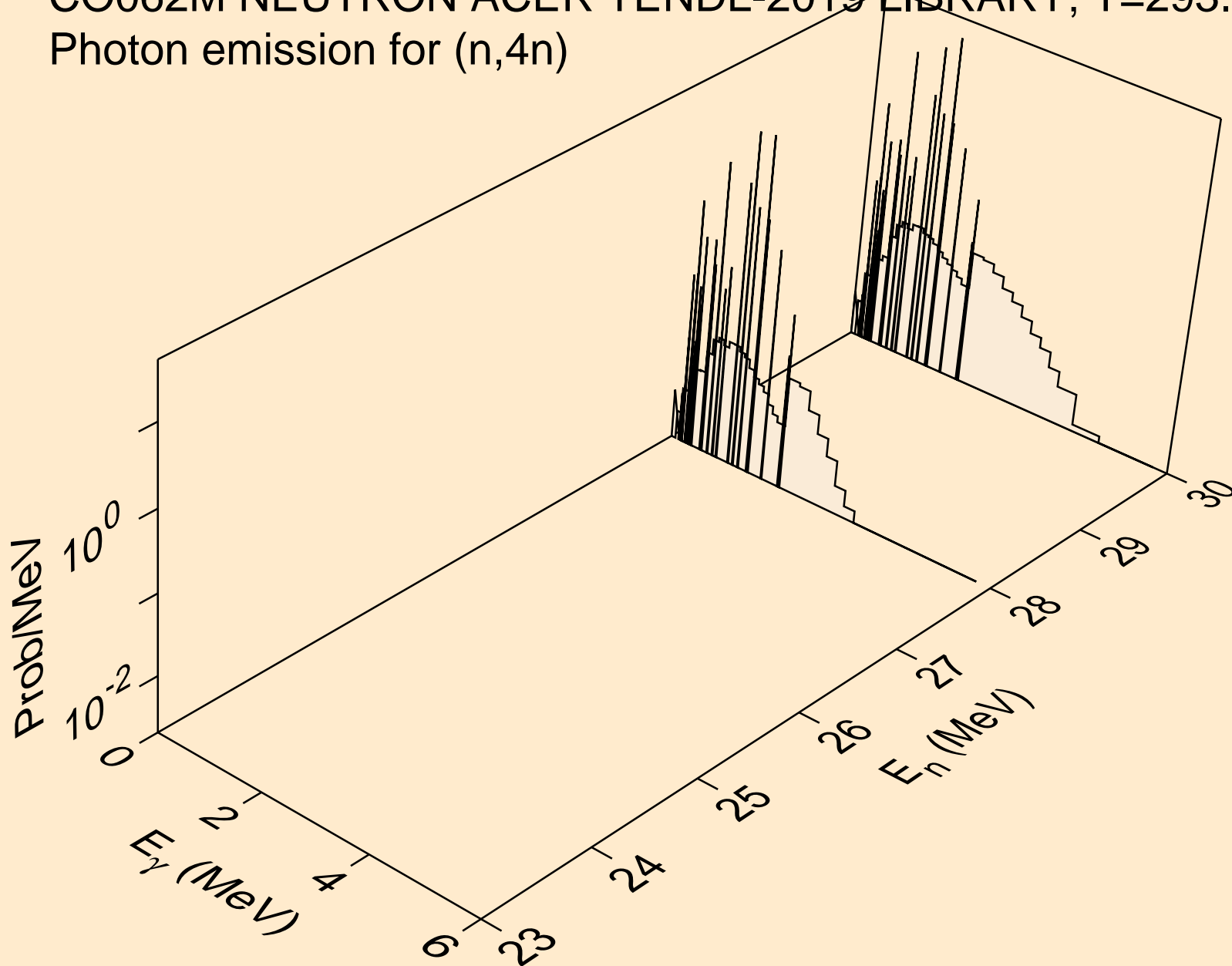

CO062M NEUTRON ACER TENDL-2019 LIBRARY; T=293.16K
Photon emission for (n,2np)

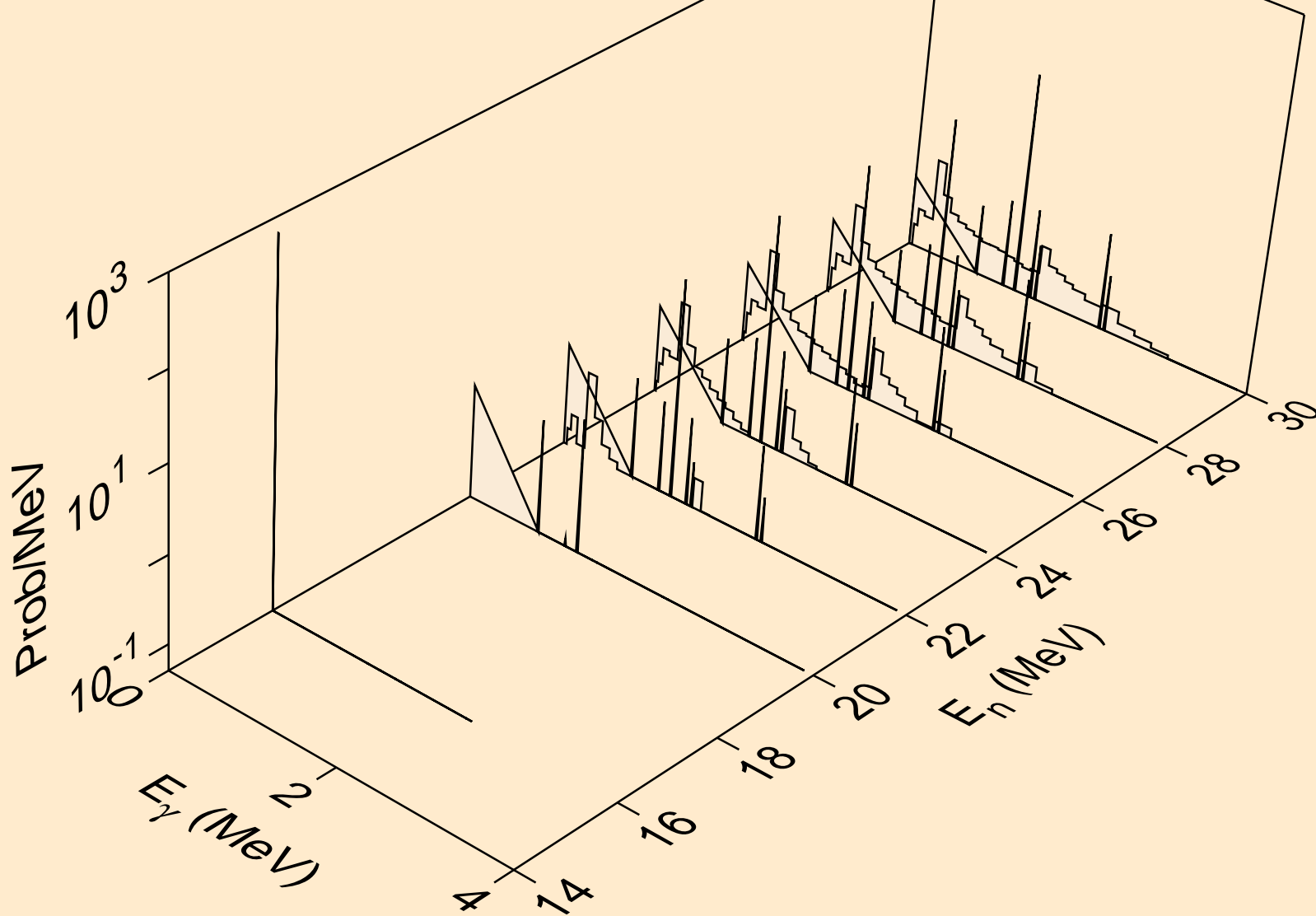

CO062M NEUTRON ACER TENDL-2019 LIBRARY; T=293.16K
Photon emission for (n,3np)

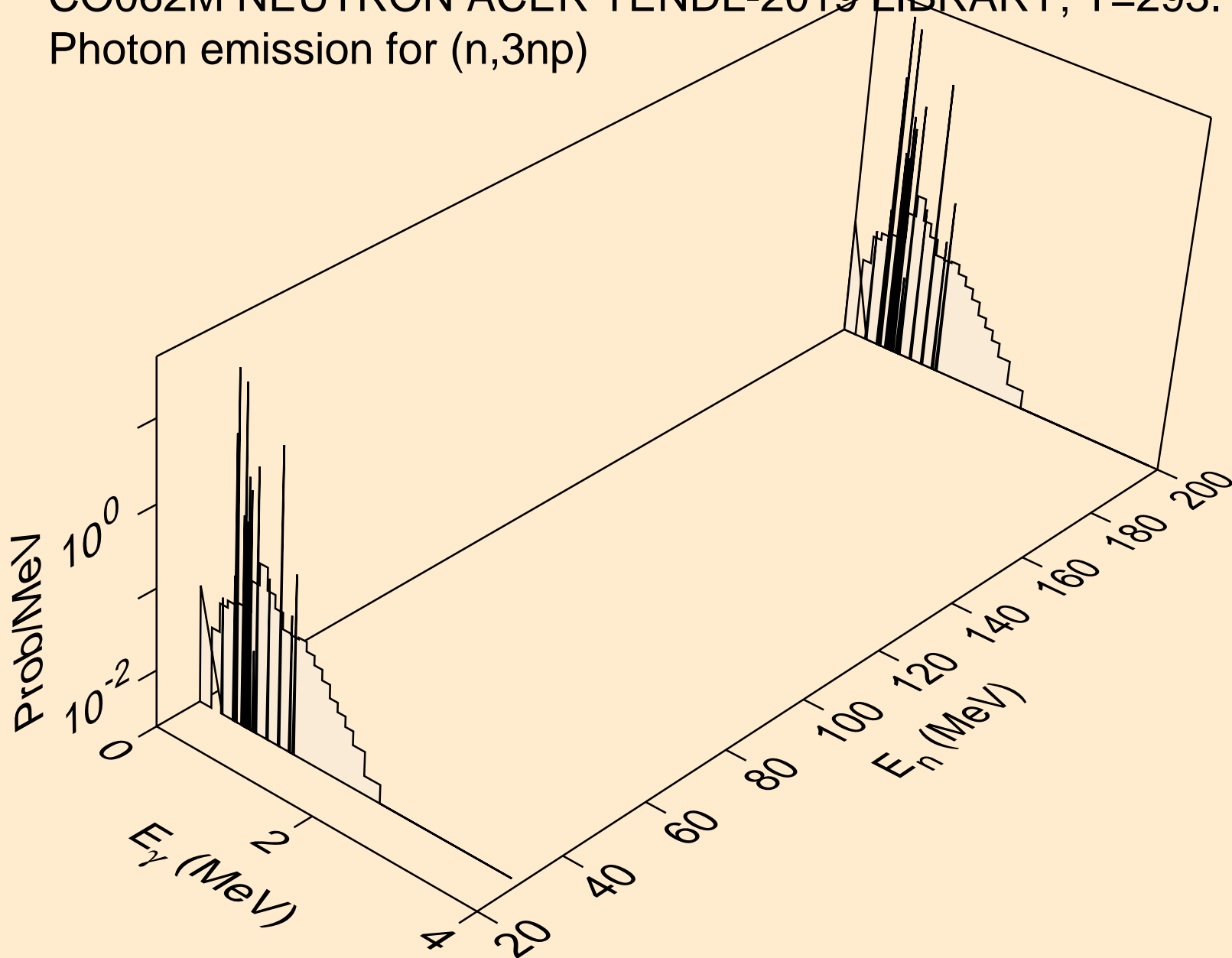

CO062M NEUTRON ACER TENDL-2019 LIBRARY; T=293.16K
Photon emission for (n,2np)

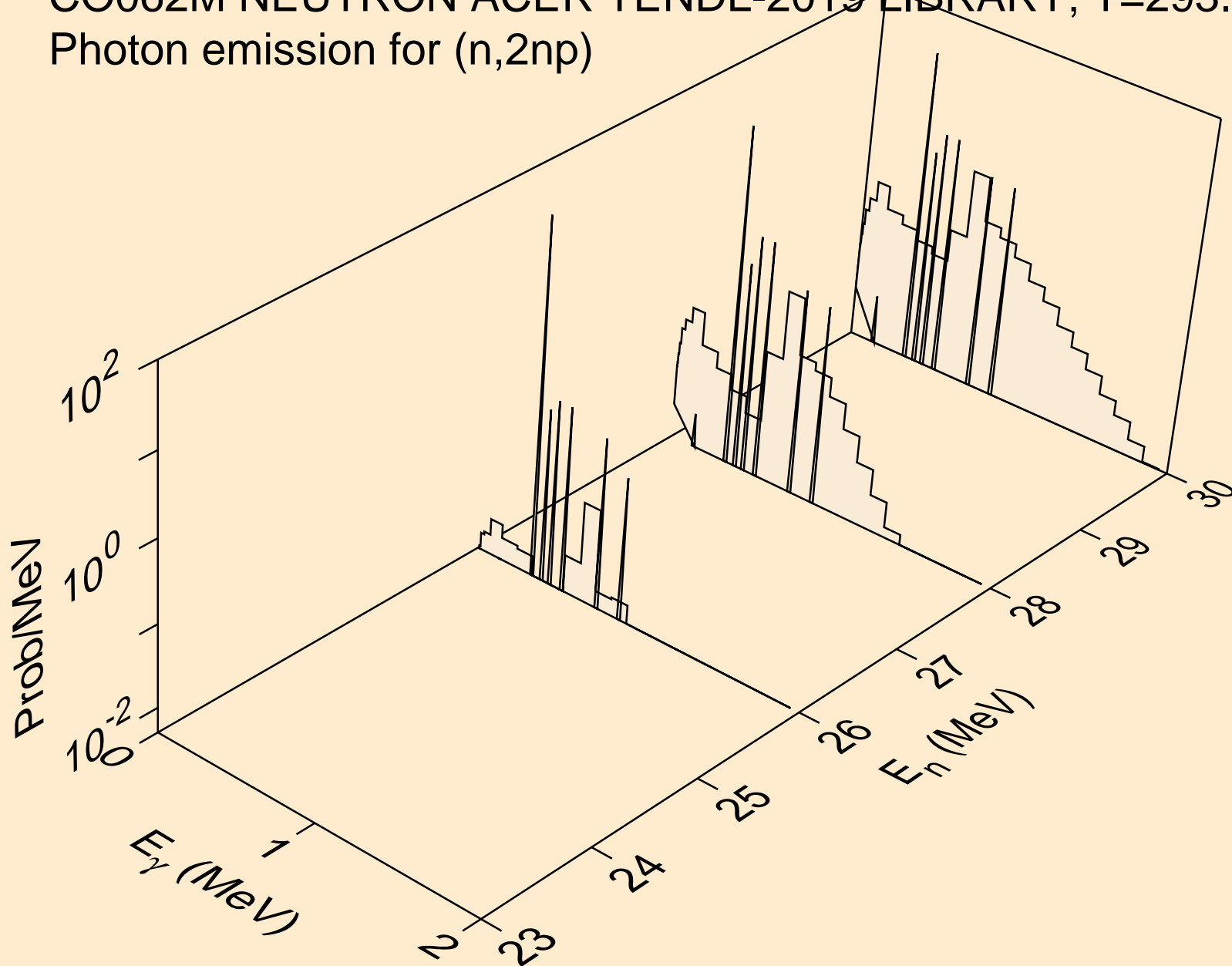

CO062M NEUTRON ACER TENDL-2019 LIBRARY; T=293.16K
Photon emission for (n,npa)

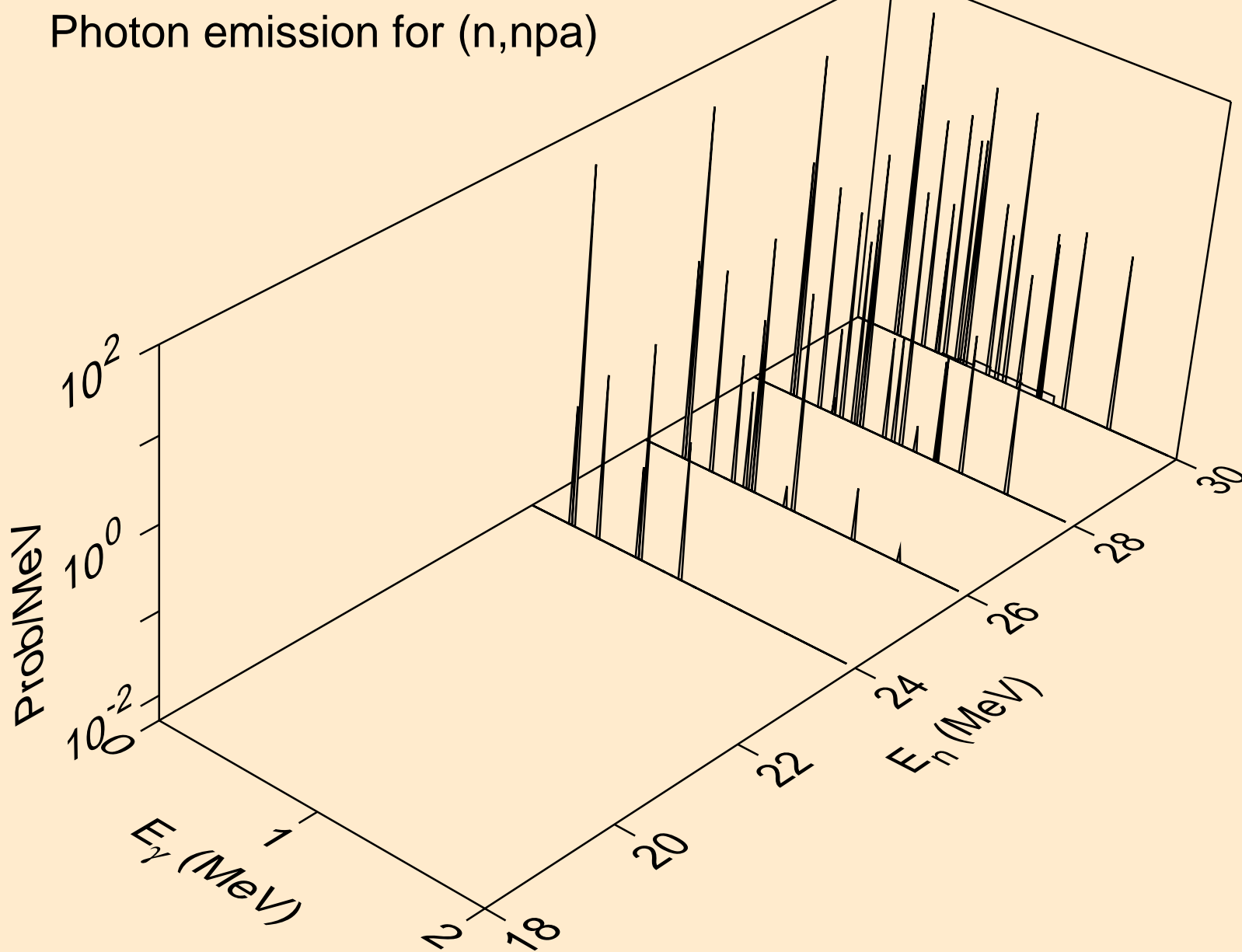

CO062M NEUTRON ACER TENDL-2019 LIBRARY; T=293.16K
Photon emission for (n,n*2)

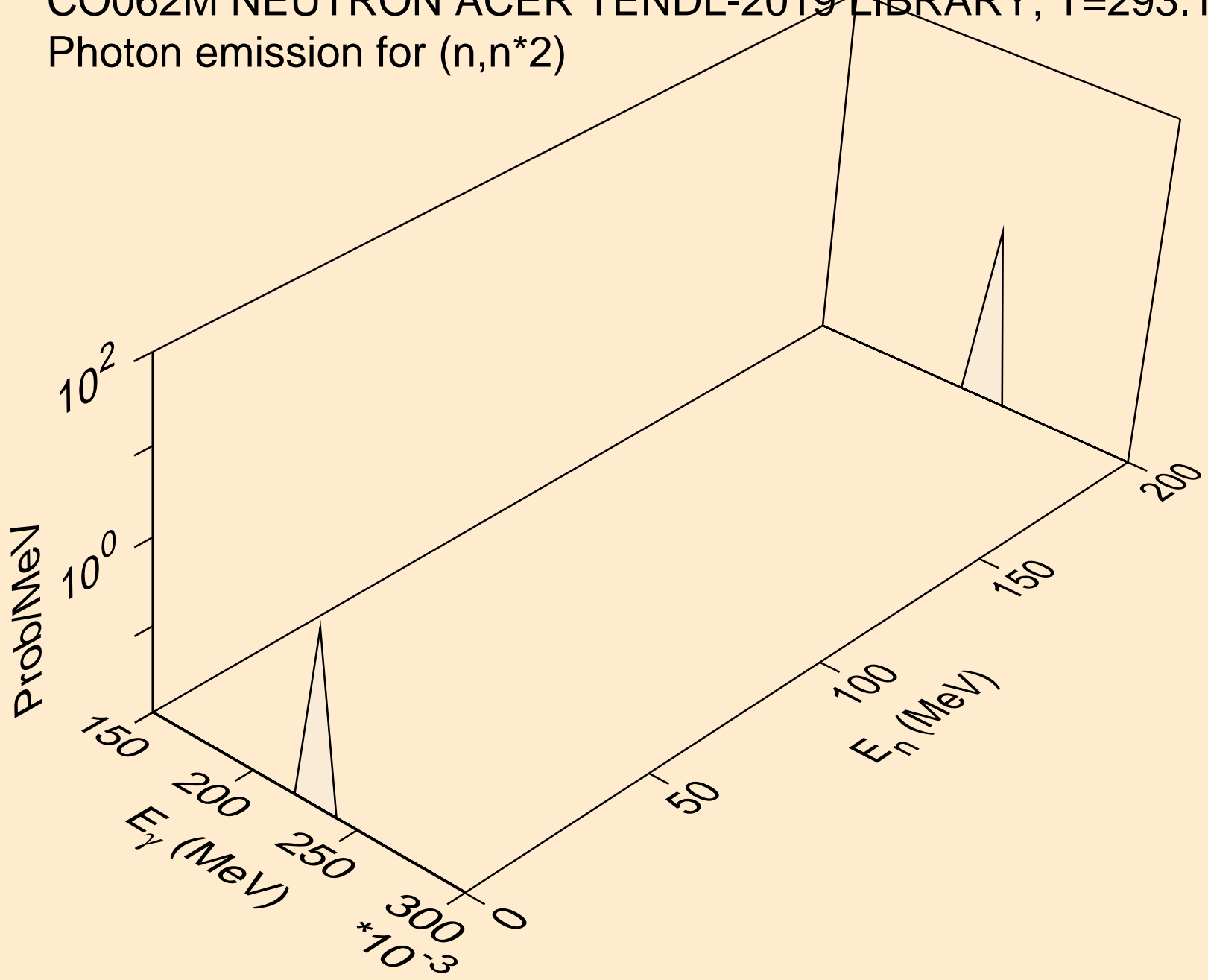

CO062M NEUTRON ACER TENDL-2019 LIBRARY; T=293.16K
Photon emission for (n,n*3)

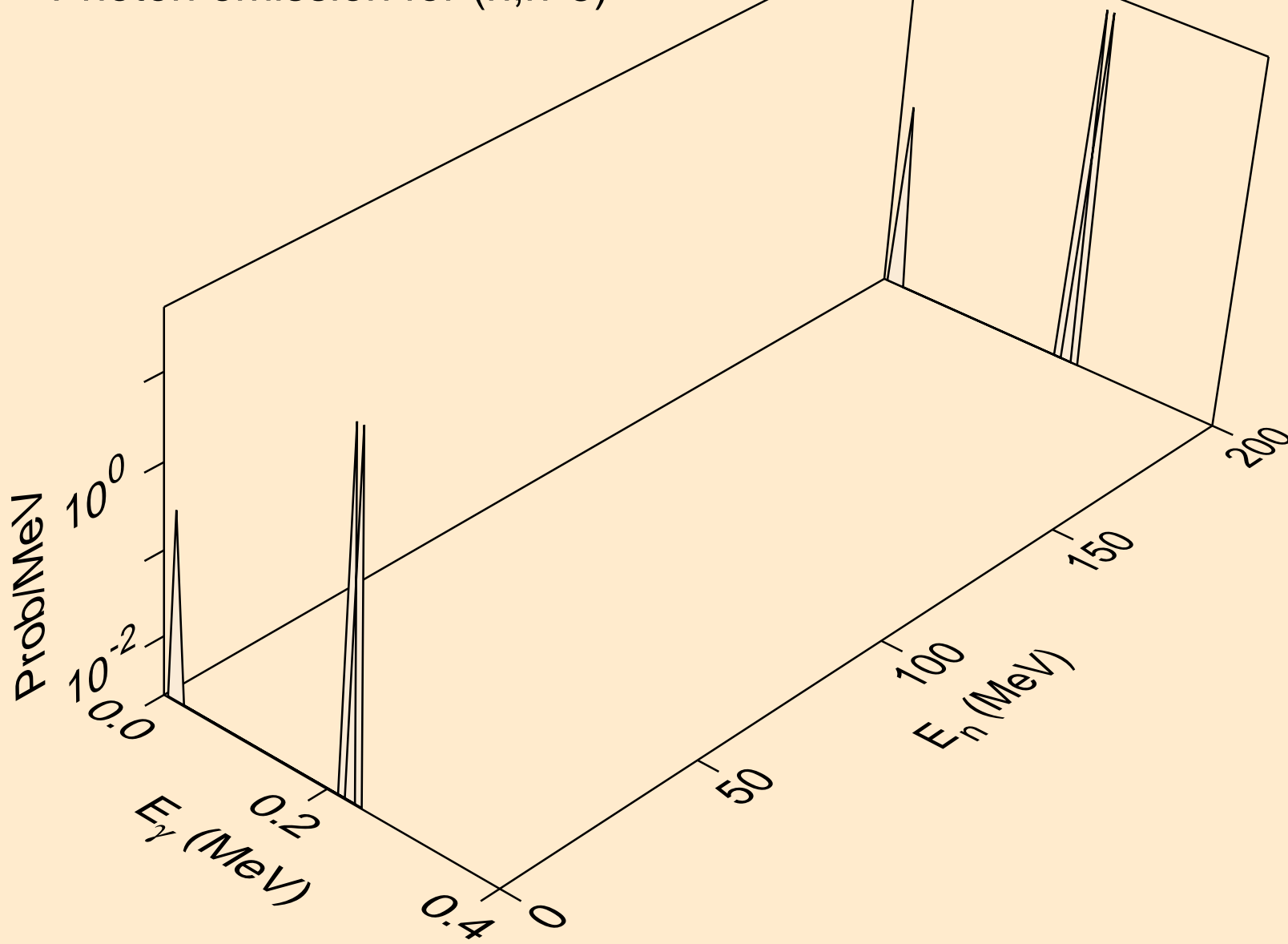

CO062M NEUTRON ACER TENDL-2019 LIBRARY; T=293.16K
Photon emission for (n,n*4)

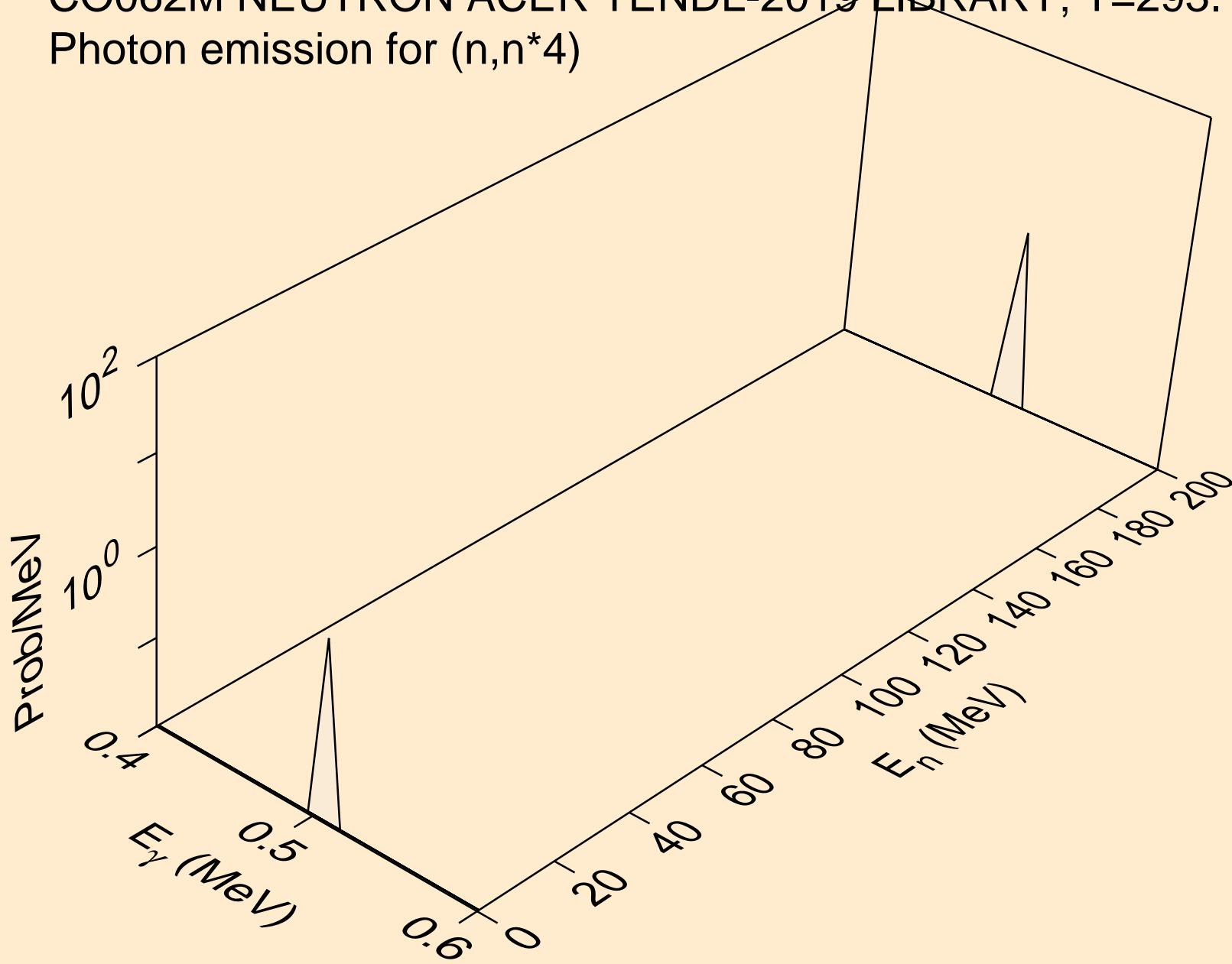

CO062M NEUTRON ACER TENDL-2019 LIBRARY; T=293.16K
Photon emission for (n,n*5)

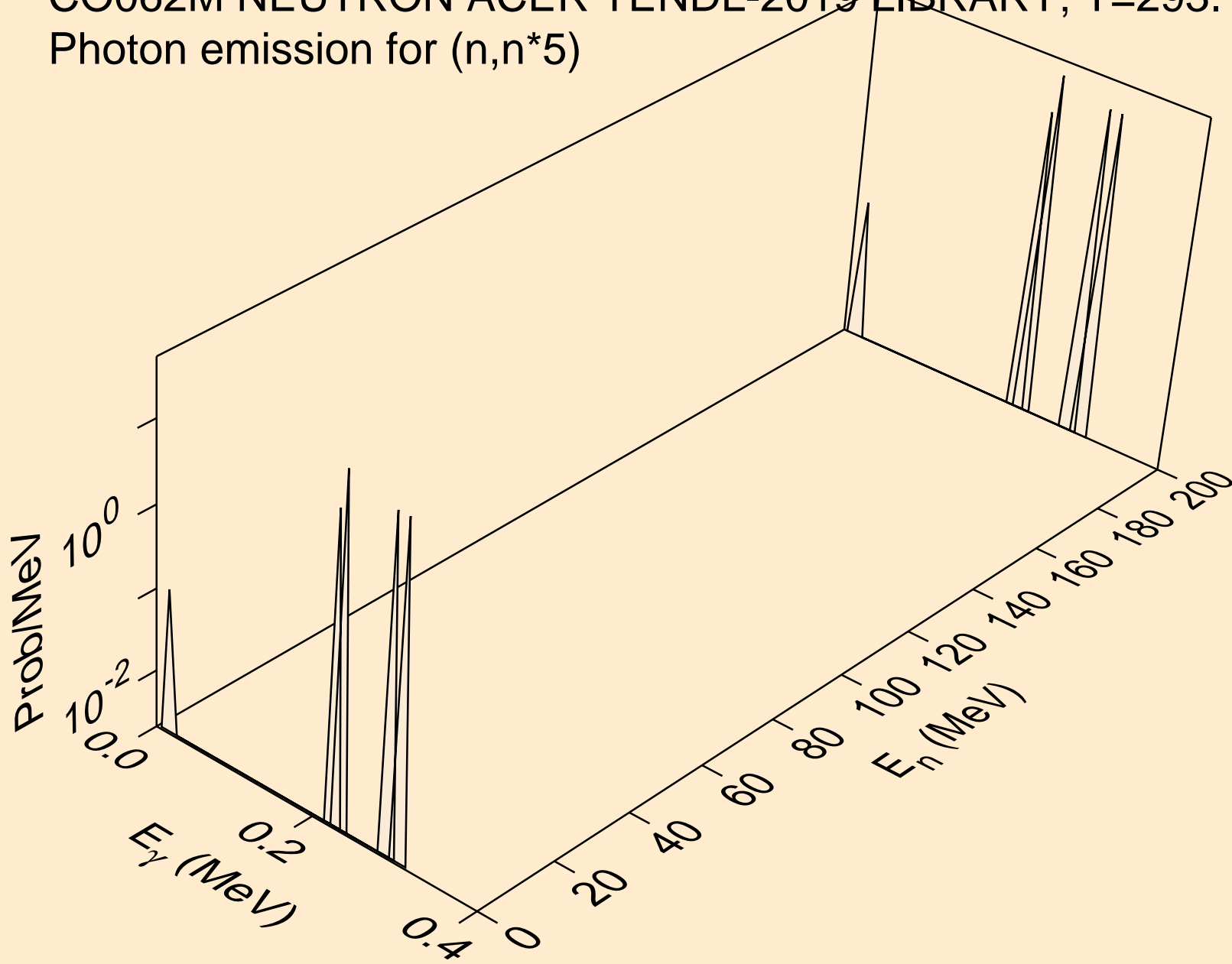

CO062M NEUTRON ACER TENDL-2019 LIBRARY; T=293.16K
Photon emission for (n,n*6)

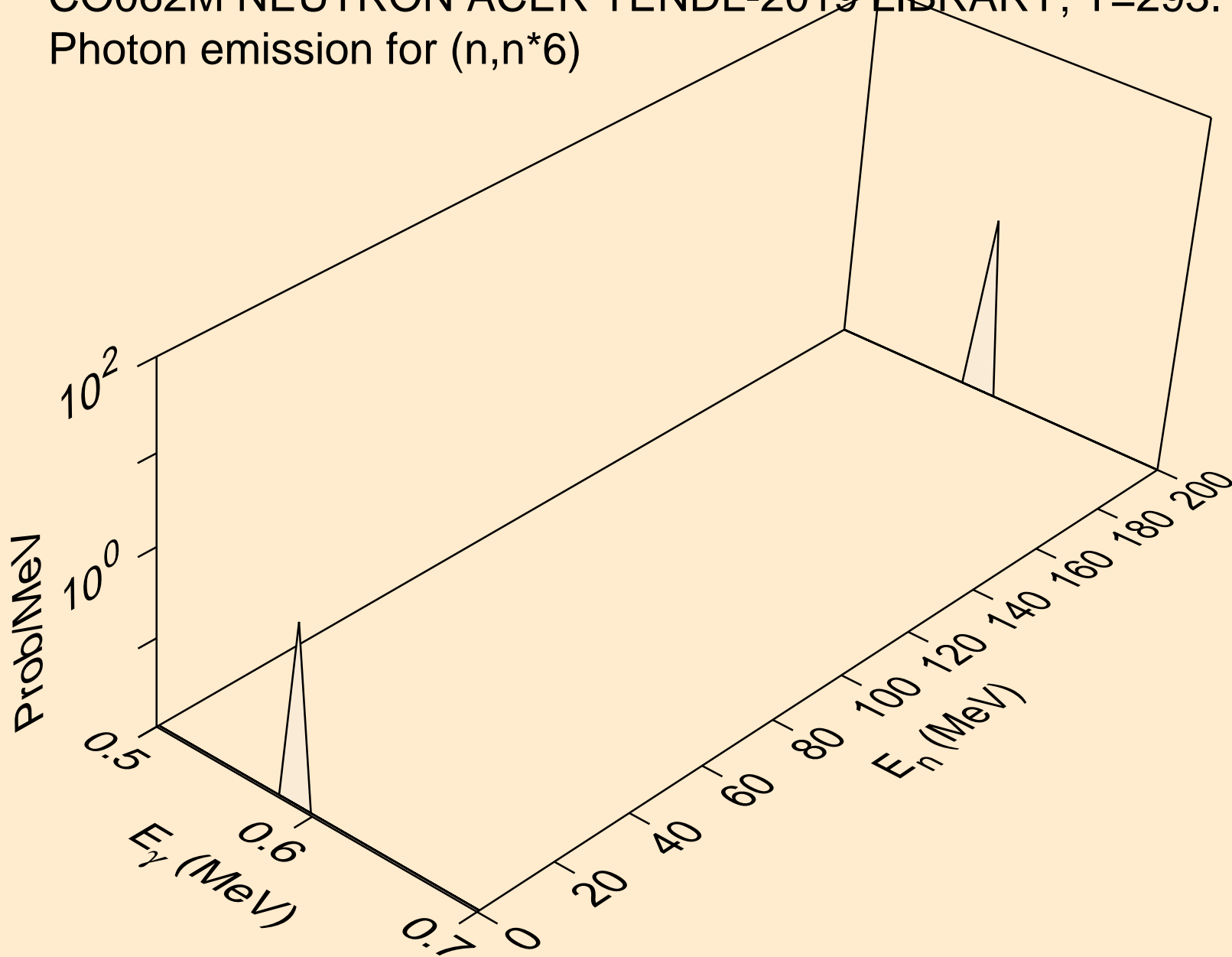

CO062M NEUTRON ACER TENDL-2019 LIBRARY; T=293.16K
Photon emission for (n,n*7)

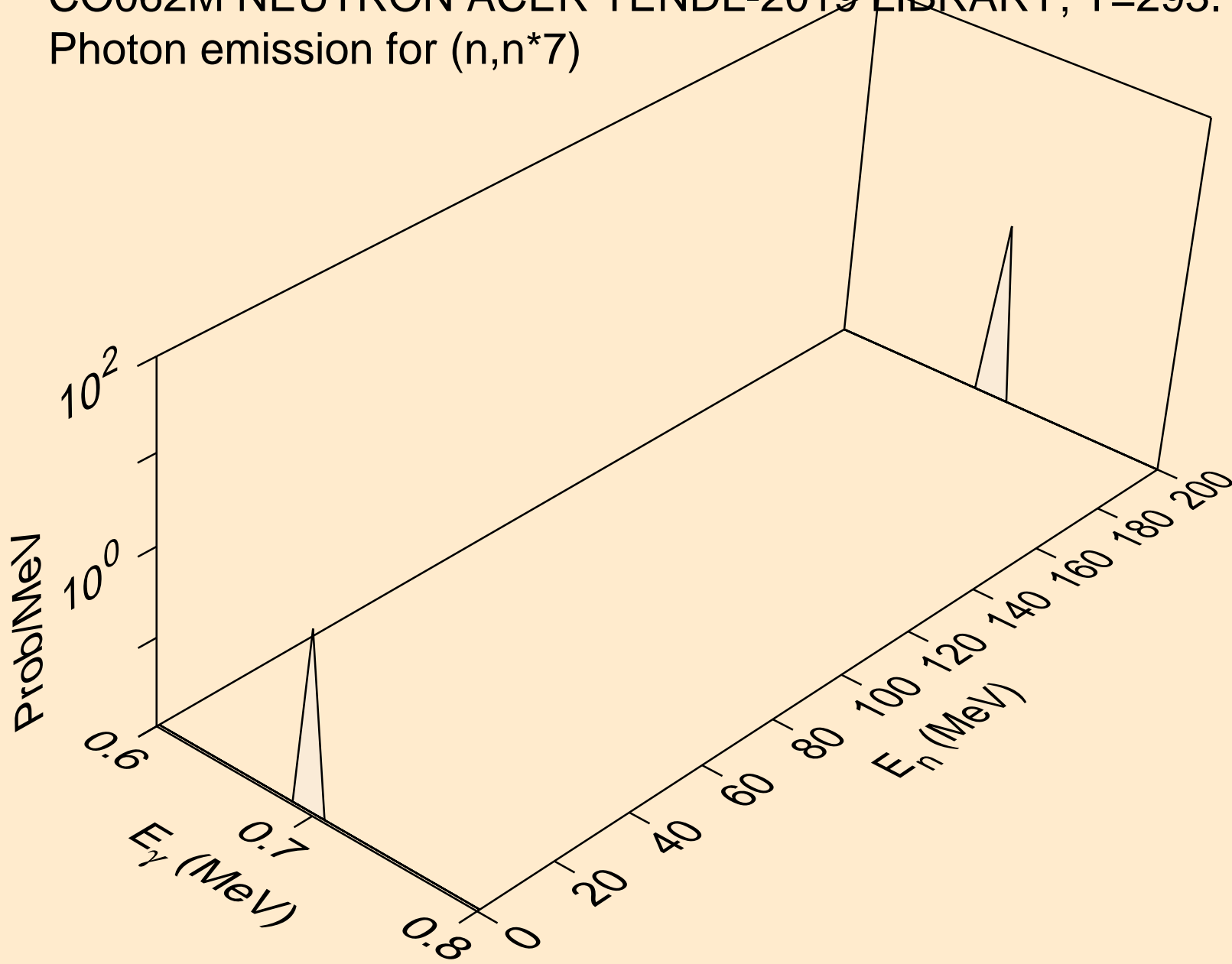

CO062M NEUTRON ACER TENDL-2019 LIBRARY; T=293.16K
Photon emission for (n,n*8)

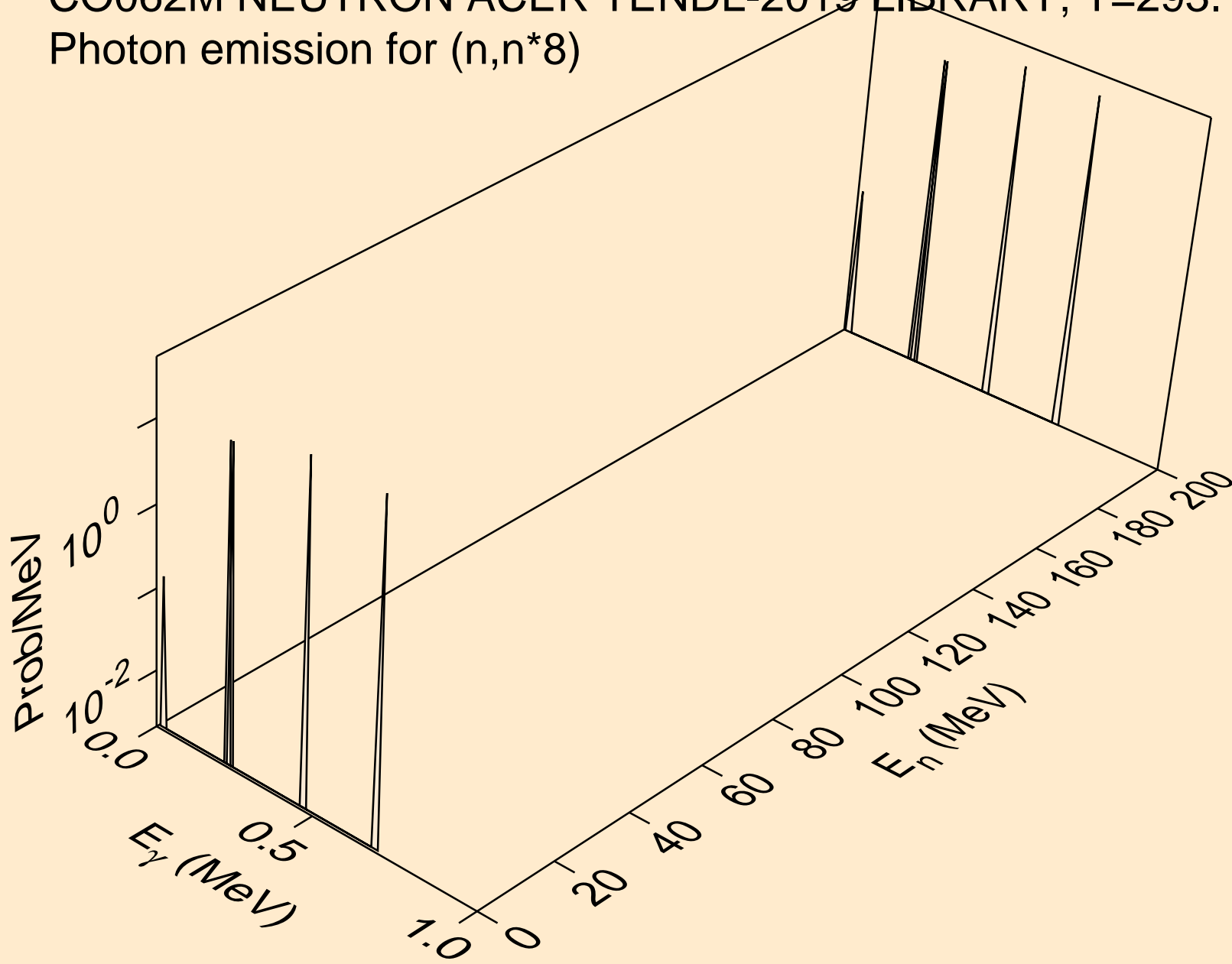

CO062M NEUTRON ACER TENDL-2019 LIBRARY; T=293.16K
Photon emission for (n,n*9)

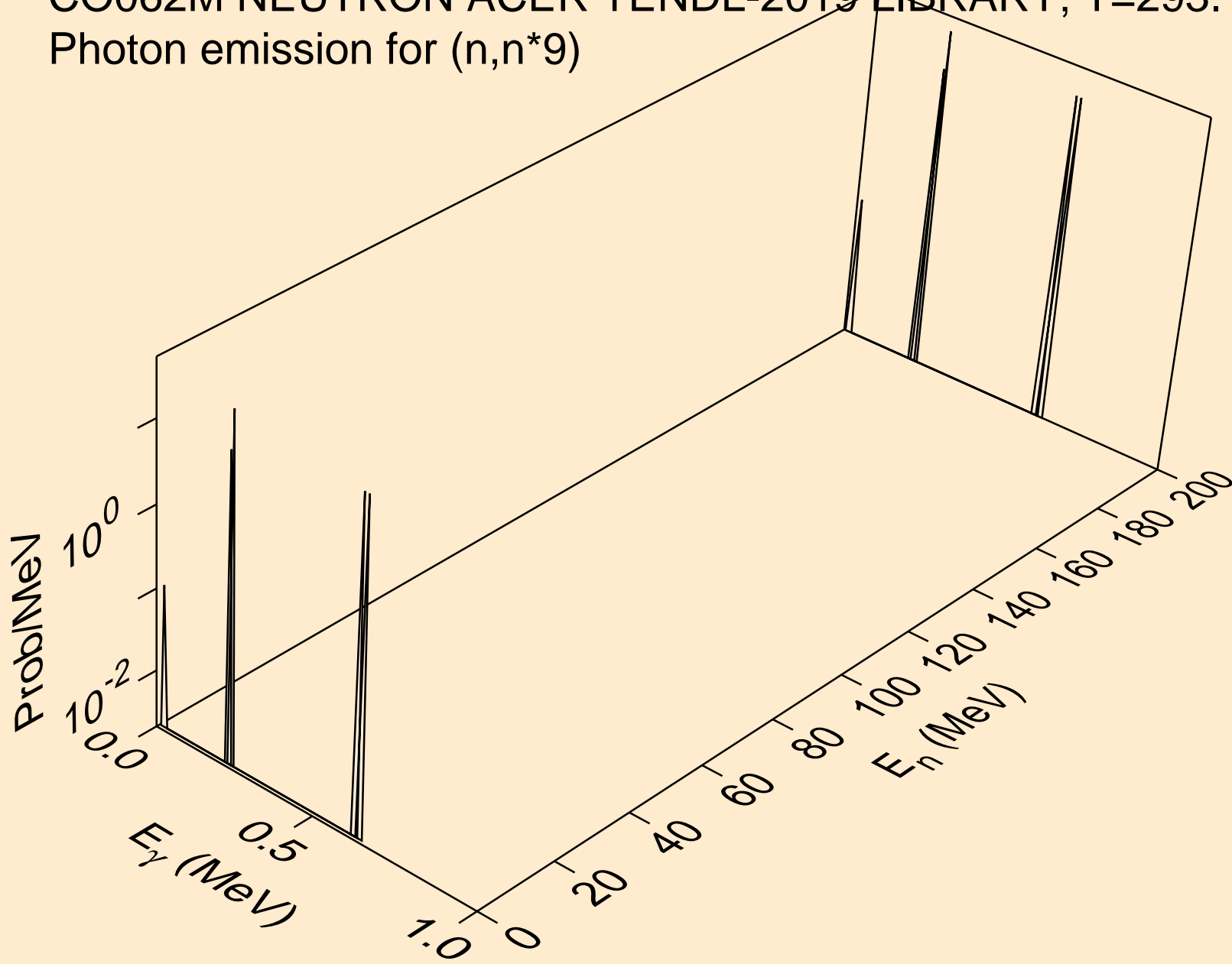

CO062M NEUTRON ACER TENDL-2019 LIBRARY; T=293.16K
Photon emission for (n,n*10)

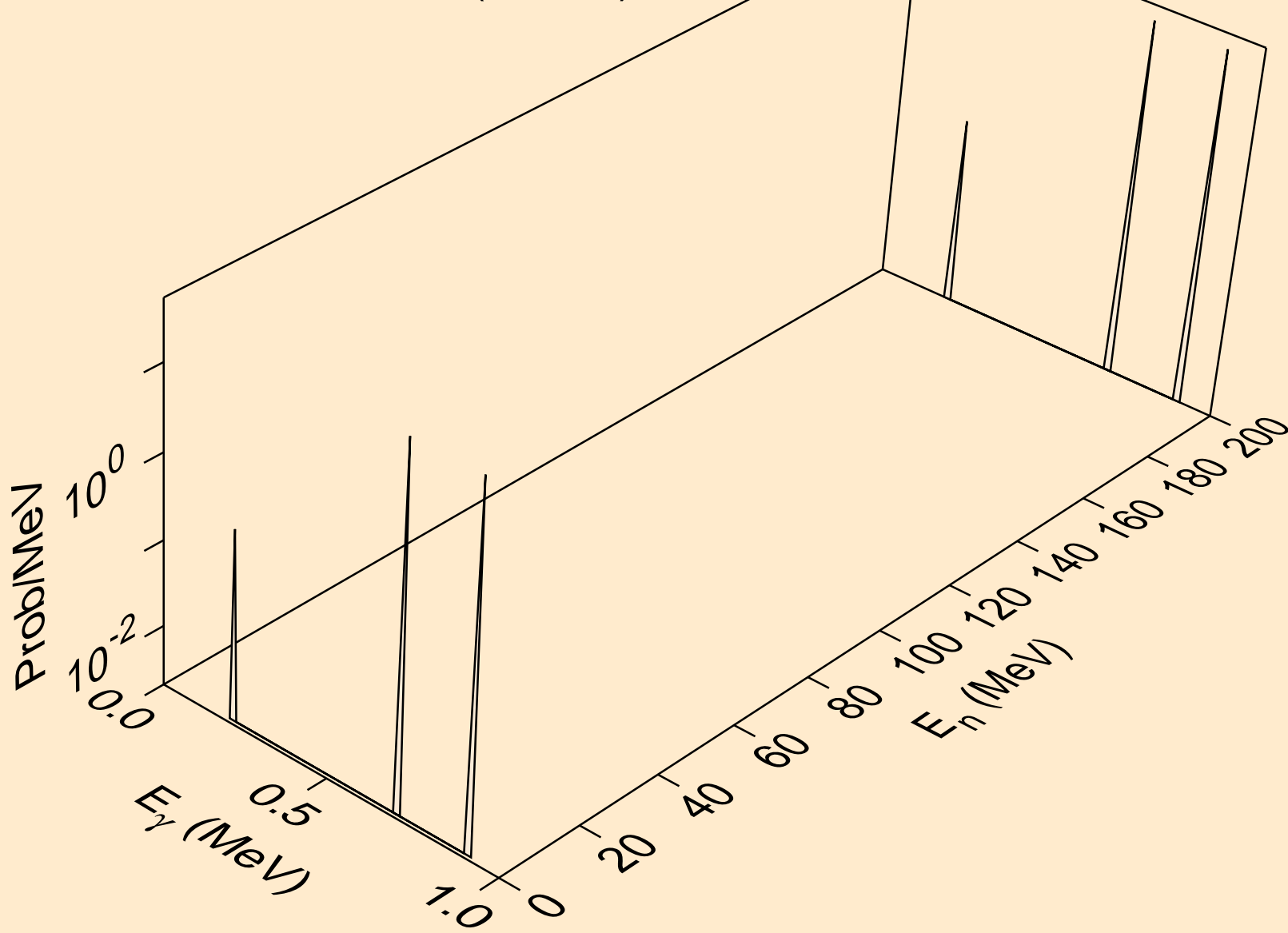

CO062M NEUTRON ACER TENDL-2019 LIBRARY; T=293.16K
Photon emission for (n,n*11)

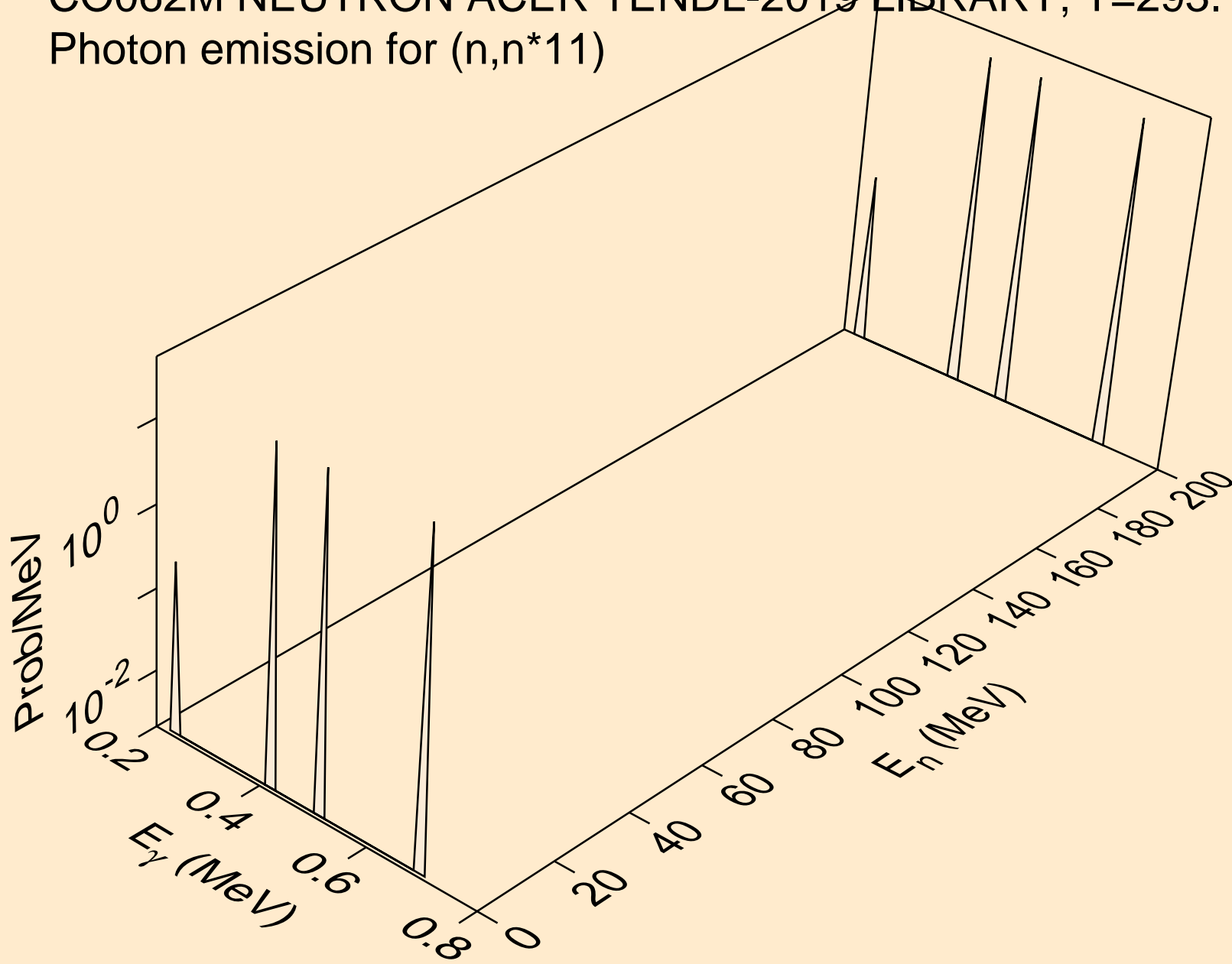

CO062M NEUTRON ACER TENDL-2019 LIBRARY; T=293.16K
Photon emission for (n,n*12)

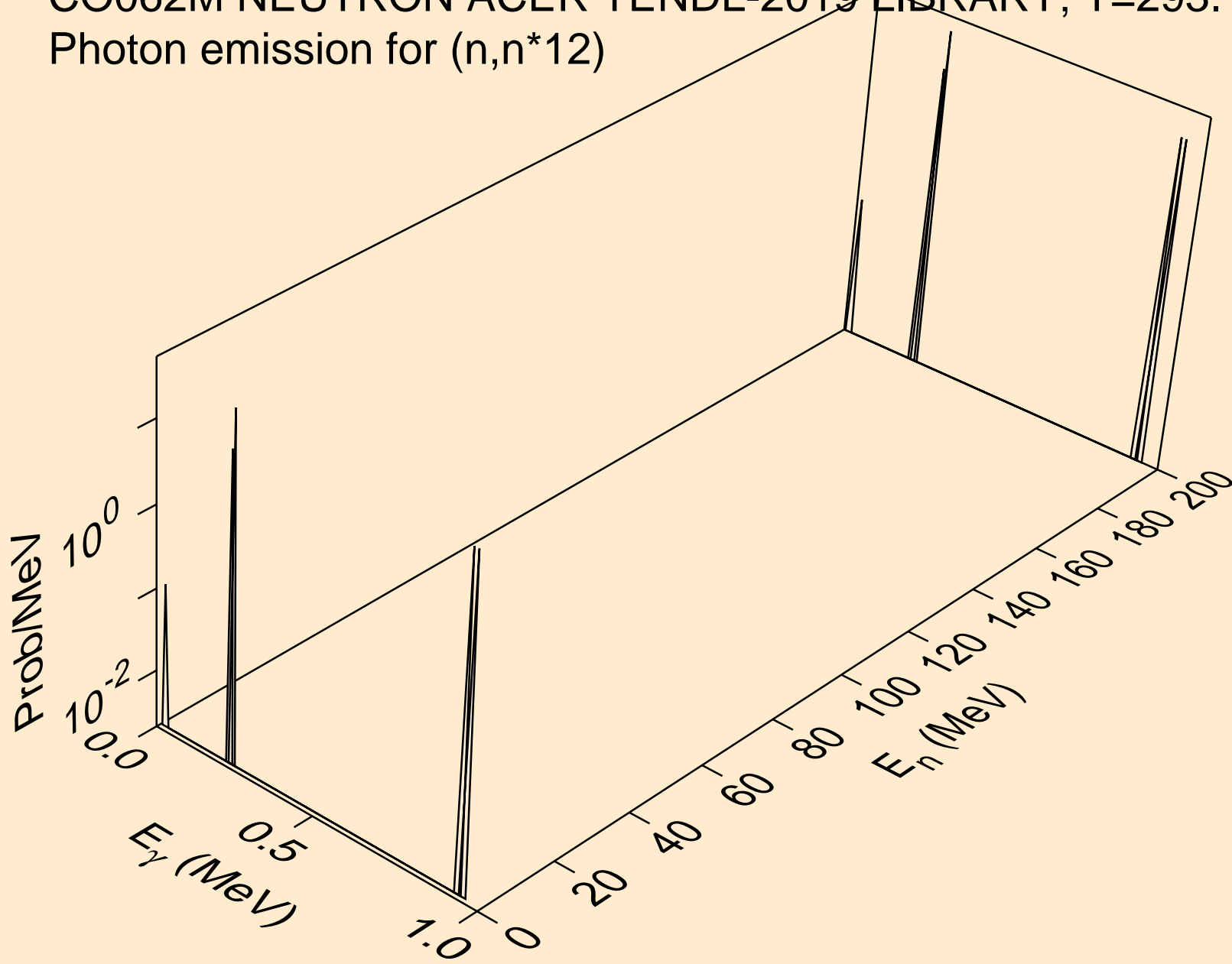

CO062M NEUTRON ACER TENDL-2019 LIBRARY; T=293.16K
Photon emission for (n,n*13)

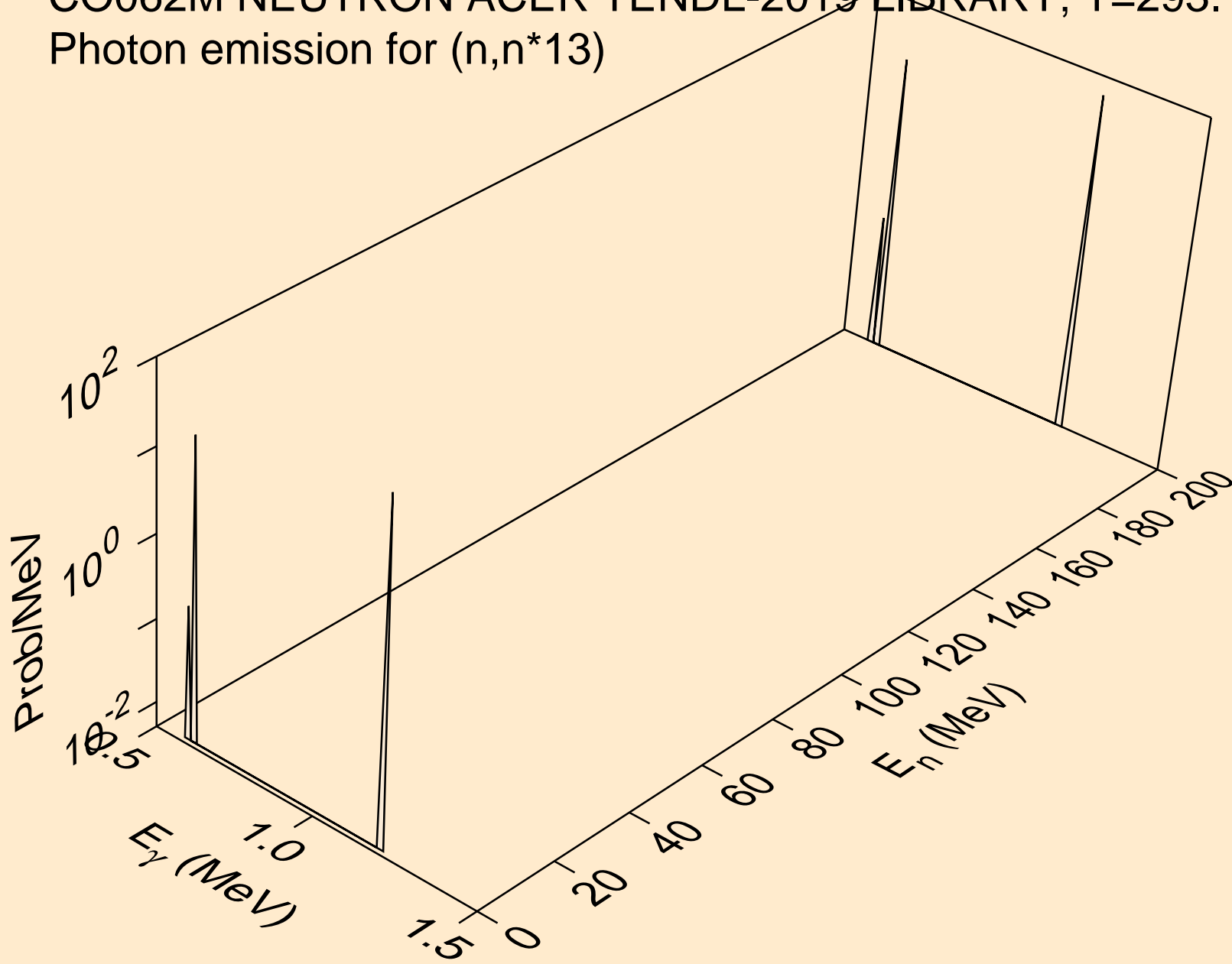

CO062M NEUTRON ACER TENDL-2019 LIBRARY; T=293.16K
Photon emission for (n,n*14)

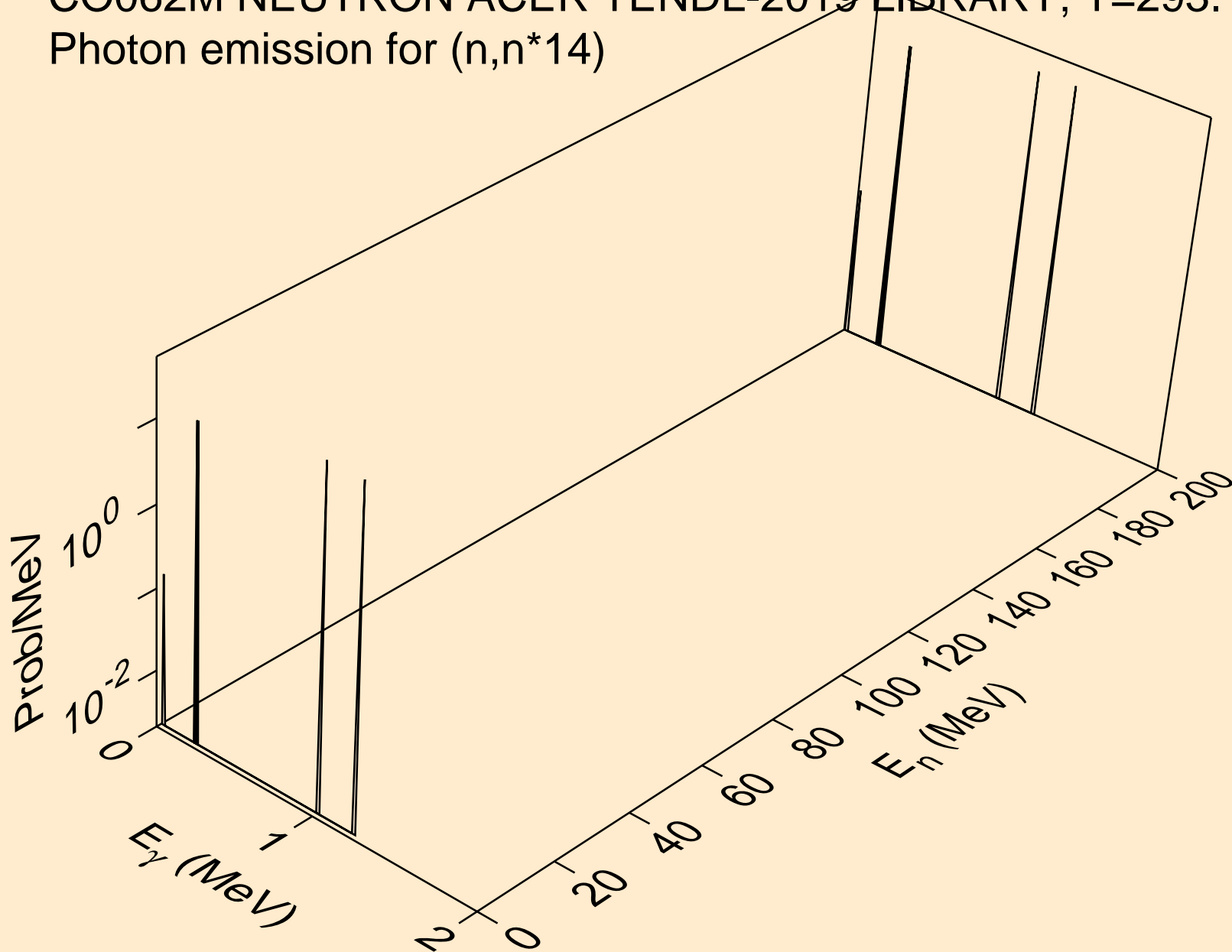

CO062M NEUTRON ACER TENDL-2019 LIBRARY; T=293.16K
Photon emission for (n,n*15)

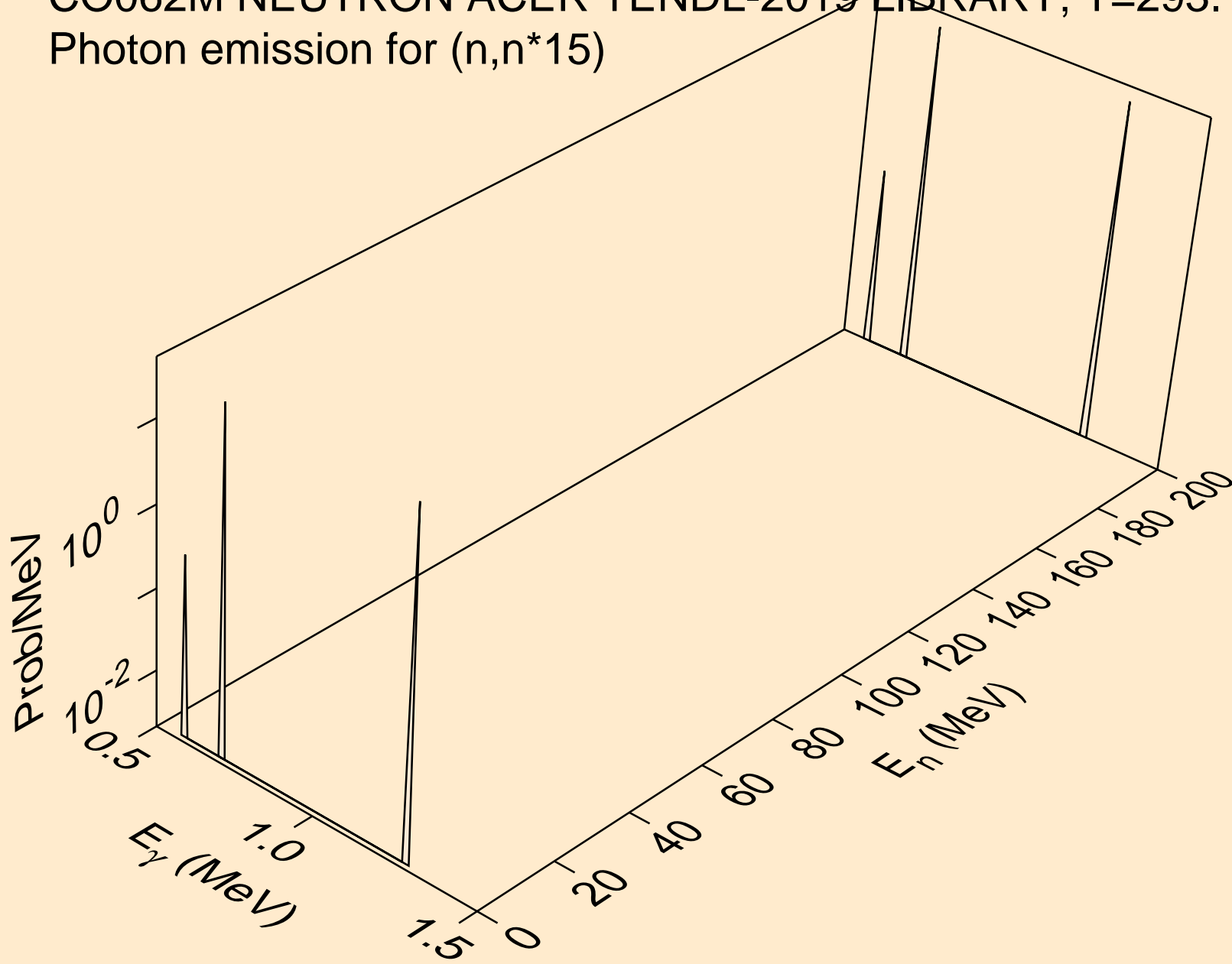

CO062M NEUTRON ACER TENDL-2019 LIBRARY; T=293.16K
Photon emission for (n,n*16)

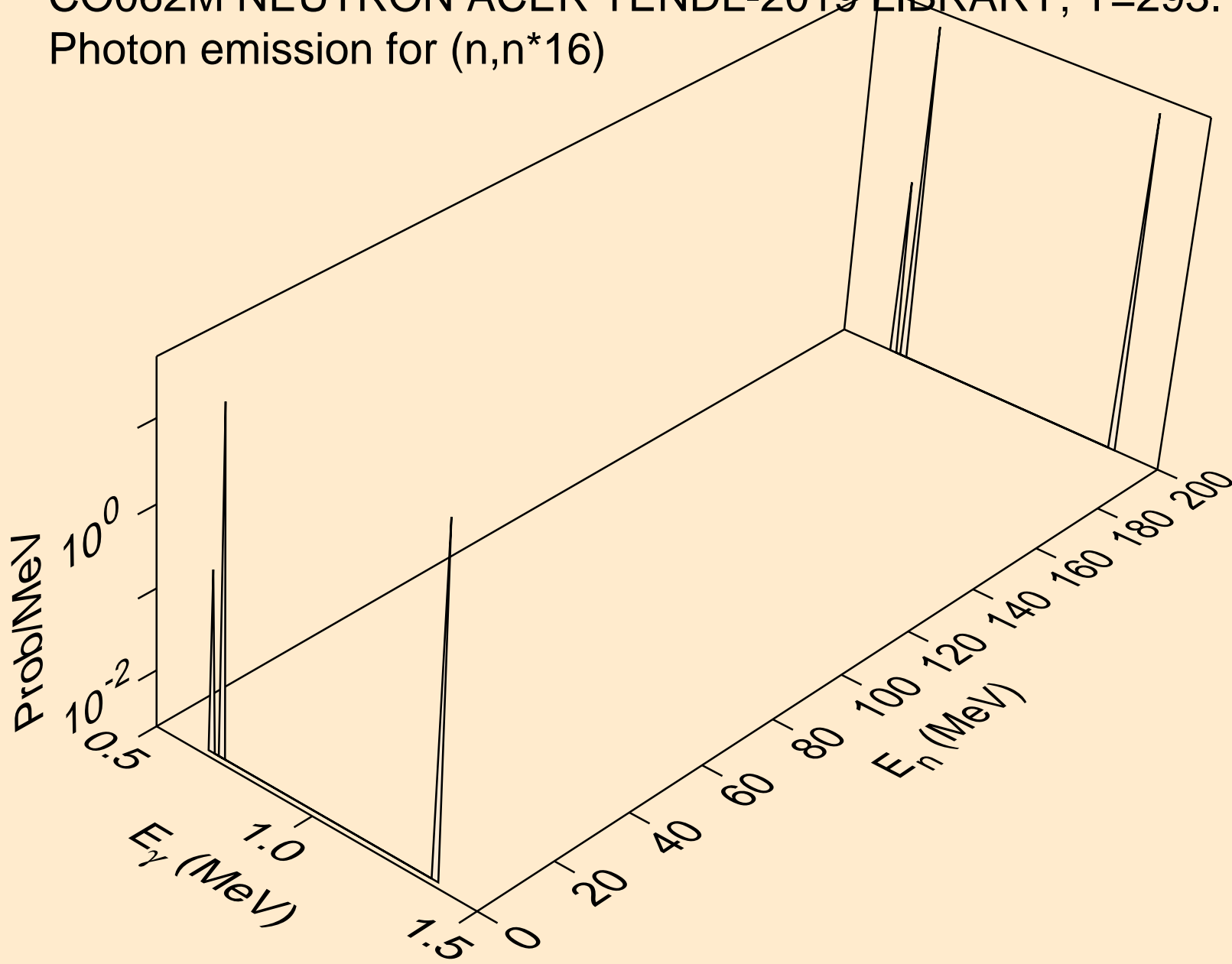

CO062M NEUTRON ACER TENDL-2019 LIBRARY; T=293.16K
Photon emission for (n,n*17)

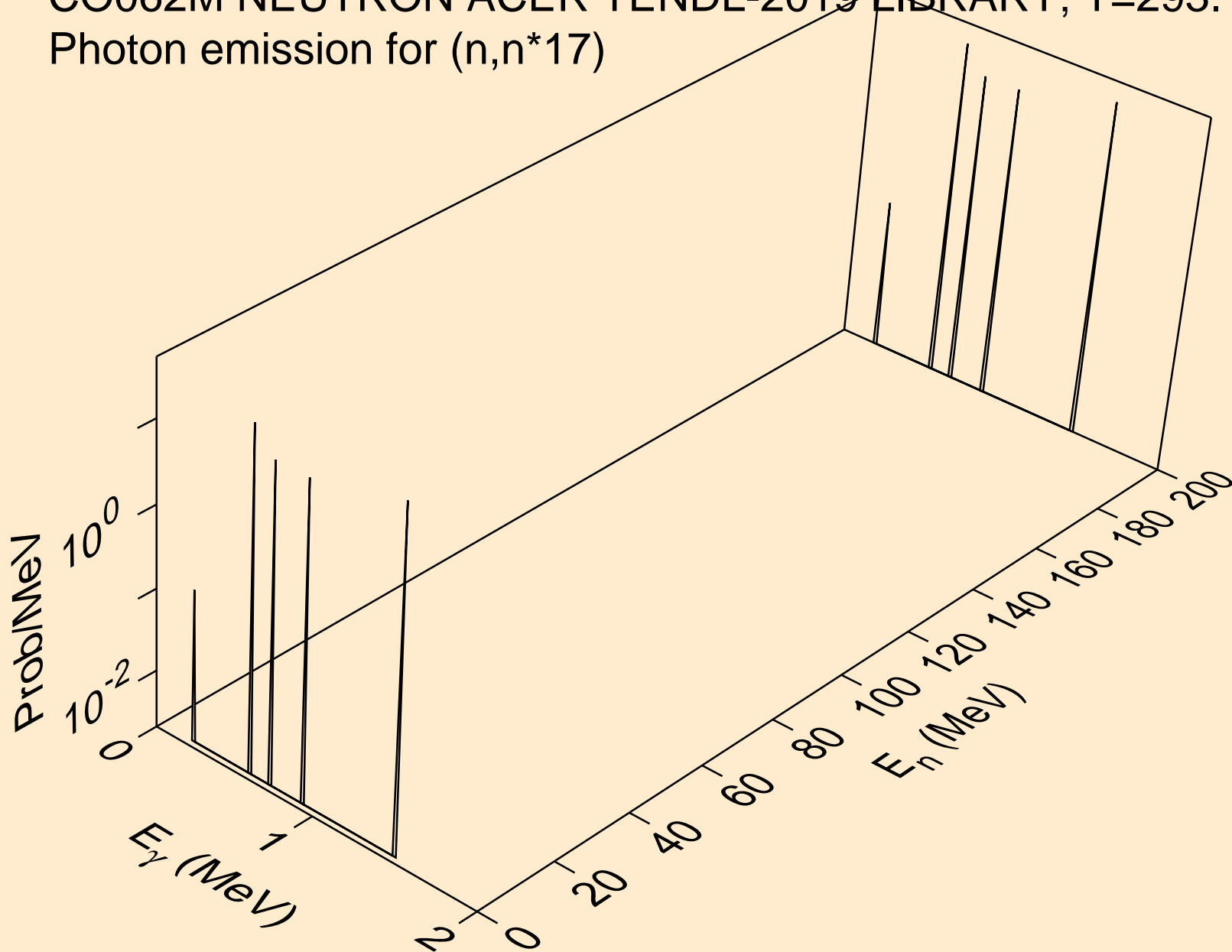

CO062M NEUTRON ACER TENDL-2019 LIBRARY; T=293.16K
Photon emission for (n,n*18)

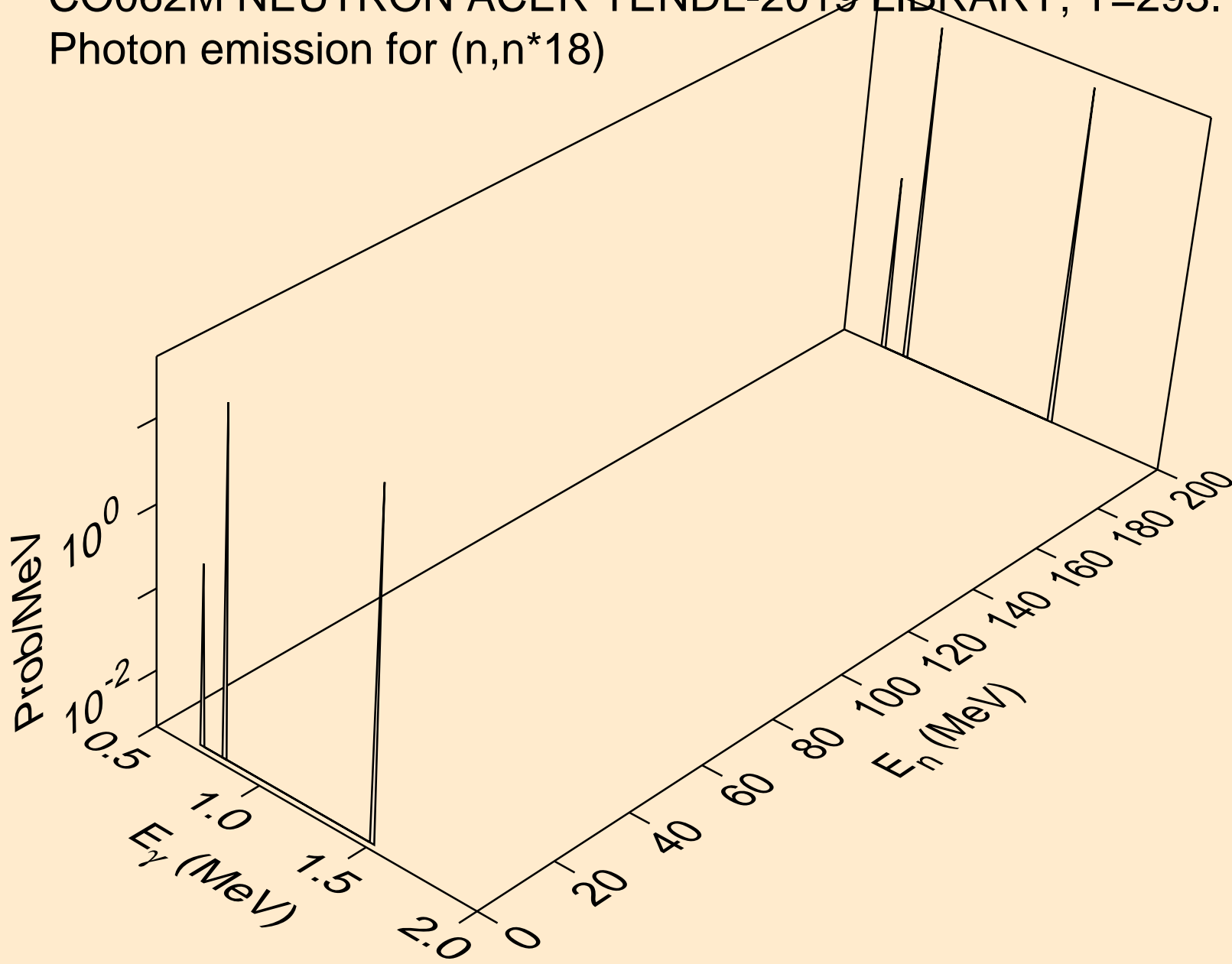

CO062M NEUTRON ACER TENDL-2019 LIBRARY; T=293.16K
Photon emission for (n,n*19)

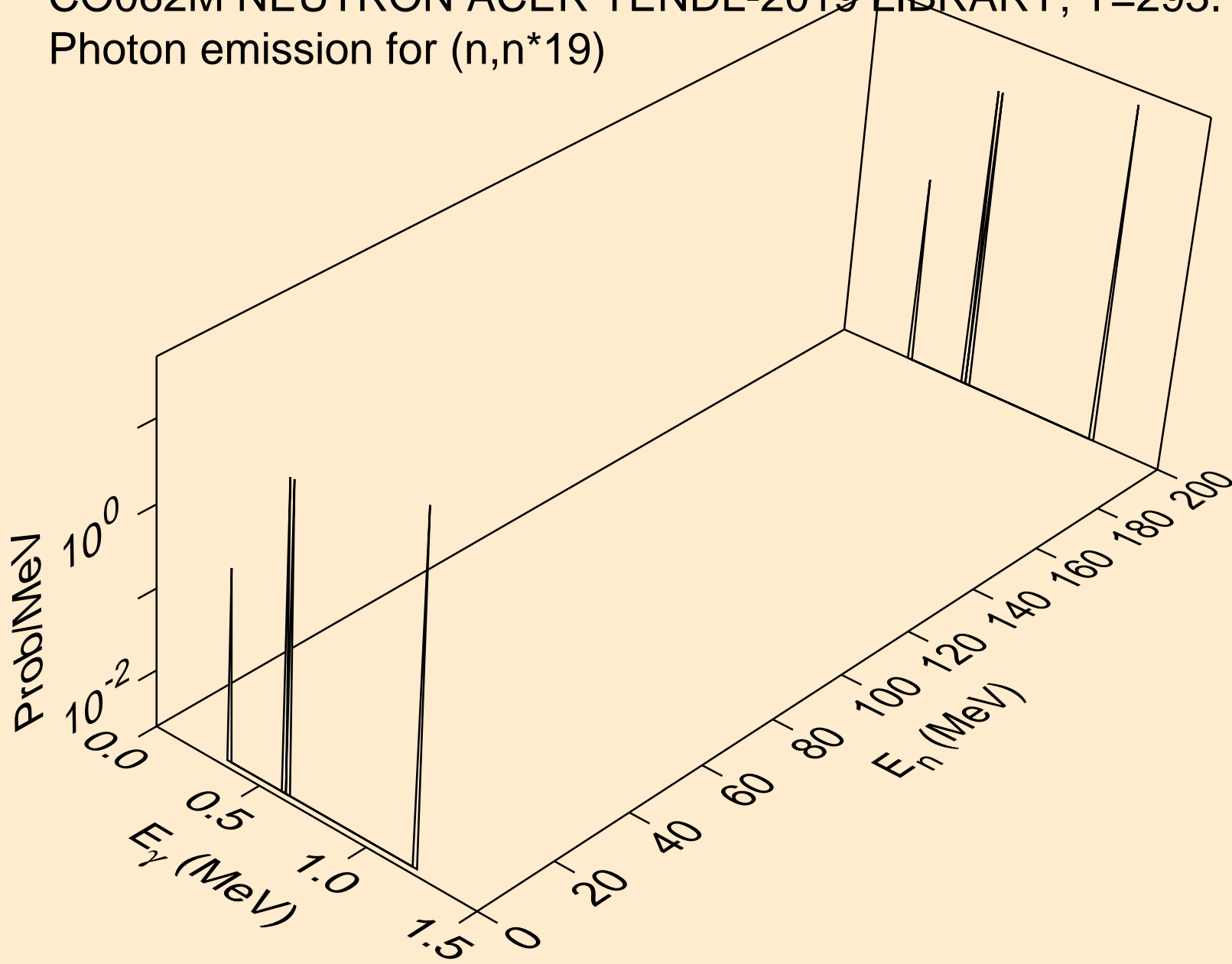

CO062M NEUTRON ACER TENDL-2019 LIBRARY; T=293.16K
Photon emission for (n,n*20)

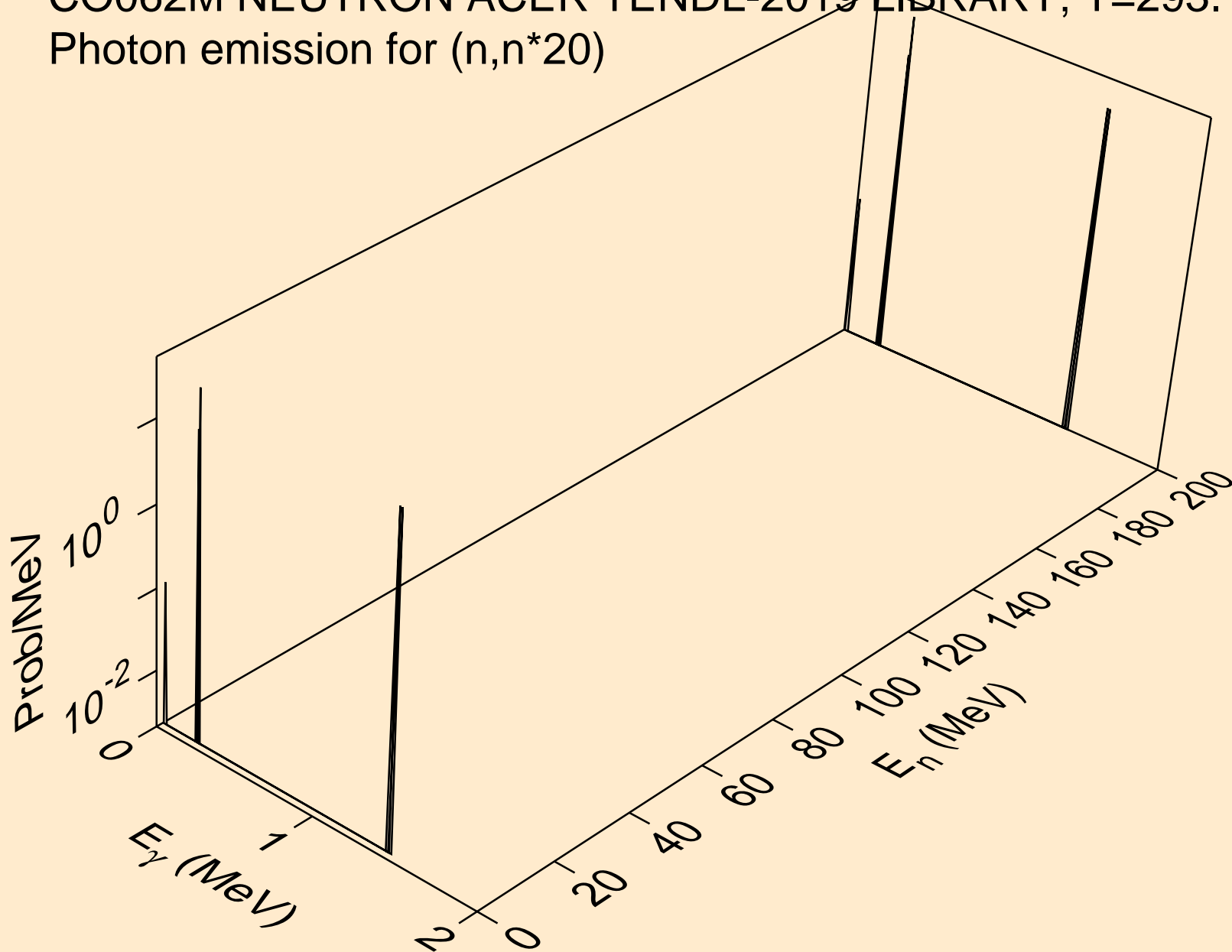

CO062M NEUTRON ACER TENDL-2019 LIBRARY; T=293.16K
Photon emission for (n,n*21)

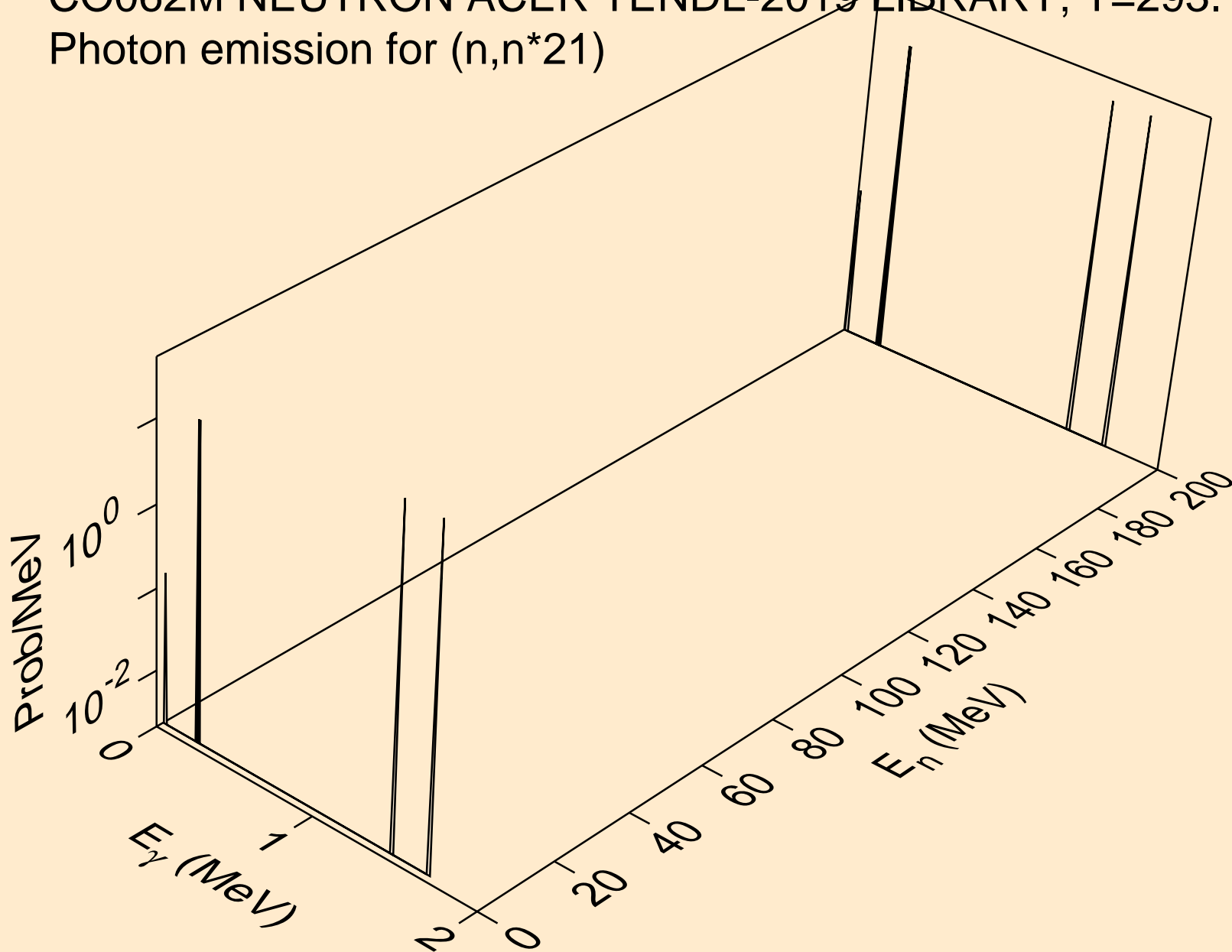

CO062M NEUTRON ACER TENDL-2019 LIBRARY; T=293.16K
Photon emission for (n,n*22)

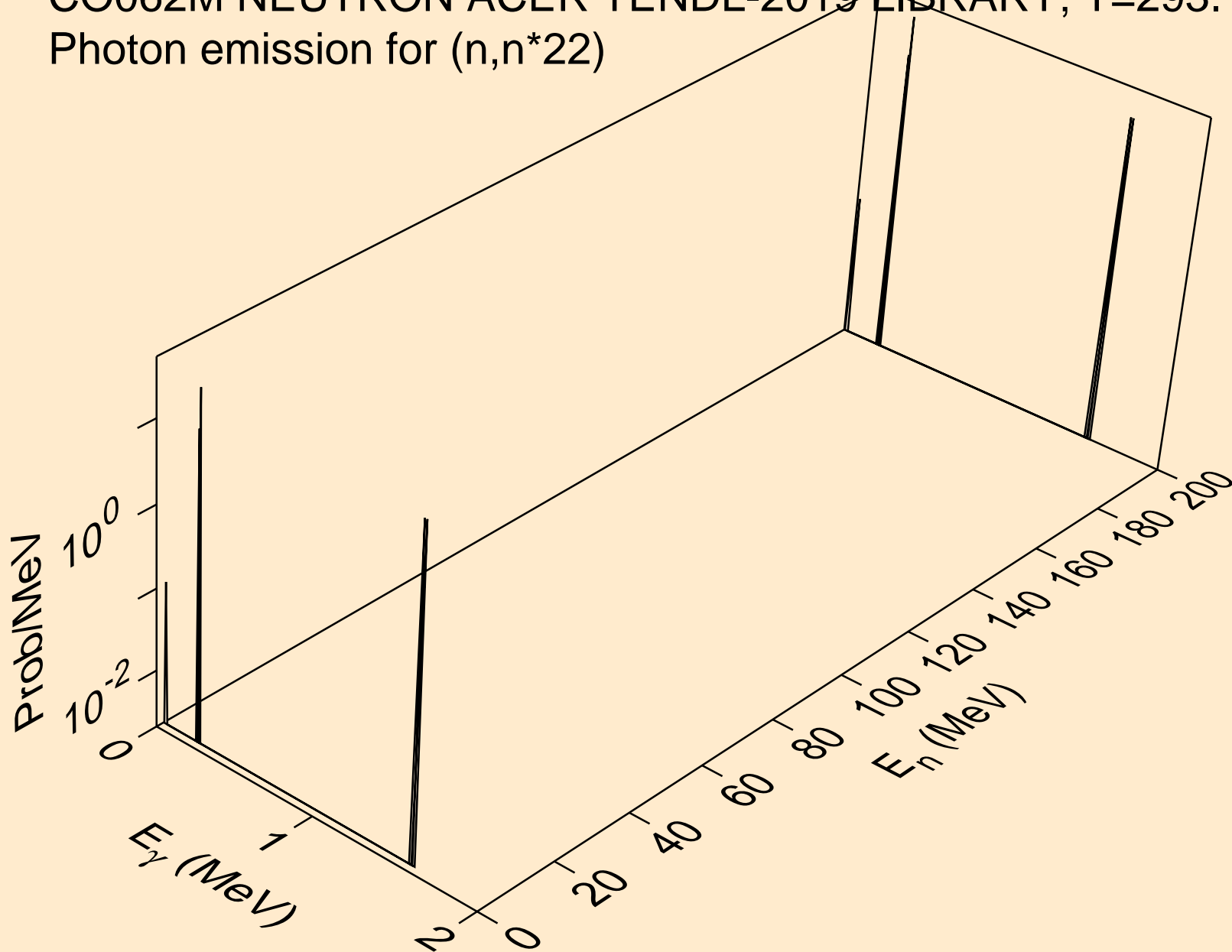

CO062M NEUTRON ACER TENDL-2019 LIBRARY; T=293.16K
Photon emission for (n,n*23)

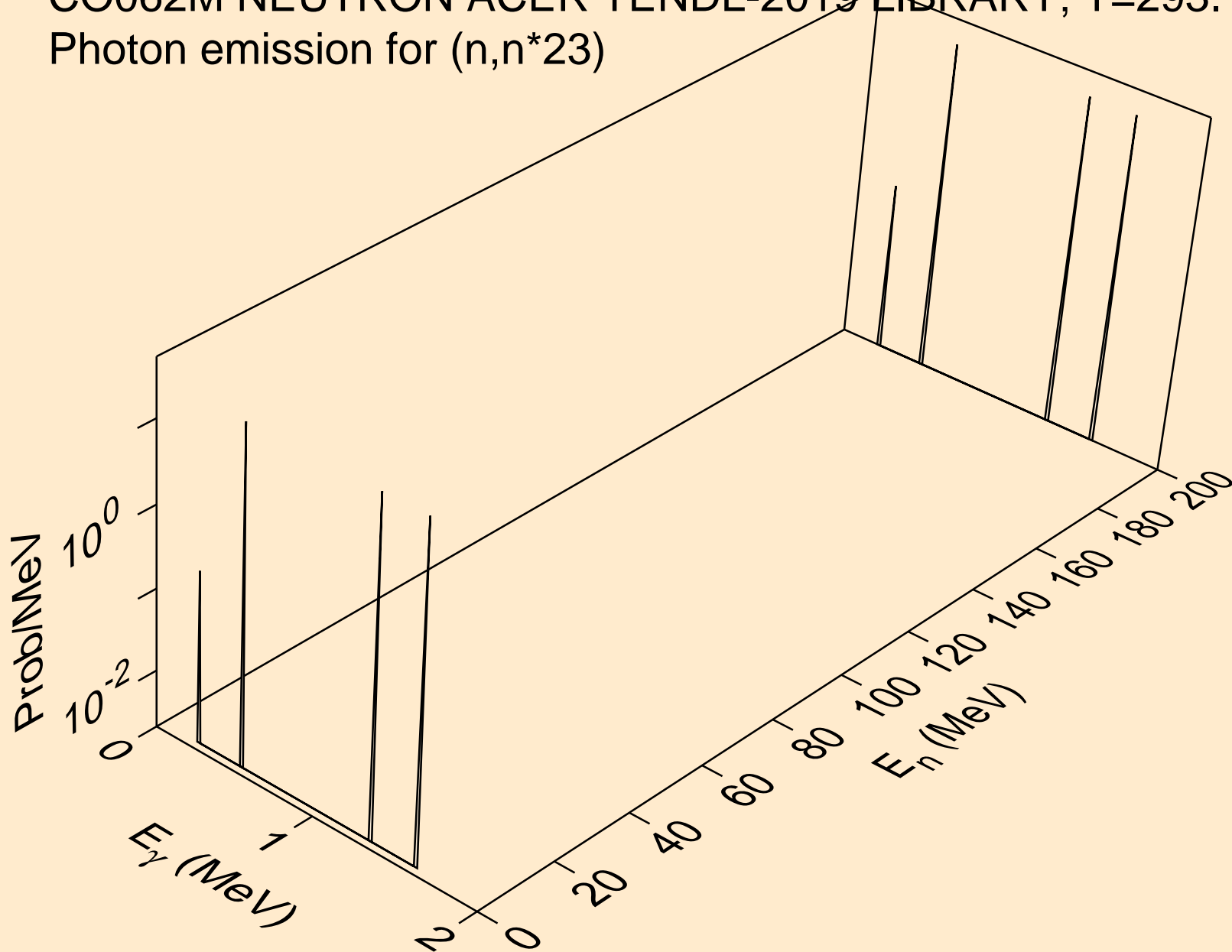

CO062M NEUTRON ACER TENDL-2019 LIBRARY; T=293.16K
Photon emission for (n,n*24)

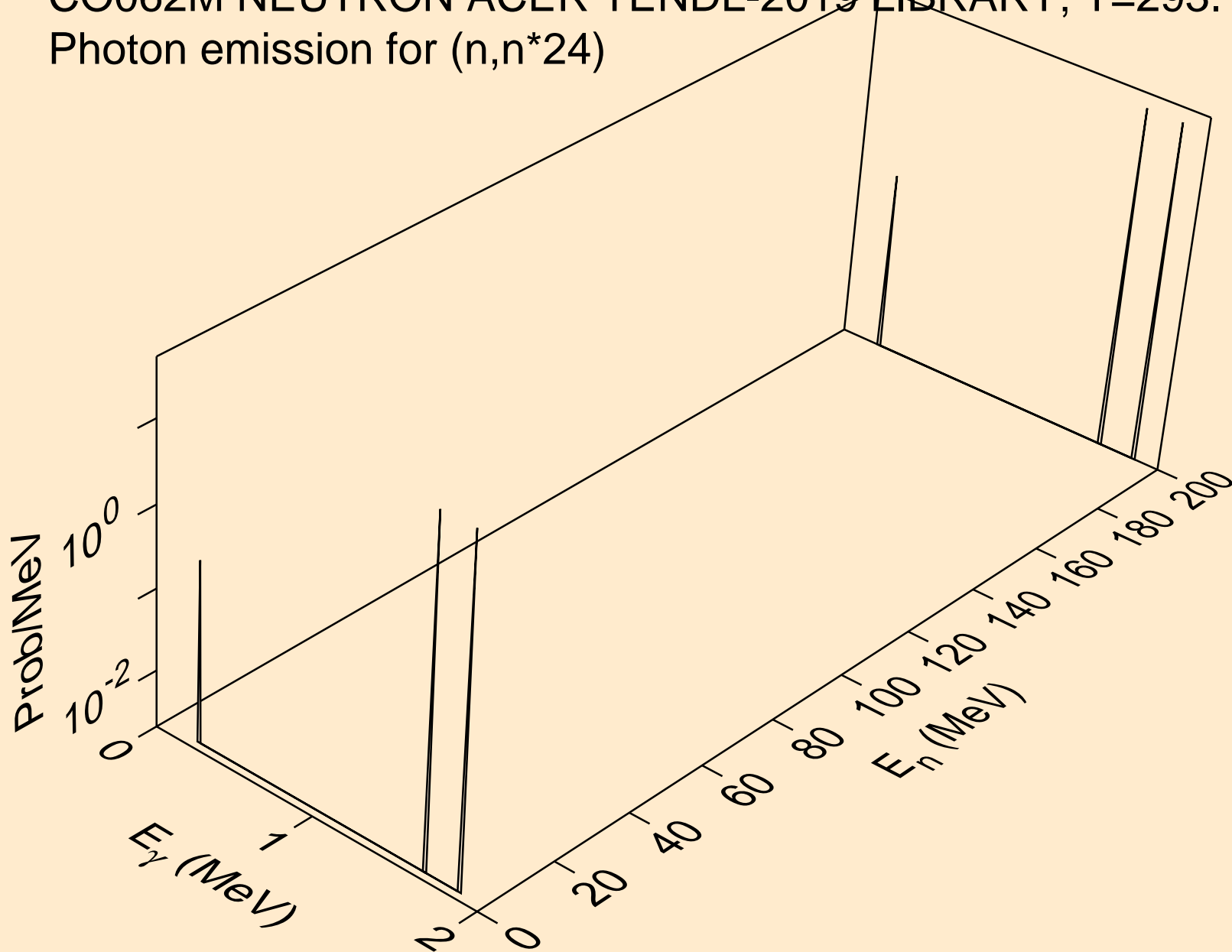

CO062M NEUTRON ACER TENDL-2019 LIBRARY; T=293.16K
Photon emission for (n,n*25)

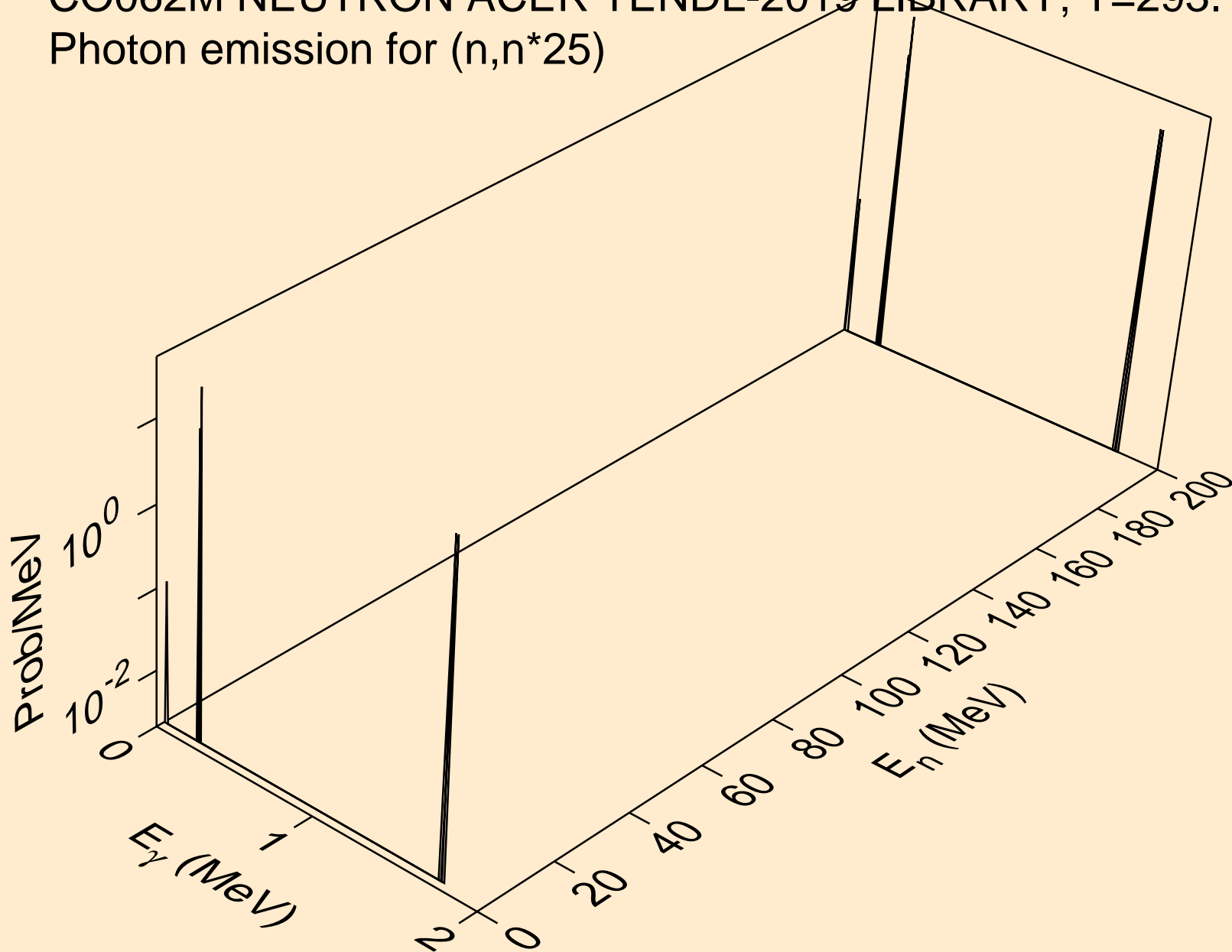

CO062M NEUTRON ACER TENDL-2019 LIBRARY; T=293.16K
Photon emission for (n,n*26)

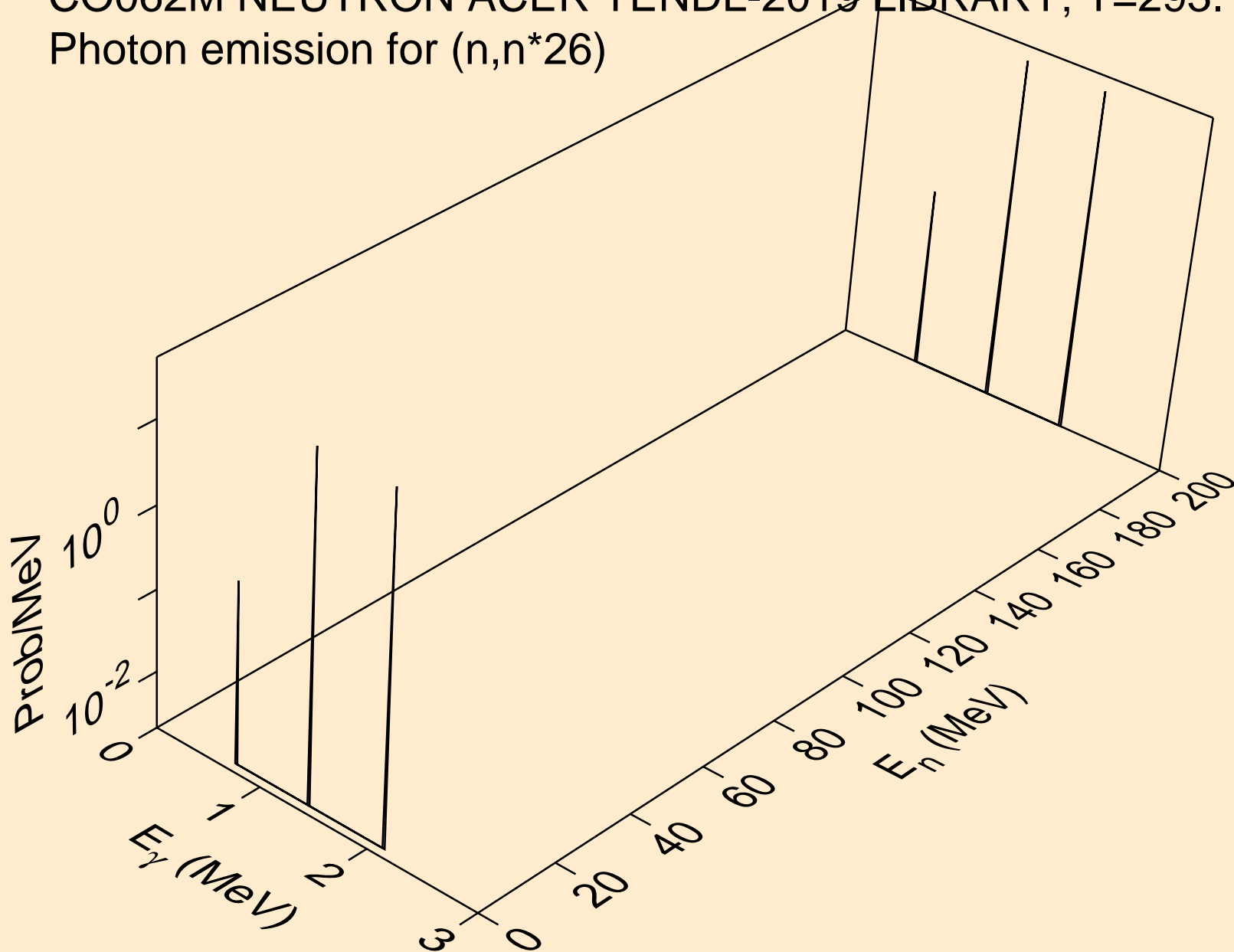

CO062M NEUTRON ACER TENDL-2019 LIBRARY; T=293.16K
Photon emission for (n,n*27)

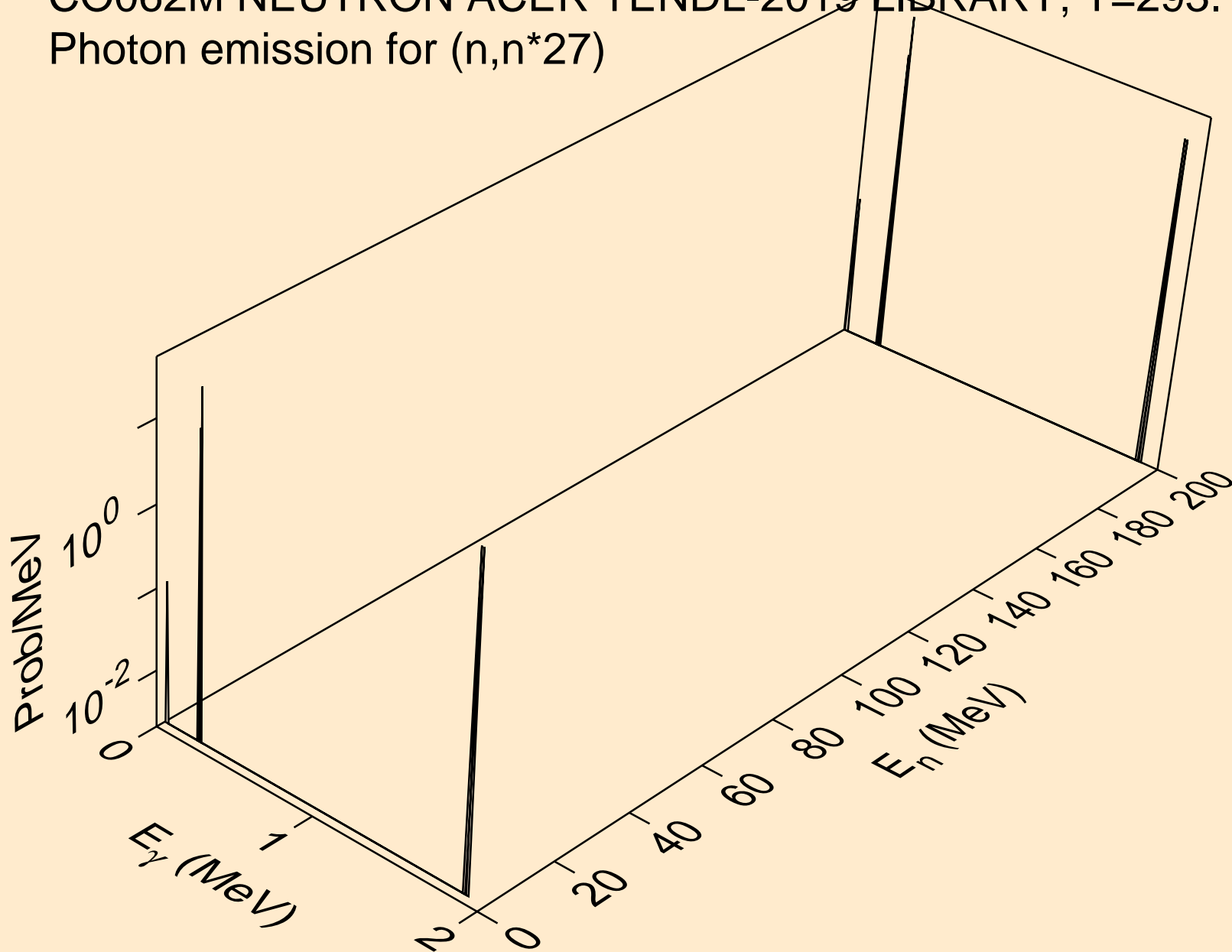

CO062M NEUTRON ACER TENDL-2019 LIBRARY; T=293.16K
Photon emission for (n,n*28)

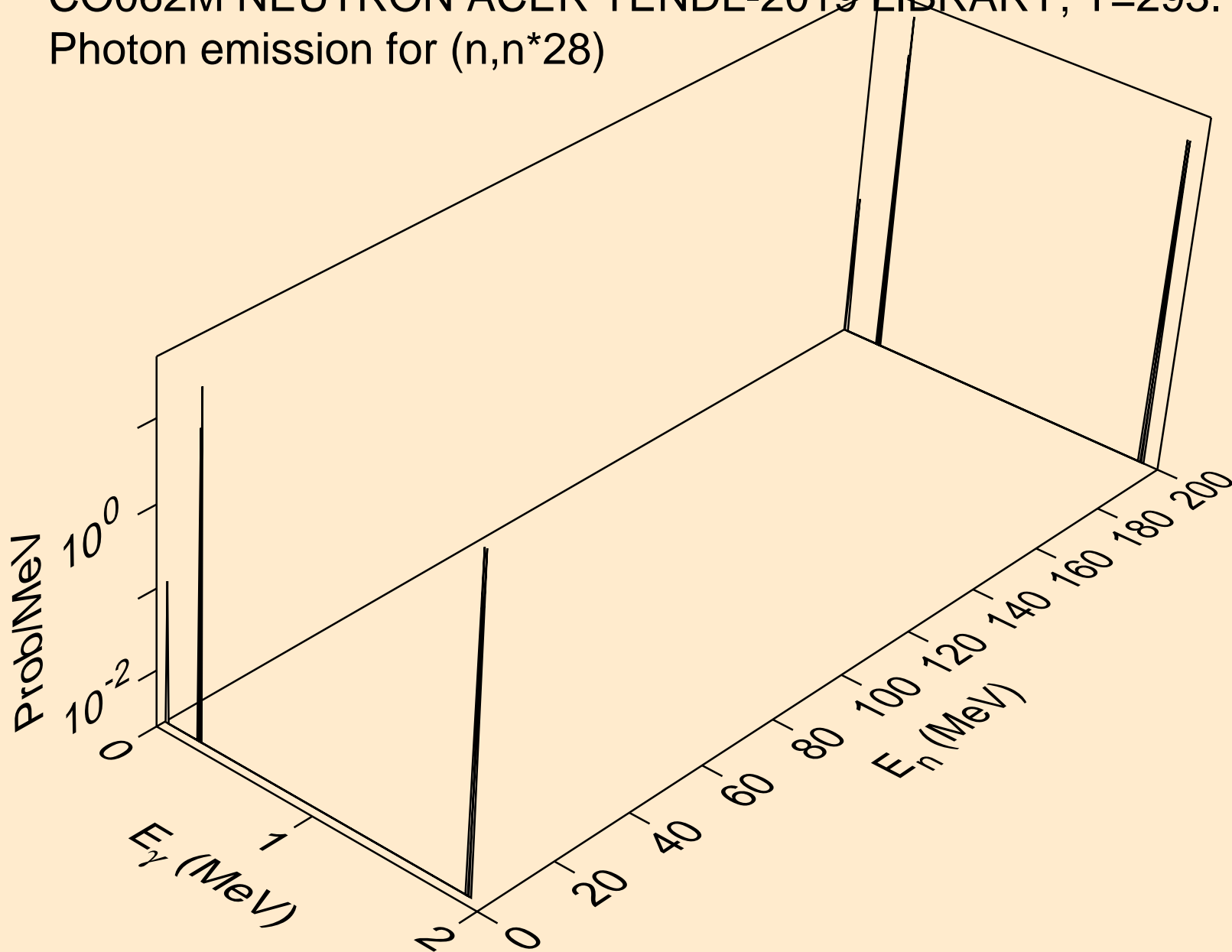

CO062M NEUTRON ACER TENDL-2019 LIBRARY; T=293.16K
Photon emission for (n,n*29)

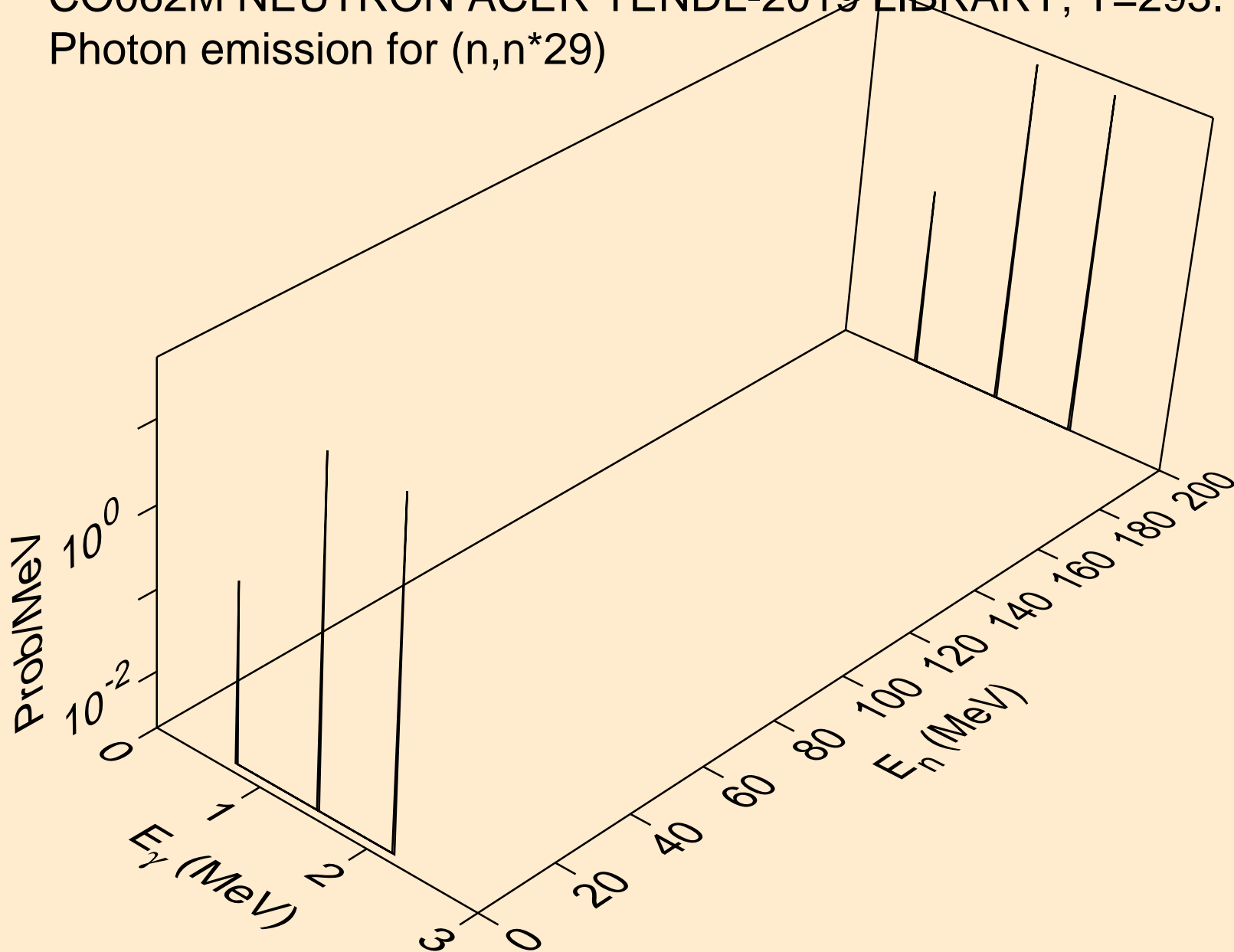

CO062M NEUTRON ACER TENDL-2019 LIBRARY; T=293.16K
Photon emission for (n,n*c)

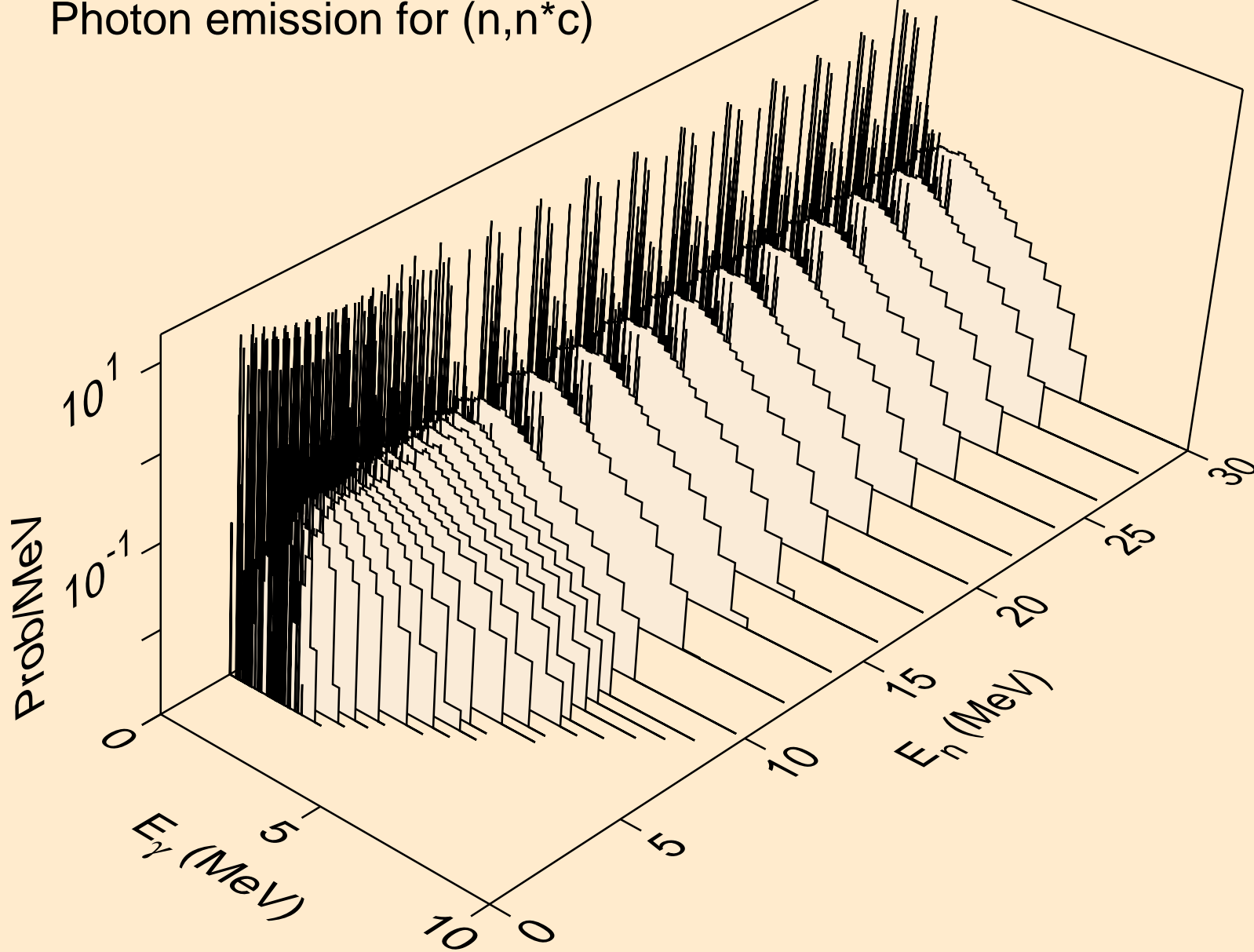

CO062M NEUTRON ACER TENDL-2019 LIBRARY; T=293.16K
Photon emission for (n,gma)

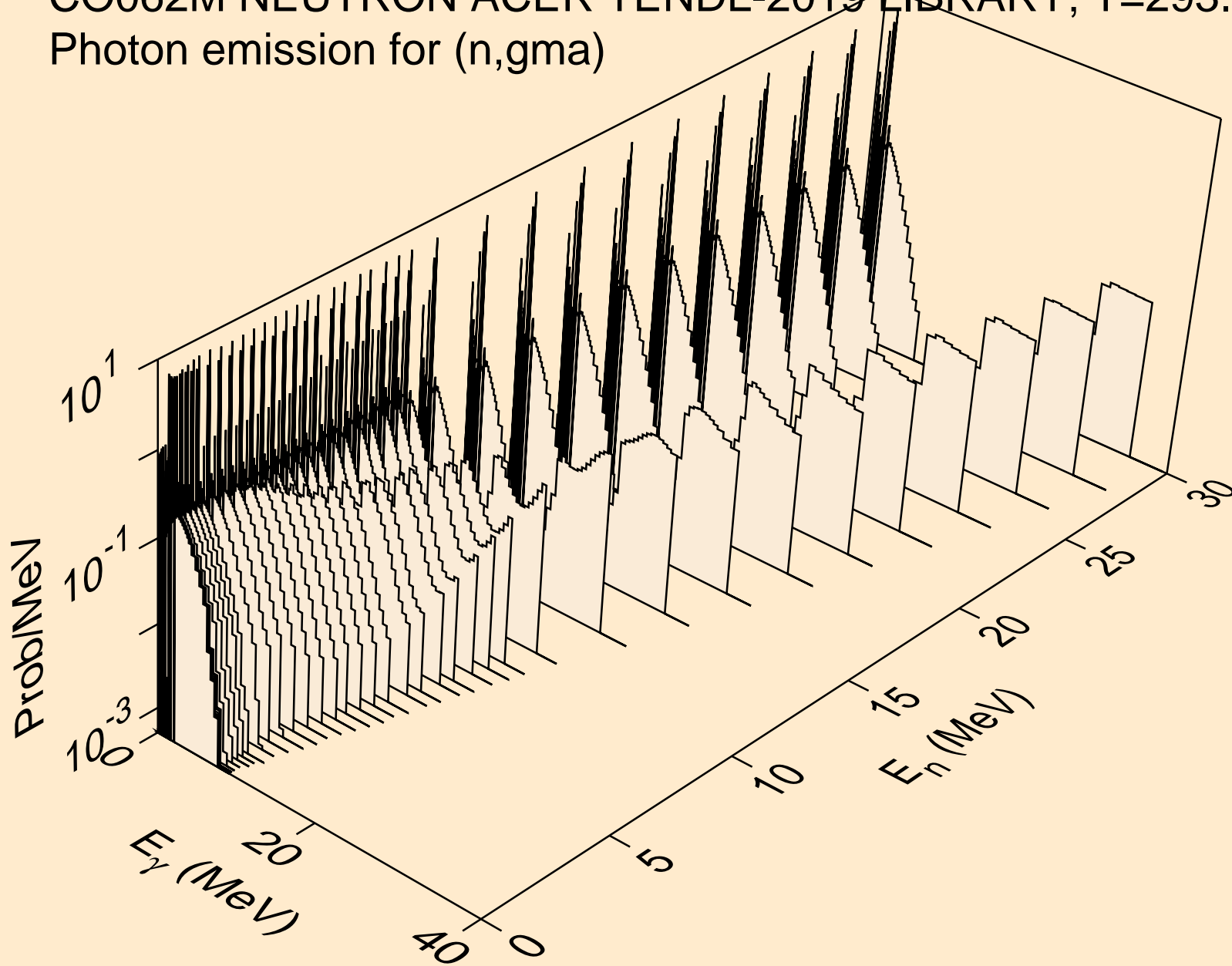

CO062M NEUTRON ACER TENDL-2019 LIBRARY; T=293.16K
Photon emission for (n,p)

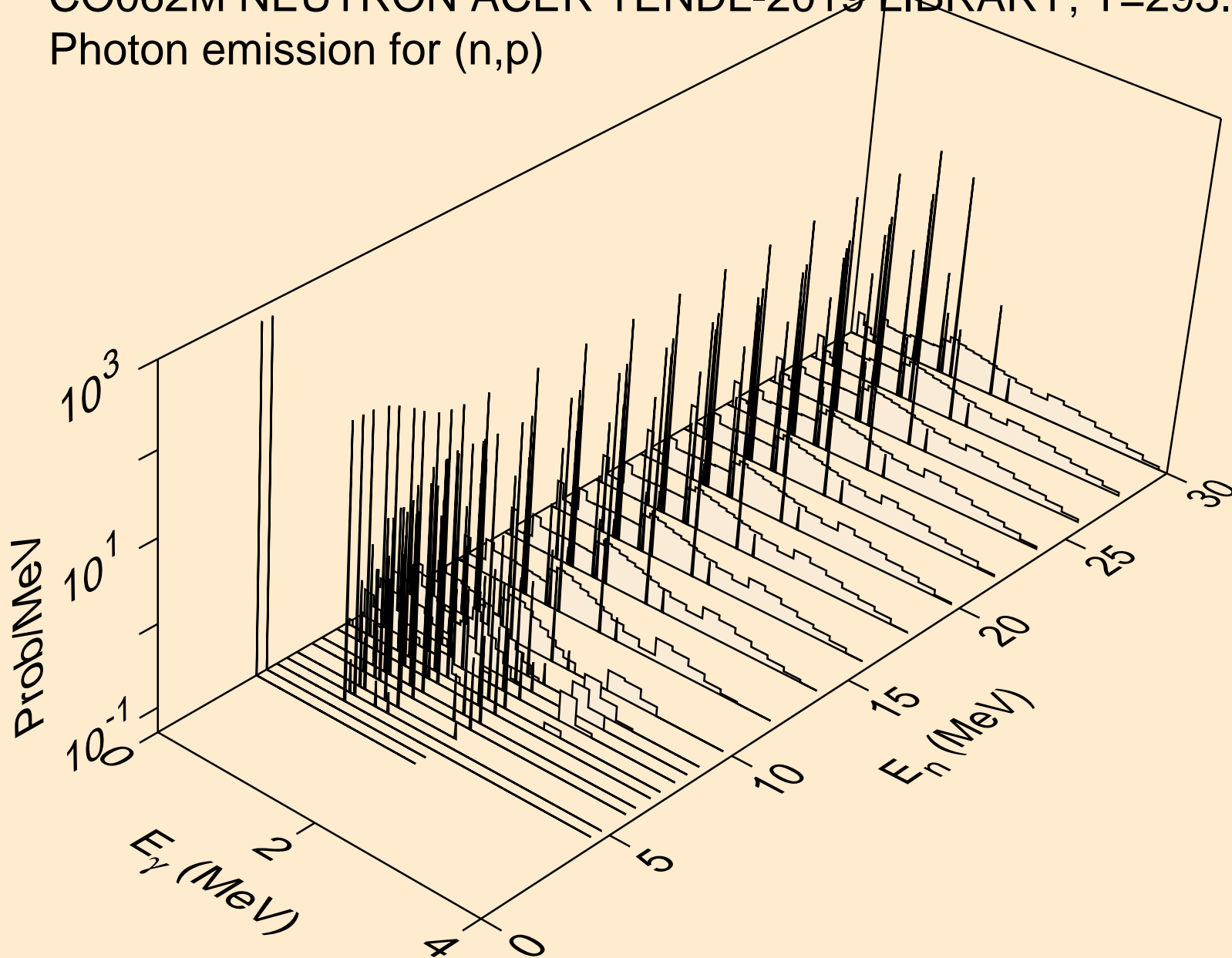

CO062M NEUTRON ACER TENDL-2019 LIBRARY; T=293.16K
Photon emission for (n,d)

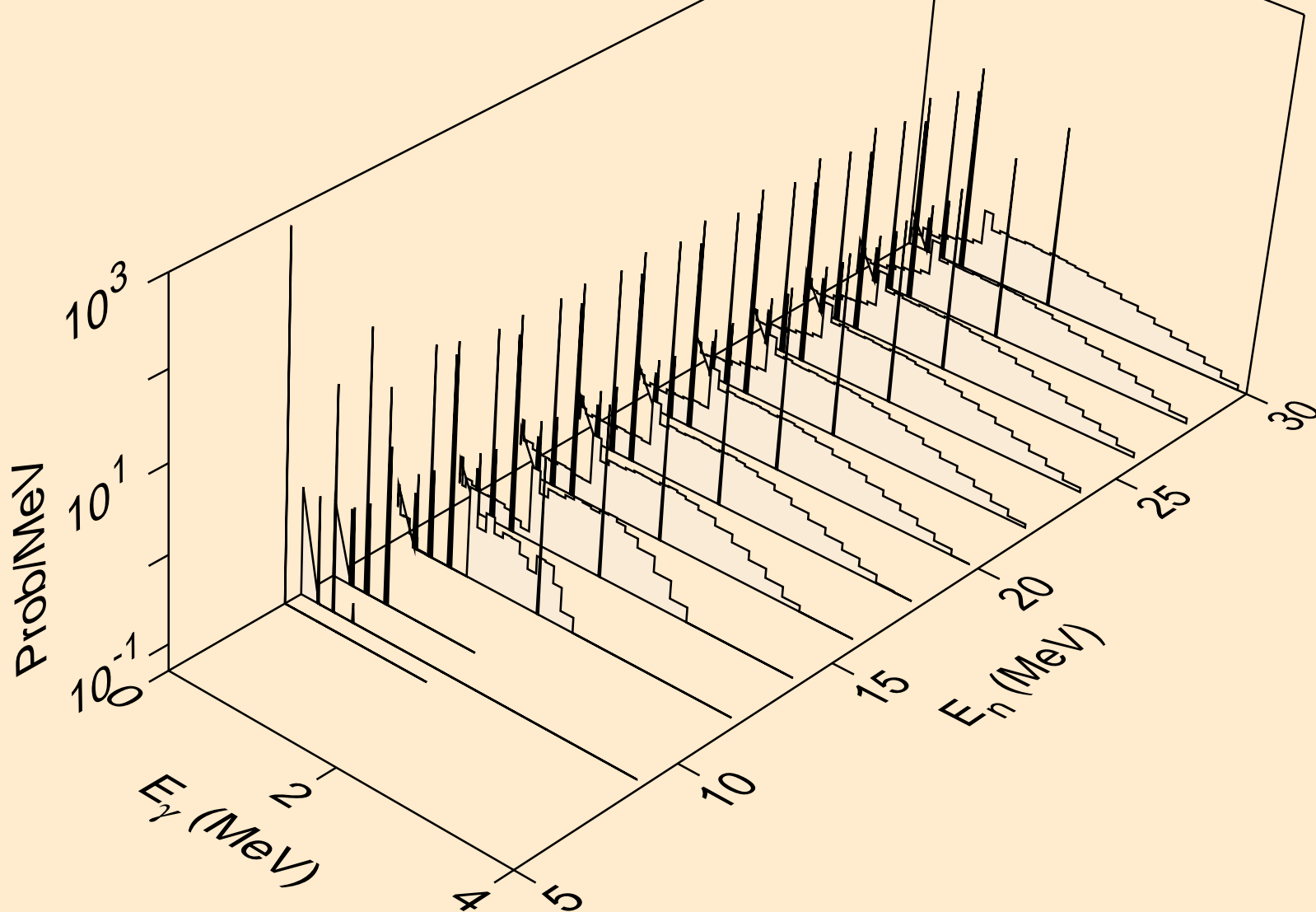

CO062M NEUTRON ACER TENDL-2019 LIBRARY; T=293.16K
Photon emission for (n,t)

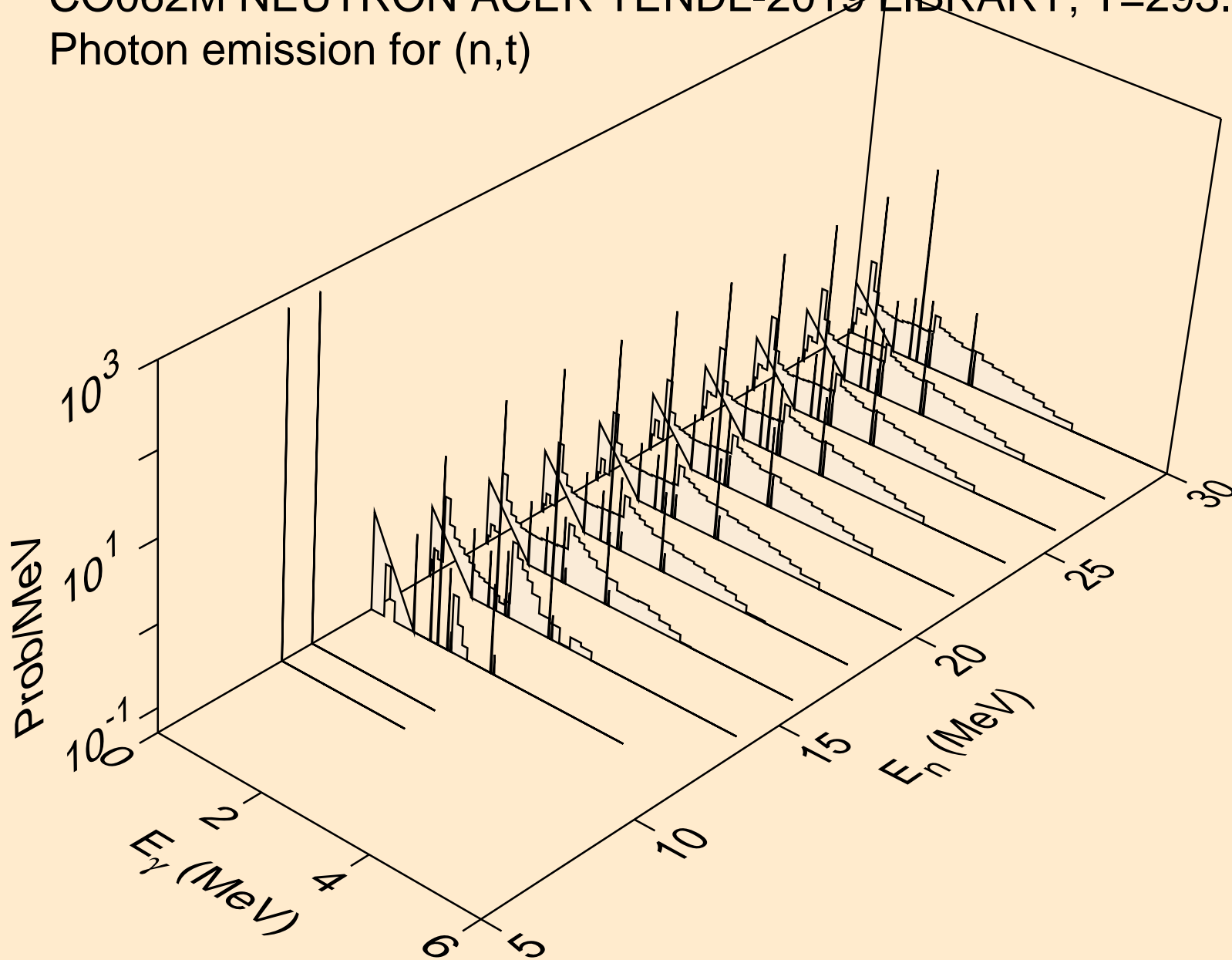

CO062M NEUTRON ACER TENDL-2019 LIBRARY; T=293.16K
Photon emission for (n,he3)

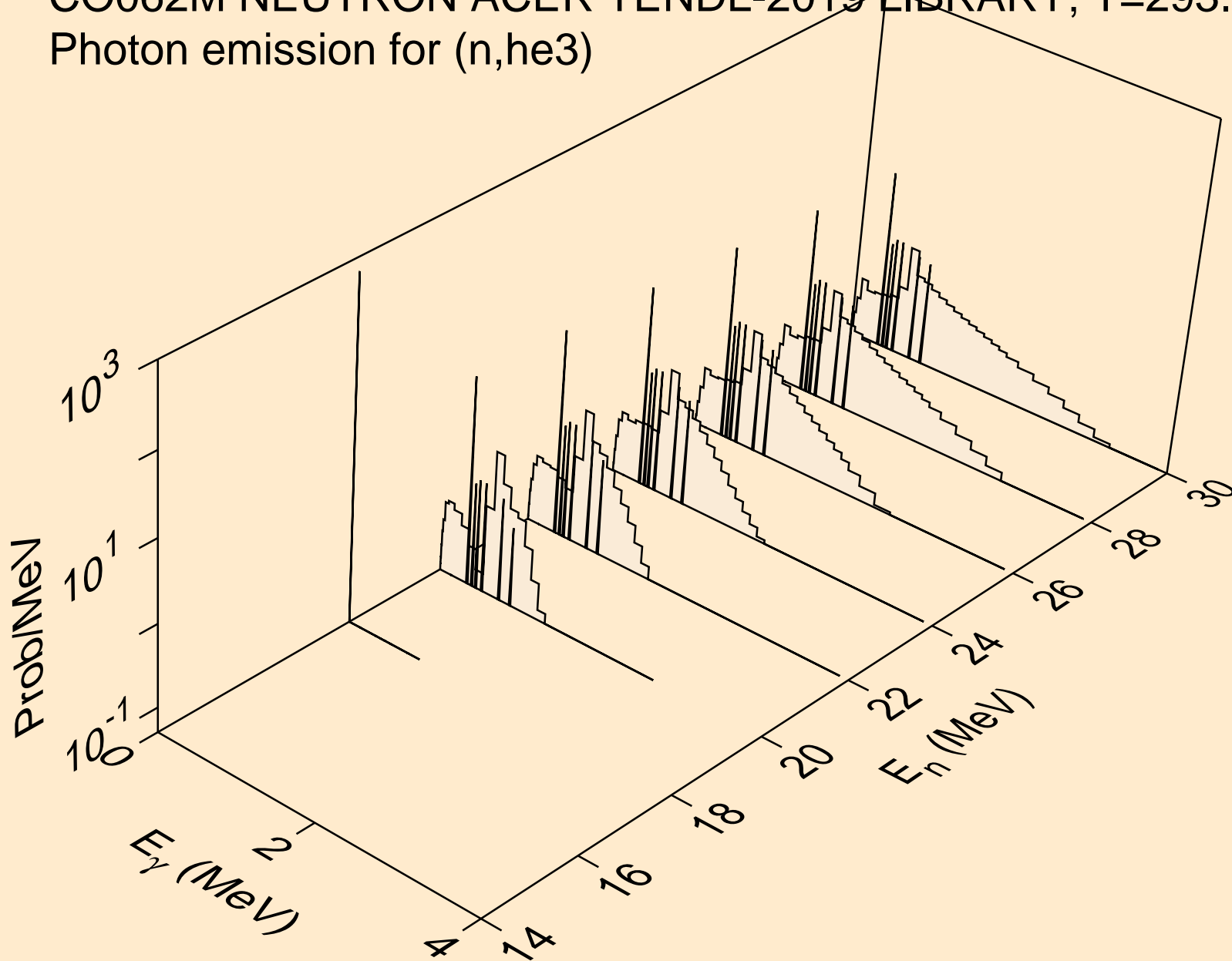

CO062M NEUTRON ACER TENDL-2019 LIBRARY; T=293.16K
Photon emission for (n,a)

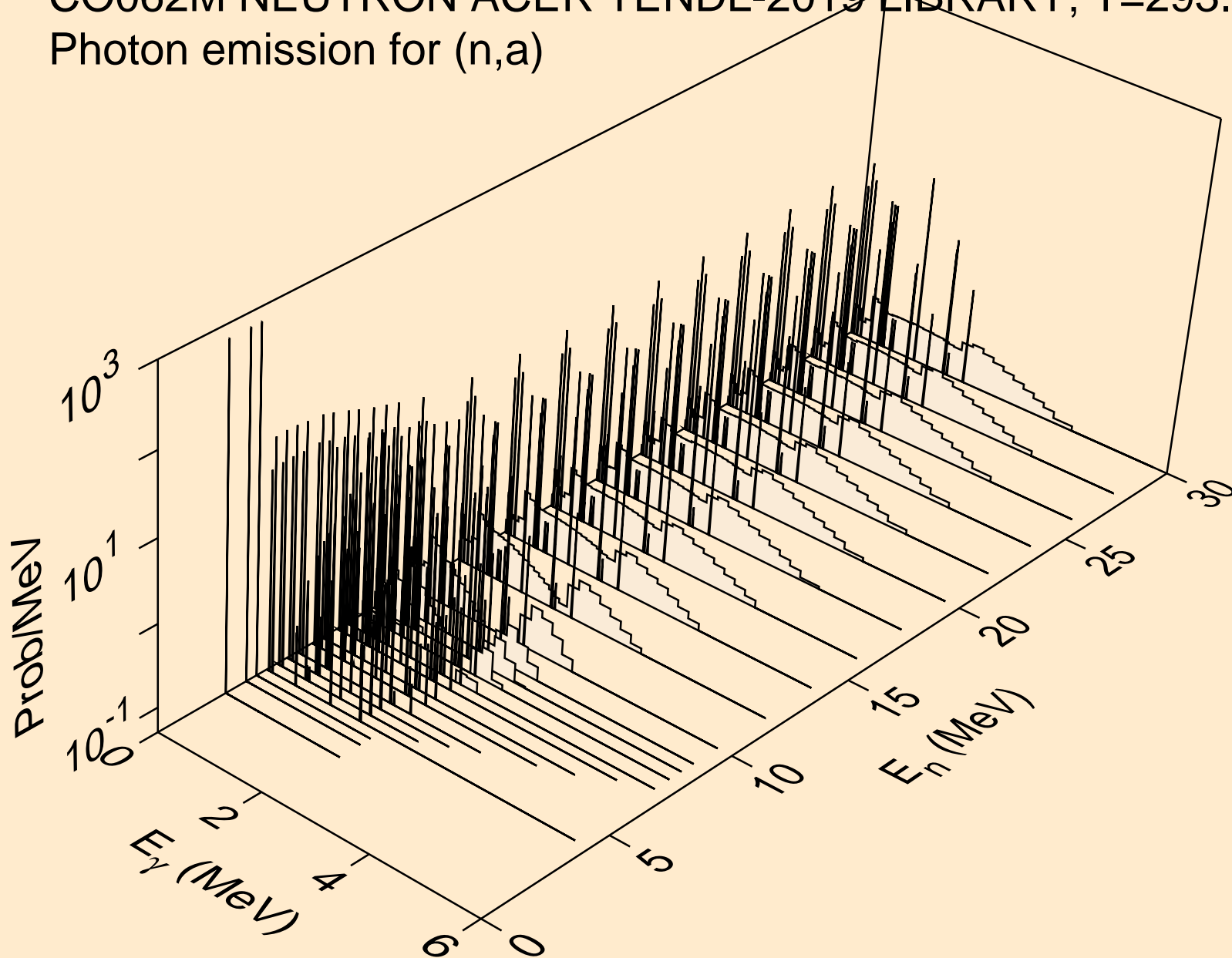

CO062M NEUTRON ACER TENDL-2019 LIBRARY; T=293.16K
Photon emission for (n,2a)

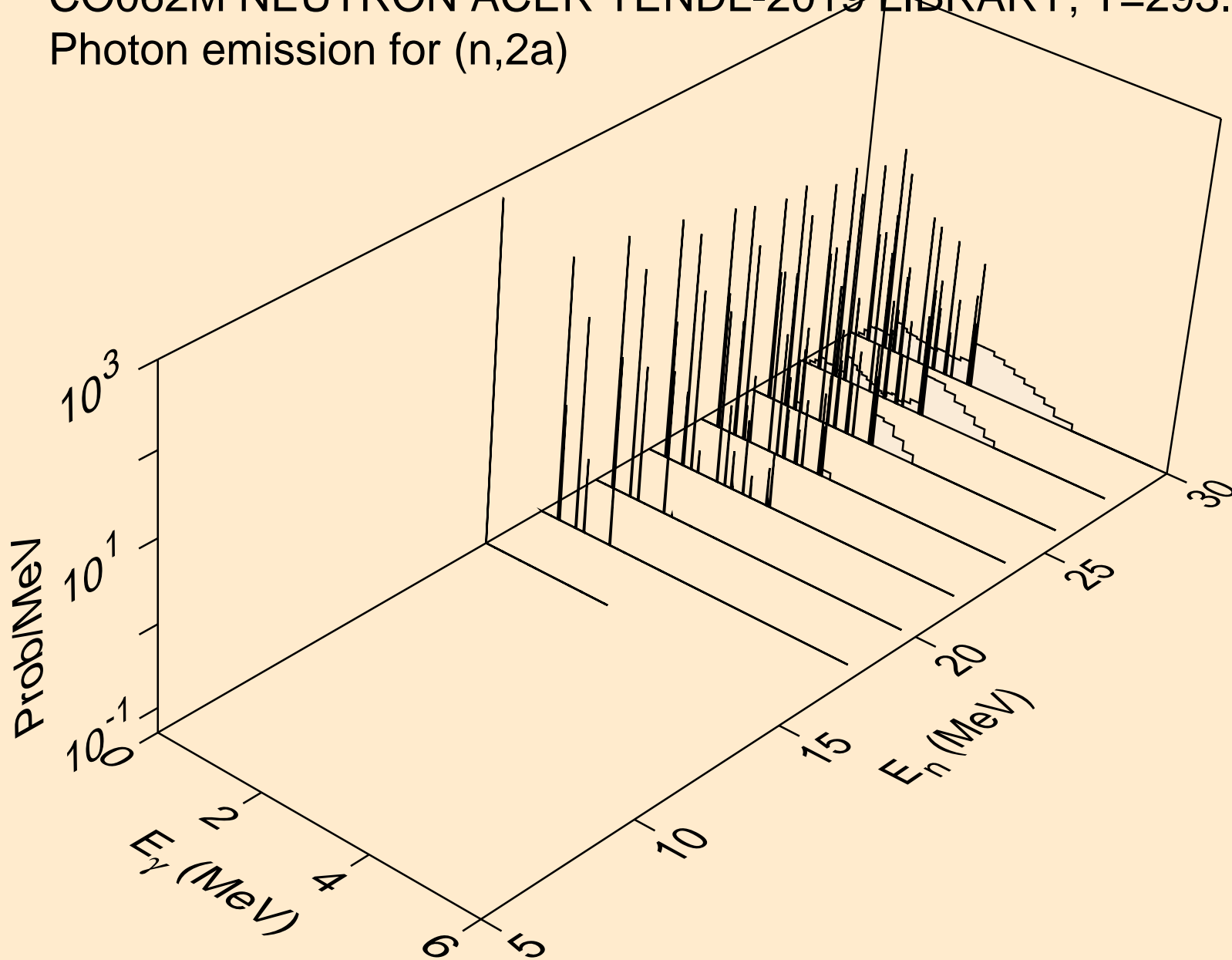

CO062M NEUTRON ACER TENDL-2019 LIBRARY; T=293.16K
Photon emission for (n,2p)

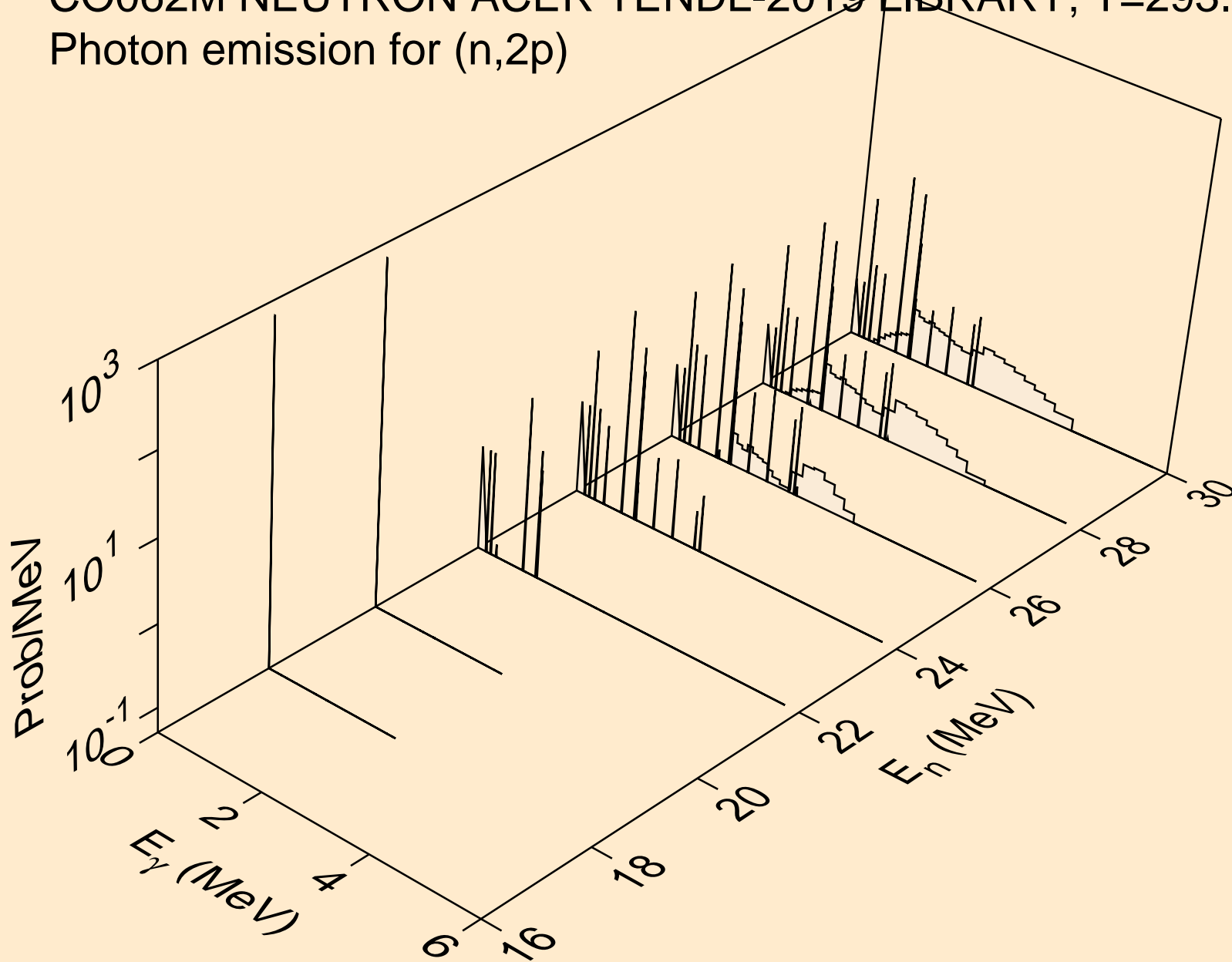

CO062M NEUTRON ACER TENDL-2019 LIBRARY; T=293.16K
Photon emission for (n,p α)

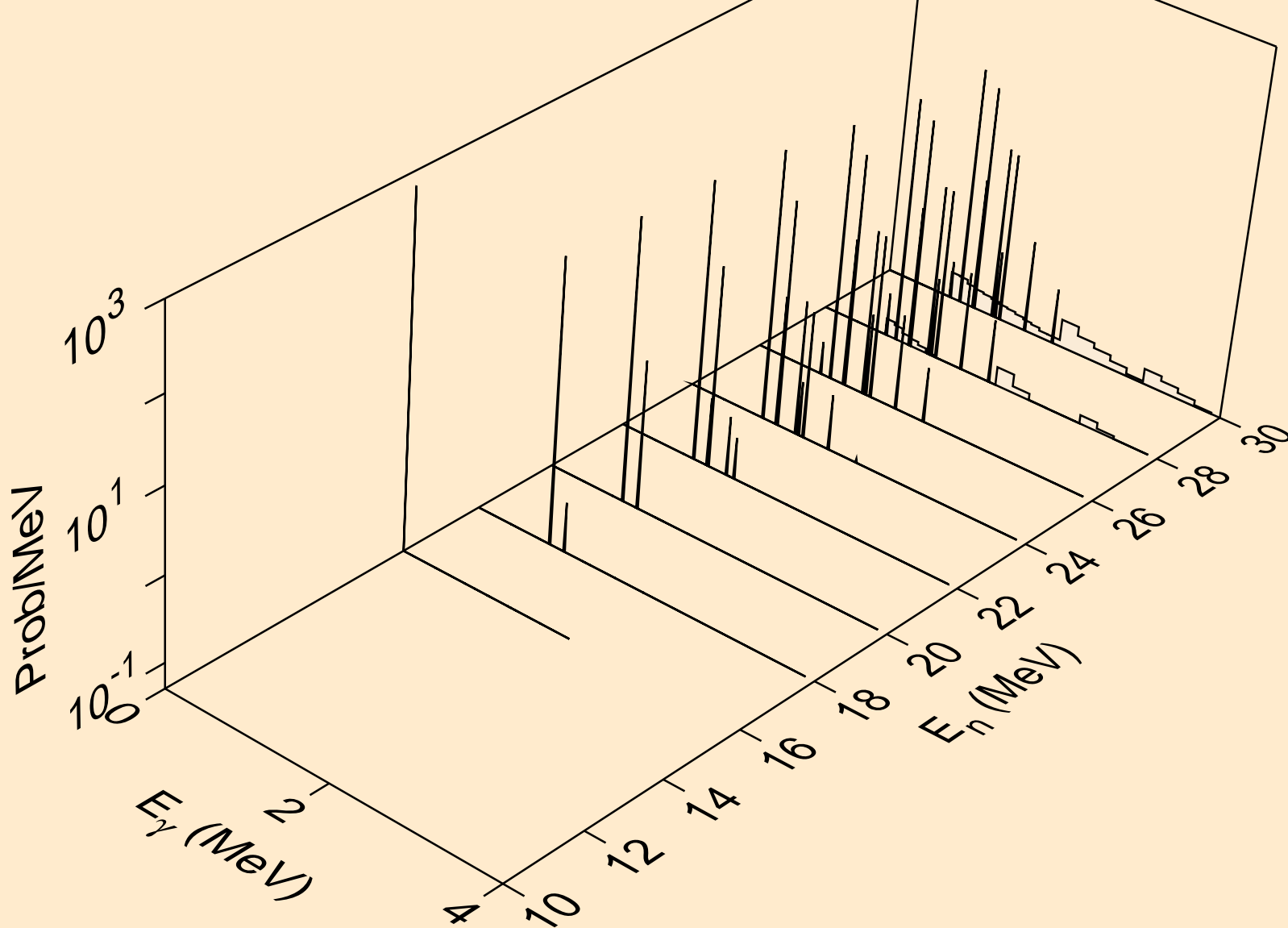

CO062M NEUTRON ACER TENDL-2019 LIBRARY; T=293.16K
Photon emission for (n,pd)

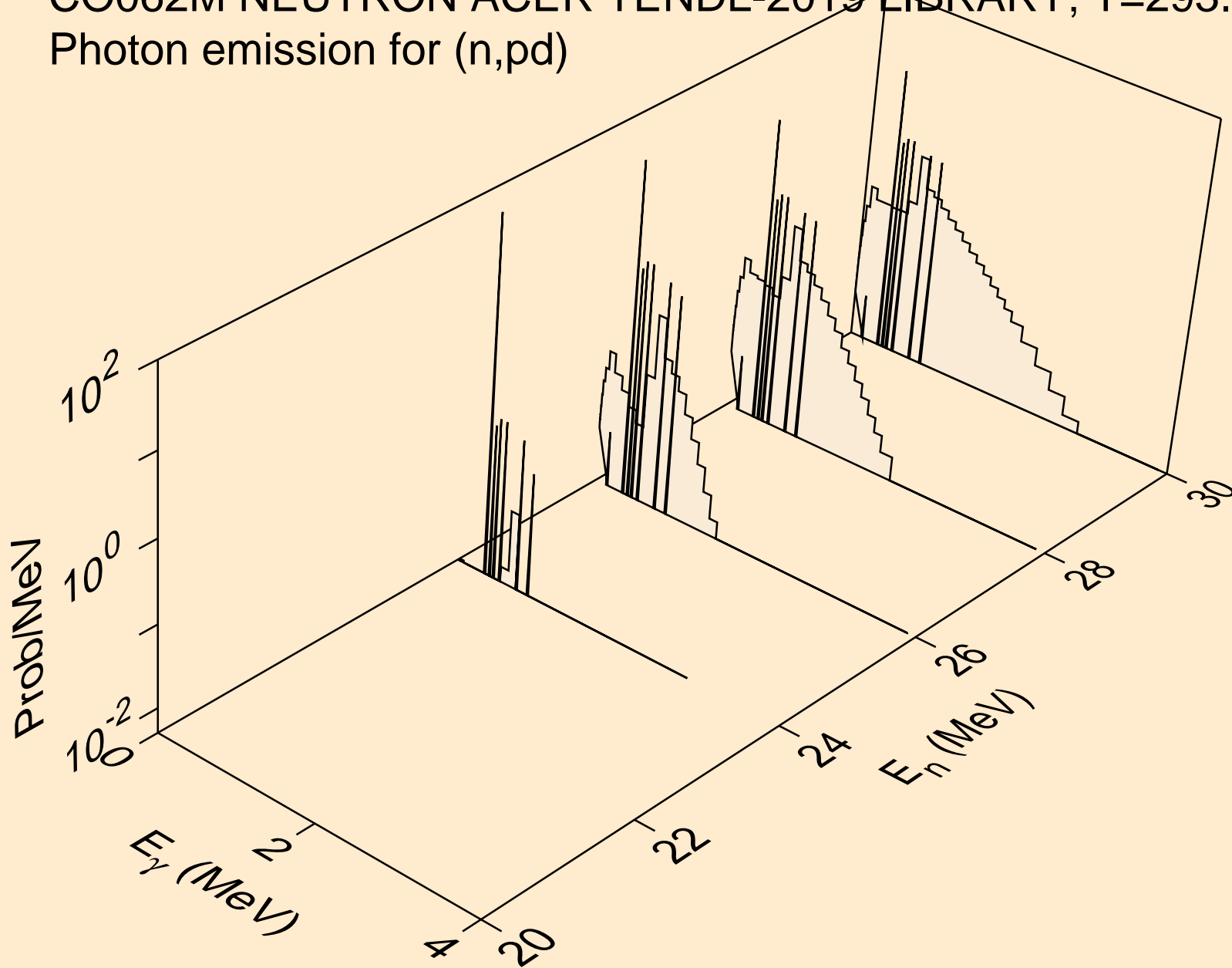

CO062M NEUTRON ACER TENDL-2019 LIBRARY; T=293.16K
Photon emission for (n,pt)

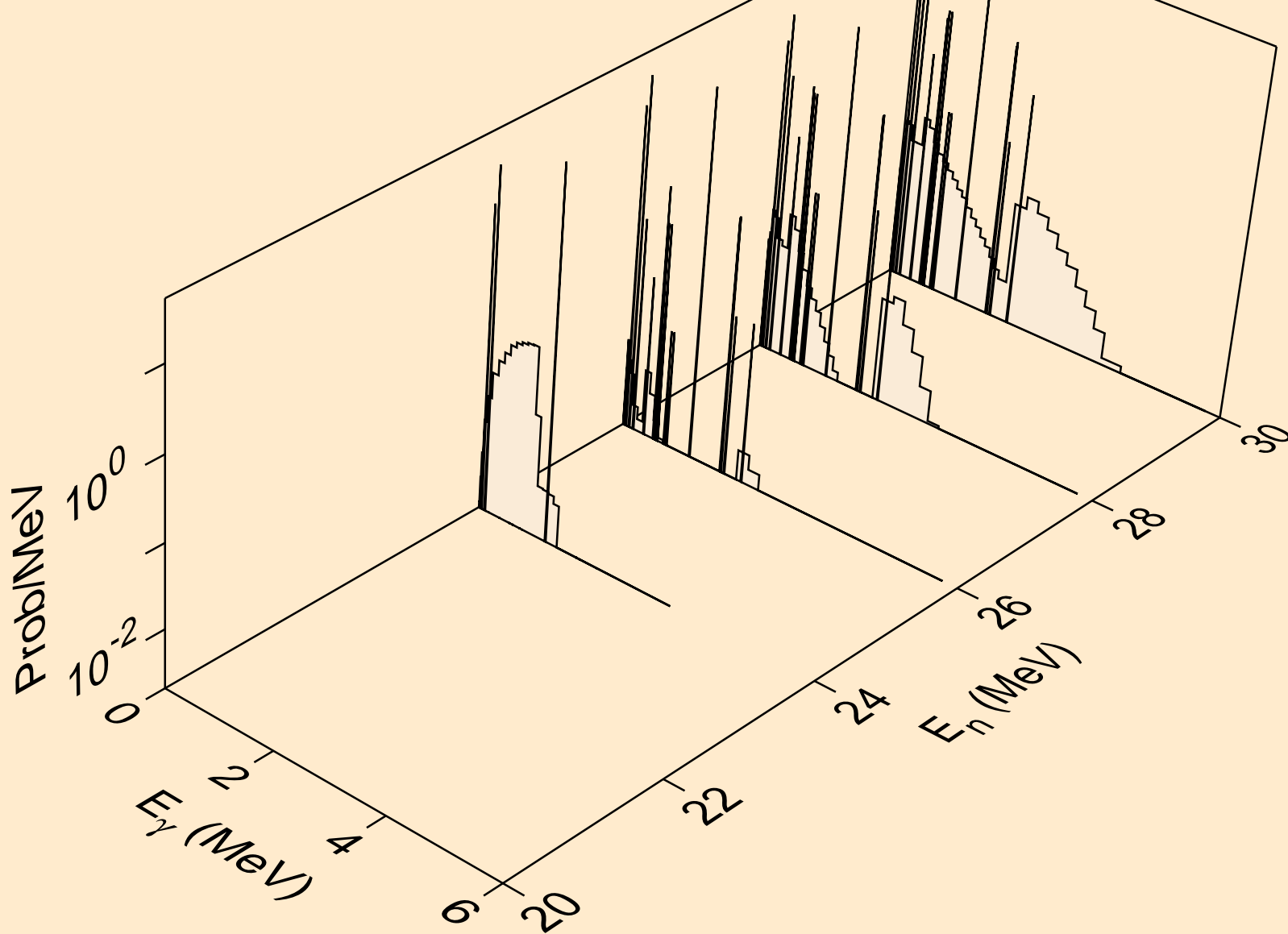

CO062M NEUTRON ACER TENDL-2019 LIBRARY; T=293.16K
Photon emission for (n,da)

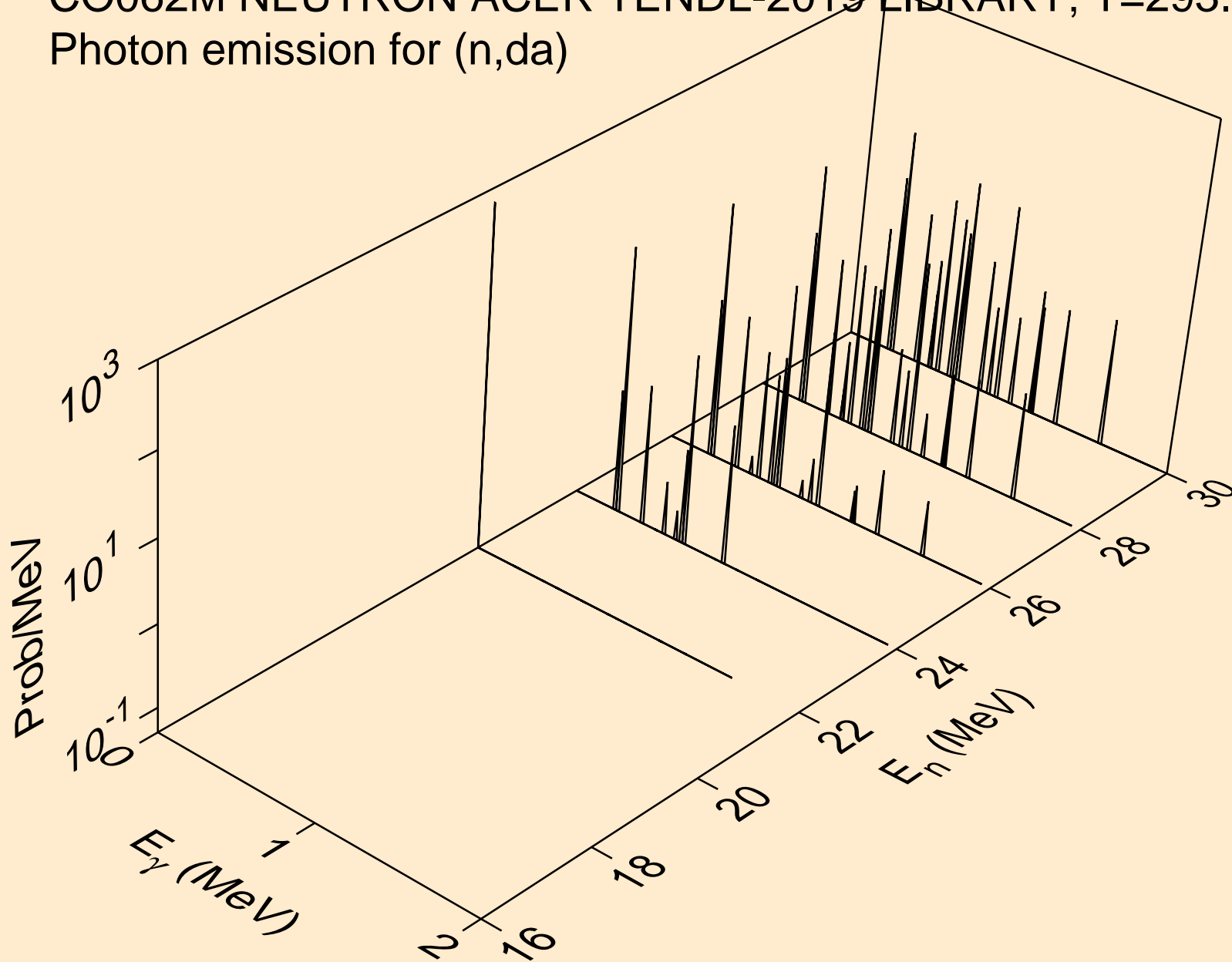

CO062M NEUTRON ACER TENDL-2019 LIBRARY; T=293.16K
thermal capture photon spectrum

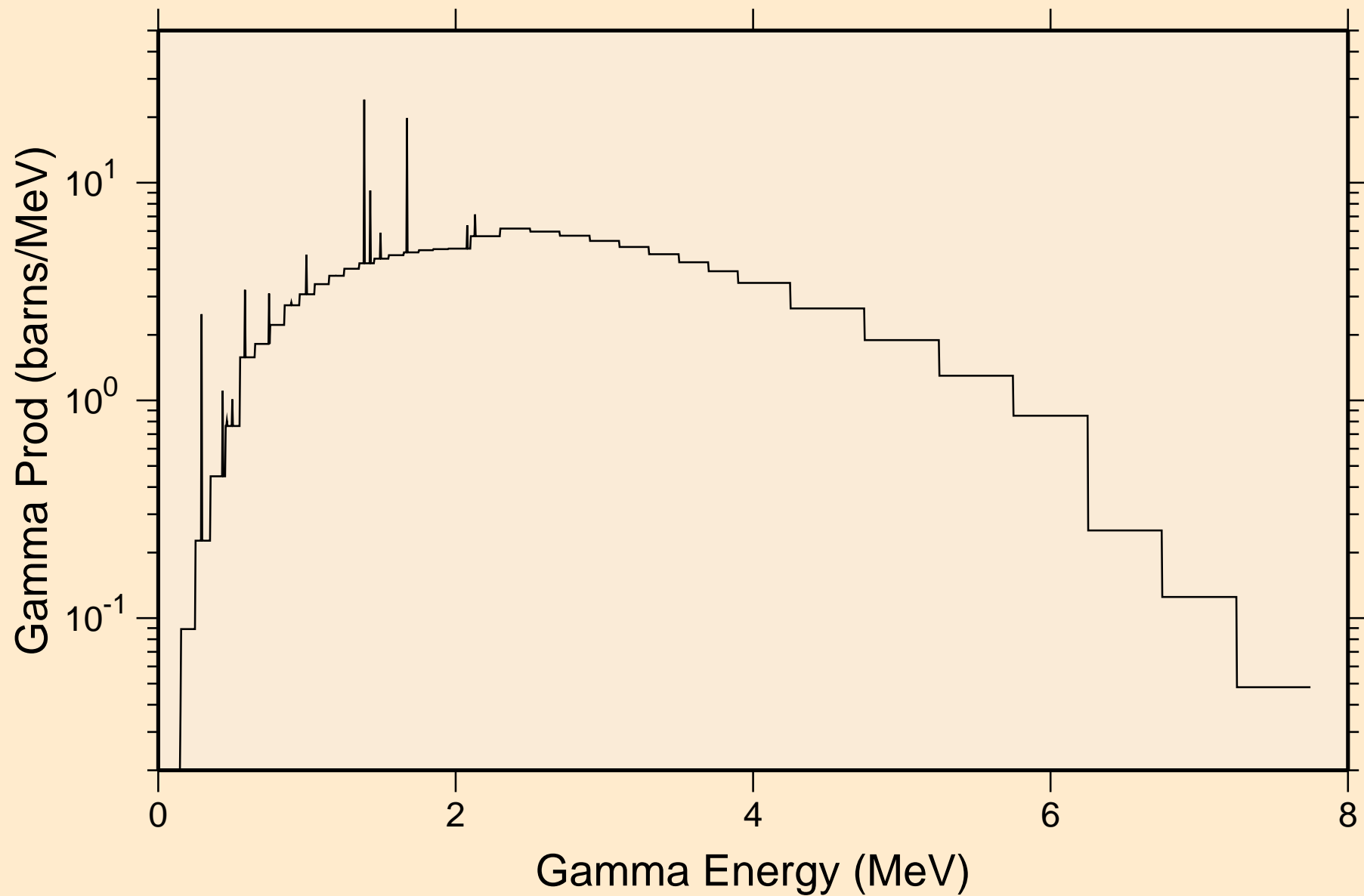

CO062M NEUTRON ACER TENDL-2019 LIBRARY; T=293.16K
14 MeV photon spectrum

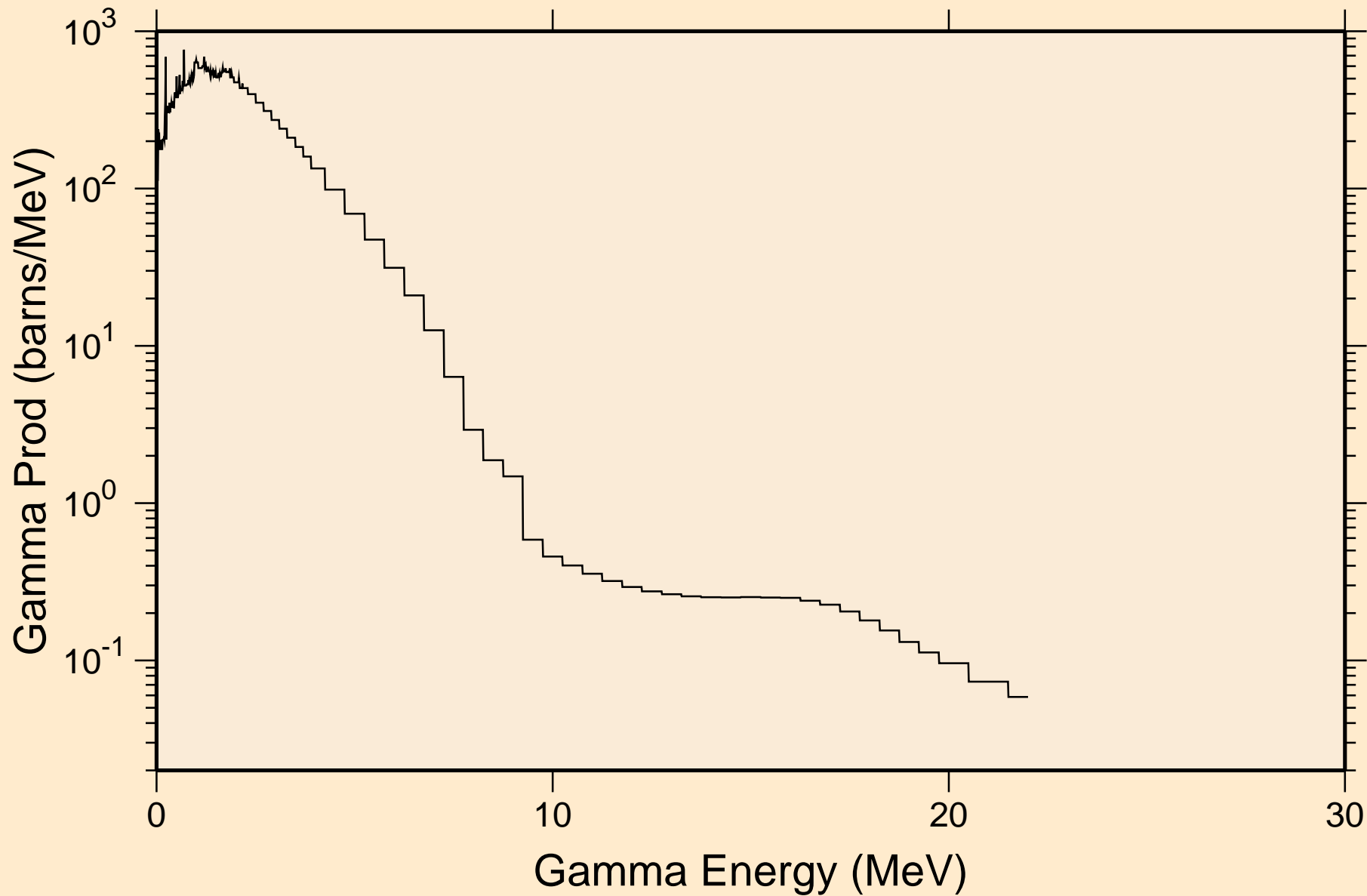

CO062M NEUTRON ACER TENDL-2019 LIBRARY; T=293.16K

Particle heating contributions

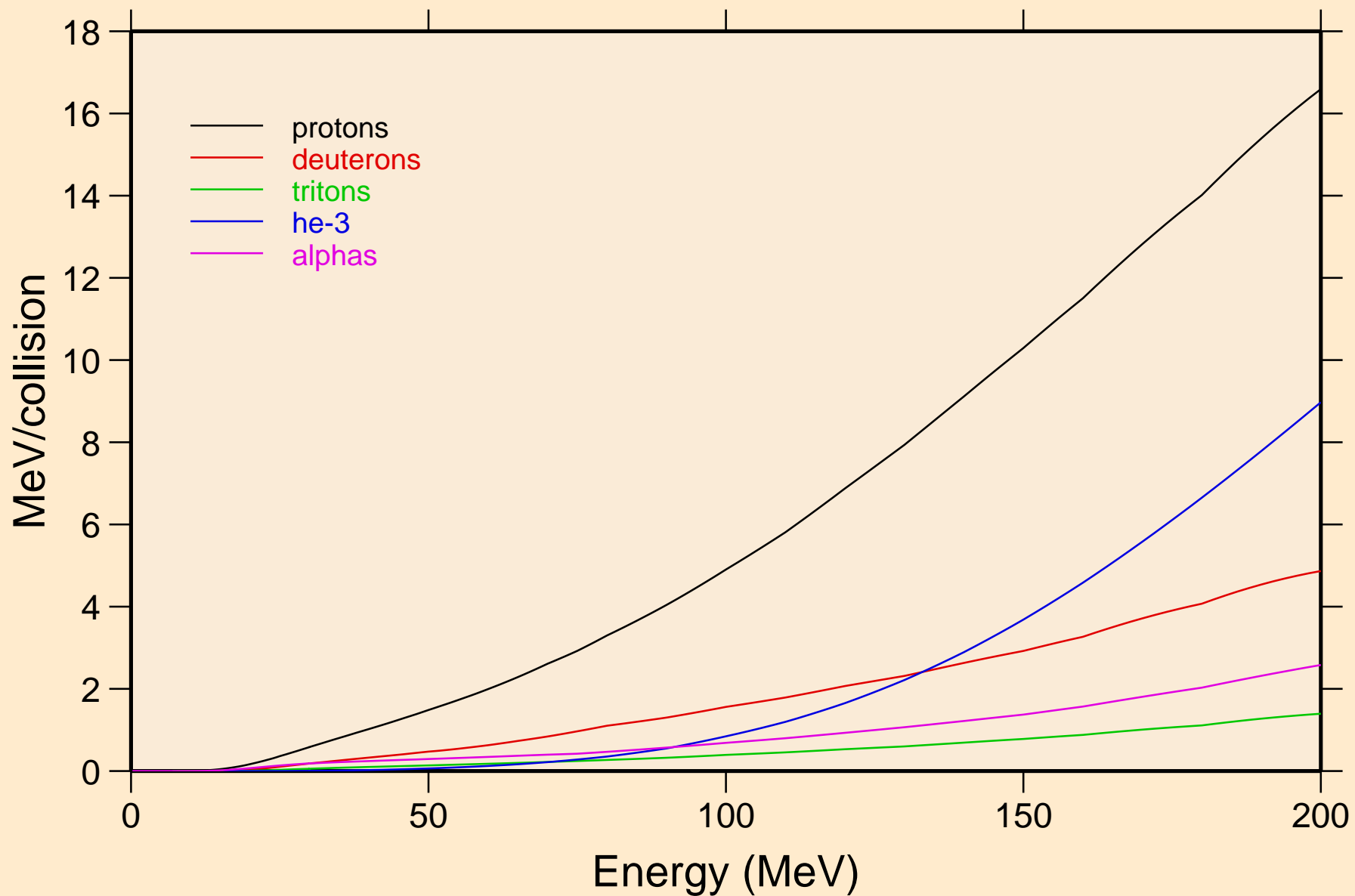

CO062M NEUTRON ACER TENDL-2019 LIBRARY; T=293.16K
Recoil Heating

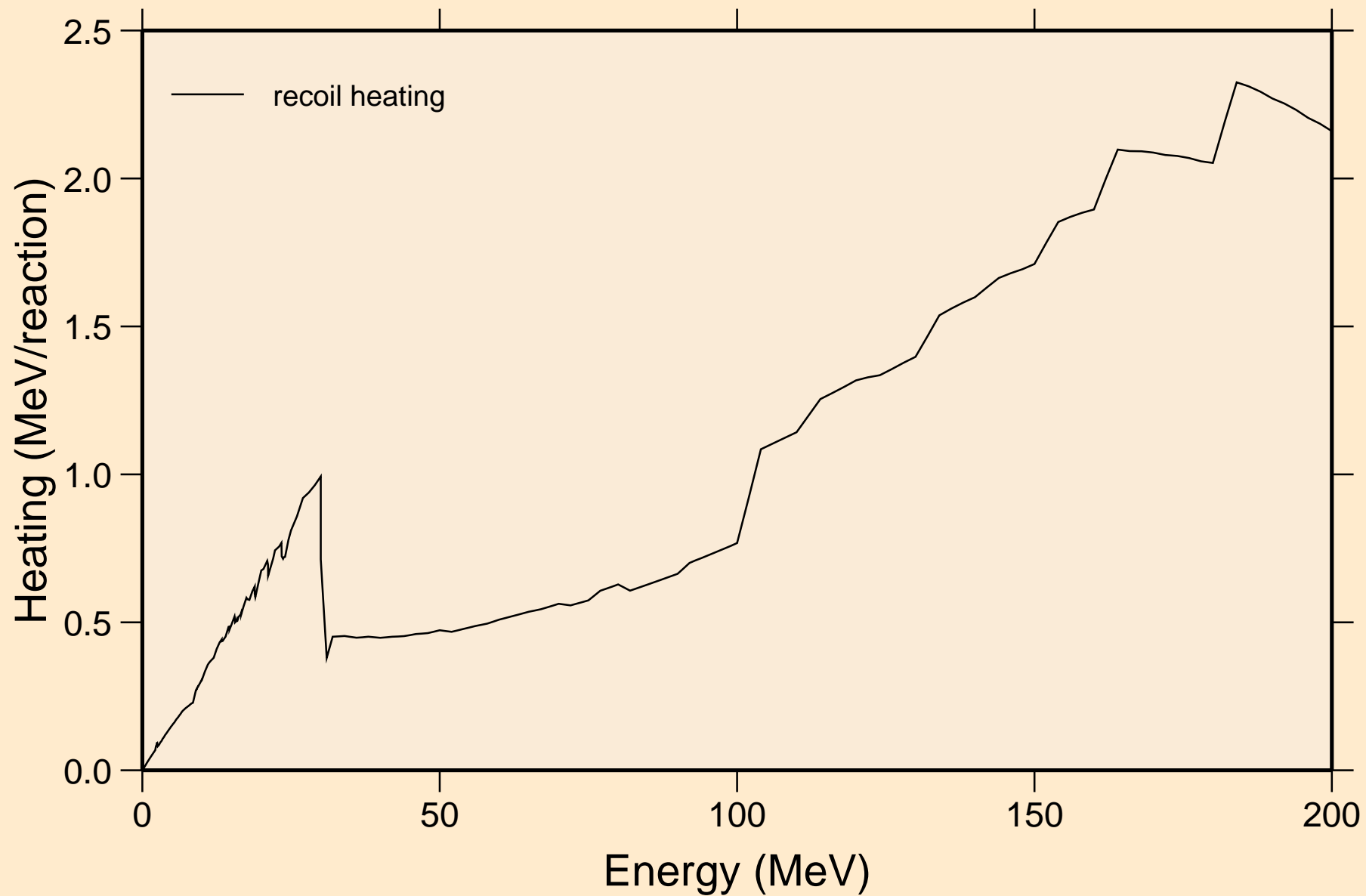

CO062M NEUTRON ACER TENDL-2019 LIBRARY; T=293.16K
Particle production cross sections

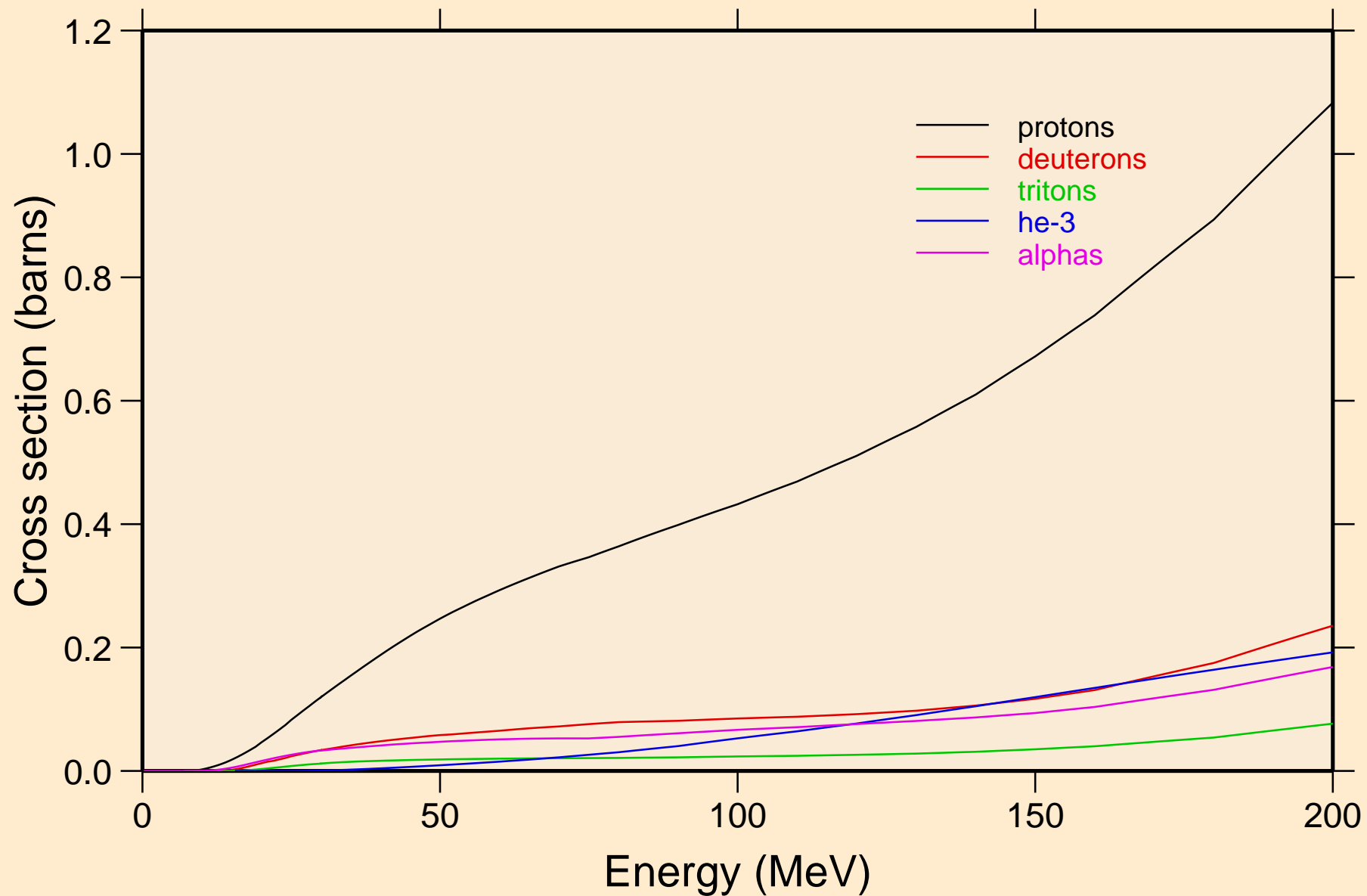

CO062M NEUTRON ACER TENDL-2019 LIBRARY; T=293.16K
protons from (n,x)

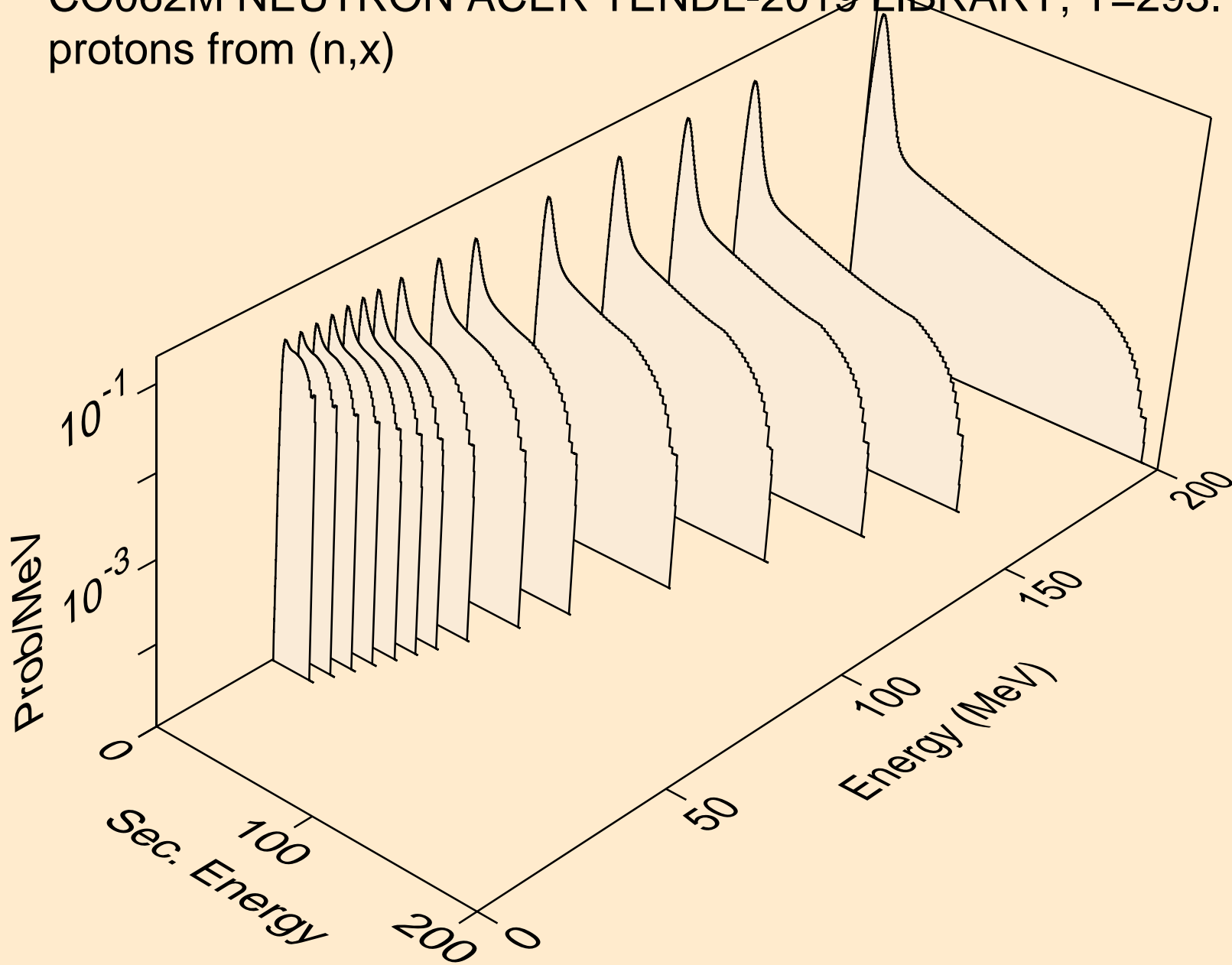

CO062M NEUTRON ACER TENDL-2019 LIBRARY; T=293.16K
protons from (n,n*)p

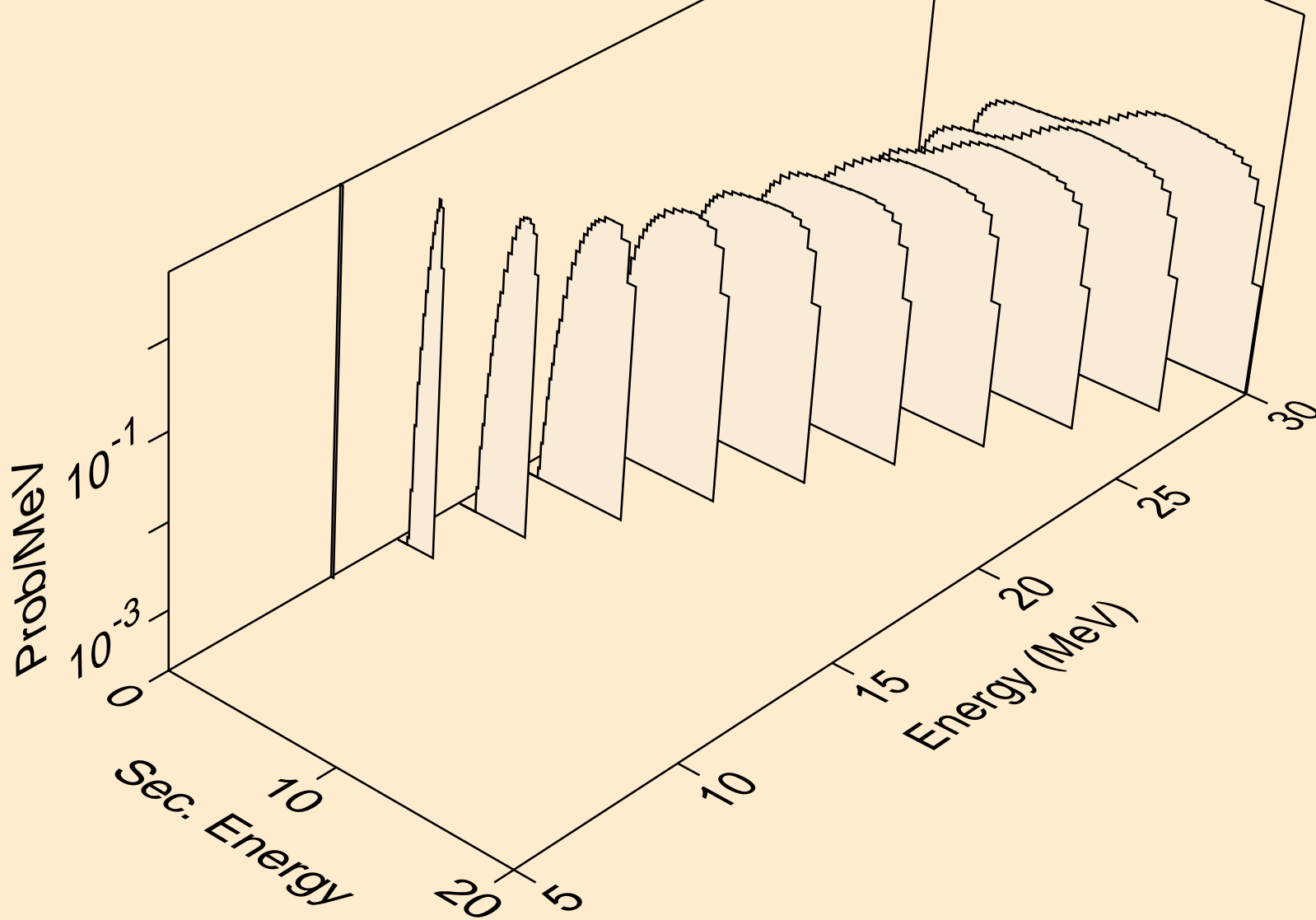

CO062M NEUTRON ACER TENDL-2019 LIBRARY; T=293.16K
protons from (n,2np)

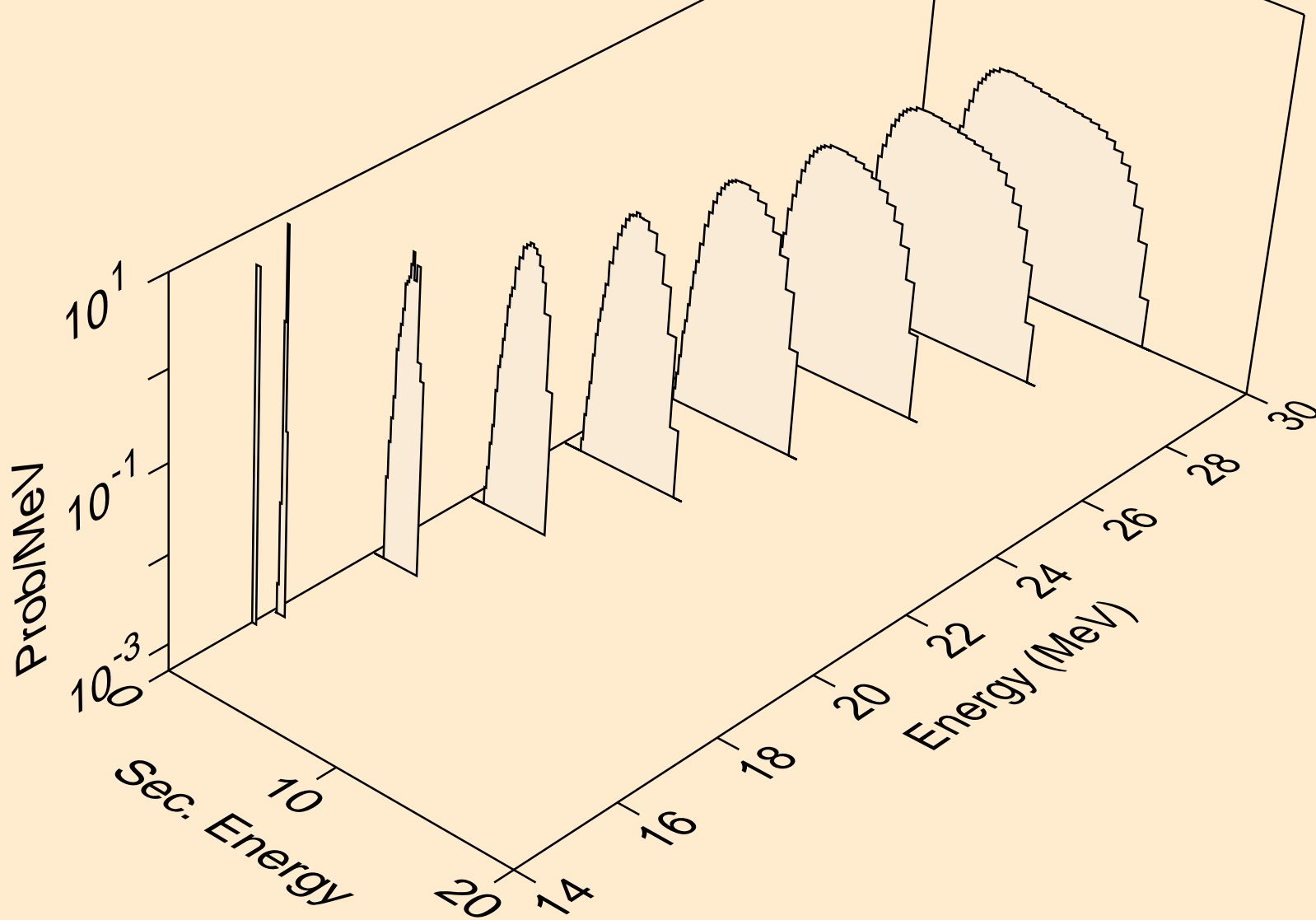

CO062M NEUTRON ACER TENDL-2019 LIBRARY; T=293.16K
protons from (n,3np)

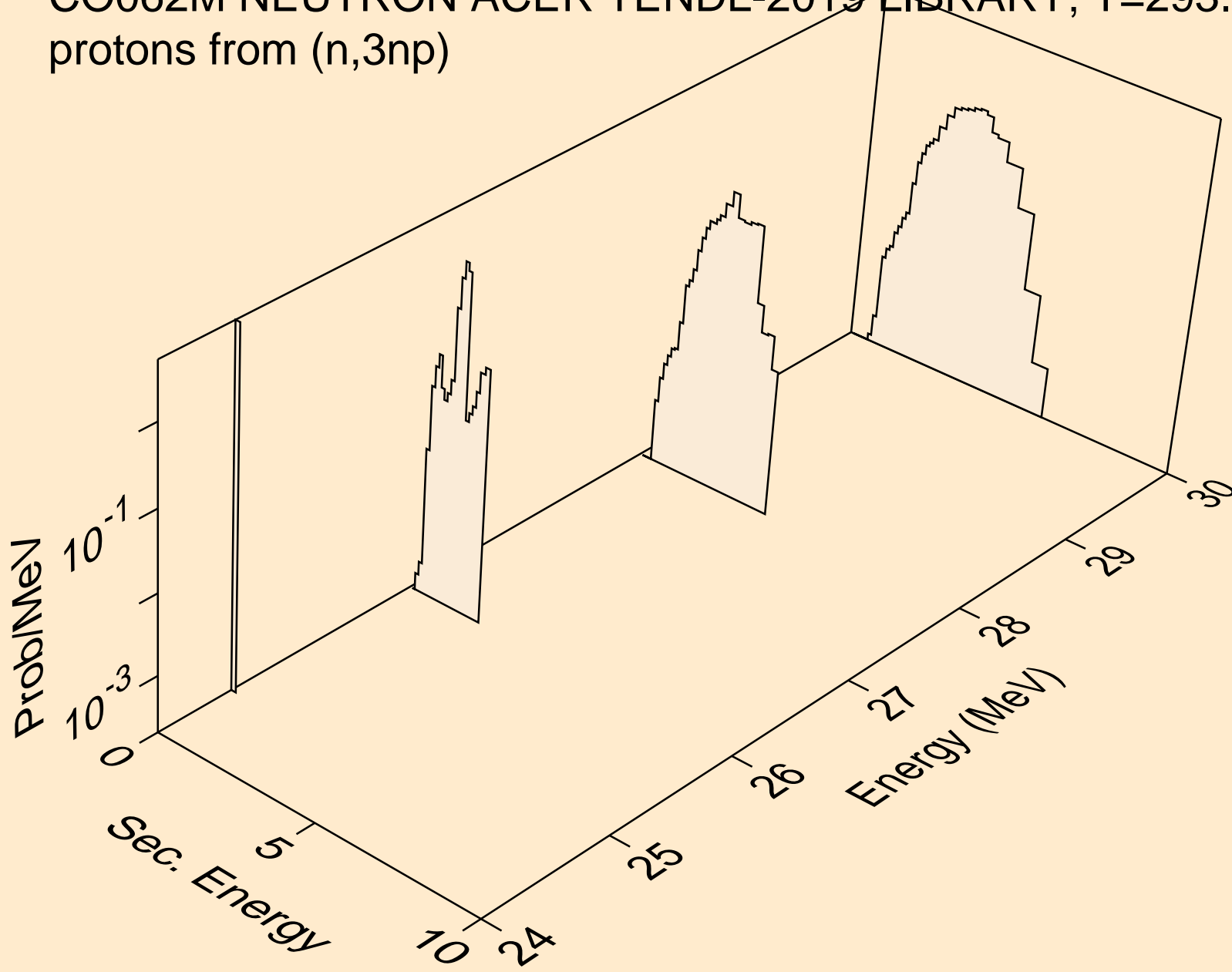

CO062M NEUTRON ACER TENDL-2019 LIBRARY; T=293.16K
protons from (n,2np)

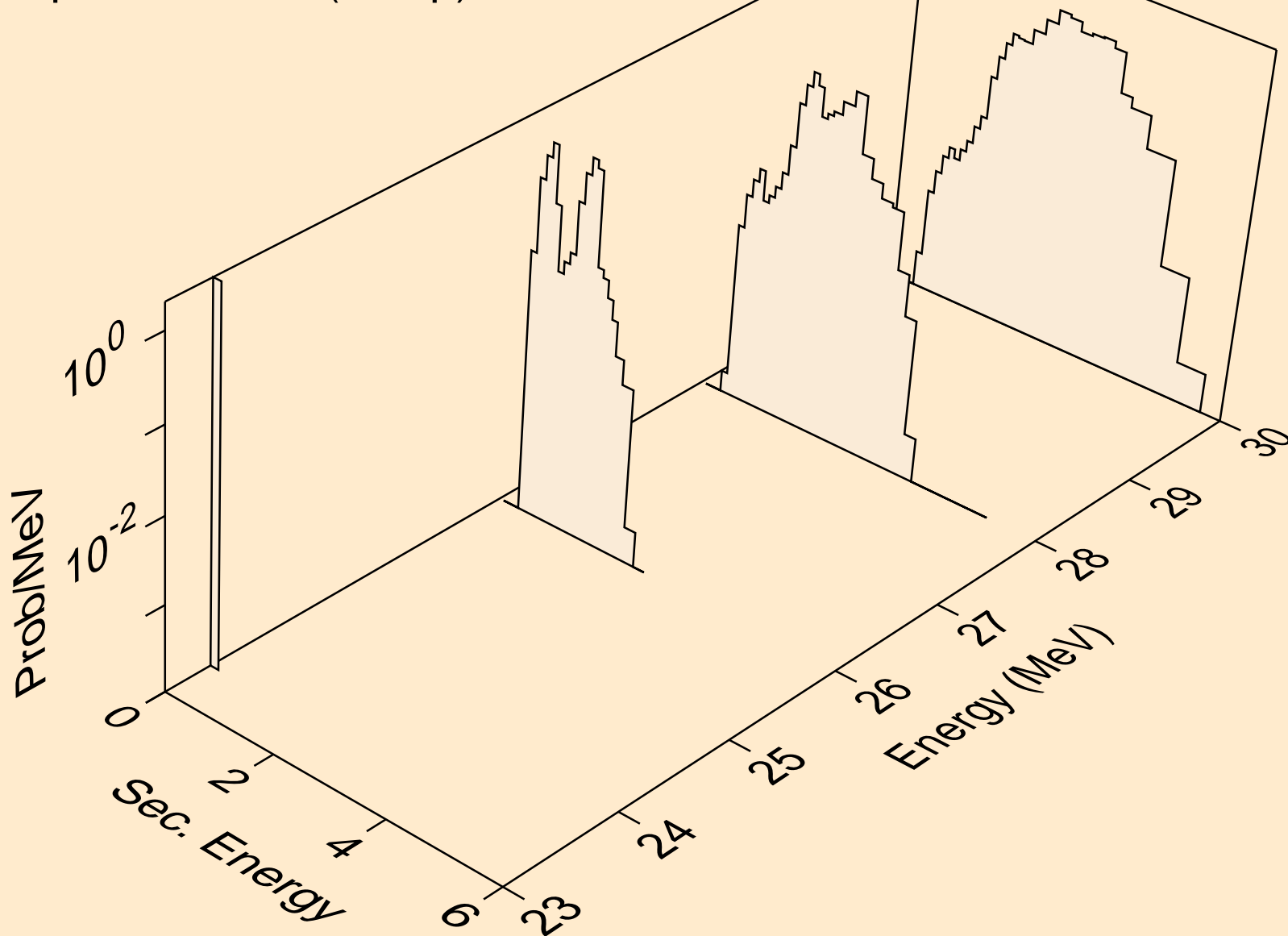

CO062M NEUTRON ACER TENDL-2019 LIBRARY; T=293.16K
protons from (n,npa)

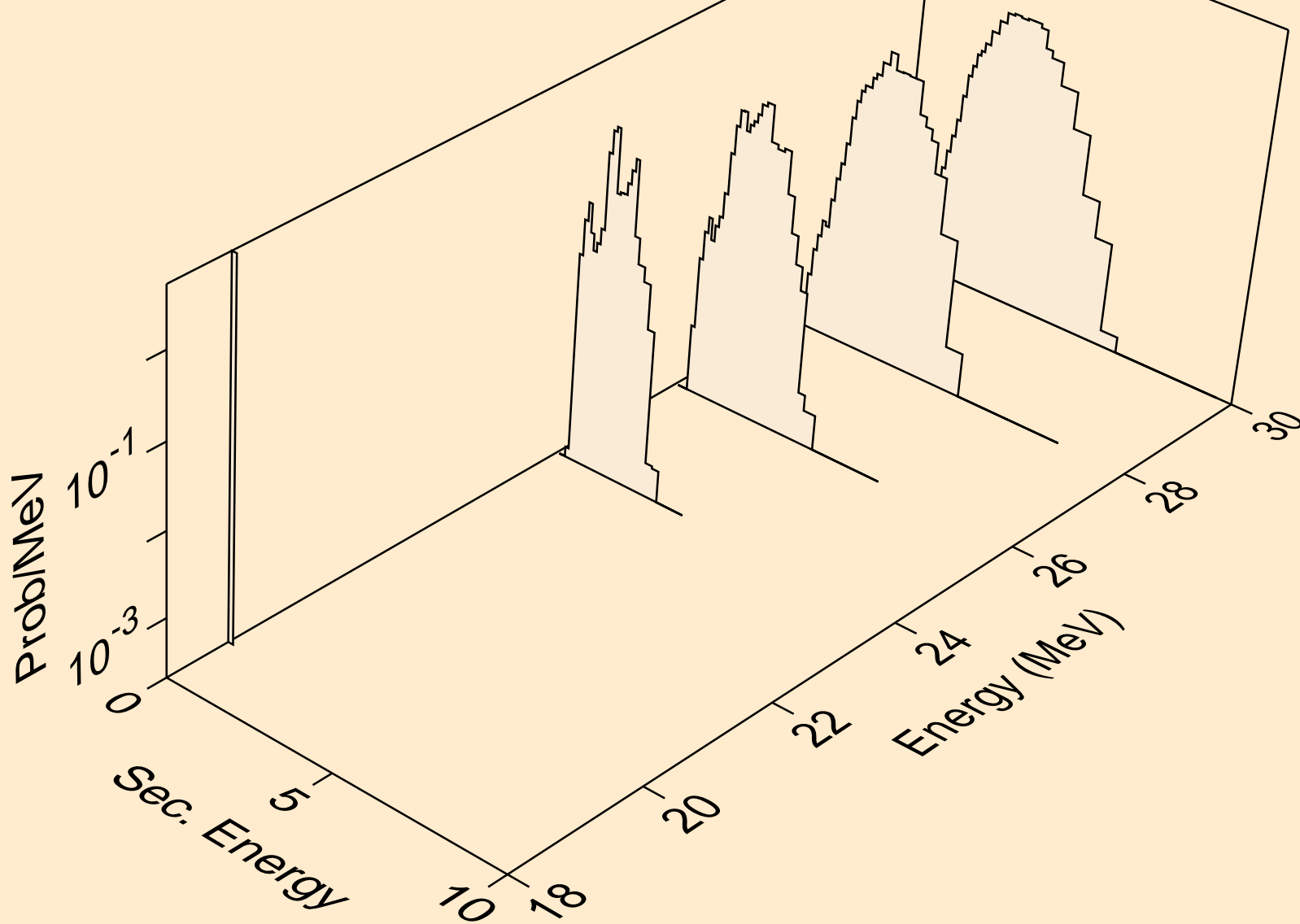

CO062M NEUTRON ACER TENDL-2019 LIBRARY; T=293.16K
protons from (n,p)

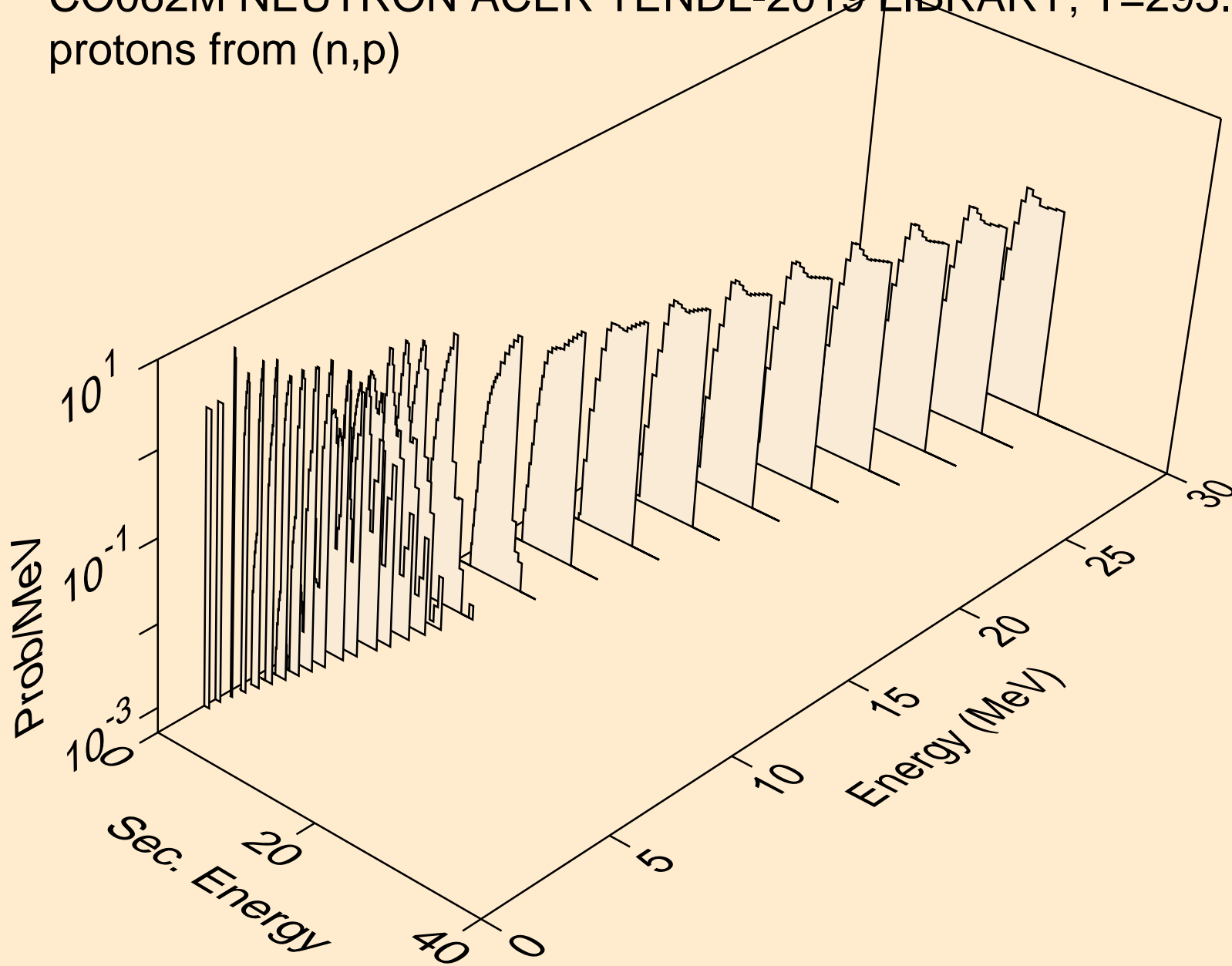

CO062M NEUTRON ACER TENDL-2019 LIBRARY; T=293.16K
protons from (n,2p)

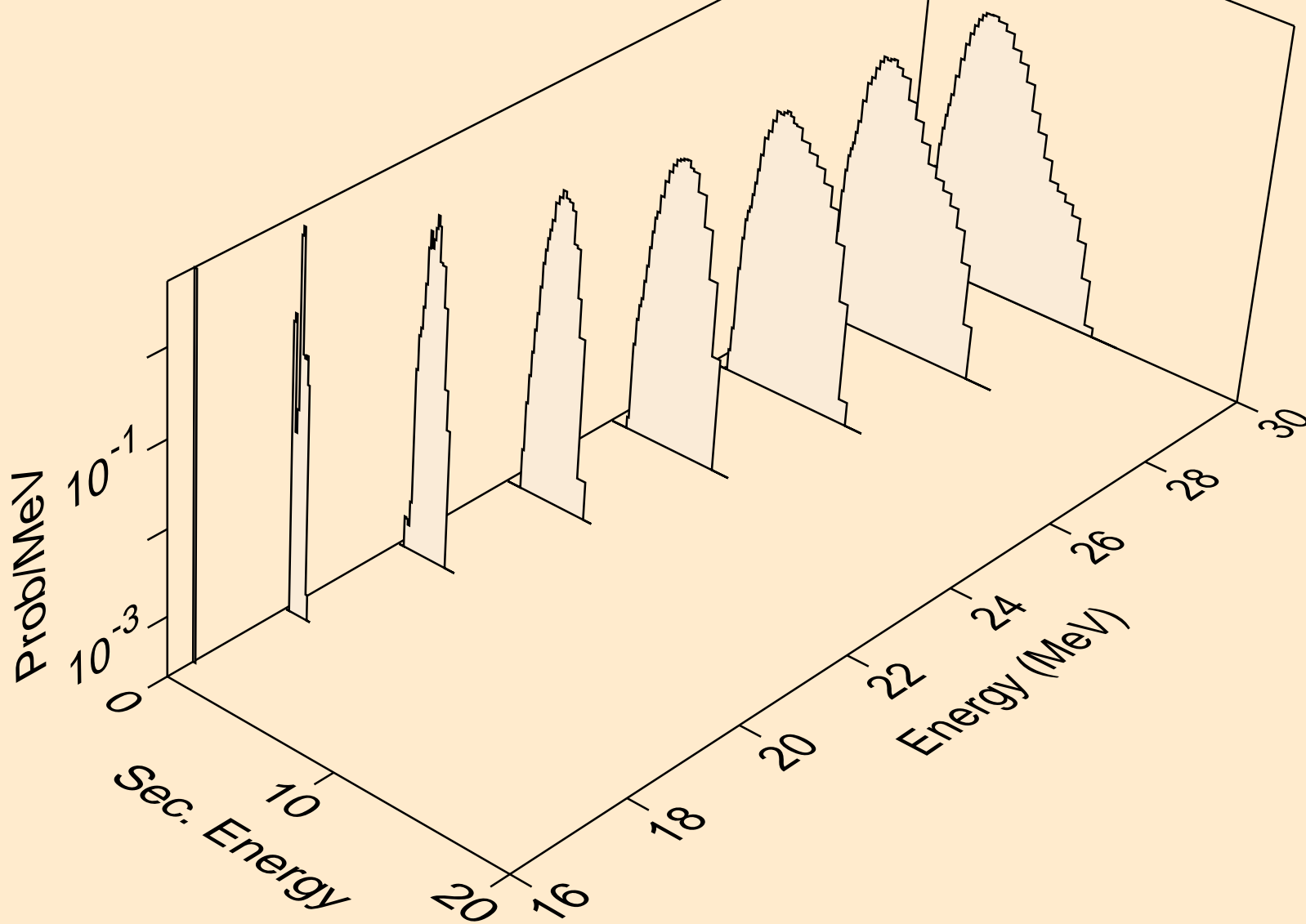

CO062M NEUTRON ACER TENDL-2019 LIBRARY; T=293.16K
protons from (n,p)

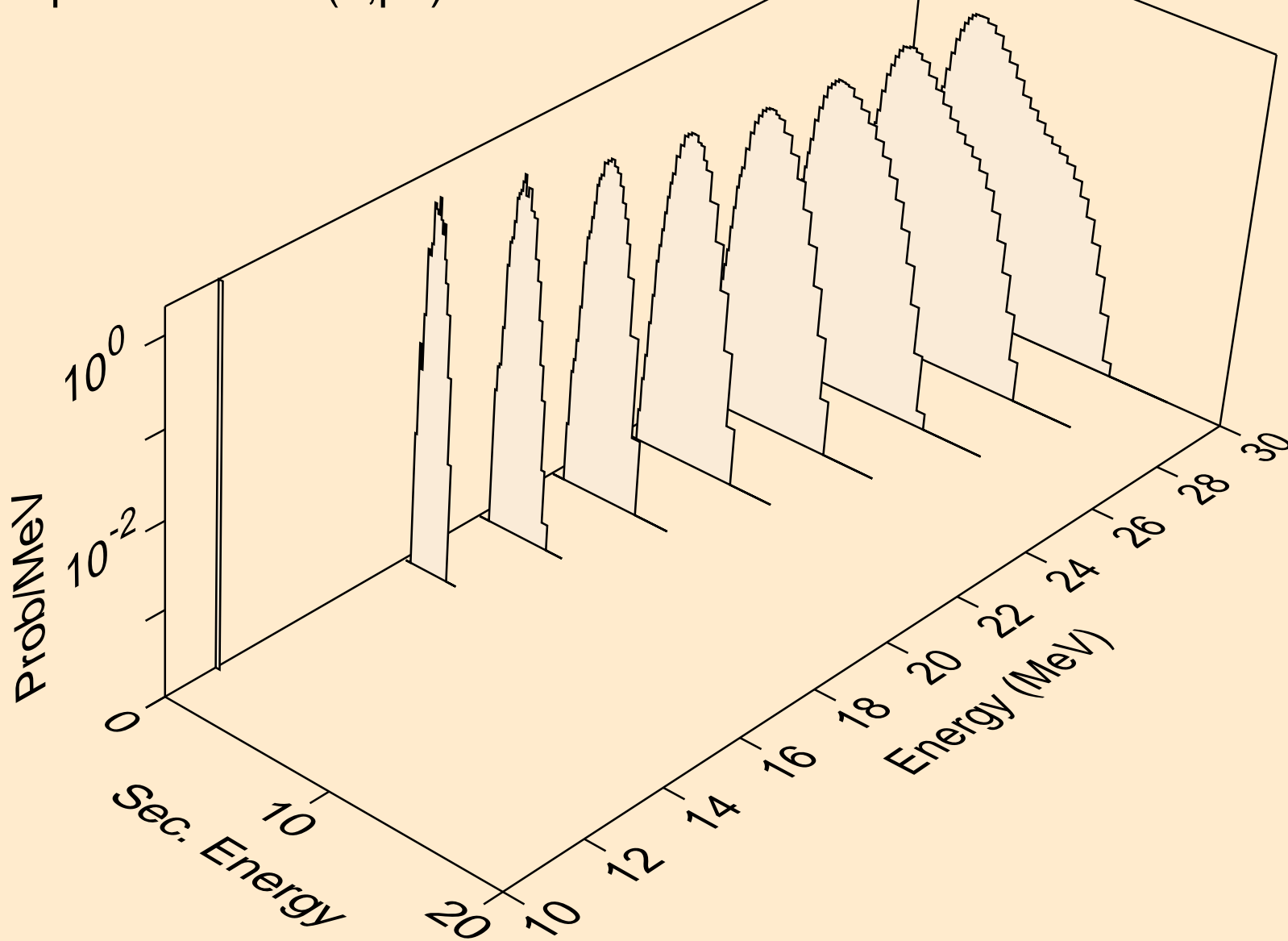

CO062M NEUTRON ACER TENDL-2019 LIBRARY; T=293.16K
protons from (n,pd)

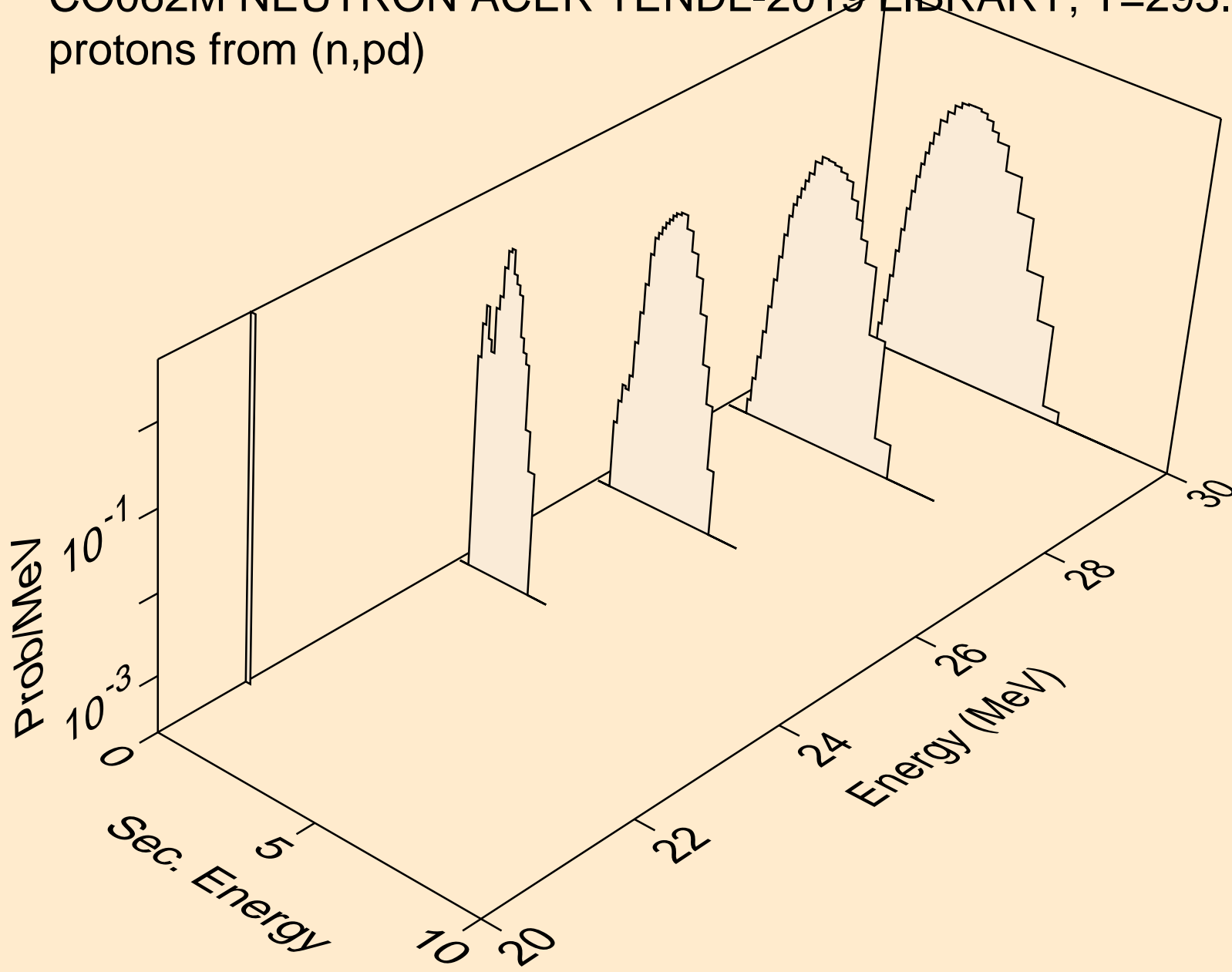

CO062M NEUTRON ACER TENDL-2019 LIBRARY; T=293.16K
protons from (n,pt)

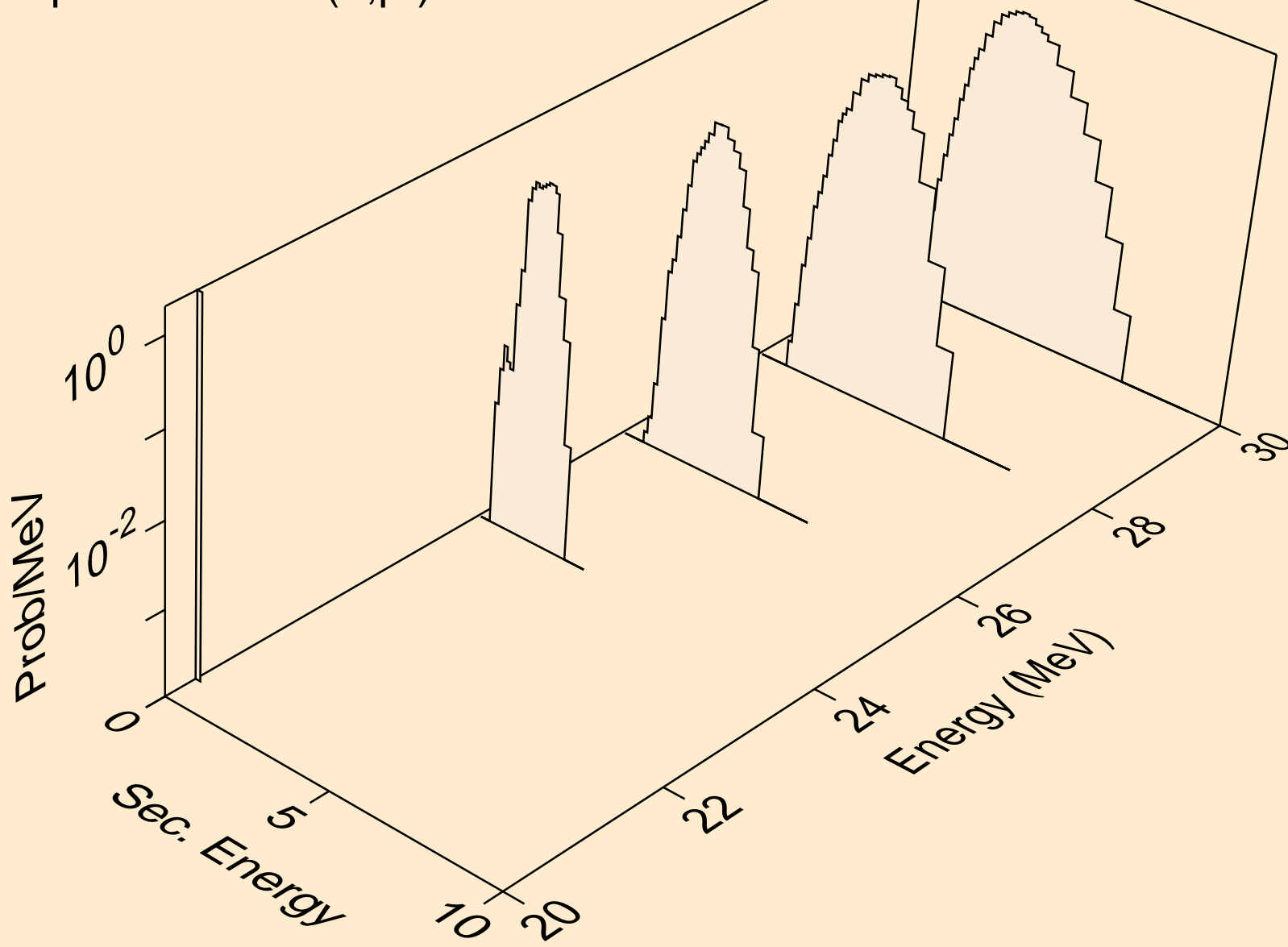

CO062M NEUTRON ACER TENDL-2019 LIBRARY; T=293.16K
deuterons from (n,x)

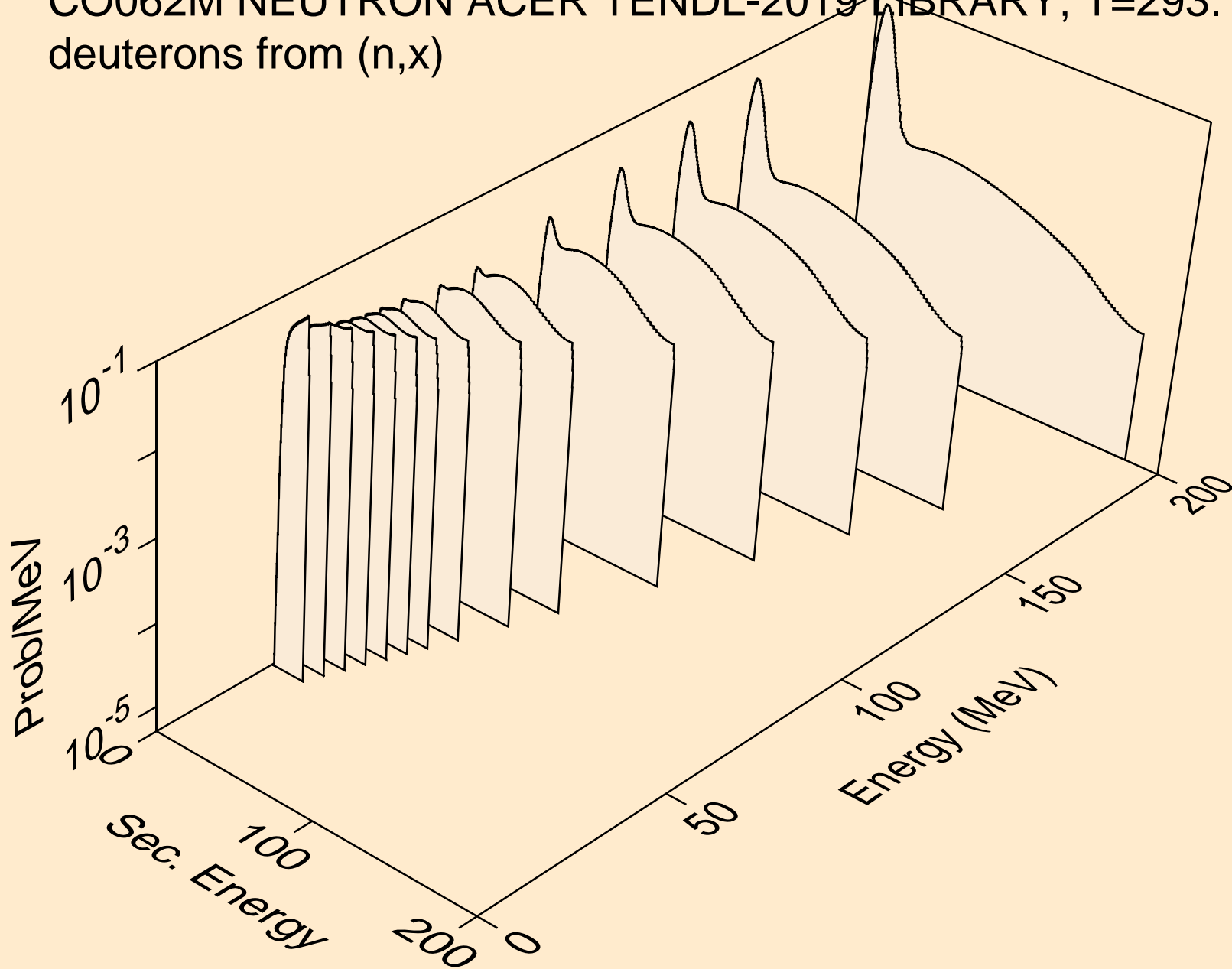

CO062M NEUTRON ACER TENDL-2019 LIBRARY; T=293.16K
deuterons from (n,2nd)

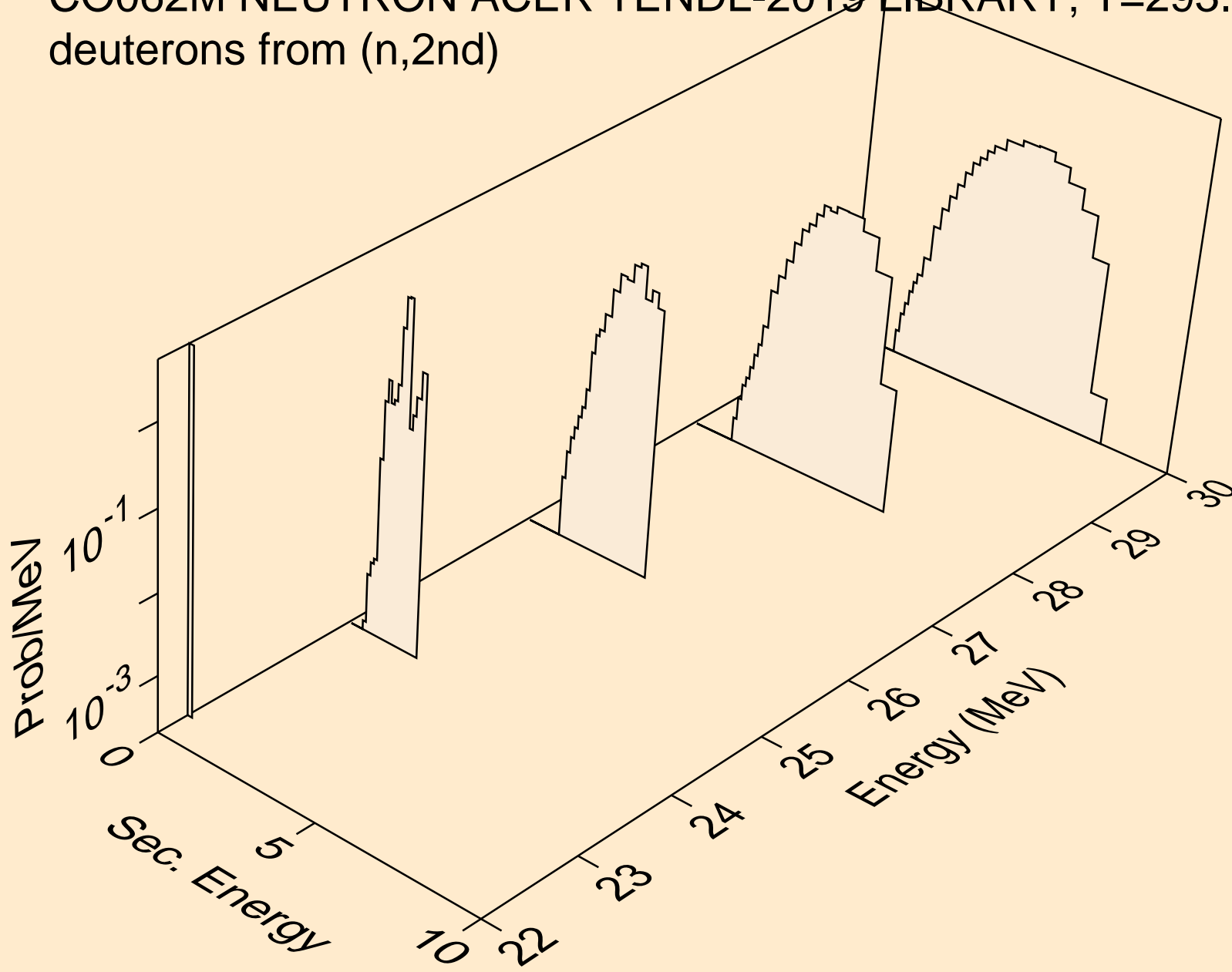

CO062M NEUTRON ACER TENDL-2019 LIBRARY; T=293.16K
deuterons from (n,n*)d

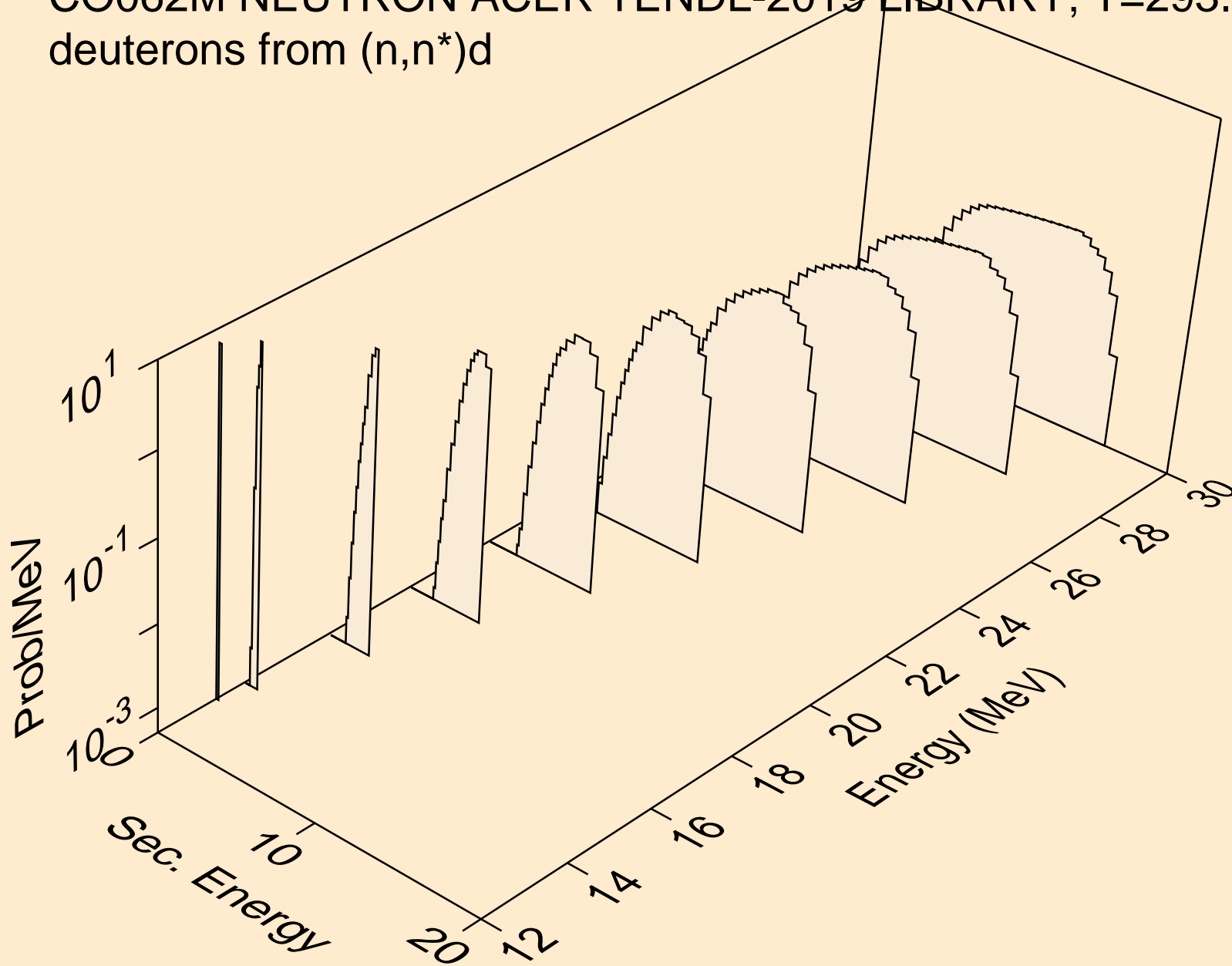

CO062M NEUTRON ACER TENDL-2019 LIBRARY; T=293.16K
deuterons from (n,d)

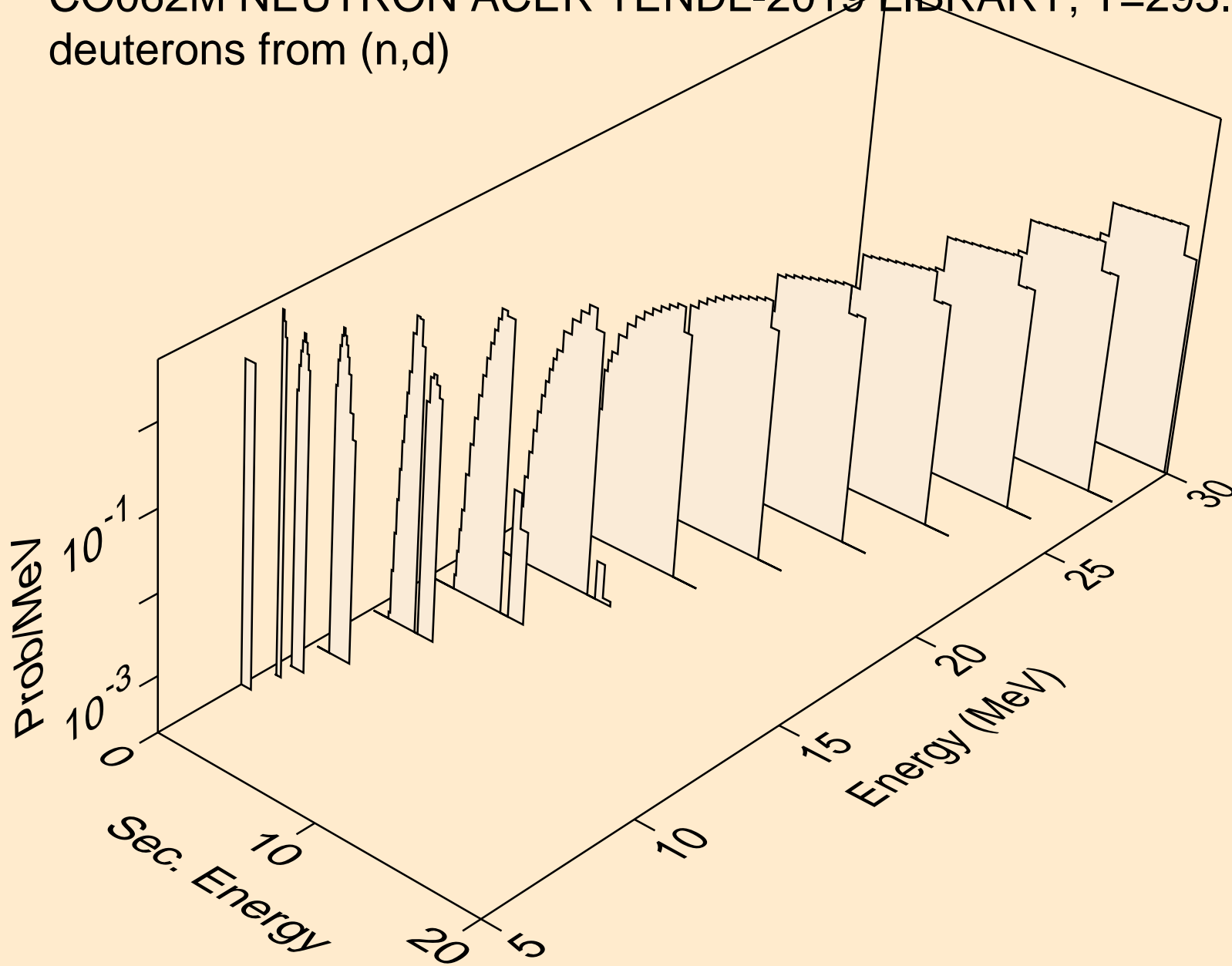

CO062M NEUTRON ACER TENDL-2019 LIBRARY; T=293.16K
deuterons from (n,pd)

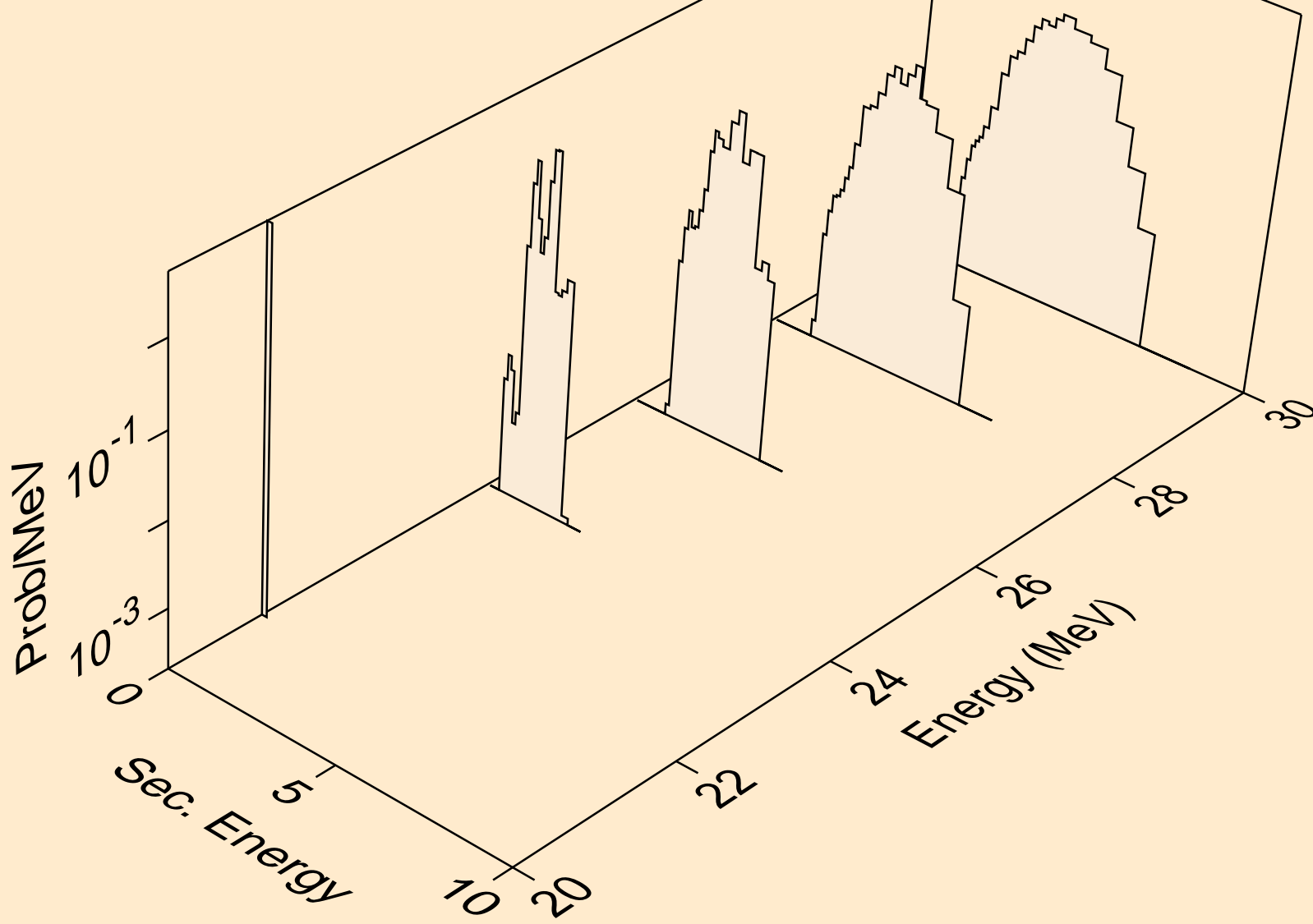

CO062M NEUTRON ACER TENDL-2019 LIBRARY; T=293.16K
deuterons from (n,da)

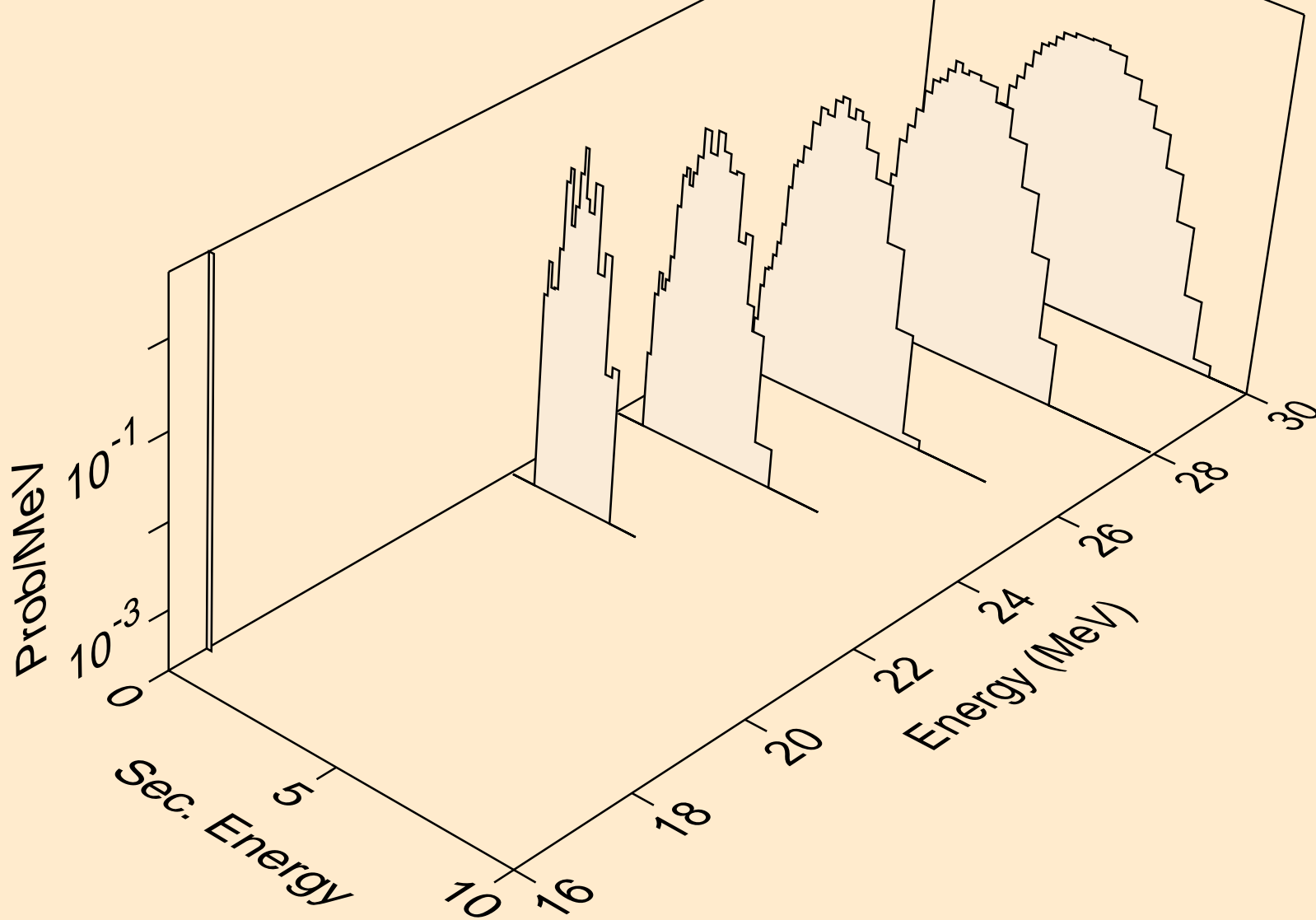

CO062M NEUTRON ACER TENDL-2019 LIBRARY; T=293.16K
tritons from (n,x)

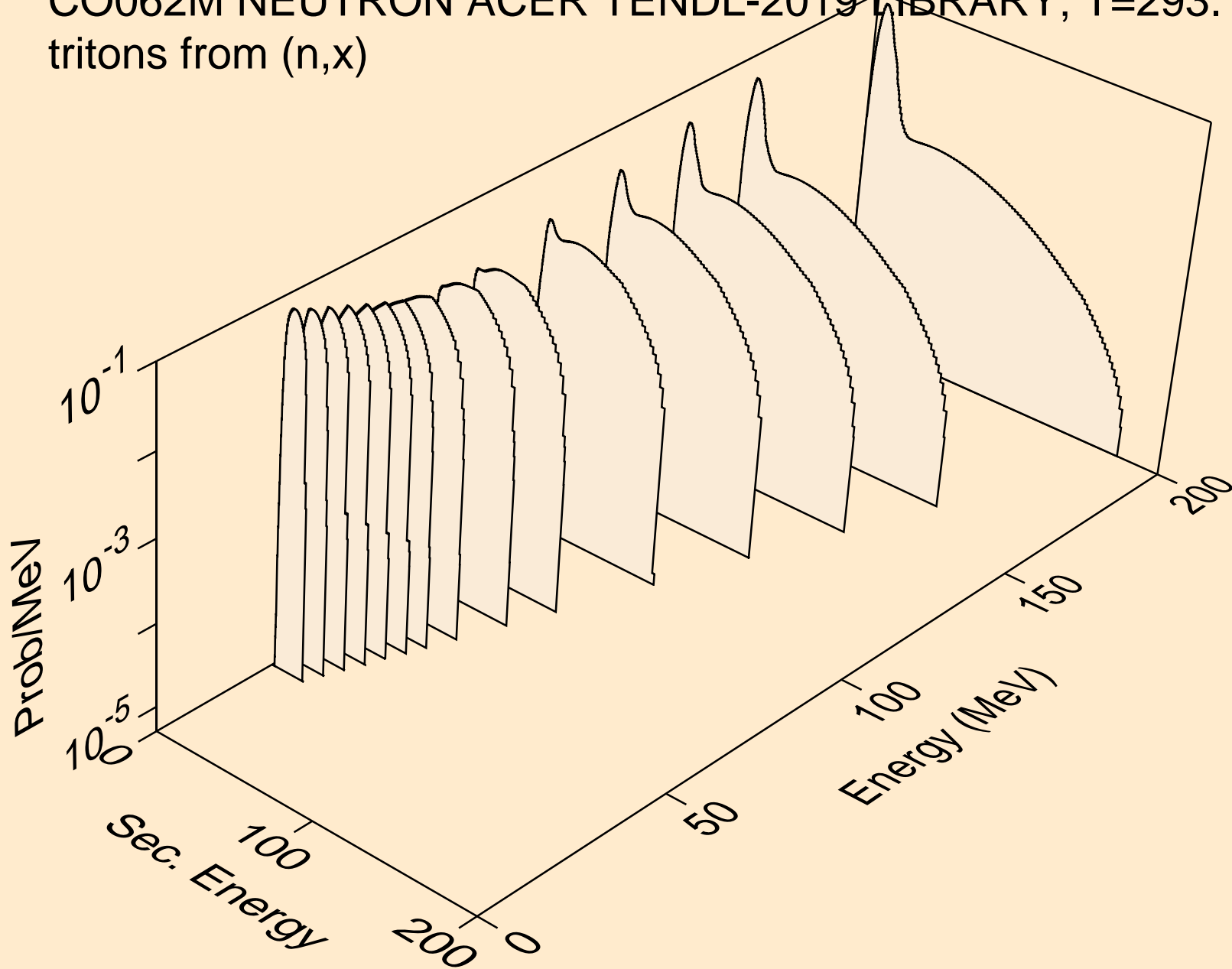

CO062M NEUTRON ACER TENDL-2019 LIBRARY; T=293.16K
tritons from (n,n*)t

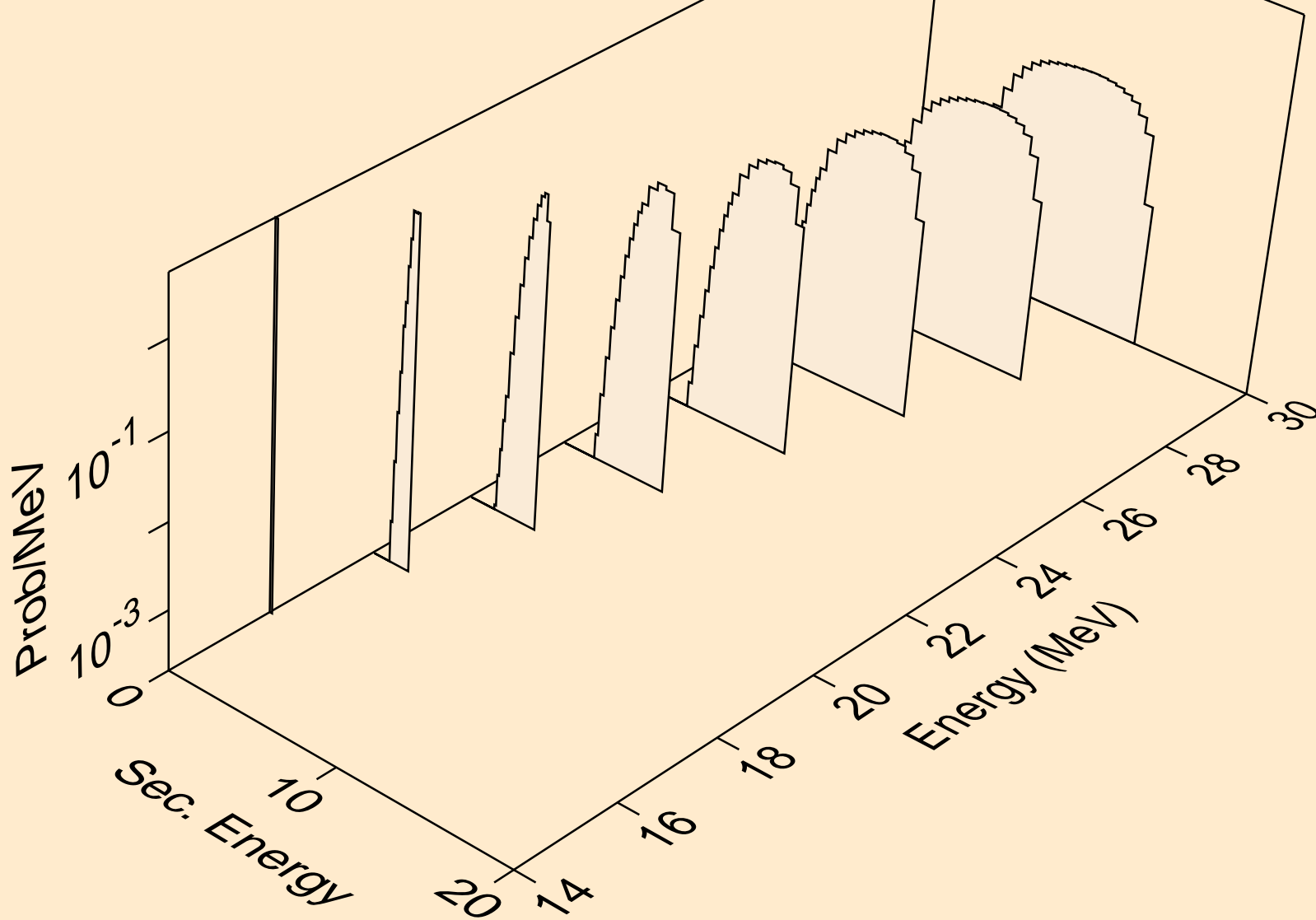

CO062M NEUTRON ACER TENDL-2019 LIBRARY; T=293.16K
tritons from (n,t)

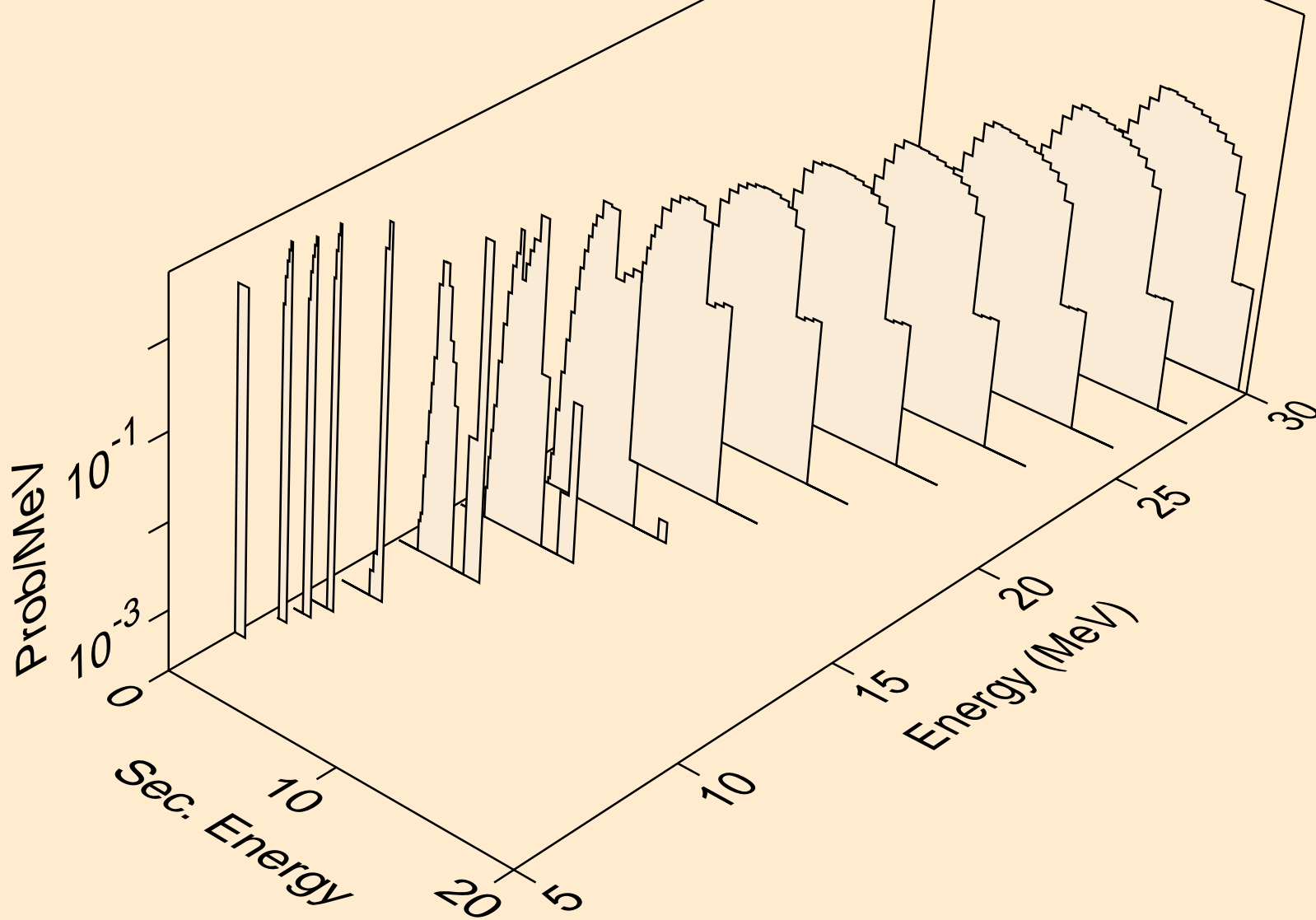

CO062M NEUTRON ACER TENDL-2019 LIBRARY; T=293.16K
tritons from (n,pt)

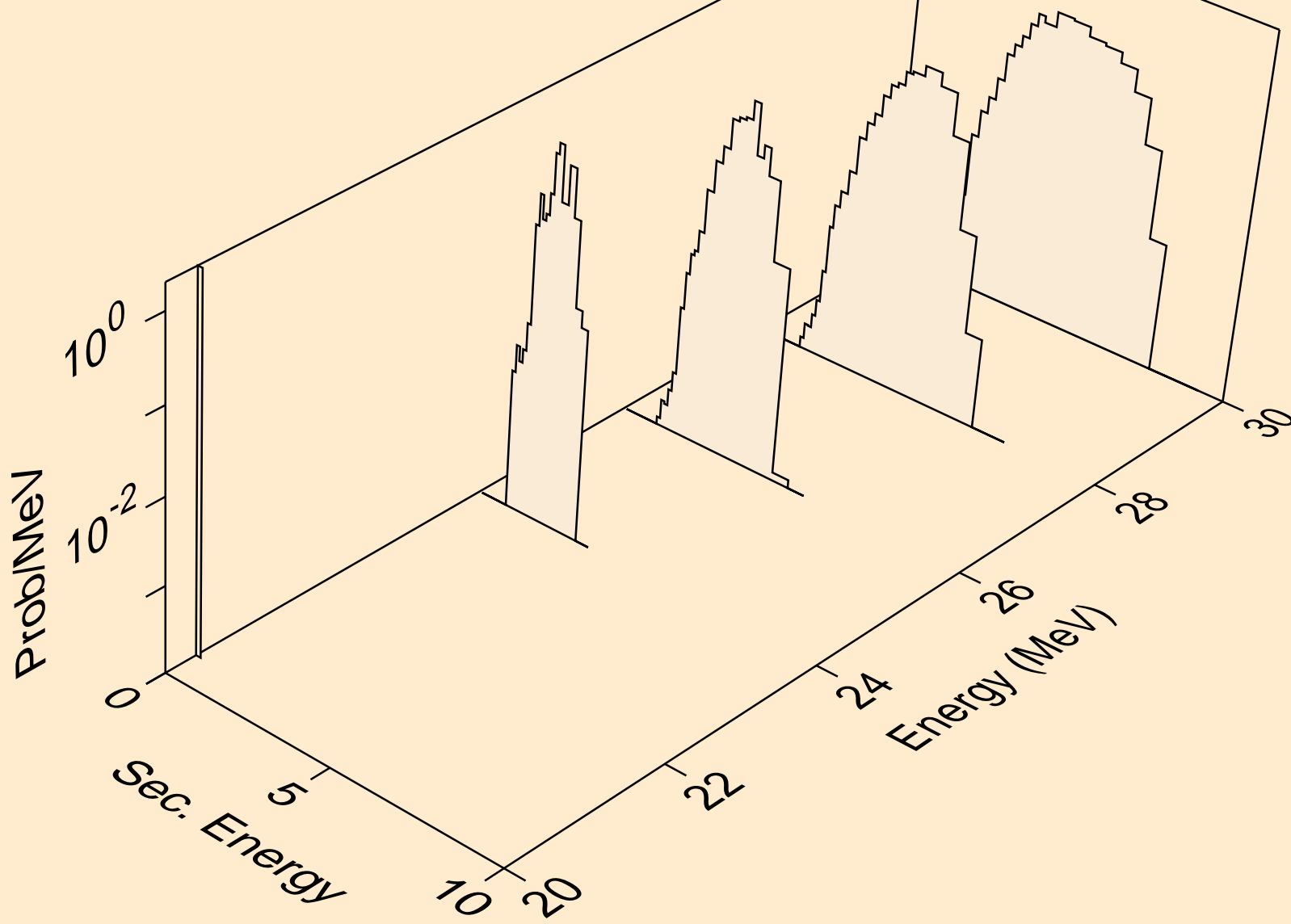

CO062M NEUTRON ACER TENDL-2019 LIBRARY; T=293.16K
he3s from (n,x)

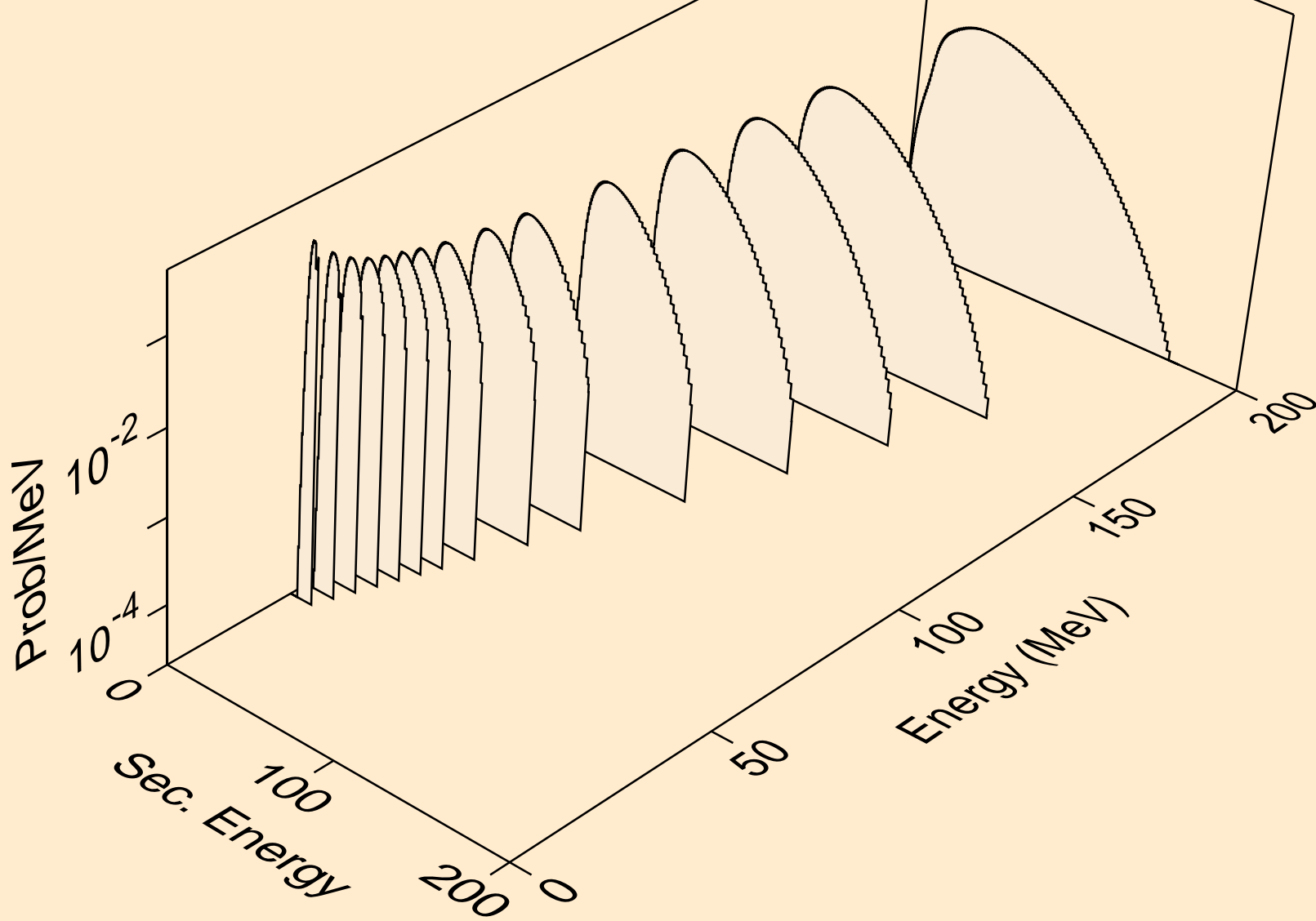

CO062M NEUTRON ACER TENDL-2019 LIBRARY; T=293.16K
he3s from (n,n*)he3

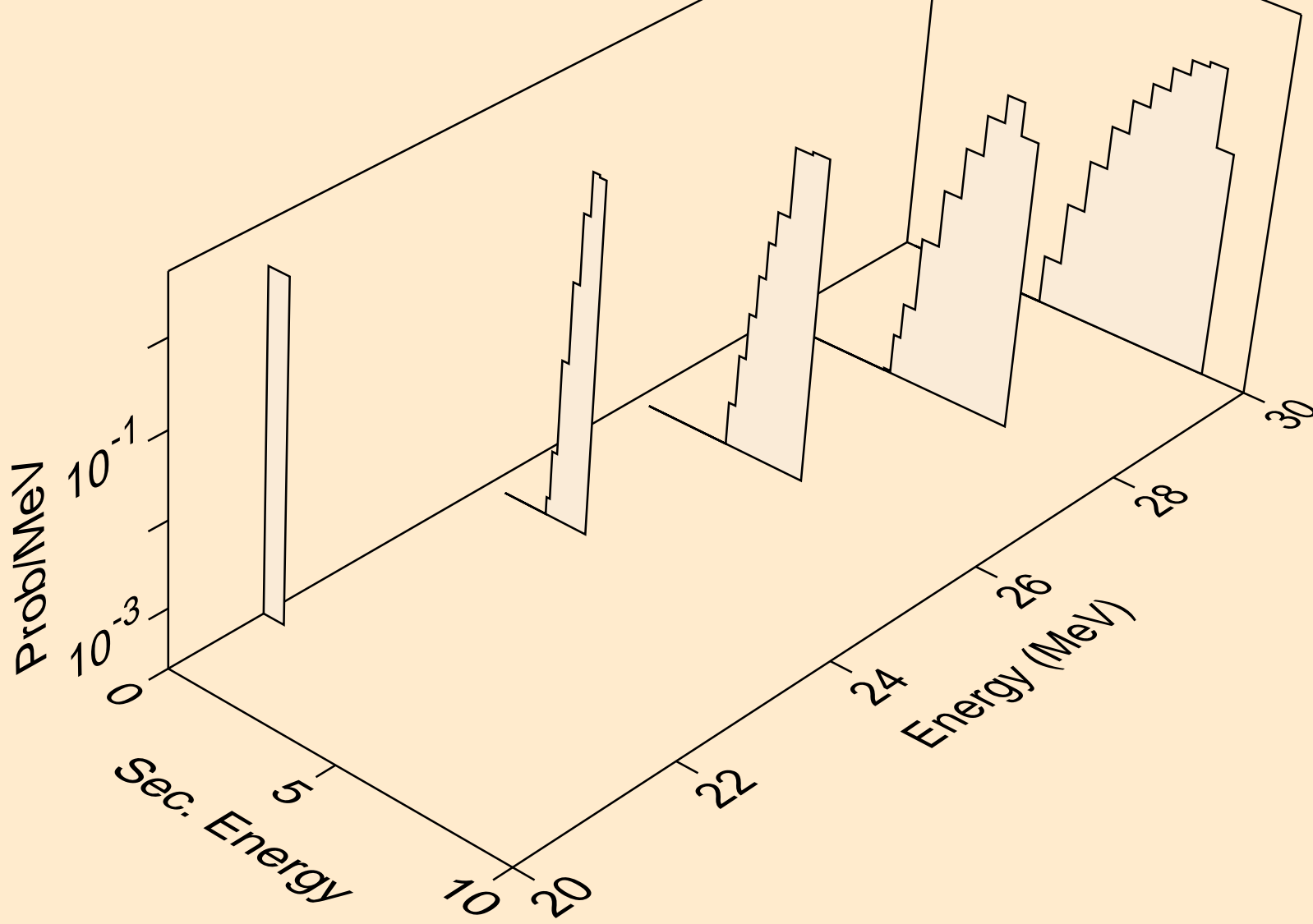

CO062M NEUTRON ACER TENDL-2019 LIBRARY; T=293.16K
he3s from (n,he3)

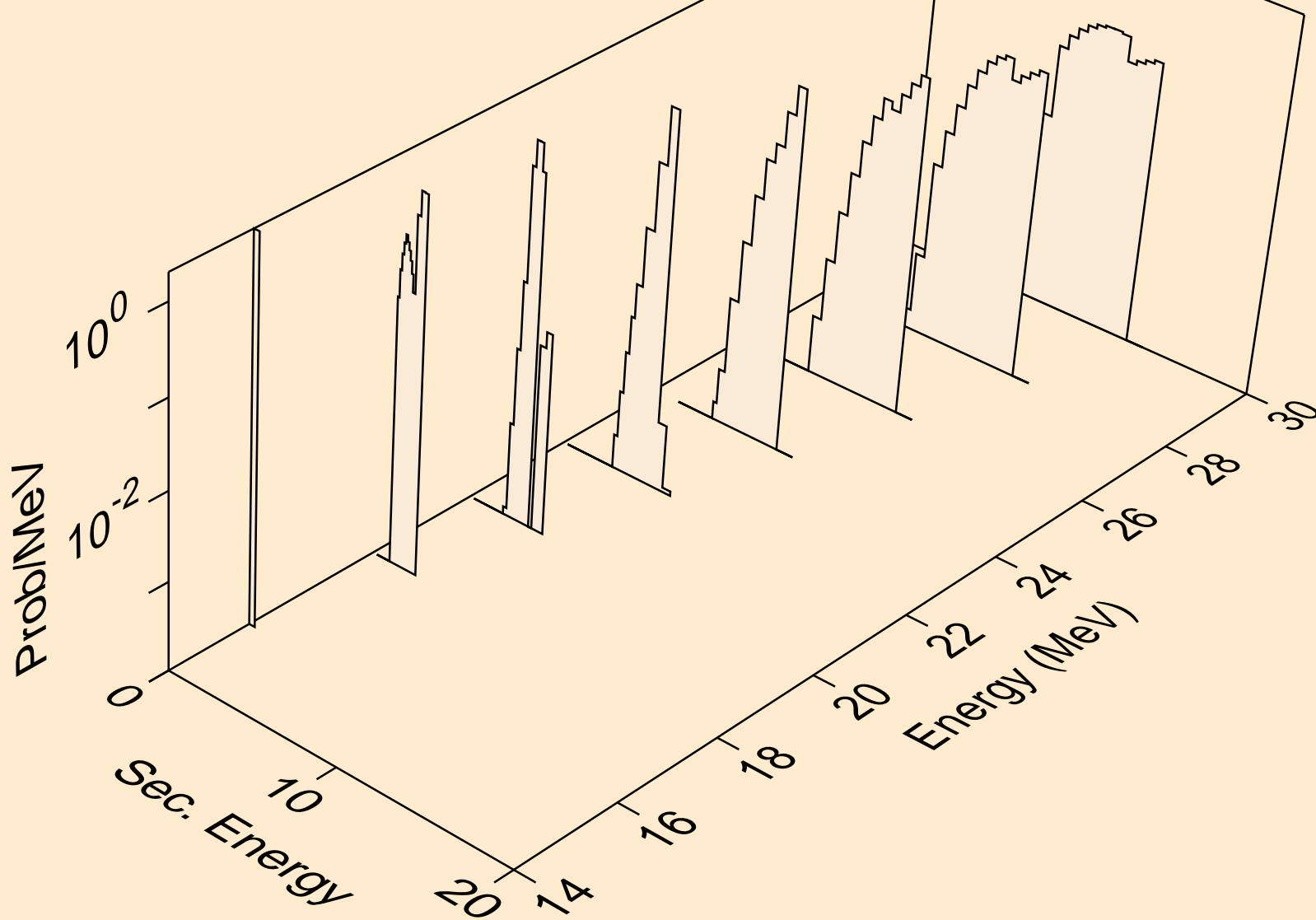

CO062M NEUTRON ACER TENDL-2019 LIBRARY; T=293.16K
alphas from (n,x)

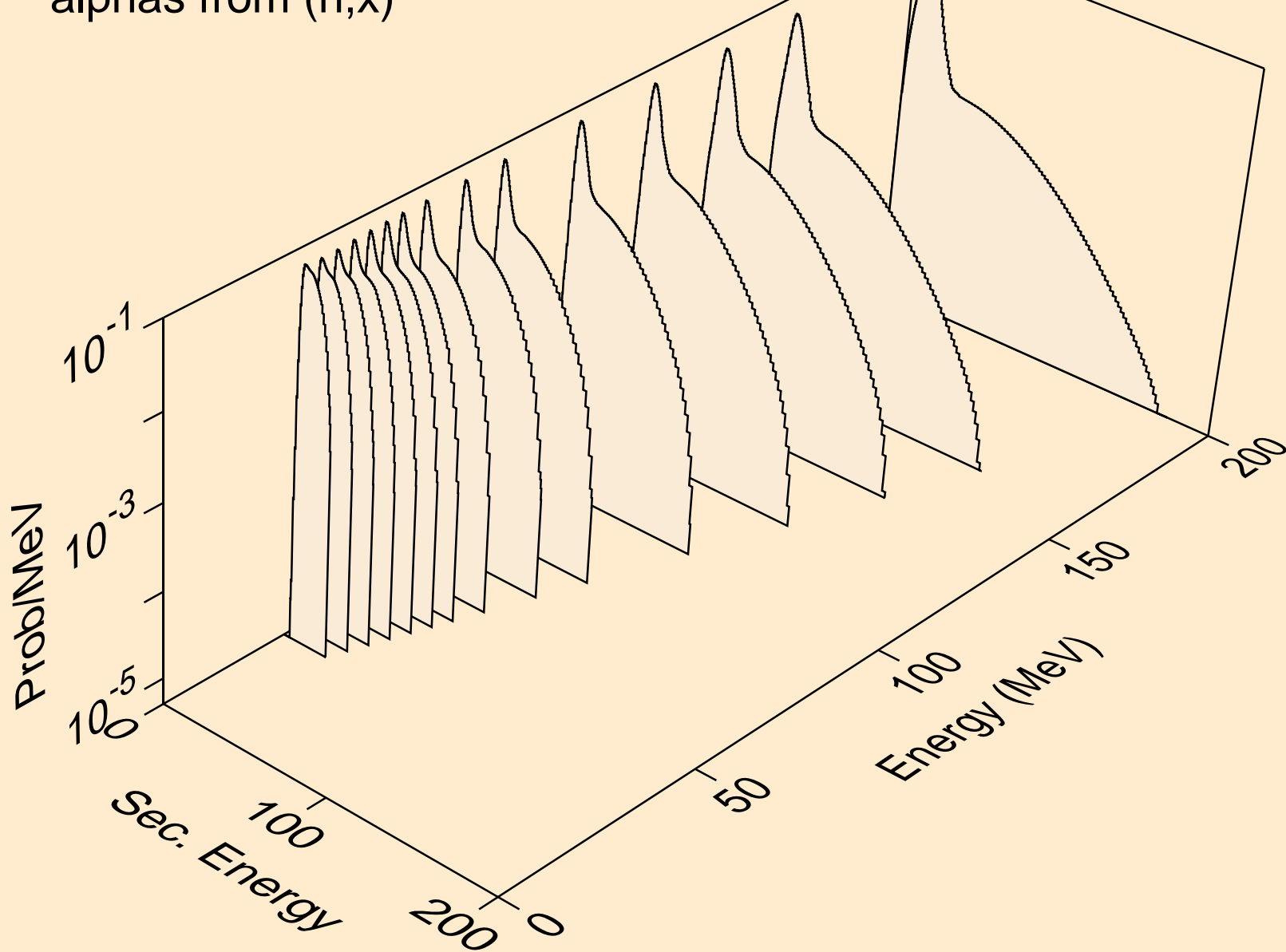

CO062M NEUTRON ACER TENDL-2019 LIBRARY; T=293.16K
alphas from (n,n*)a

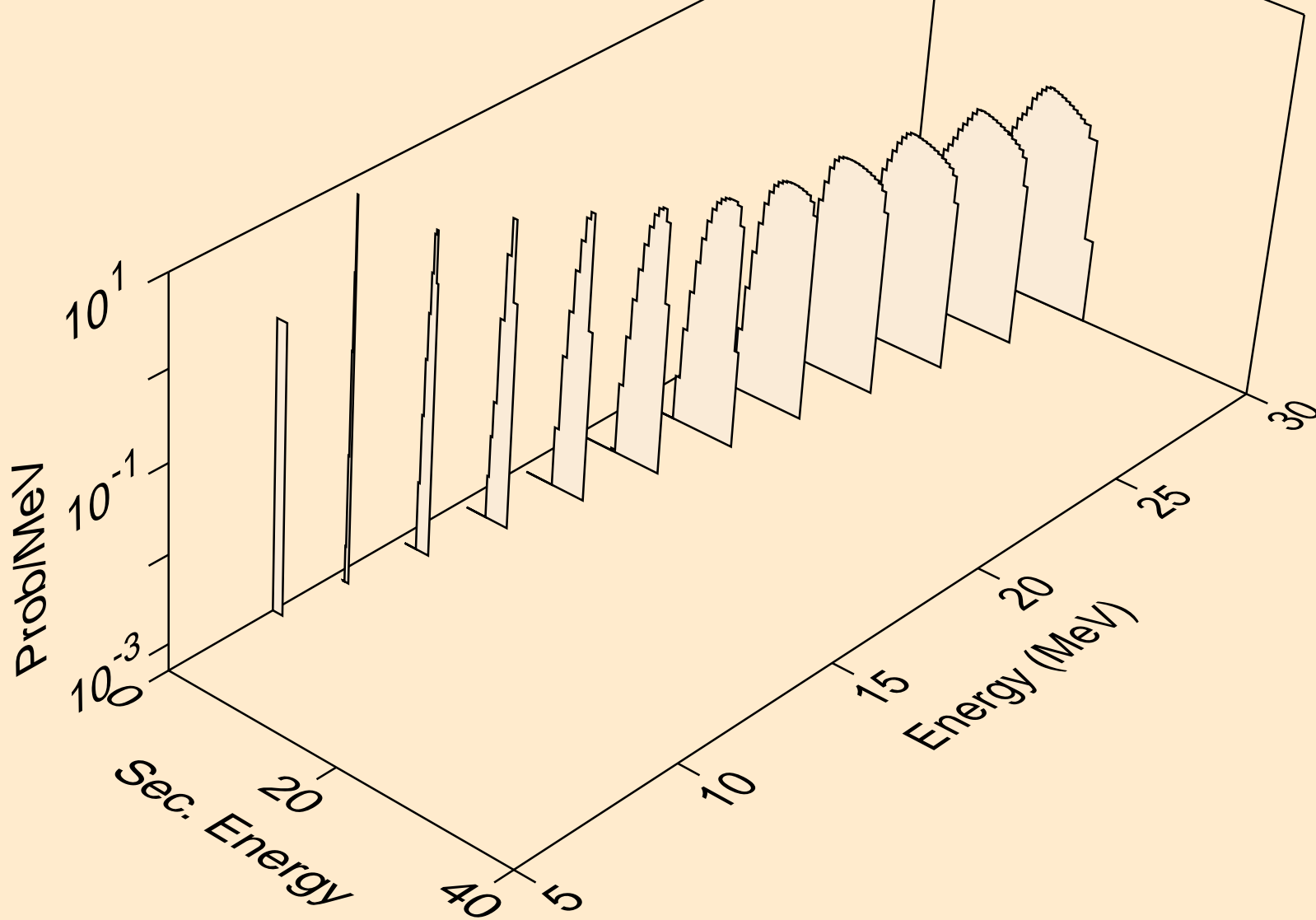

CO062M NEUTRON ACER TENDL-2019 LIBRARY; T=293.16K
alphas from (n,2n)a

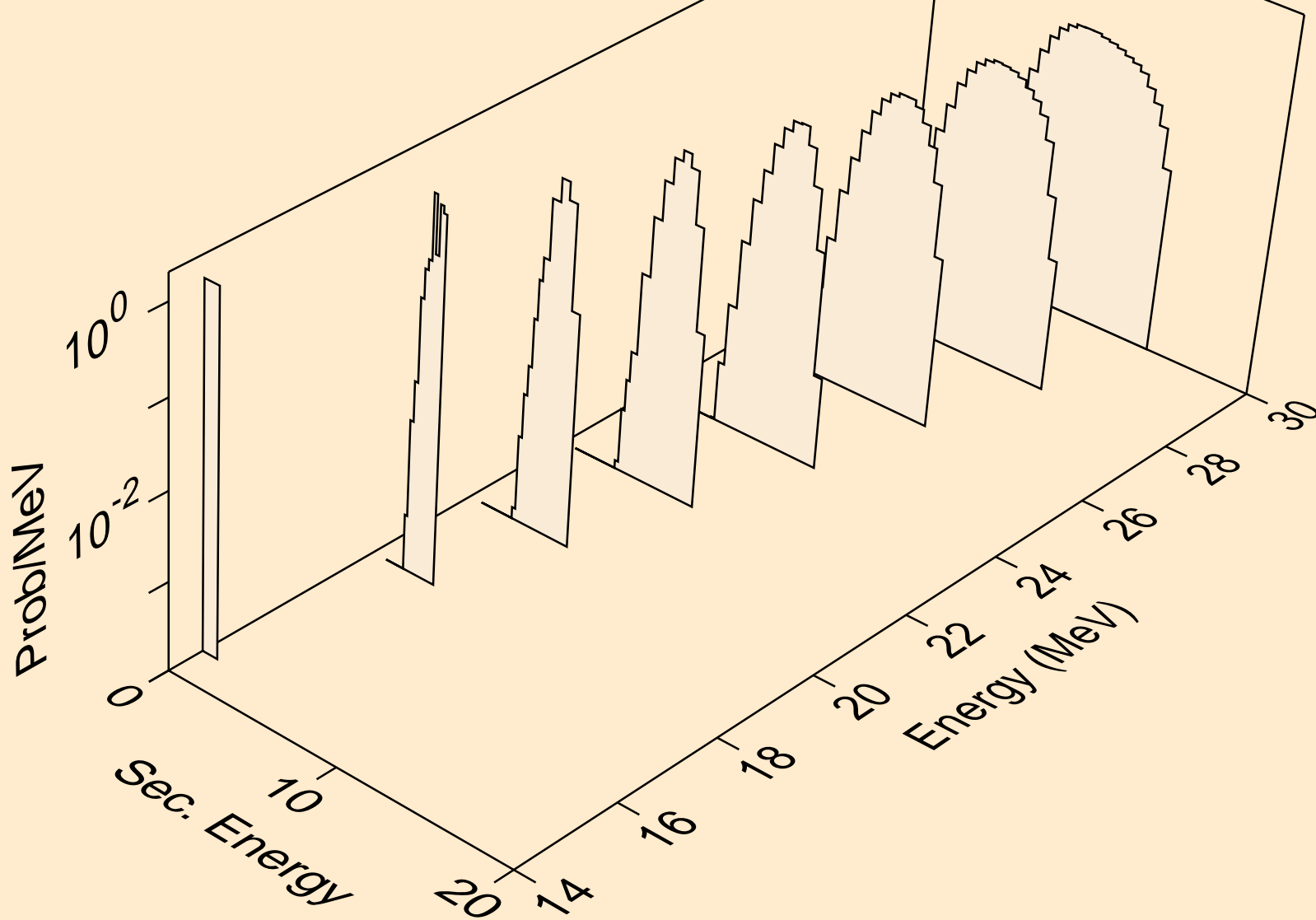

CO062M NEUTRON ACER TENDL-2019 LIBRARY; T=293.16K
alphas from (n,3n)a

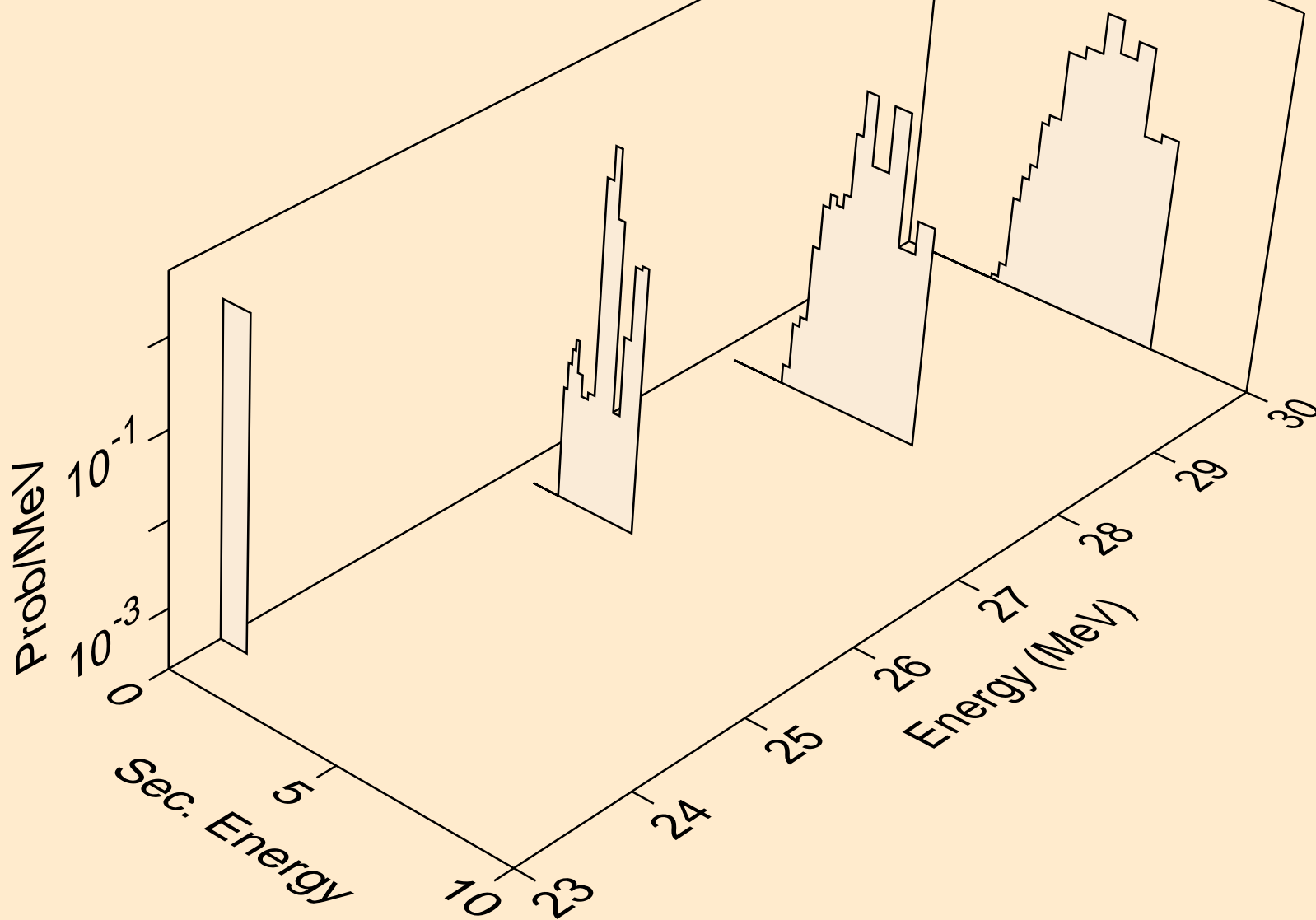

CO062M NEUTRON ACER TENDL-2019 LIBRARY; T=293.16K
alphas from (n,n*)2a

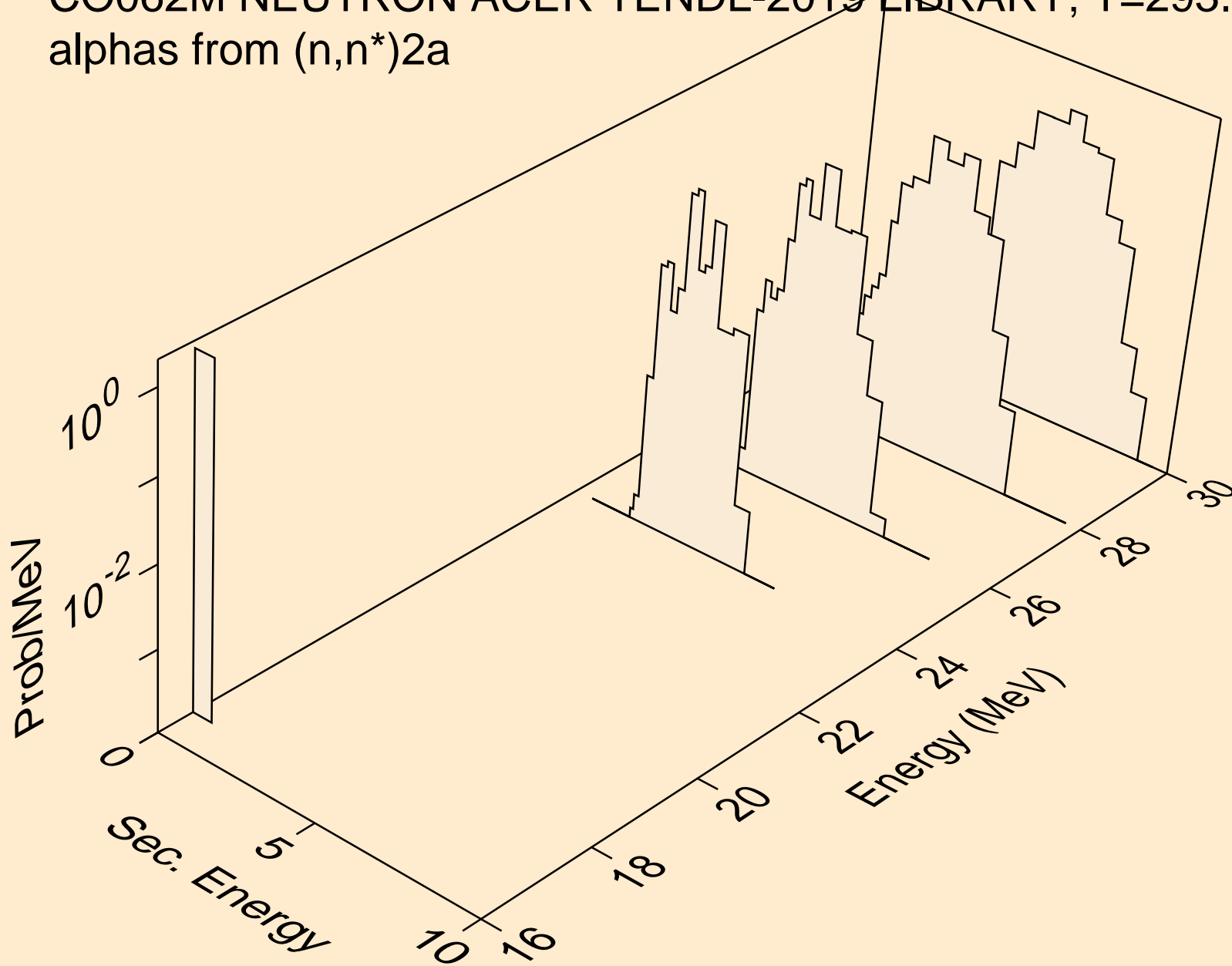

CO062M NEUTRON ACER TENDL-2019 LIBRARY; T=293.16K
alphas from (n,npa)

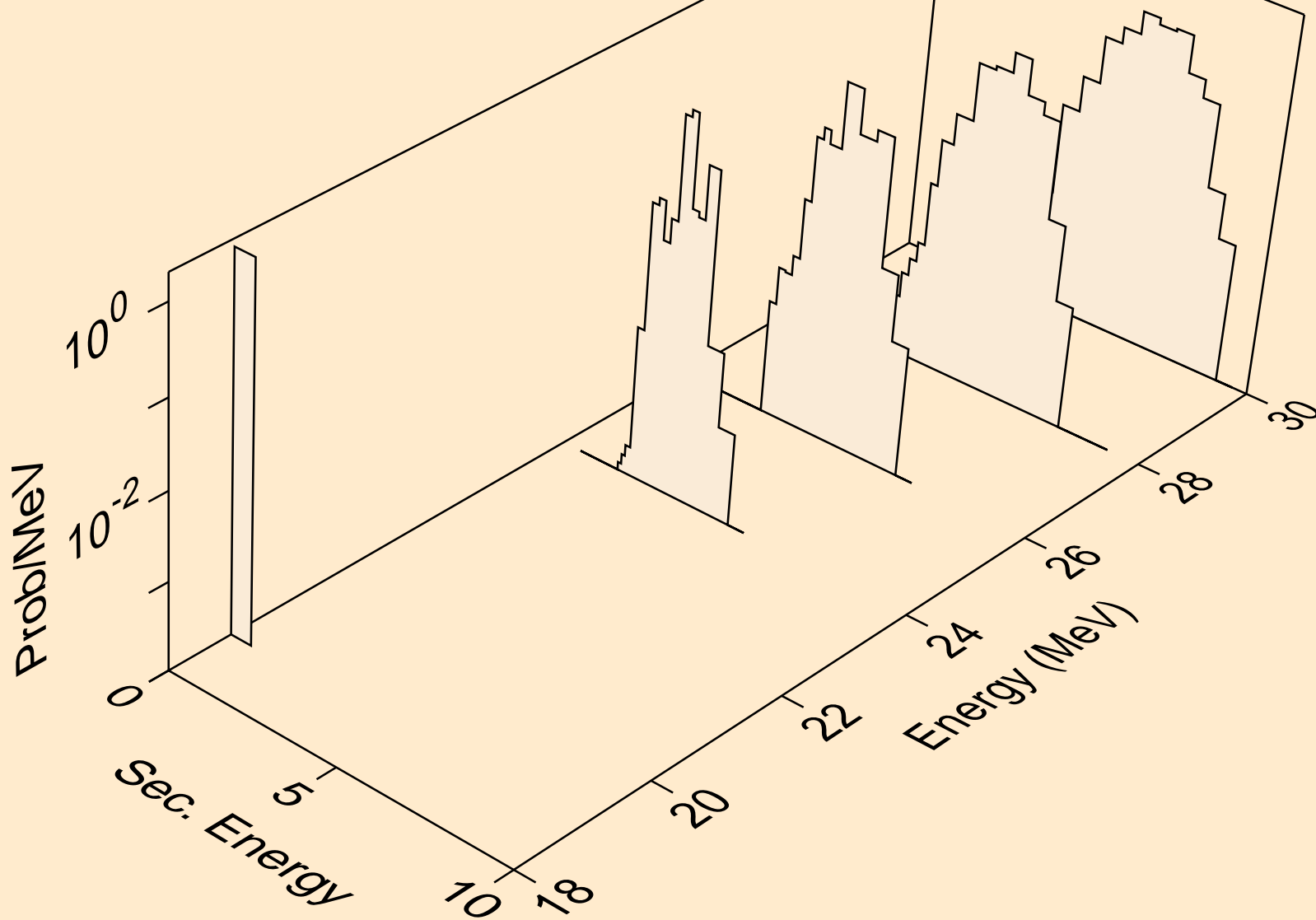

CO062M NEUTRON ACER TENDL-2019 LIBRARY; T=293.16K
alphas from (n,a)

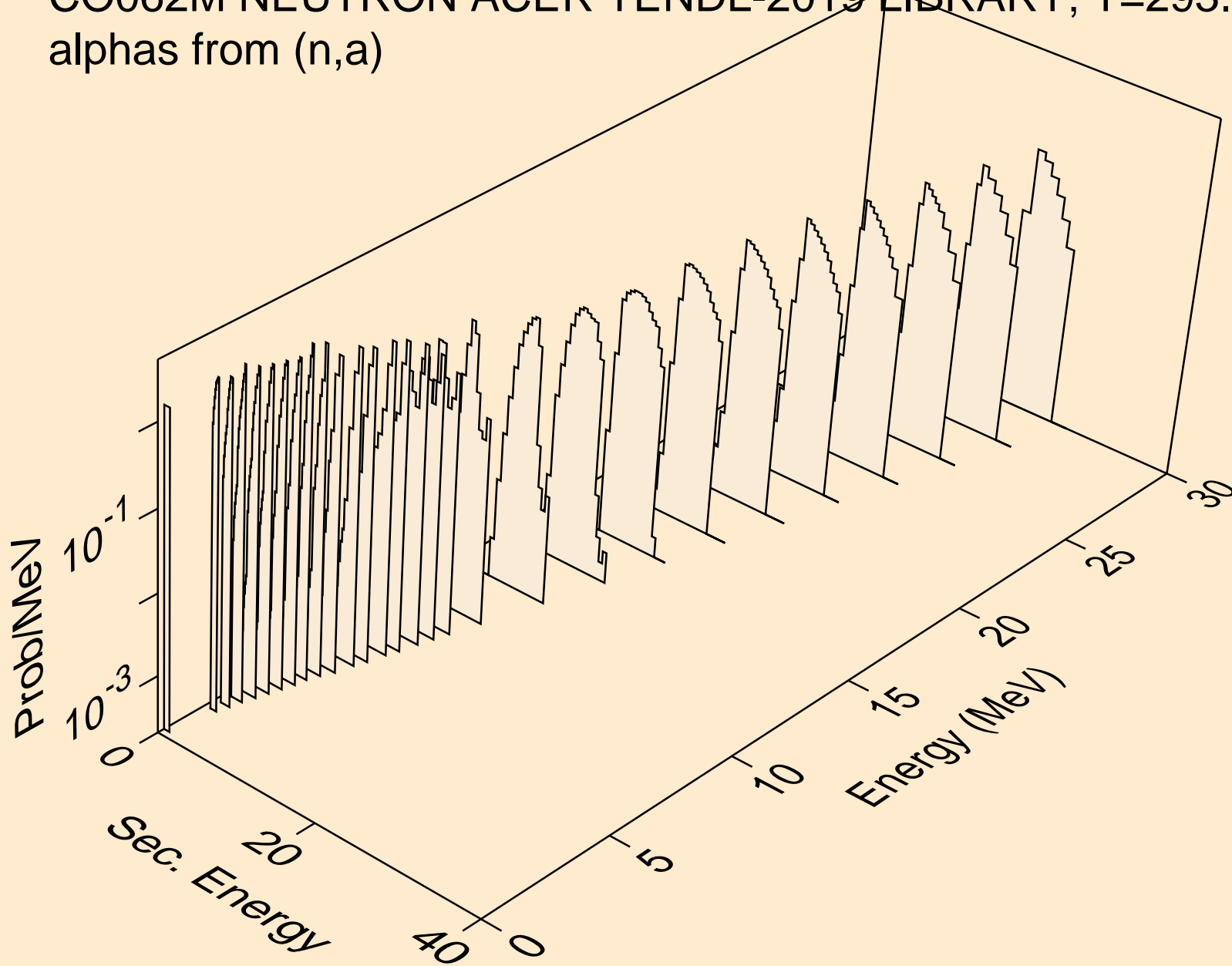

CO062M NEUTRON ACER TENDL-2019 LIBRARY; T=293.16K
alphas from (n,2a)

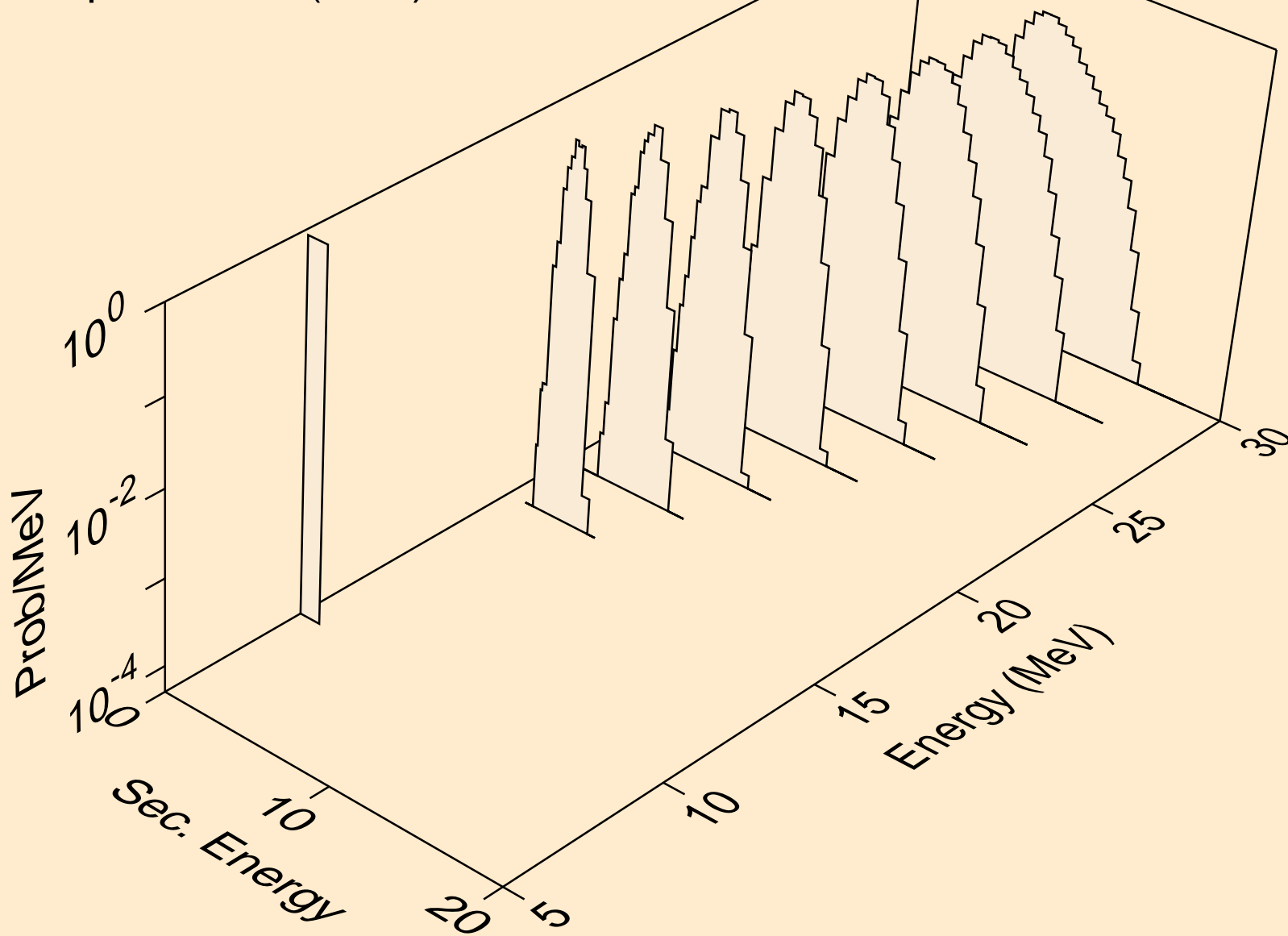

CO062M NEUTRON ACER TENDL-2019 LIBRARY; T=293.16K
alphas from (n,pa)

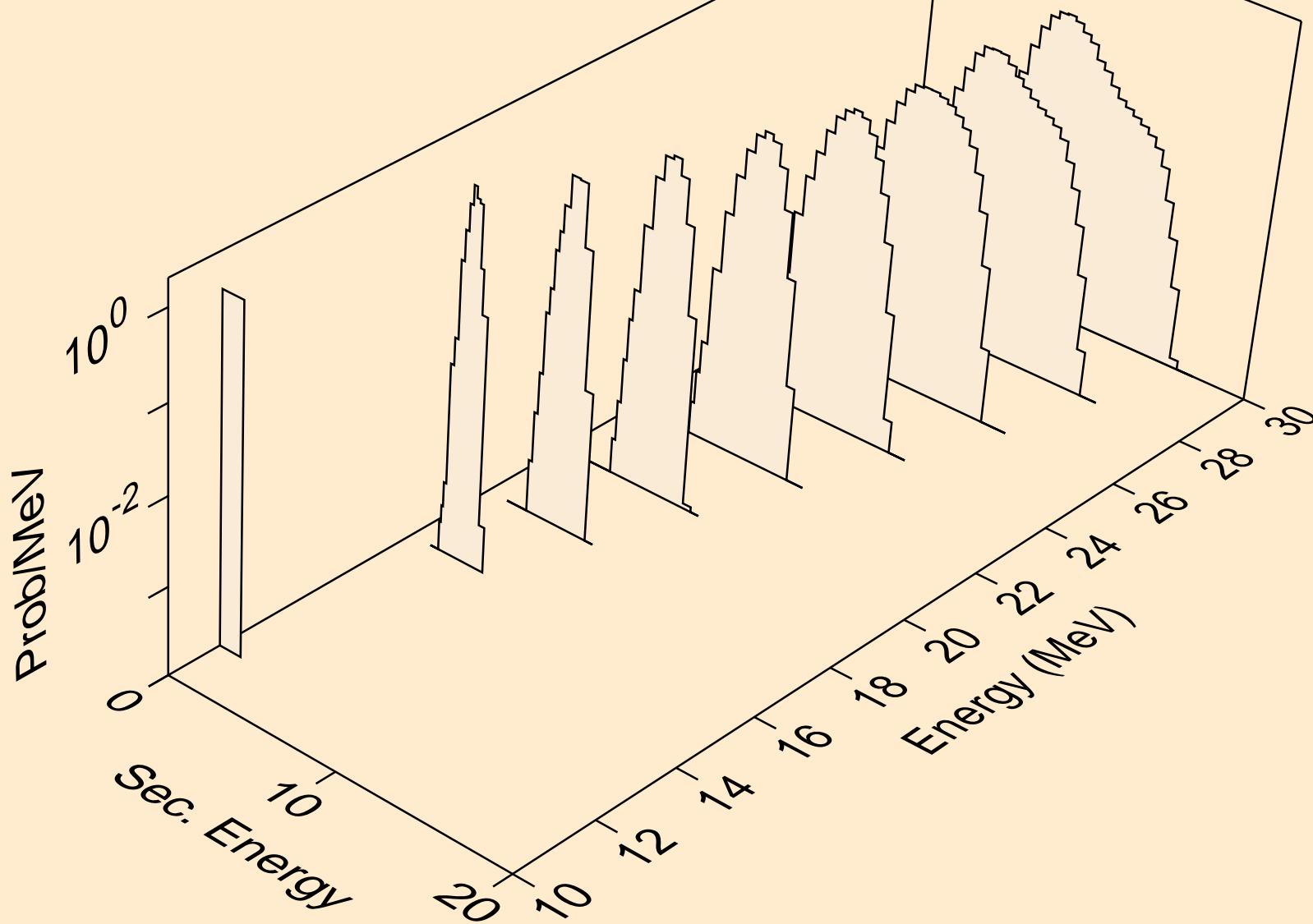

CO062M NEUTRON ACER TENDL-2019 LIBRARY; T=293.16K
alphas from (n,da)

