

# CS115 NEUTRON ACER TENDL-2019 LIBRARY; T=293.16K

## Principal cross sections

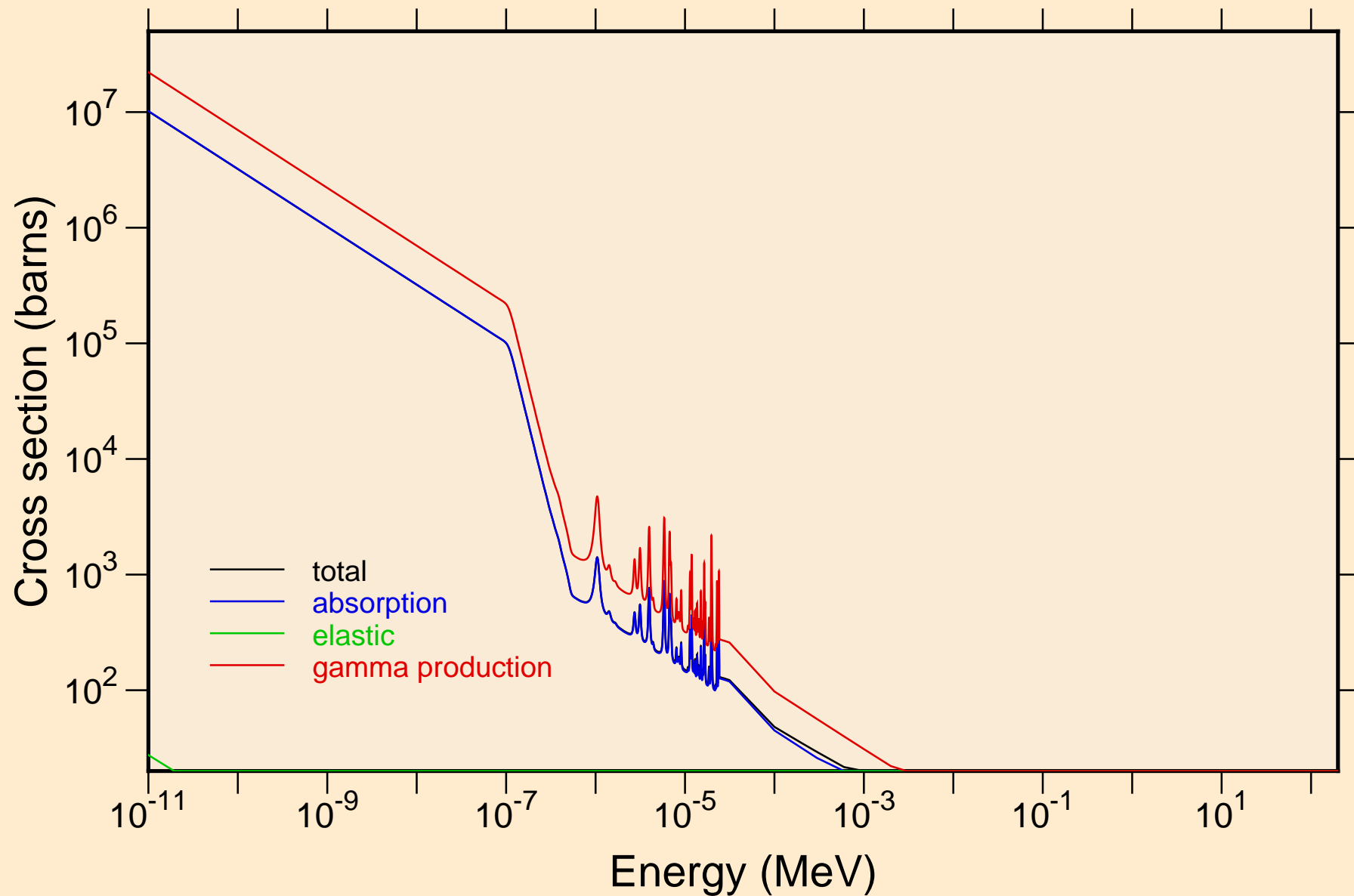

CS115 NEUTRON ACER TENDL-2019 LIBRARY; T=293.16K  
resonance total cross section

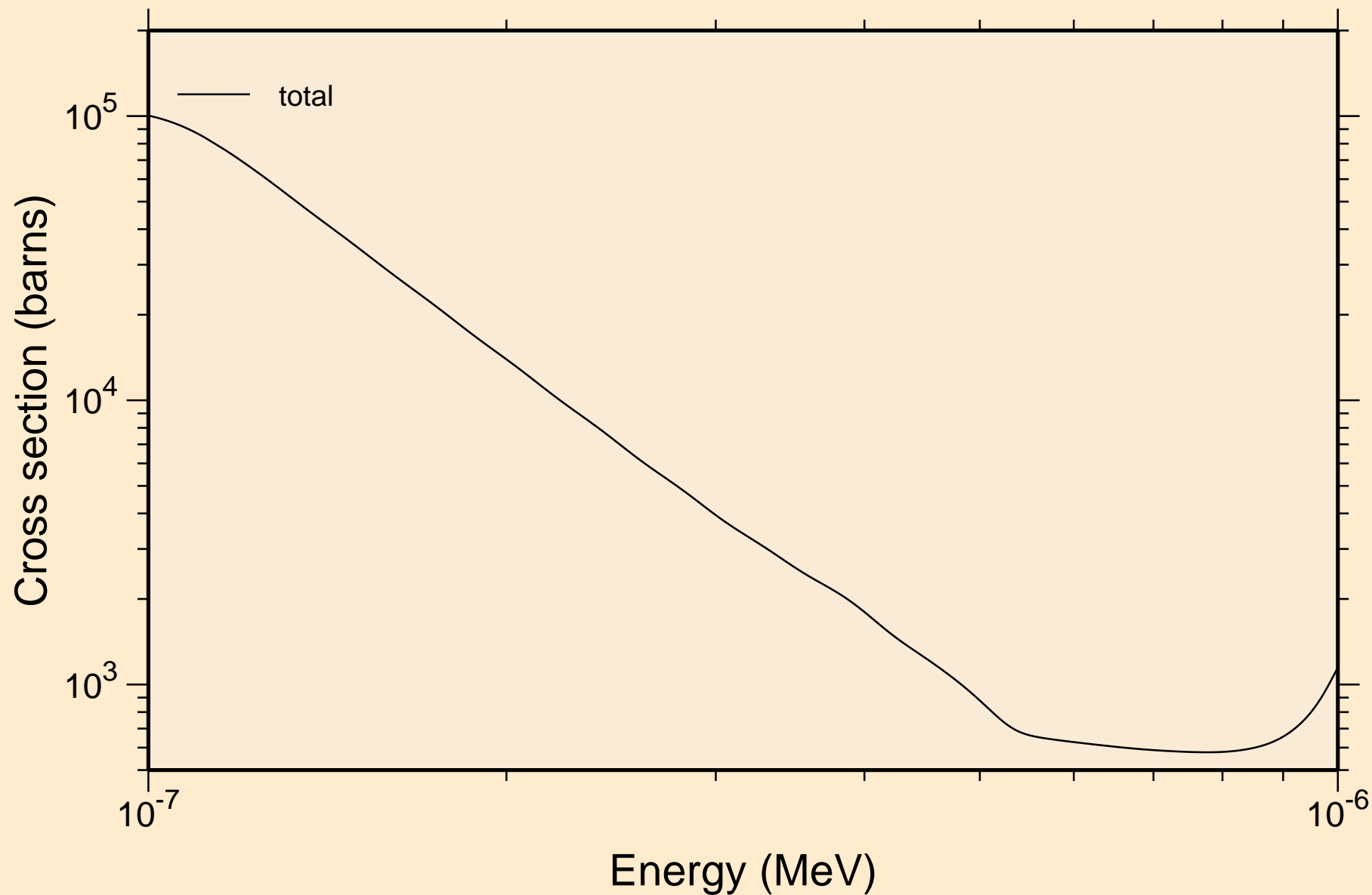

CS115 NEUTRON ACER TENDL-2019 LIBRARY; T=293.16K  
resonance total cross section

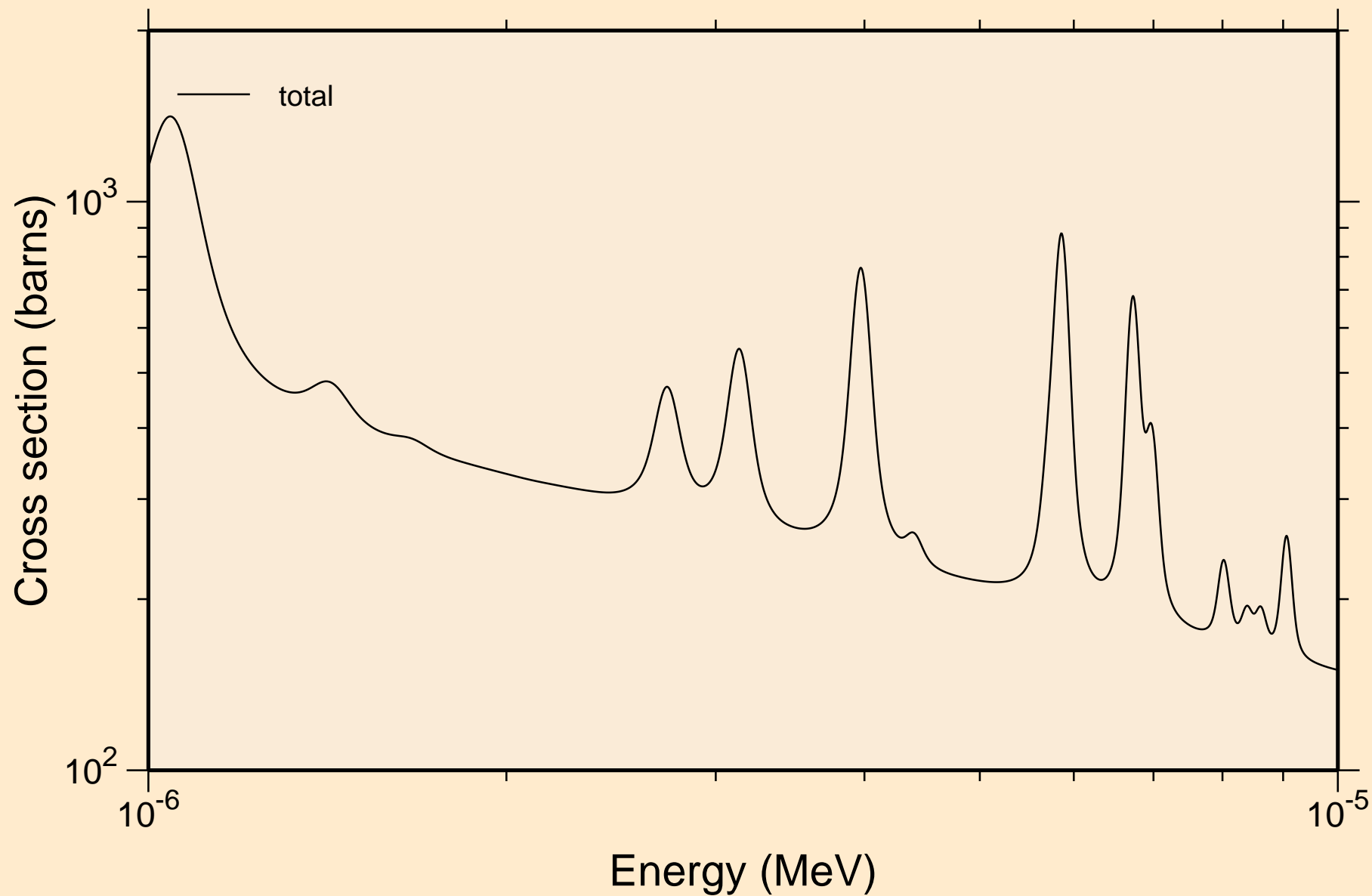

CS115 NEUTRON ACER TENDL-2019 LIBRARY; T=293.16K  
resonance total cross section

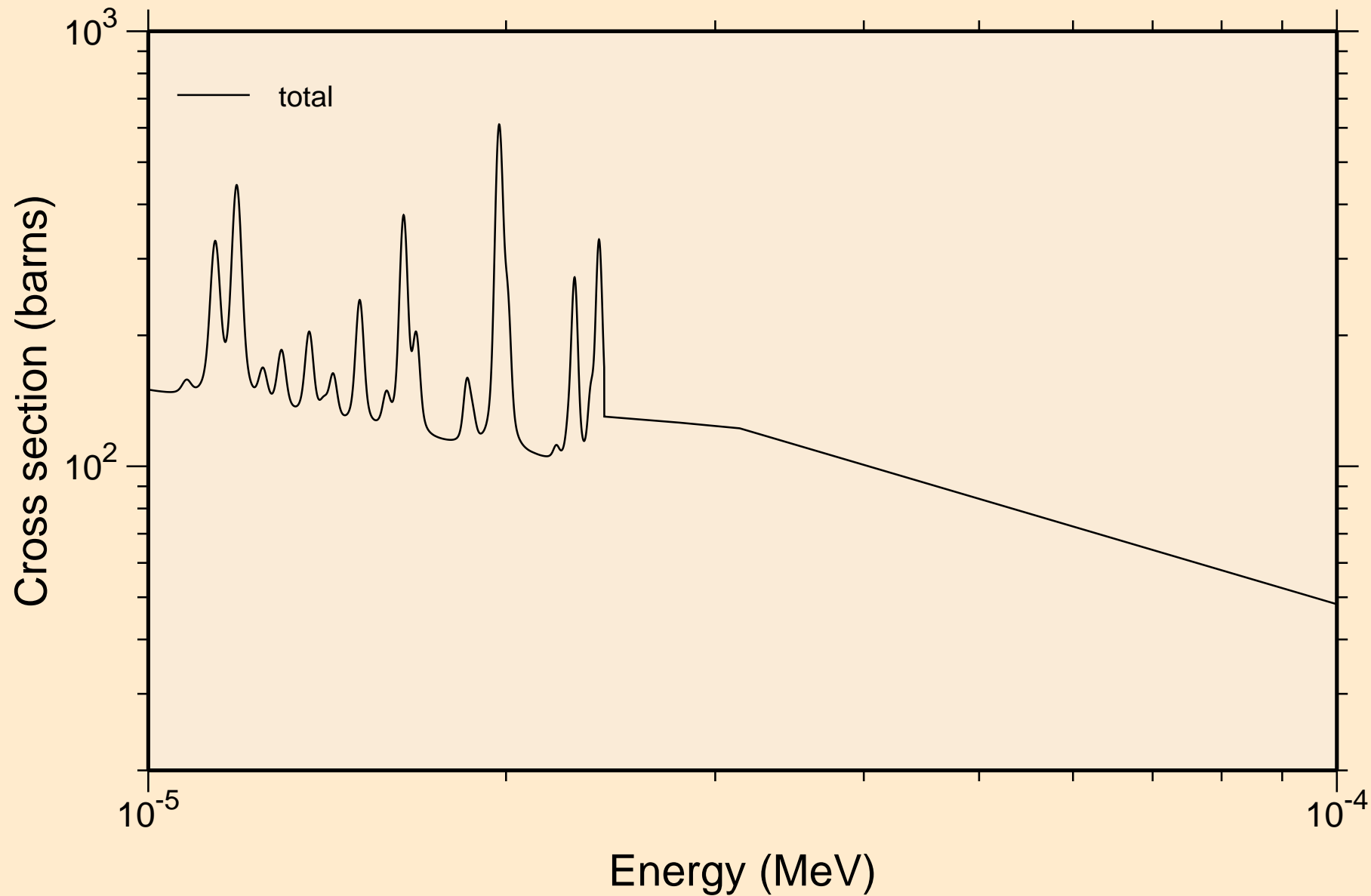

CS115 NEUTRON ACER TENDL-2019 LIBRARY; T=293.16K  
resonance total cross section

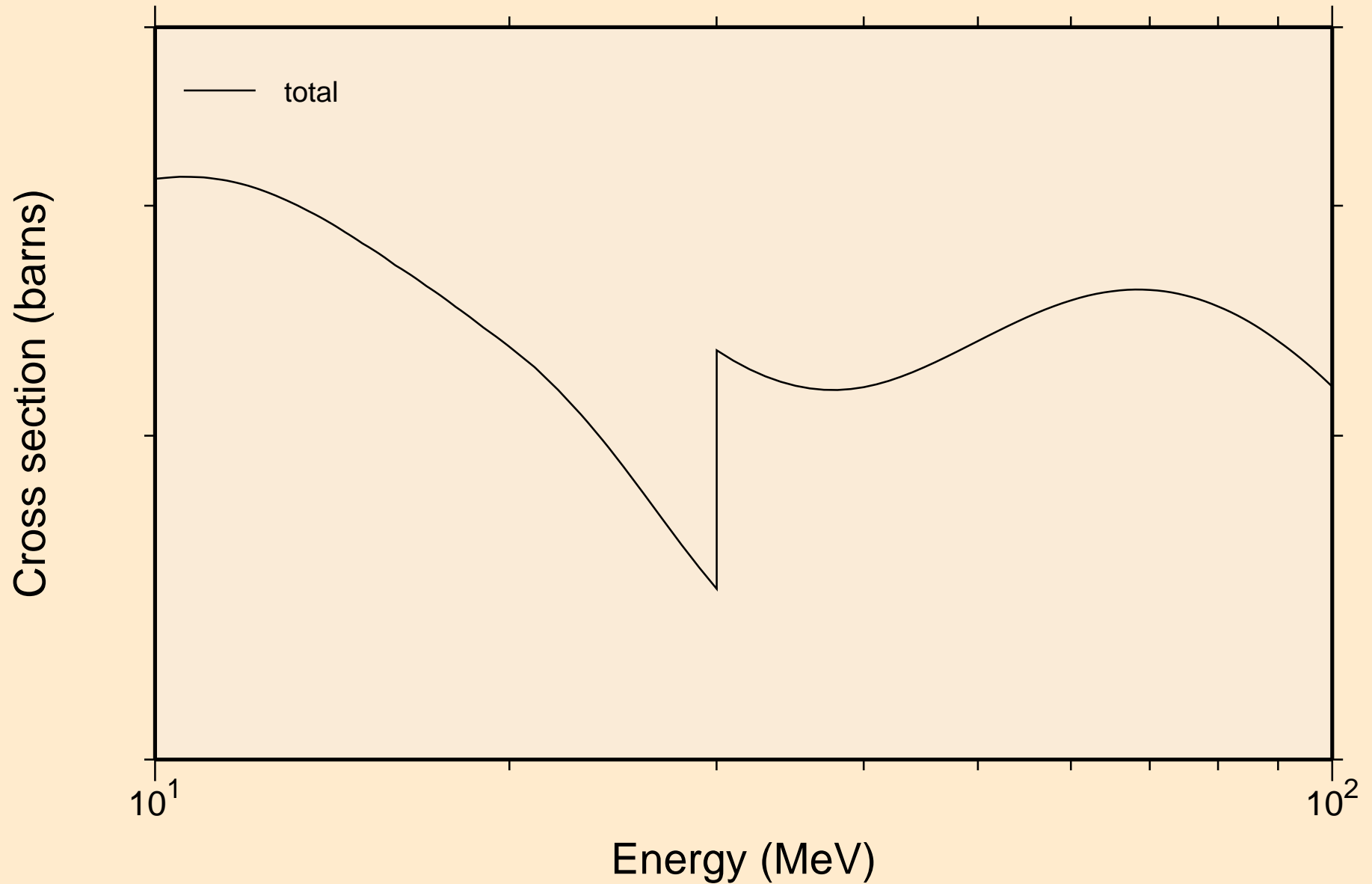

CS115 NEUTRON ACER TENDL-2019 LIBRARY; T=293.16K  
resonance absorption cross sections

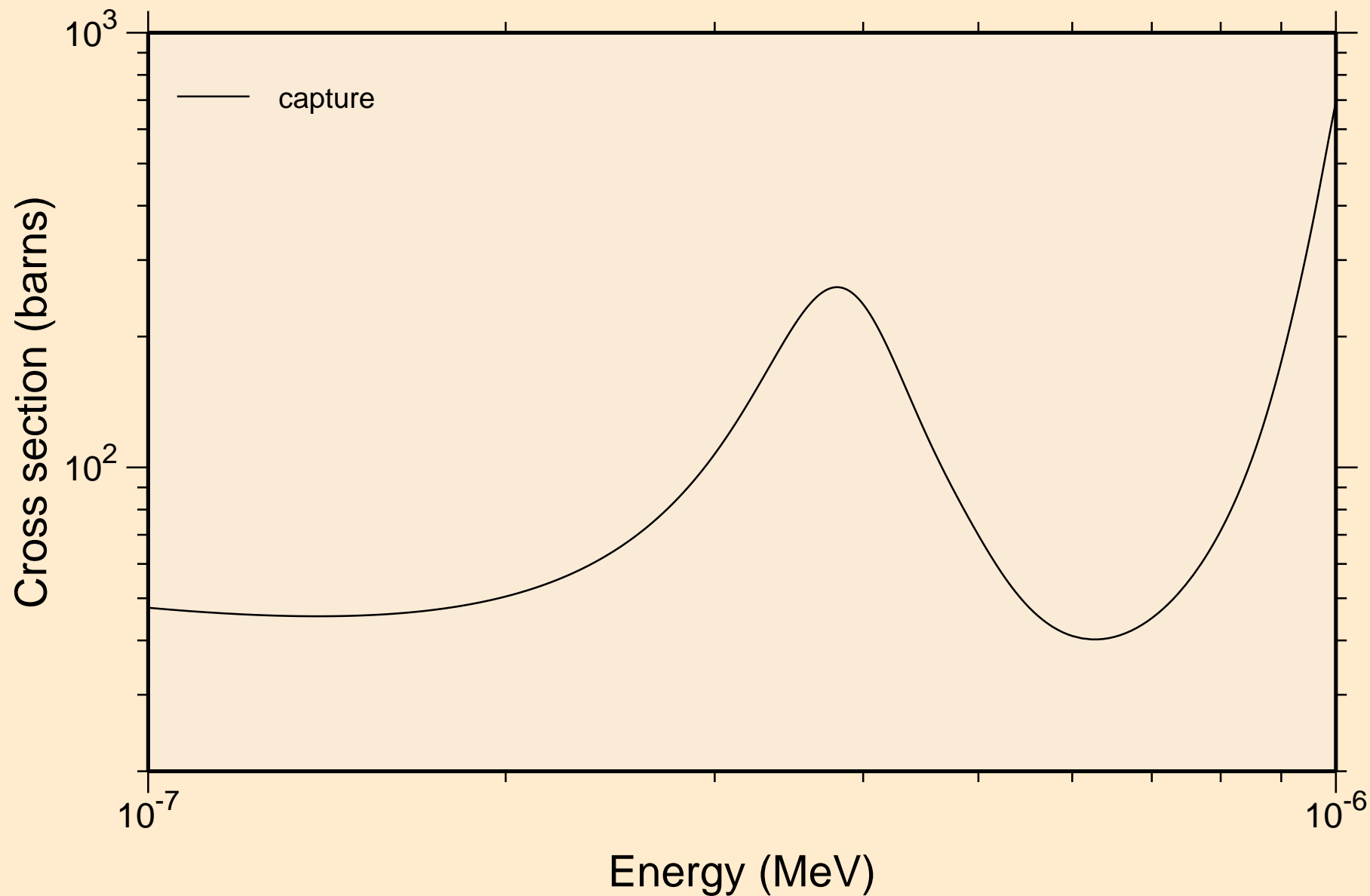

CS115 NEUTRON ACER TENDL-2019 LIBRARY; T=293.16K  
resonance absorption cross sections

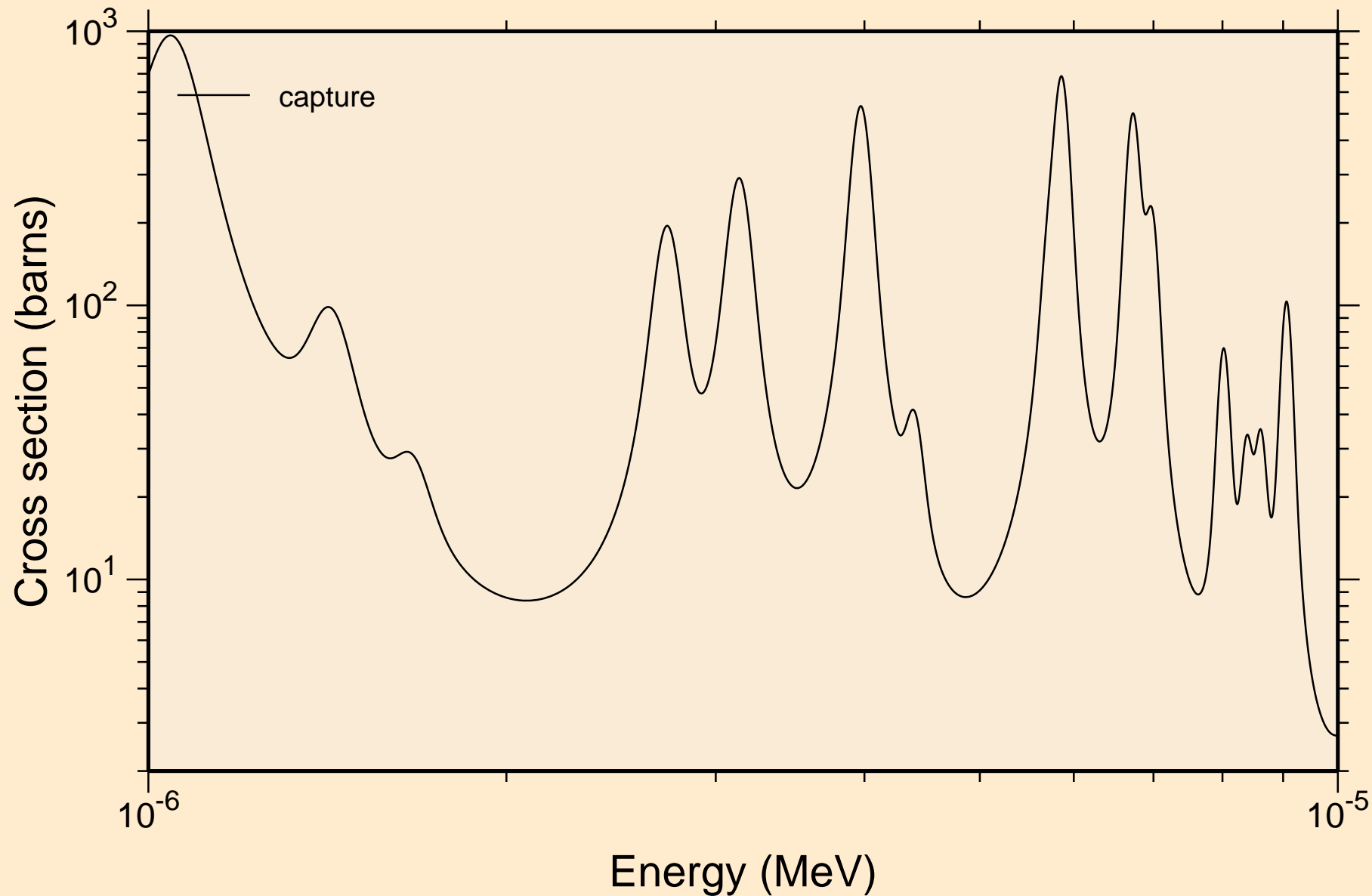

CS115 NEUTRON ACER TENDL-2019 LIBRARY; T=293.16K  
resonance absorption cross sections

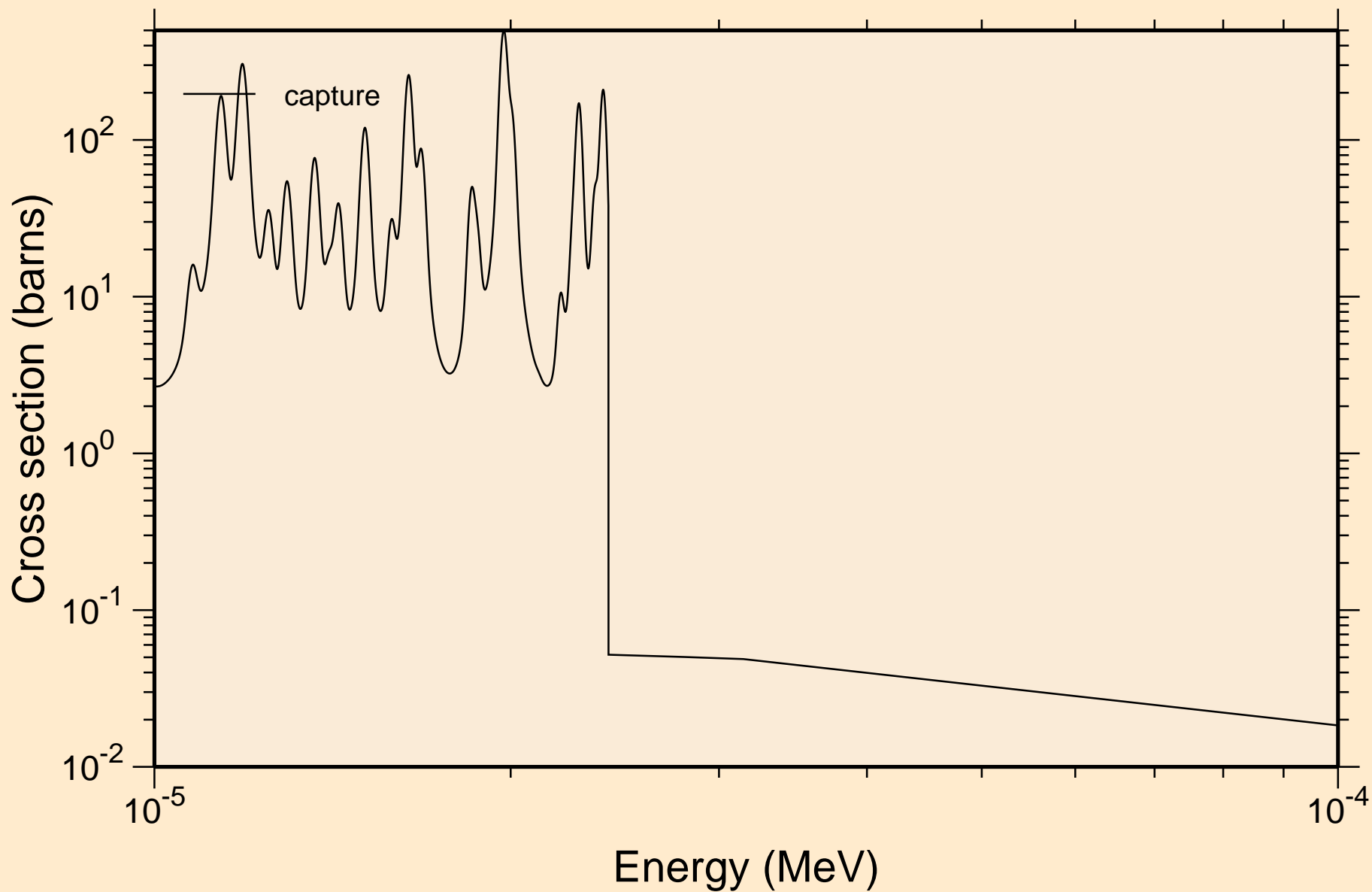



CS115 NEUTRON ACER TENDL-2019 LIBRARY; T=293.16K  
resonance absorption cross sections

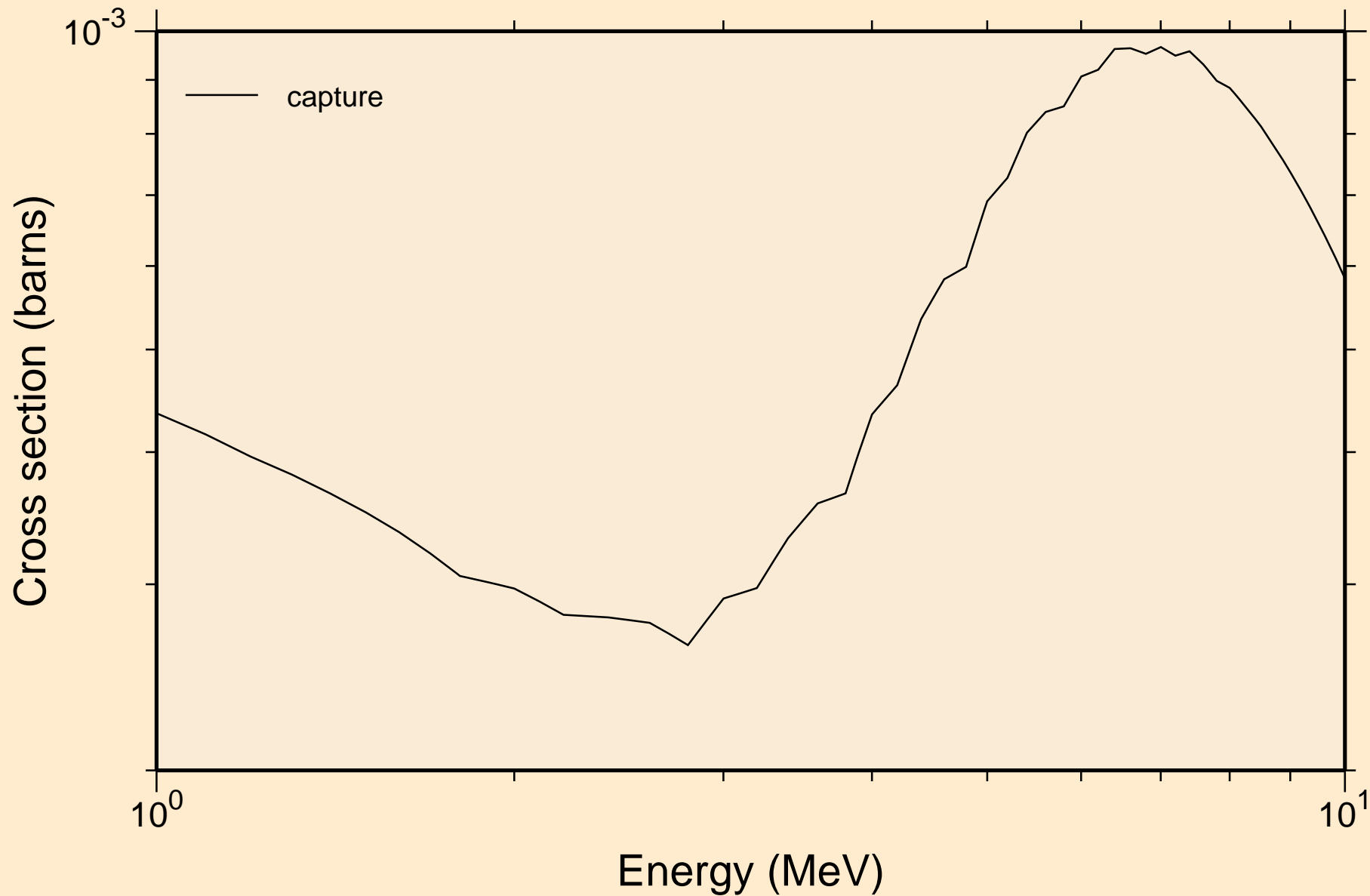

CS115 NEUTRON ACER TENDL-2019 LIBRARY; T=293.16K  
Heating

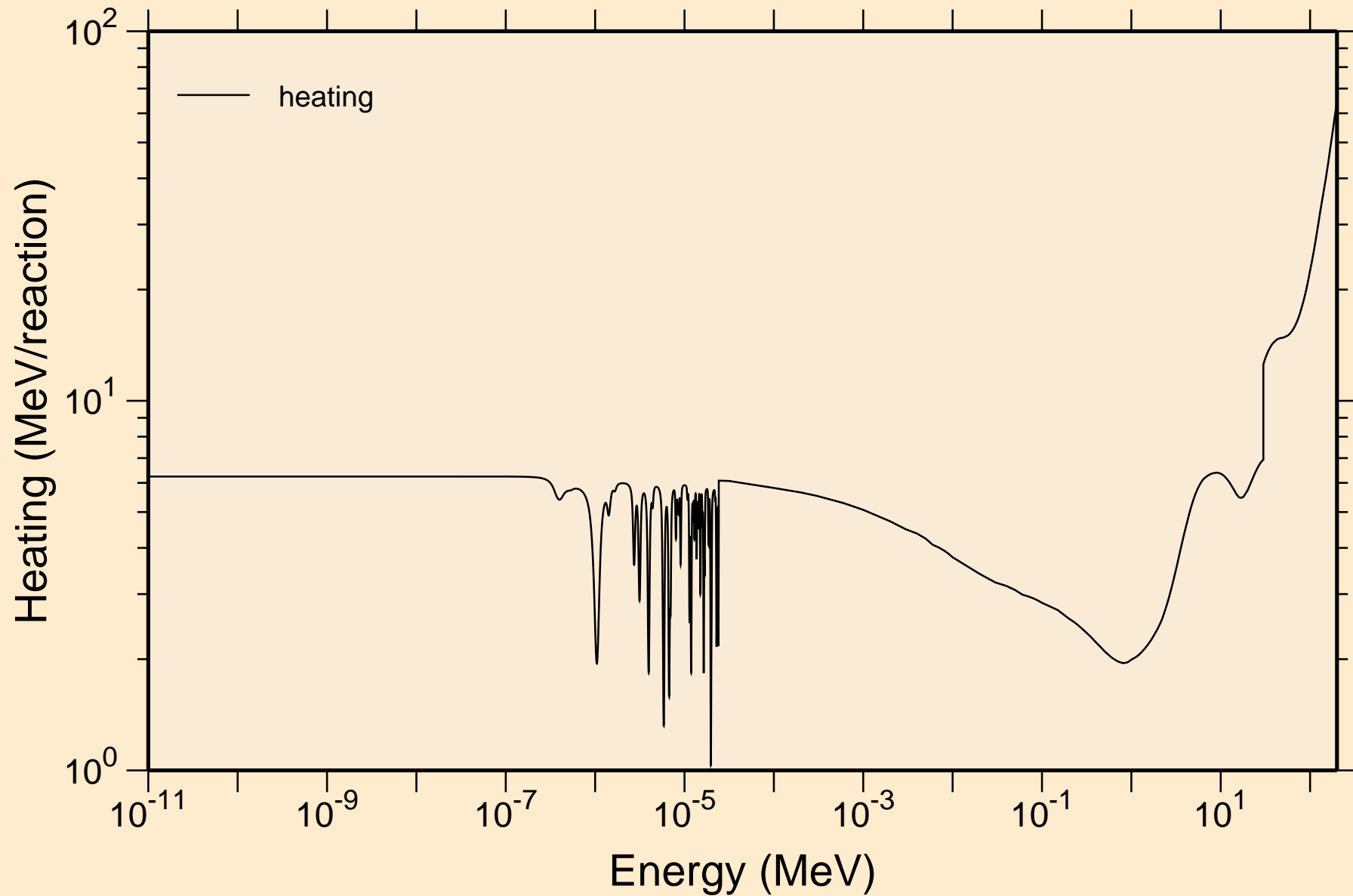

CS115 NEUTRON ACER TENDL-2019 LIBRARY; T=293.16K  
Damage

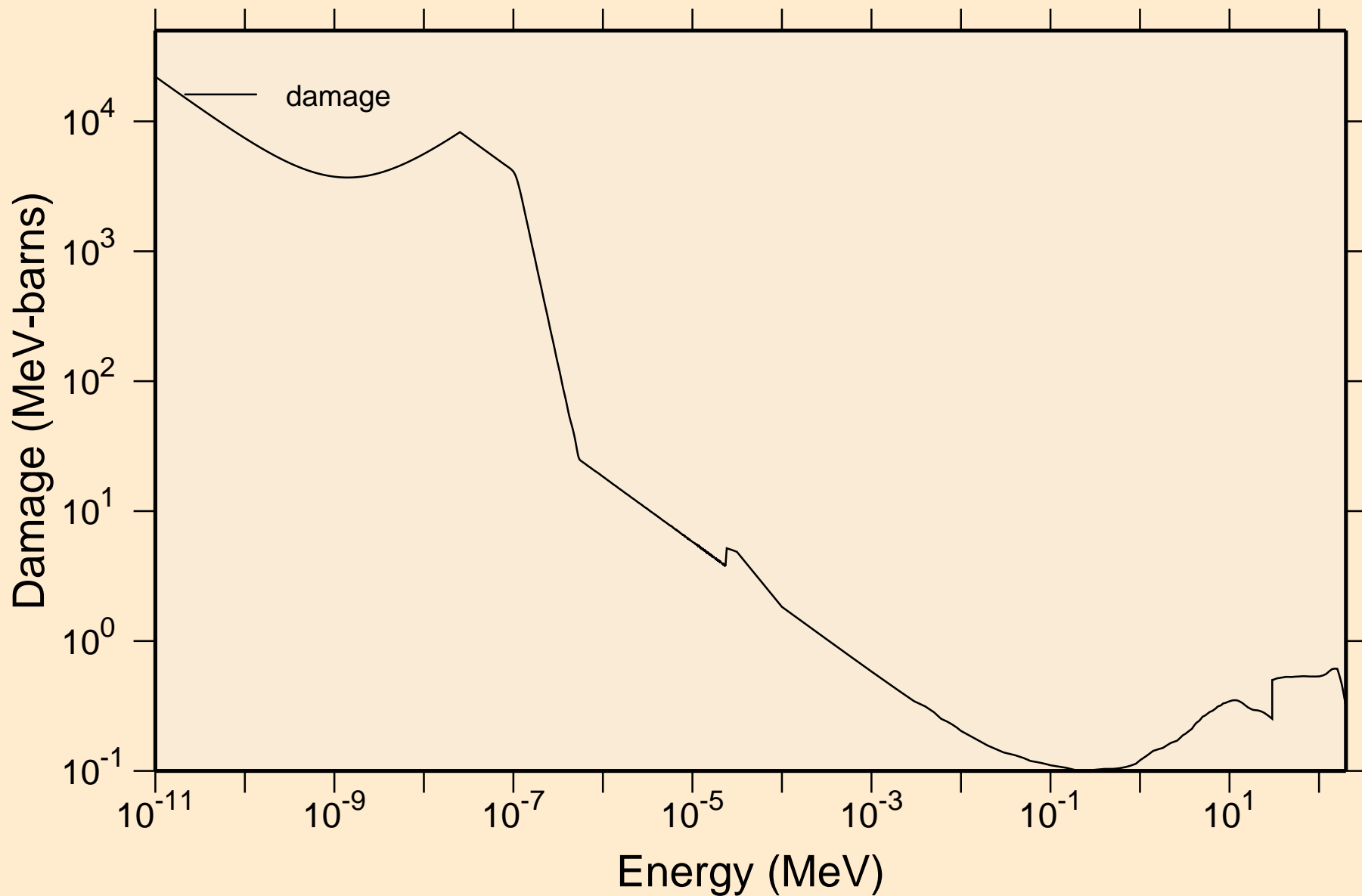

CS115 NEUTRON ACER TENDL-2019 LIBRARY; T=293.16K  
Non-threshold reactions

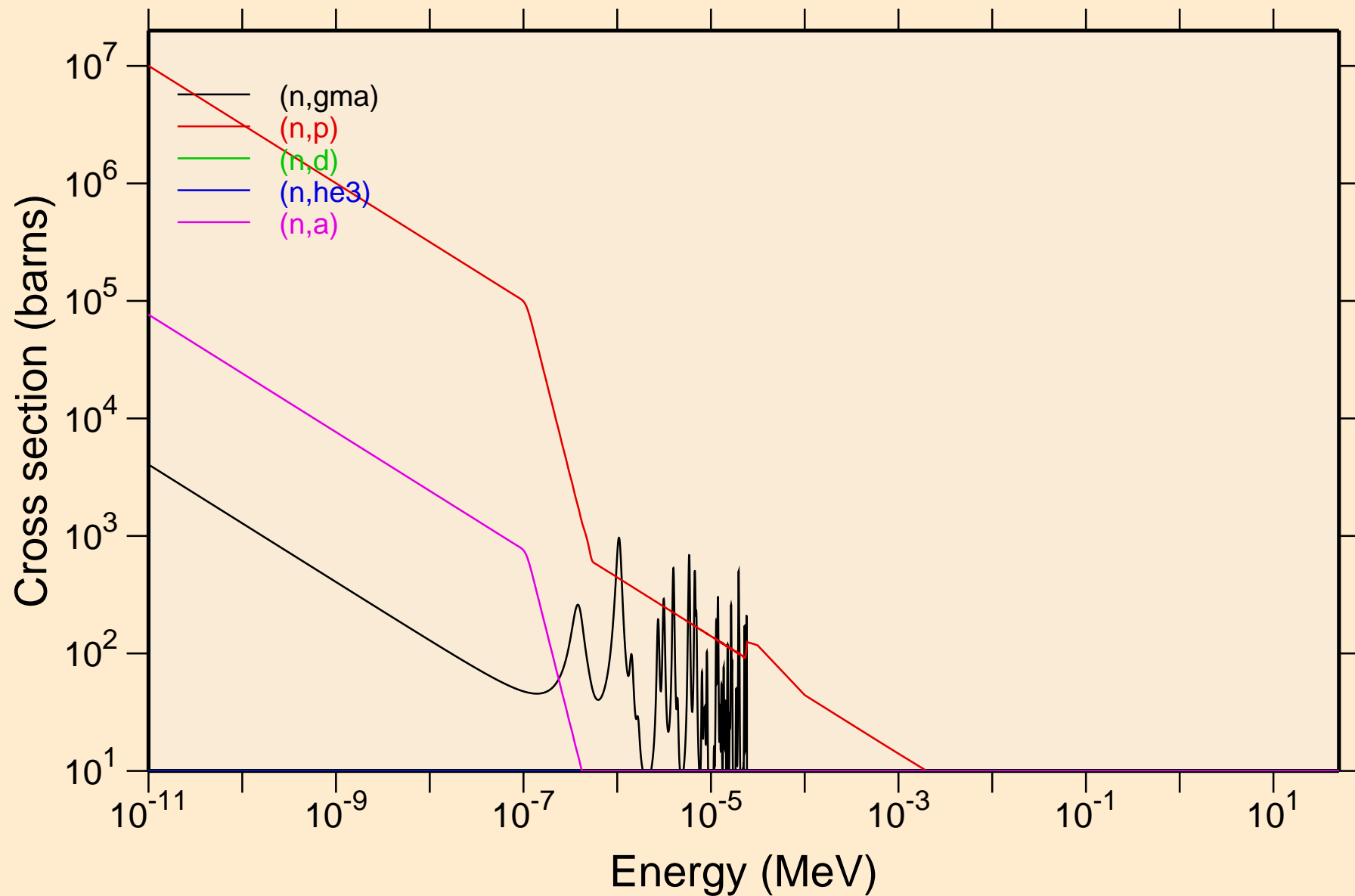

# CS115 NEUTRON ACER TENDL-2019 LIBRARY; T=293.16K

## Non-threshold reactions

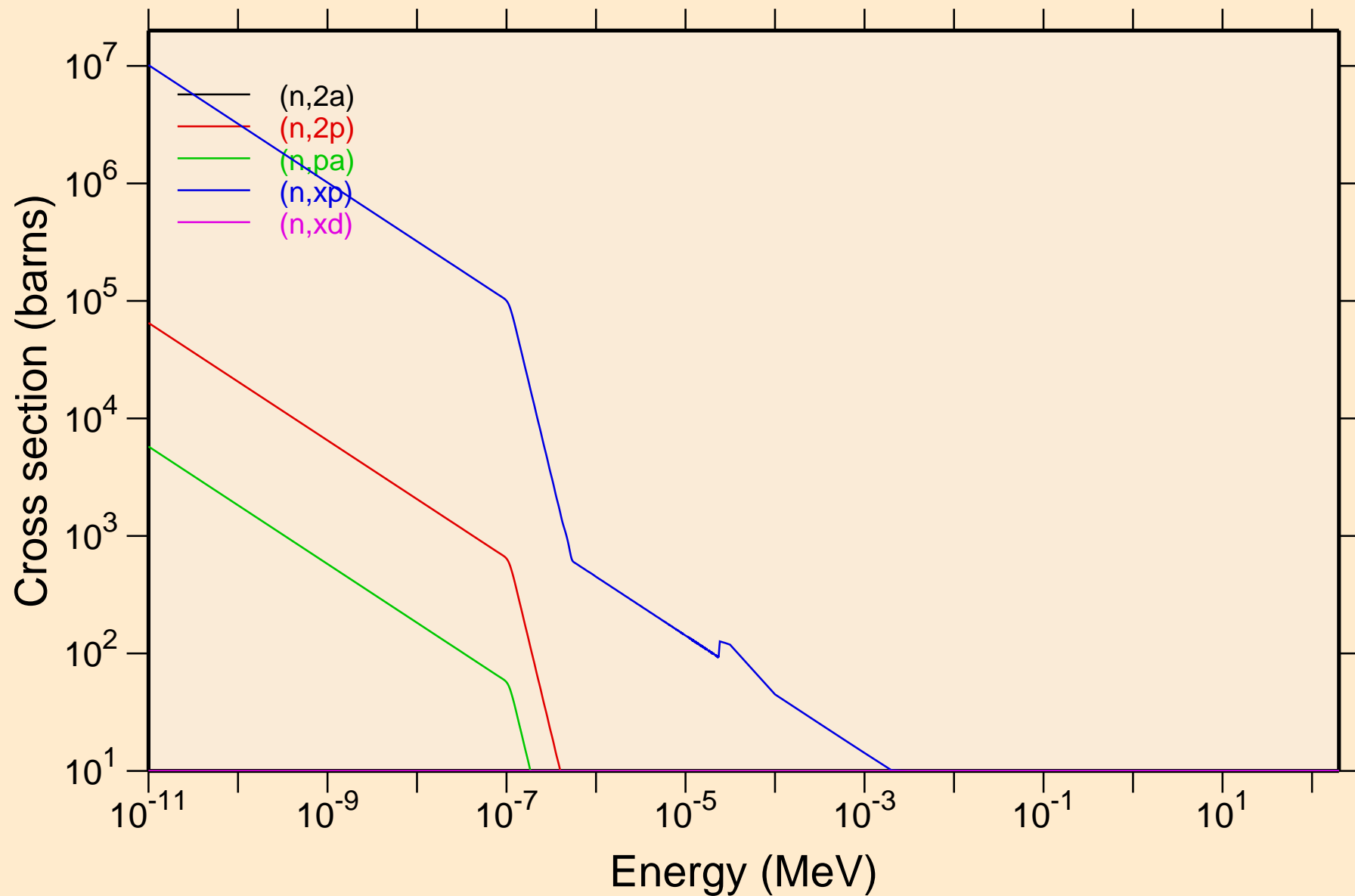

CS115 NEUTRON ACER TENDL-2019 LIBRARY; T=293.16K  
Non-threshold reactions

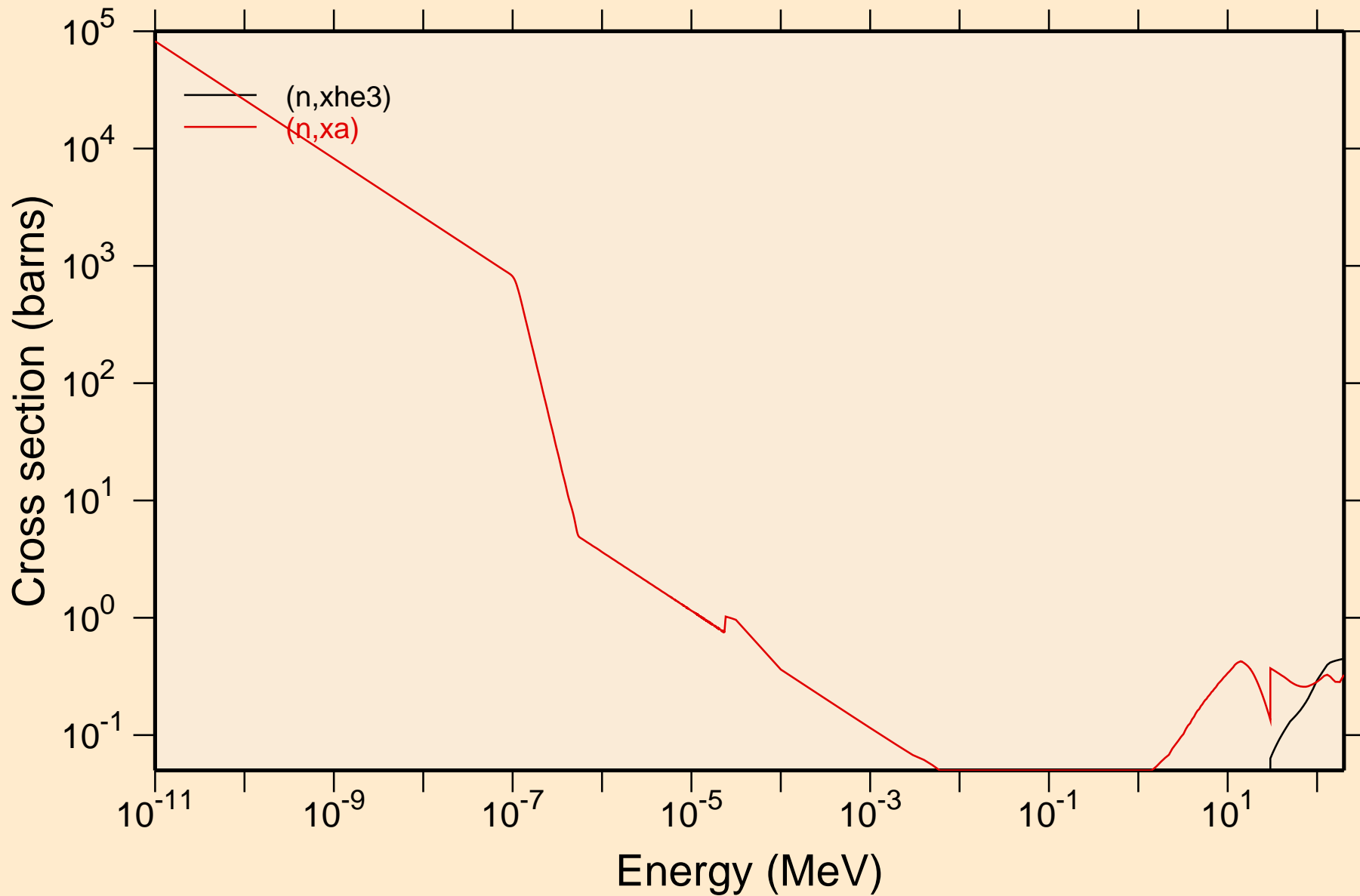

# CS115 NEUTRON ACER TENDL-2019 LIBRARY; T=293.16K

## Principal cross sections

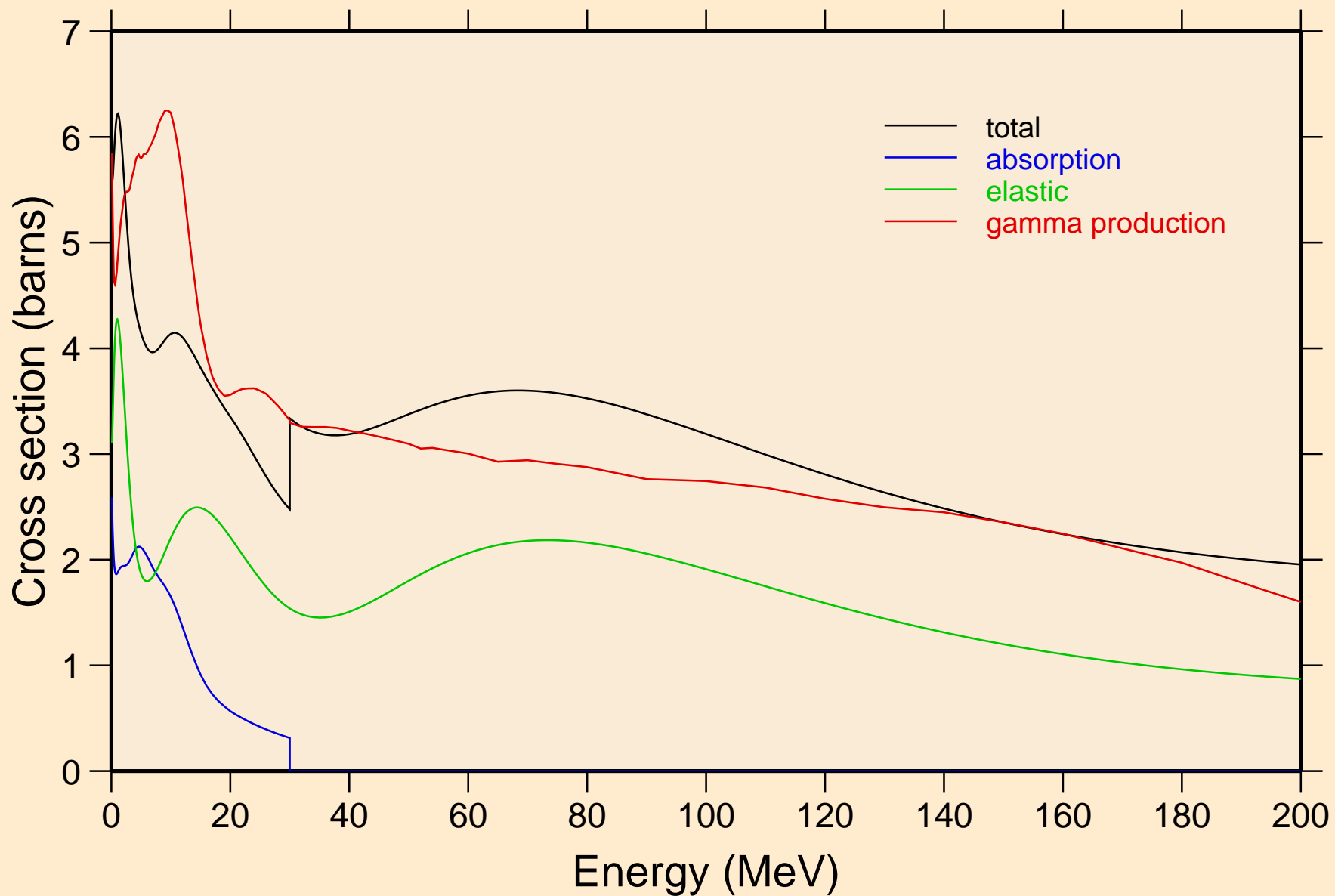

CS115 NEUTRON ACER TENDL-2019 LIBRARY; T=293.16K  
Heating

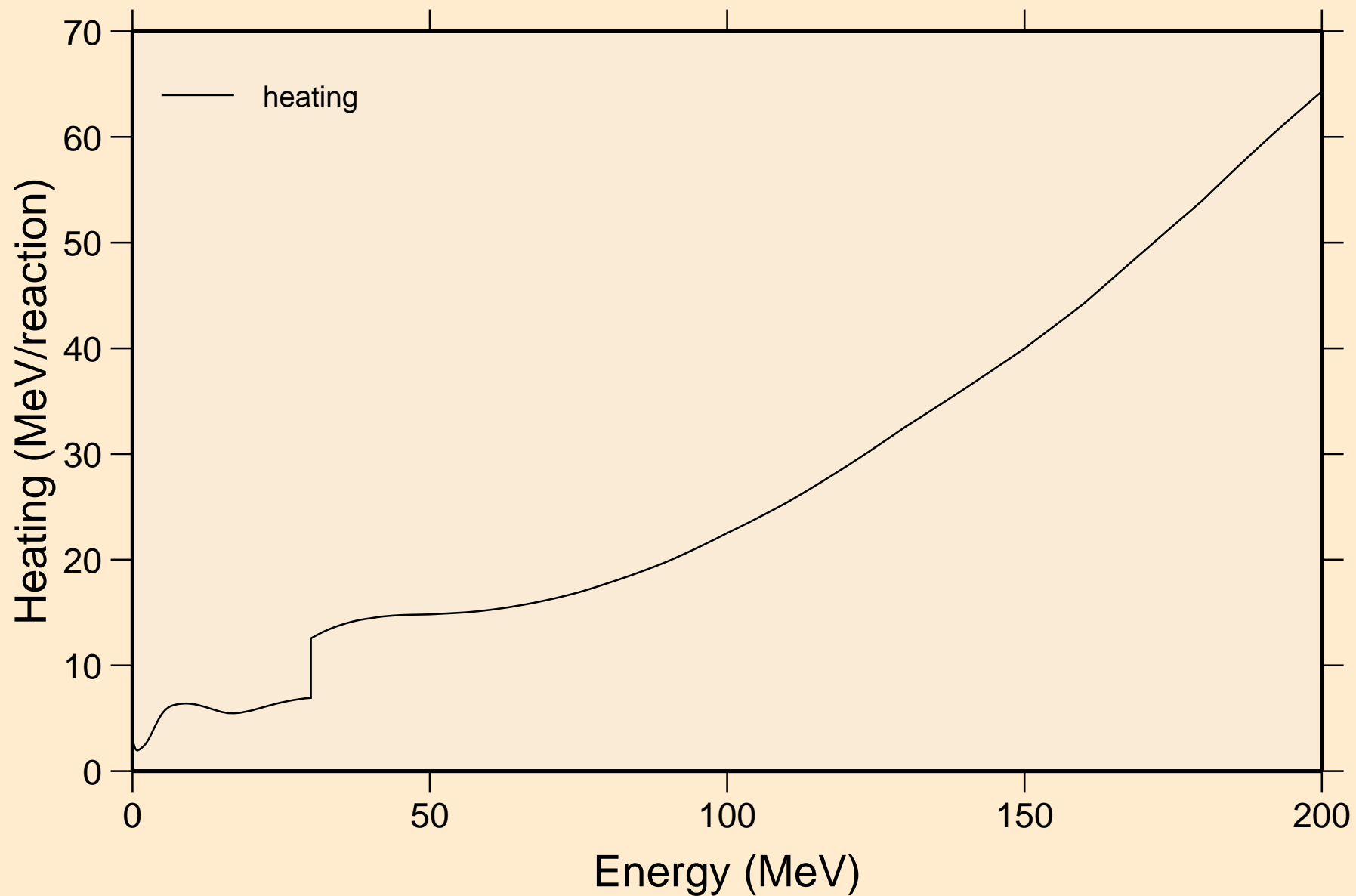



CS115 NEUTRON ACER TENDL-2019 LIBRARY; T=293.16K  
Damage

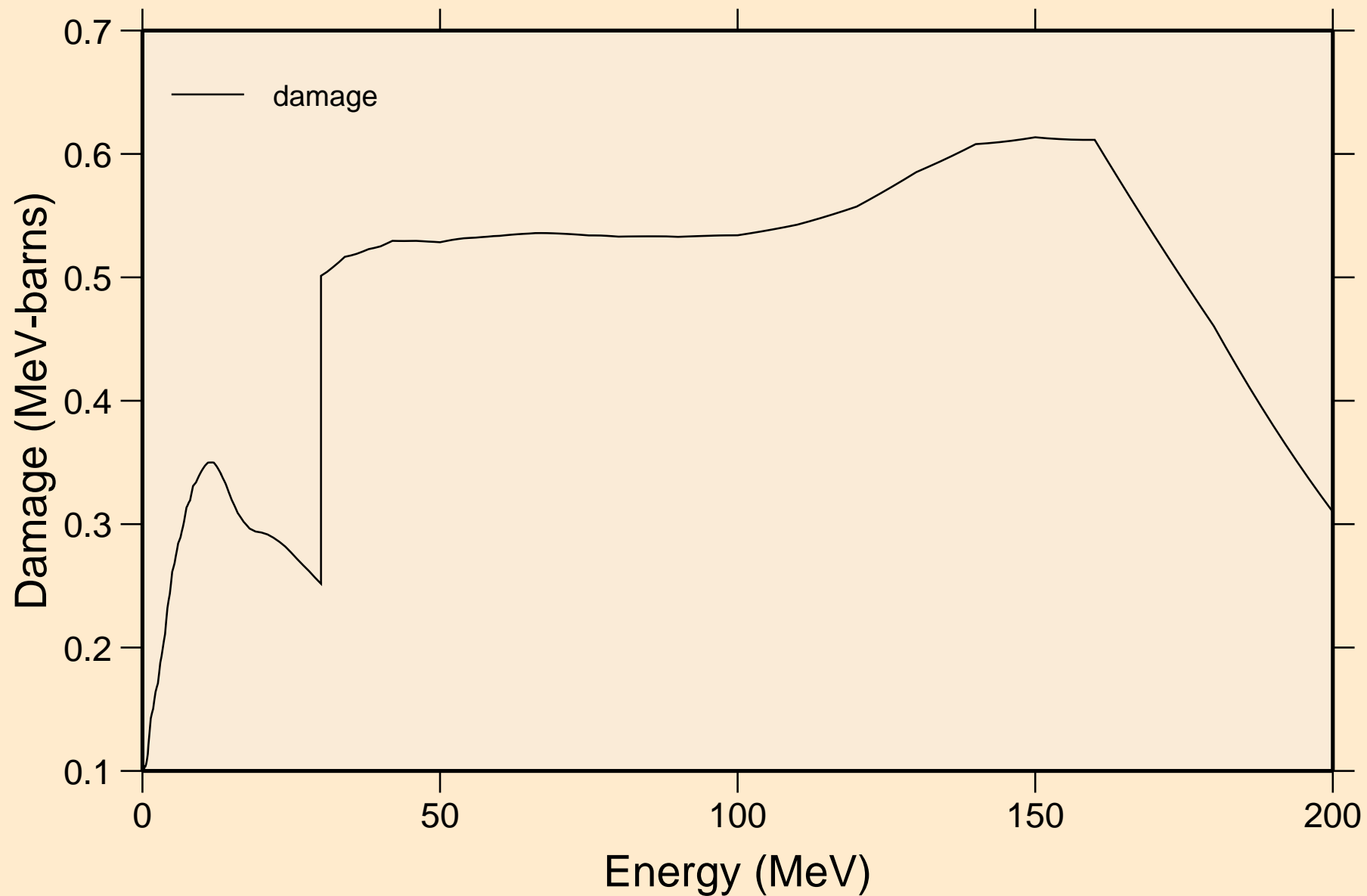

CS115 NEUTRON ACER TENDL-2019 LIBRARY; T=293.16K  
Non-threshold reactions

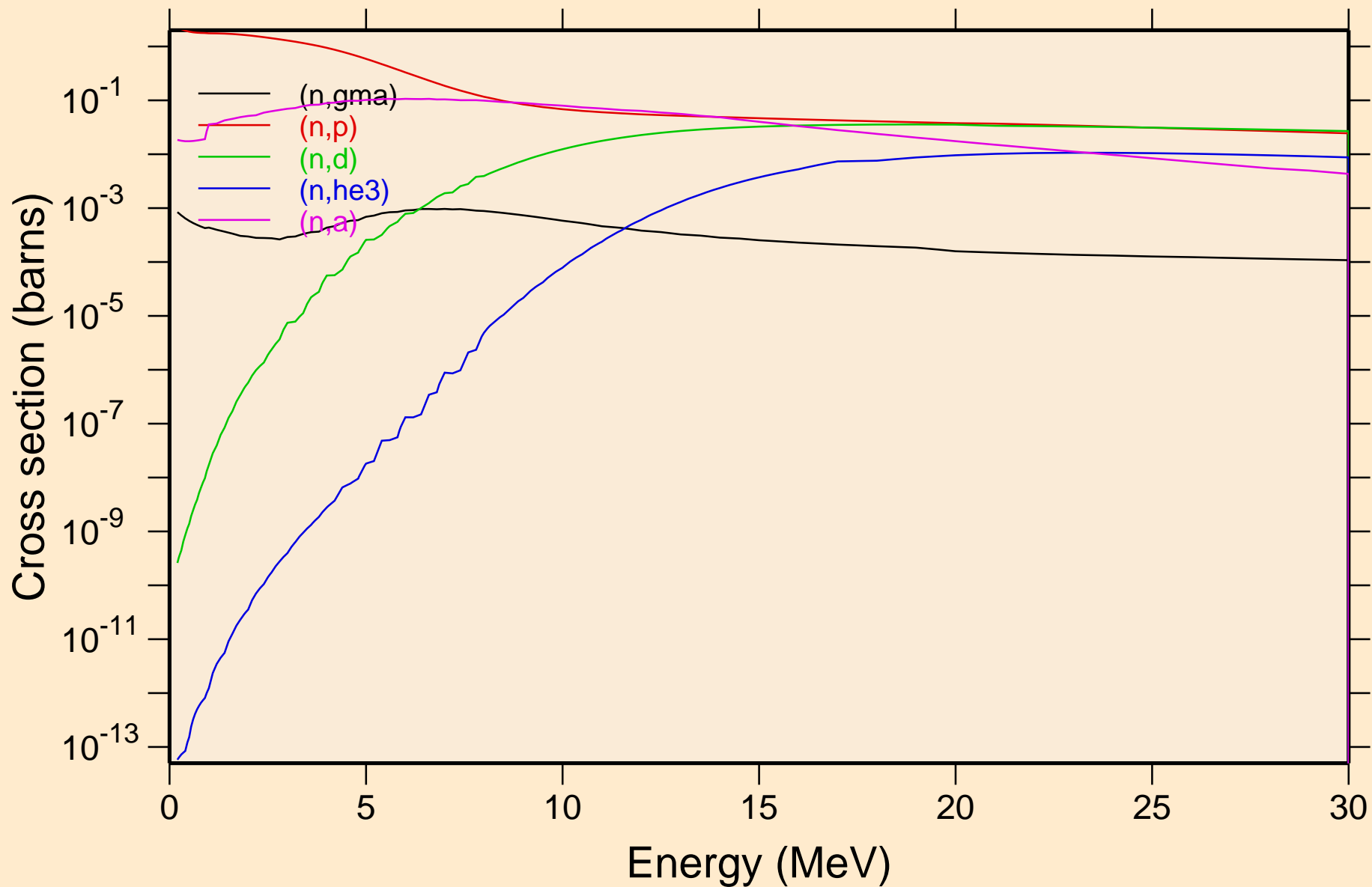

CS115 NEUTRON ACER TENDL-2019 LIBRARY; T=293.16K  
Non-threshold reactions

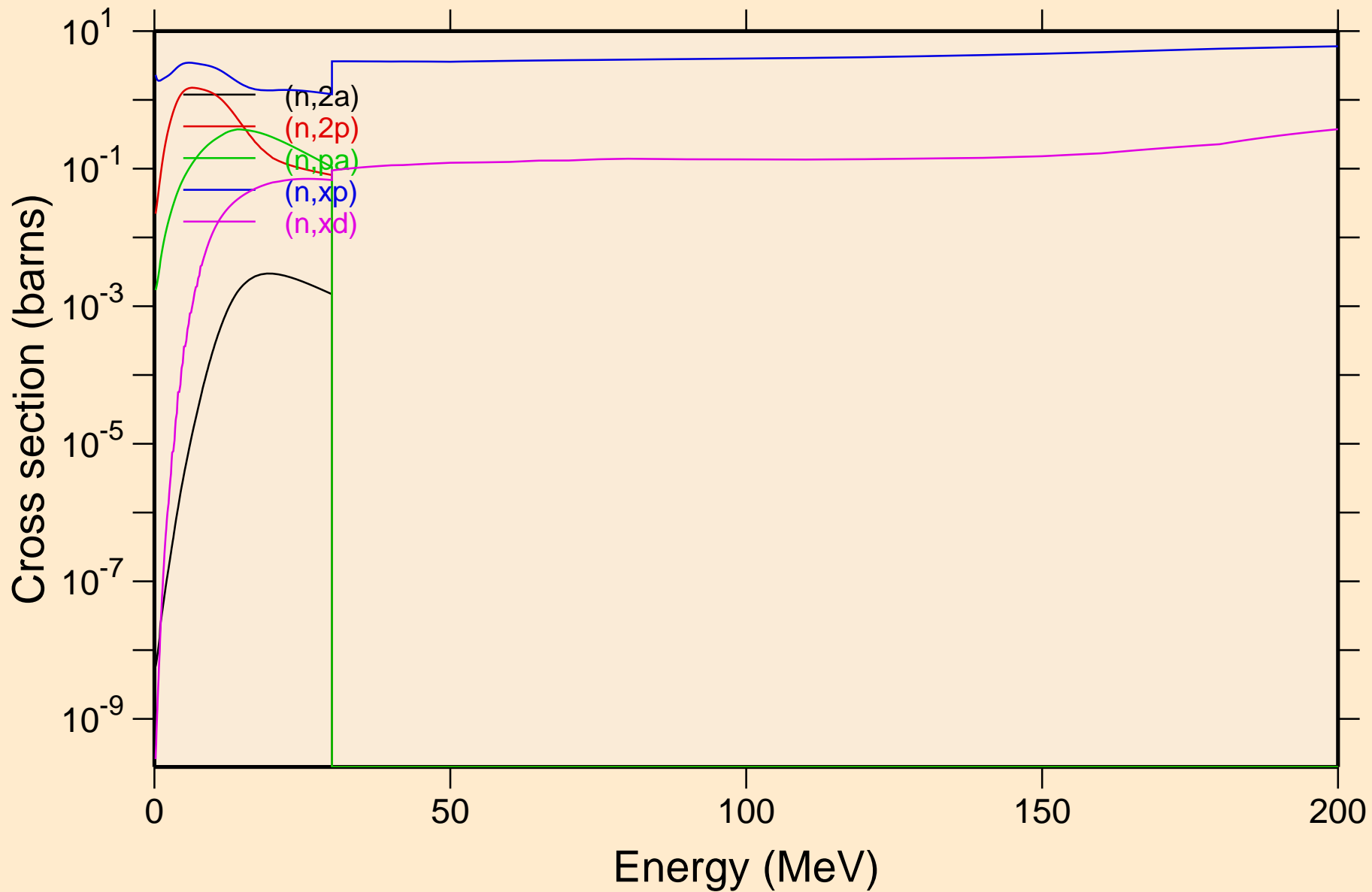

CS115 NEUTRON ACER TENDL-2019 LIBRARY; T=293.16K  
Non-threshold reactions

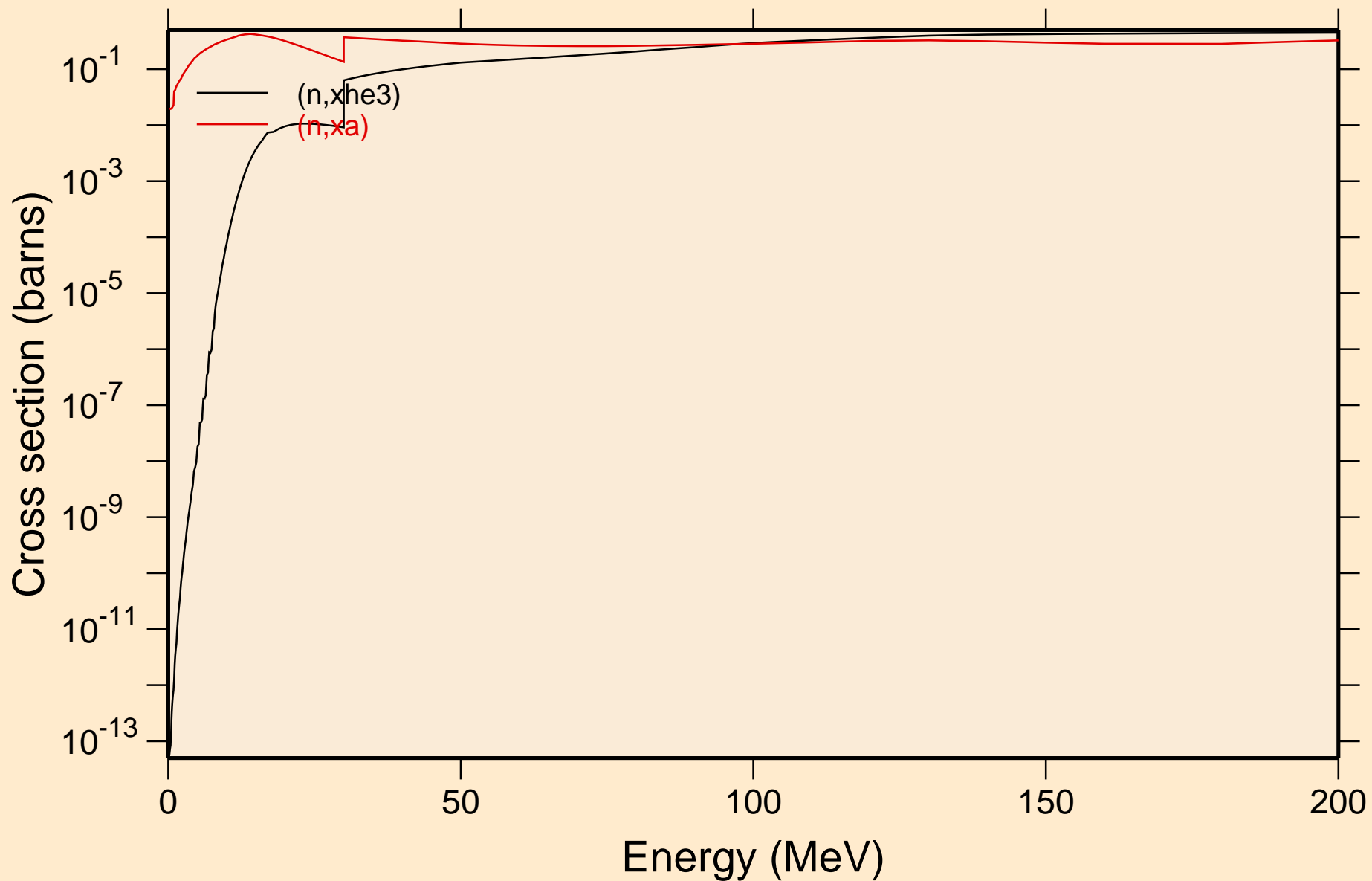

CS115 NEUTRON ACER TENDL-2019 LIBRARY; T=293.16K  
Inelastic levels

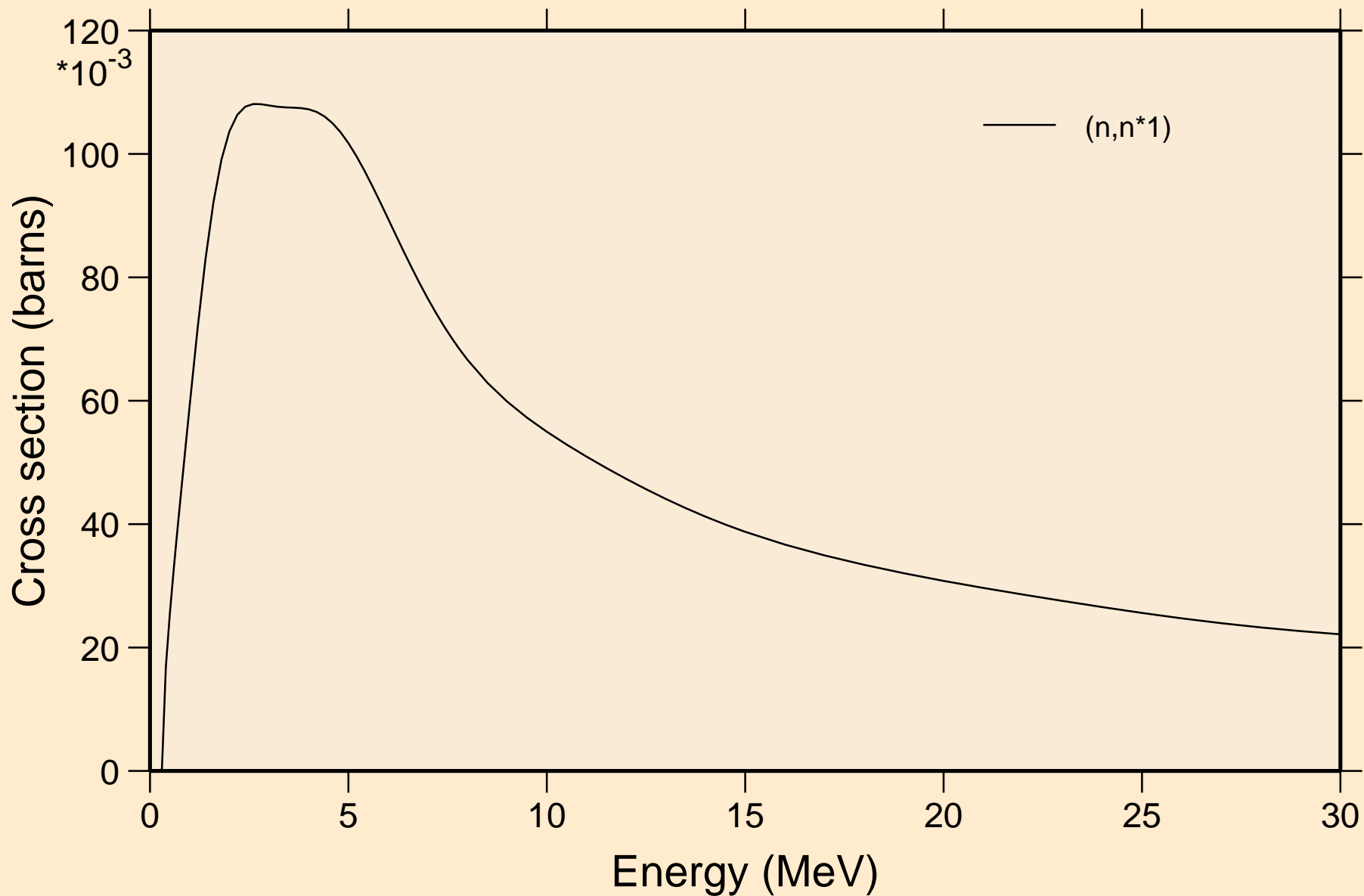

# CS115 NEUTRON ACER TENDL-2019 LIBRARY; T=293.16K

## Threshold reactions

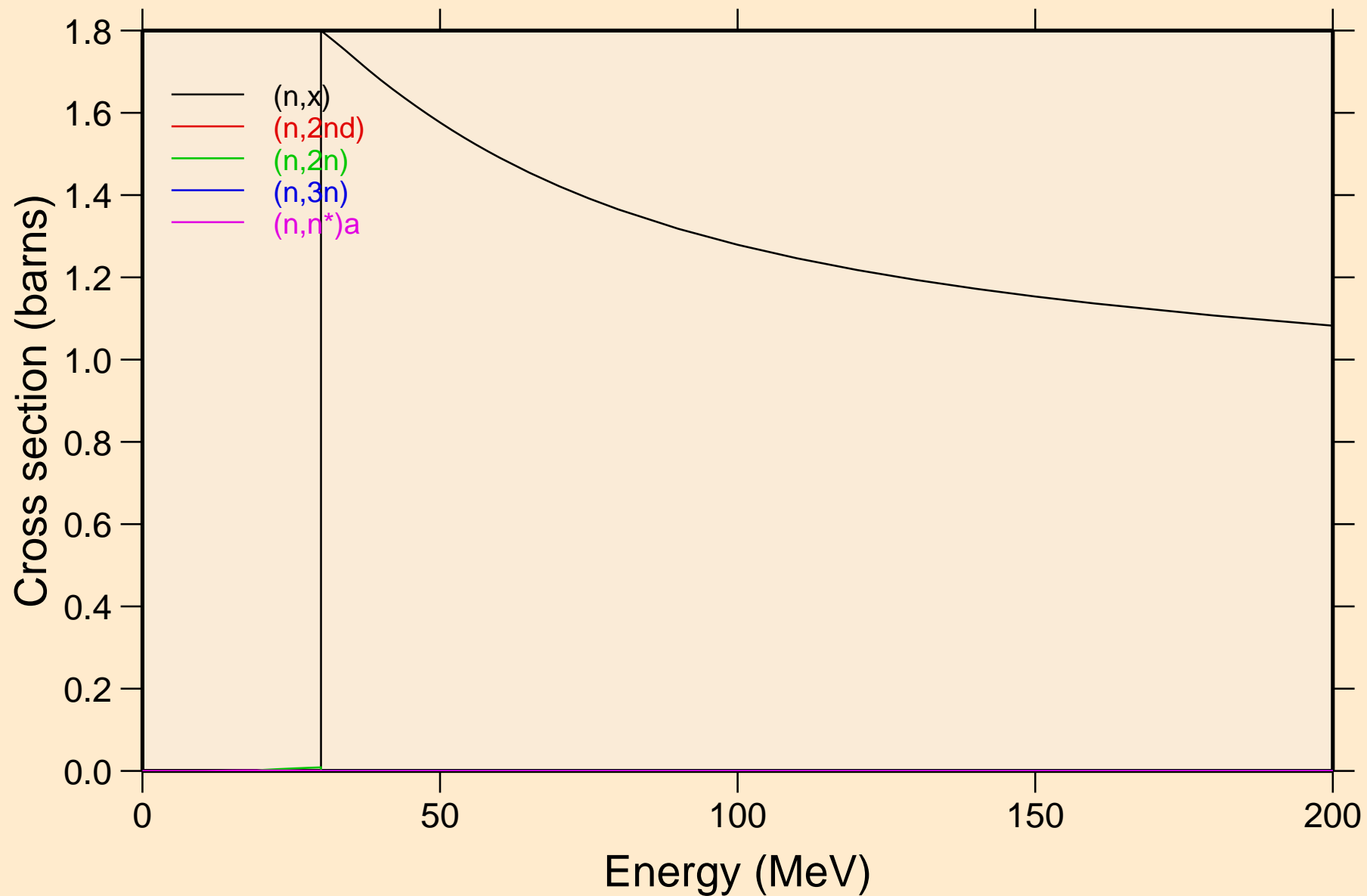

CS115 NEUTRON ACER TENDL-2019 LIBRARY; T=293.16K  
Threshold reactions

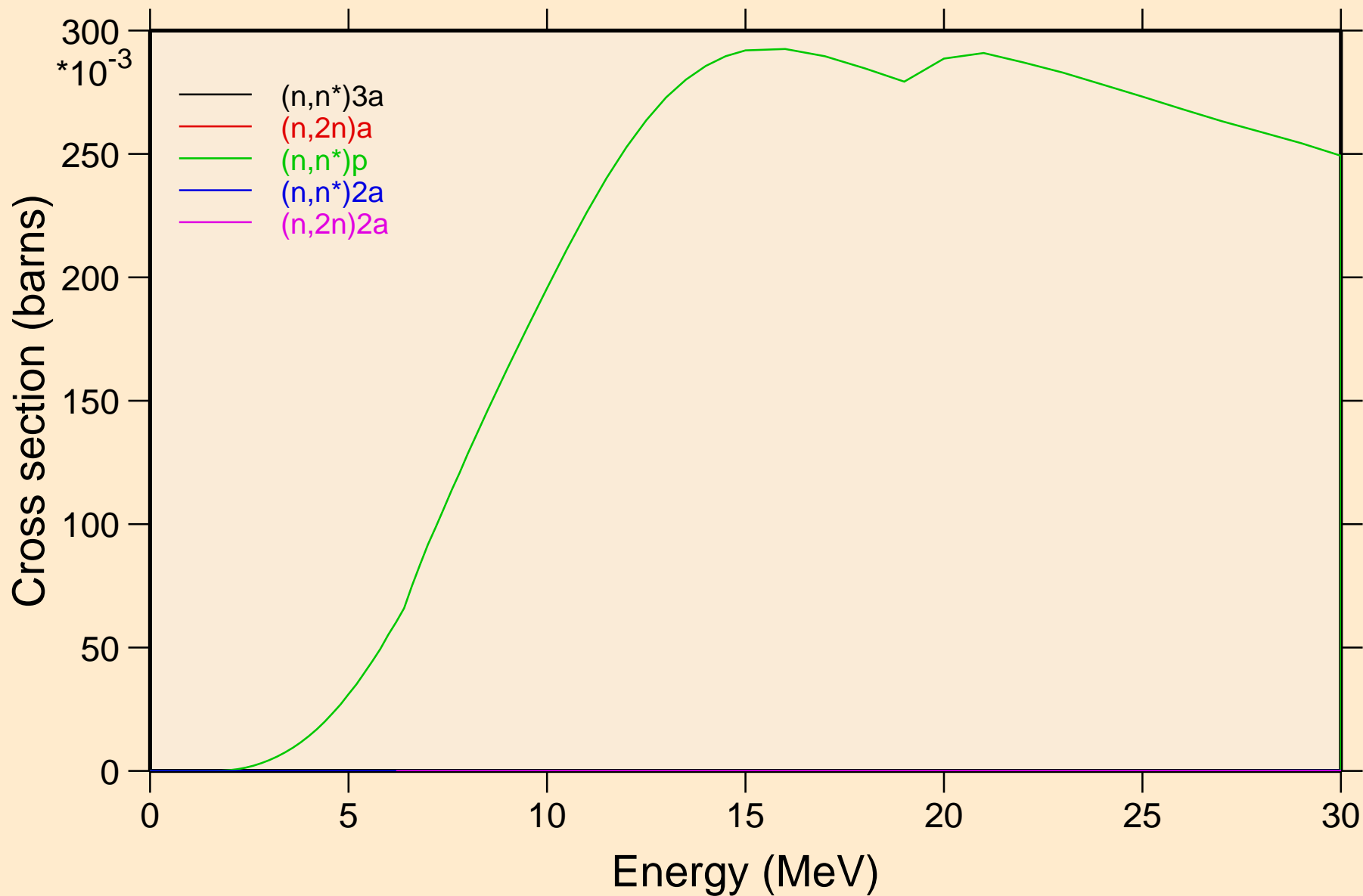

# CS115 NEUTRON ACER TENDL-2019 LIBRARY; T=293.16K

## Threshold reactions

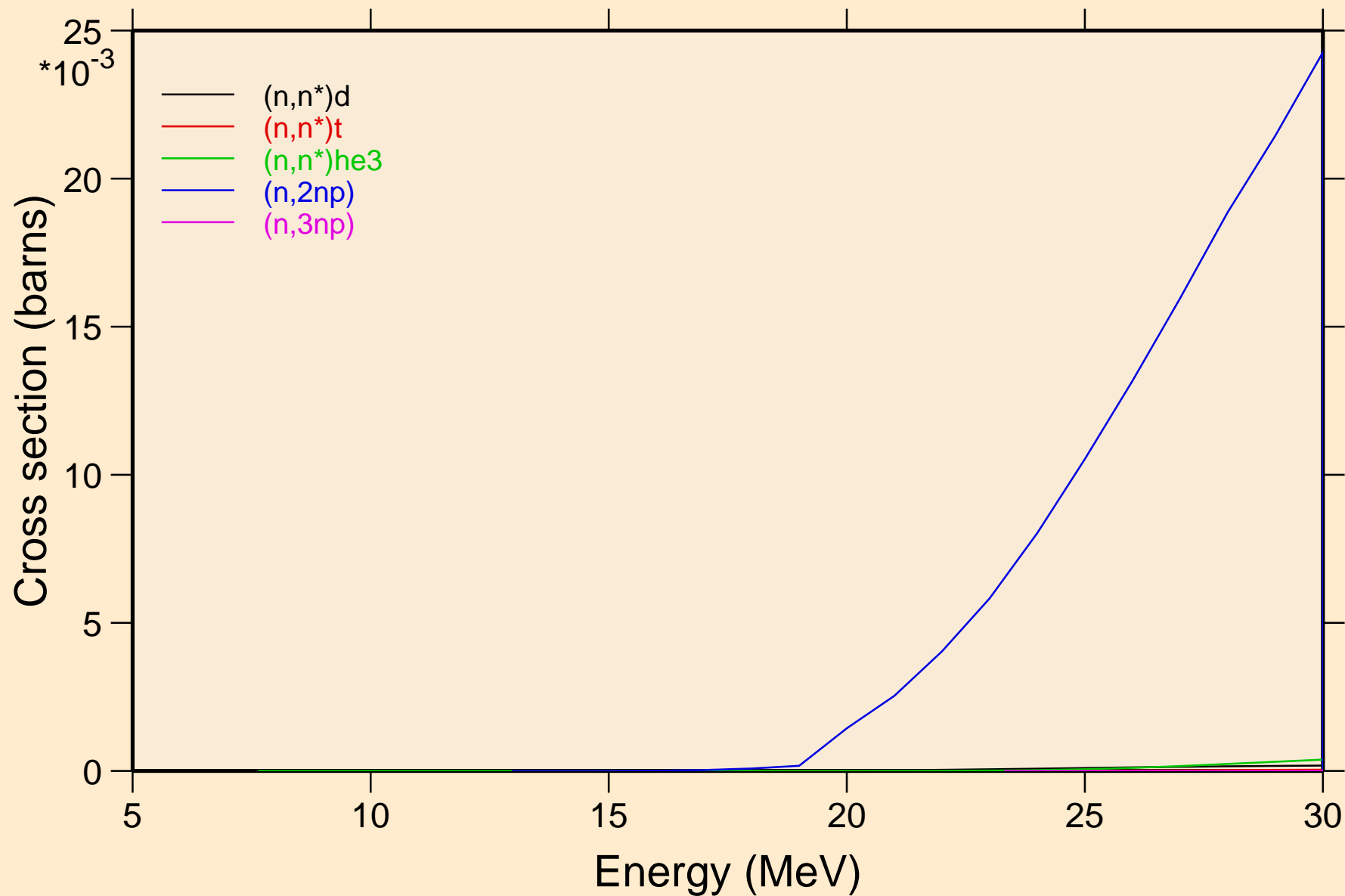



# CS115 NEUTRON ACER TENDL-2019 LIBRARY; T=293.16K

## Threshold reactions

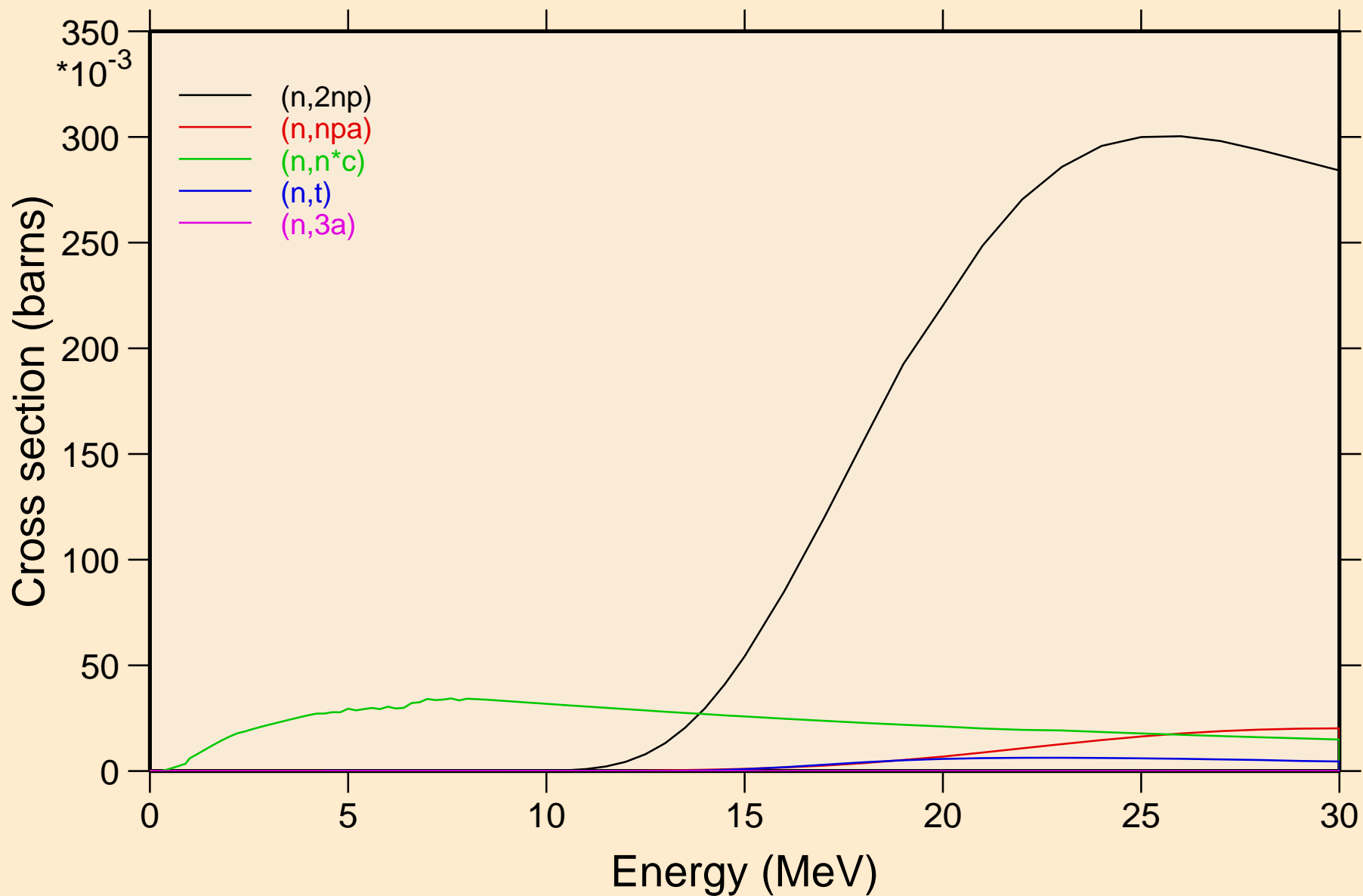

# CS115 NEUTRON ACER TENDL-2019 LIBRARY; T=293.16K

## Threshold reactions

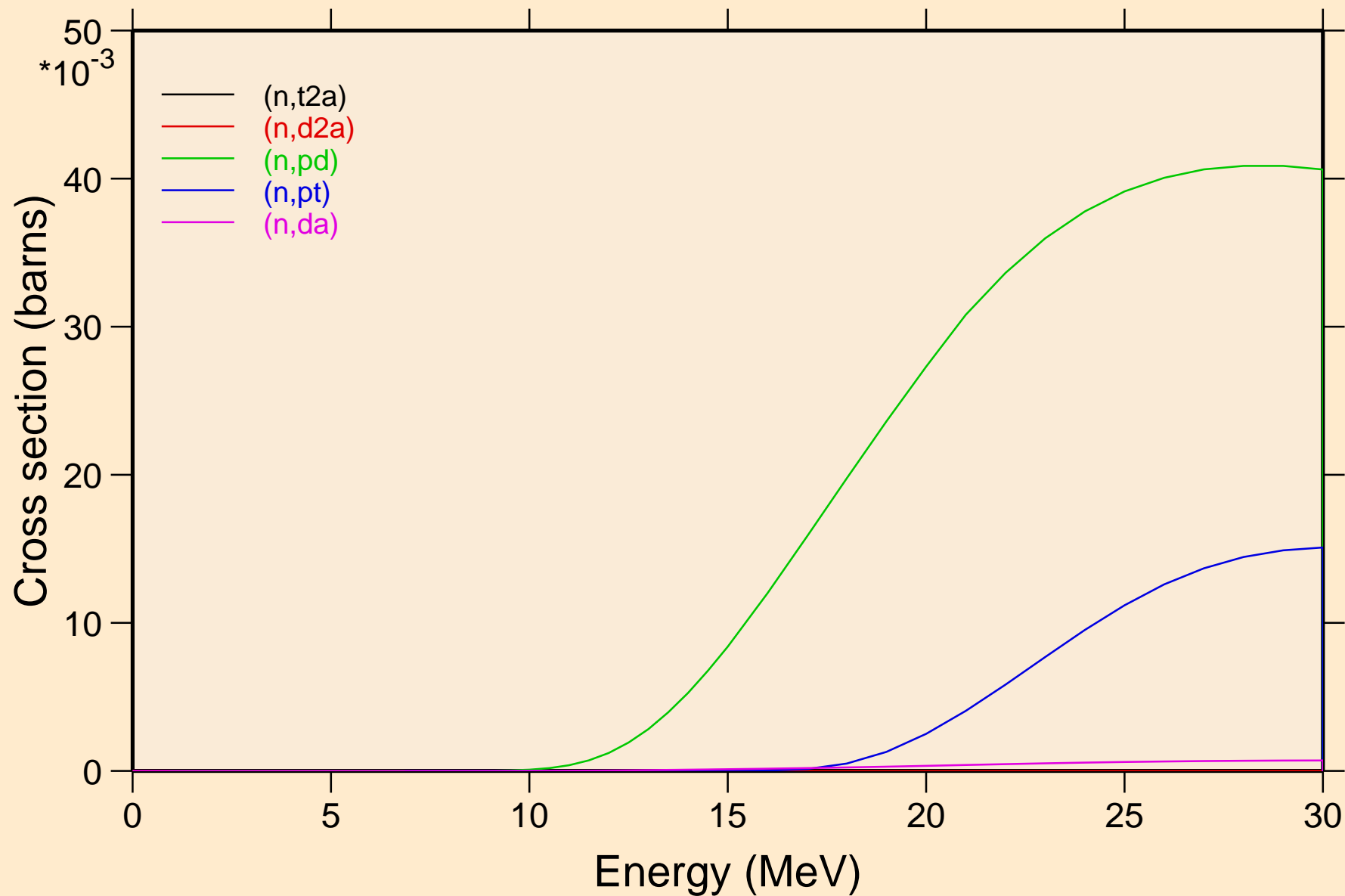

CS115 NEUTRON ACER TENDL-2019 LIBRARY; T=293.16K  
Threshold reactions

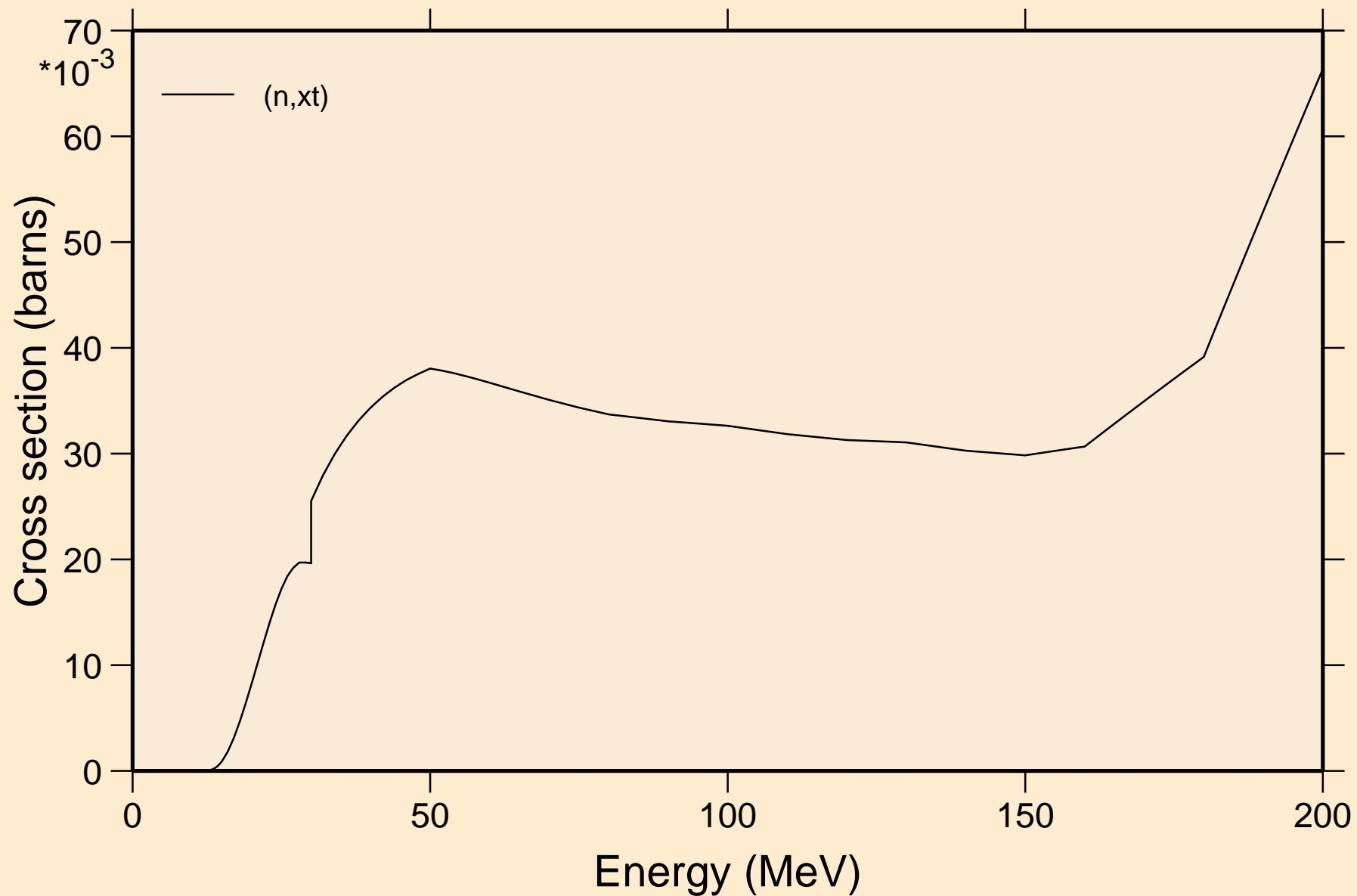

CS115 NEUTRON ACER TENDL-2019 LIBRARY; T=293.16K  
angular distribution for elastic

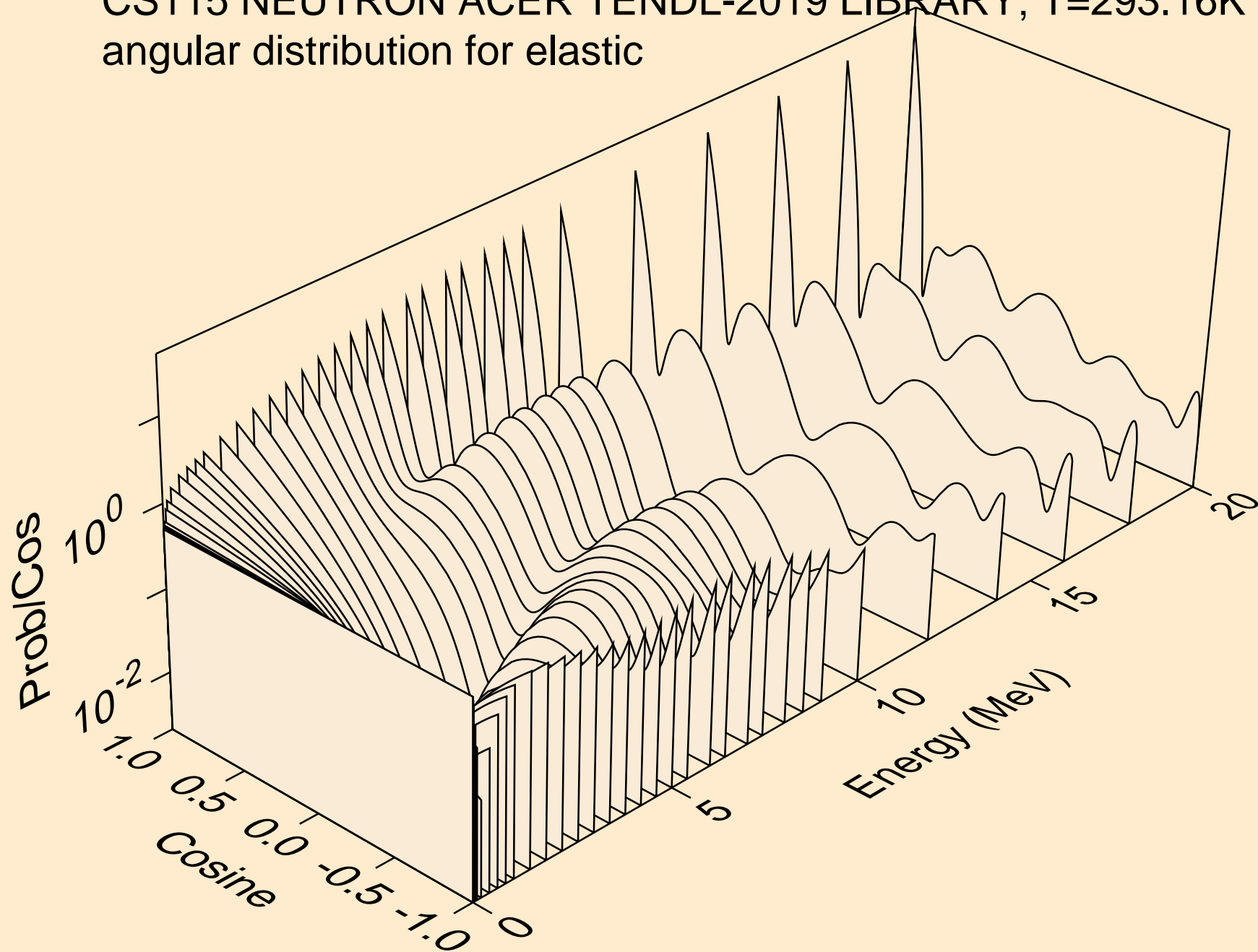

CS115 NEUTRON ACER TENDL-2019 LIBRARY; T=293.16K  
angular distribution for elastic

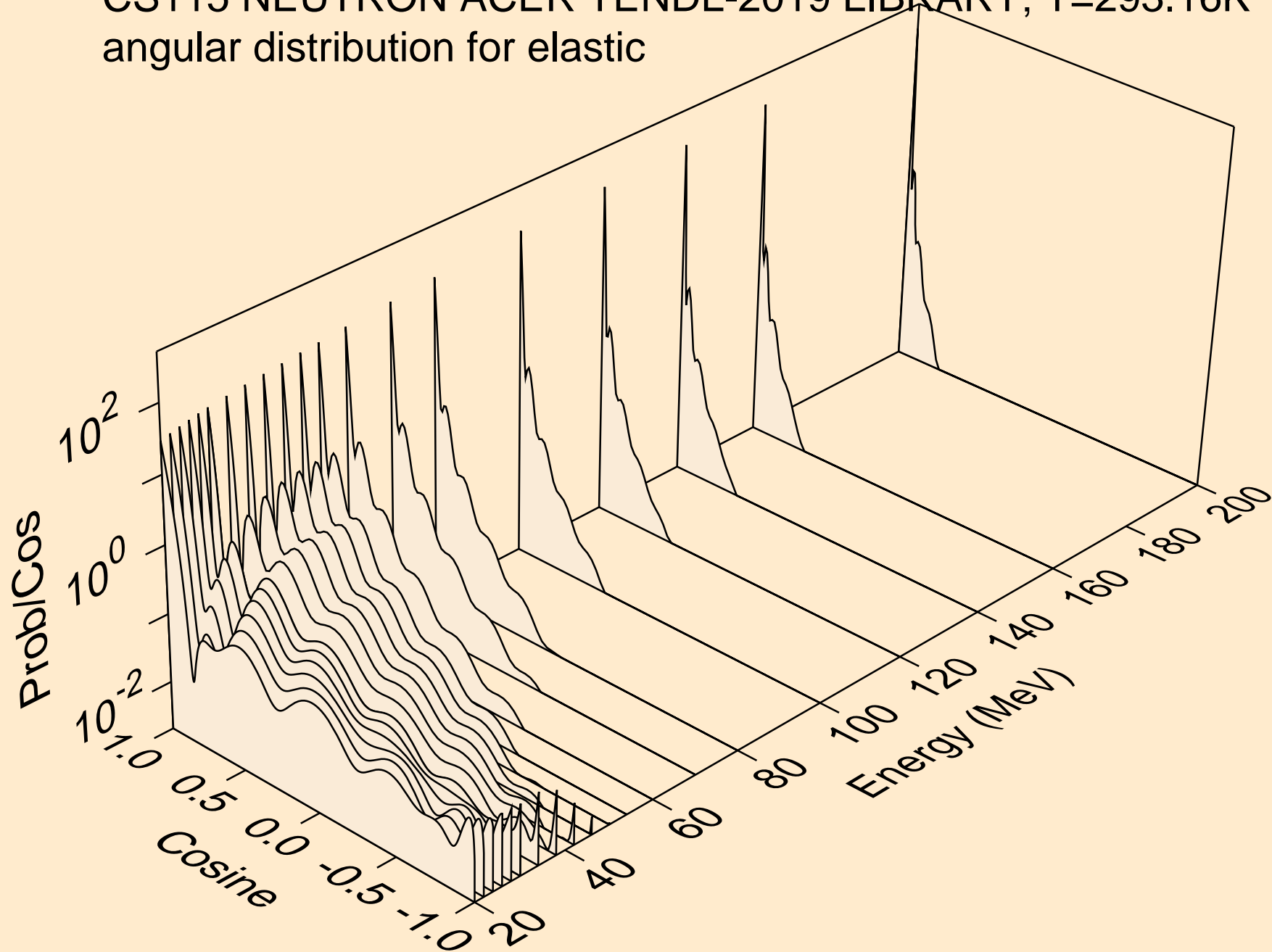

CS115 NEUTRON ACER TENDL-2019 LIBRARY; T=293.16K  
angular distribution for (n,n\*1)

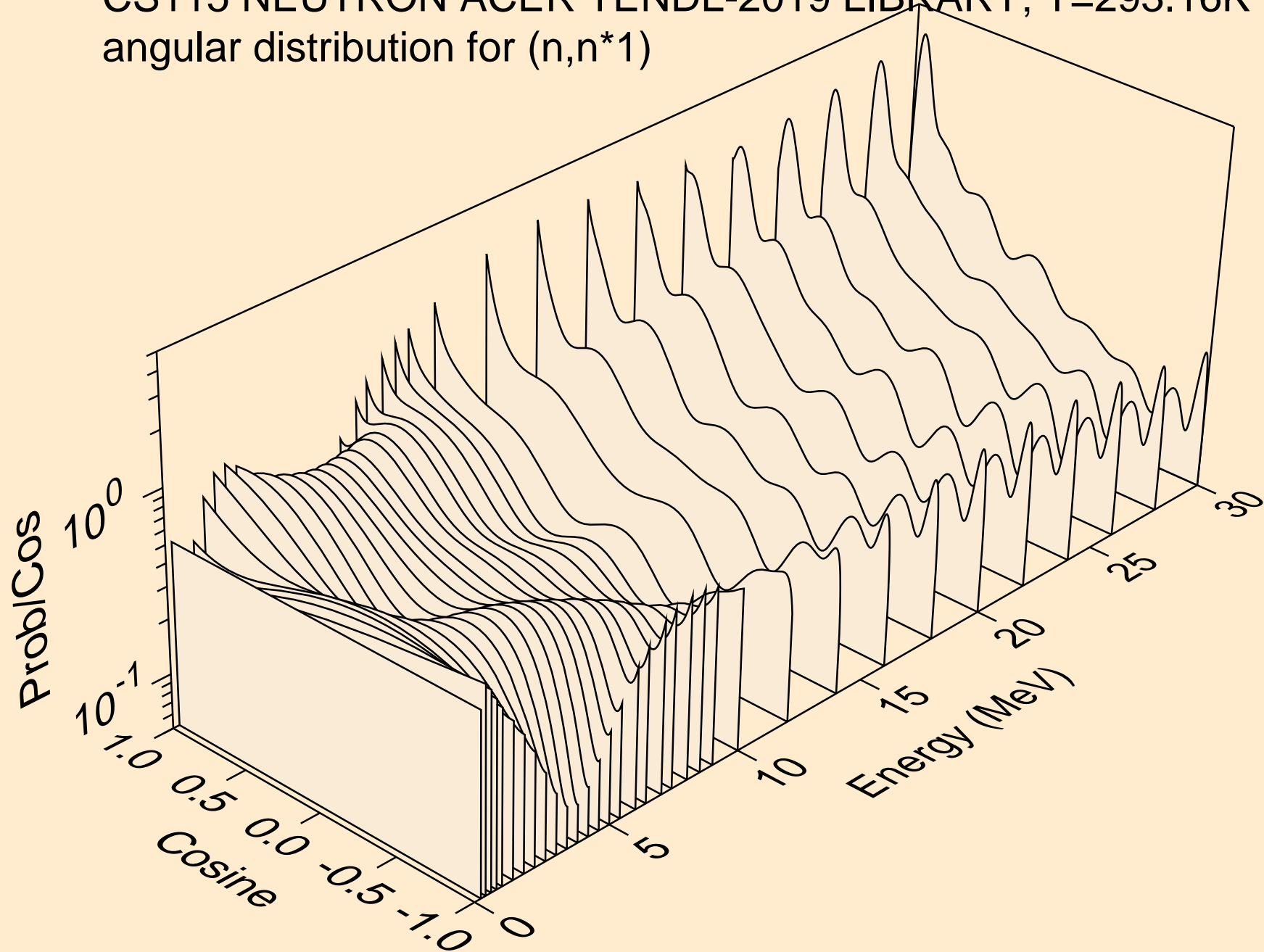

CS115 NEUTRON ACER TENDL-2019 LIBRARY; T=293.16K  
Neutron emission for (n,x)

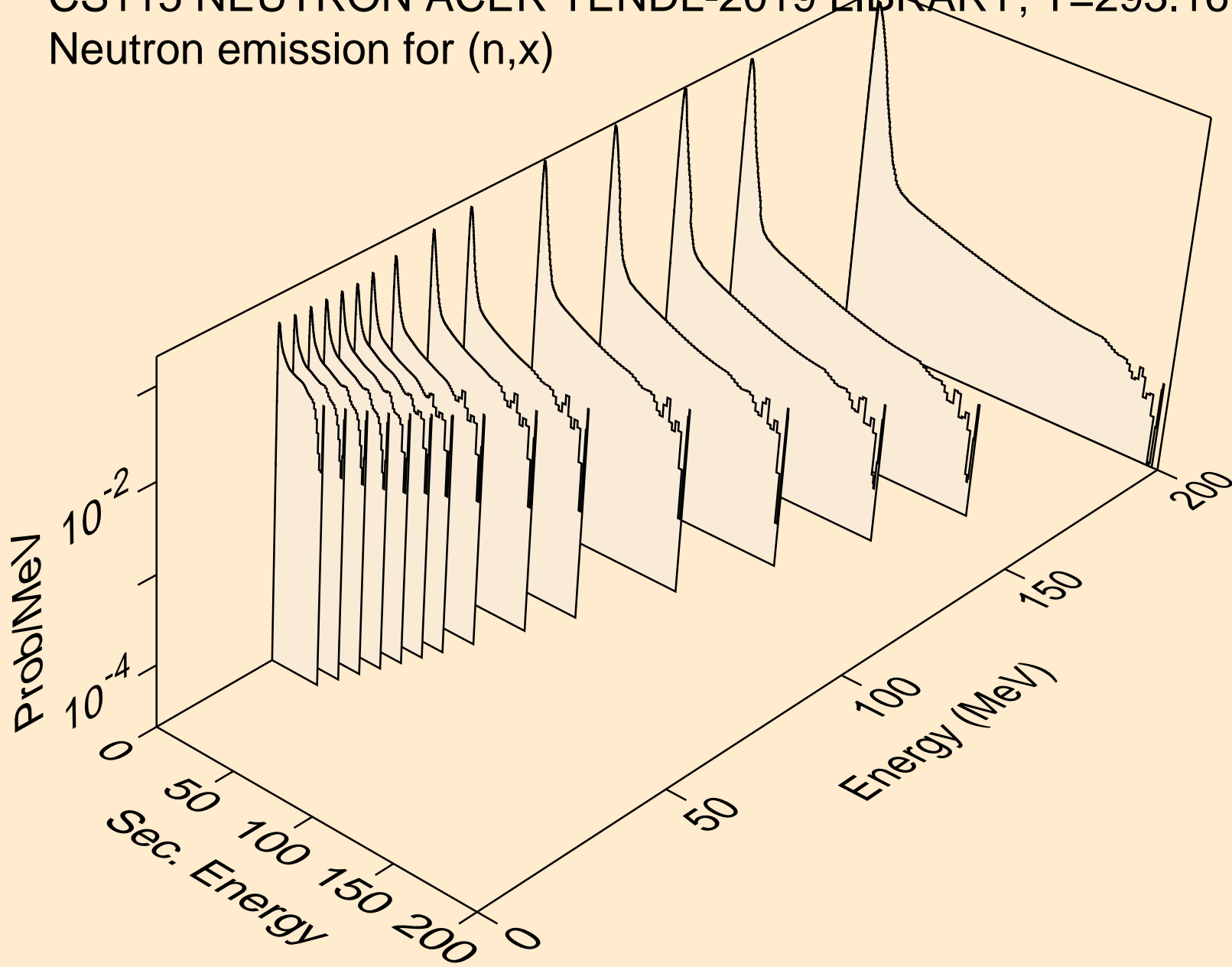

CS115 NEUTRON ACER TENDL-2019 LIBRARY; T=293.16K  
Neutron emission for (n,2nd)

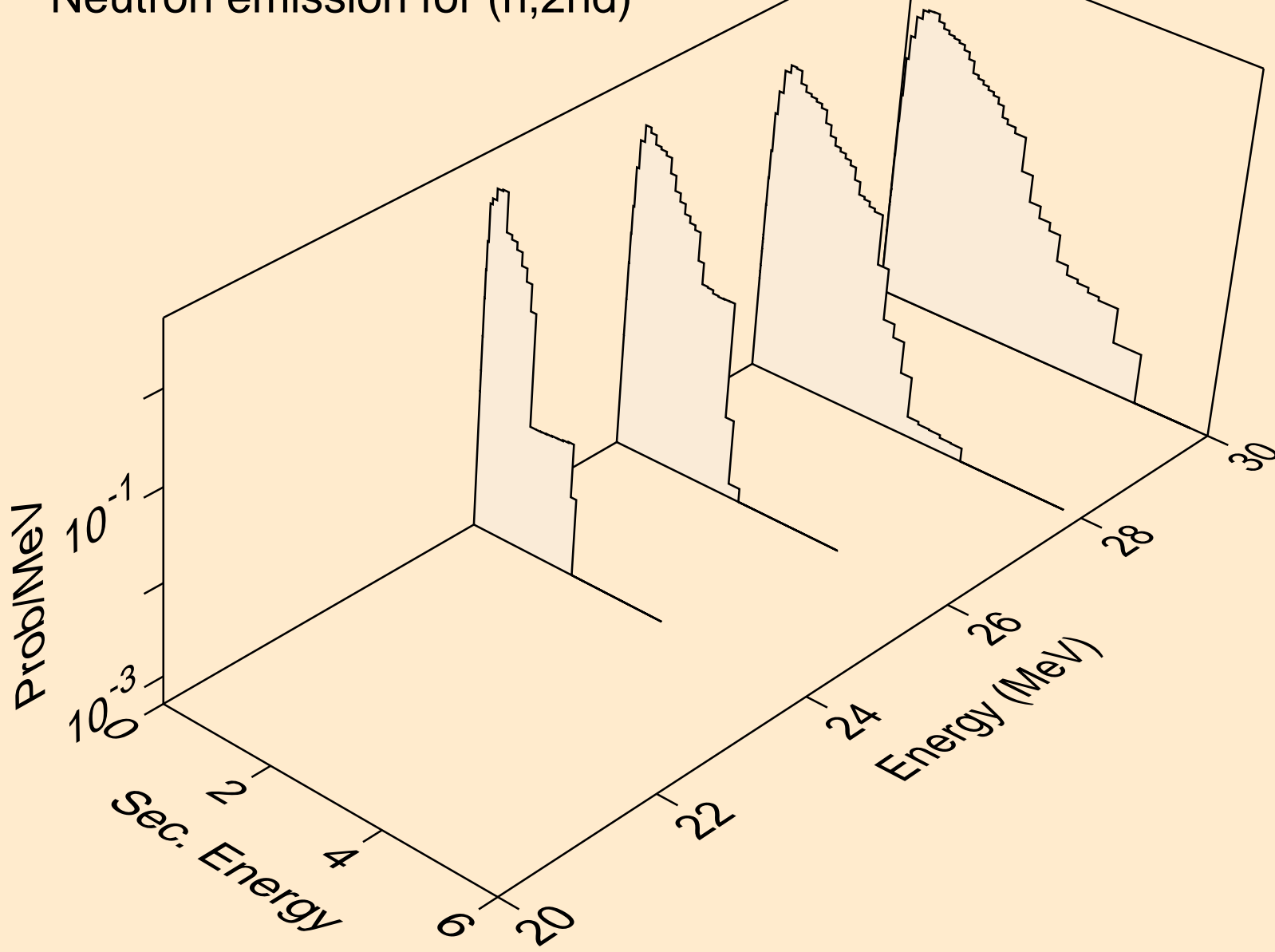



CS115 NEUTRON ACER TENDL-2019 LIBRARY; T=293.16K  
Neutron emission for (n,2n)

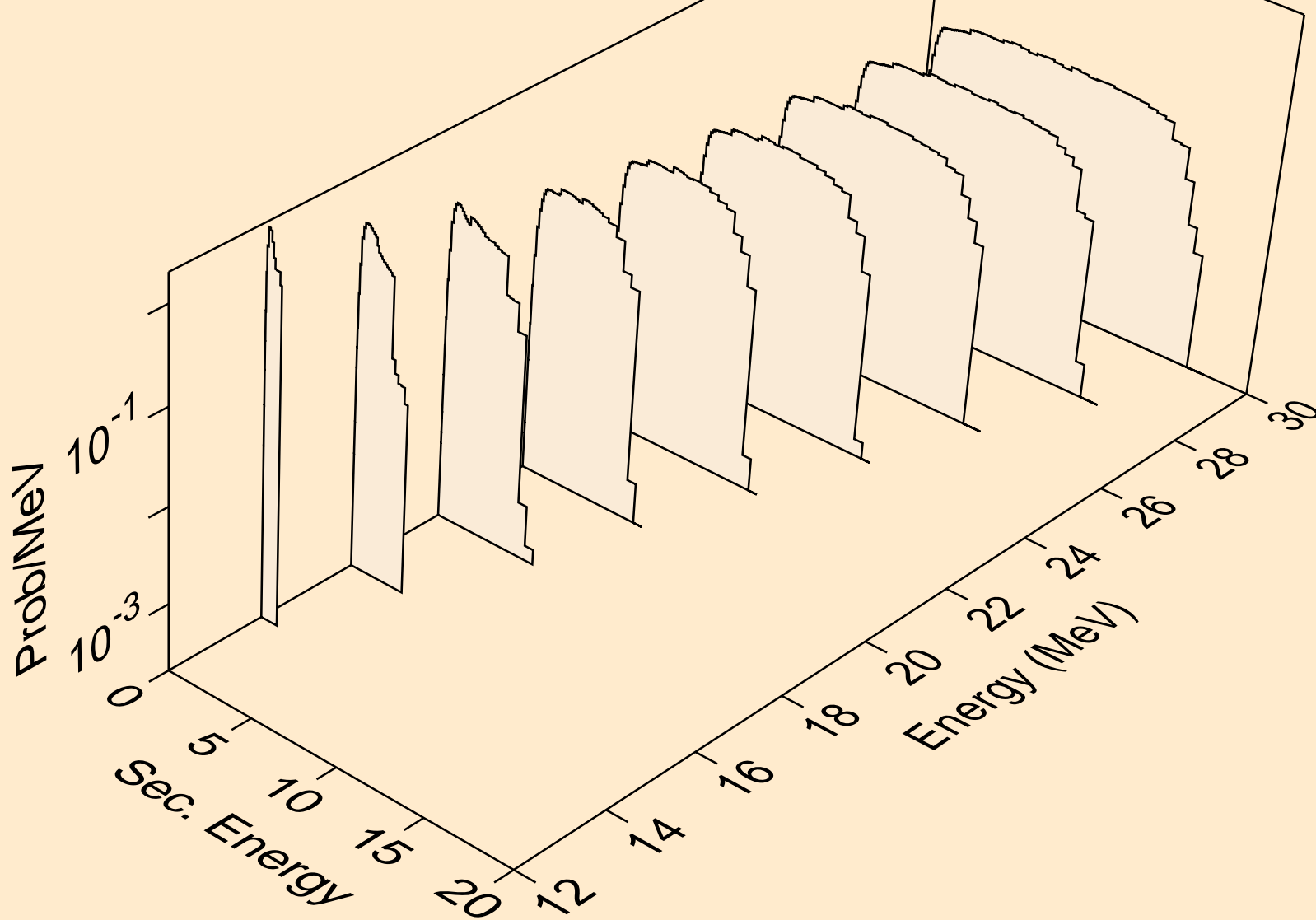

CS115 NEUTRON ACER TENDL-2019 LIBRARY; T=293.16K  
Neutron emission for (n,3n)

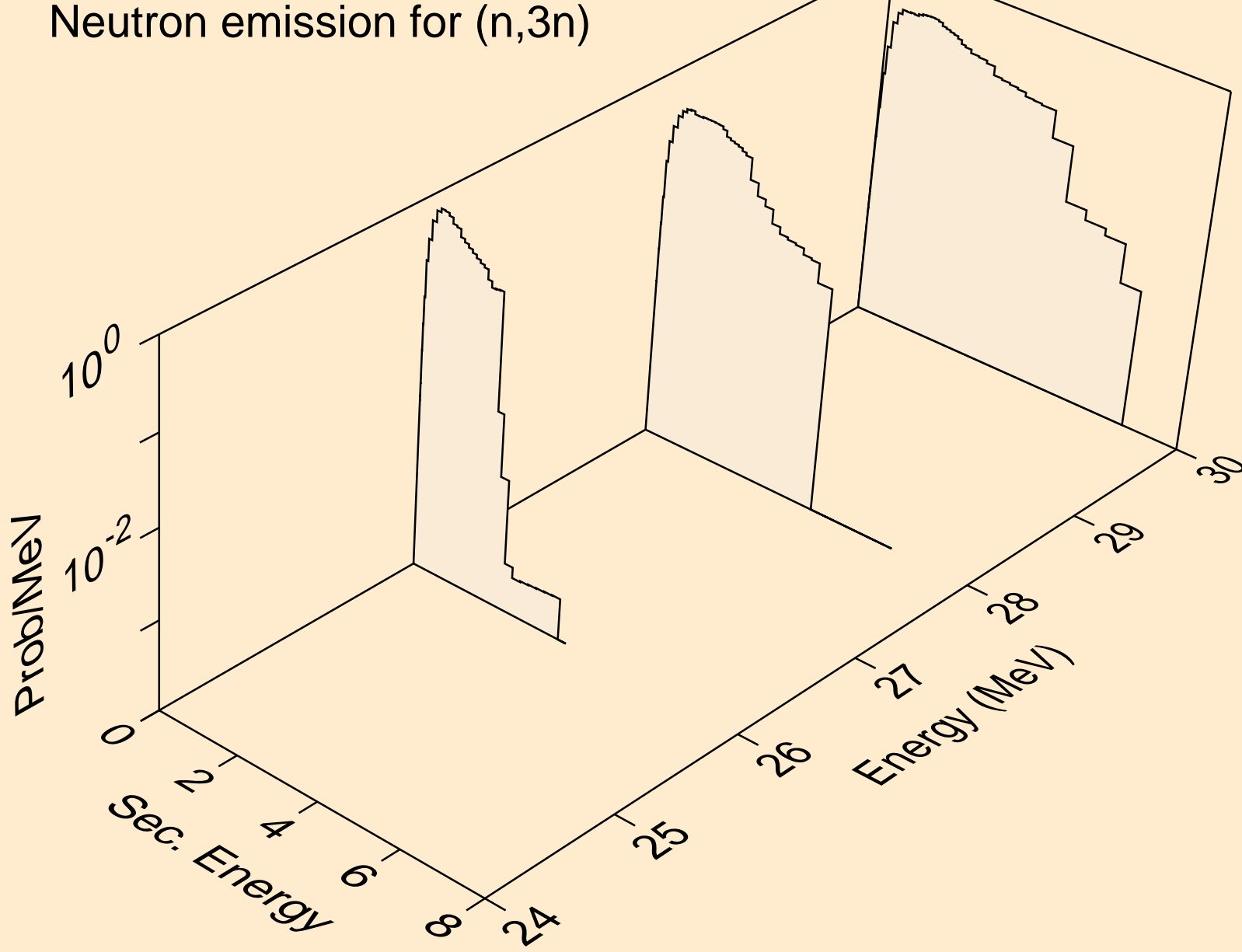

CS115 NEUTRON ACER TENDL-2019 LIBRARY; T=293.16K  
Neutron emission for (n,n\*)a

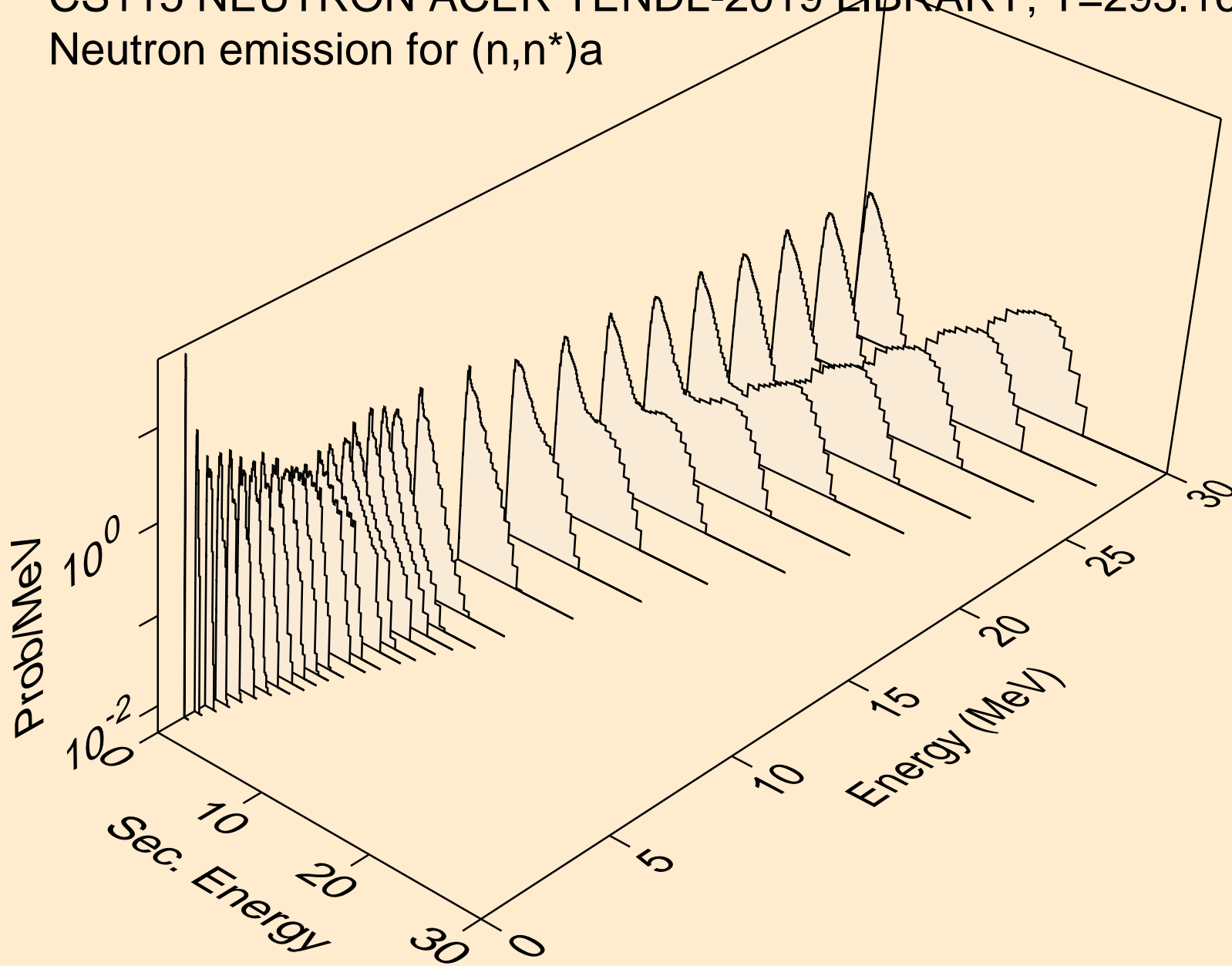

CS115 NEUTRON ACER TENDL-2019 LIBRARY; T=293.16K  
Neutron emission for (n,n\*)3a

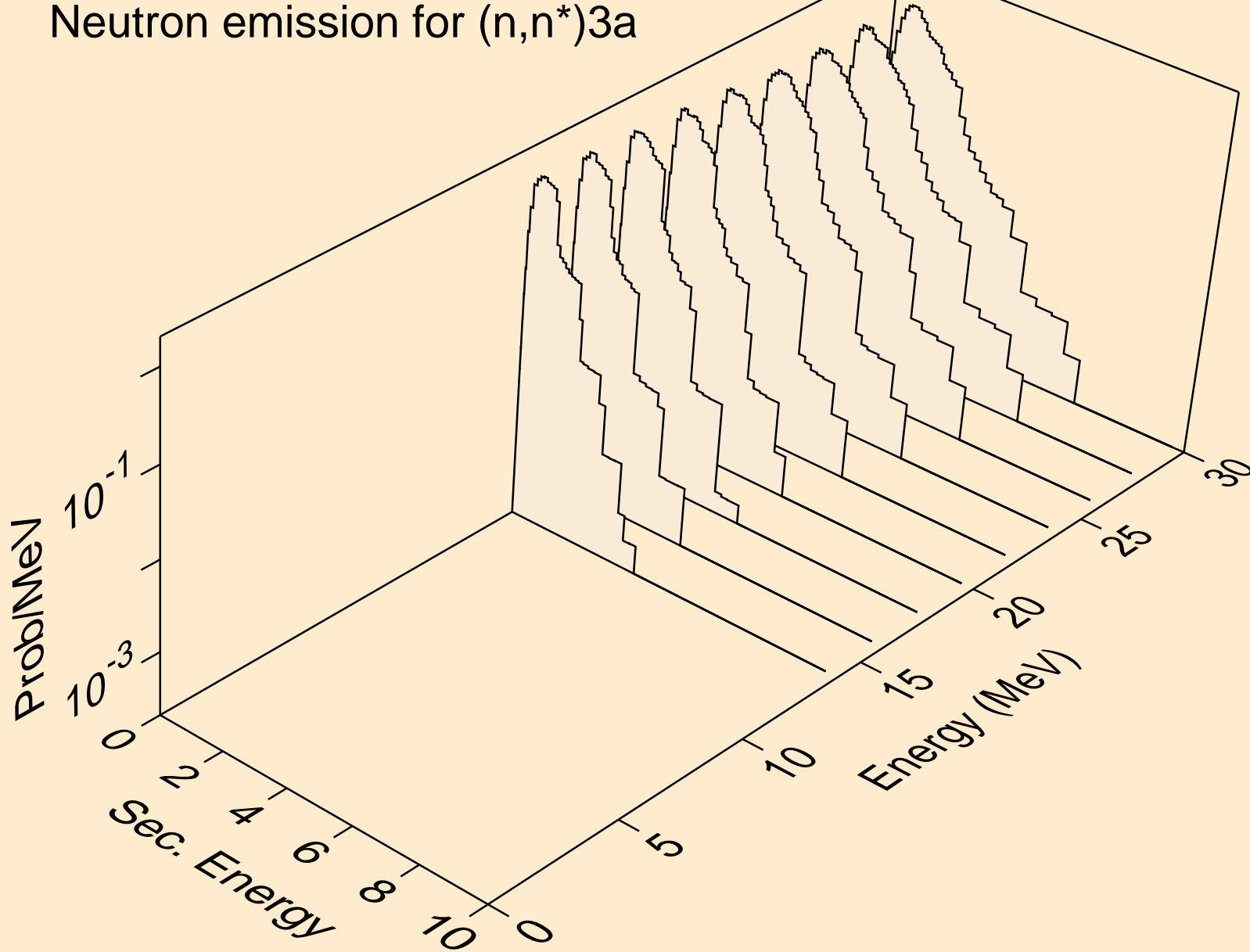

CS115 NEUTRON ACER TENDL-2019 LIBRARY; T=293.16K  
Neutron emission for (n,2n)a

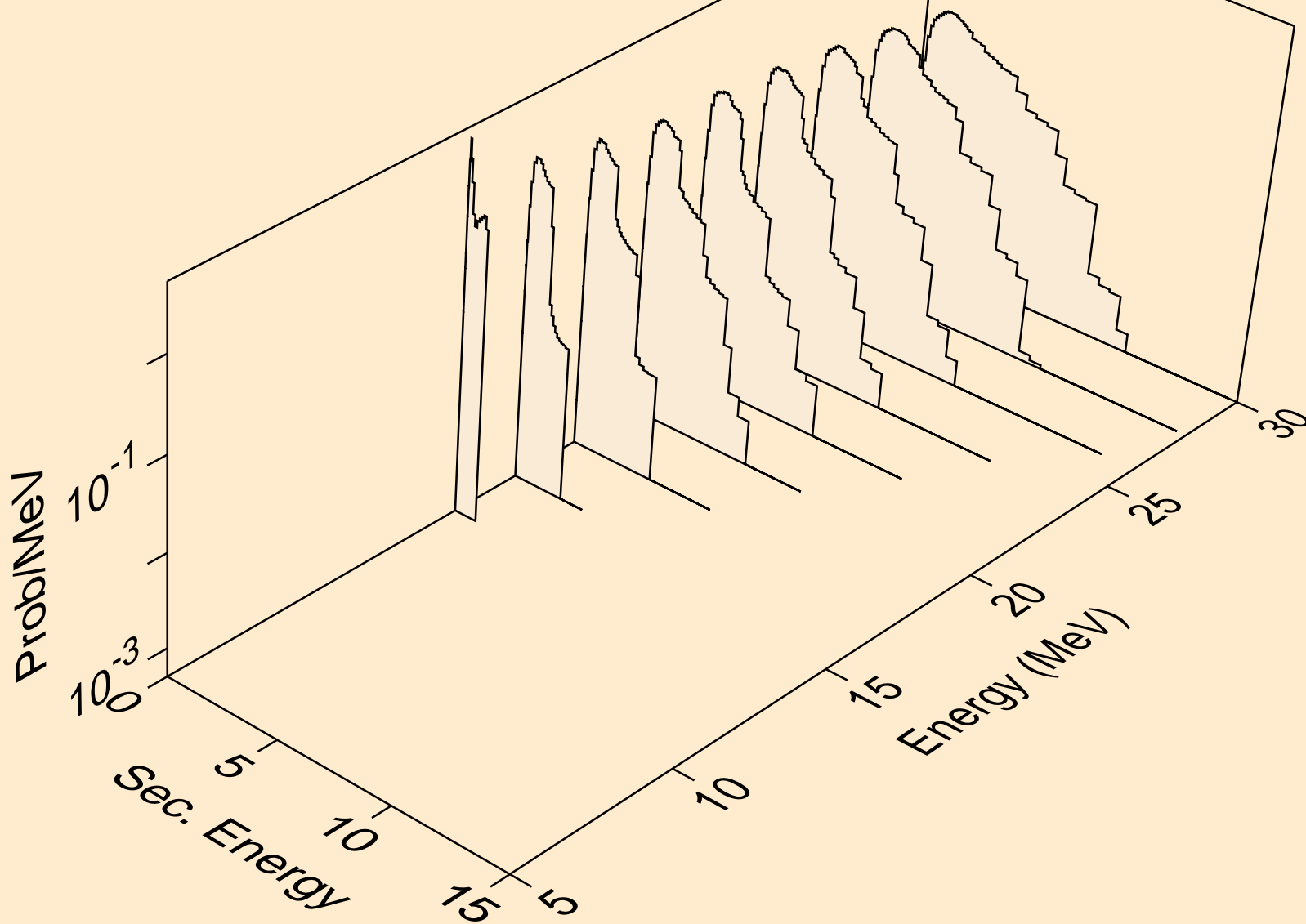

CS115 NEUTRON ACER TENDL-2019 LIBRARY; T=293.16K  
Neutron emission for (n,n\*)p

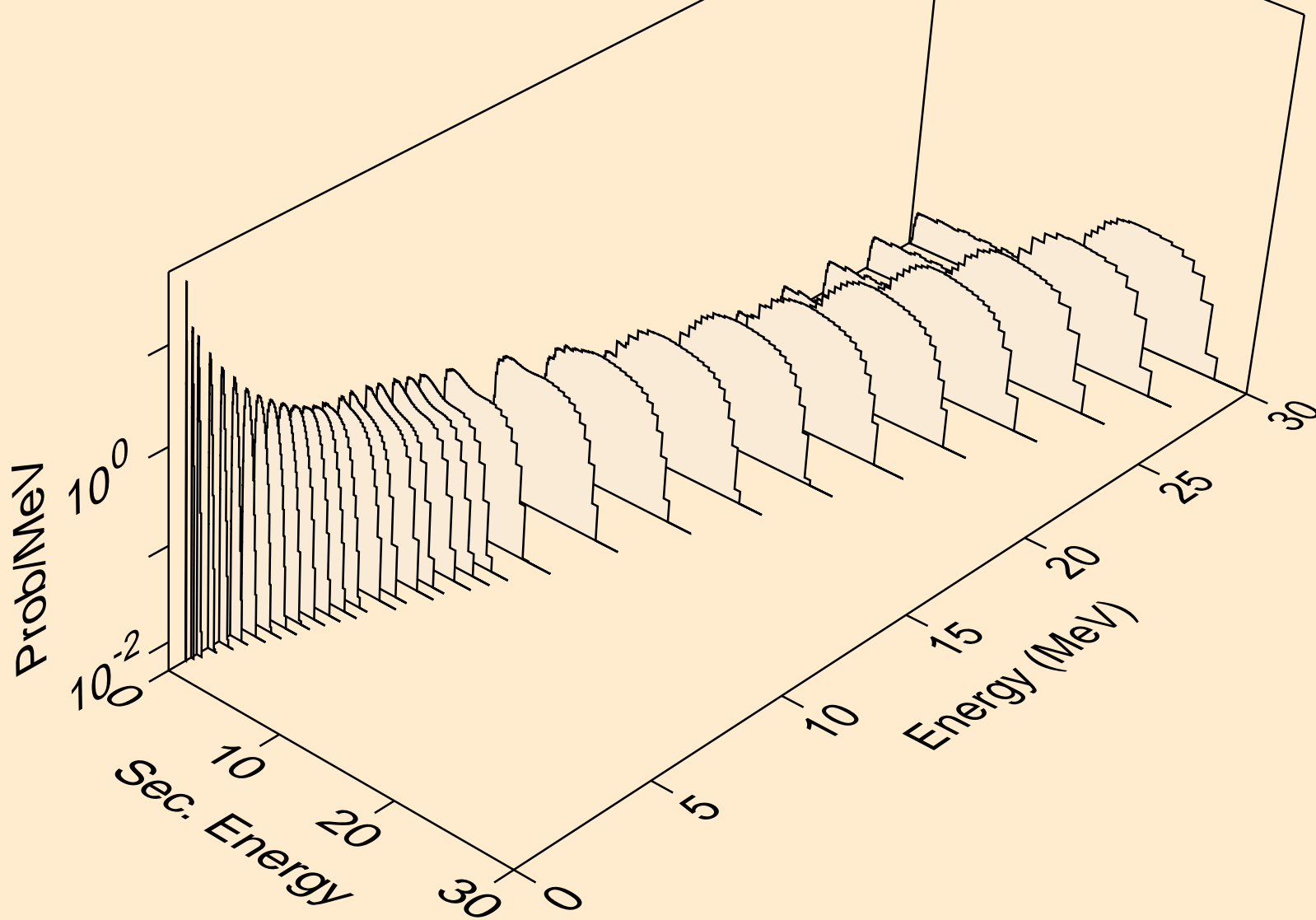

CS115 NEUTRON ACER TENDL-2019 LIBRARY; T=293.16K  
Neutron emission for (n,n\*)2a

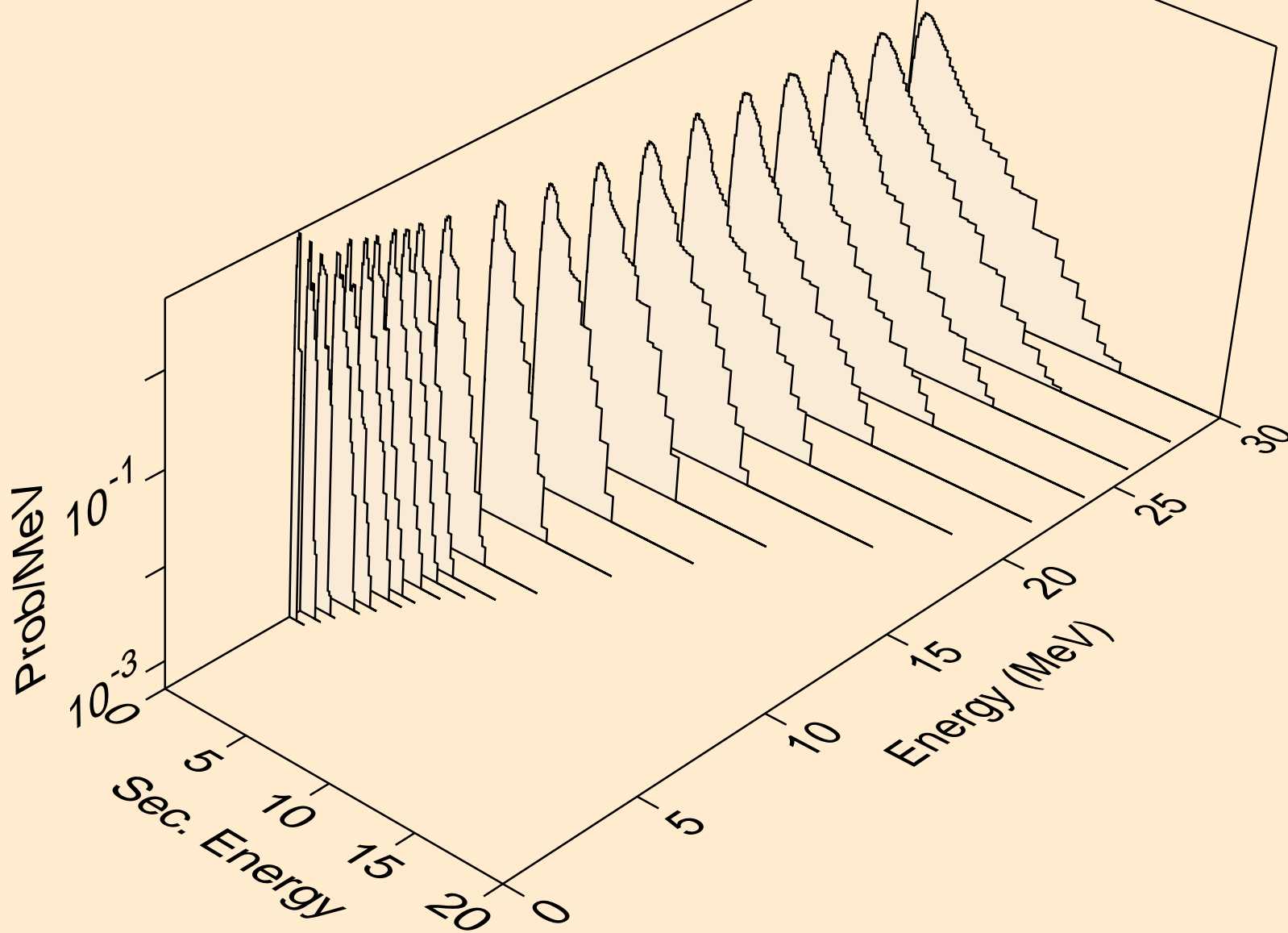

CS115 NEUTRON ACER TENDL-2019 LIBRARY; T=293.16K  
Neutron emission for (n,2n)2a

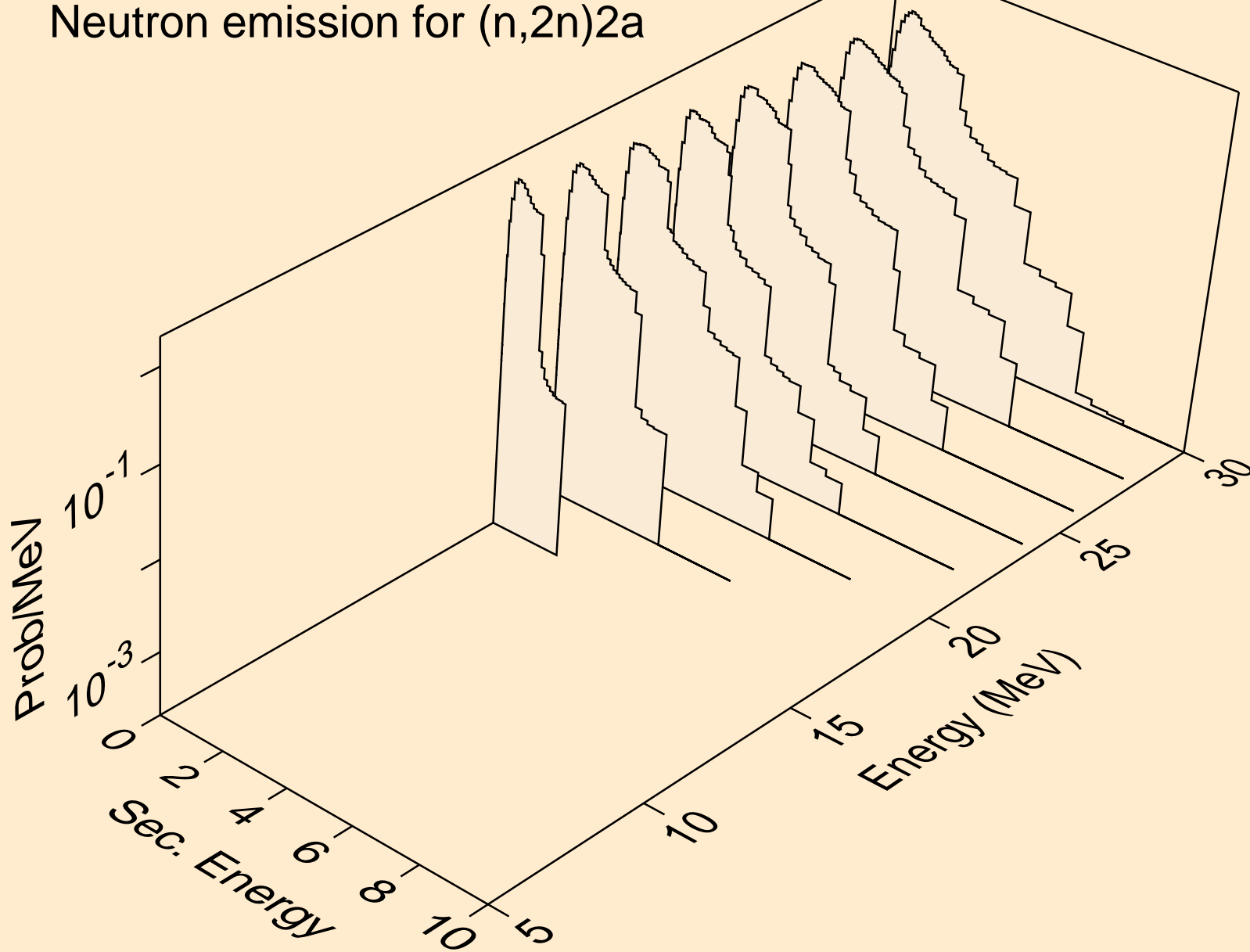



CS115 NEUTRON ACER TENDL-2019 LIBRARY; T=293.16K  
Neutron emission for (n,n\*)d

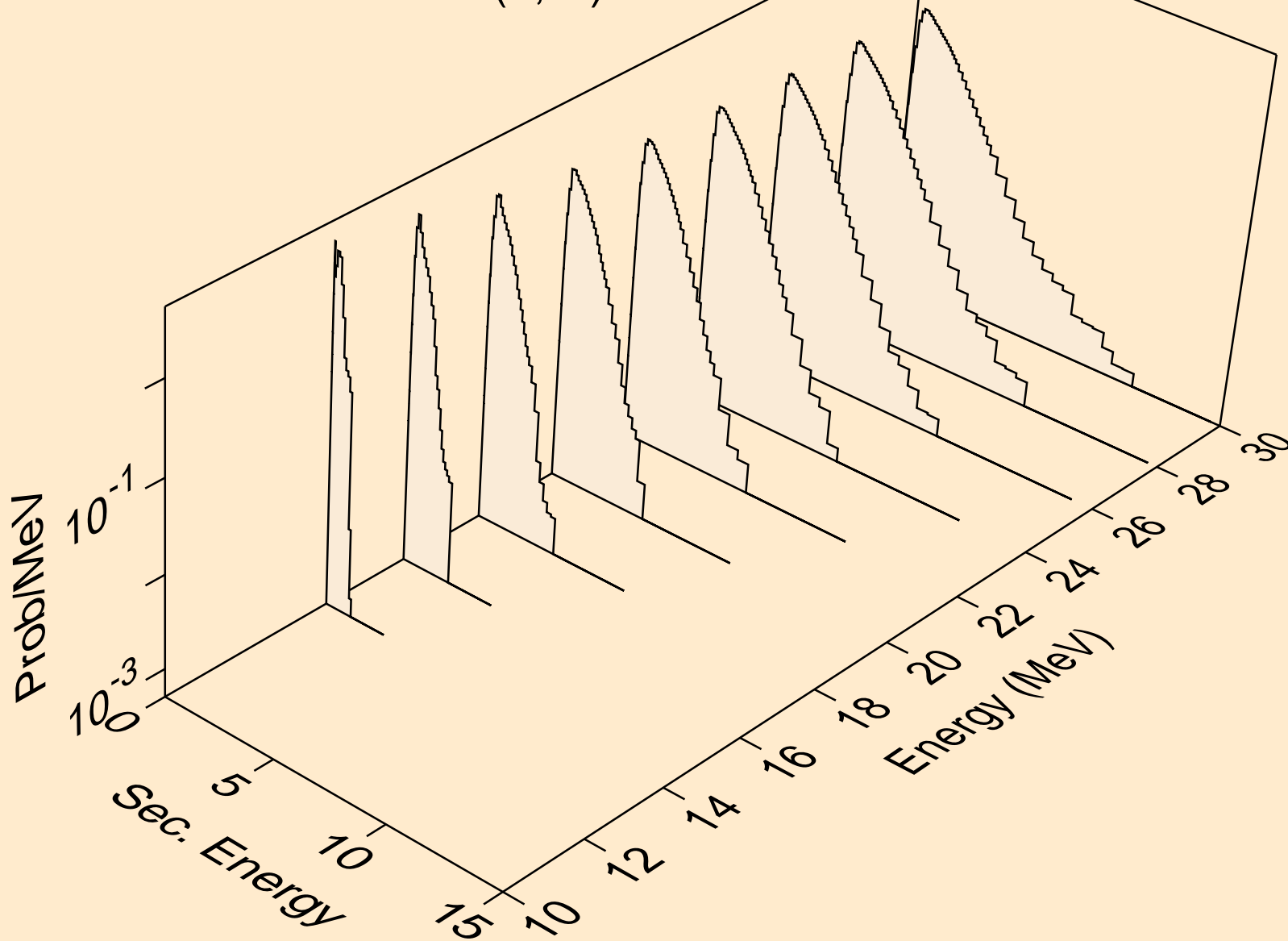

CS115 NEUTRON ACER TENDL-2019 LIBRARY; T=293.16K  
Neutron emission for (n,n\*)t

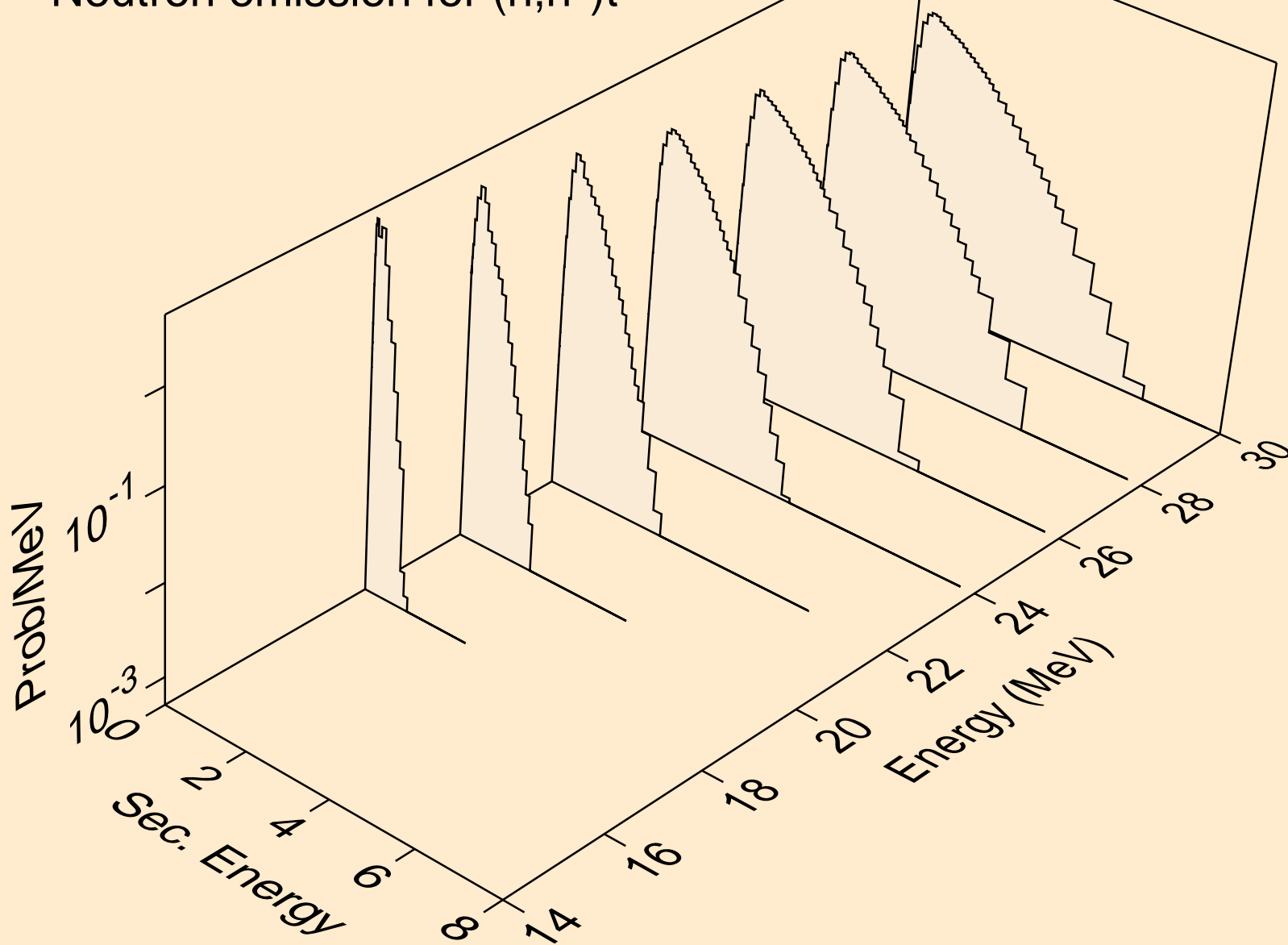

CS115 NEUTRON ACER TENDL-2019 LIBRARY; T=293.16K  
Neutron emission for (n,n\*)he3

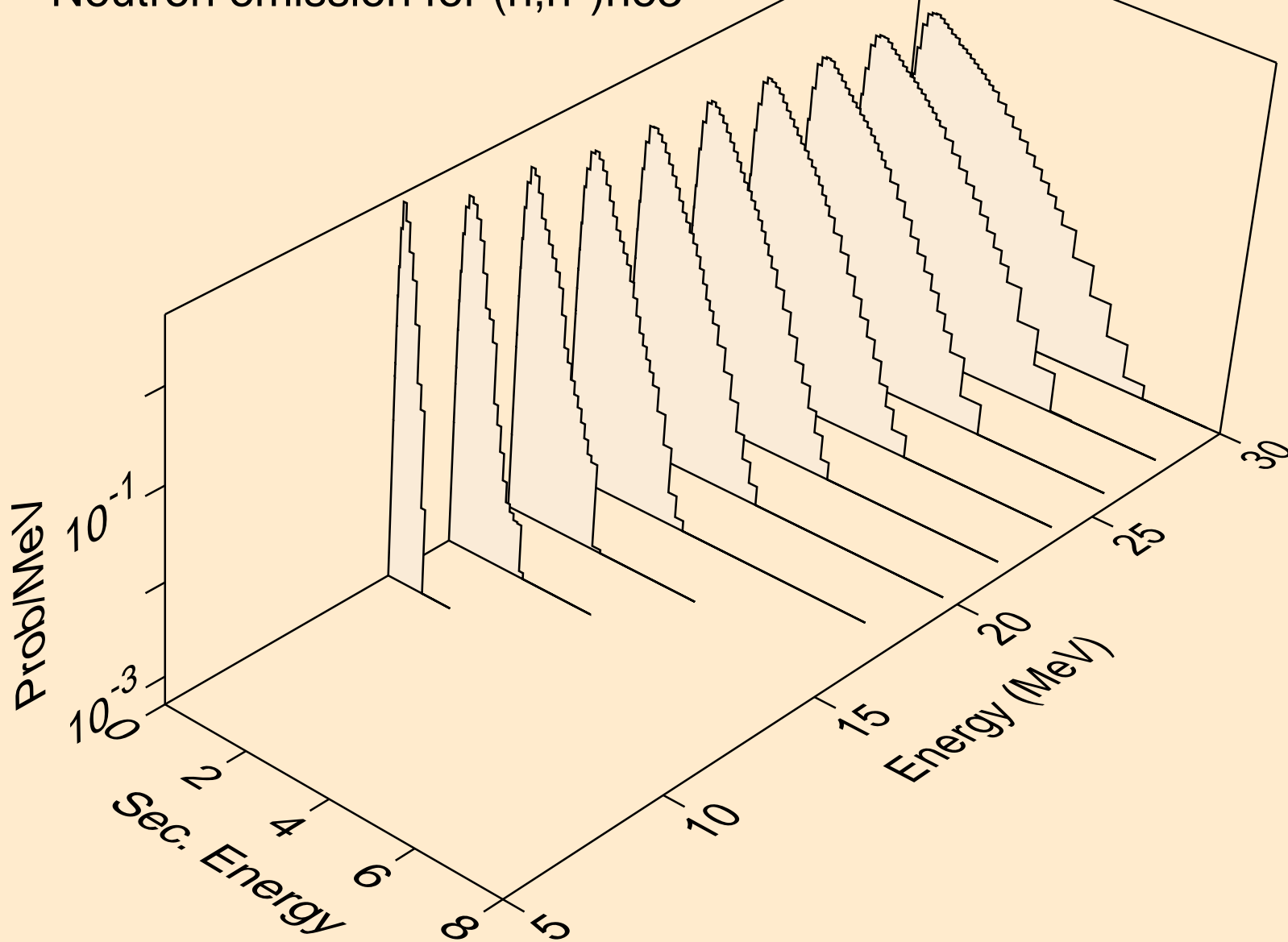

CS115 NEUTRON ACER TENDL-2019 LIBRARY; T=293.16K  
Neutron emission for (n,2np)

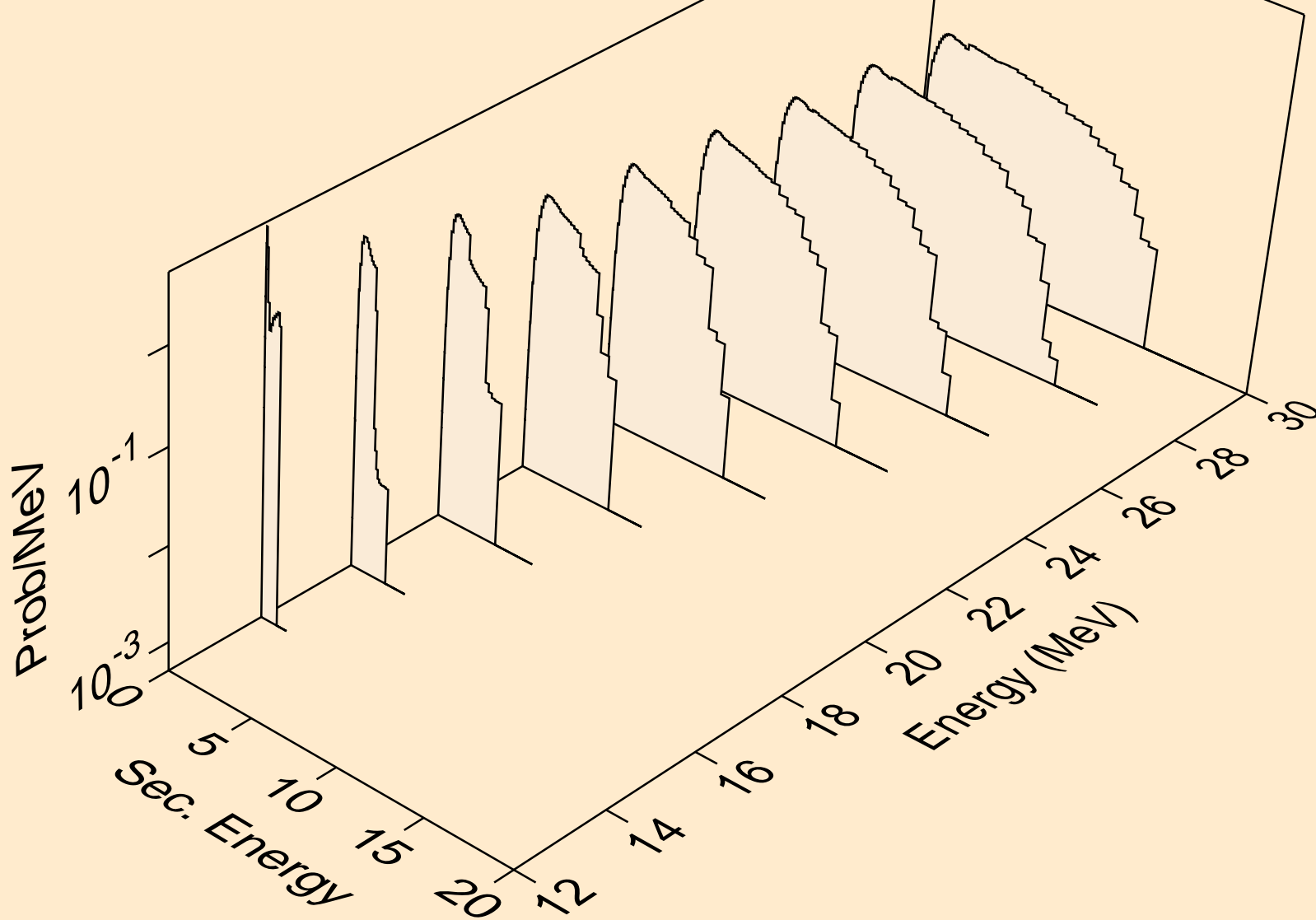

CS115 NEUTRON ACER TENDL-2019 LIBRARY; T=293.16K  
Neutron emission for (n,3np)

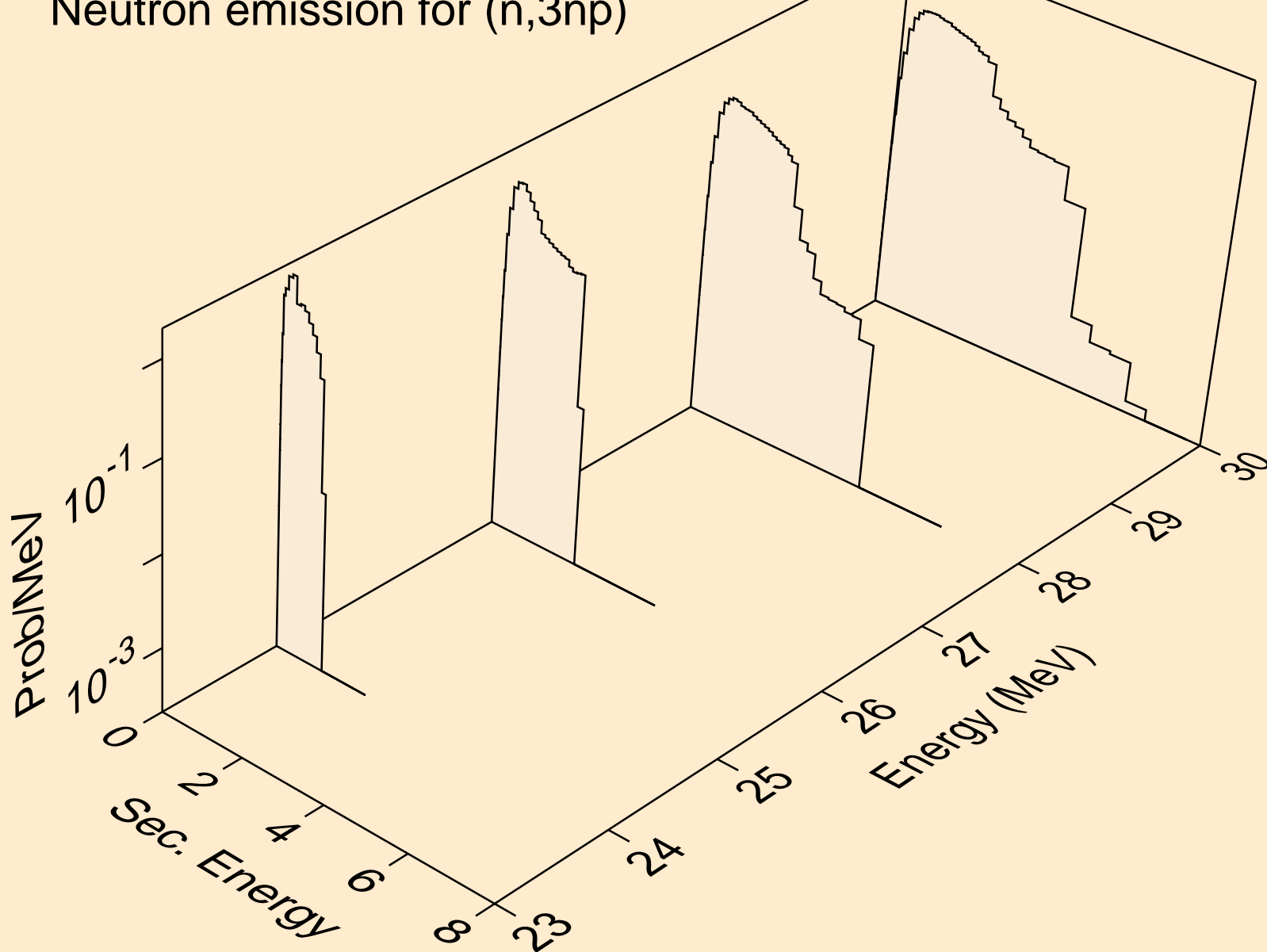

CS115 NEUTRON ACER TENDL-2019 LIBRARY; T=293.16K  
Neutron emission for (n,2np)

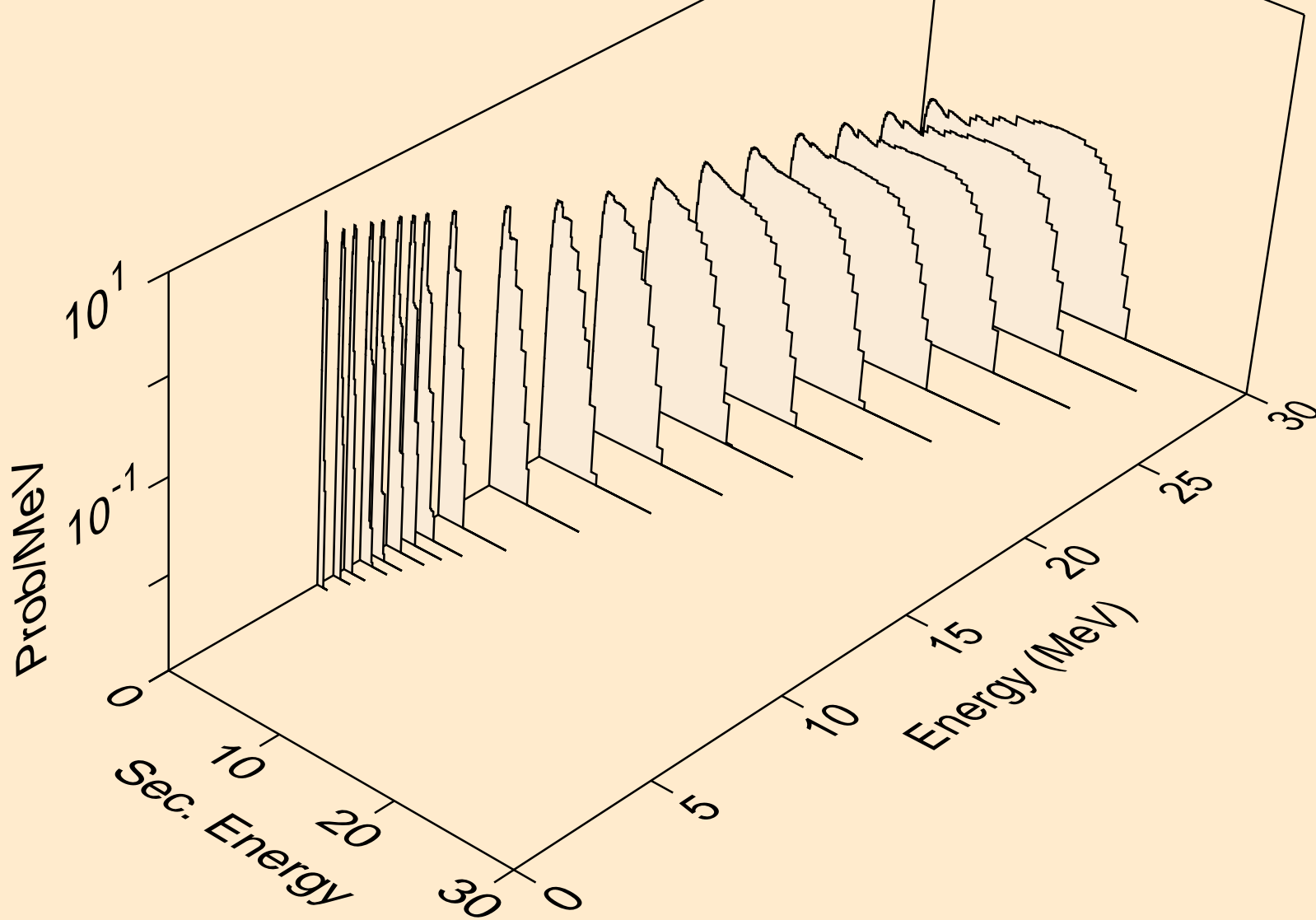

CS115 NEUTRON ACER TENDL-2019 LIBRARY; T=293.16K  
Neutron emission for (n,npa)

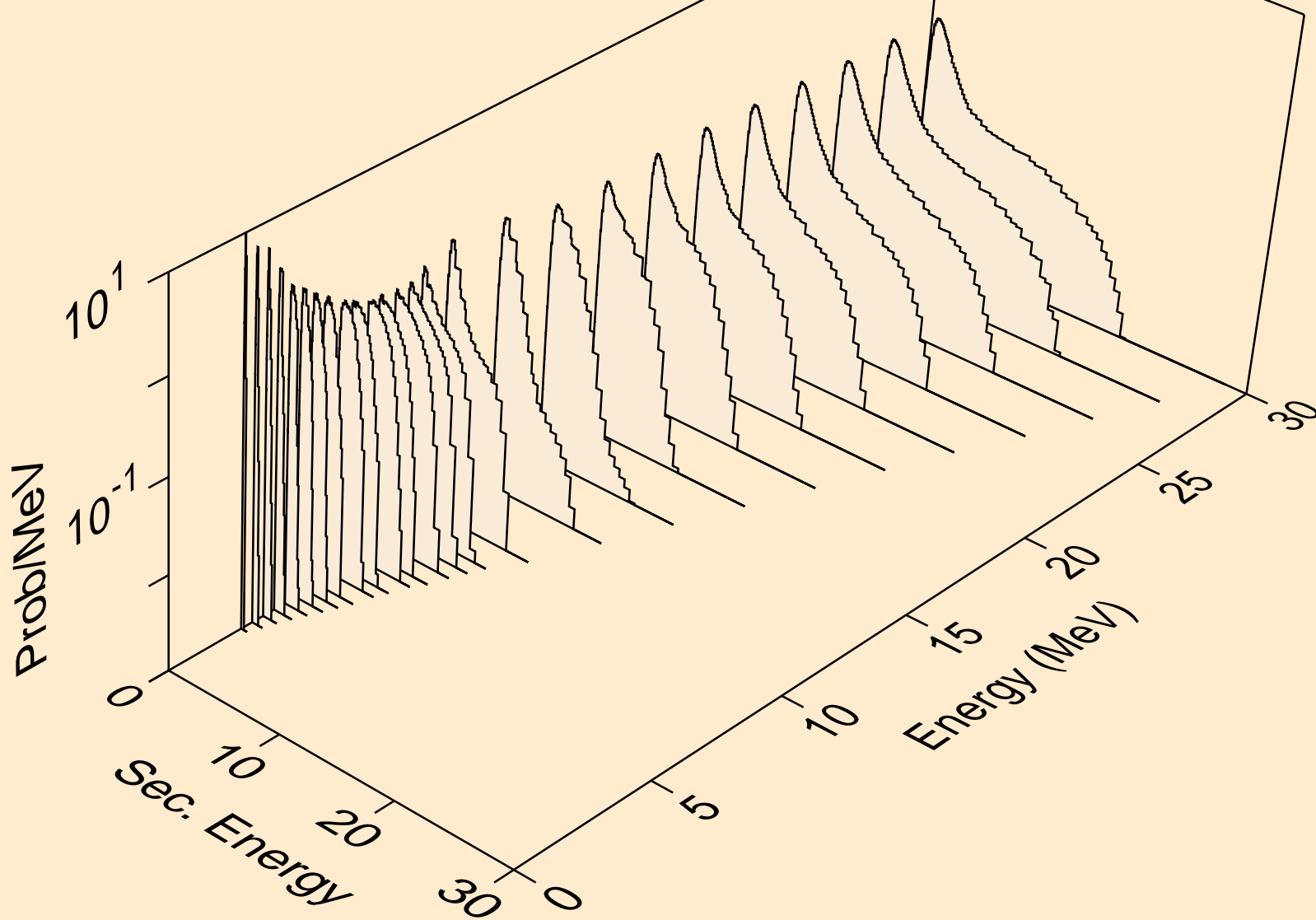

CS115 NEUTRON ACER TENDL-2019 LIBRARY; T=293.16K  
Neutron emission for (n,n\*c)

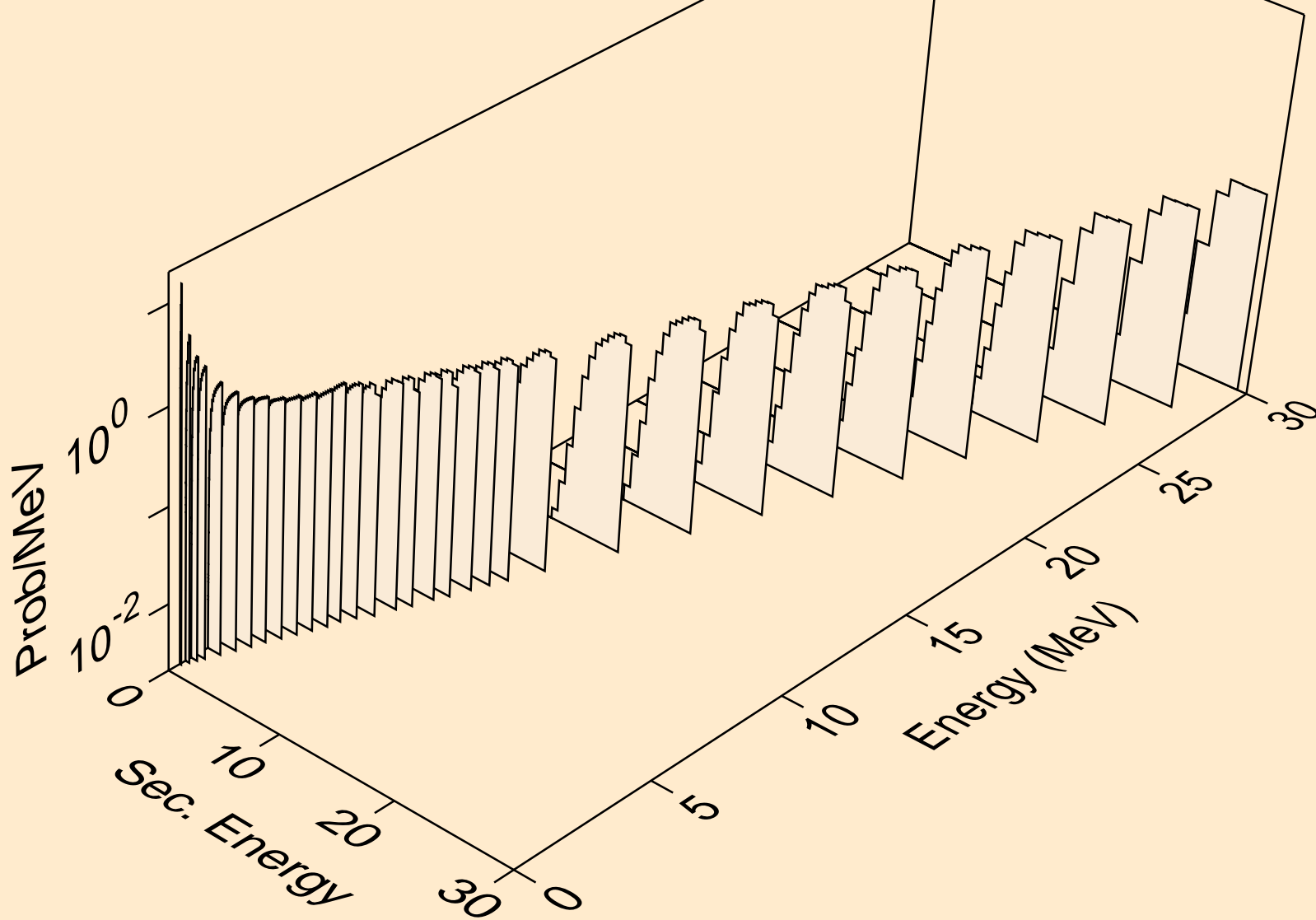



CS115 NEUTRON ACER TENDL-2019 LIBRARY; T=293.16K  
Photon emission for (n,x)

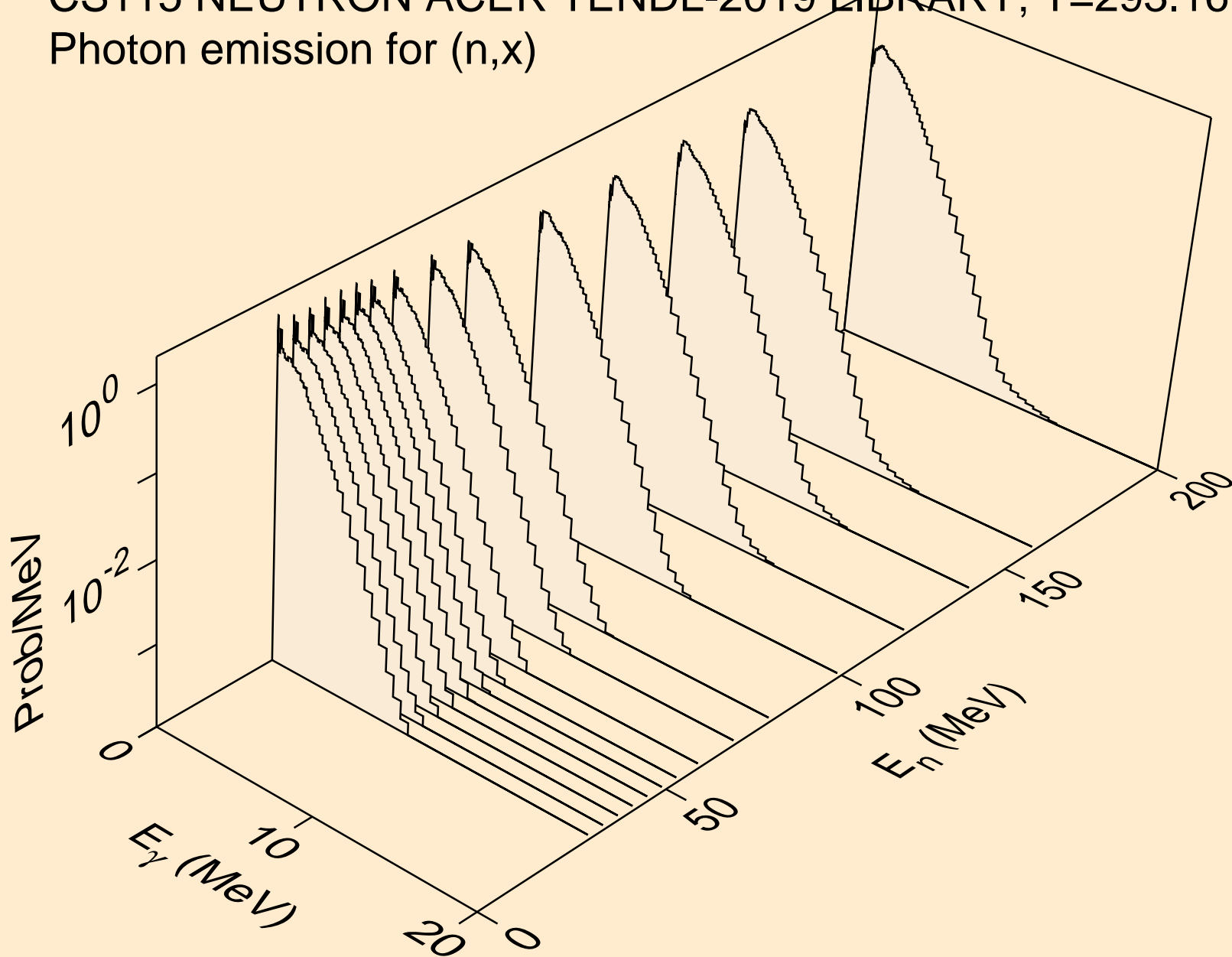

CS115 NEUTRON ACER TENDL-2019 LIBRARY; T=293.16K  
Photon emission for (n,2nd)

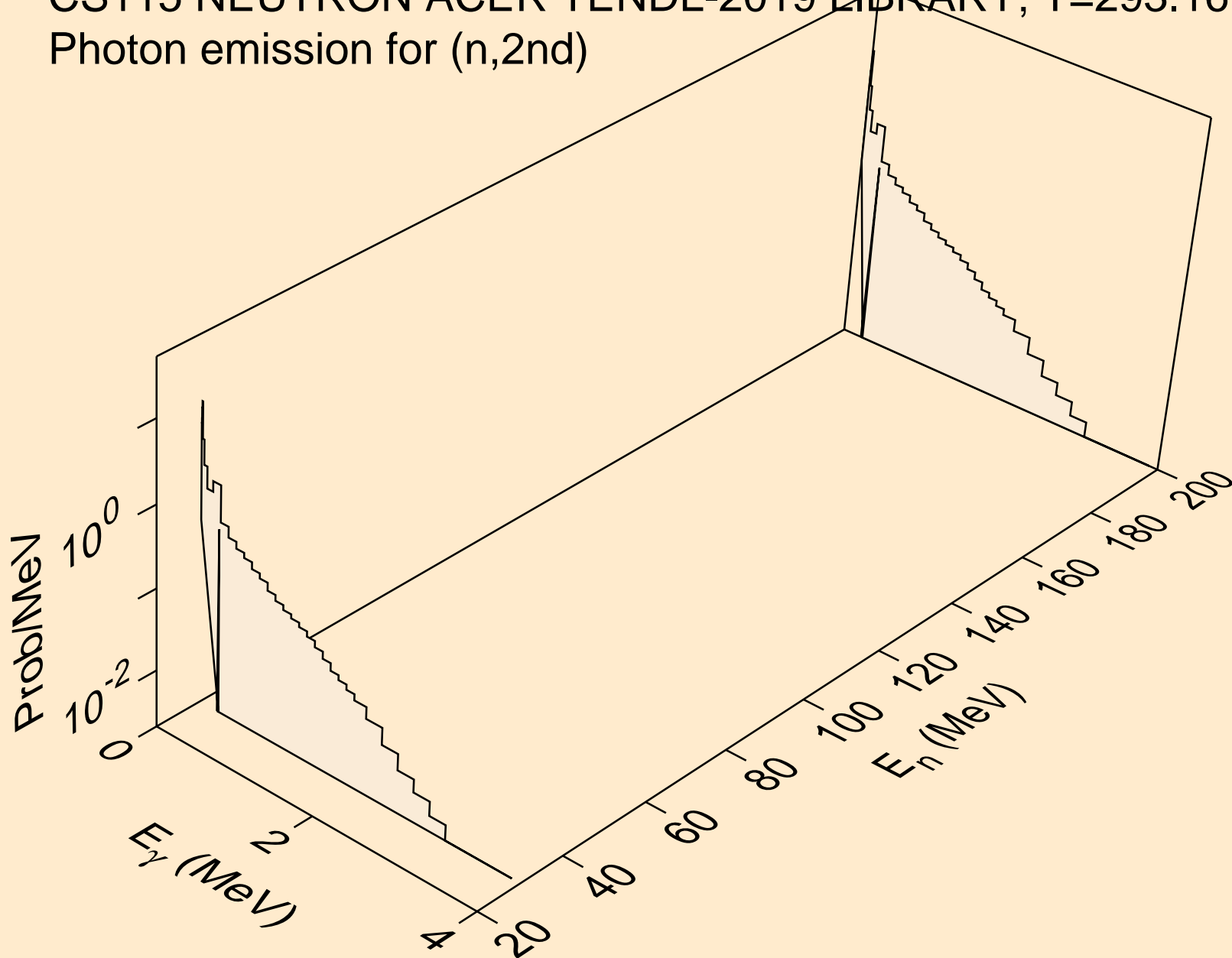

CS115 NEUTRON ACER TENDL-2019 LIBRARY; T=293.16K  
Photon emission for (n,2n)

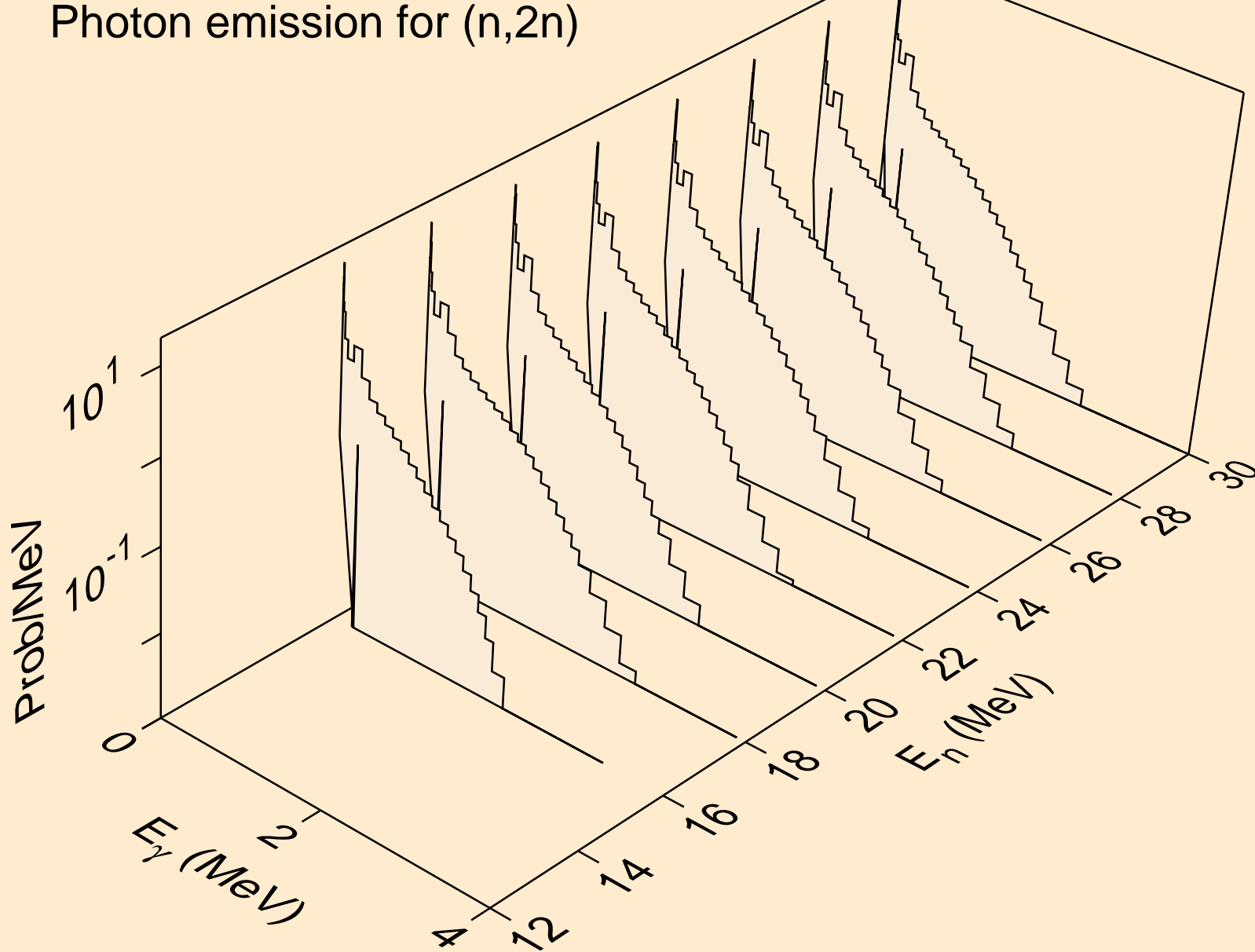

CS115 NEUTRON ACER TENDL-2019 LIBRARY; T=293.16K  
Photon emission for (n,3n)

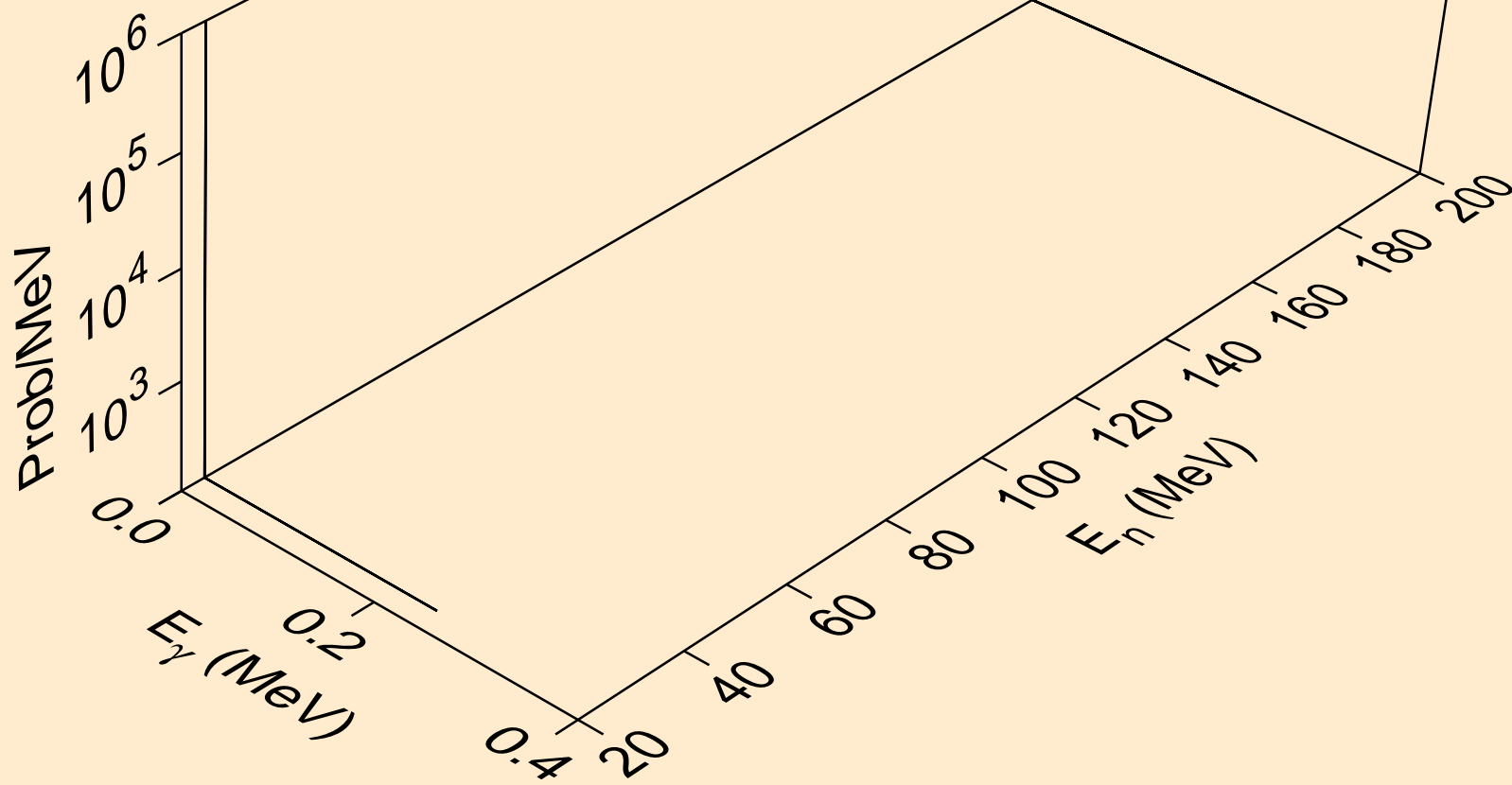

CS115 NEUTRON ACER TENDL-2019 LIBRARY; T=293.16K  
Photon emission for (n,n\*)a

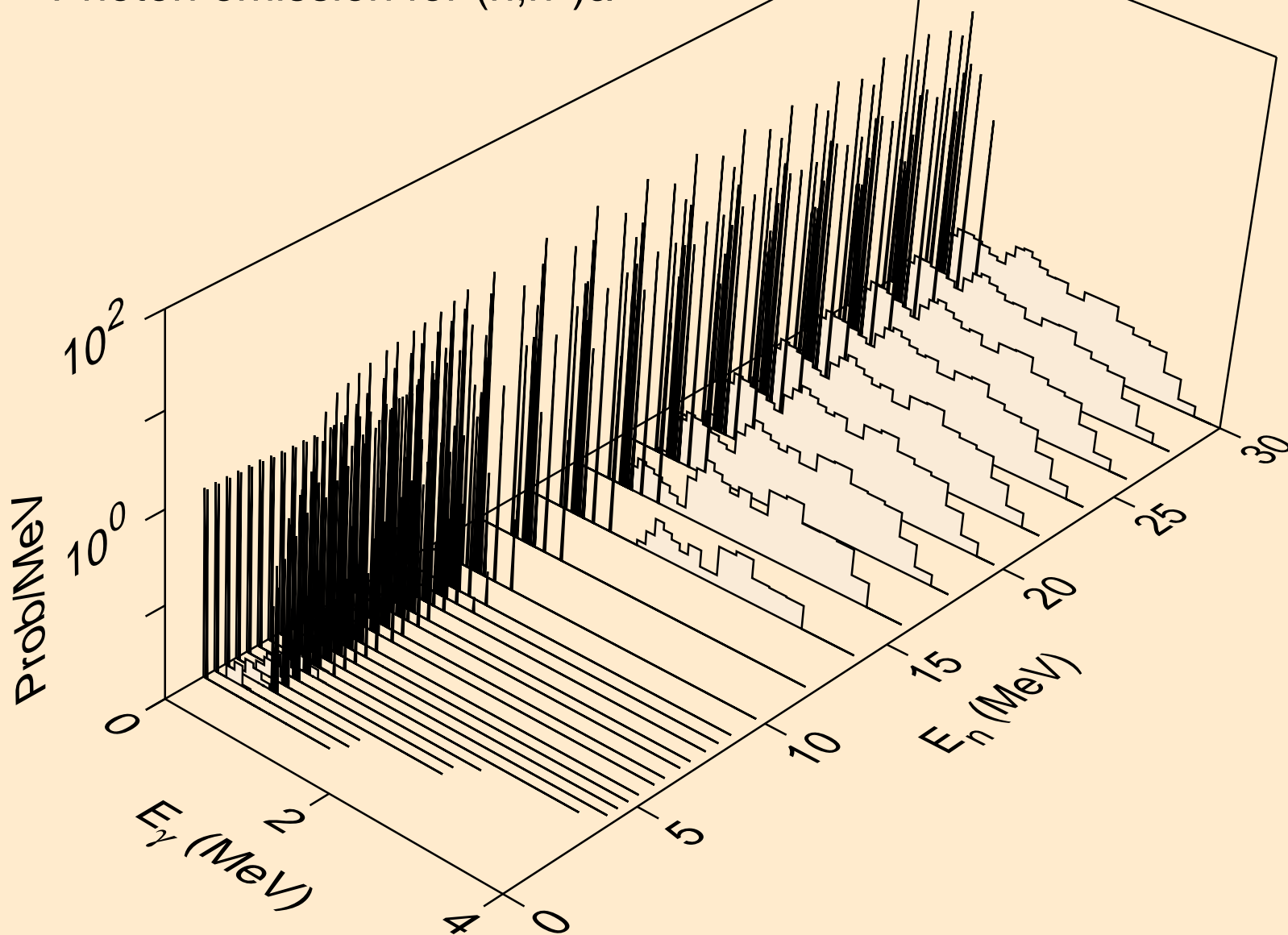

CS115 NEUTRON ACER TENDL-2019 LIBRARY; T=293.16K  
Photon emission for (n,n\*)3a

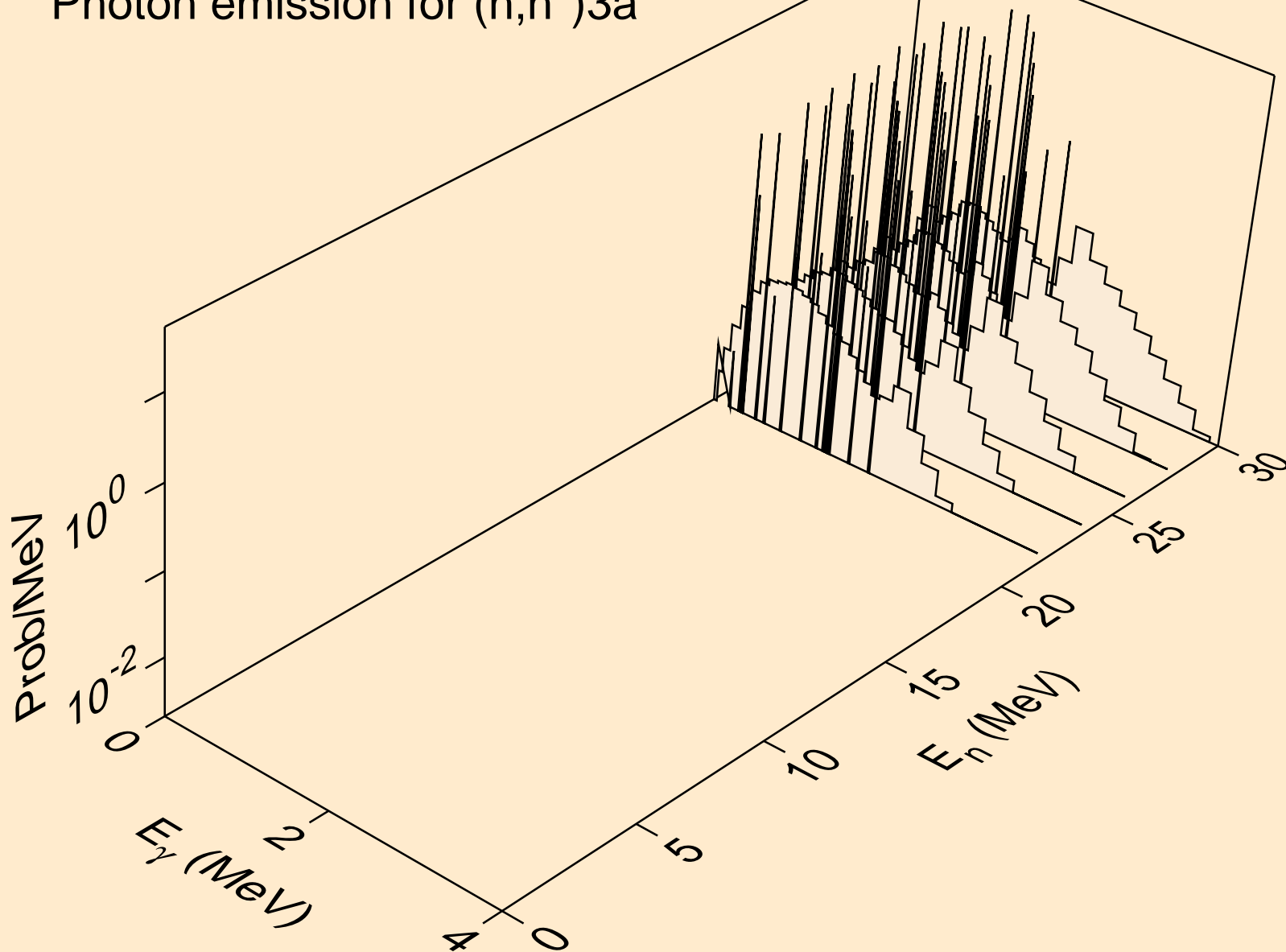

CS115 NEUTRON ACER TENDL-2019 LIBRARY; T=293.16K  
Photon emission for (n,2n) $\alpha$

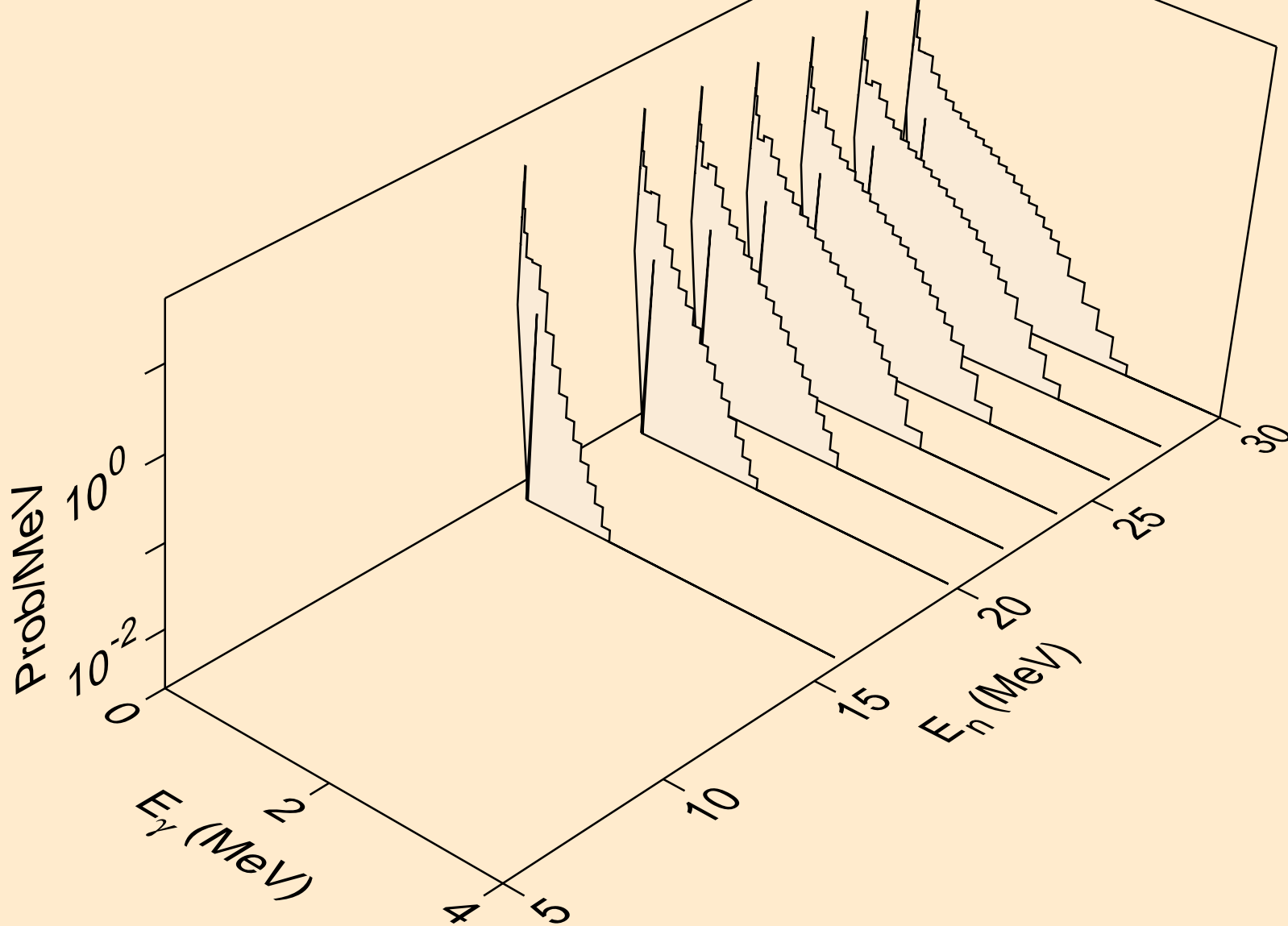

CS115 NEUTRON ACER TENDL-2019 LIBRARY; T=293.16K  
Photon emission for (n,n\*)p

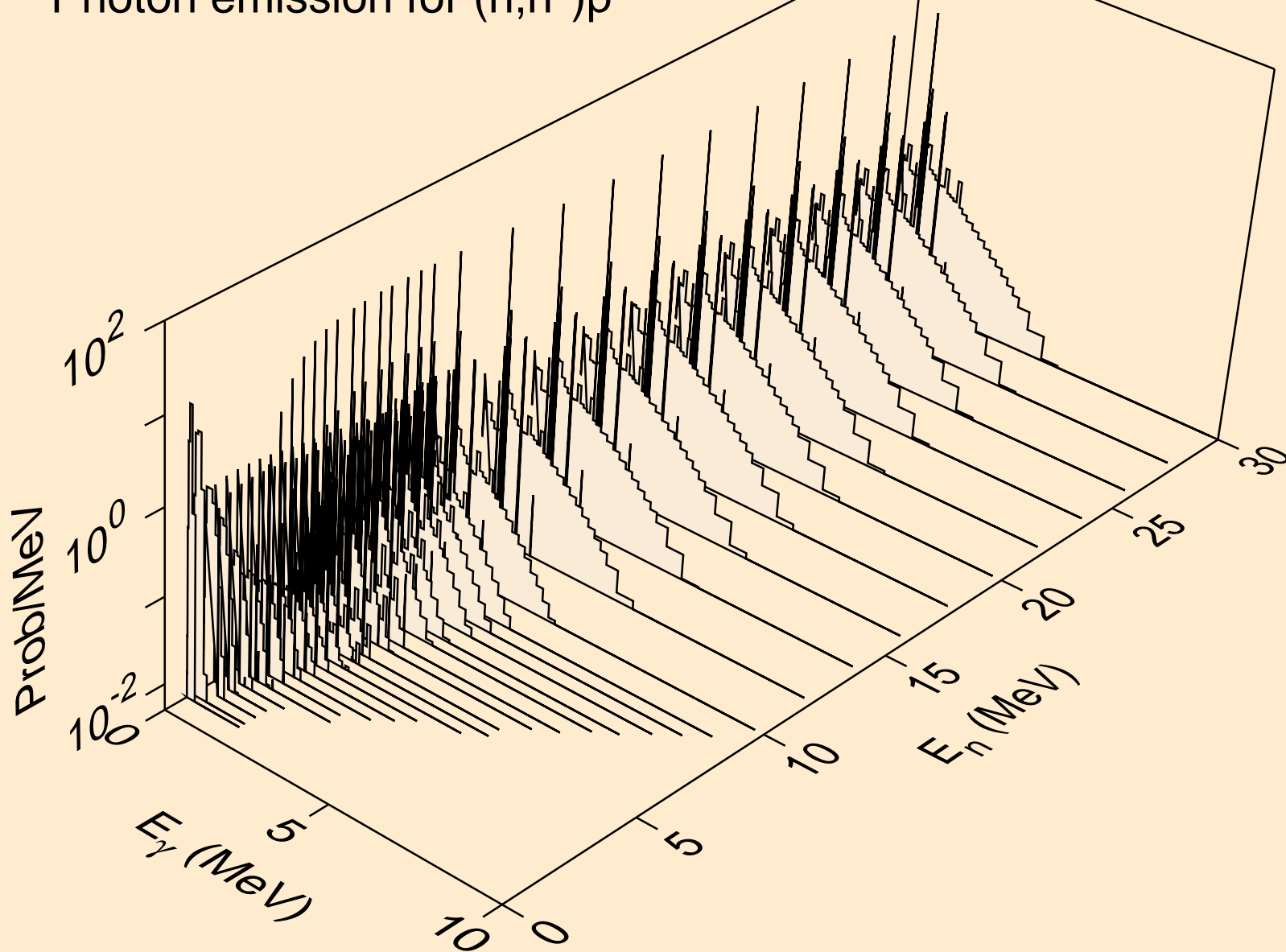



CS115 NEUTRON ACER TENDL-2019 LIBRARY; T=293.16K  
Photon emission for (n,n\*)2a

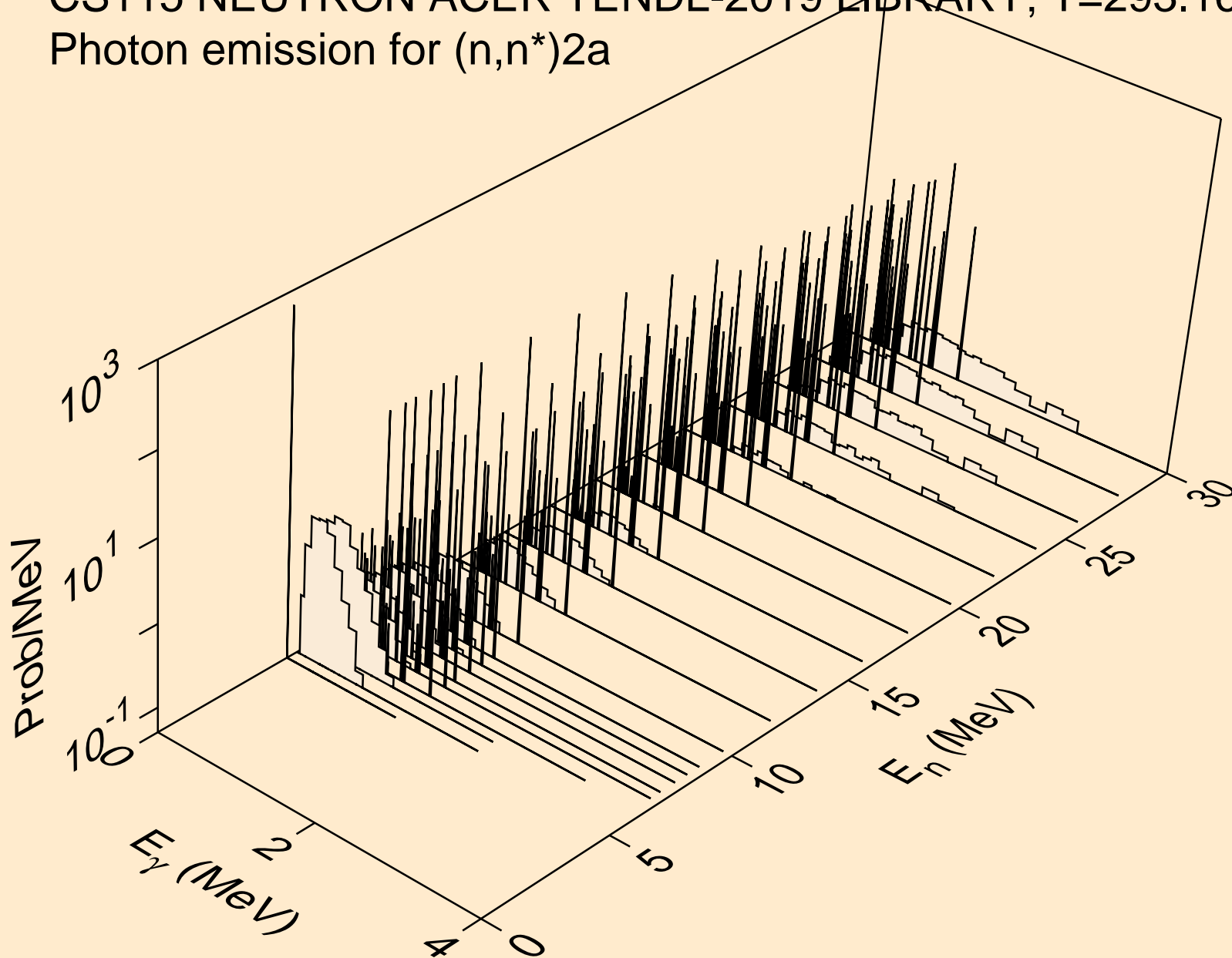

CS115 NEUTRON ACER TENDL-2019 LIBRARY; T=293.16K  
Photon emission for (n,2n)2a

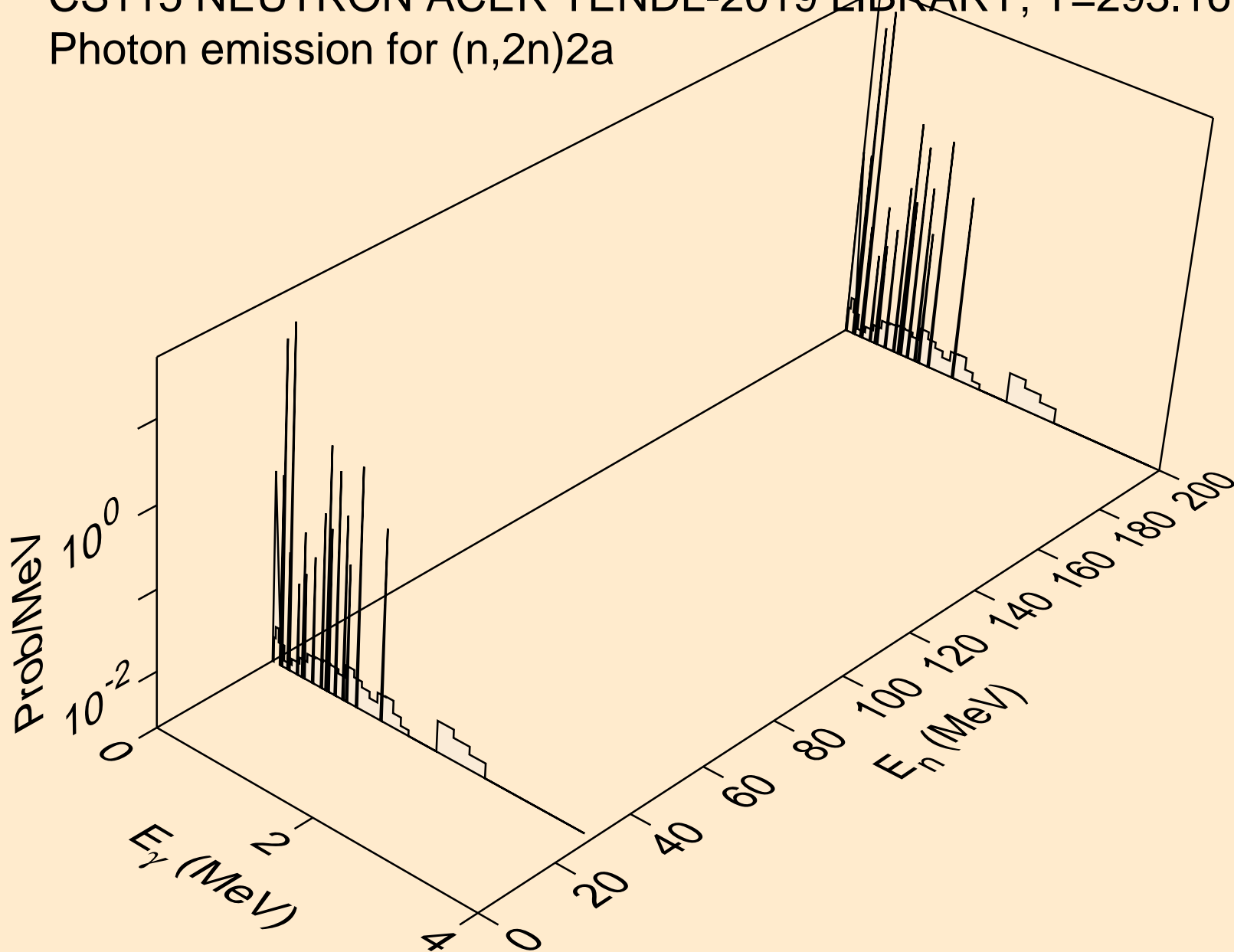

CS115 NEUTRON ACER TENDL-2019 LIBRARY; T=293.16K  
Photon emission for (n,n\*)d

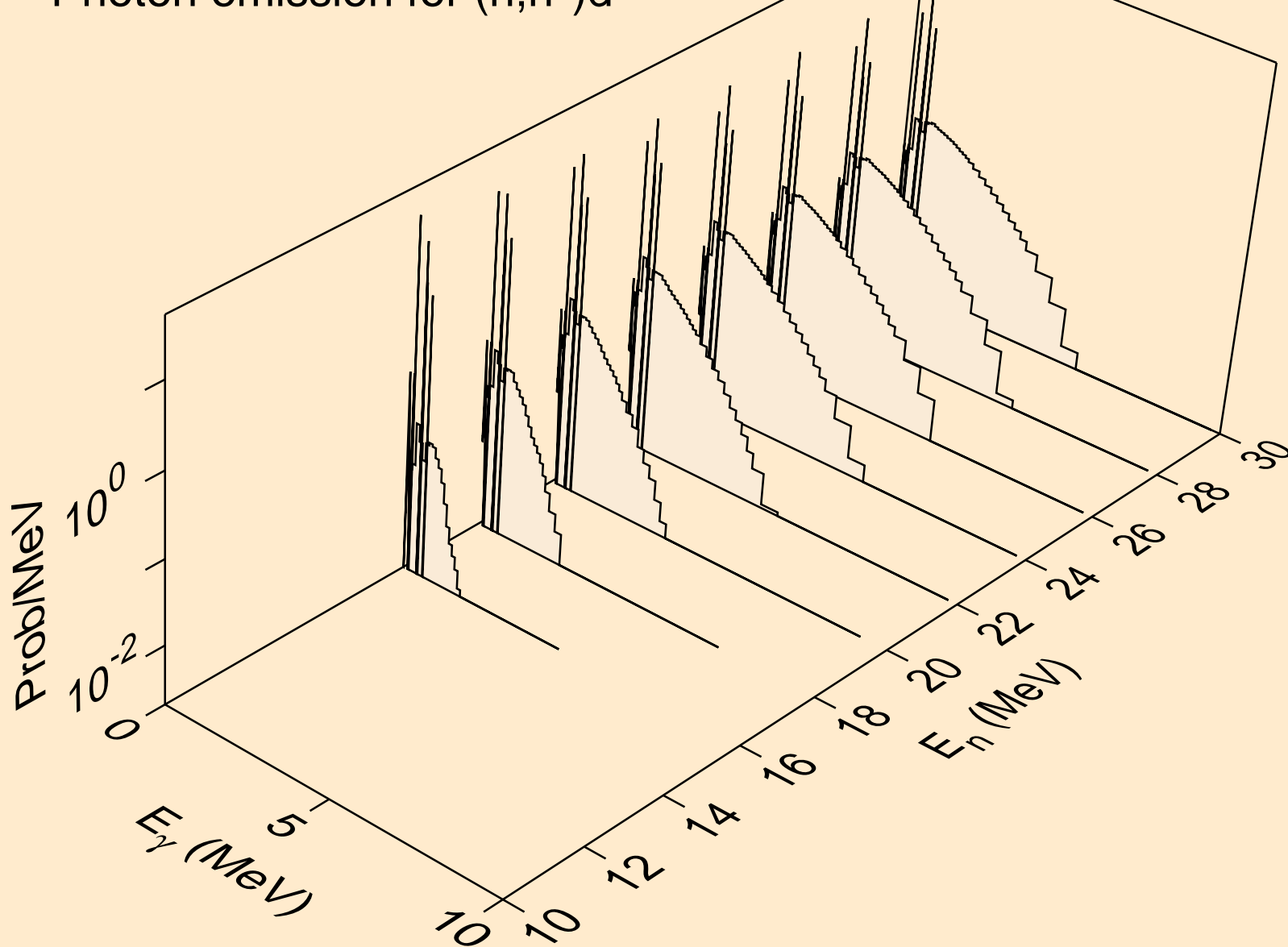

CS115 NEUTRON ACER TENDL-2019 LIBRARY; T=293.16K  
Photon emission for (n,n\*)t

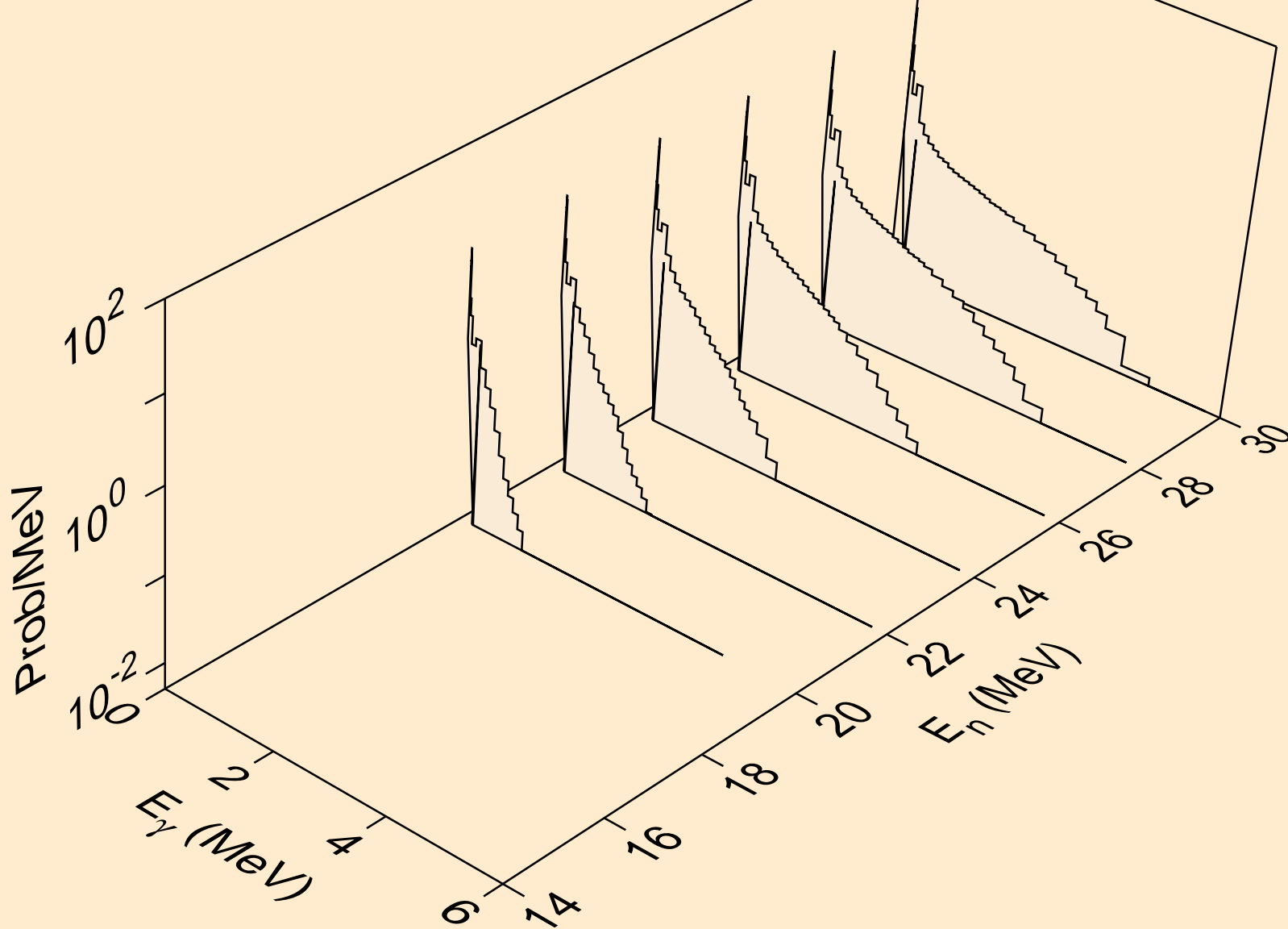

CS115 NEUTRON ACER TENDL-2019 LIBRARY; T=293.16K  
Photon emission for (n,n\*)he3

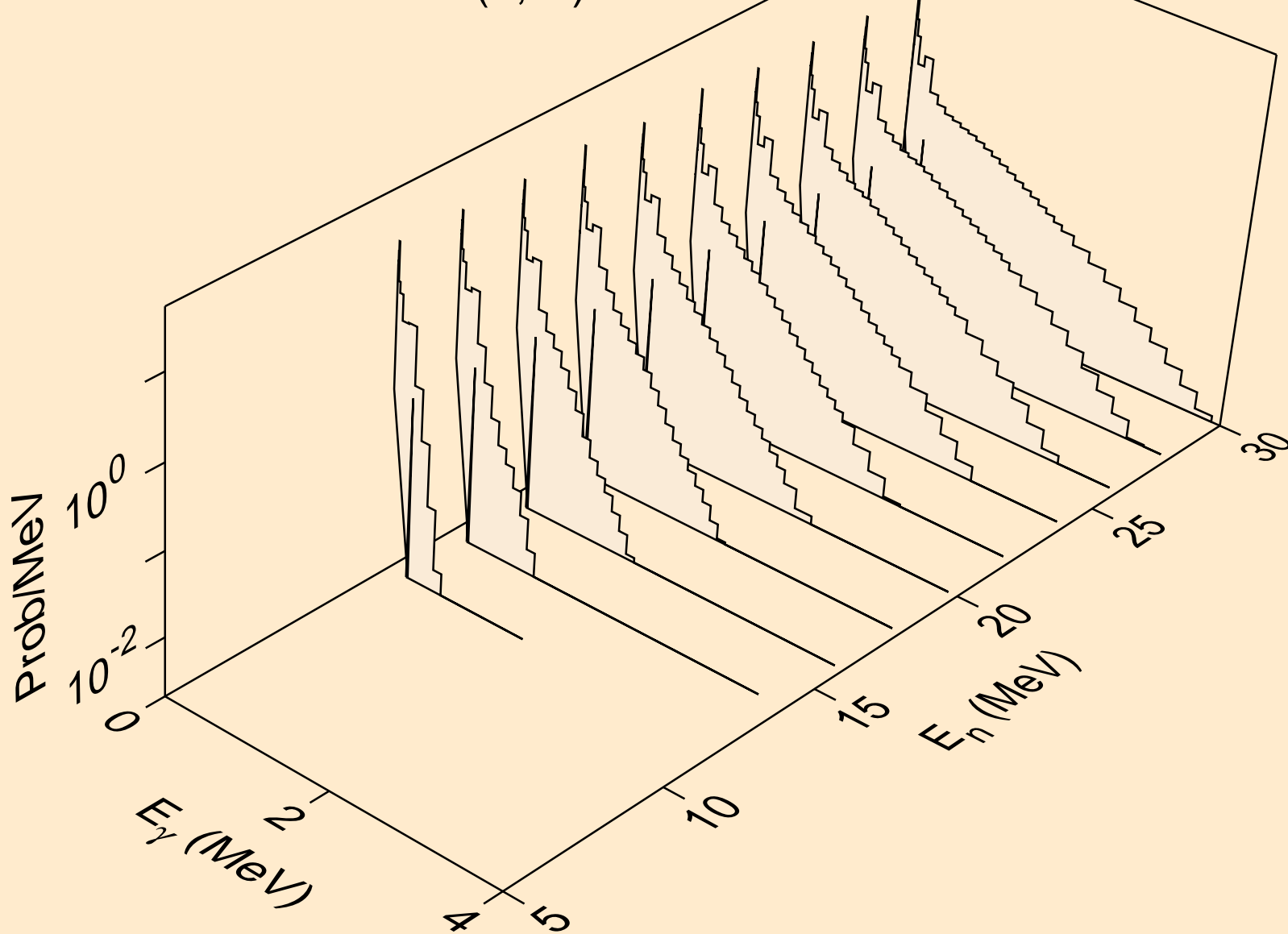

CS115 NEUTRON ACER TENDL-2019 LIBRARY; T=293.16K  
Photon emission for (n,2np)

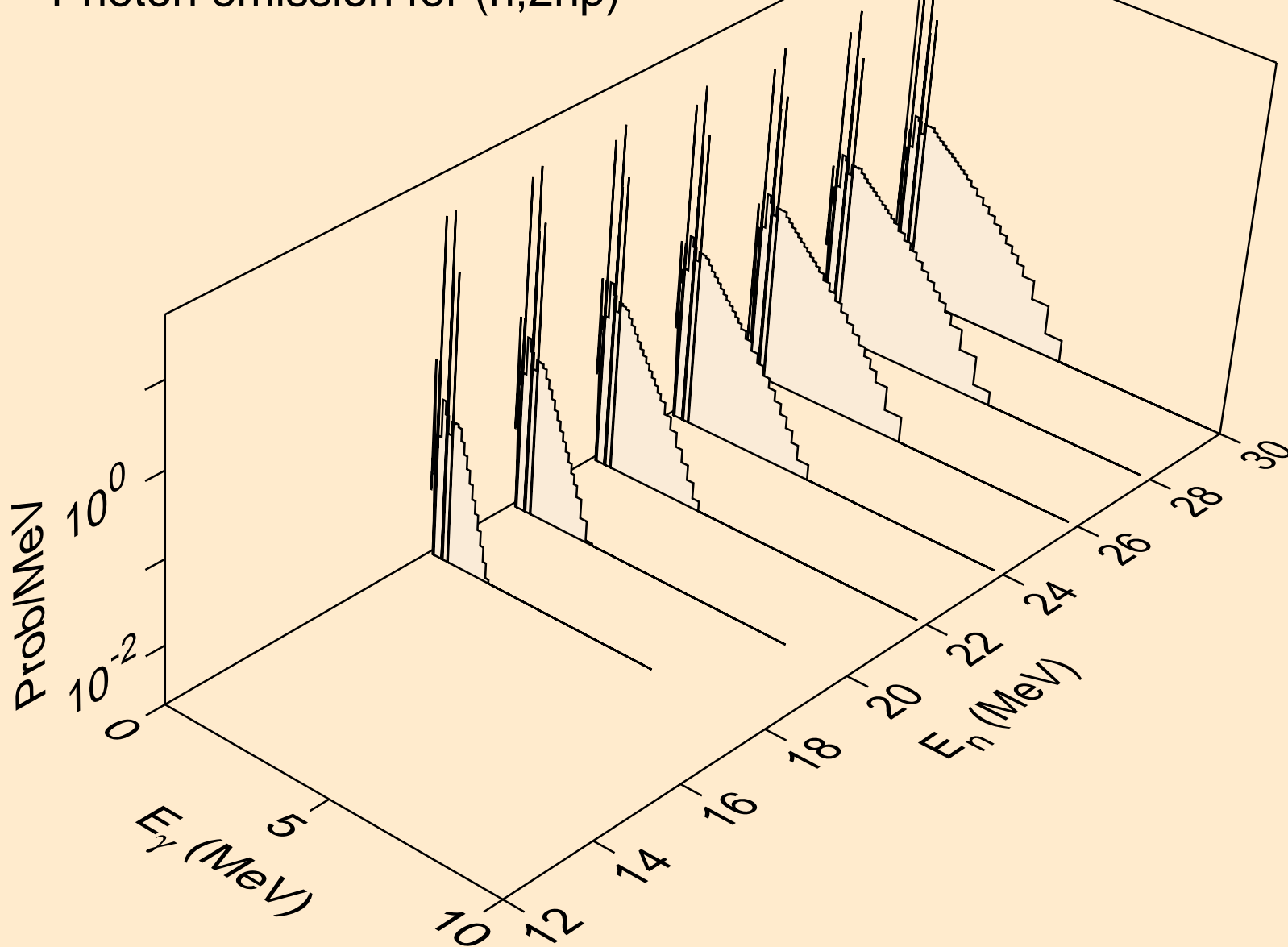

CS115 NEUTRON ACER TENDL-2019 LIBRARY; T=293.16K  
Photon emission for (n,3np)

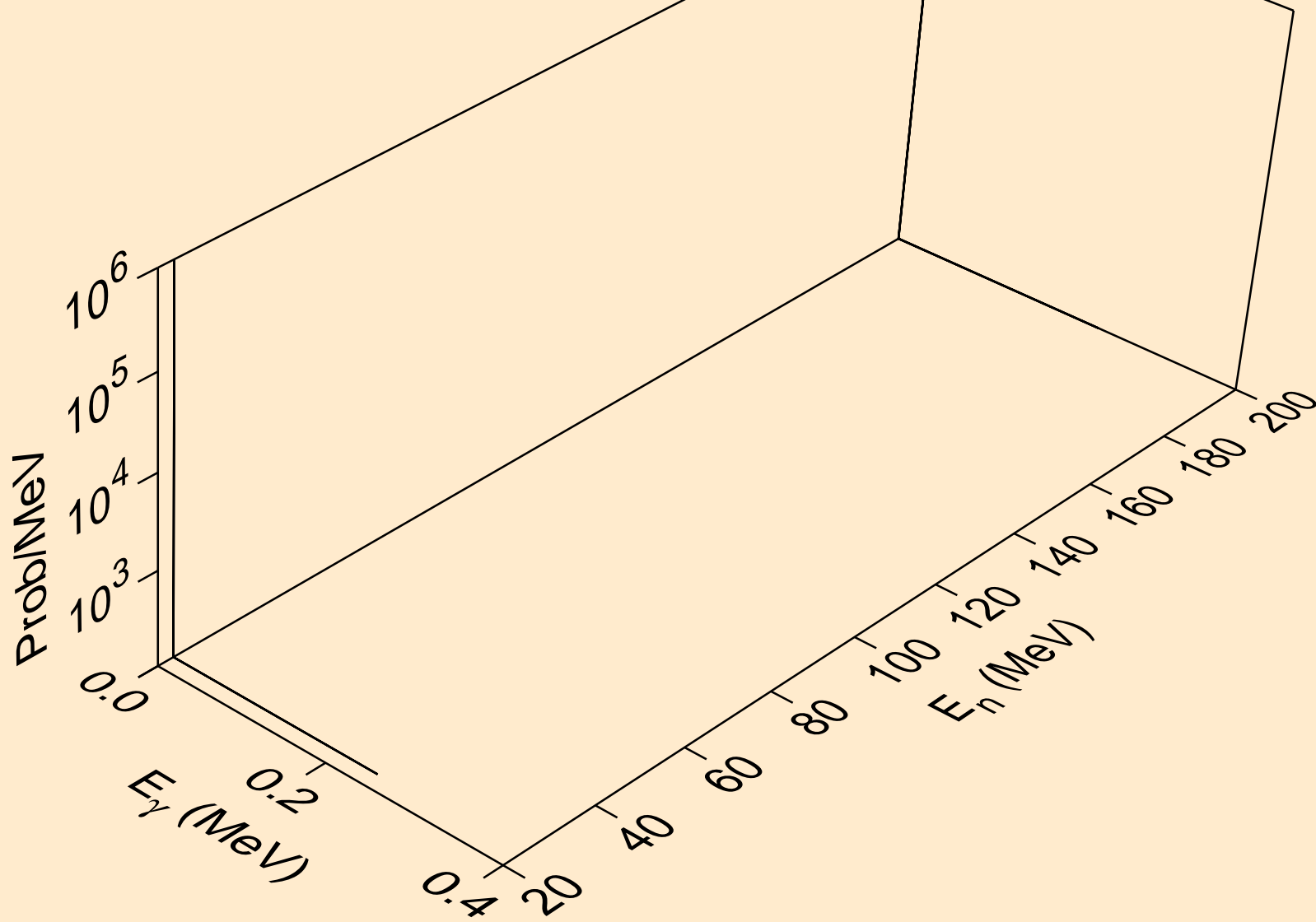

CS115 NEUTRON ACER TENDL-2019 LIBRARY; T=293.16K  
Photon emission for (n,2np)

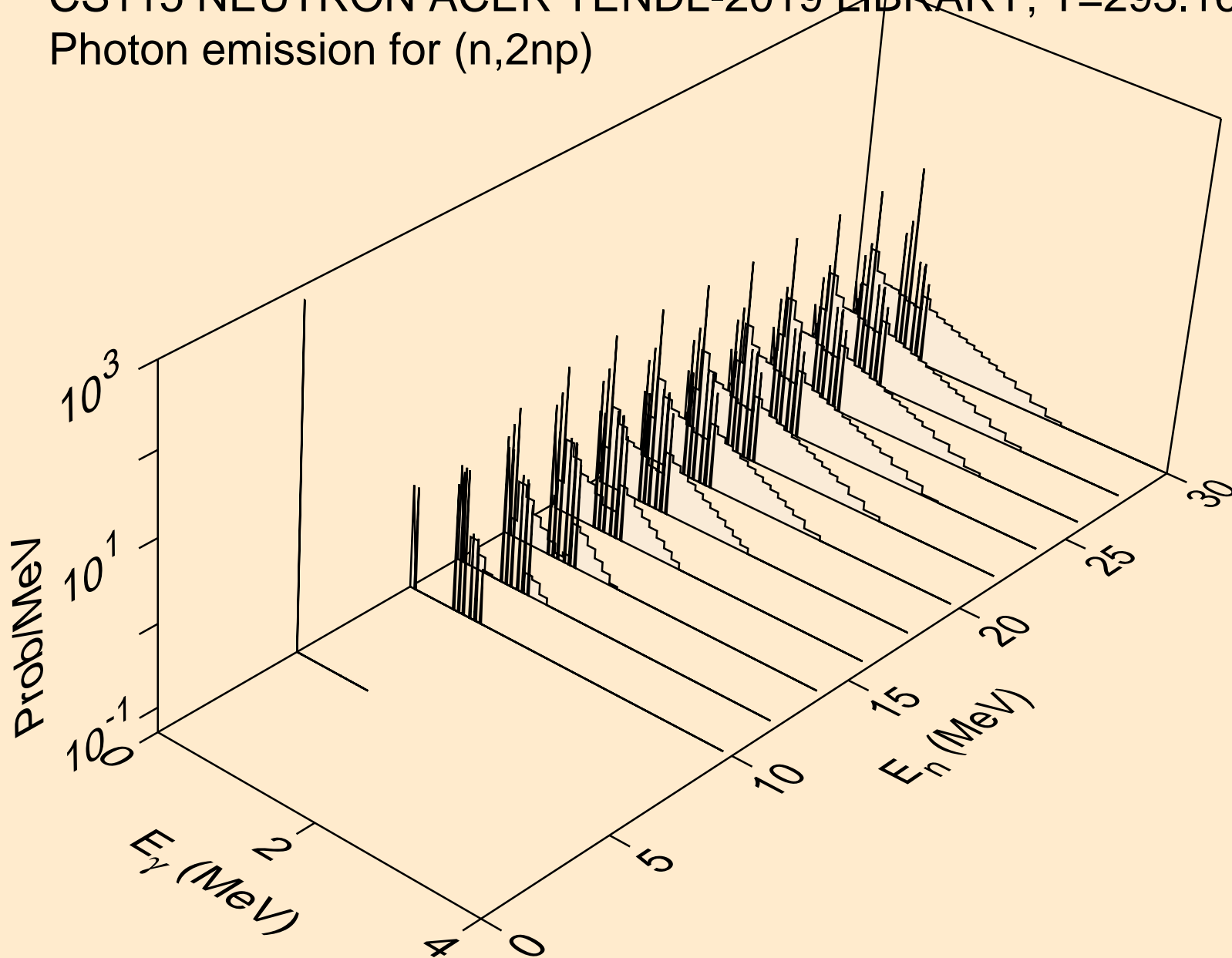



CS115 NEUTRON ACER TENDL-2019 LIBRARY; T=293.16K  
Photon emission for (n,npa)

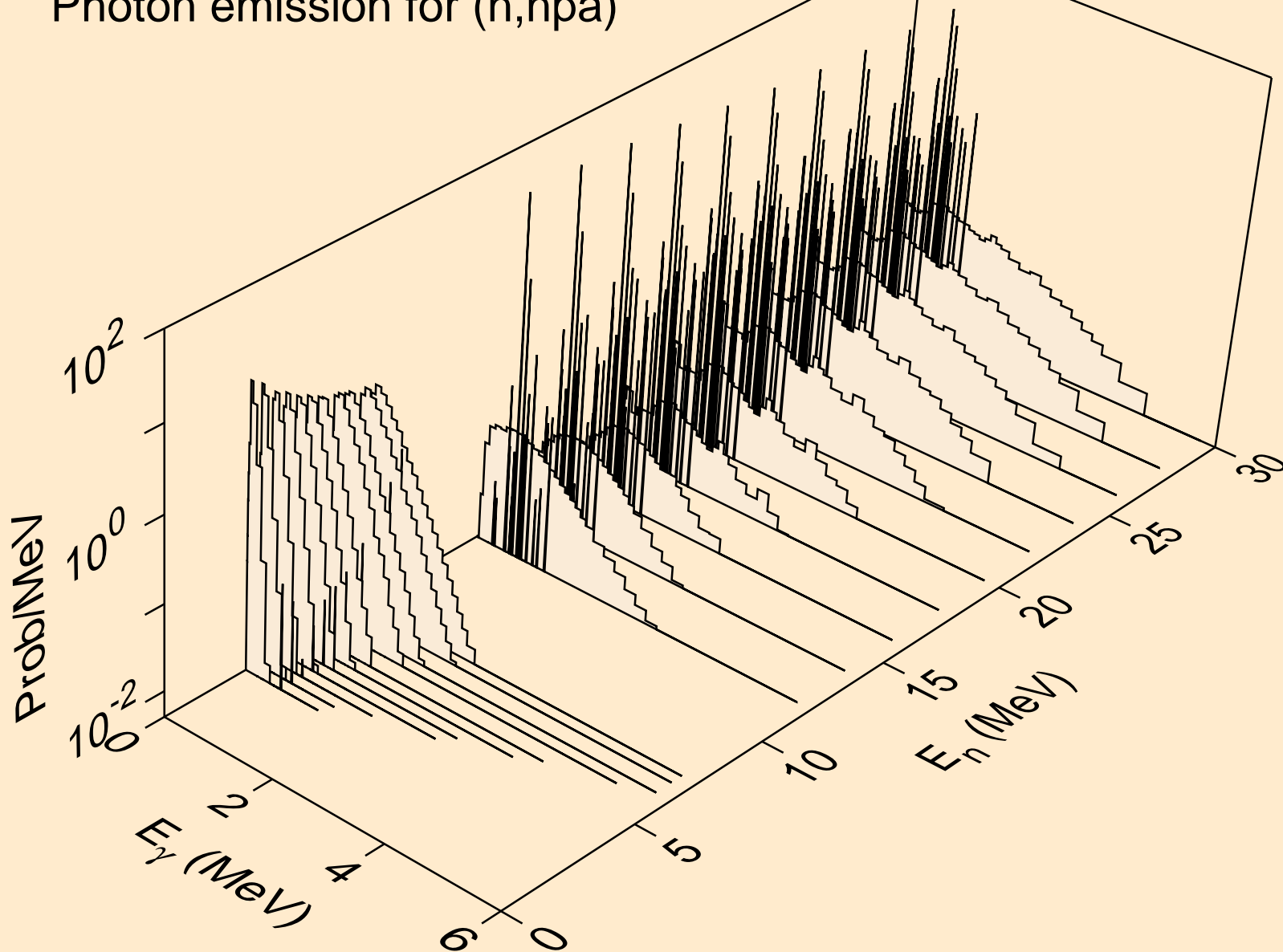

CS115 NEUTRON ACER TENDL-2019 LIBRARY; T=293.16K  
Photon emission for (n,n\*c)

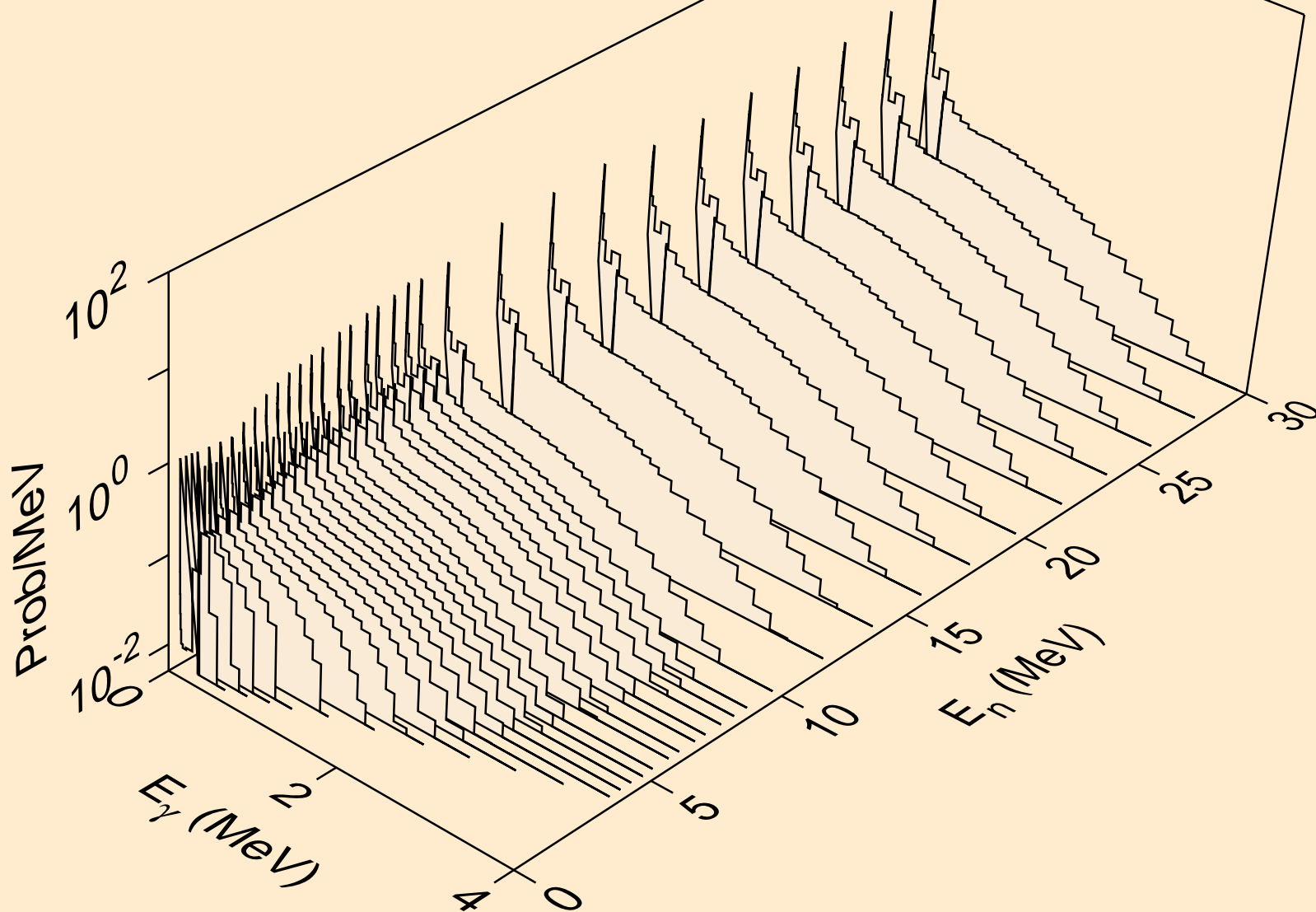

CS115 NEUTRON ACER TENDL-2019 LIBRARY; T=293.16K  
Photon emission for (n,gma)

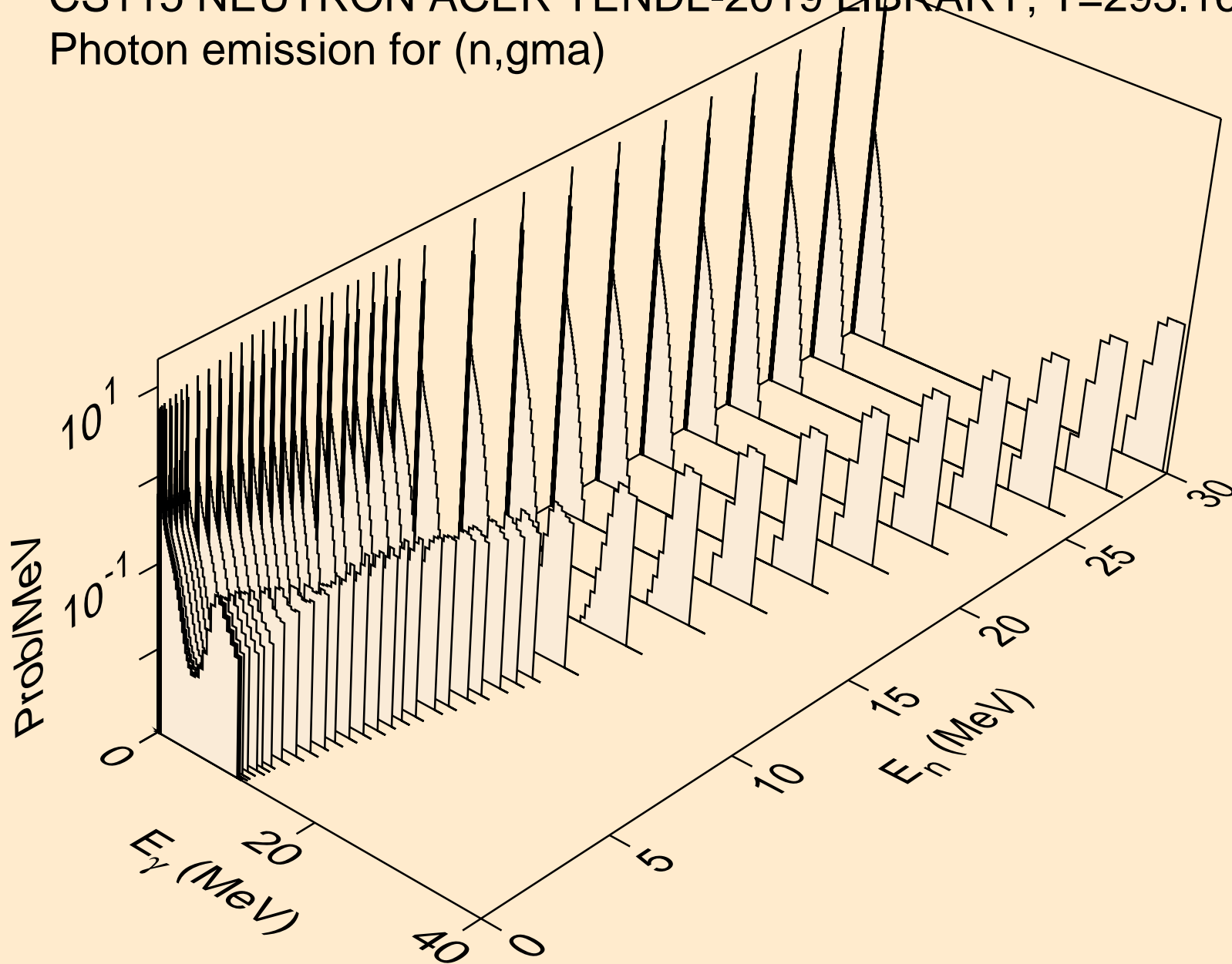

CS115 NEUTRON ACER TENDL-2019 LIBRARY; T=293.16K  
Photon emission for (n,p)

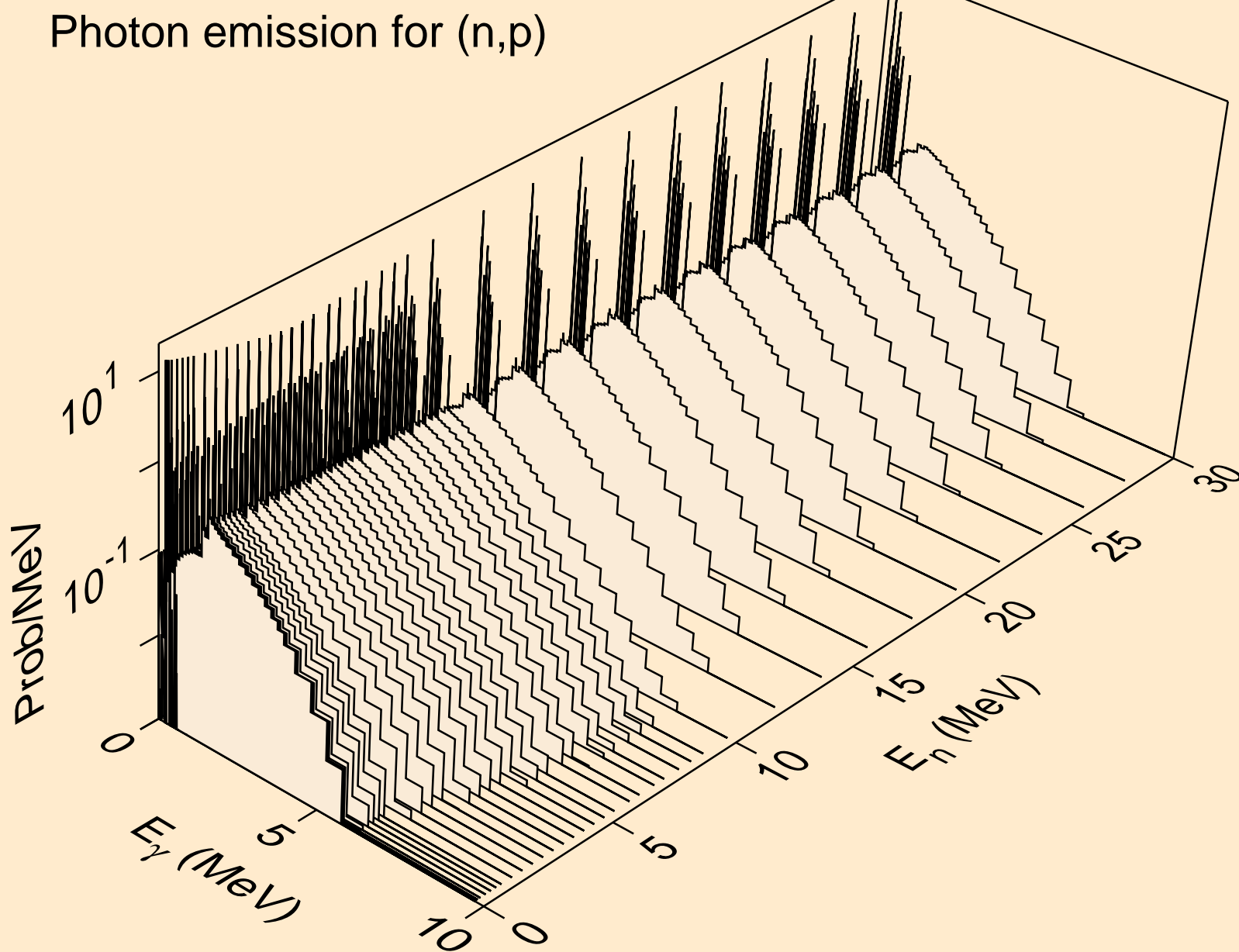

CS115 NEUTRON ACER TENDL-2019 LIBRARY; T=293.16K  
Photon emission for (n,d)

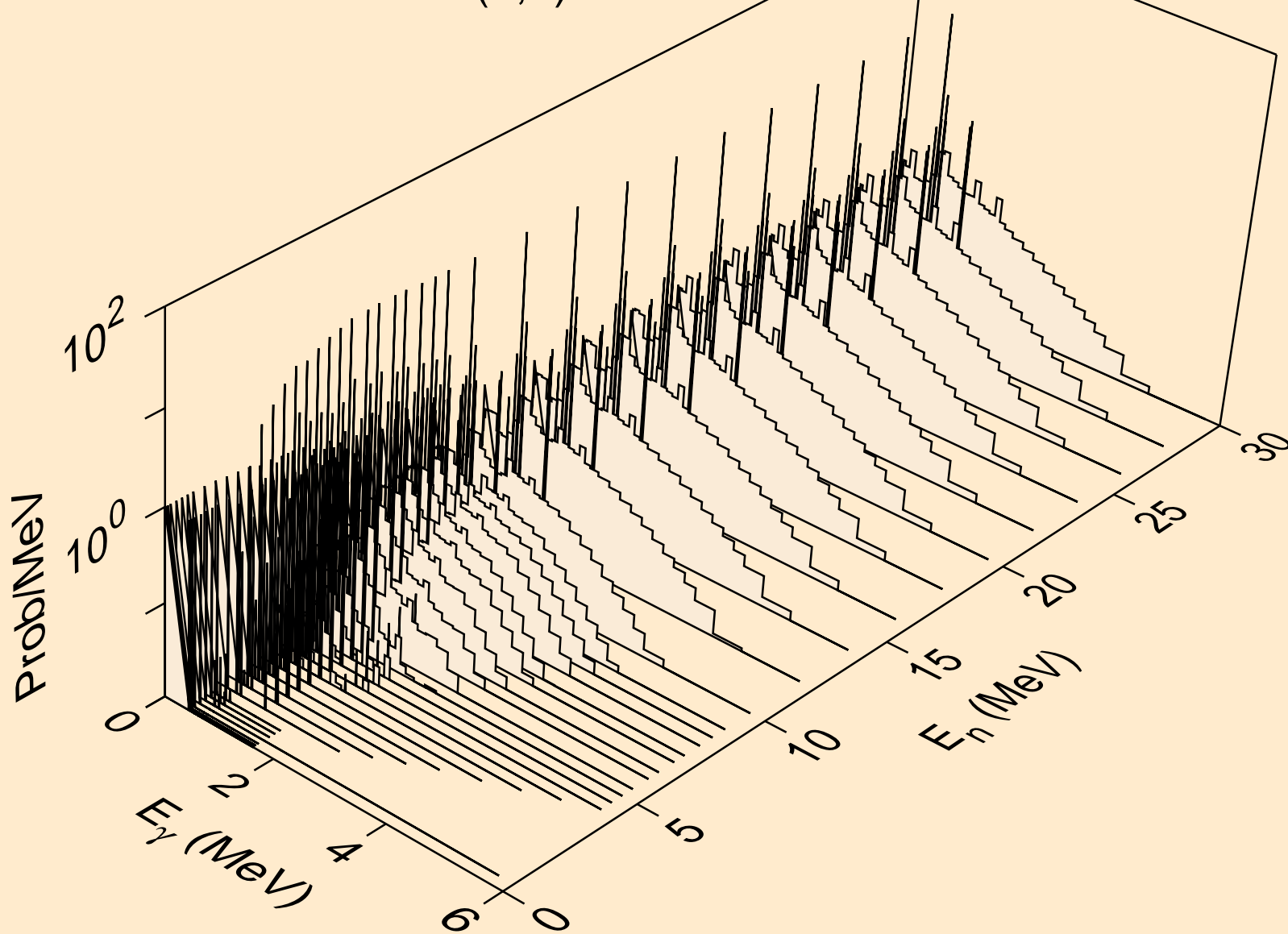

CS115 NEUTRON ACER TENDL-2019 LIBRARY; T=293.16K  
Photon emission for (n,t)

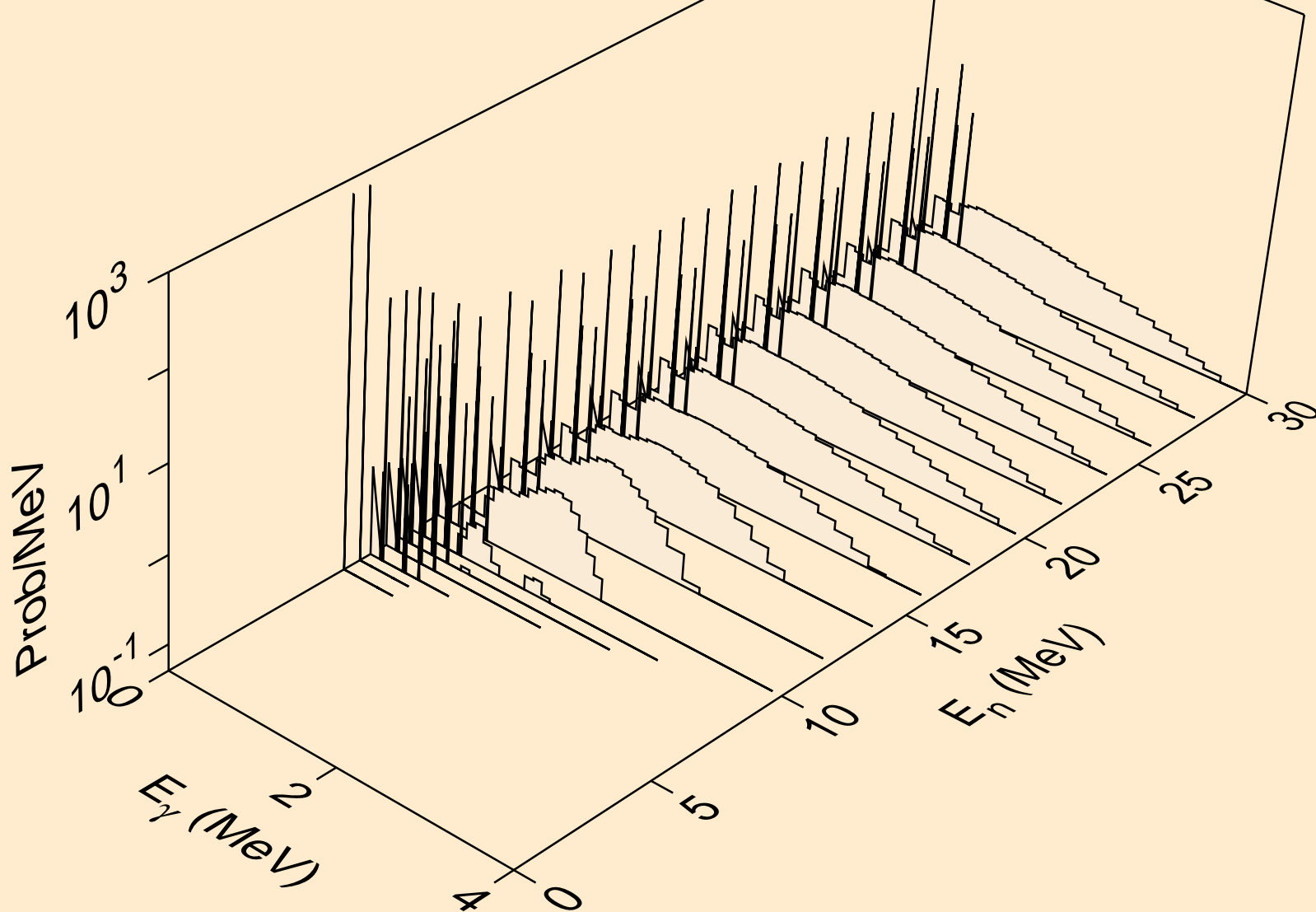

CS115 NEUTRON ACER TENDL-2019 LIBRARY; T=293.16K  
Photon emission for (n,he3)

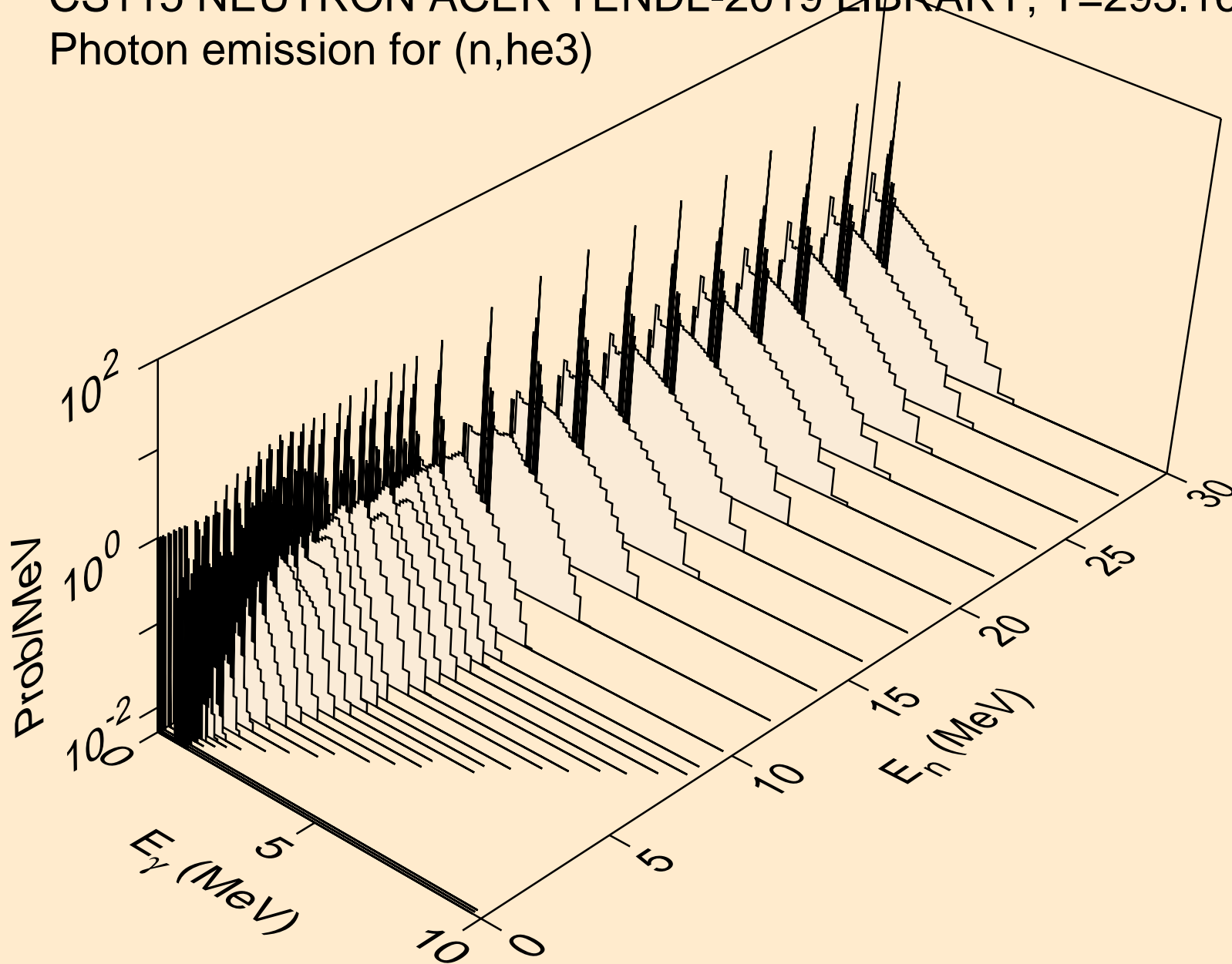

CS115 NEUTRON ACER TENDL-2019 LIBRARY; T=293.16K  
Photon emission for (n,a)

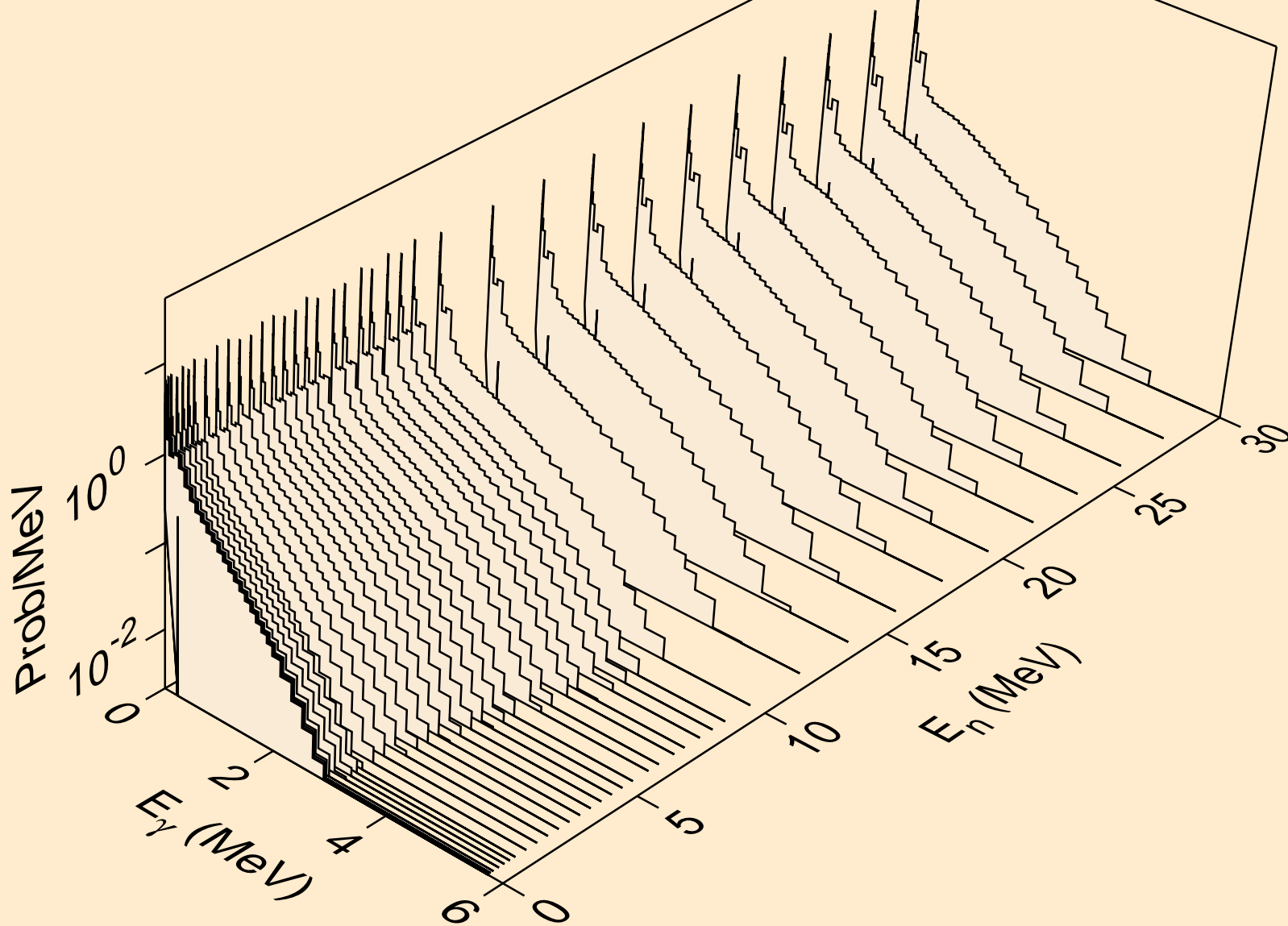



CS115 NEUTRON ACER TENDL-2019 LIBRARY; T=293.16K  
Photon emission for (n,2a)

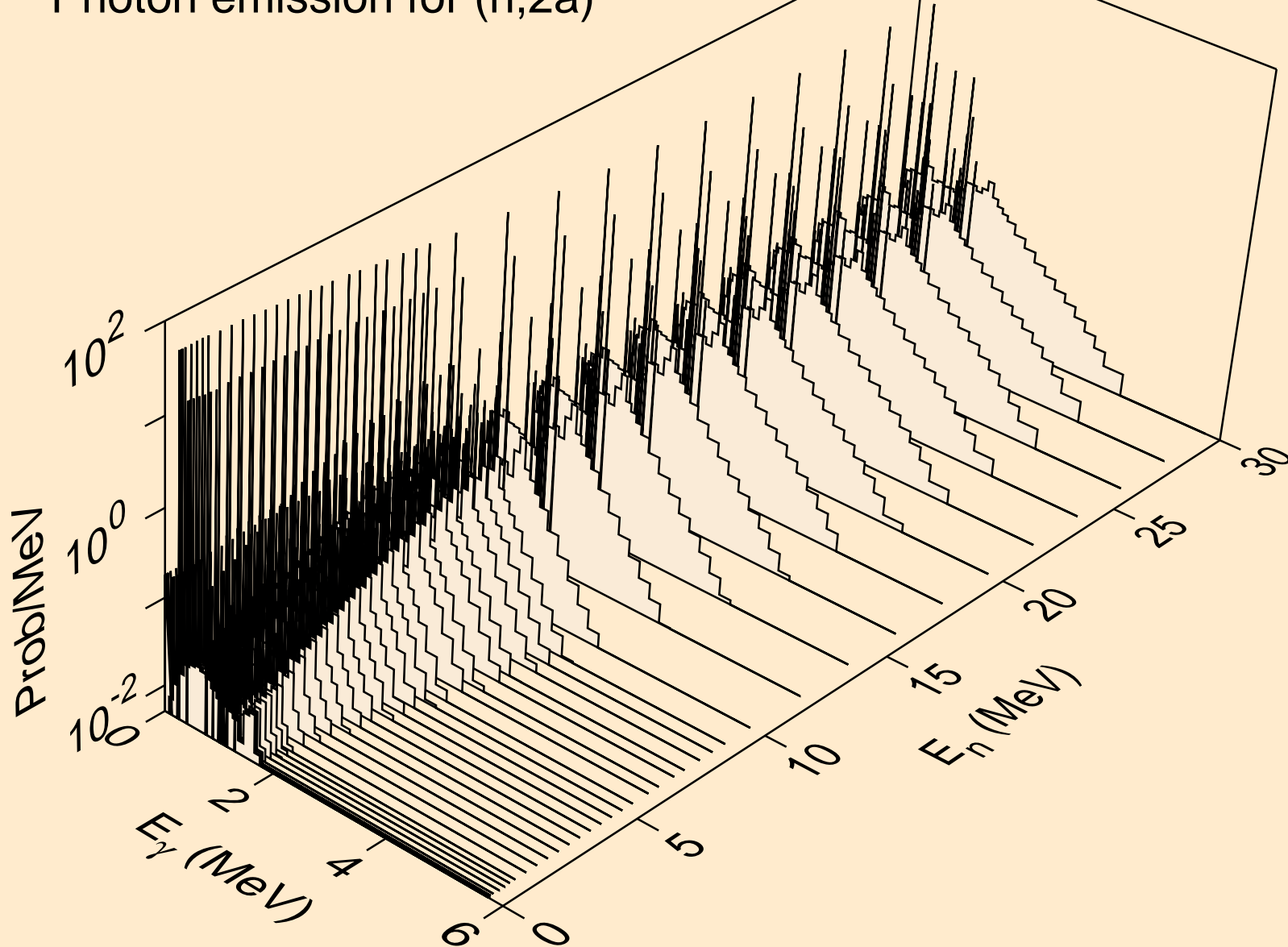

CS115 NEUTRON ACER TENDL-2019 LIBRARY; T=293.16K  
Photon emission for (n,3a)

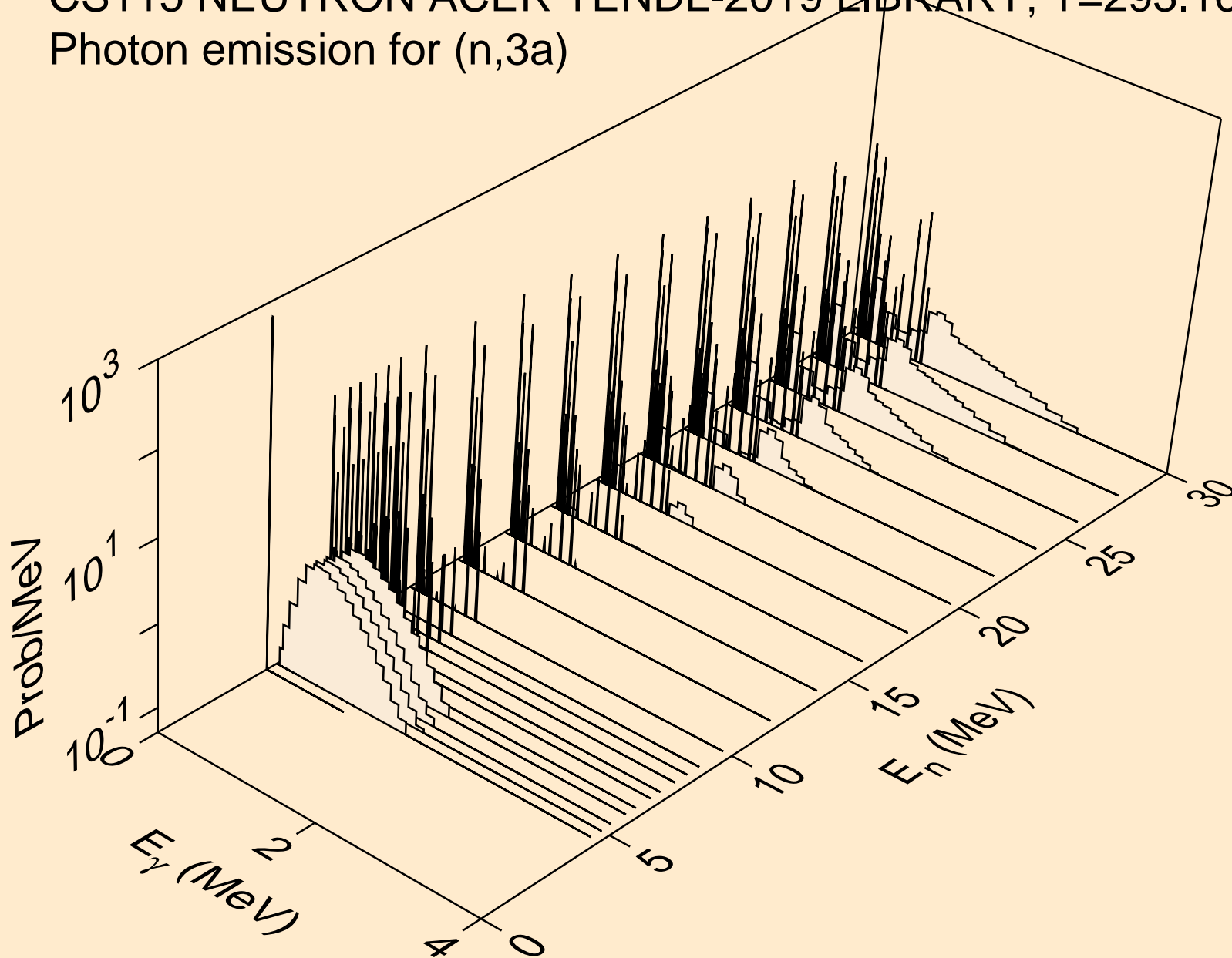

CS115 NEUTRON ACER TENDL-2019 LIBRARY; T=293.16K  
Photon emission for (n,2p)

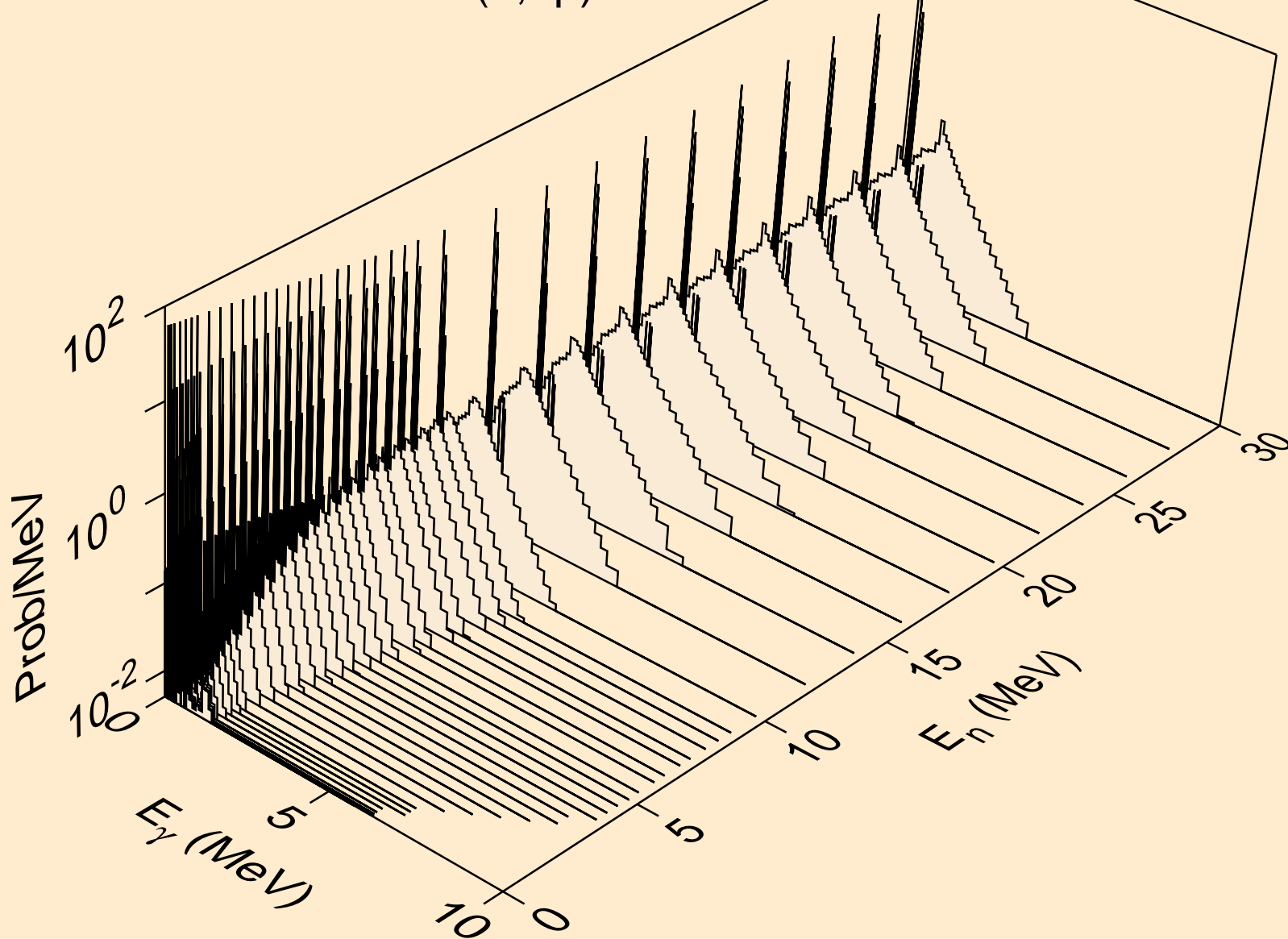

CS115 NEUTRON ACER TENDL-2019 LIBRARY; T=293.16K  
Photon emission for (n,p $\alpha$ )

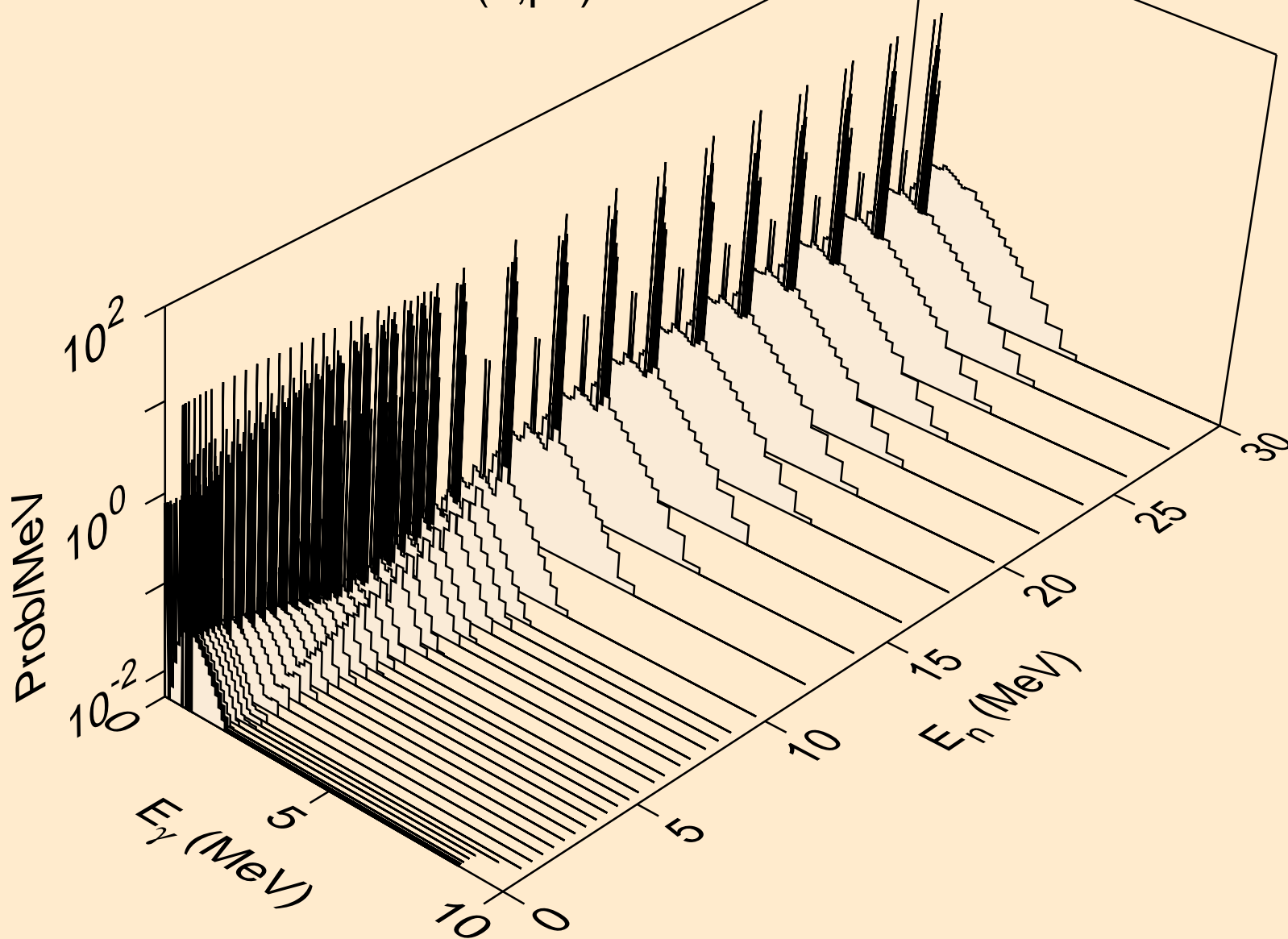

CS115 NEUTRON ACER TENDL-2019 LIBRARY; T=293.16K  
Photon emission for (n,t2a)

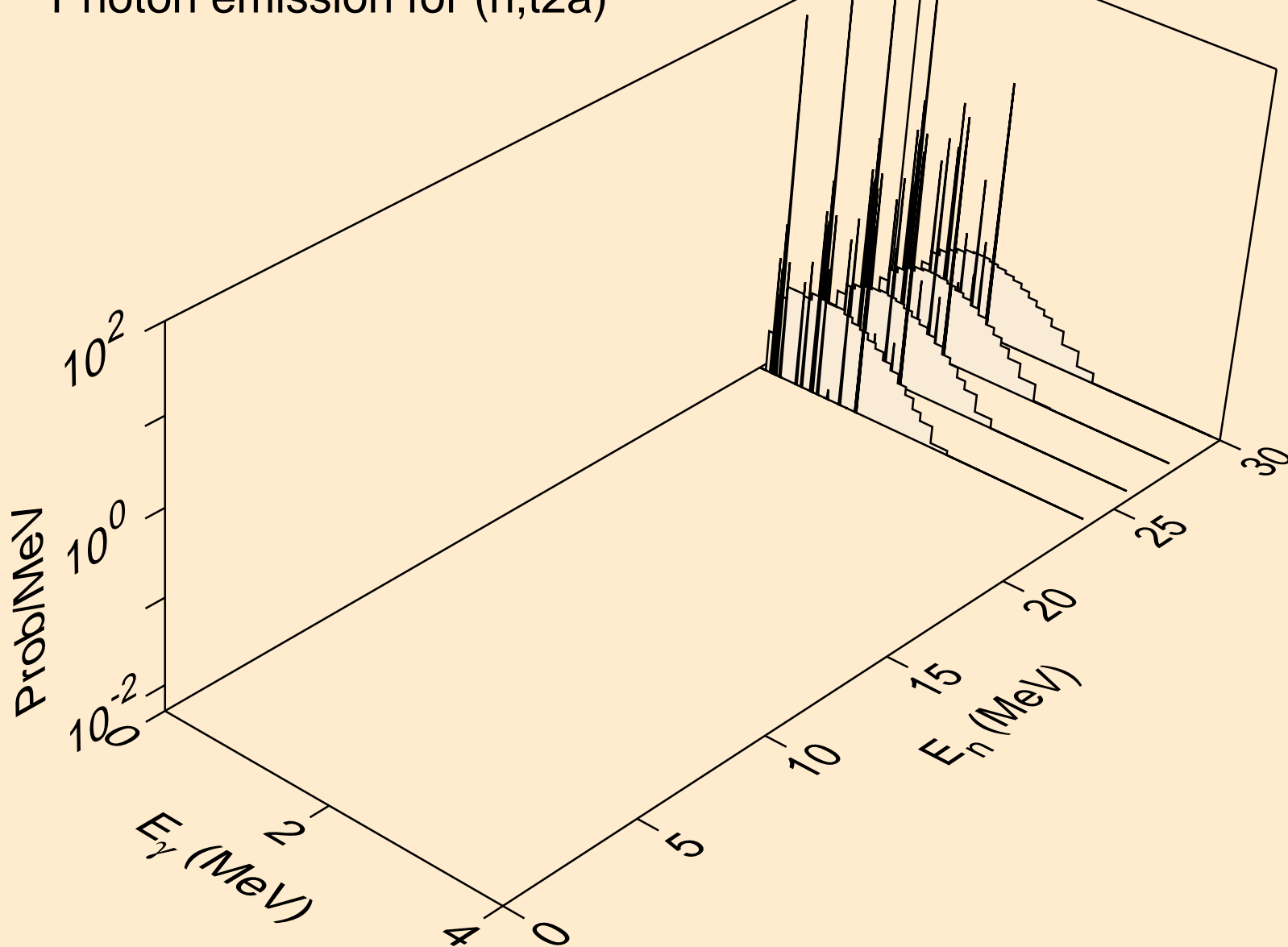

CS115 NEUTRON ACER TENDL-2019 LIBRARY; T=293.16K  
Photon emission for (n,d2a)

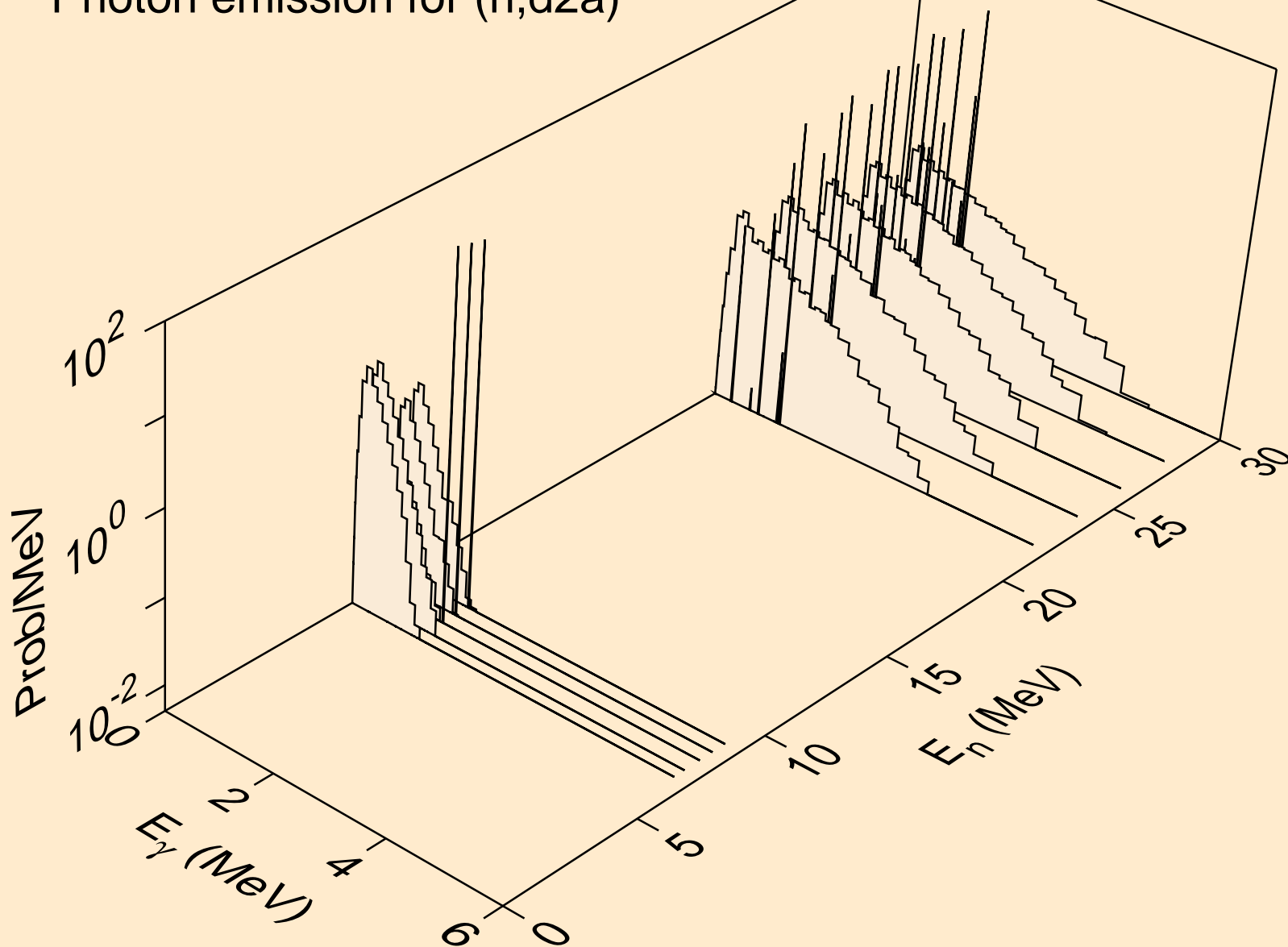

CS115 NEUTRON ACER TENDL-2019 LIBRARY; T=293.16K  
Photon emission for (n,pd)

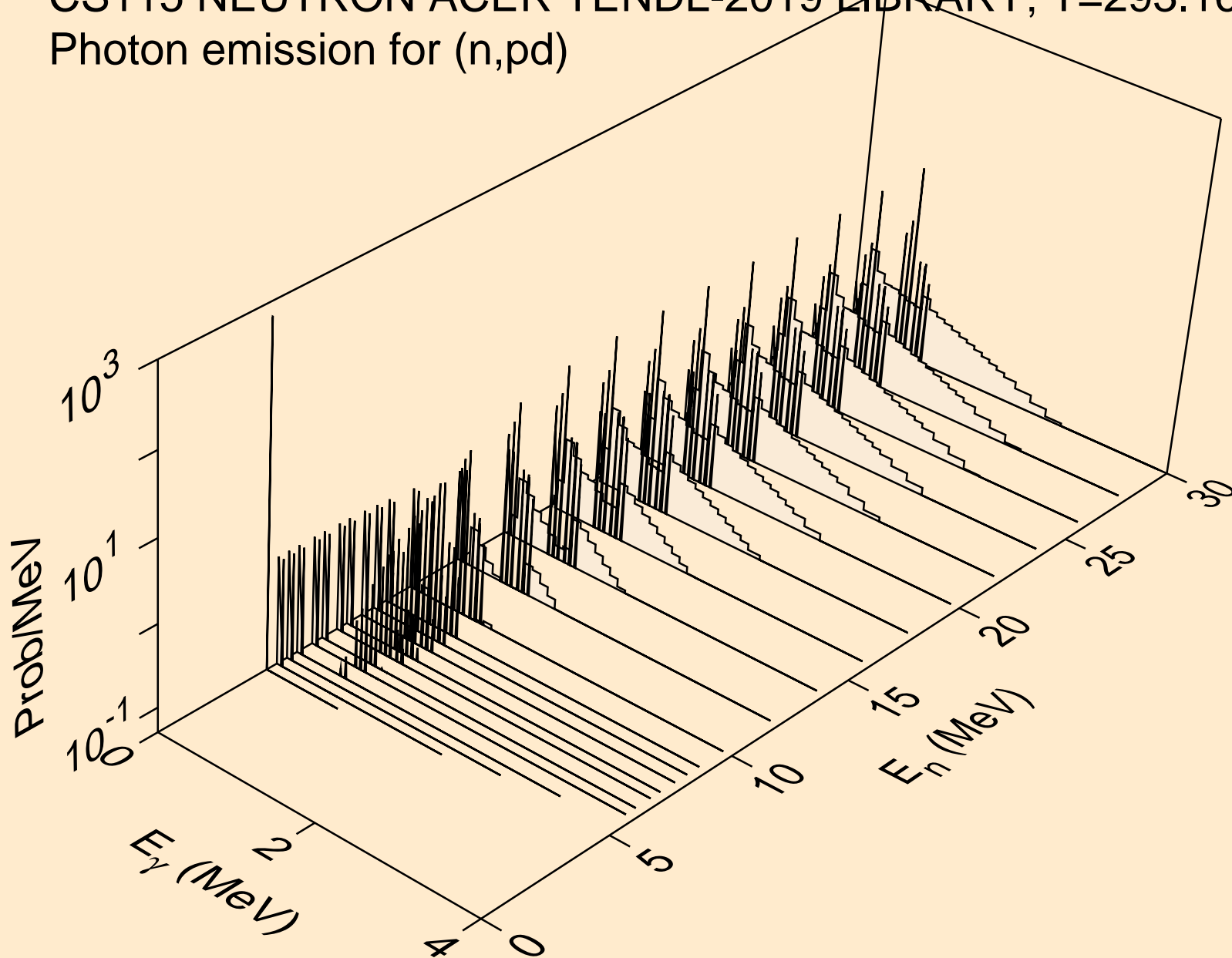

CS115 NEUTRON ACER TENDL-2019 LIBRARY; T=293.16K  
Photon emission for (n,pt)

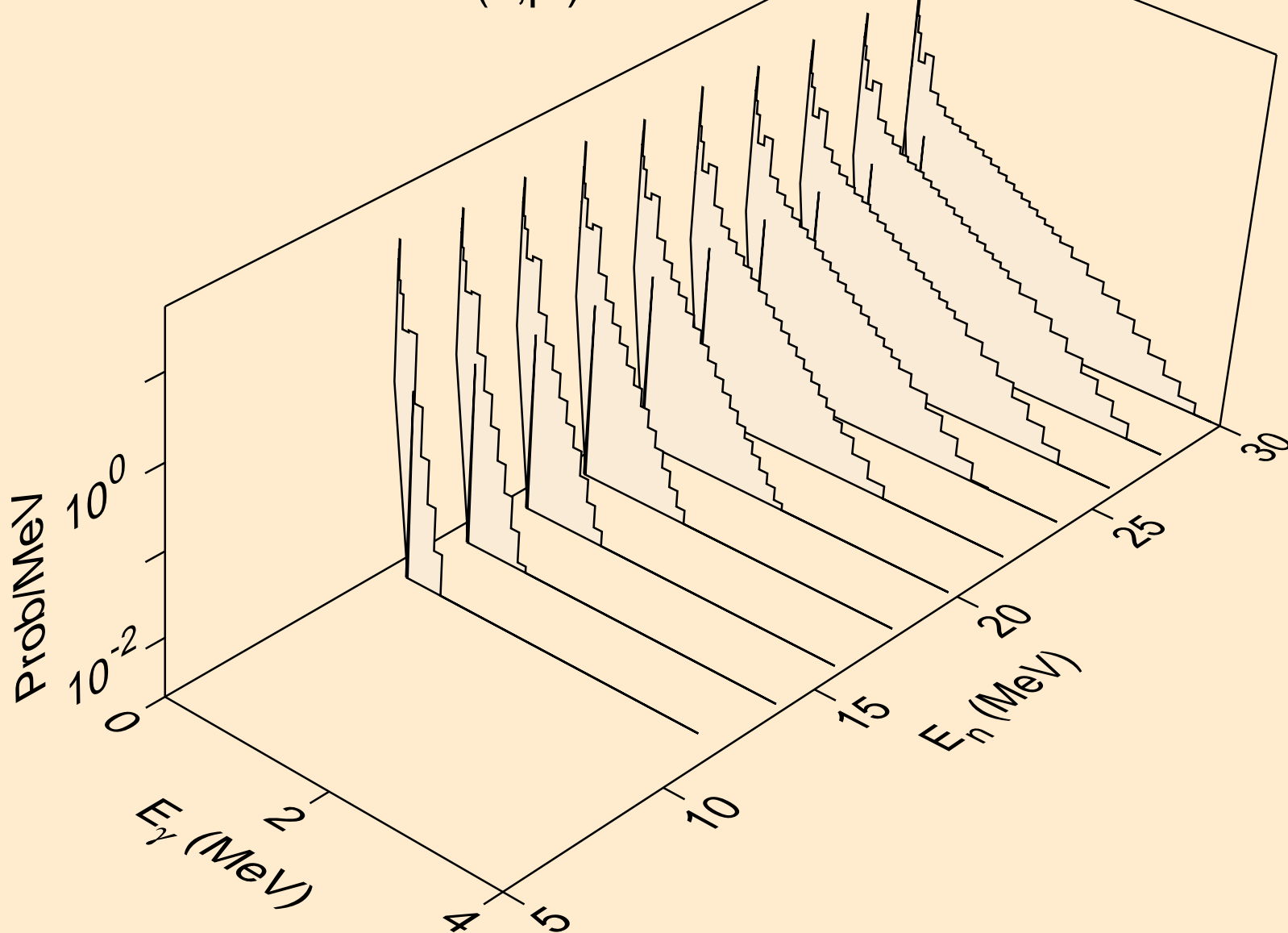



CS115 NEUTRON ACER TENDL-2019 LIBRARY; T=293.16K  
Photon emission for (n,da)

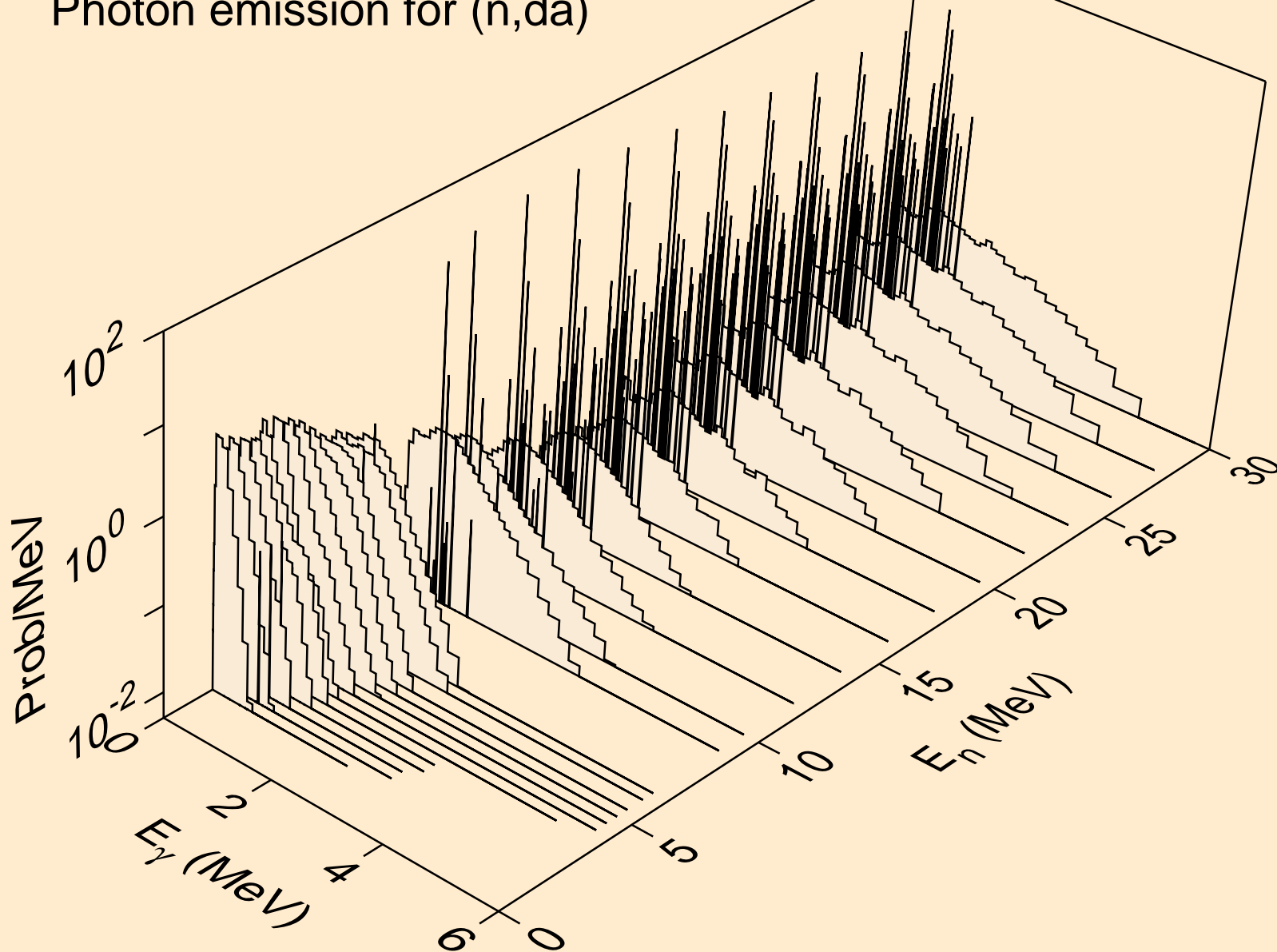

CS115 NEUTRON ACER TENDL-2019 LIBRARY; T=293.16K  
thermal capture photon spectrum

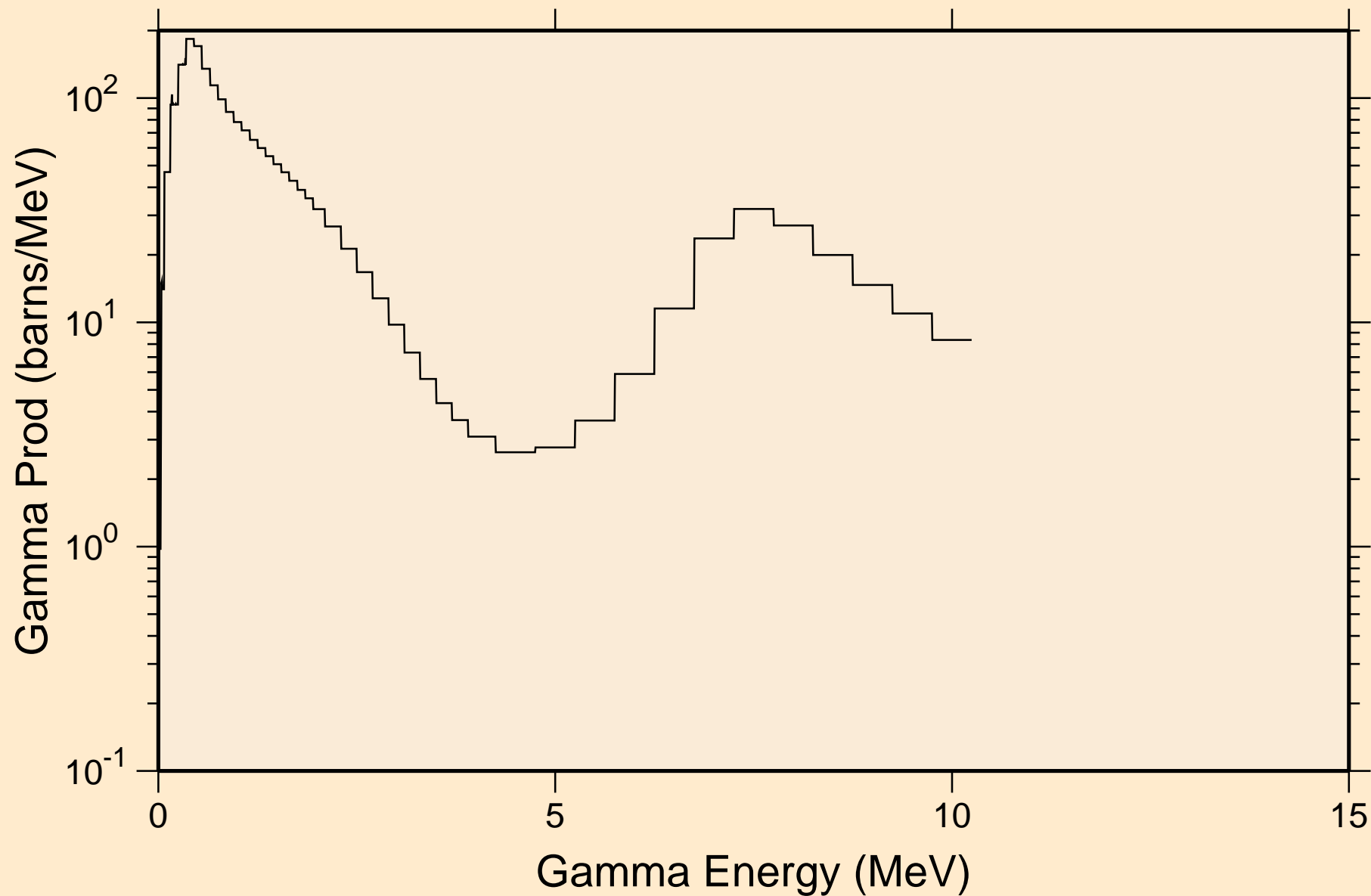

CS115 NEUTRON ACER TENDL-2019 LIBRARY; T=293.16K  
14 MeV photon spectrum

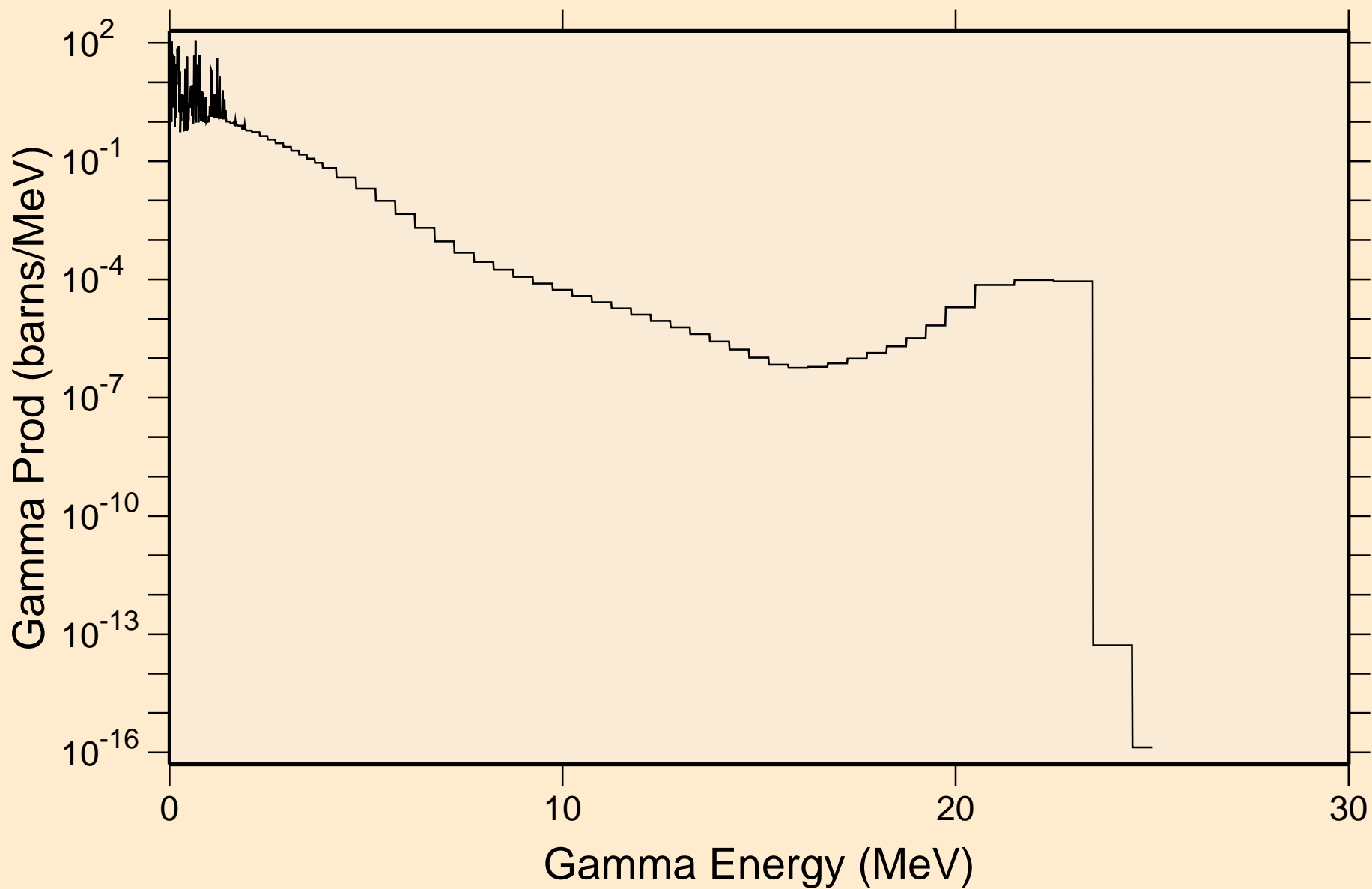

# CS115 NEUTRON ACER TENDL-2019 LIBRARY; T=293.16K

## Particle heating contributions

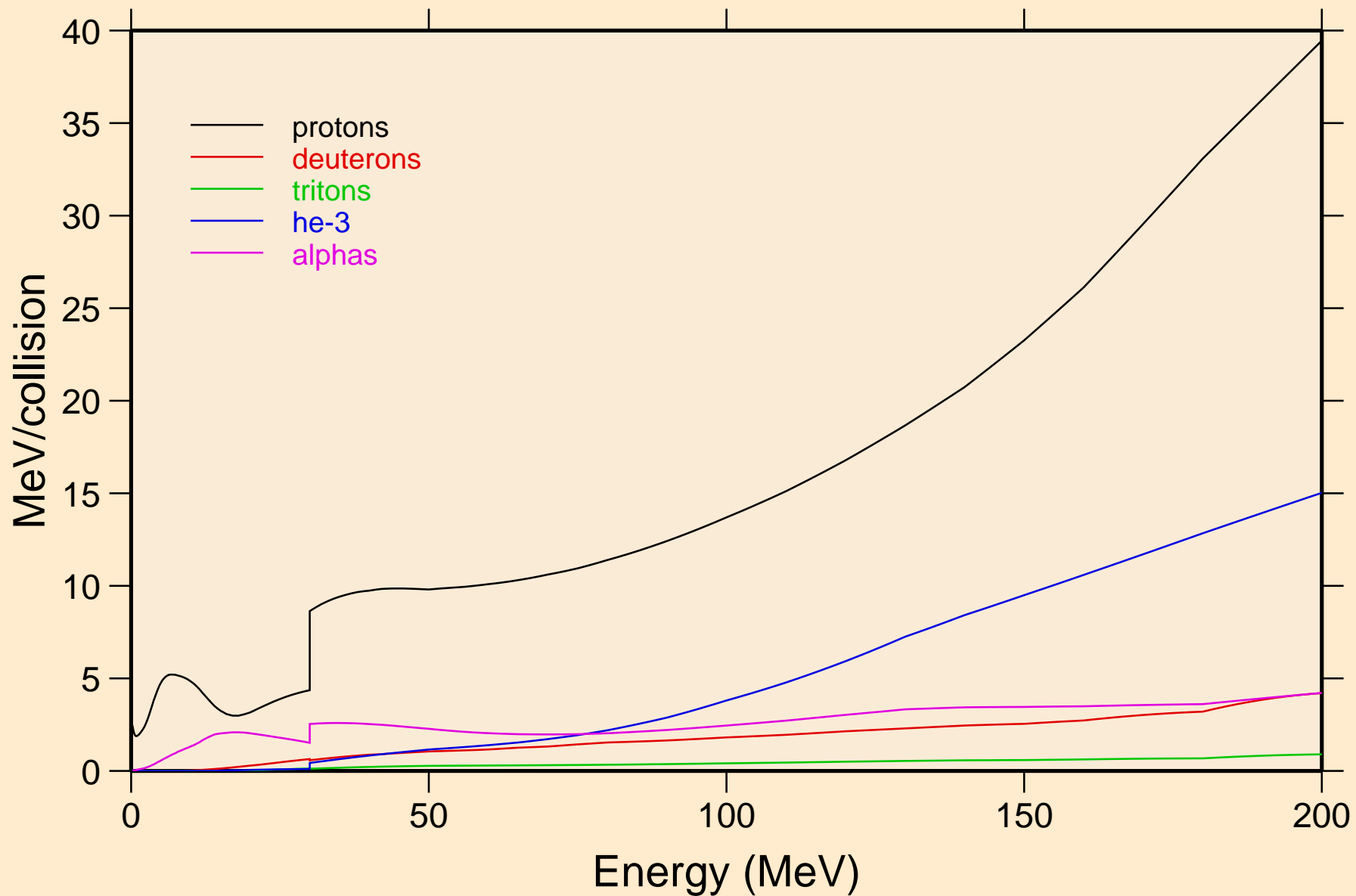

CS115 NEUTRON ACER TENDL-2019 LIBRARY; T=293.16K  
Recoil Heating

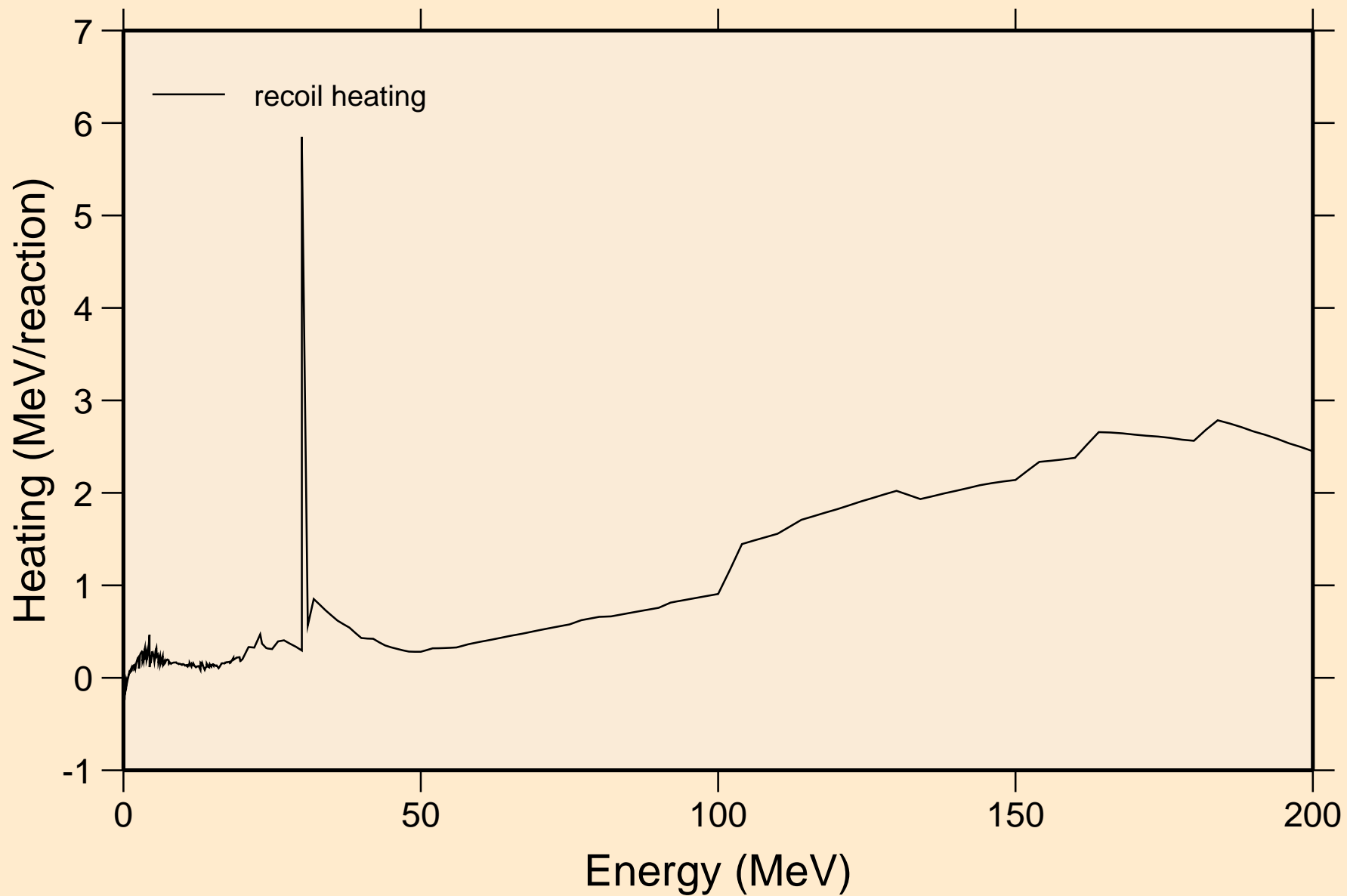

CS115 NEUTRON ACER TENDL-2019 LIBRARY; T=293.16K  
Particle production cross sections

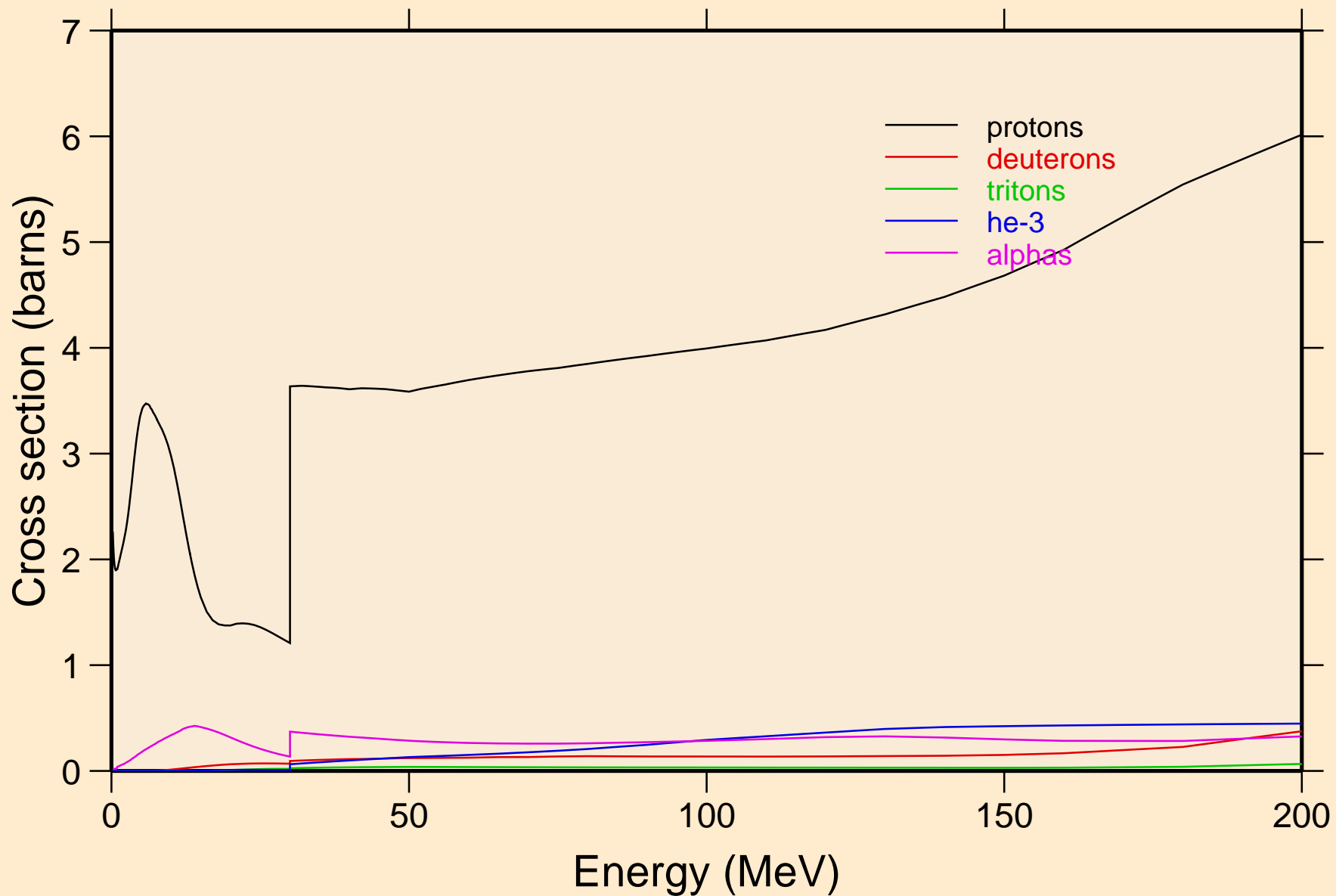

CS115 NEUTRON ACER TENDL-2019 LIBRARY; T=293.16K  
protons from (n,x)

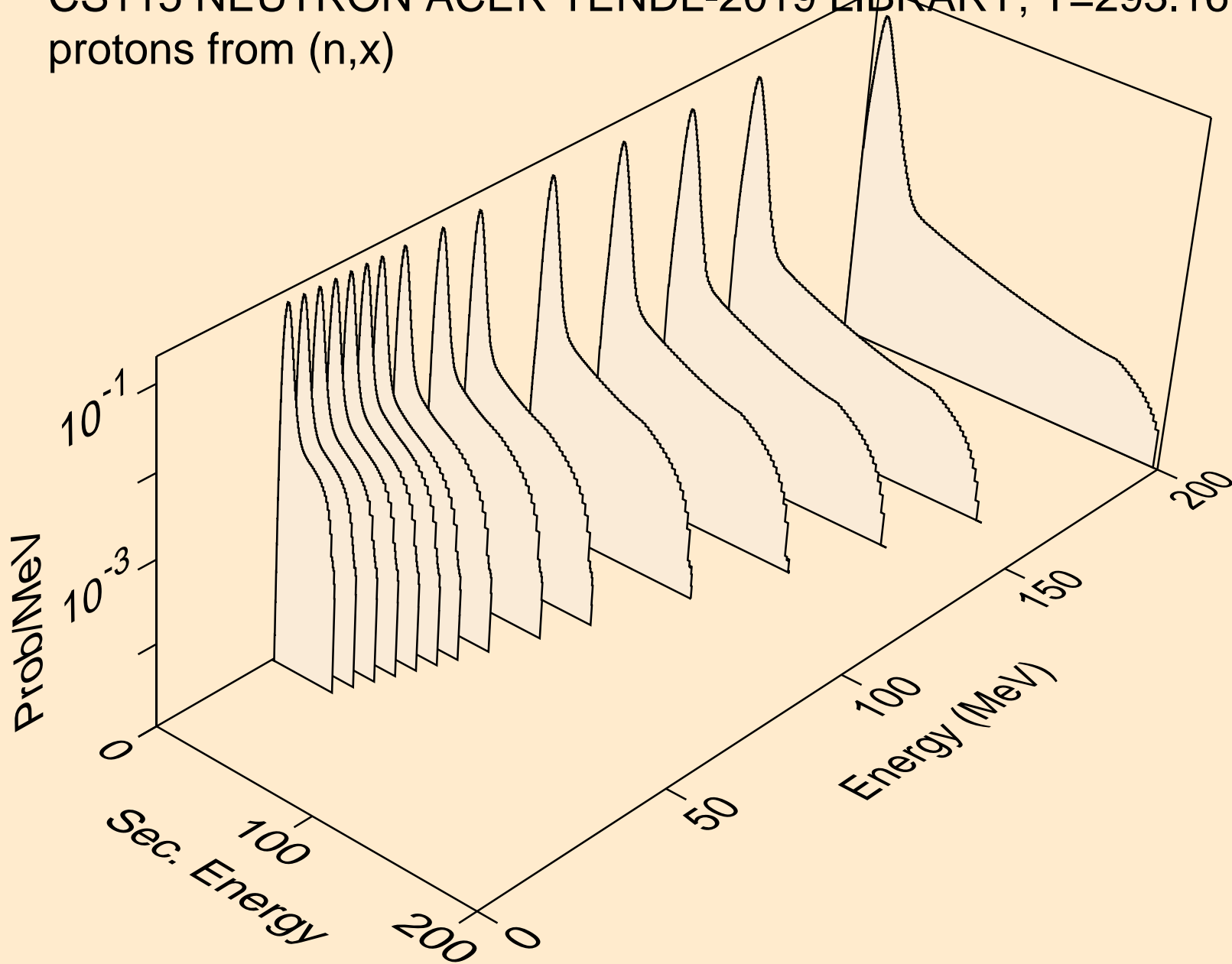

CS115 NEUTRON ACER TENDL-2019 LIBRARY; T=293.16K  
protons from (n,n\*)p

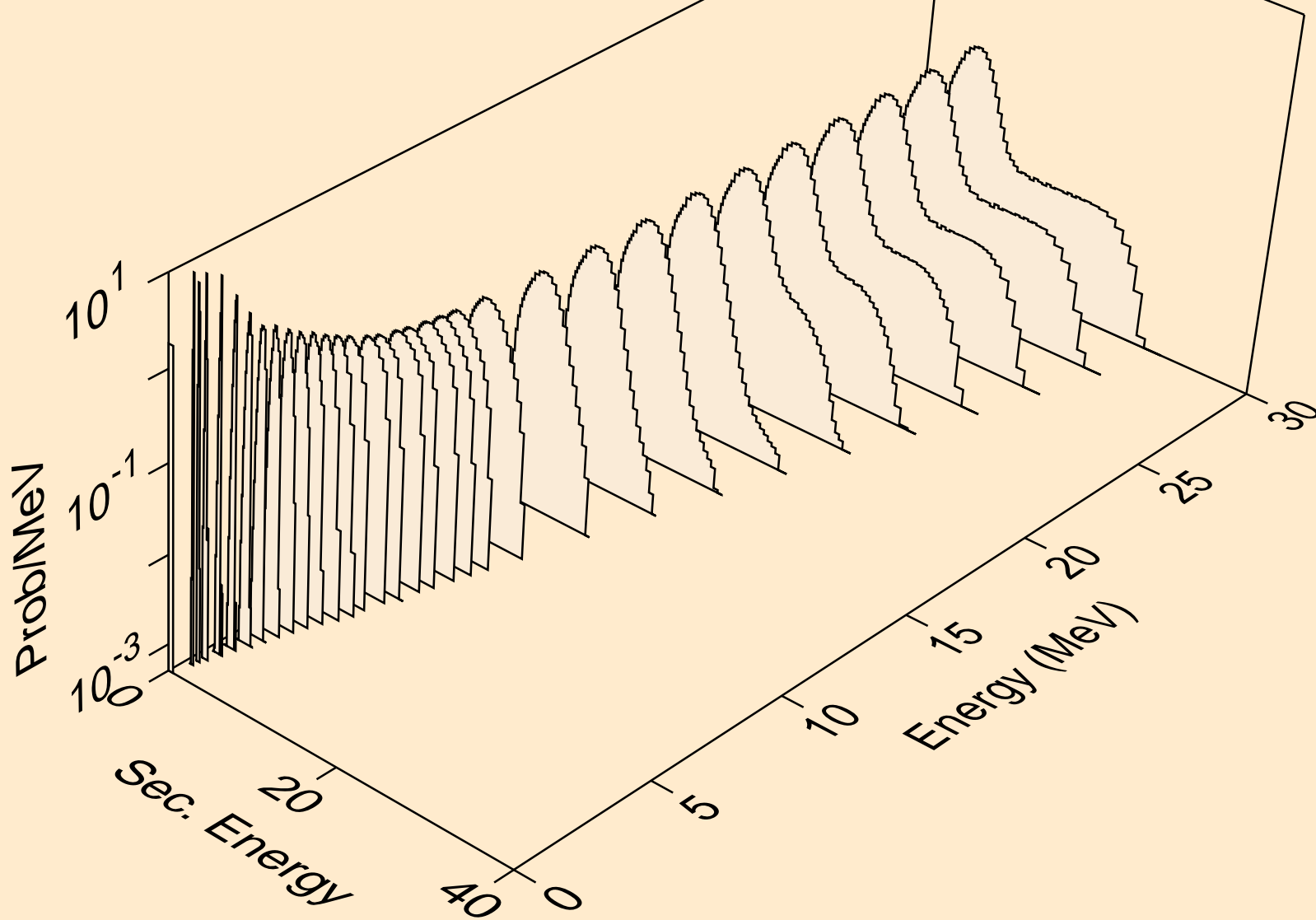



CS115 NEUTRON ACER TENDL-2019 LIBRARY; T=293.16K  
protons from (n,2np)

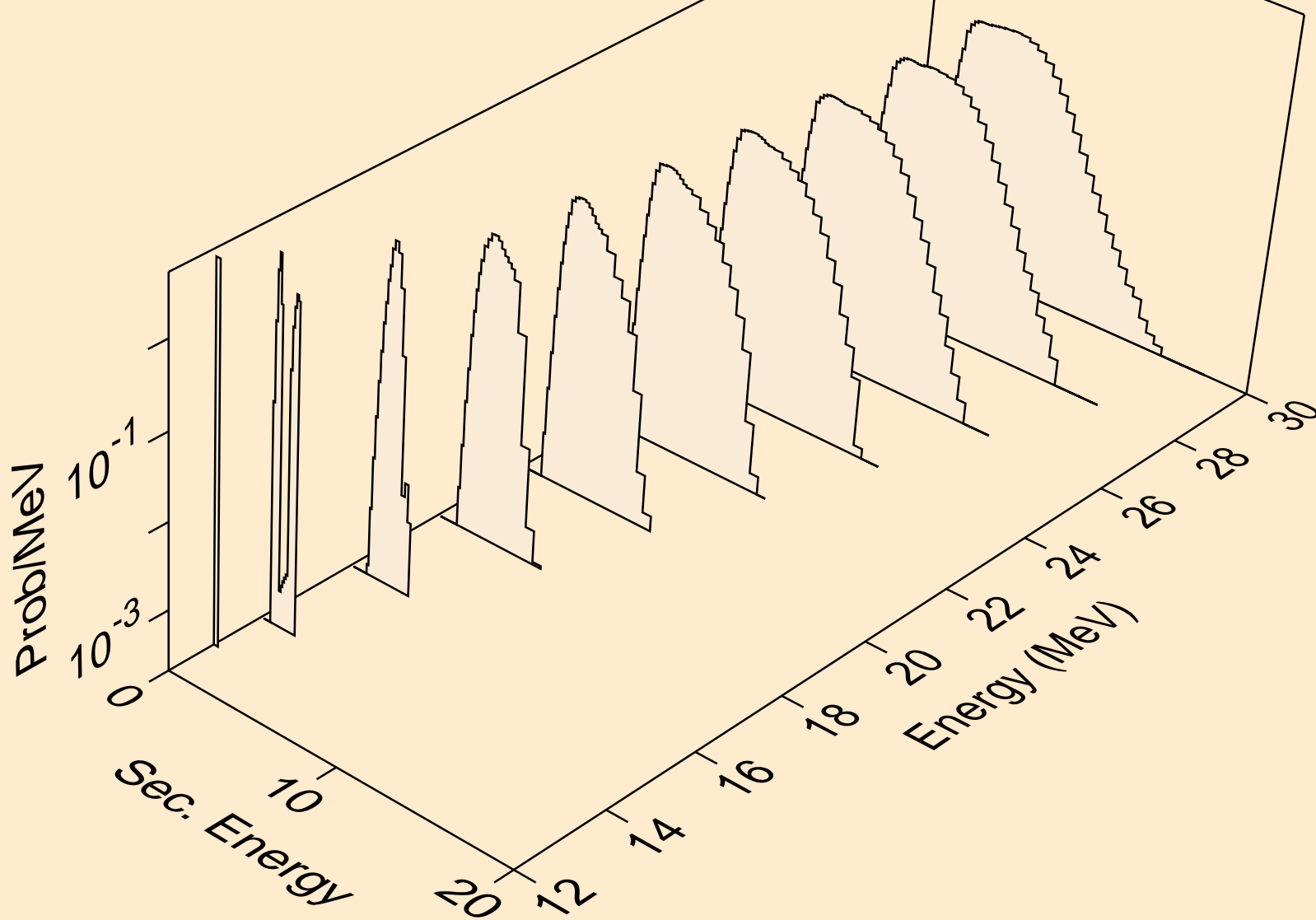

CS115 NEUTRON ACER TENDL-2019 LIBRARY; T=293.16K  
protons from (n,3np)

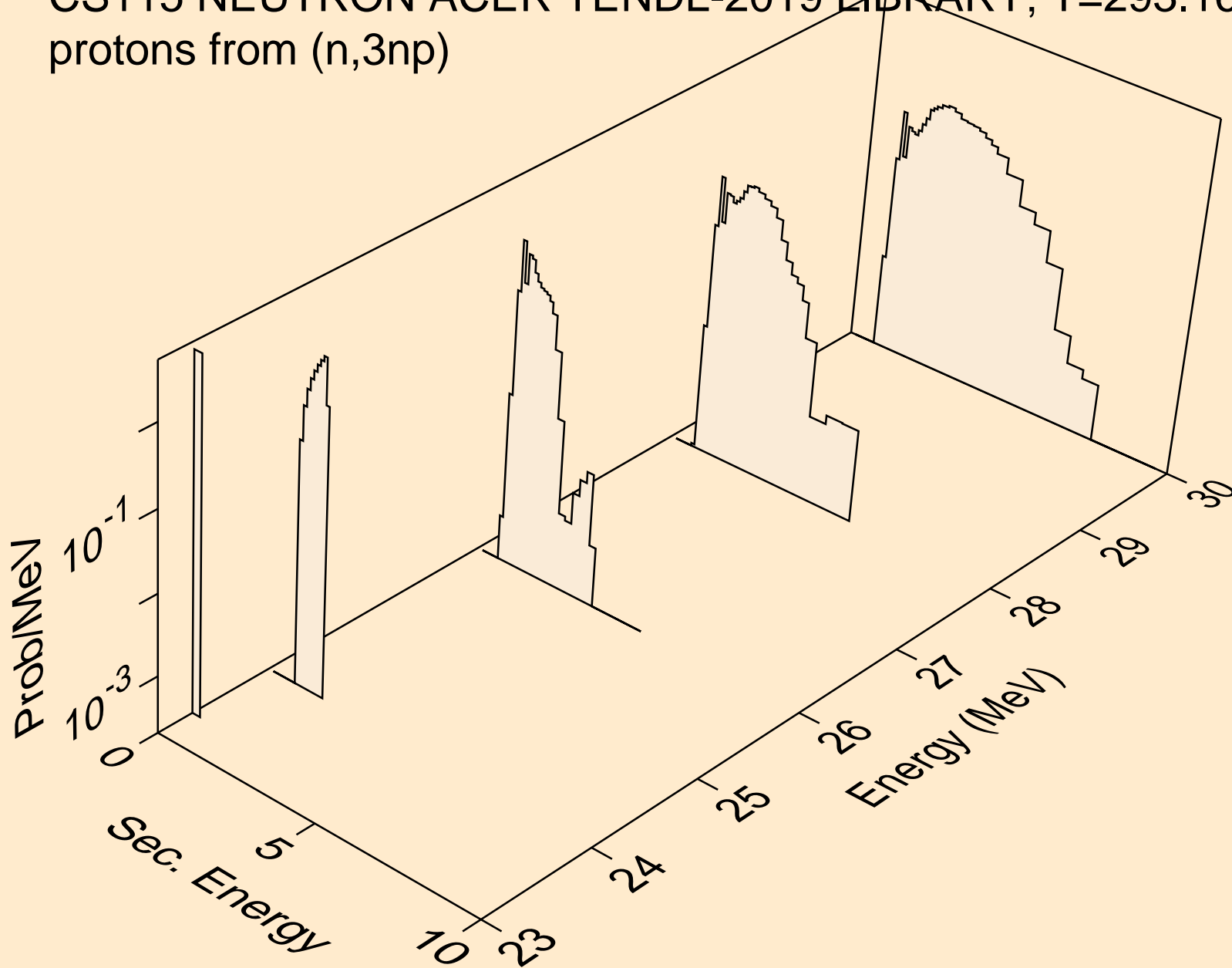

CS115 NEUTRON ACER TENDL-2019 LIBRARY; T=293.16K  
protons from (n,2np)

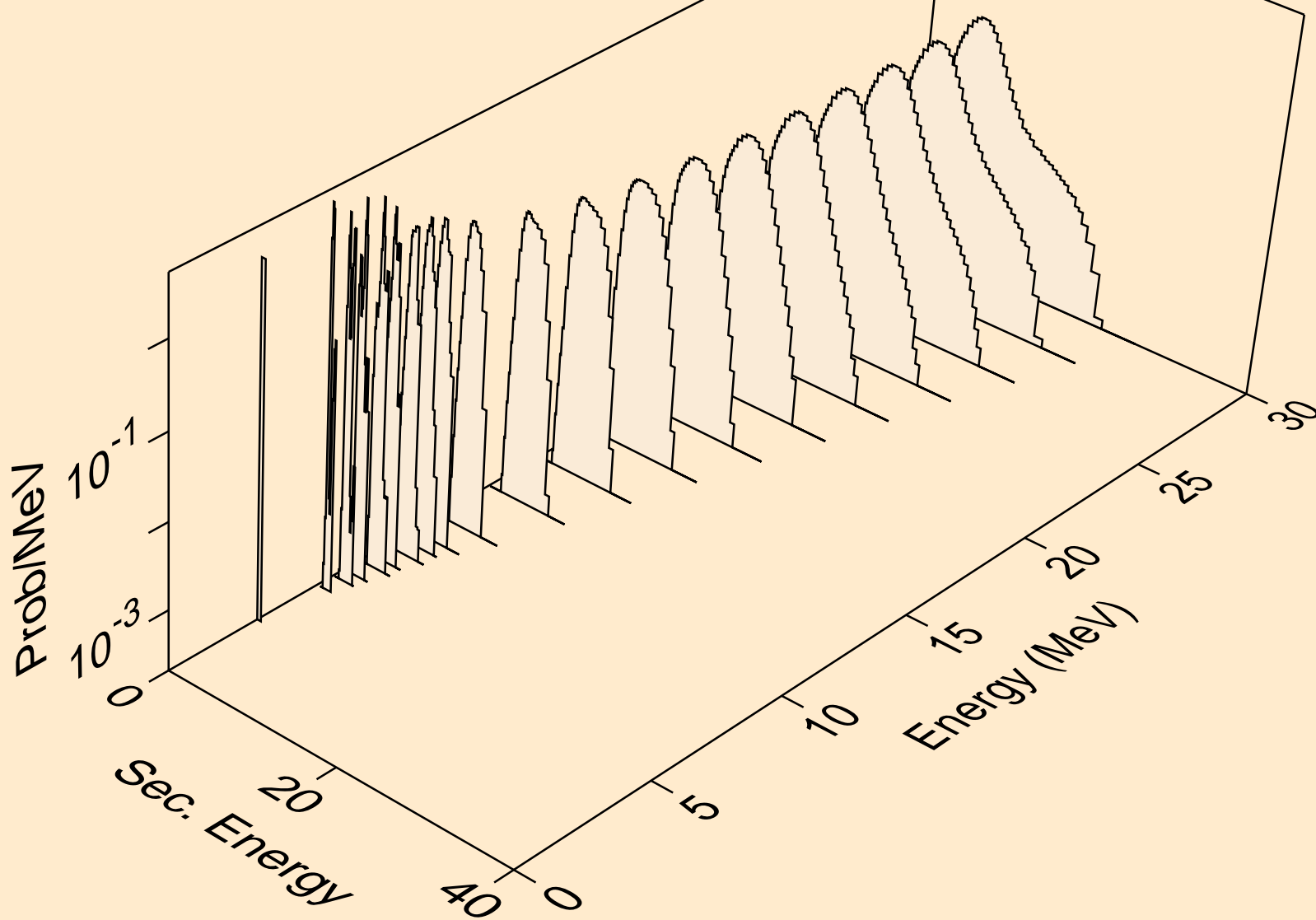

CS115 NEUTRON ACER TENDL-2019 LIBRARY; T=293.16K  
protons from (n,npa)

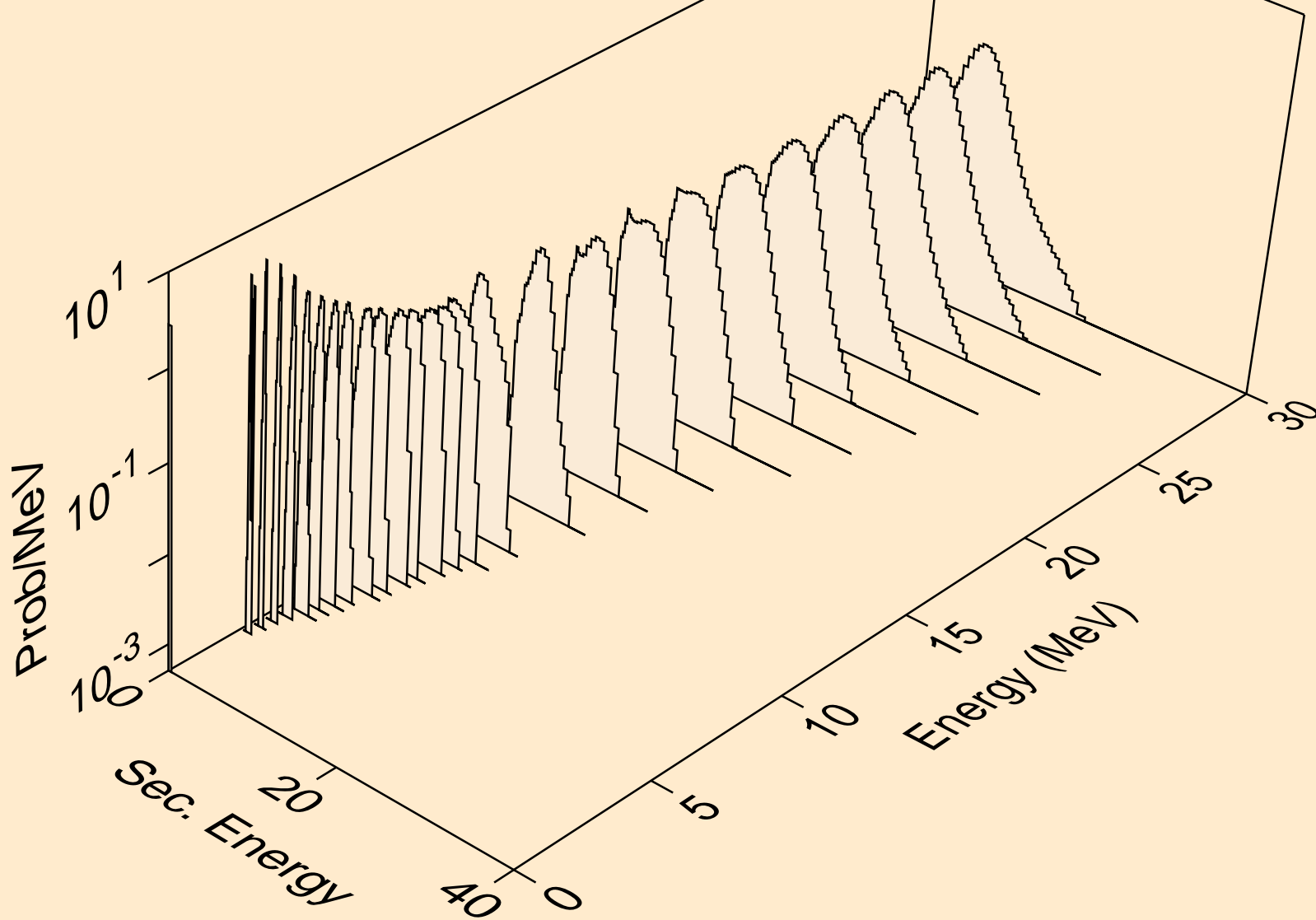

CS115 NEUTRON ACER TENDL-2019 LIBRARY; T=293.16K  
protons from (n,p)

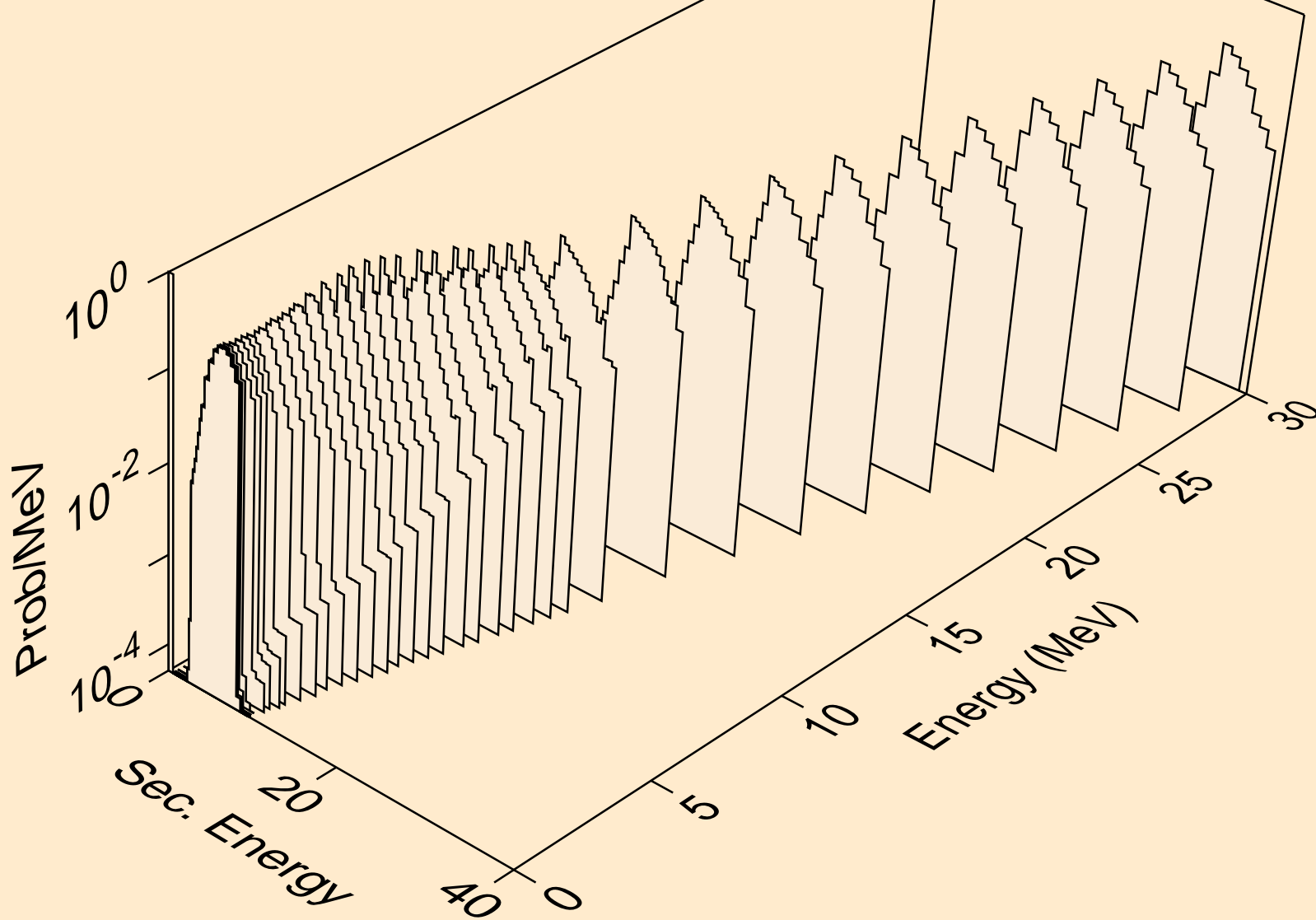

CS115 NEUTRON ACER TENDL-2019 LIBRARY; T=293.16K  
protons from (n,2p)

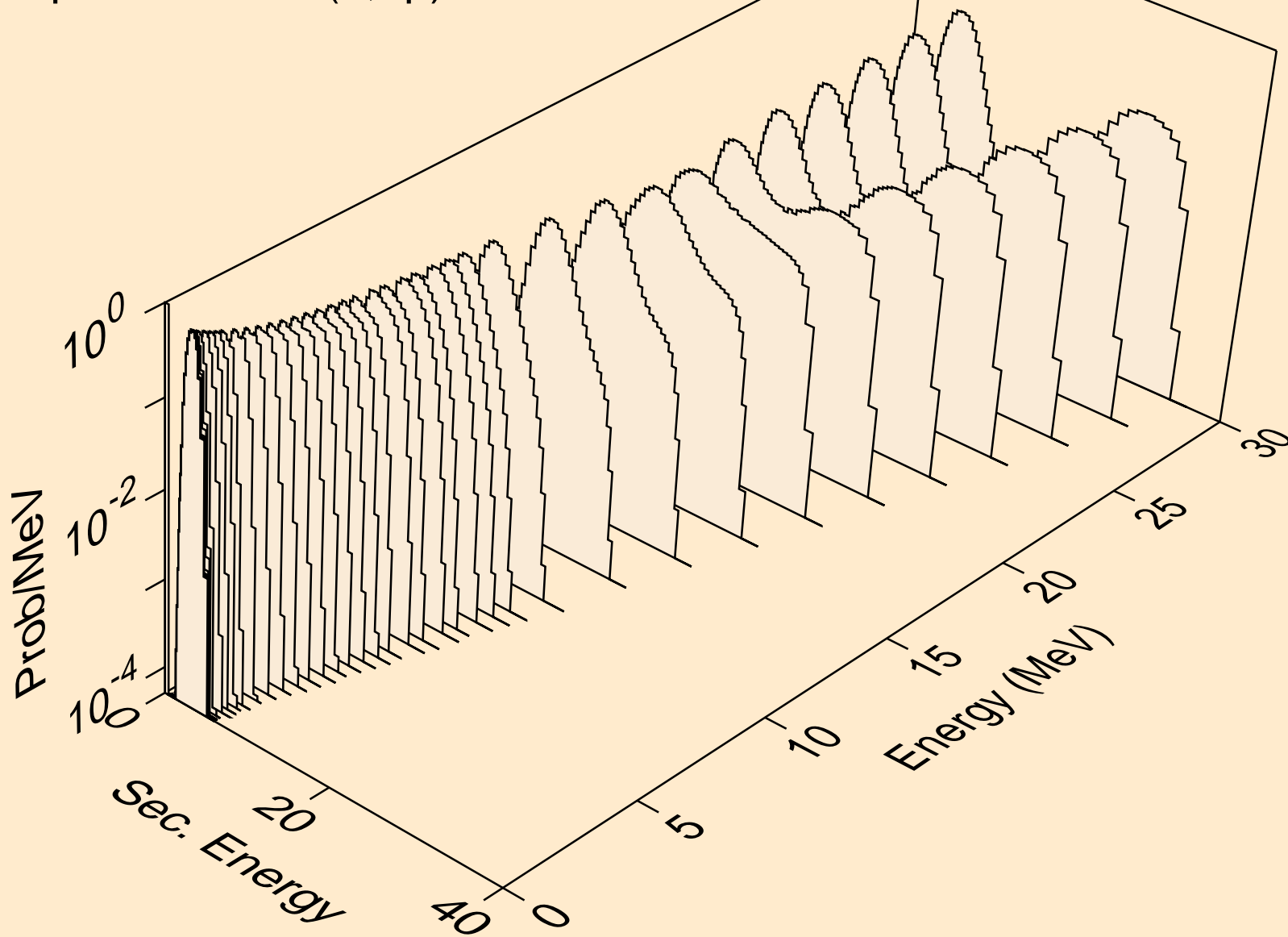

CS115 NEUTRON ACER TENDL-2019 LIBRARY; T=293.16K  
protons from (n,p)

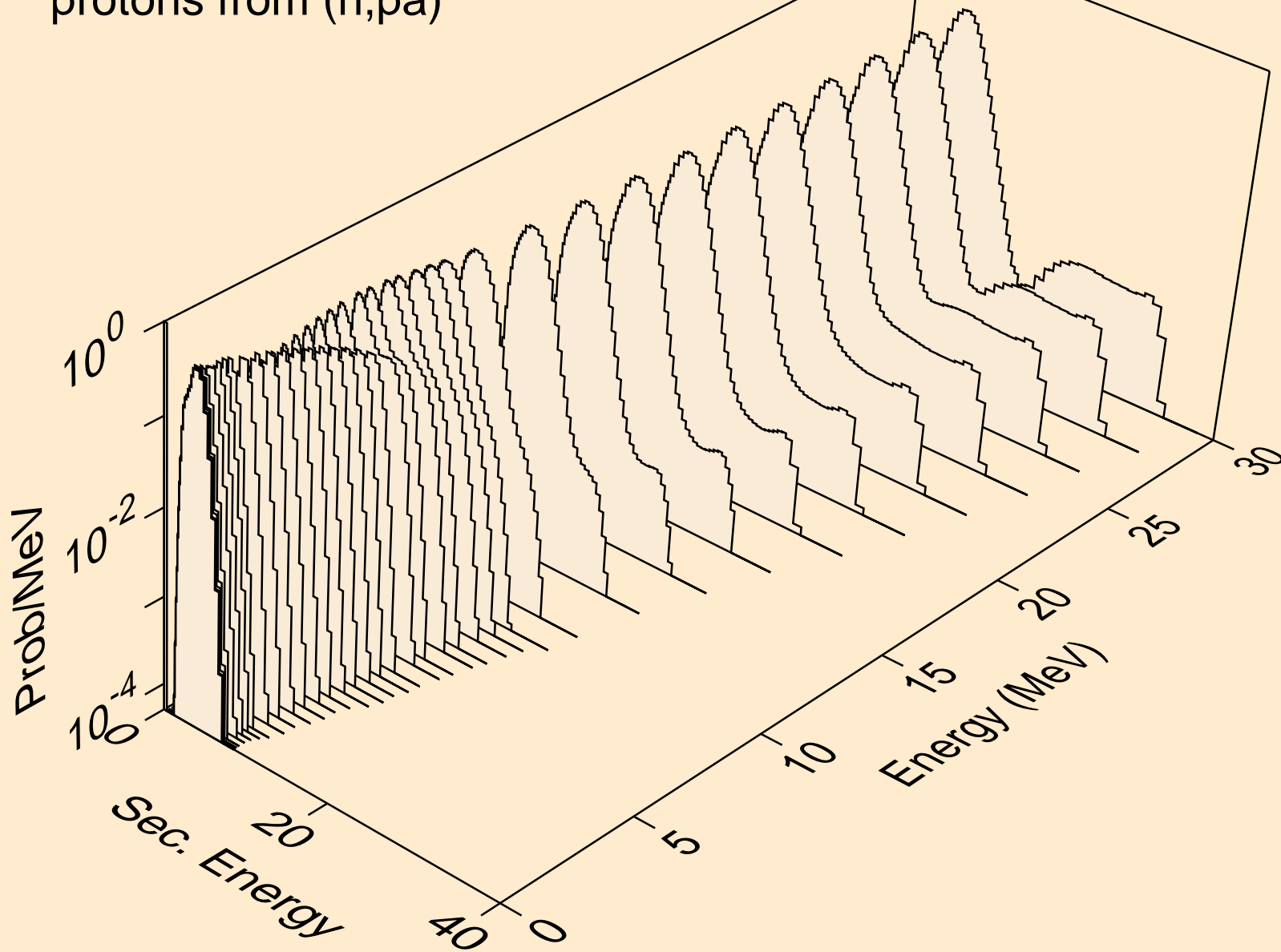

CS115 NEUTRON ACER TENDL-2019 LIBRARY; T=293.16K  
protons from (n,pd)

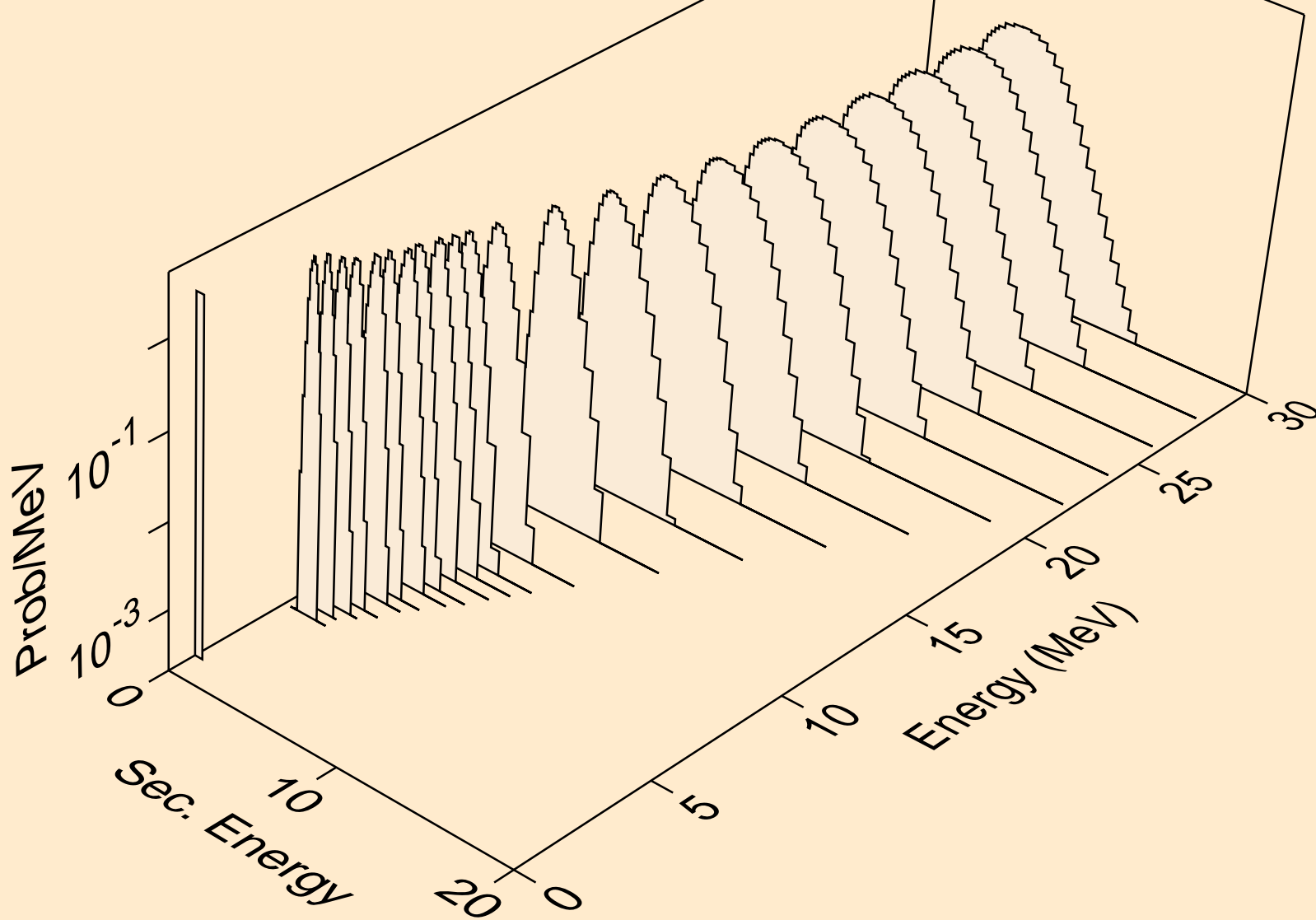



CS115 NEUTRON ACER TENDL-2019 LIBRARY; T=293.16K  
protons from (n,pt)

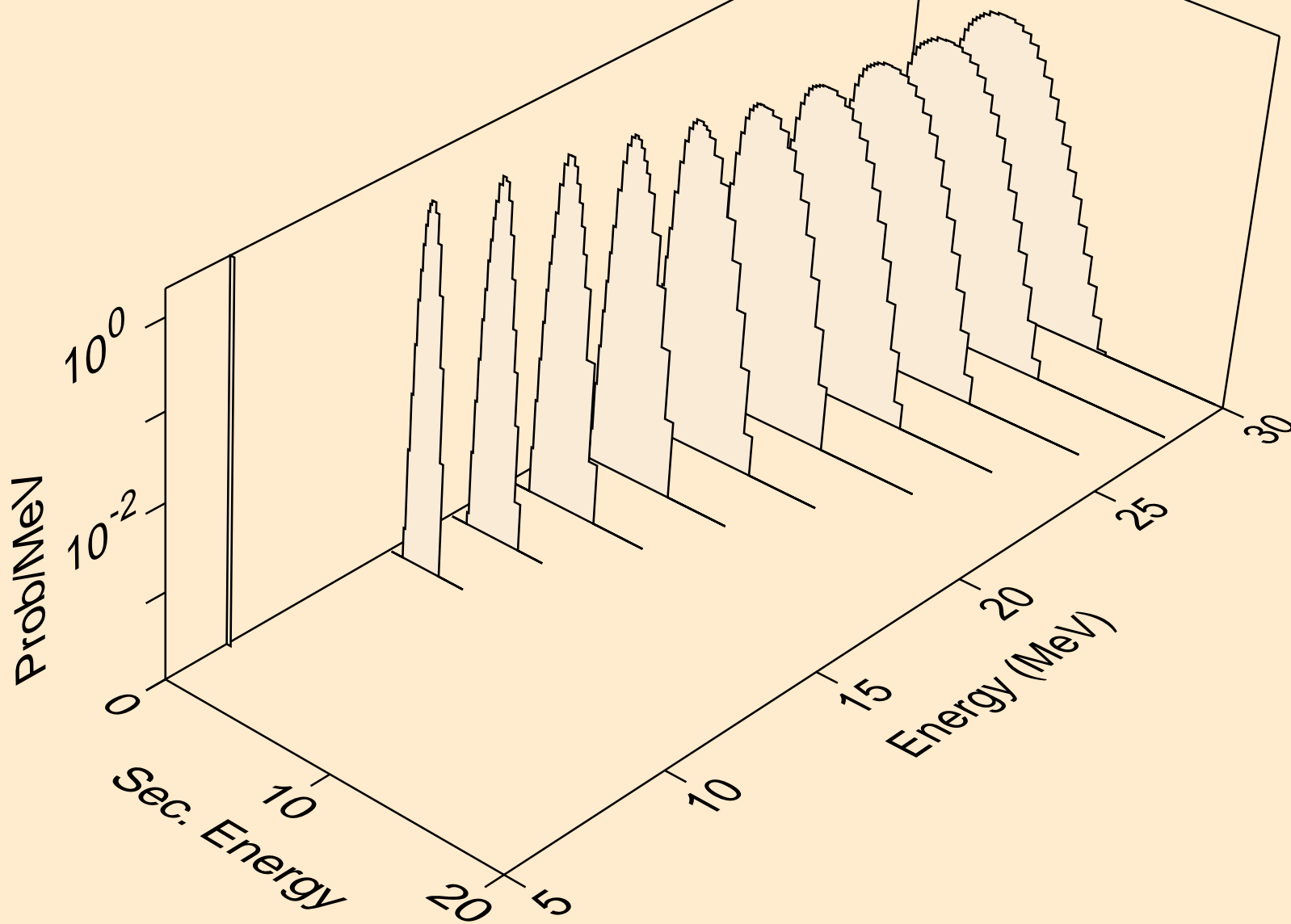

CS115 NEUTRON ACER TENDL-2019 LIBRARY; T=293.16K  
deuterons from (n,x)

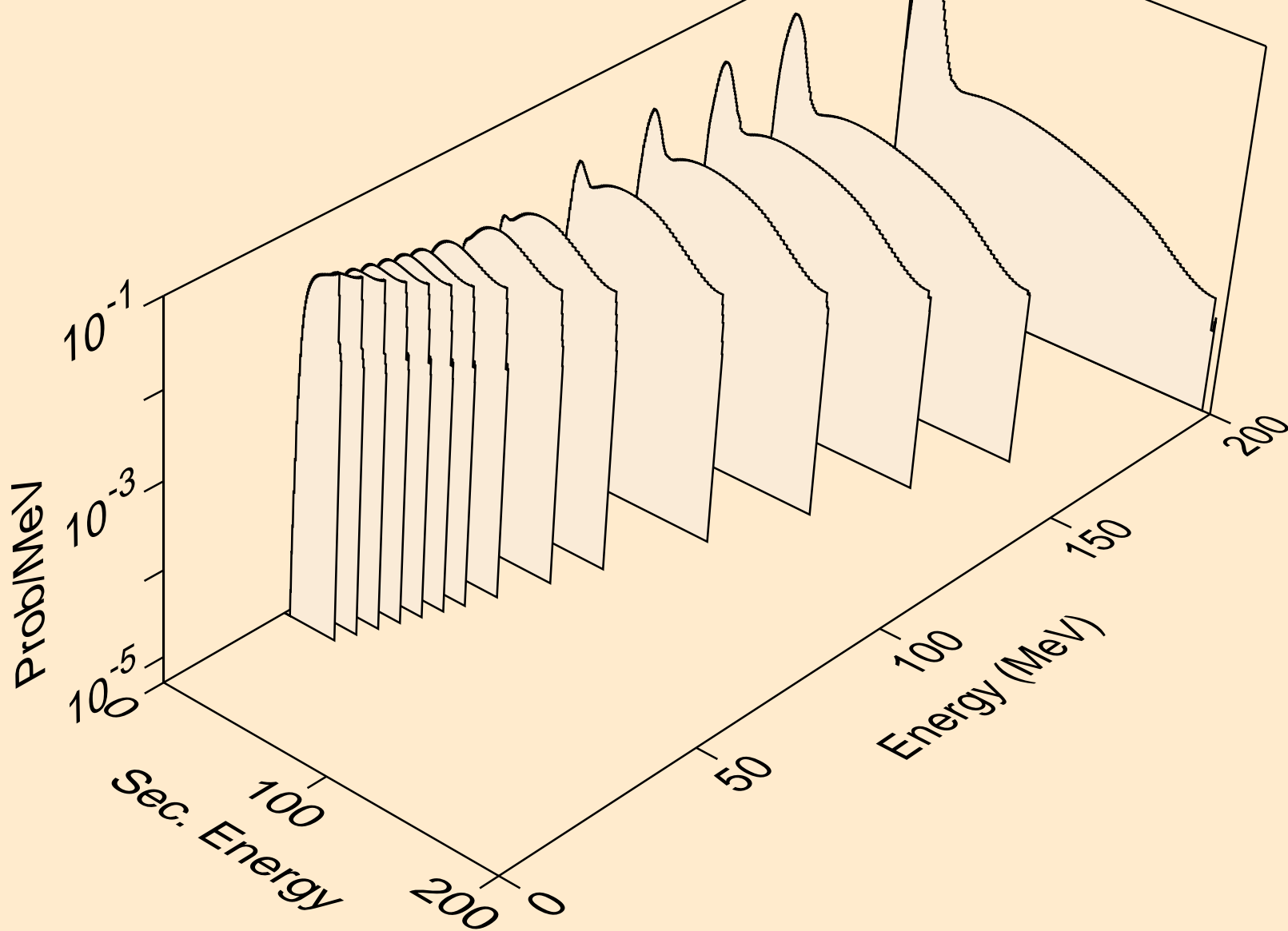

CS115 NEUTRON ACER TENDL-2019 LIBRARY; T=293.16K  
deuterons from (n,2nd)

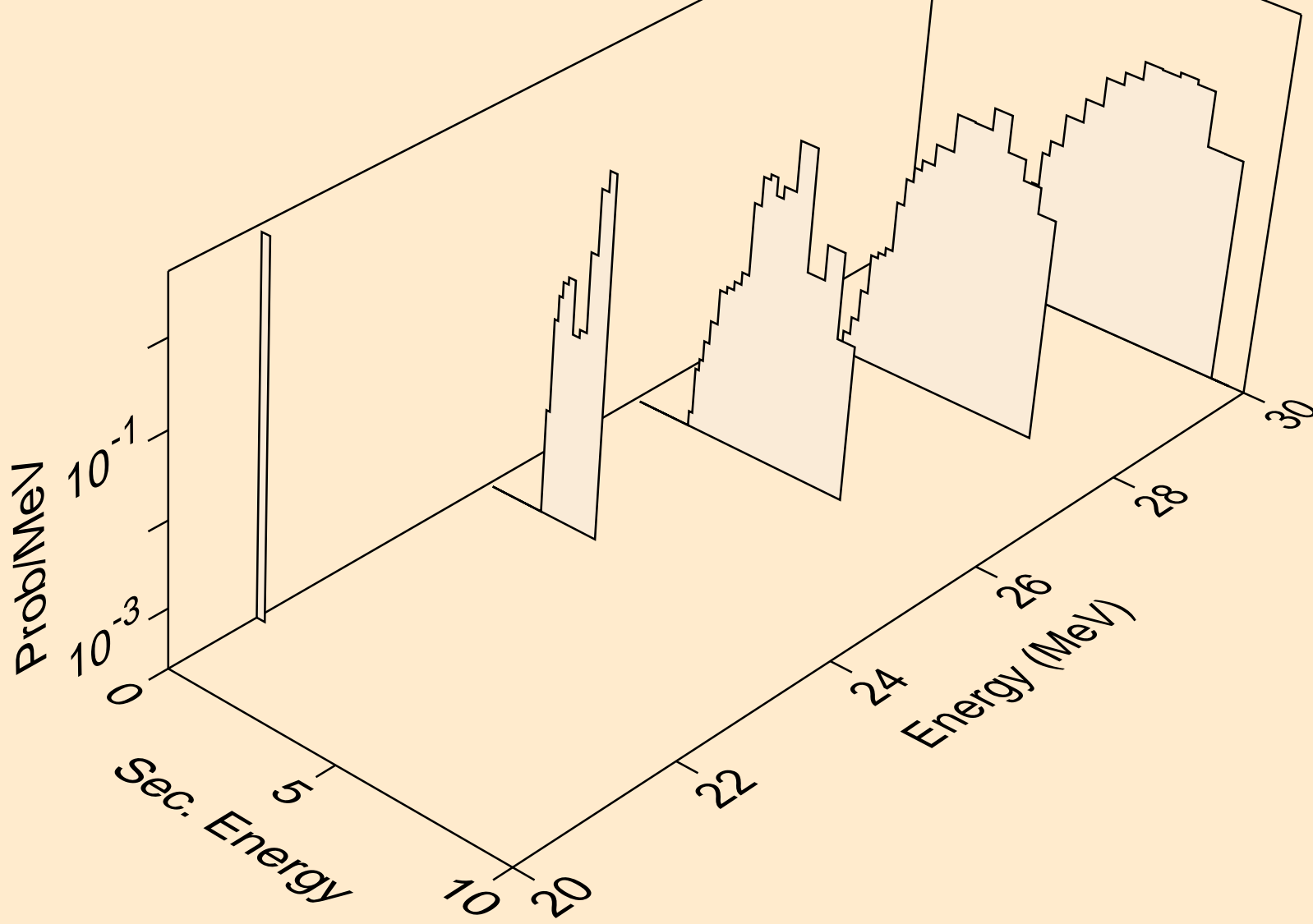

CS115 NEUTRON ACER TENDL-2019 LIBRARY; T=293.16K  
deuterons from (n,n\*)d

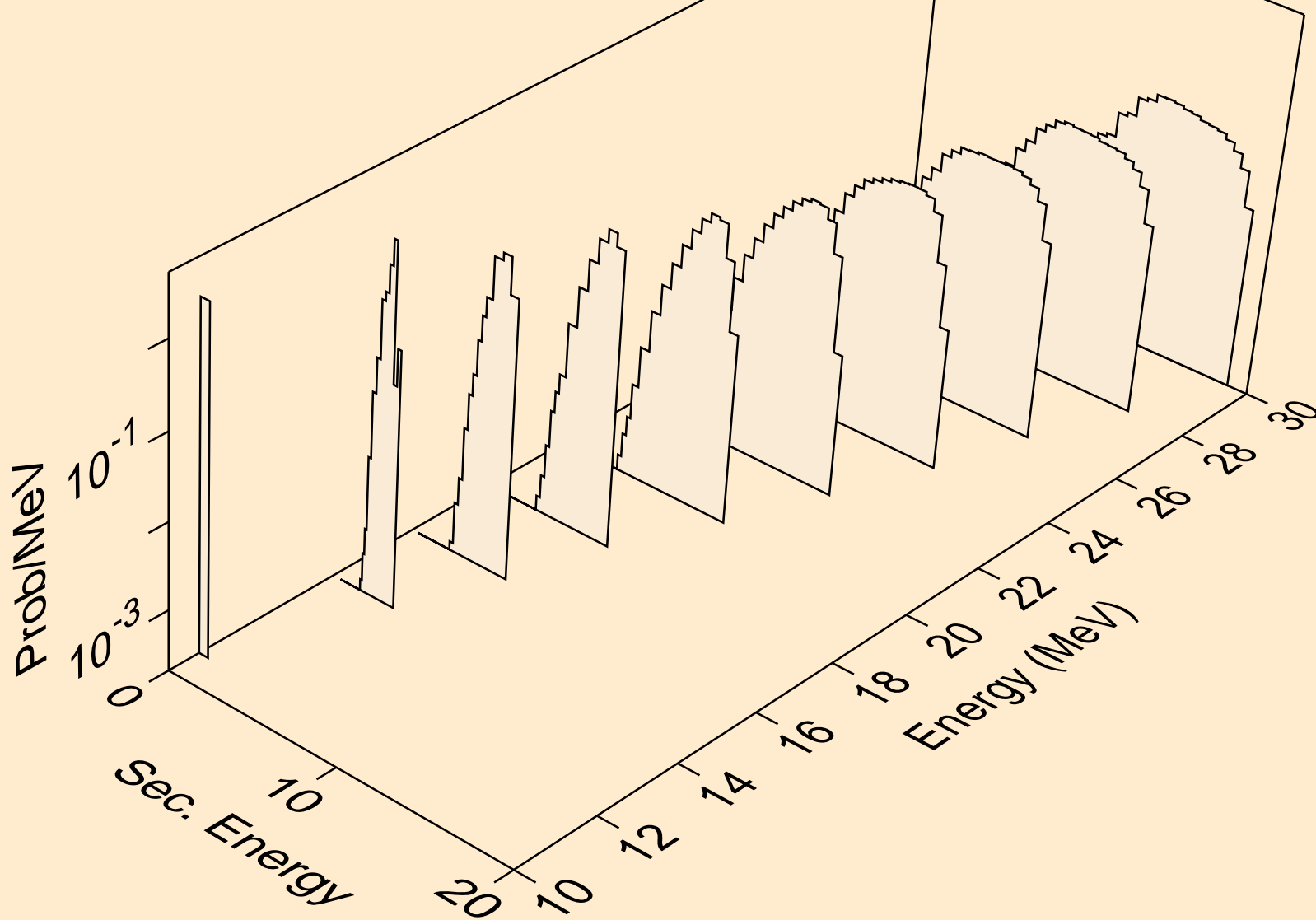

CS115 NEUTRON ACER TENDL-2019 LIBRARY; T=293.16K  
deuterons from (n,d)

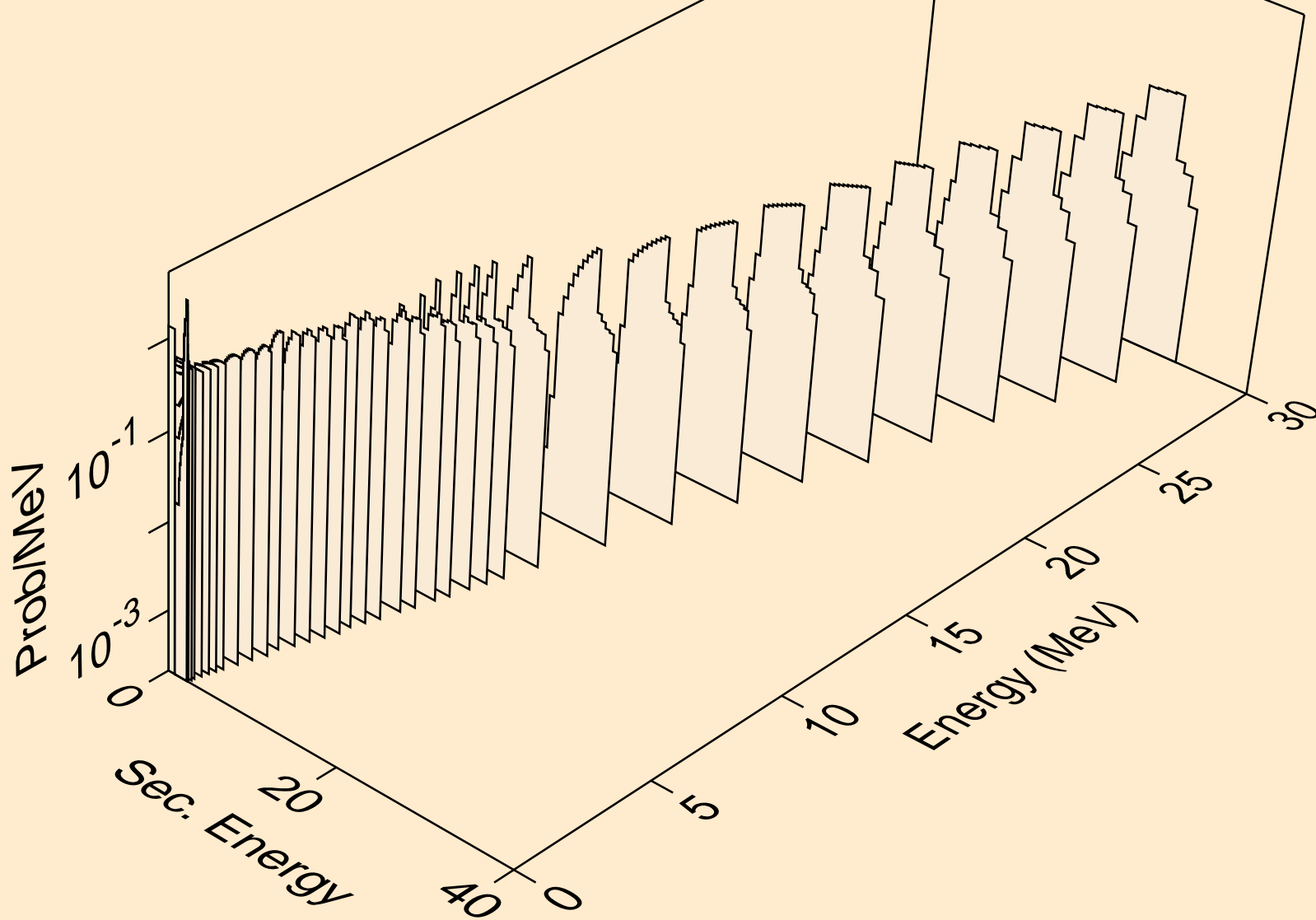

CS115 NEUTRON ACER TENDL-2019 LIBRARY; T=293.16K  
deuterons from (n,d2a)

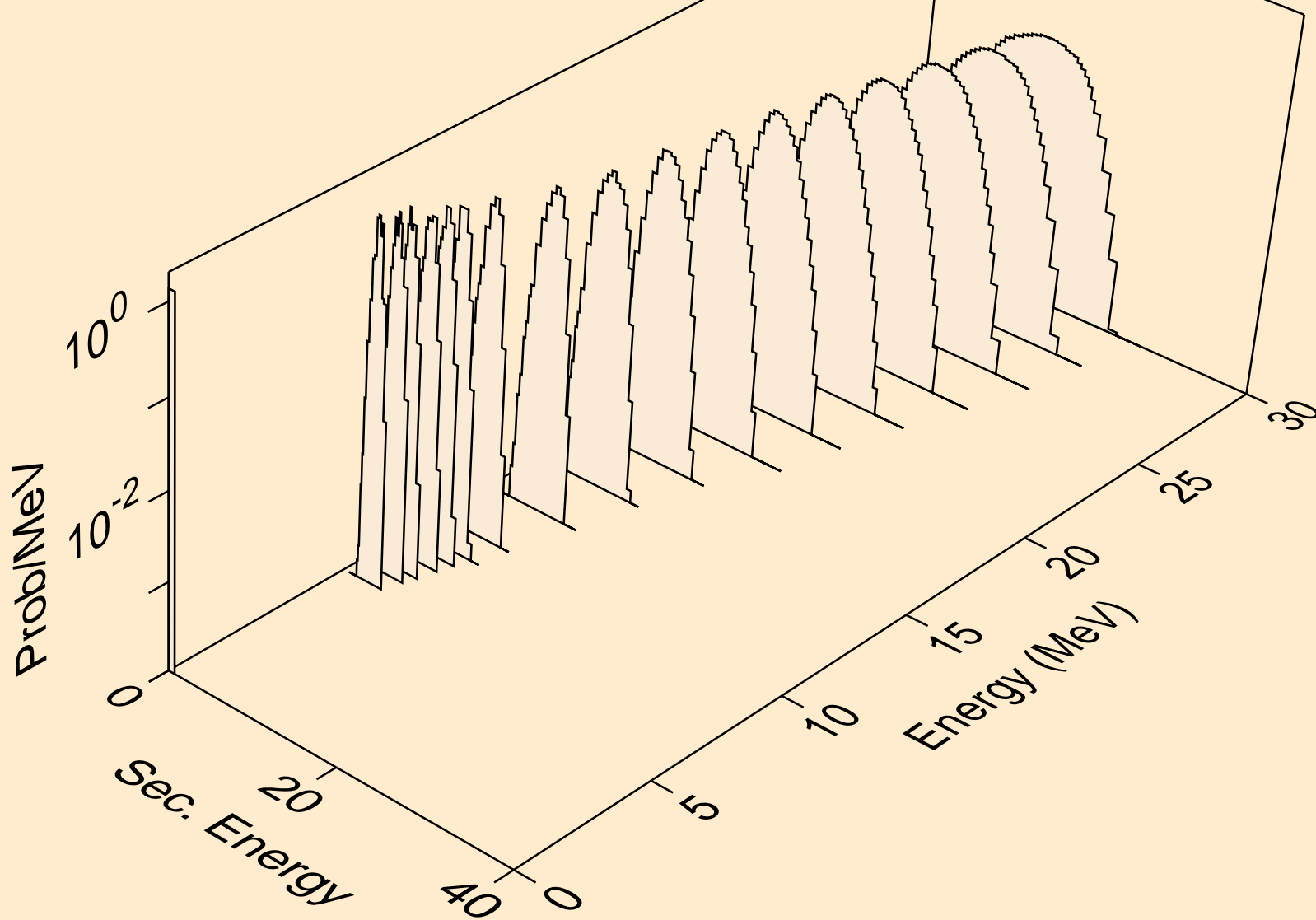

CS115 NEUTRON ACER TENDL-2019 LIBRARY; T=293.16K  
deuterons from (n,pd)

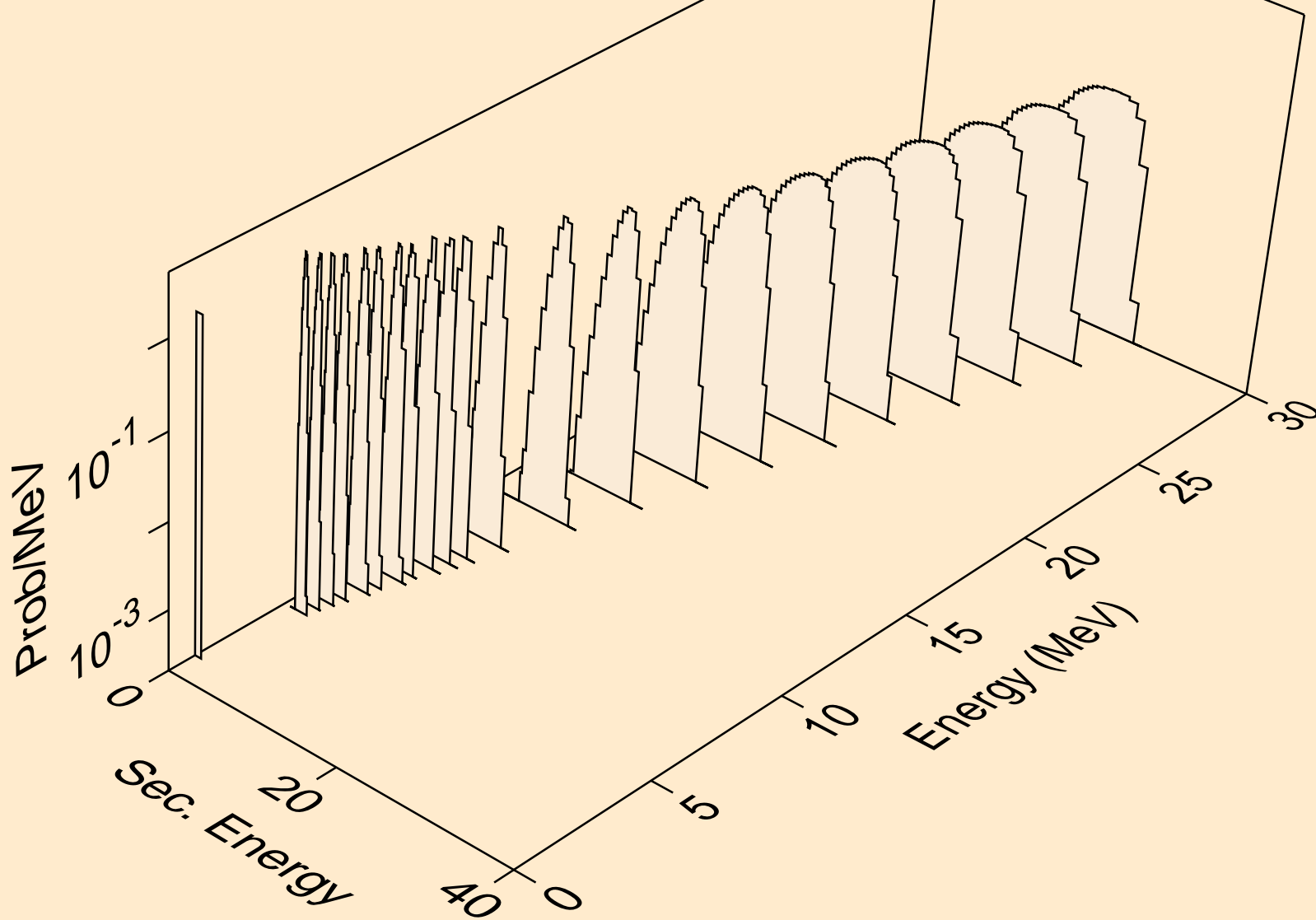

CS115 NEUTRON ACER TENDL-2019 LIBRARY; T=293.16K  
deuterons from (n,da)

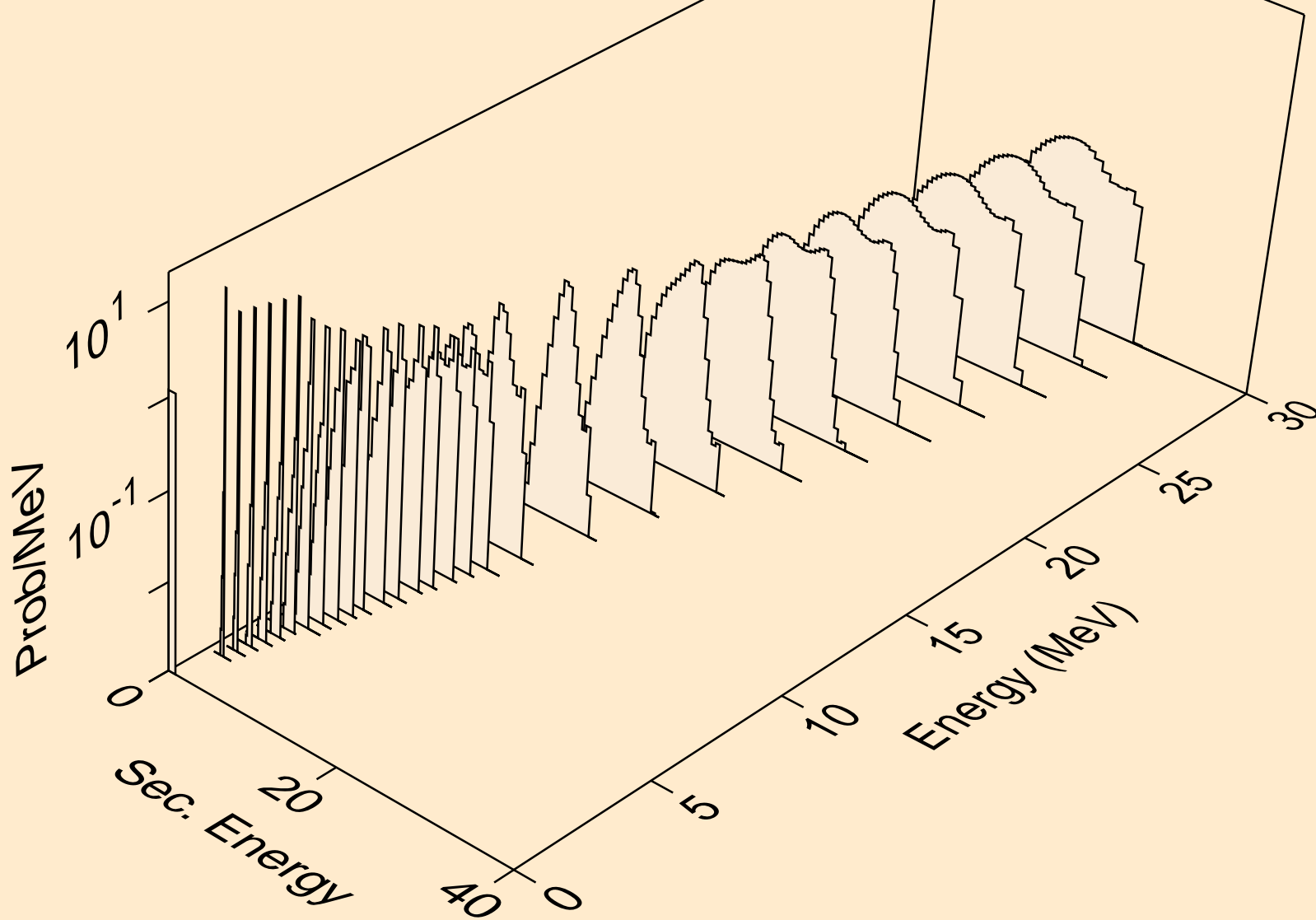



CS115 NEUTRON ACER TENDL-2019 LIBRARY; T=293.16K  
tritons from (n,x)

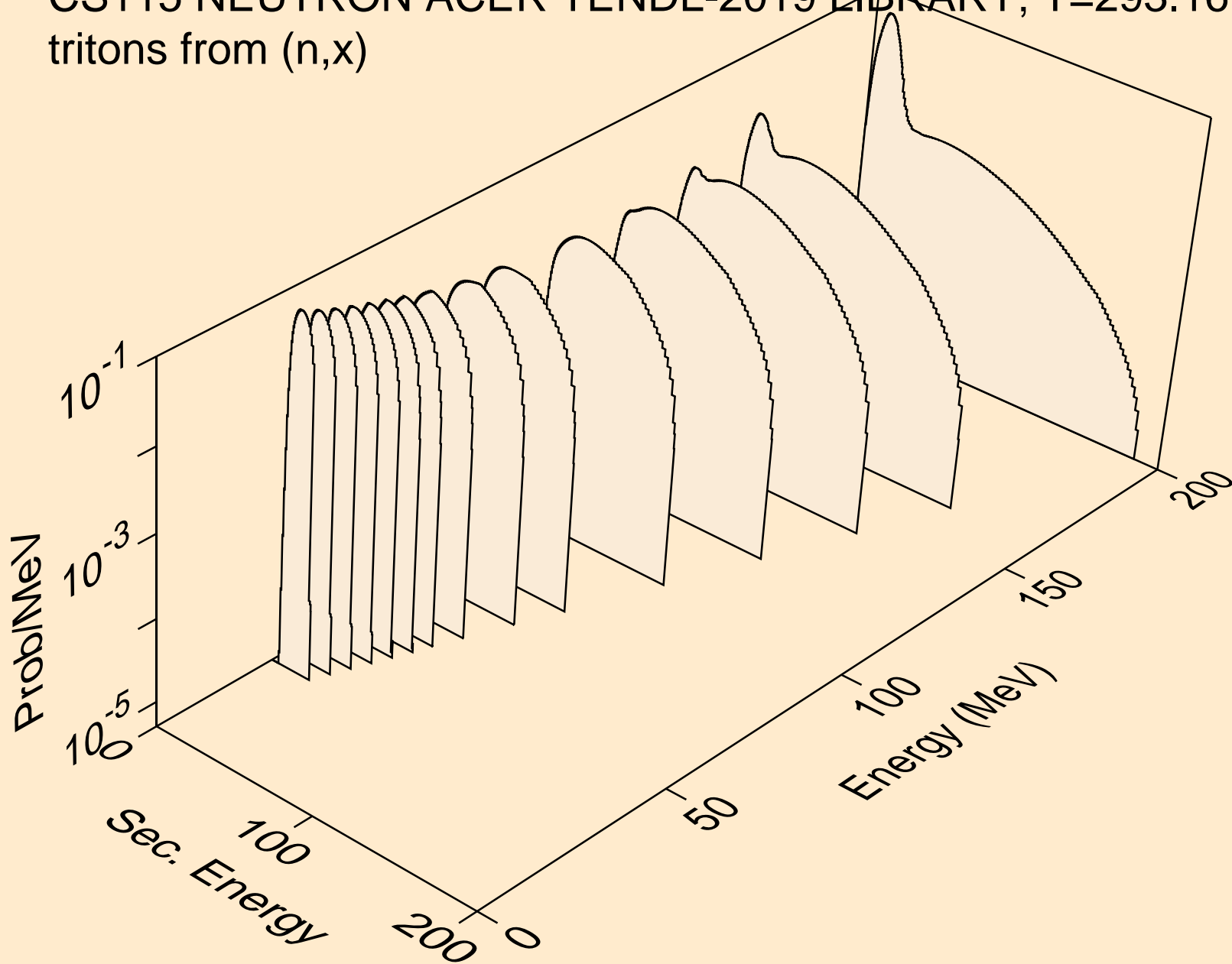

CS115 NEUTRON ACER TENDL-2019 LIBRARY; T=293.16K  
tritons from (n,n\*)t

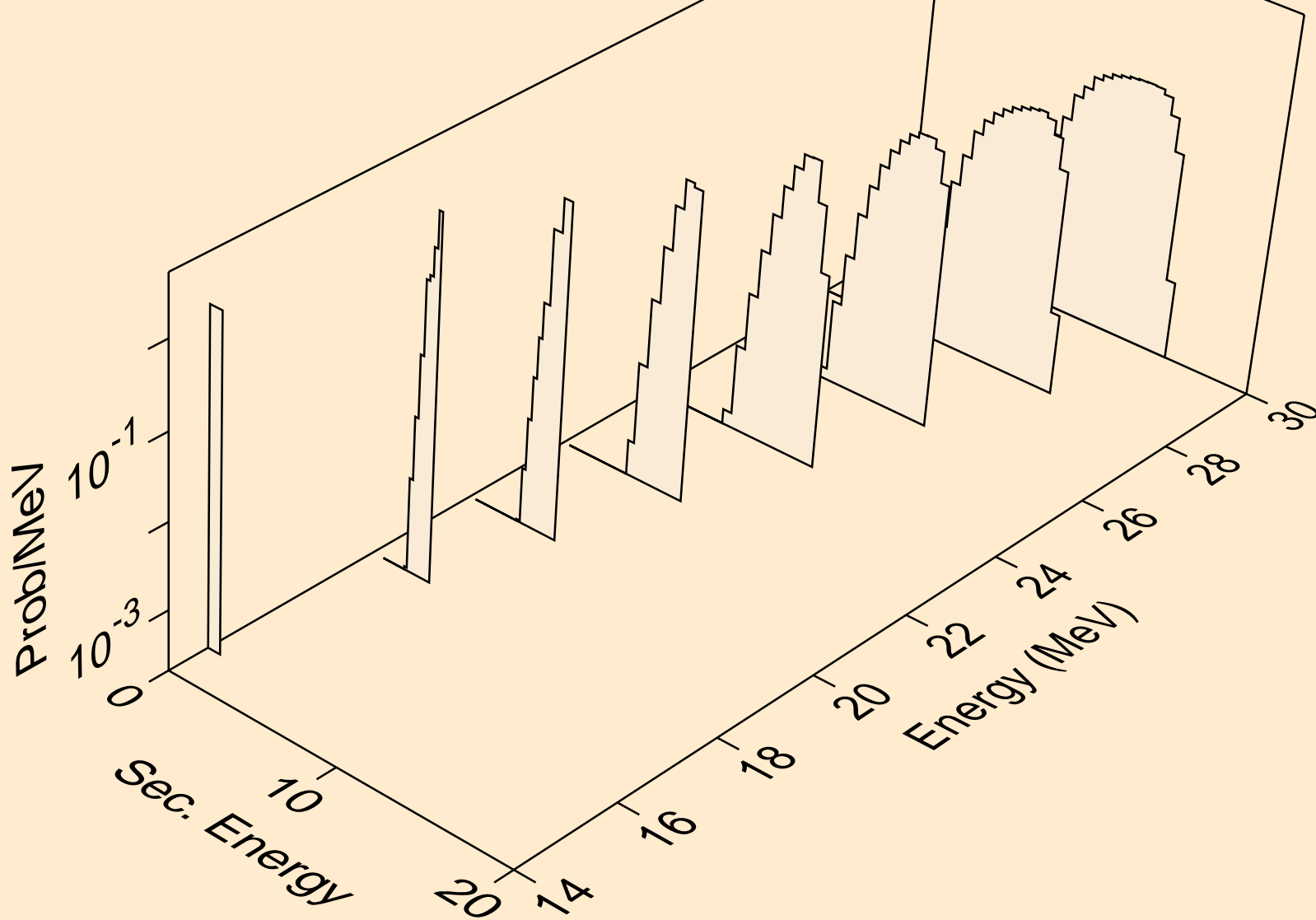

CS115 NEUTRON ACER TENDL-2019 LIBRARY; T=293.16K  
tritons from (n,t)

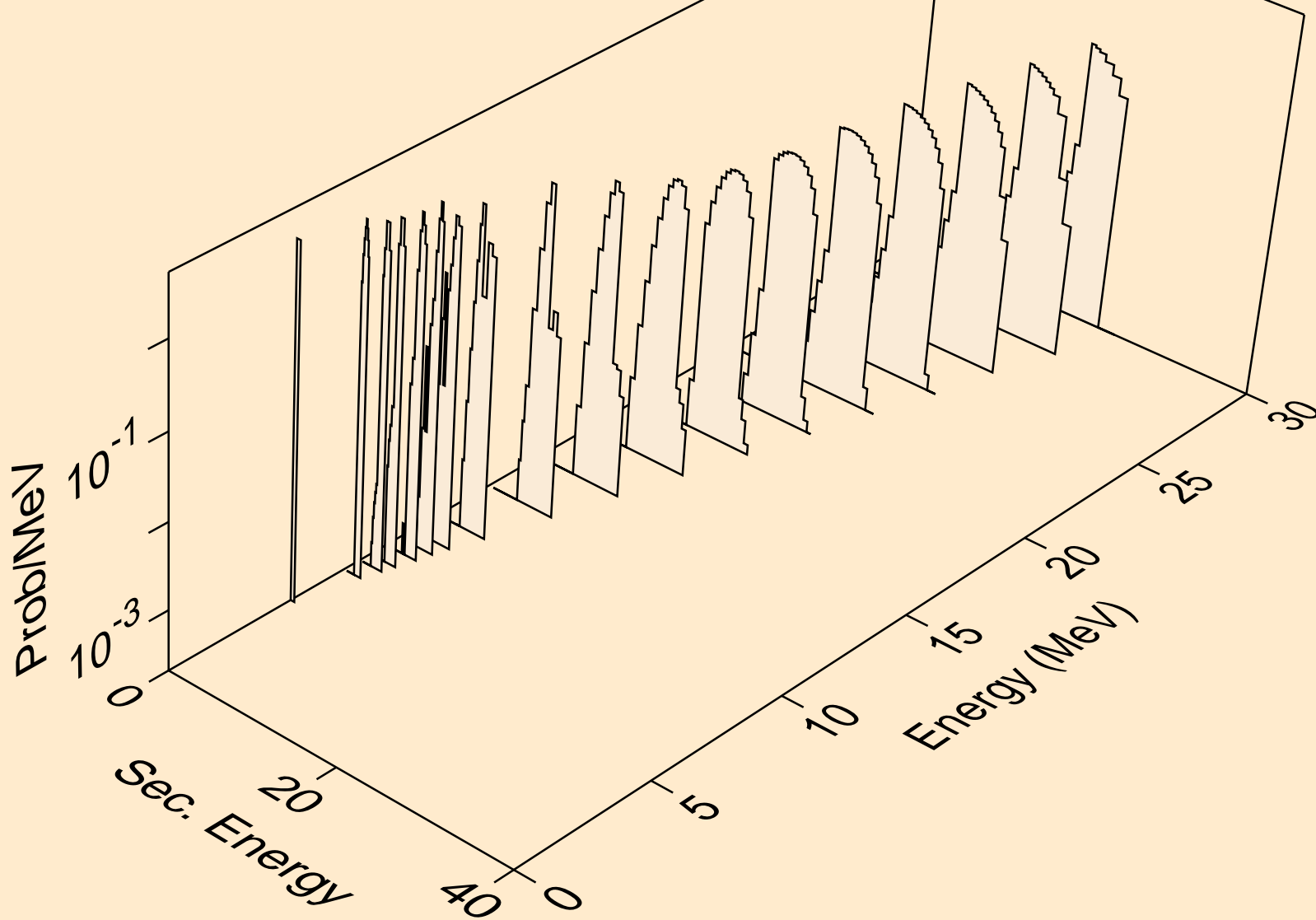

CS115 NEUTRON ACER TENDL-2019 LIBRARY; T=293.16K  
tritons from (n,t2a)

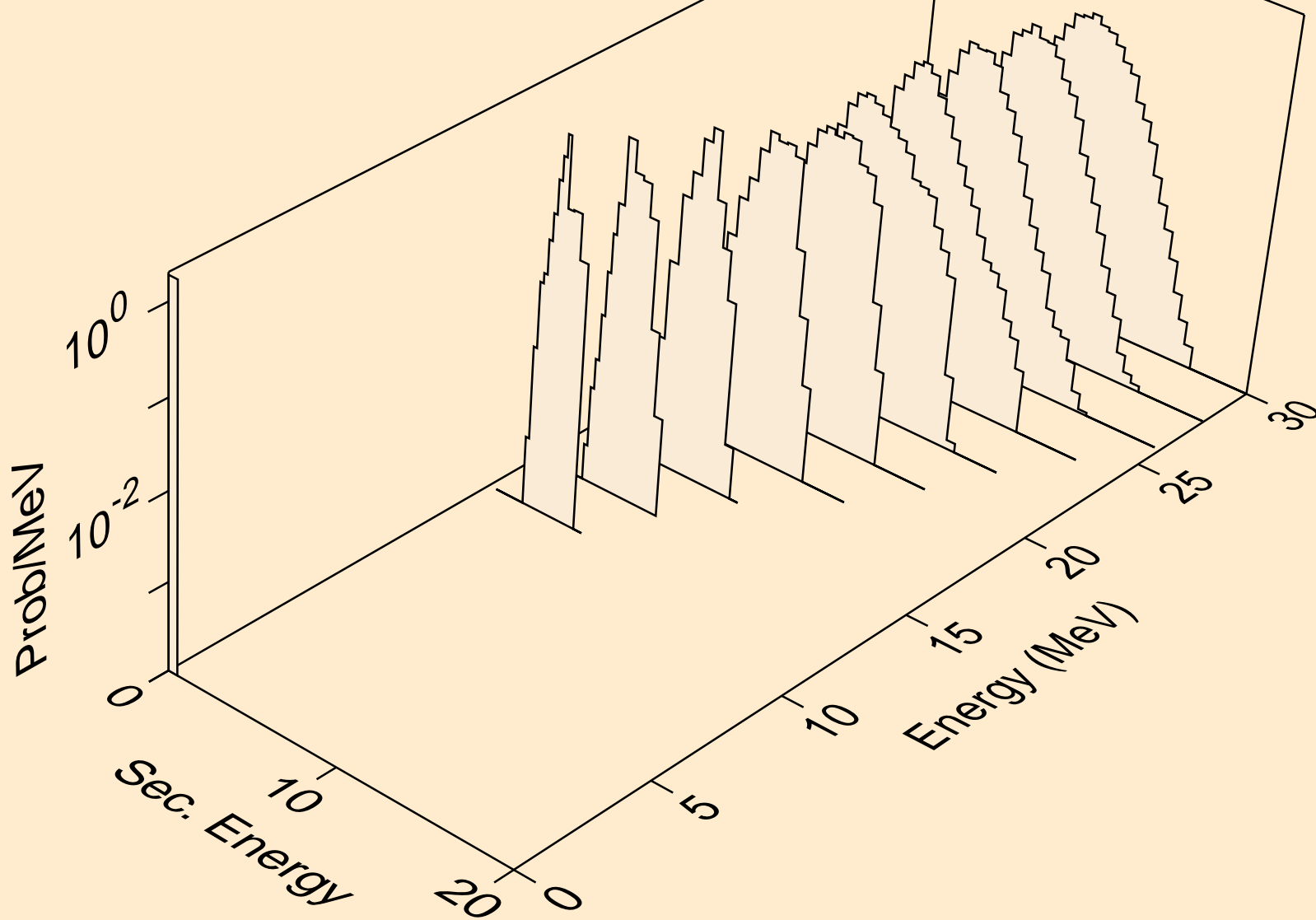

CS115 NEUTRON ACER TENDL-2019 LIBRARY; T=293.16K  
tritons from (n,pt)

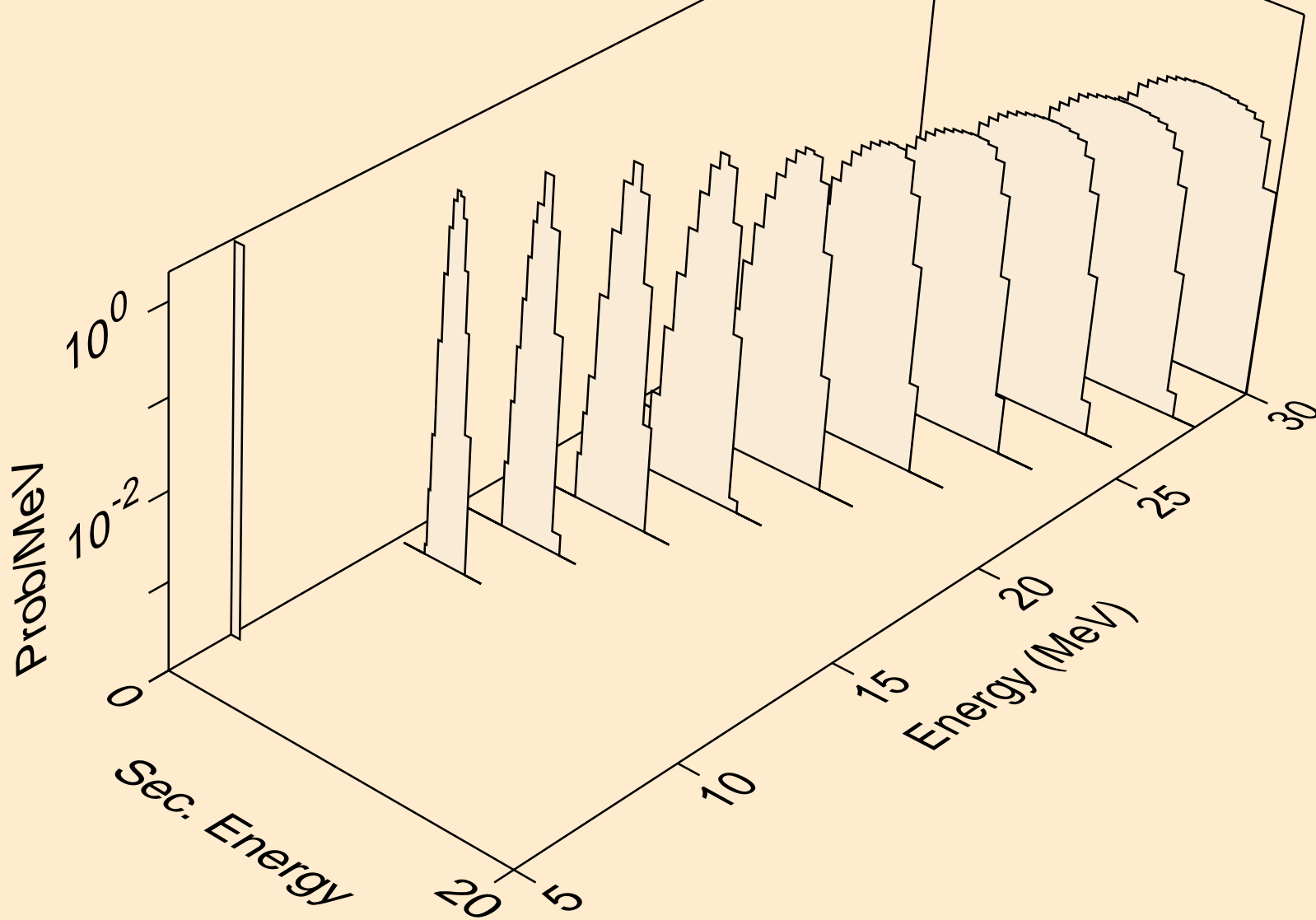

CS115 NEUTRON ACER TENDL-2019 LIBRARY; T=293.16K  
he3s from (n,x)

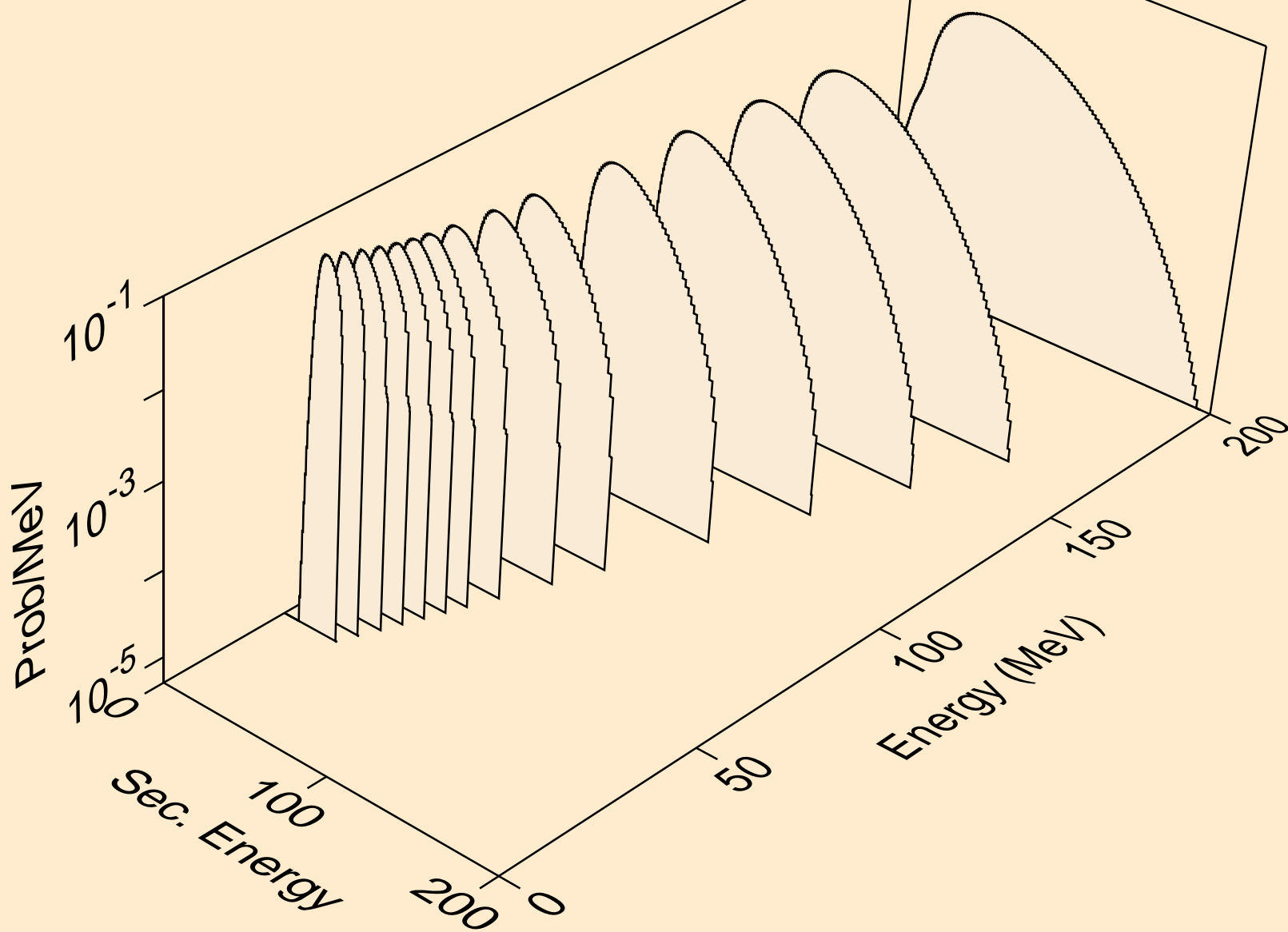

CS115 NEUTRON ACER TENDL-2019 LIBRARY; T=293.16K  
he3s from (n,n\*)he3

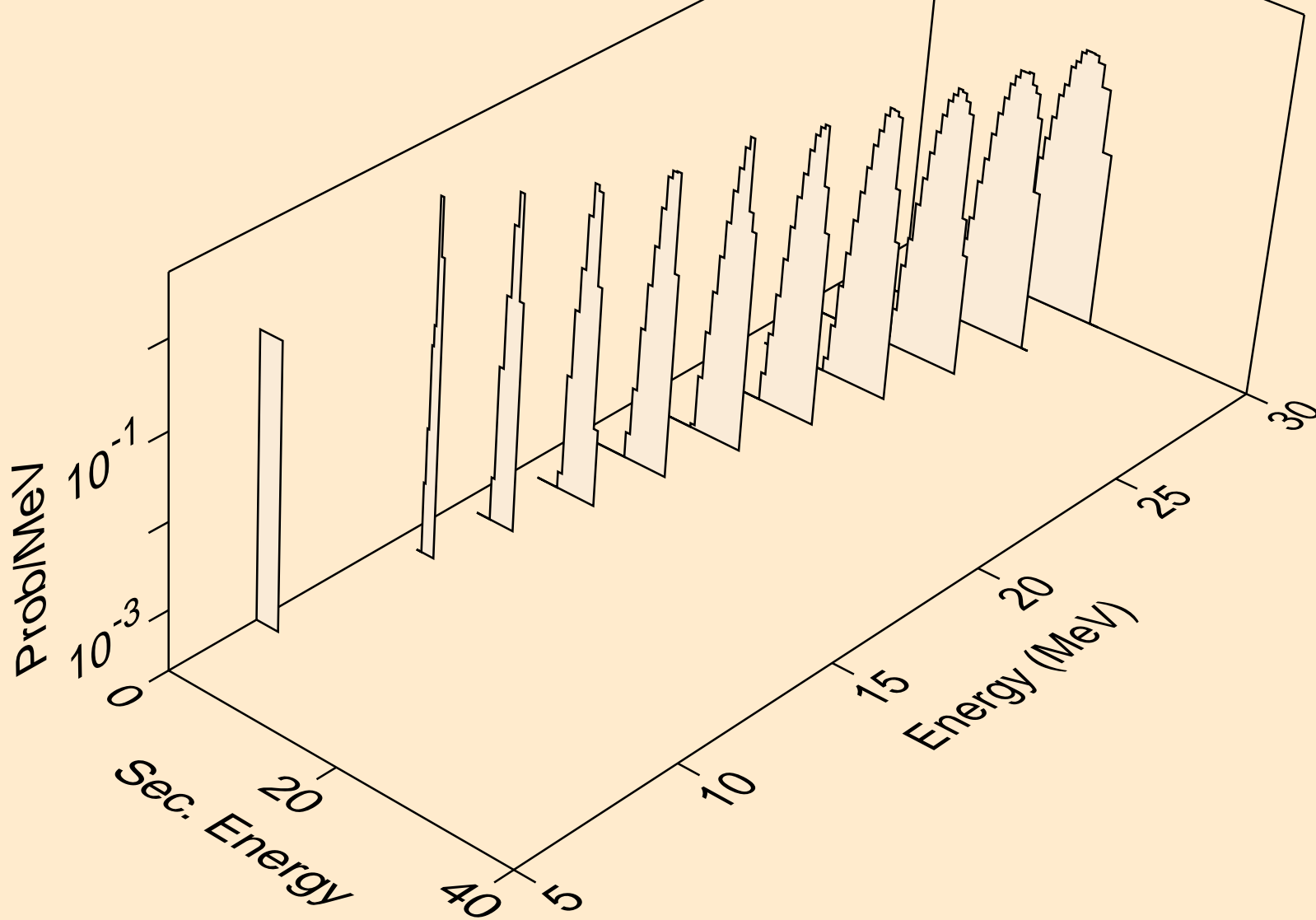

CS115 NEUTRON ACER TENDL-2019 LIBRARY; T=293.16K  
he3s from (n,he3)

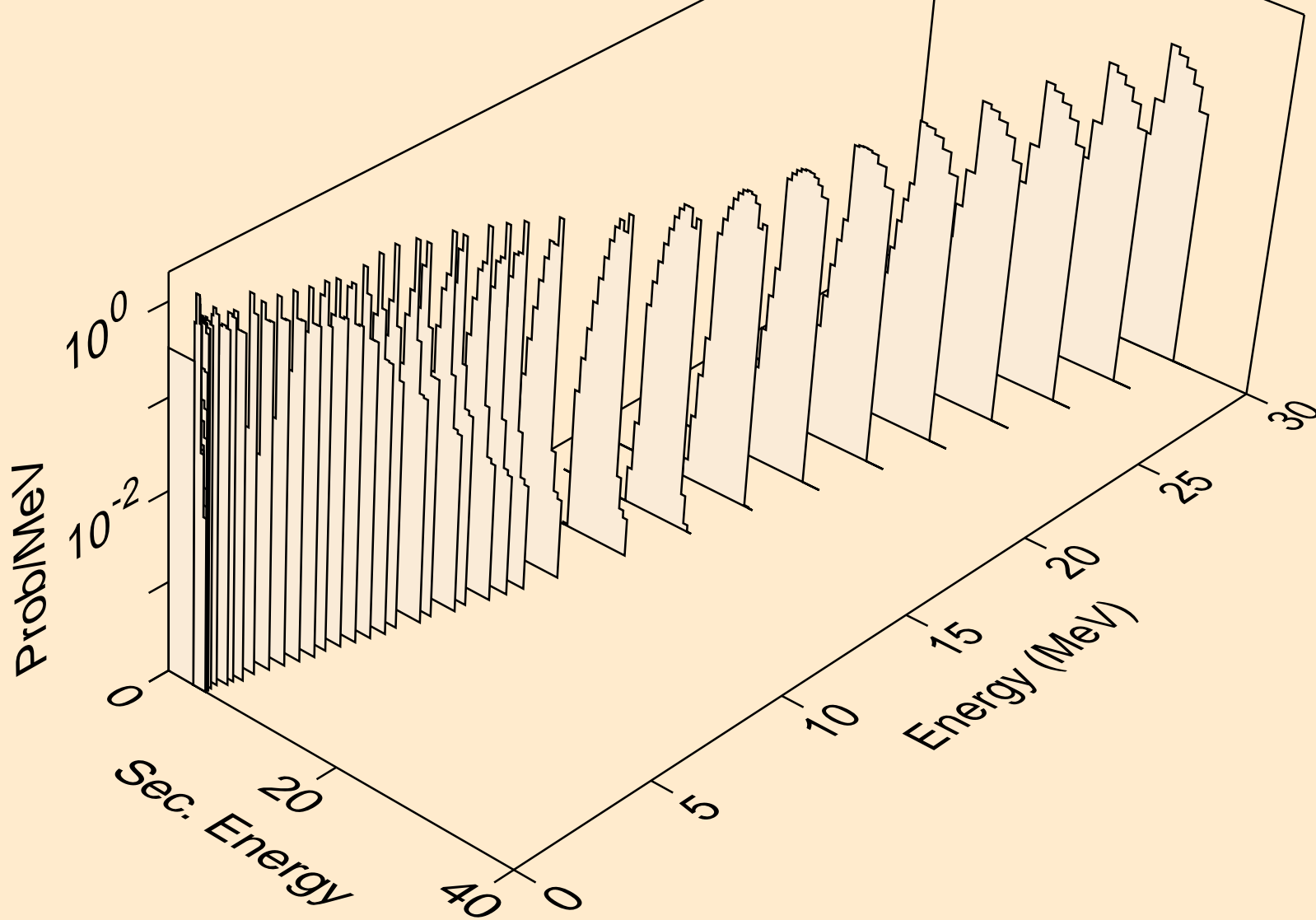



CS115 NEUTRON ACER TENDL-2019 LIBRARY; T=293.16K  
alphas from (n,x)

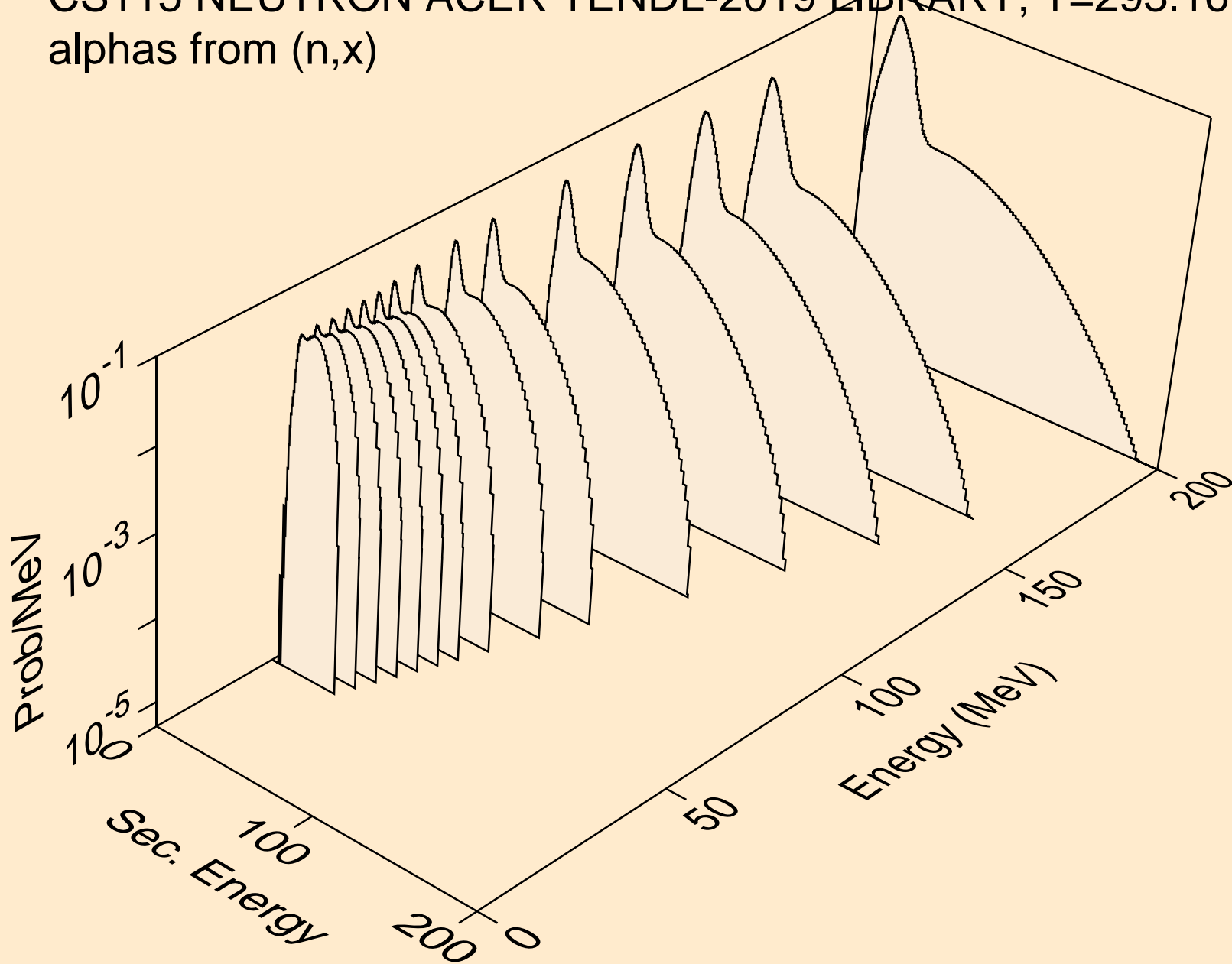

CS115 NEUTRON ACER TENDL-2019 LIBRARY; T=293.16K  
alphas from (n,n\*)a

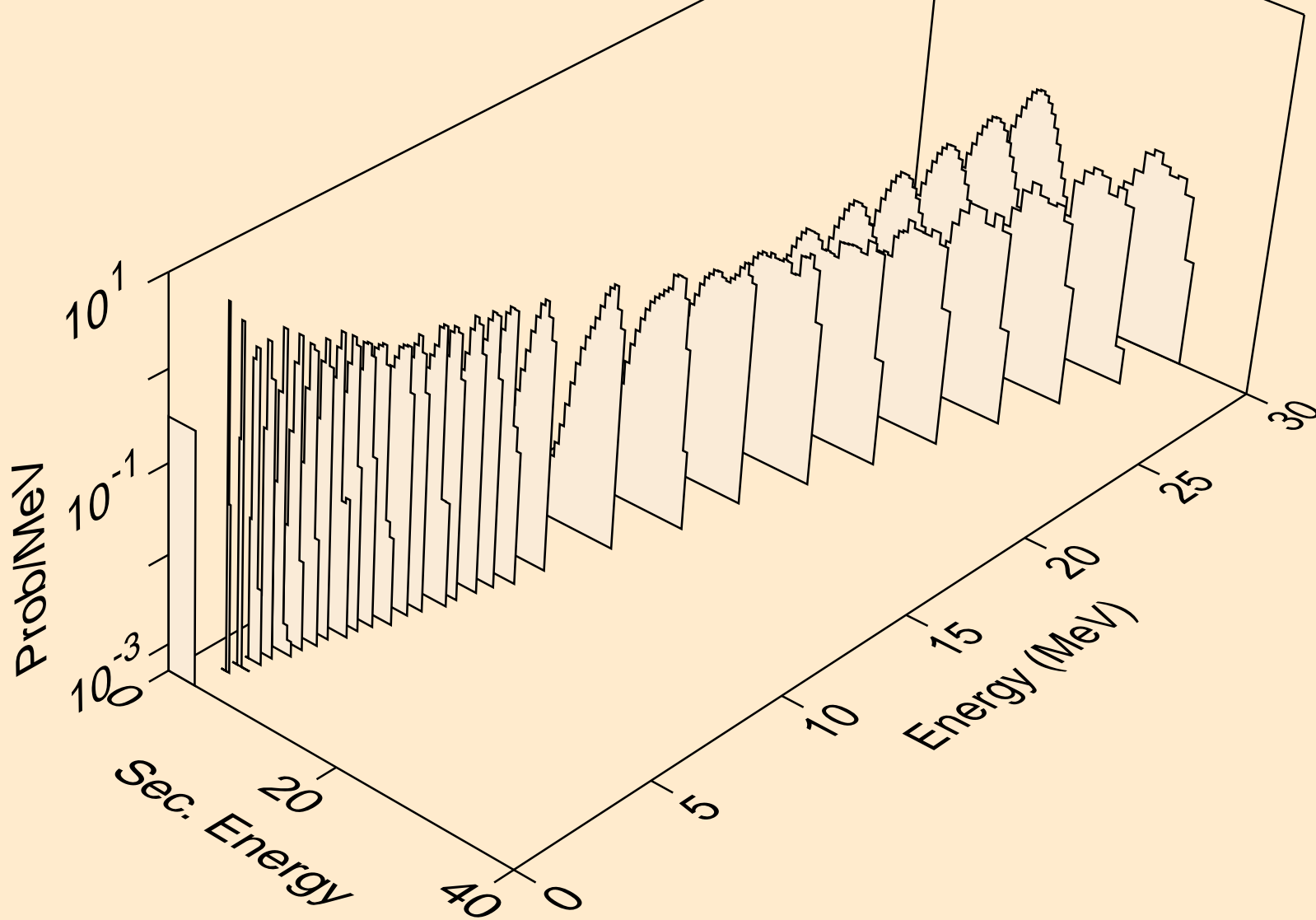

CS115 NEUTRON ACER TENDL-2019 LIBRARY; T=293.16K  
alphas from (n,n\*)3a

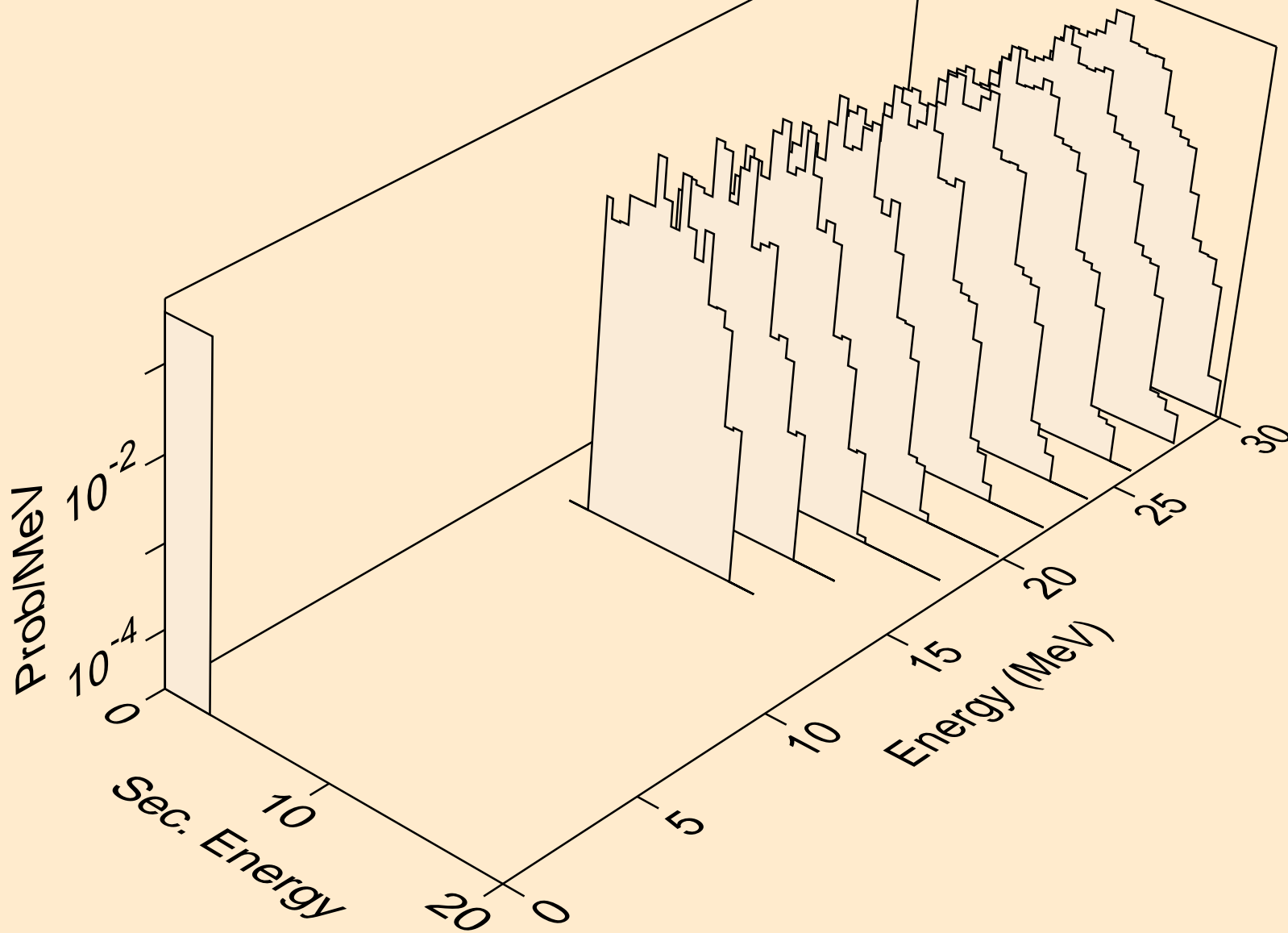

CS115 NEUTRON ACER TENDL-2019 LIBRARY; T=293.16K  
alphas from (n,2n)a

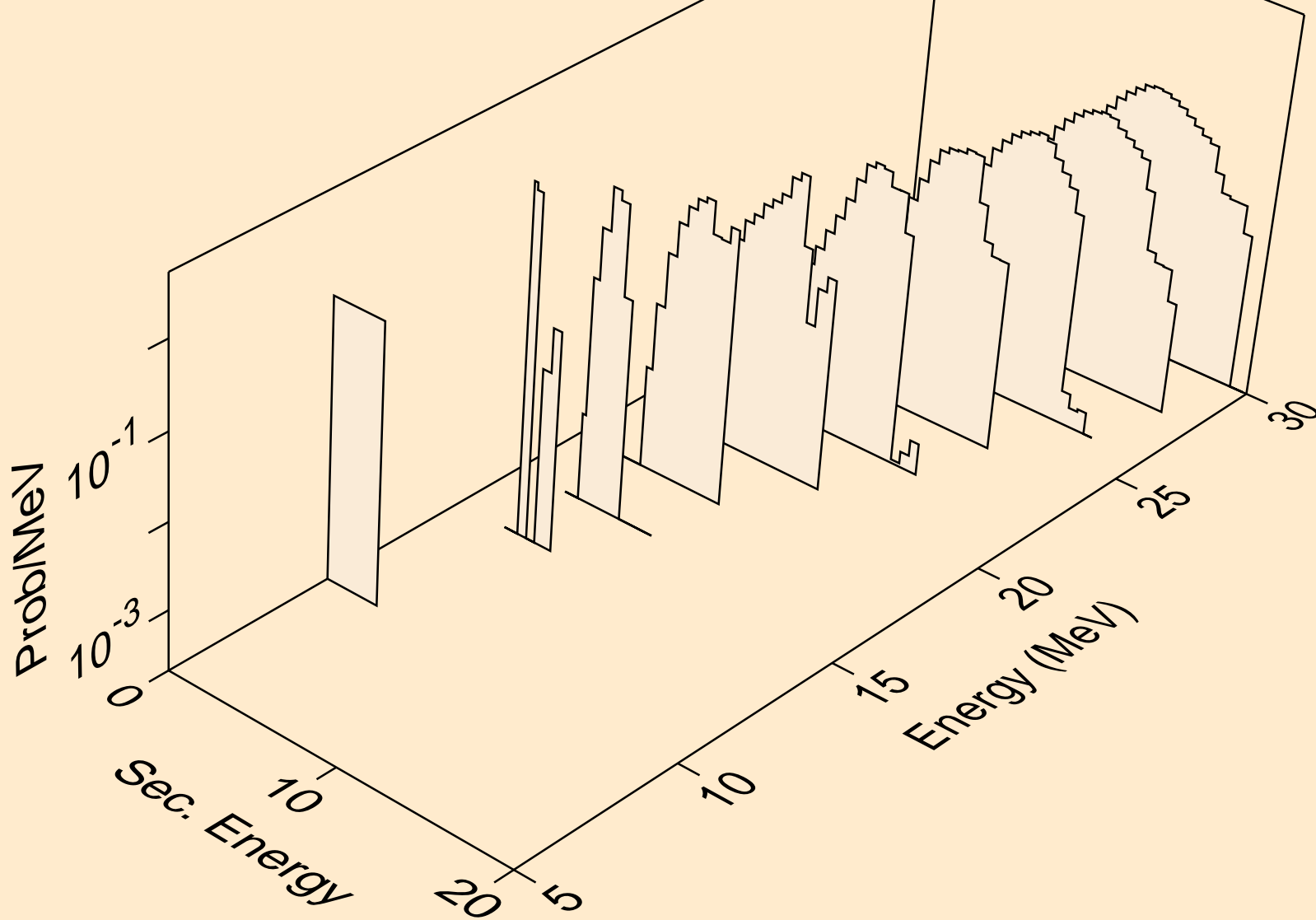

CS115 NEUTRON ACER TENDL-2019 LIBRARY; T=293.16K  
alphas from (n,n\*)2a

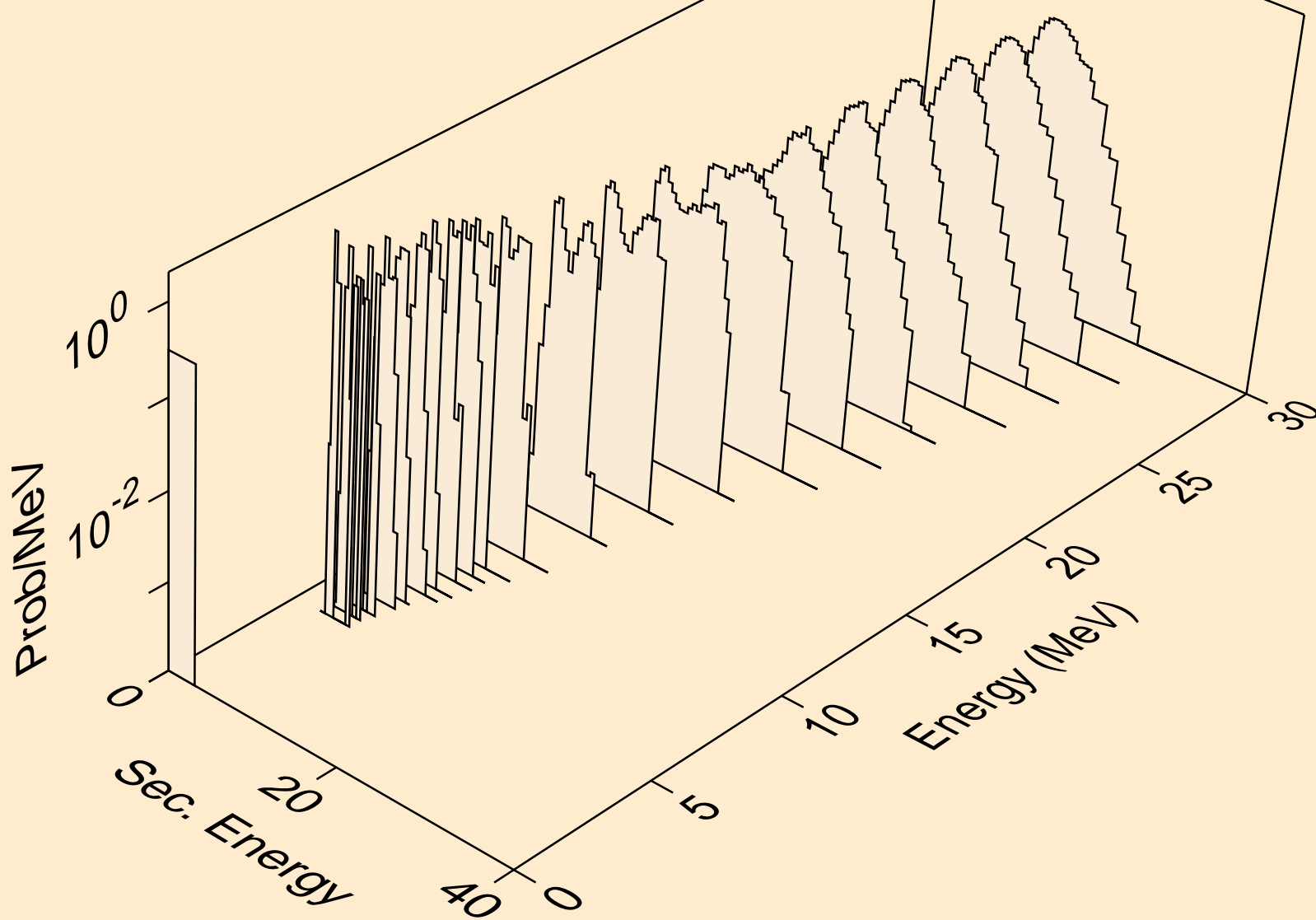

CS115 NEUTRON ACER TENDL-2019 LIBRARY; T=293.16K  
alphas from (n,2n)2a

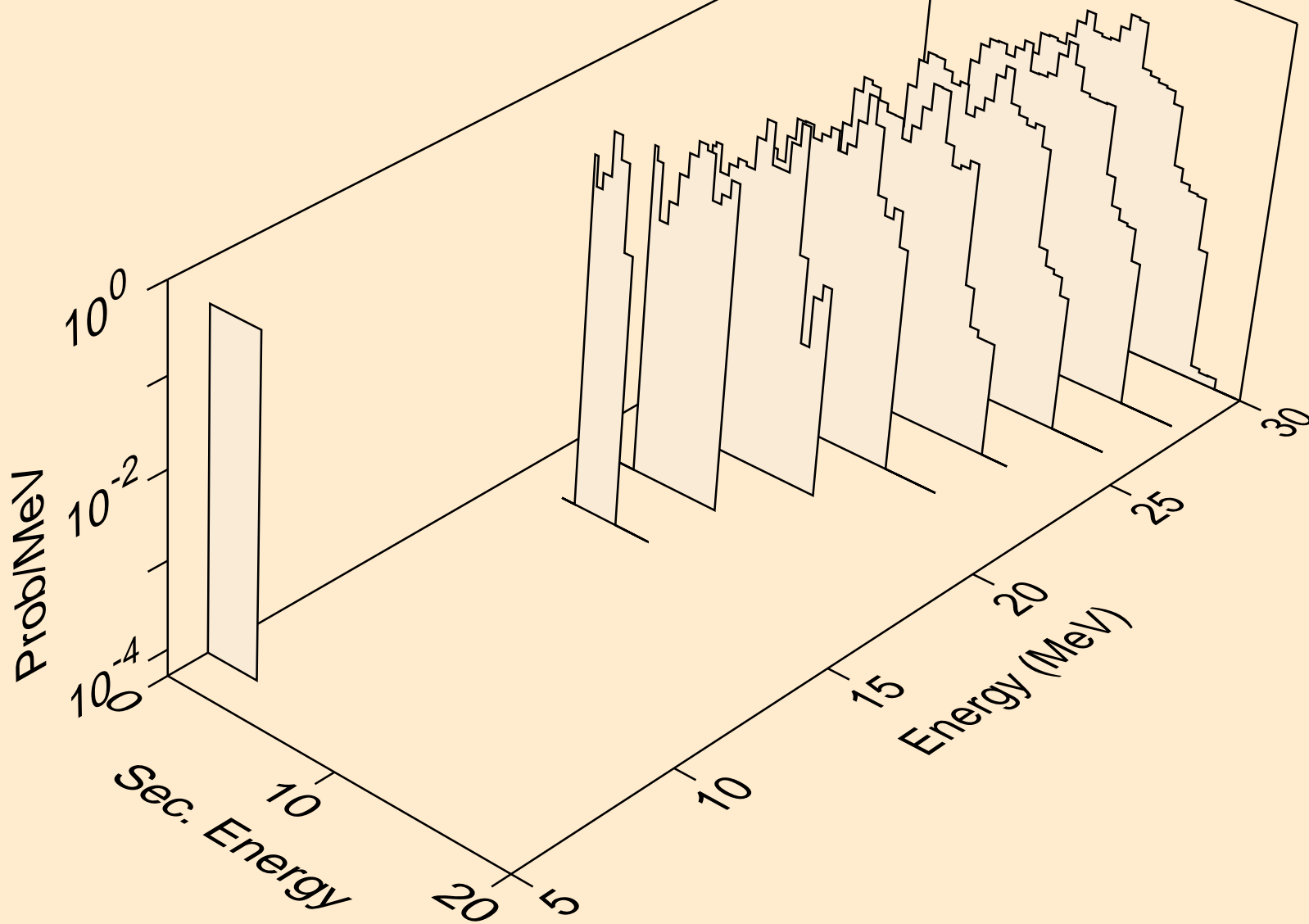

CS115 NEUTRON ACER TENDL-2019 LIBRARY; T=293.16K  
alphas from (n,npa)

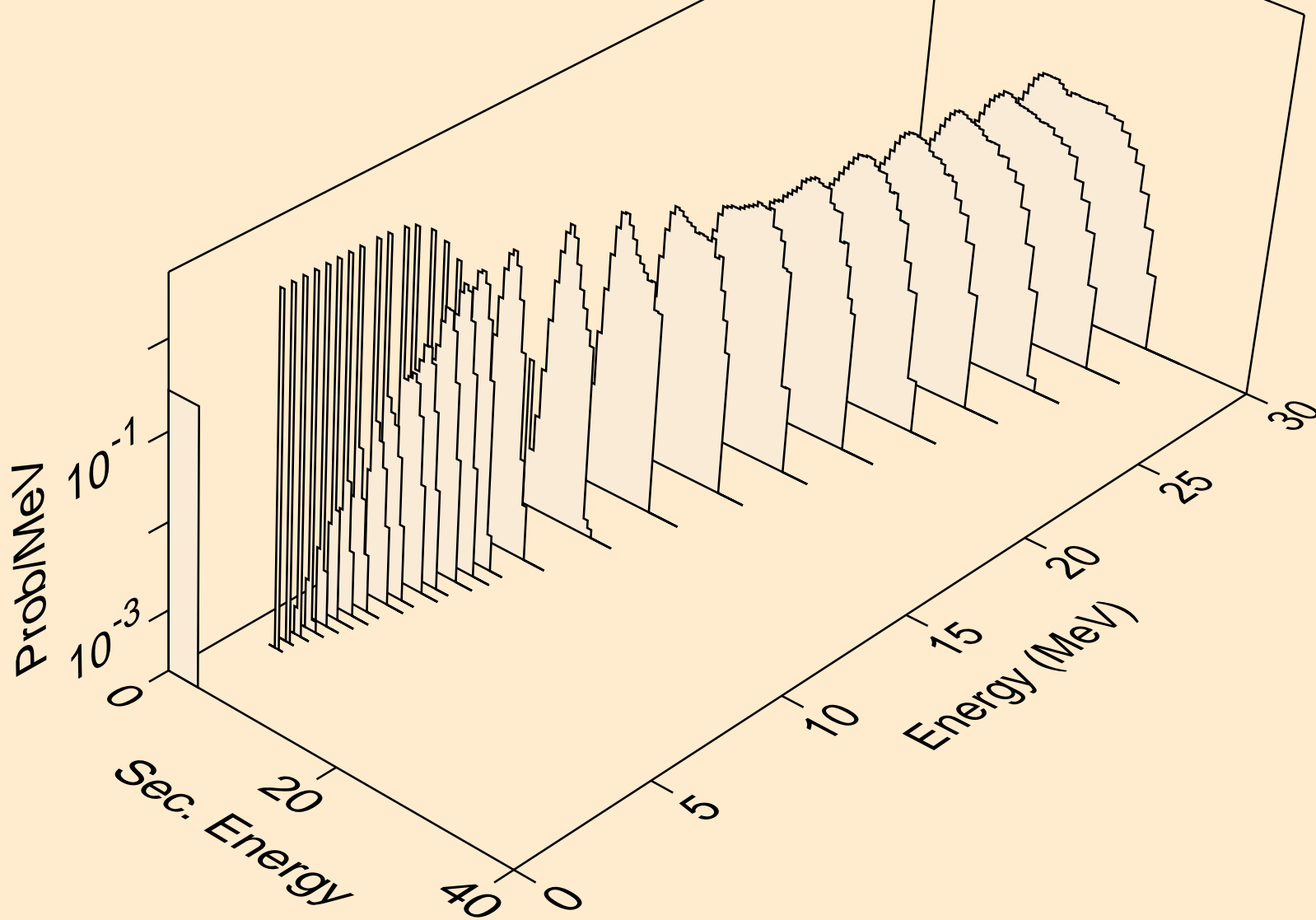

CS115 NEUTRON ACER TENDL-2019 LIBRARY; T=293.16K  
alphas from (n,a)

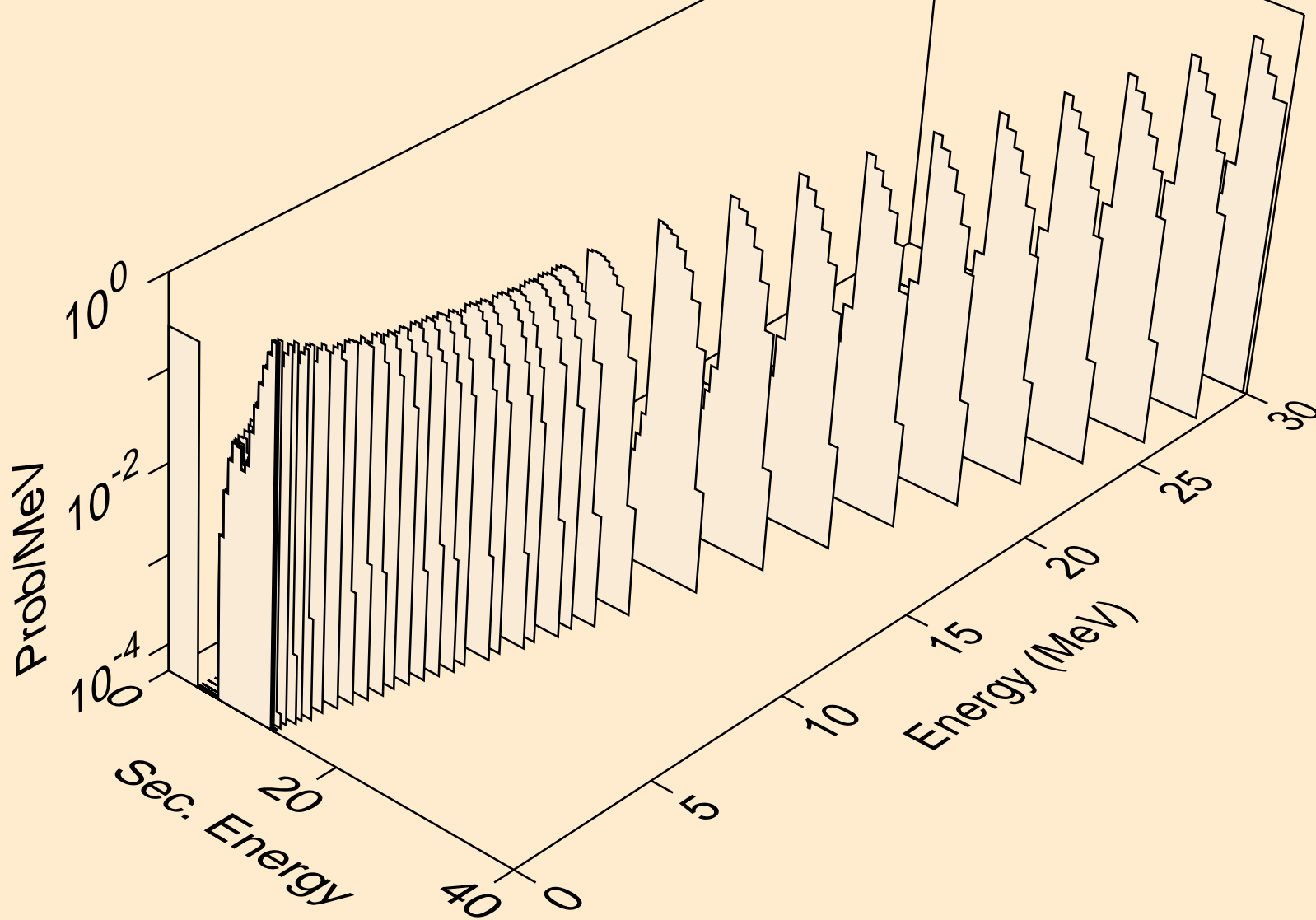



CS115 NEUTRON ACER TENDL-2019 LIBRARY; T=293.16K  
alphas from (n,2a)

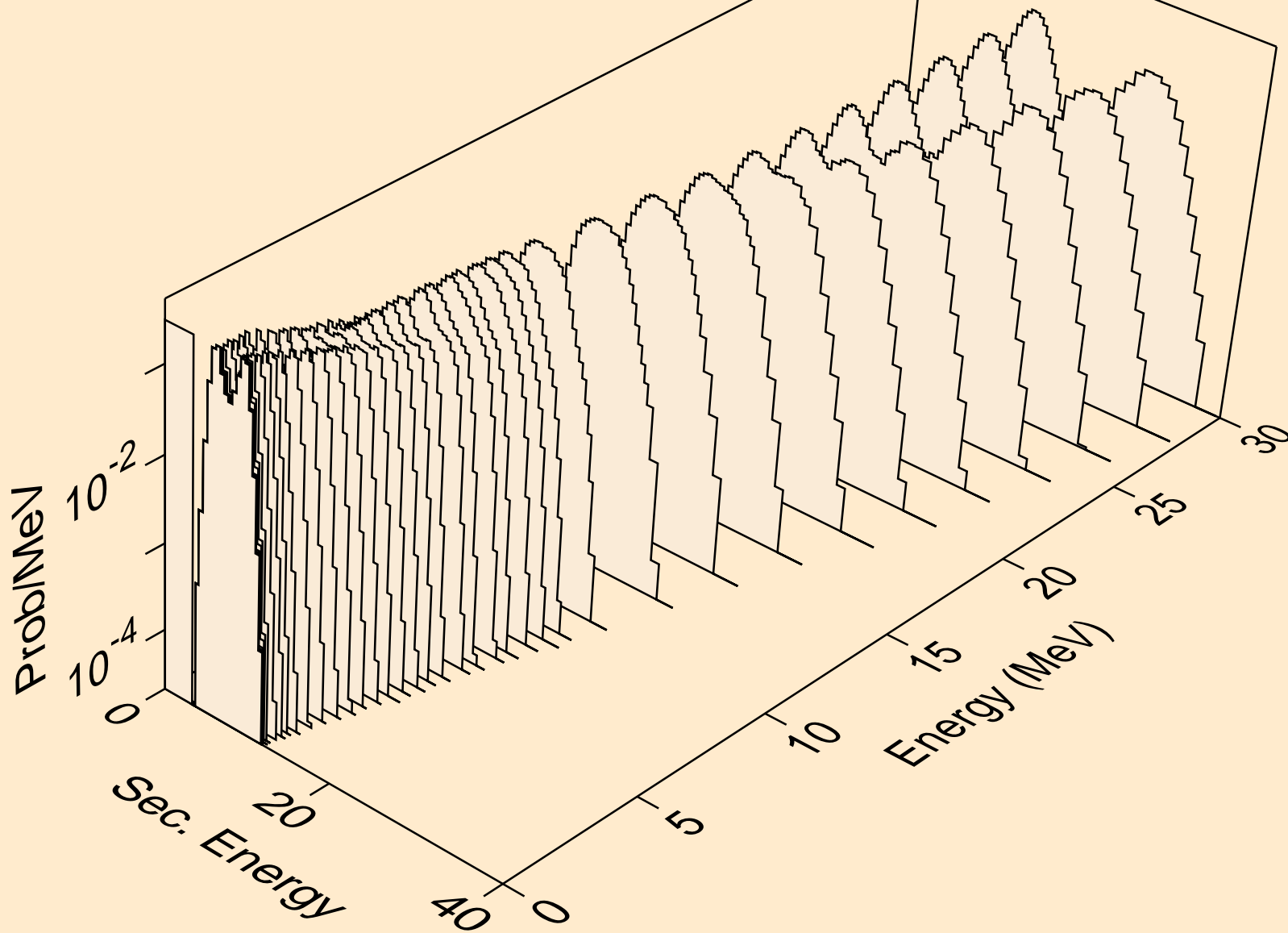

CS115 NEUTRON ACER TENDL-2019 LIBRARY; T=293.16K  
alphas from (n,3a)

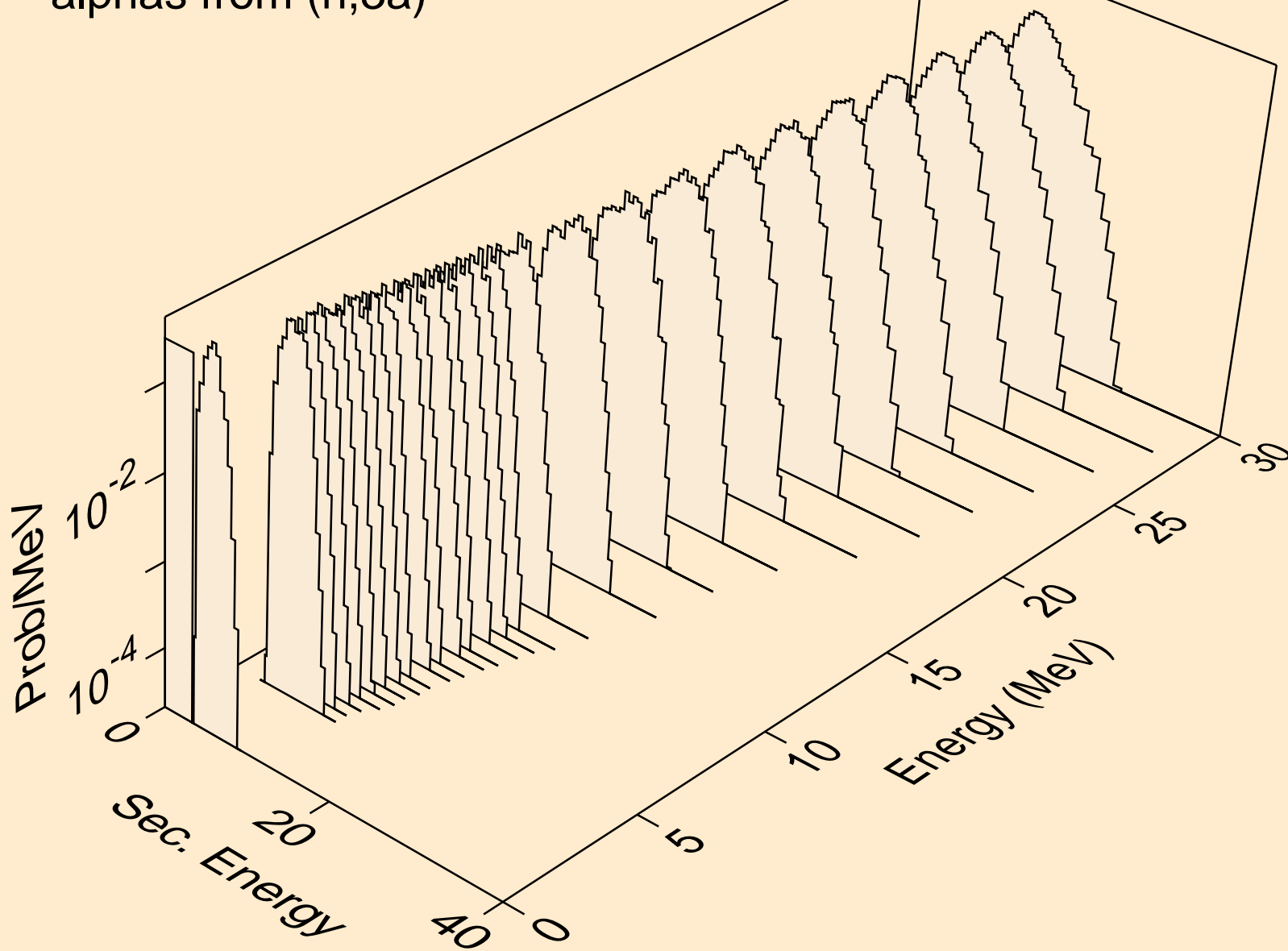

CS115 NEUTRON ACER TENDL-2019 LIBRARY; T=293.16K  
alphas from (n,pa)

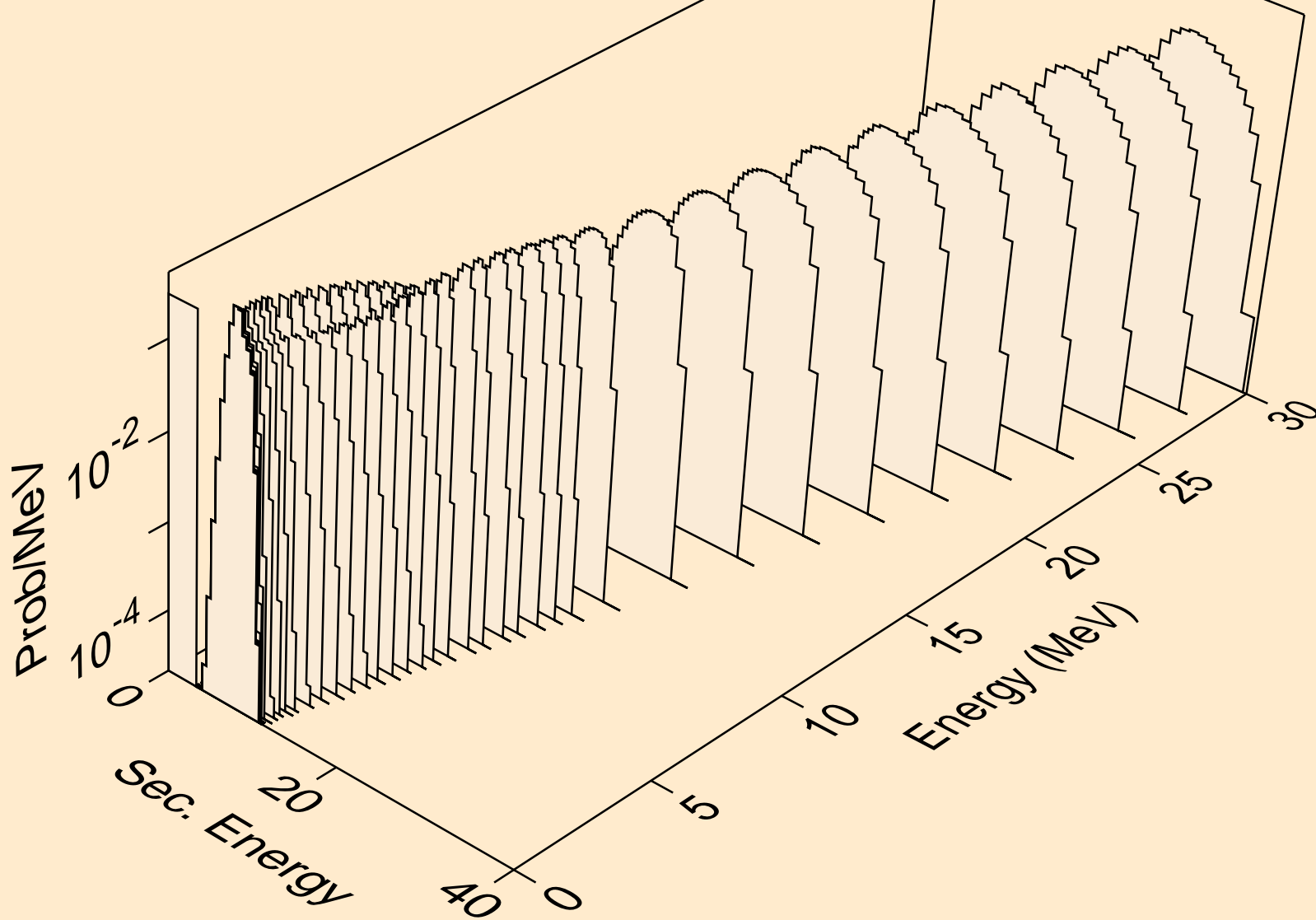

CS115 NEUTRON ACER TENDL-2019 LIBRARY; T=293.16K  
alphas from (n,t2a)

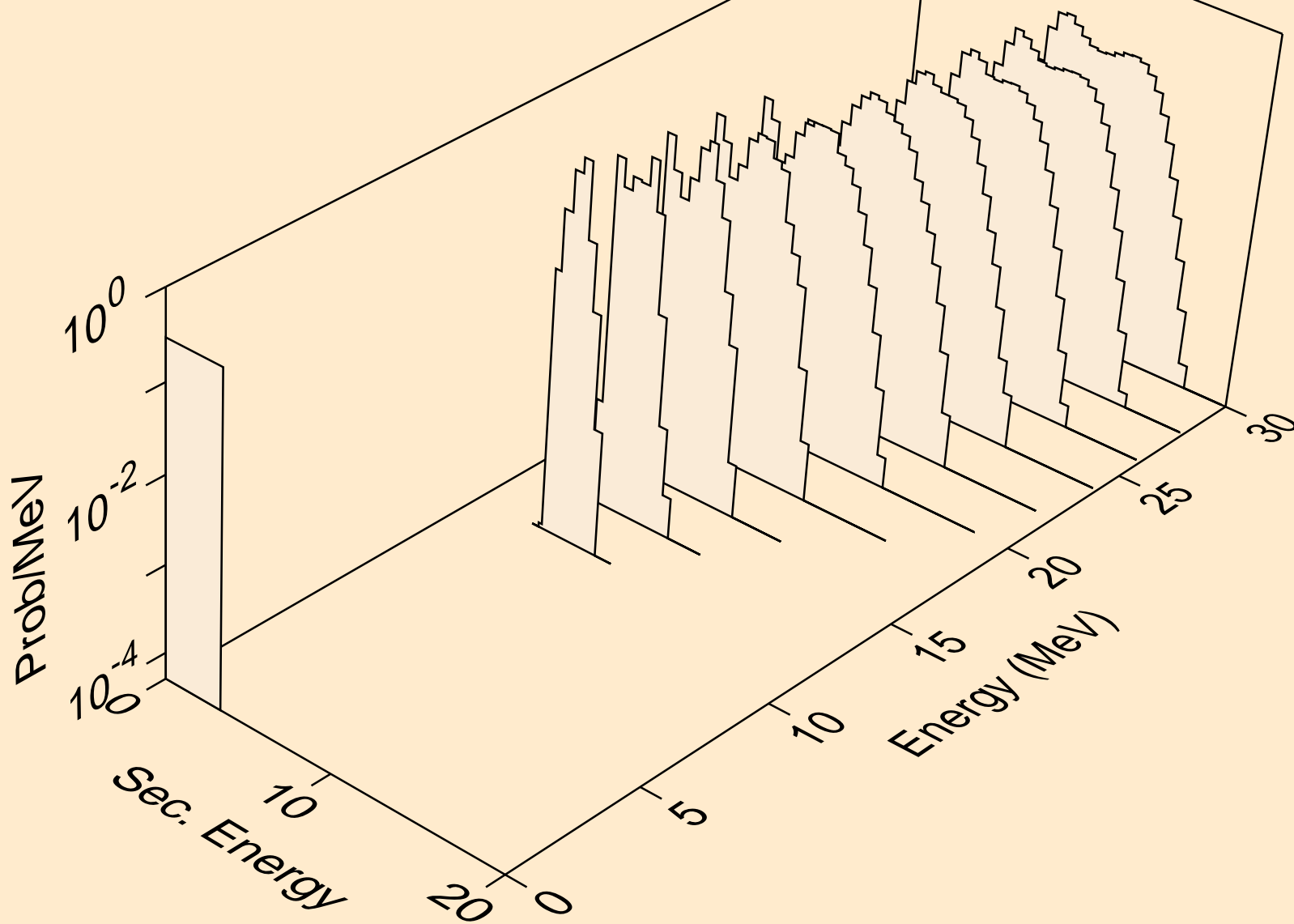

CS115 NEUTRON ACER TENDL-2019 LIBRARY; T=293.16K  
alphas from (n,d2a)

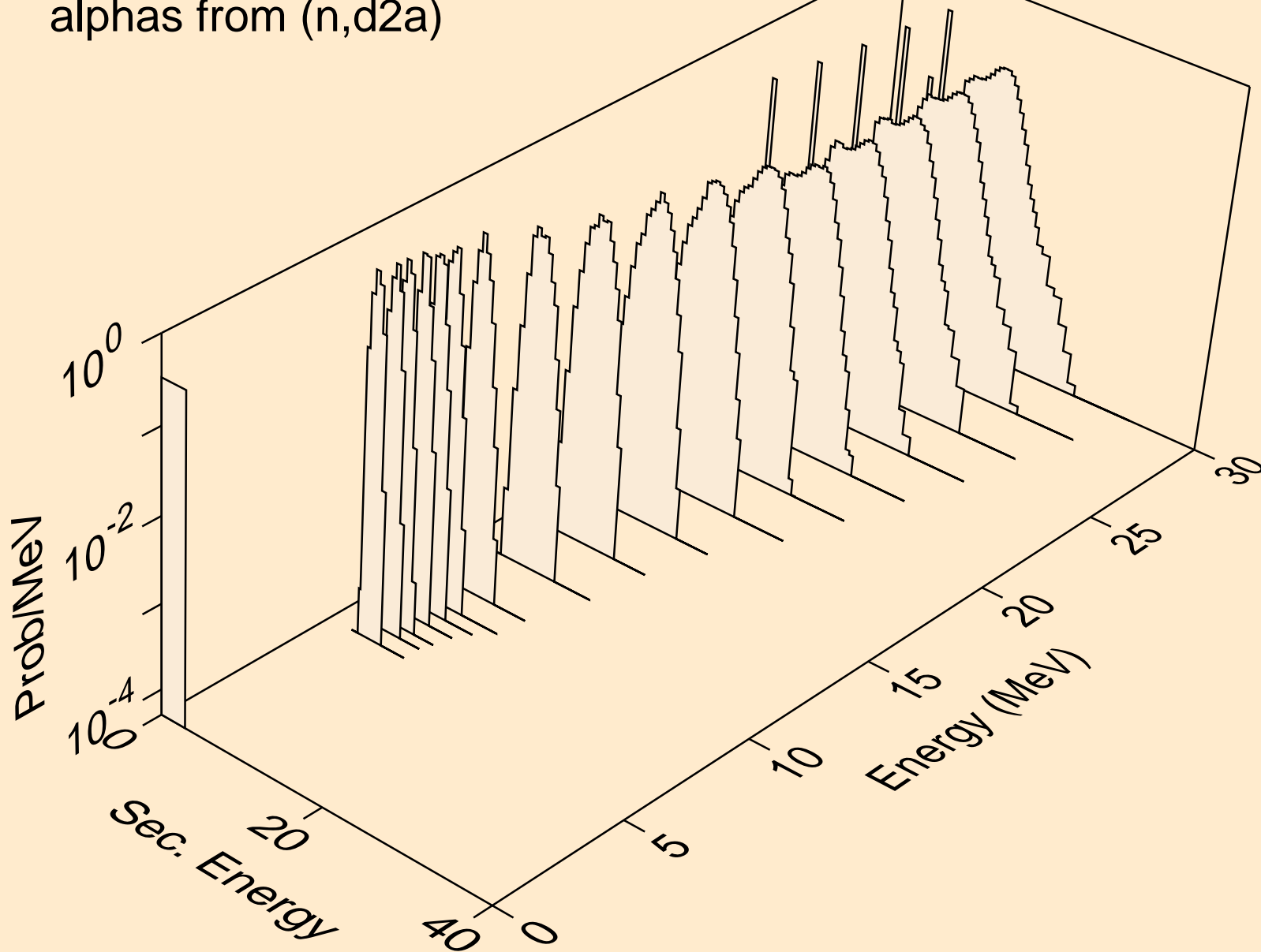

CS115 NEUTRON ACER TENDL-2019 LIBRARY; T=293.16K  
alphas from (n,da)

