

CS118M NEUTRON ACER TENDL-2019 LIBRARY; T=293.16K  
Principal cross sections

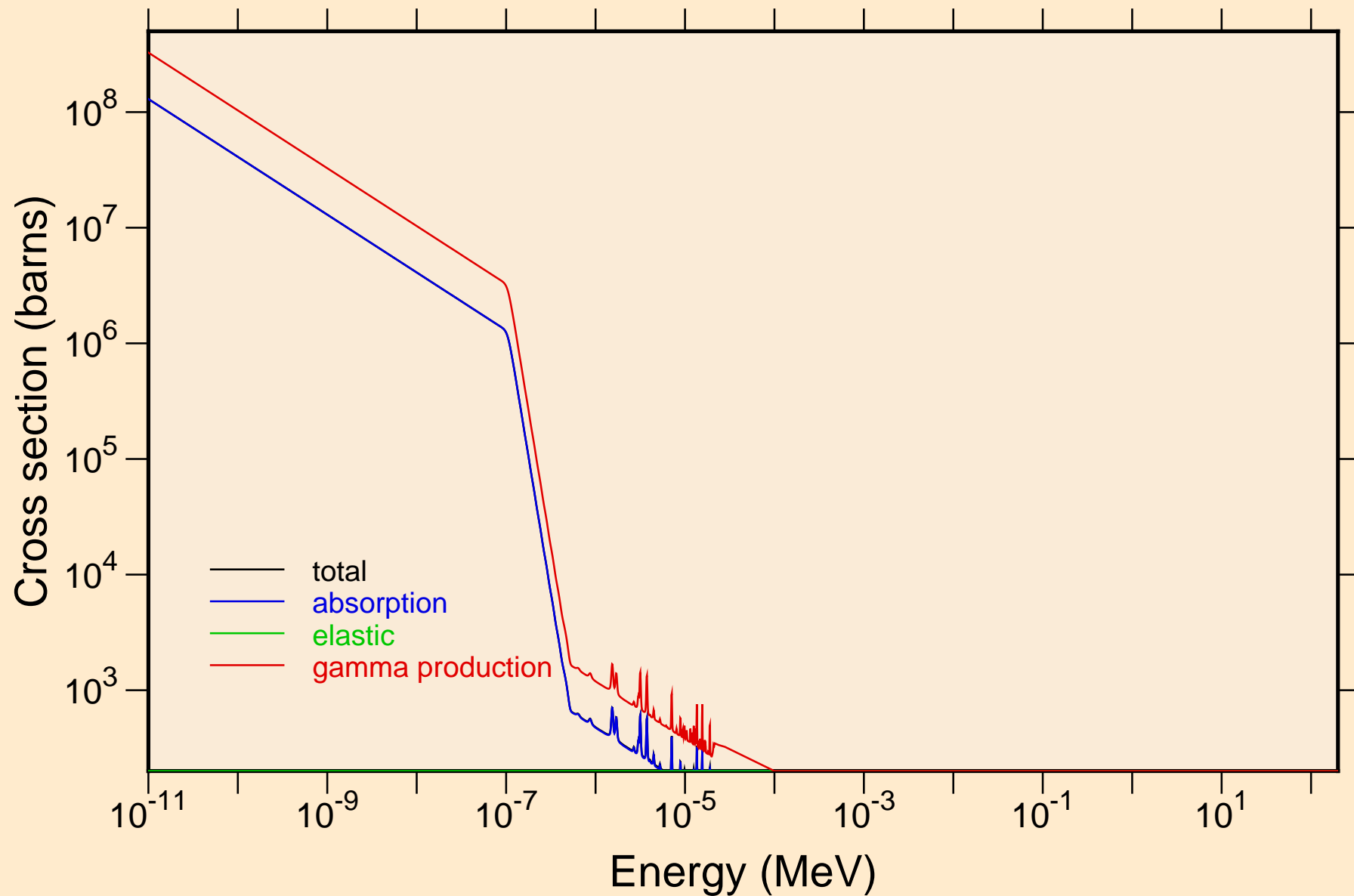

CS118M NEUTRON ACER TENDL-2019 LIBRARY; T=293.16K  
resonance total cross section

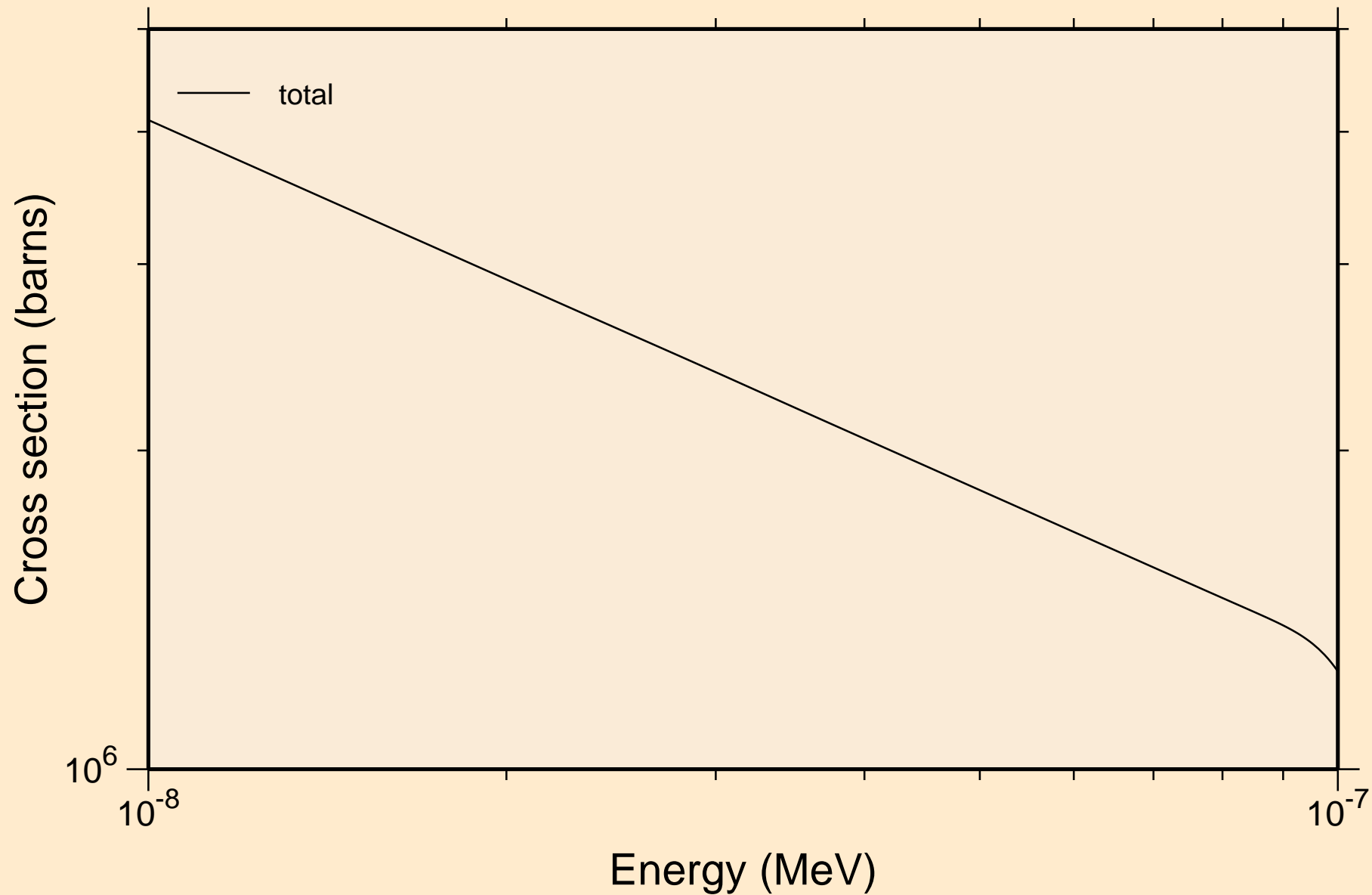

CS118M NEUTRON ACER TENDL-2019 LIBRARY; T=293.16K  
resonance total cross section

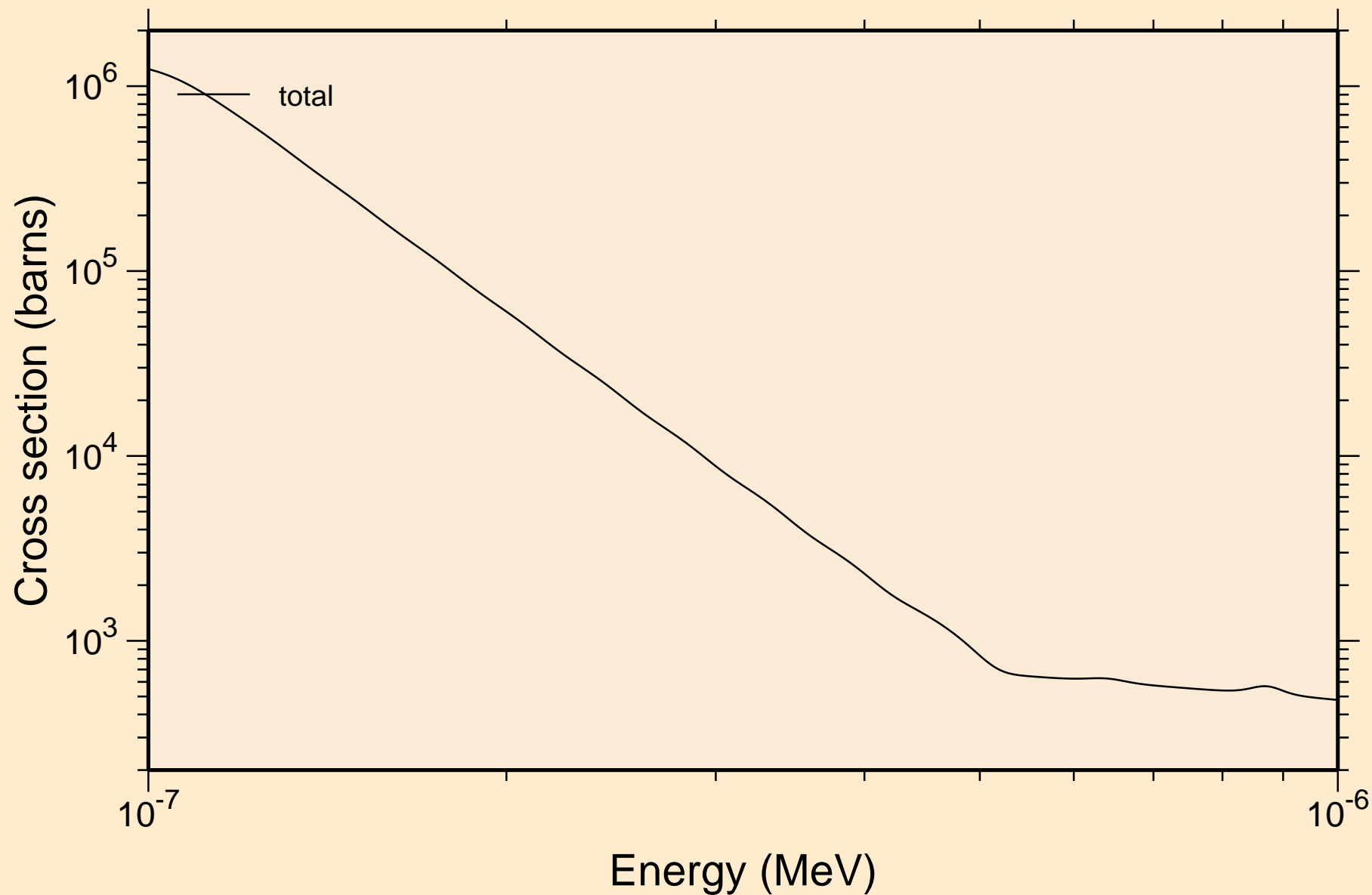

CS118M NEUTRON ACER TENDL-2019 LIBRARY; T=293.16K  
resonance total cross section

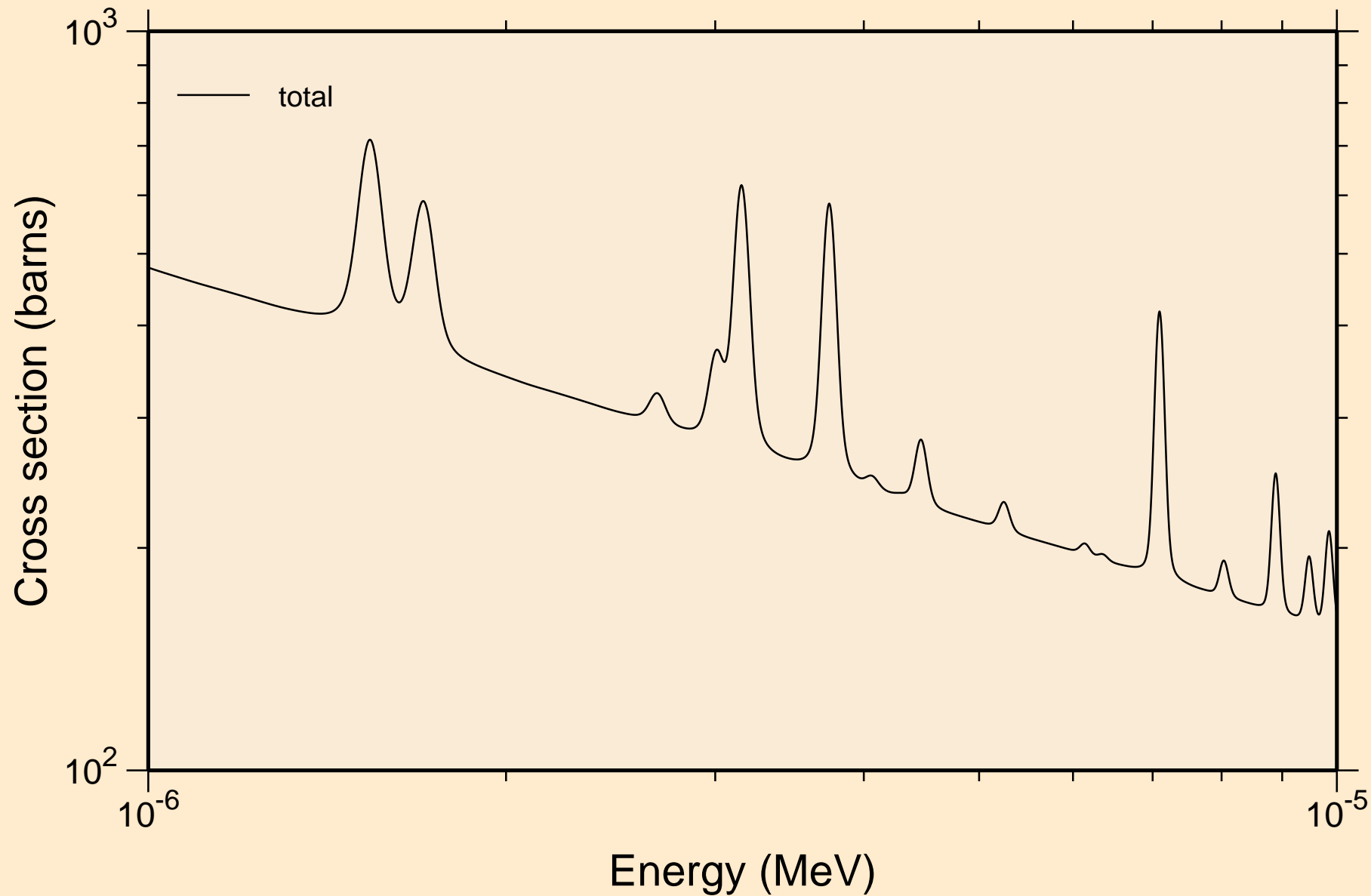

CS118M NEUTRON ACER TENDL-2019 LIBRARY; T=293.16K  
resonance total cross section

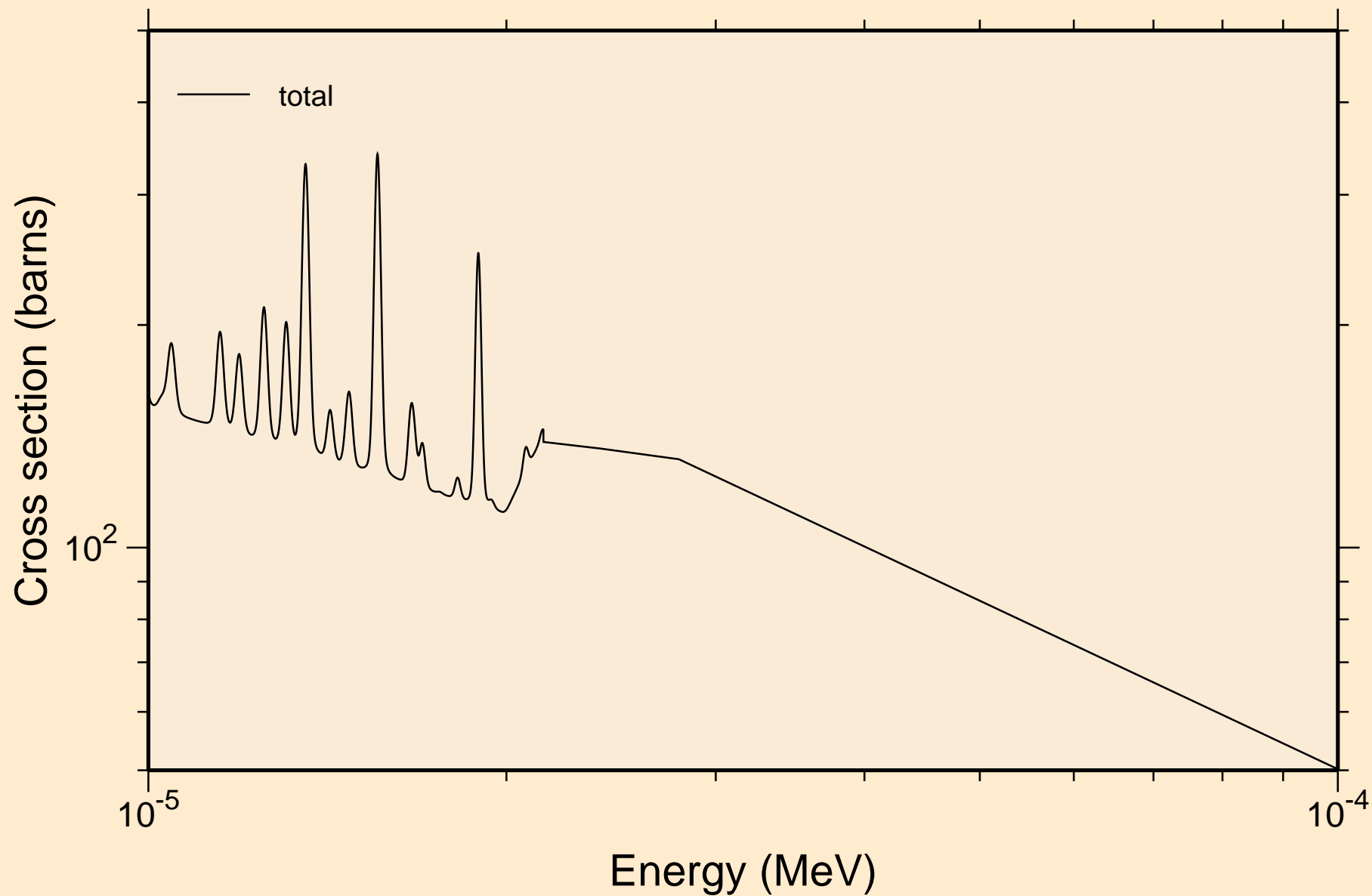

CS118M NEUTRON ACER TENDL-2019 LIBRARY; T=293.16K  
resonance total cross section

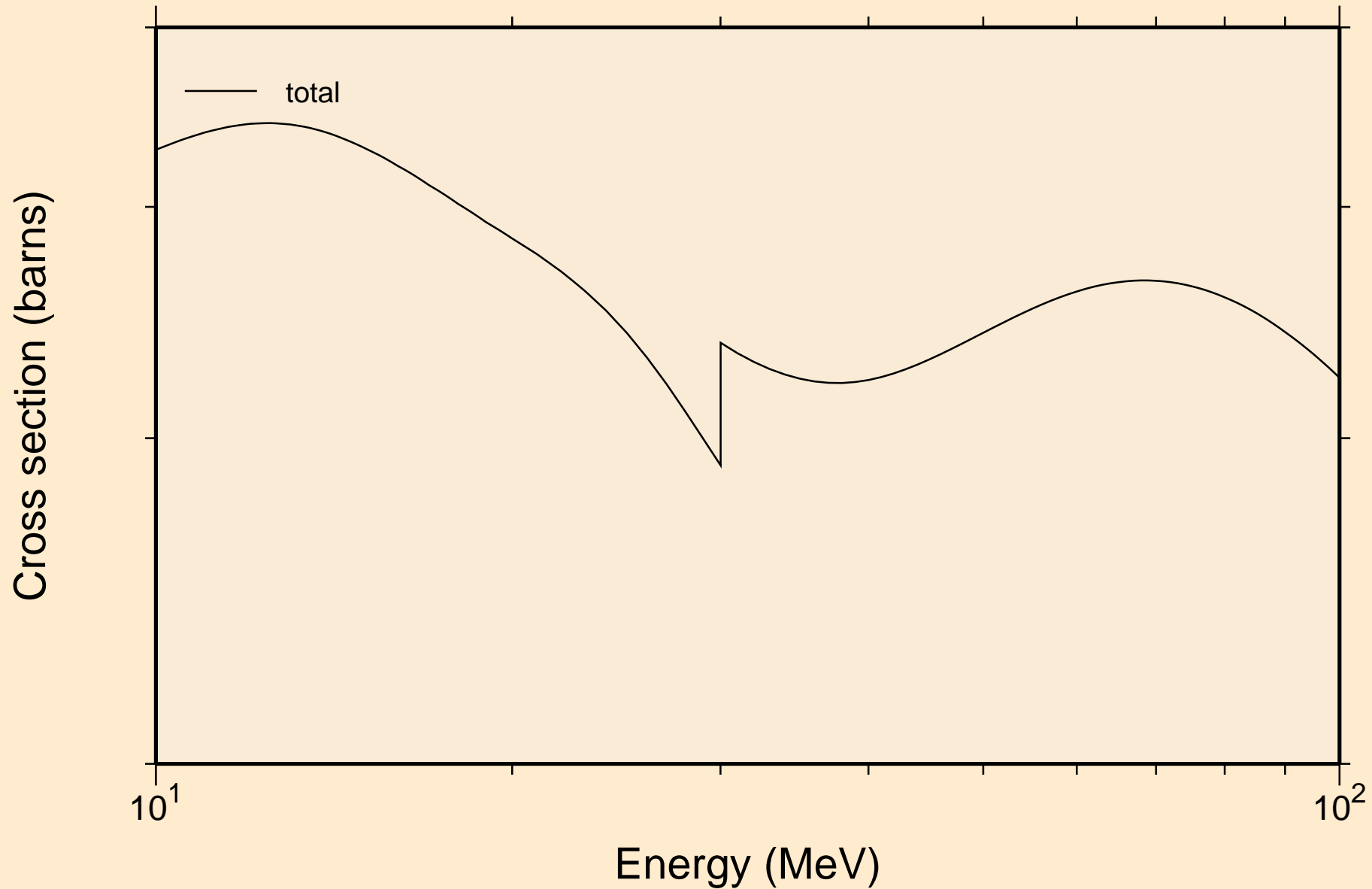

CS118M NEUTRON ACER TENDL-2019 LIBRARY; T=293.16K  
resonance absorption cross sections

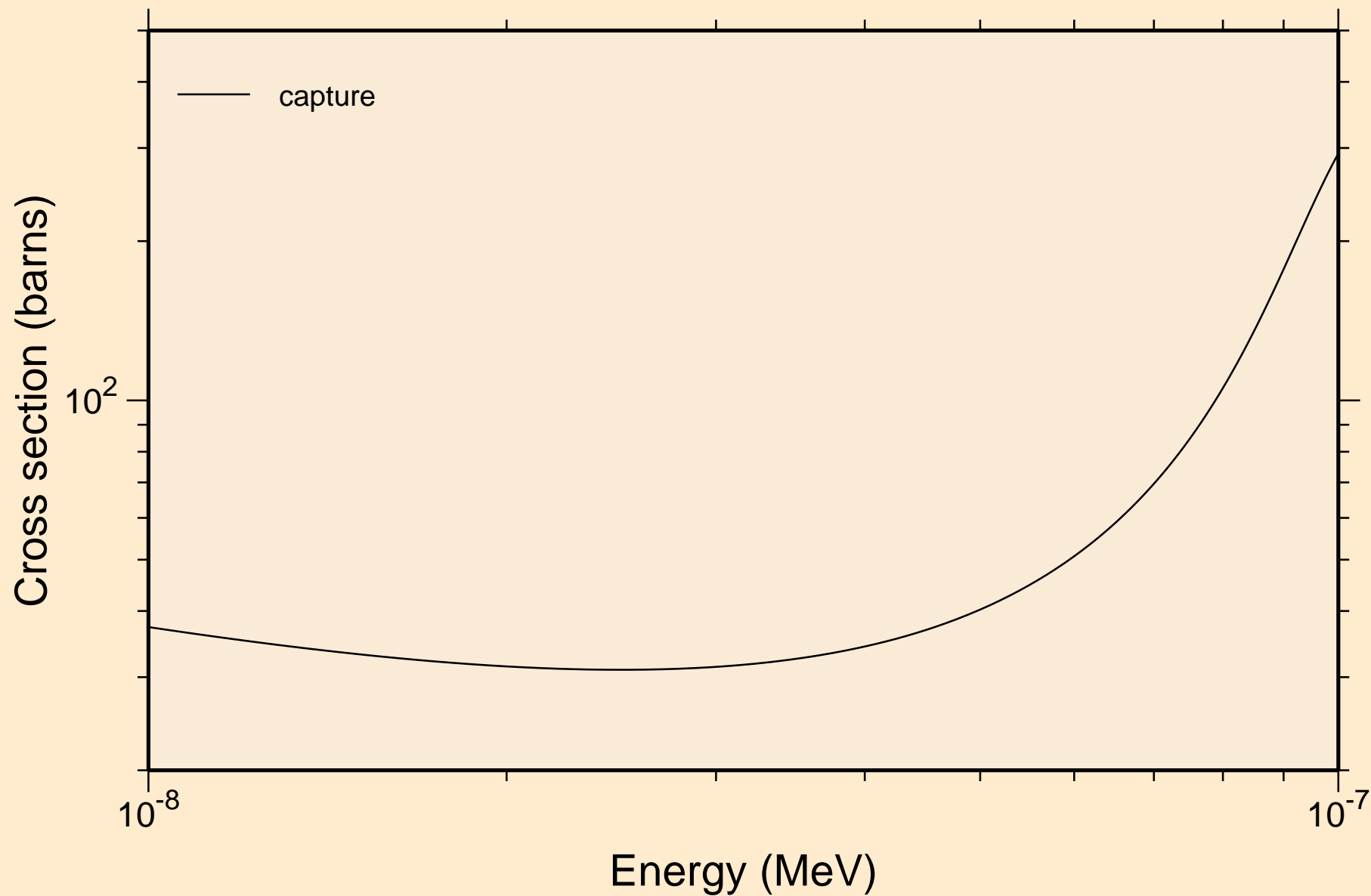

CS118M NEUTRON ACER TENDL-2019 LIBRARY; T=293.16K  
resonance absorption cross sections

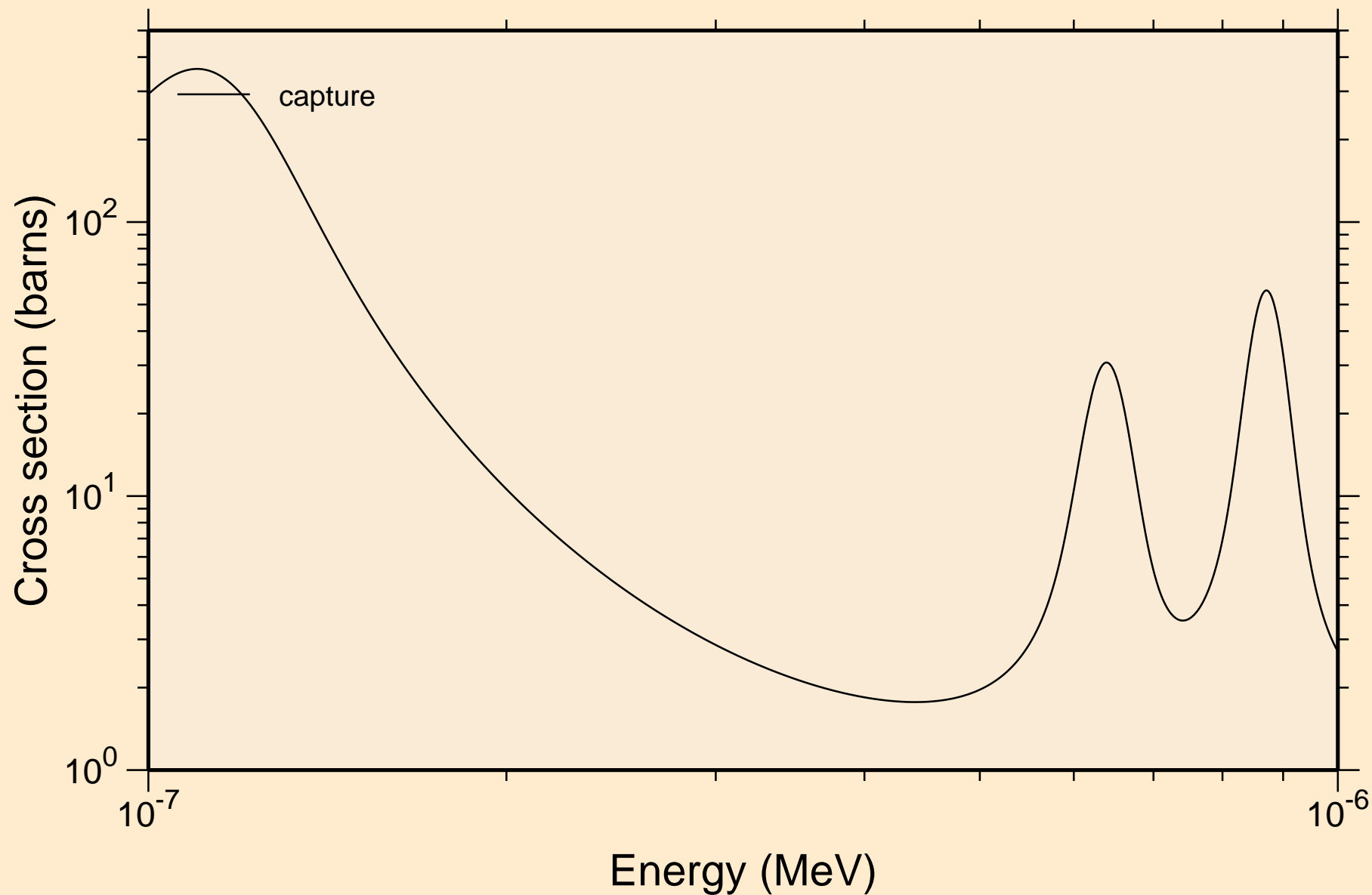



CS118M NEUTRON ACER TENDL-2019 LIBRARY; T=293.16K  
resonance absorption cross sections

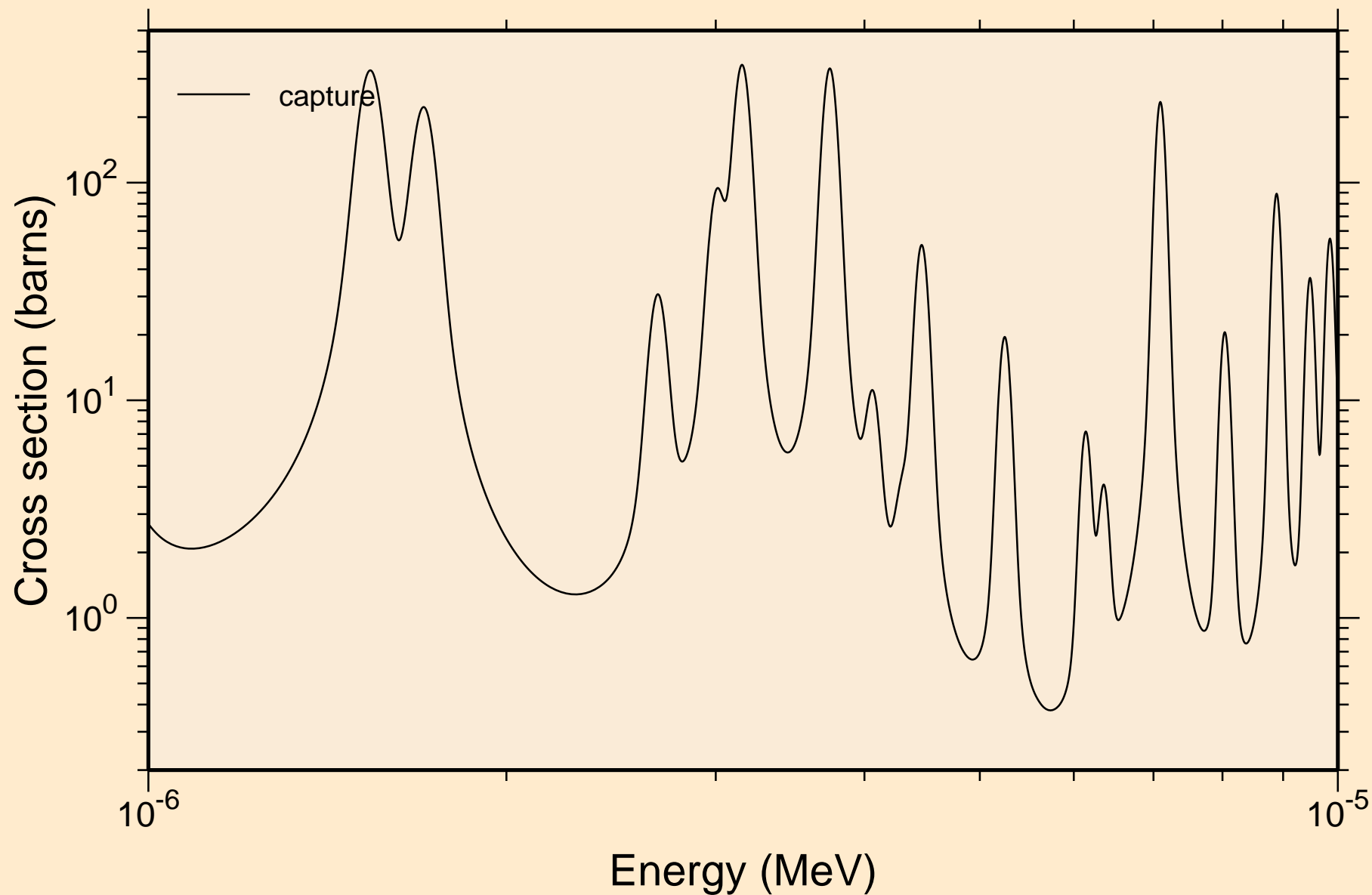

CS118M NEUTRON ACER TENDL-2019 LIBRARY; T=293.16K  
resonance absorption cross sections

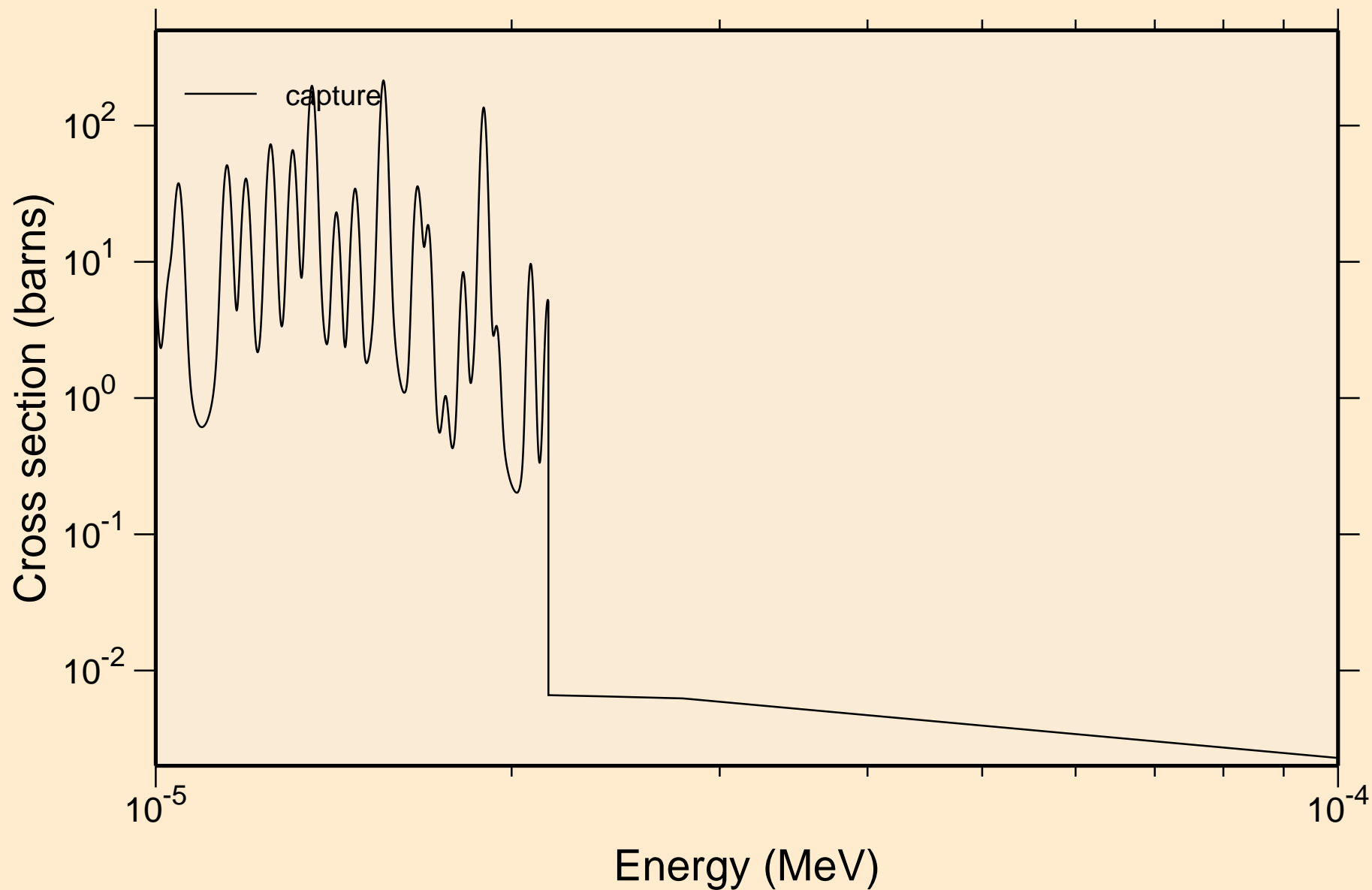

CS118M NEUTRON ACER TENDL-2019 LIBRARY; T=293.16K  
resonance absorption cross sections

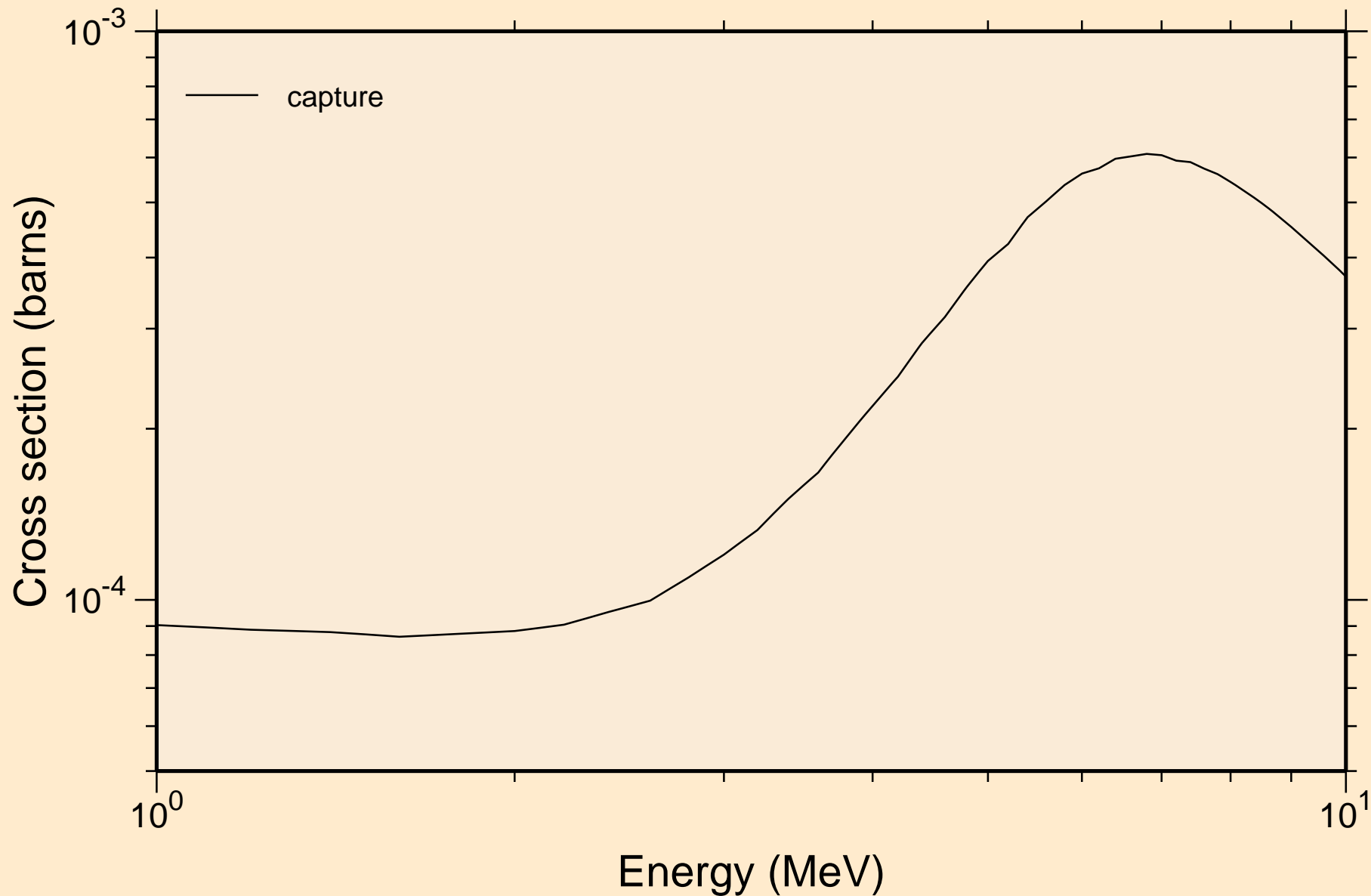

CS118M NEUTRON ACER TENDL-2019 LIBRARY; T=293.16K  
Heating

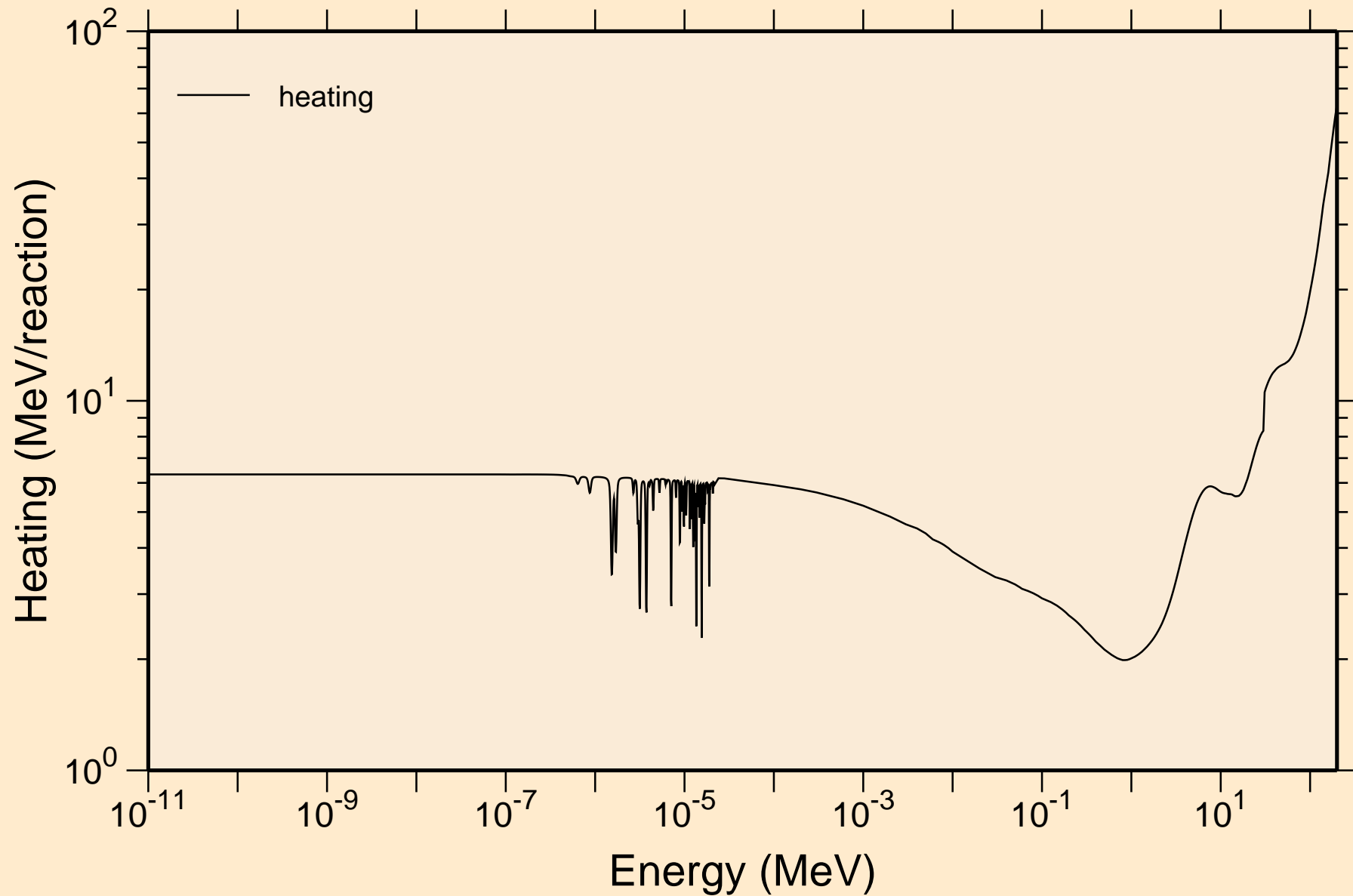

# CS118M NEUTRON ACER TENDL-2019 LIBRARY; T=293.16K Damage

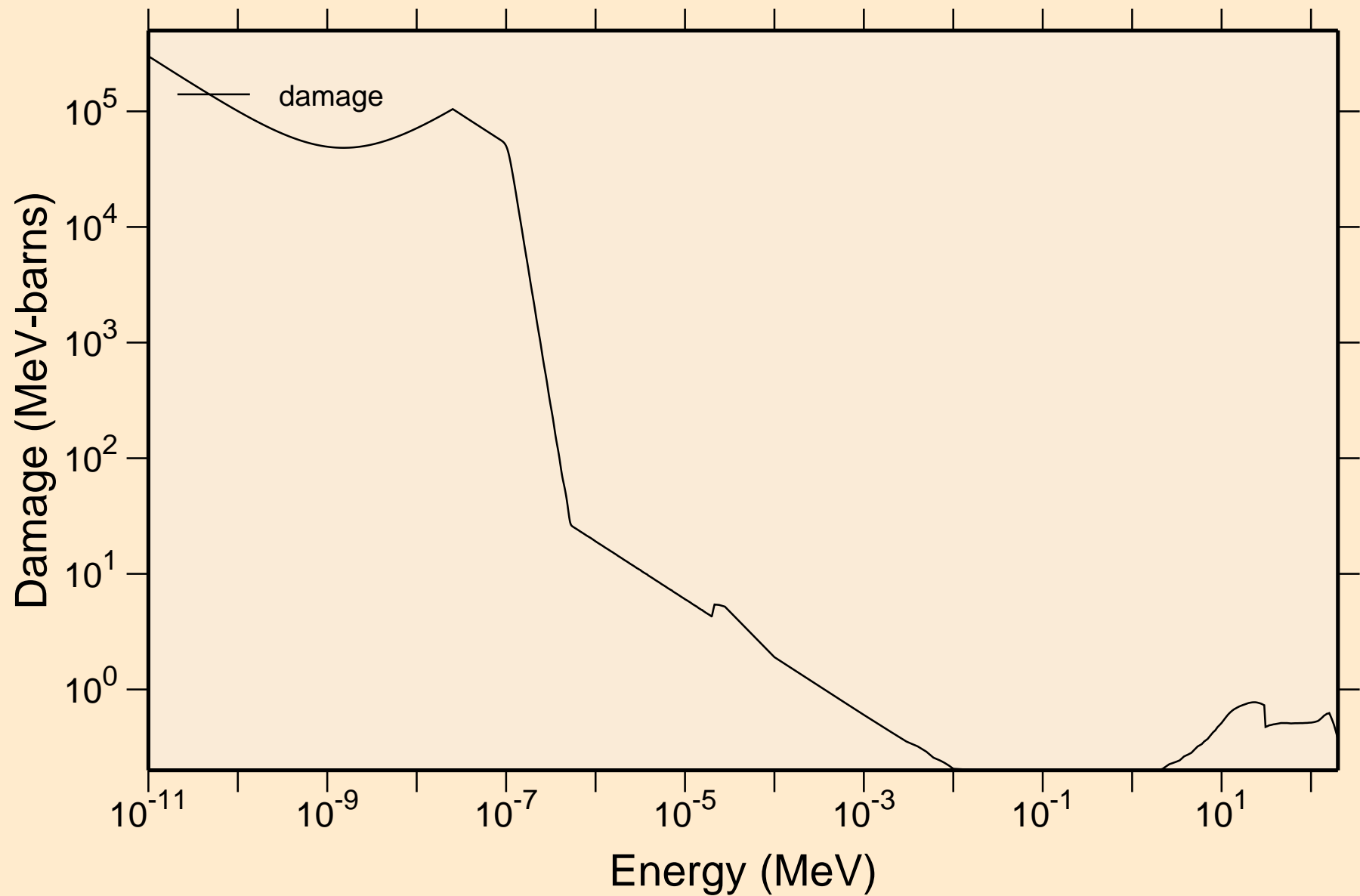

# CS118M NEUTRON ACER TENDL-2019 LIBRARY; T=293.16K

## Non-threshold reactions

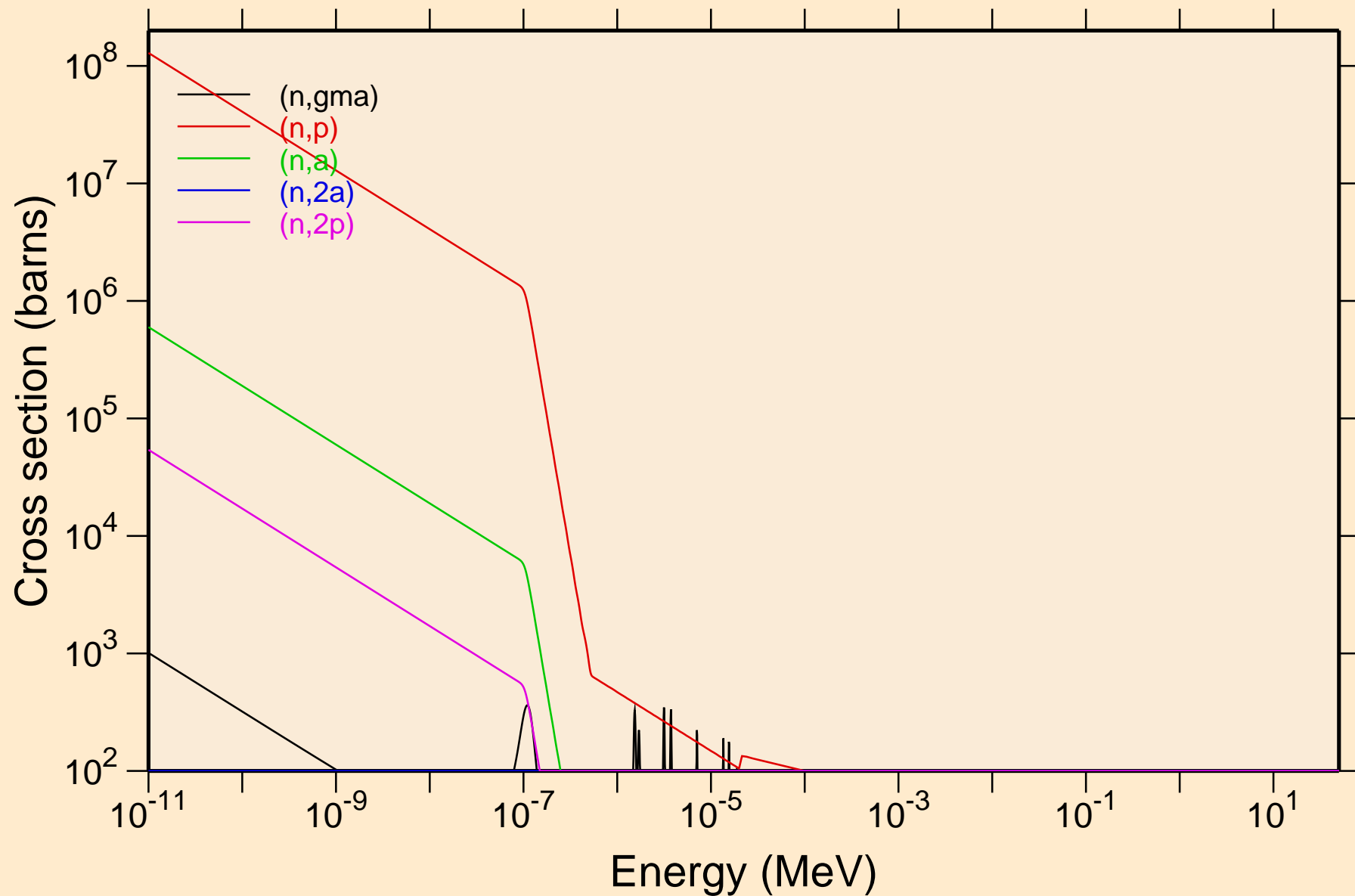

CS118M NEUTRON ACER TENDL-2019 LIBRARY; T=293.16K  
Non-threshold reactions

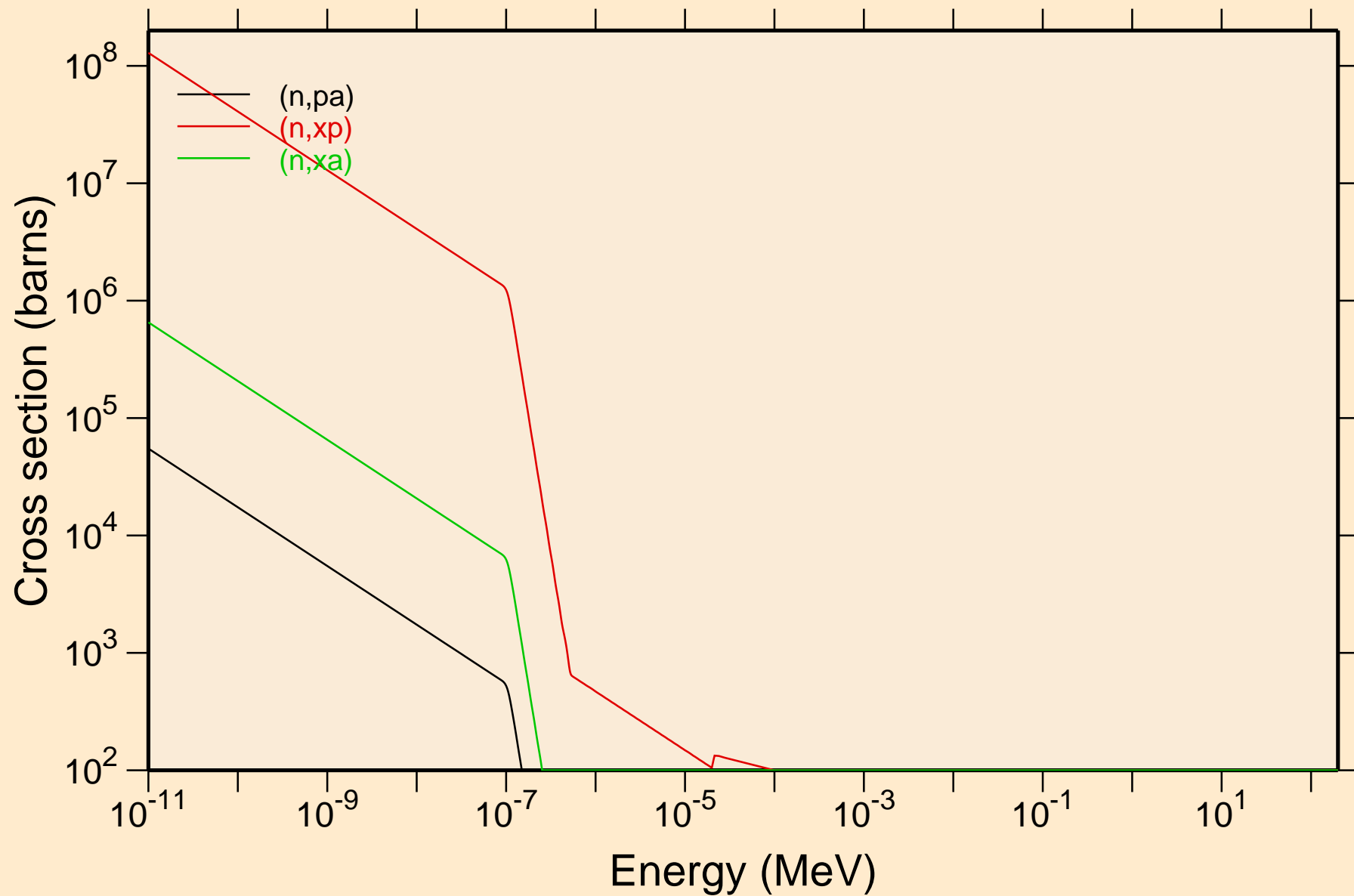

CS118M NEUTRON ACER TENDL-2019 LIBRARY; T=293.16K  
Principal cross sections

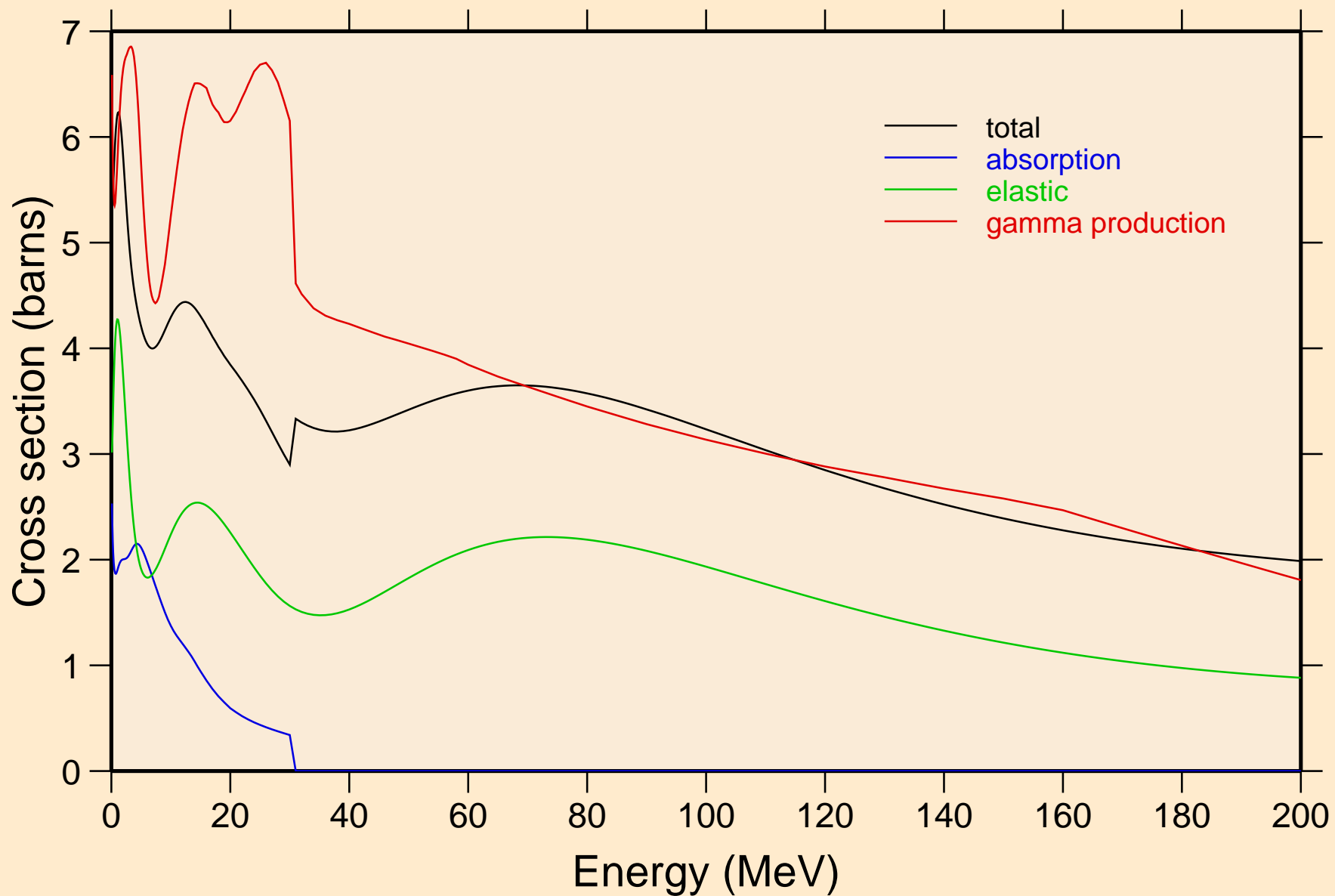



CS118M NEUTRON ACER TENDL-2019 LIBRARY; T=293.16K  
Heating

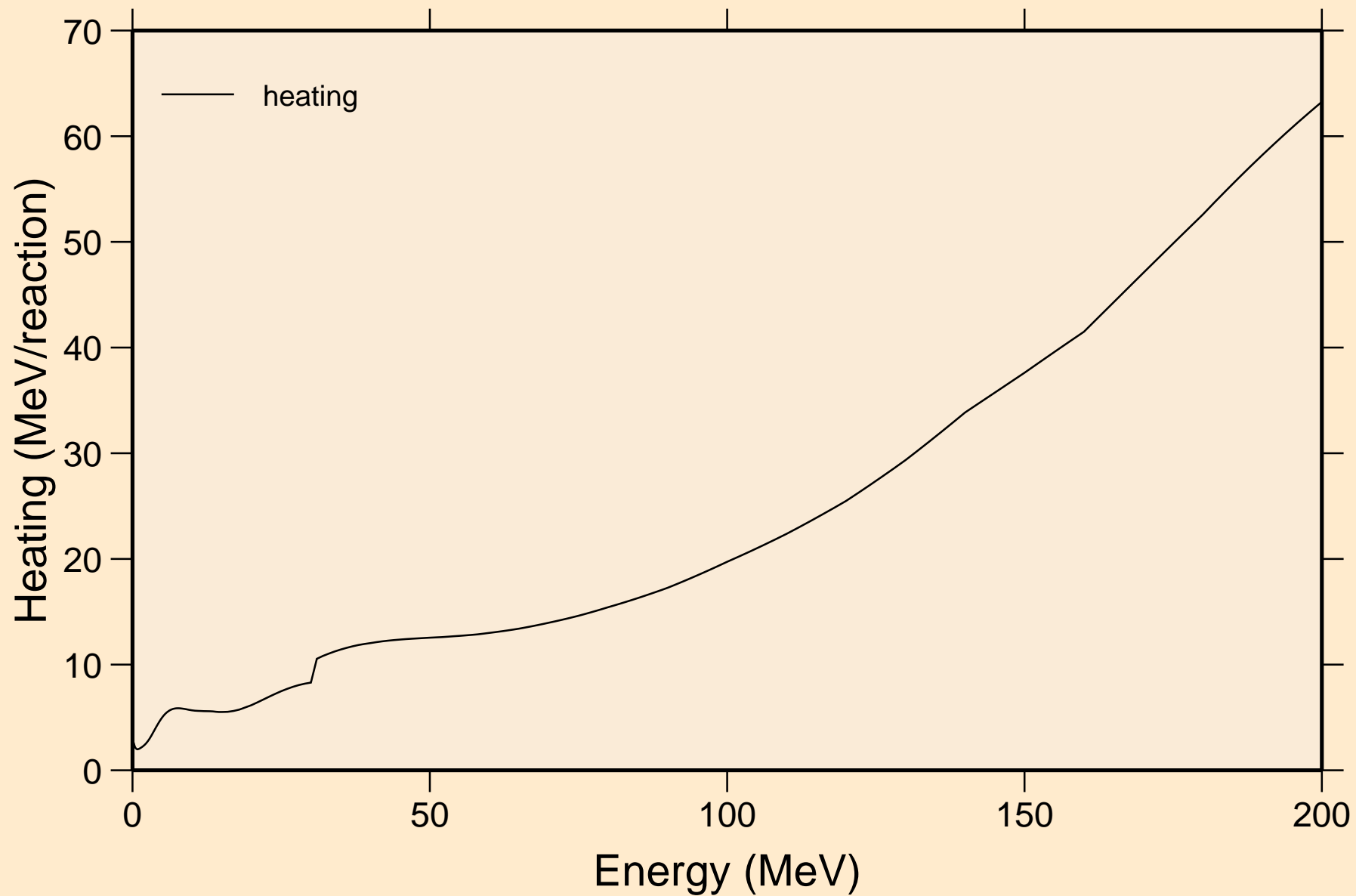

# CS118M NEUTRON ACER TENDL-2019 LIBRARY; T=293.16K Damage

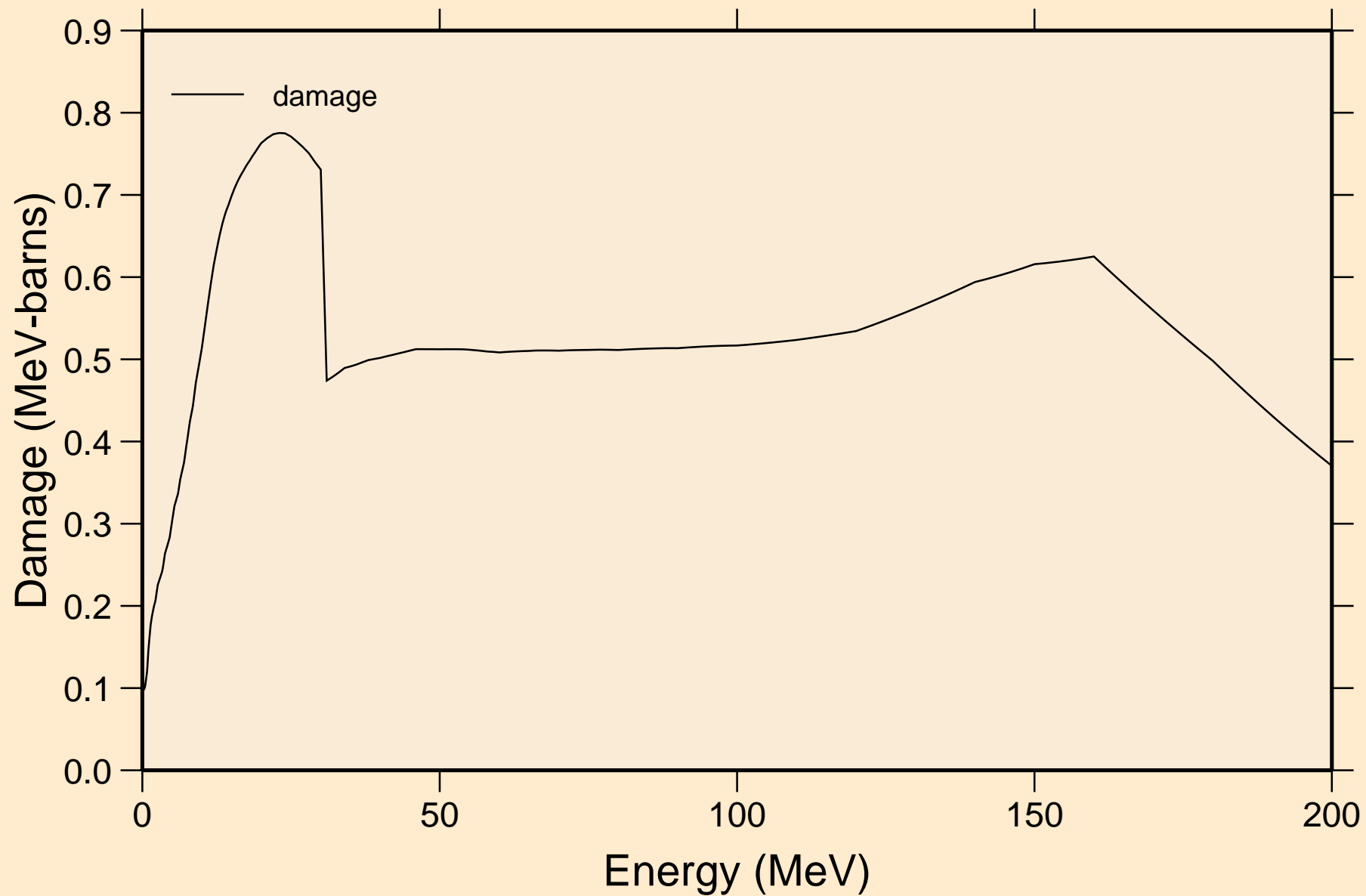

CS118M NEUTRON ACER TENDL-2019 LIBRARY; T=293.16K  
Non-threshold reactions

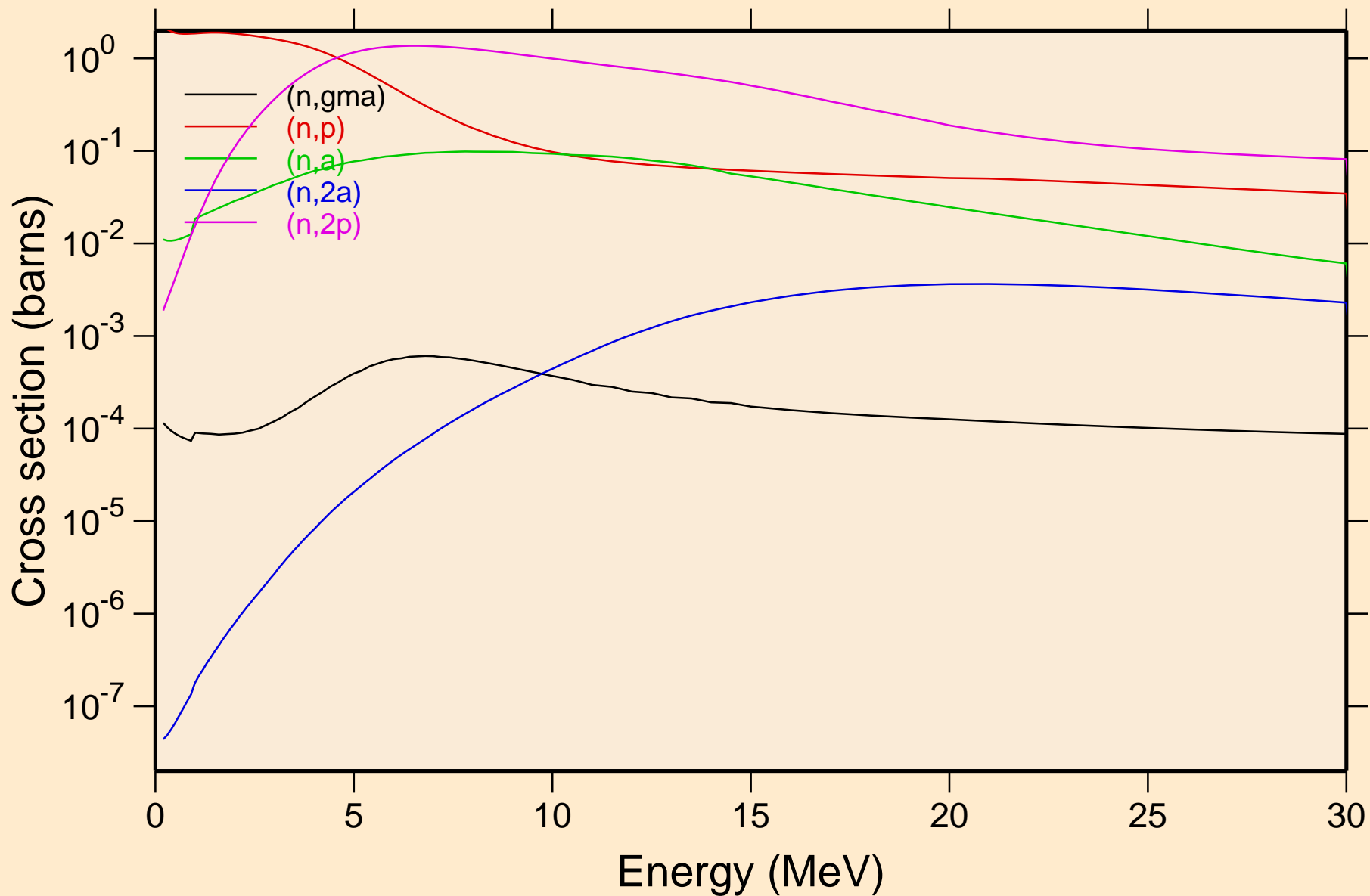

CS118M NEUTRON ACER TENDL-2019 LIBRARY; T=293.16K  
Non-threshold reactions

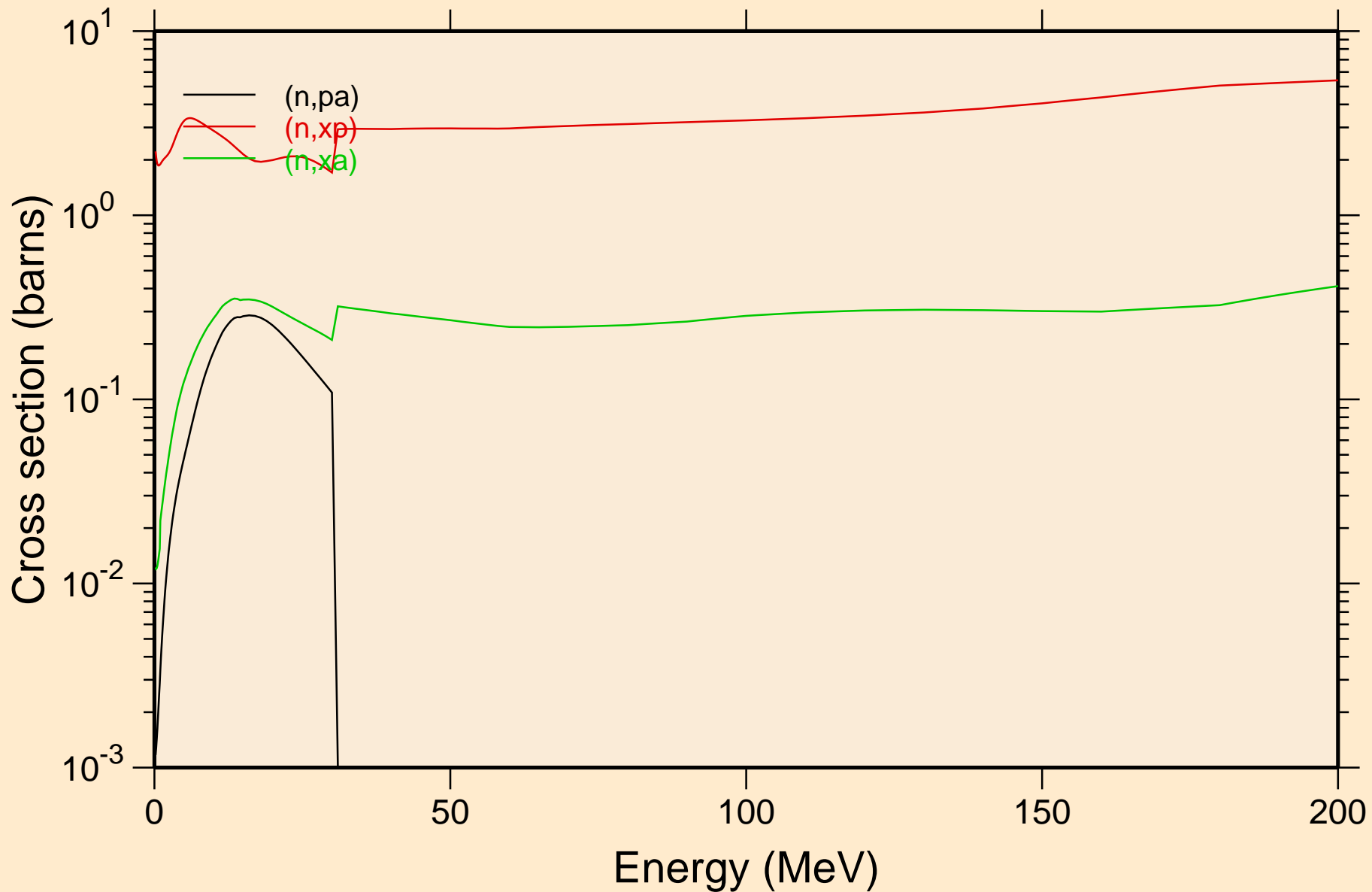

CS118M NEUTRON ACER TENDL-2019 LIBRARY; T=293.16K  
Inelastic levels

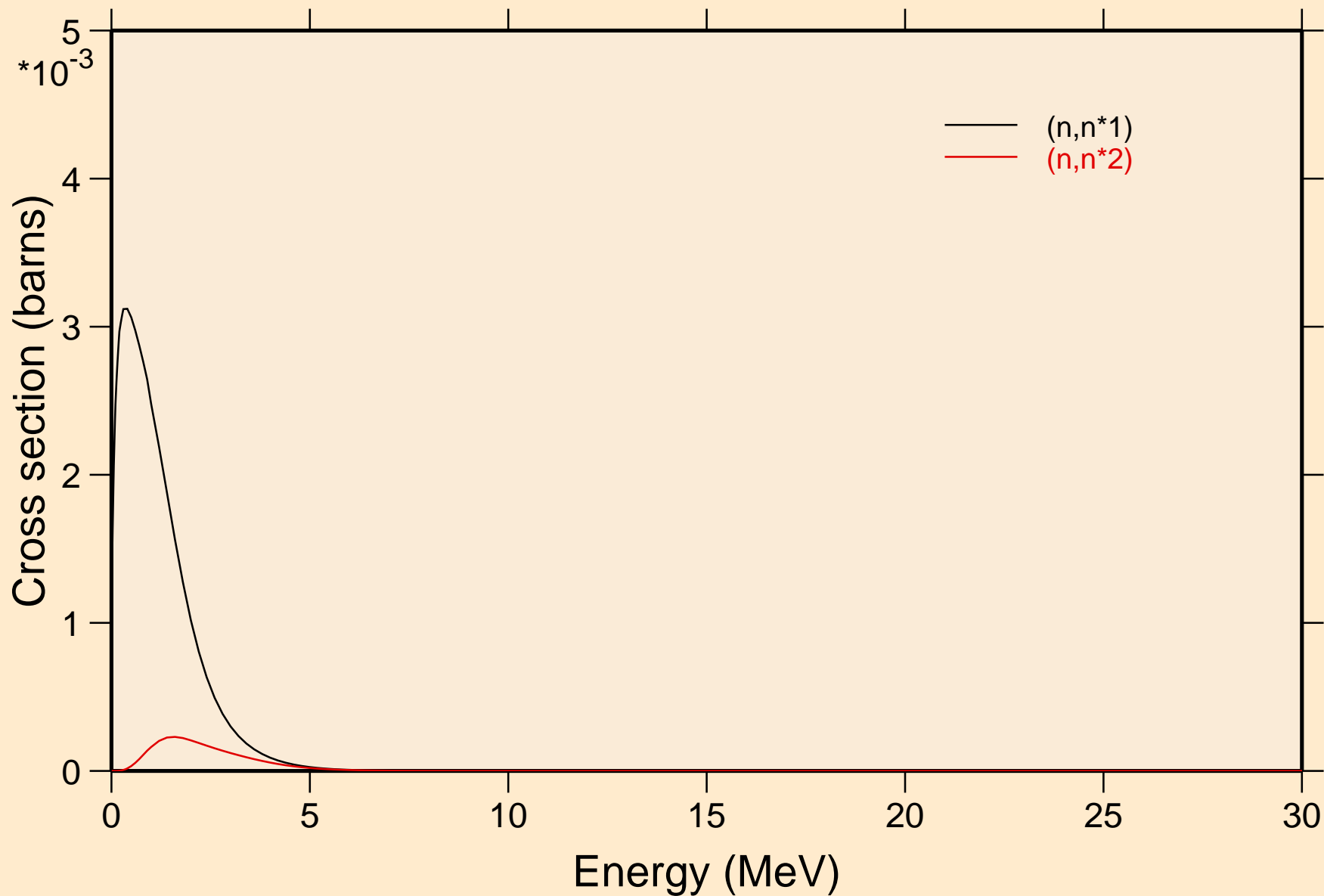

CS118M NEUTRON ACER TENDL-2019 LIBRARY; T=293.16K  
Threshold reactions

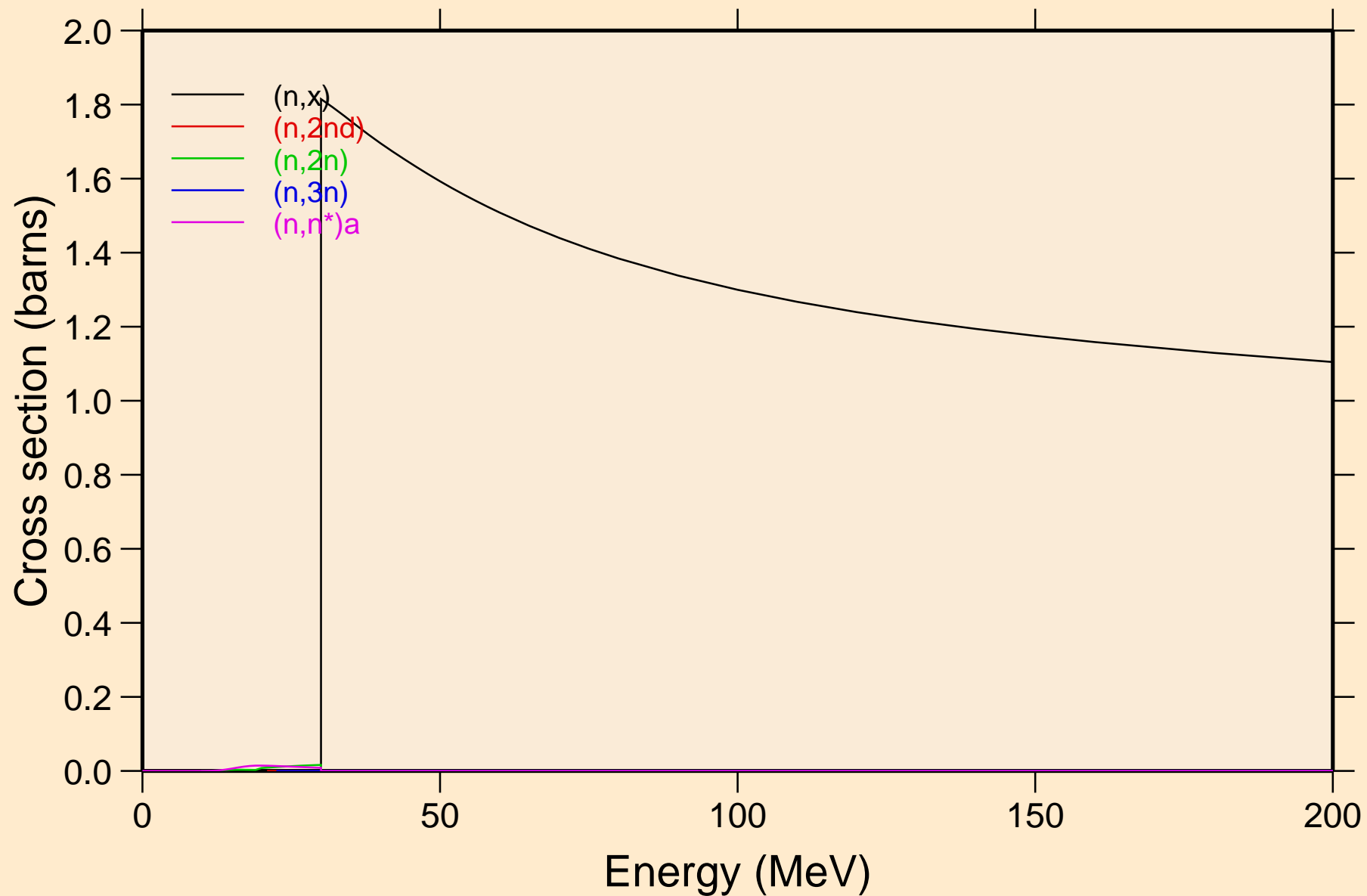

CS118M NEUTRON ACER TENDL-2019 LIBRARY; T=293.16K  
Threshold reactions

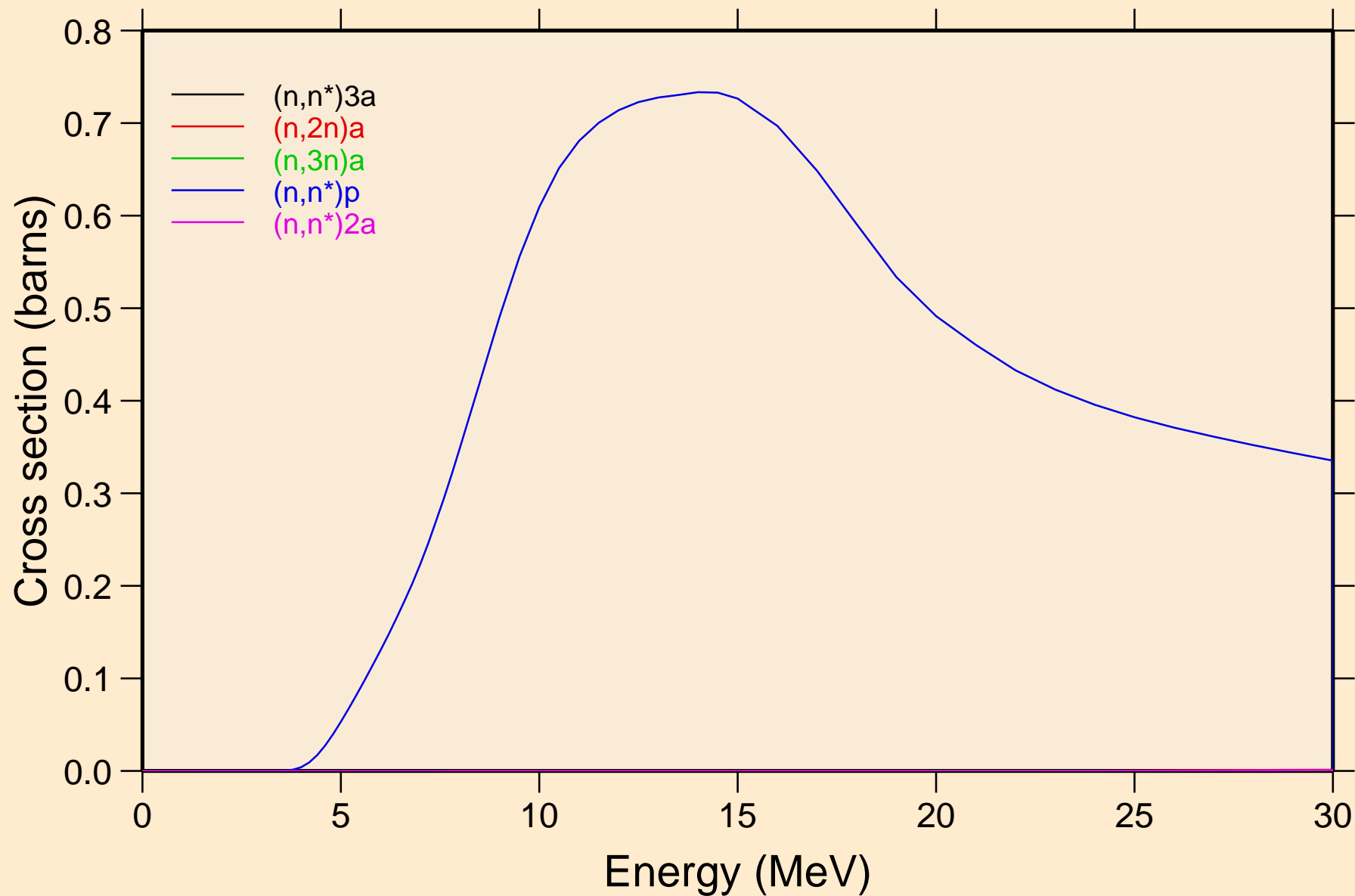

# CS118M NEUTRON ACER TENDL-2019 LIBRARY; T=293.16K

## Threshold reactions

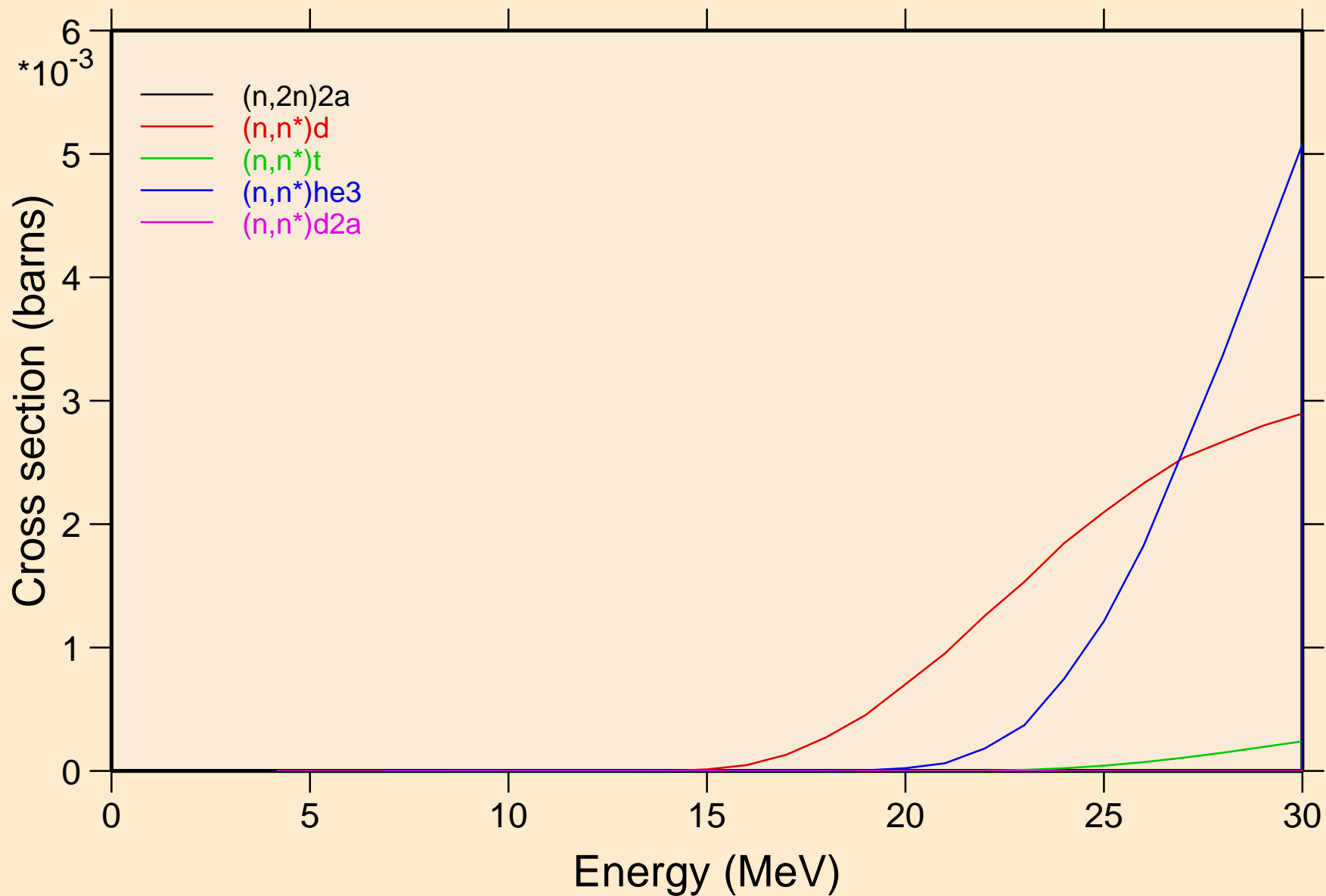



CS118M NEUTRON ACER TENDL-2019 LIBRARY; T=293.16K  
Threshold reactions

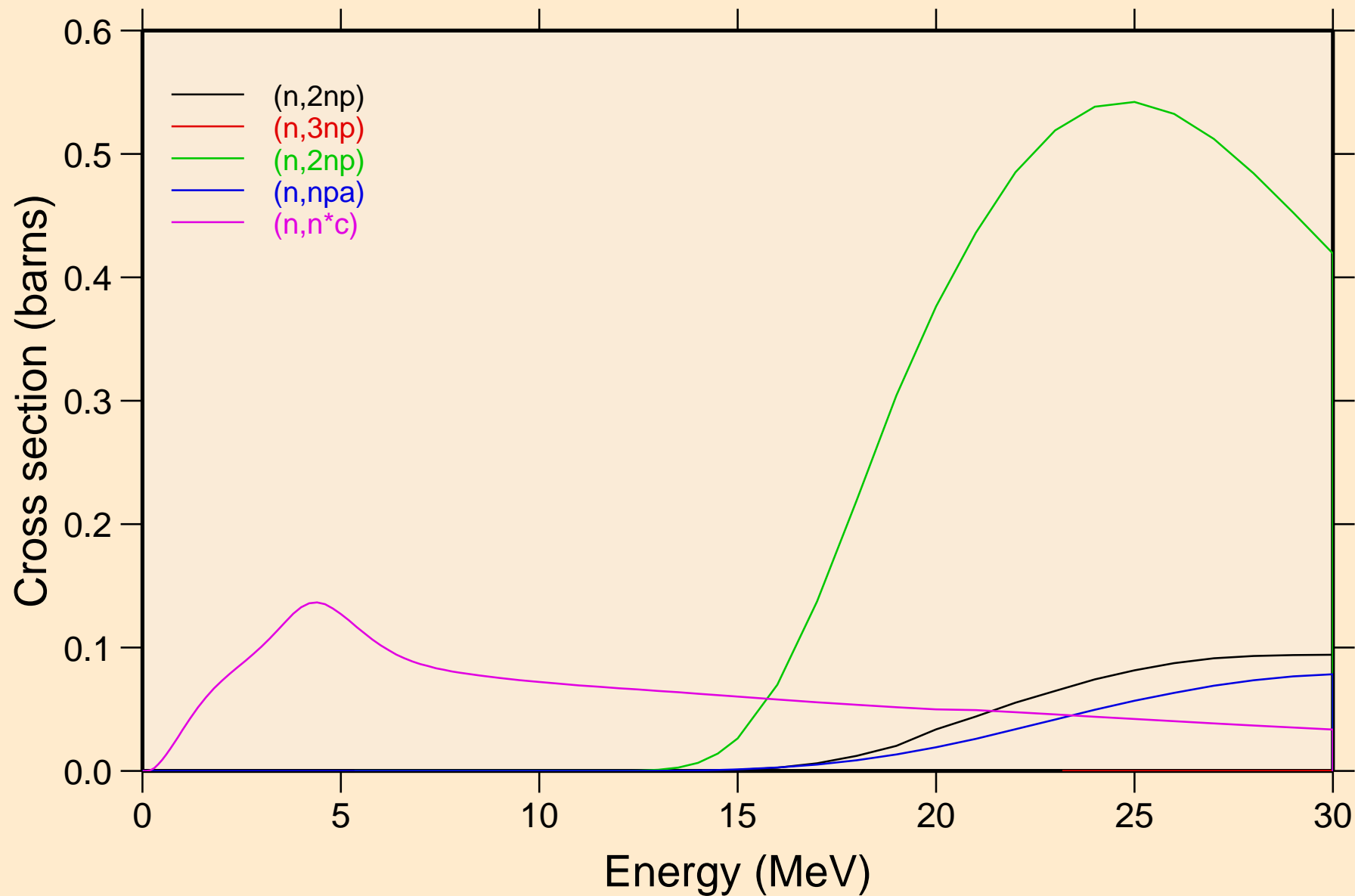

CS118M NEUTRON ACER TENDL-2019 LIBRARY; T=293.16K  
Threshold reactions

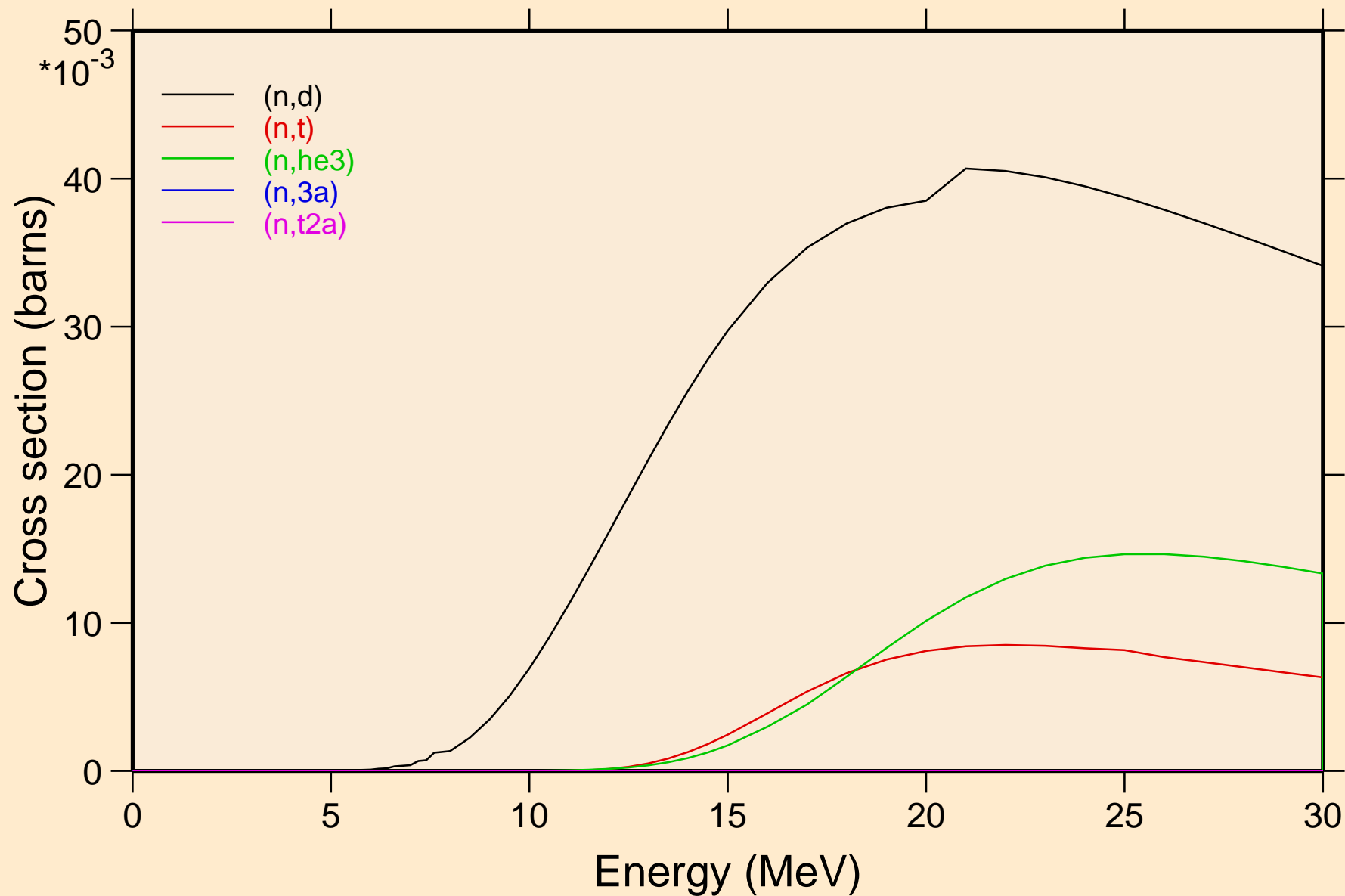

CS118M NEUTRON ACER TENDL-2019 LIBRARY; T=293.16K  
Threshold reactions

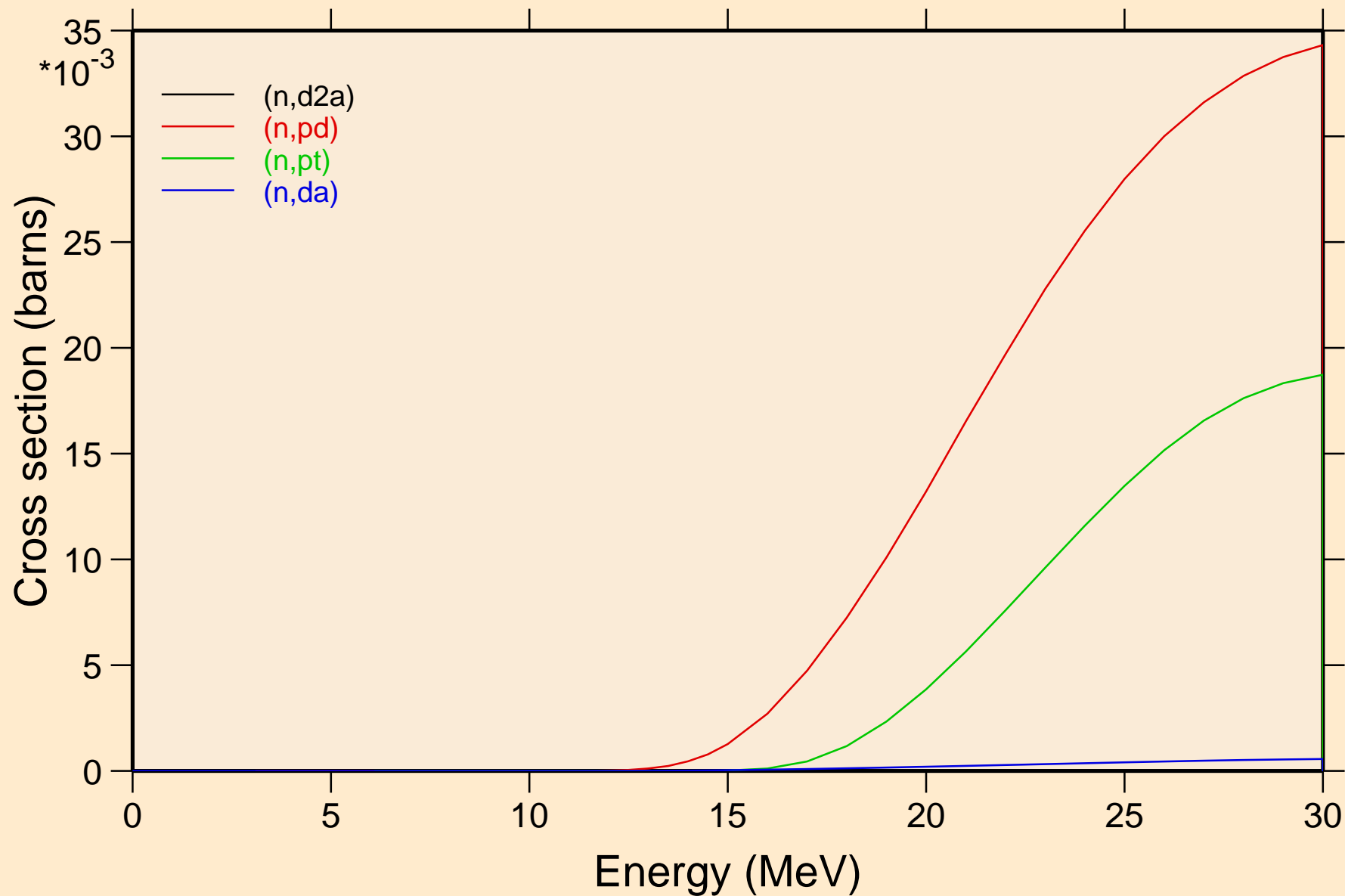

CS118M NEUTRON ACER TENDL-2019 LIBRARY; T=293.16K  
Threshold reactions

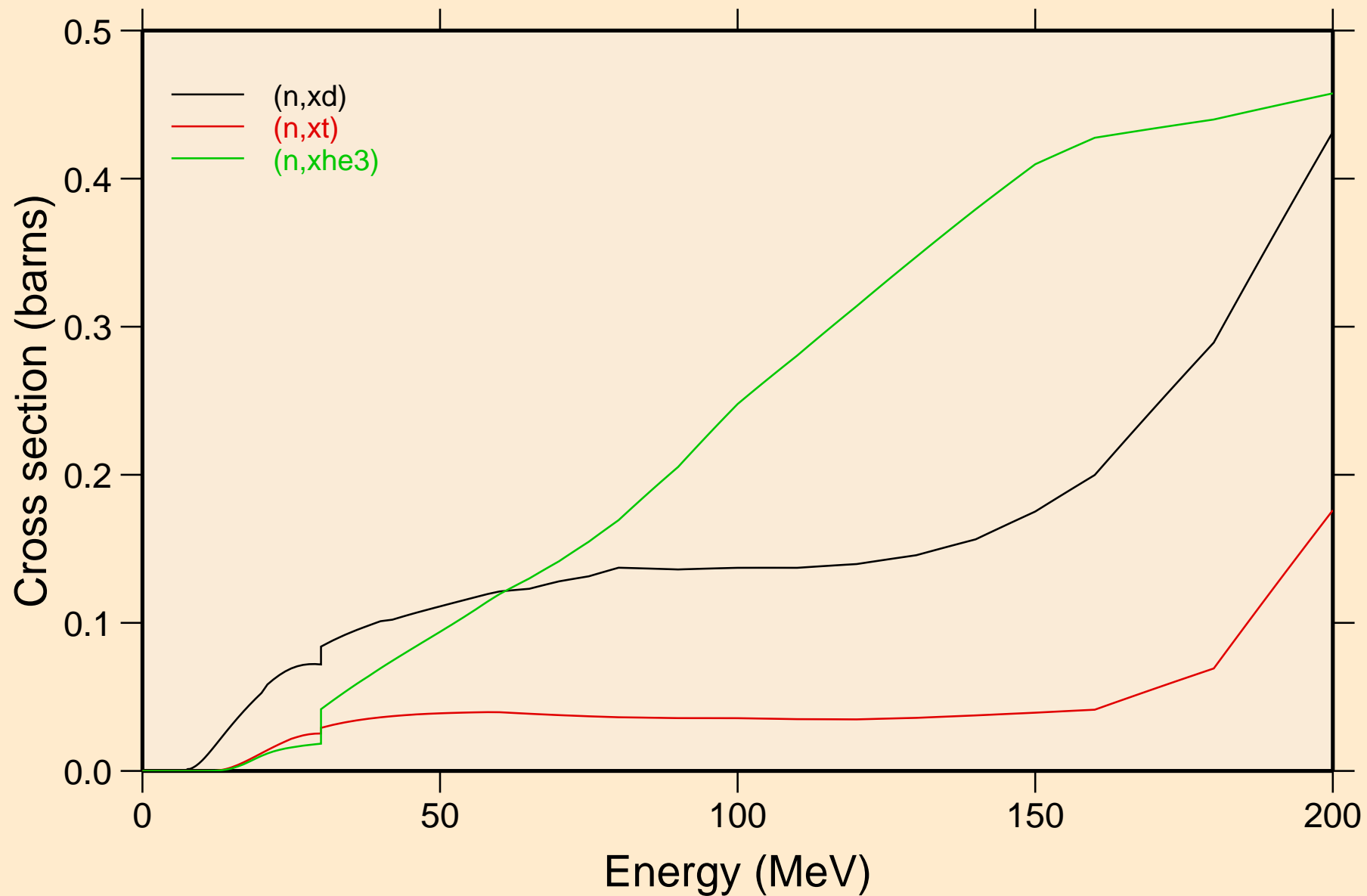

CS118M NEUTRON ACER TENDL-2019 LIBRARY; T=293.16K  
angular distribution for elastic

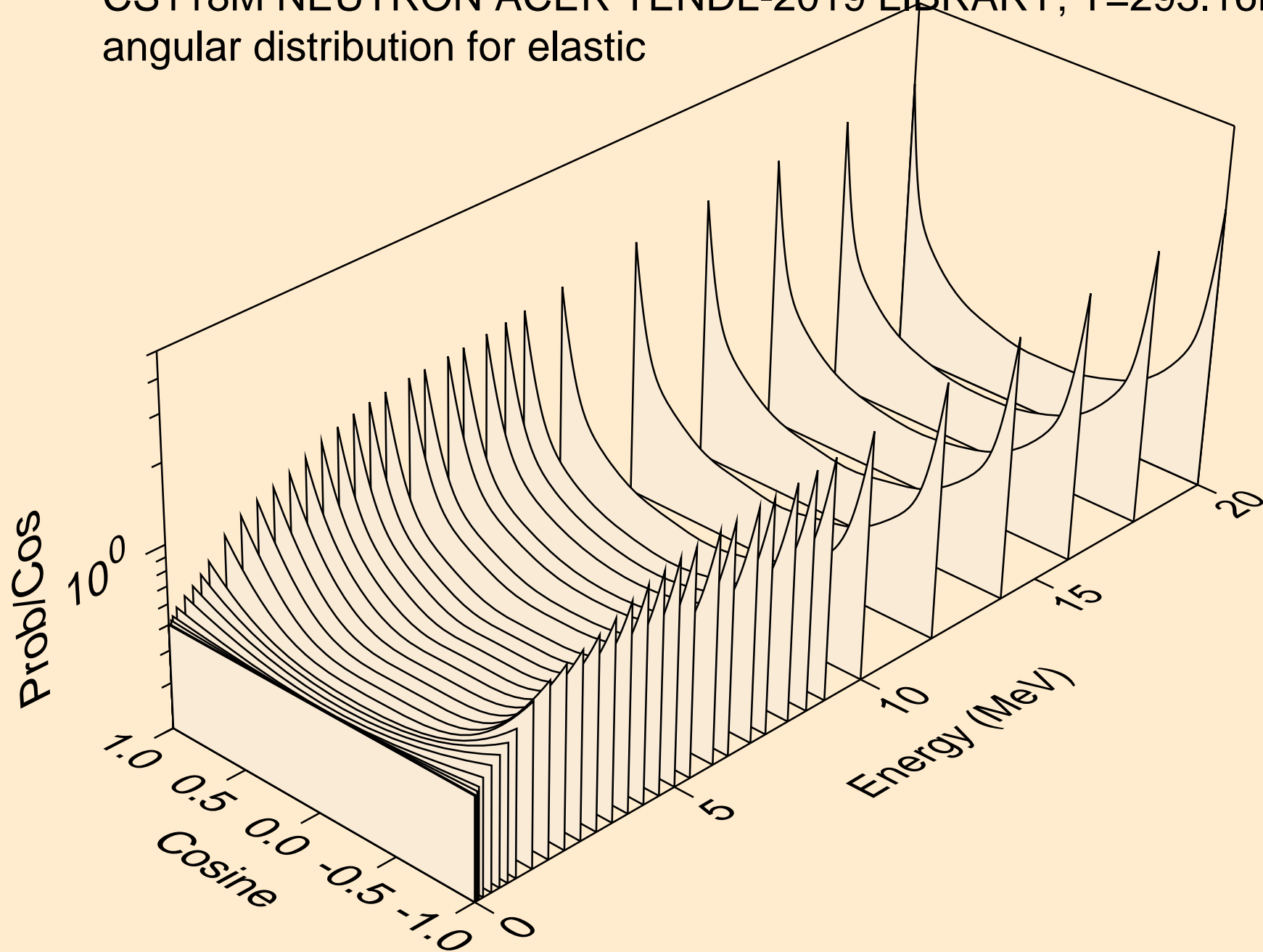

CS118M NEUTRON ACER TENDL-2019 LIBRARY; T=293.16K  
angular distribution for elastic

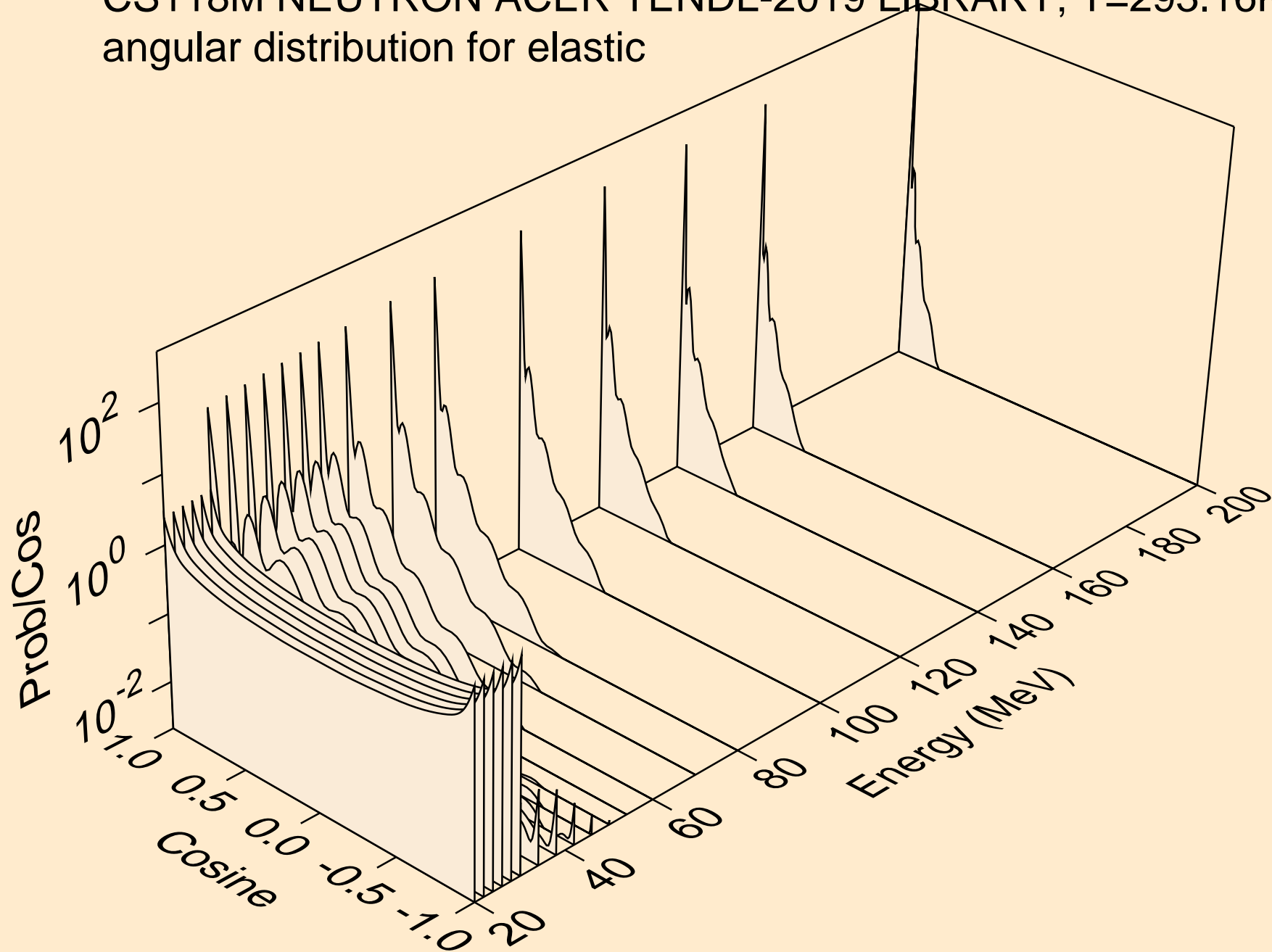

CS118M NEUTRON ACER TENDL-2019 LIBRARY; T=293.16K  
angular distribution for (n,n\*1)

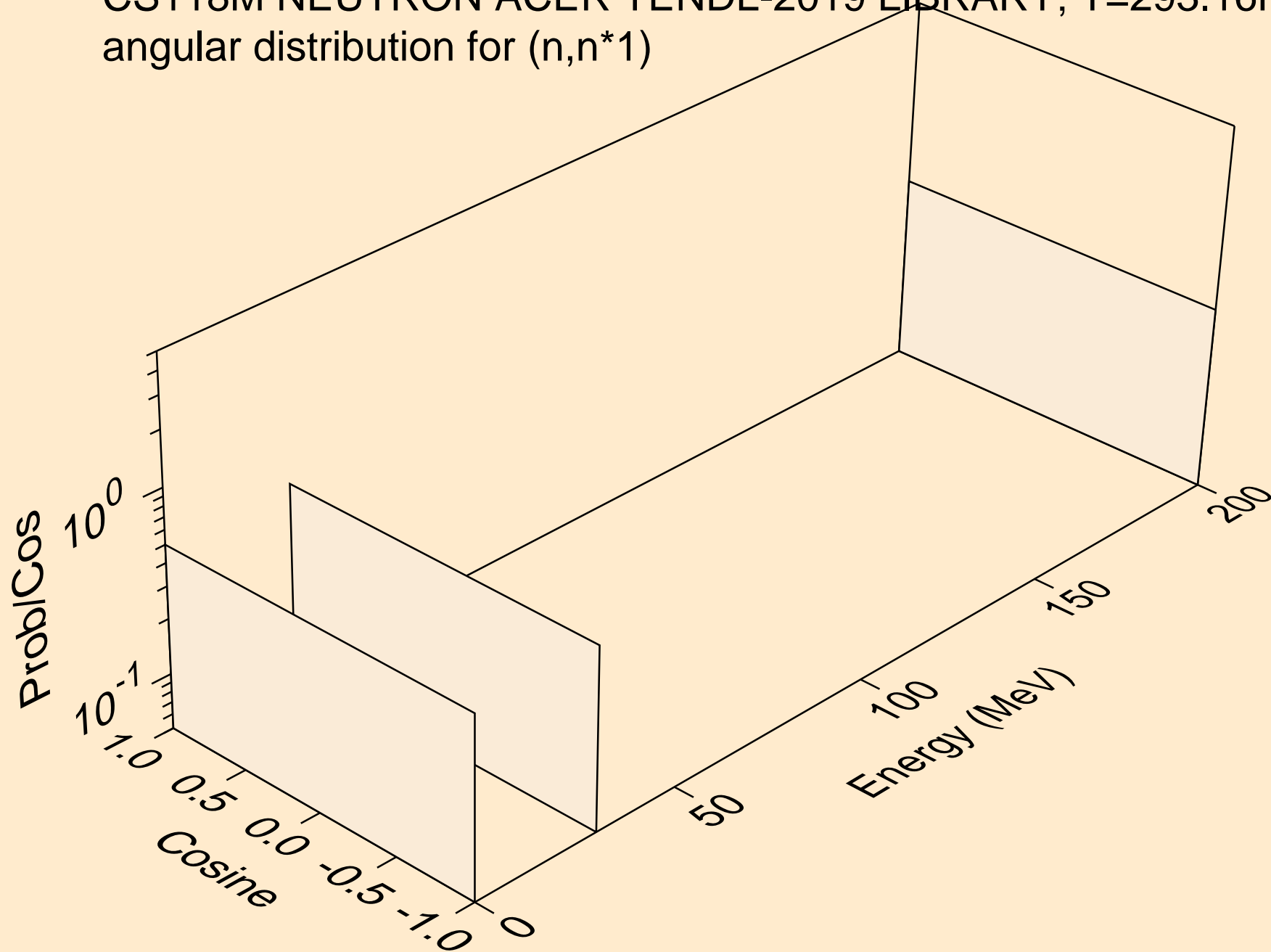

CS118M NEUTRON ACER TENDL-2019 LIBRARY; T=293.16K  
angular distribution for (n,n\*2)

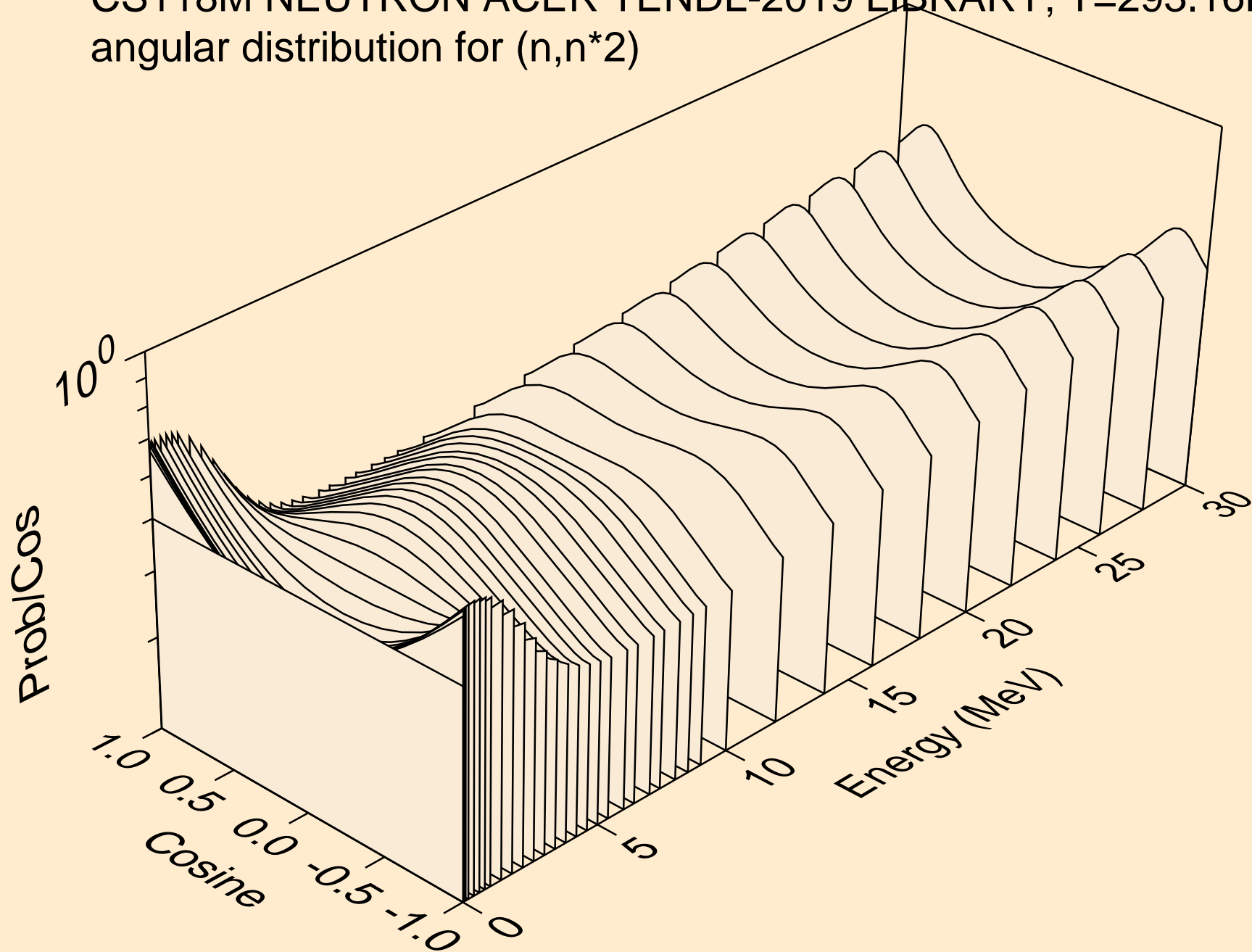



CS118M NEUTRON ACER TENDL-2019 LIBRARY; T=293.16K  
Neutron emission for (n,x)

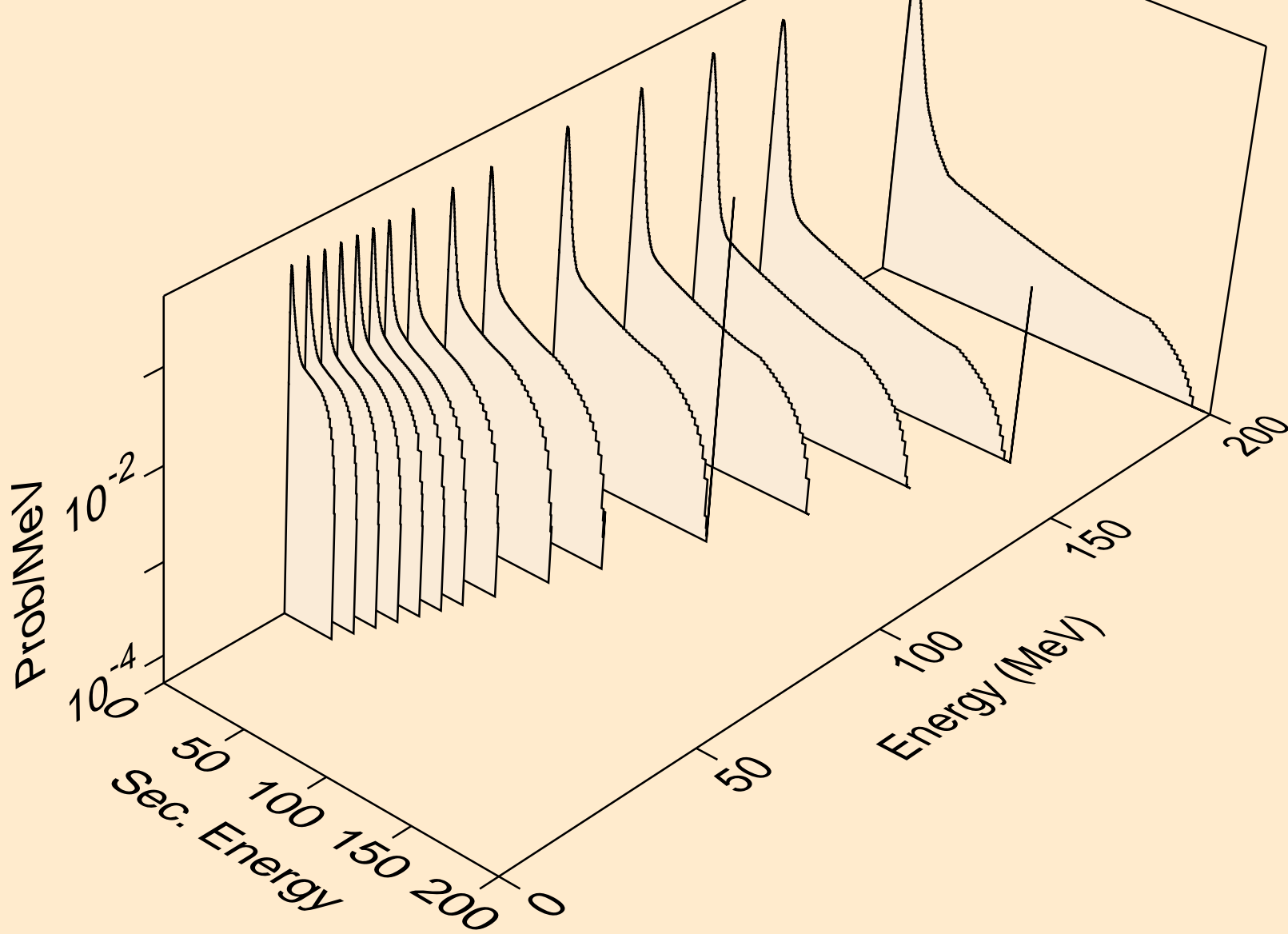

CS118M NEUTRON ACER TENDL-2019 LIBRARY; T=293.16K  
Neutron emission for (n,2nd)

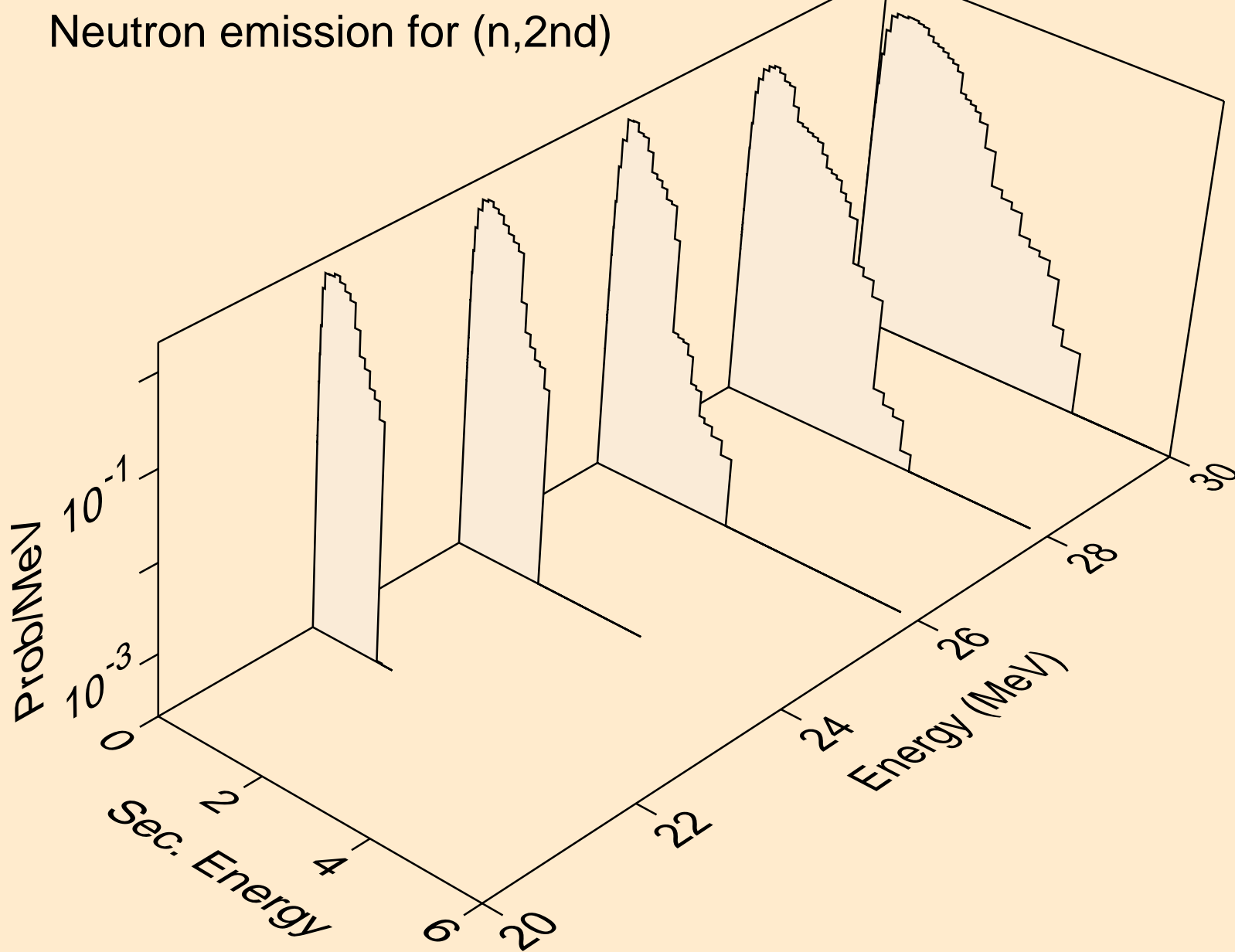

CS118M NEUTRON ACER TENDL-2019 LIBRARY; T=293.16K  
Neutron emission for (n,2n)

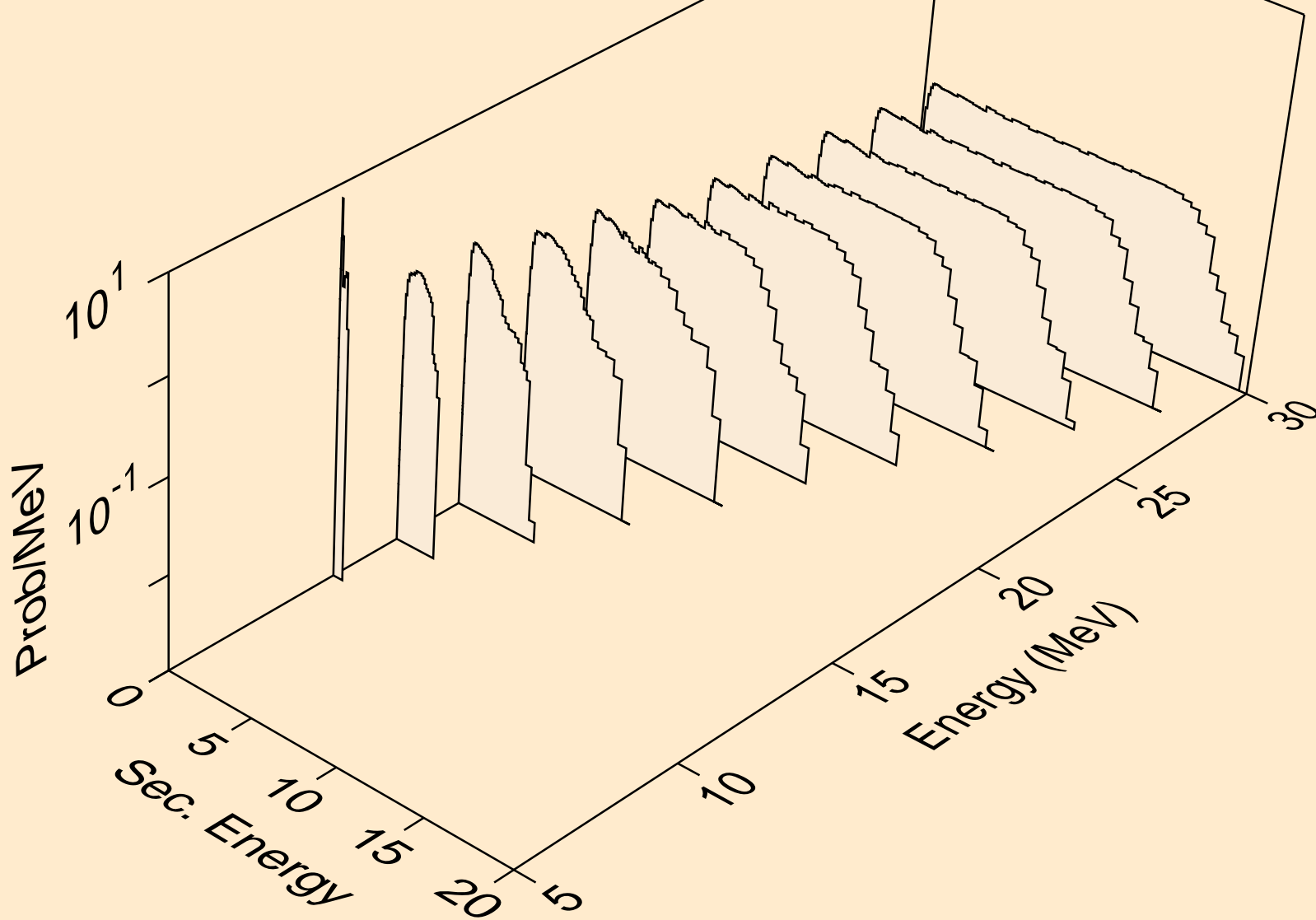

CS118M NEUTRON ACER TENDL-2019 LIBRARY; T=293.16K  
Neutron emission for (n,3n)

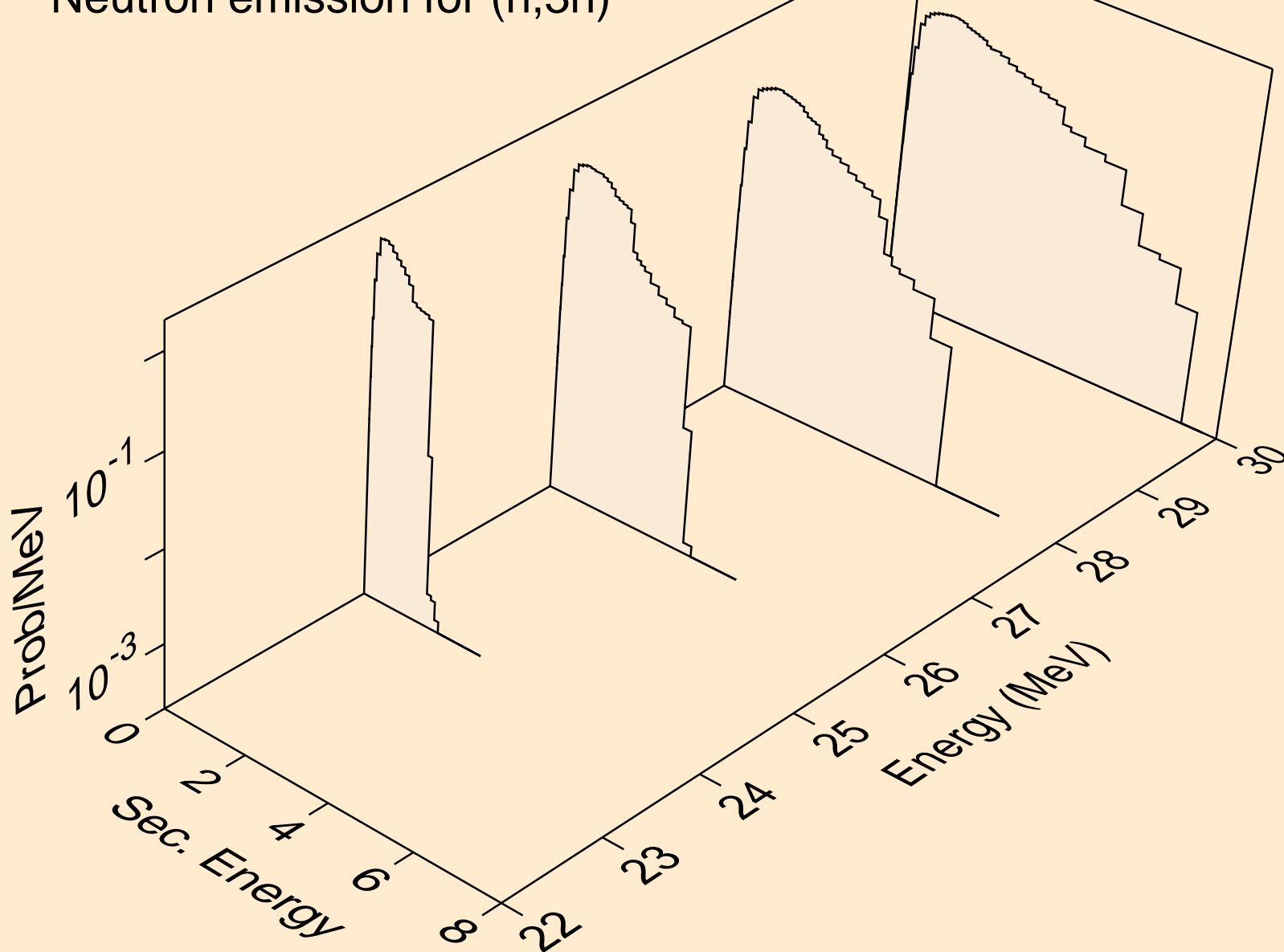

CS118M NEUTRON ACER TENDL-2019 LIBRARY; T=293.16K  
Neutron emission for (n,n\*)a

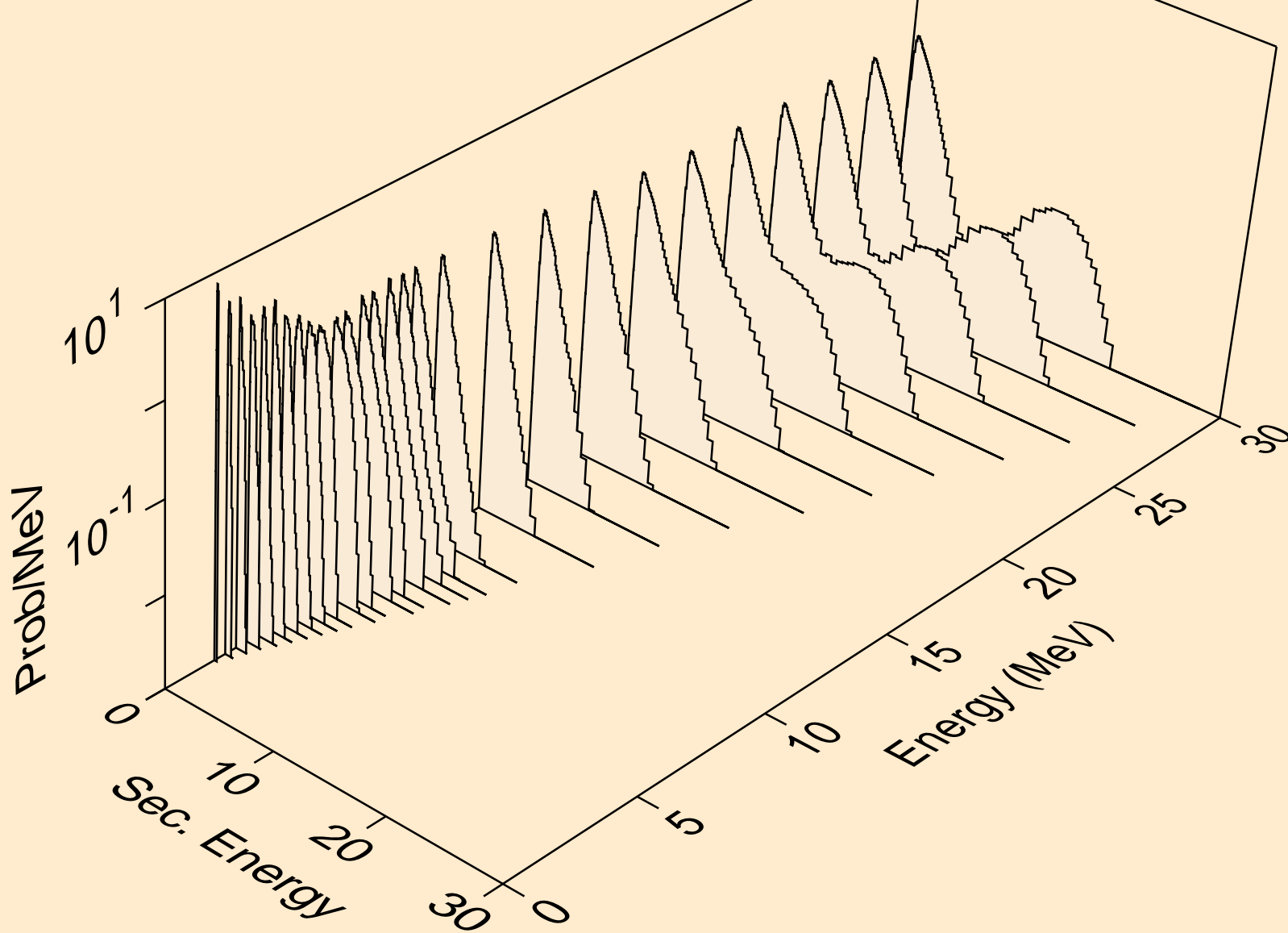

CS118M NEUTRON ACER TENDL-2019 LIBRARY; T=293.16K  
Neutron emission for (n,n\*)3a

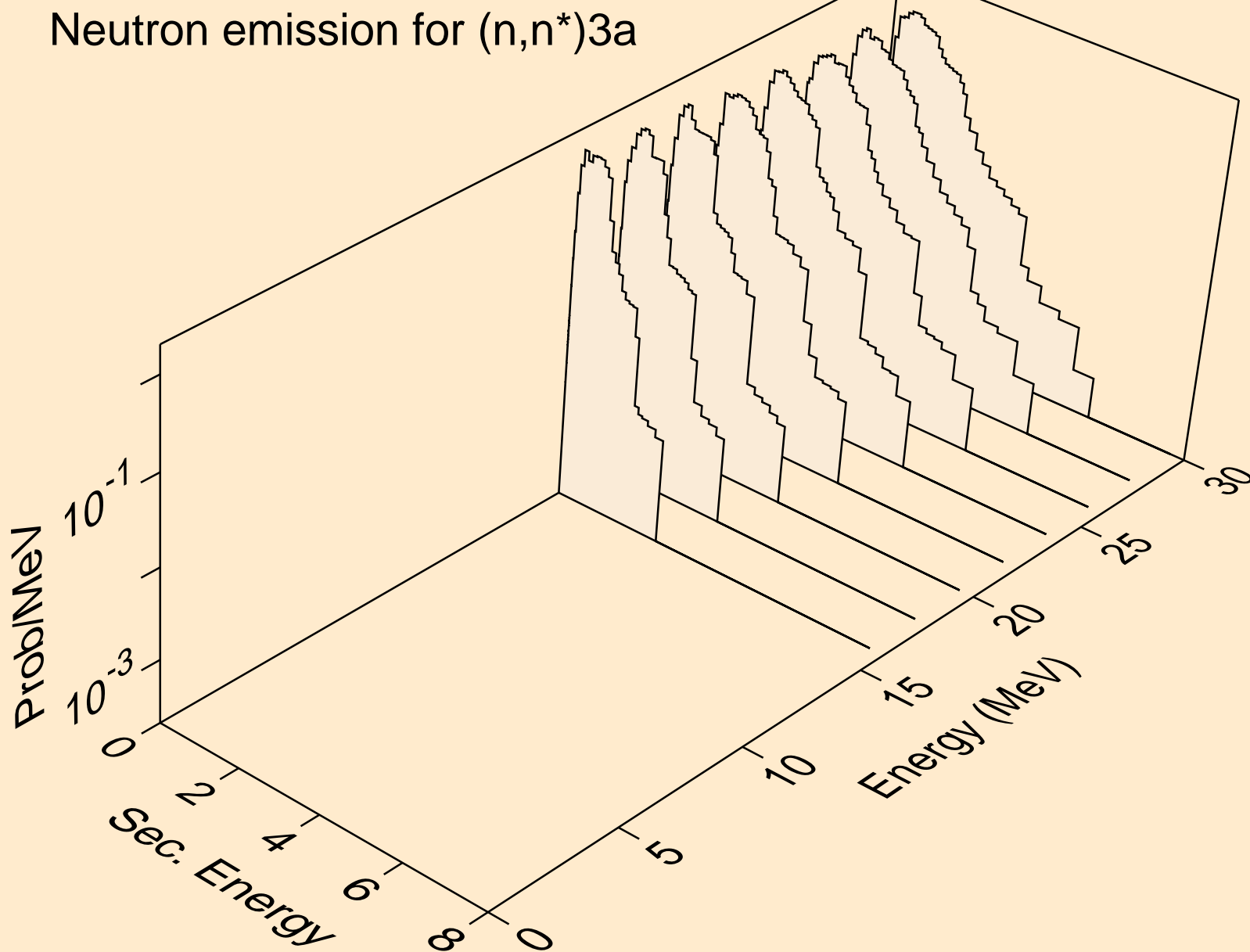

CS118M NEUTRON ACER TENDL-2019 LIBRARY; T=293.16K  
Neutron emission for (n,2n)a

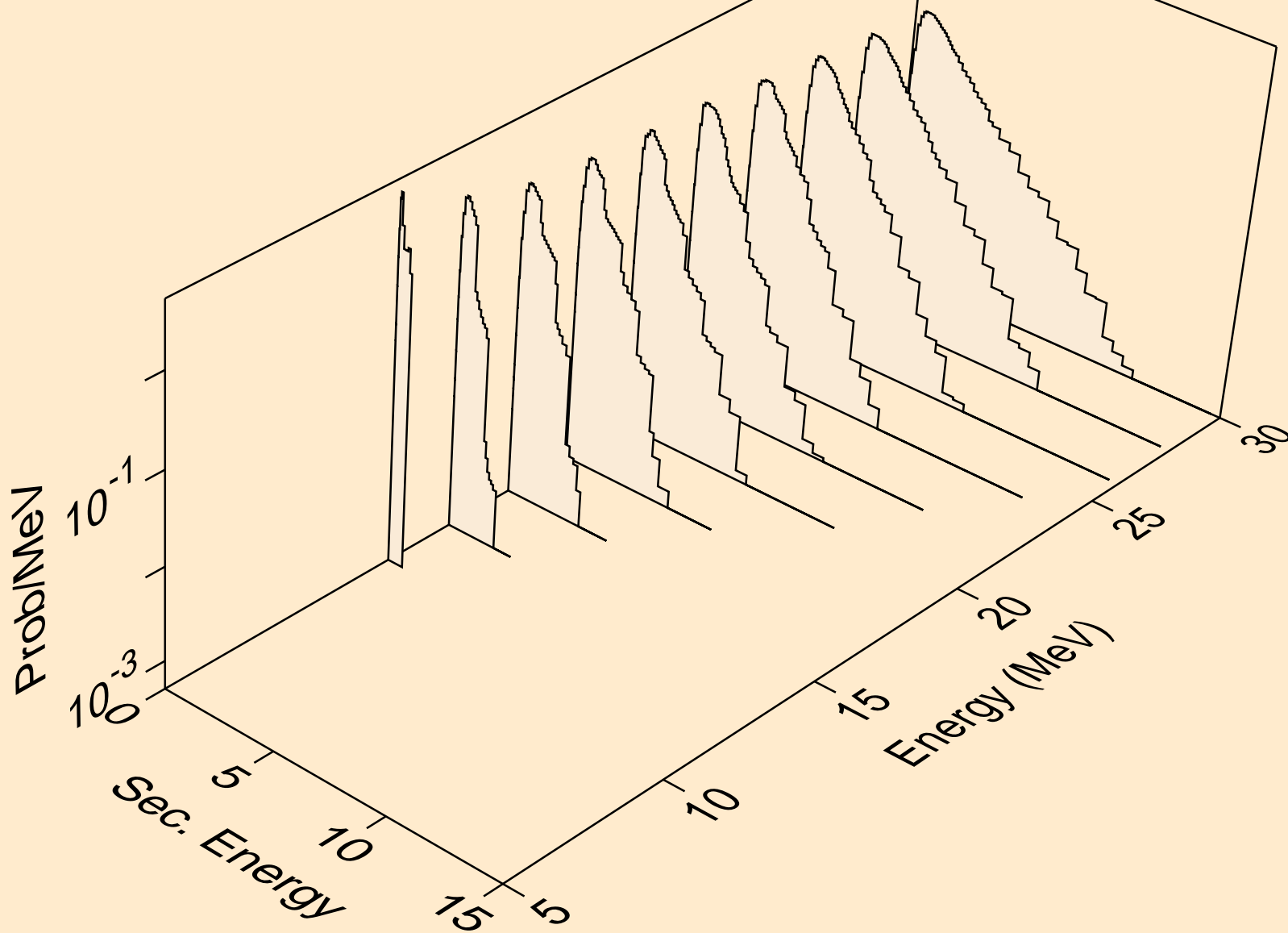

CS118M NEUTRON ACER TENDL-2019 LIBRARY; T=293.16K  
Neutron emission for (n,3n)a

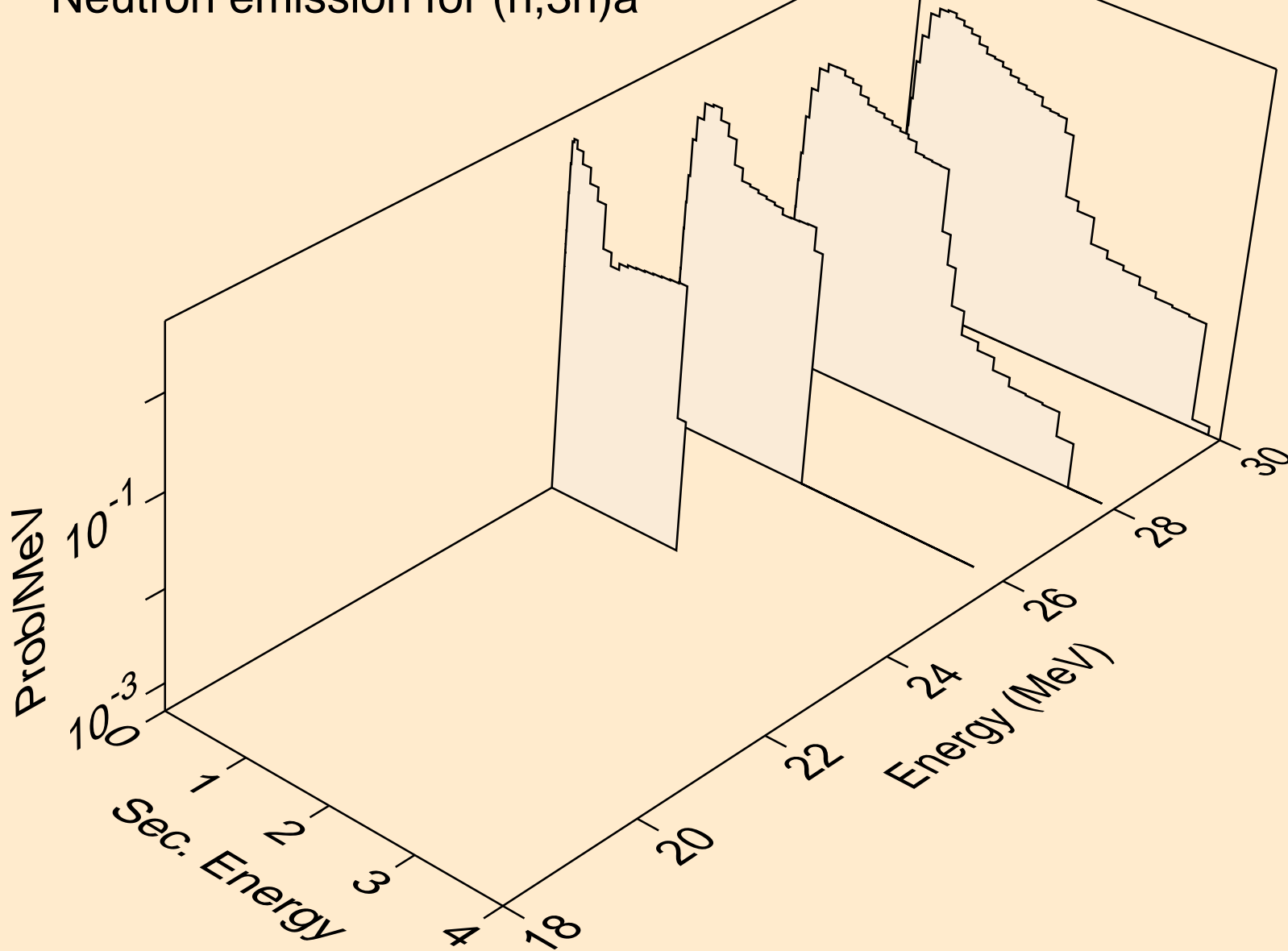



CS118M NEUTRON ACER TENDL-2019 LIBRARY; T=293.16K  
Neutron emission for (n,n\*)p

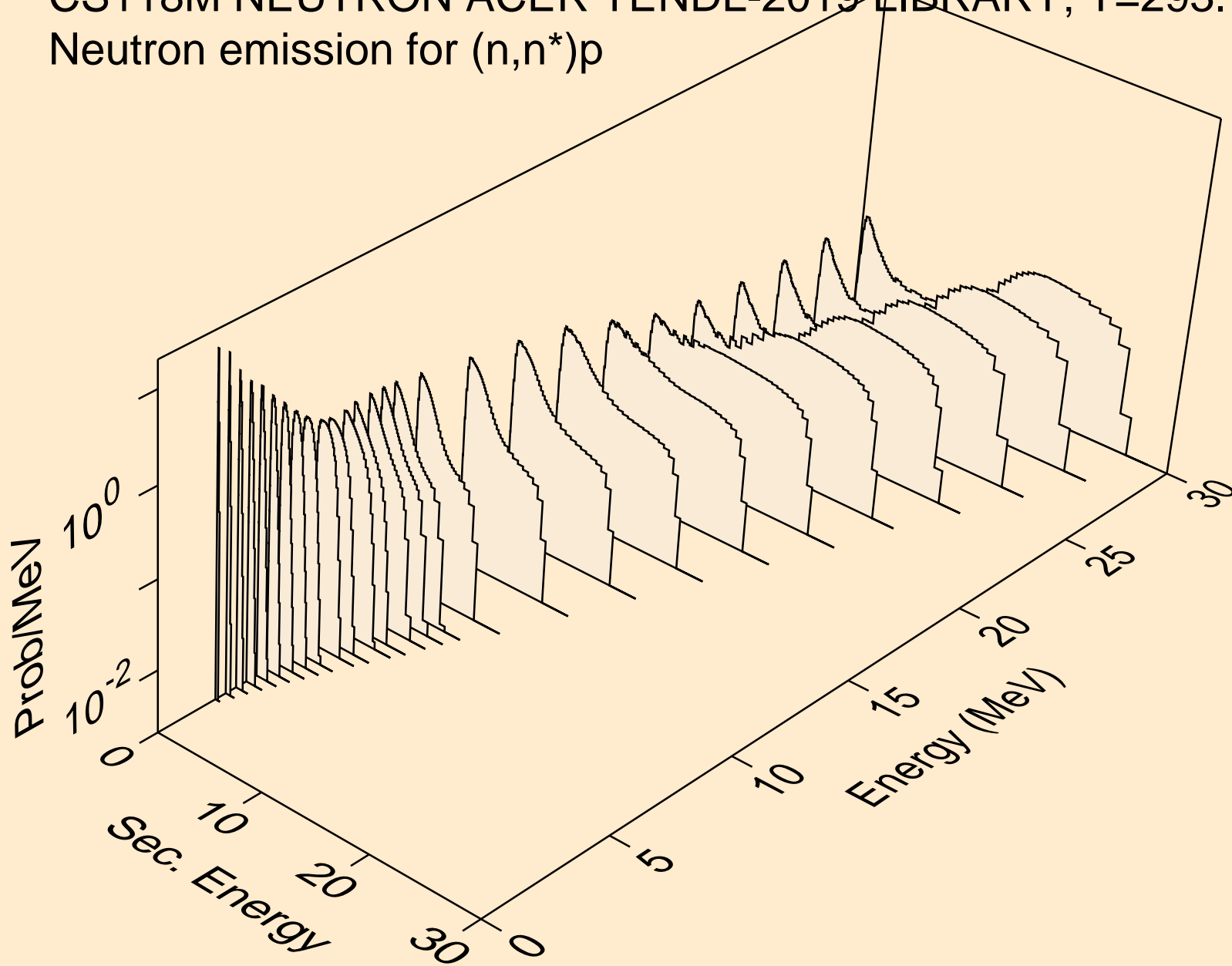

CS118M NEUTRON ACER TENDL-2019 LIBRARY; T=293.16K  
Neutron emission for (n,n\*)2a

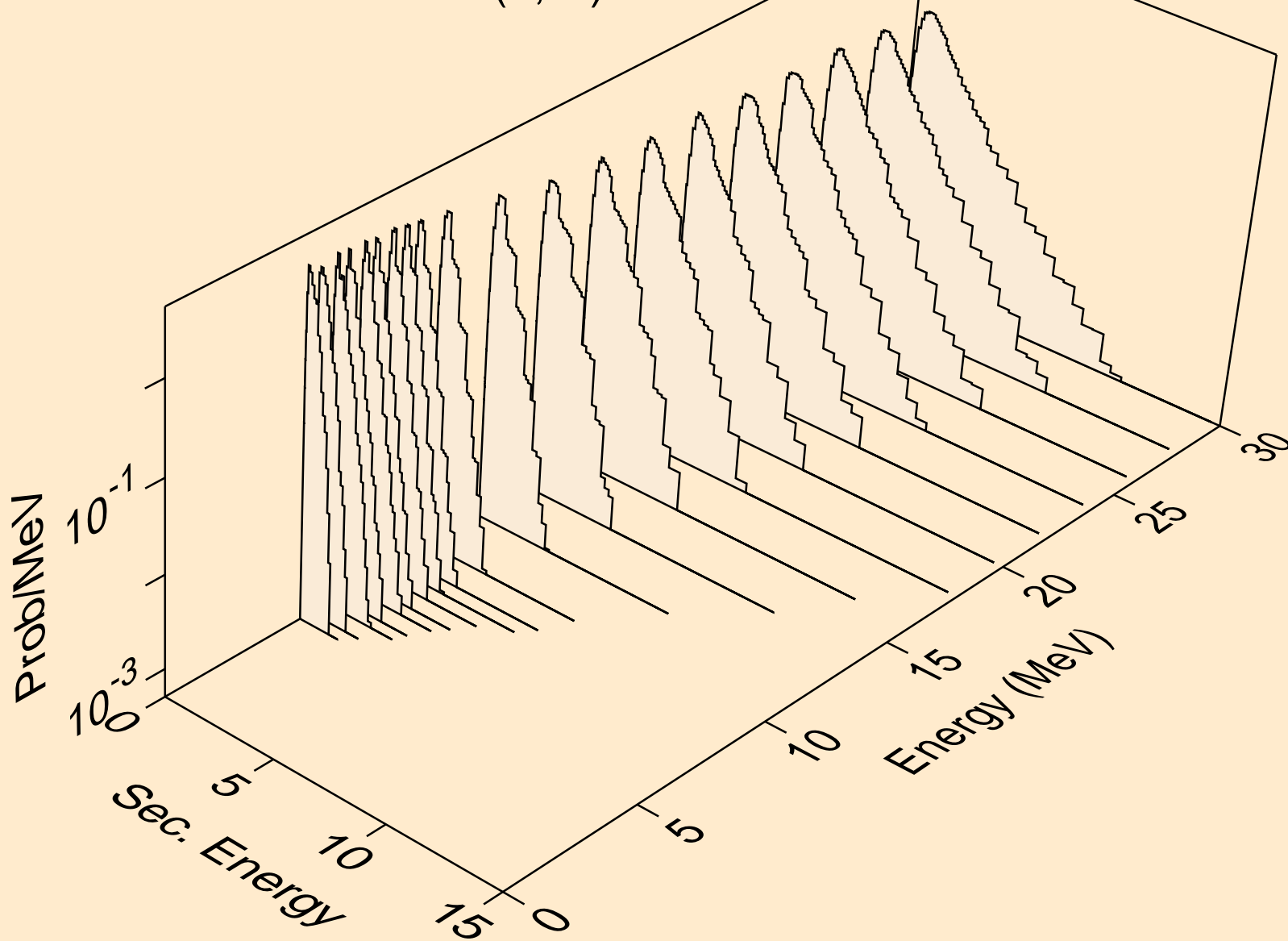

CS118M NEUTRON ACER TENDL-2019 LIBRARY; T=293.16K  
Neutron emission for (n,2n)2a

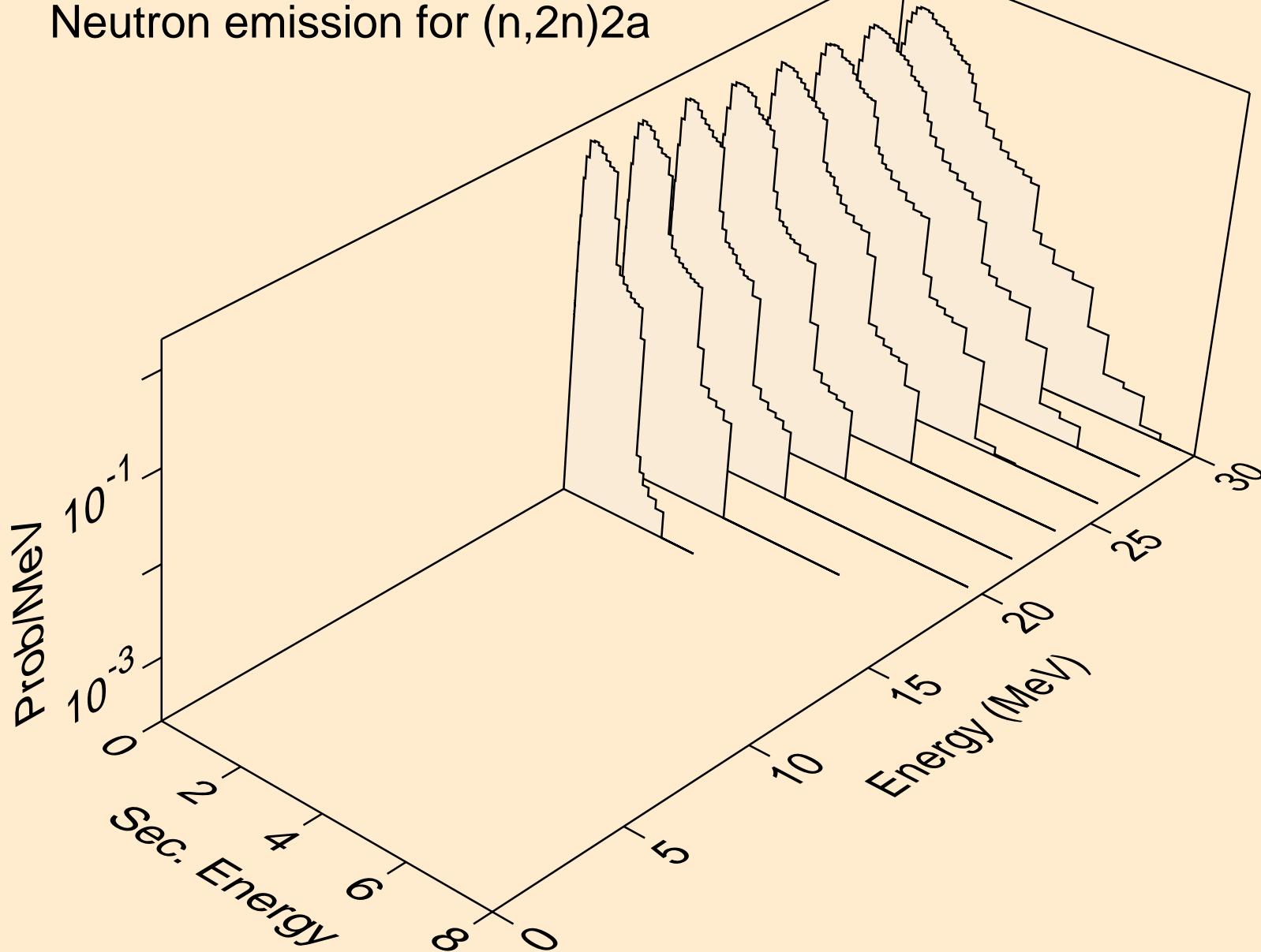

CS118M NEUTRON ACER TENDL-2019 LIBRARY; T=293.16K  
Neutron emission for (n,n\*)d

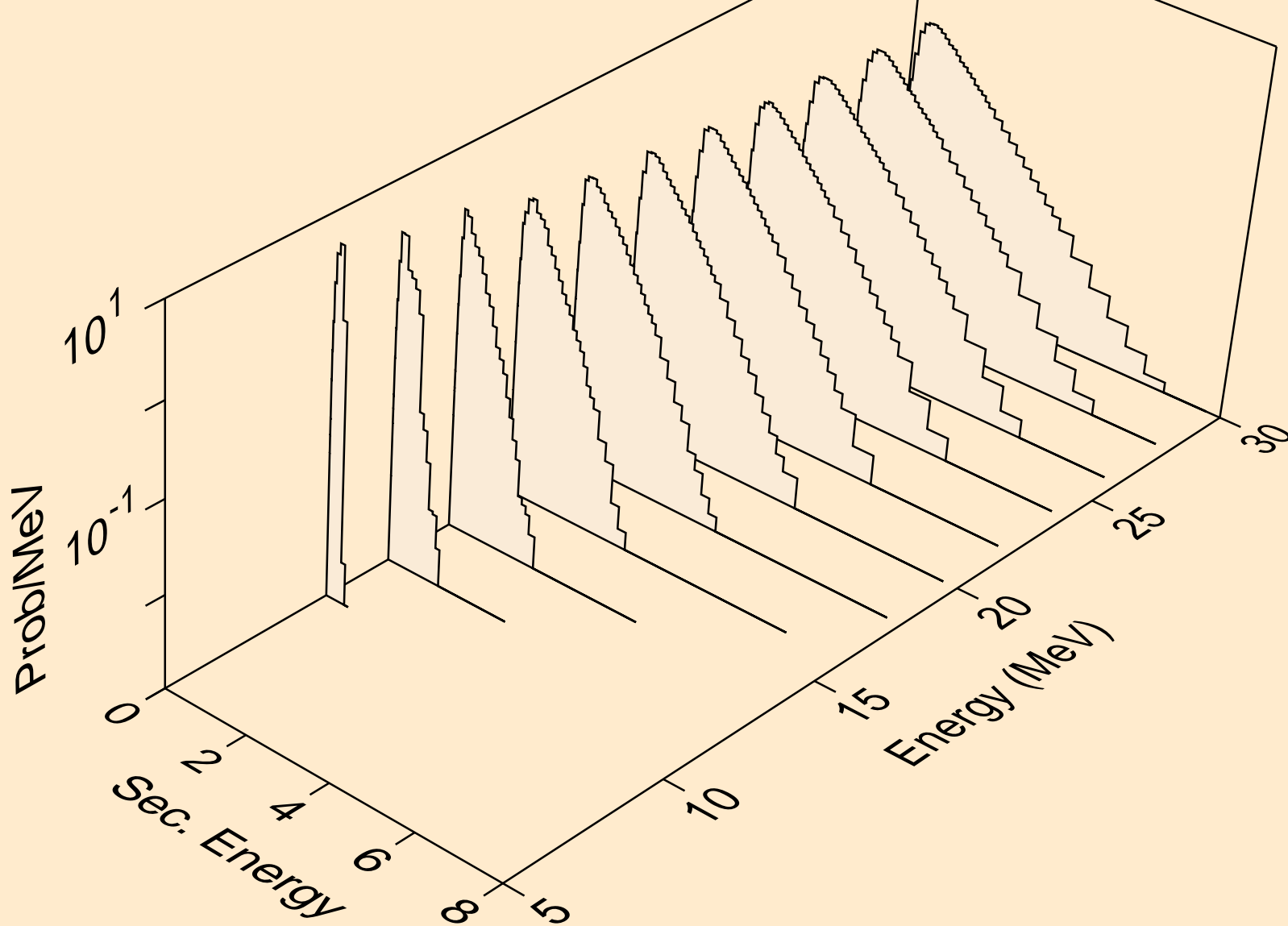

CS118M NEUTRON ACER TENDL-2019 LIBRARY; T=293.16K  
Neutron emission for (n,n\*)t

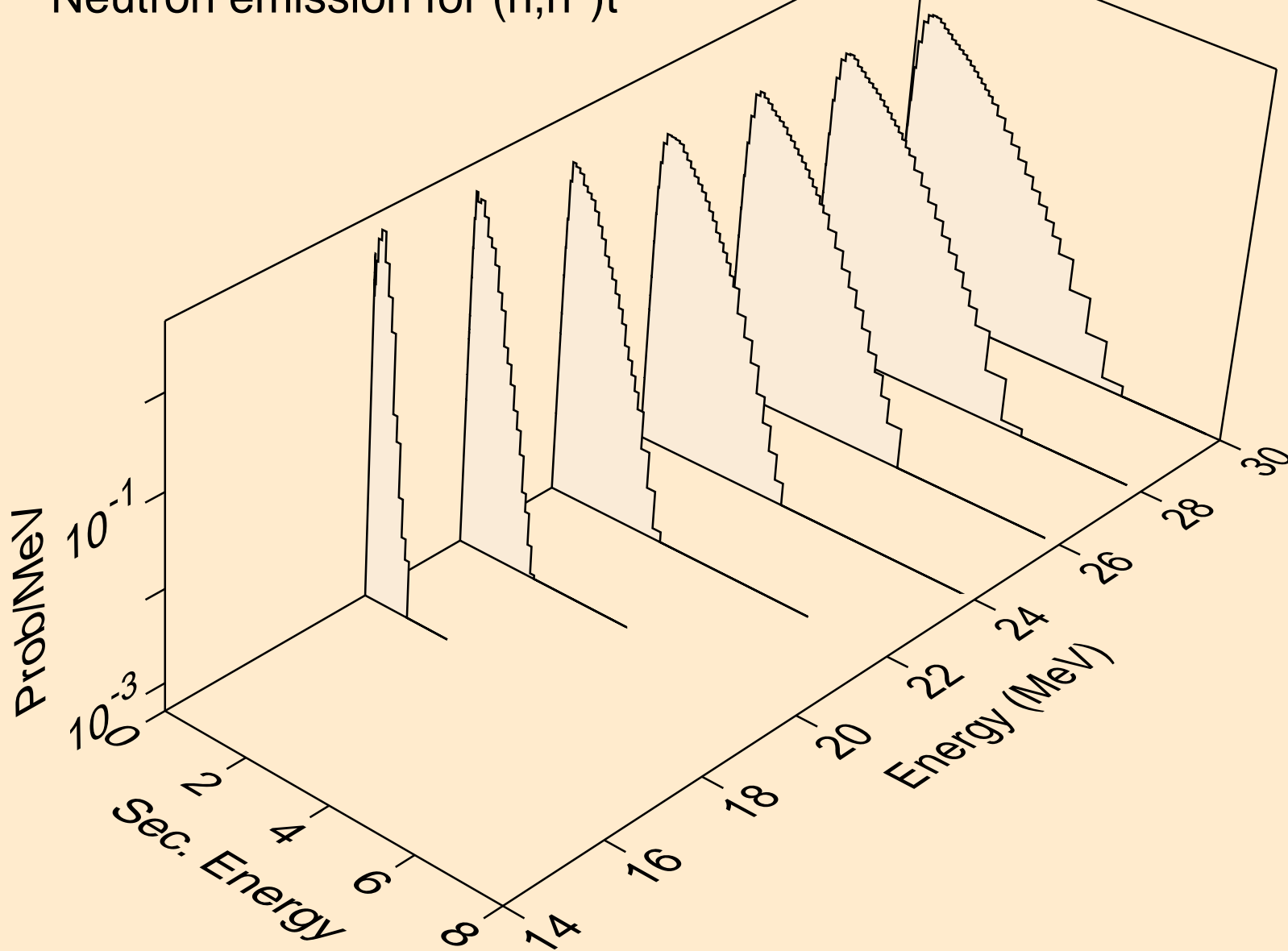

CS118M NEUTRON ACER TENDL-2019 LIBRARY; T=293.16K  
Neutron emission for (n,n\*)he3

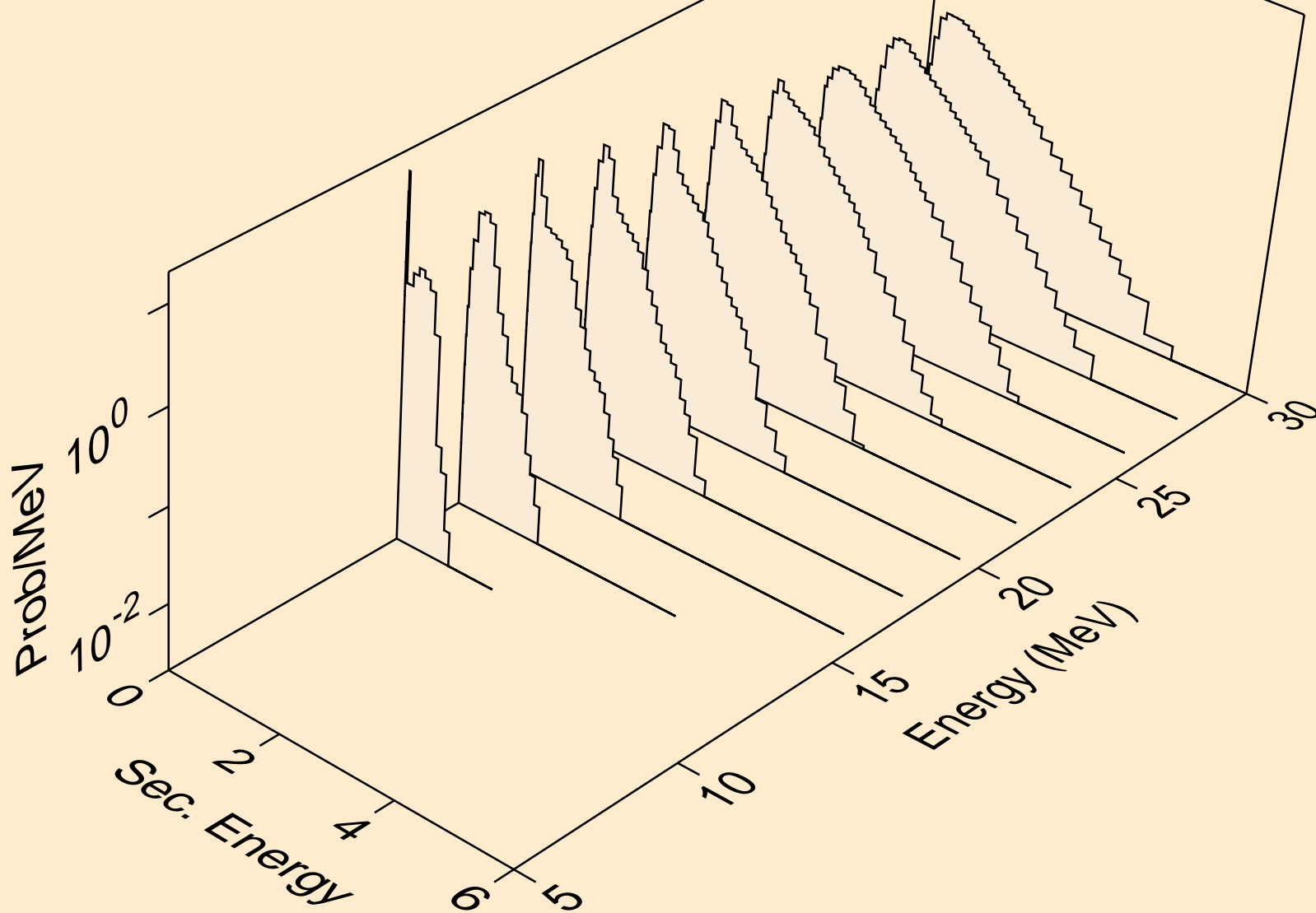

CS118M NEUTRON ACER TENDL-2019 LIBRARY; T=293.16K  
Neutron emission for (n,n\*)d2a

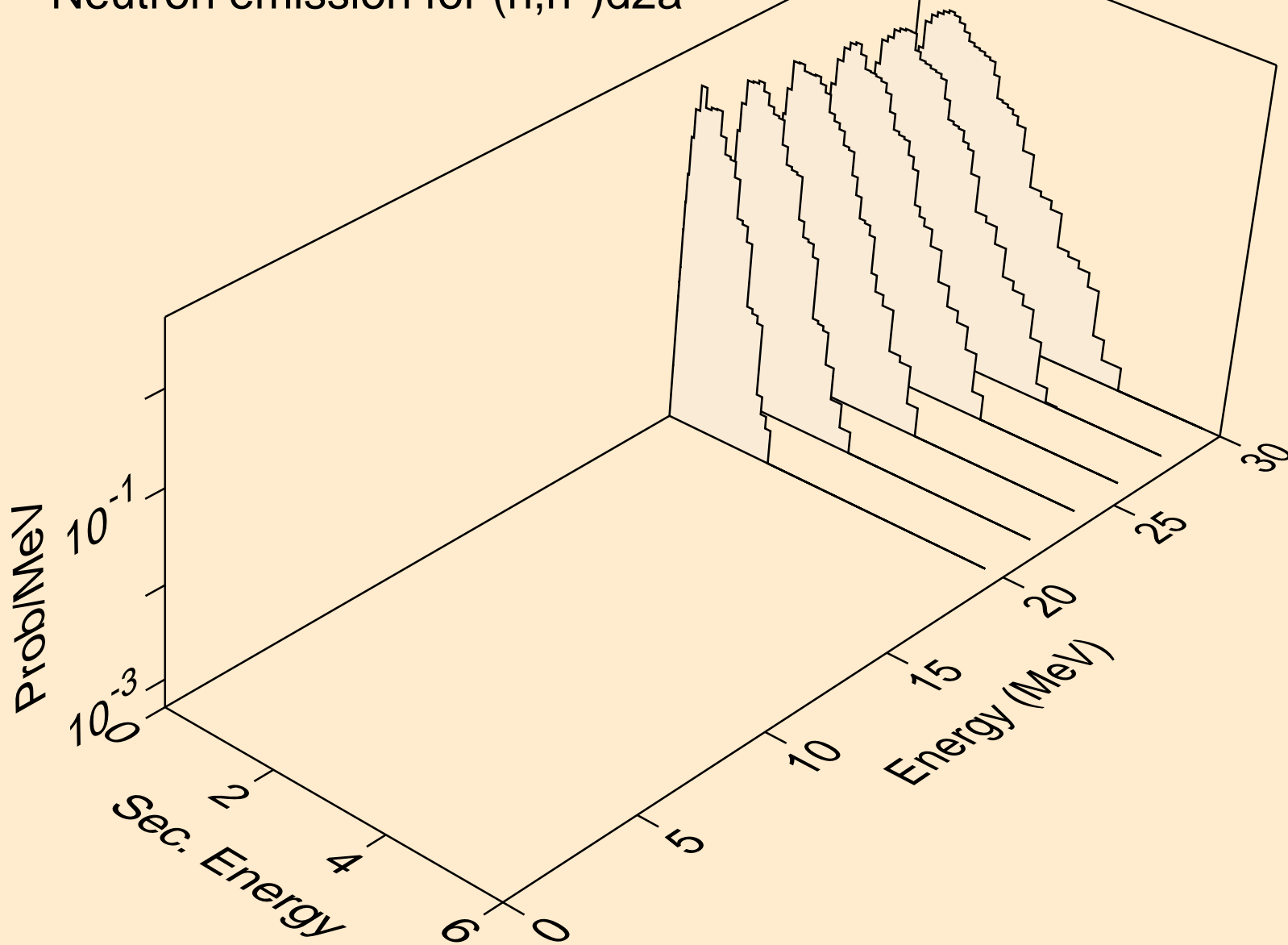

CS118M NEUTRON ACER TENDL-2019 LIBRARY; T=293.16K  
Neutron emission for (n,2np)

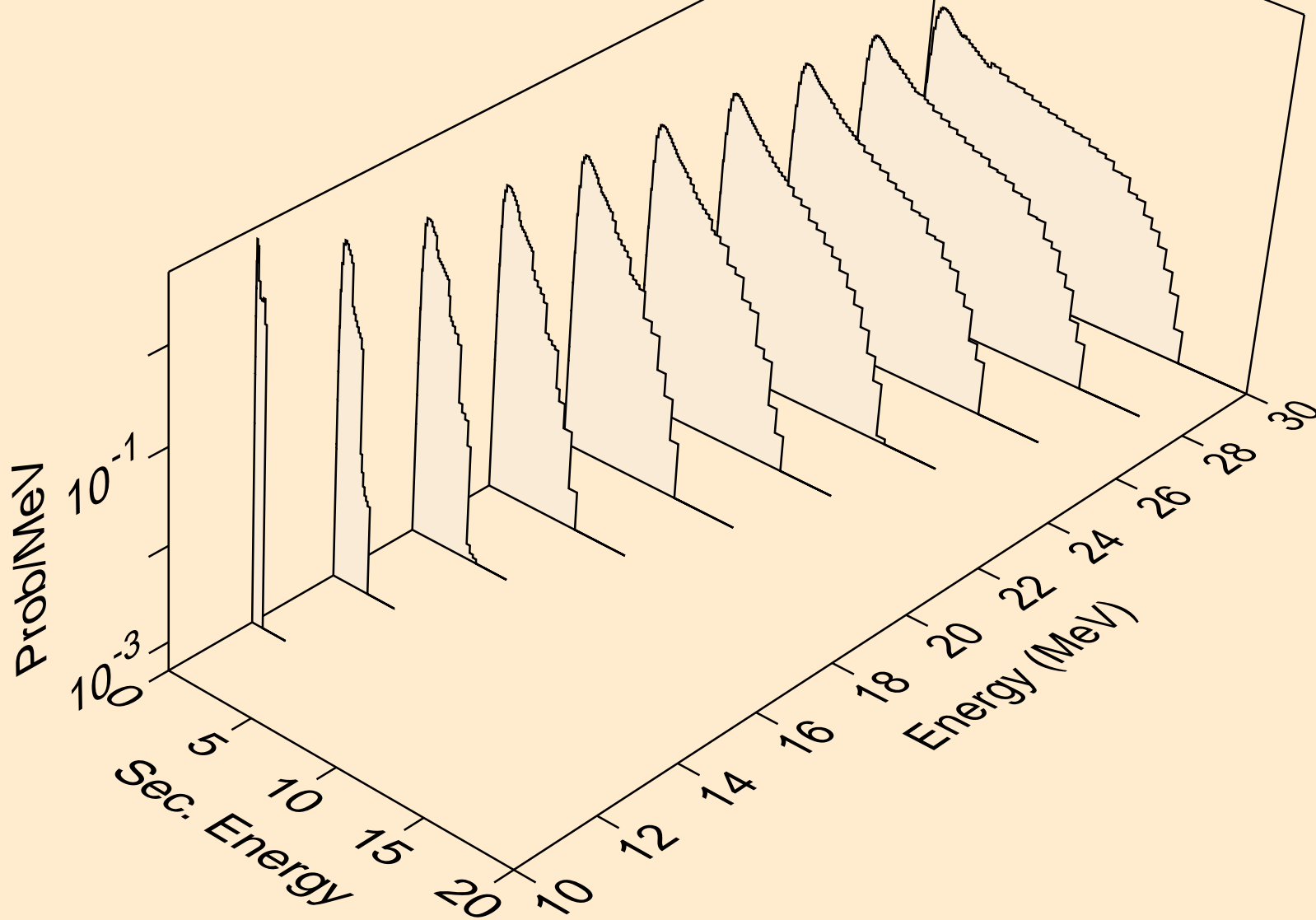



CS118M NEUTRON ACER TENDL-2019 LIBRARY; T=293.16K  
Neutron emission for (n,3np)

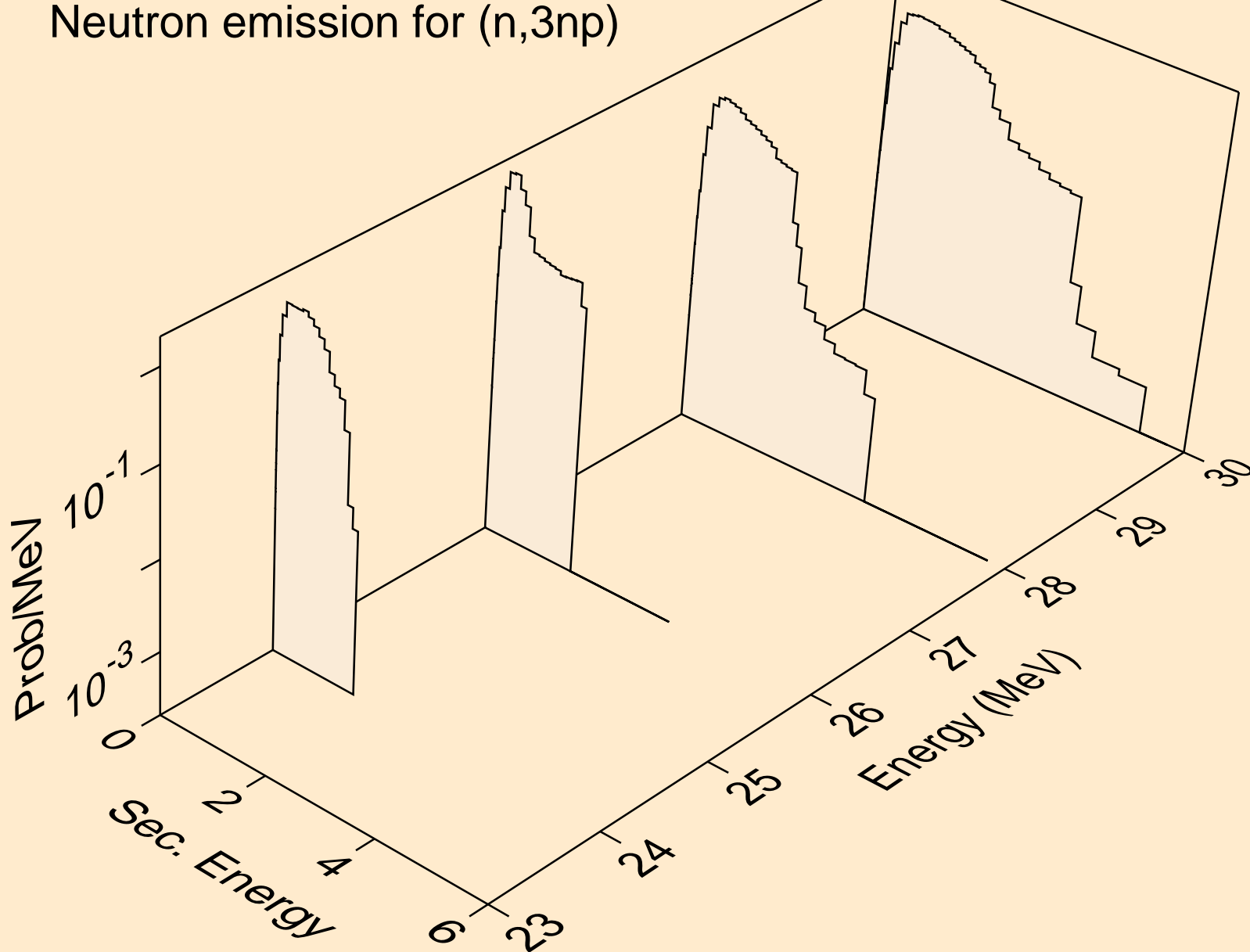

CS118M NEUTRON ACER TENDL-2019 LIBRARY; T=293.16K  
Neutron emission for (n,2np)

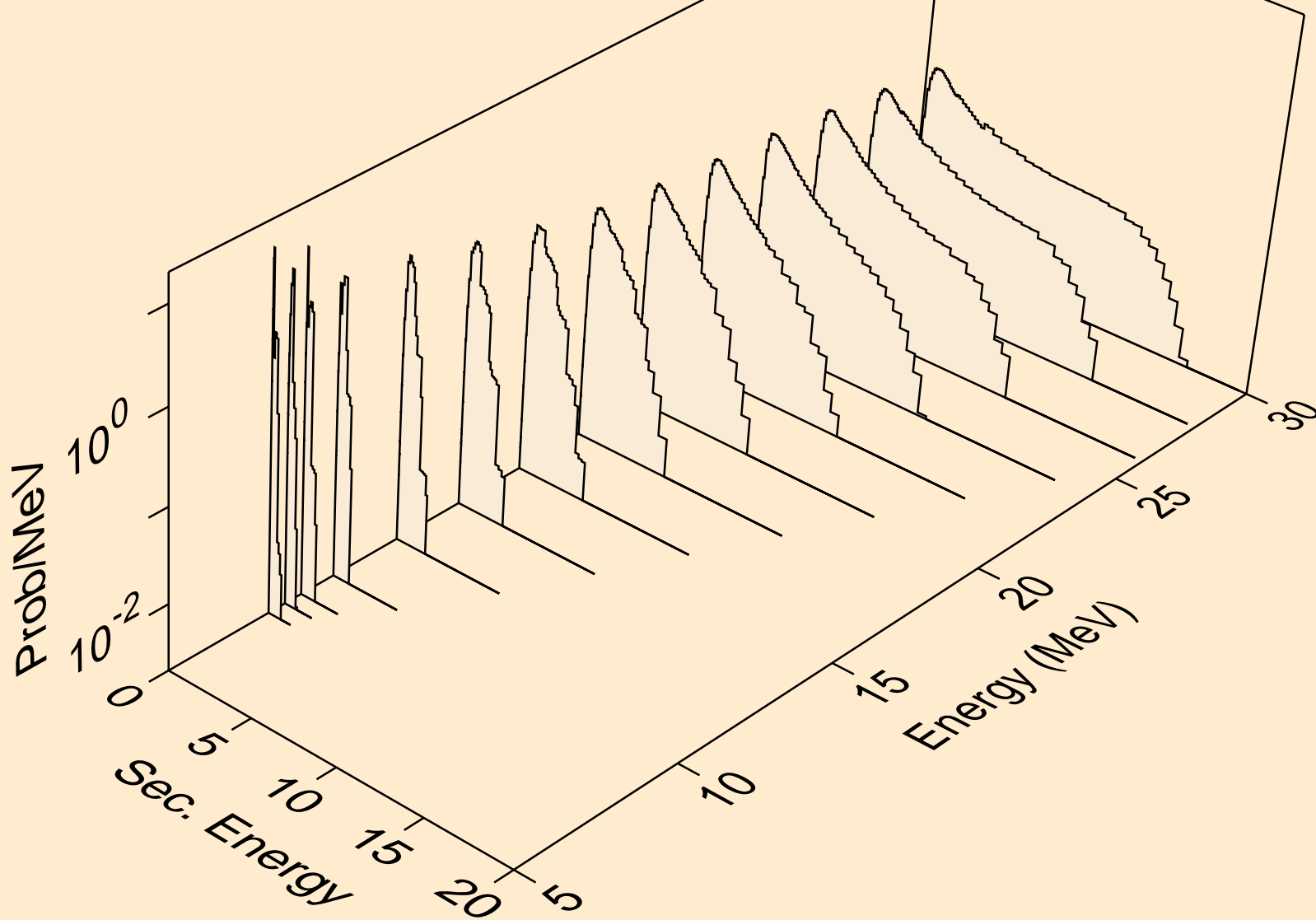

CS118M NEUTRON ACER TENDL-2019 LIBRARY; T=293.16K  
Neutron emission for (n,npa)

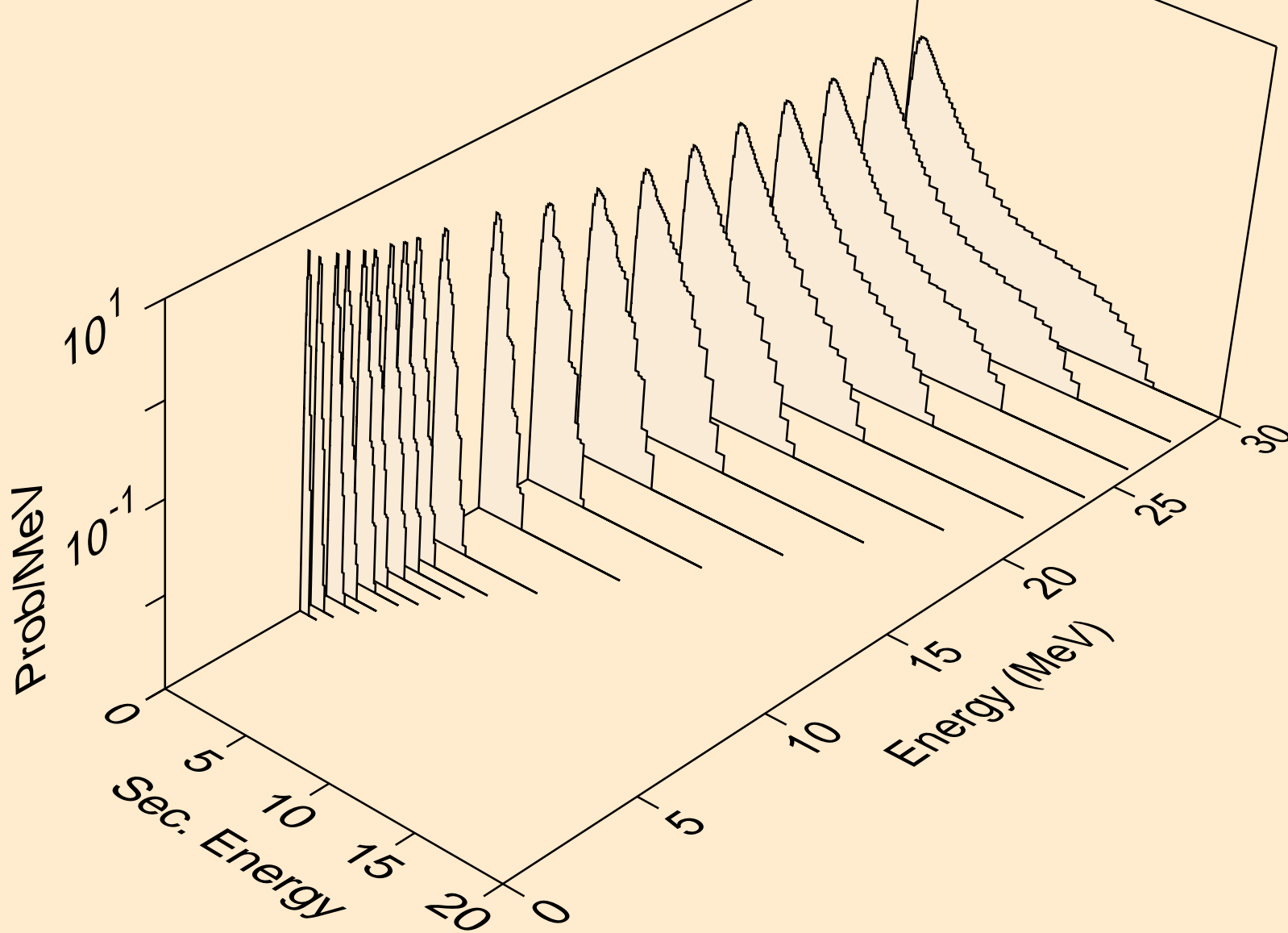

CS118M NEUTRON ACER TENDL-2019 LIBRARY; T=293.16K  
Neutron emission for (n,n\*c)

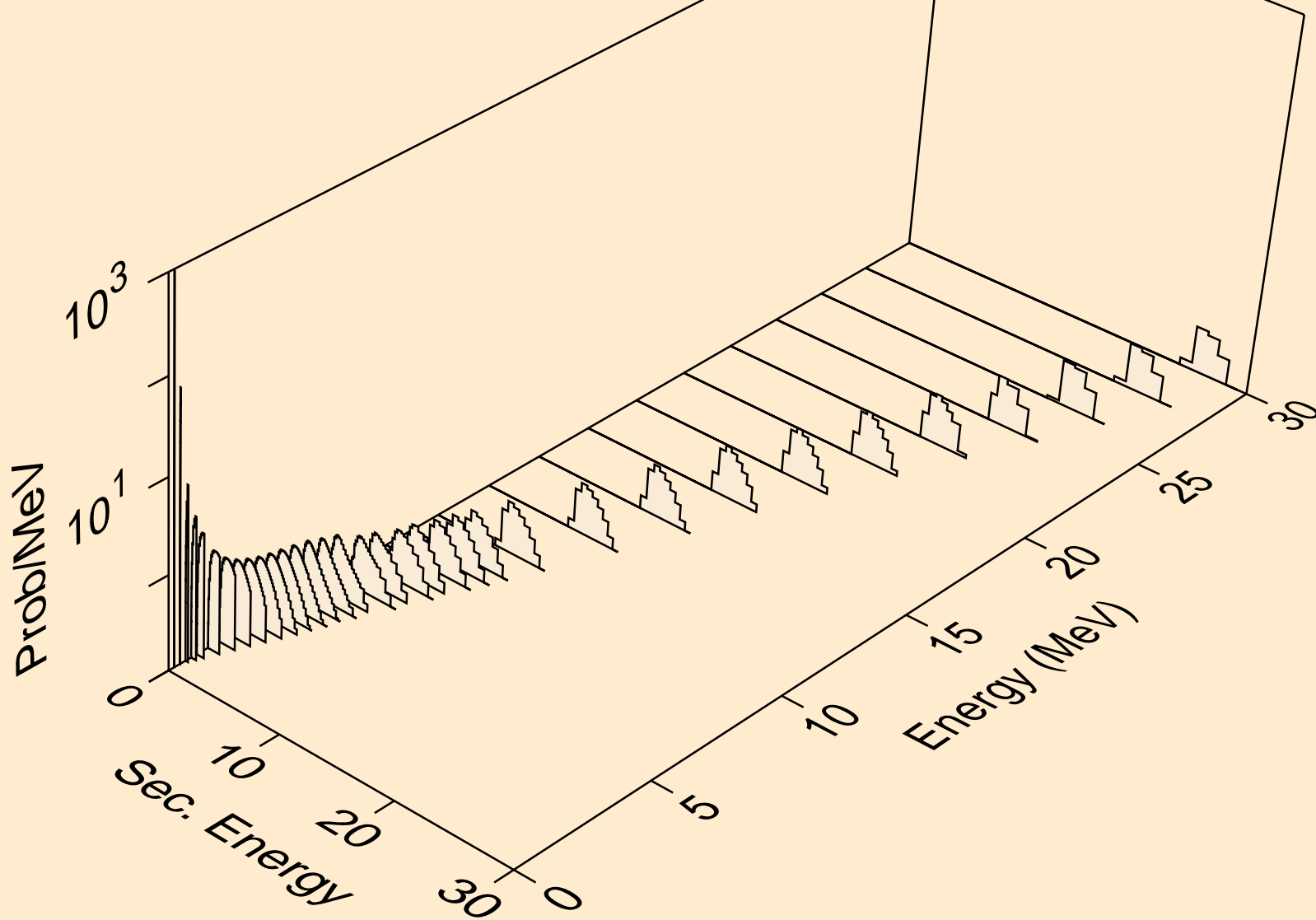

CS118M NEUTRON ACER TENDL-2019 LIBRARY; T=293.16K  
Photon emission for (n,x)

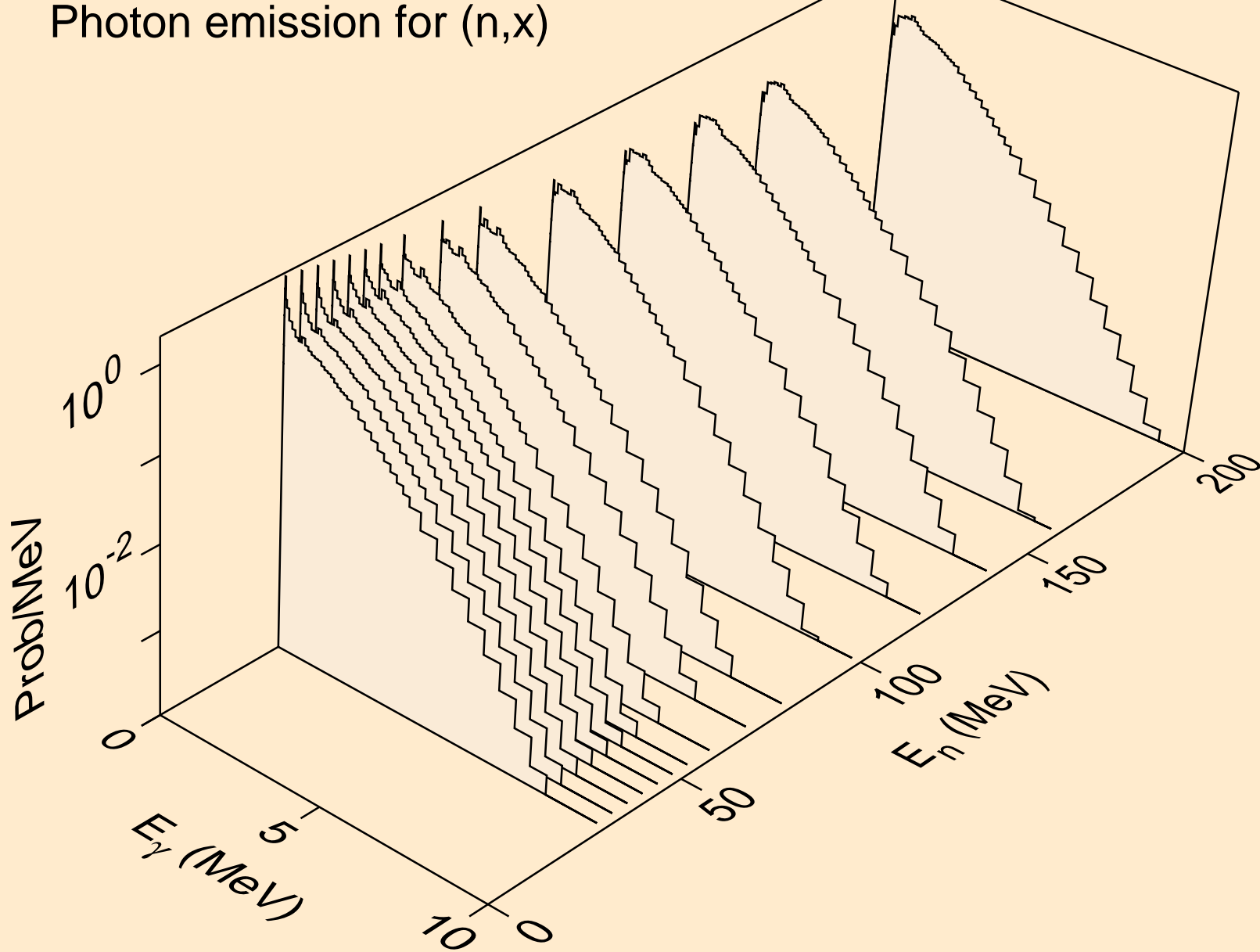

CS118M NEUTRON ACER TENDL-2019 LIBRARY; T=293.16K  
Photon emission for (n,2nd)

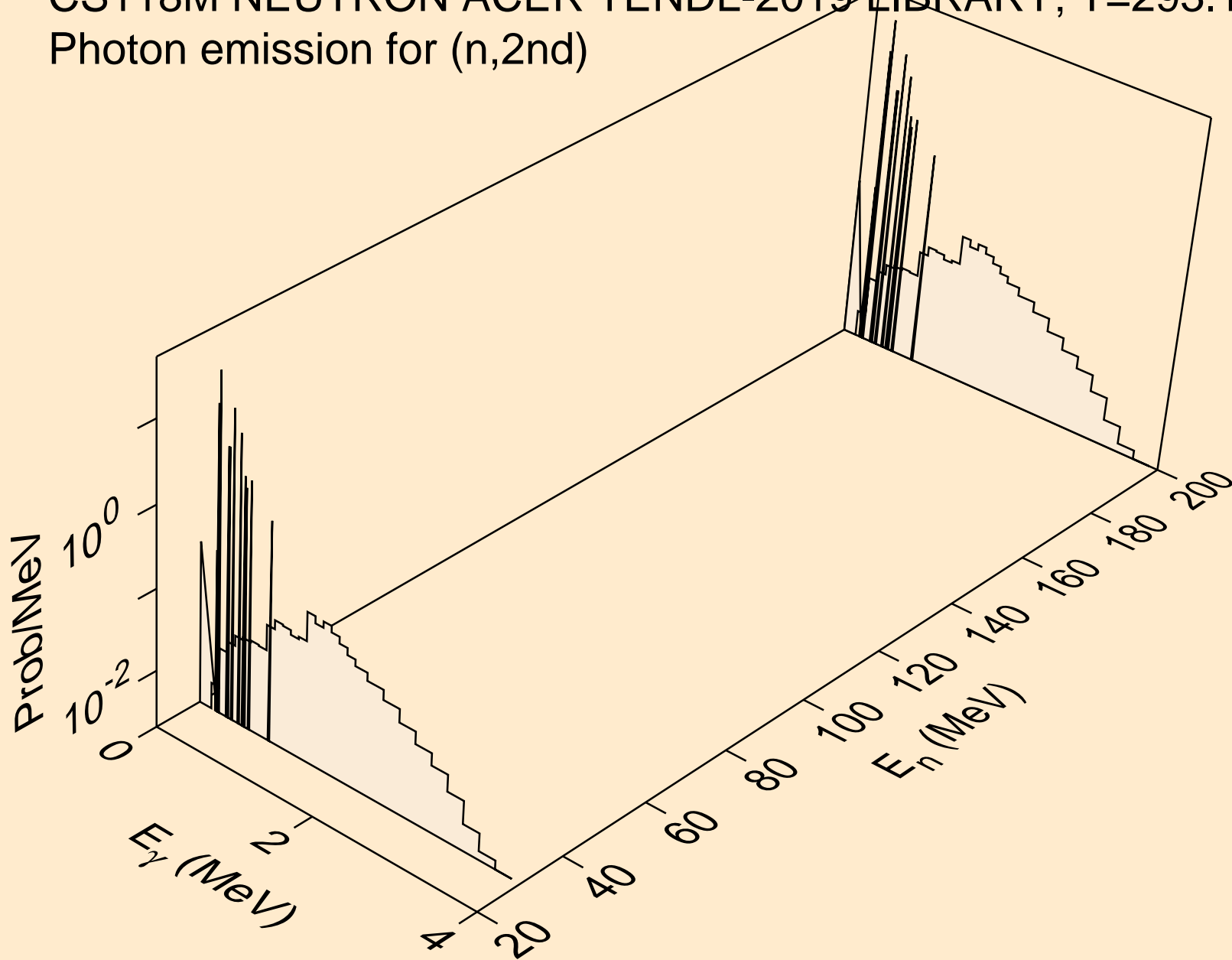

CS118M NEUTRON ACER TENDL-2019 LIBRARY; T=293.16K  
Photon emission for (n,2n)

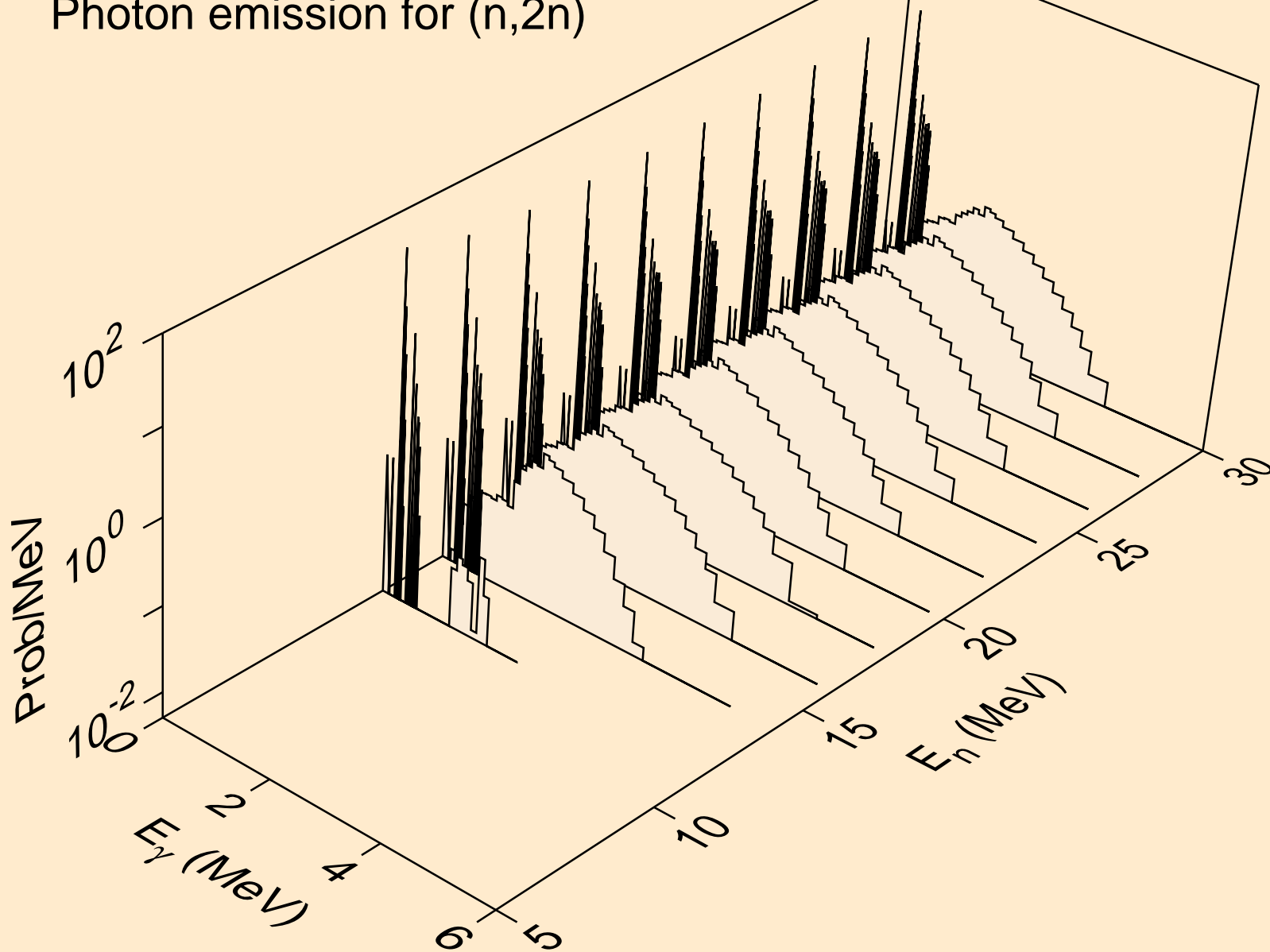

CS118M NEUTRON ACER TENDL-2019 LIBRARY; T=293.16K  
Photon emission for (n,3n)

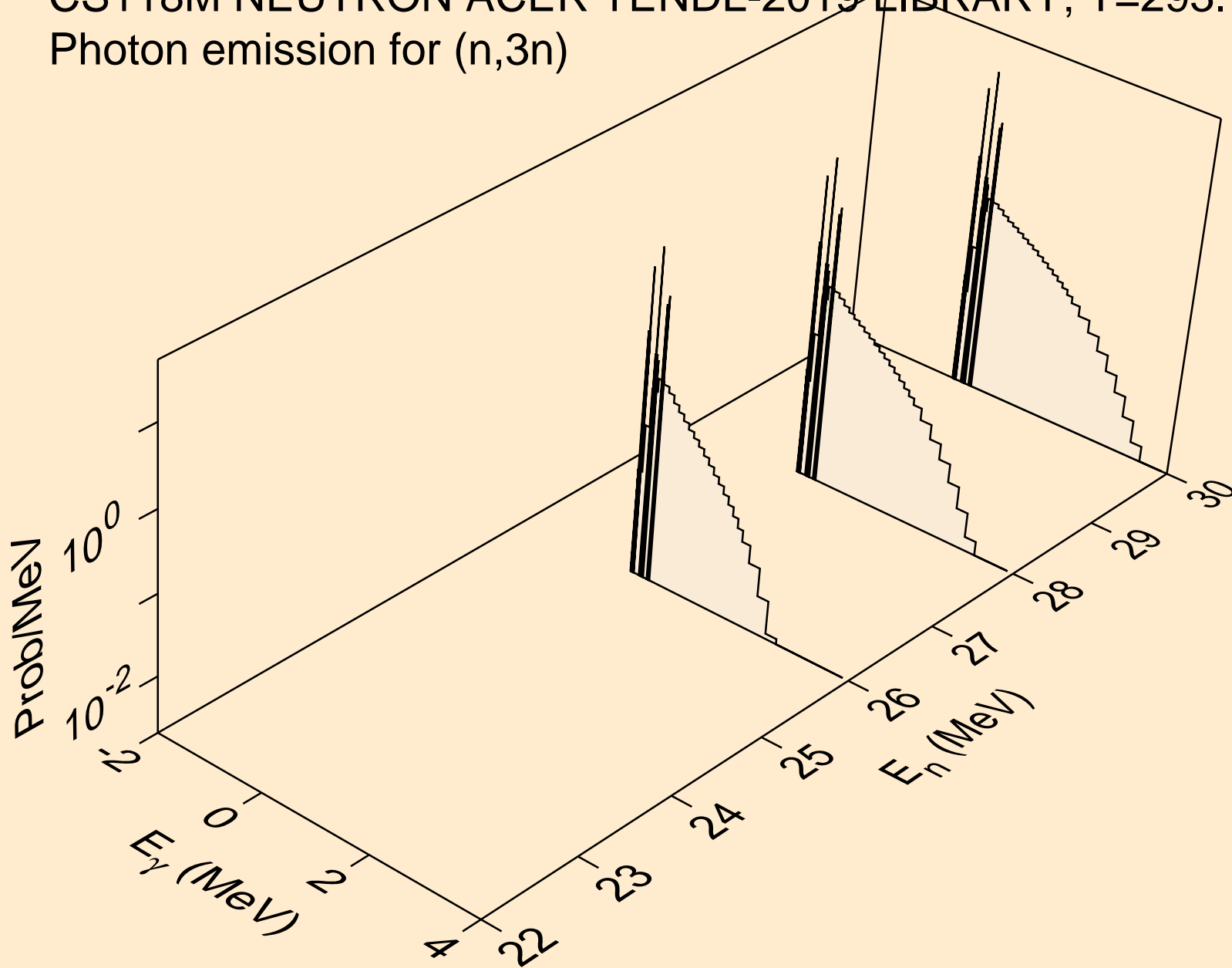



CS118M NEUTRON ACER TENDL-2019 LIBRARY; T=293.16K  
Photon emission for (n,n\*)a

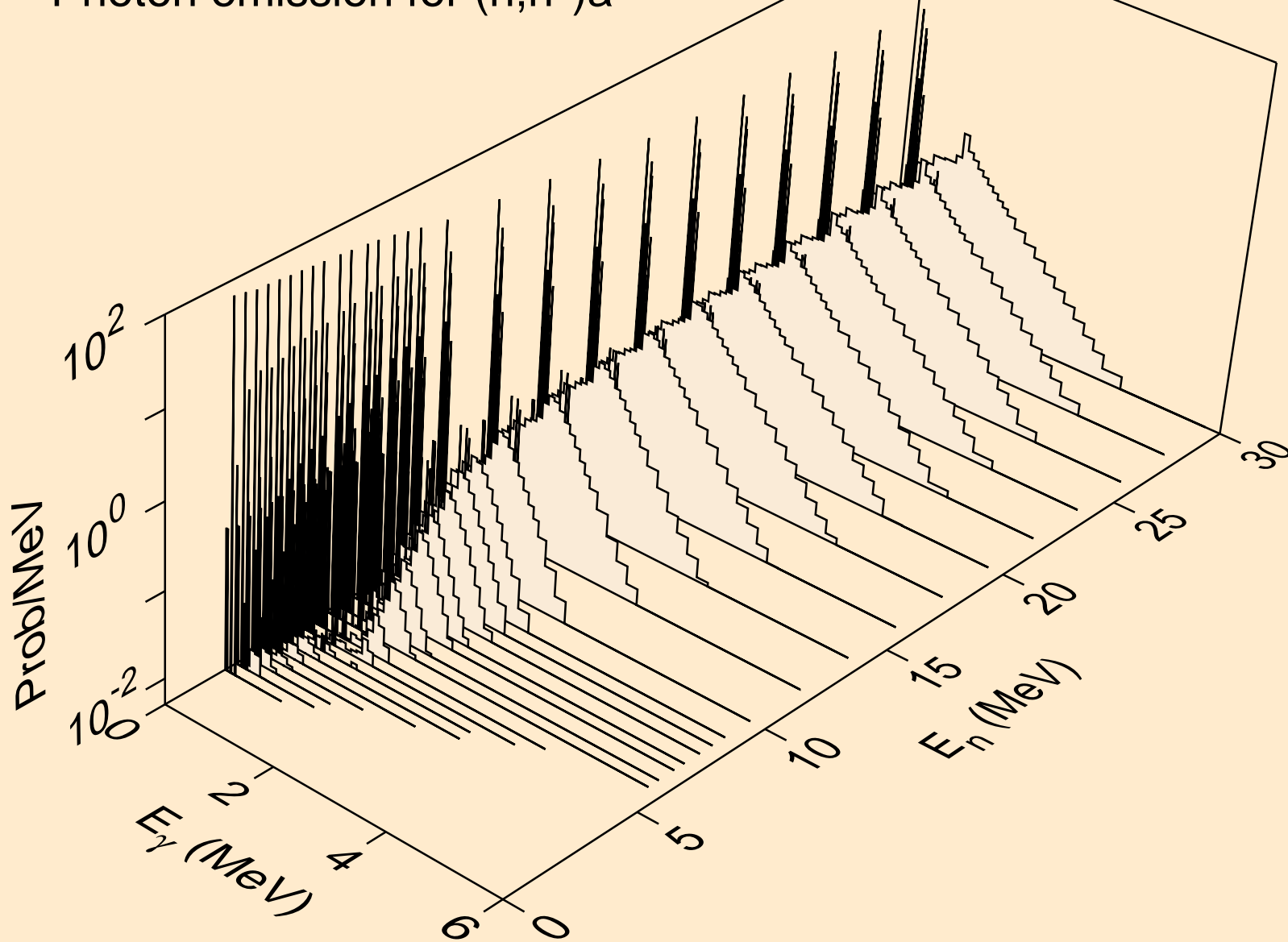

CS118M NEUTRON ACER TENDL-2019 LIBRARY; T=293.16K  
Photon emission for (n,n\*)3a

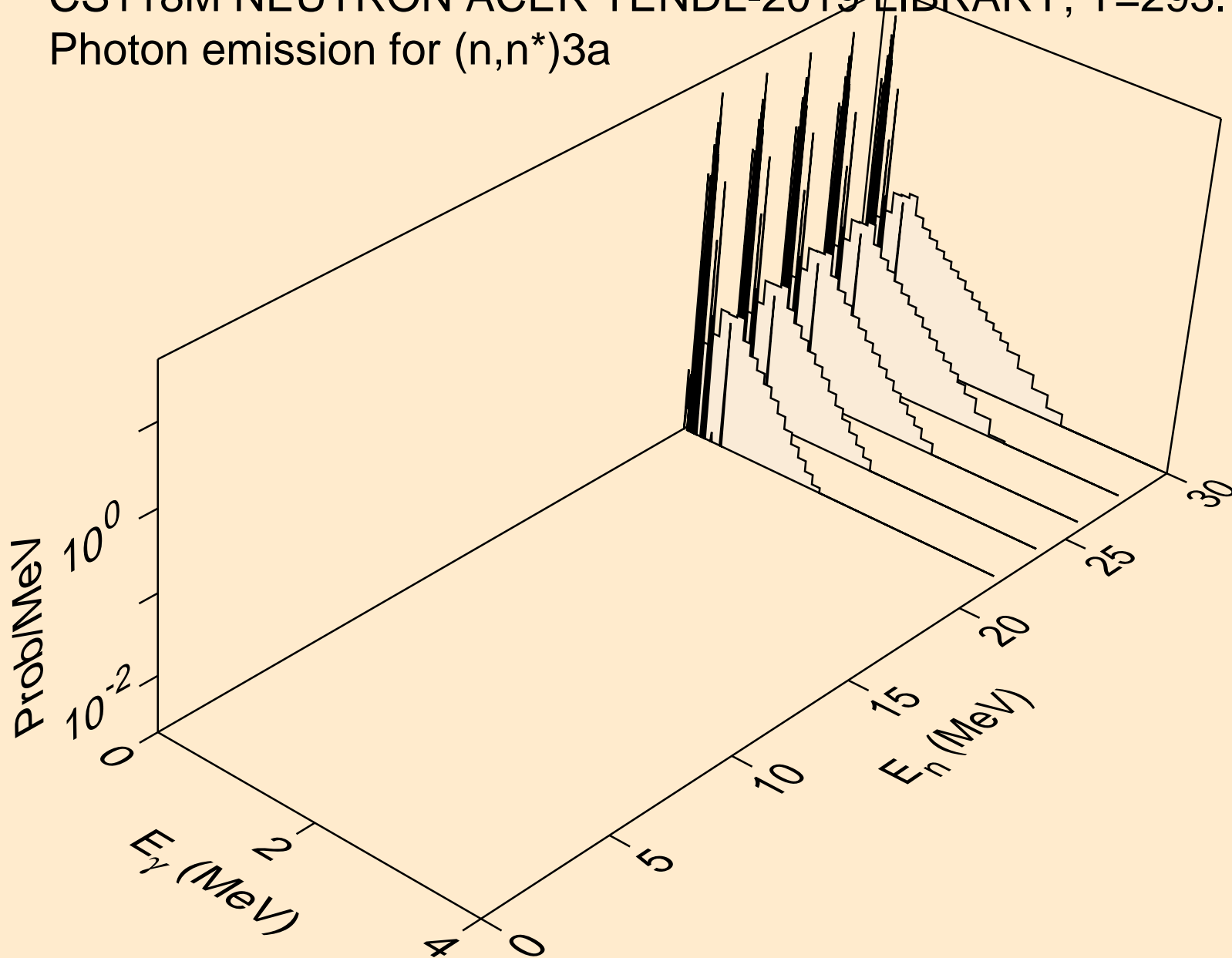

CS118M NEUTRON ACER TENDL-2019 LIBRARY; T=293.16K  
Photon emission for (n,2n)a

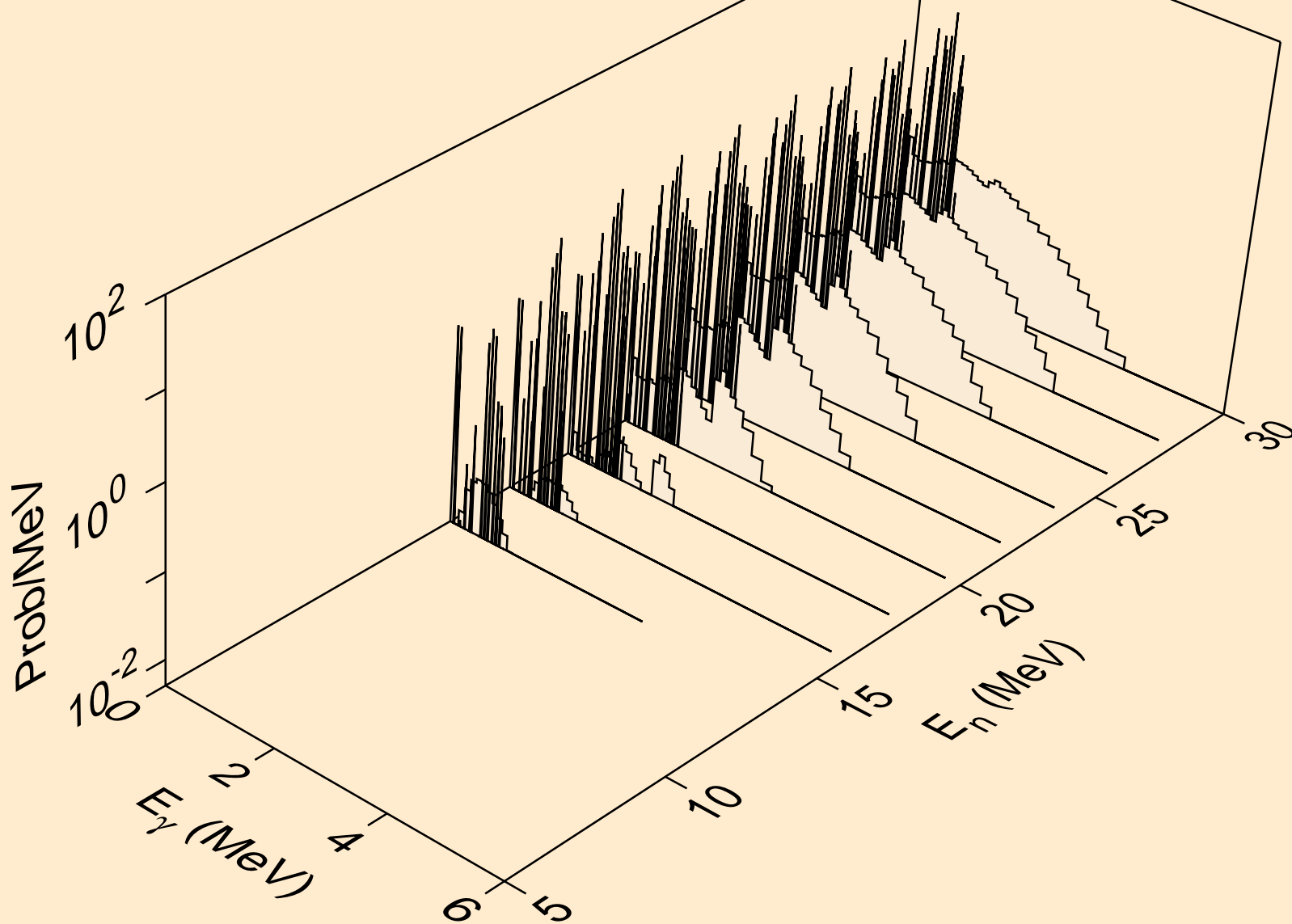

CS118M NEUTRON ACER TENDL-2019 LIBRARY; T=293.16K  
Photon emission for (n,3n)a

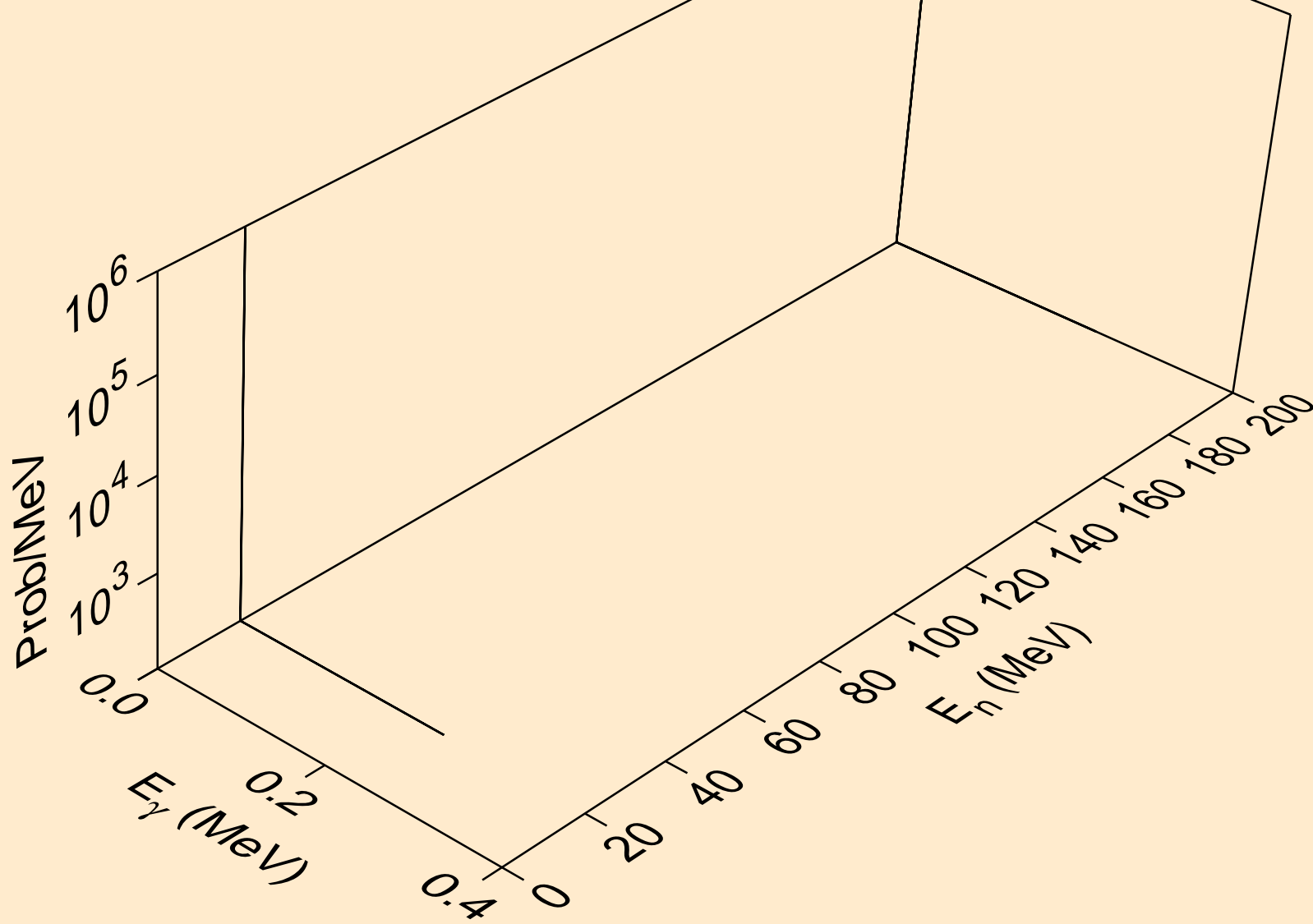

CS118M NEUTRON ACER TENDL-2019 LIBRARY; T=293.16K  
Photon emission for (n,n\*)p

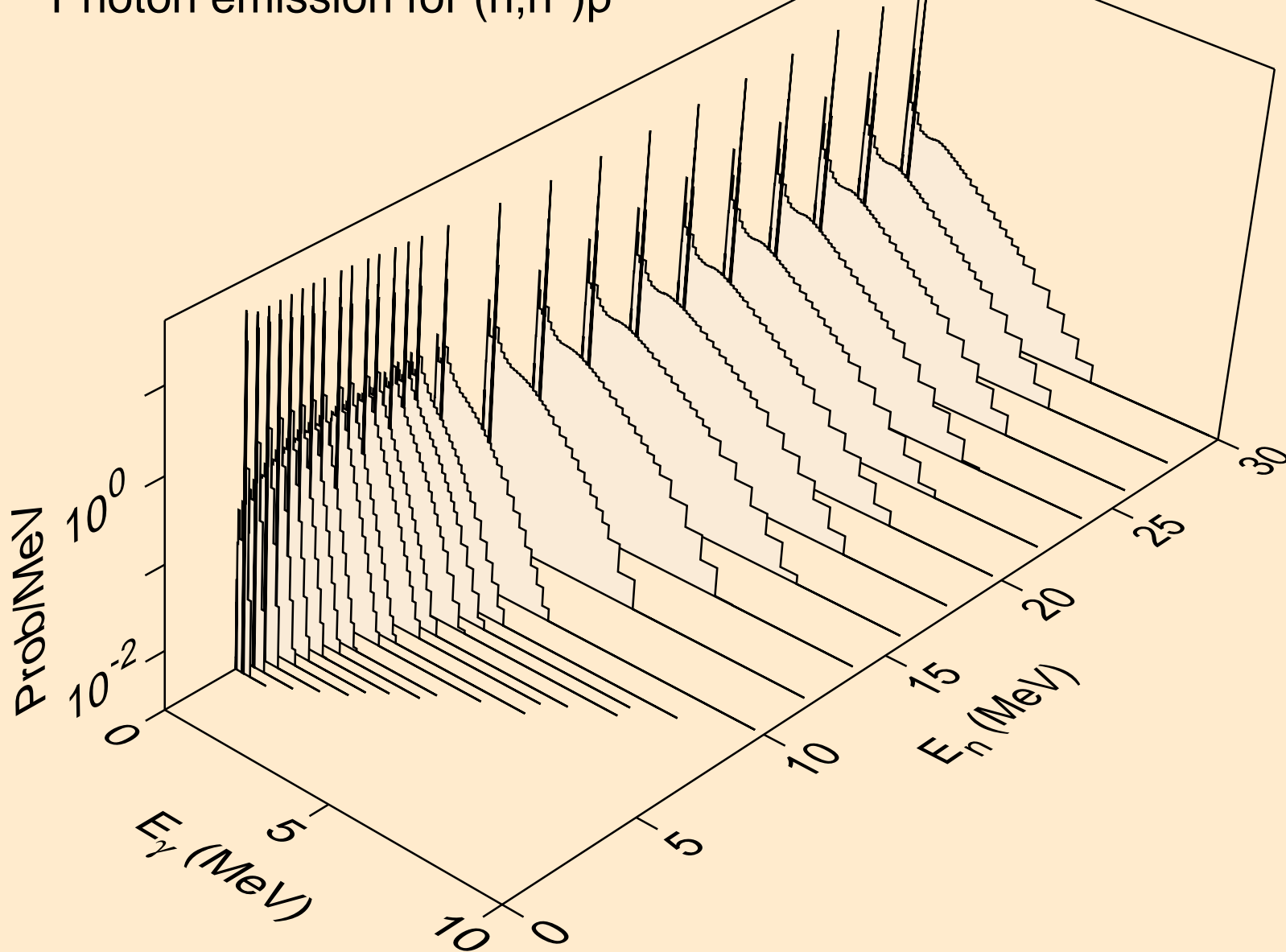

CS118M NEUTRON ACER TENDL-2019 LIBRARY; T=293.16K  
Photon emission for (n,n\*)2a

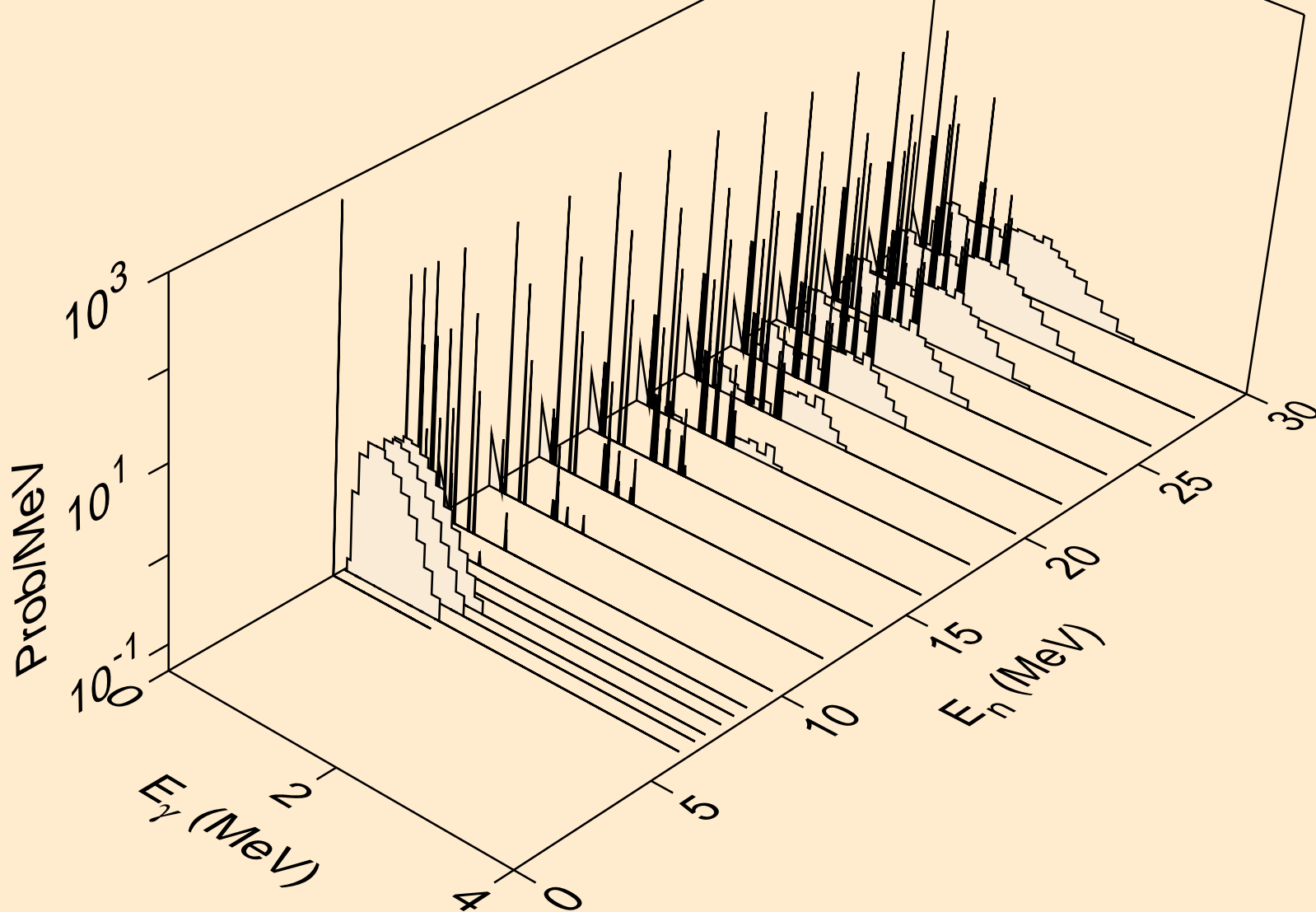

CS118M NEUTRON ACER TENDL-2019 LIBRARY; T=293.16K  
Photon emission for (n,2n)2a

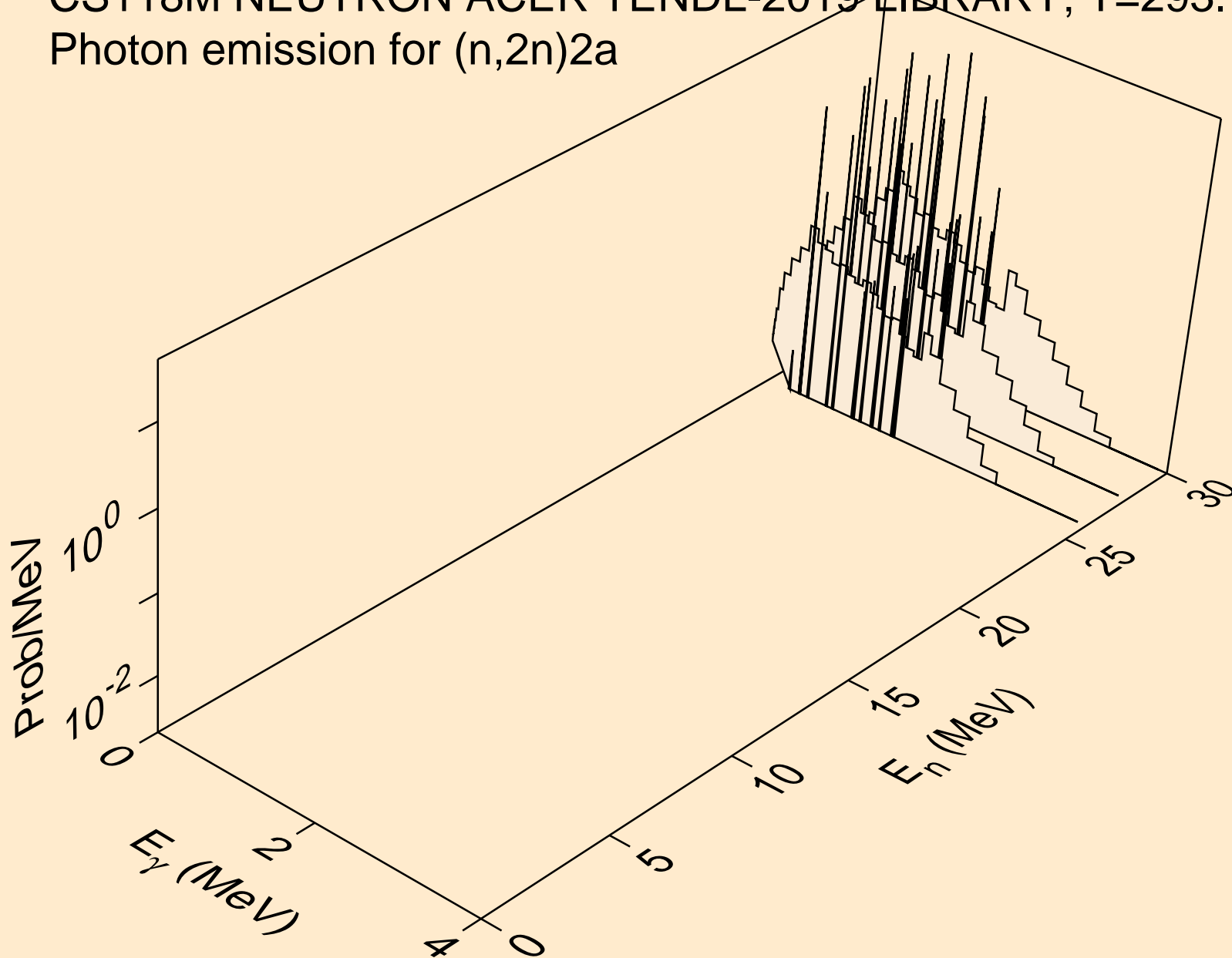

CS118M NEUTRON ACER TENDL-2019 LIBRARY; T=293.16K  
Photon emission for (n,n\*)d

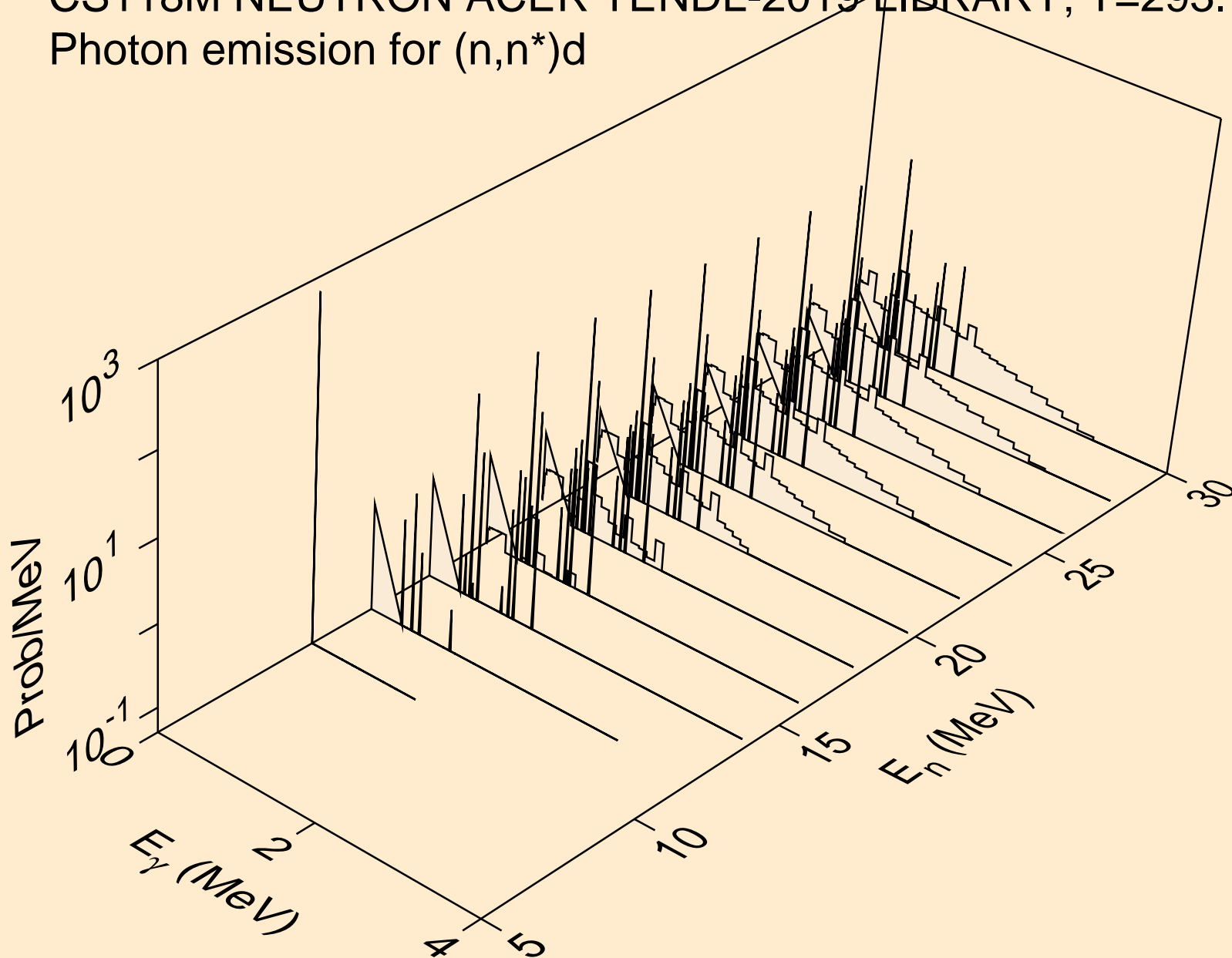



CS118M NEUTRON ACER TENDL-2019 LIBRARY; T=293.16K  
Photon emission for (n,n\*)t

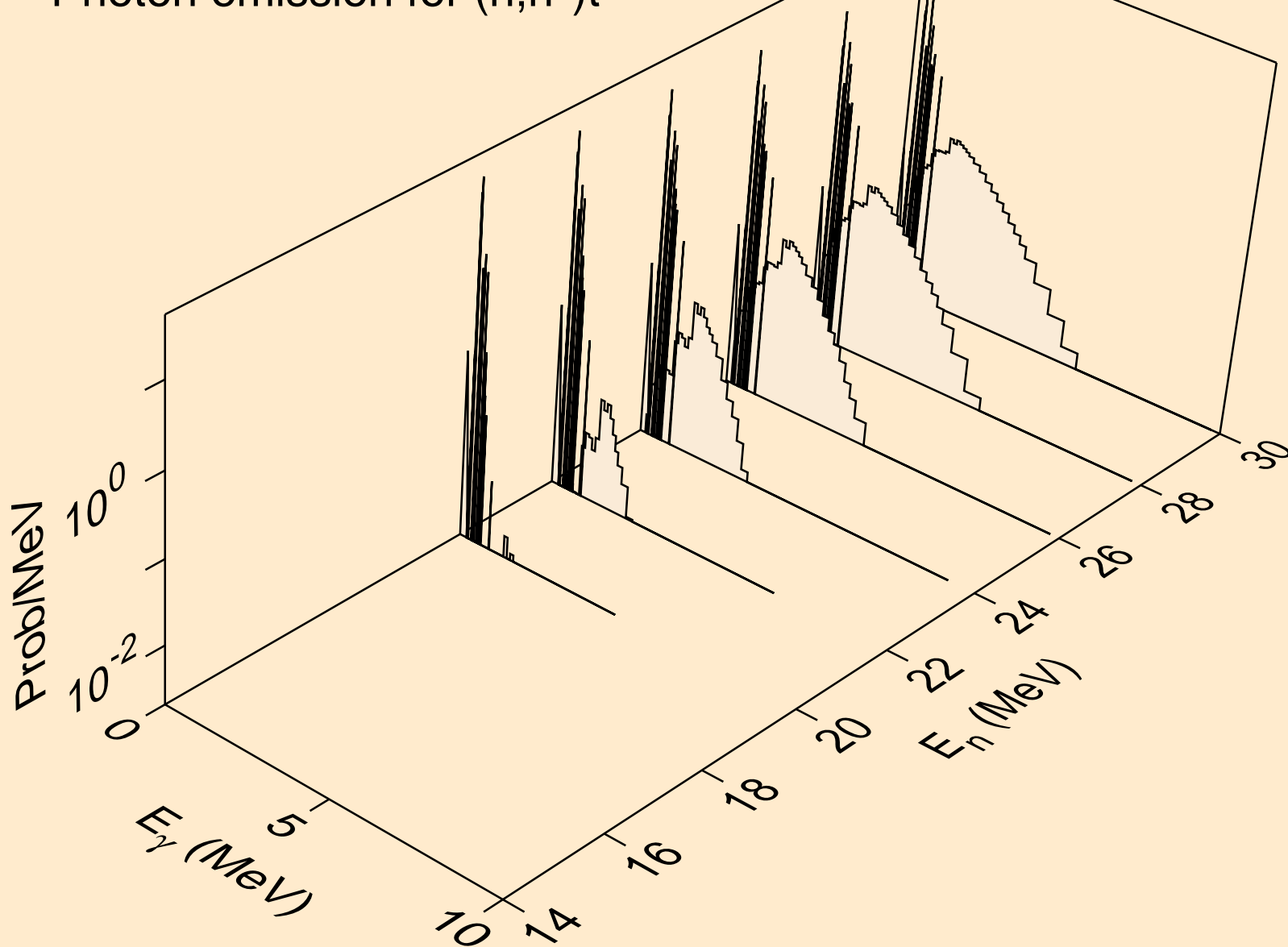

CS118M NEUTRON ACER TENDL-2019 LIBRARY; T=293.16K  
Photon emission for (n,n\*)he3

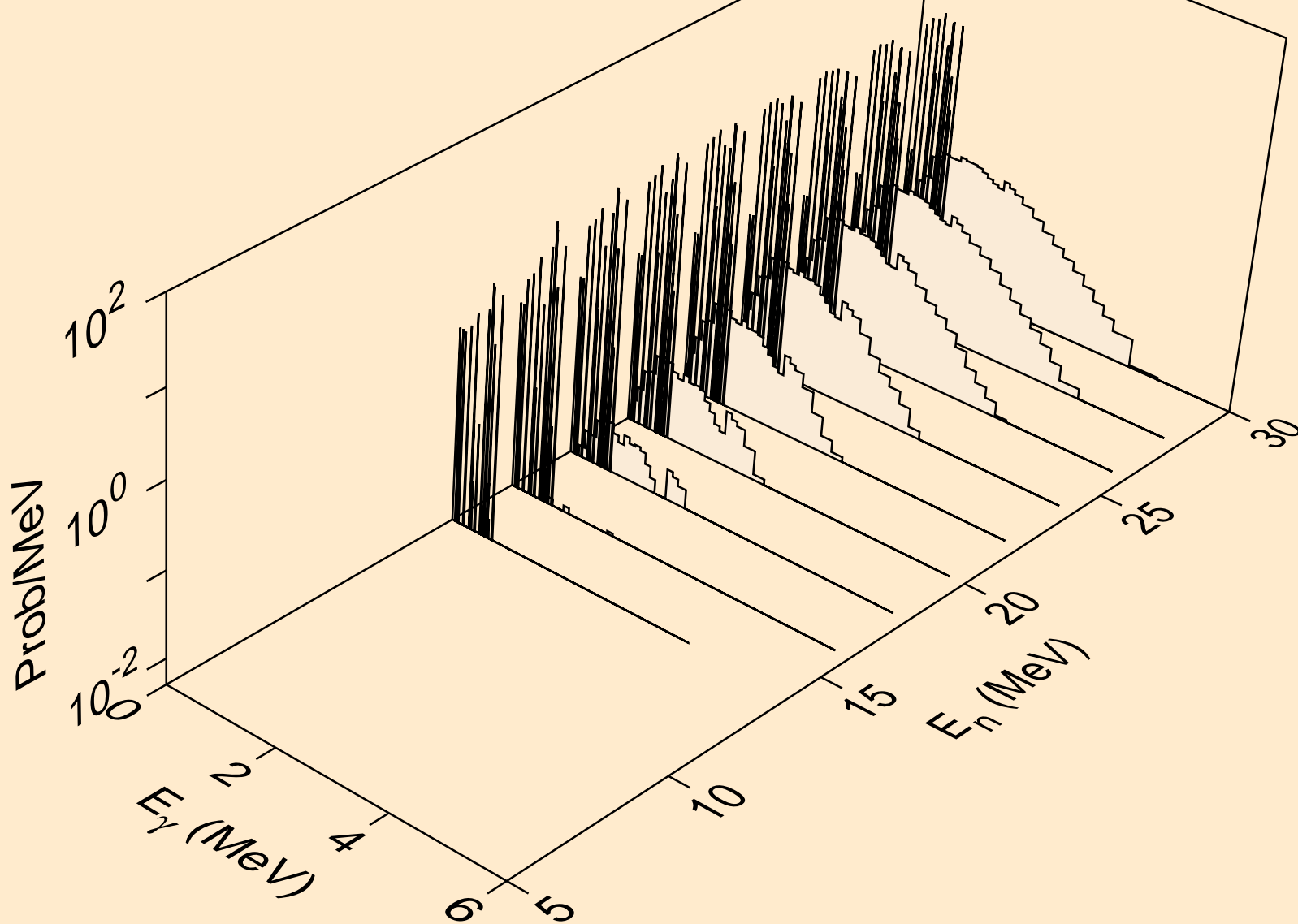

CS118M NEUTRON ACER TENDL-2019 LIBRARY; T=293.16K  
Photon emission for (n,n\*)d2a

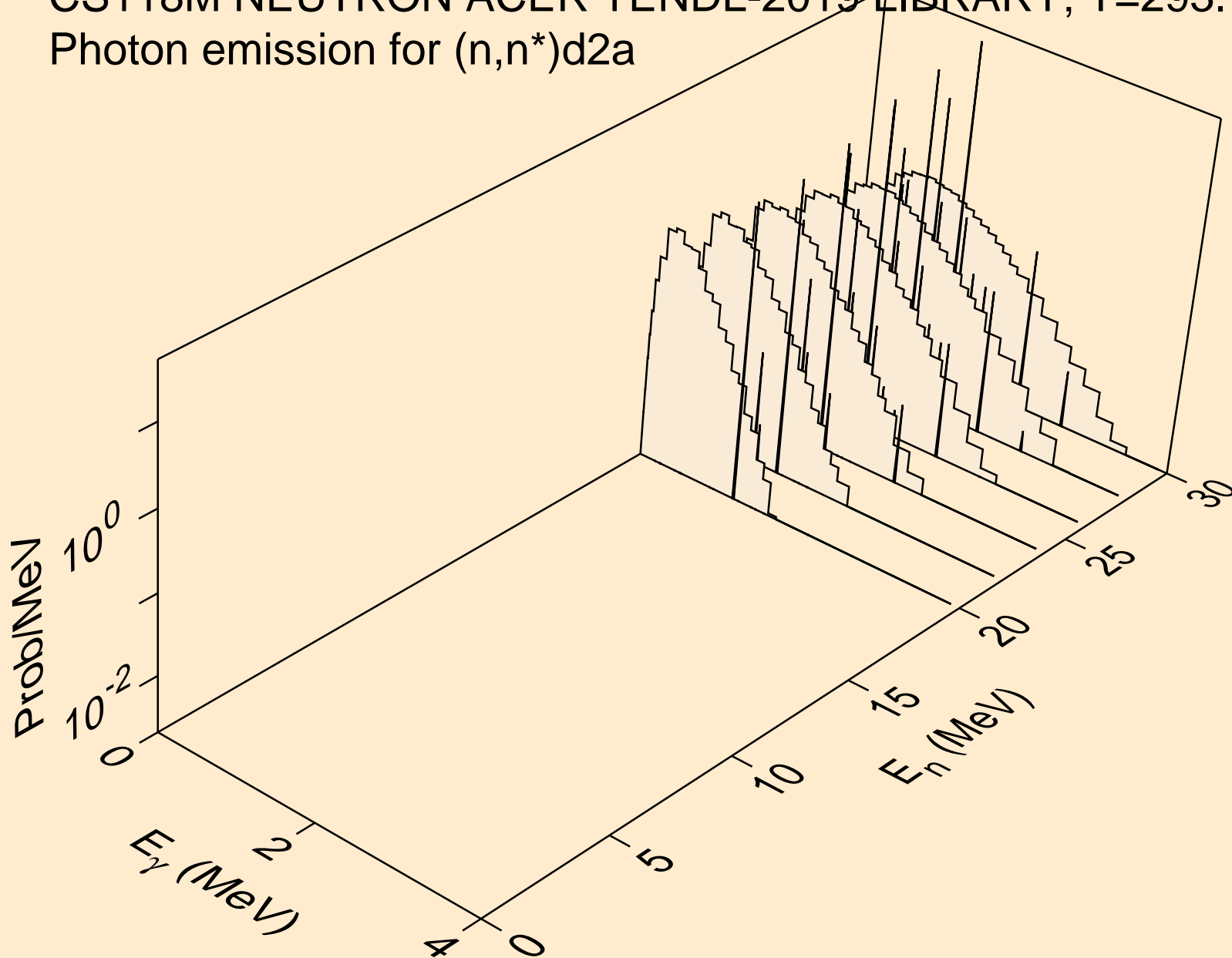

CS118M NEUTRON ACER TENDL-2019 LIBRARY; T=293.16K  
Photon emission for (n,2np)

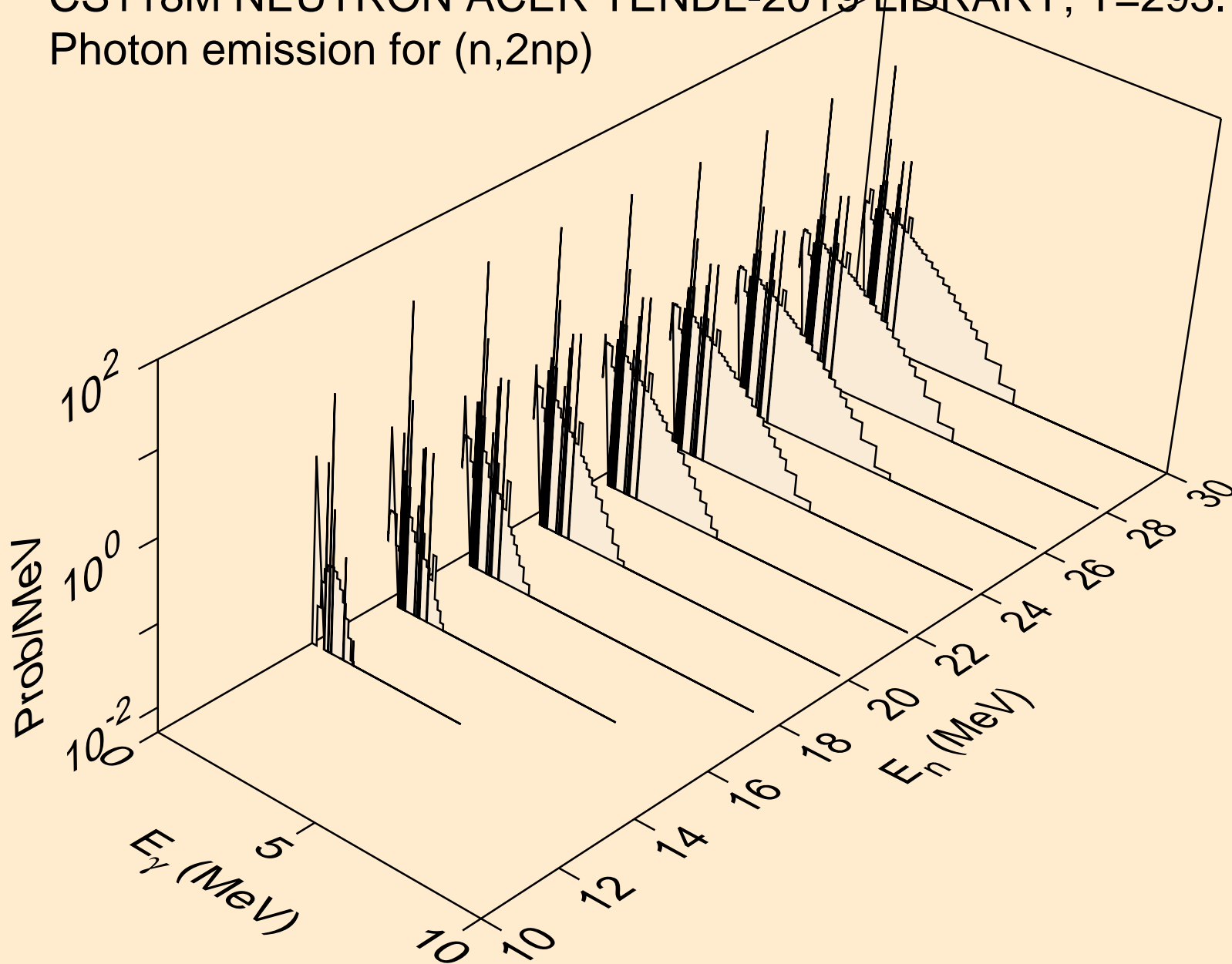

CS118M NEUTRON ACER TENDL-2019 LIBRARY; T=293.16K  
Photon emission for (n,3np)

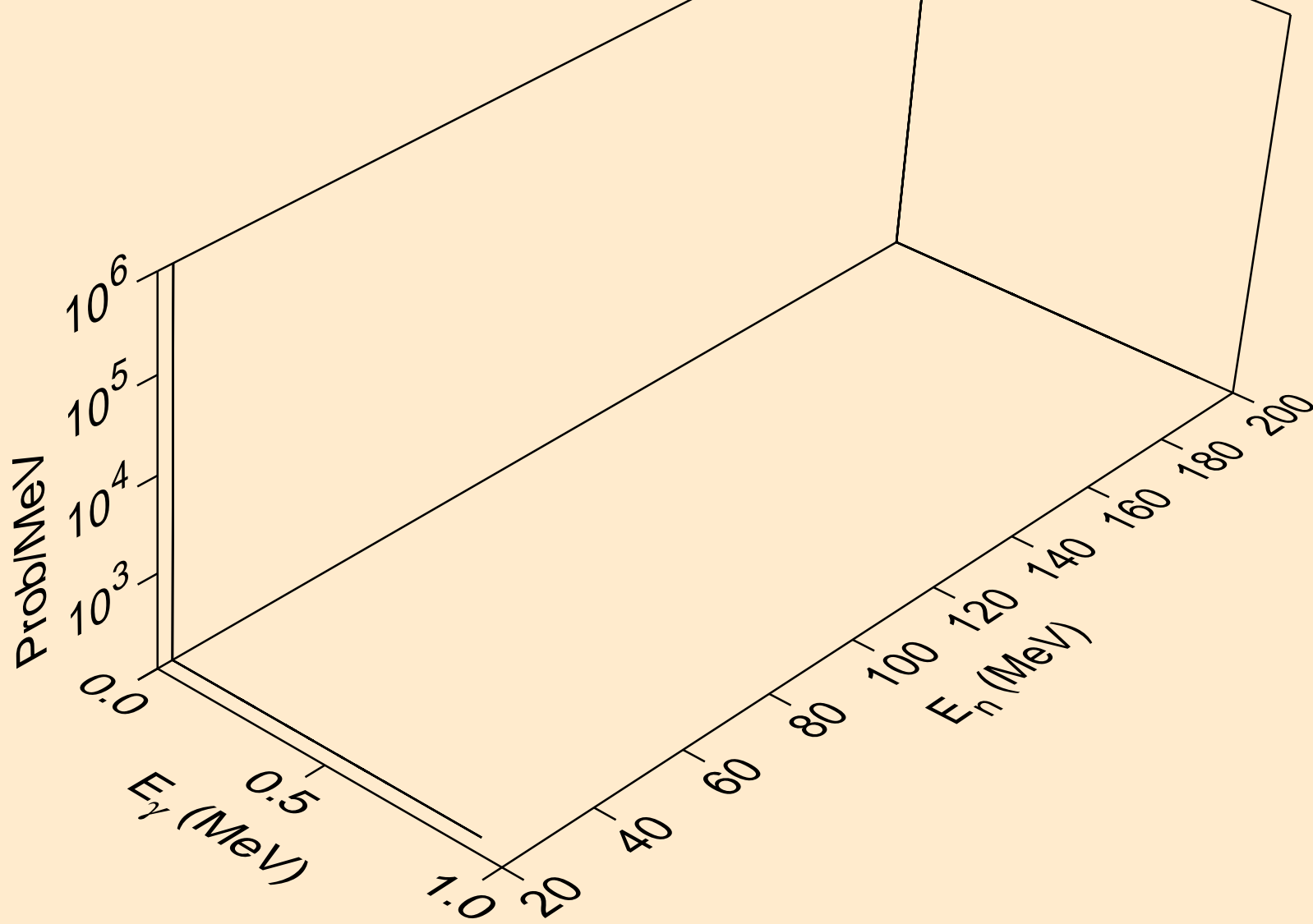

CS118M NEUTRON ACER TENDL-2019 LIBRARY; T=293.16K  
Photon emission for (n,2np)

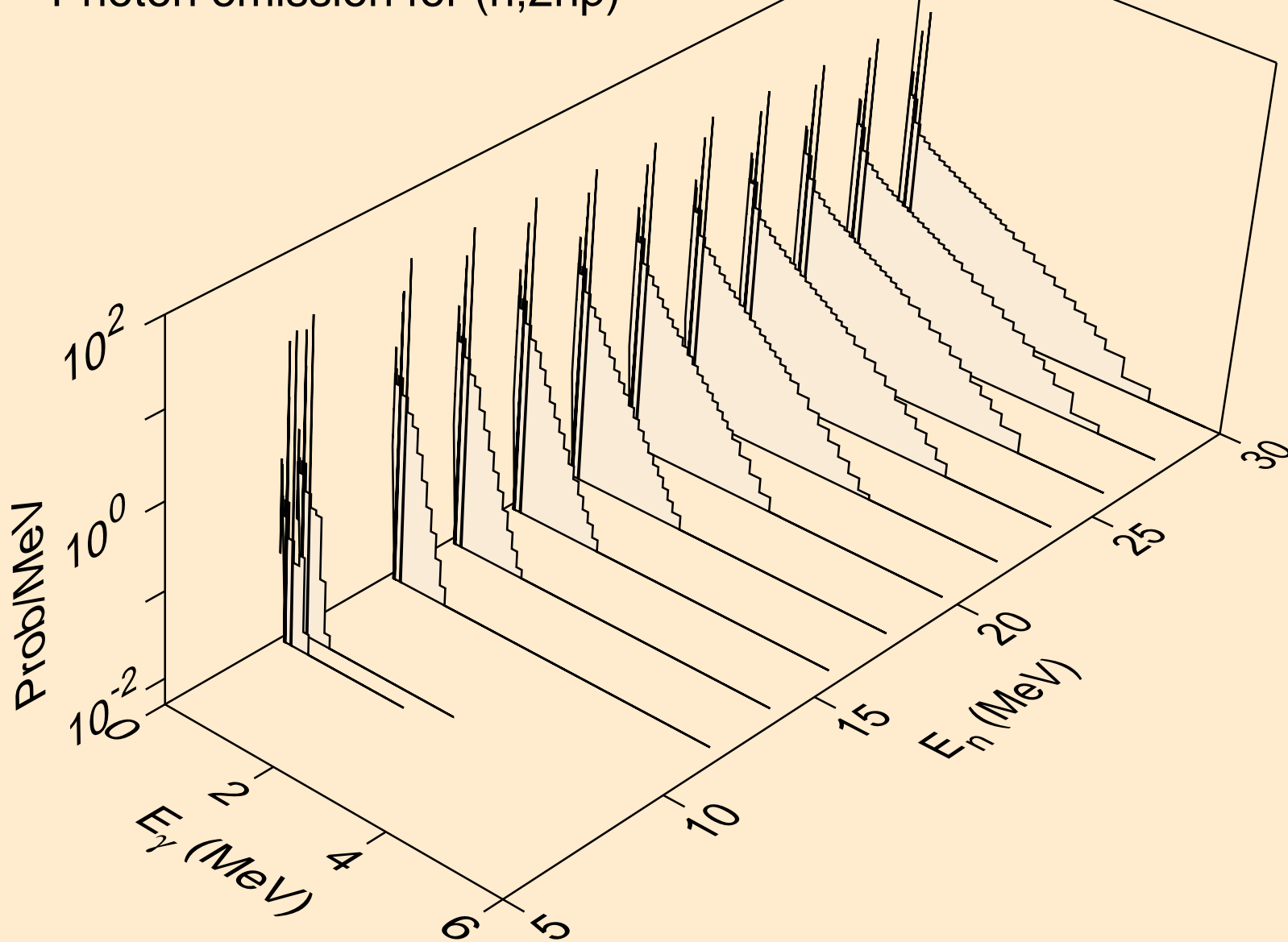

CS118M NEUTRON ACER TENDL-2019 LIBRARY; T=293.16K  
Photon emission for (n,npa)

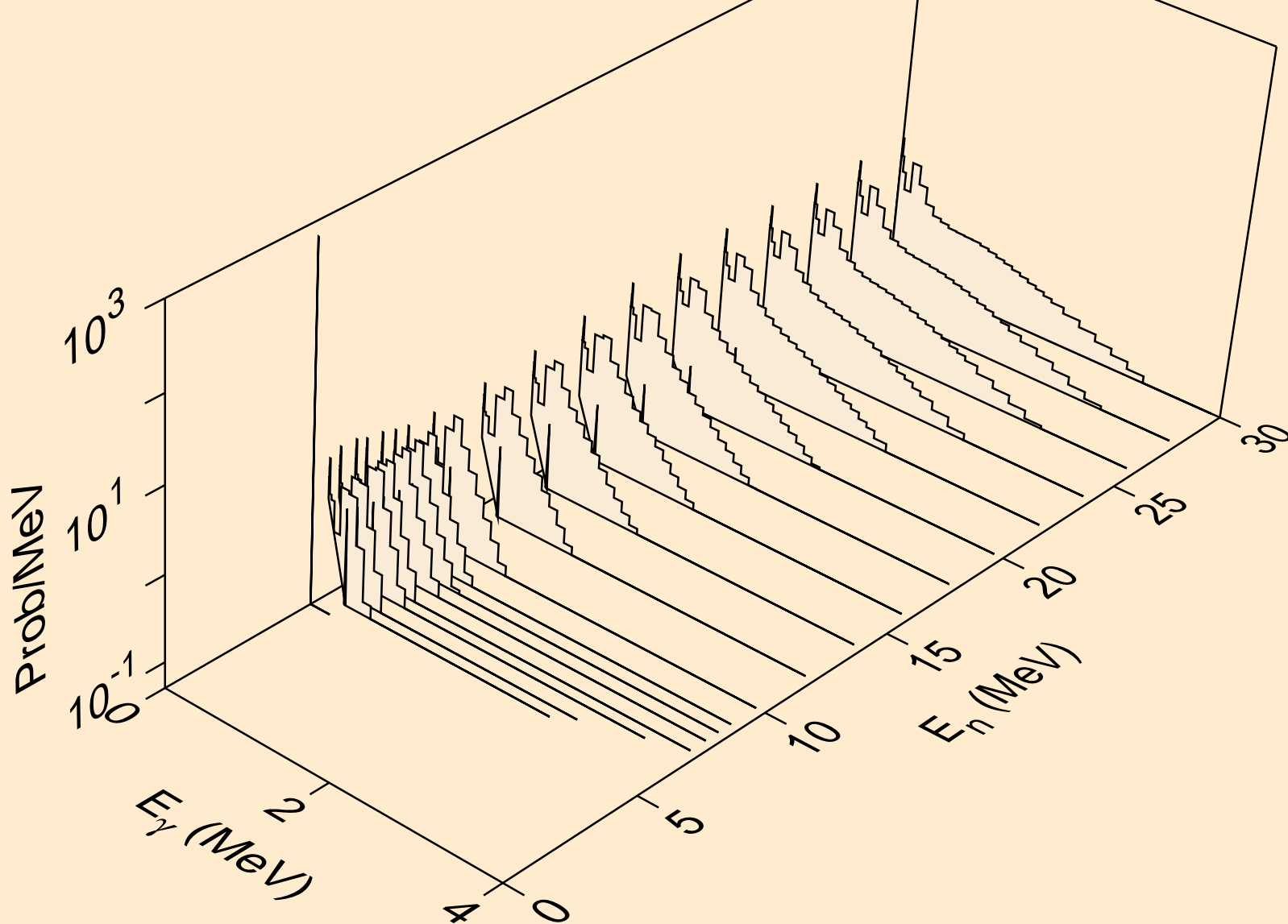

CS118M NEUTRON ACER TENDL-2019 LIBRARY; T=293.16K  
Photon emission for (n,n\*2)

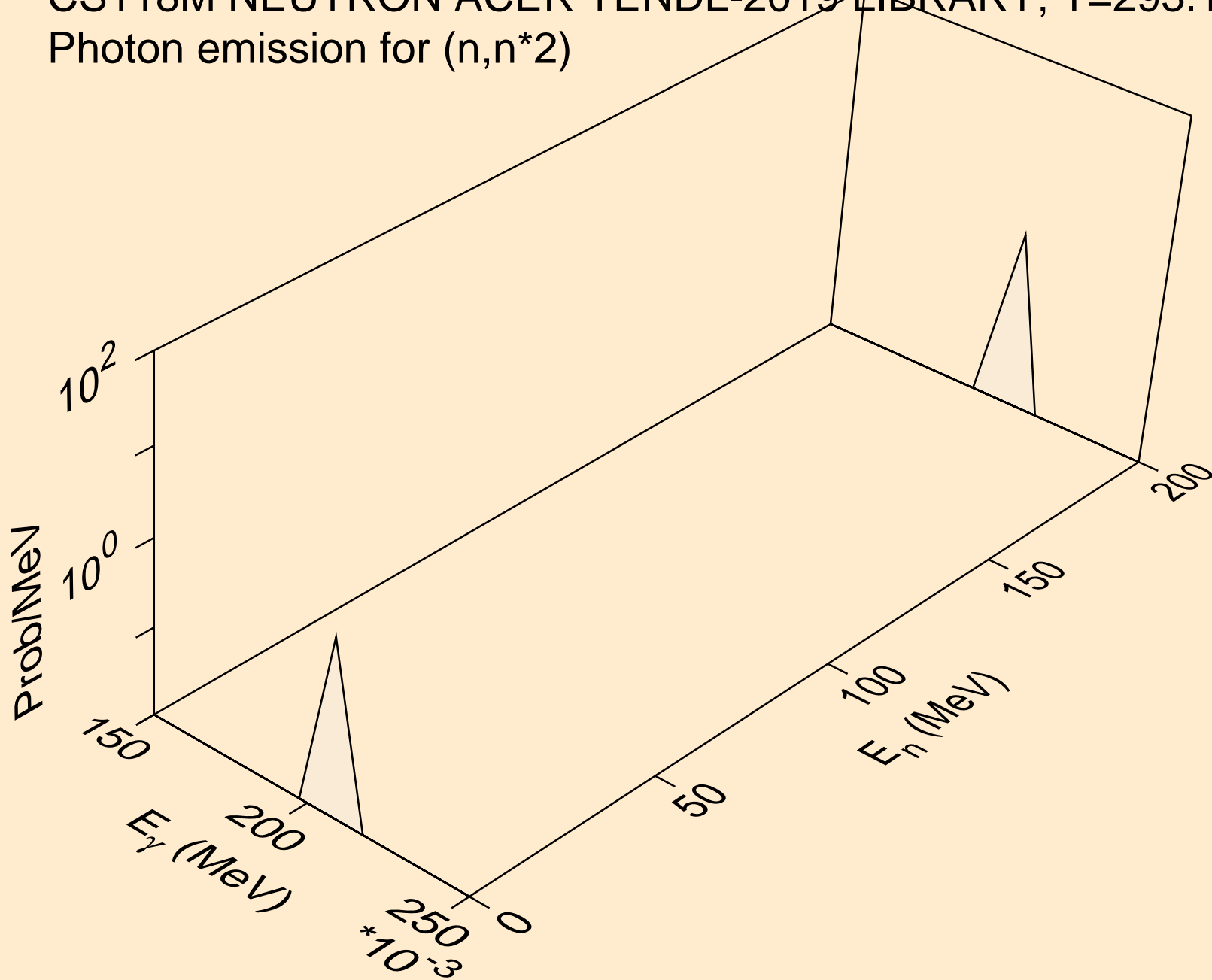



CS118M NEUTRON ACER TENDL-2019 LIBRARY; T=293.16K  
Photon emission for (n,n\*c)

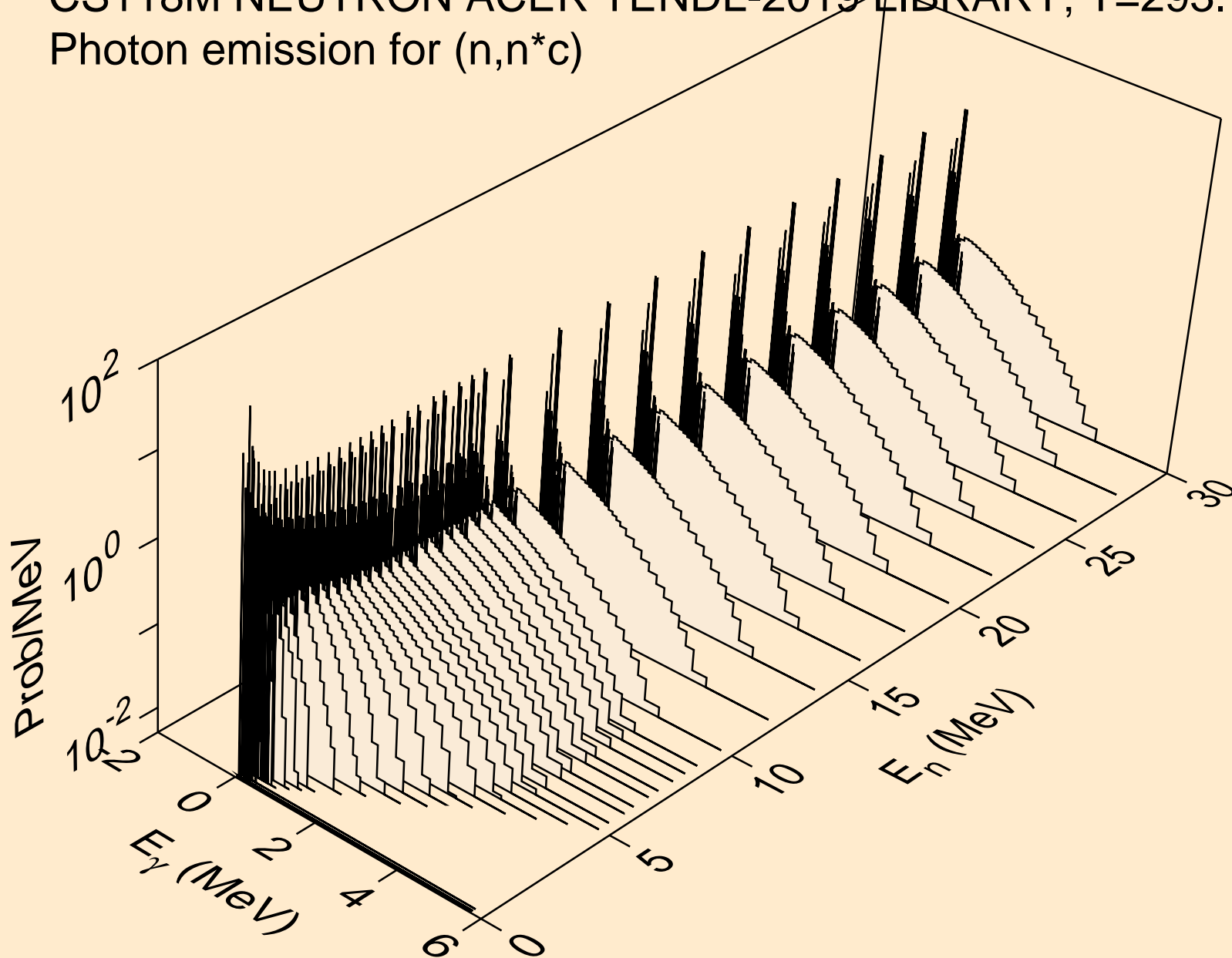

CS118M NEUTRON ACER TENDL-2019 LIBRARY; T=293.16K  
Photon emission for (n,gma)

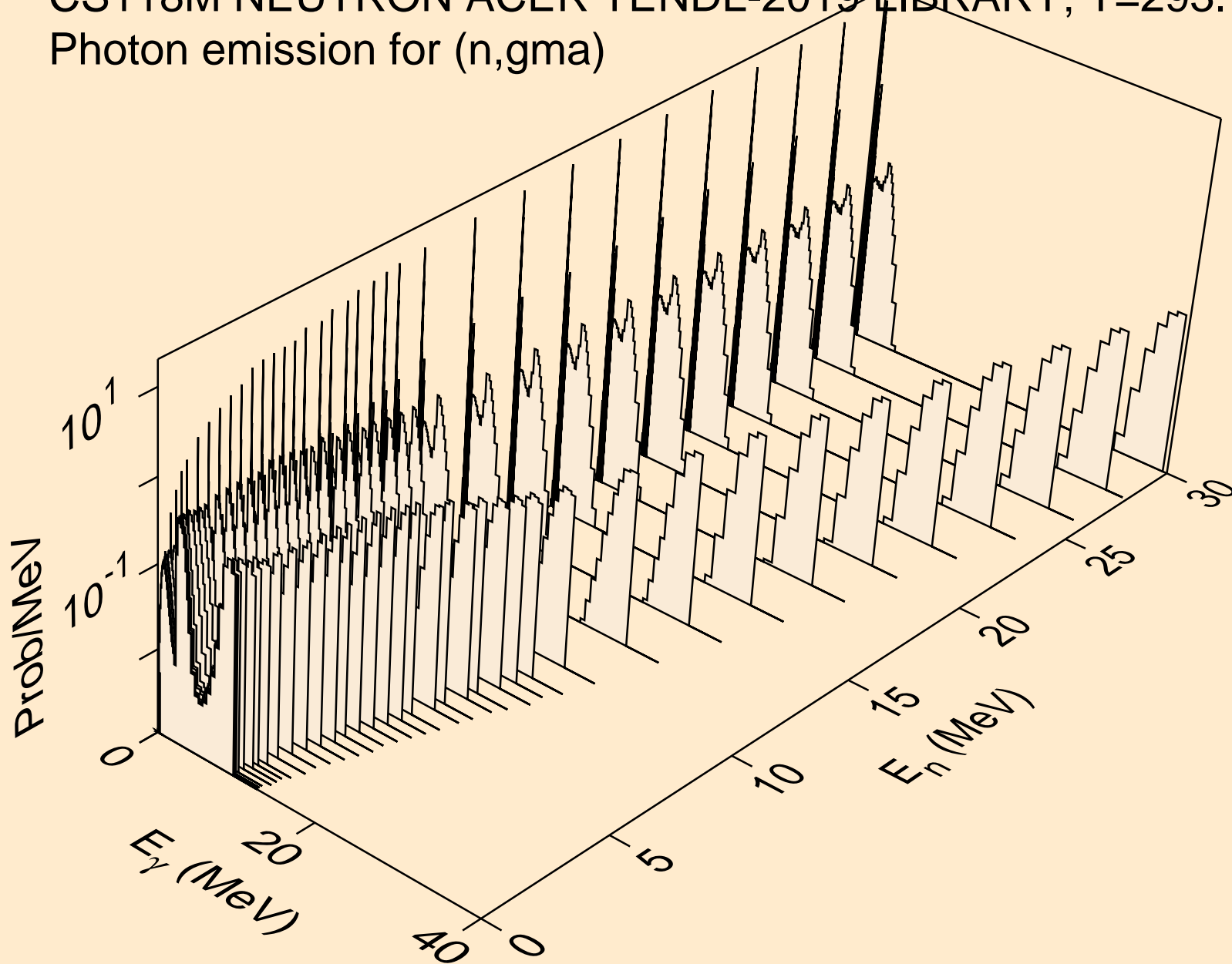

CS118M NEUTRON ACER TENDL-2019 LIBRARY; T=293.16K  
Photon emission for (n,p)

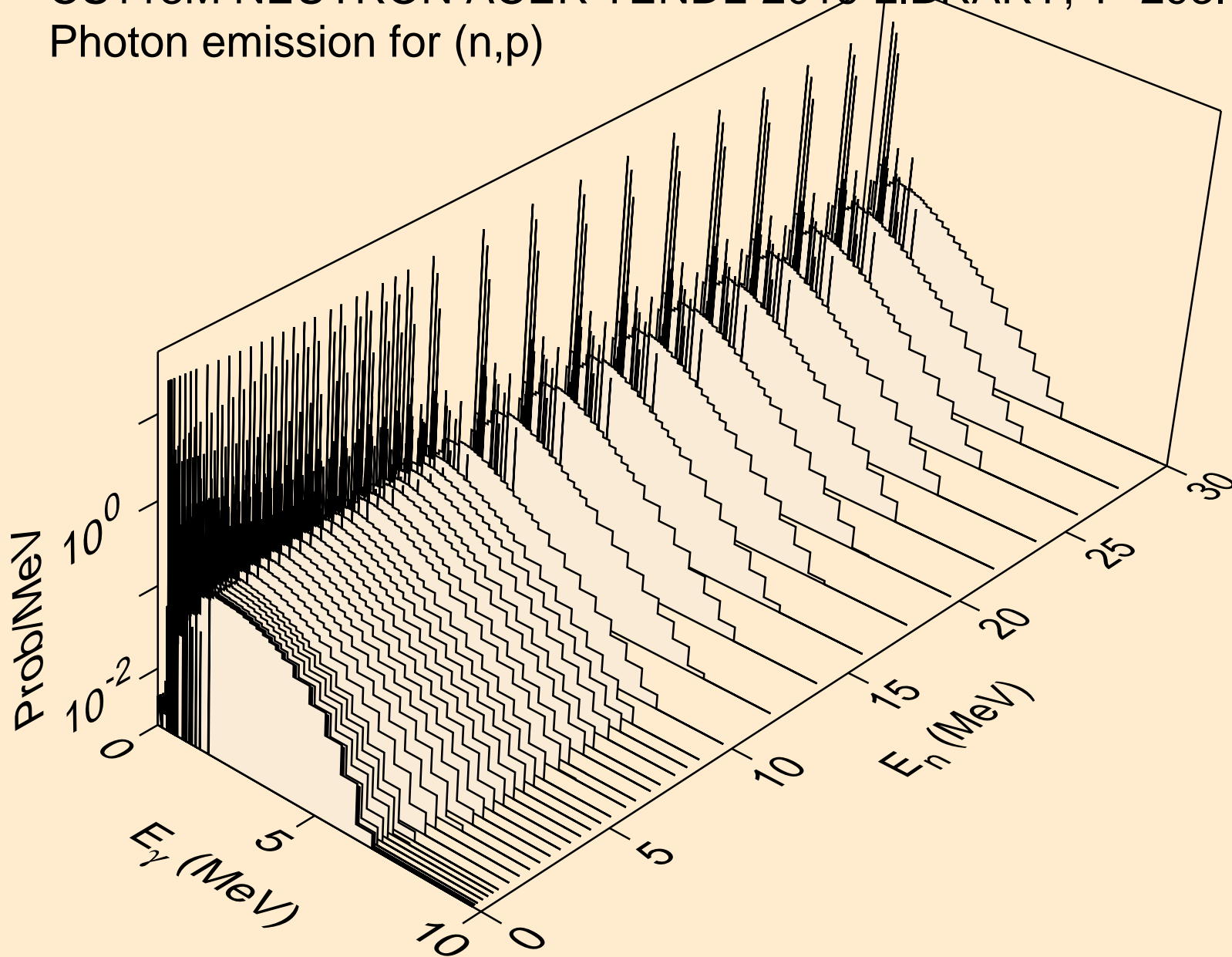

CS118M NEUTRON ACER TENDL-2019 LIBRARY; T=293.16K  
Photon emission for (n,d)

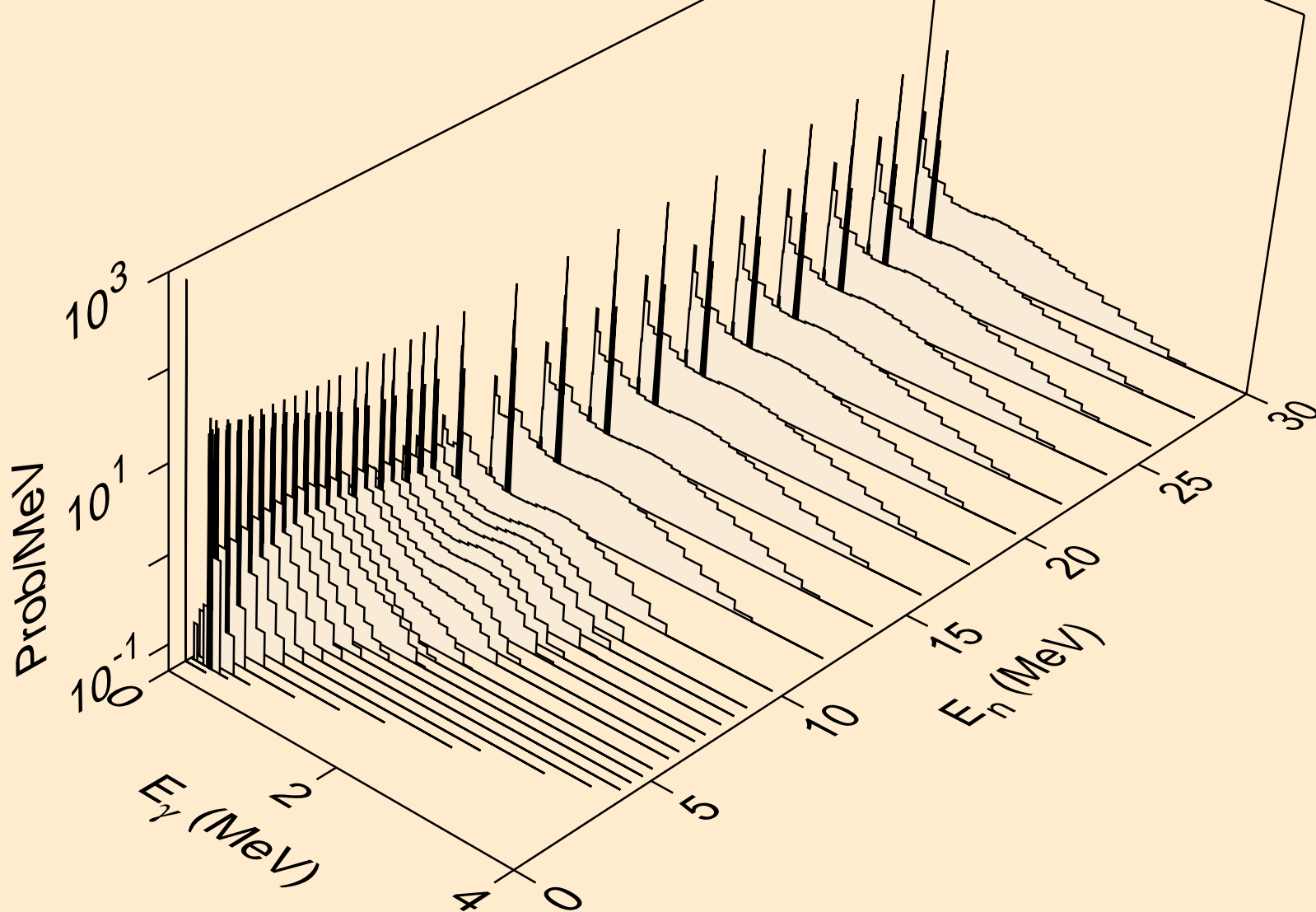

CS118M NEUTRON ACER TENDL-2019 LIBRARY; T=293.16K  
Photon emission for (n,t)

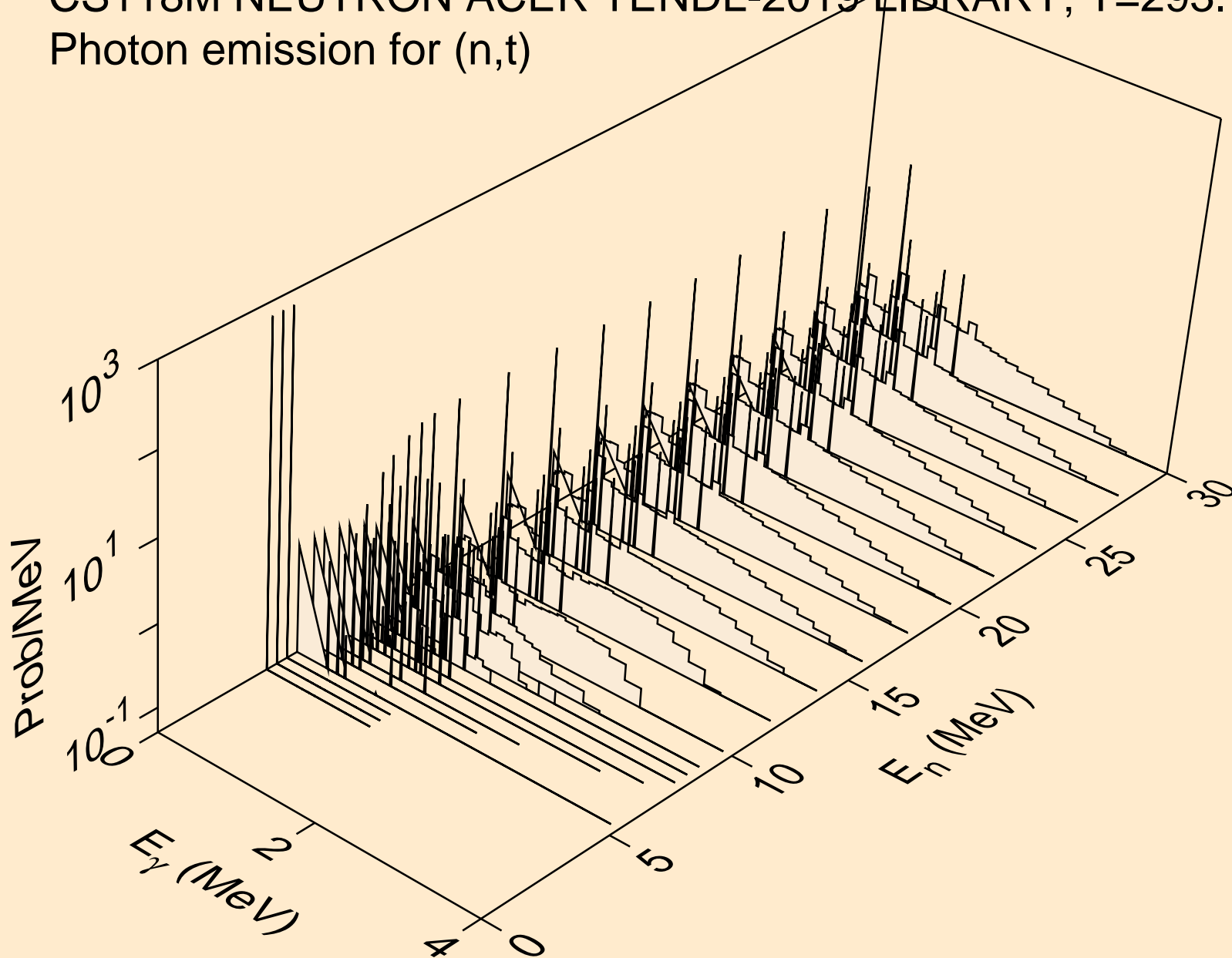

CS118M NEUTRON ACER TENDL-2019 LIBRARY; T=293.16K  
Photon emission for (n,he3)

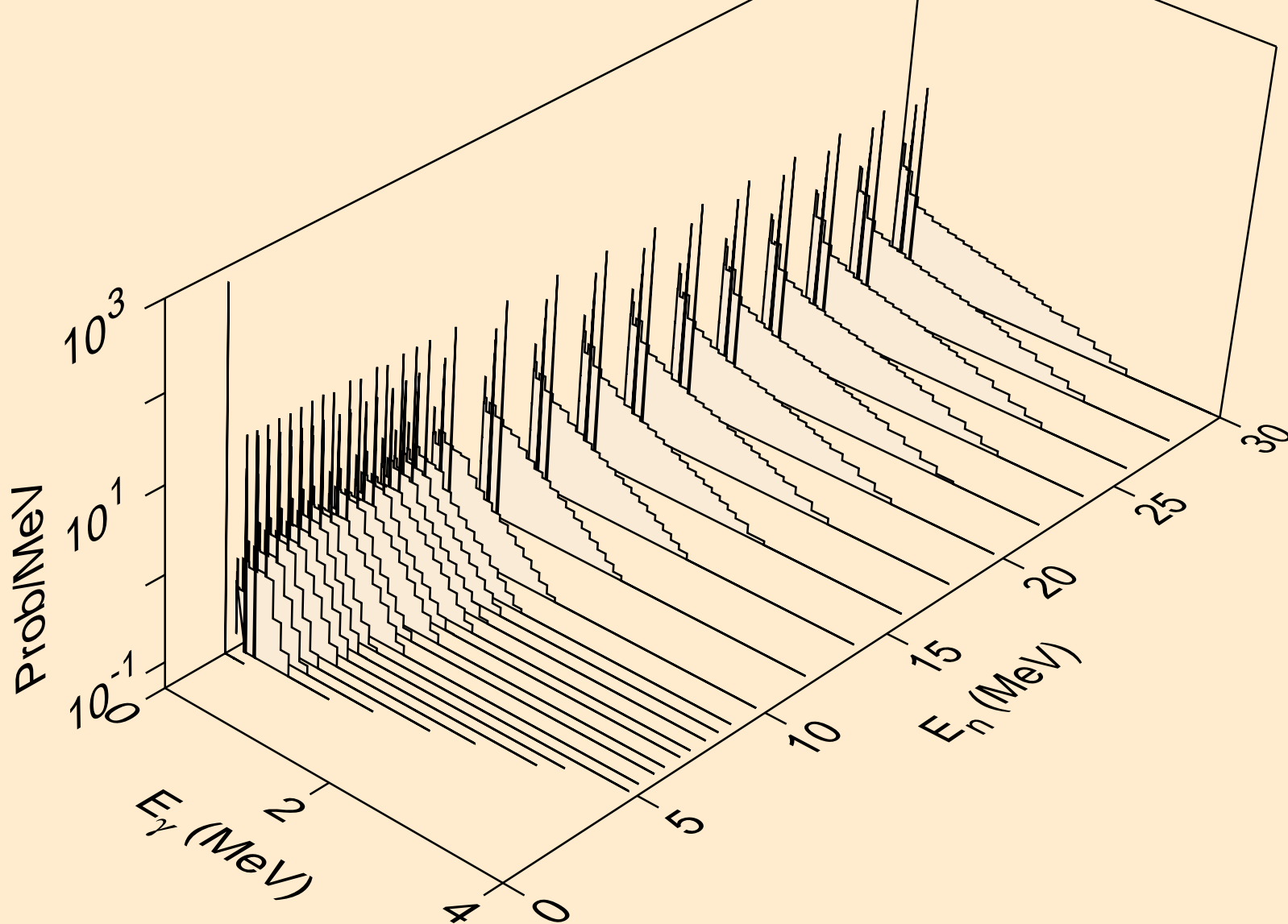

CS118M NEUTRON ACER TENDL-2019 LIBRARY; T=293.16K  
Photon emission for (n,a)

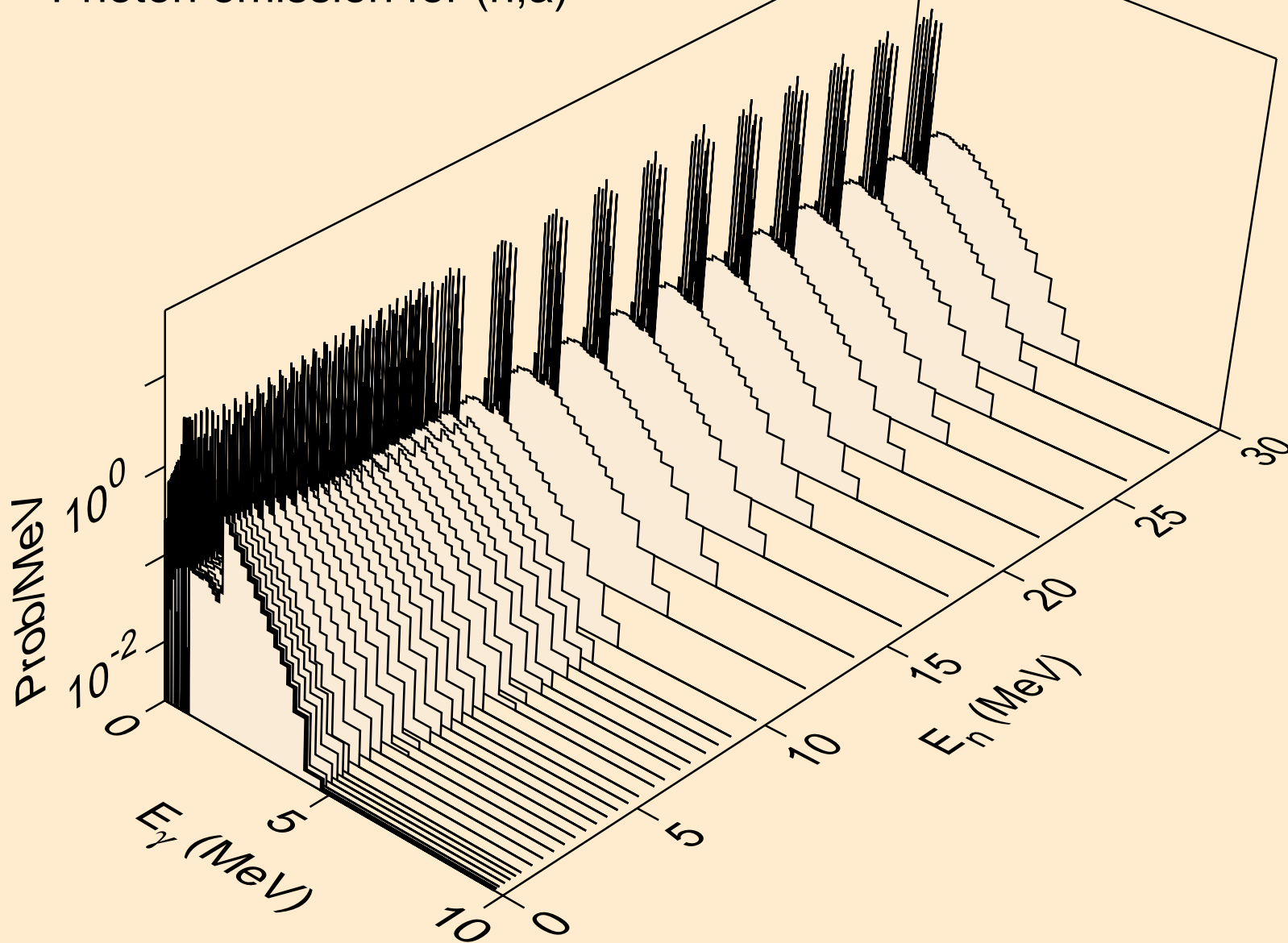

CS118M NEUTRON ACER TENDL-2019 LIBRARY; T=293.16K  
Photon emission for (n,2a)

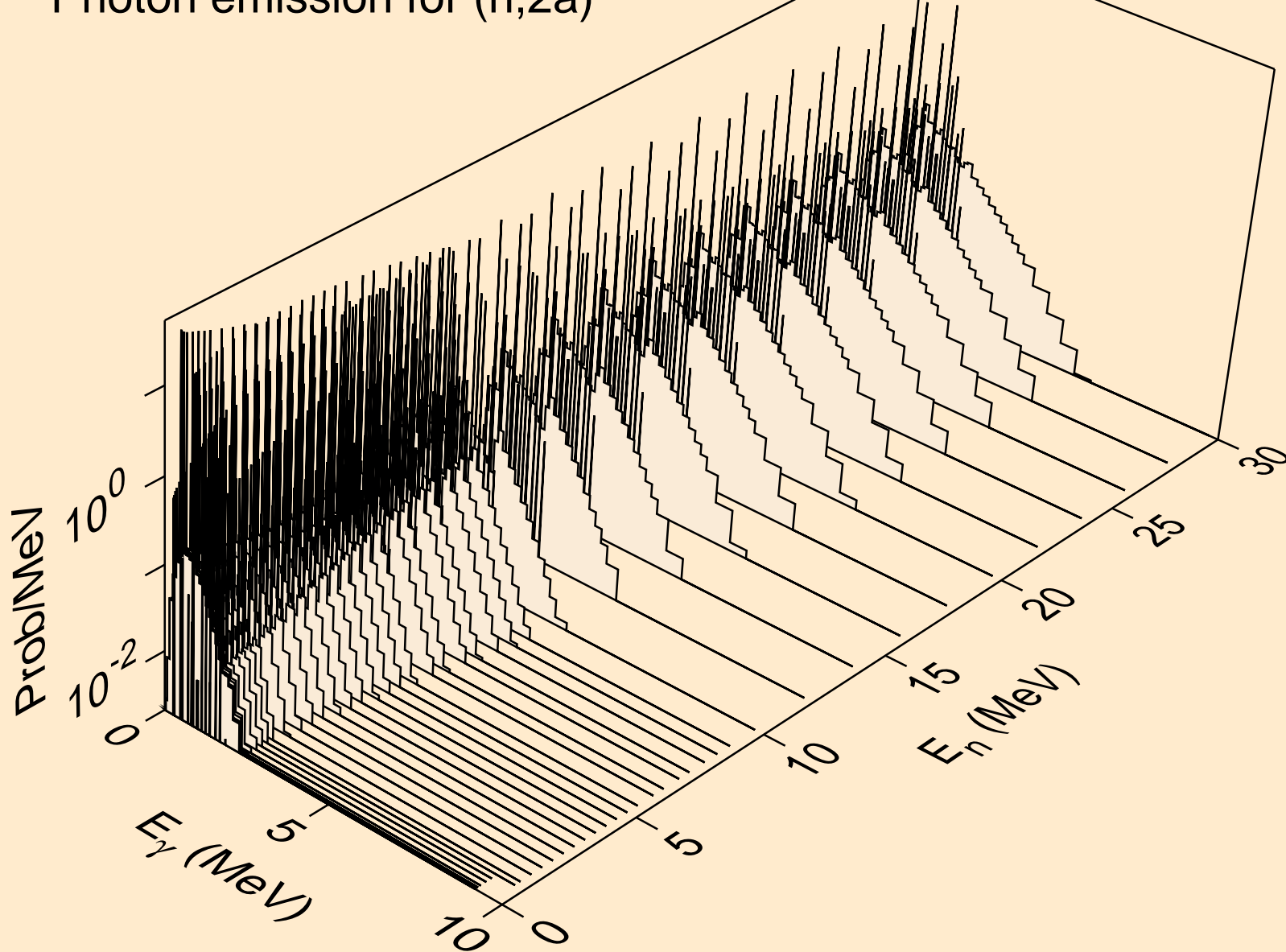



CS118M NEUTRON ACER TENDL-2019 LIBRARY; T=293.16K  
Photon emission for (n,3a)

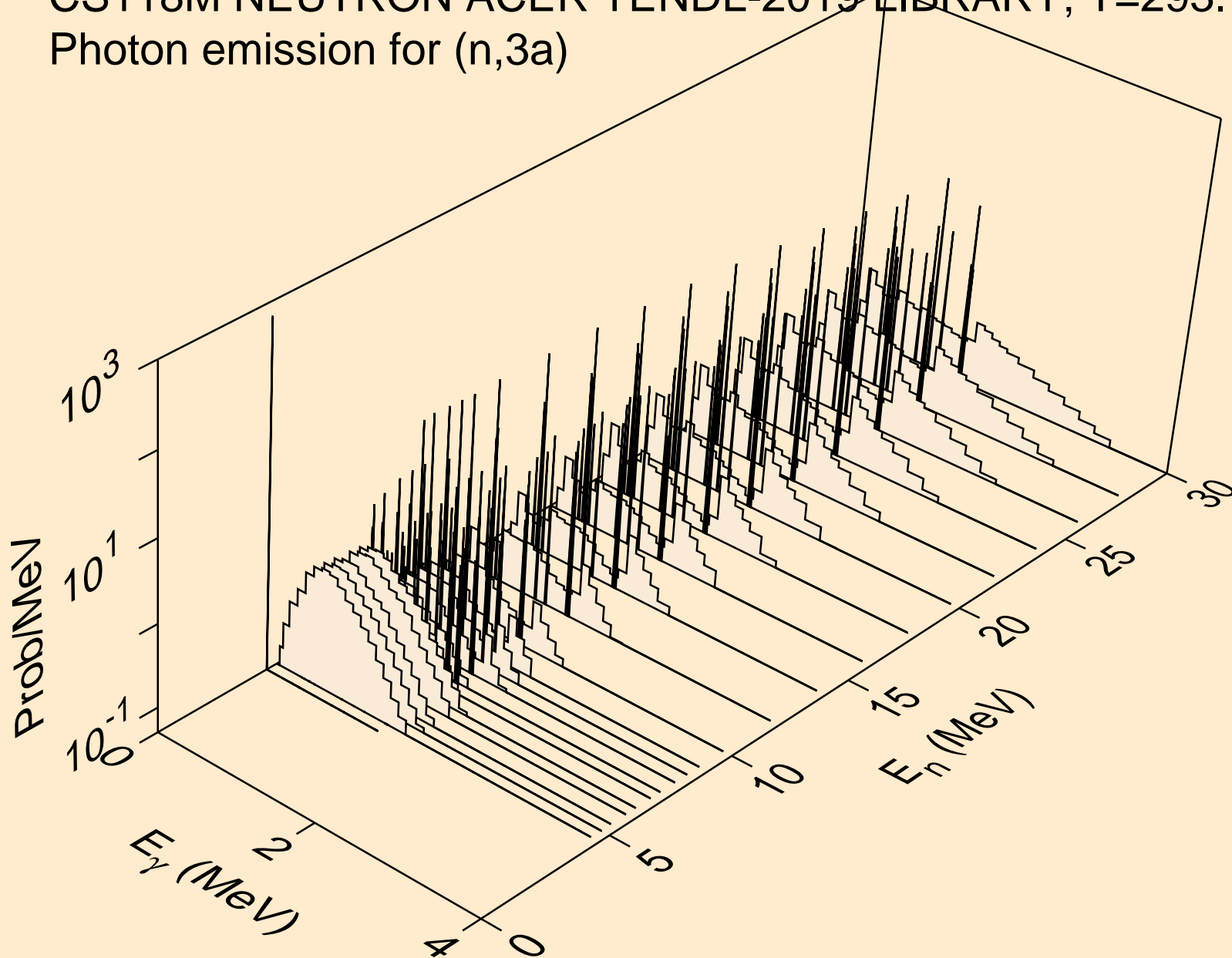

CS118M NEUTRON ACER TENDL-2019 LIBRARY; T=293.16K  
Photon emission for (n,2p)

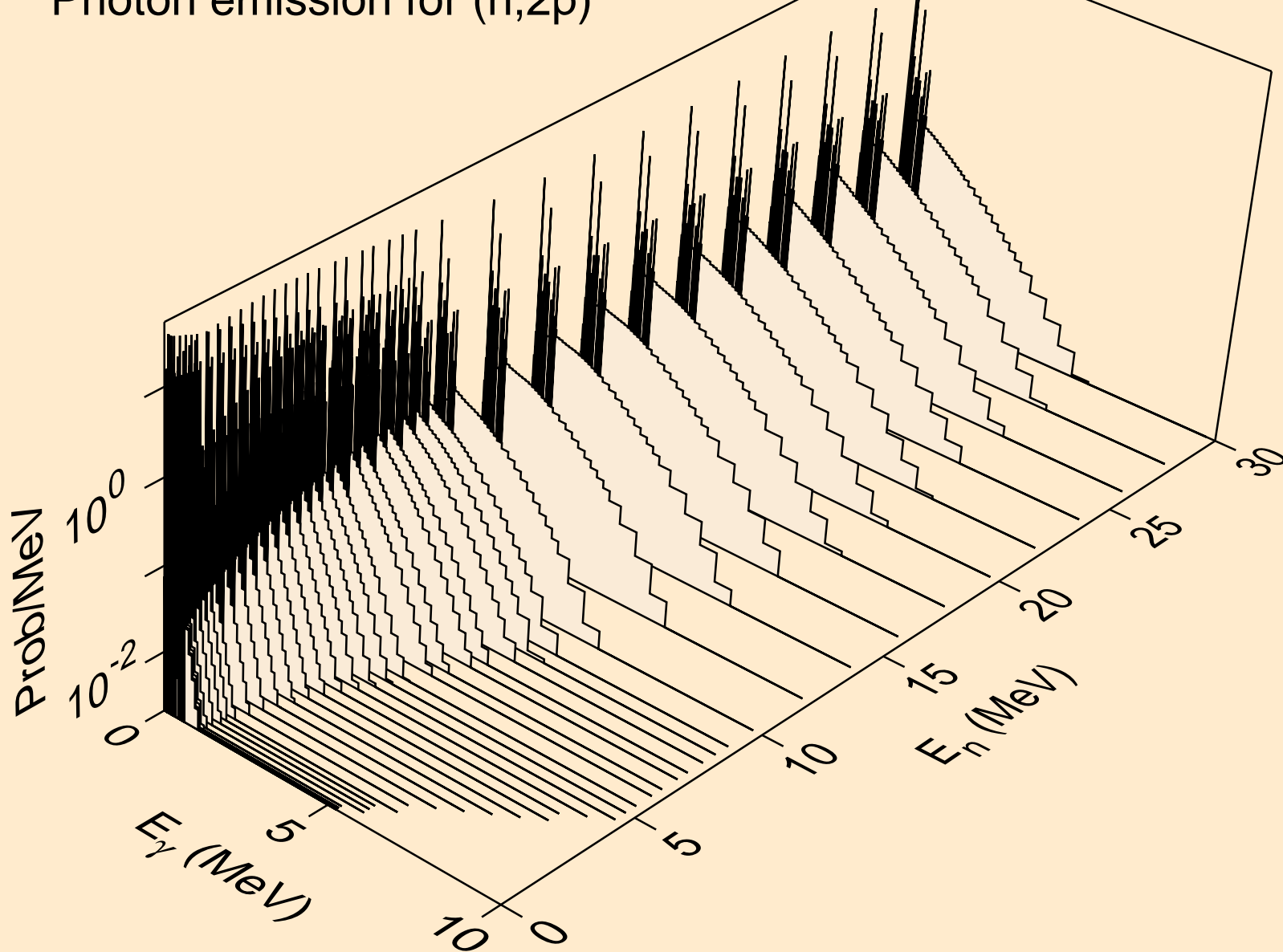

CS118M NEUTRON ACER TENDL-2019 LIBRARY; T=293.16K  
Photon emission for (n,p $\alpha$ )

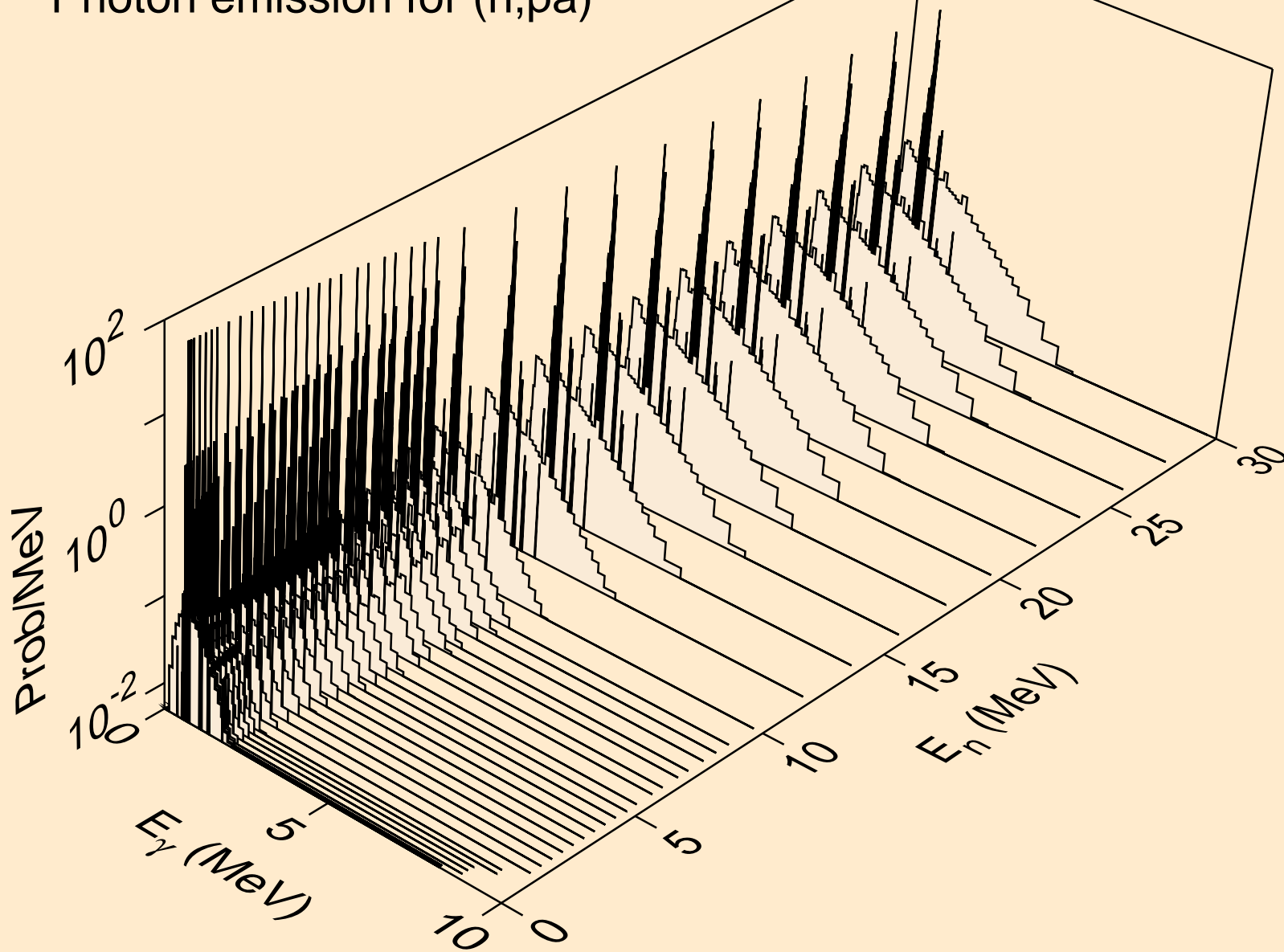

CS118M NEUTRON ACER TENDL-2019 LIBRARY; T=293.16K  
Photon emission for (n,t2a)

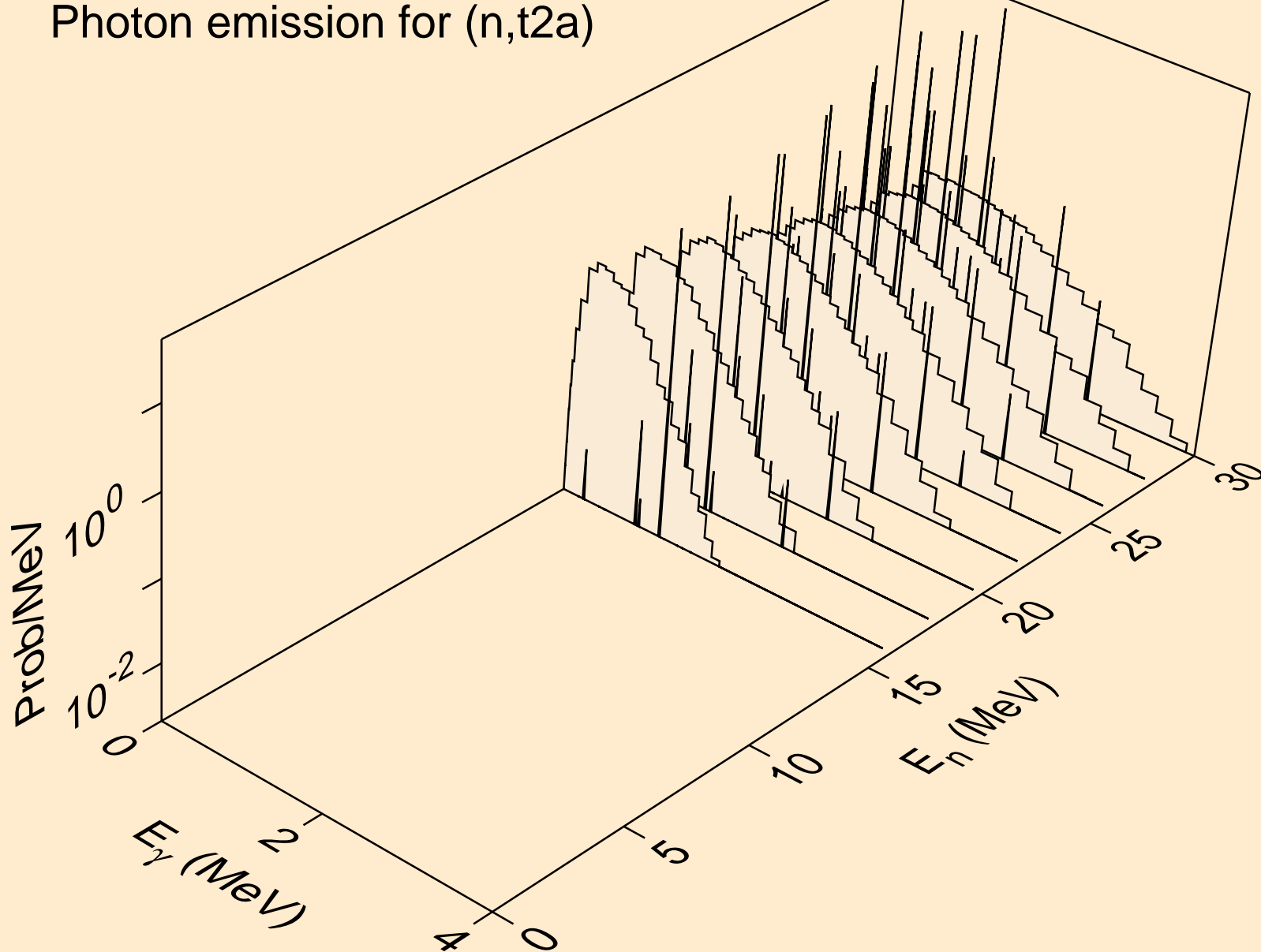

CS118M NEUTRON ACER TENDL-2019 LIBRARY; T=293.16K  
Photon emission for (n,d2a)

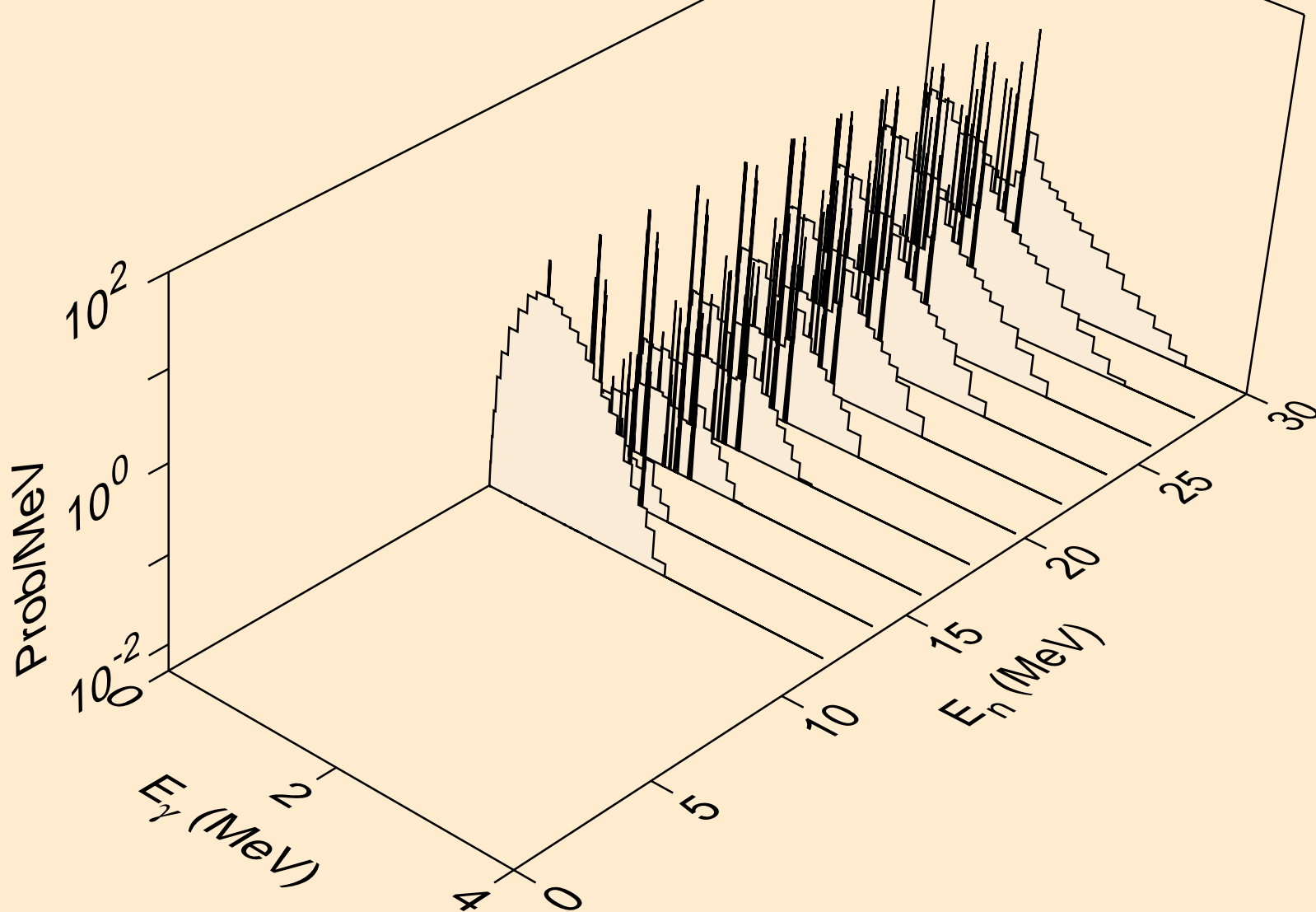

CS118M NEUTRON ACER TENDL-2019 LIBRARY; T=293.16K  
Photon emission for (n,pd)

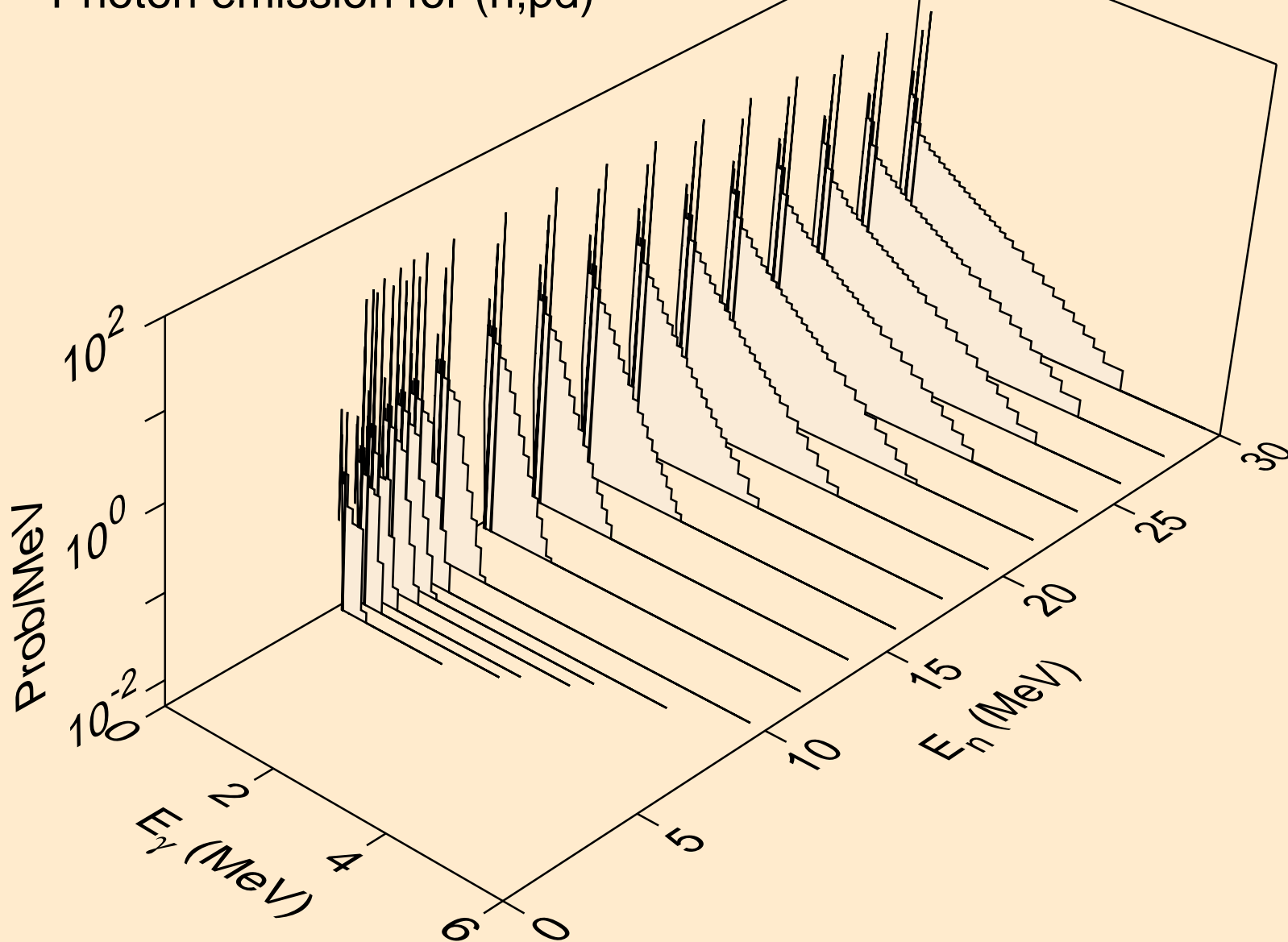

CS118M NEUTRON ACER TENDL-2019 LIBRARY; T=293.16K  
Photon emission for (n,pt)

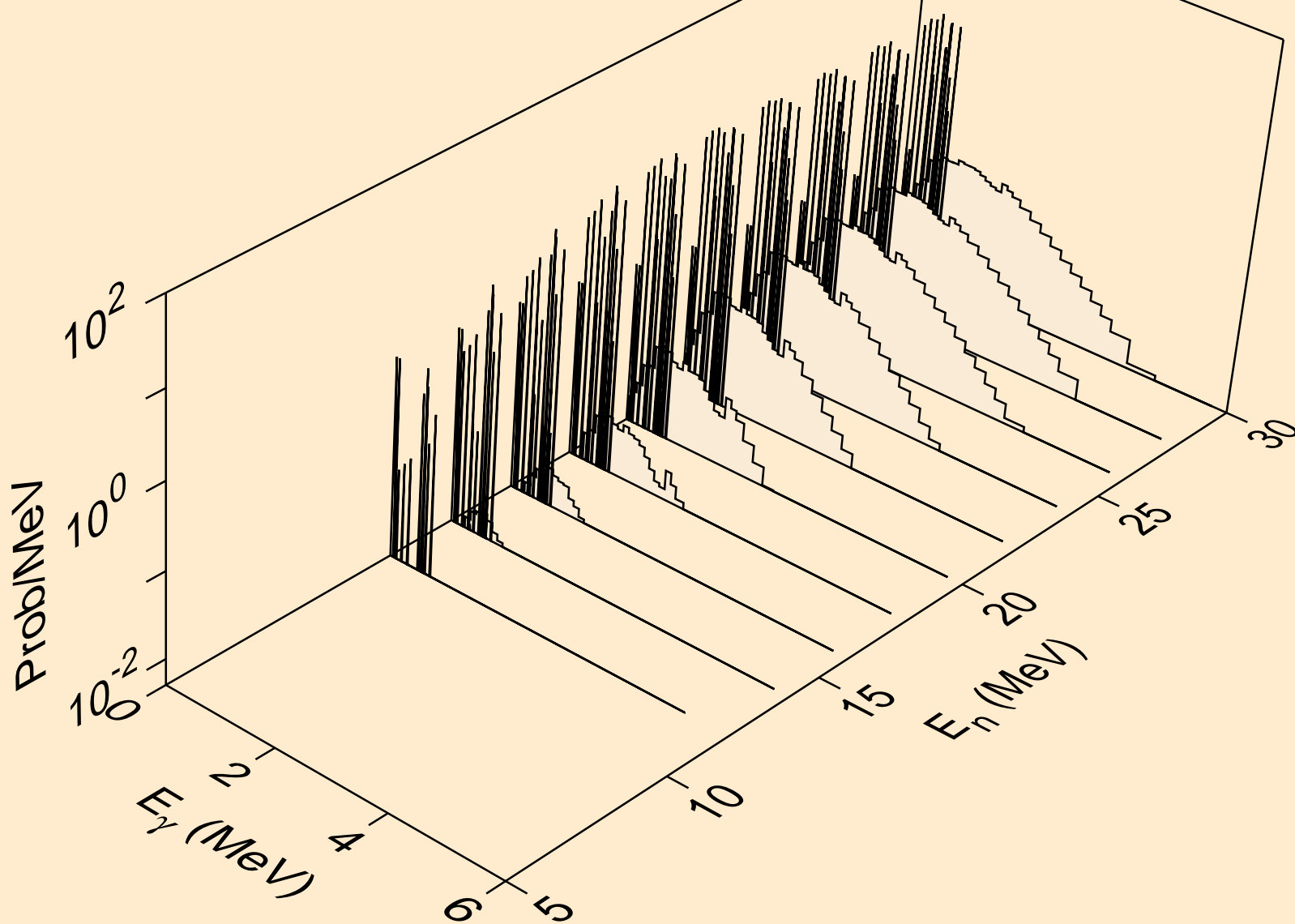

CS118M NEUTRON ACER TENDL-2019 LIBRARY; T=293.16K  
Photon emission for (n,da)

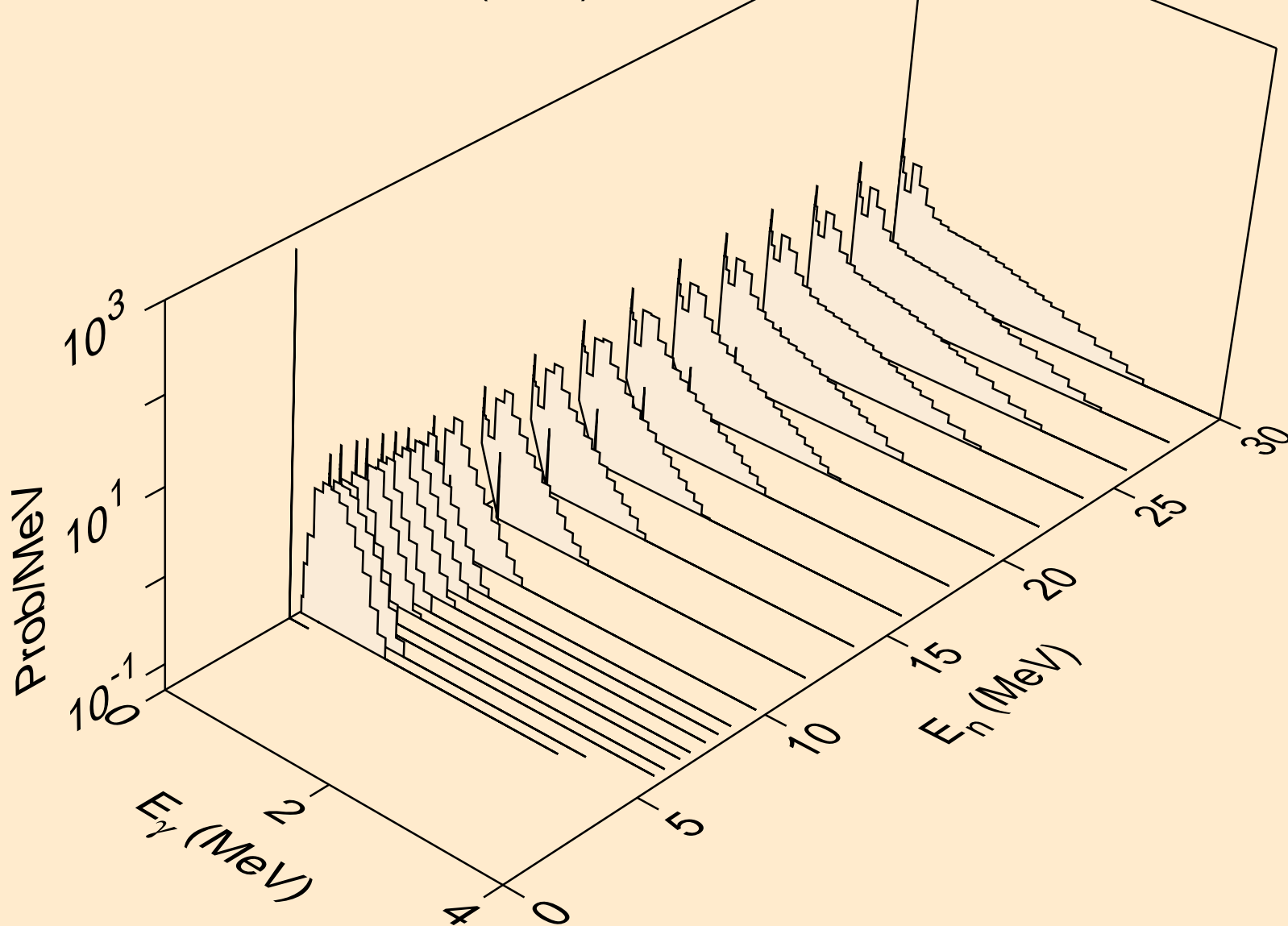



CS118M NEUTRON ACER TENDL-2019 LIBRARY; T=293.16K  
thermal capture photon spectrum

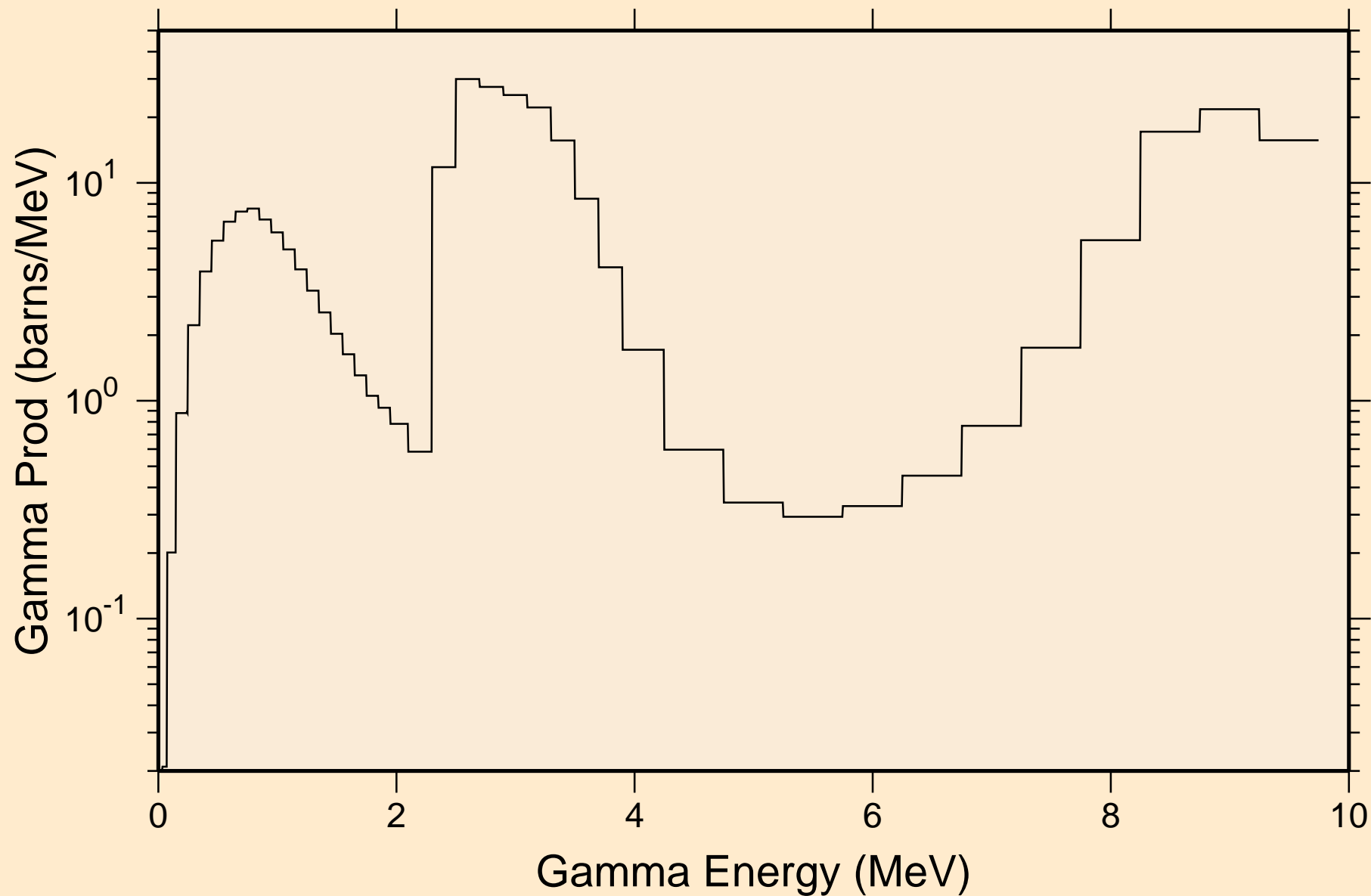

CS118M NEUTRON ACER TENDL-2019 LIBRARY; T=293.16K  
14 MeV photon spectrum

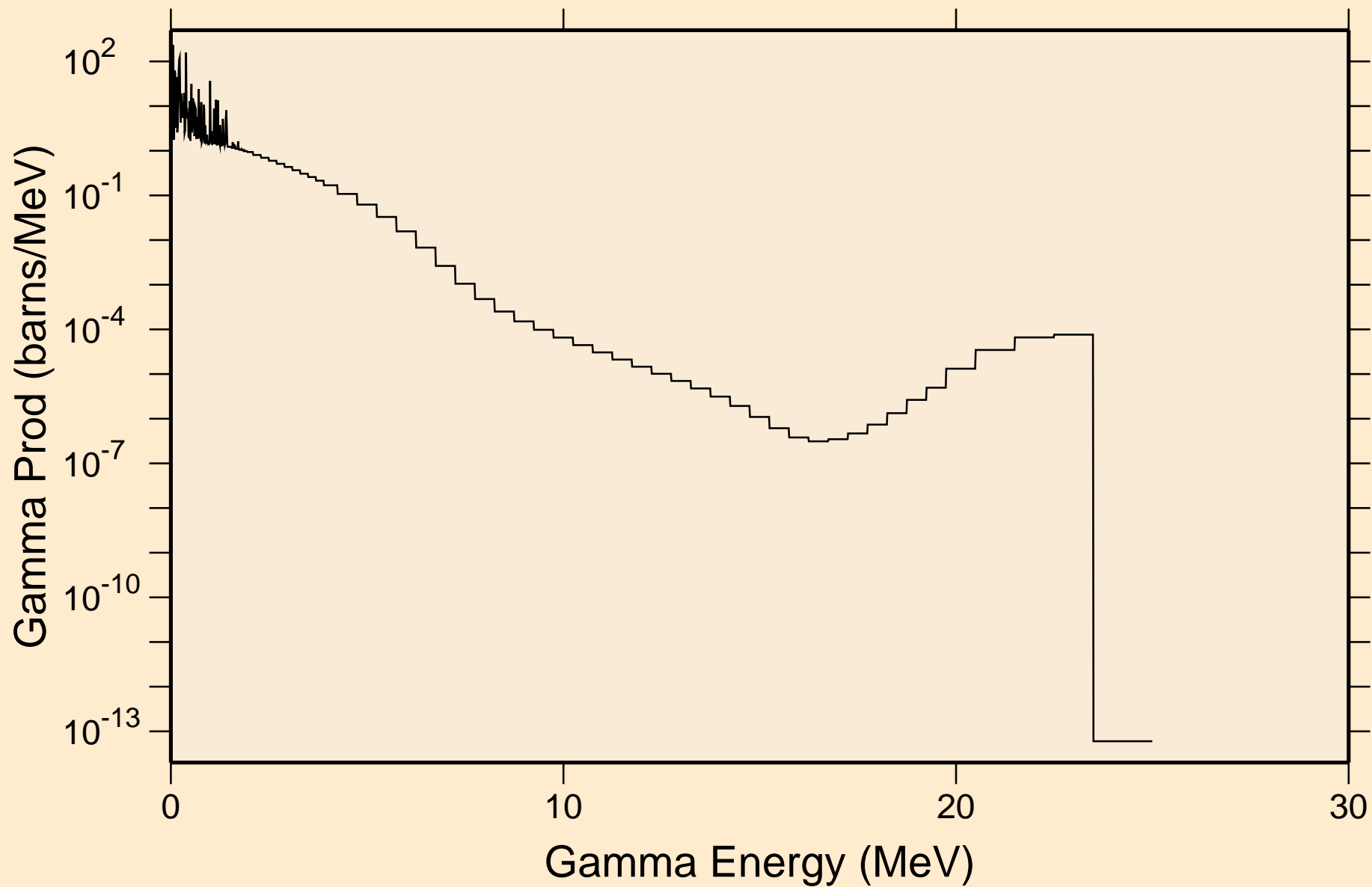

# CS118M NEUTRON ACER TENDL-2019 LIBRARY; T=293.16K

## Particle heating contributions

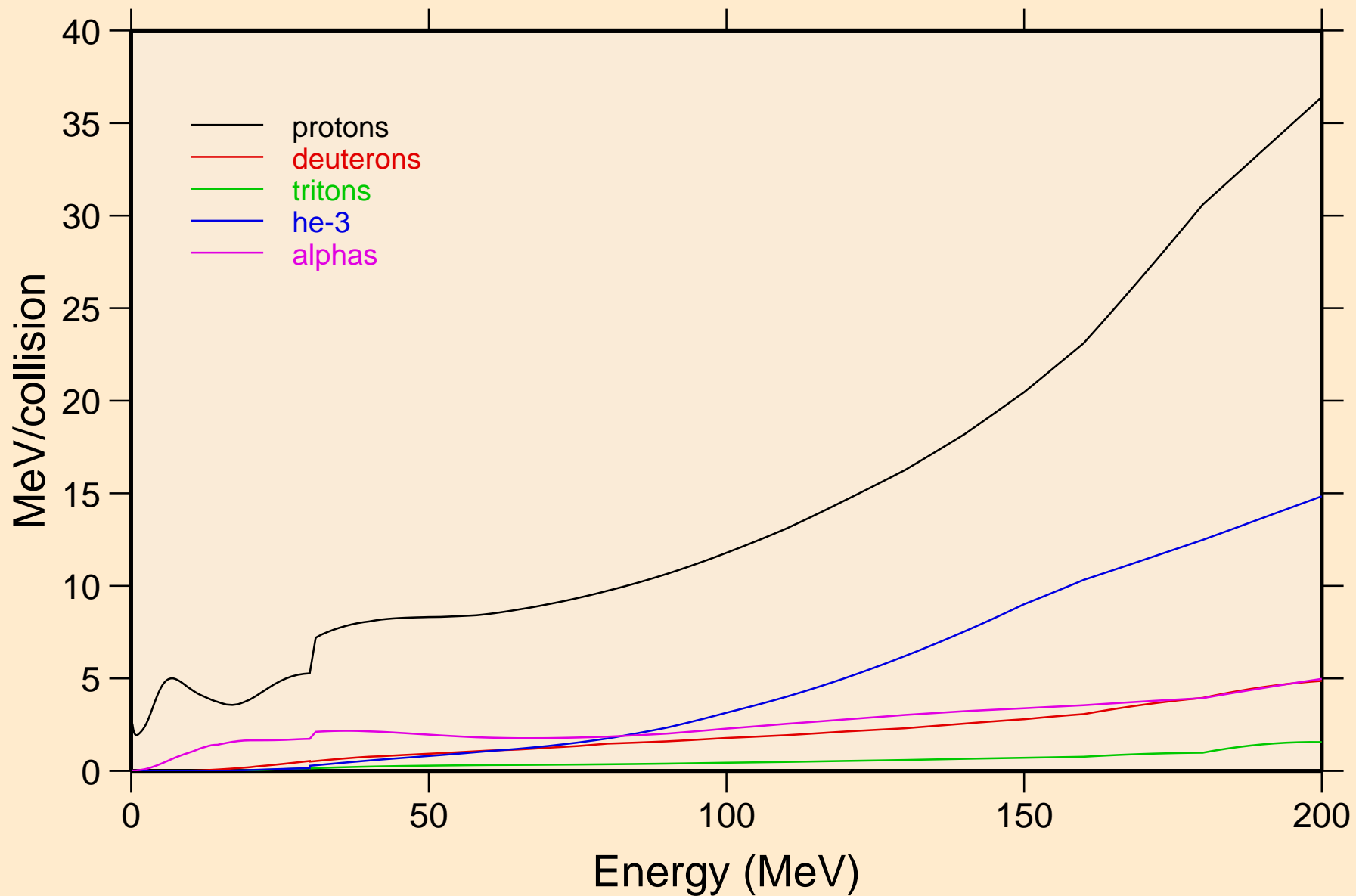

CS118M NEUTRON ACER TENDL-2019 LIBRARY; T=293.16K  
Recoil Heating

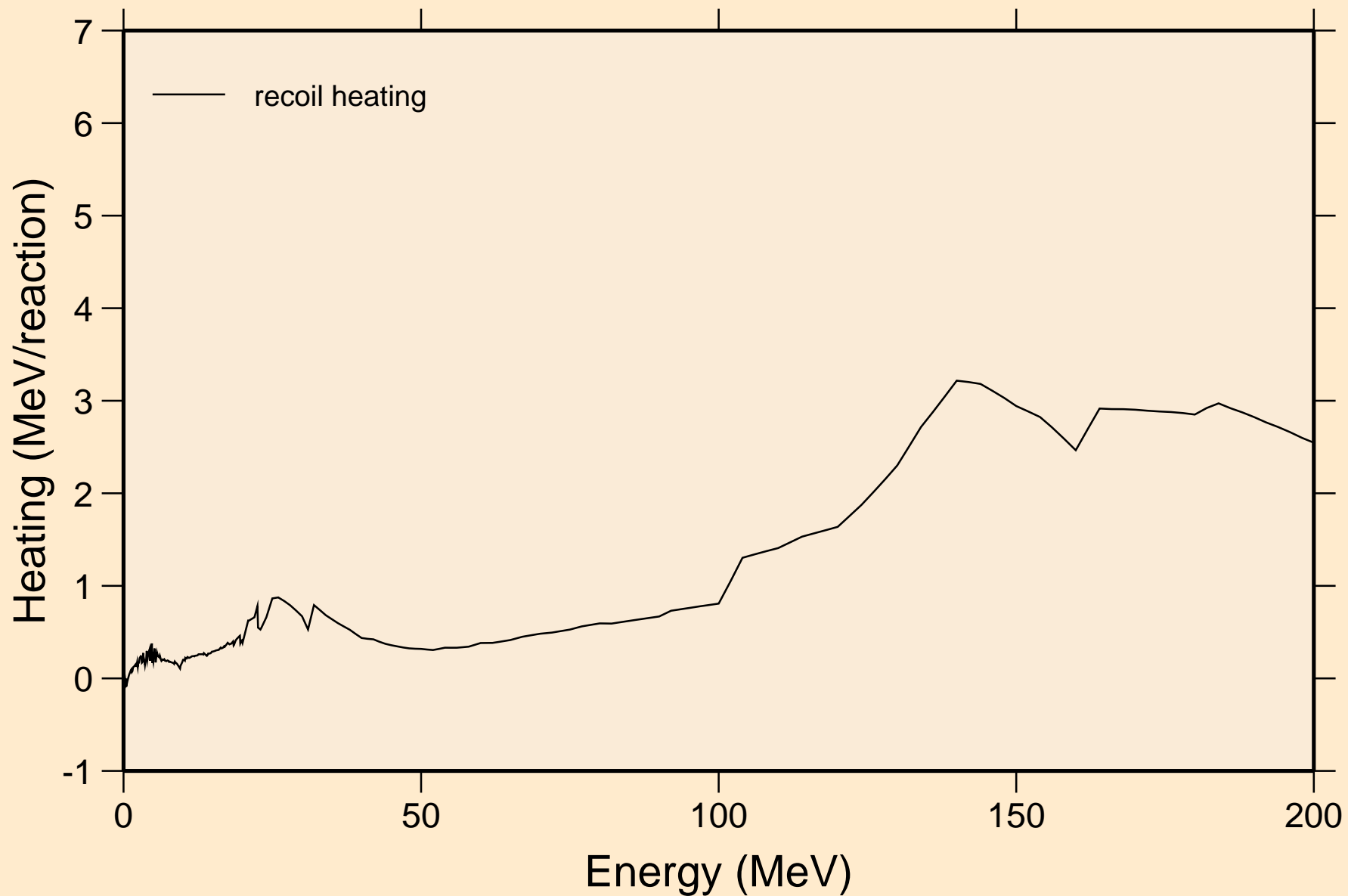

# CS118M NEUTRON ACER TENDL-2019 LIBRARY; T=293.16K

## Particle production cross sections

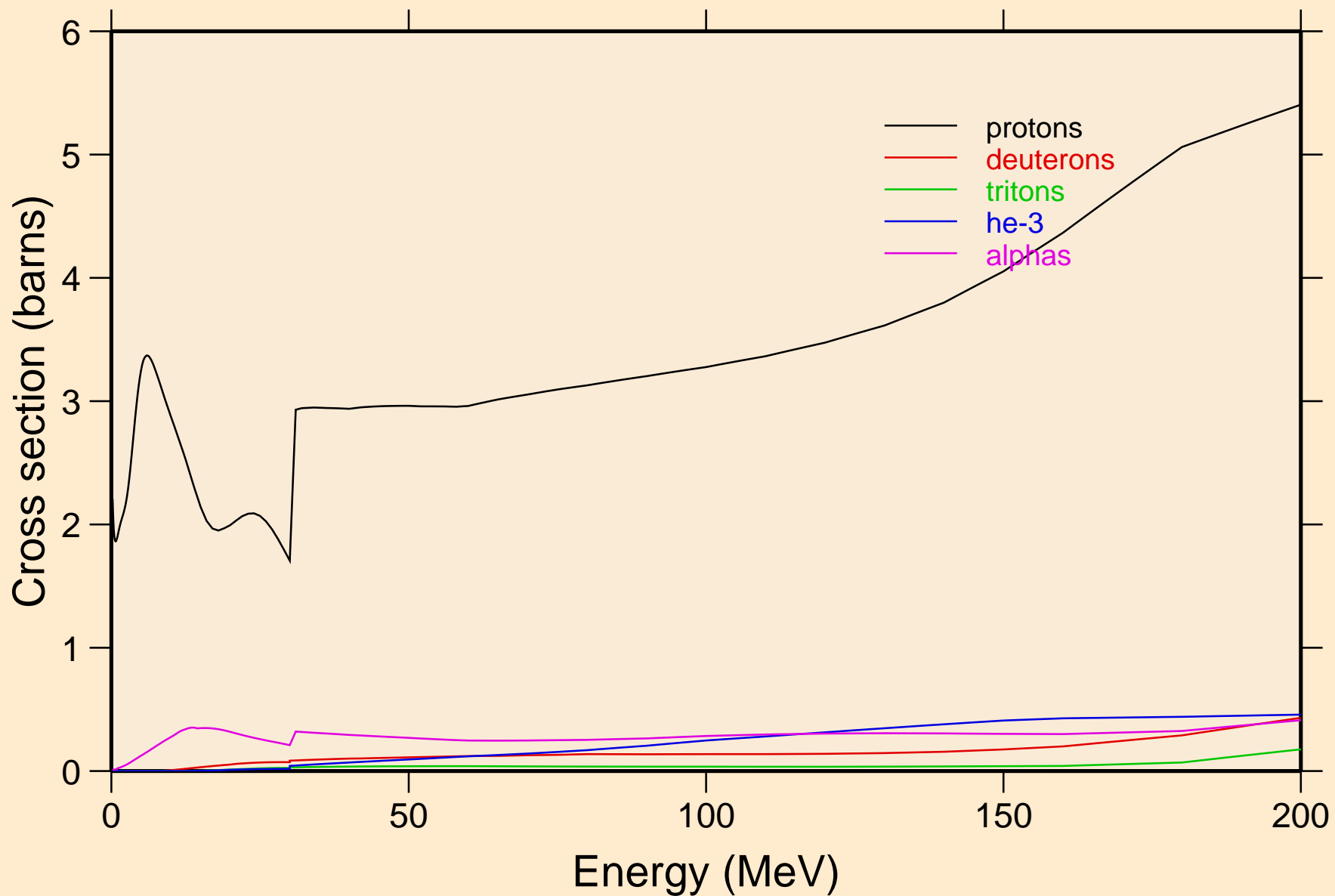

CS118M NEUTRON ACER TENDL-2019 LIBRARY; T=293.16K  
protons from (n,x)

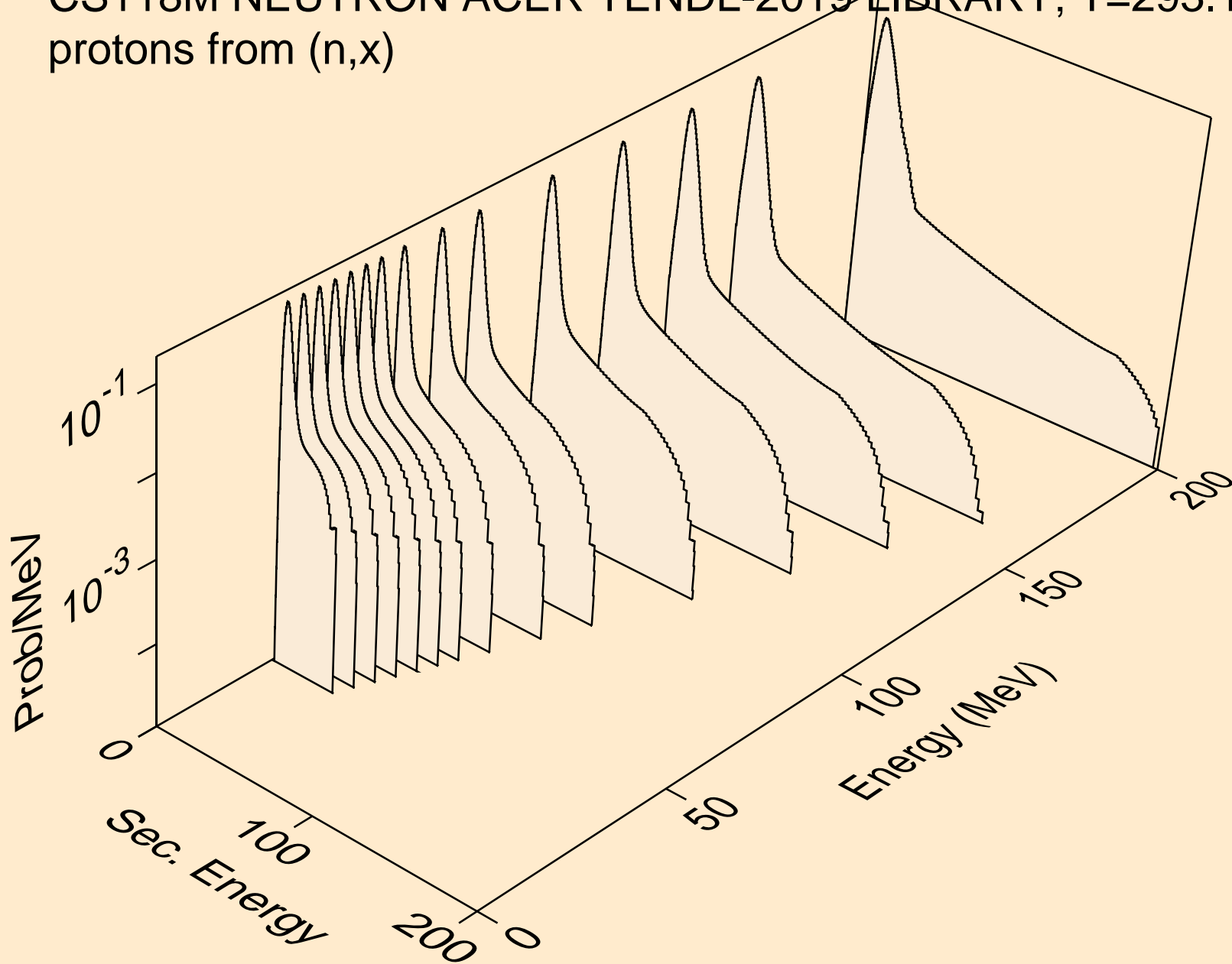

CS118M NEUTRON ACER TENDL-2019 LIBRARY; T=293.16K  
protons from (n,n\*)p

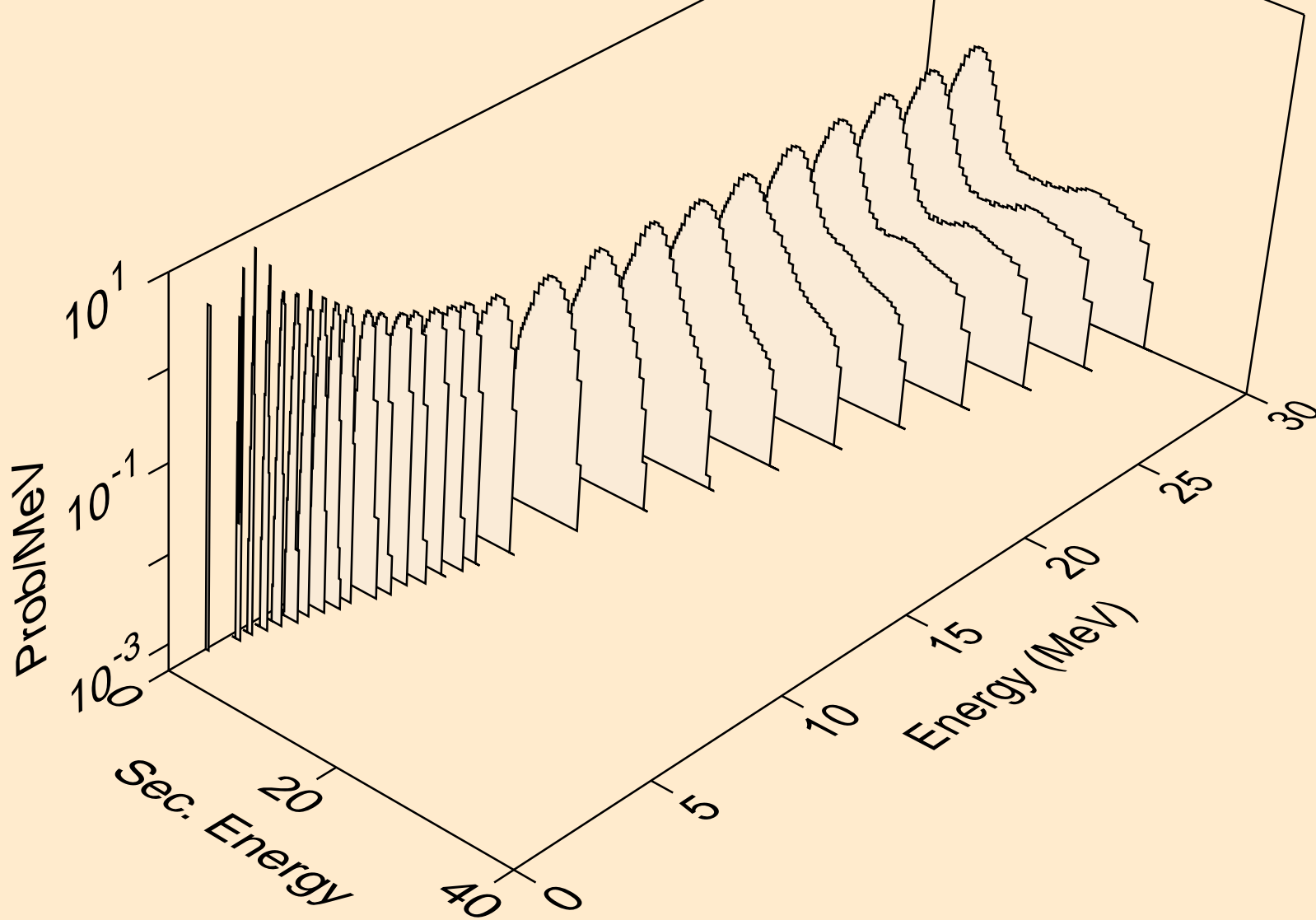

CS118M NEUTRON ACER TENDL-2019 LIBRARY; T=293.16K  
protons from (n,2np)

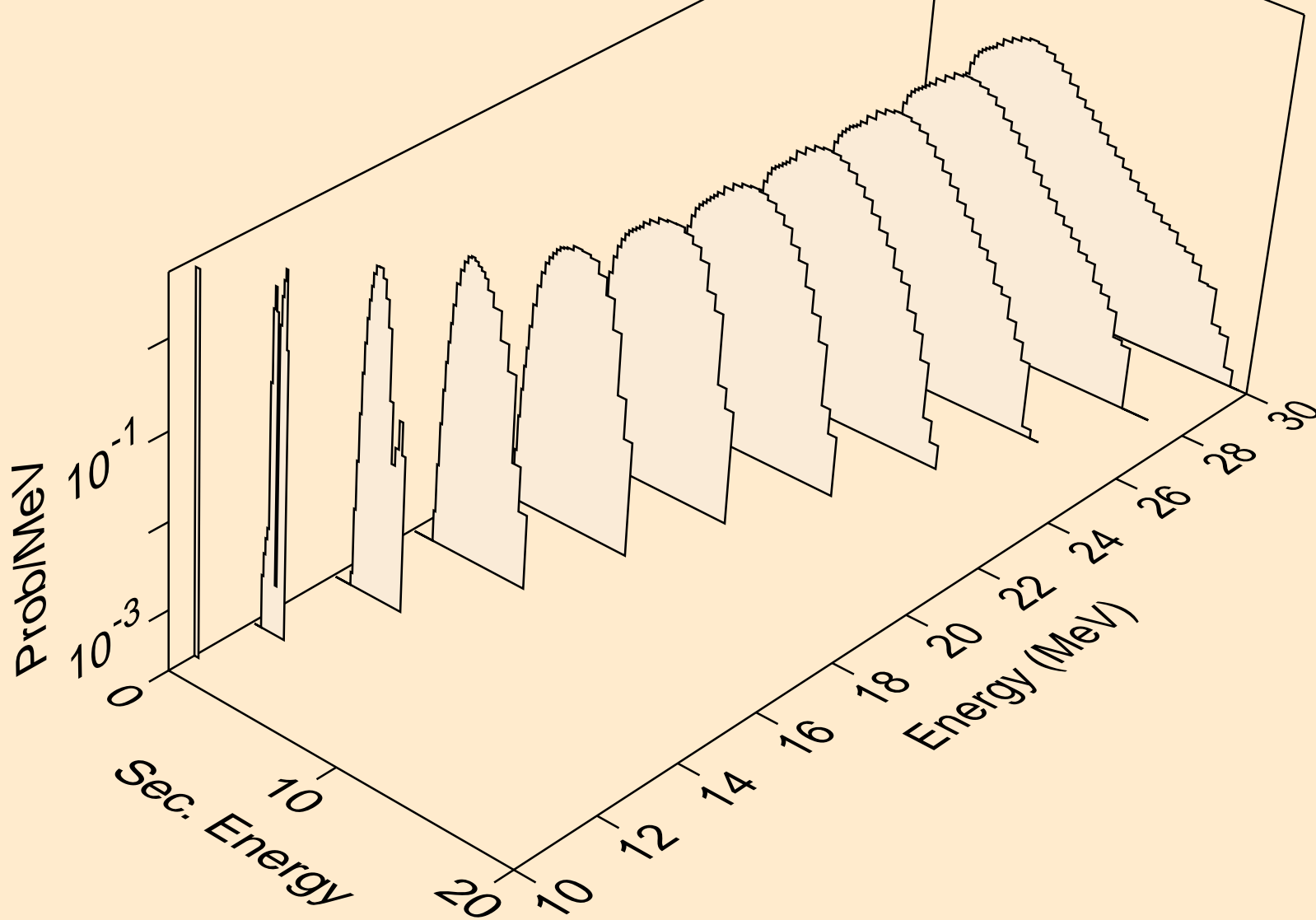



CS118M NEUTRON ACER TENDL-2019 LIBRARY; T=293.16K  
protons from (n,3np)

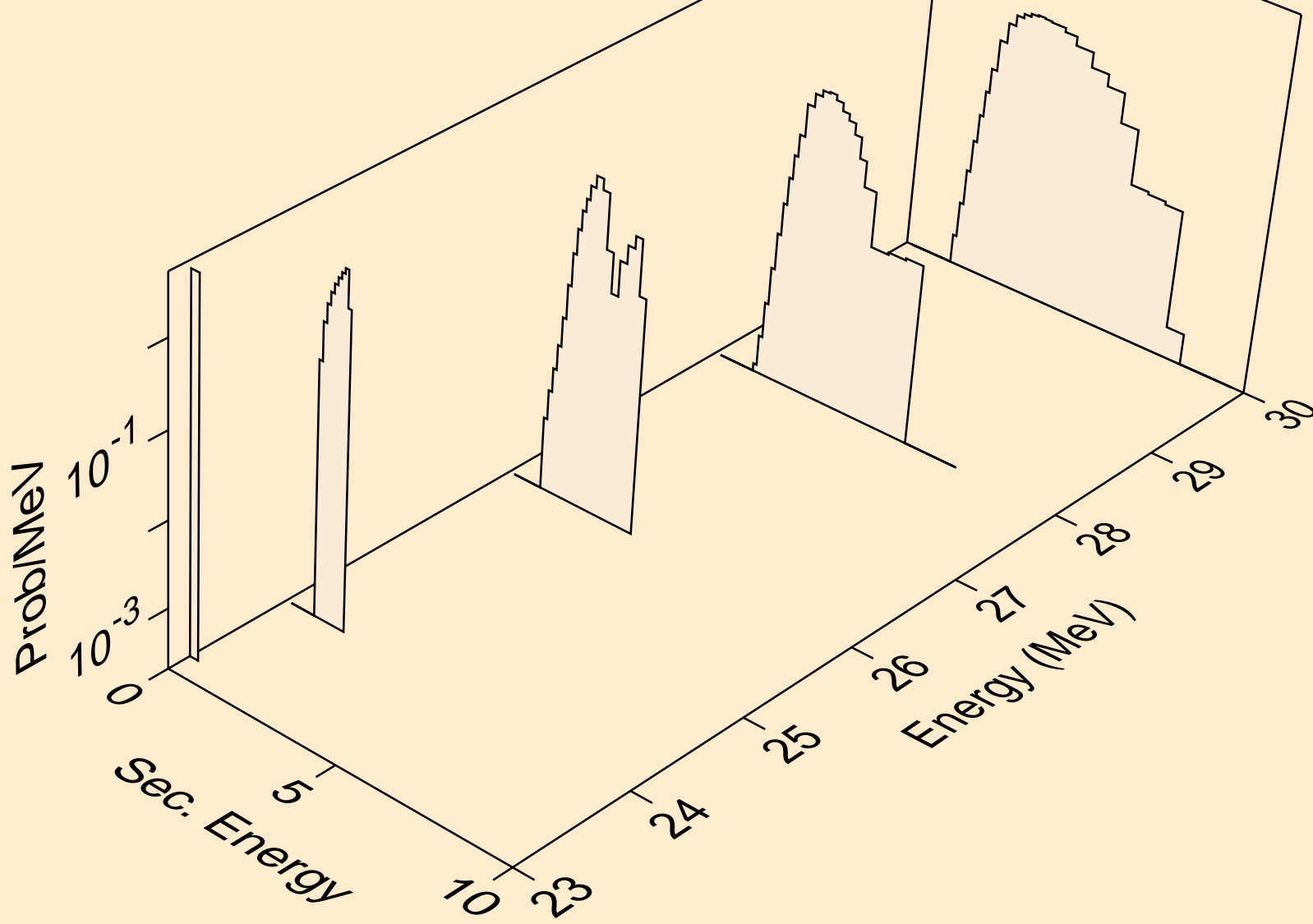

CS118M NEUTRON ACER TENDL-2019 LIBRARY; T=293.16K  
protons from (n,2np)

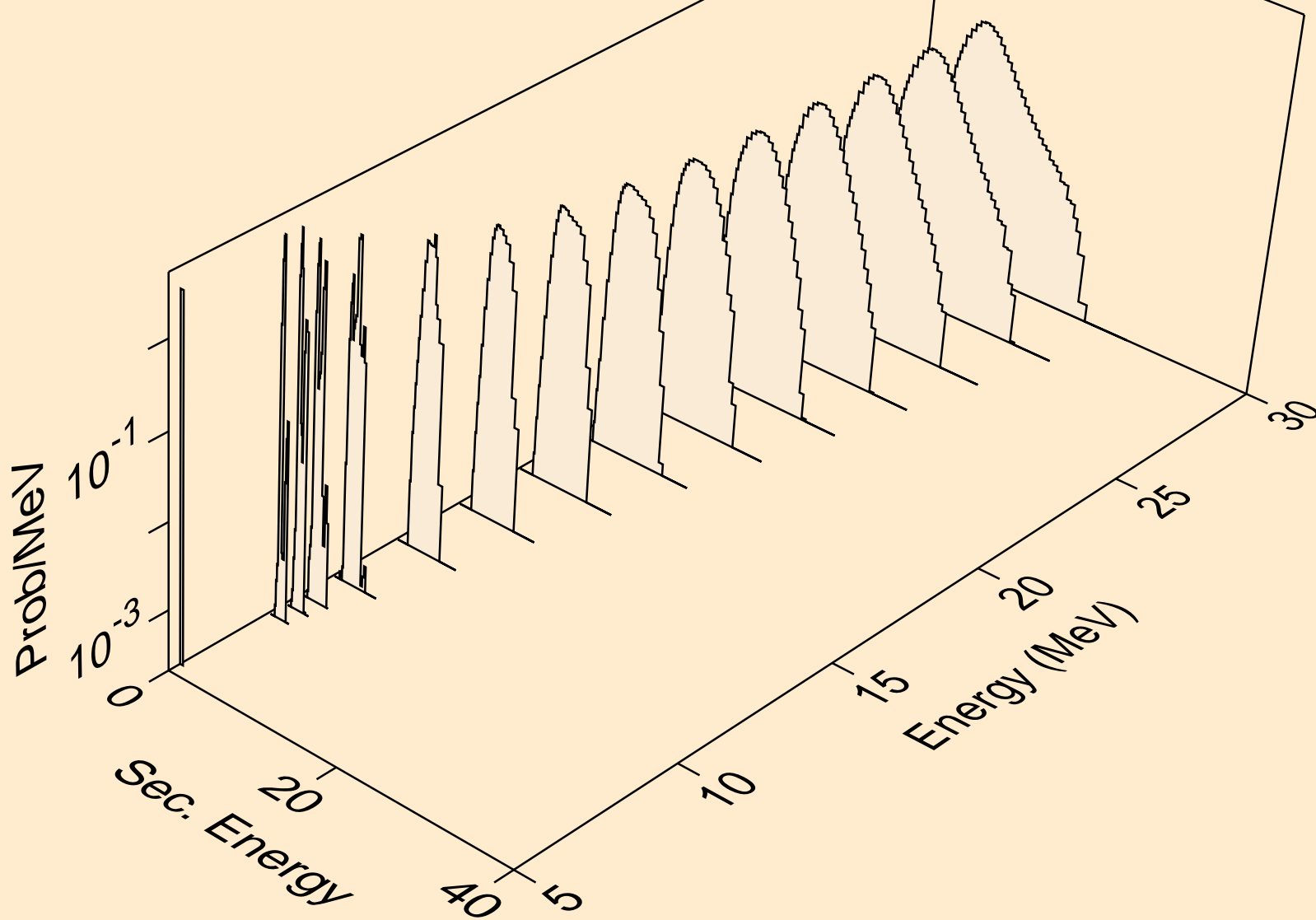

CS118M NEUTRON ACER TENDL-2019 LIBRARY; T=293.16K  
protons from (n,npa)

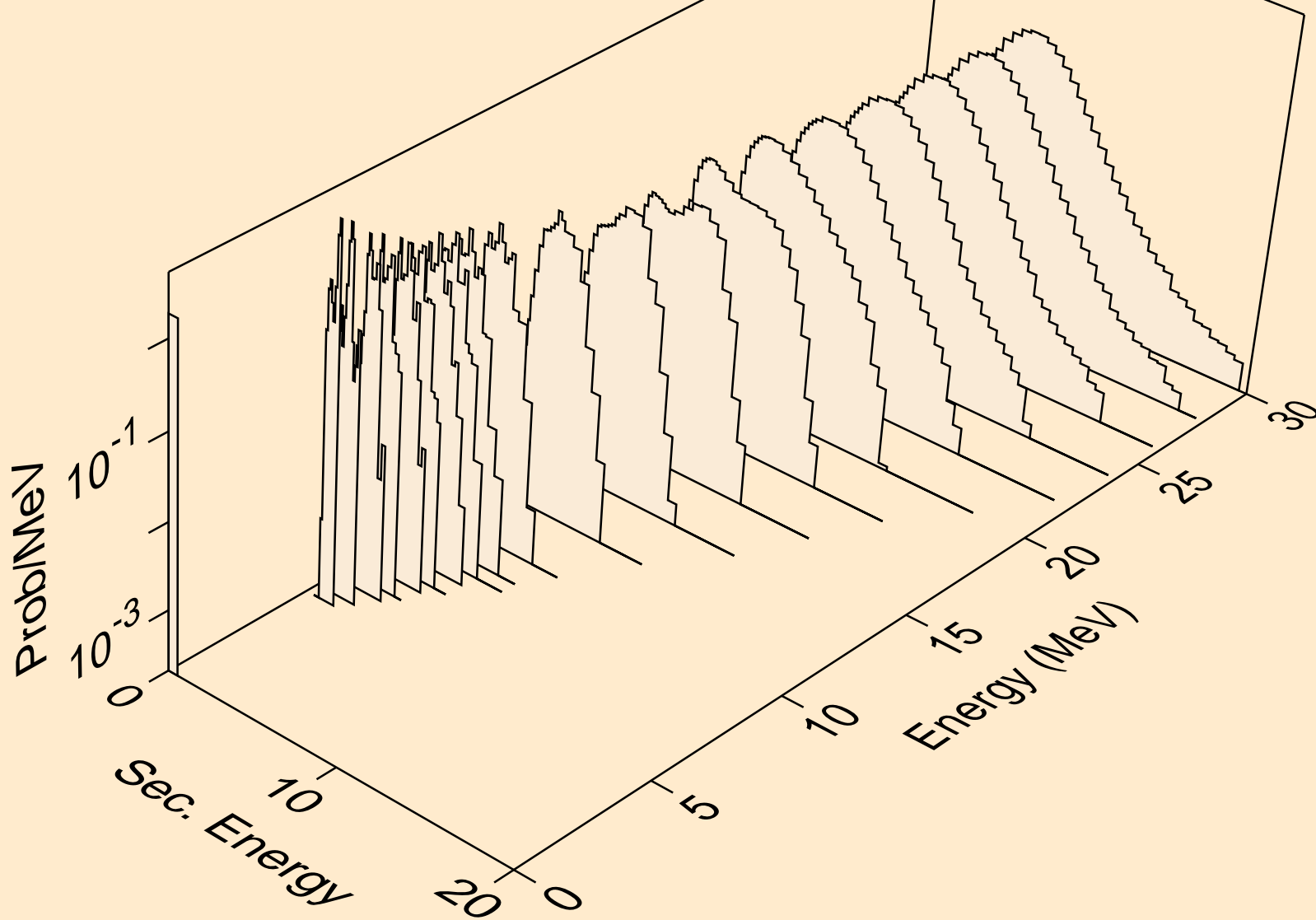

CS118M NEUTRON ACER TENDL-2019 LIBRARY; T=293.16K  
protons from (n,p)

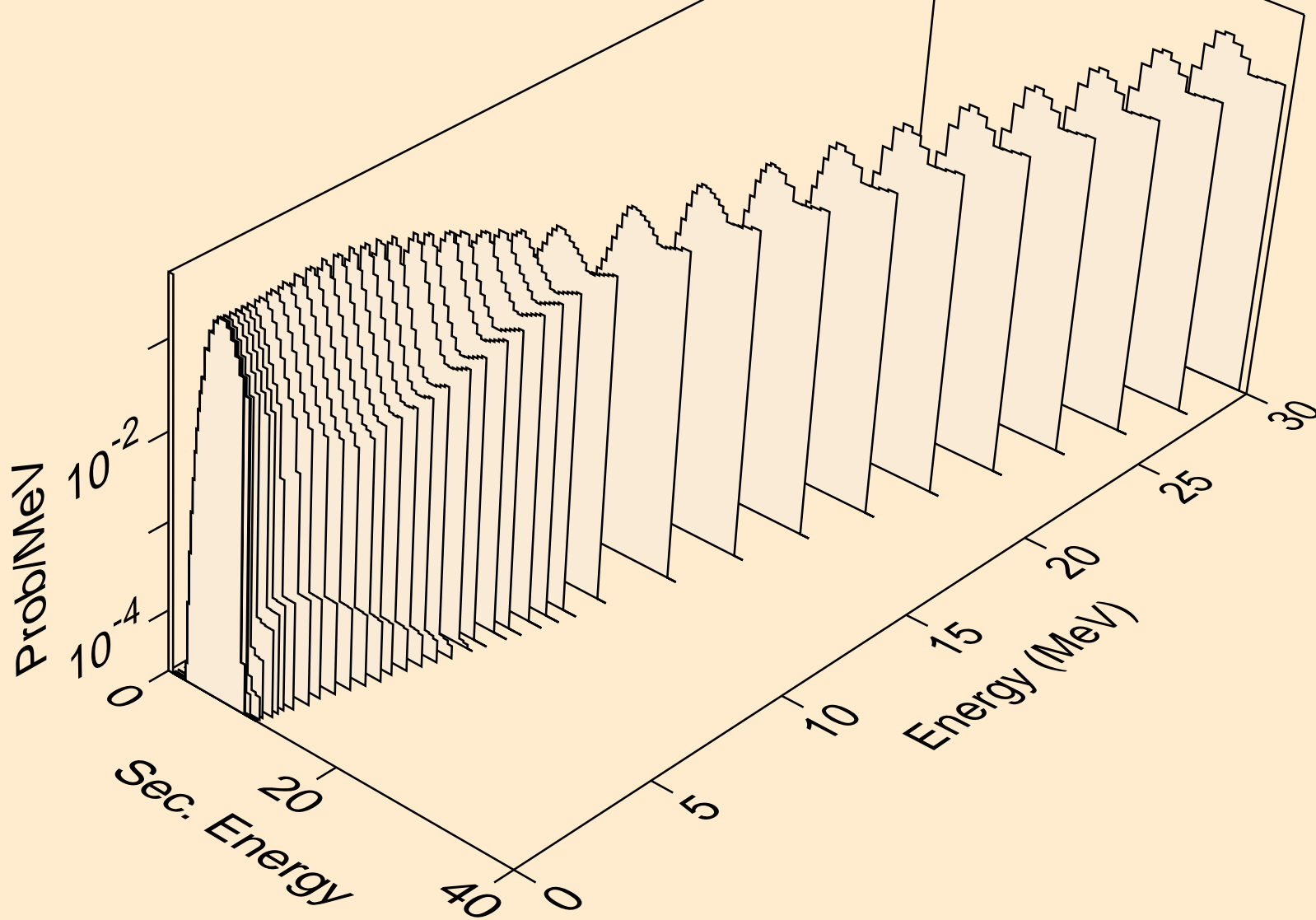

CS118M NEUTRON ACER TENDL-2019 LIBRARY; T=293.16K  
protons from (n,2p)

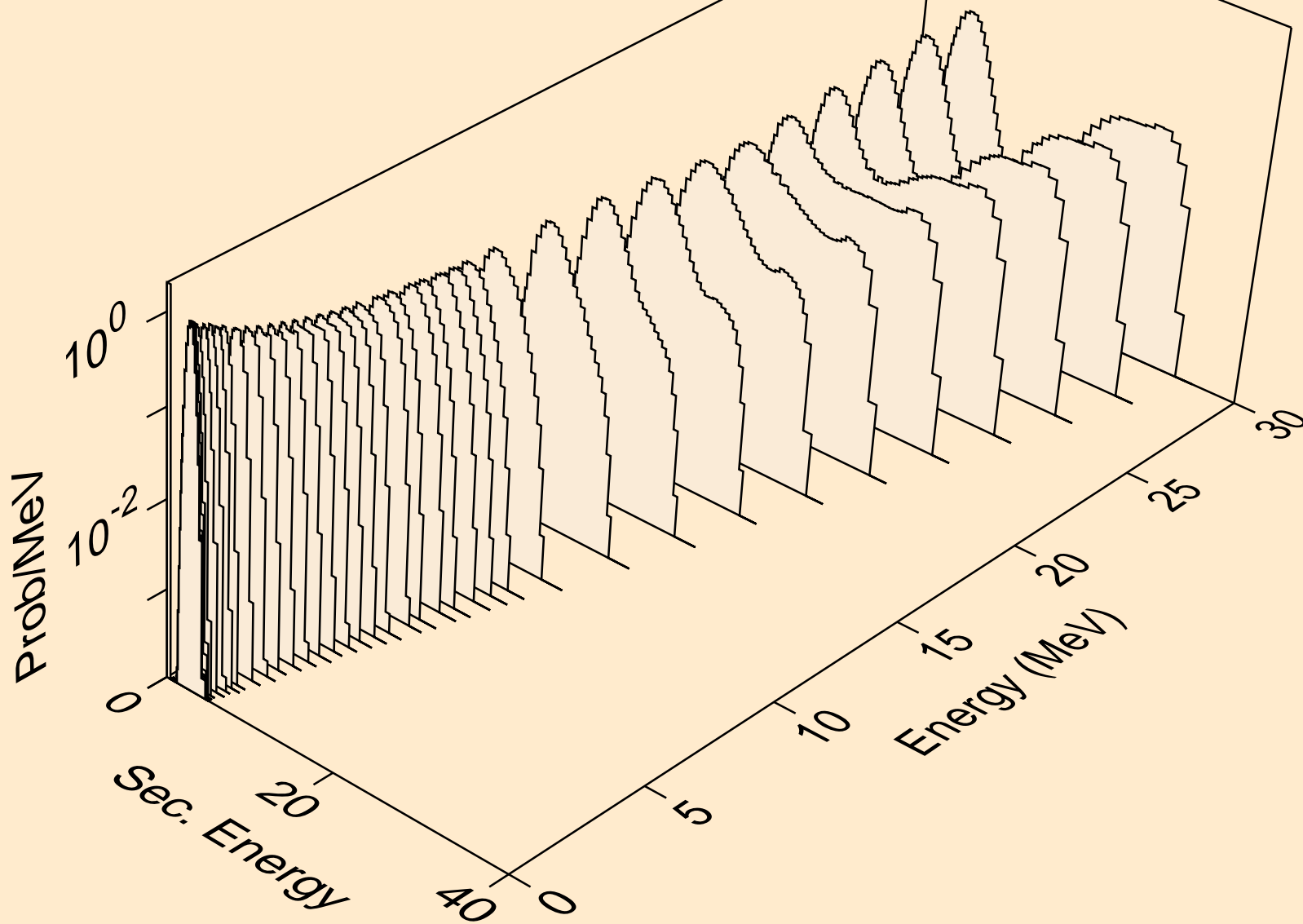

CS118M NEUTRON ACER TENDL-2019 LIBRARY; T=293.16K  
protons from (n,p)

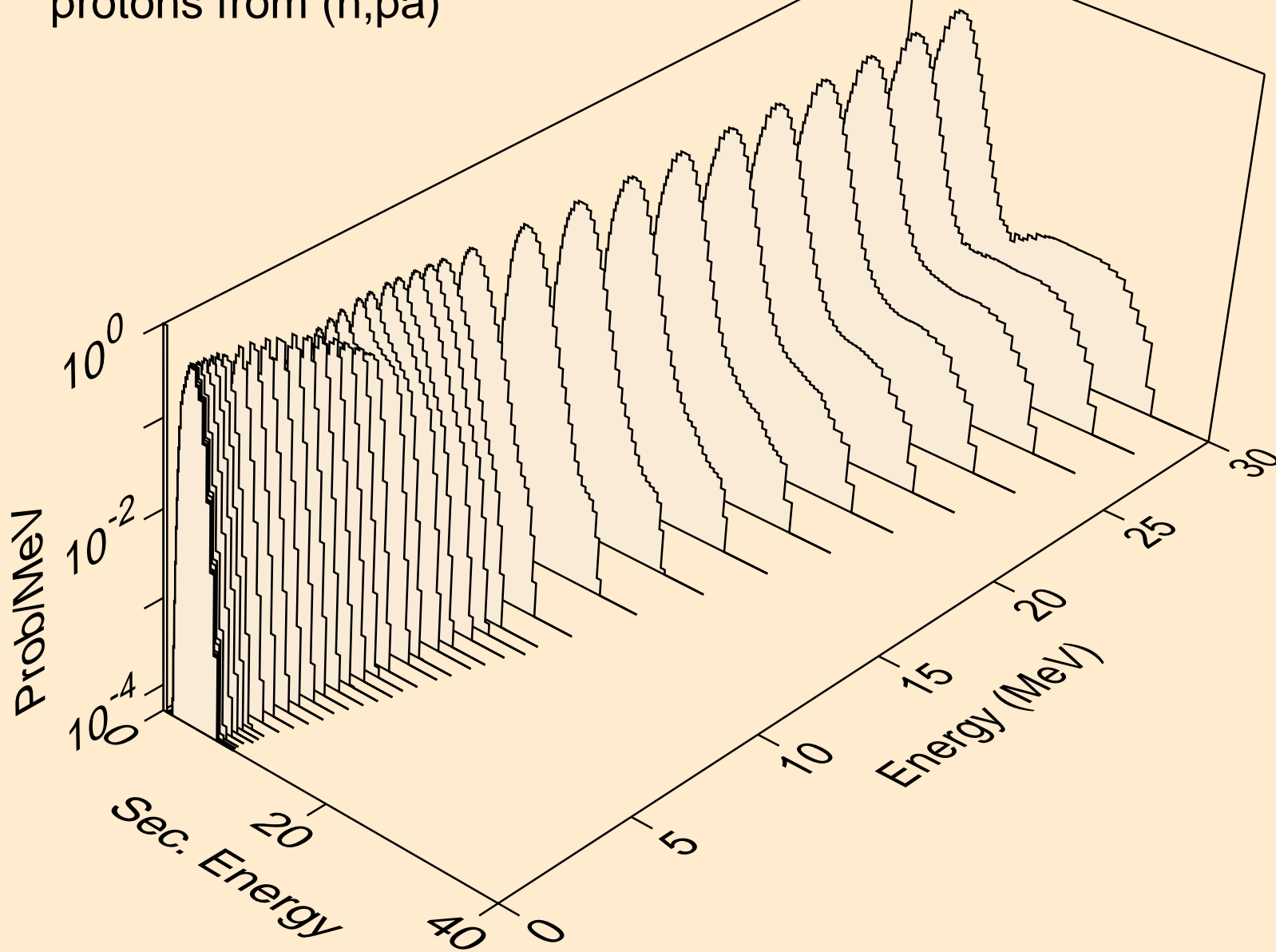

CS118M NEUTRON ACER TENDL-2019 LIBRARY; T=293.16K  
protons from (n,pd)

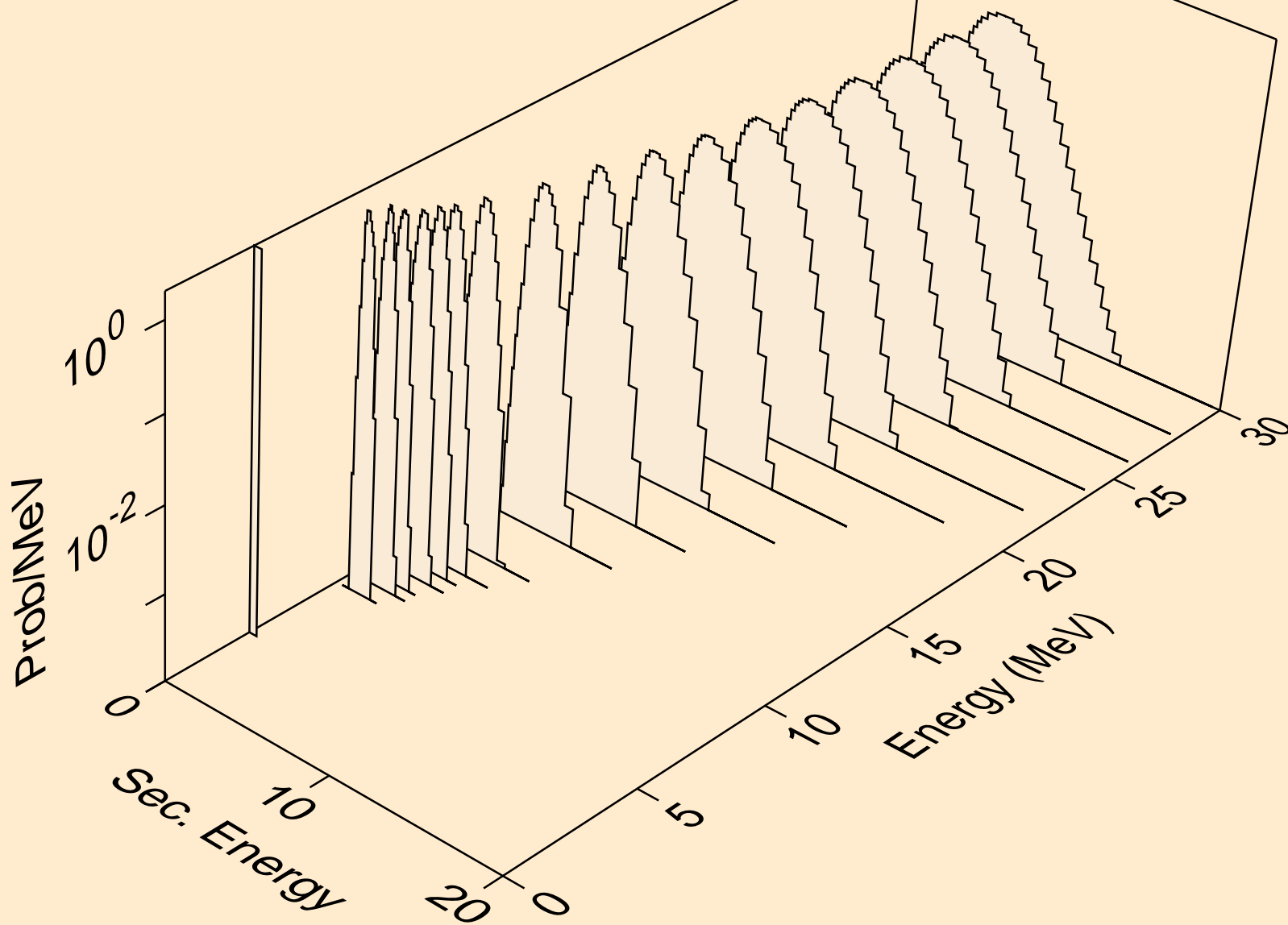

CS118M NEUTRON ACER TENDL-2019 LIBRARY; T=293.16K  
protons from (n,pt)

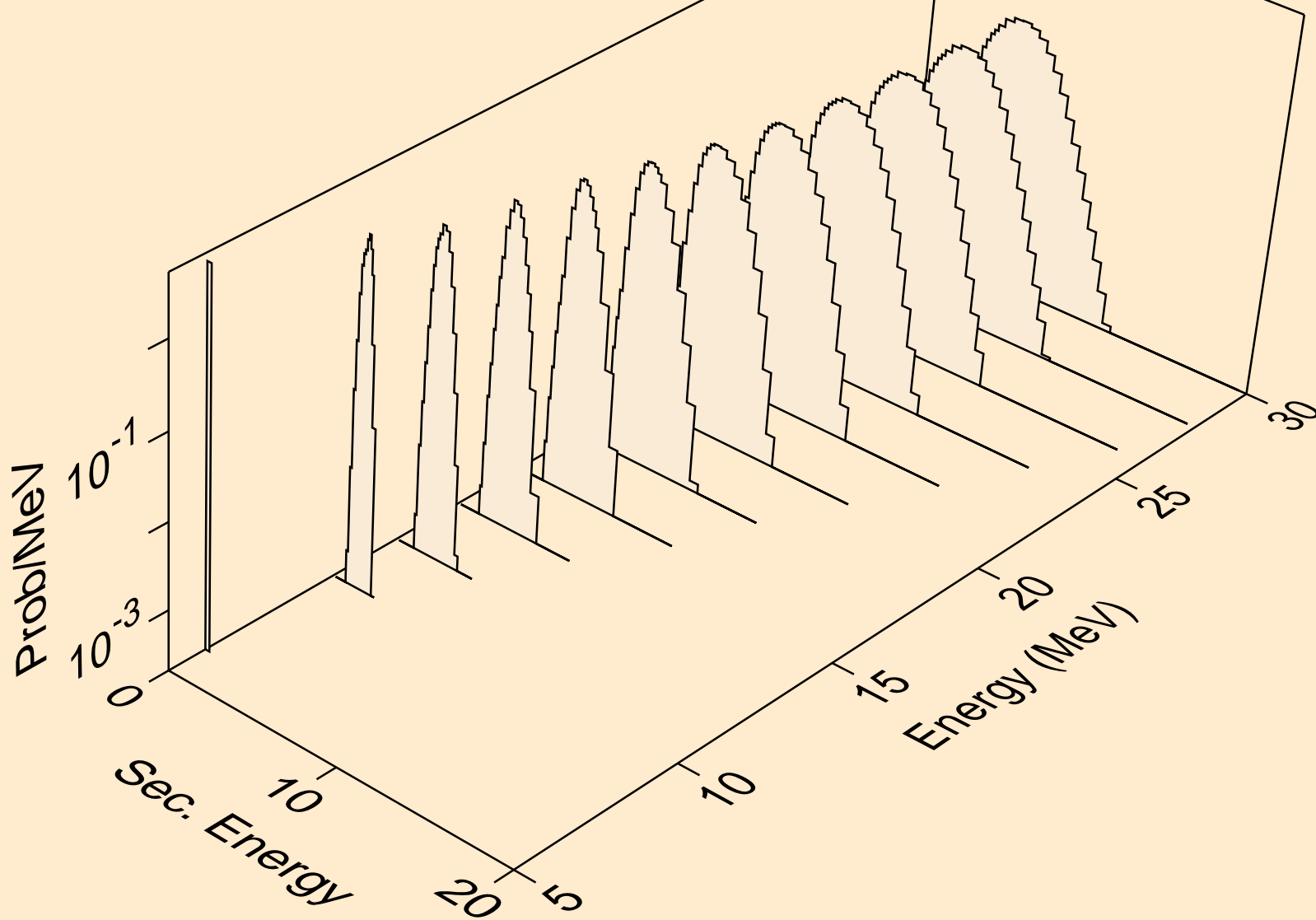



CS118M NEUTRON ACER TENDL-2019 LIBRARY; T=293.16K  
deuterons from (n,x)

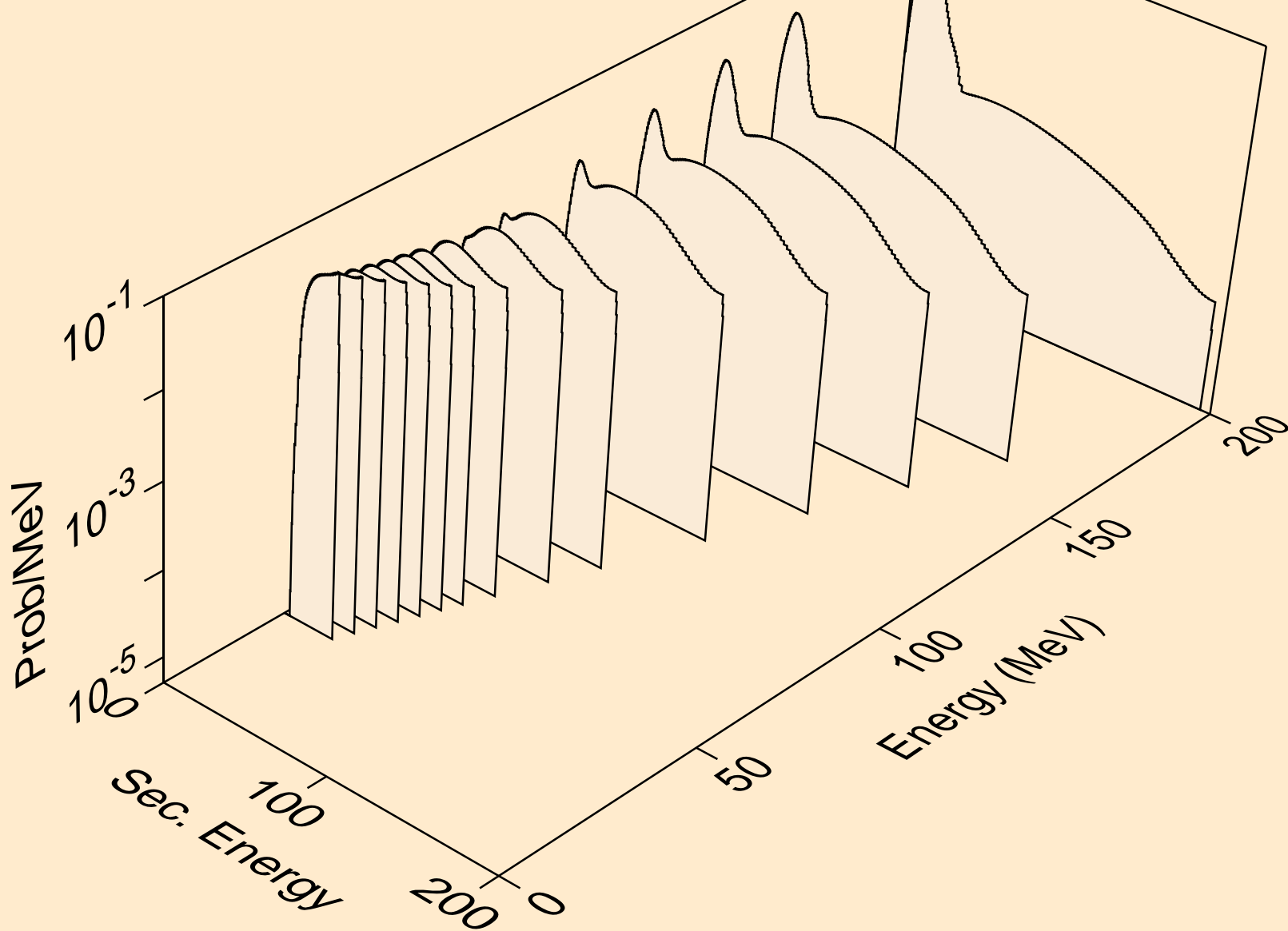

CS118M NEUTRON ACER TENDL-2019 LIBRARY; T=293.16K  
deuterons from (n,2nd)

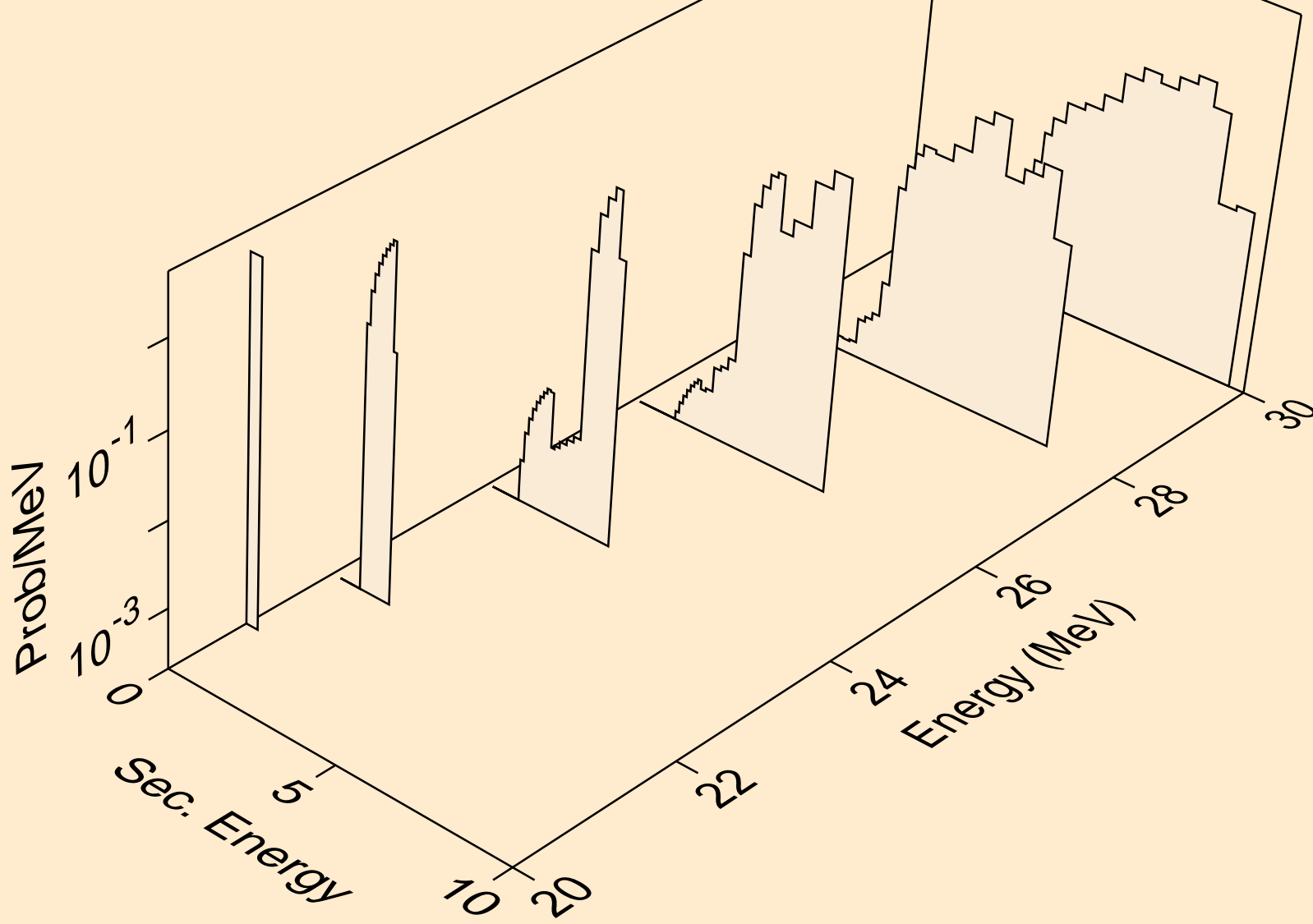

CS118M NEUTRON ACER TENDL-2019 LIBRARY; T=293.16K  
deuterons from (n,n\*)d

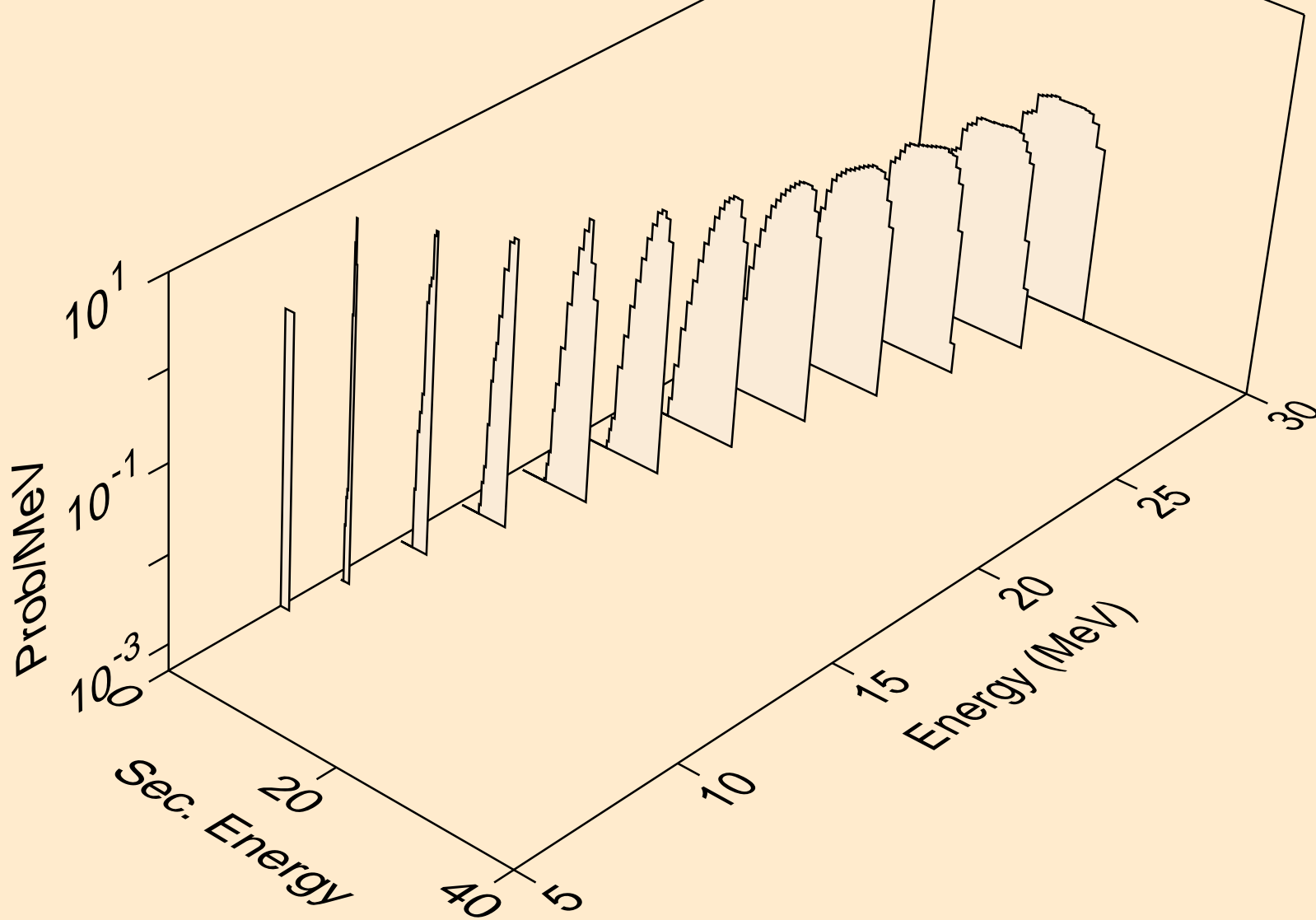

CS118M NEUTRON ACER TENDL-2019 LIBRARY; T=293.16K  
deuterons from (n,n\*)d2a

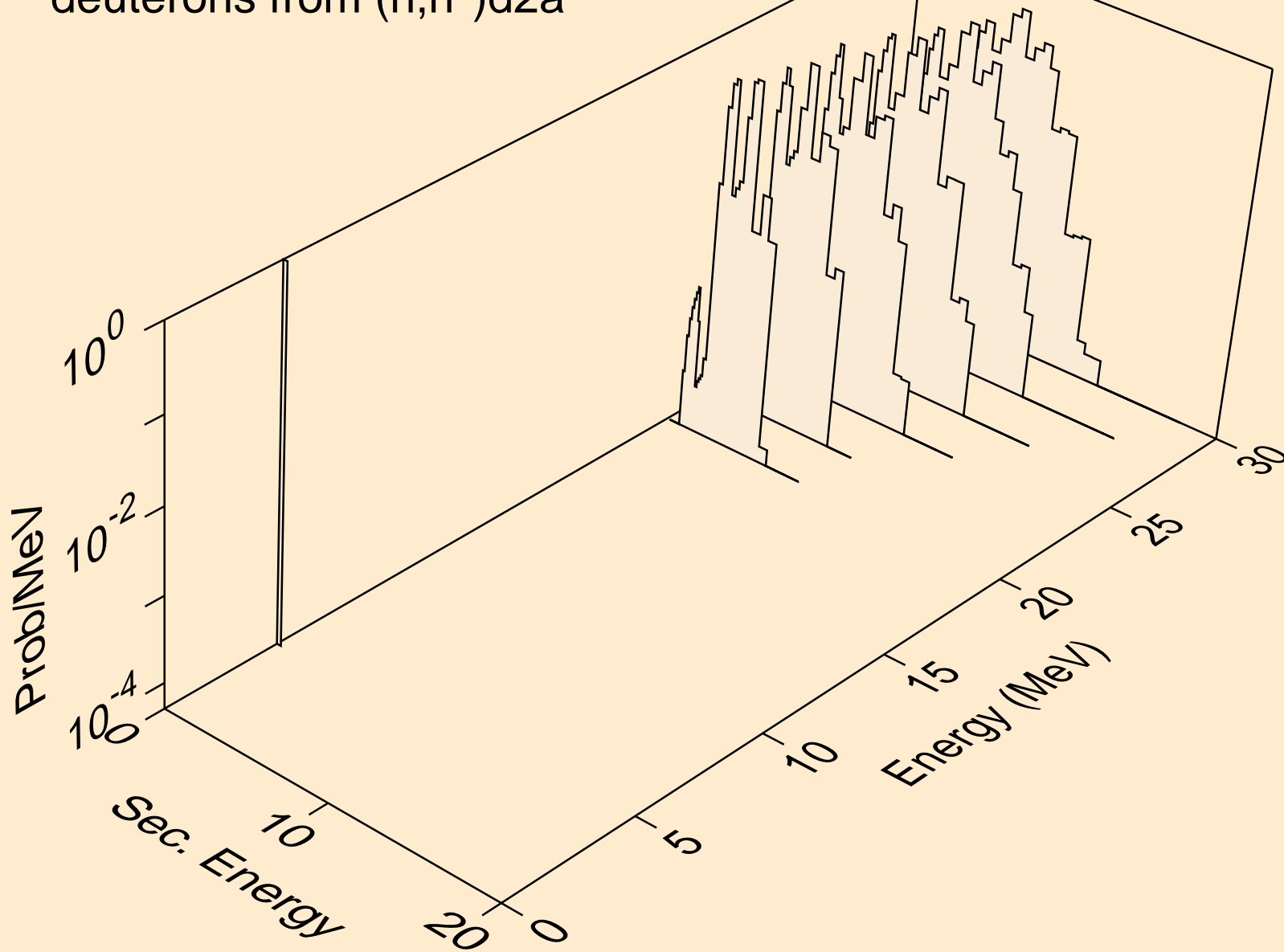

CS118M NEUTRON ACER TENDL-2019 LIBRARY; T=293.16K  
deuterons from (n,d)

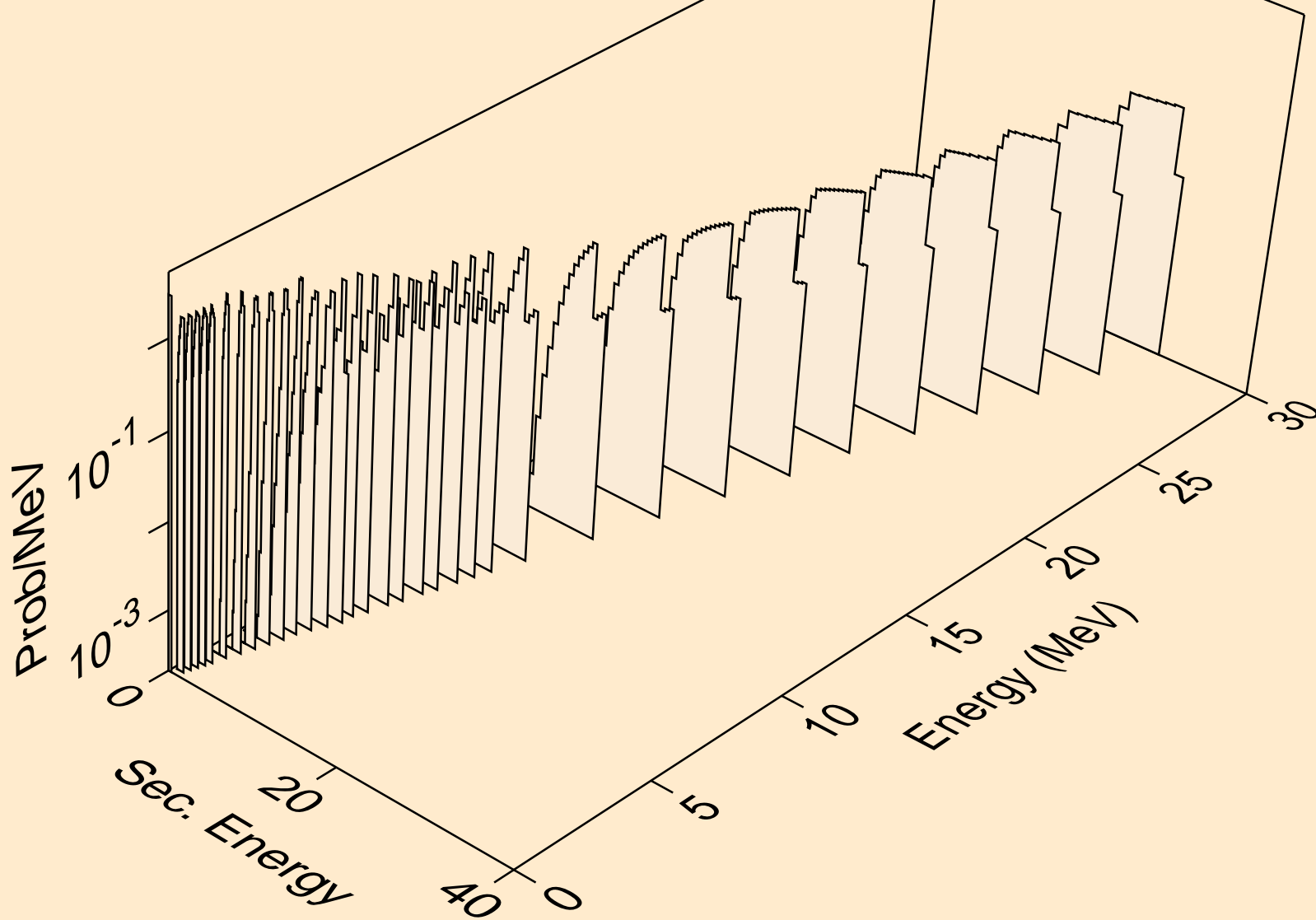

CS118M NEUTRON ACER TENDL-2019 LIBRARY; T=293.16K  
deuterons from (n,d2a)

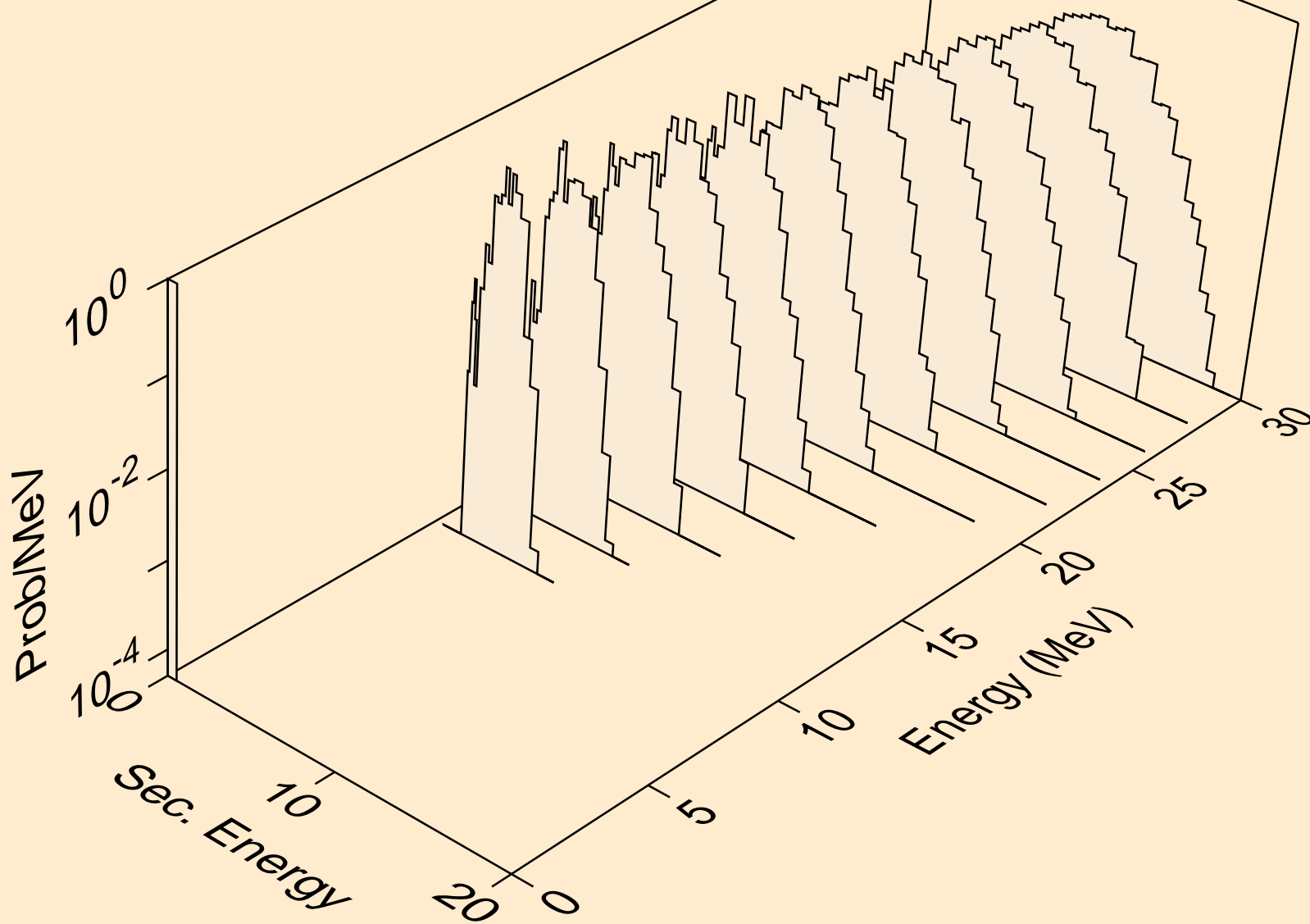

CS118M NEUTRON ACER TENDL-2019 LIBRARY; T=293.16K  
deuterons from (n,pd)

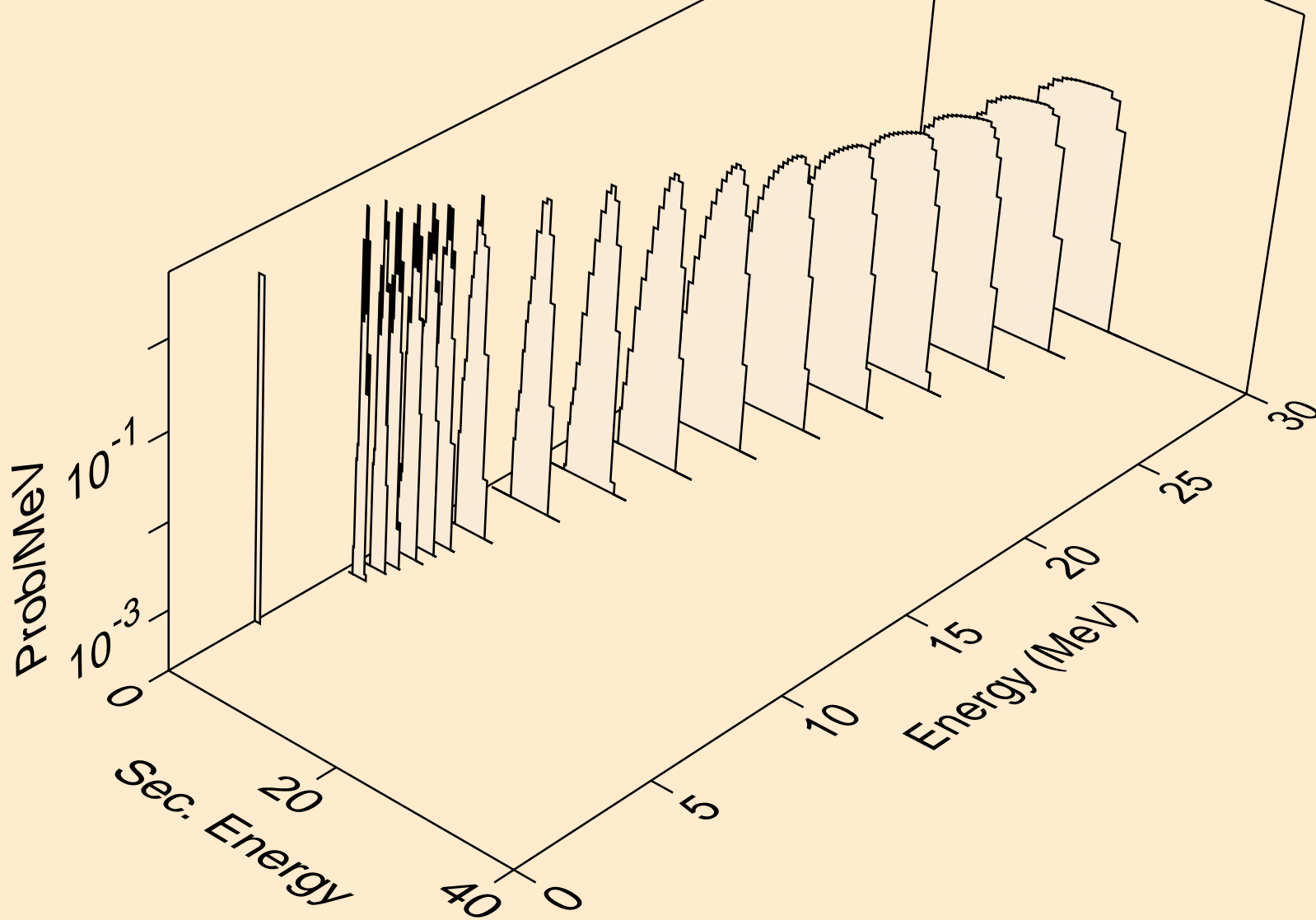

CS118M NEUTRON ACER TENDL-2019 LIBRARY; T=293.16K  
deuterons from (n,da)

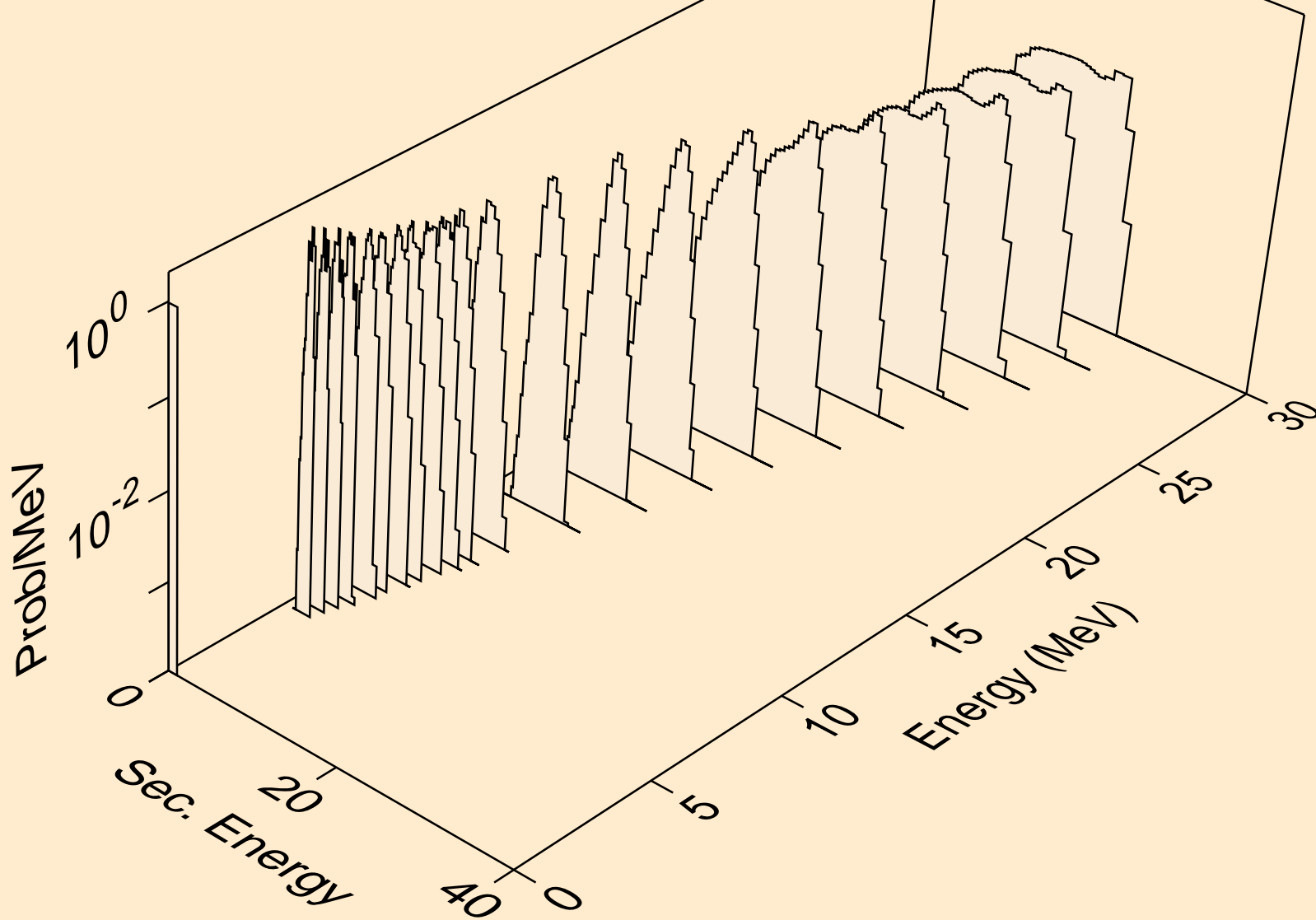



CS118M NEUTRON ACER TENDL-2019 LIBRARY; T=293.16K  
tritons from (n,x)

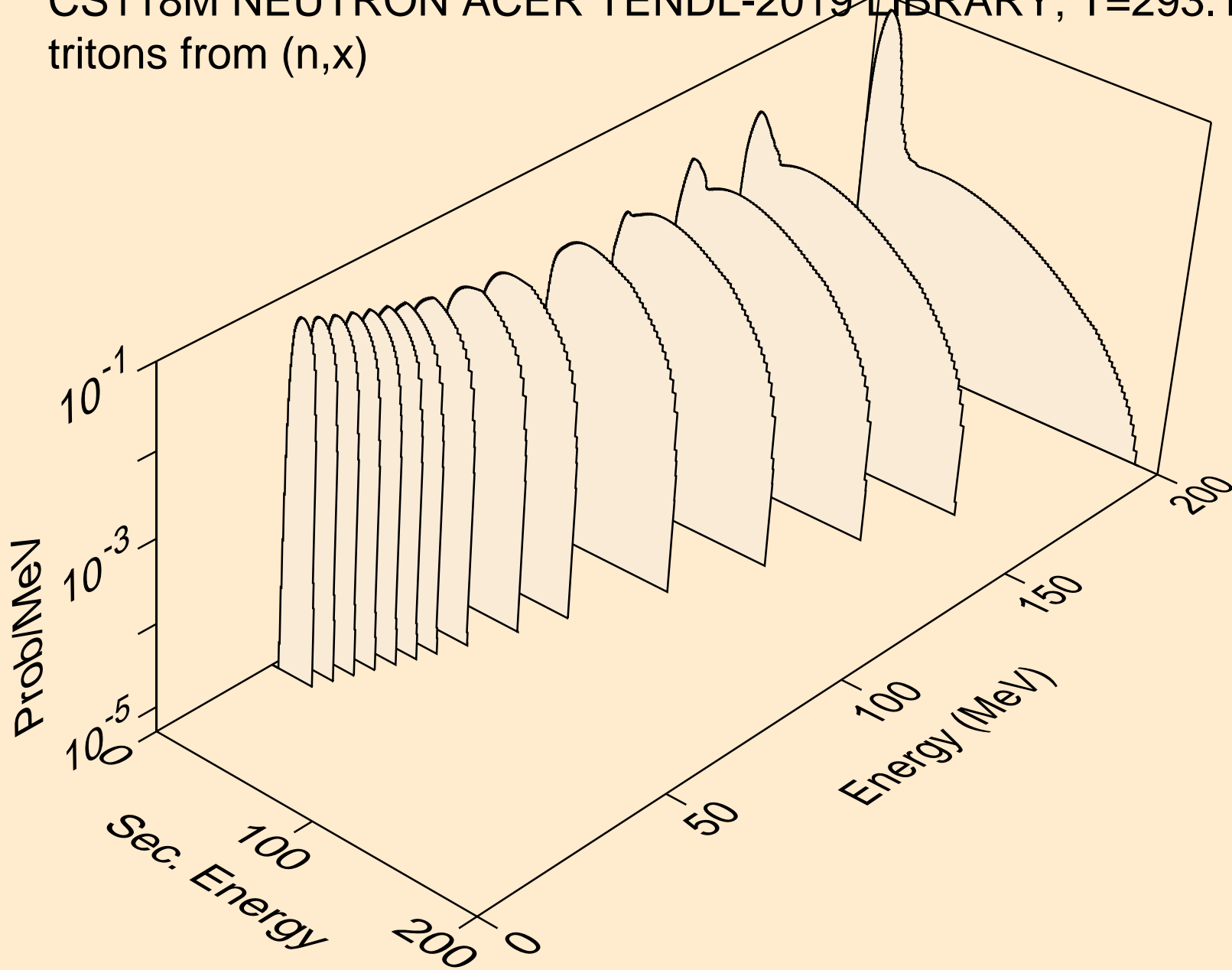

CS118M NEUTRON ACER TENDL-2019 LIBRARY; T=293.16K  
tritons from (n,n\*)t

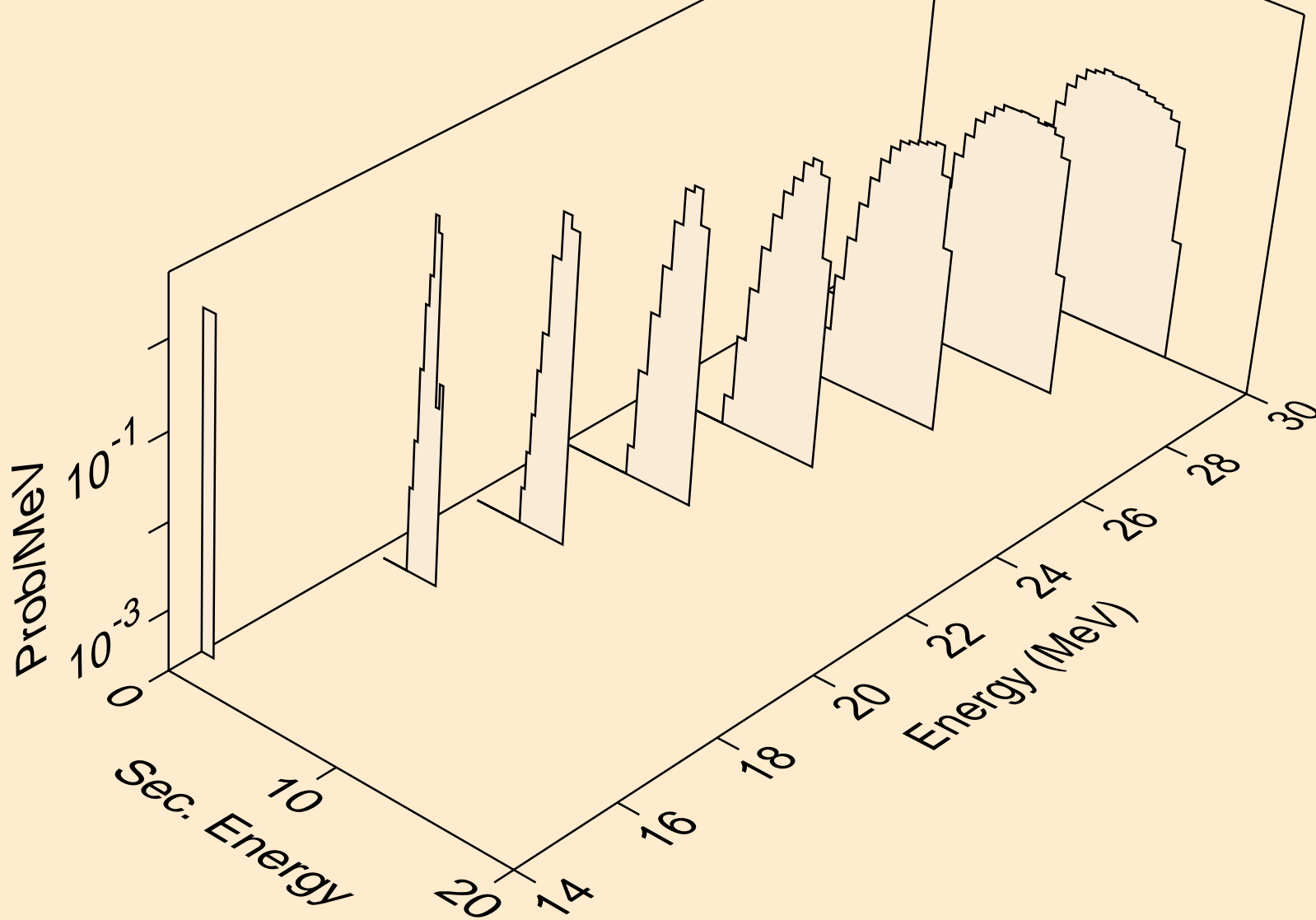

CS118M NEUTRON ACER TENDL-2019 LIBRARY; T=293.16K  
tritons from (n,t)

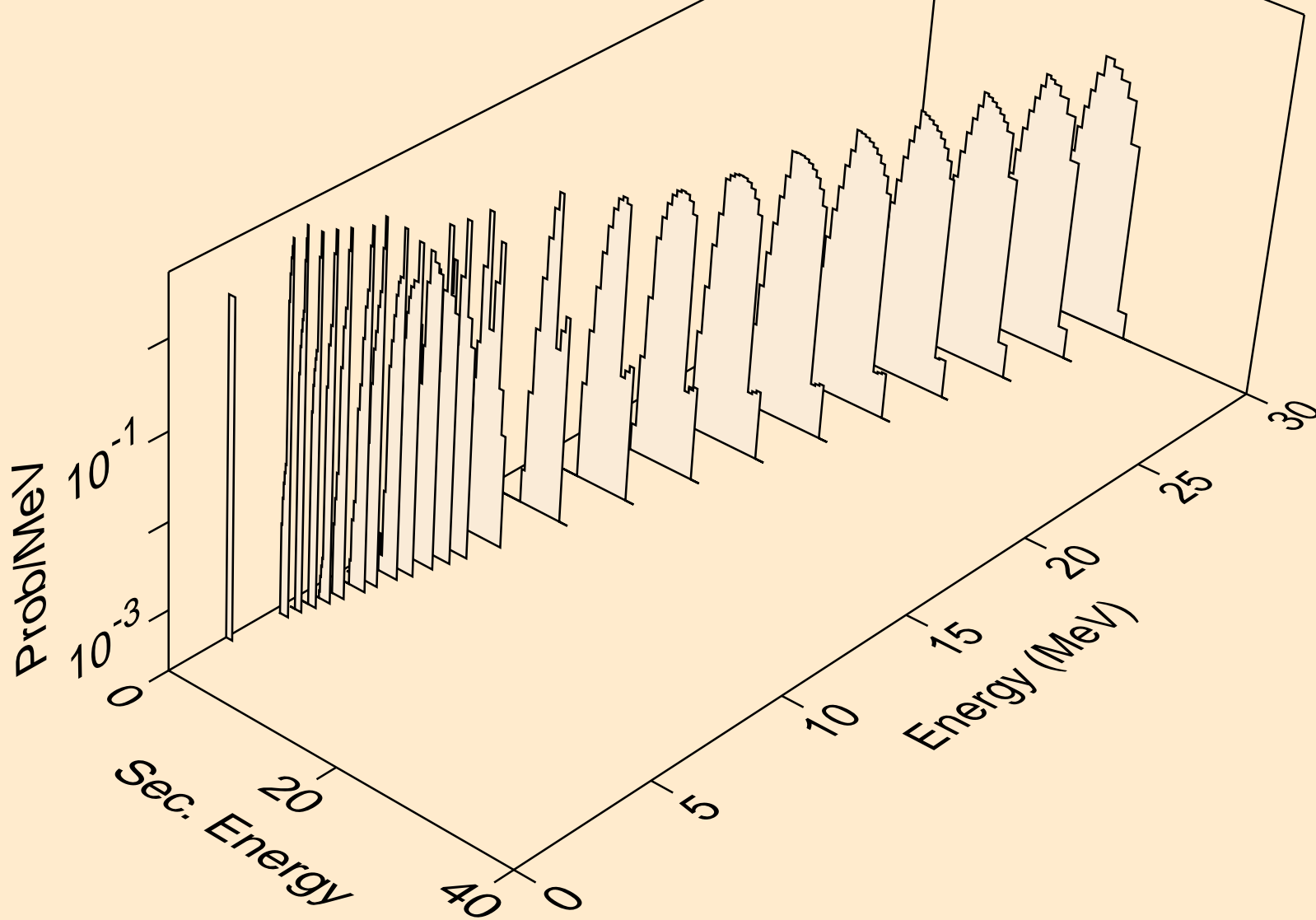

CS118M NEUTRON ACER TENDL-2019 LIBRARY; T=293.16K  
tritons from (n,t2a)

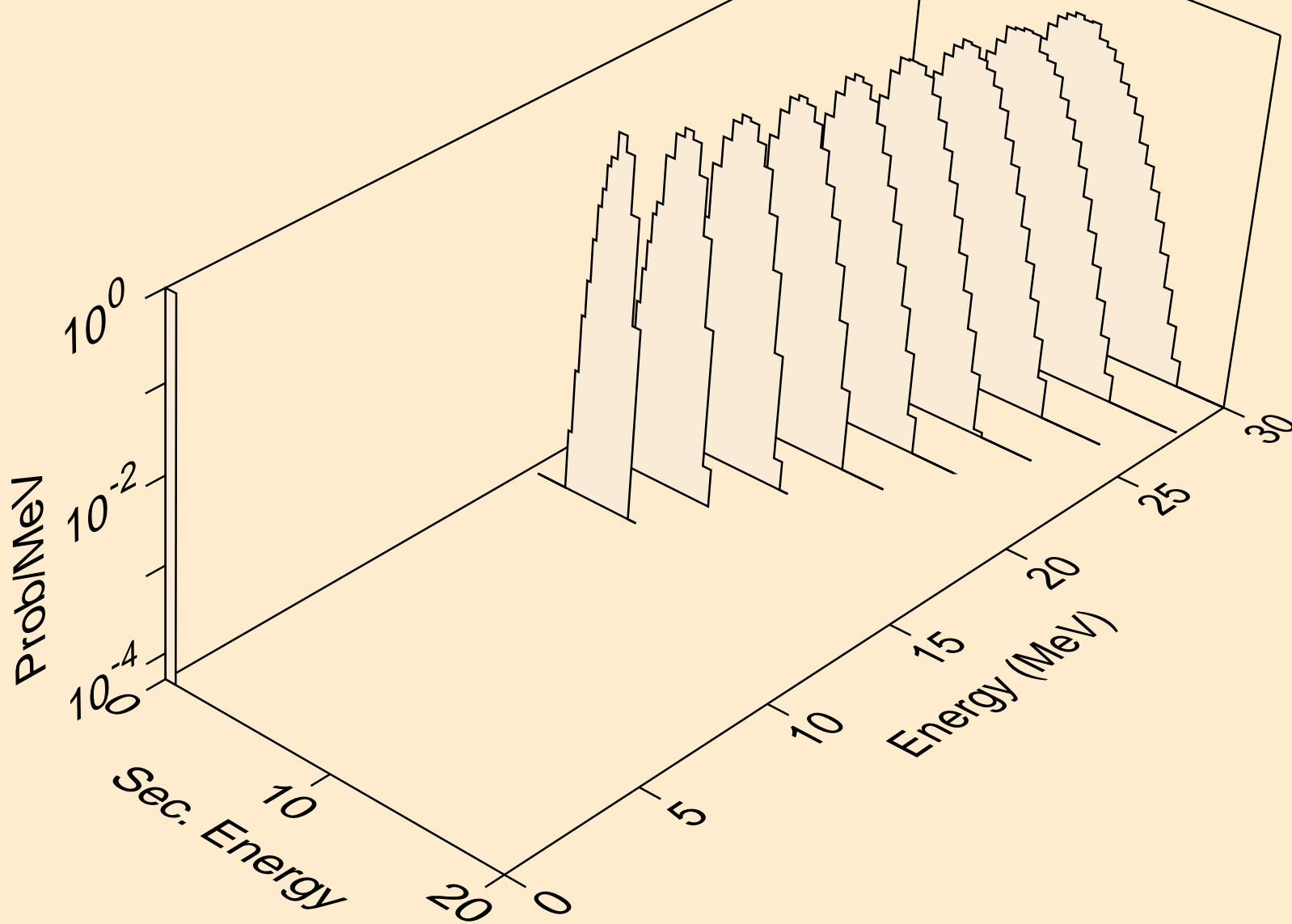

CS118M NEUTRON ACER TENDL-2019 LIBRARY; T=293.16K  
tritons from (n,pt)

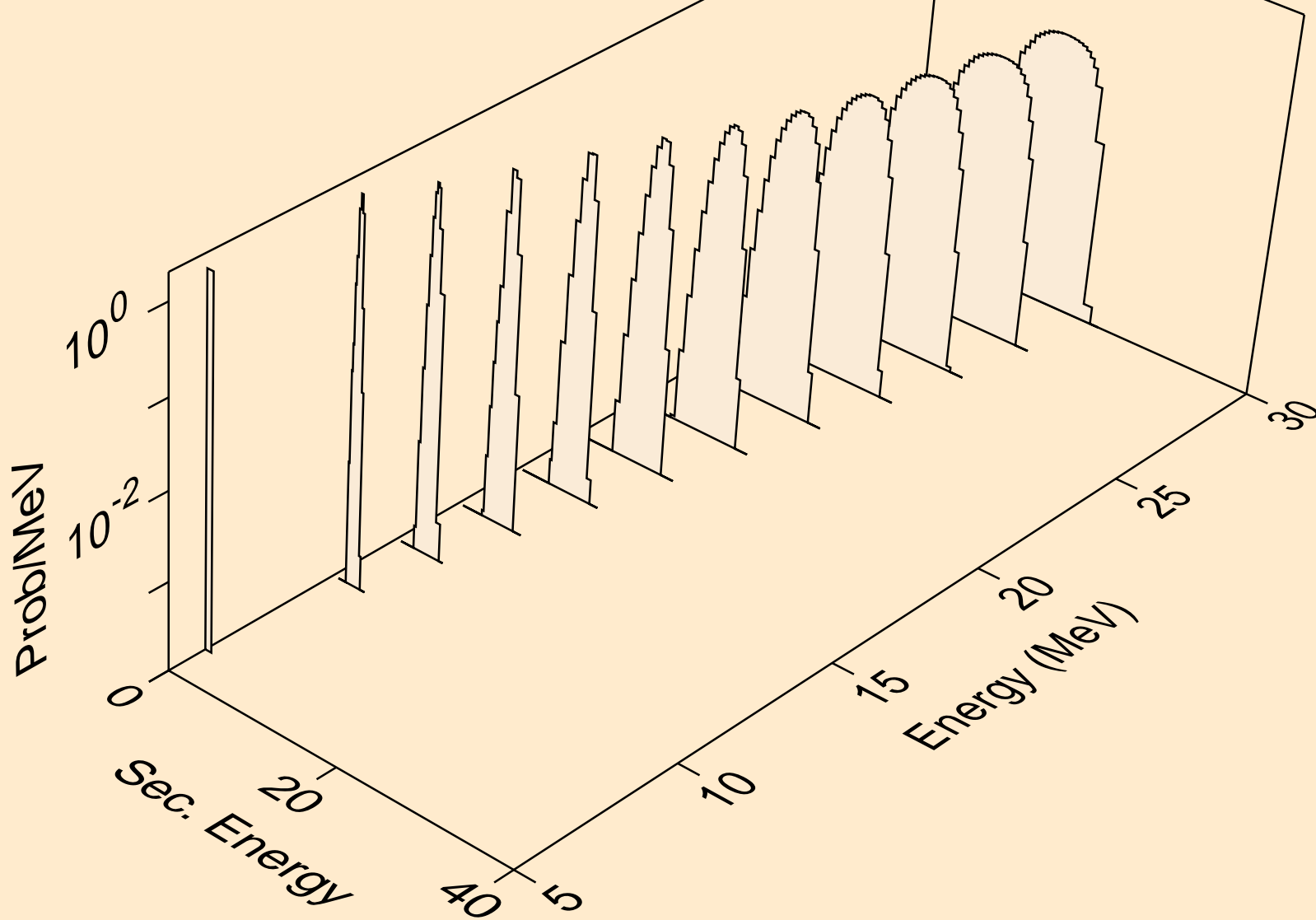

CS118M NEUTRON ACER TENDL-2019 LIBRARY; T=293.16K  
he3s from (n,x)

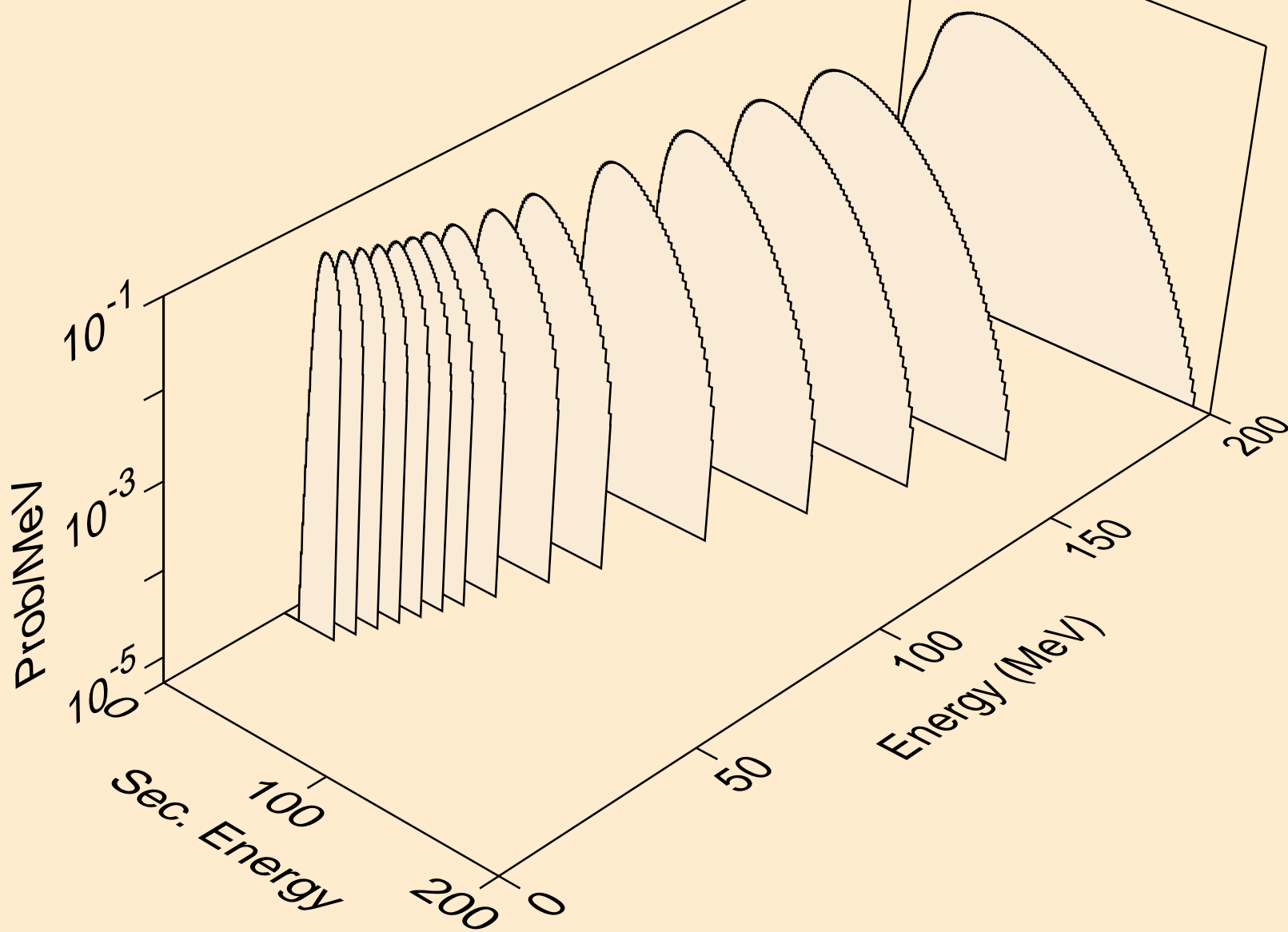

CS118M NEUTRON ACER TENDL-2019 LIBRARY; T=293.16K  
he3s from (n,n\*)he3

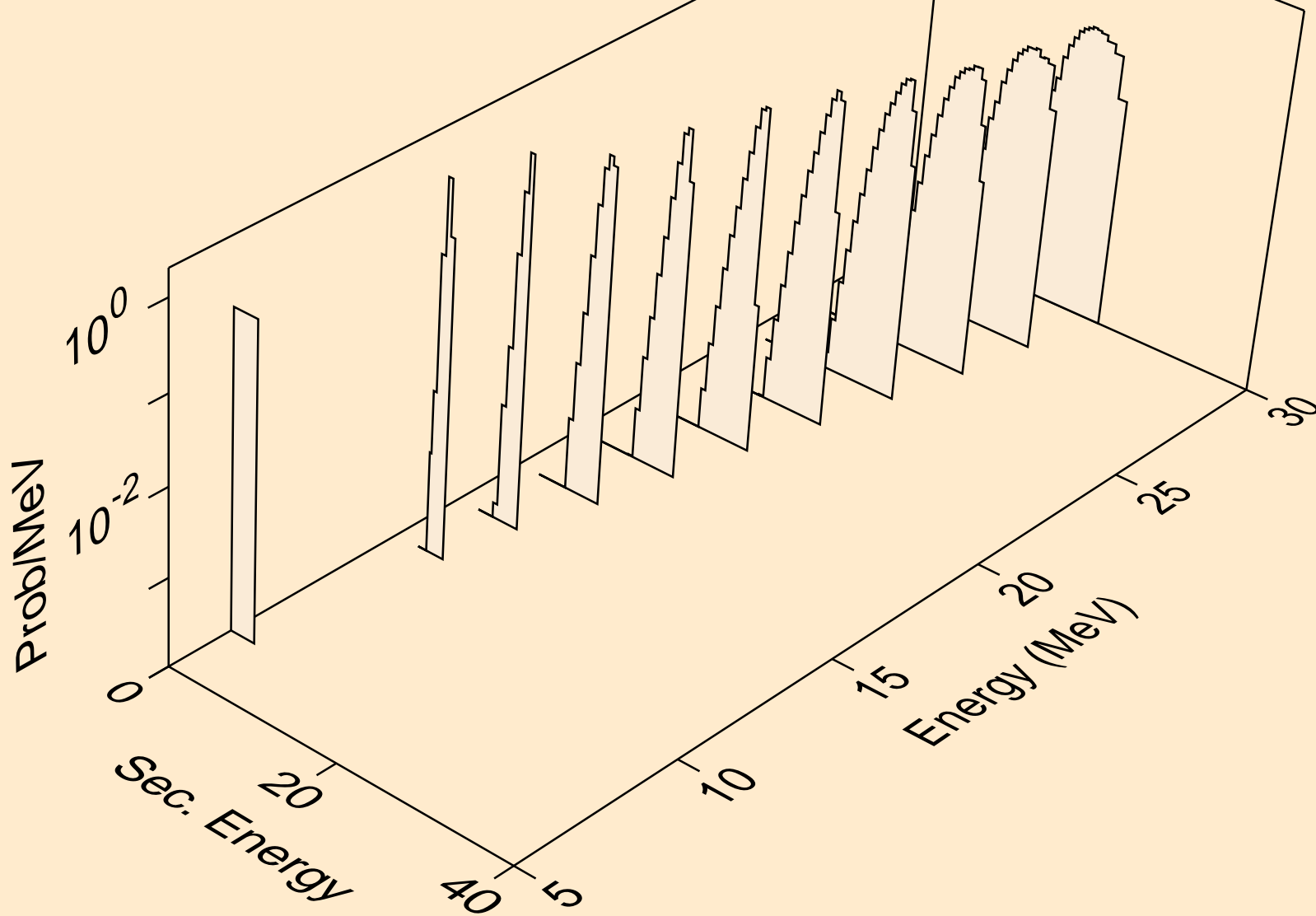

CS118M NEUTRON ACER TENDL-2019 LIBRARY; T=293.16K  
he3s from (n,he3)

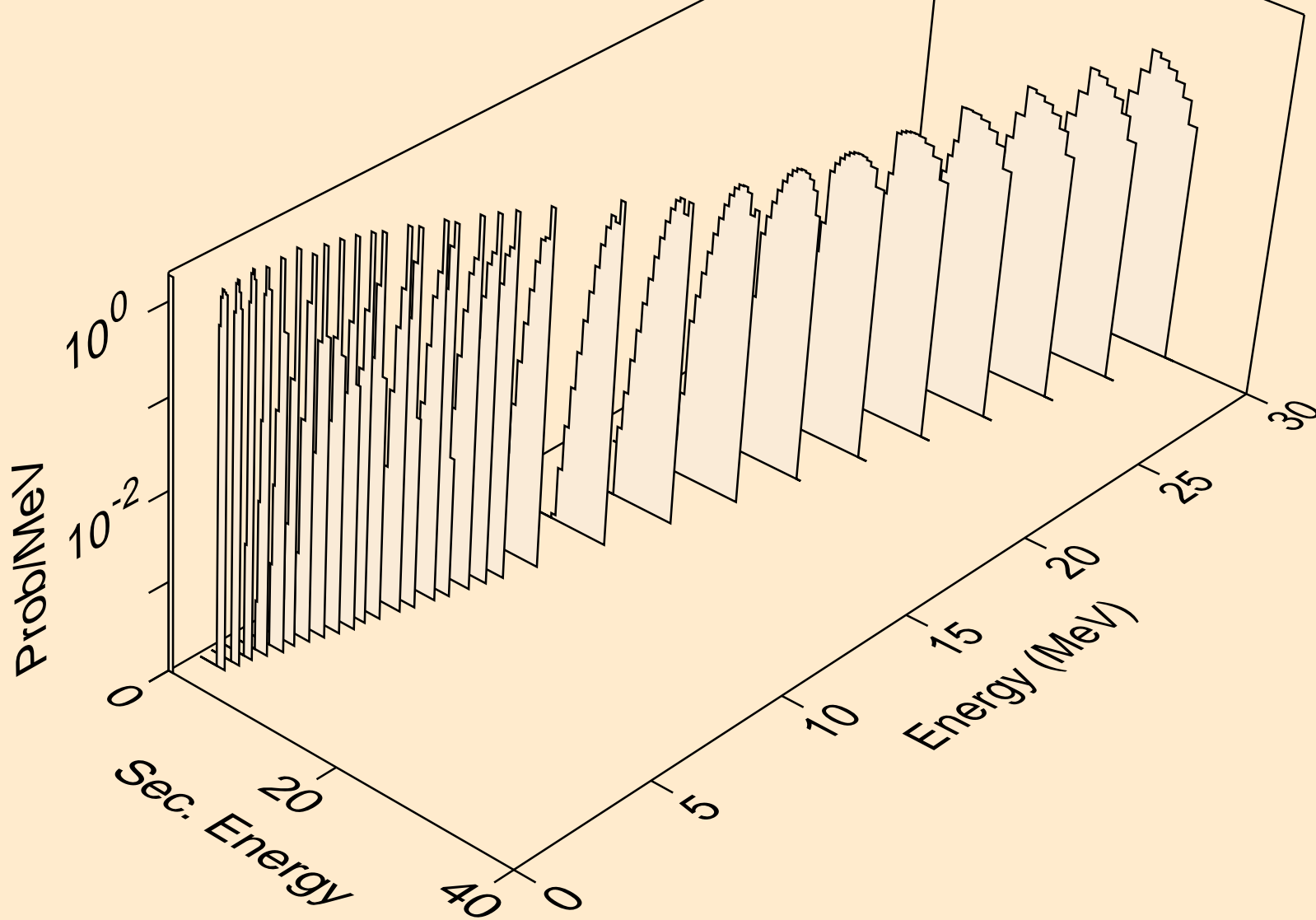



CS118M NEUTRON ACER TENDL-2019 LIBRARY; T=293.16K  
alphas from (n,x)

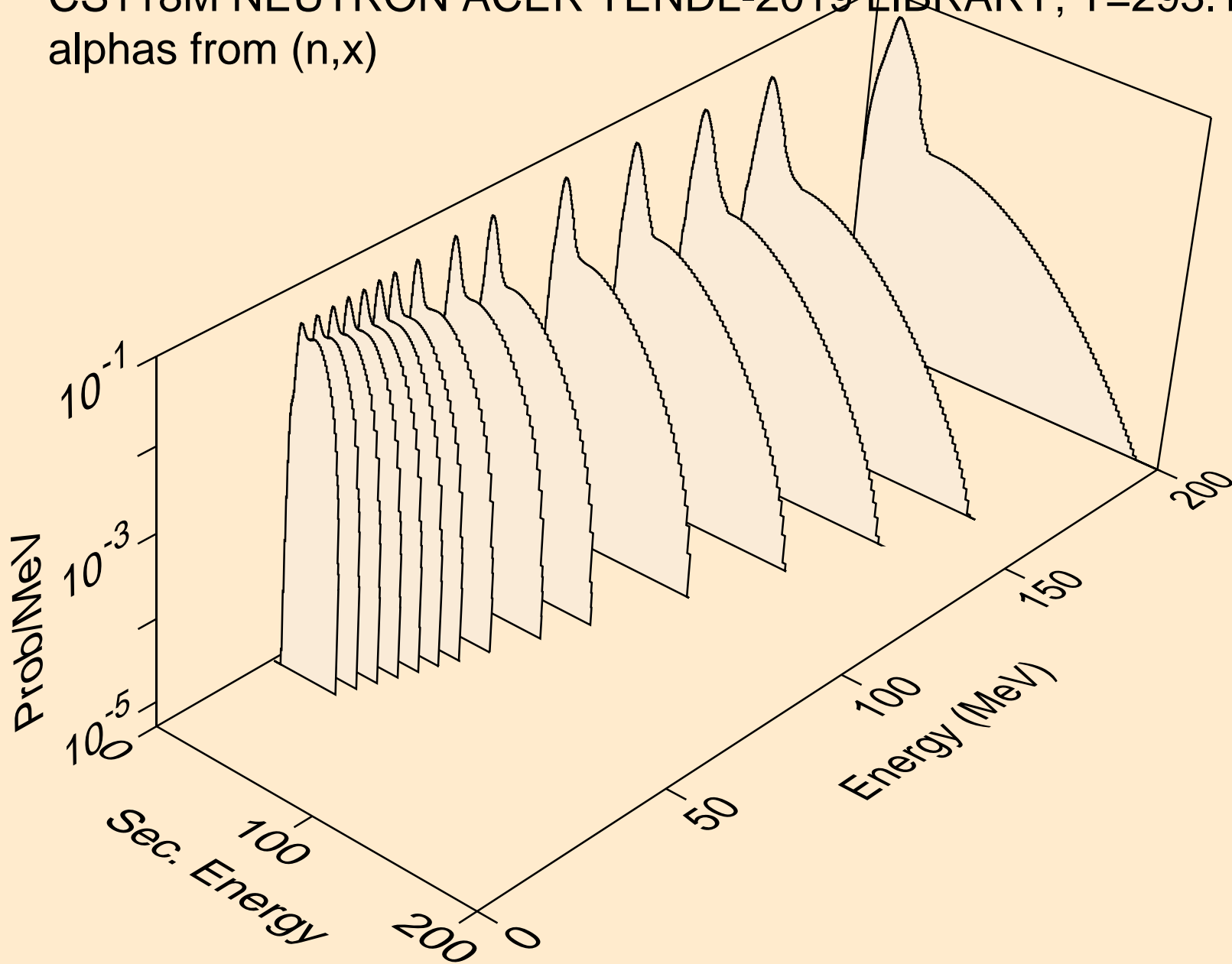

CS118M NEUTRON ACER TENDL-2019 LIBRARY; T=293.16K  
alphas from (n,n\*)a

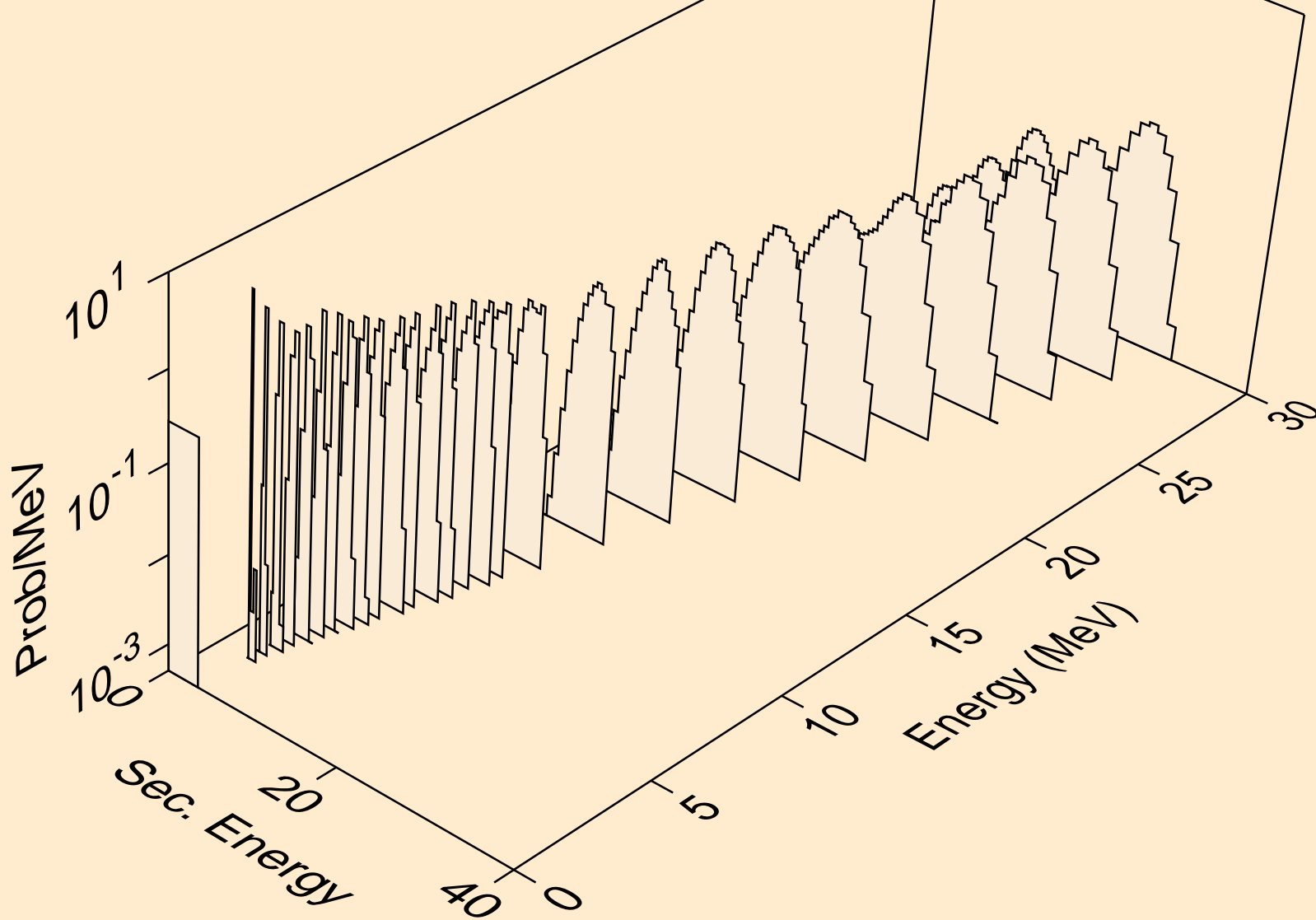

CS118M NEUTRON ACER TENDL-2019 LIBRARY; T=293.16K  
alphas from (n,n\*)3a

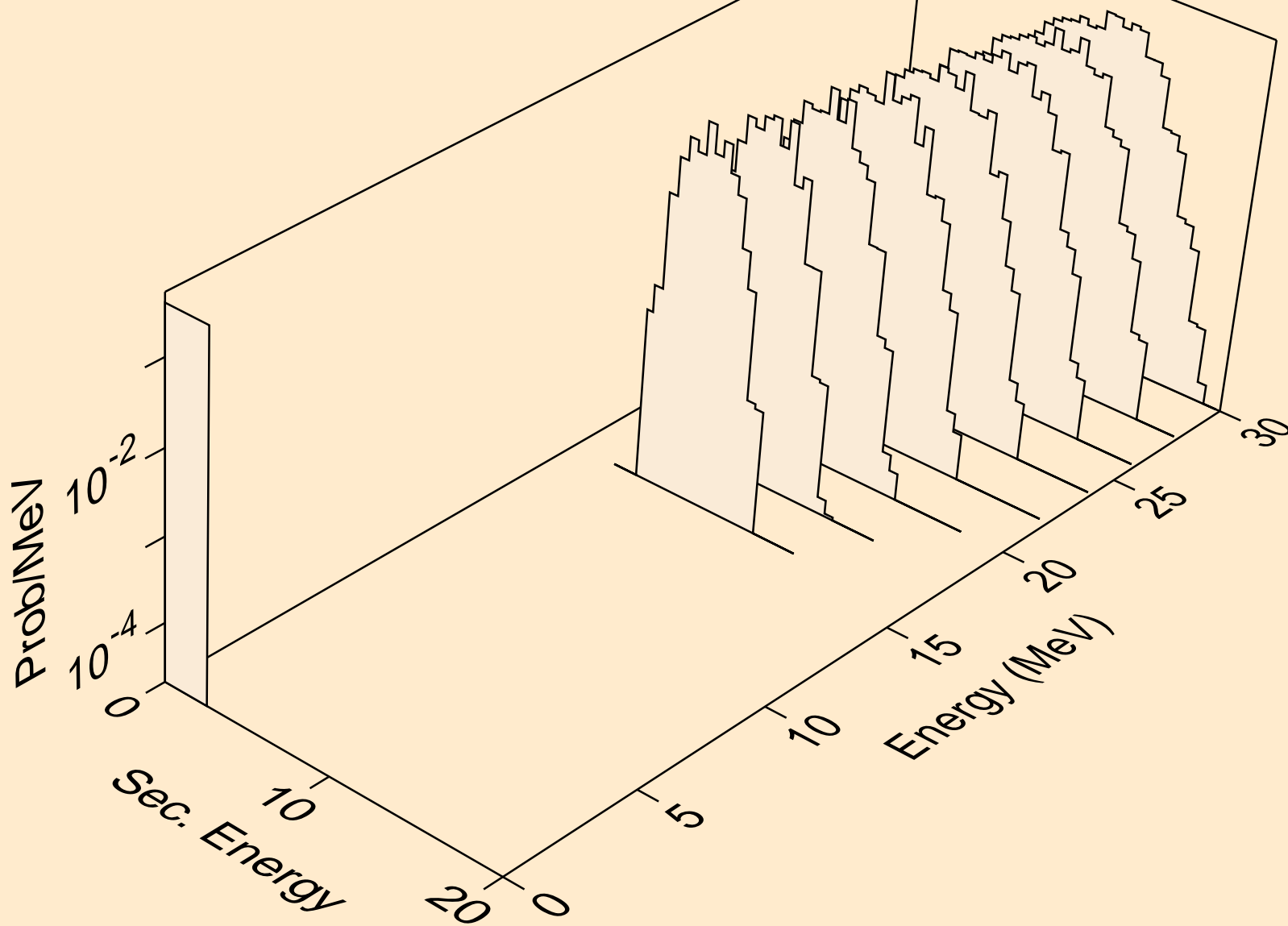

CS118M NEUTRON ACER TENDL-2019 LIBRARY; T=293.16K  
alphas from (n,2n)a

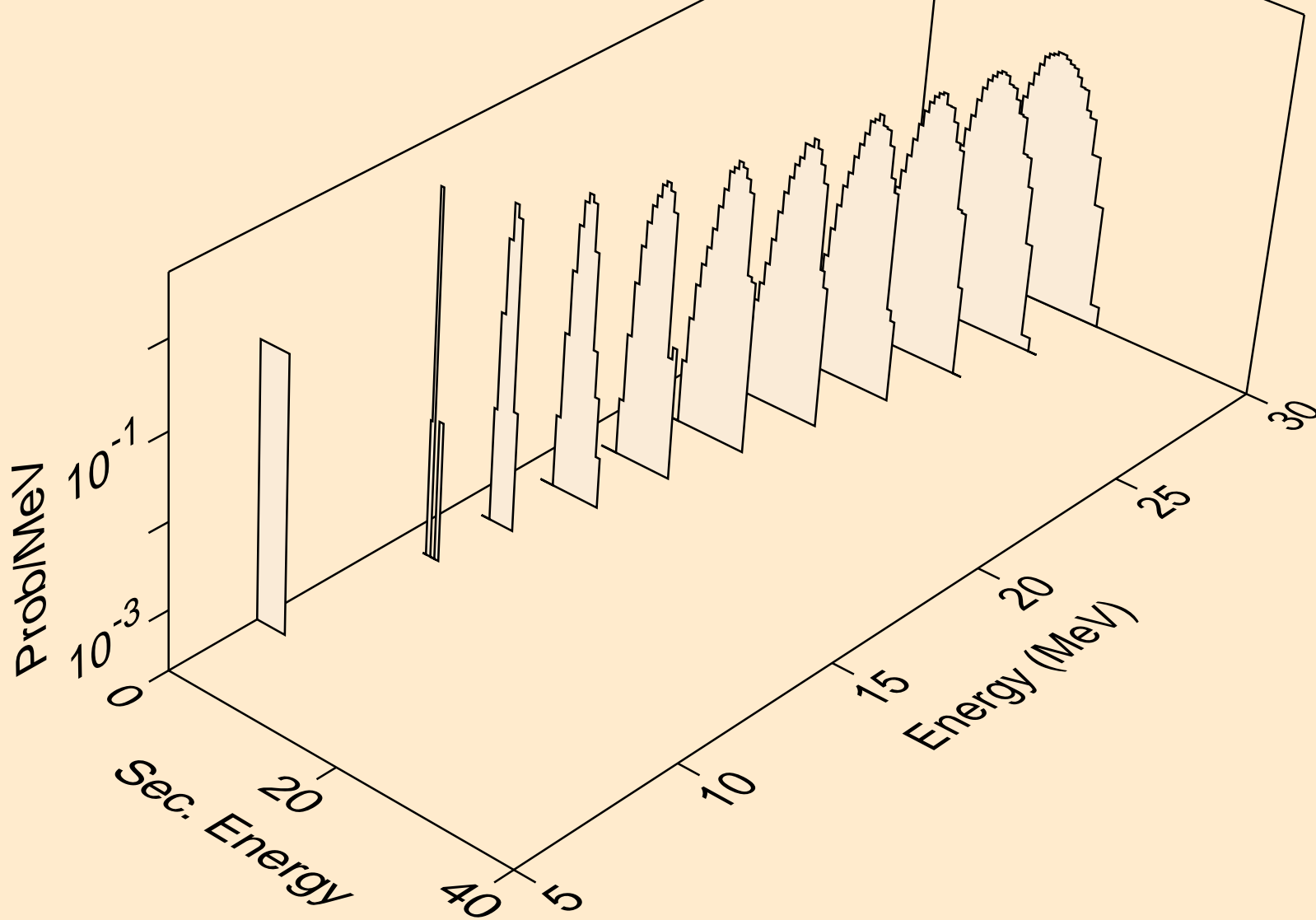

CS118M NEUTRON ACER TENDL-2019 LIBRARY; T=293.16K  
alphas from (n,3n)a

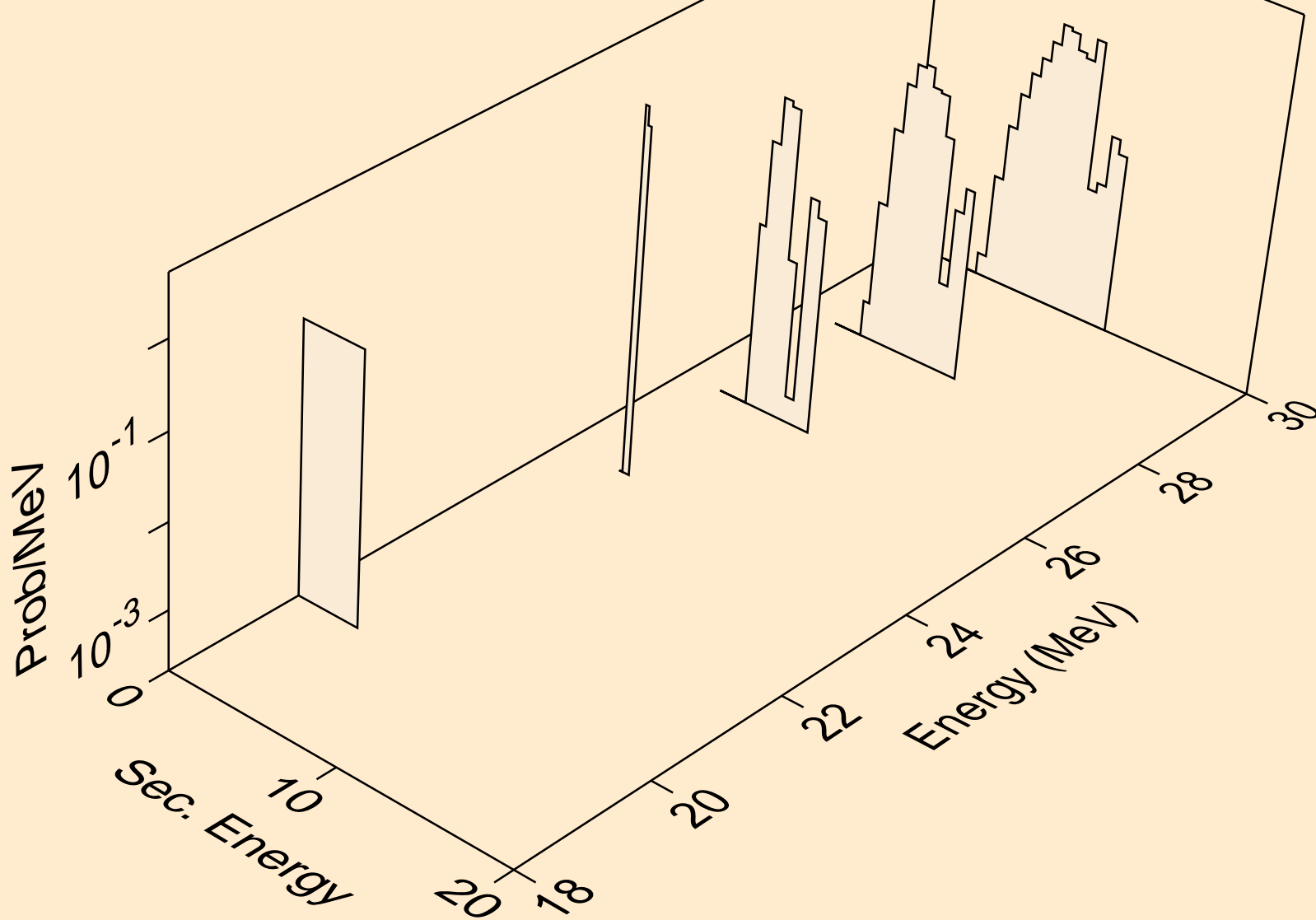

CS118M NEUTRON ACER TENDL-2019 LIBRARY; T=293.16K  
alphas from (n,n\*)2a

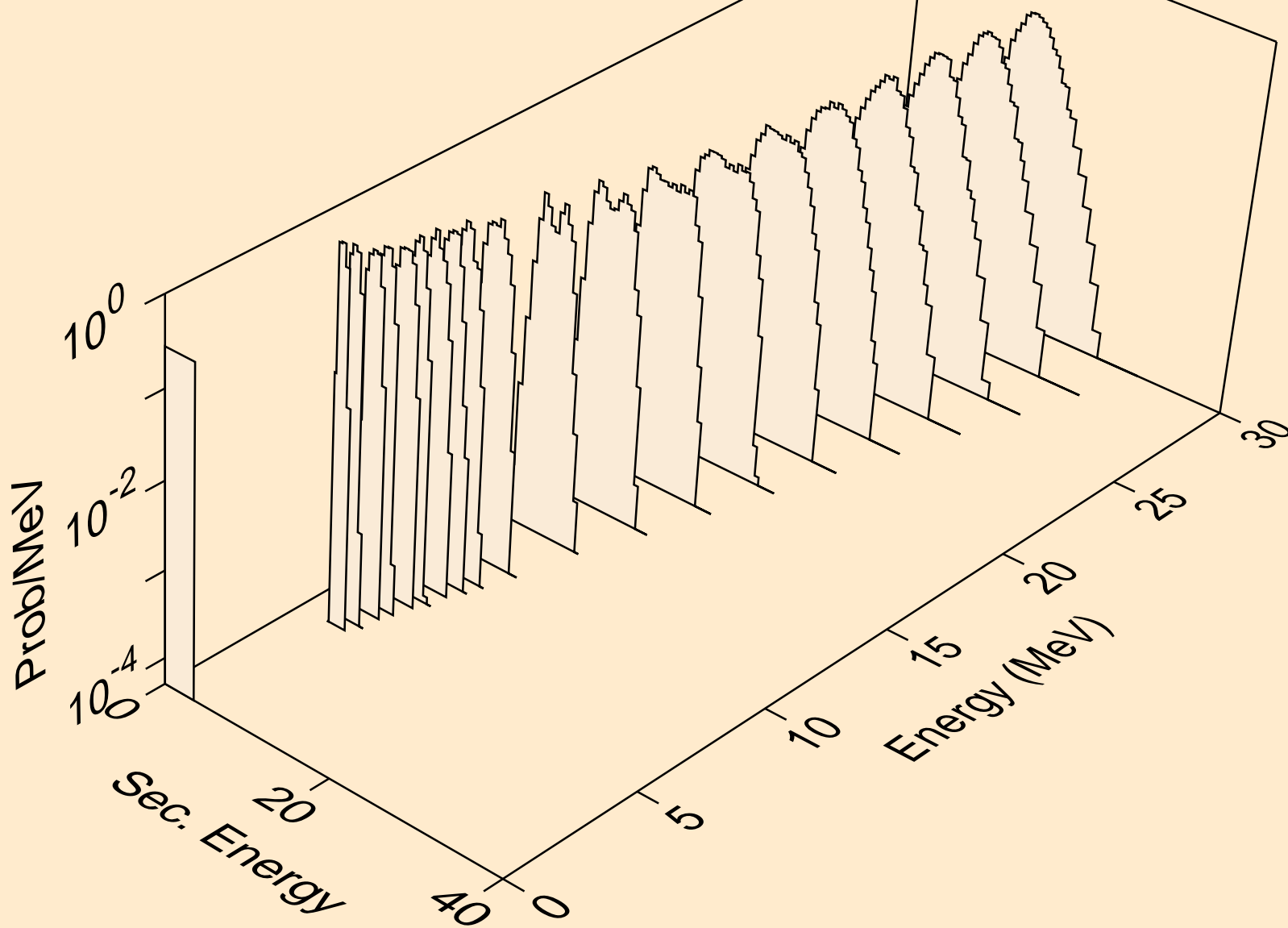

CS118M NEUTRON ACER TENDL-2019 LIBRARY; T=293.16K  
alphas from (n,2n)2a

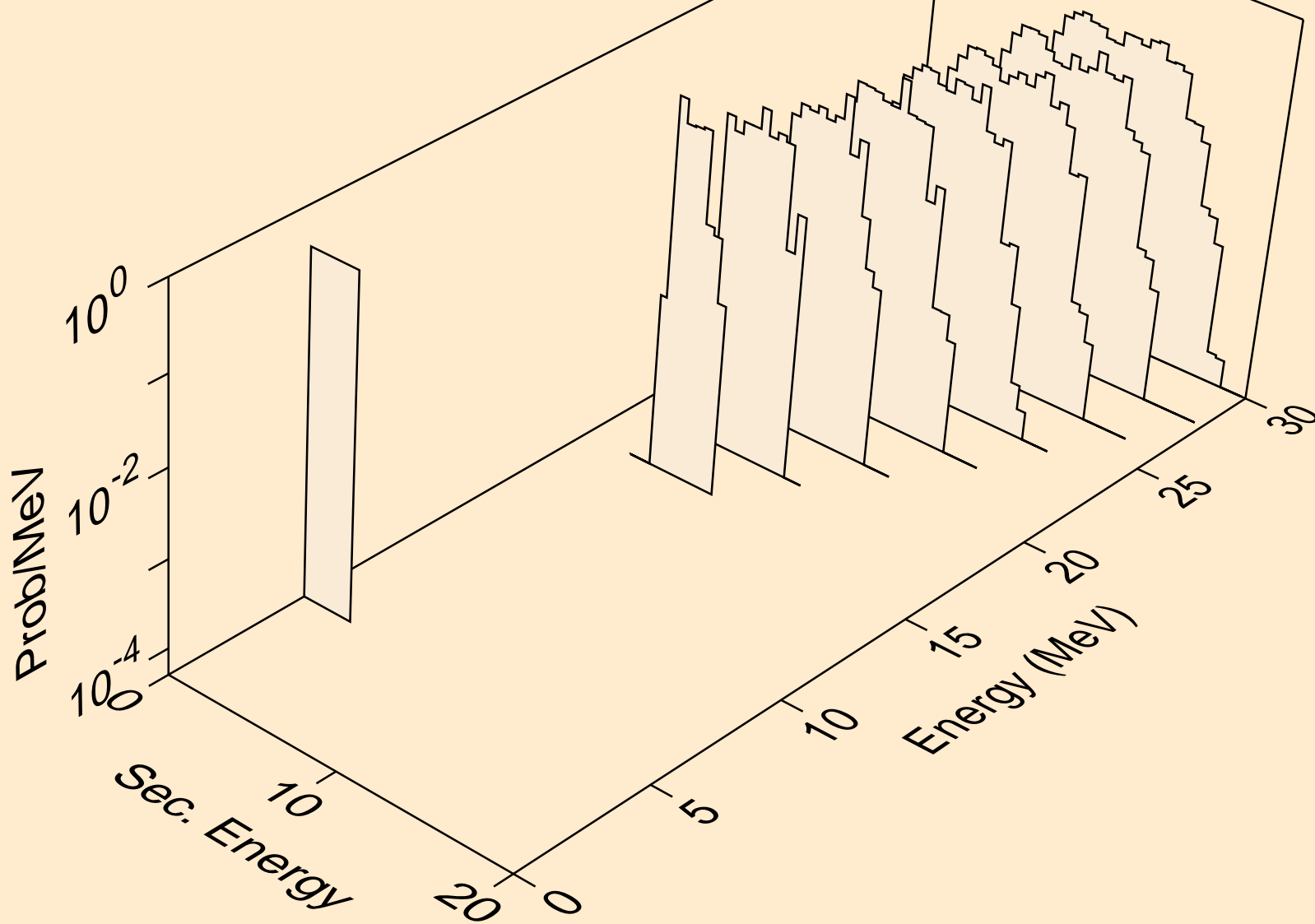

CS118M NEUTRON ACER TENDL-2019 LIBRARY; T=293.16K  
alphas from (n,n\*)d2a

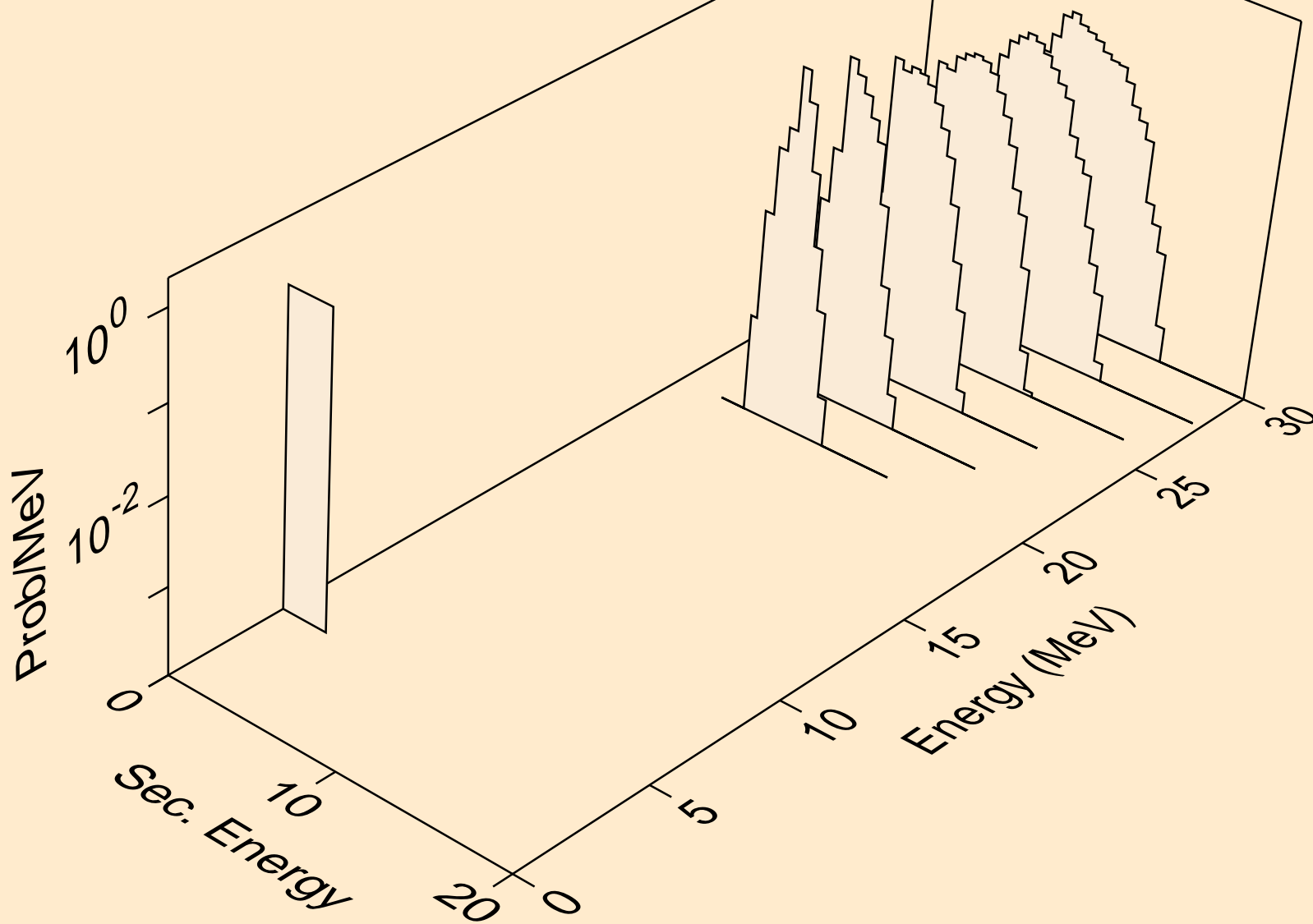



CS118M NEUTRON ACER TENDL-2019 LIBRARY; T=293.16K  
alphas from (n,npa)

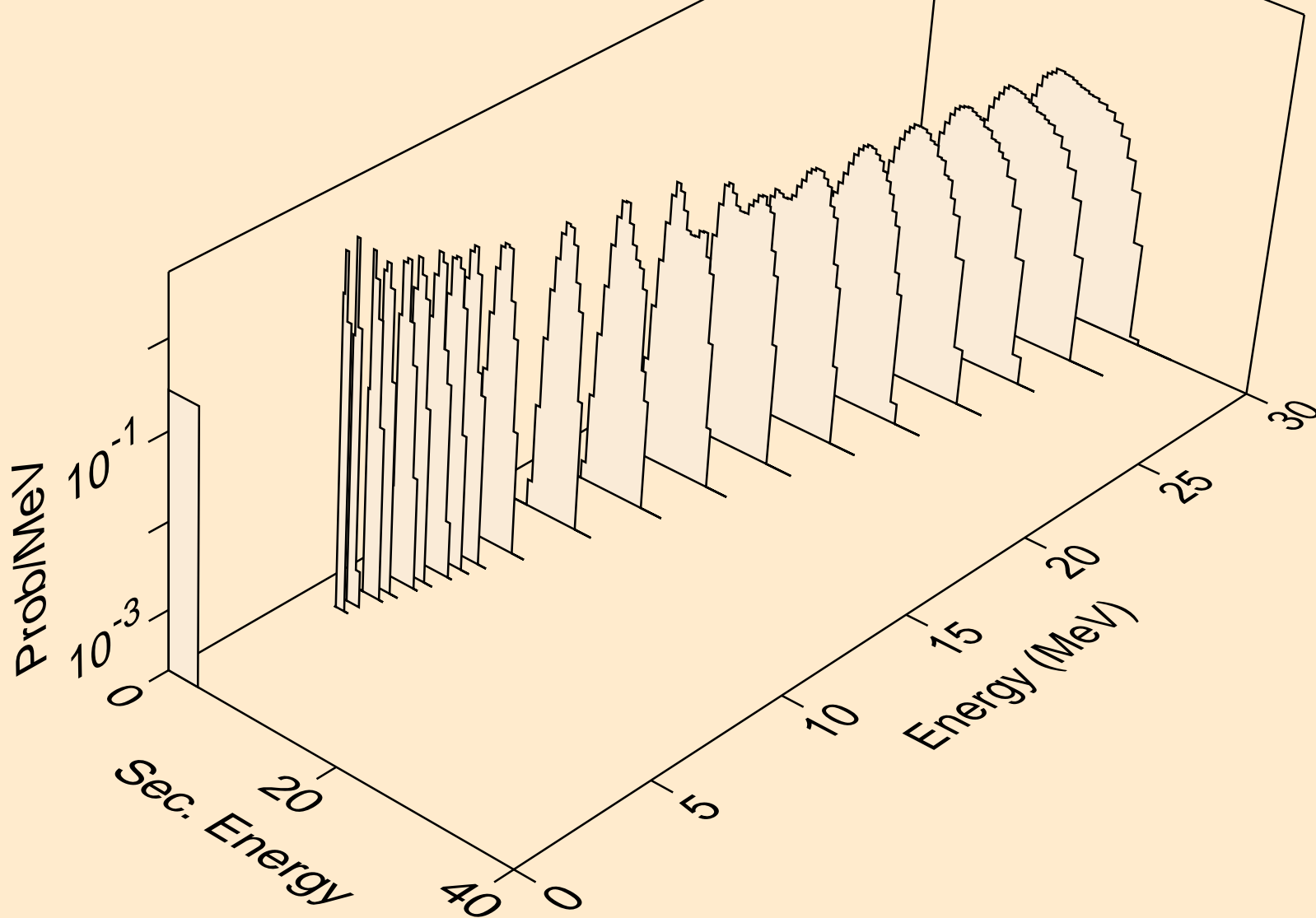

CS118M NEUTRON ACER TENDL-2019 LIBRARY; T=293.16K  
alphas from (n,a)

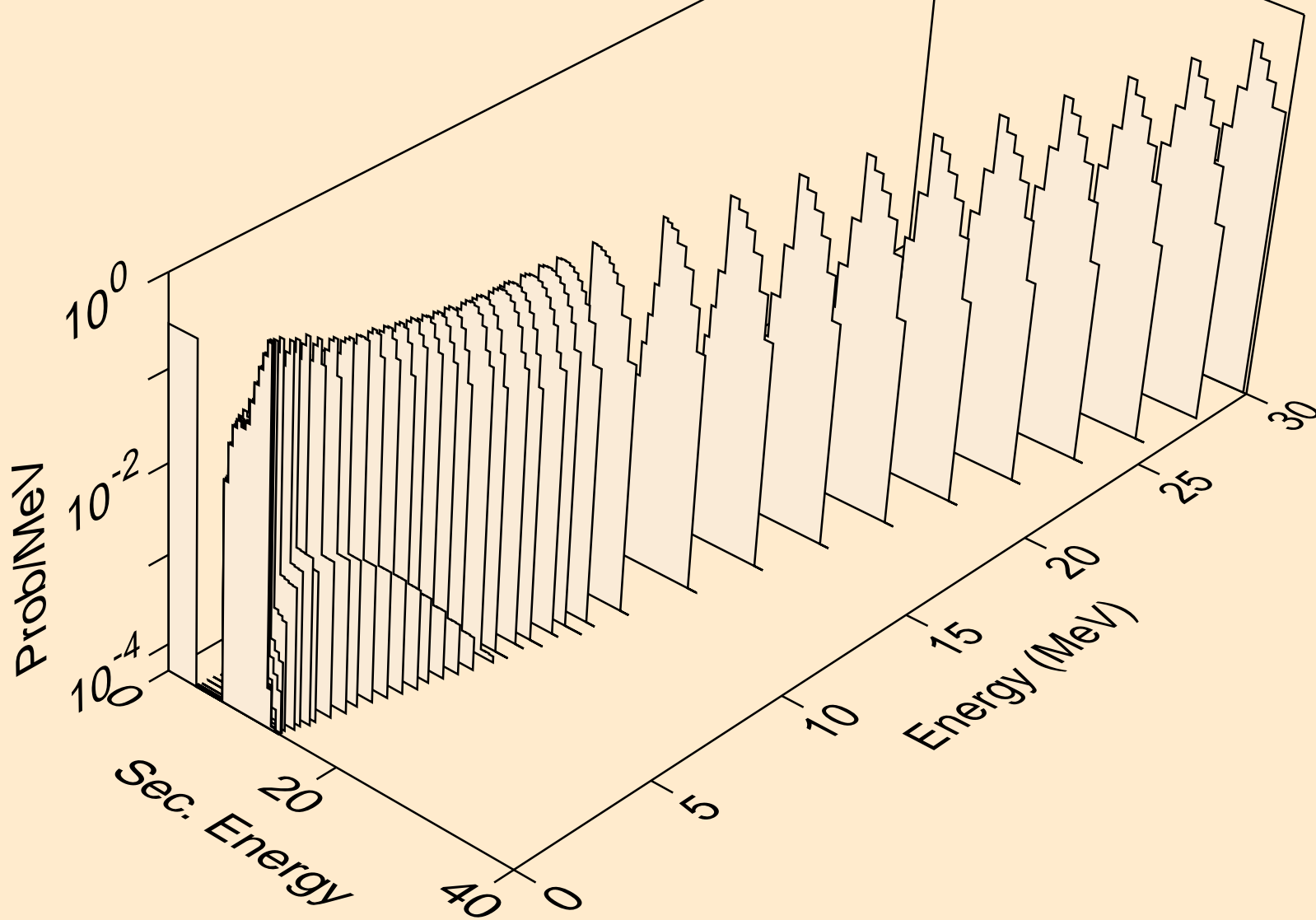

CS118M NEUTRON ACER TENDL-2019 LIBRARY; T=293.16K  
alphas from (n,2a)

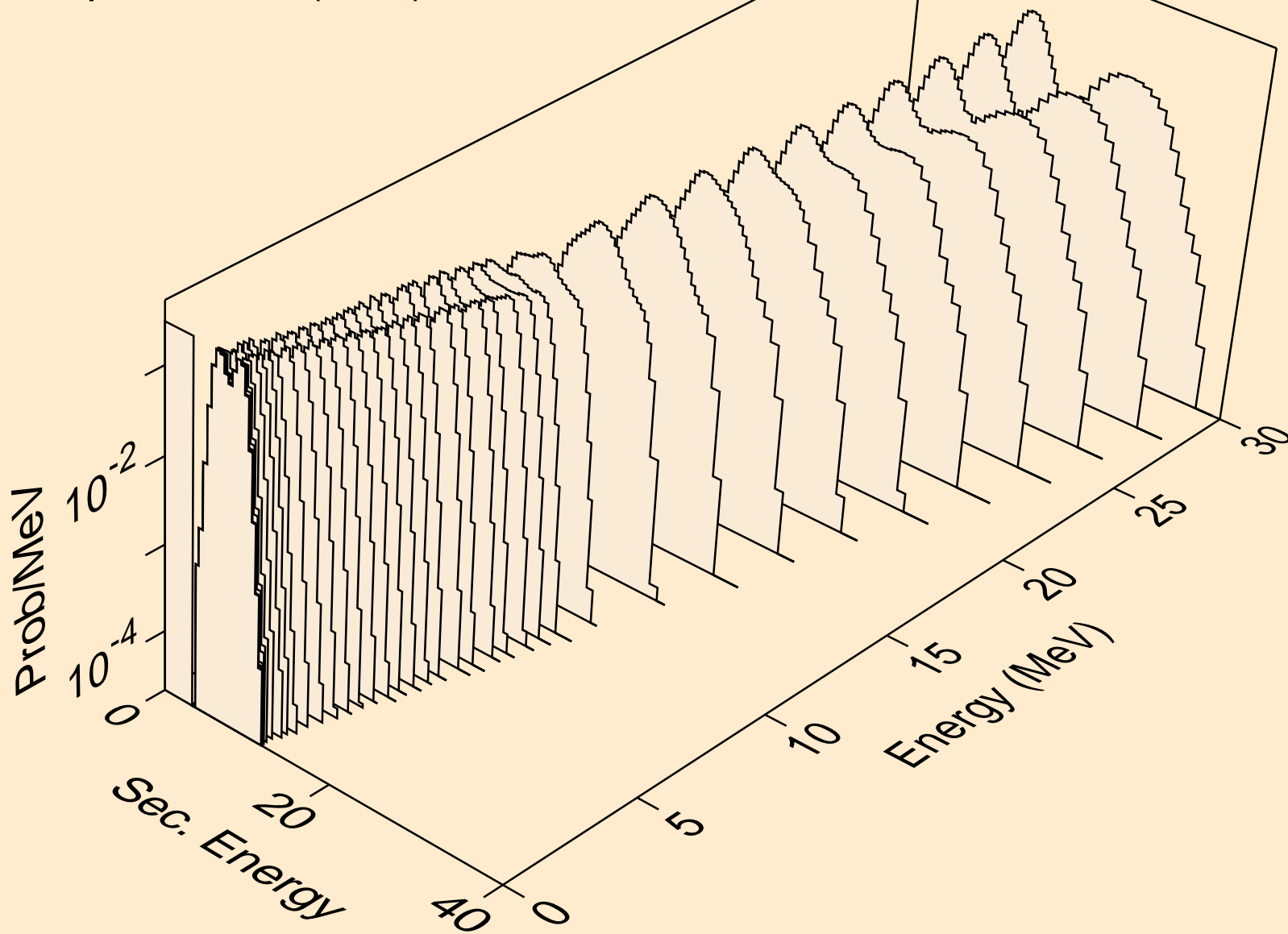

CS118M NEUTRON ACER TENDL-2019 LIBRARY; T=293.16K  
alphas from (n,3a)

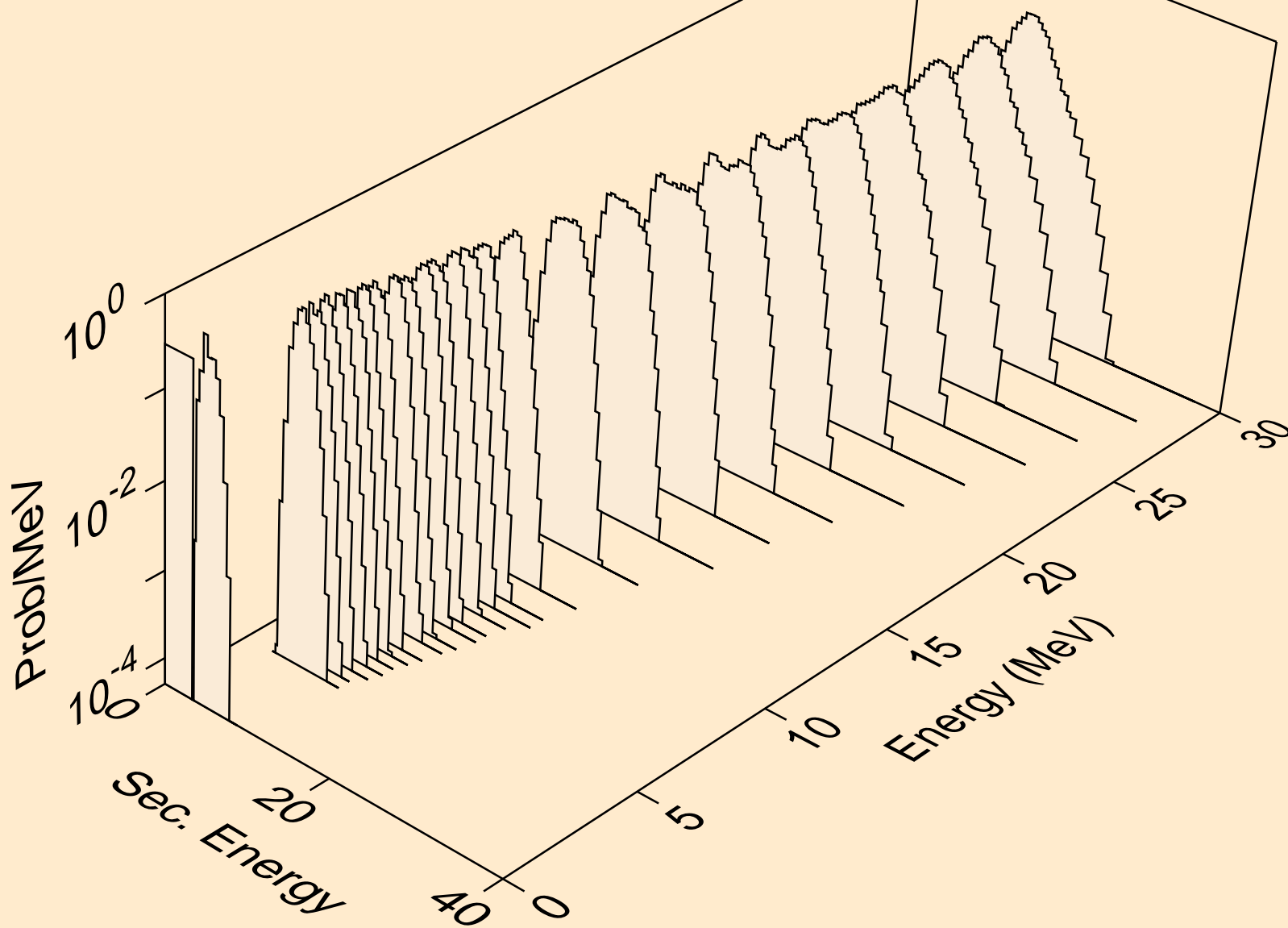

CS118M NEUTRON ACER TENDL-2019 LIBRARY; T=293.16K  
alphas from (n,pa)

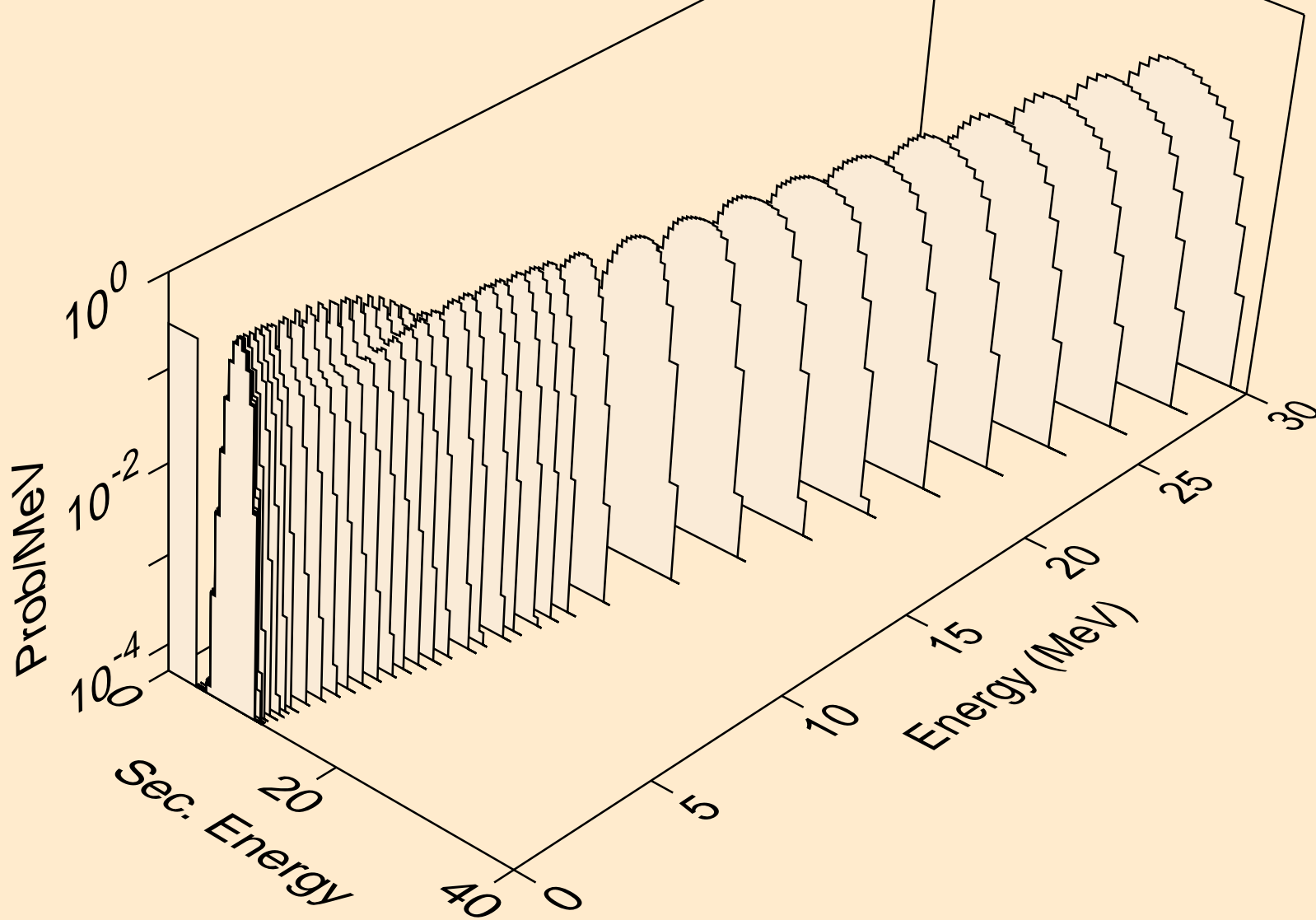

CS118M NEUTRON ACER TENDL-2019 LIBRARY; T=293.16K  
alphas from (n,t2a)

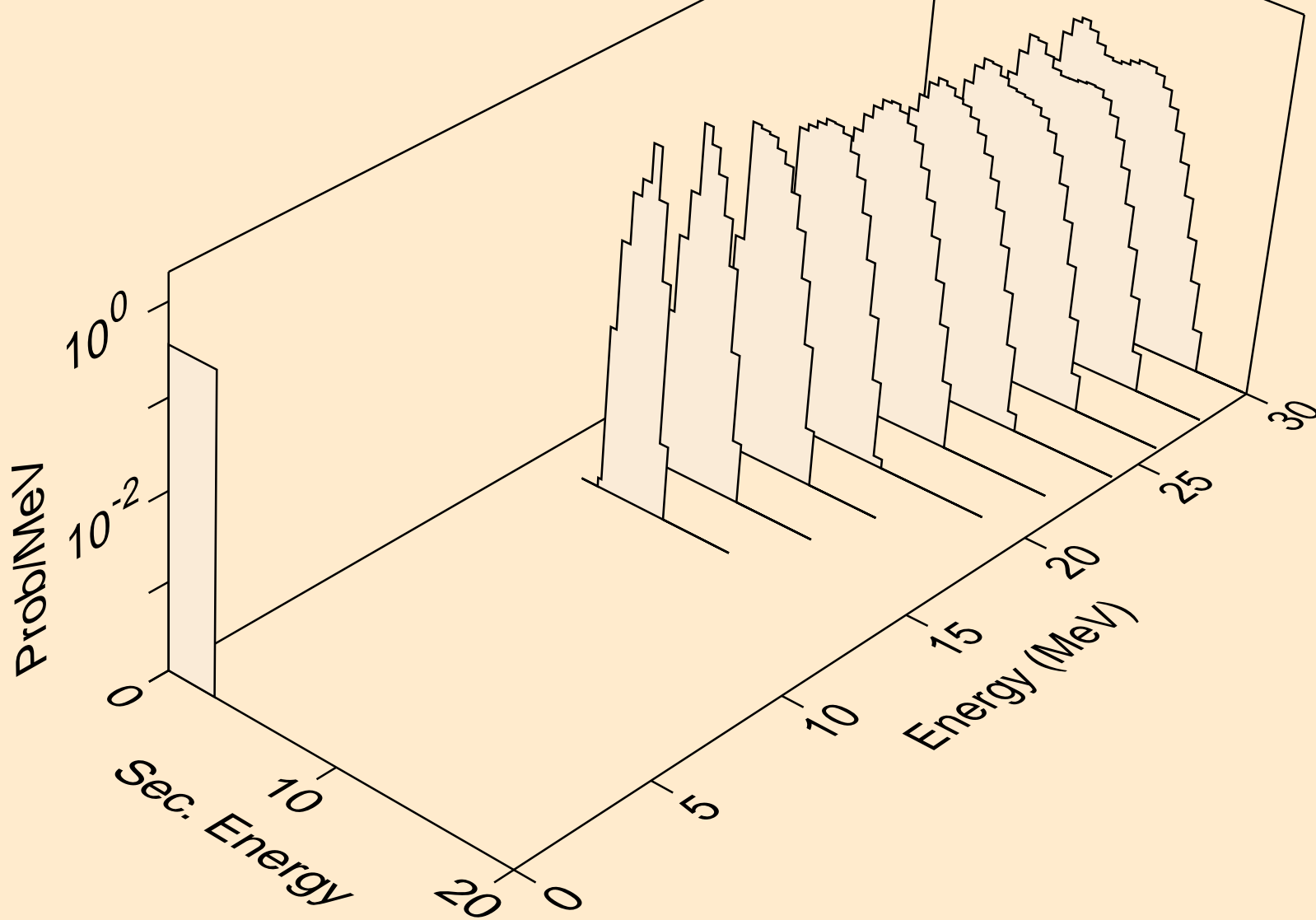

CS118M NEUTRON ACER TENDL-2019 LIBRARY; T=293.16K  
alphas from (n,d2a)

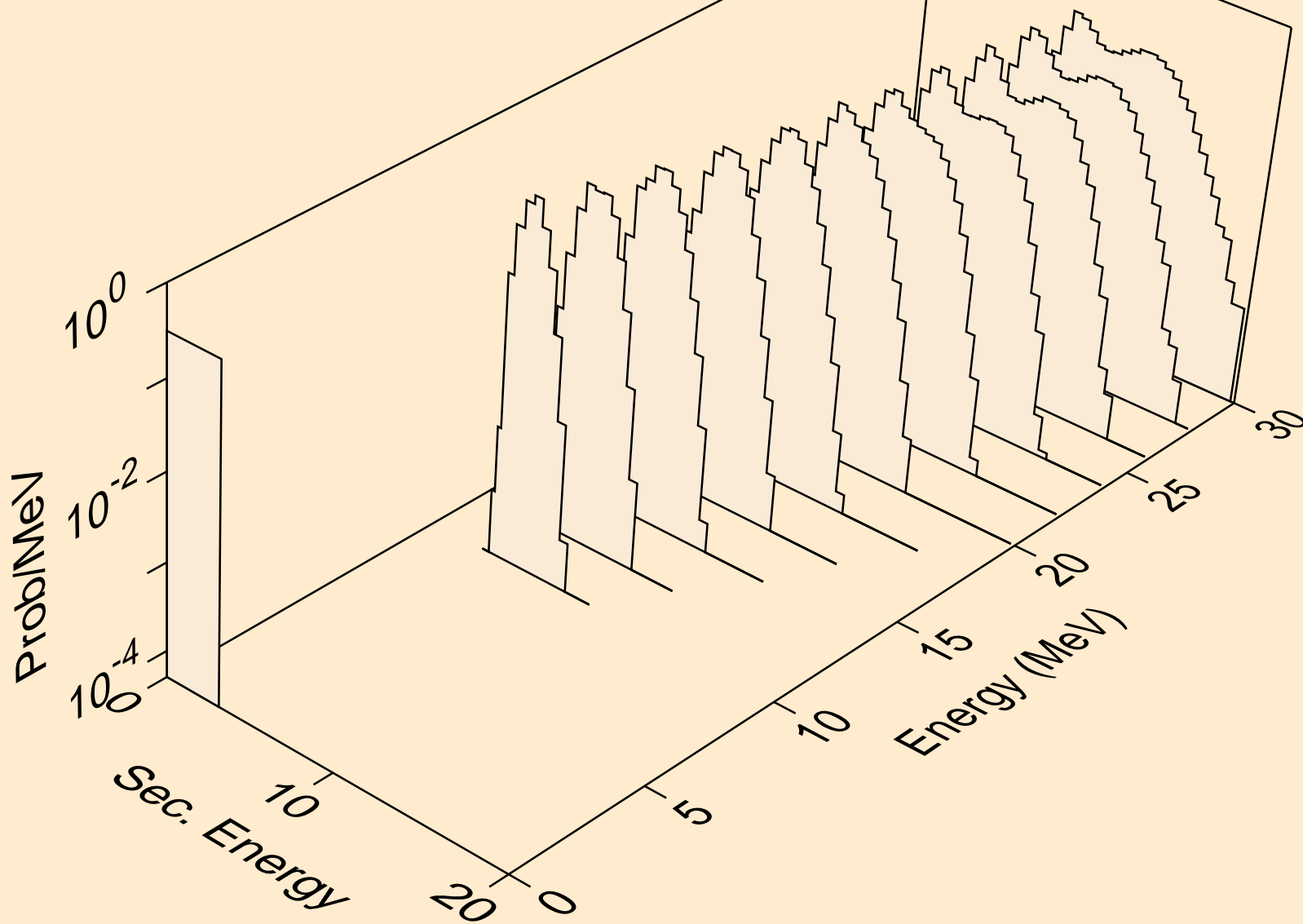

CS118M NEUTRON ACER TENDL-2019 LIBRARY; T=293.16K  
alphas from (n,da)

