

CS129 NEUTRON ACER TENDL-2019 LIBRARY; T=293.16K

Principal cross sections

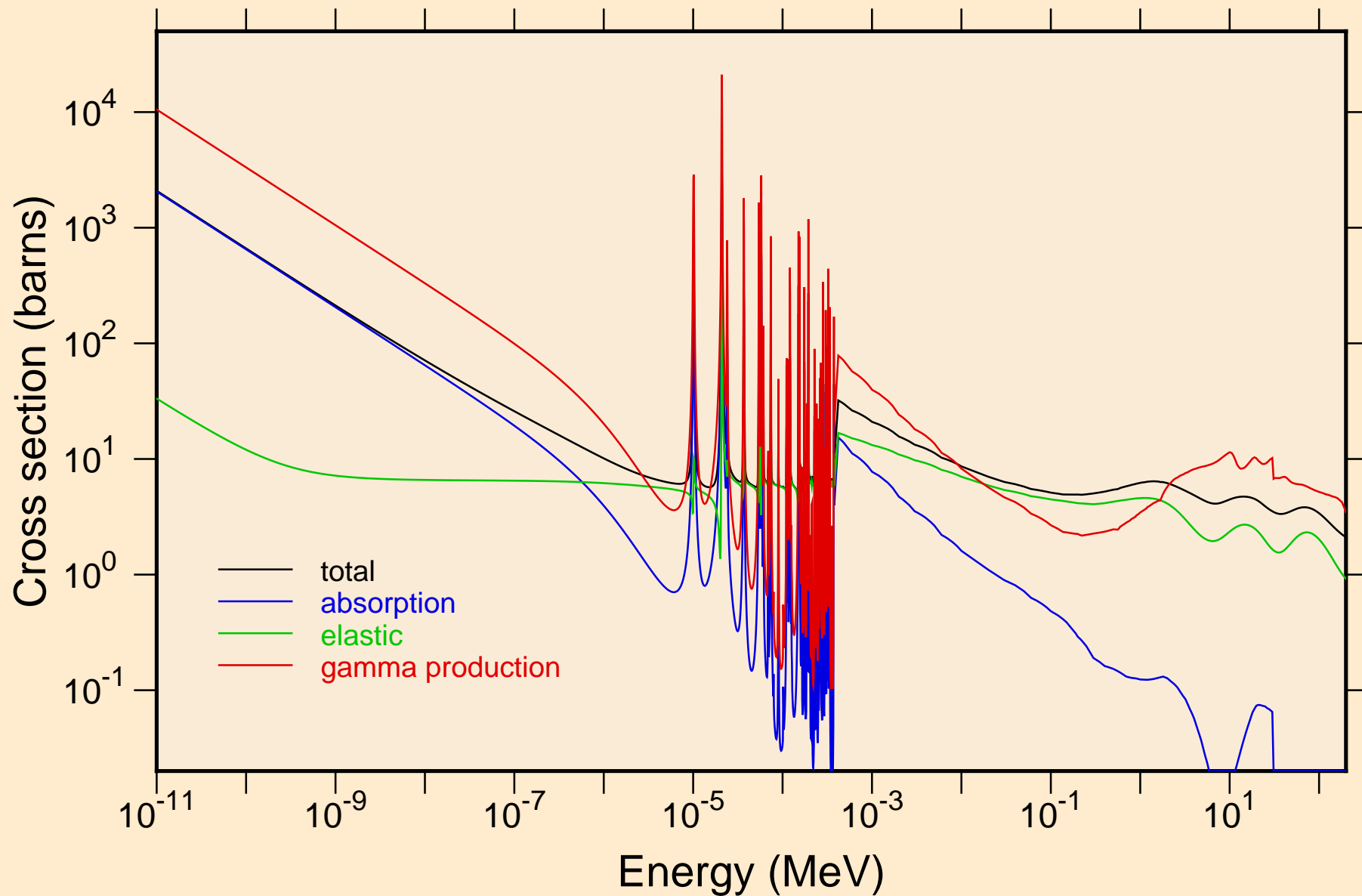

CS129 NEUTRON ACER TENDL-2019 LIBRARY; T=293.16K
resonance total cross section

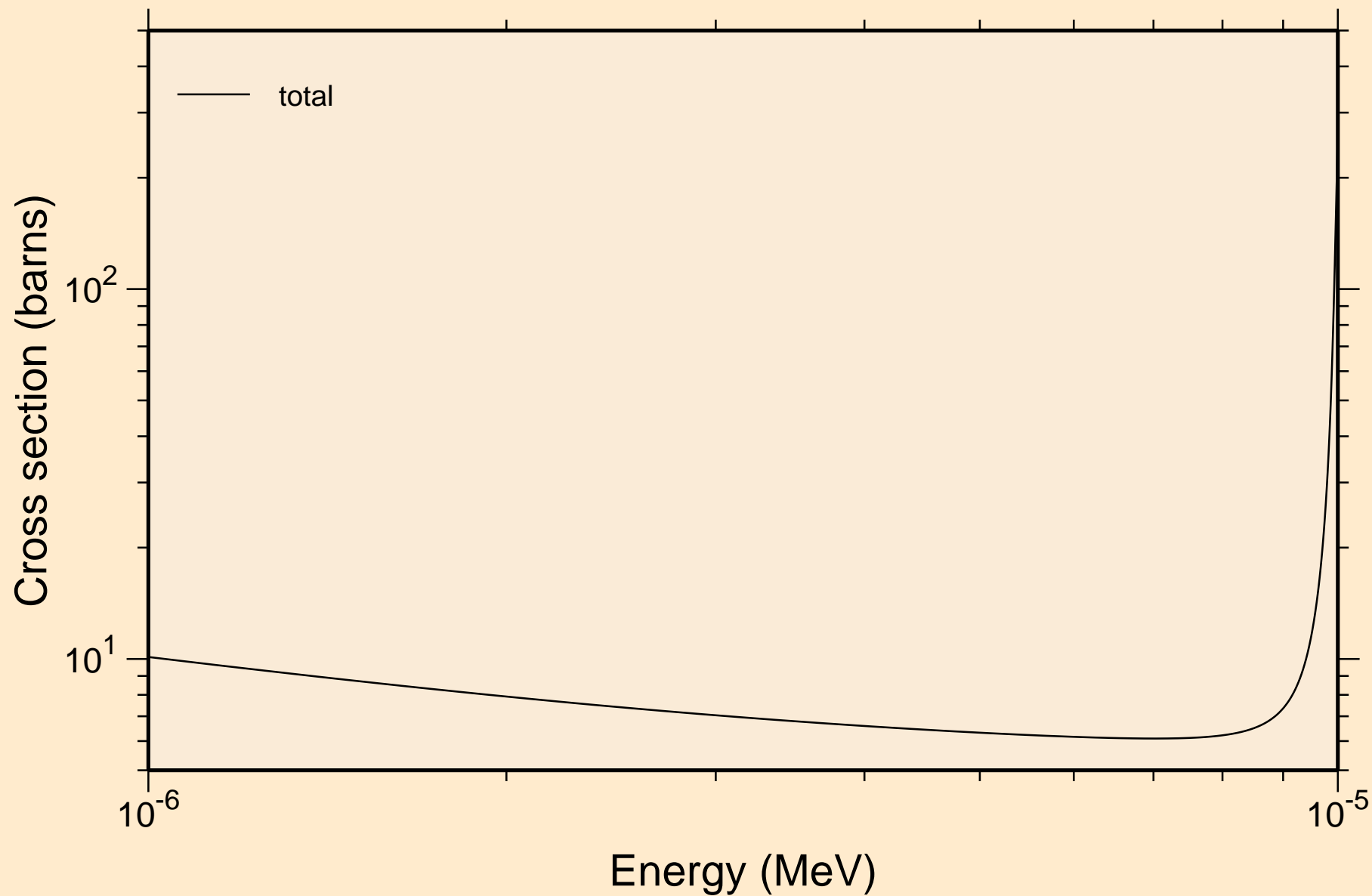

CS129 NEUTRON ACER TENDL-2019 LIBRARY; T=293.16K
resonance total cross section

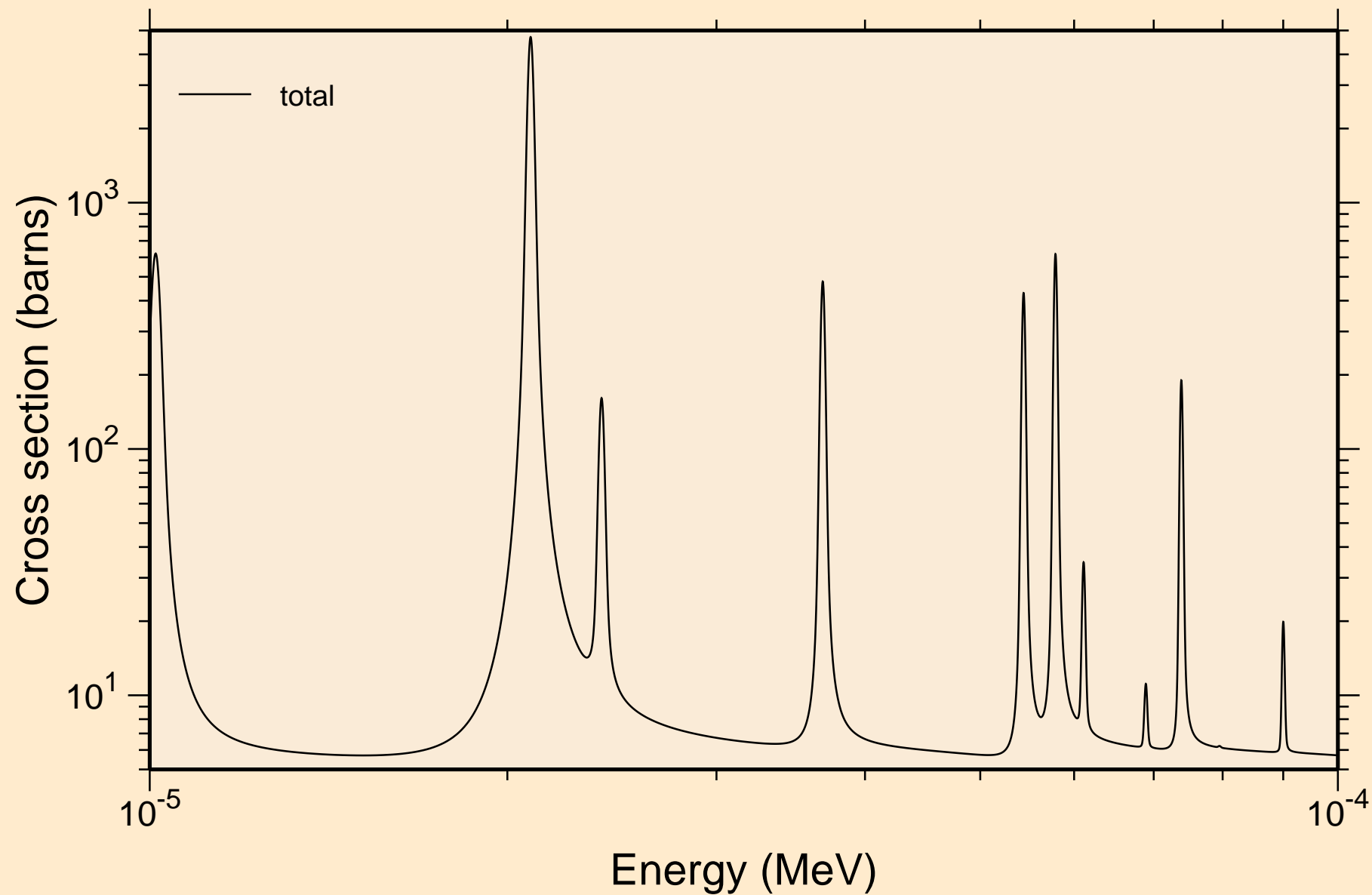

CS129 NEUTRON ACER TENDL-2019 LIBRARY; T=293.16K
resonance total cross section

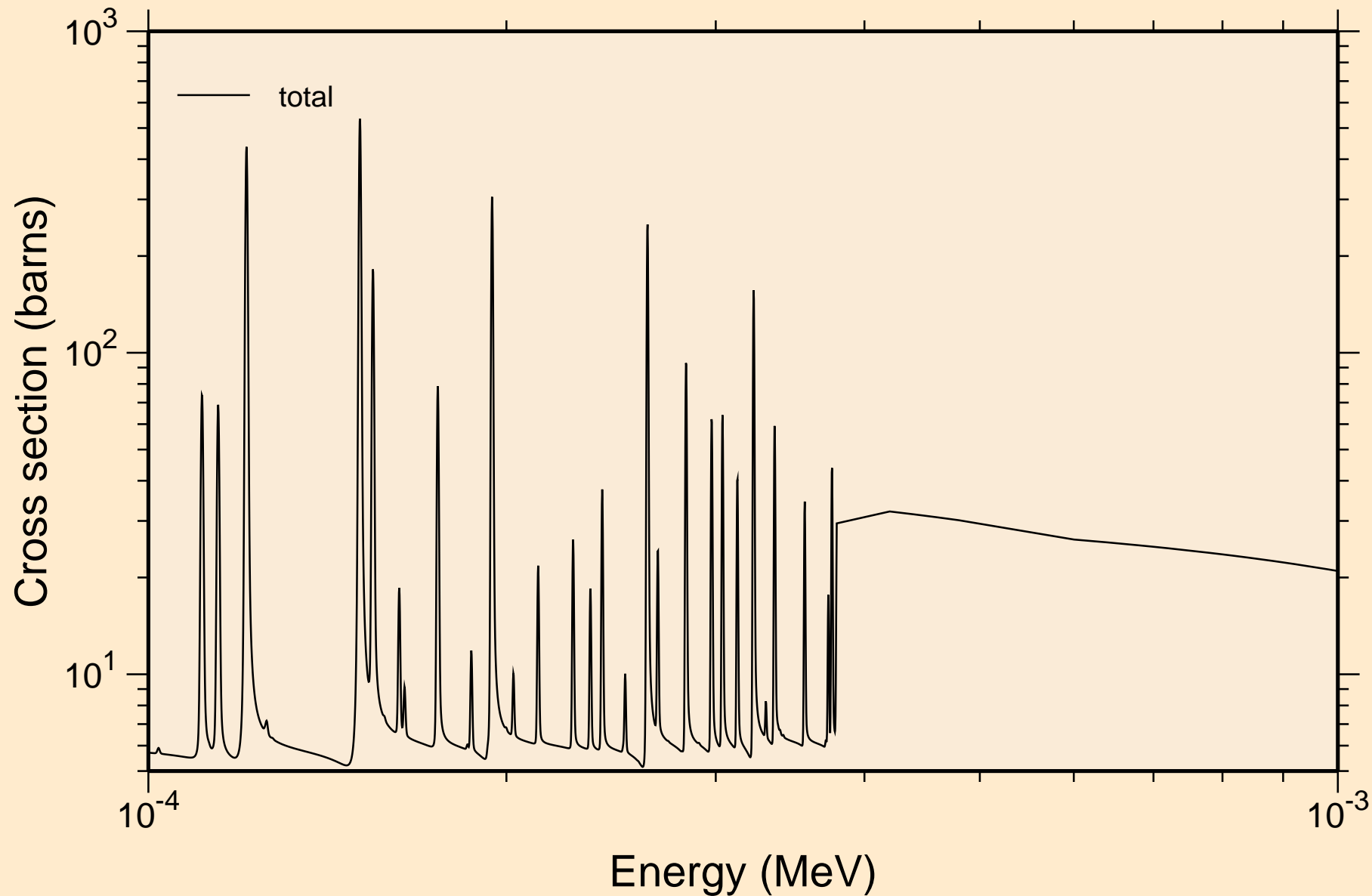

CS129 NEUTRON ACER TENDL-2019 LIBRARY; T=293.16K
resonance total cross section

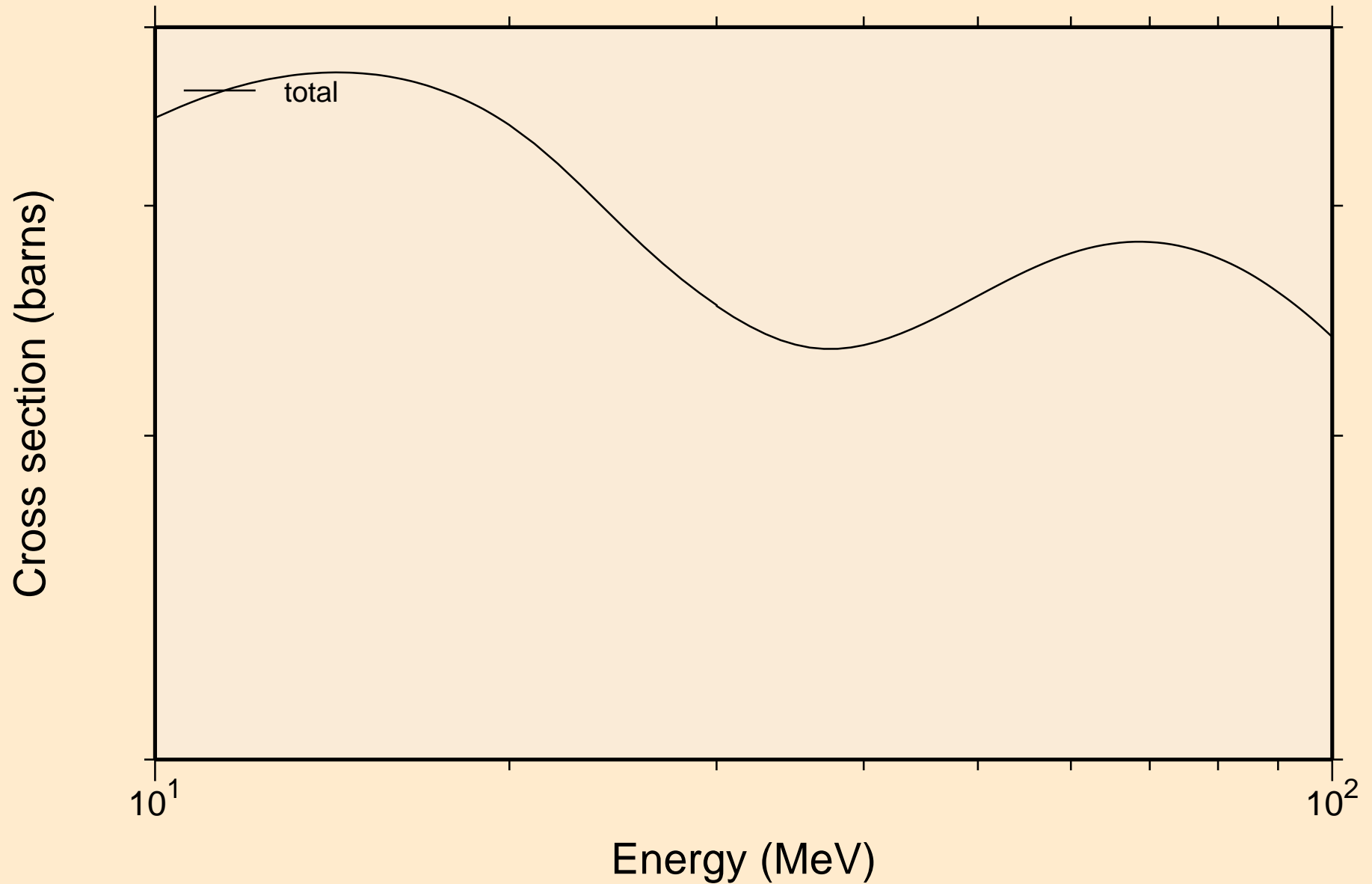

CS129 NEUTRON ACER TENDL-2019 LIBRARY; T=293.16K
resonance absorption cross sections

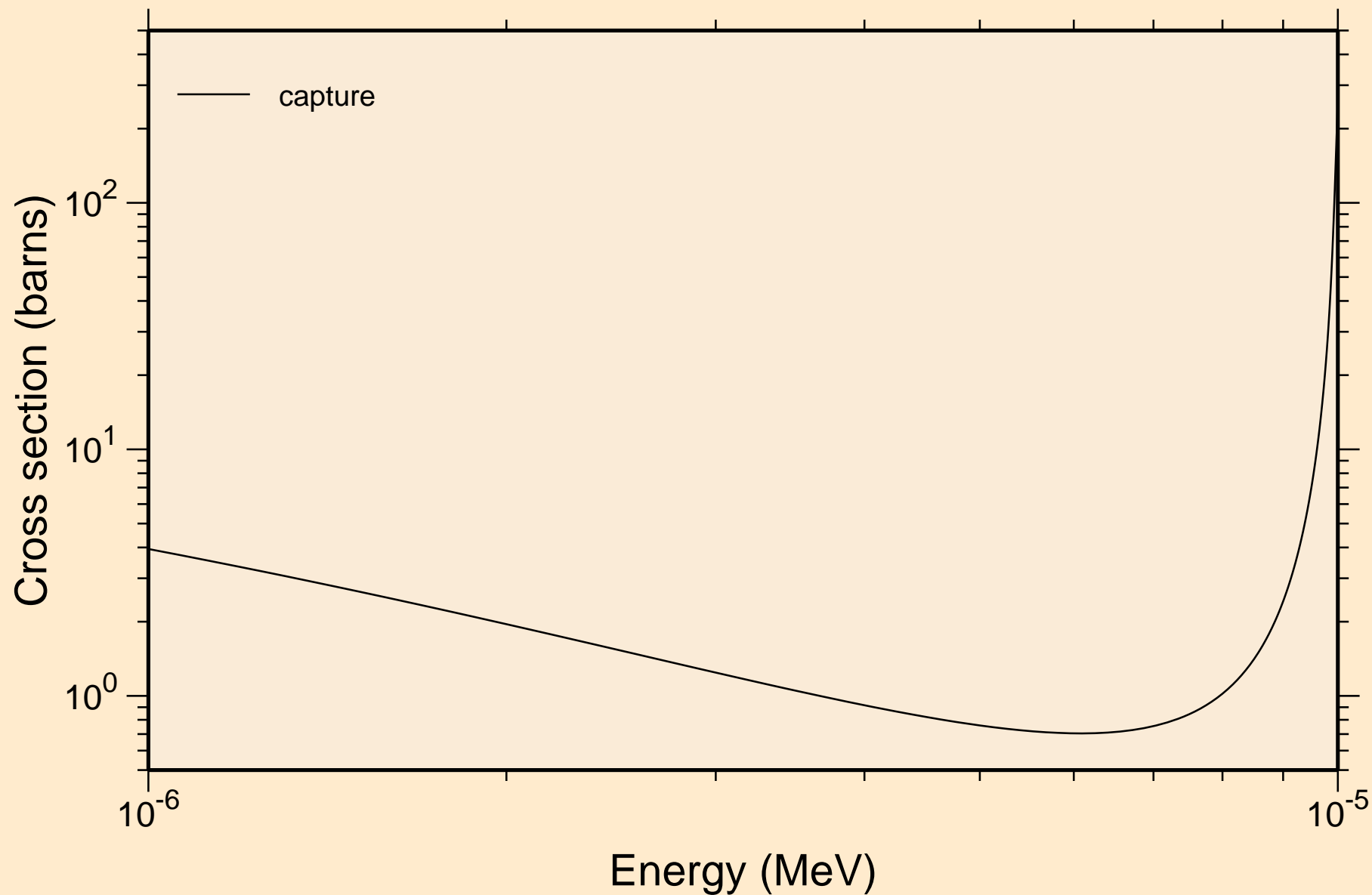

CS129 NEUTRON ACER TENDL-2019 LIBRARY; T=293.16K
resonance absorption cross sections

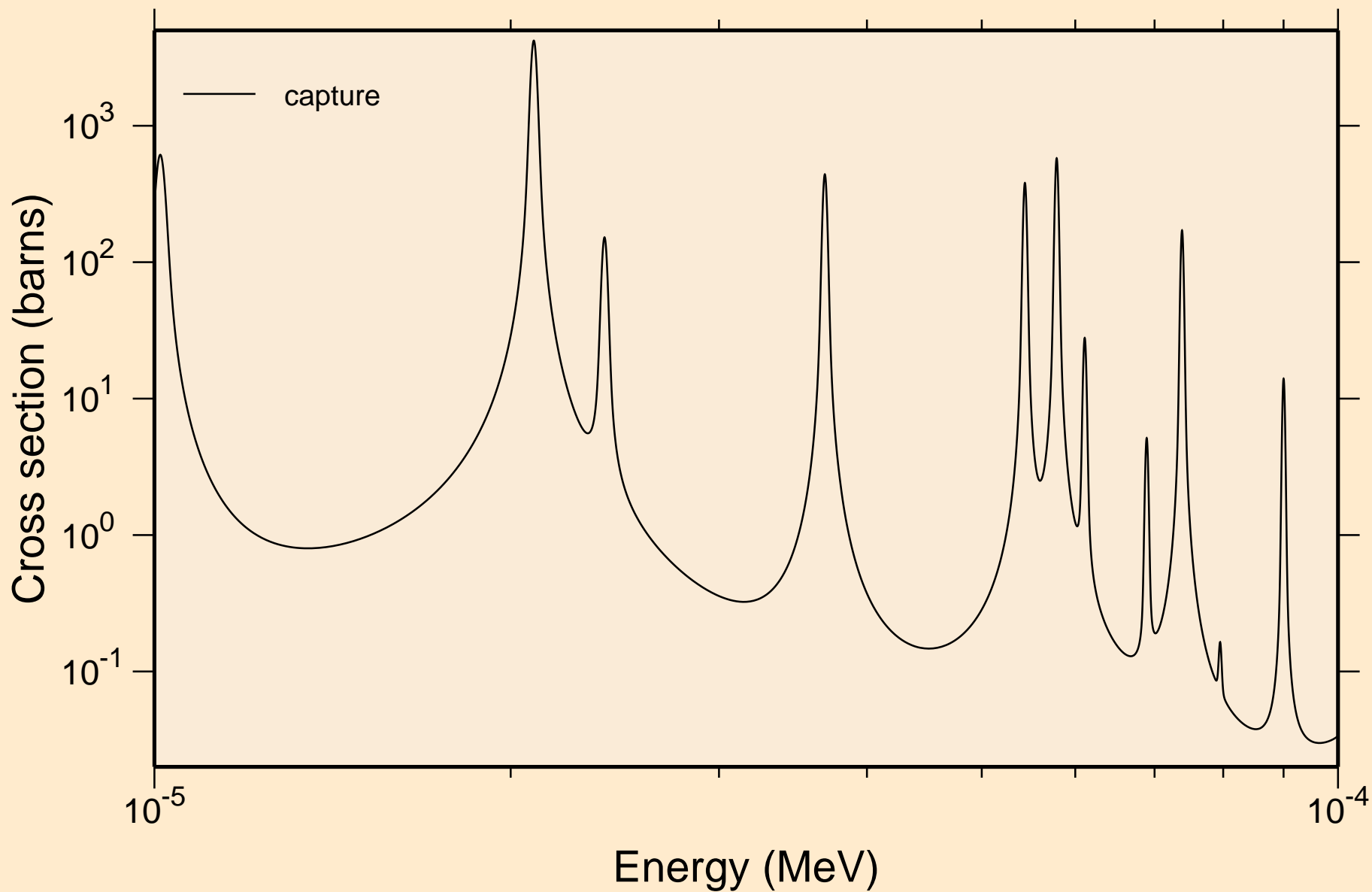

CS129 NEUTRON ACER TENDL-2019 LIBRARY; T=293.16K
resonance absorption cross sections

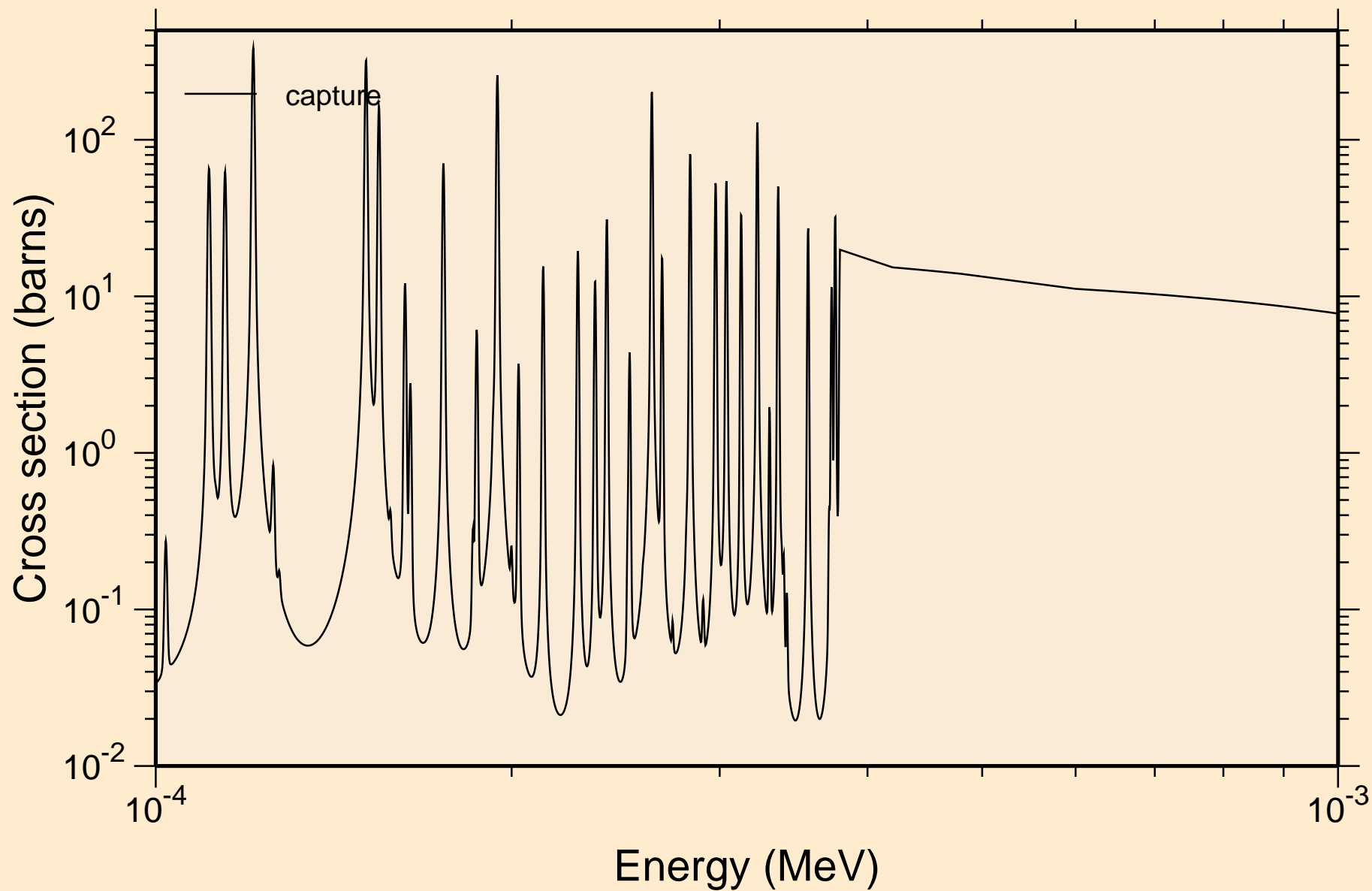

CS129 NEUTRON ACER TENDL-2019 LIBRARY; T=293.16K
resonance absorption cross sections

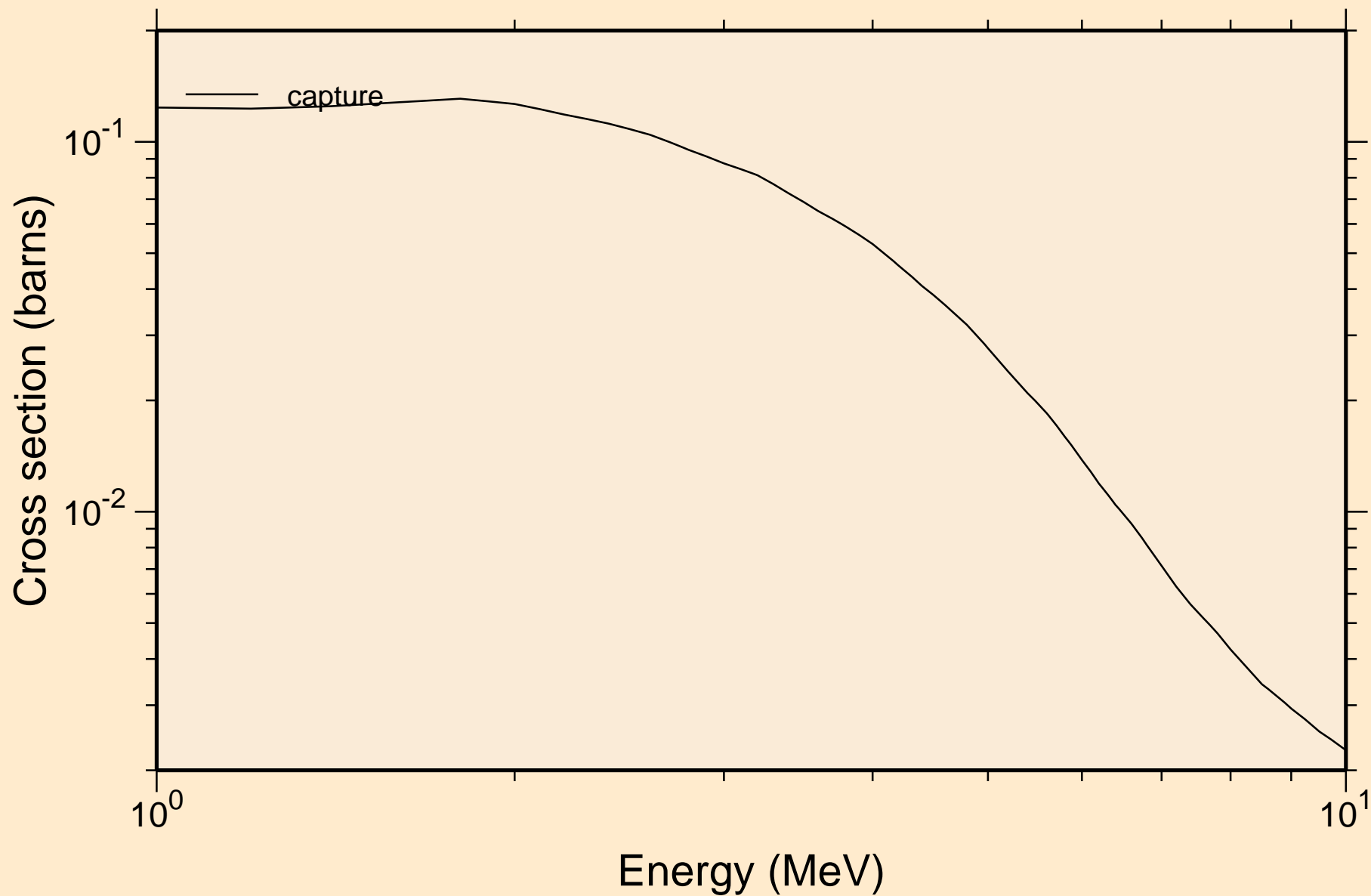

CS129 NEUTRON ACER TENDL-2019 LIBRARY; T=293.16K
Heating

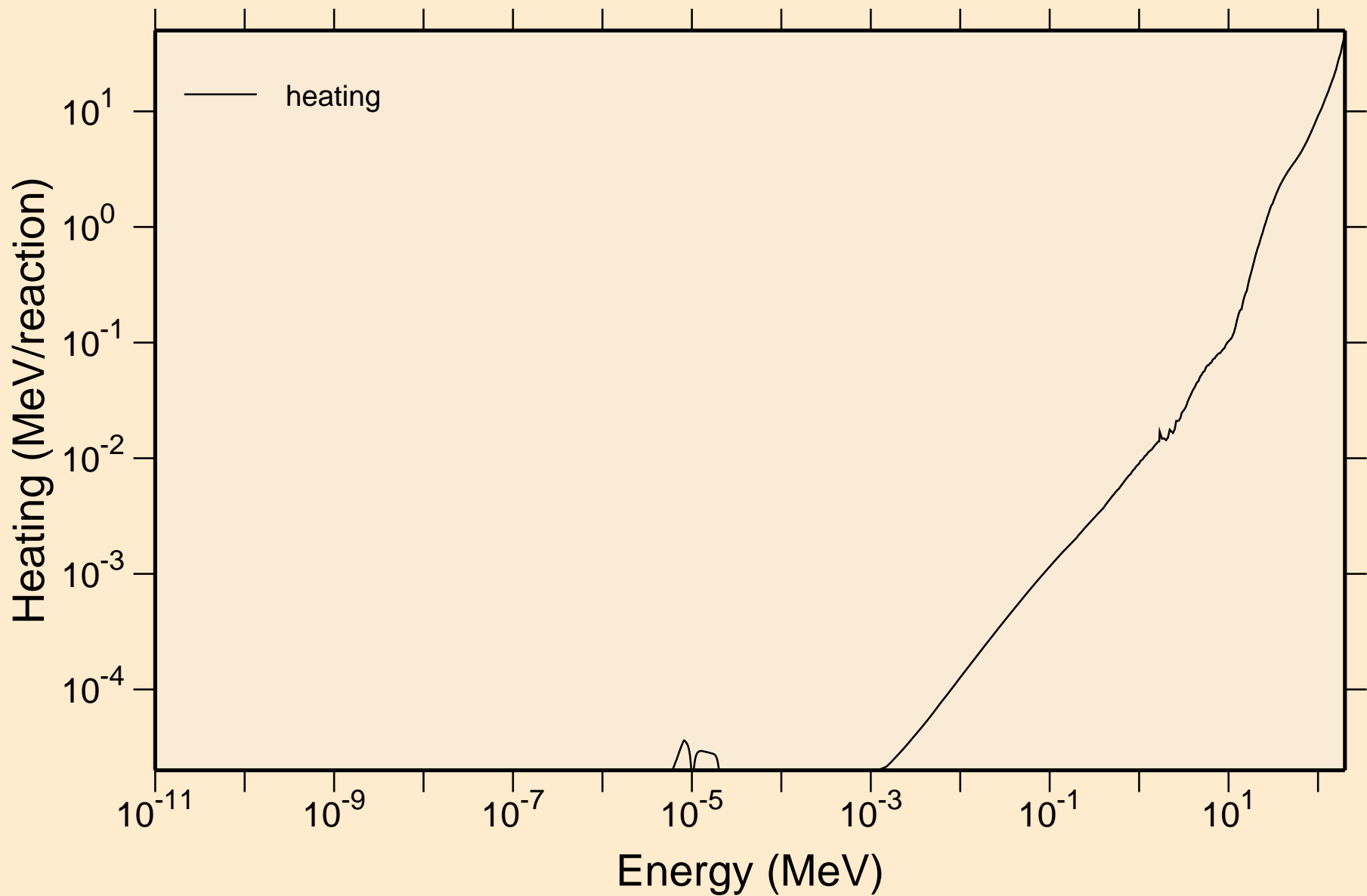

CS129 NEUTRON ACER TENDL-2019 LIBRARY; T=293.16K Damage

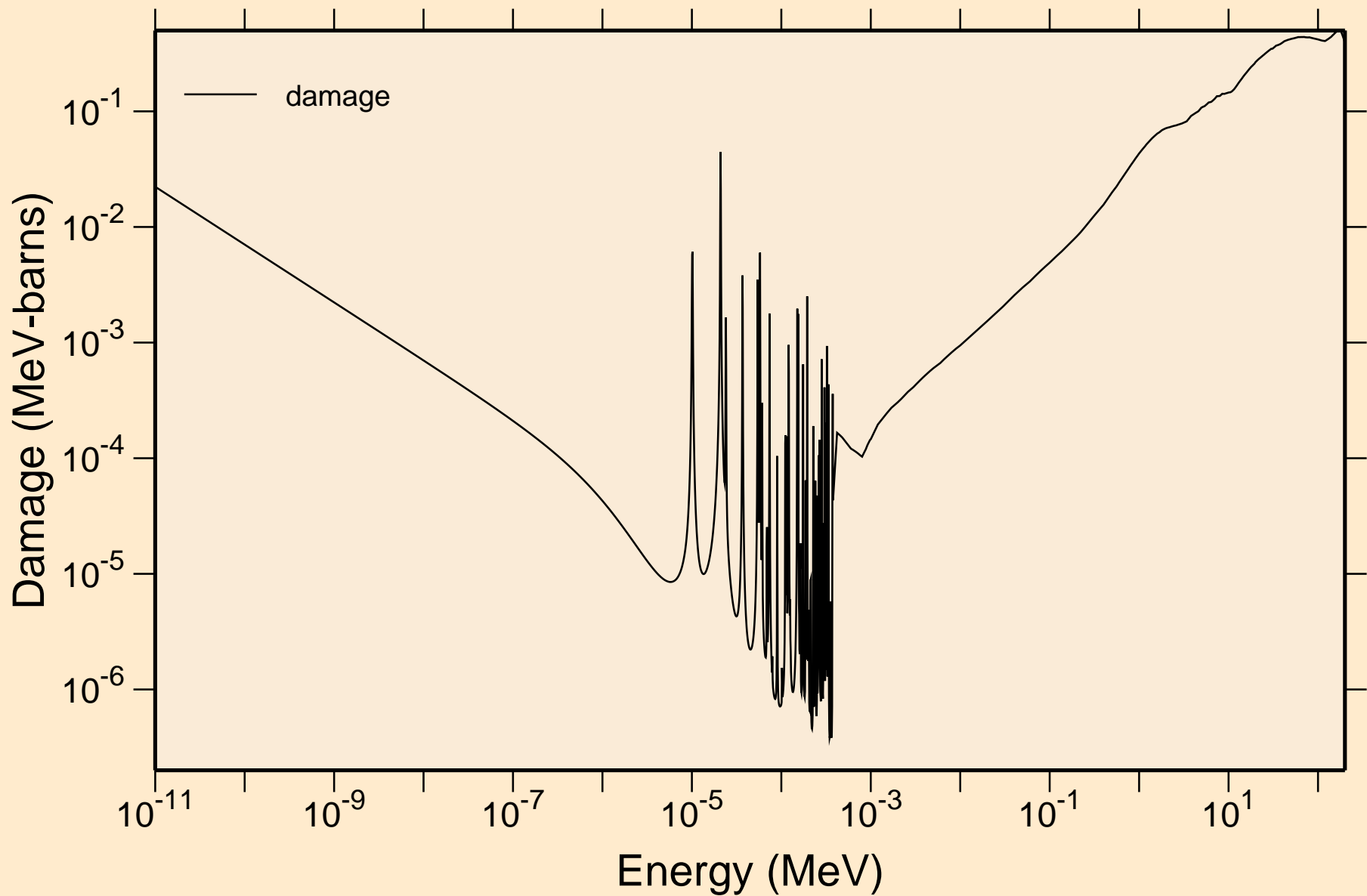

CS129 NEUTRON ACER TENDL-2019 LIBRARY; T=293.16K

Non-threshold reactions

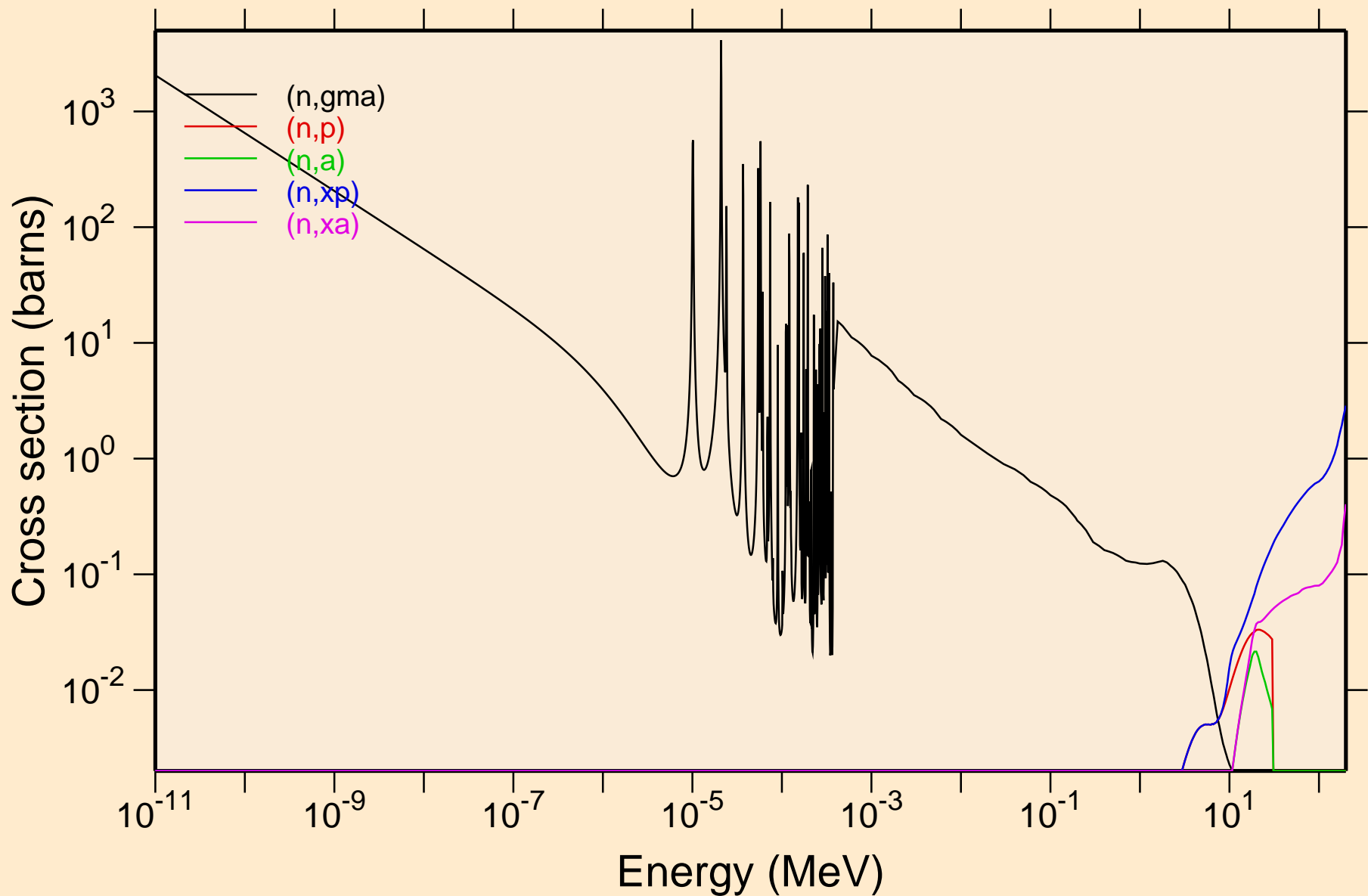

CS129 NEUTRON ACER TENDL-2019 LIBRARY; T=293.16K

Principal cross sections

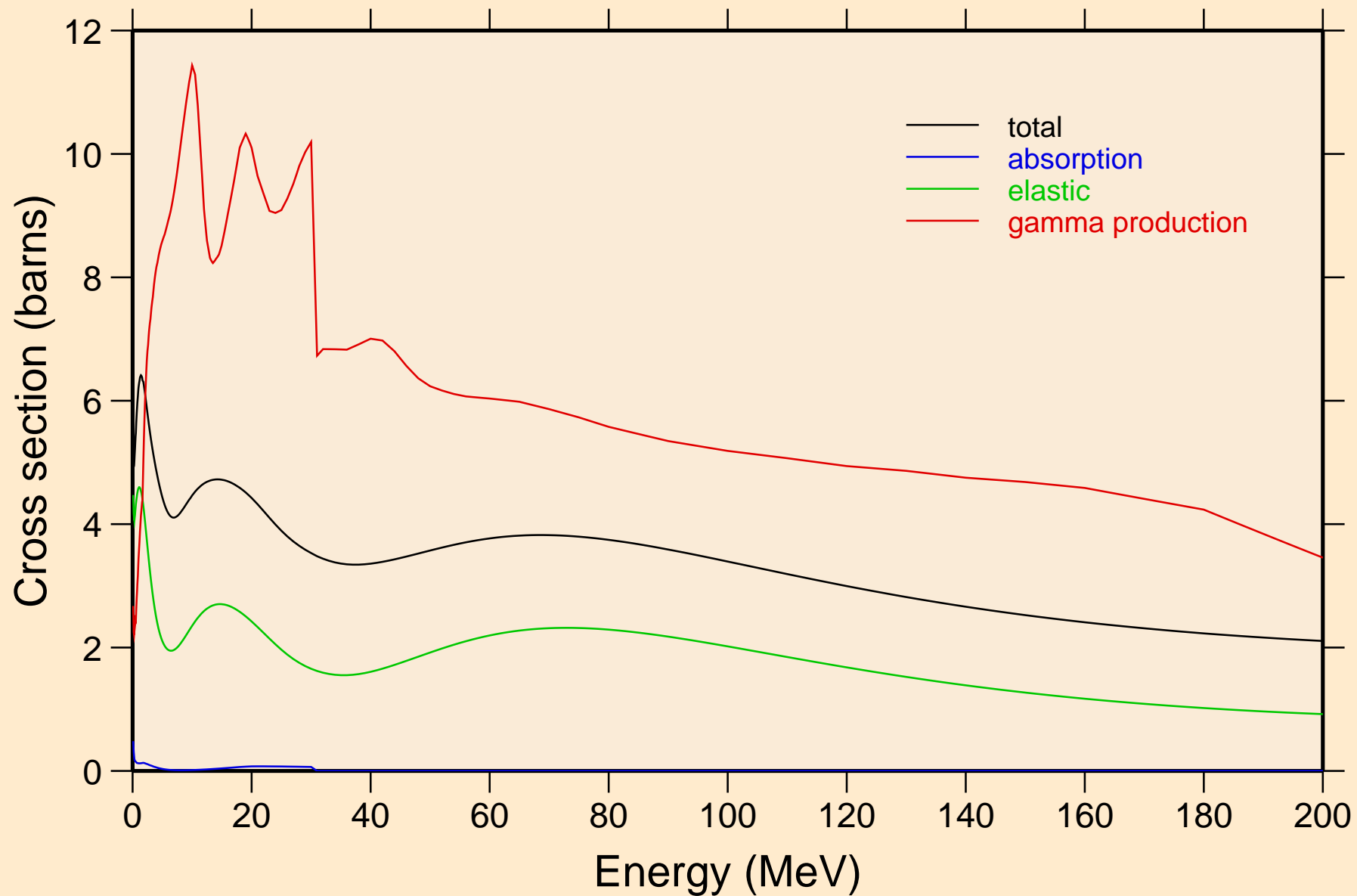

CS129 NEUTRON ACER TENDL-2019 LIBRARY; T=293.16K
Heating

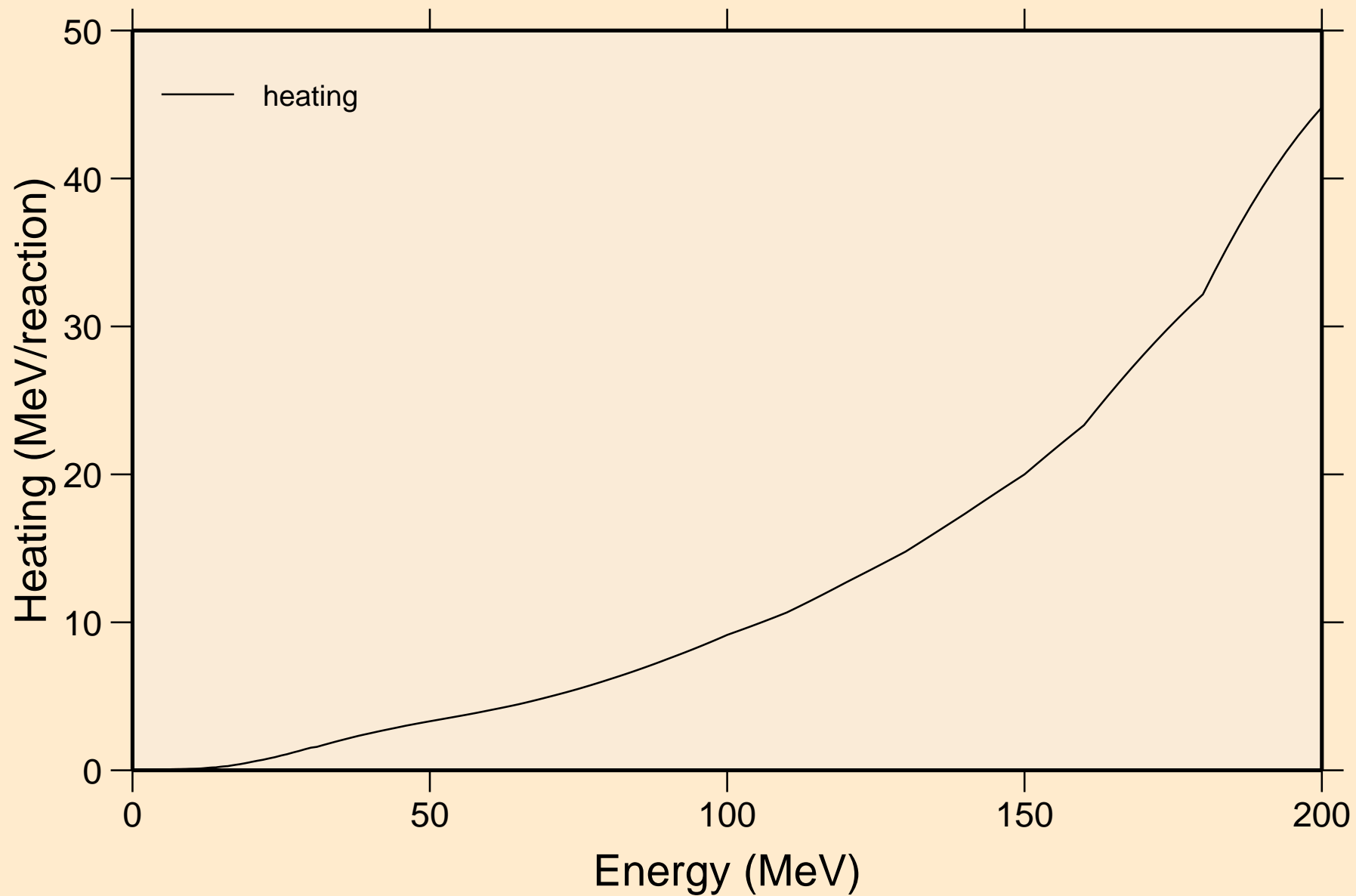

CS129 NEUTRON ACER TENDL-2019 LIBRARY; T=293.16K
Damage

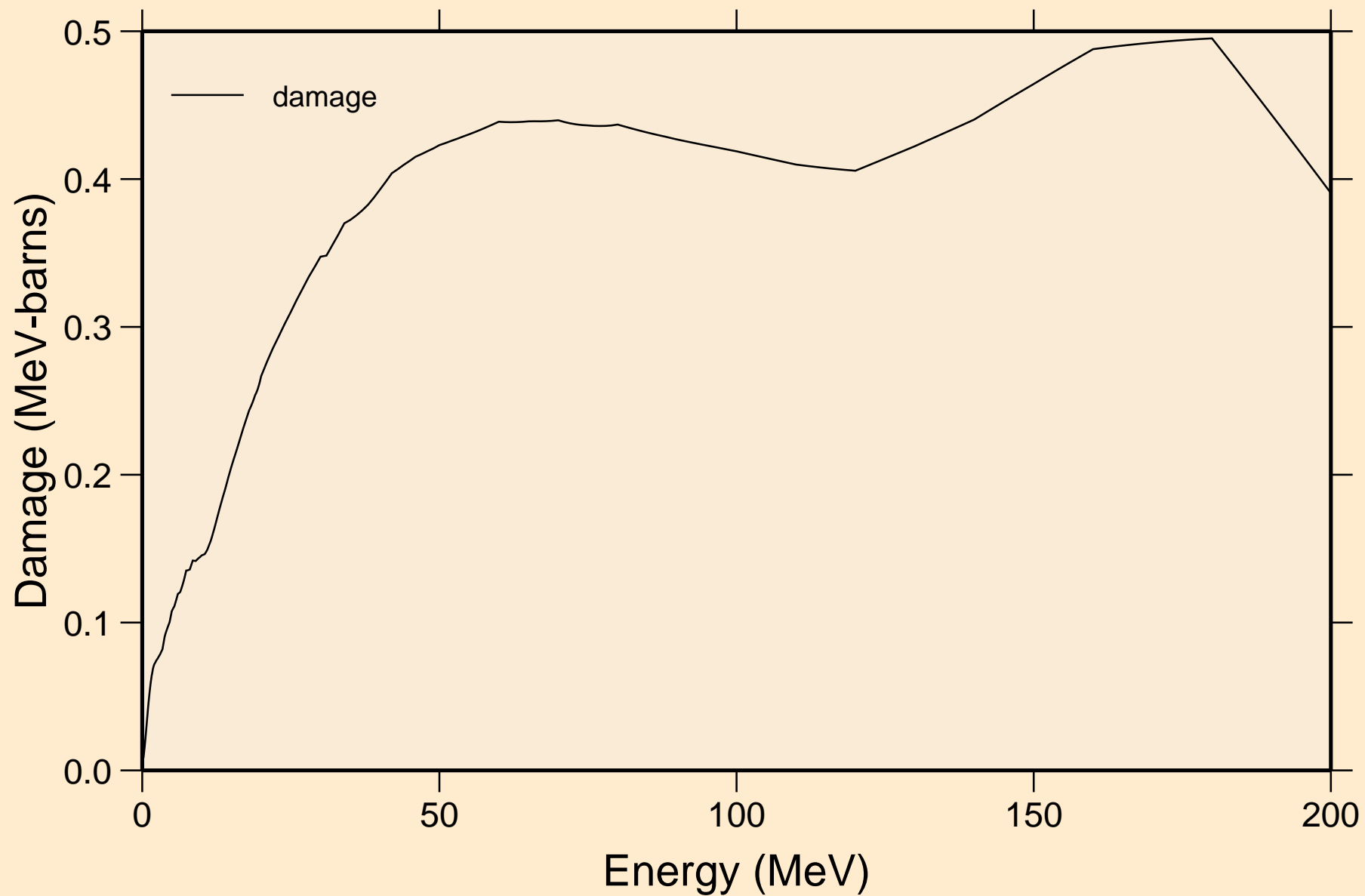

CS129 NEUTRON ACER TENDL-2019 LIBRARY; T=293.16K
Non-threshold reactions

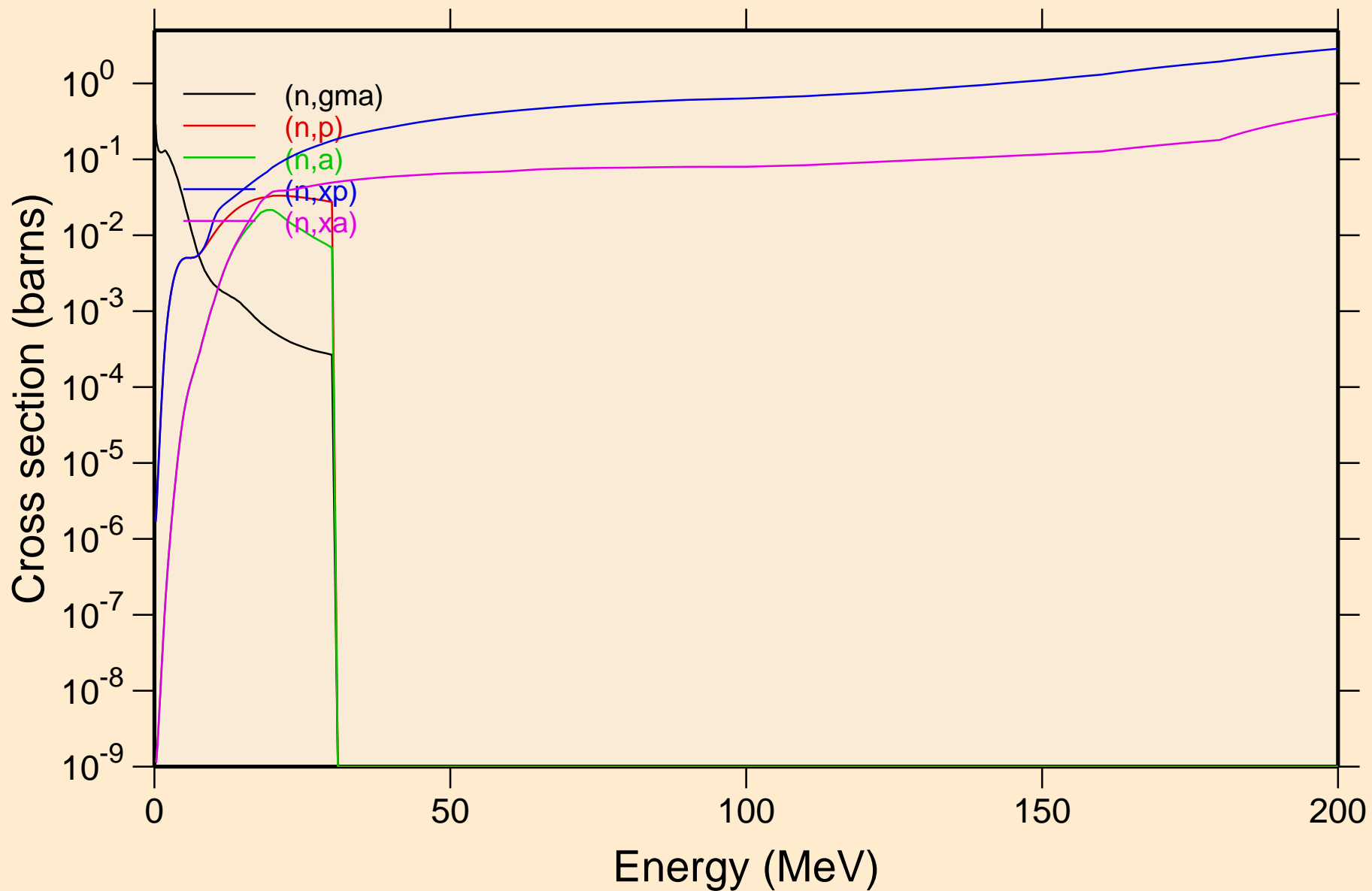

CS129 NEUTRON ACER TENDL-2019 LIBRARY; T=293.16K
Inelastic levels

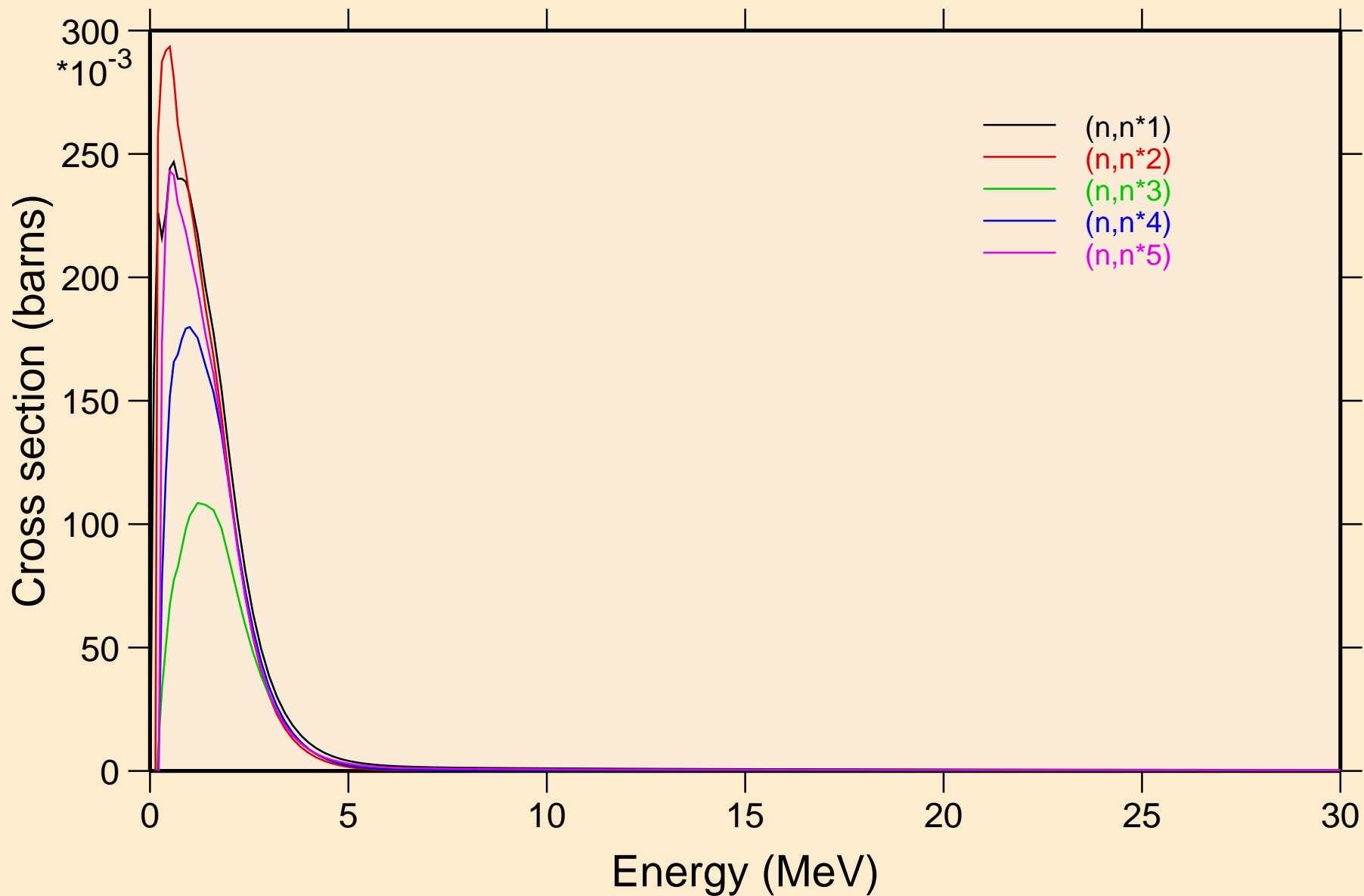

CS129 NEUTRON ACER TENDL-2019 LIBRARY; T=293.16K
Inelastic levels

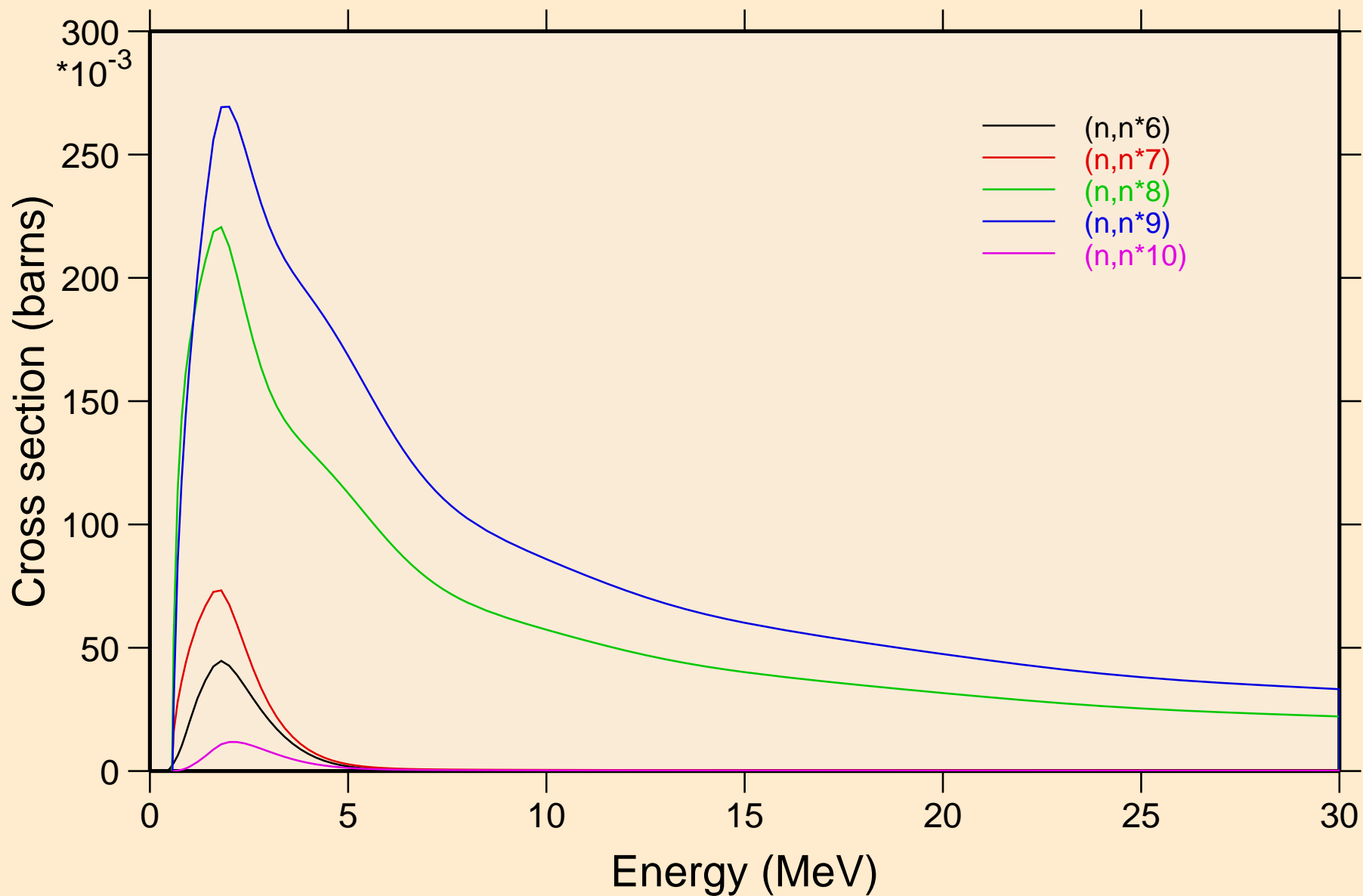

CS129 NEUTRON ACER TENDL-2019 LIBRARY; T=293.16K
Inelastic levels

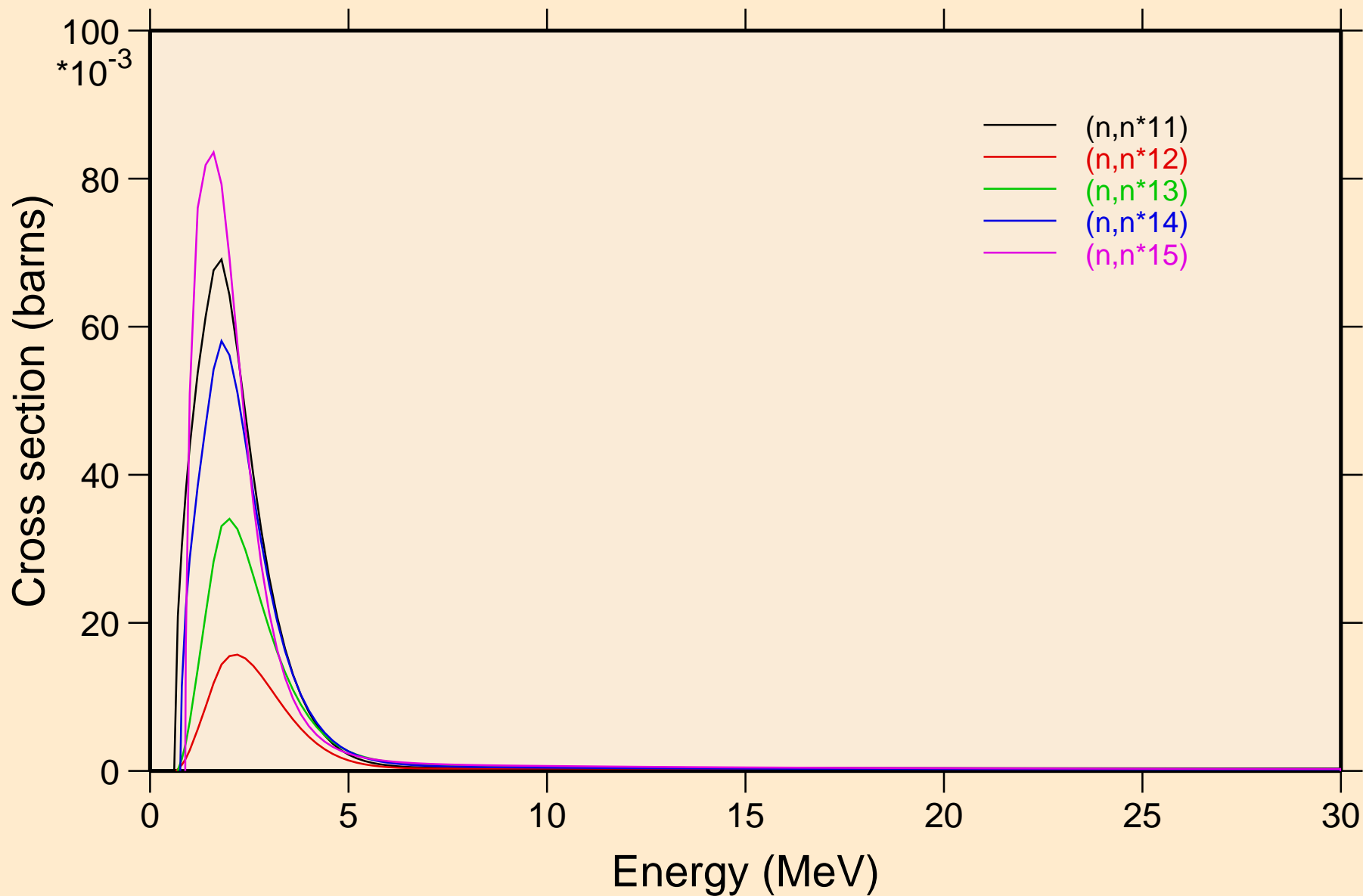

CS129 NEUTRON ACER TENDL-2019 LIBRARY; T=293.16K
Inelastic levels

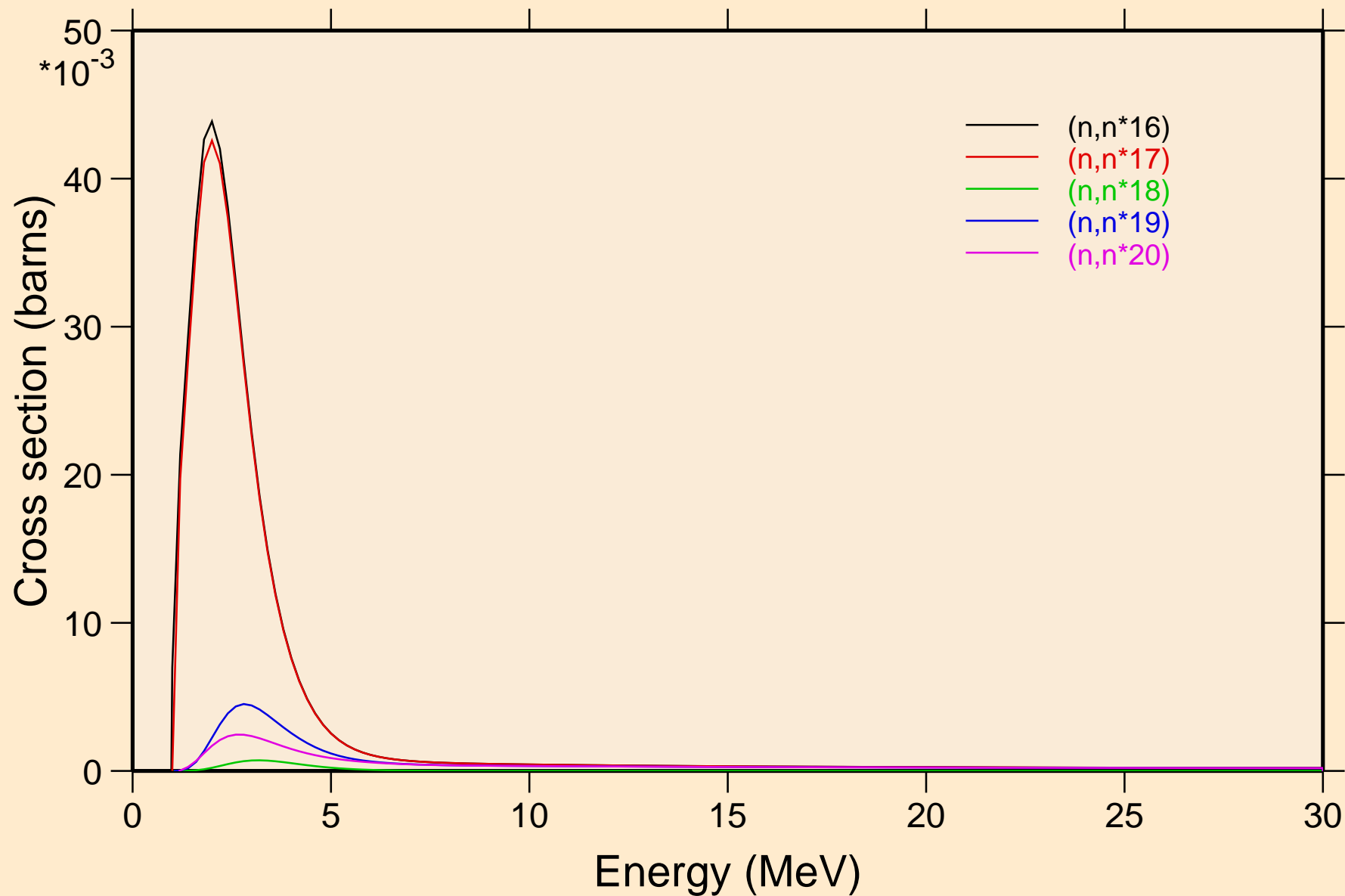

CS129 NEUTRON ACER TENDL-2019 LIBRARY; T=293.16K
Inelastic levels

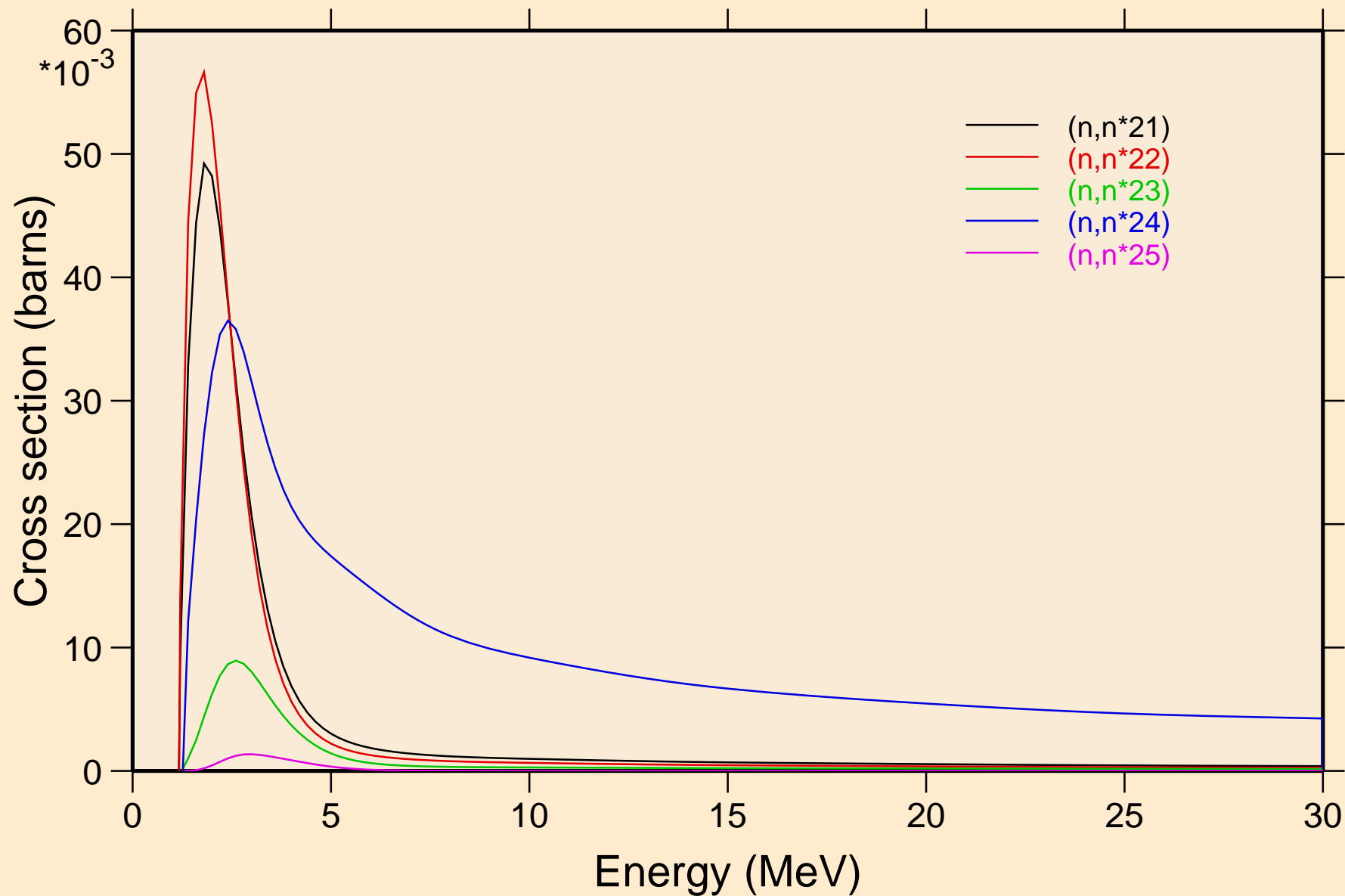

CS129 NEUTRON ACER TENDL-2019 LIBRARY; T=293.16K
Inelastic levels

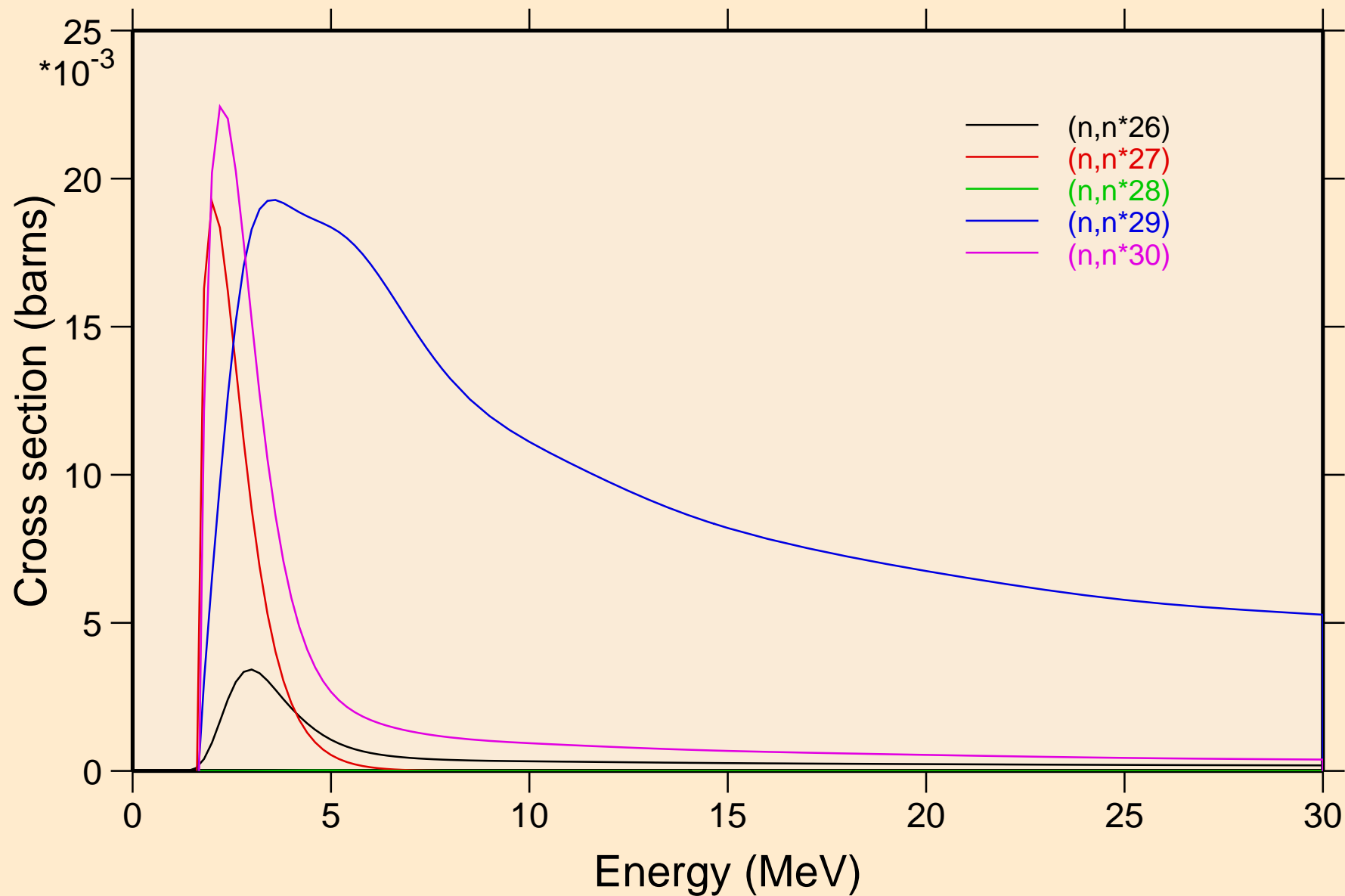

CS129 NEUTRON ACER TENDL-2019 LIBRARY; T=293.16K

Threshold reactions

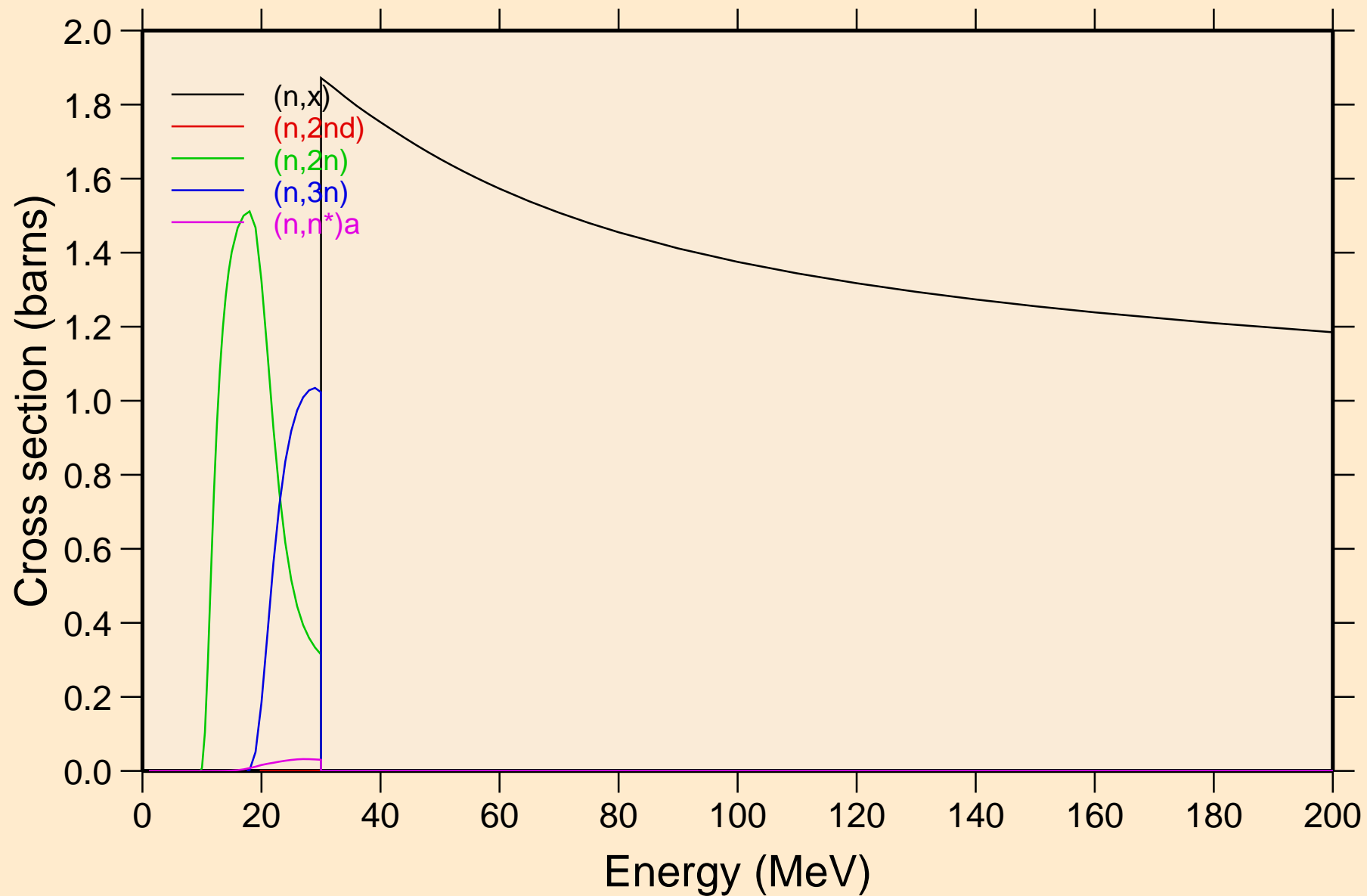

CS129 NEUTRON ACER TENDL-2019 LIBRARY; T=293.16K
Threshold reactions

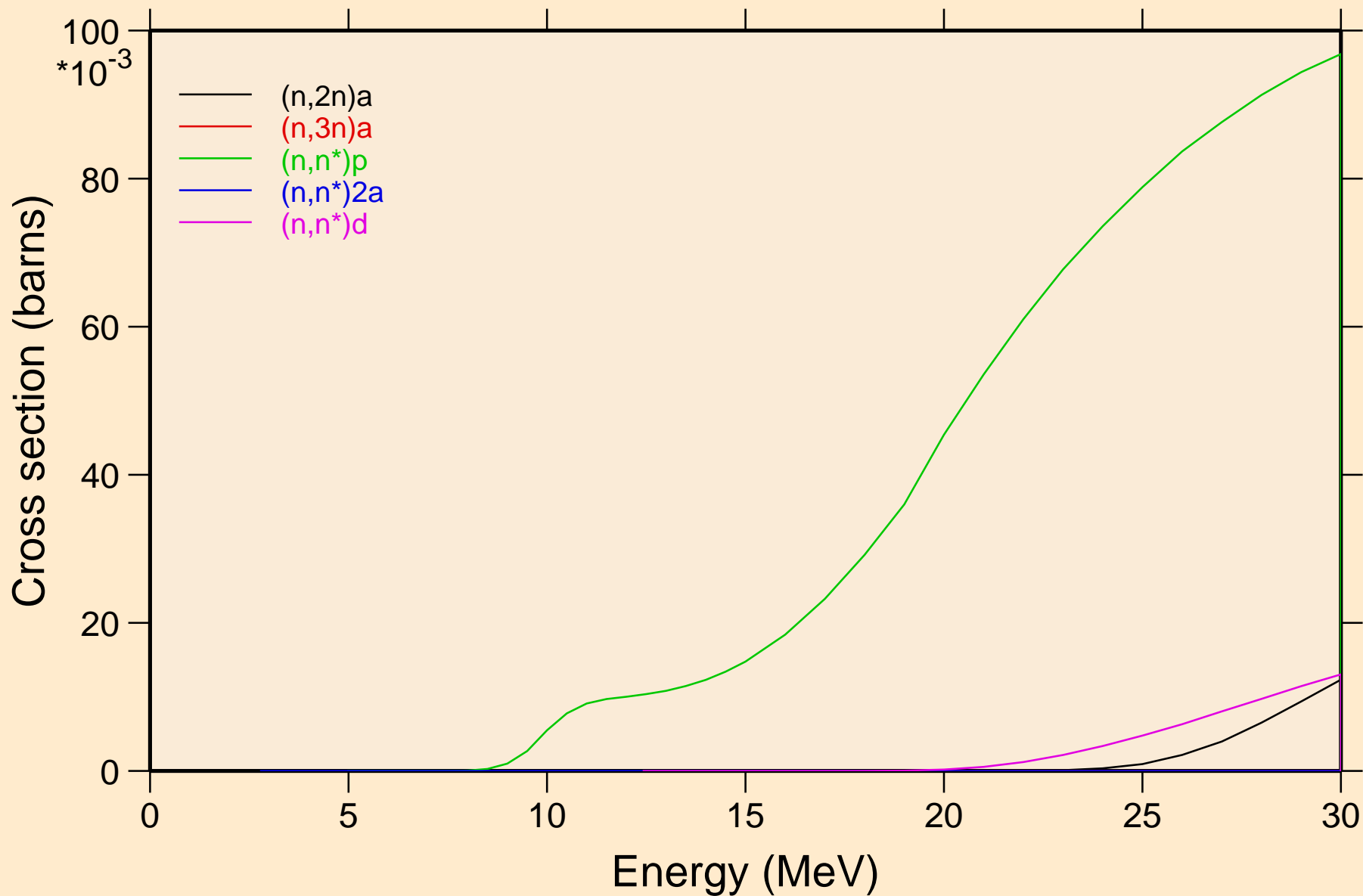

CS129 NEUTRON ACER TENDL-2019 LIBRARY; T=293.16K

Threshold reactions

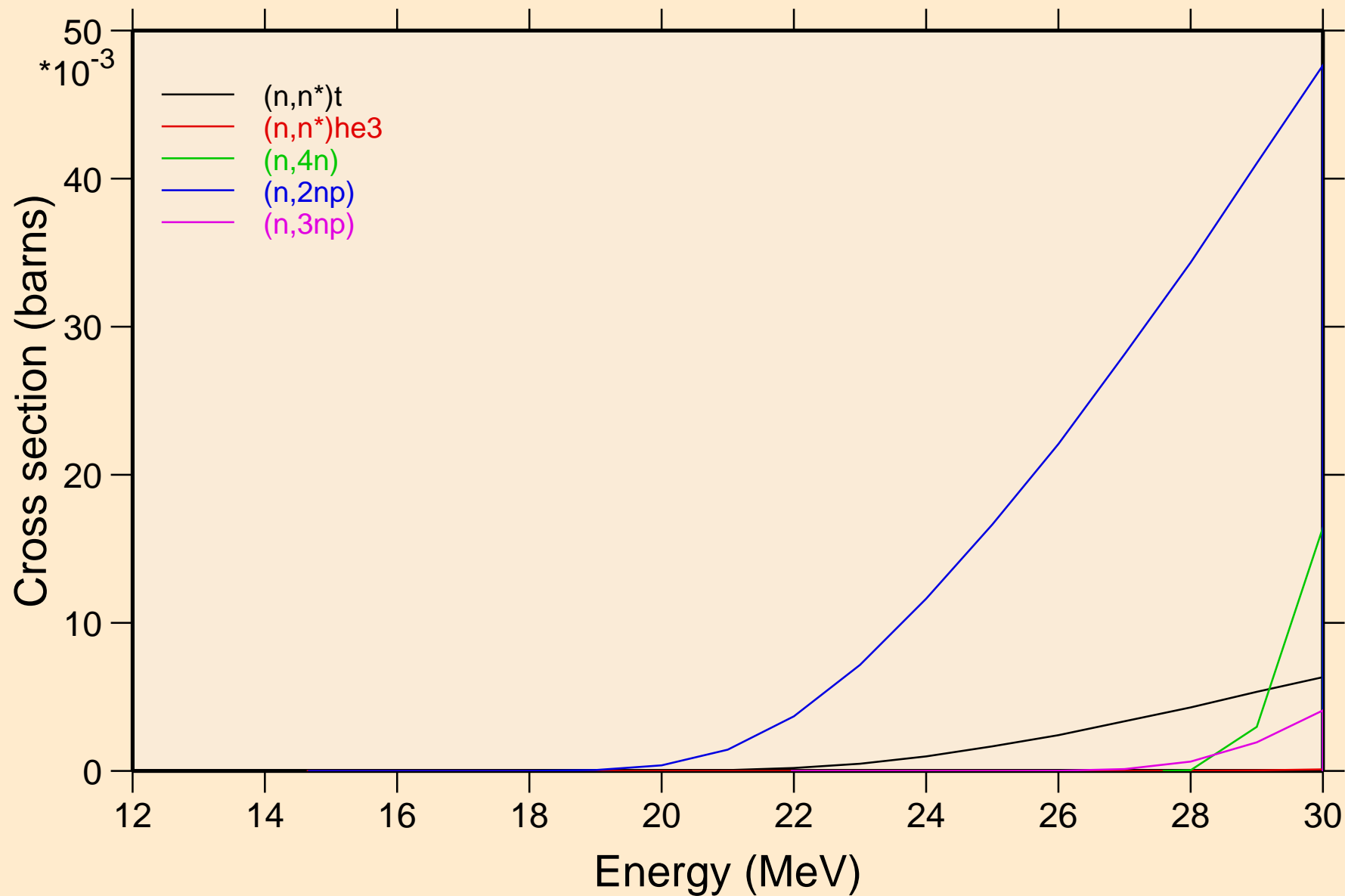

CS129 NEUTRON ACER TENDL-2019 LIBRARY; T=293.16K

Threshold reactions

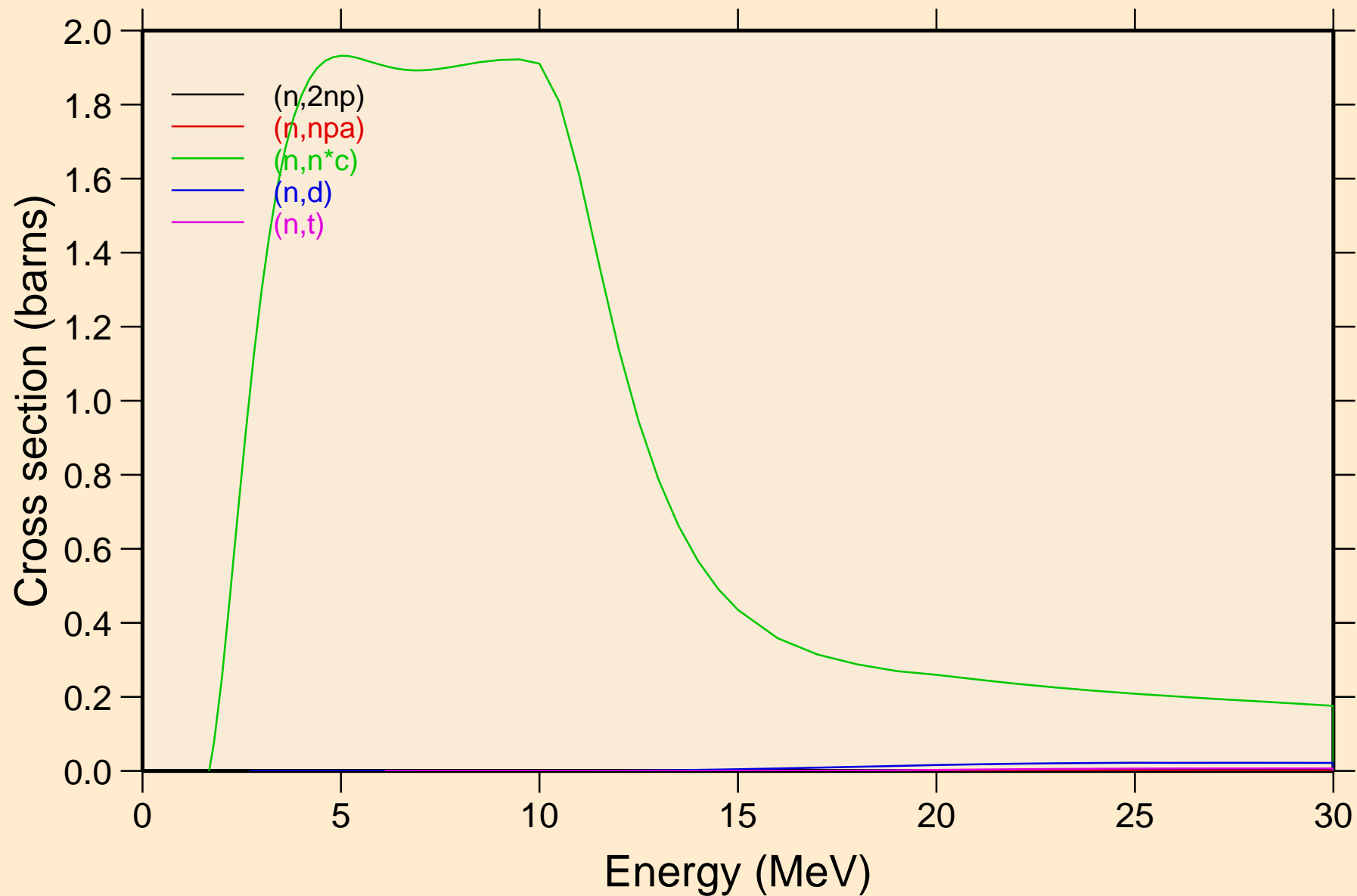

CS129 NEUTRON ACER TENDL-2019 LIBRARY; T=293.16K
Threshold reactions

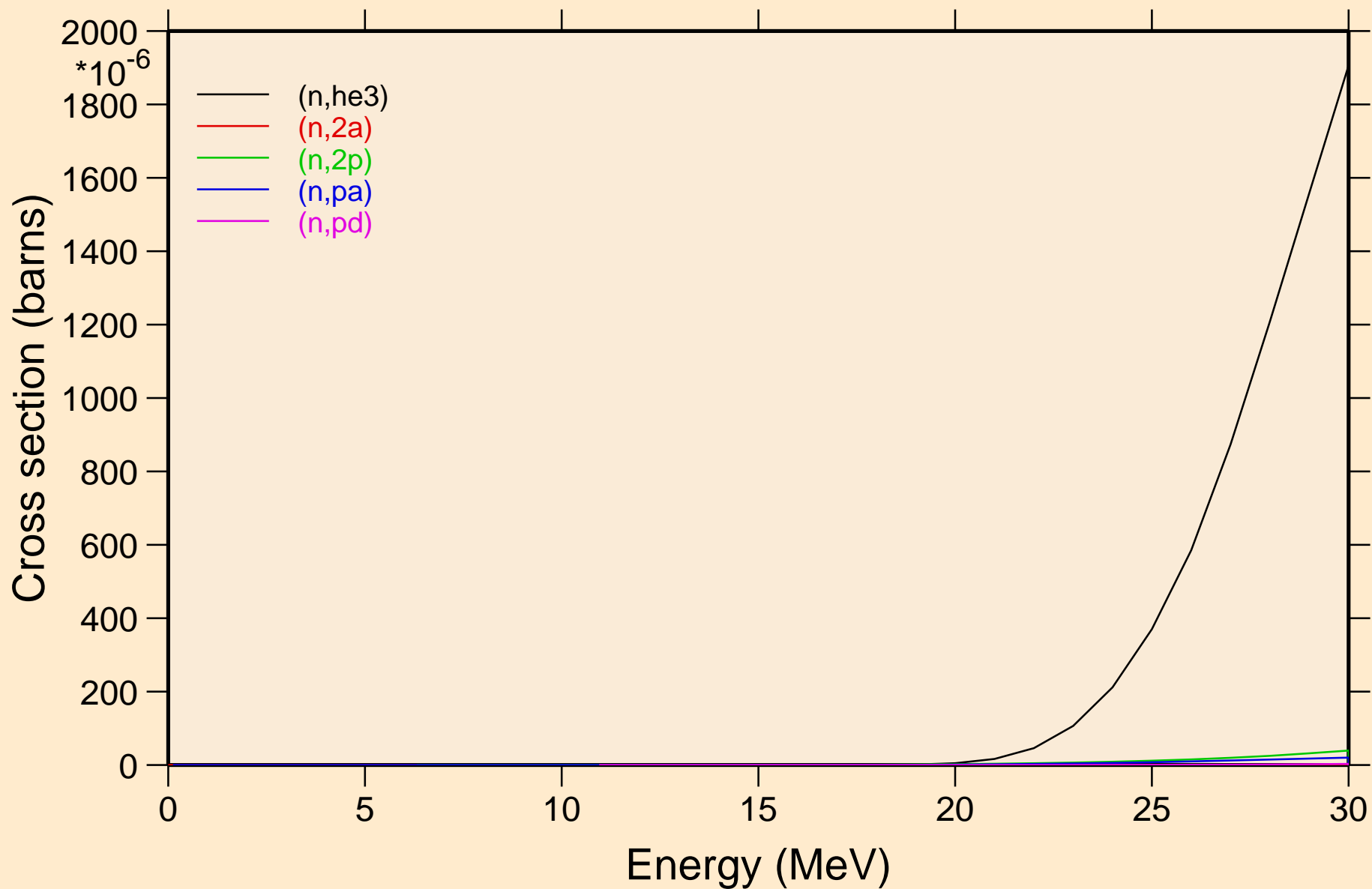

CS129 NEUTRON ACER TENDL-2019 LIBRARY; T=293.16K
Threshold reactions

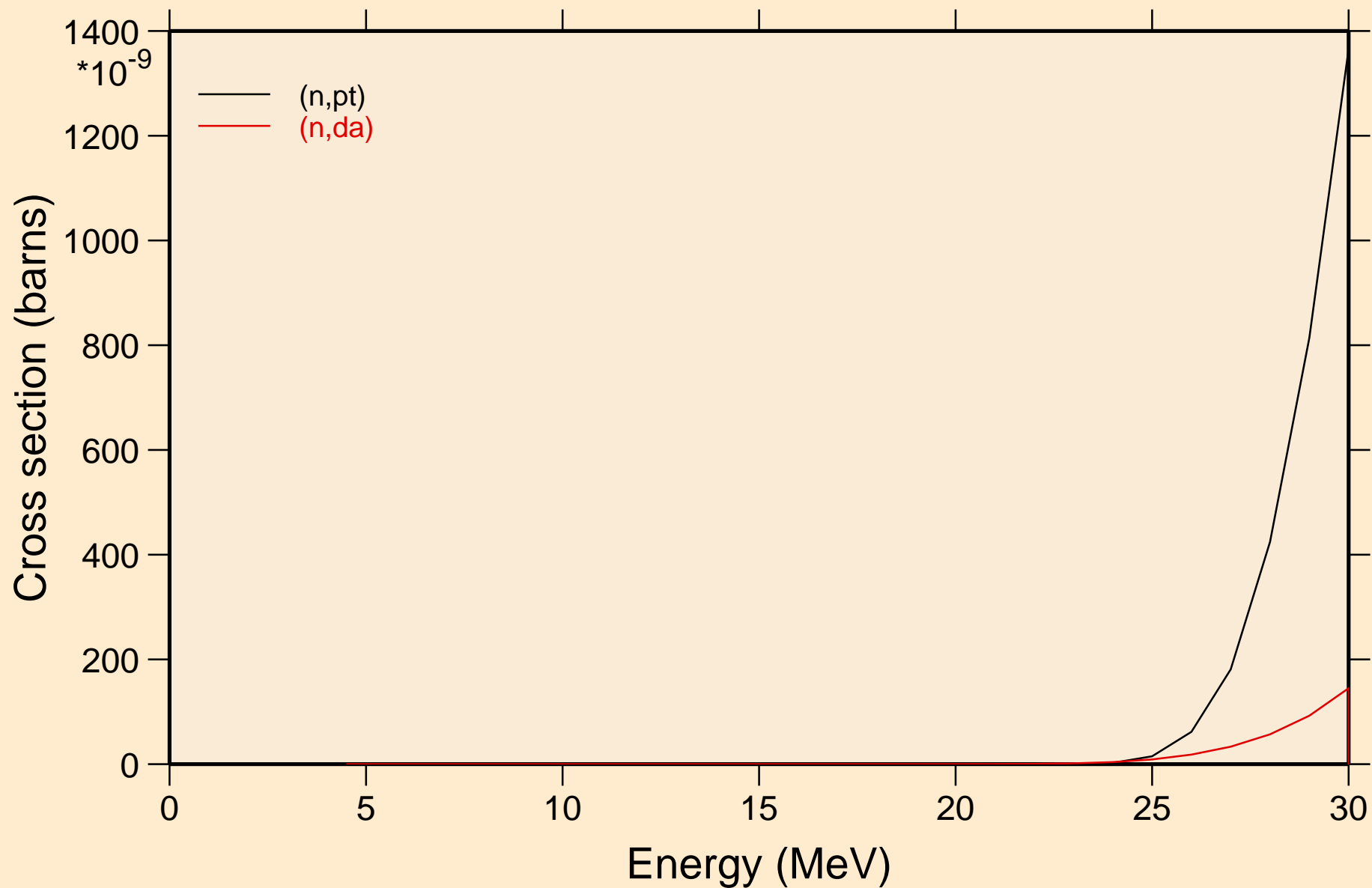

CS129 NEUTRON ACER TENDL-2019 LIBRARY; T=293.16K
Threshold reactions

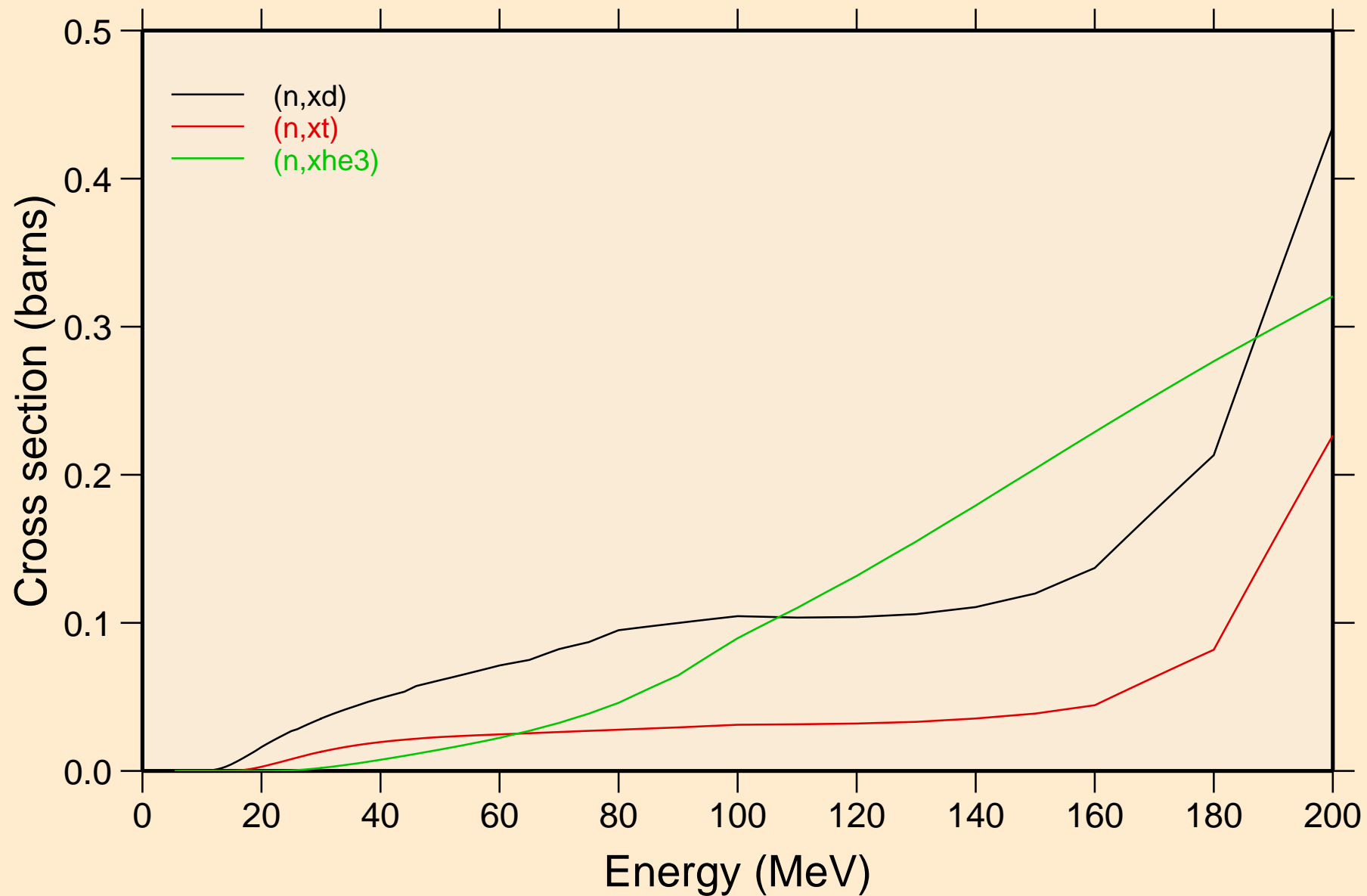

CS129 NEUTRON ACER TENDL-2019 LIBRARY; T=293.16K
angular distribution for elastic

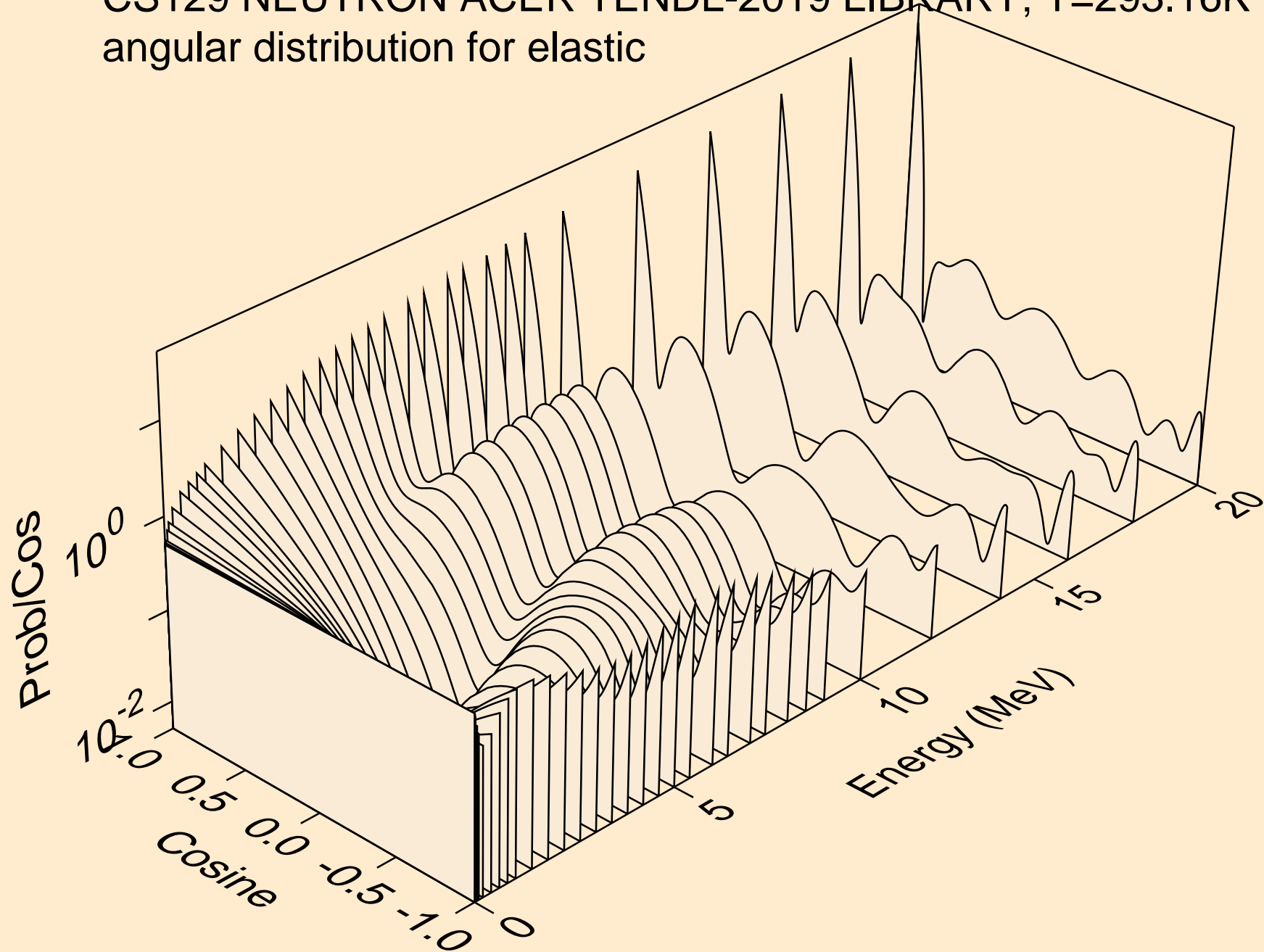

CS129 NEUTRON ACER TENDL-2019 LIBRARY; T=293.16K
angular distribution for elastic

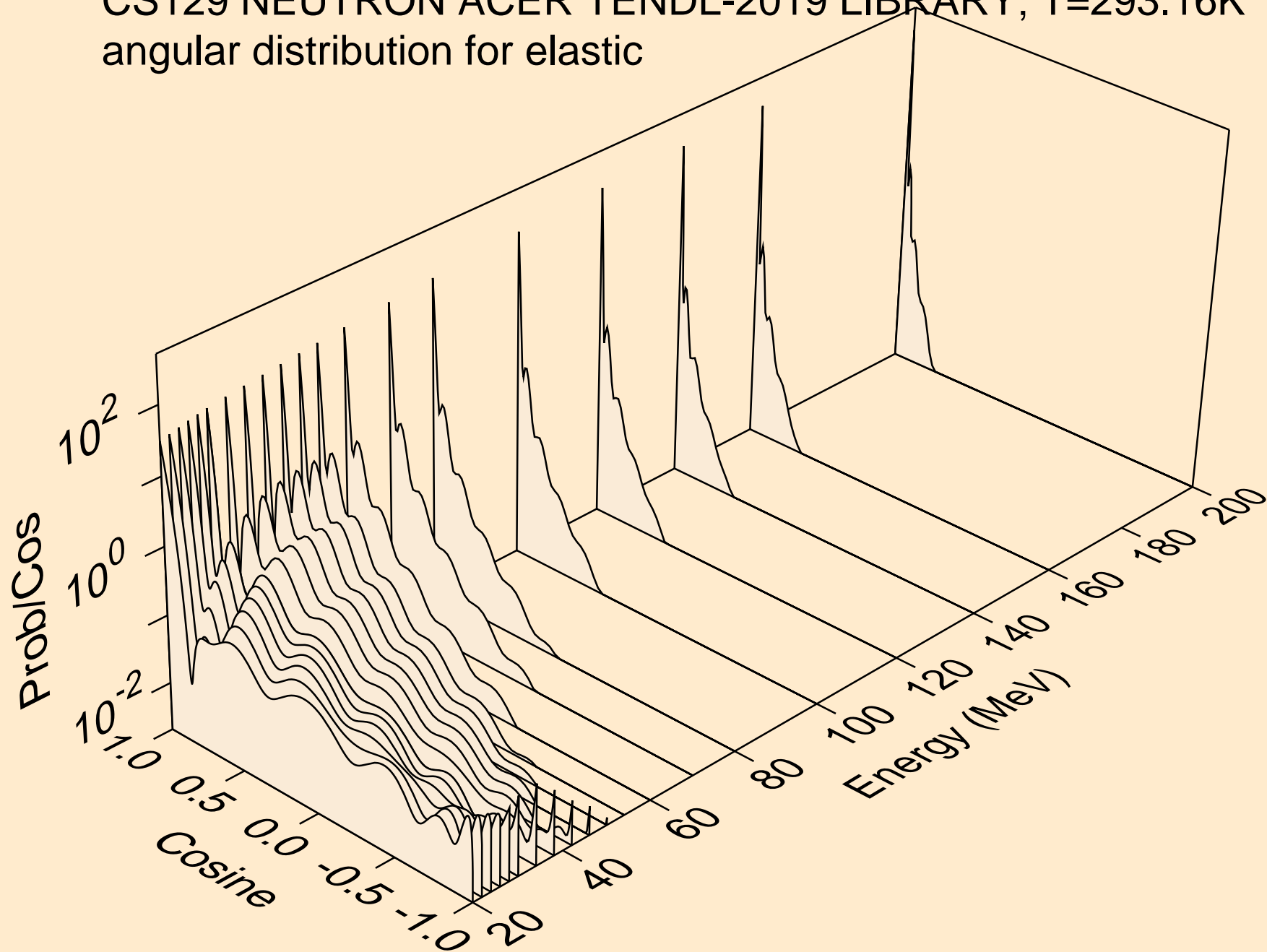

CS129 NEUTRON ACER TENDL-2019 LIBRARY; T=293.16K
angular distribution for (n,n*1)

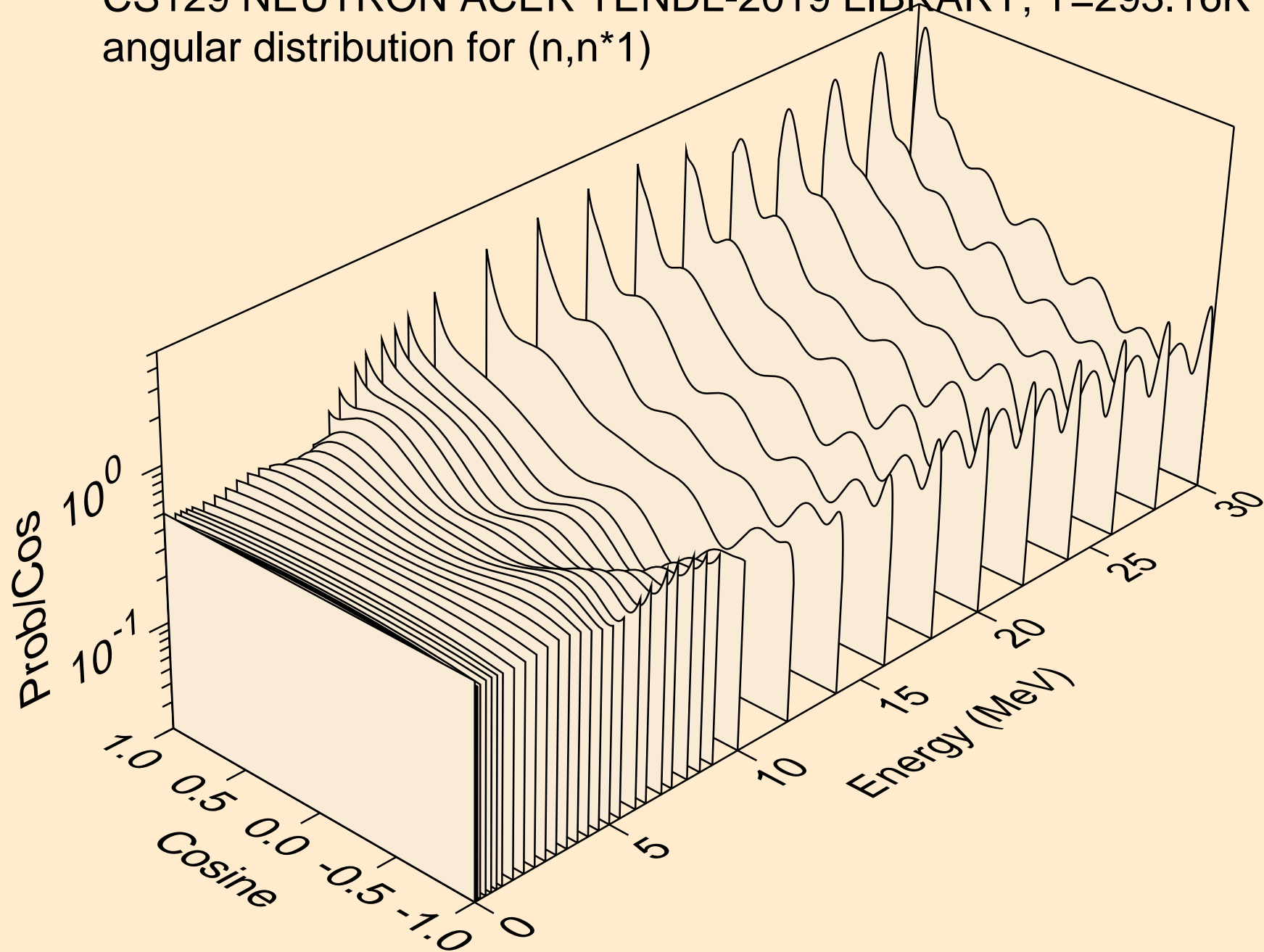

CS129 NEUTRON ACER TENDL-2019 LIBRARY; T=293.16K
angular distribution for (n,n*2)

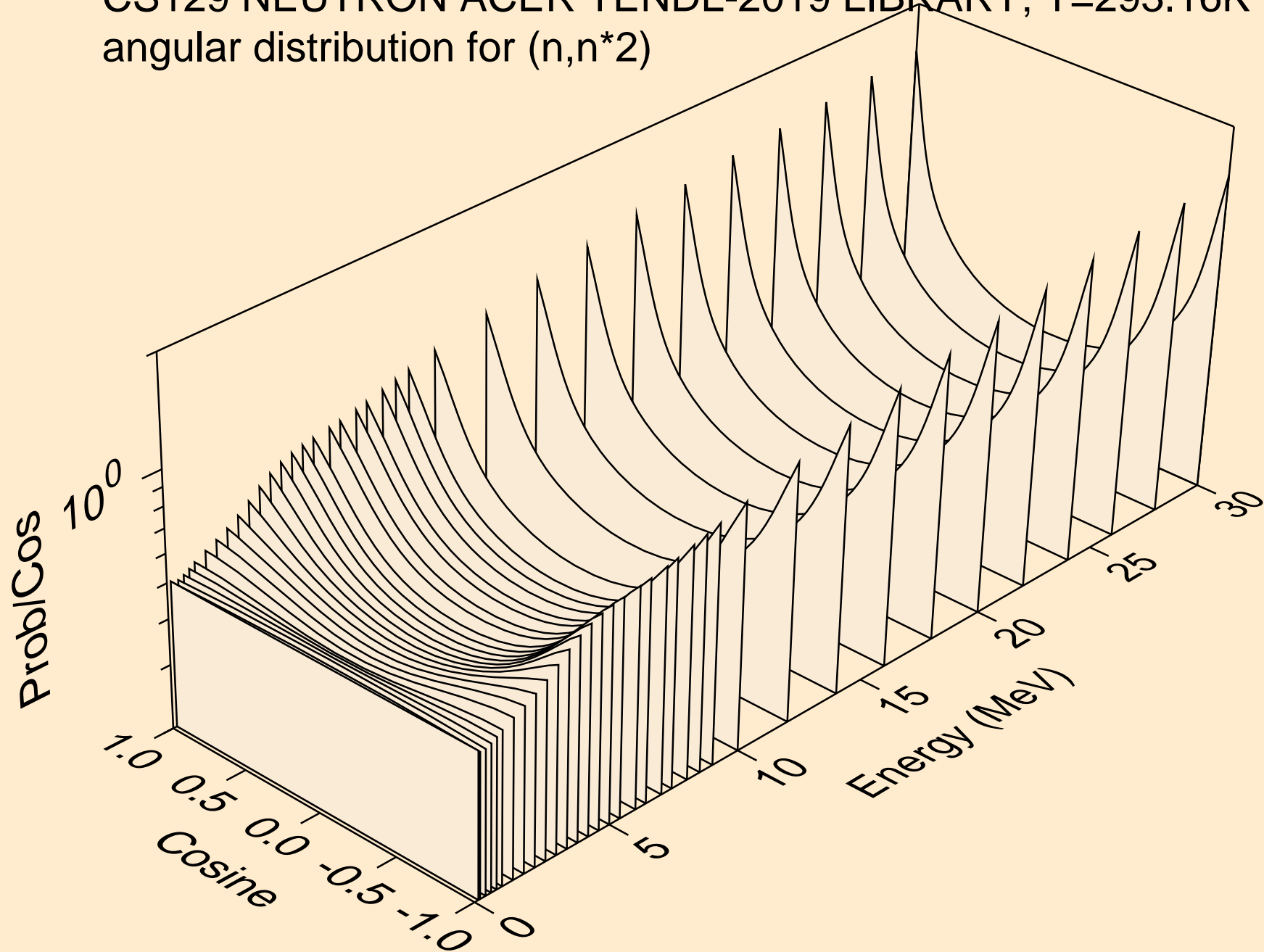

CS129 NEUTRON ACER TENDL-2019 LIBRARY; T=293.16K
angular distribution for (n,n*3)

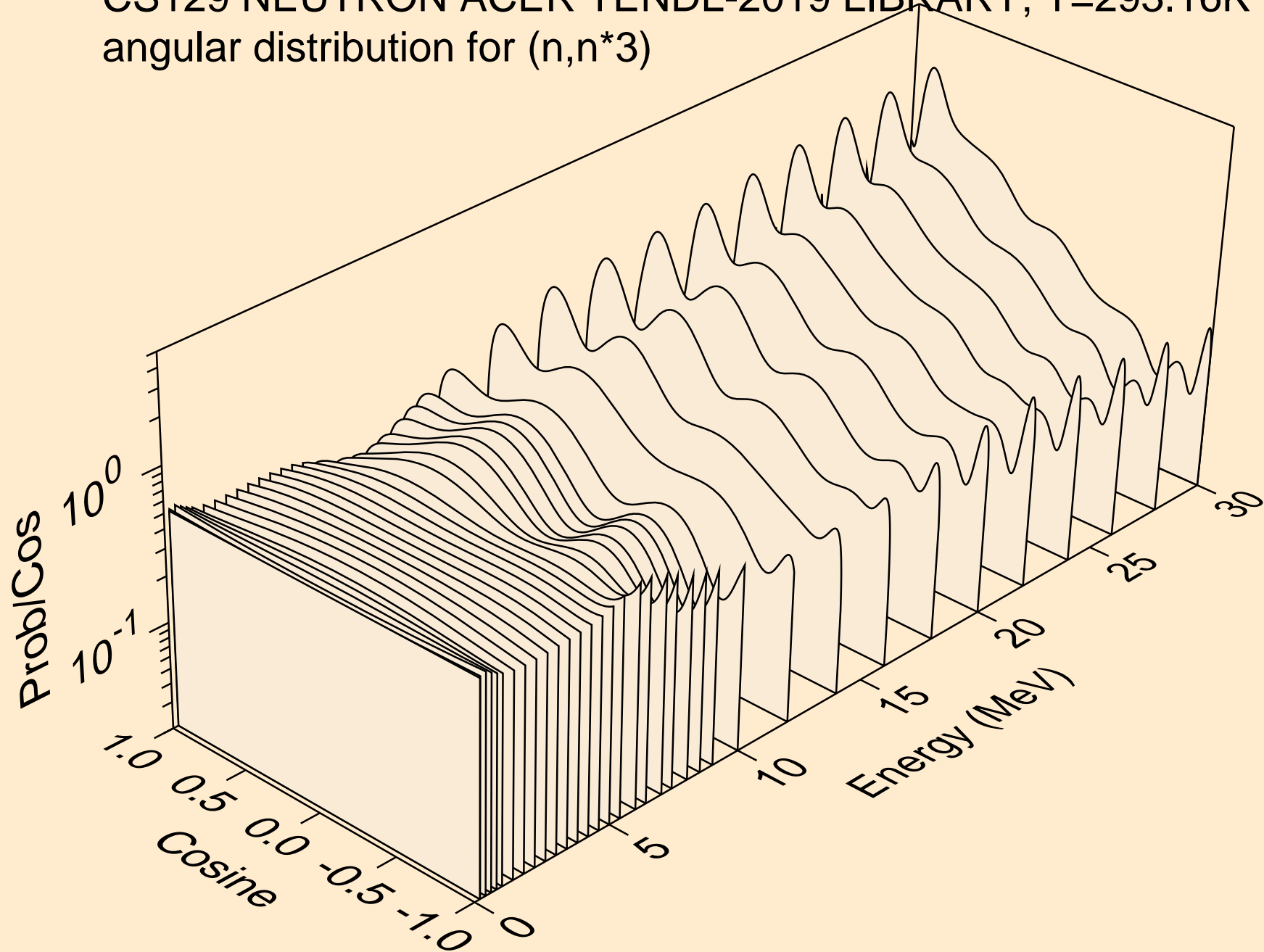

CS129 NEUTRON ACER TENDL-2019 LIBRARY; T=293.16K
angular distribution for (n,n*4)

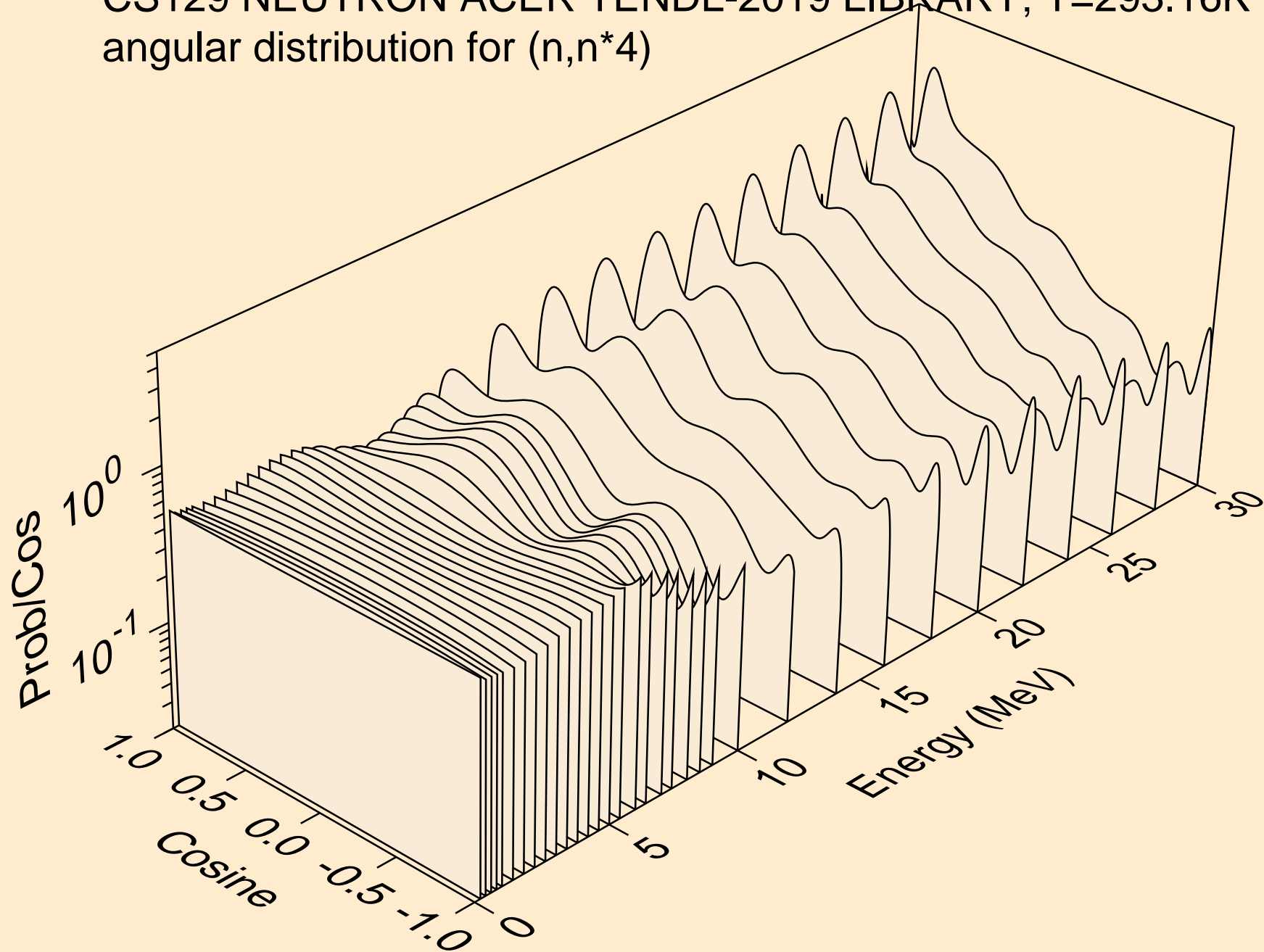

CS129 NEUTRON ACER TENDL-2019 LIBRARY; T=293.16K
angular distribution for (n,n*5)

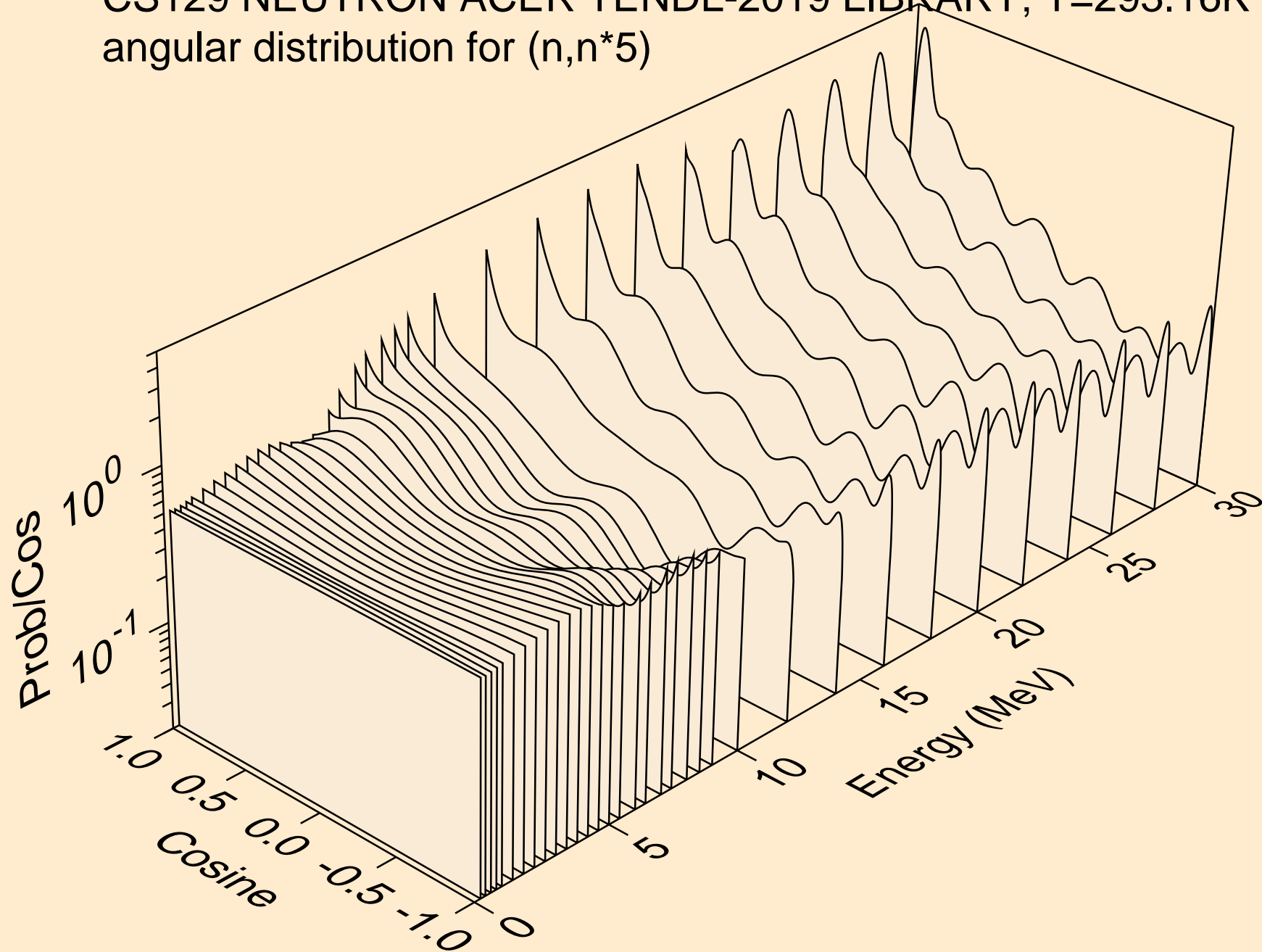

CS129 NEUTRON ACER TENDL-2019 LIBRARY; T=293.16K
angular distribution for (n,n*6)

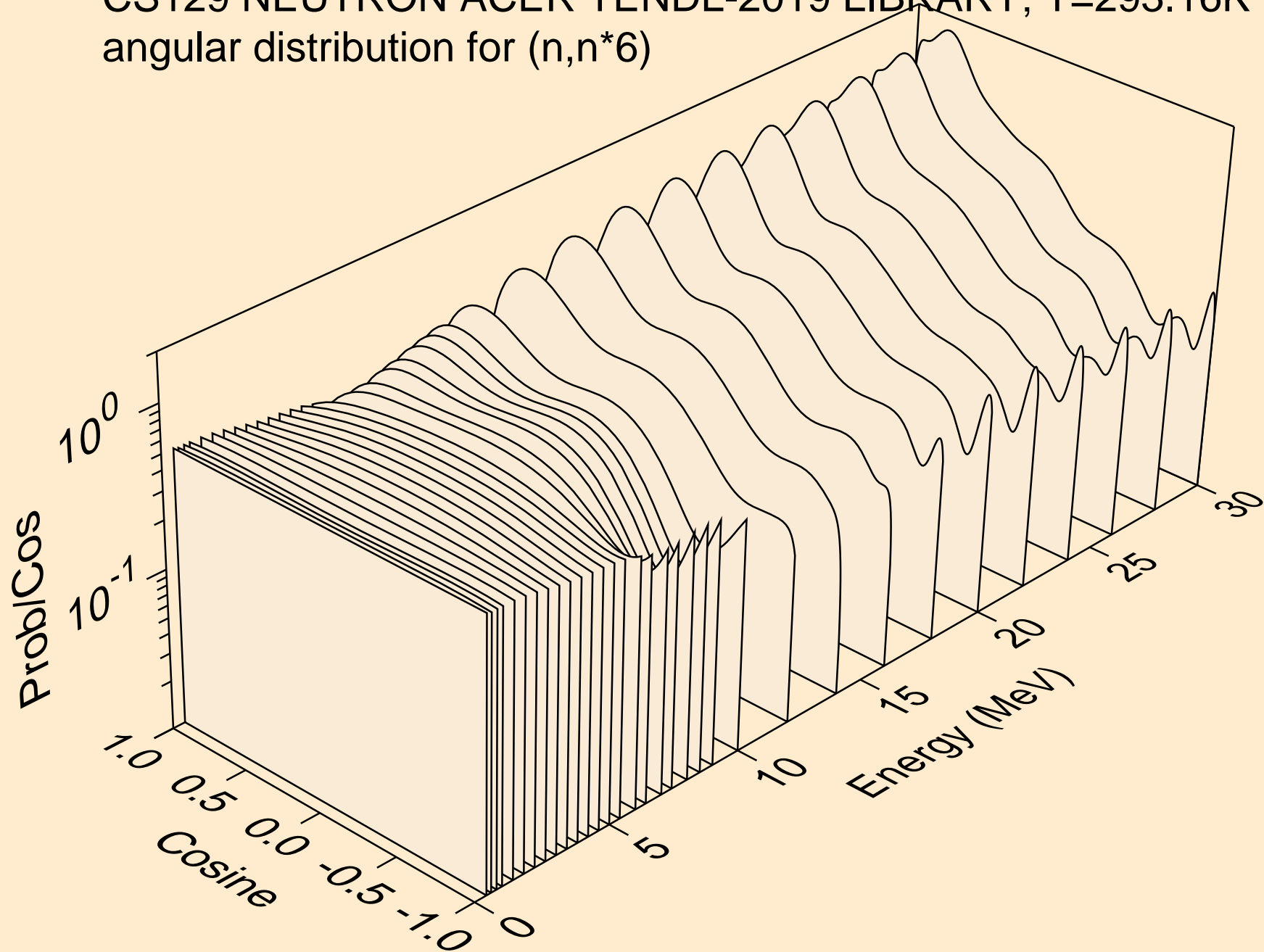

CS129 NEUTRON ACER TENDL-2019 LIBRARY; T=293.16K
angular distribution for (n,n*7)

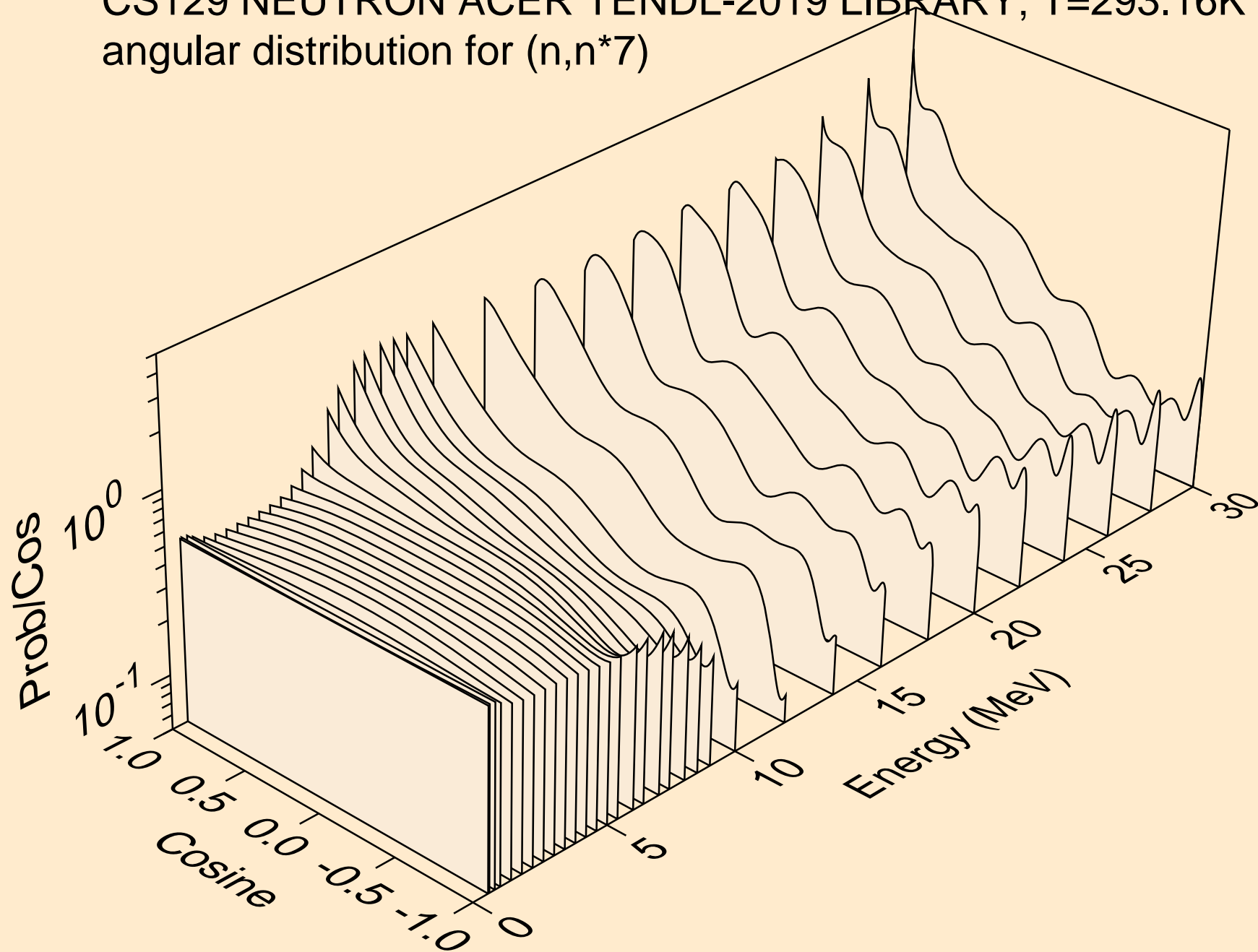

CS129 NEUTRON ACER TENDL-2019 LIBRARY; T=293.16K
angular distribution for (n,n*8)

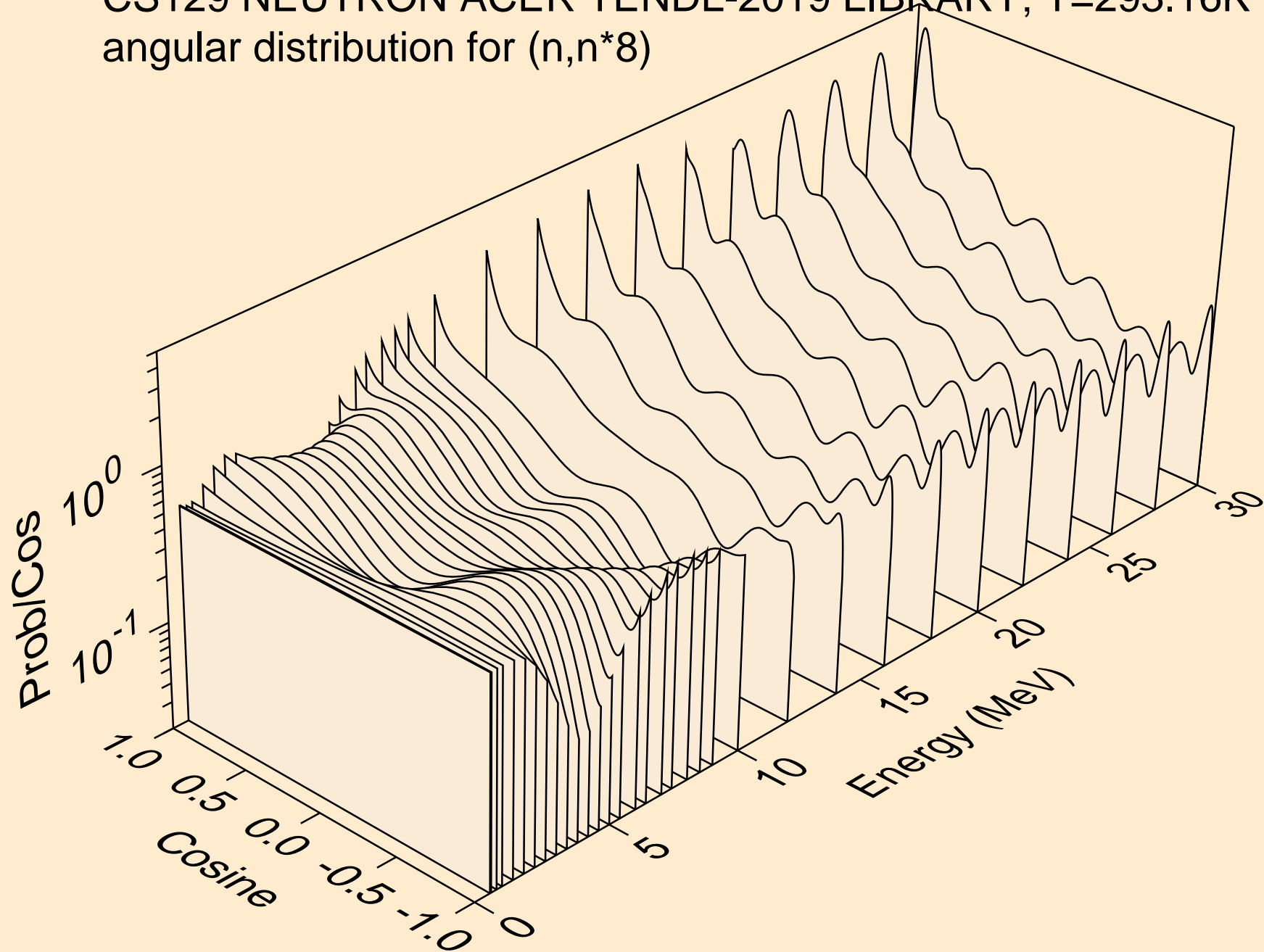

CS129 NEUTRON ACER TENDL-2019 LIBRARY; T=293.16K
angular distribution for (n,n*9)

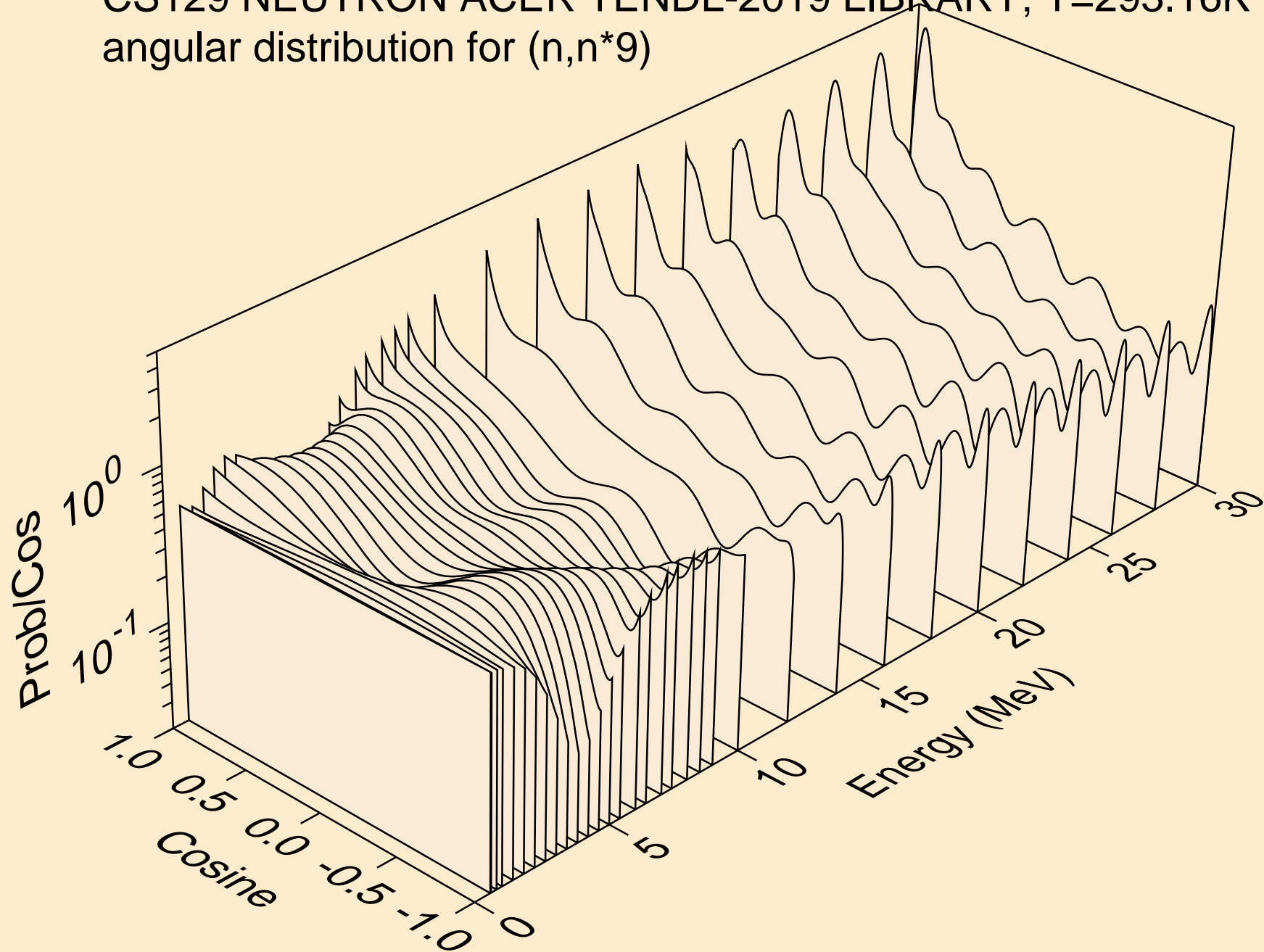

CS129 NEUTRON ACER TENDL-2019 LIBRARY; T=293.16K
angular distribution for (n,n*10)

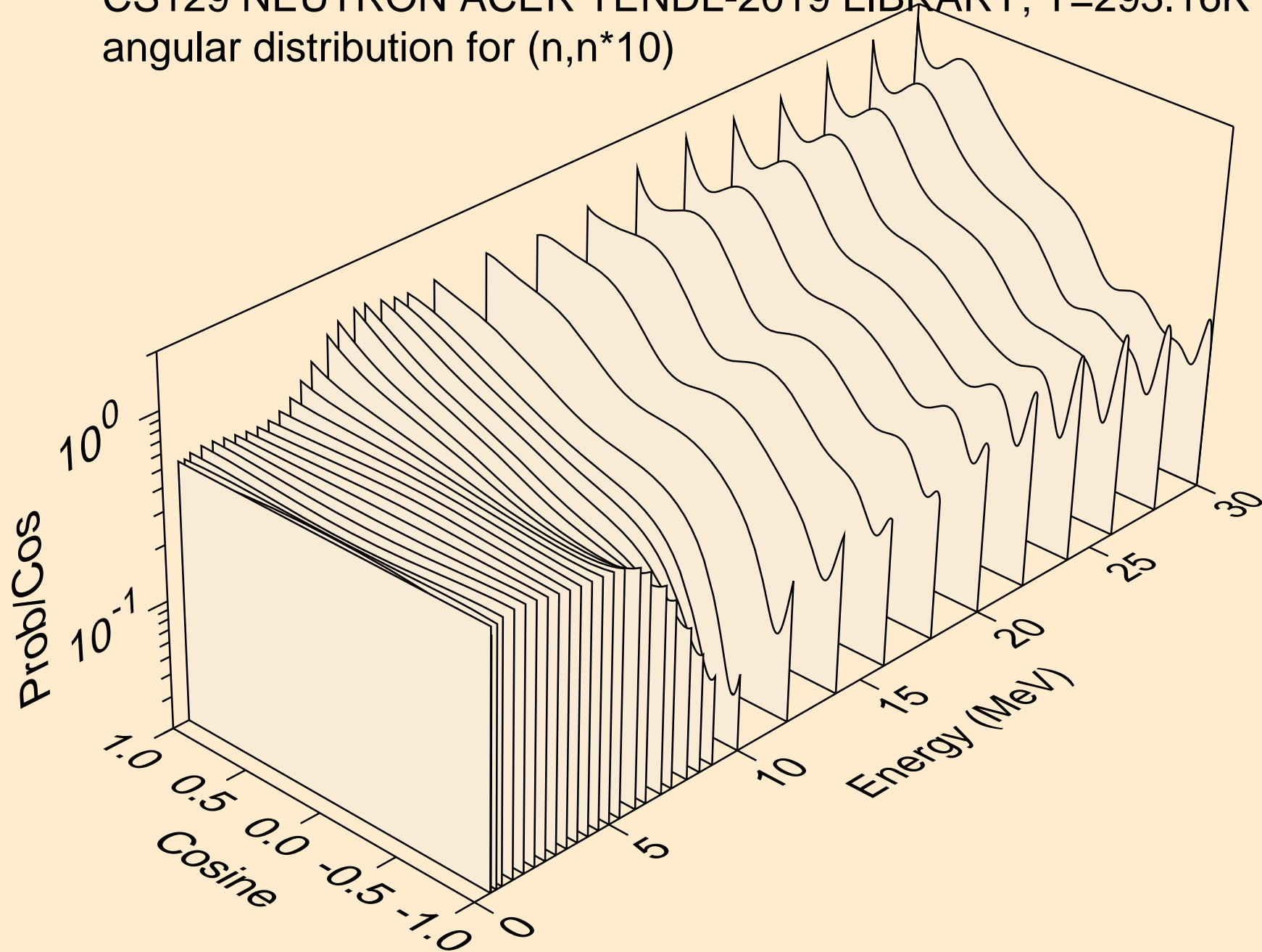

CS129 NEUTRON ACER TENDL-2019 LIBRARY; T=293.16K
angular distribution for (n,n*11)

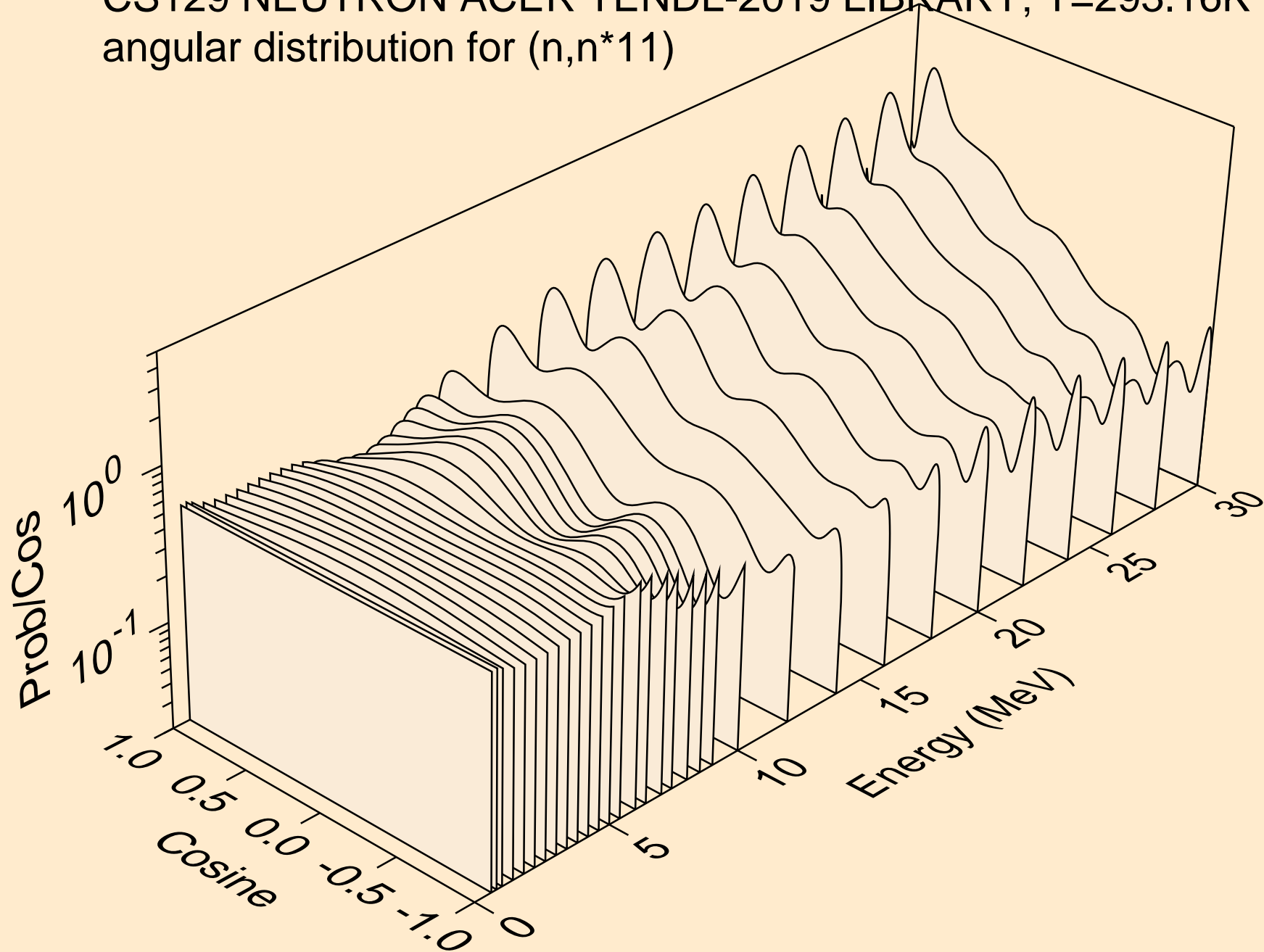

CS129 NEUTRON ACER TENDL-2019 LIBRARY; T=293.16K
angular distribution for (n,n*12)

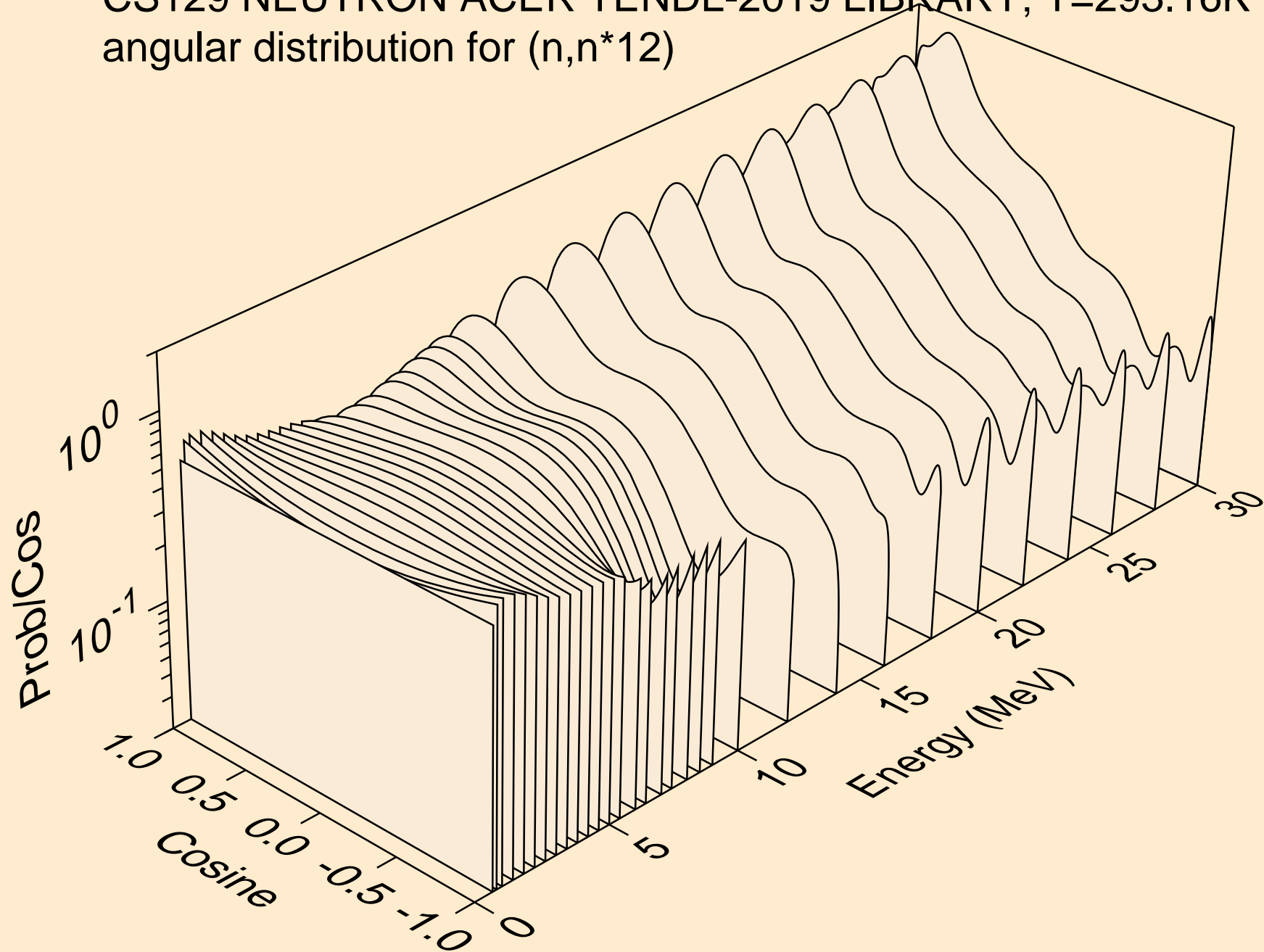

CS129 NEUTRON ACER TENDL-2019 LIBRARY; T=293.16K
angular distribution for (n,n*13)

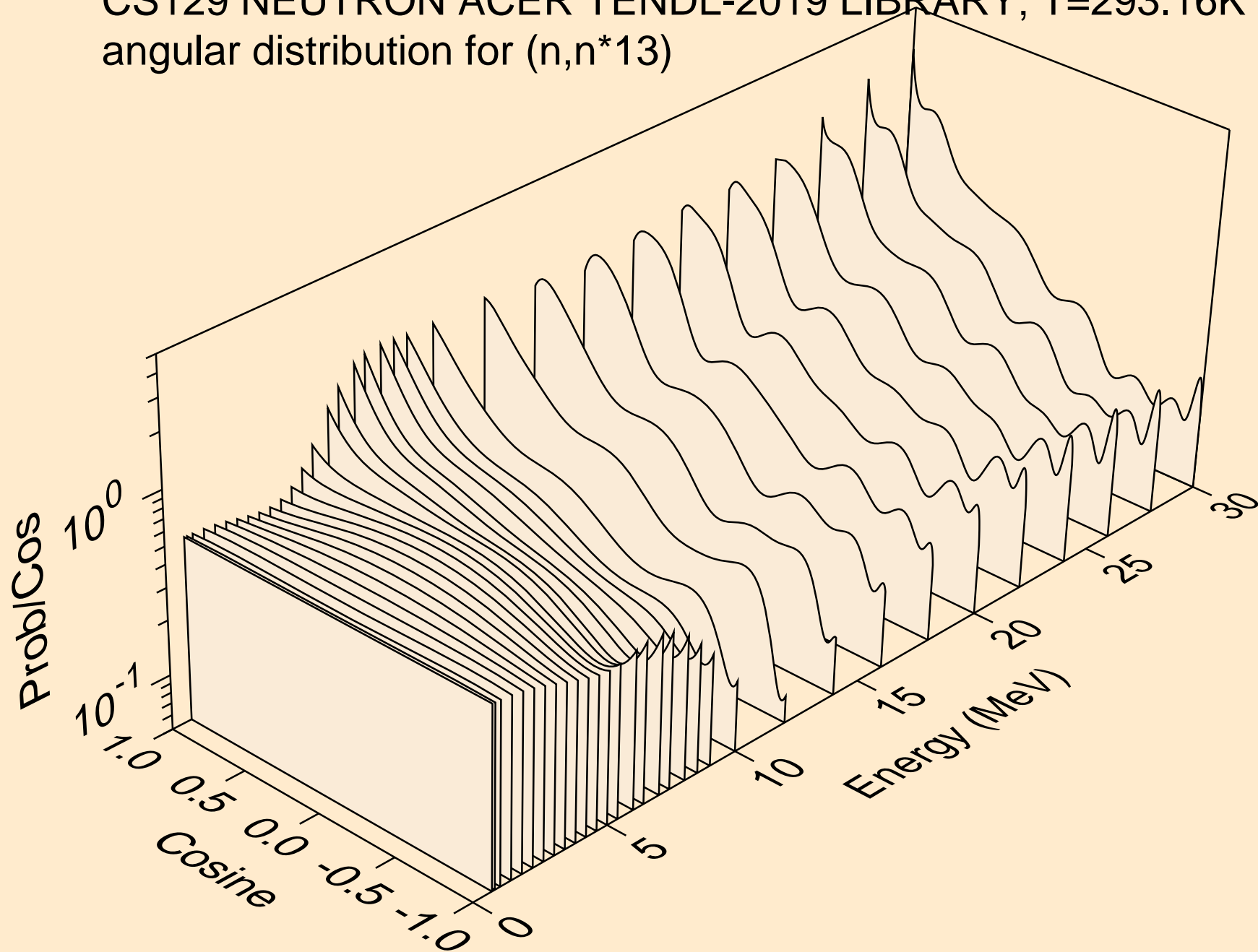

CS129 NEUTRON ACER TENDL-2019 LIBRARY; T=293.16K
angular distribution for (n,n*14)

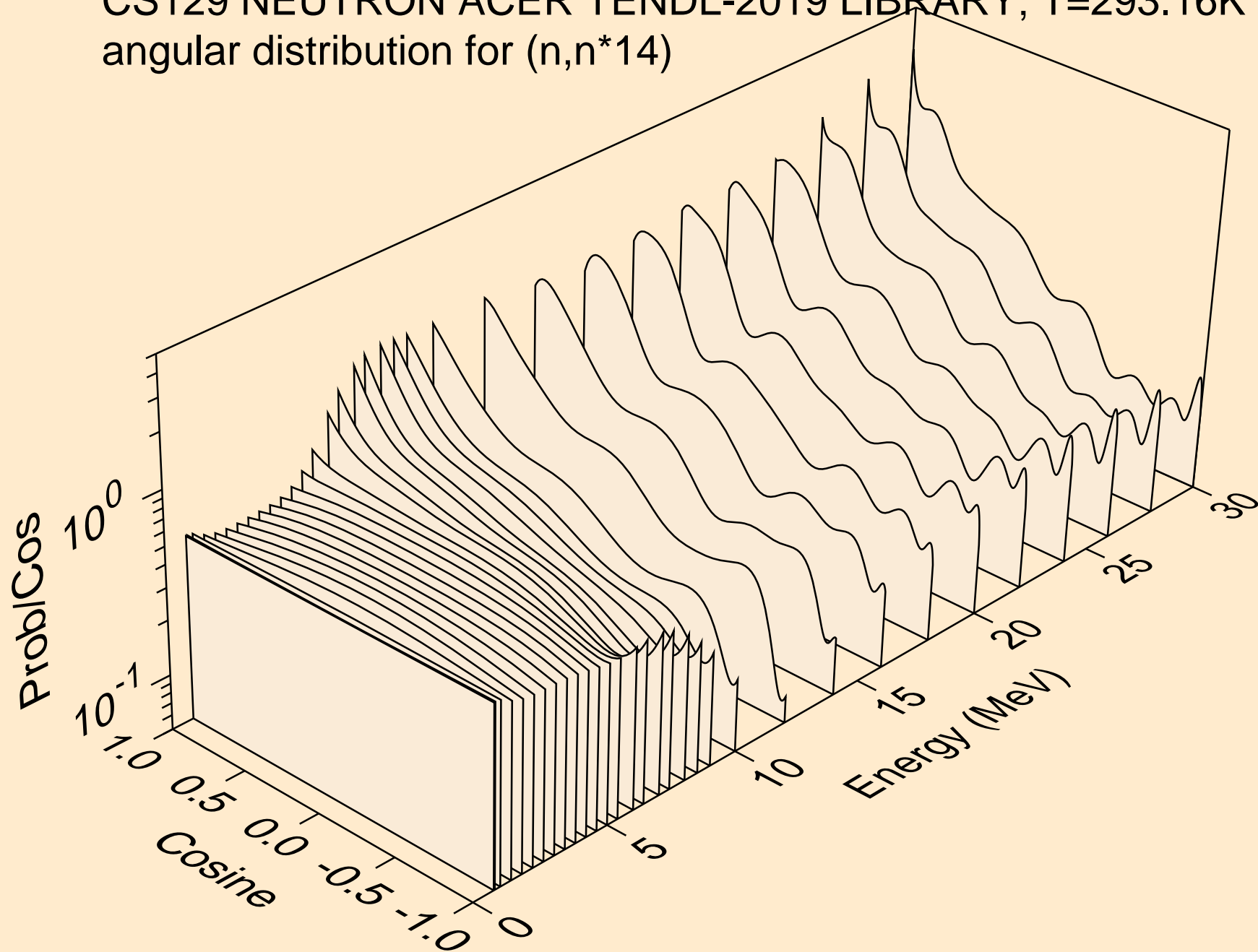

CS129 NEUTRON ACER TENDL-2019 LIBRARY; T=293.16K
angular distribution for (n,n*15)

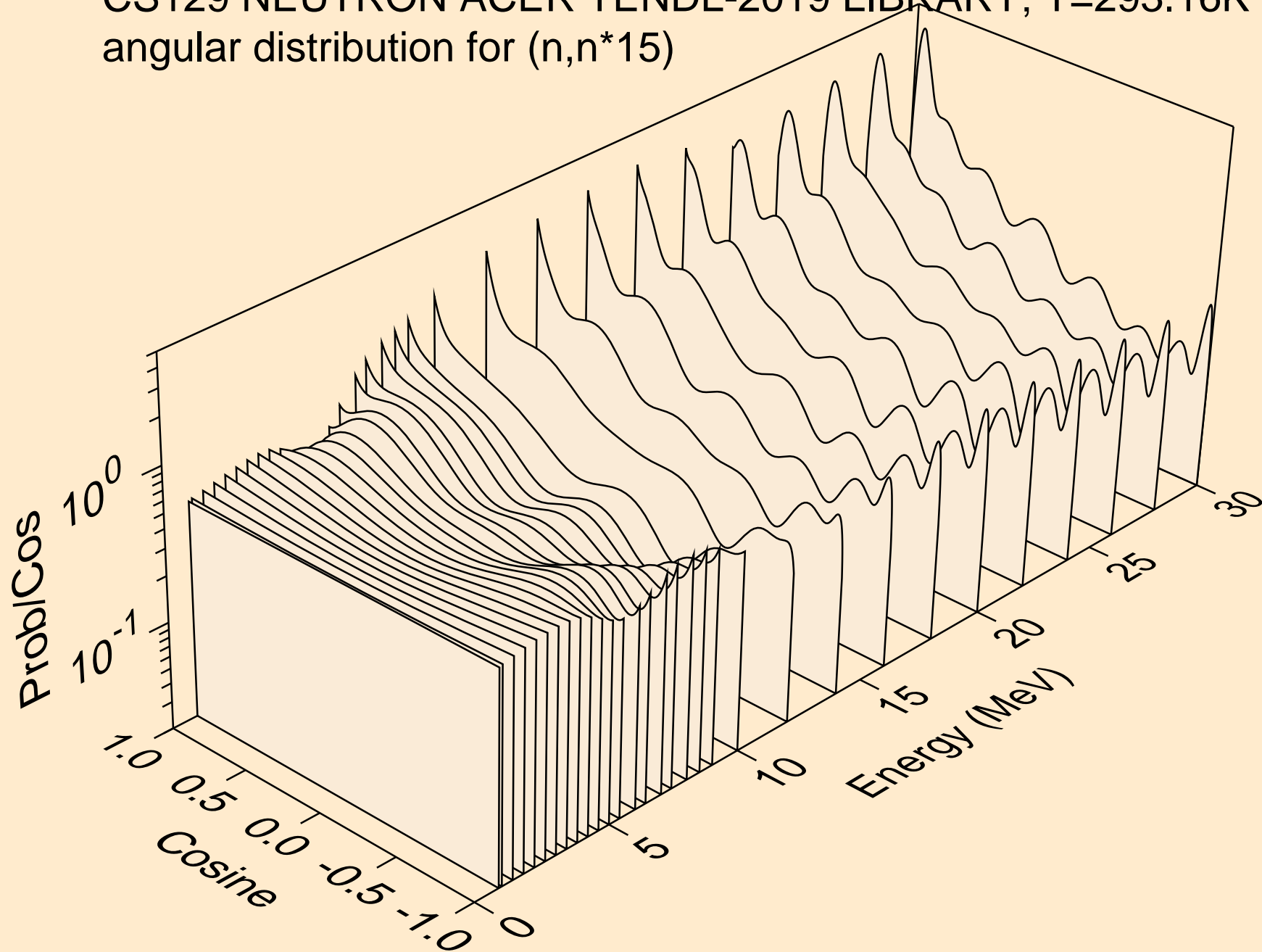

CS129 NEUTRON ACER TENDL-2019 LIBRARY; T=293.16K
angular distribution for (n,n*16)

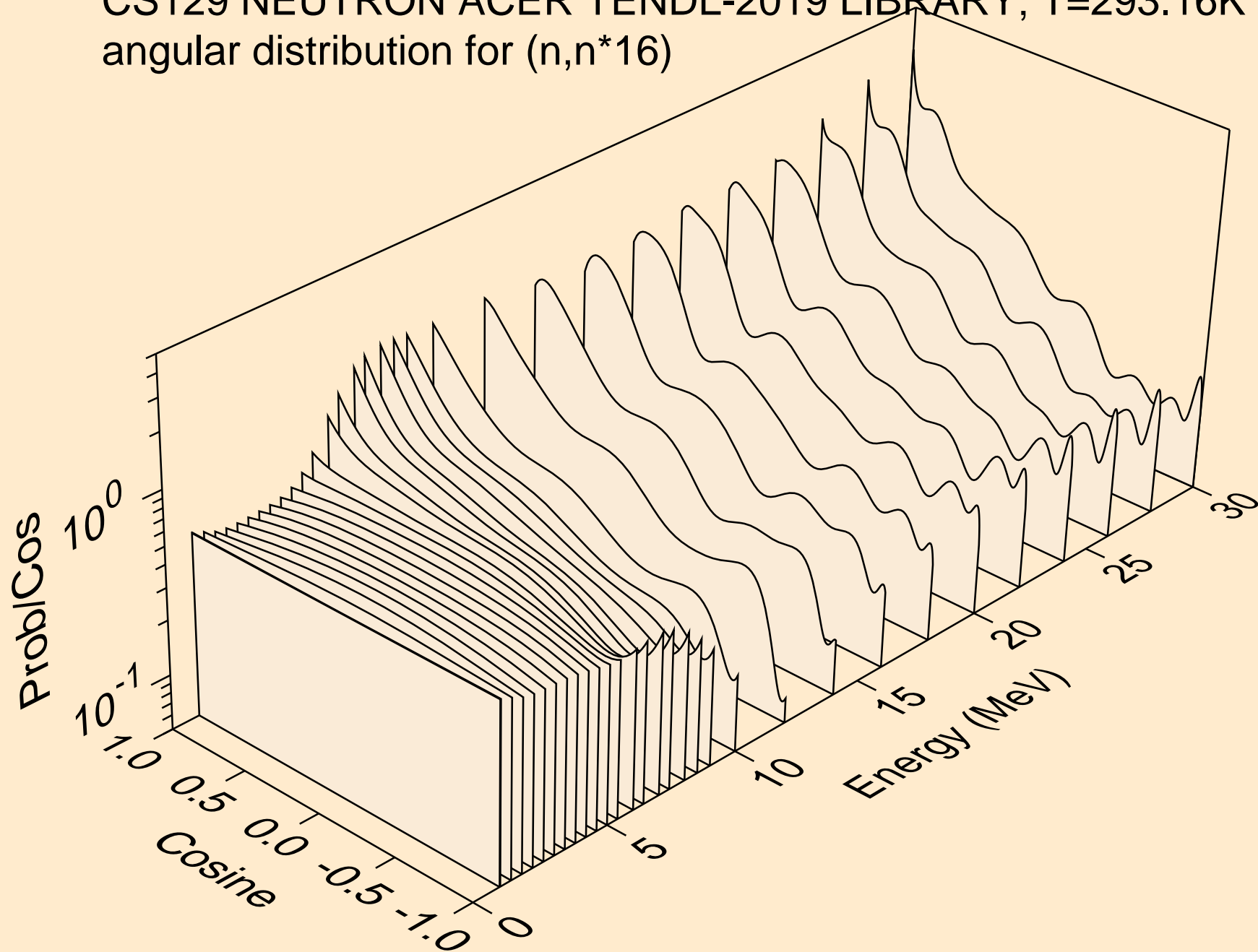

CS129 NEUTRON ACER TENDL-2019 LIBRARY; T=293.16K
angular distribution for (n,n*17)

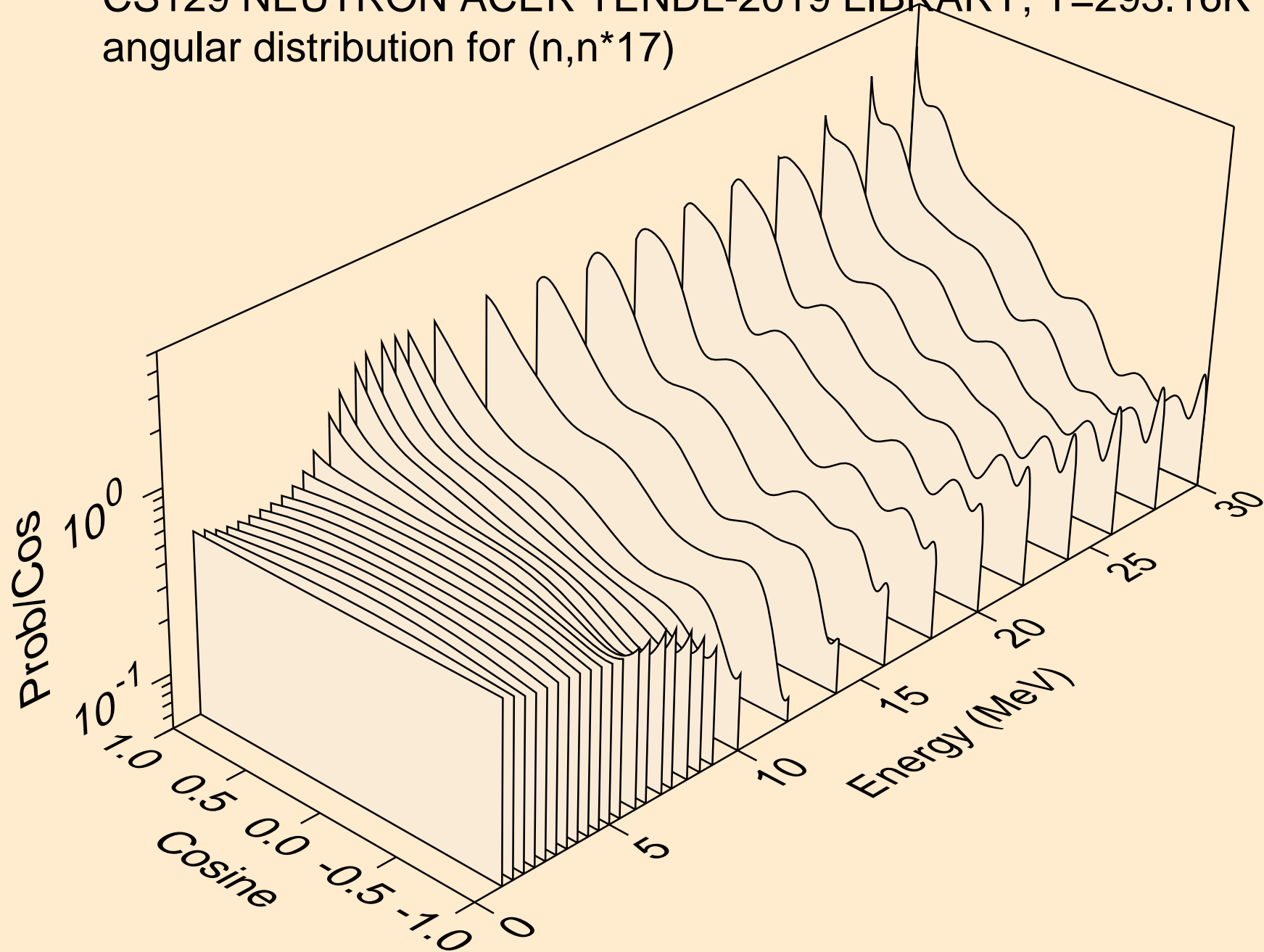

CS129 NEUTRON ACER TENDL-2019 LIBRARY; T=293.16K
angular distribution for (n,n*18)

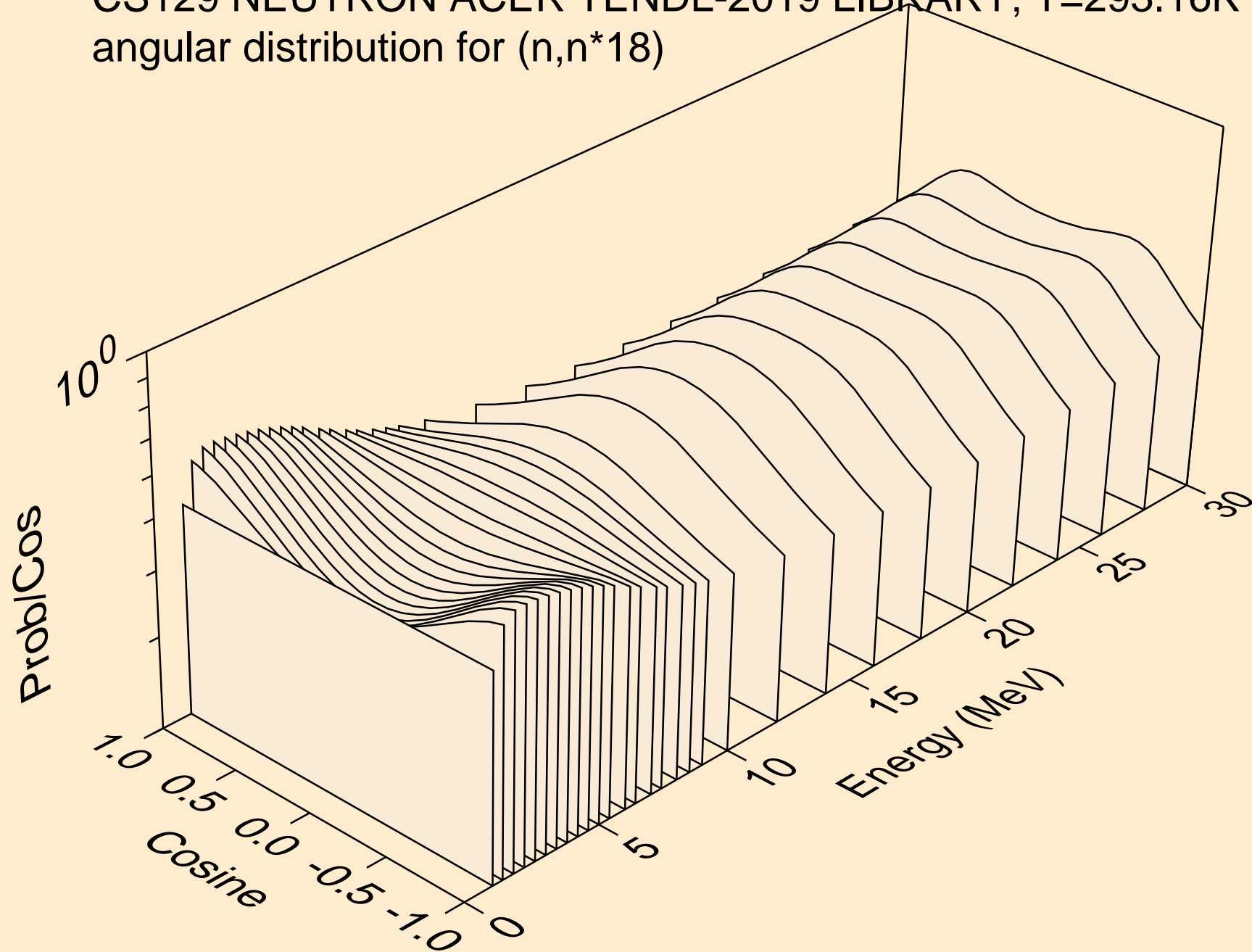

CS129 NEUTRON ACER TENDL-2019 LIBRARY; T=293.16K
angular distribution for (n,n*19)

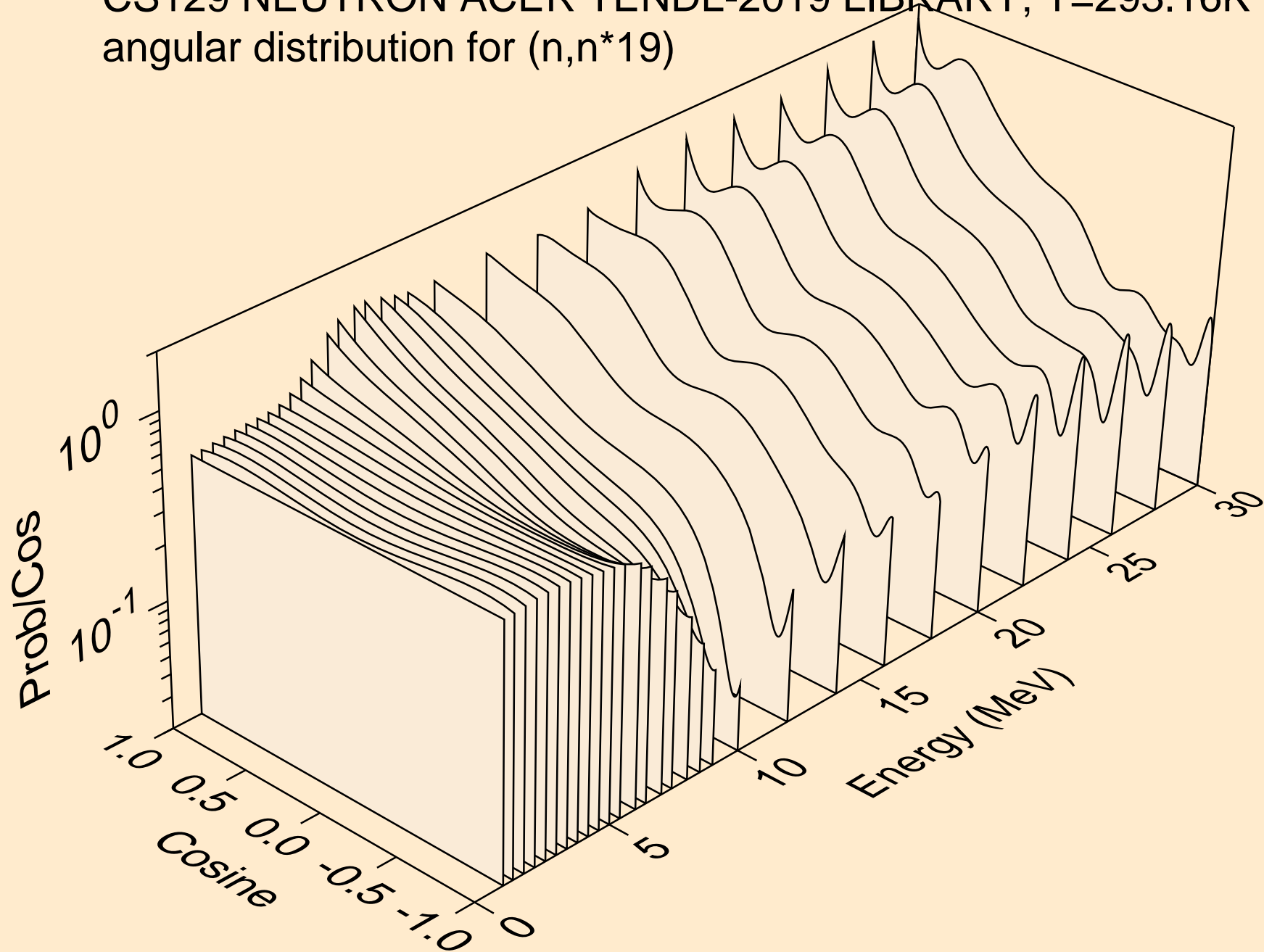

CS129 NEUTRON ACER TENDL-2019 LIBRARY; T=293.16K
angular distribution for (n,n*20)

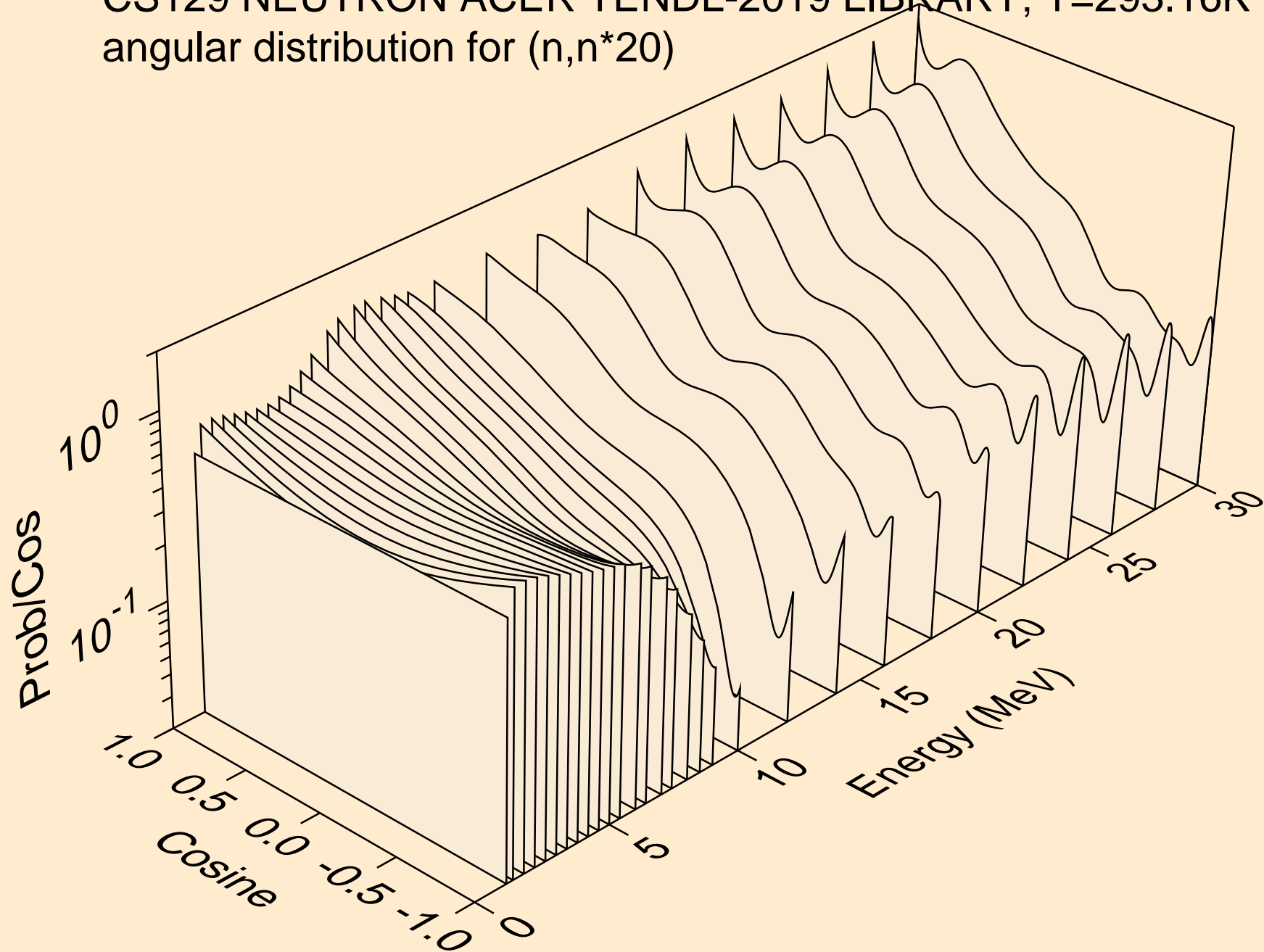

CS129 NEUTRON ACER TENDL-2019 LIBRARY; T=293.16K
angular distribution for (n,n*21)

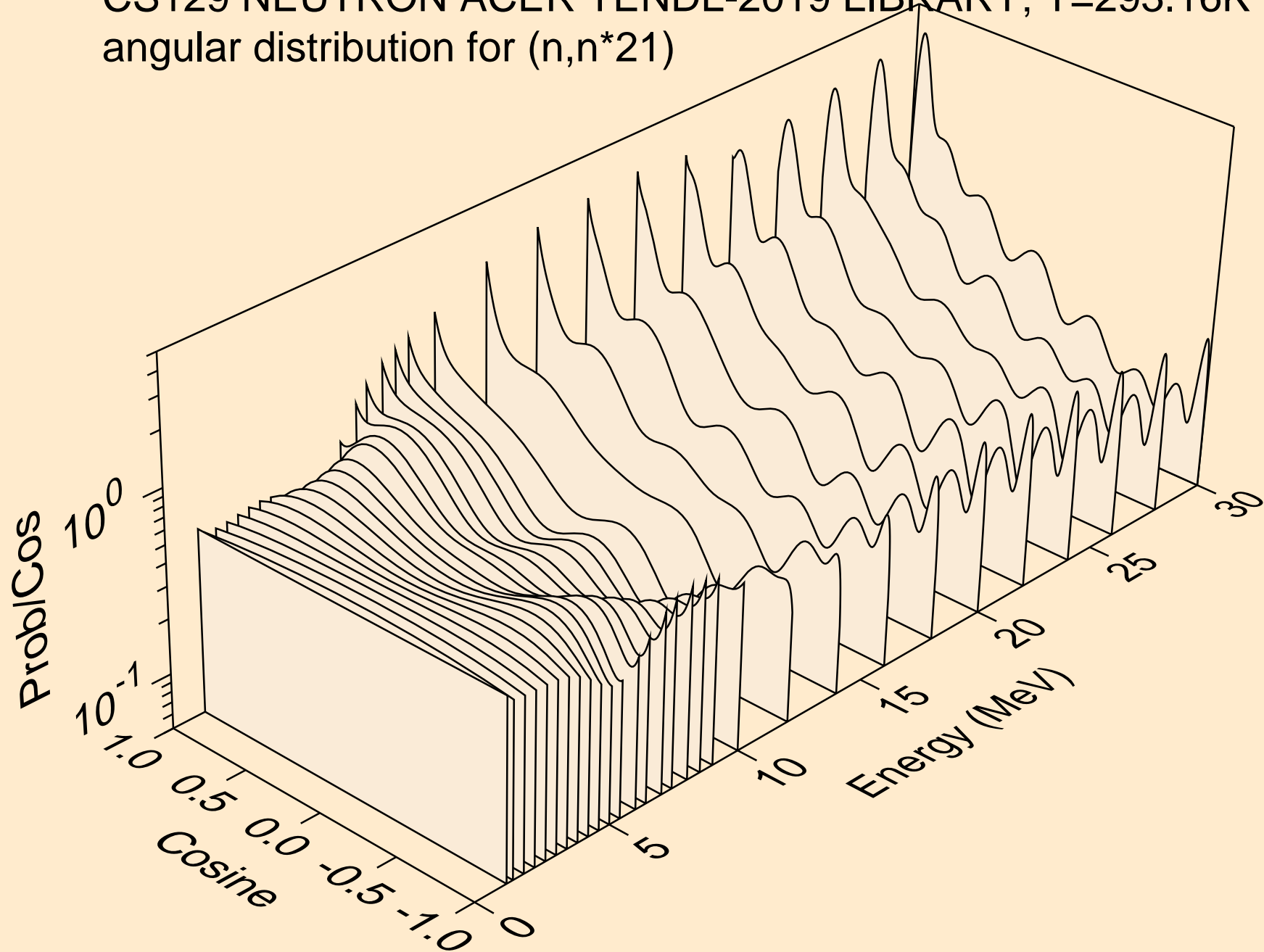

CS129 NEUTRON ACER TENDL-2019 LIBRARY; T=293.16K
angular distribution for (n,n*22)

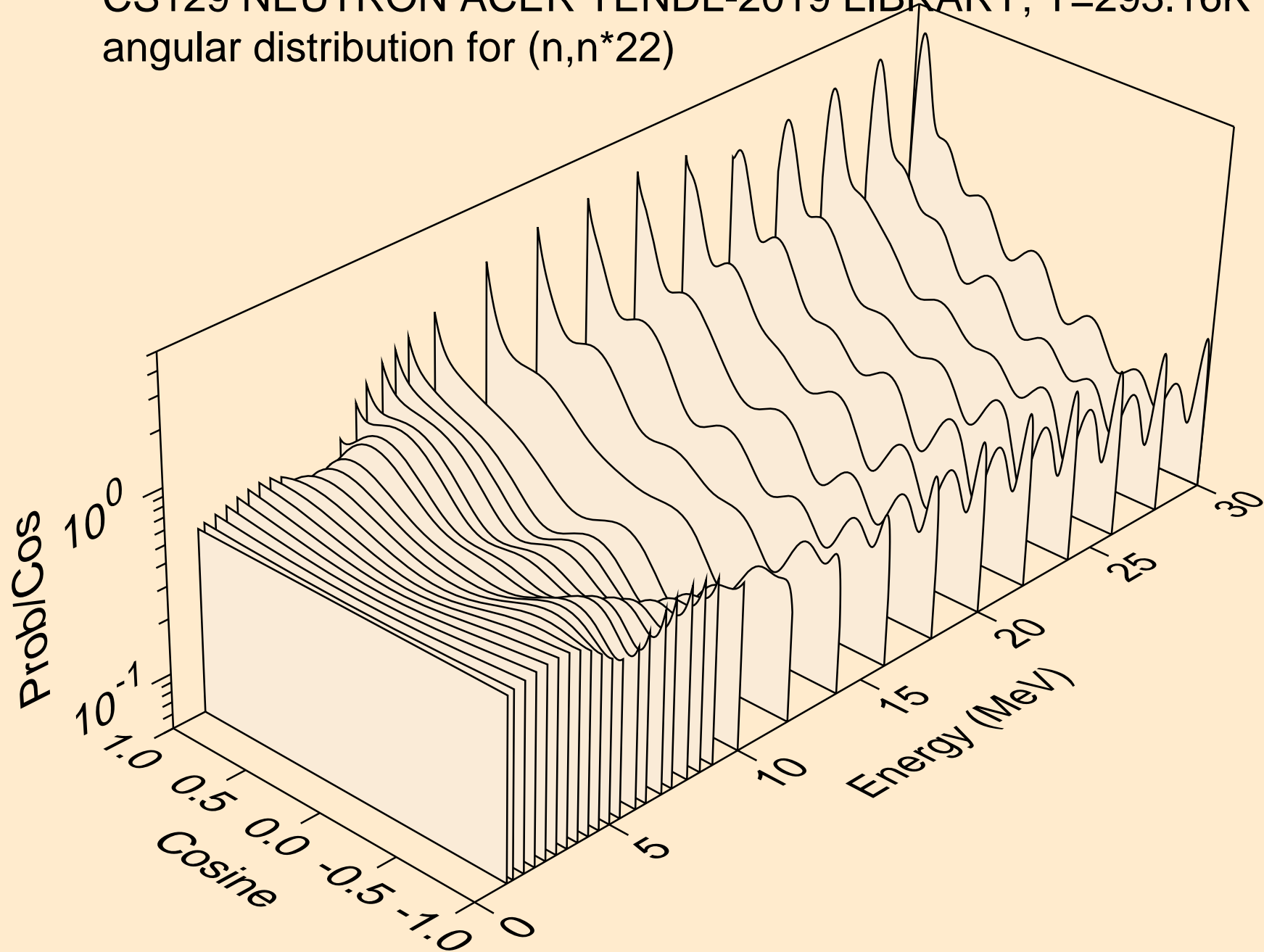

CS129 NEUTRON ACER TENDL-2019 LIBRARY; T=293.16K
angular distribution for (n,n*23)

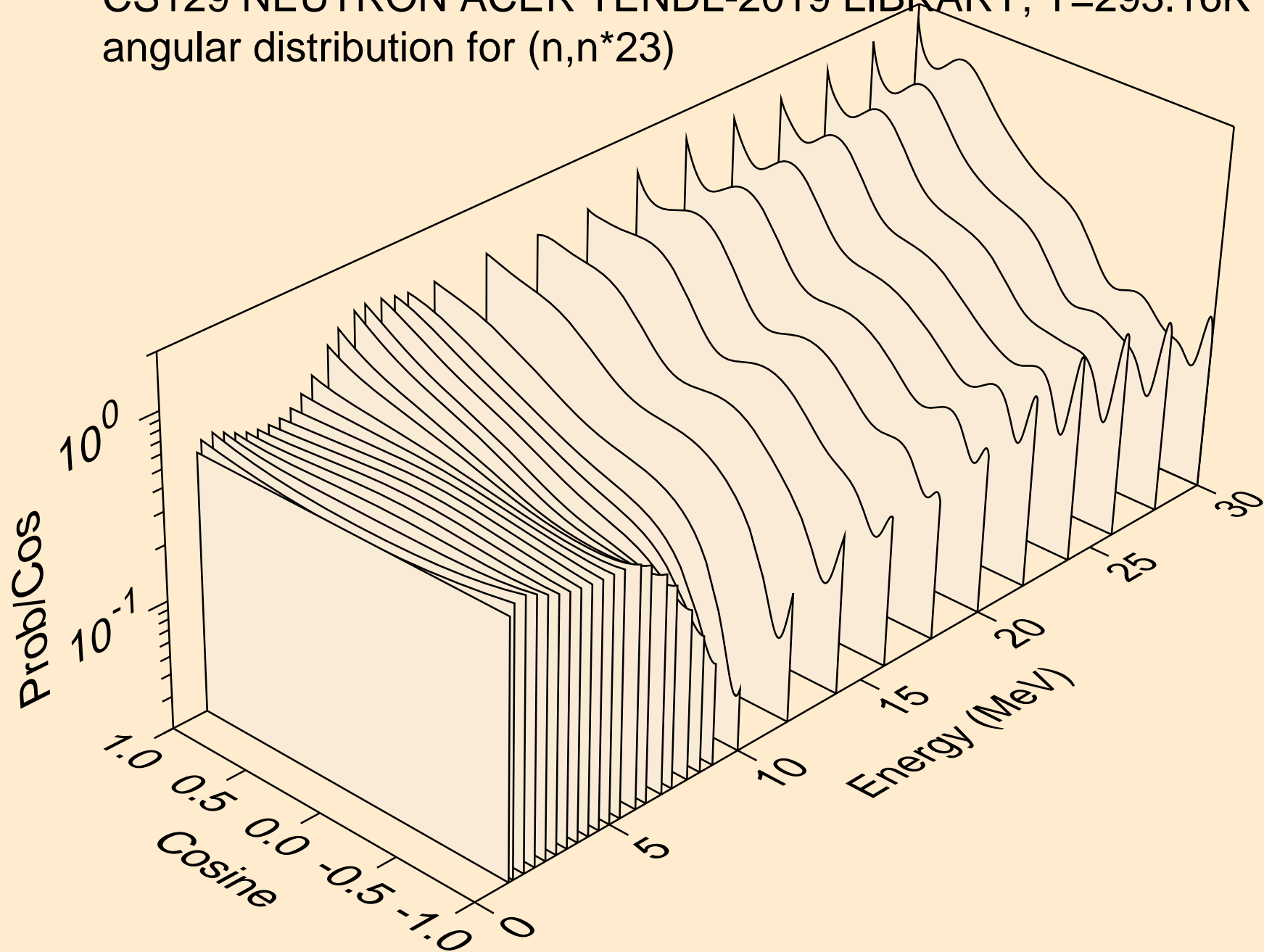

CS129 NEUTRON ACER TENDL-2019 LIBRARY; T=293.16K
angular distribution for (n,n*24)

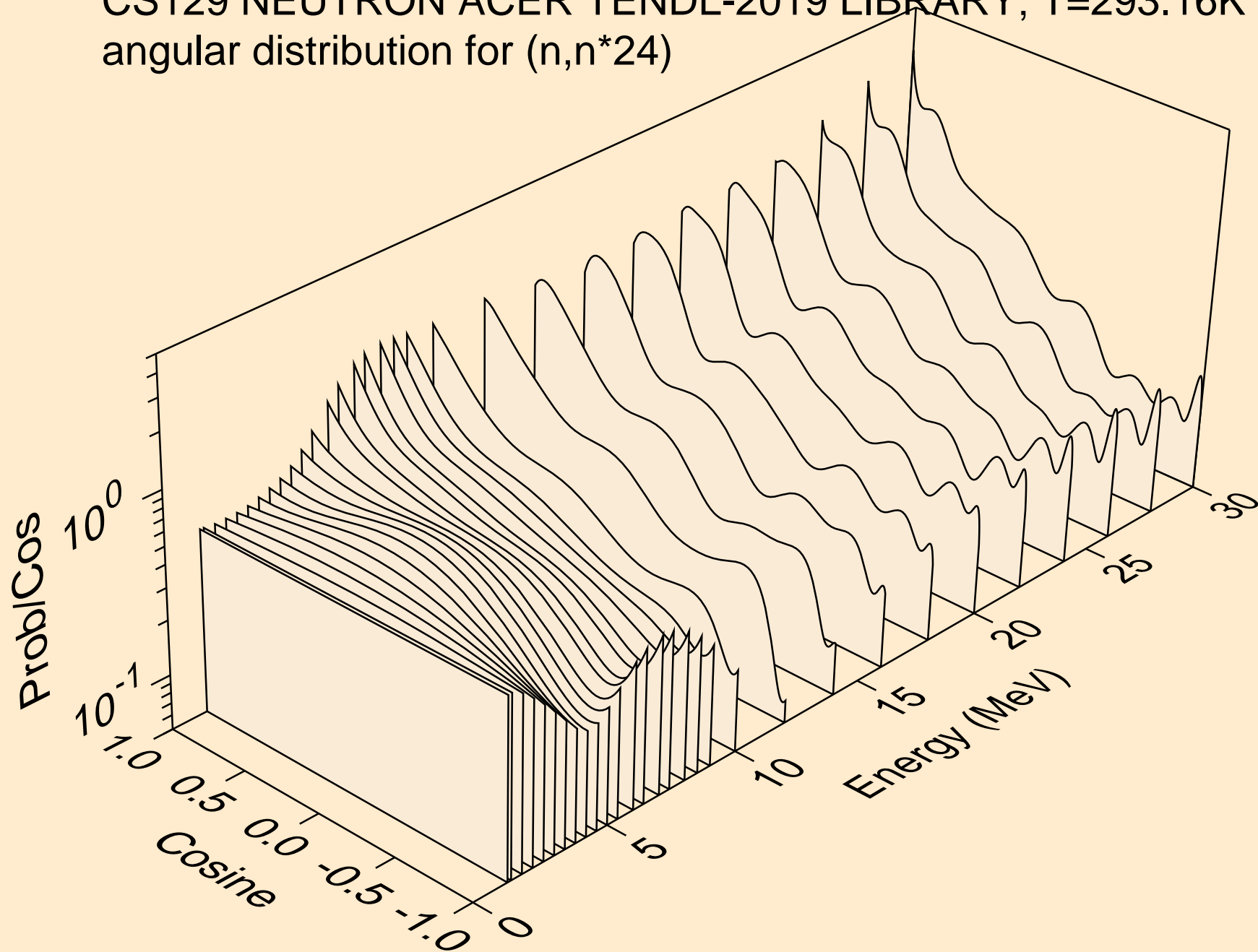

CS129 NEUTRON ACER TENDL-2019 LIBRARY; T=293.16K
angular distribution for (n,n*25)

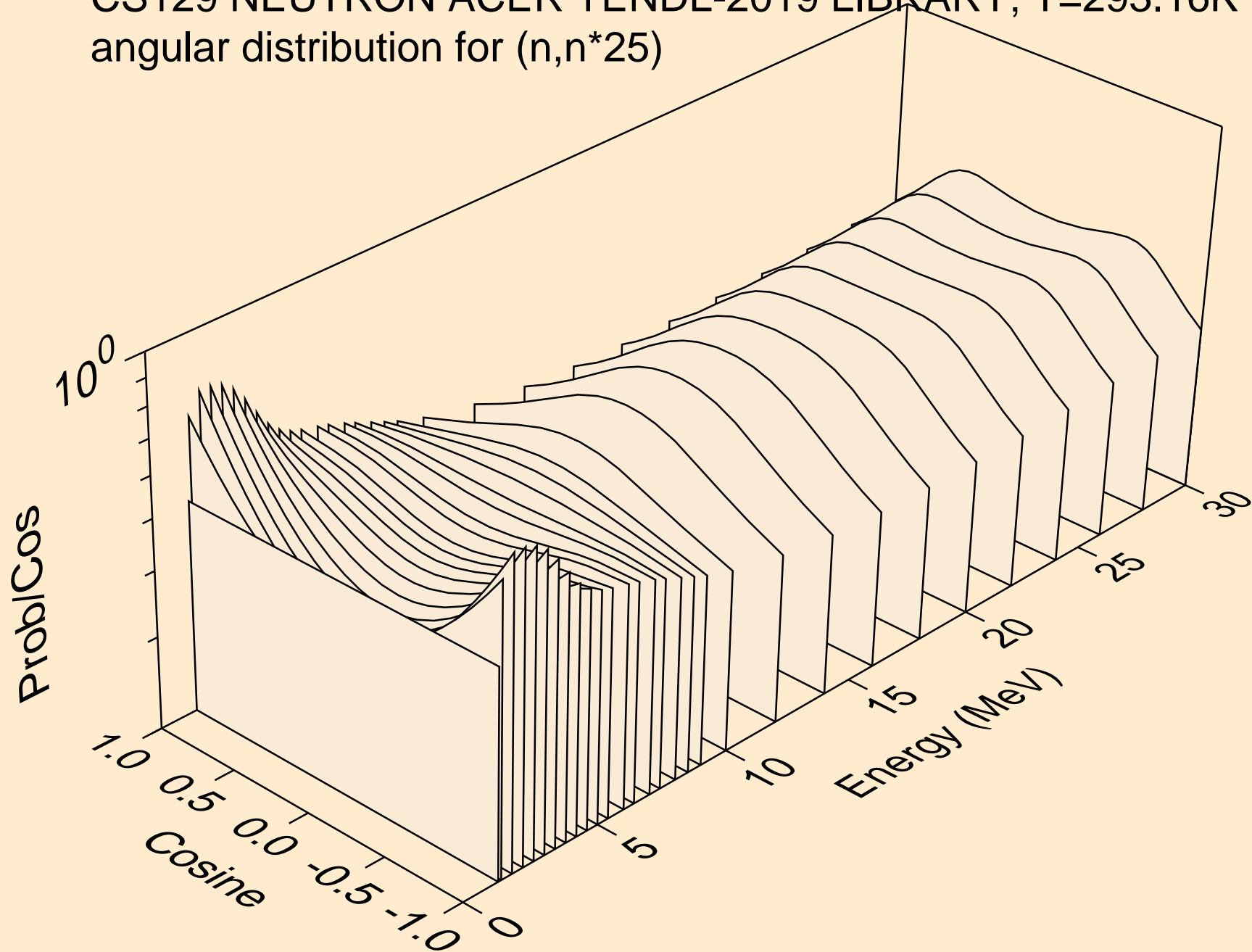

CS129 NEUTRON ACER TENDL-2019 LIBRARY; T=293.16K
angular distribution for (n,n*26)

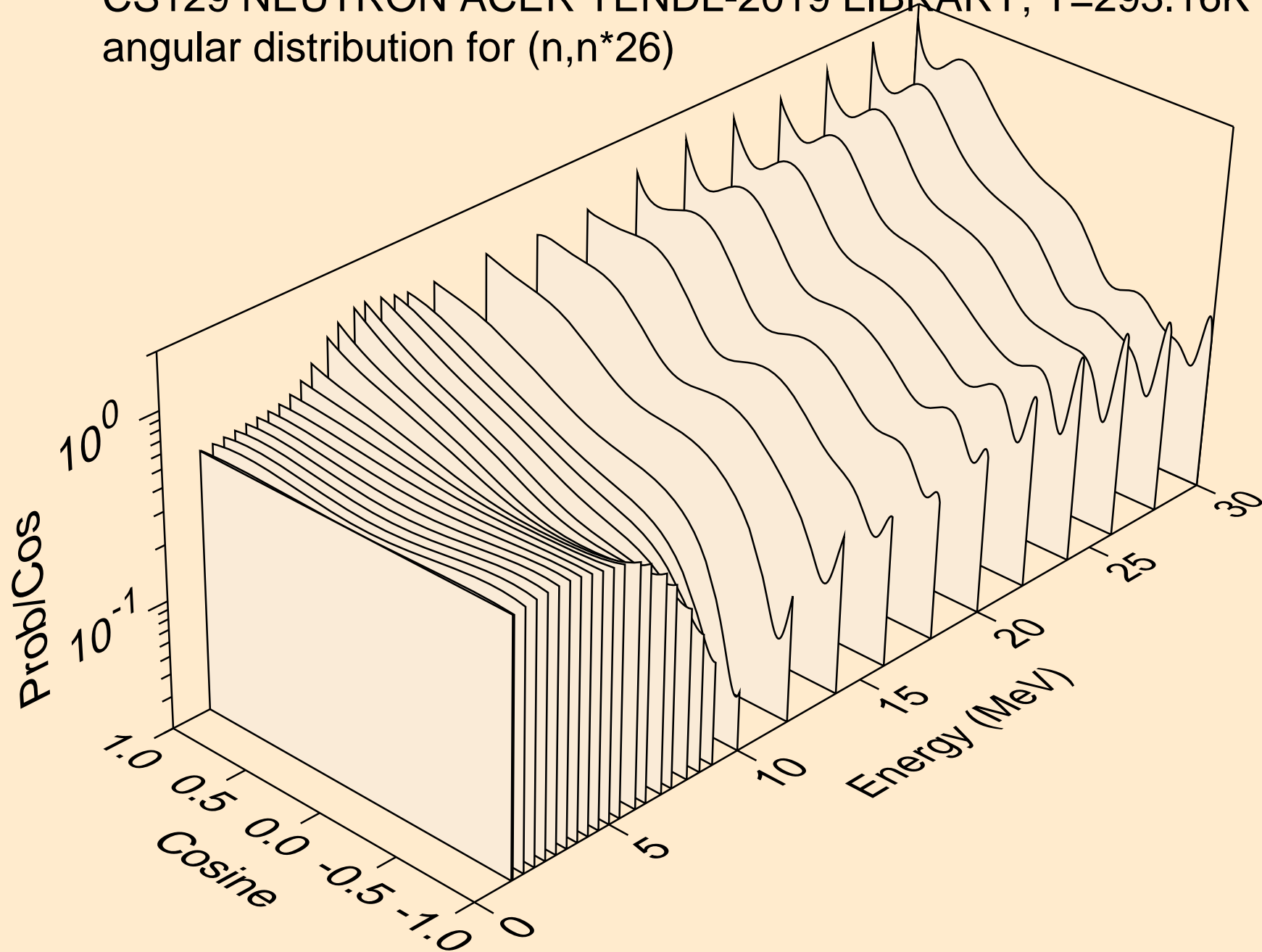

CS129 NEUTRON ACER TENDL-2019 LIBRARY; T=293.16K
angular distribution for (n,n*27)

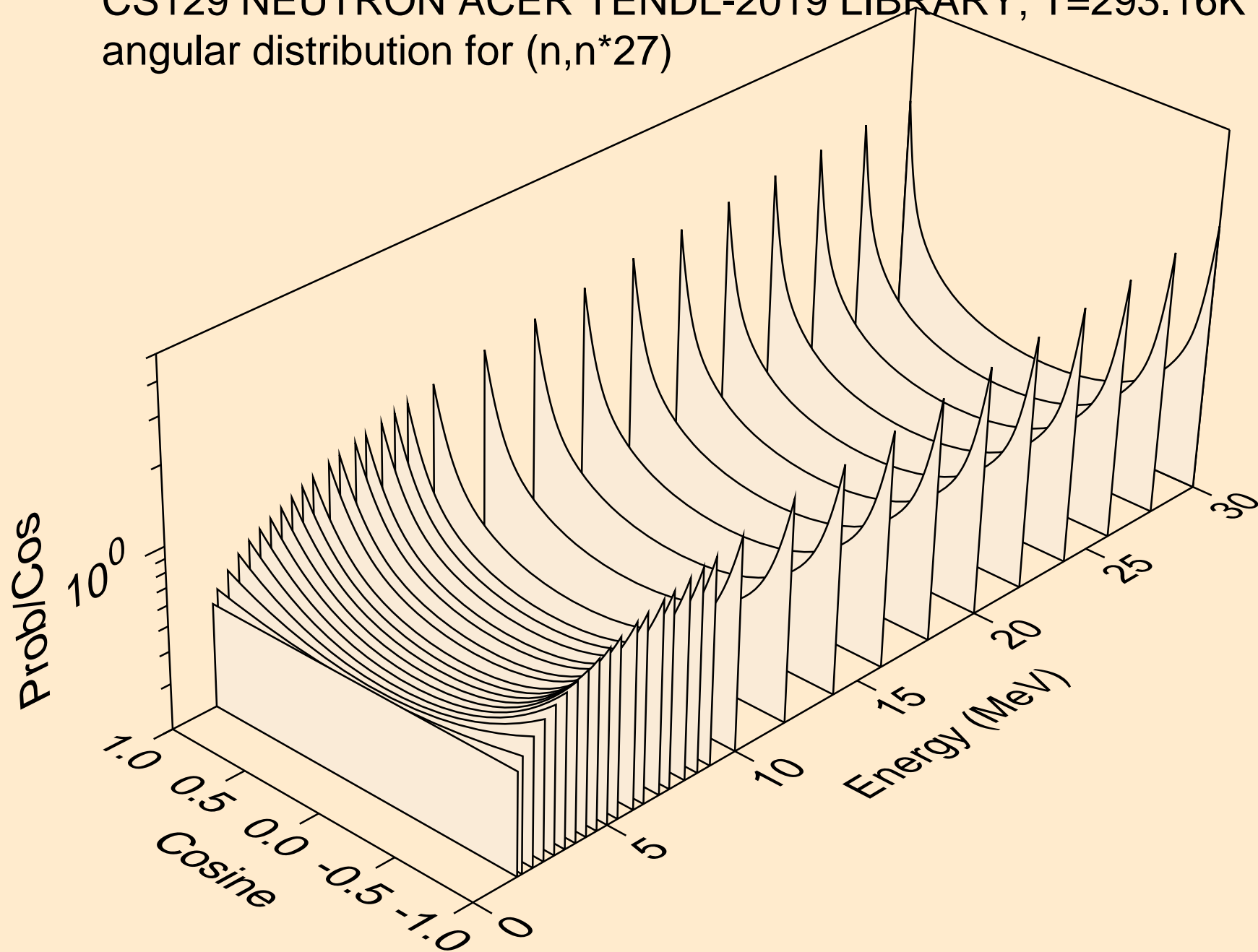

CS129 NEUTRON ACER TENDL-2019 LIBRARY; T=293.16K
angular distribution for (n,n*28)

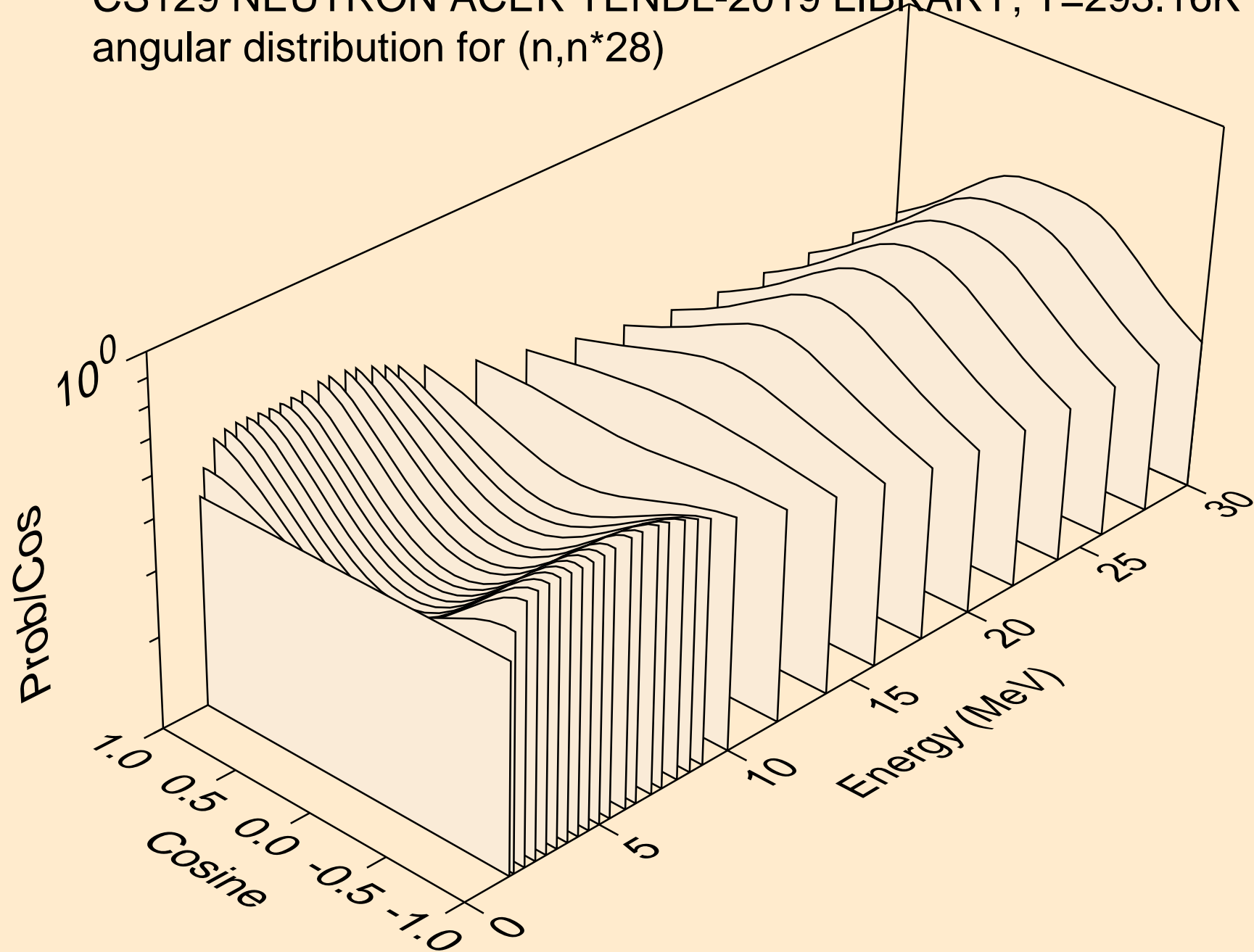

CS129 NEUTRON ACER TENDL-2019 LIBRARY; T=293.16K
angular distribution for (n,n*29)

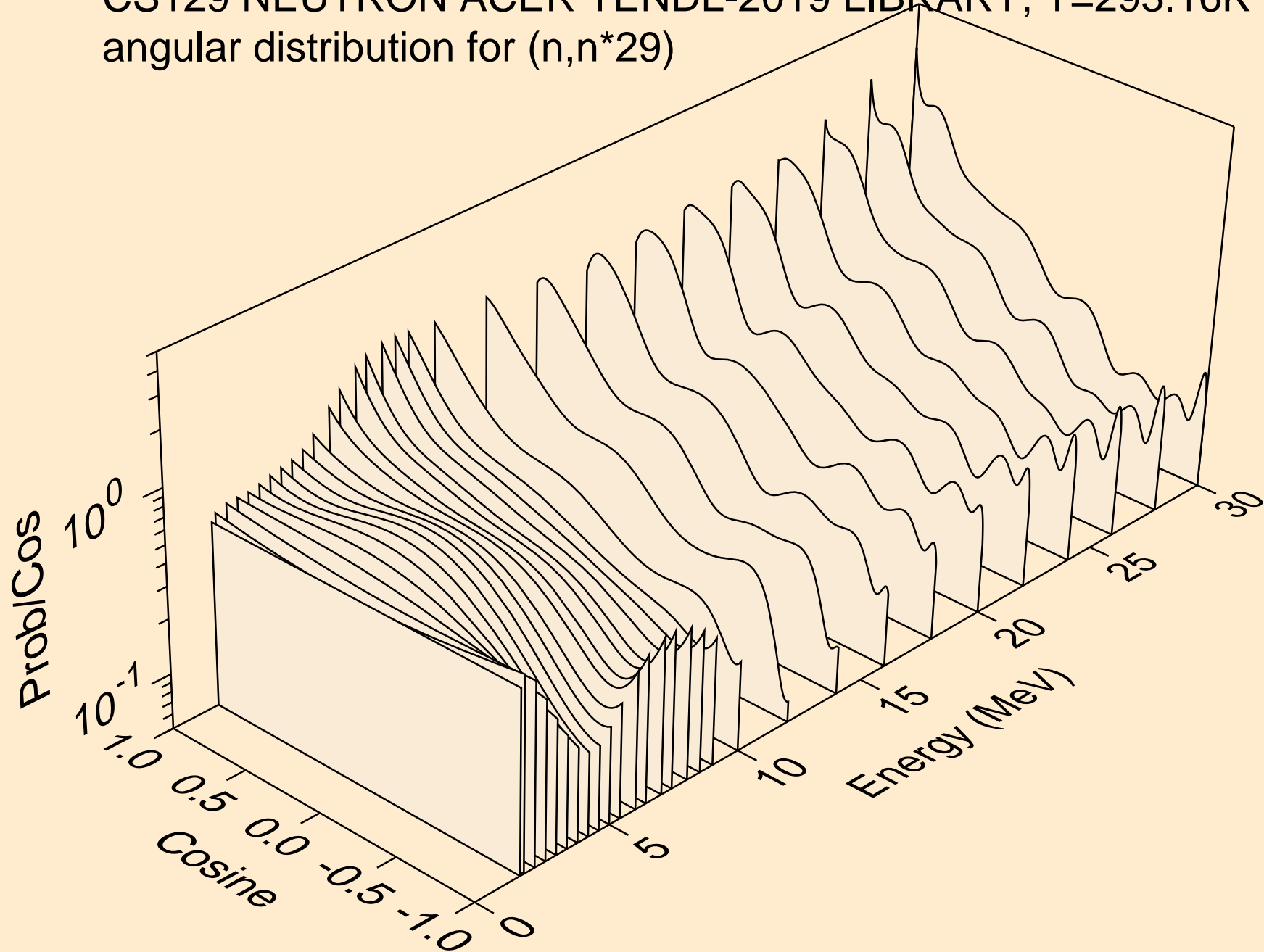

CS129 NEUTRON ACER TENDL-2019 LIBRARY; T=293.16K
angular distribution for (n,n*30)

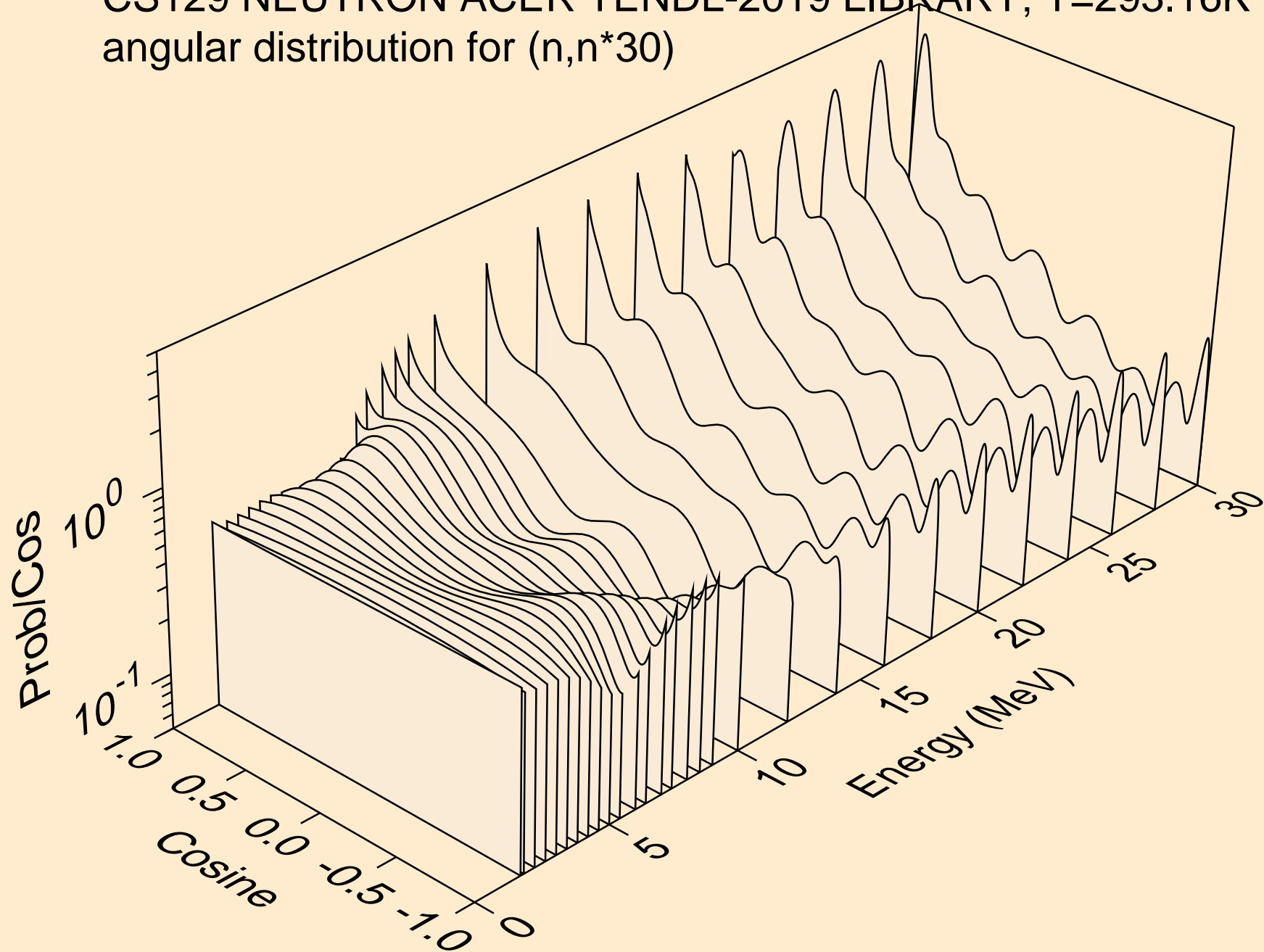

CS129 NEUTRON ACER TENDL-2019 LIBRARY; T=293.16K
Neutron emission for (n,x)

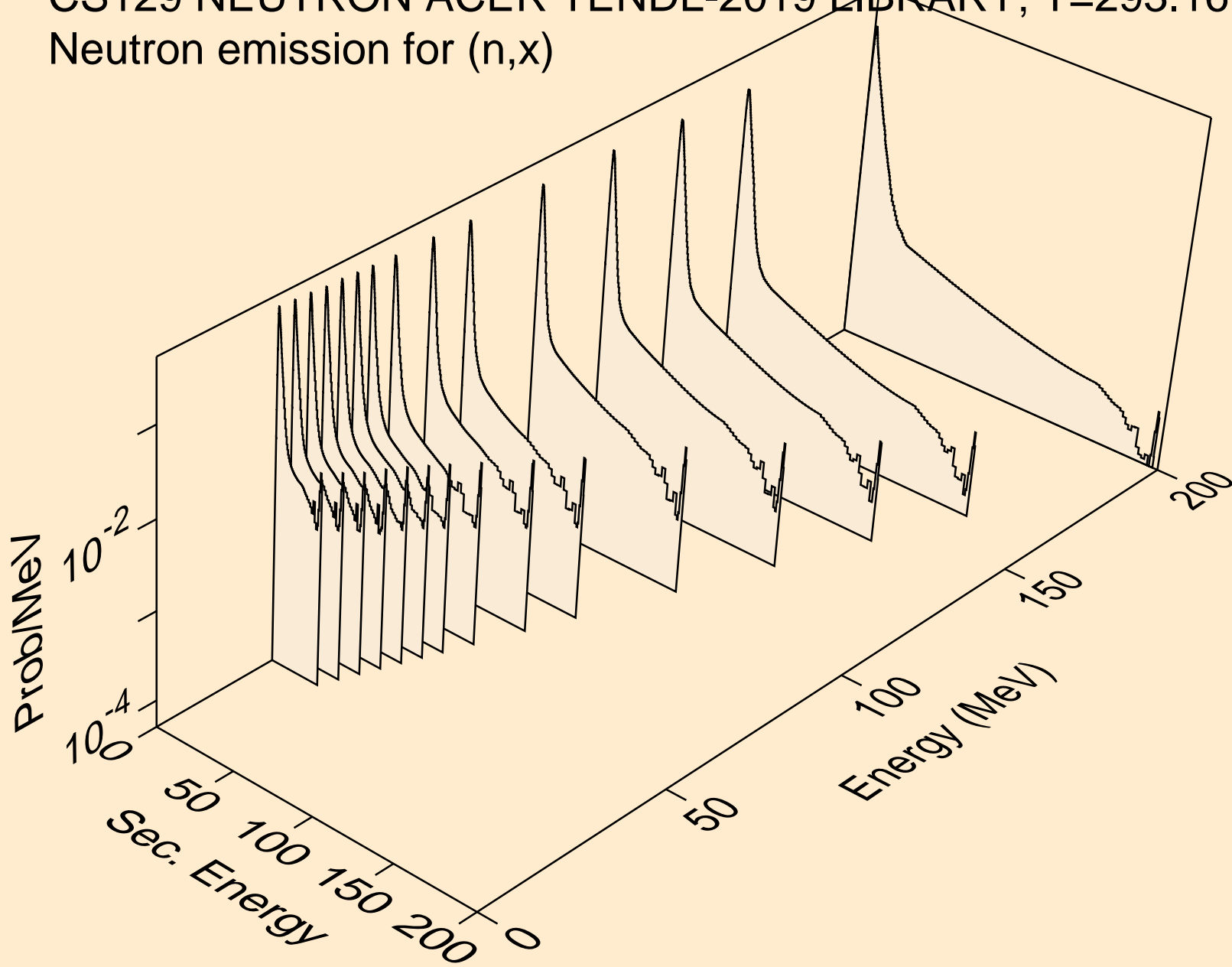

CS129 NEUTRON ACER TENDL-2019 LIBRARY; T=293.16K
Neutron emission for (n,2nd)

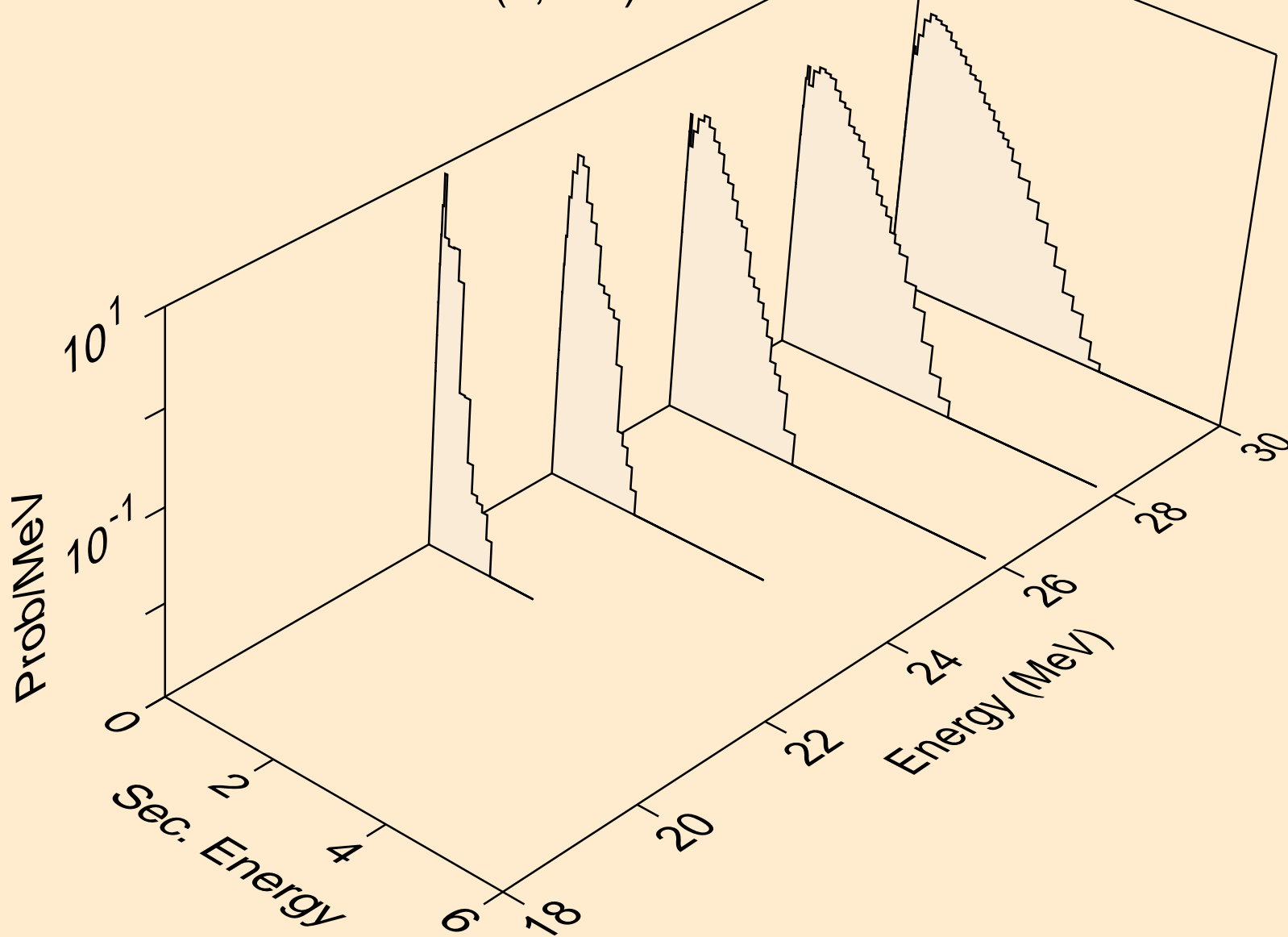

CS129 NEUTRON ACER TENDL-2019 LIBRARY; T=293.16K
Neutron emission for (n,2n)

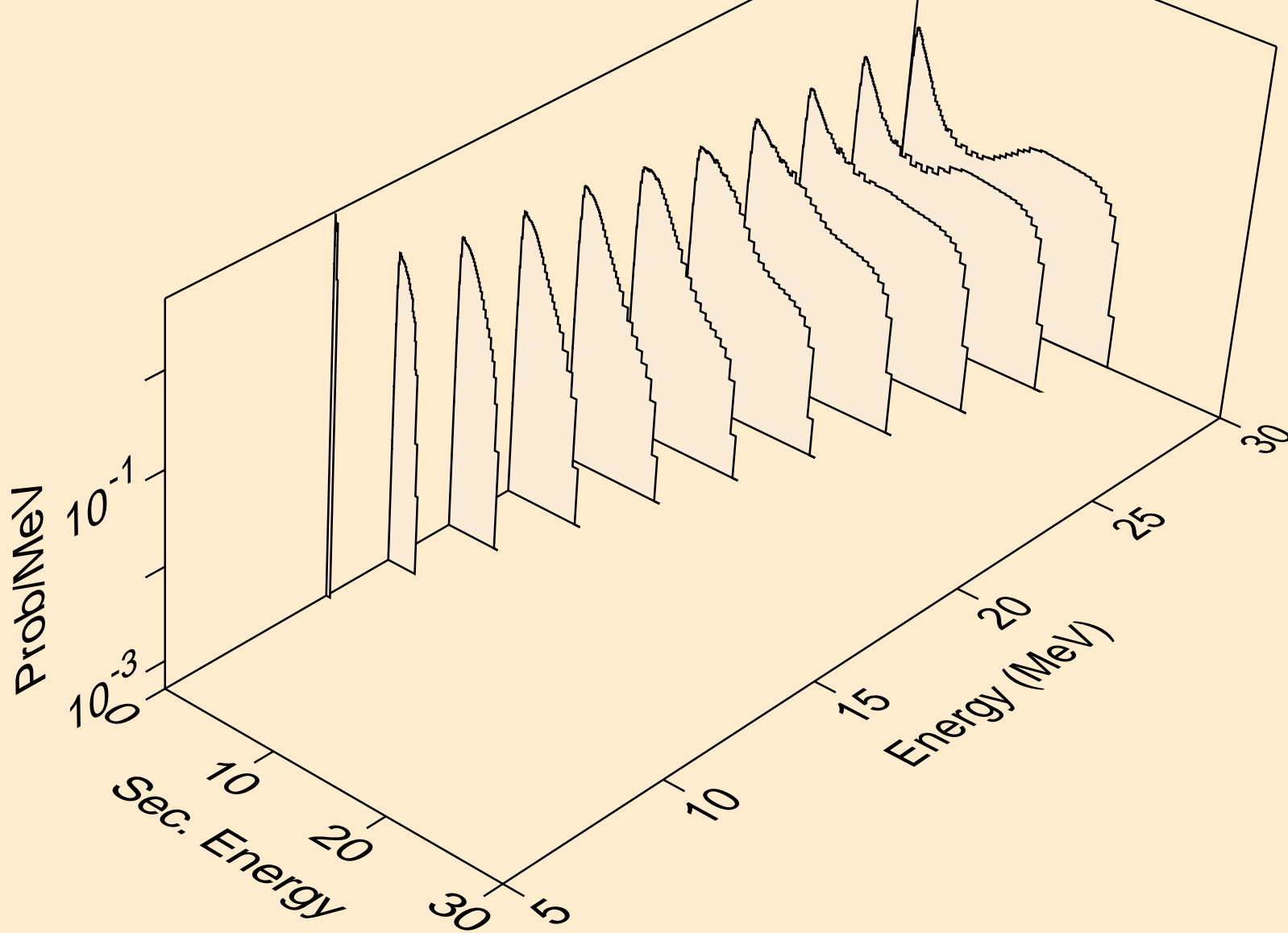

CS129 NEUTRON ACER TENDL-2019 LIBRARY; T=293.16K
Neutron emission for (n,3n)

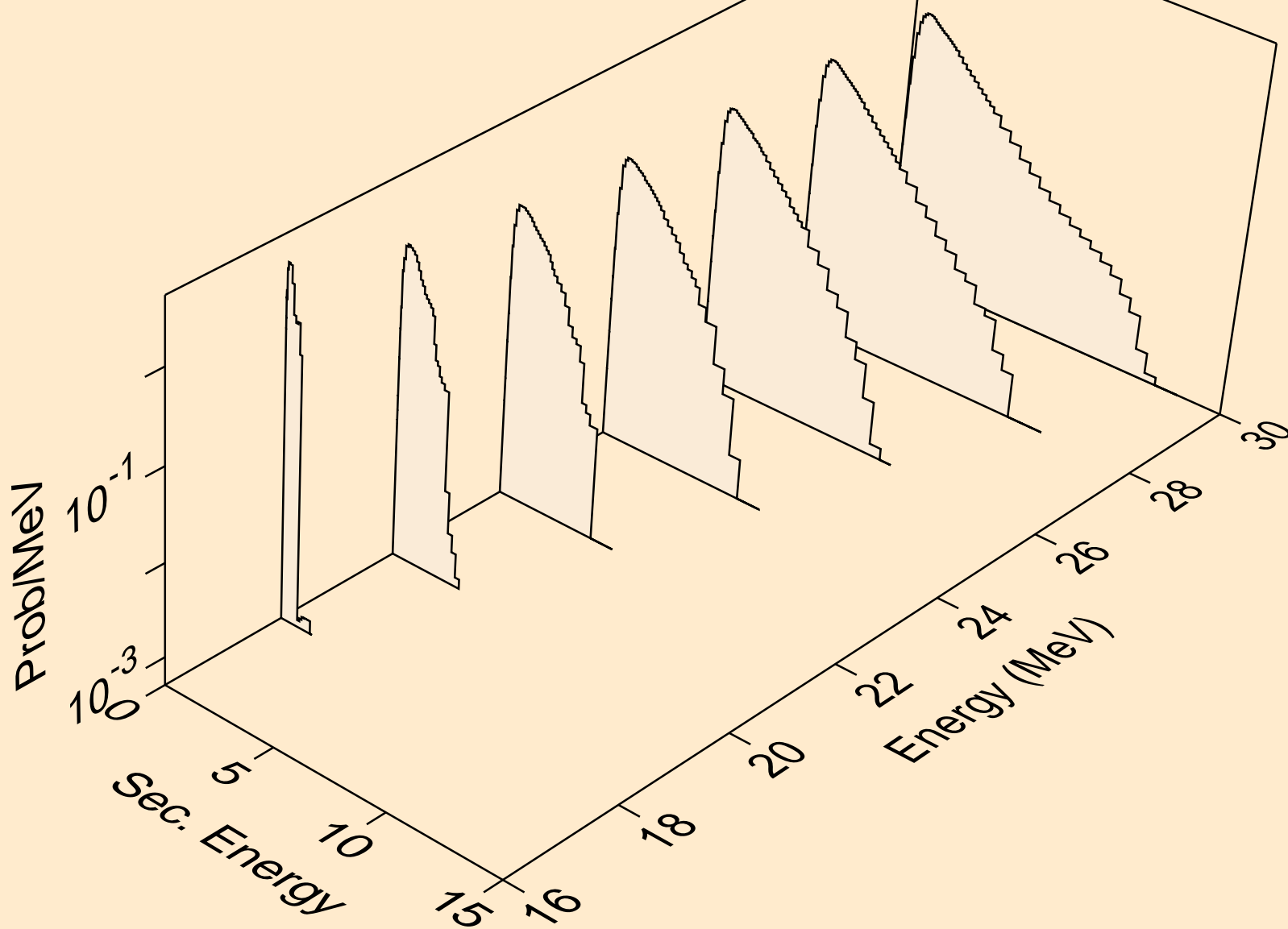

CS129 NEUTRON ACER TENDL-2019 LIBRARY; T=293.16K
Neutron emission for (n,n*)a

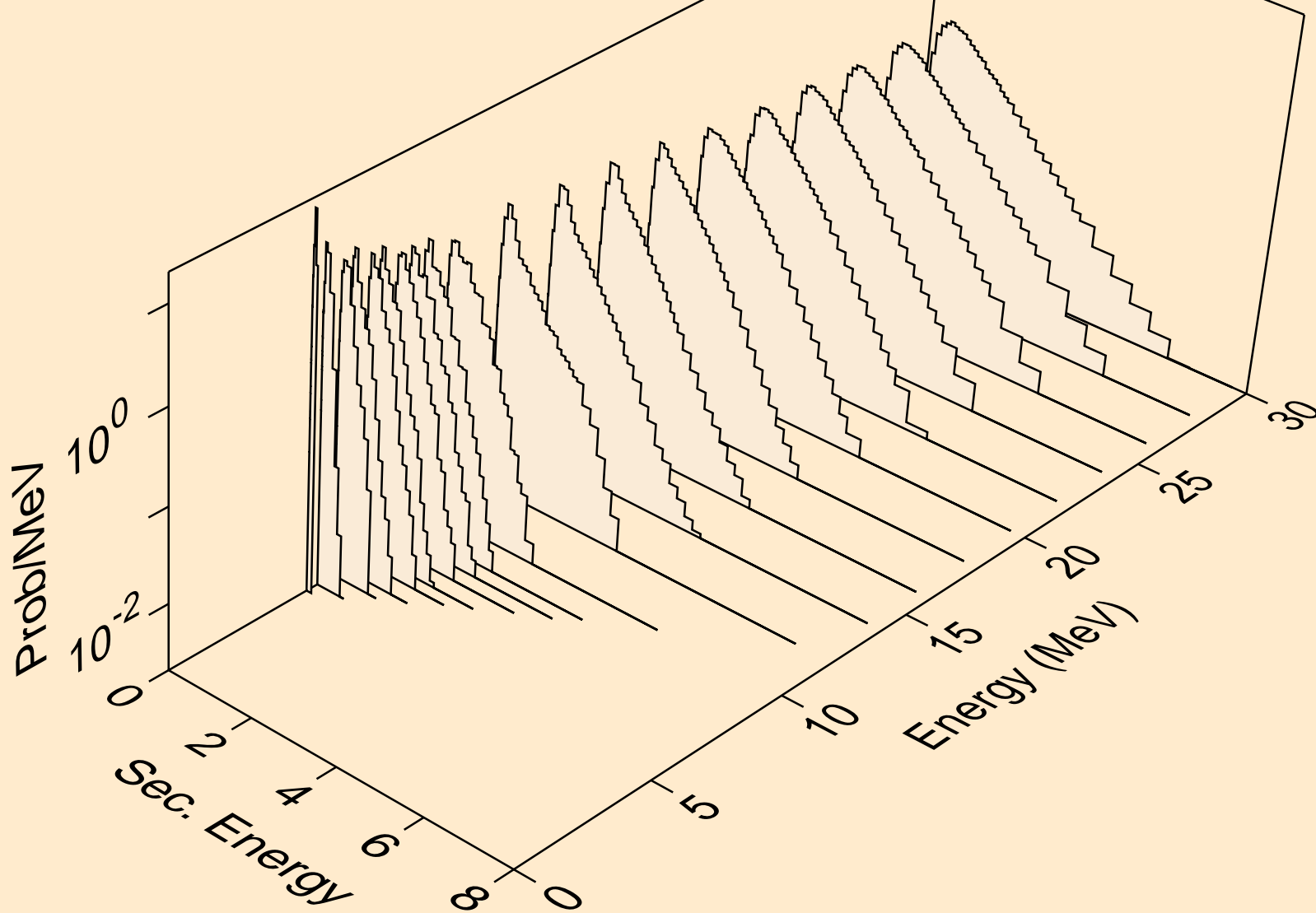

CS129 NEUTRON ACER TENDL-2019 LIBRARY; T=293.16K
Neutron emission for (n,2n)a

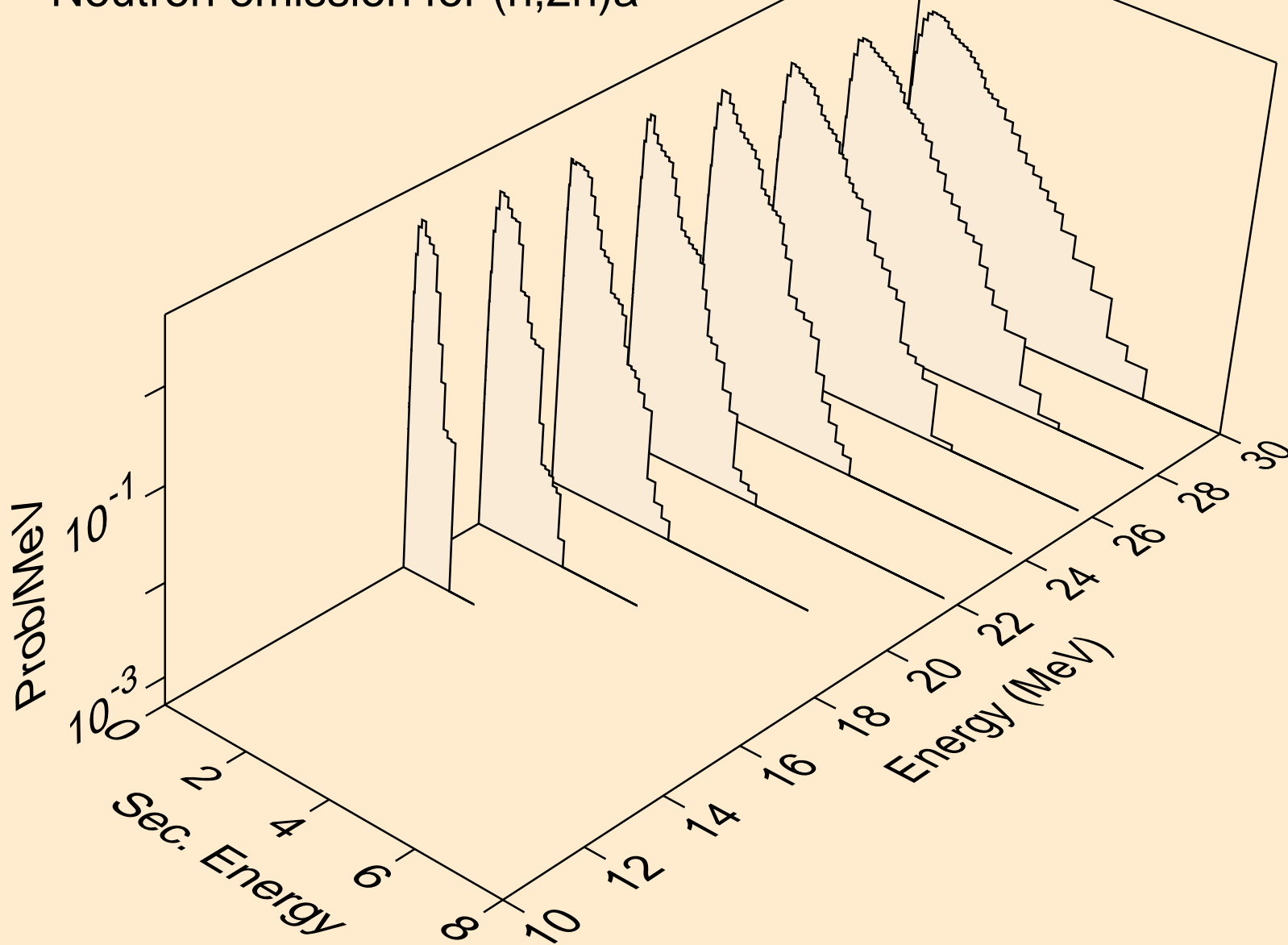

CS129 NEUTRON ACER TENDL-2019 LIBRARY; T=293.16K
Neutron emission for (n,3n)a

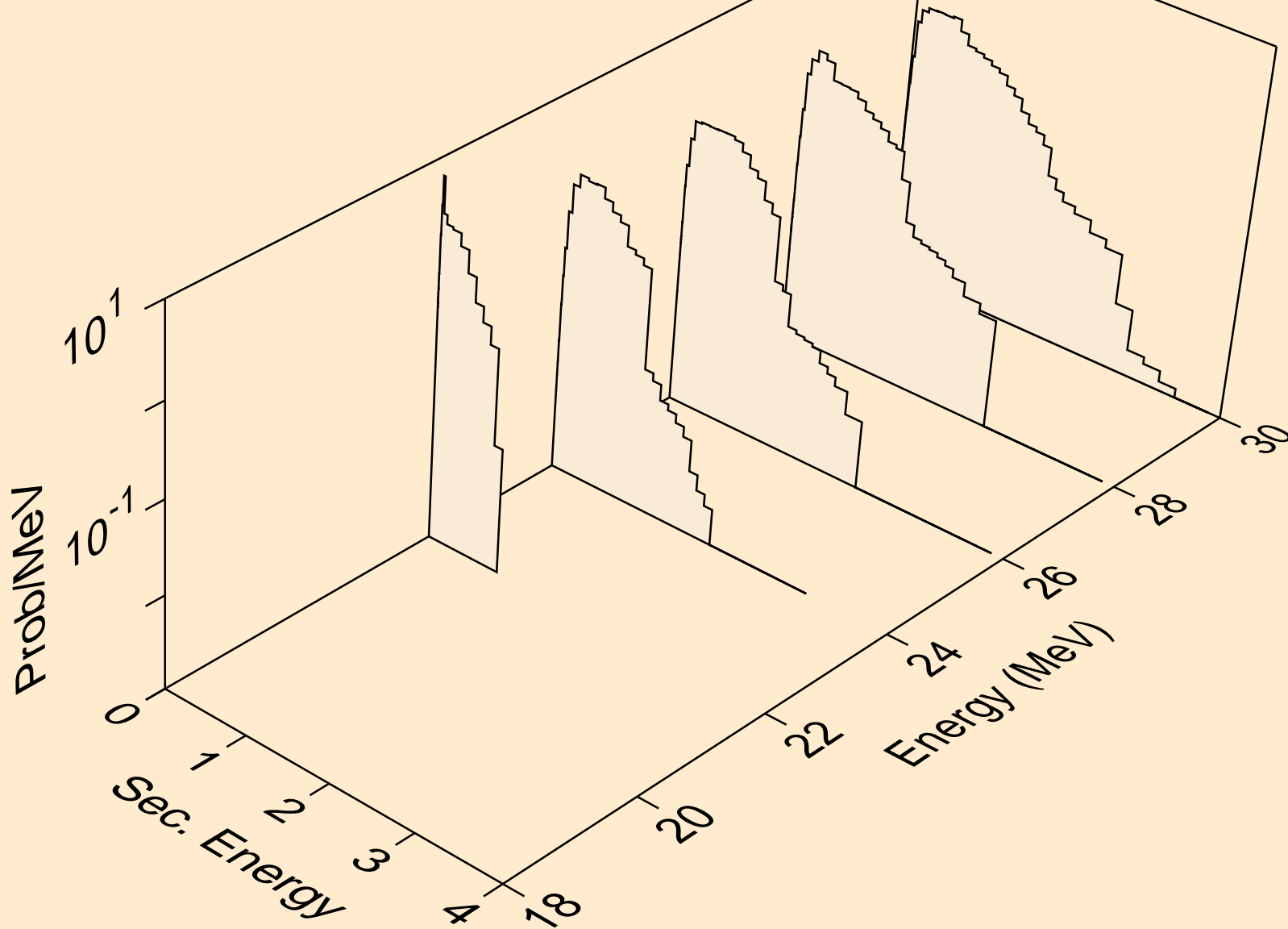

CS129 NEUTRON ACER TENDL-2019 LIBRARY; T=293.16K
Neutron emission for (n,n*)p

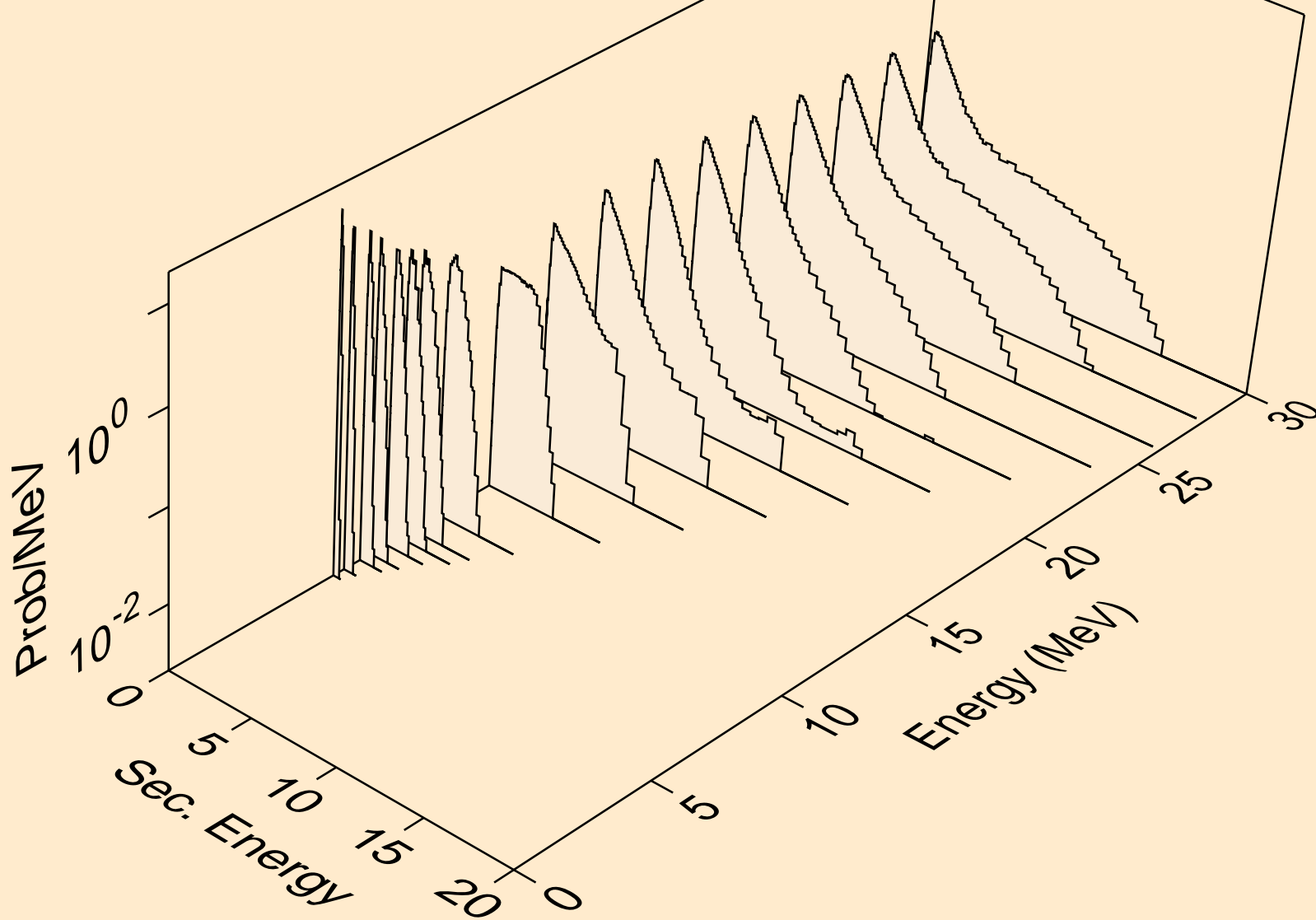

CS129 NEUTRON ACER TENDL-2019 LIBRARY; T=293.16K
Neutron emission for (n,n*)2a

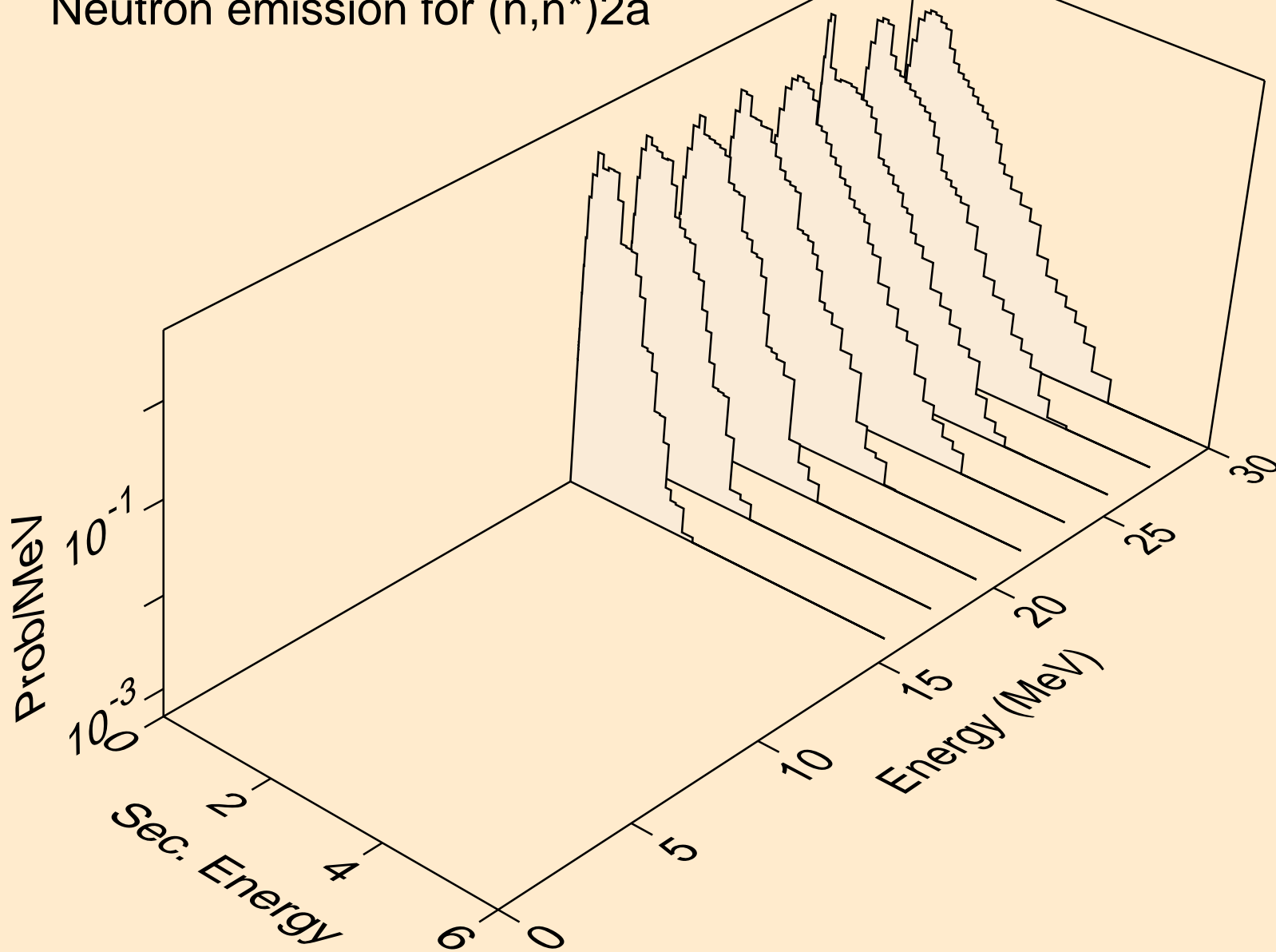

CS129 NEUTRON ACER TENDL-2019 LIBRARY; T=293.16K
Neutron emission for (n,n*)d

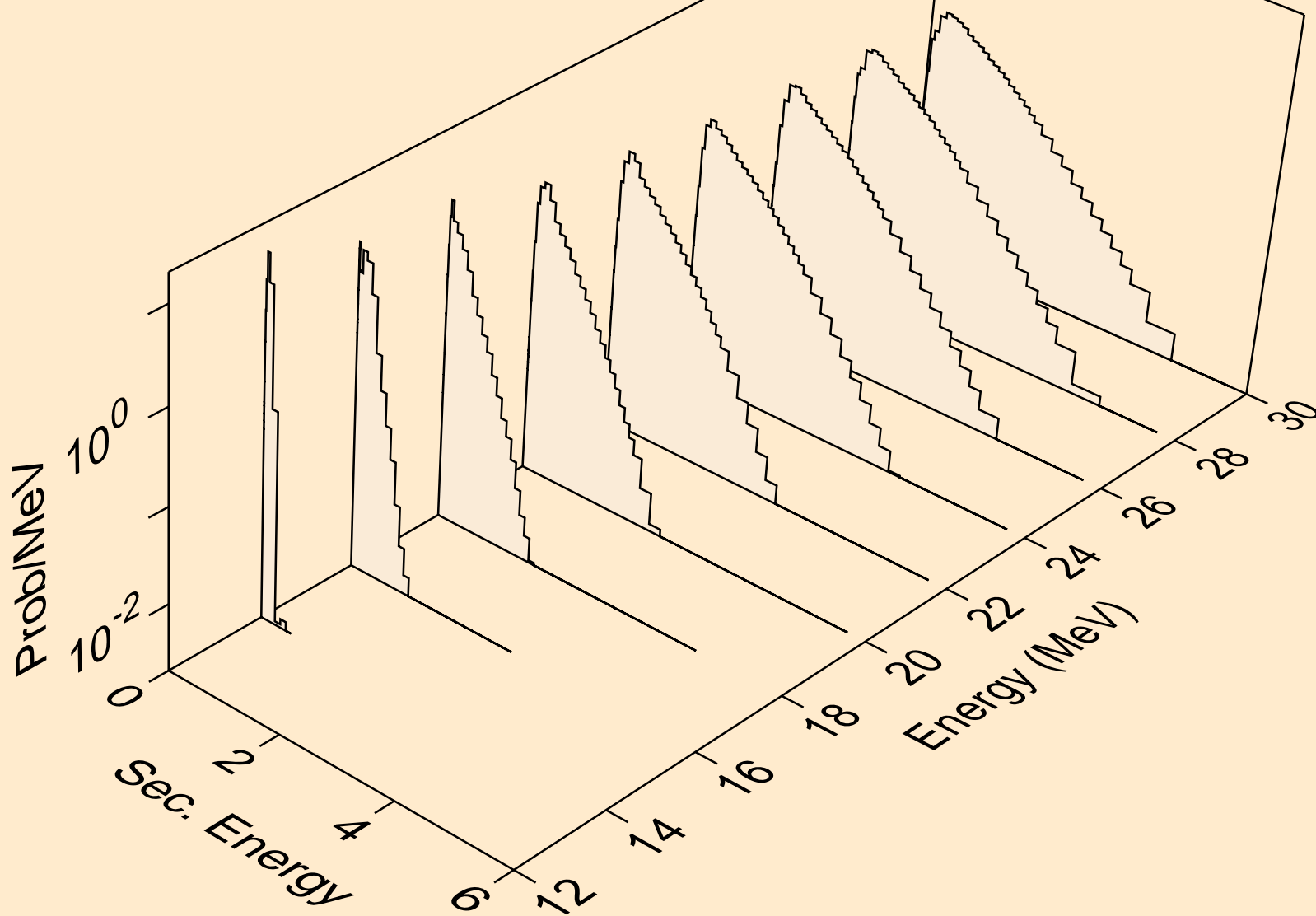

CS129 NEUTRON ACER TENDL-2019 LIBRARY; T=293.16K
Neutron emission for (n,n*)t

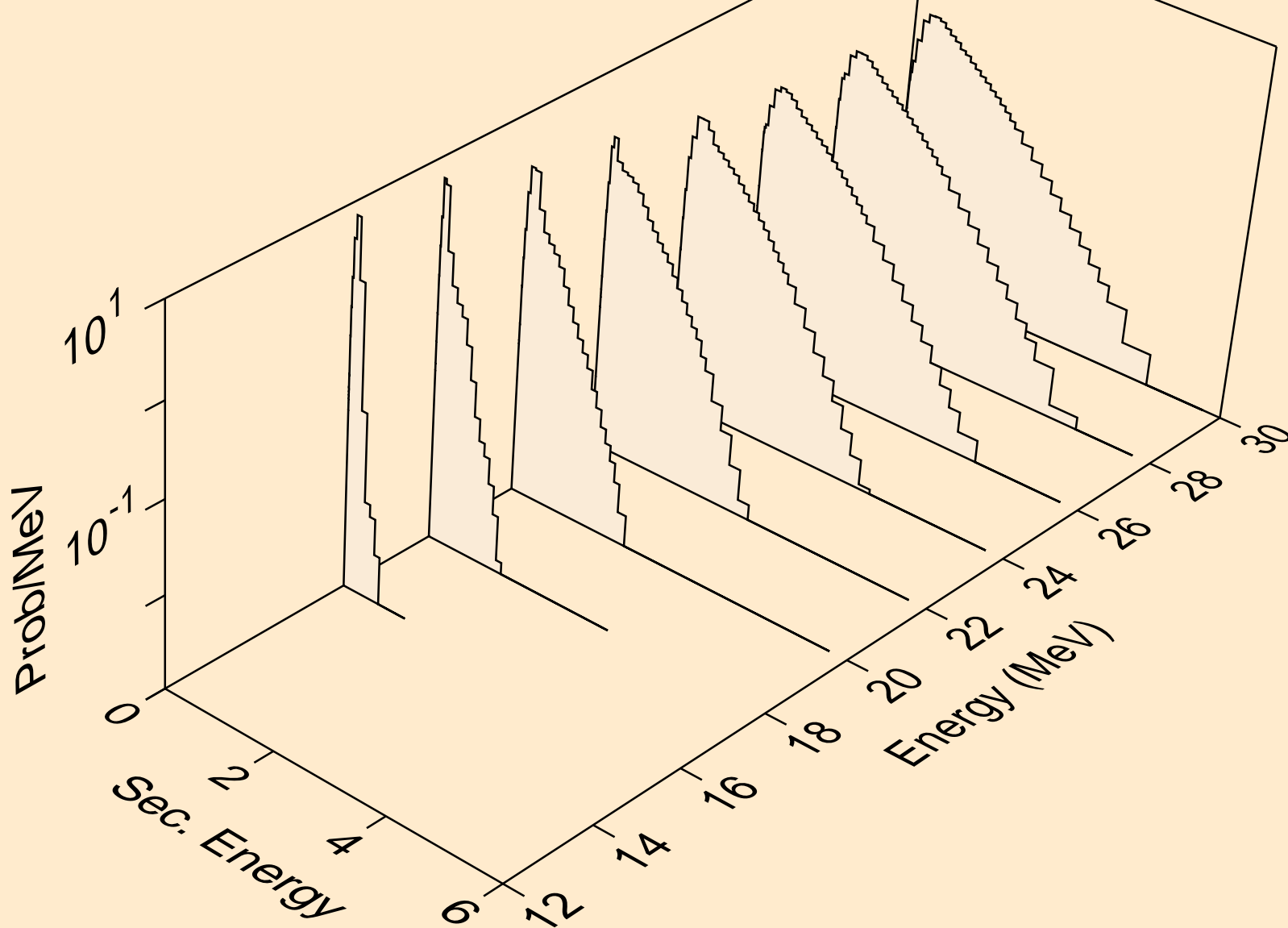

CS129 NEUTRON ACER TENDL-2019 LIBRARY; T=293.16K
Neutron emission for (n,n*)he3

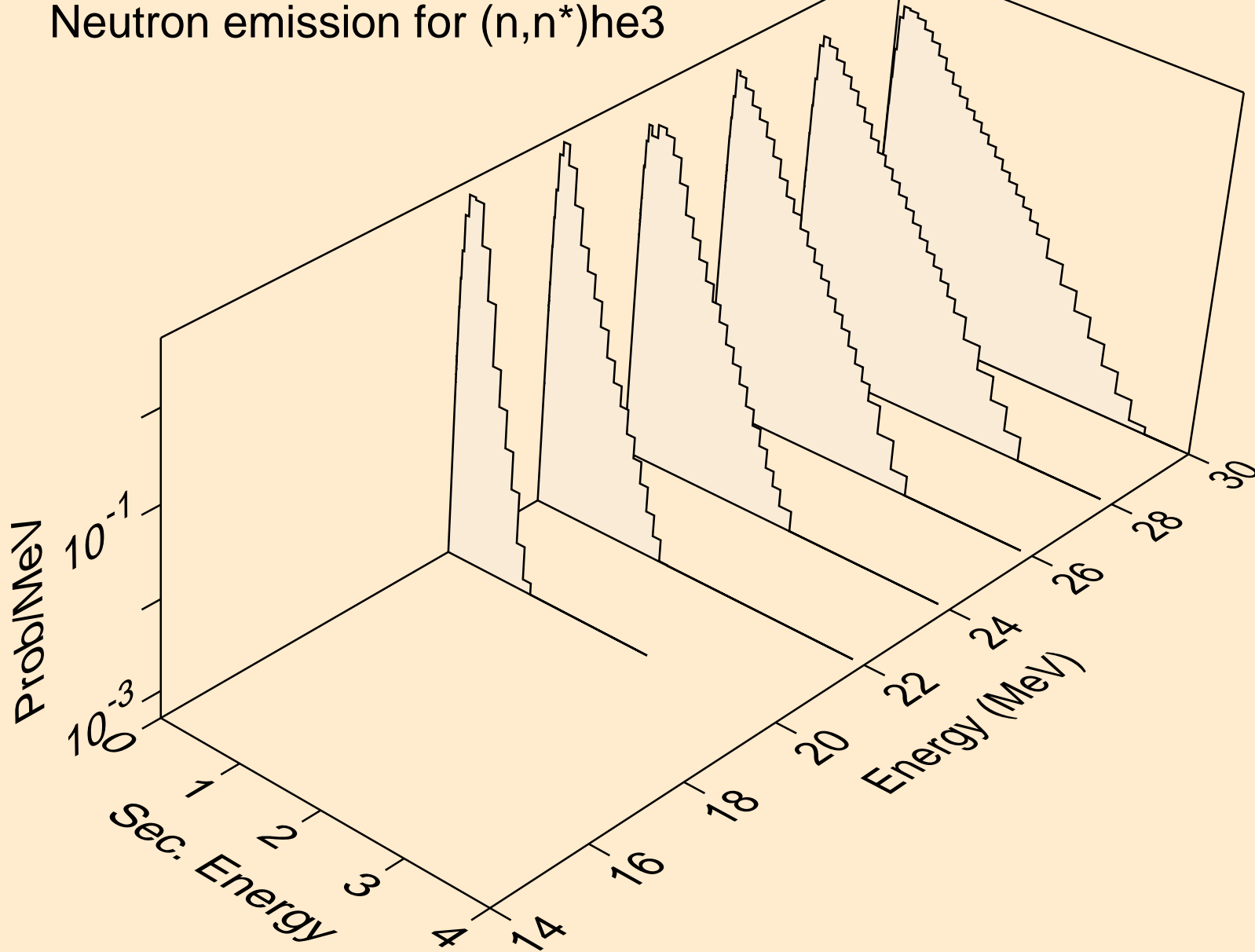

CS129 NEUTRON ACER TENDL-2019 LIBRARY; T=293.16K
Neutron emission for (n,4n)

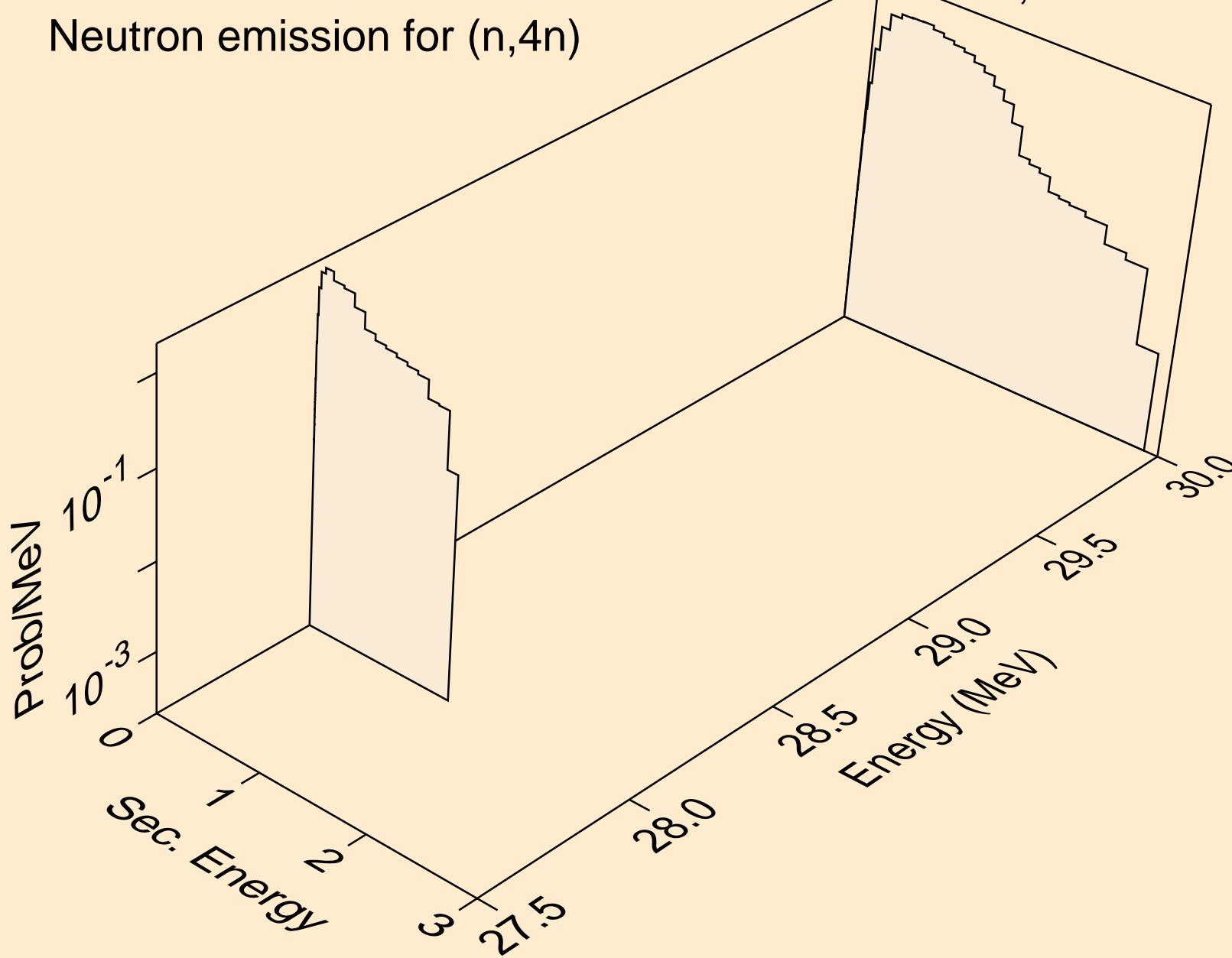

CS129 NEUTRON ACER TENDL-2019 LIBRARY; T=293.16K
Neutron emission for (n,2np)

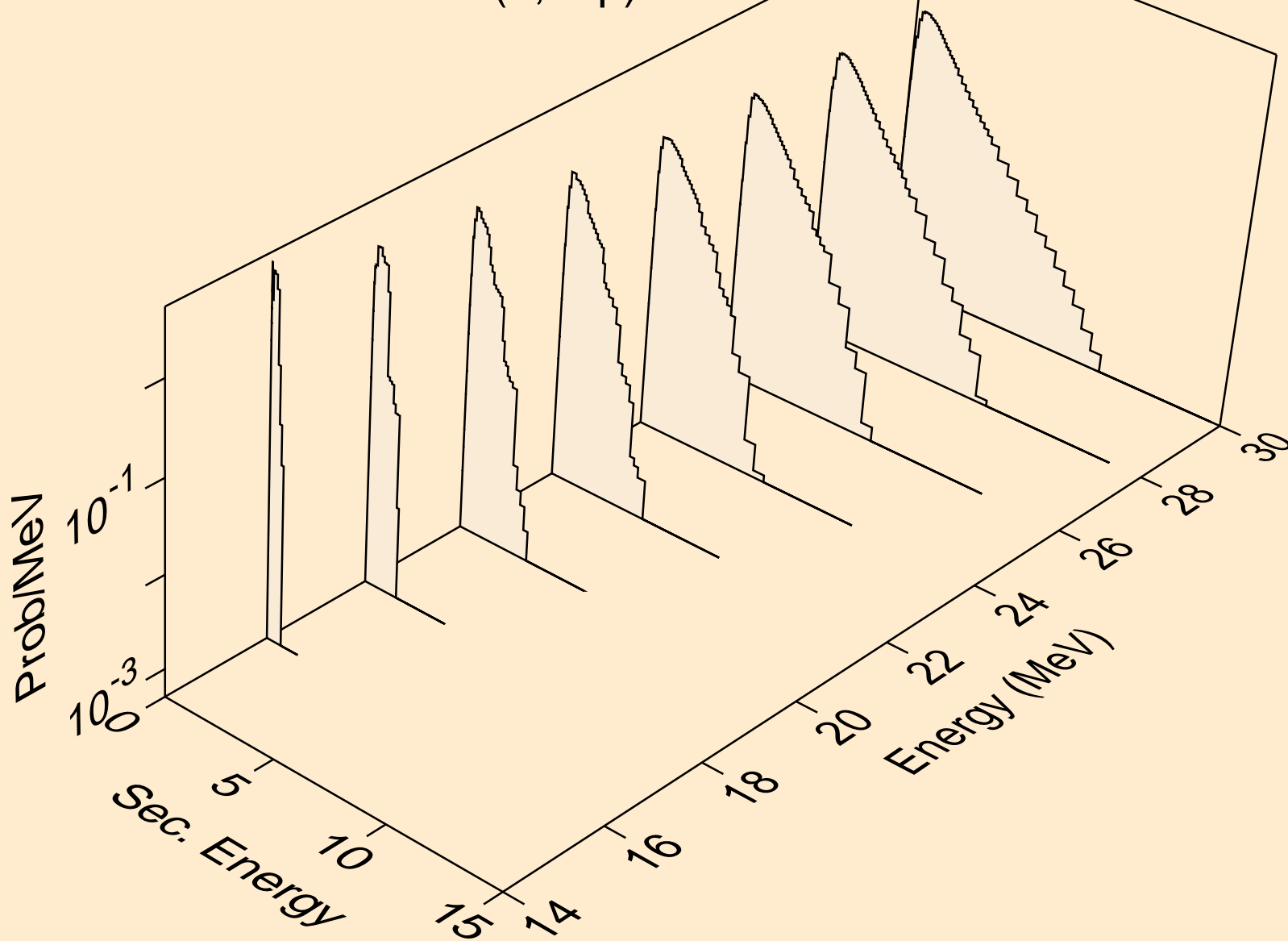

CS129 NEUTRON ACER TENDL-2019 LIBRARY; T=293.16K
Neutron emission for (n,3np)

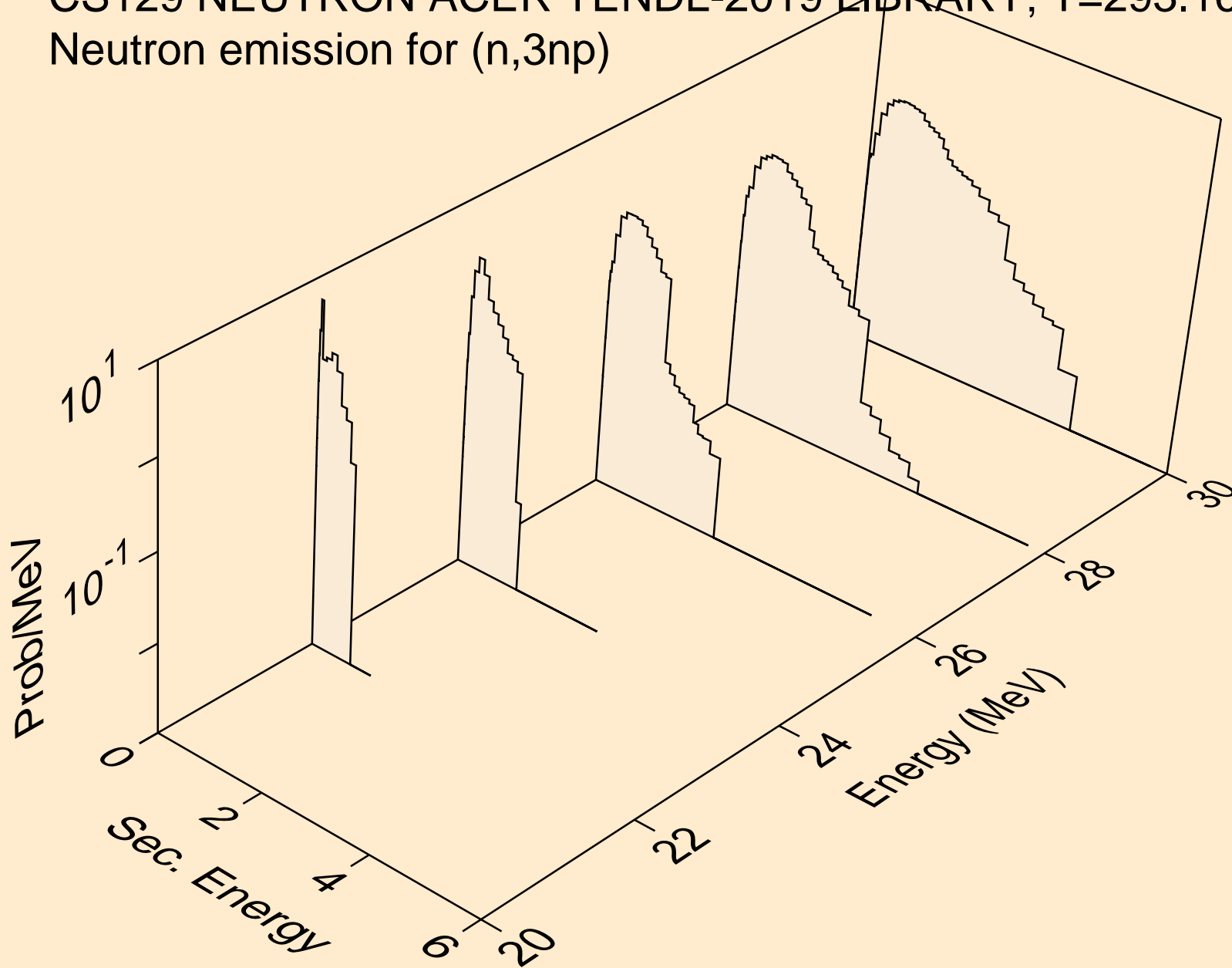

CS129 NEUTRON ACER TENDL-2019 LIBRARY; T=293.16K
Neutron emission for (n,2np)

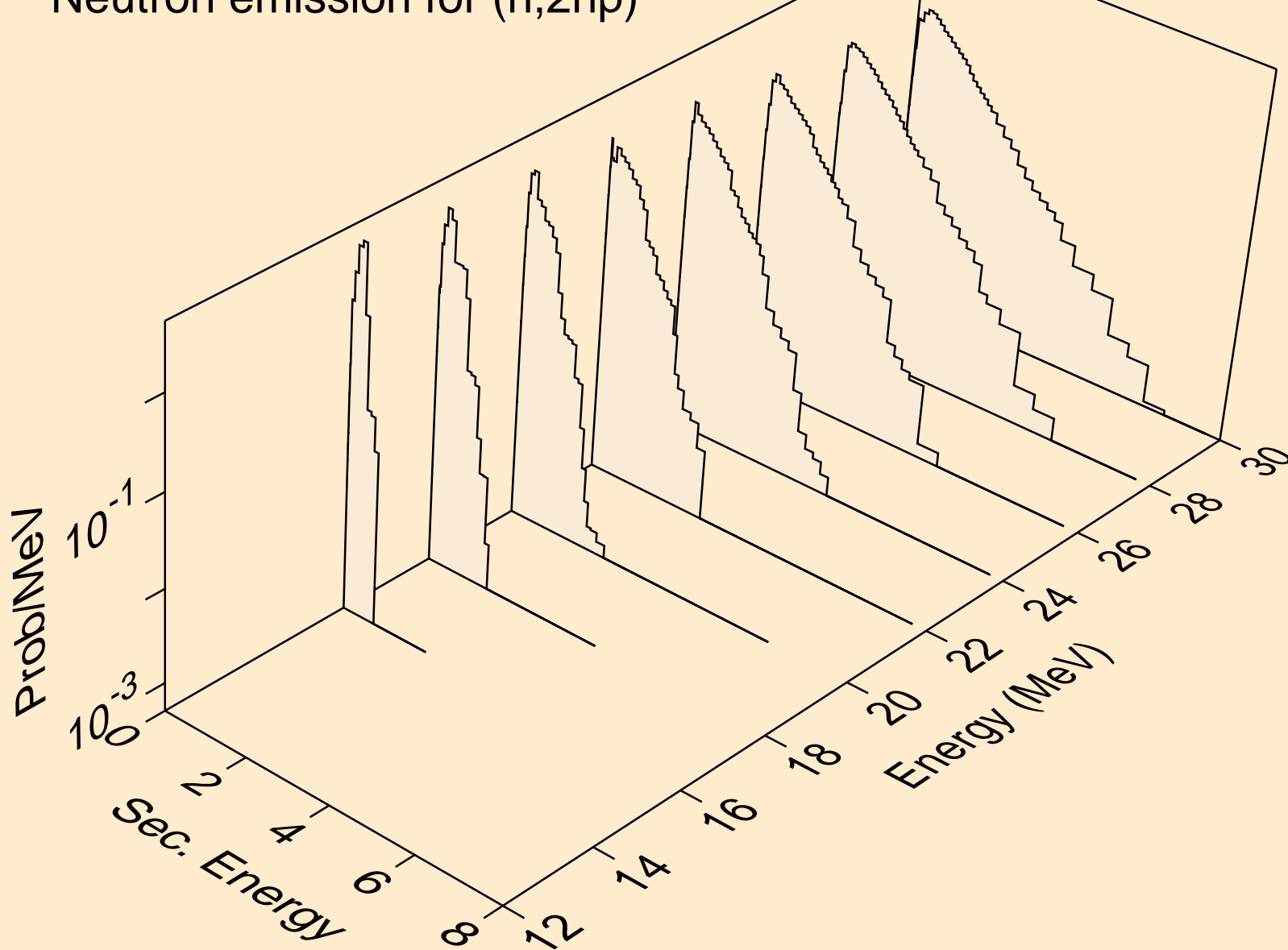

CS129 NEUTRON ACER TENDL-2019 LIBRARY; T=293.16K
Neutron emission for (n,npa)

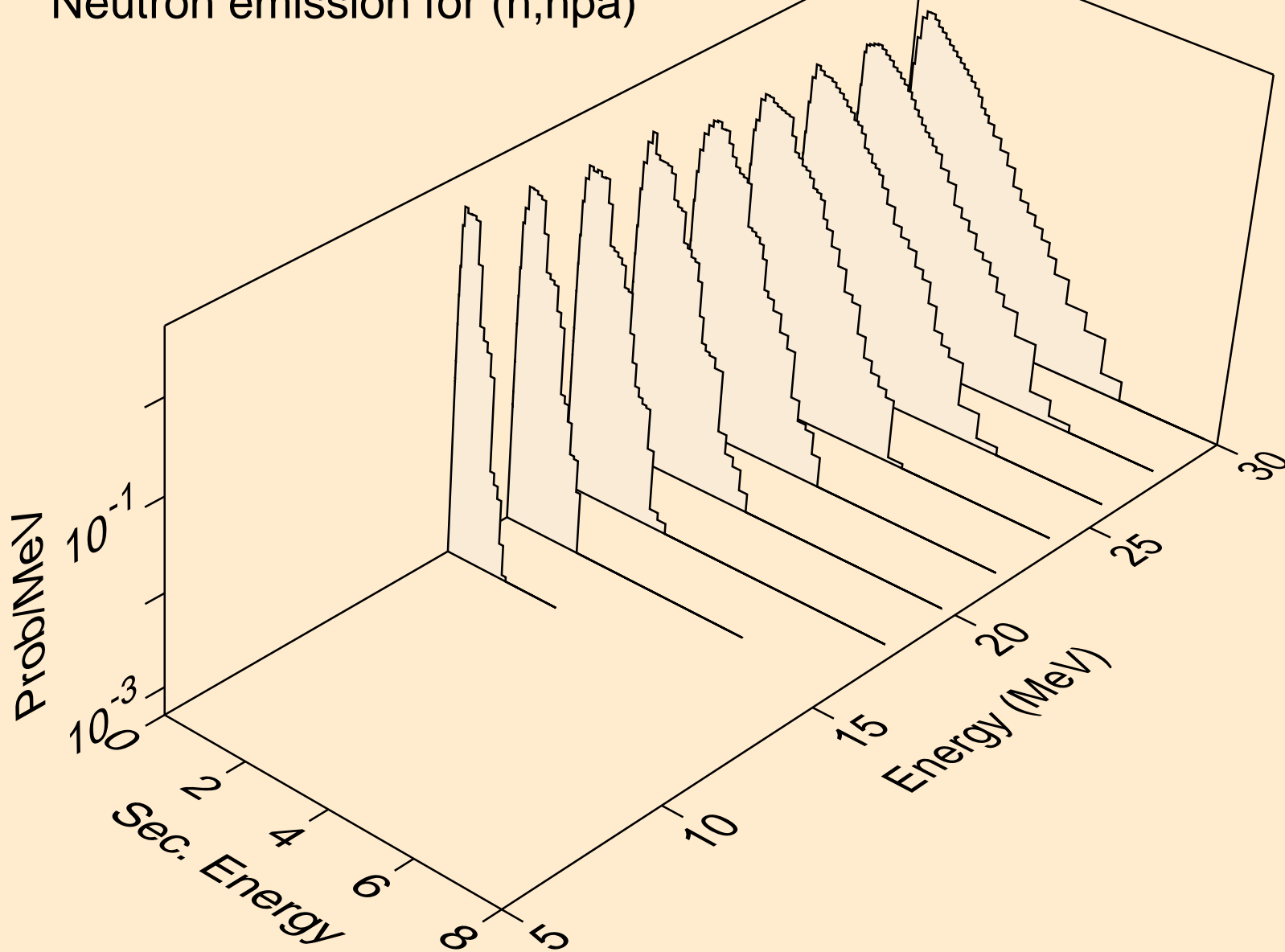

CS129 NEUTRON ACER TENDL-2019 LIBRARY; T=293.16K
Neutron emission for (n,n*c)

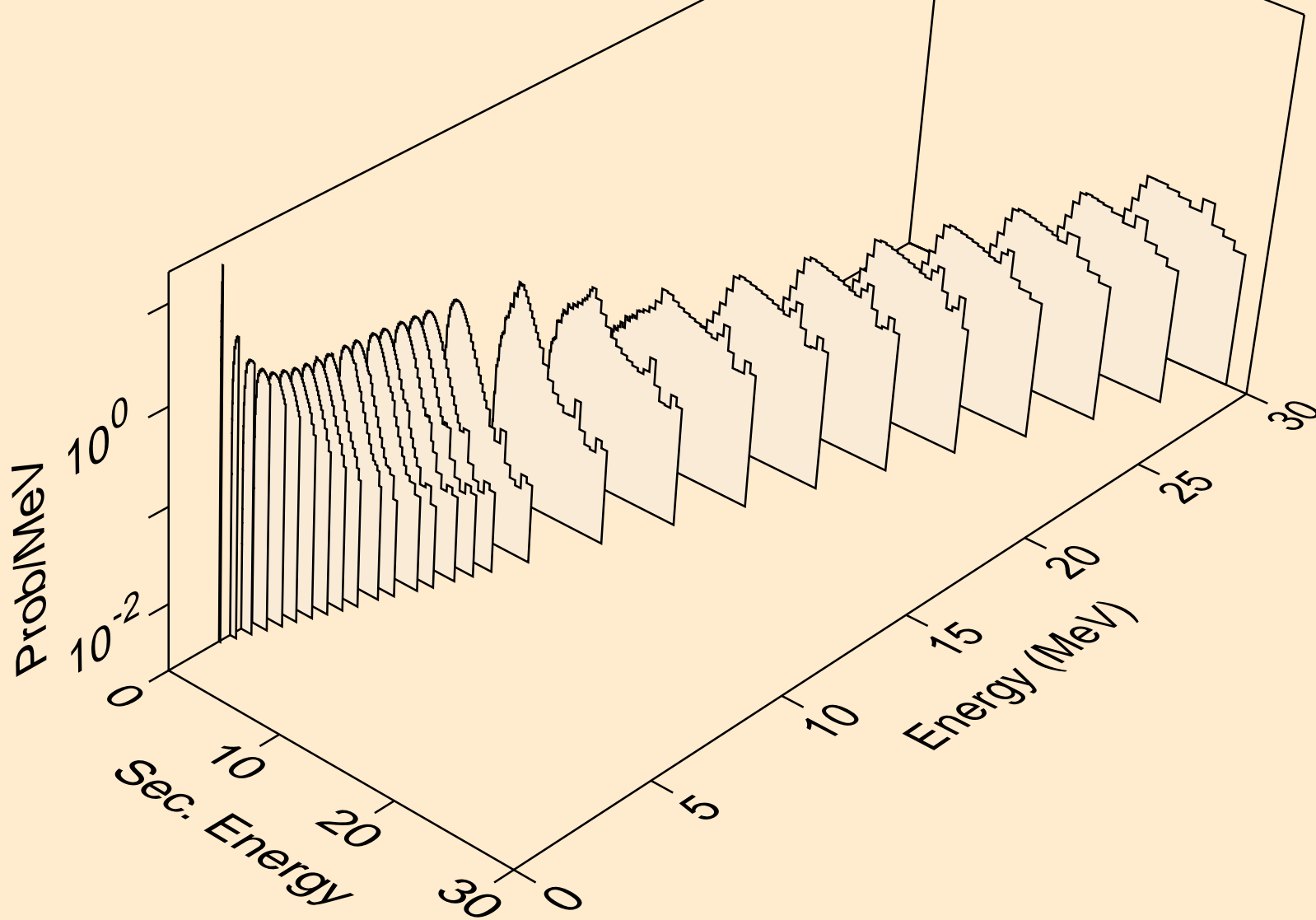

CS129 NEUTRON ACER TENDL-2019 LIBRARY; T=293.16K
Photon emission for (n,x)

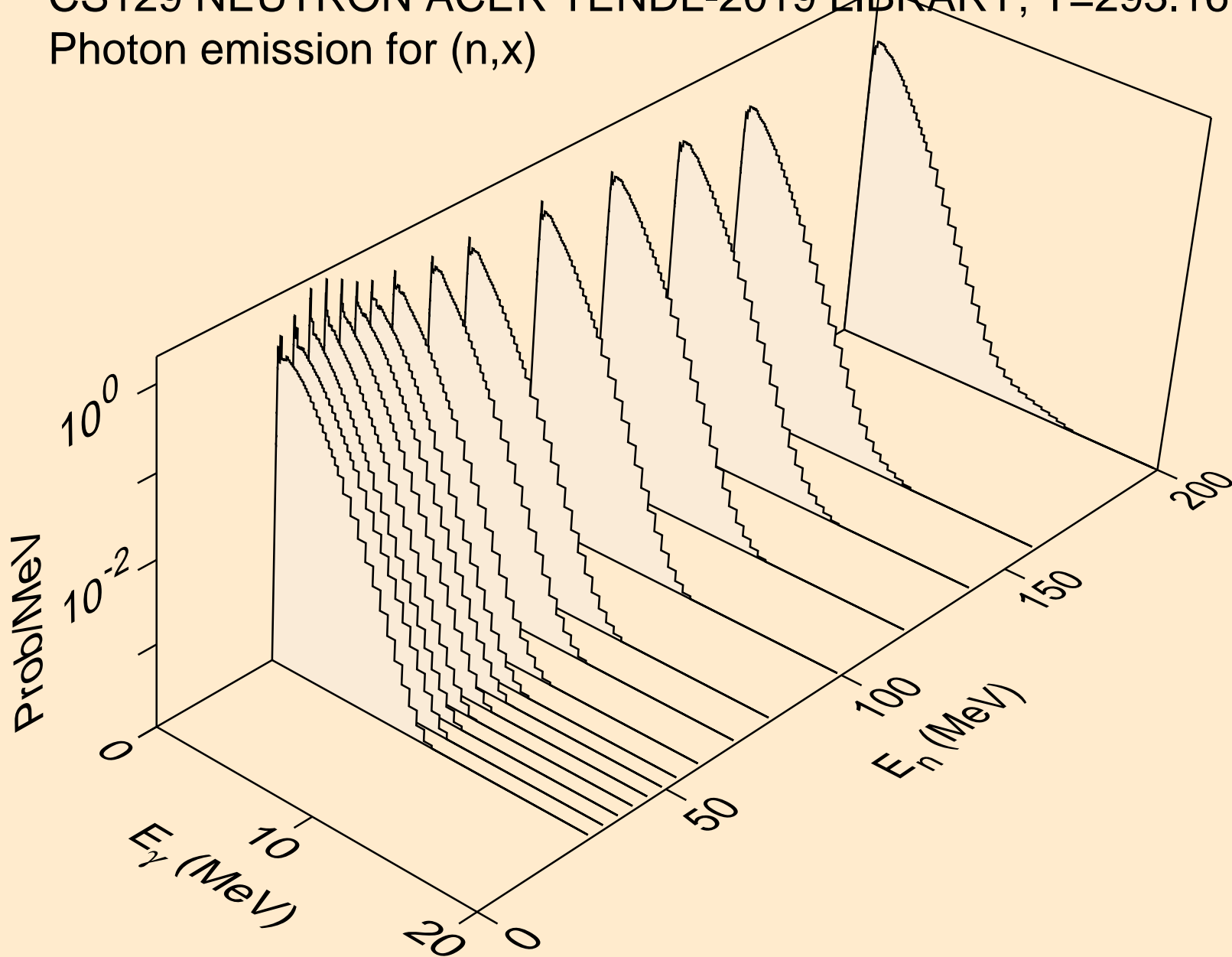

CS129 NEUTRON ACER TENDL-2019 LIBRARY; T=293.16K
Photon emission for (n,2nd)

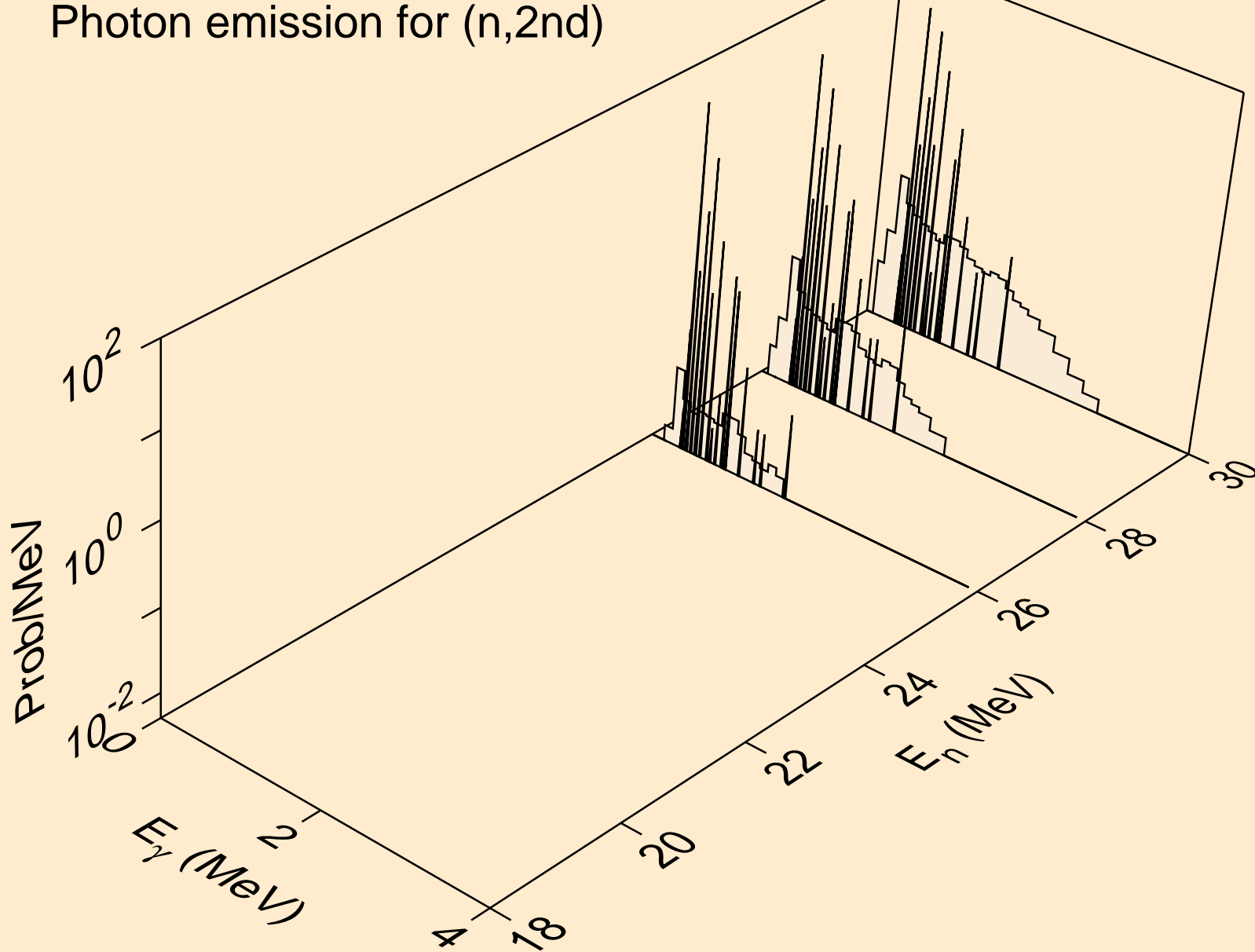

CS129 NEUTRON ACER TENDL-2019 LIBRARY; T=293.16K
Photon emission for (n,2n)

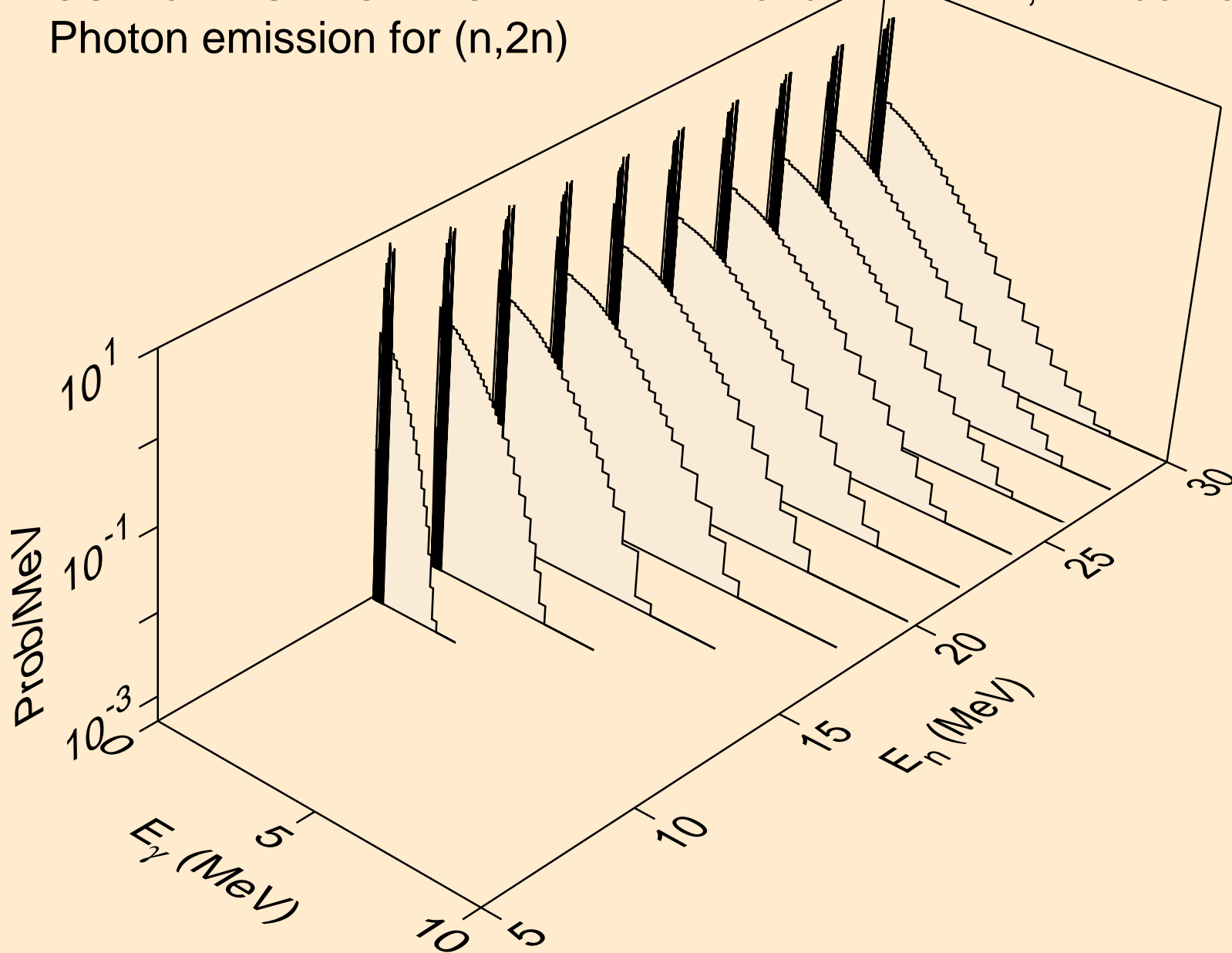

CS129 NEUTRON ACER TENDL-2019 LIBRARY; T=293.16K
Photon emission for (n,3n)

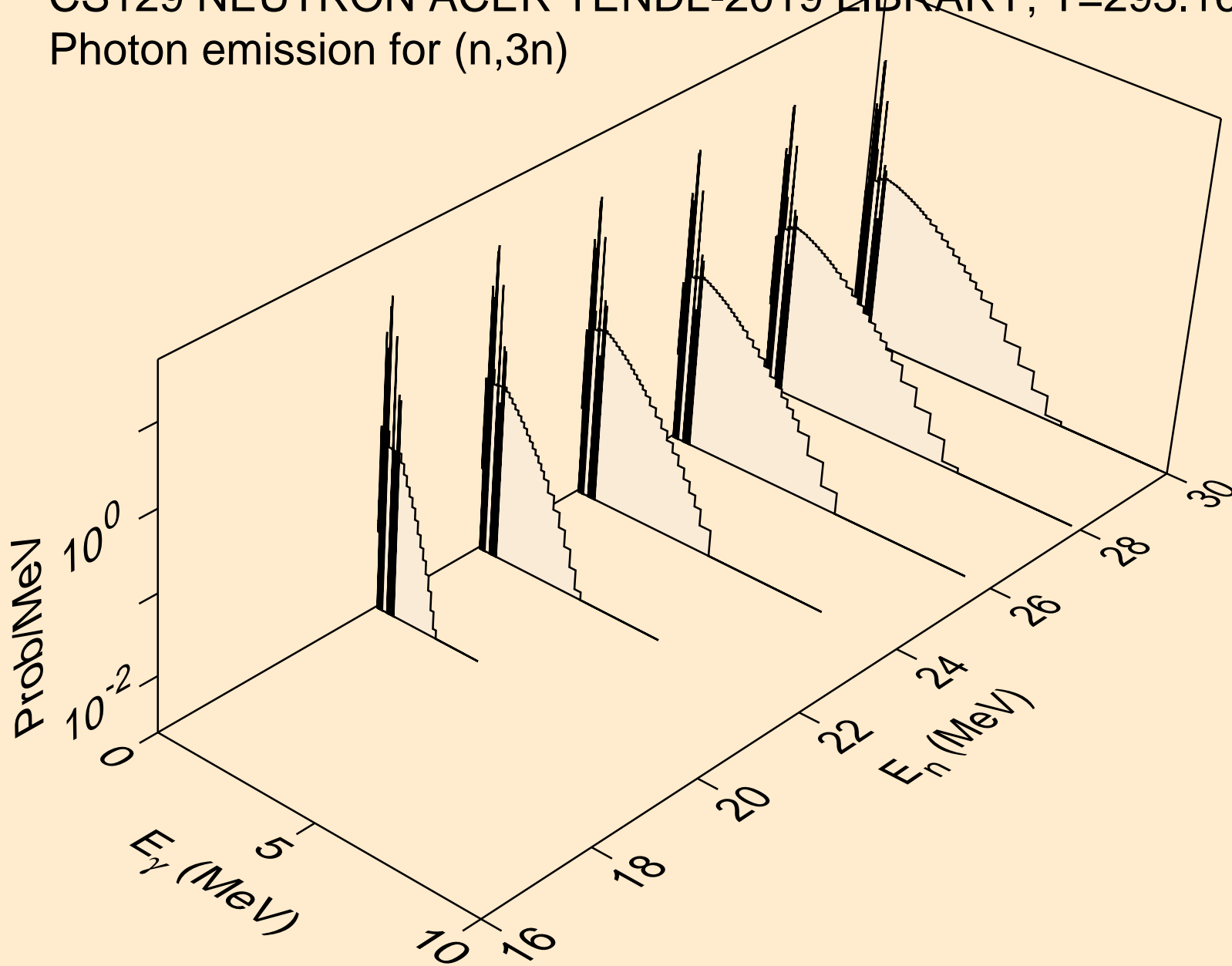

CS129 NEUTRON ACER TENDL-2019 LIBRARY; T=293.16K
Photon emission for (n,n*)a

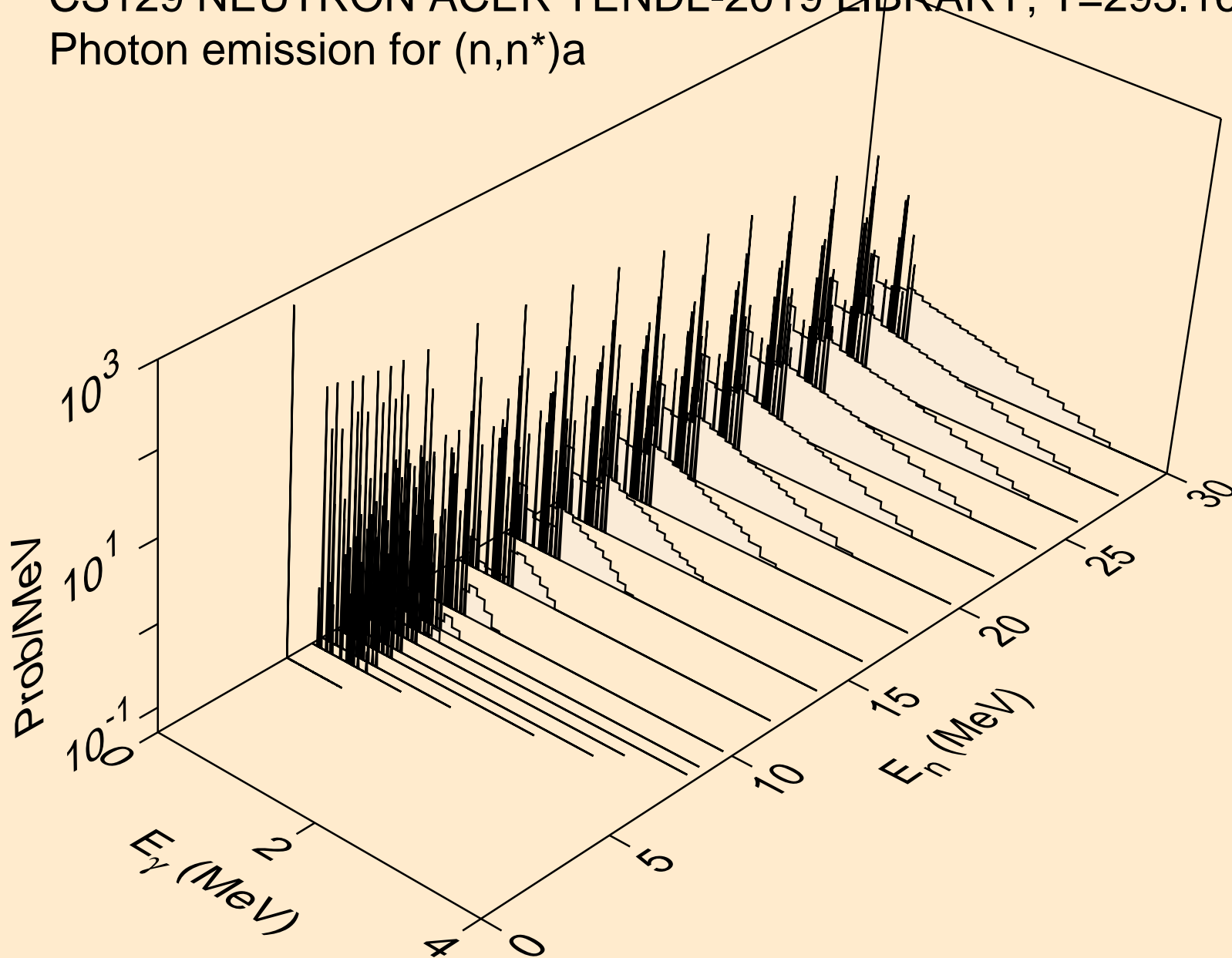

CS129 NEUTRON ACER TENDL-2019 LIBRARY; T=293.16K
Photon emission for (n,2n)a

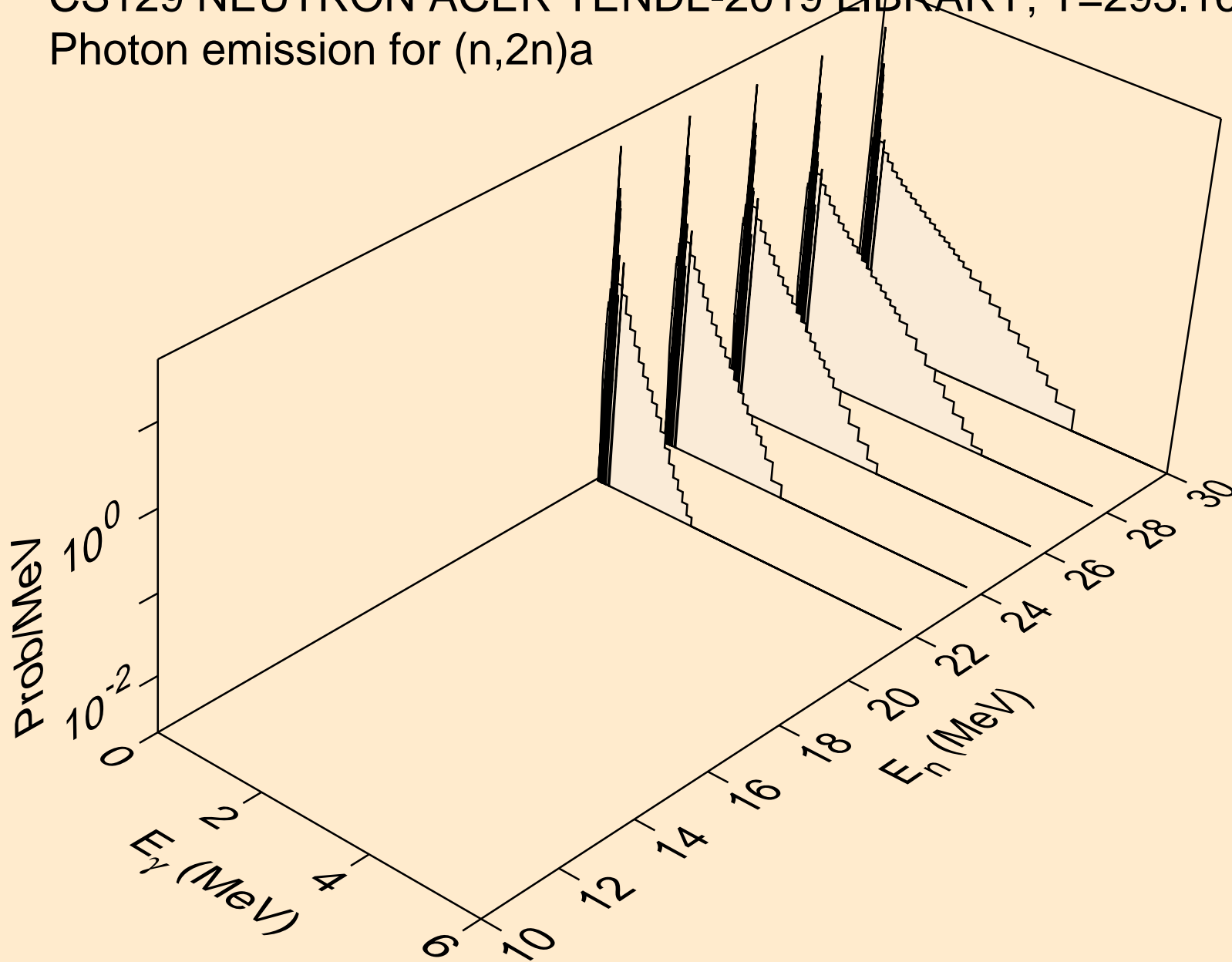

CS129 NEUTRON ACER TENDL-2019 LIBRARY; T=293.16K
Photon emission for (n,3n)a

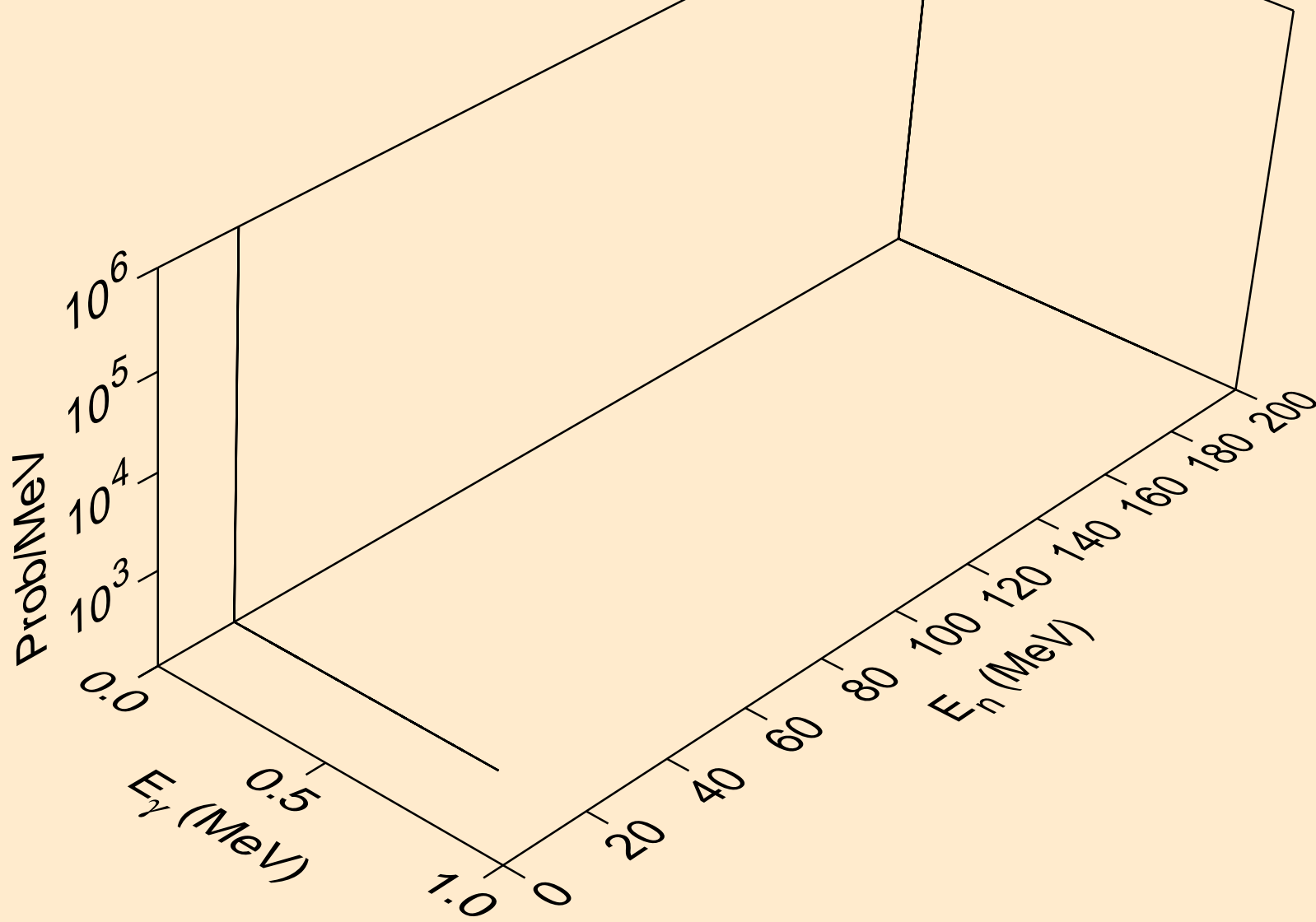

CS129 NEUTRON ACER TENDL-2019 LIBRARY; T=293.16K
Photon emission for (n,n*)p

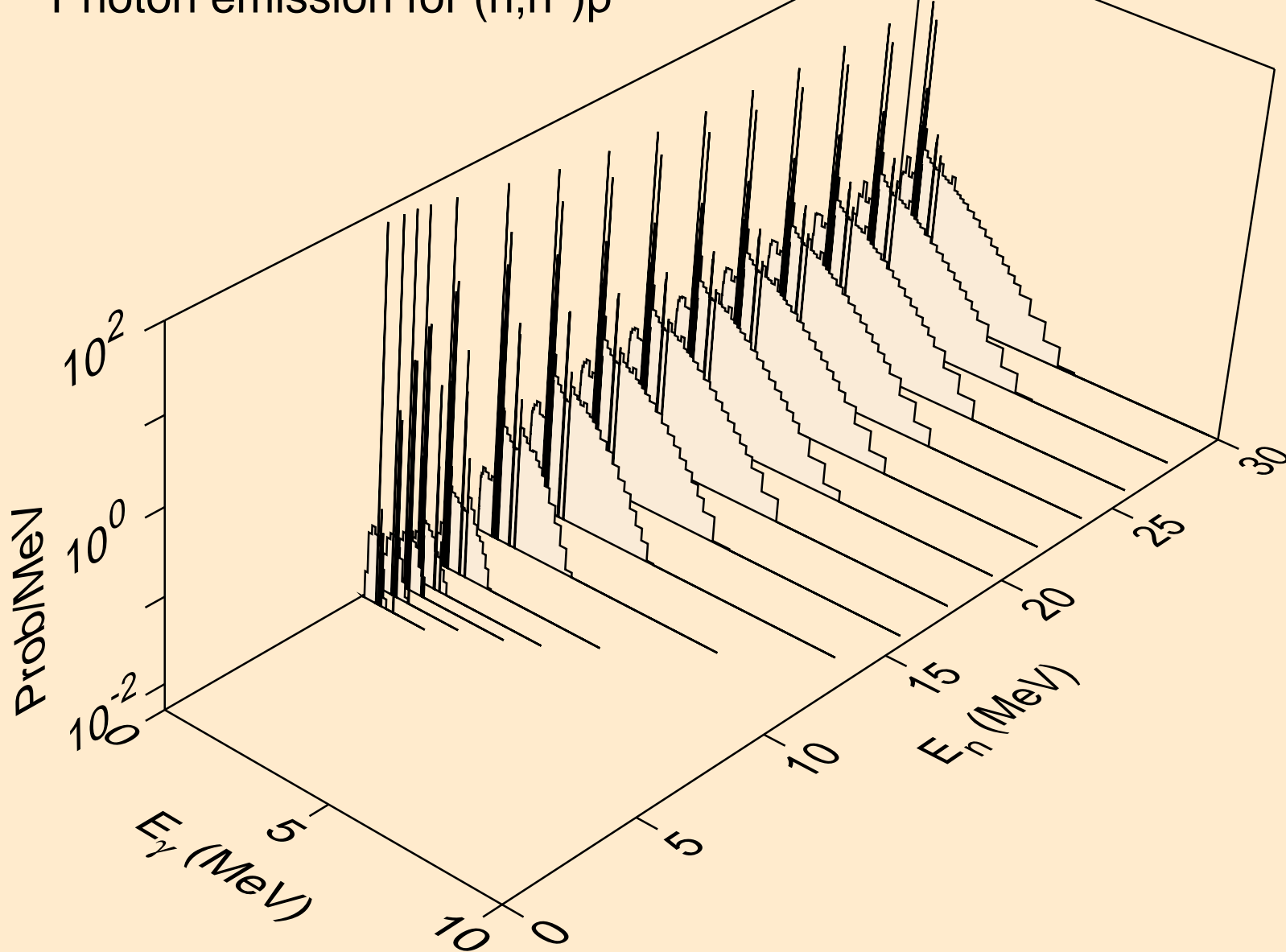

CS129 NEUTRON ACER TENDL-2019 LIBRARY; T=293.16K
Photon emission for (n,n*)2a

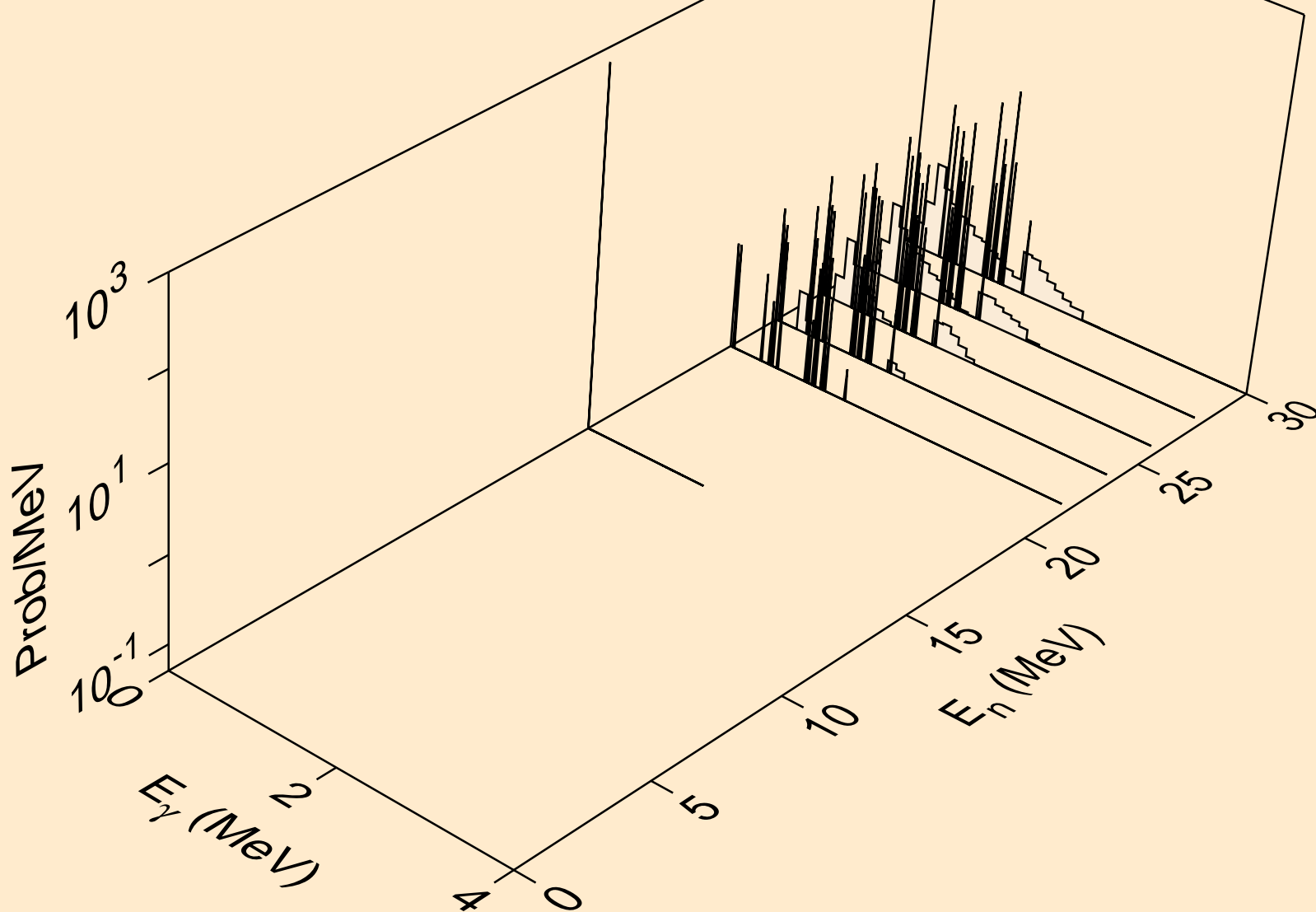

CS129 NEUTRON ACER TENDL-2019 LIBRARY; T=293.16K
Photon emission for (n,n*)d

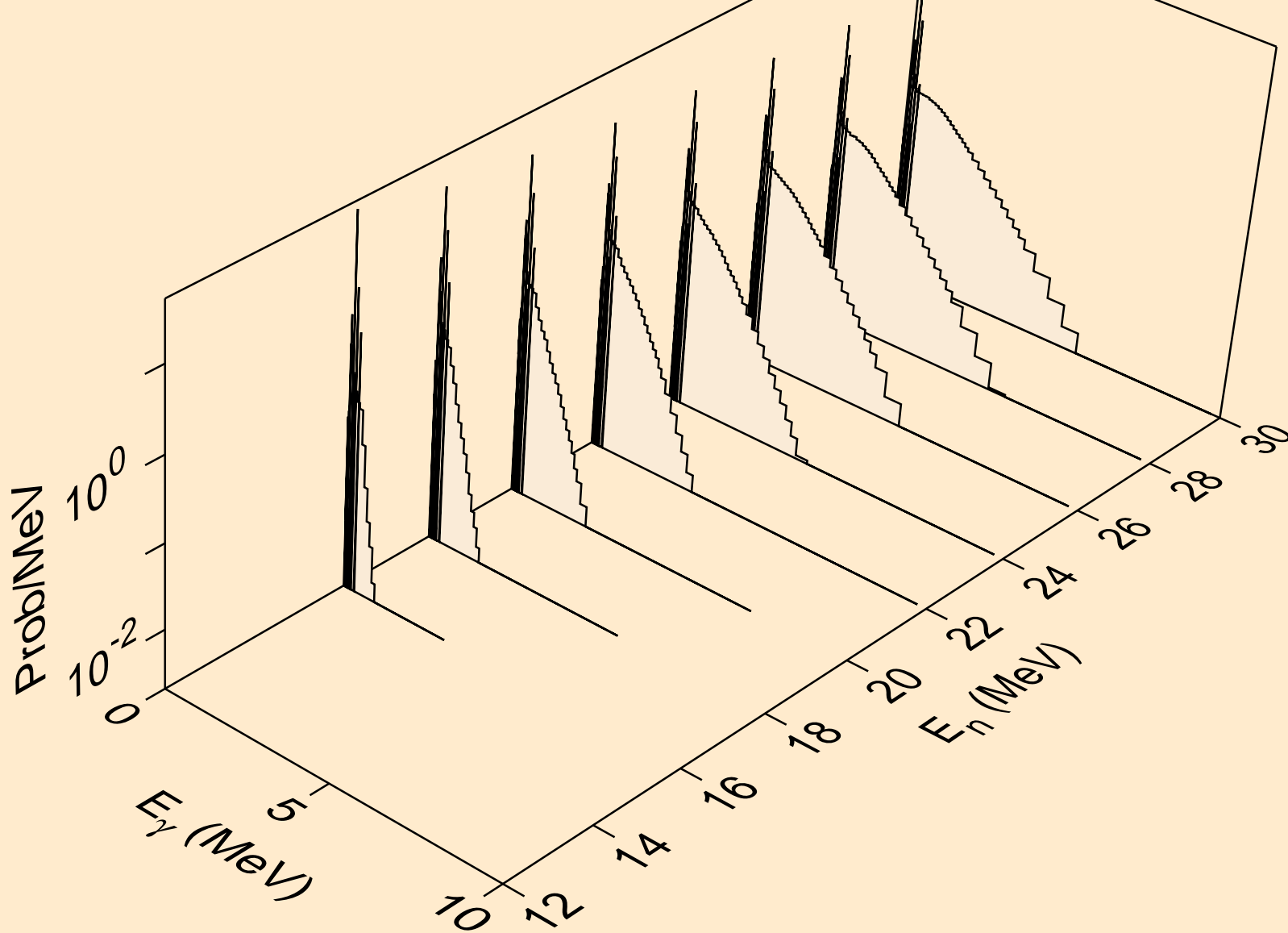

CS129 NEUTRON ACER TENDL-2019 LIBRARY; T=293.16K
Photon emission for (n,n*)t

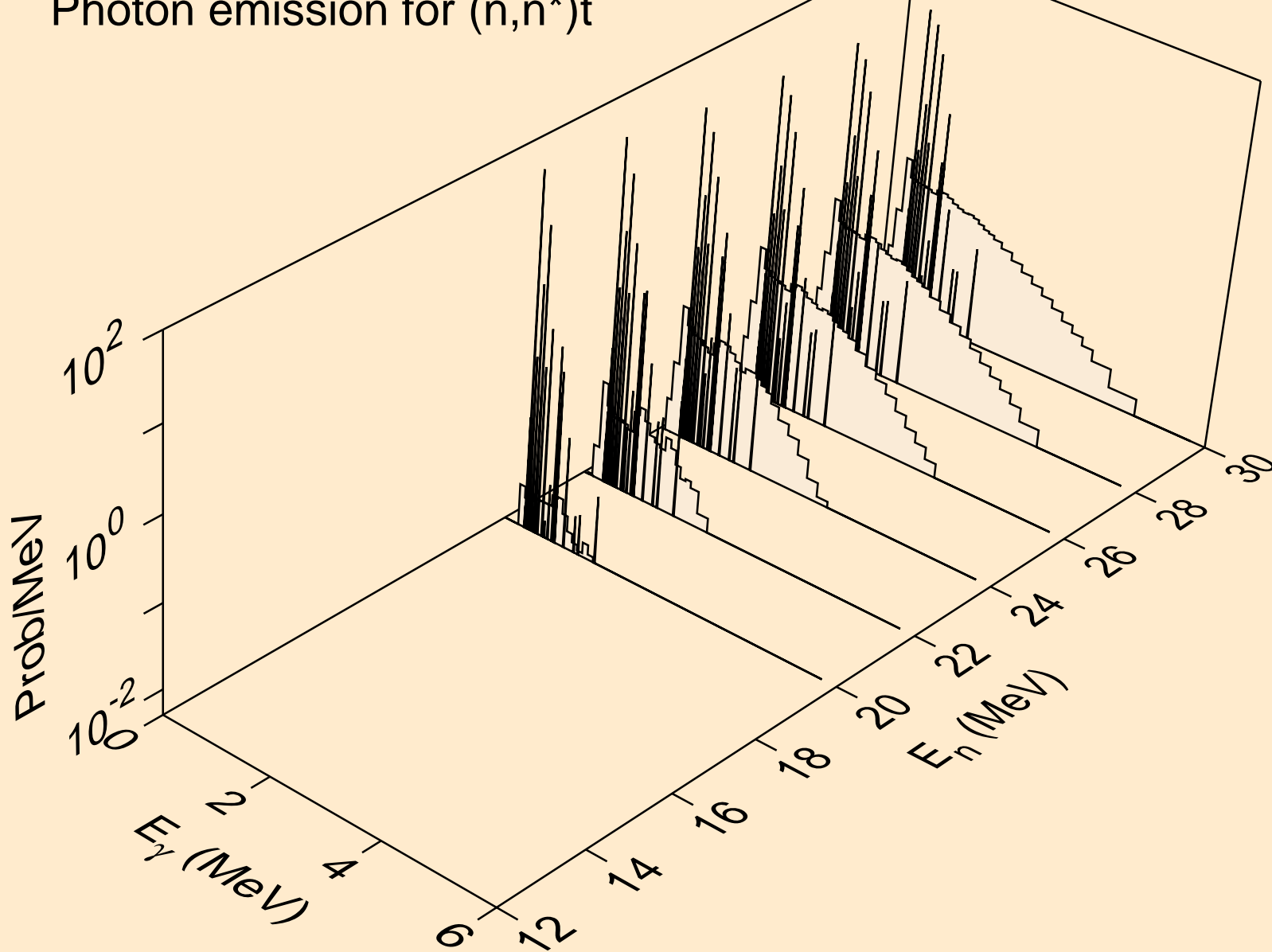

CS129 NEUTRON ACER TENDL-2019 LIBRARY; T=293.16K
Photon emission for (n,n*)he3

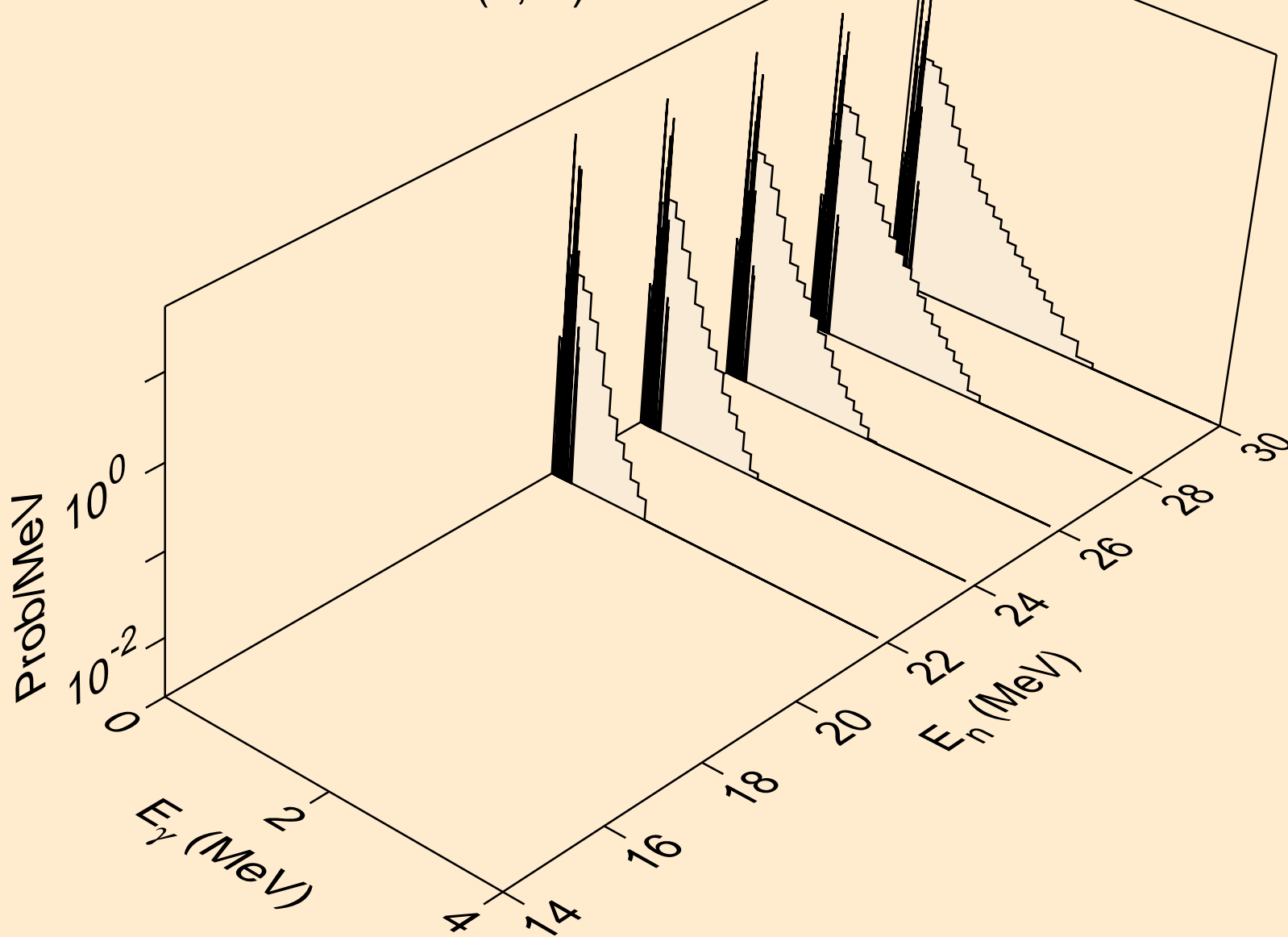

CS129 NEUTRON ACER TENDL-2019 LIBRARY; T=293.16K
Photon emission for (n,4n)

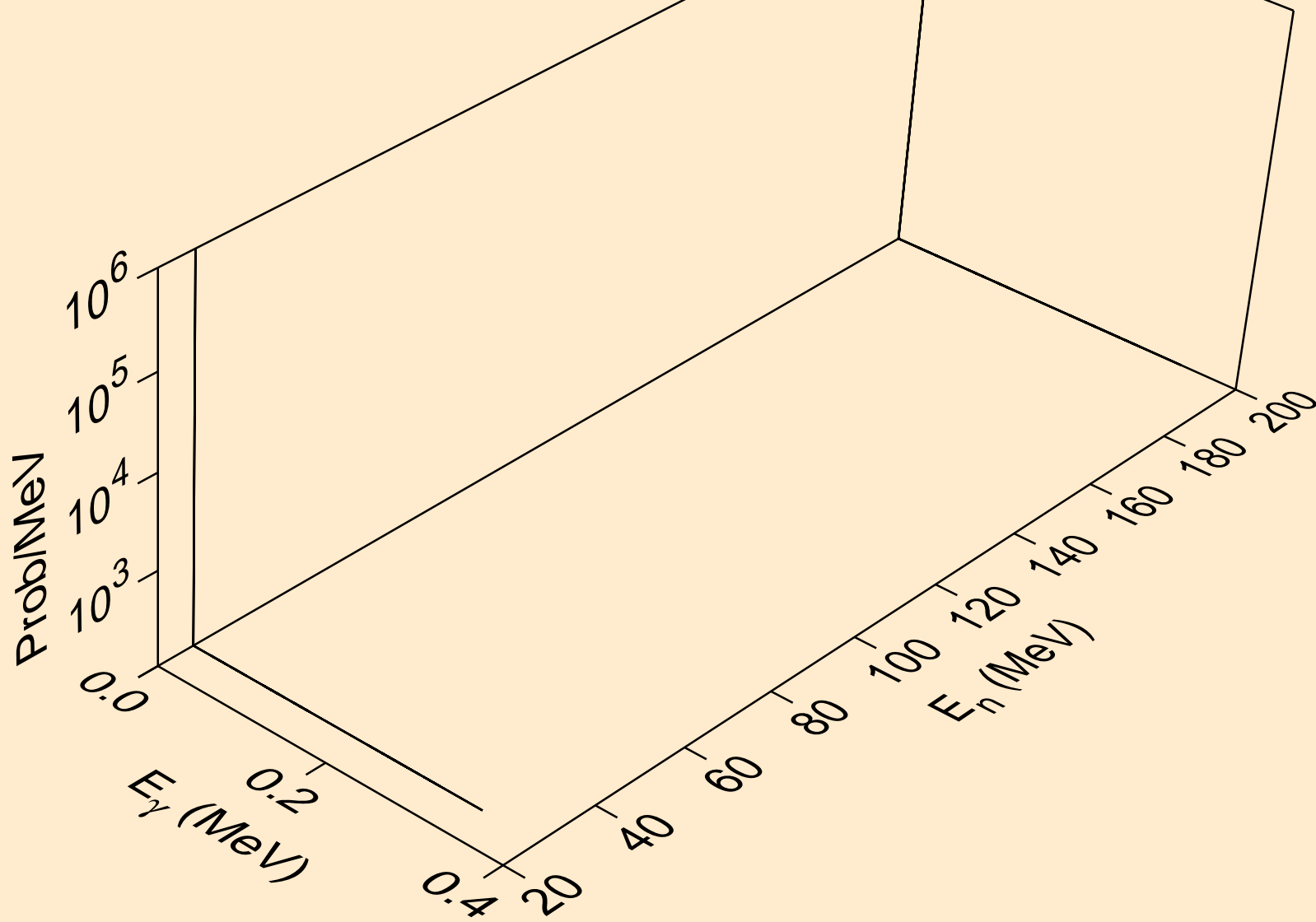

CS129 NEUTRON ACER TENDL-2019 LIBRARY; T=293.16K
Photon emission for (n,2np)

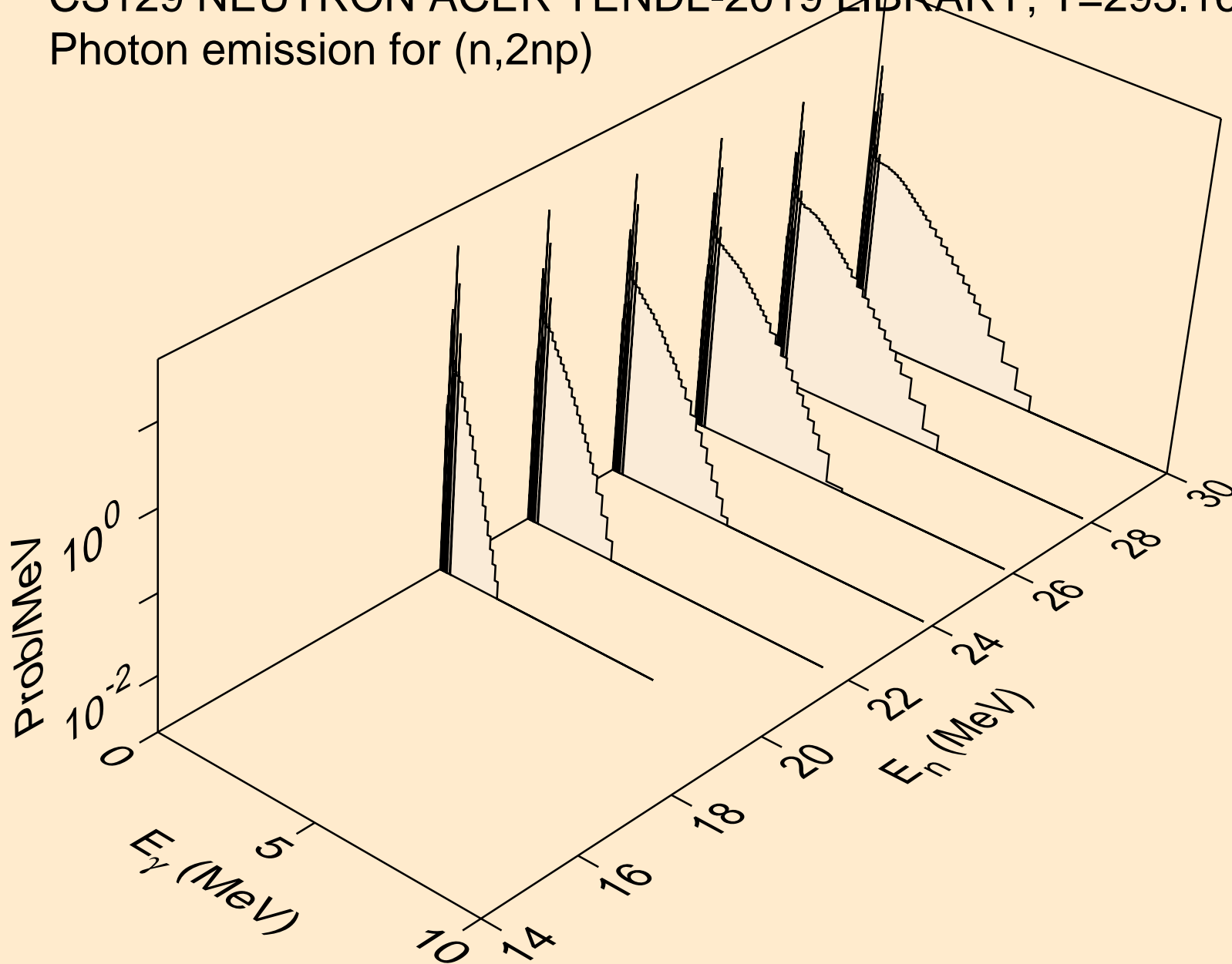

CS129 NEUTRON ACER TENDL-2019 LIBRARY; T=293.16K
Photon emission for (n,3np)

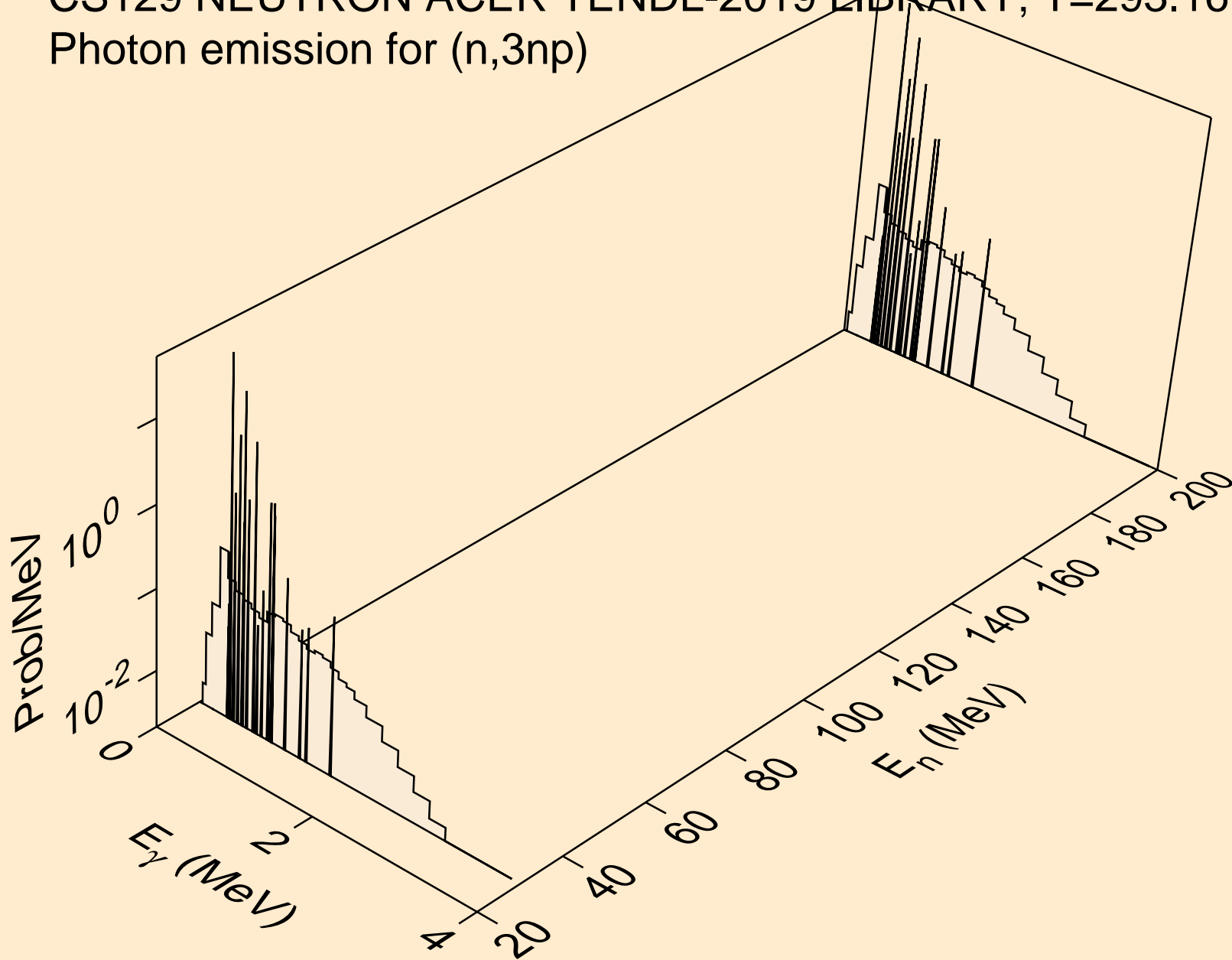

CS129 NEUTRON ACER TENDL-2019 LIBRARY; T=293.16K
Photon emission for (n,2np)

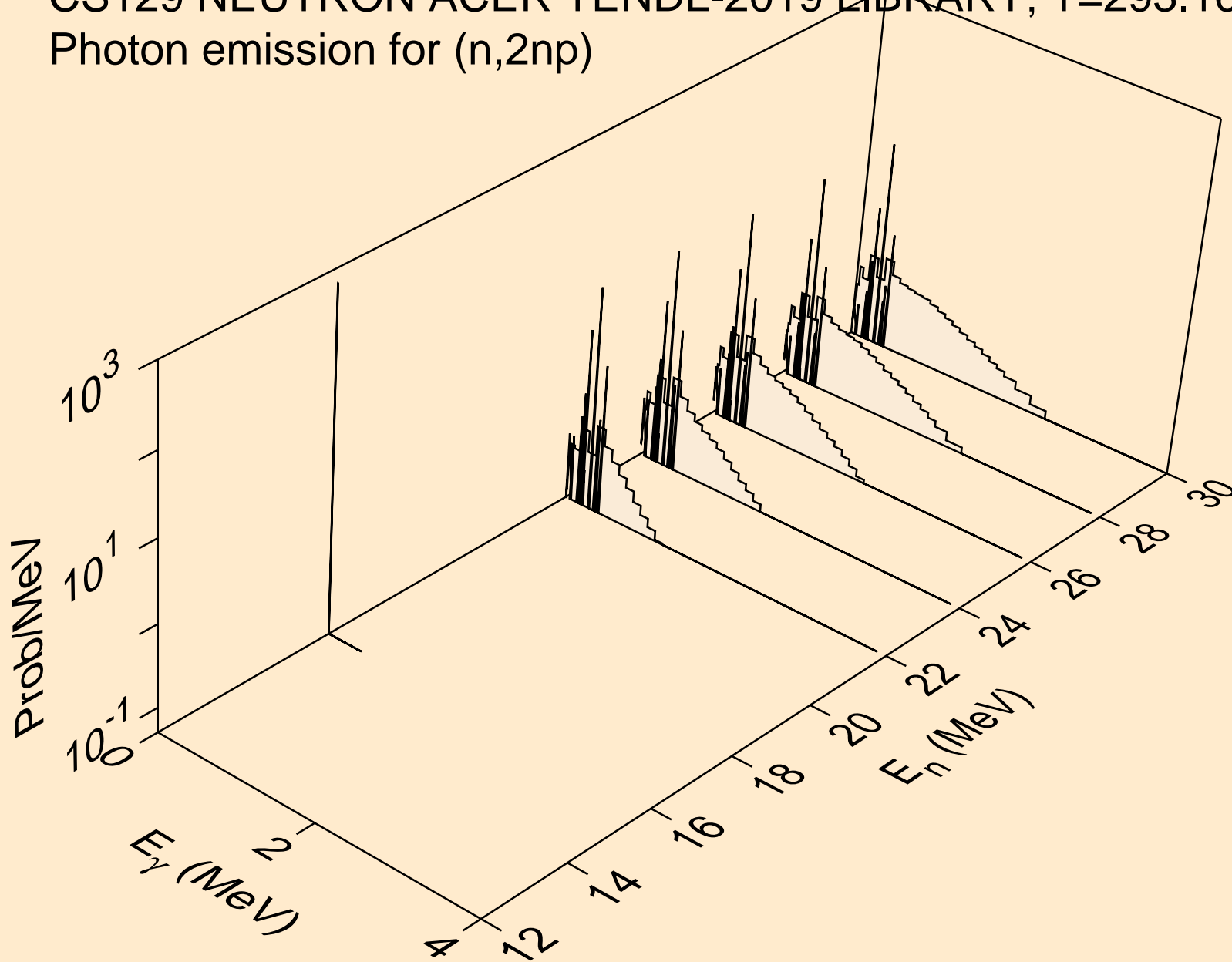

CS129 NEUTRON ACER TENDL-2019 LIBRARY; T=293.16K
Photon emission for (n,npa)

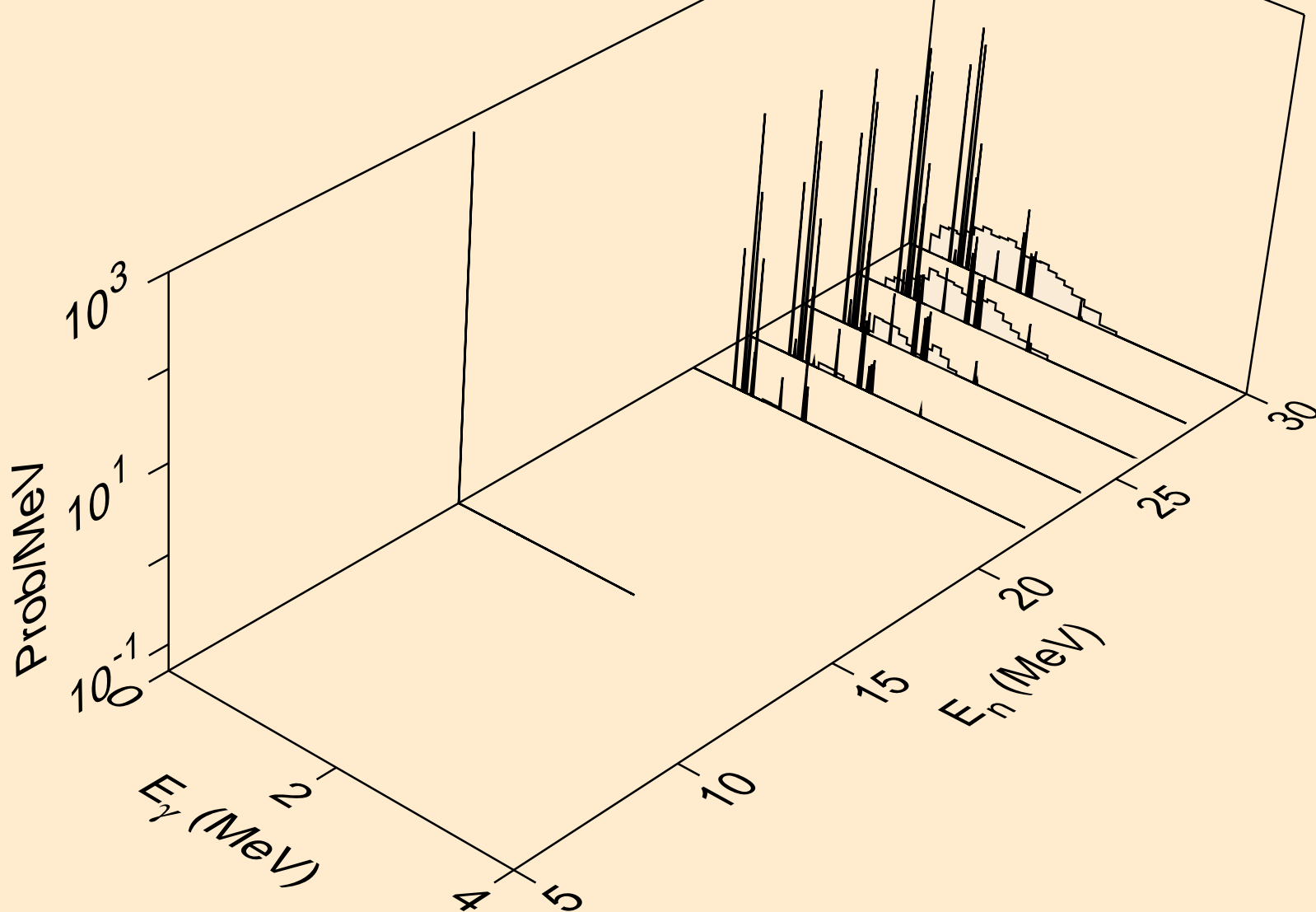

CS129 NEUTRON ACER TENDL-2019 LIBRARY; T=293.16K
Photon emission for (n,n*c)

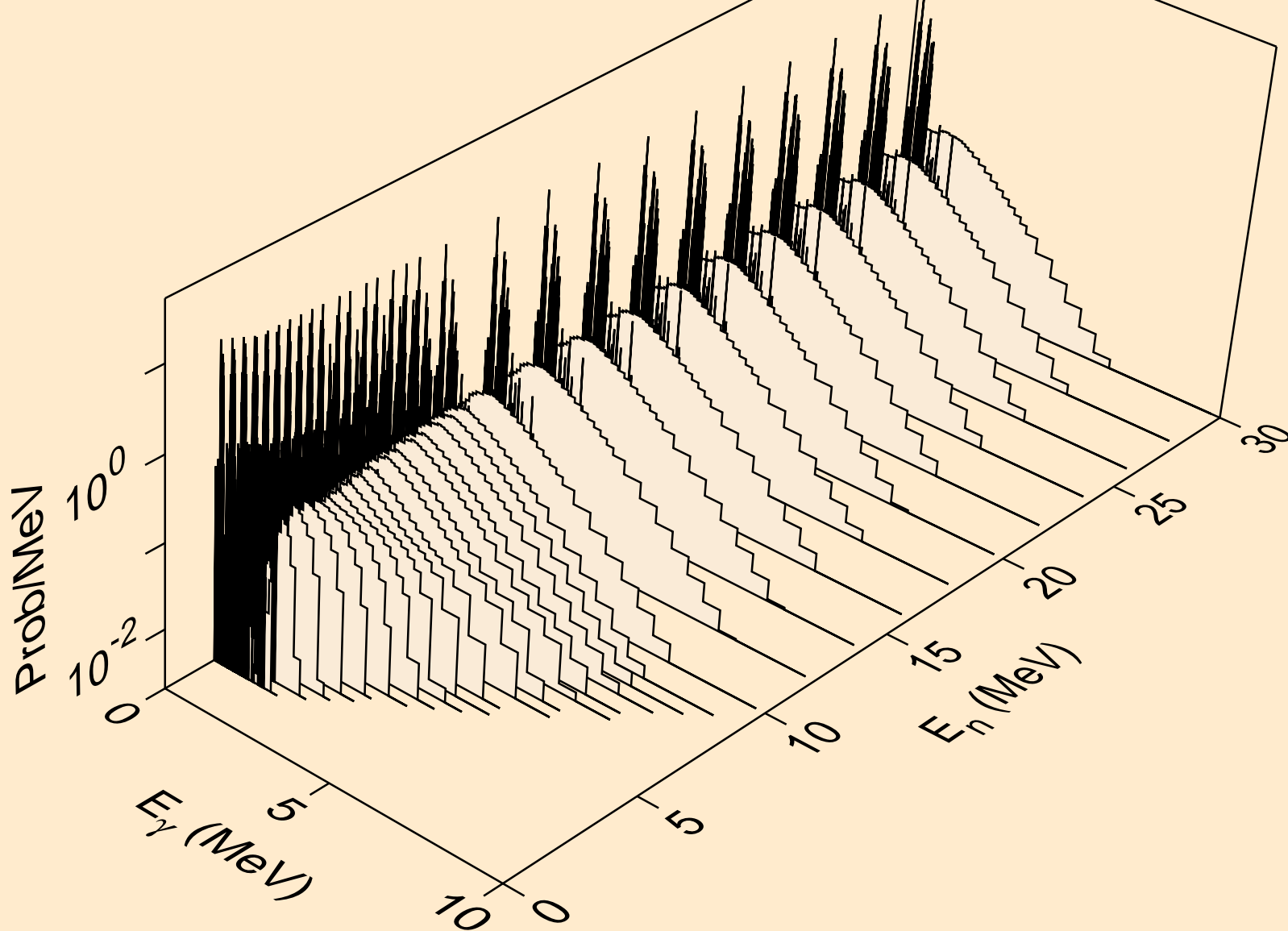

CS129 NEUTRON ACER TENDL-2019 LIBRARY; T=293.16K
Photon emission for (n,gma)

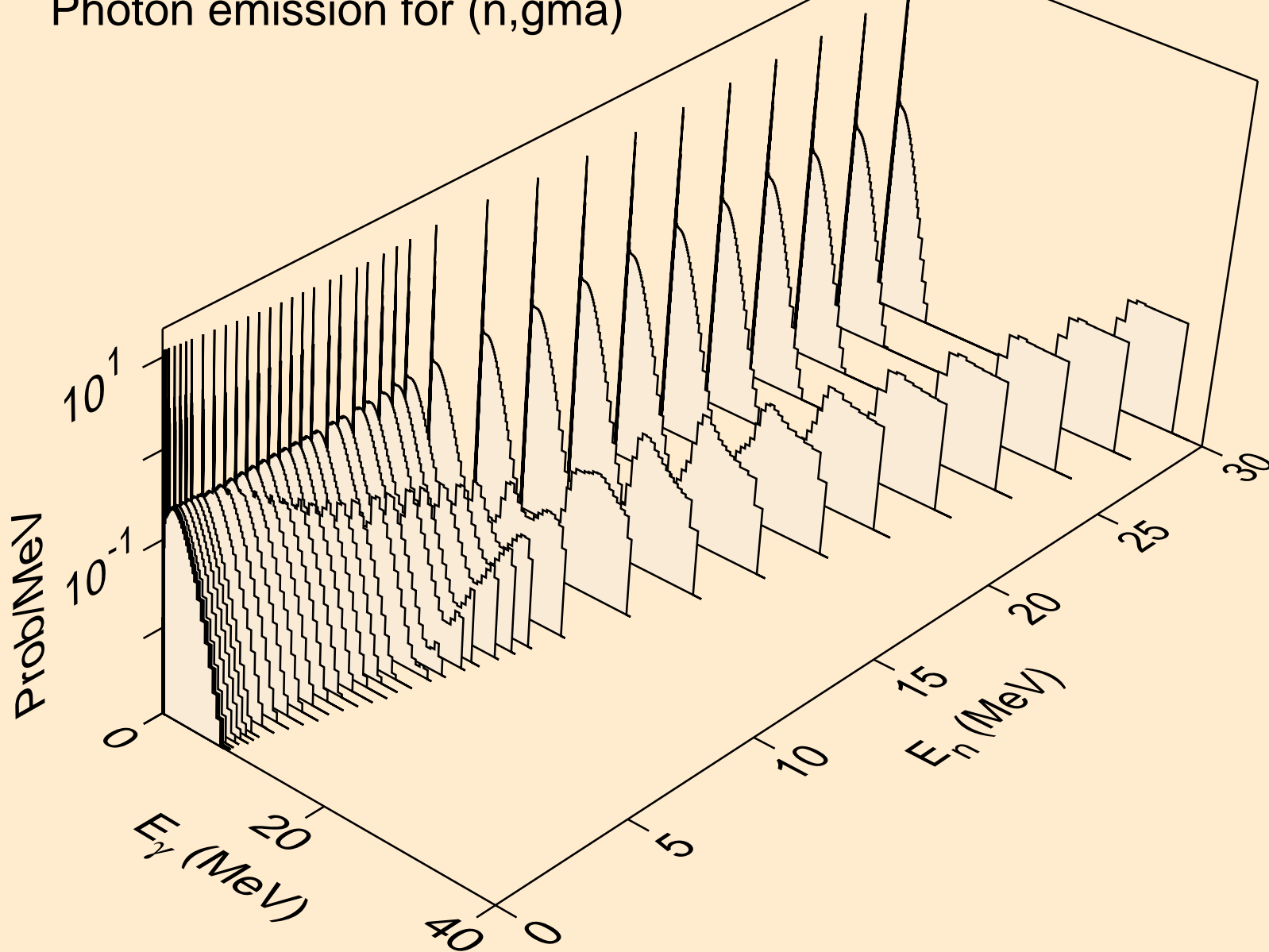

CS129 NEUTRON ACER TENDL-2019 LIBRARY; T=293.16K
Photon emission for (n,p)

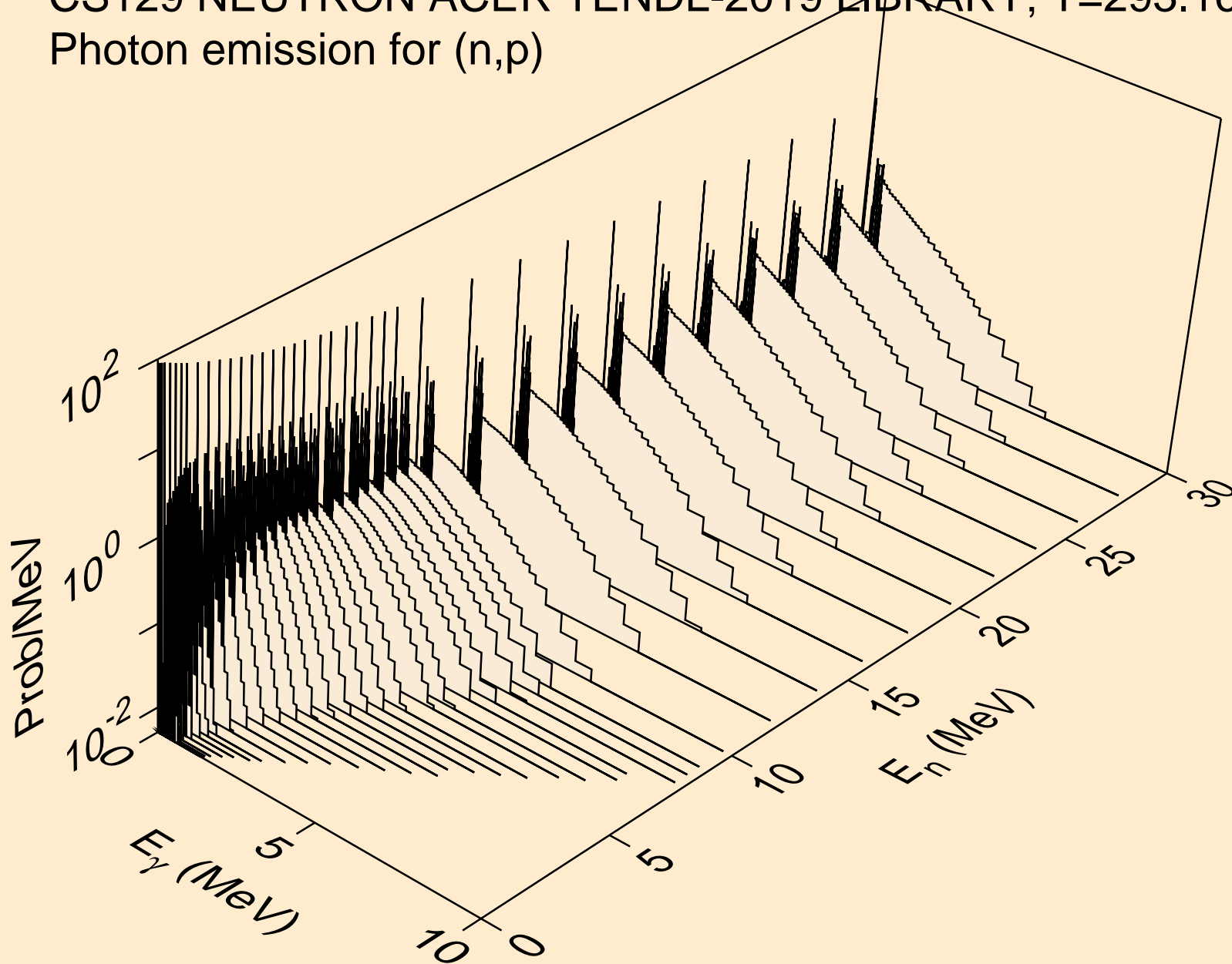

CS129 NEUTRON ACER TENDL-2019 LIBRARY; T=293.16K
Photon emission for (n,d)

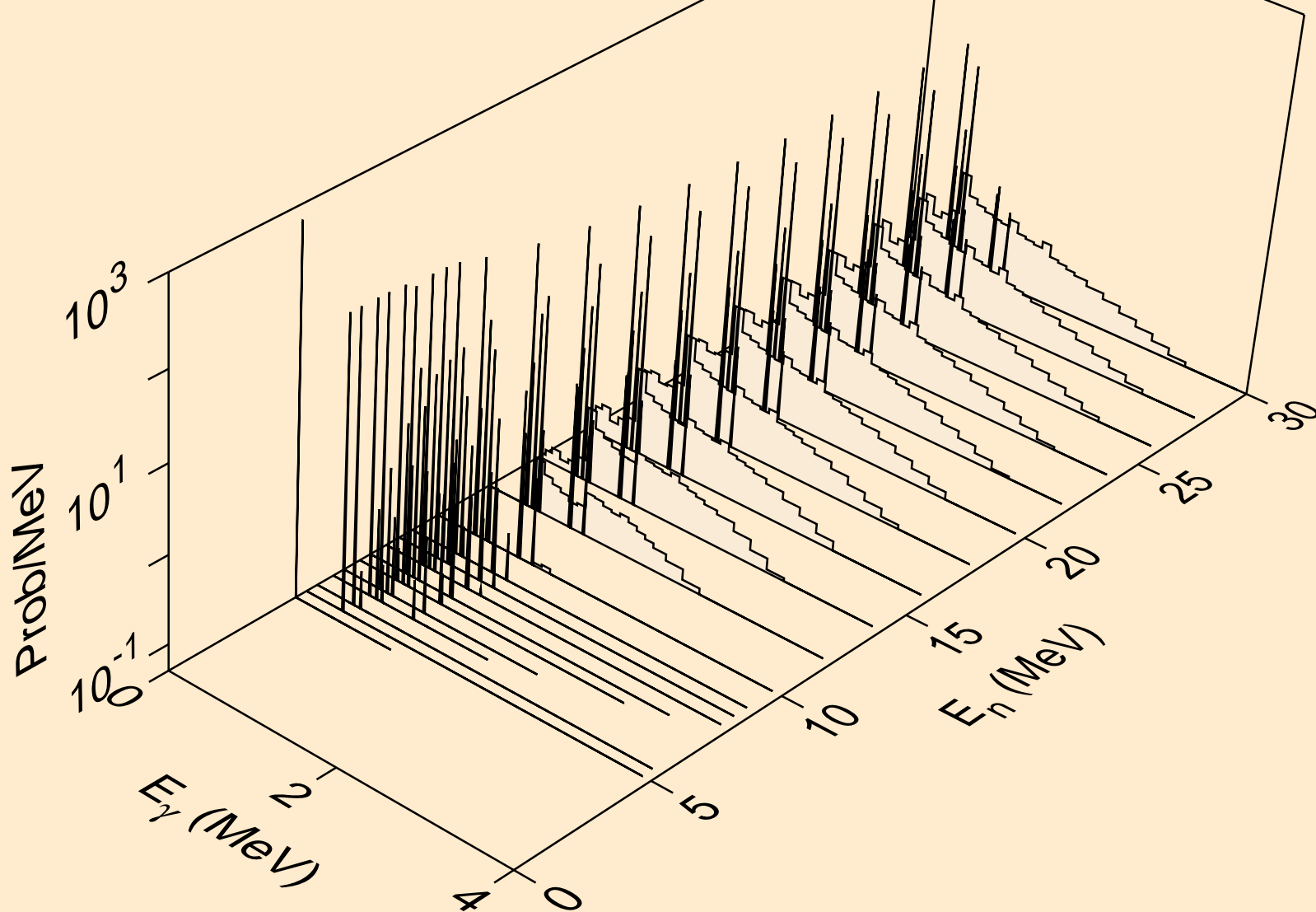

CS129 NEUTRON ACER TENDL-2019 LIBRARY; T=293.16K
Photon emission for (n,t)

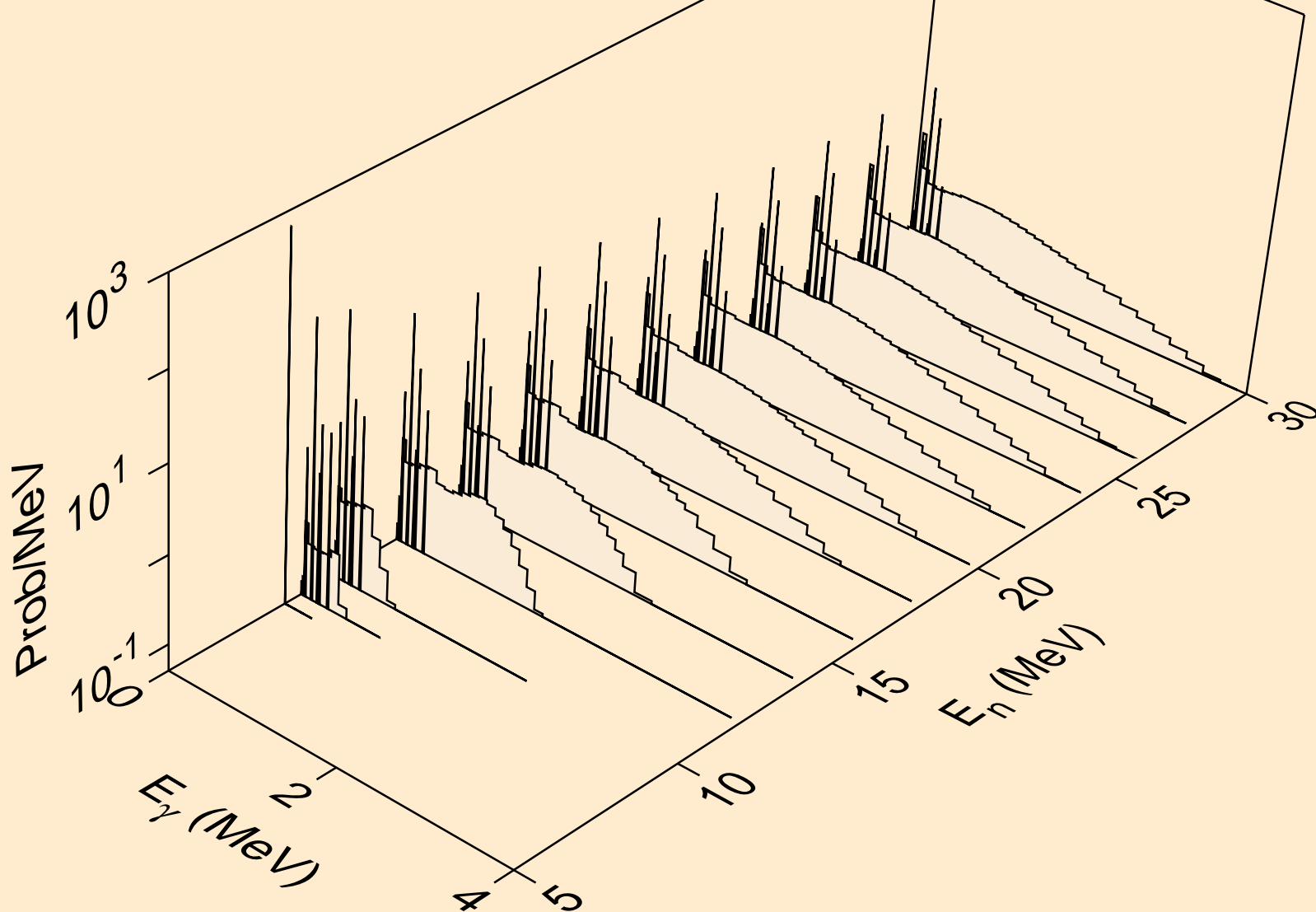

CS129 NEUTRON ACER TENDL-2019 LIBRARY; T=293.16K
Photon emission for (n,he3)

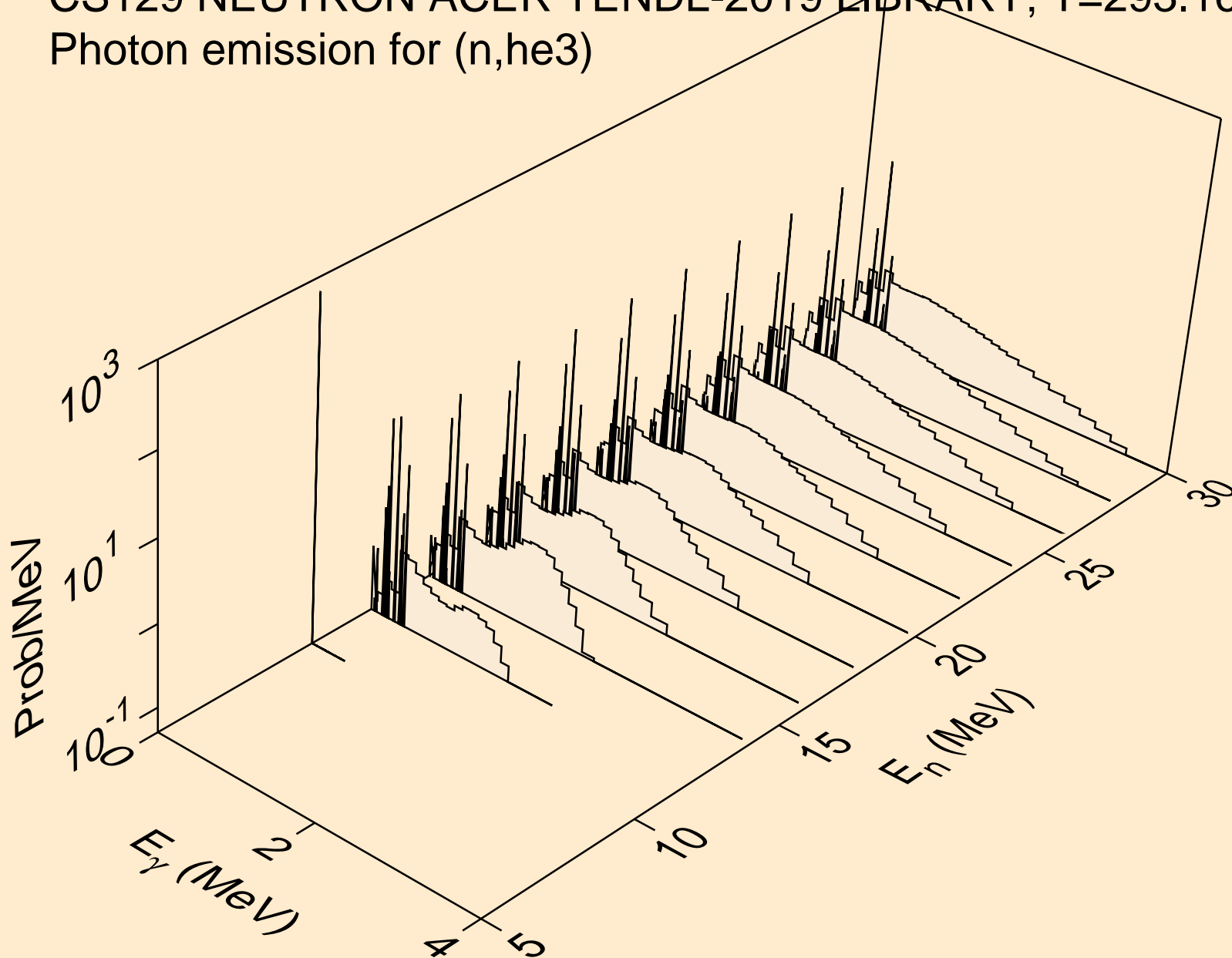

CS129 NEUTRON ACER TENDL-2019 LIBRARY; T=293.16K
Photon emission for (n,a)

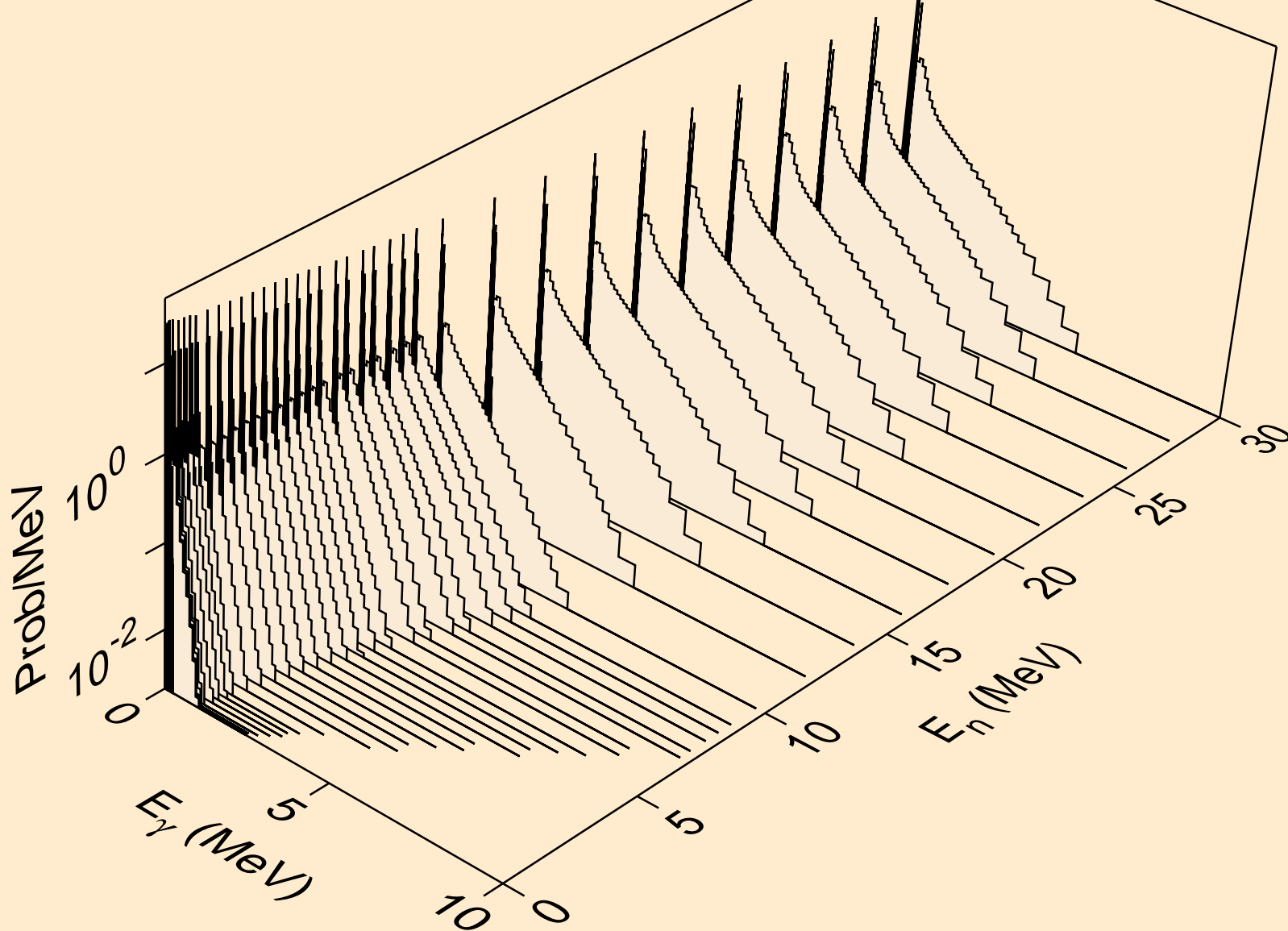

CS129 NEUTRON ACER TENDL-2019 LIBRARY; T=293.16K
Photon emission for (n,2a)

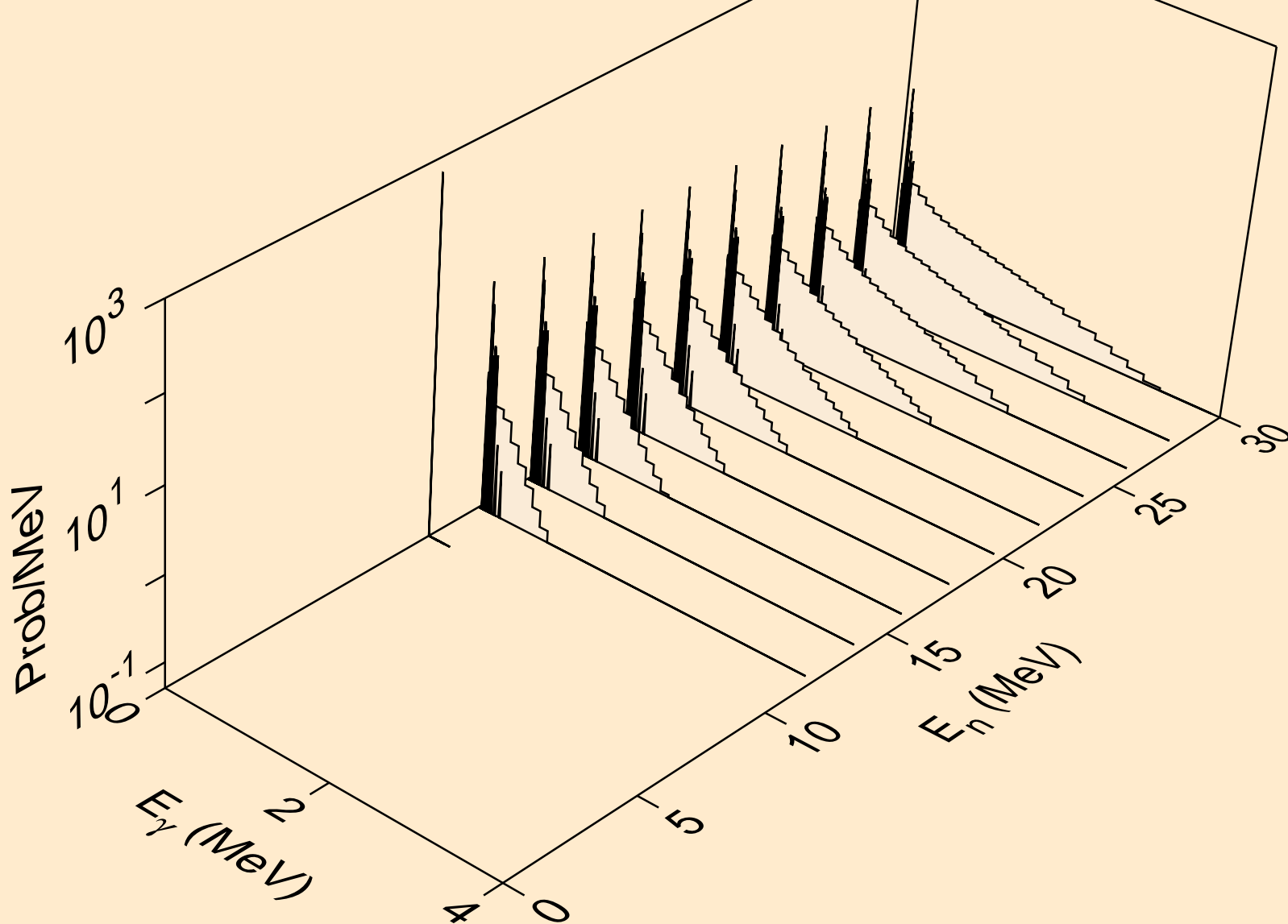

CS129 NEUTRON ACER TENDL-2019 LIBRARY; T=293.16K
Photon emission for (n,2p)

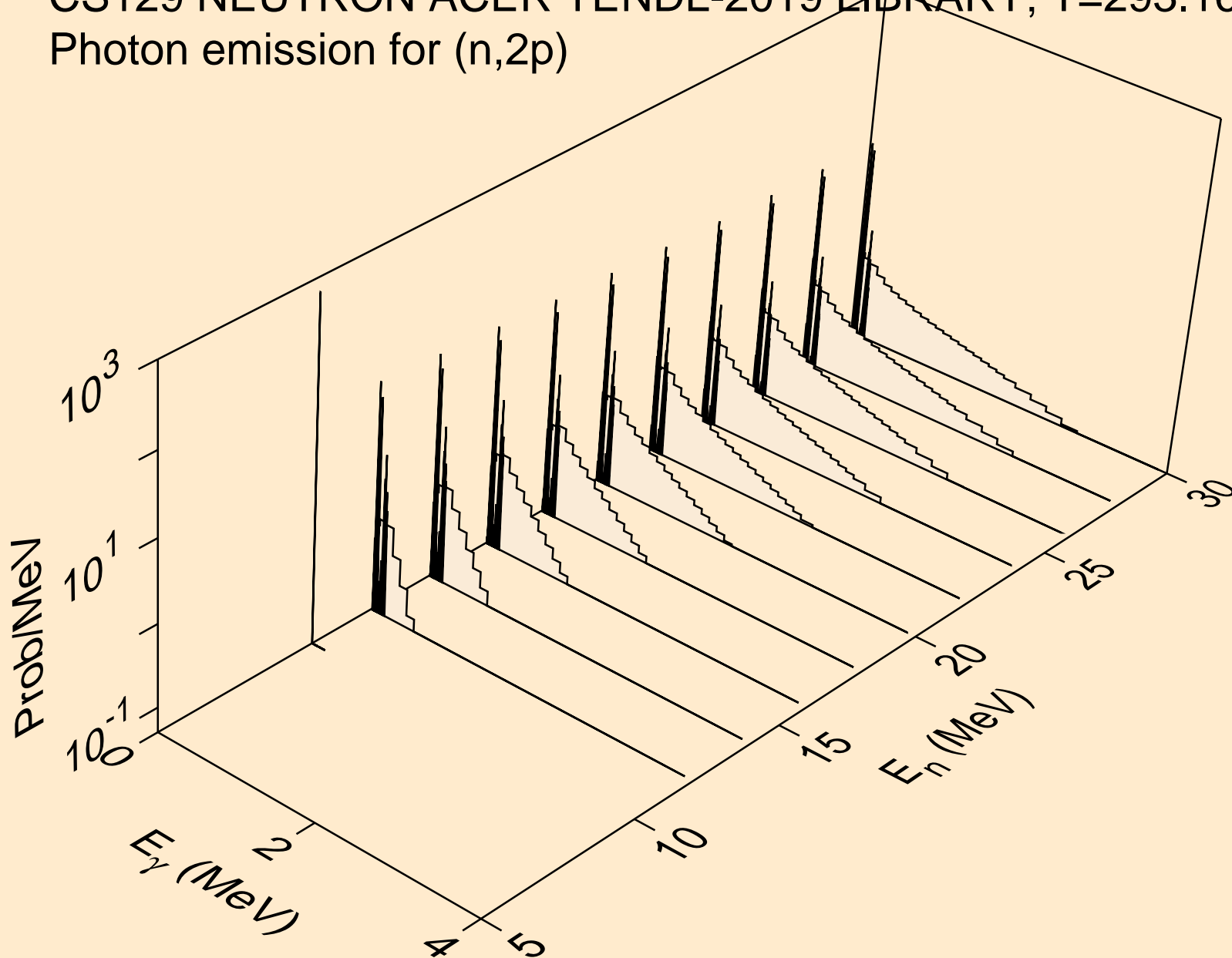

CS129 NEUTRON ACER TENDL-2019 LIBRARY; T=293.16K
Photon emission for (n,p α)

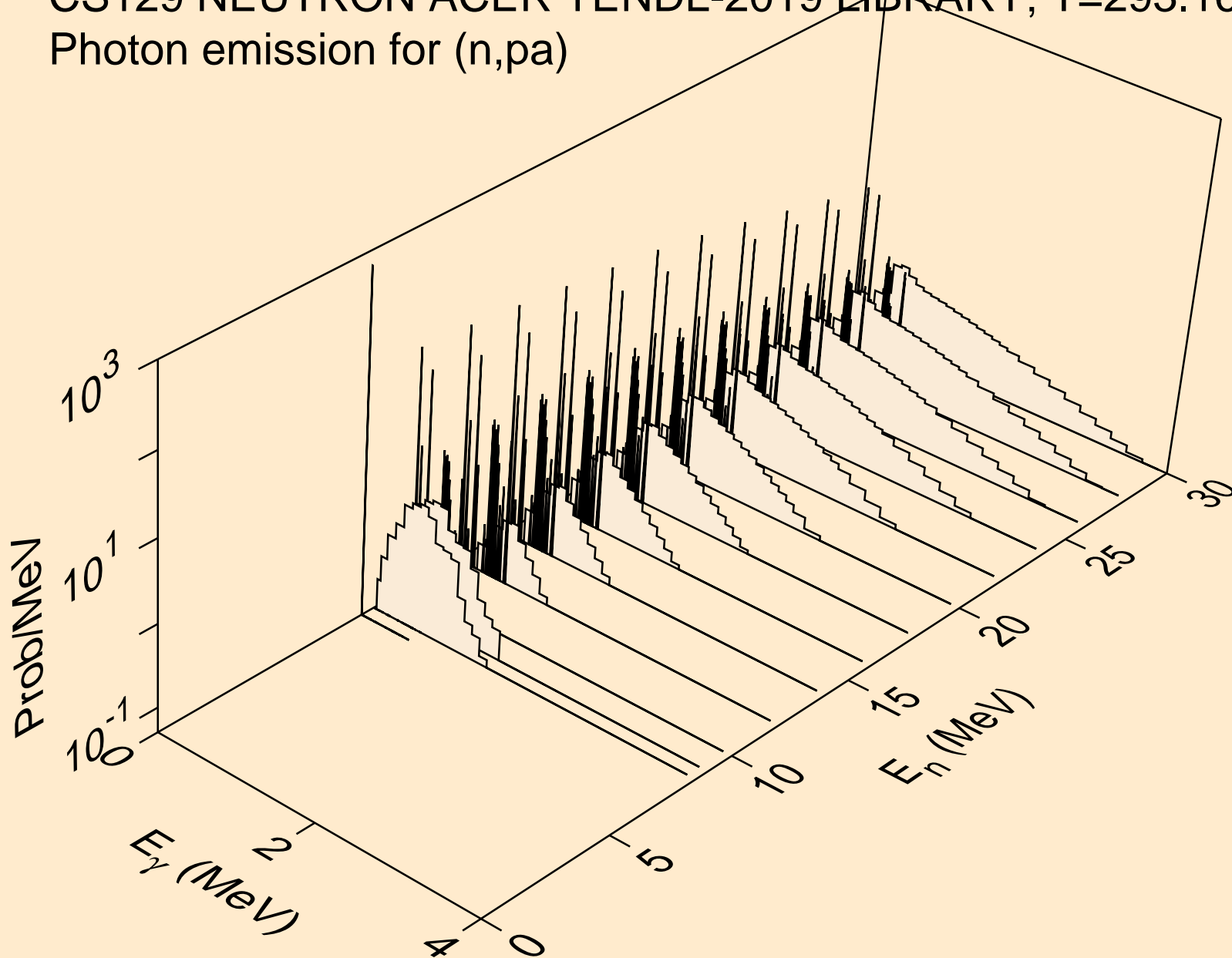

CS129 NEUTRON ACER TENDL-2019 LIBRARY; T=293.16K
Photon emission for (n,pd)

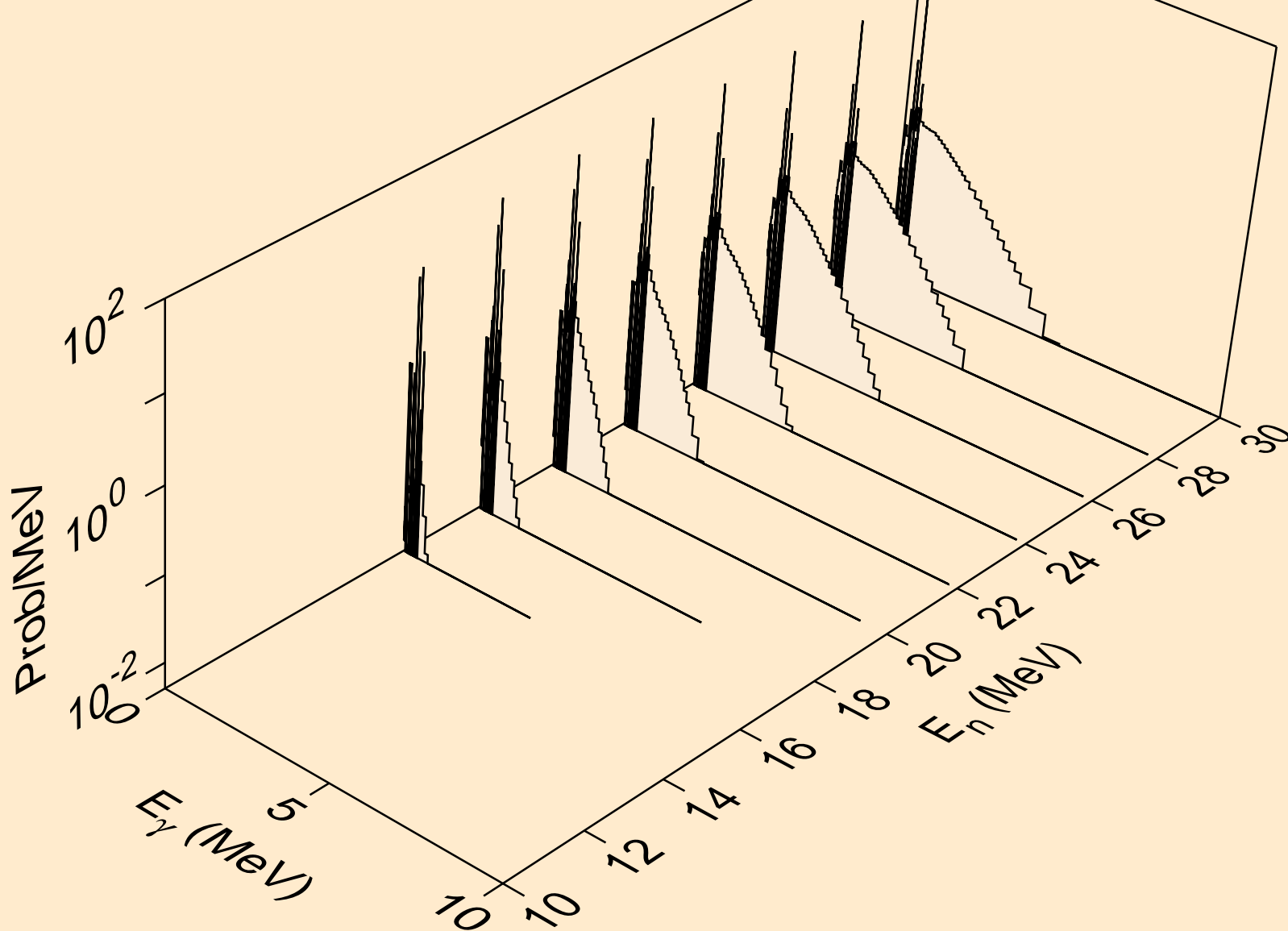

CS129 NEUTRON ACER TENDL-2019 LIBRARY; T=293.16K
Photon emission for (n,pt)

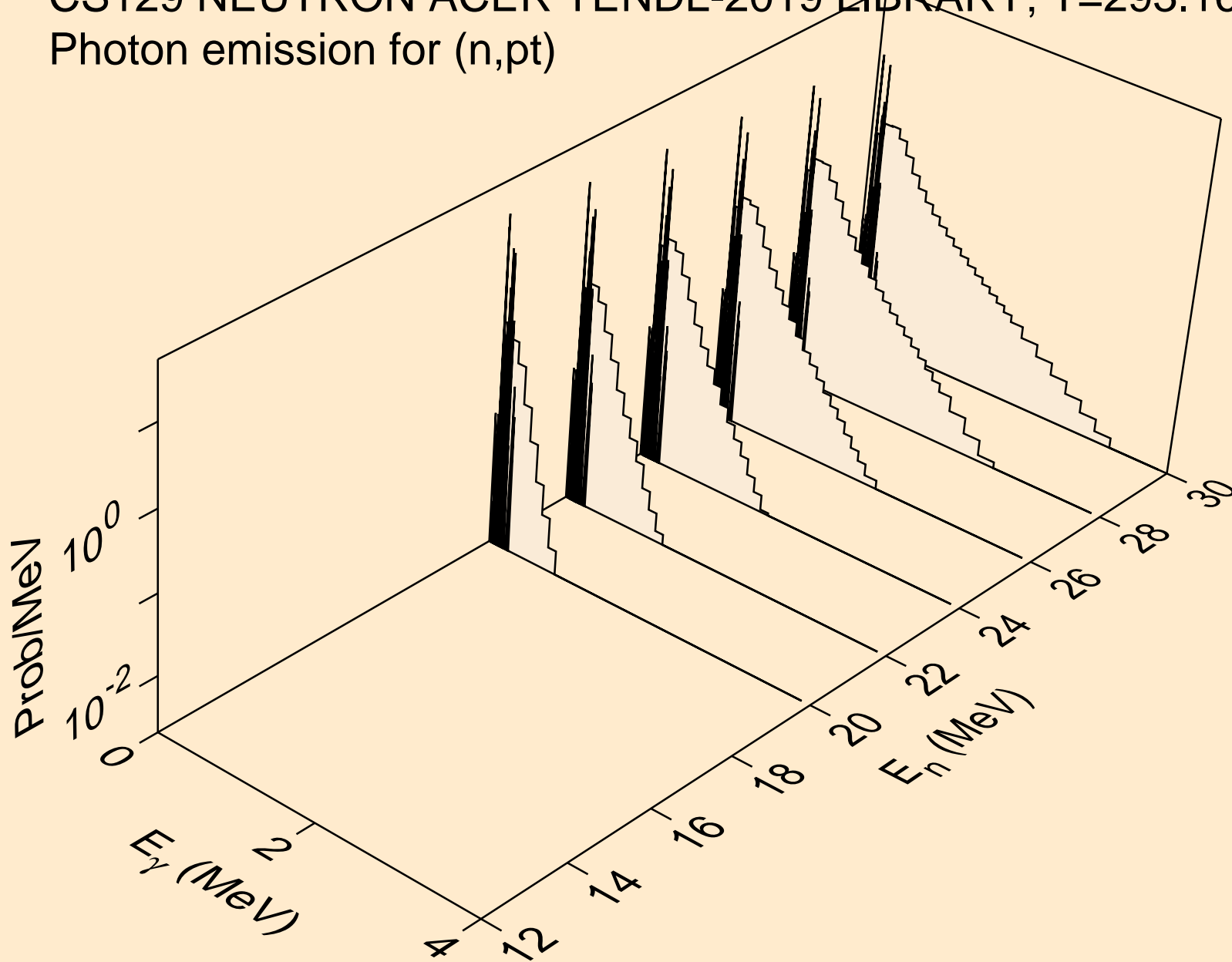

CS129 NEUTRON ACER TENDL-2019 LIBRARY; T=293.16K
Photon emission for (n,da)

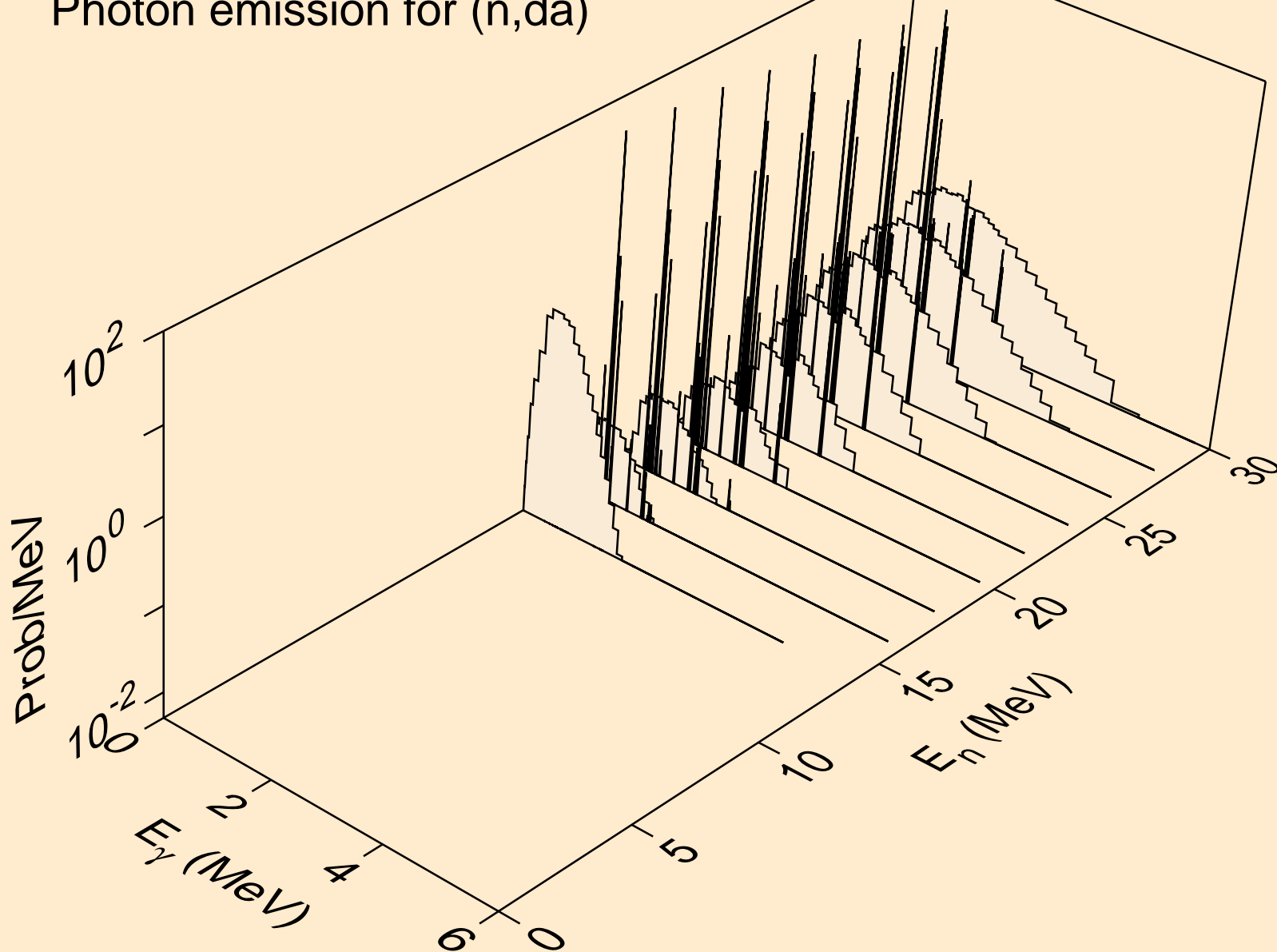

CS129 NEUTRON ACER TENDL-2019 LIBRARY; T=293.16K
thermal capture photon spectrum

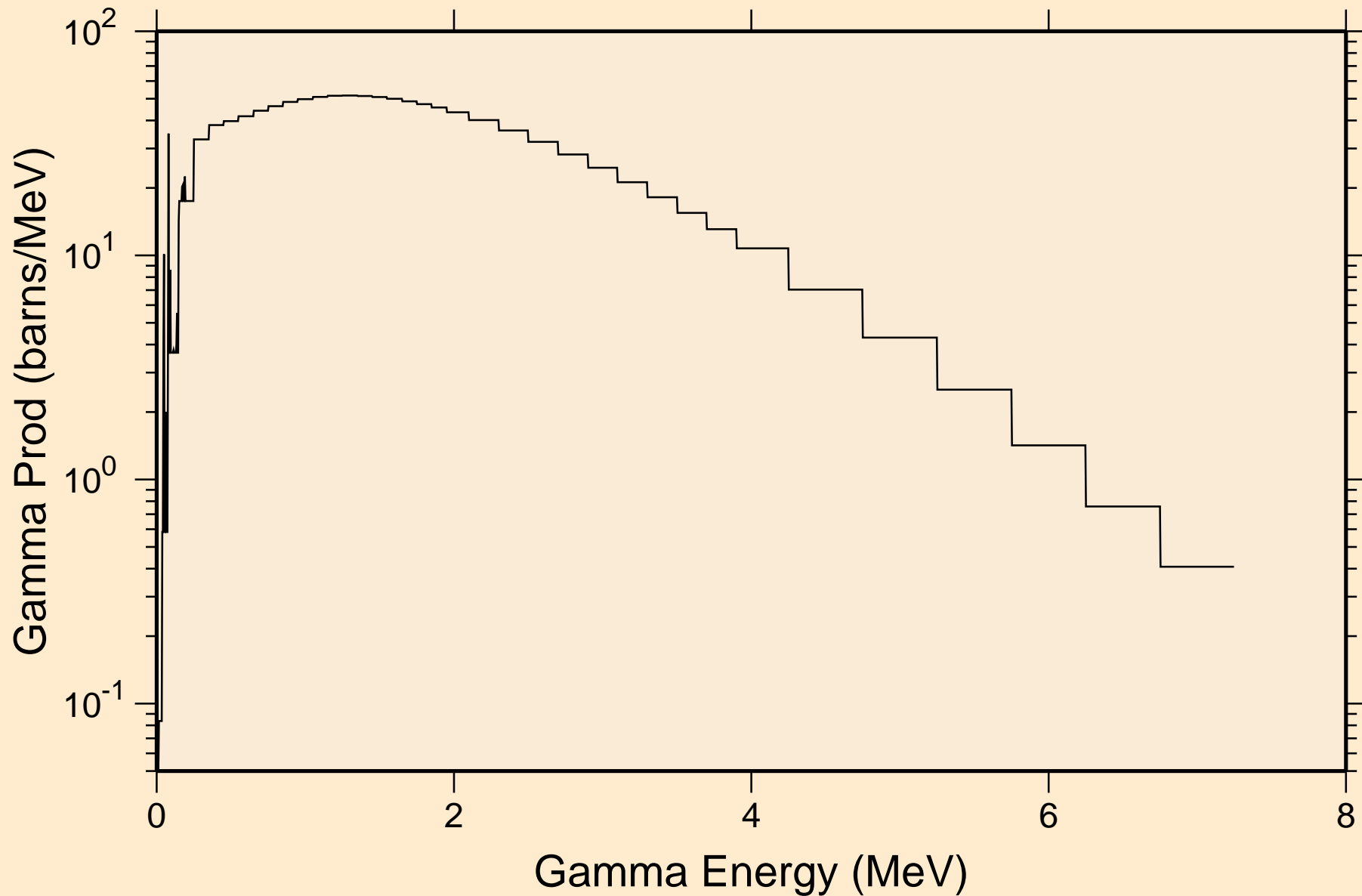

CS129 NEUTRON ACER TENDL-2019 LIBRARY; T=293.16K
14 MeV photon spectrum

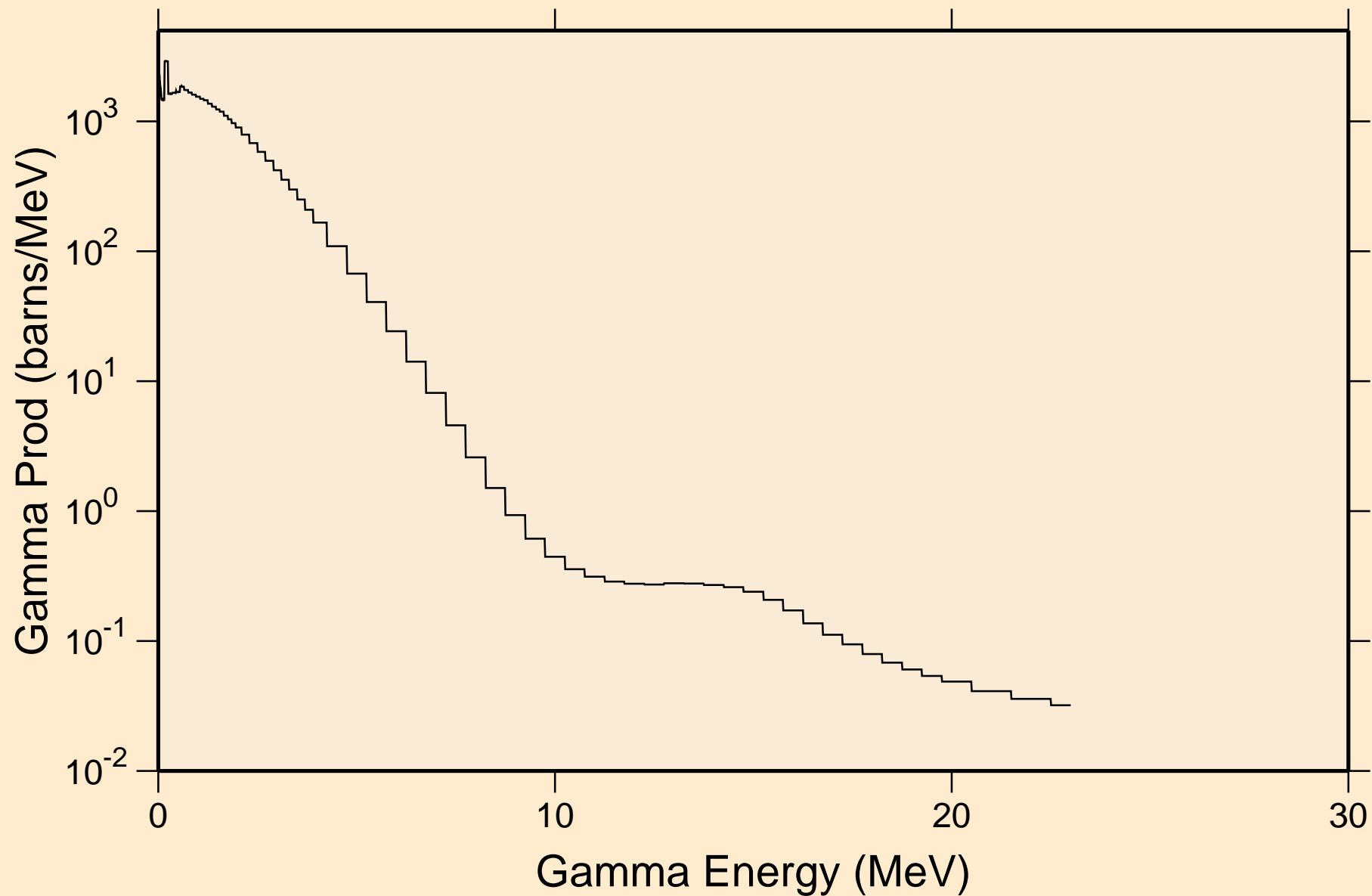

CS129 NEUTRON ACER TENDL-2019 LIBRARY; T=293.16K
Particle heating contributions

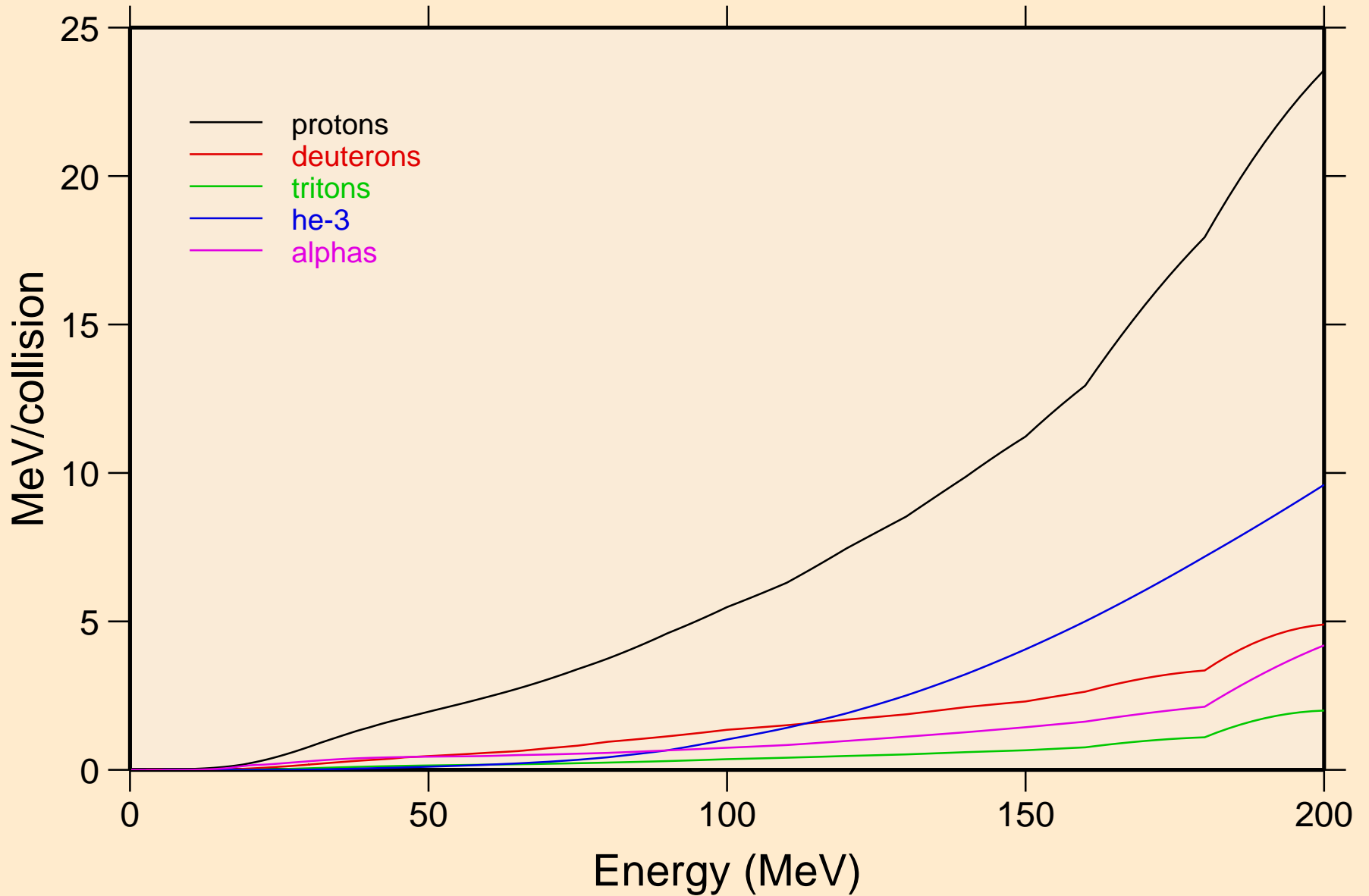

CS129 NEUTRON ACER TENDL-2019 LIBRARY; T=293.16K
Recoil Heating

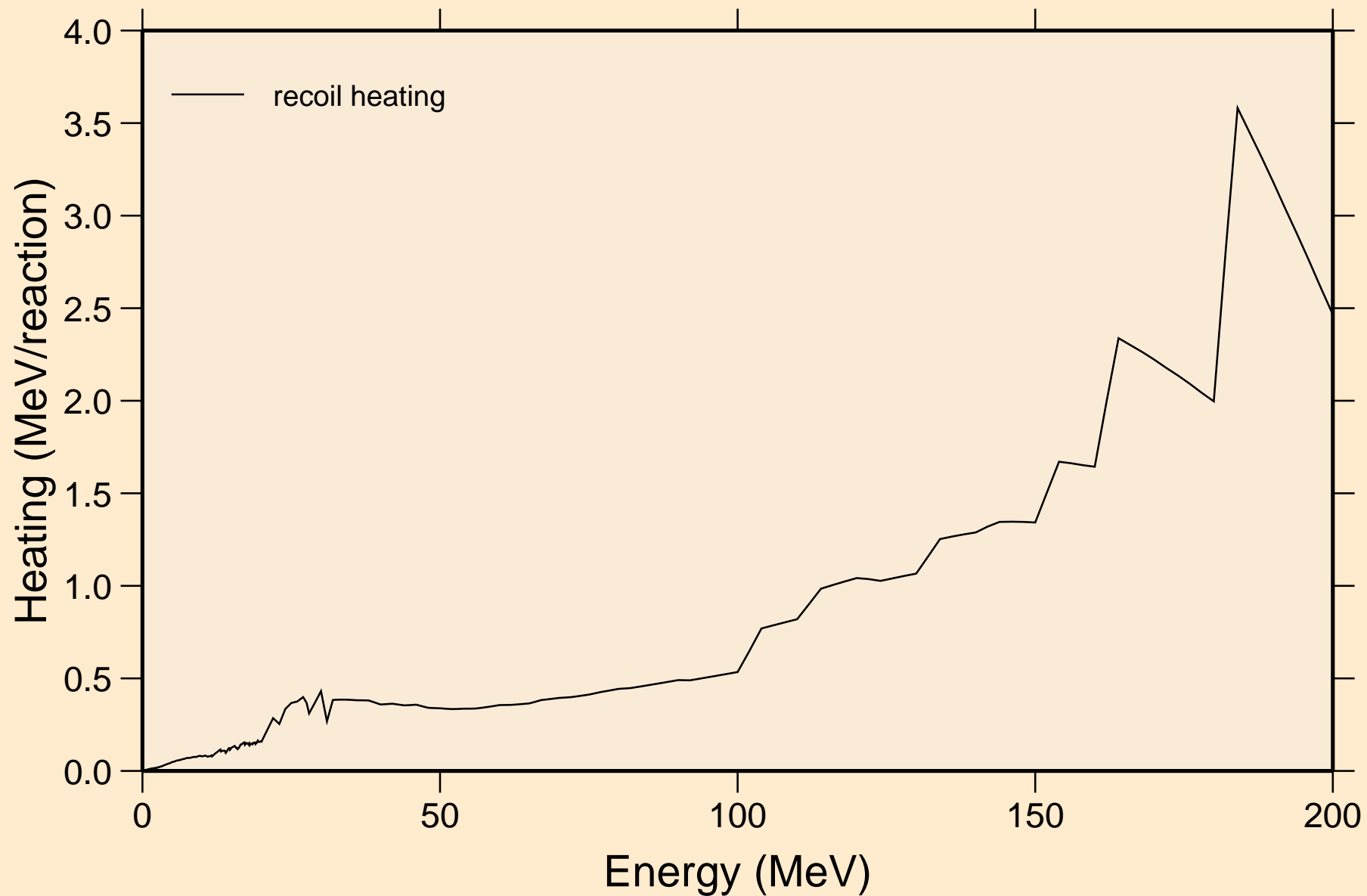

CS129 NEUTRON ACER TENDL-2019 LIBRARY; T=293.16K
Particle production cross sections

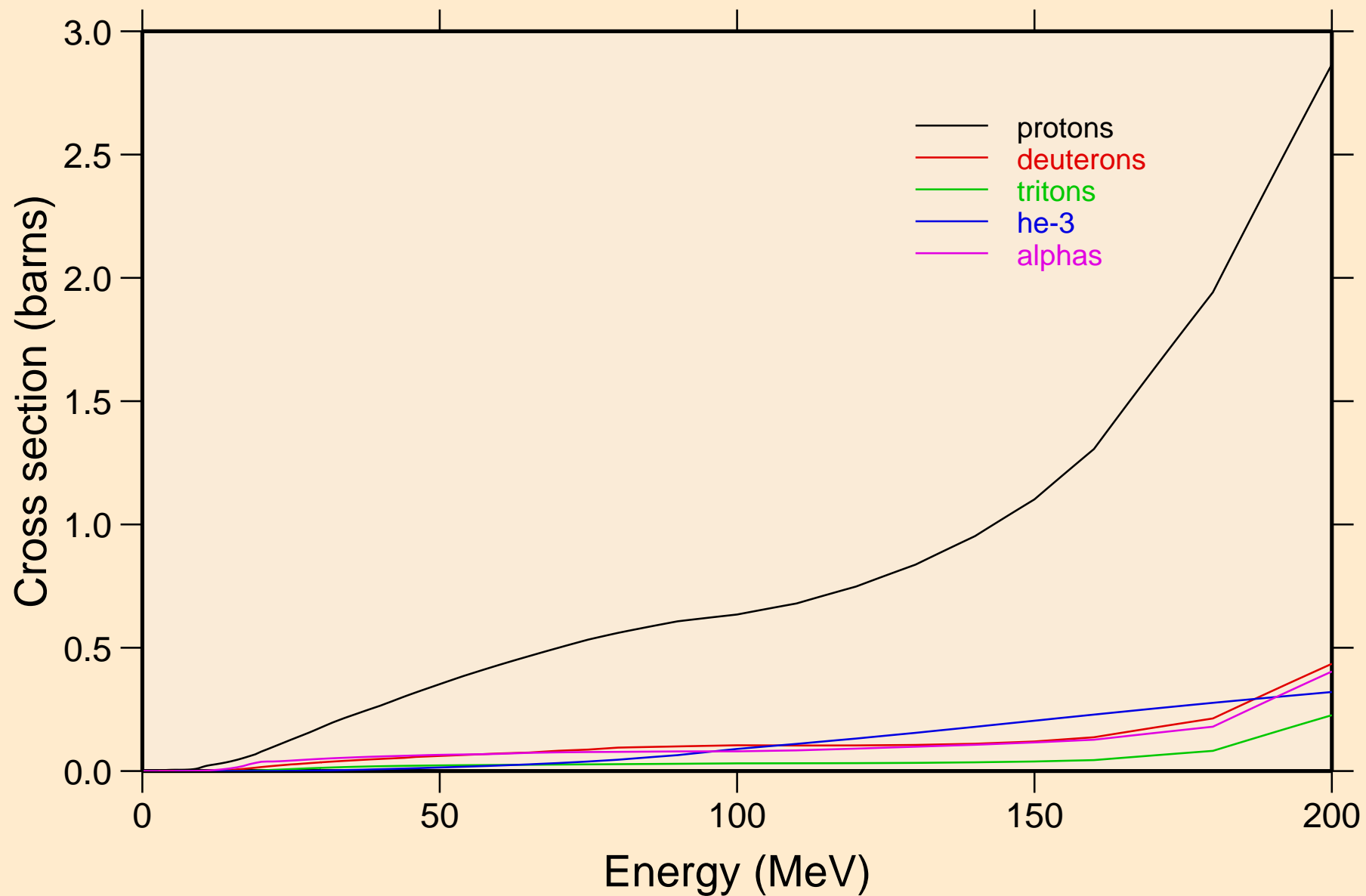

CS129 NEUTRON ACER TENDL-2019 LIBRARY; T=293.16K
protons from (n,x)

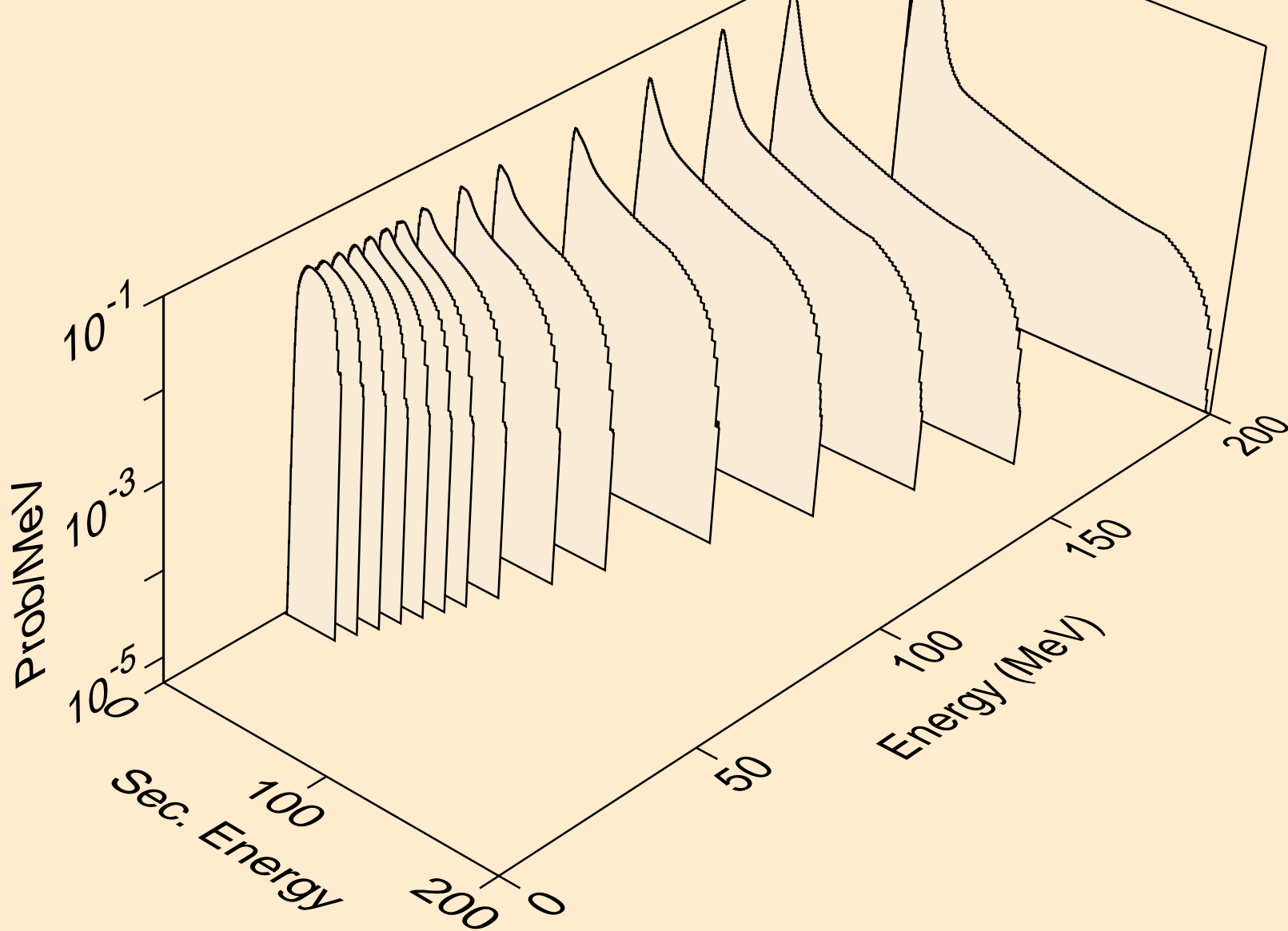

CS129 NEUTRON ACER TENDL-2019 LIBRARY; T=293.16K
protons from (n,n*)p

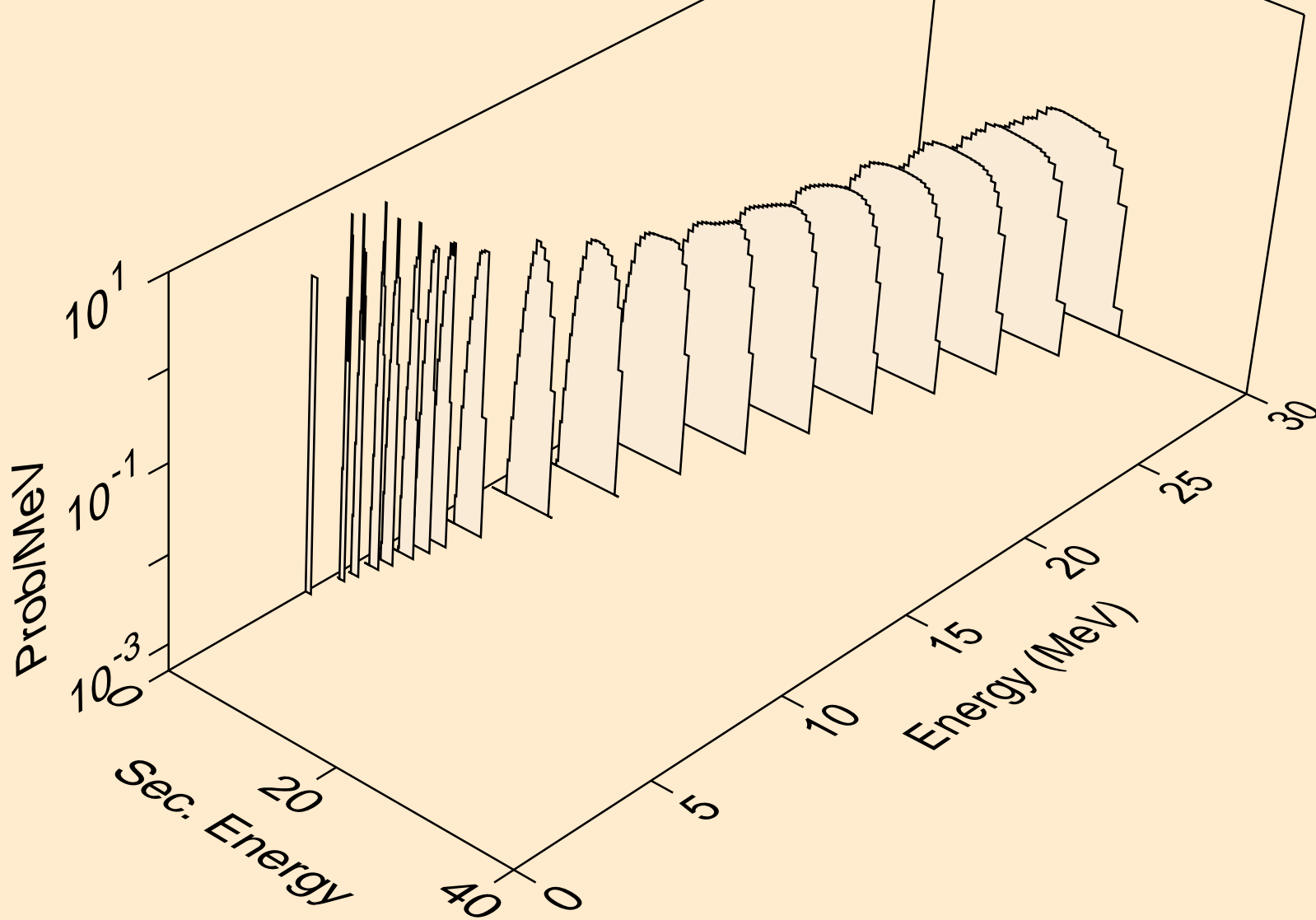

CS129 NEUTRON ACER TENDL-2019 LIBRARY; T=293.16K
protons from (n,2np)

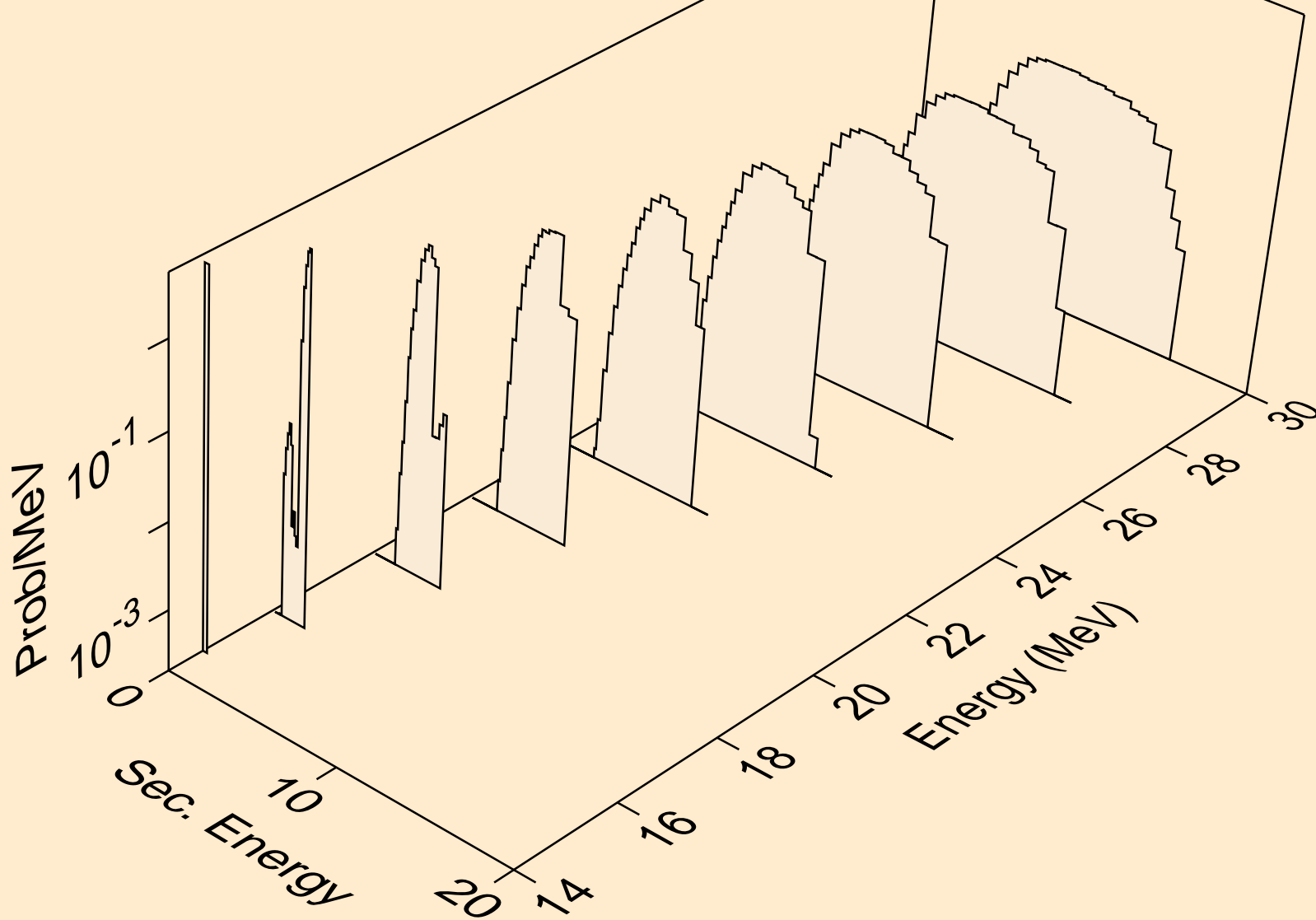

CS129 NEUTRON ACER TENDL-2019 LIBRARY; T=293.16K
protons from (n,3np)

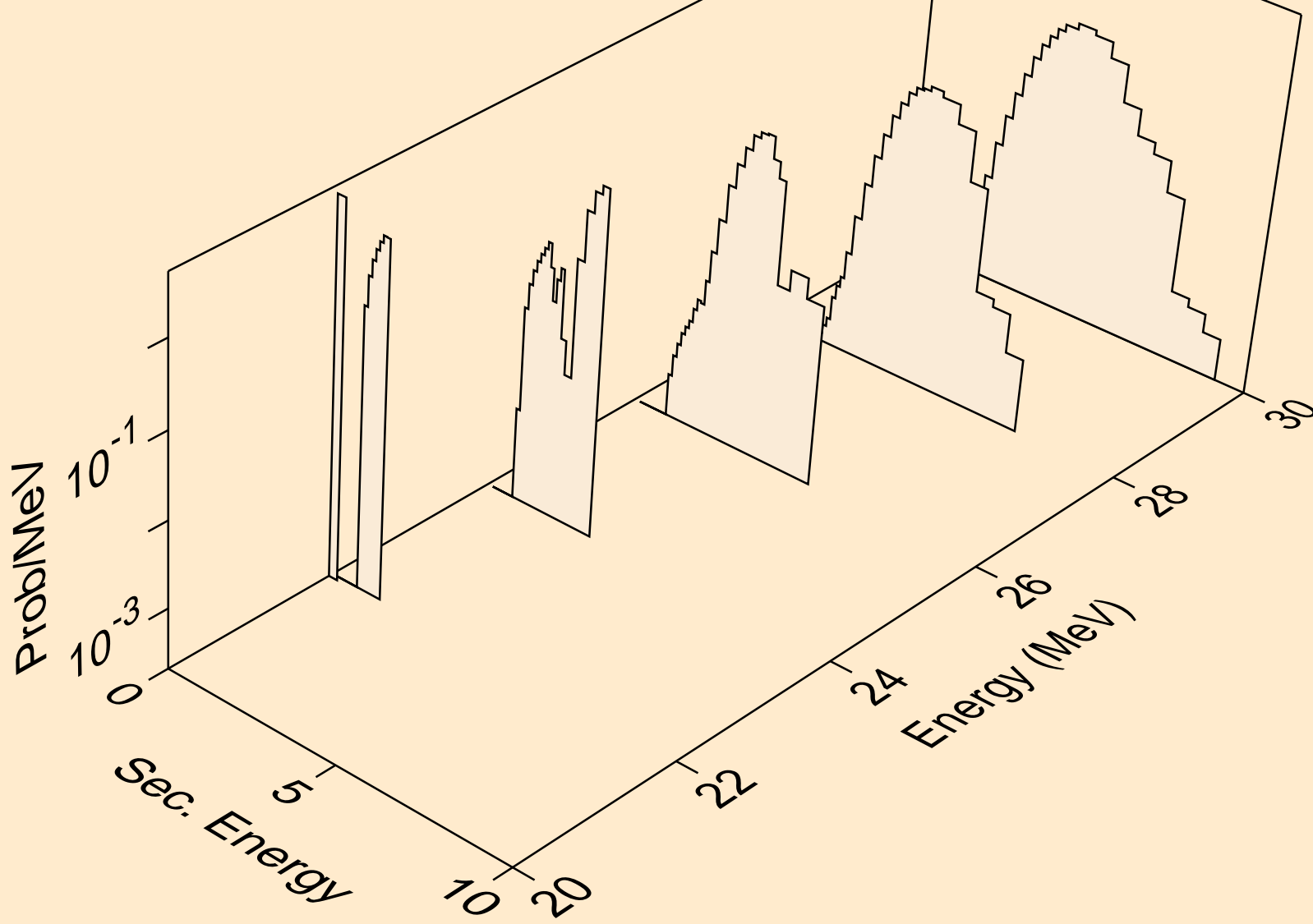

CS129 NEUTRON ACER TENDL-2019 LIBRARY; T=293.16K
protons from (n,2np)

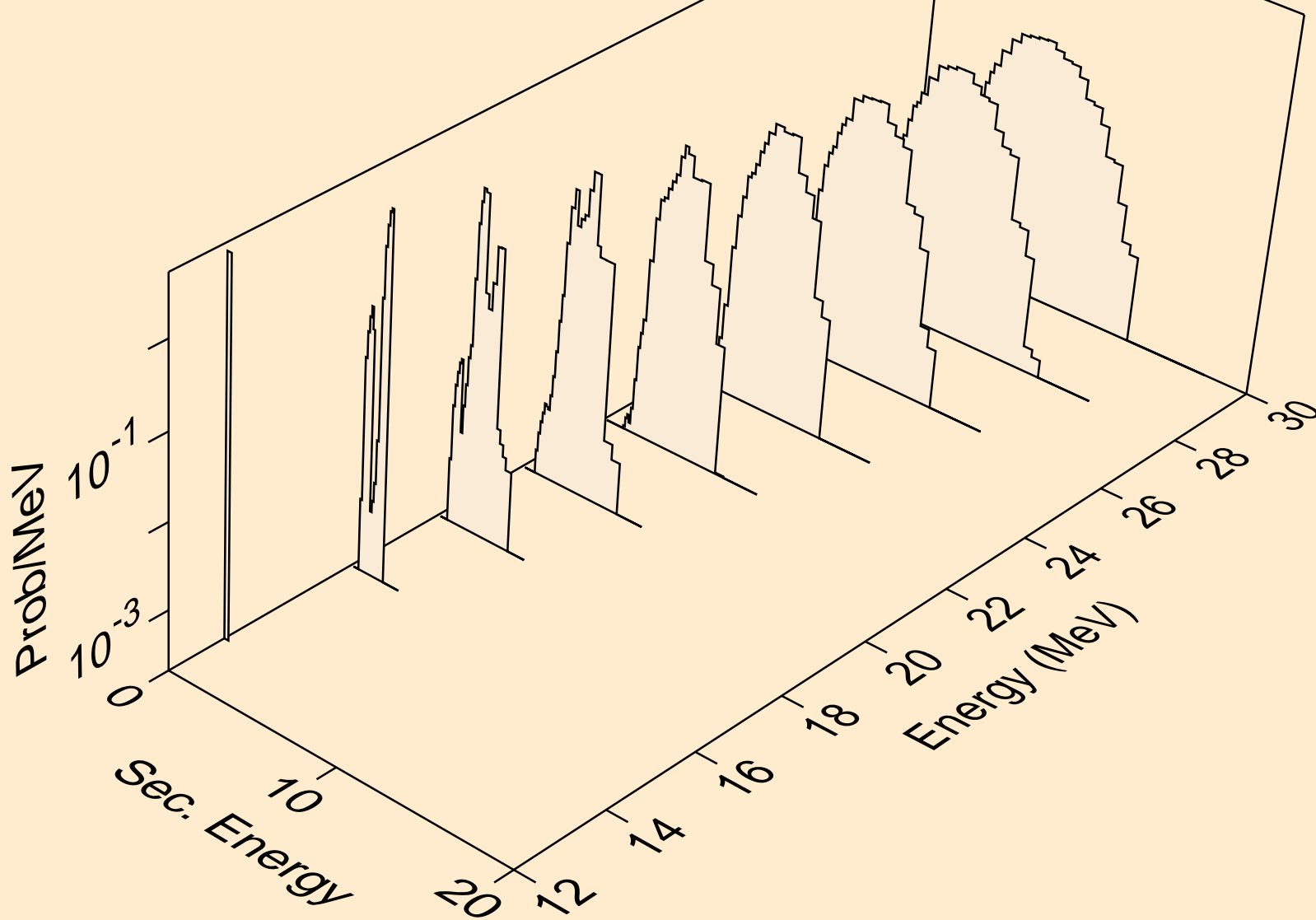

CS129 NEUTRON ACER TENDL-2019 LIBRARY; T=293.16K
protons from (n,npa)

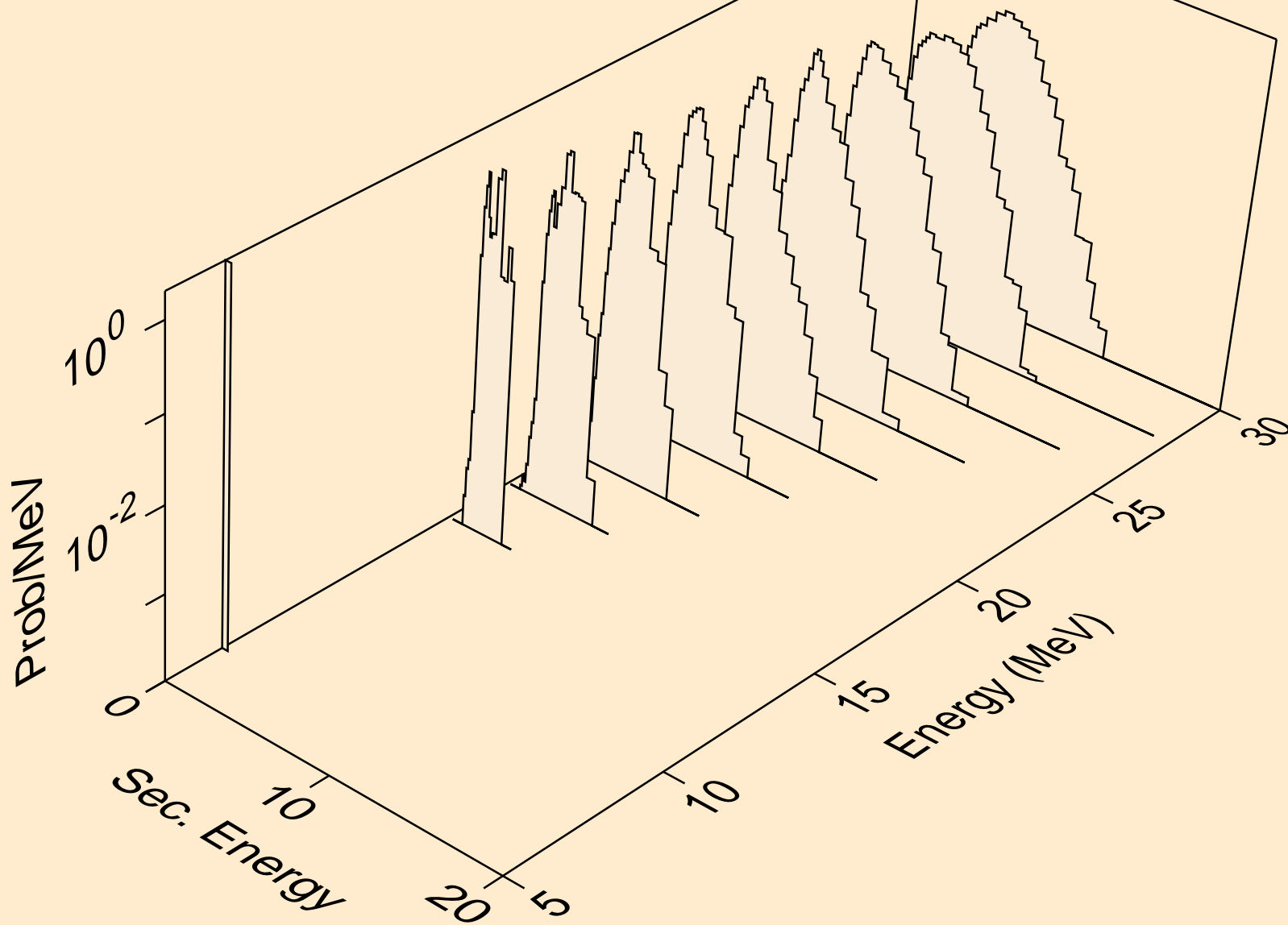

CS129 NEUTRON ACER TENDL-2019 LIBRARY; T=293.16K
protons from (n,p)

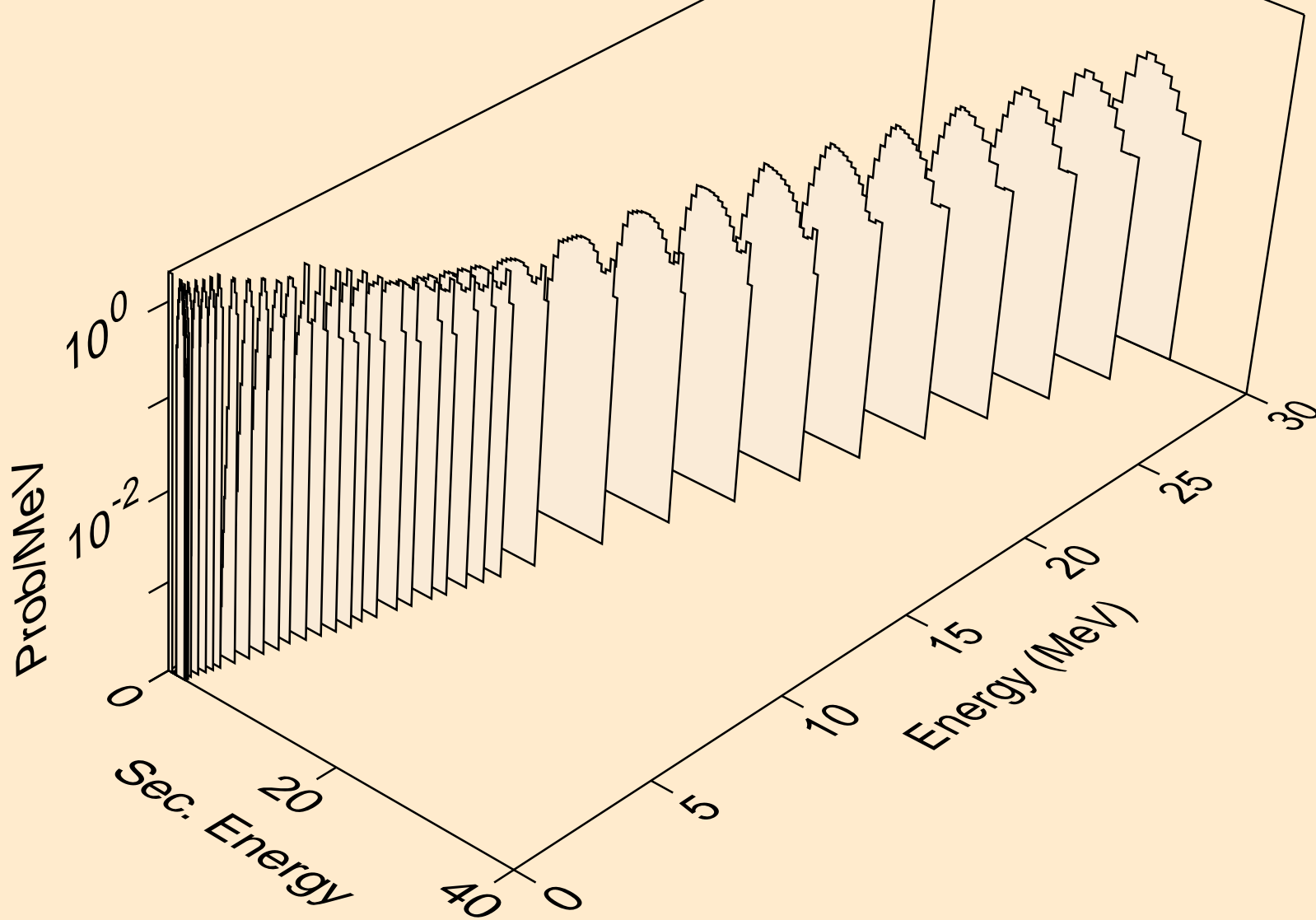

CS129 NEUTRON ACER TENDL-2019 LIBRARY; T=293.16K
protons from (n,2p)

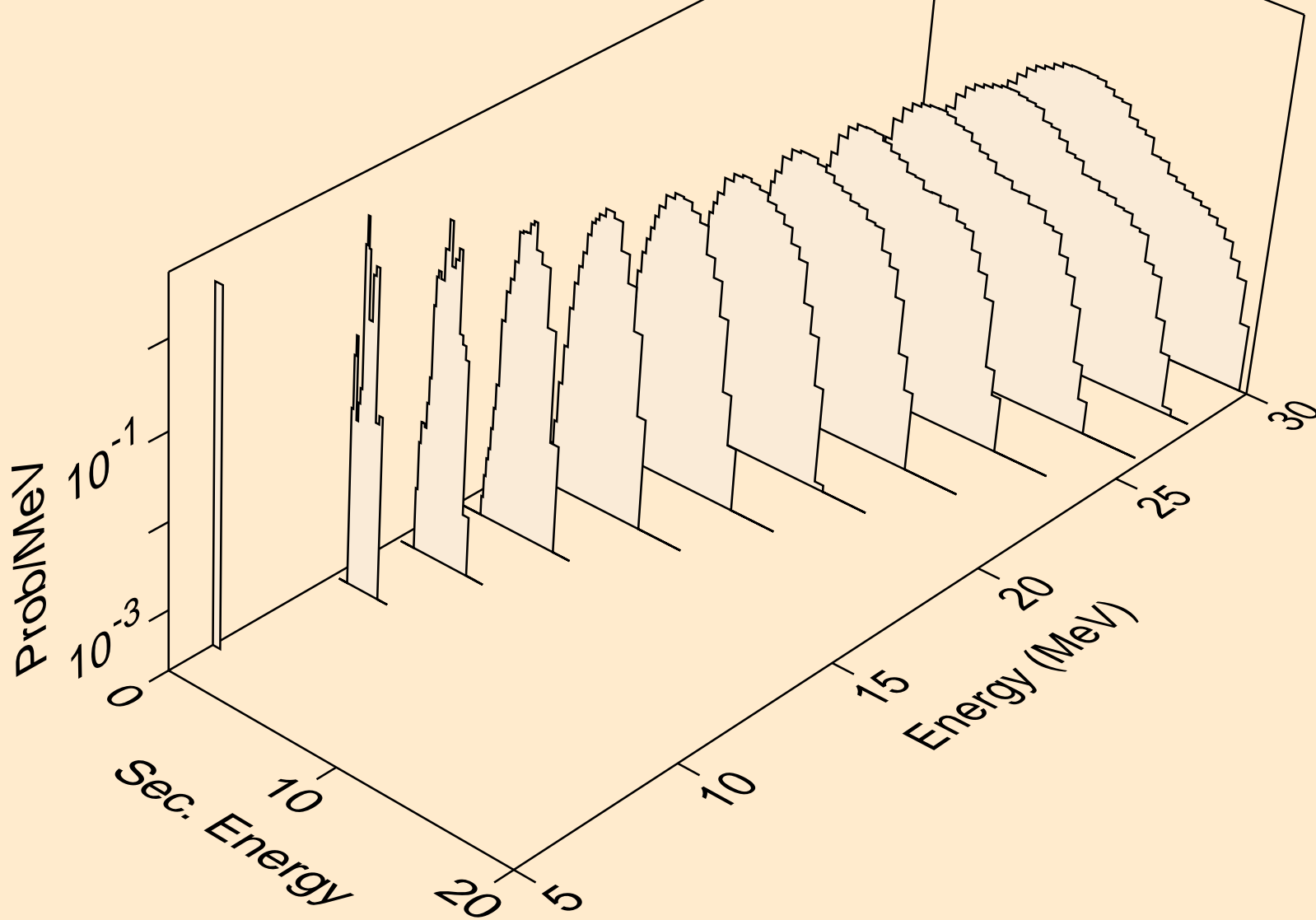

CS129 NEUTRON ACER TENDL-2019 LIBRARY; T=293.16K
protons from (n,p)

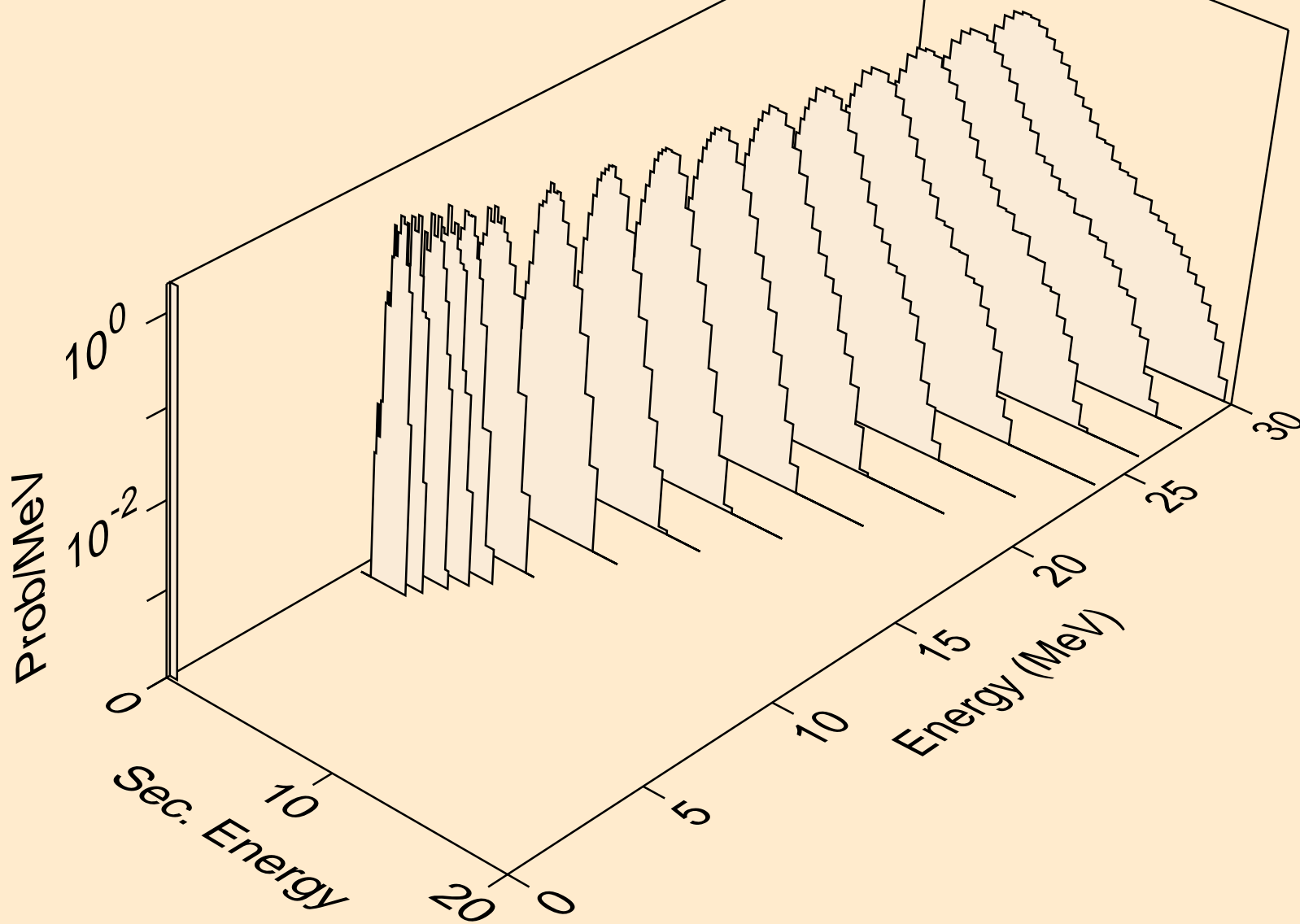

CS129 NEUTRON ACER TENDL-2019 LIBRARY; T=293.16K
protons from (n,pd)

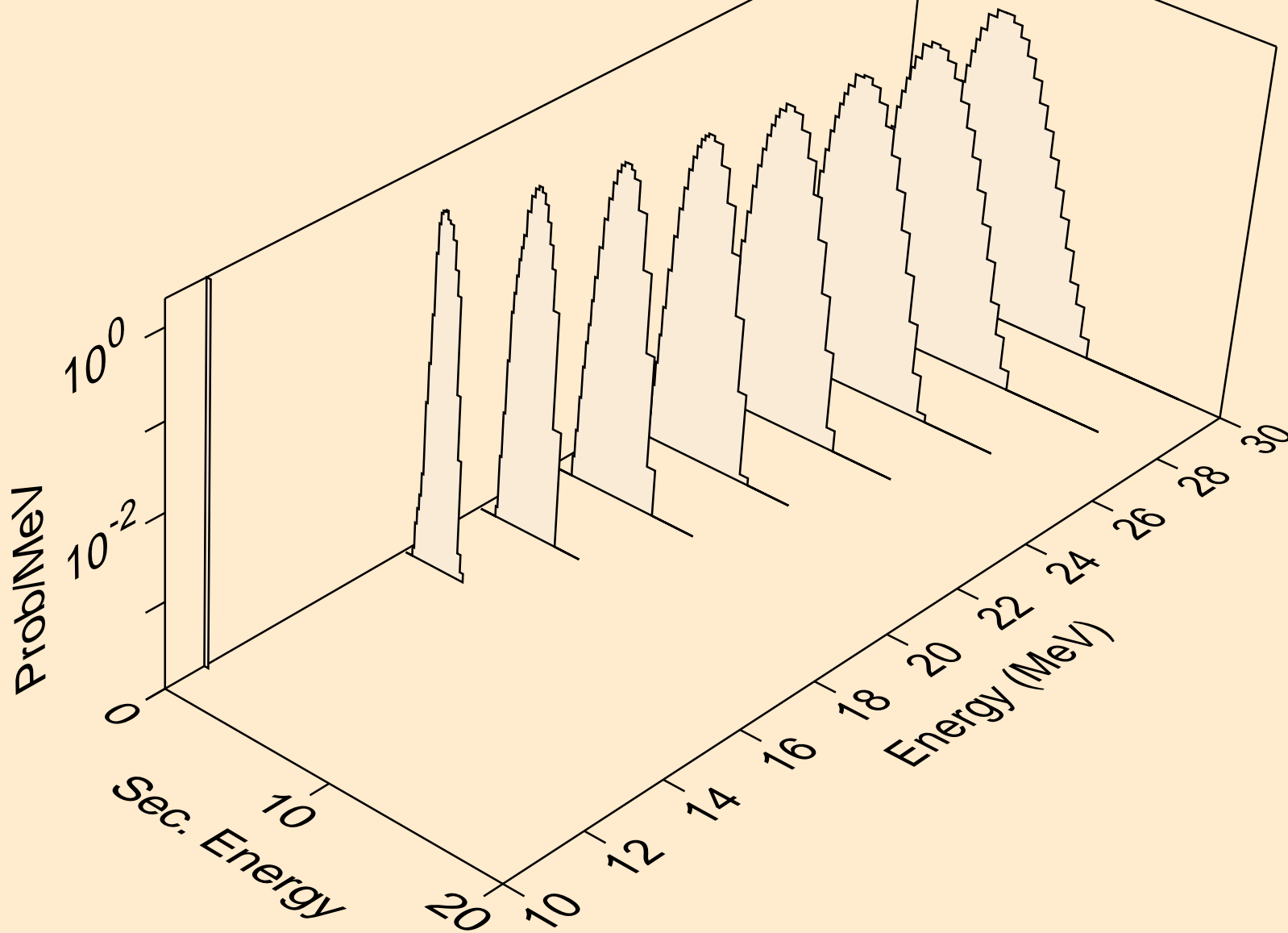

CS129 NEUTRON ACER TENDL-2019 LIBRARY; T=293.16K
protons from (n,pt)

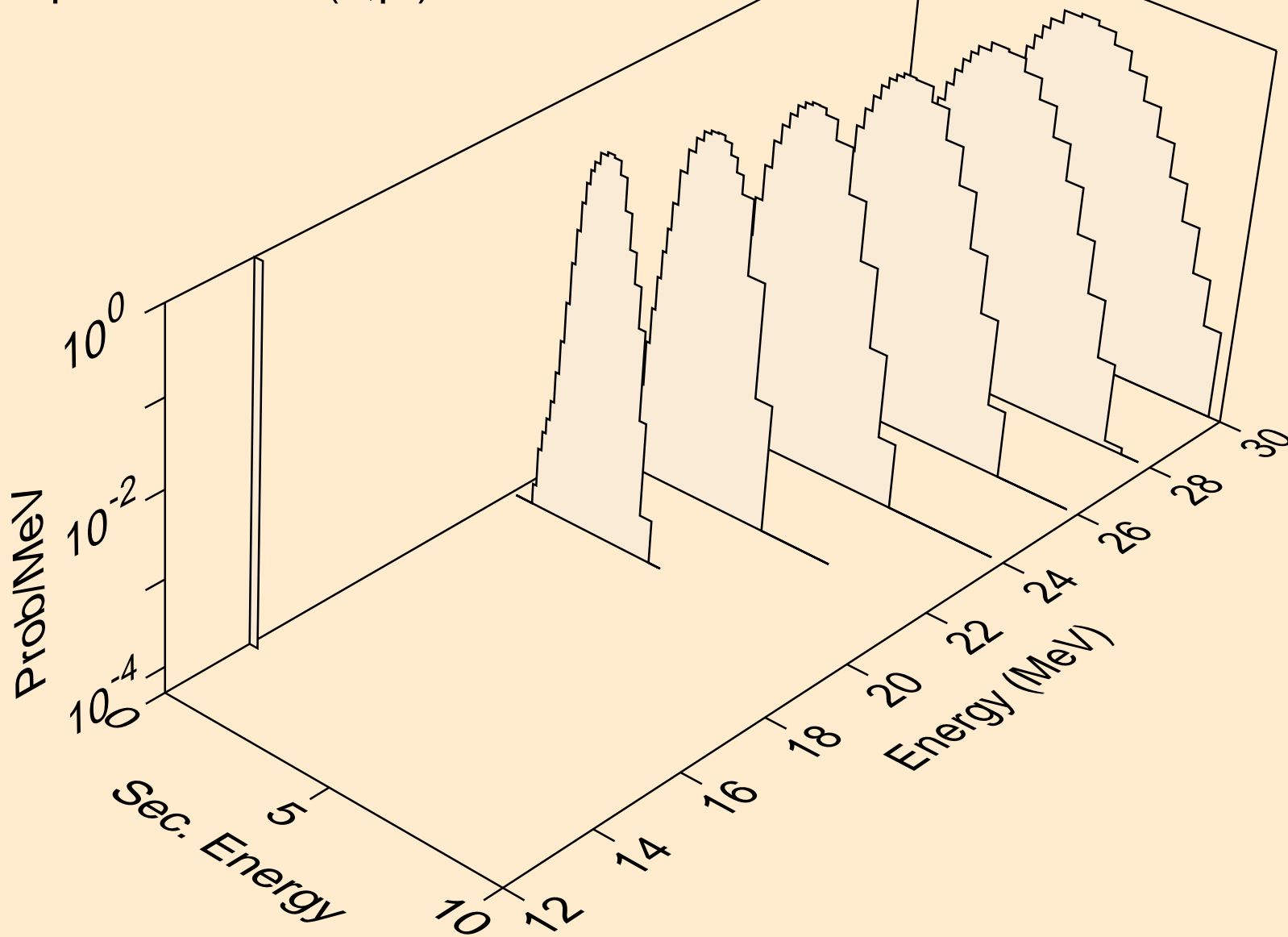

CS129 NEUTRON ACER TENDL-2019 LIBRARY; T=293.16K
deuterons from (n,x)

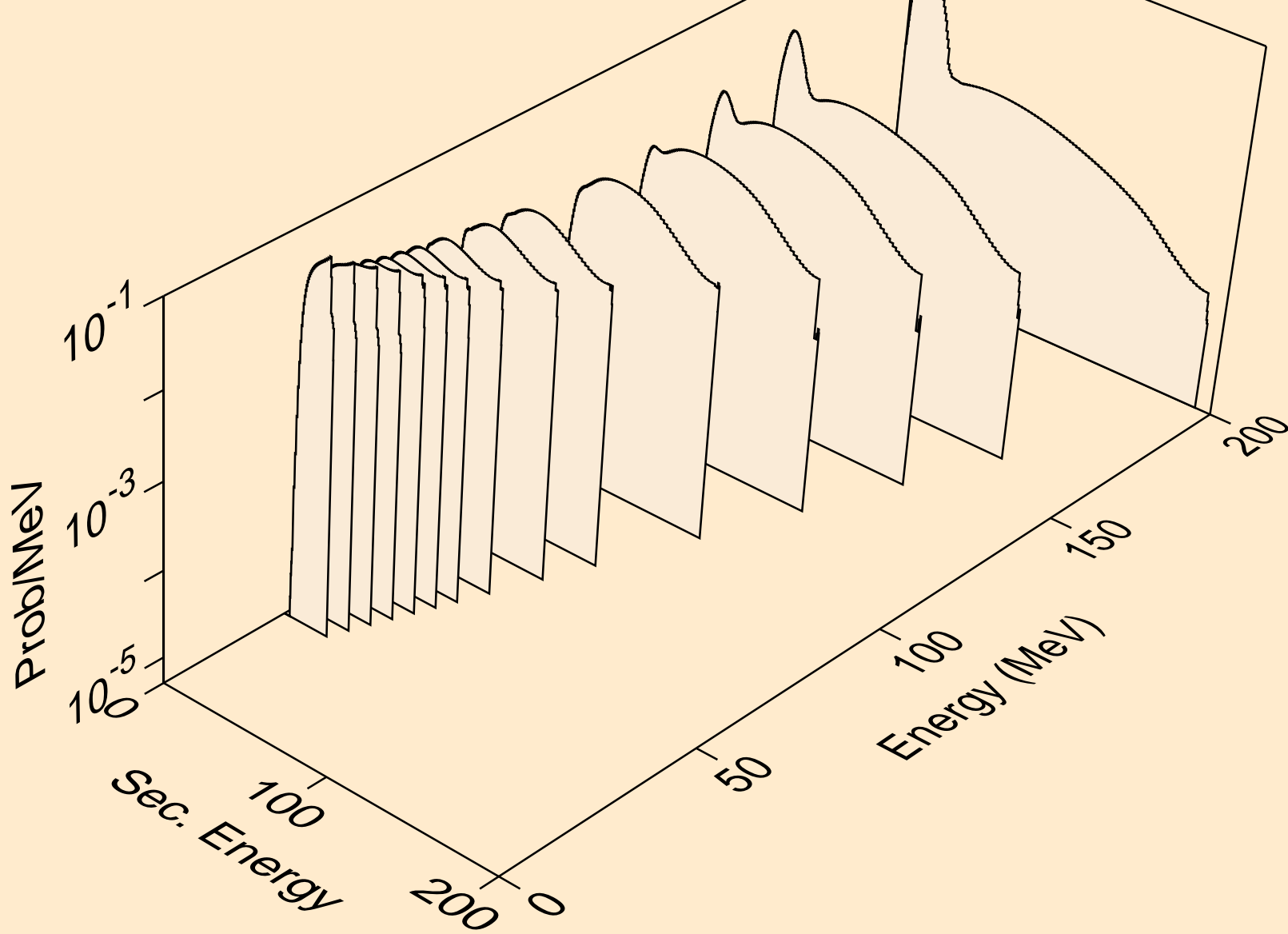

CS129 NEUTRON ACER TENDL-2019 LIBRARY; T=293.16K
deuterons from (n,2nd)

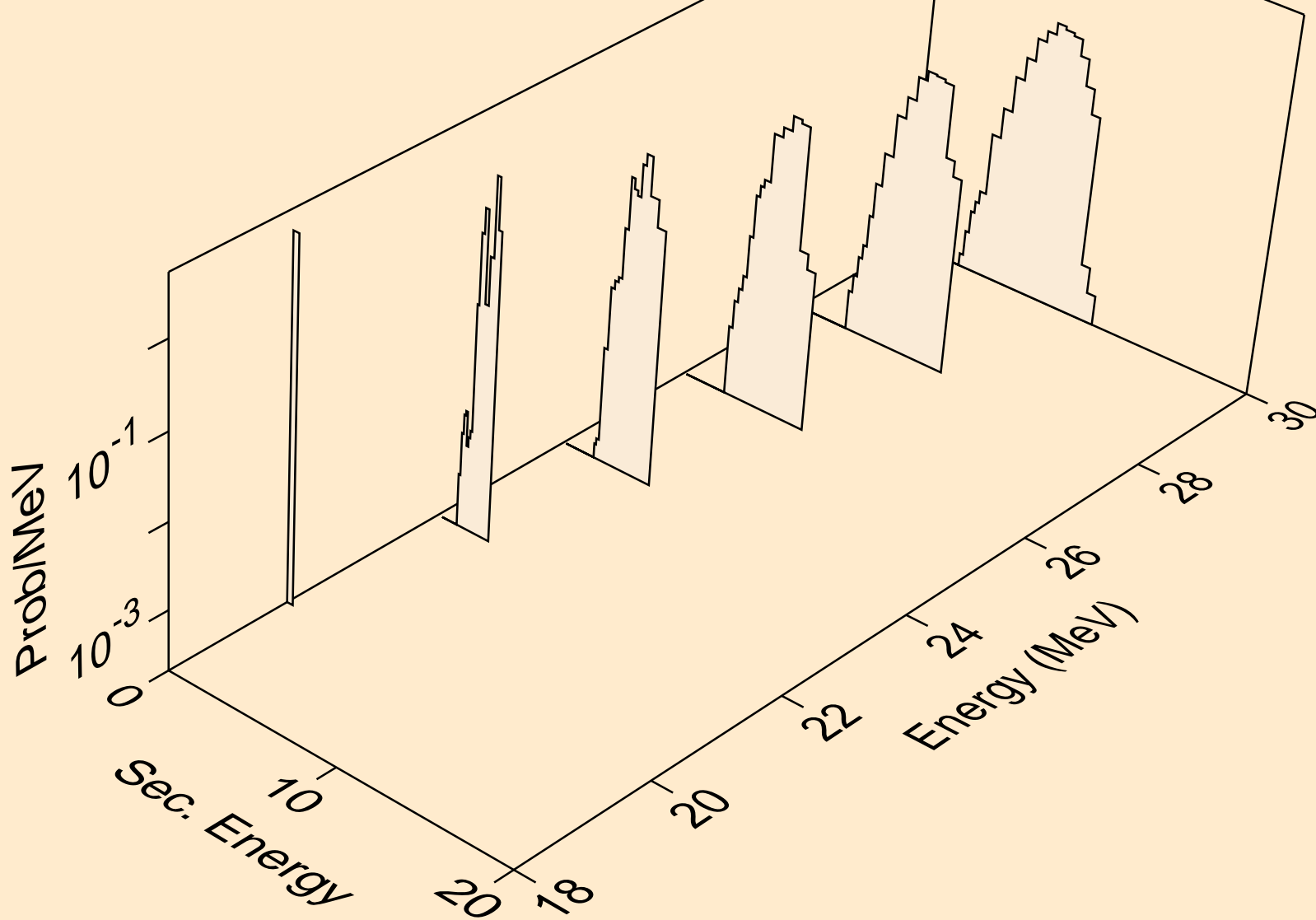

CS129 NEUTRON ACER TENDL-2019 LIBRARY; T=293.16K
deuterons from (n,n*)d

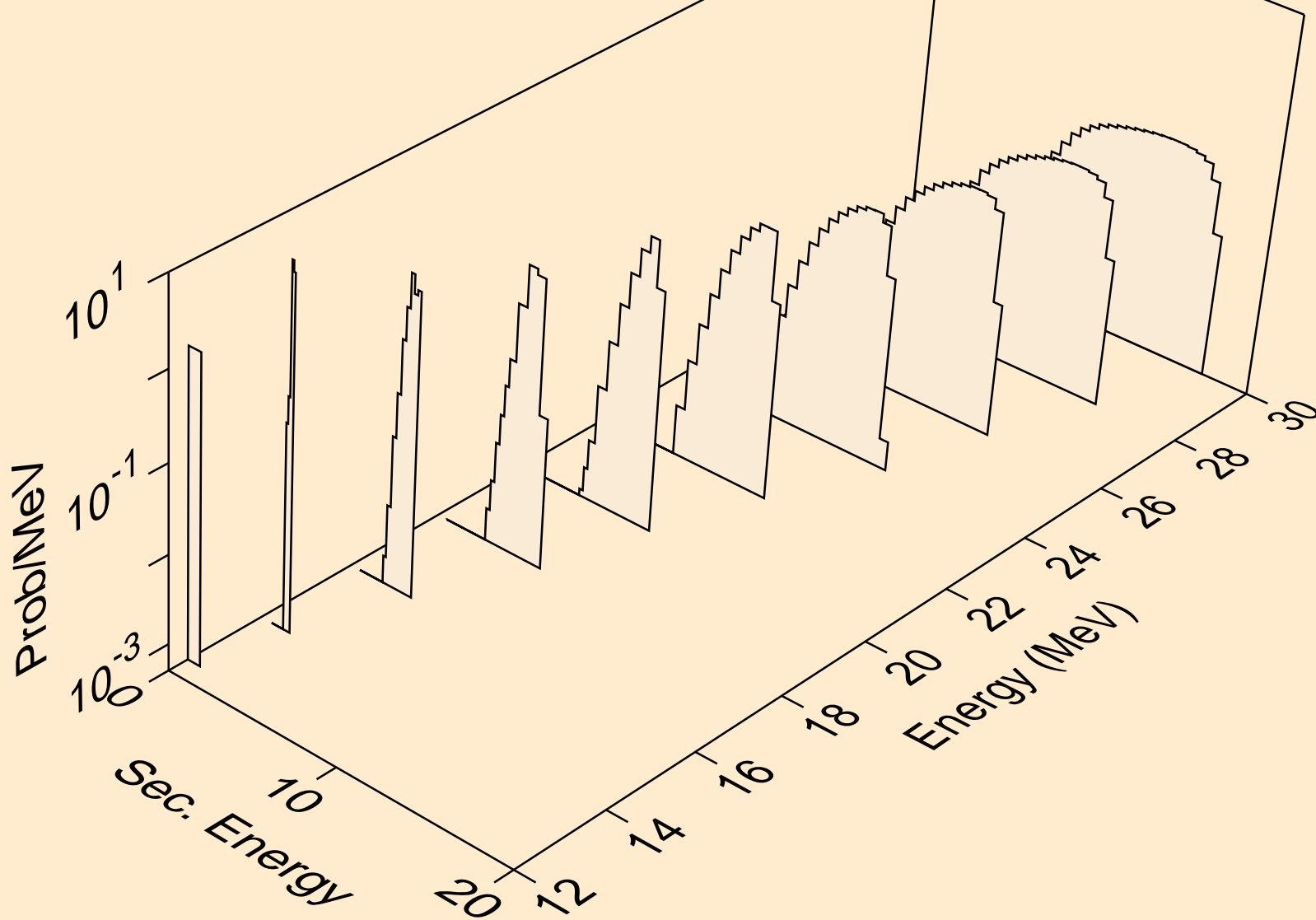

CS129 NEUTRON ACER TENDL-2019 LIBRARY; T=293.16K
deuterons from (n,d)

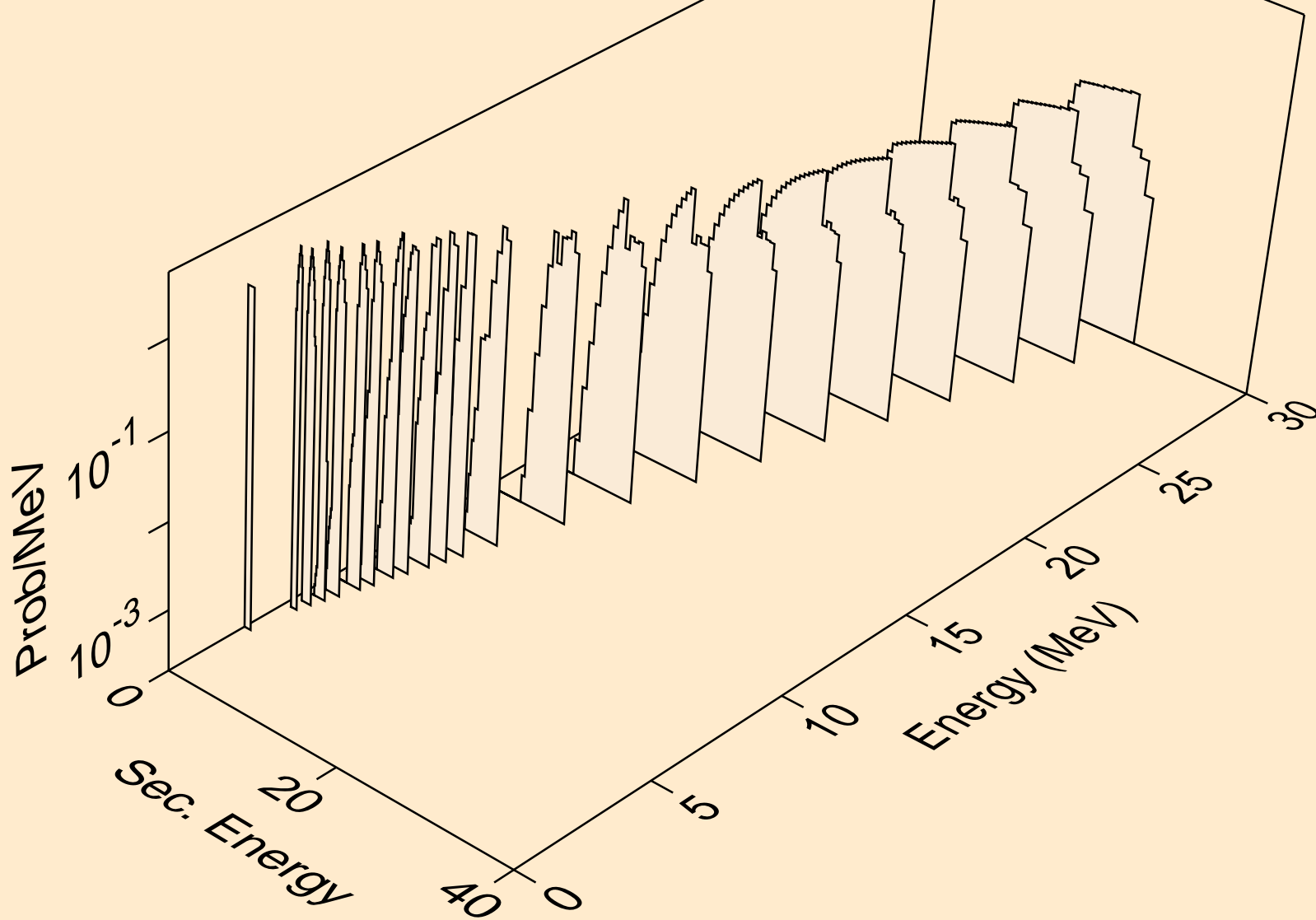

CS129 NEUTRON ACER TENDL-2019 LIBRARY; T=293.16K
deuterons from (n,pd)

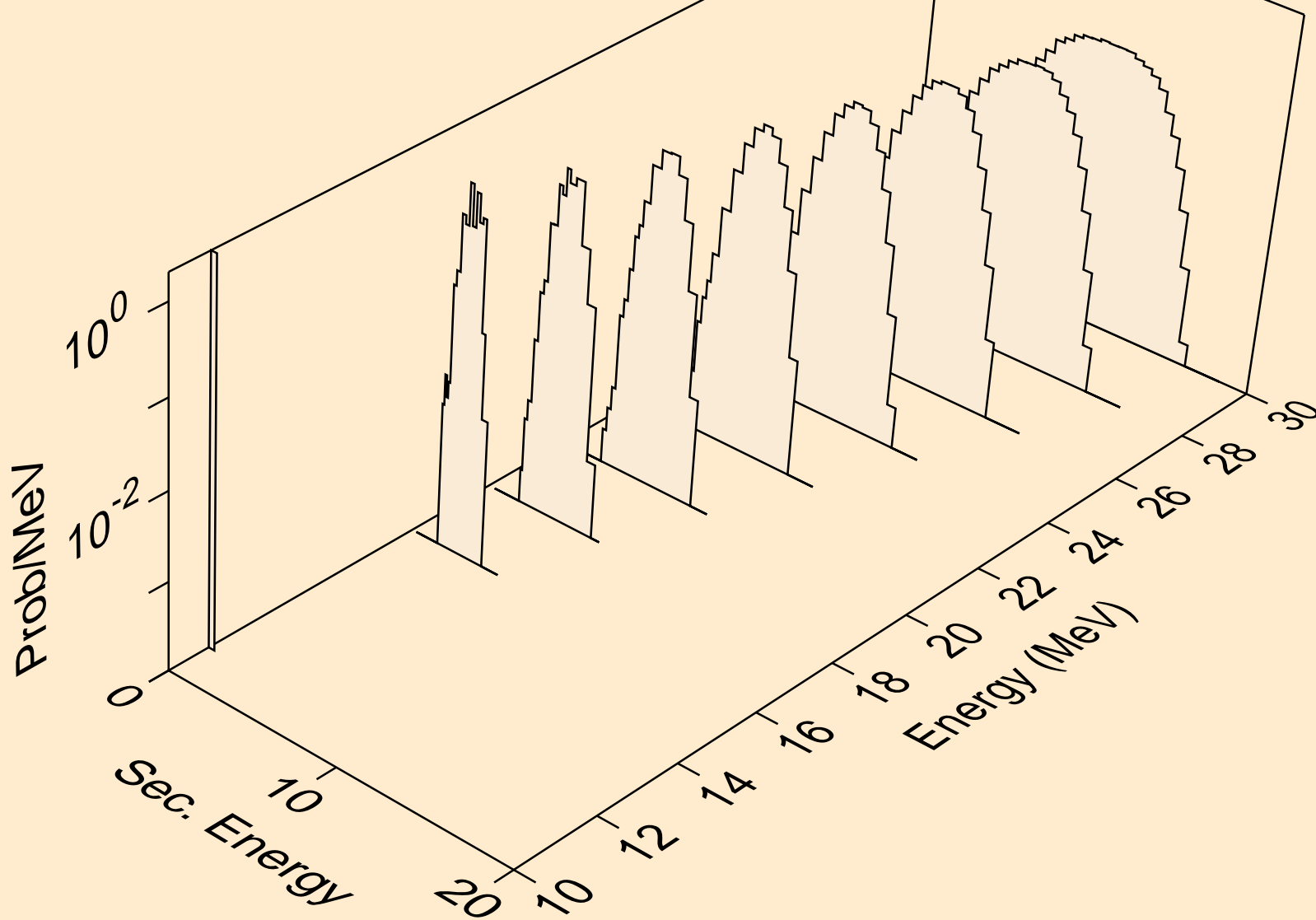

CS129 NEUTRON ACER TENDL-2019 LIBRARY; T=293.16K
deuterons from (n,da)

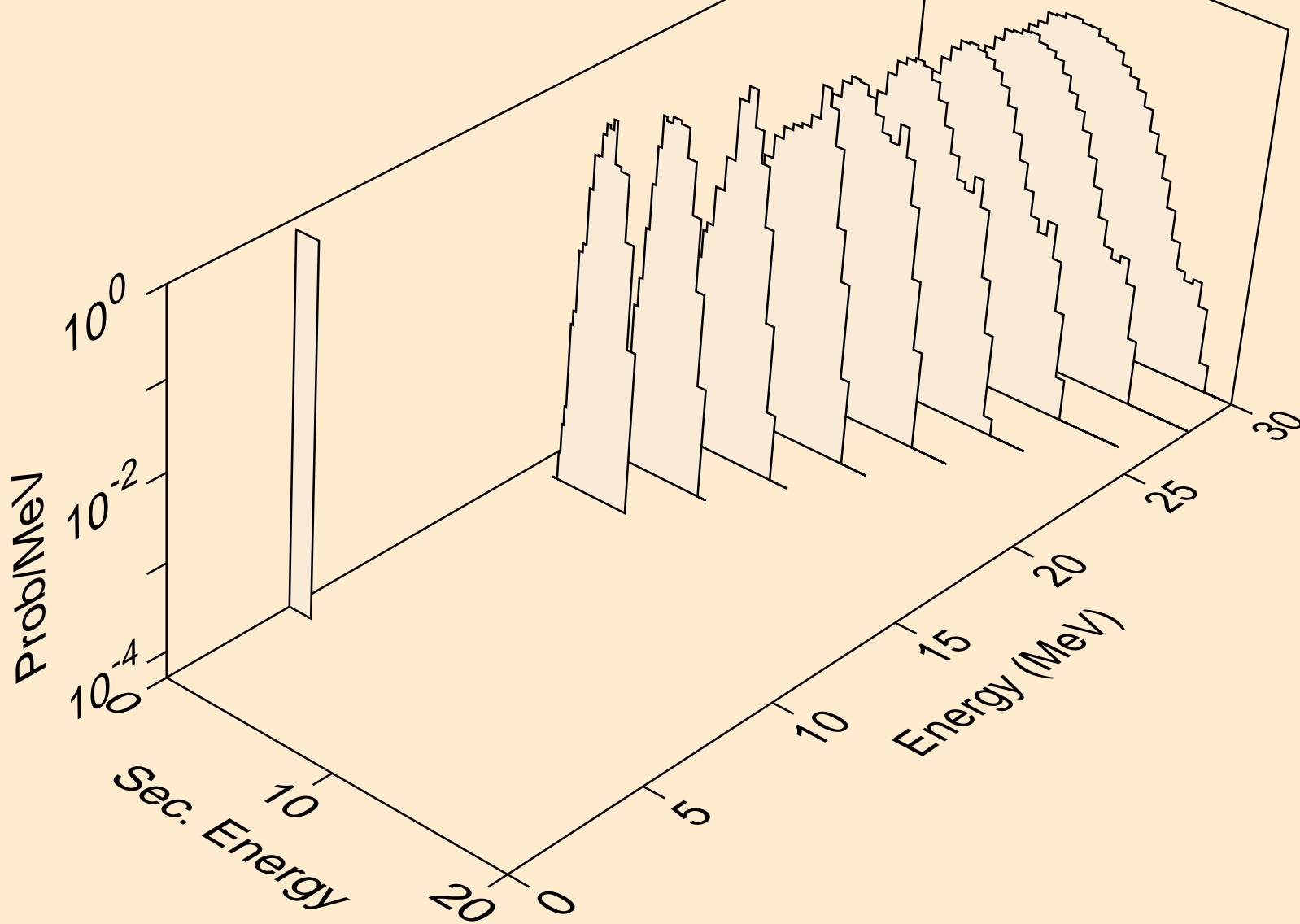

CS129 NEUTRON ACER TENDL-2019 LIBRARY; T=293.16K
tritons from (n,x)

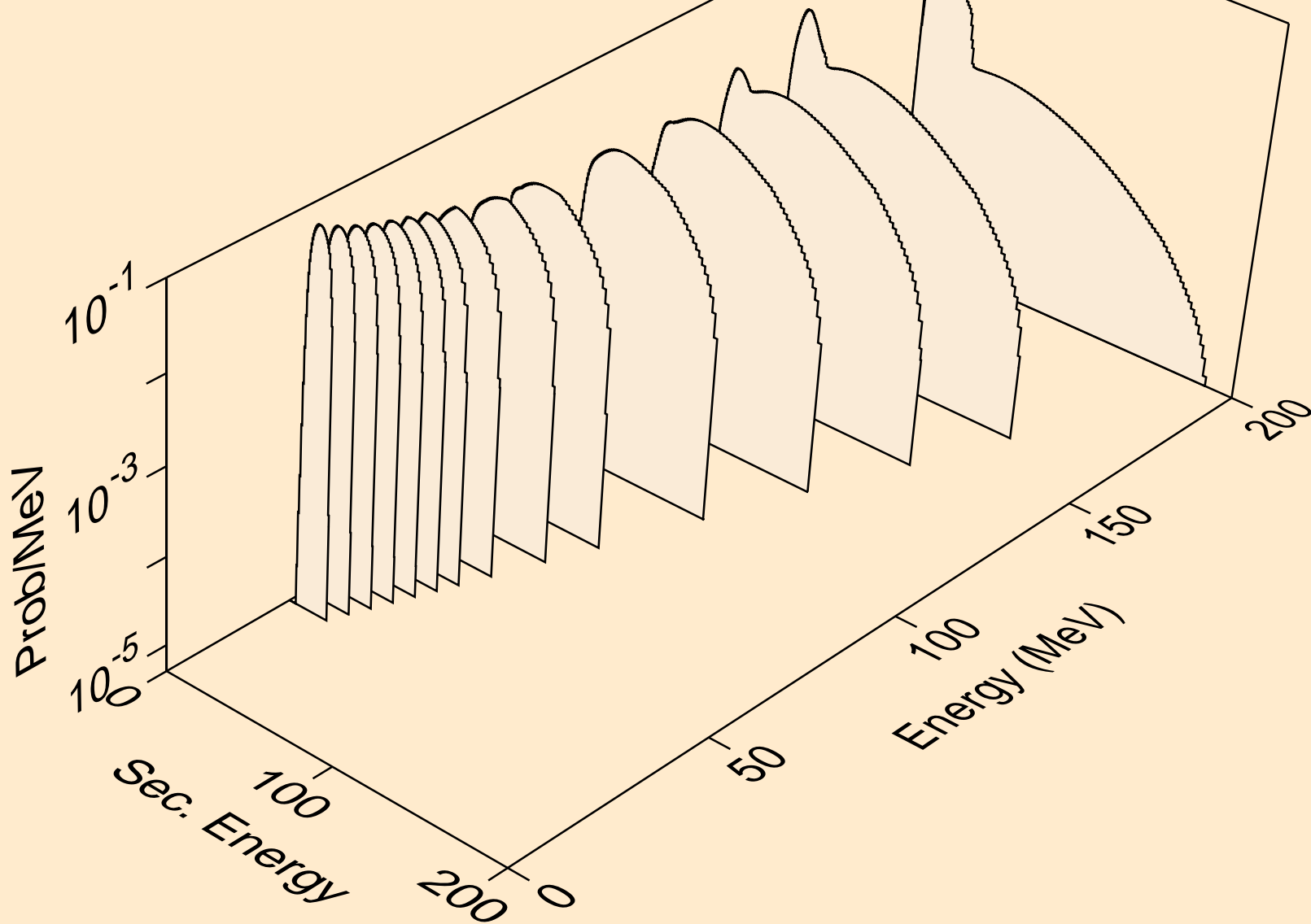

CS129 NEUTRON ACER TENDL-2019 LIBRARY; T=293.16K
tritons from (n,n*)t

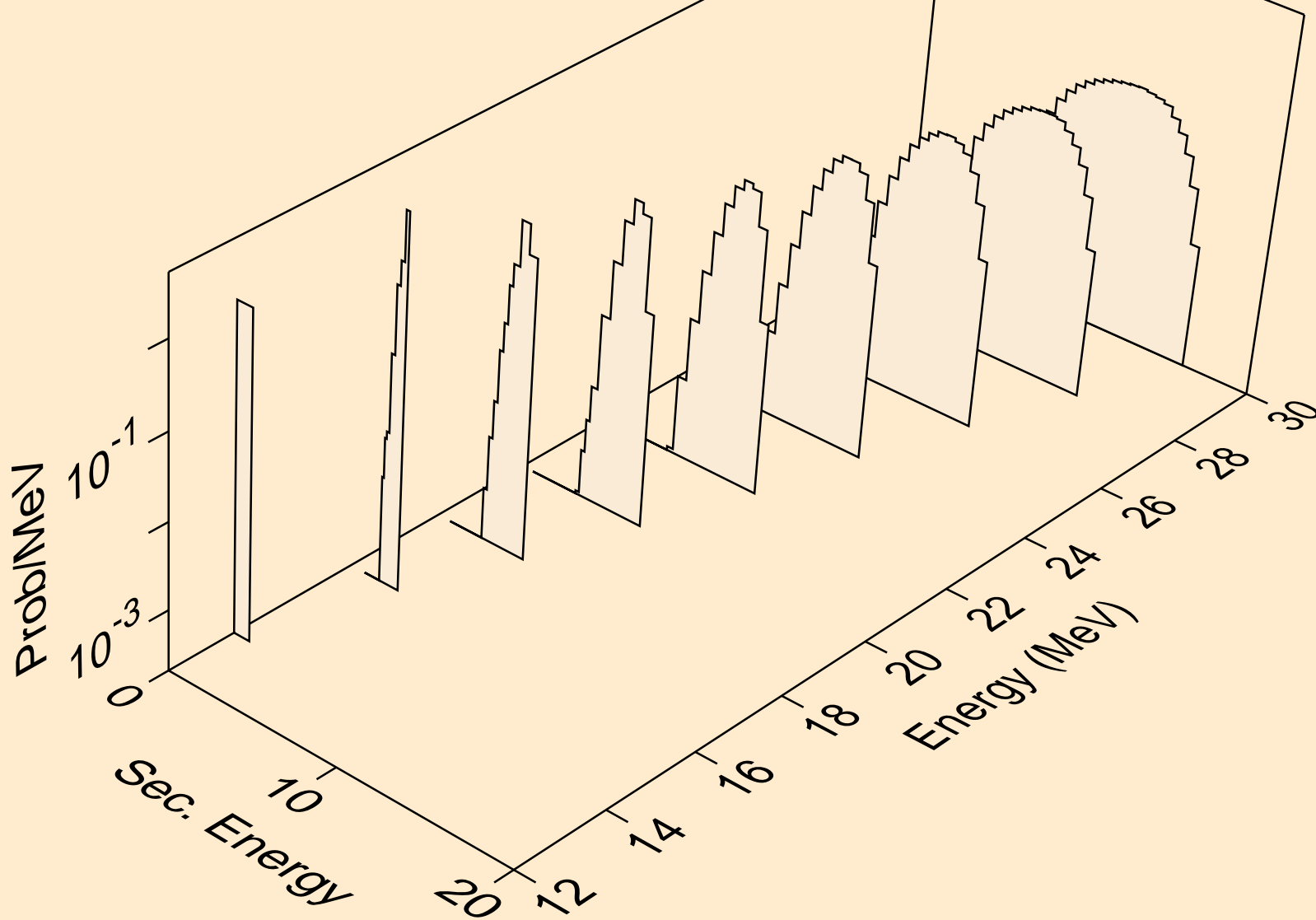

CS129 NEUTRON ACER TENDL-2019 LIBRARY; T=293.16K
tritons from (n,t)

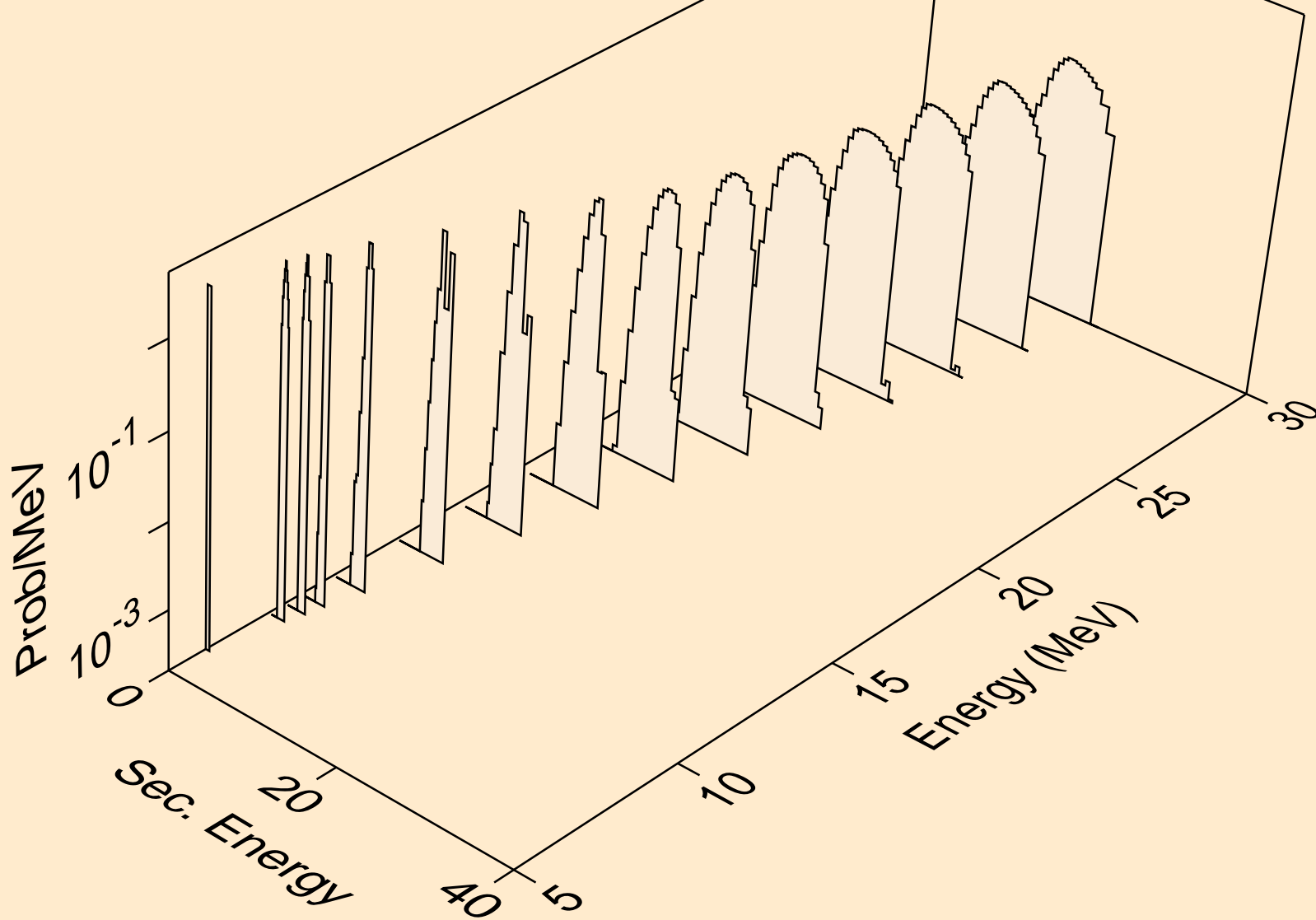

CS129 NEUTRON ACER TENDL-2019 LIBRARY; T=293.16K
tritons from (n,pt)

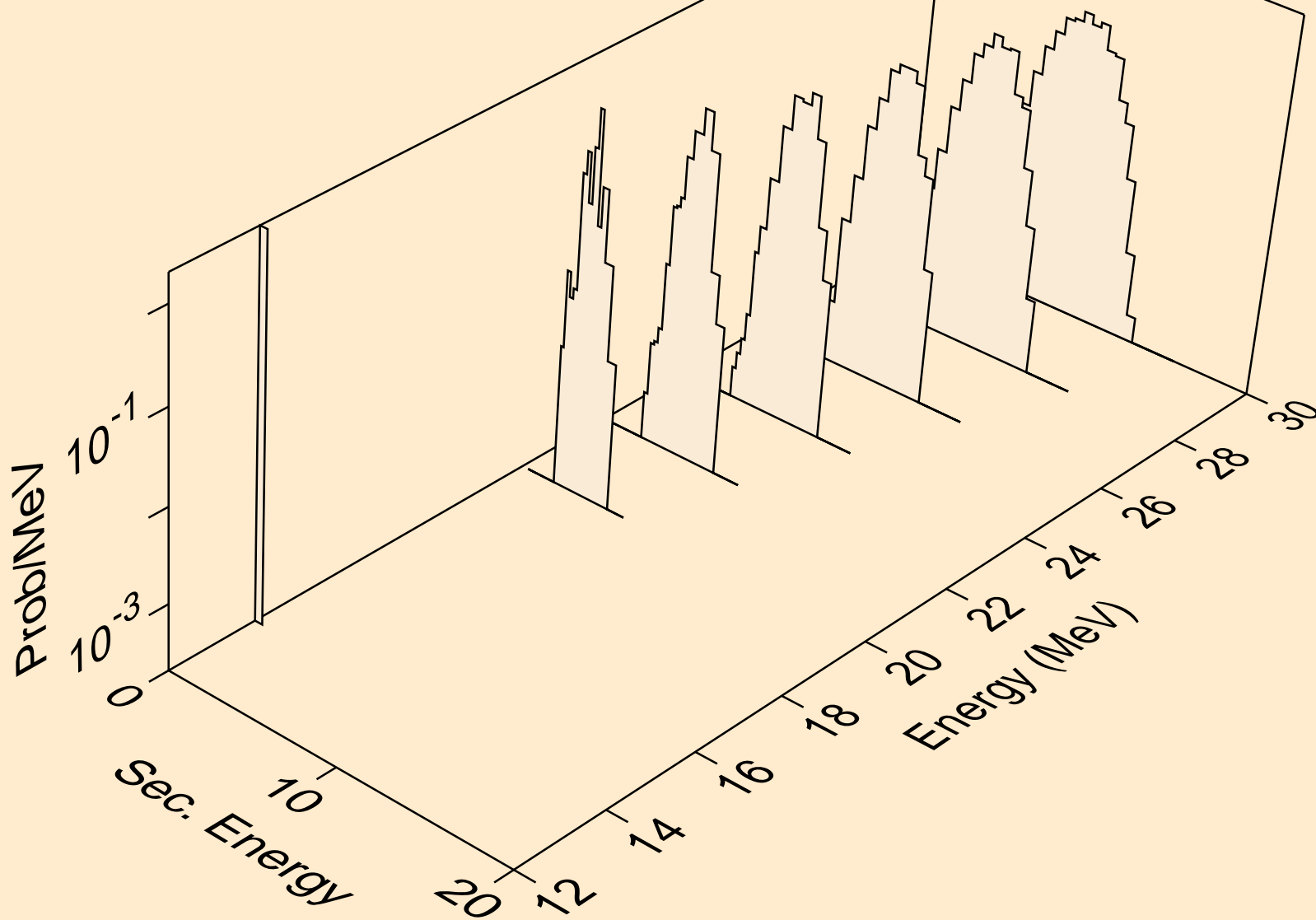

CS129 NEUTRON ACER TENDL-2019 LIBRARY; T=293.16K
he3s from (n,x)

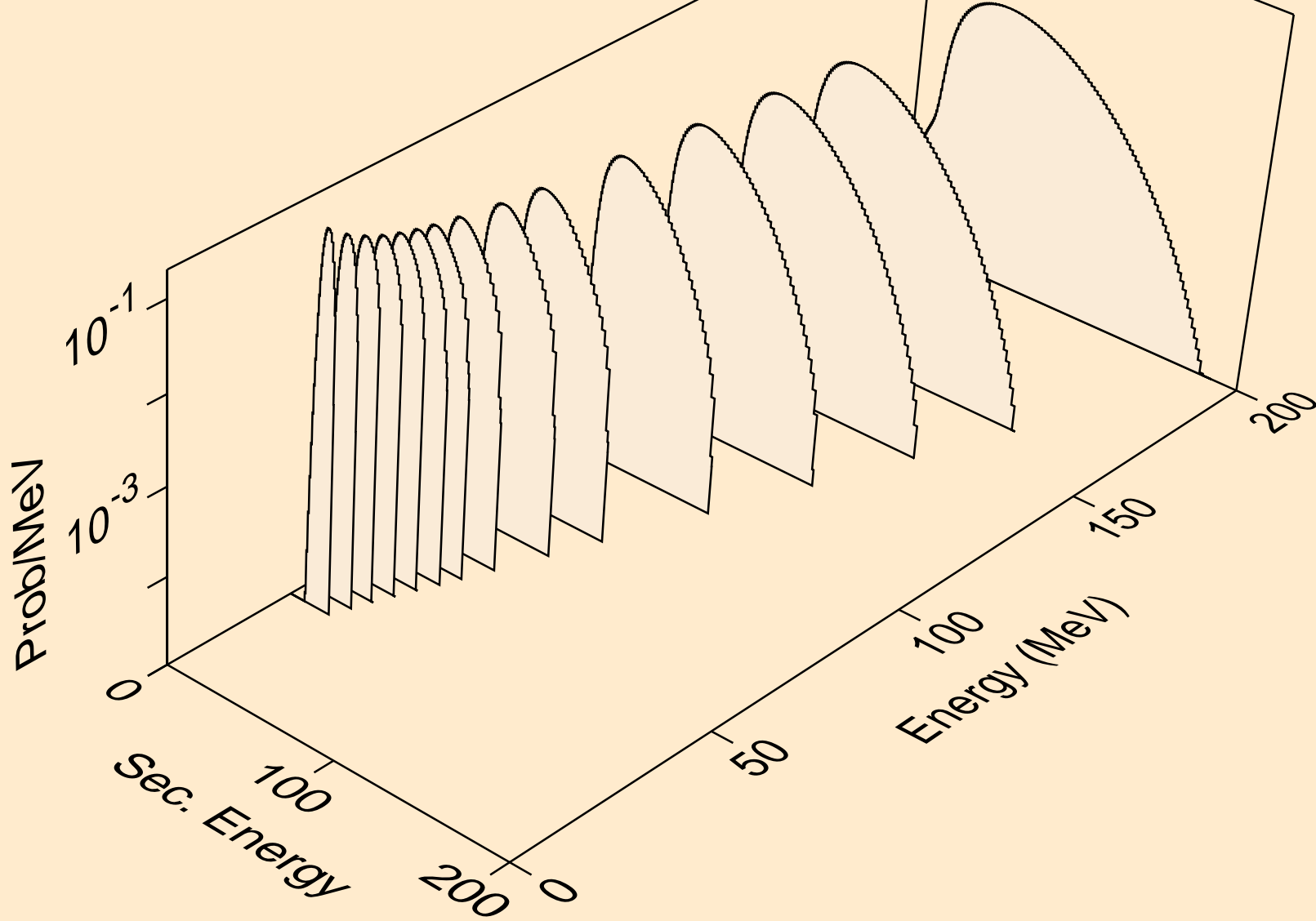

CS129 NEUTRON ACER TENDL-2019 LIBRARY; T=293.16K
he3s from (n,n*)he3

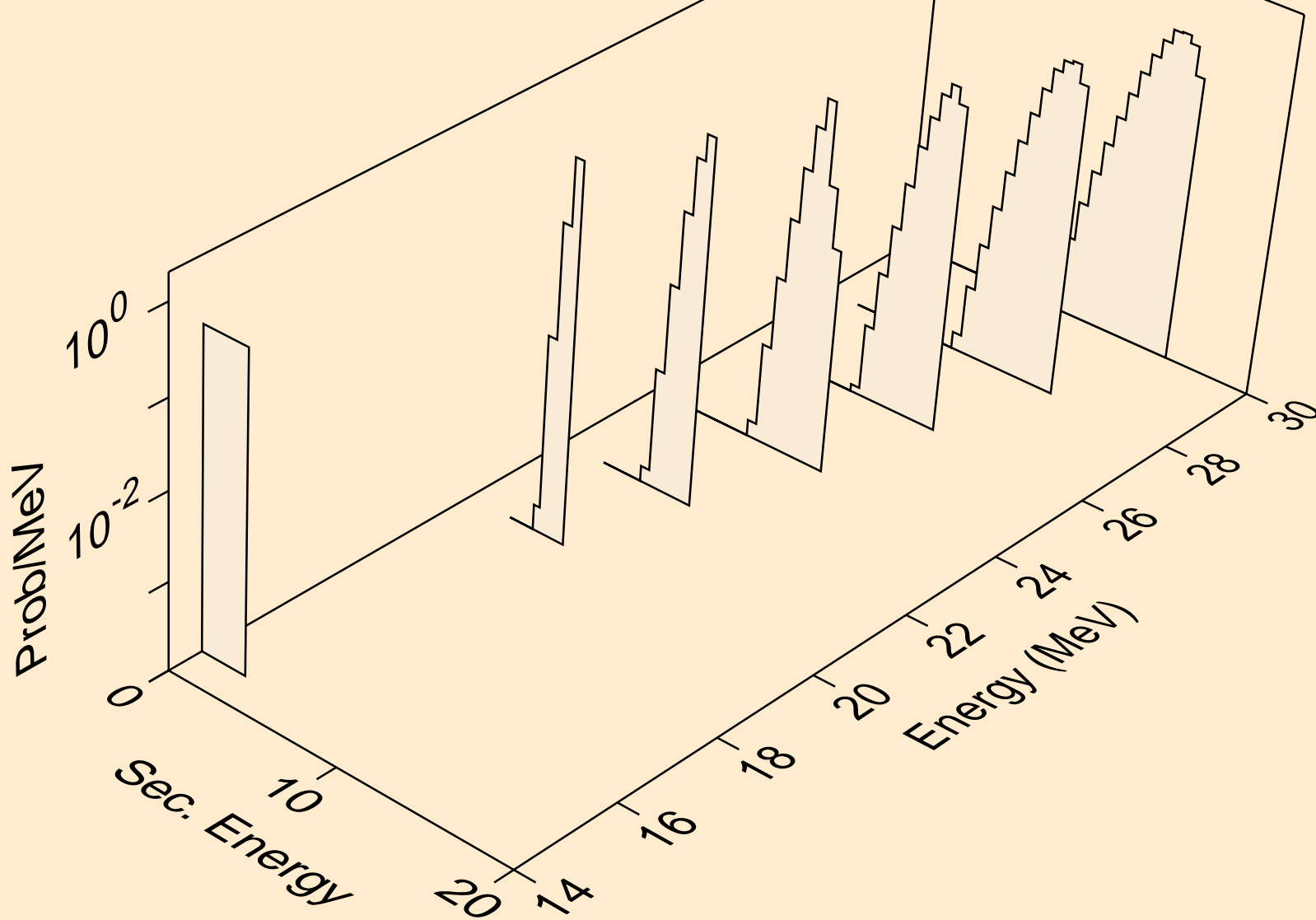

CS129 NEUTRON ACER TENDL-2019 LIBRARY; T=293.16K
he3s from (n,he3)

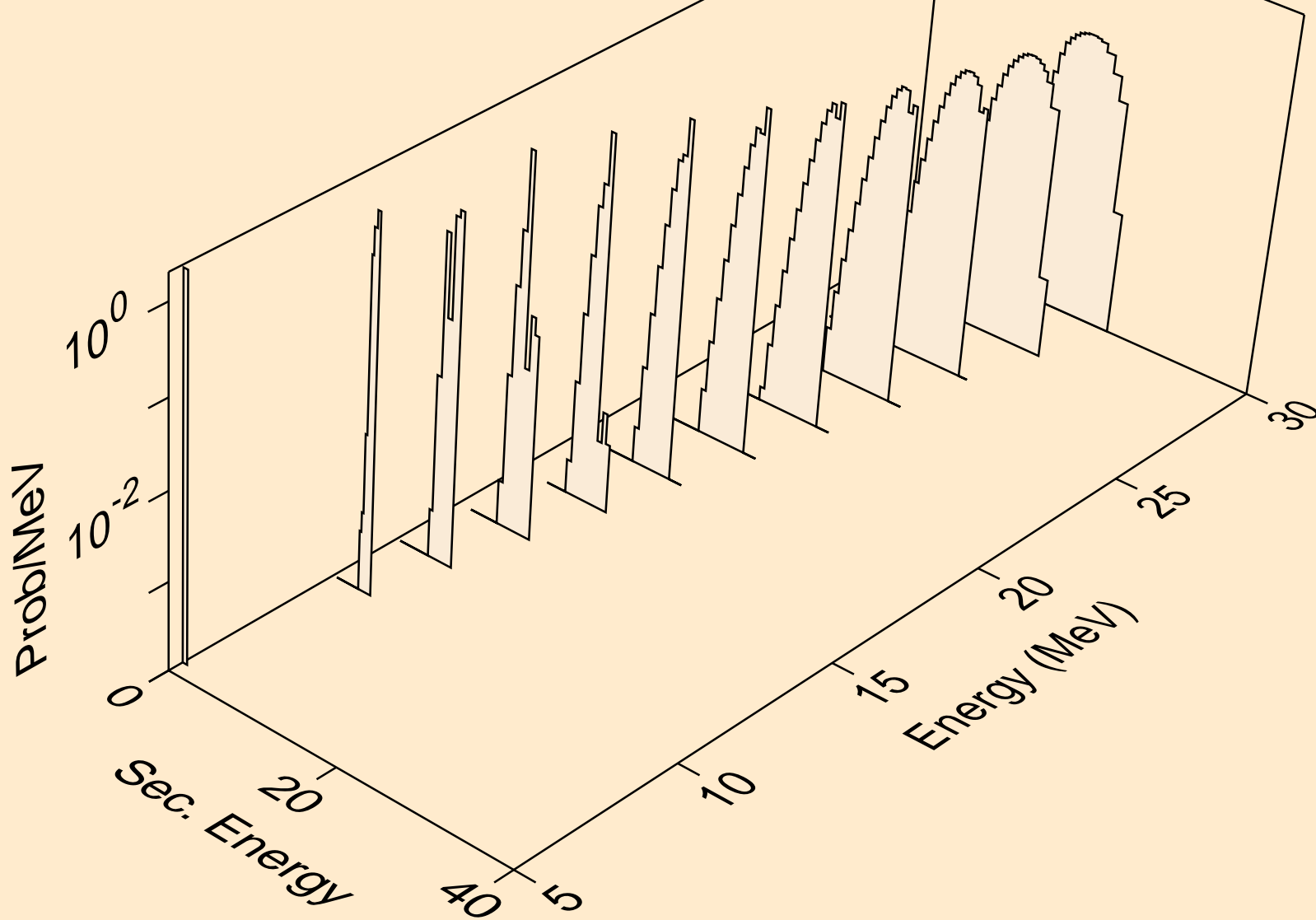

CS129 NEUTRON ACER TENDL-2019 LIBRARY; T=293.16K
alphas from (n,x)

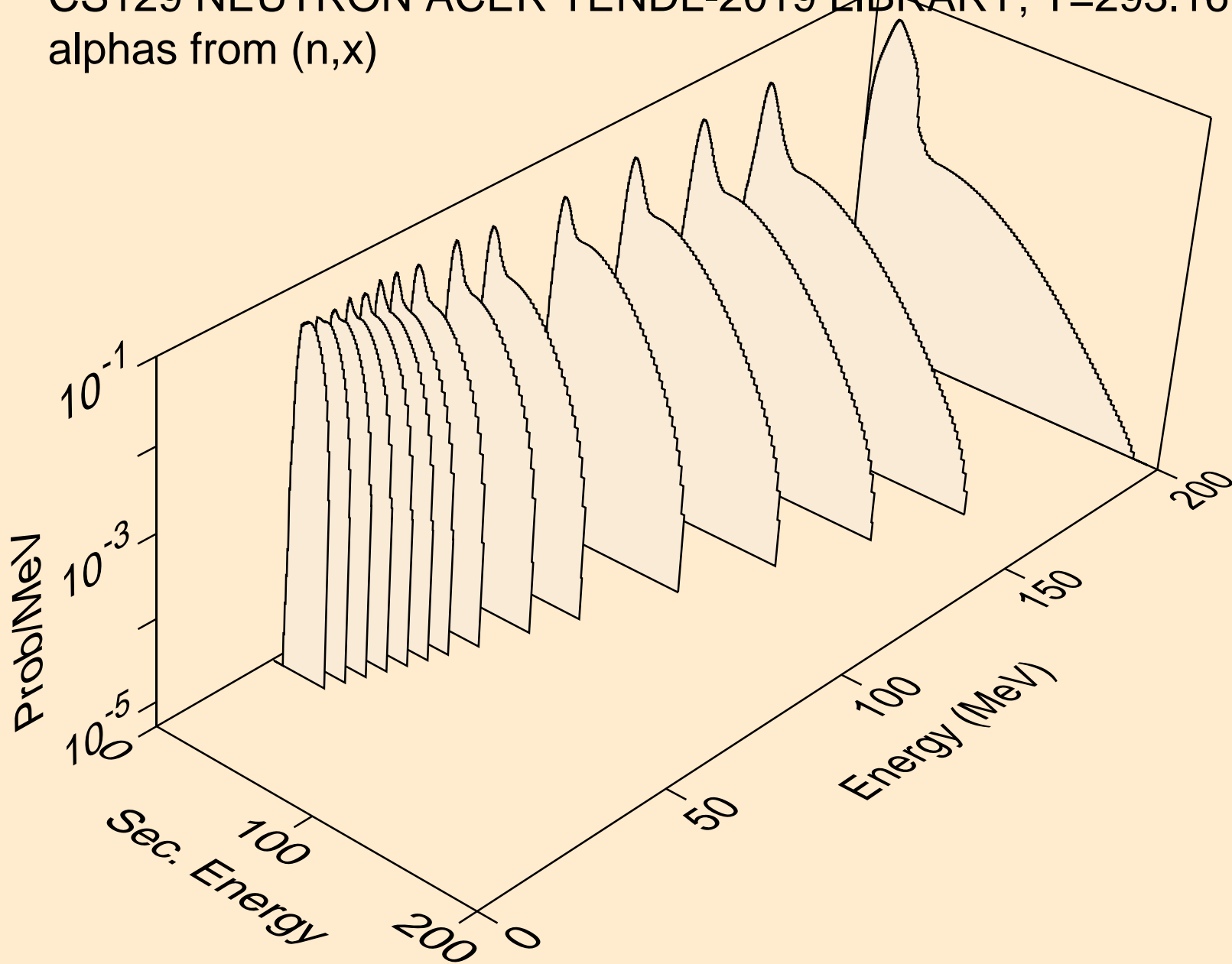

CS129 NEUTRON ACER TENDL-2019 LIBRARY; T=293.16K
alphas from (n,n*)a

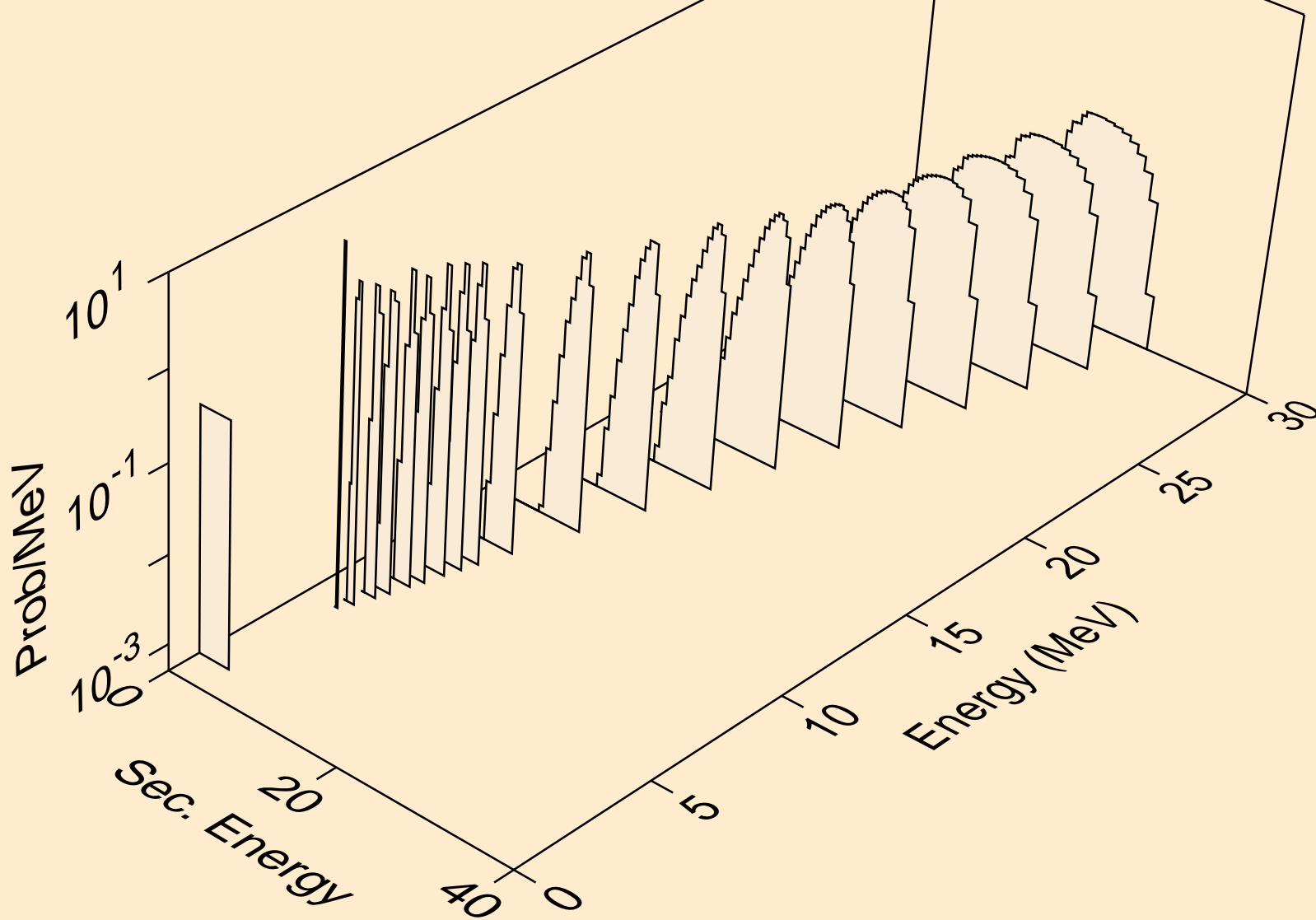

CS129 NEUTRON ACER TENDL-2019 LIBRARY; T=293.16K
alphas from (n,2n)a

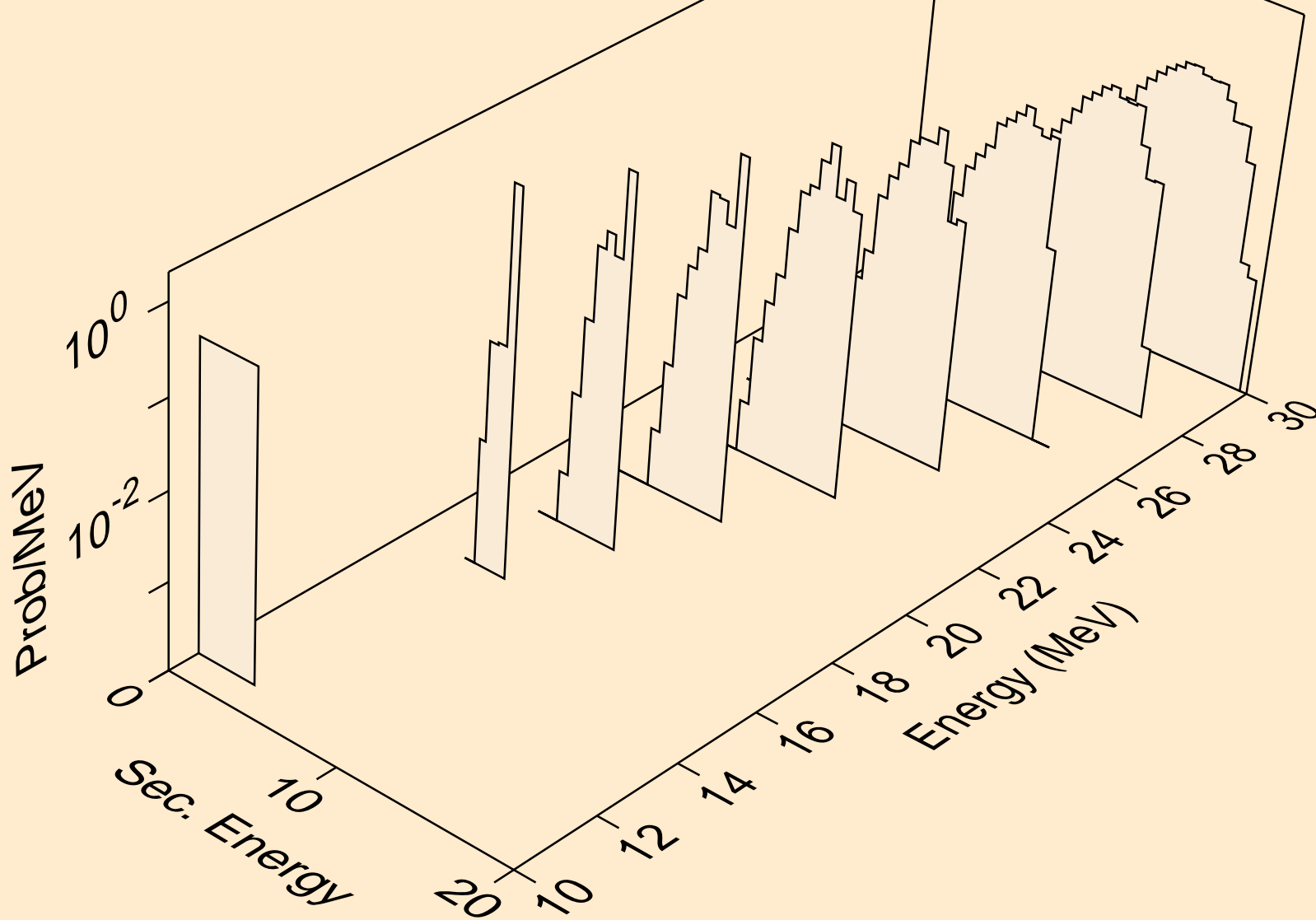

CS129 NEUTRON ACER TENDL-2019 LIBRARY; T=293.16K
alphas from (n,3n)a

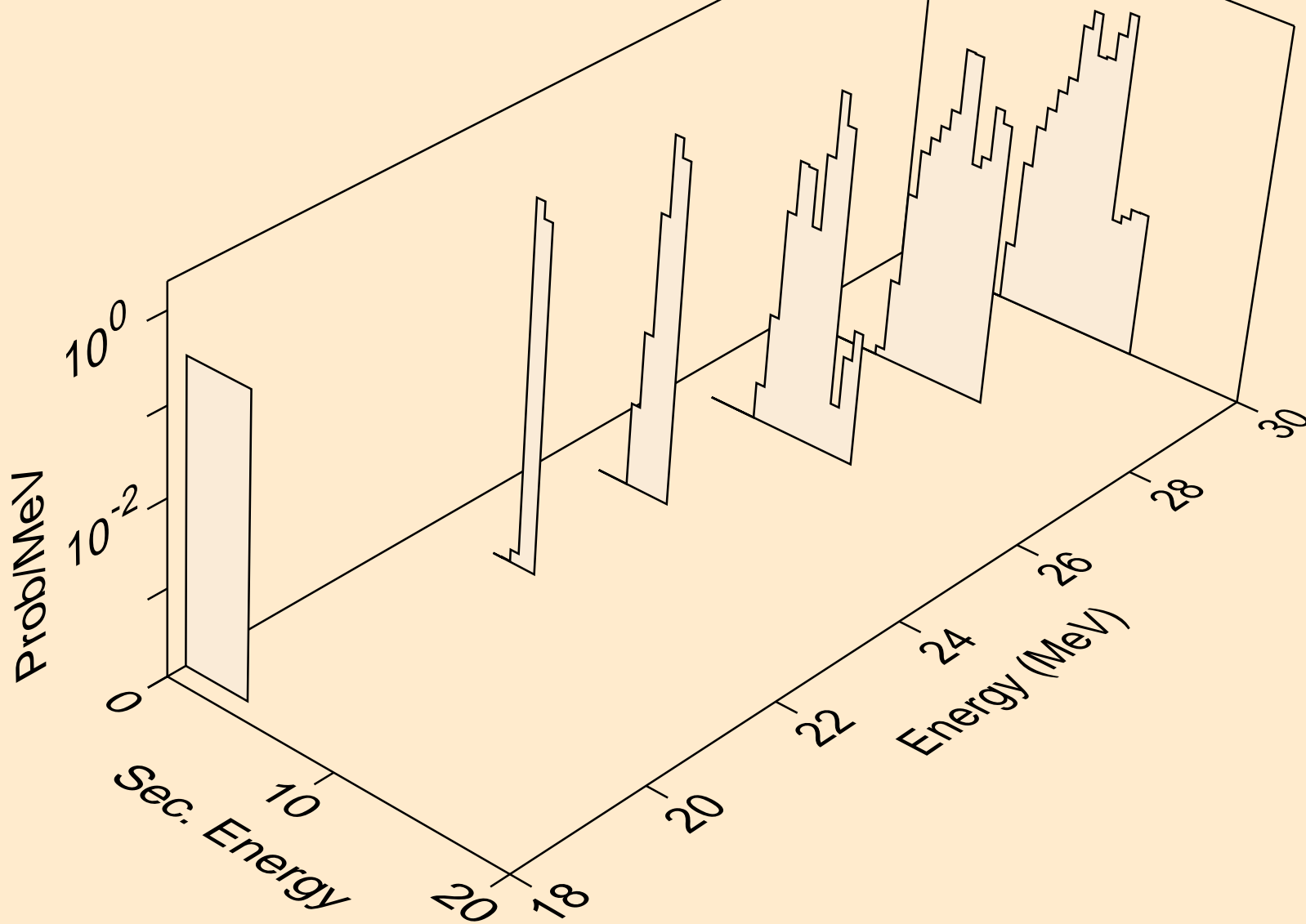

CS129 NEUTRON ACER TENDL-2019 LIBRARY; T=293.16K
alphas from (n,n*)2a

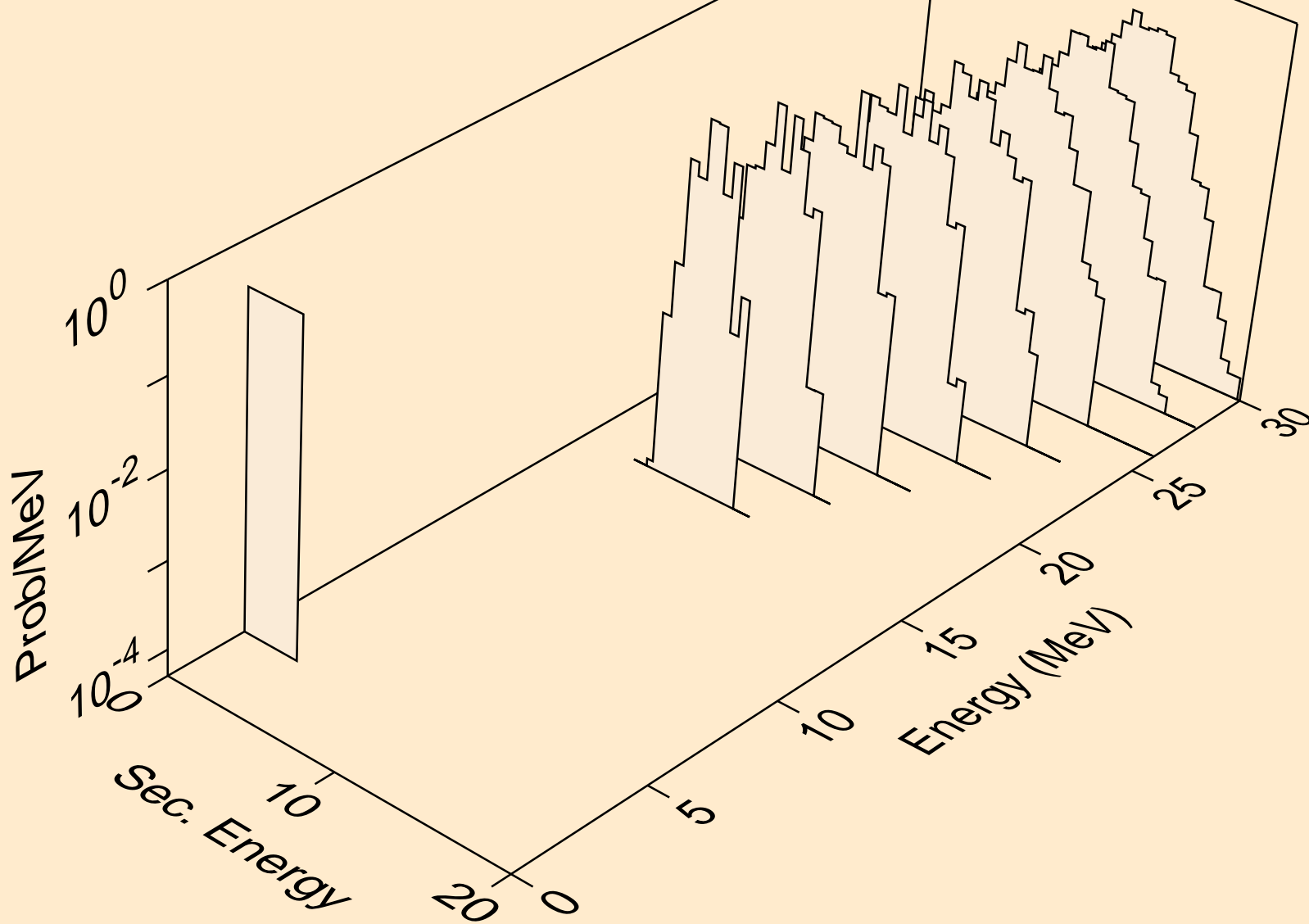

CS129 NEUTRON ACER TENDL-2019 LIBRARY; T=293.16K
alphas from (n,npa)

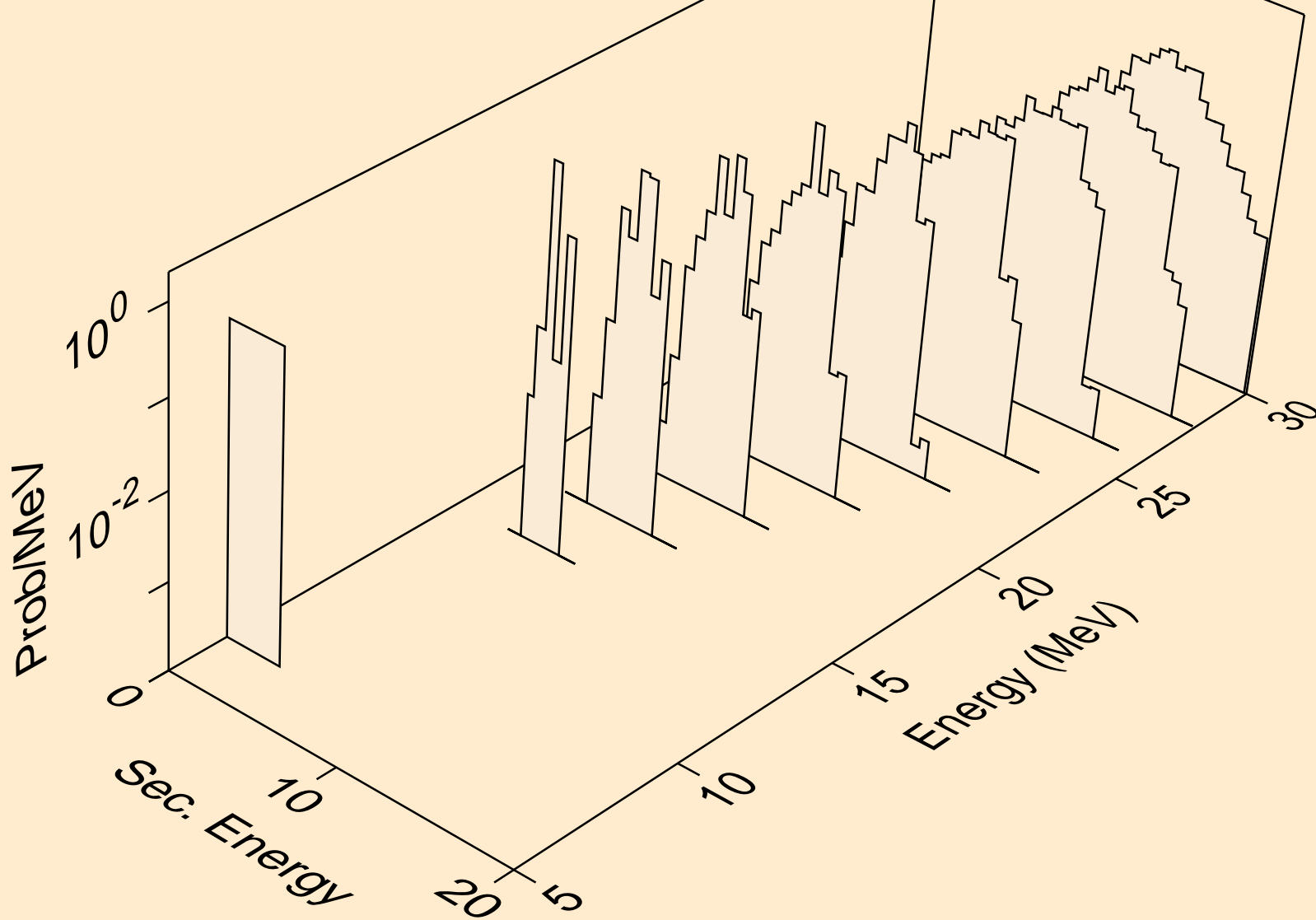

CS129 NEUTRON ACER TENDL-2019 LIBRARY; T=293.16K
alphas from (n,a)

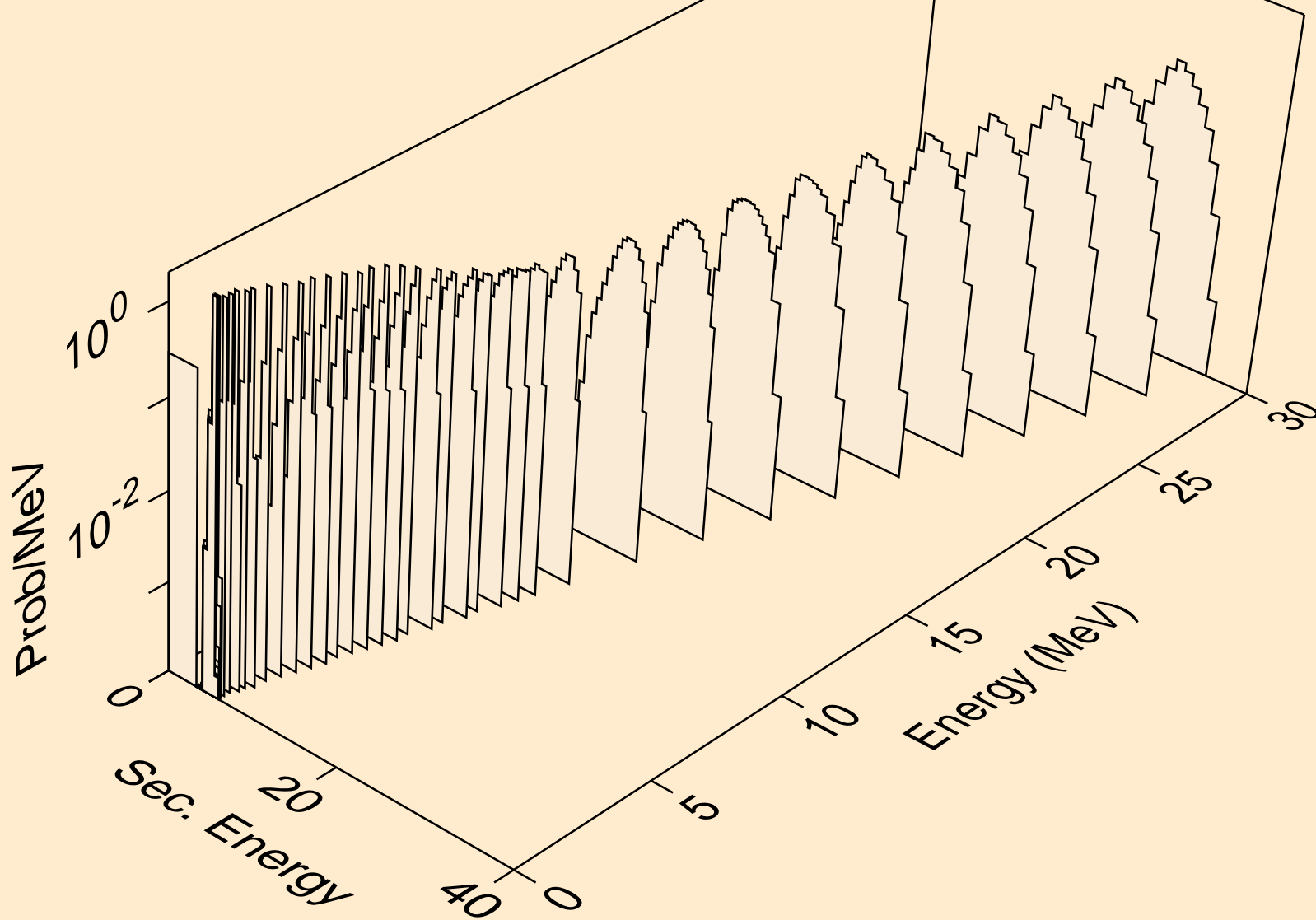

CS129 NEUTRON ACER TENDL-2019 LIBRARY; T=293.16K
alphas from (n,2a)

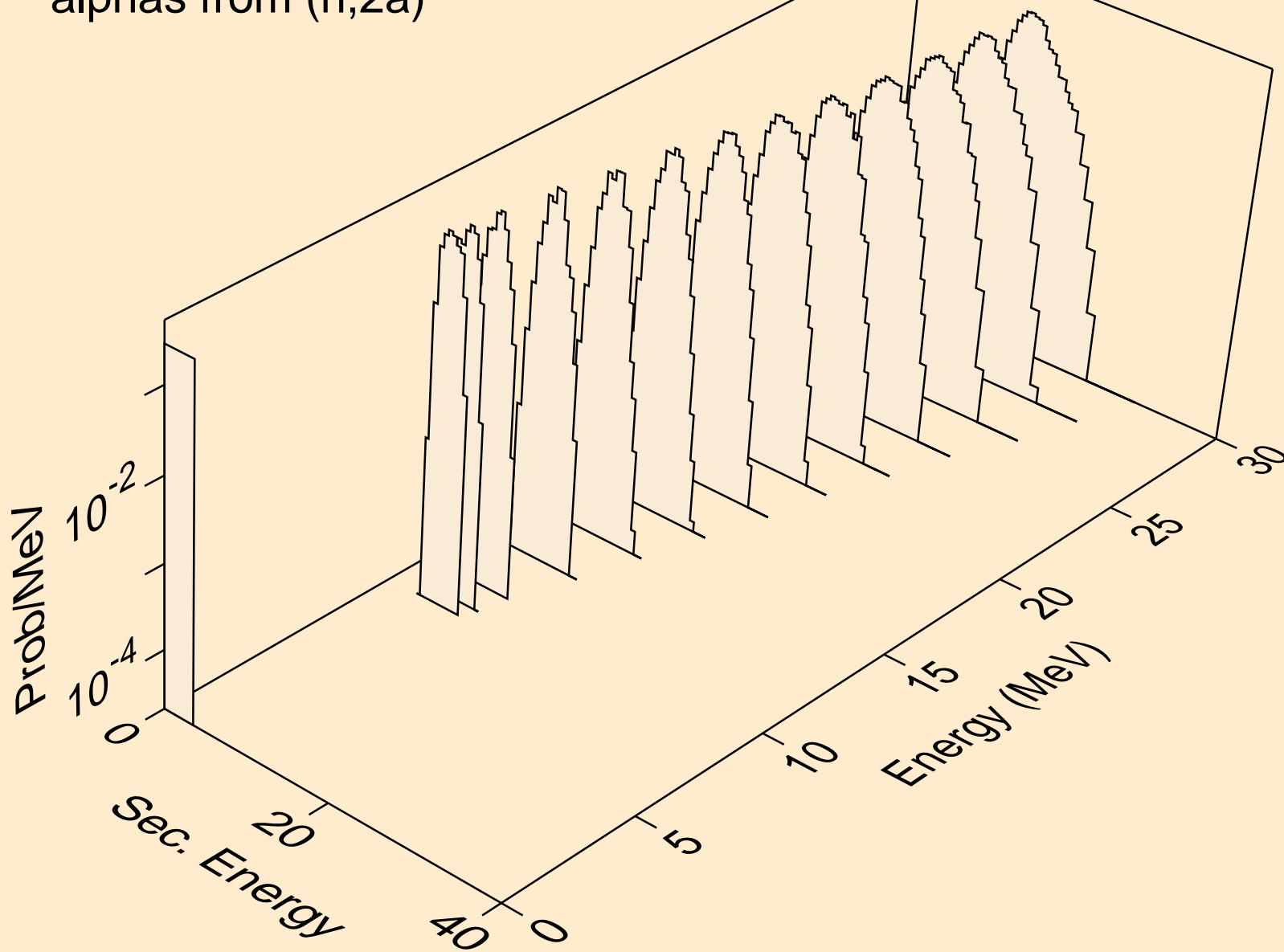

CS129 NEUTRON ACER TENDL-2019 LIBRARY; T=293.16K
alphas from (n,pa)

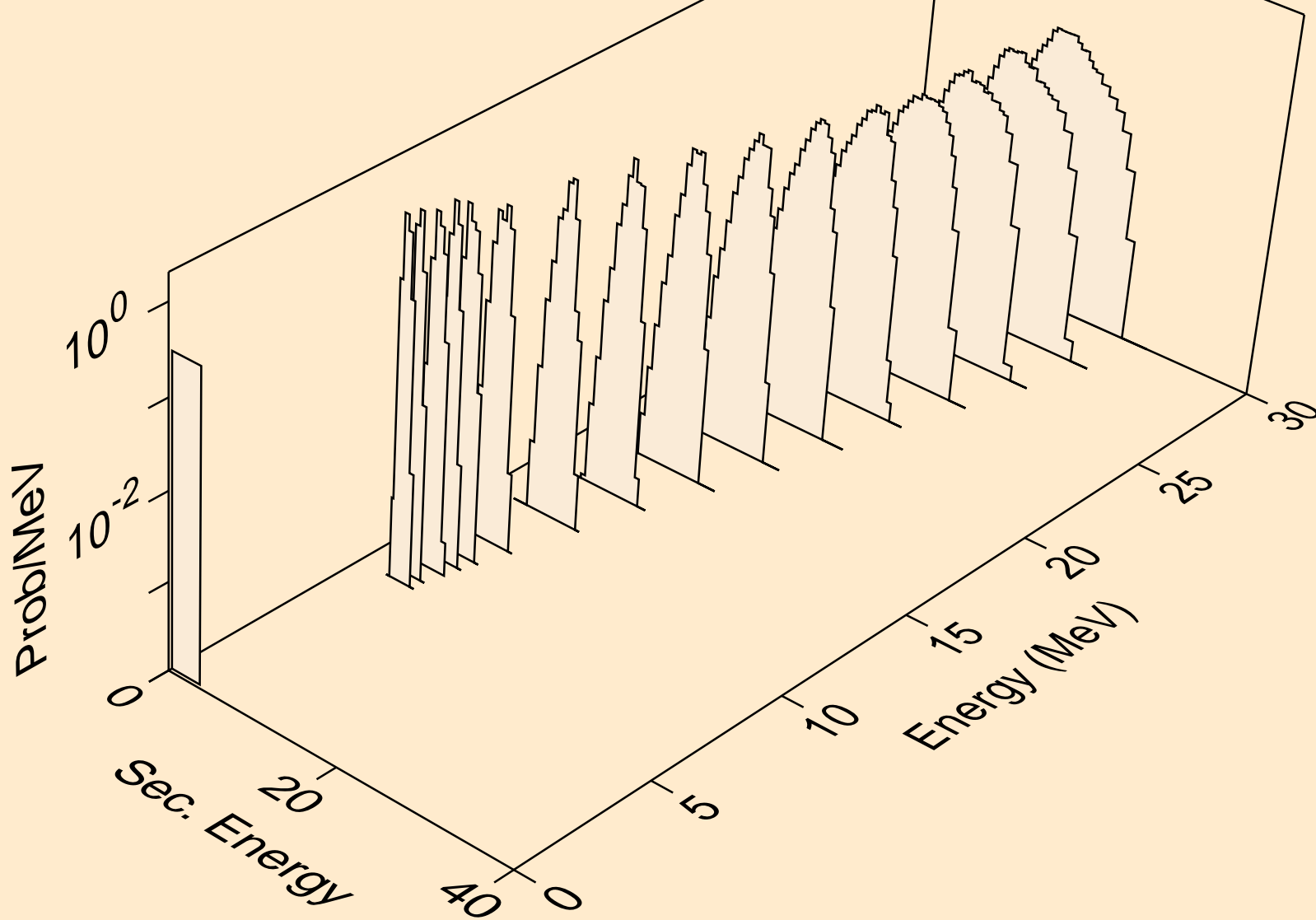

CS129 NEUTRON ACER TENDL-2019 LIBRARY; T=293.16K
alphas from (n,da)

