

CS135M NEUTRON ACER TENDL-2019 LIBRARY; T=293.16K  
Principal cross sections

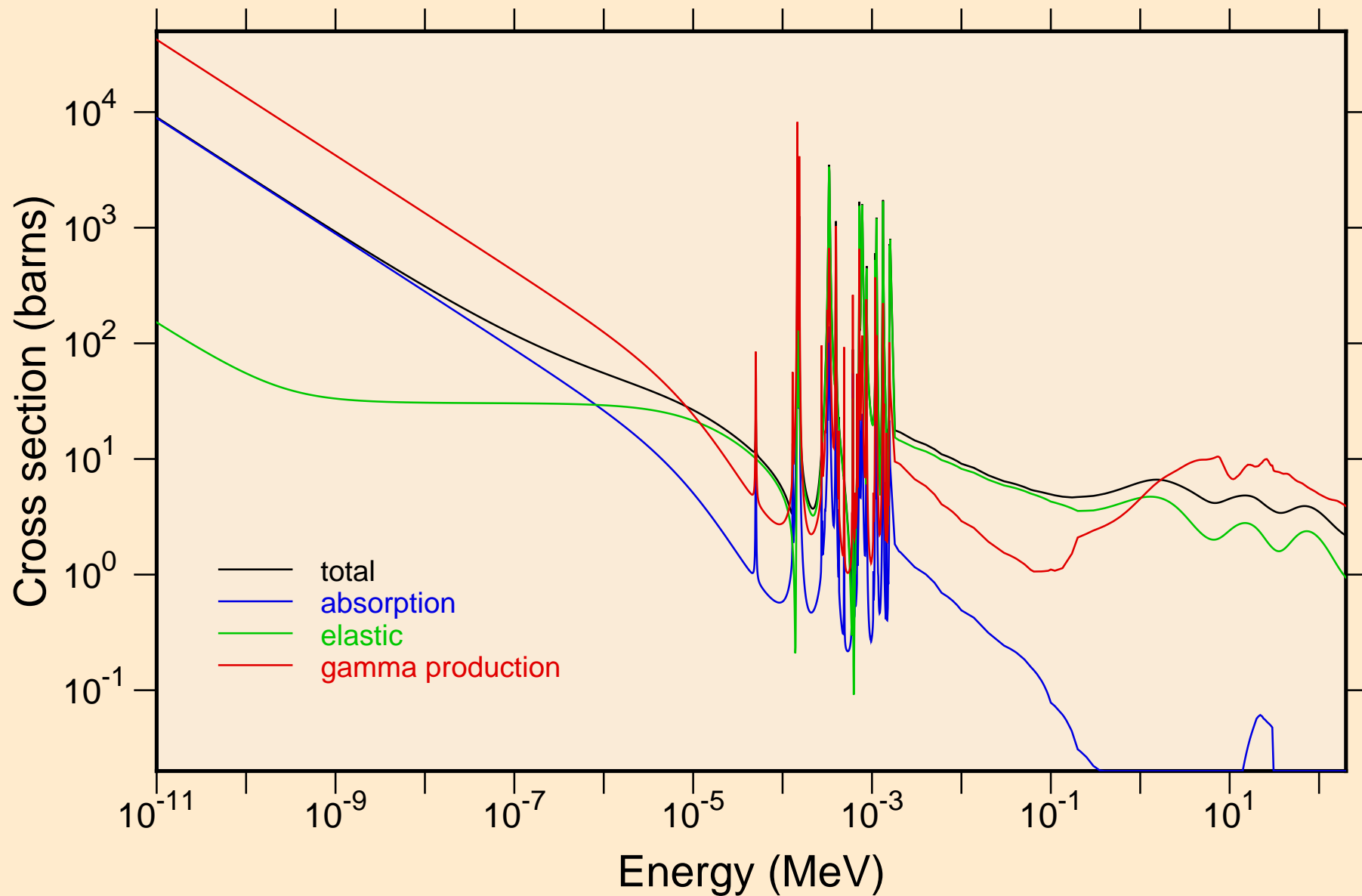

CS135M NEUTRON ACER TENDL-2019 LIBRARY; T=293.16K  
resonance total cross section

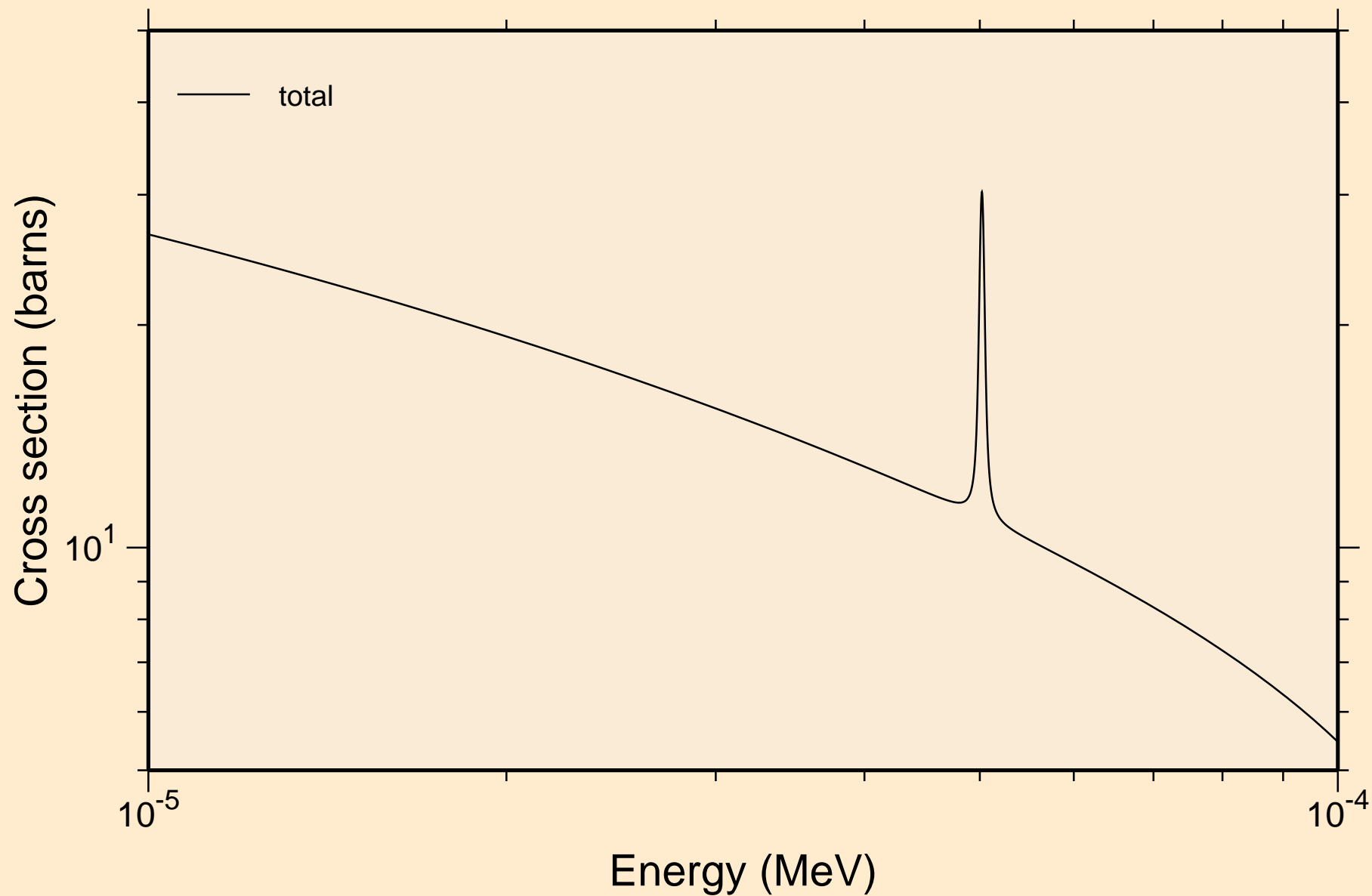

CS135M NEUTRON ACER TENDL-2019 LIBRARY; T=293.16K  
resonance total cross section

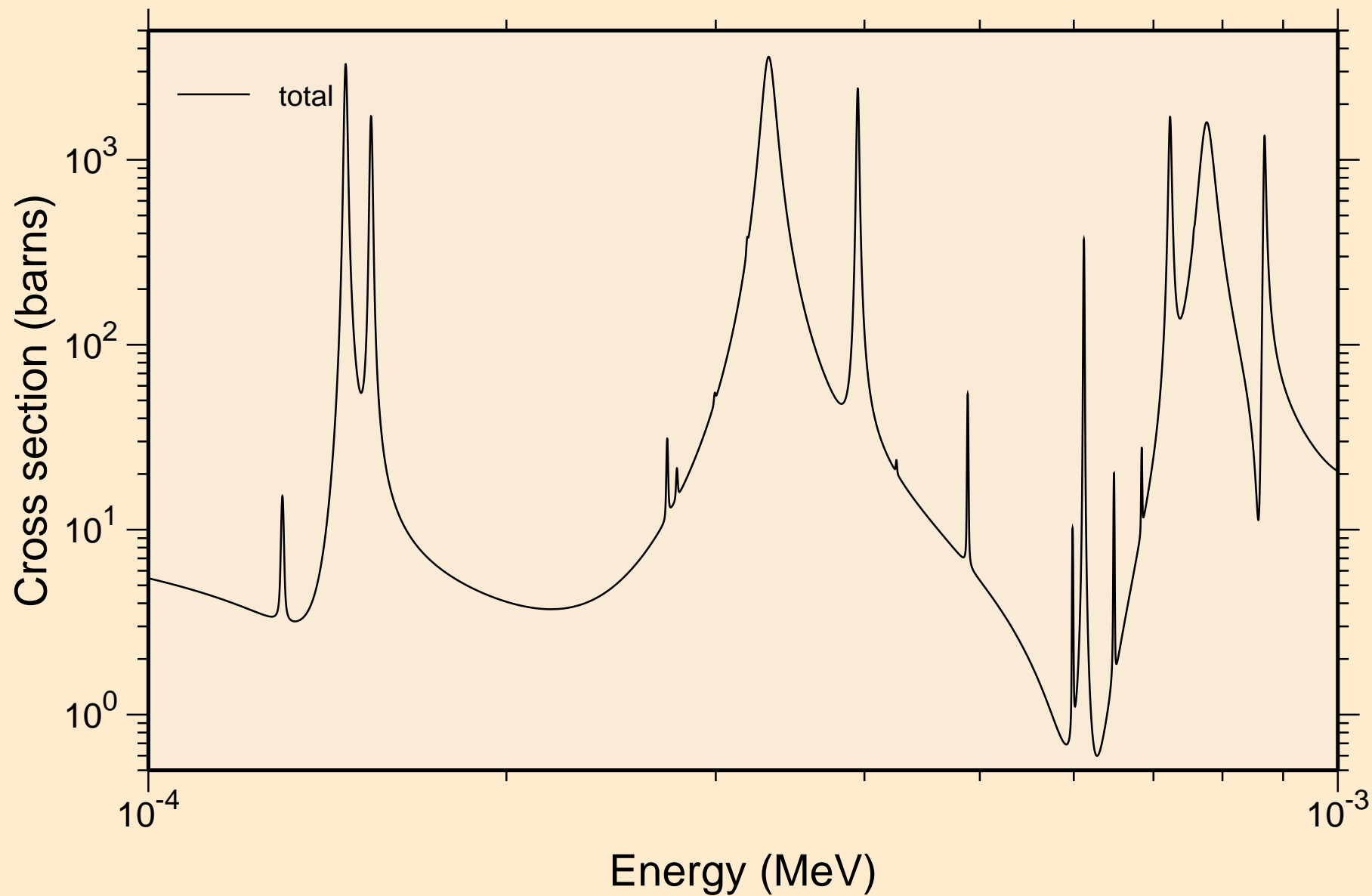

CS135M NEUTRON ACER TENDL-2019 LIBRARY; T=293.16K  
resonance total cross section

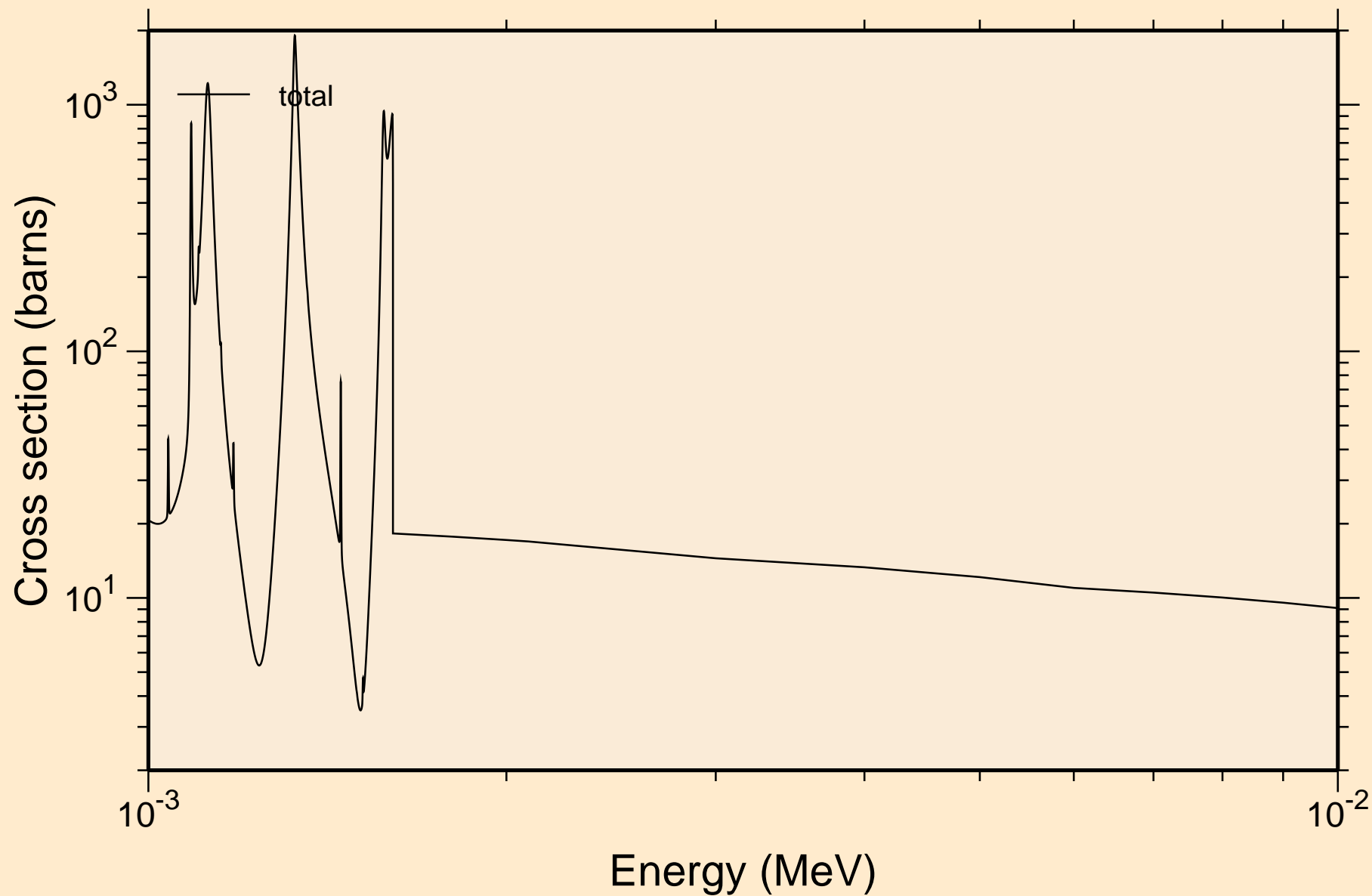

C<sup>135</sup>M NEUTRON ACER TENDL-2019 LIBRARY; T=293.16K  
resonance total cross section

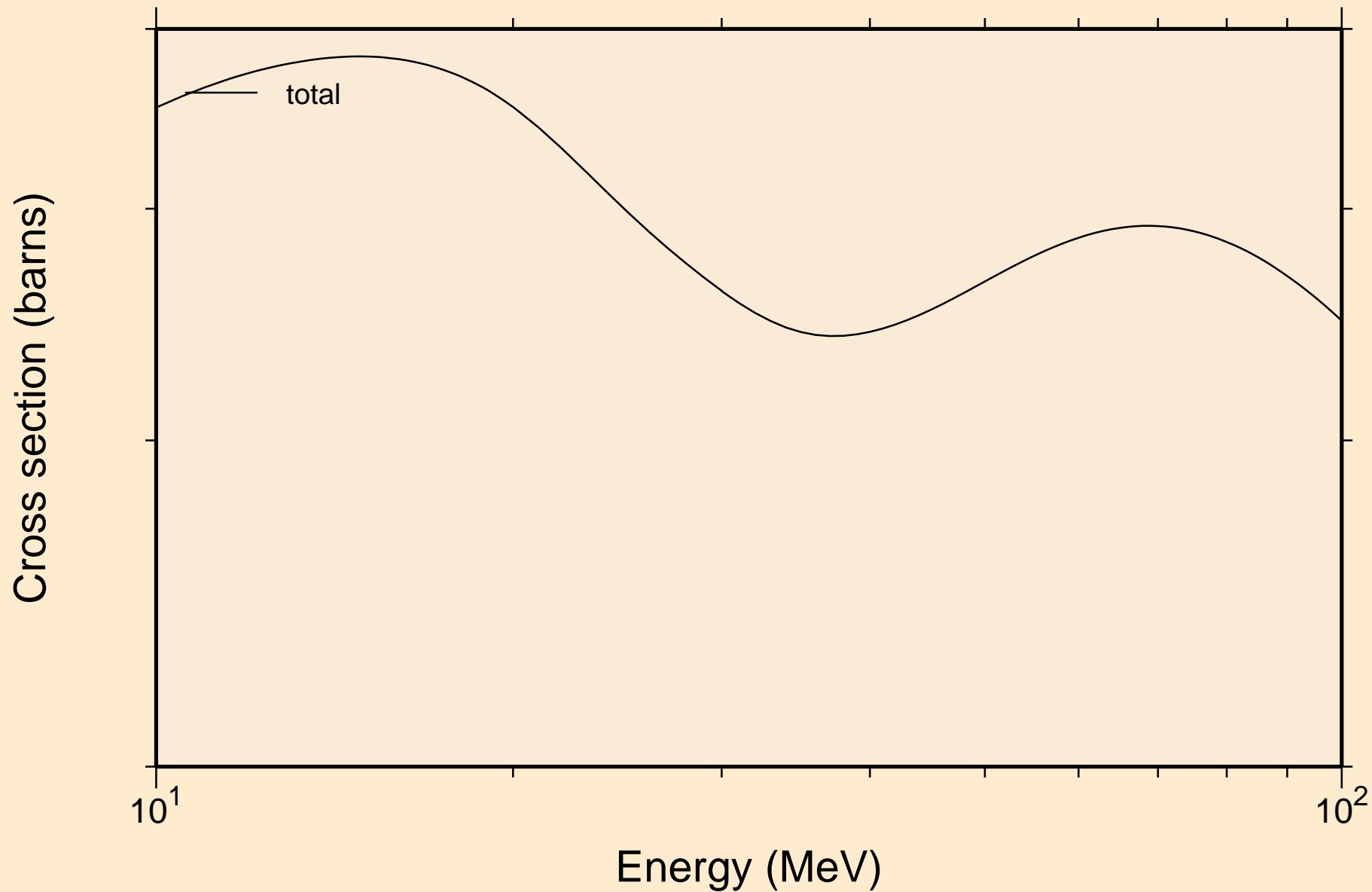

CS135M NEUTRON ACER TENDL-2019 LIBRARY; T=293.16K  
resonance absorption cross sections

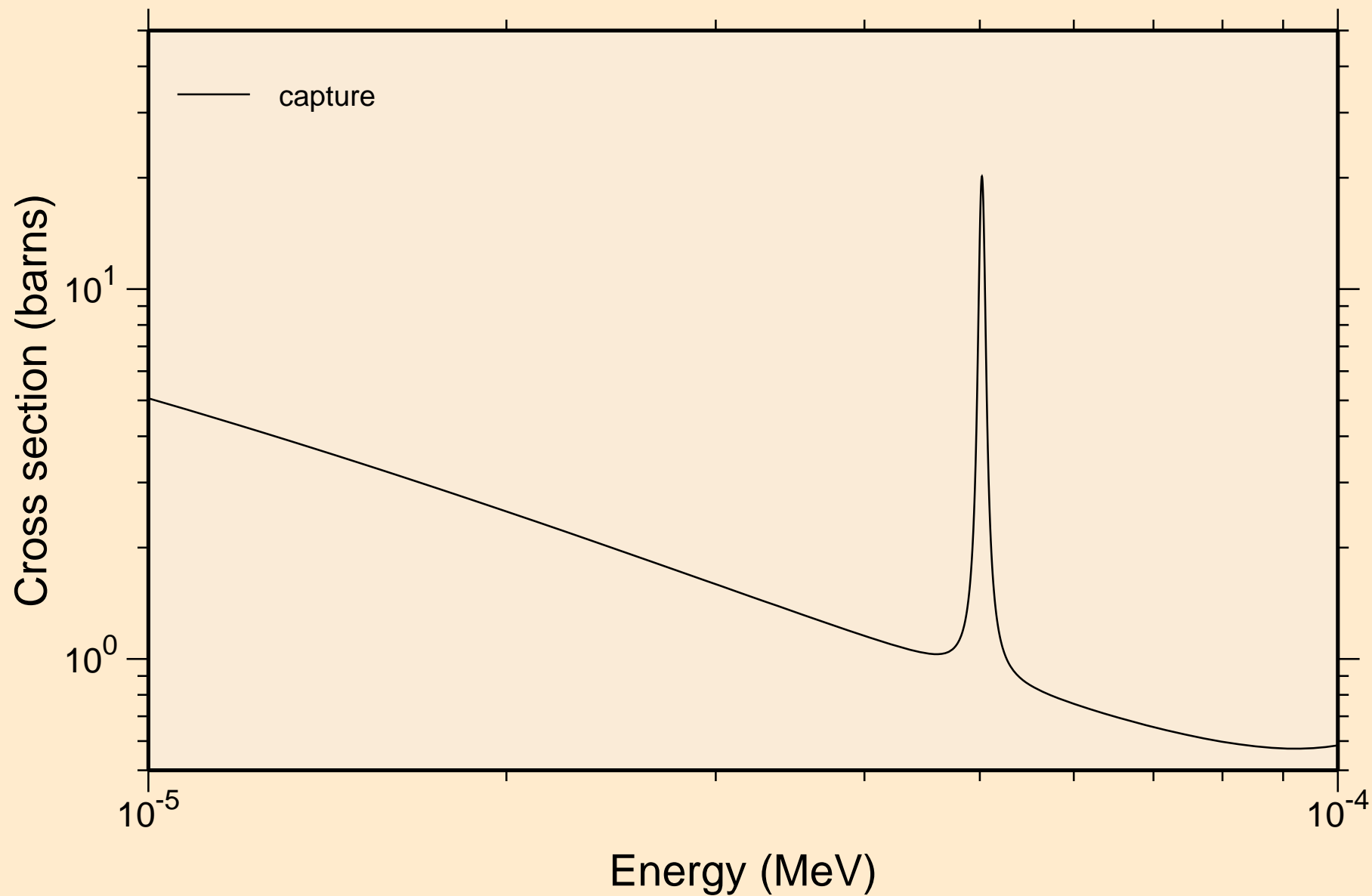

CS135M NEUTRON ACER TENDL-2019 LIBRARY; T=293.16K  
resonance absorption cross sections

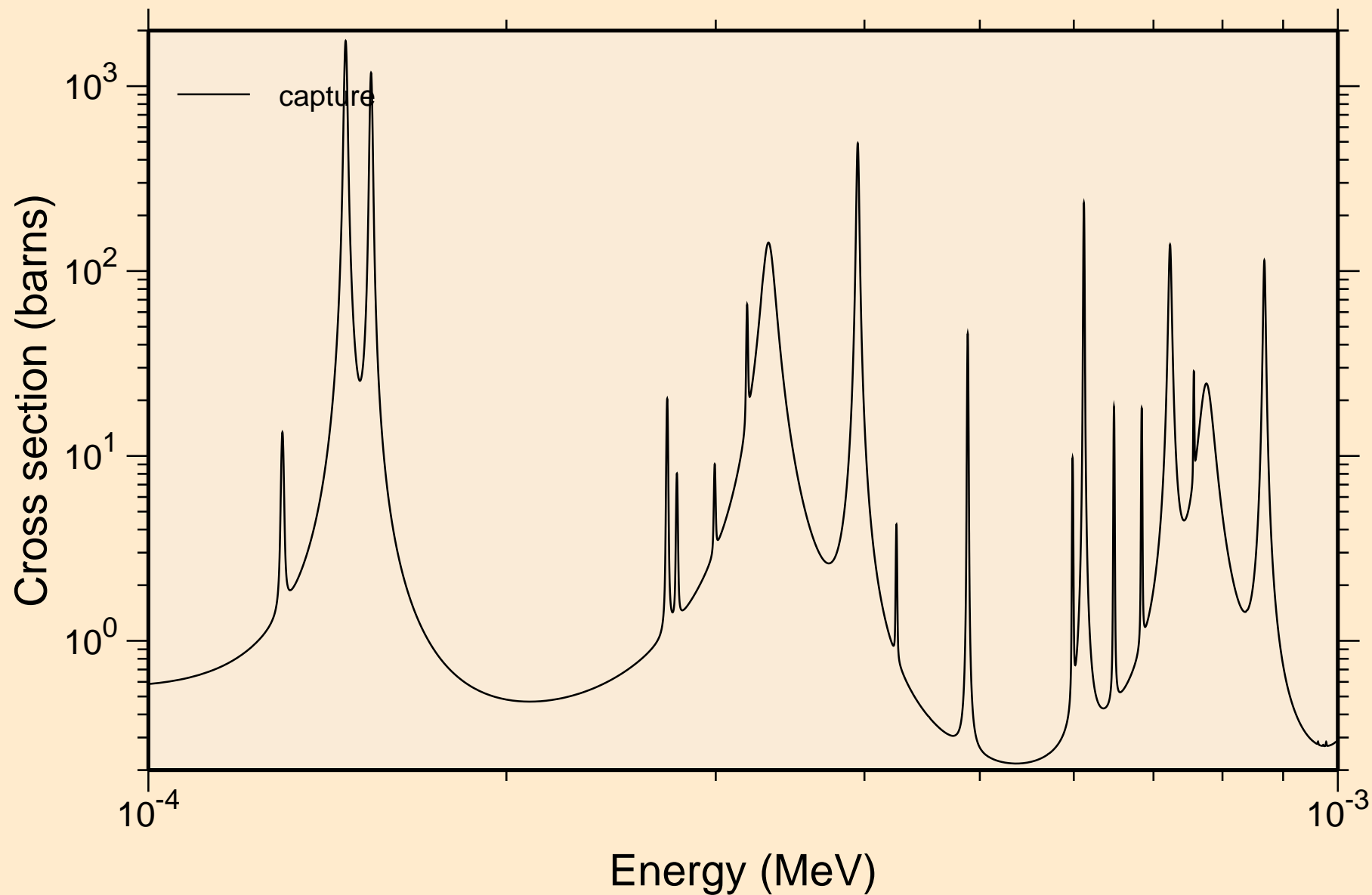

CS135M NEUTRON ACER TENDL-2019 LIBRARY; T=293.16K  
resonance absorption cross sections

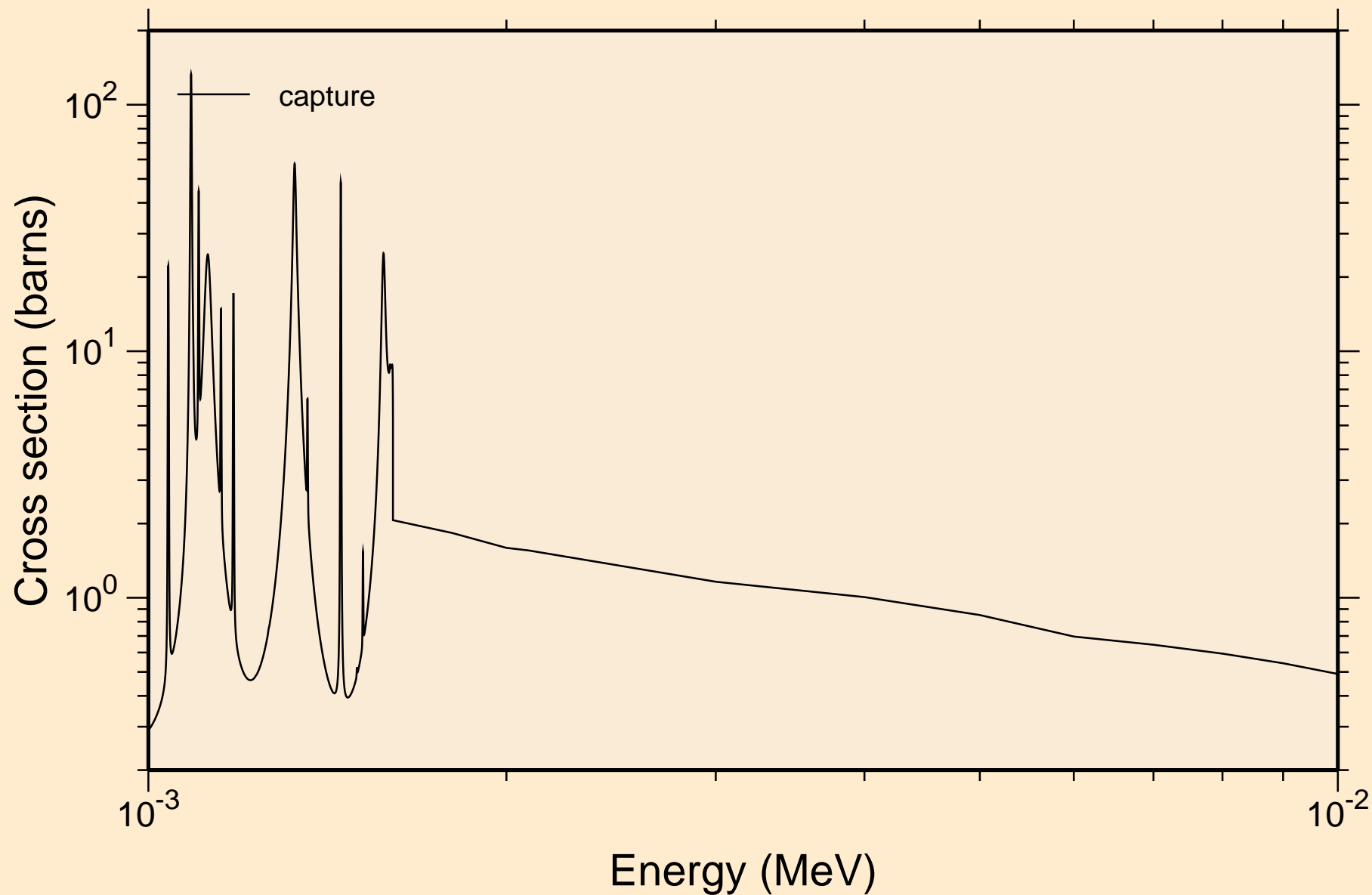



CS135M NEUTRON ACER TENDL-2019 LIBRARY; T=293.16K  
resonance absorption cross sections

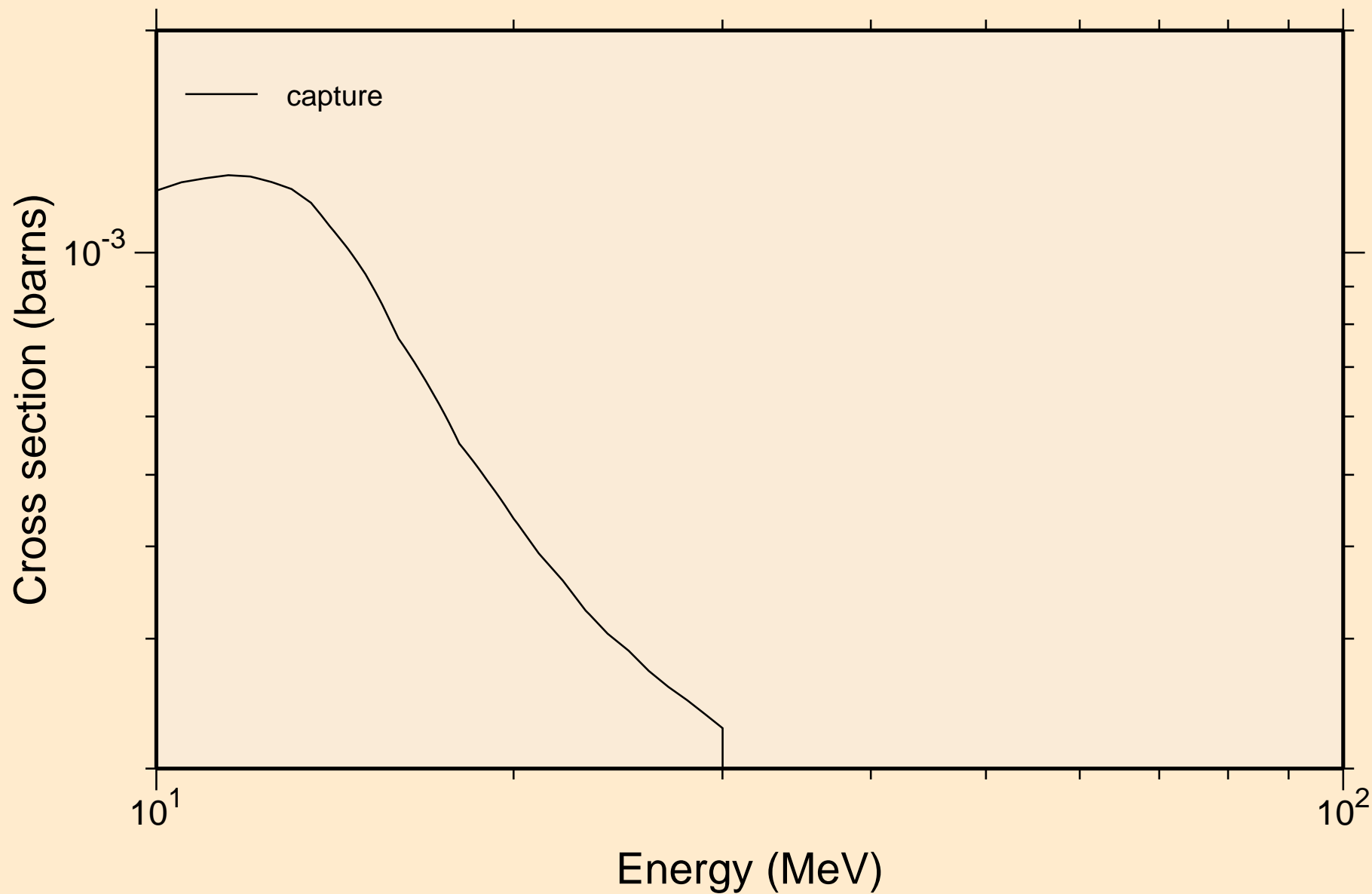

CS135M NEUTRON ACER TENDL-2019 LIBRARY; T=293.16K  
Heating

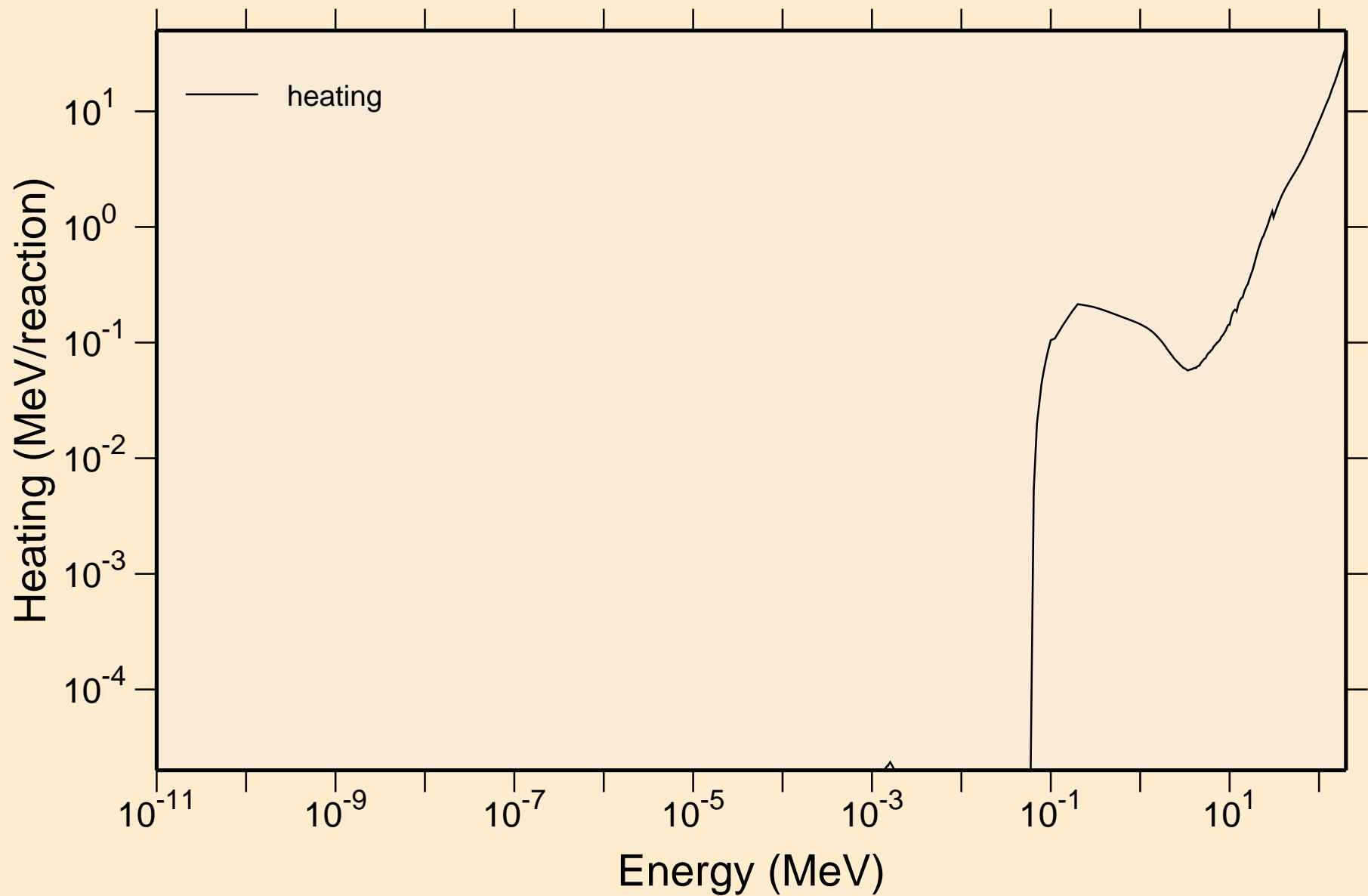

# CS135M NEUTRON ACER TENDL-2019 LIBRARY; T=293.16K Damage

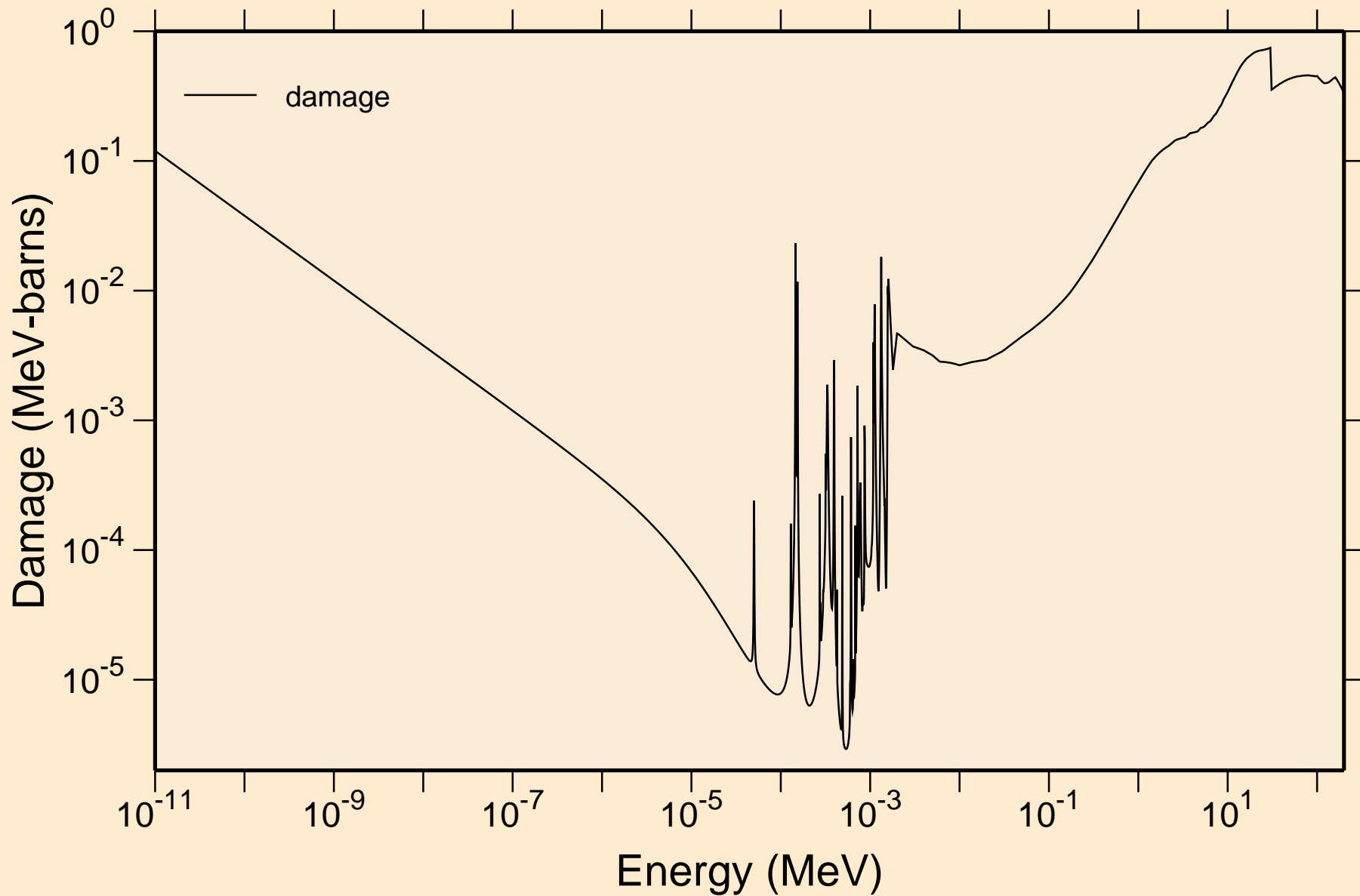

# CS135M NEUTRON ACER TENDL-2019 LIBRARY; T=293.16K

## Non-threshold reactions

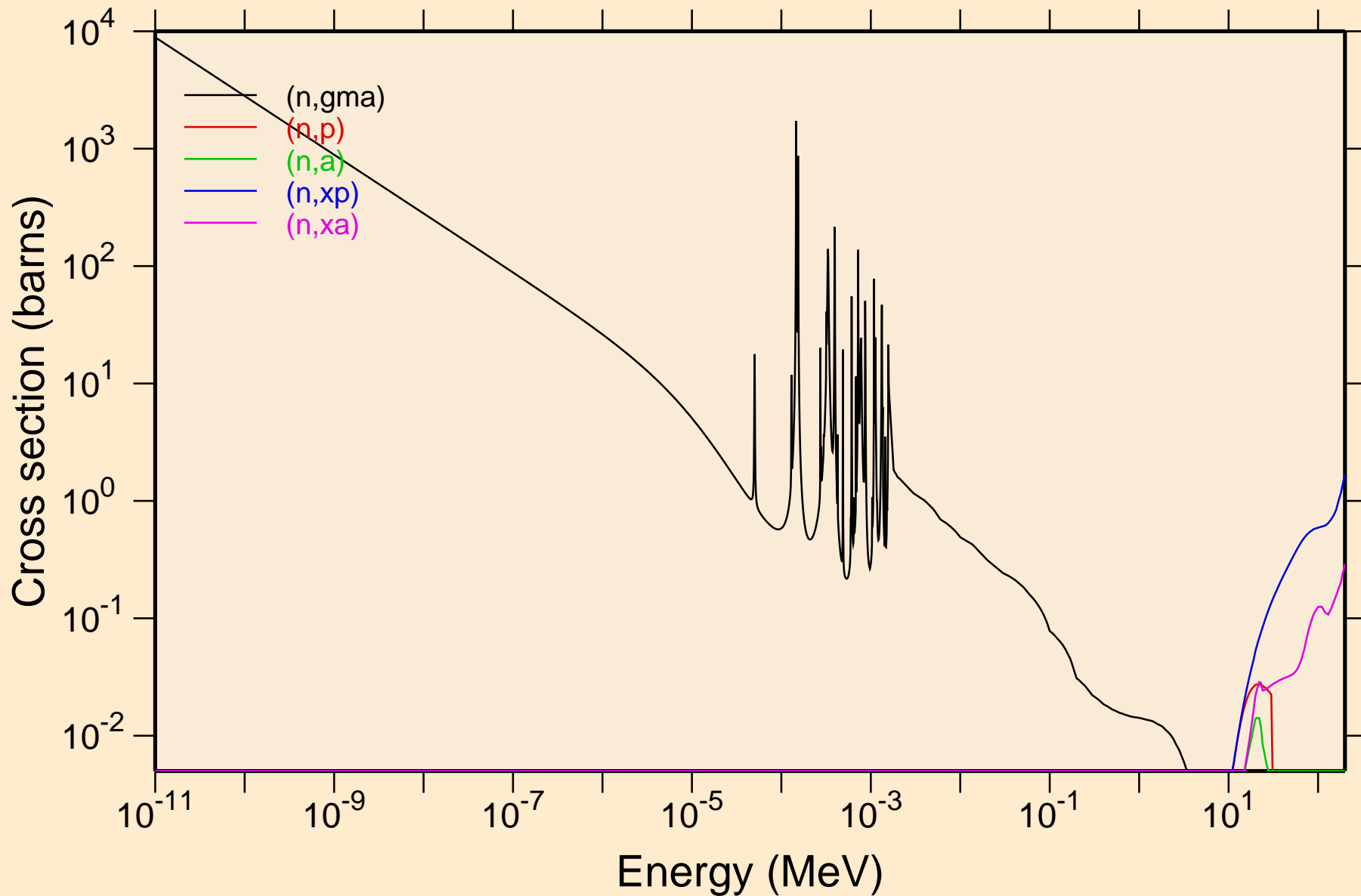

CS135M NEUTRON ACER TENDL-2019 LIBRARY; T=293.16K  
Principal cross sections

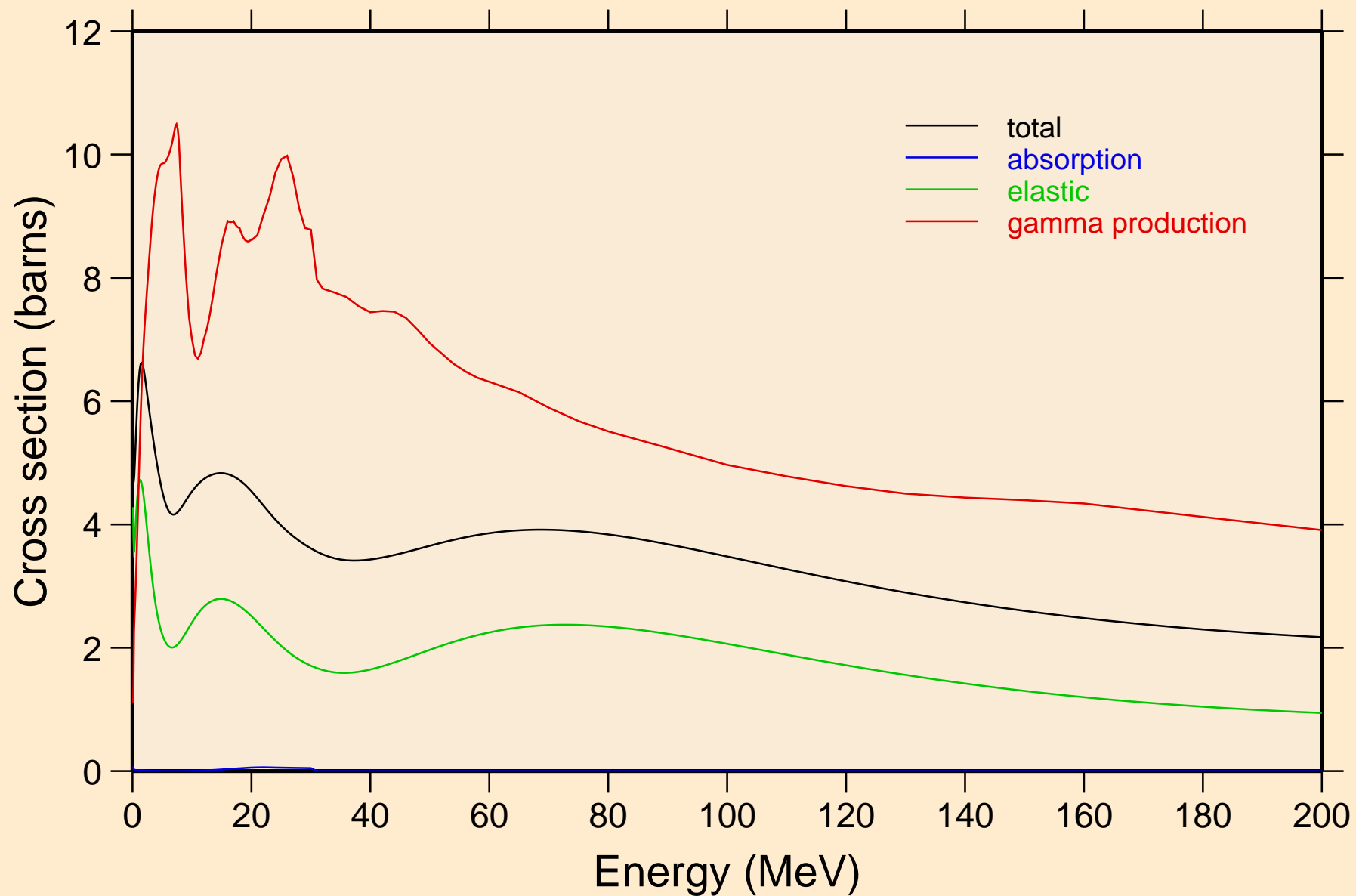

CS135M NEUTRON ACER TENDL-2019 LIBRARY; T=293.16K  
Heating

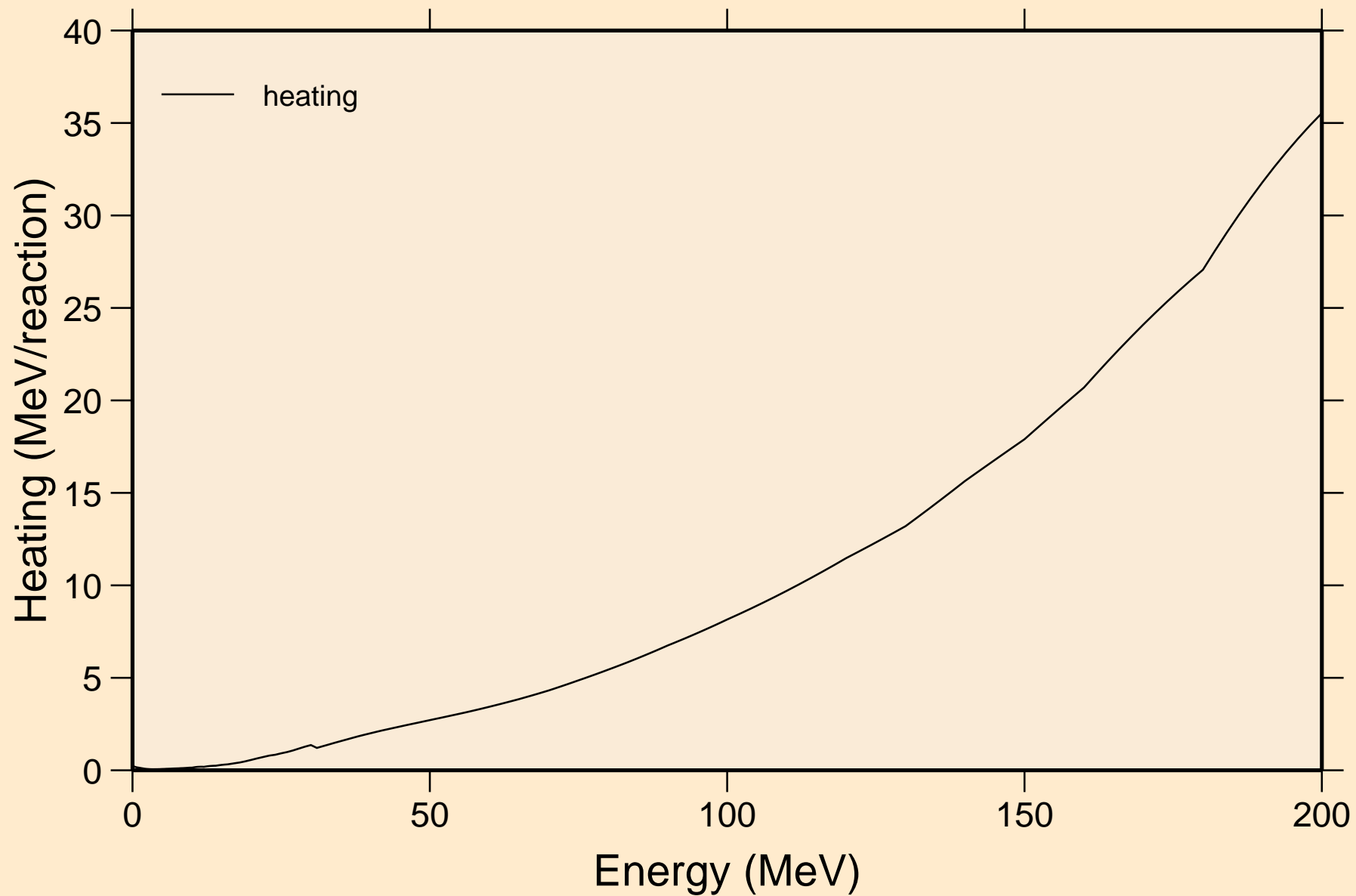

CS135M NEUTRON ACER TENDL-2019 LIBRARY; T=293.16K  
Damage

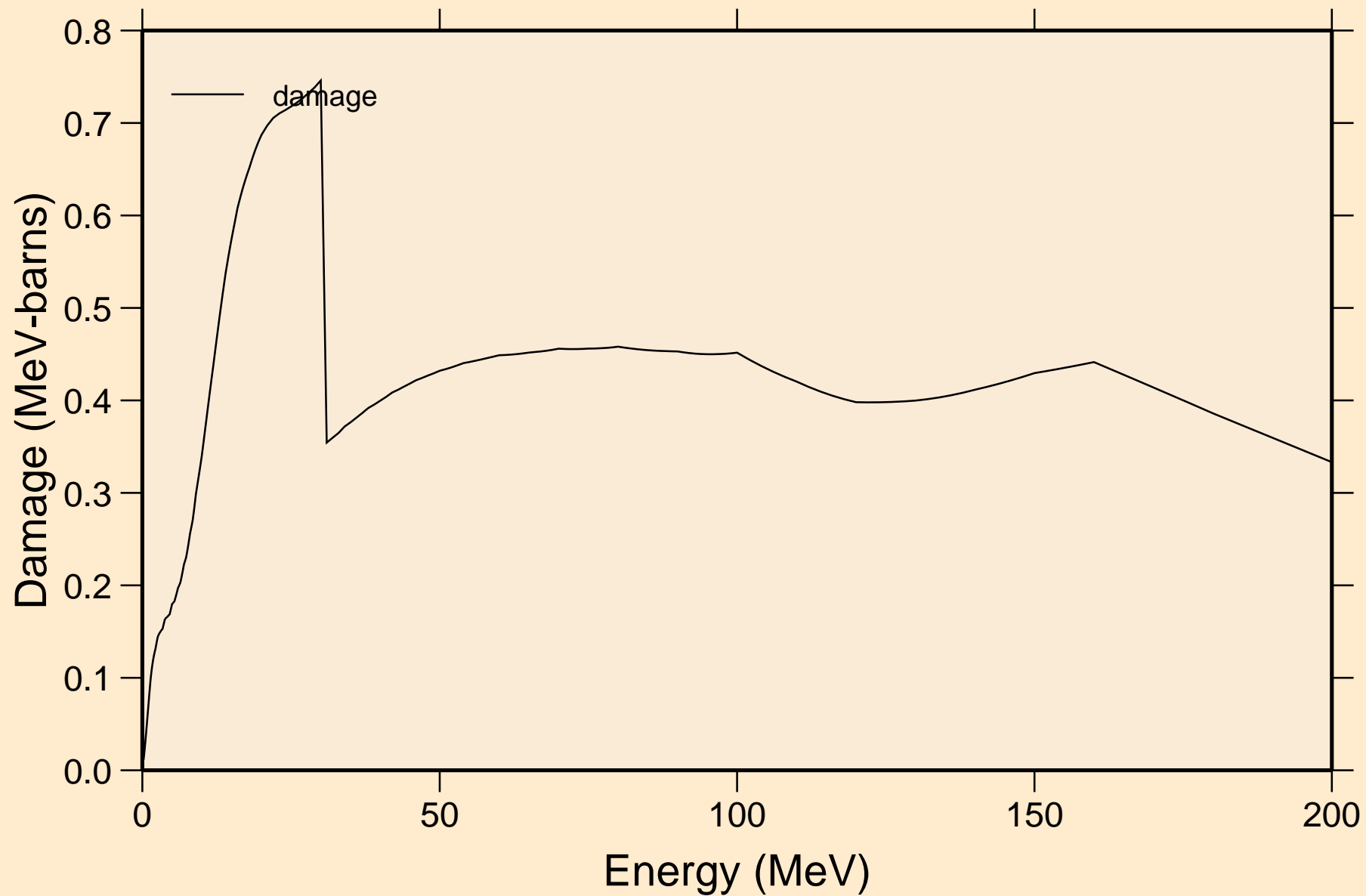

CS135M NEUTRON ACER TENDL-2019 LIBRARY; T=293.16K  
Non-threshold reactions

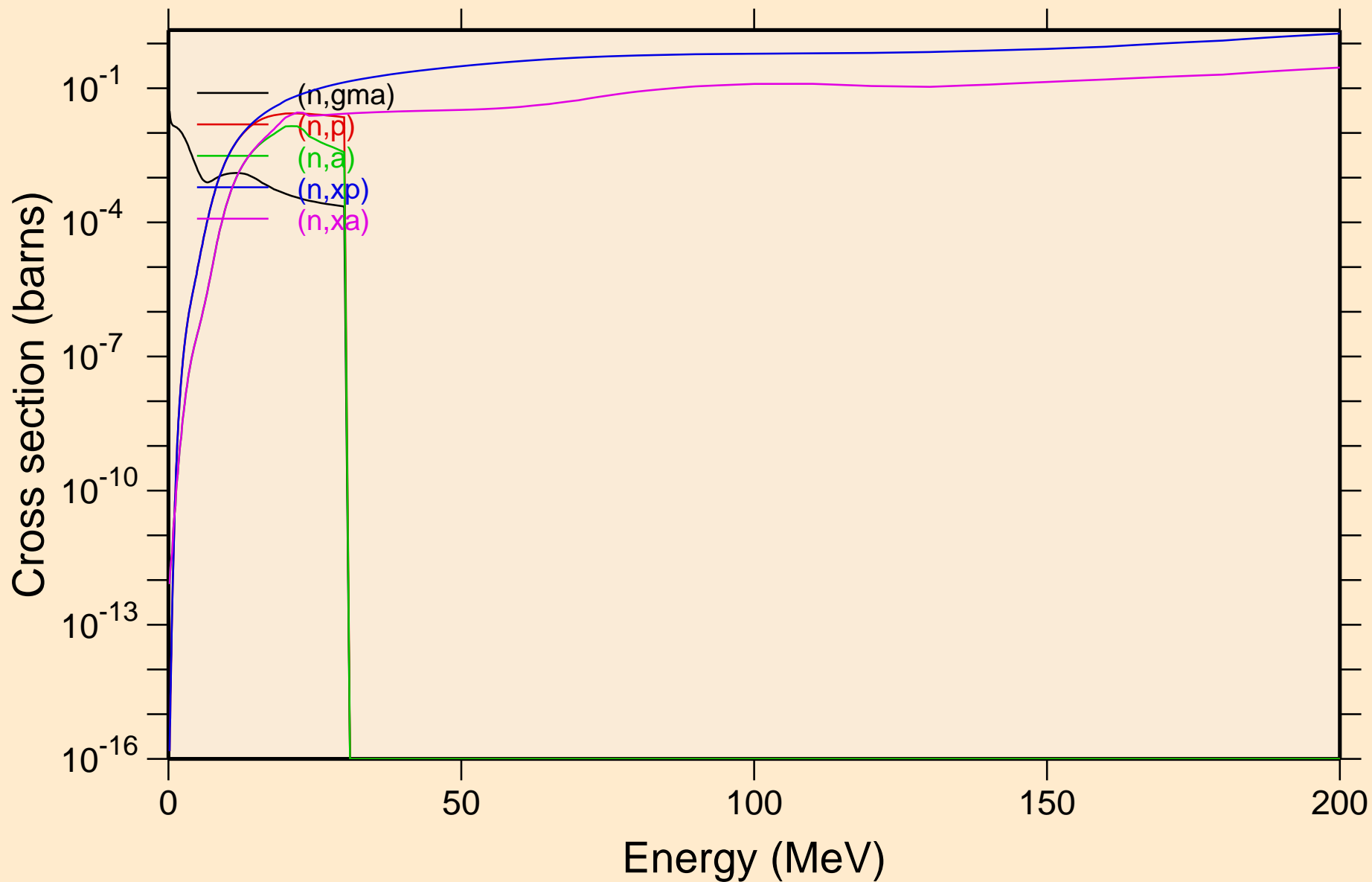



CS135M NEUTRON ACER TENDL-2019 LIBRARY; T=293.16K  
Inelastic levels

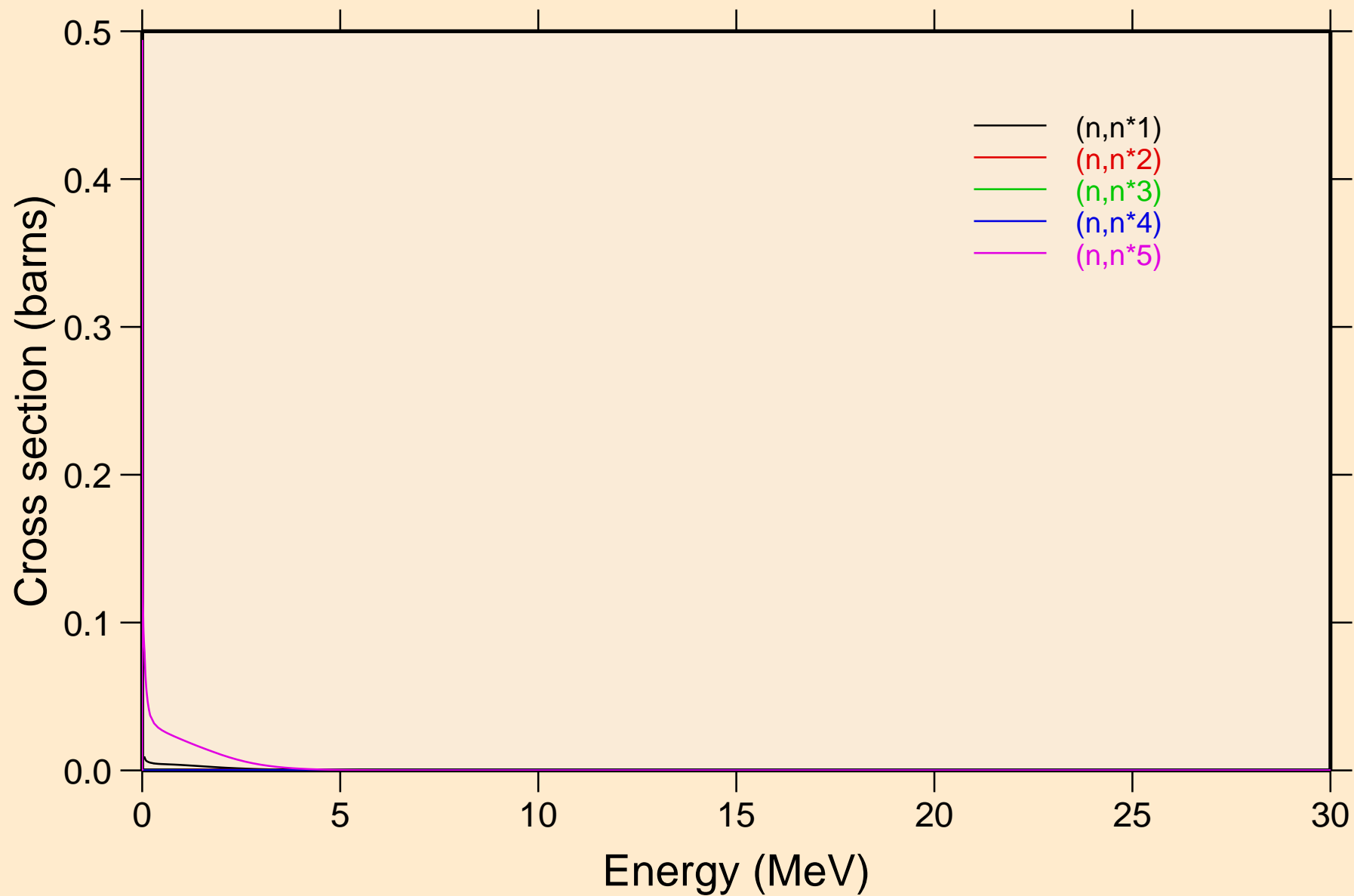

CS135M NEUTRON ACER TENDL-2019 LIBRARY; T=293.16K  
Inelastic levels

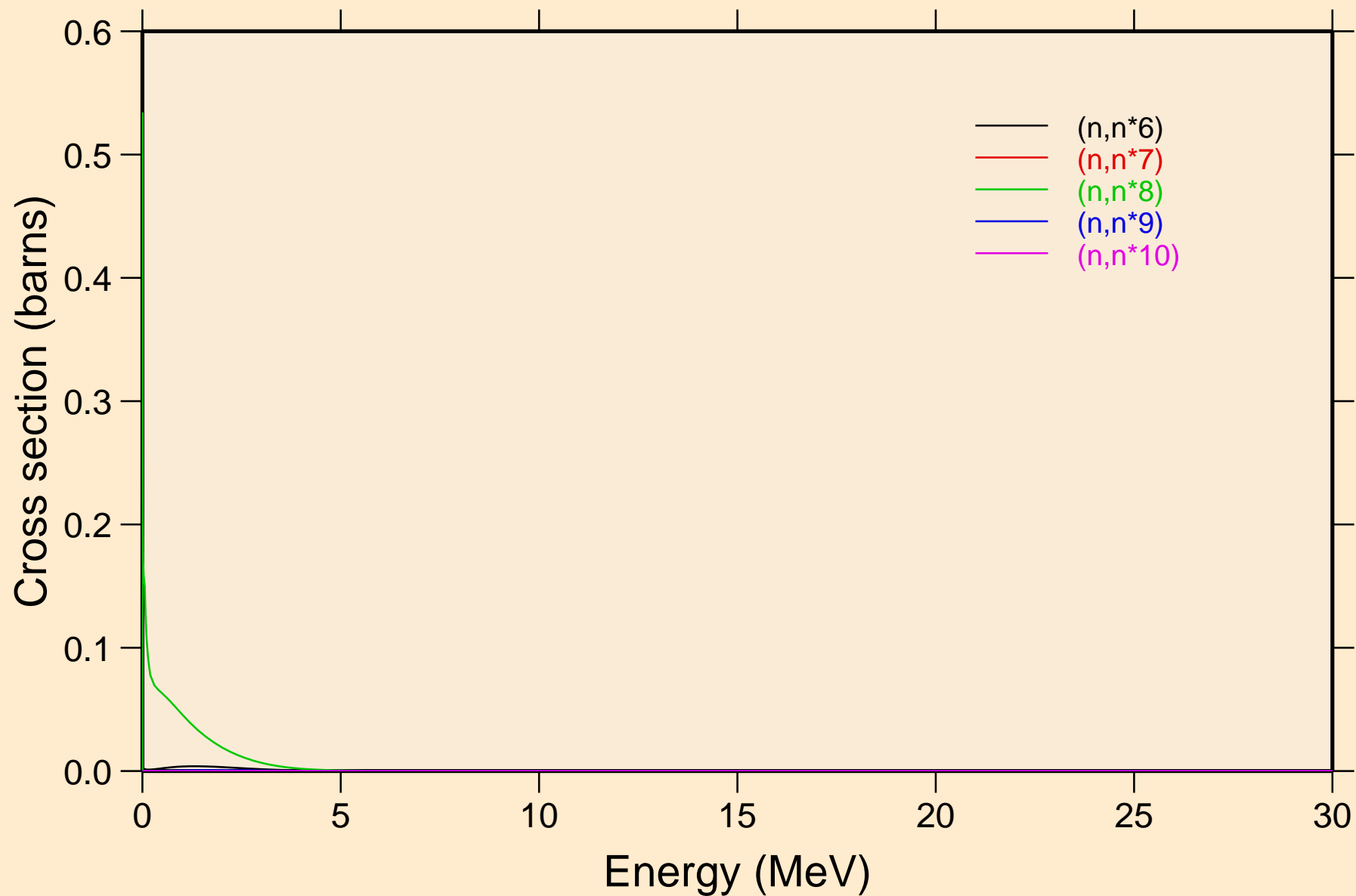

CS135M NEUTRON ACER TENDL-2019 LIBRARY; T=293.16K  
Inelastic levels

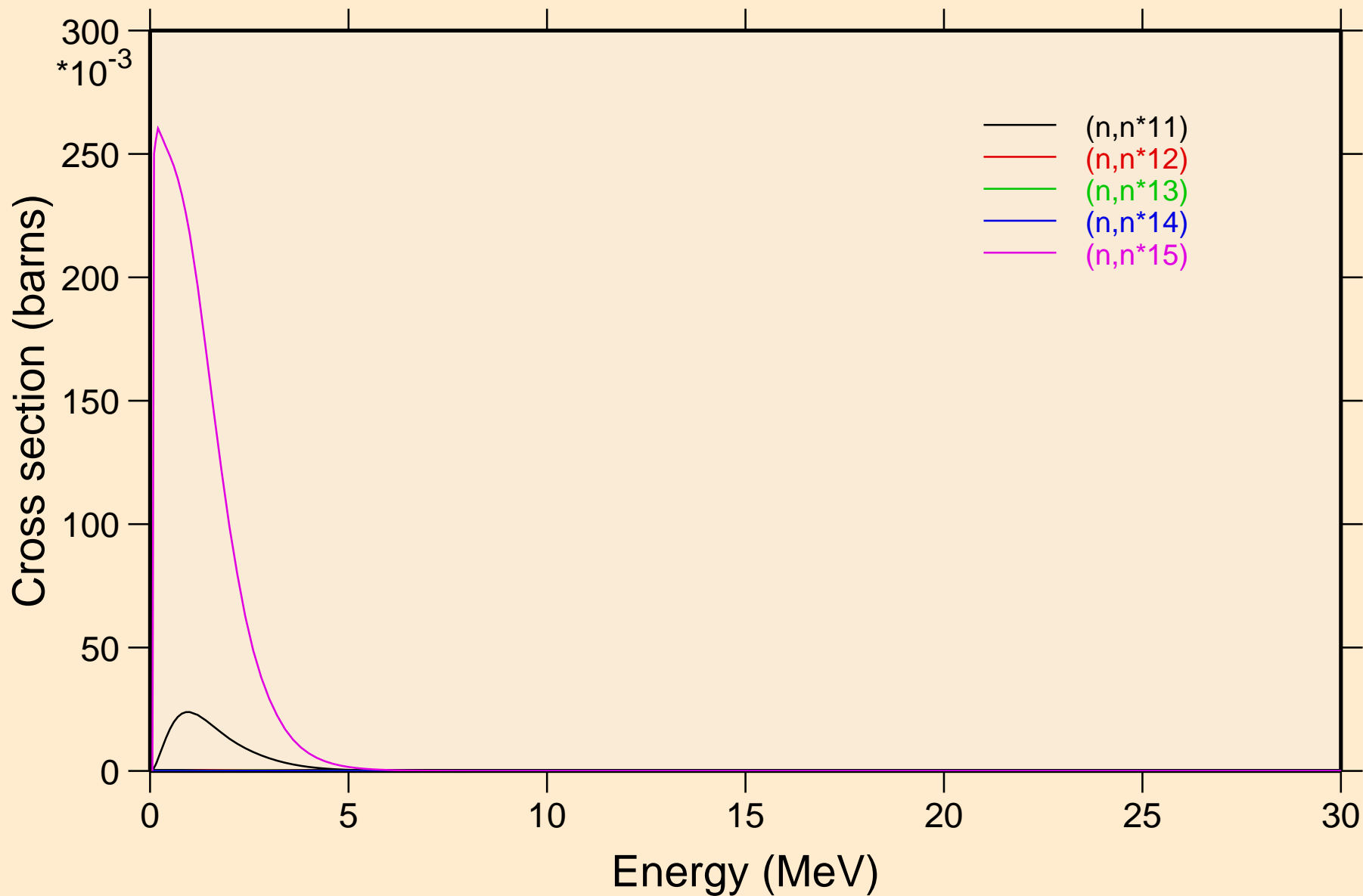

CS135M NEUTRON ACER TENDL-2019 LIBRARY; T=293.16K  
Inelastic levels

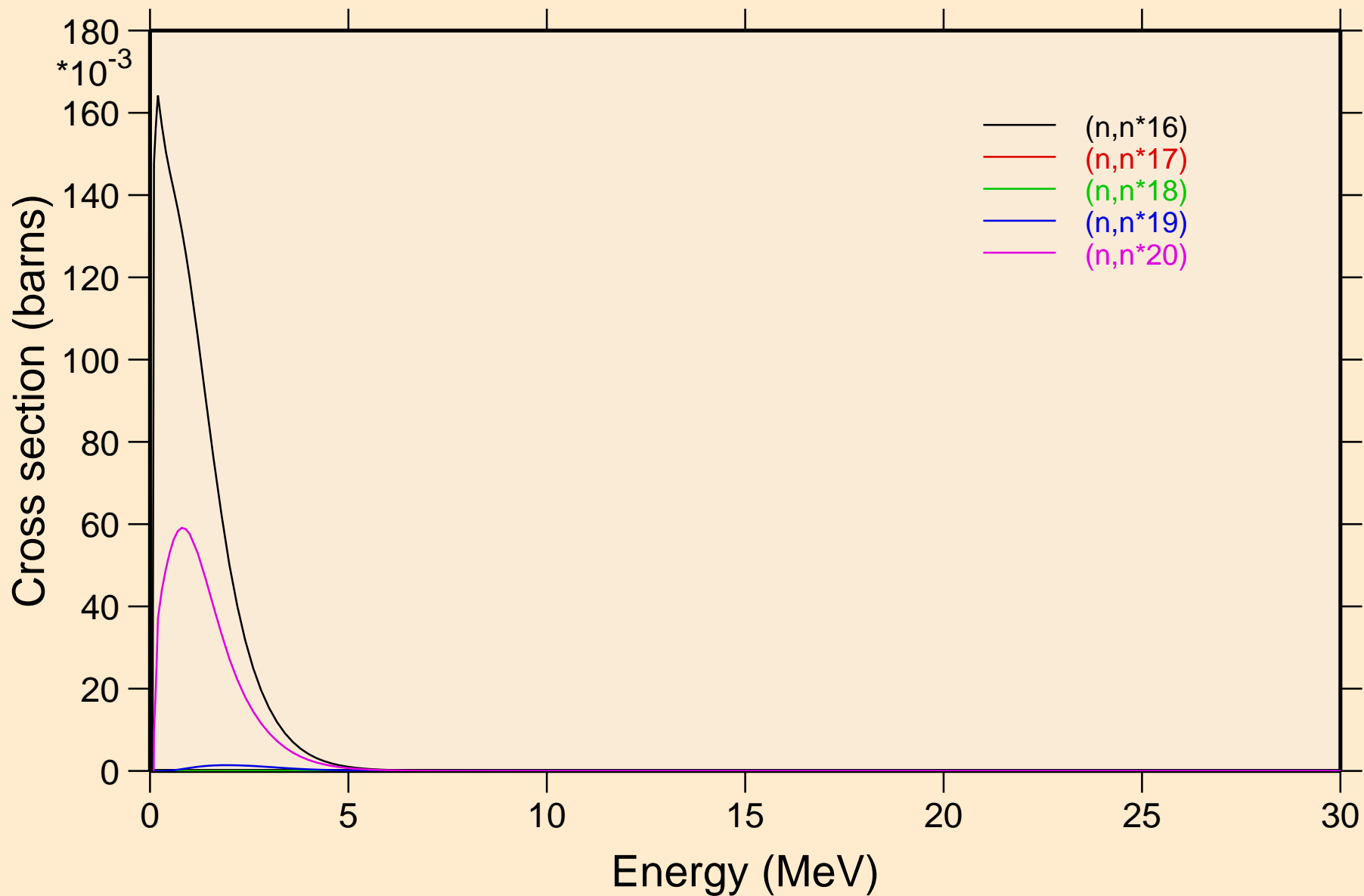

CS135M NEUTRON ACER TENDL-2019 LIBRARY; T=293.16K  
Inelastic levels

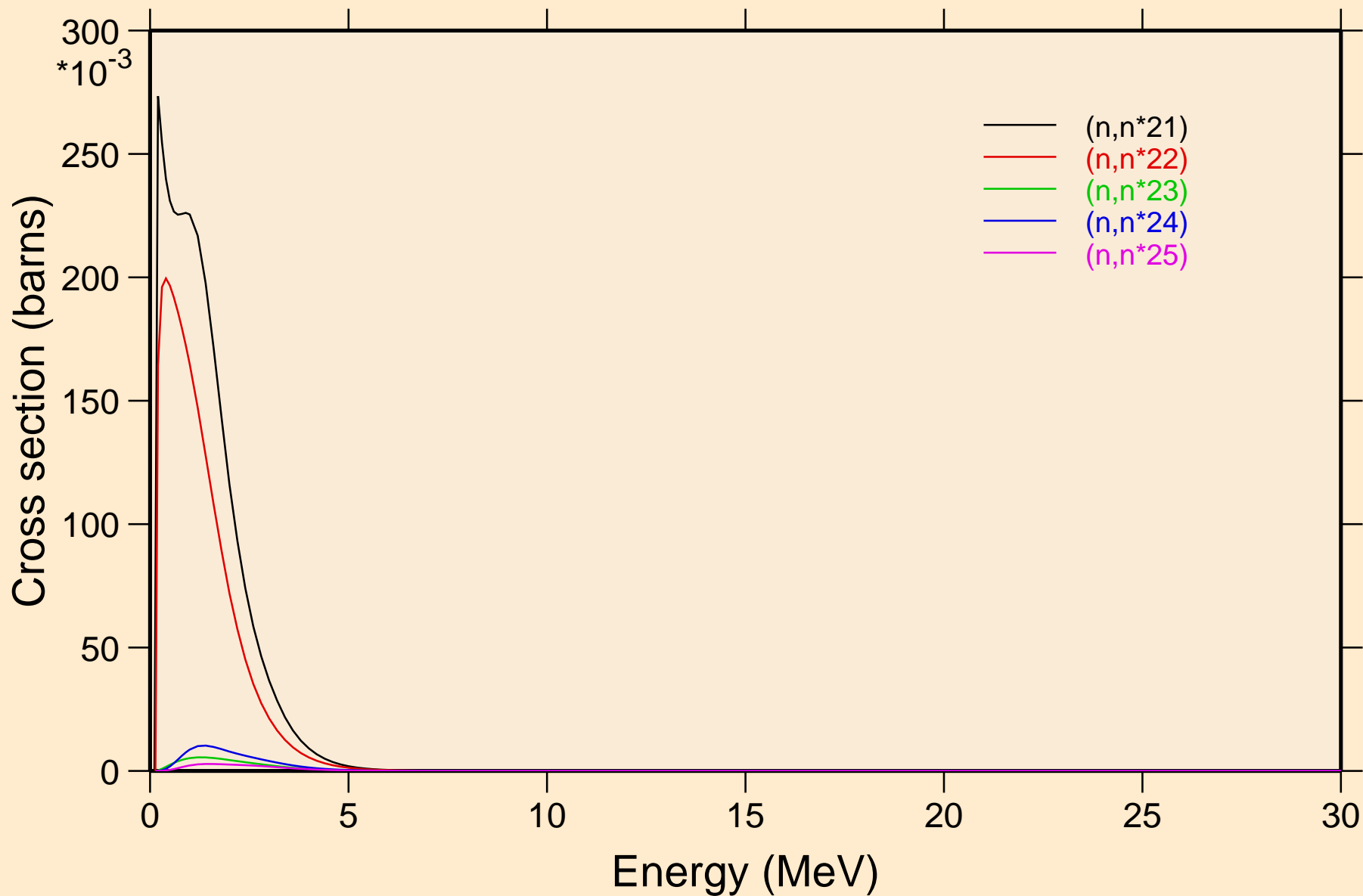

CS135M NEUTRON ACER TENDL-2019 LIBRARY; T=293.16K  
Inelastic levels

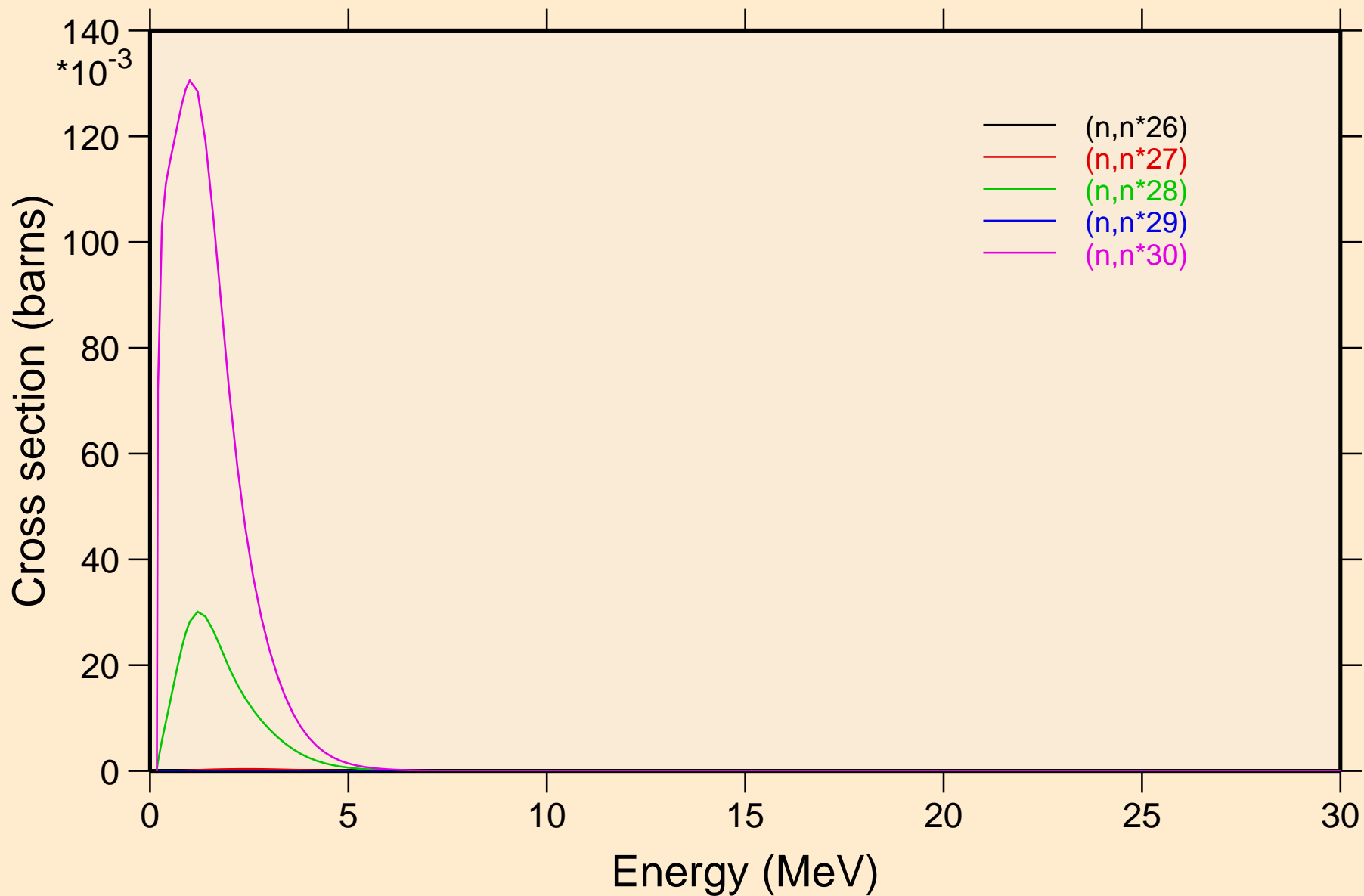

# CS135M NEUTRON ACER TENDL-2019 LIBRARY; T=293.16K

## Threshold reactions

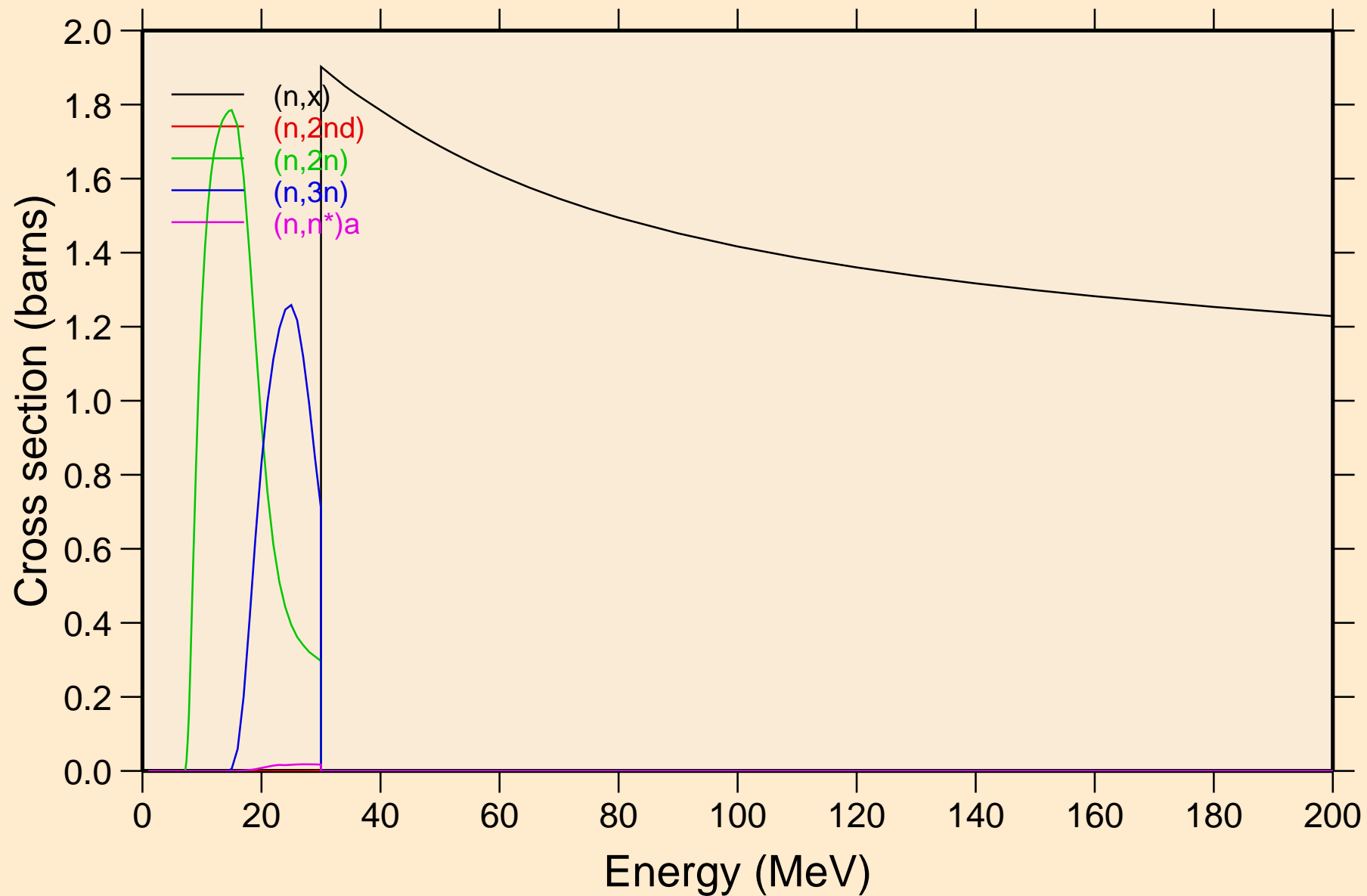

# CS135M NEUTRON ACER TENDL-2019 LIBRARY; T=293.16K

## Threshold reactions

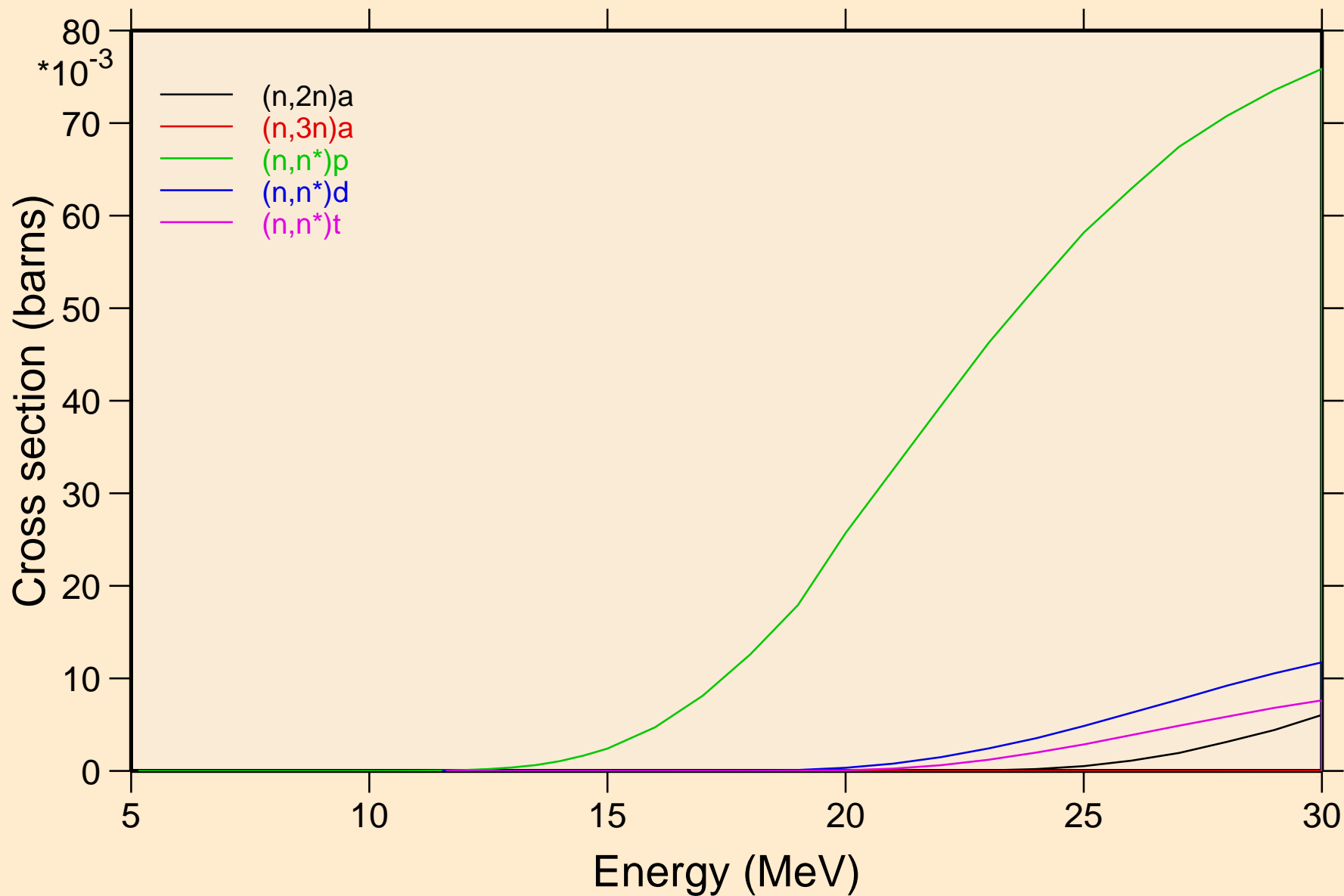



CS135M NEUTRON ACER TENDL-2019 LIBRARY; T=293.16K  
Threshold reactions

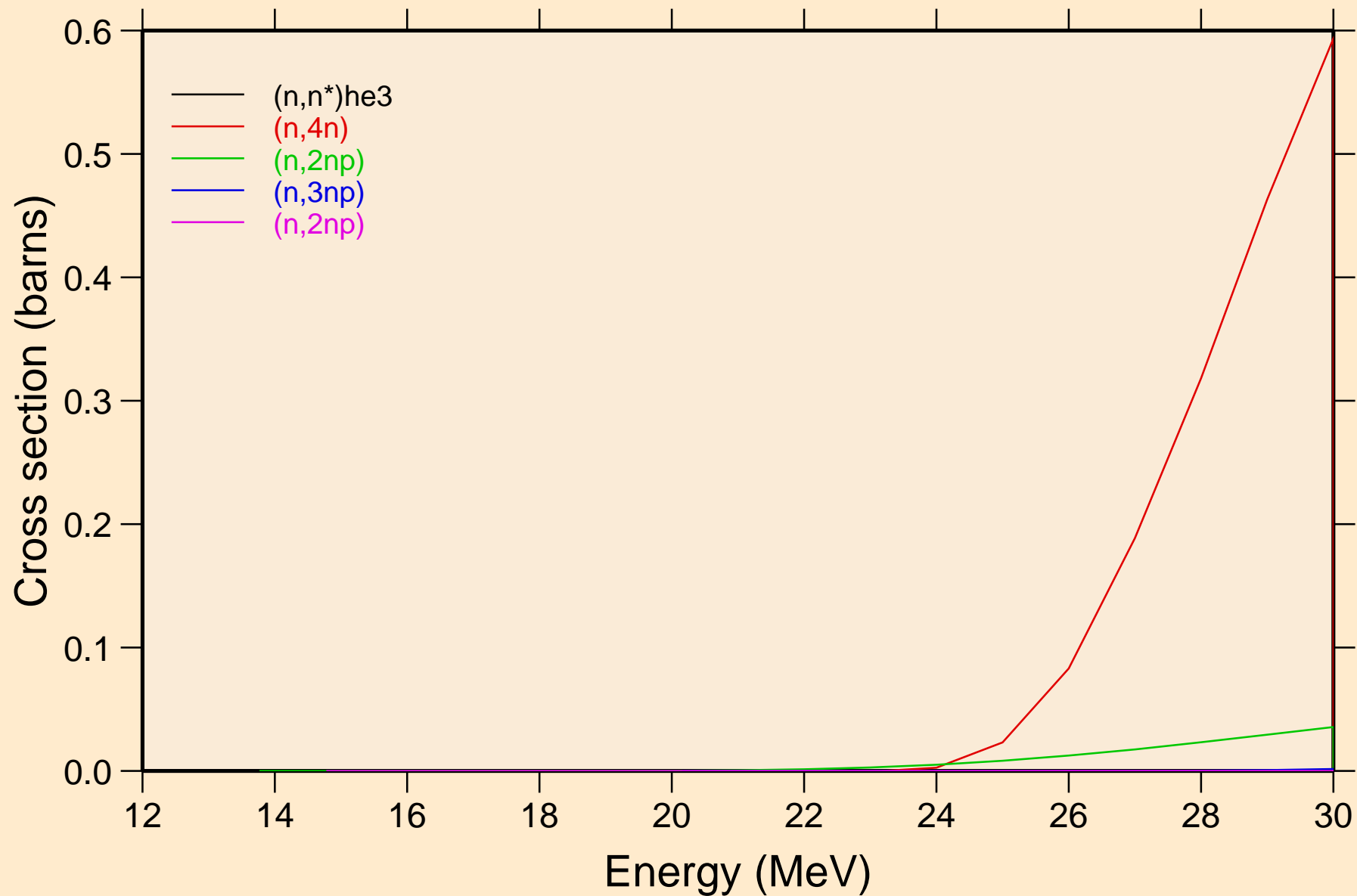

CS135M NEUTRON ACER TENDL-2019 LIBRARY; T=293.16K  
Threshold reactions

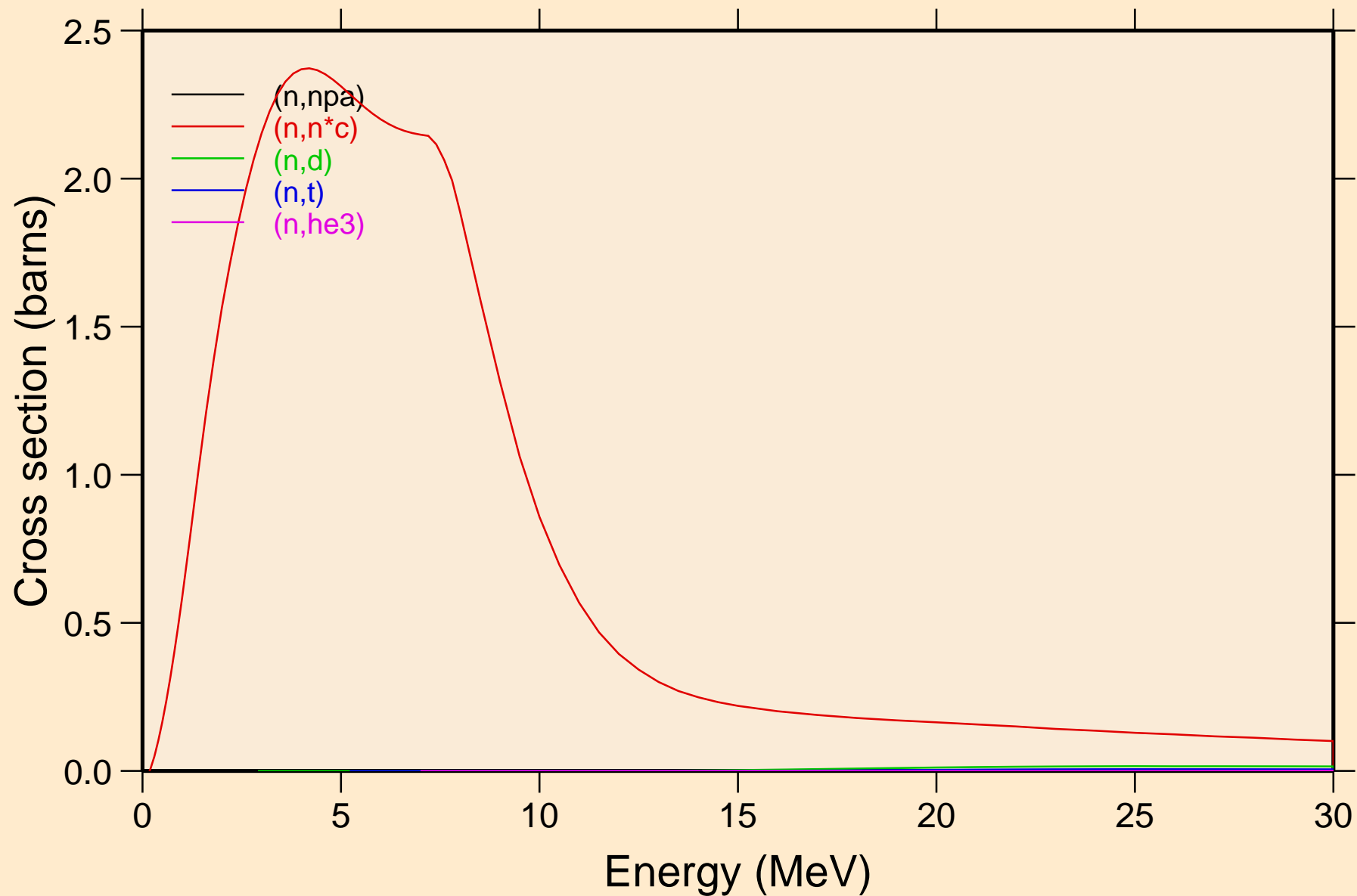

CS135M NEUTRON ACER TENDL-2019 LIBRARY; T=293.16K  
Threshold reactions

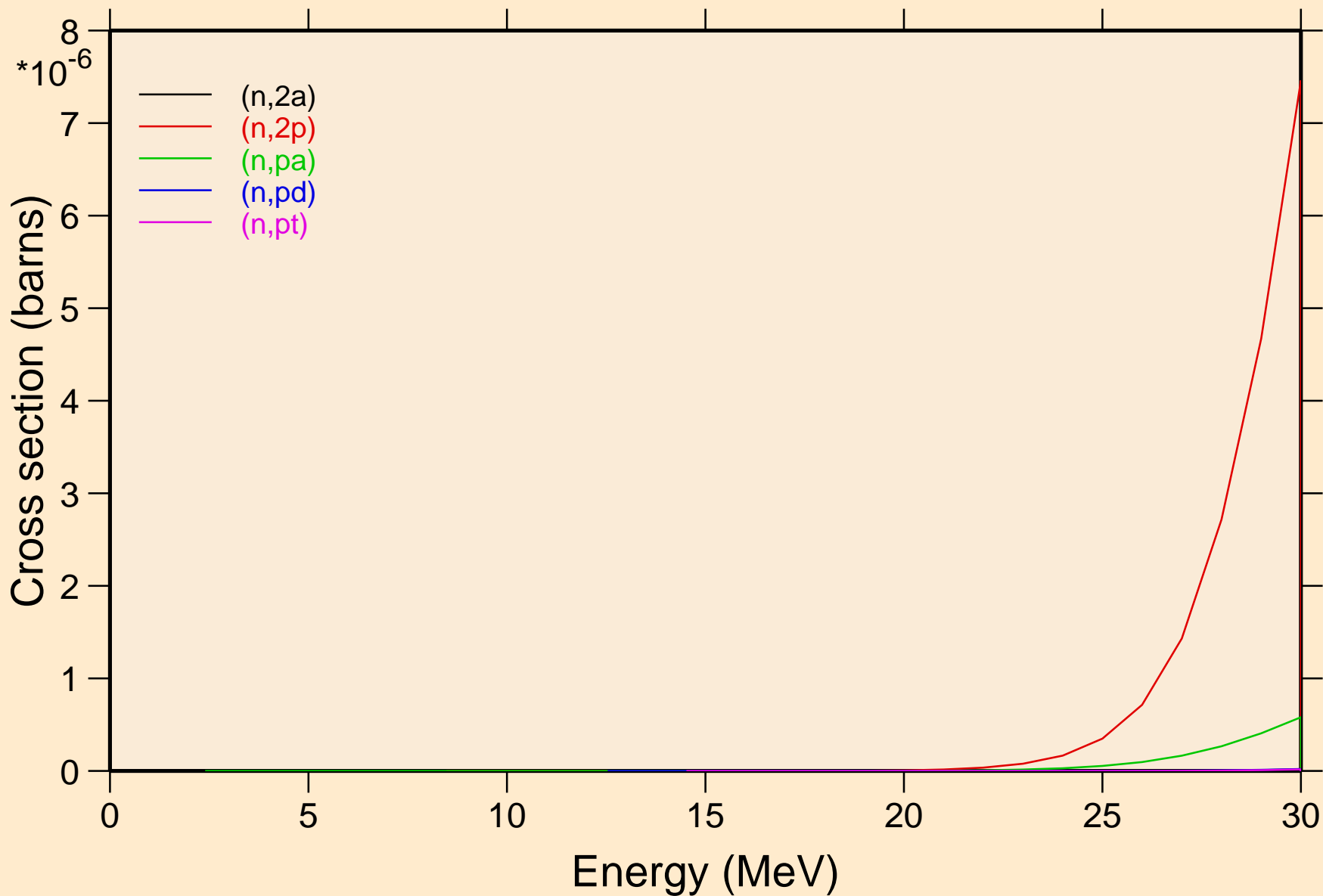

CS135M NEUTRON ACER TENDL-2019 LIBRARY; T=293.16K  
Threshold reactions

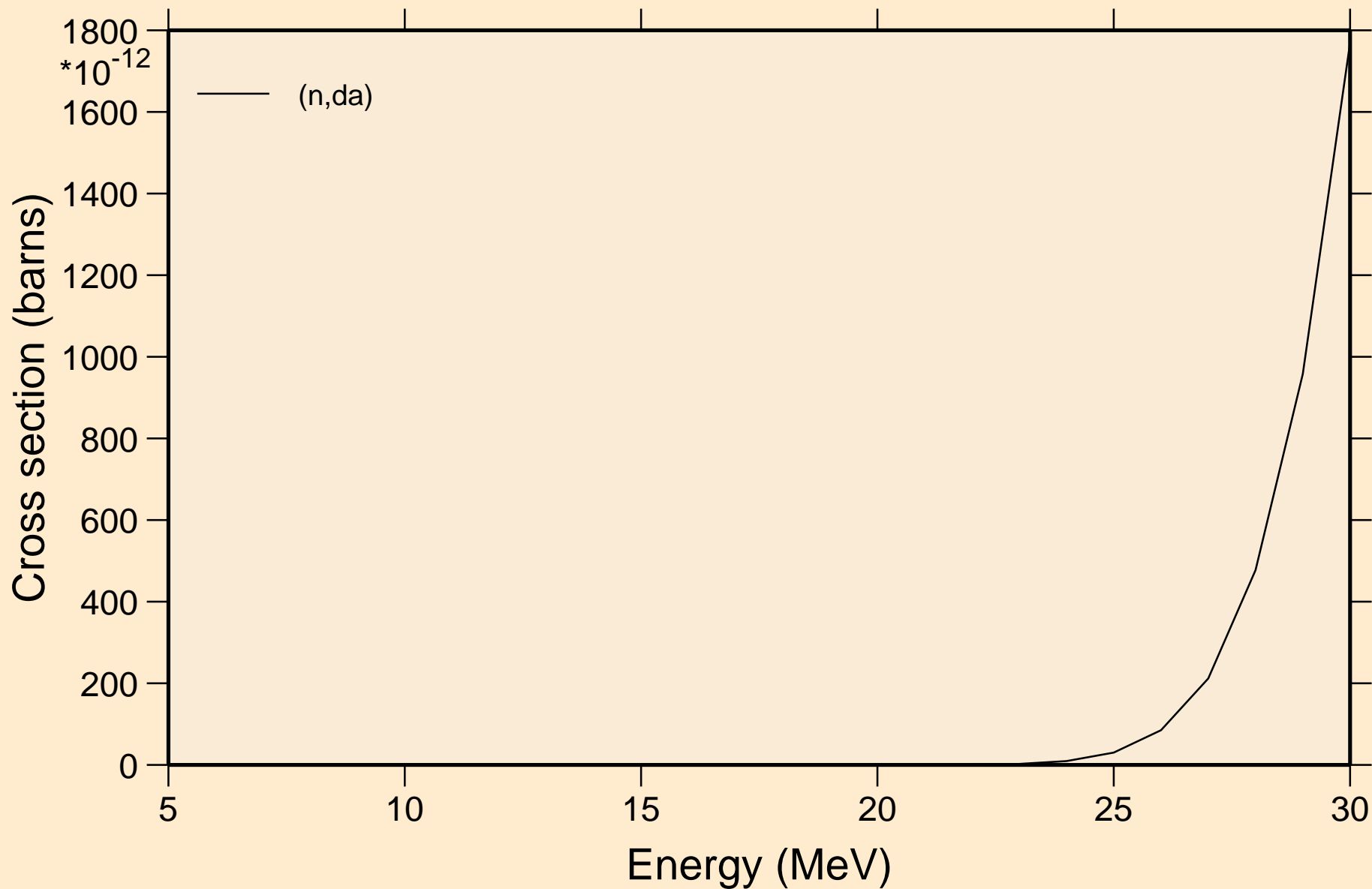

CS135M NEUTRON ACER TENDL-2019 LIBRARY; T=293.16K  
Threshold reactions

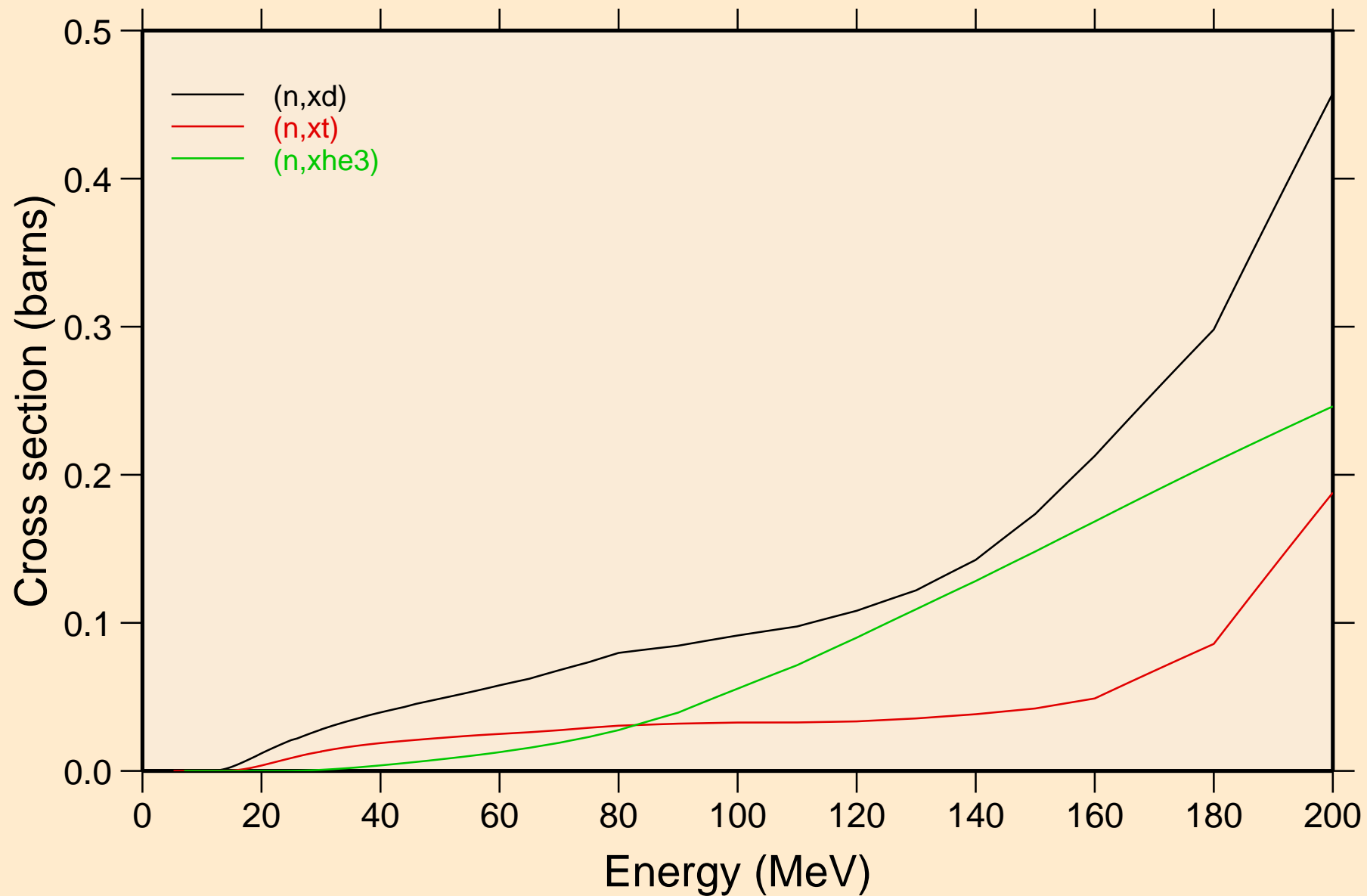

CS135M NEUTRON ACER TENDL-2019 LIBRARY; T=293.16K  
angular distribution for elastic

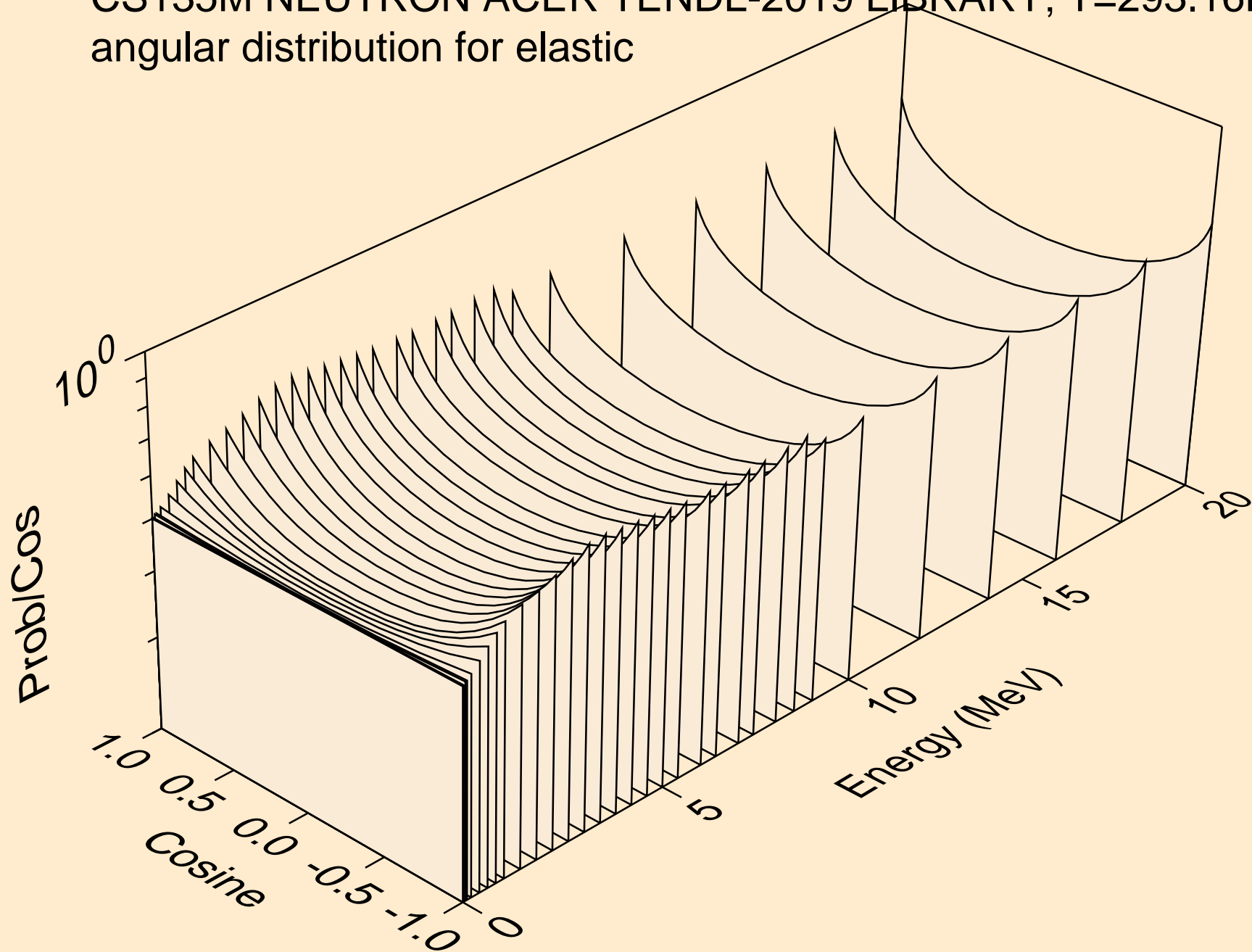

CS135M NEUTRON ACER TENDL-2019 LIBRARY; T=293.16K  
angular distribution for elastic

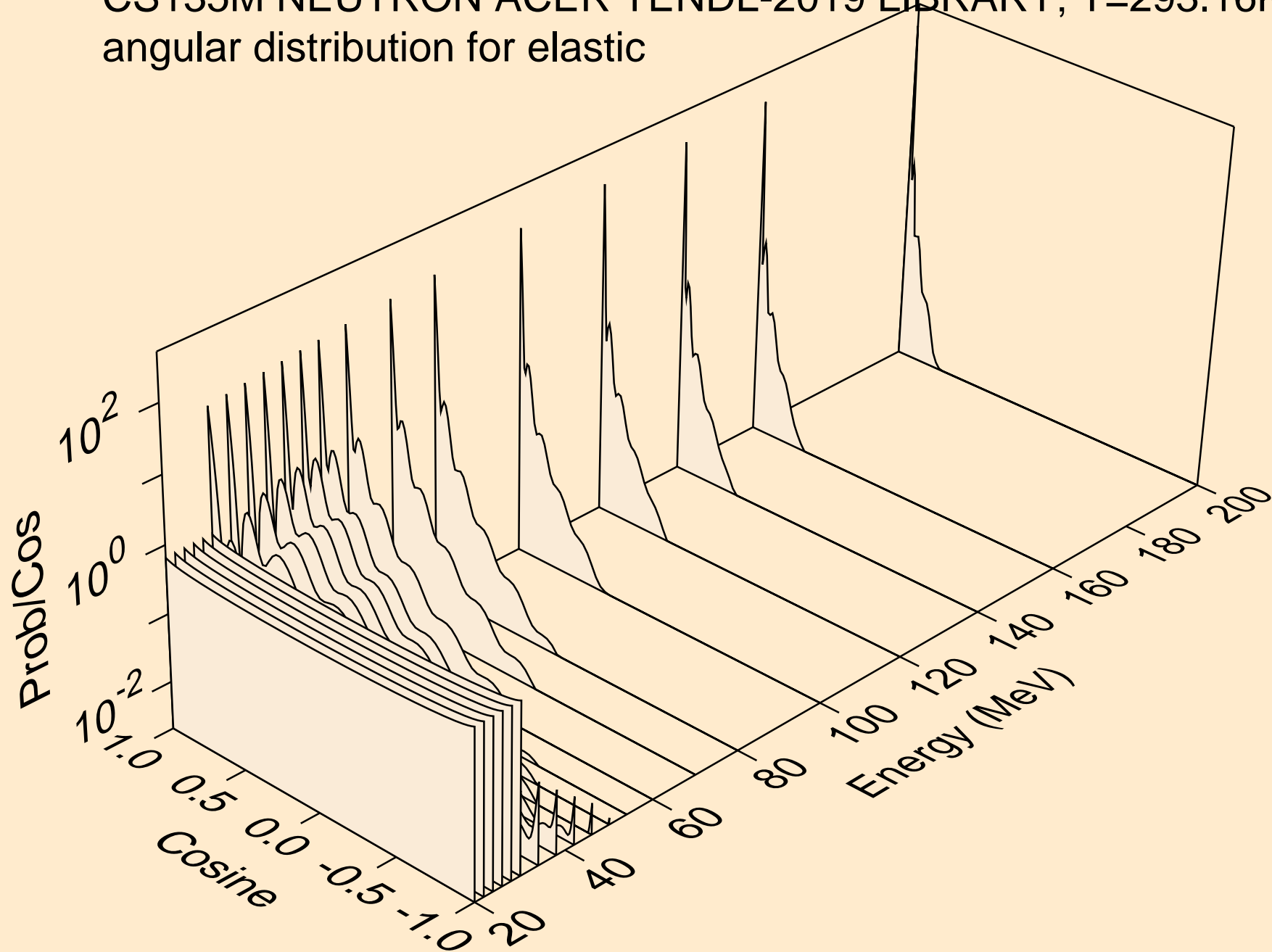

CS135M NEUTRON ACER TENDL-2019 LIBRARY; T=293.16K  
angular distribution for (n,n\*1)

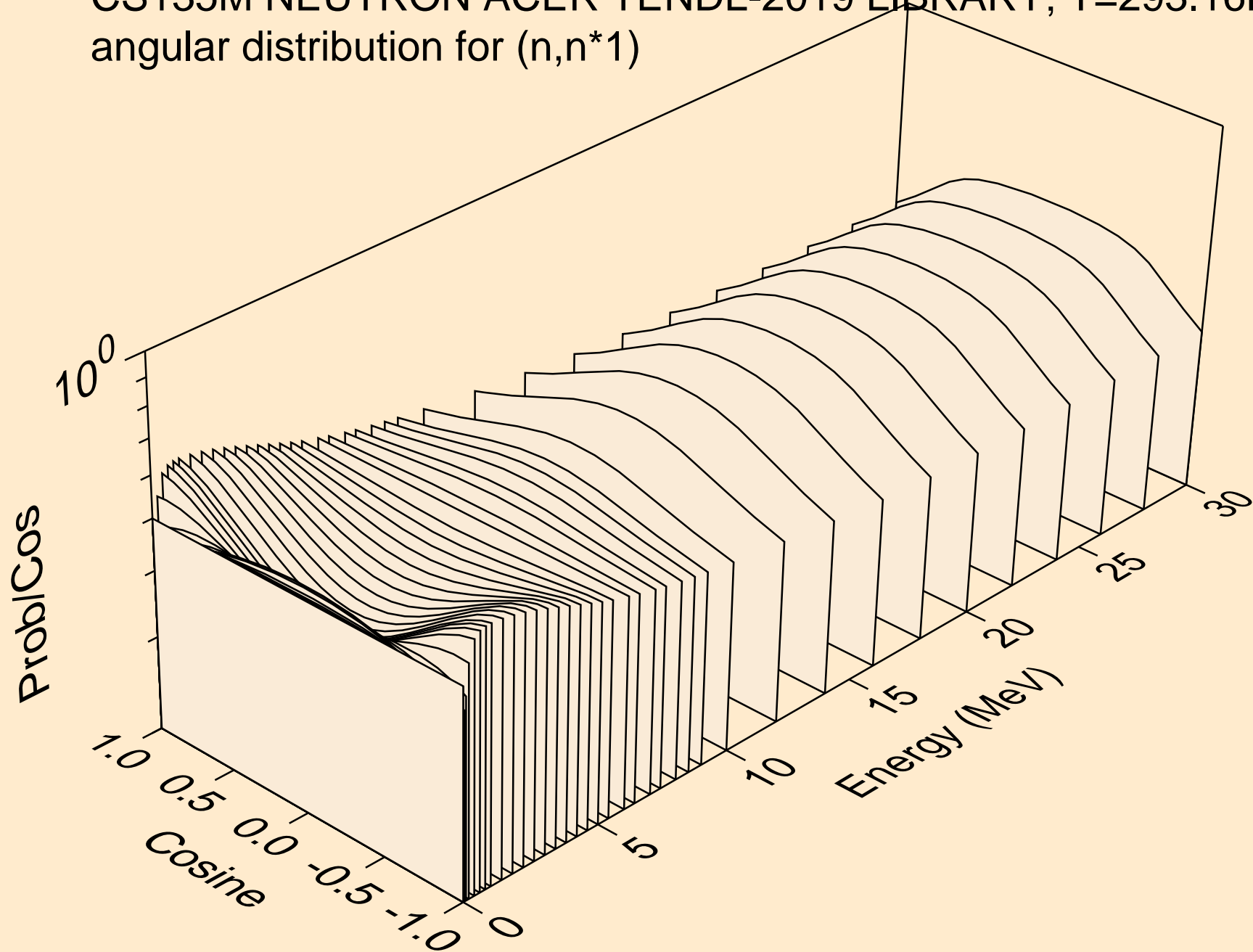



CS135M NEUTRON ACER TENDL-2019 LIBRARY; T=293.16K  
angular distribution for (n,n\*2)

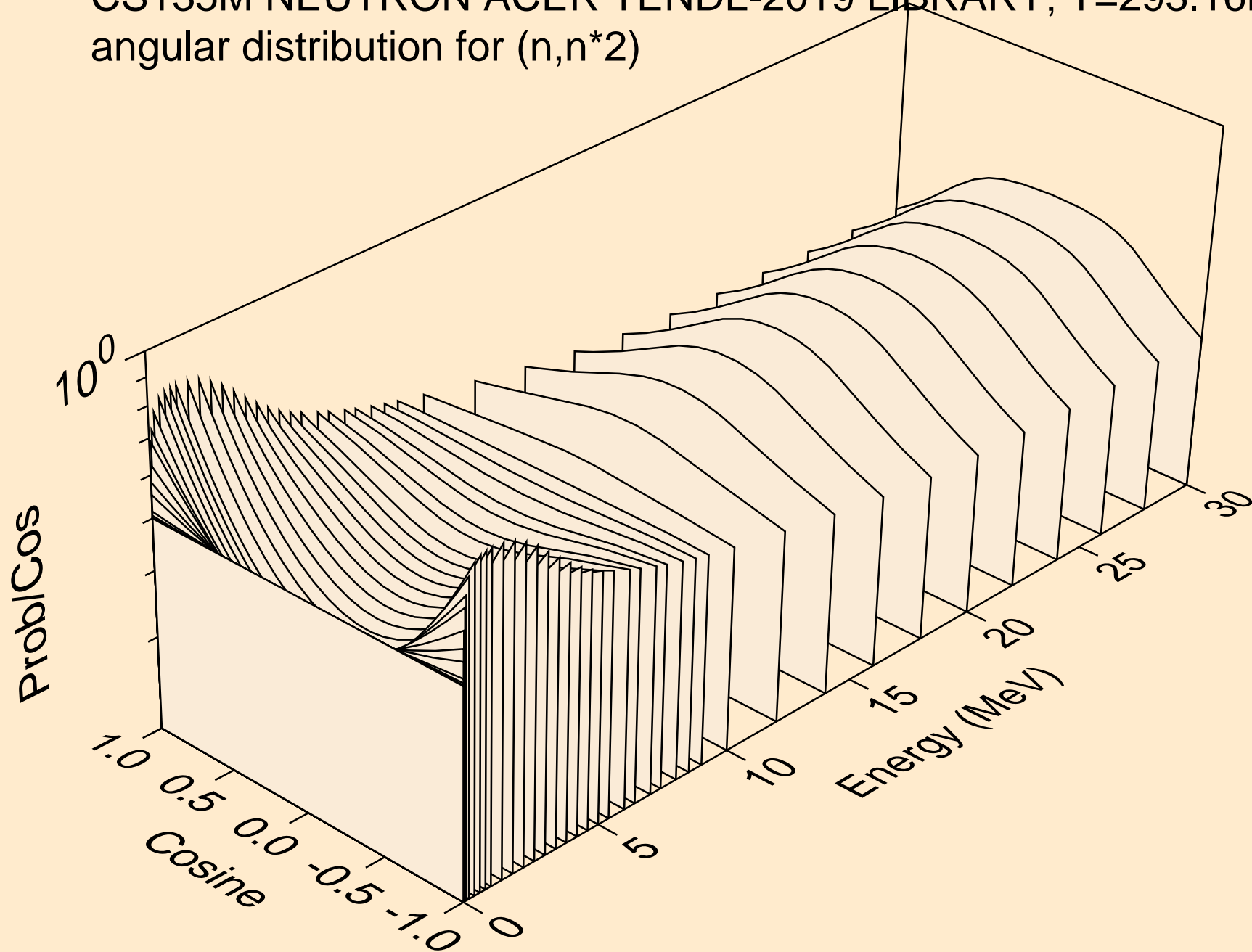

CS135M NEUTRON ACER TENDL-2019 LIBRARY; T=293.16K  
angular distribution for (n,n\*3)

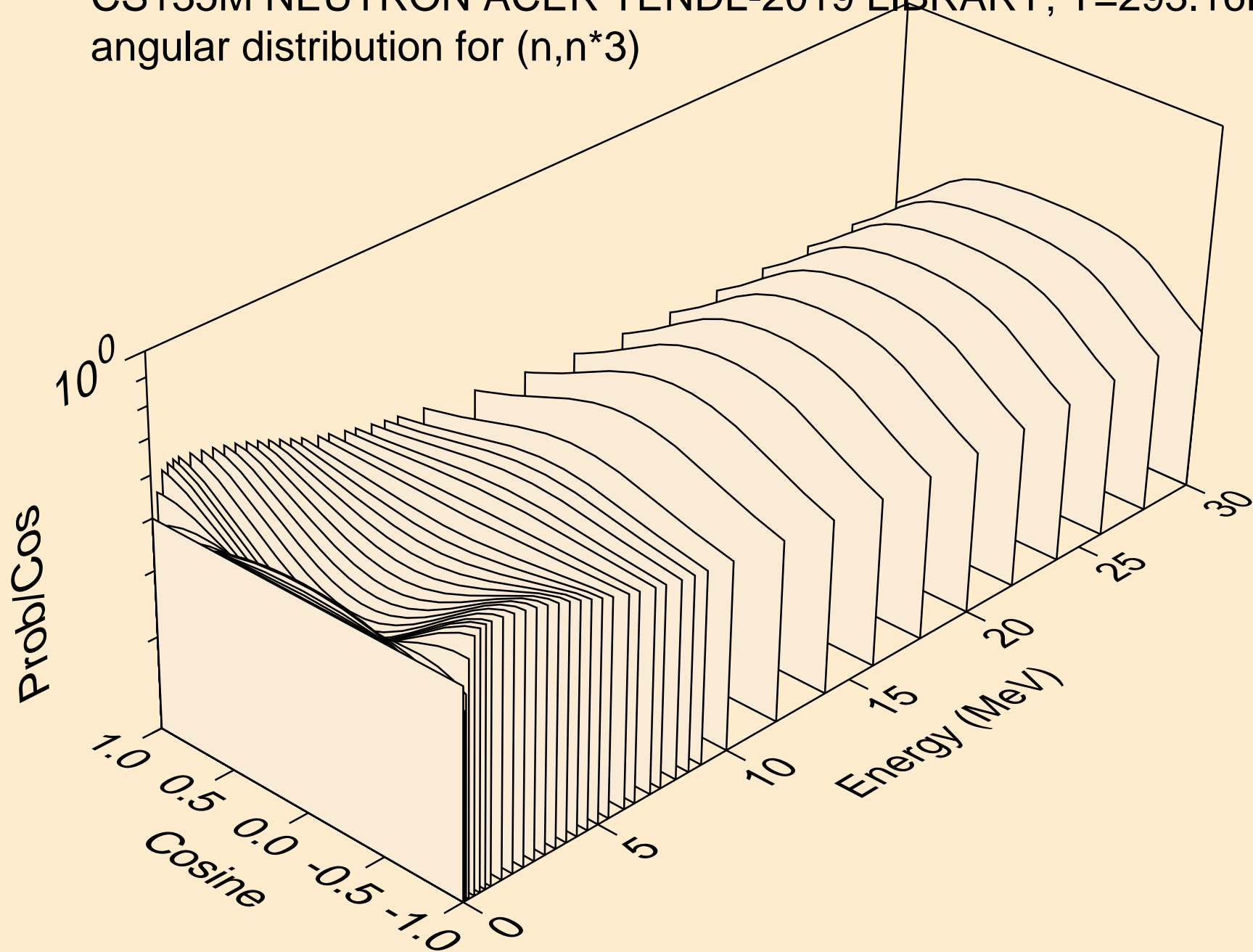

CS135M NEUTRON ACER TENDL-2019 LIBRARY; T=293.16K  
angular distribution for (n,n\*4)

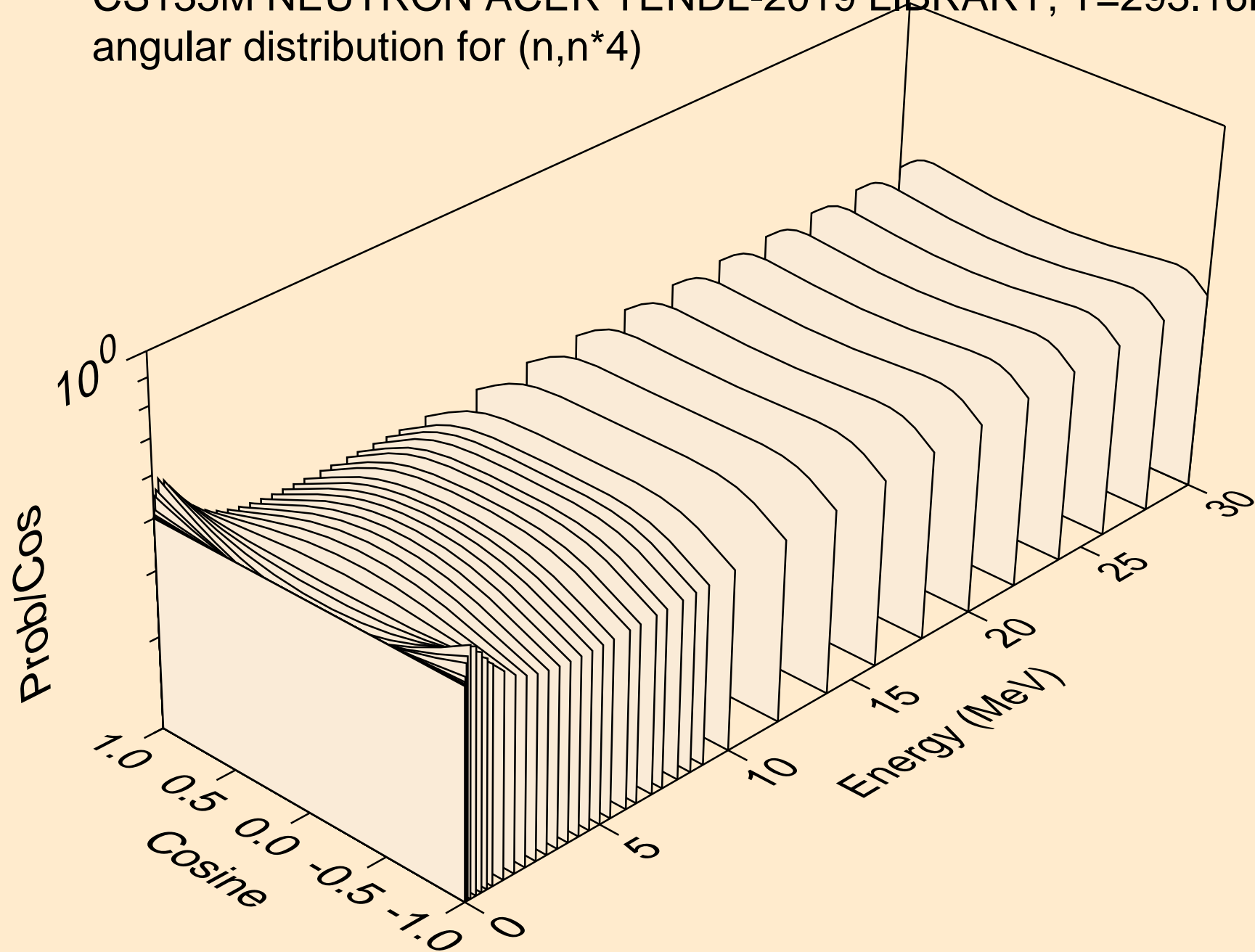

CS135M NEUTRON ACER TENDL-2019 LIBRARY; T=293.16K  
angular distribution for (n,n\*5)

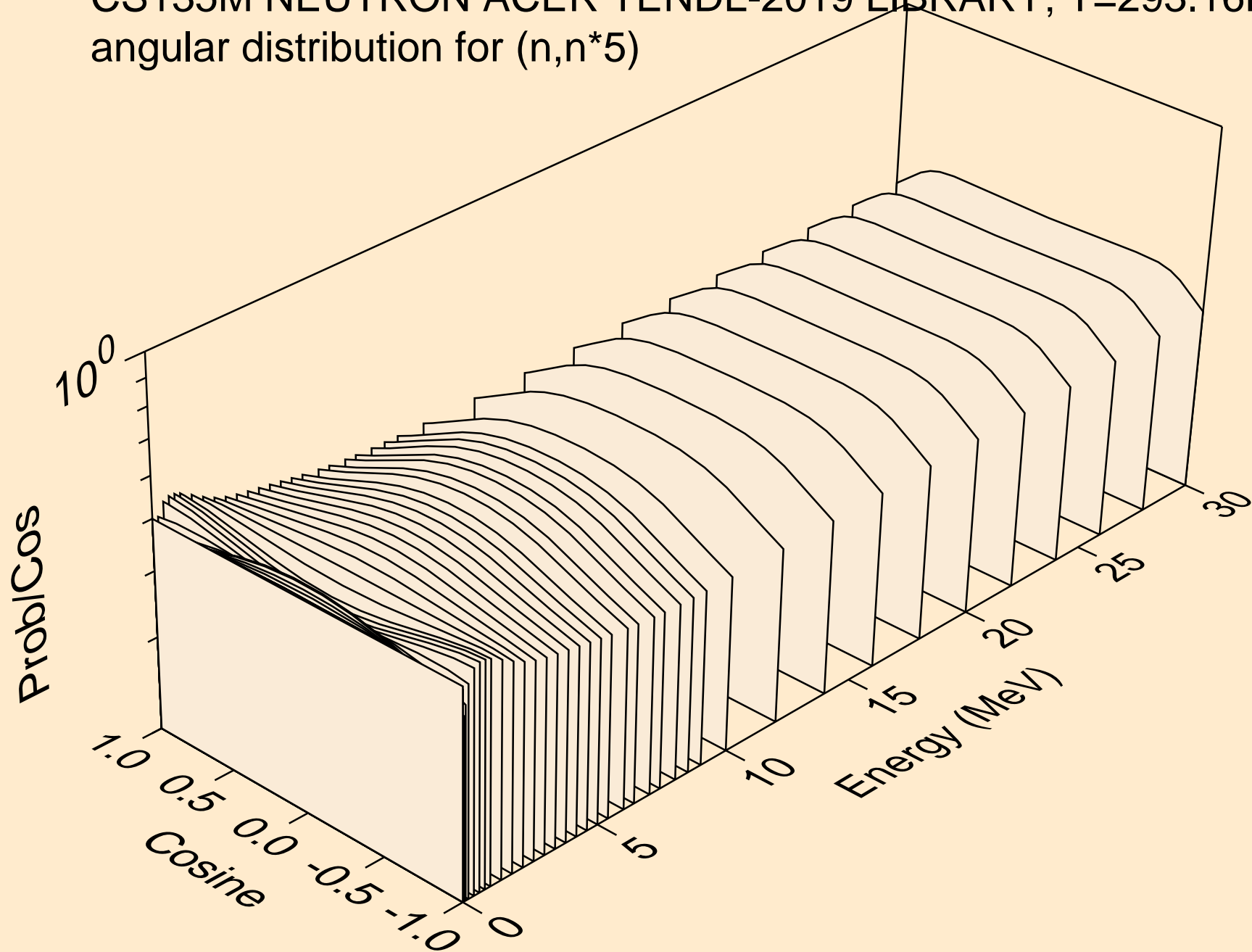

CS135M NEUTRON ACER TENDL-2019 LIBRARY; T=293.16K  
angular distribution for (n,n\*6)

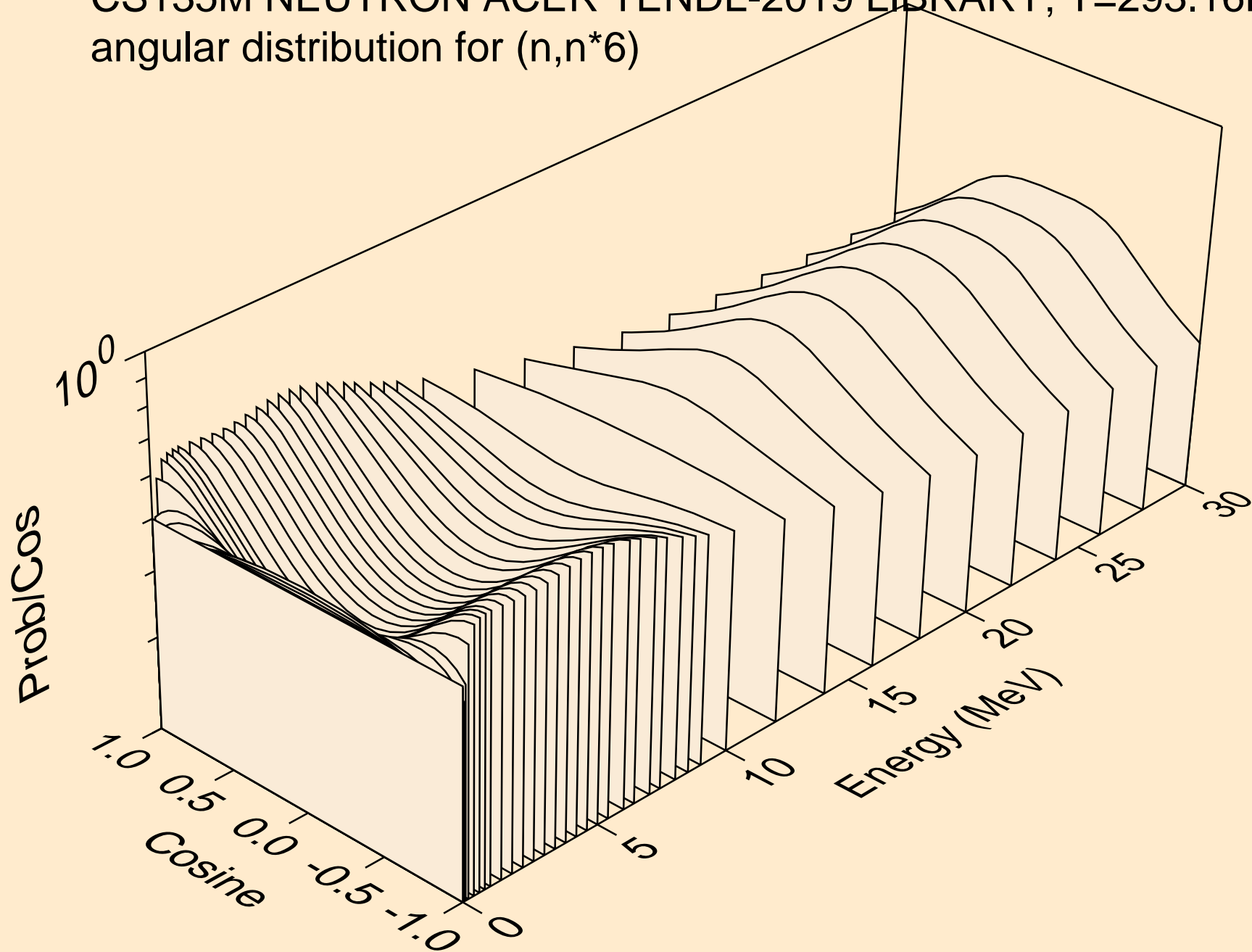

CS135M NEUTRON ACER TENDL-2019 LIBRARY; T=293.16K  
angular distribution for (n,n\*7)

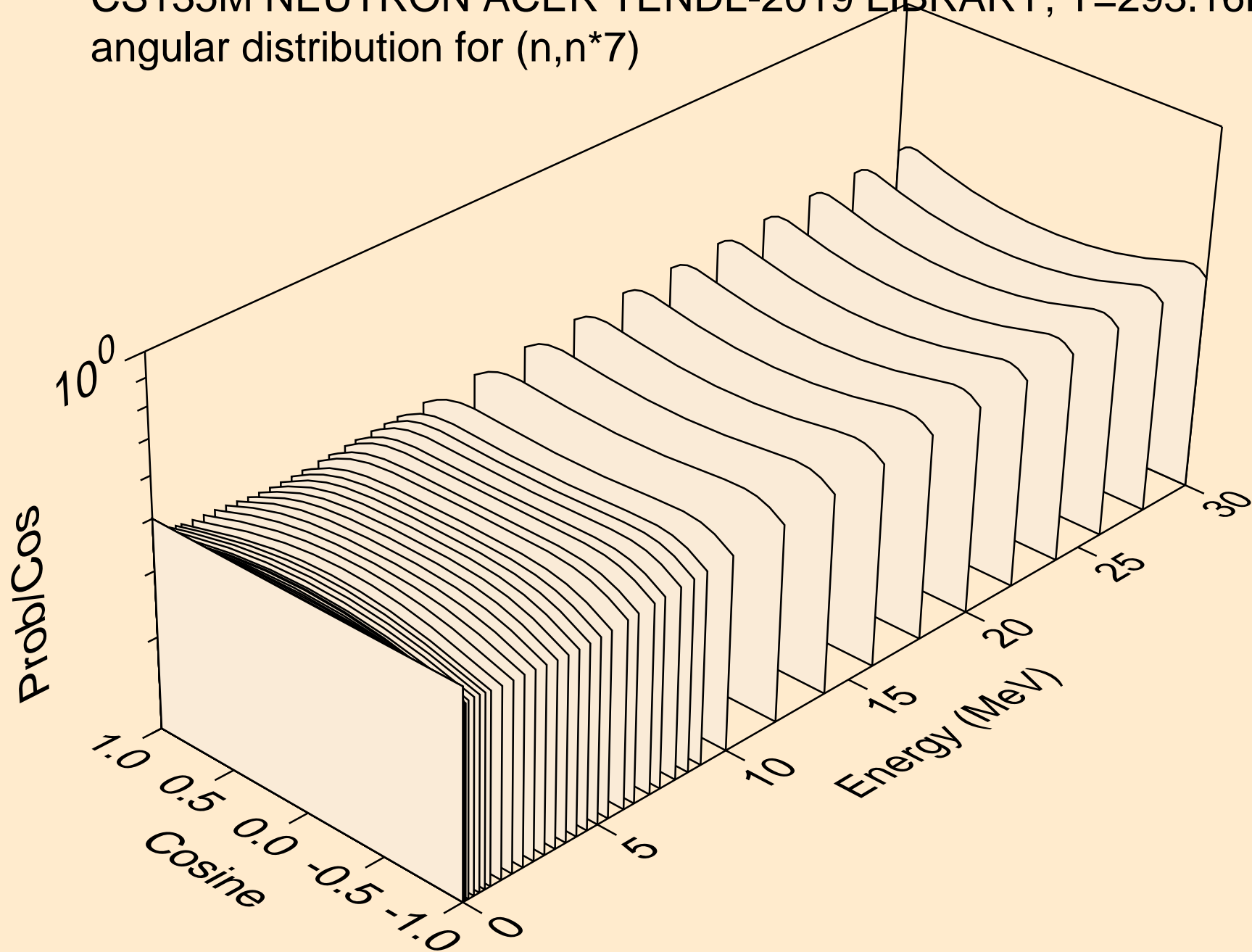

CS135M NEUTRON ACER TENDL-2019 LIBRARY; T=293.16K  
angular distribution for (n,n\*8)

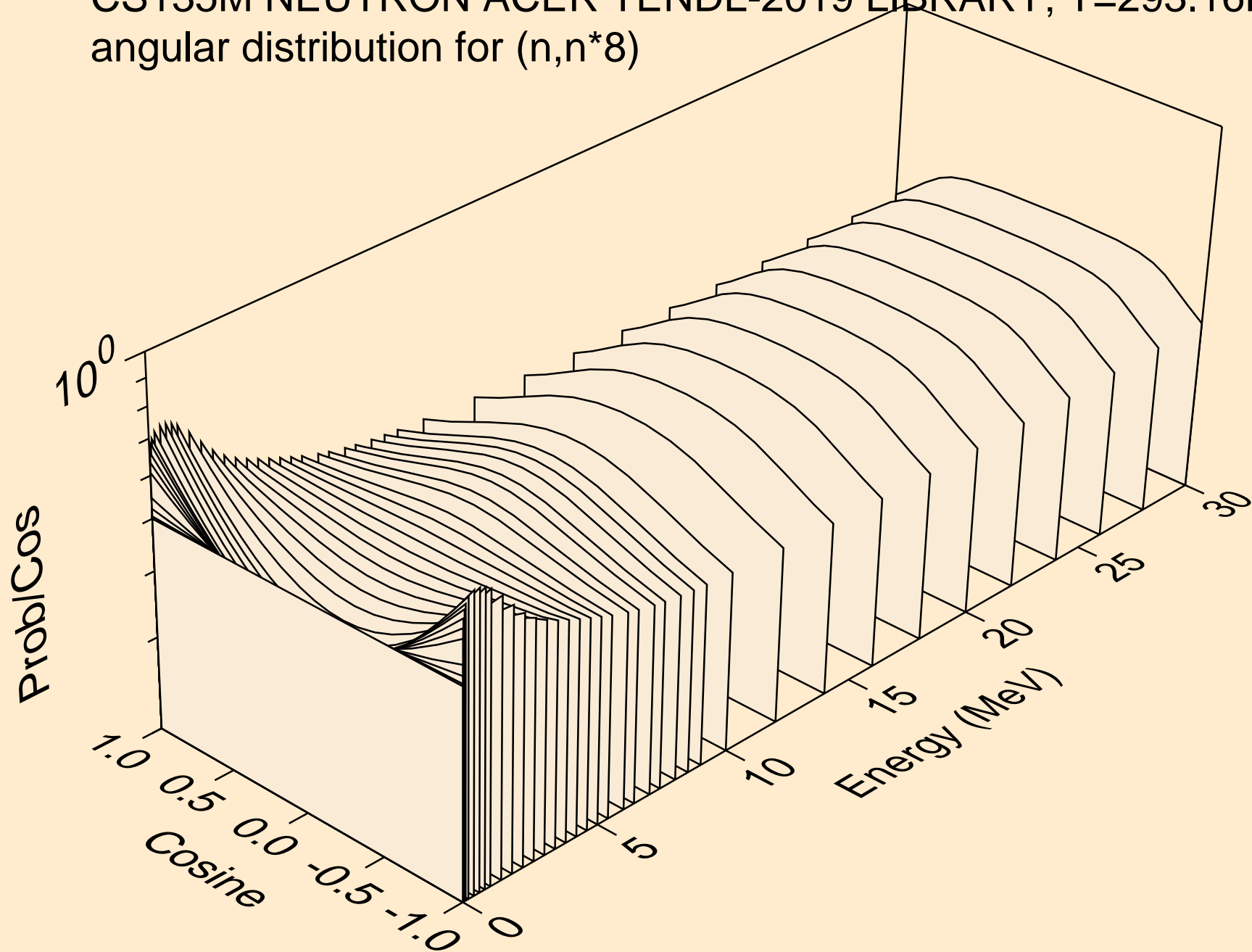

CS135M NEUTRON ACER TENDL-2019 LIBRARY; T=293.16K  
angular distribution for (n,n\*9)

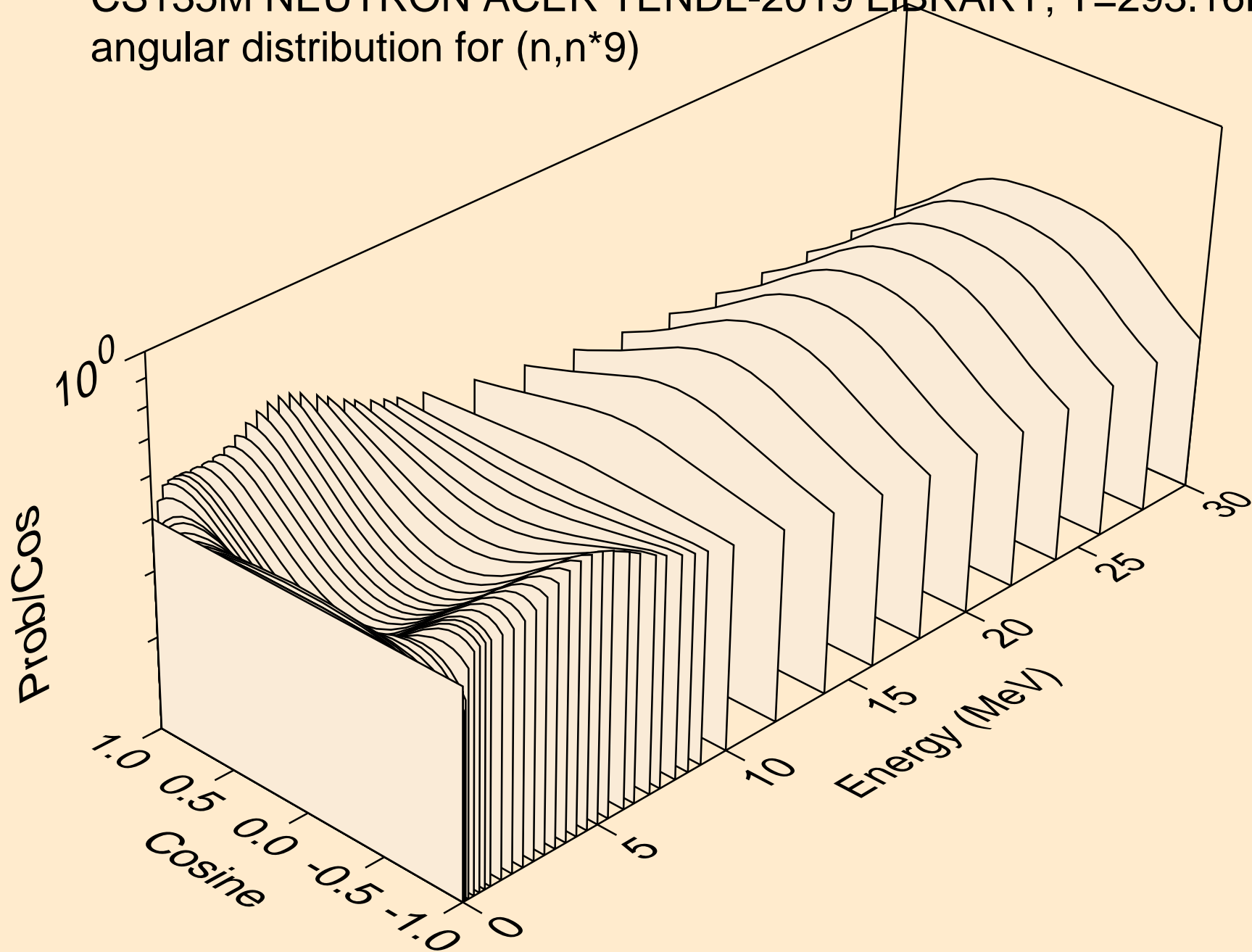



CS135M NEUTRON ACER TENDL-2019 LIBRARY; T=293.16K  
angular distribution for (n,n\*10)

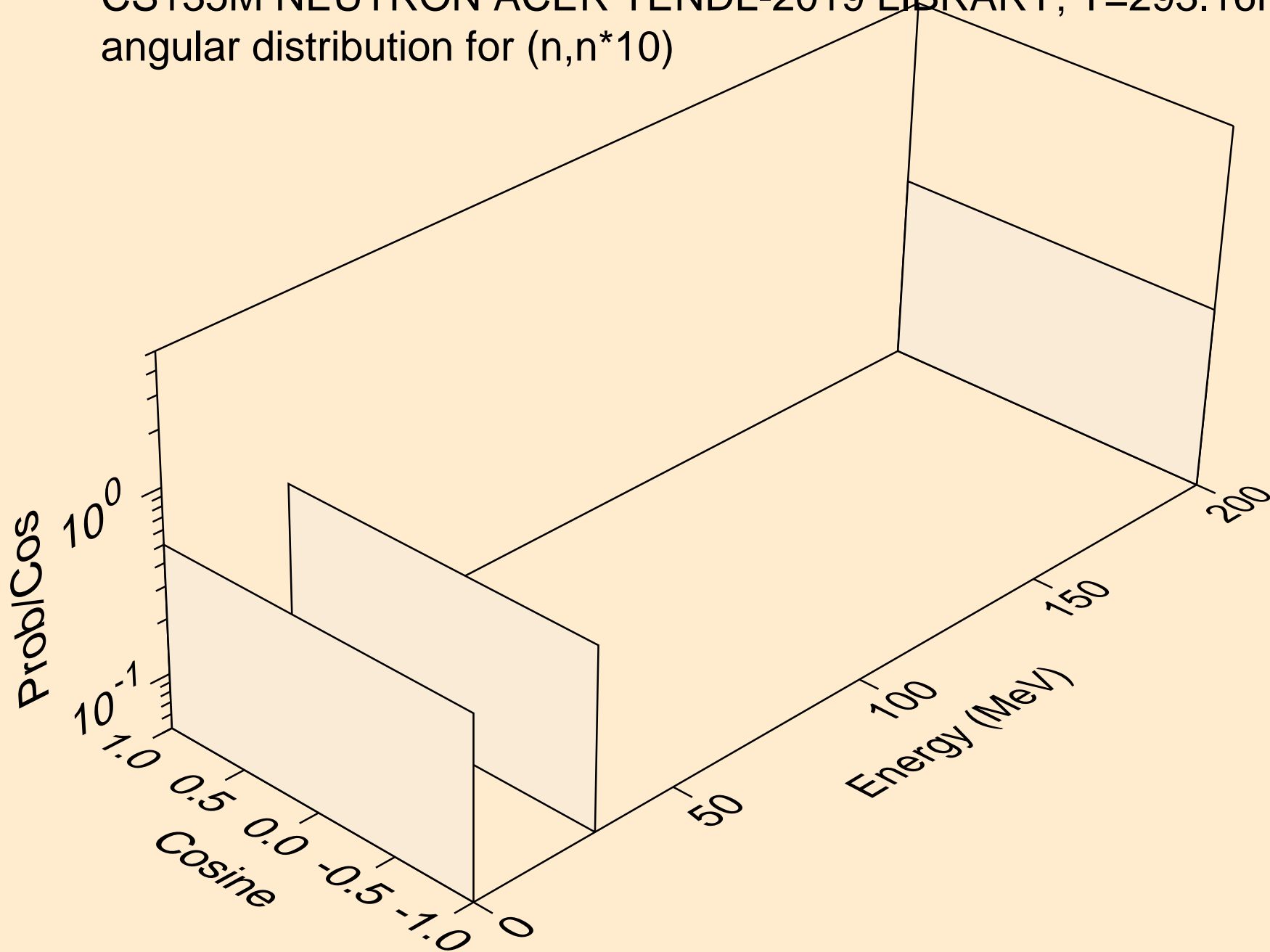

CS135M NEUTRON ACER TENDL-2019 LIBRARY; T=293.16K  
angular distribution for (n,n\*11)

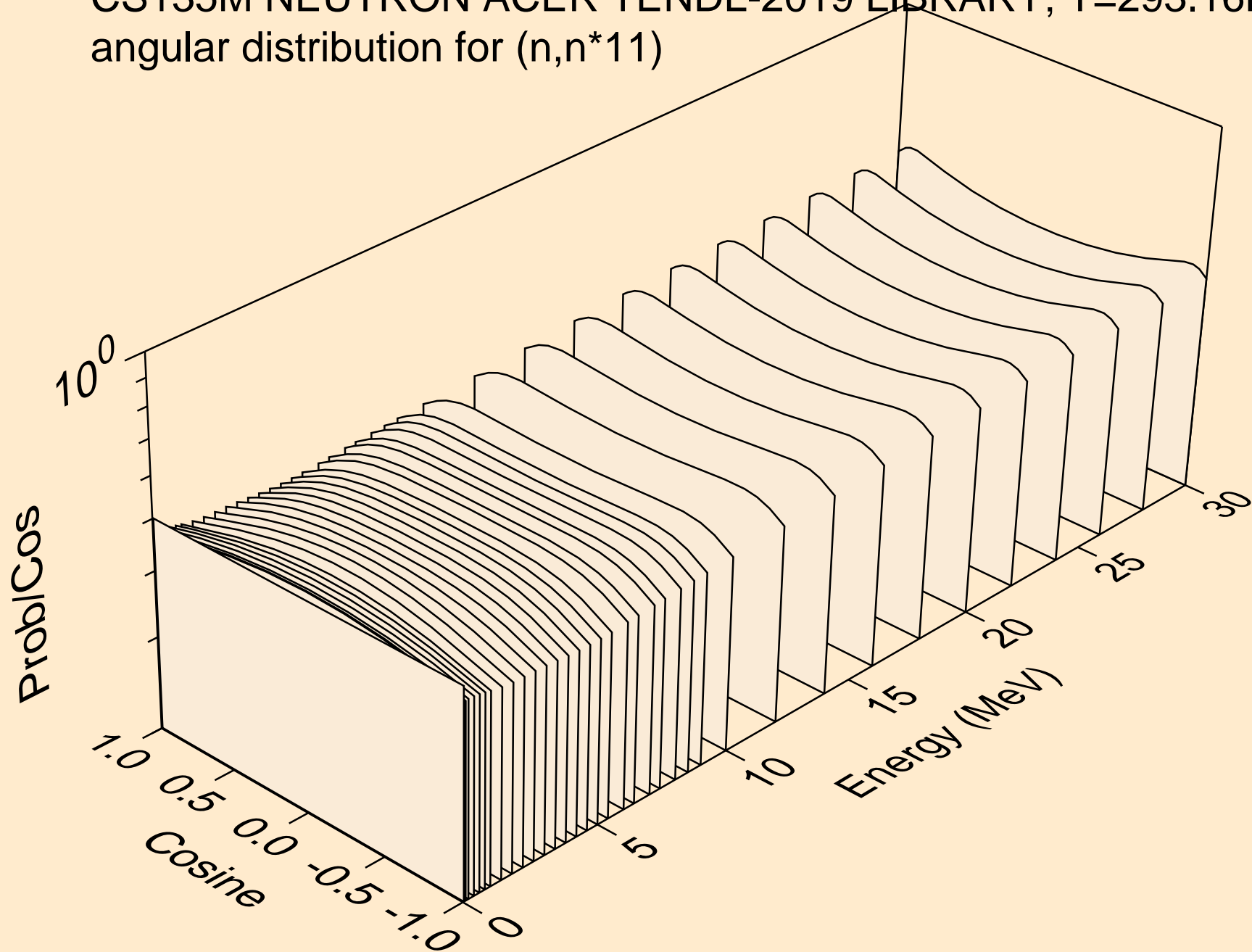

CS135M NEUTRON ACER TENDL-2019 LIBRARY; T=293.16K  
angular distribution for (n,n\*12)

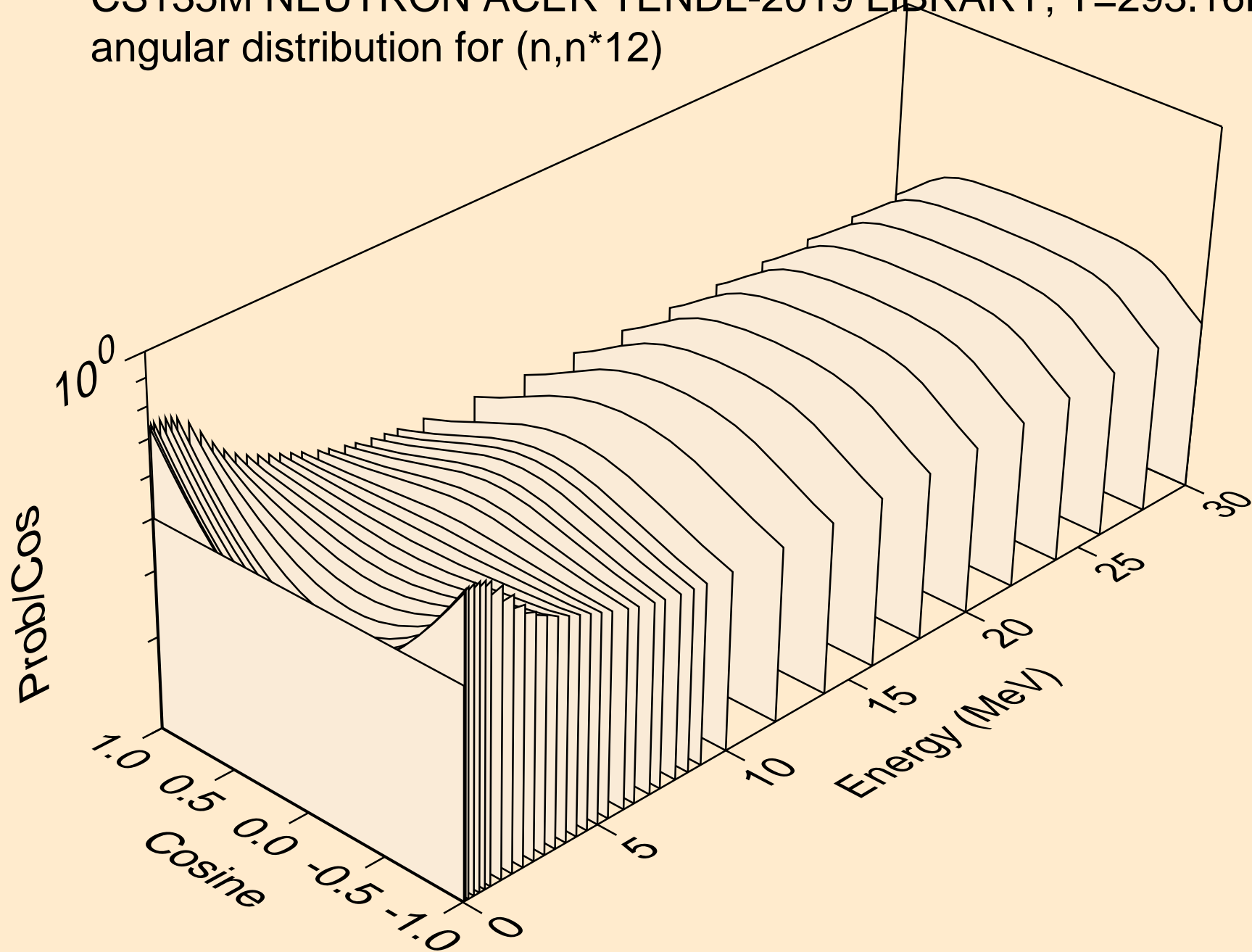

CS135M NEUTRON ACER TENDL-2019 LIBRARY; T=293.16K  
angular distribution for (n,n\*13)

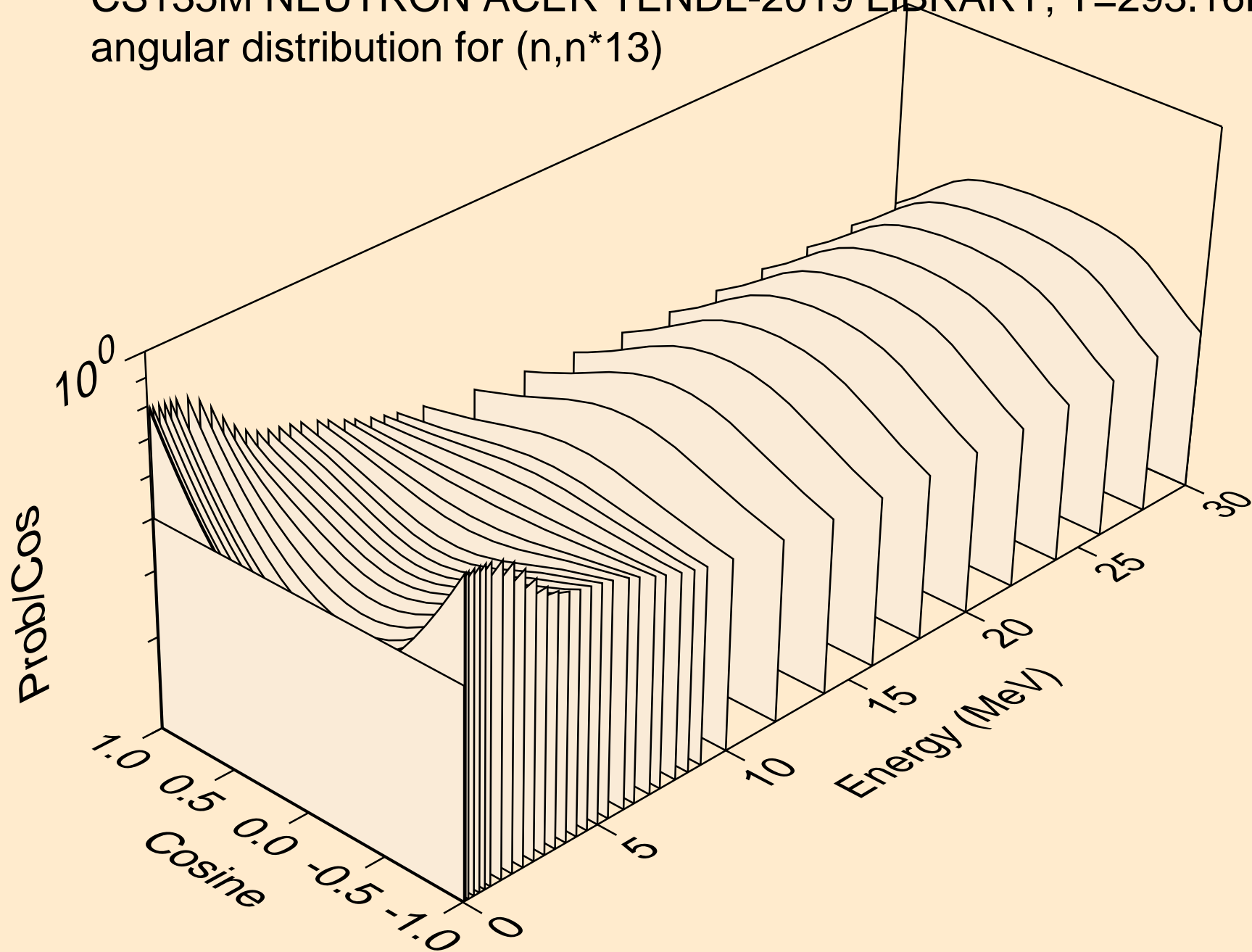

CS135M NEUTRON ACER TENDL-2019 LIBRARY; T=293.16K  
angular distribution for (n,n\*14)

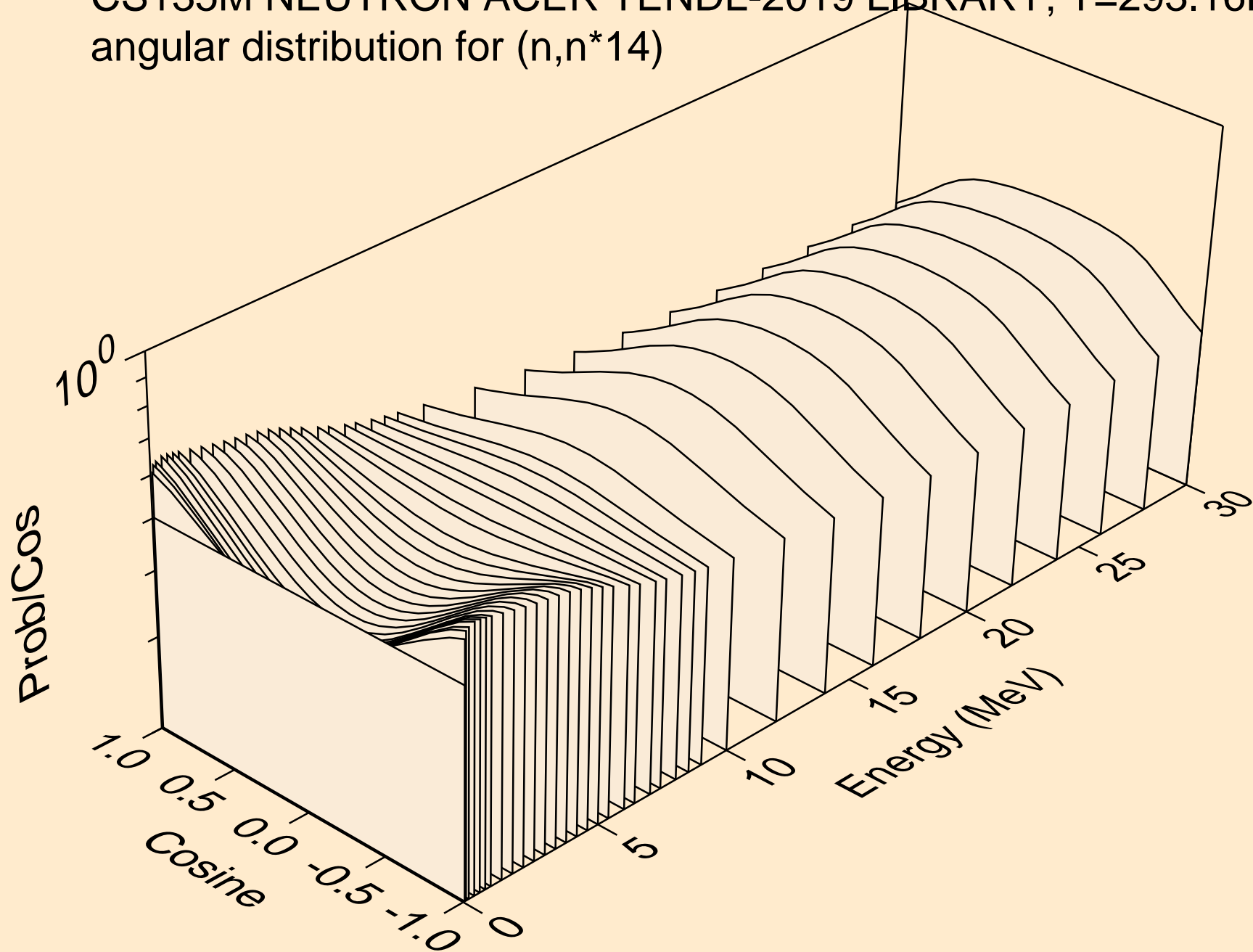

CS135M NEUTRON ACER TENDL-2019 LIBRARY; T=293.16K  
angular distribution for (n,n\*15)

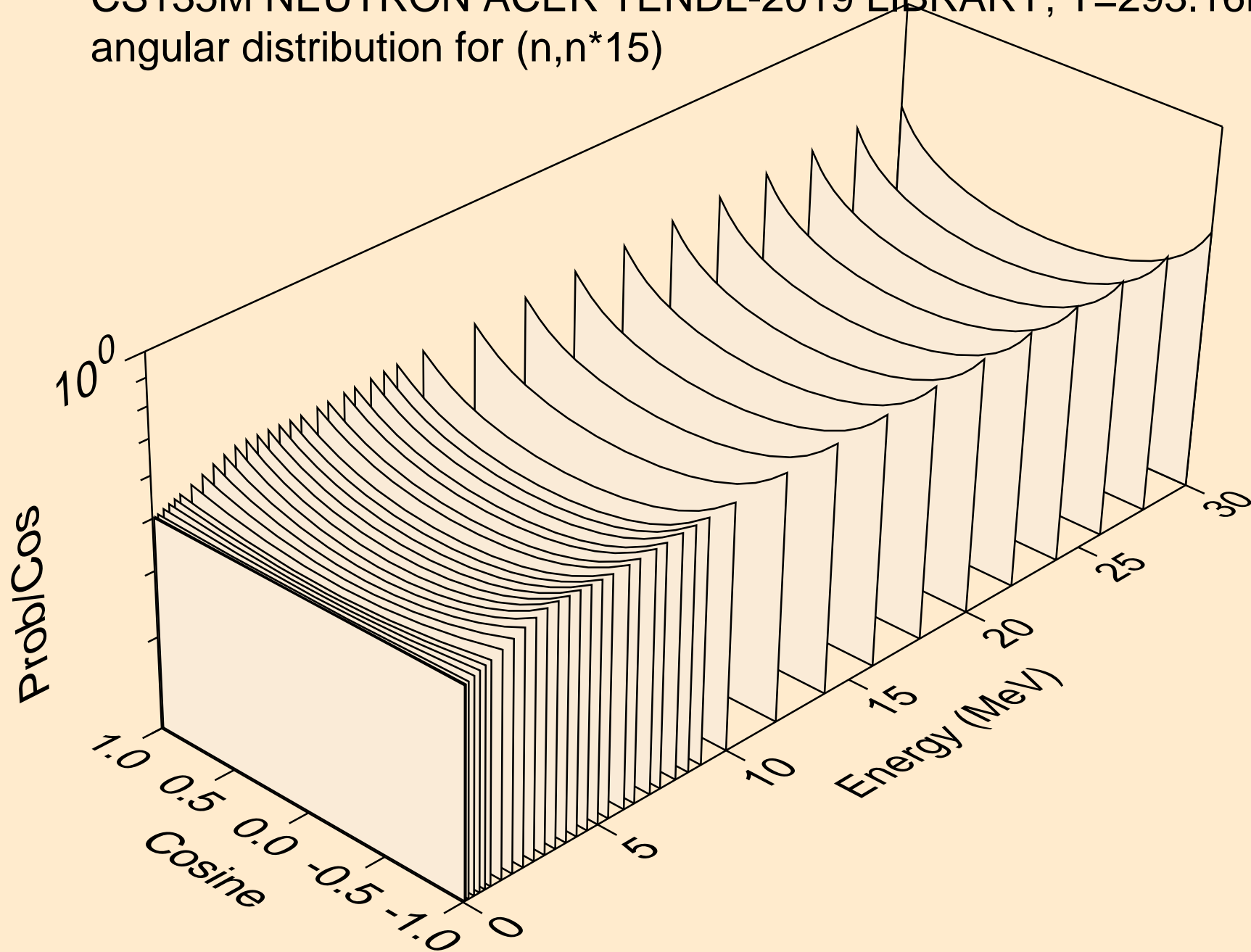

CS135M NEUTRON ACER TENDL-2019 LIBRARY; T=293.16K  
angular distribution for (n,n\*16)

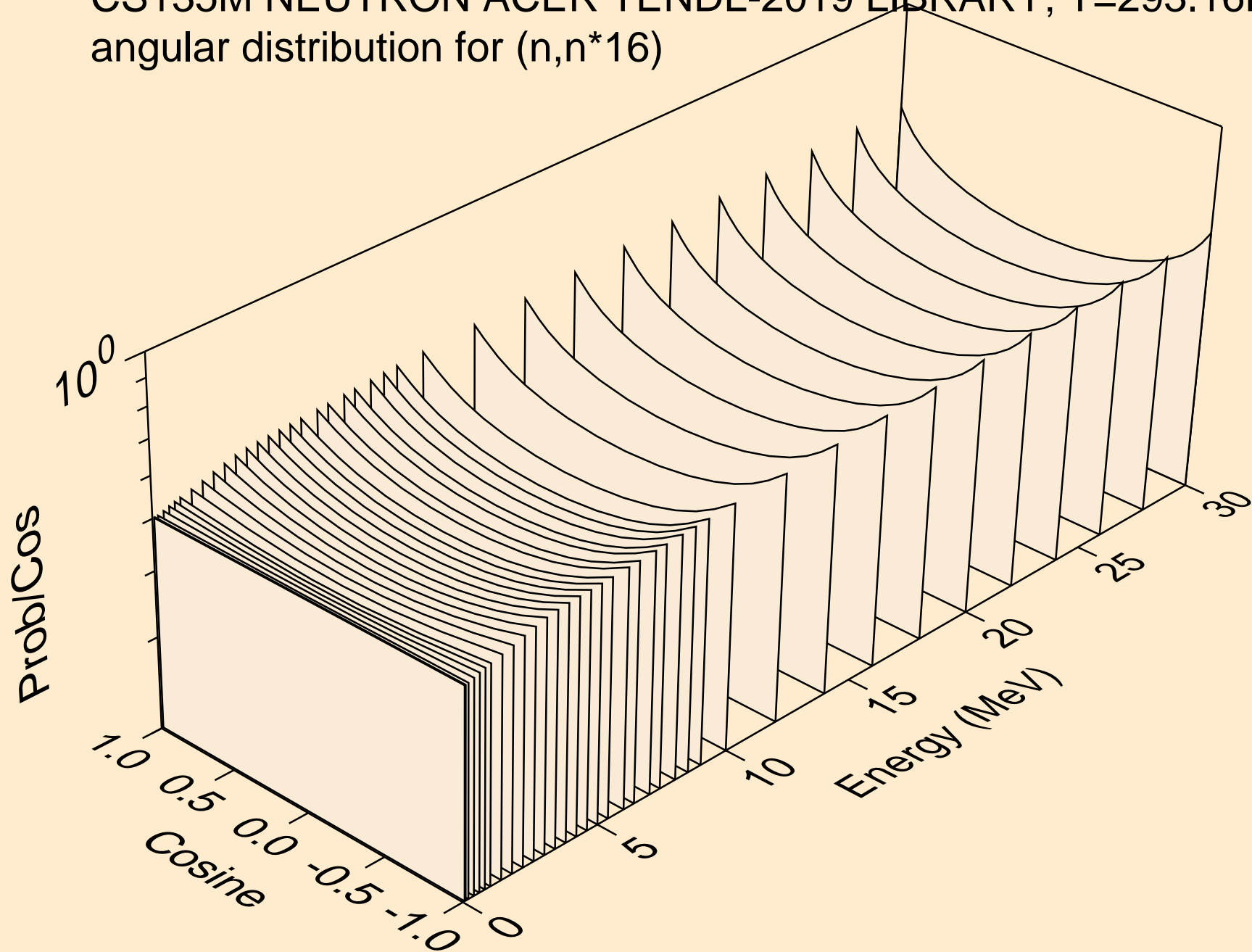

CS135M NEUTRON ACER TENDL-2019 LIBRARY; T=293.16K  
angular distribution for (n,n\*17)

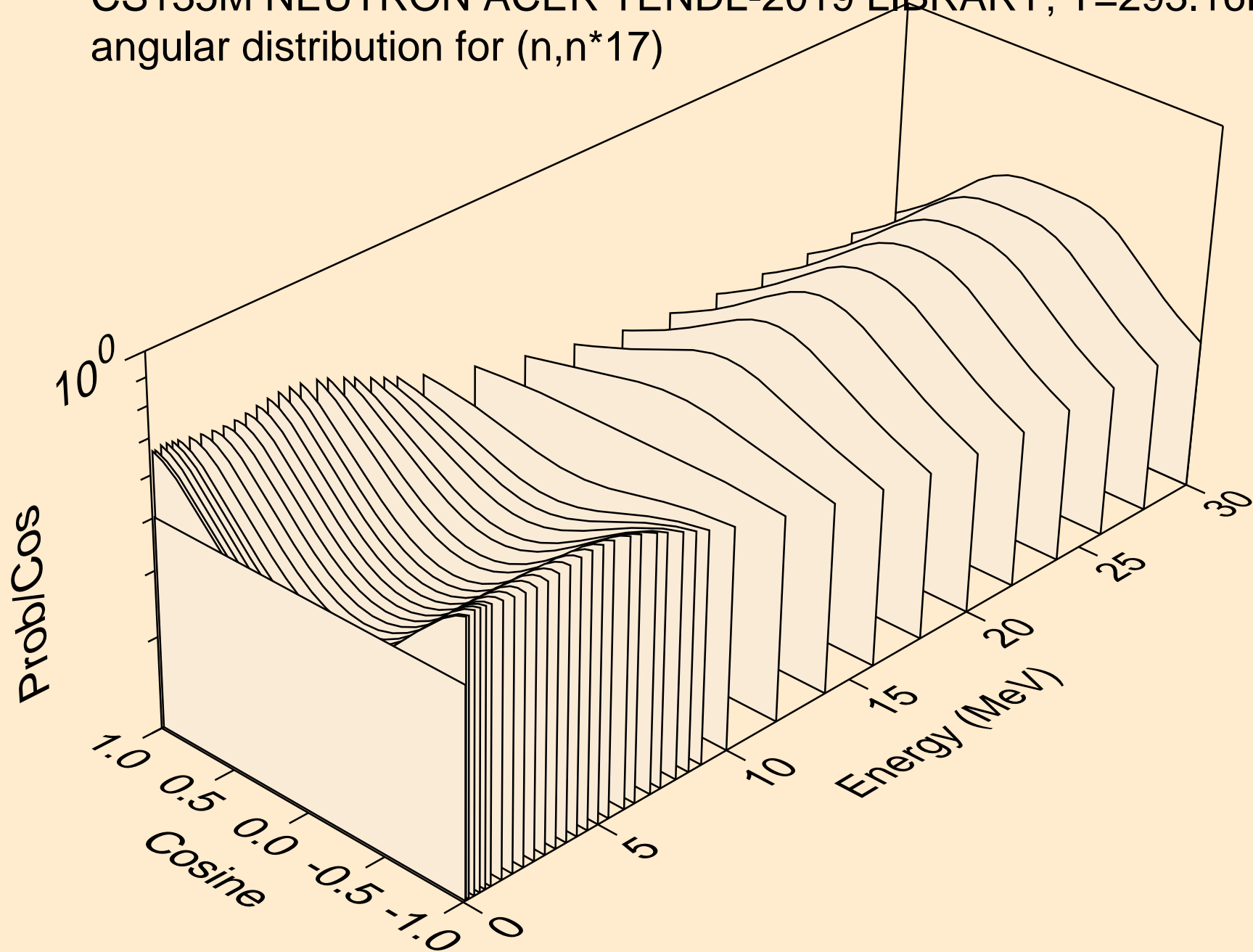



CS135M NEUTRON ACER TENDL-2019 LIBRARY; T=293.16K  
angular distribution for (n,n\*18)

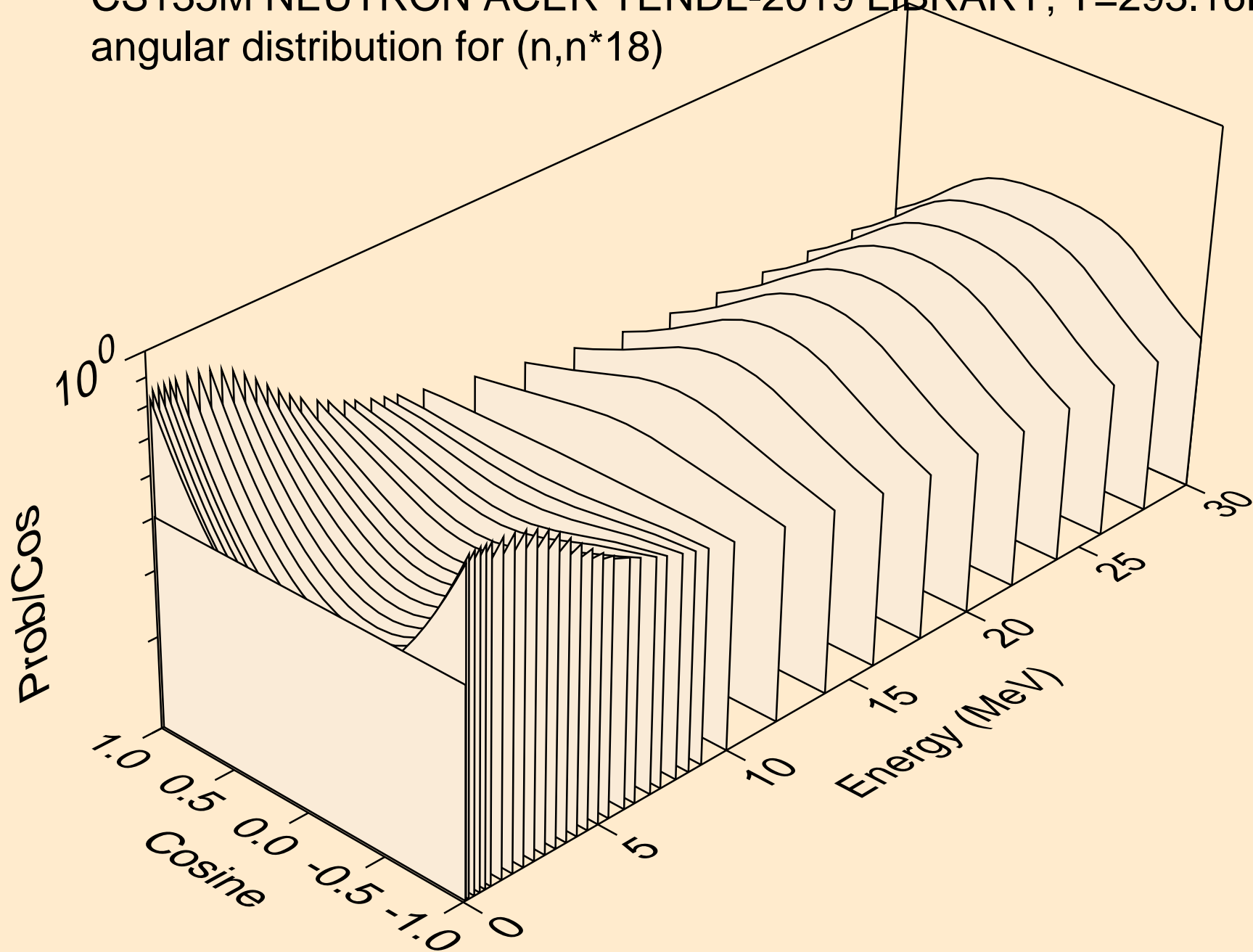

CS135M NEUTRON ACER TENDL-2019 LIBRARY; T=293.16K  
angular distribution for (n,n\*19)

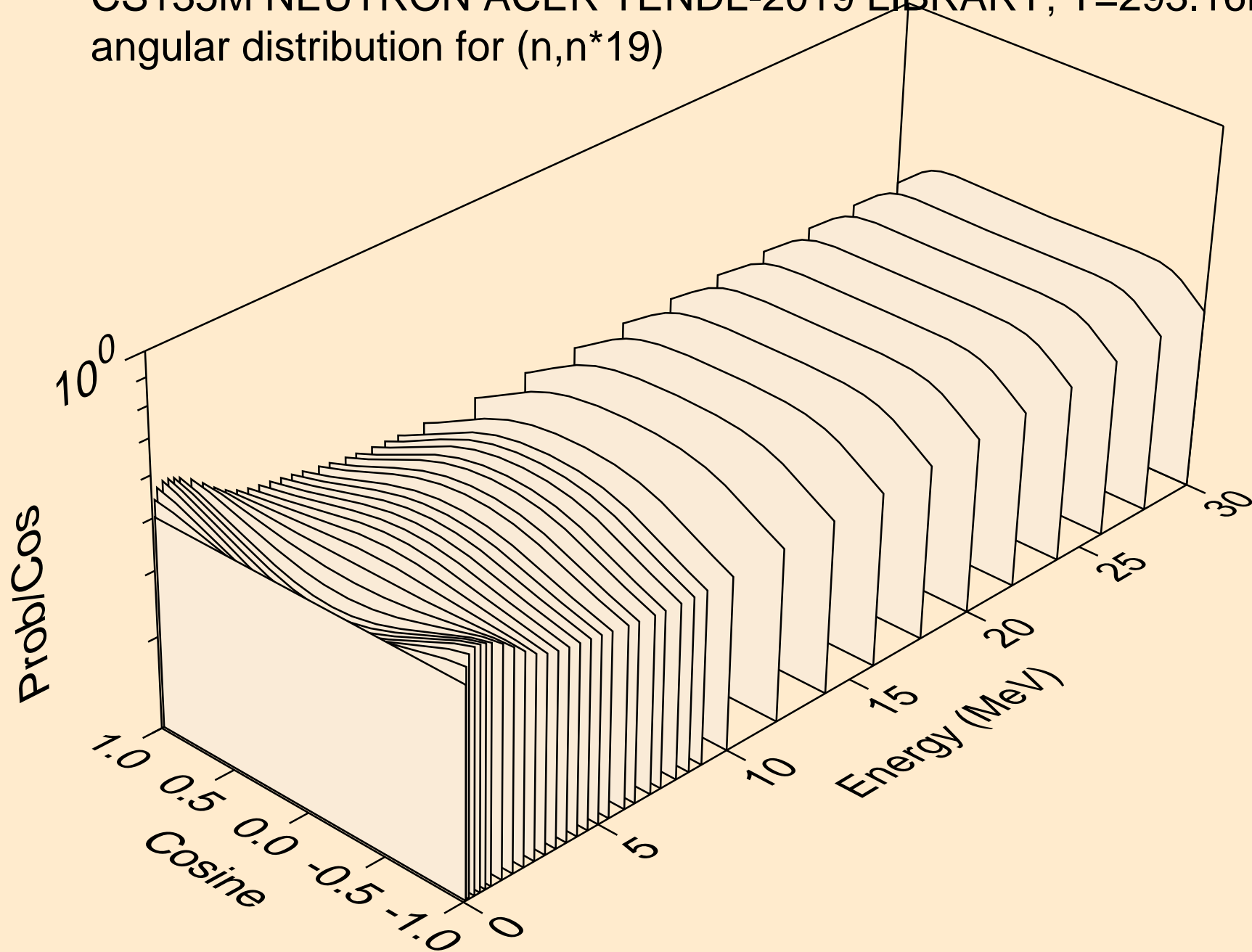

CS135M NEUTRON ACER TENDL-2019 LIBRARY; T=293.16K  
angular distribution for (n,n\*20)

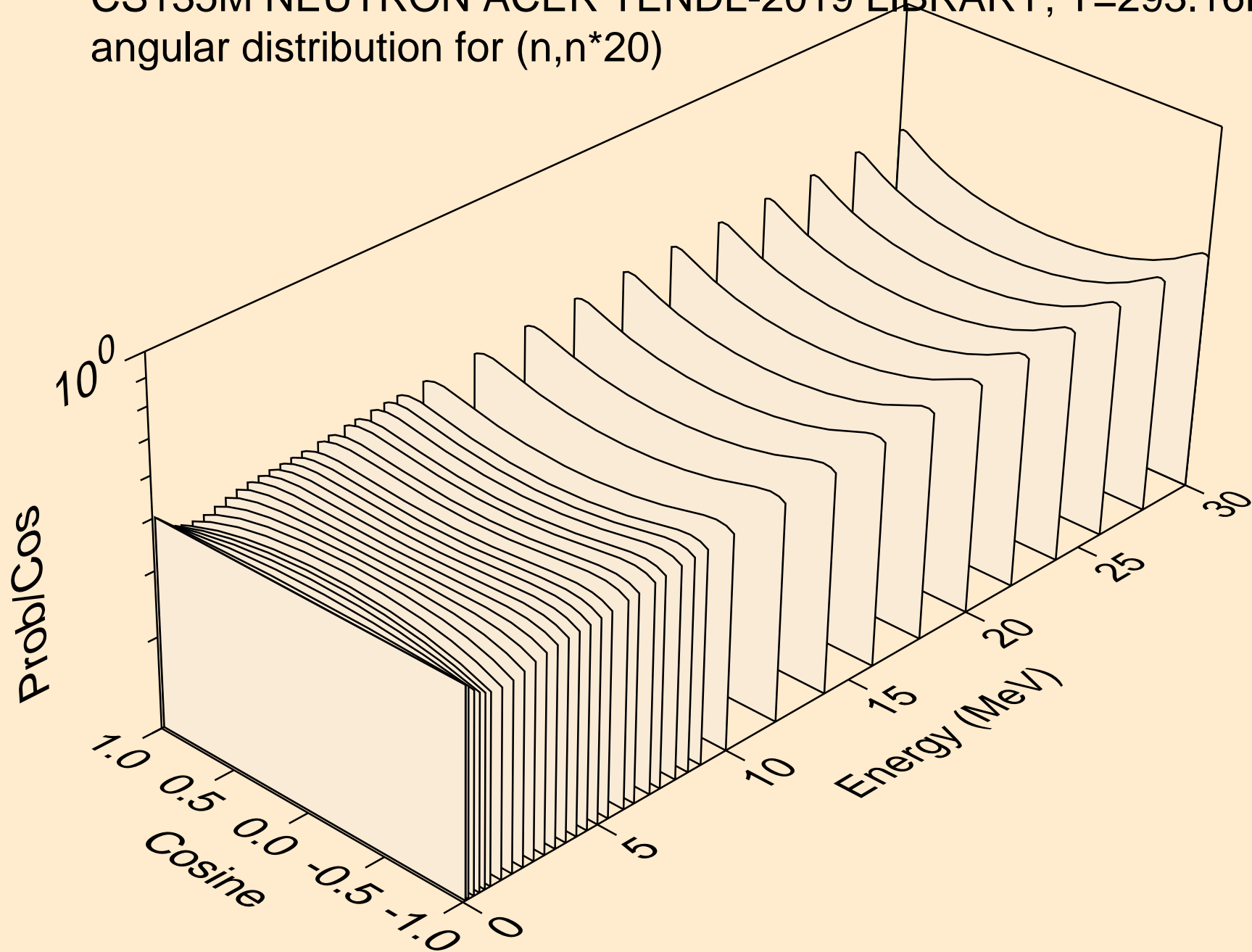

CS135M NEUTRON ACER TENDL-2019 LIBRARY; T=293.16K  
angular distribution for (n,n\*21)

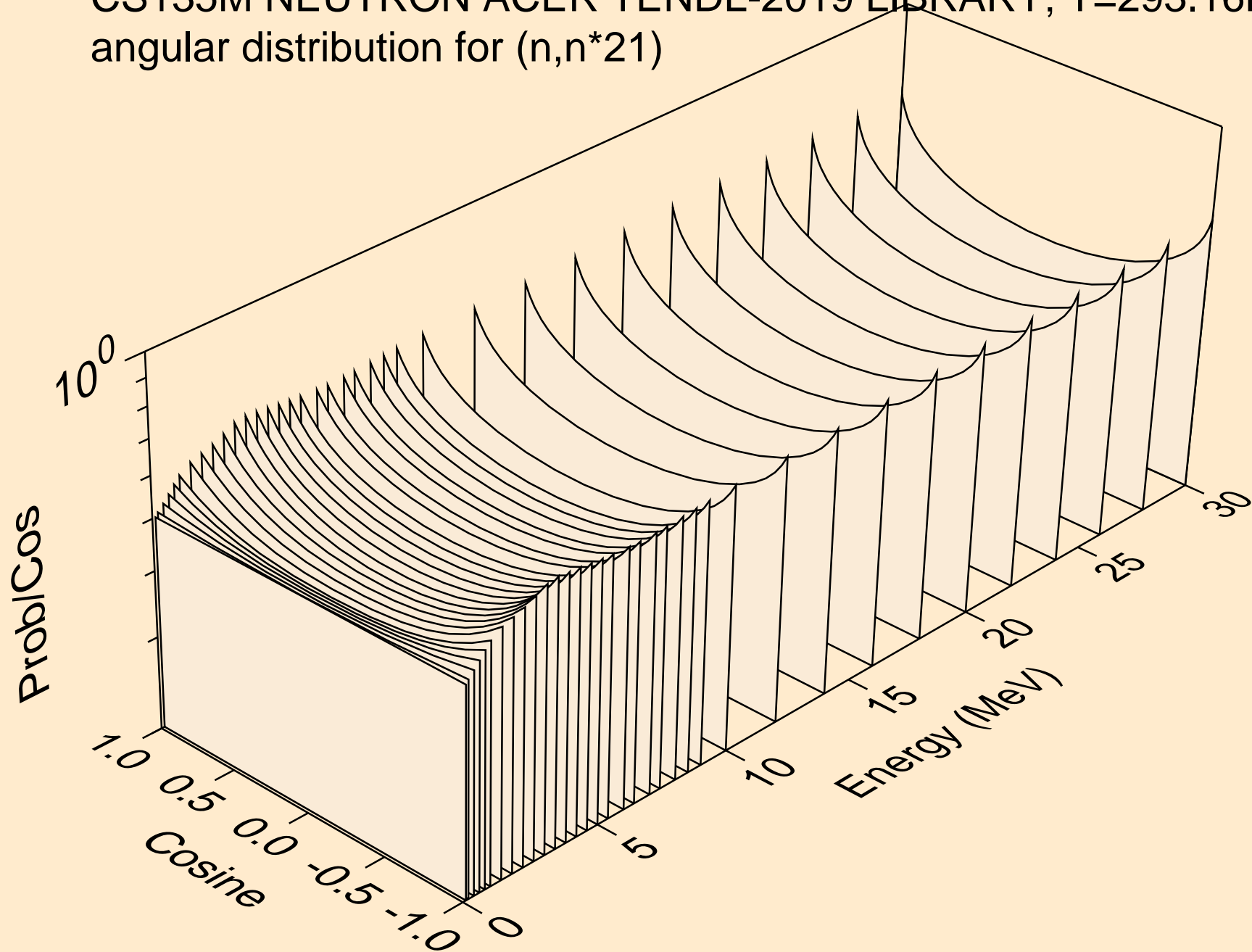

CS135M NEUTRON ACER TENDL-2019 LIBRARY; T=293.16K  
angular distribution for (n,n\*22)

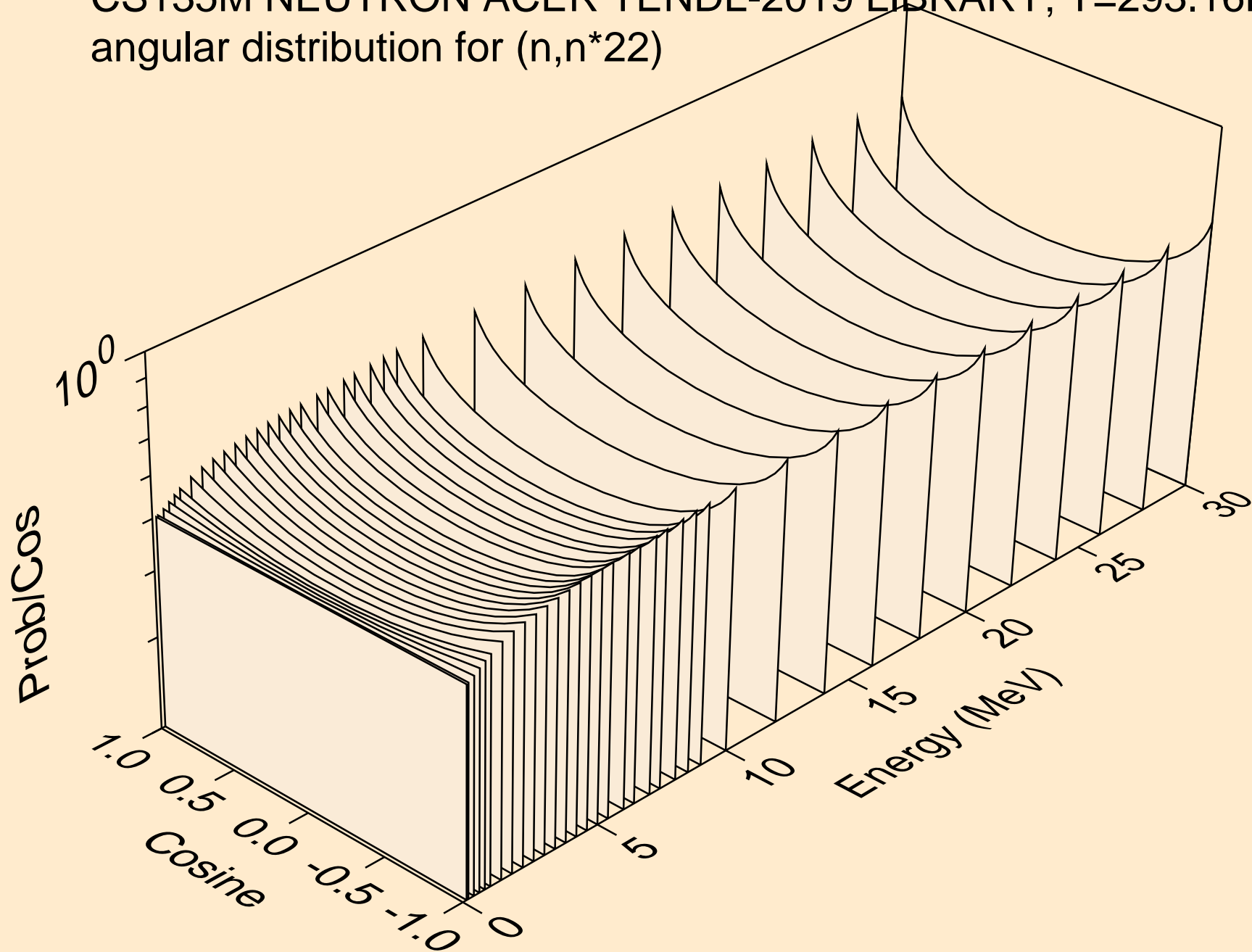

CS135M NEUTRON ACER TENDL-2019 LIBRARY; T=293.16K  
angular distribution for (n,n\*23)

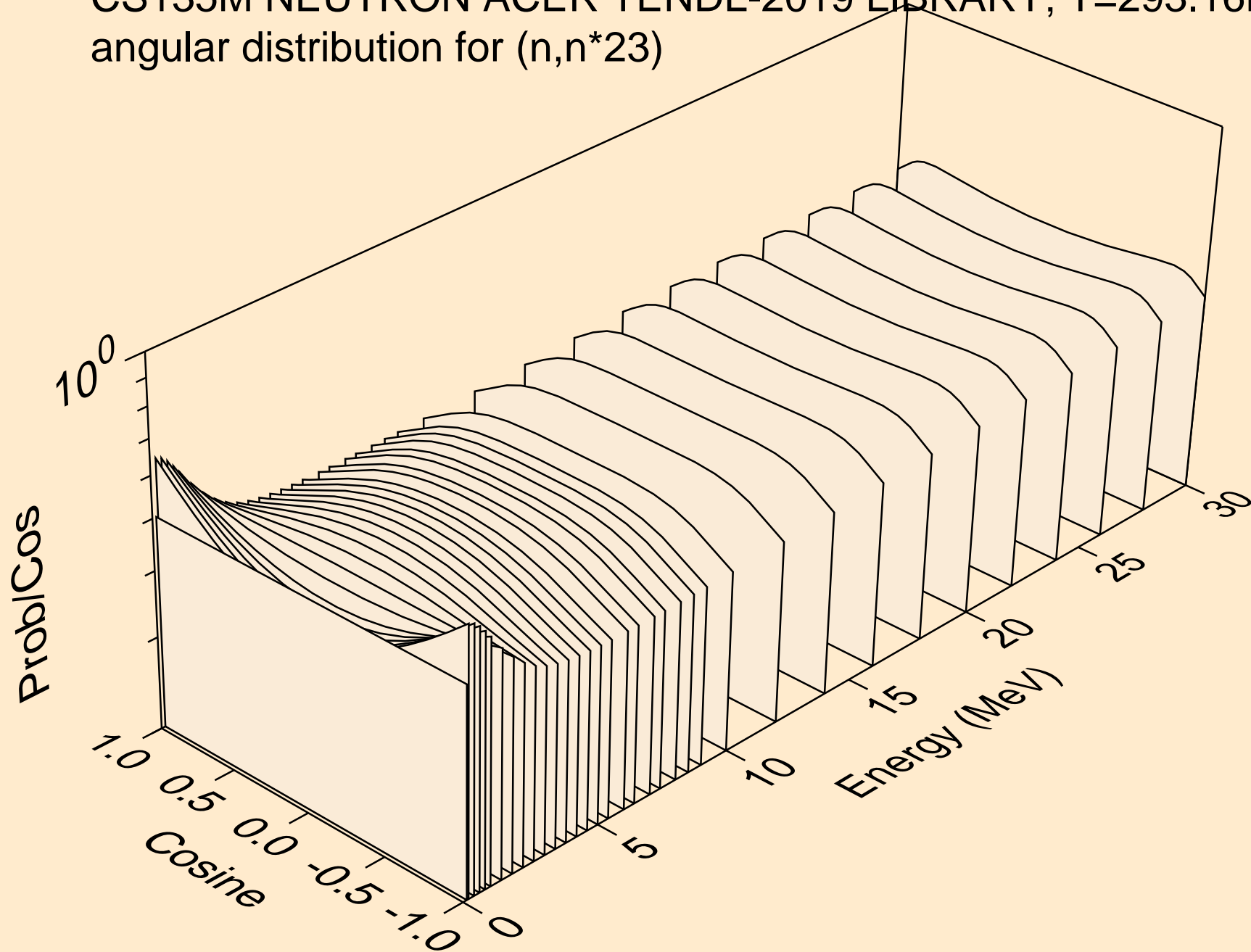

CS135M NEUTRON ACER TENDL-2019 LIBRARY; T=293.16K  
angular distribution for (n,n\*24)

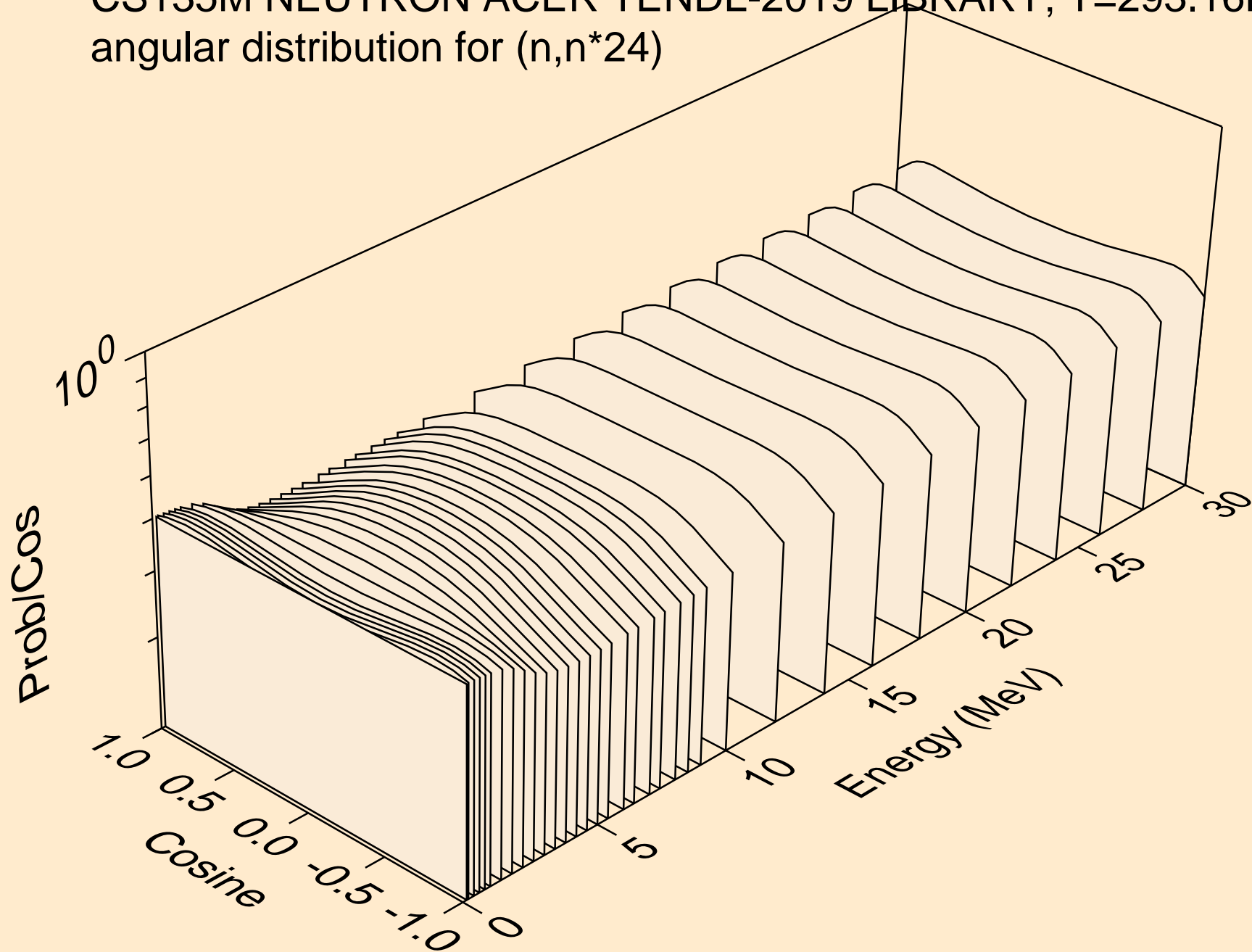

CS135M NEUTRON ACER TENDL-2019 LIBRARY; T=293.16K  
angular distribution for (n,n\*25)

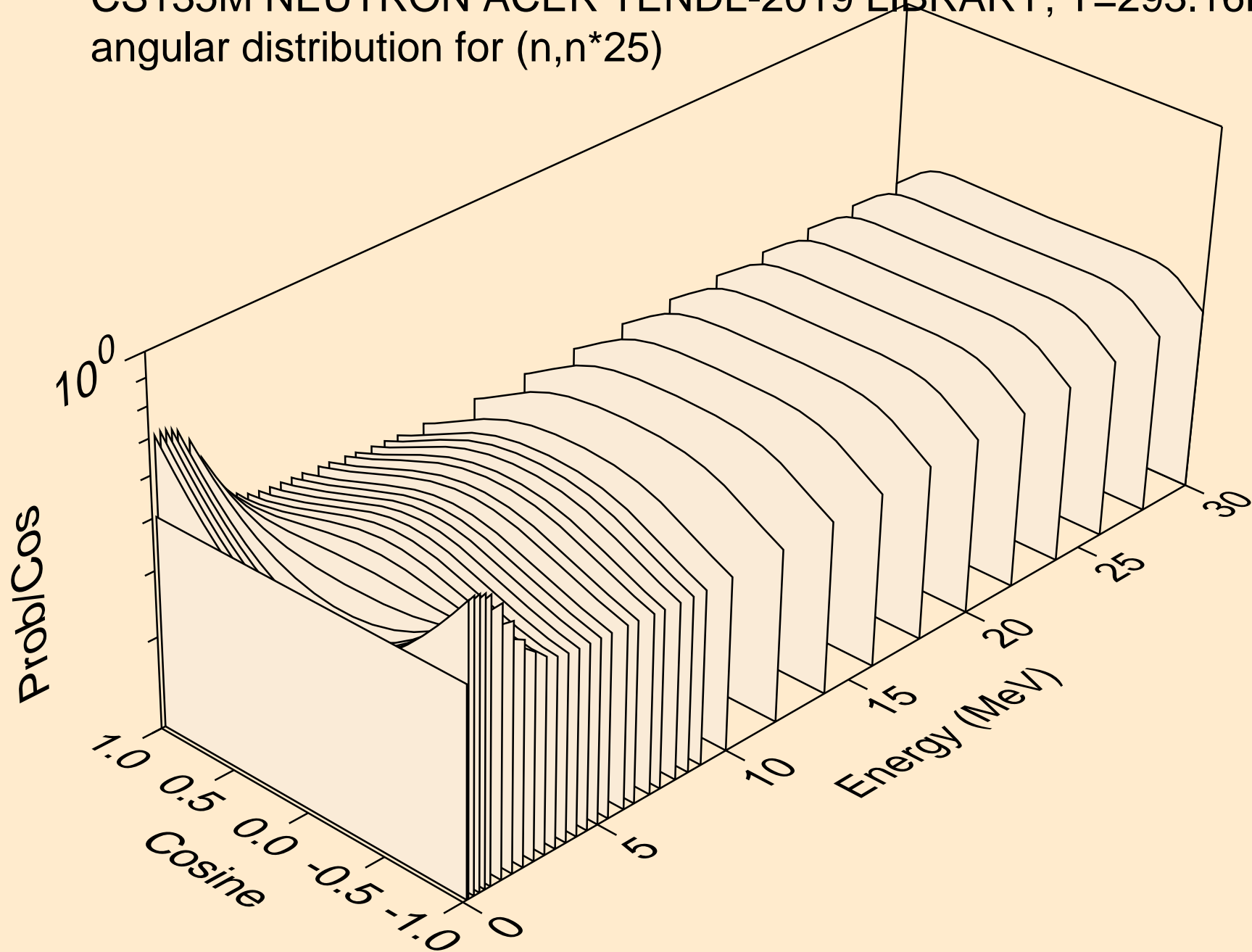



CS135M NEUTRON ACER TENDL-2019 LIBRARY; T=293.16K  
angular distribution for (n,n\*26)

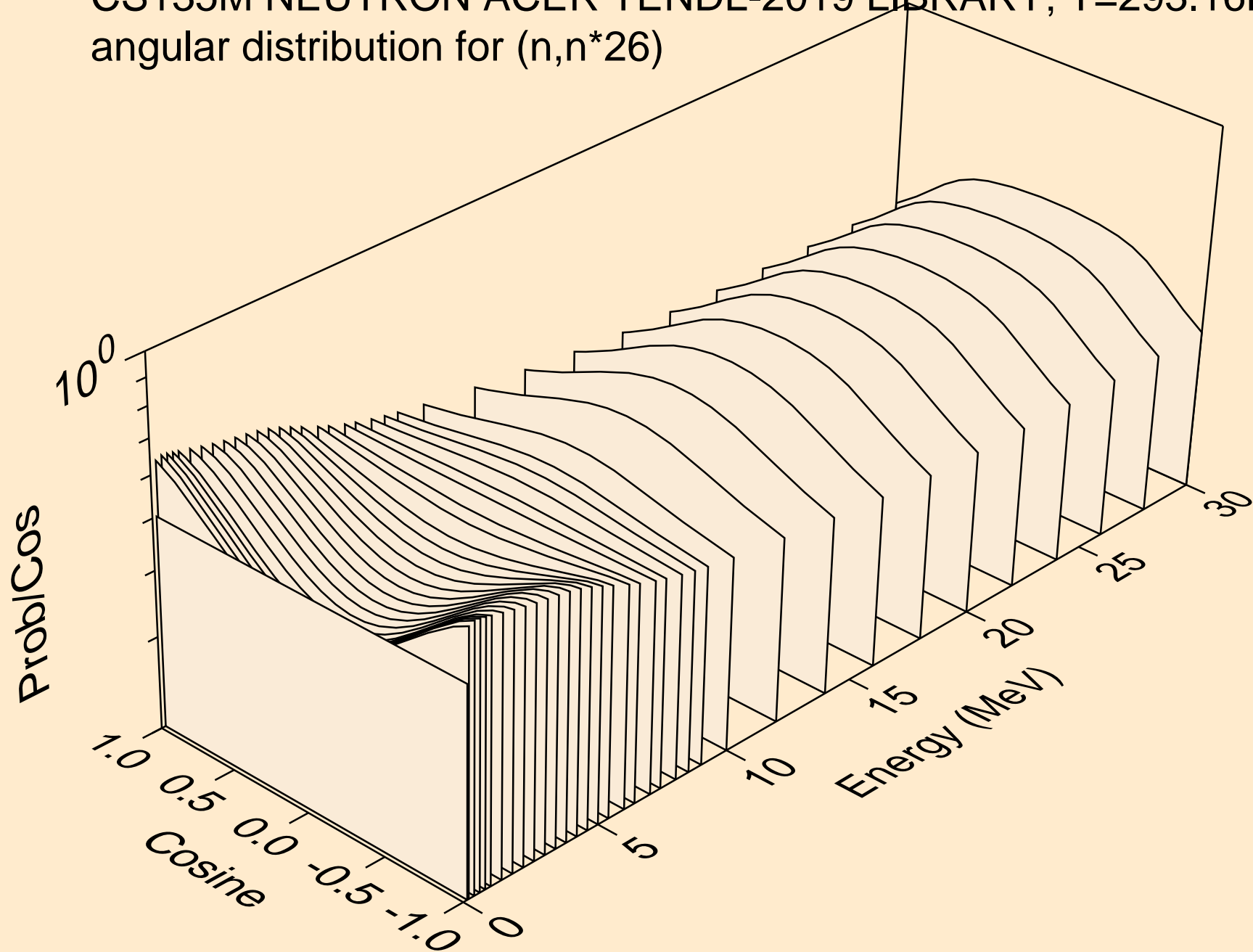

CS135M NEUTRON ACER TENDL-2019 LIBRARY; T=293.16K  
angular distribution for (n,n\*27)

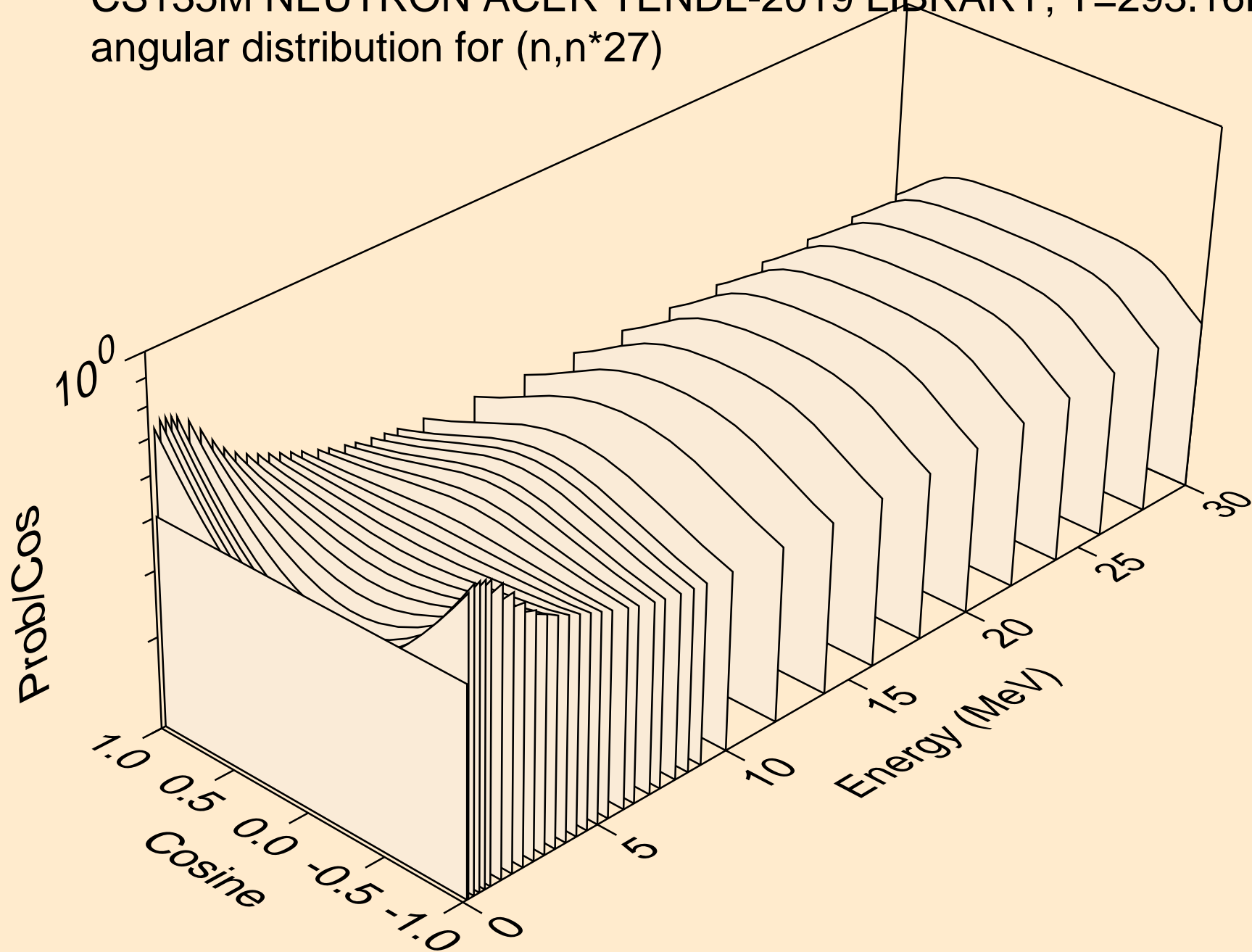

CS135M NEUTRON ACER TENDL-2019 LIBRARY; T=293.16K  
angular distribution for (n,n\*28)

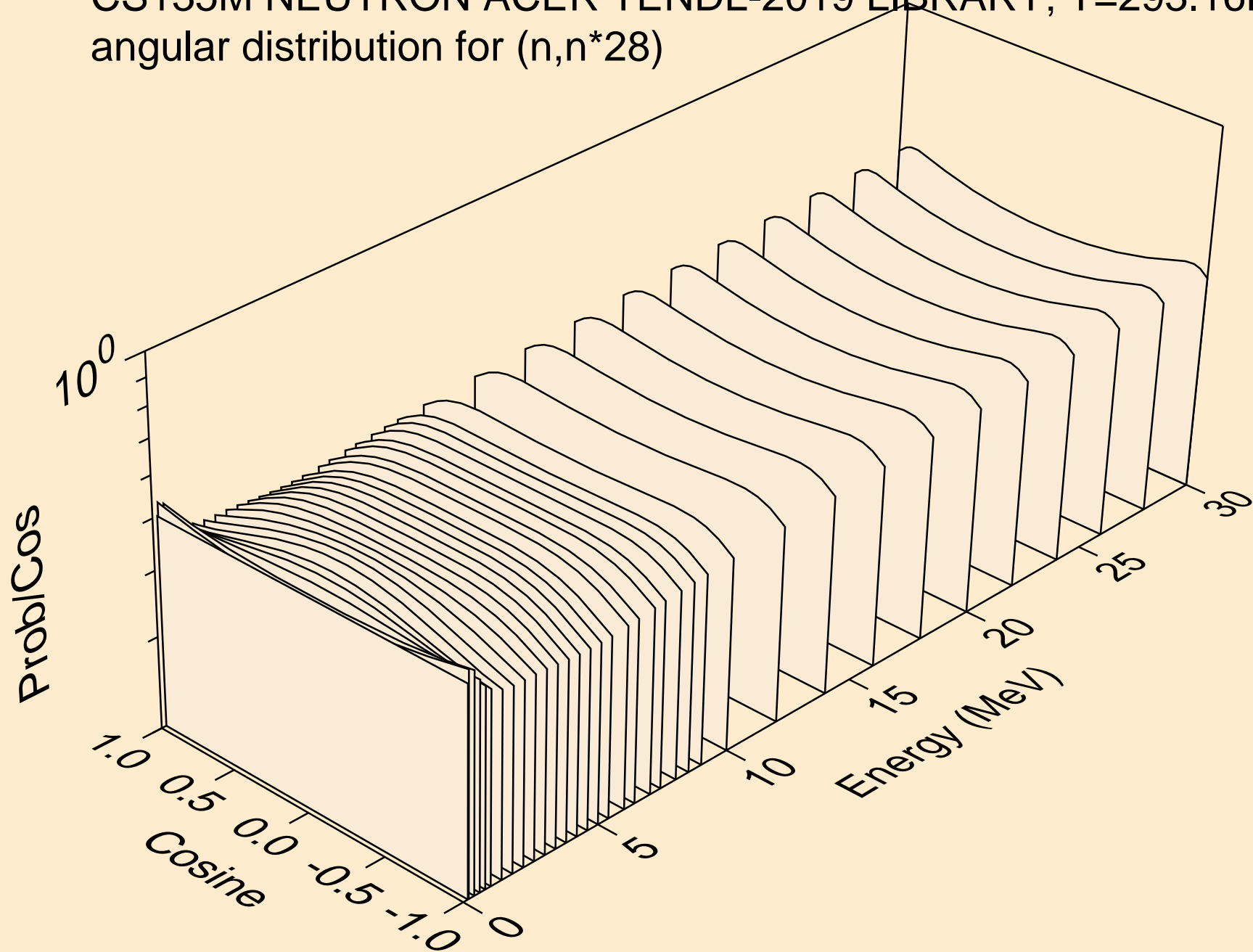

CS135M NEUTRON ACER TENDL-2019 LIBRARY; T=293.16K  
angular distribution for (n,n\*29)

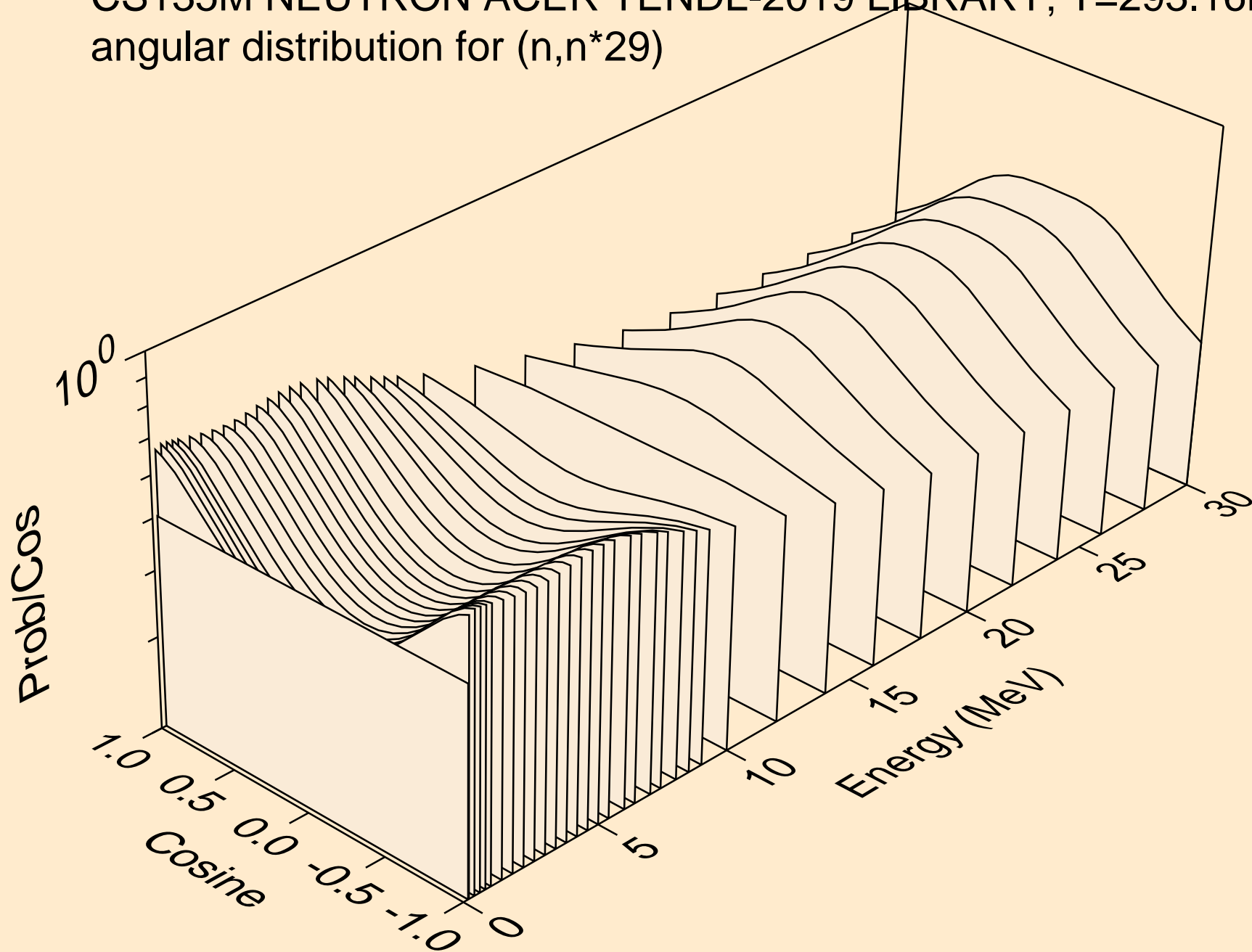

CS135M NEUTRON ACER TENDL-2019 LIBRARY; T=293.16K  
angular distribution for (n,n\*30)

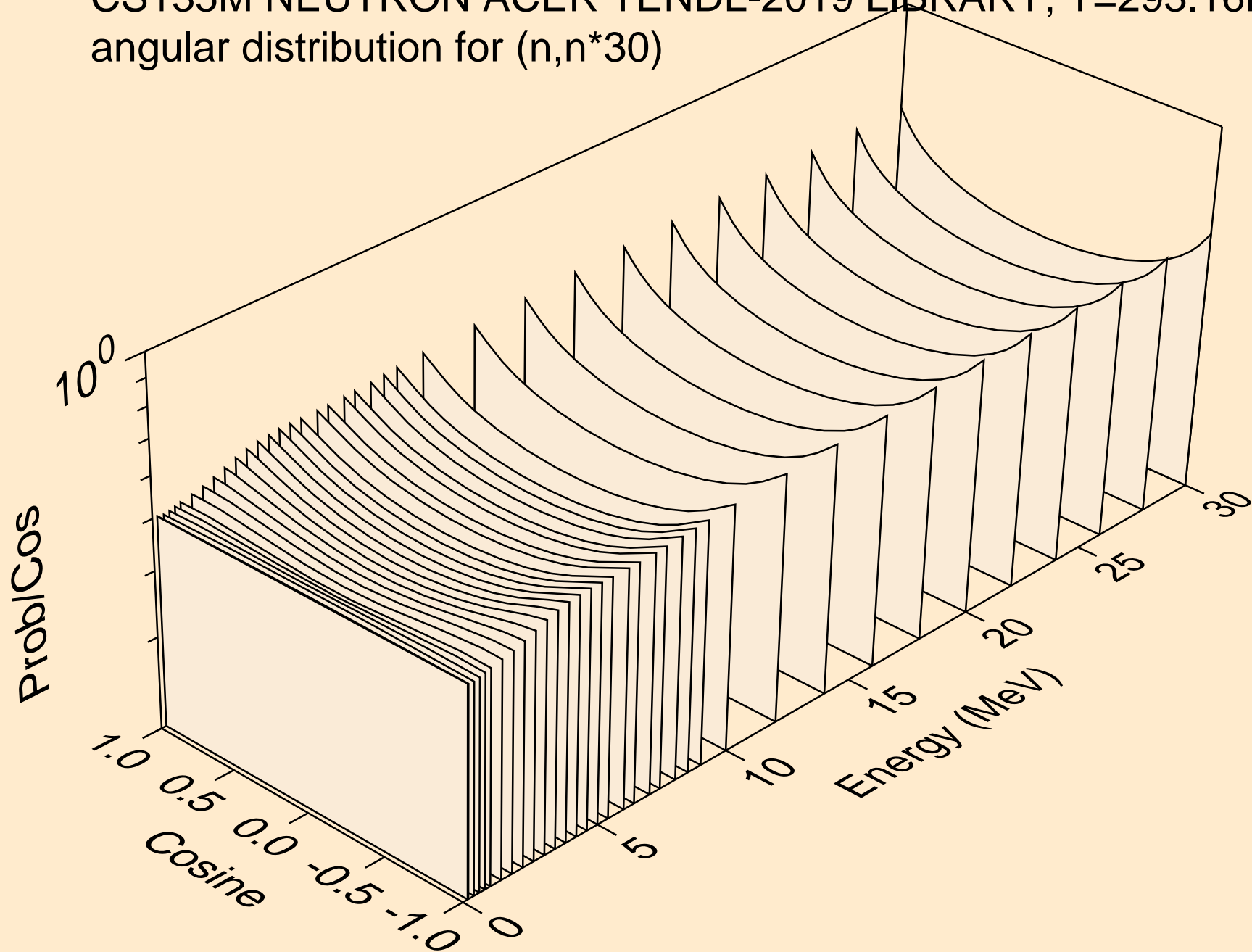

CS135M NEUTRON ACER TENDL-2019 LIBRARY; T=293.16K  
Neutron emission for (n,x)

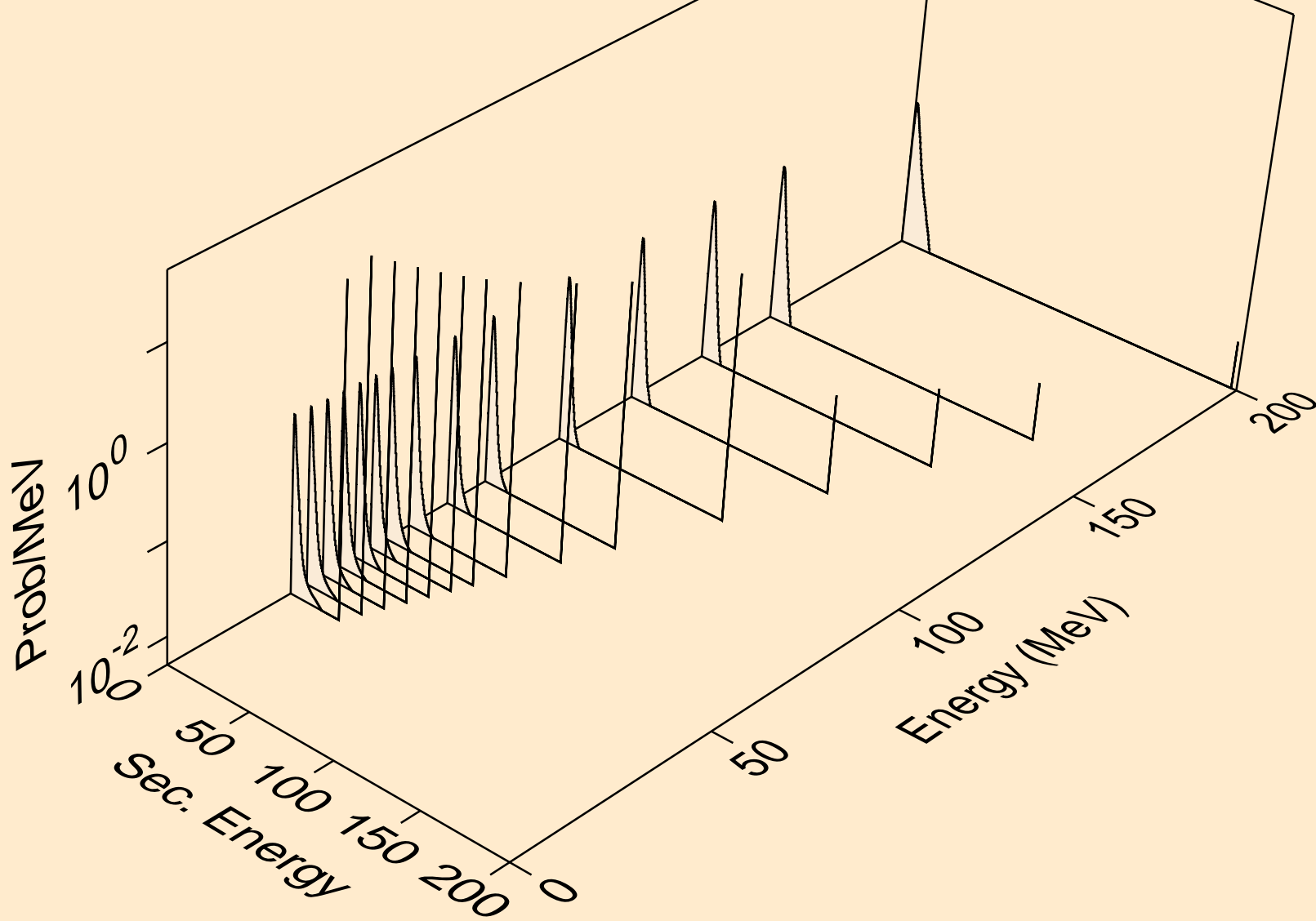

CS135M NEUTRON ACER TENDL-2019 LIBRARY; T=293.16K  
Neutron emission for (n,2nd)

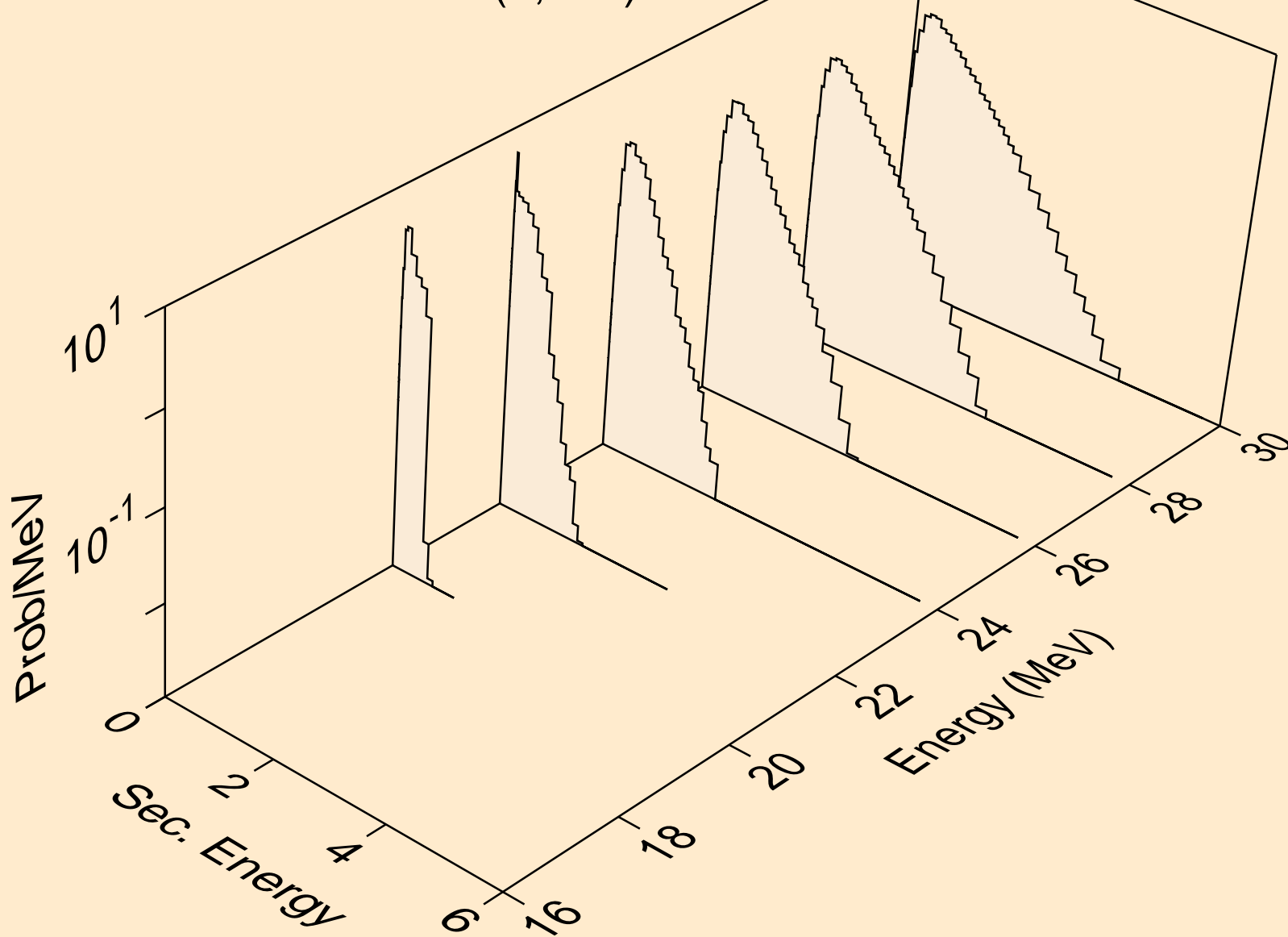

CS135M NEUTRON ACER TENDL-2019 LIBRARY; T=293.16K  
Neutron emission for (n,2n)

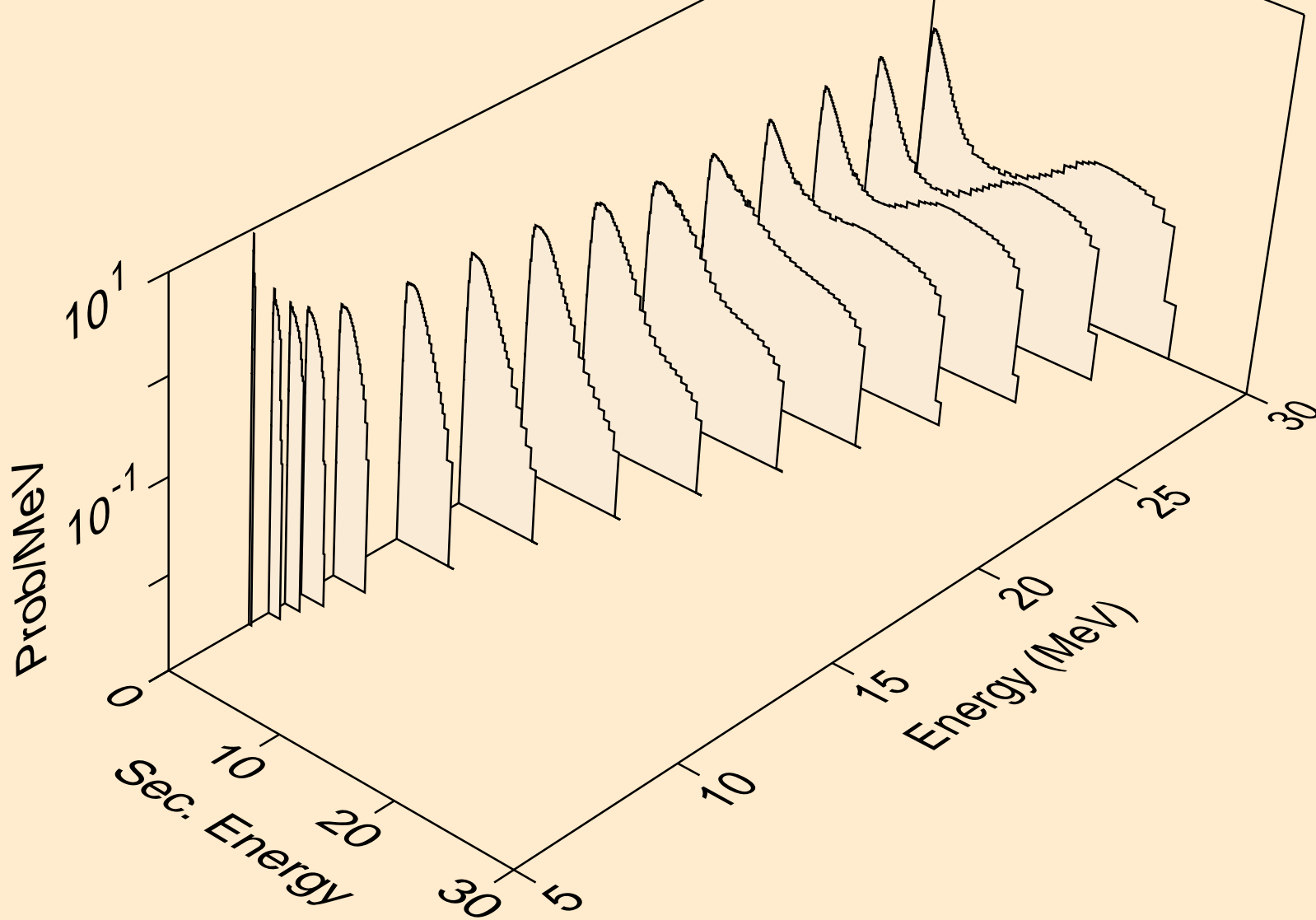



CS135M NEUTRON ACER TENDL-2019 LIBRARY; T=293.16K  
Neutron emission for (n,3n)

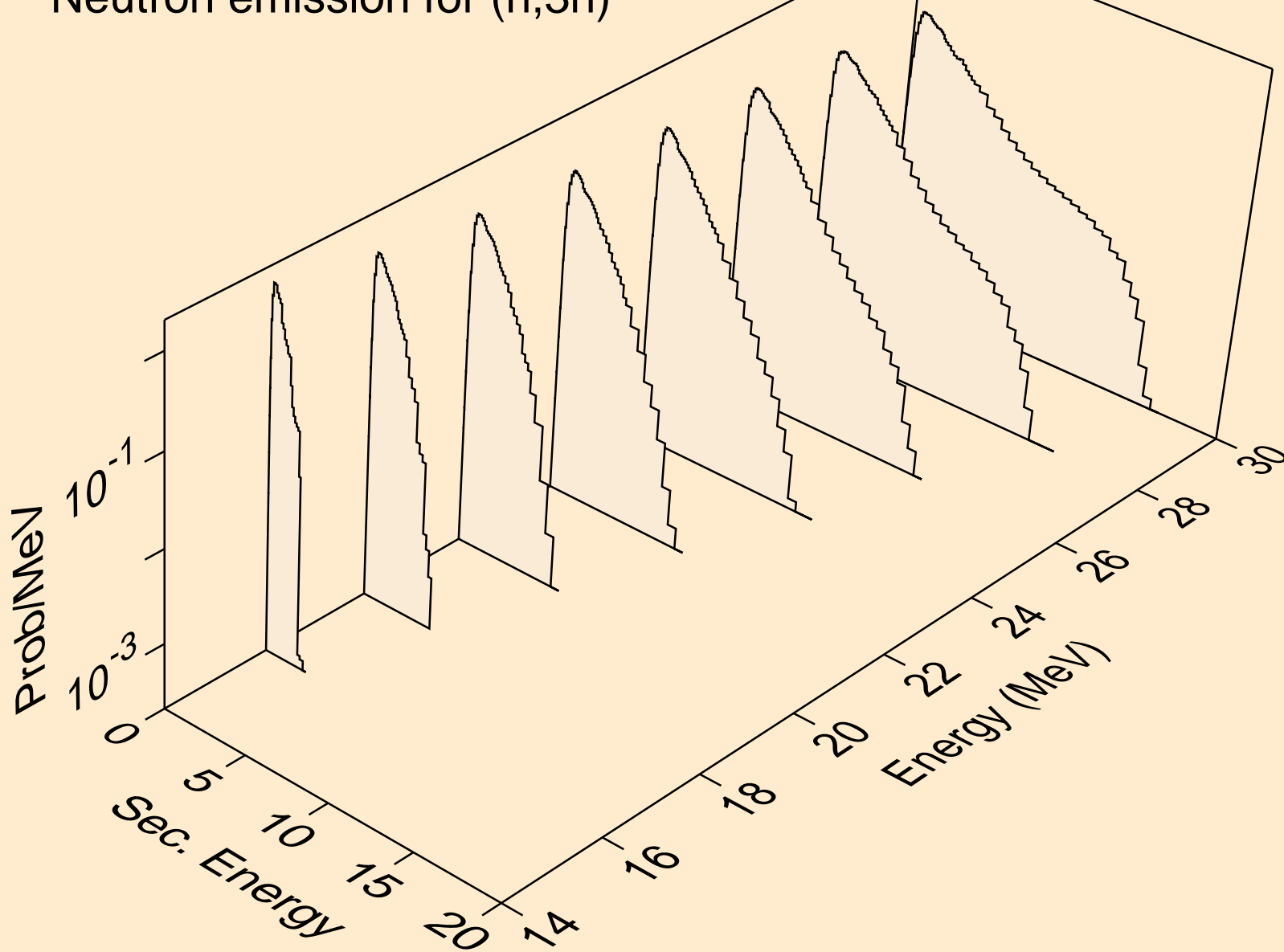

CS135M NEUTRON ACER TENDL-2019 LIBRARY; T=293.16K  
Neutron emission for (n,n\*)a

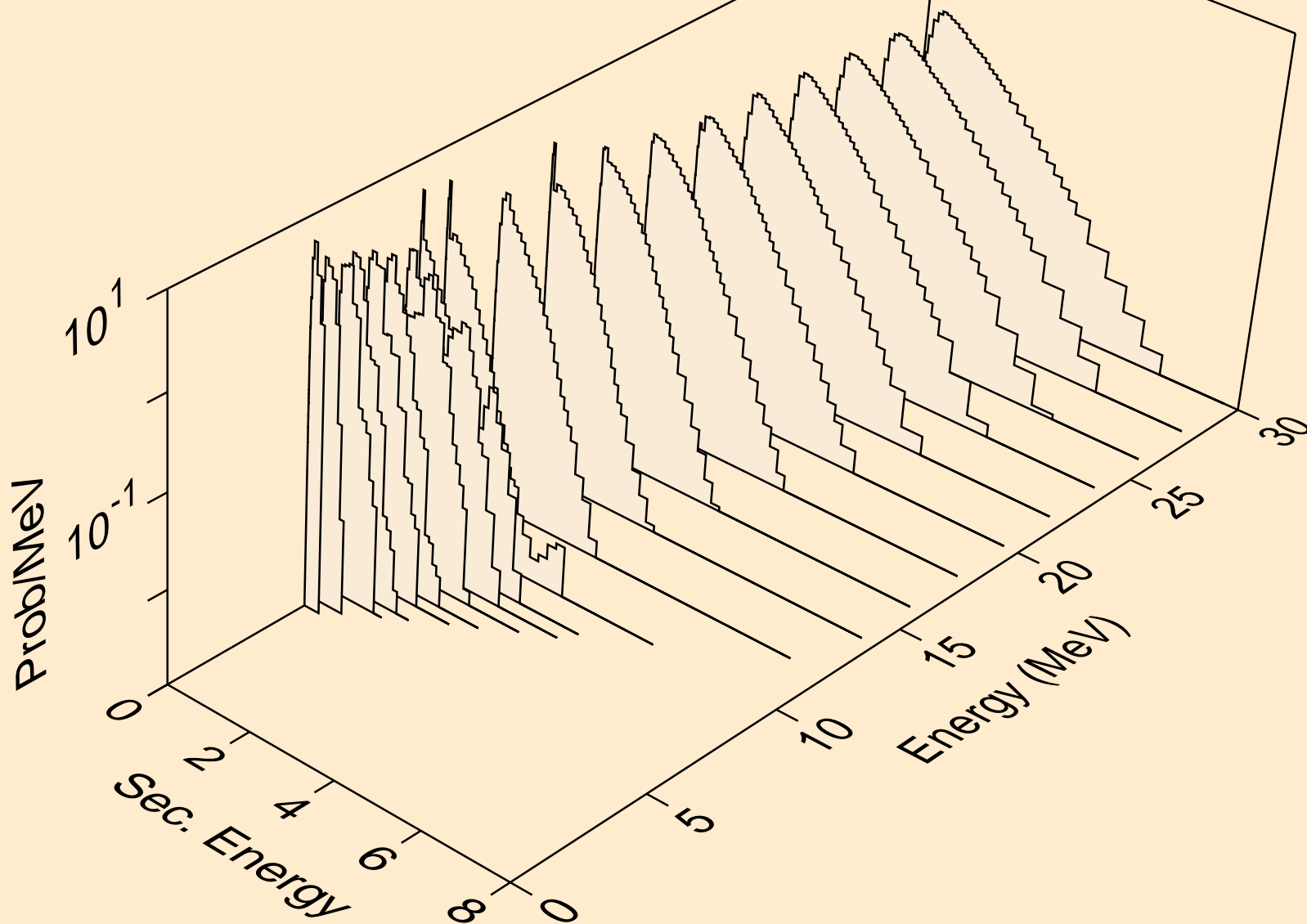

CS135M NEUTRON ACER TENDL-2019 LIBRARY; T=293.16K  
Neutron emission for (n,2n)a

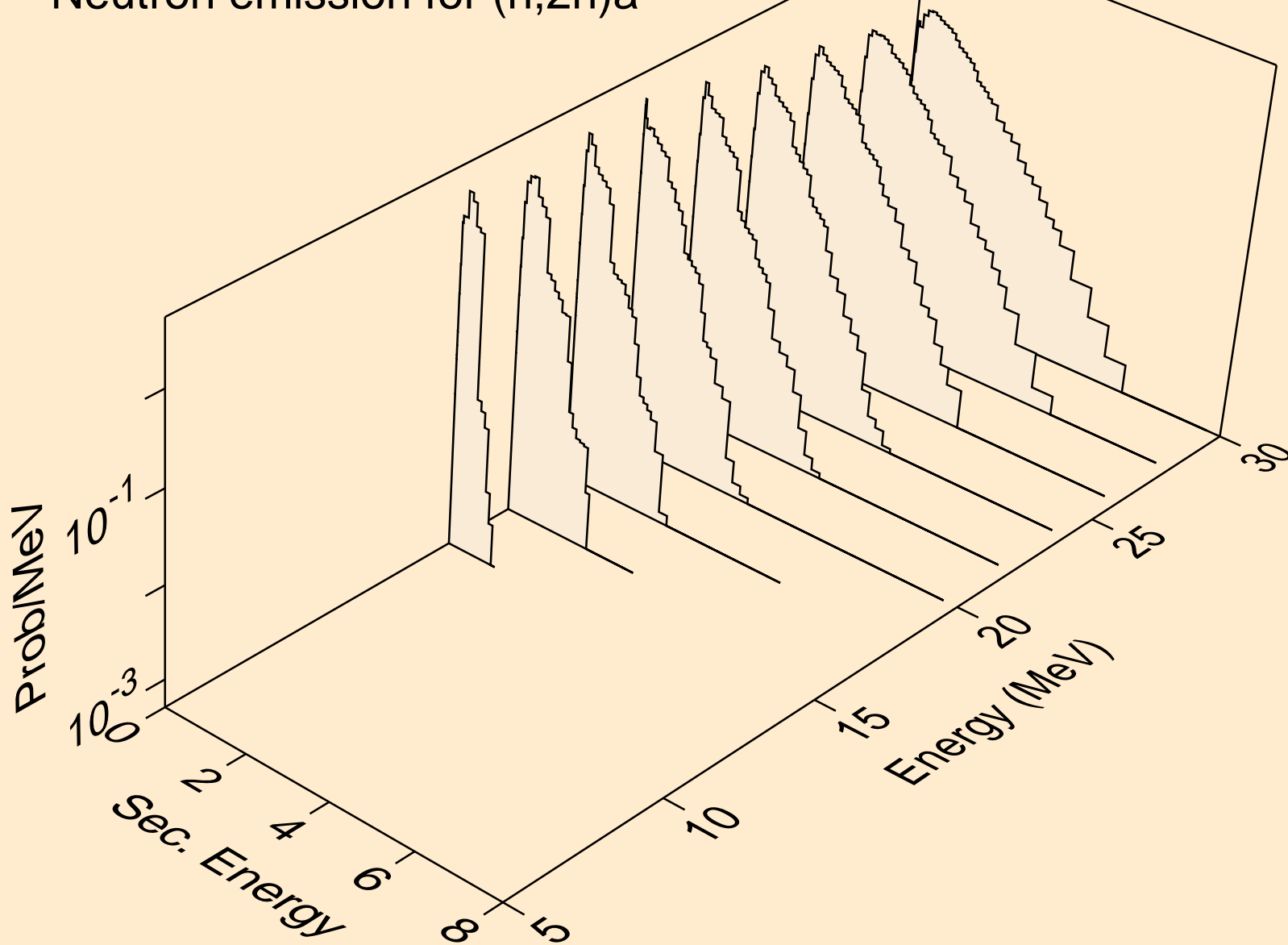

CS135M NEUTRON ACER TENDL-2019 LIBRARY; T=293.16K  
Neutron emission for (n,3n)a

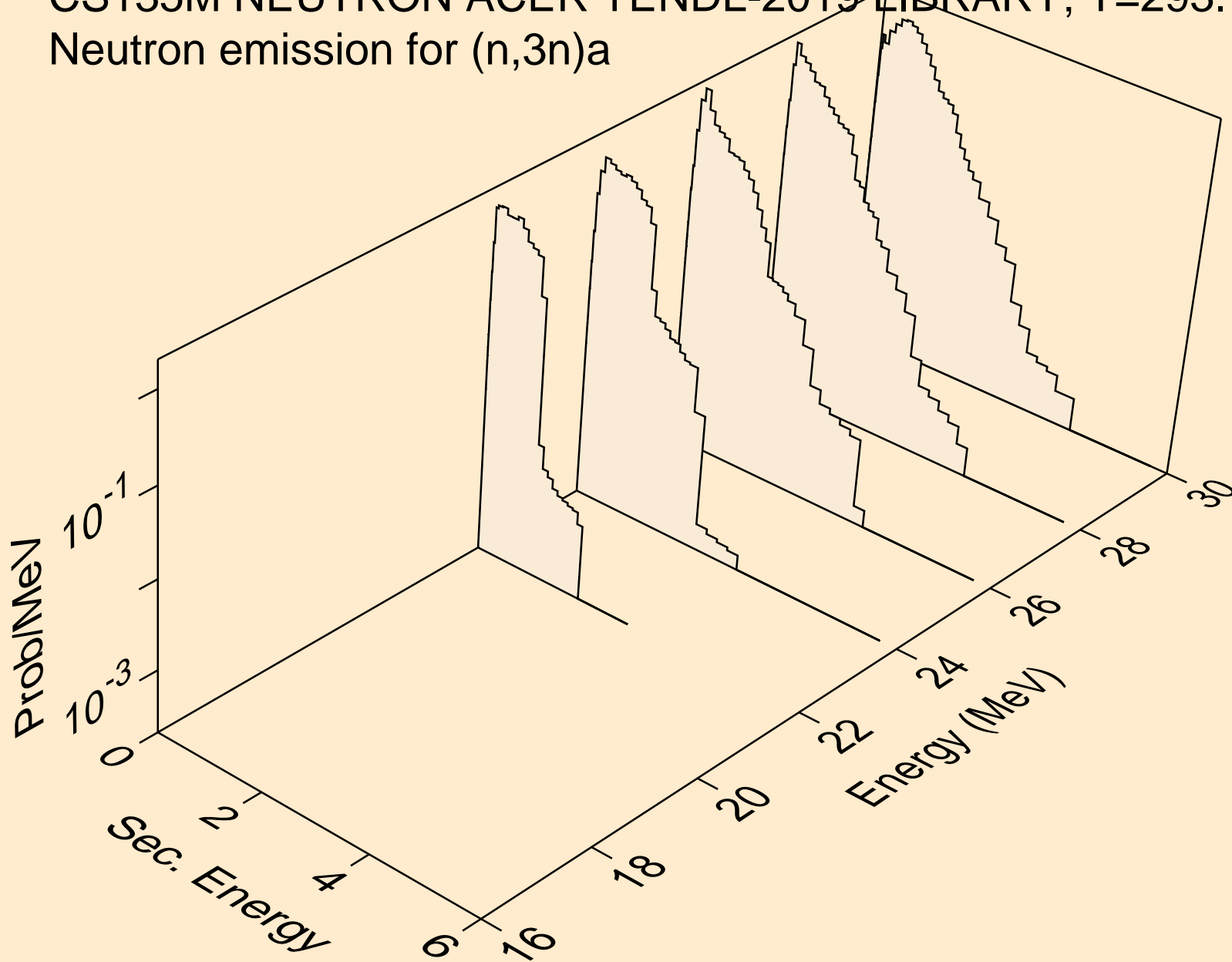

CS135M NEUTRON ACER TENDL-2019 LIBRARY; T=293.16K  
Neutron emission for (n,n\*)p

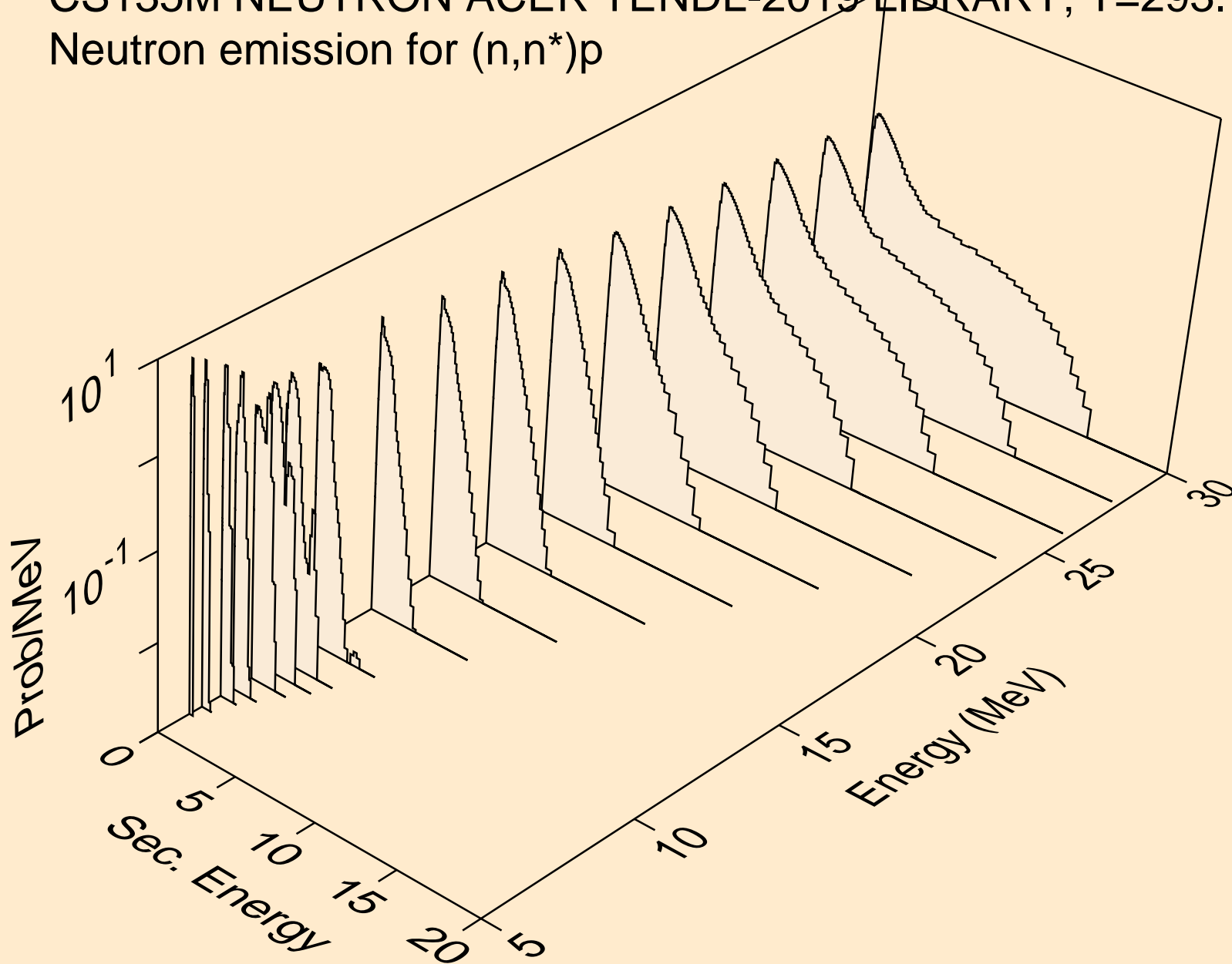

CS135M NEUTRON ACER TENDL-2019 LIBRARY; T=293.16K  
Neutron emission for (n,n\*)d

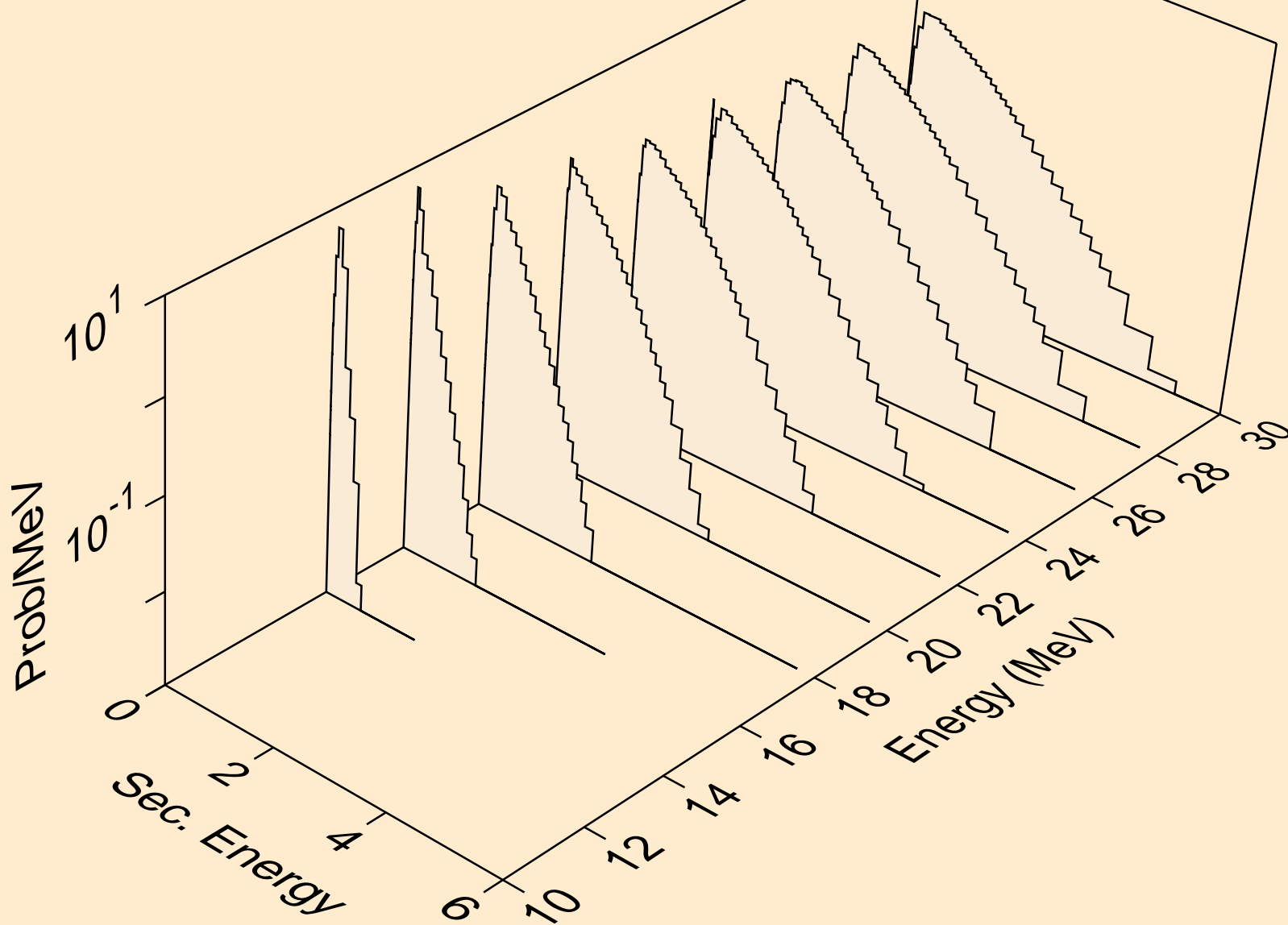

CS135M NEUTRON ACER TENDL-2019 LIBRARY; T=293.16K  
Neutron emission for (n,n\*)t

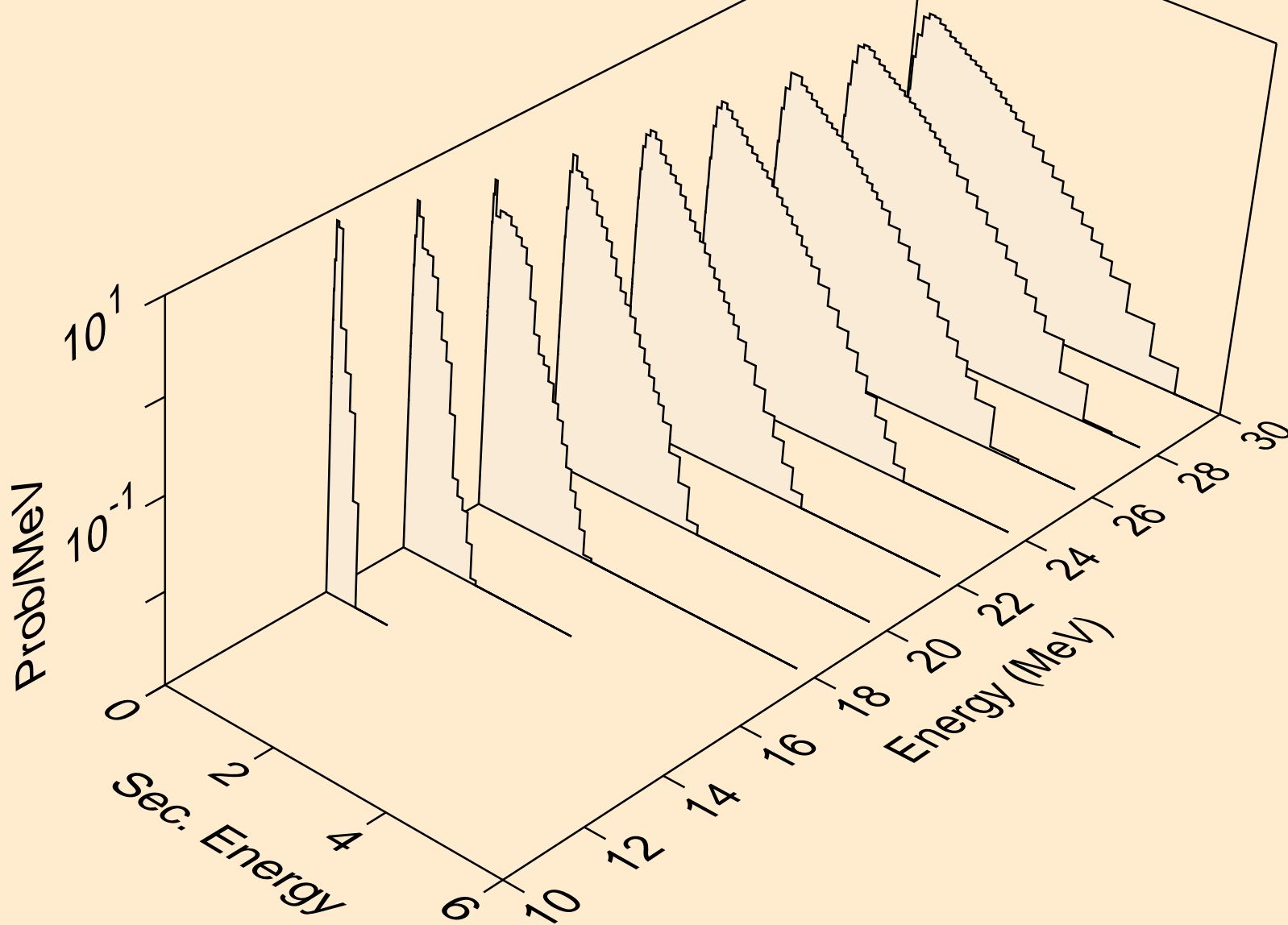

CS135M NEUTRON ACER TENDL-2019 LIBRARY; T=293.16K  
Neutron emission for (n,n\*)he3

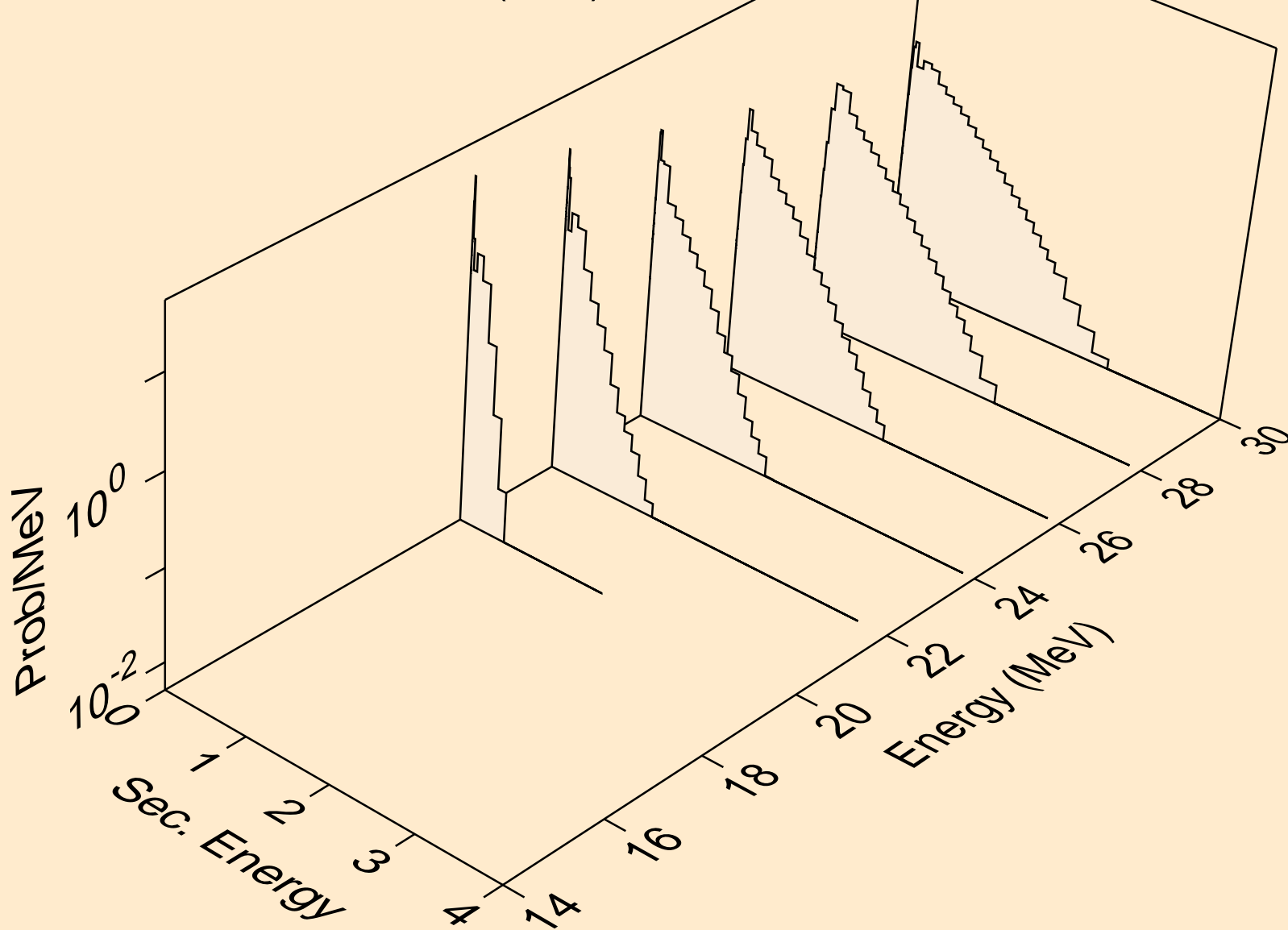



CS135M NEUTRON ACER TENDL-2019 LIBRARY; T=293.16K  
Neutron emission for (n,4n)

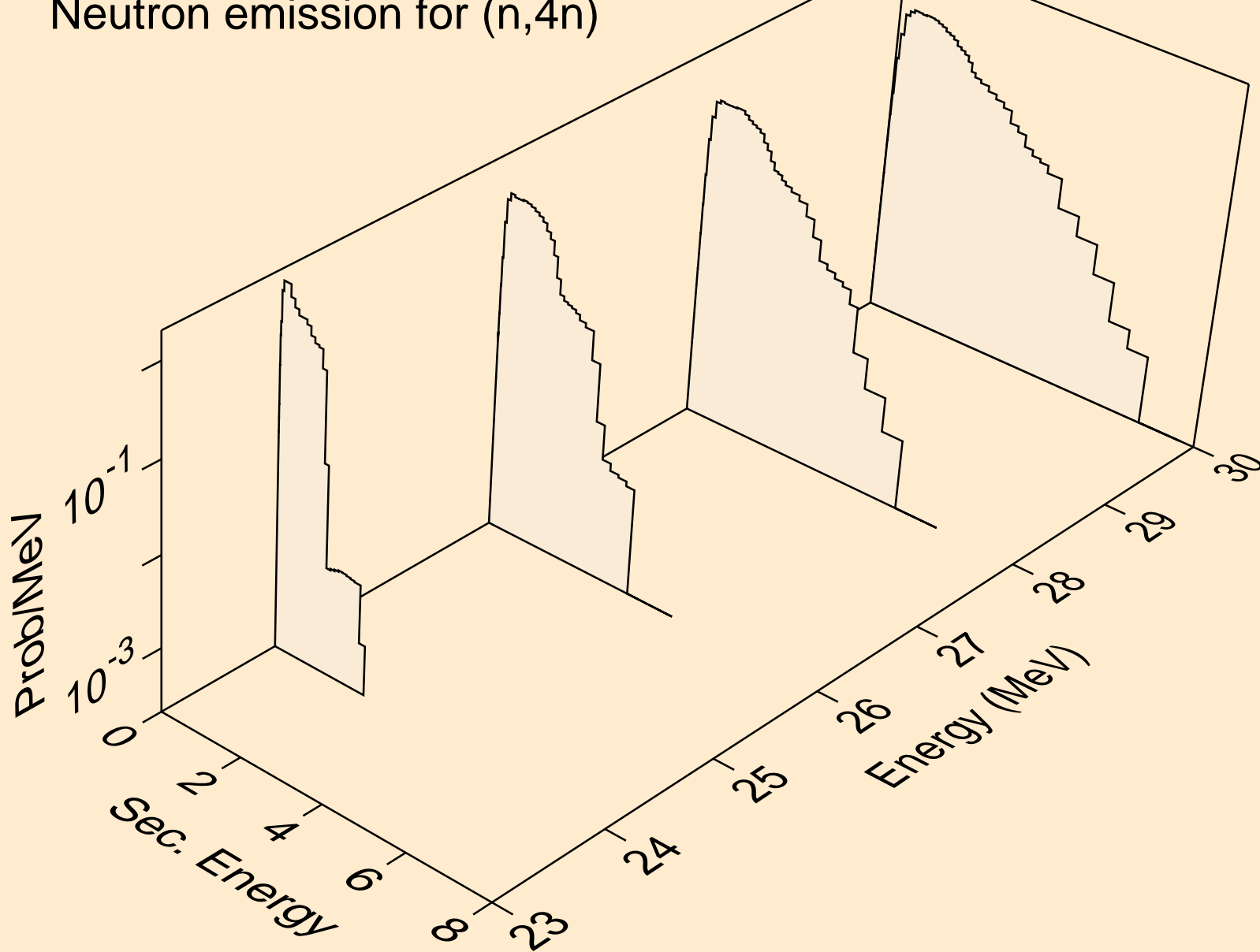

CS135M NEUTRON ACER TENDL-2019 LIBRARY; T=293.16K  
Neutron emission for (n,2np)

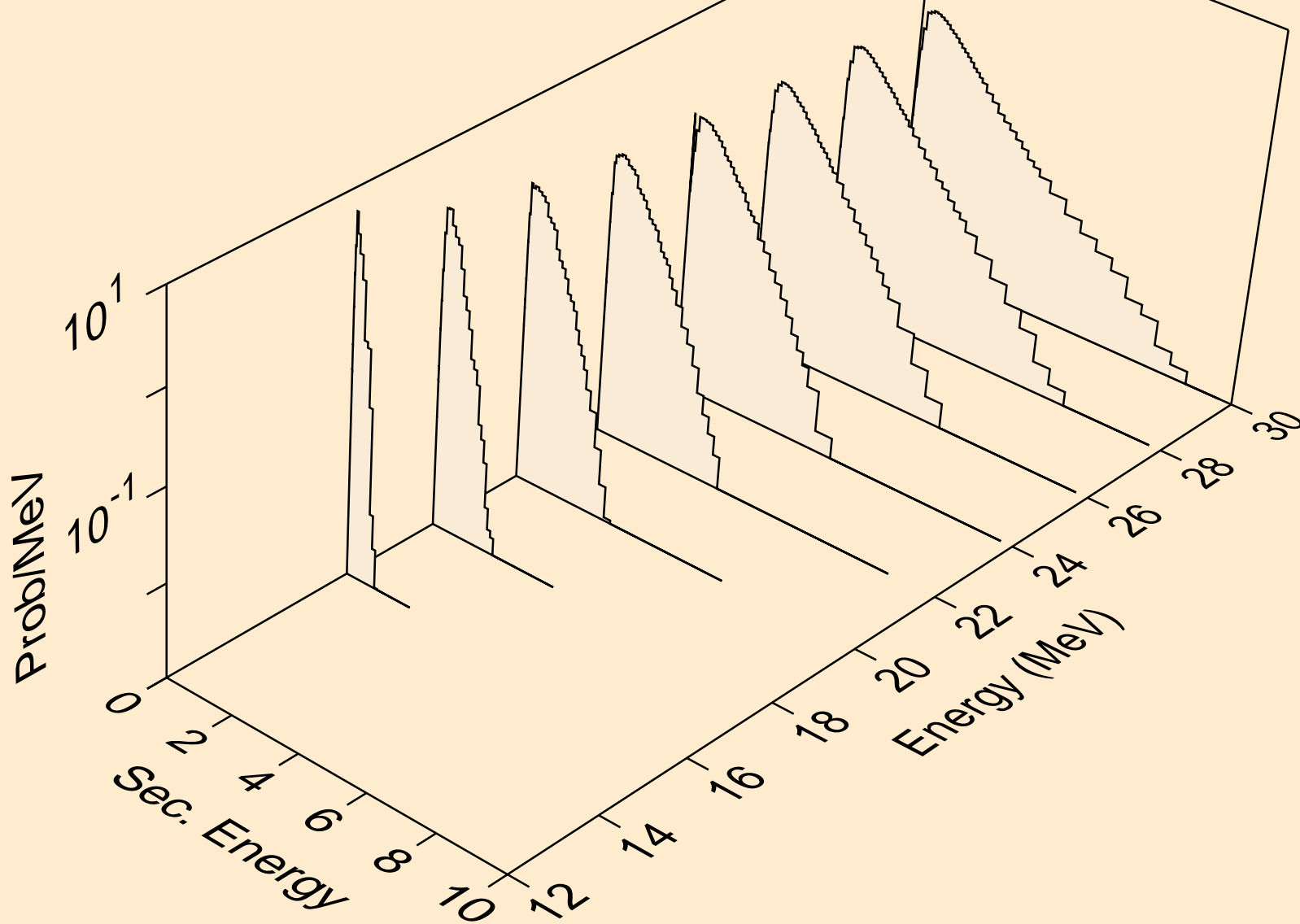

CS135M NEUTRON ACER TENDL-2019 LIBRARY; T=293.16K  
Neutron emission for (n,3np)

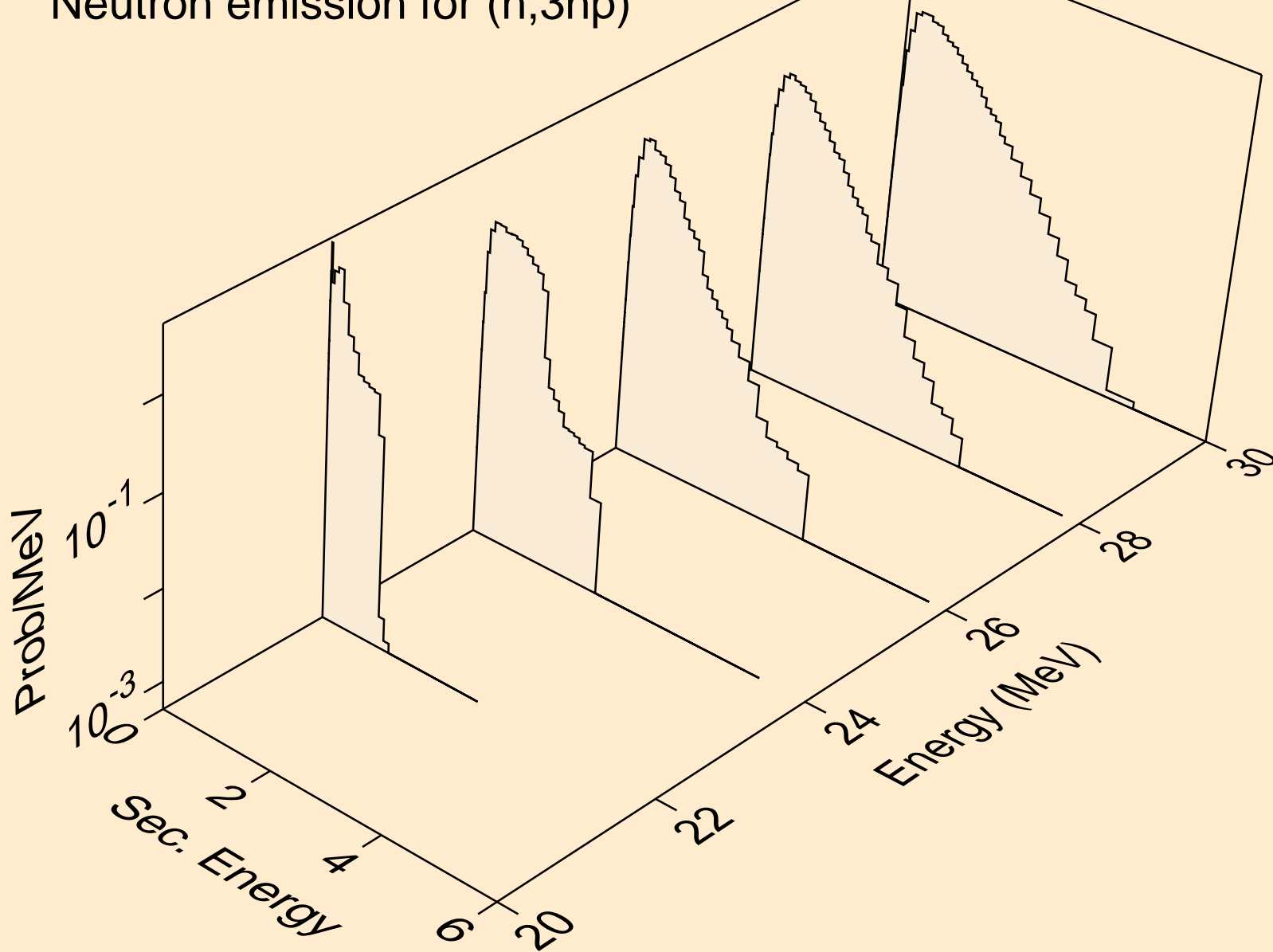

CS135M NEUTRON ACER TENDL-2019 LIBRARY; T=293.16K  
Neutron emission for (n,2np)

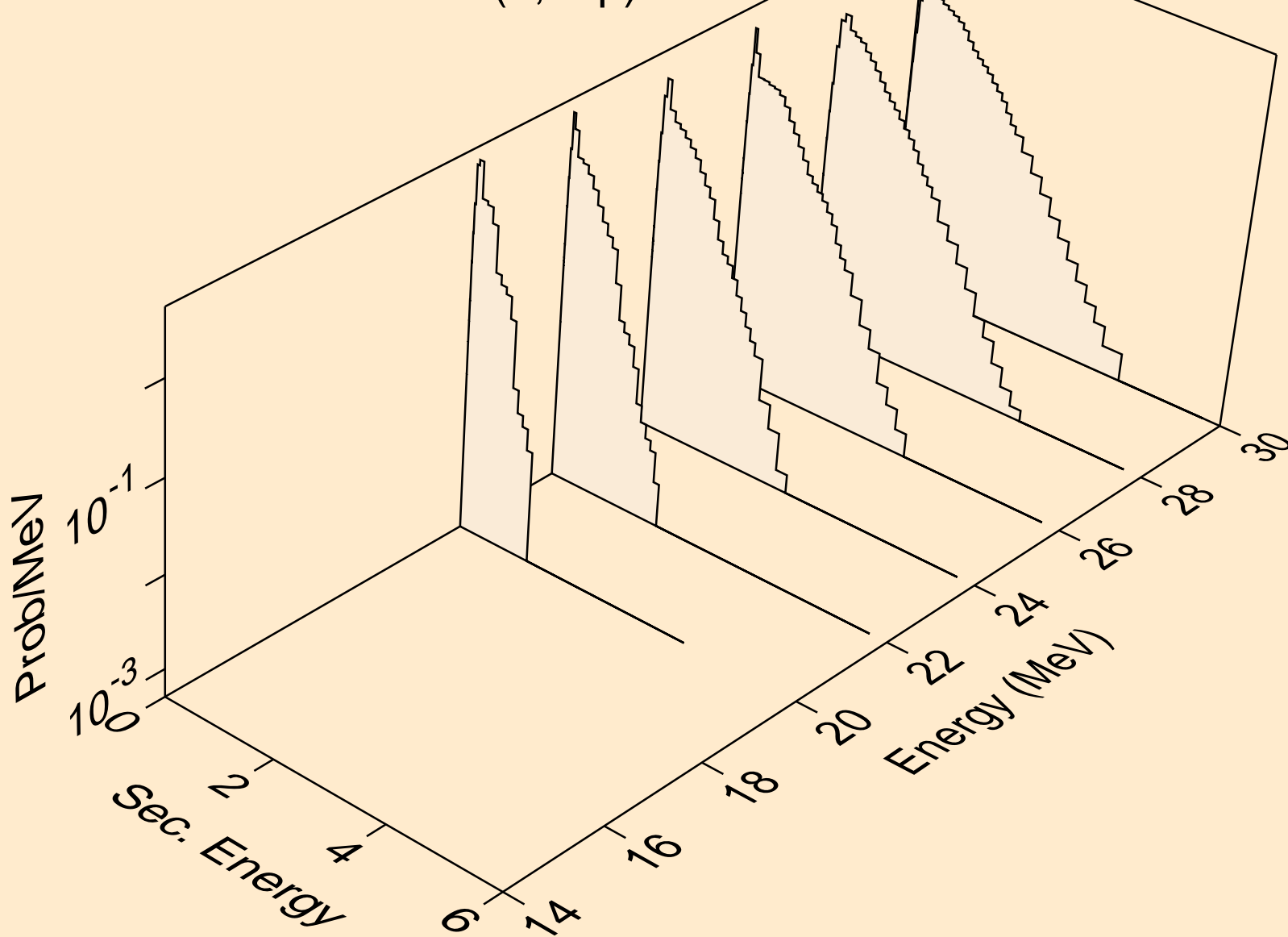

CS135M NEUTRON ACER TENDL-2019 LIBRARY; T=293.16K  
Neutron emission for (n,npa)

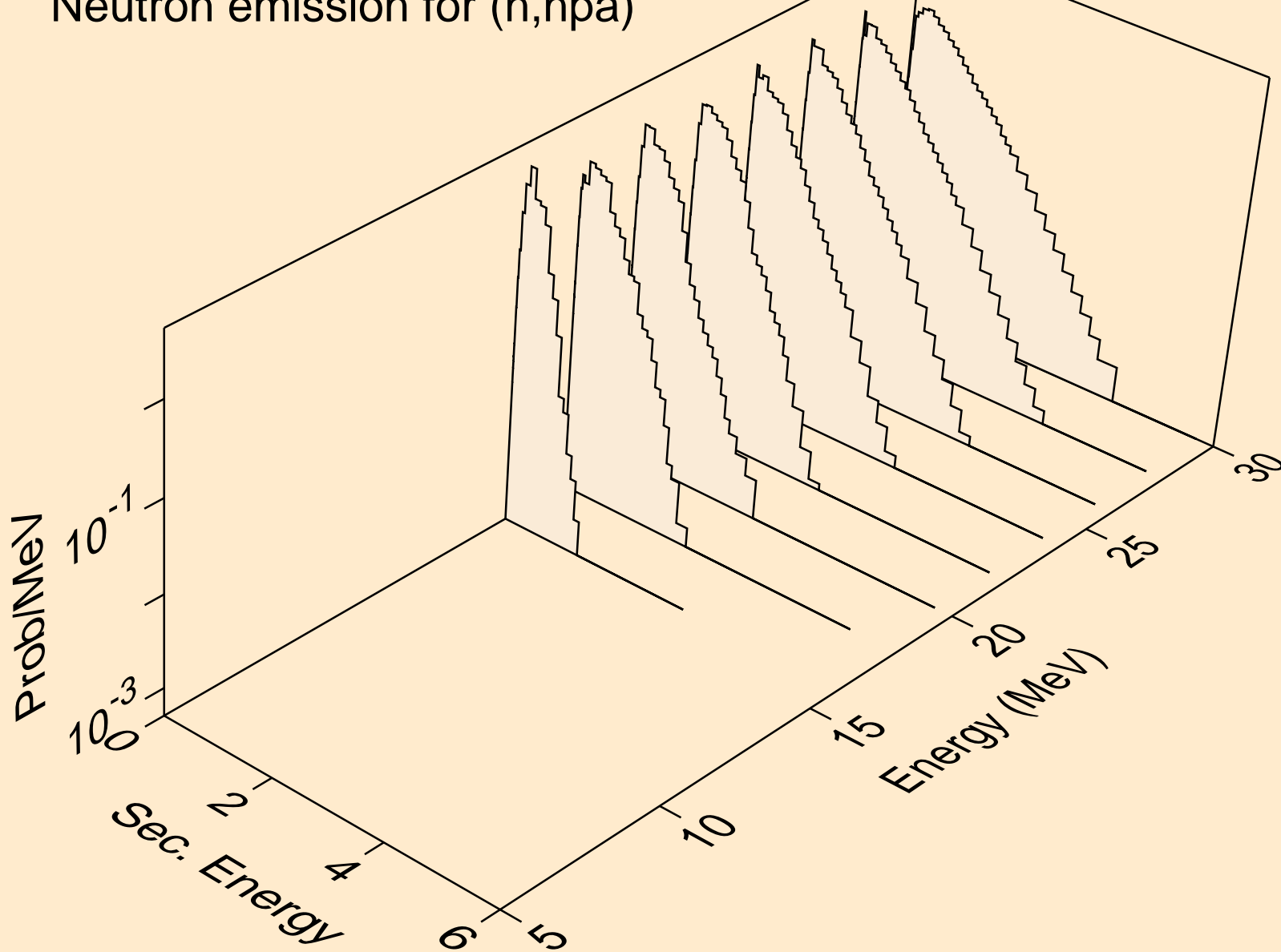

CS135M NEUTRON ACER TENDL-2019 LIBRARY; T=293.16K  
Neutron emission for (n,n\*c)

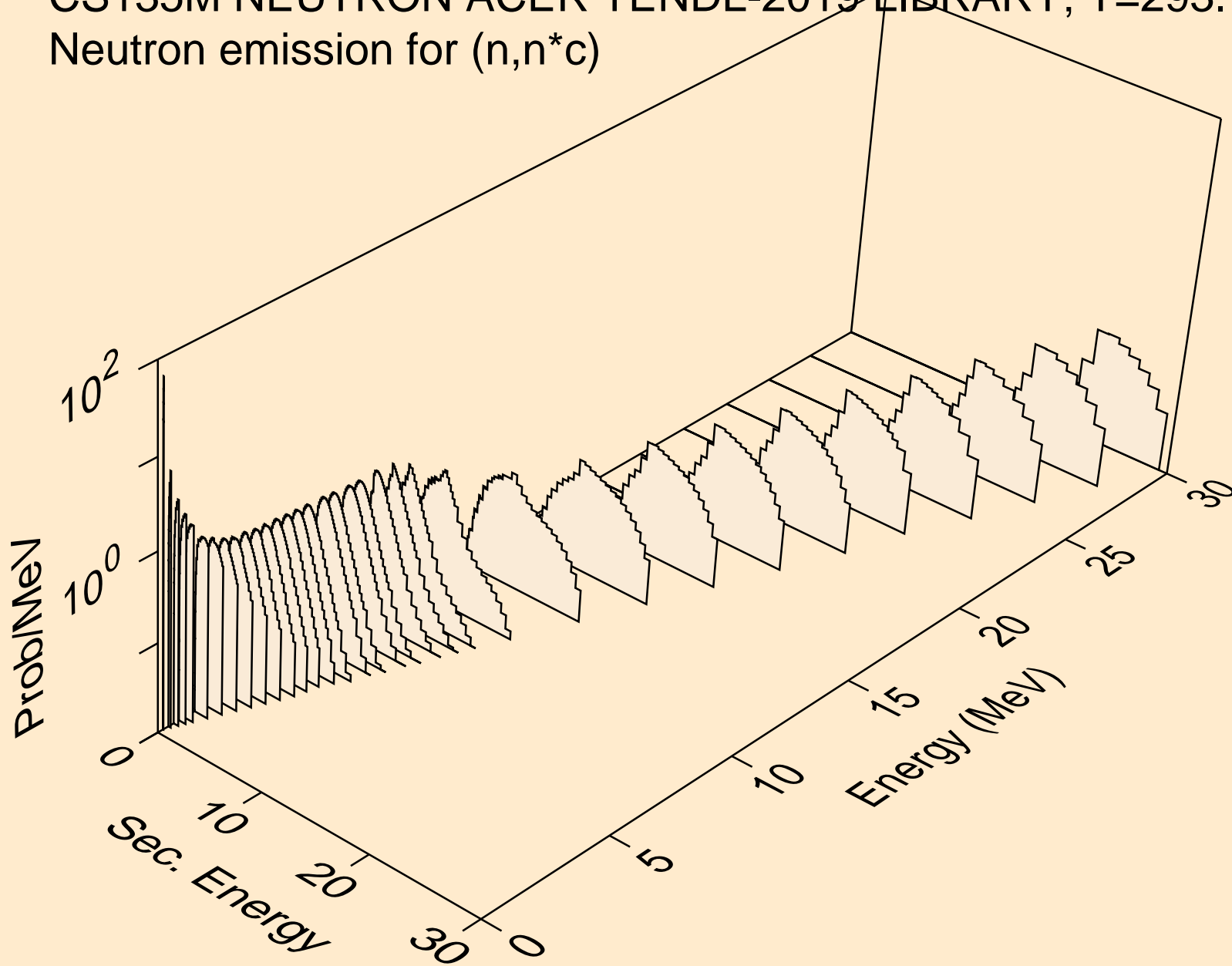

CS135M NEUTRON ACER TENDL-2019 LIBRARY; T=293.16K  
Photon emission for (n,x)

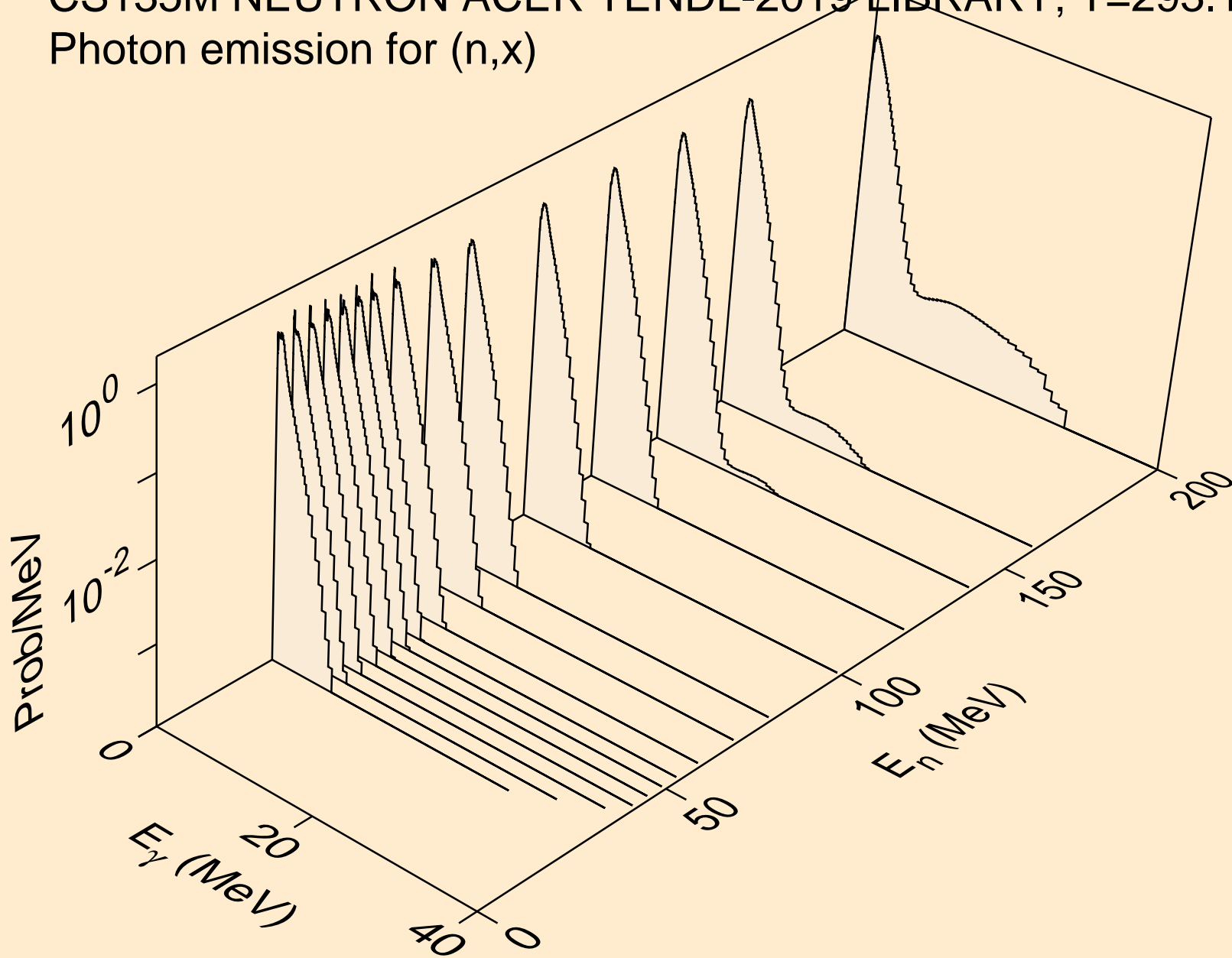

CS135M NEUTRON ACER TENDL-2019 LIBRARY; T=293.16K  
Photon emission for (n,2nd)

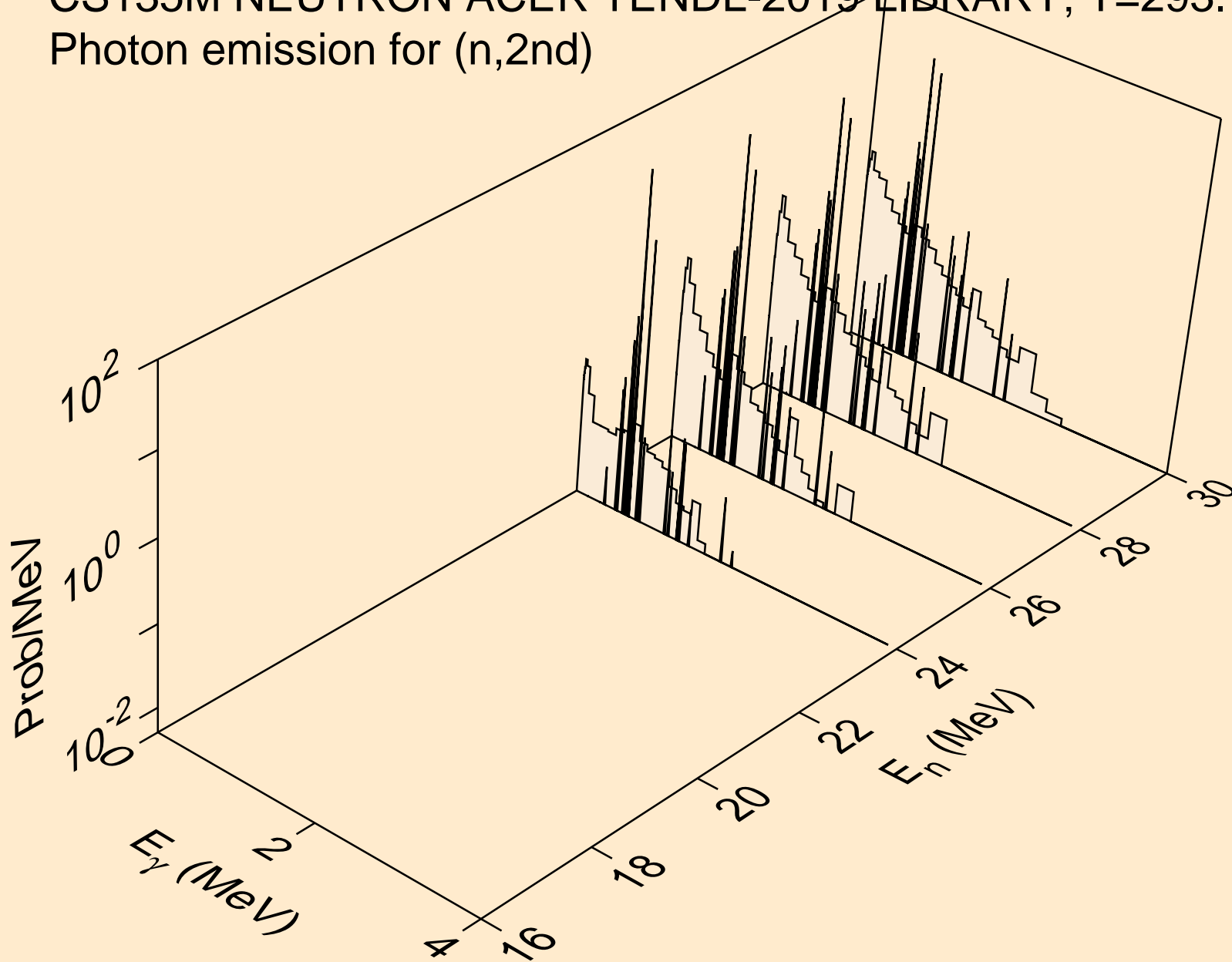



CS135M NEUTRON ACER TENDL-2019 LIBRARY; T=293.16K  
Photon emission for (n,2n)

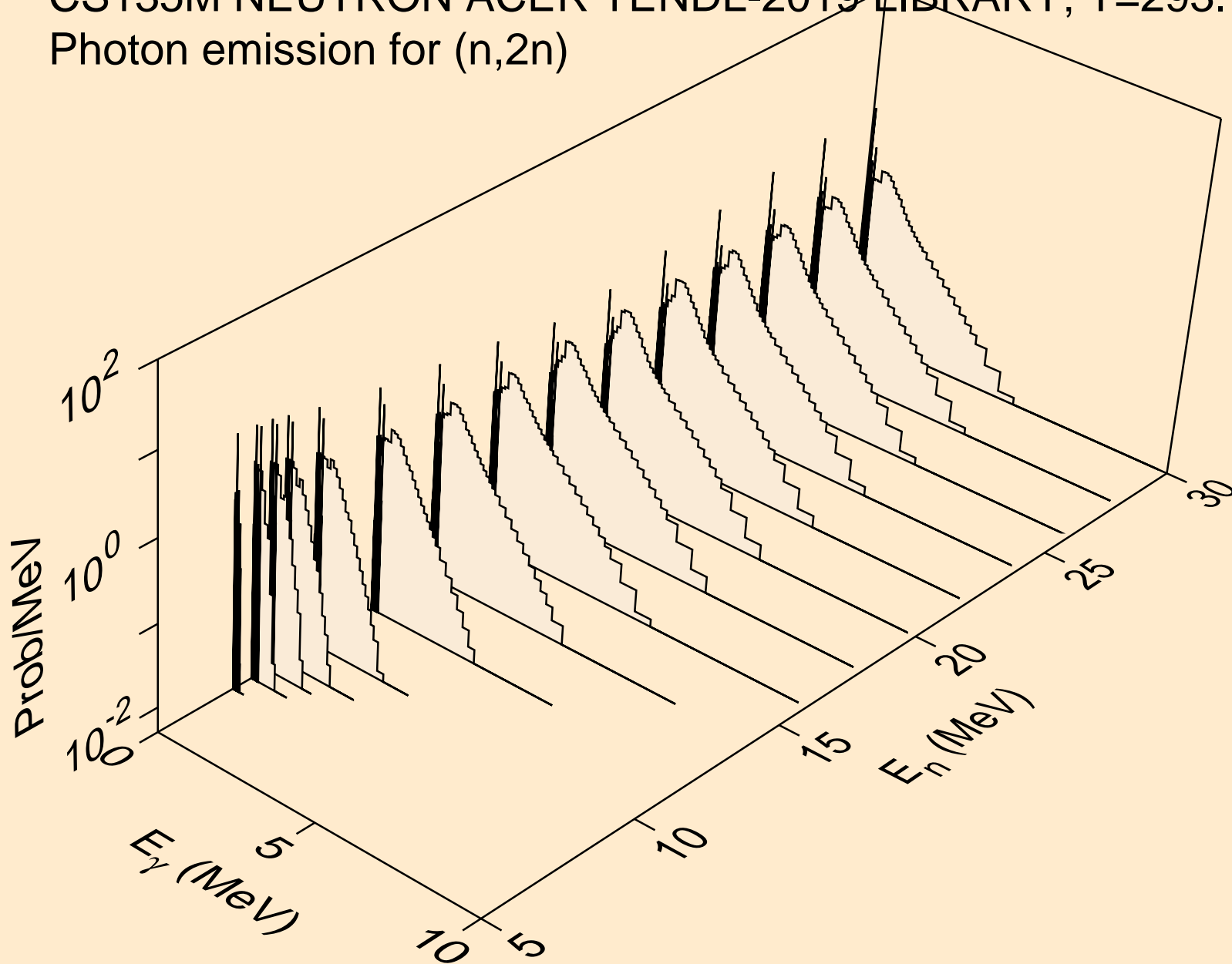

CS135M NEUTRON ACER TENDL-2019 LIBRARY; T=293.16K  
Photon emission for (n,3n)

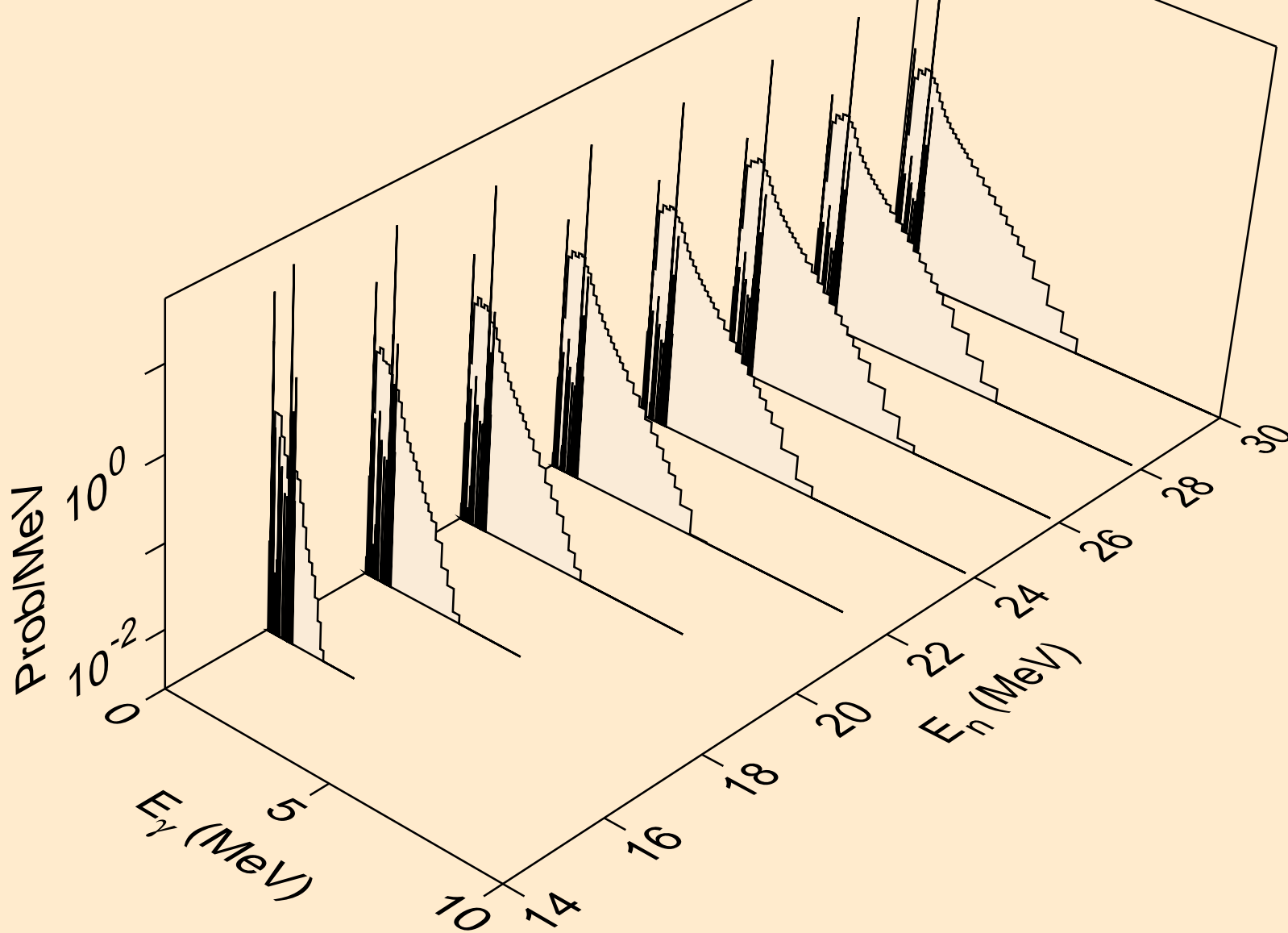

CS135M NEUTRON ACER TENDL-2019 LIBRARY; T=293.16K  
Photon emission for (n,n\*)a

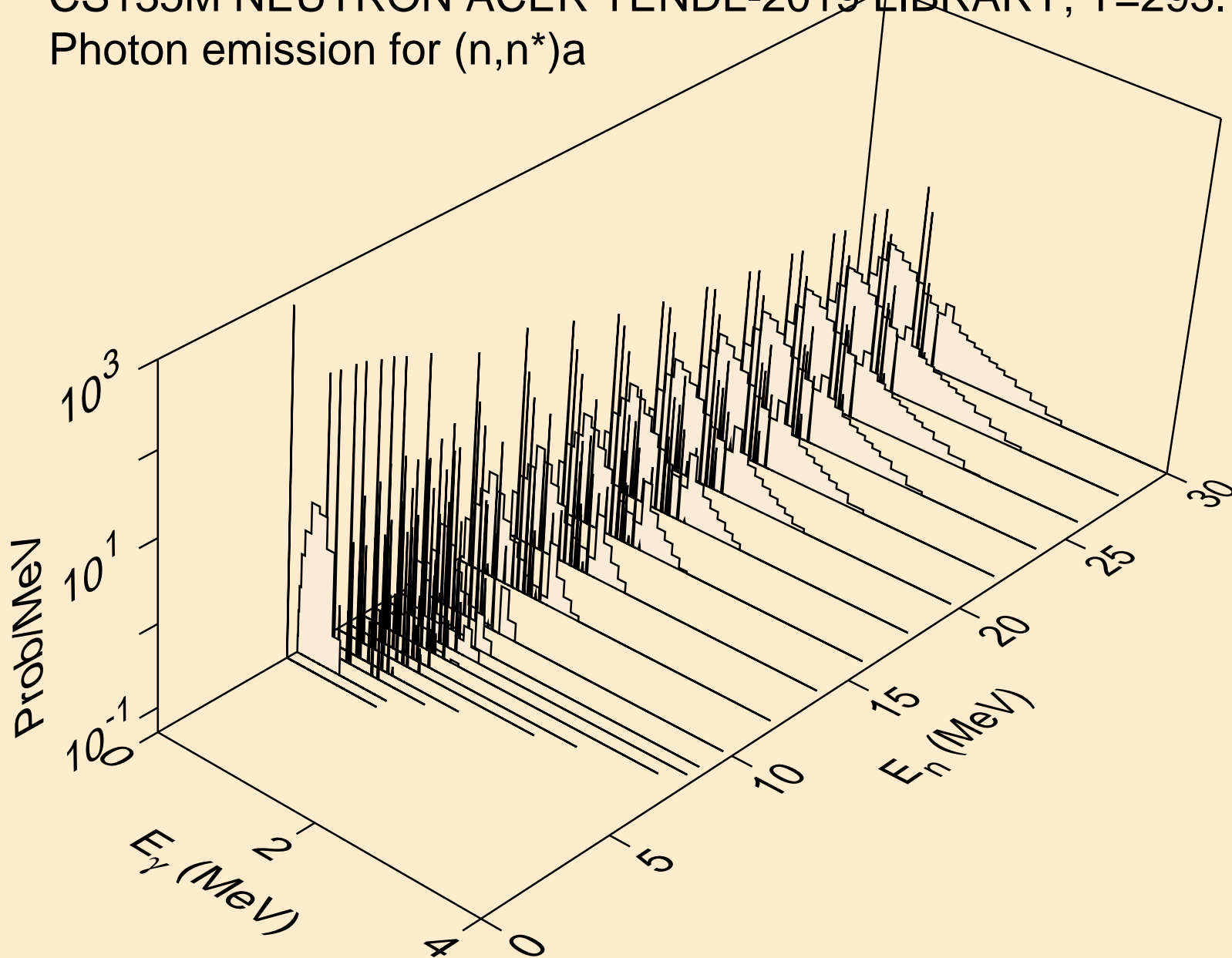

CS135M NEUTRON ACER TENDL-2019 LIBRARY; T=293.16K  
Photon emission for (n,2n)a

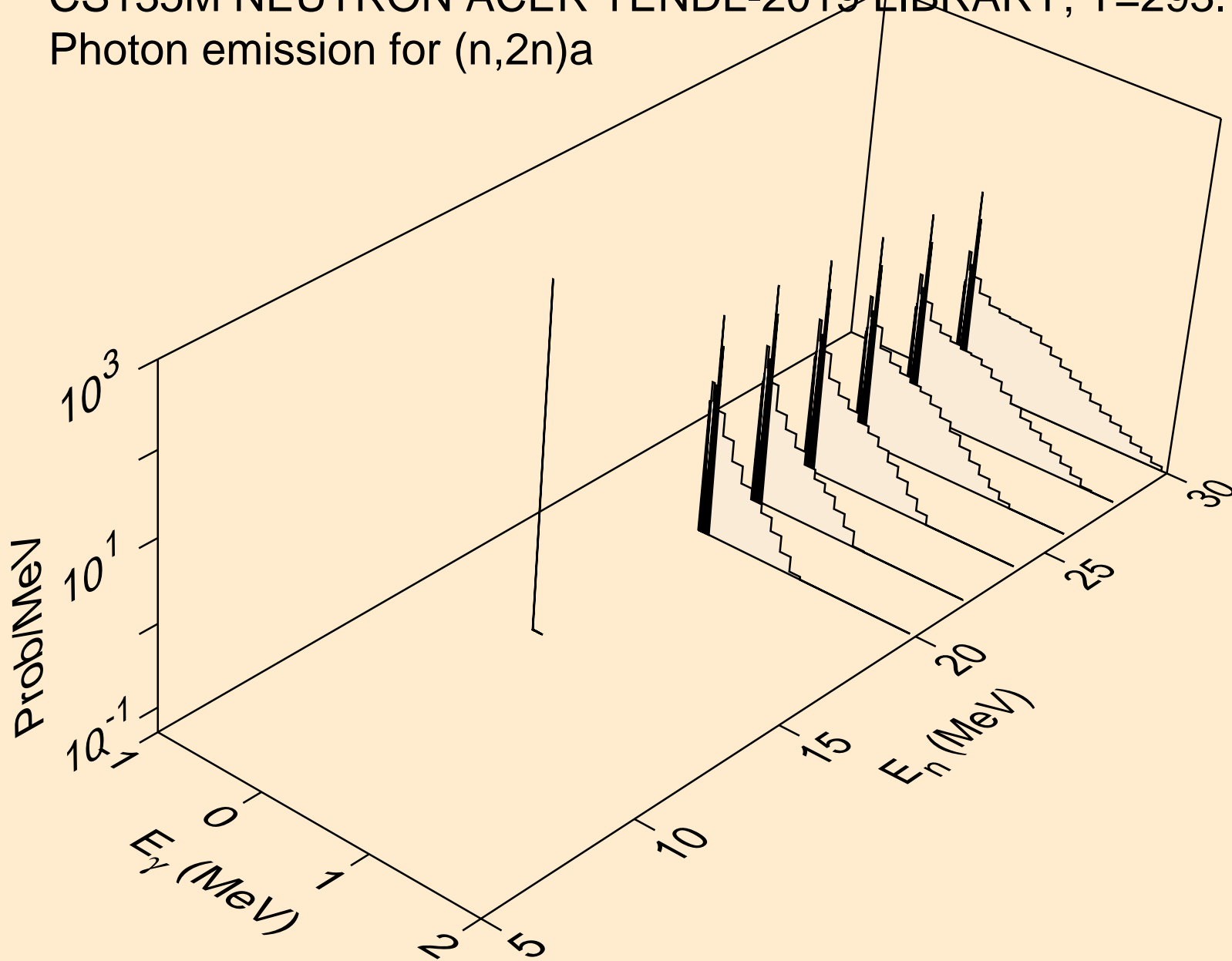

CS135M NEUTRON ACER TENDL-2019 LIBRARY; T=293.16K  
Photon emission for (n,3n)a

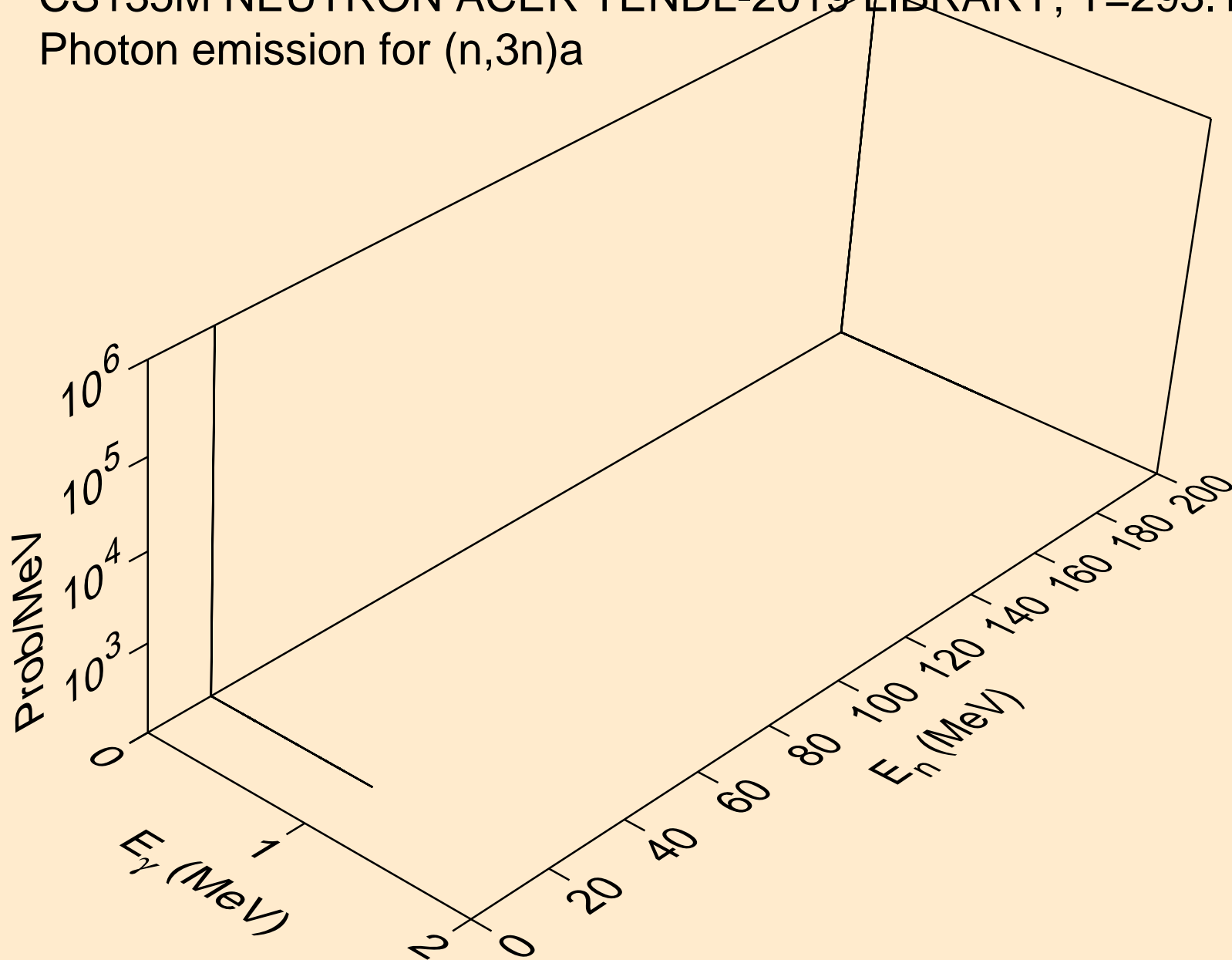

CS135M NEUTRON ACER TENDL-2019 LIBRARY; T=293.16K  
Photon emission for (n,n\*)p

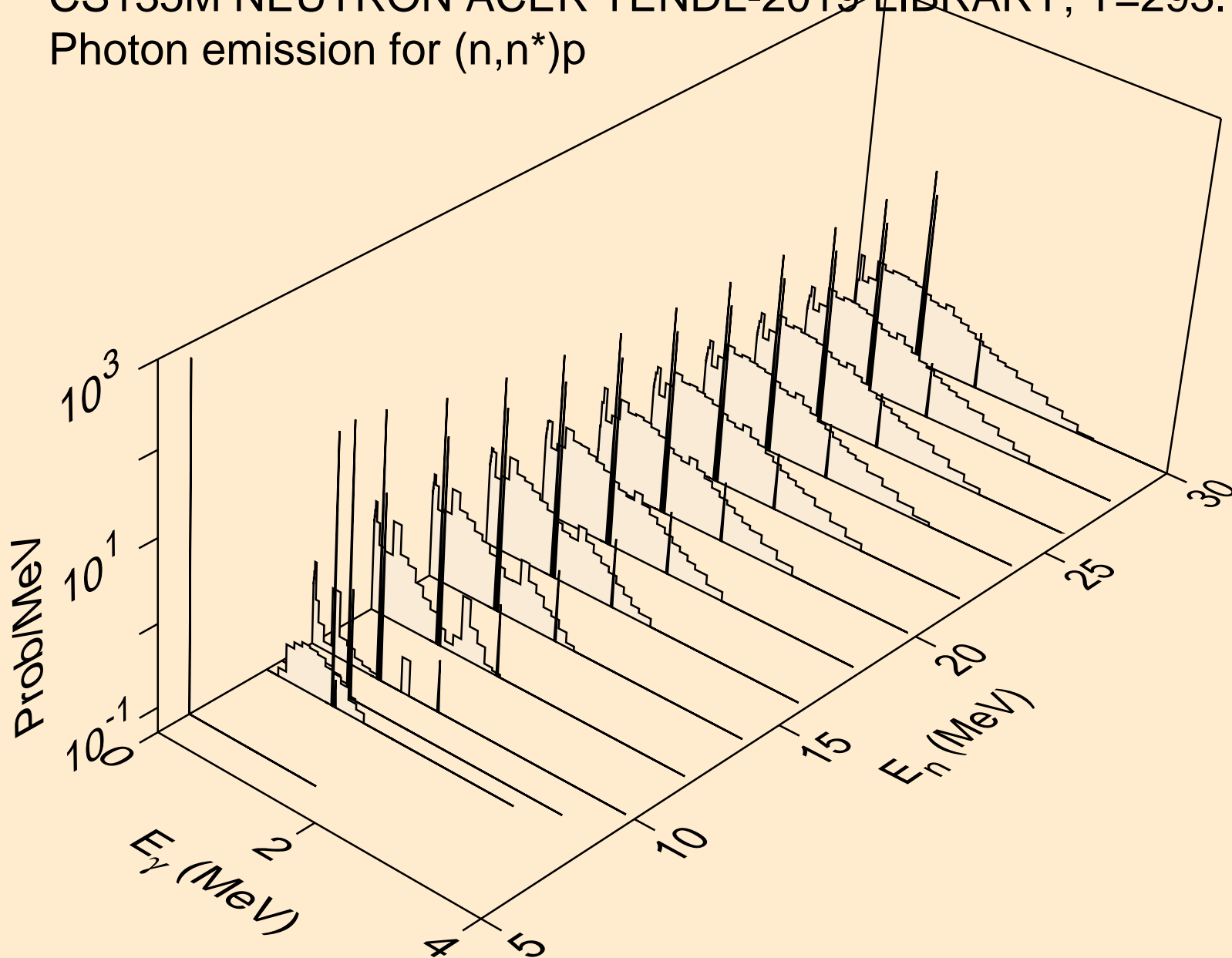

CS135M NEUTRON ACER TENDL-2019 LIBRARY; T=293.16K  
Photon emission for (n,n\*)d

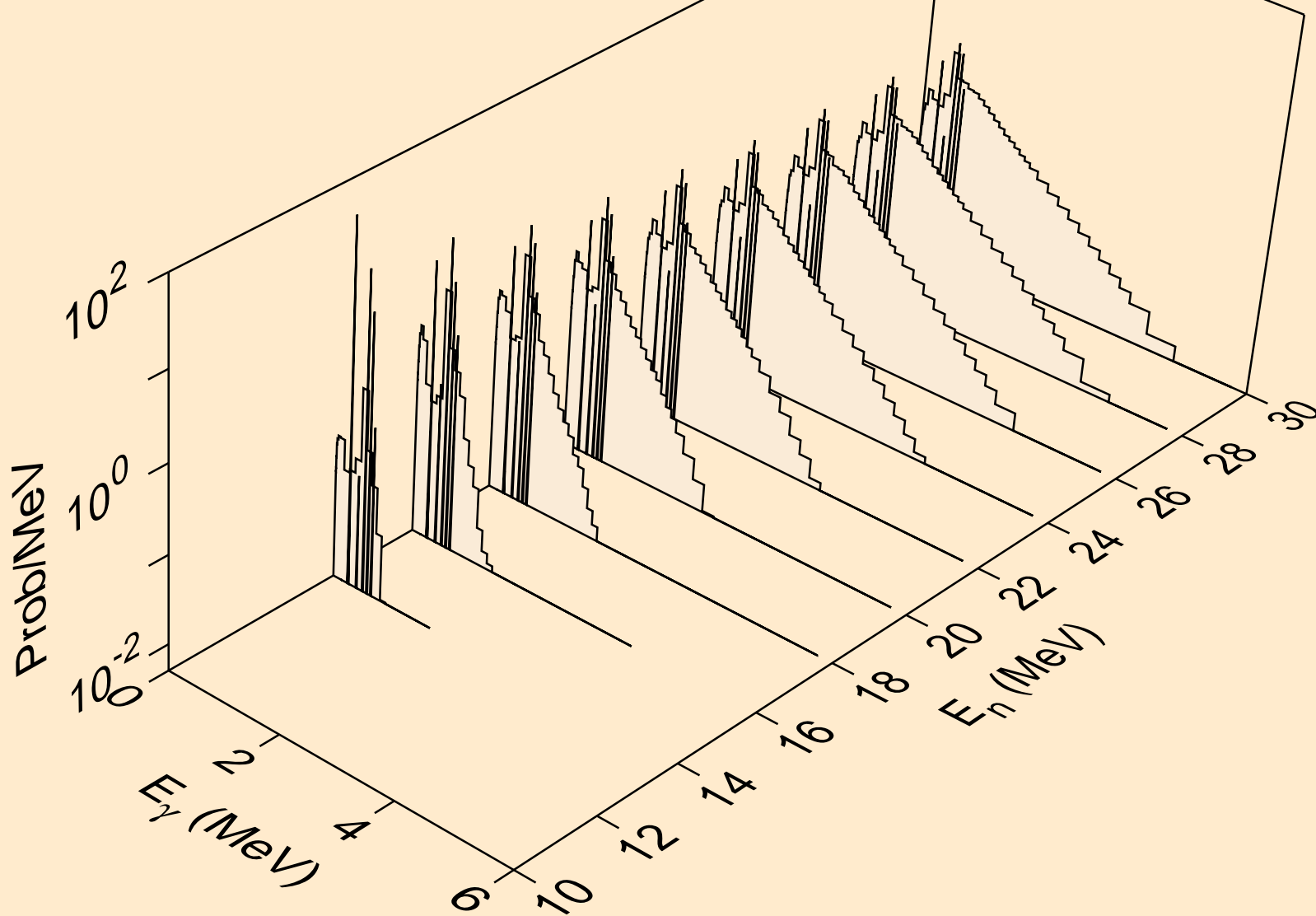

CS135M NEUTRON ACER TENDL-2019 LIBRARY; T=293.16K  
Photon emission for (n,n\*)t

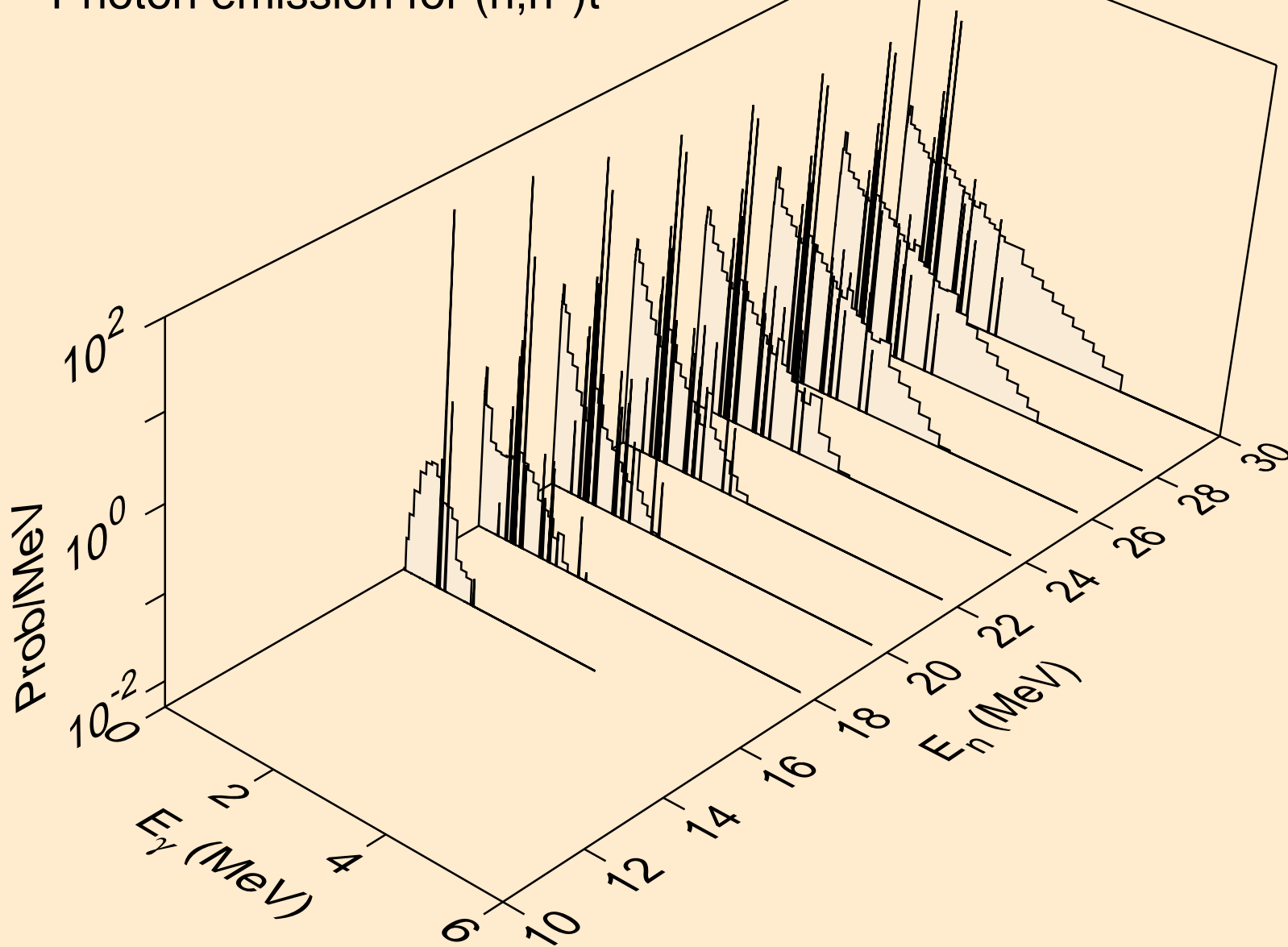



CS135M NEUTRON ACER TENDL-2019 LIBRARY; T=293.16K  
Photon emission for (n,n\*)he3

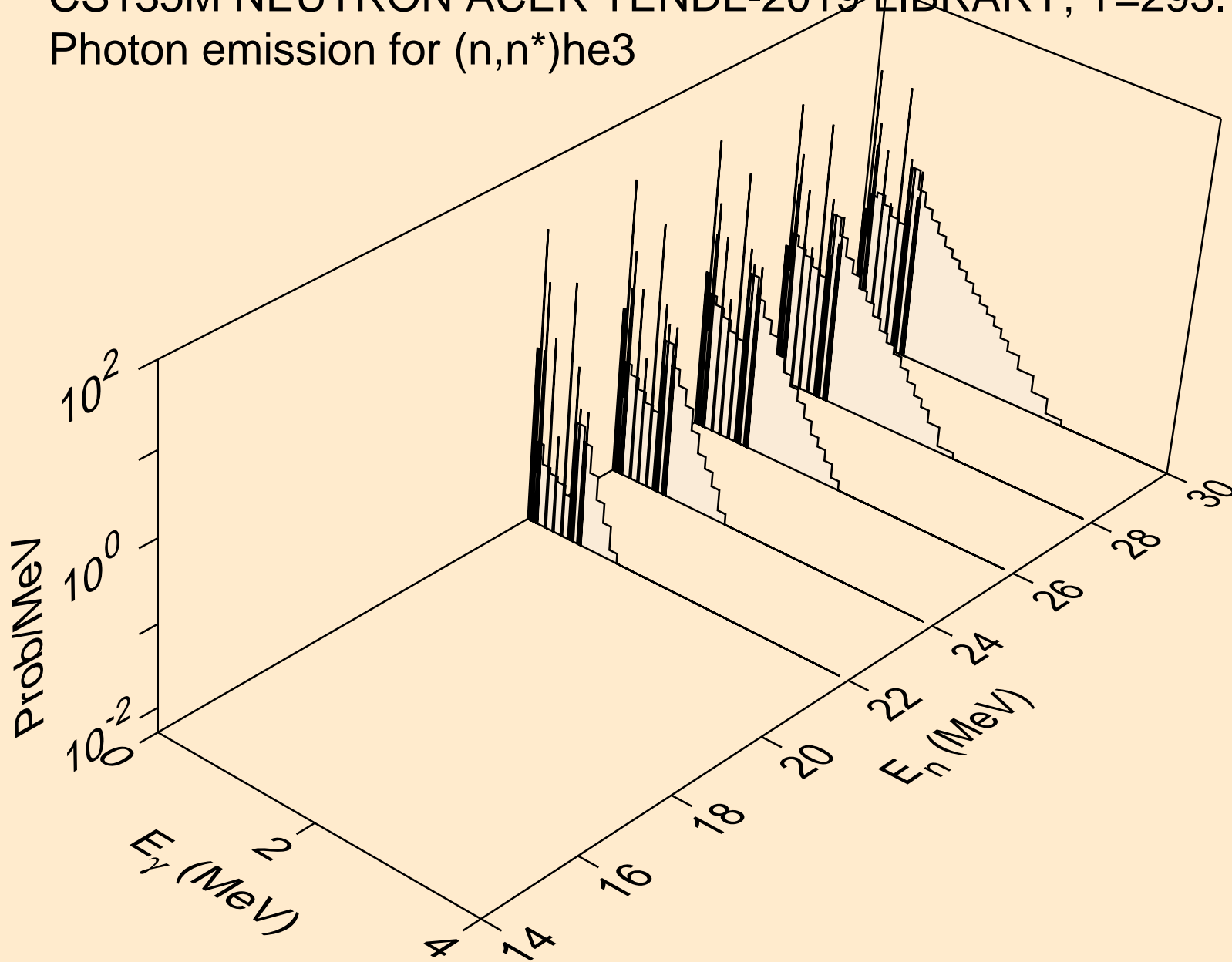

CS135M NEUTRON ACER TENDL-2019 LIBRARY; T=293.16K  
Photon emission for (n,4n)

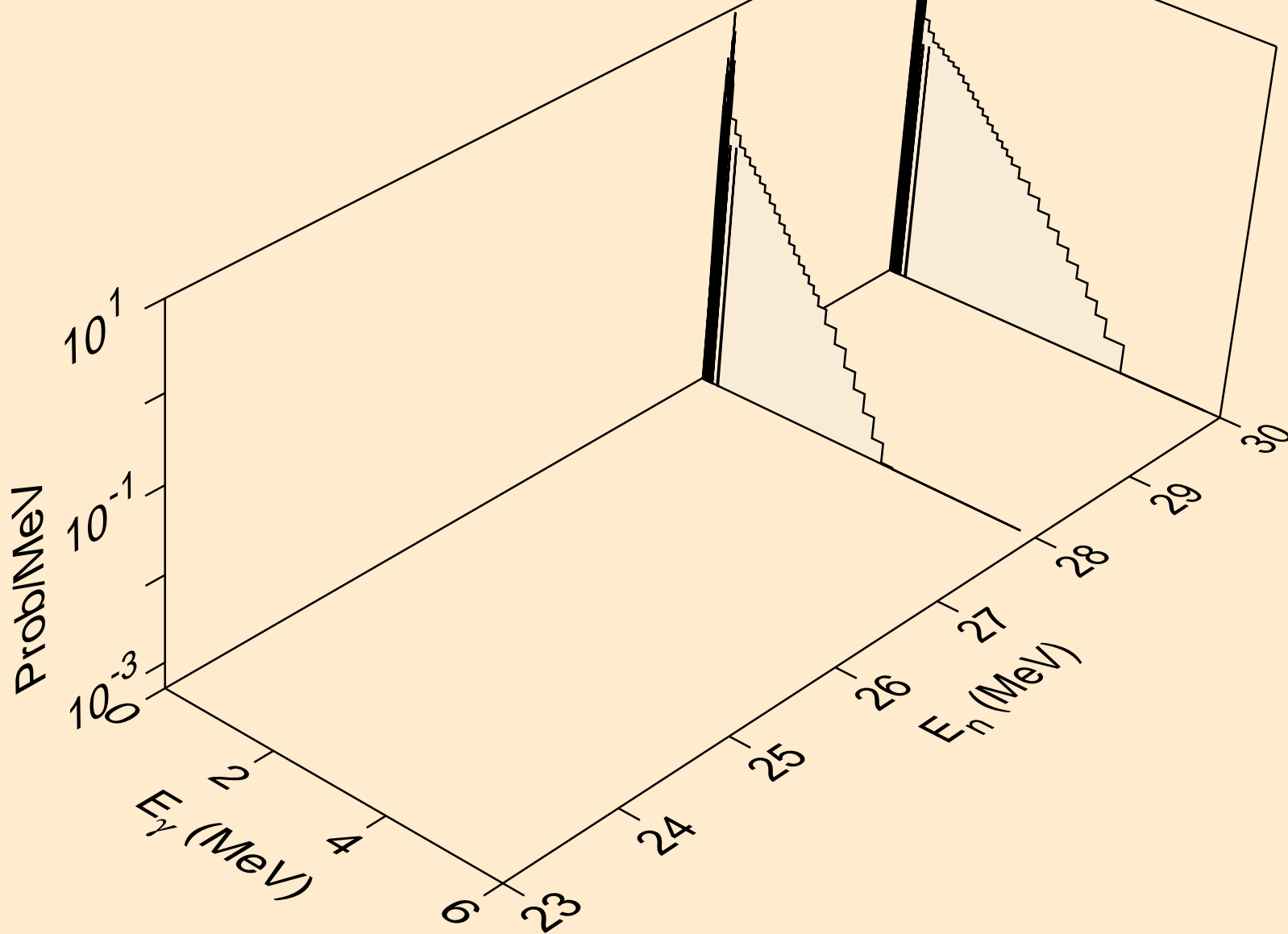

CS135M NEUTRON ACER TENDL-2019 LIBRARY; T=293.16K  
Photon emission for (n,2np)

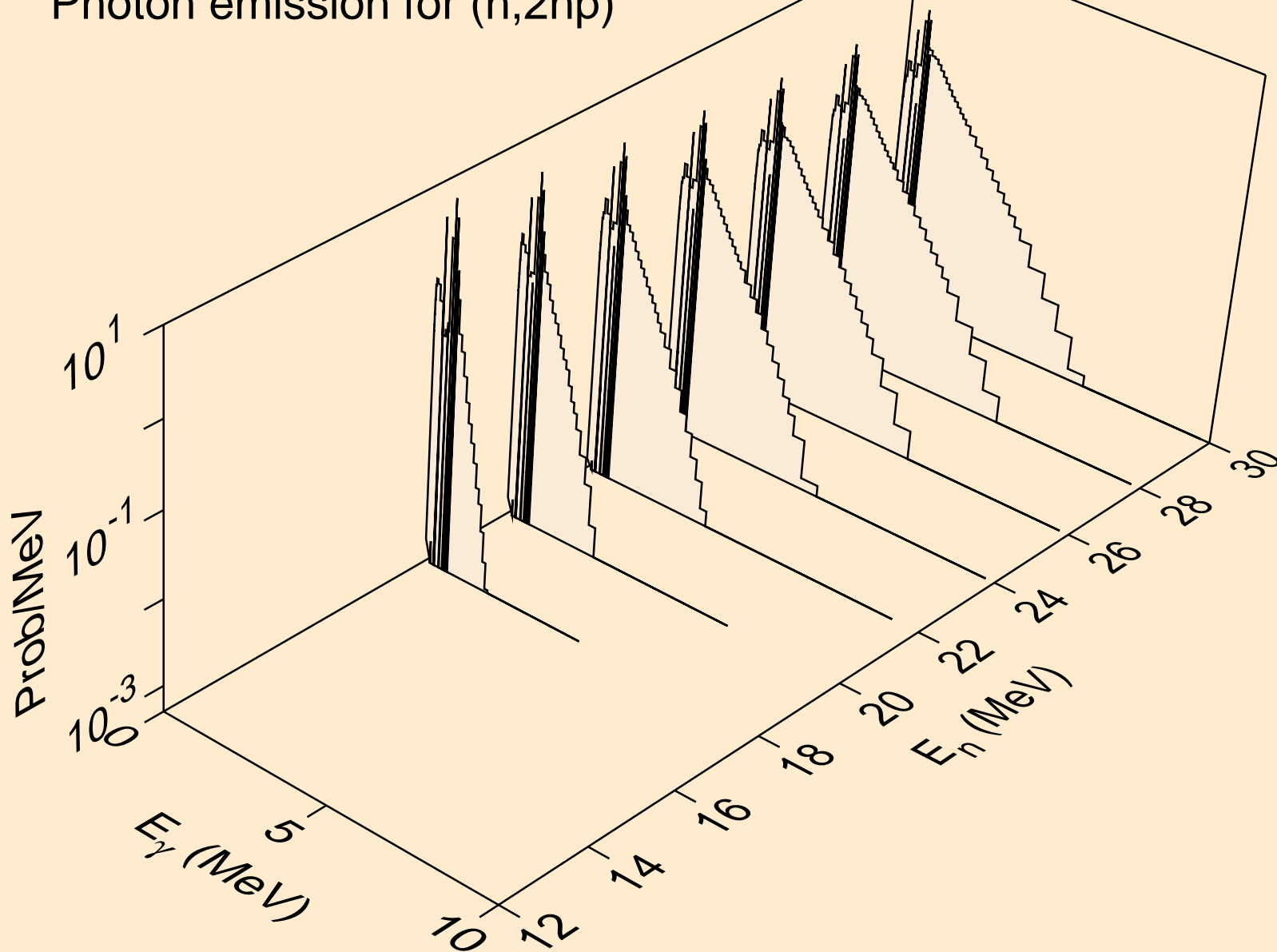

CS135M NEUTRON ACER TENDL-2019 LIBRARY; T=293.16K  
Photon emission for (n,3np)

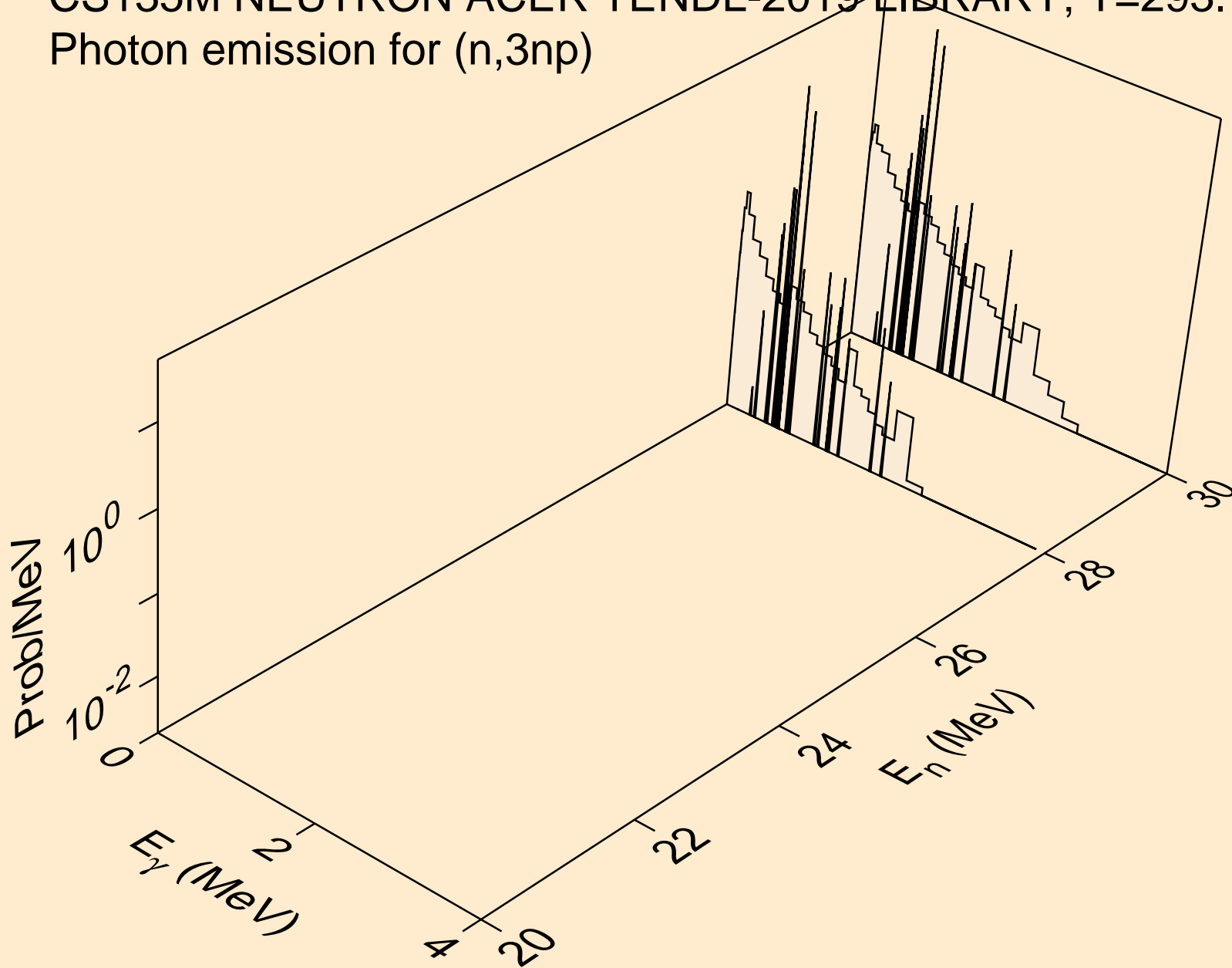

CS135M NEUTRON ACER TENDL-2019 LIBRARY; T=293.16K  
Photon emission for (n,2np)

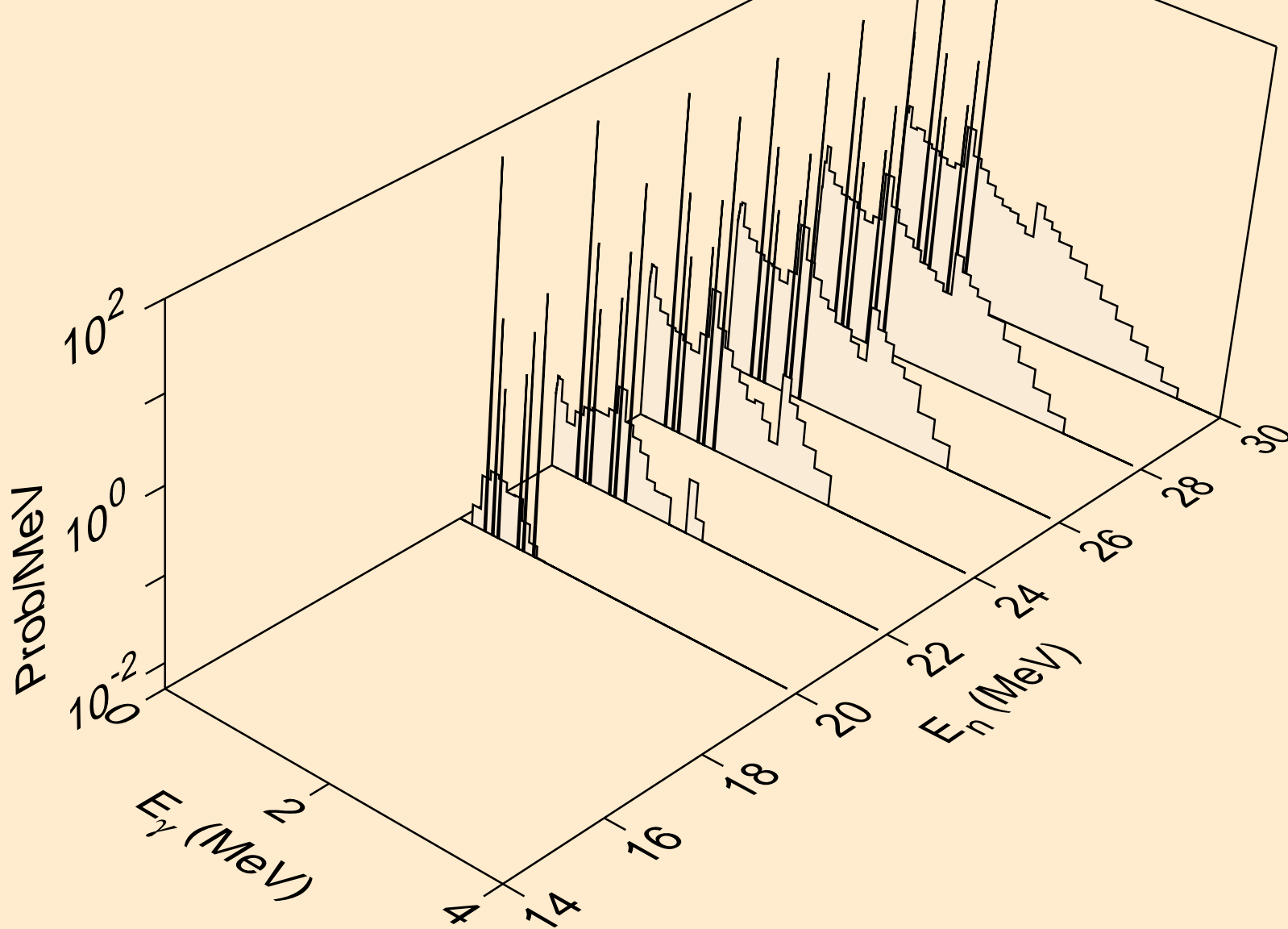

CS135M NEUTRON ACER TENDL-2019 LIBRARY; T=293.16K  
Photon emission for (n,npa)

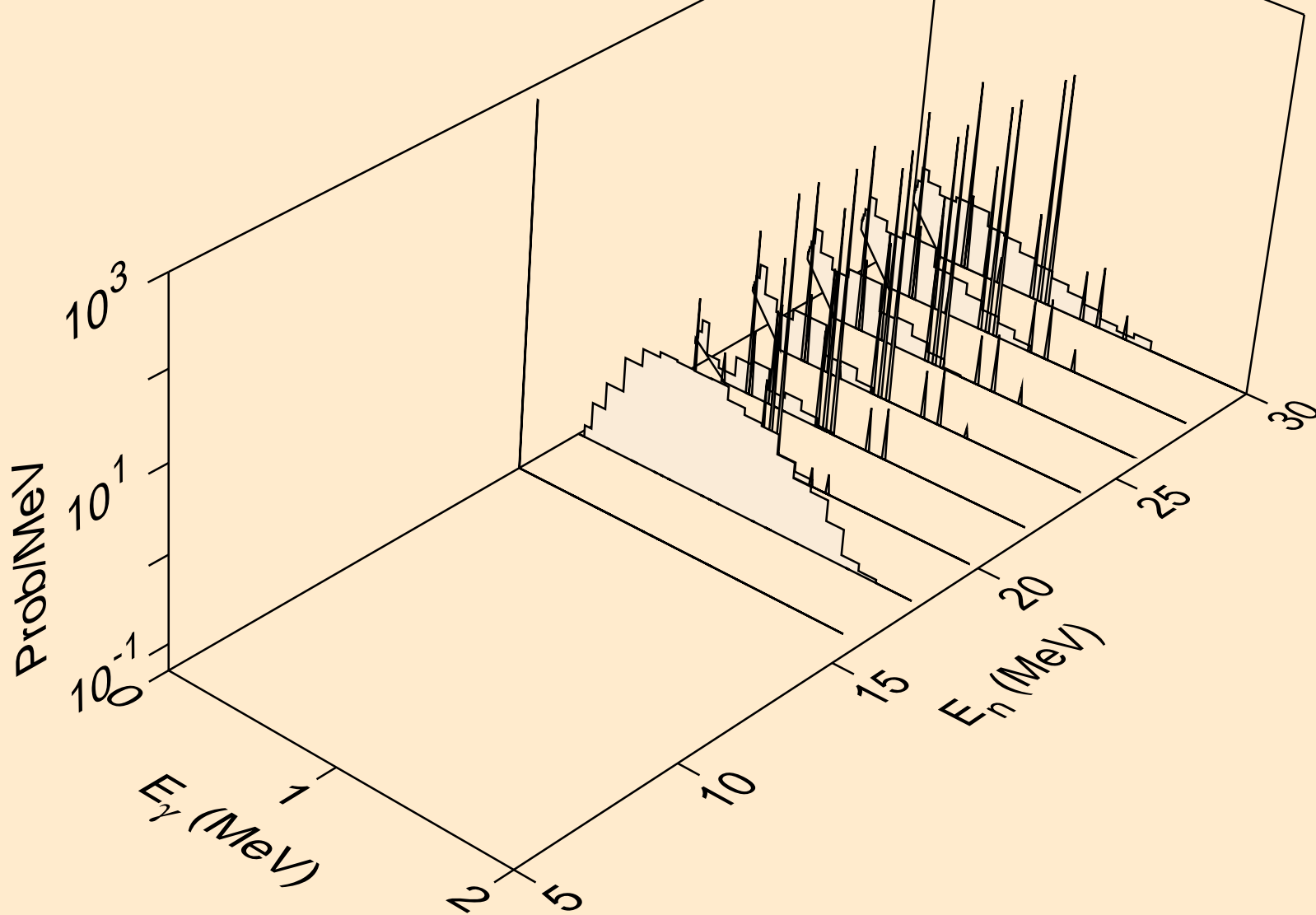

CS135M NEUTRON ACER TENDL-2019 LIBRARY; T=293.16K  
Photon emission for (n,n\*1)

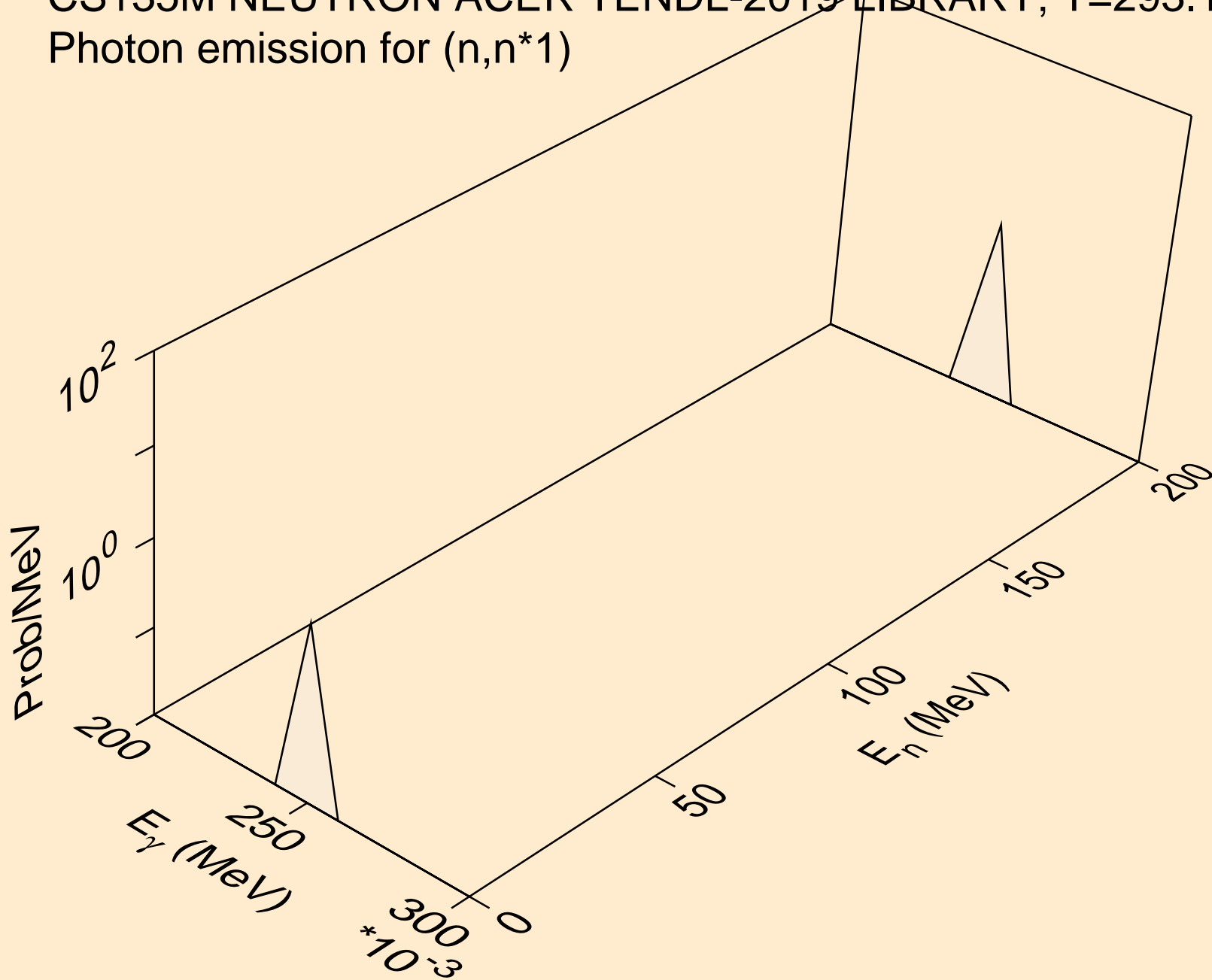

CS135M NEUTRON ACER TENDL-2019 LIBRARY; T=293.16K  
Photon emission for (n,n\*2)

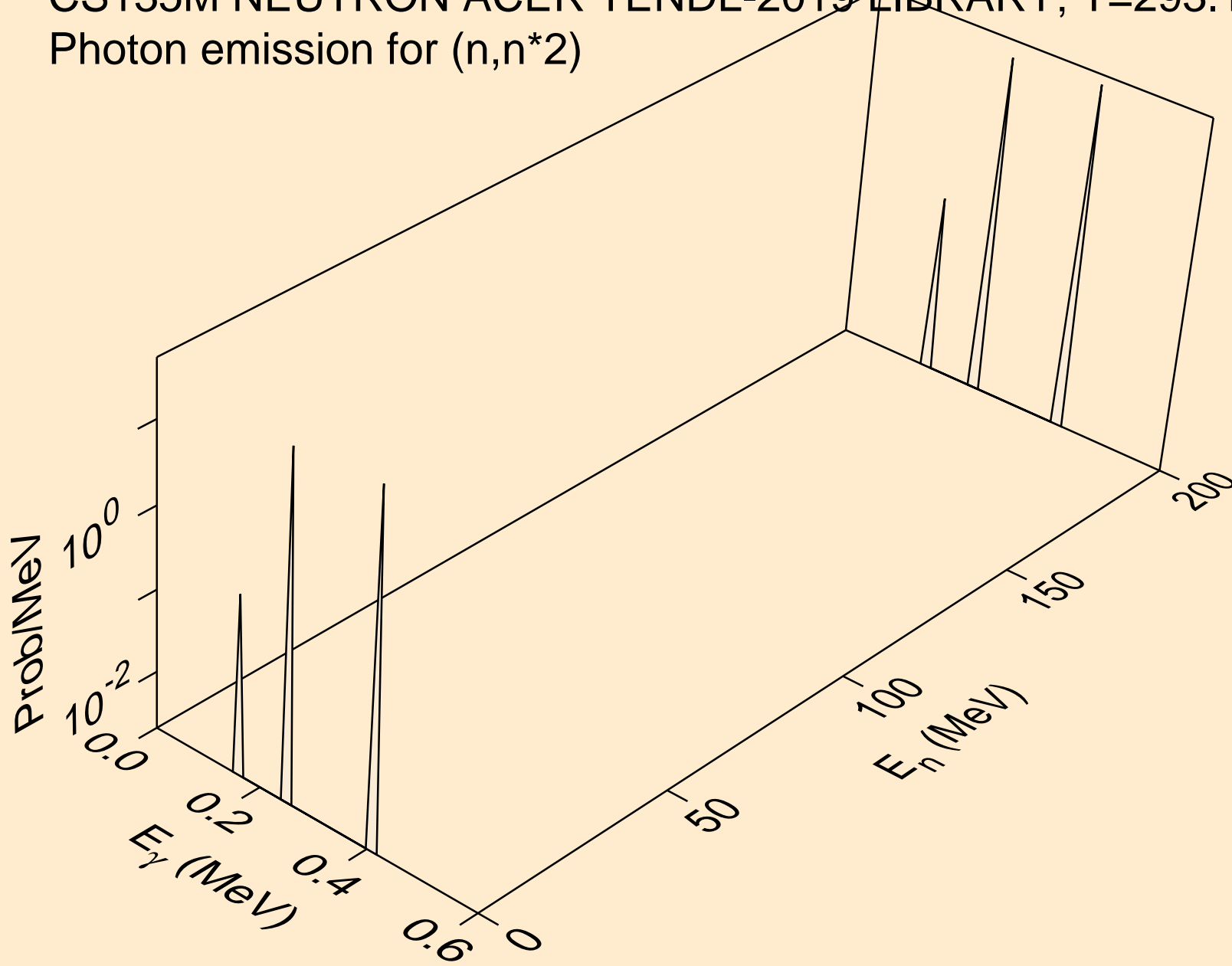



CS135M NEUTRON ACER TENDL-2019 LIBRARY; T=293.16K  
Photon emission for (n,n\*3)

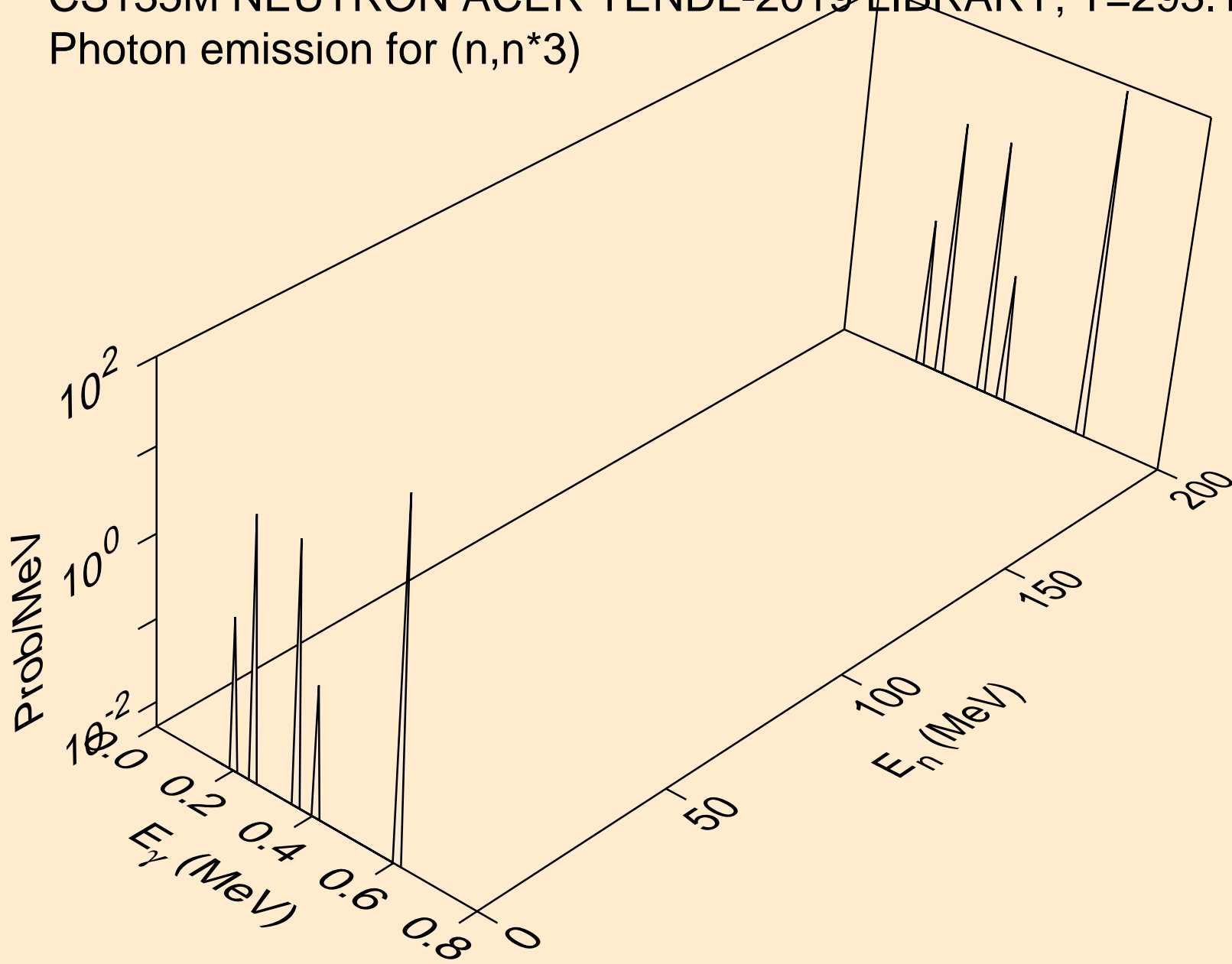

CS135M NEUTRON ACER TENDL-2019 LIBRARY; T=293.16K  
Photon emission for (n,n\*4)

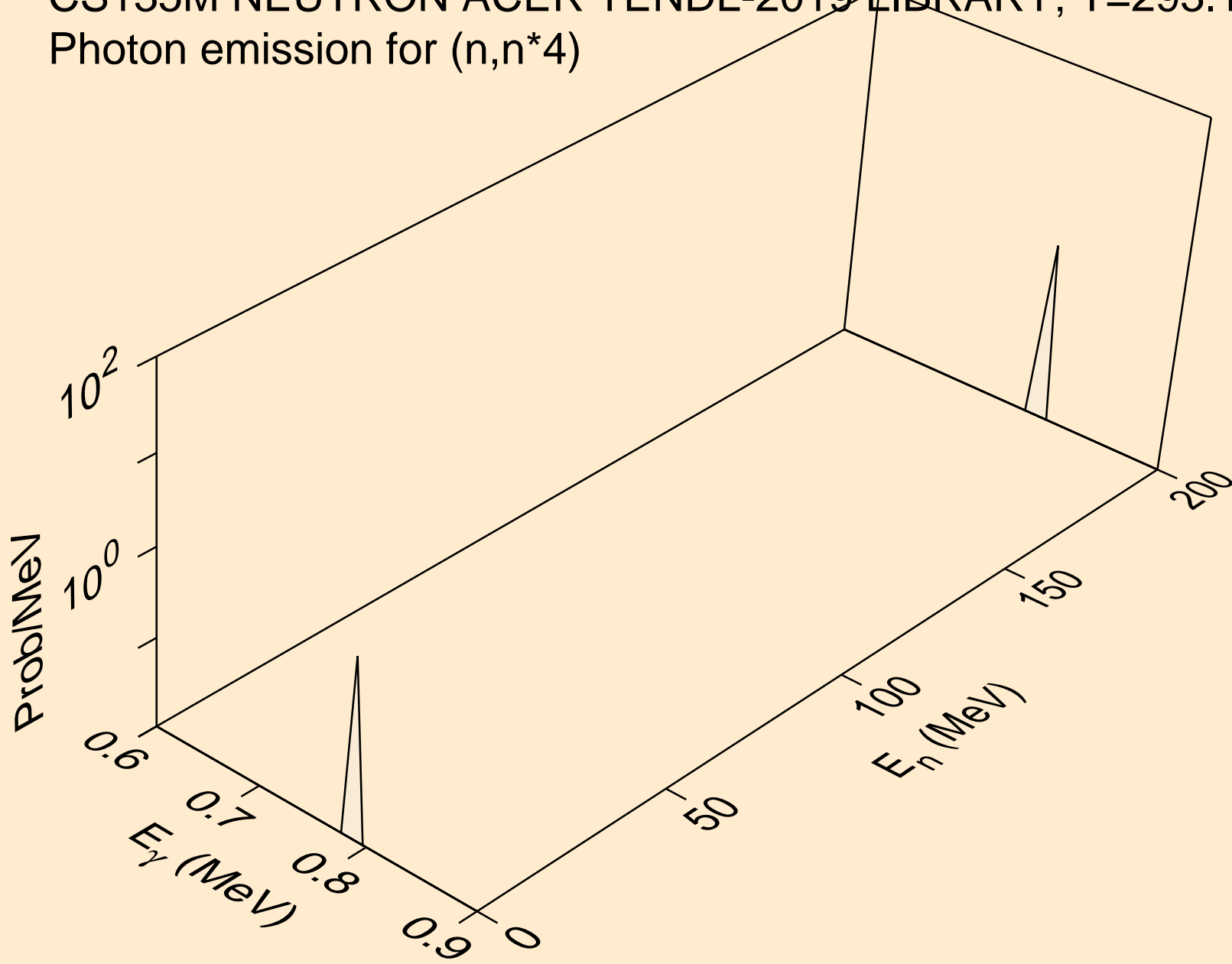

CS135M NEUTRON ACER TENDL-2019 LIBRARY; T=293.16K  
Photon emission for (n,n\*5)

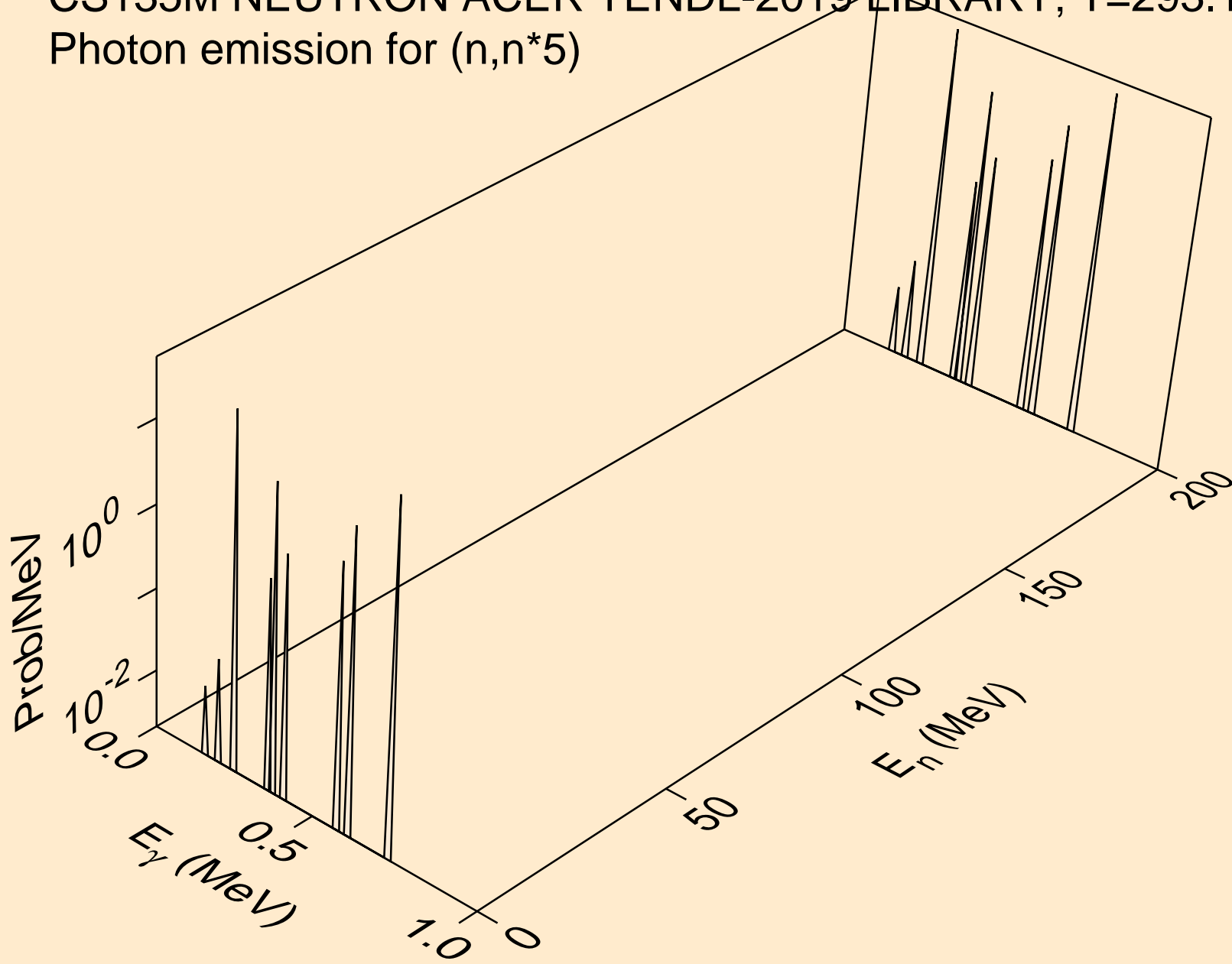

CS135M NEUTRON ACER TENDL-2019 LIBRARY; T=293.16K  
Photon emission for (n,n\*6)

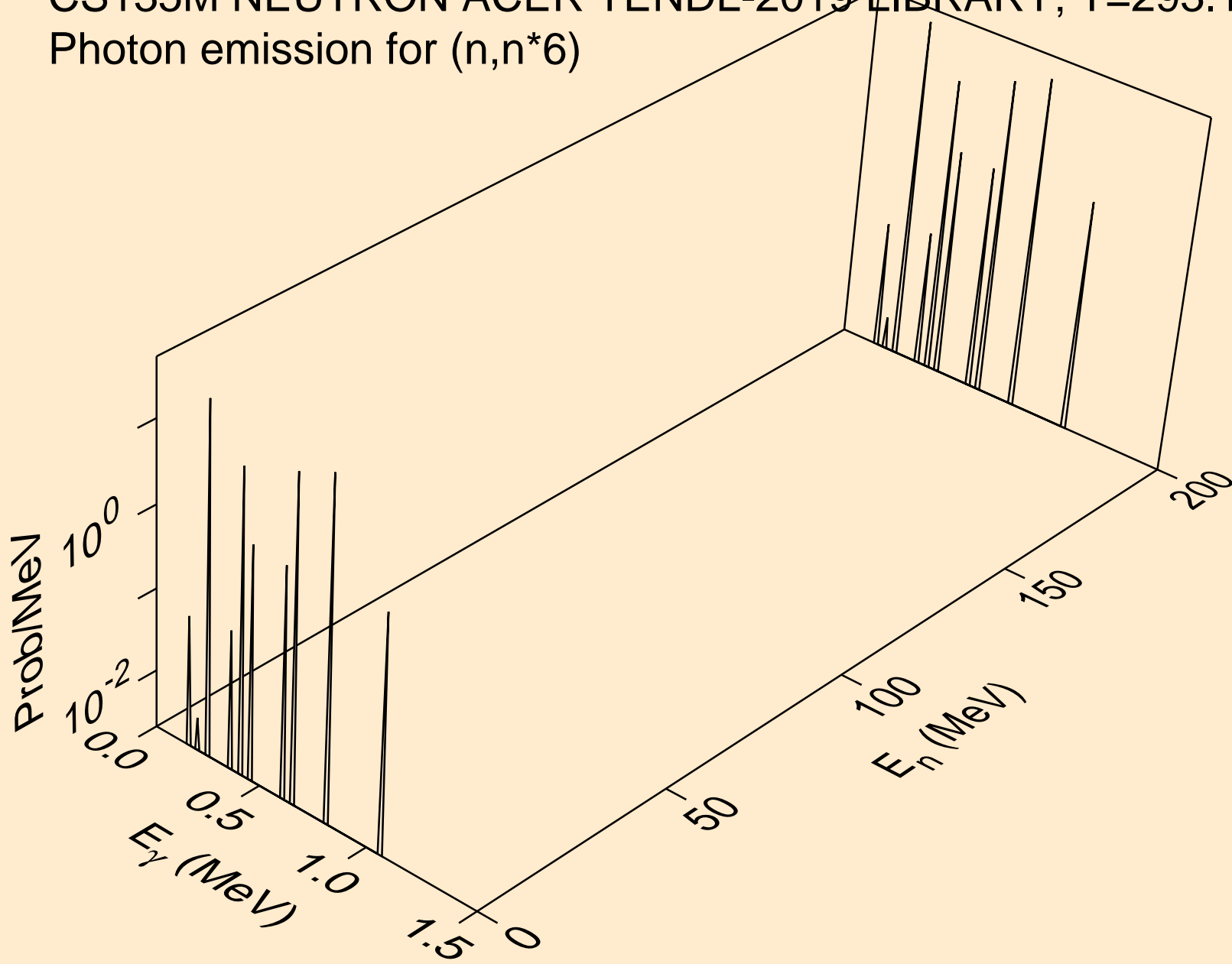

CS135M NEUTRON ACER TENDL-2019 LIBRARY; T=293.16K  
Photon emission for (n,n\*7)

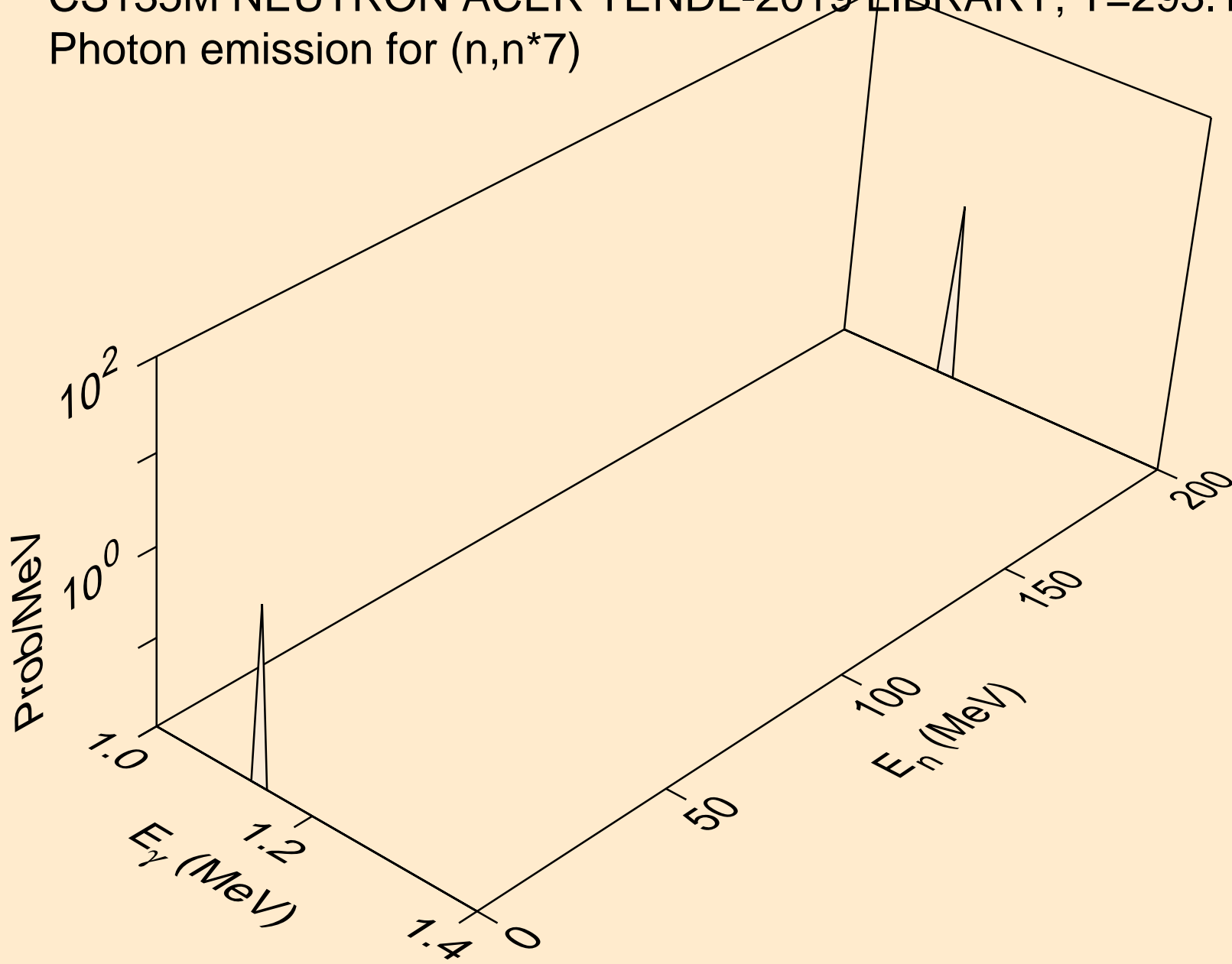

CS135M NEUTRON ACER TENDL-2019 LIBRARY; T=293.16K  
Photon emission for (n,n\*8)

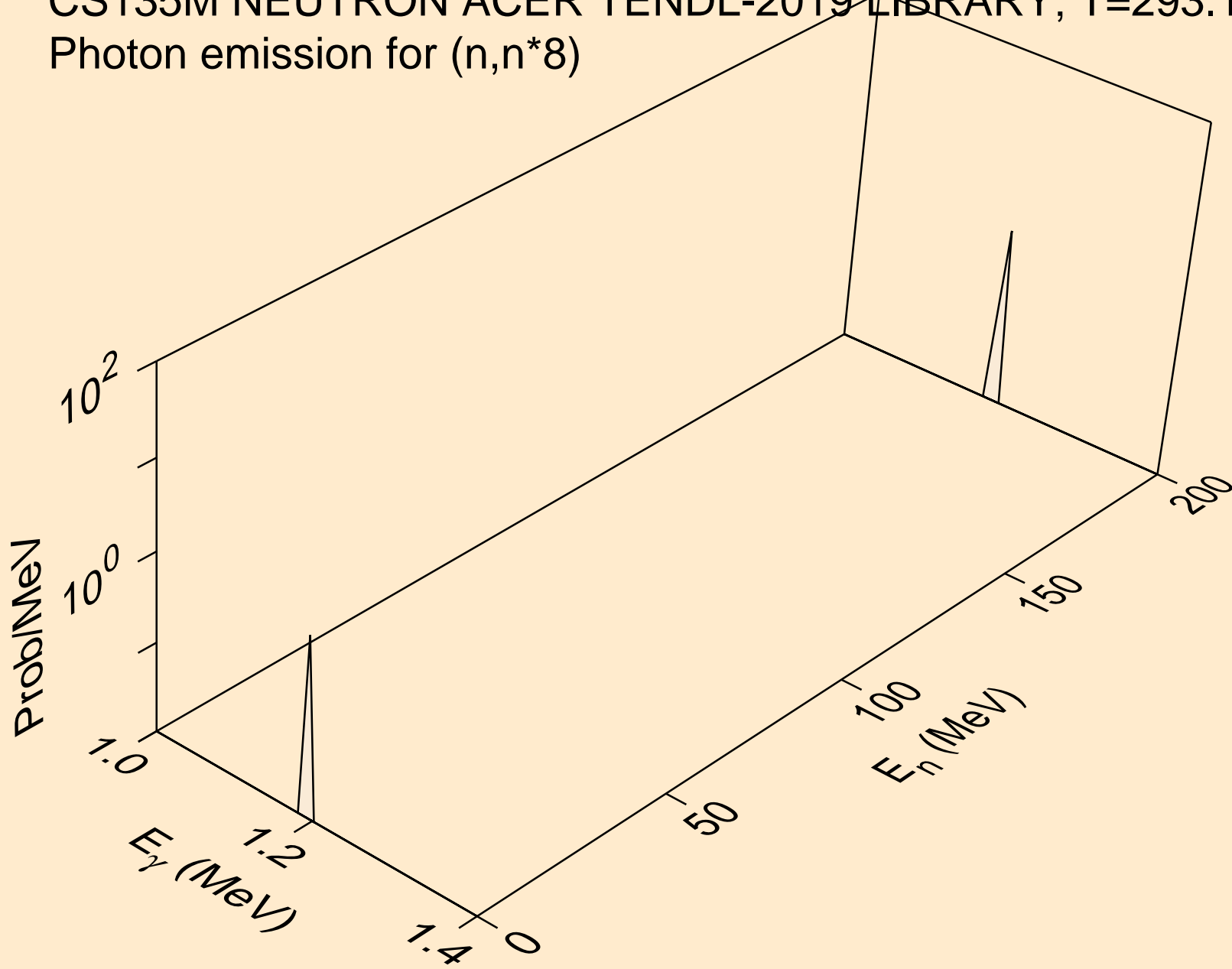

CS135M NEUTRON ACER TENDL-2019 LIBRARY; T=293.16K  
Photon emission for (n,n\*9)

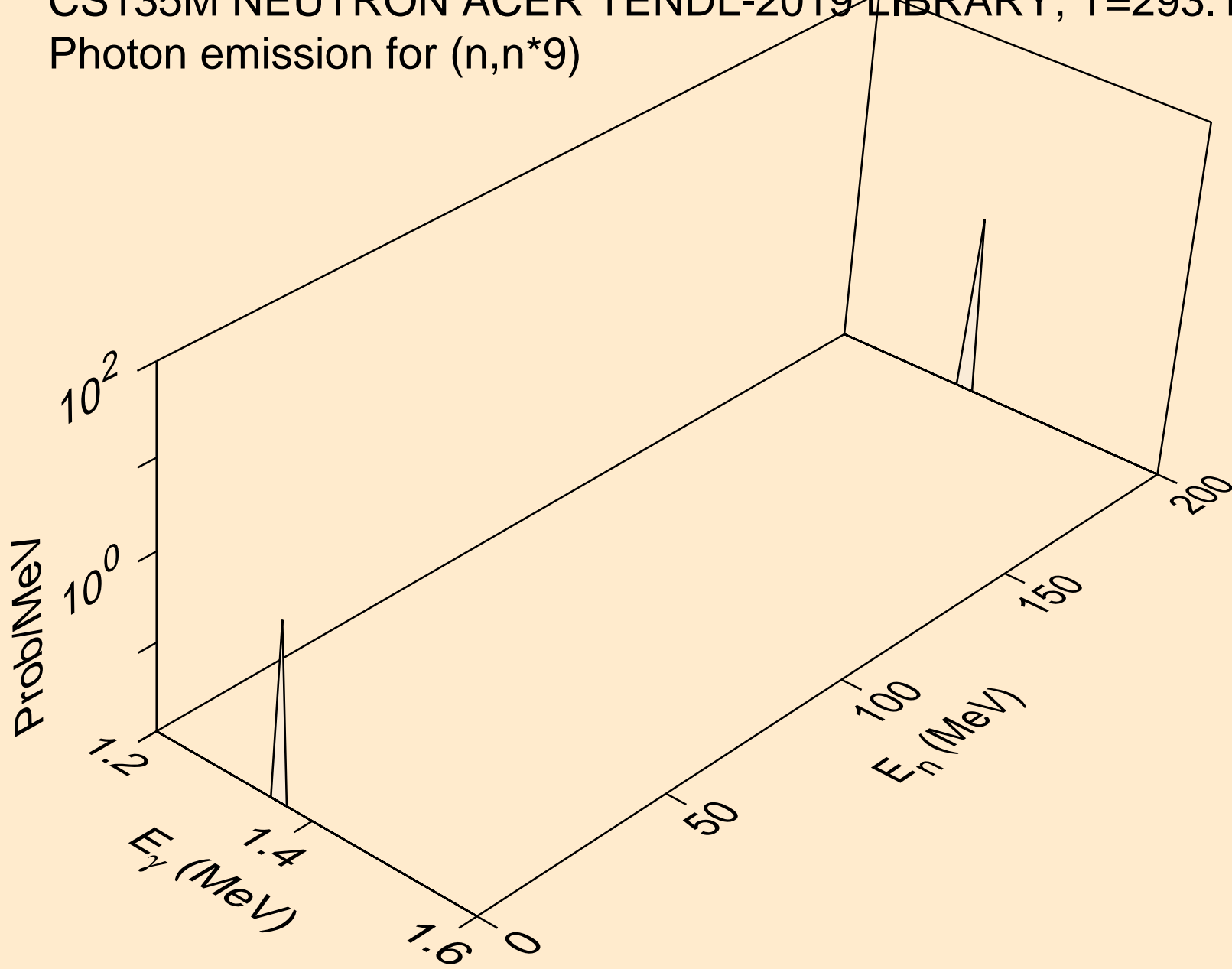

CS135M NEUTRON ACER TENDL-2019 LIBRARY; T=293.16K  
Photon emission for (n,n\*11)

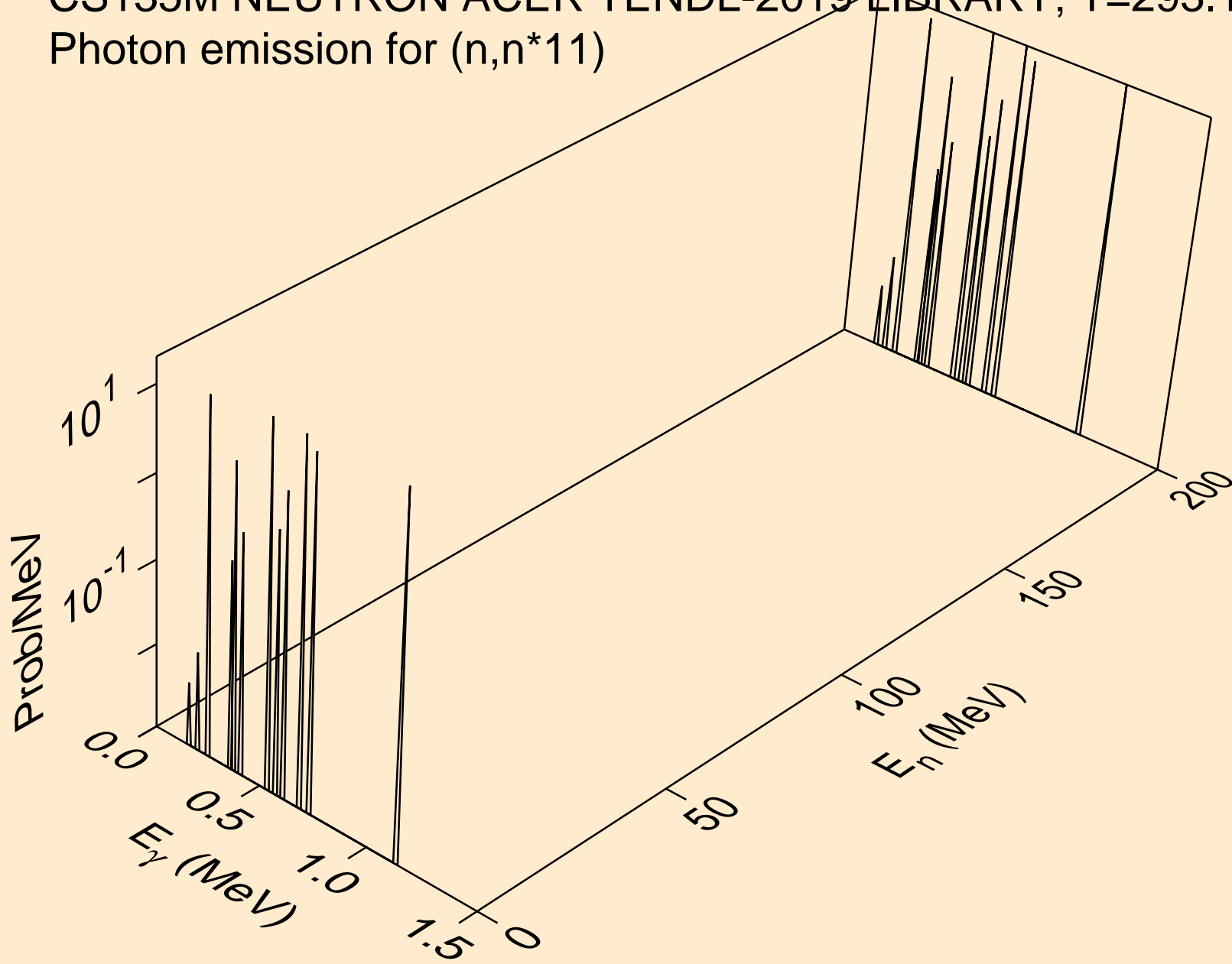



CS135M NEUTRON ACER TENDL-2019 LIBRARY; T=293.16K  
Photon emission for (n,n\*12)

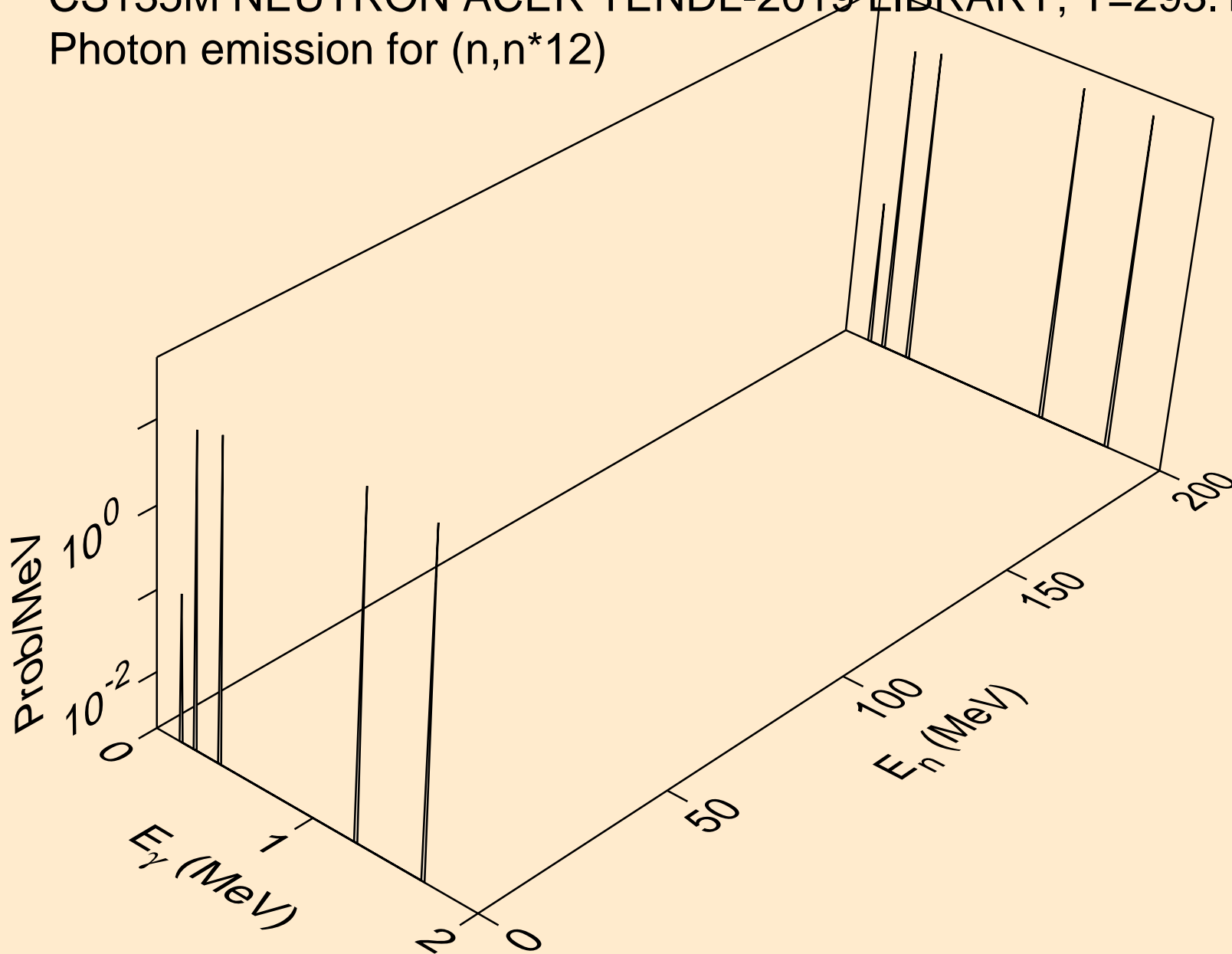

CS135M NEUTRON ACER TENDL-2019 LIBRARY; T=293.16K  
Photon emission for (n,n\*13)

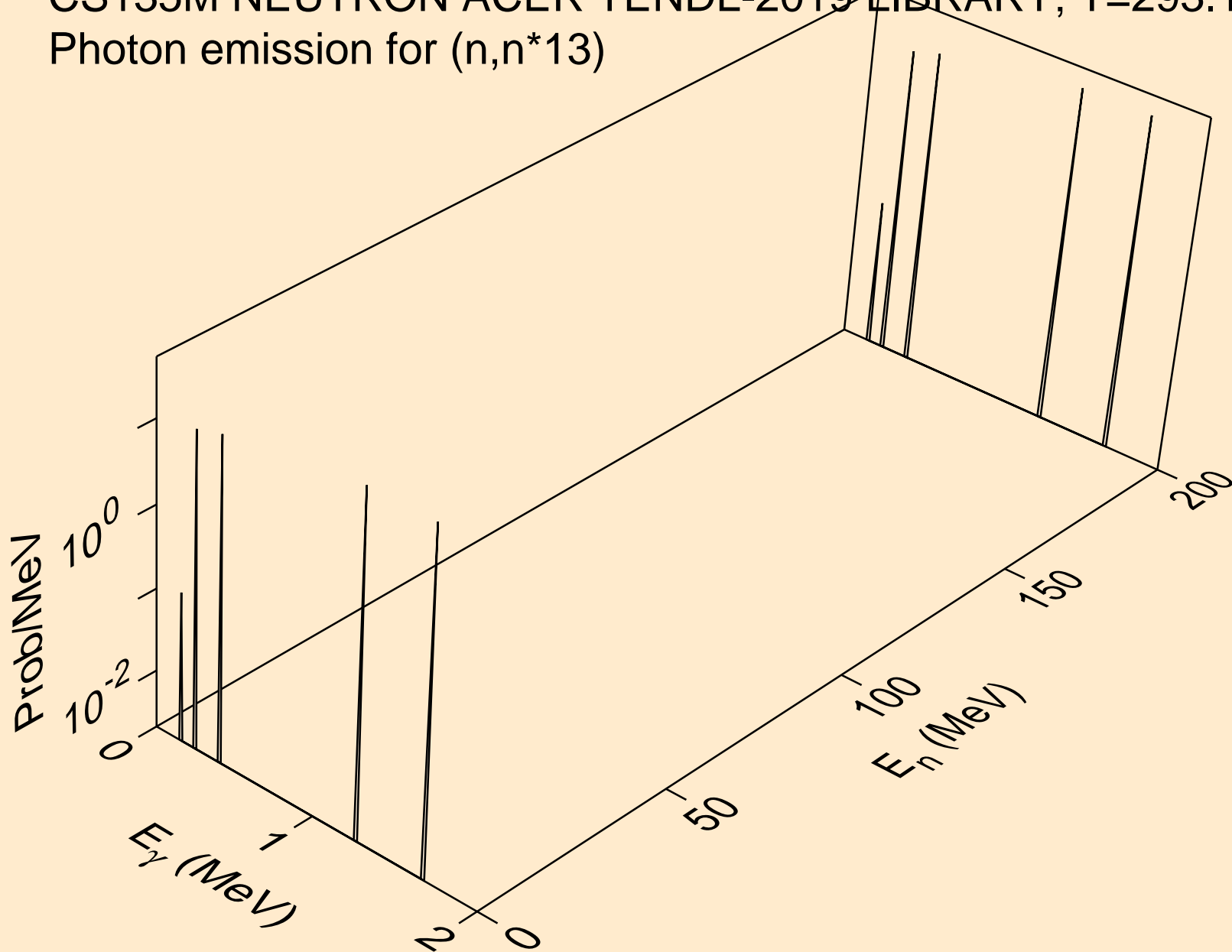

CS135M NEUTRON ACER TENDL-2019 LIBRARY; T=293.16K  
Photon emission for (n,n\*14)

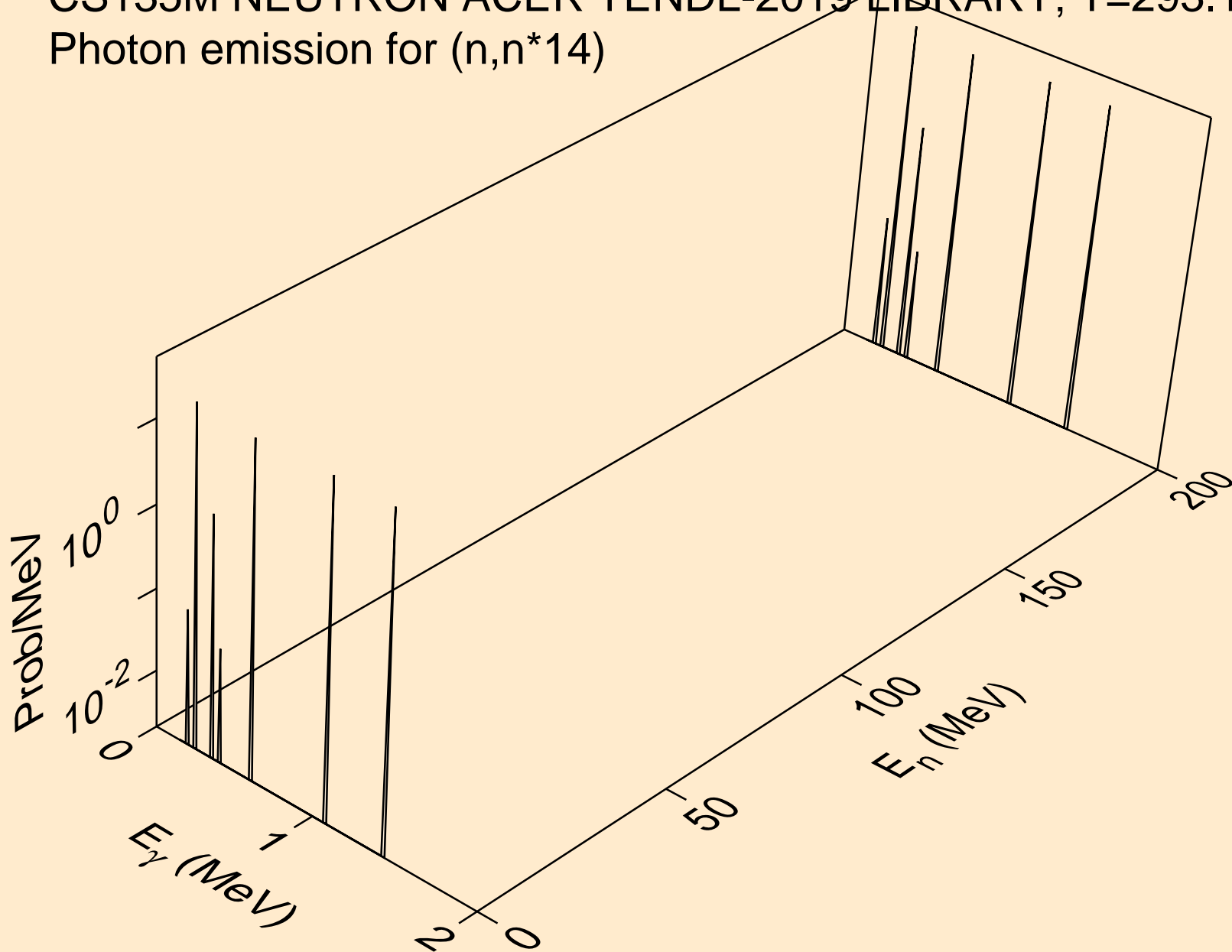

CS135M NEUTRON ACER TENDL-2019 LIBRARY; T=293.16K  
Photon emission for (n,n\*15)

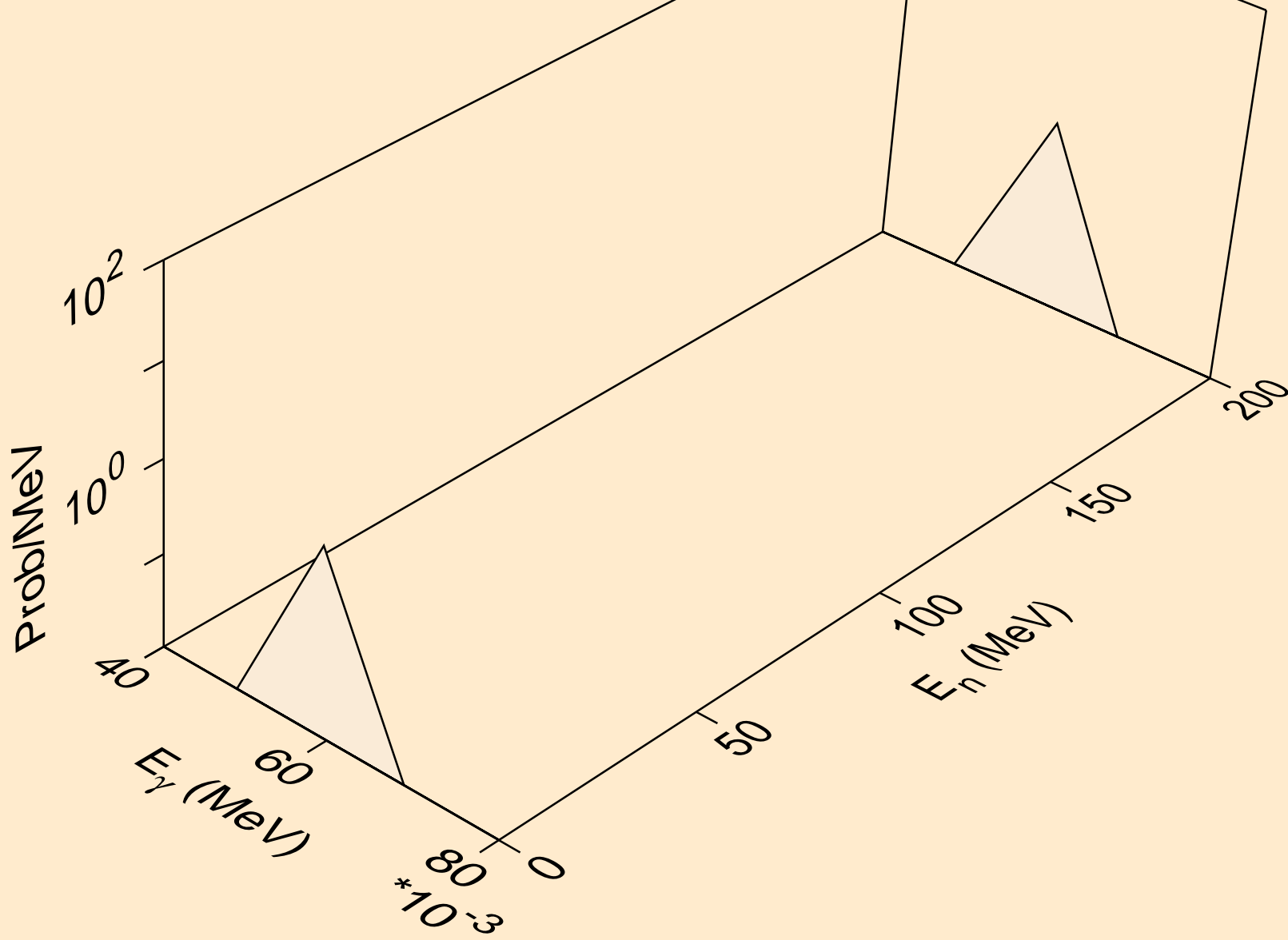

CS135M NEUTRON ACER TENDL-2019 LIBRARY; T=293.16K  
Photon emission for (n,n\*16)

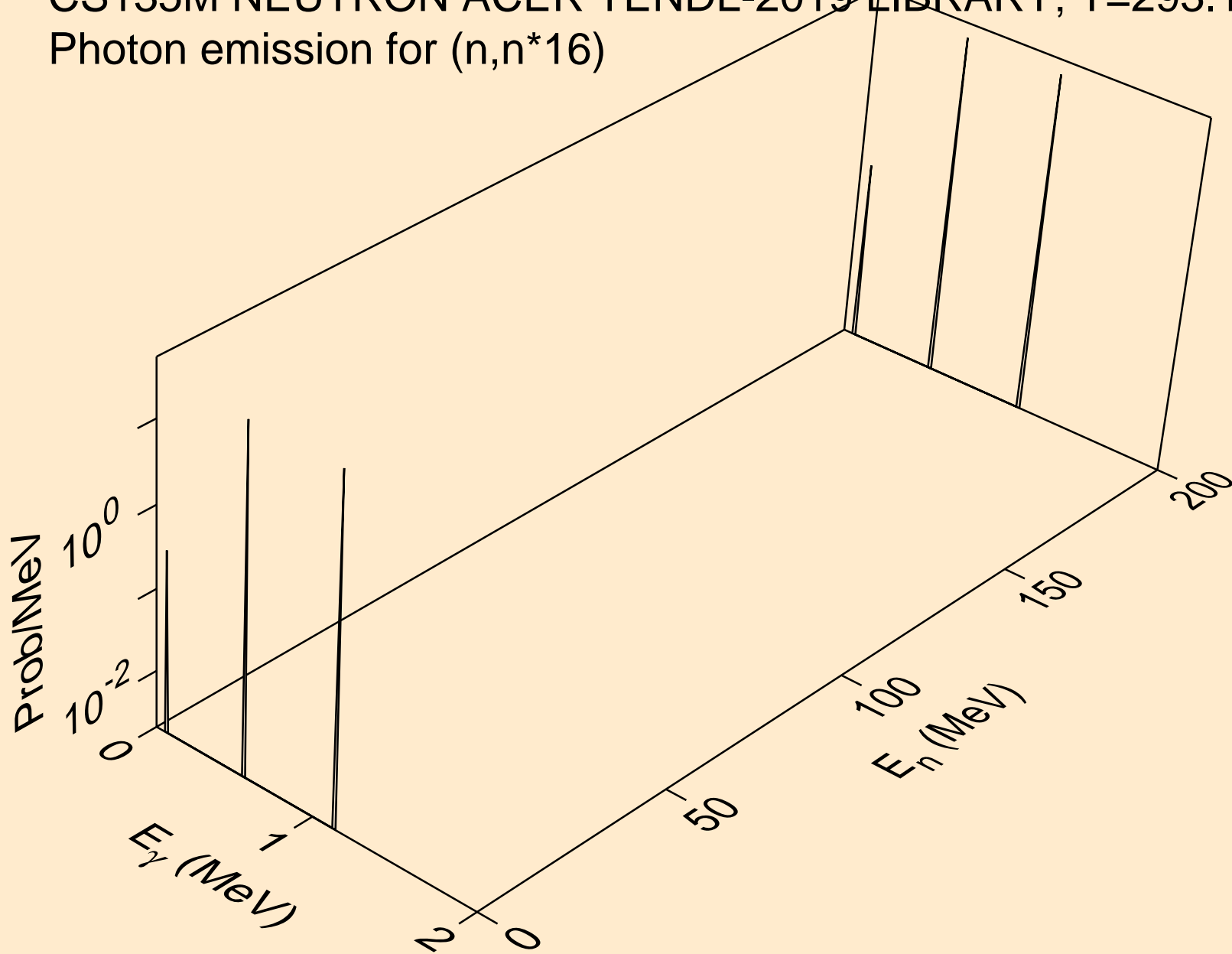

CS135M NEUTRON ACER TENDL-2019 LIBRARY; T=293.16K  
Photon emission for (n,n\*17)

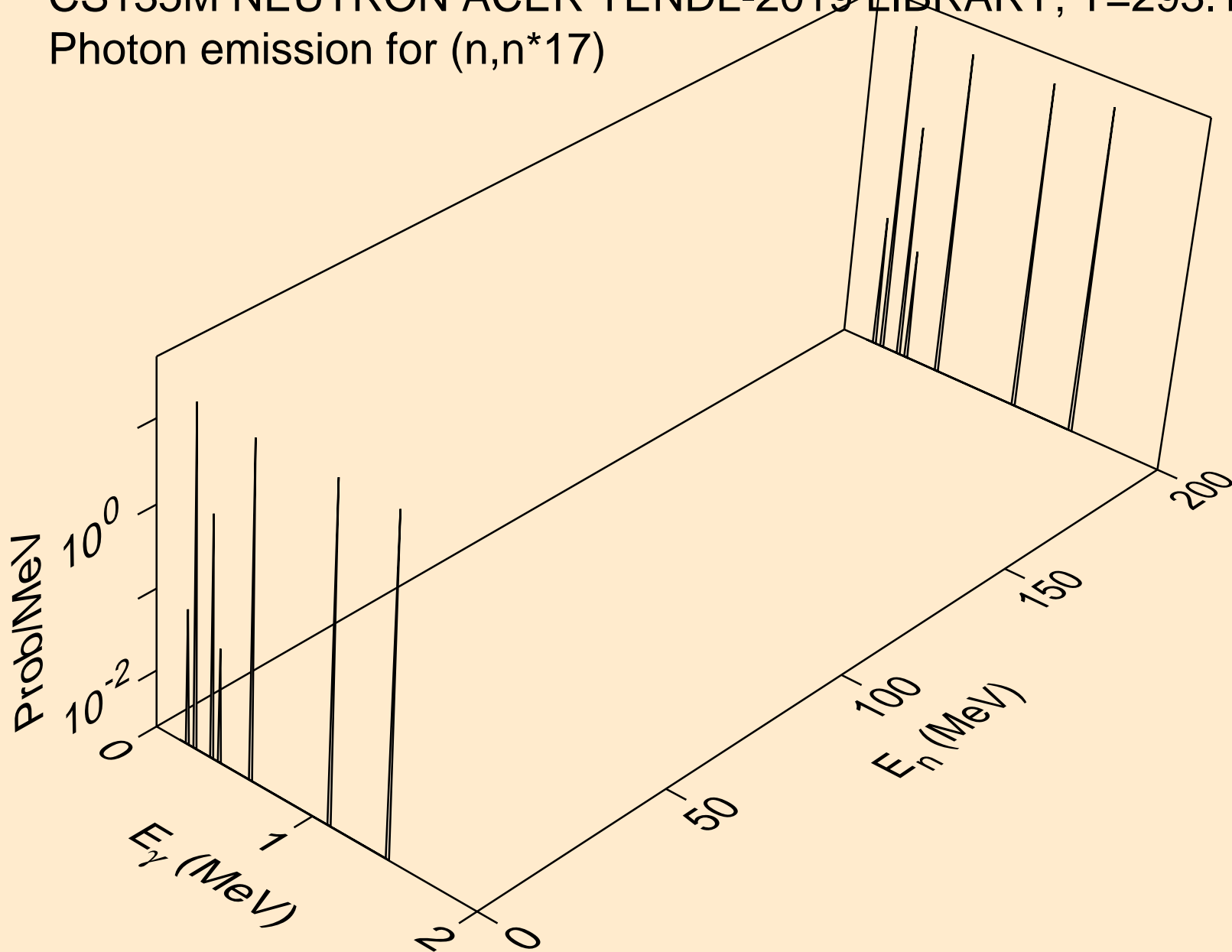

CS135M NEUTRON ACER TENDL-2019 LIBRARY; T=293.16K  
Photon emission for (n,n\*18)

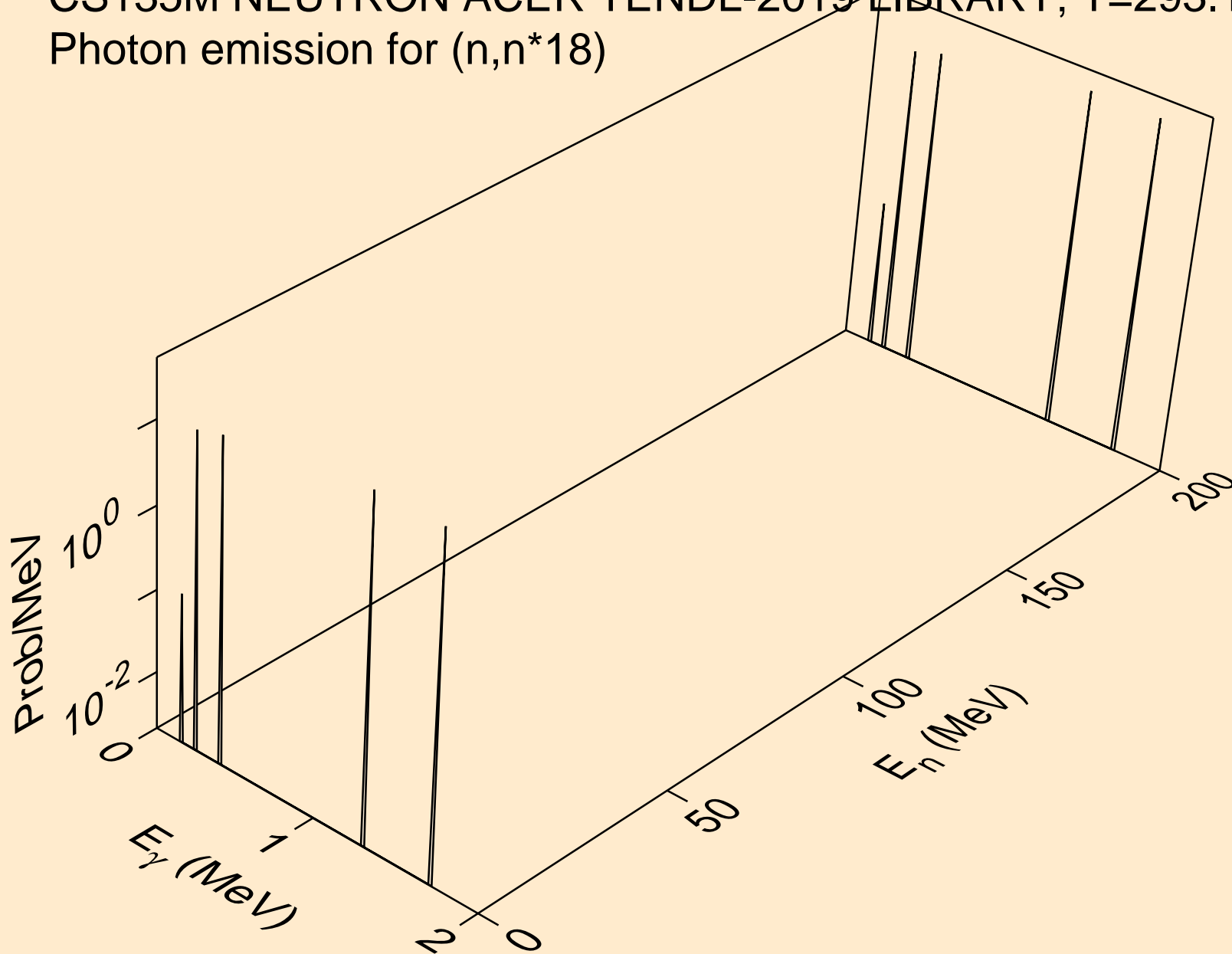

CS135M NEUTRON ACER TENDL-2019 LIBRARY; T=293.16K  
Photon emission for (n,n\*19)

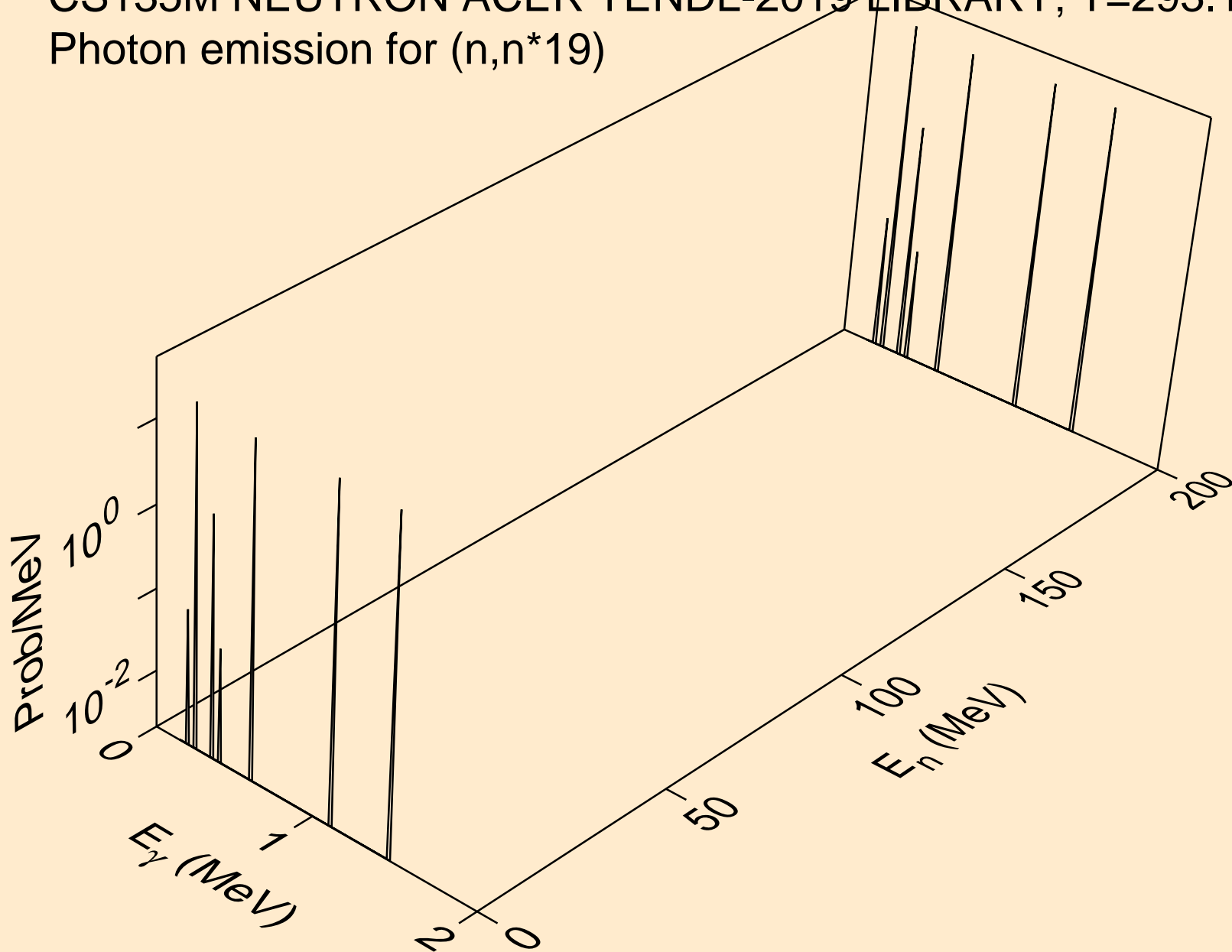



CS135M NEUTRON ACER TENDL-2019 LIBRARY; T=293.16K  
Photon emission for (n,n\*20)

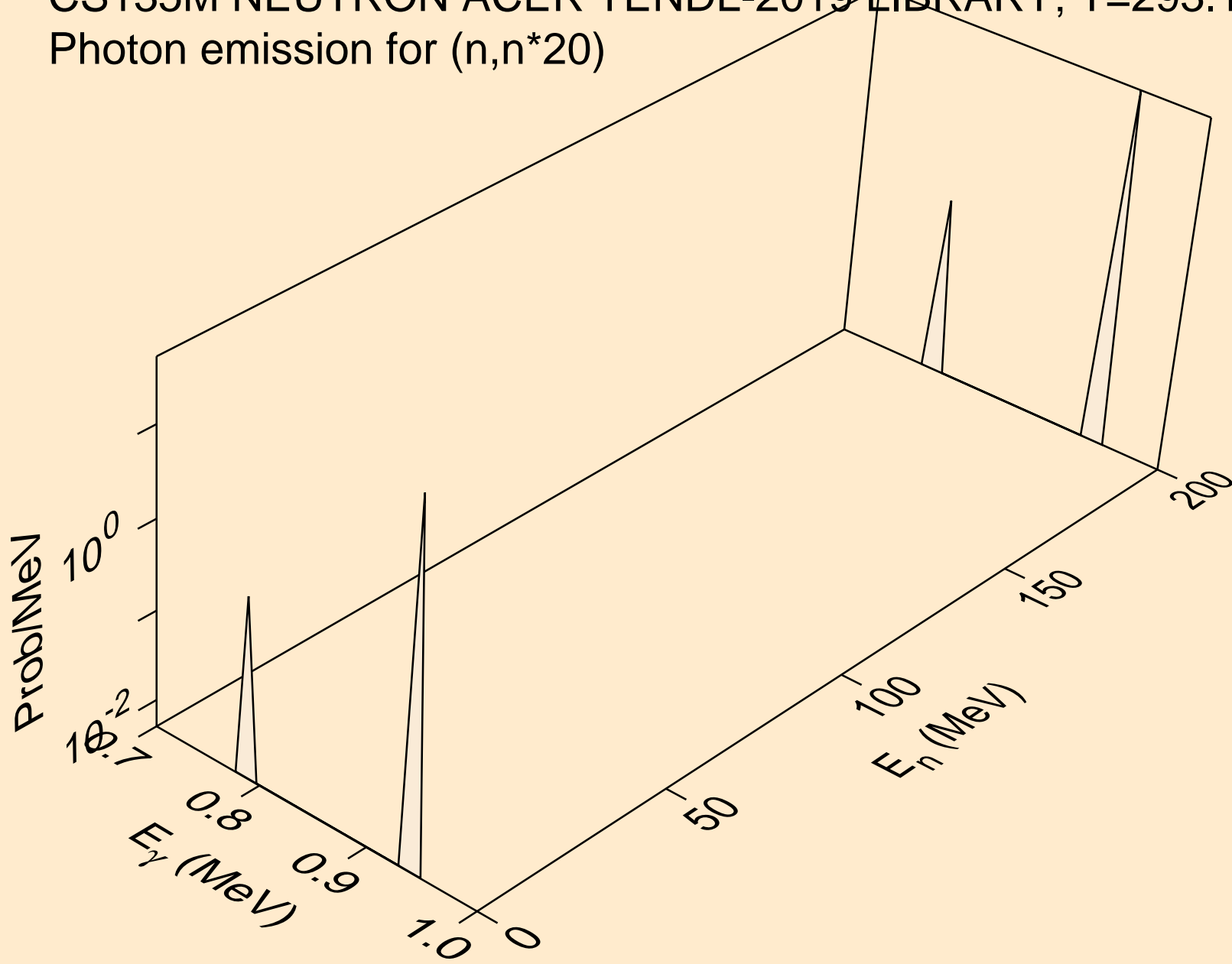

CS135M NEUTRON ACER TENDL-2019 LIBRARY; T=293.16K  
Photon emission for (n,n\*21)

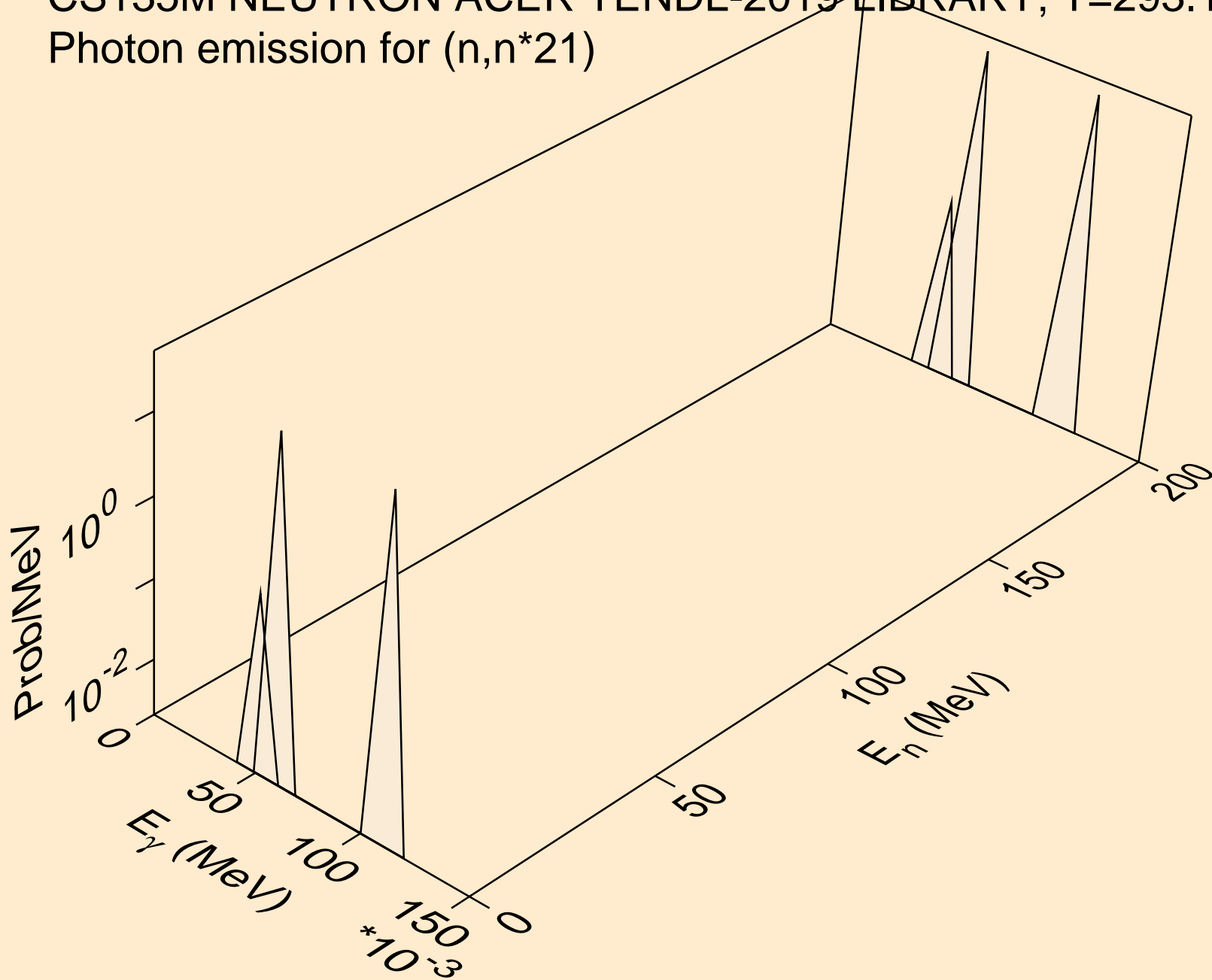

CS135M NEUTRON ACER TENDL-2019 LIBRARY; T=293.16K  
Photon emission for (n,n\*22)

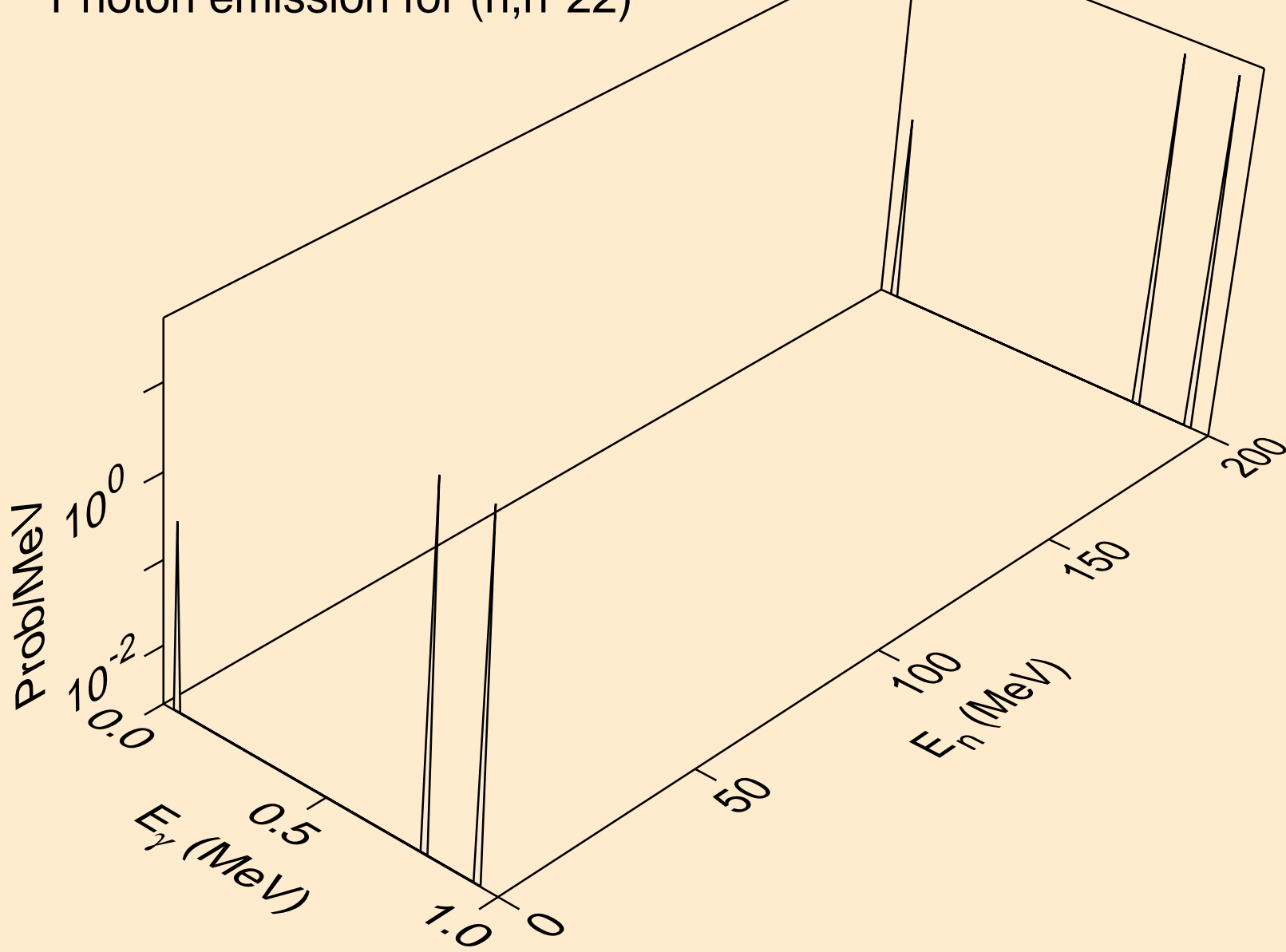

CS135M NEUTRON ACER TENDL-2019 LIBRARY; T=293.16K  
Photon emission for (n,n\*23)

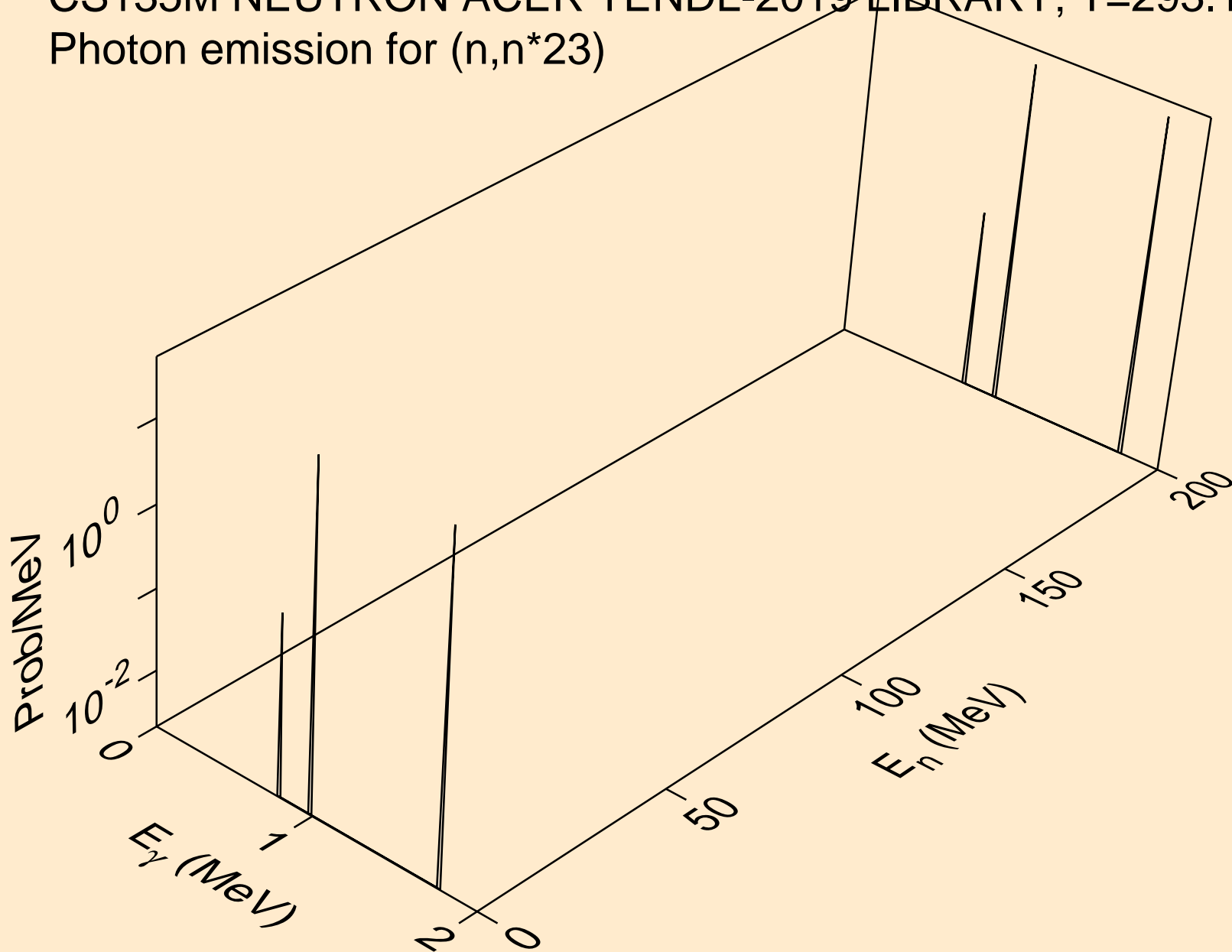

CS135M NEUTRON ACER TENDL-2019 LIBRARY; T=293.16K  
Photon emission for (n,n\*24)

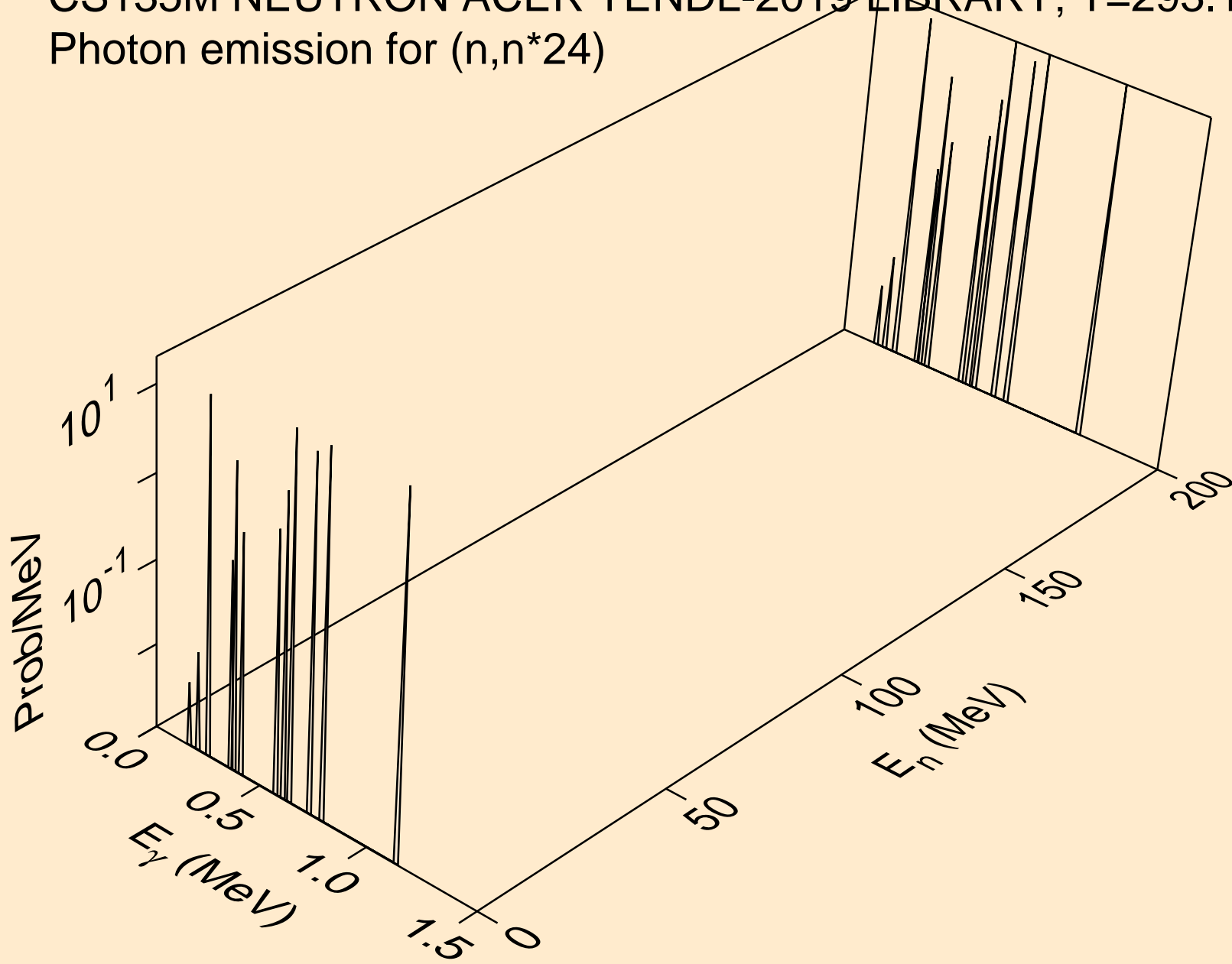

CS135M NEUTRON ACER TENDL-2019 LIBRARY; T=293.16K  
Photon emission for (n,n\*25)

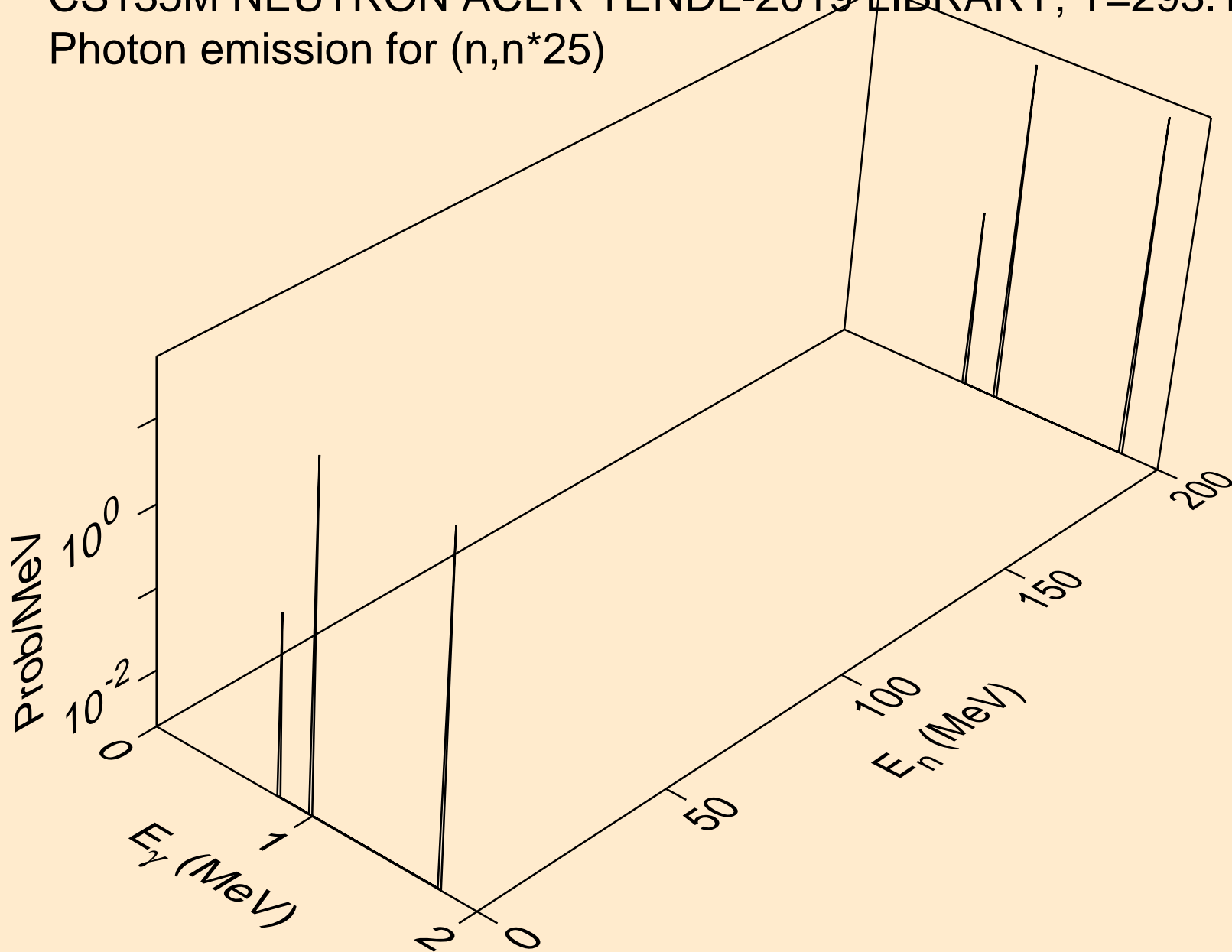

CS135M NEUTRON ACER TENDL-2019 LIBRARY; T=293.16K  
Photon emission for (n,n\*26)

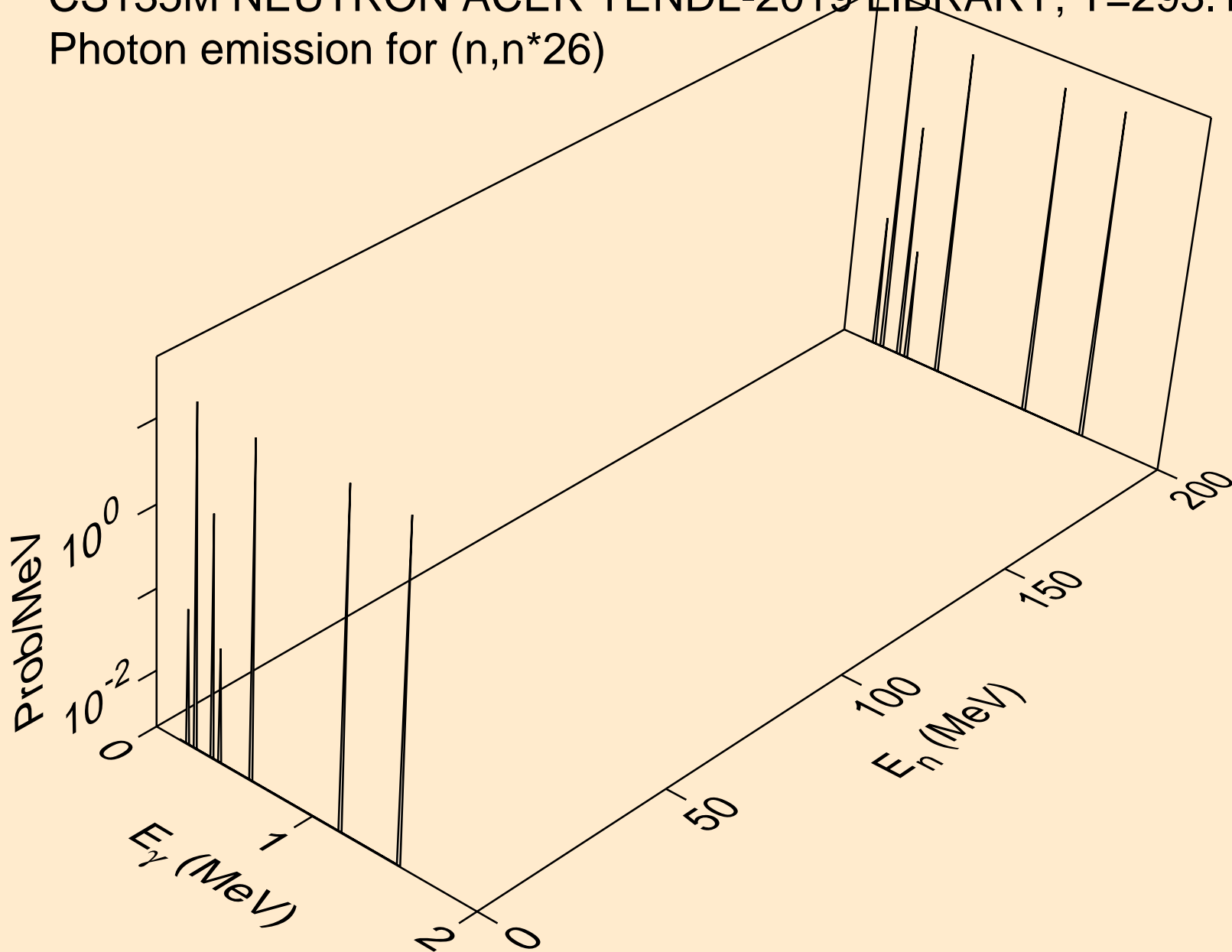

CS135M NEUTRON ACER TENDL-2019 LIBRARY; T=293.16K  
Photon emission for (n,n\*27)

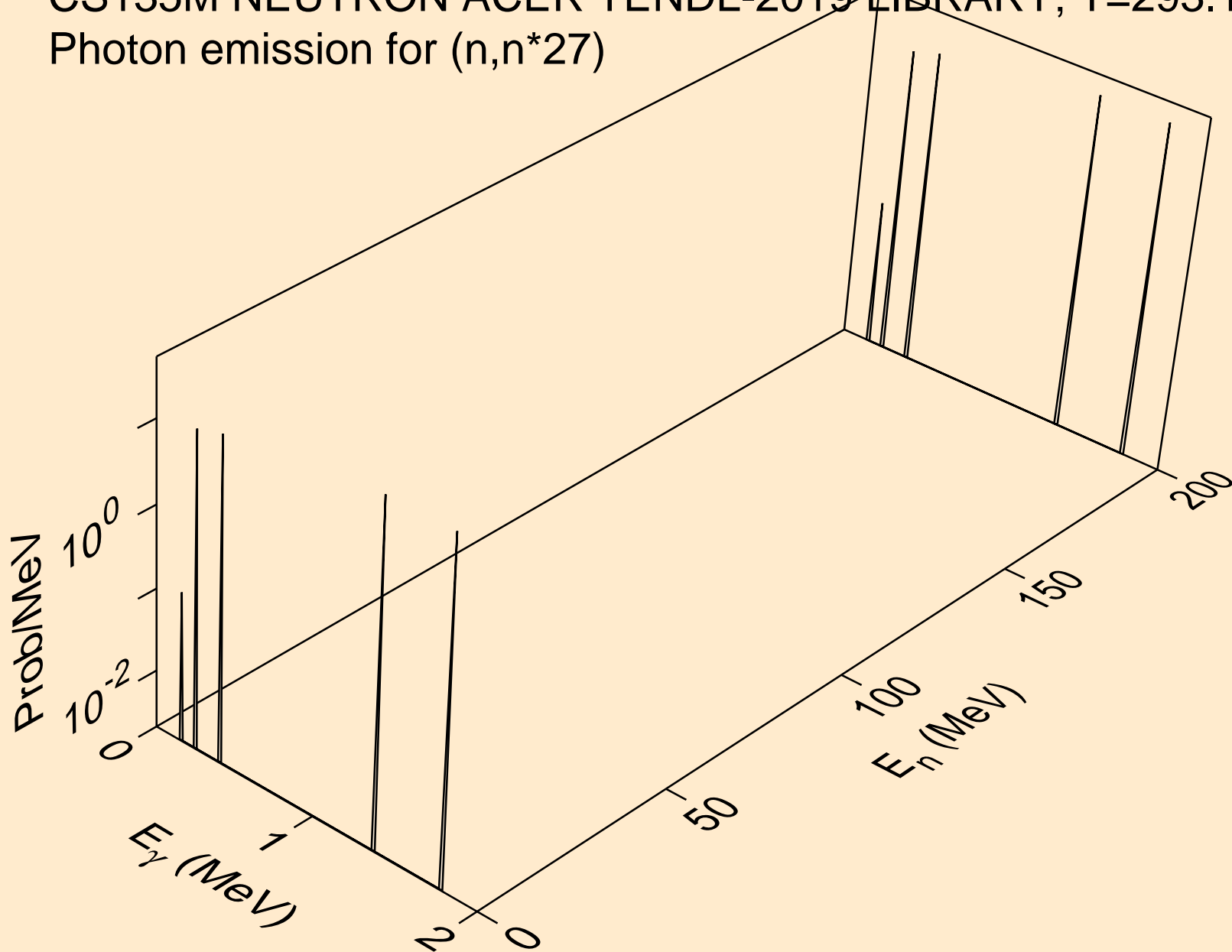



CS135M NEUTRON ACER TENDL-2019 LIBRARY; T=293.16K  
Photon emission for (n,n\*28)

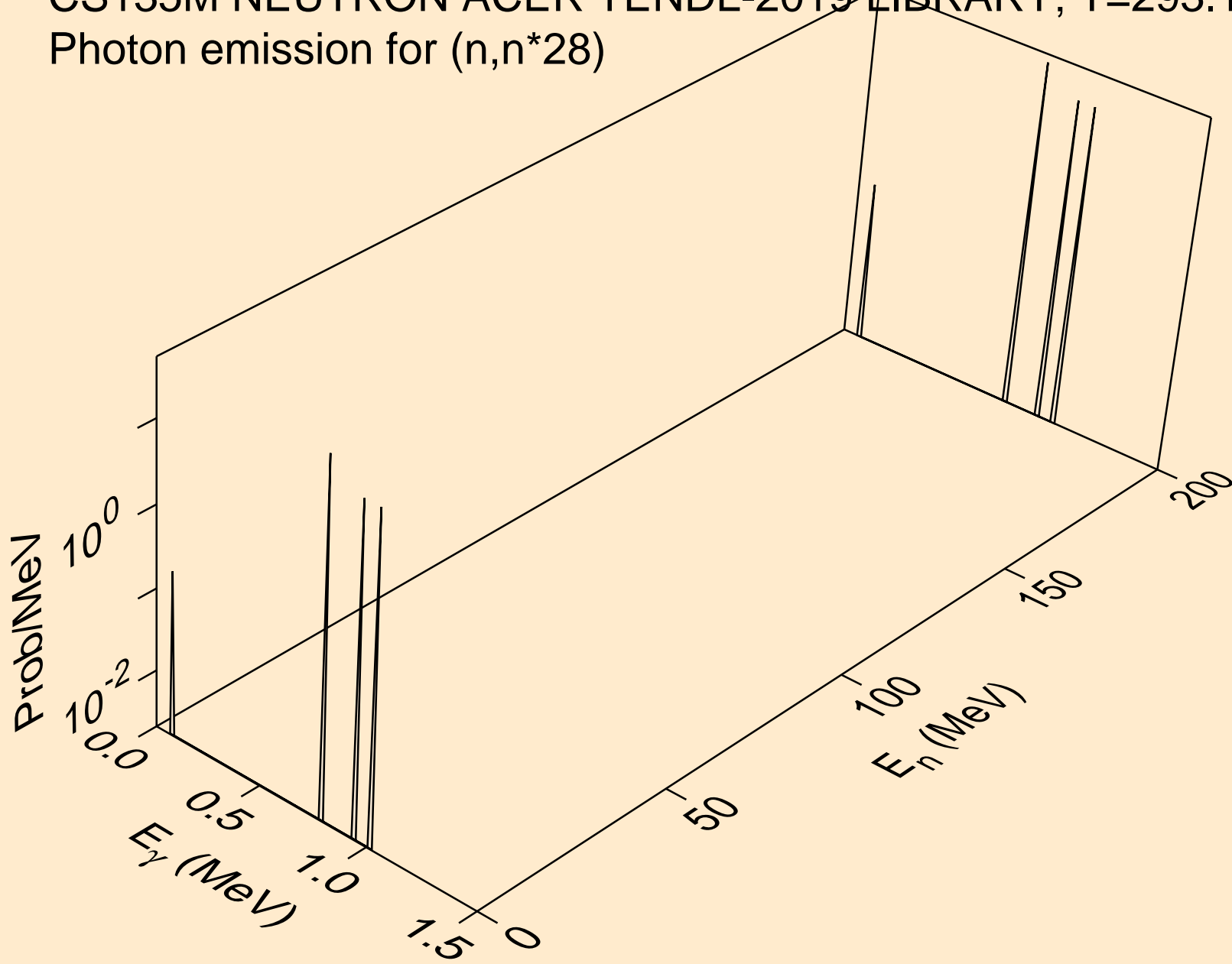

CS135M NEUTRON ACER TENDL-2019 LIBRARY; T=293.16K  
Photon emission for (n,n\*29)

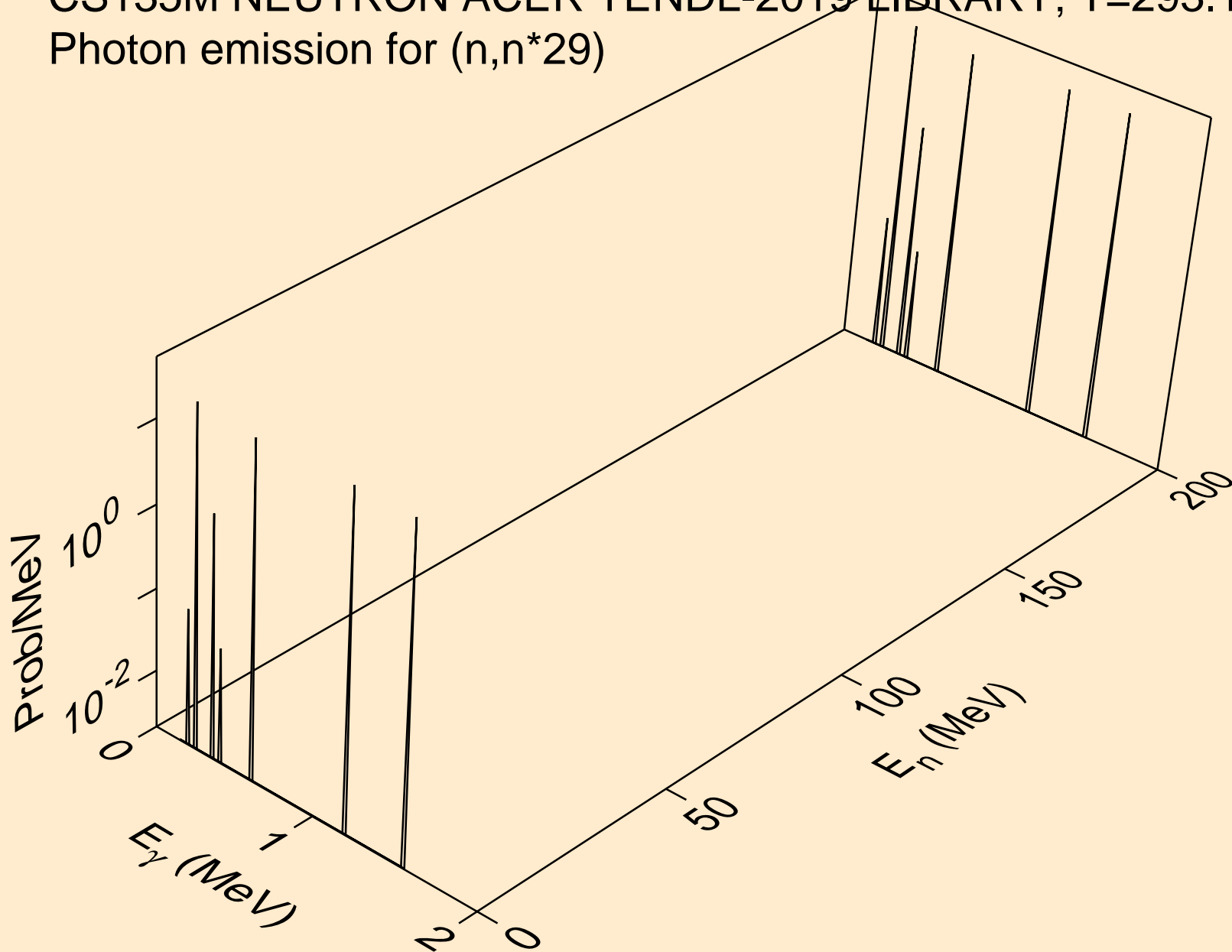

CS135M NEUTRON ACER TENDL-2019 LIBRARY; T=293.16K  
Photon emission for (n,n\*30)

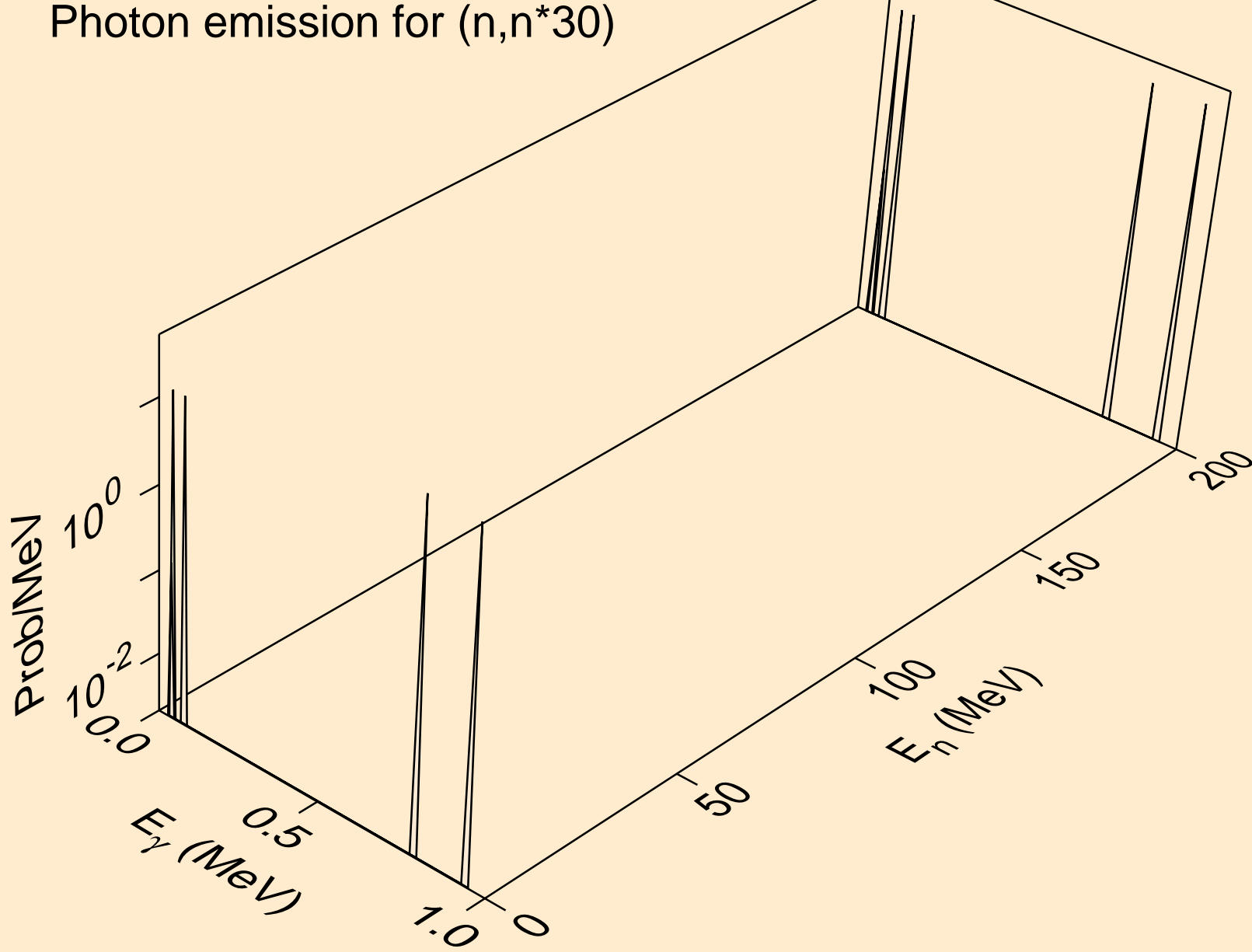

CS135M NEUTRON ACER TENDL-2019 LIBRARY; T=293.16K  
Photon emission for (n,n\*c)

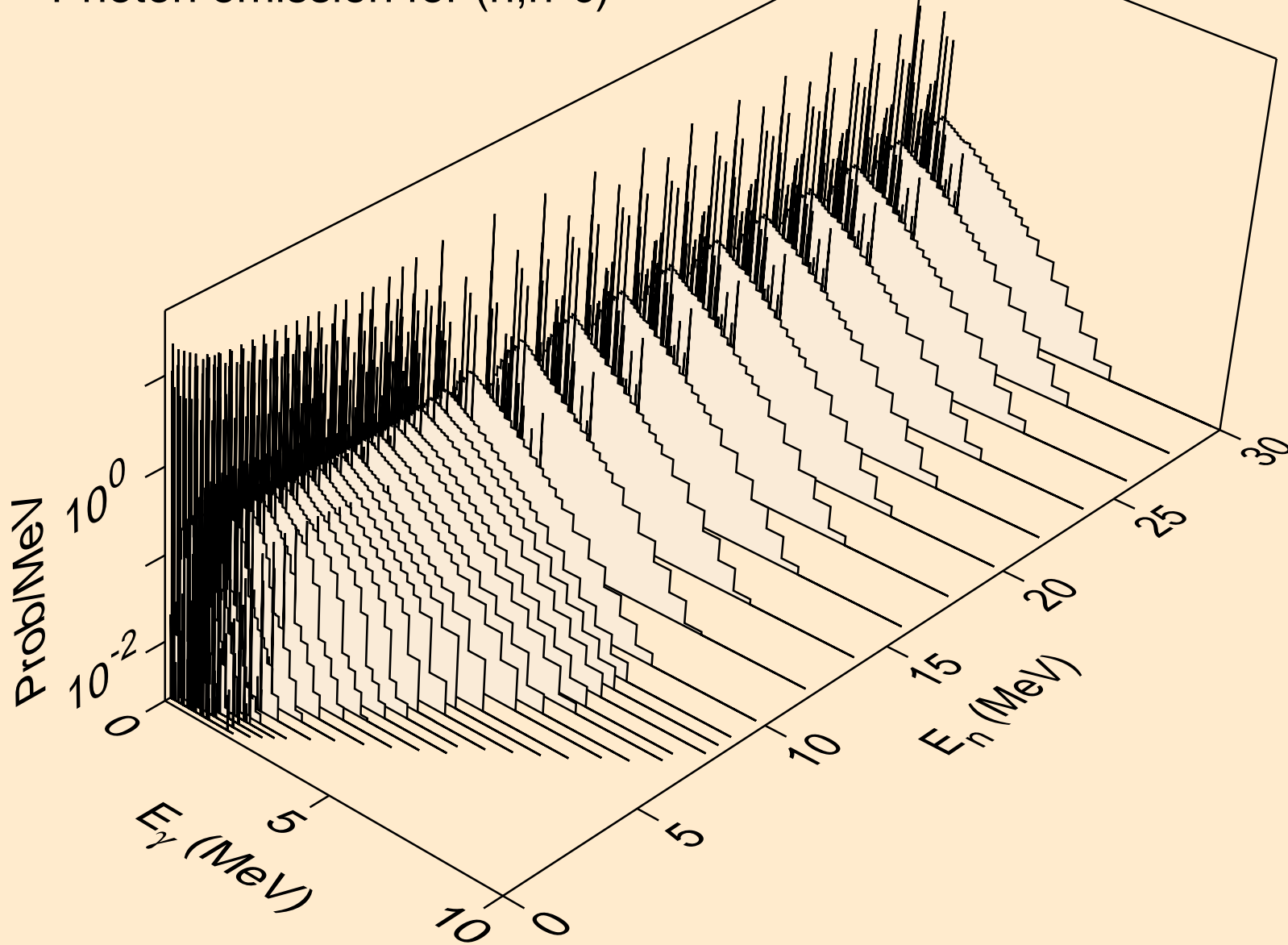

CS135M NEUTRON ACER TENDL-2019 LIBRARY; T=293.16K  
Photon emission for (n,gma)

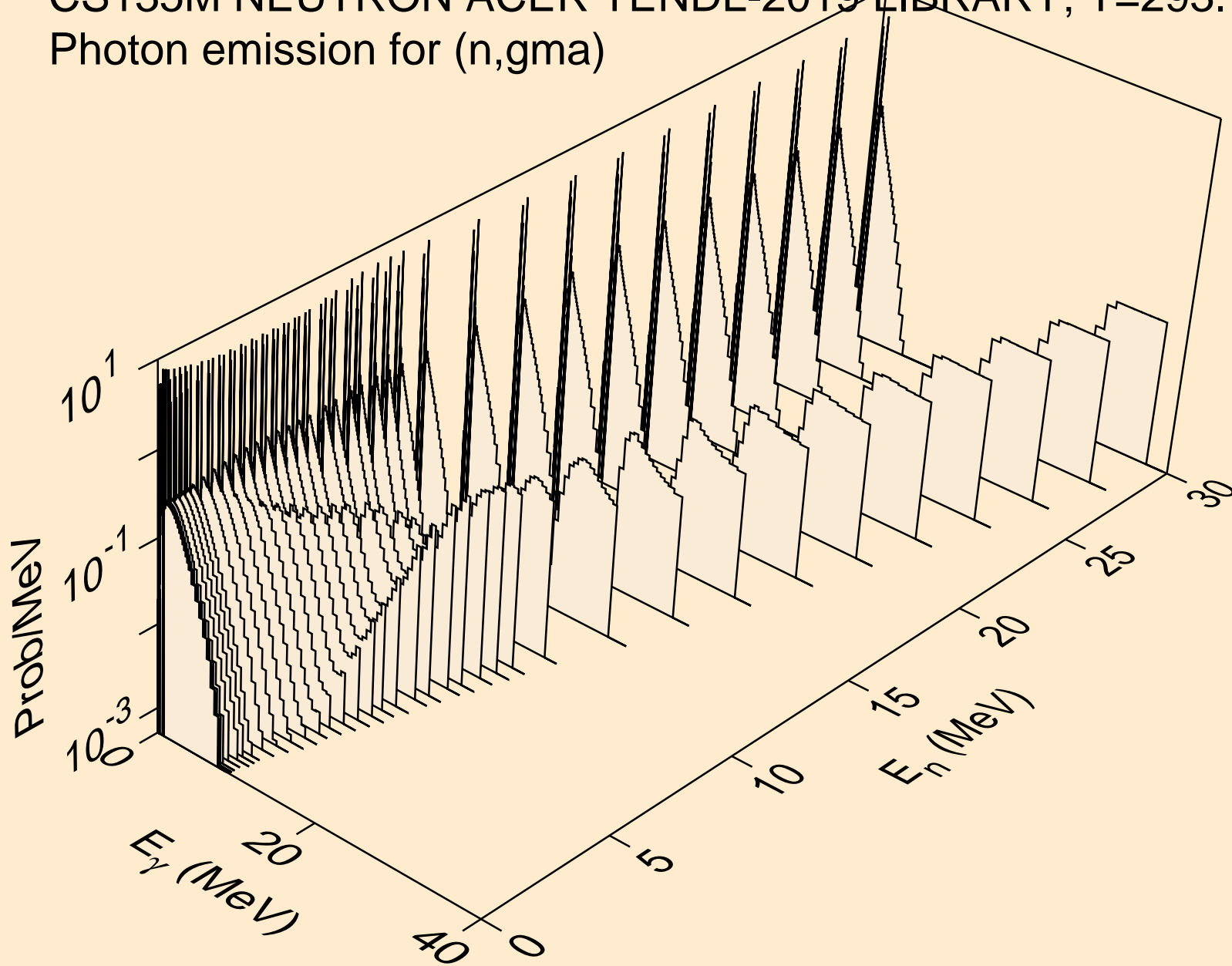

CS135M NEUTRON ACER TENDL-2019 LIBRARY; T=293.16K  
Photon emission for (n,p)

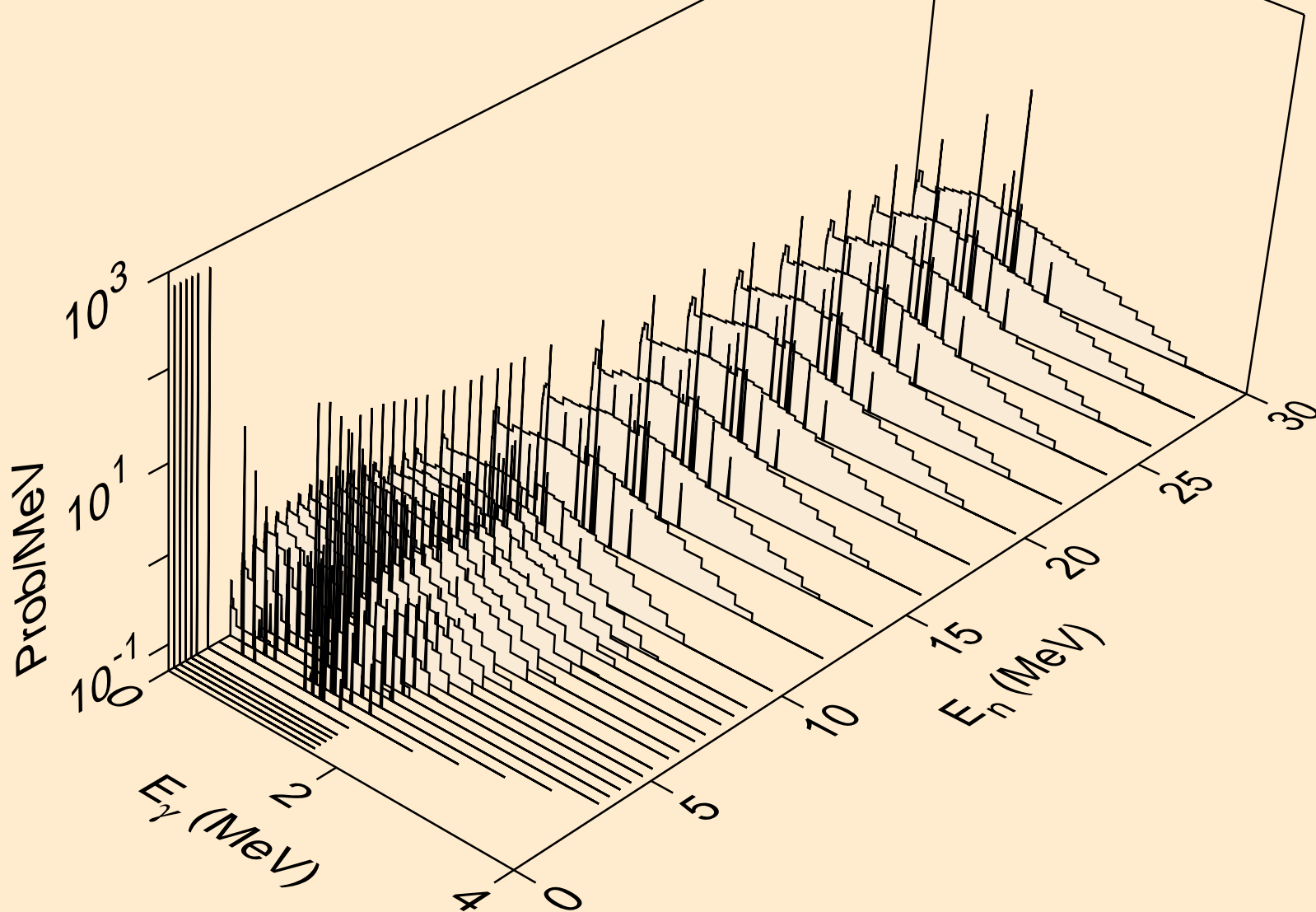

CS135M NEUTRON ACER TENDL-2019 LIBRARY; T=293.16K  
Photon emission for (n,d)

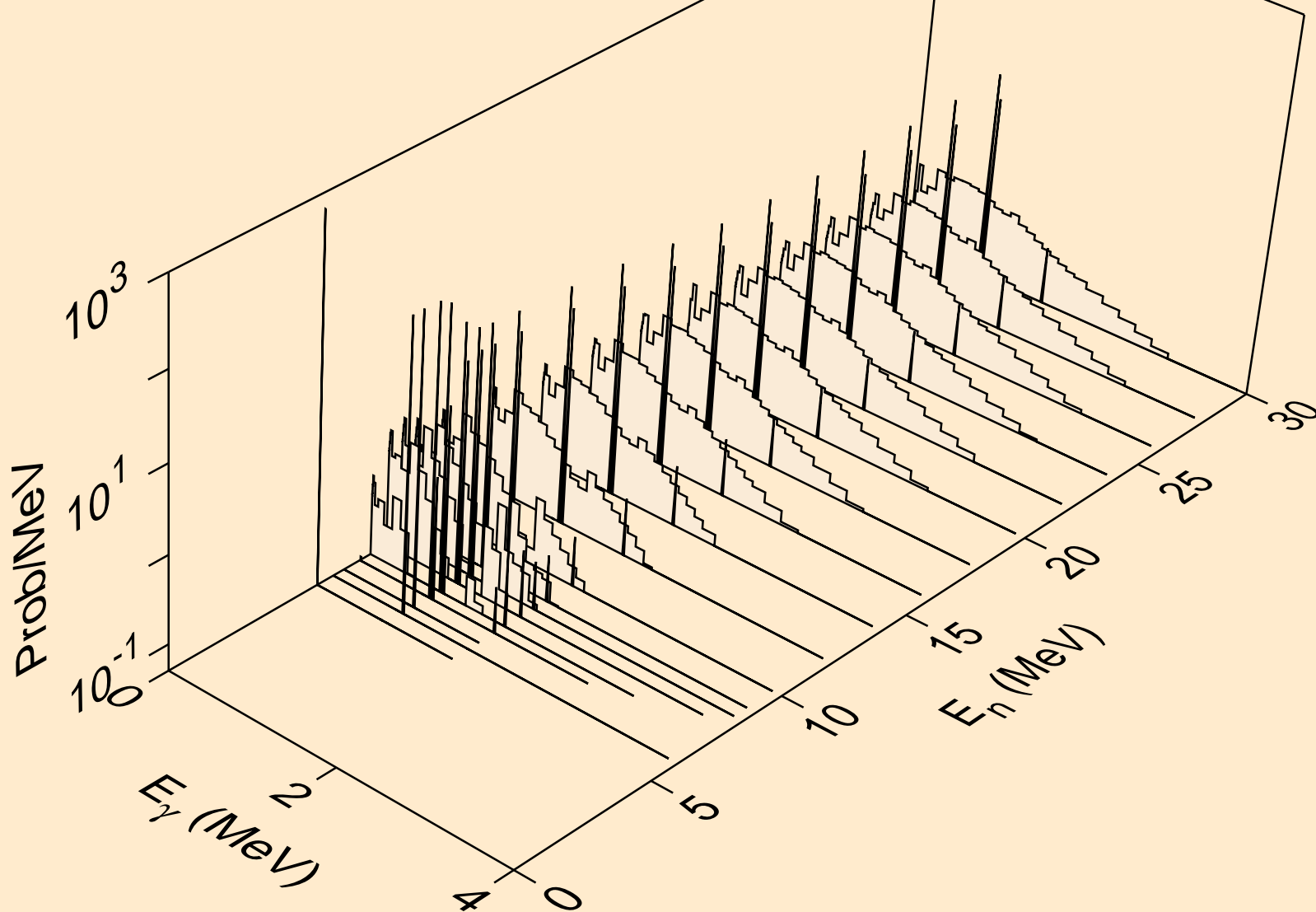

CS135M NEUTRON ACER TENDL-2019 LIBRARY; T=293.16K  
Photon emission for (n,t)

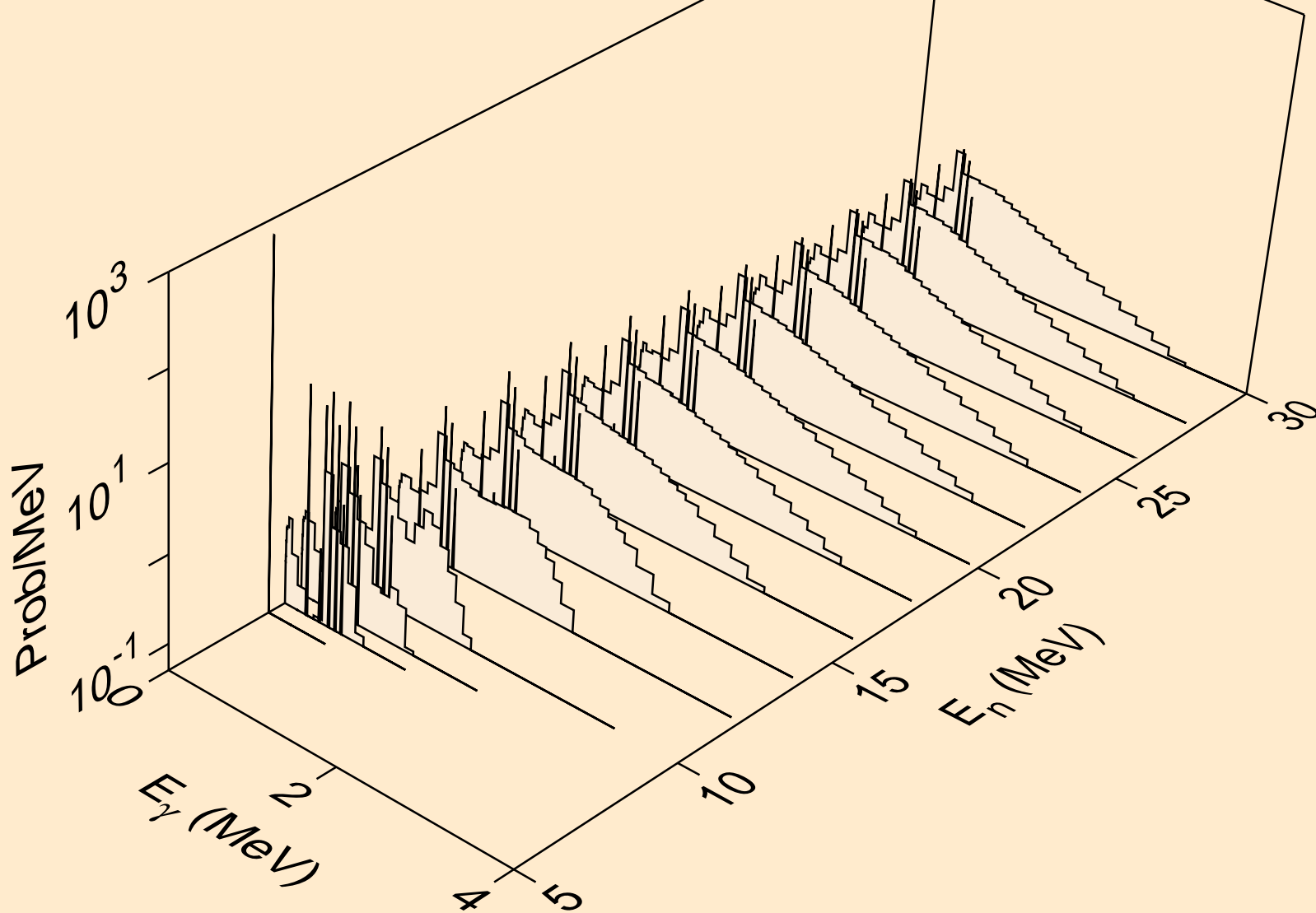



CS135M NEUTRON ACER TENDL-2019 LIBRARY; T=293.16K  
Photon emission for (n,he3)

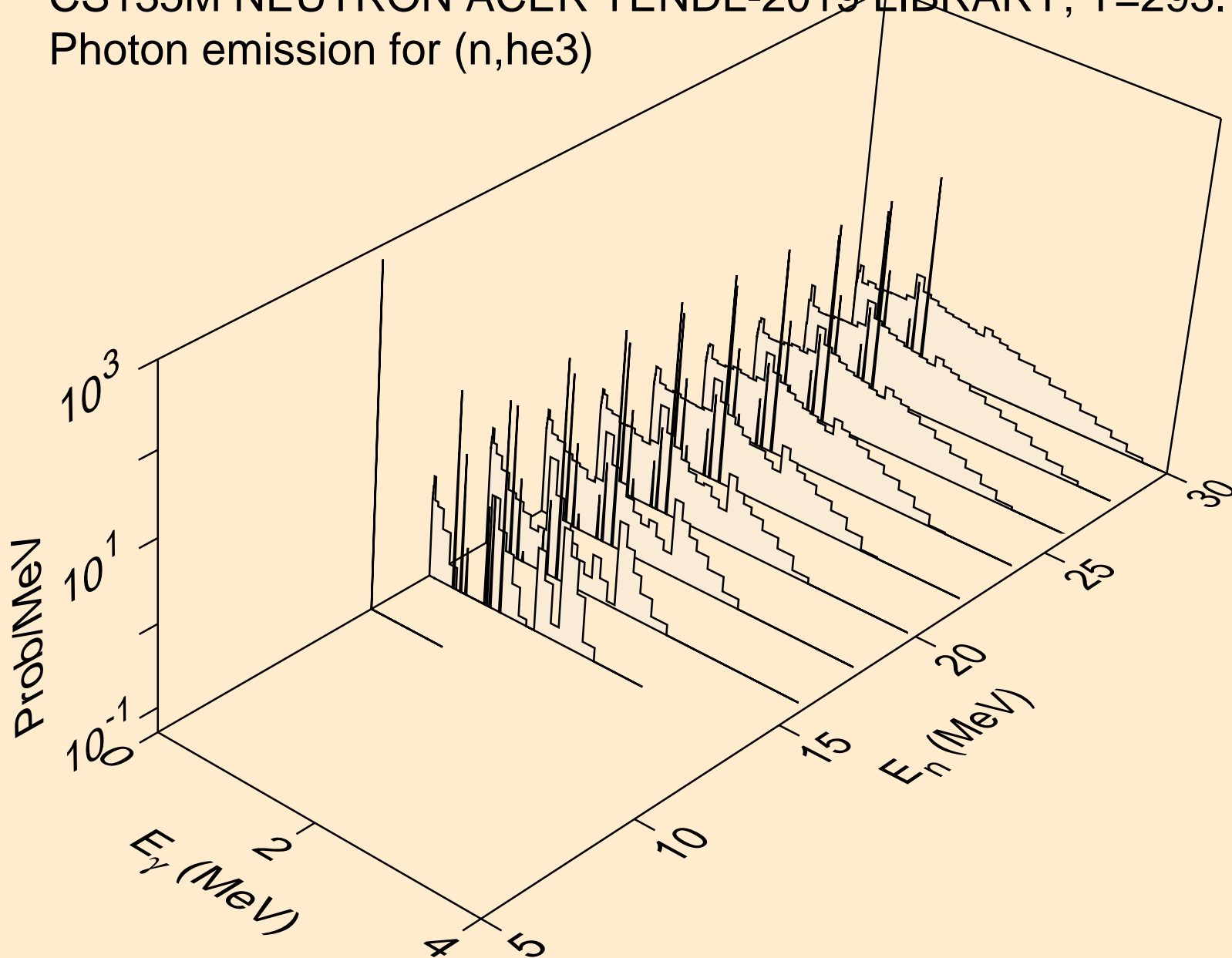

CS135M NEUTRON ACER TENDL-2019 LIBRARY; T=293.16K  
Photon emission for (n,a)

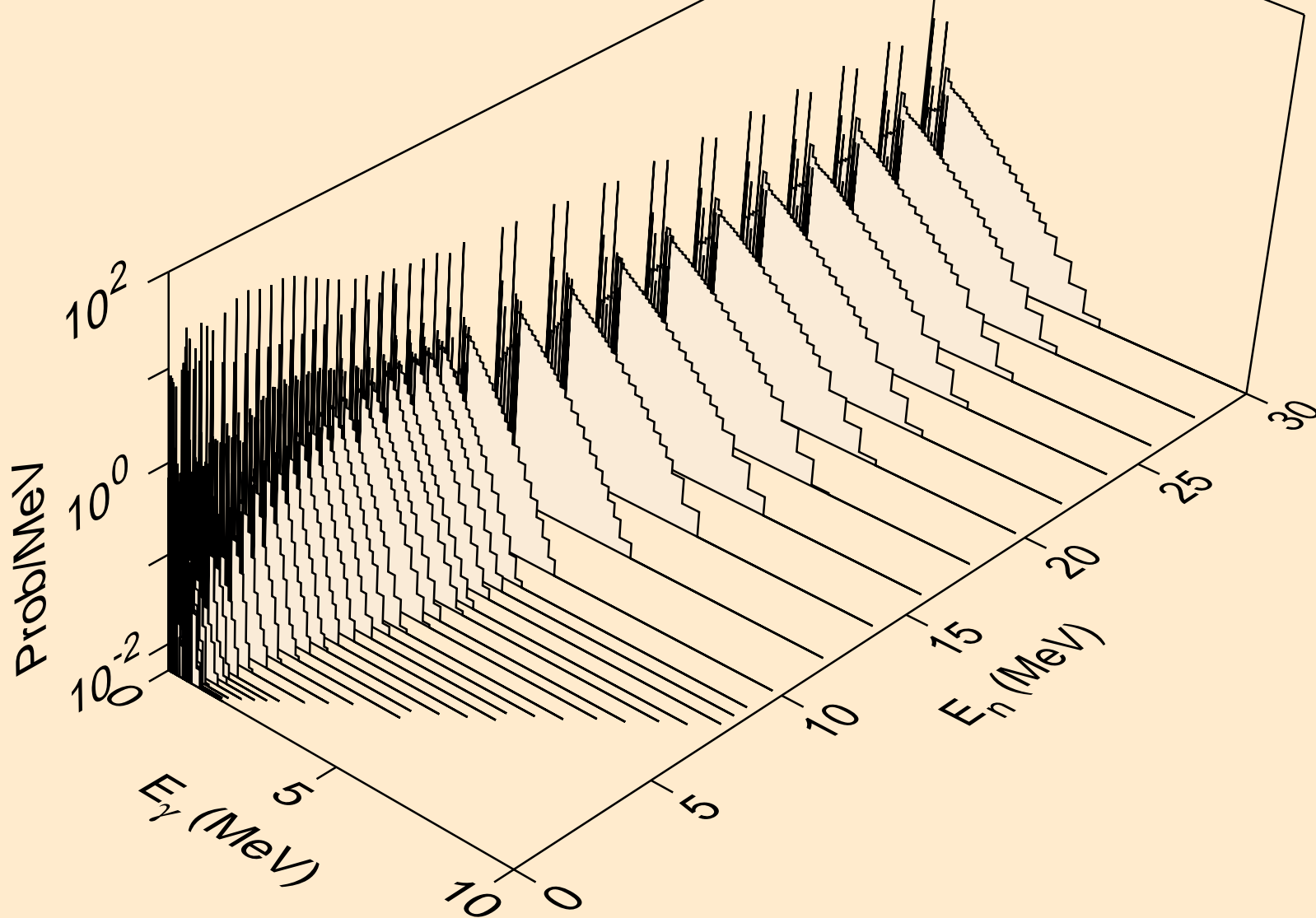

CS135M NEUTRON ACER TENDL-2019 LIBRARY; T=293.16K  
Photon emission for (n,2a)

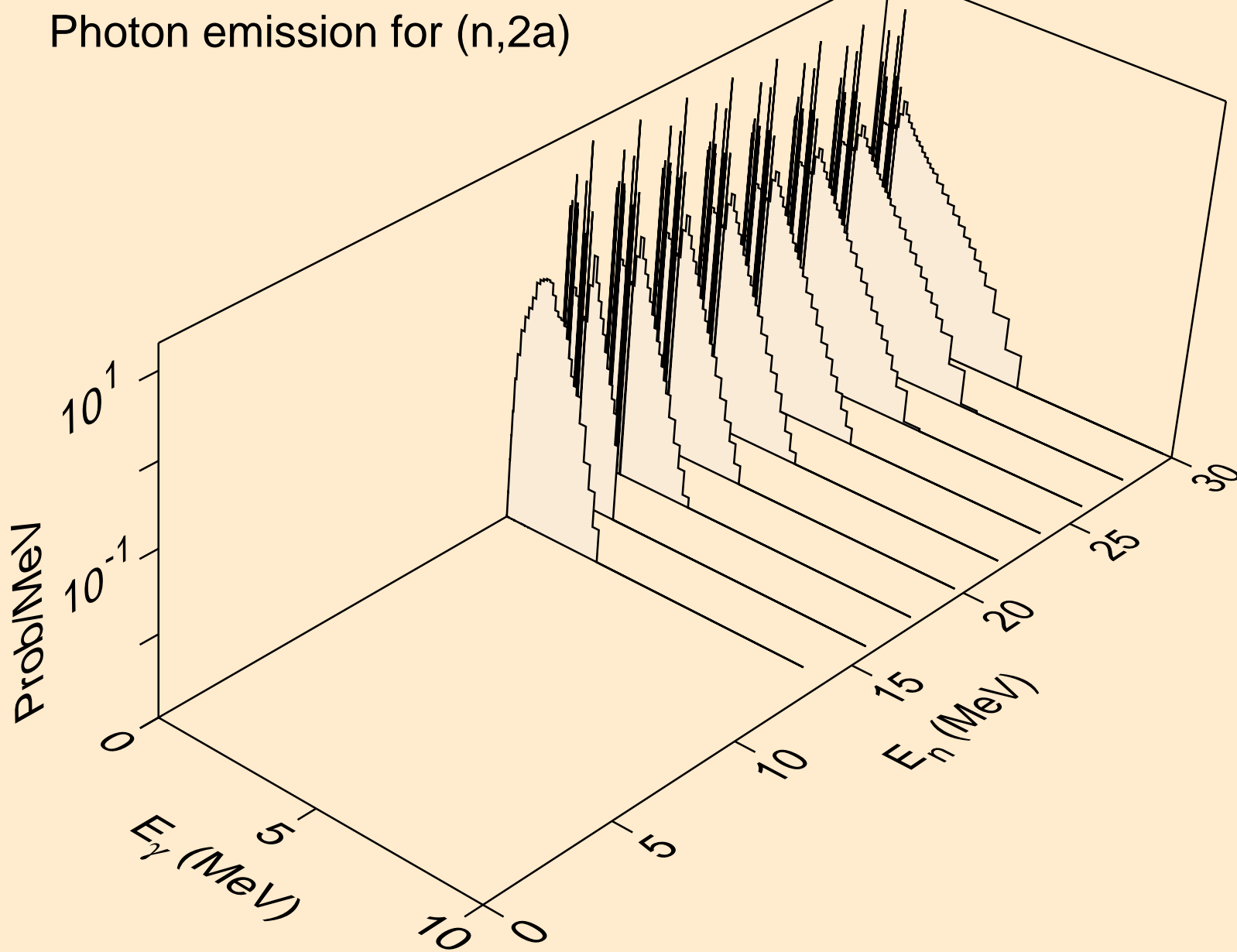

CS135M NEUTRON ACER TENDL-2019 LIBRARY; T=293.16K  
Photon emission for (n,2p)

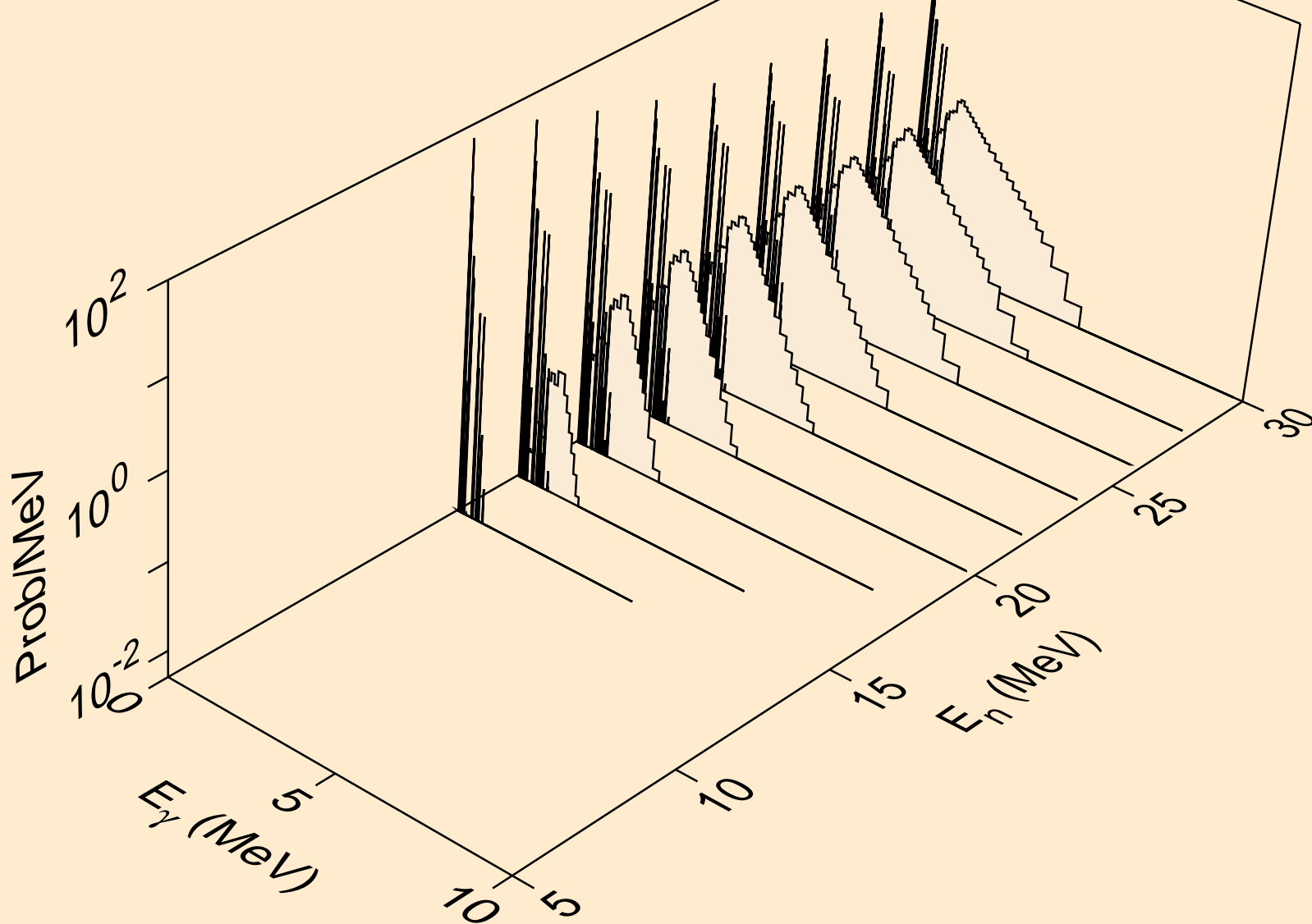

CS135M NEUTRON ACER TENDL-2019 LIBRARY; T=293.16K  
Photon emission for (n,p $\alpha$ )

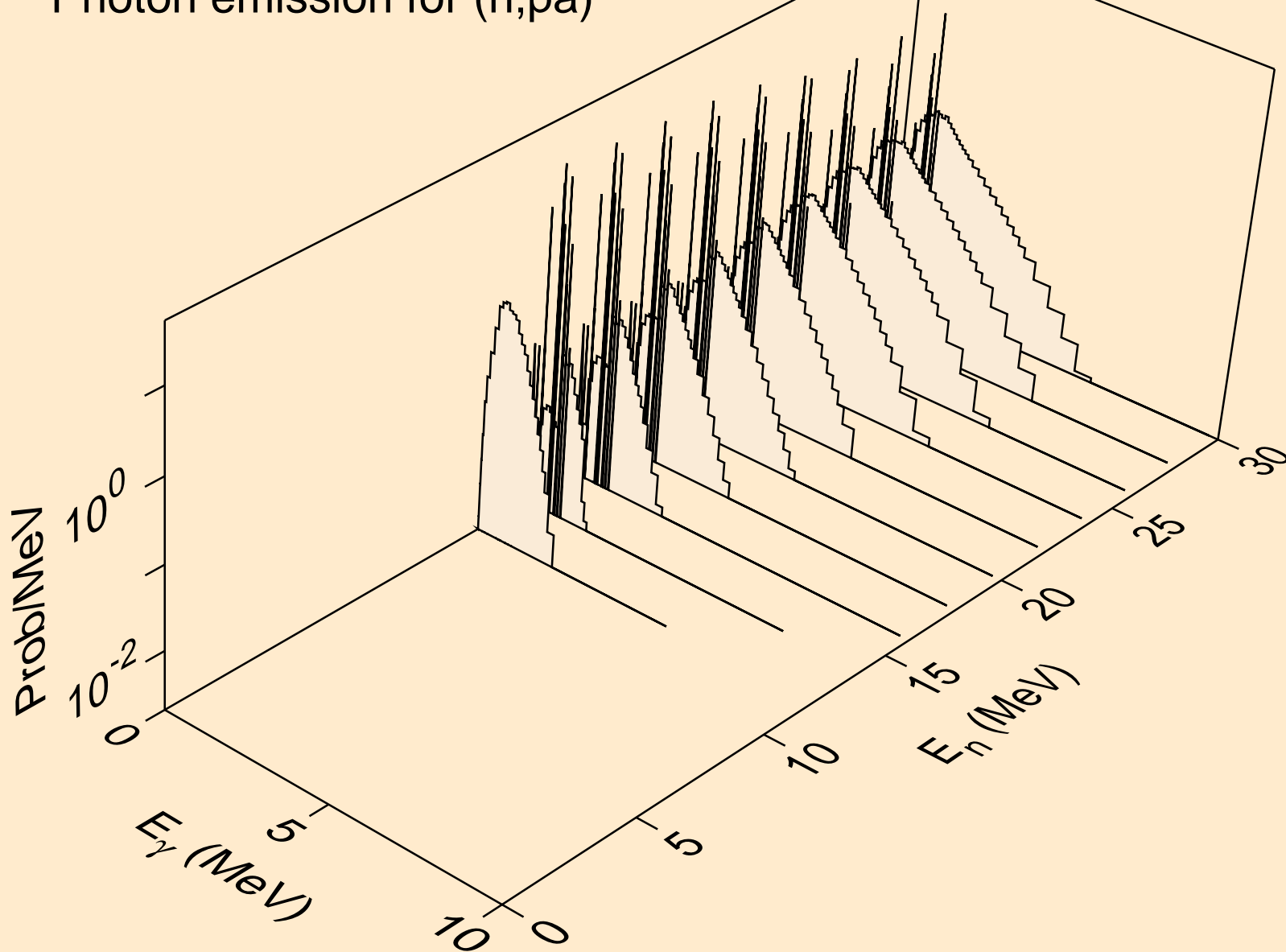

CS135M NEUTRON ACER TENDL-2019 LIBRARY; T=293.16K  
Photon emission for (n,pd)

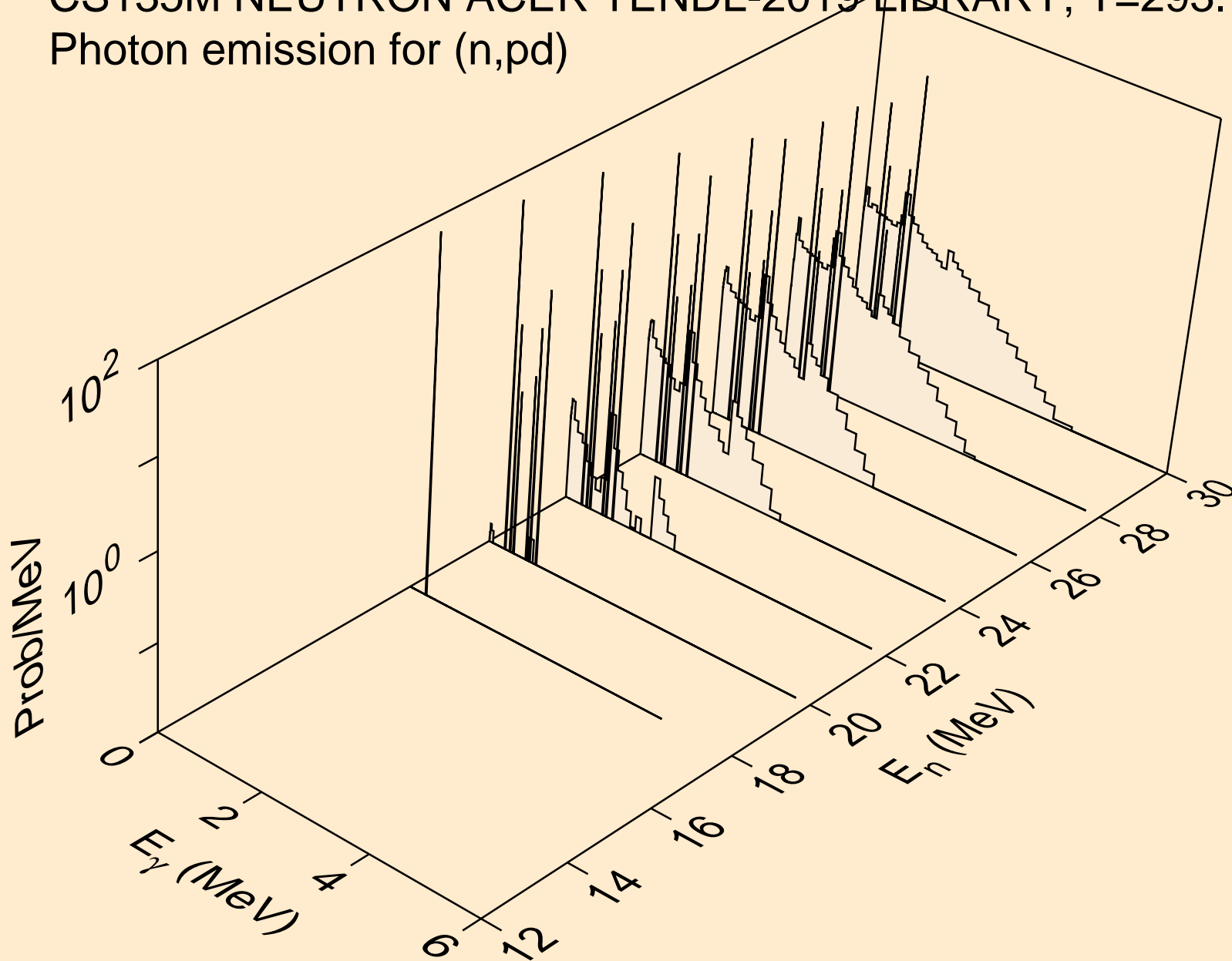

CS135M NEUTRON ACER TENDL-2019 LIBRARY; T=293.16K  
Photon emission for (n,pt)

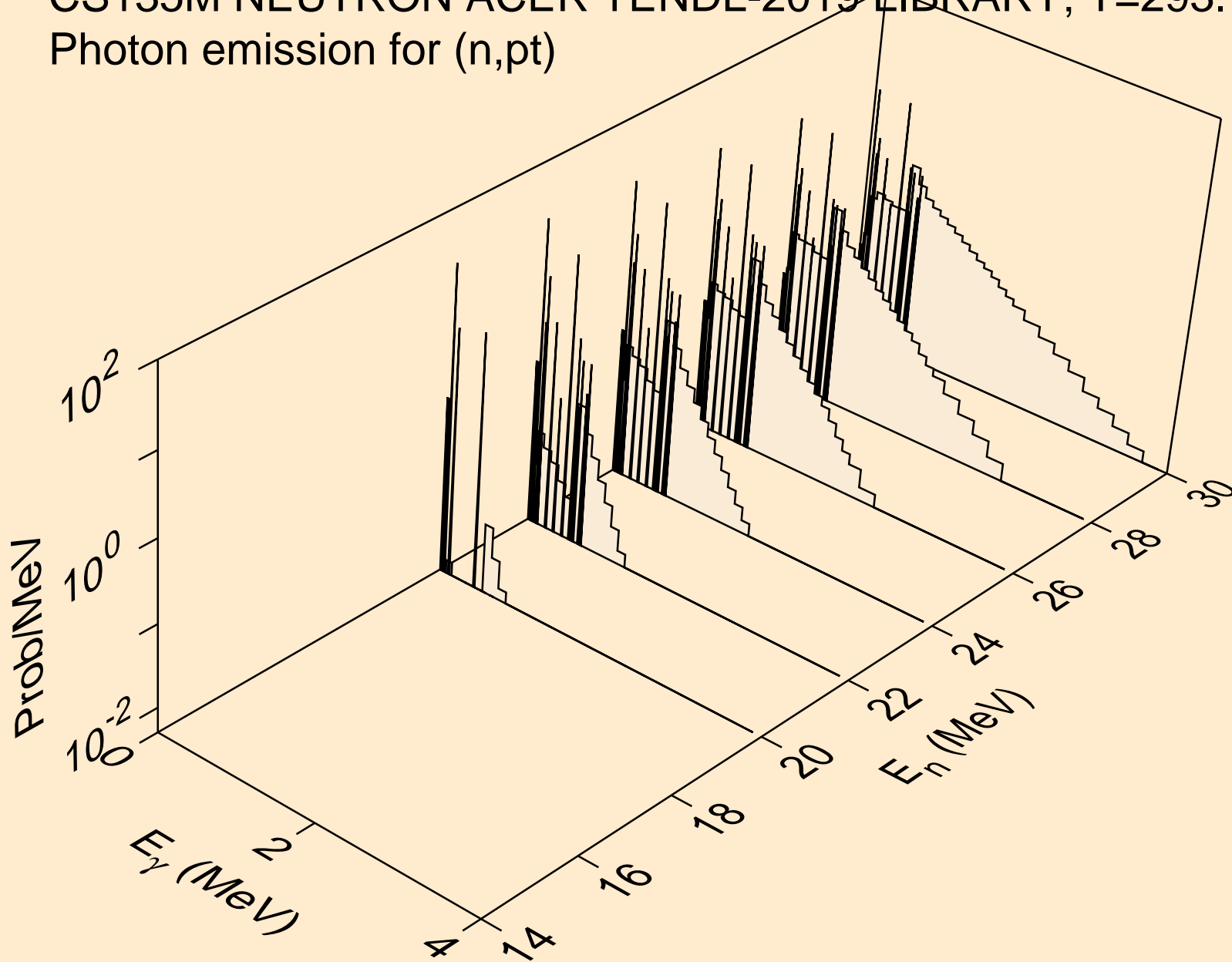

CS135M NEUTRON ACER TENDL-2019 LIBRARY; T=293.16K  
Photon emission for (n,da)

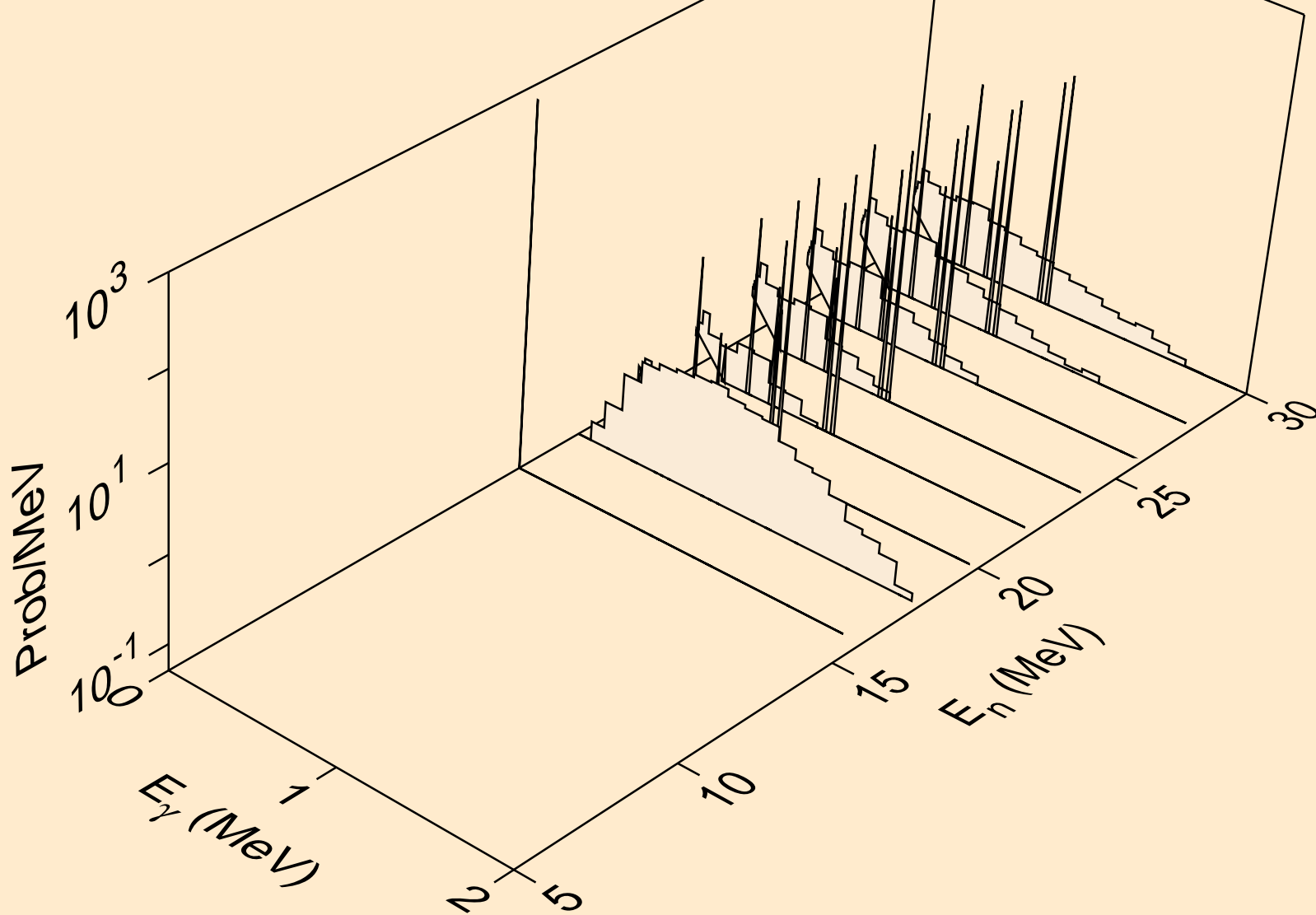



CS135M NEUTRON ACER TENDL-2019 LIBRARY; T=293.16K  
thermal capture photon spectrum

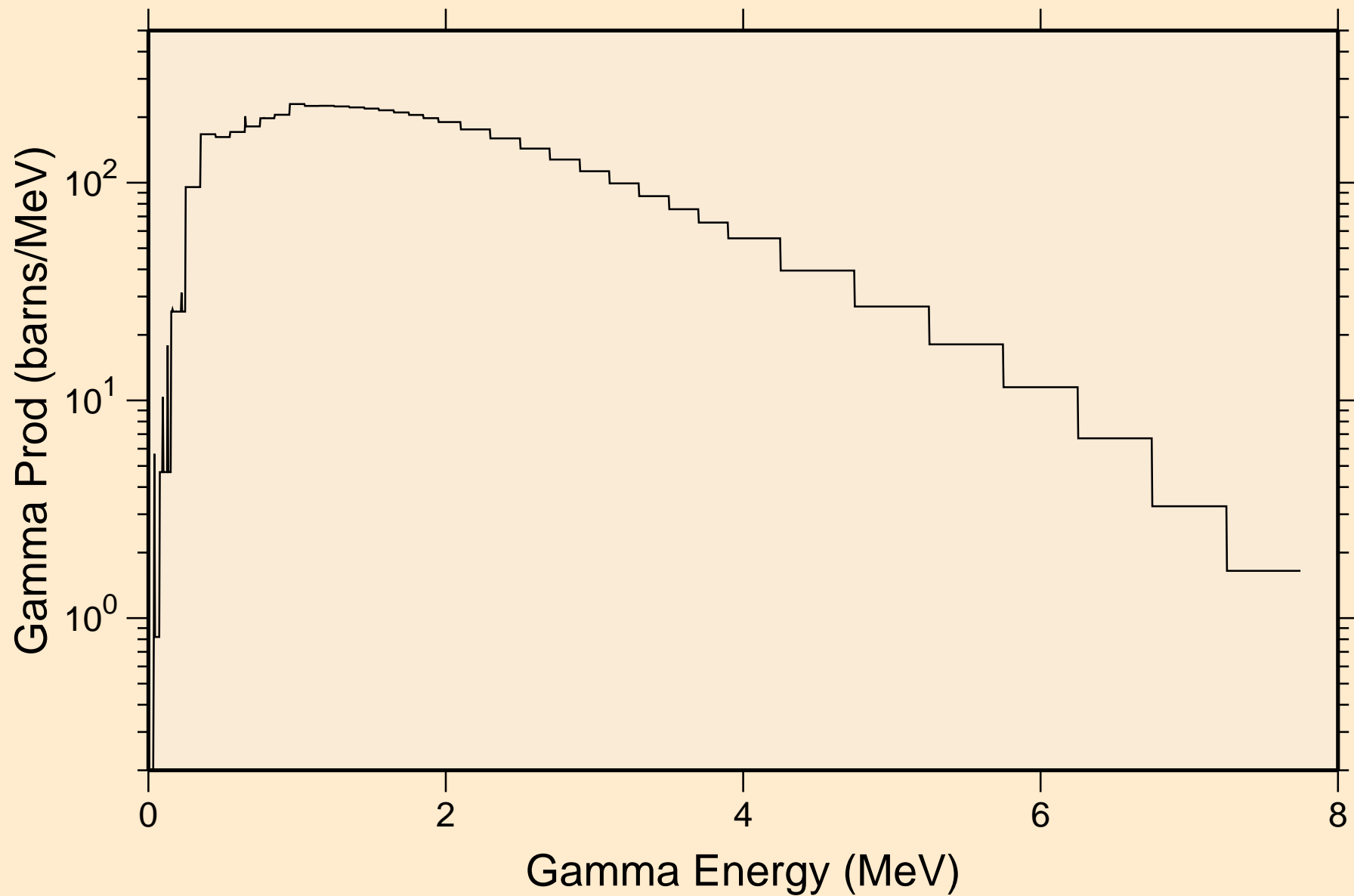

CS135M NEUTRON ACER TENDL-2019 LIBRARY; T=293.16K  
14 MeV photon spectrum

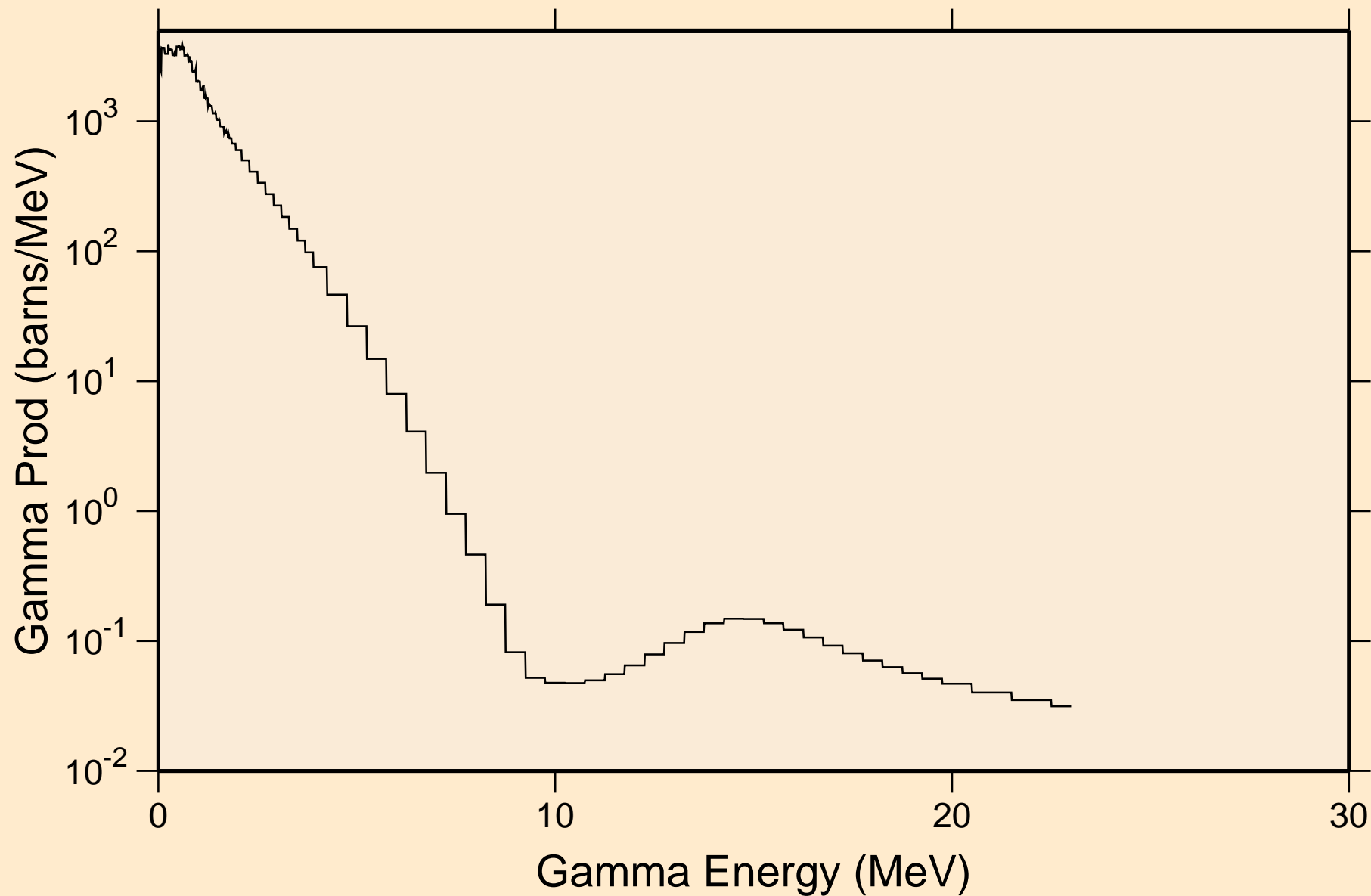

# CS135M NEUTRON ACER TENDL-2019 LIBRARY; T=293.16K

## Particle heating contributions

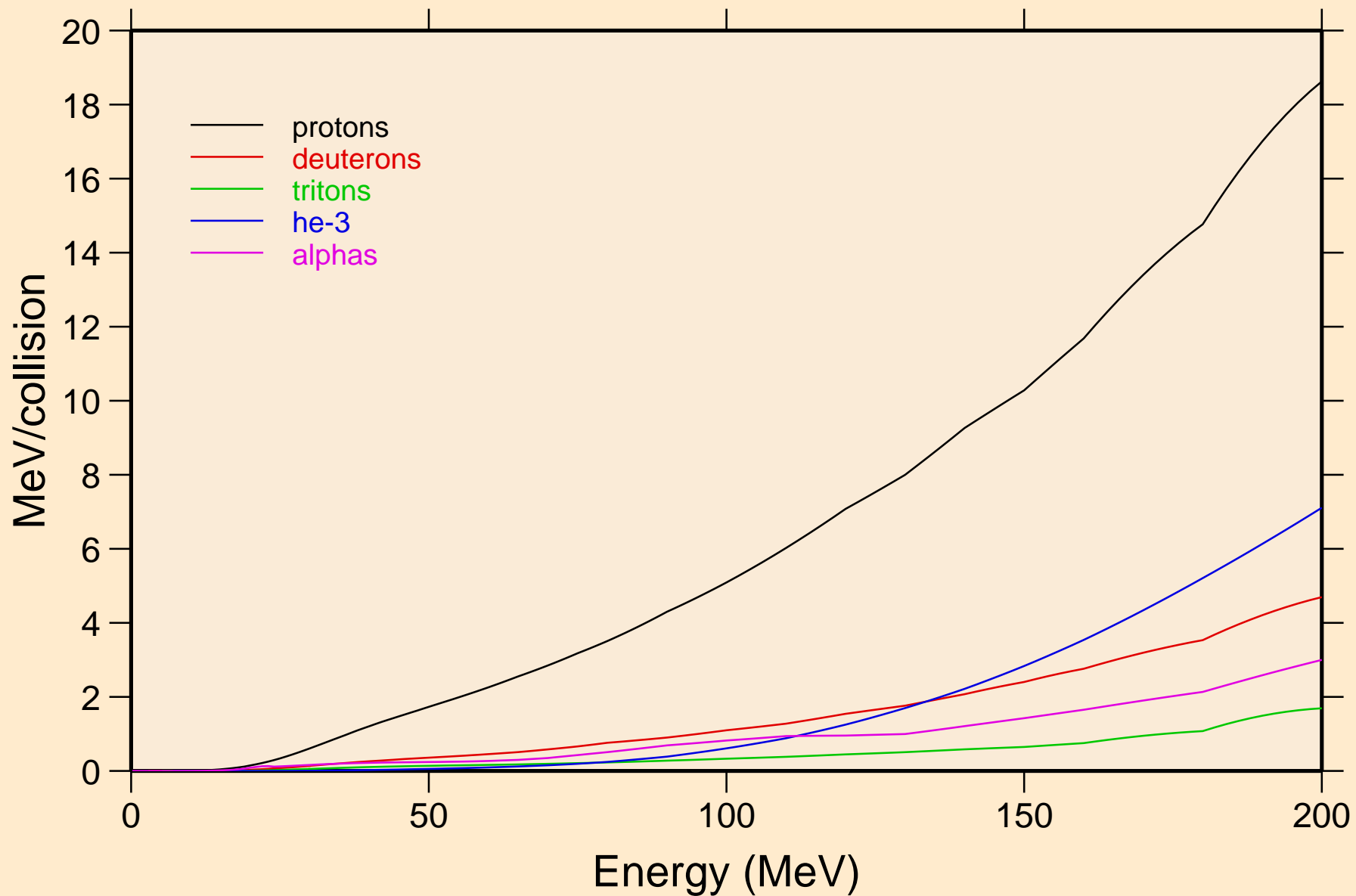

CS135M NEUTRON ACER TENDL-2019 LIBRARY; T=293.16K  
Recoil Heating

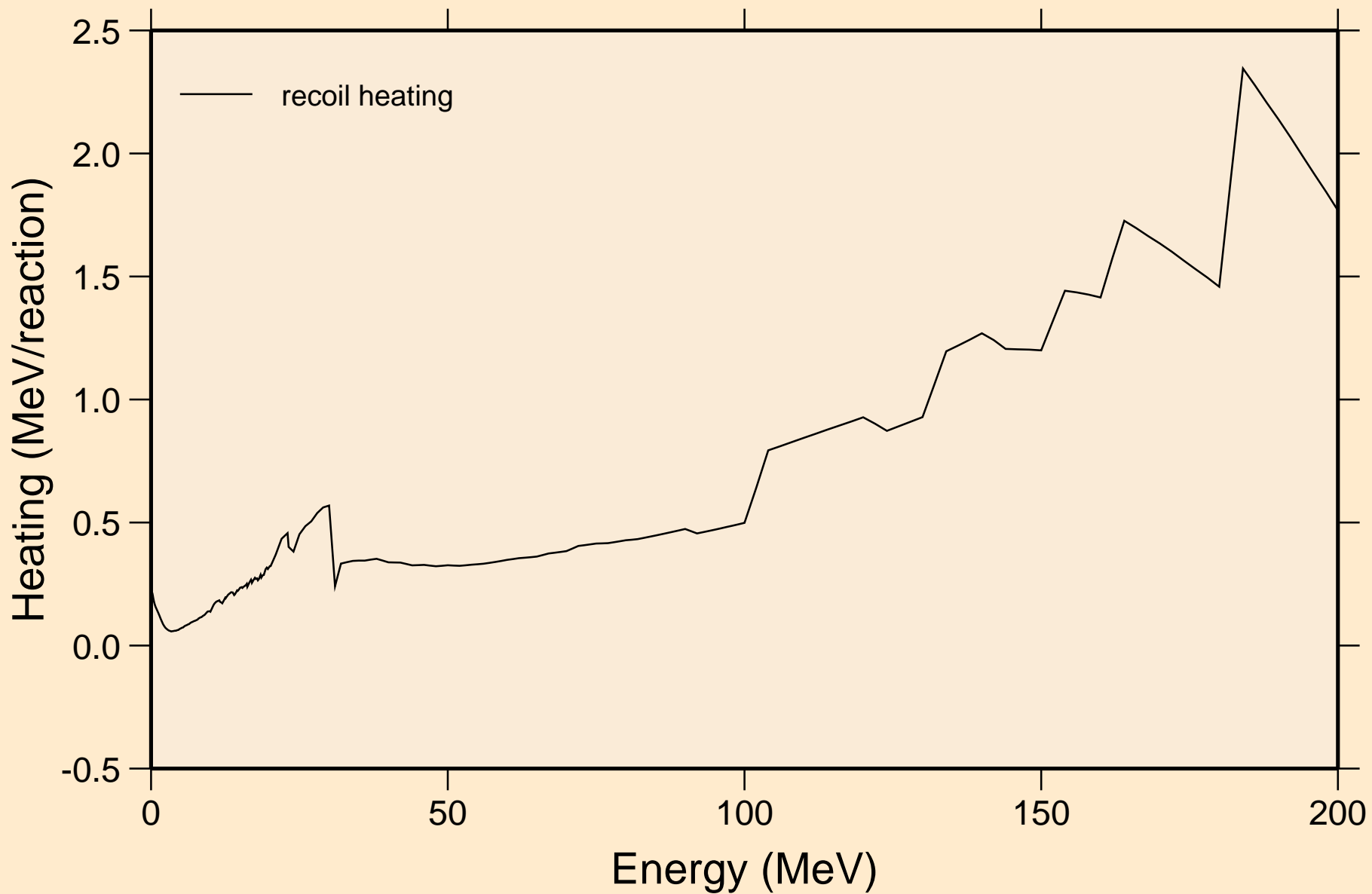

CS135M NEUTRON ACER TENDL-2019 LIBRARY; T=293.16K  
Particle production cross sections

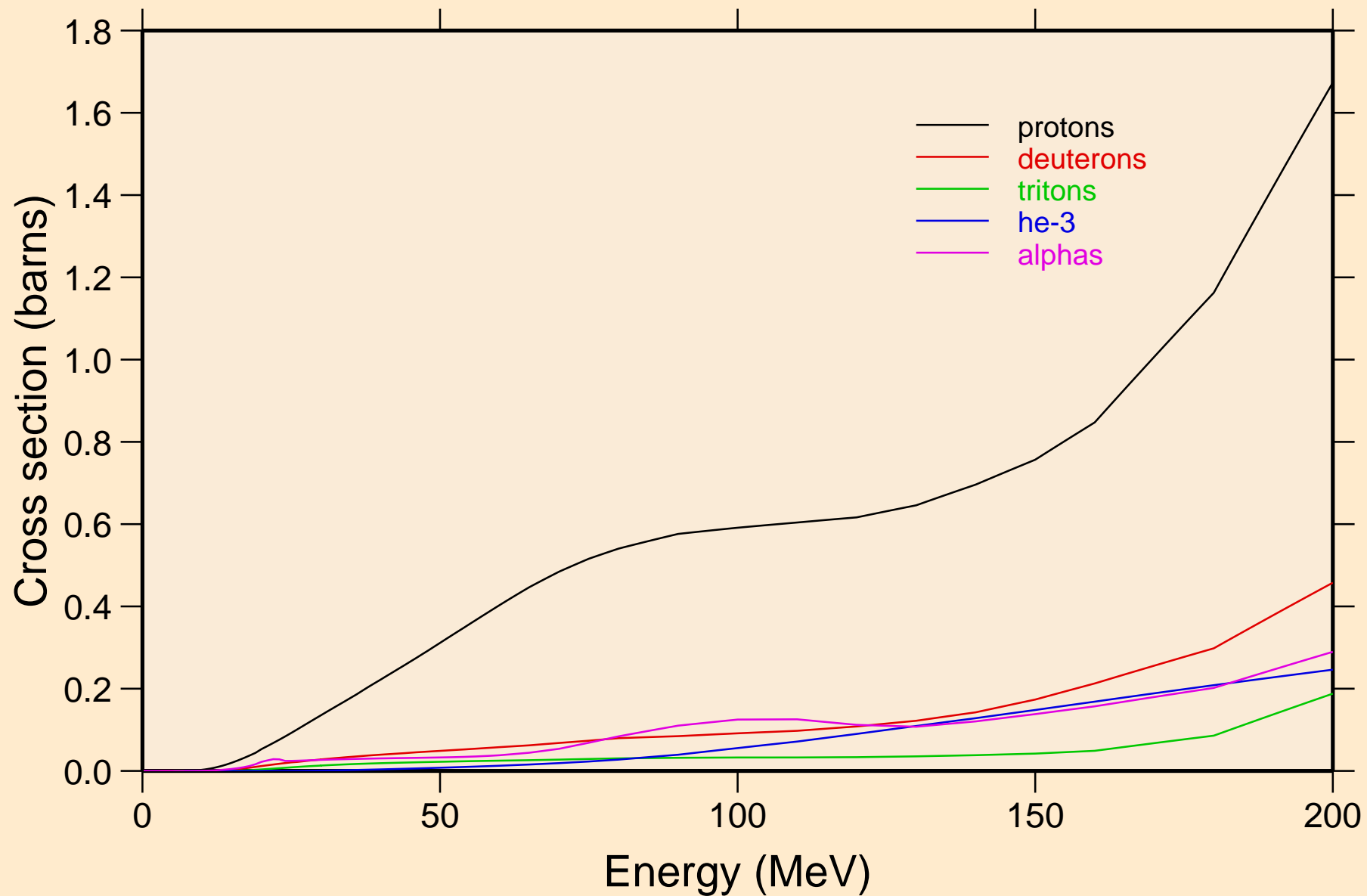

CS135M NEUTRON ACER TENDL-2019 LIBRARY; T=293.16K  
protons from (n,x)

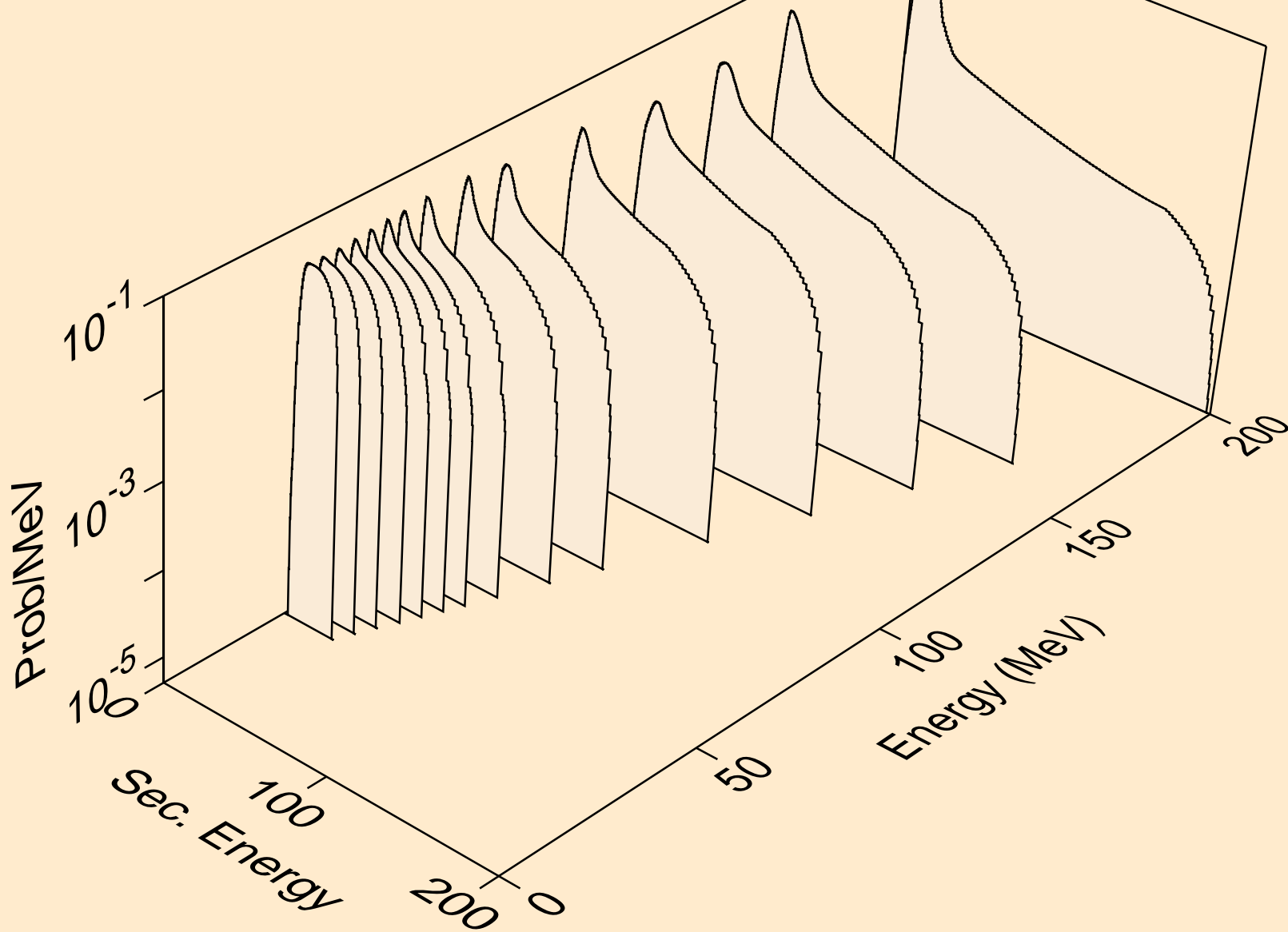

CS135M NEUTRON ACER TENDL-2019 LIBRARY; T=293.16K  
protons from (n,n\*)p

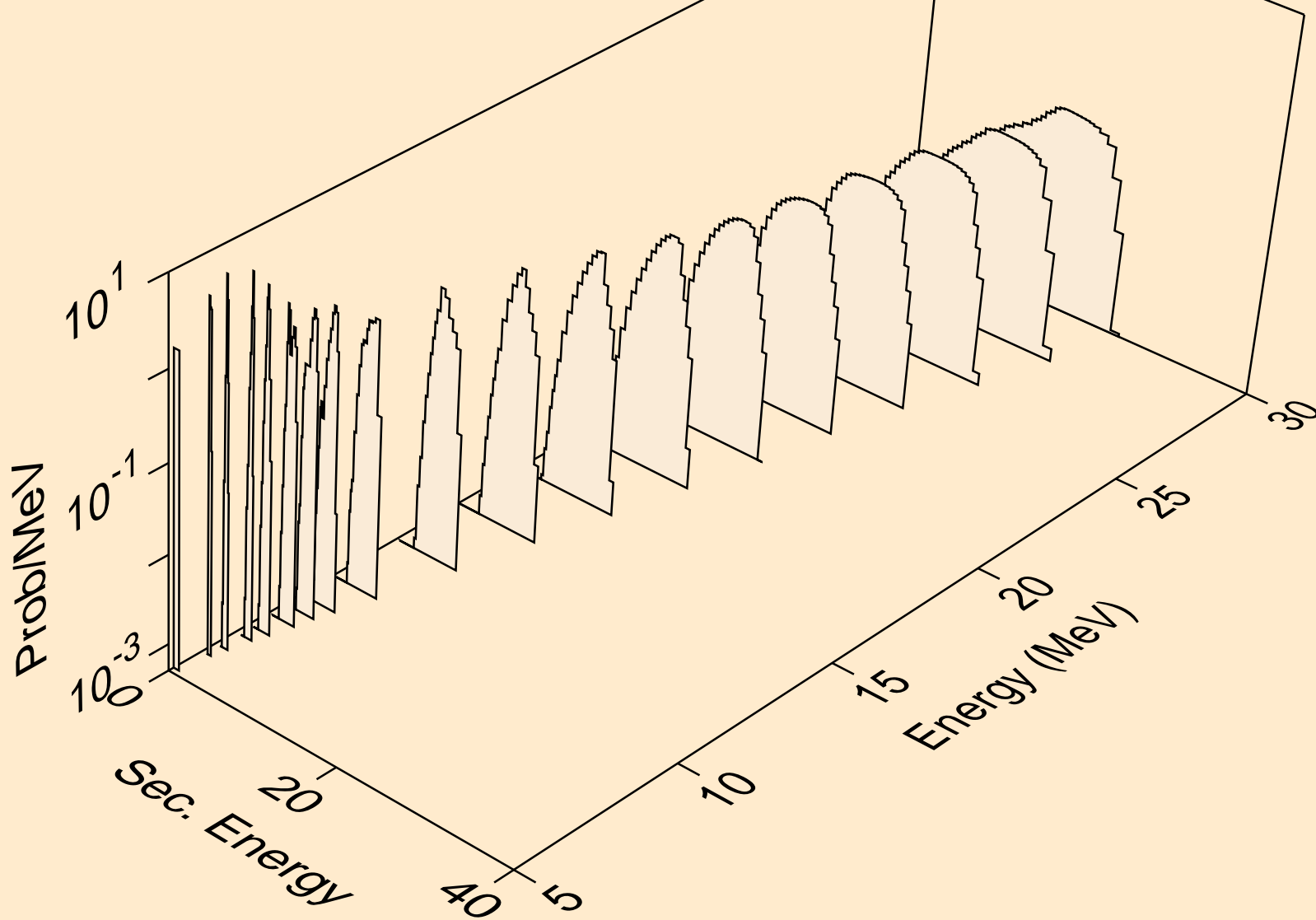

CS135M NEUTRON ACER TENDL-2019 LIBRARY; T=293.16K  
protons from (n,2np)

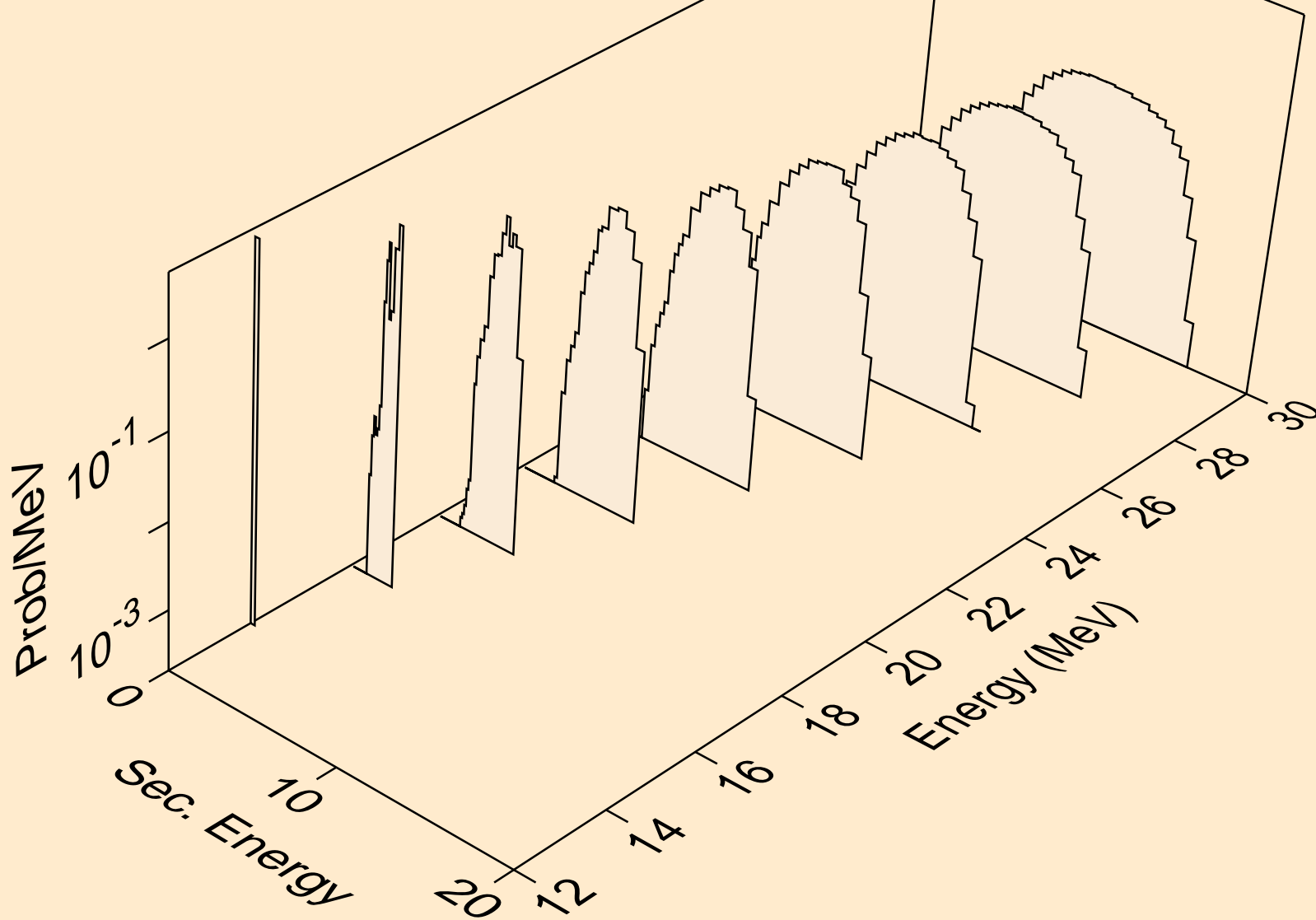



CS135M NEUTRON ACER TENDL-2019 LIBRARY; T=293.16K  
protons from (n,3np)

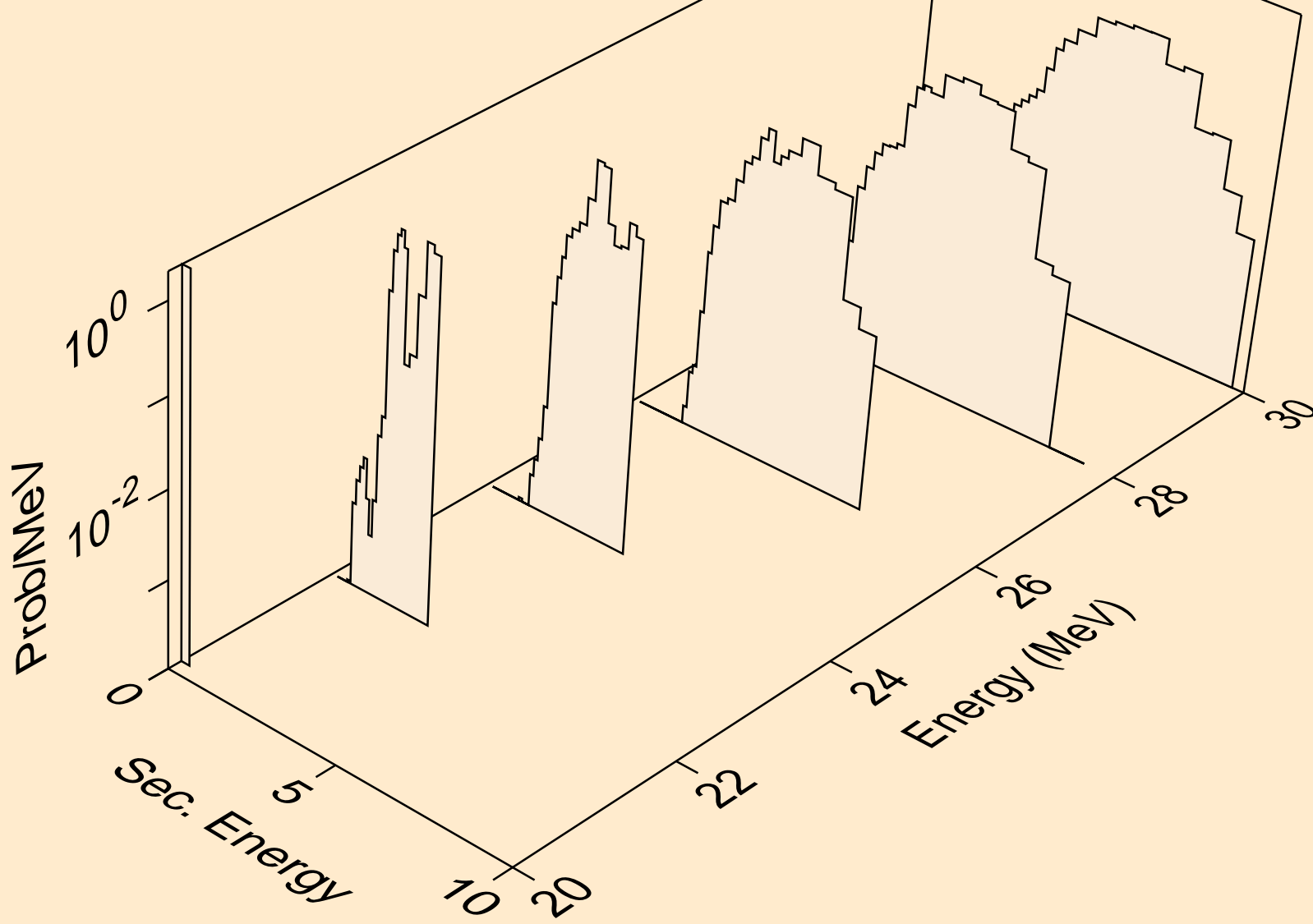

CS135M NEUTRON ACER TENDL-2019 LIBRARY; T=293.16K  
protons from (n,2np)

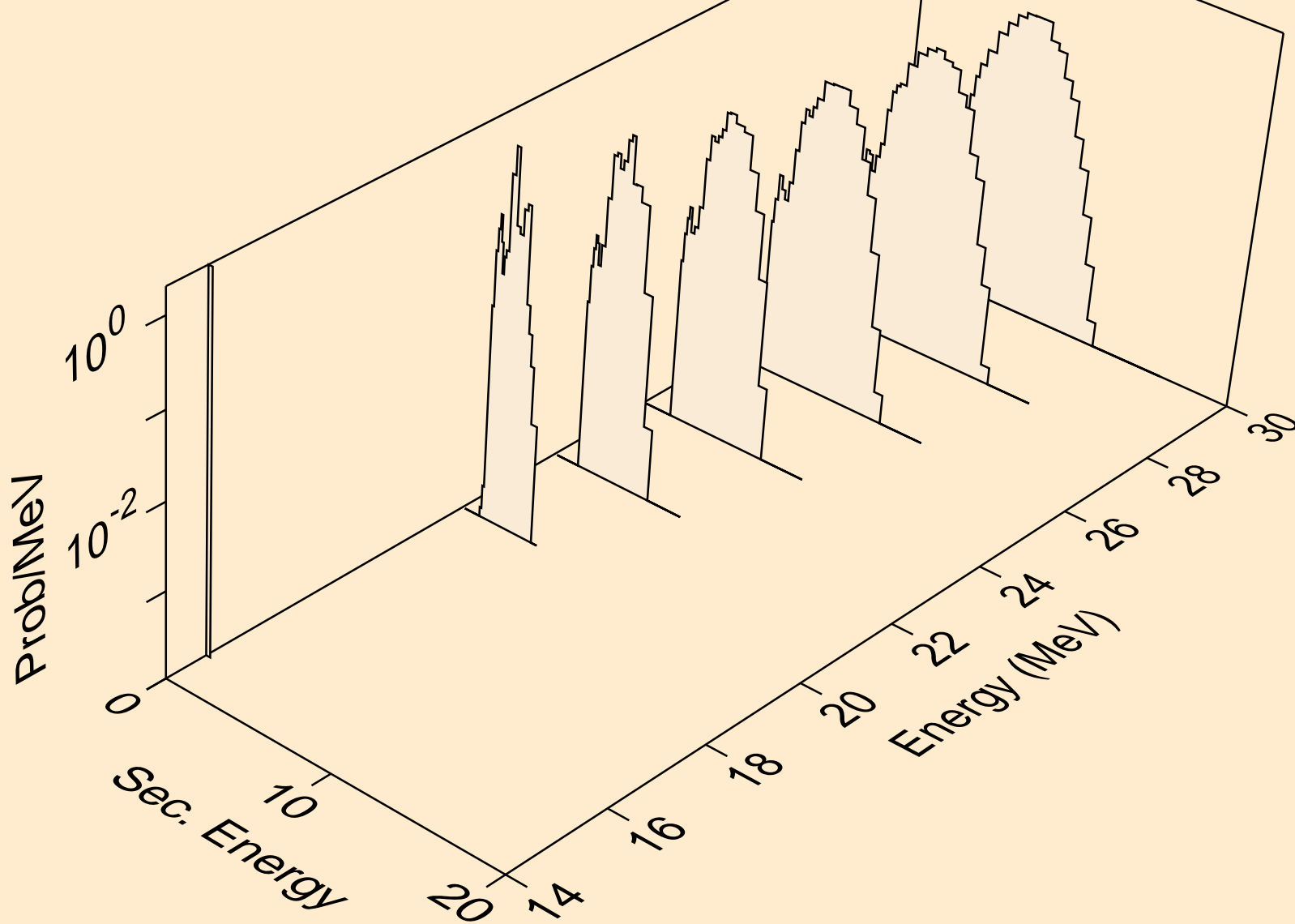

CS135M NEUTRON ACER TENDL-2019 LIBRARY; T=293.16K  
protons from (n,npa)

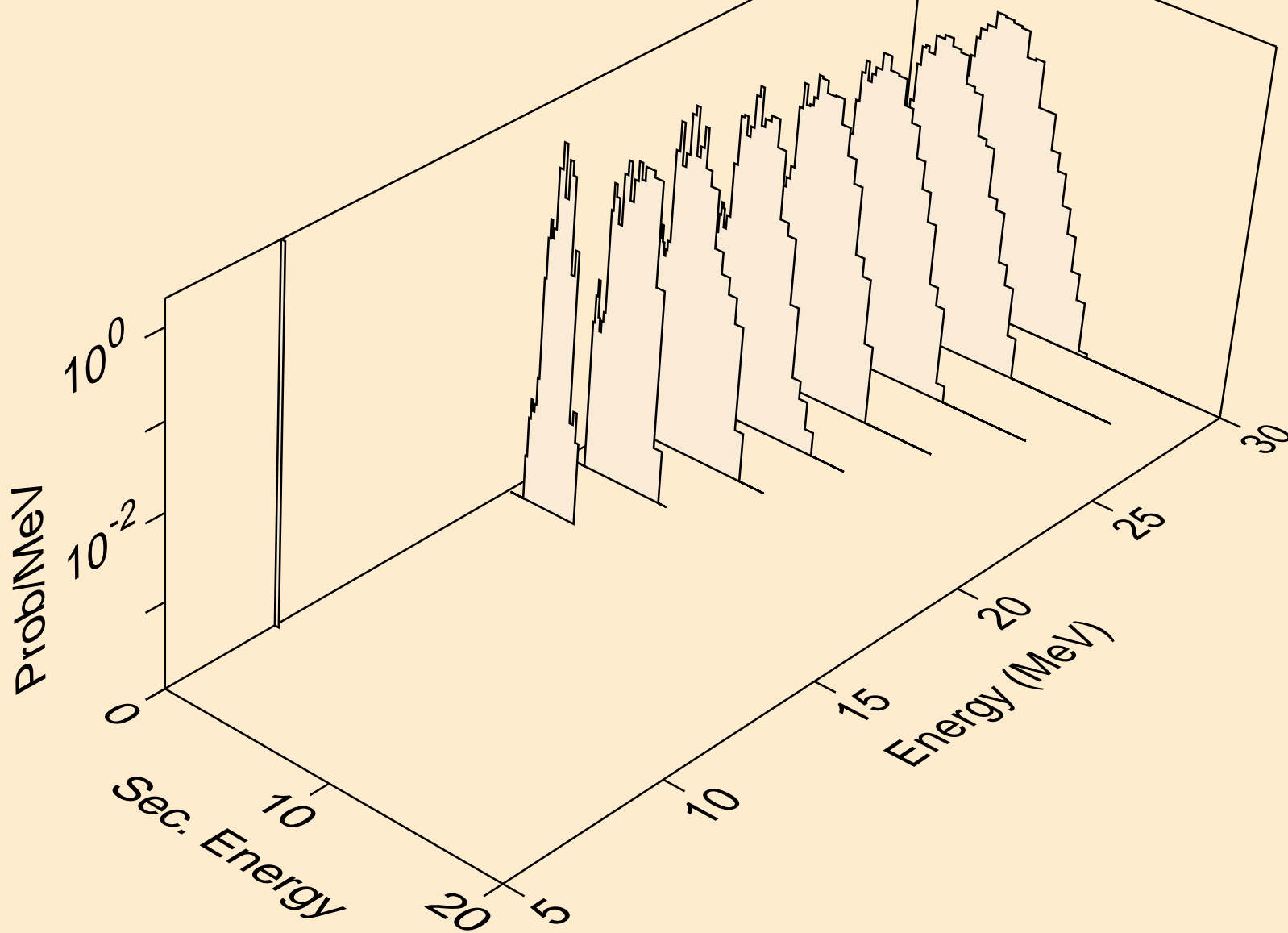

CS135M NEUTRON ACER TENDL-2019 LIBRARY; T=293.16K  
protons from (n,p)

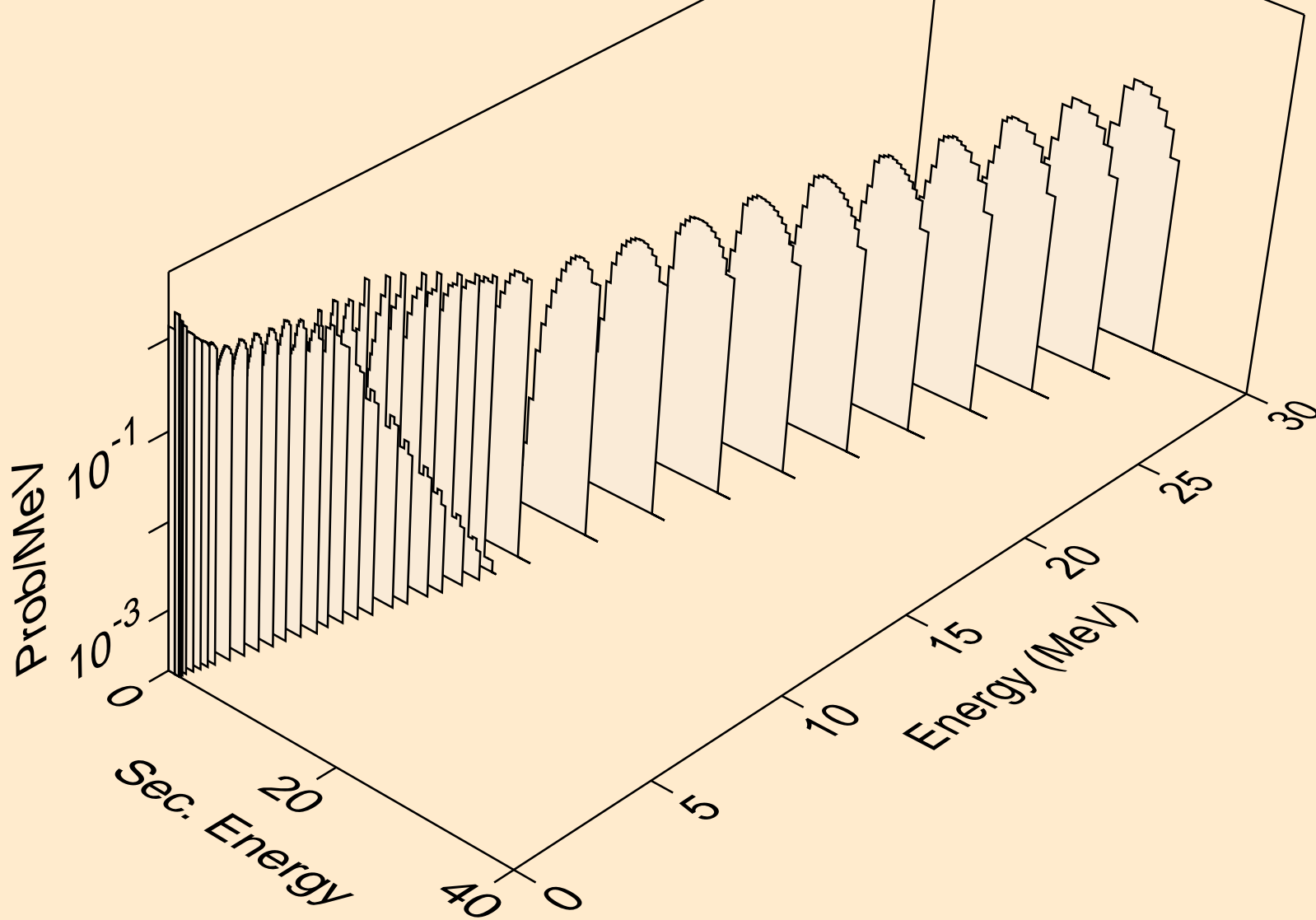

CS135M NEUTRON ACER TENDL-2019 LIBRARY; T=293.16K  
protons from (n,2p)

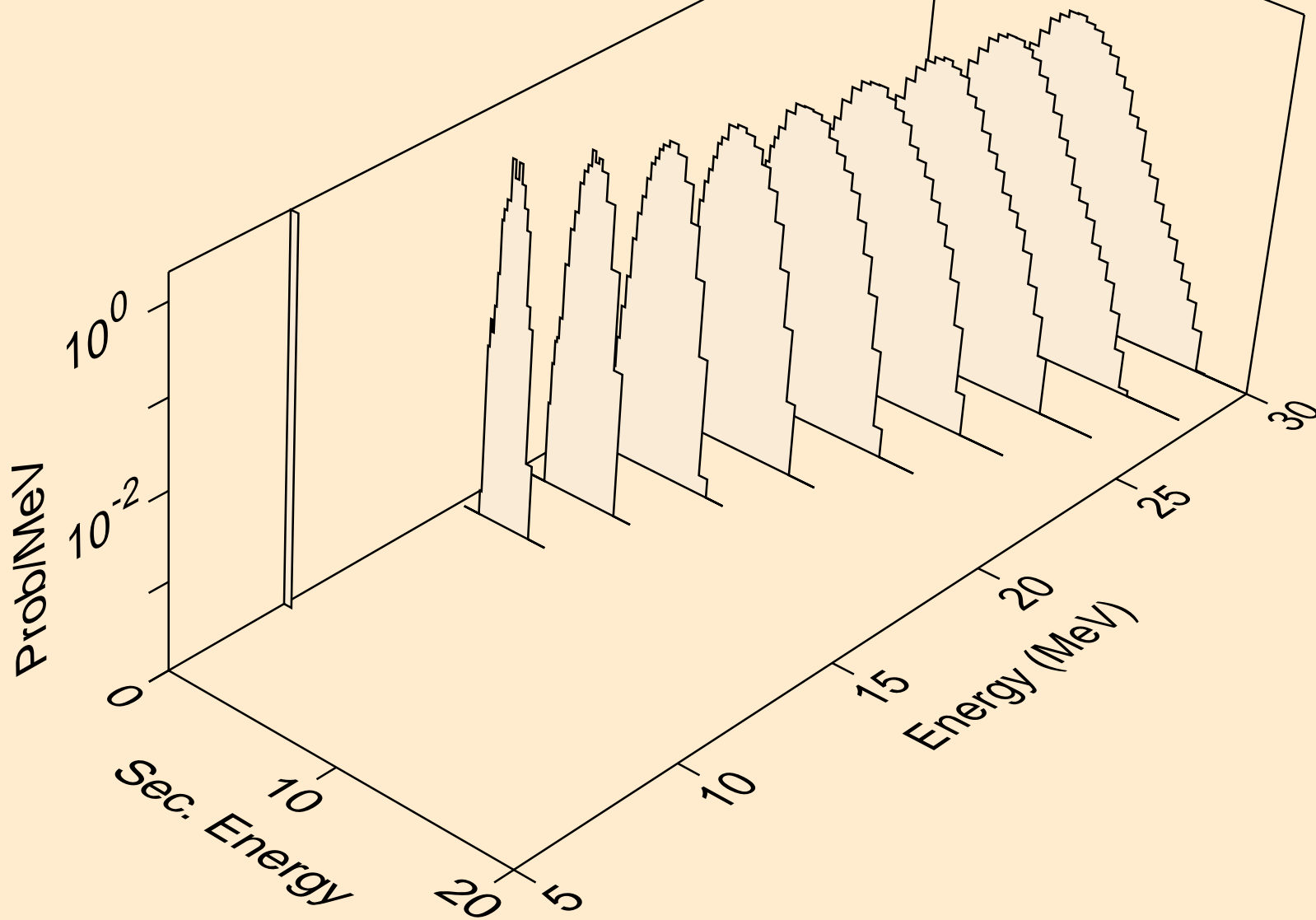

CS135M NEUTRON ACER TENDL-2019 LIBRARY; T=293.16K  
protons from (n,p)

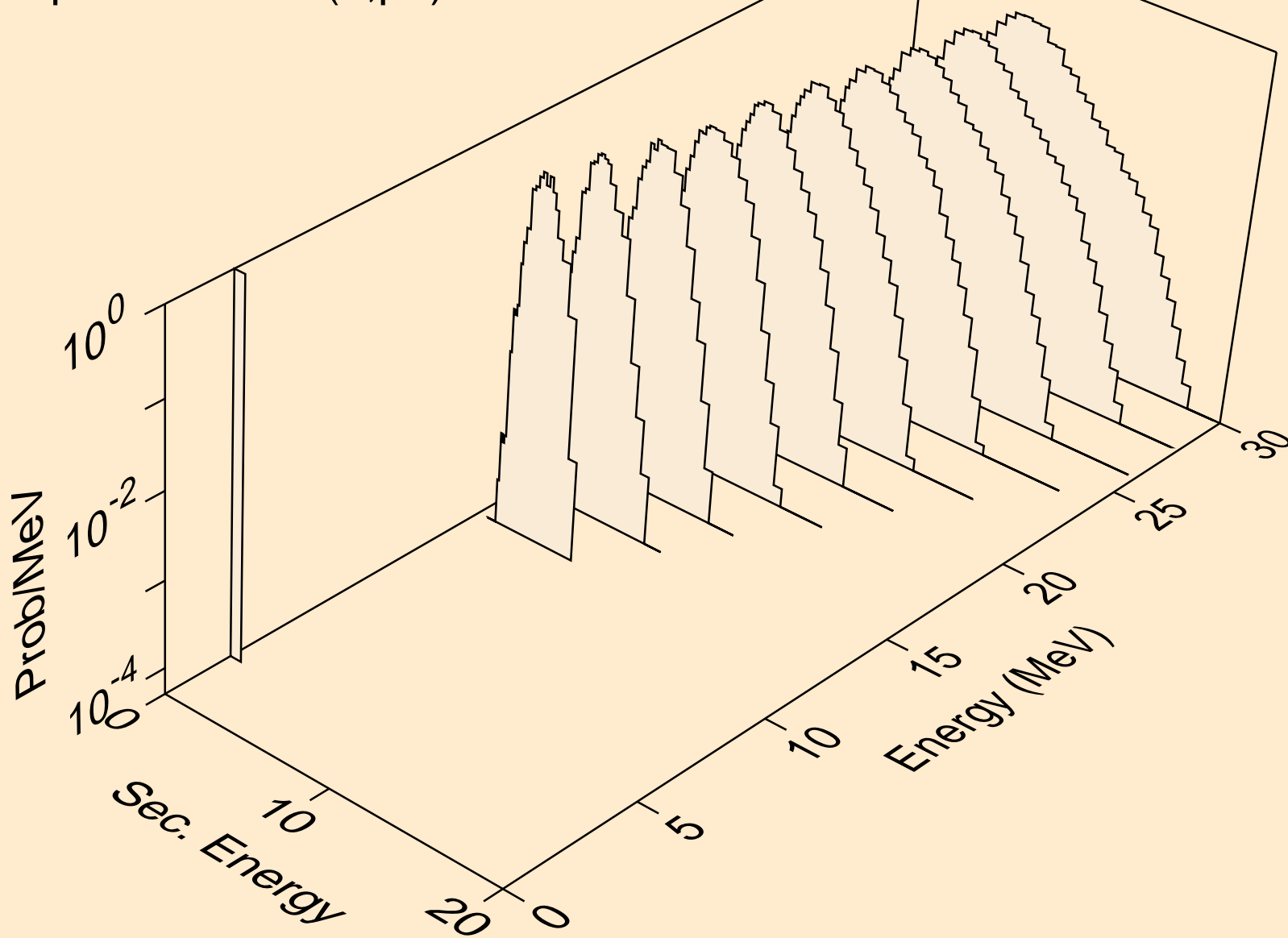

CS135M NEUTRON ACER TENDL-2019 LIBRARY; T=293.16K  
protons from (n,pd)

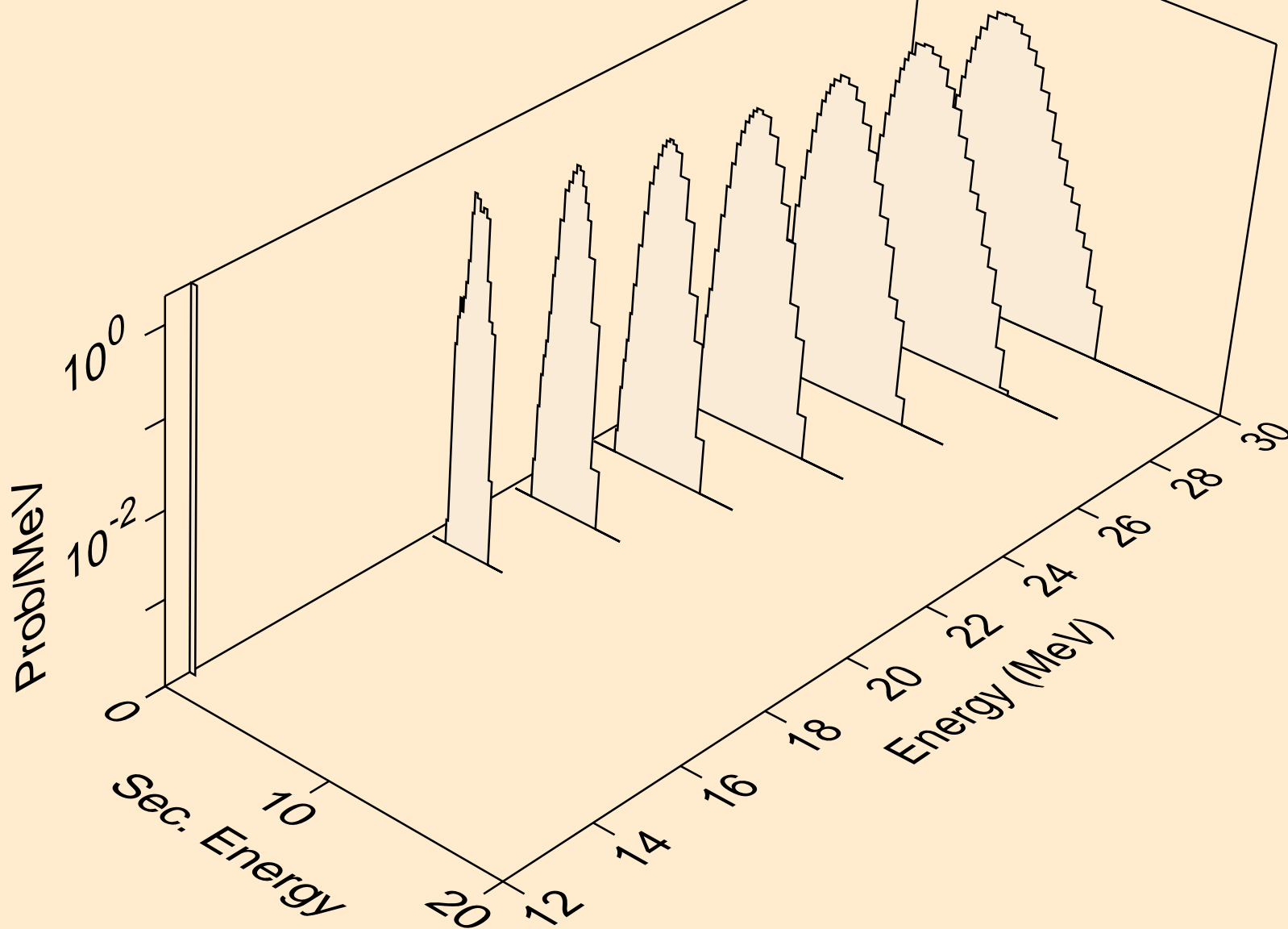

CS135M NEUTRON ACER TENDL-2019 LIBRARY; T=293.16K  
protons from (n,pt)

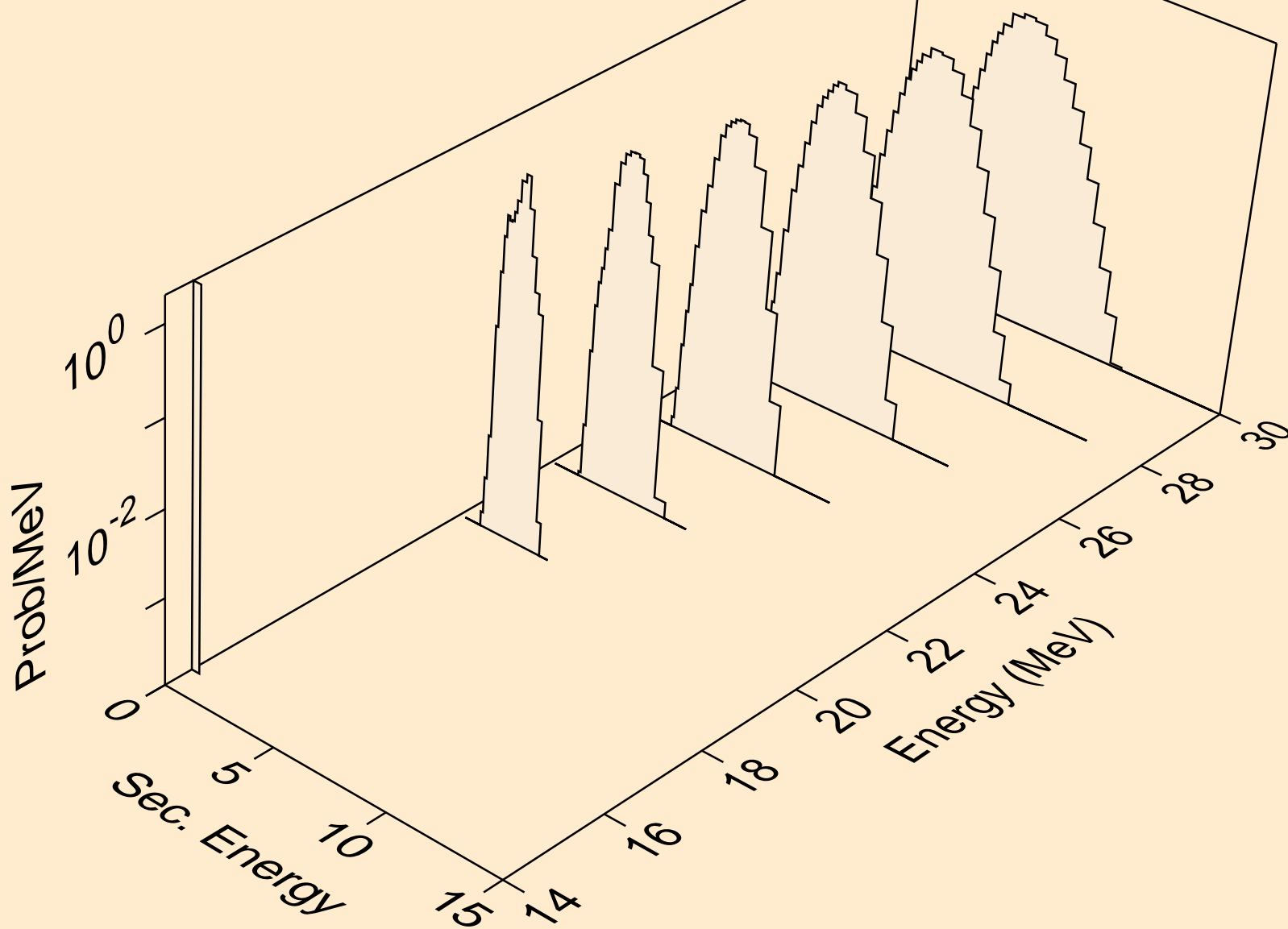



CS135M NEUTRON ACER TENDL-2019 LIBRARY; T=293.16K  
deuterons from (n,x)

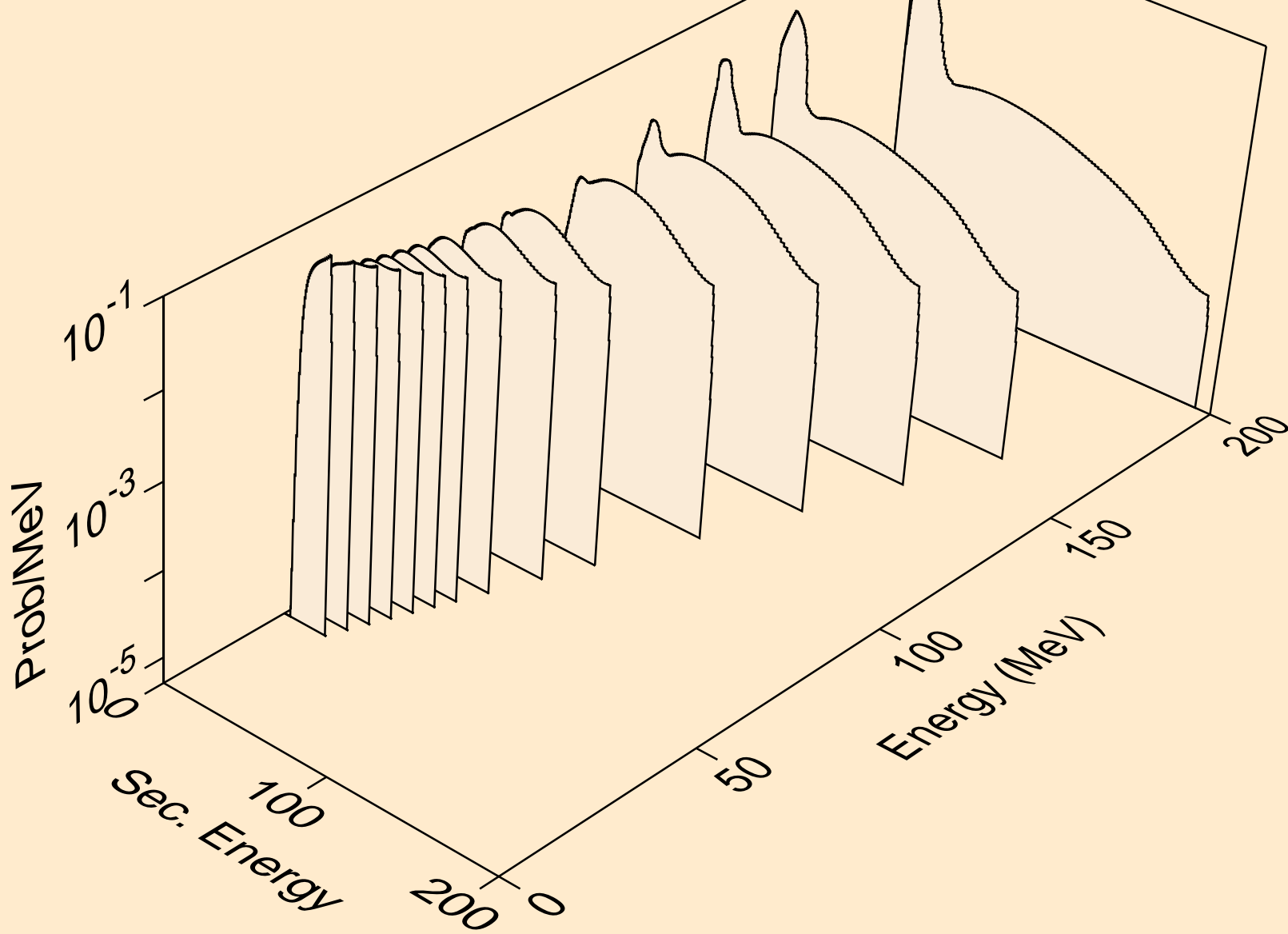

CS135M NEUTRON ACER TENDL-2019 LIBRARY; T=293.16K  
deuterons from (n,2nd)

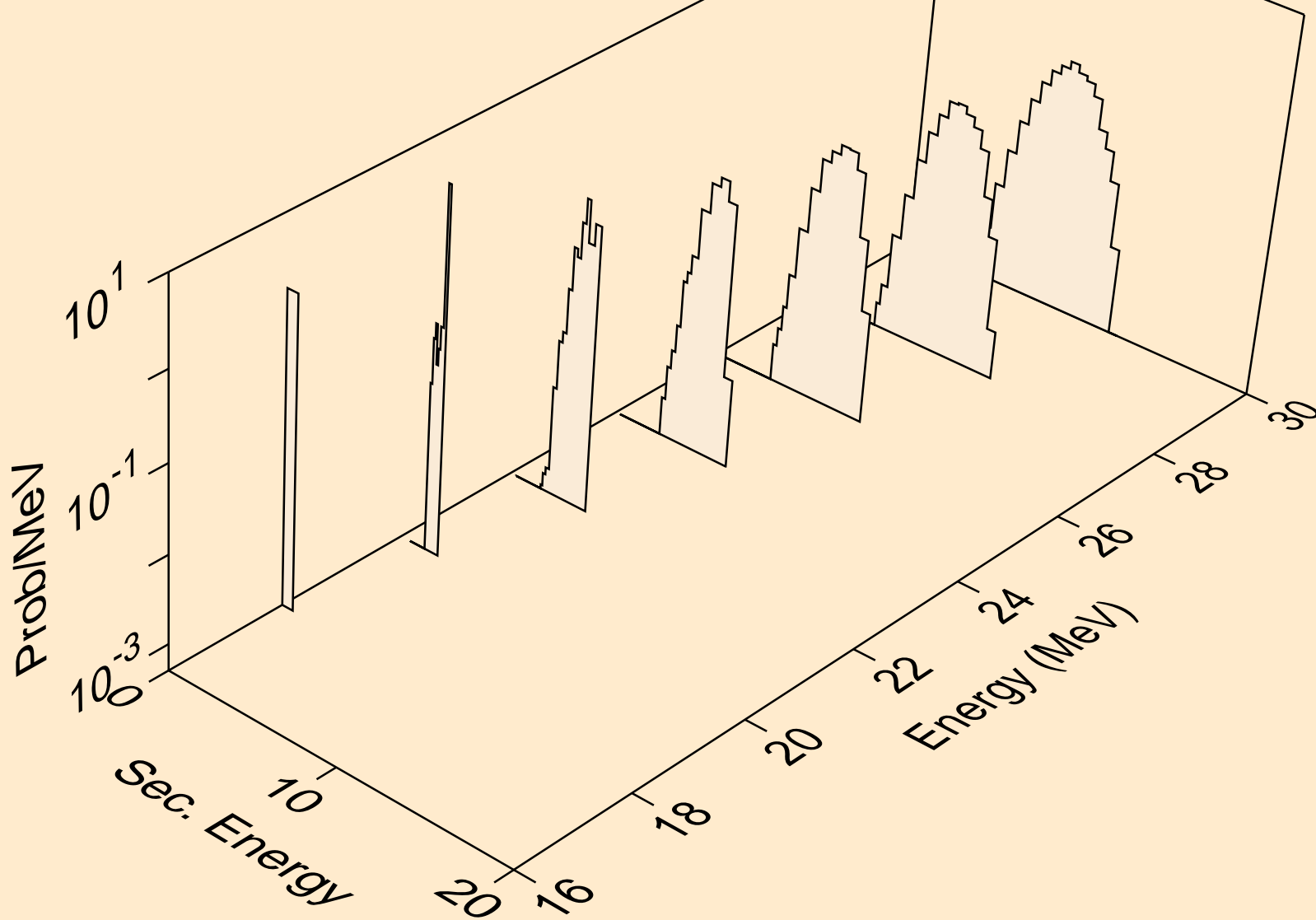

CS135M NEUTRON ACER TENDL-2019 LIBRARY; T=293.16K  
deuterons from (n,n\*)d

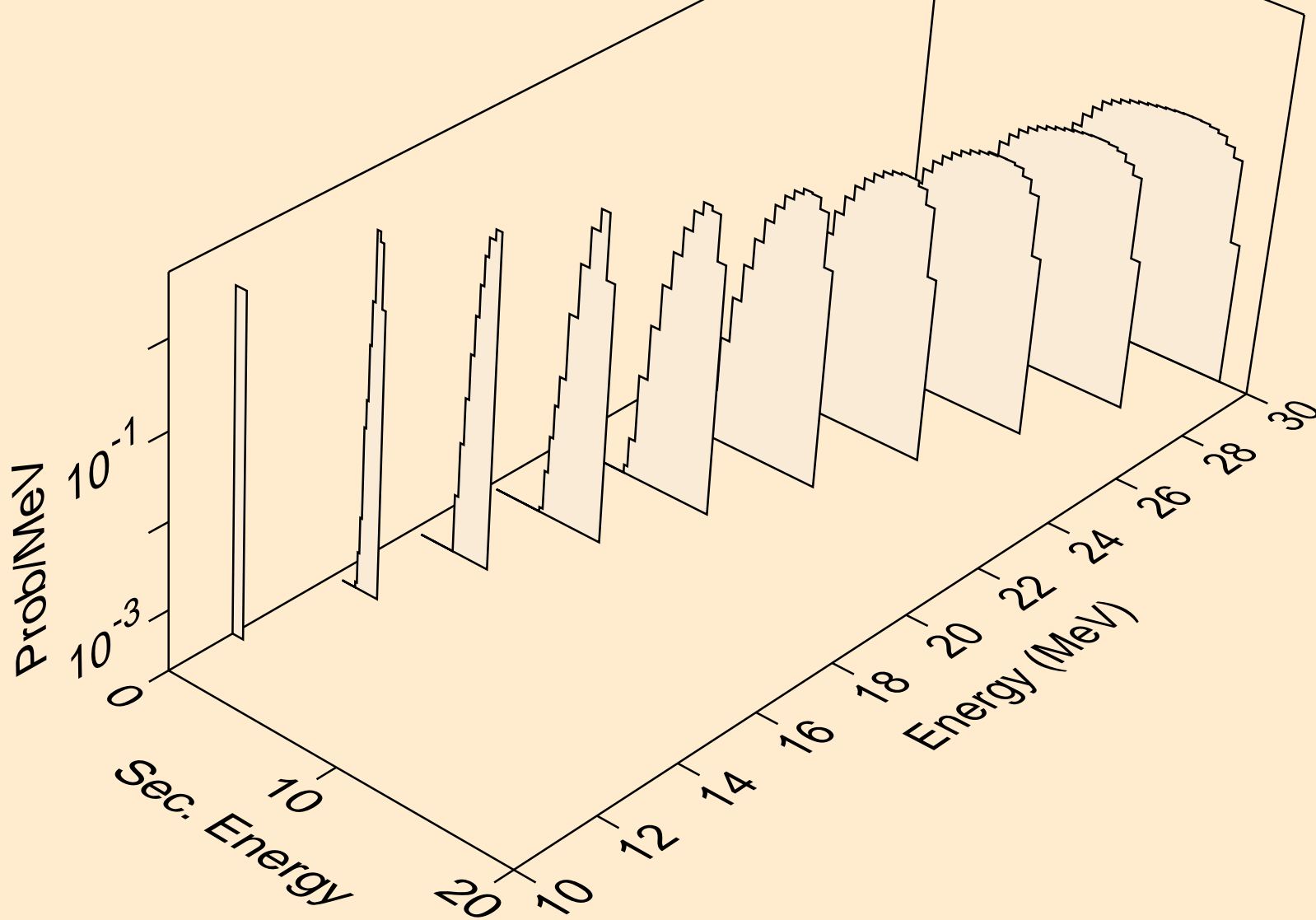

CS135M NEUTRON ACER TENDL-2019 LIBRARY; T=293.16K  
deuterons from (n,d)

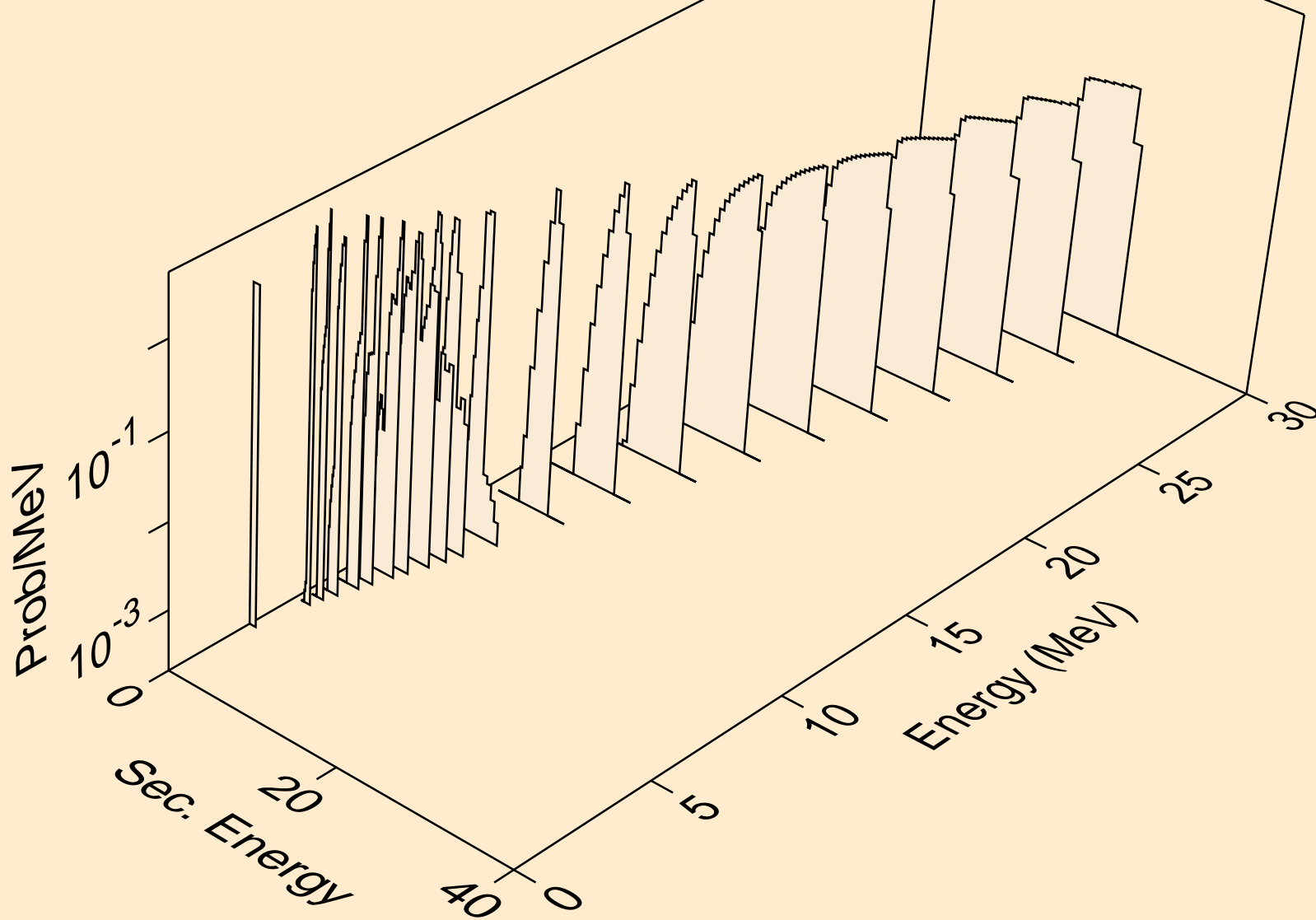

CS135M NEUTRON ACER TENDL-2019 LIBRARY; T=293.16K  
deuterons from (n,pd)

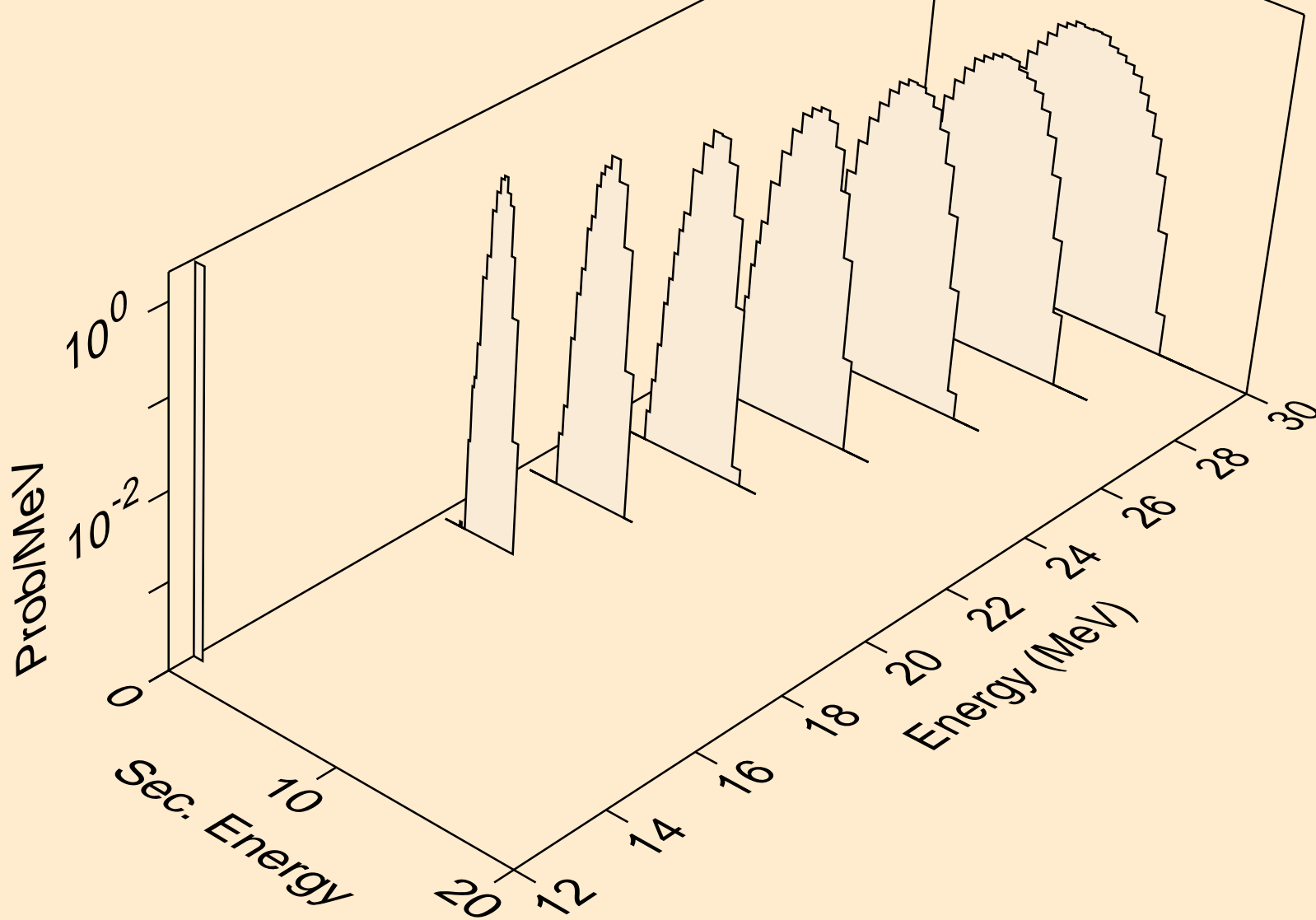

CS135M NEUTRON ACER TENDL-2019 LIBRARY; T=293.16K  
deuterons from (n,da)

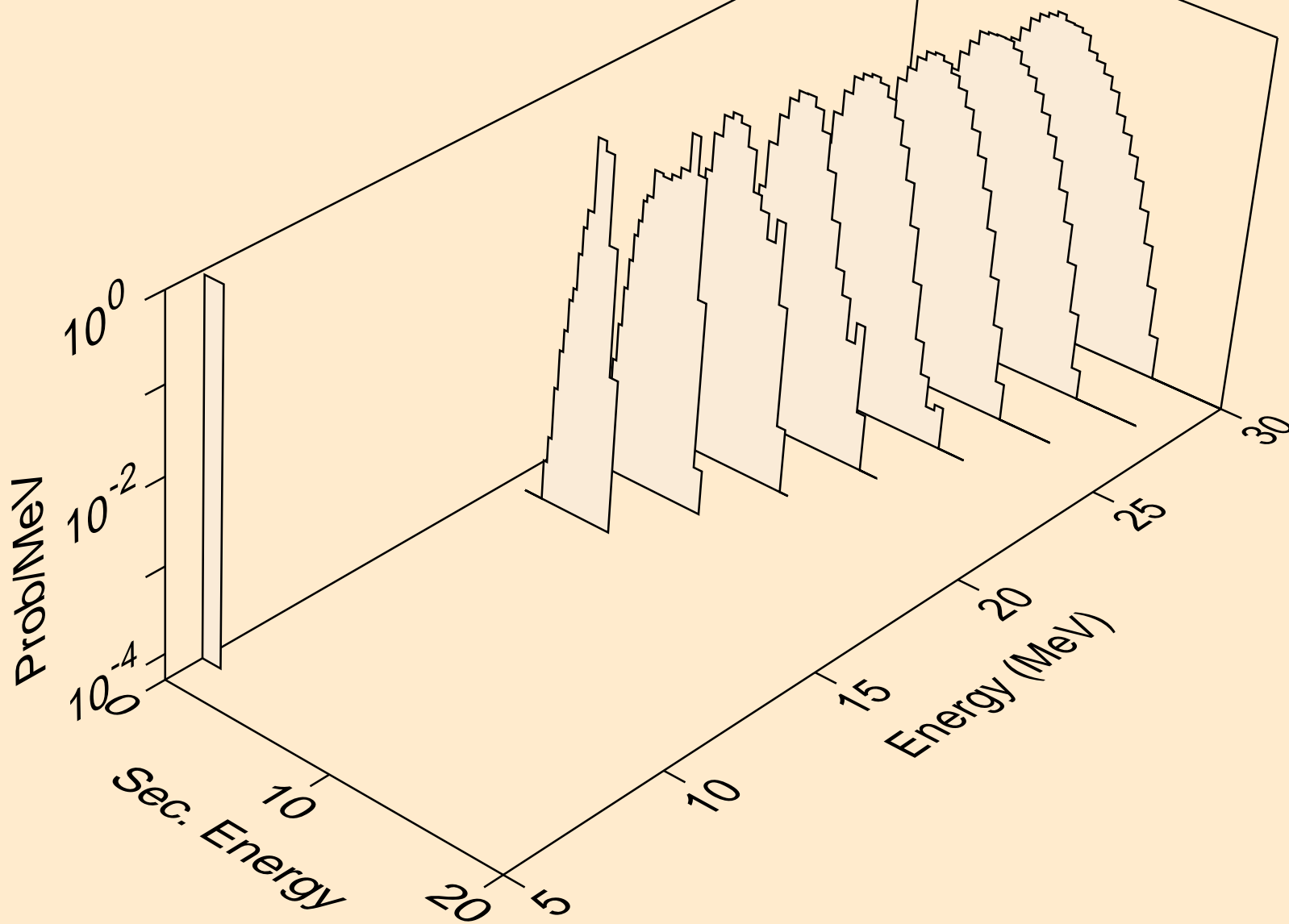

CS135M NEUTRON ACER TENDL-2019 LIBRARY; T=293.16K  
tritons from (n,x)

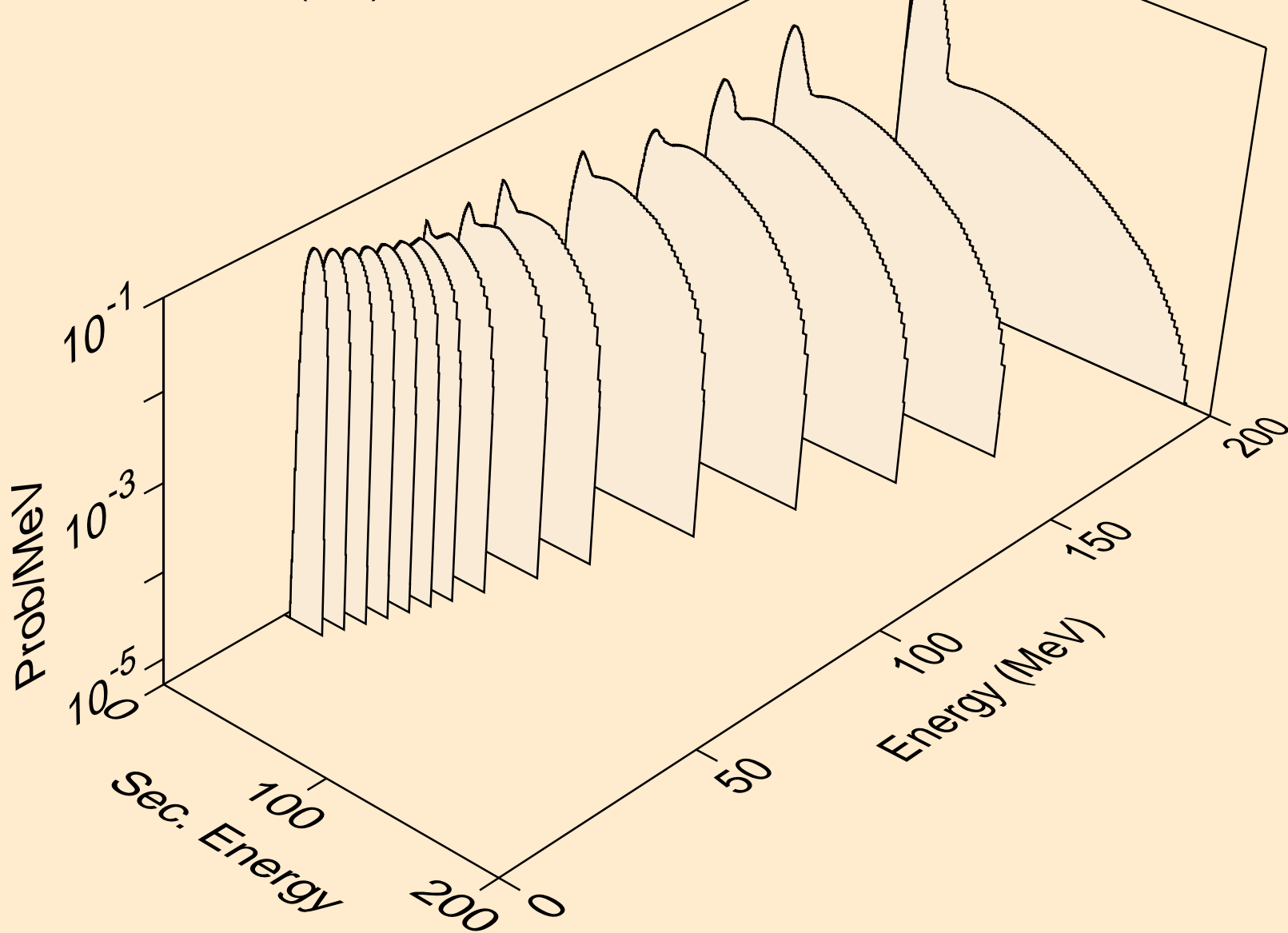

CS135M NEUTRON ACER TENDL-2019 LIBRARY; T=293.16K  
tritons from (n,n\*)t

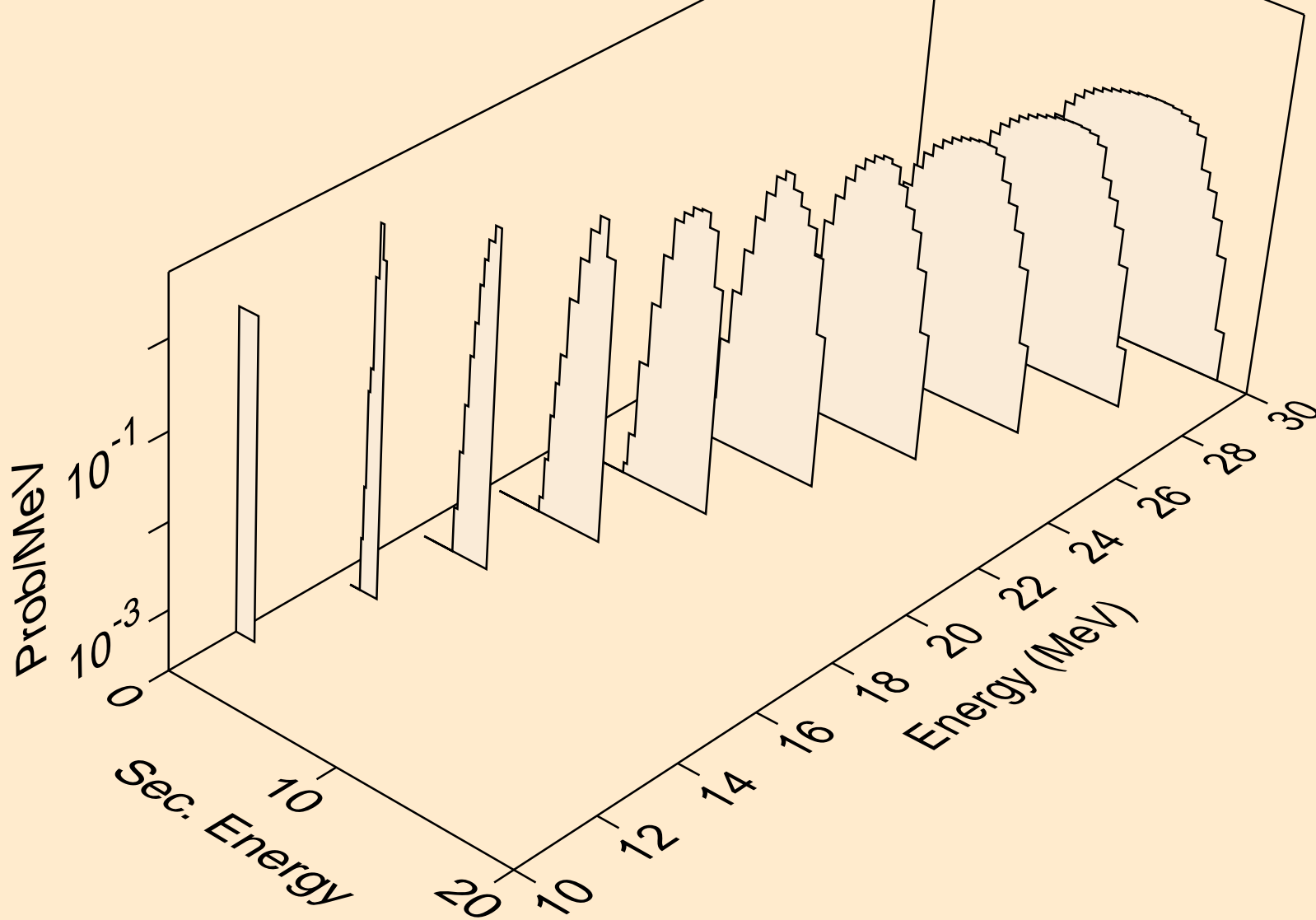



CS135M NEUTRON ACER TENDL-2019 LIBRARY; T=293.16K  
tritons from (n,t)

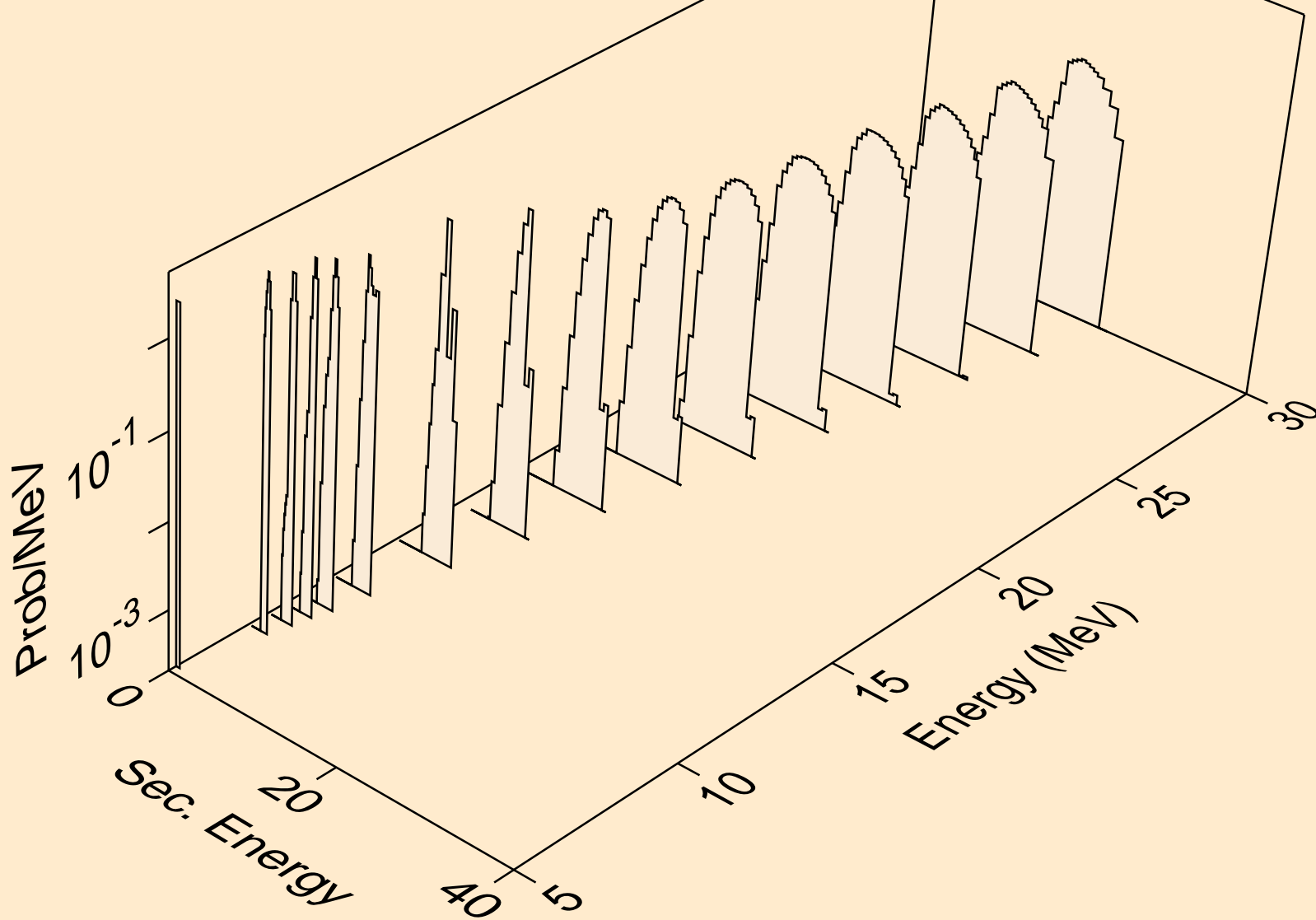

CS135M NEUTRON ACER TENDL-2019 LIBRARY; T=293.16K  
tritons from (n,pt)

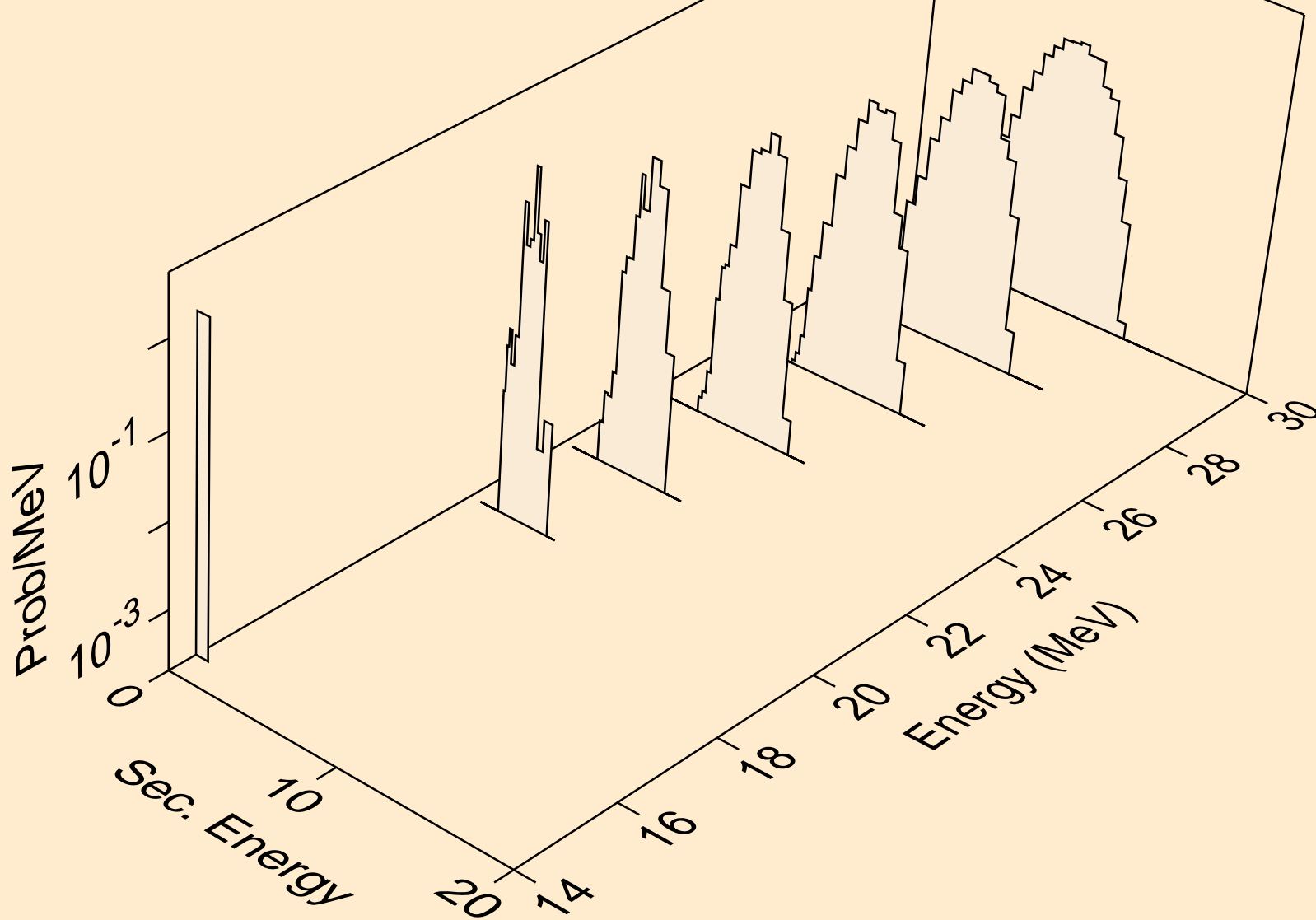

CS135M NEUTRON ACER TENDL-2019 LIBRARY; T=293.16K  
he3s from (n,x)

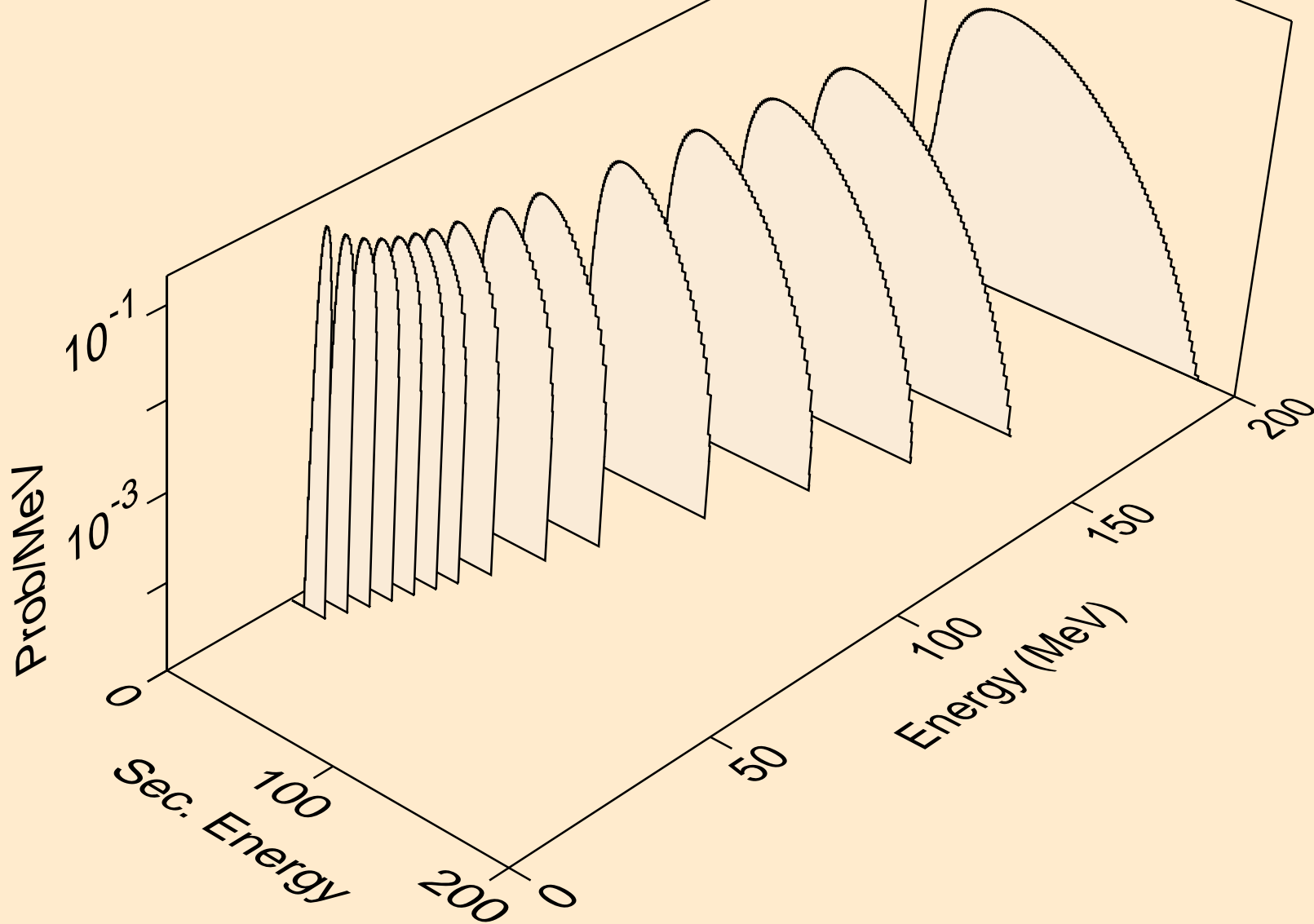

CS135M NEUTRON ACER TENDL-2019 LIBRARY; T=293.16K  
he3s from (n,n\*)he3

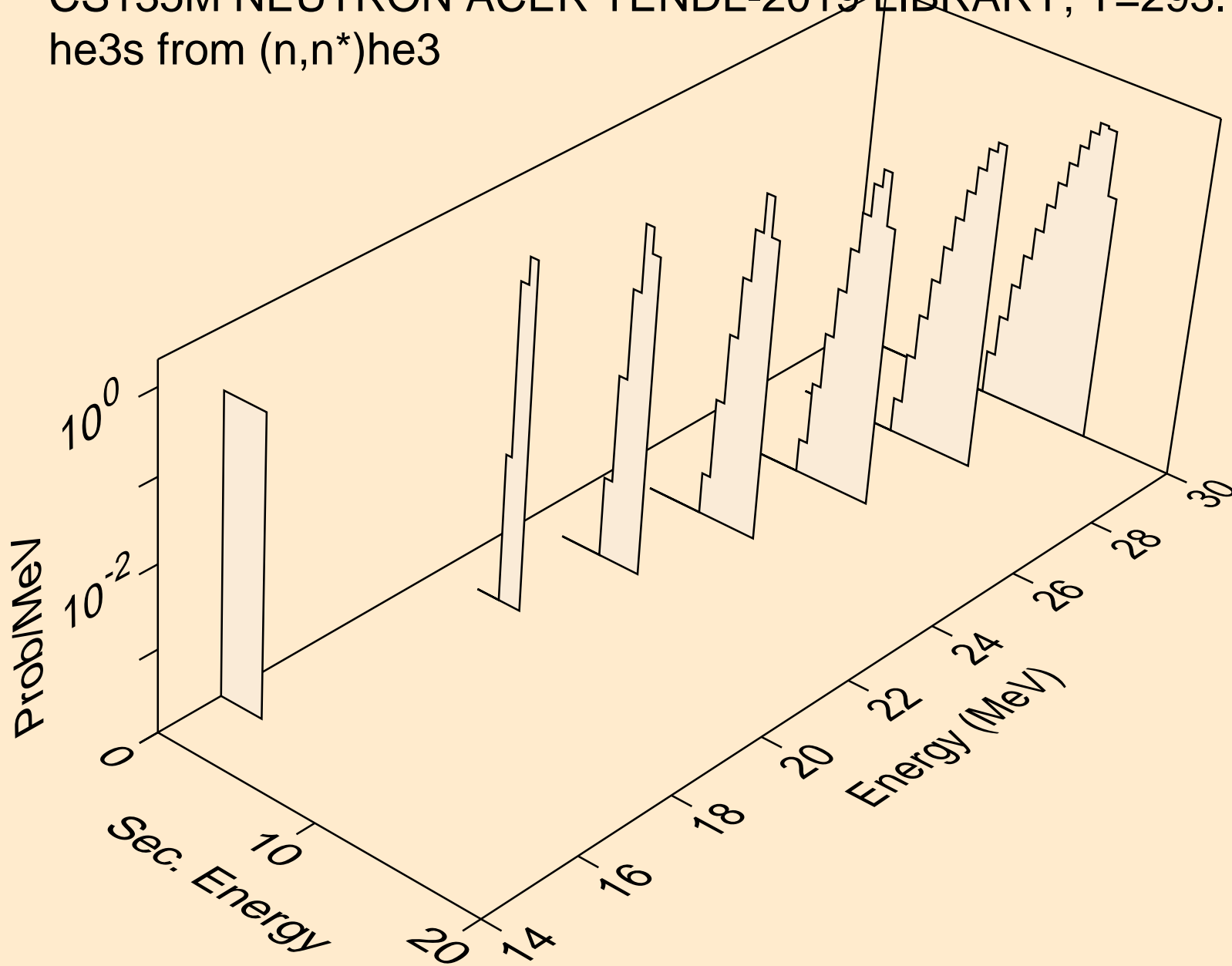

CS135M NEUTRON ACER TENDL-2019 LIBRARY; T=293.16K  
he3s from (n,he3)

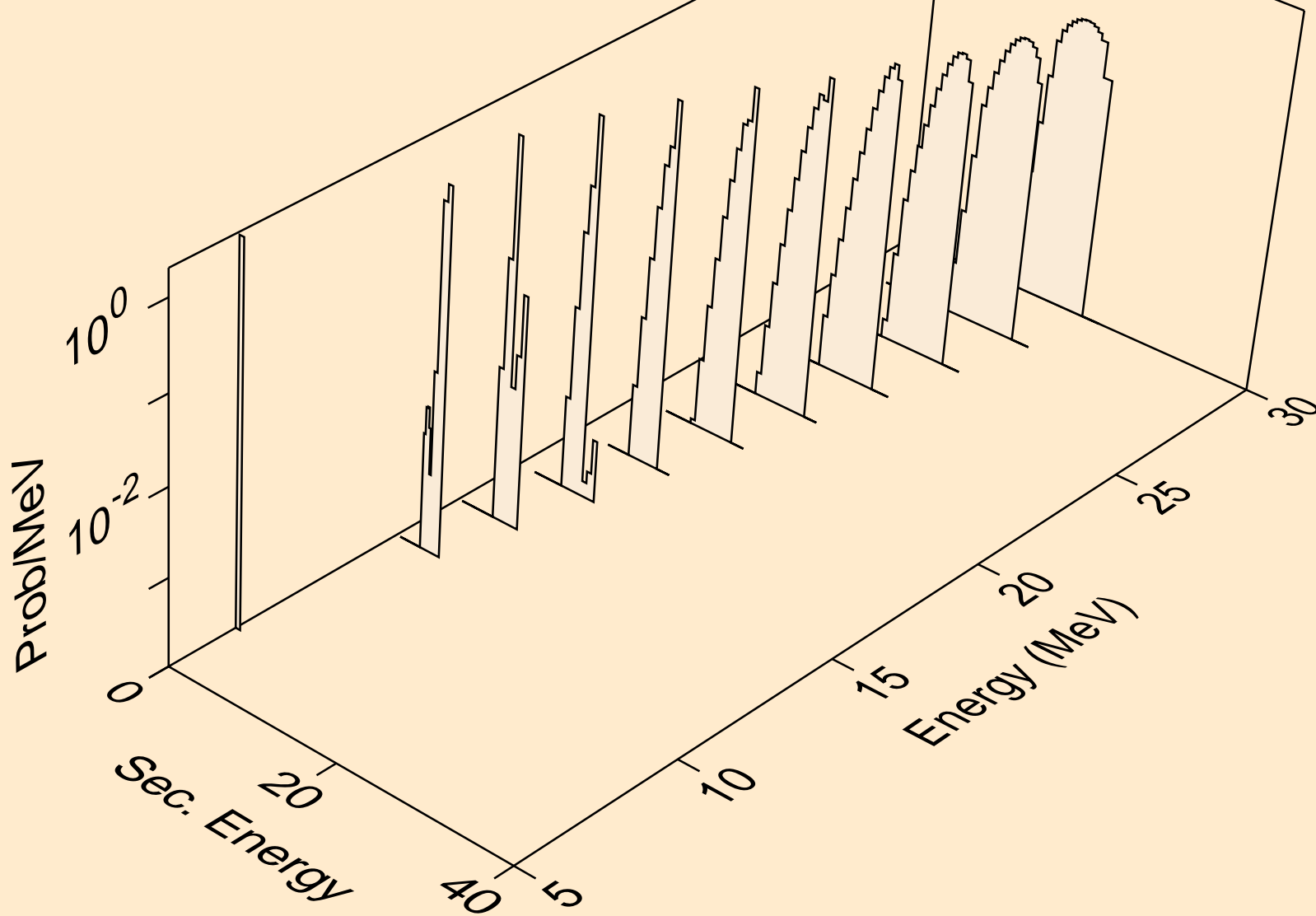

CS135M NEUTRON ACER TENDL-2019 LIBRARY; T=293.16K  
alphas from (n,x)

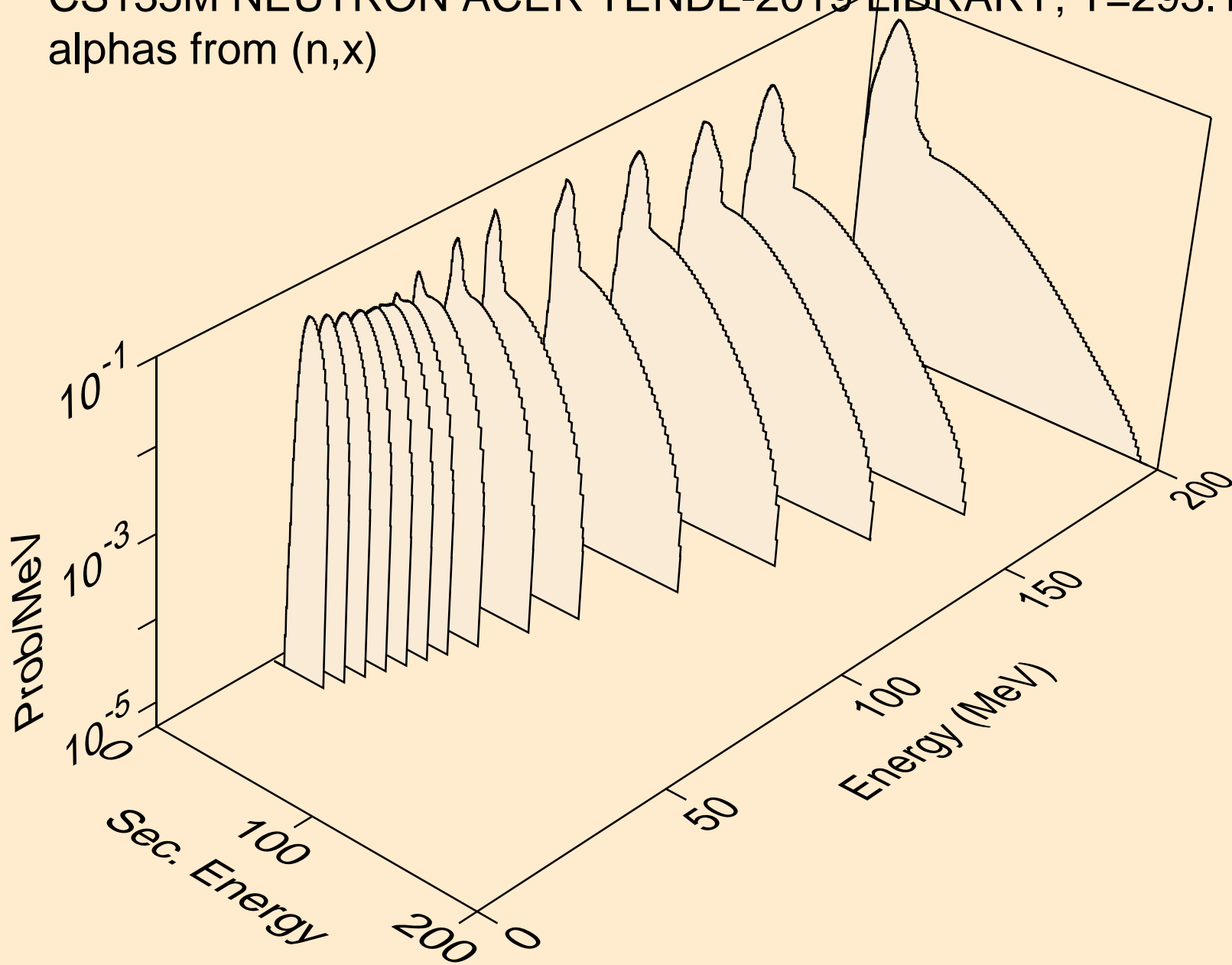

CS135M NEUTRON ACER TENDL-2019 LIBRARY; T=293.16K  
alphas from (n,n\*)a

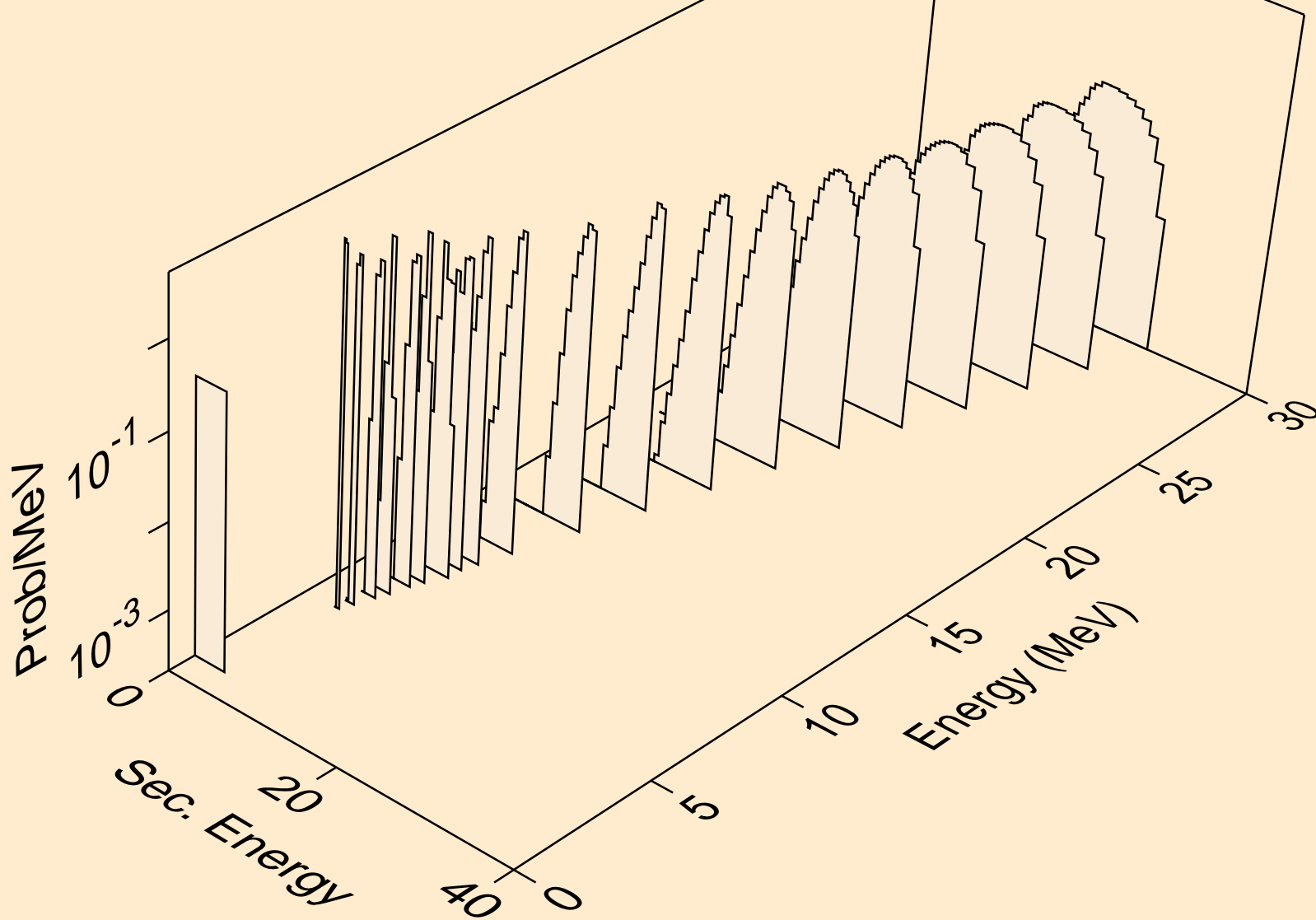

CS135M NEUTRON ACER TENDL-2019 LIBRARY; T=293.16K  
alphas from (n,2n)a

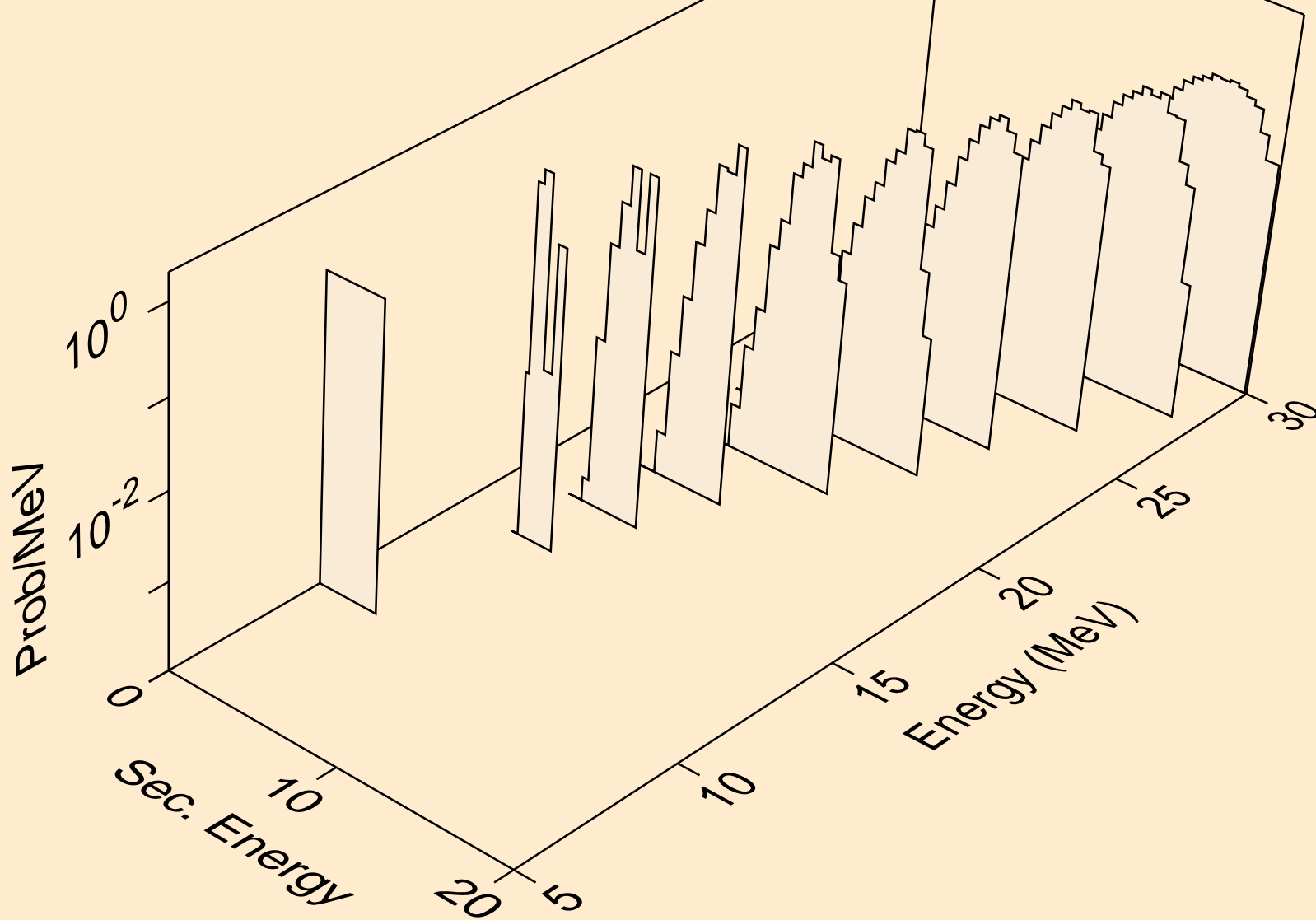



CS135M NEUTRON ACER TENDL-2019 LIBRARY; T=293.16K  
alphas from (n,3n)a

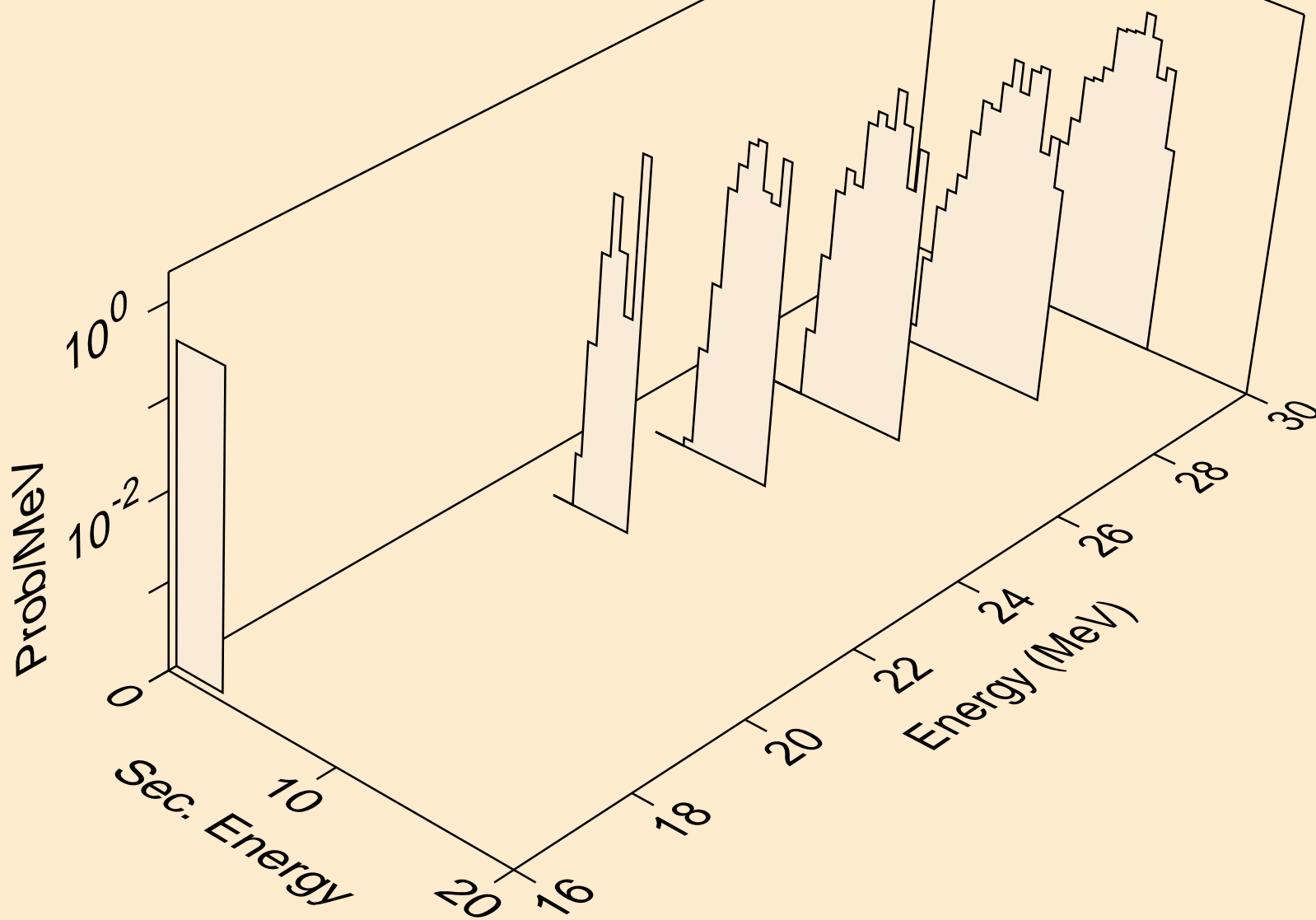

CS135M NEUTRON ACER TENDL-2019 LIBRARY; T=293.16K  
alphas from (n,npa)

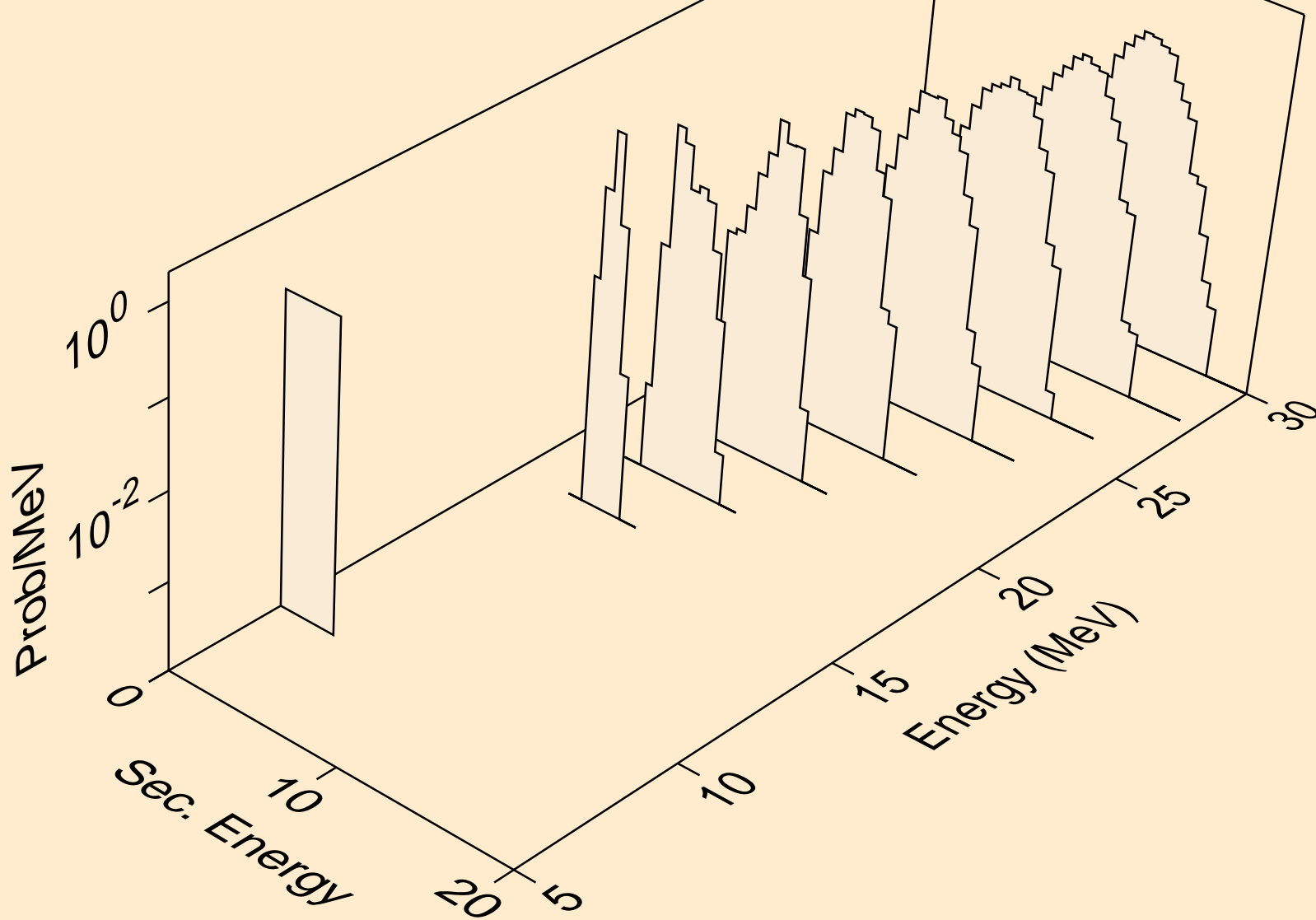

CS135M NEUTRON ACER TENDL-2019 LIBRARY; T=293.16K  
alphas from (n,a)

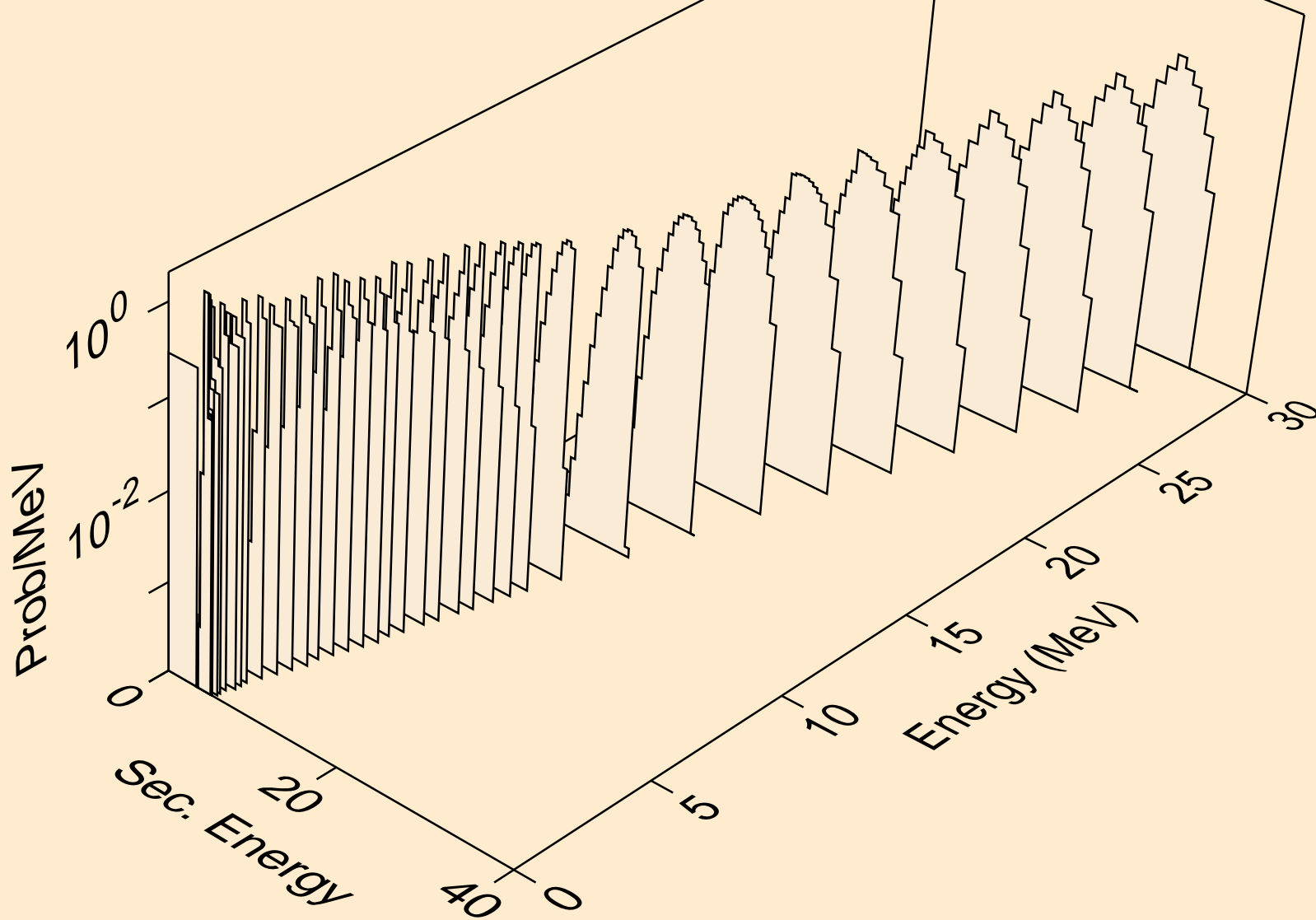

CS135M NEUTRON ACER TENDL-2019 LIBRARY; T=293.16K  
alphas from (n,2a)

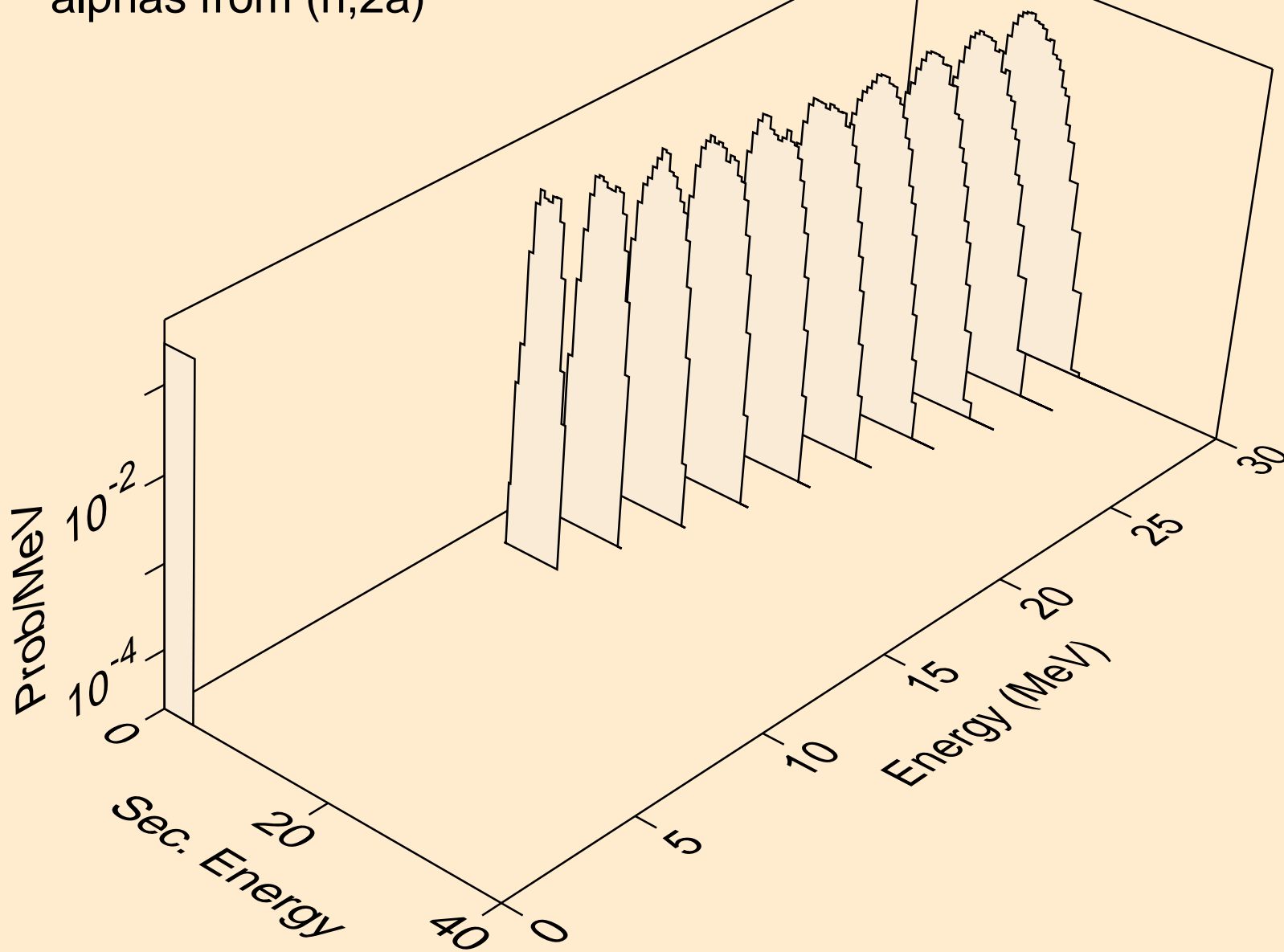

CS135M NEUTRON ACER TENDL-2019 LIBRARY; T=293.16K  
alphas from (n,pa)

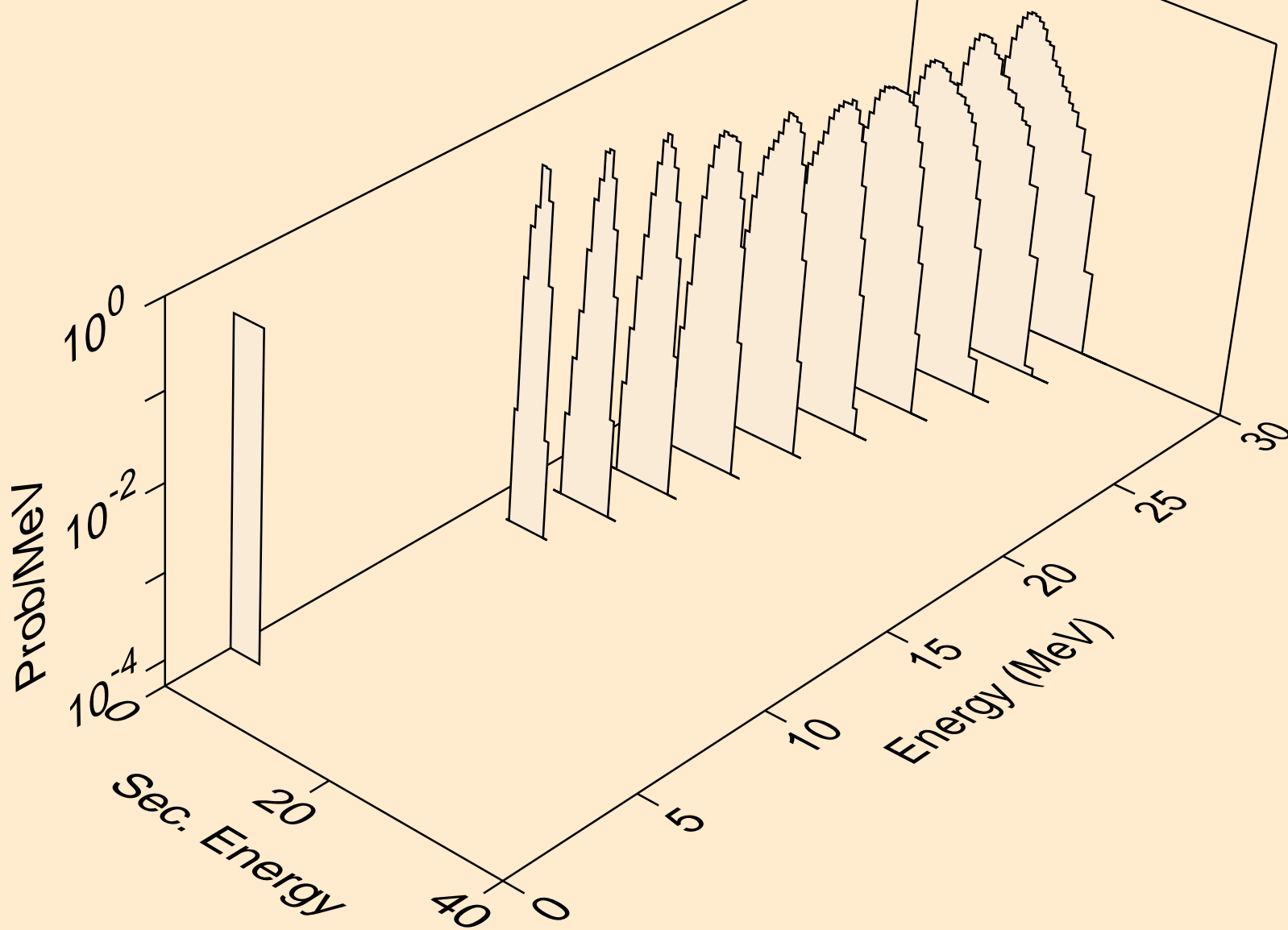

CS135M NEUTRON ACER TENDL-2019 LIBRARY; T=293.16K  
alphas from (n,da)

