

CU058 NEUTRON ACER TENDL-2019 LIBRARY; T=293.16K
Principal cross sections

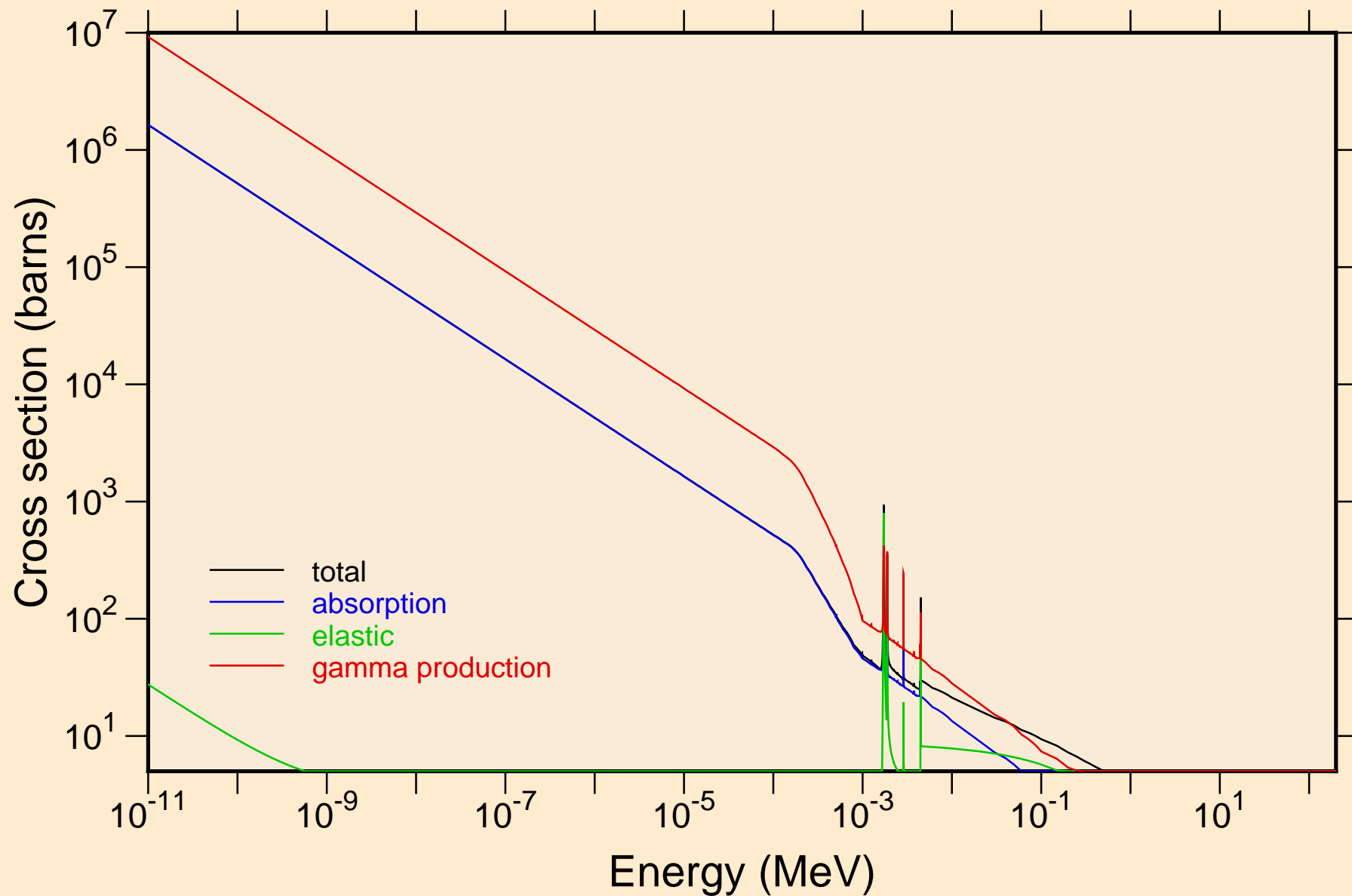

CU058 NEUTRON ACER TENDL-2019 LIBRARY; T=293.16K
resonance total cross section

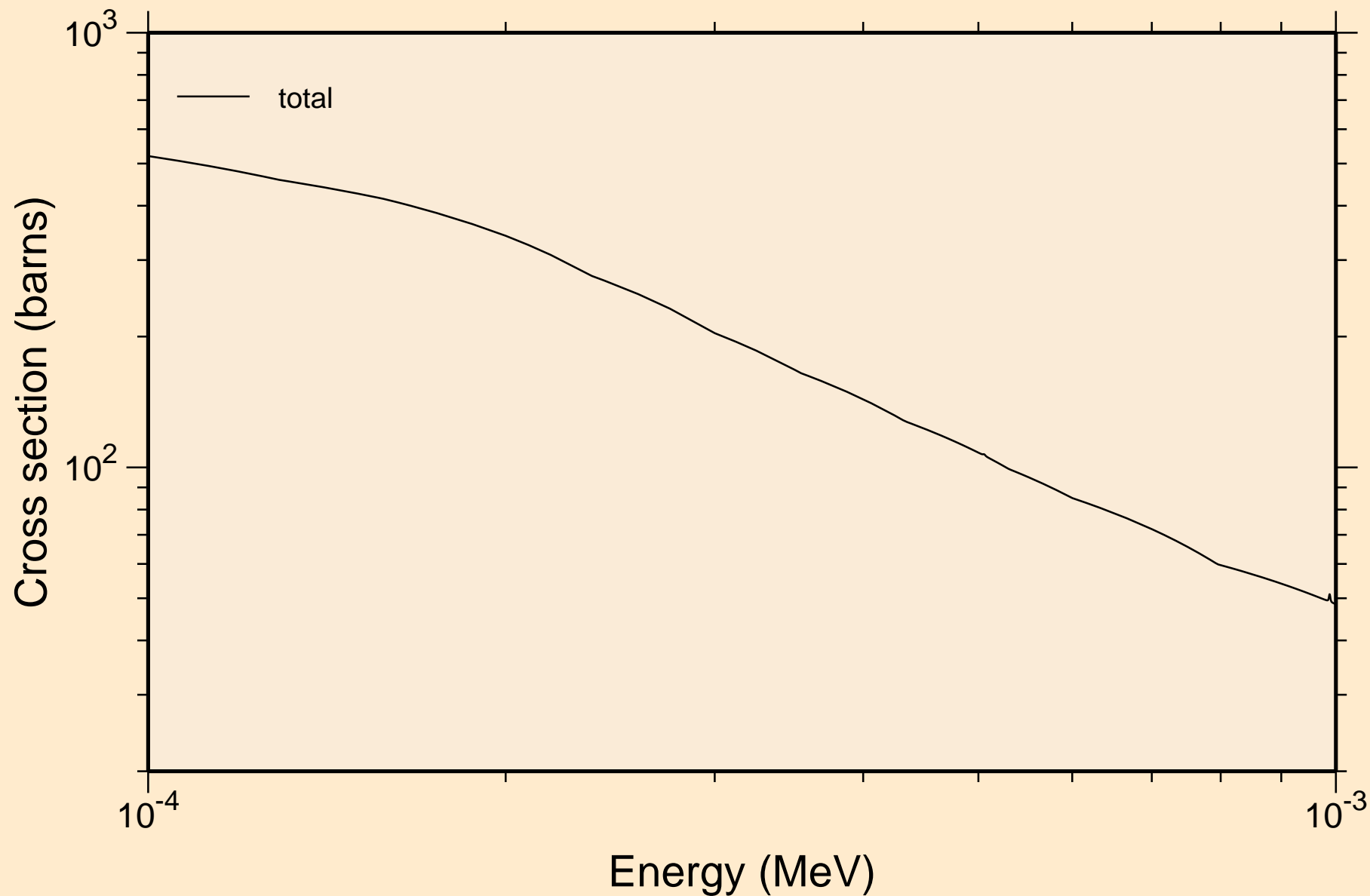

CU058 NEUTRON ACER TENDL-2019 LIBRARY; T=293.16K
resonance total cross section

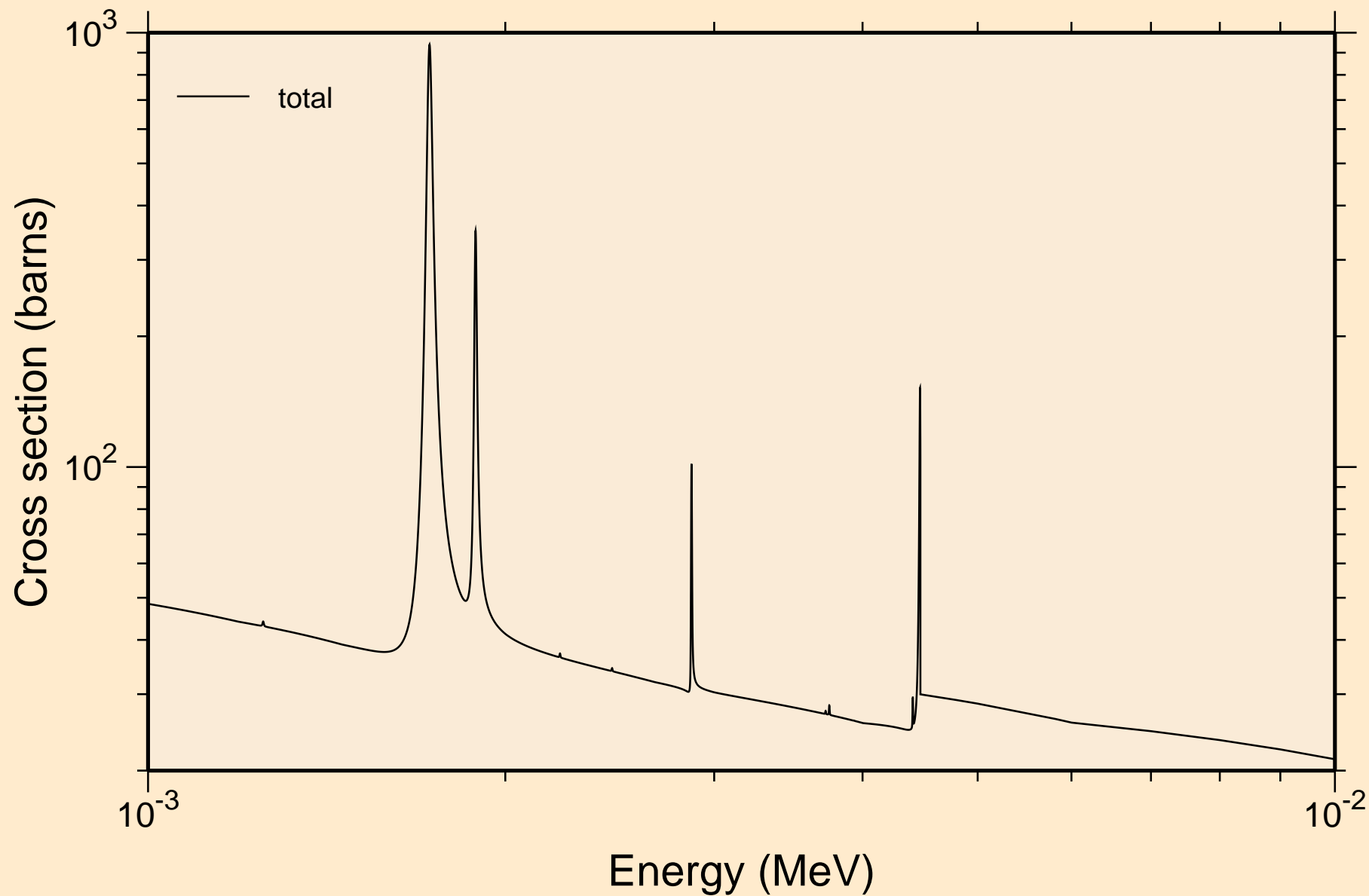

CU058 NEUTRON ACER TENDL-2019 LIBRARY; T=293.16K
resonance total cross section

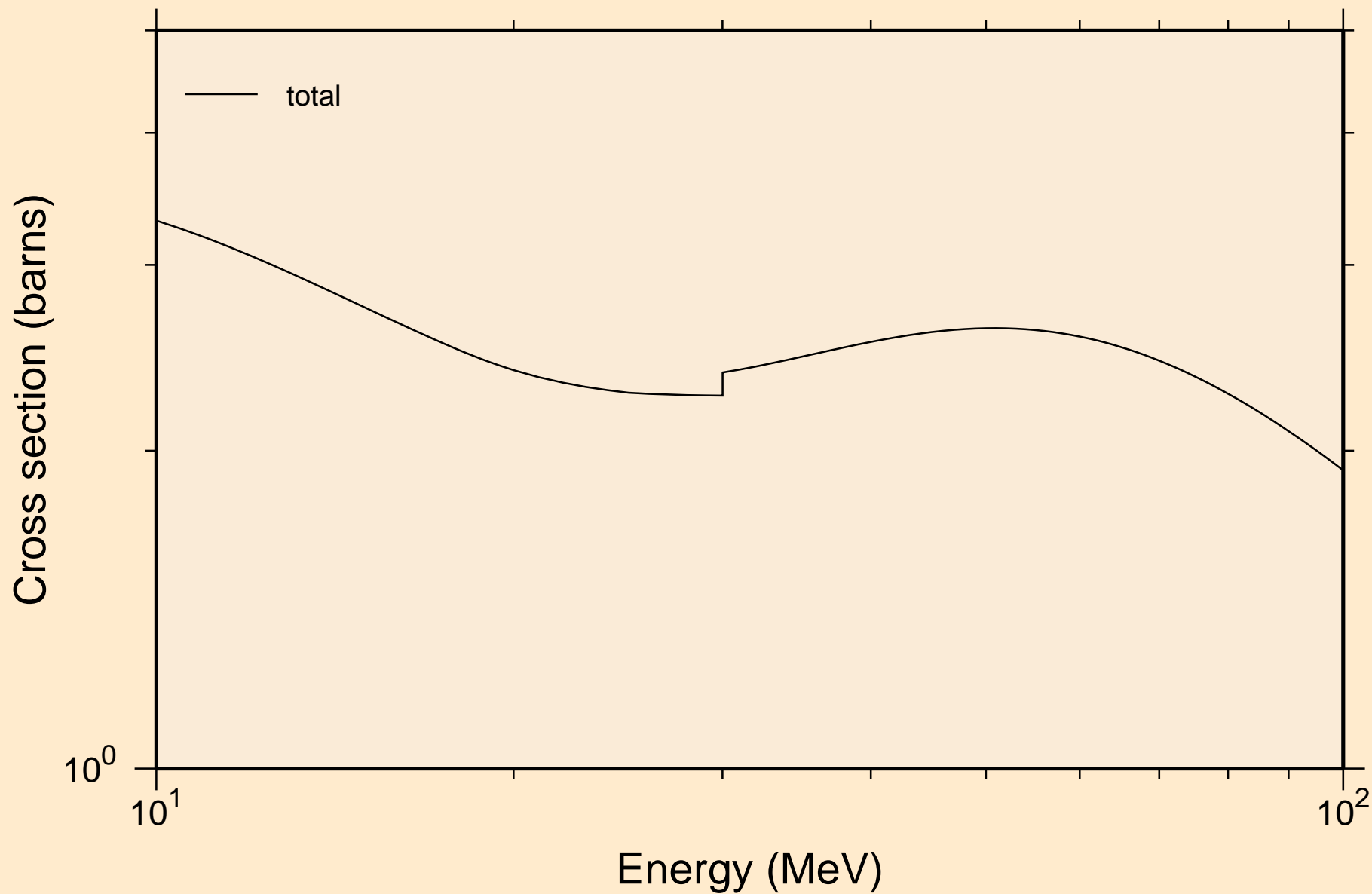

CU058 NEUTRON ACER TENDL-2019 LIBRARY; T=293.16K
resonance absorption cross sections

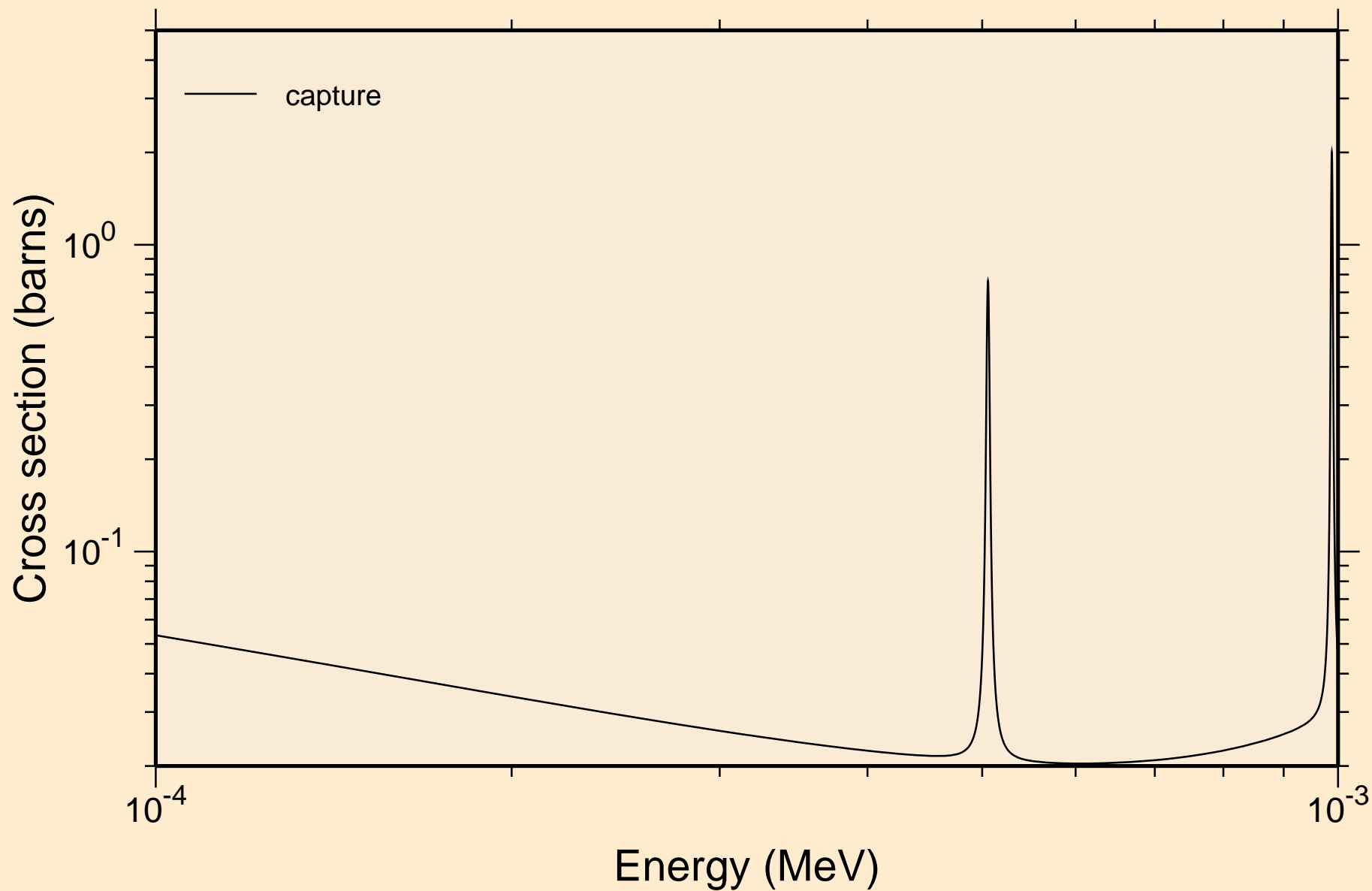

CU058 NEUTRON ACER TENDL-2019 LIBRARY; T=293.16K
resonance absorption cross sections

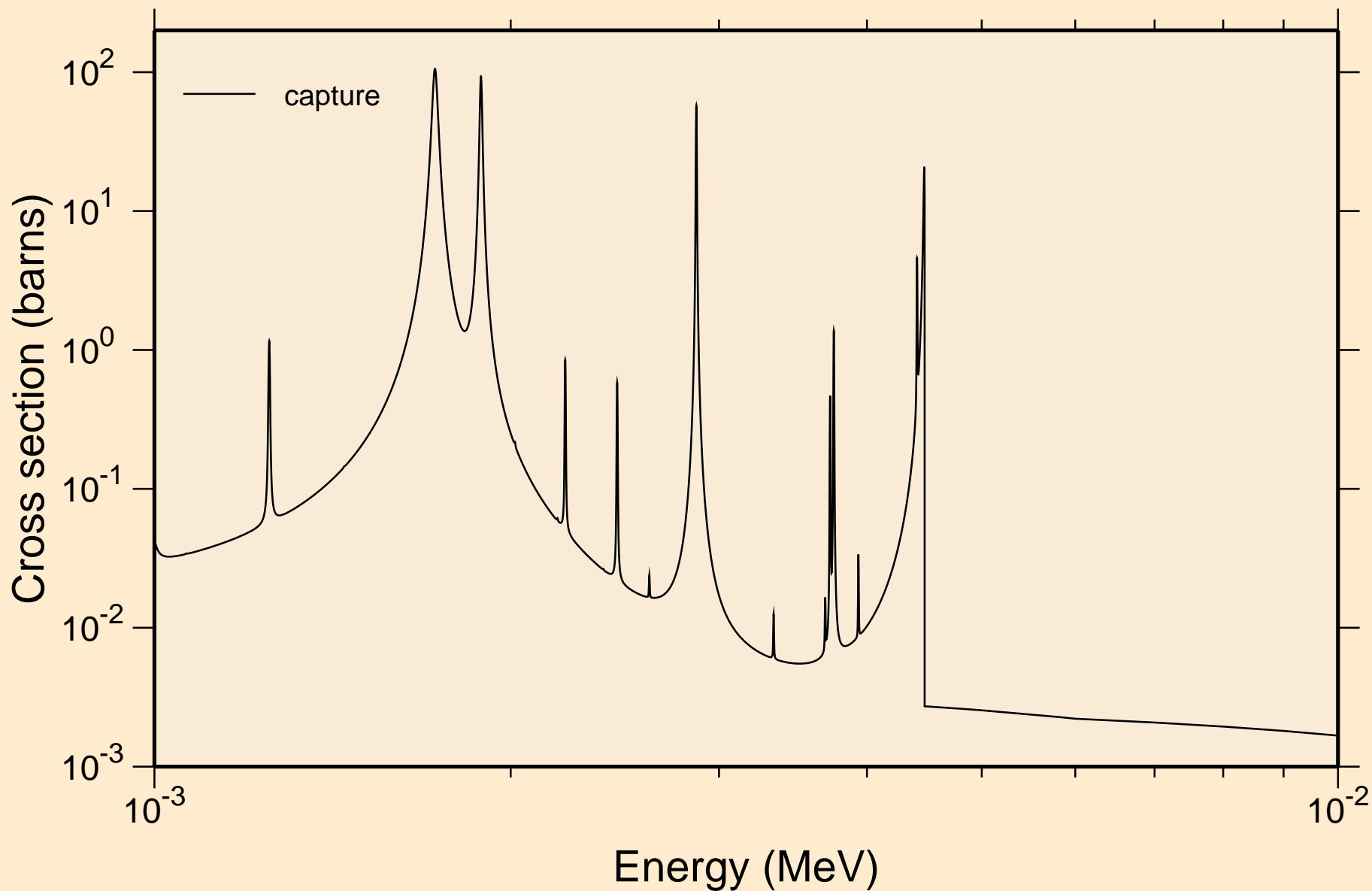

CU058 NEUTRON ACER TENDL-2019 LIBRARY; T=293.16K
resonance absorption cross sections

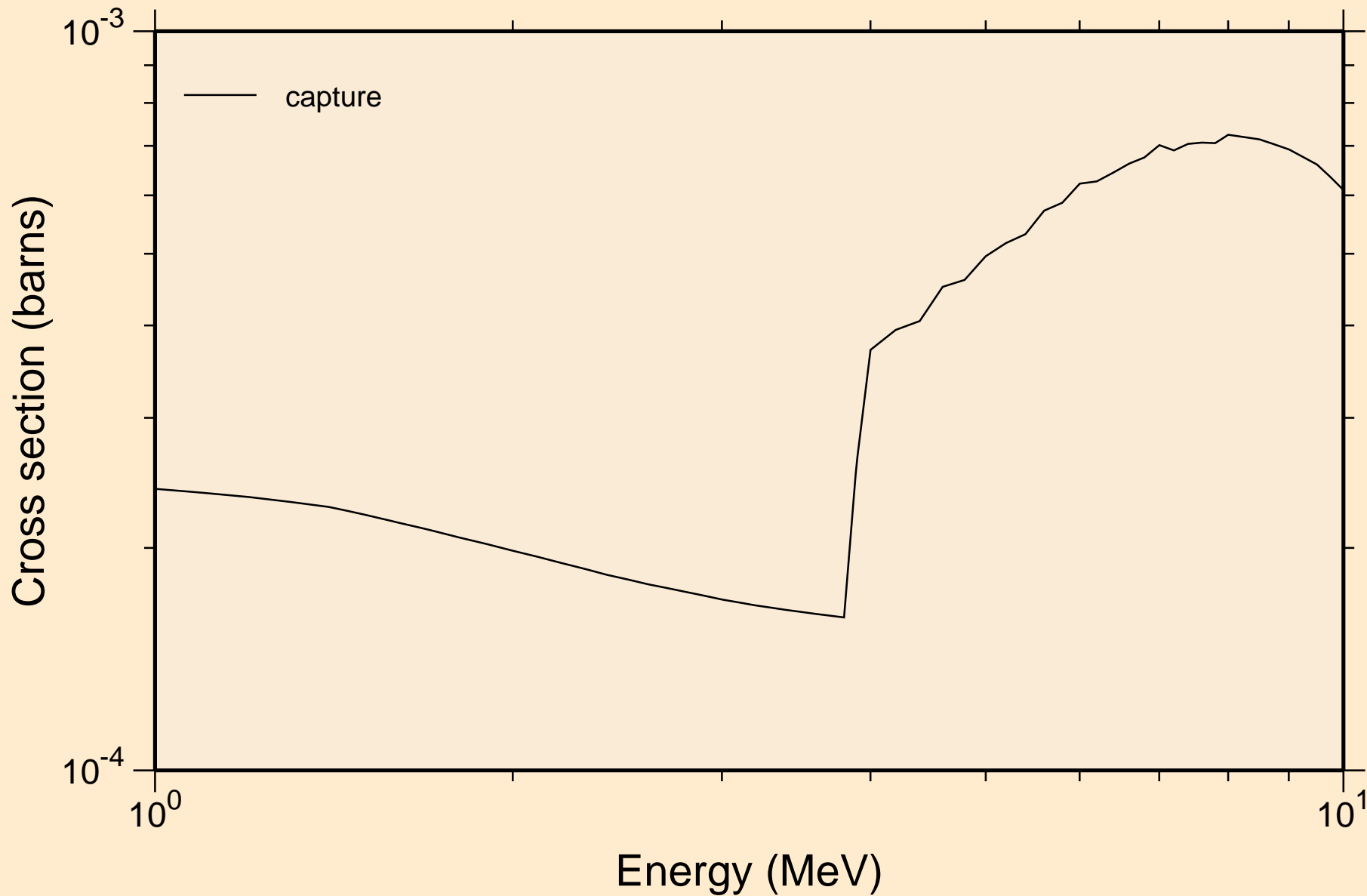

CU058 NEUTRON ACER TENDL-2019 LIBRARY; T=293.16K
Heating

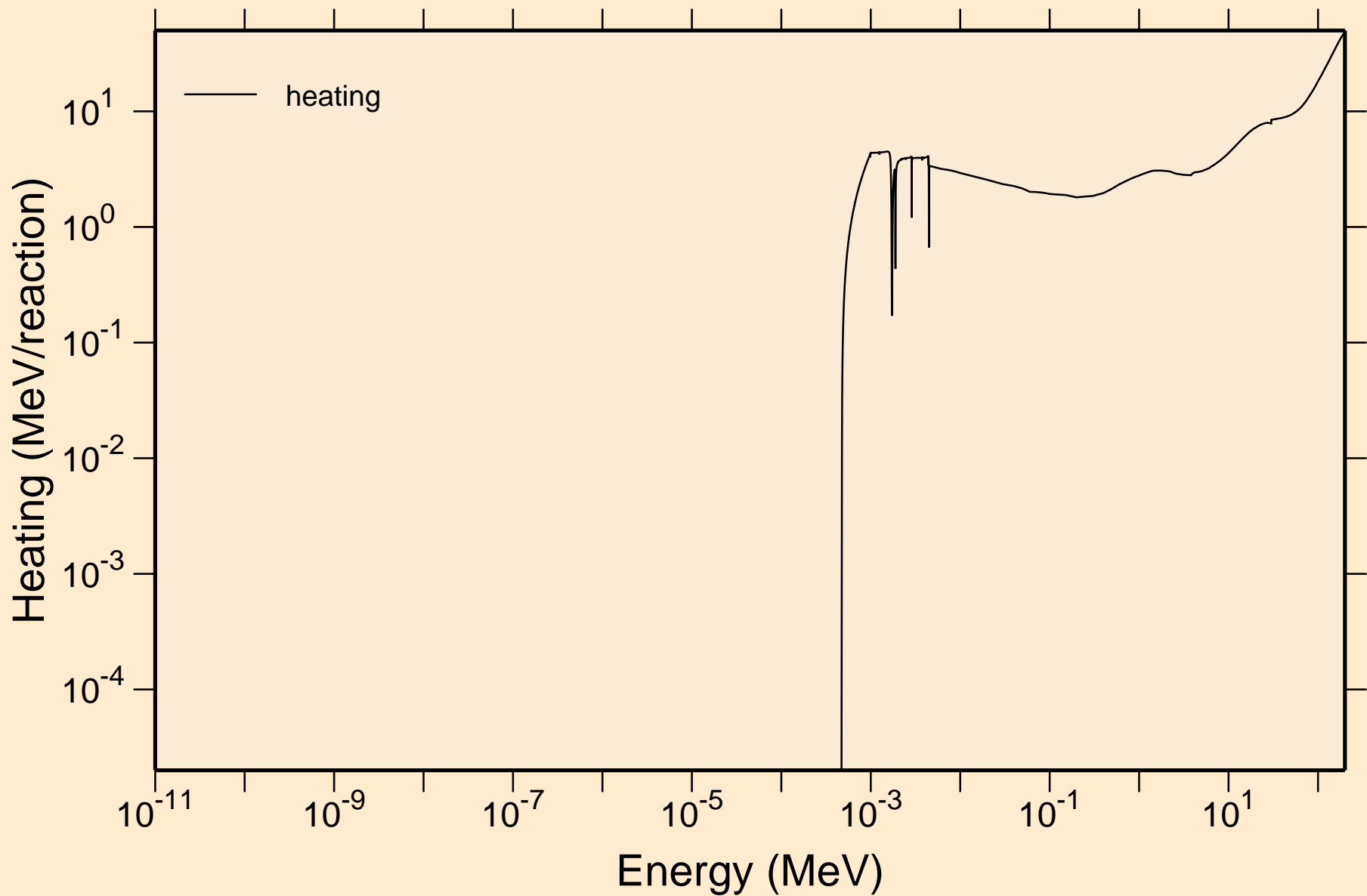

CU058 NEUTRON ACER TENDL-2019 LIBRARY; T=293.16K
Damage

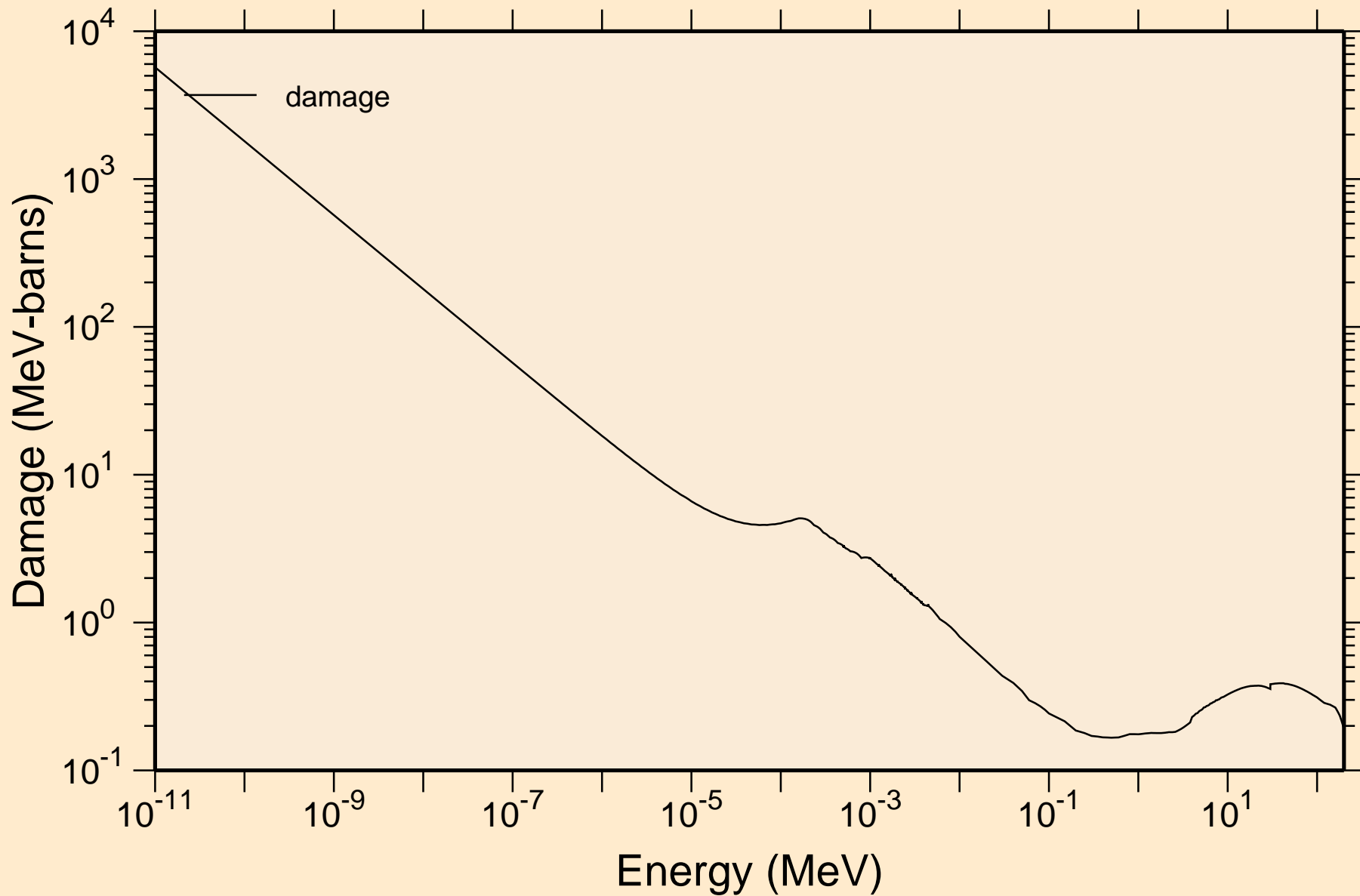

CU058 NEUTRON ACER TENDL-2019 LIBRARY; T=293.16K
Non-threshold reactions

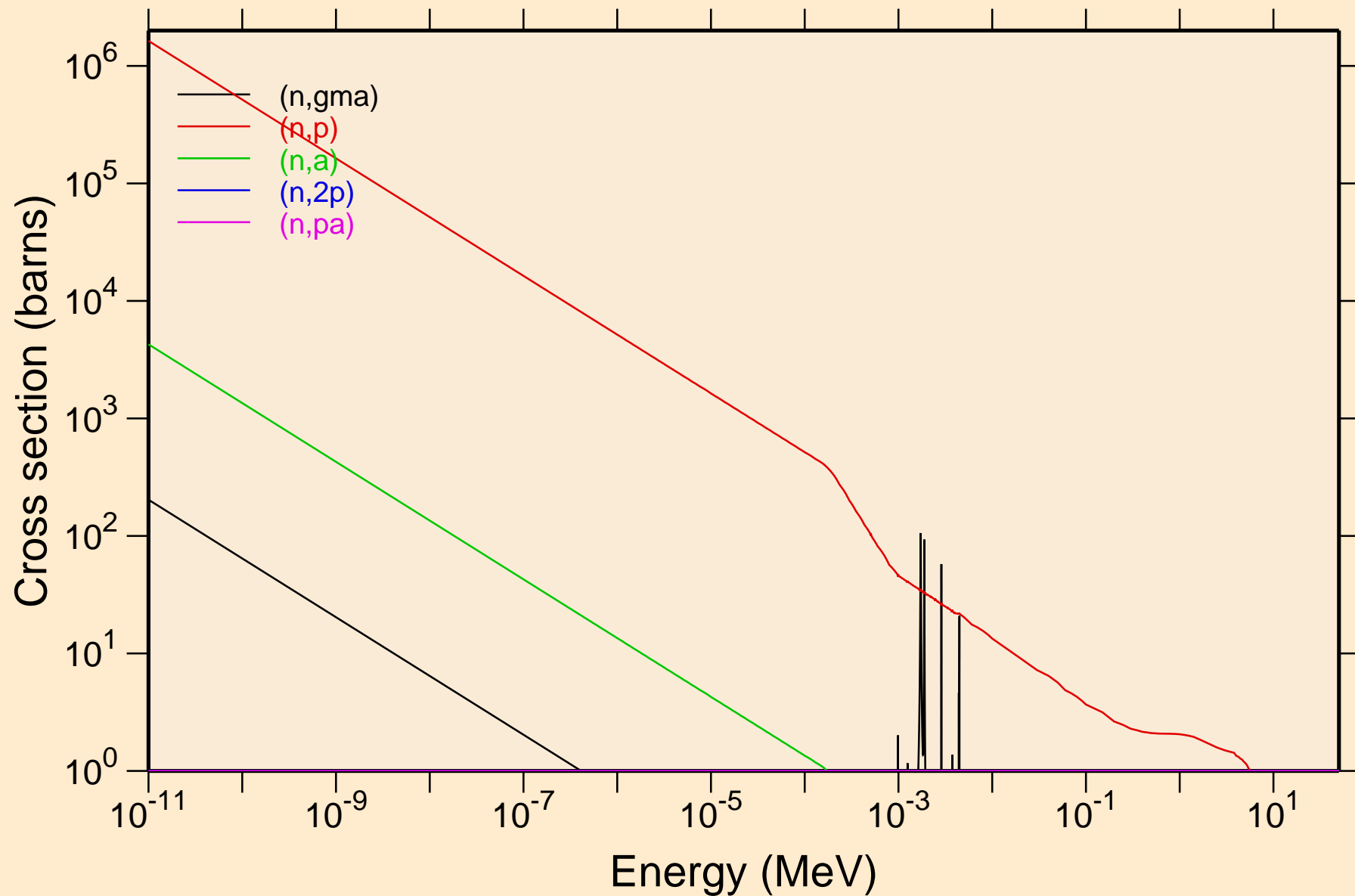

CU058 NEUTRON ACER TENDL-2019 LIBRARY; T=293.16K
Non-threshold reactions

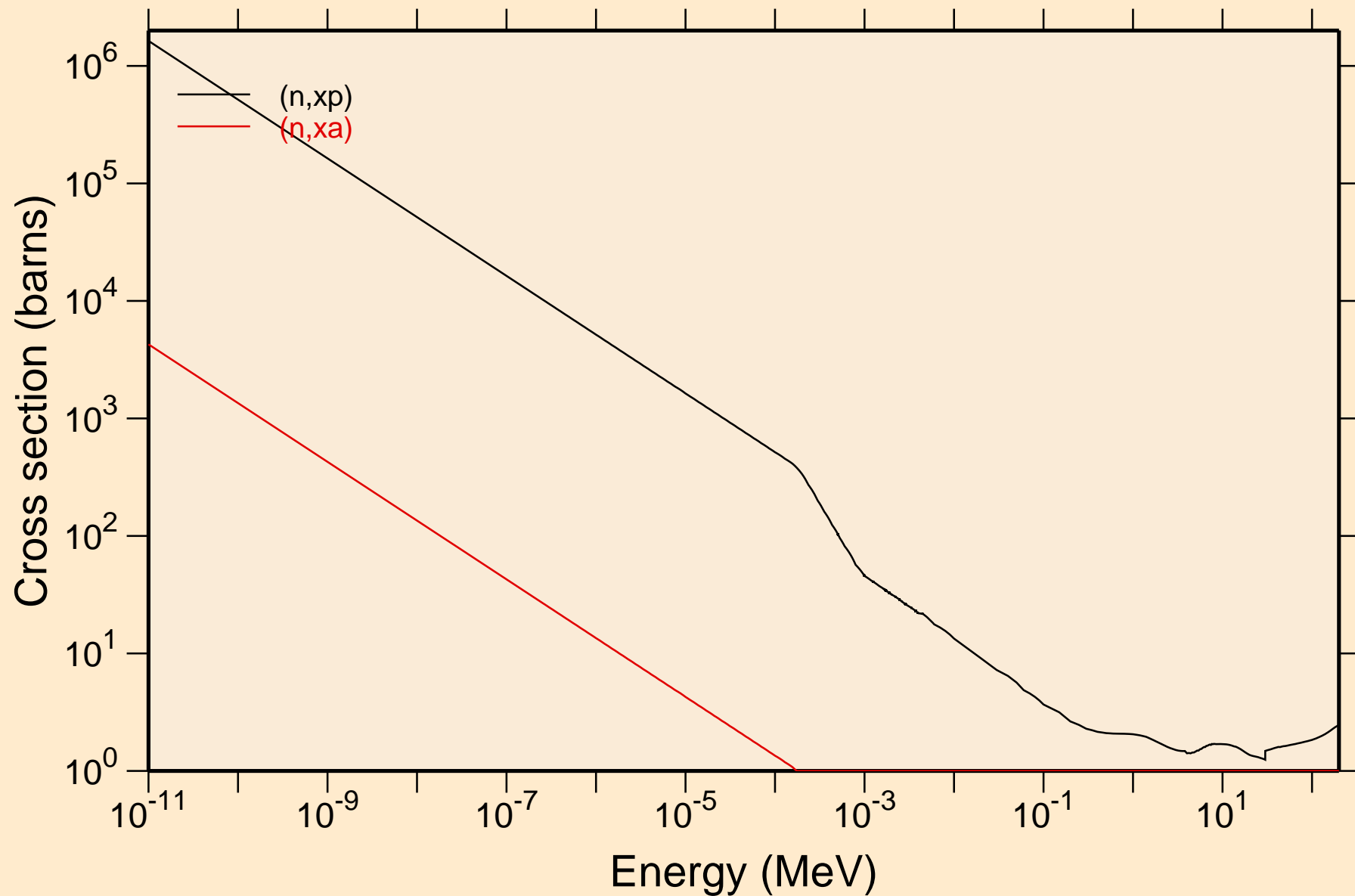

CU058 NEUTRON ACER TENDL-2019 LIBRARY; T=293.16K
Principal cross sections

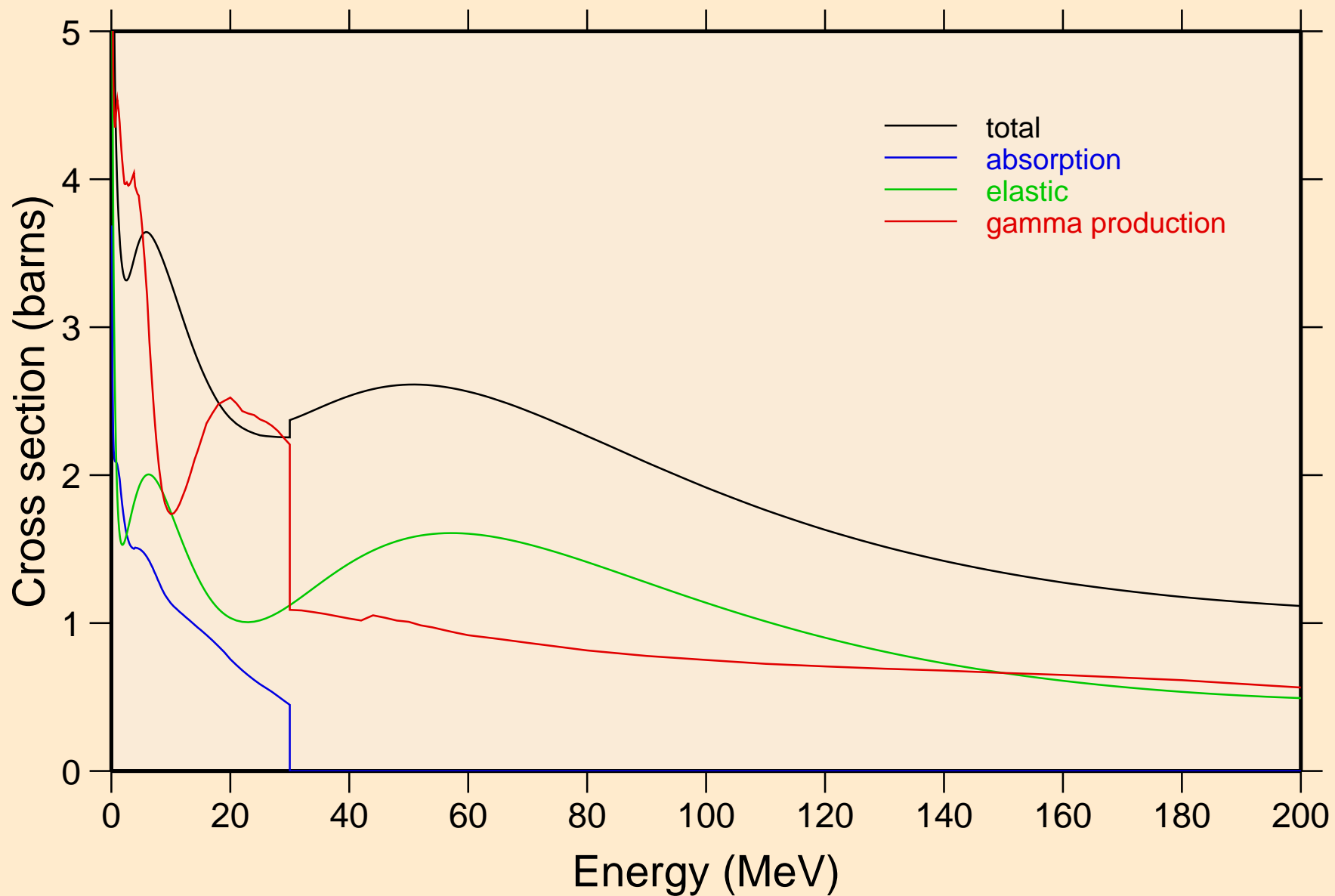

CU058 NEUTRON ACER TENDL-2019 LIBRARY; T=293.16K
Heating

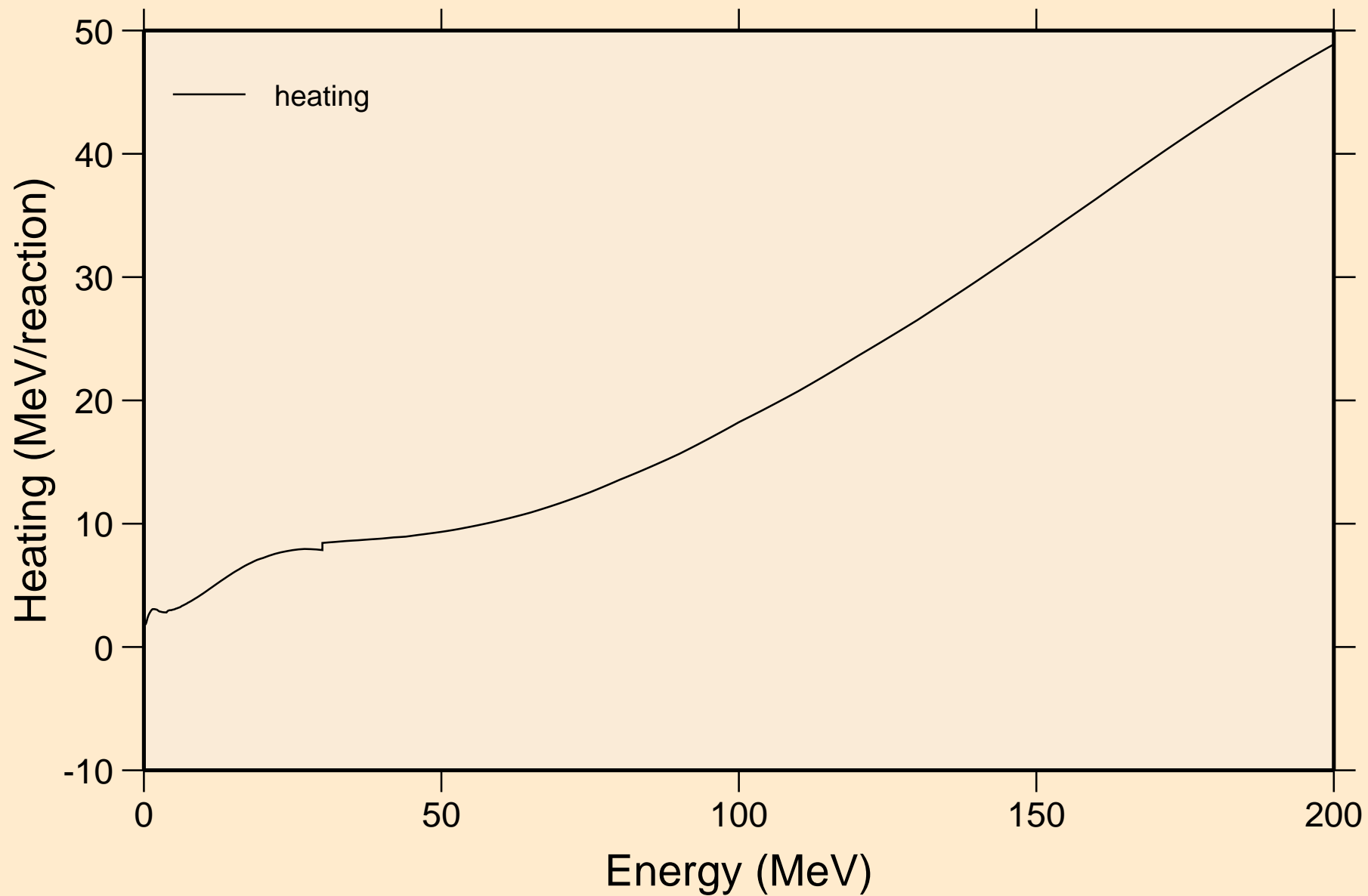

CU058 NEUTRON ACER TENDL-2019 LIBRARY; T=293.16K
Damage

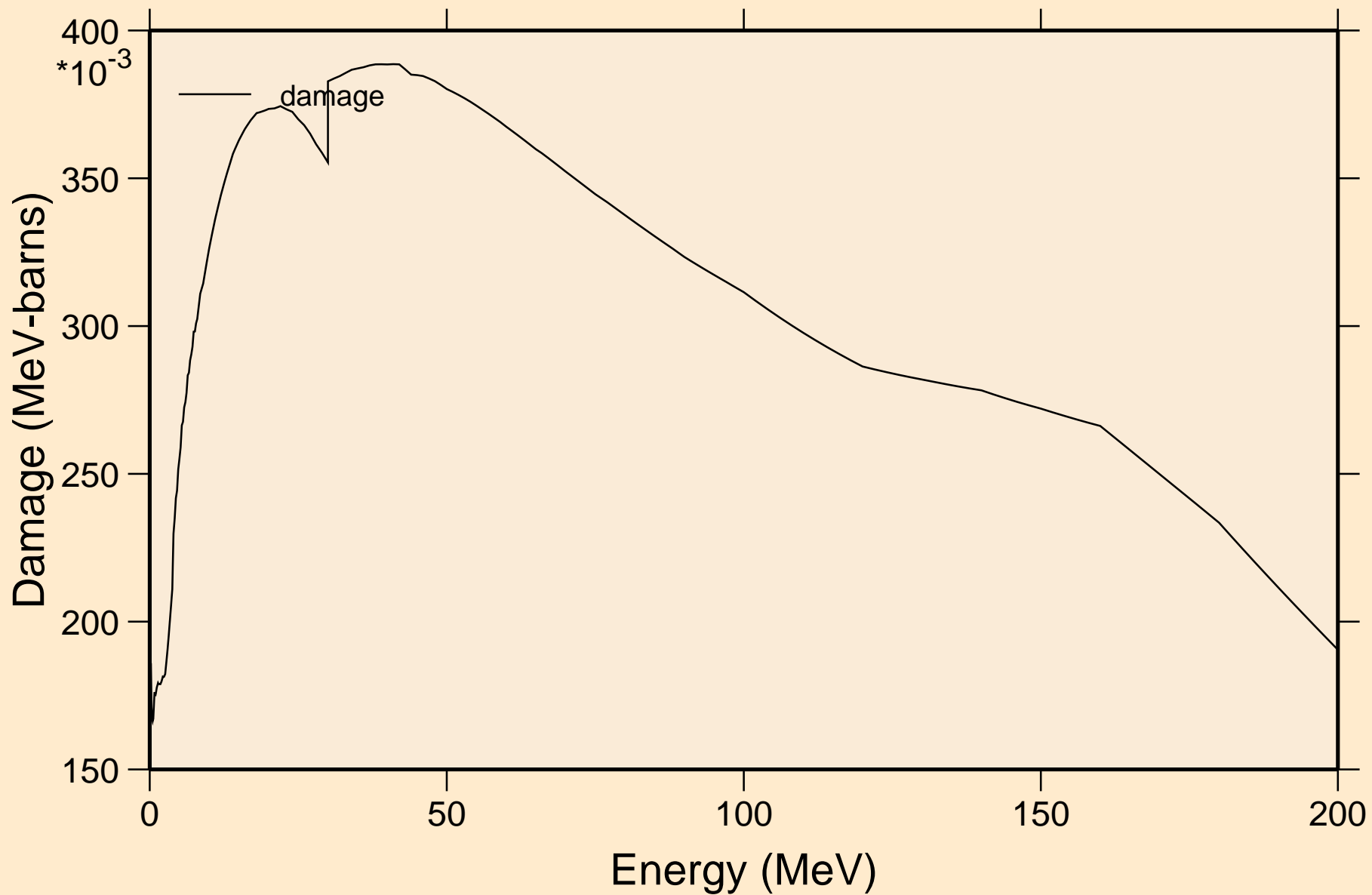

CU058 NEUTRON ACER TENDL-2019 LIBRARY; T=293.16K
Non-threshold reactions

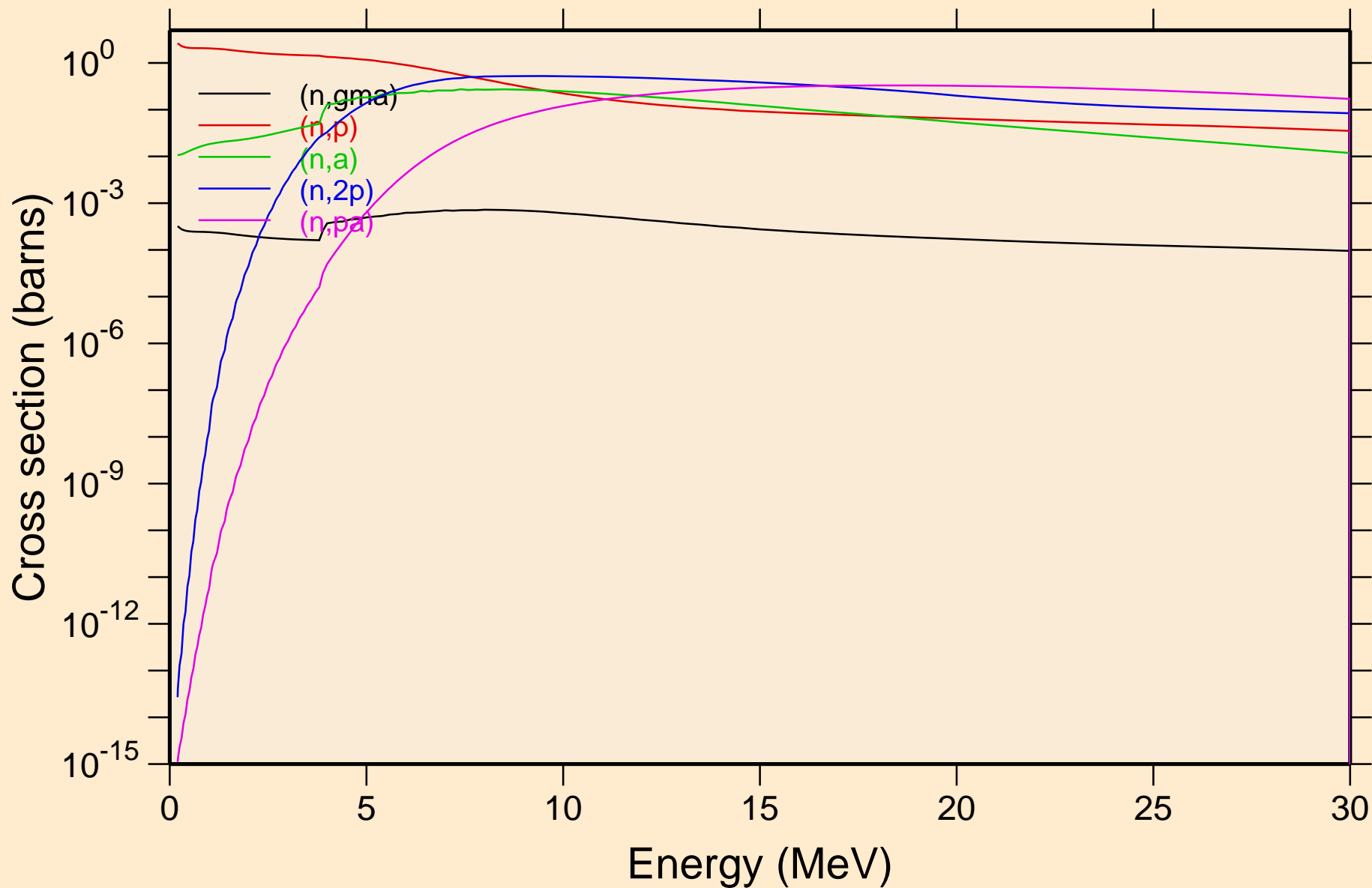

CU058 NEUTRON ACER TENDL-2019 LIBRARY; T=293.16K
Non-threshold reactions

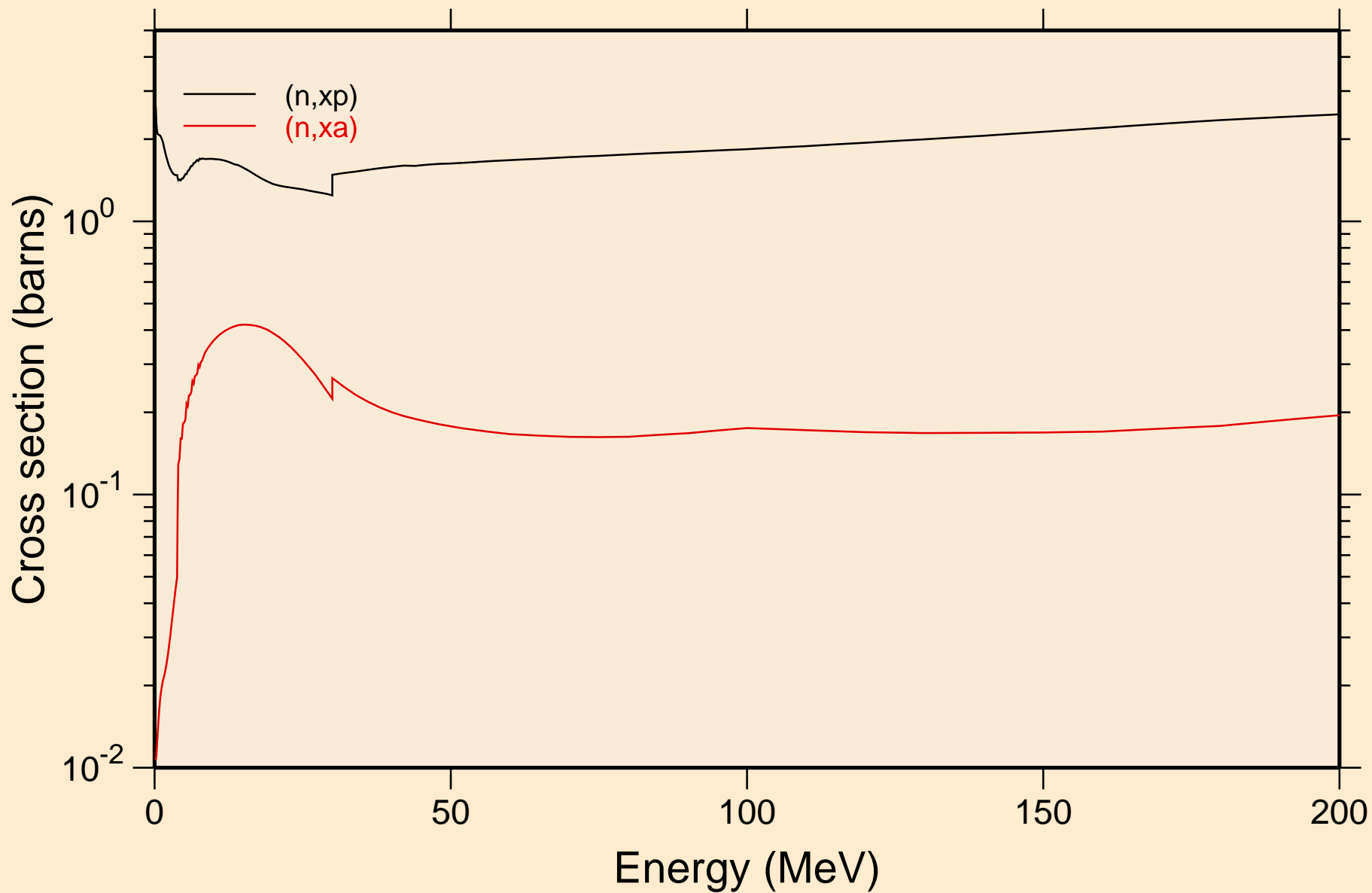

CU058 NEUTRON ACER TENDL-2019 LIBRARY; T=293.16K
Inelastic levels

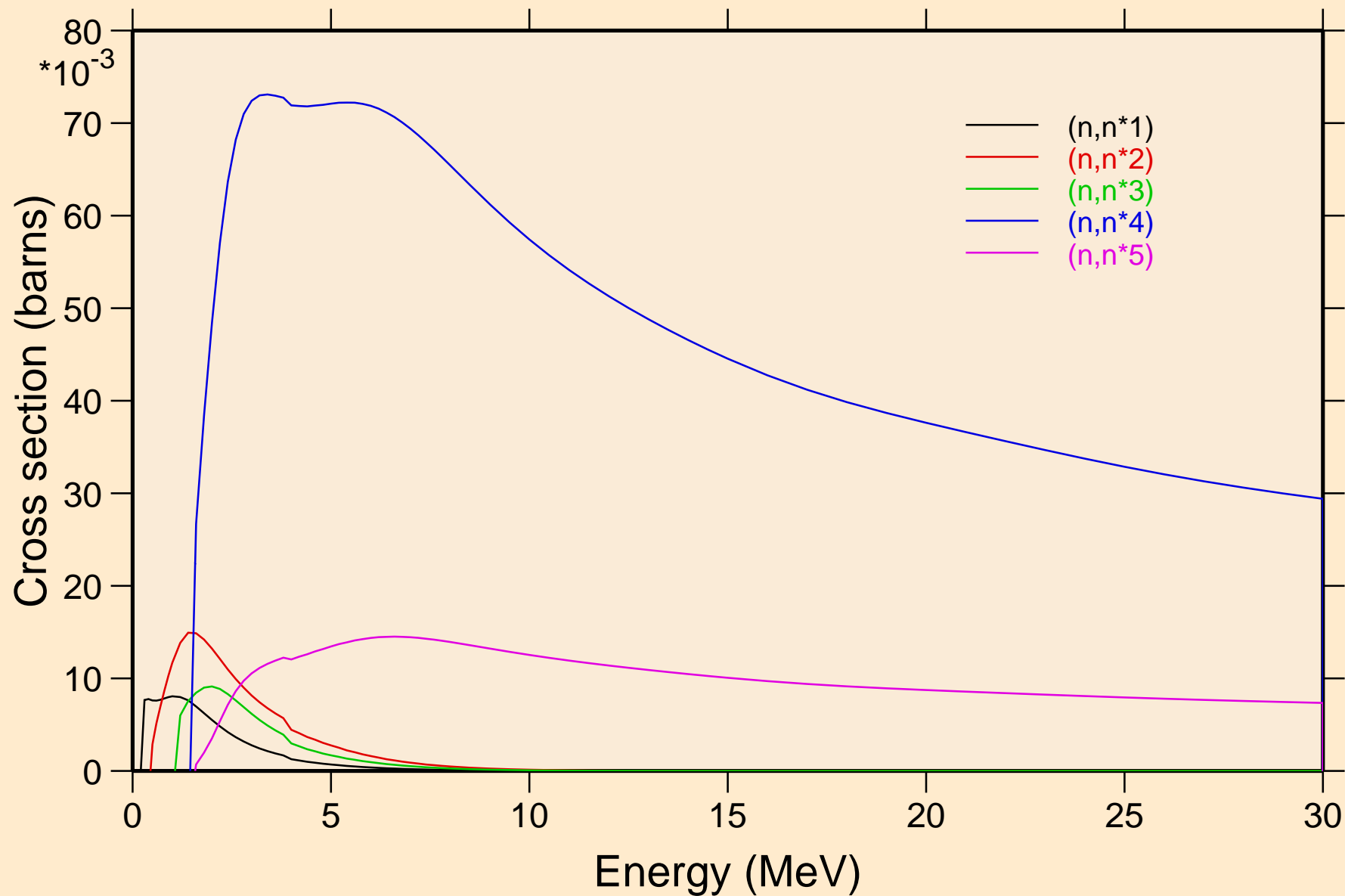

CU058 NEUTRON ACER TENDL-2019 LIBRARY; T=293.16K
Inelastic levels

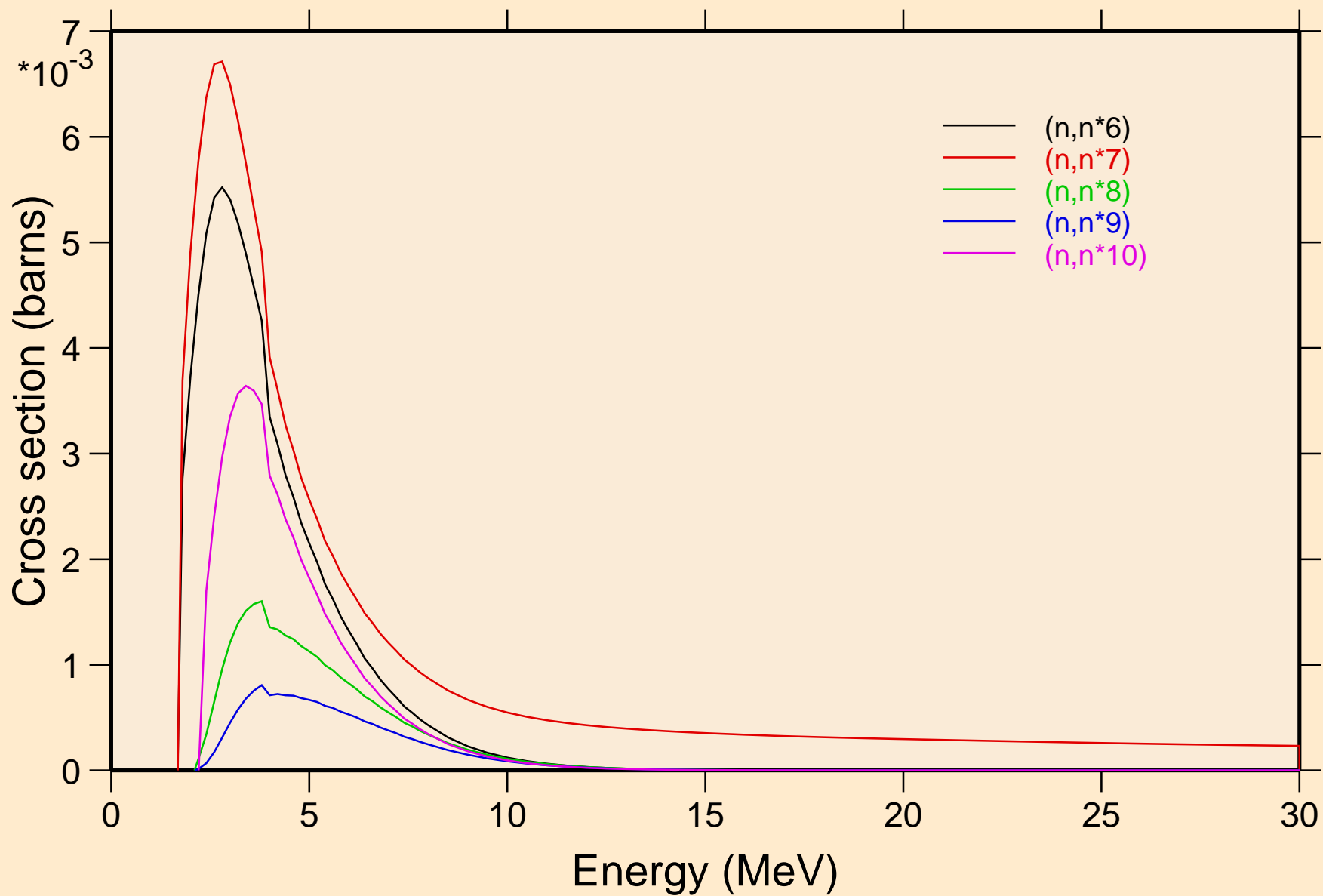

CU058 NEUTRON ACER TENDL-2019 LIBRARY; T=293.16K
Inelastic levels

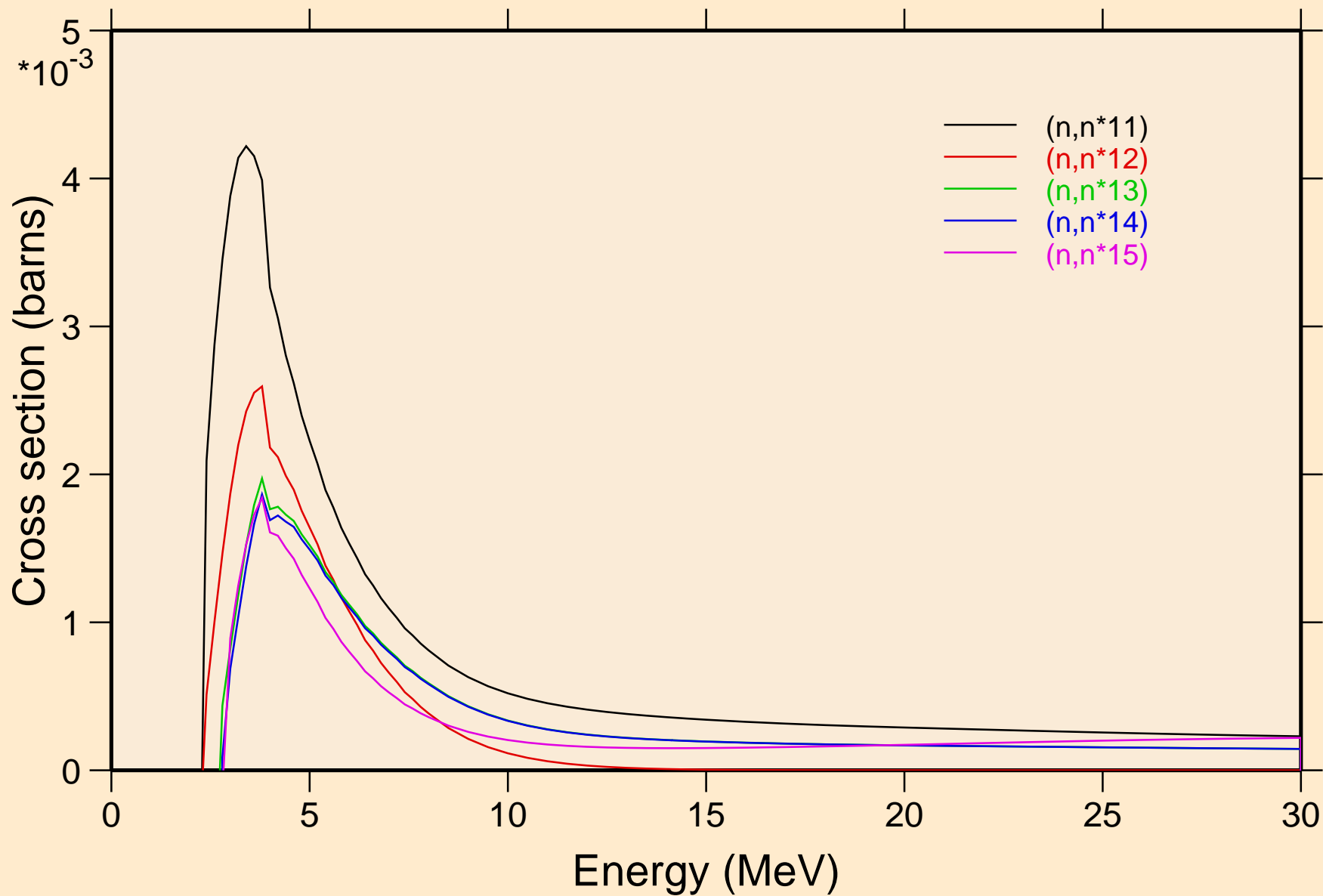

CU058 NEUTRON ACER TENDL-2019 LIBRARY; T=293.16K
Inelastic levels

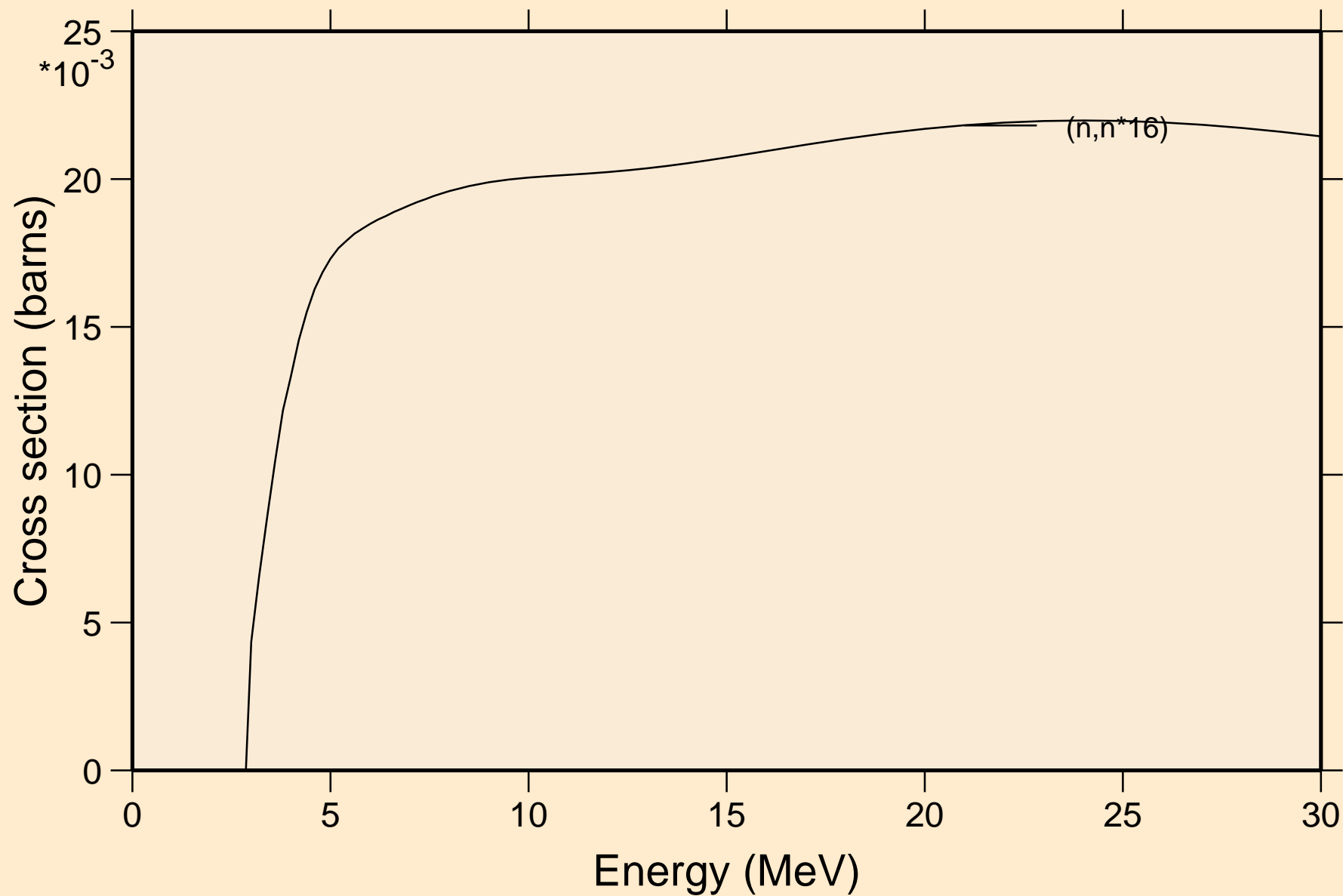

CU058 NEUTRON ACER TENDL-2019 LIBRARY; T=293.16K
Threshold reactions

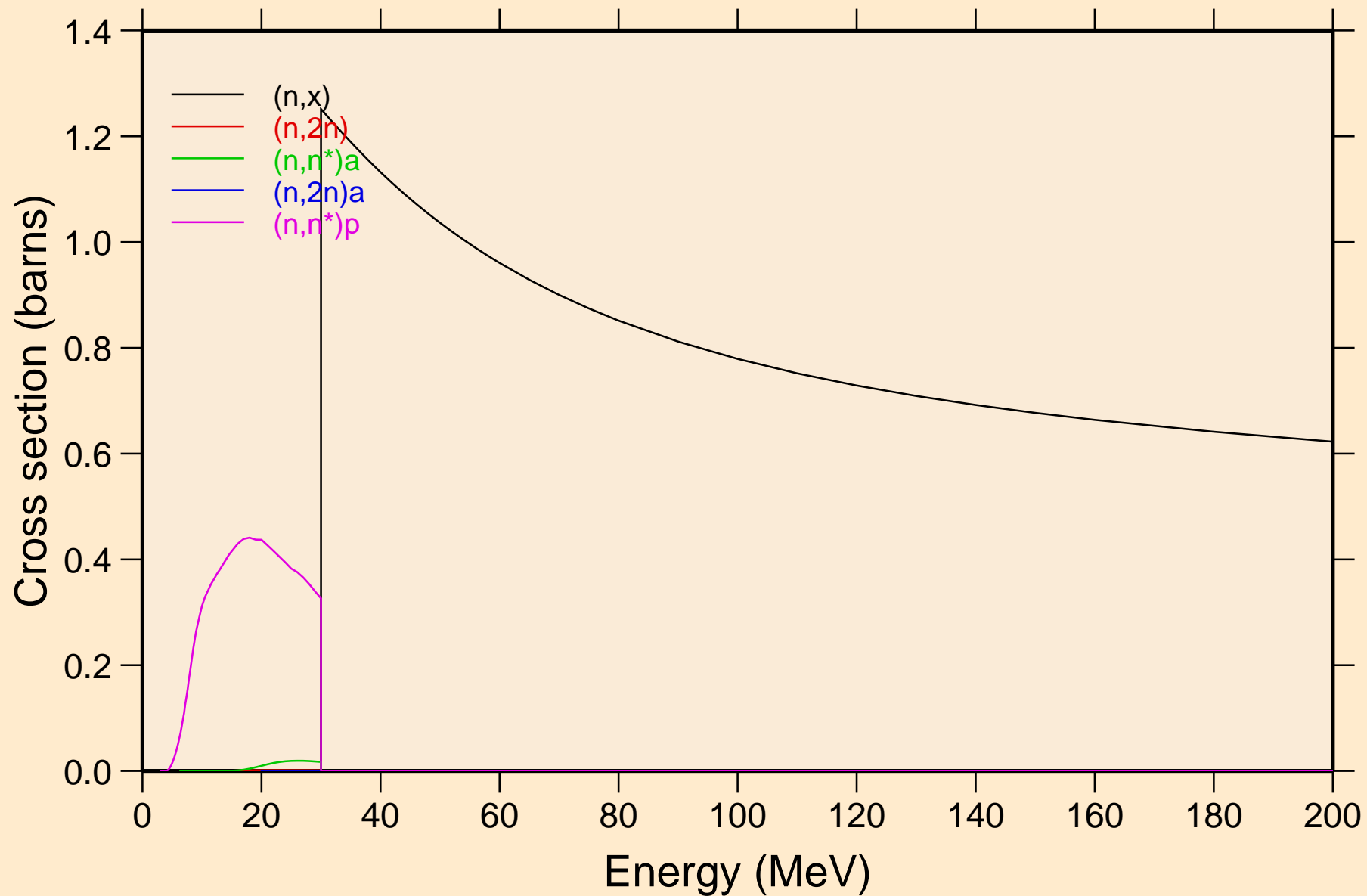

CU058 NEUTRON ACER TENDL-2019 LIBRARY; T=293.16K

Threshold reactions

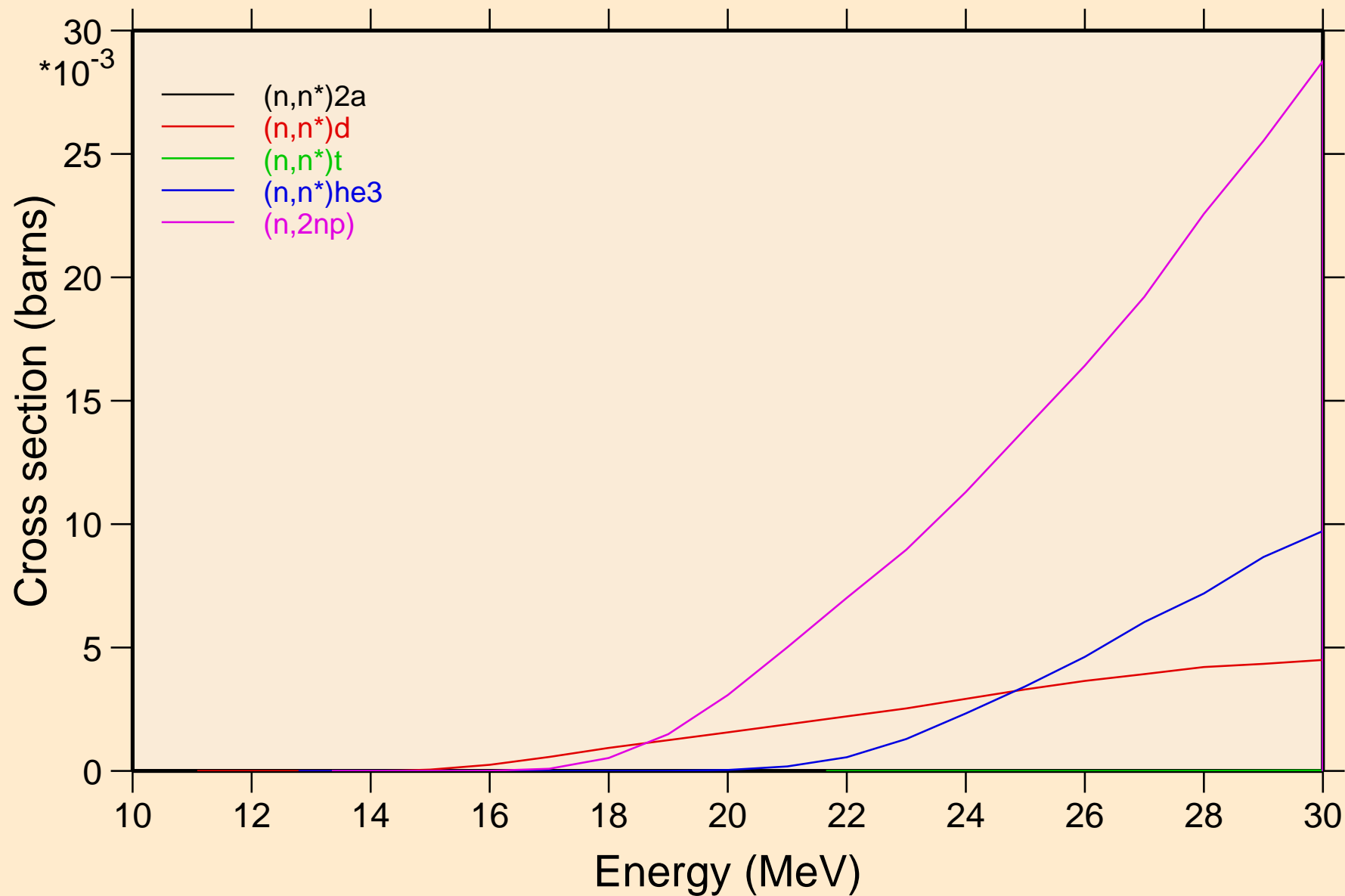

CU058 NEUTRON ACER TENDL-2019 LIBRARY; T=293.16K

Threshold reactions

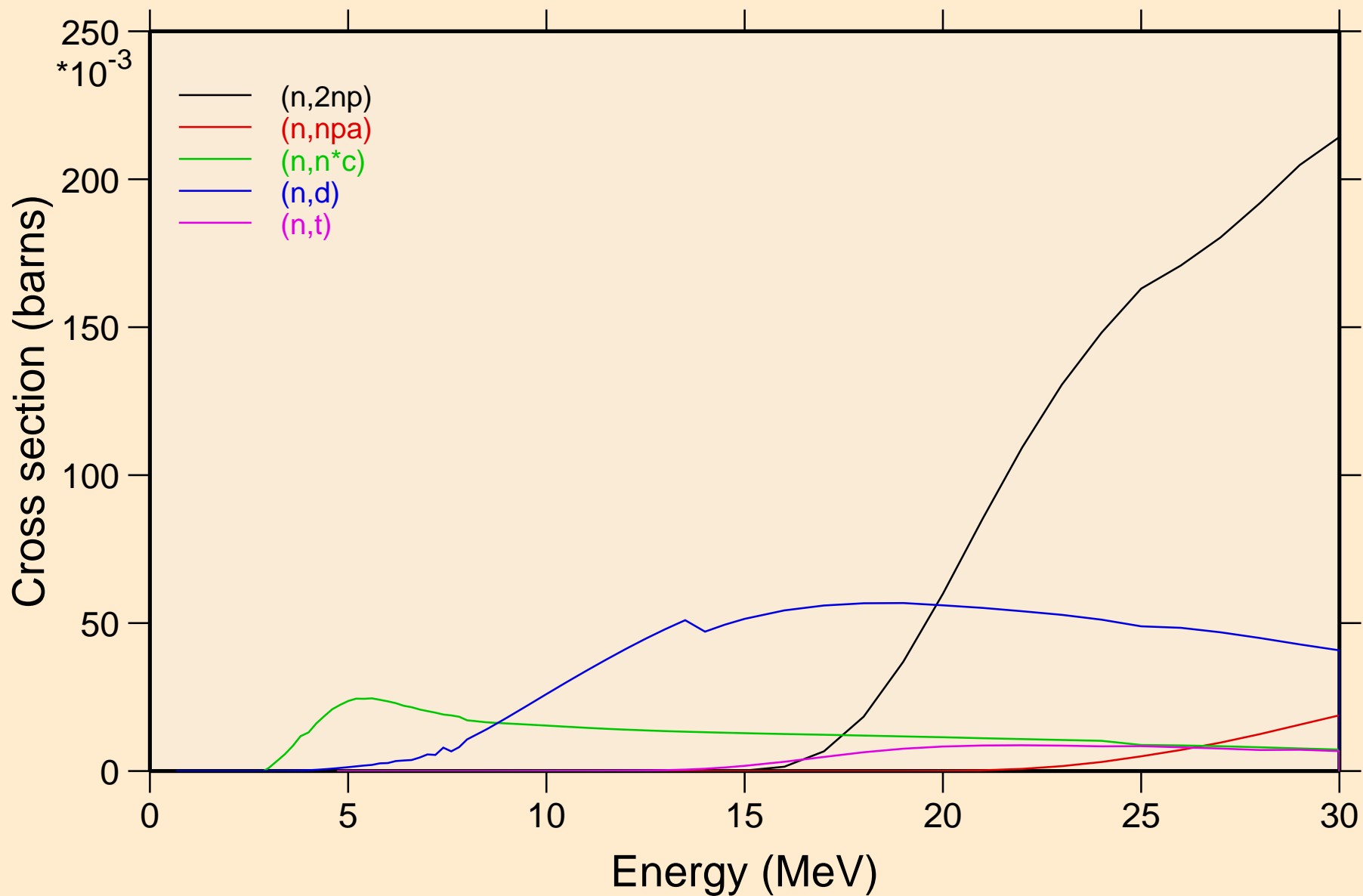

CU058 NEUTRON ACER TENDL-2019 LIBRARY; T=293.16K
Threshold reactions

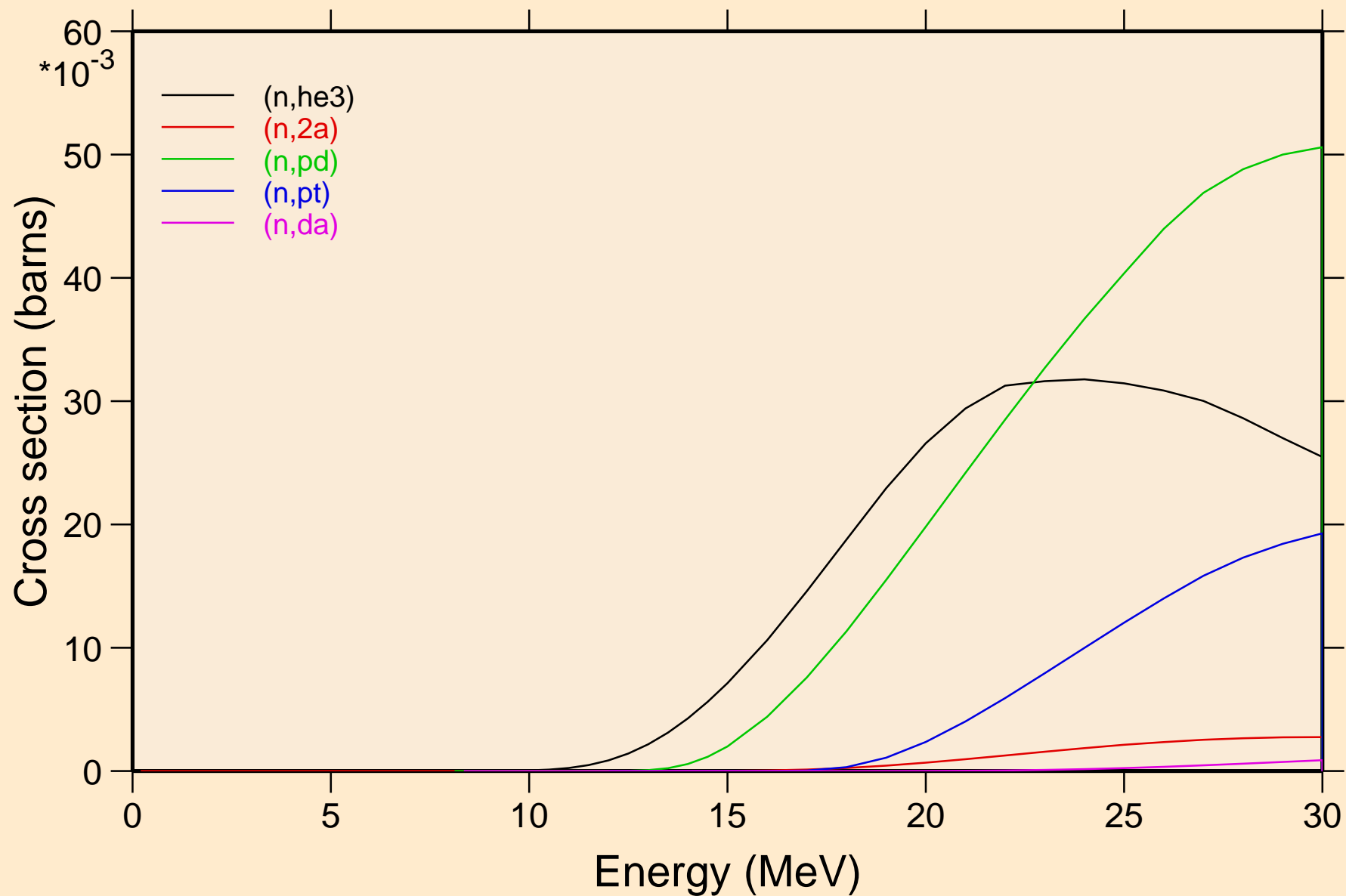

CU058 NEUTRON ACER TENDL-2019 LIBRARY; T=293.16K
Threshold reactions

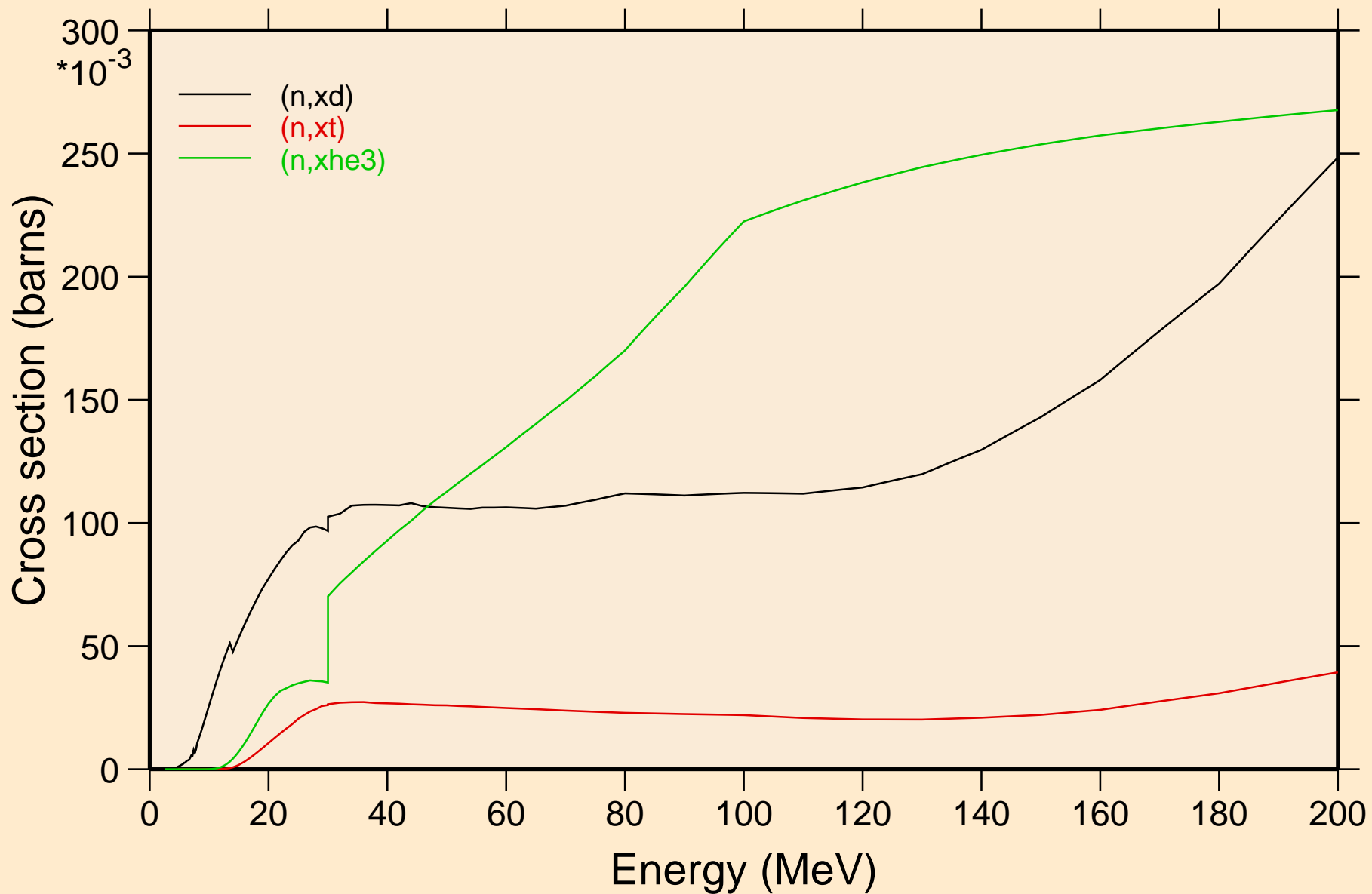

CU058 NEUTRON ACER TENDL-2019 LIBRARY; T=293.16K
angular distribution for elastic

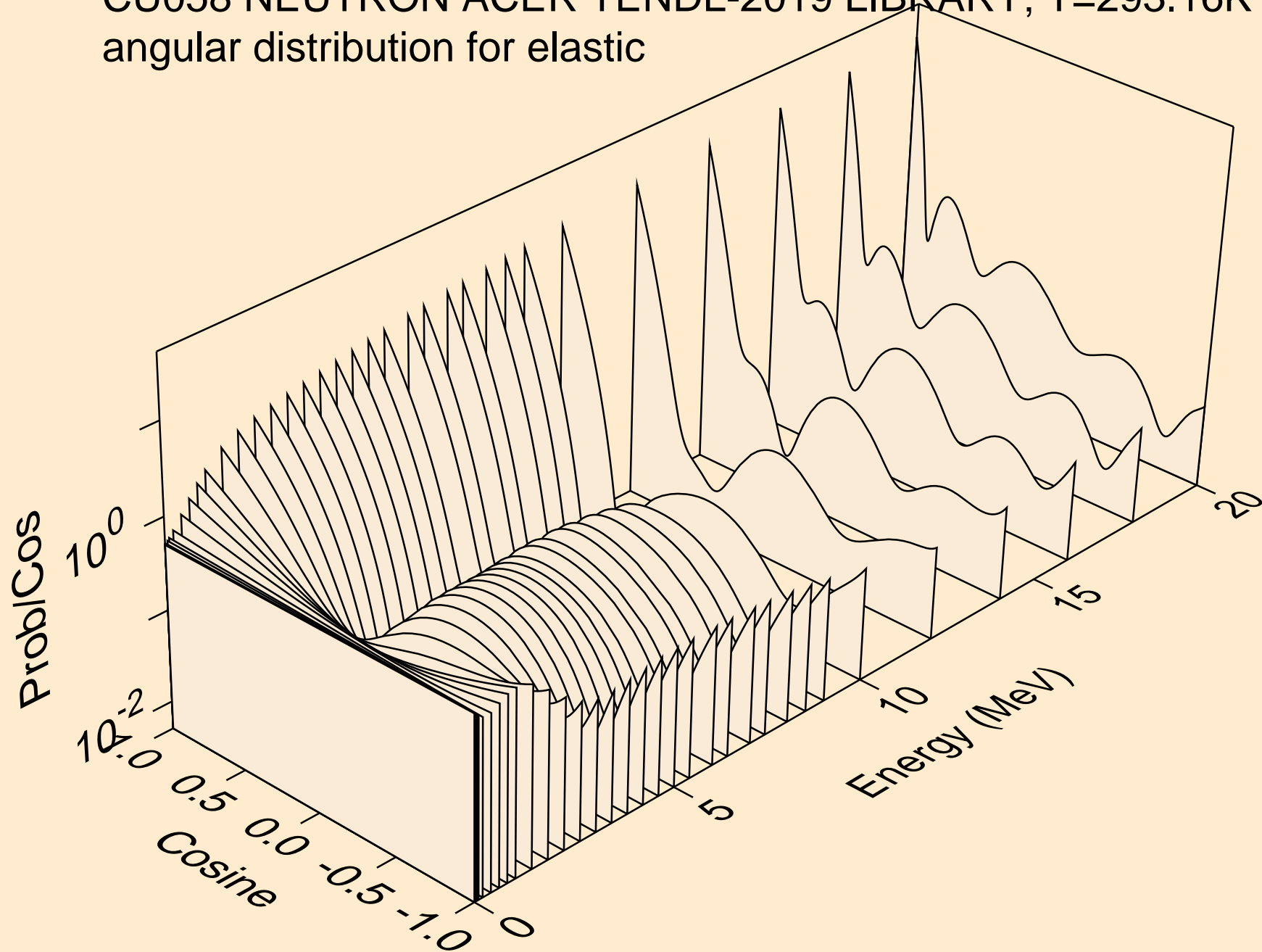

CU058 NEUTRON ACER TENDL-2019 LIBRARY; T=293.16K
angular distribution for elastic

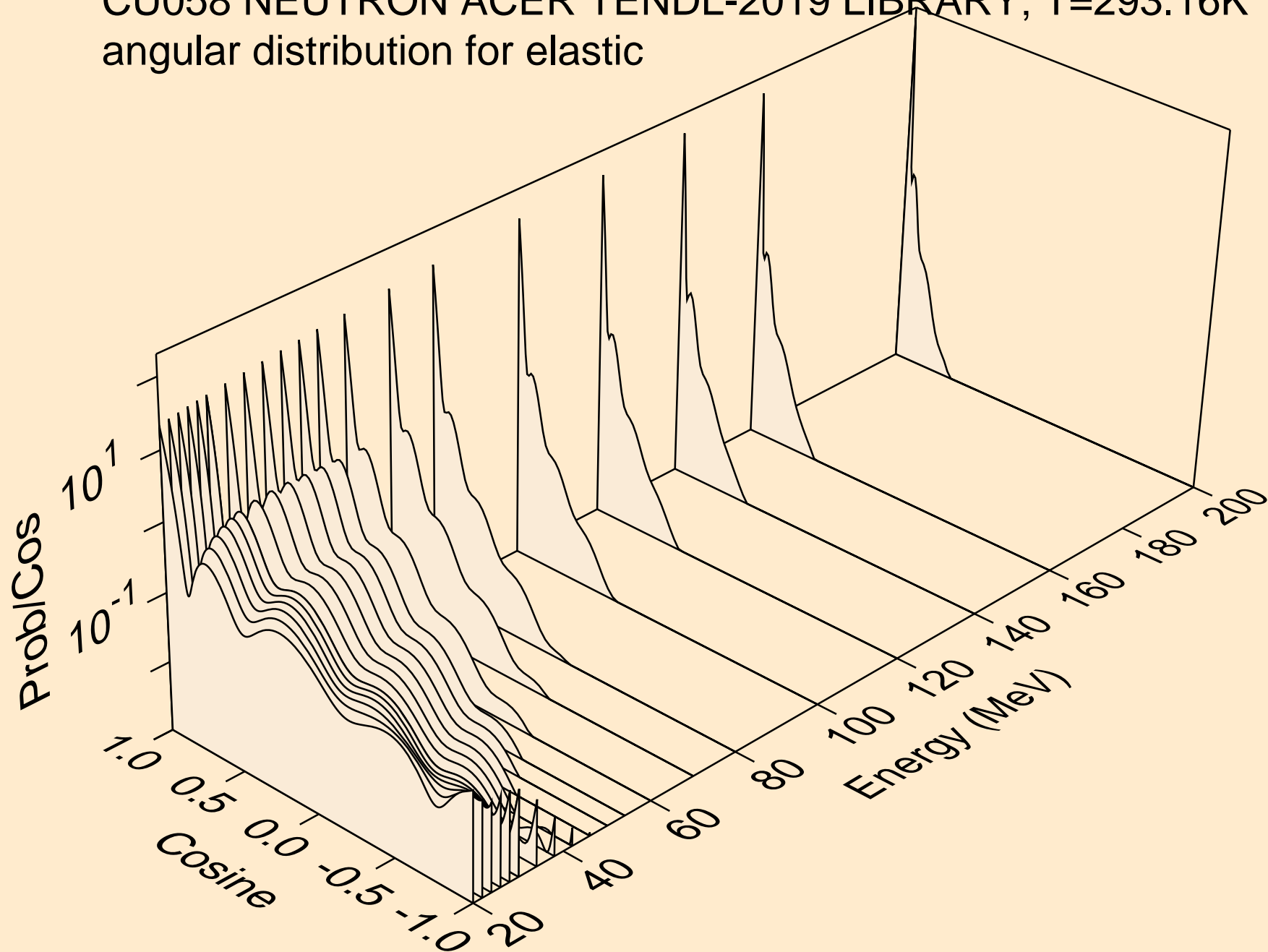

CU058 NEUTRON ACER TENDL-2019 LIBRARY; T=293.16K
angular distribution for (n,n*1)

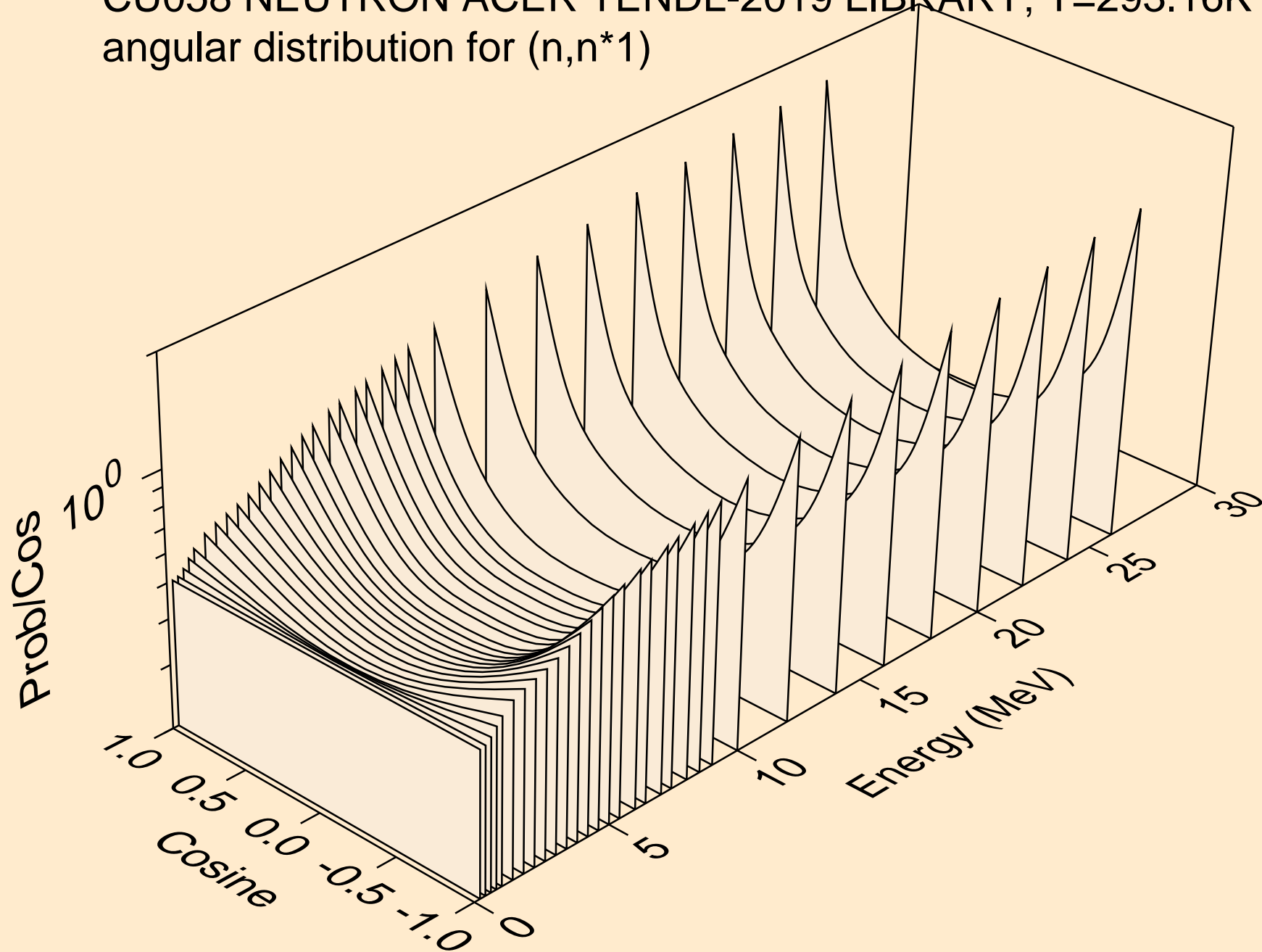

CU058 NEUTRON ACER TENDL-2019 LIBRARY; T=293.16K
angular distribution for (n,n*2)

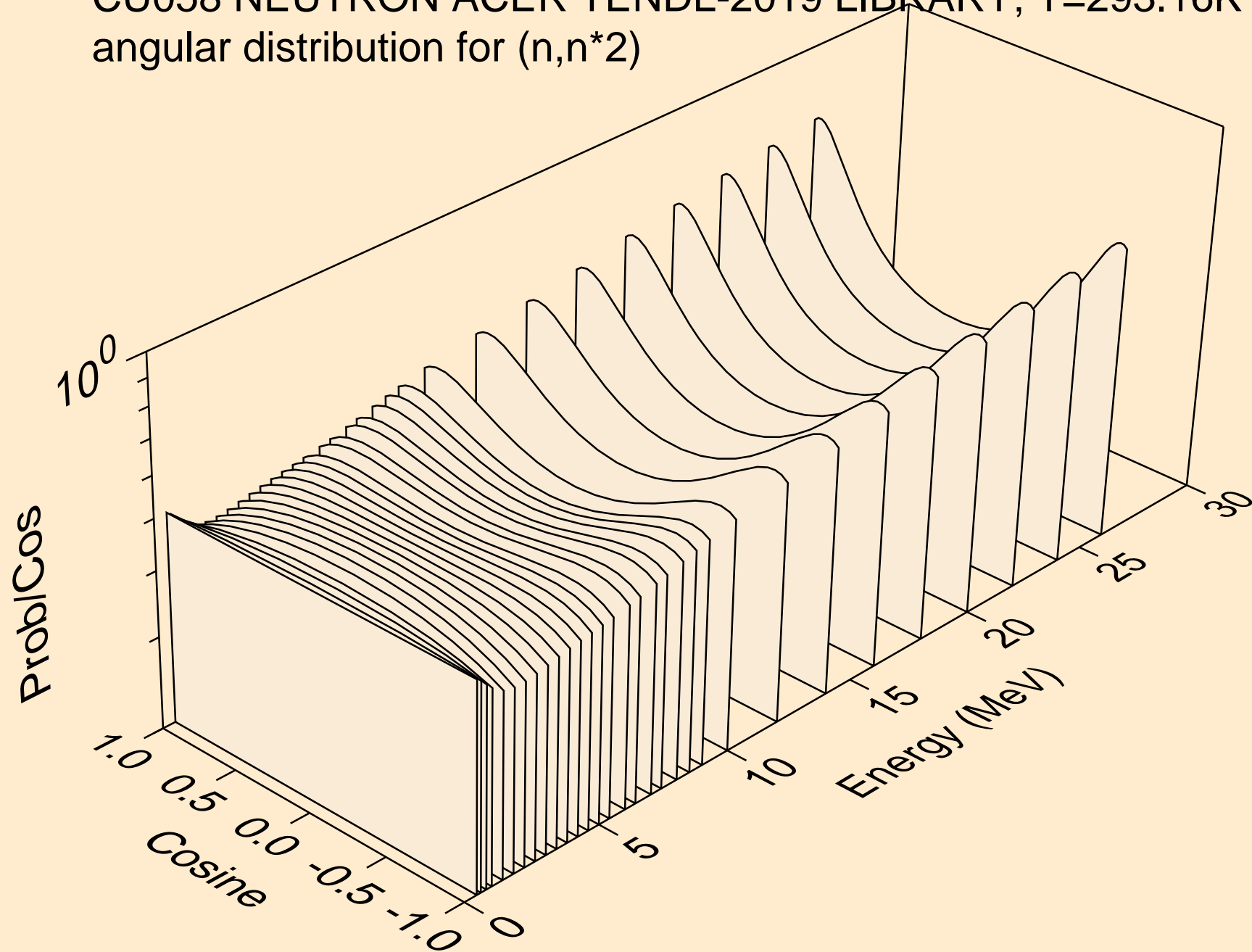

CU058 NEUTRON ACER TENDL-2019 LIBRARY; T=293.16K
angular distribution for (n,n*3)

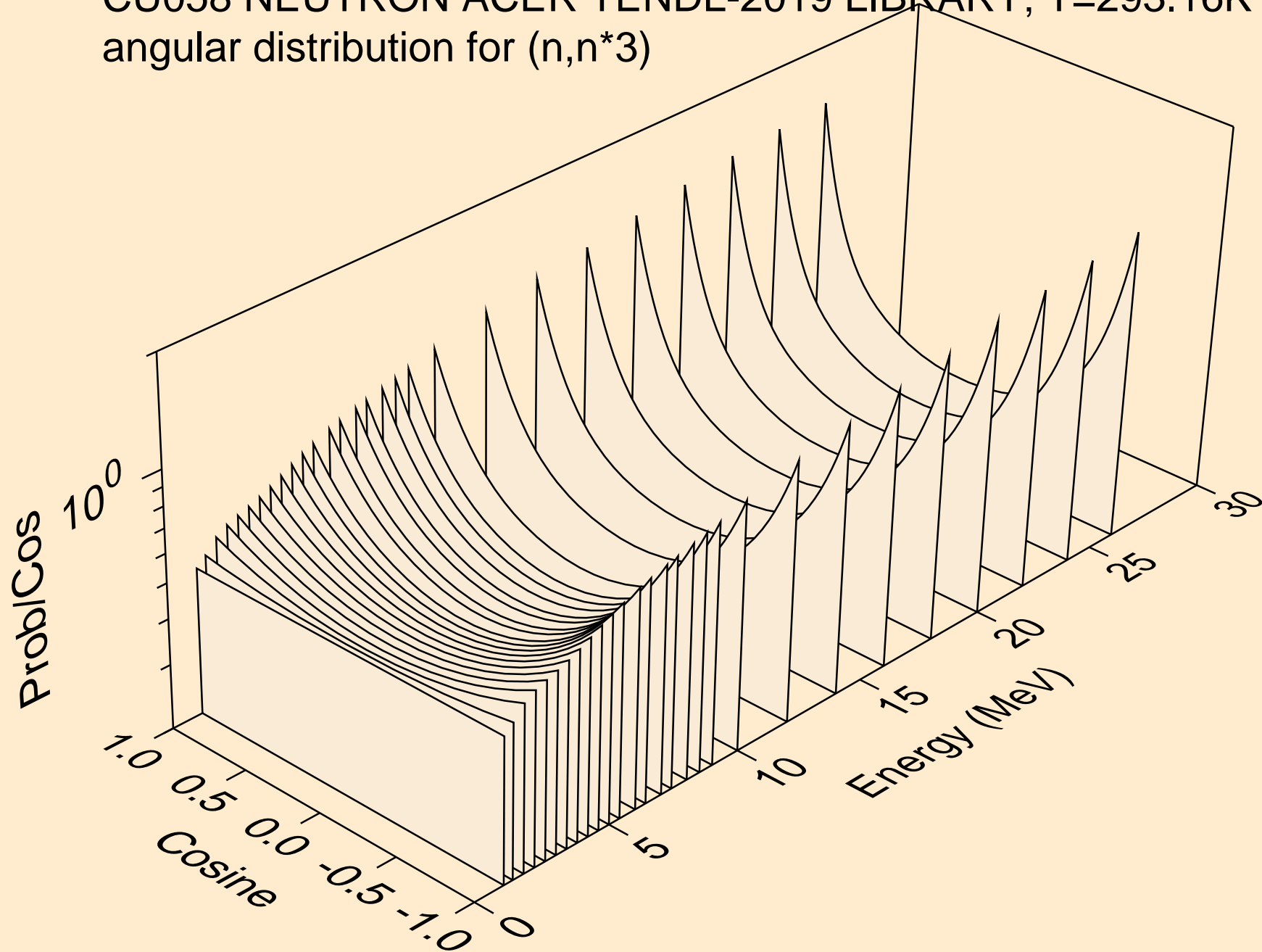

CU058 NEUTRON ACER TENDL-2019 LIBRARY; T=293.16K
angular distribution for (n,n*4)

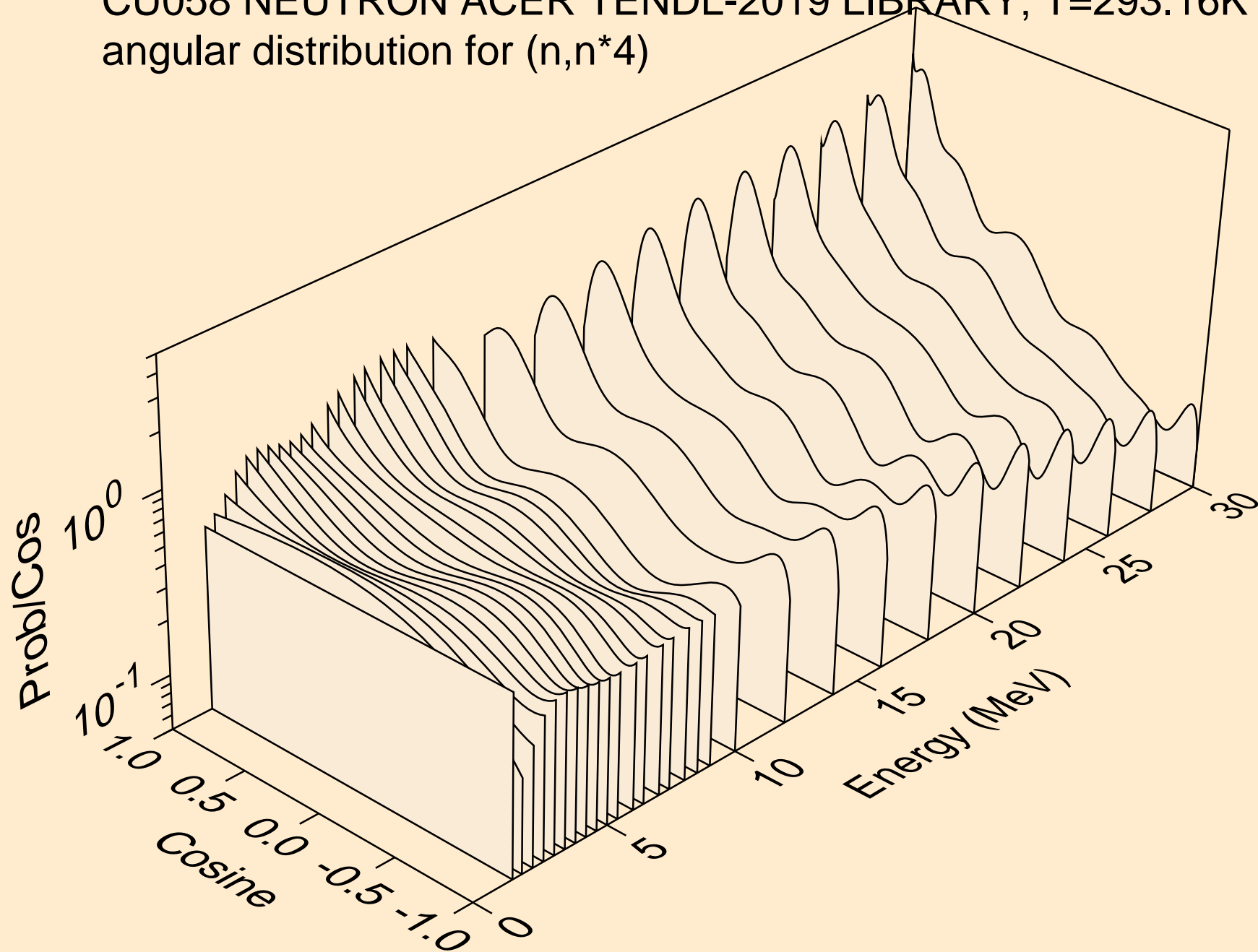

CU058 NEUTRON ACER TENDL-2019 LIBRARY; T=293.16K
angular distribution for (n,n*5)

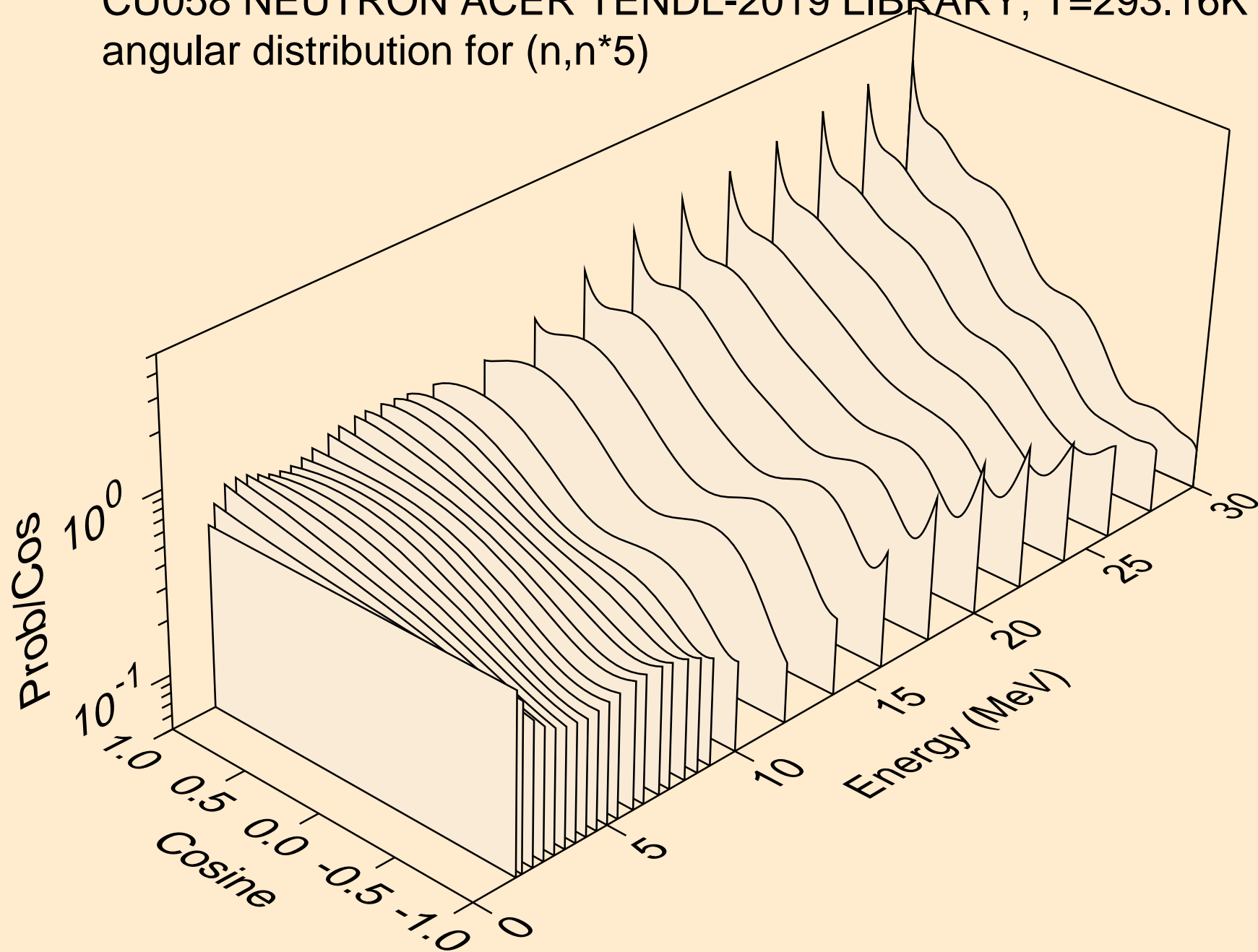

CU058 NEUTRON ACER TENDL-2019 LIBRARY; T=293.16K
angular distribution for (n,n*6)

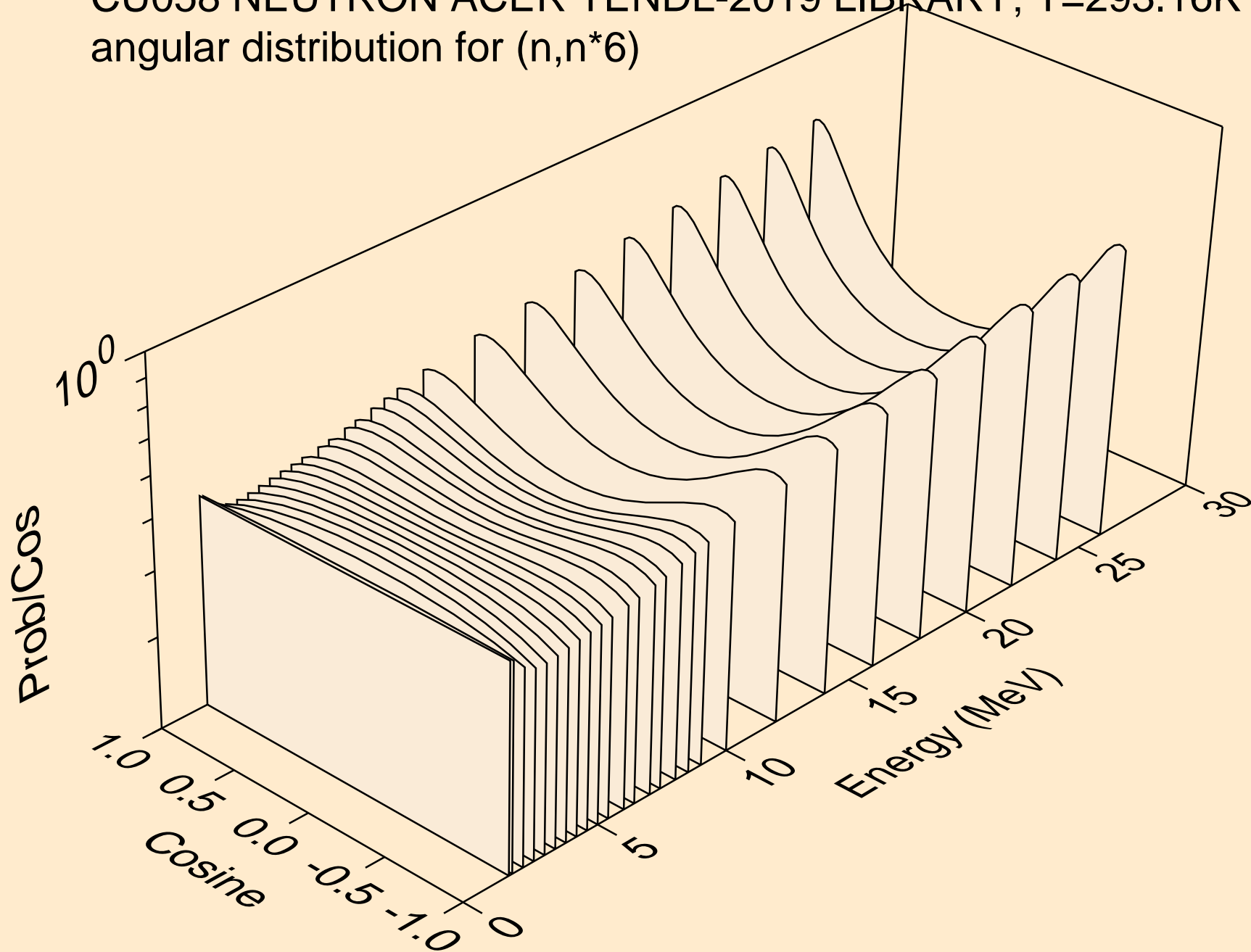

CU058 NEUTRON ACER TENDL-2019 LIBRARY; T=293.16K
angular distribution for (n,n*7)

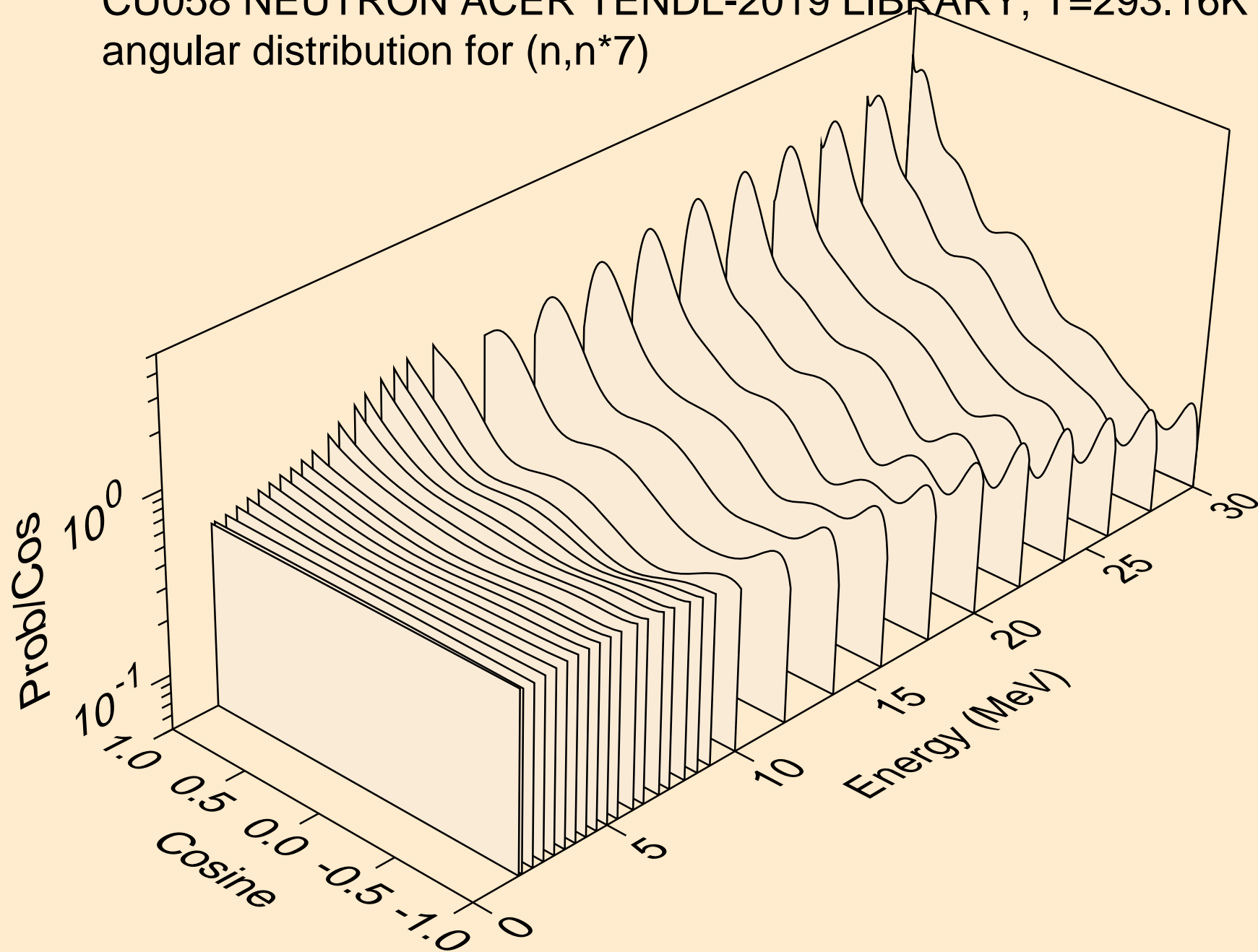

CU058 NEUTRON ACER TENDL-2019 LIBRARY; T=293.16K
angular distribution for (n,n*8)

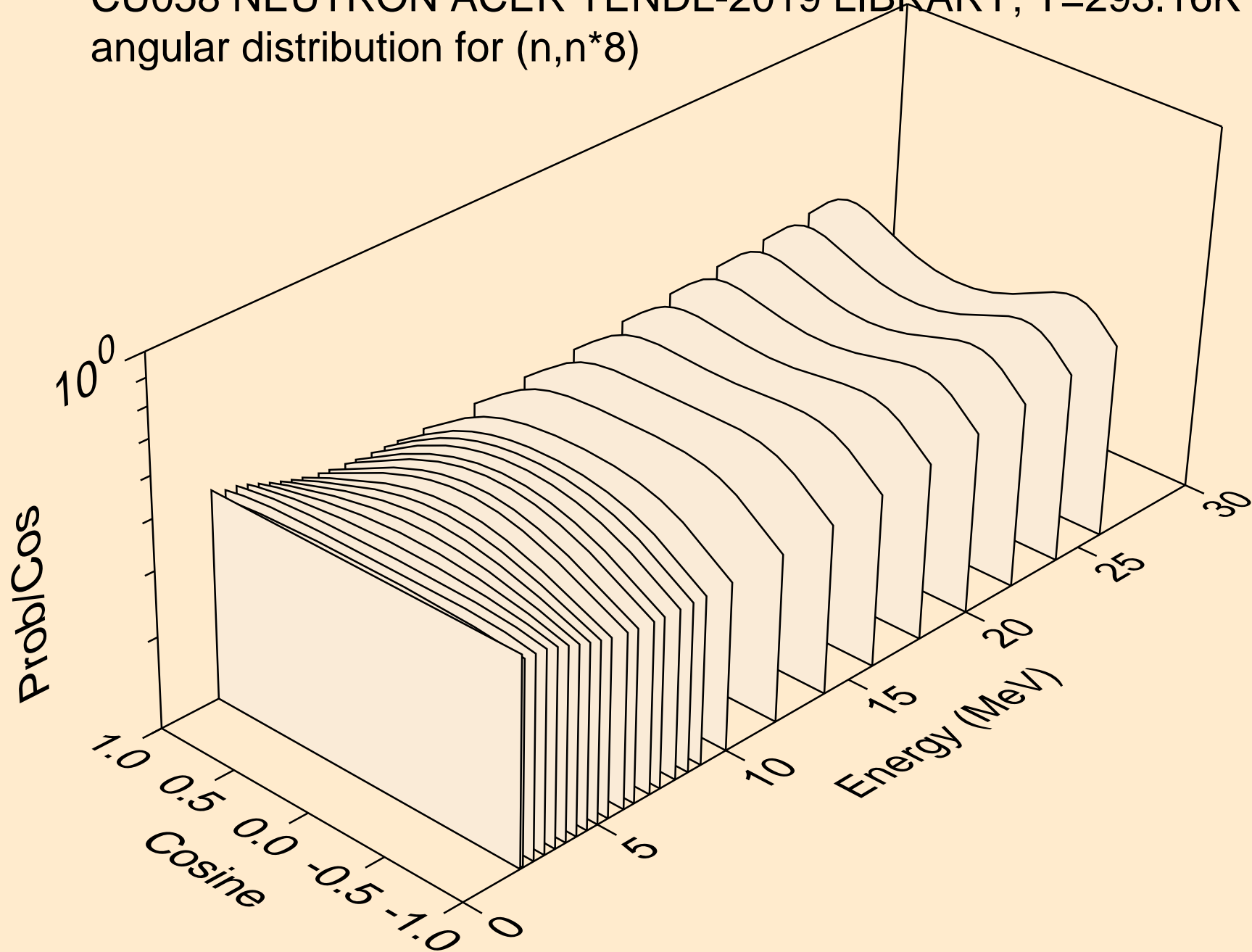

CU058 NEUTRON ACER TENDL-2019 LIBRARY; T=293.16K
angular distribution for (n,n*9)

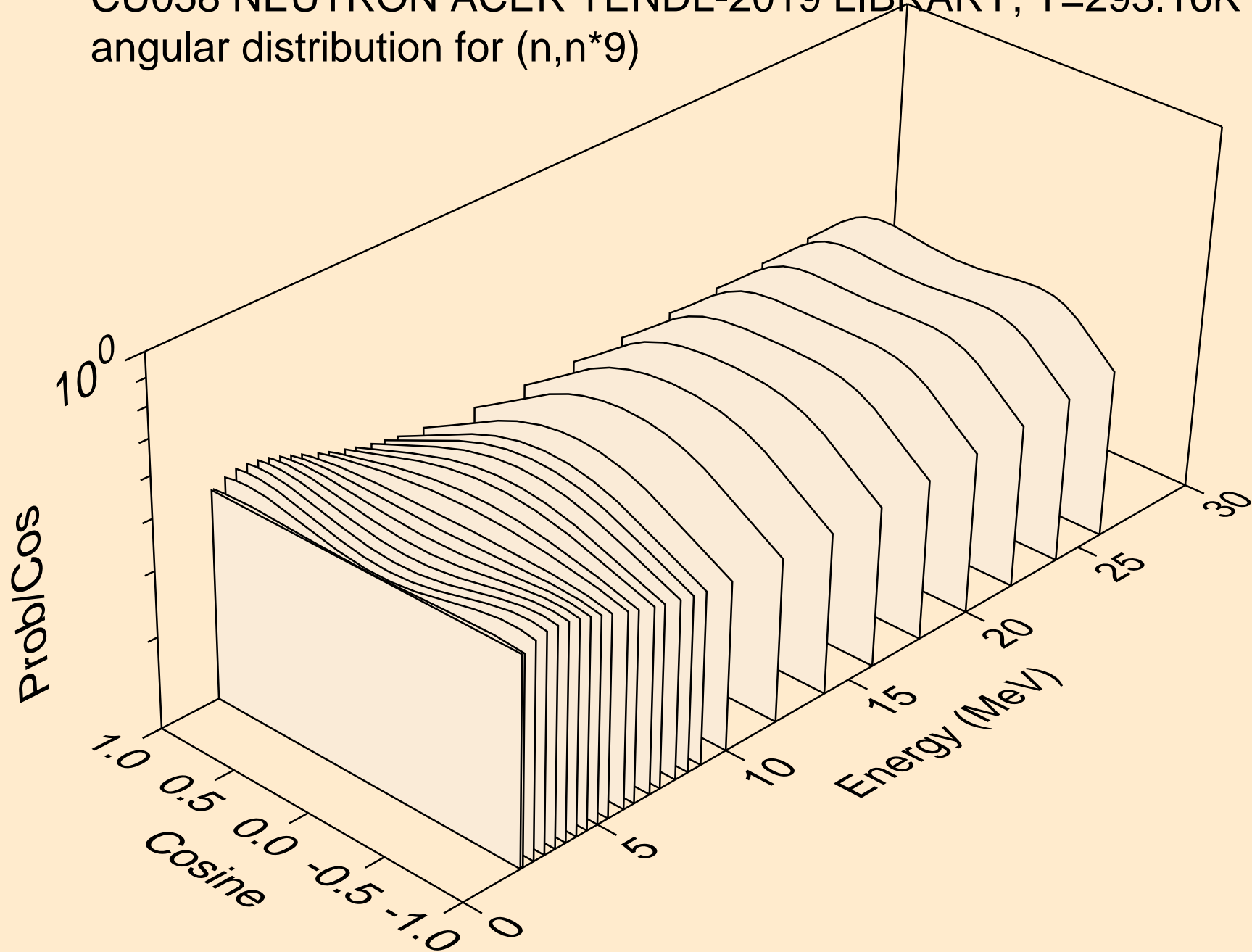

CU058 NEUTRON ACER TENDL-2019 LIBRARY; T=293.16K
angular distribution for (n,n*10)

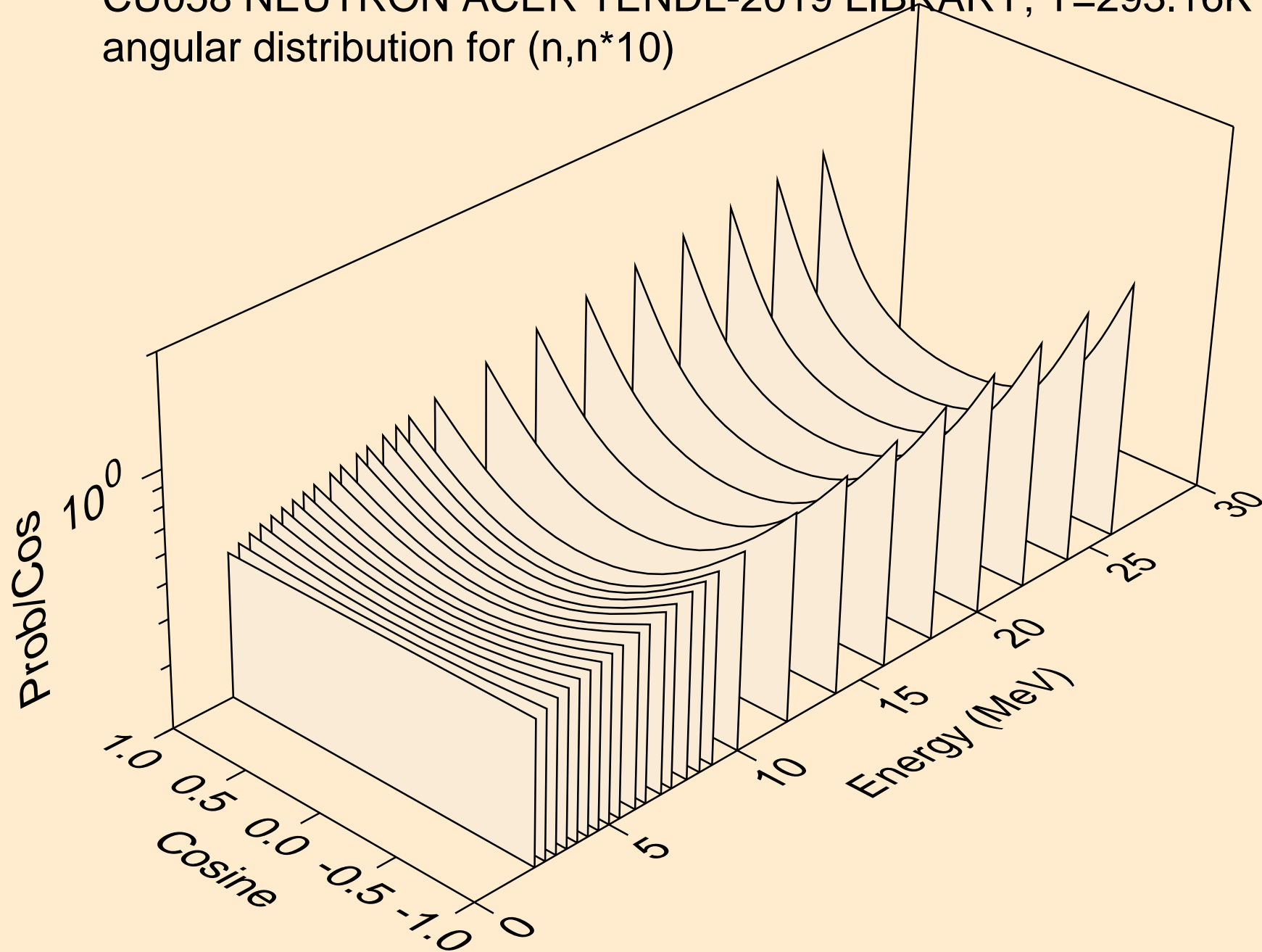

CU058 NEUTRON ACER TENDL-2019 LIBRARY; T=293.16K
angular distribution for (n,n*11)

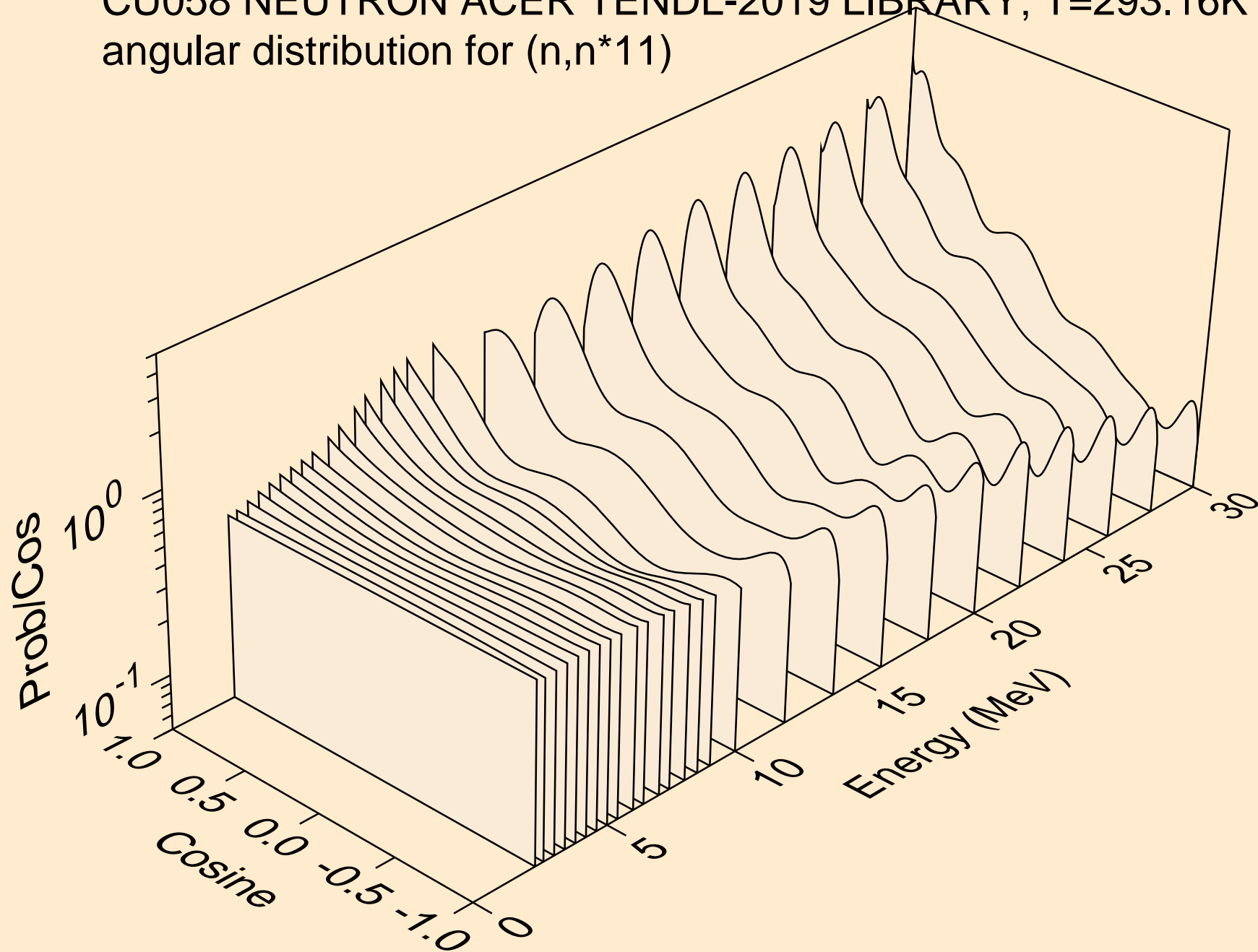

CU058 NEUTRON ACER TENDL-2019 LIBRARY; T=293.16K
angular distribution for (n,n*12)

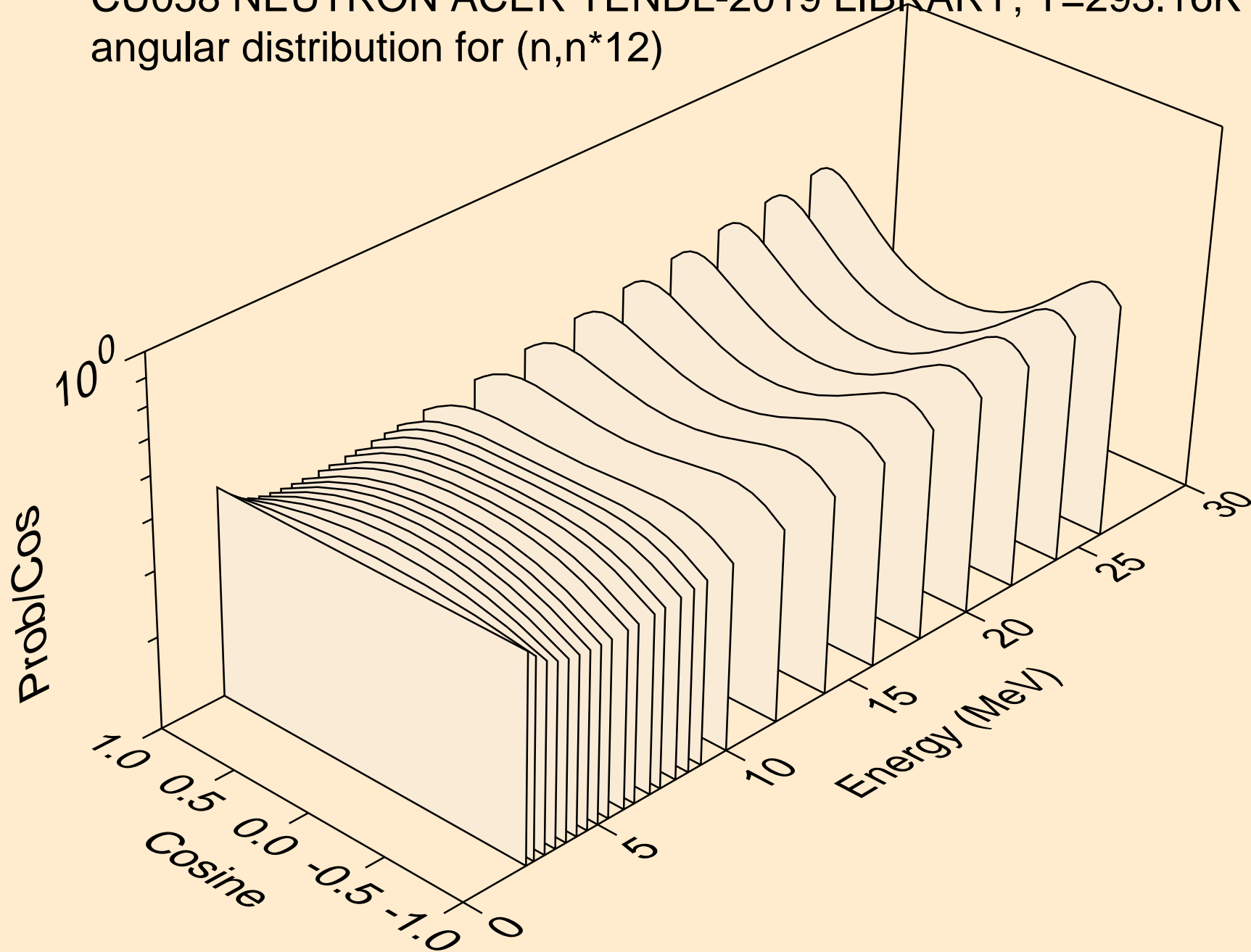

CU058 NEUTRON ACER TENDL-2019 LIBRARY; T=293.16K
angular distribution for (n,n*13)

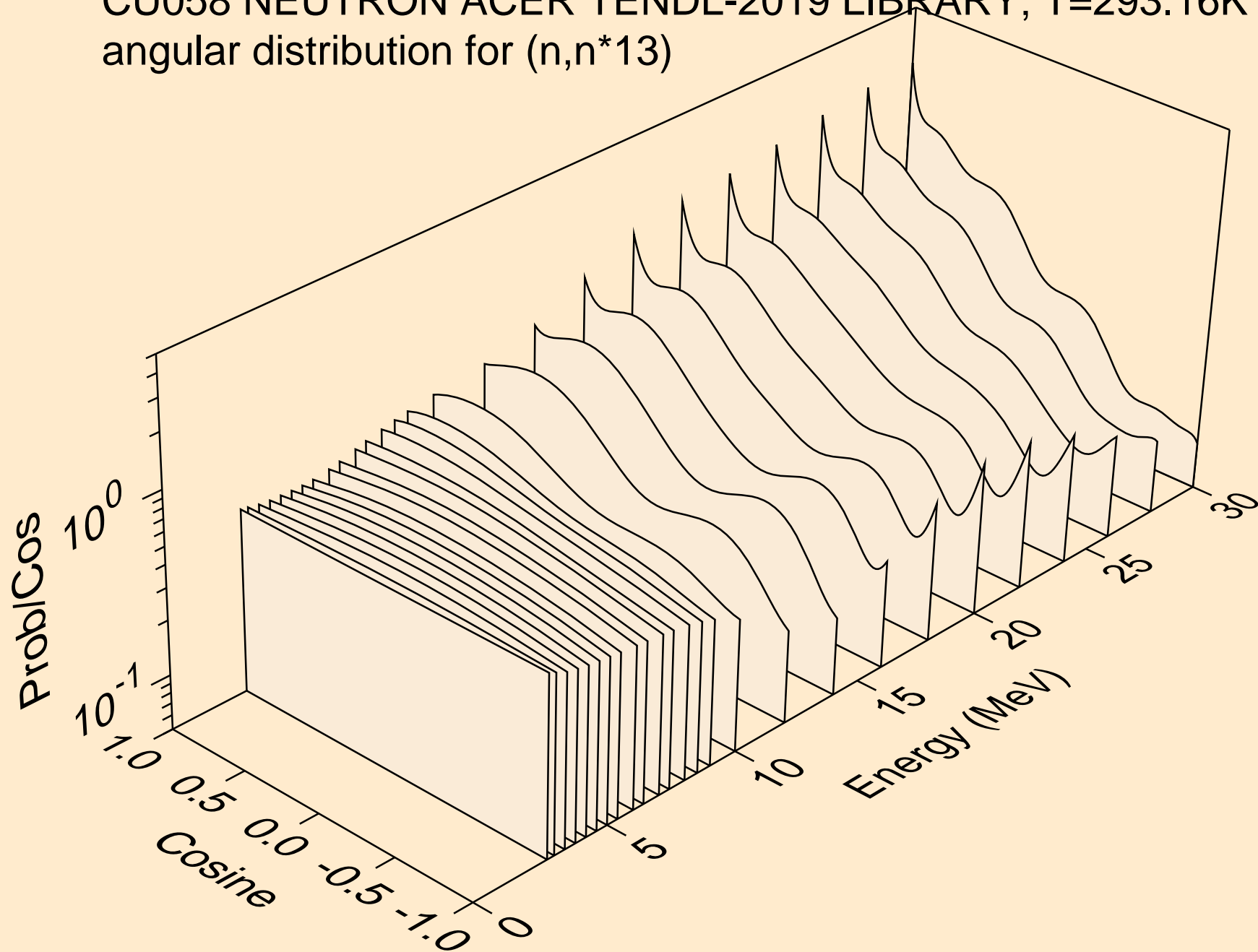

CU058 NEUTRON ACER TENDL-2019 LIBRARY; T=293.16K
angular distribution for (n,n*14)

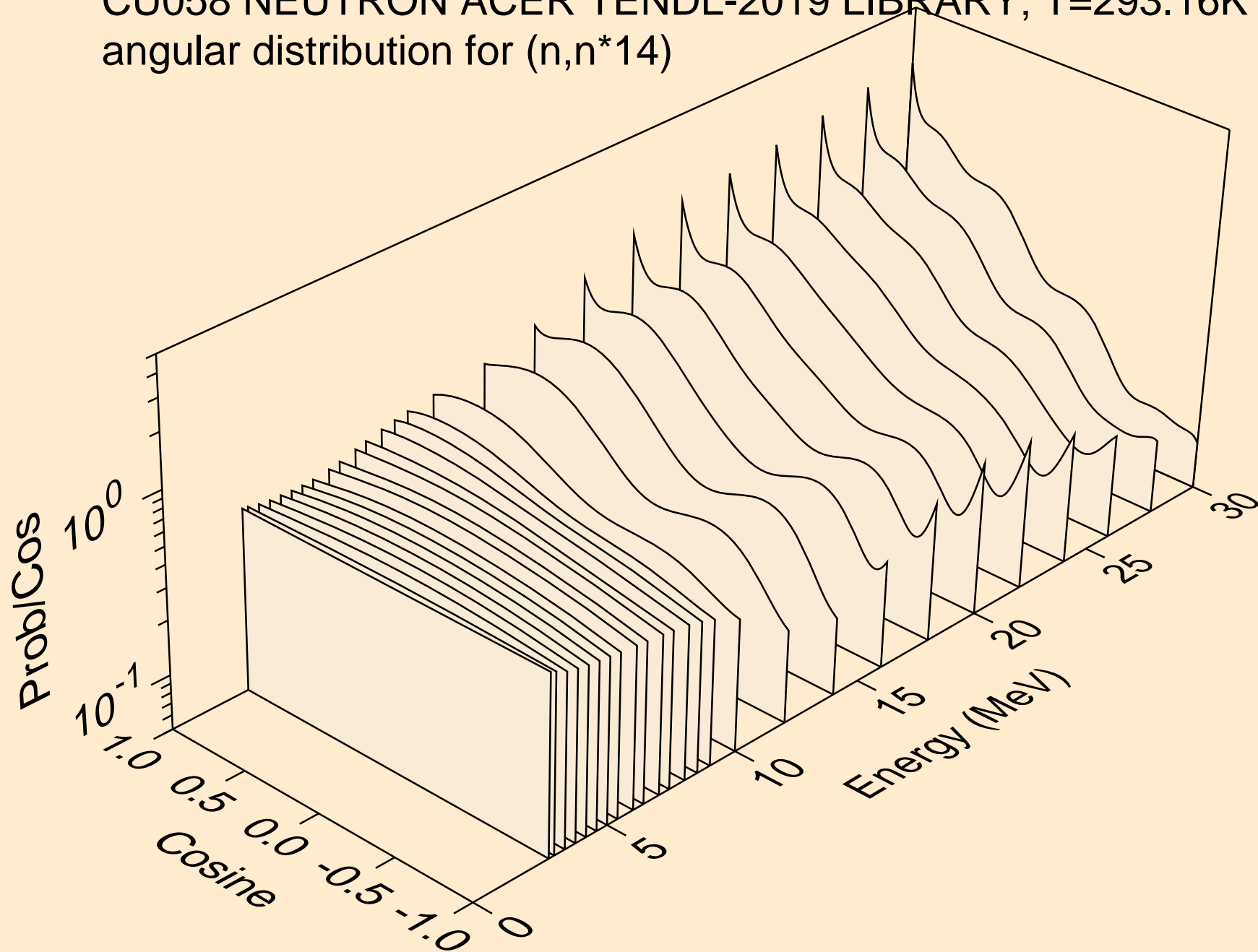

CU058 NEUTRON ACER TENDL-2019 LIBRARY; T=293.16K
angular distribution for (n,n*15)

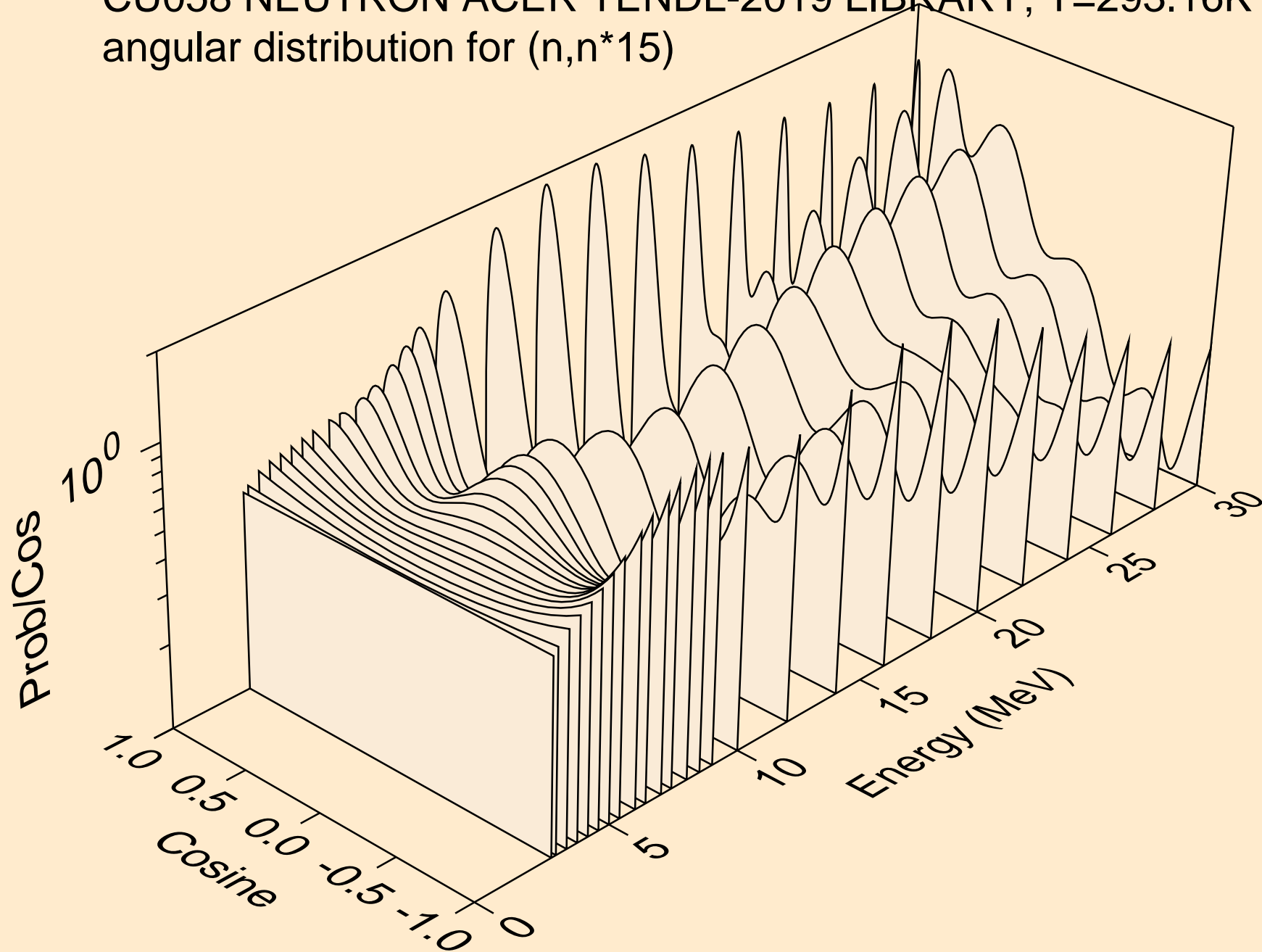

CU058 NEUTRON ACER TENDL-2019 LIBRARY; T=293.16K
angular distribution for (n,n*16)

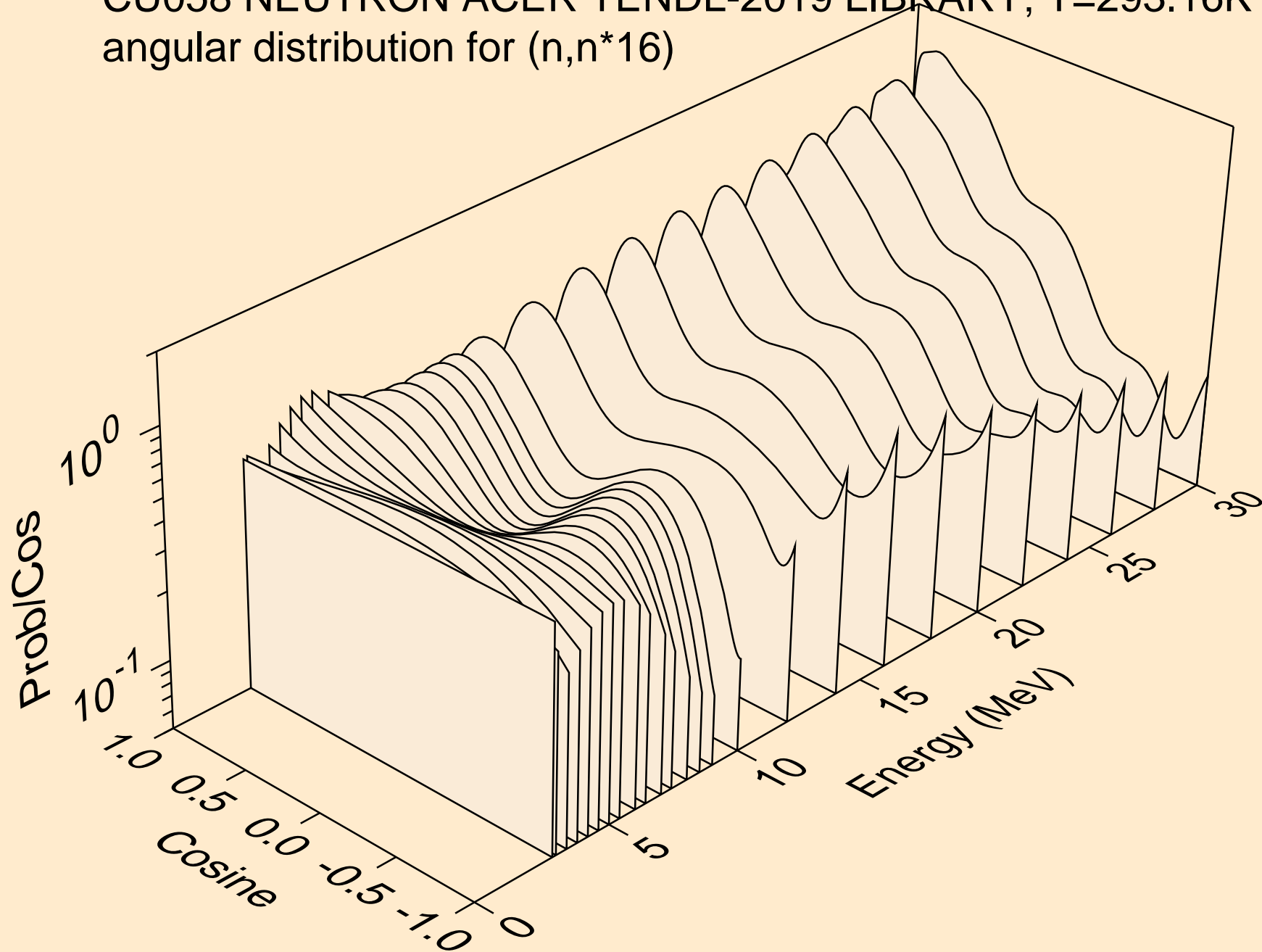

CU058 NEUTRON ACER TENDL-2019 LIBRARY; T=293.16K
Neutron emission for (n,x)

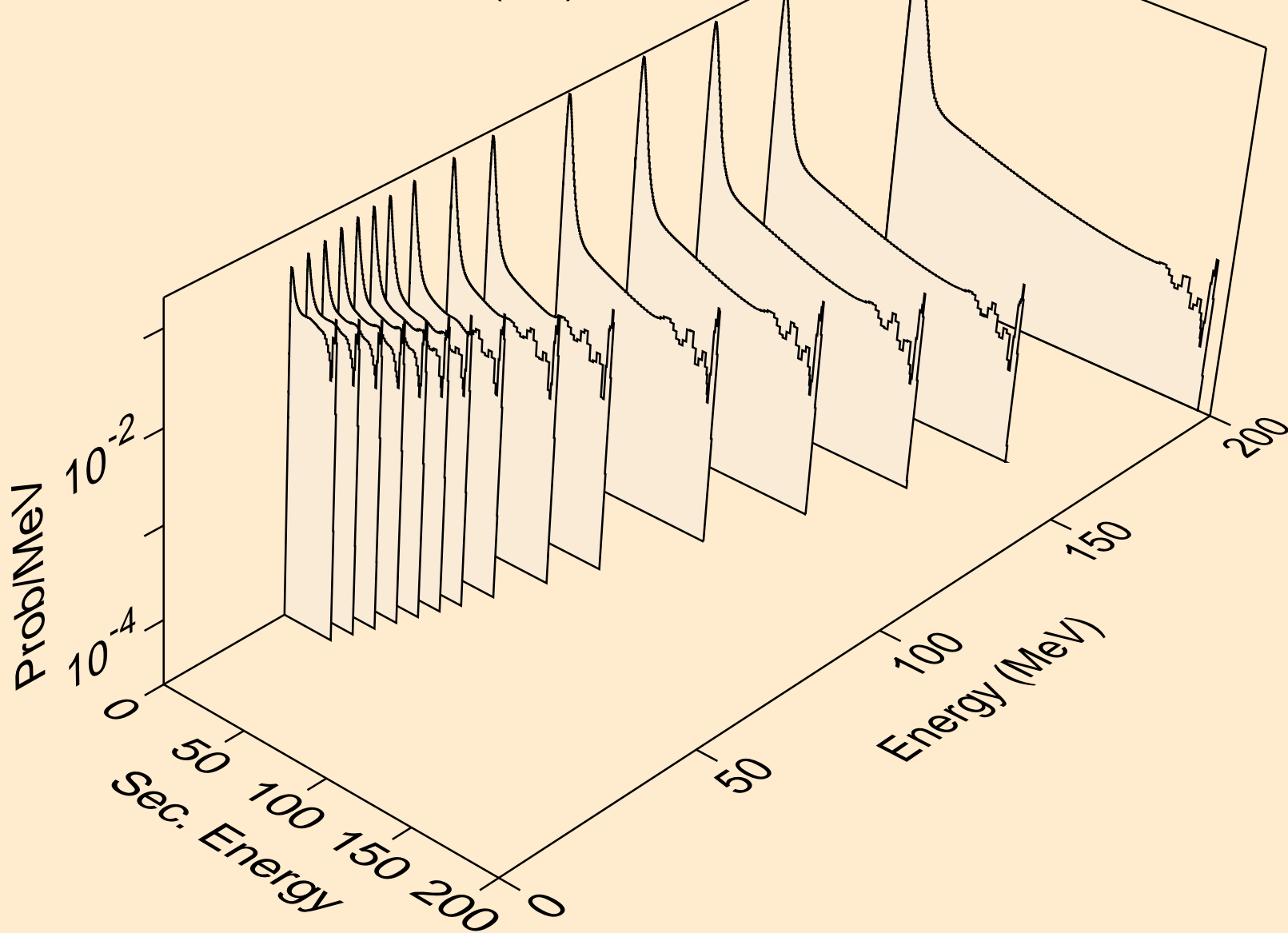

CU058 NEUTRON ACER TENDL-2019 LIBRARY; T=293.16K
Neutron emission for (n,2n)

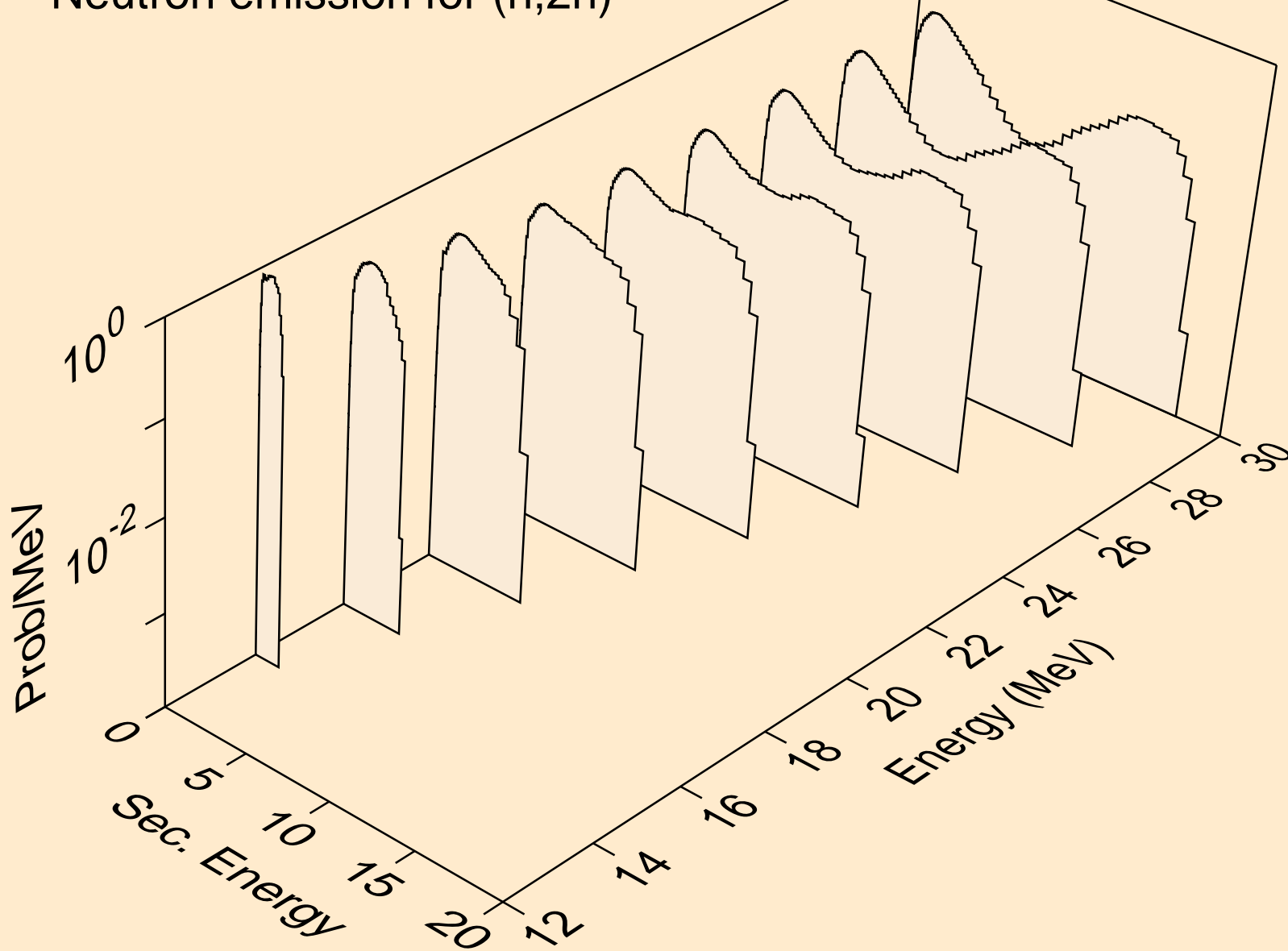

CU058 NEUTRON ACER TENDL-2019 LIBRARY; T=293.16K
Neutron emission for (n,n*)a

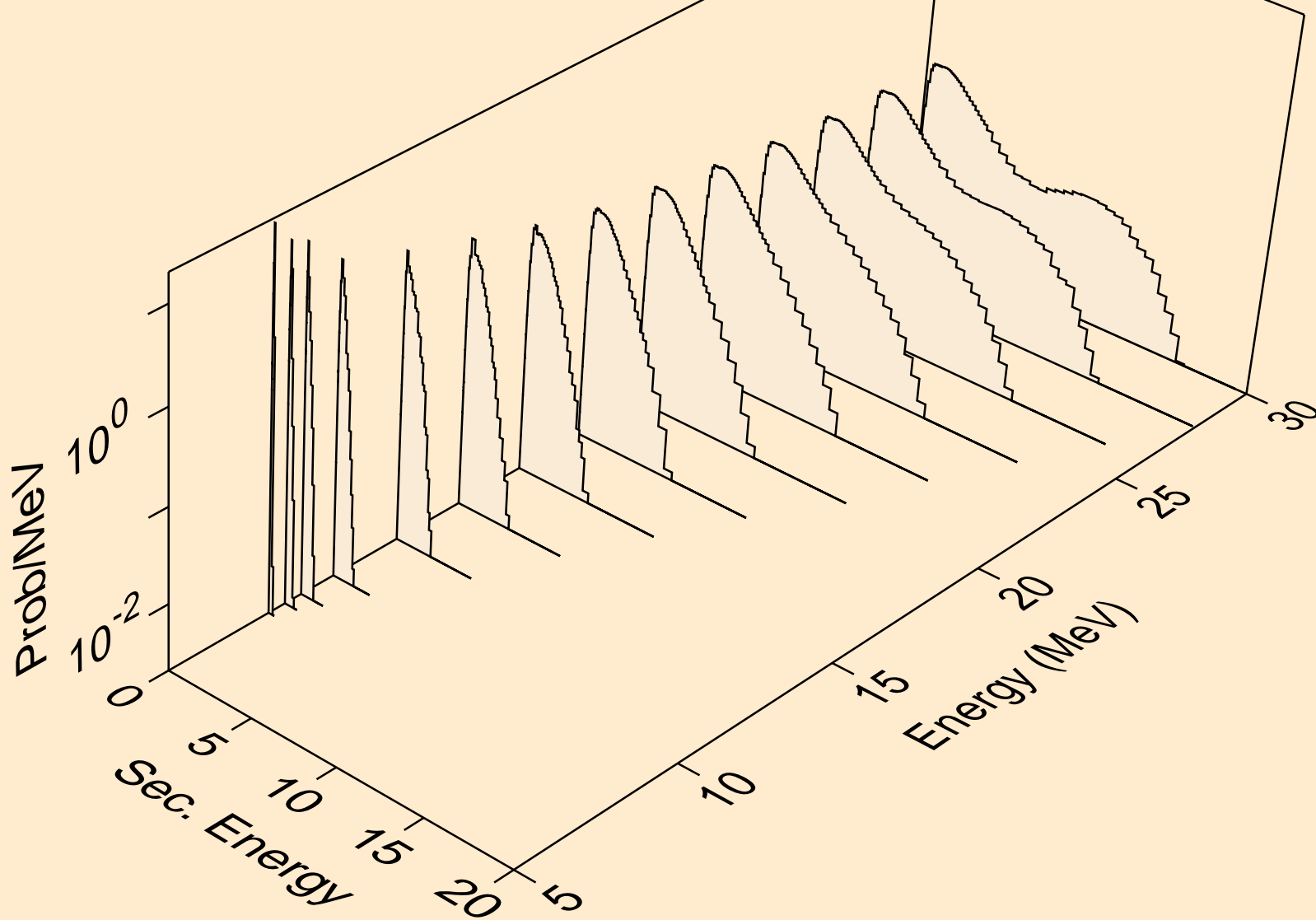

CU058 NEUTRON ACER TENDL-2019 LIBRARY; T=293.16K
Neutron emission for (n,2n)a

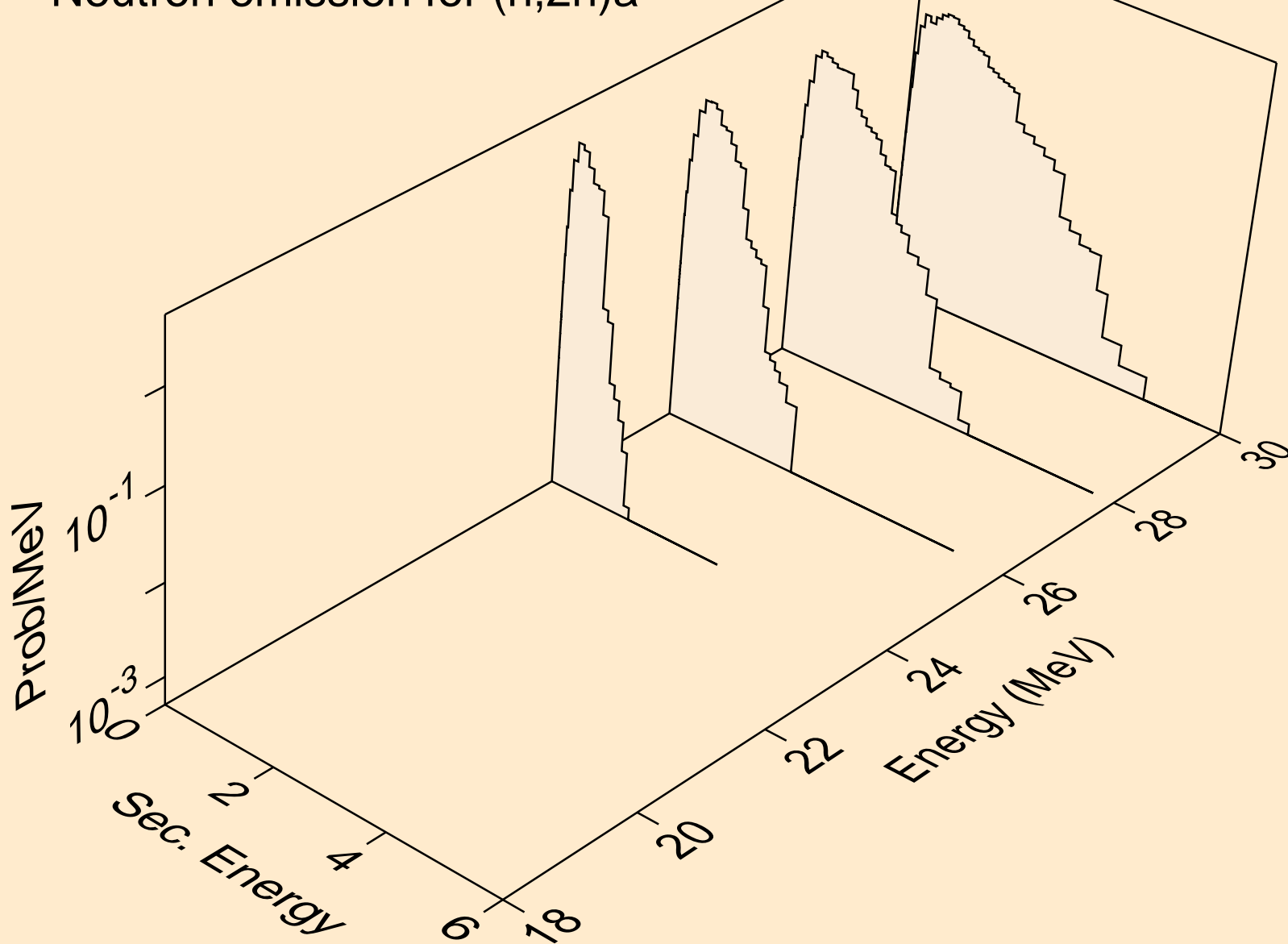

CU058 NEUTRON ACER TENDL-2019 LIBRARY; T=293.16K
Neutron emission for (n,n*)p

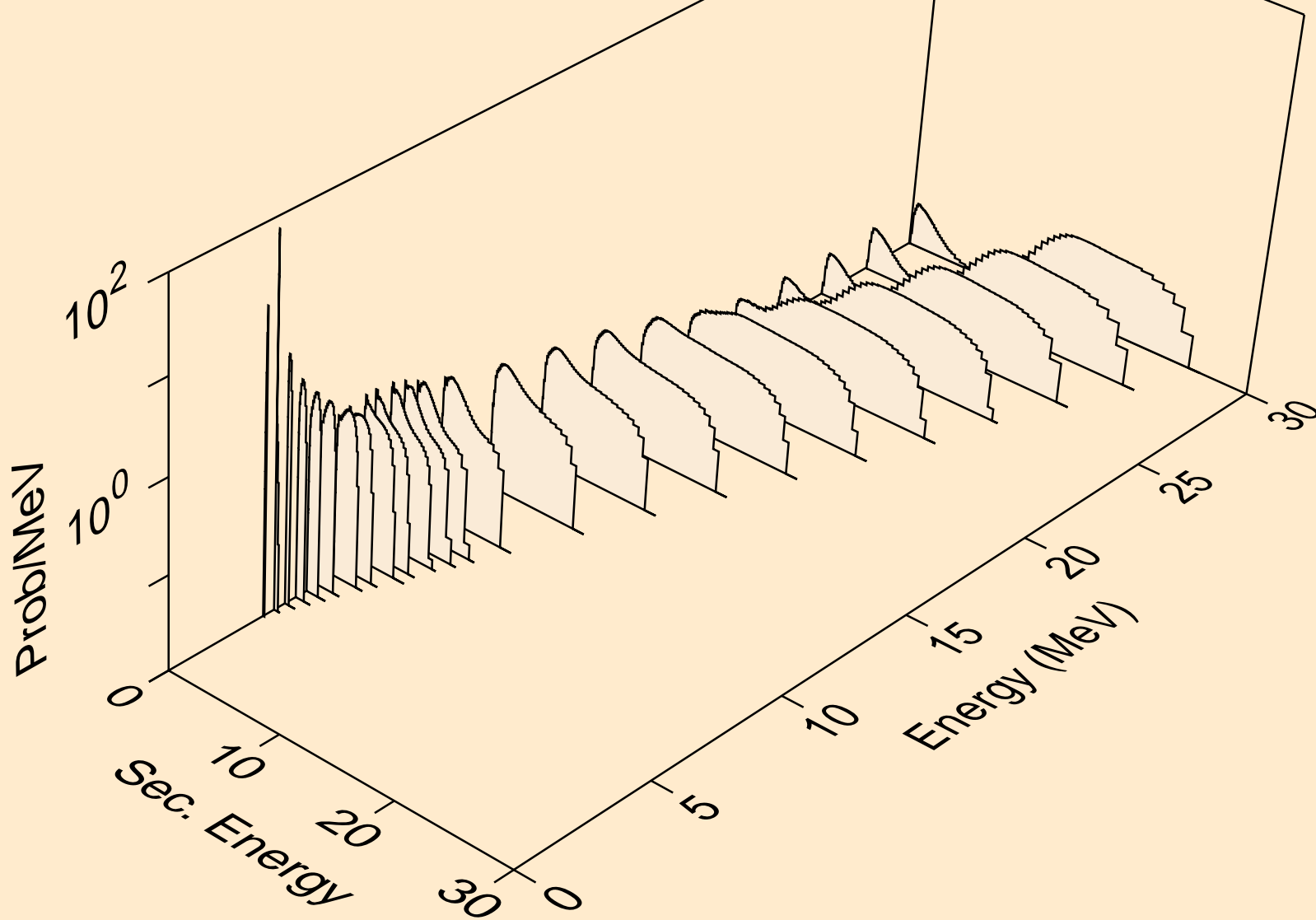

CU058 NEUTRON ACER TENDL-2019 LIBRARY; T=293.16K
Neutron emission for (n,n*)2a

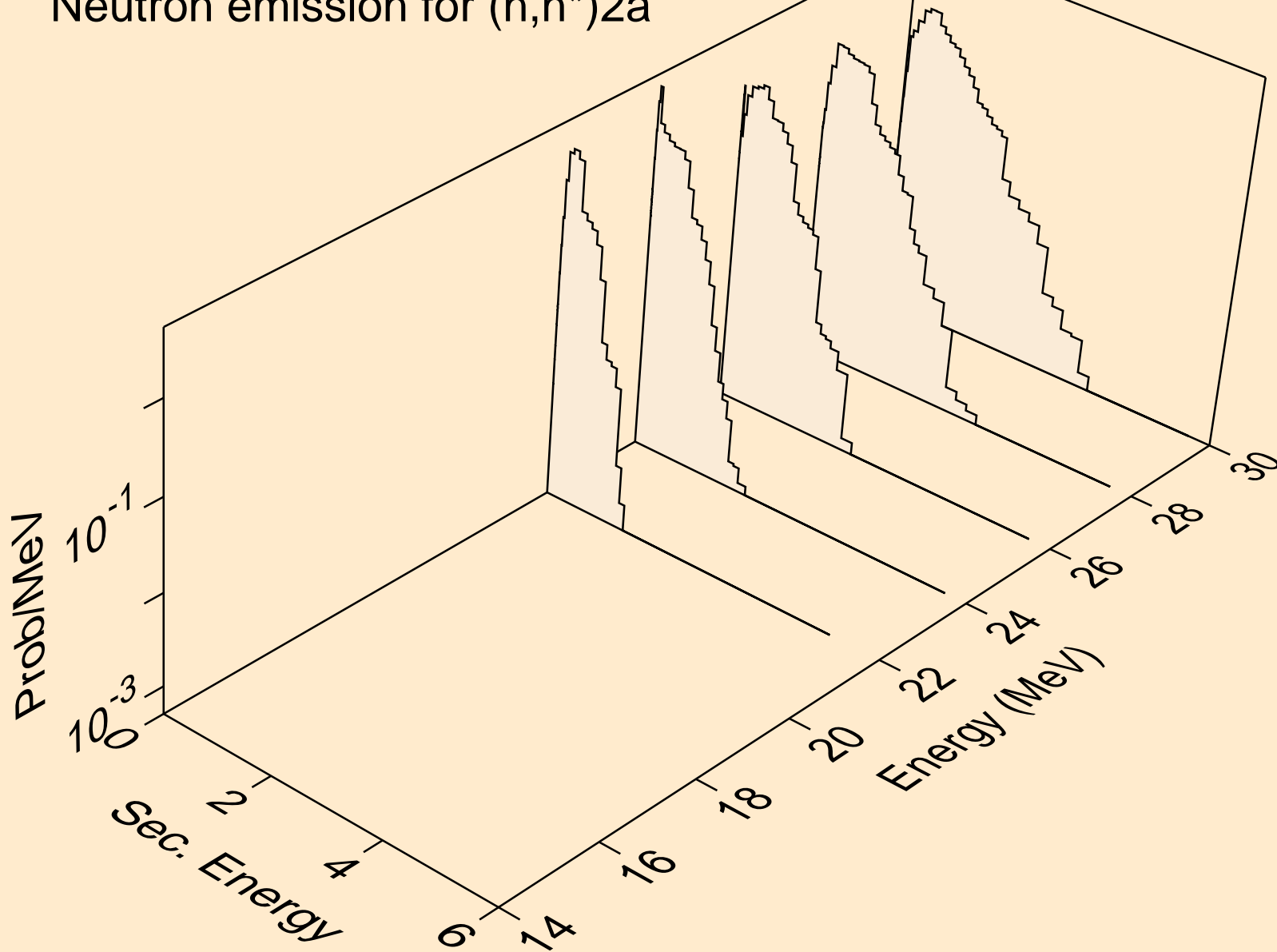

CU058 NEUTRON ACER TENDL-2019 LIBRARY; T=293.16K
Neutron emission for (n,n*)d

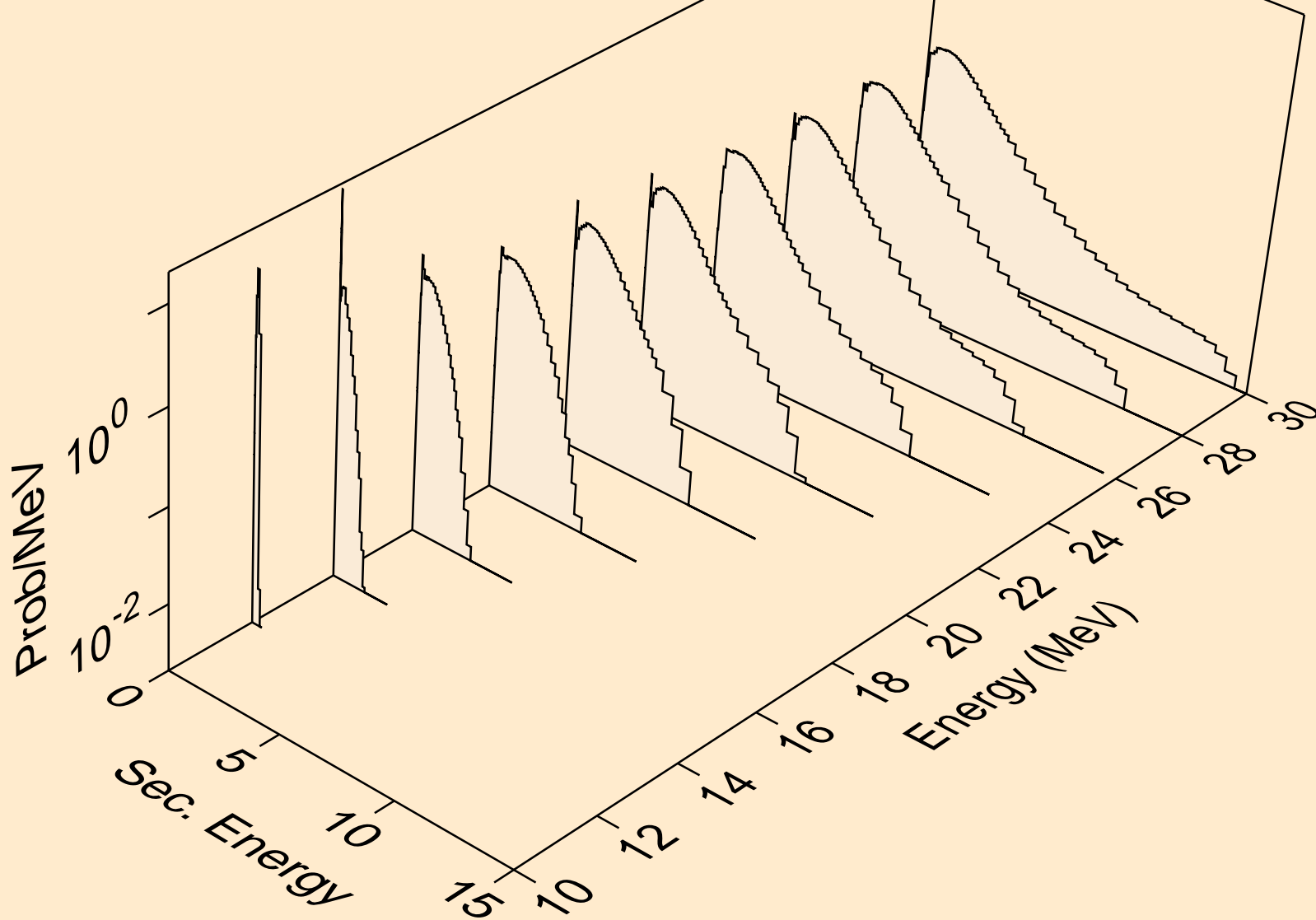

CU058 NEUTRON ACER TENDL-2019 LIBRARY; T=293.16K
Neutron emission for (n,n*)t

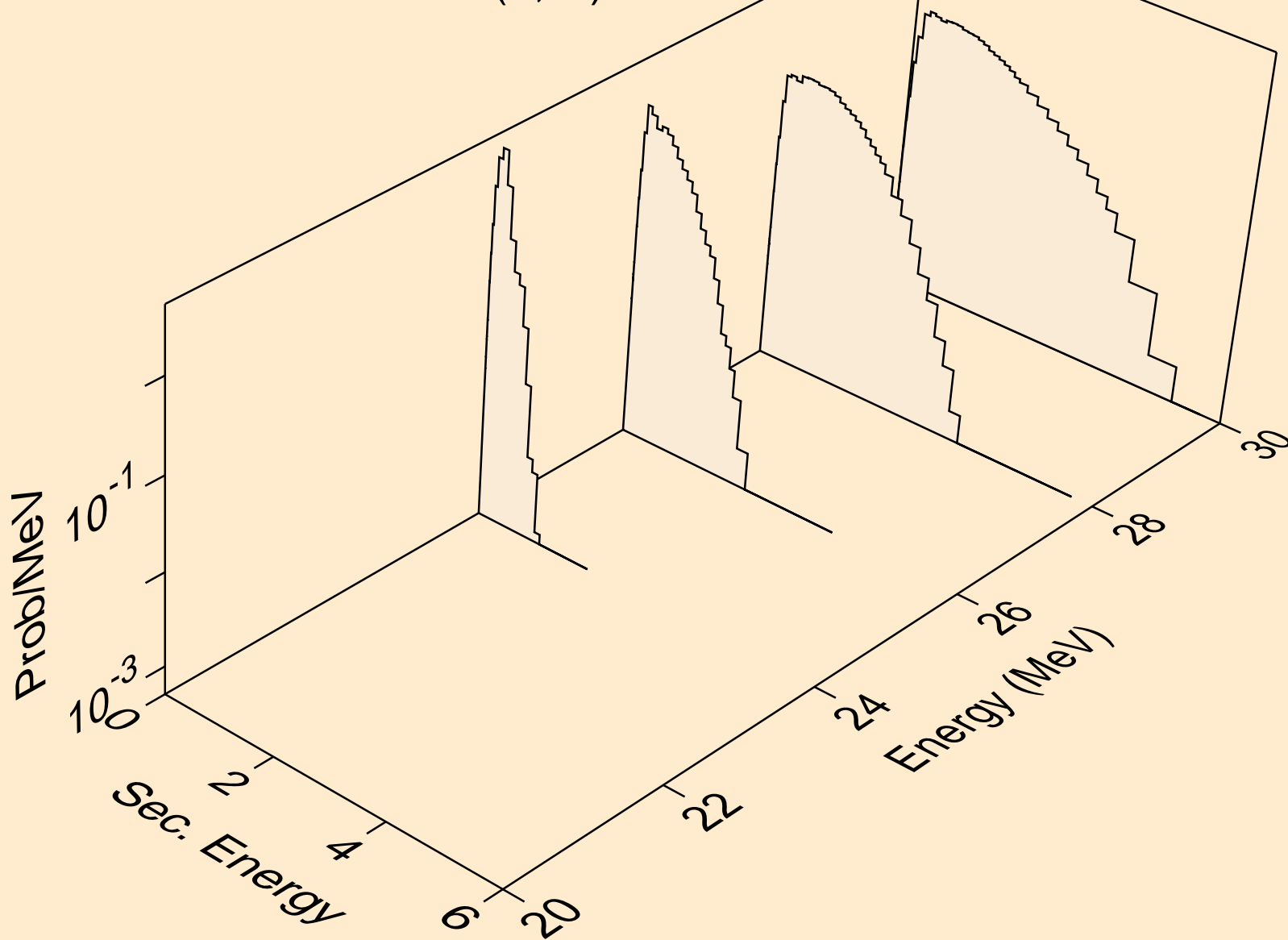

CU058 NEUTRON ACER TENDL-2019 LIBRARY; T=293.16K
Neutron emission for (n,n*)he3

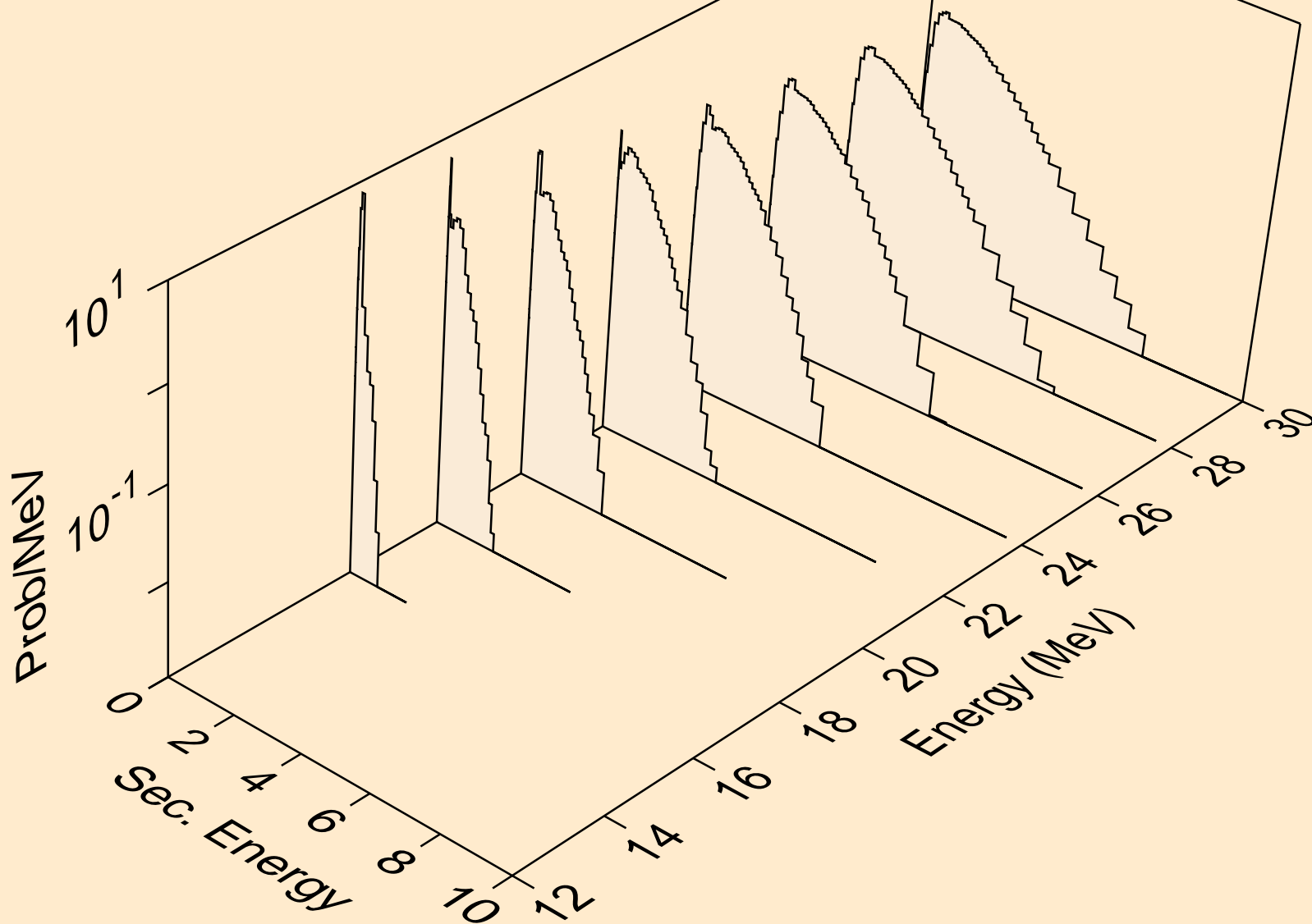

CU058 NEUTRON ACER TENDL-2019 LIBRARY; T=293.16K
Neutron emission for (n,2np)

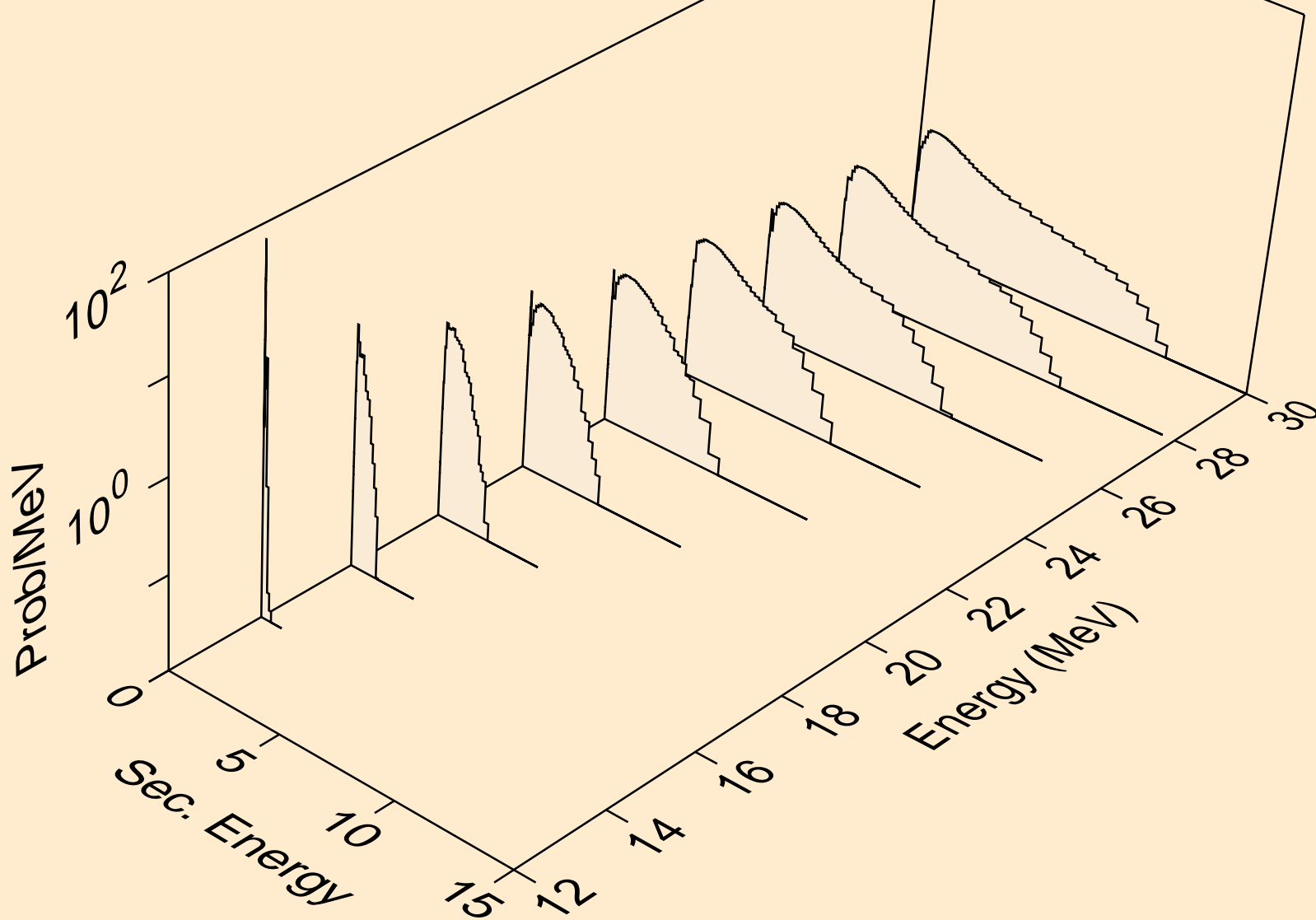

CU058 NEUTRON ACER TENDL-2019 LIBRARY; T=293.16K
Neutron emission for (n,2np)

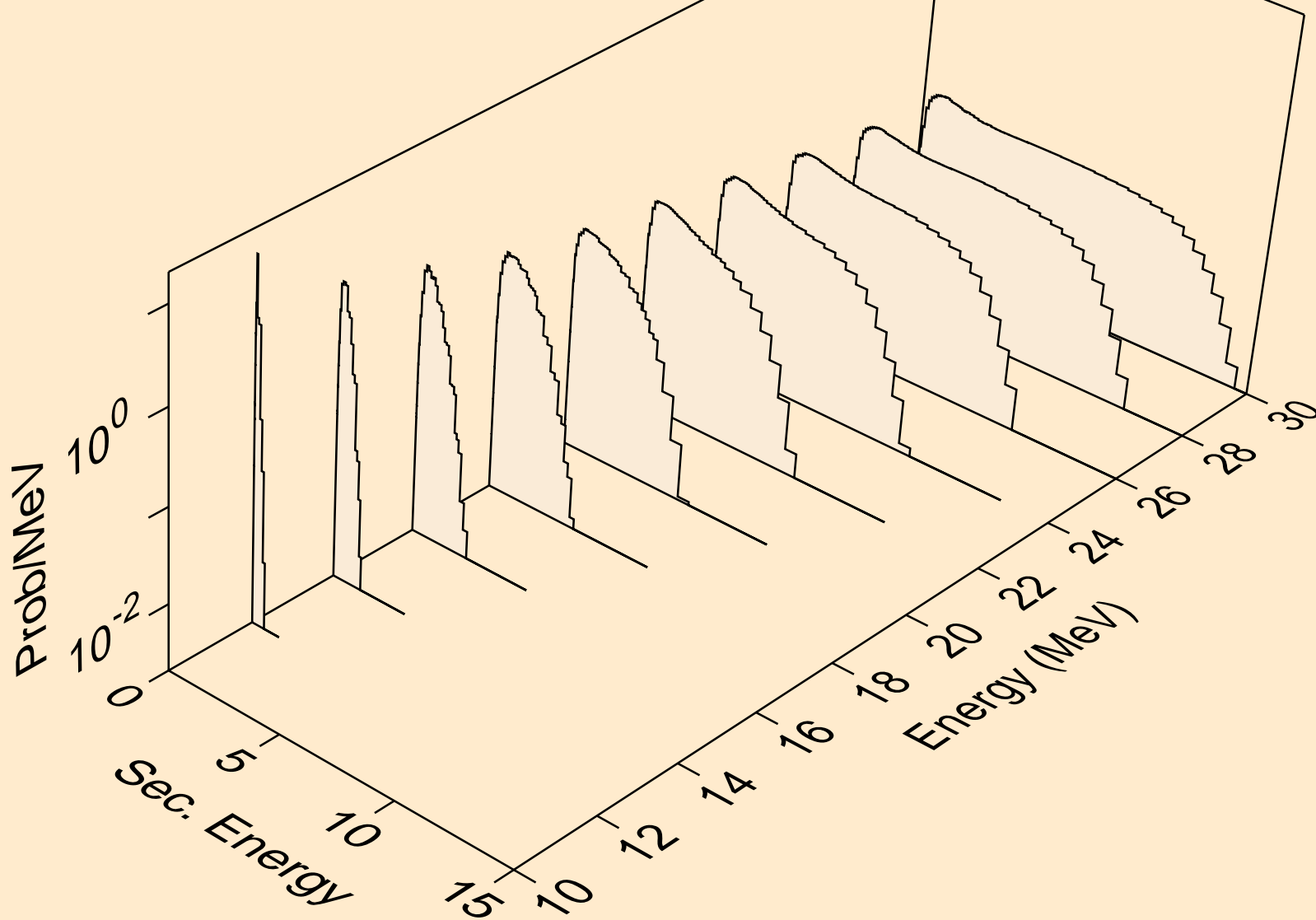

CU058 NEUTRON ACER TENDL-2019 LIBRARY; T=293.16K
Neutron emission for (n,npa)

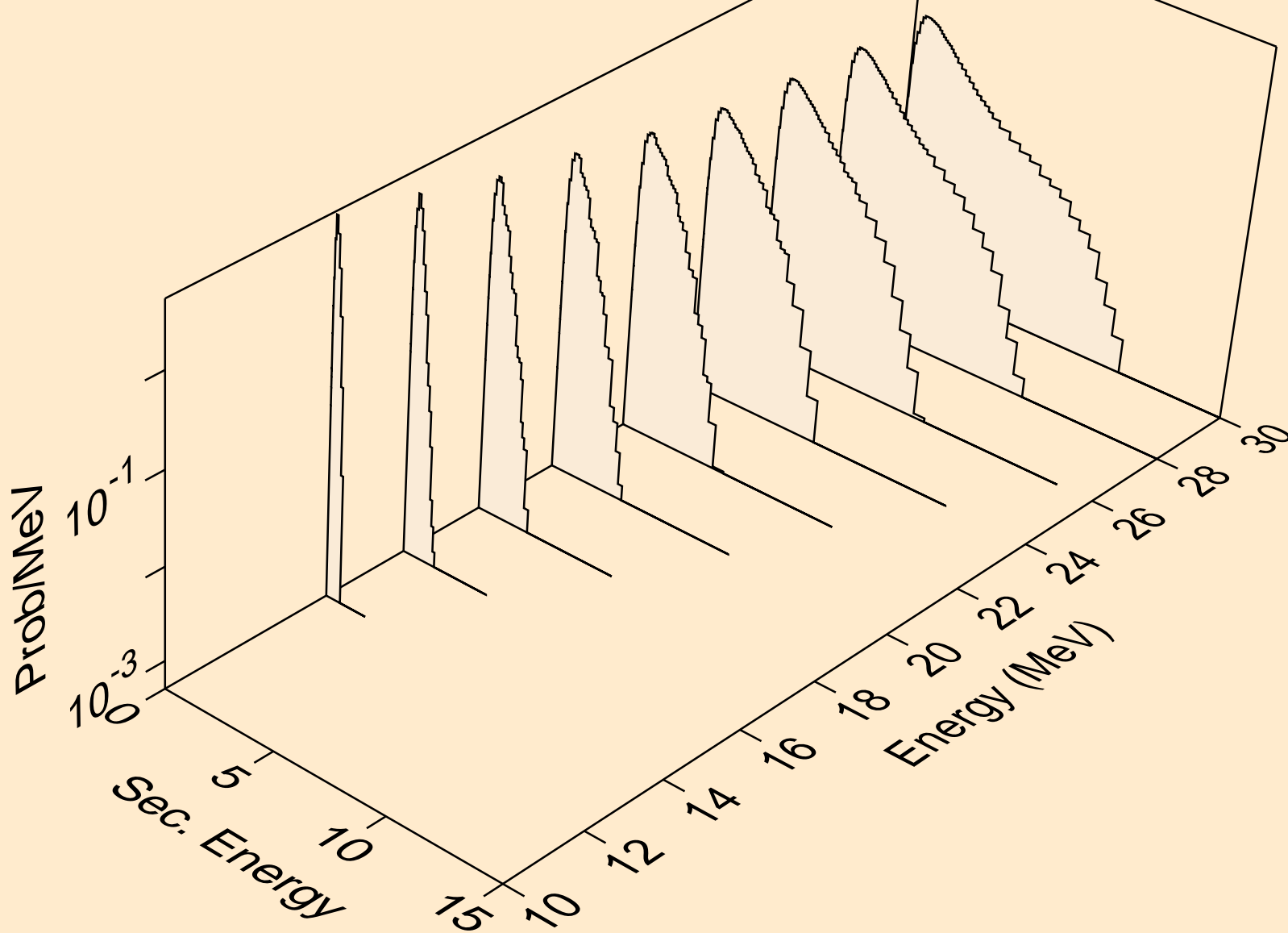

CU058 NEUTRON ACER TENDL-2019 LIBRARY; T=293.16K
Neutron emission for (n,n*c)

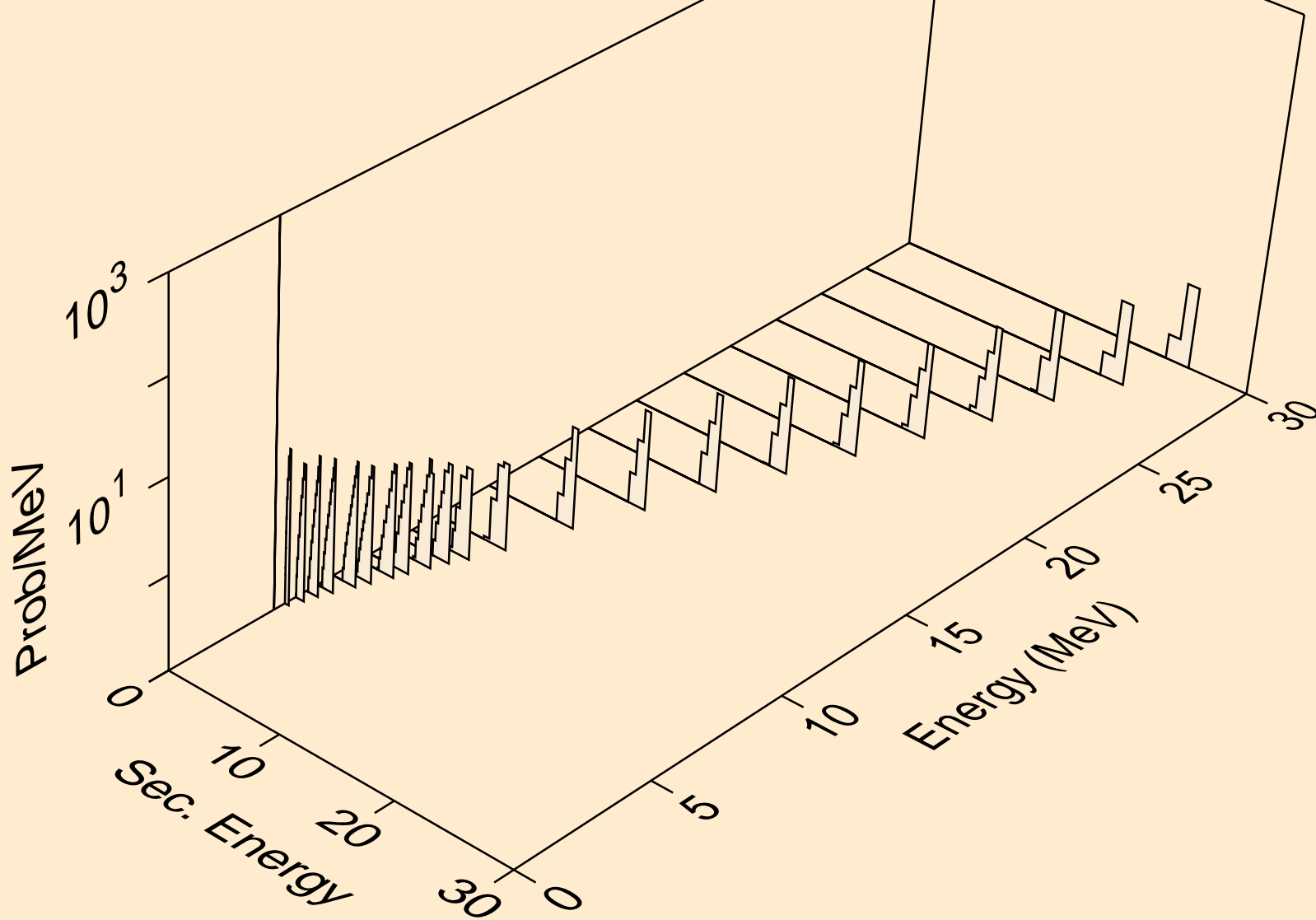

CU058 NEUTRON ACER TENDL-2019 LIBRARY; T=293.16K
Photon emission for (n,x)

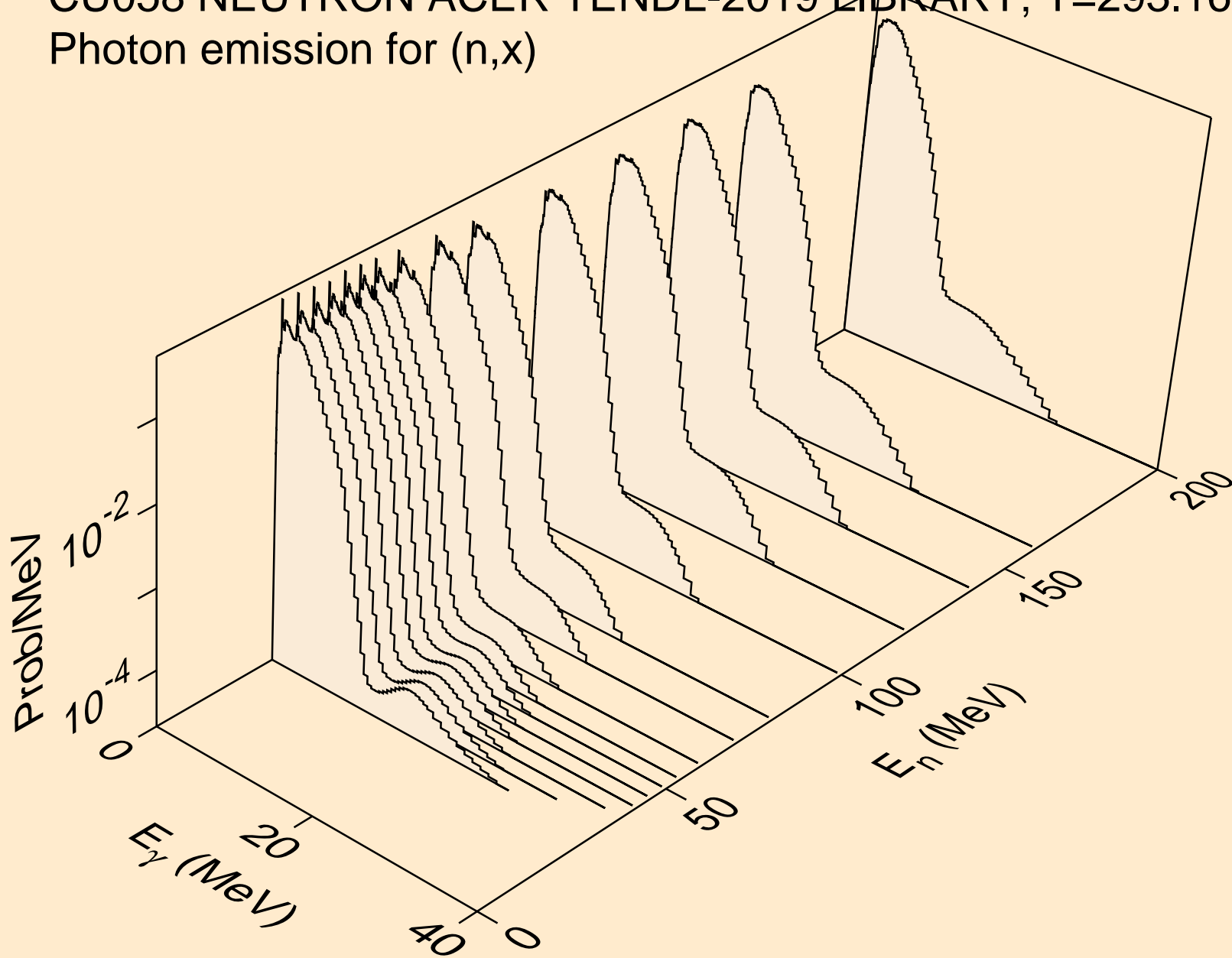

CU058 NEUTRON ACER TENDL-2019 LIBRARY; T=293.16K
Photon emission for (n,2n)

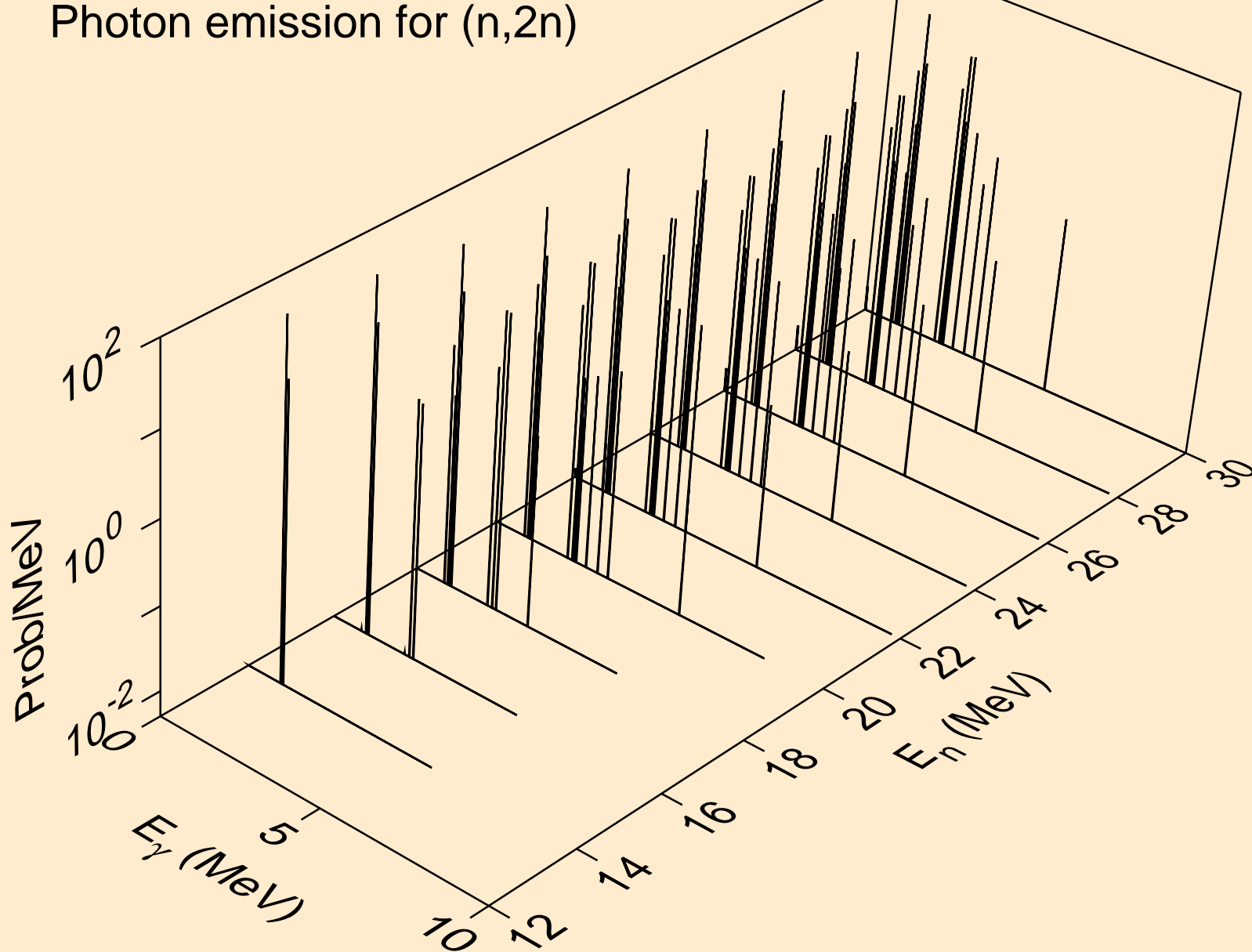

CU058 NEUTRON ACER TENDL-2019 LIBRARY; T=293.16K
Photon emission for (n,n*)a

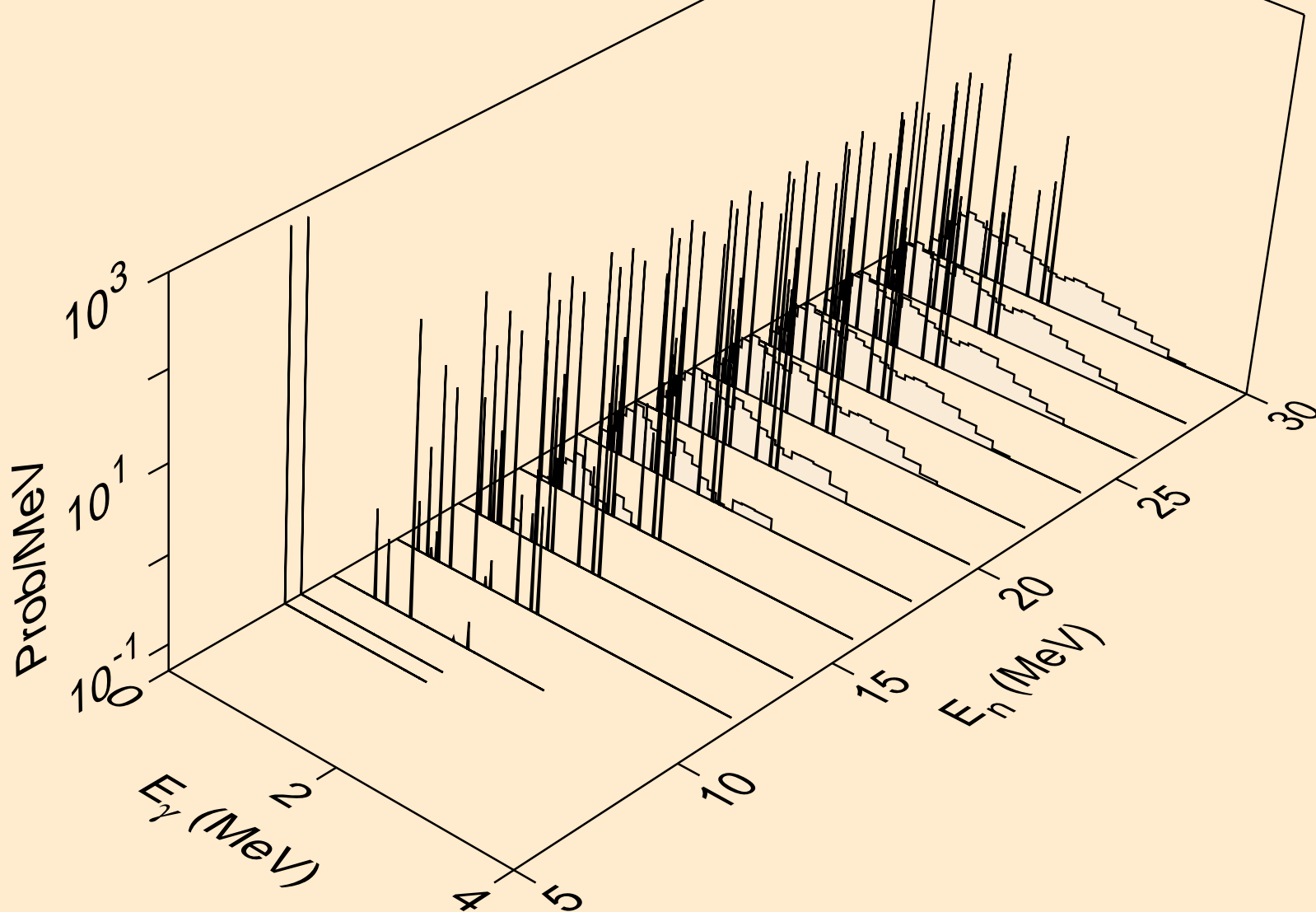

CU058 NEUTRON ACER TENDL-2019 LIBRARY; T=293.16K
Photon emission for (n,2n)a

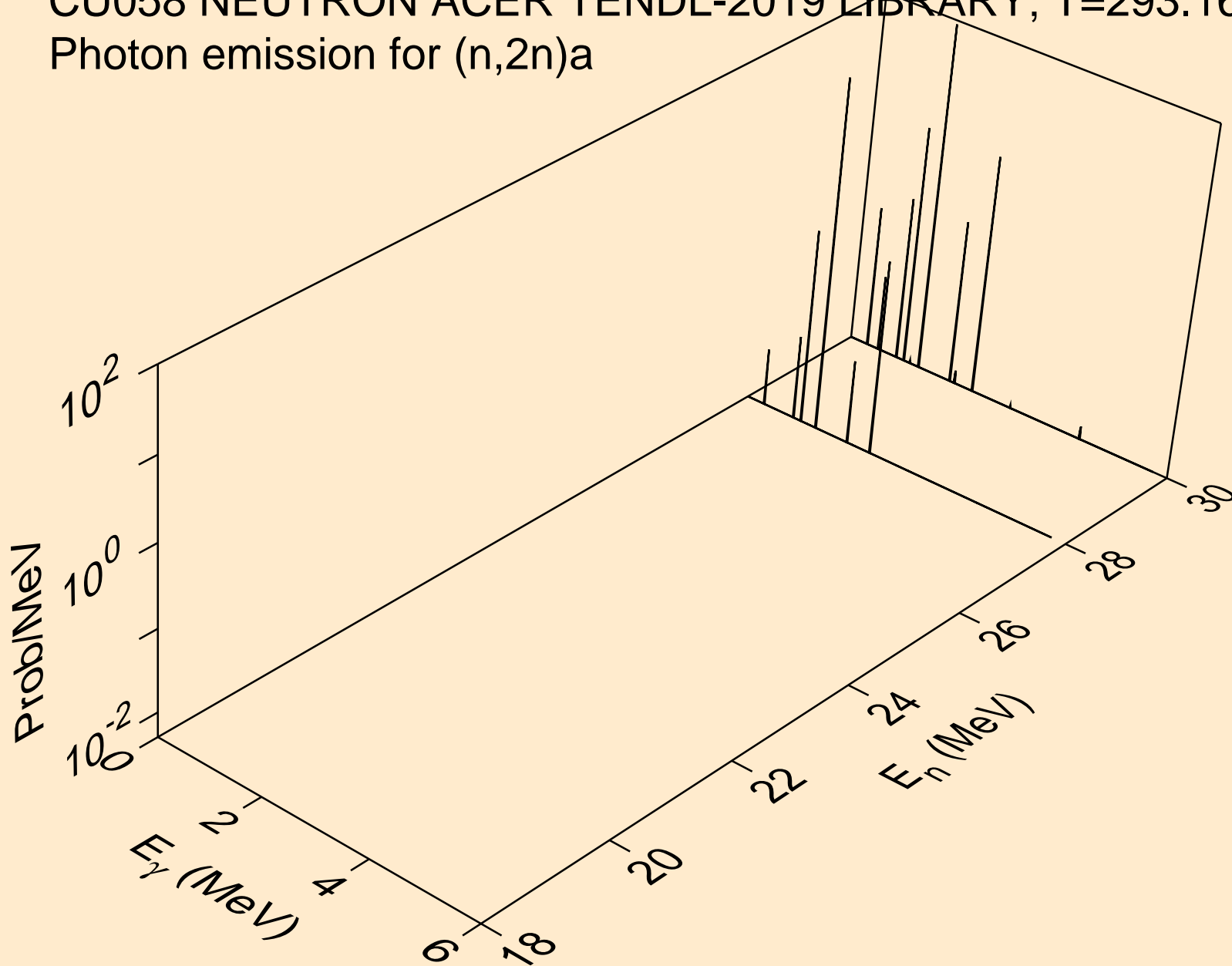

CU058 NEUTRON ACER TENDL-2019 LIBRARY; T=293.16K
Photon emission for (n,n*)p

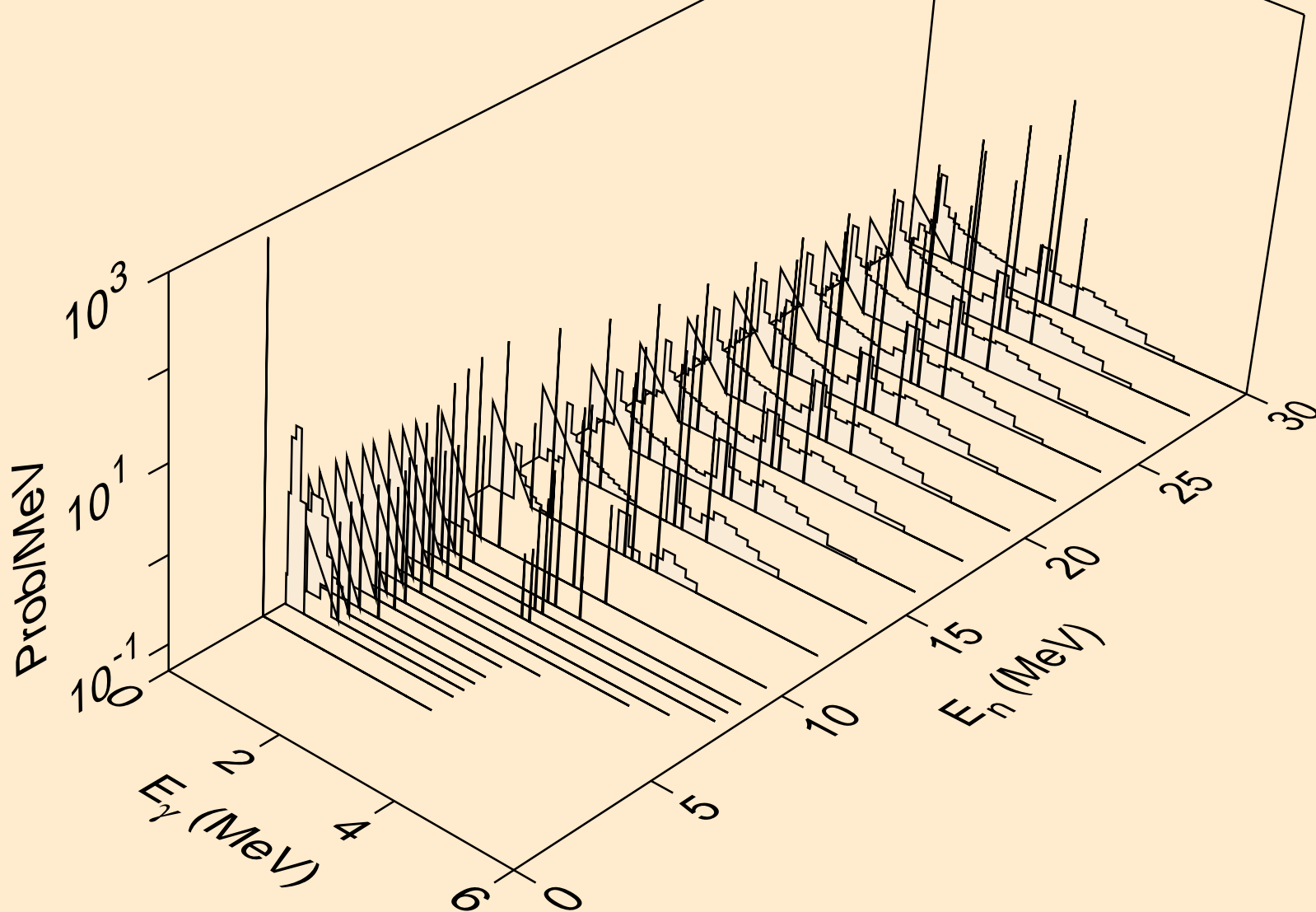

CU058 NEUTRON ACER TENDL-2019 LIBRARY; T=293.16K
Photon emission for (n,n*)2a

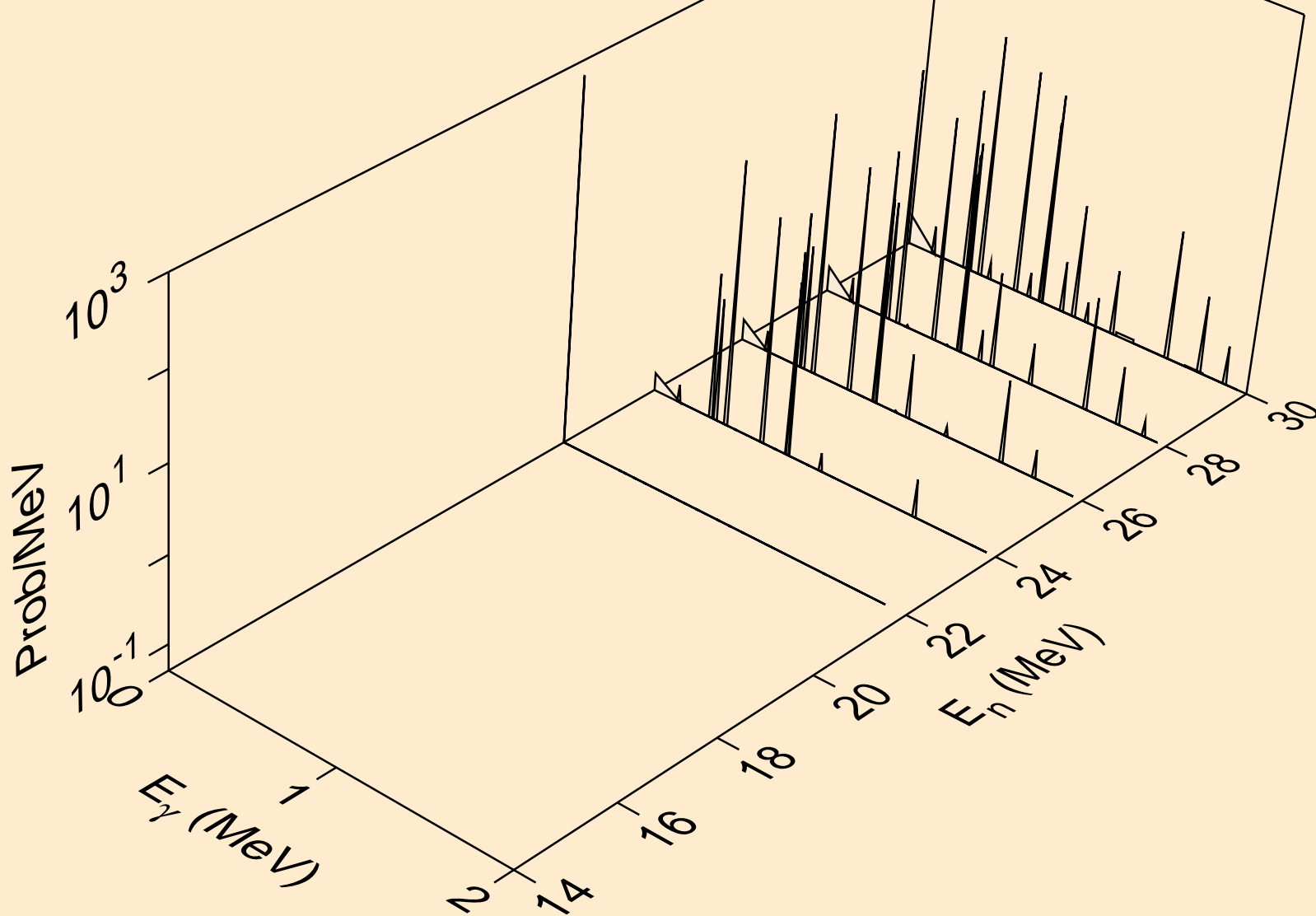

CU058 NEUTRON ACER TENDL-2019 LIBRARY; T=293.16K
Photon emission for (n,n*)d

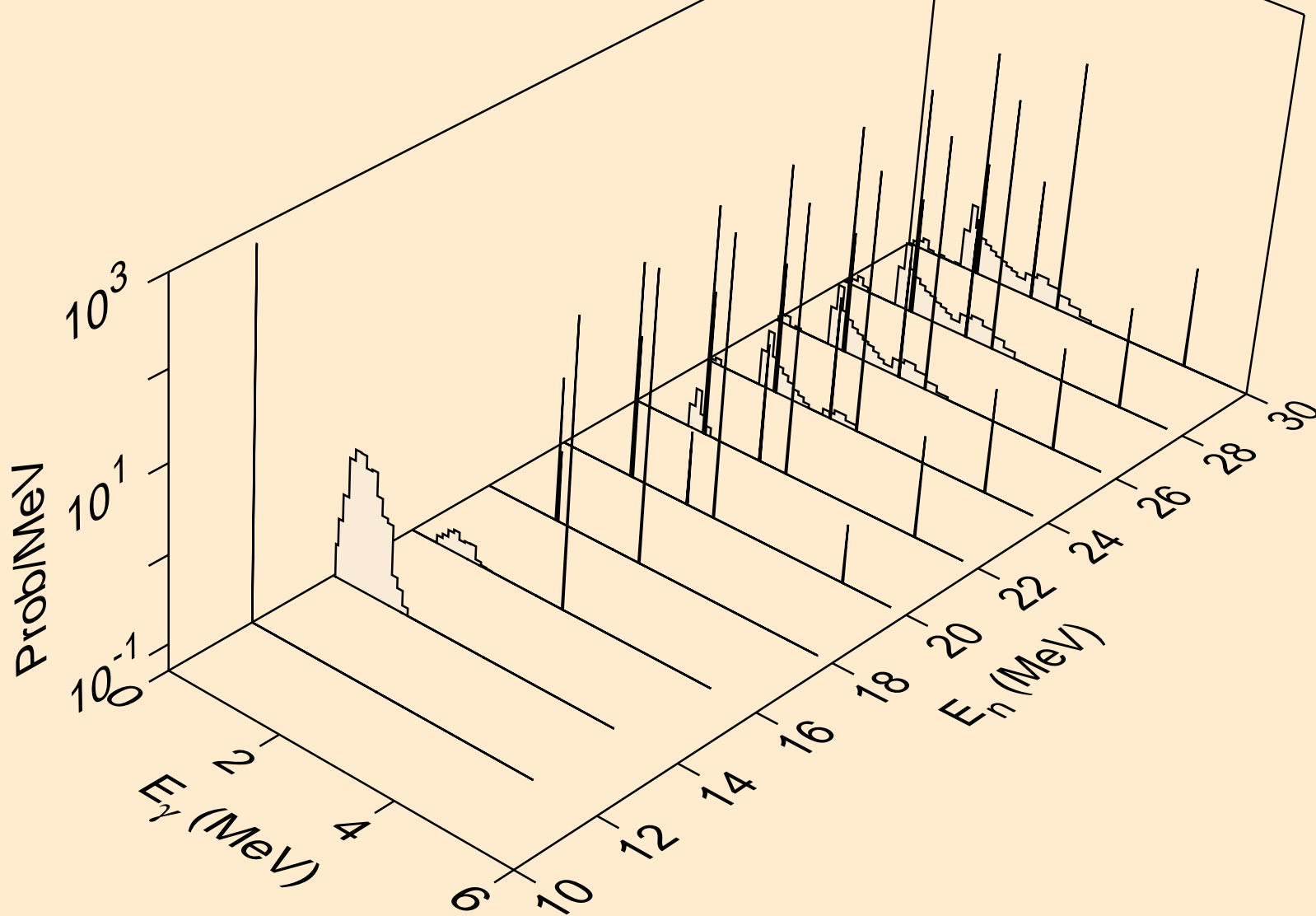

CU058 NEUTRON ACER TENDL-2019 LIBRARY; T=293.16K
Photon emission for (n,n*)t

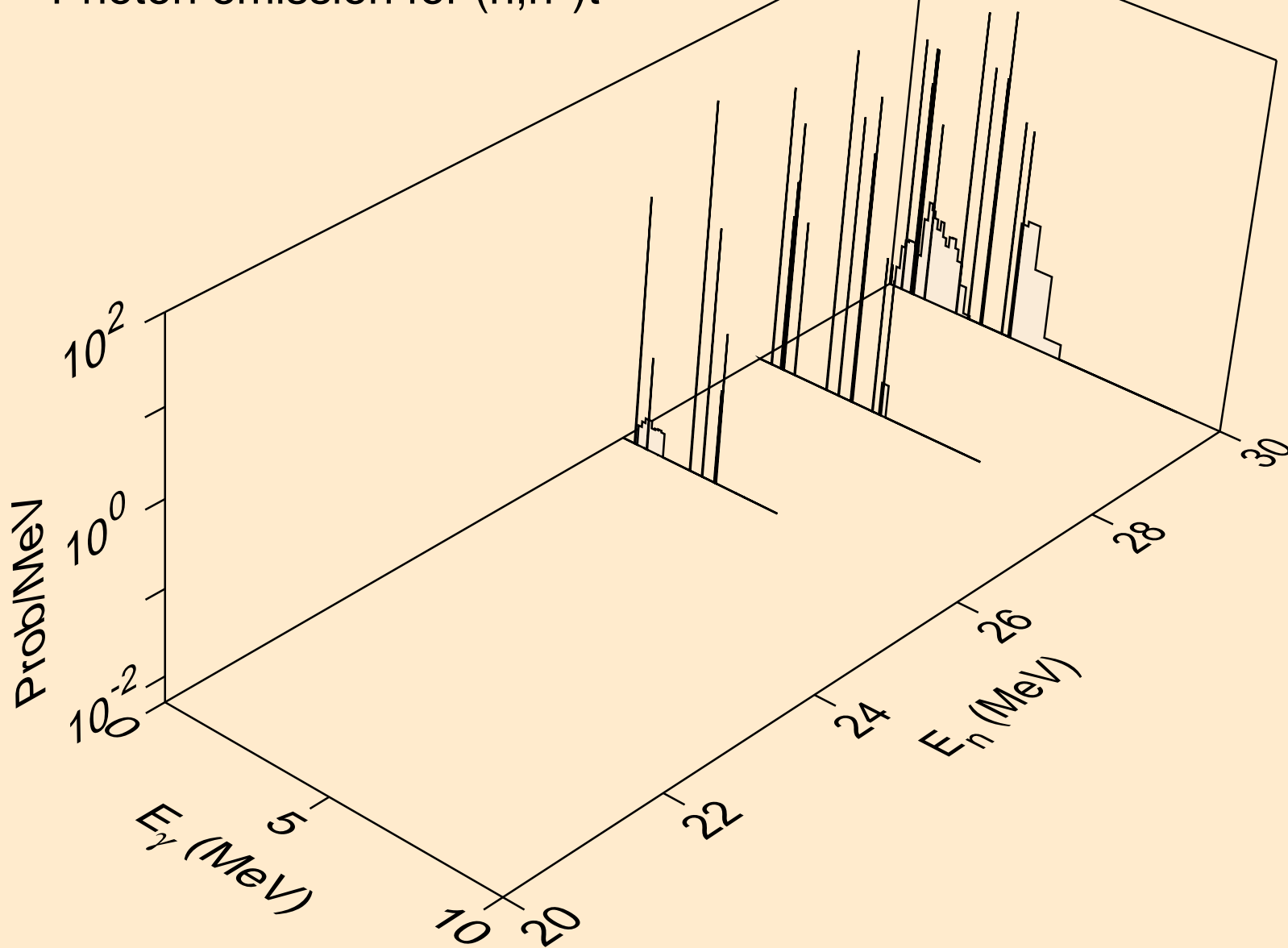

CU058 NEUTRON ACER TENDL-2019 LIBRARY; T=293.16K
Photon emission for (n,n*)he3

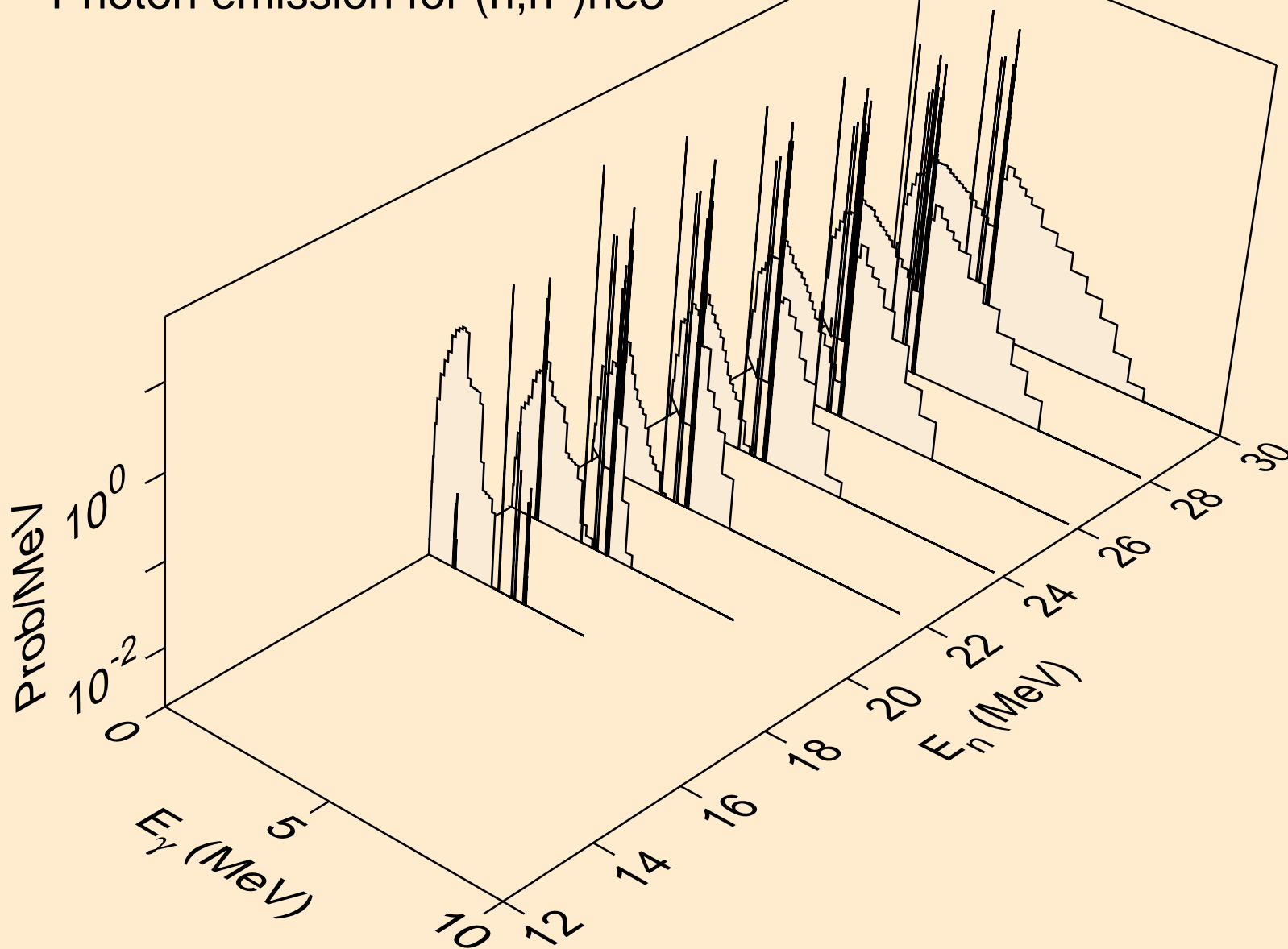

CU058 NEUTRON ACER TENDL-2019 LIBRARY; T=293.16K
Photon emission for (n,2np)

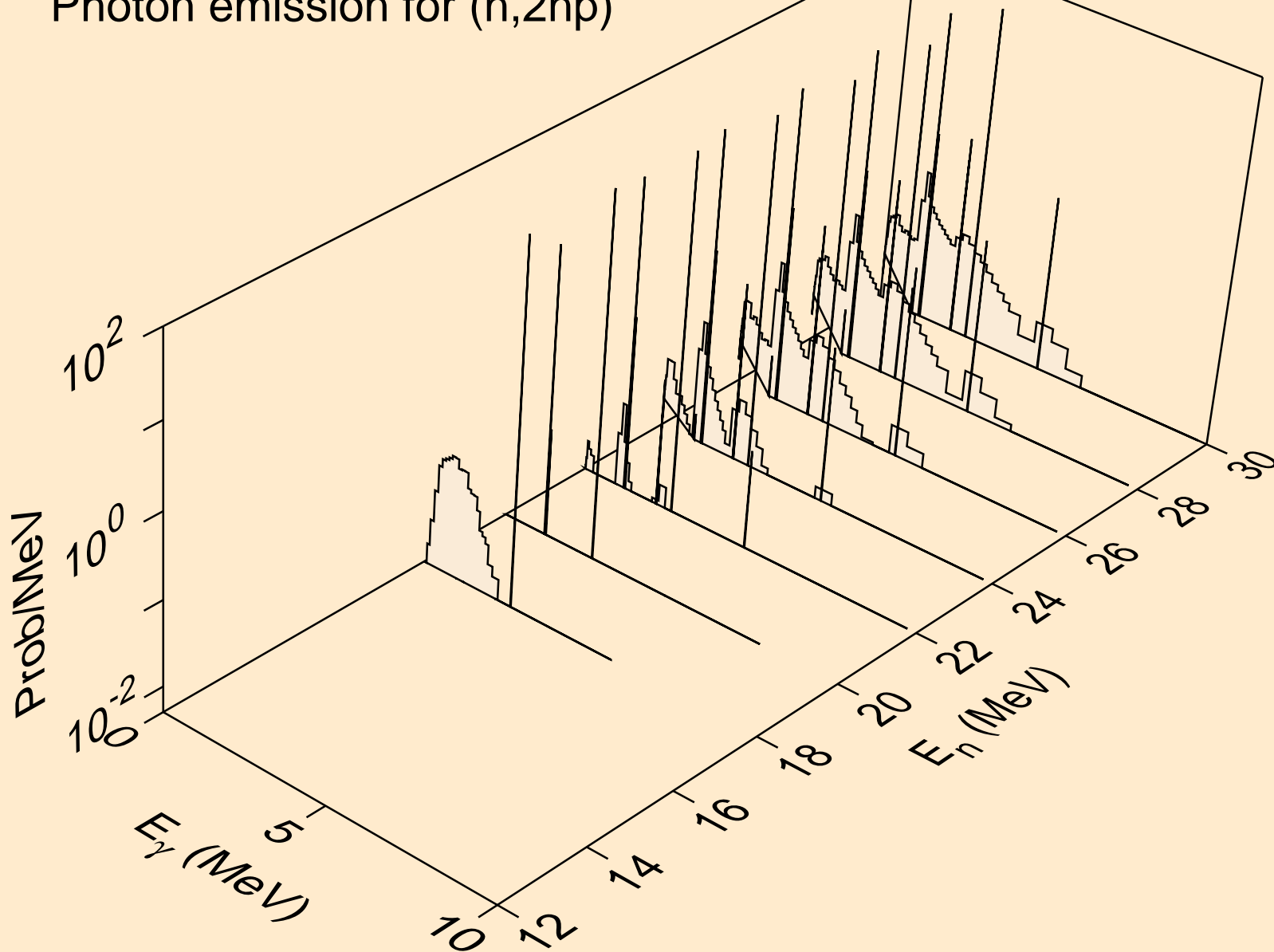

CU058 NEUTRON ACER TENDL-2019 LIBRARY; T=293.16K
Photon emission for (n,2np)

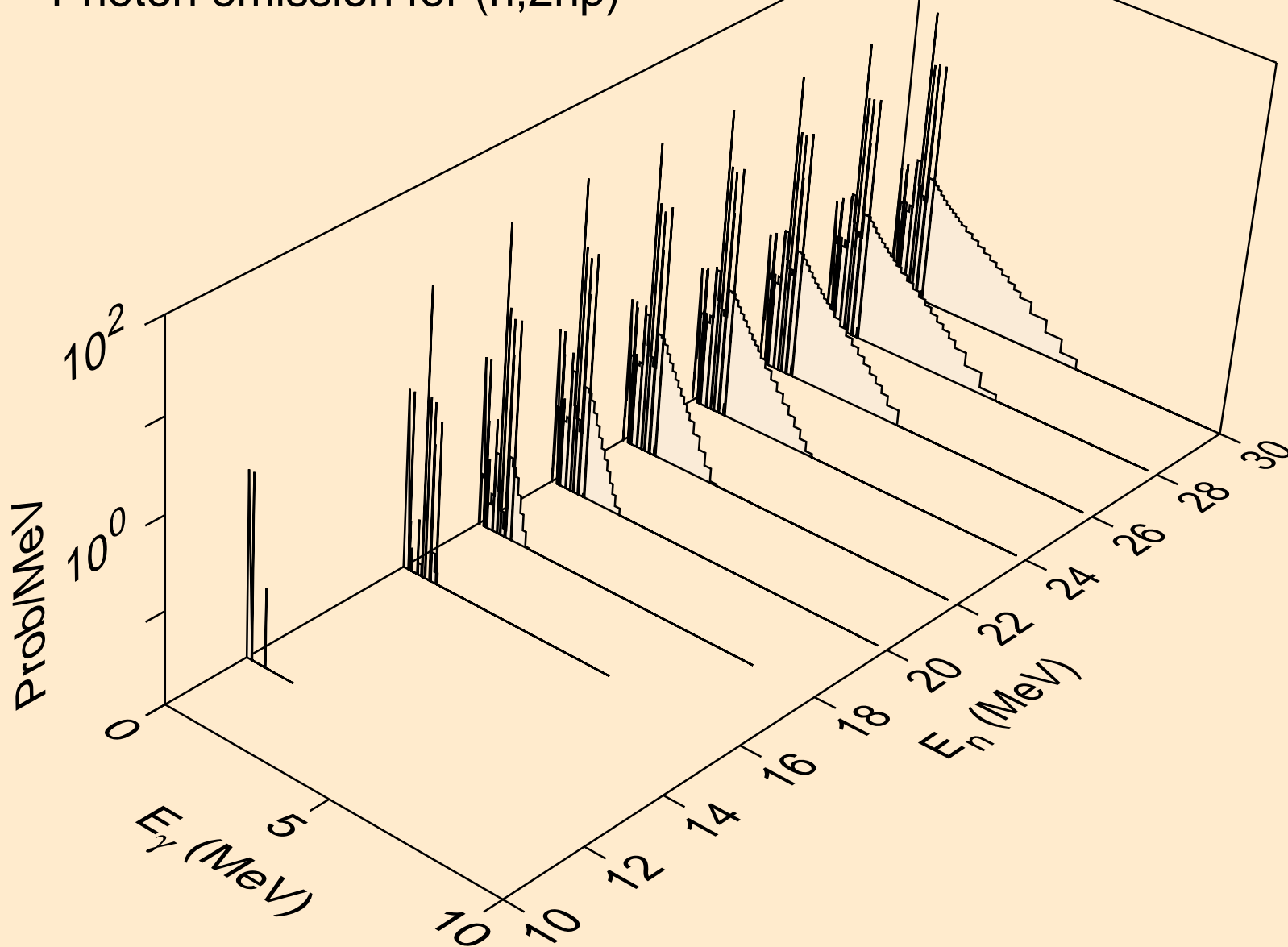

CU058 NEUTRON ACER TENDL-2019 LIBRARY; T=293.16K
Photon emission for (n,npa)

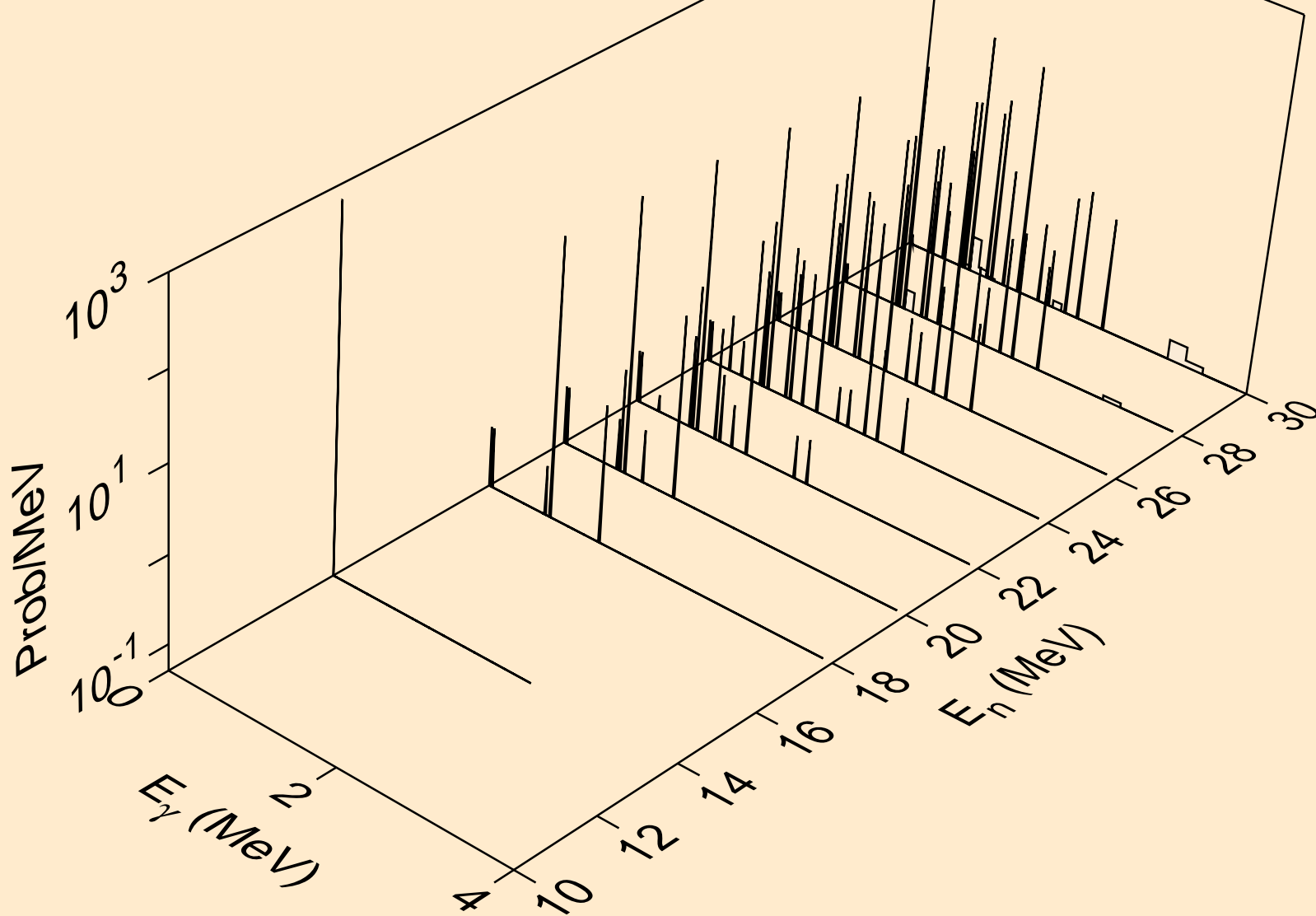

CU058 NEUTRON ACER TENDL-2019 LIBRARY; T=293.16K
Photon emission for (n,n*c)

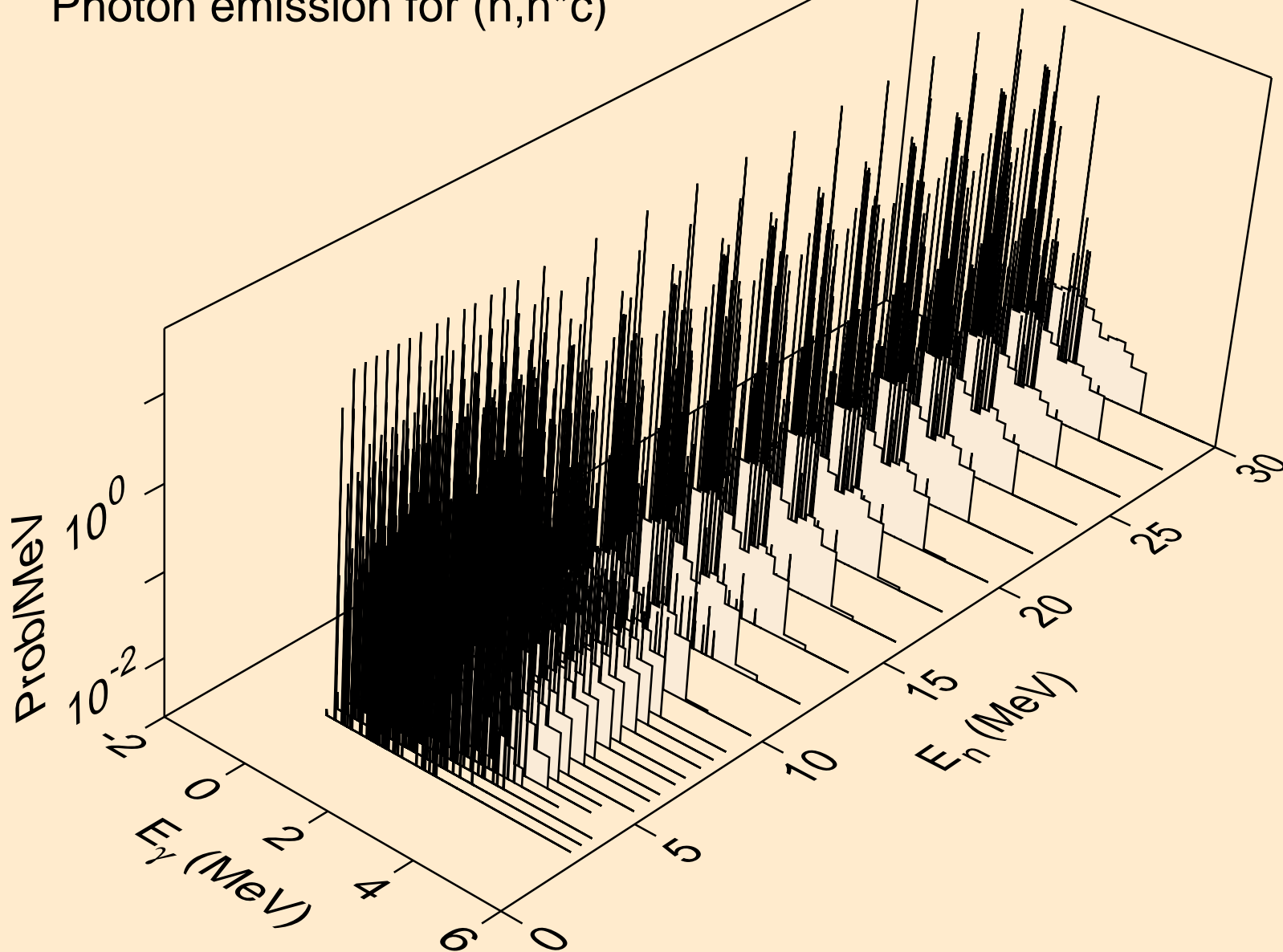

CU058 NEUTRON ACER TENDL-2019 LIBRARY; T=293.16K
Photon emission for (n,gma)

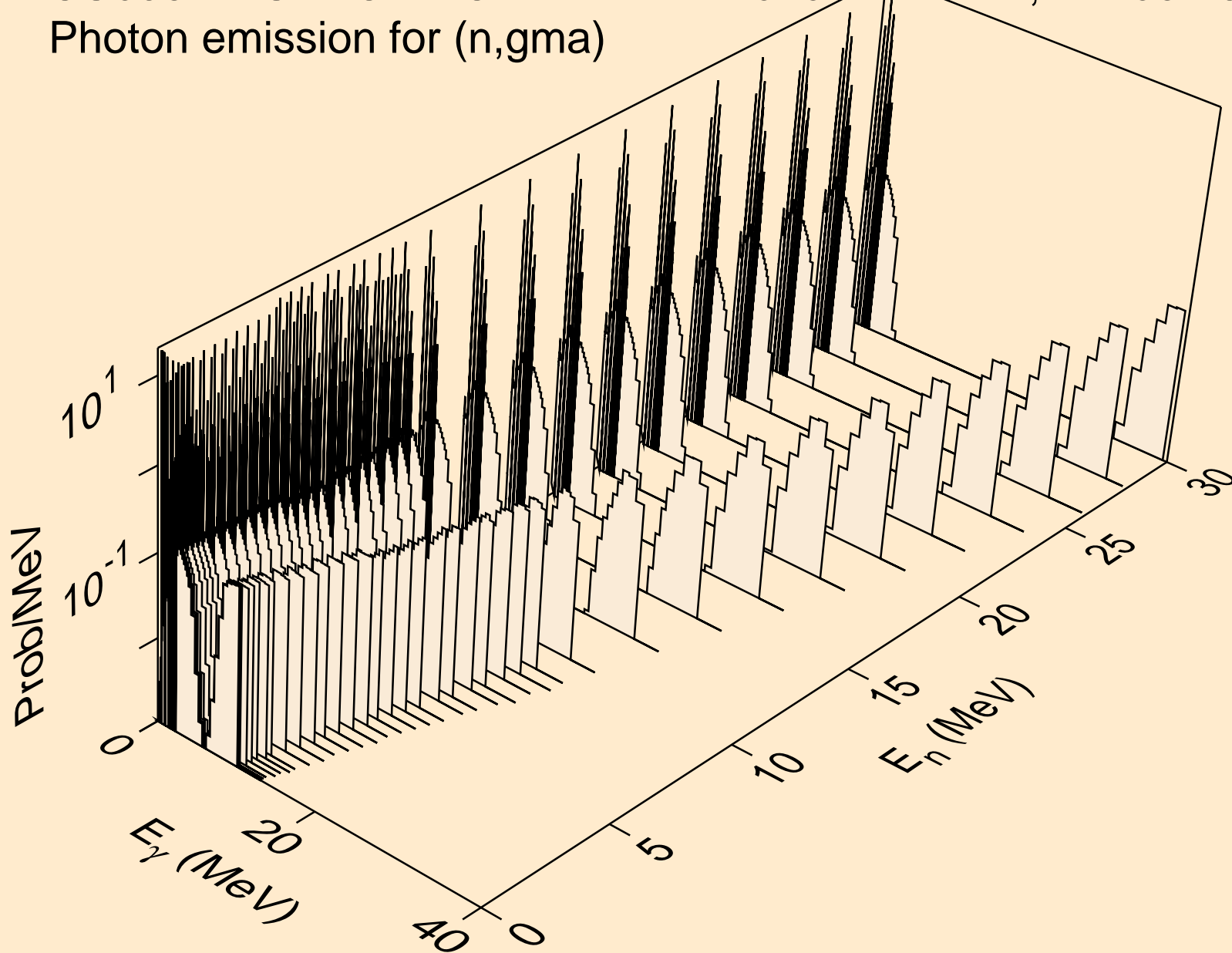

CU058 NEUTRON ACER TENDL-2019 LIBRARY; T=293.16K
Photon emission for (n,p)

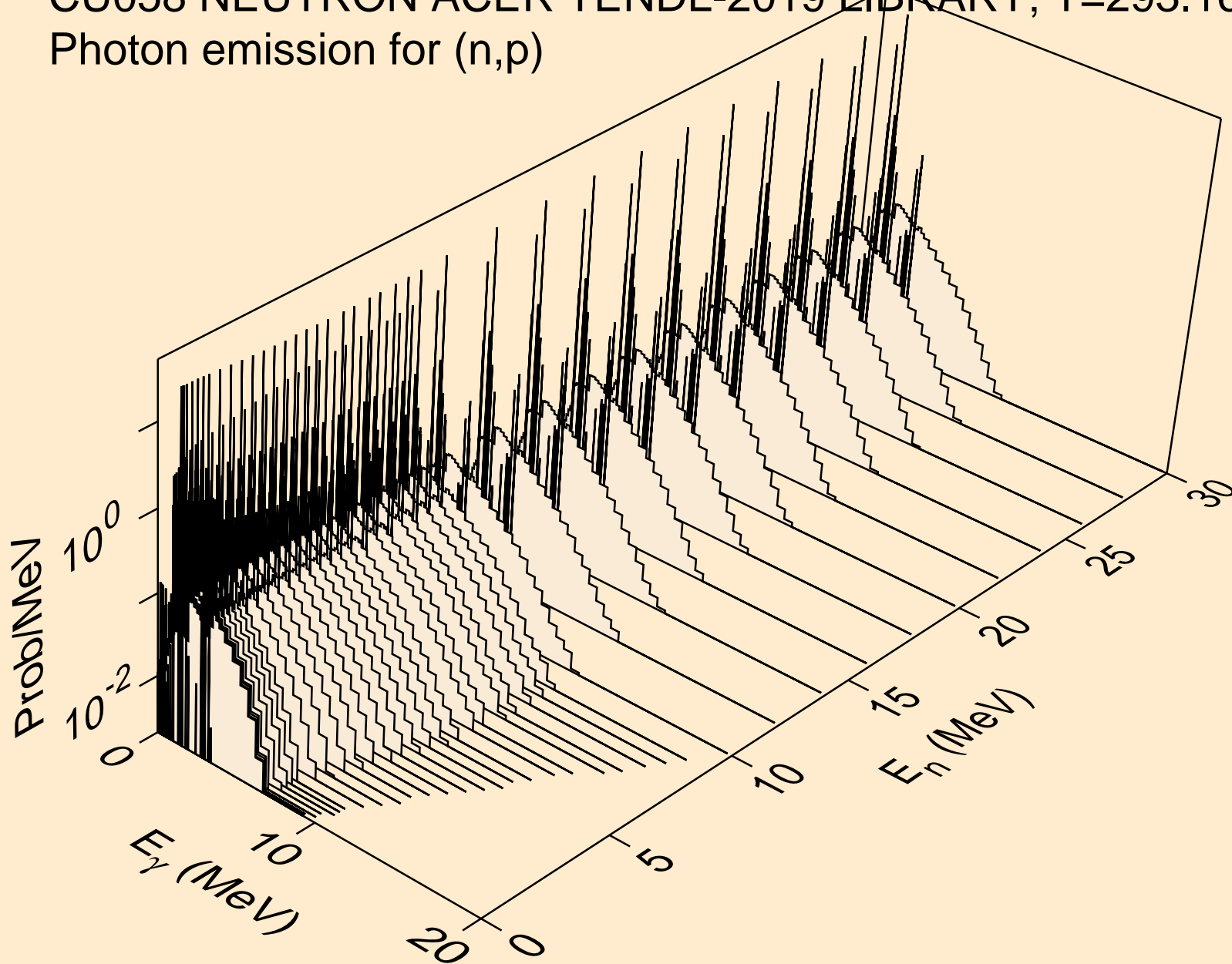

CU058 NEUTRON ACER TENDL-2019 LIBRARY; T=293.16K
Photon emission for (n,d)

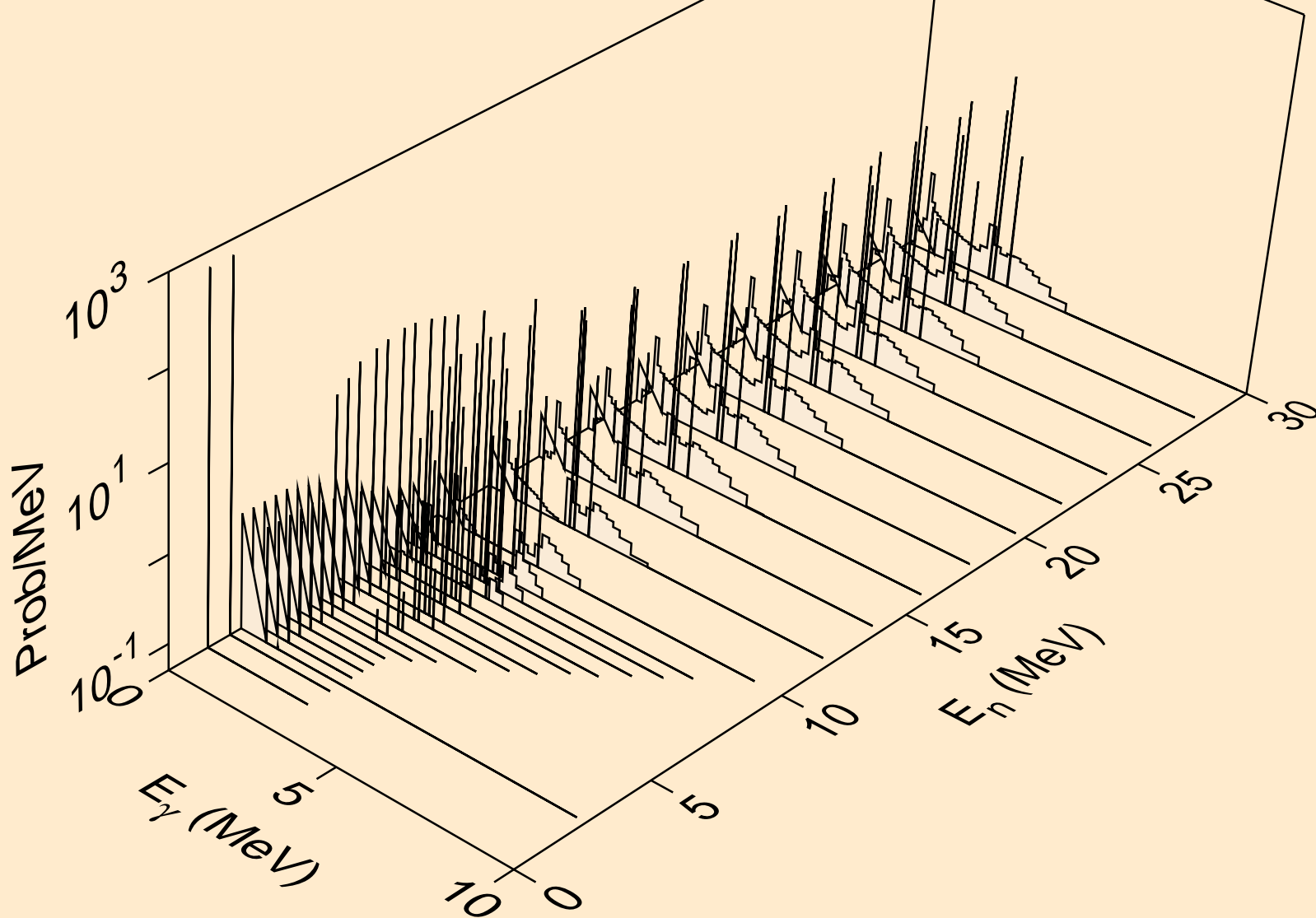

CU058 NEUTRON ACER TENDL-2019 LIBRARY; T=293.16K
Photon emission for (n,t)

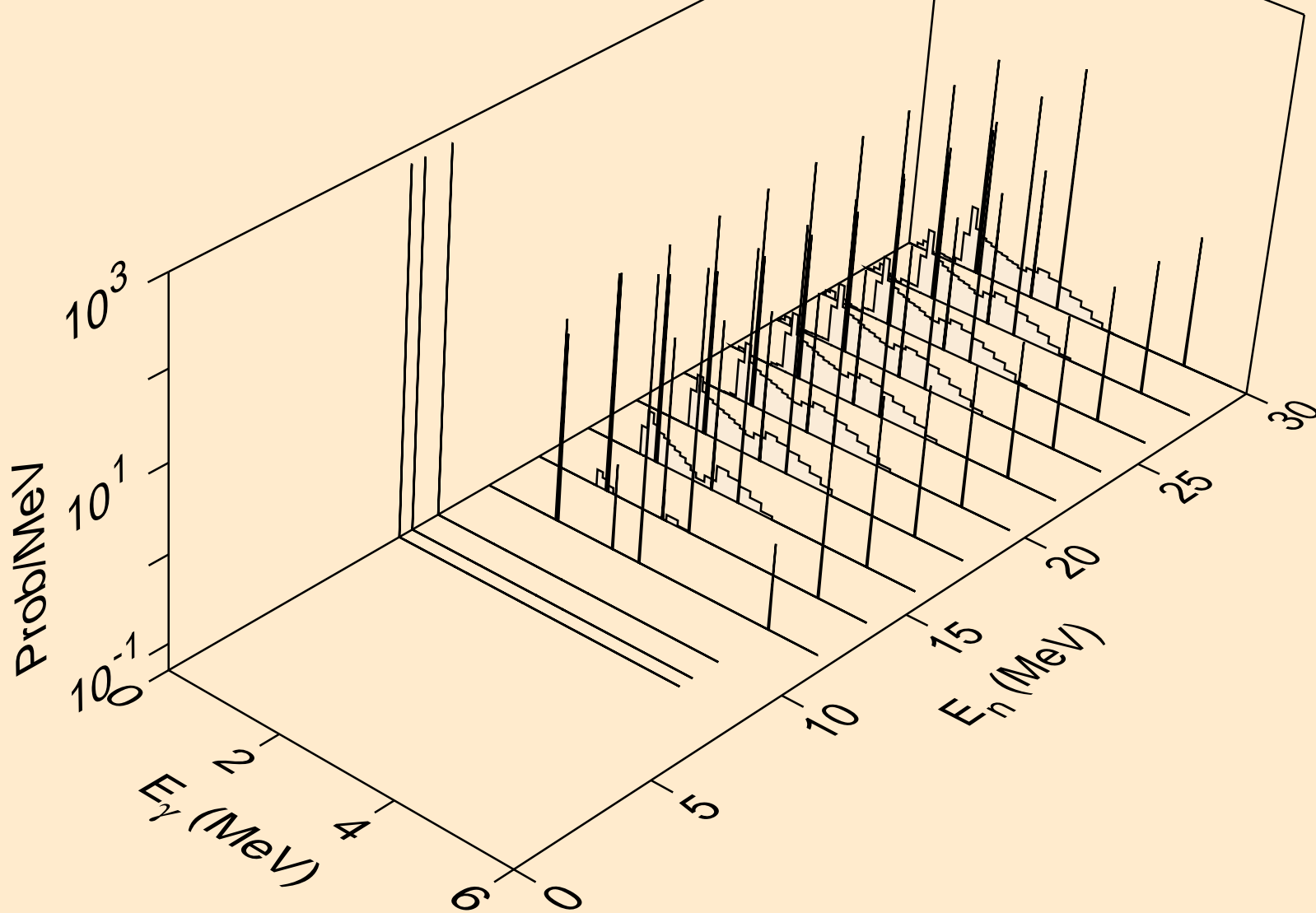

CU058 NEUTRON ACER TENDL-2019 LIBRARY; T=293.16K
Photon emission for (n,he3)

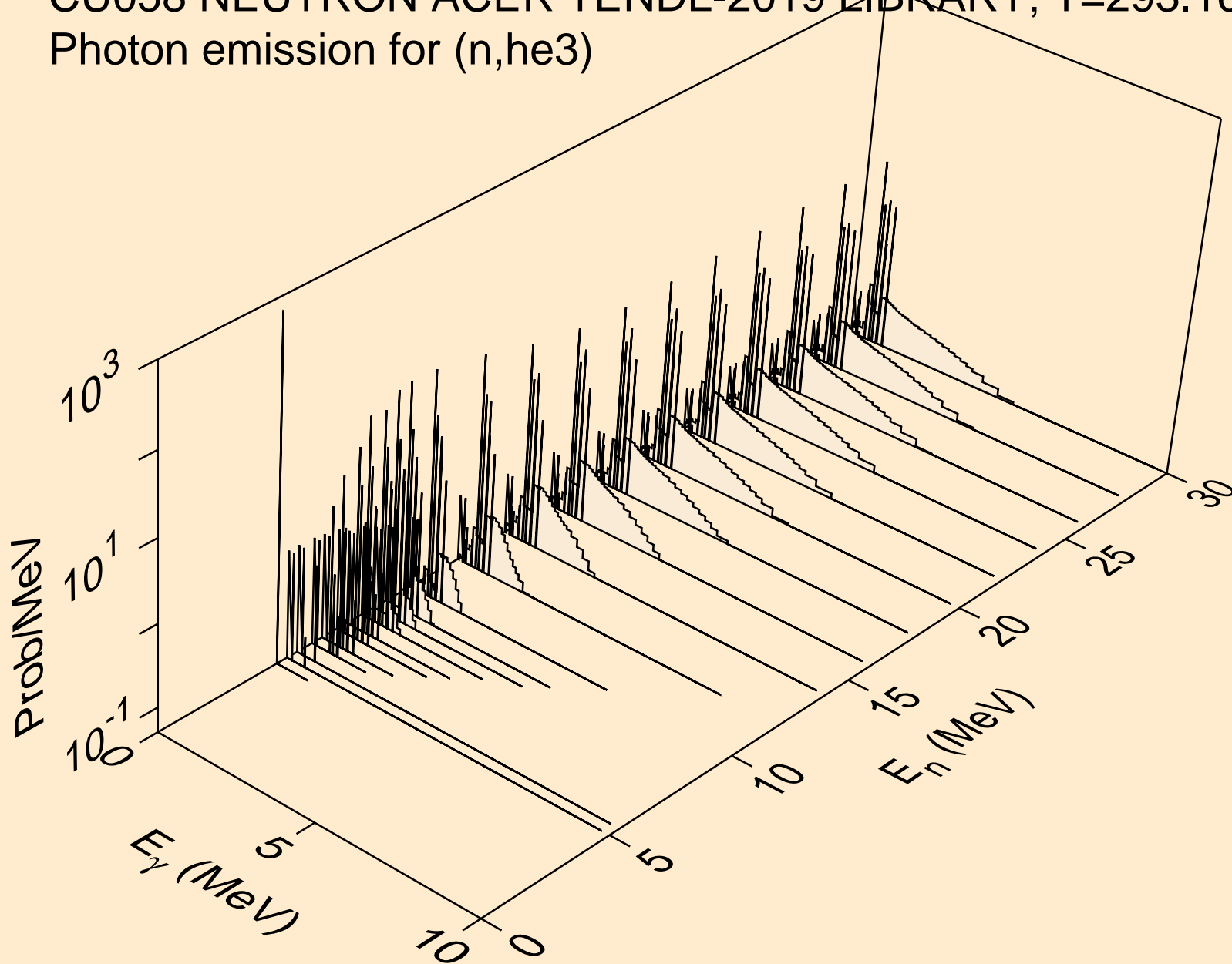

CU058 NEUTRON ACER TENDL-2019 LIBRARY; T=293.16K
Photon emission for (n,a)

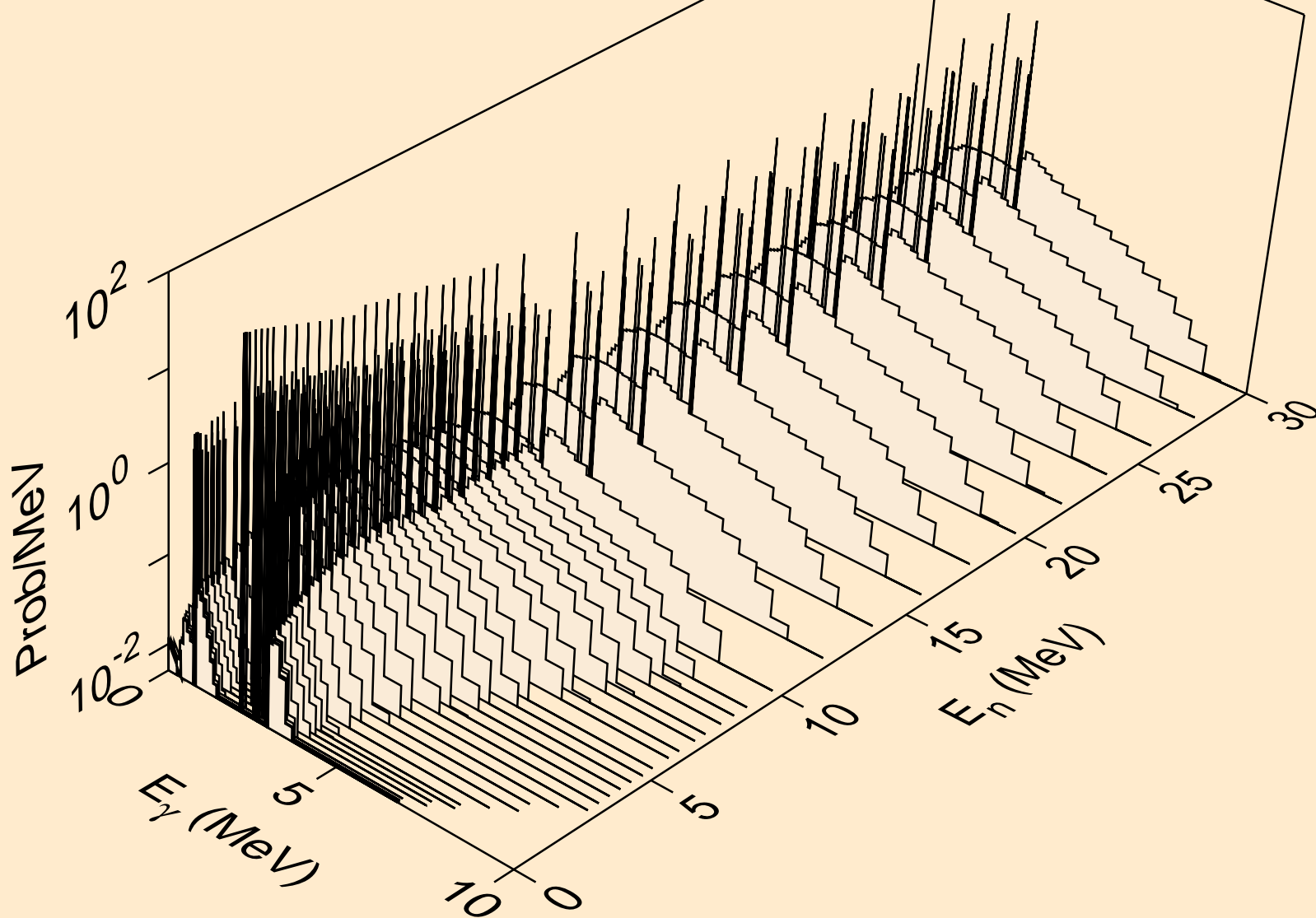

CU058 NEUTRON ACER TENDL-2019 LIBRARY; T=293.16K
Photon emission for (n,2a)

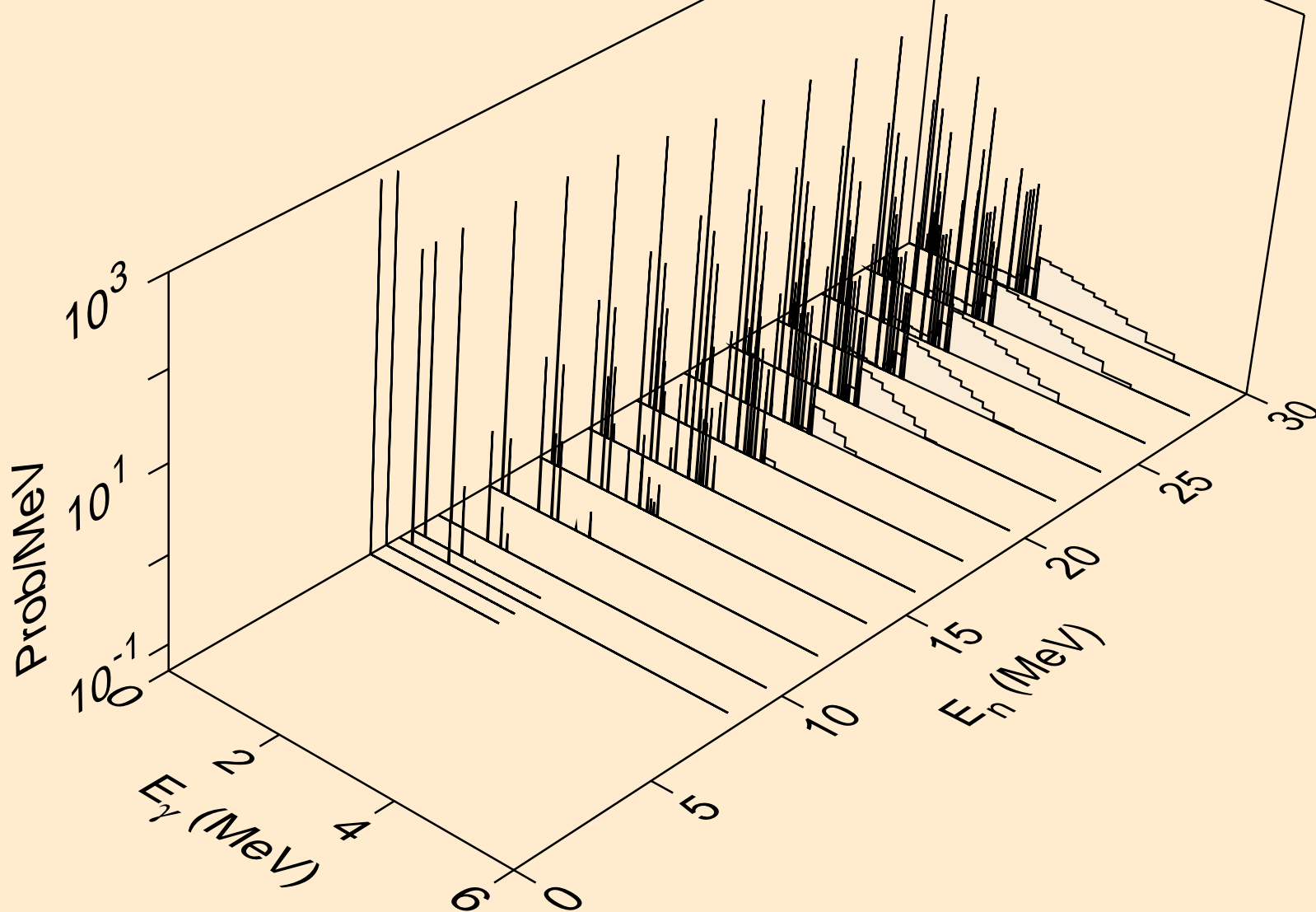

CU058 NEUTRON ACER TENDL-2019 LIBRARY; T=293.16K
Photon emission for (n,2p)

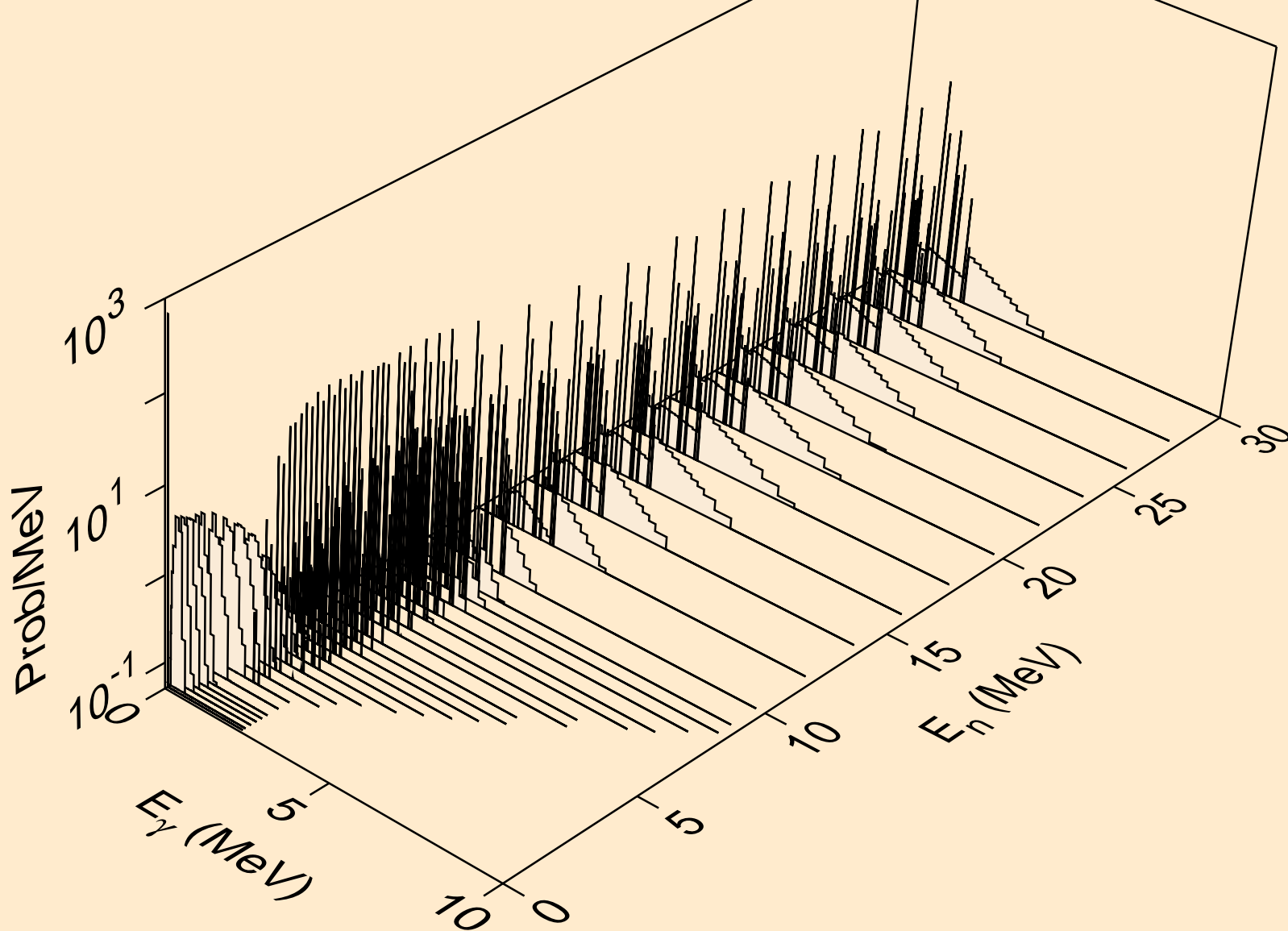

CU058 NEUTRON ACER TENDL-2019 LIBRARY; T=293.16K
Photon emission for (n,p α)

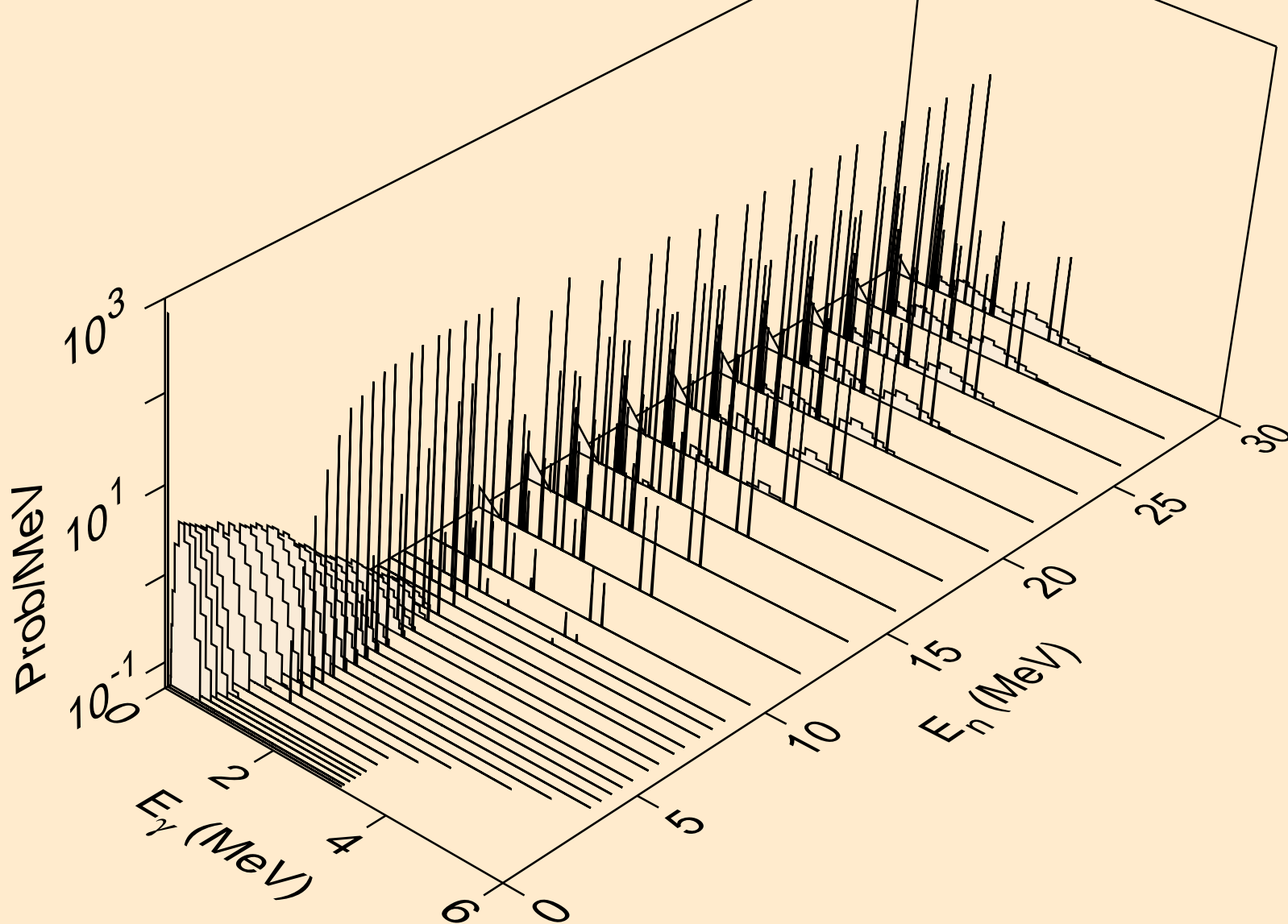

CU058 NEUTRON ACER TENDL-2019 LIBRARY; T=293.16K
Photon emission for (n,pd)

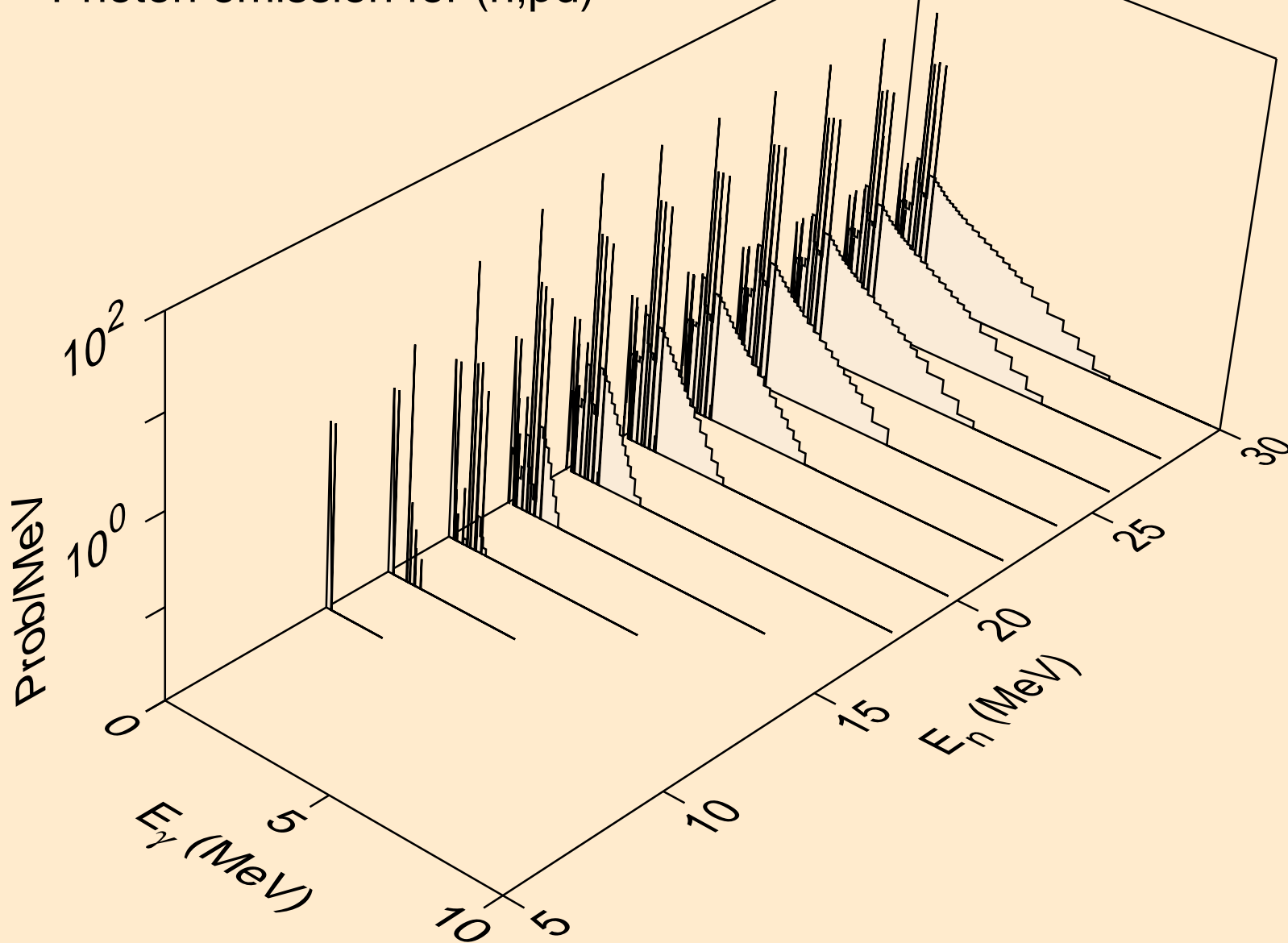

CU058 NEUTRON ACER TENDL-2019 LIBRARY; T=293.16K
Photon emission for (n,pt)

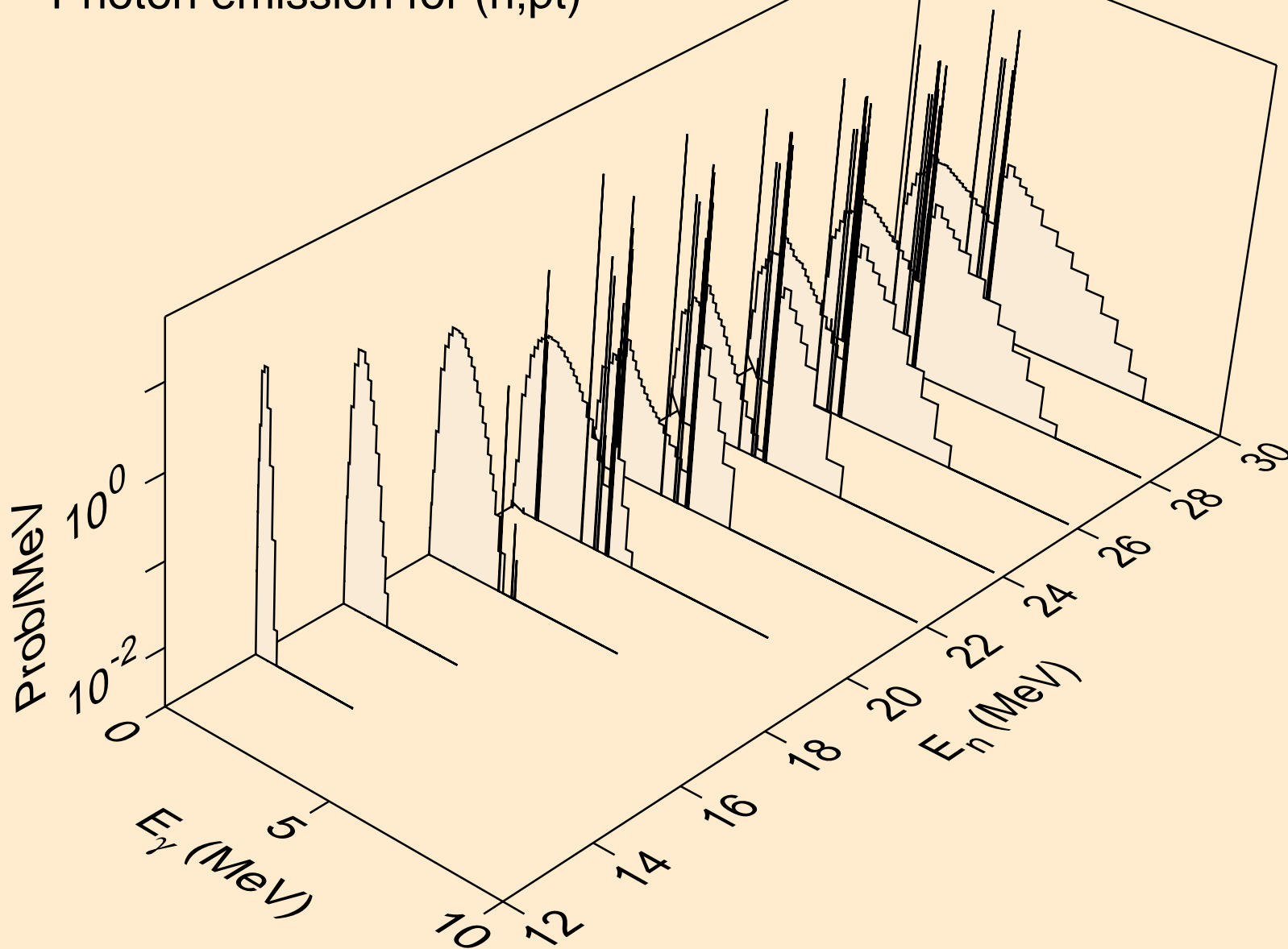

CU058 NEUTRON ACER TENDL-2019 LIBRARY; T=293.16K
Photon emission for (n,da)

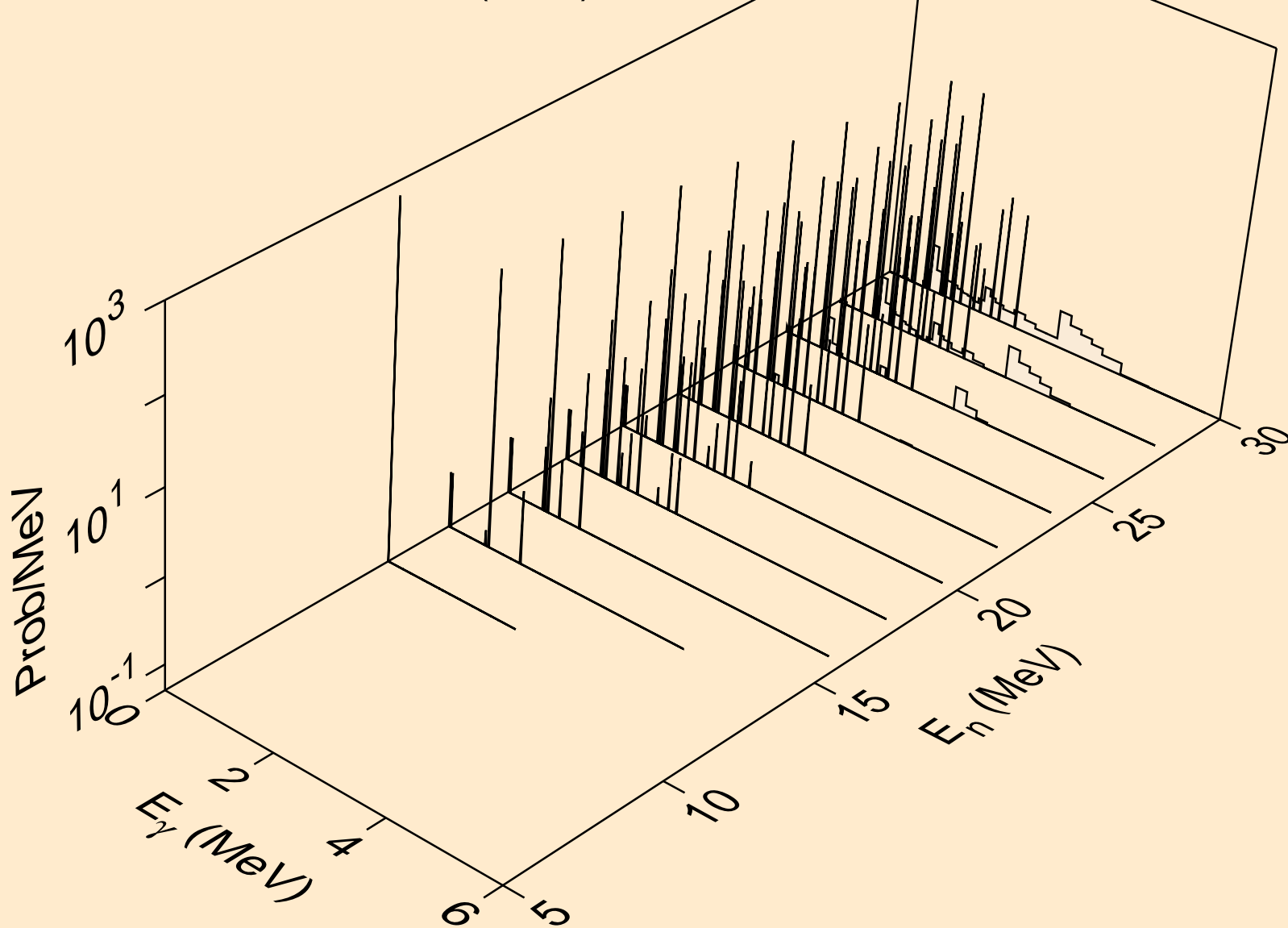

CU058 NEUTRON ACER TENDL-2019 LIBRARY; T=293.16K
thermal capture photon spectrum

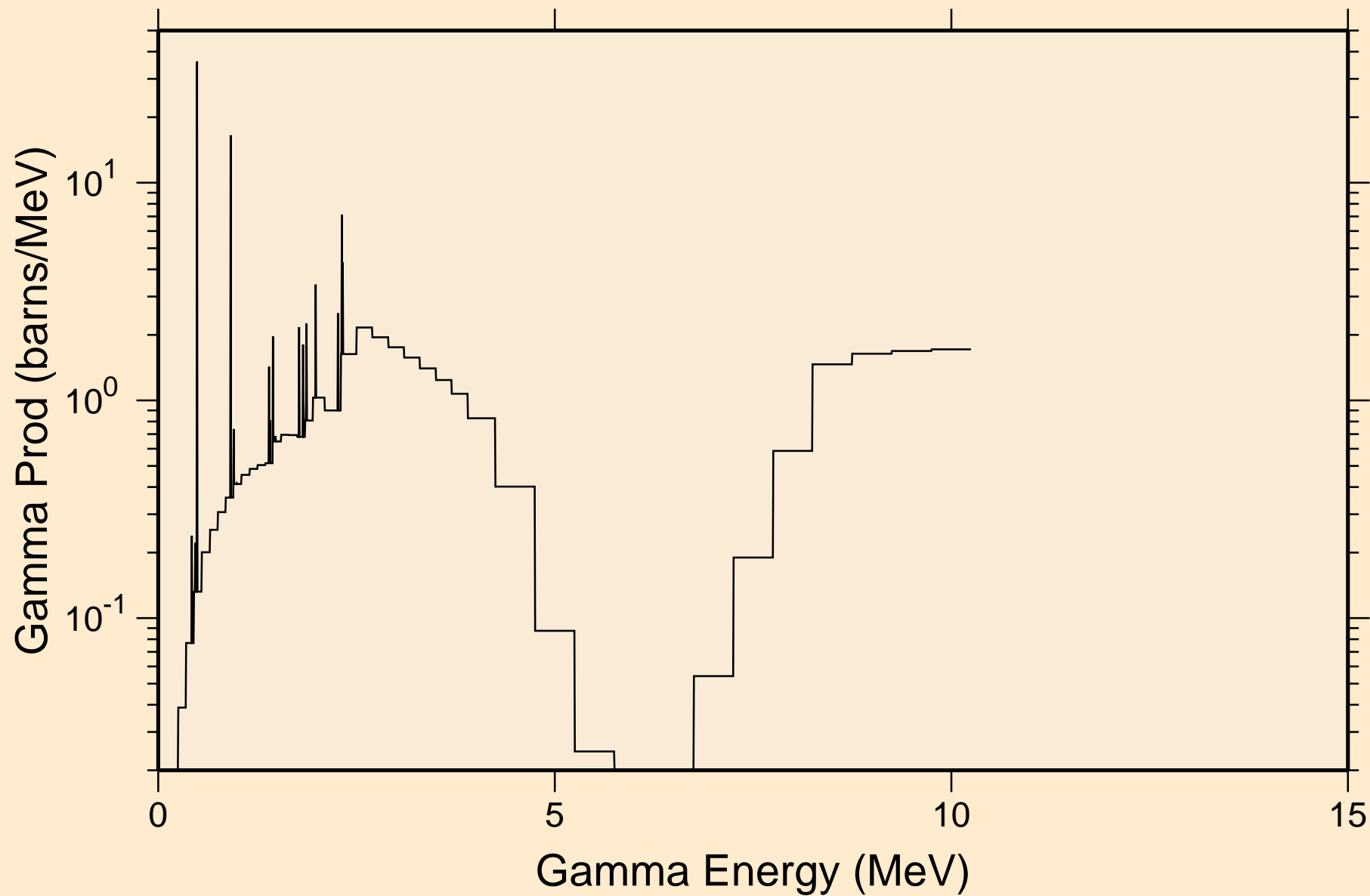

CU058 NEUTRON ACER TENDL-2019 LIBRARY; T=293.16K
14 MeV photon spectrum

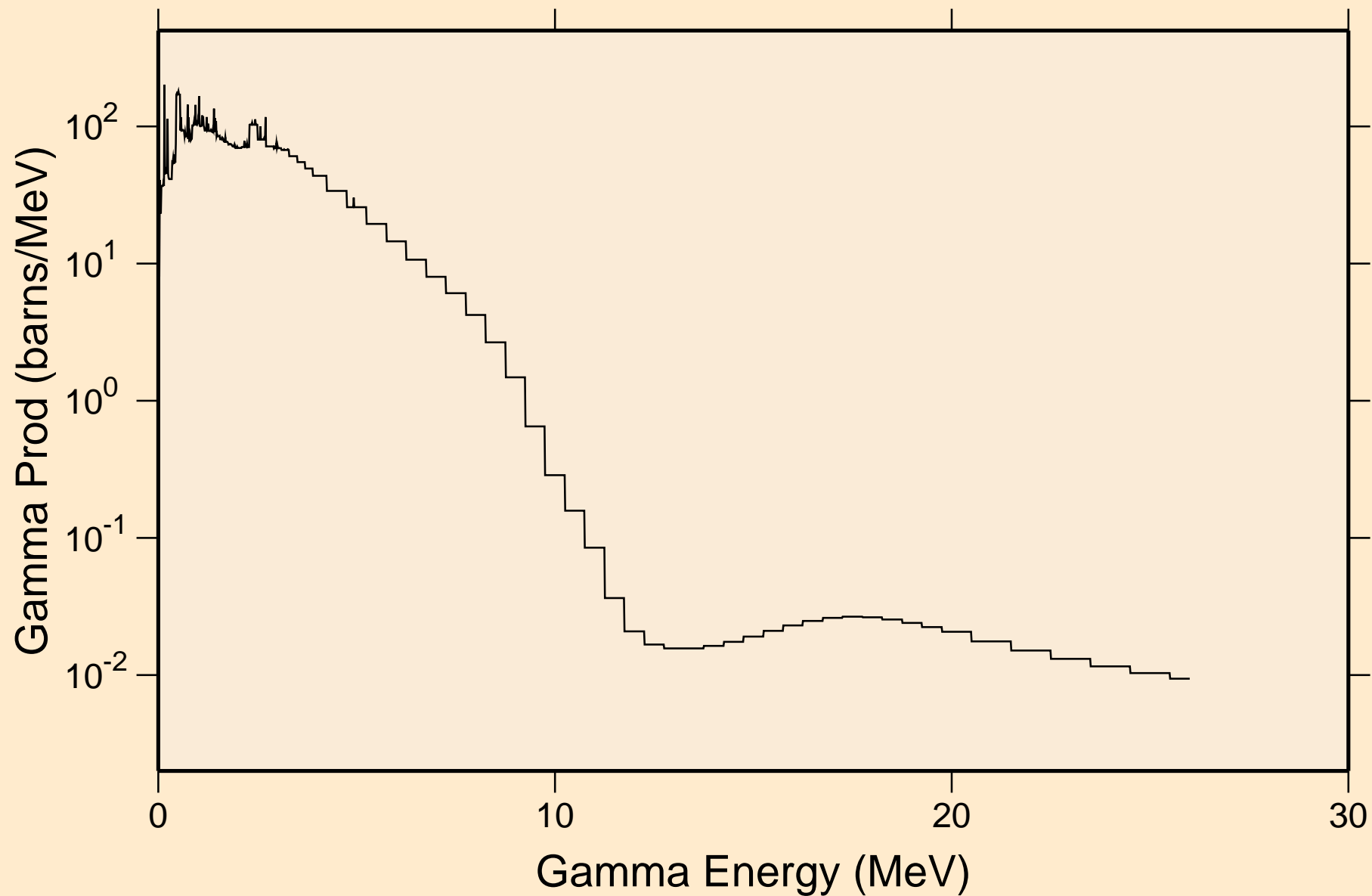

CU058 NEUTRON ACER TENDL-2019 LIBRARY; T=293.16K

Particle heating contributions

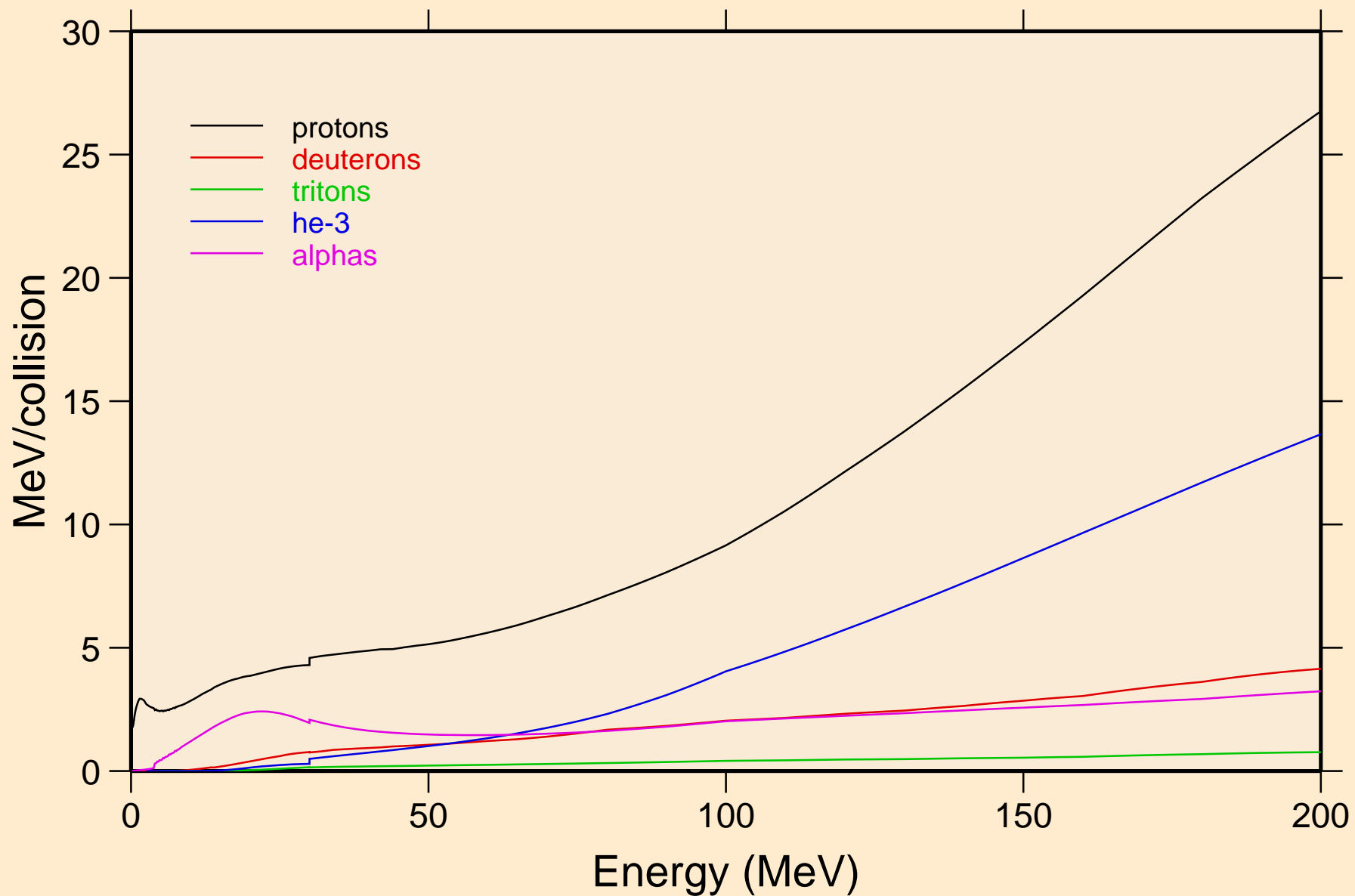

CU058 NEUTRON ACER TENDL-2019 LIBRARY; T=293.16K
Recoil Heating

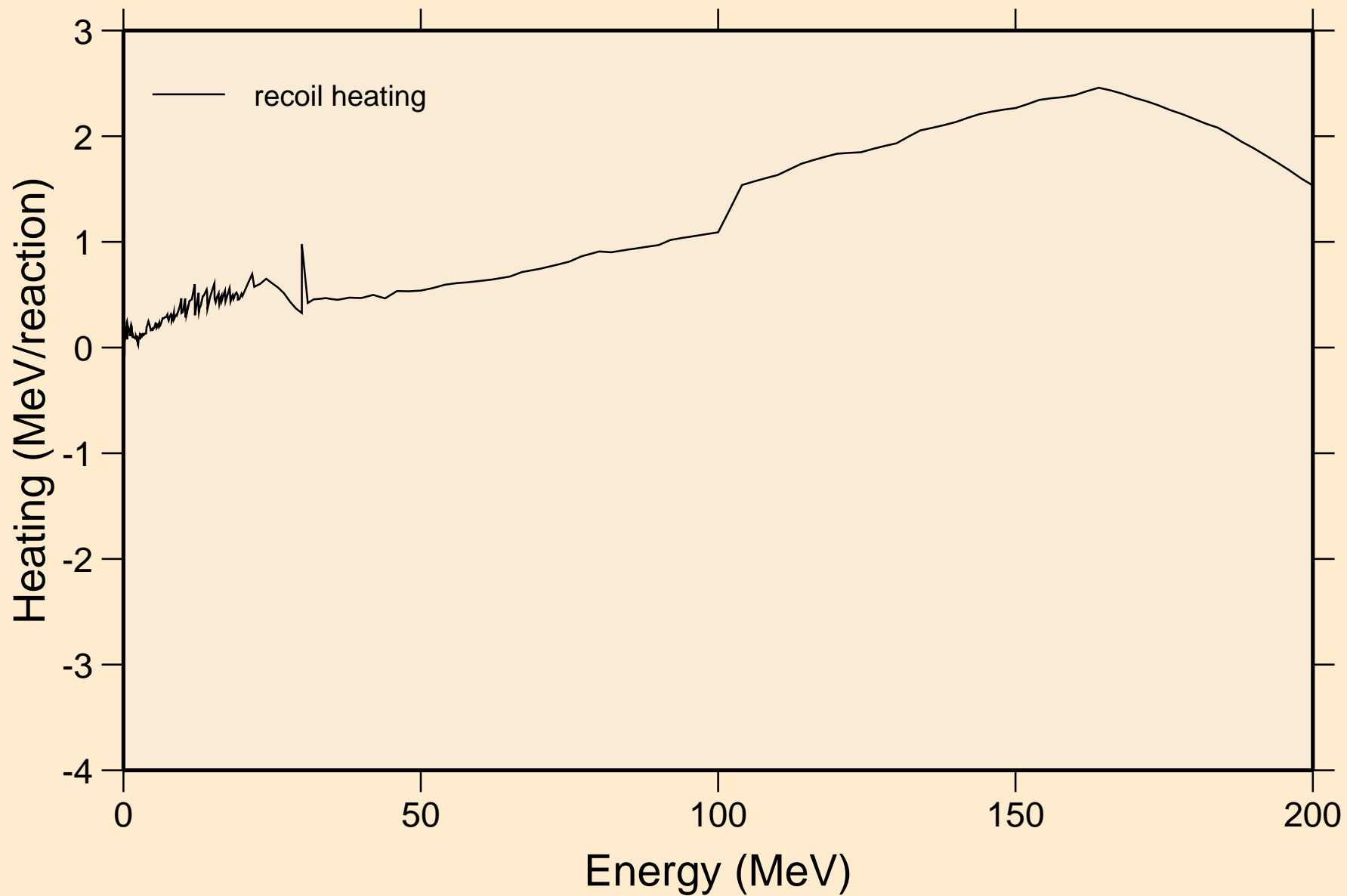

CU058 NEUTRON ACER TENDL-2019 LIBRARY; T=293.16K

Particle production cross sections

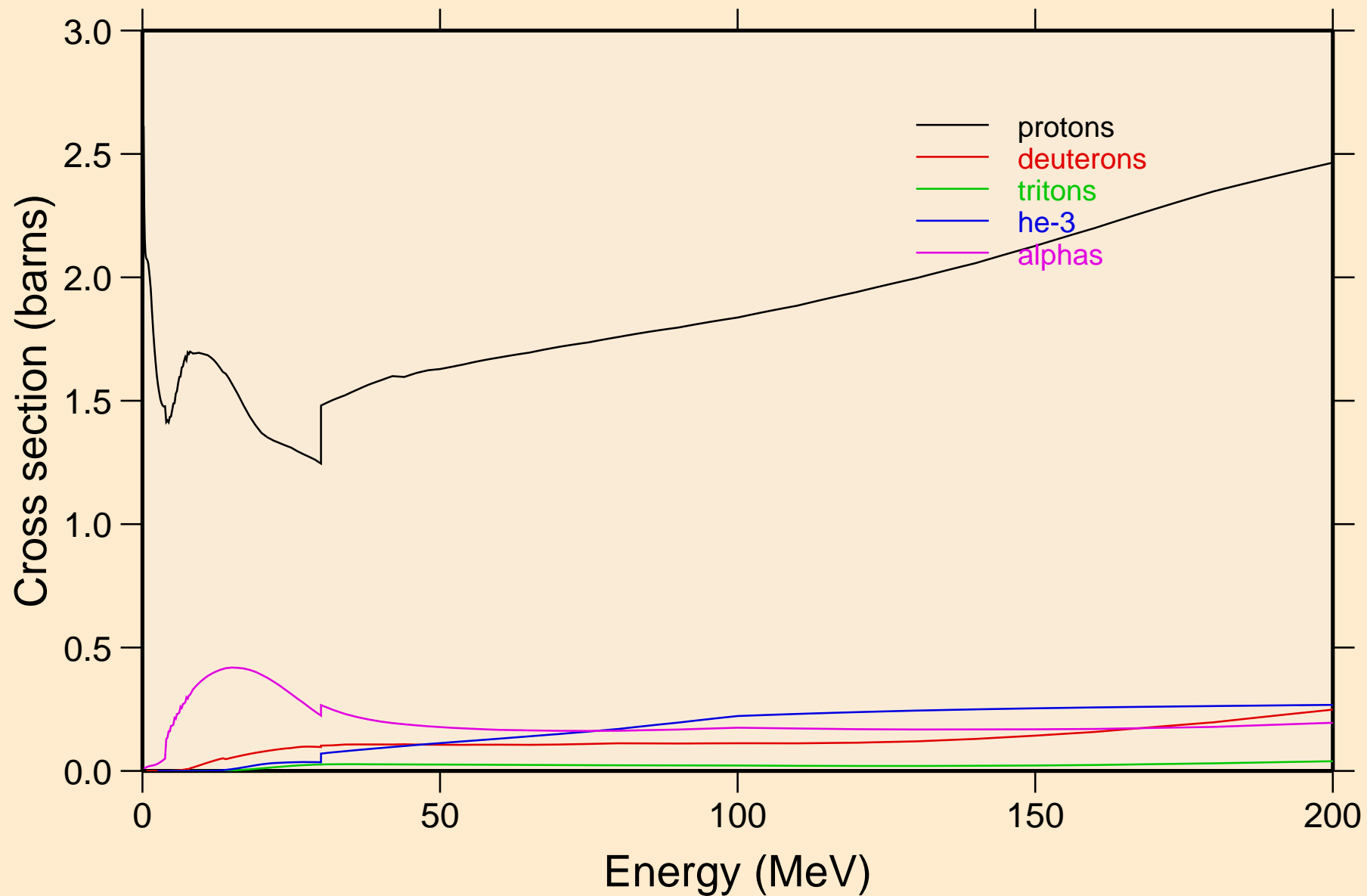

CU058 NEUTRON ACER TENDL-2019 LIBRARY; T=293.16K
protons from (n,x)

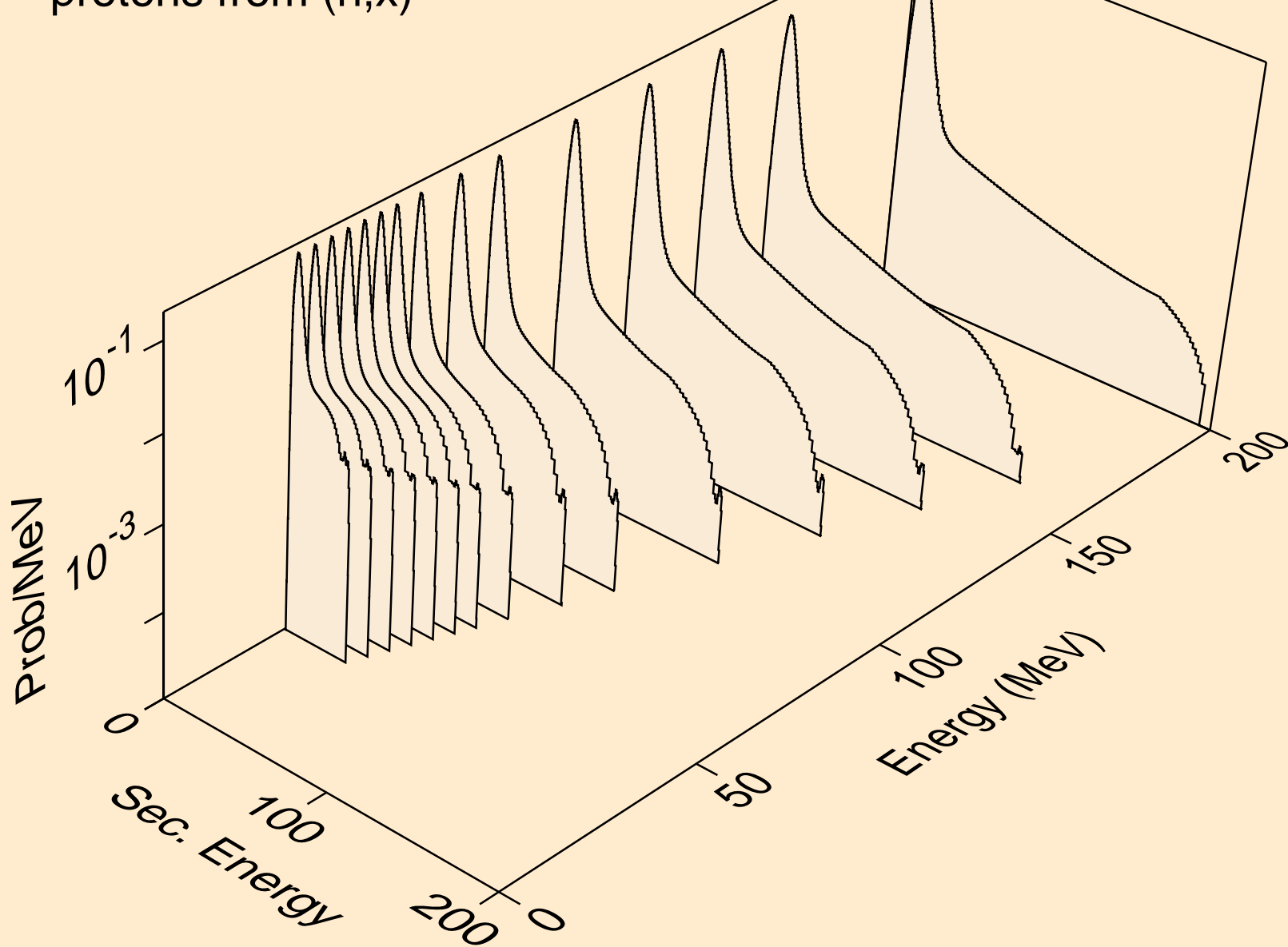

CU058 NEUTRON ACER TENDL-2019 LIBRARY; T=293.16K
protons from (n,n*)p

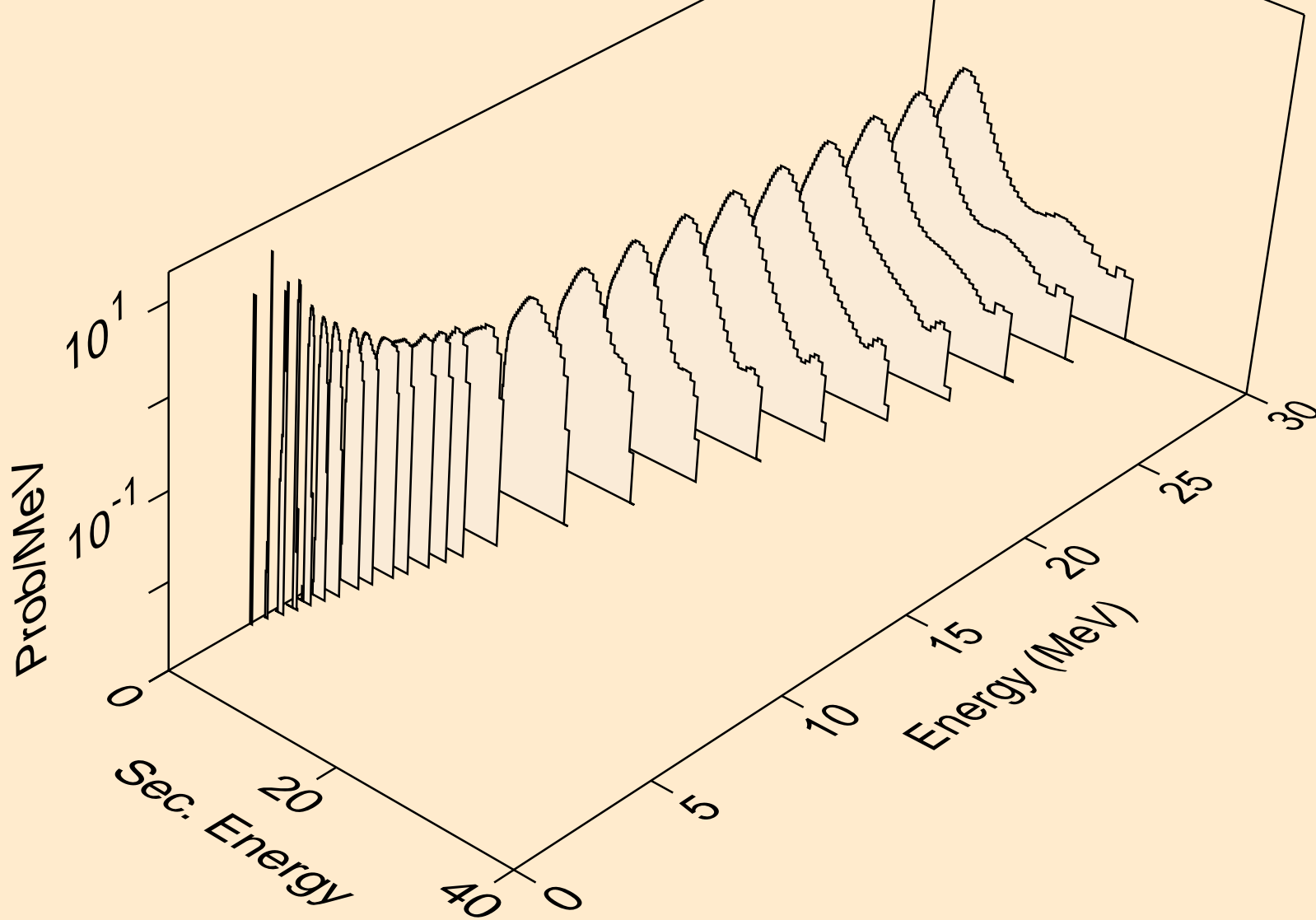

CU058 NEUTRON ACER TENDL-2019 LIBRARY; T=293.16K
protons from (n,2np)

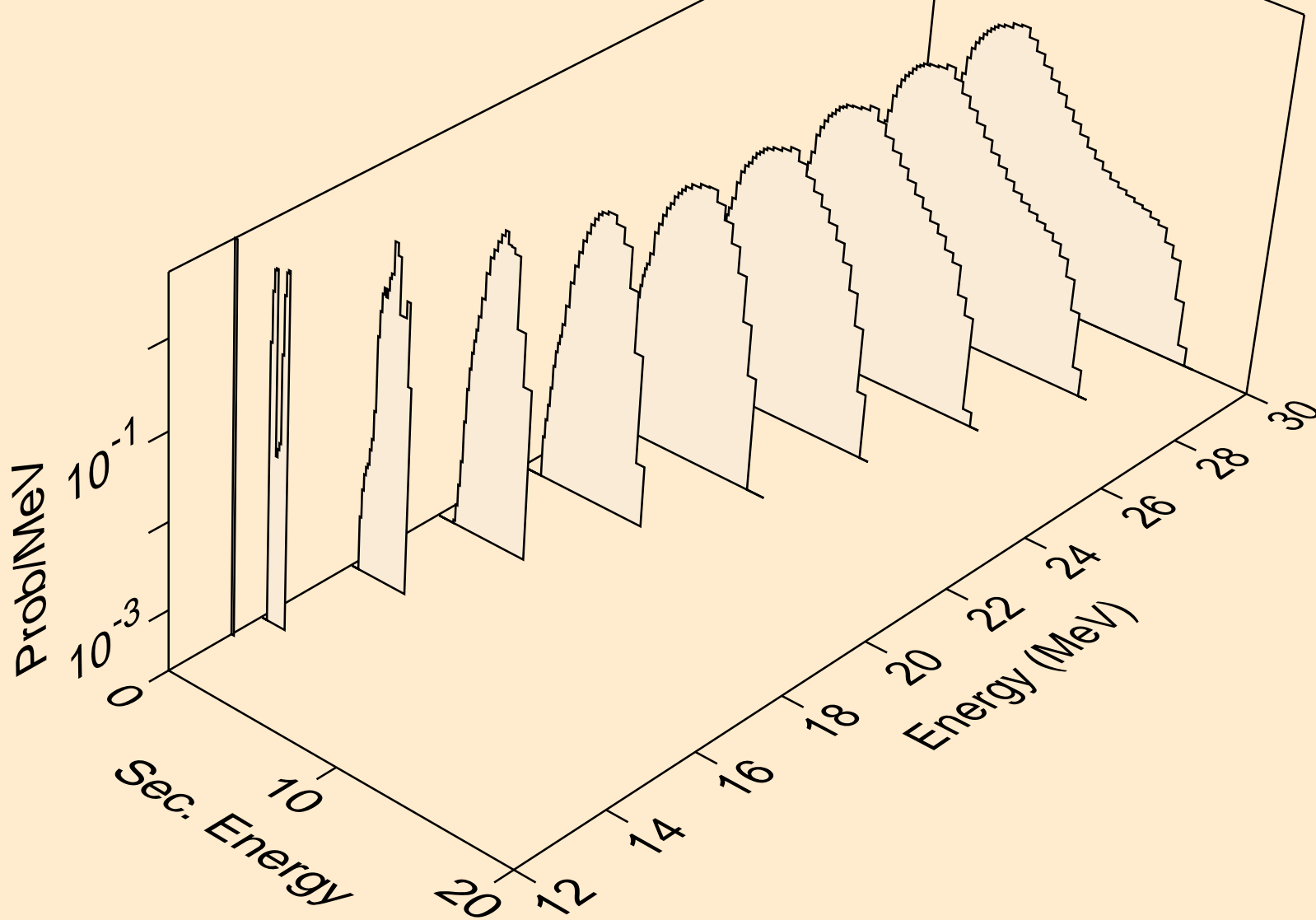

CU058 NEUTRON ACER TENDL-2019 LIBRARY; T=293.16K
protons from (n,2np)

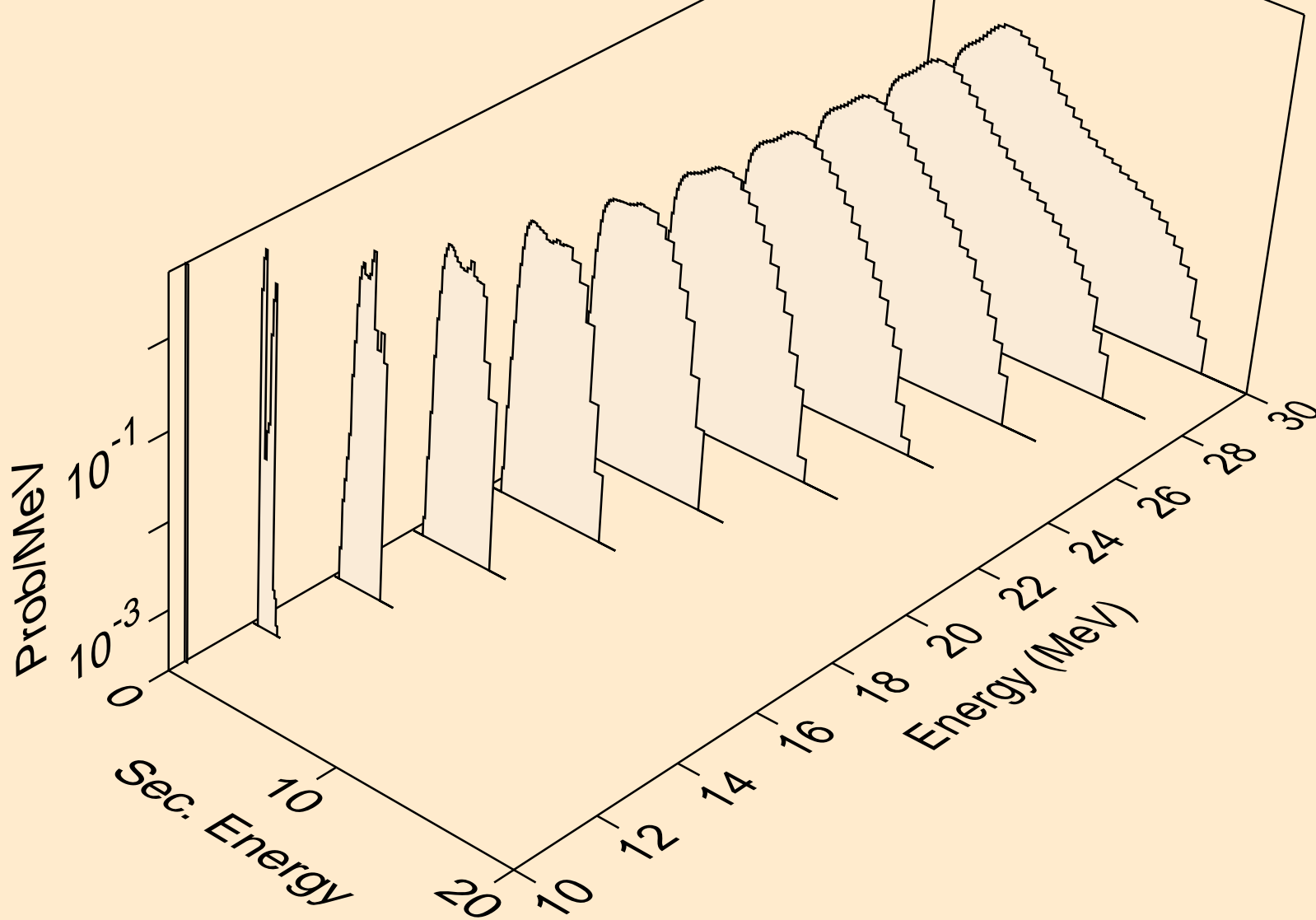

CU058 NEUTRON ACER TENDL-2019 LIBRARY; T=293.16K
protons from (n,npa)

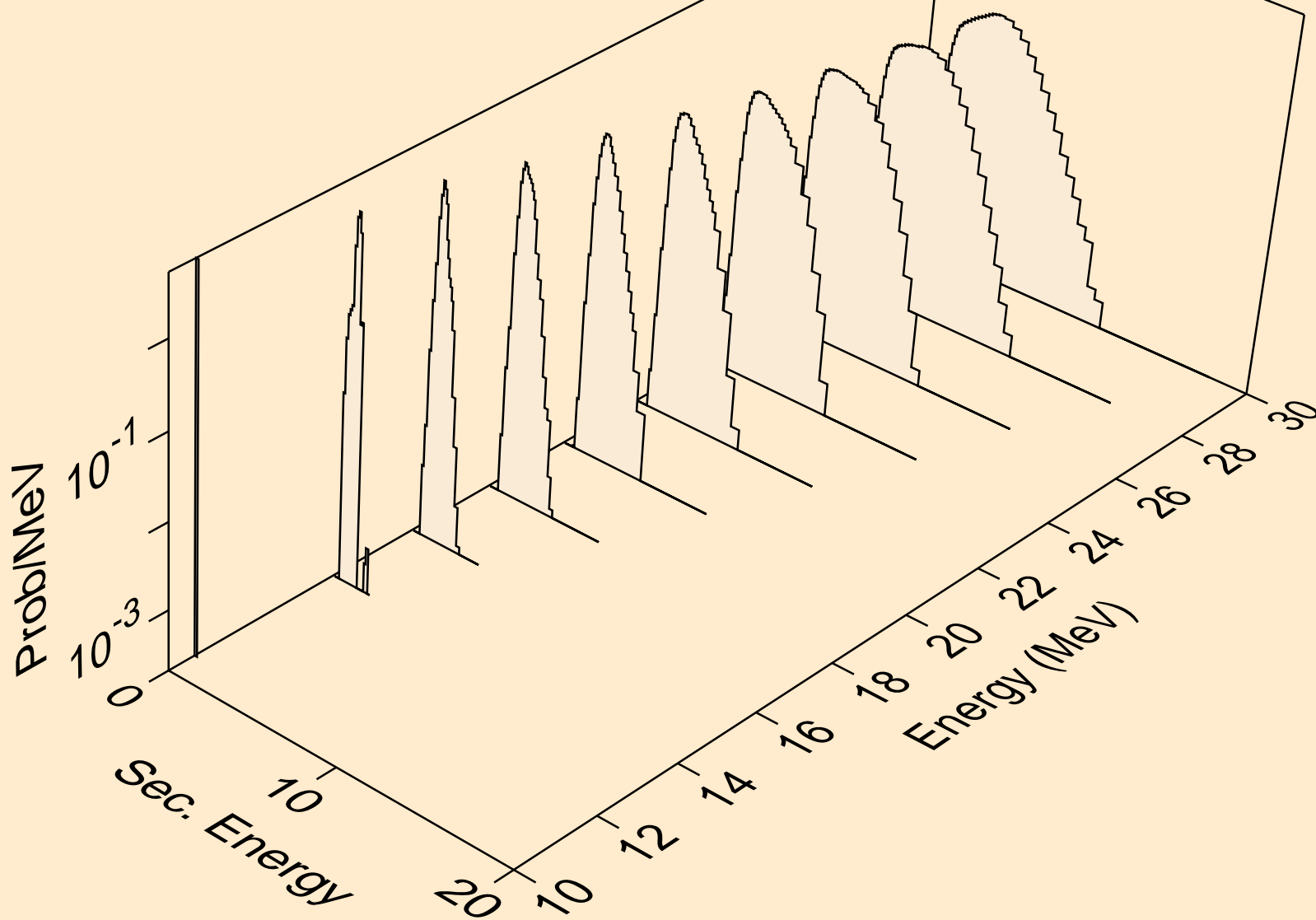

CU058 NEUTRON ACER TENDL-2019 LIBRARY; T=293.16K
protons from (n,p)

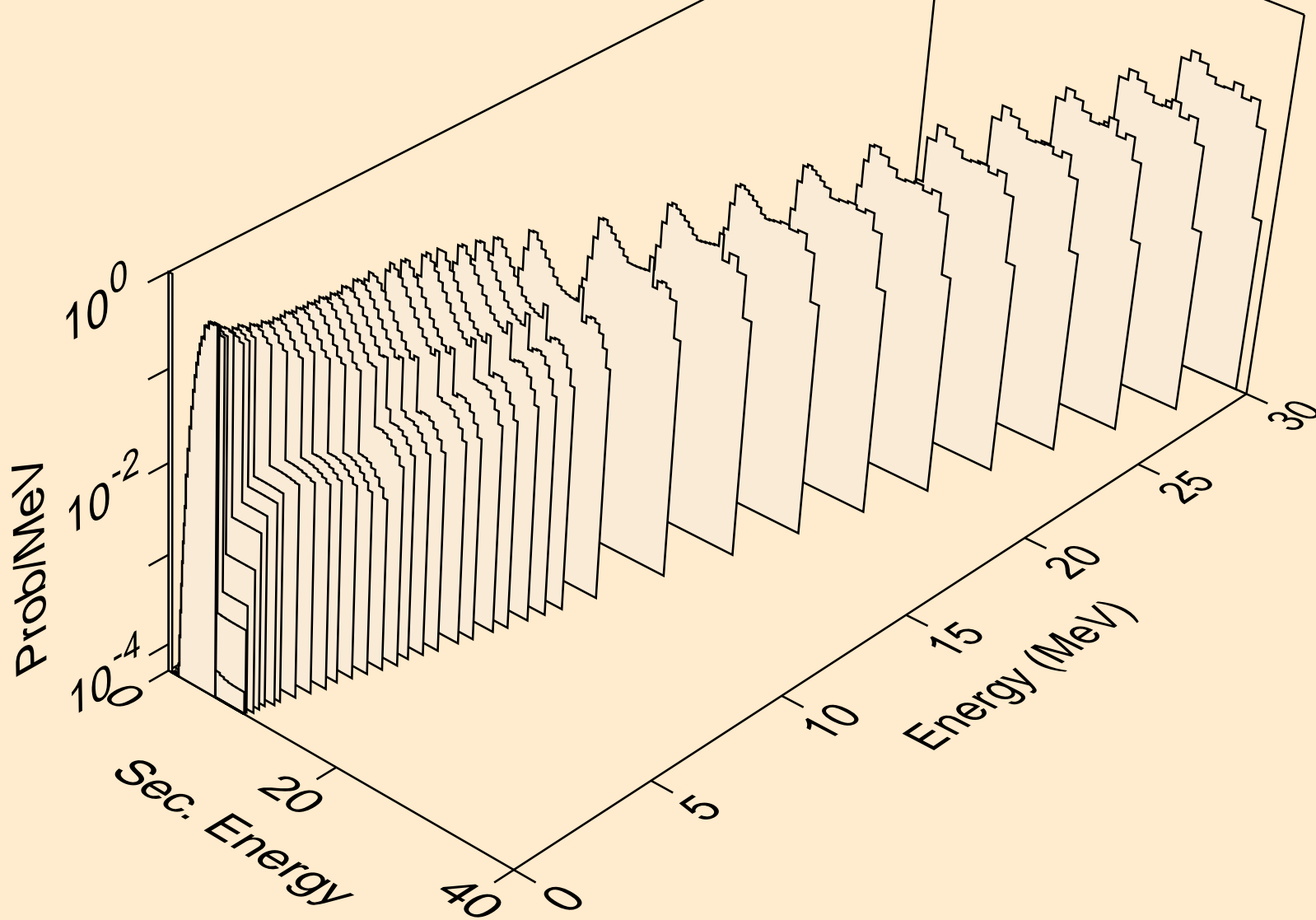

CU058 NEUTRON ACER TENDL-2019 LIBRARY; T=293.16K
protons from (n,2p)

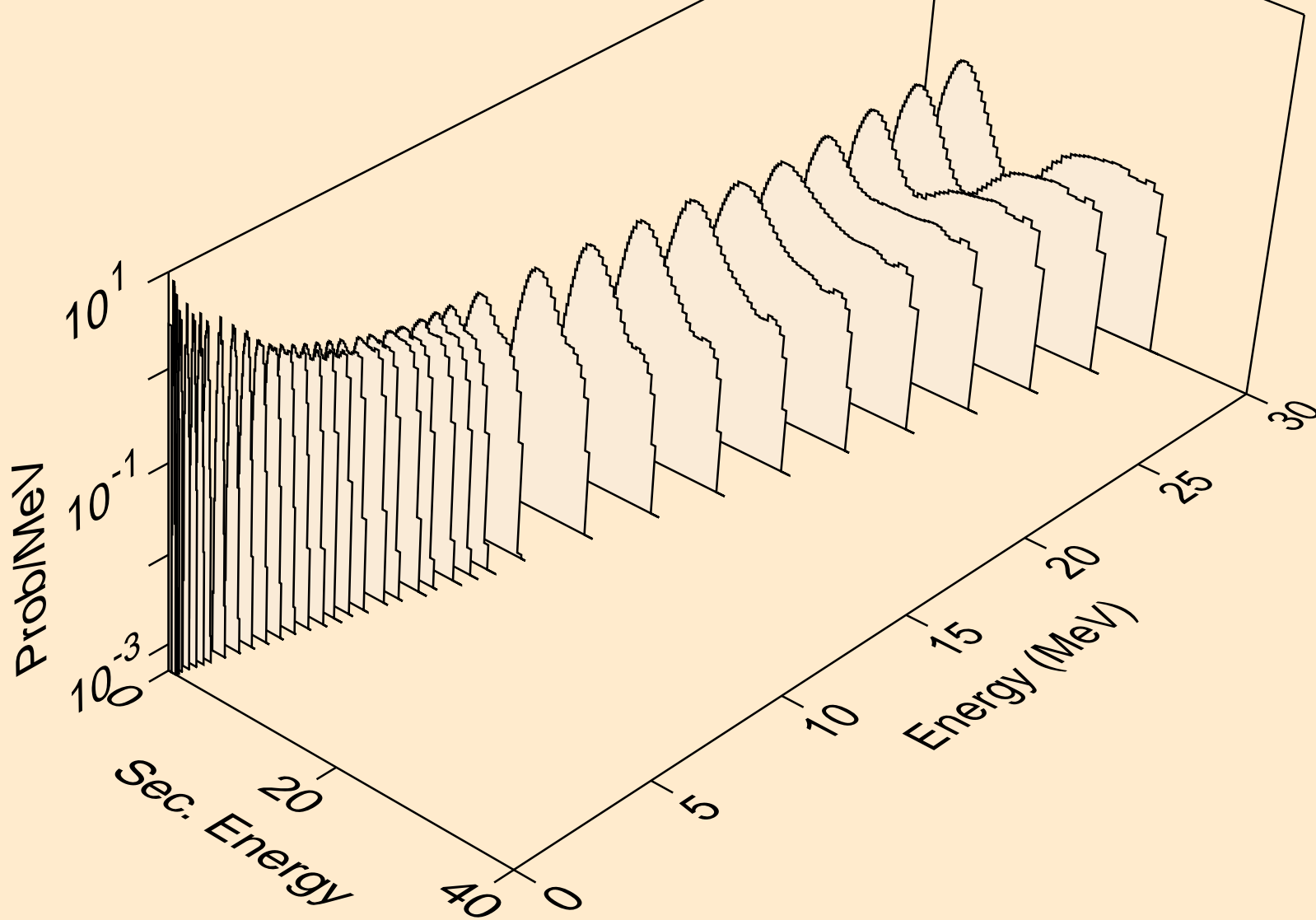

CU058 NEUTRON ACER TENDL-2019 LIBRARY; T=293.16K
protons from (n,p)

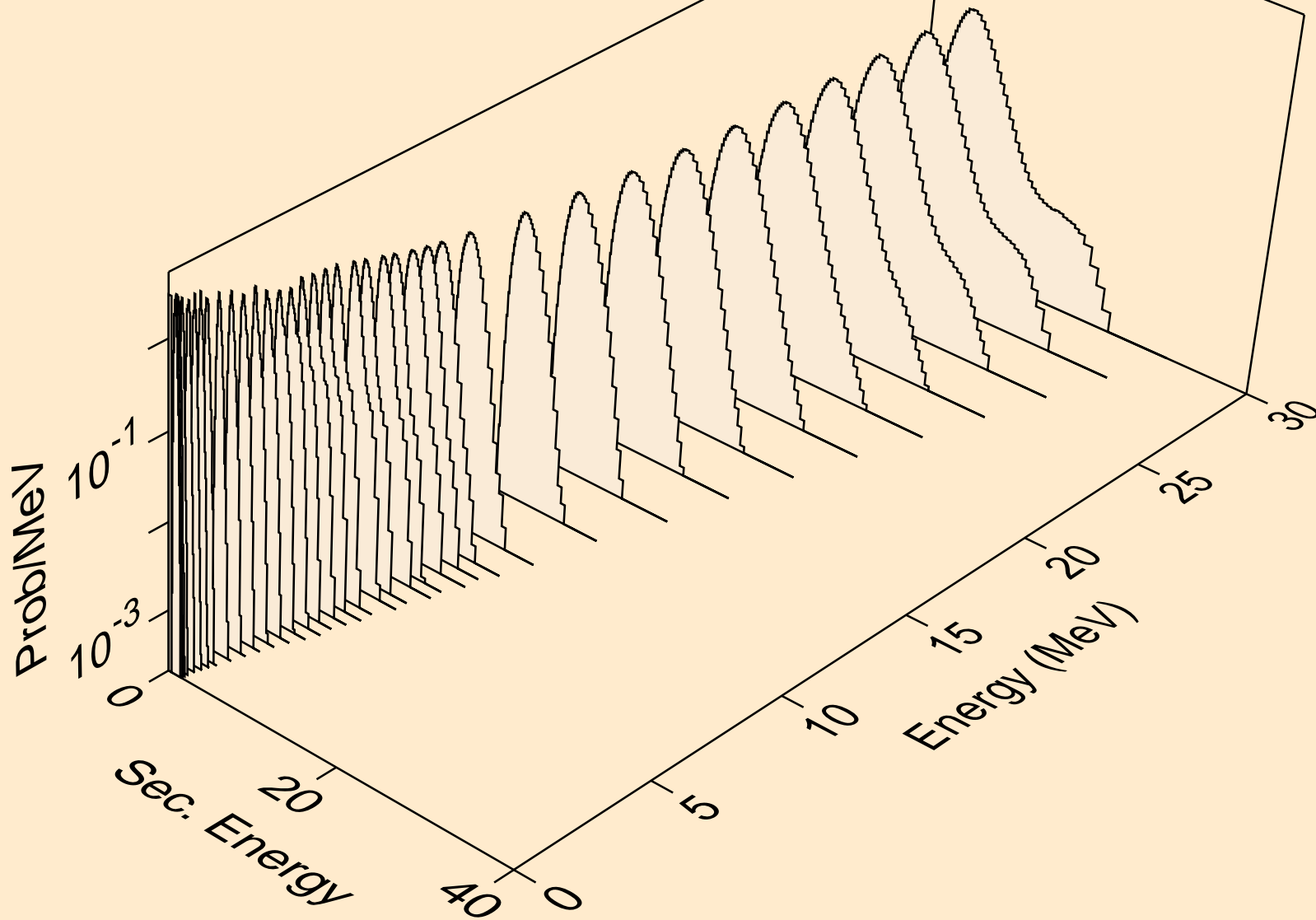

CU058 NEUTRON ACER TENDL-2019 LIBRARY; T=293.16K
protons from (n,pd)

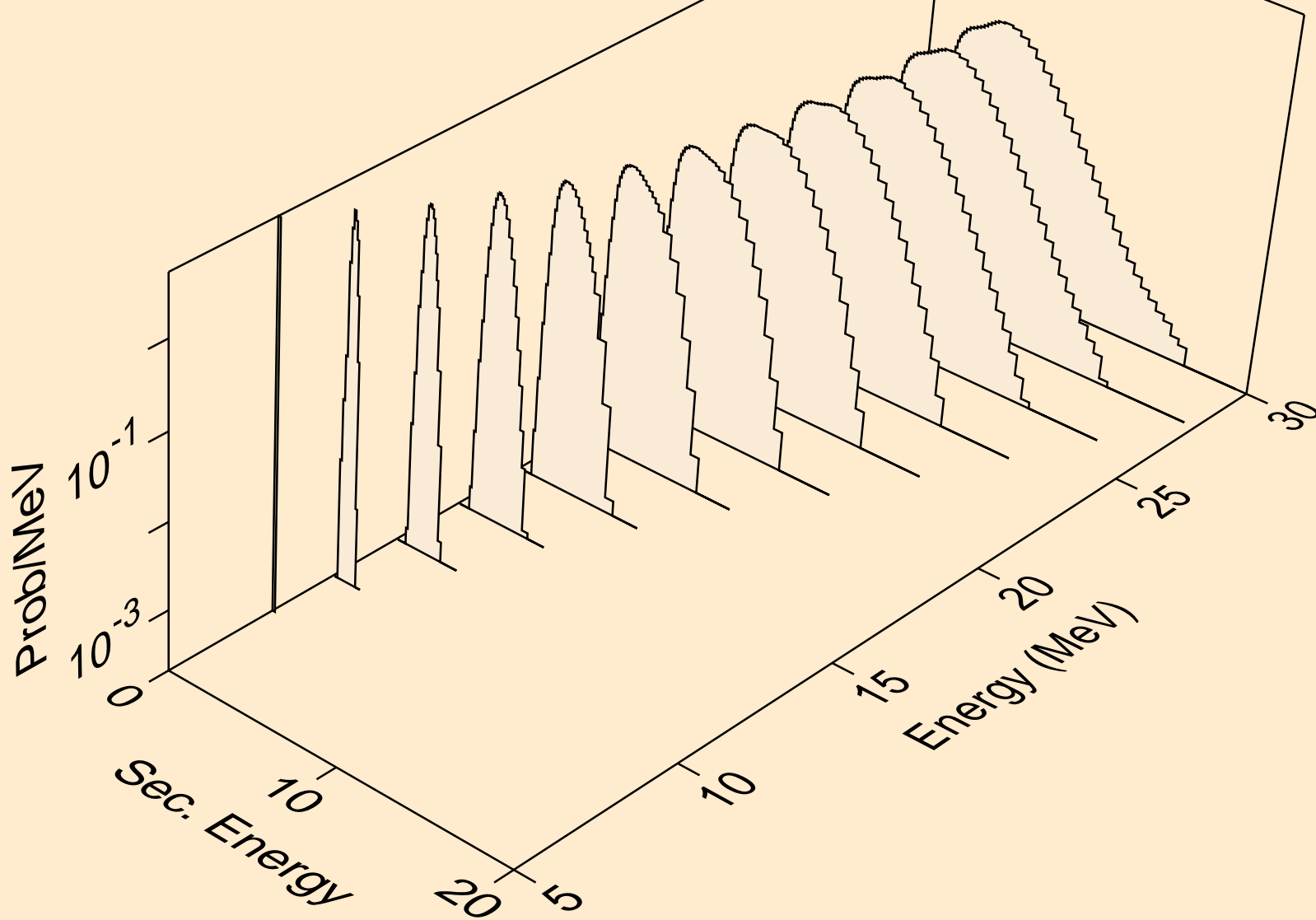

CU058 NEUTRON ACER TENDL-2019 LIBRARY; T=293.16K
protons from (n,pt)

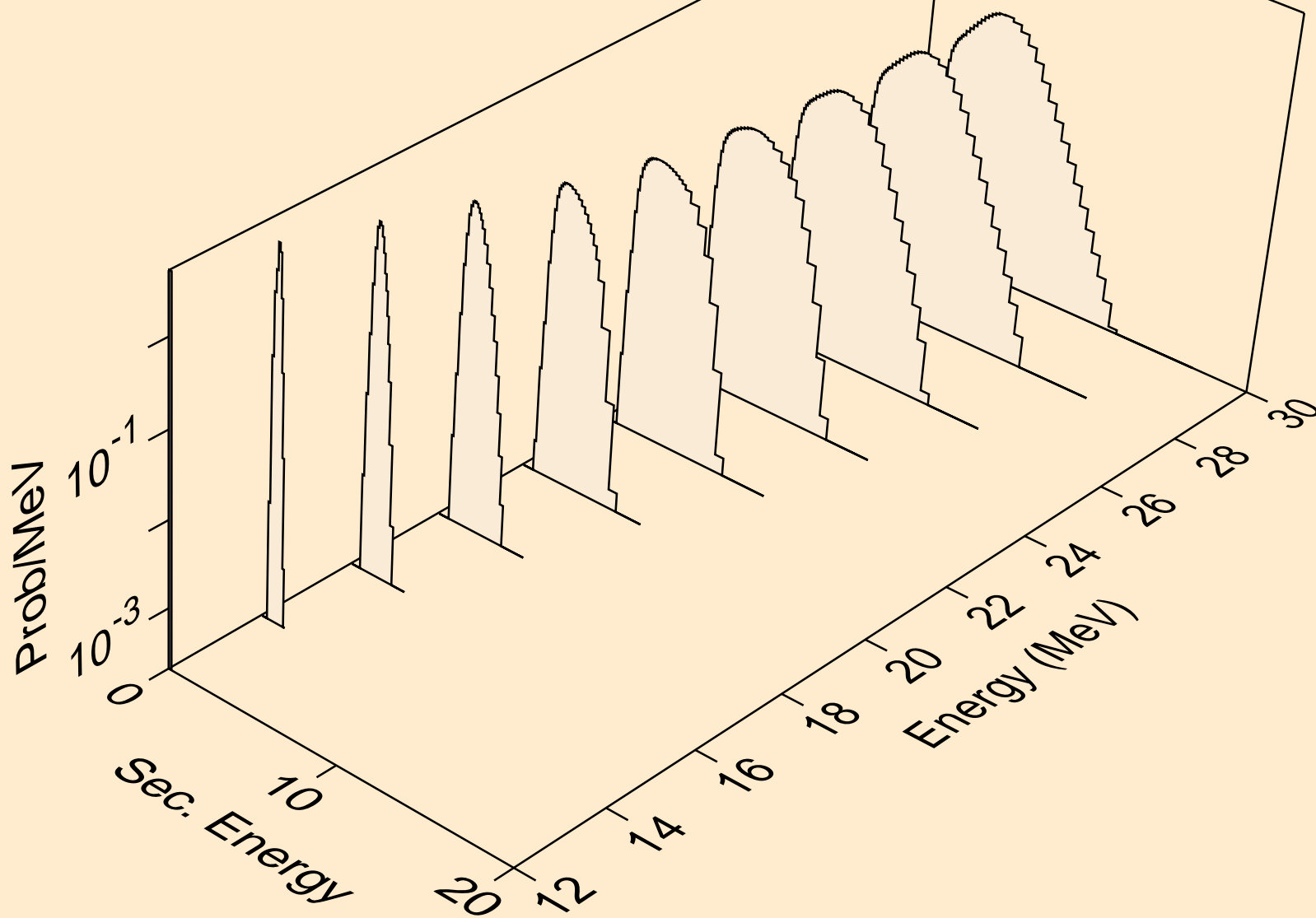

CU058 NEUTRON ACER TENDL-2019 LIBRARY; T=293.16K
deuterons from (n,x)

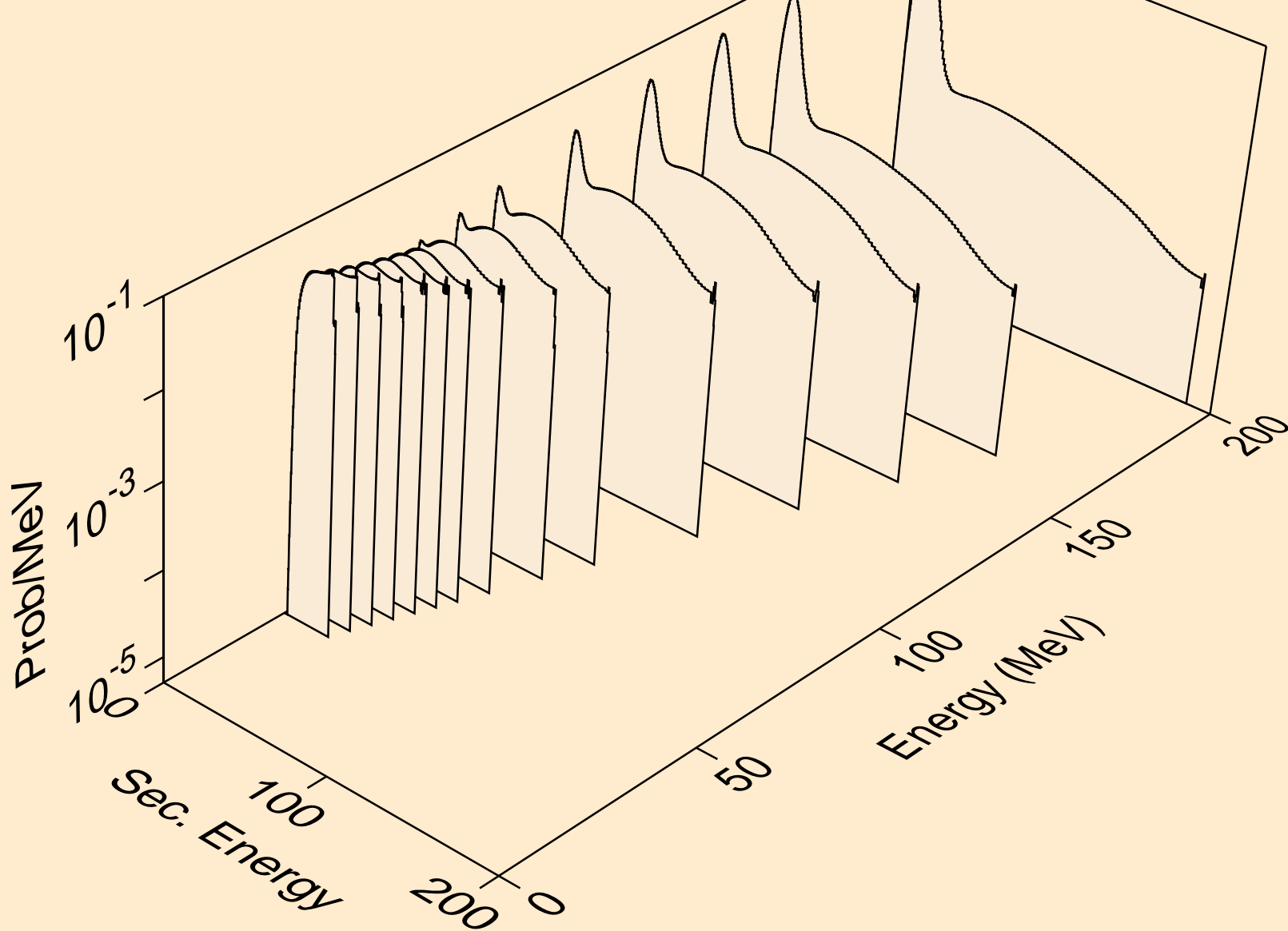

CU058 NEUTRON ACER TENDL-2019 LIBRARY; T=293.16K
deuterons from (n,n*)d

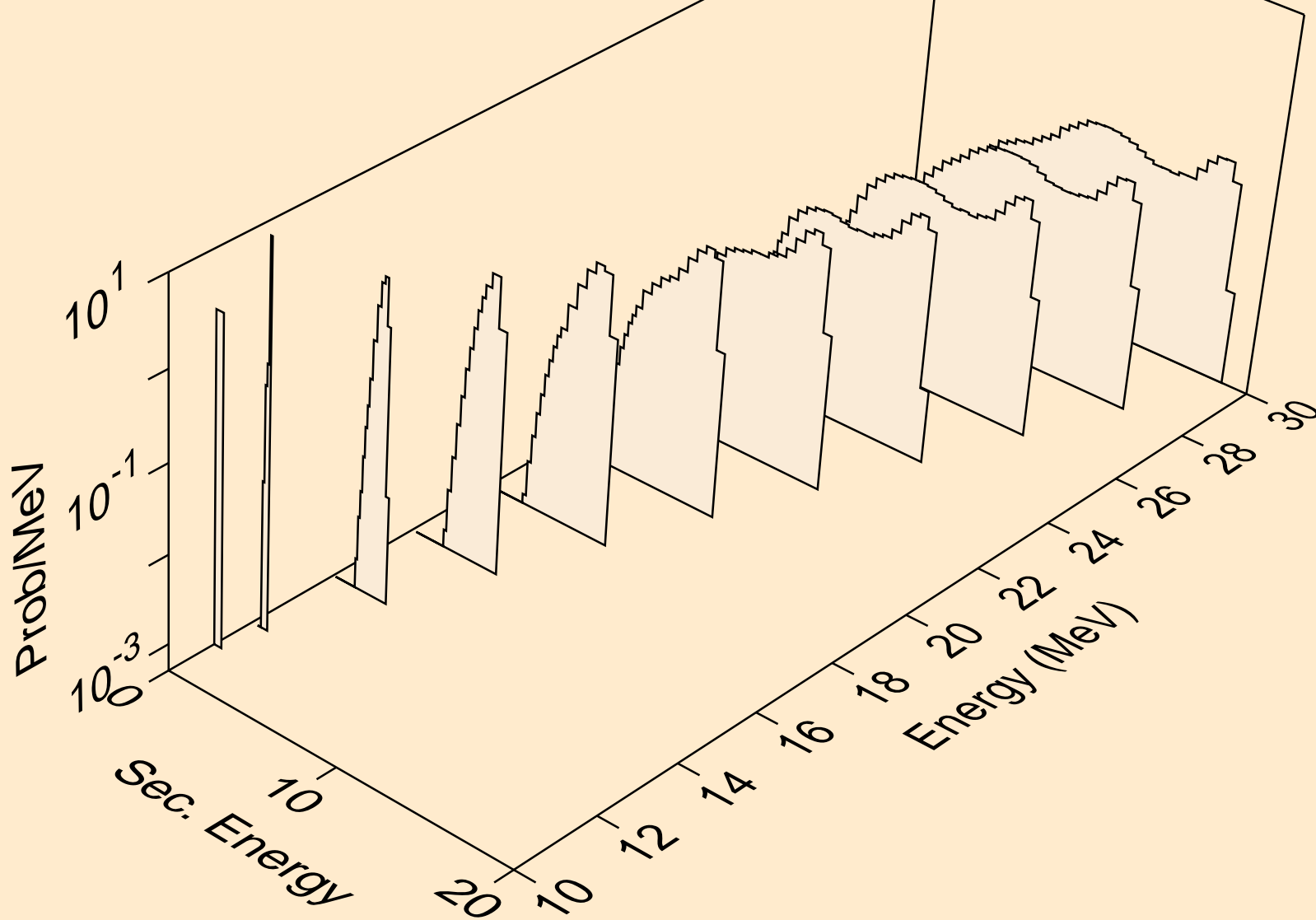

CU058 NEUTRON ACER TENDL-2019 LIBRARY; T=293.16K
deuterons from (n,d)

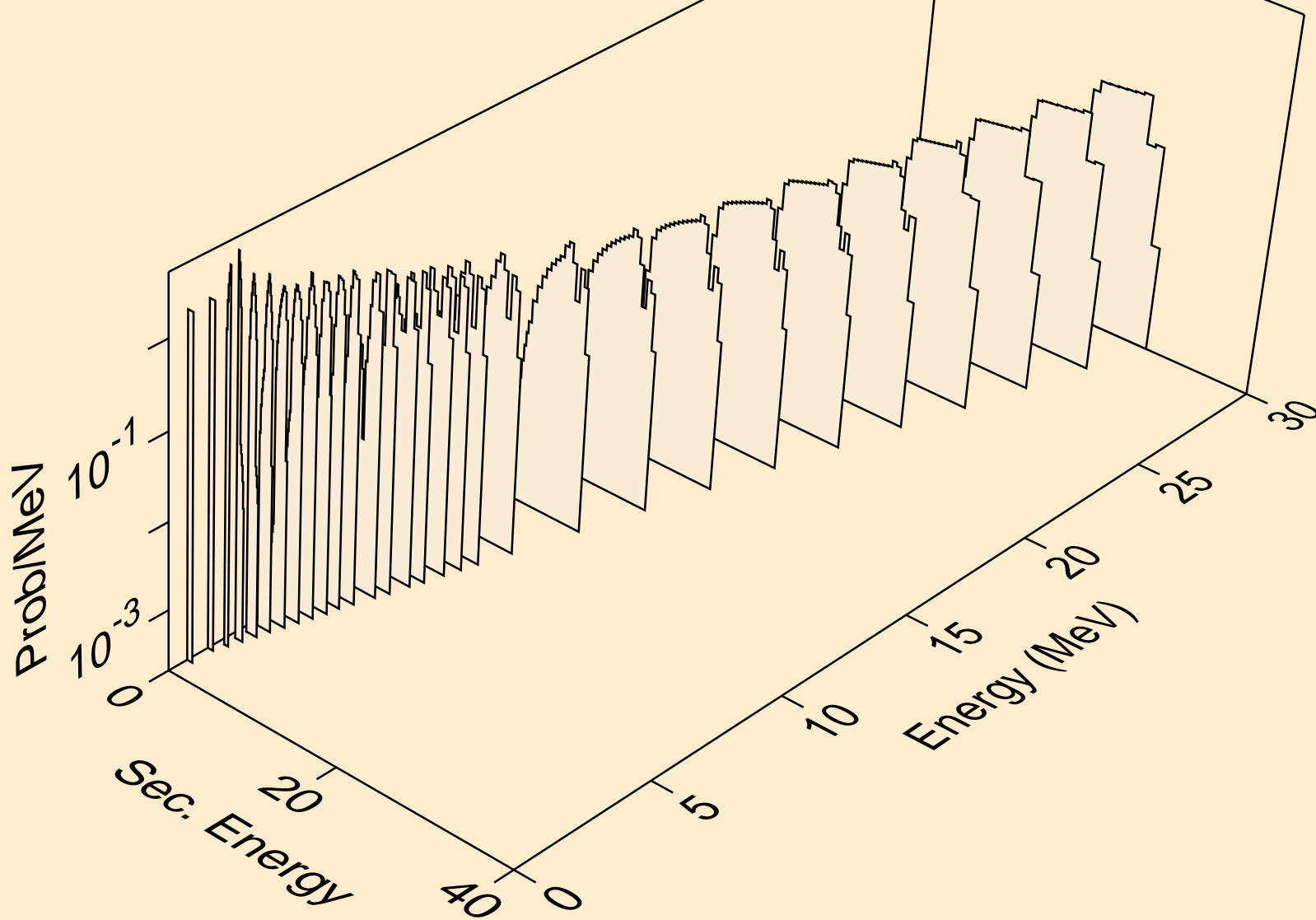

CU058 NEUTRON ACER TENDL-2019 LIBRARY; T=293.16K
deuterons from (n,pd)

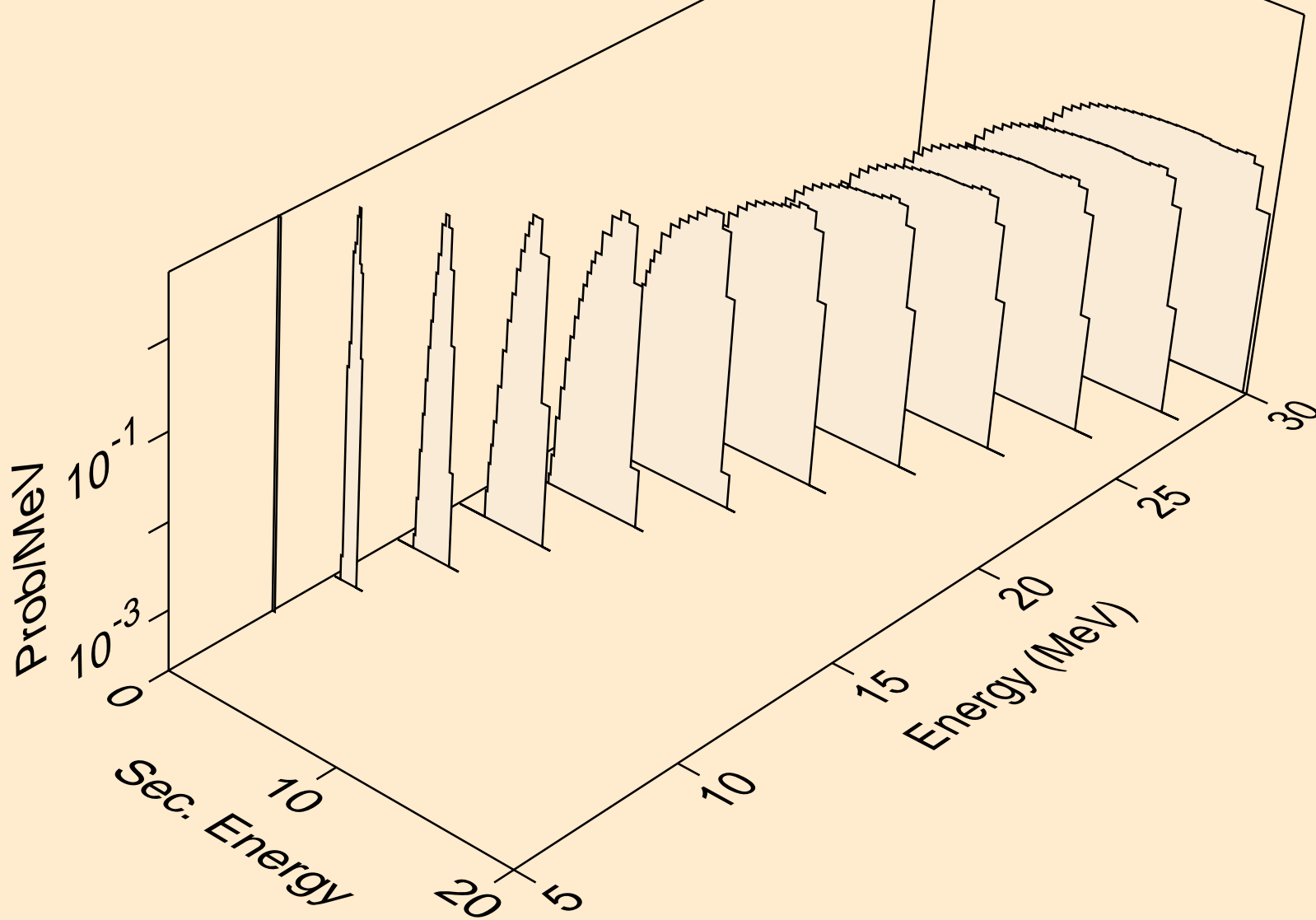

CU058 NEUTRON ACER TENDL-2019 LIBRARY; T=293.16K
deuterons from (n,da)

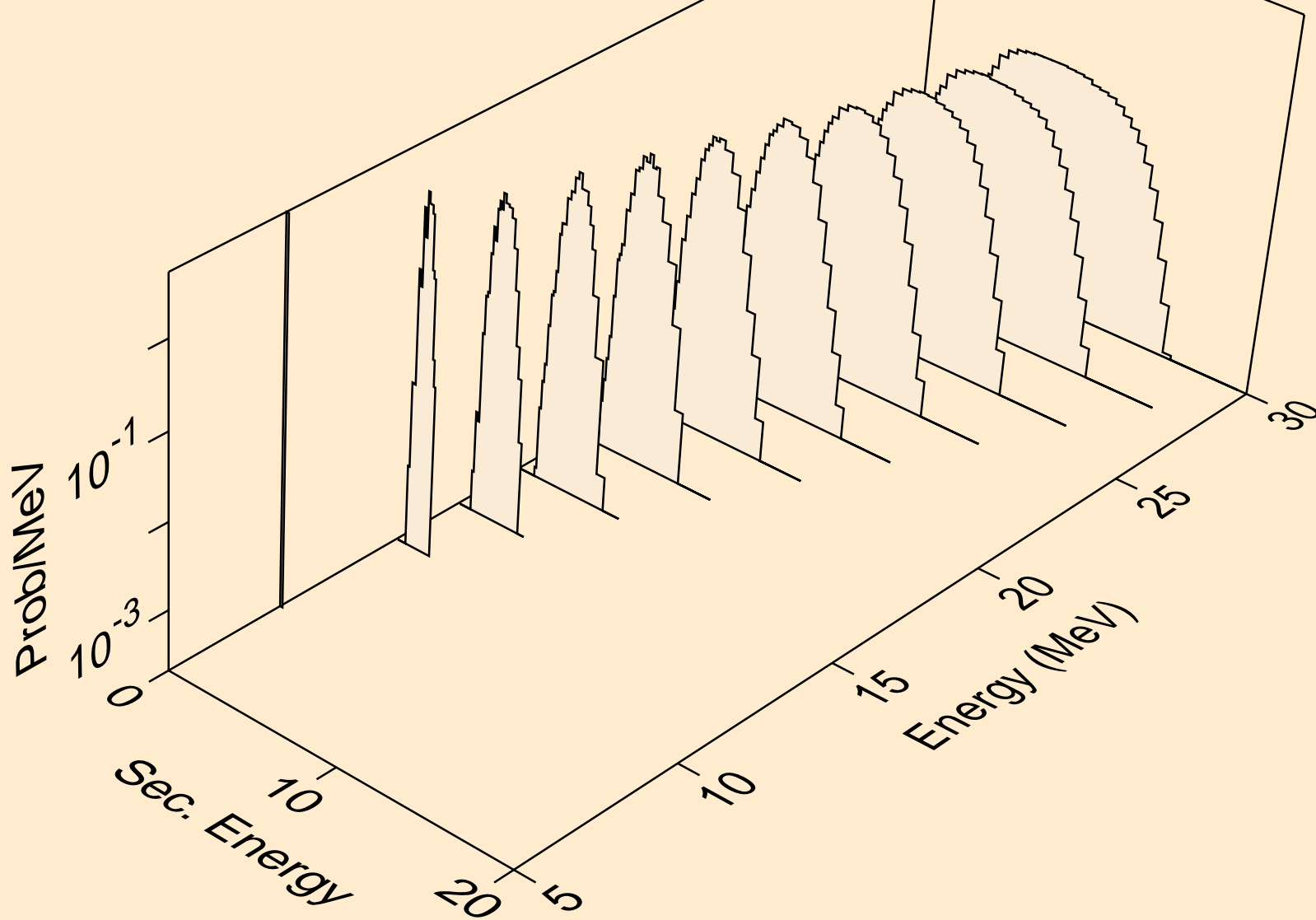

CU058 NEUTRON ACER TENDL-2019 LIBRARY; T=293.16K
tritons from (n,x)

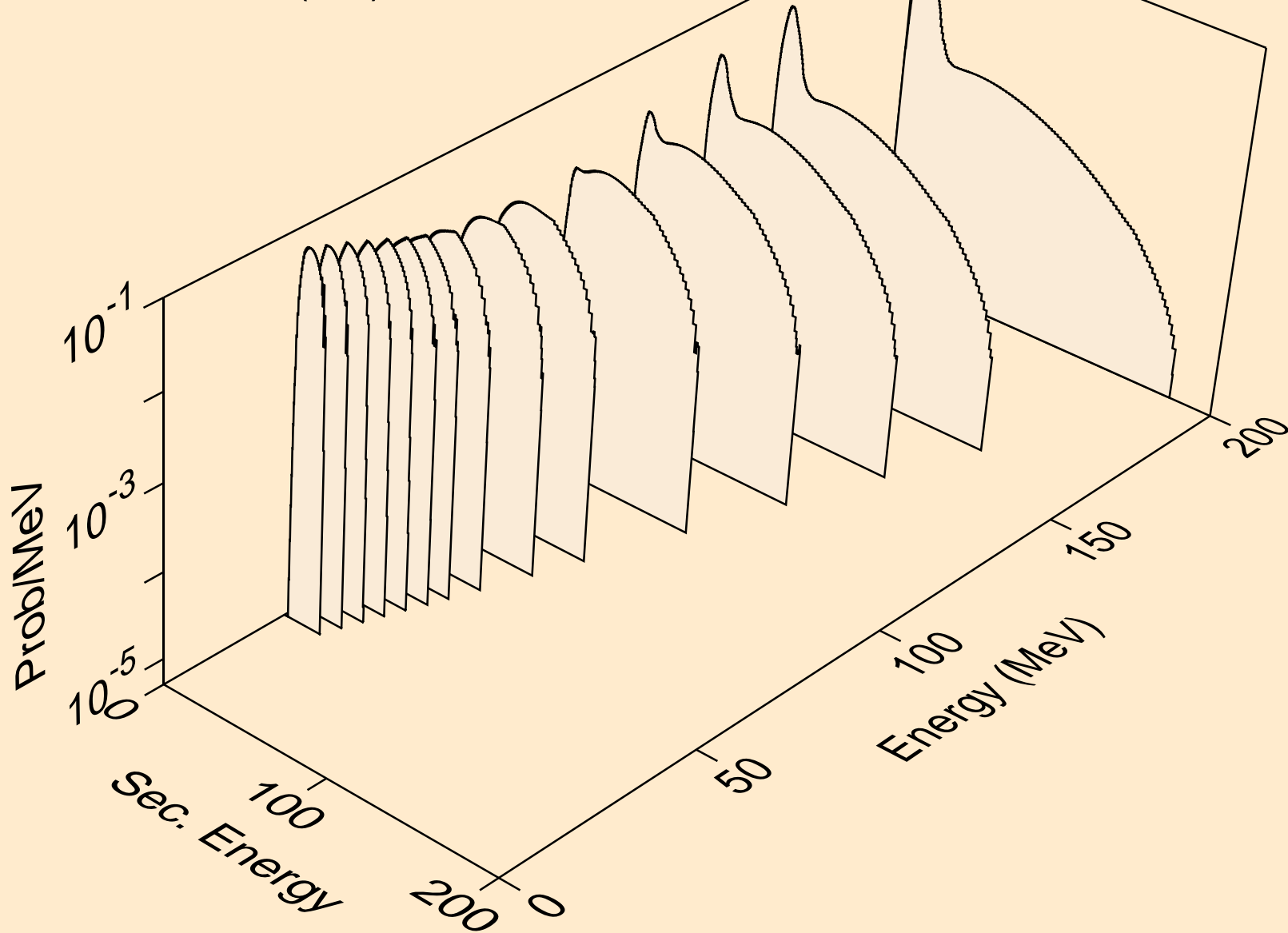

CU058 NEUTRON ACER TENDL-2019 LIBRARY; T=293.16K
tritons from (n,n*)t

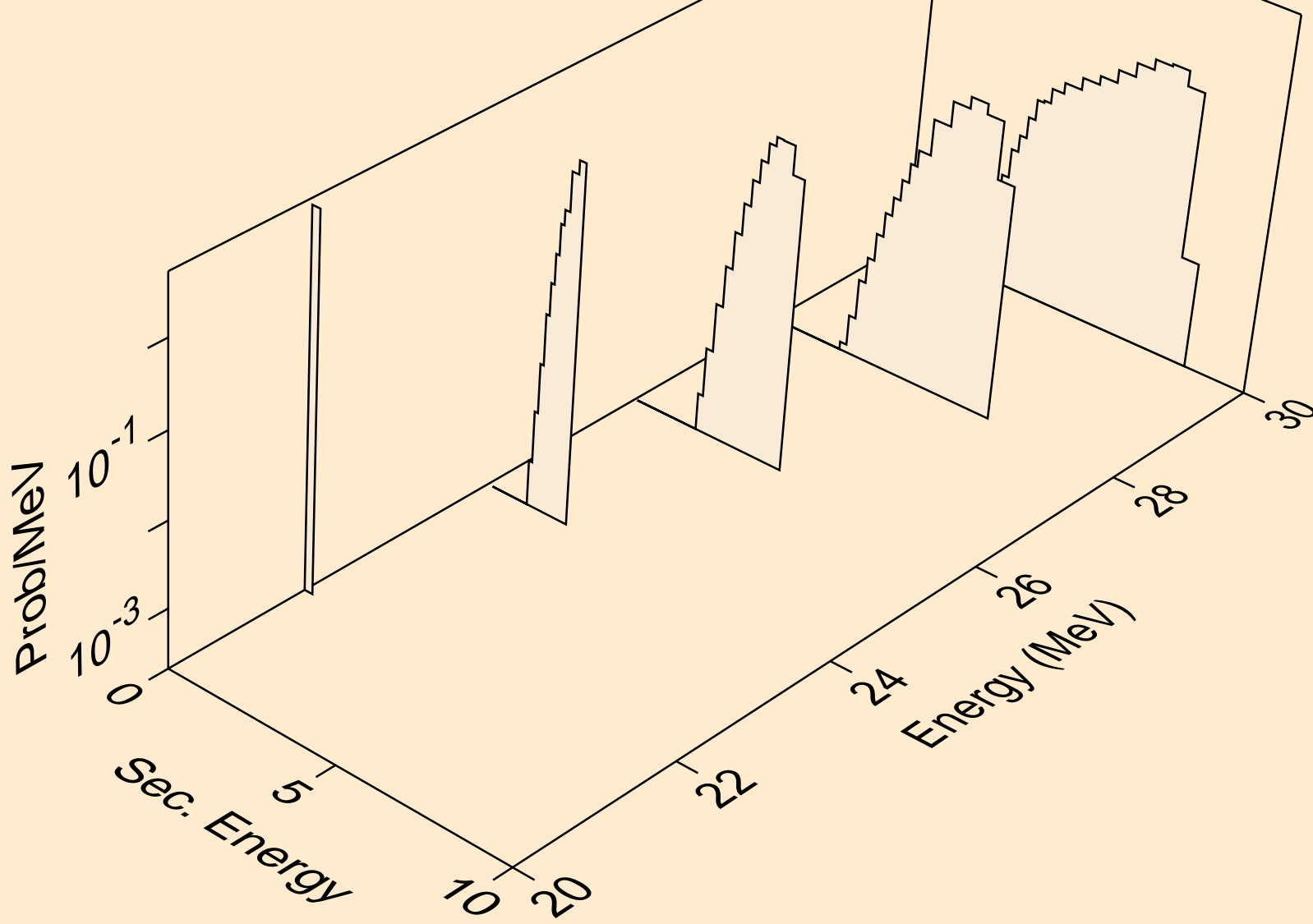

CU058 NEUTRON ACER TENDL-2019 LIBRARY; T=293.16K
tritons from (n,t)

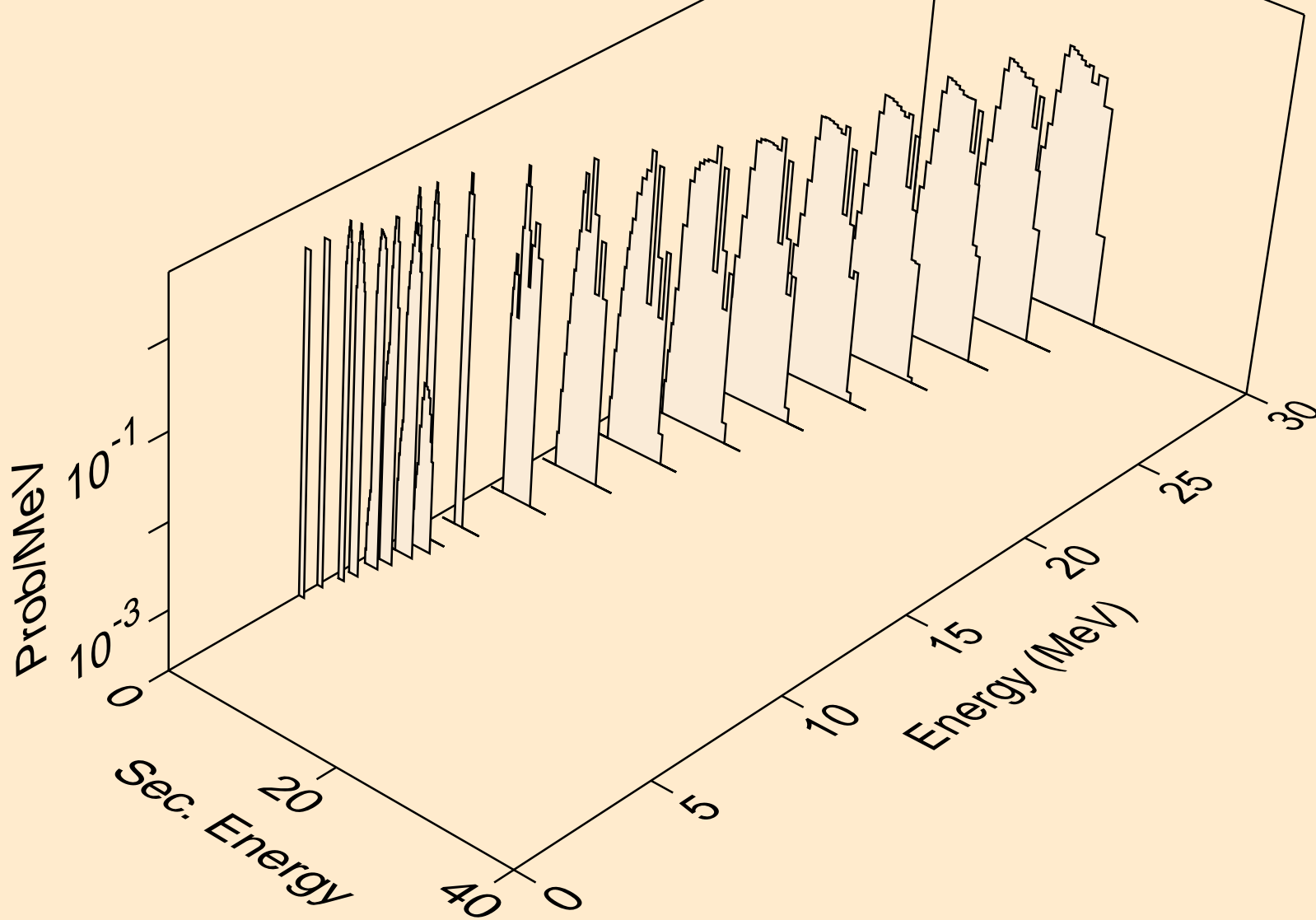

CU058 NEUTRON ACER TENDL-2019 LIBRARY; T=293.16K
tritons from (n,pt)

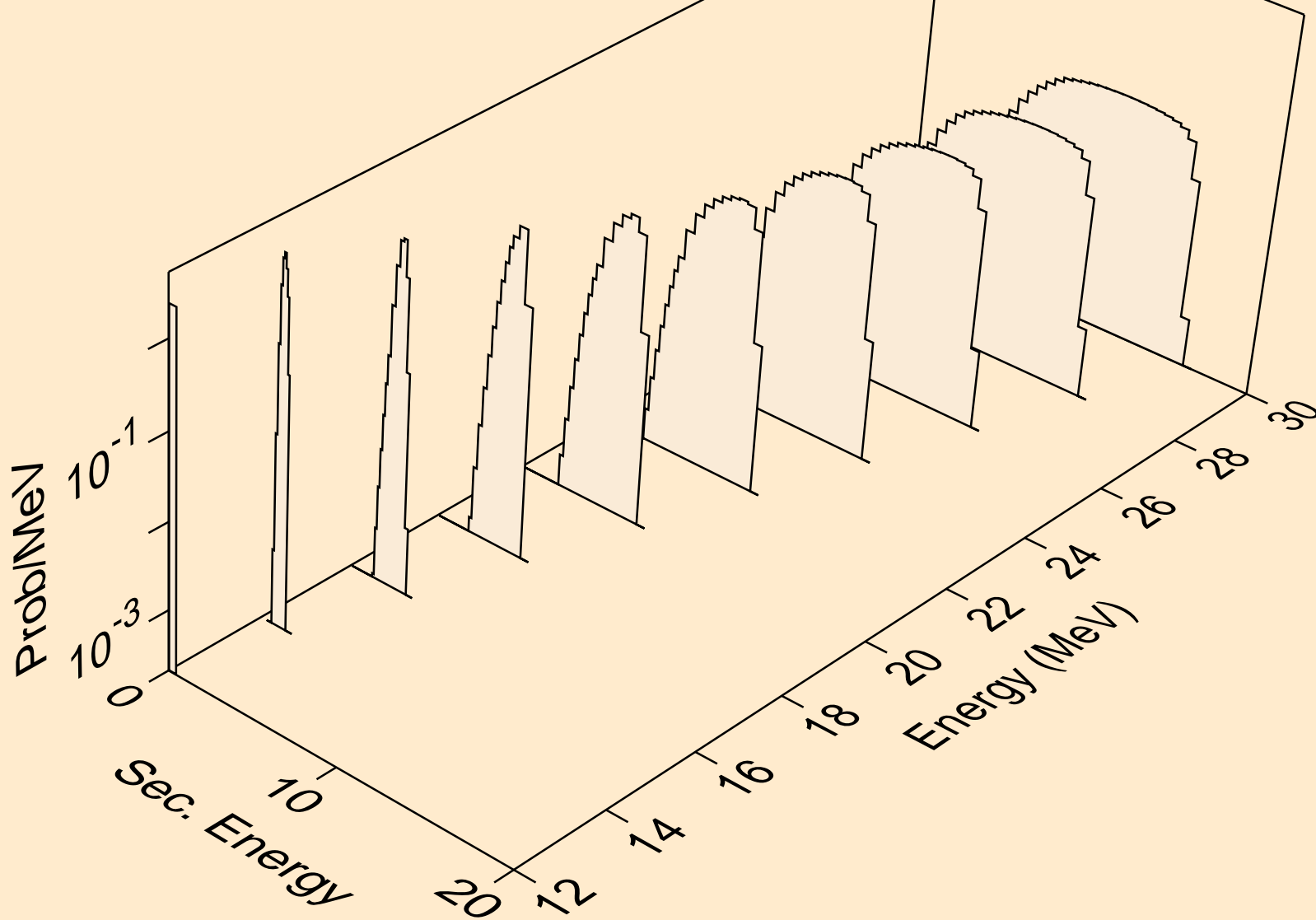

CU058 NEUTRON ACER TENDL-2019 LIBRARY; T=293.16K
he3s from (n,x)

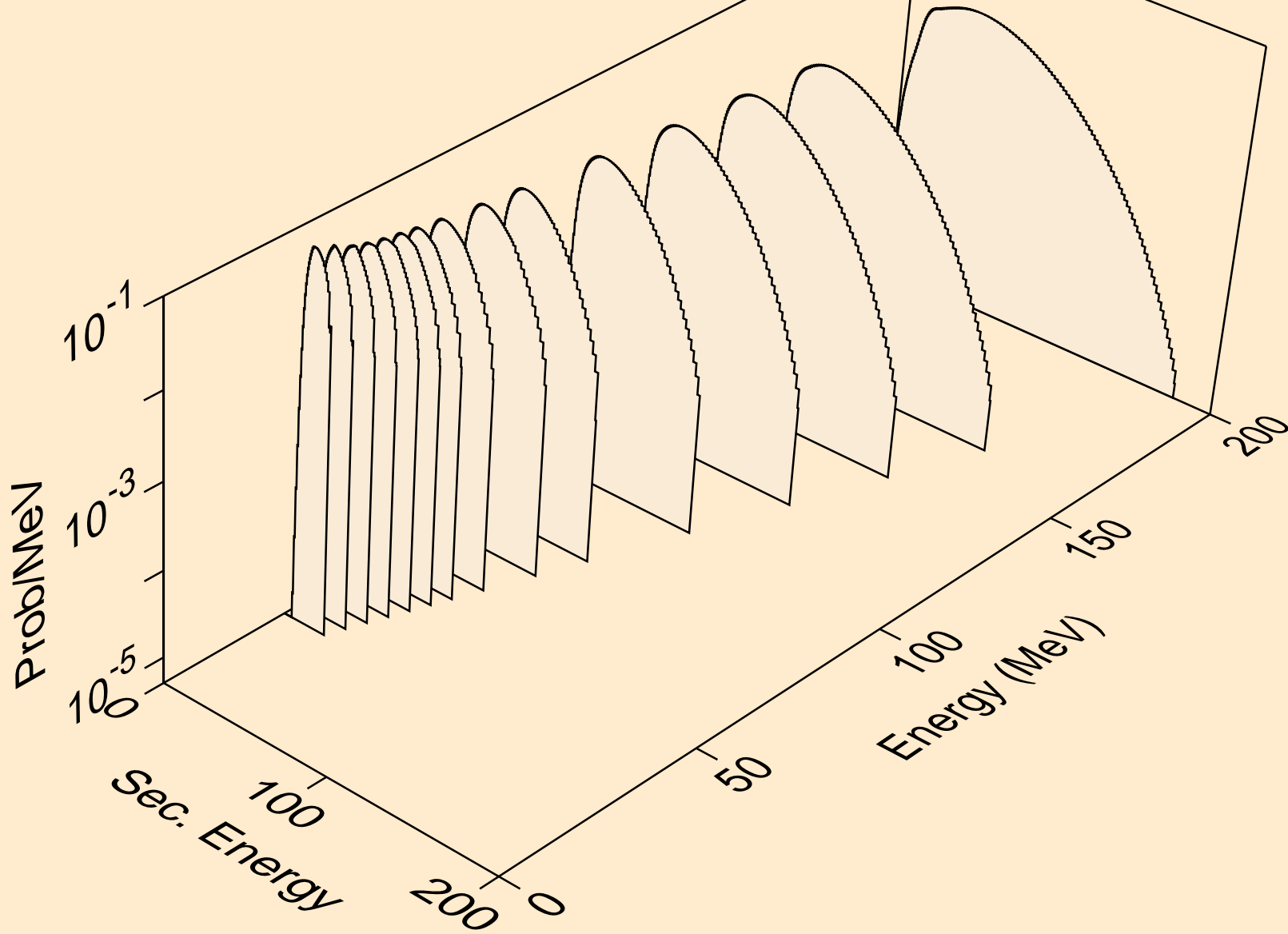

CU058 NEUTRON ACER TENDL-2019 LIBRARY; T=293.16K
he3s from (n,n*)he3

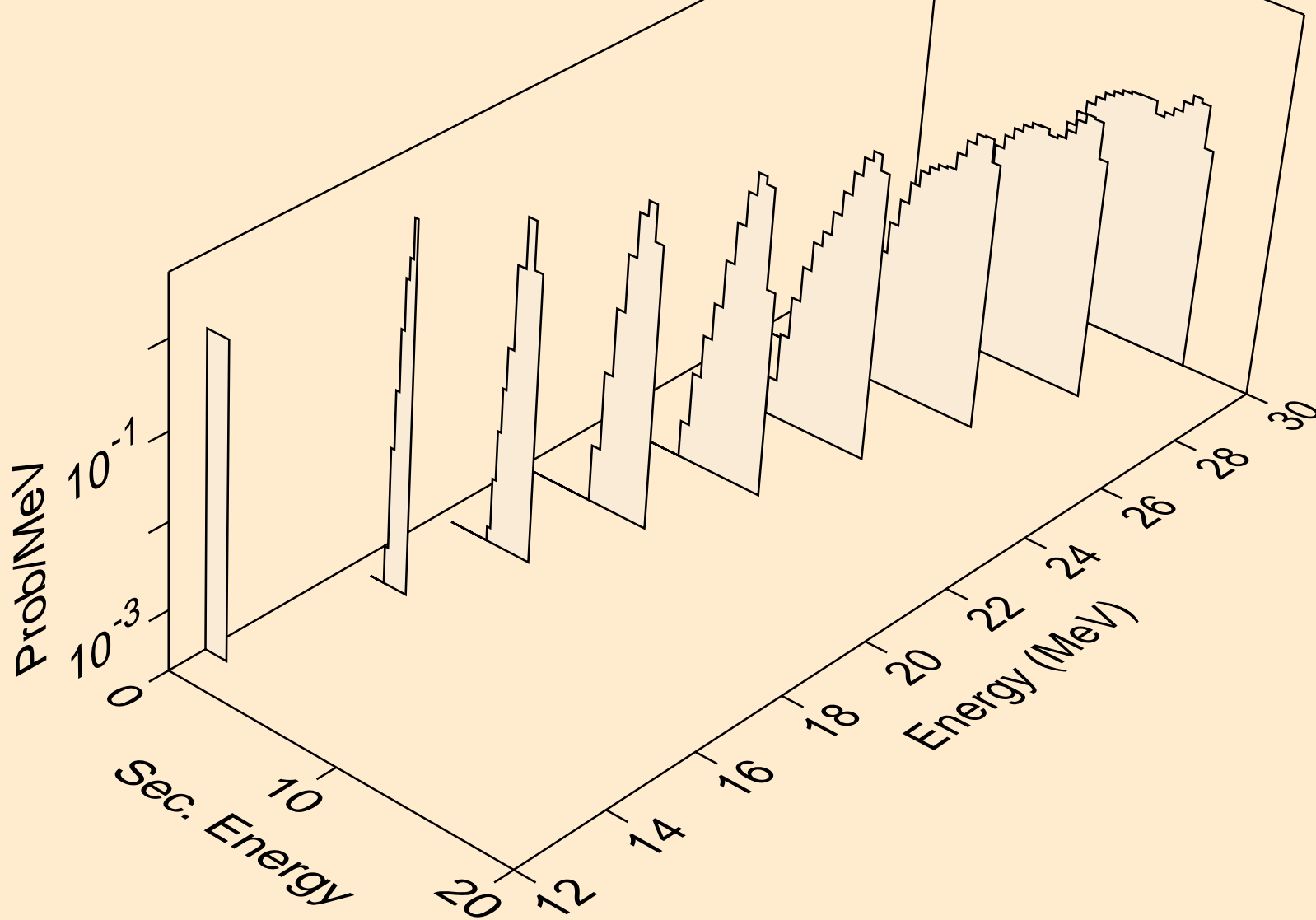

CU058 NEUTRON ACER TENDL-2019 LIBRARY; T=293.16K
he3s from (n,he3)

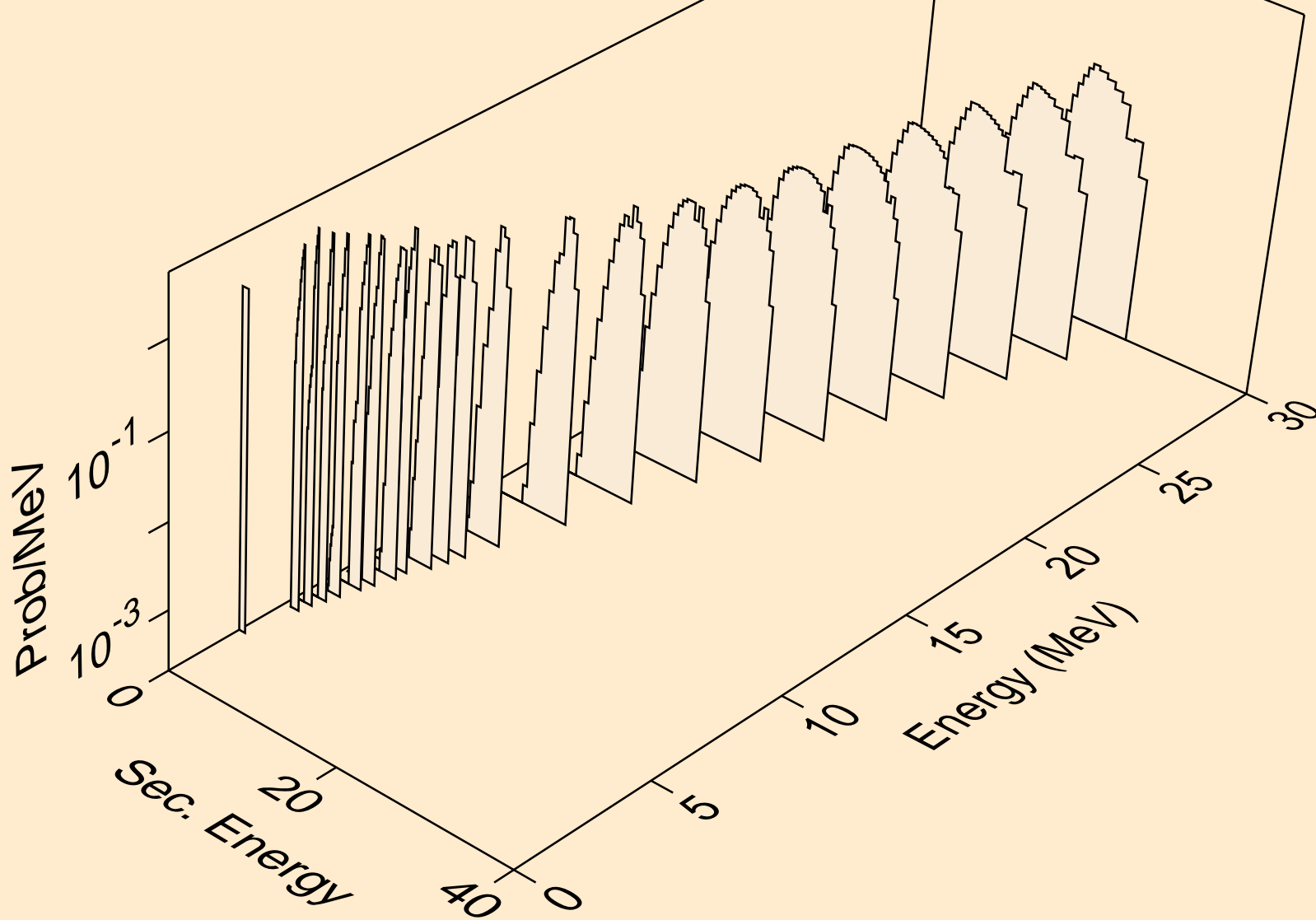

CU058 NEUTRON ACER TENDL-2019 LIBRARY; T=293.16K
alphas from (n,x)

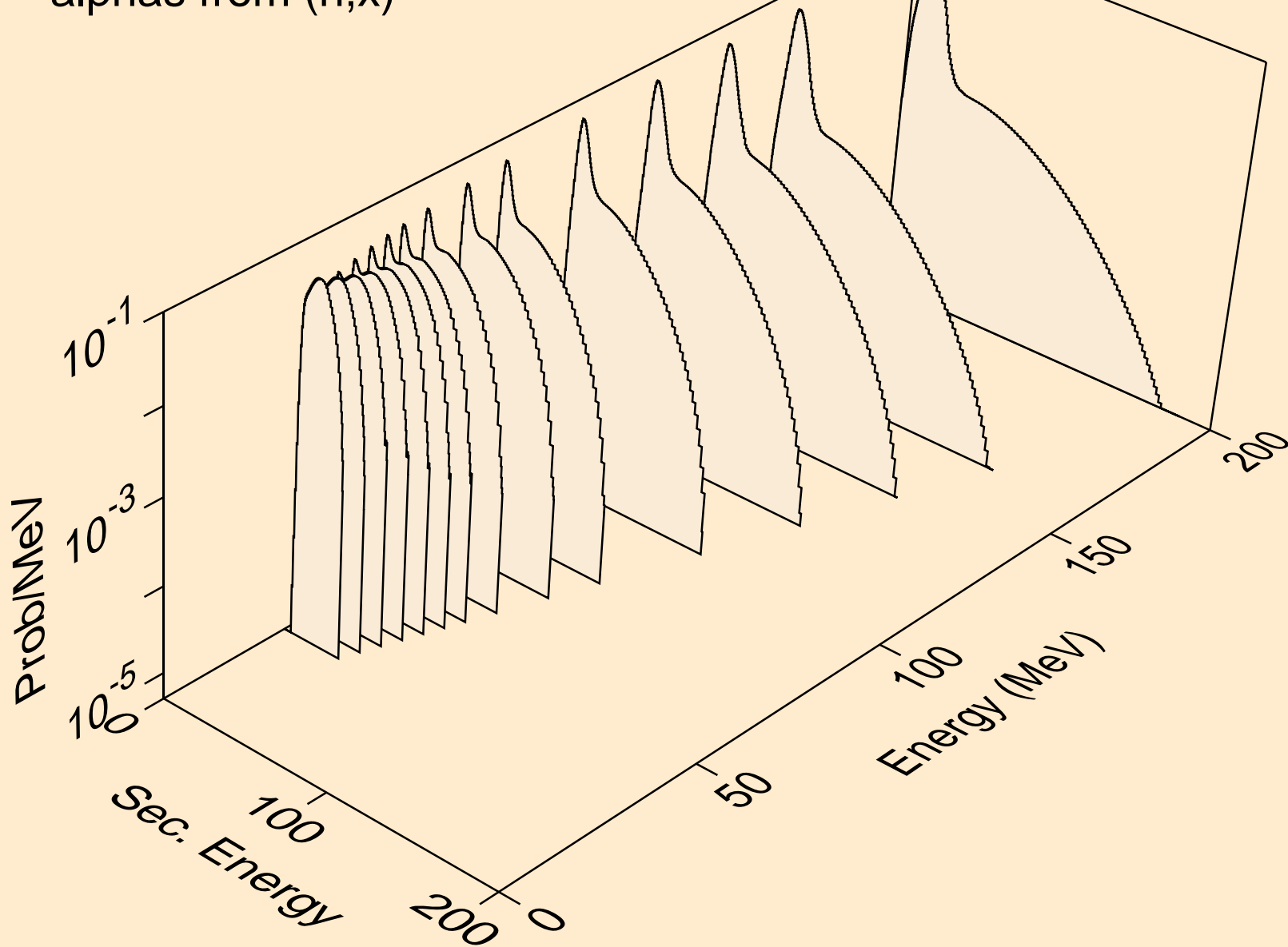

CU058 NEUTRON ACER TENDL-2019 LIBRARY; T=293.16K
alphas from (n,n*)a

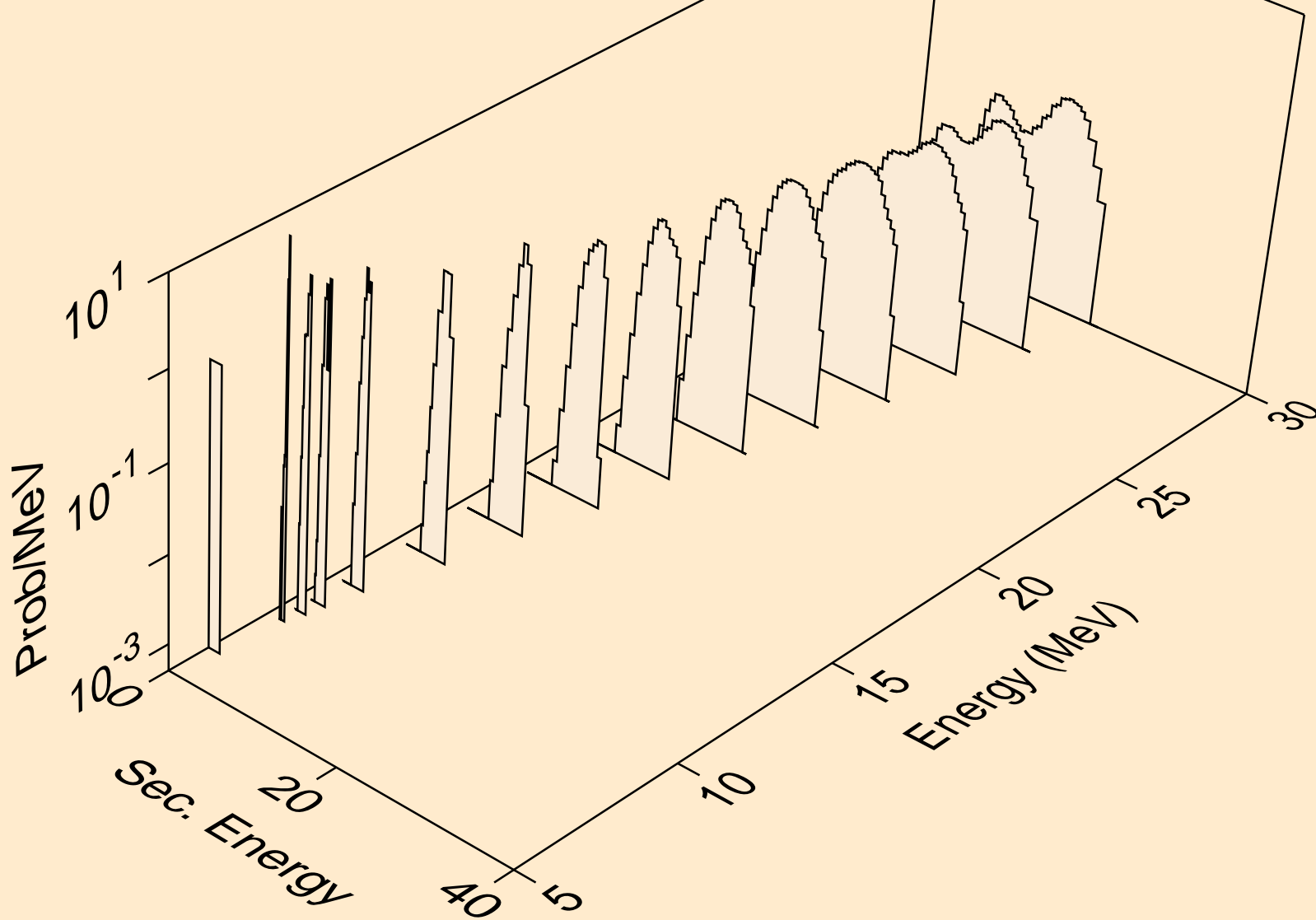

CU058 NEUTRON ACER TENDL-2019 LIBRARY; T=293.16K
alphas from (n,2n)a

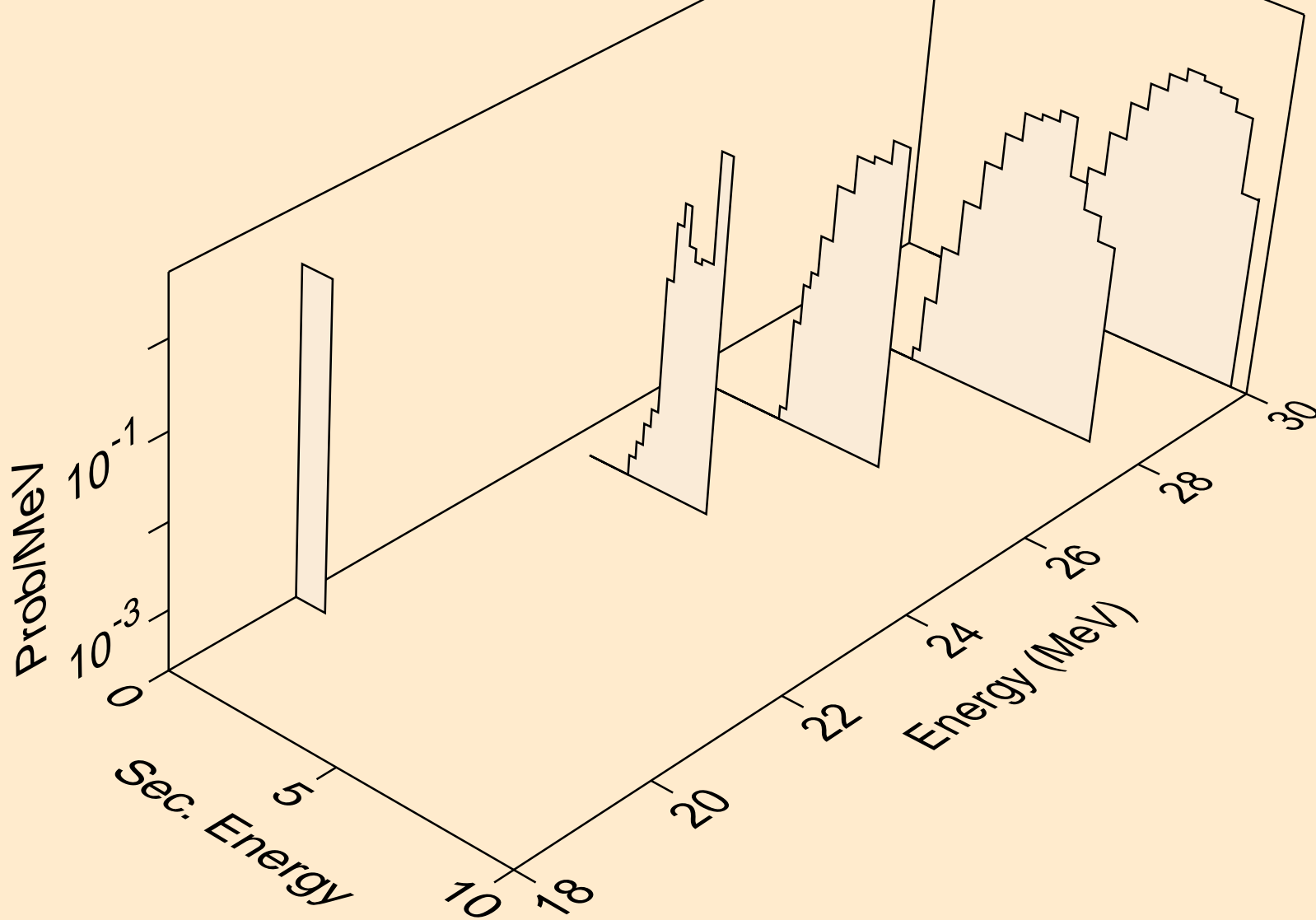

CU058 NEUTRON ACER TENDL-2019 LIBRARY; T=293.16K
alphas from (n,n*)2a

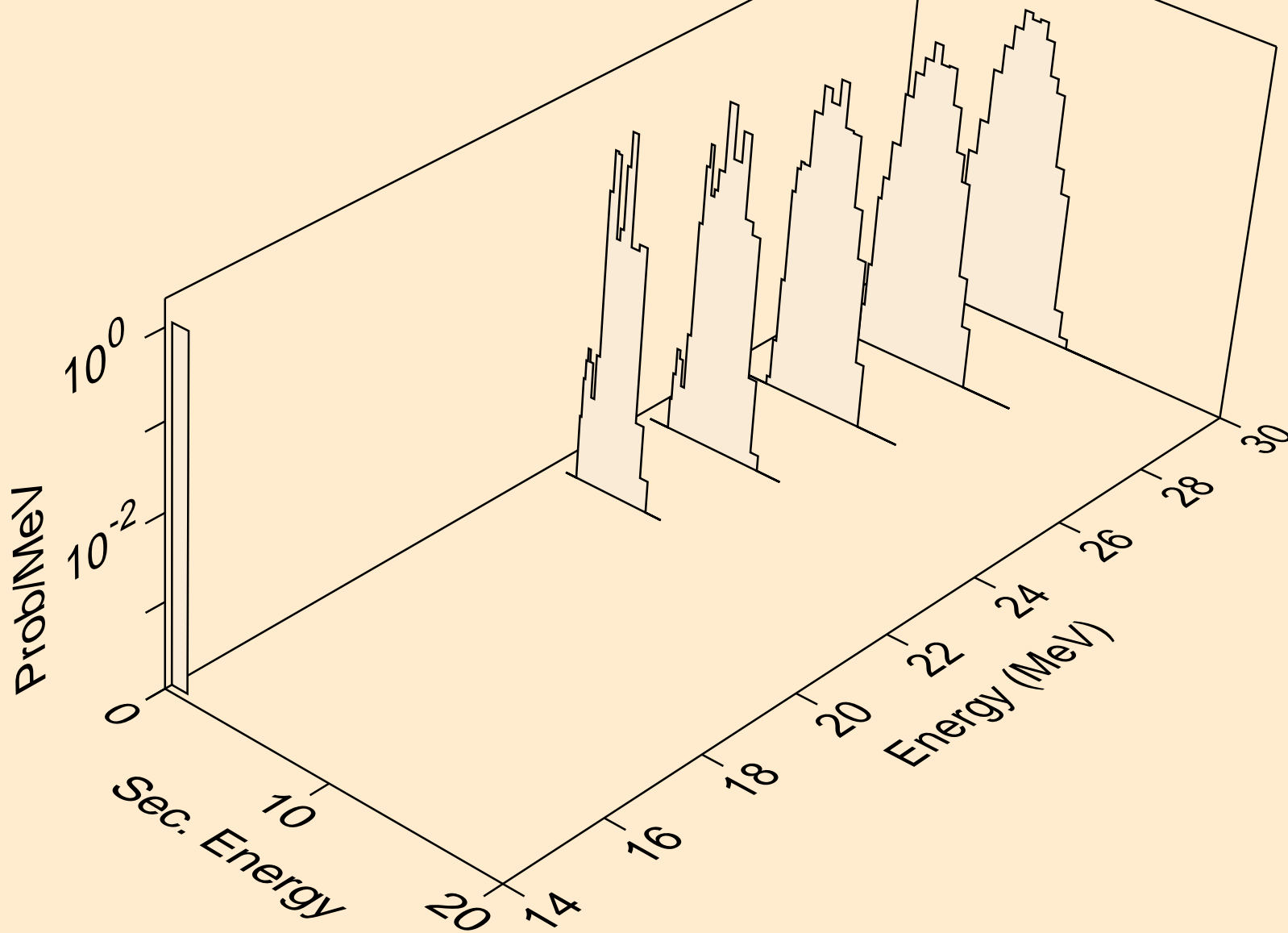

CU058 NEUTRON ACER TENDL-2019 LIBRARY; T=293.16K
alphas from (n,npa)

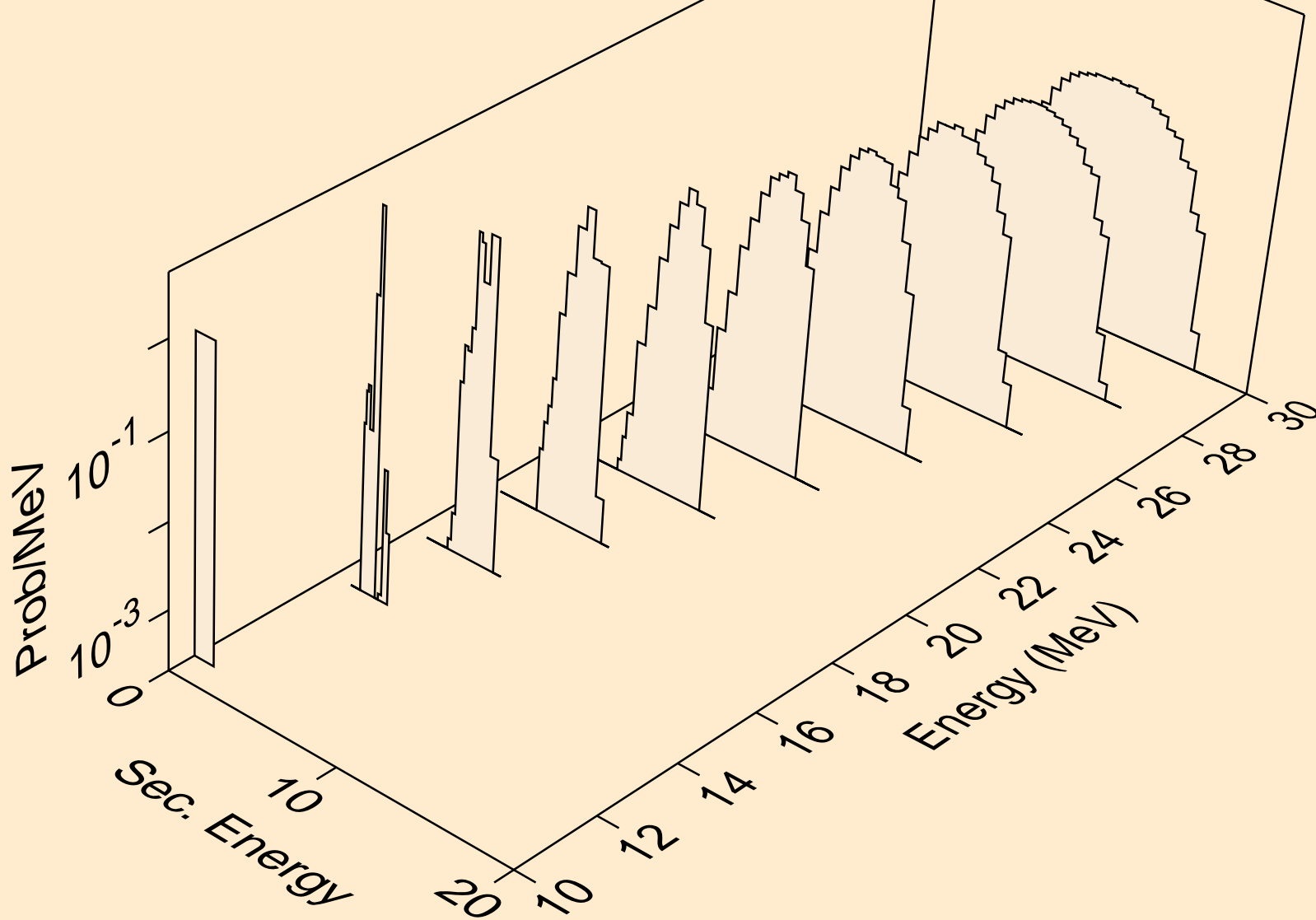

CU058 NEUTRON ACER TENDL-2019 LIBRARY; T=293.16K
alphas from (n,a)

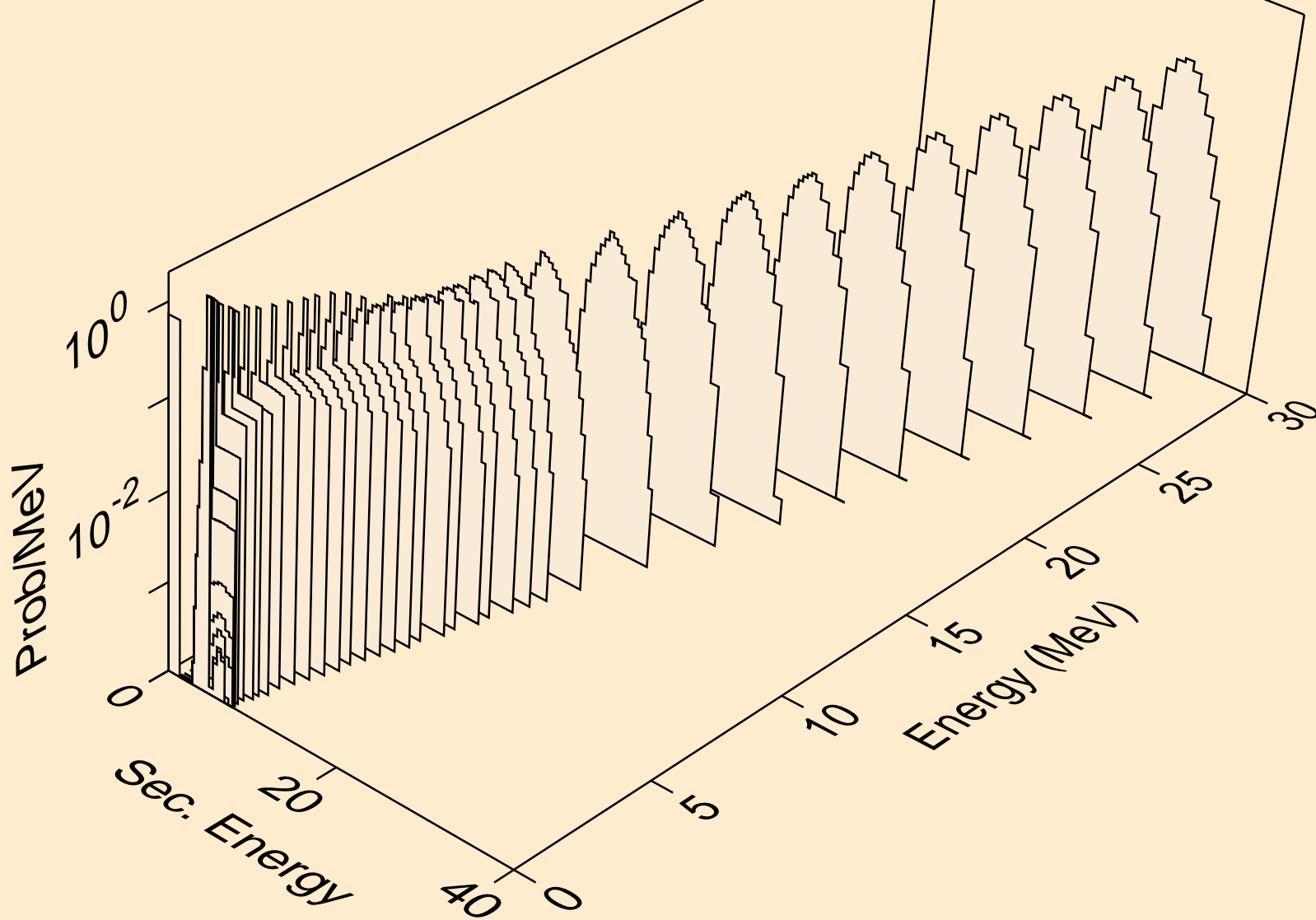

CU058 NEUTRON ACER TENDL-2019 LIBRARY; T=293.16K
alphas from (n,2a)

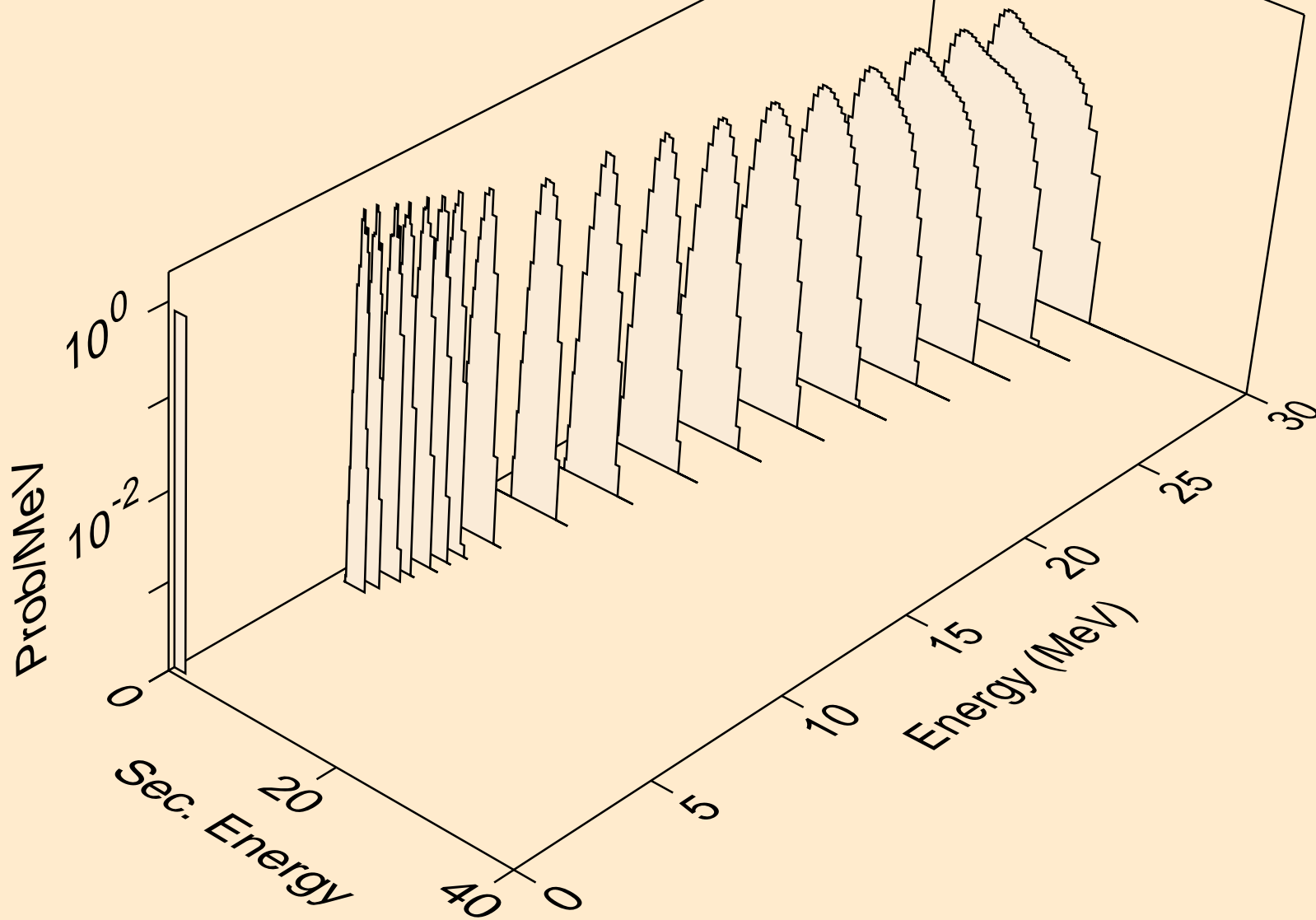

CU058 NEUTRON ACER TENDL-2019 LIBRARY; T=293.16K
alphas from (n,pa)

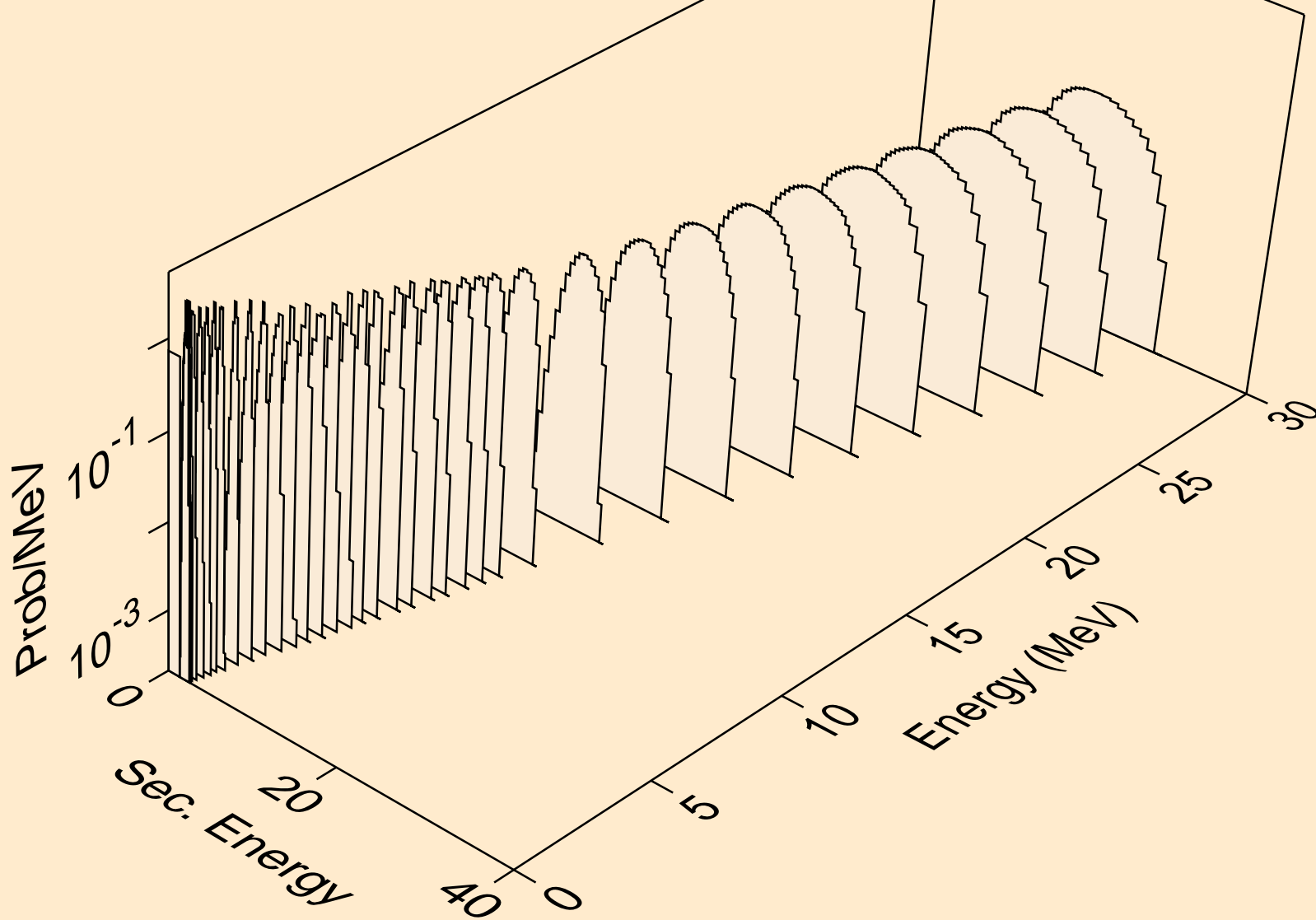

CU058 NEUTRON ACER TENDL-2019 LIBRARY; T=293.16K
alphas from (n,da)

