

CU069 NEUTRON ACER TENDL-2019 LIBRARY; T=293.16K
Principal cross sections

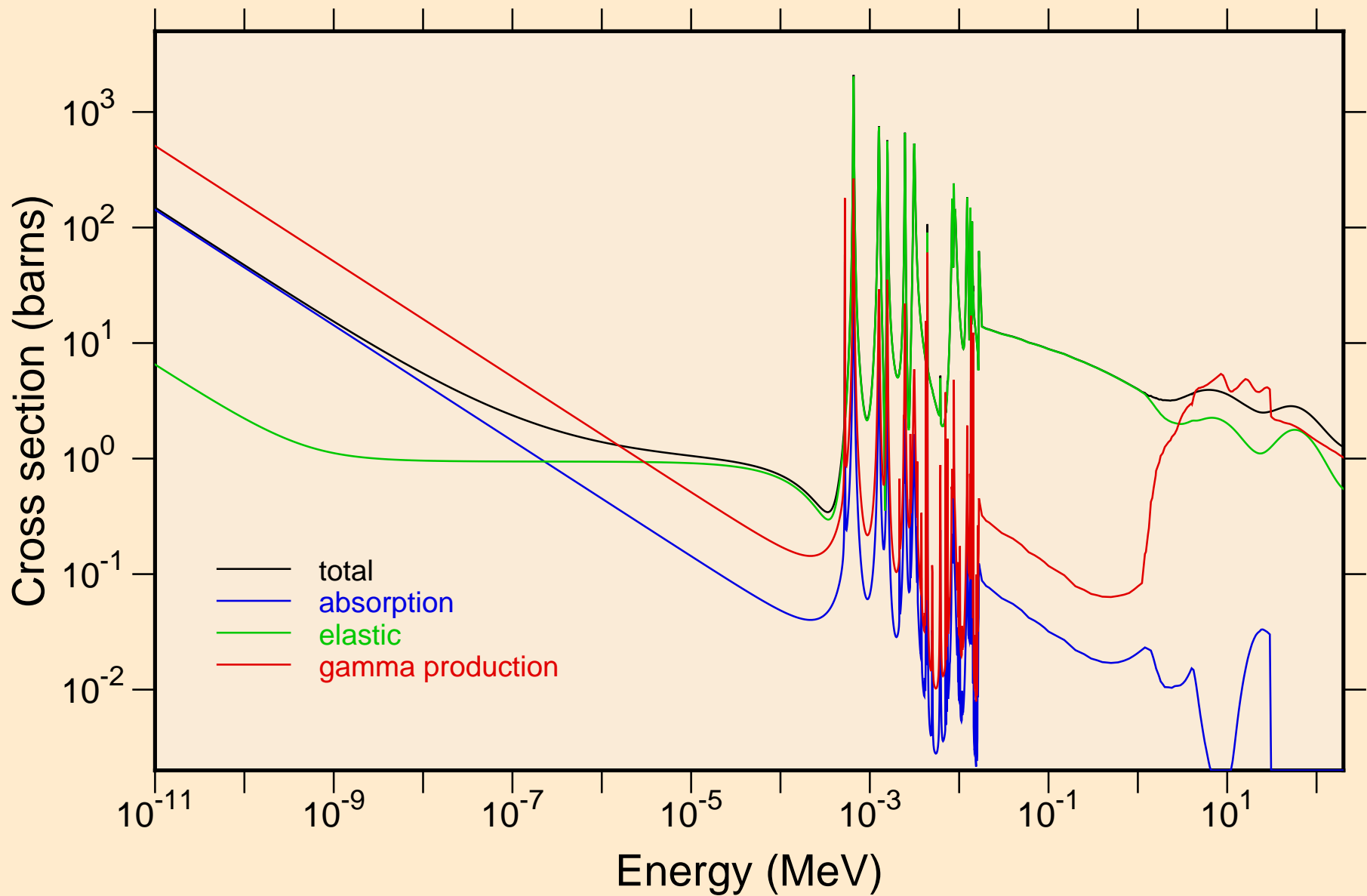

CU069 NEUTRON ACER TENDL-2019 LIBRARY; T=293.16K
resonance total cross section

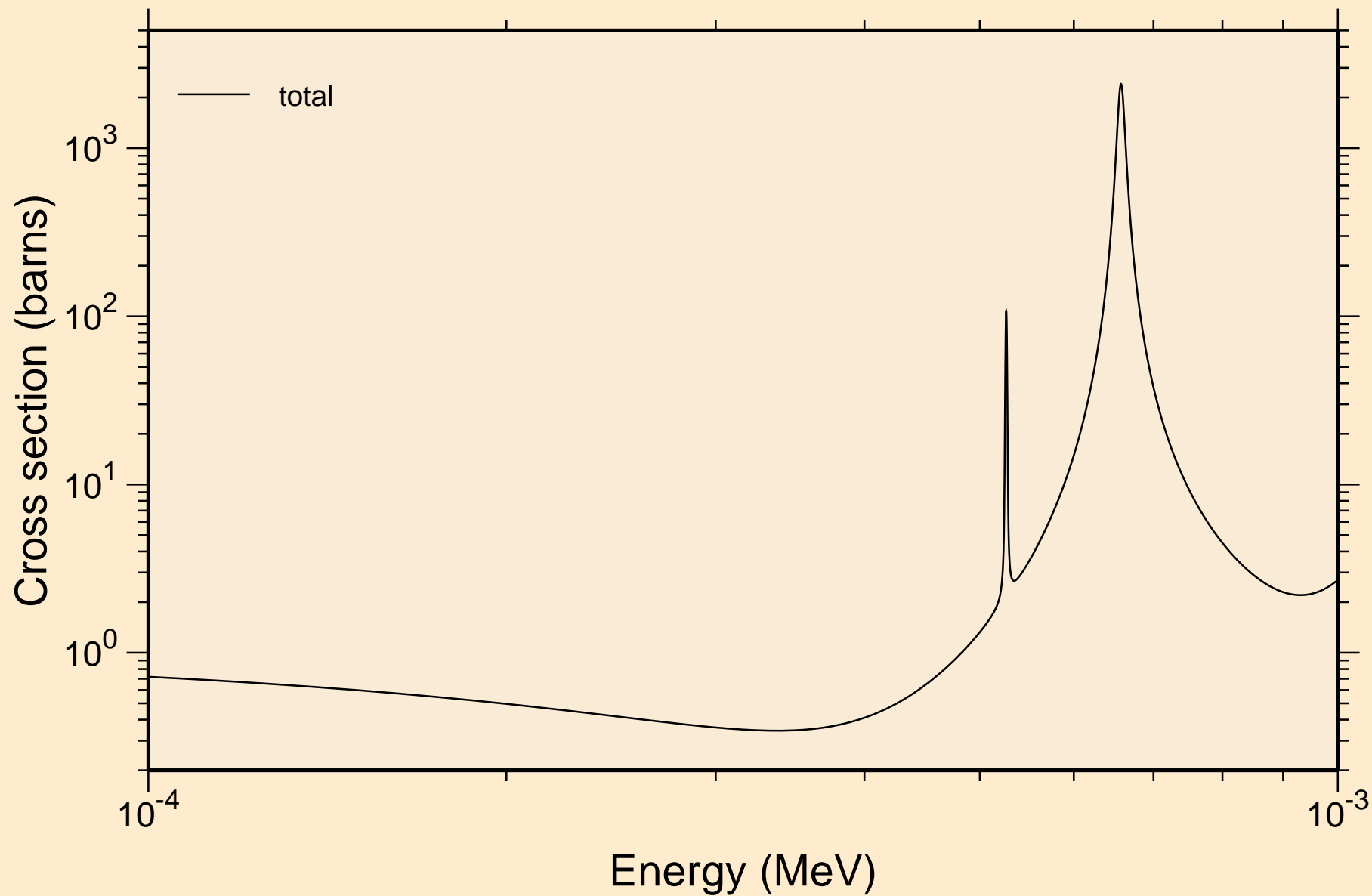

CU069 NEUTRON ACER TENDL-2019 LIBRARY; T=293.16K
resonance total cross section

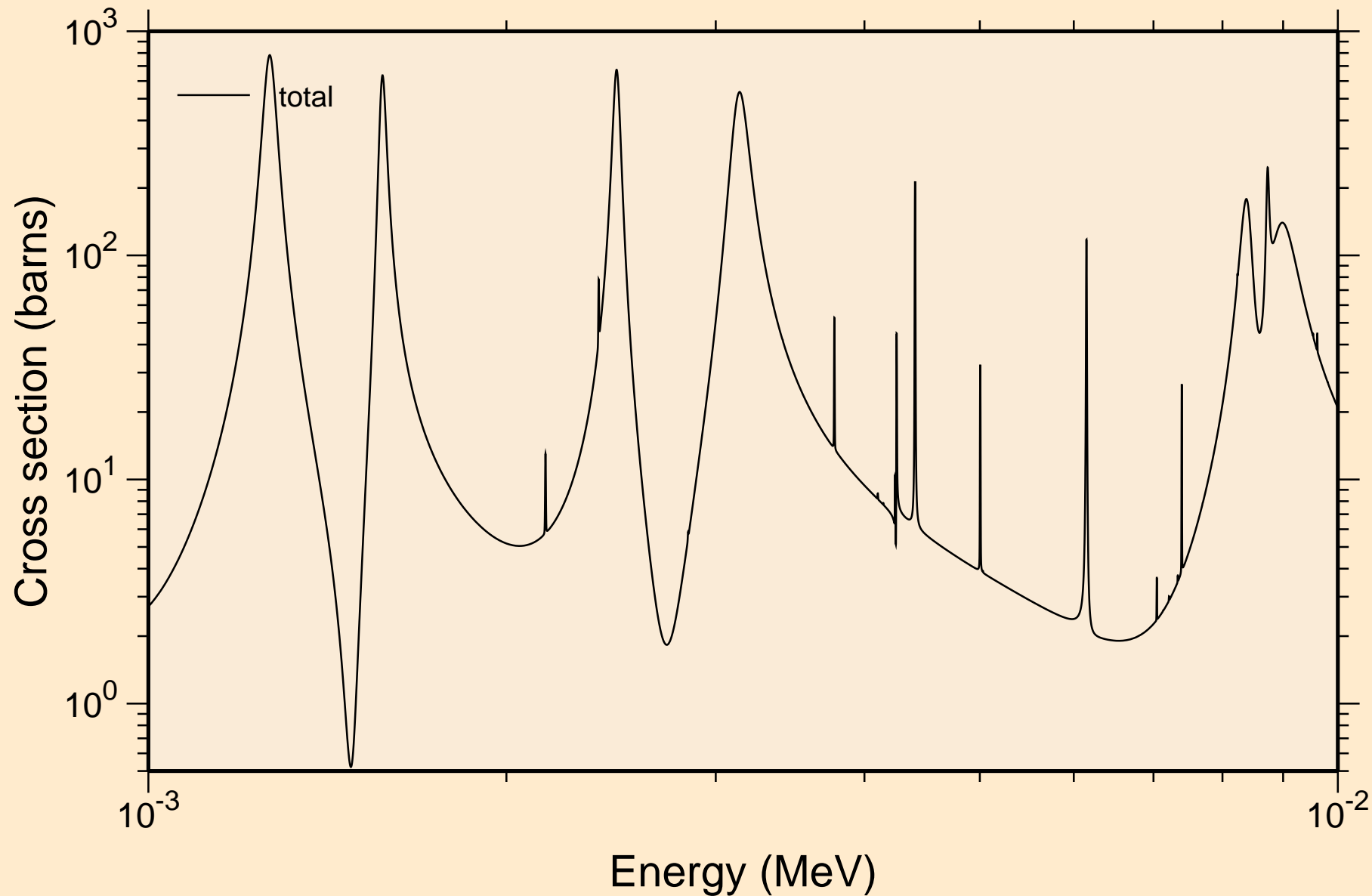

CU069 NEUTRON ACER TENDL-2019 LIBRARY; T=293.16K
resonance total cross section

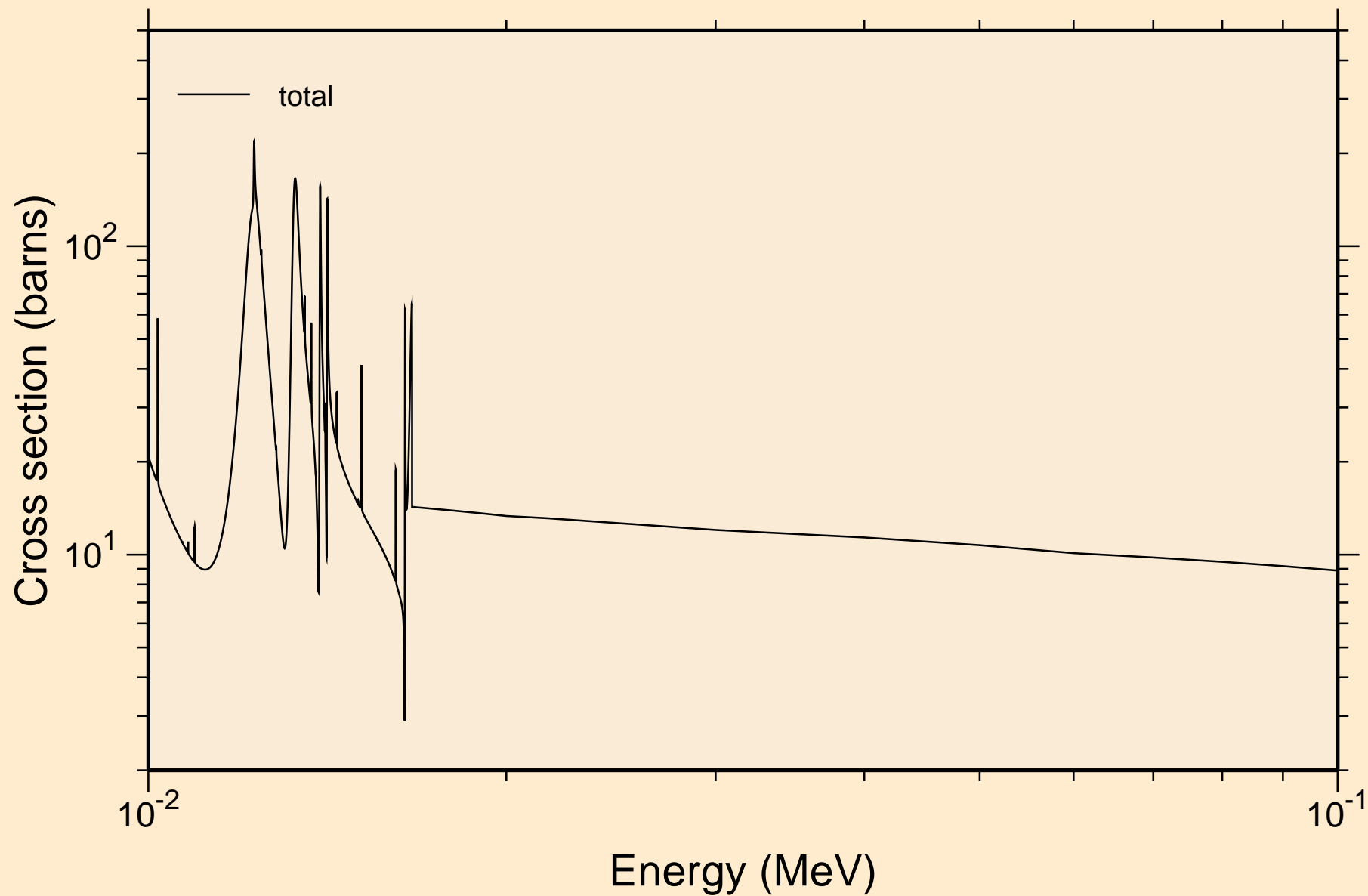

CŪ069 NEUTRON ACER TENDL-2019 LIBRARY; T=293.16K
resonance total cross section

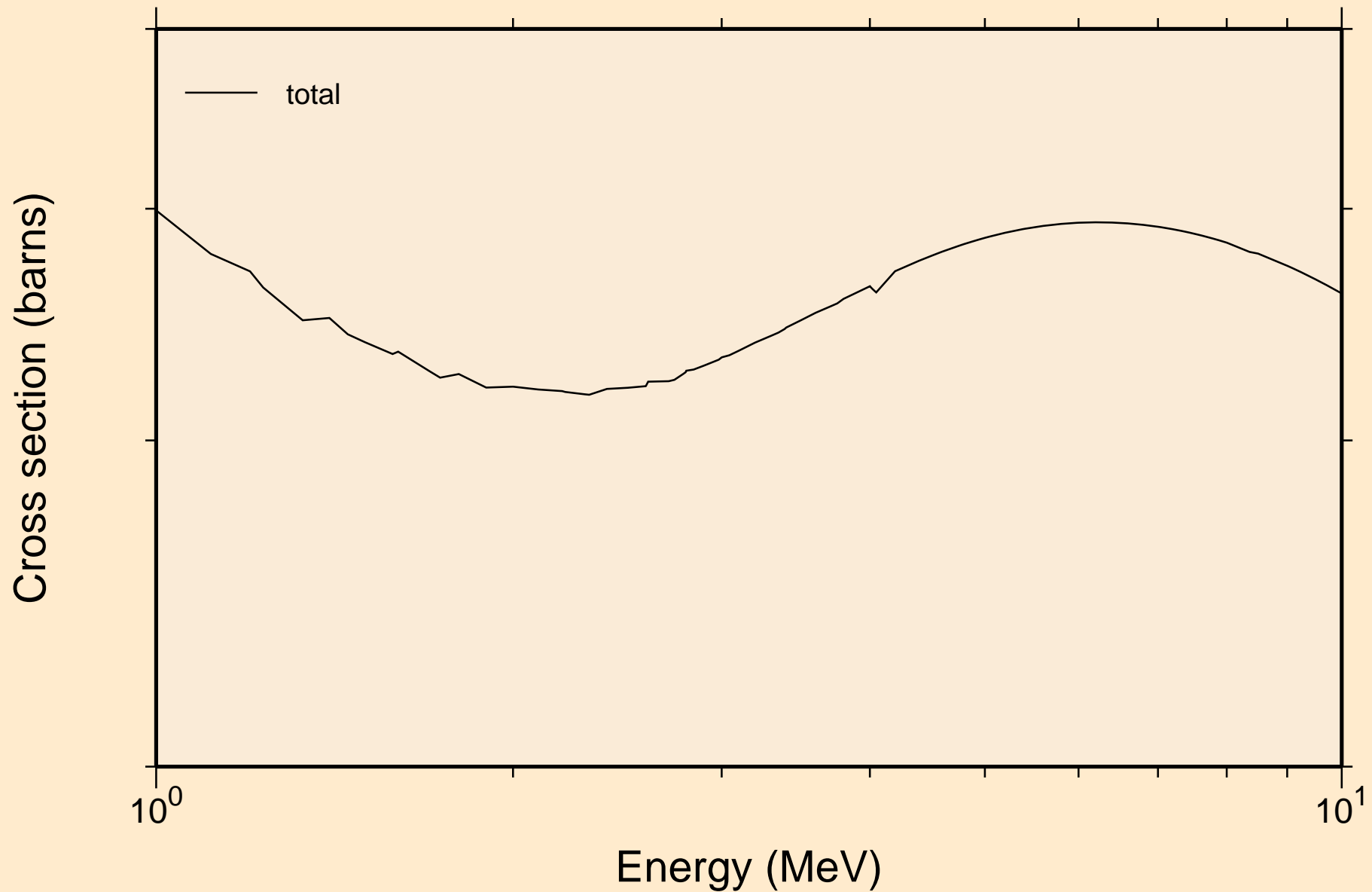

CU069 NEUTRON ACER TENDL-2019 LIBRARY; T=293.16K
resonance absorption cross sections

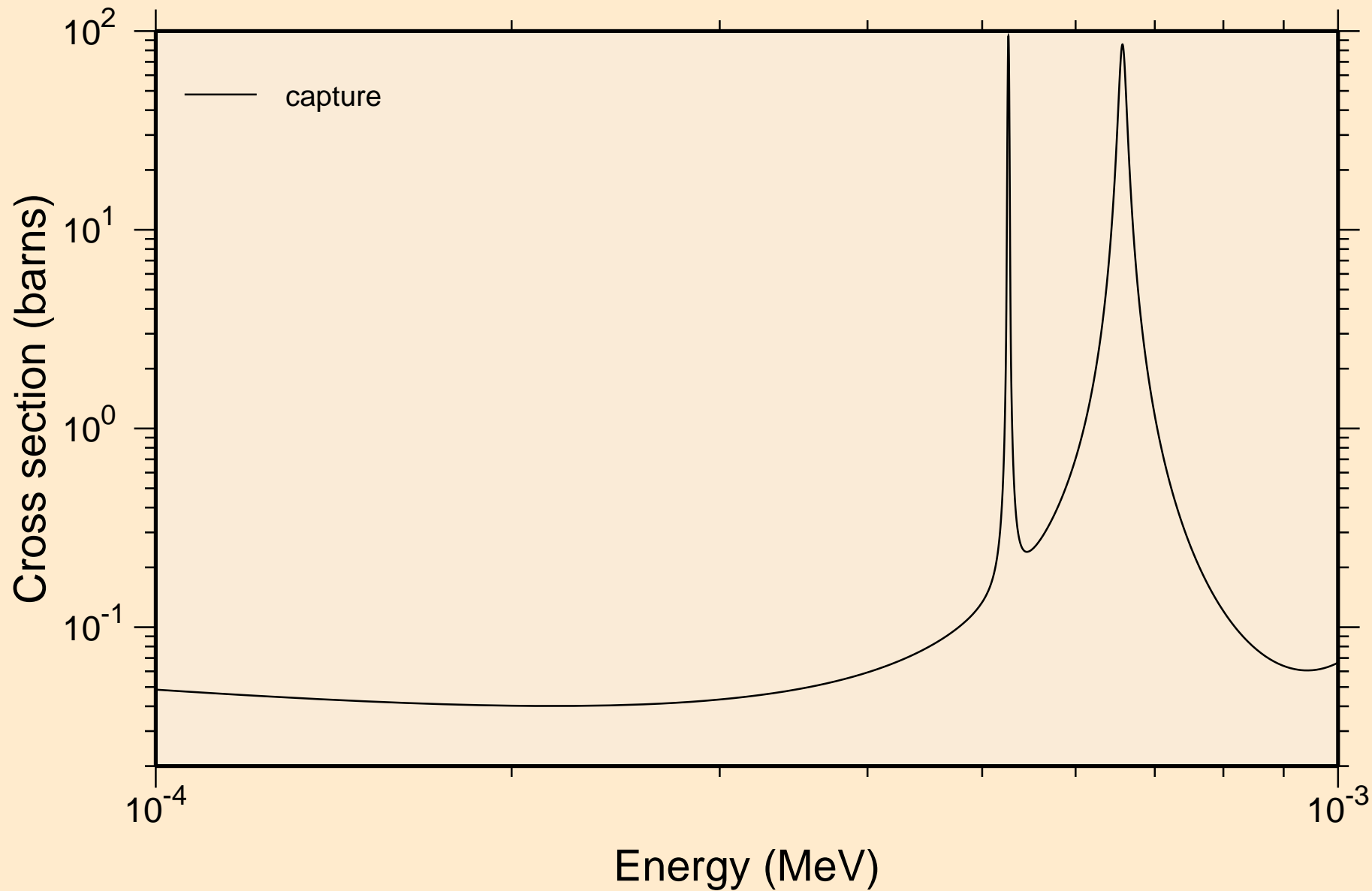

CU069 NEUTRON ACER TENDL-2019 LIBRARY; T=293.16K
resonance absorption cross sections

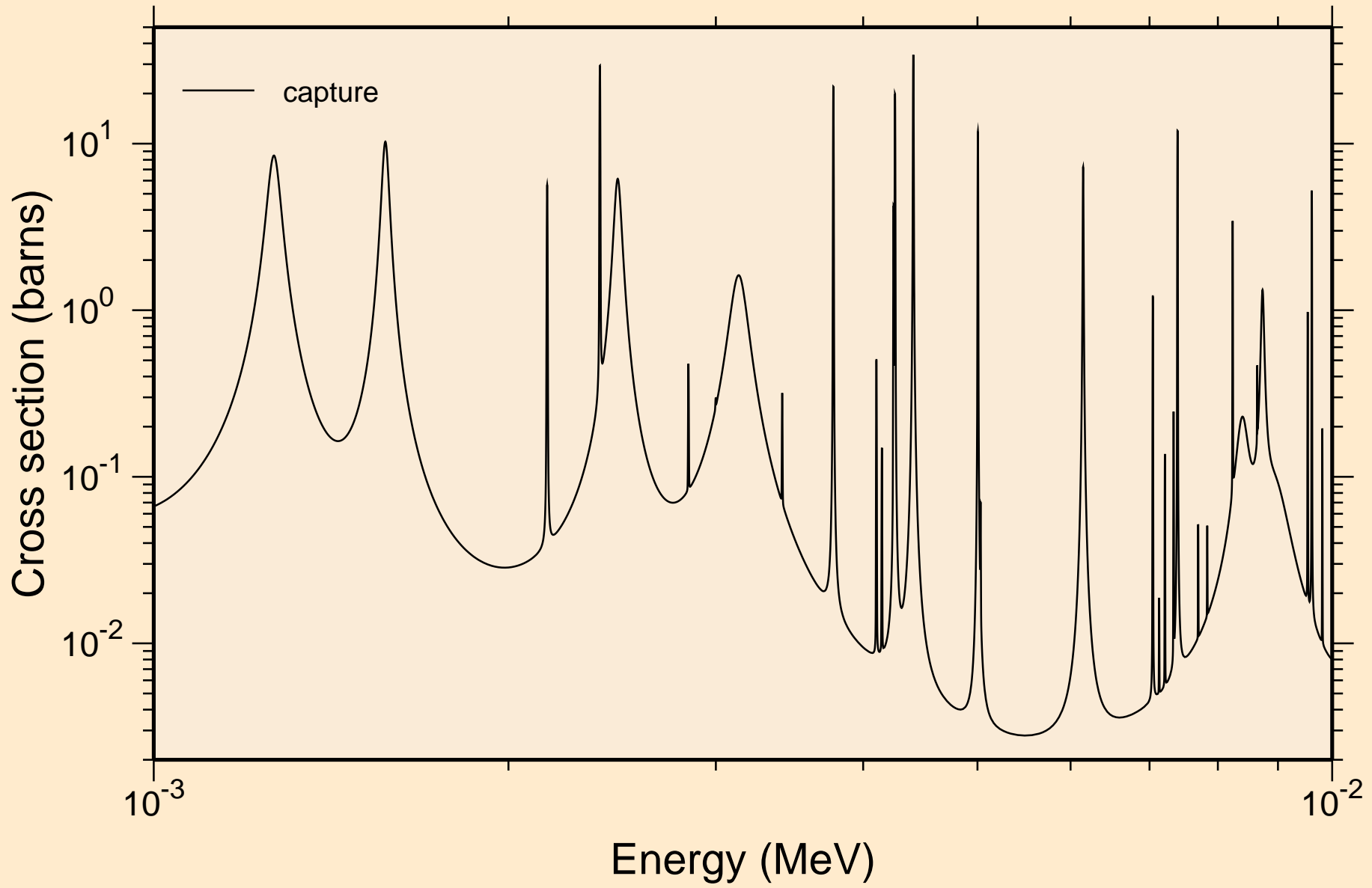

CU069 NEUTRON ACER TENDL-2019 LIBRARY; T=293.16K
resonance absorption cross sections

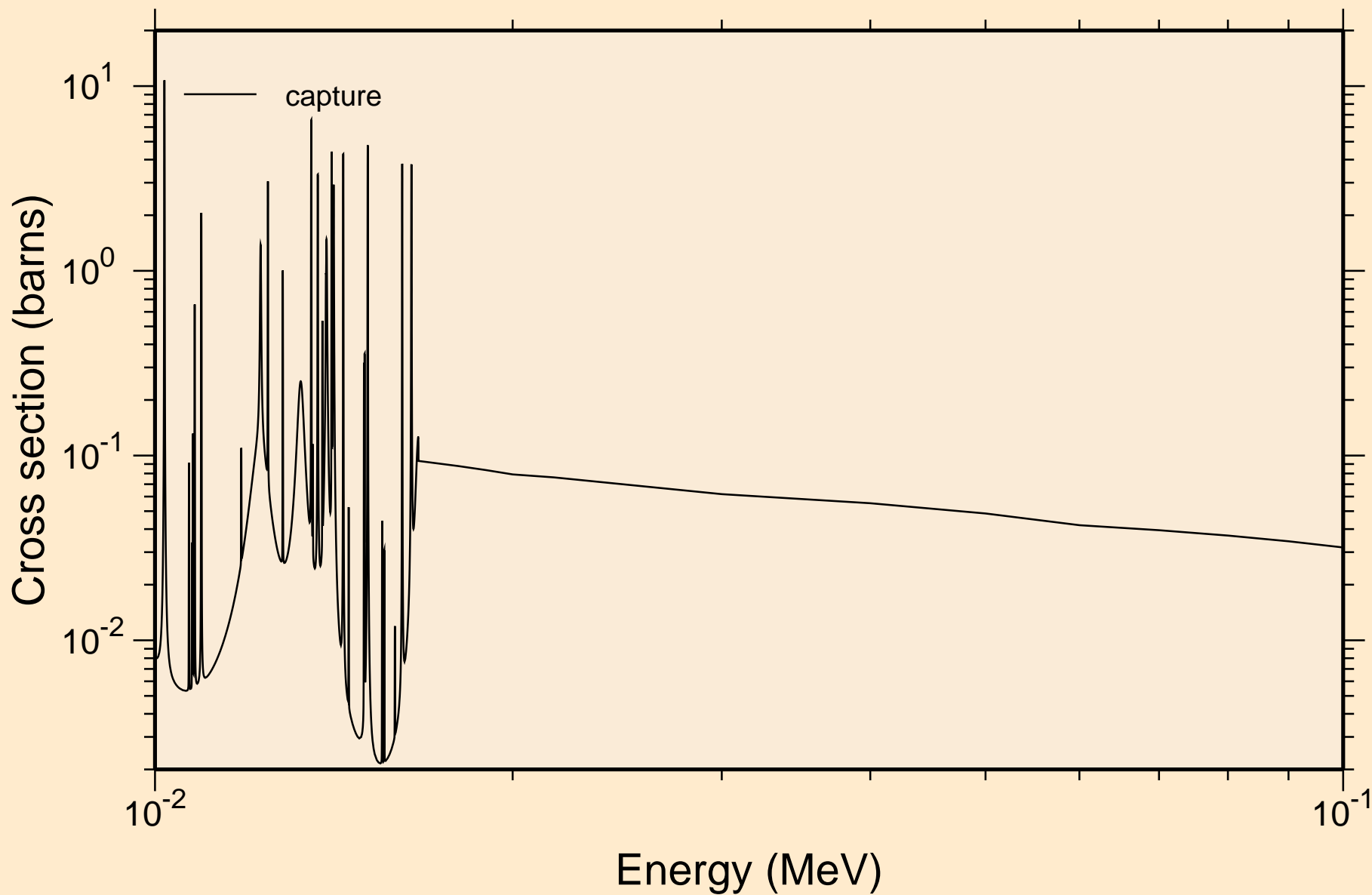

CU069 NEUTRON ACER TENDL-2019 LIBRARY; T=293.16K
resonance absorption cross sections

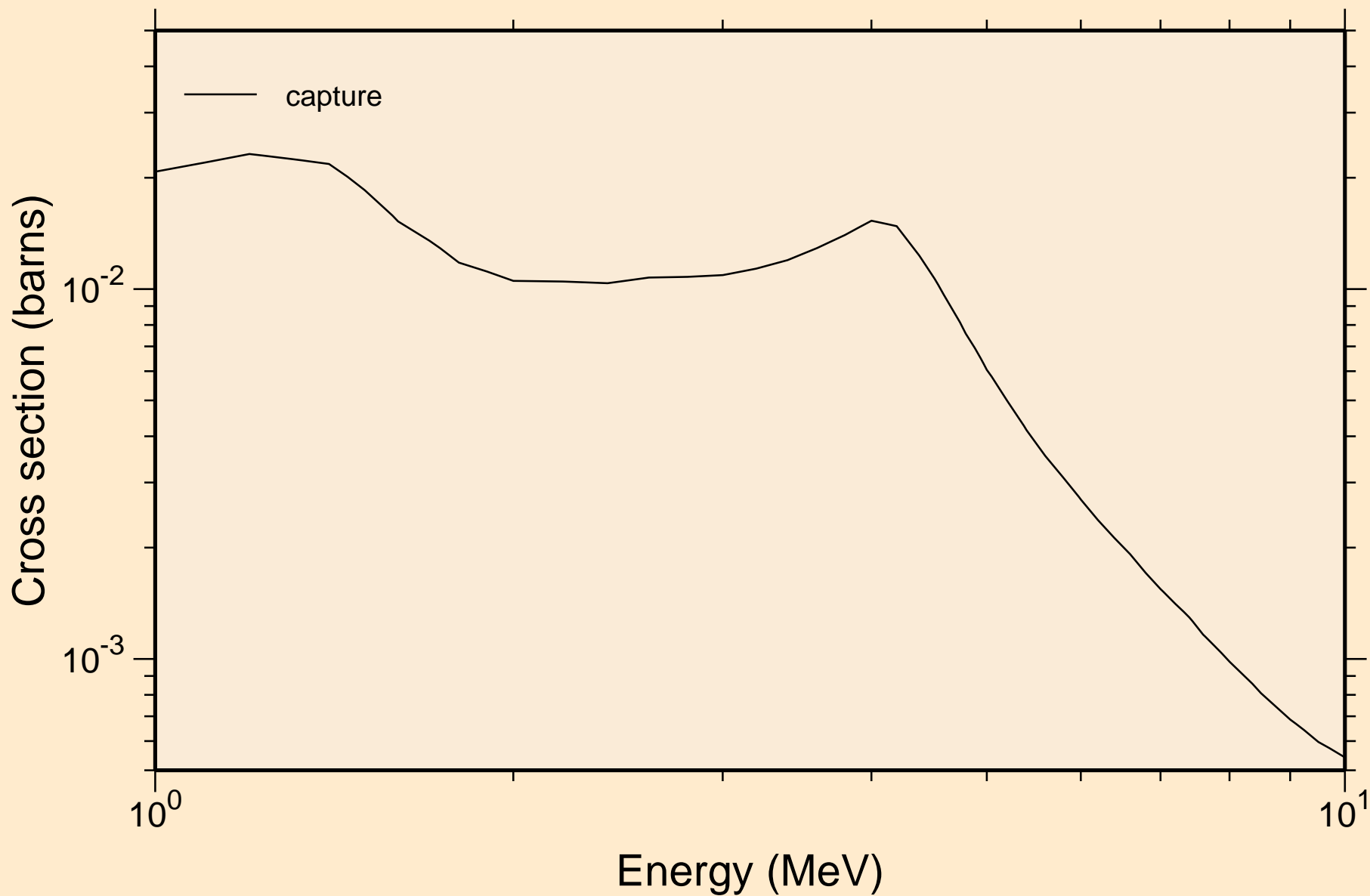

CU069 NEUTRON ACER TENDL-2019 LIBRARY; T=293.16K
Heating

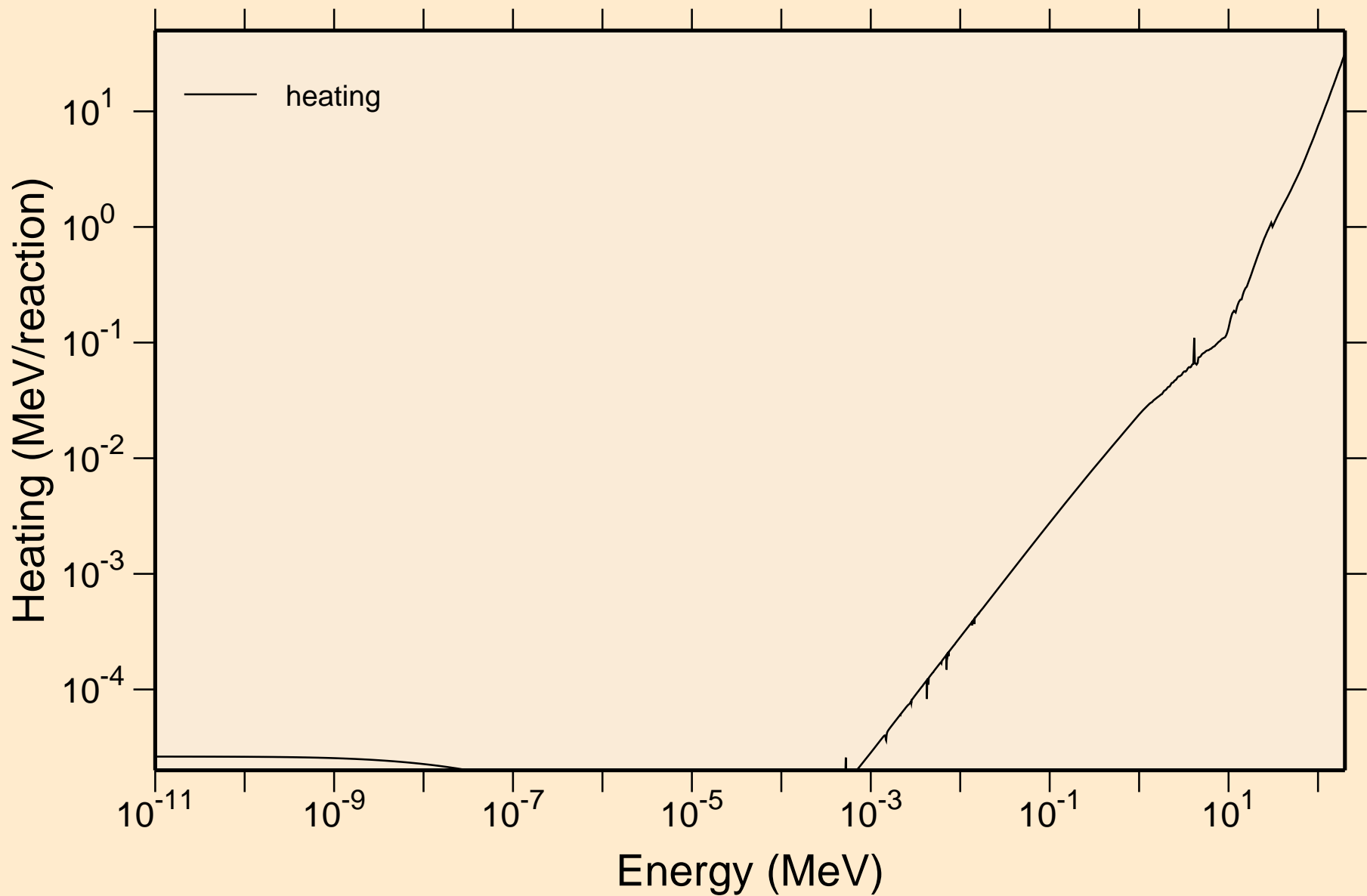

CU069 NEUTRON ACER TENDL-2019 LIBRARY; T=293.16K
Damage

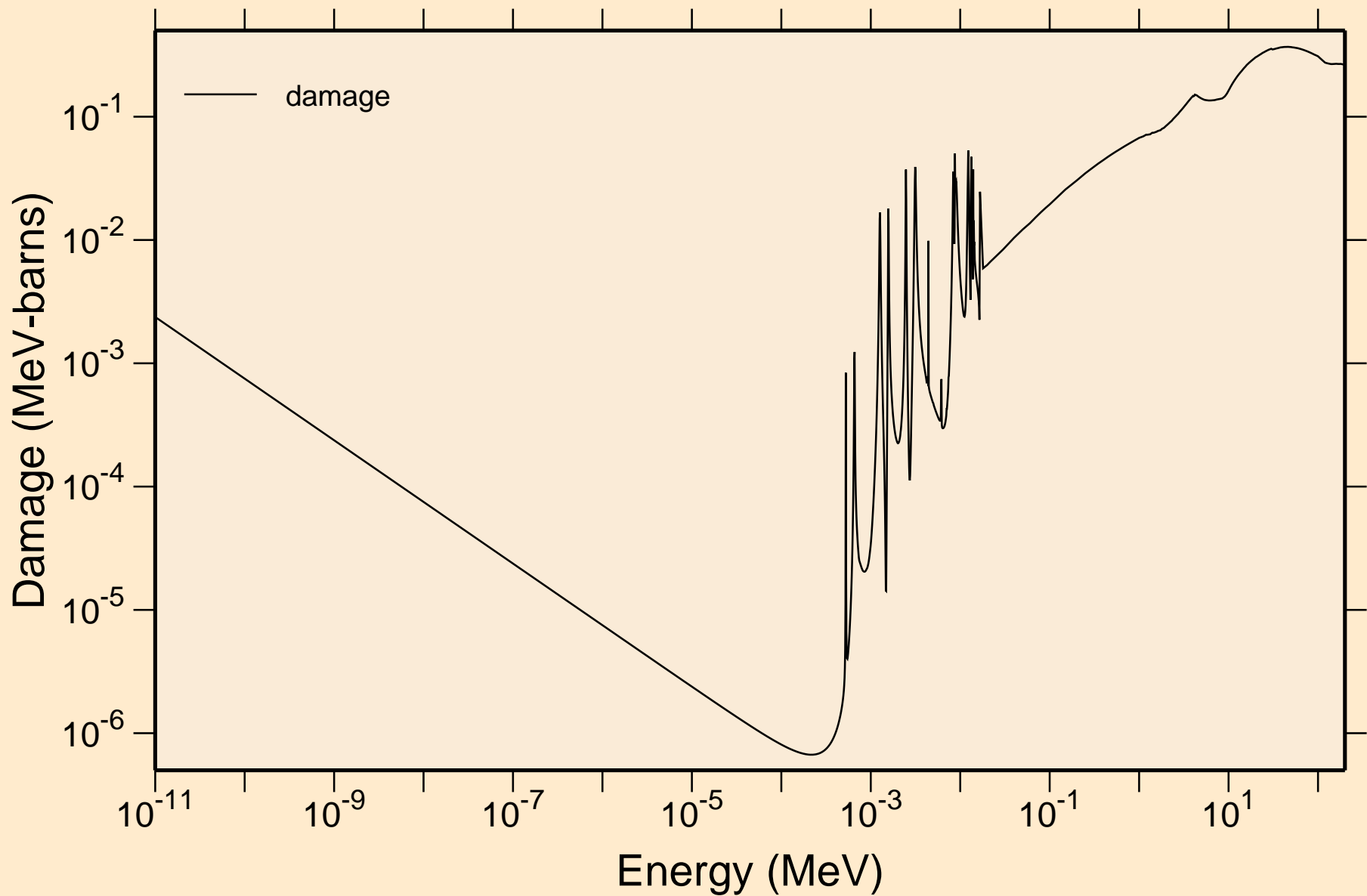

CU069 NEUTRON ACER TENDL-2019 LIBRARY; T=293.16K
Non-threshold reactions

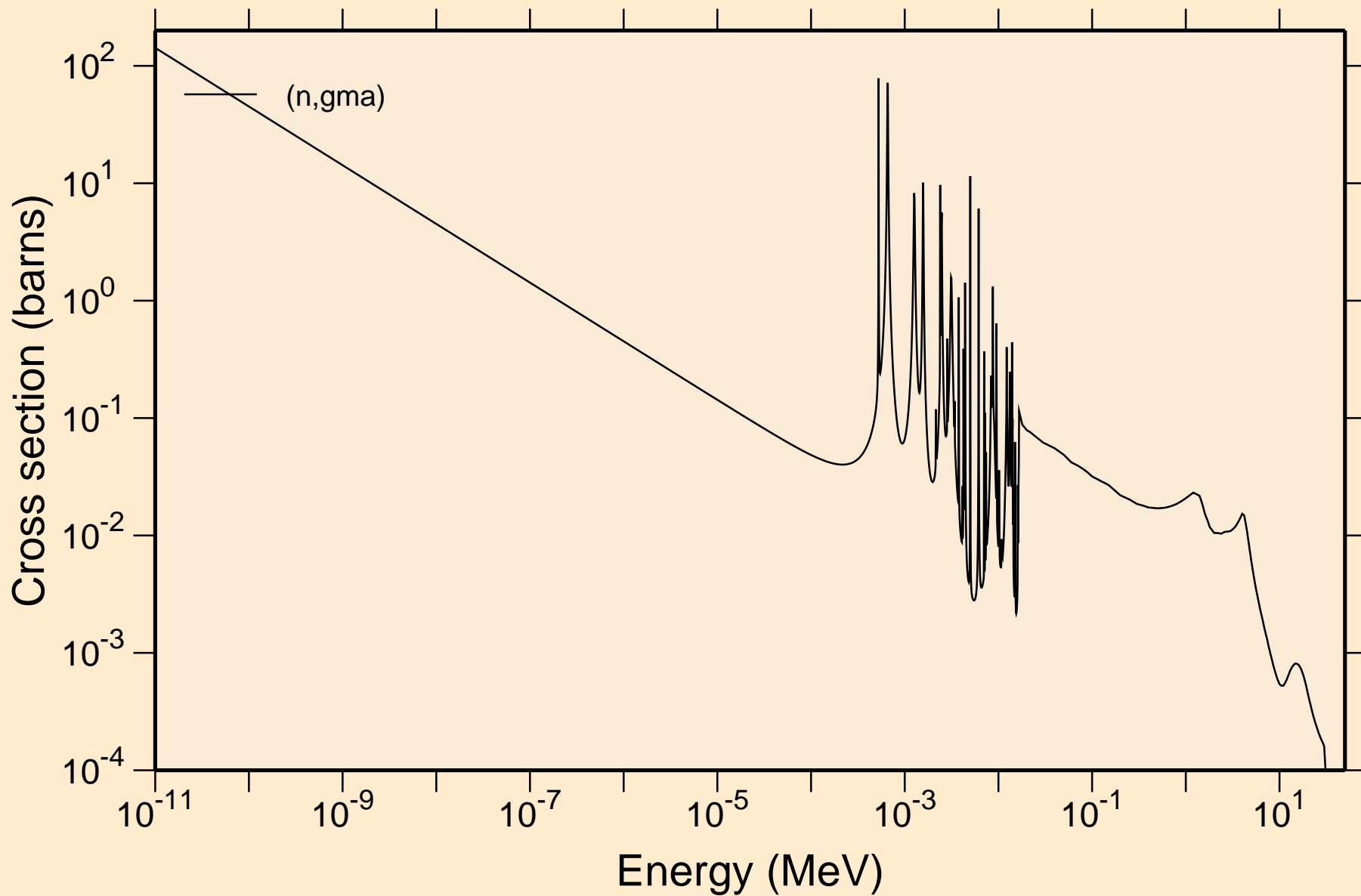

CU069 NEUTRON ACER TENDL-2019 LIBRARY; T=293.16K
Principal cross sections

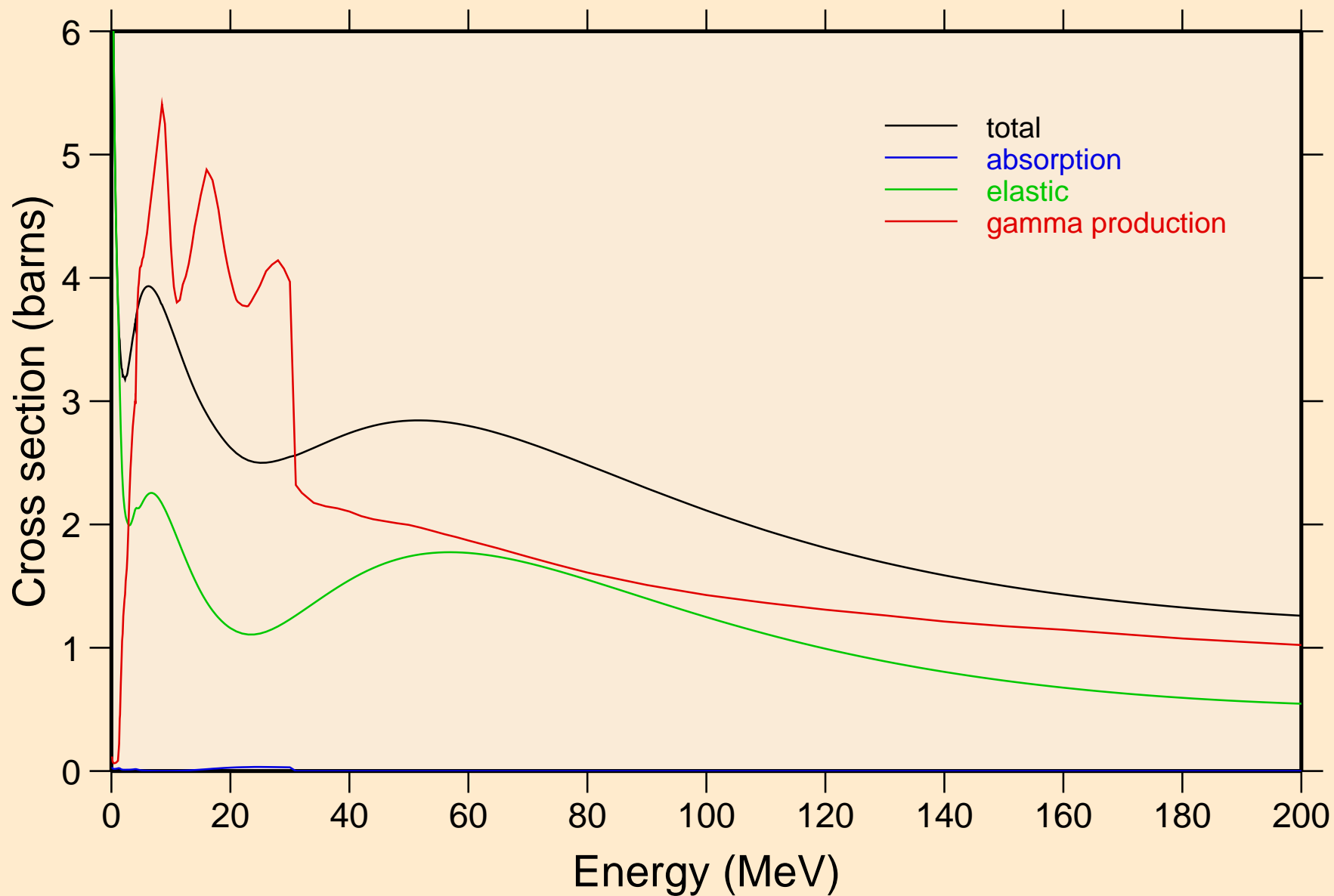

CU069 NEUTRON ACER TENDL-2019 LIBRARY; T=293.16K
Heating

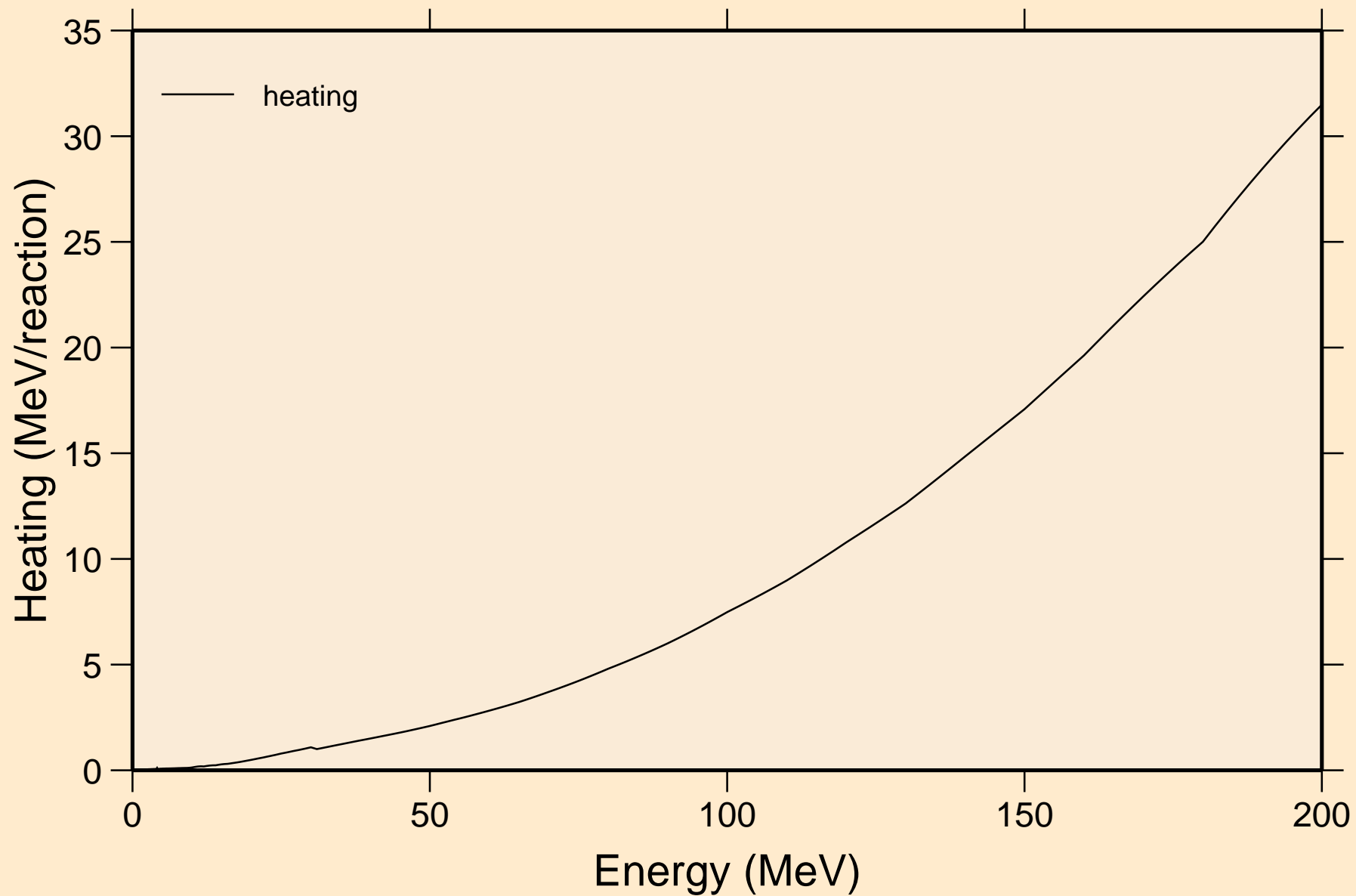

CU069 NEUTRON ACER TENDL-2019 LIBRARY; T=293.16K
Damage

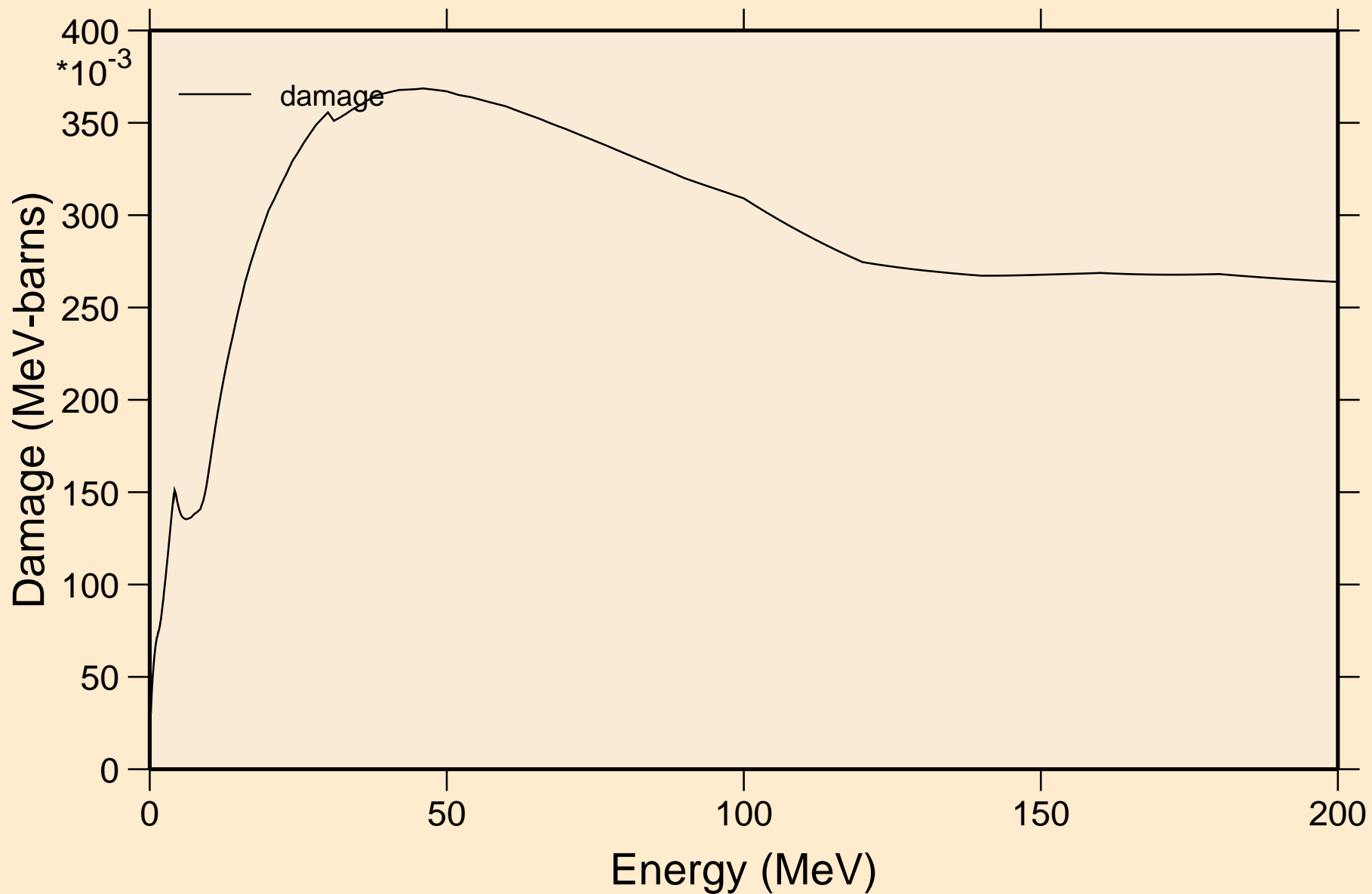

CU069 NEUTRON ACER TENDL-2019 LIBRARY; T=293.16K
Non-threshold reactions

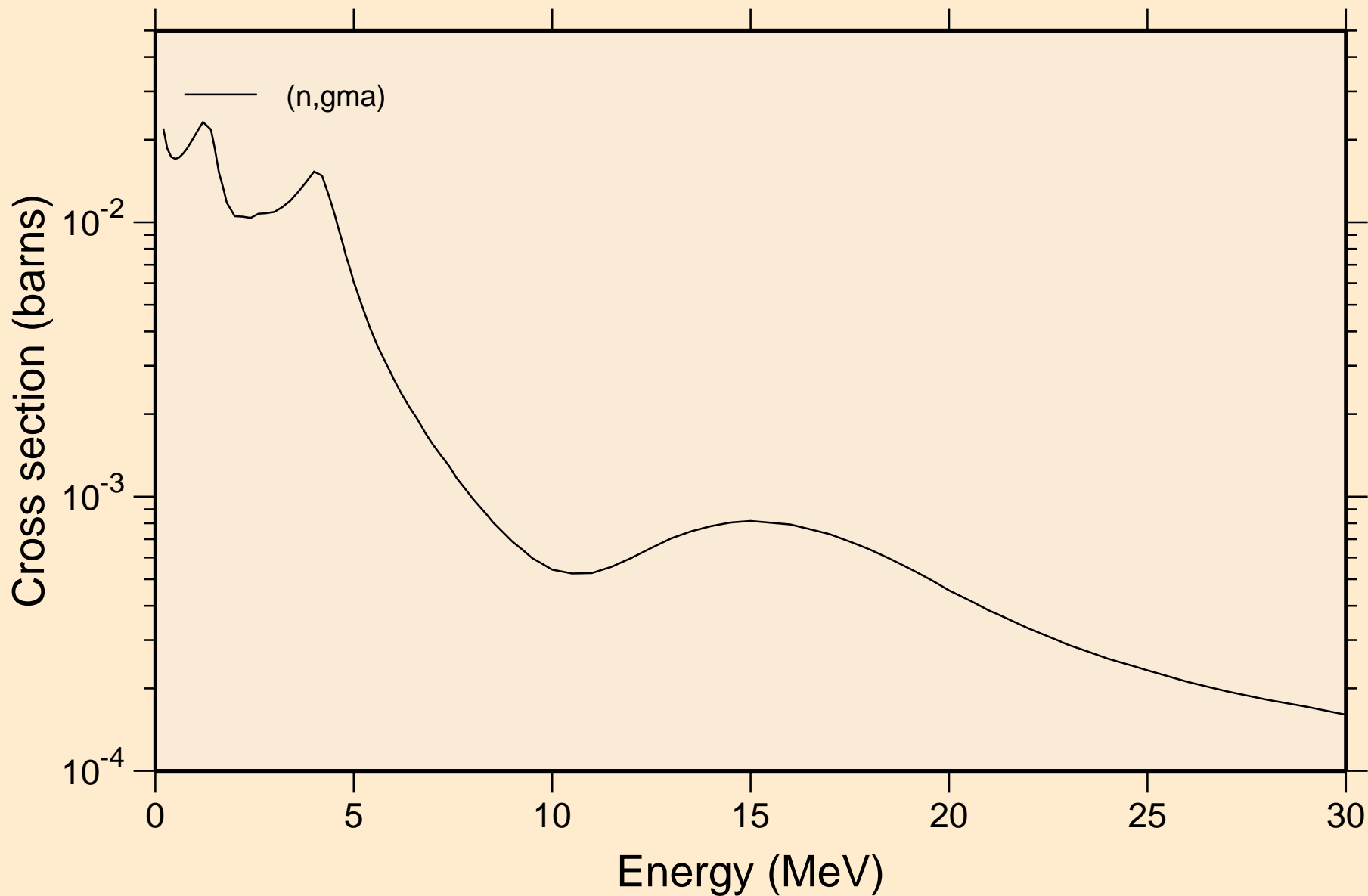

CU069 NEUTRON ACER TENDL-2019 LIBRARY; T=293.16K
Inelastic levels

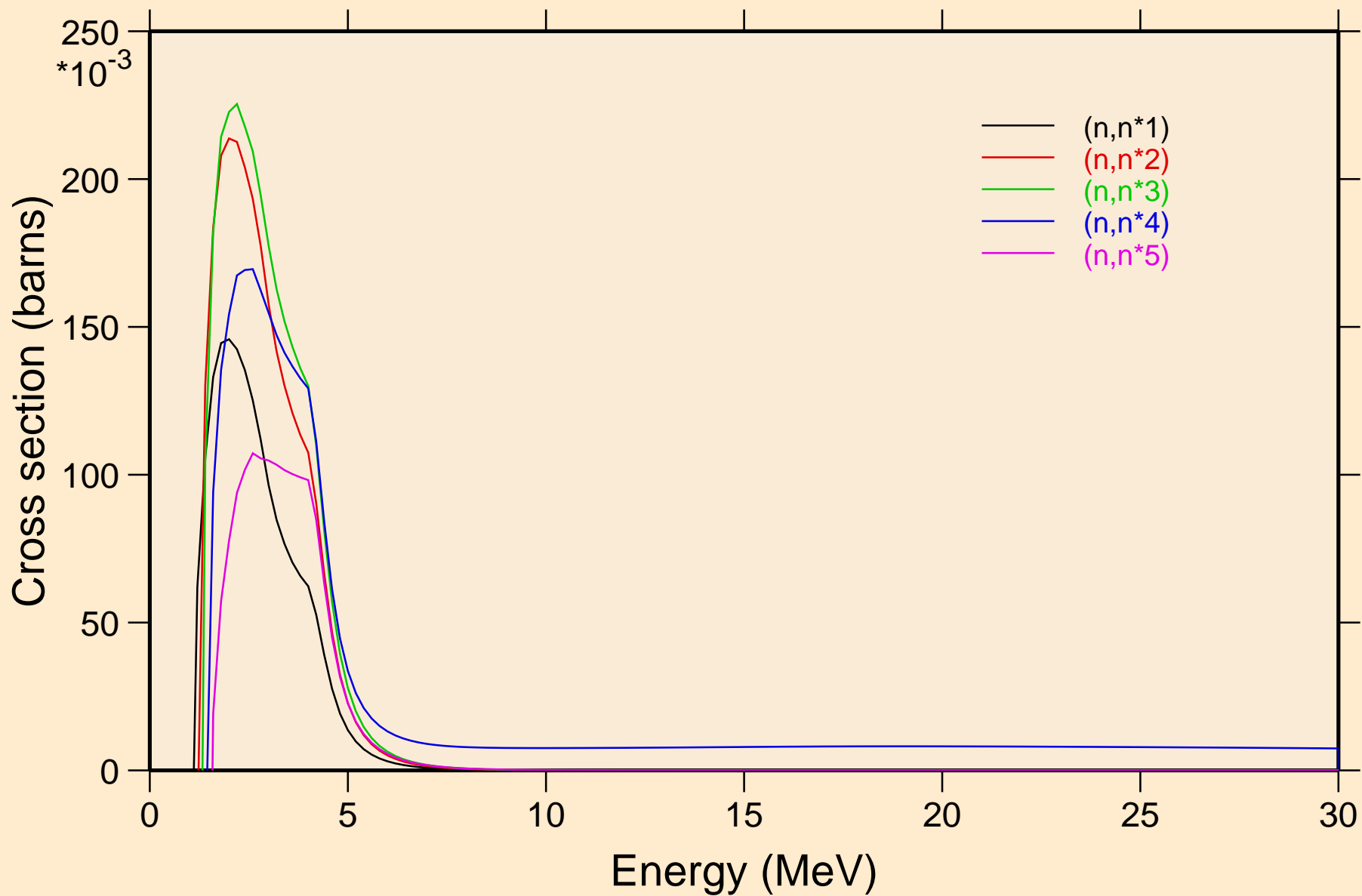

CU069 NEUTRON ACER TENDL-2019 LIBRARY; T=293.16K
Inelastic levels

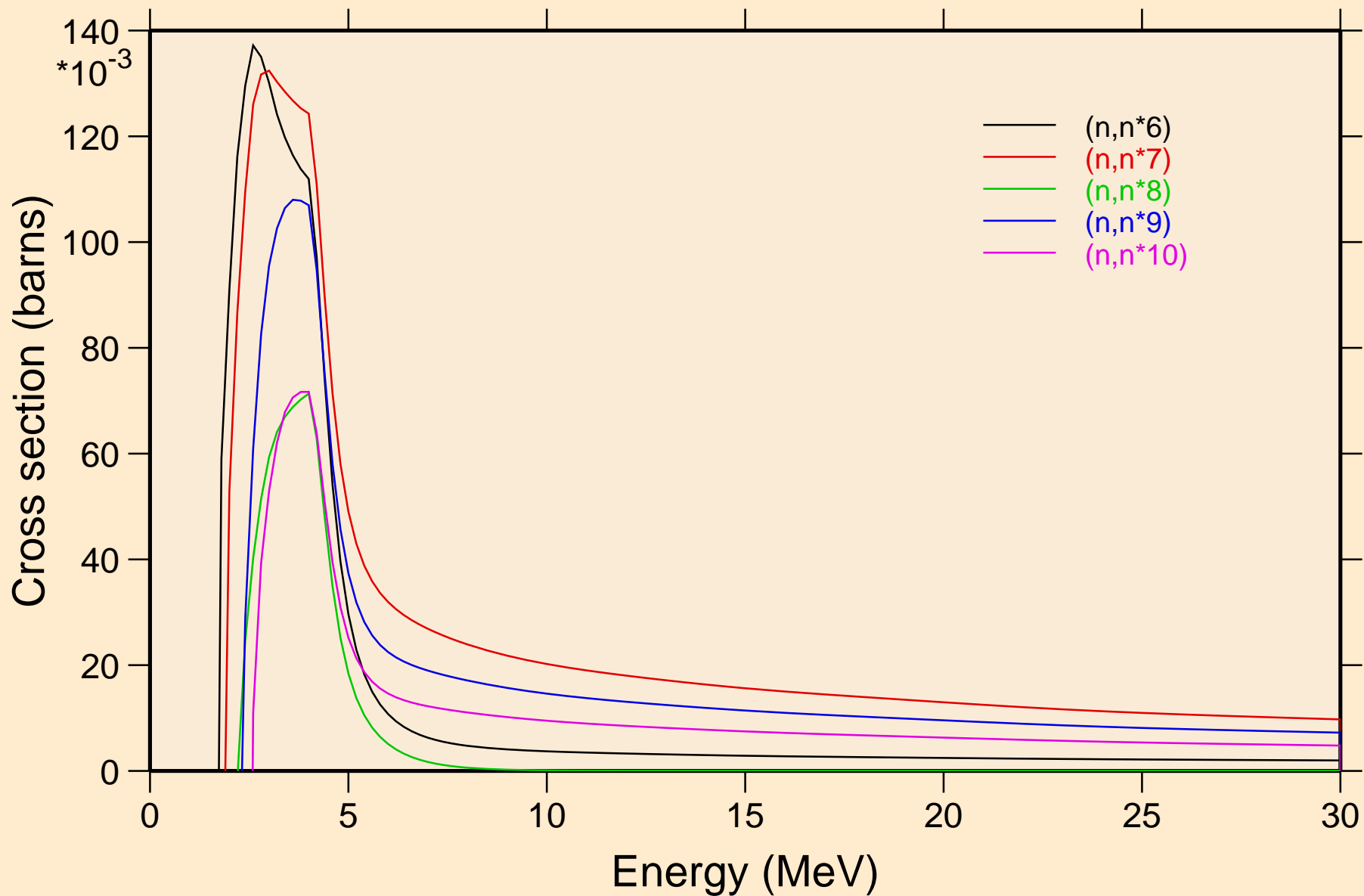

CU069 NEUTRON ACER TENDL-2019 LIBRARY; T=293.16K
Inelastic levels

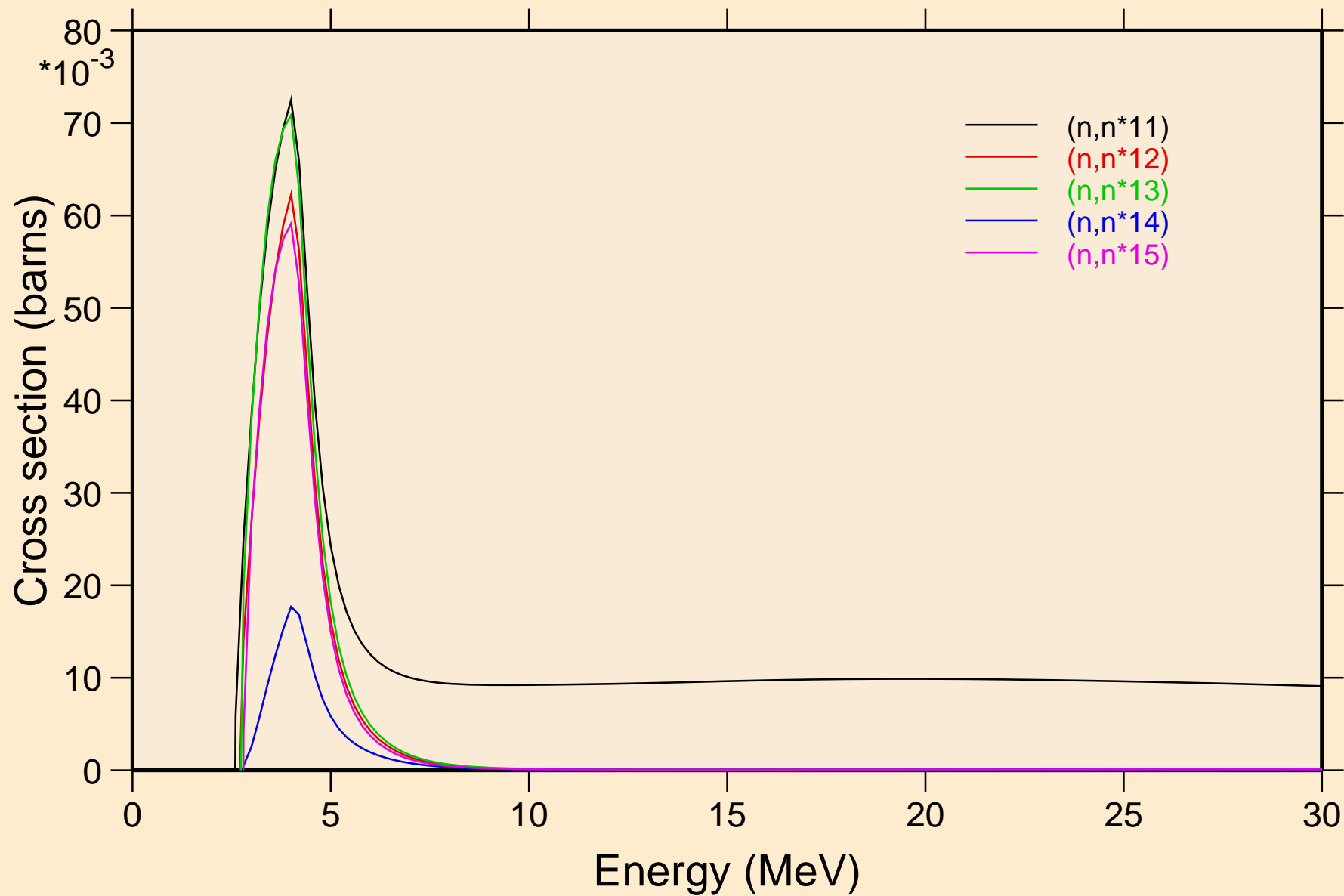

CU069 NEUTRON ACER TENDL-2019 LIBRARY; T=293.16K
Inelastic levels

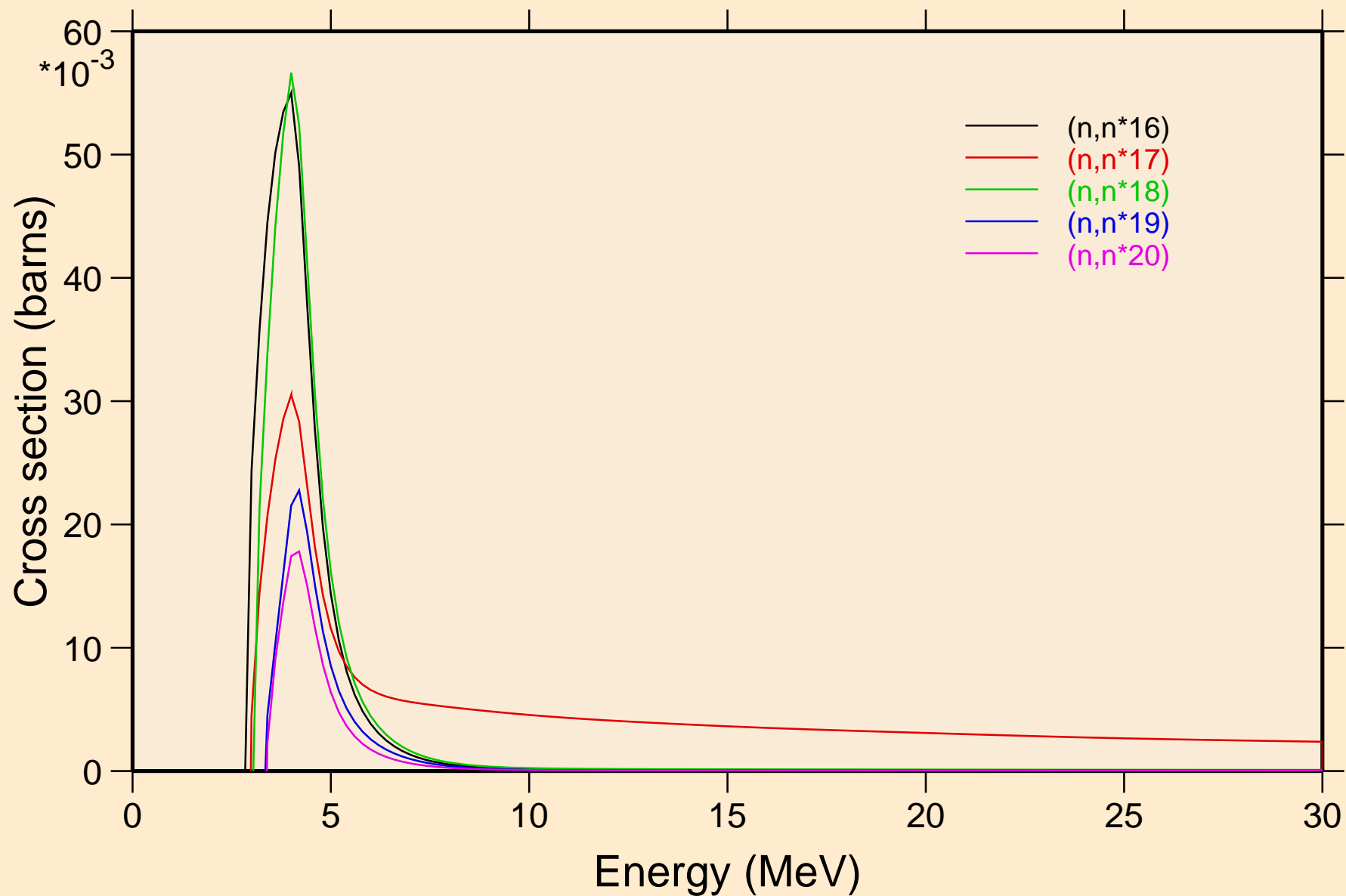

CU069 NEUTRON ACER TENDL-2019 LIBRARY; T=293.16K
Inelastic levels

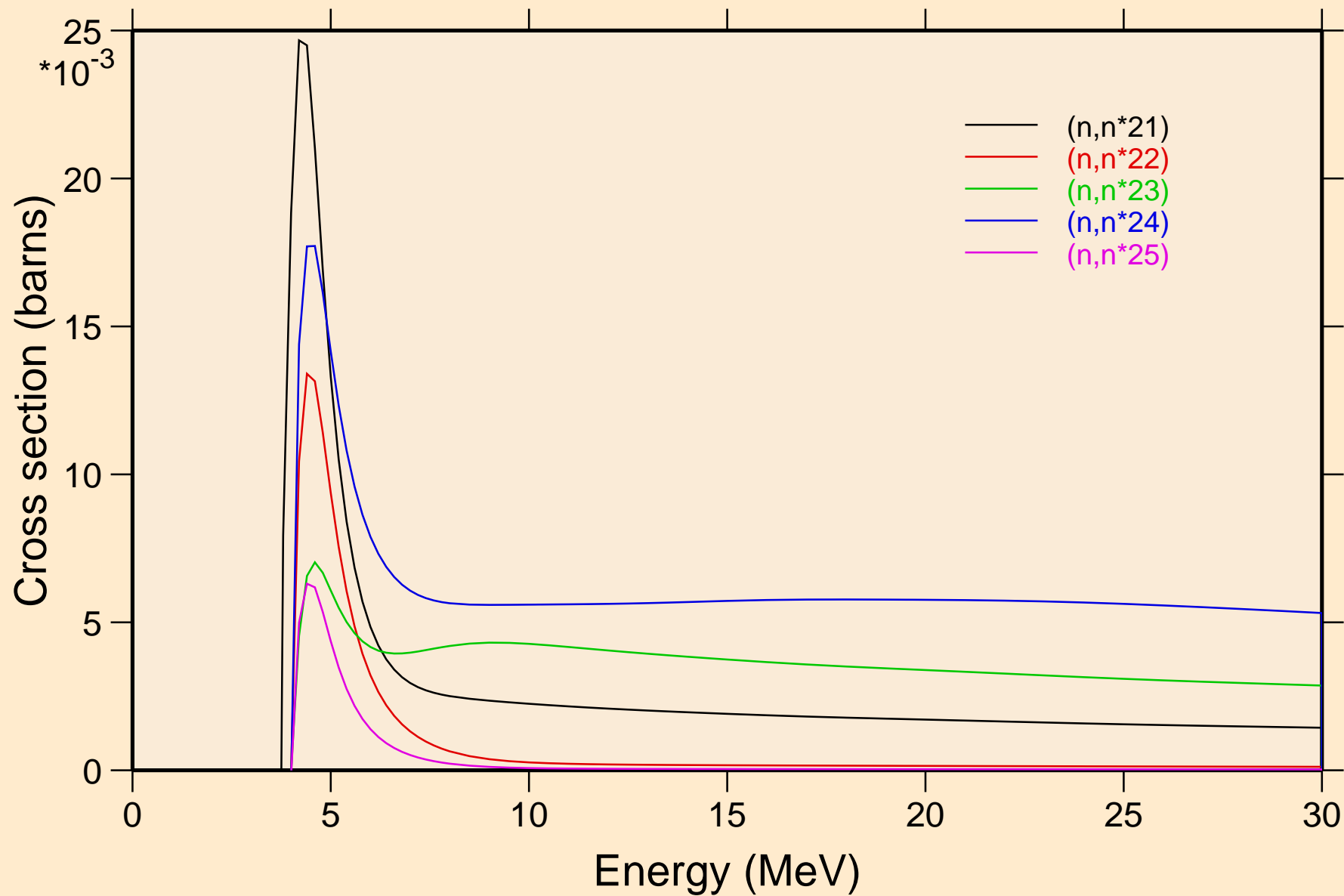

CU069 NEUTRON ACER TENDL-2019 LIBRARY; T=293.16K
Inelastic levels

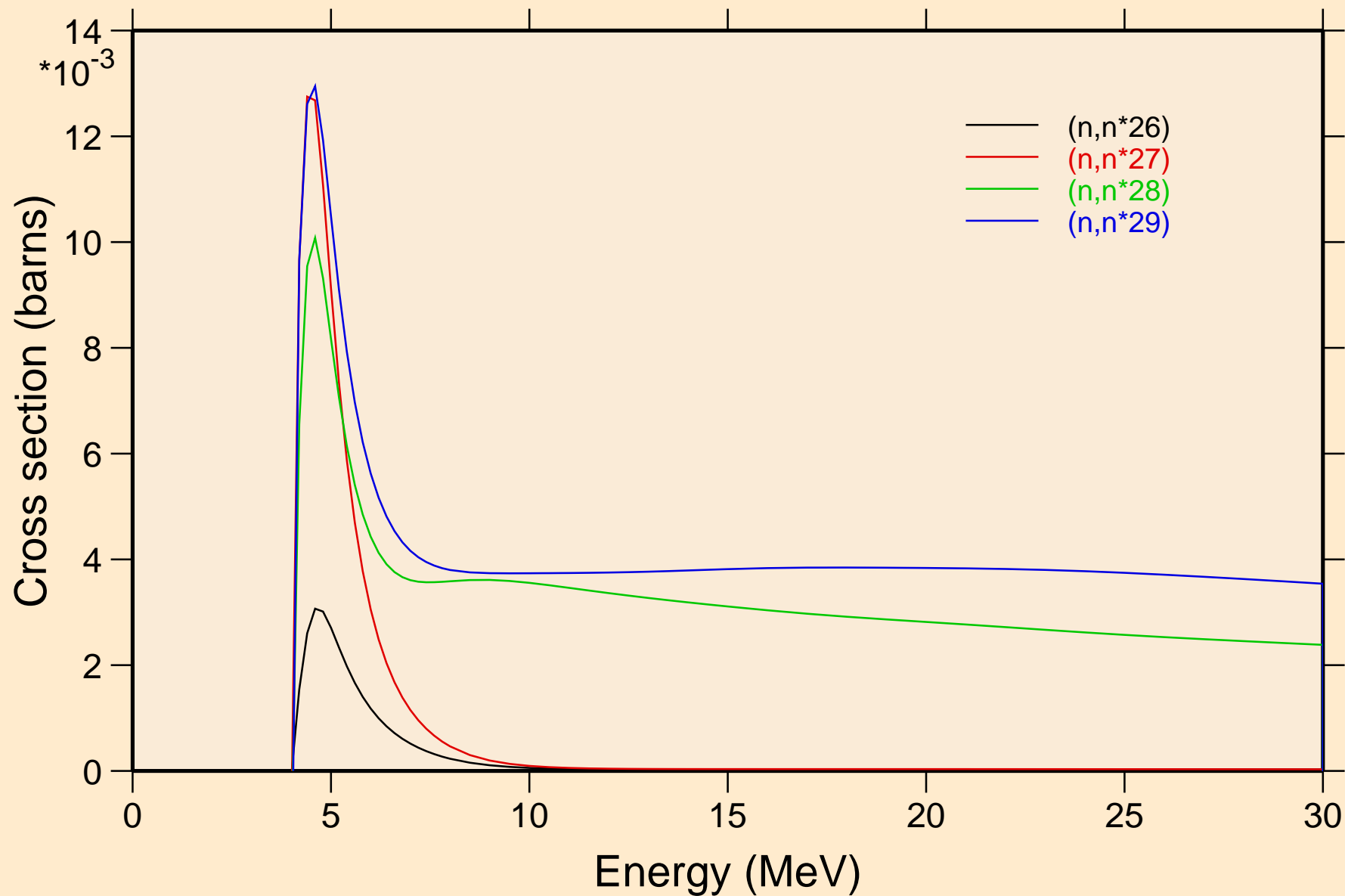

CU069 NEUTRON ACER TENDL-2019 LIBRARY; T=293.16K
Threshold reactions

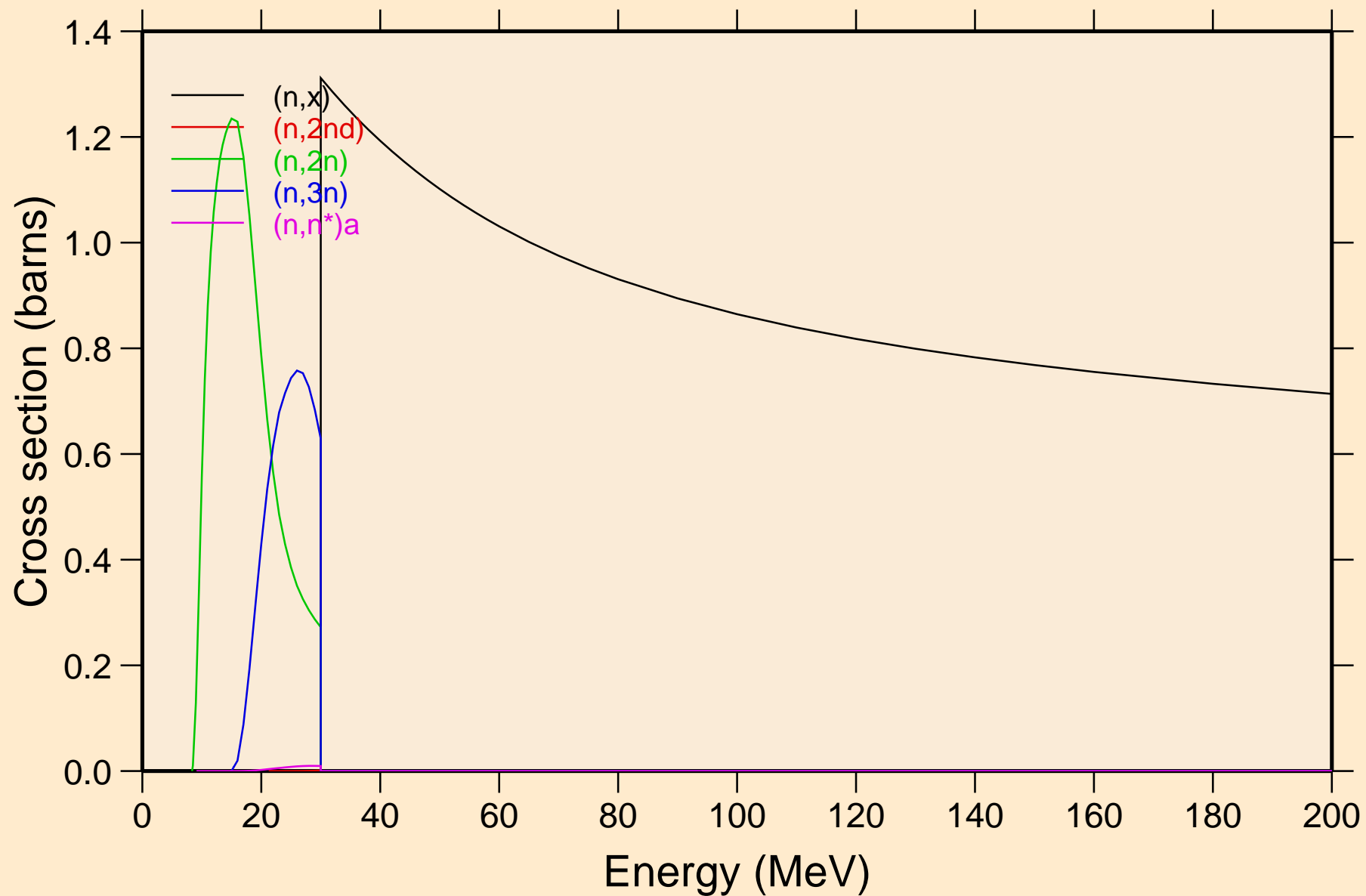

CU069 NEUTRON ACER TENDL-2019 LIBRARY; T=293.16K
Threshold reactions

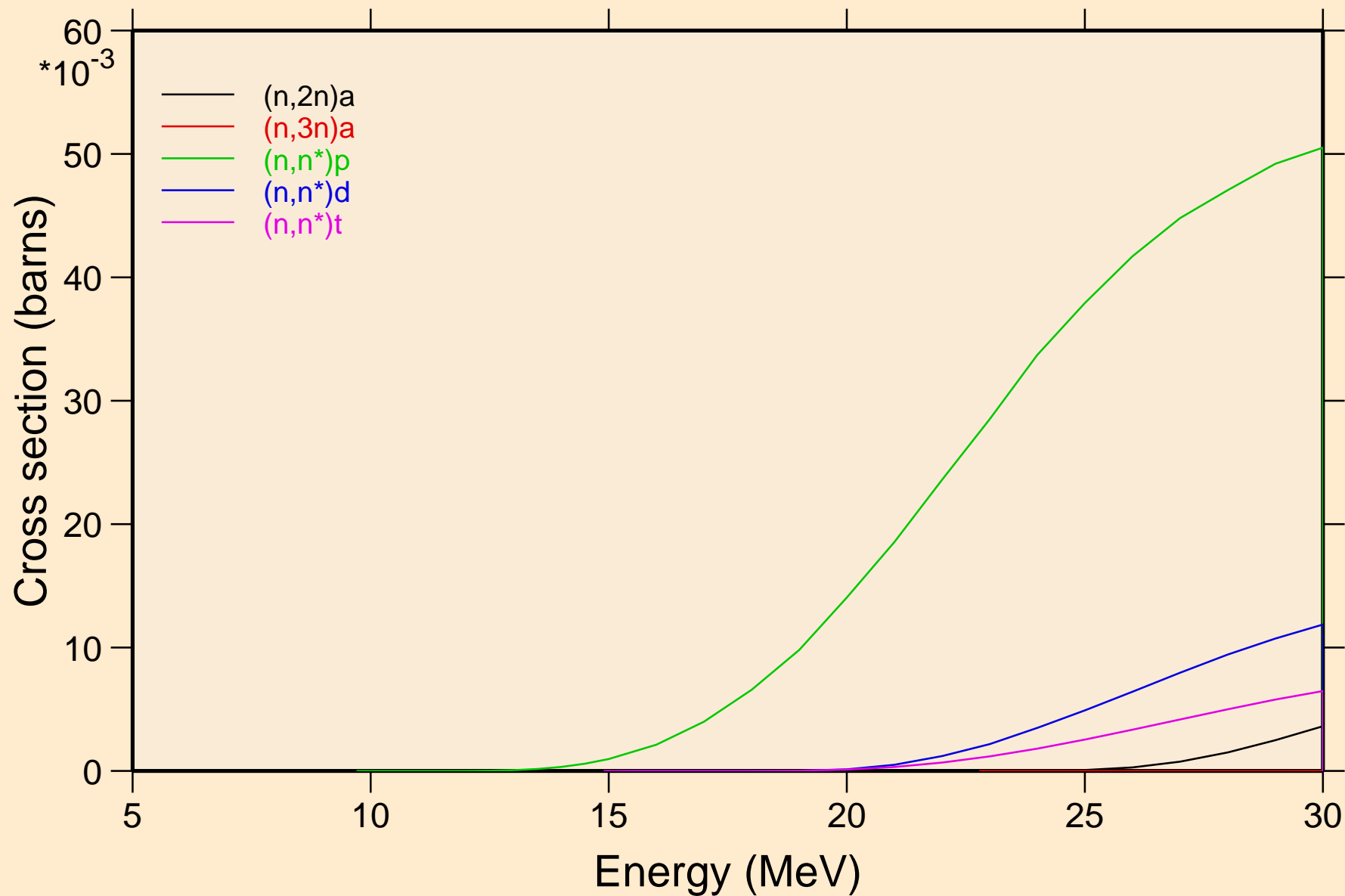

CU069 NEUTRON ACER TENDL-2019 LIBRARY; T=293.16K
Threshold reactions

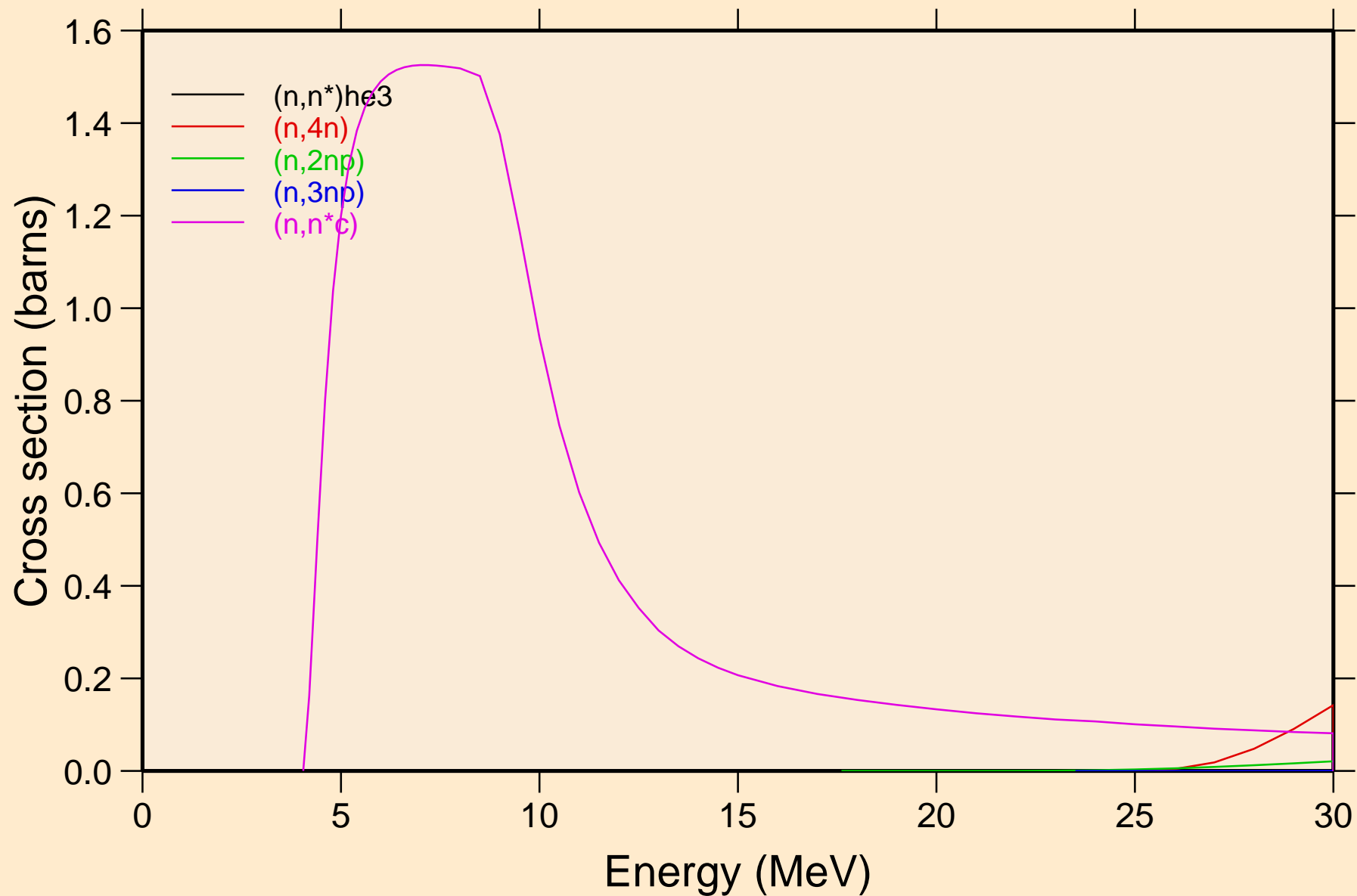

CU069 NEUTRON ACER TENDL-2019 LIBRARY; T=293.16K
Threshold reactions

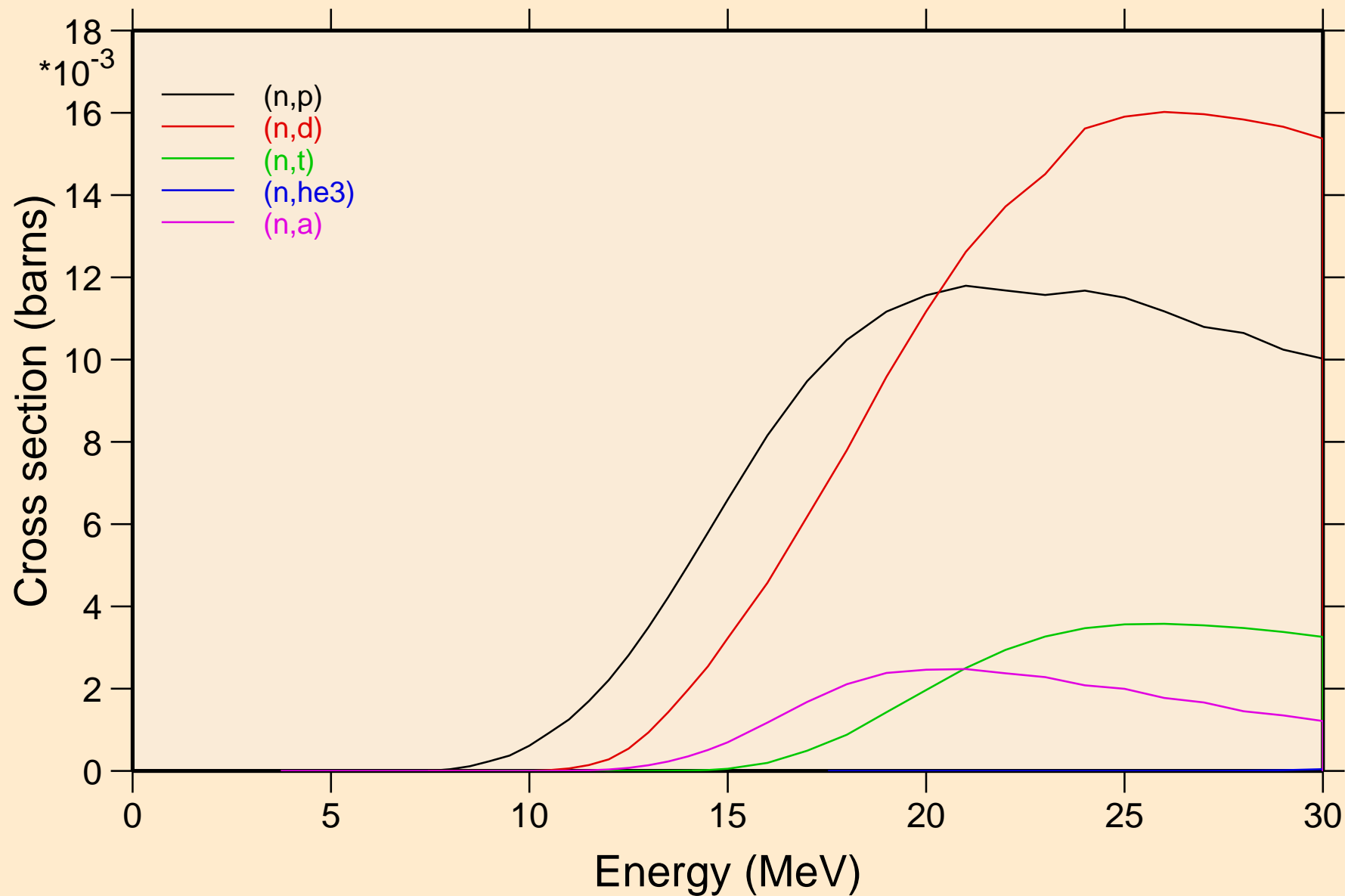

CU069 NEUTRON ACER TENDL-2019 LIBRARY; T=293.16K
Threshold reactions

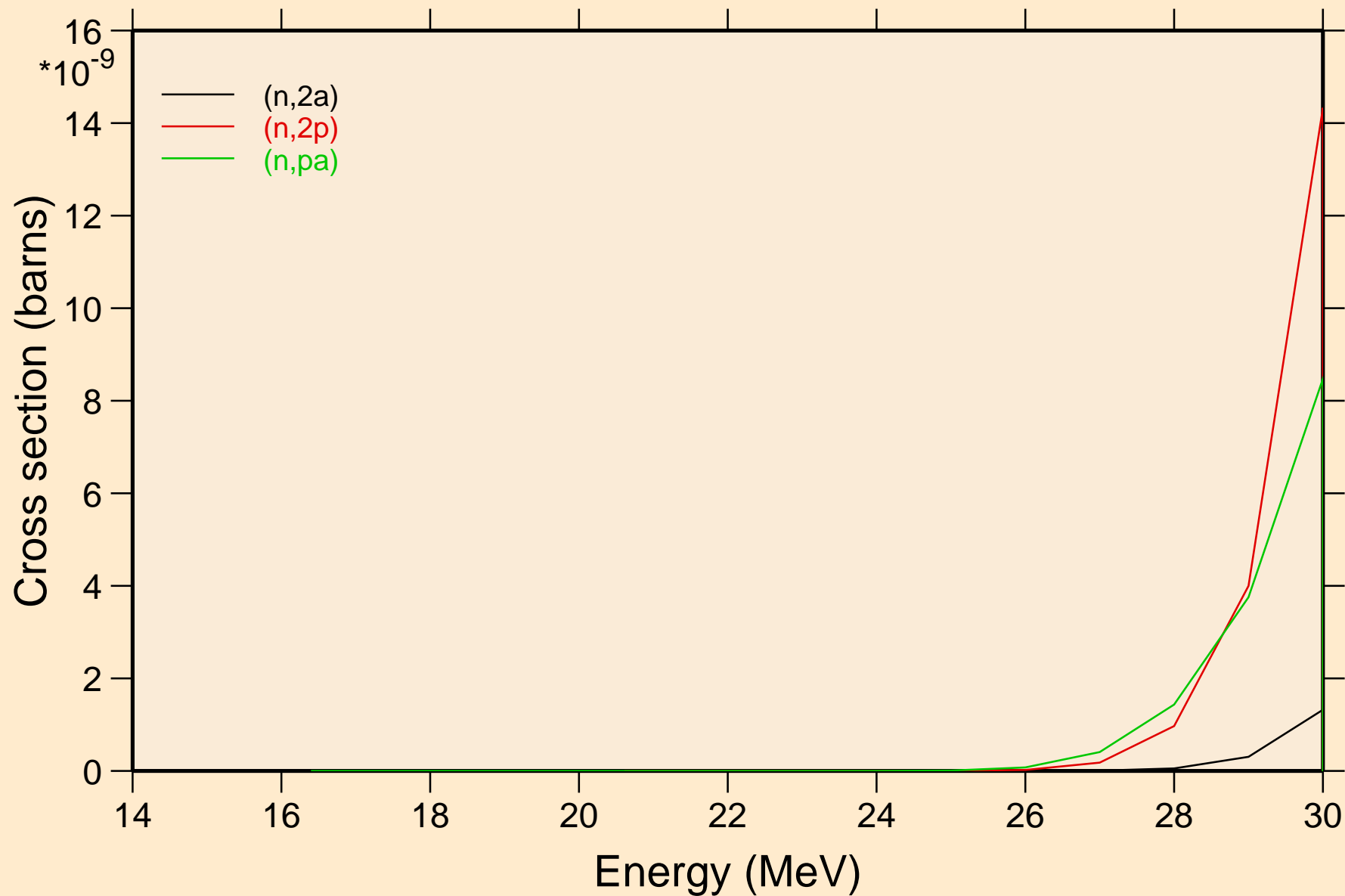

CU069 NEUTRON ACER TENDL-2019 LIBRARY; T=293.16K
Threshold reactions

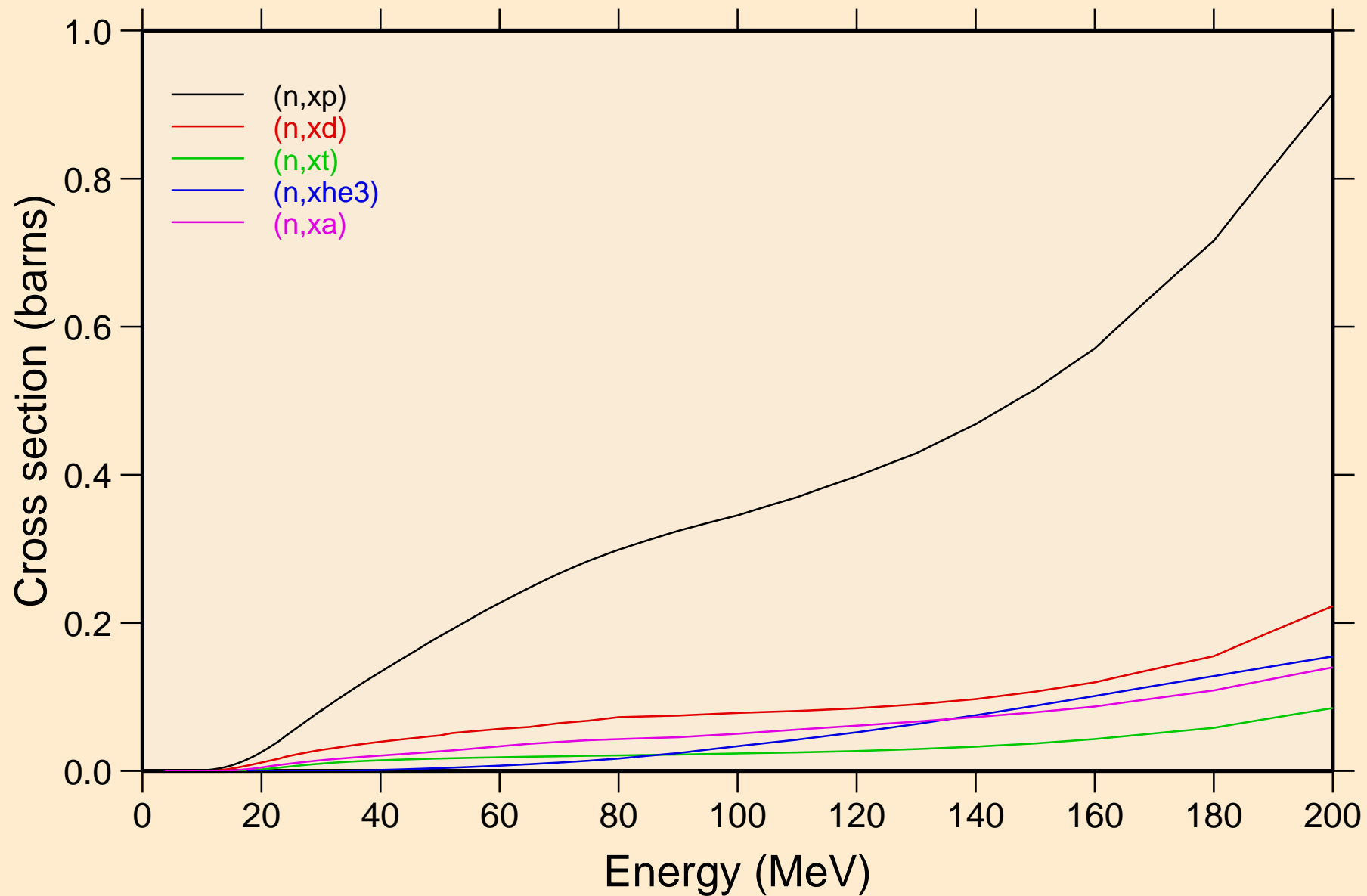

CU069 NEUTRON ACER TENDL-2019 LIBRARY; T=293.16K
angular distribution for elastic

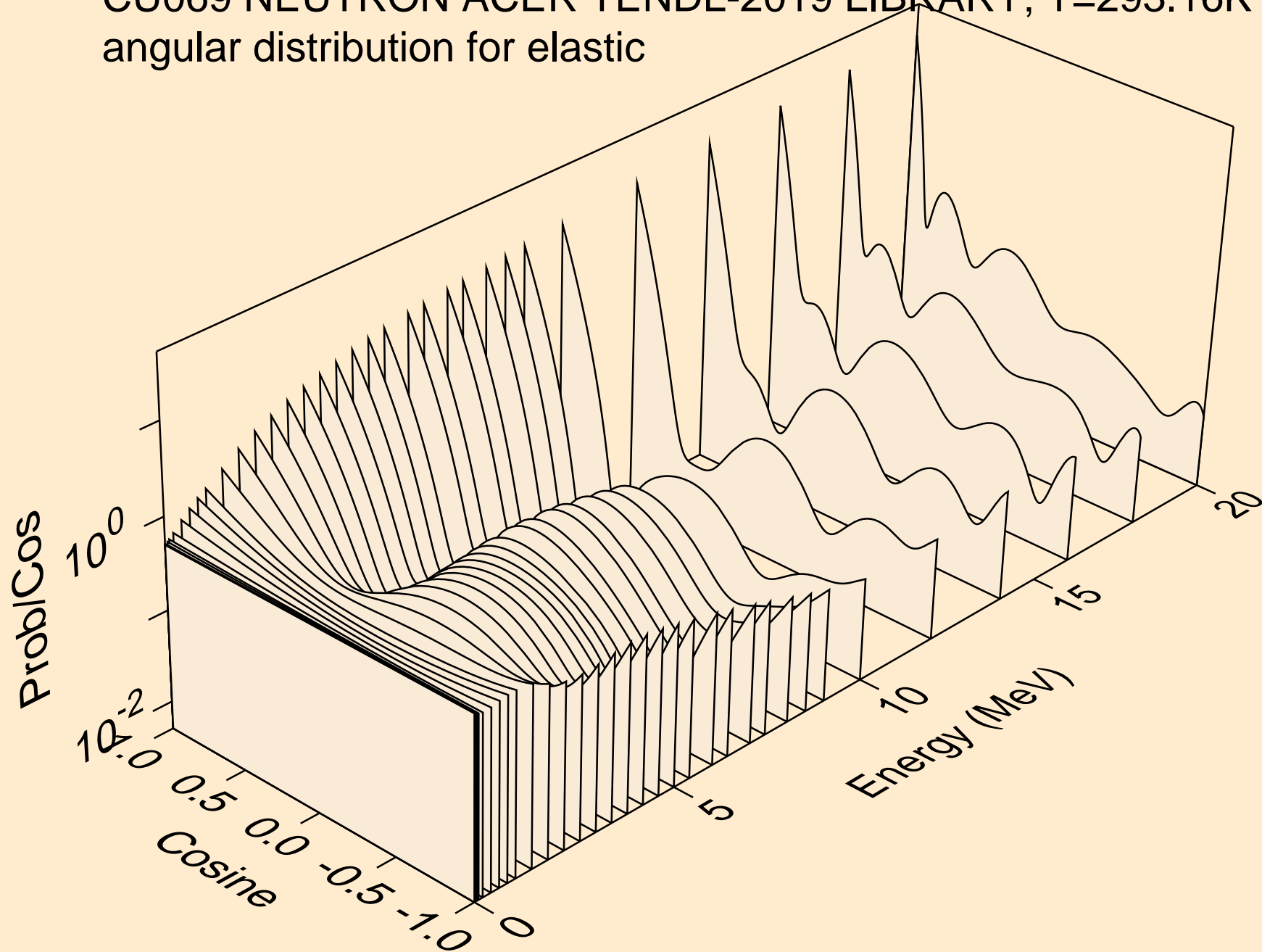

CU069 NEUTRON ACER TENDL-2019 LIBRARY; T=293.16K
angular distribution for elastic

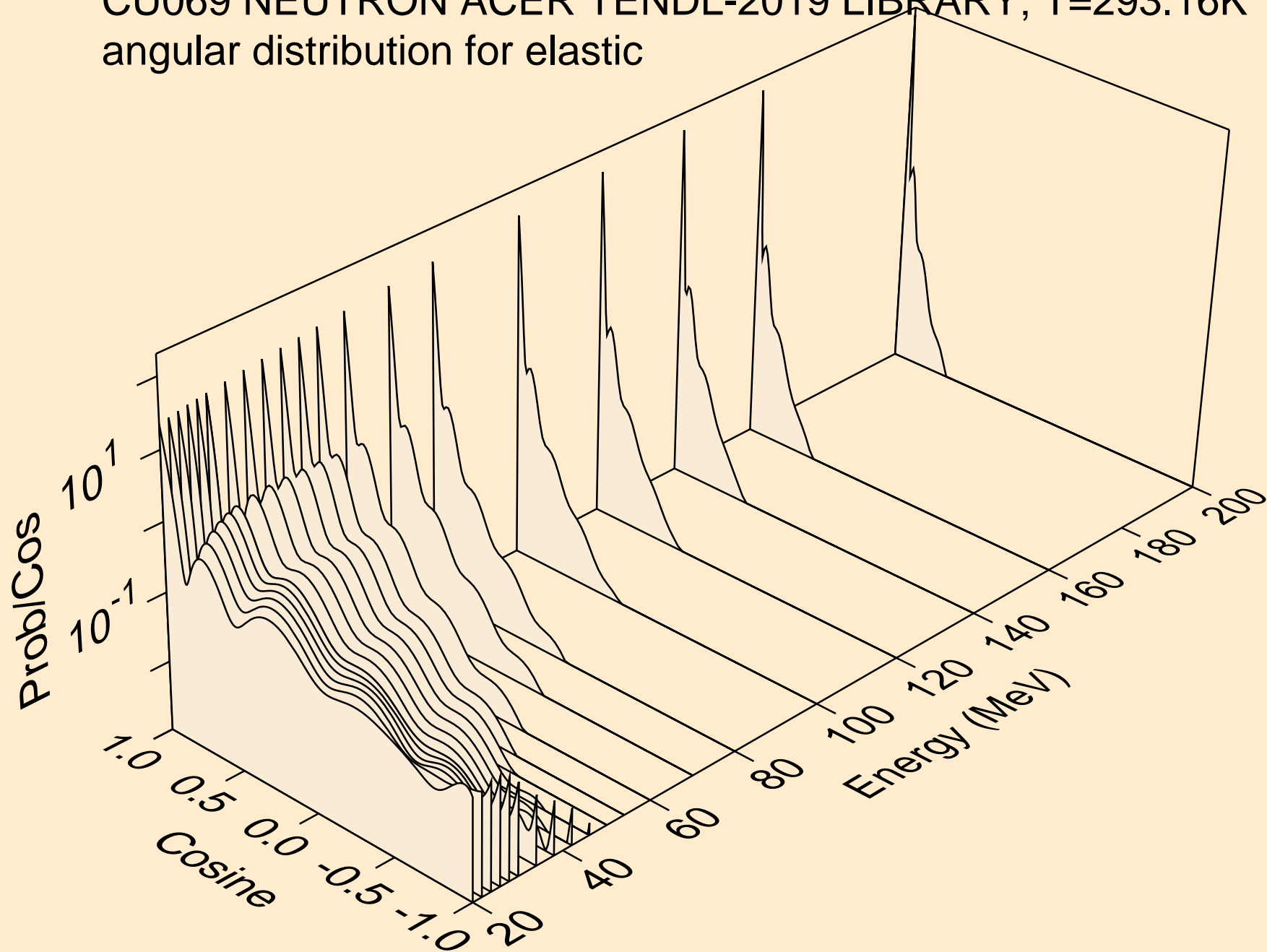

CU069 NEUTRON ACER TENDL-2019 LIBRARY; T=293.16K
angular distribution for (n,n*1)

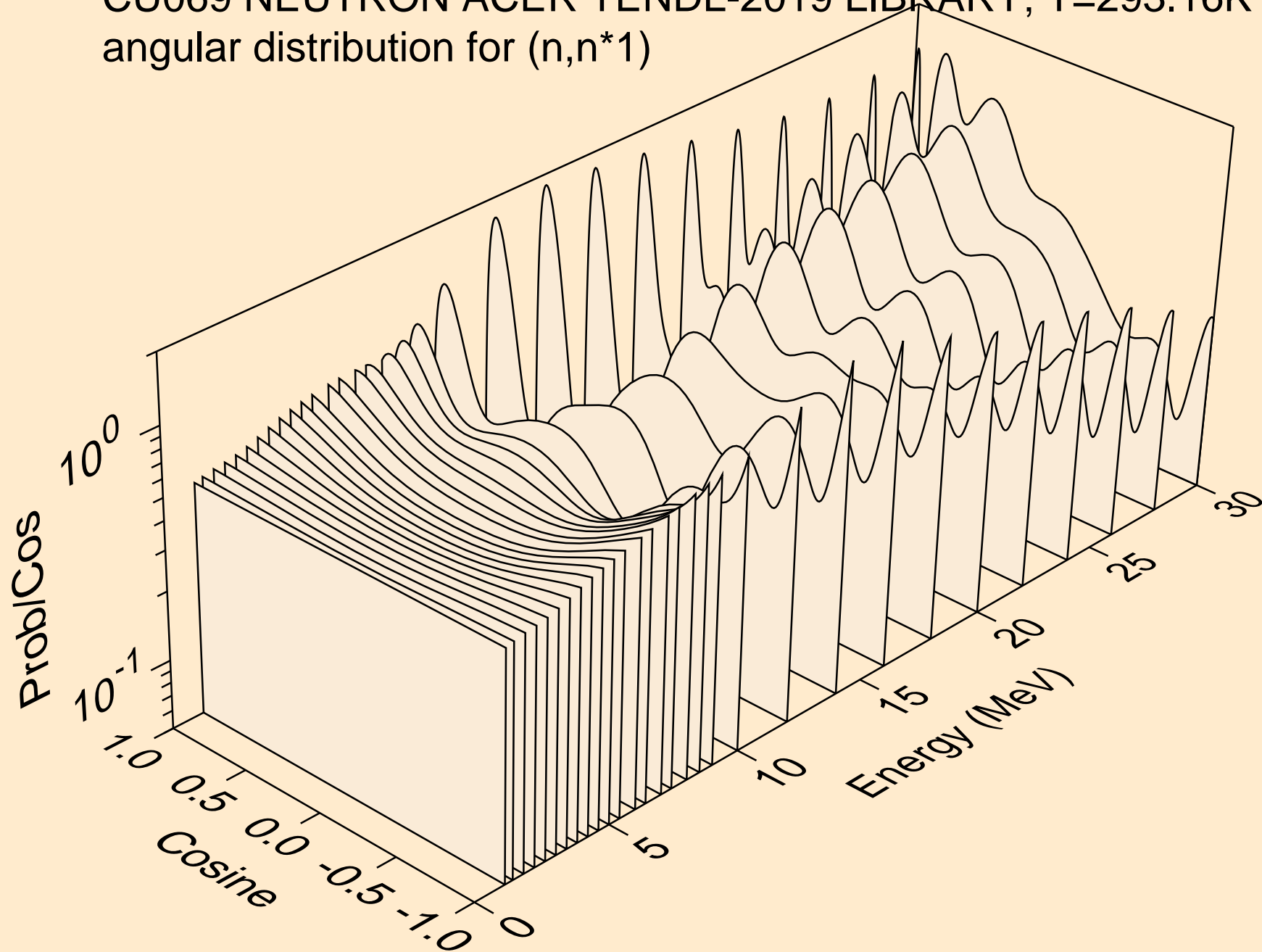

CU069 NEUTRON ACER TENDL-2019 LIBRARY; T=293.16K
angular distribution for (n,n*2)

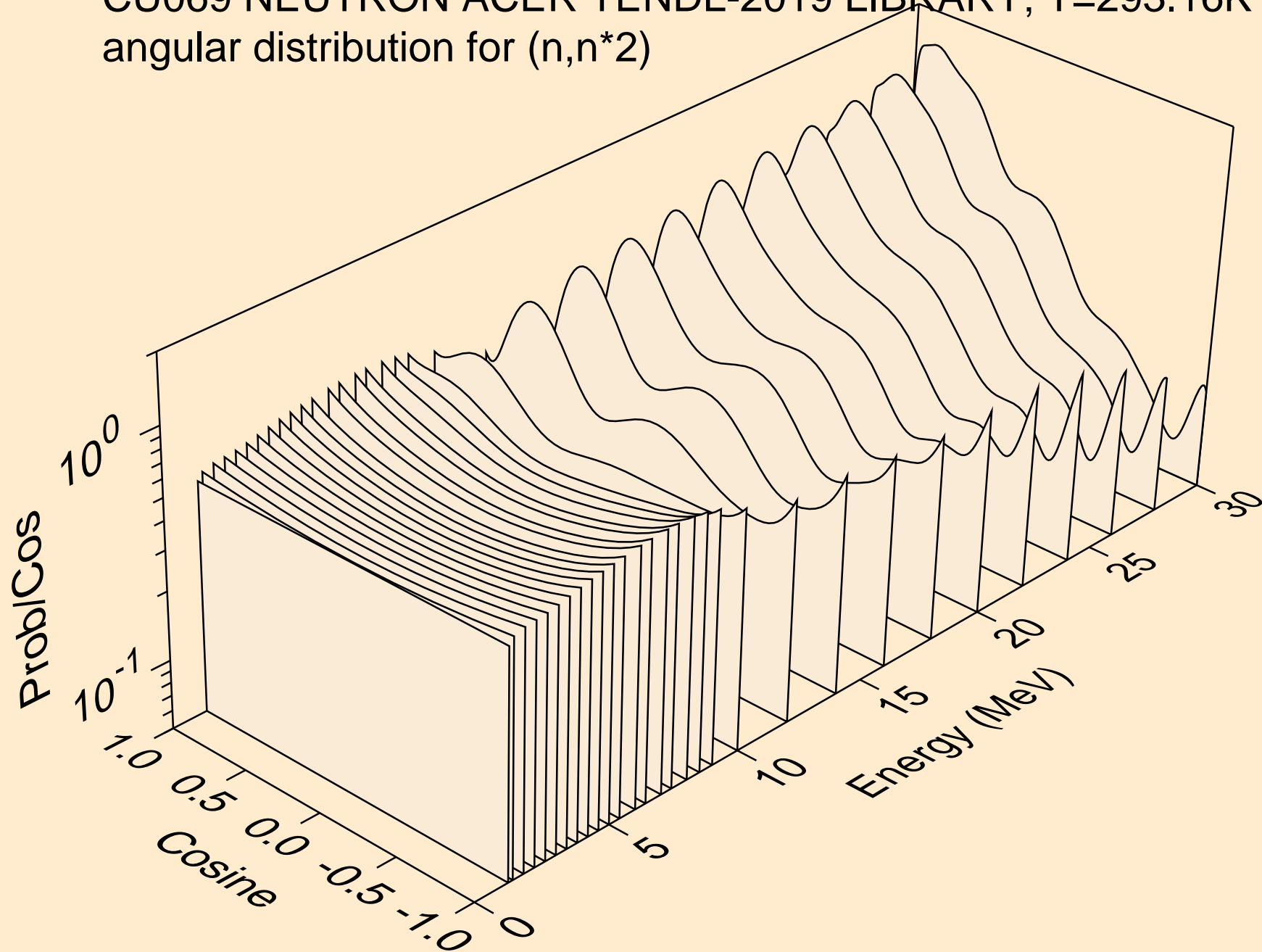

CU069 NEUTRON ACER TENDL-2019 LIBRARY; T=293.16K
angular distribution for (n,n*3)

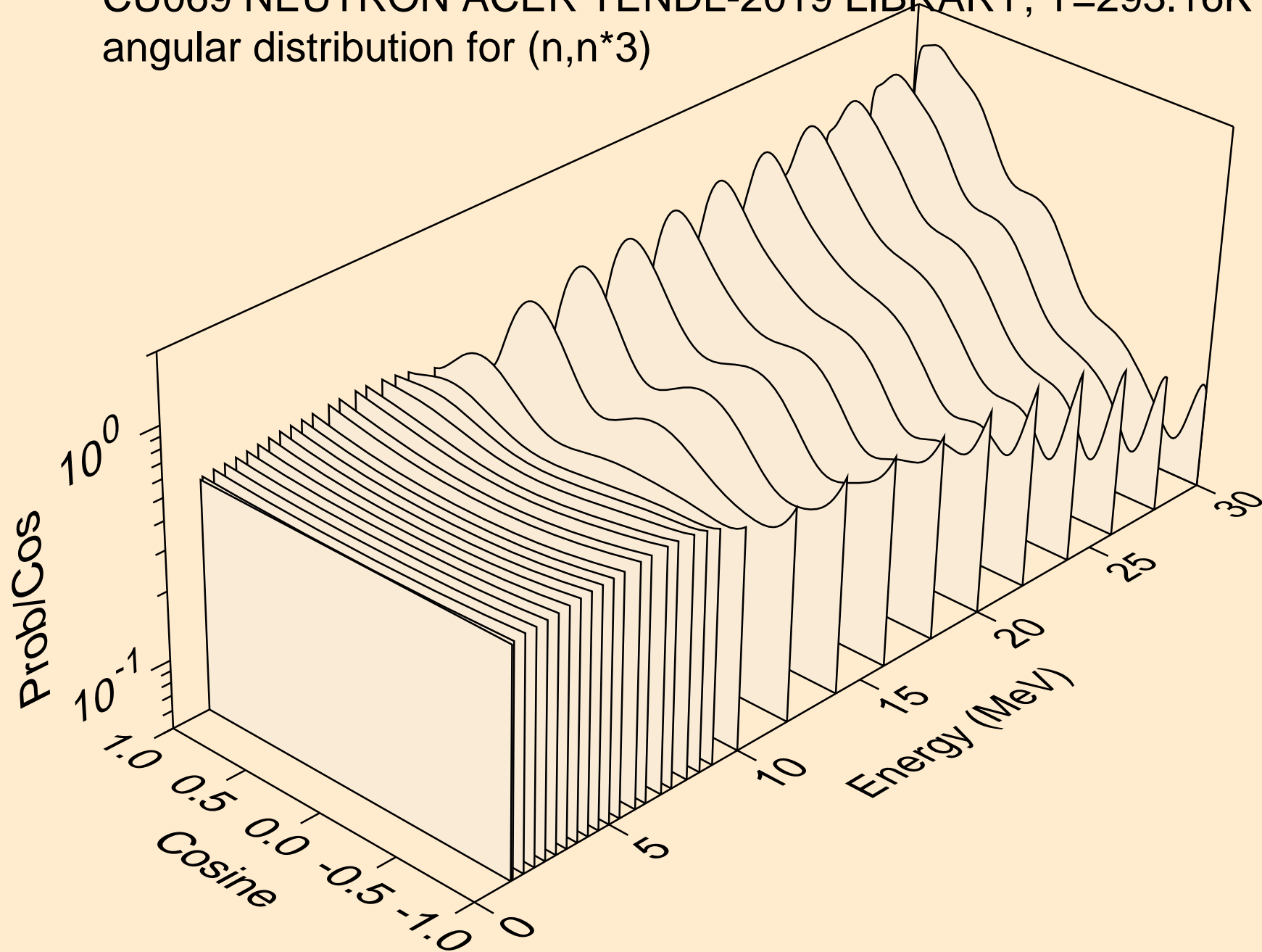

CU069 NEUTRON ACER TENDL-2019 LIBRARY; T=293.16K
angular distribution for (n,n*4)

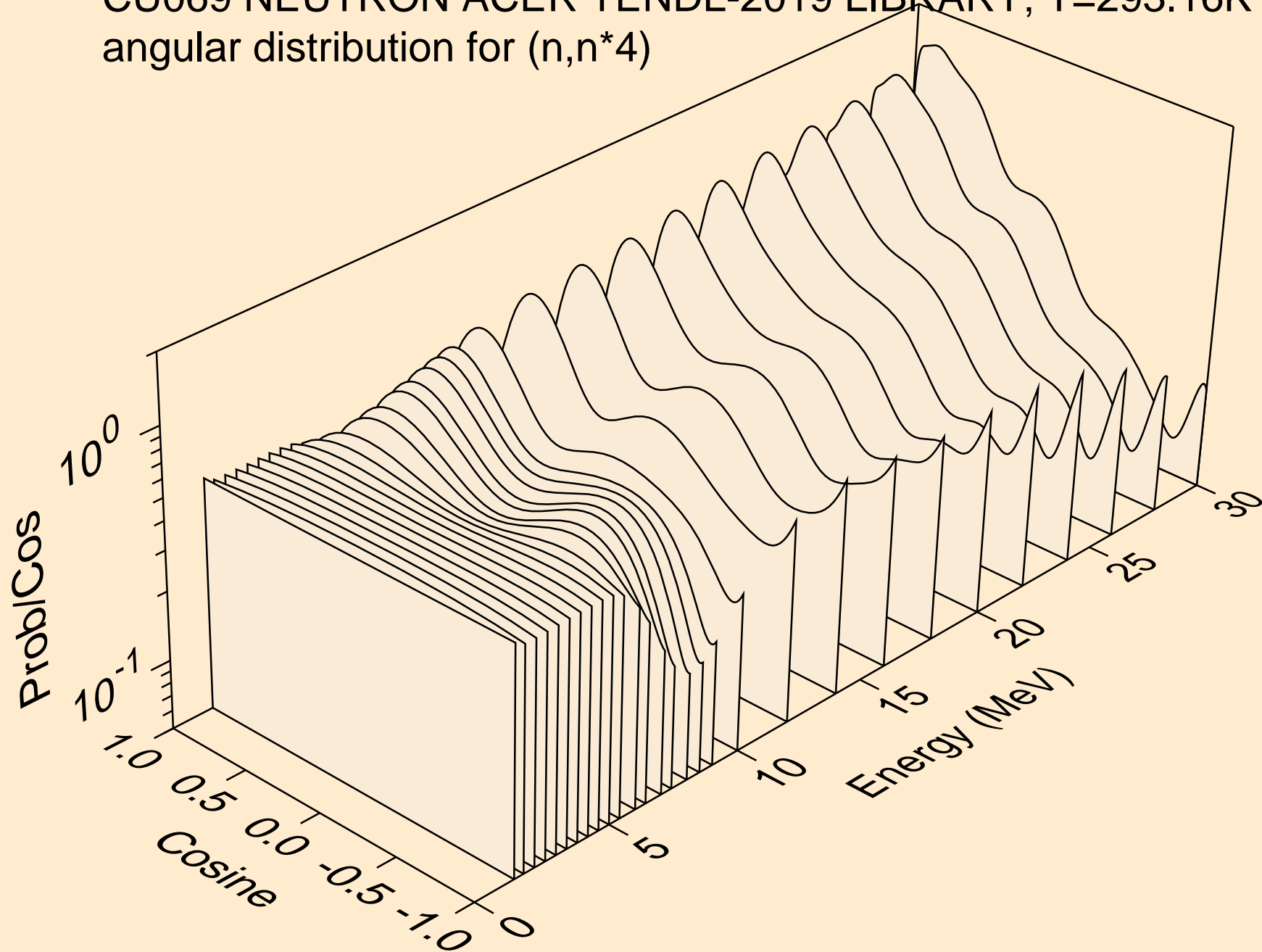

CU069 NEUTRON ACER TENDL-2019 LIBRARY; T=293.16K
angular distribution for (n,n*5)

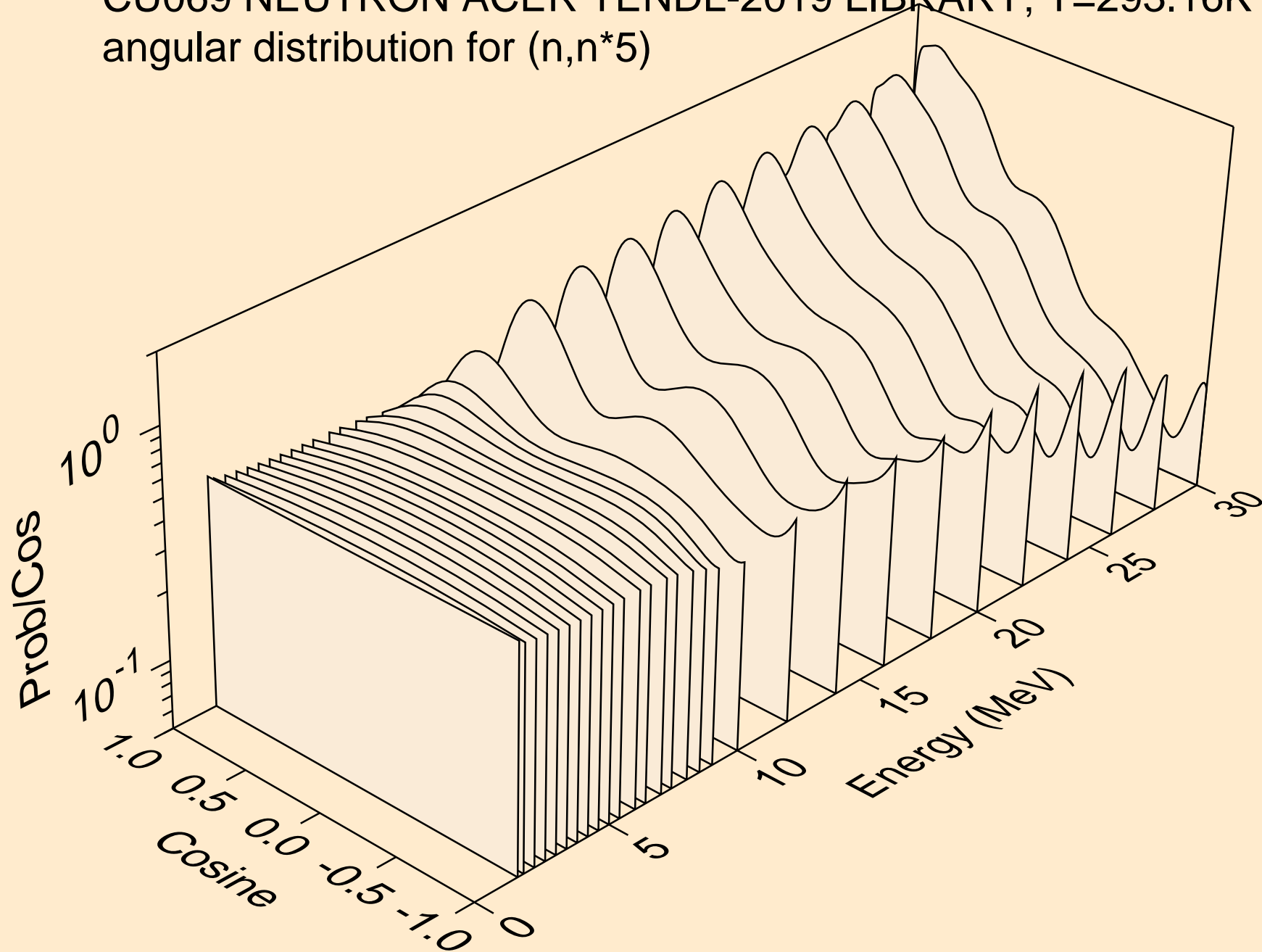

CU069 NEUTRON ACER TENDL-2019 LIBRARY; T=293.16K
angular distribution for (n,n*6)

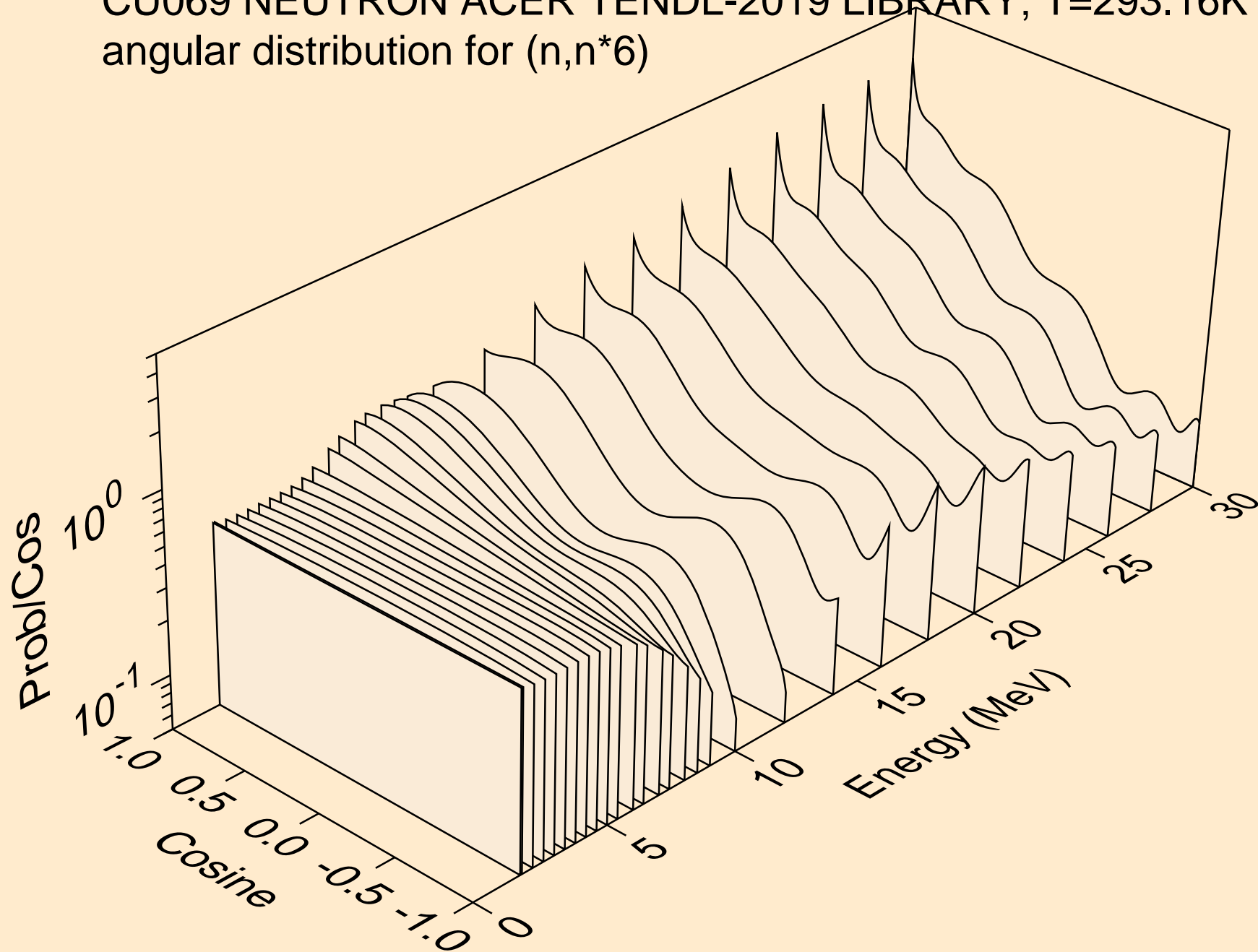

CU069 NEUTRON ACER TENDL-2019 LIBRARY; T=293.16K
angular distribution for (n,n*7)

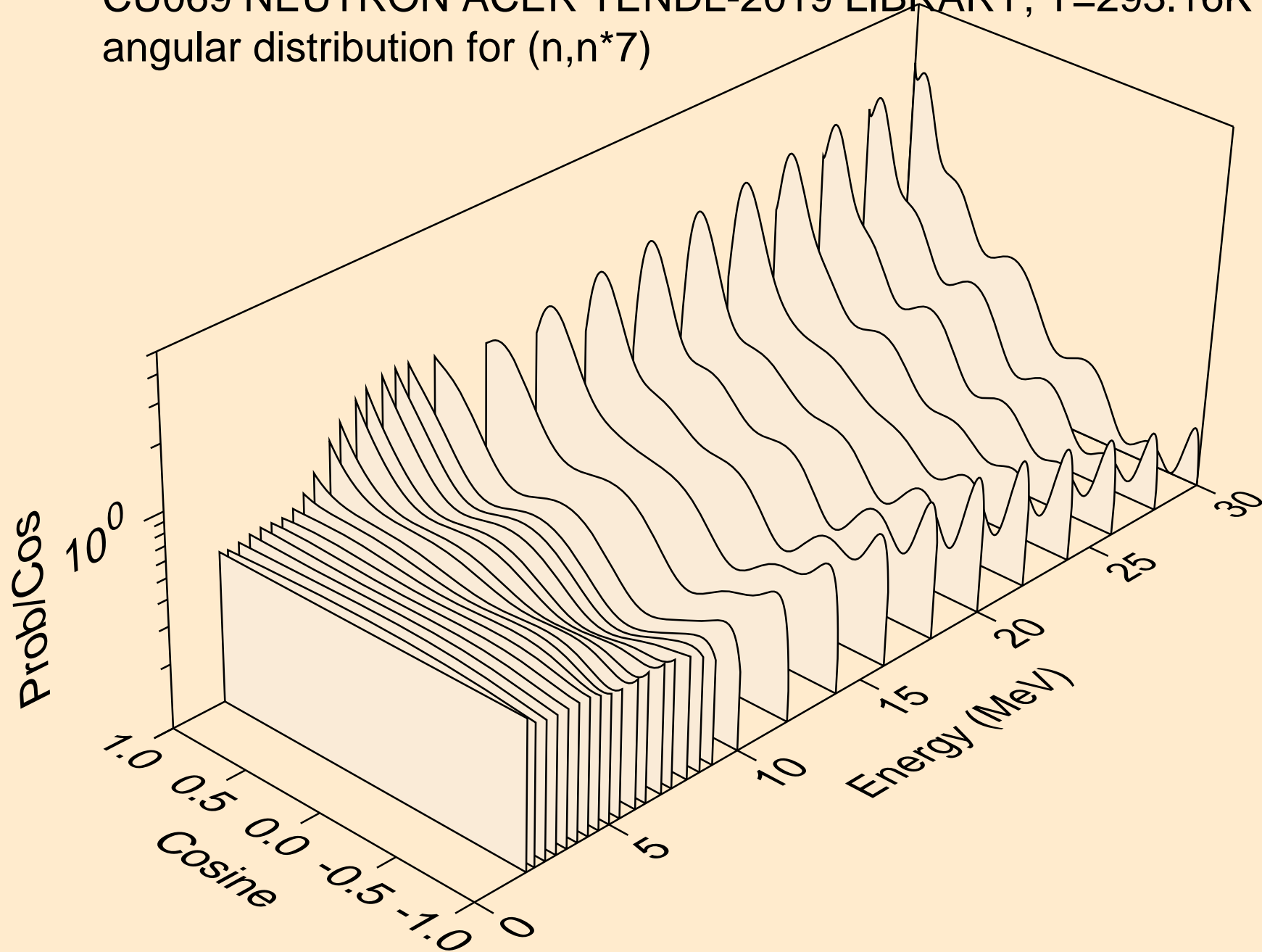

CU069 NEUTRON ACER TENDL-2019 LIBRARY; T=293.16K
angular distribution for (n,n*8)

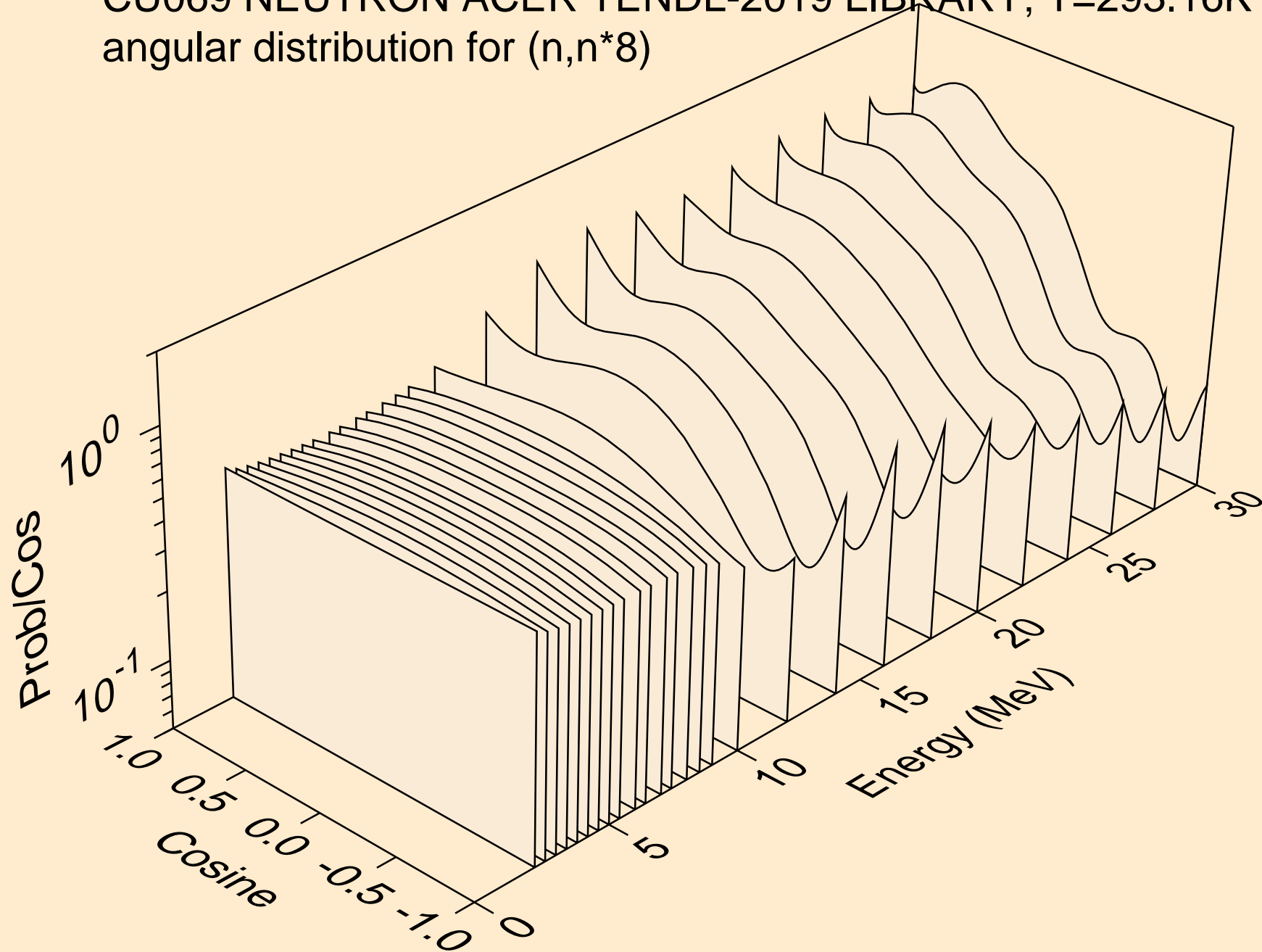

CU069 NEUTRON ACER TENDL-2019 LIBRARY; T=293.16K
angular distribution for (n,n*9)

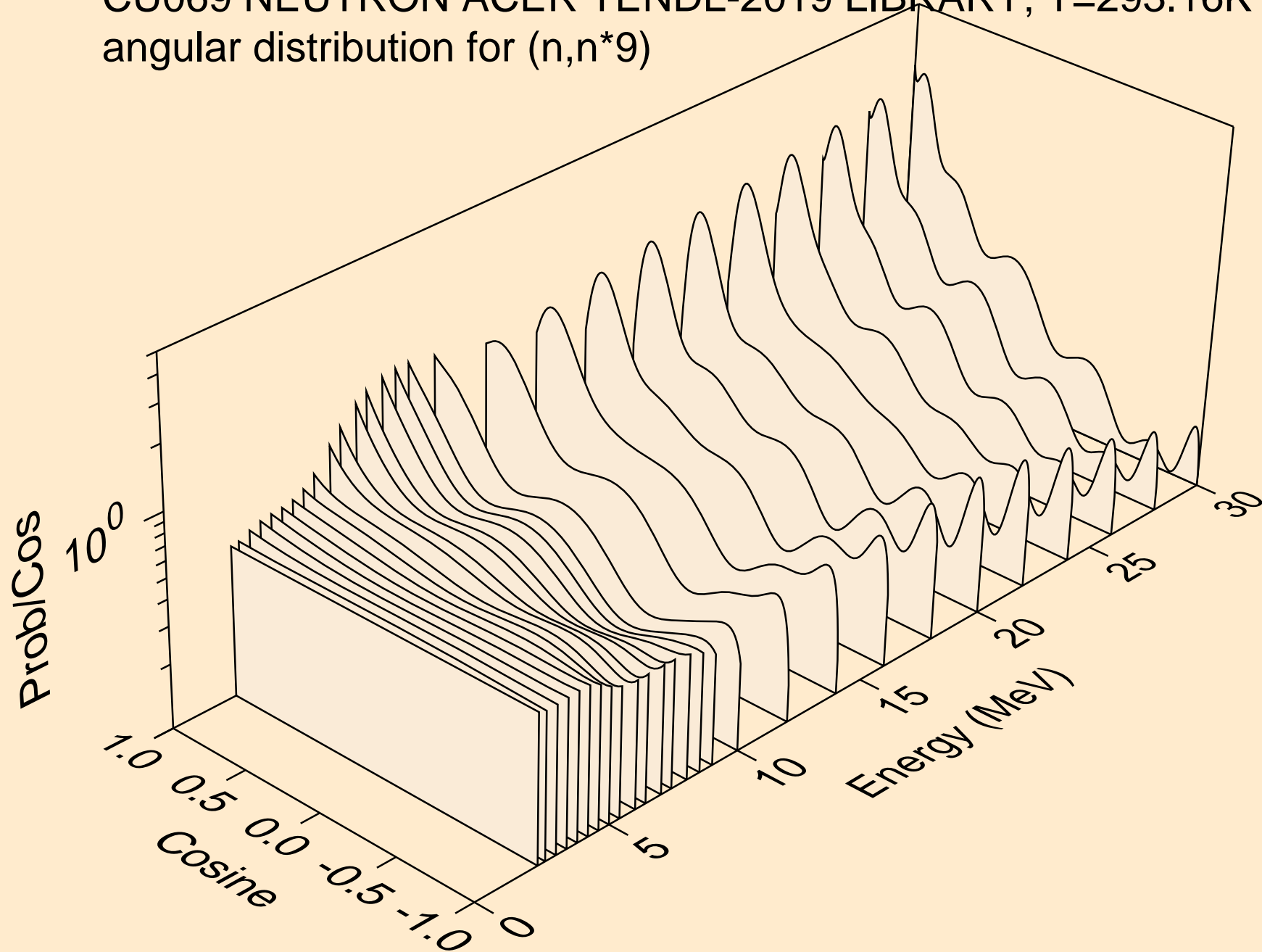

CU069 NEUTRON ACER TENDL-2019 LIBRARY; T=293.16K
angular distribution for (n,n*10)

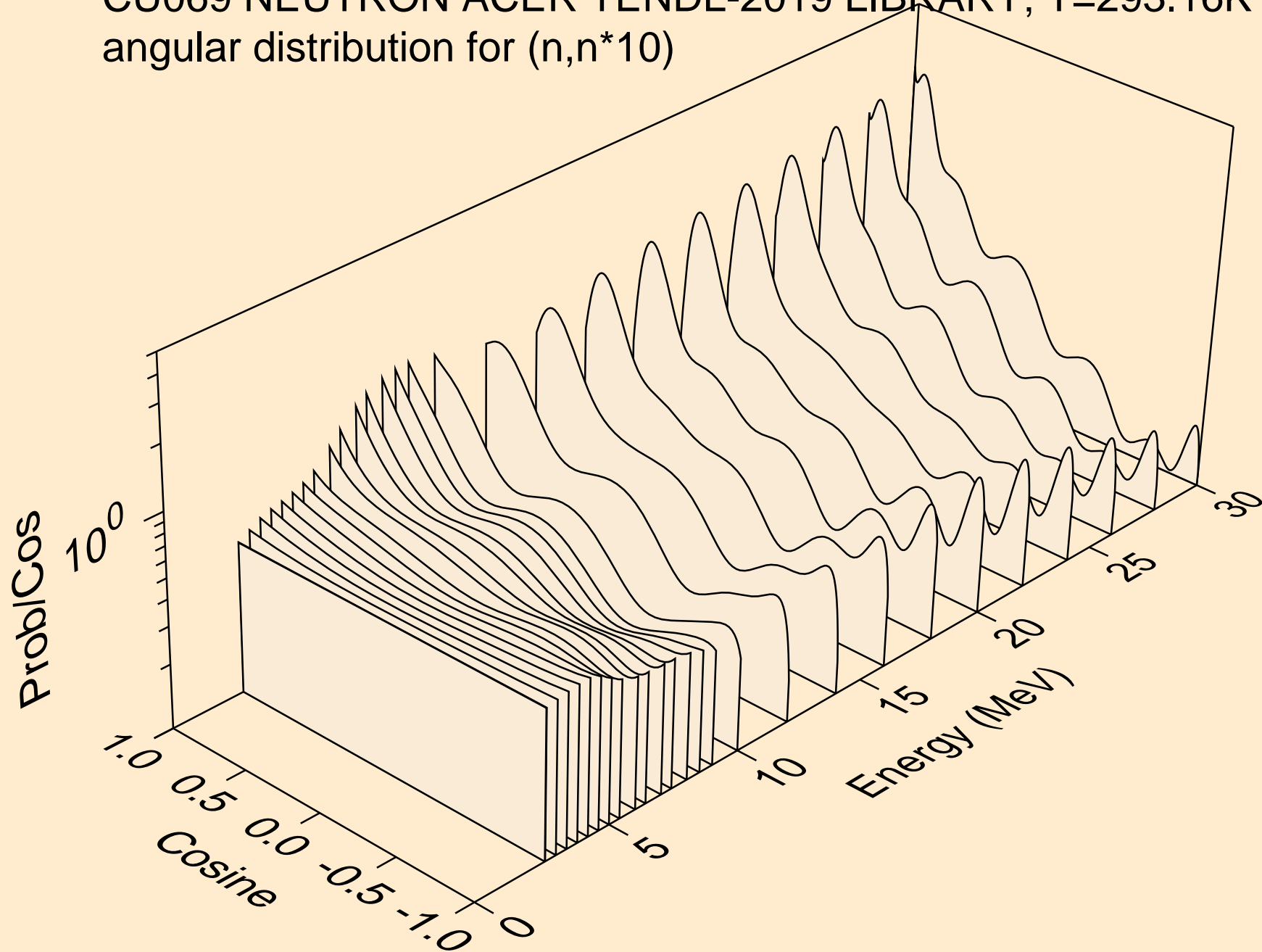

CU069 NEUTRON ACER TENDL-2019 LIBRARY; T=293.16K
angular distribution for (n,n*11)

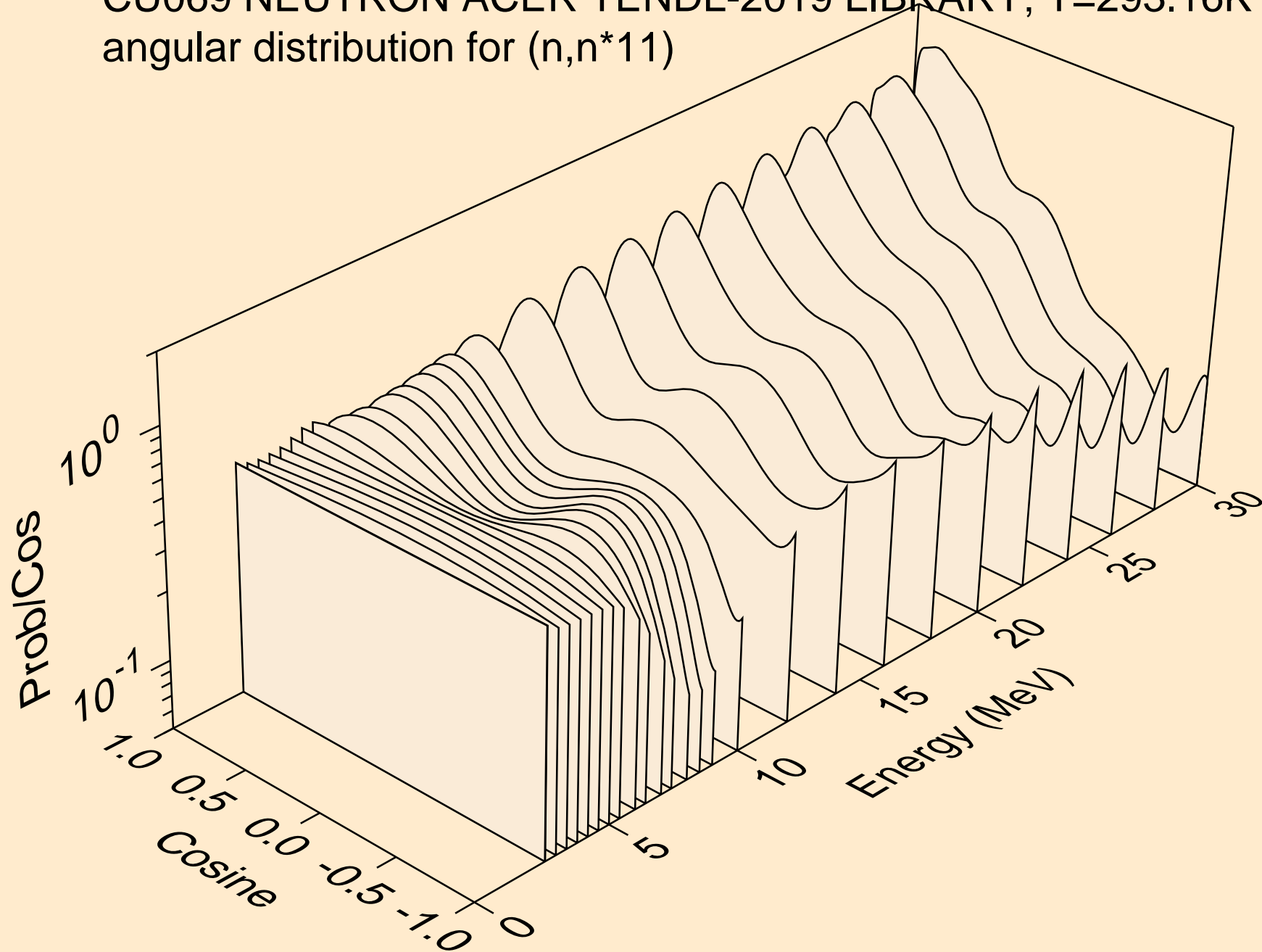

CU069 NEUTRON ACER TENDL-2019 LIBRARY; T=293.16K
angular distribution for (n,n*12)

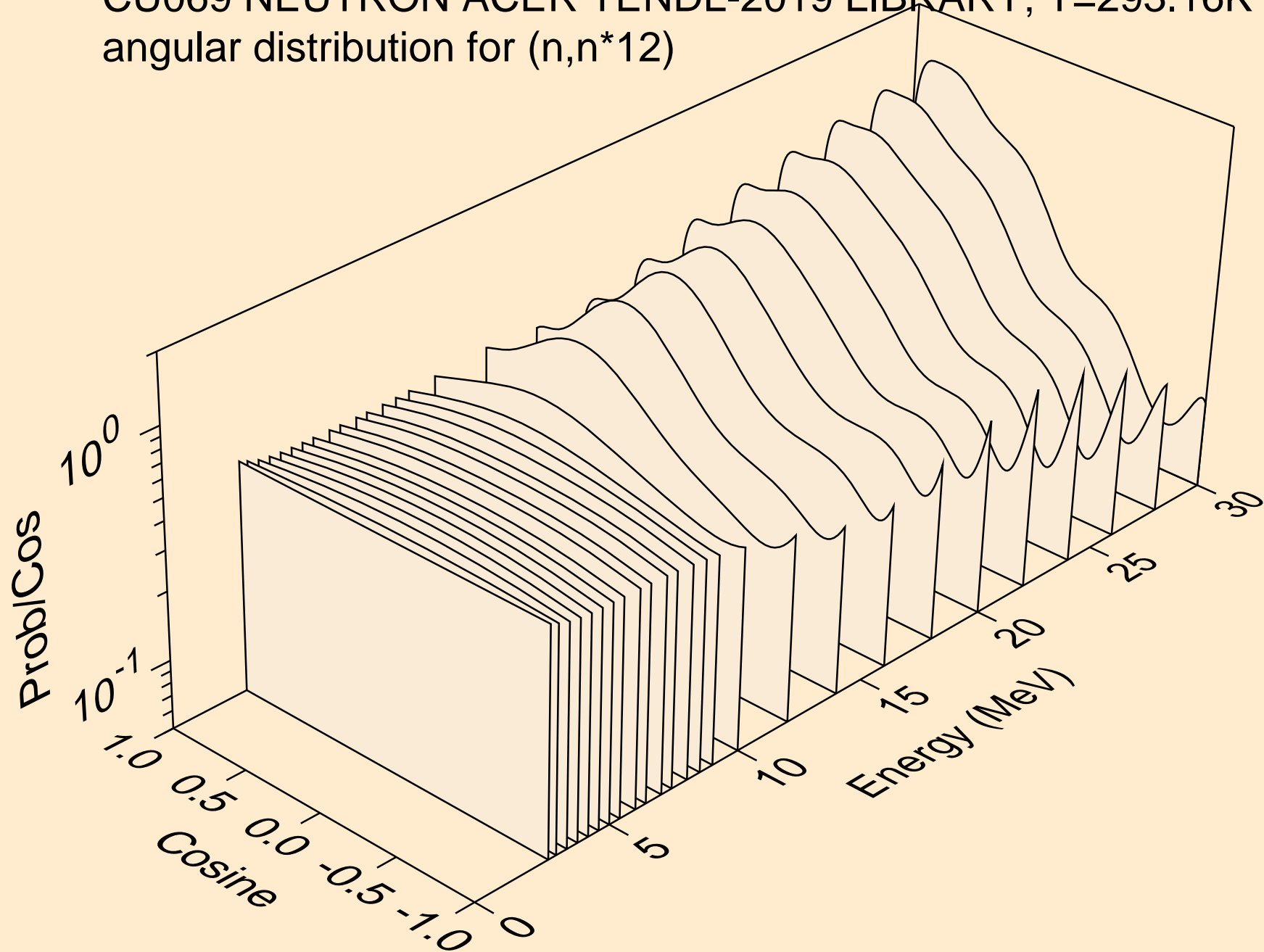

CU069 NEUTRON ACER TENDL-2019 LIBRARY; T=293.16K
angular distribution for (n,n*13)

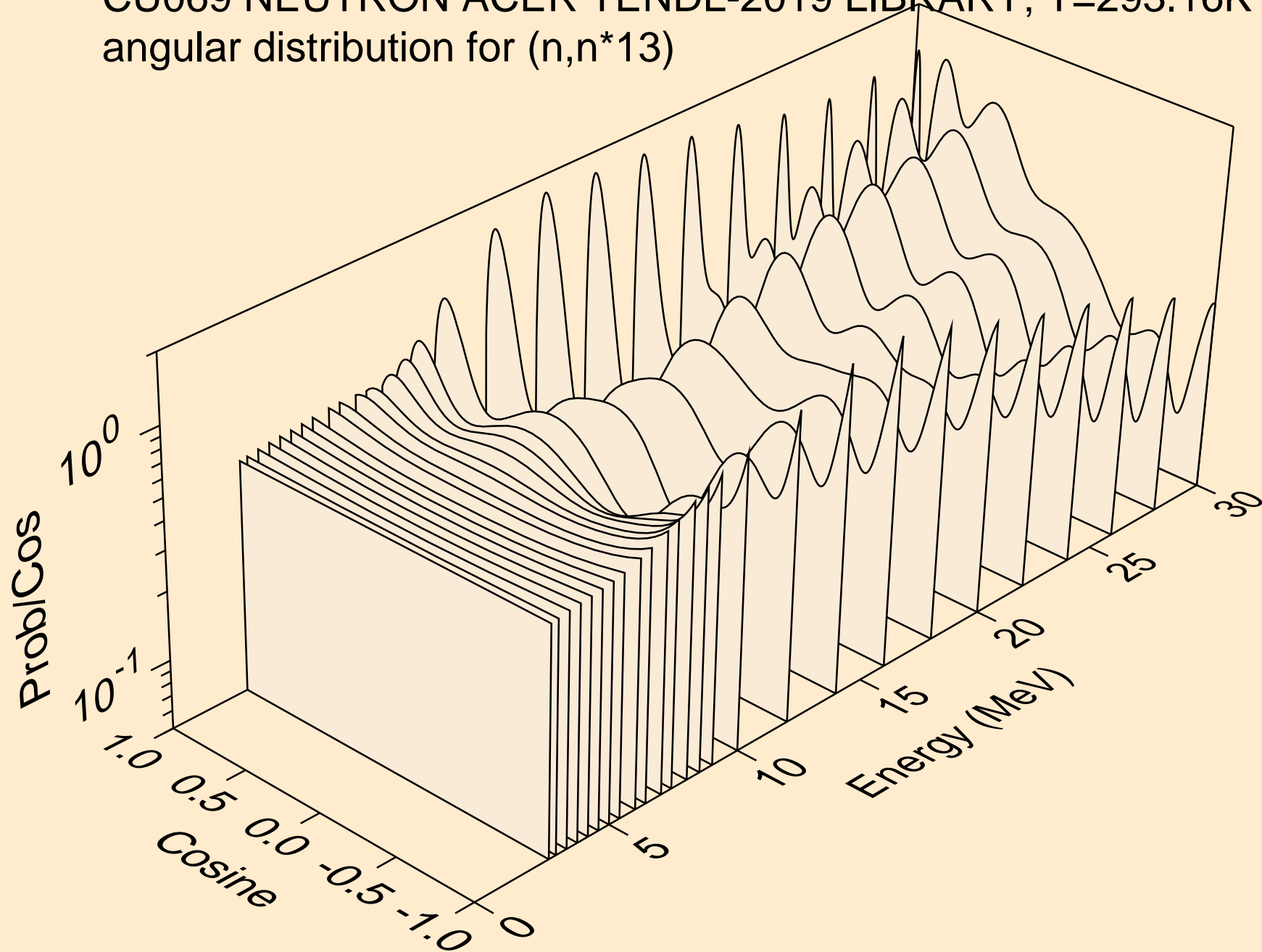

CU069 NEUTRON ACER TENDL-2019 LIBRARY; T=293.16K
angular distribution for (n,n*14)

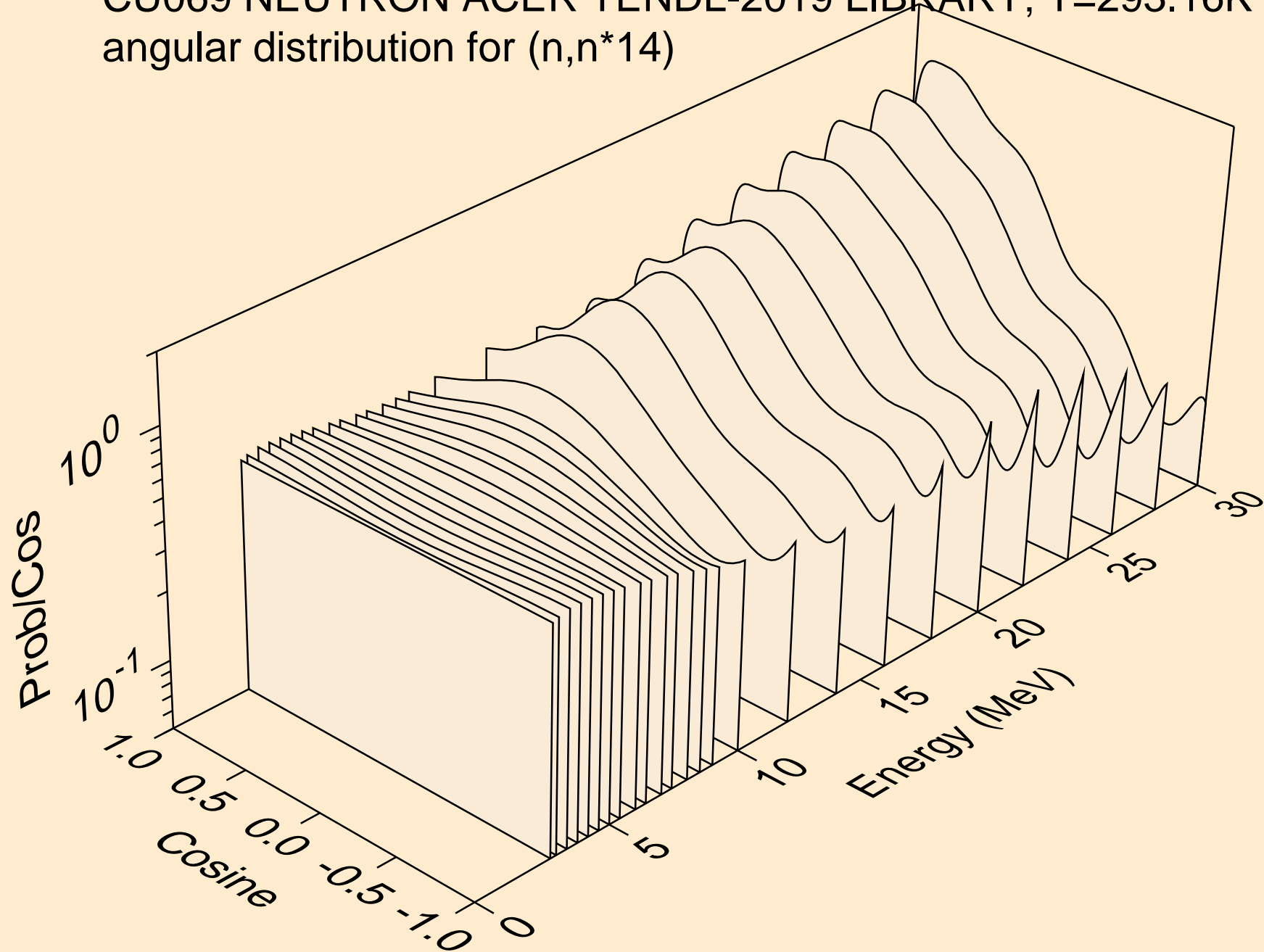

CU069 NEUTRON ACER TENDL-2019 LIBRARY; T=293.16K
angular distribution for (n,n*15)

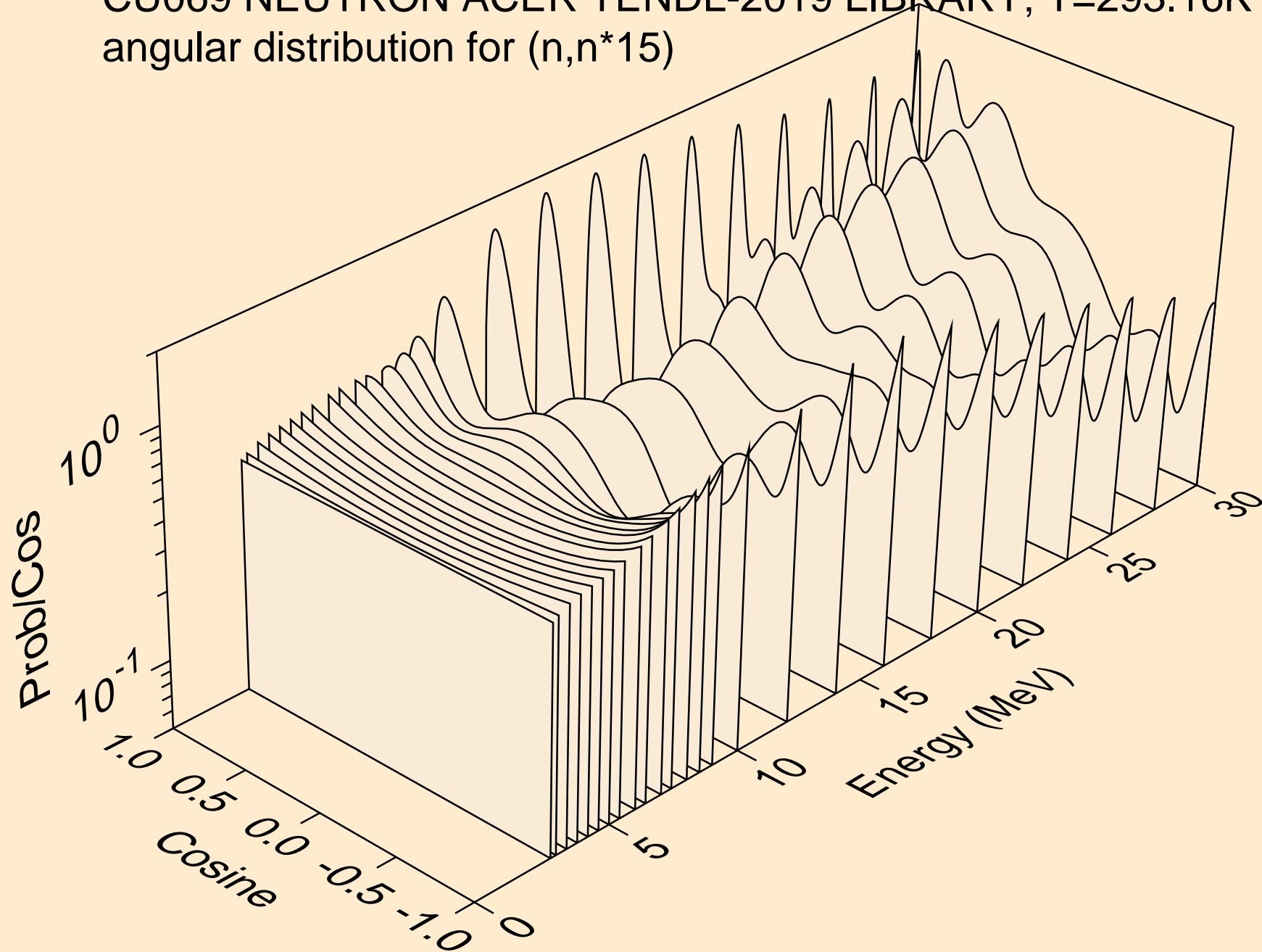

CU069 NEUTRON ACER TENDL-2019 LIBRARY; T=293.16K
angular distribution for (n,n*16)

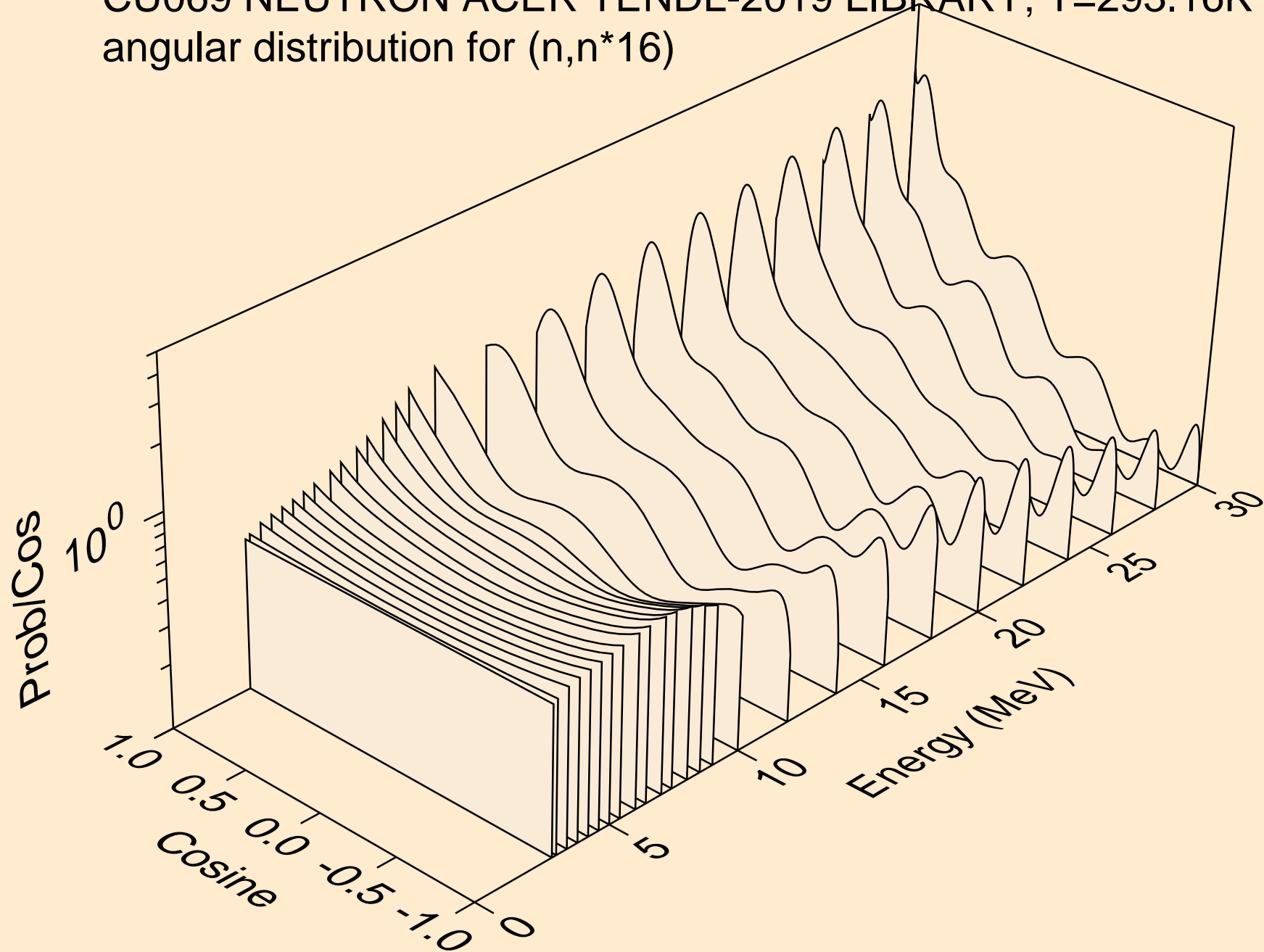

CU069 NEUTRON ACER TENDL-2019 LIBRARY; T=293.16K
angular distribution for (n,n*17)

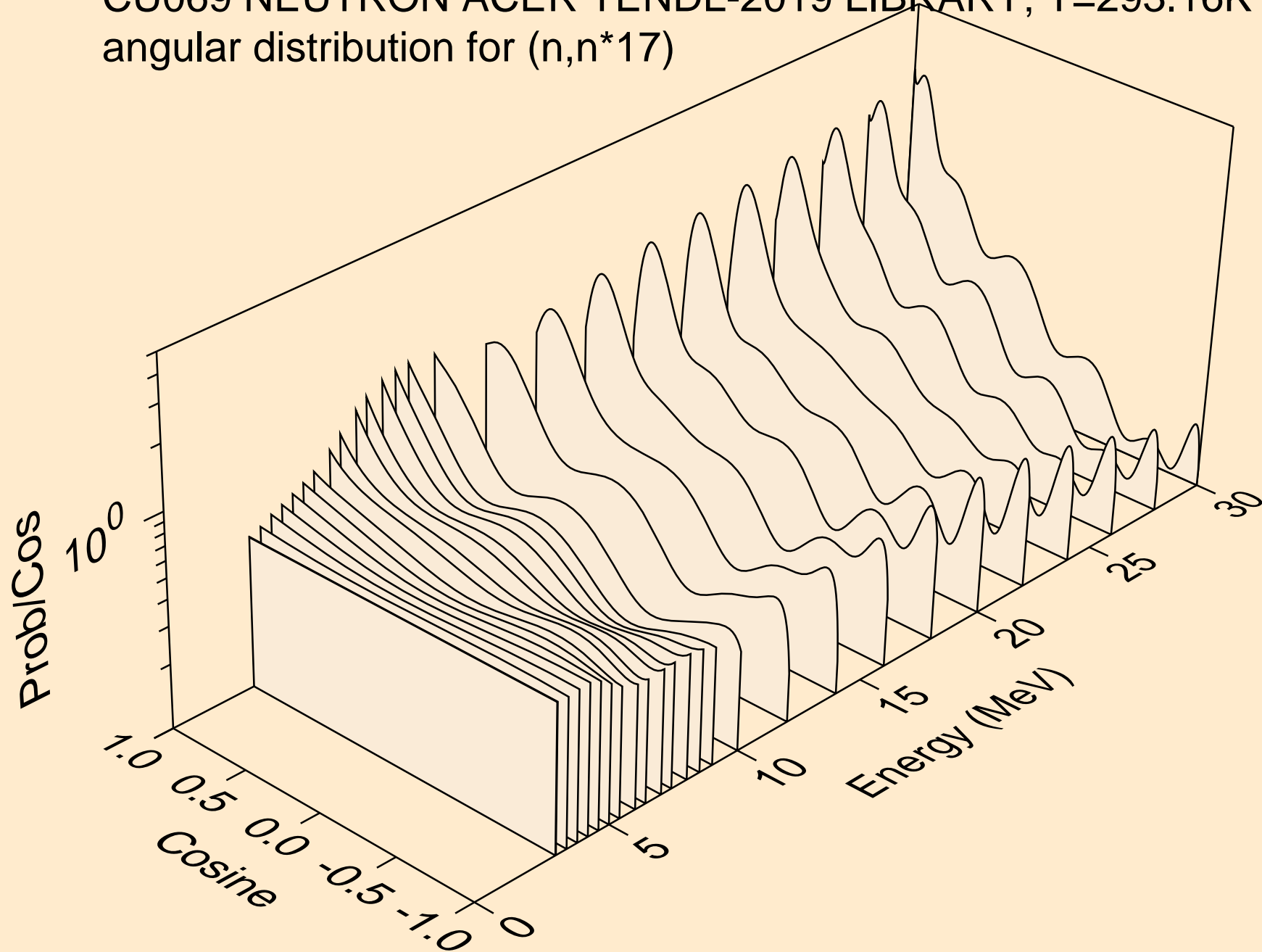

CU069 NEUTRON ACER TENDL-2019 LIBRARY; T=293.16K
angular distribution for (n,n*18)

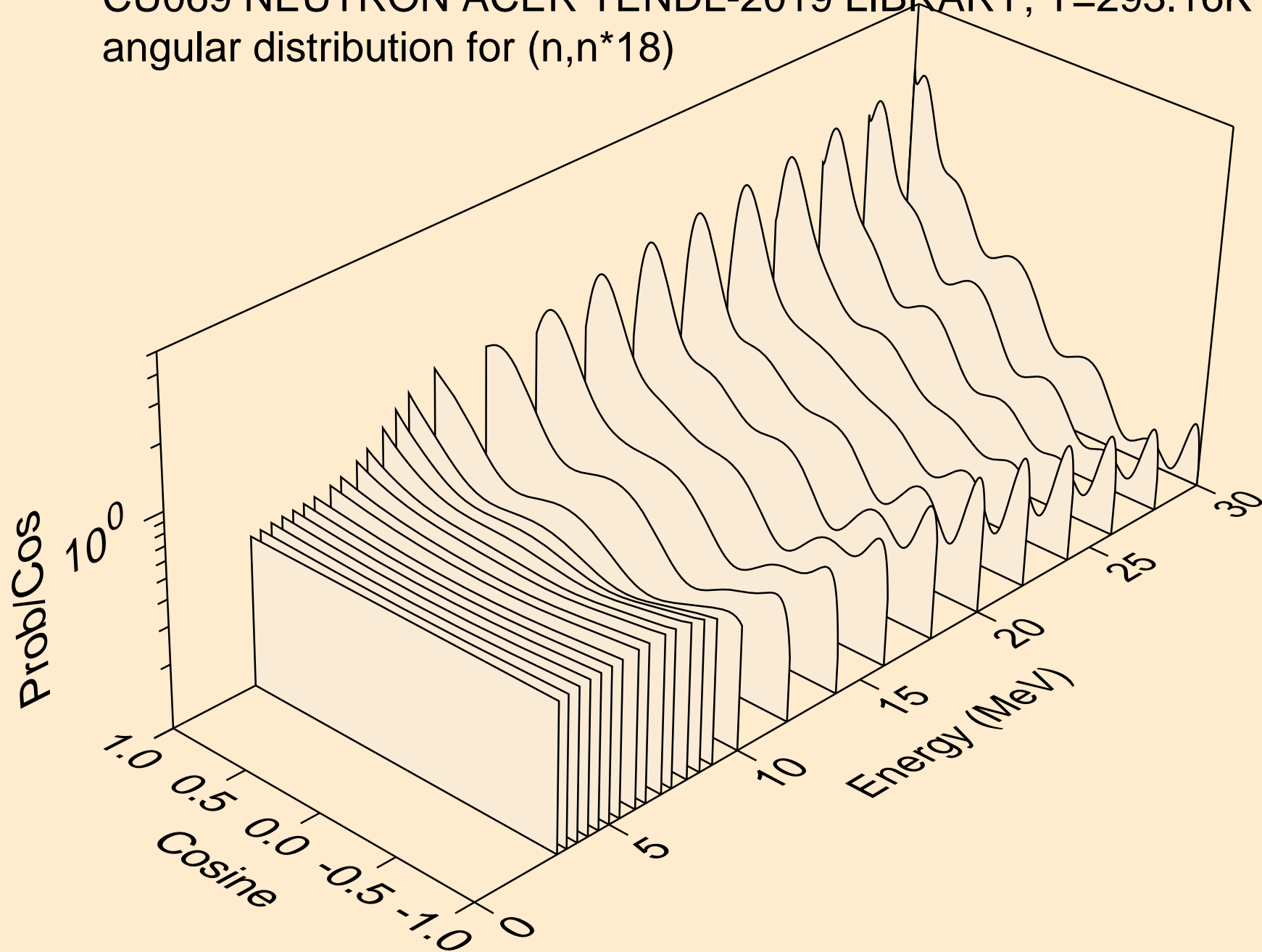

CU069 NEUTRON ACER TENDL-2019 LIBRARY; T=293.16K
angular distribution for (n,n*19)

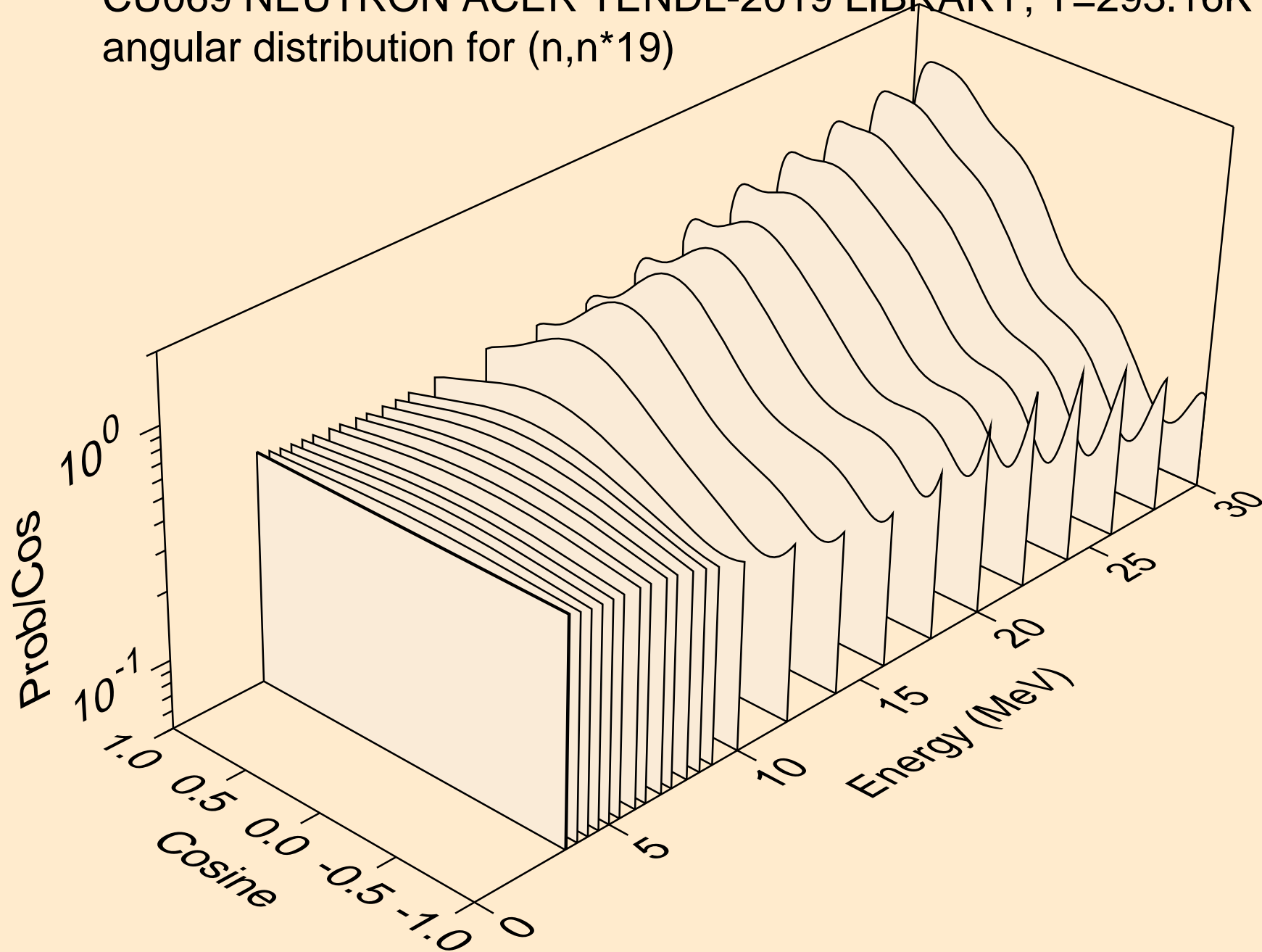

CU069 NEUTRON ACER TENDL-2019 LIBRARY; T=293.16K
angular distribution for (n,n*20)

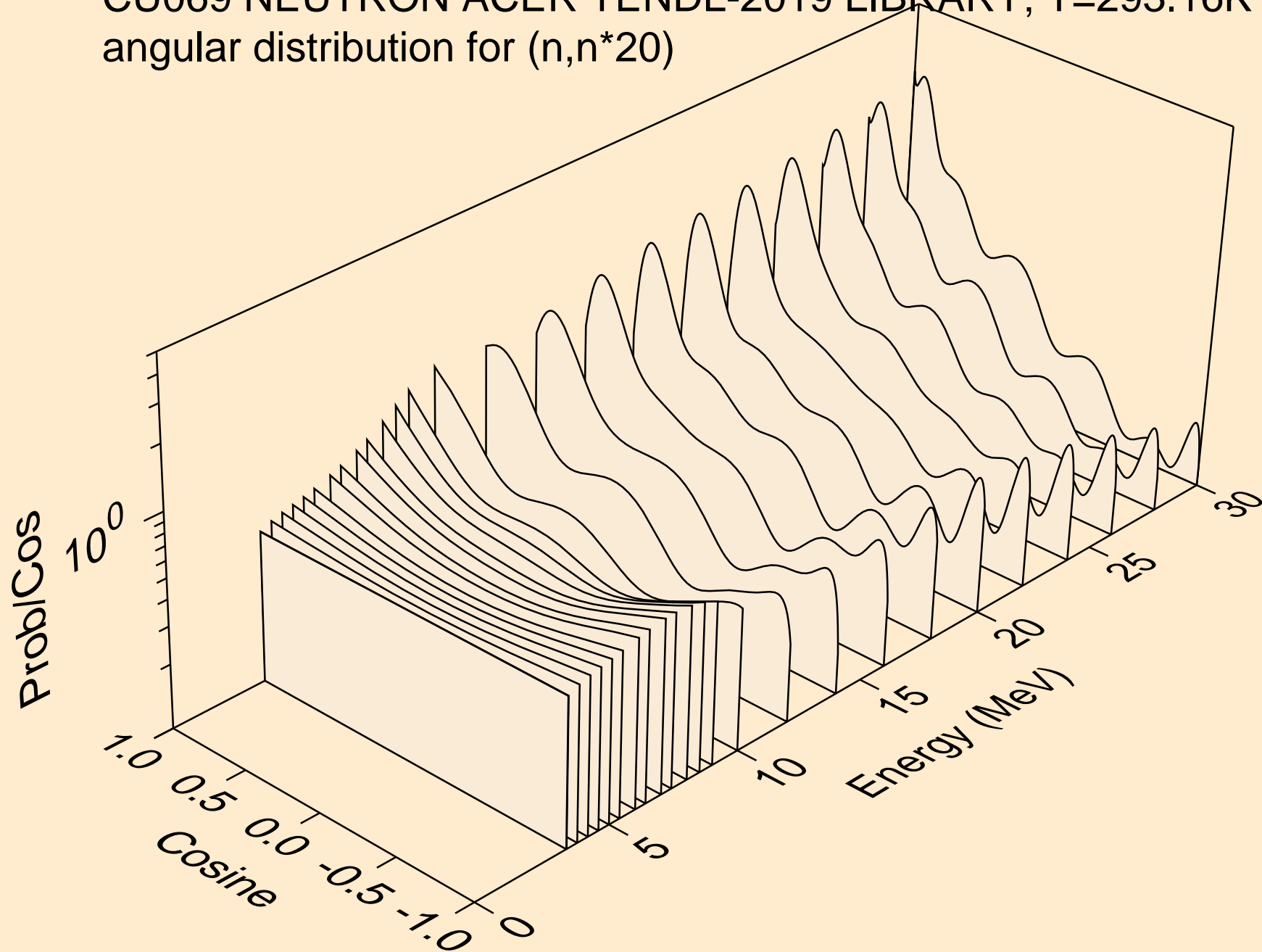

CU069 NEUTRON ACER TENDL-2019 LIBRARY; T=293.16K
angular distribution for (n,n*21)

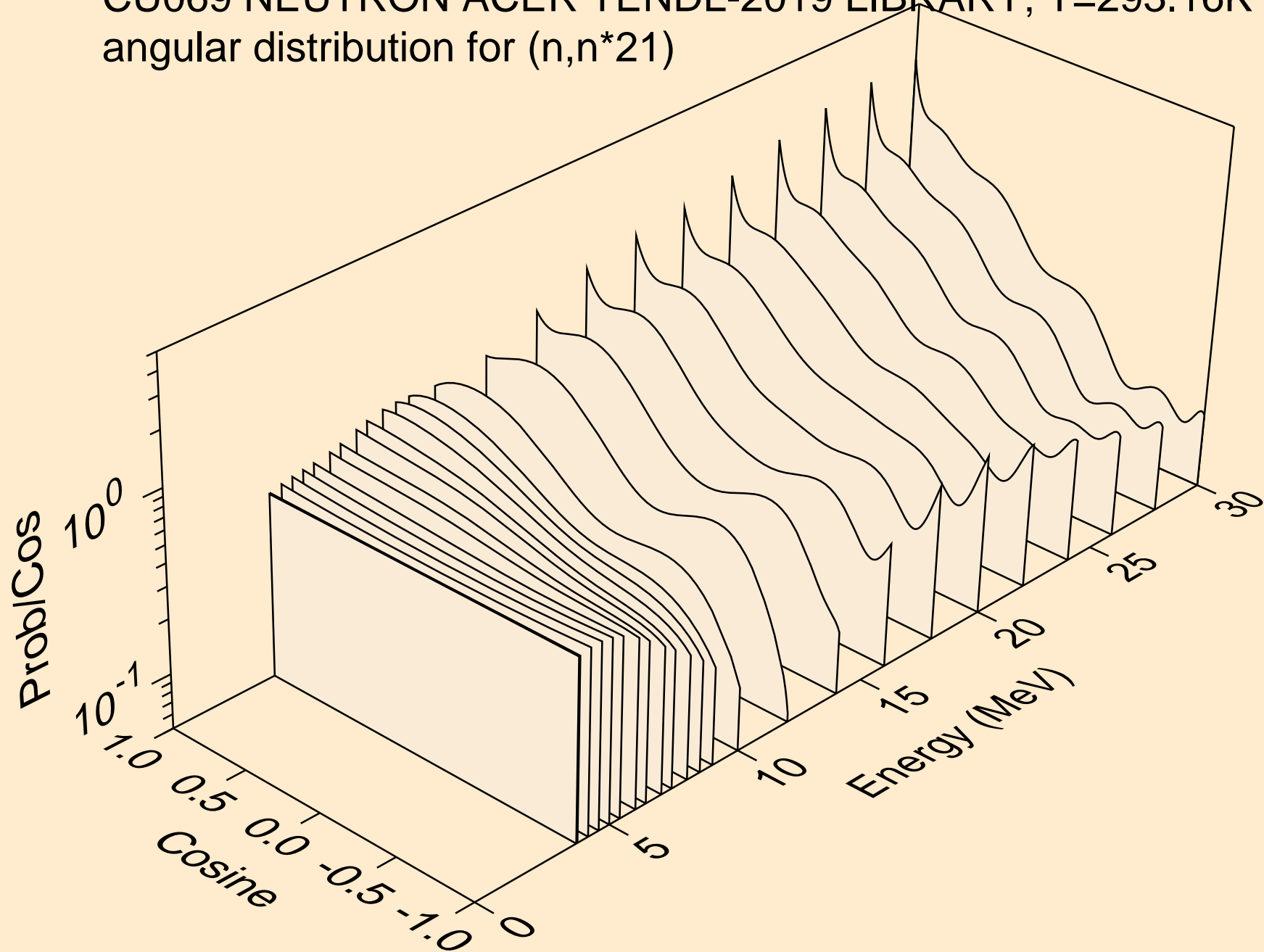

CU069 NEUTRON ACER TENDL-2019 LIBRARY; T=293.16K
angular distribution for (n,n*22)

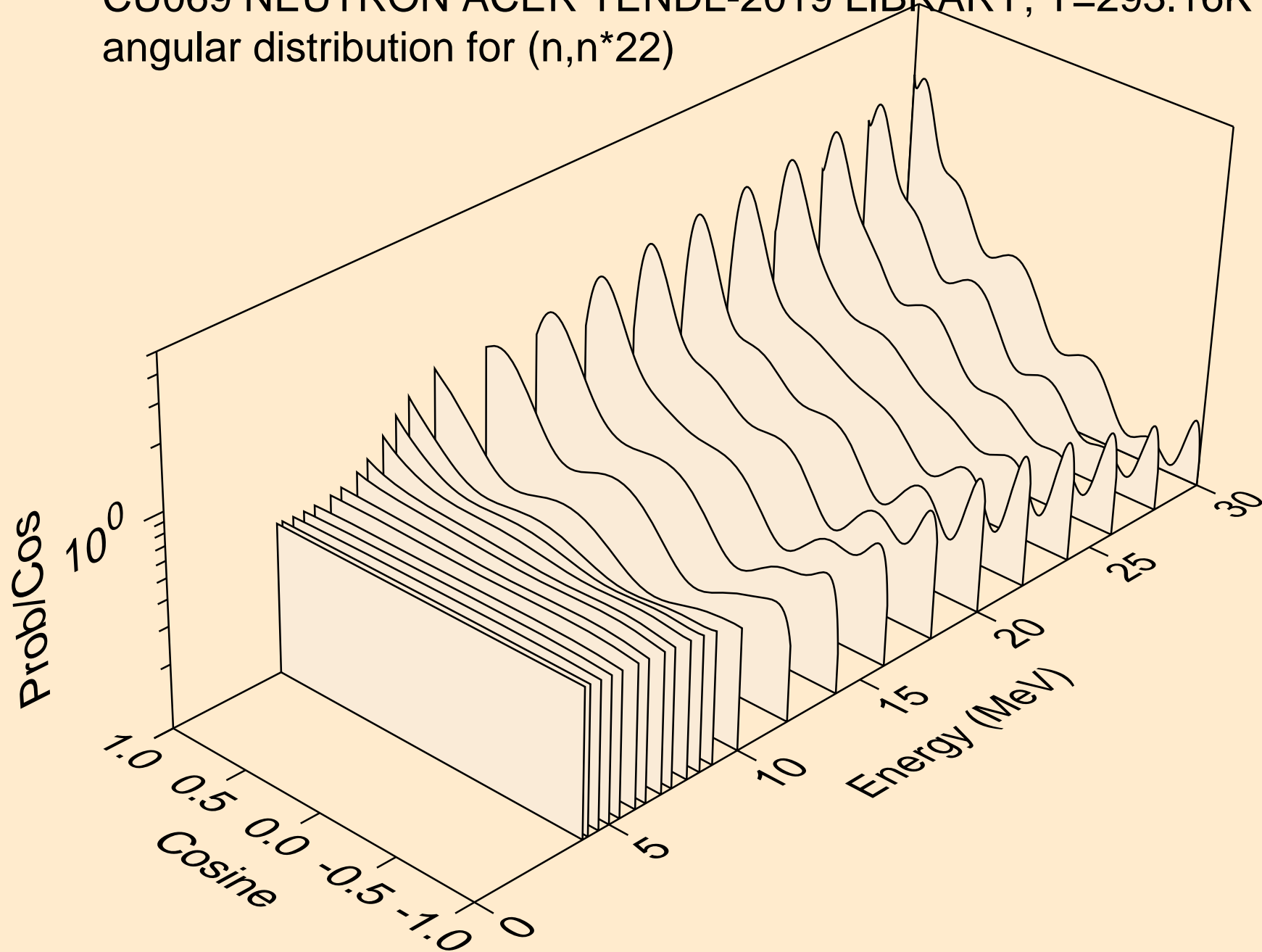

CU069 NEUTRON ACER TENDL-2019 LIBRARY; T=293.16K
angular distribution for (n,n*23)

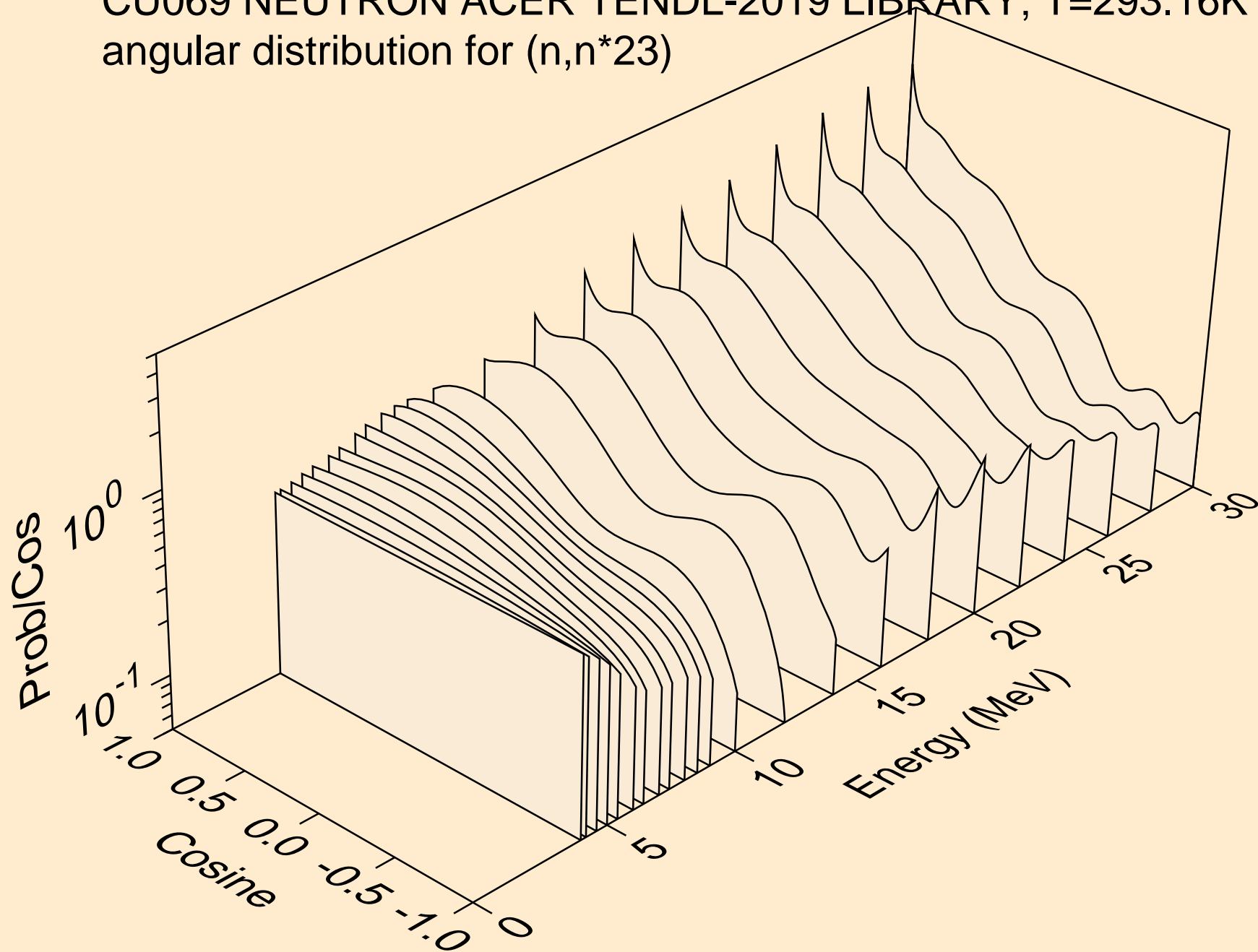

CU069 NEUTRON ACER TENDL-2019 LIBRARY; T=293.16K
angular distribution for (n,n*24)

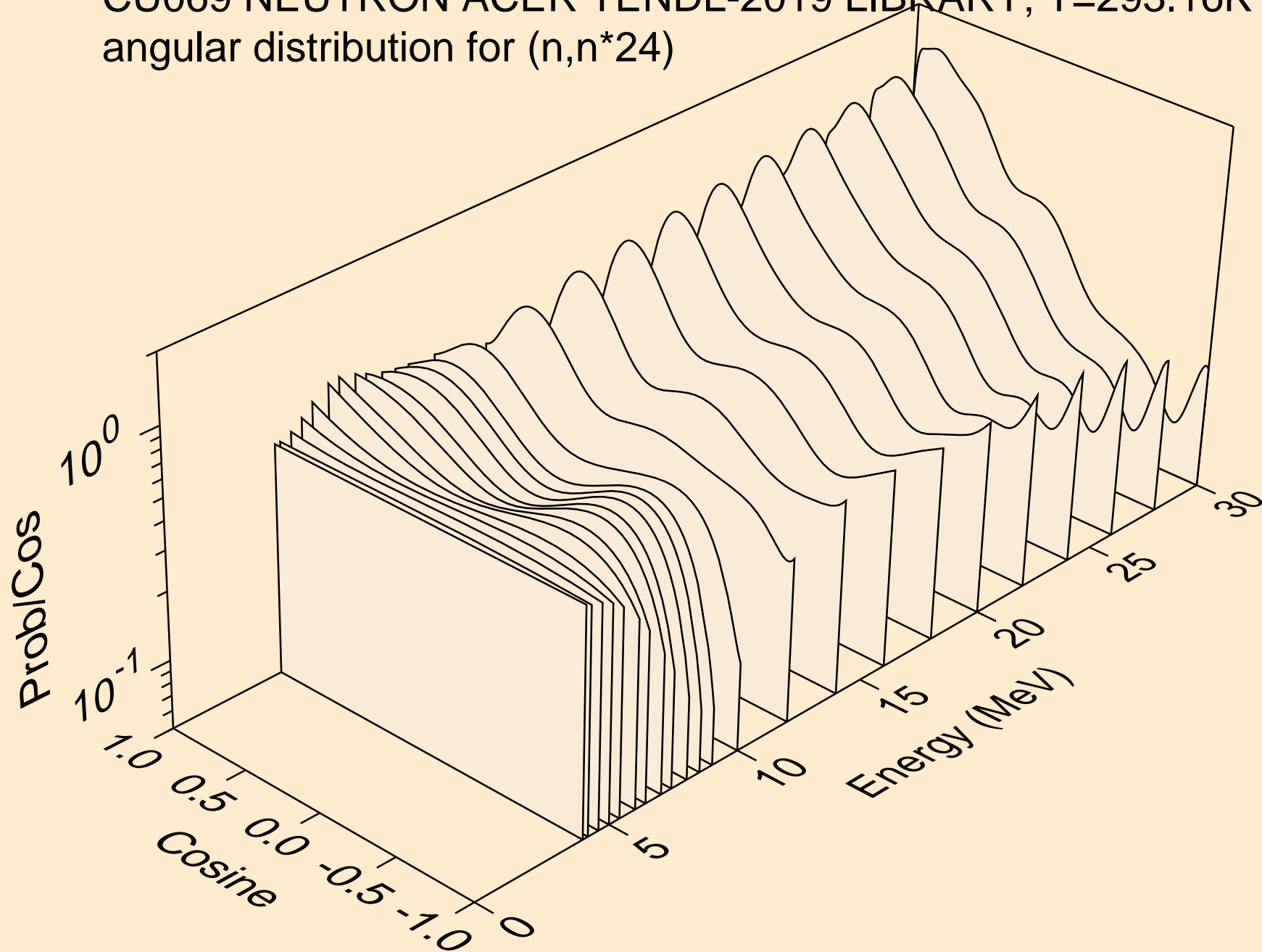

CU069 NEUTRON ACER TENDL-2019 LIBRARY; T=293.16K
angular distribution for (n,n*25)

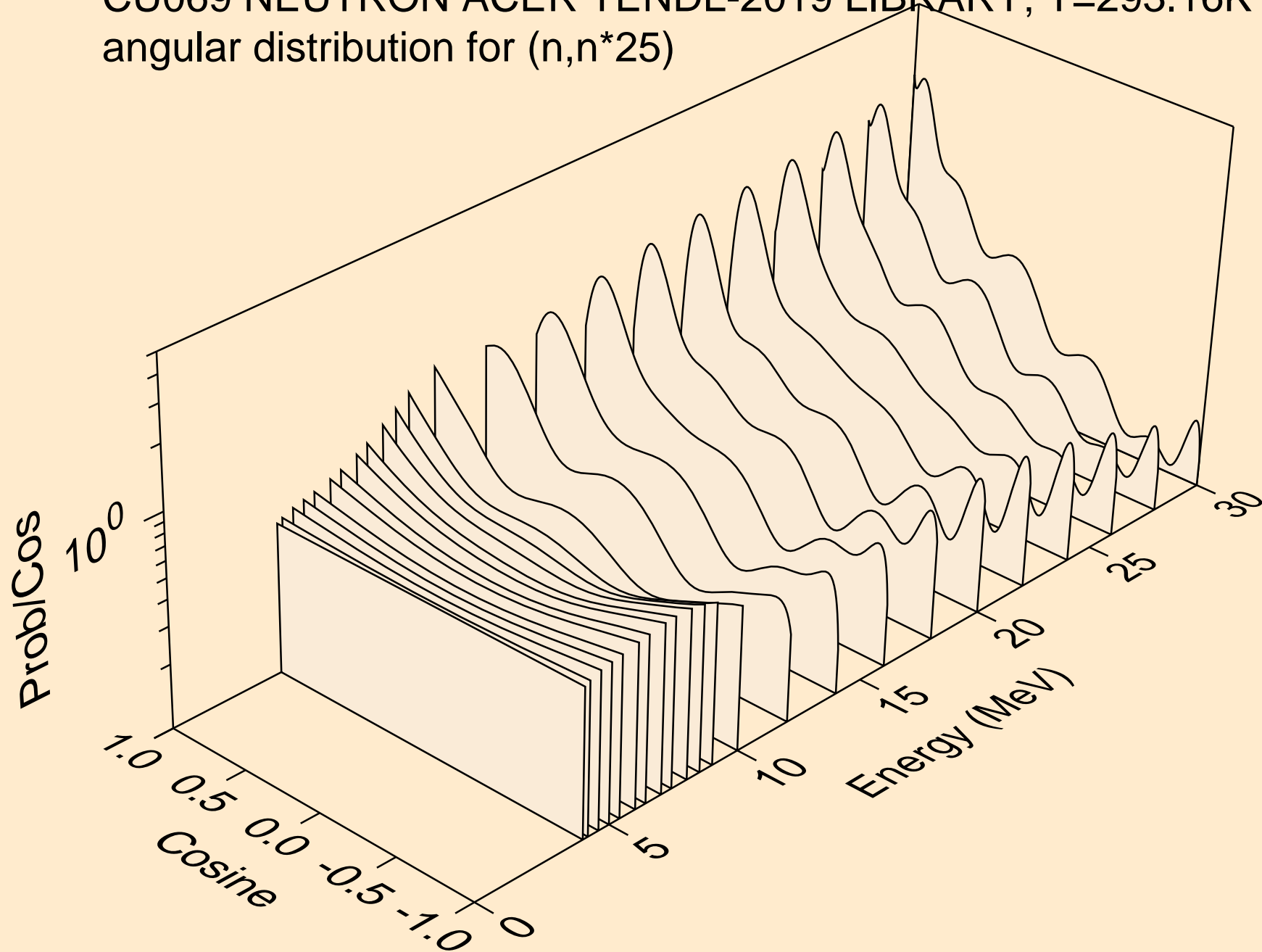

CU069 NEUTRON ACER TENDL-2019 LIBRARY; T=293.16K
angular distribution for (n,n*26)

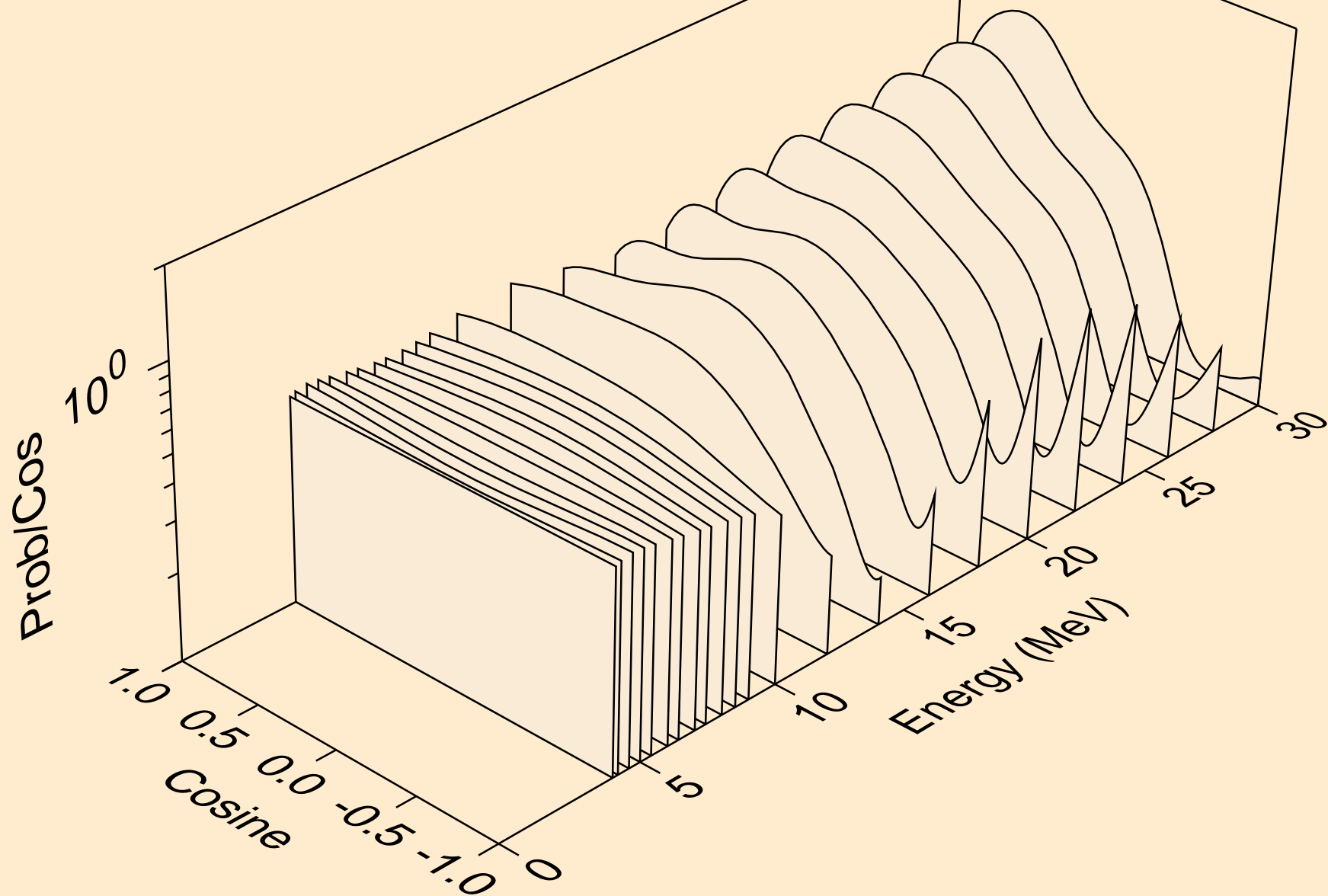

CU069 NEUTRON ACER TENDL-2019 LIBRARY; T=293.16K
angular distribution for (n,n*27)

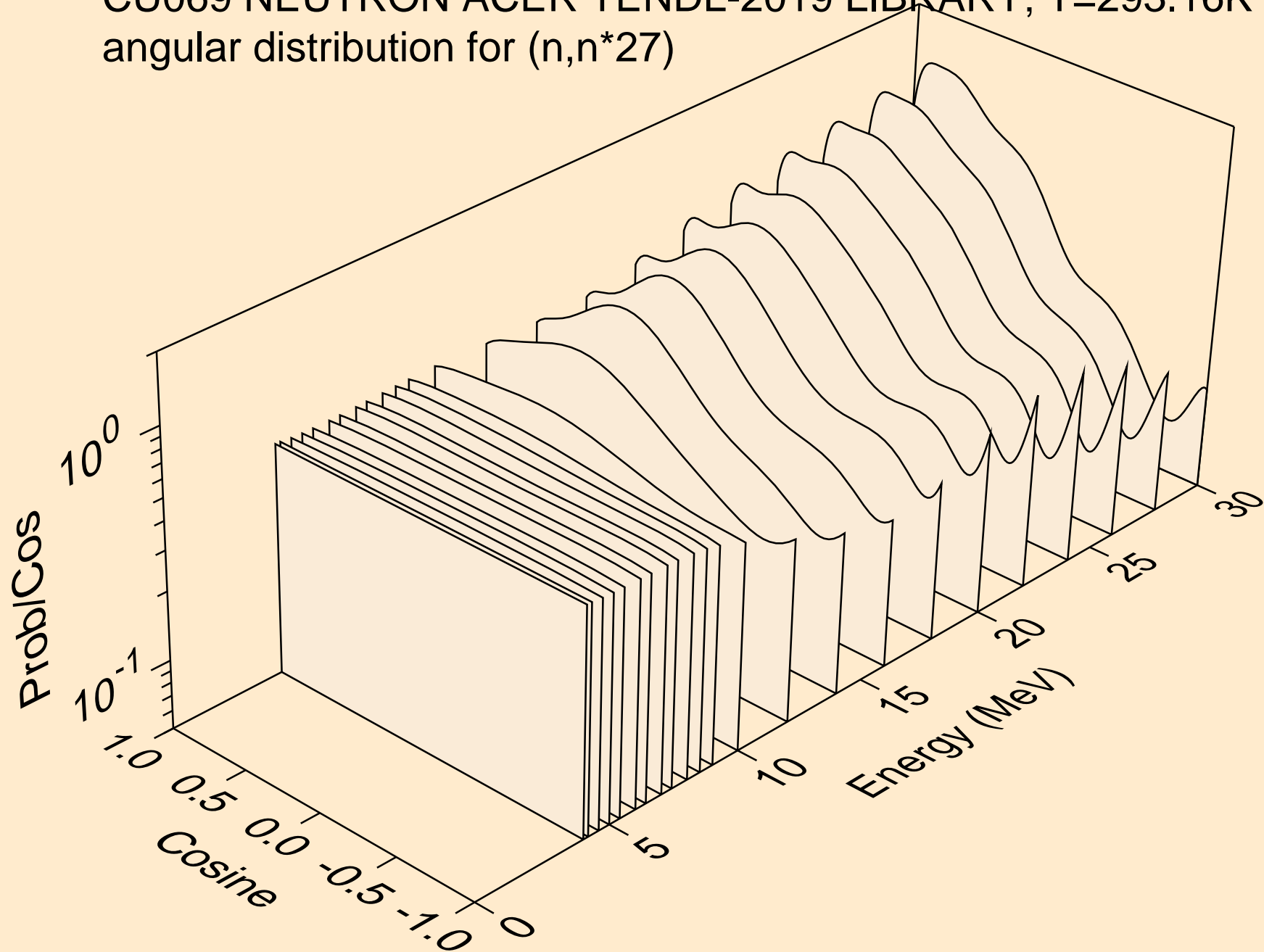

CU069 NEUTRON ACER TENDL-2019 LIBRARY; T=293.16K
angular distribution for (n,n*28)

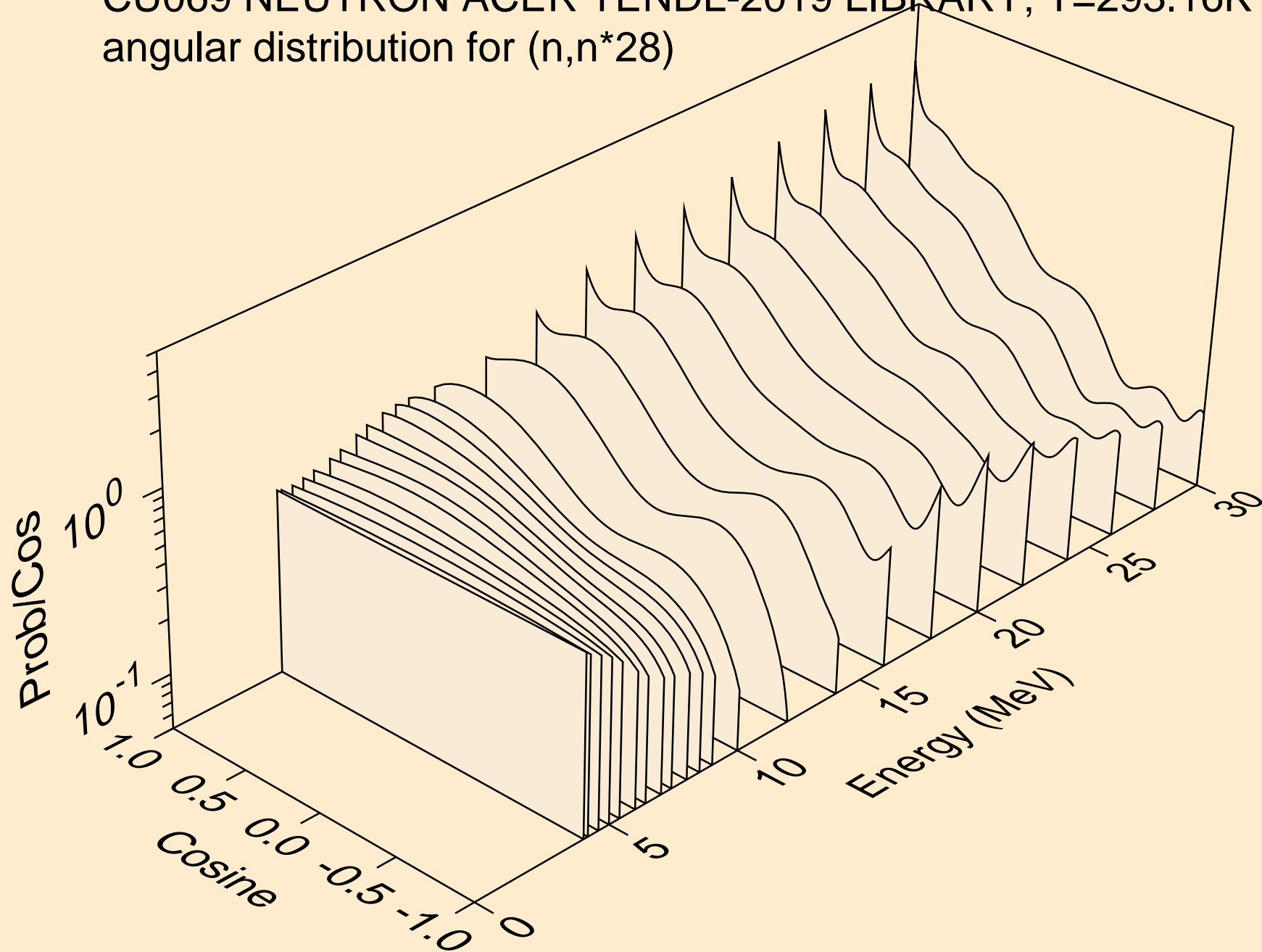

CU069 NEUTRON ACER TENDL-2019 LIBRARY; T=293.16K
angular distribution for (n,n*29)

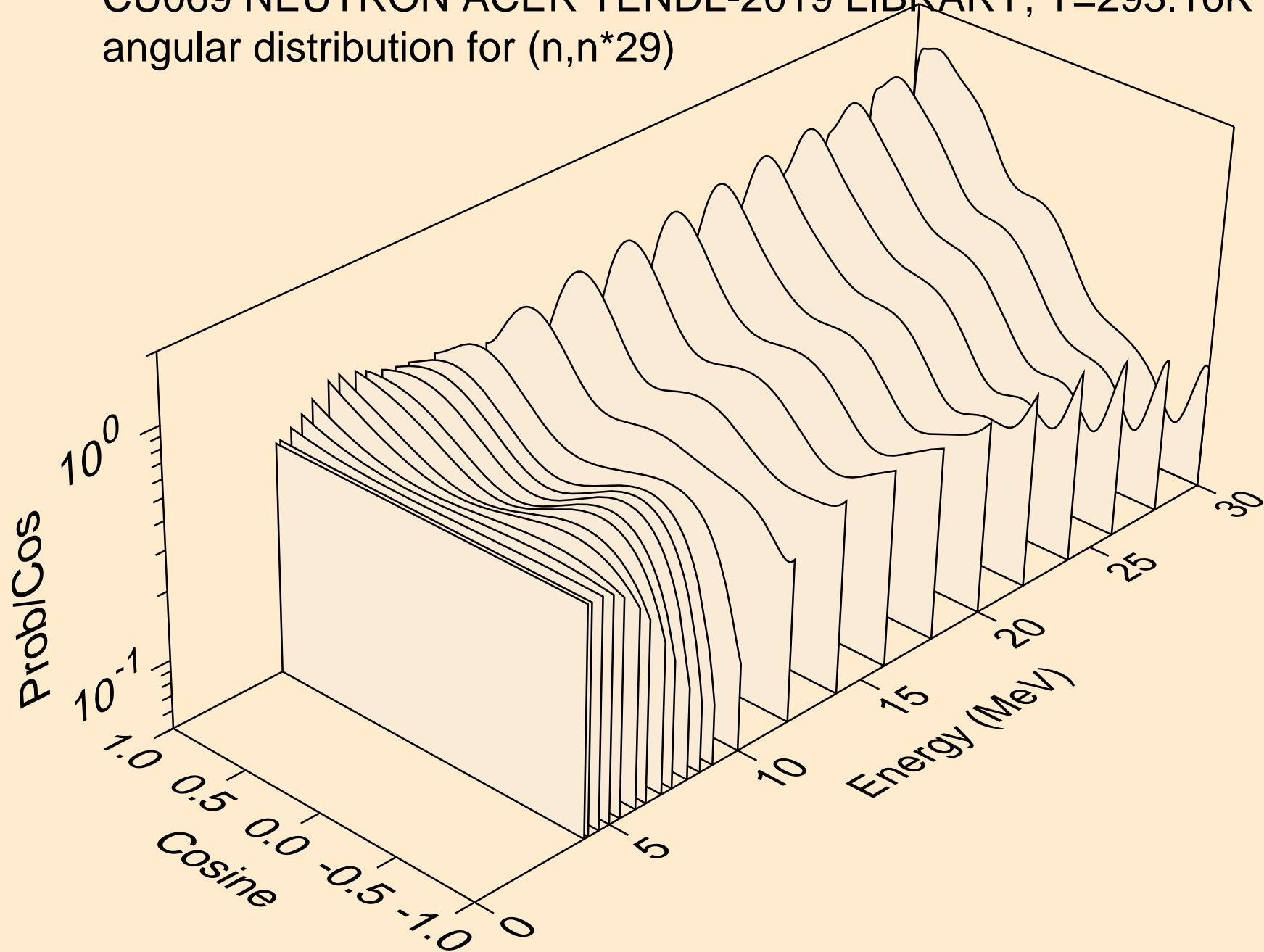

CU069 NEUTRON ACER TENDL-2019 LIBRARY; T=293.16K
Neutron emission for (n,x)

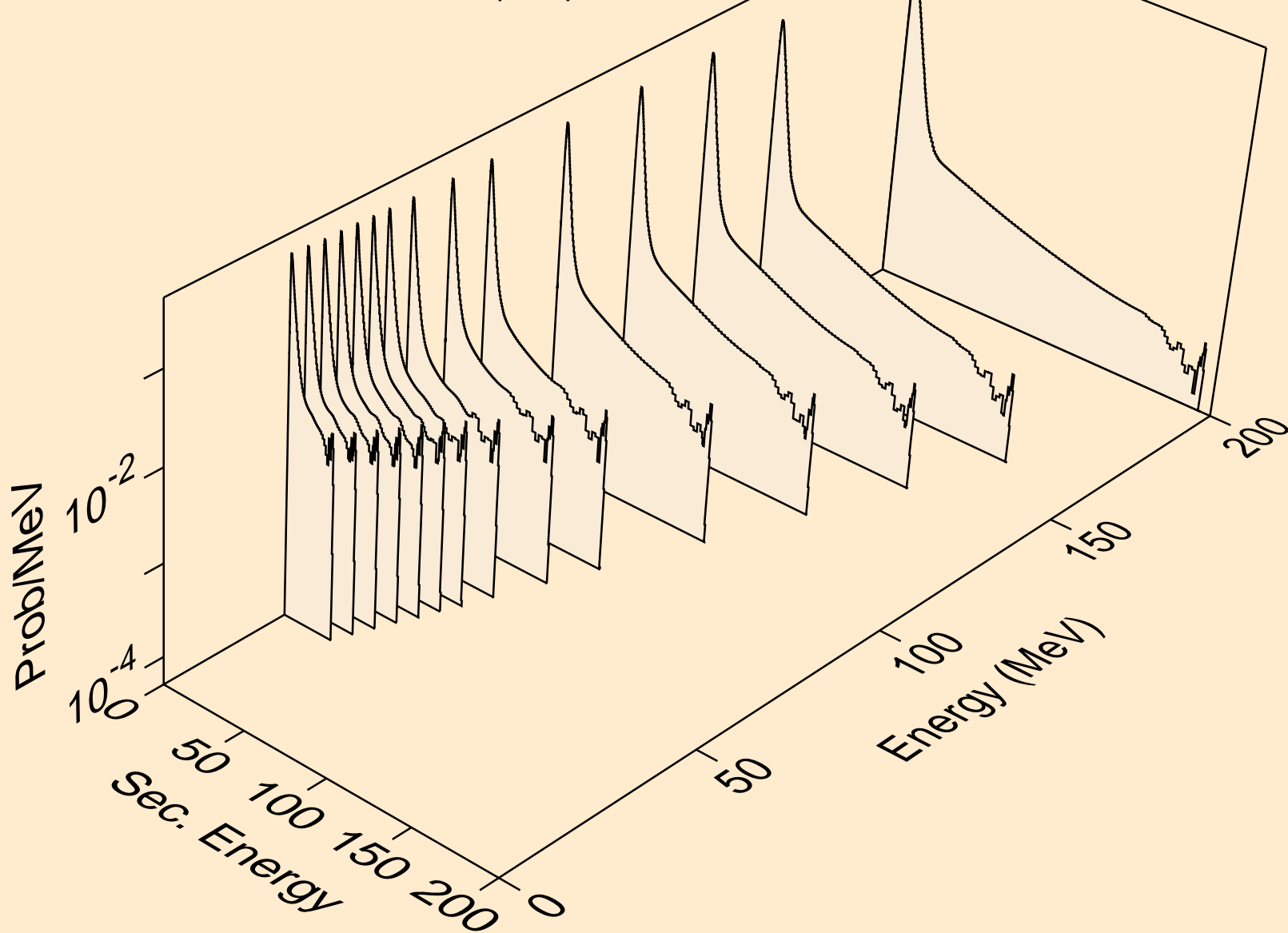

CU069 NEUTRON ACER TENDL-2019 LIBRARY; T=293.16K
Neutron emission for (n,2nd)

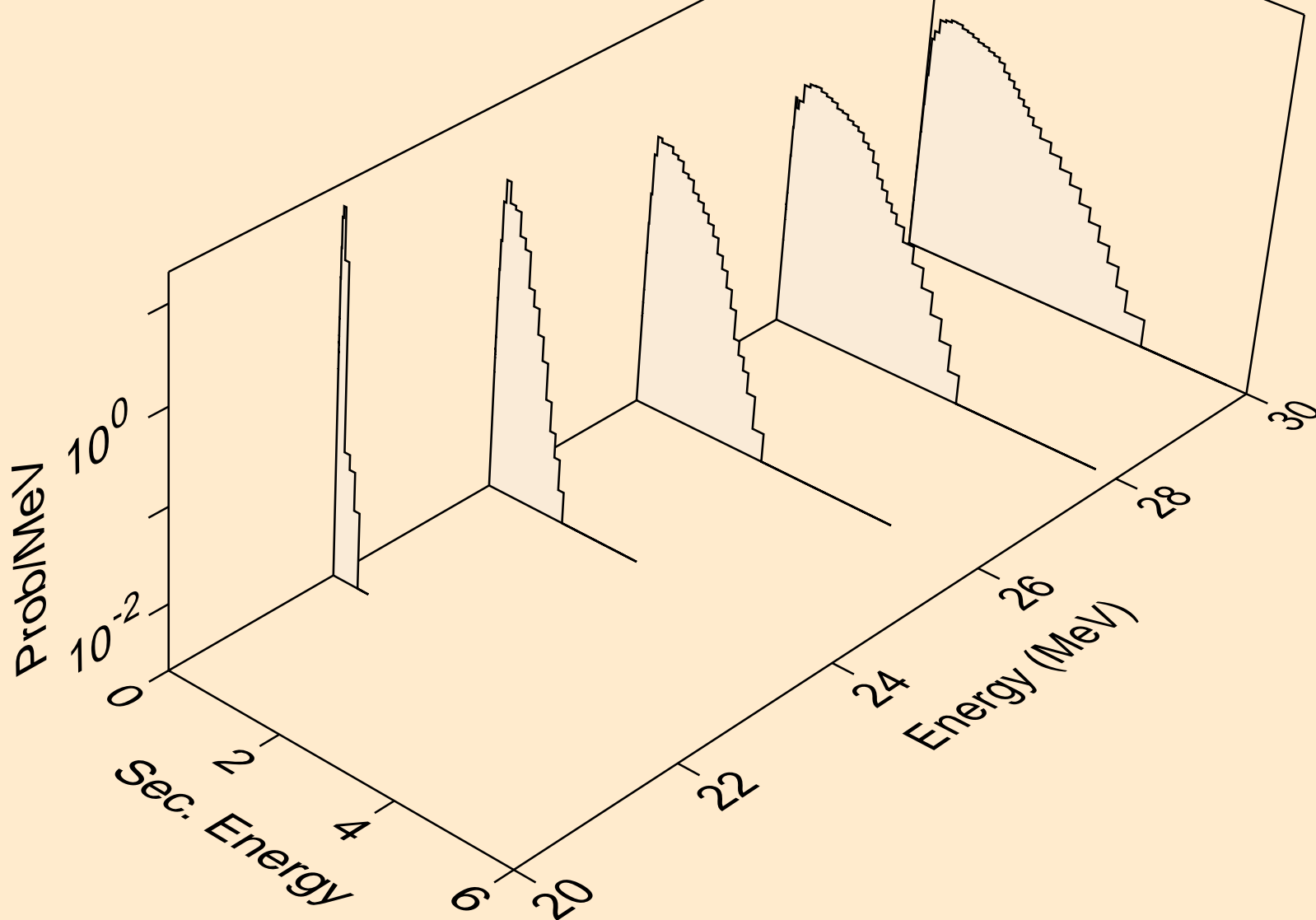

CU069 NEUTRON ACER TENDL-2019 LIBRARY; T=293.16K
Neutron emission for (n,2n)

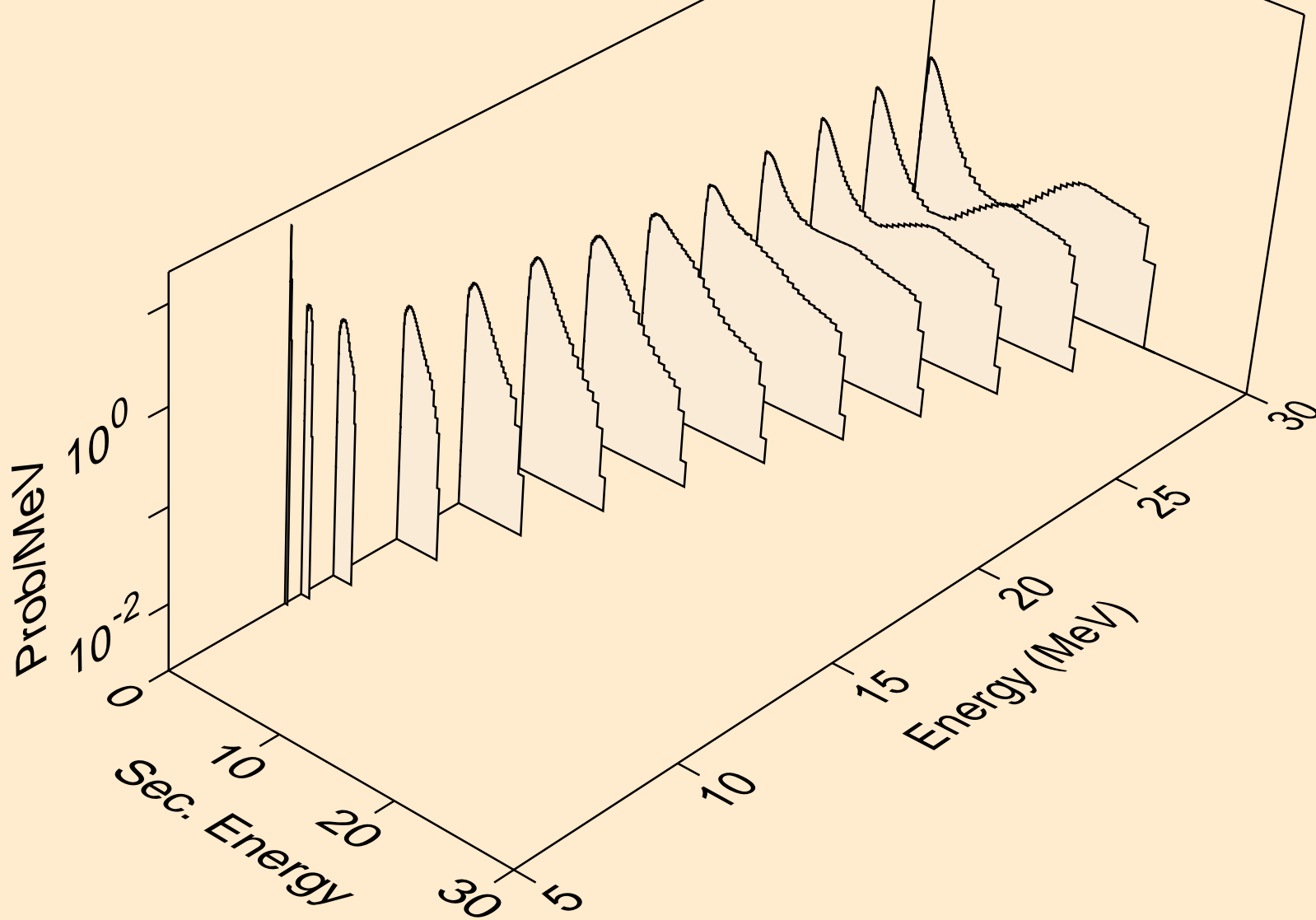

CU069 NEUTRON ACER TENDL-2019 LIBRARY; T=293.16K
Neutron emission for (n,3n)

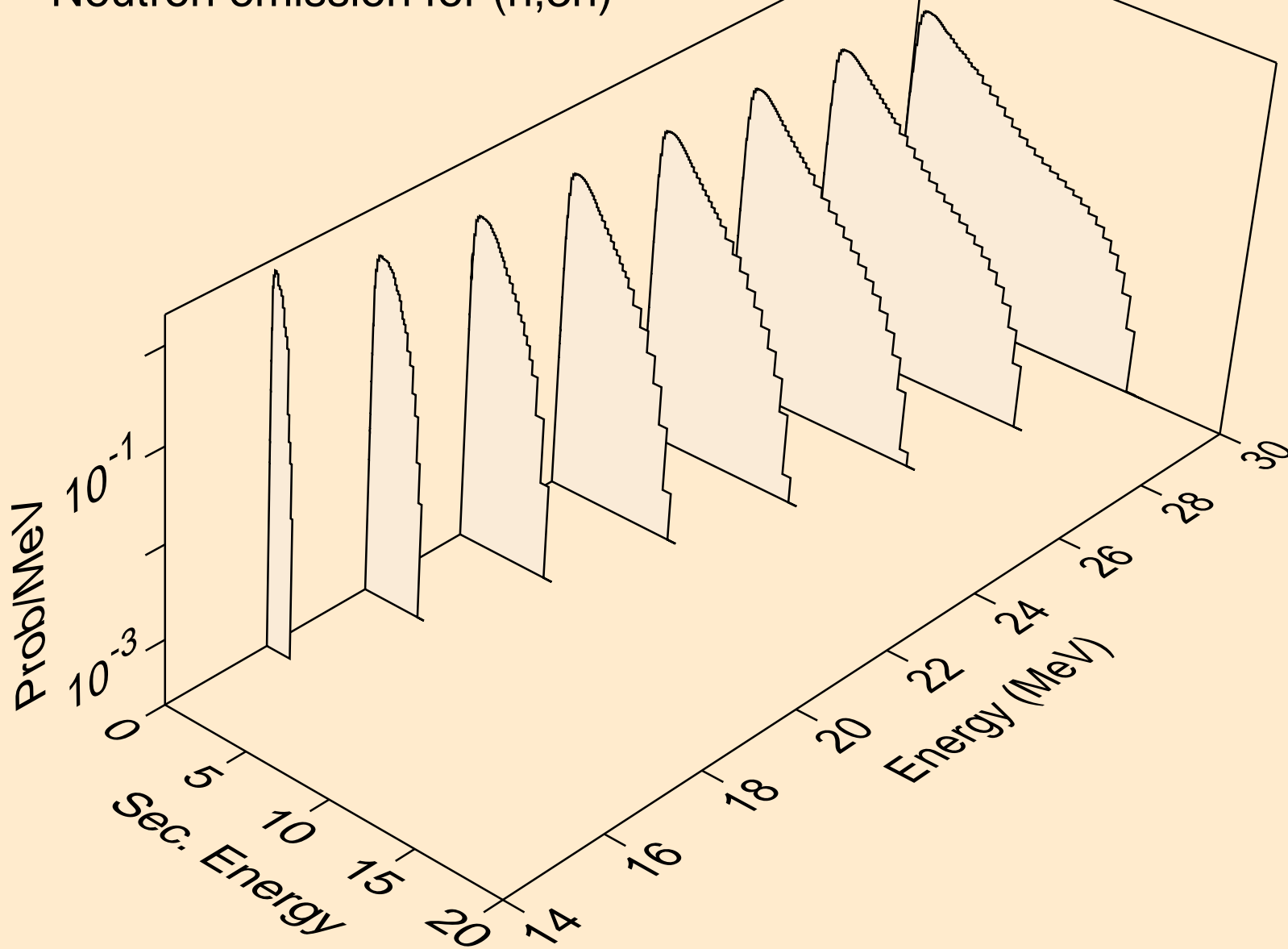

CU069 NEUTRON ACER TENDL-2019 LIBRARY; T=293.16K
Neutron emission for (n,n*)a

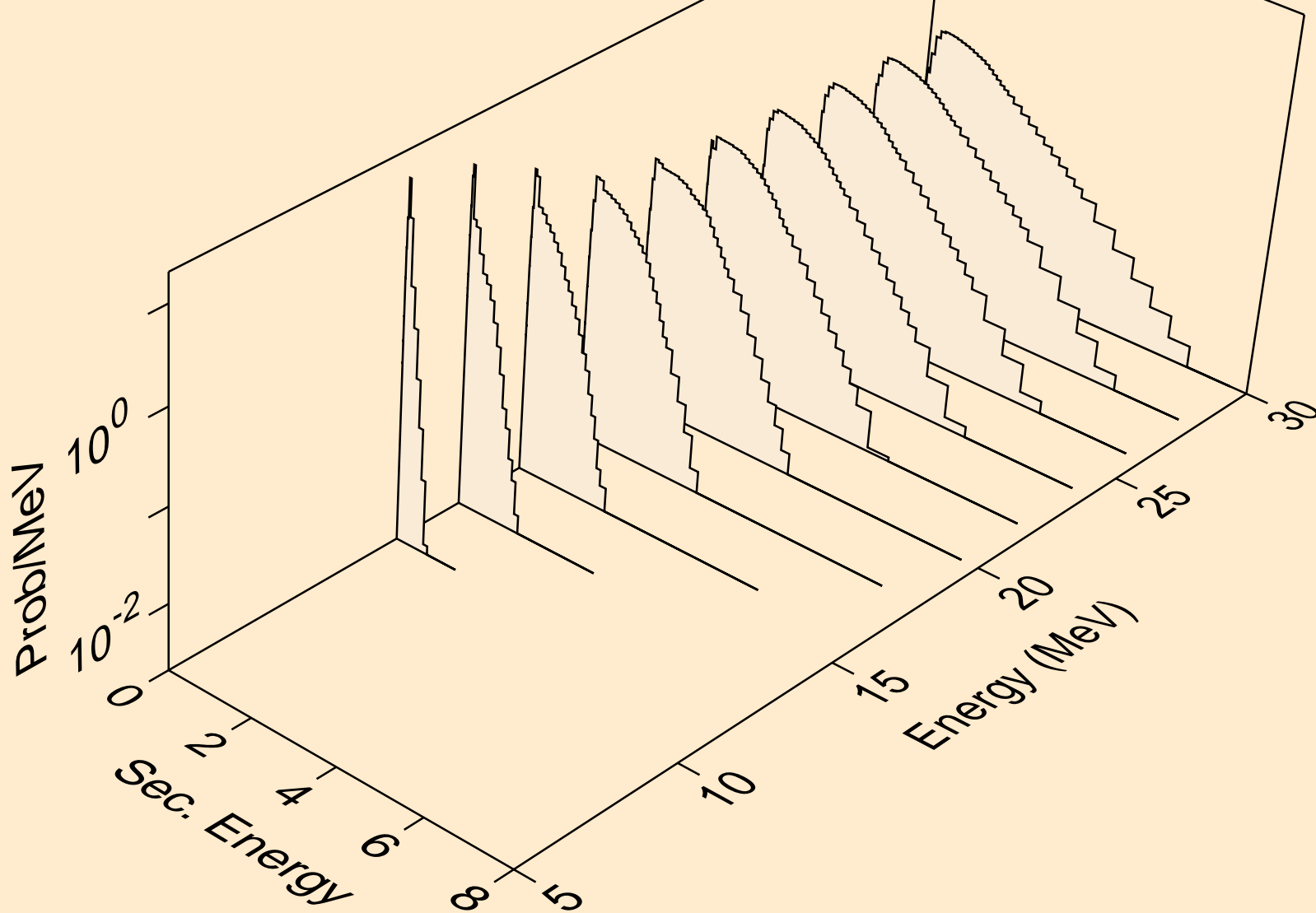

CU069 NEUTRON ACER TENDL-2019 LIBRARY; T=293.16K
Neutron emission for (n,2n)a

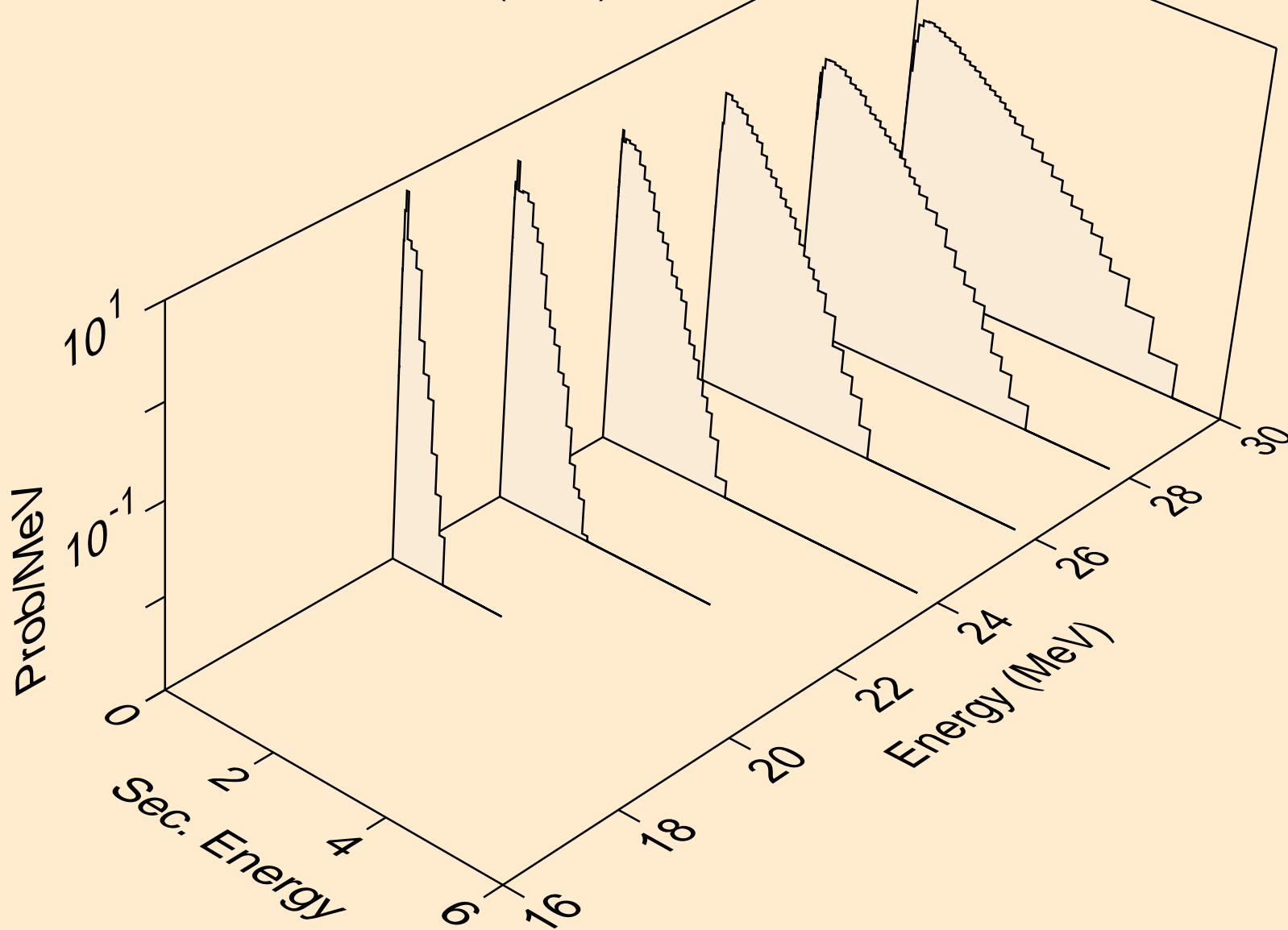

CU069 NEUTRON ACER TENDL-2019 LIBRARY; T=293.16K
Neutron emission for (n,3n)a

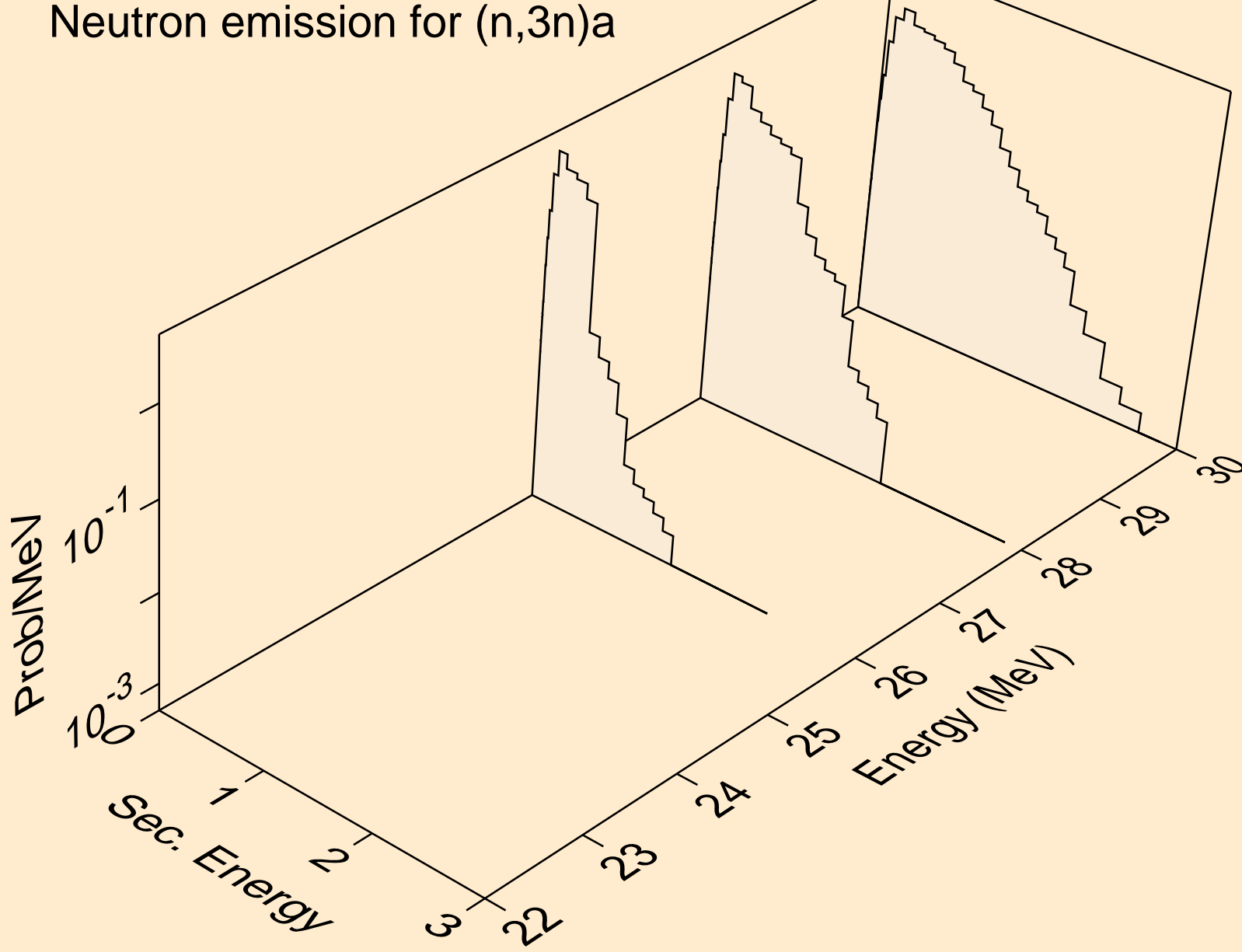

CU069 NEUTRON ACER TENDL-2019 LIBRARY; T=293.16K
Neutron emission for (n,n*)p

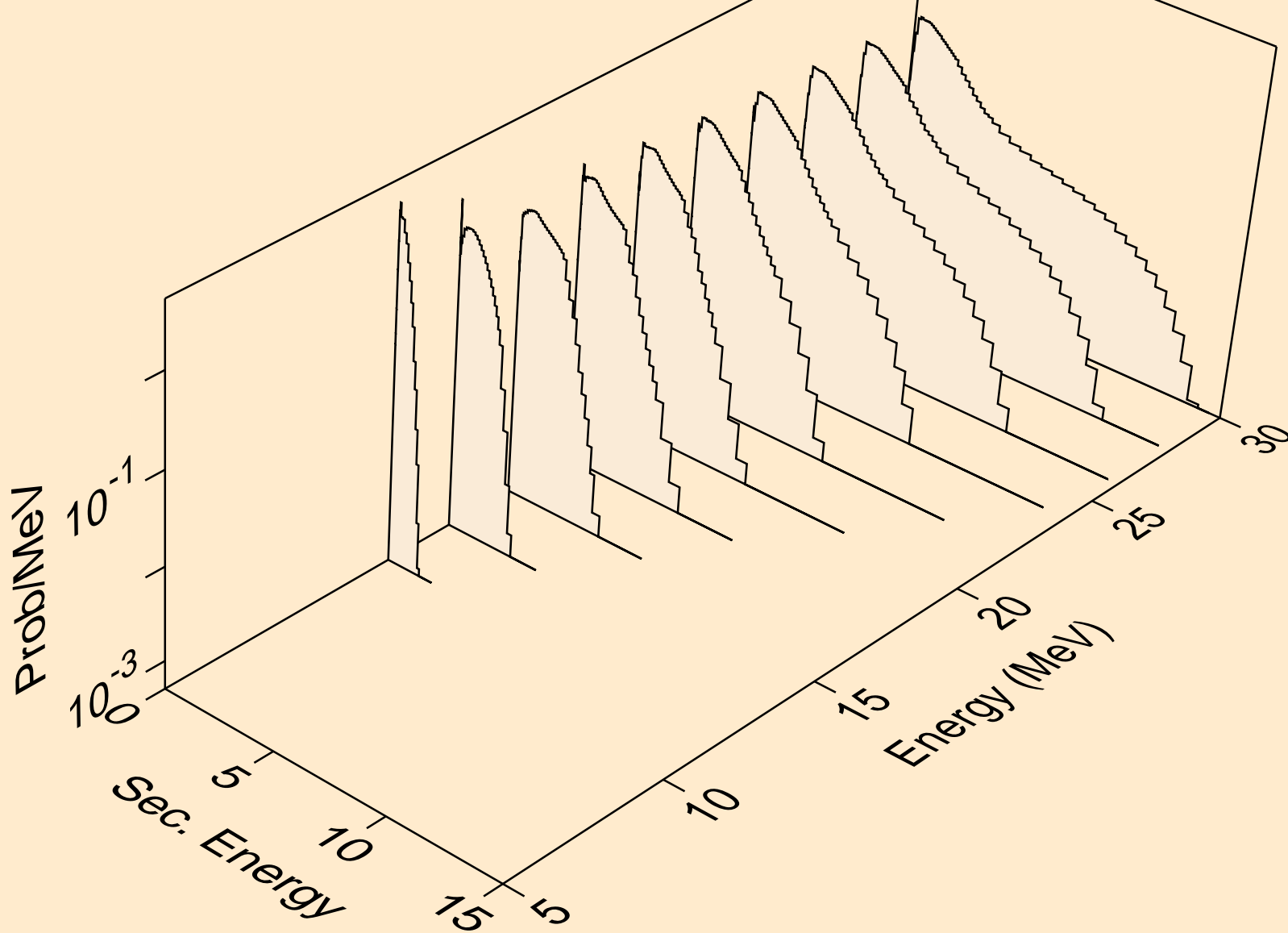

CU069 NEUTRON ACER TENDL-2019 LIBRARY; T=293.16K
Neutron emission for (n,n*)d

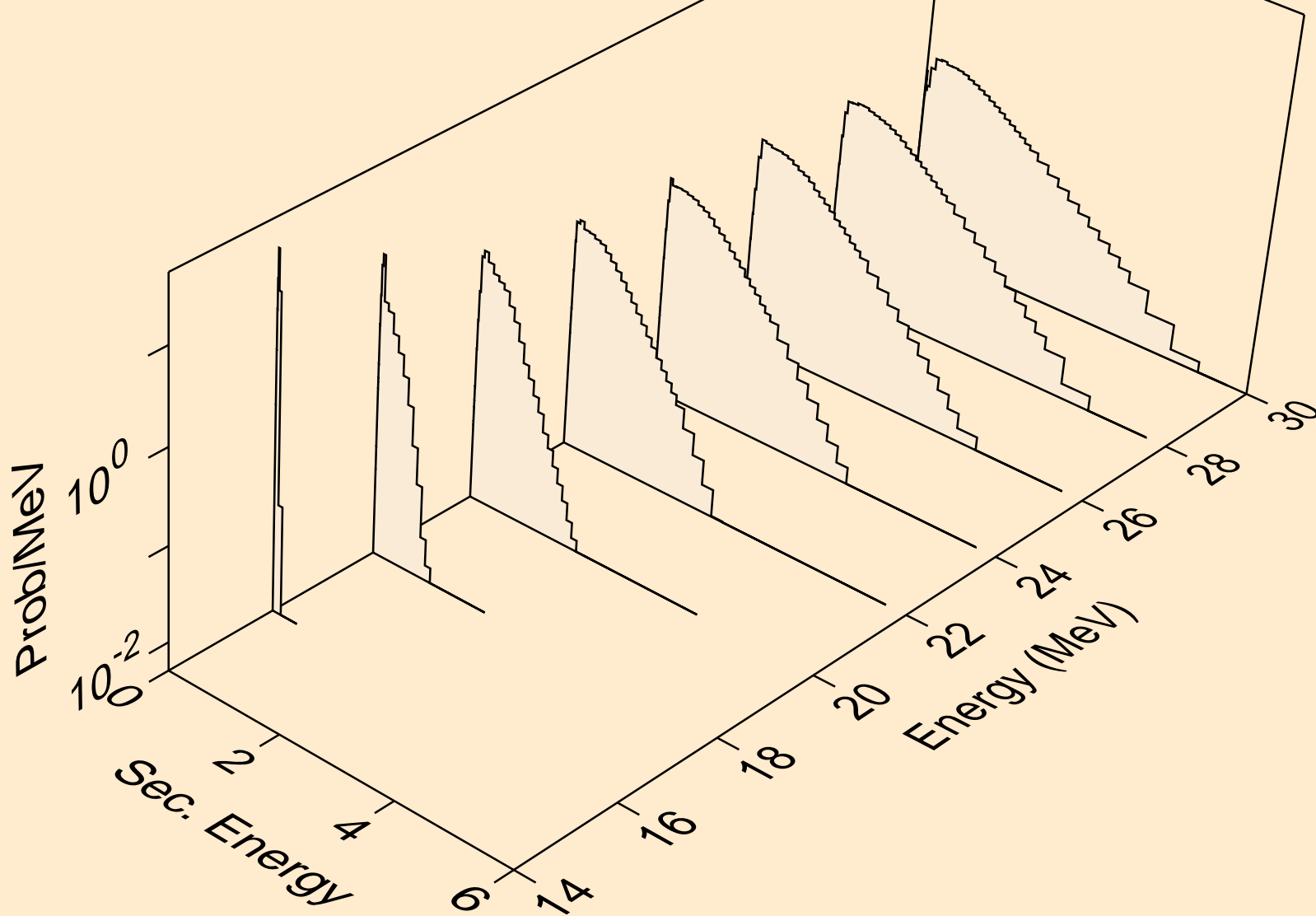

CU069 NEUTRON ACER TENDL-2019 LIBRARY; T=293.16K
Neutron emission for (n,n*)t

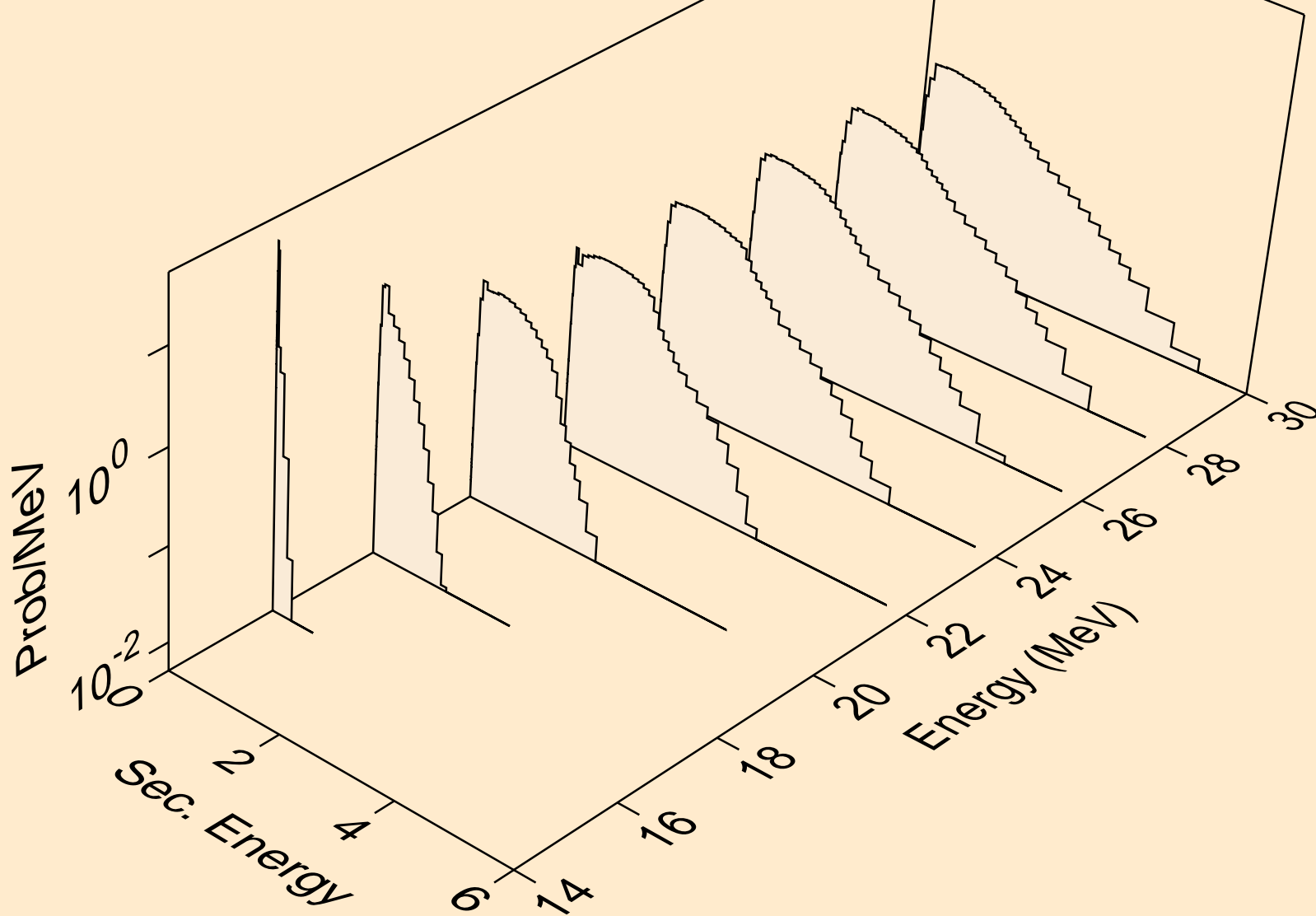

CU069 NEUTRON ACER TENDL-2019 LIBRARY; T=293.16K
Neutron emission for (n,n*)he3

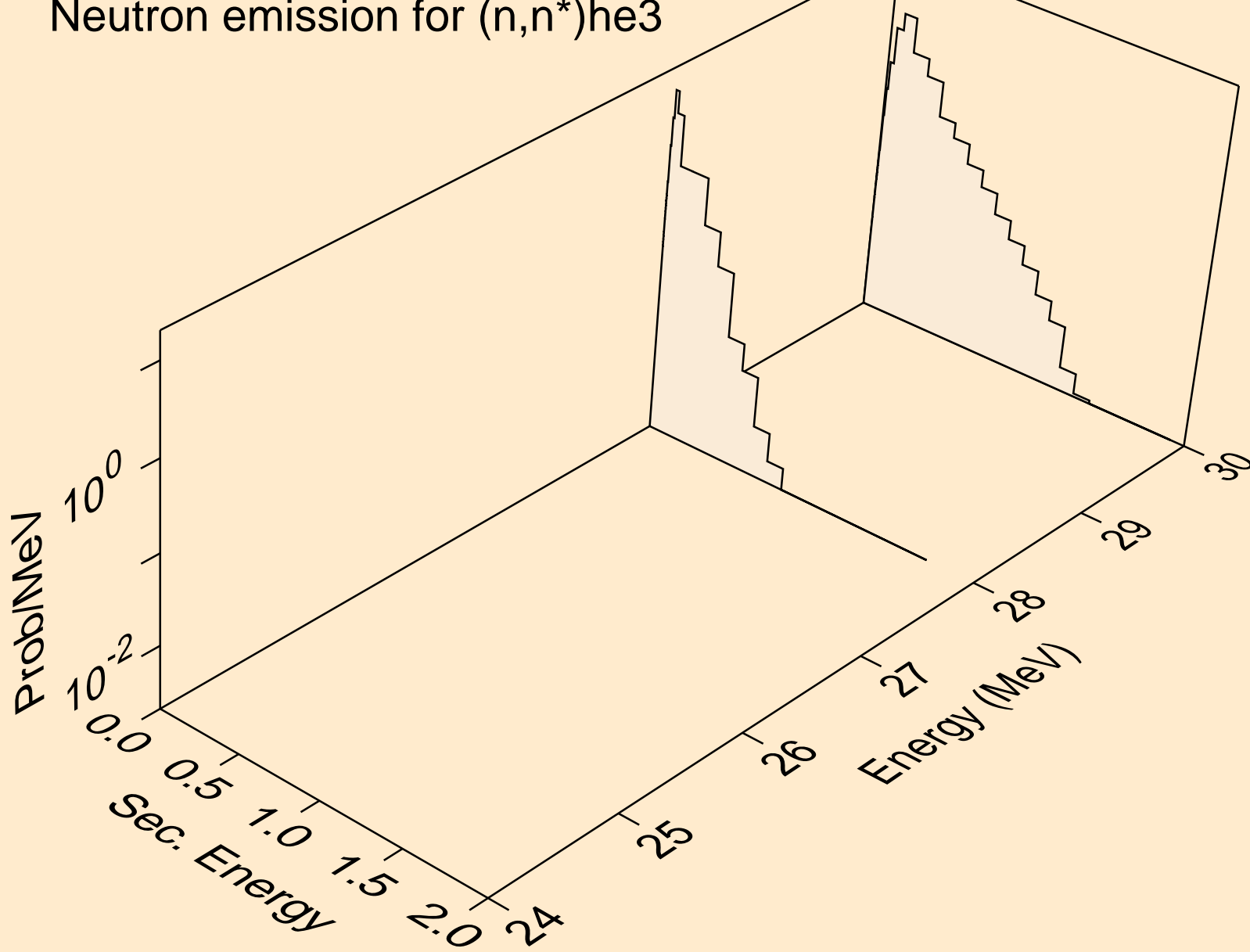

CU069 NEUTRON ACER TENDL-2019 LIBRARY; T=293.16K
Neutron emission for (n,4n)

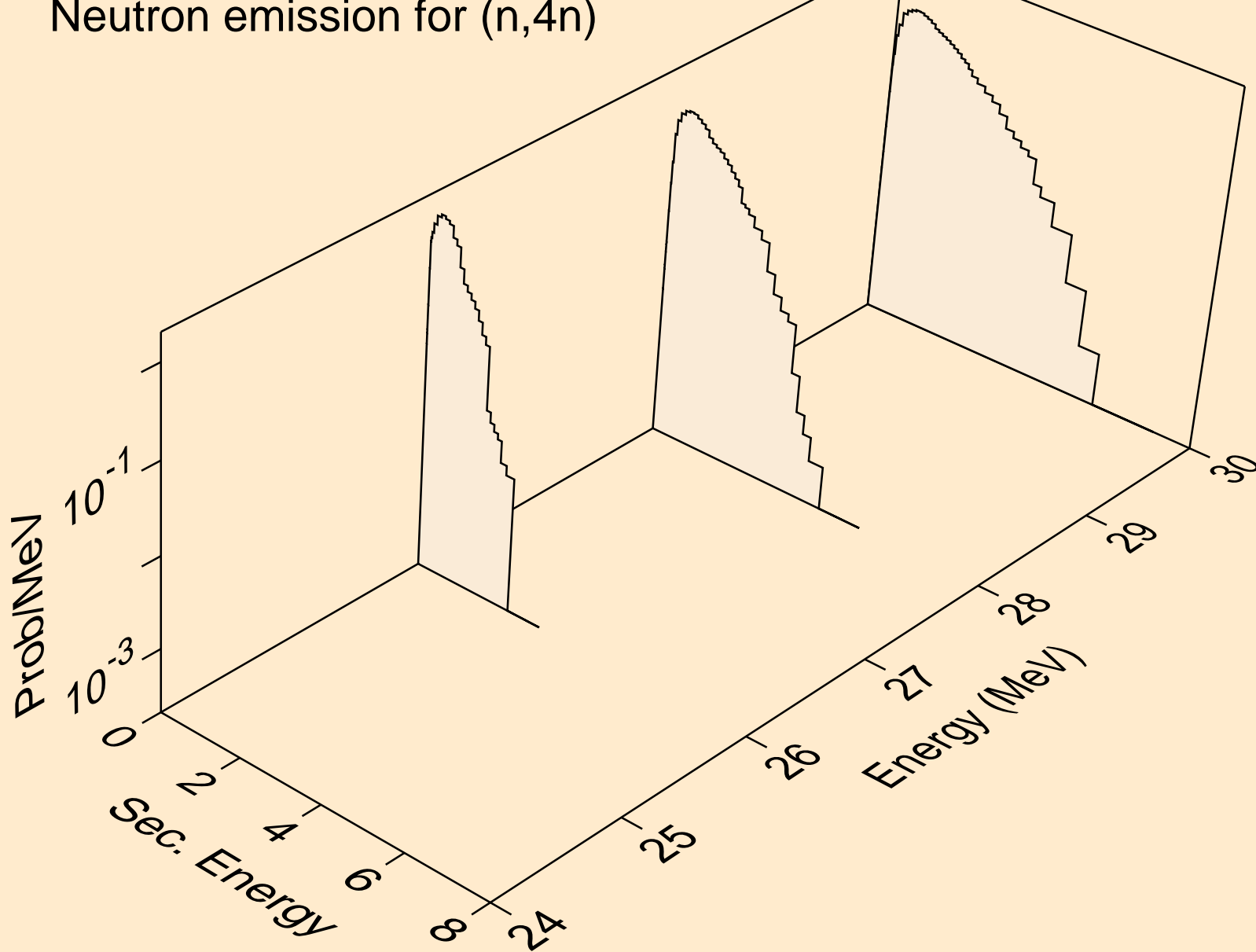

CU069 NEUTRON ACER TENDL-2019 LIBRARY; T=293.16K
Neutron emission for (n,2np)

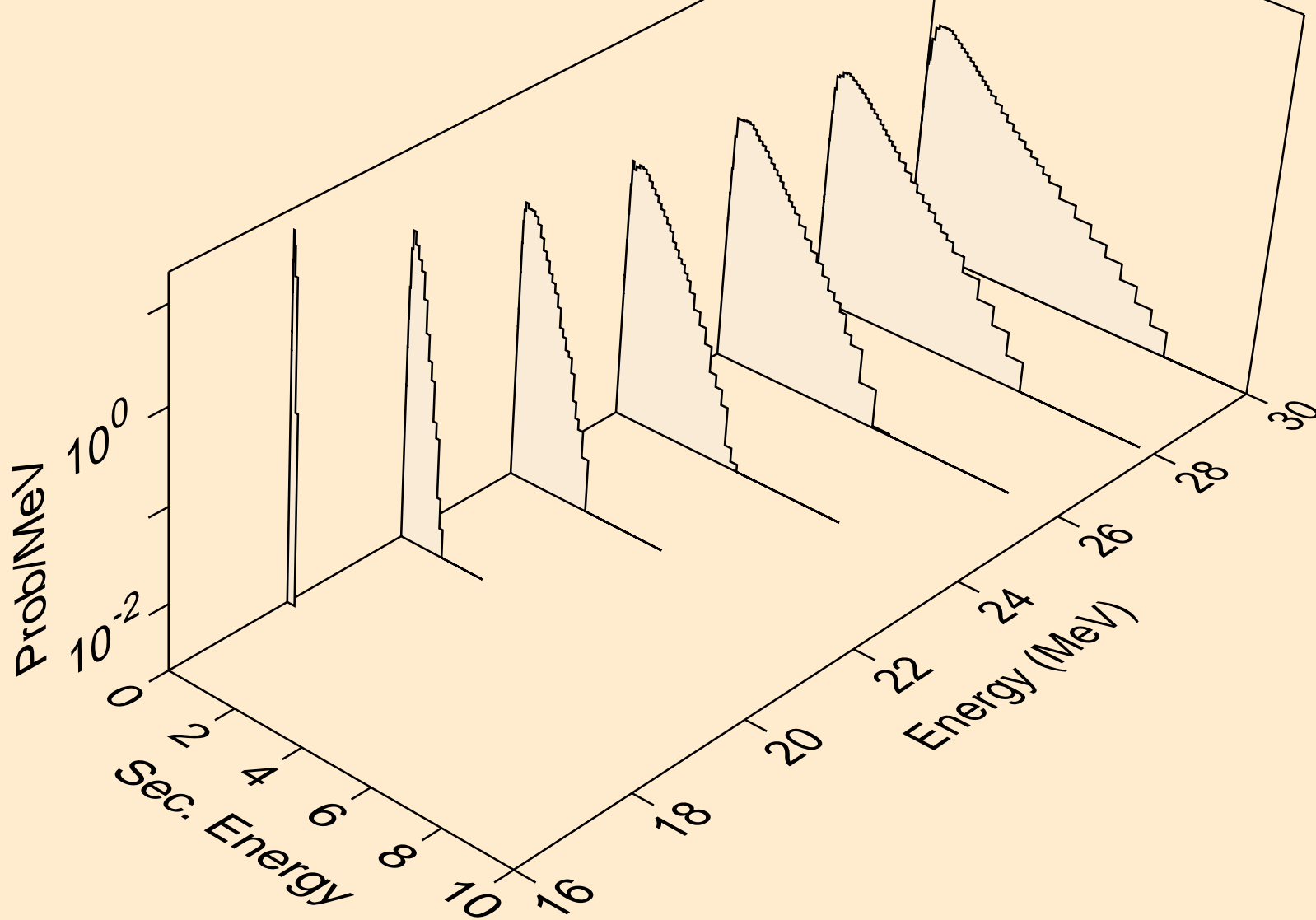

CU069 NEUTRON ACER TENDL-2019 LIBRARY; T=293.16K
Neutron emission for (n,3np)

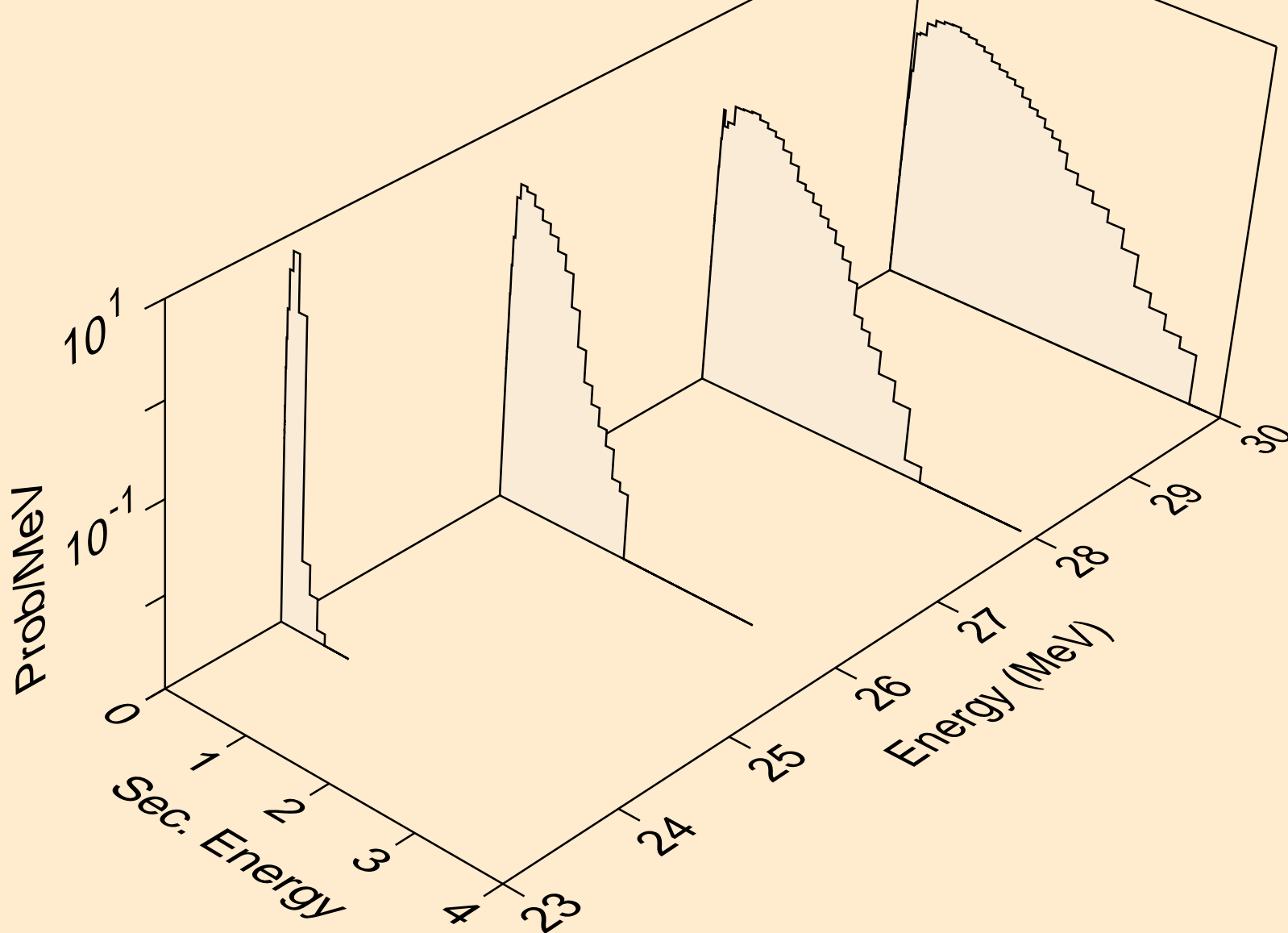

CU069 NEUTRON ACER TENDL-2019 LIBRARY; T=293.16K
Neutron emission for (n,n*c)

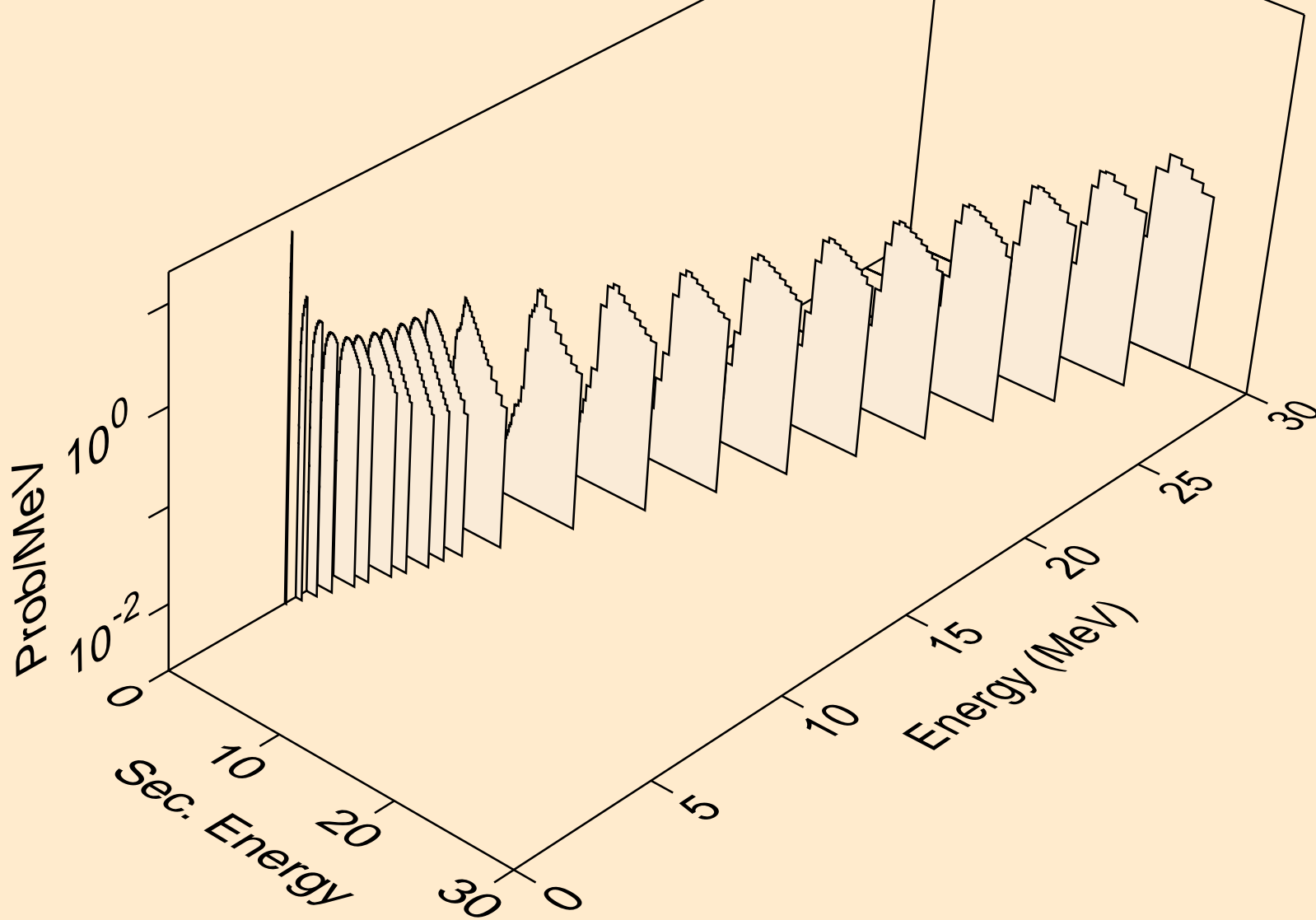

CU069 NEUTRON ACER TENDL-2019 LIBRARY; T=293.16K
Photon emission for (n,x)

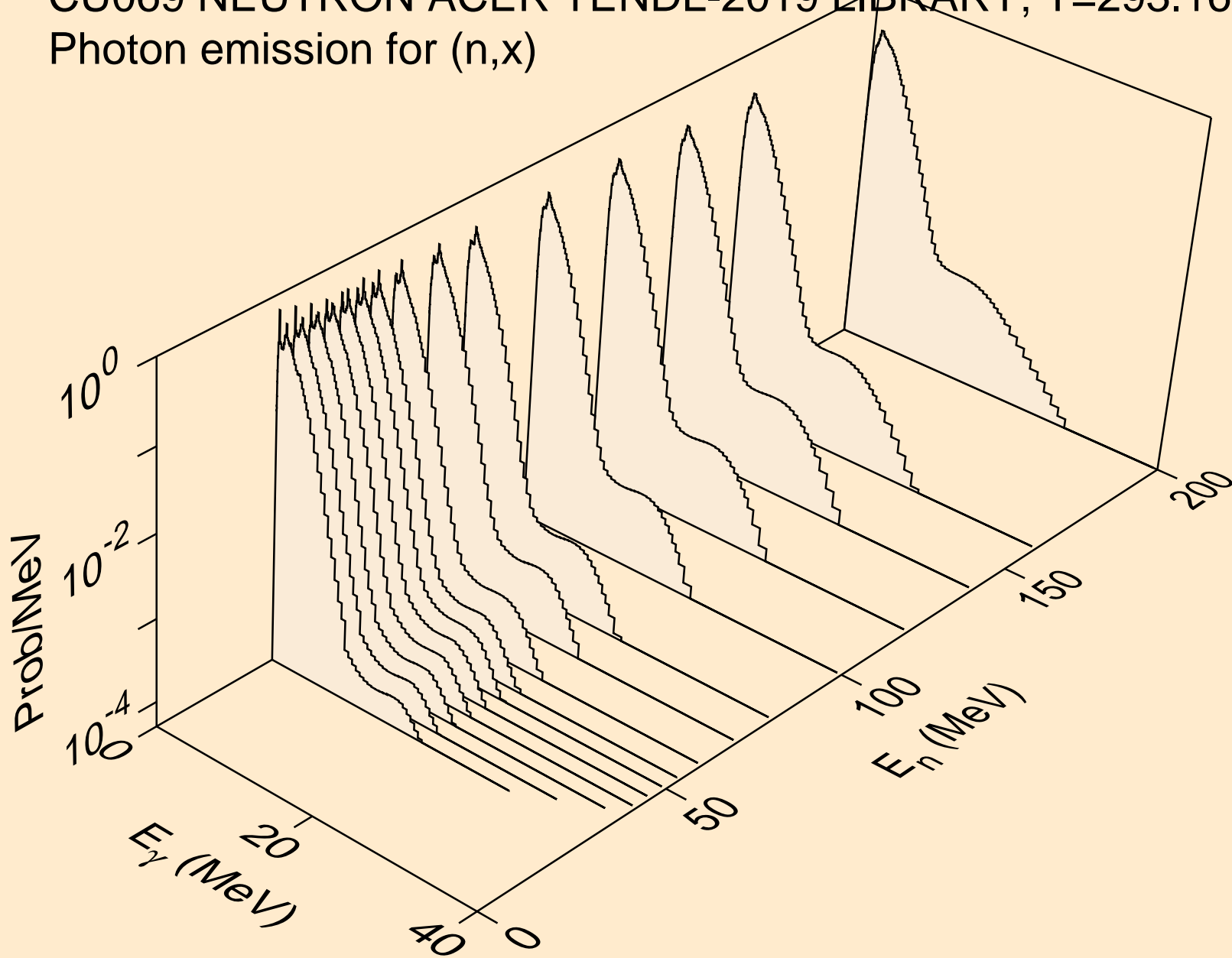

CU069 NEUTRON ACER TENDL-2019 LIBRARY; T=293.16K
Photon emission for (n,2nd)

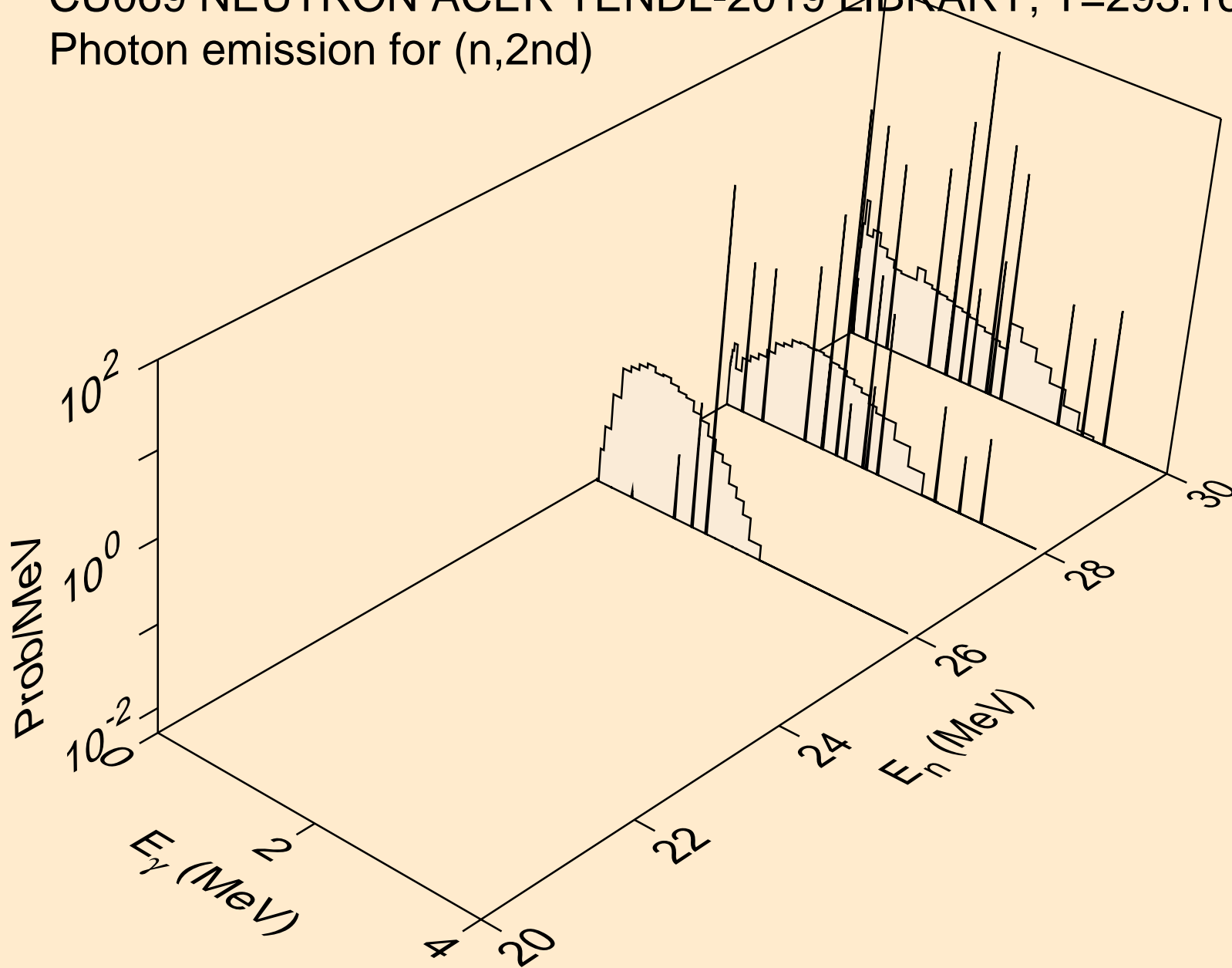

CU069 NEUTRON ACER TENDL-2019 LIBRARY; T=293.16K
Photon emission for (n,2n)

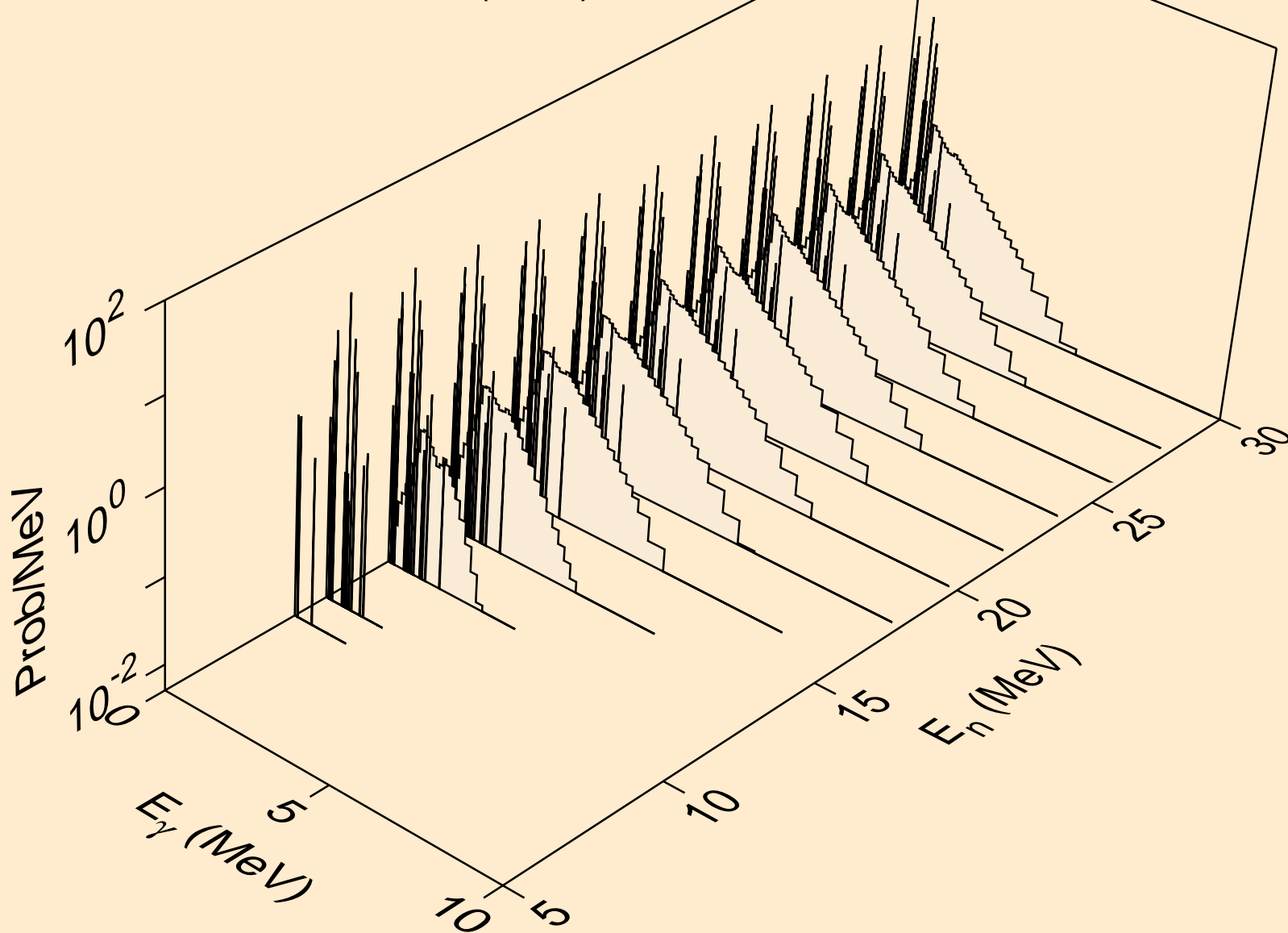

CU069 NEUTRON ACER TENDL-2019 LIBRARY; T=293.16K
Photon emission for (n,3n)

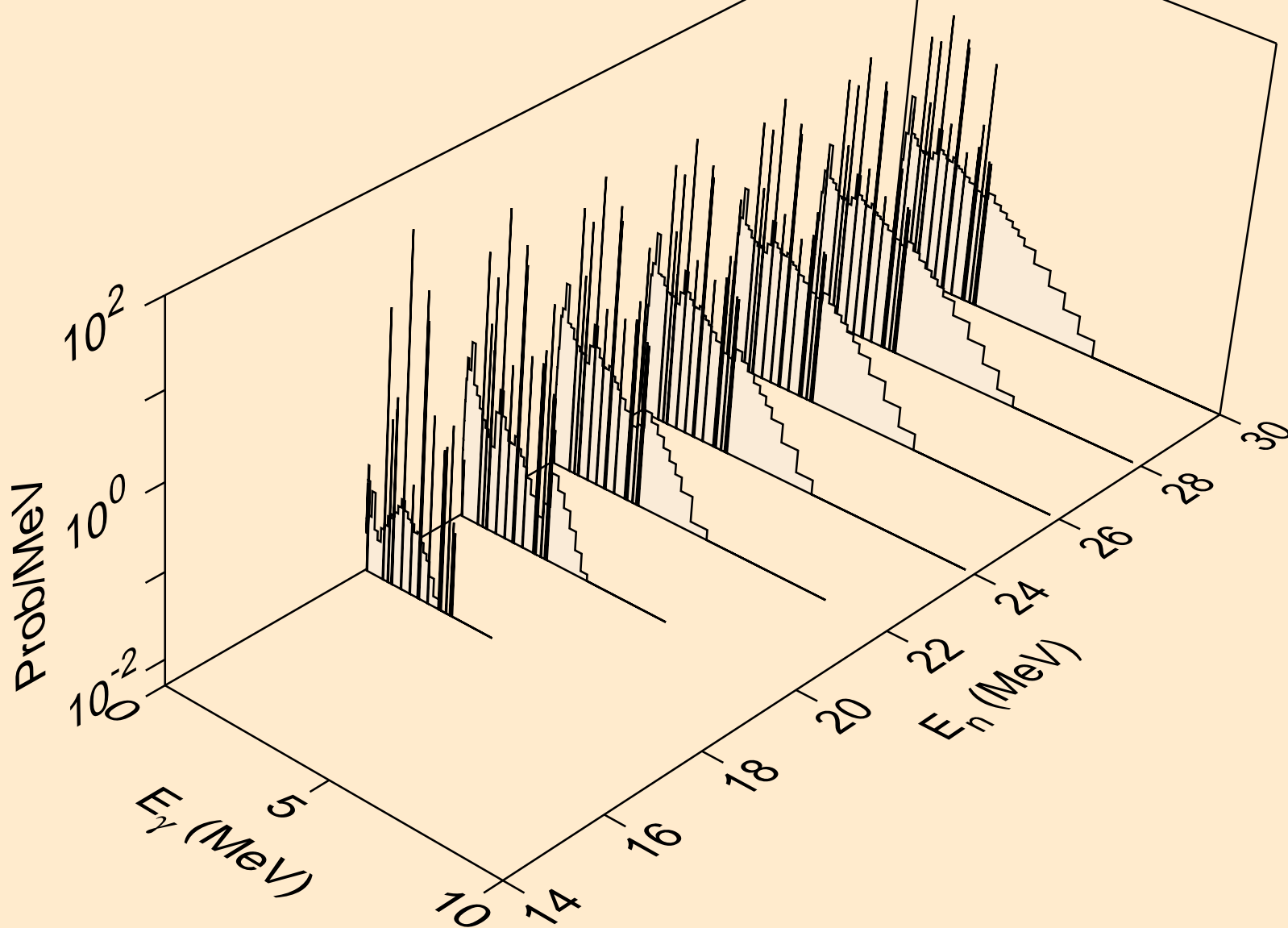

CU069 NEUTRON ACER TENDL-2019 LIBRARY; T=293.16K
Photon emission for (n,n*)a

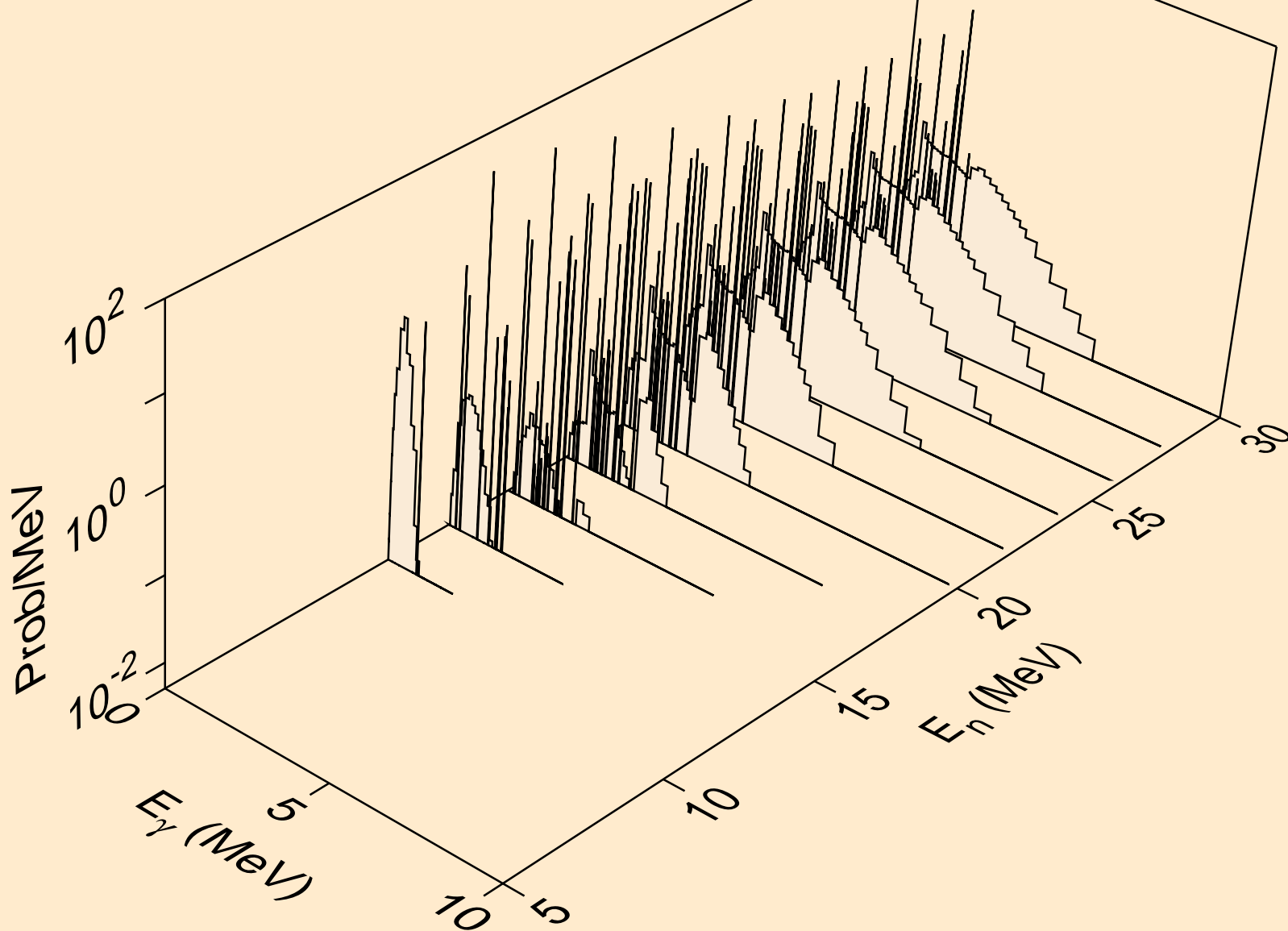

CU069 NEUTRON ACER TENDL-2019 LIBRARY; T=293.16K
Photon emission for (n,2n)a

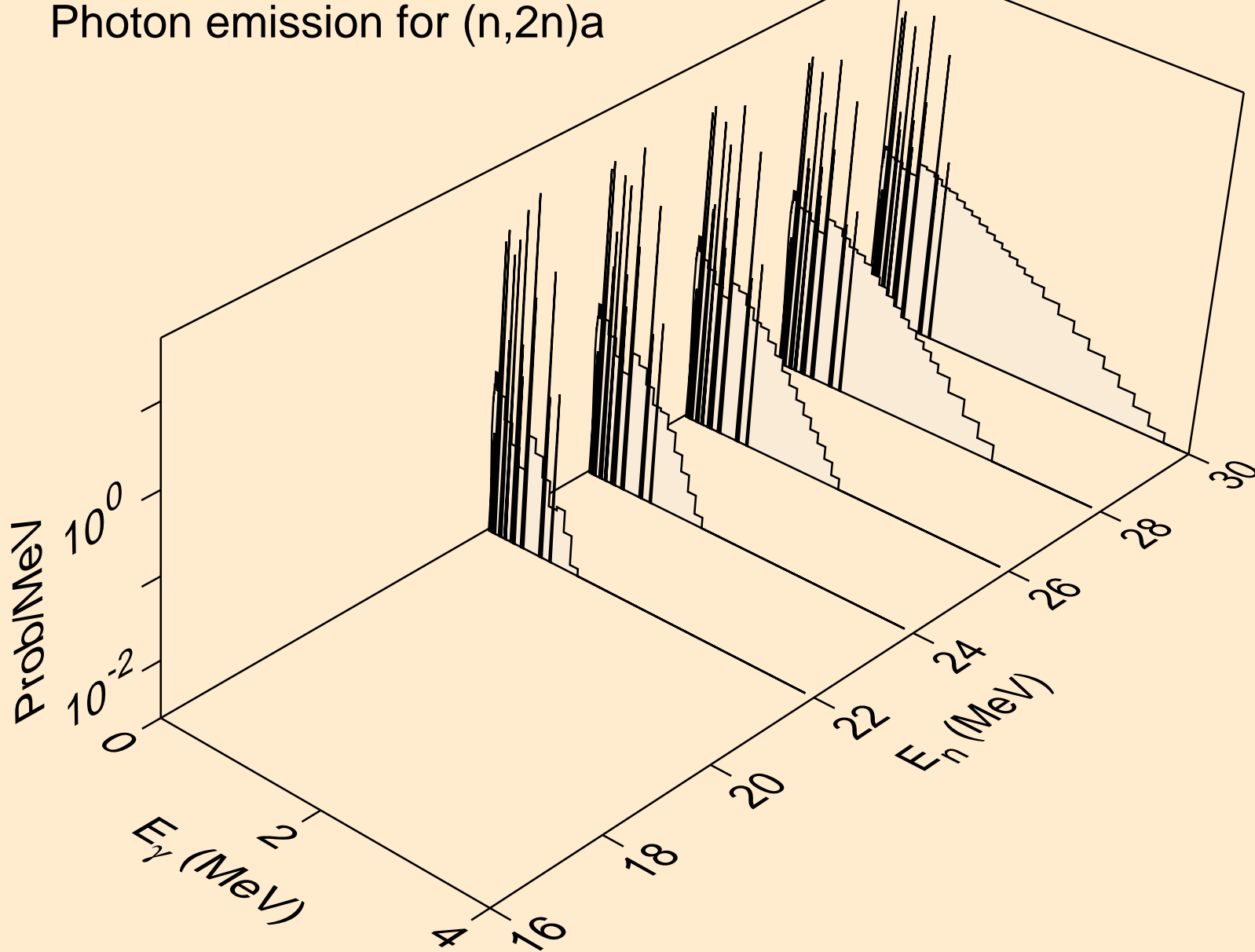

CU069 NEUTRON ACER TENDL-2019 LIBRARY; T=293.16K
Photon emission for (n,3n)a

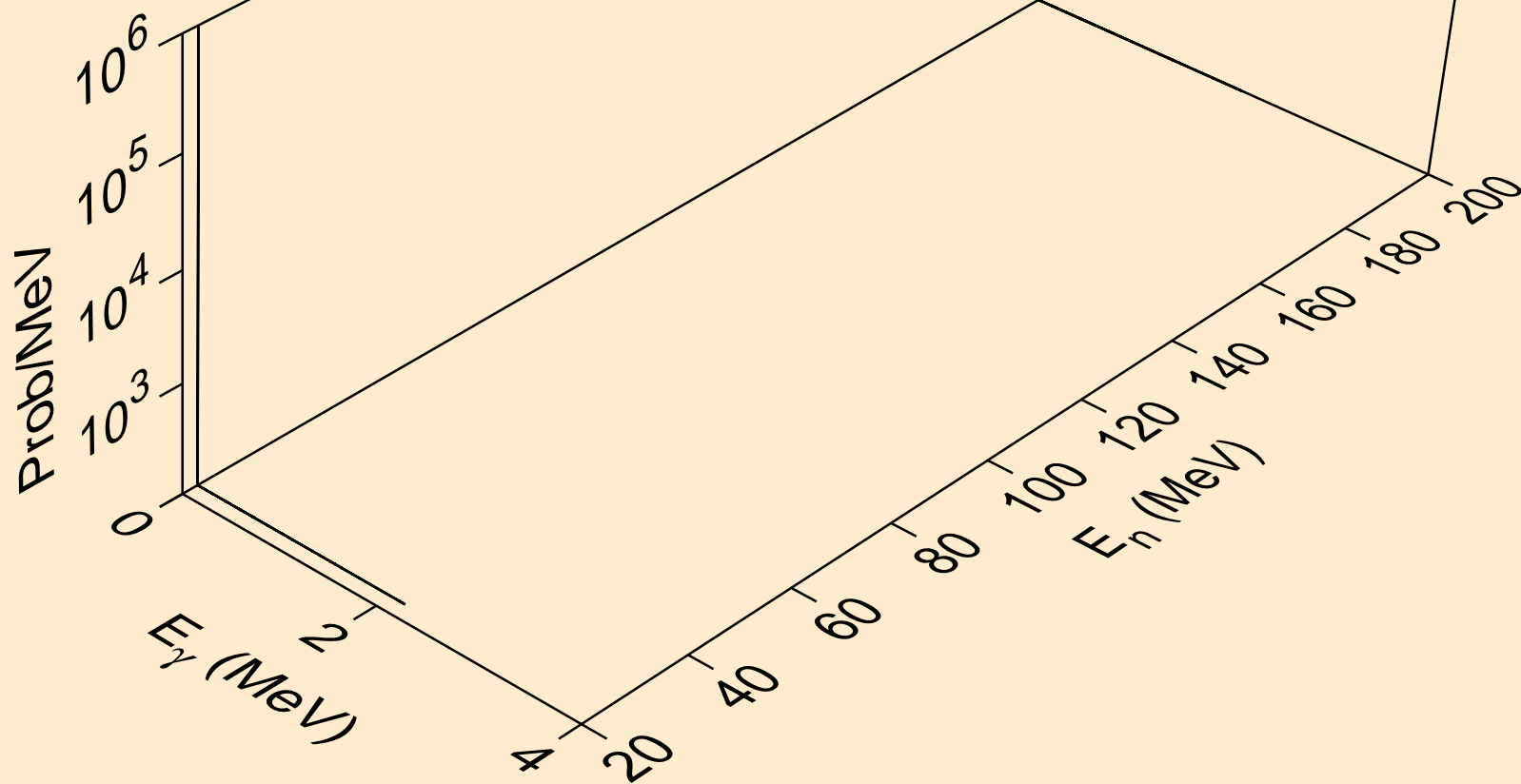

CU069 NEUTRON ACER TENDL-2019 LIBRARY; T=293.16K
Photon emission for (n,n*)p

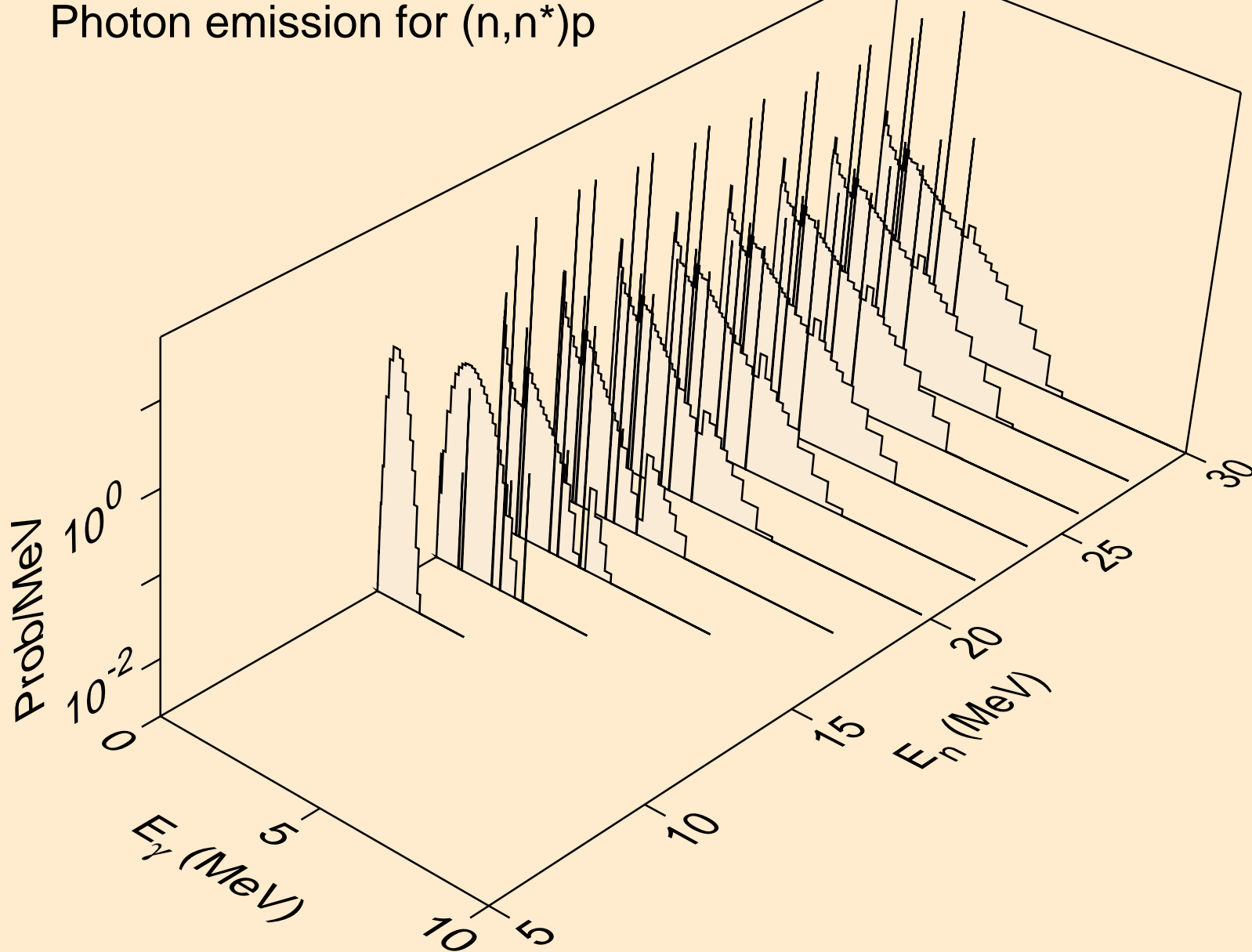

CU069 NEUTRON ACER TENDL-2019 LIBRARY; T=293.16K
Photon emission for (n,n*)d

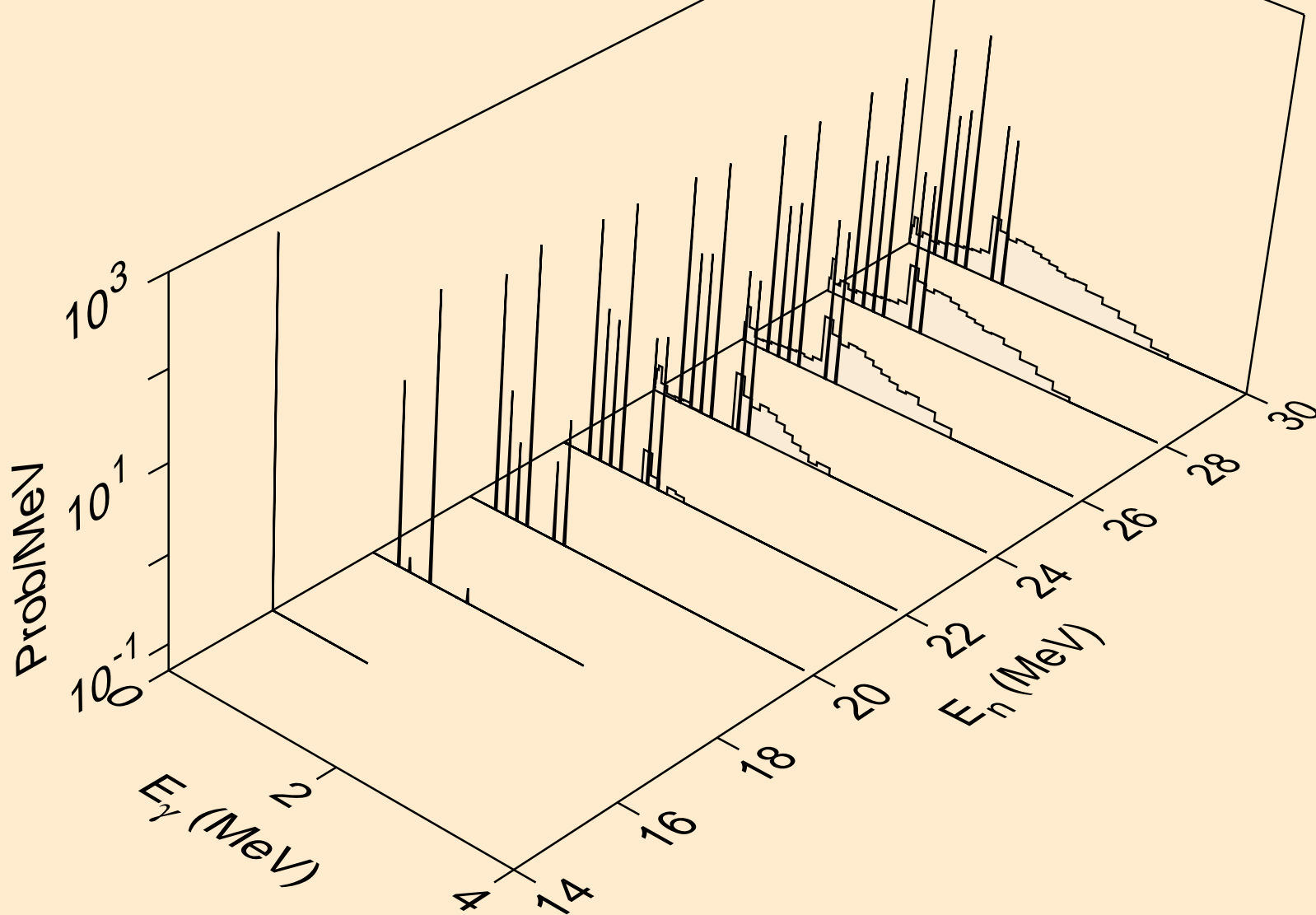

CU069 NEUTRON ACER TENDL-2019 LIBRARY; T=293.16K
Photon emission for (n,n*)t

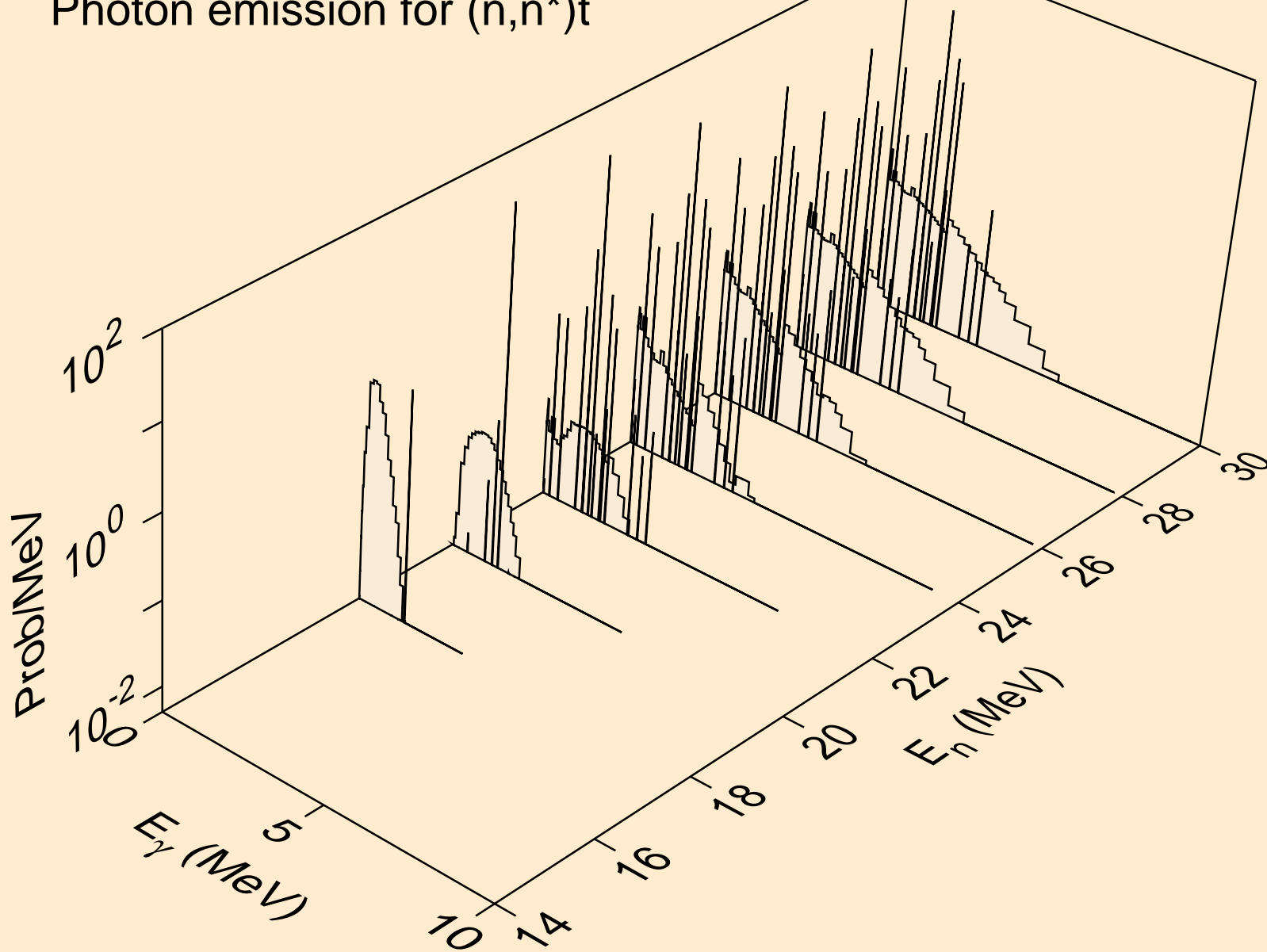

CU069 NEUTRON ACER TENDL-2019 LIBRARY; T=293.16K
Photon emission for (n,n*)he3

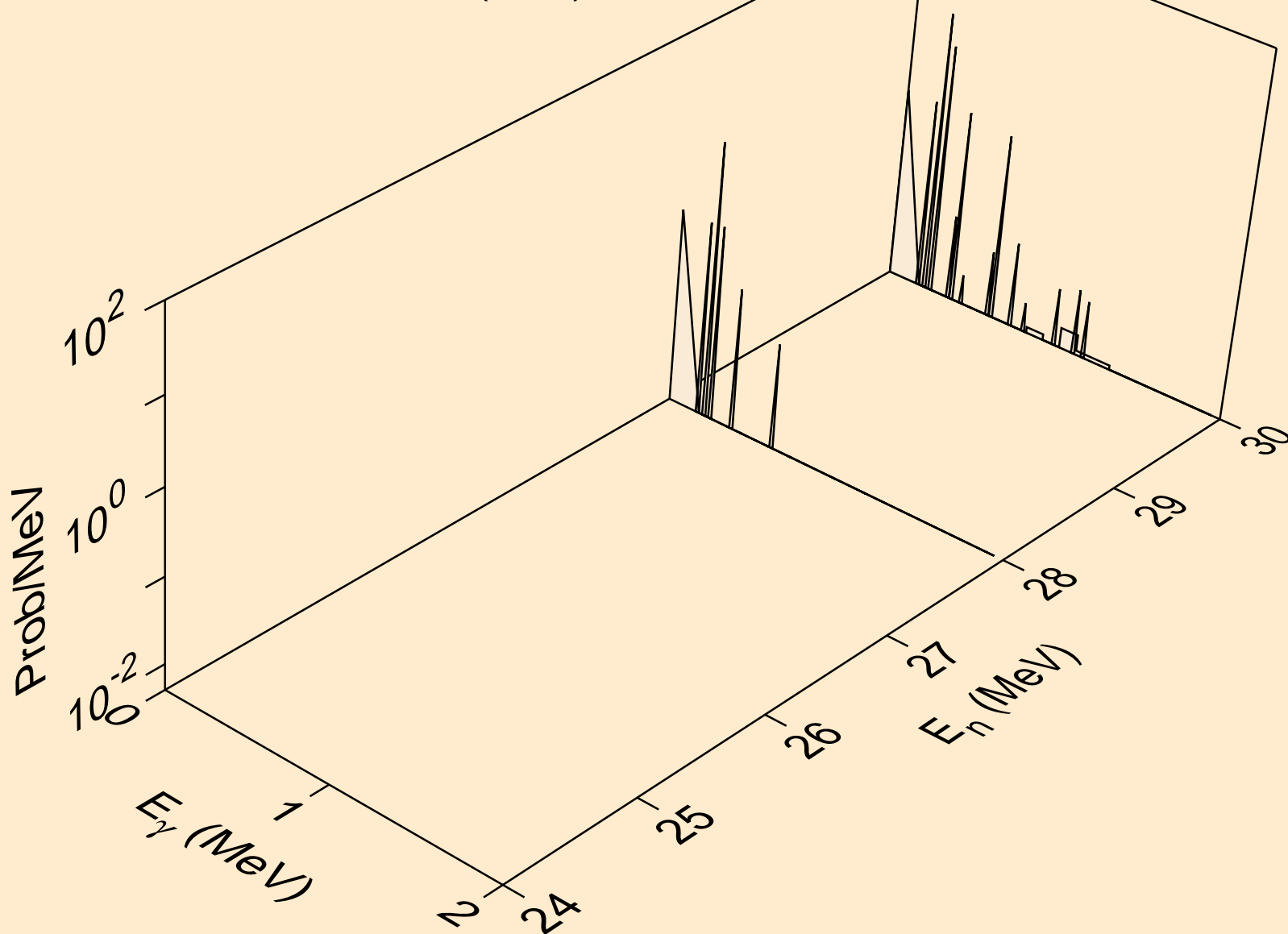

CU069 NEUTRON ACER TENDL-2019 LIBRARY; T=293.16K
Photon emission for (n,4n)

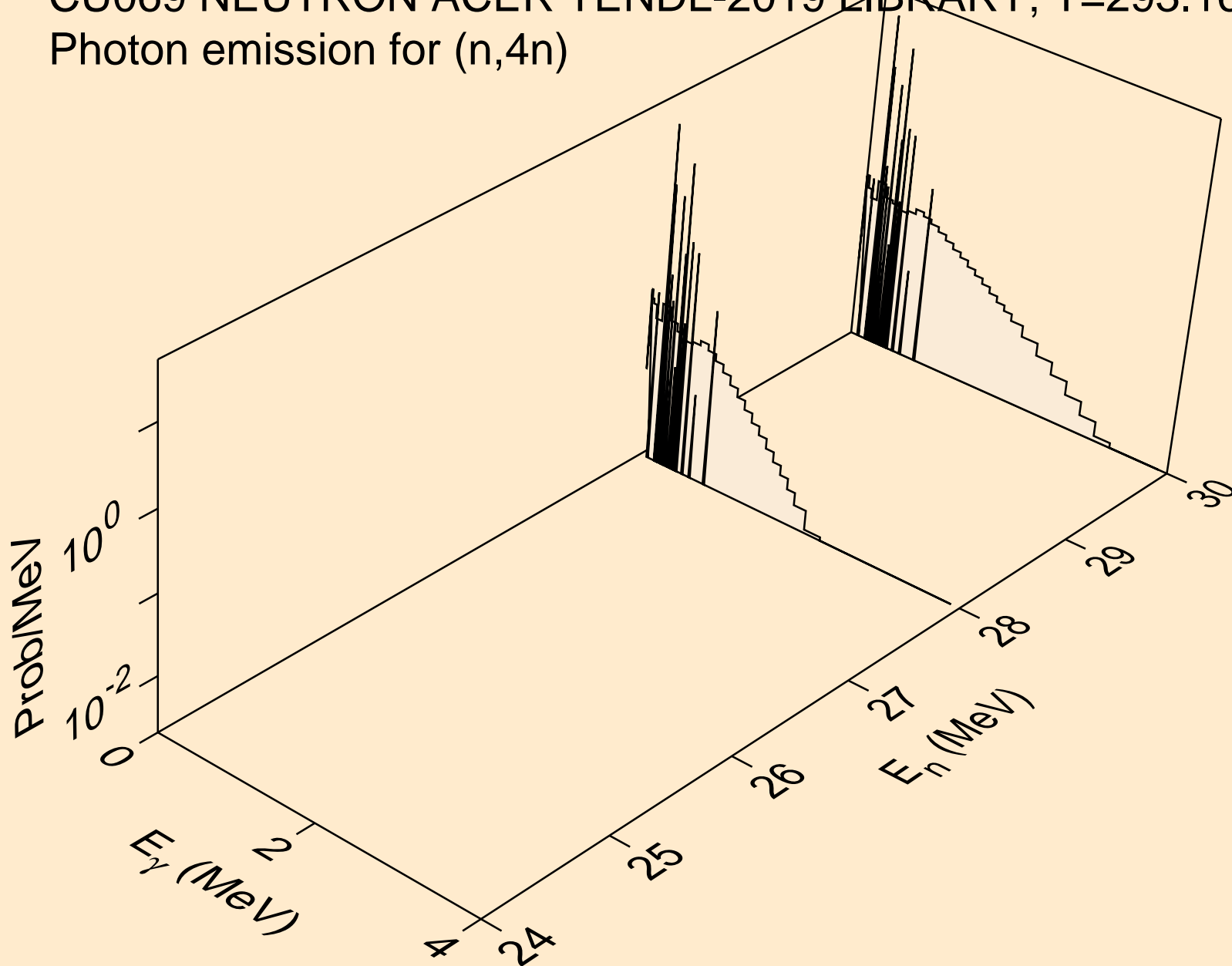

CU069 NEUTRON ACER TENDL-2019 LIBRARY; T=293.16K
Photon emission for (n,2np)

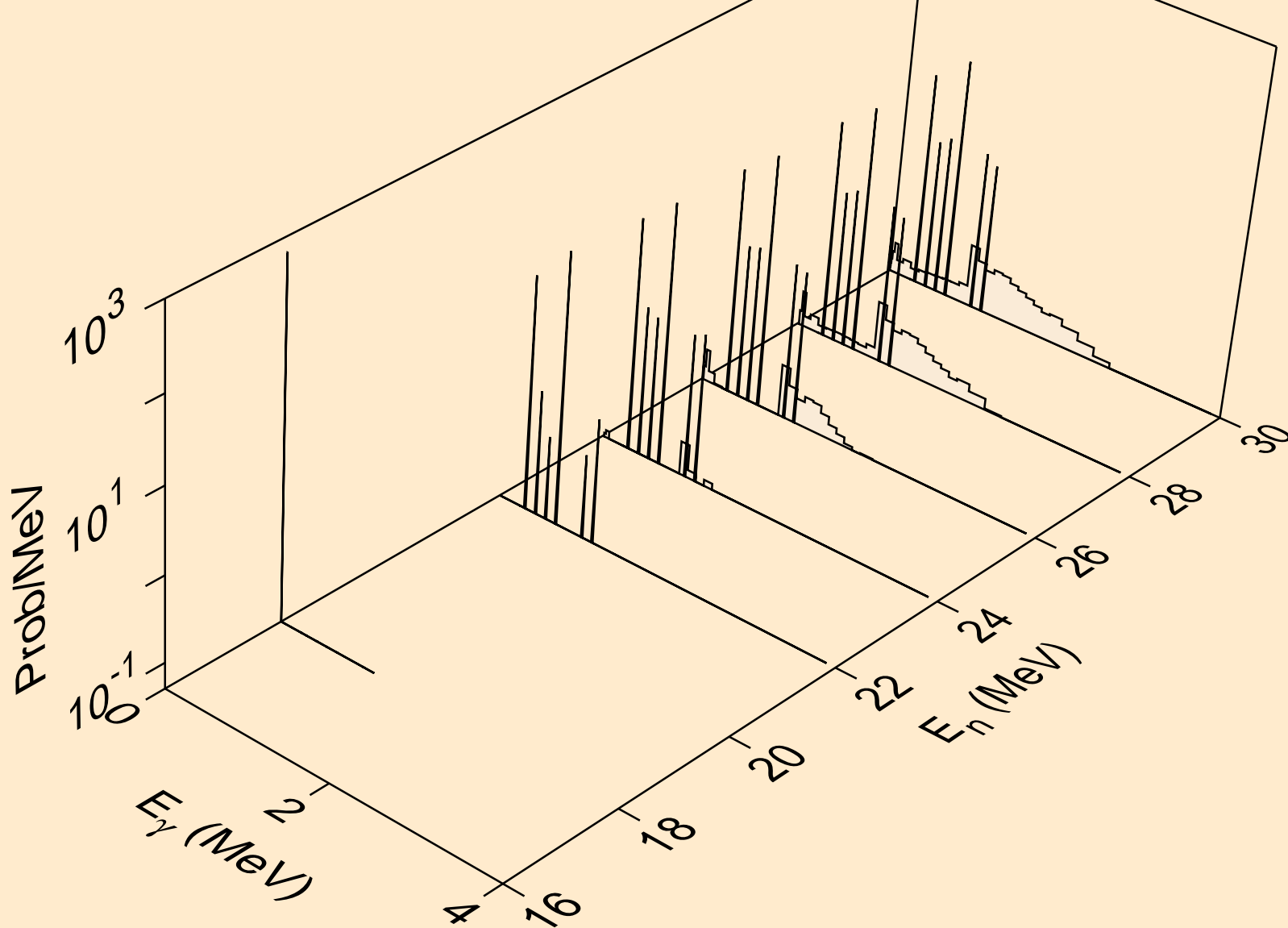

CU069 NEUTRON ACER TENDL-2019 LIBRARY; T=293.16K
Photon emission for (n,3np)

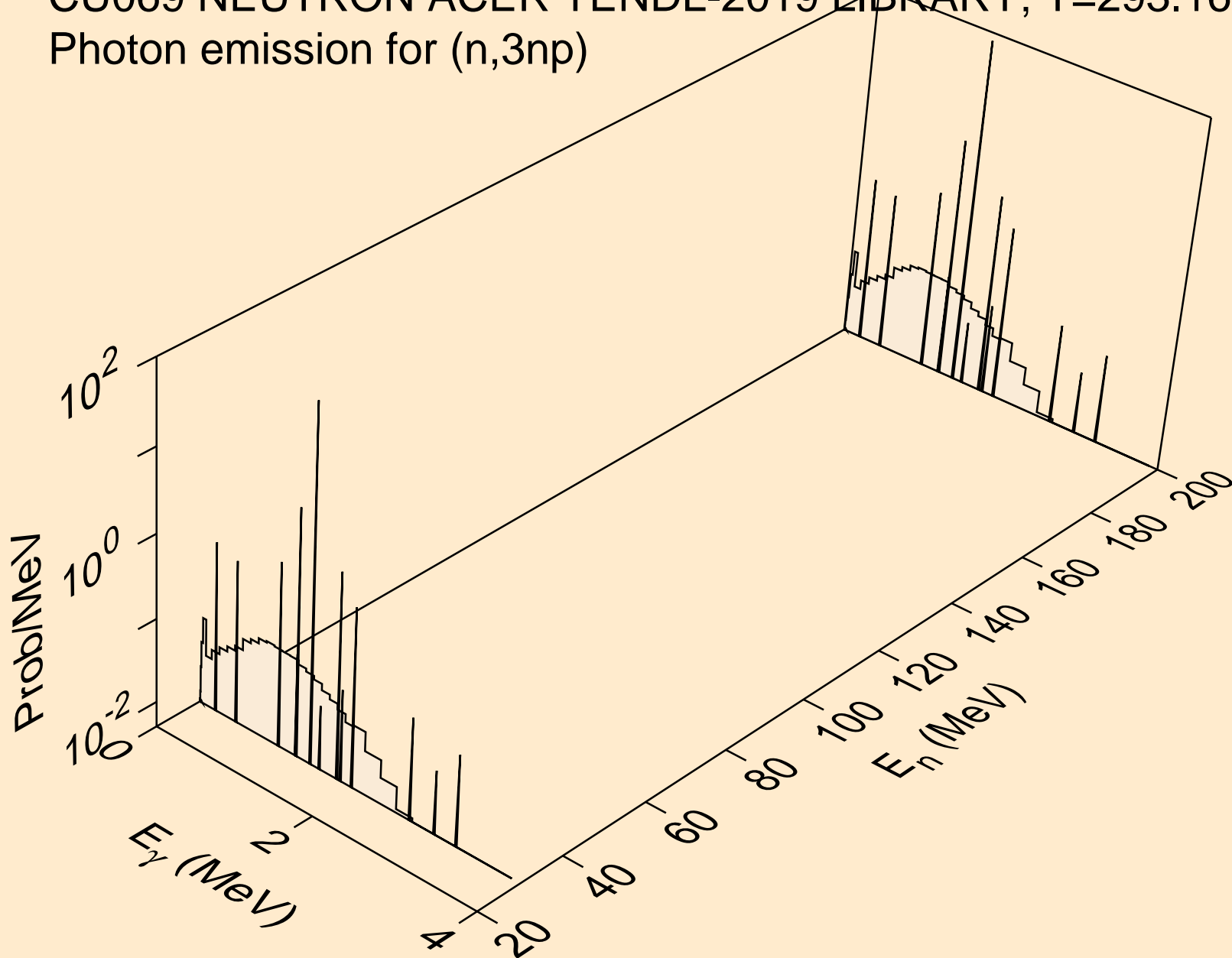

CU069 NEUTRON ACER TENDL-2019 LIBRARY; T=293.16K
Photon emission for (n,n*c)

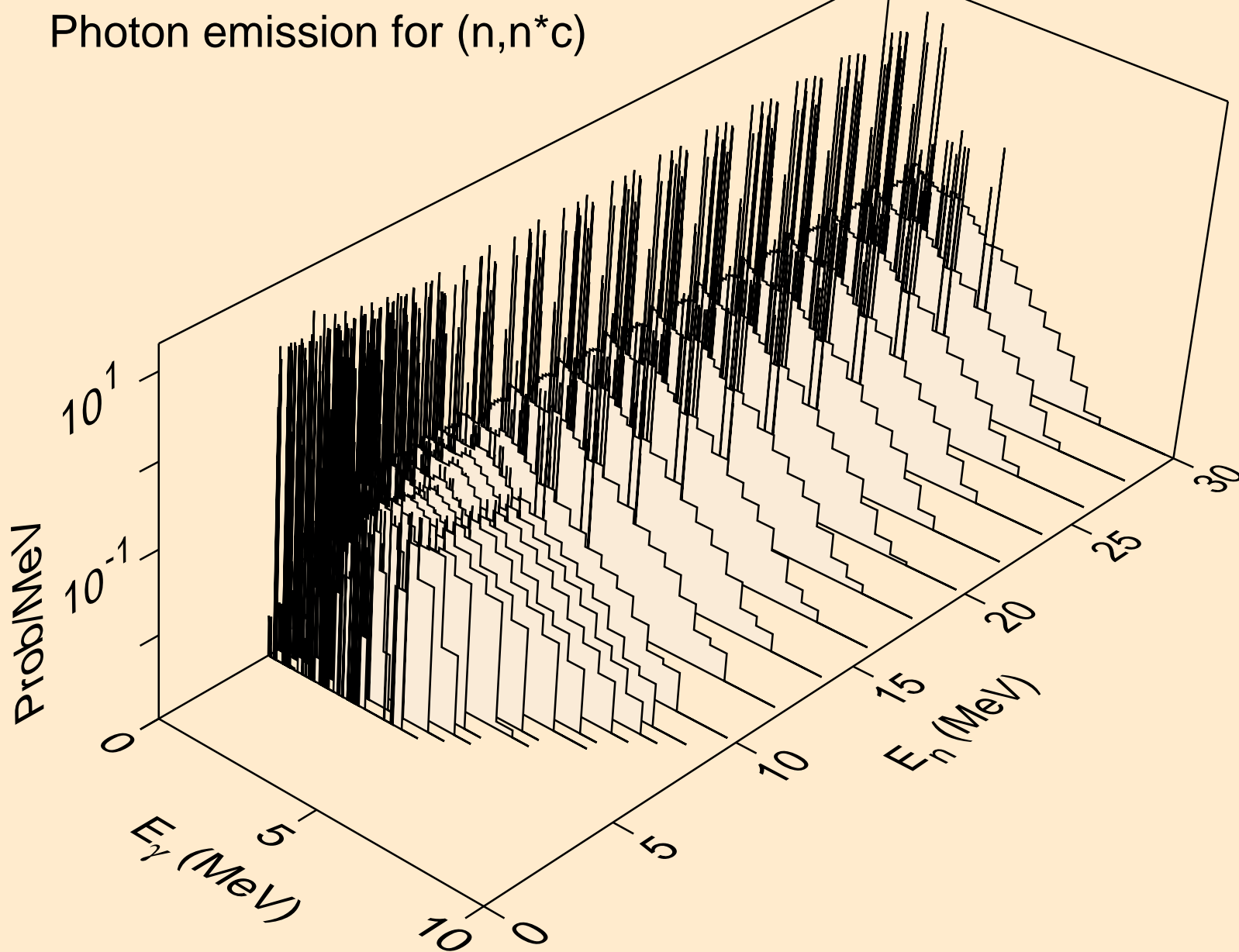

CU069 NEUTRON ACER TENDL-2019 LIBRARY; T=293.16K
Photon emission for (n,gma)

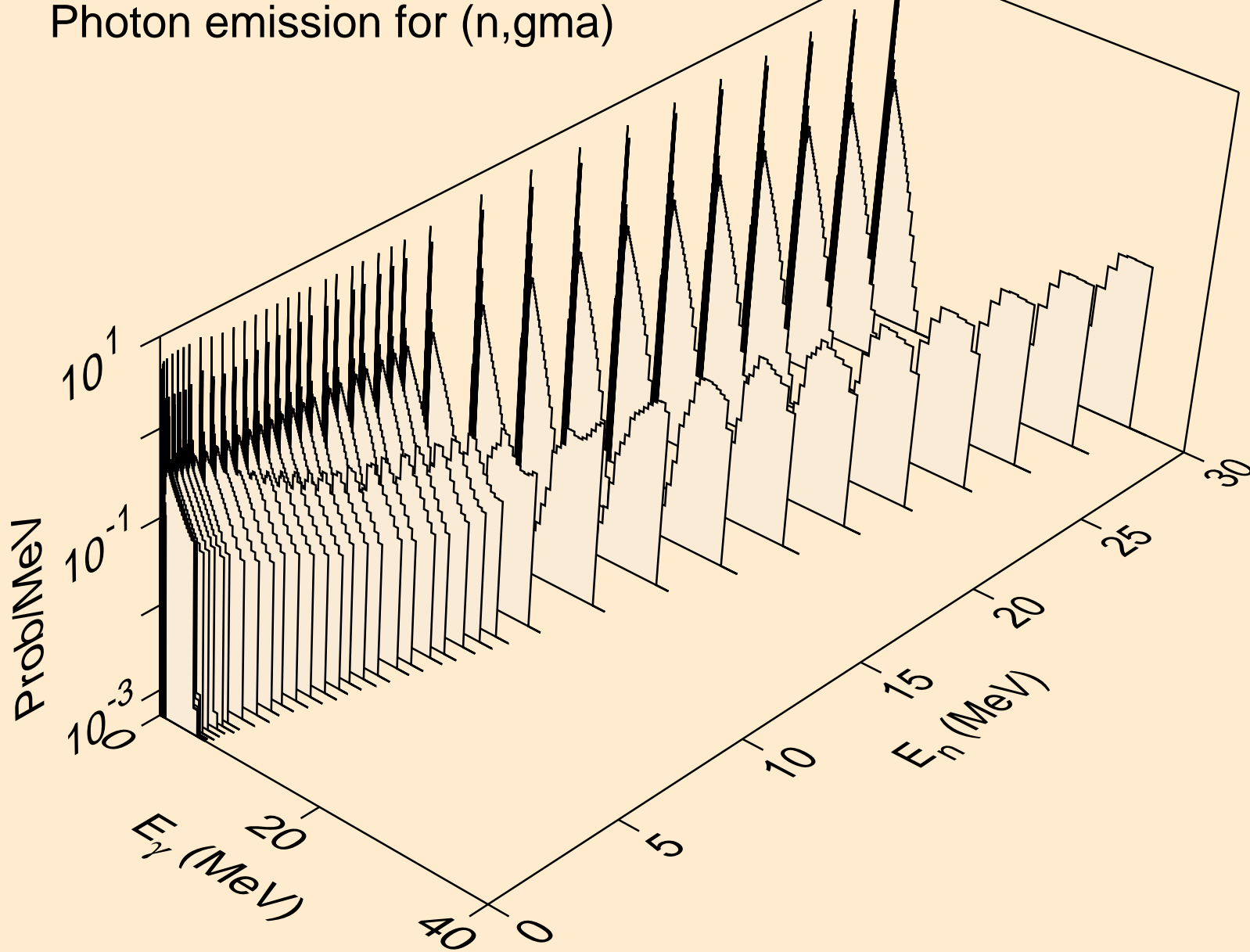

CU069 NEUTRON ACER TENDL-2019 LIBRARY; T=293.16K
Photon emission for (n,p)

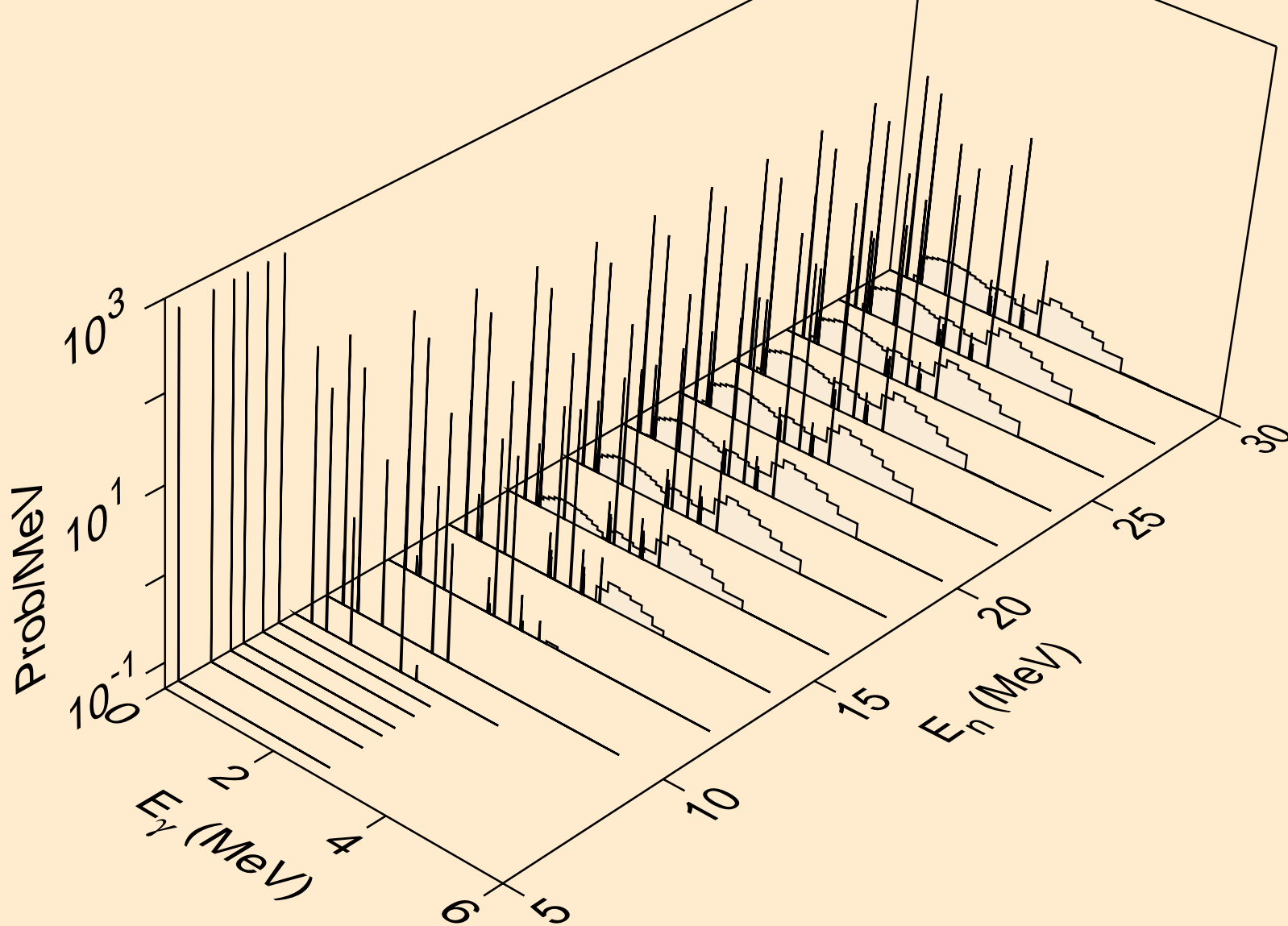

CU069 NEUTRON ACER TENDL-2019 LIBRARY; T=293.16K
Photon emission for (n,d)

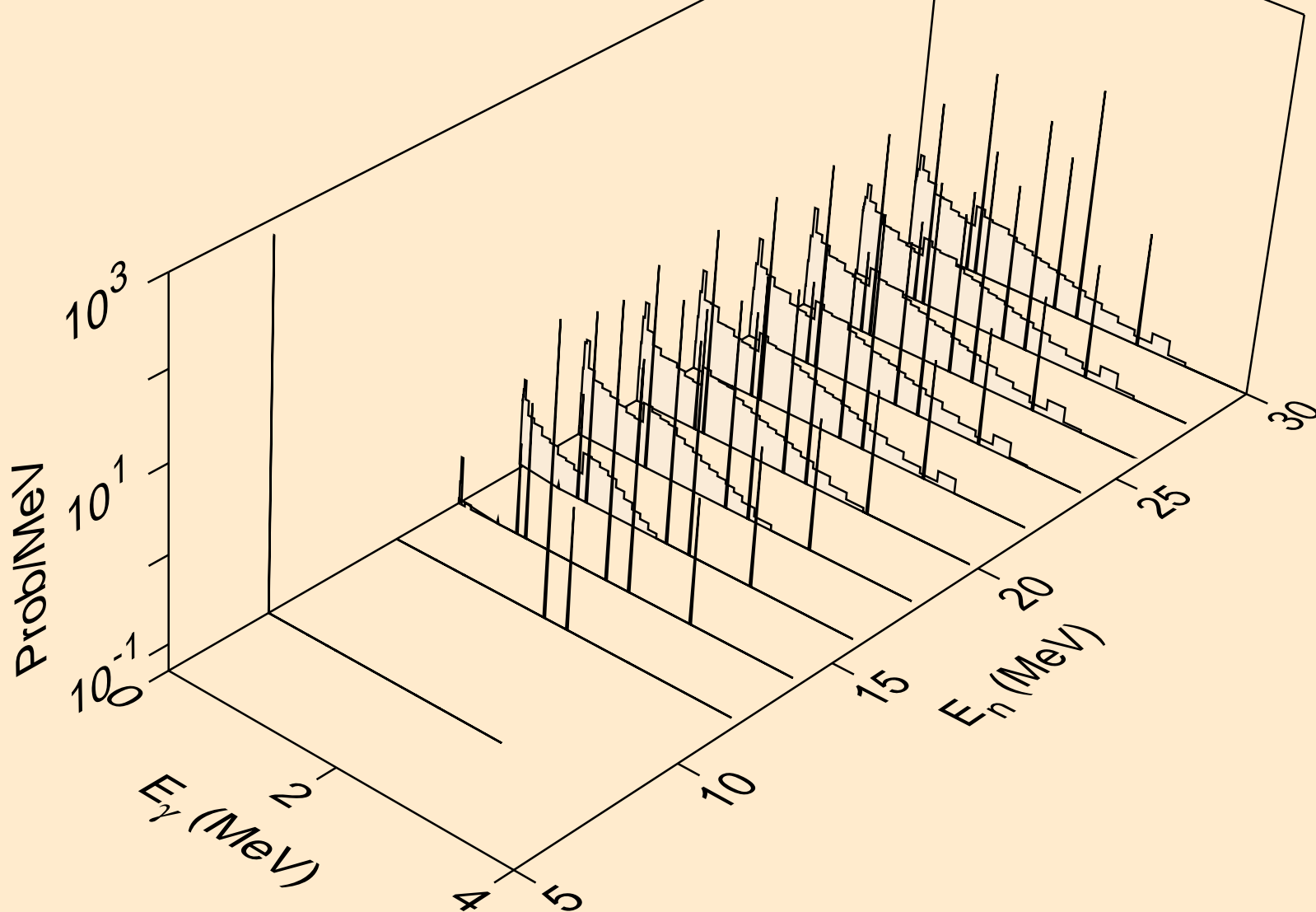

CU069 NEUTRON ACER TENDL-2019 LIBRARY; T=293.16K
Photon emission for (n,t)

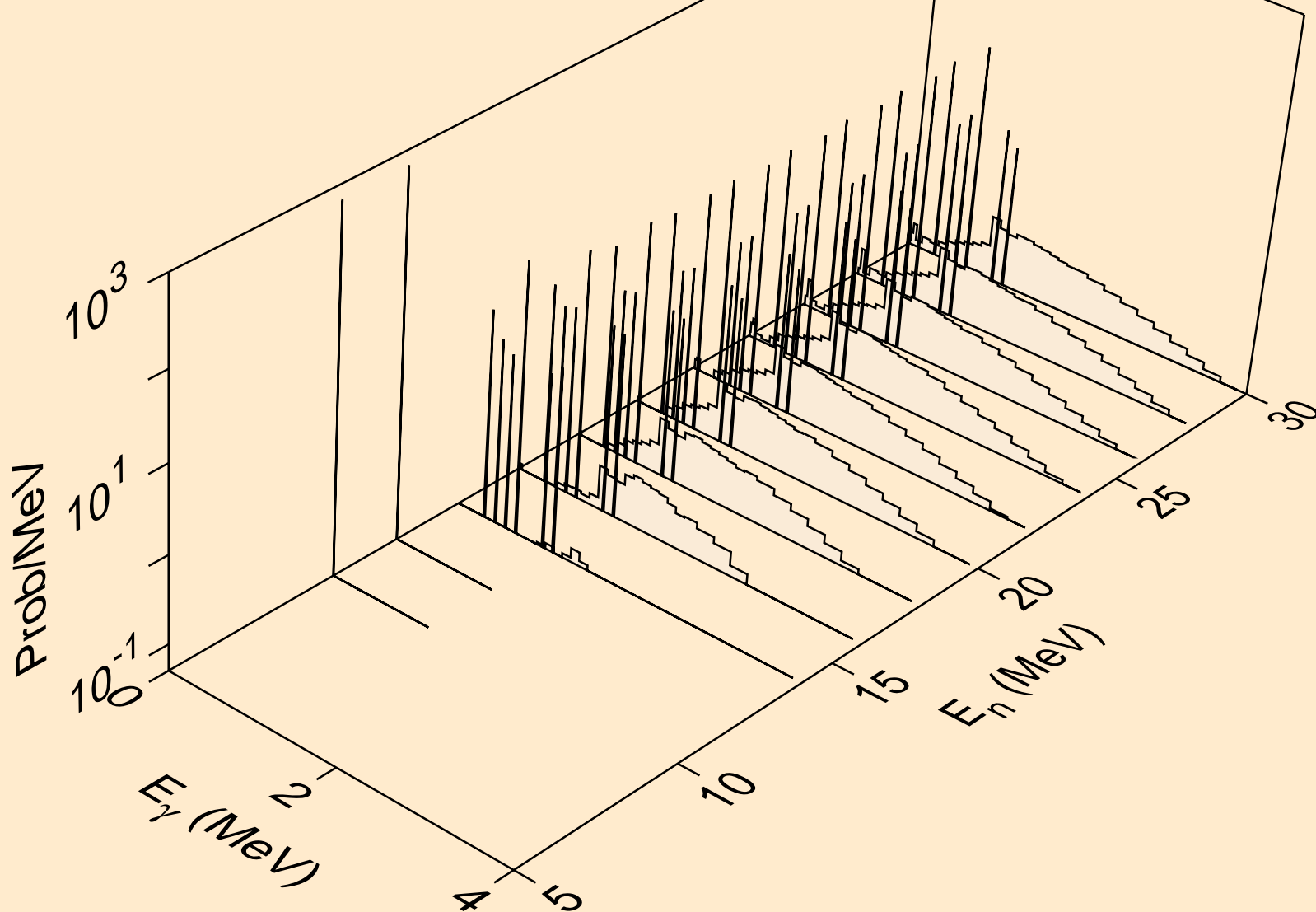

CU069 NEUTRON ACER TENDL-2019 LIBRARY; T=293.16K
Photon emission for (n,he3)

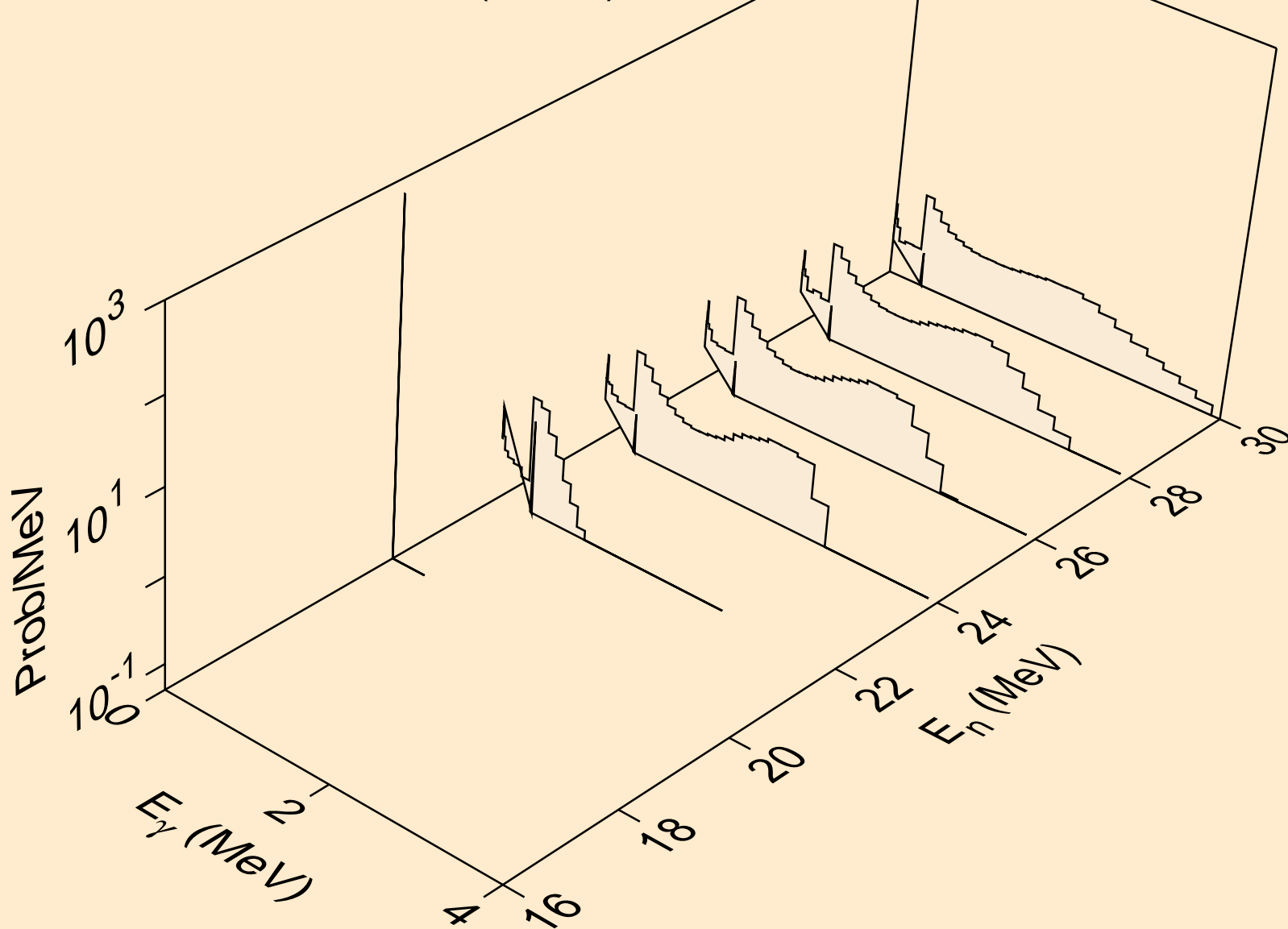

CU069 NEUTRON ACER TENDL-2019 LIBRARY; T=293.16K
Photon emission for (n,a)

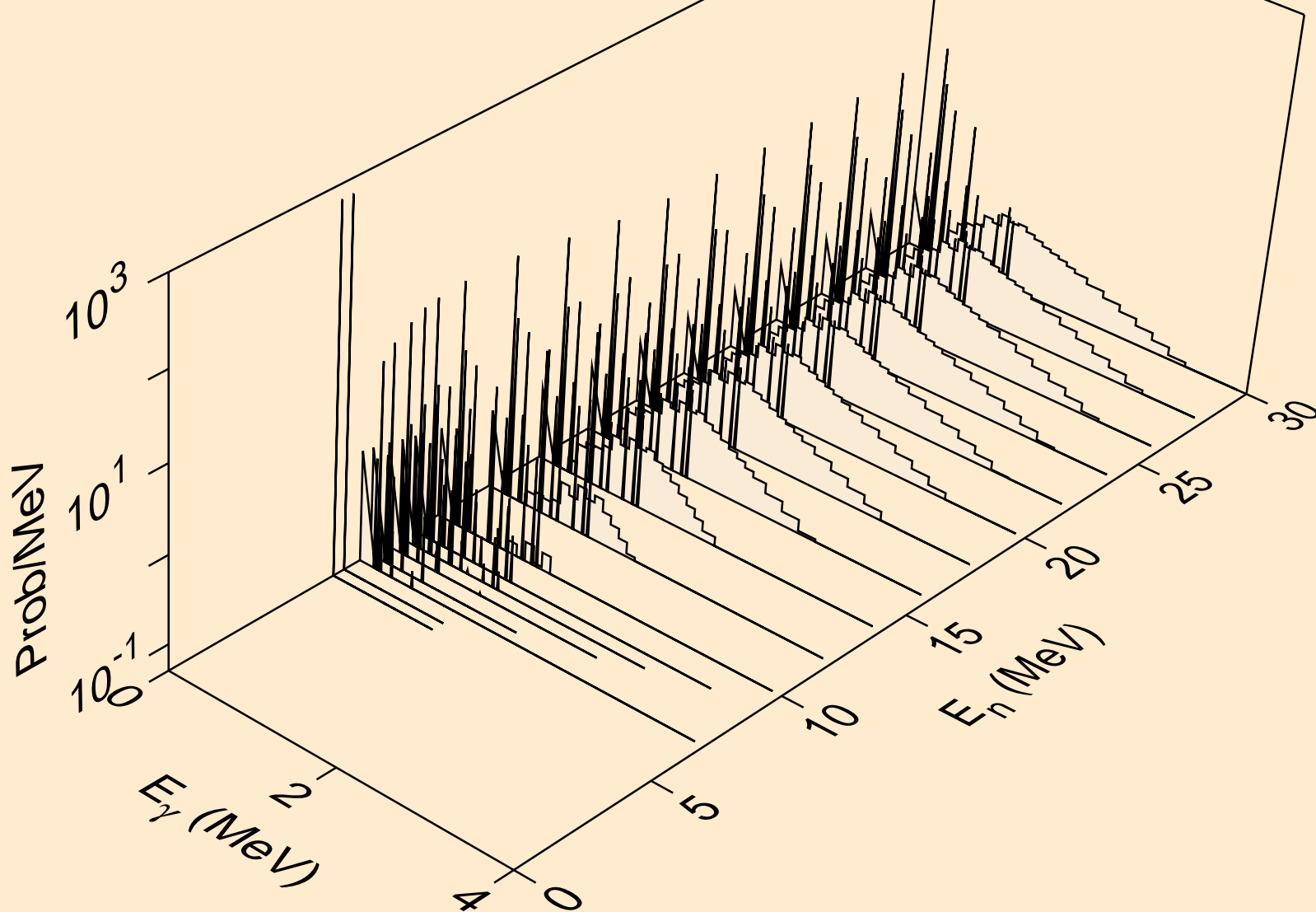

CU069 NEUTRON ACER TENDL-2019 LIBRARY; T=293.16K
Photon emission for (n,2a)

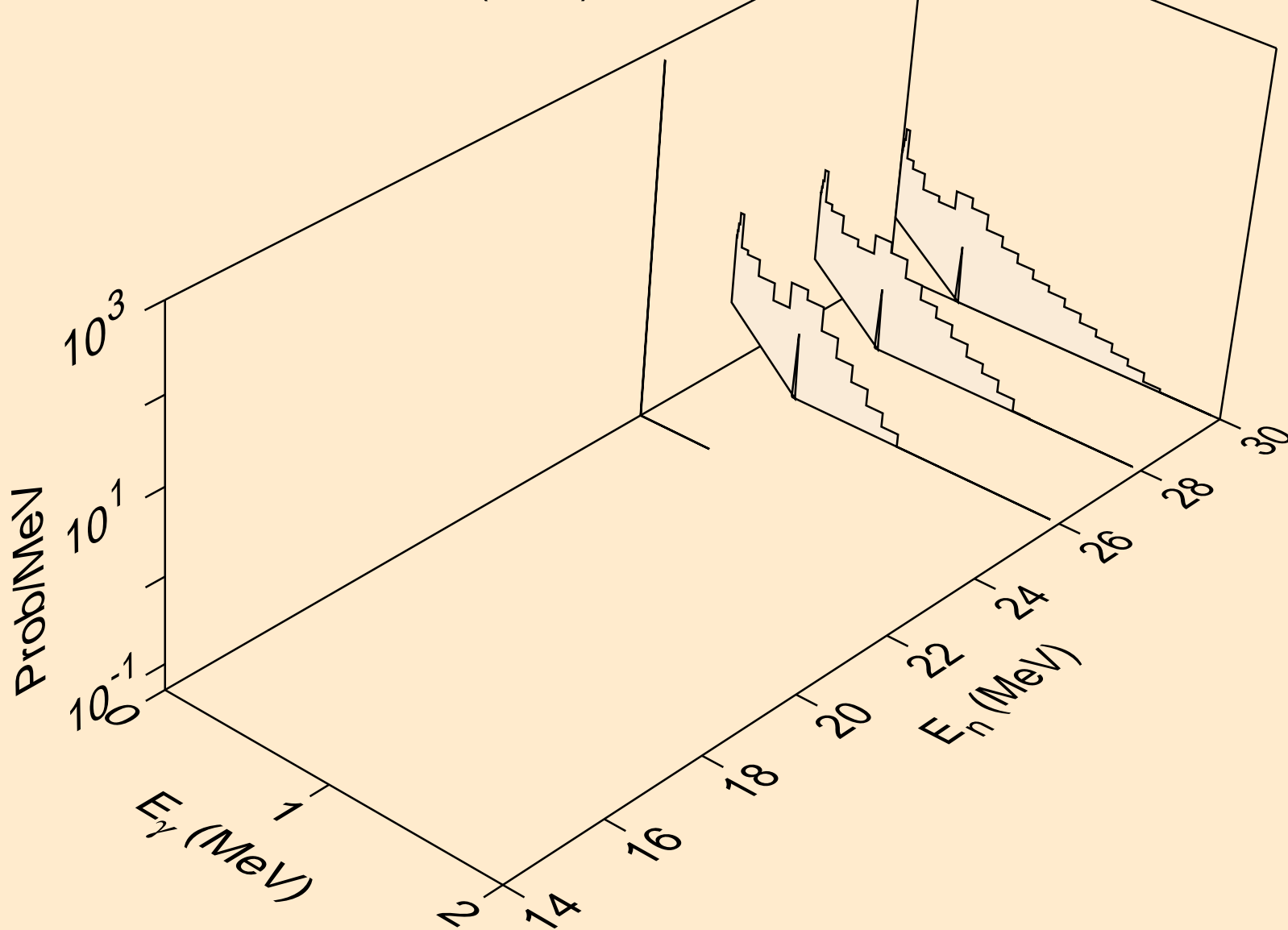

CU069 NEUTRON ACER TENDL-2019 LIBRARY; T=293.16K
Photon emission for (n,2p)

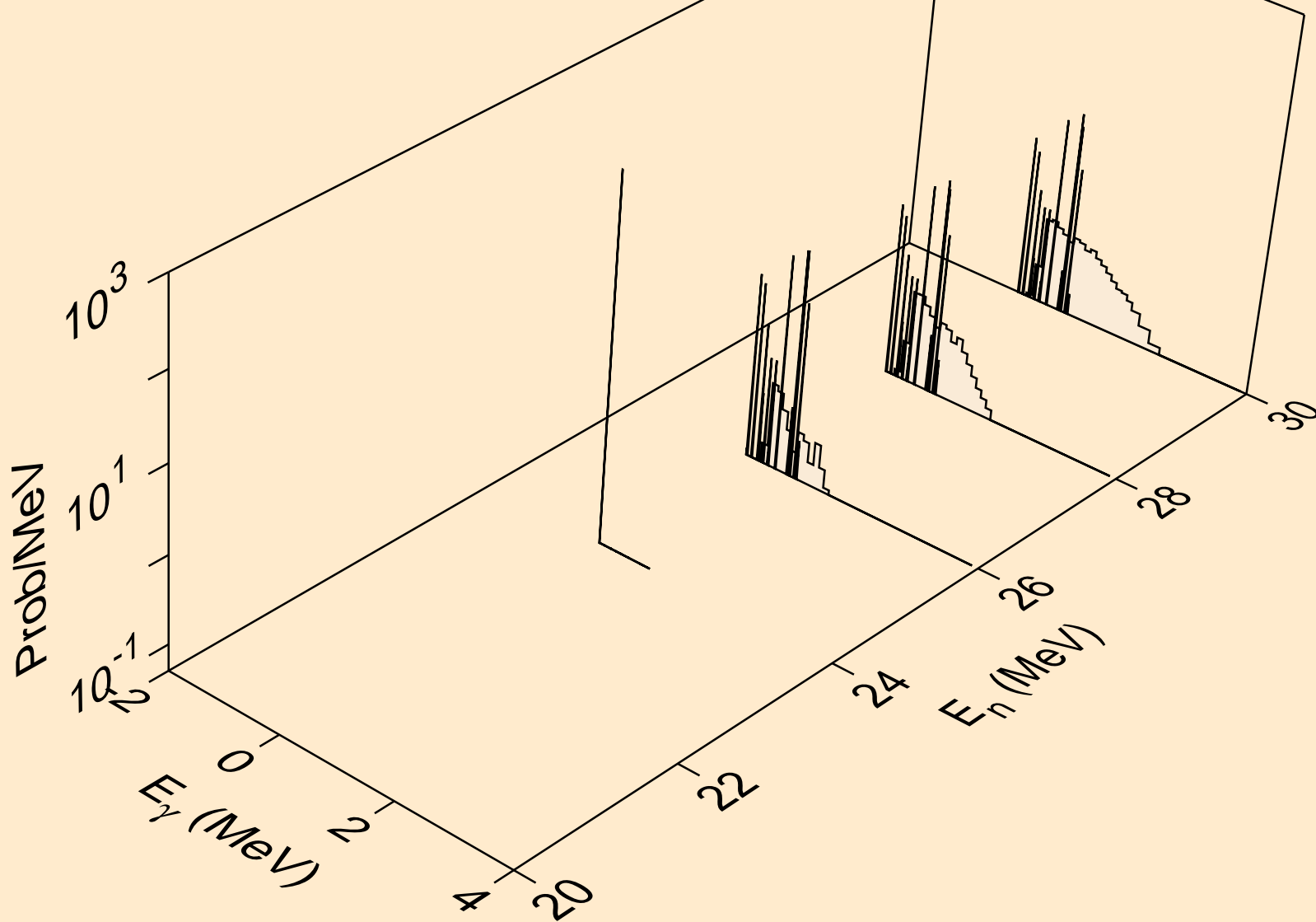

CU069 NEUTRON ACER TENDL-2019 LIBRARY; T=293.16K
Photon emission for (n,p)

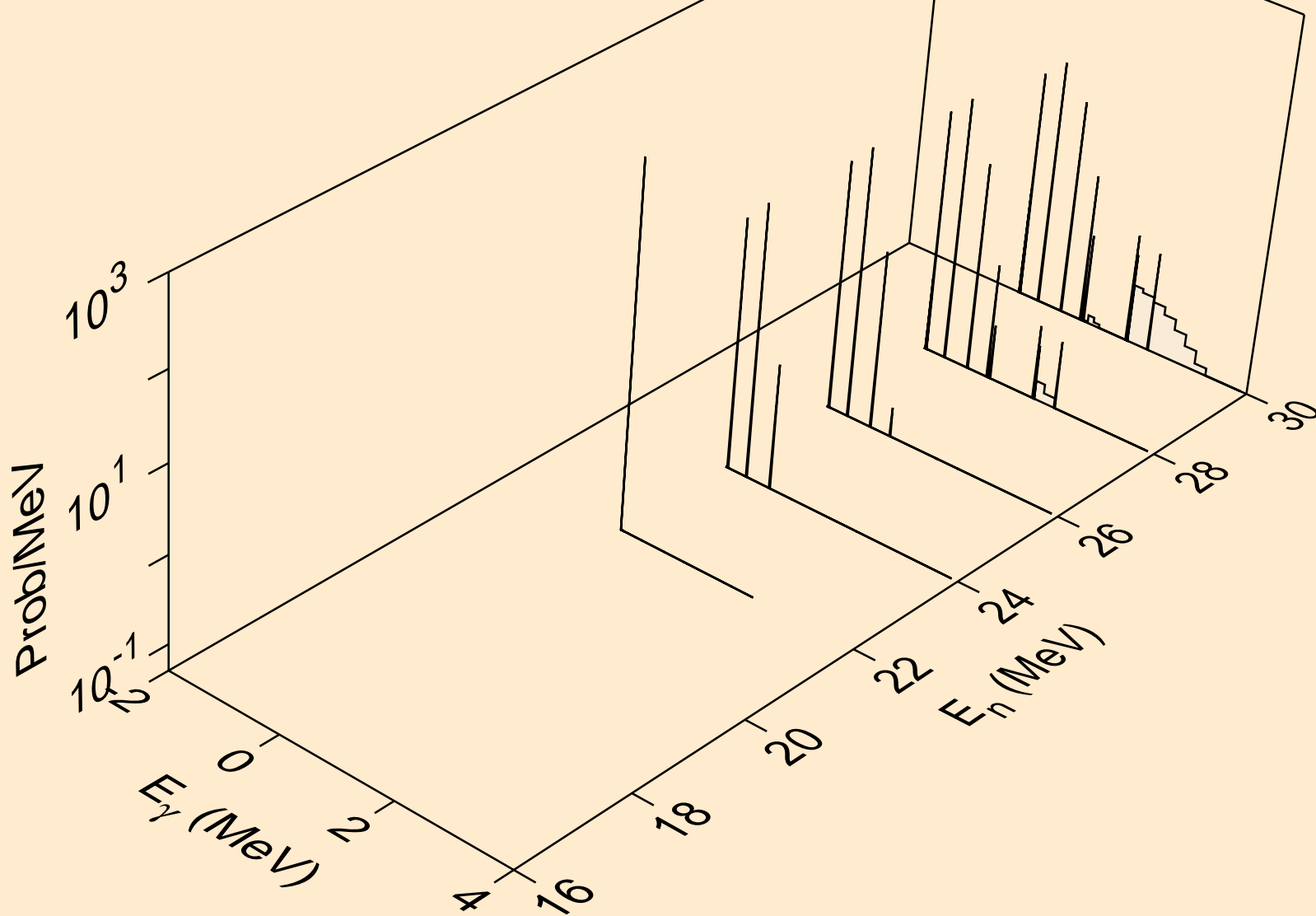

CU069 NEUTRON ACER TENDL-2019 LIBRARY; T=293.16K
thermal capture photon spectrum

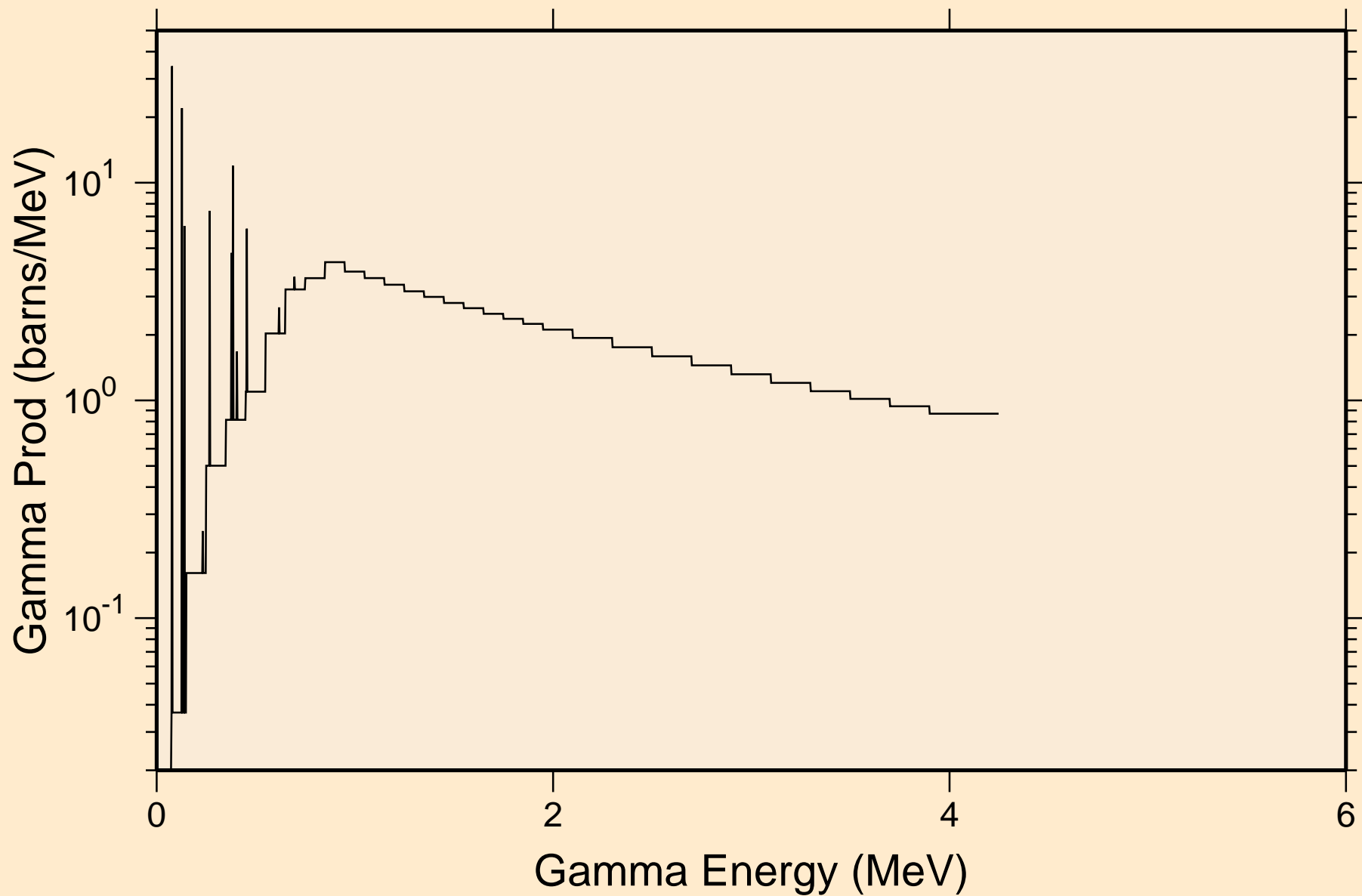

CU069 NEUTRON ACER TENDL-2019 LIBRARY; T=293.16K
14 MeV photon spectrum

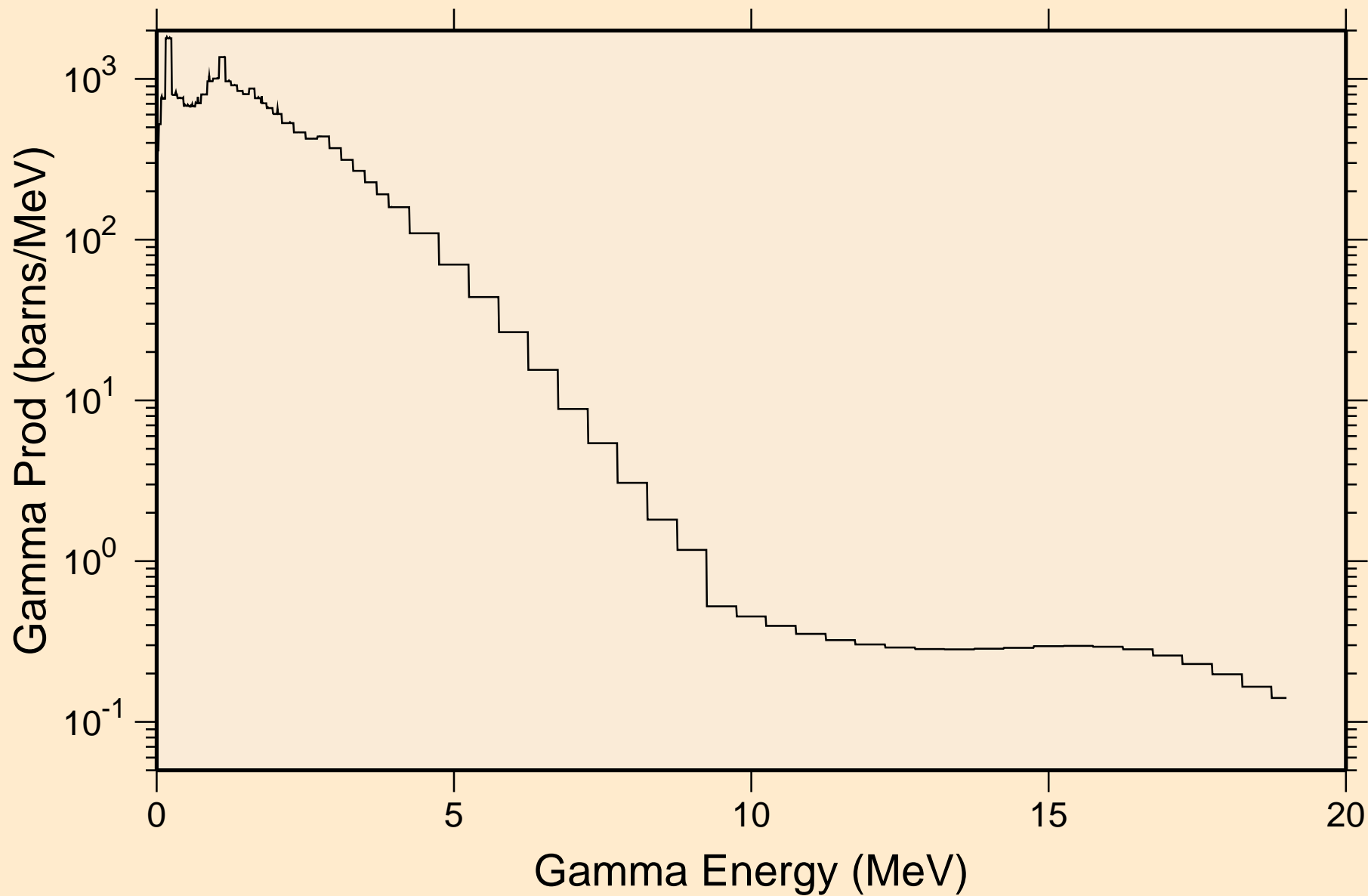

CU069 NEUTRON ACER TENDL-2019 LIBRARY; T=293.16K
Particle heating contributions

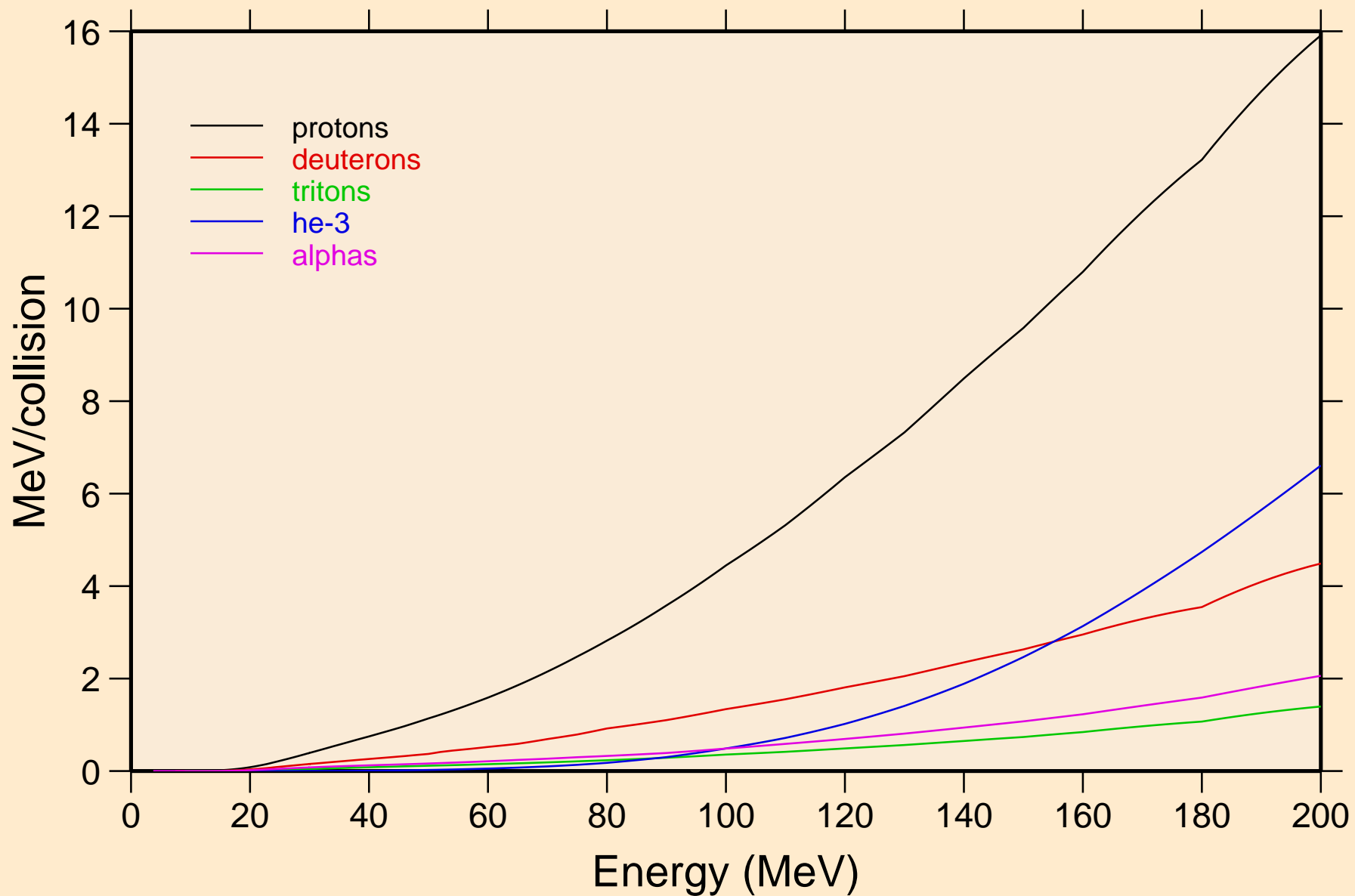

CU069 NEUTRON ACER TENDL-2019 LIBRARY; T=293.16K
Recoil Heating

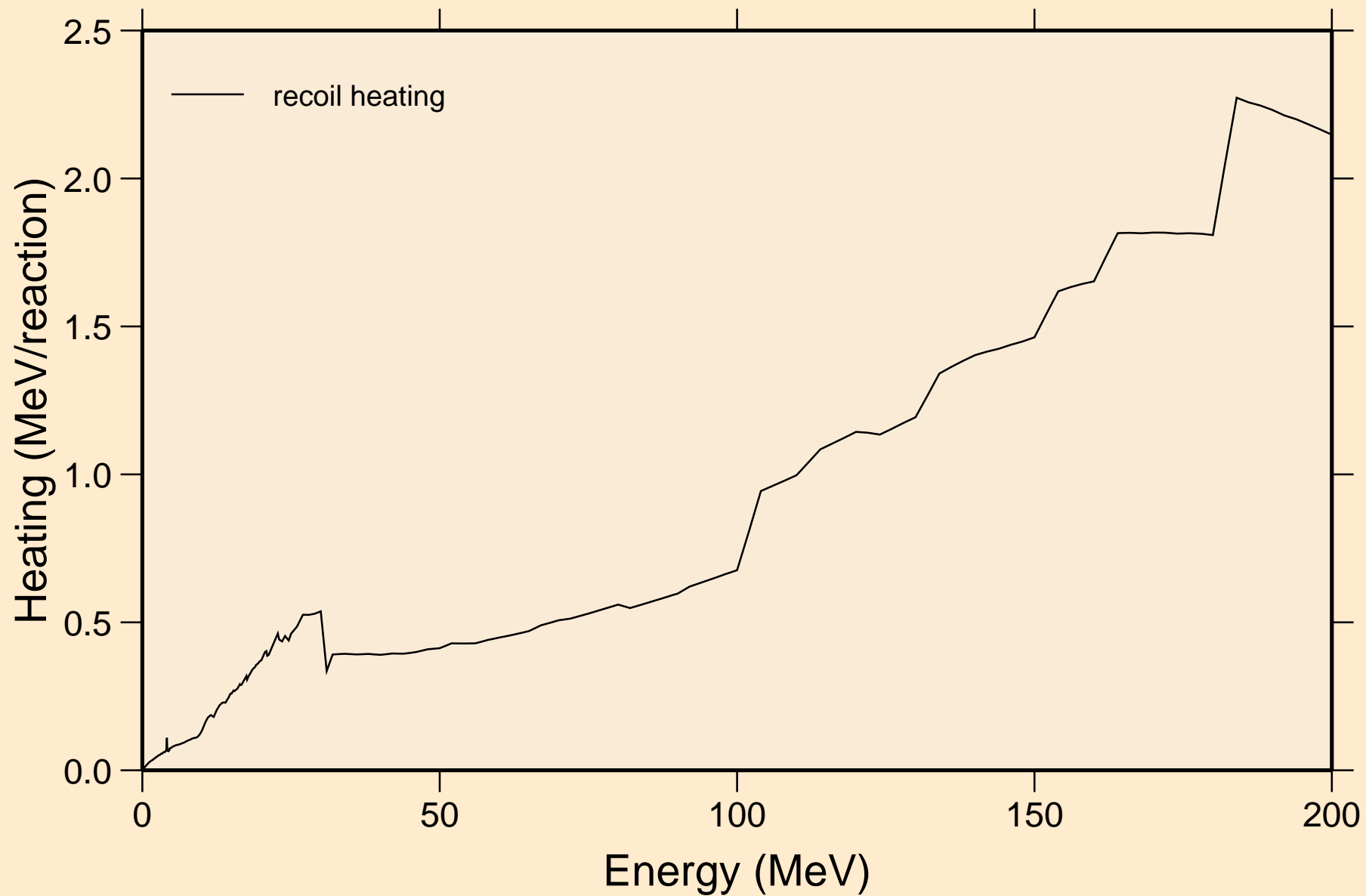

CU069 NEUTRON ACER TENDL-2019 LIBRARY; T=293.16K
Particle production cross sections

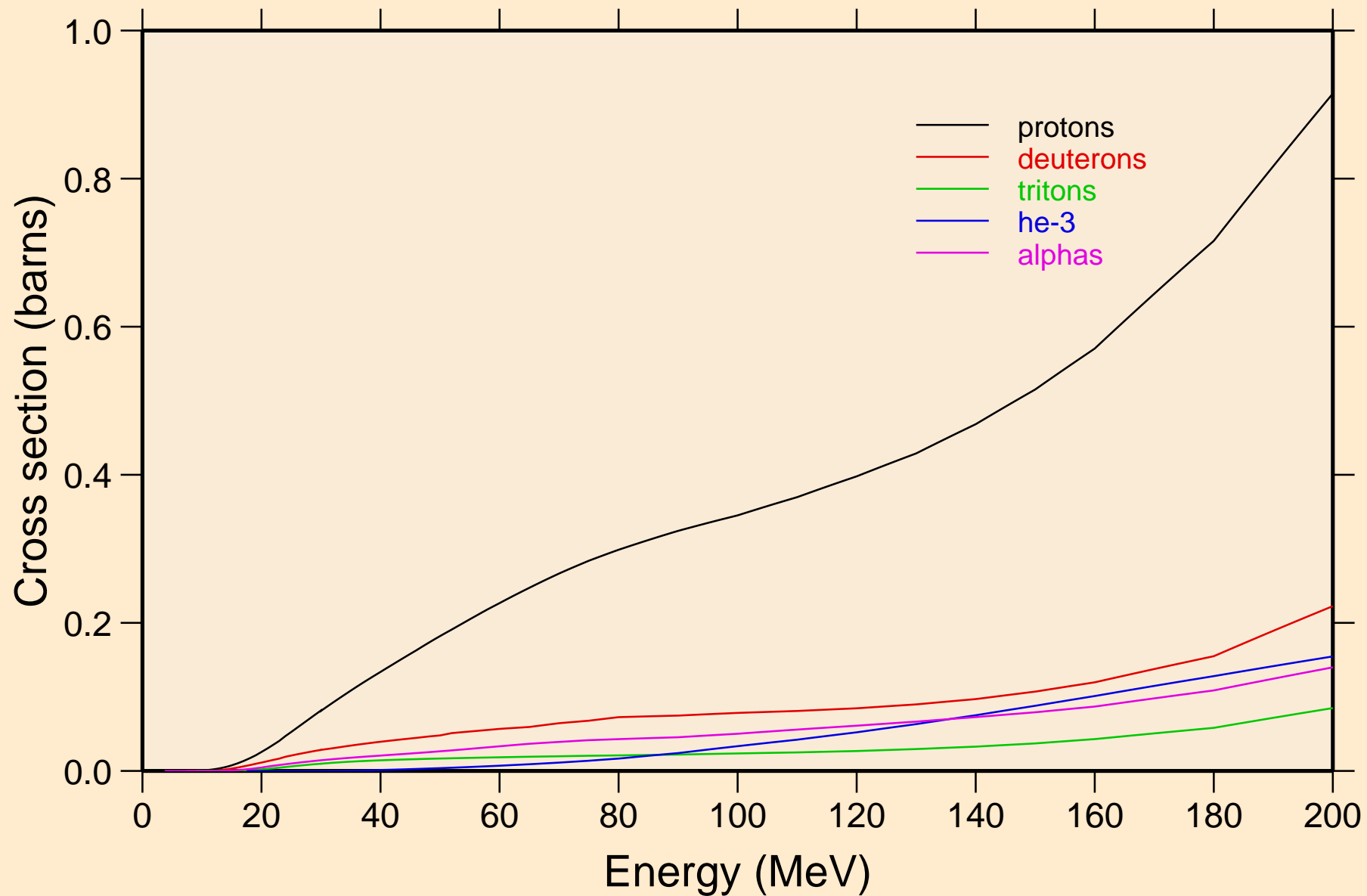

CU069 NEUTRON ACER TENDL-2019 LIBRARY; T=293.16K
protons from (n,x)

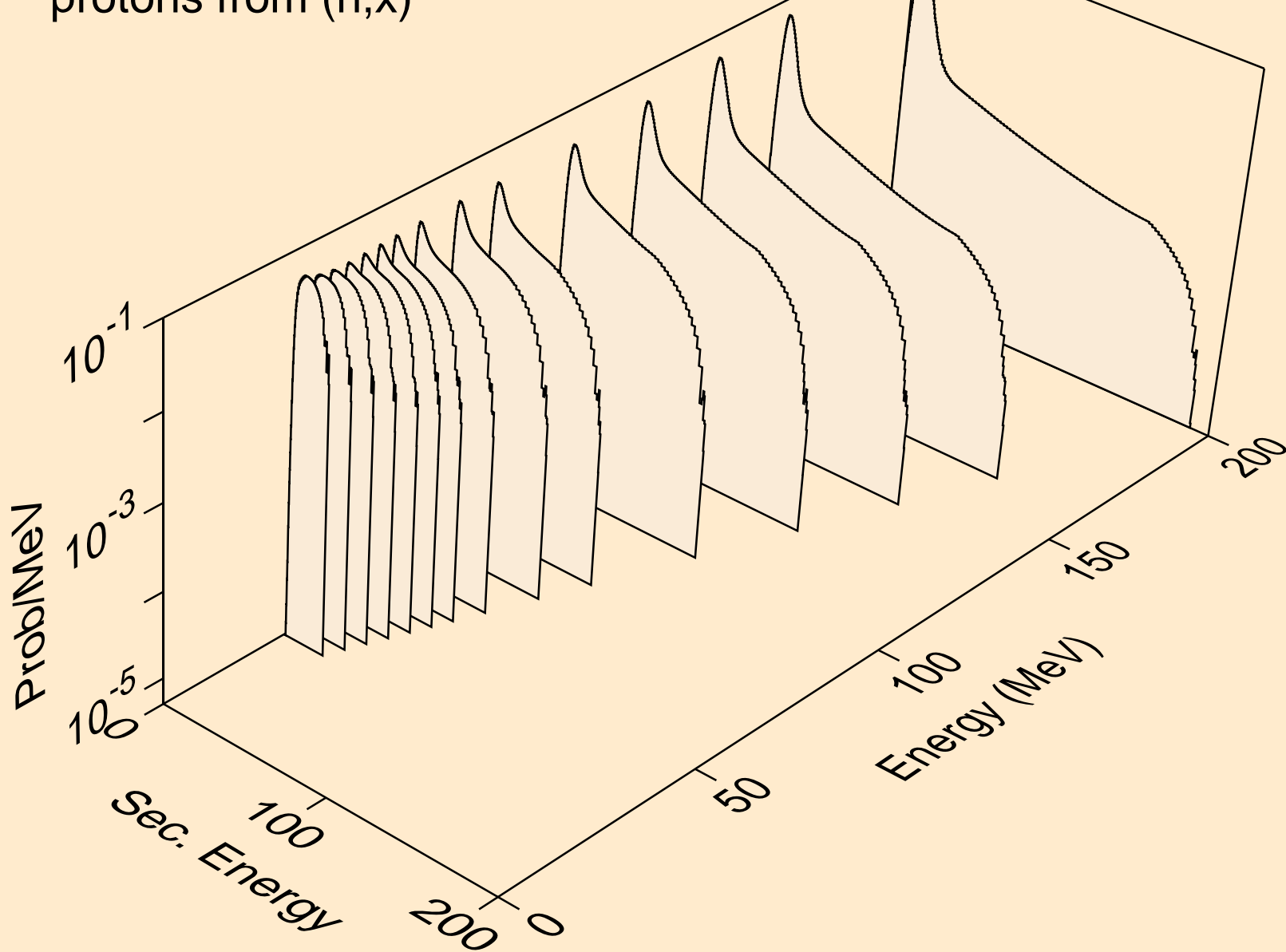

CU069 NEUTRON ACER TENDL-2019 LIBRARY; T=293.16K
protons from (n,n*)p

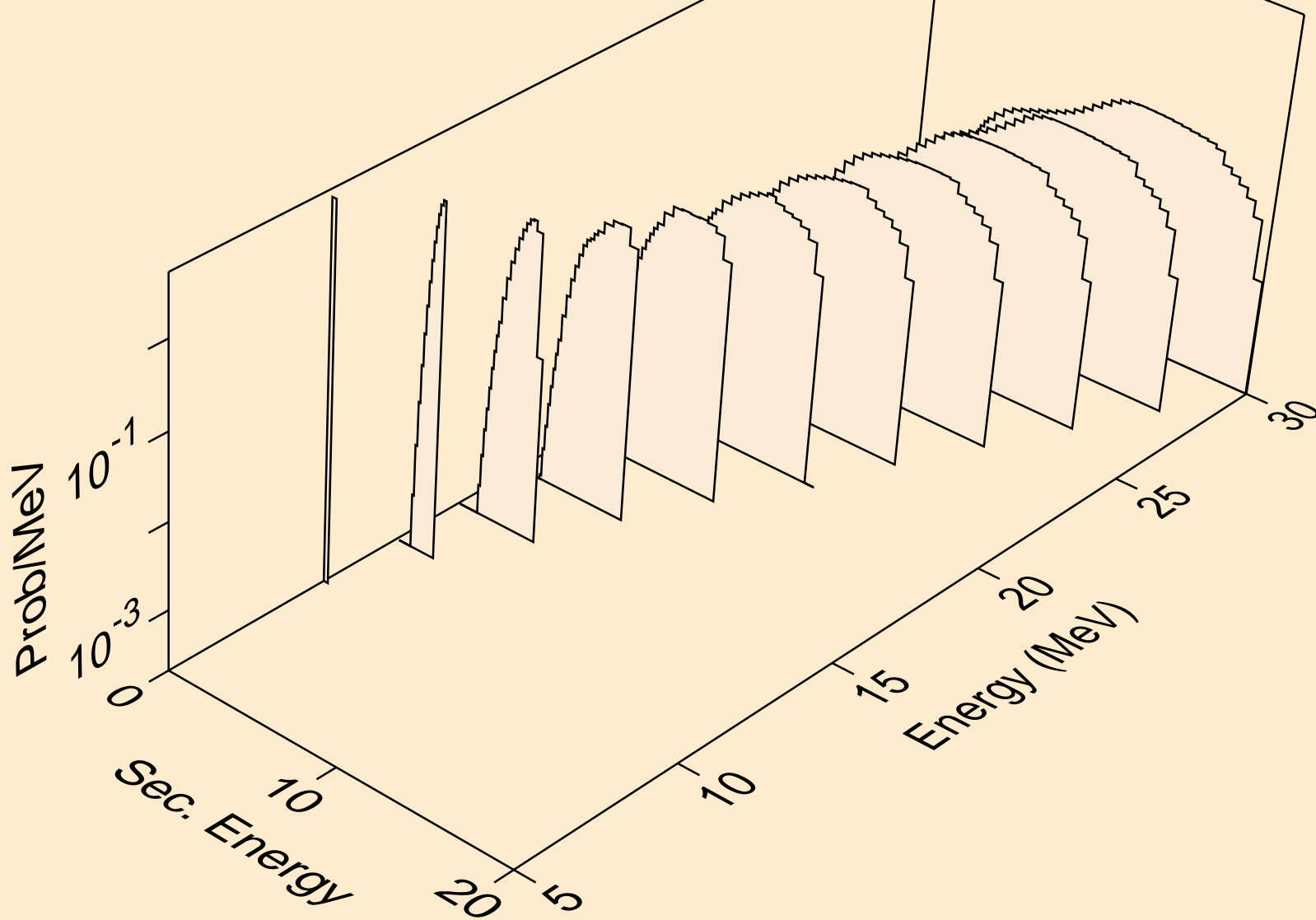

CU069 NEUTRON ACER TENDL-2019 LIBRARY; T=293.16K
protons from (n,2np)

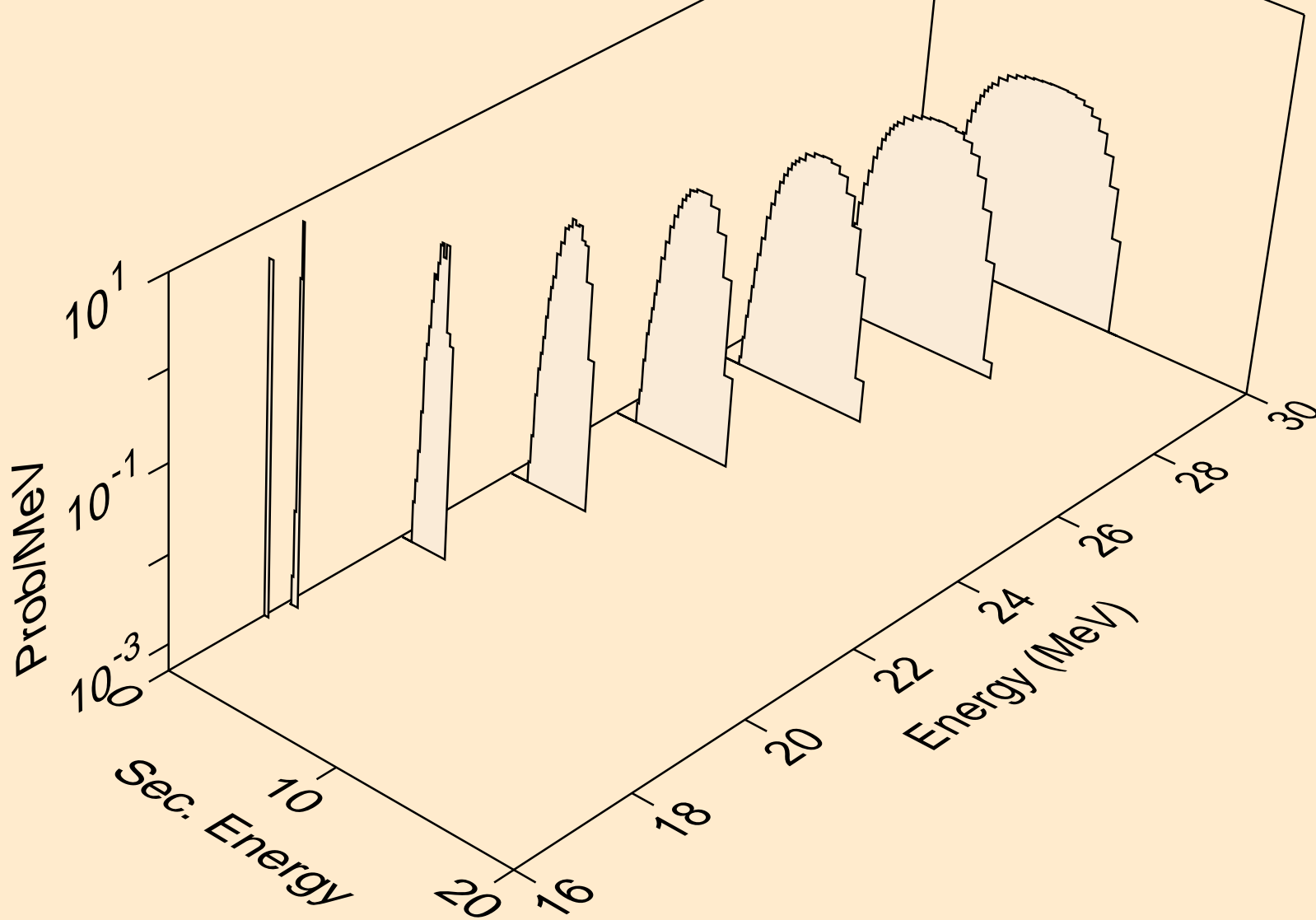

CU069 NEUTRON ACER TENDL-2019 LIBRARY; T=293.16K
protons from (n,3np)

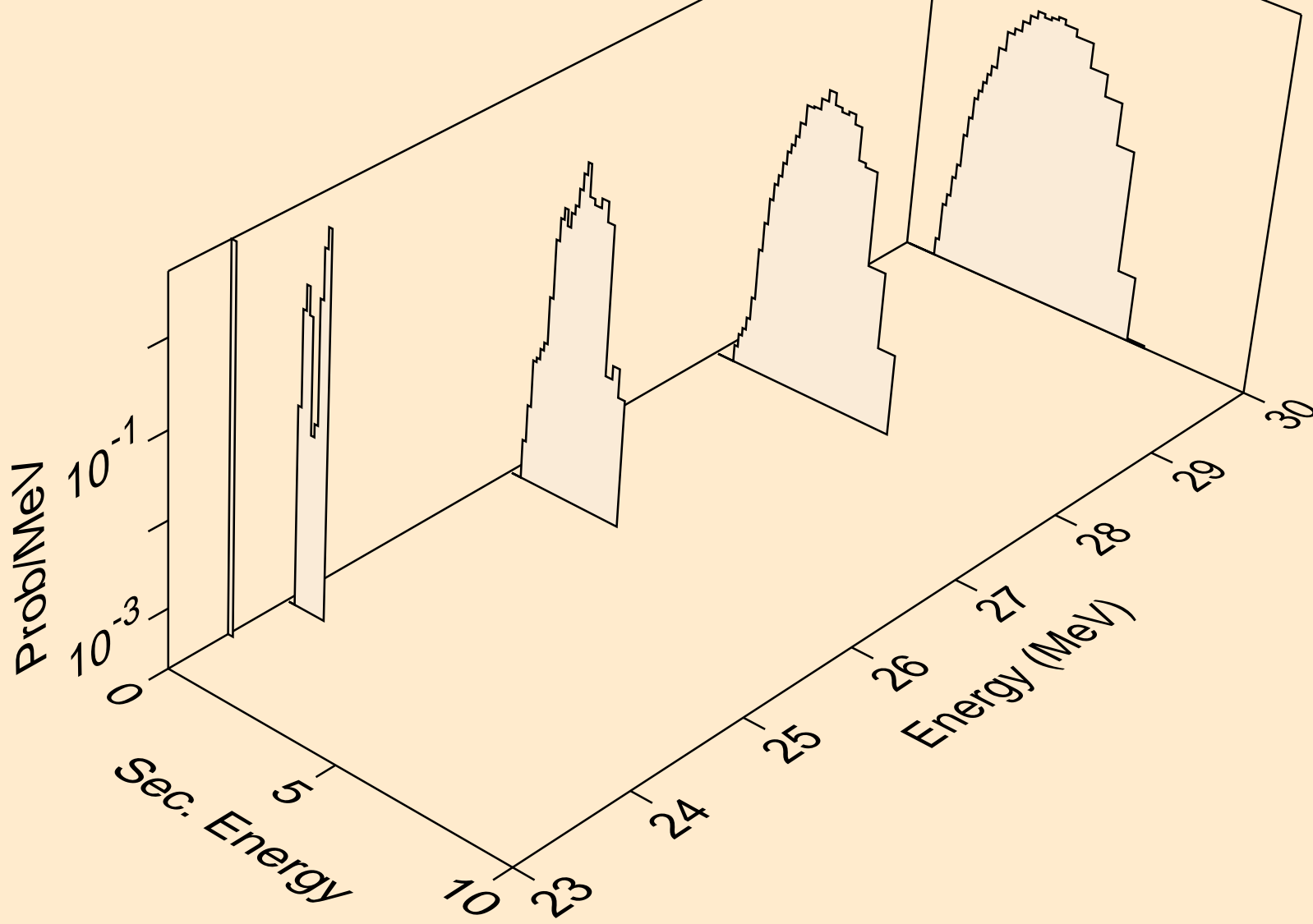

CU069 NEUTRON ACER TENDL-2019 LIBRARY; T=293.16K
protons from (n,p)

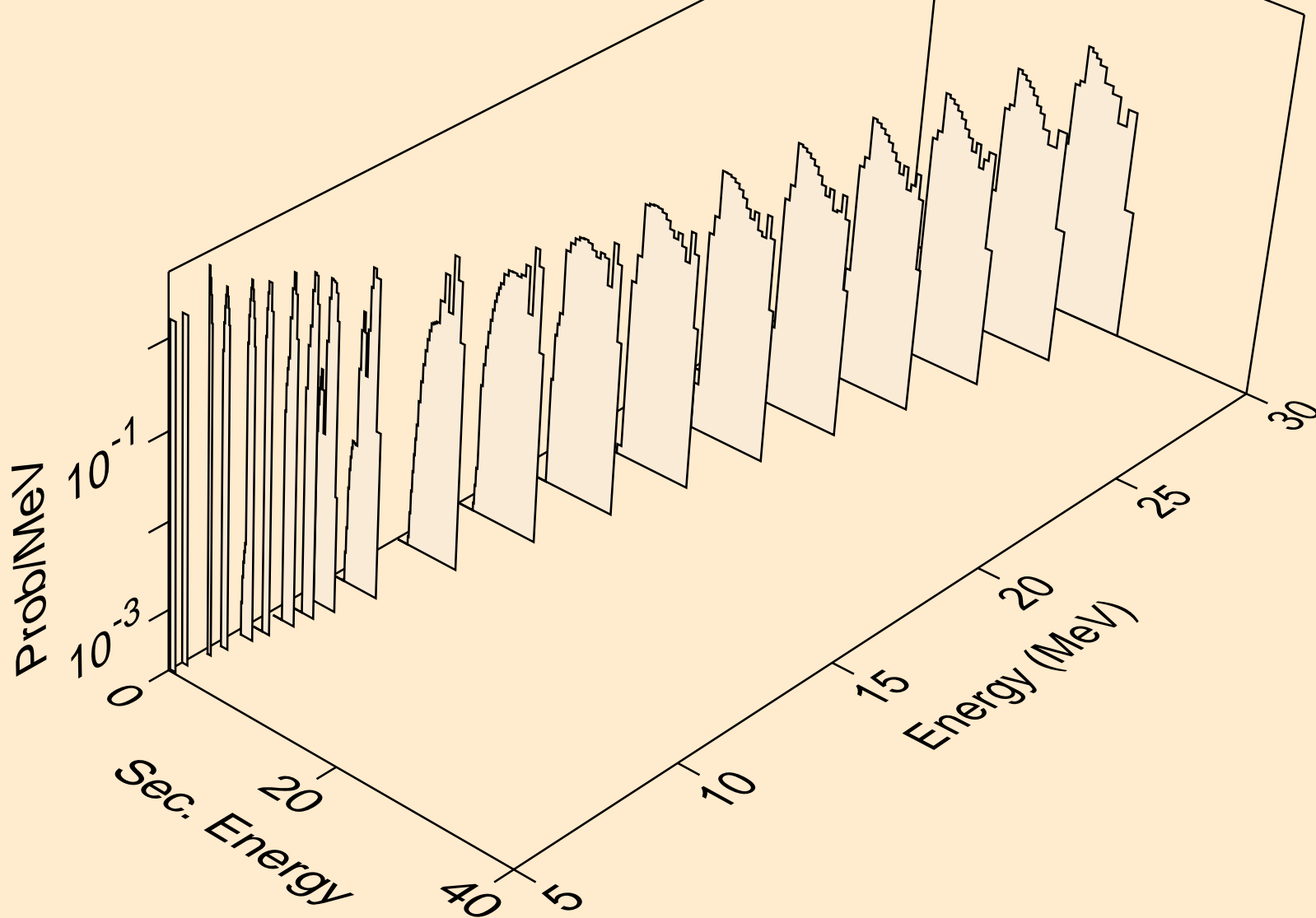

CU069 NEUTRON ACER TENDL-2019 LIBRARY; T=293.16K
protons from (n,2p)

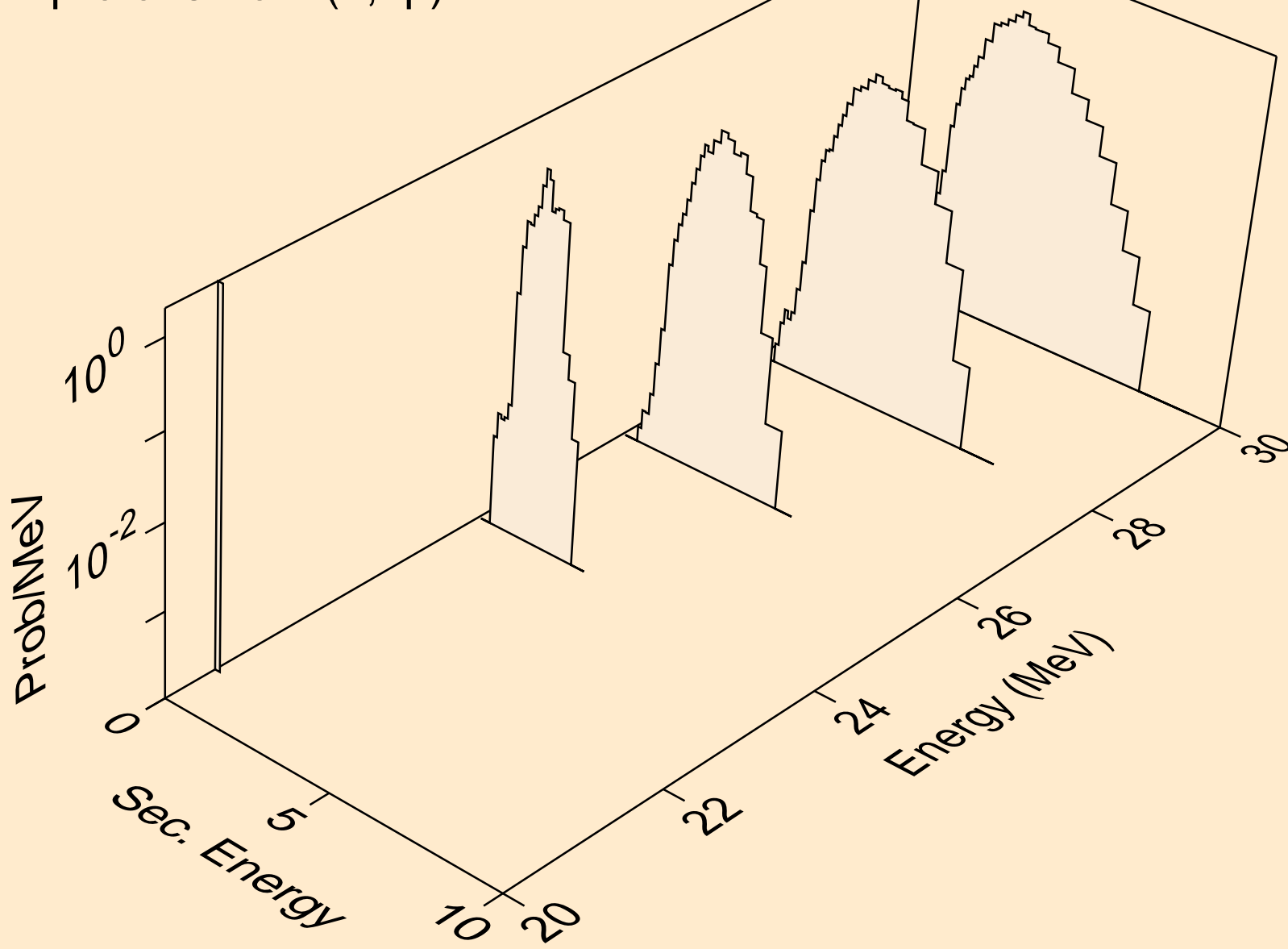

CU069 NEUTRON ACER TENDL-2019 LIBRARY; T=293.16K
protons from (n,p)

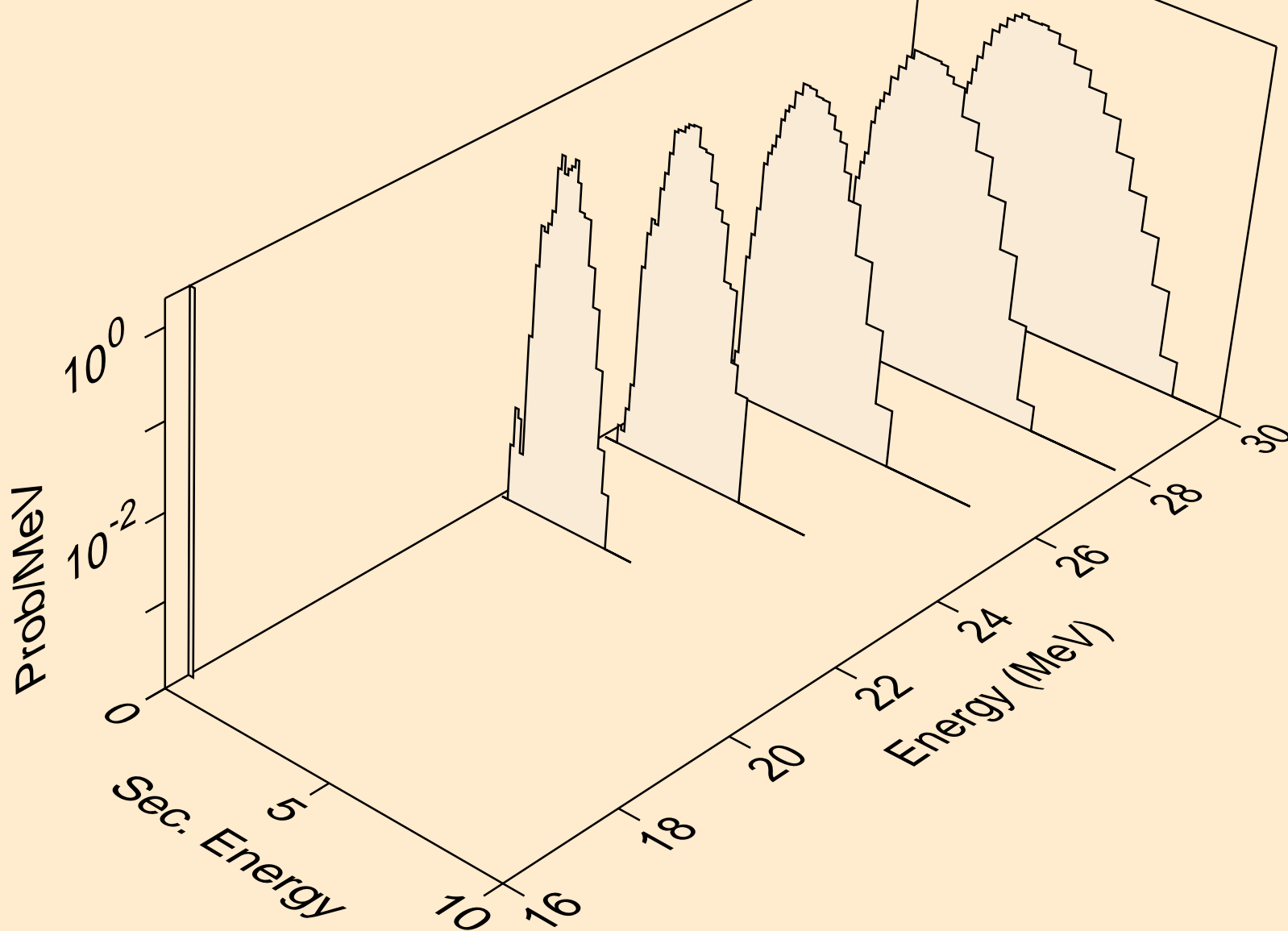

CU069 NEUTRON ACER TENDL-2019 LIBRARY; T=293.16K
deuterons from (n,x)

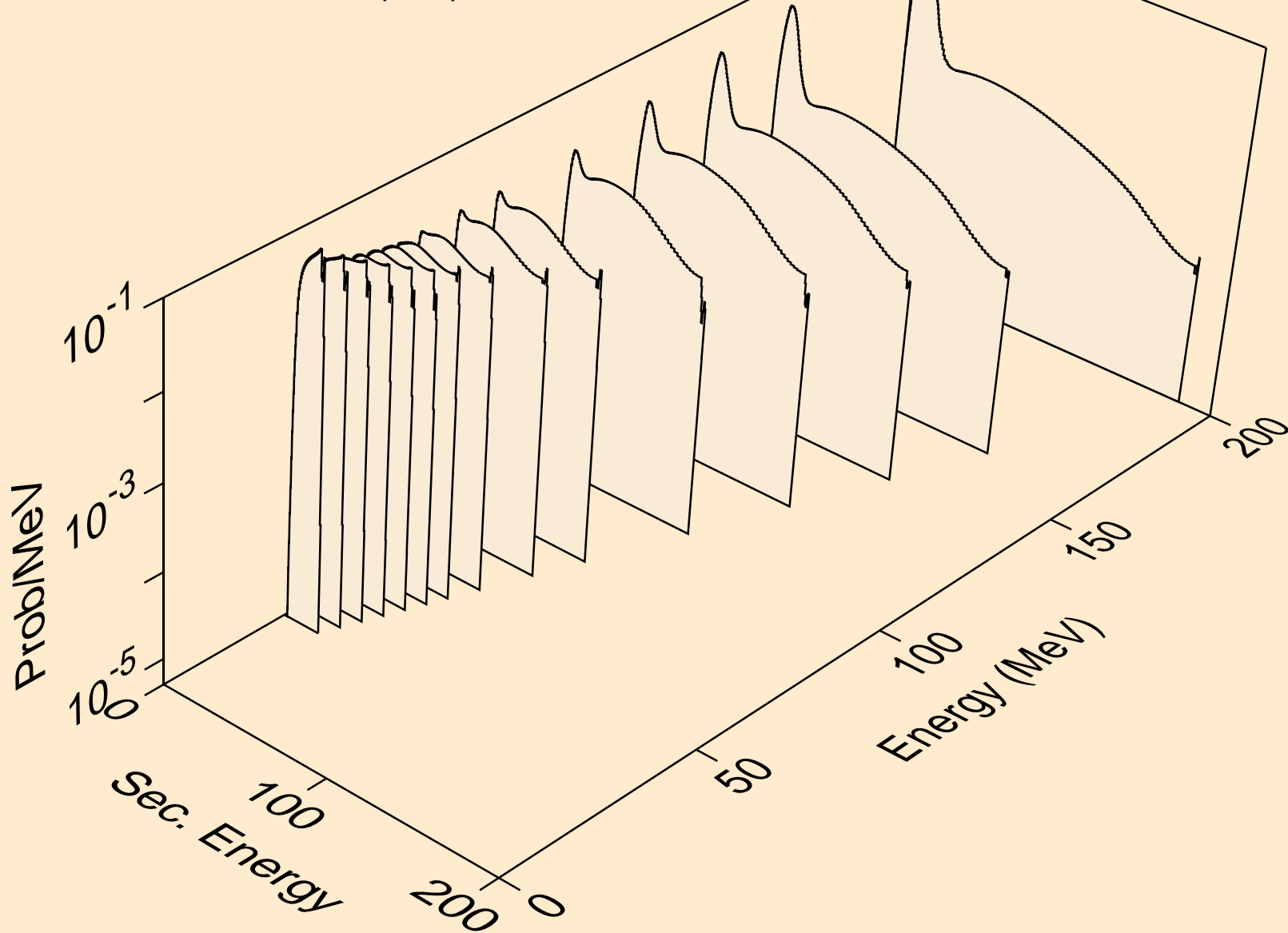

CU069 NEUTRON ACER TENDL-2019 LIBRARY; T=293.16K
deuterons from (n,2nd)

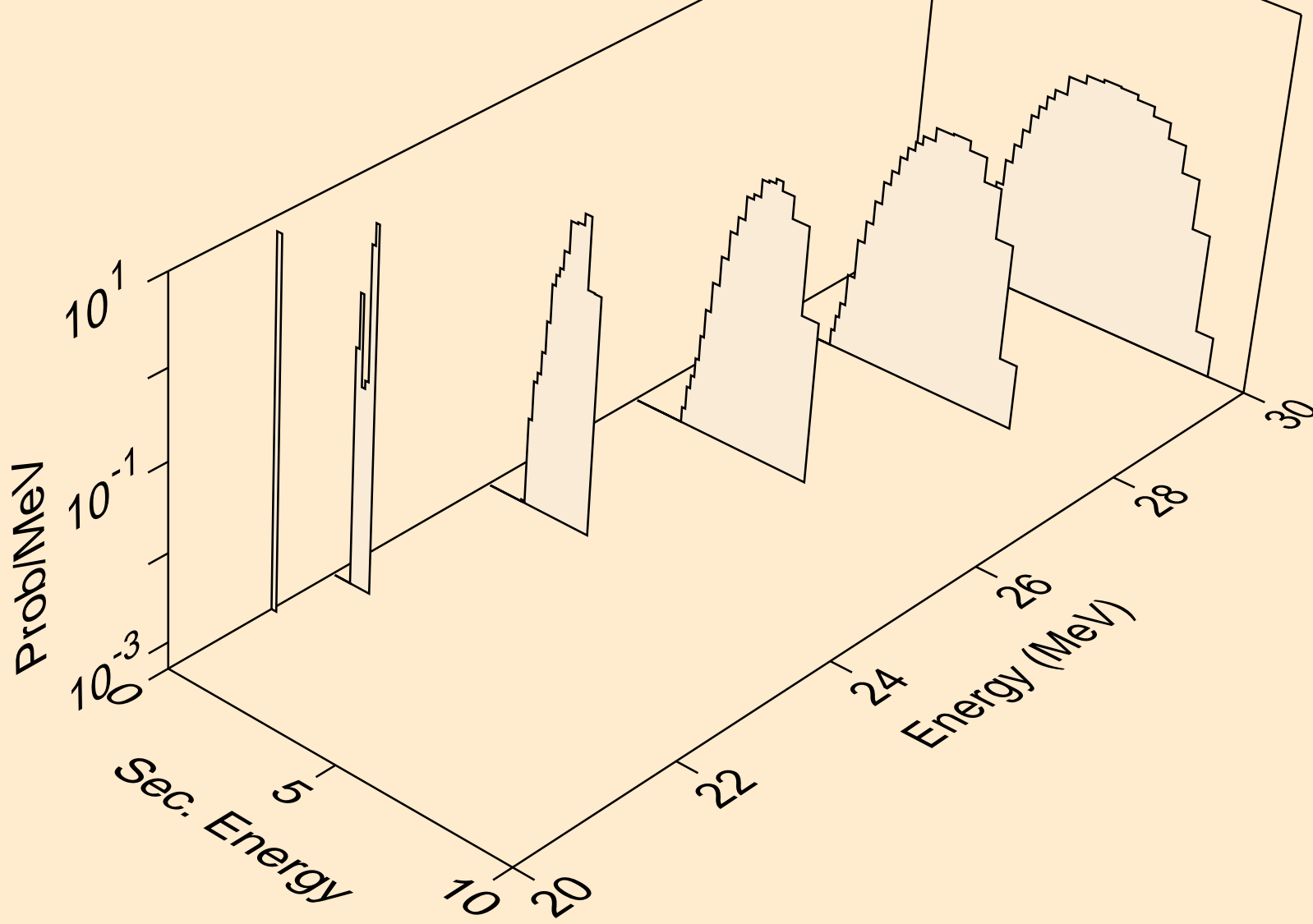

CU069 NEUTRON ACER TENDL-2019 LIBRARY; T=293.16K
deuterons from (n,n*)d

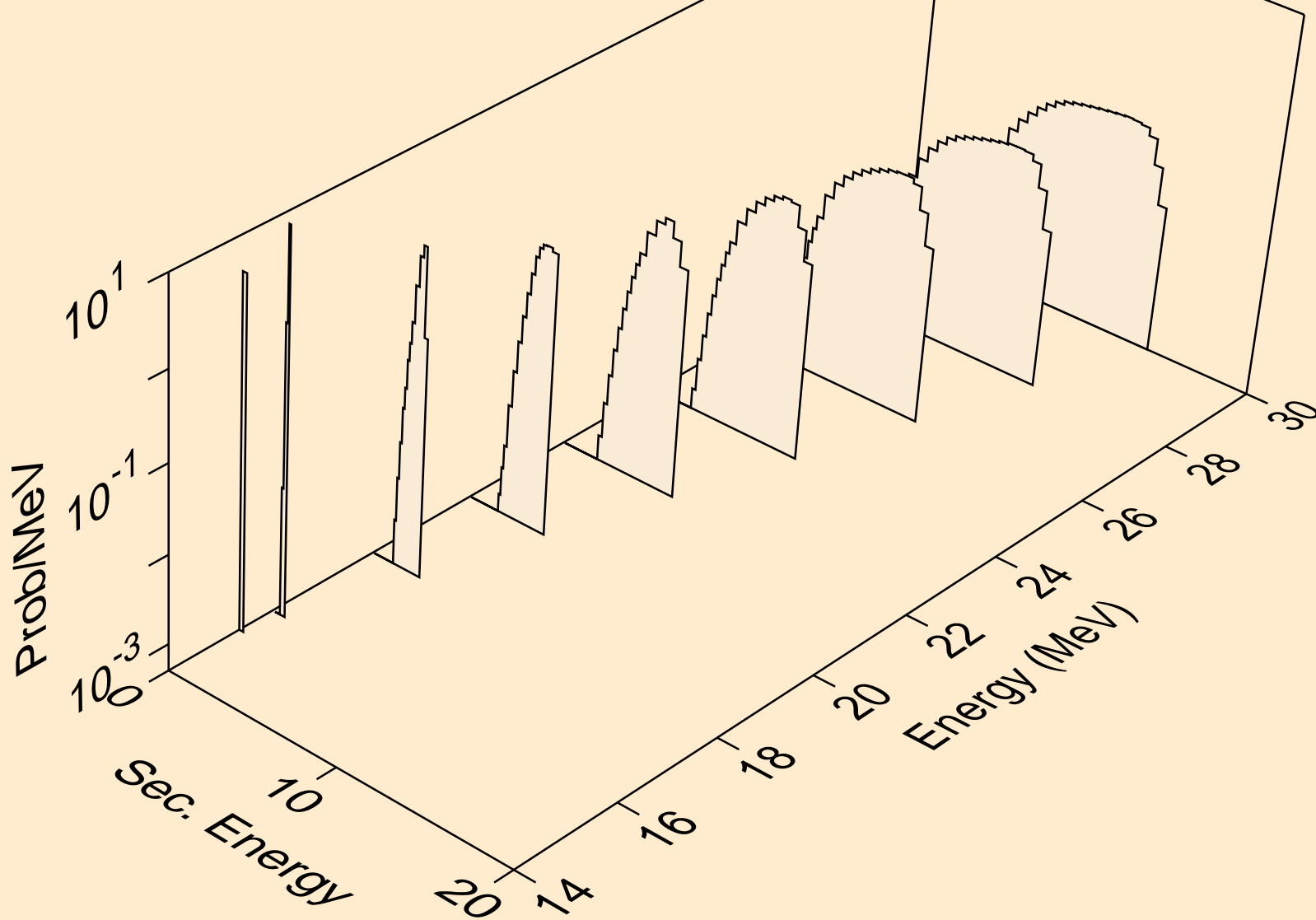

CU069 NEUTRON ACER TENDL-2019 LIBRARY; T=293.16K
deuterons from (n,d)

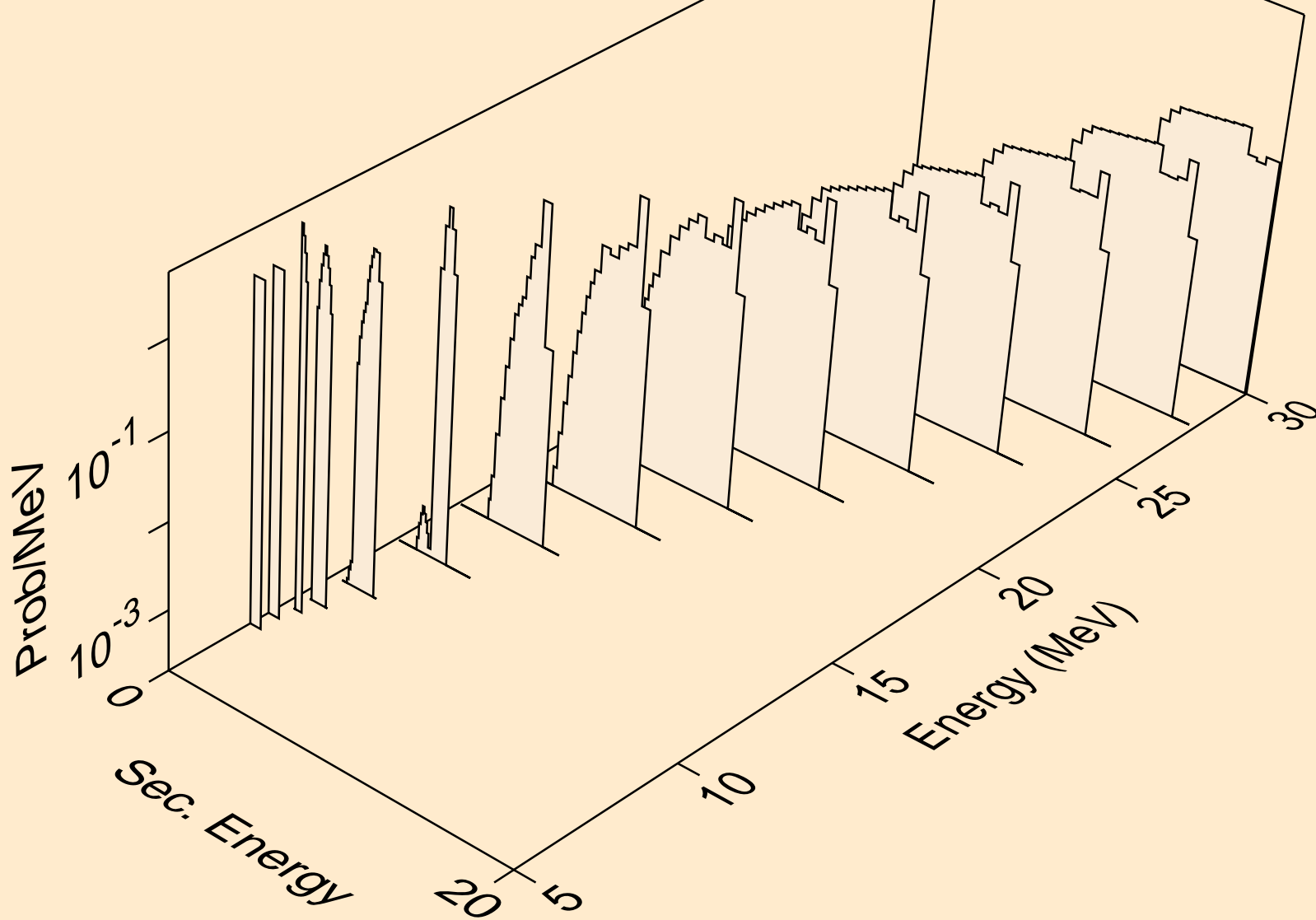

CU069 NEUTRON ACER TENDL-2019 LIBRARY; T=293.16K
tritons from (n,x)

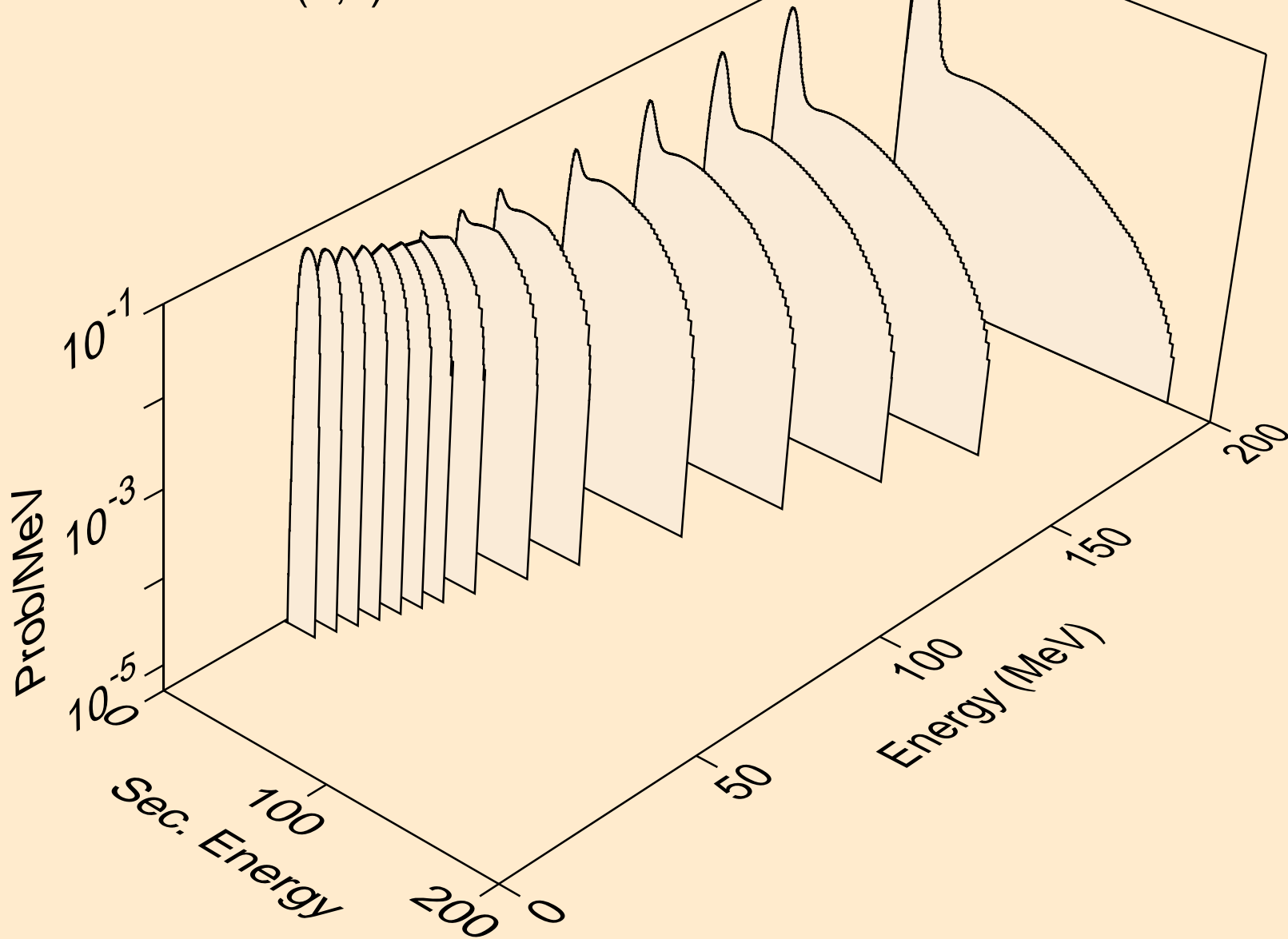

CU069 NEUTRON ACER TENDL-2019 LIBRARY; T=293.16K
tritons from (n,n*)t

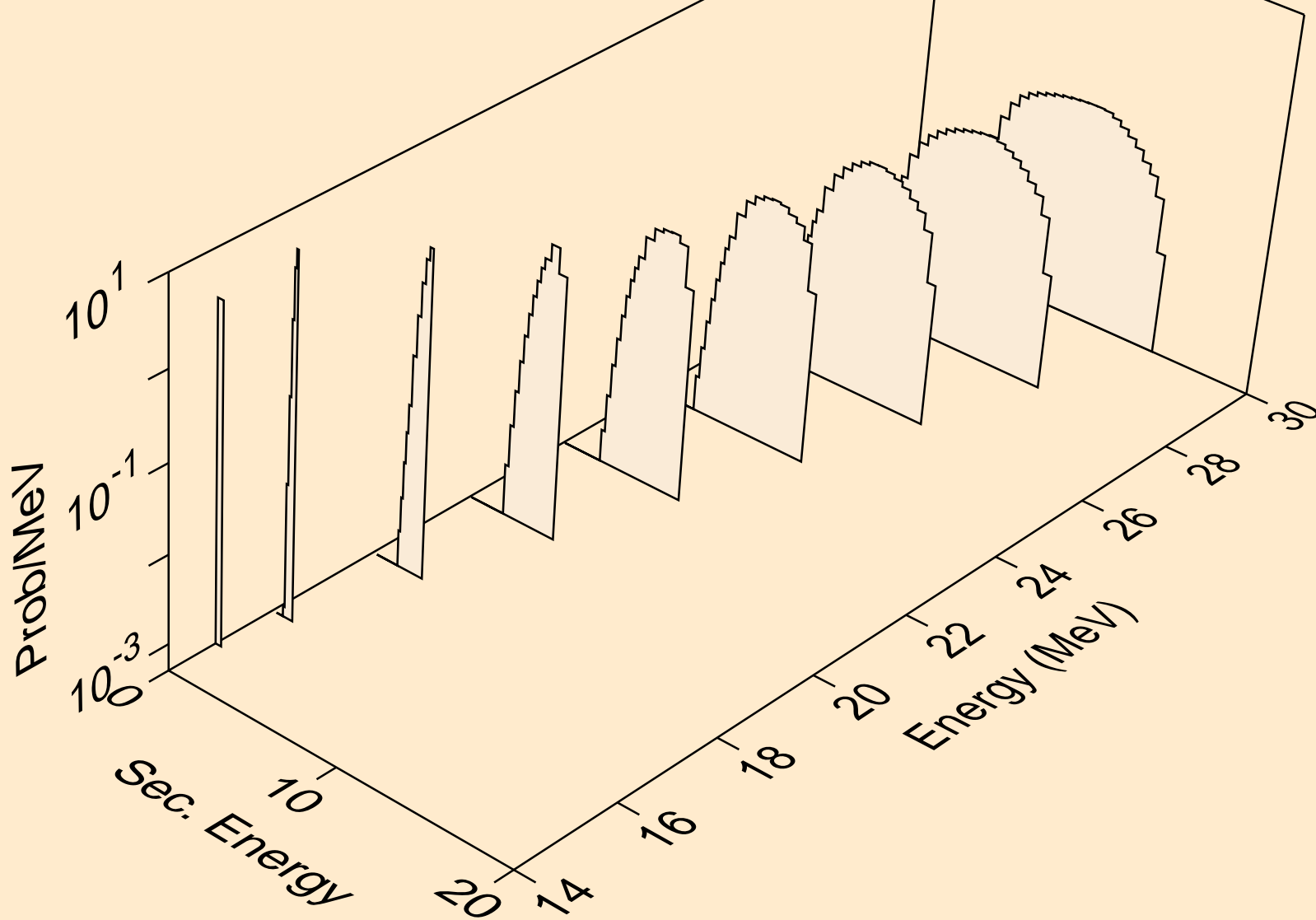

CU069 NEUTRON ACER TENDL-2019 LIBRARY; T=293.16K
tritons from (n,t)

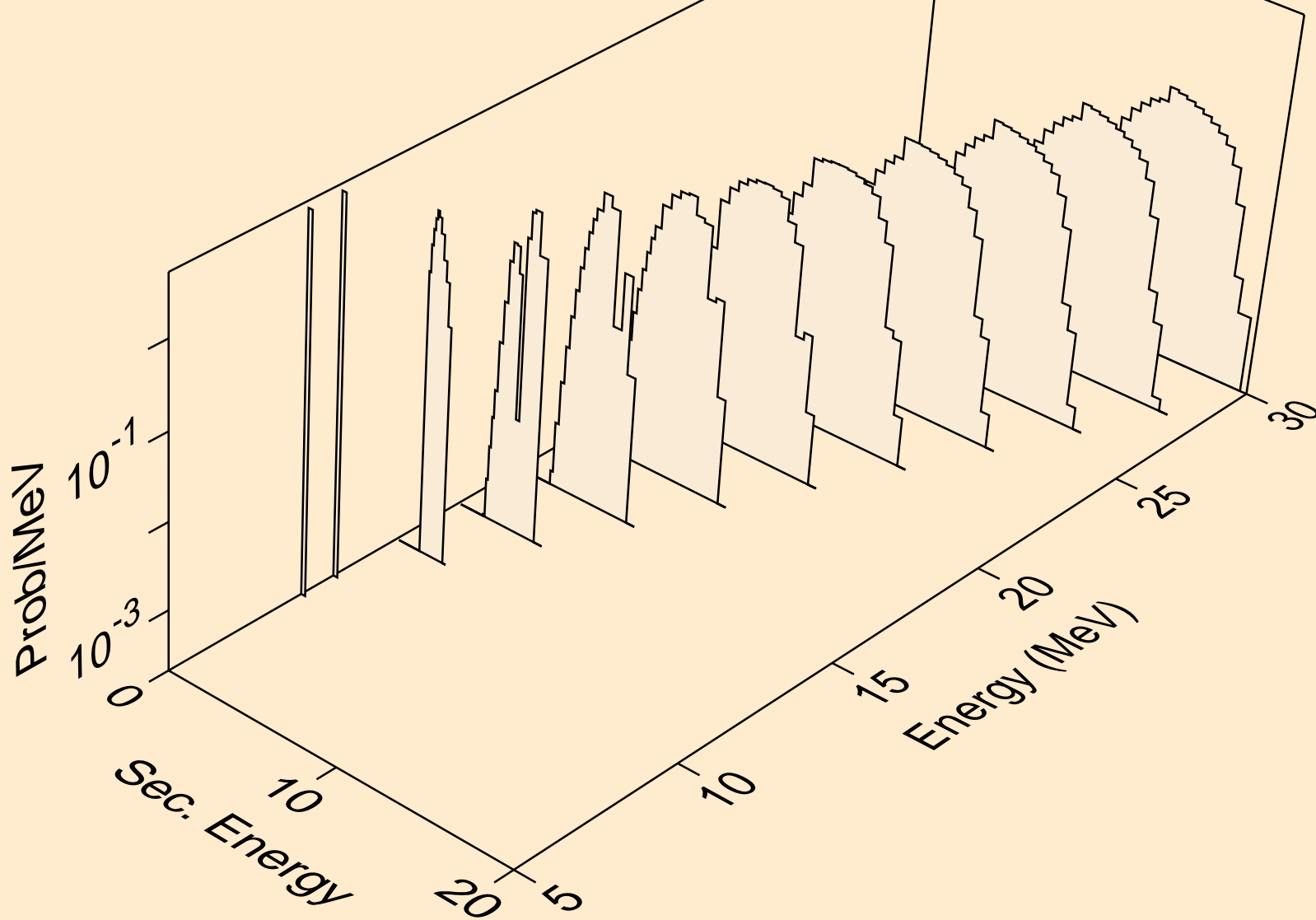

CU069 NEUTRON ACER TENDL-2019 LIBRARY; T=293.16K
he3s from (n,x)

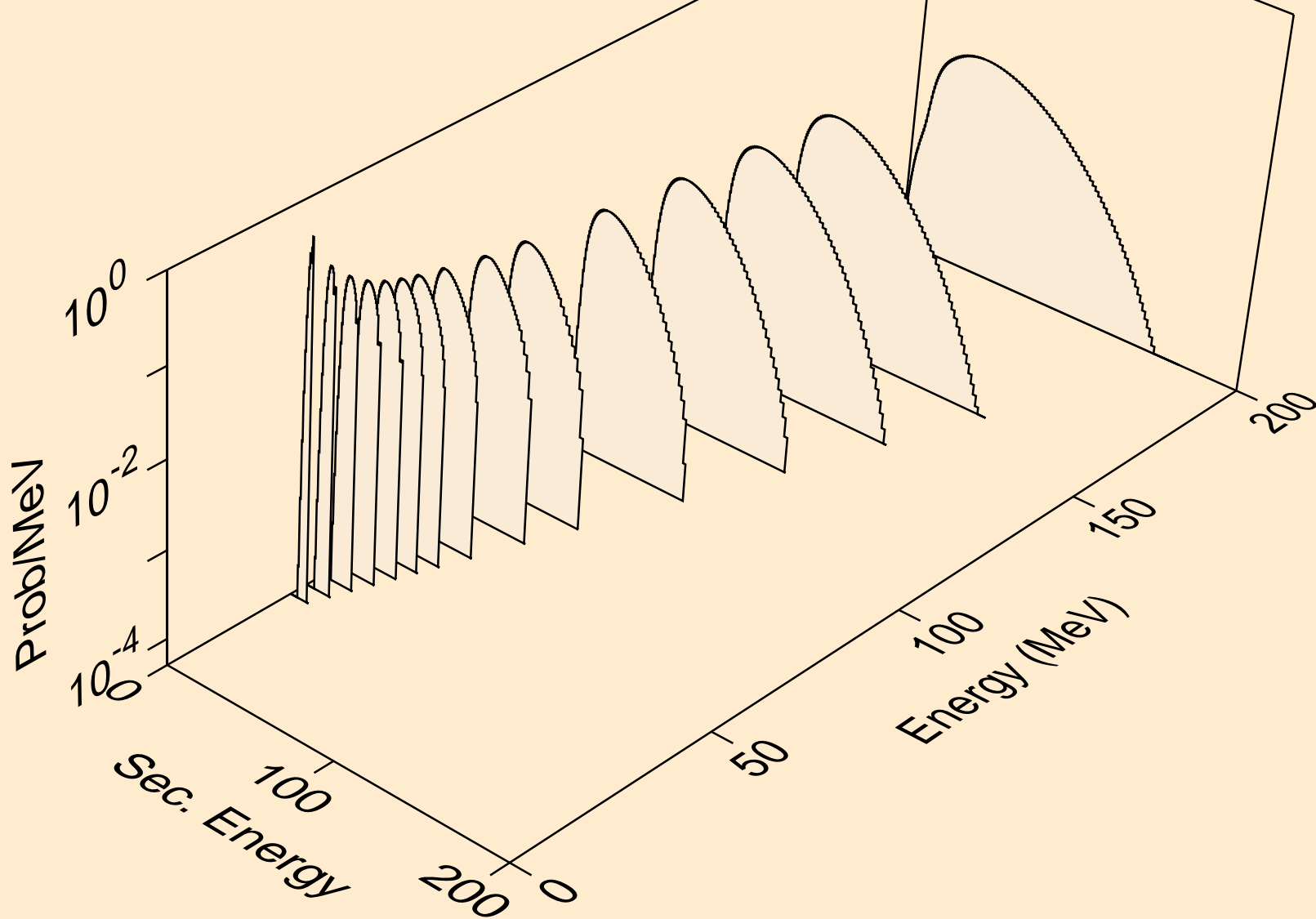

CU069 NEUTRON ACER TENDL-2019 LIBRARY; T=293.16K
he3s from (n,n*)he3

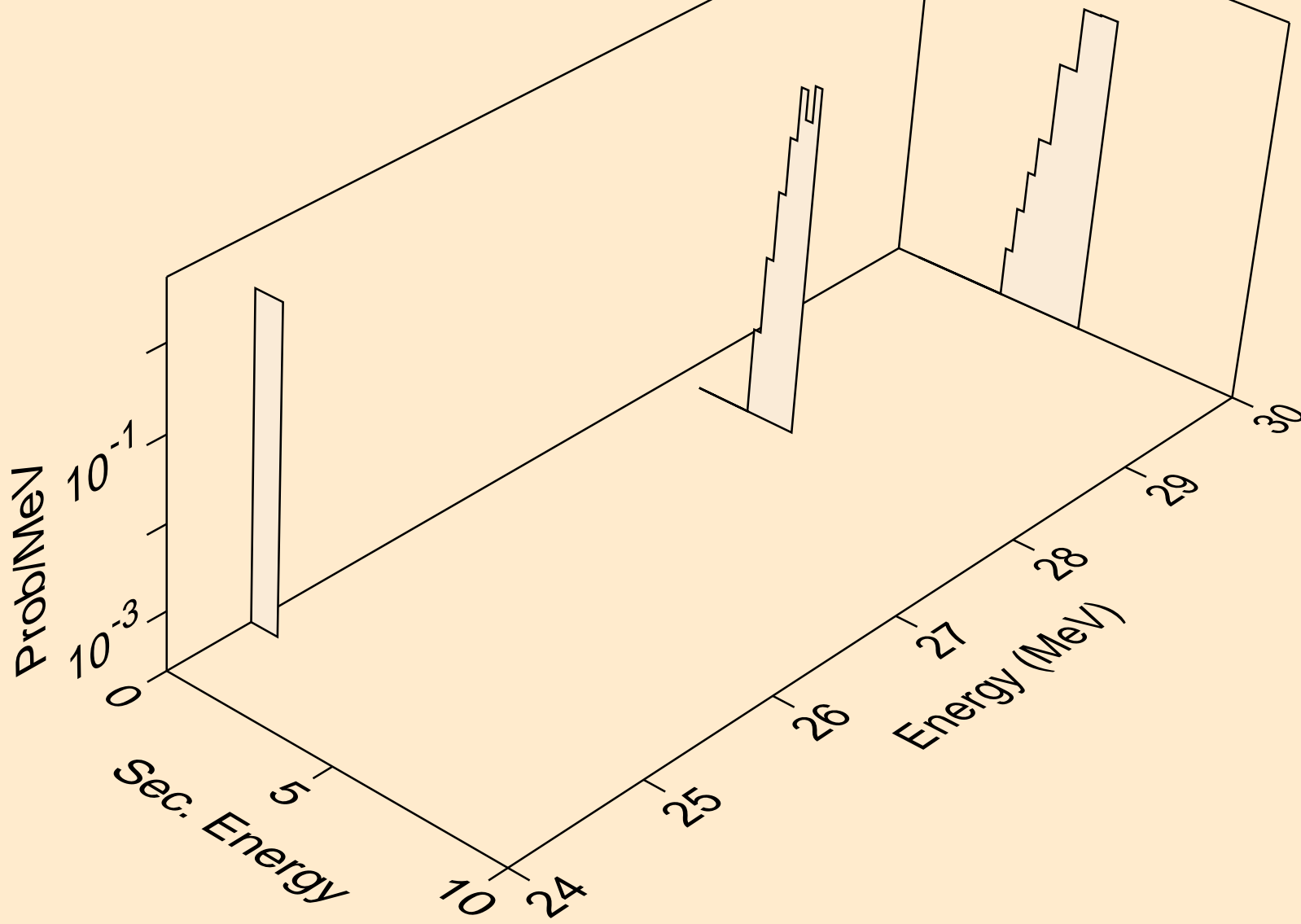

CU069 NEUTRON ACER TENDL-2019 LIBRARY; T=293.16K
he3s from (n,he3)

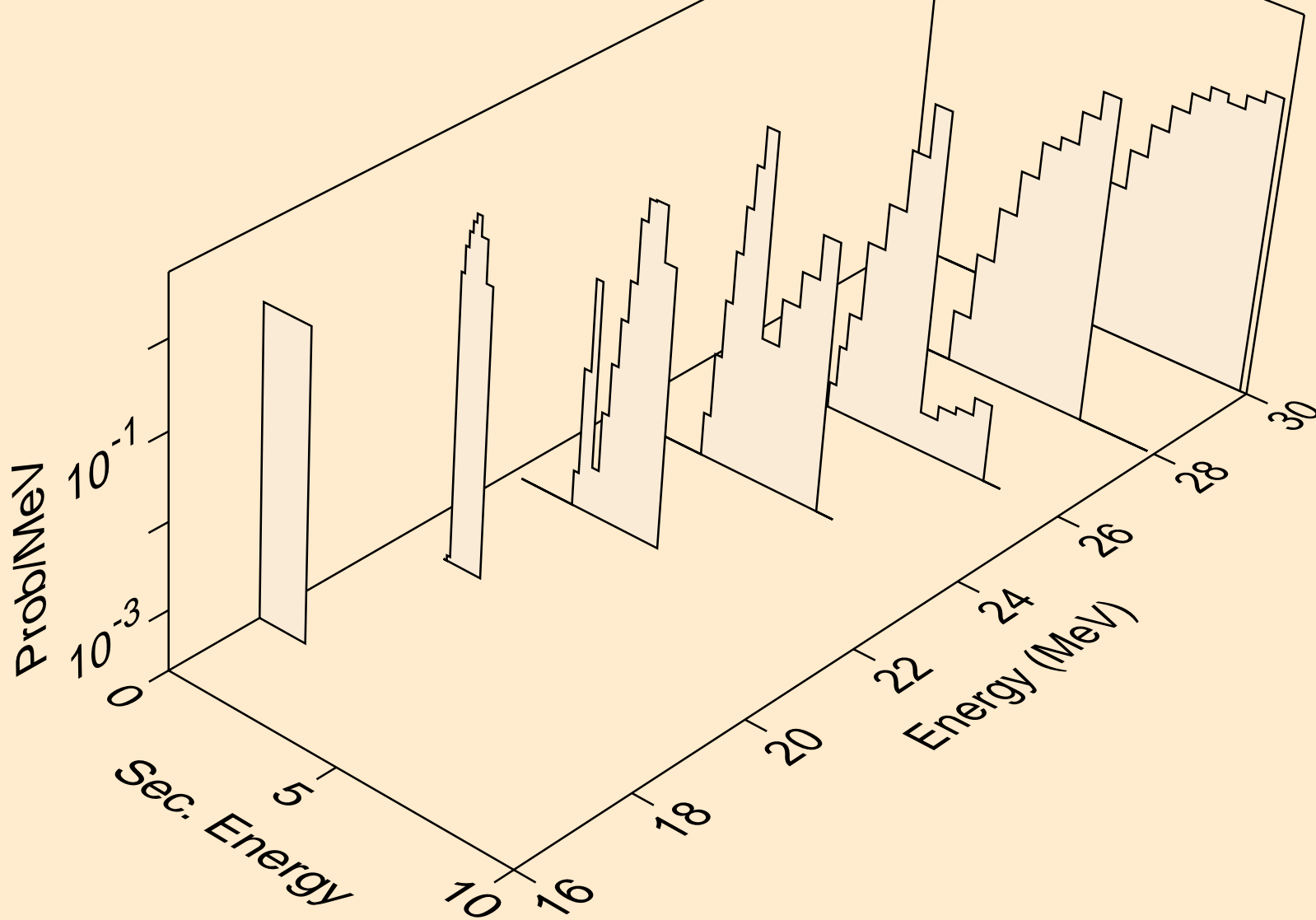

CU069 NEUTRON ACER TENDL-2019 LIBRARY; T=293.16K
alphas from (n,x)

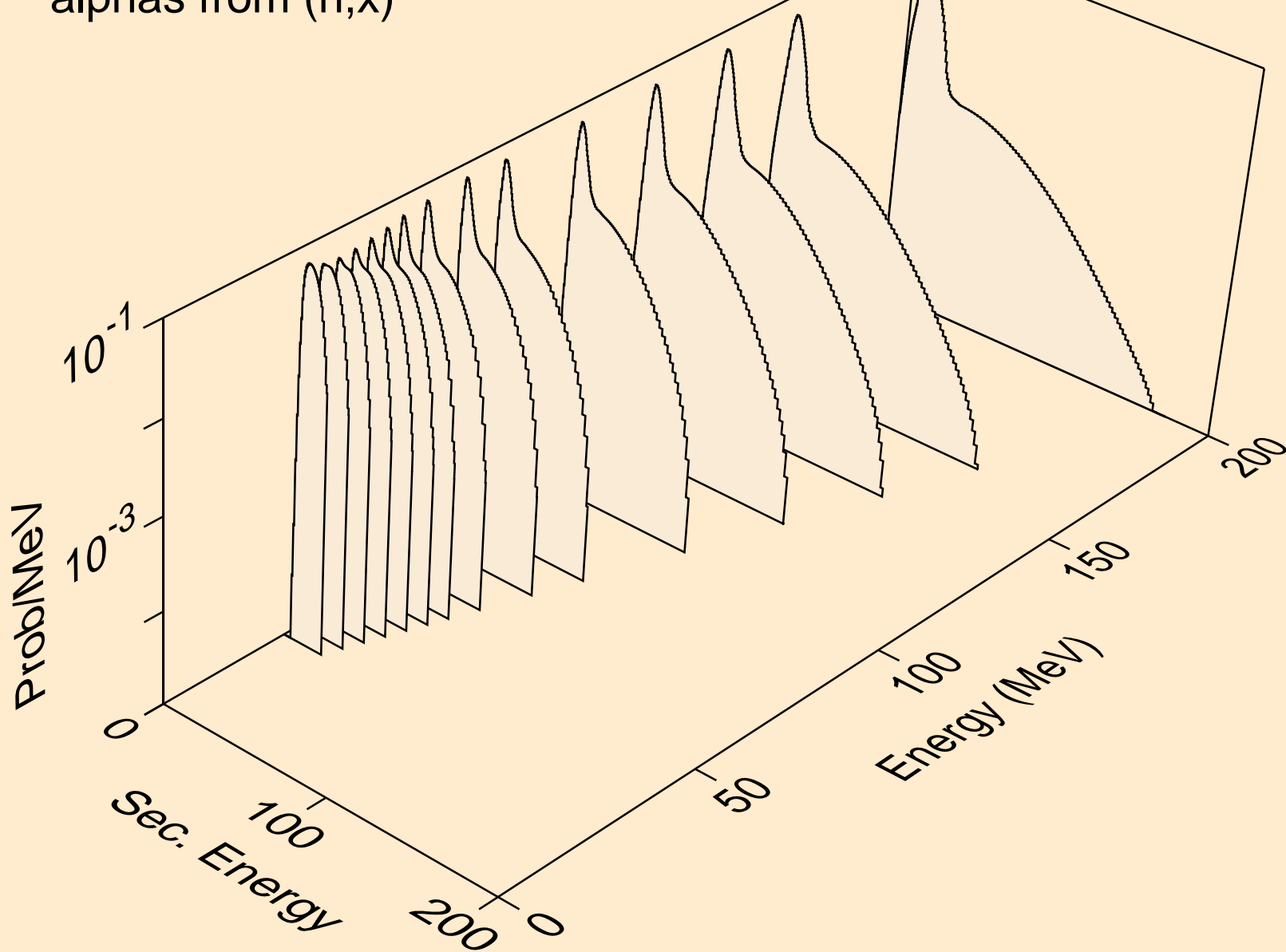

CU069 NEUTRON ACER TENDL-2019 LIBRARY; T=293.16K
alphas from (n,n*)a

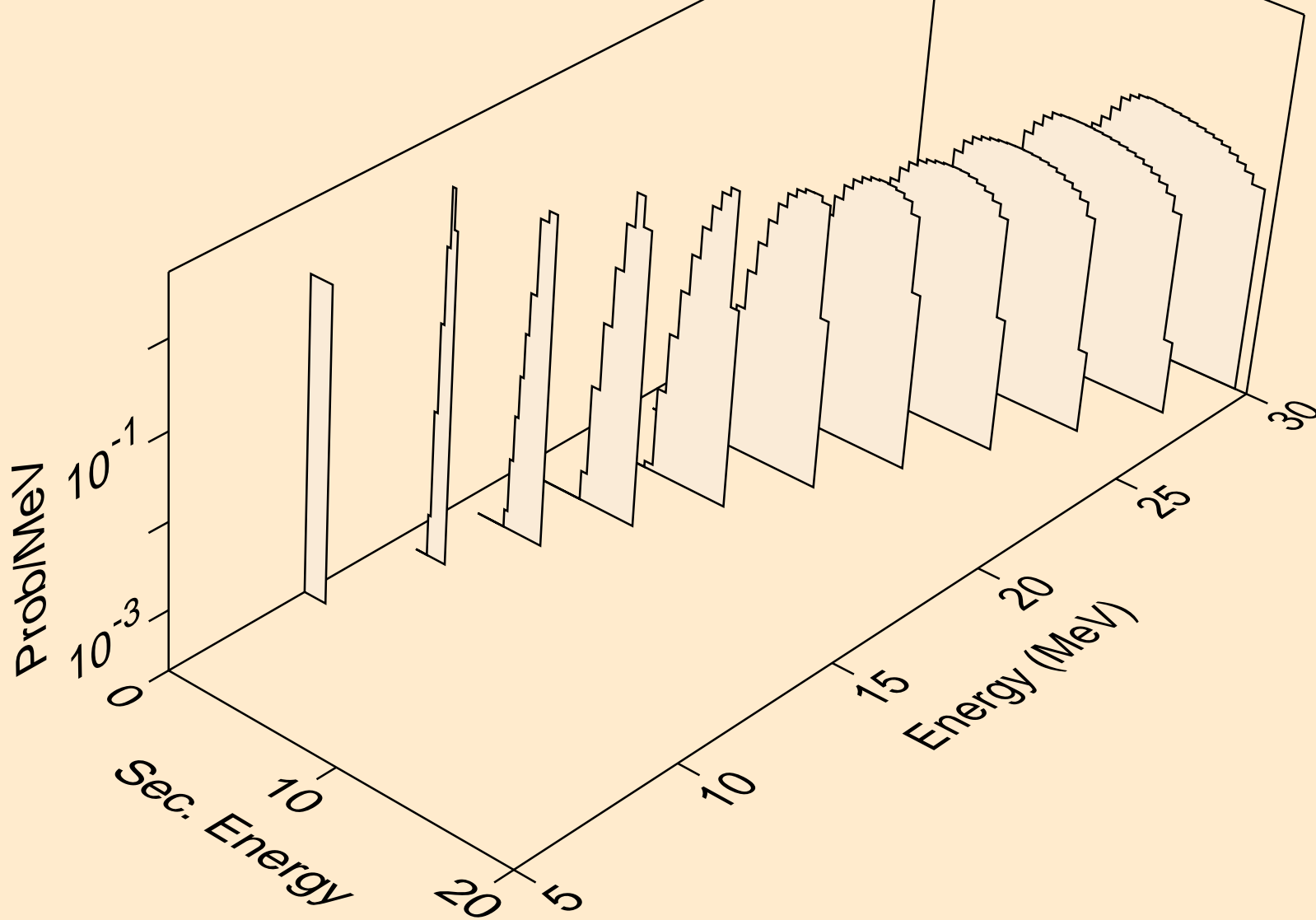

CU069 NEUTRON ACER TENDL-2019 LIBRARY; T=293.16K
alphas from (n,2n)a

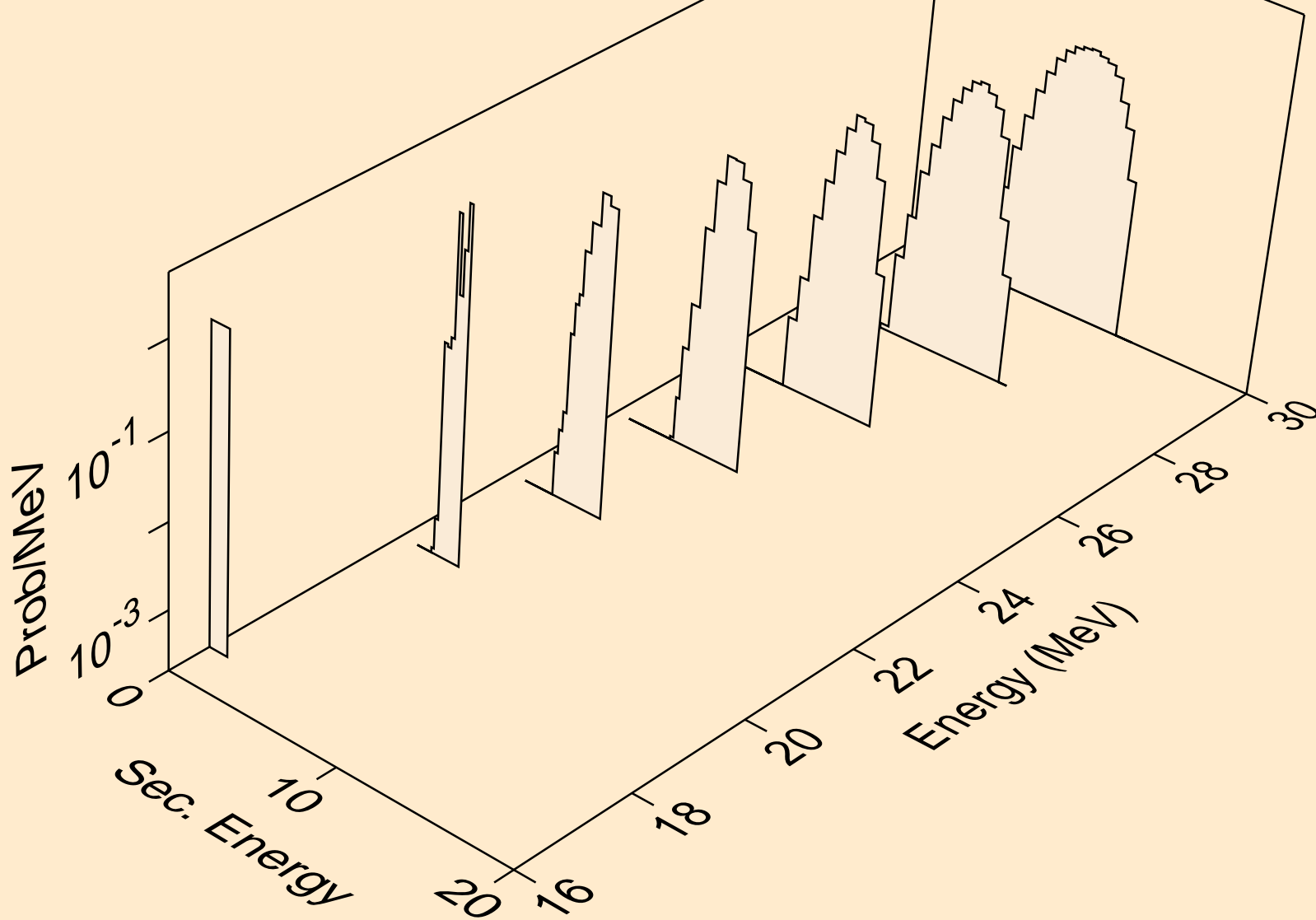

CU069 NEUTRON ACER TENDL-2019 LIBRARY; T=293.16K
alphas from (n,3n)a

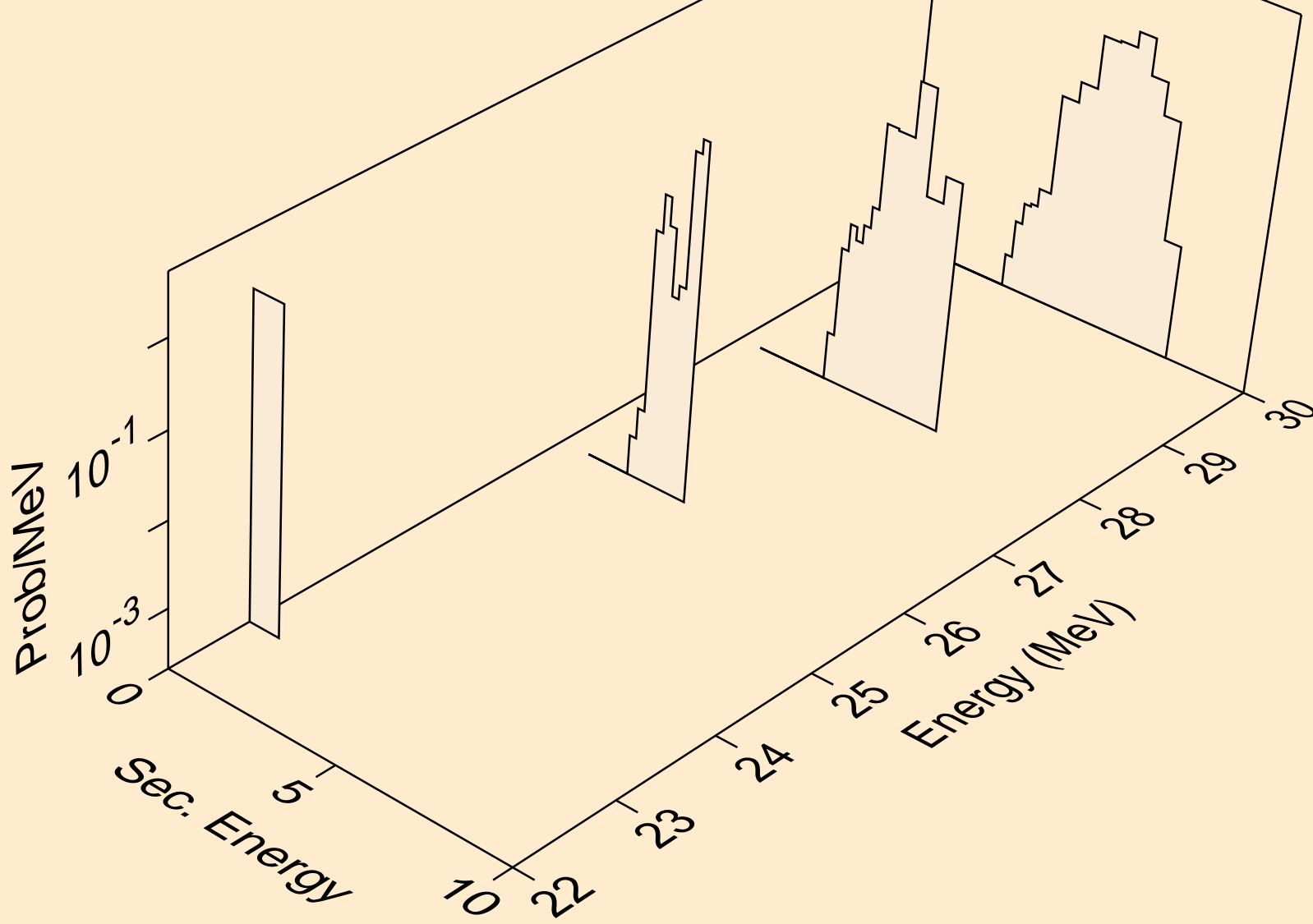

CU069 NEUTRON ACER TENDL-2019 LIBRARY; T=293.16K
alphas from (n,a)

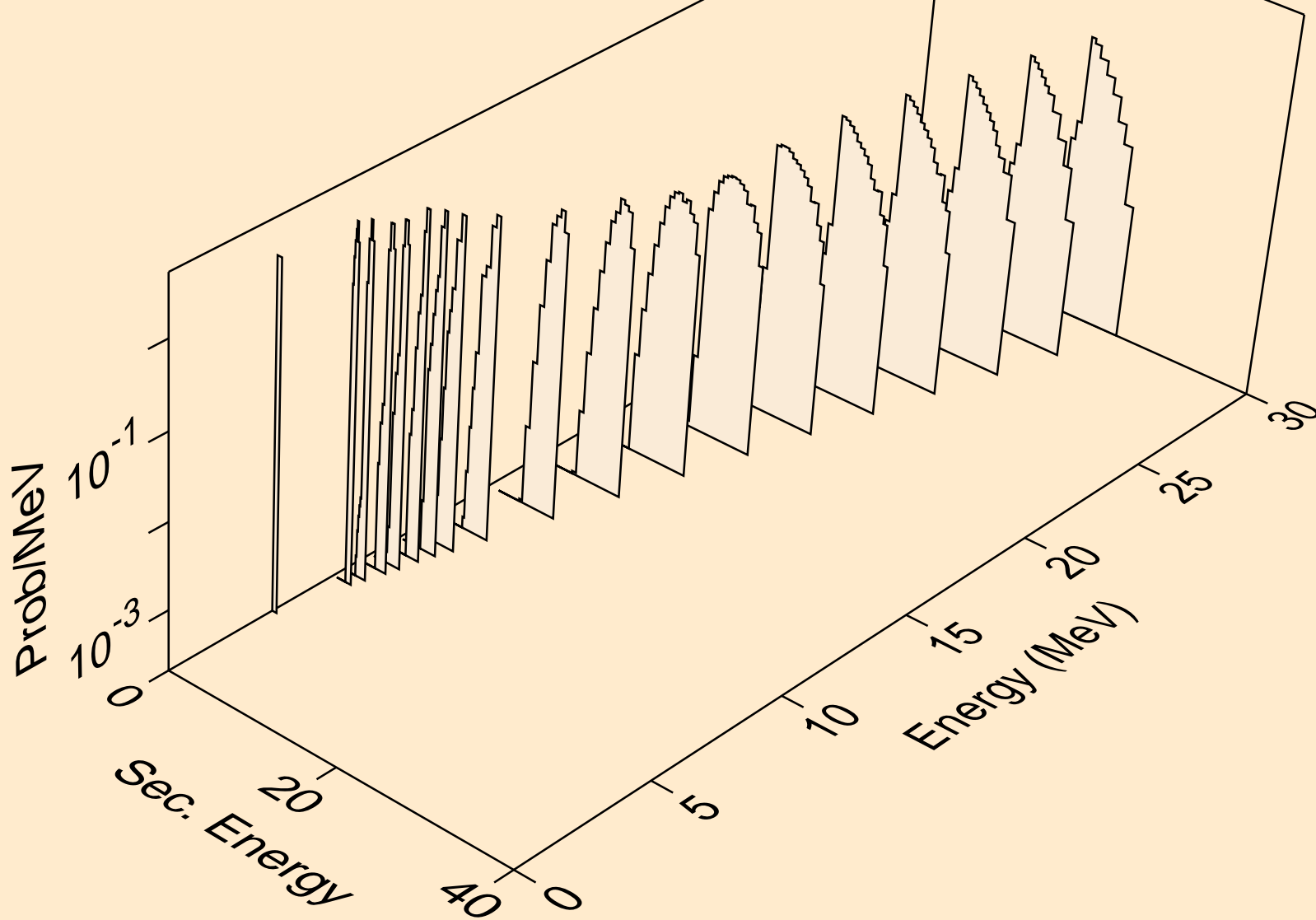

CU069 NEUTRON ACER TENDL-2019 LIBRARY; T=293.16K
alphas from (n,2a)

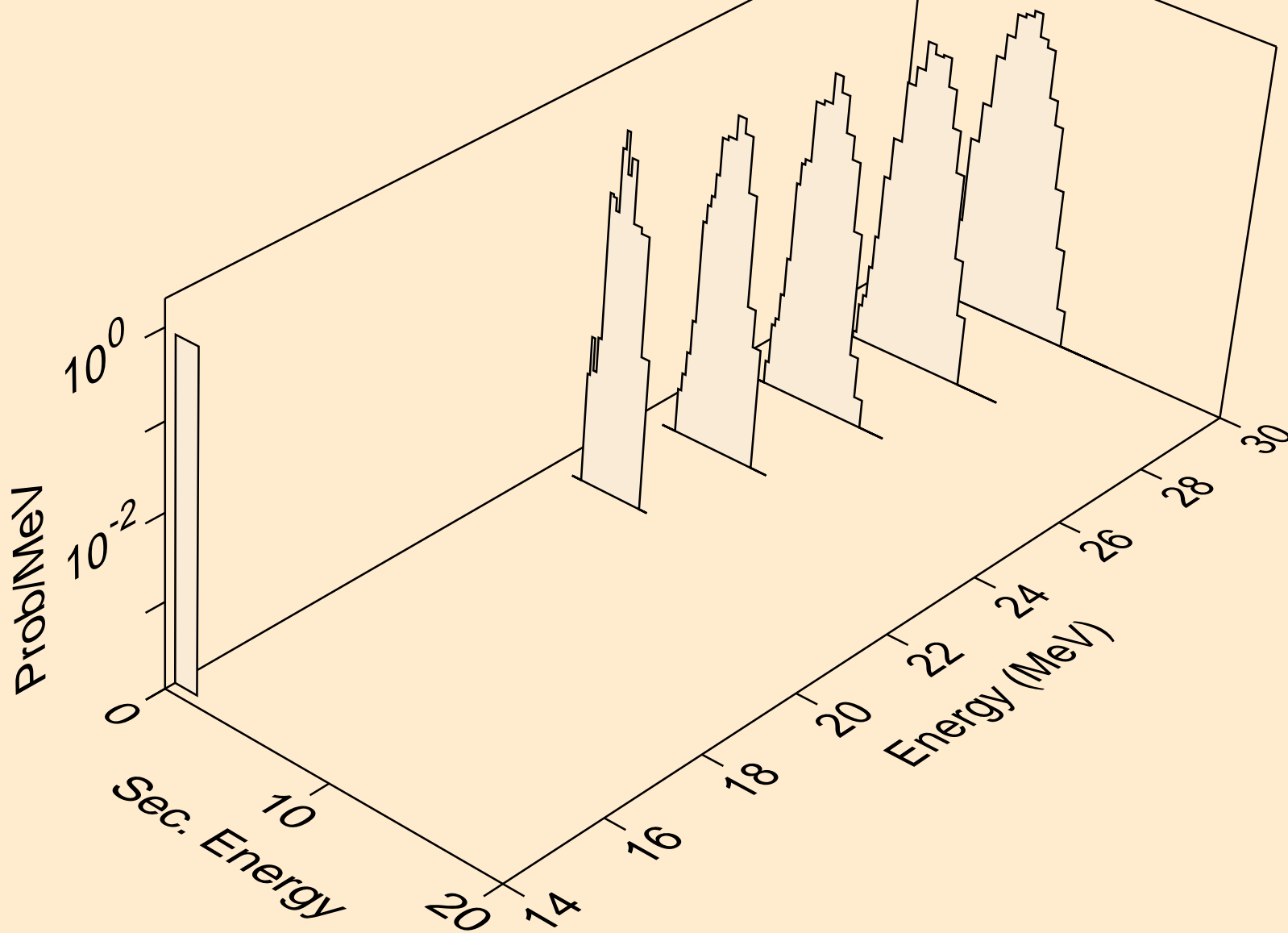

CU069 NEUTRON ACER TENDL-2019 LIBRARY; T=293.16K
alphas from (n,pa)

